

# VETERINARY MEDICINE

A textbook of the diseases of cattle, sheep  
goats, pigs and horses

---

10th Edition

---



Otto M Radostits,  
Clive C Gay,  
Kenneth W Hinchcliff,  
Peter D Constable

# VETERINARY MEDICINE

A textbook of the diseases of cattle,  
horses, sheep, pigs and goats



For Elsevier:

Commissioning Editor: *Joyce Rodenhuis*

Development Editor: *Rita Demetriou-Swanwick*

Project Manager: *Elouise Ball*

Designer: *Andy Chapman*

Illustration Manager: *Gillian Richards*

Illustrator: *Oxford Illustrations*

# VETERINARY MEDICINE

A textbook of the diseases of cattle,  
horses, sheep, pigs and goats

---

TENTH EDITION

---

**O. M. Radostits**

**C. C. Gay**

**K. W. Hinchcliff**

**P. D. Constable**

With contributions by

S. H. Done

D. E. Jacobs

B. O. Ikede

R. A. McKenzie

D. Colwell

G. Osweiler

R. J. Bildfell

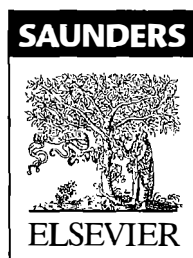

Edinburgh London New York Oxford Philadelphia St Louis Sydney Toronto

**DR. OTTO M. RADOSTITS**, August 31, 1934 – December 15, 2006.  
Senior author 5th to 7th editions. Lead author 8th to 10th editions.

Otto Martin Radostits died after a difficult but courageous battle with renal carcinoma and it is sad that he died a few days before the release of the first printing of this 10th edition. His passing marked the end of his remarkable career as an educator in large animal veterinary medicine. Through his writings, not the least this text, Otto had a profound influence on students and practicing veterinarians throughout the world.

Otto was raised on a small mixed farm in Alberta, Canada; the eldest son of Austrian immigrants. His early farm experiences and those obtained from working with a local veterinarian while attending high school sparked an interest in pursuing a career in veterinary science and were the beginning of his lifelong passion with large animal veterinary medicine. He was admitted to the Ontario Veterinary College in 1954, at that time the only English-speaking veterinary school in Canada. During his undergraduate years his clinical interests and potential were recognized such that following graduation he was invited to join the faculty as a member of the ambulatory clinic practice of the College – at that time a vigorous practice in a rural area. Otto spent the next five years teaching in this position, with the exception of a year spent at the veterinary school at Purdue University in West Lafayette, Indiana.

The Western College of Veterinary Medicine in Saskatchewan, Canada, was established in the mid 1960s and Otto was one of the founding faculty. He established the ambulatory practice and helped design the college clinical buildings and finalize the curriculum. He remained a faculty member at the Western College of Veterinary Medicine until he retired in June 2002 and was awarded the title Emeritus Professor. Here he matured as a clinical teacher to influence students and veterinarians locally and internationally through his writings and presentations at veterinary meetings.

Otto's international recognition in large animal veterinary medicine rests mainly in the strength of his writing and authorship of veterinary texts. These span the spectrum of large animal veterinary medicine from the clinical examination of the individual animal, the epidemiology, diagnosis, treatment and control of livestock diseases, to herd health and preventive medicine.

The most notable are his contributions to this textbook, which has been used by veterinary students and practicing veterinarians around the world for the past 45 years. Otto joined the original authors, Doug Blood and Jim Henderson, for the 5th edition of this text in 1979 and, in 1994, became the senior author for the 8th and subsequent editions. During his sojourn as senior author the text continued its original design as a student textbook with many

student friendly features. It also continued its significance as a reference book including the available information on all the diseases of large animals, a truly formidable task. Otto did a large part of the work and would surely have been very proud of this new edition.

In the writing of these and his other texts Otto read the veterinary literature and was a firm believer in evidenced-based medicine. He insisted that all statements in these texts were supported by references in the literature and he maintained the format of a very large bibliography at the end of each disease description. He believed that other veterinary educators should also be current with the veterinary literature and had little brief for those who were not. He could be a forceful presence in discussions but Otto was also one of the quickest to recognize new information that negated previous theories concerning a disease and was one who was always responsive to reasoned argument.

Otto taught that making a correct diagnosis was the crux to the solution of a disease problem and he had a passion for the art and science of clinical examination. And many of his students affectionately remember his admonition "We make more mistakes by not looking than by not knowing". Otto's insistence on the need for accurate diagnosis did not preclude this realization that what the practicing veterinarian needed as the final message from his books was what was the best current information on what to do to cure or prevent it.

Otto has authored other texts. In the late 1990's he became concerned that traditional skills of physical clinical examination were being supplanted by laboratory and instrumental analysis. As a consequence he consulted with veterinary clinicians around the world and in 2000 was a senior author of the text "Veterinary clinical examination and diagnosis". With his work on farms Otto recognized that disease in farm animals commonly was a population concern and recognized the limitations of "fire brigade" medicine. He authored the first major text in herd health and preventive medicine with its first edition in 1985. Otto has many other publications of significance to global veterinary medical education and presented more than 250 invited lectures and seminars in veterinary medicine in countries around the world.

Dr Radostits' contributions have been recognized in many awards. For him, probably the most important was the award of Master Teacher from his university and, nationally, the Order of Canada. The early requirement for a second printing of this 10th edition attests Dr Radostits excellence as the senior author of this text and also allows us to insert this dedication to him. We thank Elsevier and the Publishing Editor of Veterinary Medicine for the opportunity to include this dedication in this second printing.

# Table of Contents

List of tables	vii
List of illustrations	ix
List of contributors	x
Preface to Tenth Edition	xiii
Introduction	xv
How to use this book	xxi

## PART ONE: GENERAL MEDICINE

1. Clinical examination and making a diagnosis	3
Clinical examination of the individual animal	3
Making a diagnosis	22
Prognosis and therapeutic decision-making	29
Examination of the herd	31
2. General systemic states	39
Hypothermia, hyperthermia, fever	39
Septicemia/viremia	51
Toxemia and endotoxemia	53
Hypovolemic, hemorrhagic, maldistributive and obstructive shock	63
Allergy and anaphylaxis	69
Edema	72
Disturbances of free water, electrolytes and acid-base balance	73
Pain	102
Stress	107
Localized infections	110
Disturbances of appetite, food intake and nutritional status	112
Weight loss or failure to gain weight (ill-thrift)	115
Physical exercise and associated disorders	117
Diagnosis and care of recumbent adult horses	120
Sudden or unexpected death	124
3. Diseases of the newborn	127
Perinatal and postnatal diseases	127
Congenital defects	132
Physical and environmental causes of perinatal disease	138
Diseases of cloned offspring	145
Neonatal infection	146
Clinical assessment and care of critically ill newborns	160
4. Practical antimicrobial therapeutics	173
Principles of antimicrobial therapy	173
Practical usage of antimicrobial drugs	177
5. Diseases of the alimentary tract – I	189
Principles of alimentary tract dysfunction	189
Manifestations of alimentary tract dysfunction	191
Special examination	195
Principles of treatment in alimentary tract disease	203
Diseases of the buccal cavity and associated organs	205
Diseases of the pharynx and esophagus	209
Diseases of the nonruminant stomach and intestines	215
Congenital defects of the alimentary tract	280
Neoplasms of the alimentary tract	281
Diseases of the peritoneum	282
6. Diseases of the alimentary tract – II	293
Diseases of the forestomach of ruminants	293
Special examination of the alimentary tract and abdomen of cattle	301
Diseases of the rumen, reticulum and omasum	311
Diseases of the abomasum	353
Diseases of the intestines of ruminants	375
7. Diseases of the liver and pancreas	383
Diseases of the liver – introduction	383
Principles of hepatic dysfunction	383
Manifestations of liver and biliary disease	384
Special examination of the liver	387
Principles of treatment in diseases of the liver	391
Diffuse diseases of the liver	391
Focal diseases of the liver	395
Diseases of the pancreas	396
8. Diseases of the cardiovascular system	399
Principles of circulatory failure	399
Manifestations of circulatory failure	401
Special examination of the cardiovascular system	405
Arrhythmias	413
Diseases of the heart	421
Diseases of the blood vessels	434
9. Diseases of the hemolymphatic and immune systems	439
Abnormalities of plasma protein concentration	439
Hemorrhagic disease	441
Disorders of red cell number or function	450
Disorders of white cells	460
Lymphadenopathy (lymphadenitis)	464
Diseases of the spleen and thymus	464
Immune deficiency disorders (lowered resistance to infection)	466
Amyloidoses	467
Porphyrias	469
10. Diseases of the respiratory system	471
Principles of respiratory insufficiency	471
Principal manifestations of respiratory insufficiency	473
Special examination of the respiratory system	480
Principles of treatment and control of respiratory tract disease	493
Diseases of the lungs	498
Diseases of the pleura and diaphragm	519
Diseases of the upper respiratory tract	530
11. Diseases of the urinary system	543
Introduction	543
Principles of renal insufficiency	543
Clinical features of urinary tract disease	545
Special examination of the urinary system	548
Principles of treatment of urinary tract disease	553
Diseases of the kidney	555
Diseases of the bladder, ureters and urethra	561
Congenital defects of the urinary tract	571
12. Diseases of the nervous system	575
Principles of nervous dysfunction	576
Clinical manifestations of disease of the nervous system	577
Special examination of the nervous system	583
Principles of treatment of diseases of the nervous system	594
Pathophysiological mechanisms of nervous system disease	596
Diffuse diseases of the brain	596
Focal diseases of the brain	606
Diseases of the meninges	609
Toxic and metabolic encephalomyelopathies	611
Psychoses or neuroses	612
Epilepsy	613
Diseases of the spinal cord	613
Diseases of the peripheral nervous system	618
Congenital defects of the central nervous system	619
13. Diseases of the musculoskeletal system	621
Principal manifestations of musculoskeletal disease	621
Diseases of muscles	626
Diseases of bones	632
Diseases of joints	637
Congenital defects of muscles, bones and joints	648
14. Diseases of the skin, conjunctiva and external ear	651
Principles of treatment of diseases of the skin	653
Diseases of the epidermis and dermis	654
Diseases of the hair, wool, follicles, skin glands, horns and hooves	661
Diseases of the subcutis	664
Granulomatous lesions of the skin	667
Cutaneous neoplasms	667
Congenital defects of the skin	669
Congenital skin neoplasms	669
Diseases of the conjunctiva	670
Congenital defects of the eyelids and cornea	670
Diseases of the external ear	670
15. Diseases of the mammary gland	673
Introduction	673
Bovine mastitis	673
Mastitis pathogens of cattle	697

Mastitis of cattle associated with common contagious pathogens . . .	697	Diseases associated with <i>Pseudomonas</i> and <i>Burkholderia</i> spp. . . . .	1081	31. Diseases associated with physical agents . . . . .	1785
Mastitis associated with teat skin opportunistic pathogens . . . . .	708	Diseases associated with <i>Campylobacter</i> spp. . . . .	1085	32. Diseases associated with inorganic and farm chemicals . . . . .	1798
Mastitis of cattle associated with common environmental pathogens . . . . .	709	Diseases associated with <i>Leptospira</i> Borrelia spp. . . . .	1094	Diseases associated with inorganic poisons . . . . .	1799
Mastitis of cattle associated with less common pathogens . . . . .	724	Diseases associated with <i>Mycoplasma</i> spp. . . . .	1123	Diseases associated with farm chemicals . . . . .	1830
Miscellaneous causes of bovine mastitis . . . . .	726	21. Disease associated with viruses and <i>Chlamydia</i> – I . . . . .	1157	Miscellaneous farm chemicals . . . . .	1846
Control of bovine mastitis . . . . .	728	Viral diseases with manifestations attributable to involvement of the body as a whole . . . . .	1157	33. Diseases associated with toxins in plants, fungi, cyanobacteria, clavibacteria, insects and animals . . . . .	1851
Miscellaneous abnormalities of the teats and udder . . . . .	749	Viral diseases characterized by alimentary tract signs . . . . .	1223	Diseases associated with major phytotoxins . . . . .	1851
Mastitis–metritis–agalactia syndrome in sows . . . . .	754	22. Diseases associated with viruses and chlamydia – II . . . . .	1307	Poisoning by mycotoxins . . . . .	1897
Mastitis of sheep . . . . .	759	Viral diseases characterized by respiratory signs . . . . .	1307	Poisoning by cyanophyte (cyanobacterial) toxins . . . . .	1913
Mastitis of goats . . . . .	761	Viral diseases characterized by nervous signs . . . . .	1368	Poisoning by tunicaminylluracils (corynetoxins) . . . . .	1914
Mastitis of mares . . . . .	762	Viral diseases characterized by skin lesions . . . . .	1418	Diseases associated with zootoxins (animal bites and stings) . . . . .	1915
<b>PART TWO: SPECIAL MEDICINE</b>		Diseases associated with Chlamydiae . . . . .	1433	34. Diseases associated with allergy . . . . .	1921
16. Diseases associated with bacteria – I . . . . .	765	23. Diseases associated with prions . . . . .	1439	35. Diseases associated with the inheritance of undesirable characteristics . . . . .	1937
Introduction to infectious disease . . . . .	765	24. Diseases associated with Rickettsiales . . . . .	1455	Diseases characterized by chromosomal anomalies . . . . .	1939
Diseases associated with <i>Streptococcus</i> species . . . . .	768	25. Diseases associated with algae and fungi . . . . .	1471	Inherited defects of the body as a whole . . . . .	1940
Diseases associated with <i>Staphylococcus</i> species . . . . .	783	Algal diseases . . . . .	1471	Inherited defects of the alimentary tract . . . . .	1943
Diseases associated with <i>Corynebacterium</i> , <i>Rhodococcus</i> , <i>Actinobaculum</i> and <i>Arcanobacterium</i> species . . . . .	787	Fungal diseases . . . . .	1471	Inherited defects of the circulatory system . . . . .	1944
Diseases associated with <i>Listeria</i> species . . . . .	805	Dermatomycoses . . . . .	1476	Inherited defects of the urinary tract . . . . .	1948
Diseases associated with <i>Erysipelothrix rhusiopathiae</i> (insidiosus) . . . . .	810	26. Diseases associated with protozoa . . . . .	1483	Inherited defects of the nervous system . . . . .	1948
Diseases associated with <i>Bacillus</i> species . . . . .	815	Diseases associated with trypanosomes . . . . .	1531	Inherited defects of the musculoskeletal system . . . . .	1957
17. Diseases associated with bacteria – II . . . . .	821	27. Diseases associated with helminth parasites . . . . .	1541	Inherited defects of the skin . . . . .	1973
Diseases associated with <i>Clostridium</i> species . . . . .	821	Nematode diseases of the alimentary tract . . . . .	1541	Miscellaneous inherited defects . . . . .	1976
18. Diseases associated with bacteria – III . . . . .	847	Nemotode diseases of other organs . . . . .	1564	36. Specific diseases of uncertain etiology . . . . .	1981
Diseases associated with <i>Escherichia coli</i> . . . . .	847	Diseases associated with trematodes and cestodes . . . . .	1576	Diseases characterized by systemic involvement . . . . .	1981
<i>Escherichia coli</i> infections in weaned pigs . . . . .	888	28. Diseases associated with arthropod parasites . . . . .	1585	Diseases characterized by alimentary tract involvement . . . . .	1988
Diseases associated with <i>Salmonella</i> species . . . . .	896	Ked and louse infestations . . . . .	1596	Diseases characterized by respiratory tract involvement . . . . .	1996
Diseases associated with <i>Pasteurella</i> species . . . . .	921	Tick infestations . . . . .	1599	Diseases characterized by nervous system involvement . . . . .	2004
Diseases associated with <i>Brucella</i> species . . . . .	963	Miscellaneous flies, midges and mosquitoes . . . . .	1603	Diseases characterized by involvement of the musculoskeletal system . . . . .	2021
Diseases associated with <i>Moraxella</i> , <i>Histophilus</i> and <i>Haemophilus</i> species . . . . .	994	Mite infestations . . . . .	1606	Diseases characterized by involvement of the skin . . . . .	2035
19. Diseases associated with bacteria – IV . . . . .	1007	29. Metabolic diseases . . . . .	1613	<b>APPENDICES</b>	
Diseases associated with <i>Mycobacterium</i> spp. . . . .	1007	Production diseases . . . . .	1618	Conversion factors . . . . .	2045
Diseases associated with <i>Actinomyces</i> , <i>Actinobacillus</i> , <i>Nocardia</i> and <i>Dermatophilus</i> spp. . . . .	1044	30. Diseases associated with nutritional deficiencies . . . . .	1691	Reference laboratory values . . . . .	2047
20. Diseases associated with bacteria – V . . . . .	1061	Diseases associated with deficiencies of mineral nutrients . . . . .	1698	Drug doses – horses and ruminants . . . . .	2051
Diseases associated with <i>Fusobacterium</i> and <i>Bacteroides</i> spp. . . . .	1061	Disease associated with deficiencies of fat-soluble vitamins . . . . .	1771	Drug doses – pigs . . . . .	2064
		Diseases associated with deficiency of water-soluble vitamins . . . . .	1778	Index . . . . .	2067

# List of Tables

1.1	Normal average temperatures with critical points . . . . .	13	5.4	Disorders of the equine gastrointestinal tract causing colic, by anatomical site . . . . .	217	8.2	Mean cardiopulmonary values for adult horses, cattle and calves and pigs . . . . .	412
1.2	Resting pulse rates . . . . .	14	5.5	Rectal findings and associated causes of equine colic . . . . .	221	8.3	Common arrhythmias and conduction disturbances in the horse and cow . . . . .	413
1.3	Method for determining sensitivity, specificity, likelihood ratio for positive and negative tests, positive predictive value and negative predictive value of a test . . . . .	27	5.6	Differential diagnosis of common equine colics . . . . .	226	9.1	Characteristic or expected changes in hematological and serum biochemical variables in anemic animals . . . . .	454
1.4	Effect of changes in prevalence (pretest probability of disease) on the positive predictive value (PPV) and negative predictive value (NPV) of tests with 95% sensitivity and specificity (Test A) and 60% sensitivity and specificity (Test B) . . . . .	27	5.7	Analgesics and spasmolytics for use in equine colic . . . . .	227	10.1	Identification and clinical significance of breath sounds . . . . .	477
2.1	Representative laboratory values in body water and electrolyte disturbances . . . . .	89	5.8	Promotility agents, lubricants and fecal softeners for use in horses with colic . . . . .	228	10.2	Guidelines for radiographic pulmonary pattern recognition in foals . . . . .	483
2.2	Summary of disturbances of body water, electrolytes and acid-base balance in some common diseases of cattle and horses, and suggested fluid therapy . . . . .	92	5.9	Diseases causing colic in foals . . . . .	231	10.3	Representative results of cytology of bronchoalveolar lavage fluid of cattle, sheep, pigs, and horses . . . . .	488
2.3	Summary of effective strong ion difference and osmolarity of parenterally administered crystalloid solutions . . . . .	93	5.10	Differential diagnosis of common foal colics . . . . .	232	10.4	Changes in blood gas tensions in various disease states compared to values in normal animals breathing air at sea level . . . . .	491
2.4	Estimated daily energy requirements of fasting cattle . . . . .	95	5.11	Drugs used in the treatment of gastroduodenal ulcer disease of foals and adult horses . . . . .	236	10.5	Causes of epistaxis in horses . . . . .	505
2.5	Composition and indications for use of electrolyte solutions used in fluid therapy . . . . .	97	5.12	Epidemiological and clinical features of diseases of cattle in which diarrhea is a significant clinical finding . . . . .	260	10.6	Antimicrobial agents and recommended doses for treatment of pleuropneumonia in horses . . . . .	528
2.6	Examples of approximate amounts of fluid required for hydration and maintenance therapy . . . . .	98	5.13	The epidemiological and clinical features of horses with diarrhea . . . . .	261	12.1	Correlation between clinical findings and location of lesions in the nervous system of farm animals: abnormalities of mental state (behavior) . . . . .	584
2.7	Causes and diagnostic features of recumbency of more than 8 hours duration in adult horses . . . . .	121	5.14	Epidemiological and clinical features of diseases of the pig in which diarrhea is a significant clinical finding . . . . .	262	12.2	Correlation between clinical findings and location of lesion in the nervous system of farm animals: involuntary movements . . . . .	585
3.1	Concentrations and relative percentage of immunoglobulins in serum and mammary secretions of cattle and pigs . . . . .	150	5.15	Epidemiological and clinical features of the diseases of sheep and goats in which diarrhea is a significant clinical finding . . . . .	263	12.3	Correlation between clinical findings and location of lesion in the nervous system of farm animals: abnormalities of posture . . . . .	586
3.2	Immunoglobulin concentrations in the first milking of colostrum of Holstein cattle by weight of colostrum produced . . . . .	151	5.16	Epidemiological and clinical features of suckling foals with diarrhea . . . . .	274	12.4	Correlation between clinical findings and location of lesion in the nervous system of farm animals: abnormalities of gait . . . . .	587
3.3	Worksheet for calculating a sepsis score for foals less than 12 days of age . . . . .	161	6.1	Effects of some common clinical excitatory and inhibitory influences on primary cycle movements of the reticulorumen . . . . .	295	12.5	Correlation between clinical findings and location of lesion in the nervous system of farm animals: abnormalities of the visual system . . . . .	588
3.4	Criteria to assess stage of maturity of the newborn foal . . . . .	161	6.2	Differential diagnosis of causes of gastrointestinal dysfunction of cattle . . . . .	298	12.6	Correlation between clinical findings and location of lesion in the nervous system of farm animals: disturbances of prehension, chewing or swallowing . . . . .	588
3.5	Hematological values of normal foals and calves . . . . .	165	6.3	Differential diagnosis of abdominal distension in cattle . . . . .	302	13.1	Differential diagnosis of diseases of the musculoskeletal system . . . . .	622
3.6	Serum biochemical values of normal foals and calves . . . . .	166	6.4	Differential diagnosis of diseases of the digestive tract and abdomen of young calves presented with distension of the abdomen . . . . .	309	13.2	Laboratory evaluation of synovial fluid in diseases of the joints . . . . .	641
3.7	Antimicrobials used in neonatal foals . . . . .	169	6.5	Pathogenesis and interpretation of clinical findings associated with diseases of the digestive tract and abdomen of cattle . . . . .	310	14.1	Terms used to identify skin lesions . . . . .	652
3.8	Variables associated with survival in sick foals . . . . .	171	6.6	Diseases of the digestive tract and abdomen of cattle in which a laparotomy is indicated if the diagnosis can be made . . . . .	311	15.1	Estimated prevalence of infection and losses in milk production associated with bulk tank milk somatic cell count . . . . .	683
4.1	Mode of action of antimicrobial drugs . . . . .	182	6.7	Clinical and laboratory indications for an exploratory laparotomy in cattle when the diagnosis is not obvious . . . . .	311	15.2	California Mastitis Test reactions and equivalent somatic cell counts and linear scores for bovine milk and somatic cell counts for bovine colostrum . . . . .	686
5.1	Guidelines for the classification and interpretation of bovine peritoneal fluid . . . . .	199	6.8	Guidelines for the use of clinical findings in assessing the severity of grain overload in cattle for the selection of the treatment of choice . . . . .	320	15.3	Linear score calculation from the somatic cell count . . . . .	686
5.2	Characteristics of equine peritoneal fluid in selected diseases of horses . . . . .	200	6.9	Condensed tannin content of legumes, grasses and herbs fed to ruminants in temperate grazing systems . . . . .	328	15.4	Conversion of linear scores to somatic cells counts and predicted loss of milk . . . . .	687
5.3	Etiological classification of equine colic . . . . .	216	8.1	Base-apex electrocardiographic parameters in cattle and horses . . . . .	408			



15.5	Summary of three-compartment model for anatomical location of infection due to mastitis pathogens in cattle	690	21.3	Differentiation of acute vesicular disease	1226	29.7	To convert from the SI unit to the conventional unit divide by the conversion factor. To convert from the conventional unit to the S unit multiply by the conversion factor	1664
15.6	Scale used in rating udder edema	752	21.4	Differential diagnosis of diseases of cattle in which there are either oral lesions or diarrhea alone or together in the same animal	1265	29.8	Serum or plasma concentration of thyroid hormones and thyroid stimulating hormone (TSH) in foals and horses	1689
15.7	Diagnosis of free electricity problems	753	22.1	Diseases of horses characterized by signs of intra-cranial or disseminated lesions of the central nervous system	1375	30.1	Principal pathological and metabolic defects in essential trace element deficiencies	1699
16.1	Differential diagnosis of diseases of the upper respiratory tract of horses	772	22.2	Differential diagnosis of diseases characterized by lesions of the teat skin only	1381	30.2	Secondary copper deficiency status	1708
16.2	Aims and associated measures used to control transmission of <i>Streptococcus equi</i> in affected premises and herds	773	22.3	Differential diagnosis of diseases of horses characterized by discrete lesions of the skin only	1433	30.3	Copper levels of soils and plants in primary and secondary copper deficiency	1711
16.3	Differential diagnosis of diseases of pigs with skin lesions	785	22.4	Differential diagnosis of diseases of horses characterized by lesions of the skin of the lower limbs only	1434	30.4	Copper levels in body tissues and fluids in primary and secondary copper deficiency	1715
16.4	Differential diagnosis of respiratory diseases of older (not newborn) foals	803	23.1	Transmissible spongiform encephalopathies in animals and humans	1439	30.5	Diseases considered to be associated with a deficiency of either selenium or vitamin E or both (including 'selenium-responsive' disease)	1735
18.1	Risk factors and their role in acute undifferentiated diarrhea of newborn calves	847	23.2	PrP genotype and susceptibility to scrapie in National Scrapie Program (NSP) in Great Britain	1442	30.6	Glutathione peroxidase (GSH-PX) activity and selenium levels in blood and body tissues of animals deficient in selenium	1747
18.2	Age occurrence of the common enteropathogens in calves	849	23.3	Scrapie susceptibility and genotype as defined by the USA scrapie eradication plan	1443	30.7	Selenium reference range to determine selenium status of sheep and cattle in New Zealand	1748
18.3	Possible causes of bacteremia/septicemia and acute neonatal diarrhea in farm animals	852	26.1	Major <i>Babesia</i> species infective to domestic animals, their tick vectors and geographical distribution	1484	30.8	Dose rates and duration for selected selenium supplements for adult cattle	1754
18.4	Degree of dehydration in calves with experimentally induced diarrhea	859	26.2	Differential diagnosis of diseases of cattle in which red urine is a principal manifestation	1491	30.9	Some examples of estimated daily requirements of calcium, phosphorus and vitamin D	1758
18.5	Differential diagnosis of bovine respiratory disease	924	26.3	Differential diagnosis of anemia, with or without edema, in horses	1492	30.10	Approximate levels of phosphorus in soil and pasture (quoted as phosphate radical) at which phosphorus deficiency occurs in cattle	1759
18.6	Antimicrobials for treatment and prevention of bovine pneumonic pasteurellosis	941	26.4	Chemotherapeutics recommended for treatment and control of coccidiosis in calves and lambs	1505	30.11	Daily dietary allowances of vitamin A	1777
18.7	Diagnostic summary of causes of abortion in cattle	975	26.5	Definitive and intermediate hosts for <i>Sarcocystis</i> spp. Associated infections in agricultural animals	1507	32.1	Maximum tolerance levels of dietary minerals for domestic animals	1798
19.1	The relationship between the stages in the pathogenesis of Johne's disease, the presence of clinical disease and the results of diagnostic tests	1024	26.6	Summary of the theilerioses of domestic ruminants	1527	32.2	Lead levels in blood and feces of normal and poisoned animals	1803
19.2	Standard-Track Certification from the US Voluntary Johne's Disease Herd Status Program for Cattle	1039	26.7	Summary of the trypanosomoses of domestic animals and humans	1532	32.3	Differential diagnosis of diseases of cattle with clinical findings referable to brain dysfunction	1806
19.3	Fast-Track Certification from the US Voluntary Johne's Disease Herd Status Program for Cattle	1039	27.1	Anatomical distribution of trichostrongylid worms in ruminants	1542	32.4	Toxic oral doses and maximum concentrations of insecticides	1833
20.1	Differential diagnosis of lameness accompanied by foot lesions in sheep	1075	28.1	Single and multiple host ticks	1599	33.1	Plants causing glucosinolate poisoning	1867
20.2	Diagnostic summary of common causes of abortion, mummification and stillbirth in swine	1095	28.2	Ticks reported to cause paralysis	1599	33.2	Common mycotoxicoses in farm animals	1899
20.3	Forms of leptospirosis in the animal species	1100	28.3	Ticks reported to transmit protozoan disease	1600	33.3	Important venomous snakes of the world (adapted from Dorland's Illustrated Medical Dictionary, 28 edition, 1994, W. B. Saunders)	1916
20.4	Differential diagnosis of diseases of cattle characterized by acute hemolytic anemia with or without hemoglobinuria	1106	28.4	Diseases associated with bacteria, viruses and rickettsia and reported to be transmitted by ticks	1601	34.1	Method for performing the jaundiced foal agglutination test	1924
20.5	Major pathogenic <i>Mycoplasmas</i> of ruminants, swine and horses	1124	29.1	Salient features of metabolic diseases of farm animals	1614	34.2	Drugs used in the treatment of heaves in horses	1933
20.6	Summary of systemic mycoplasmoses of sheep and goats	1125	29.2	Metabolic profile parameters in cattle. Optimum values	1623	35.1	Defects acquired immunity causing disease in foals and horses	1943
20.7	Comparative properties of the two most important cattle mycoplasmas	1125	29.3	Annual (April-March) percentages outside optimum ranges of metabolic results in blood plasma in adult dairy cows	1624	36.1	Diseases of the lungs of cattle in which the essential lesion is interstitial pneumonia	1998
20.8	Members of the <i>Mycoplasma mycoides</i> cluster	1131	29.4	Relationship between the 10-point BCS scale used in New Zealand and the 5-point BCS scale used in Ireland and the USA, and the 8-point scale in Australia	1626	36.2	Differential diagnosis of comatose ('sleeper') neonatal foals	2013
21.1	Algorithm for testing horses for infection by equine infectious anemia virus when the prevalence rate is less than 1 in 1000	1176	29.5	Differential diagnosis of common causes of recumbency in parturient adult cattle	1633	36.3	Differential diagnosis of disease causing spinal ataxia in horses	2018
21.2	Nursery depopulation and clean-up protocol for elimination of PRRS	1202	29.6	Molecular weights, equivalent weights and conversions from percent to milliequivalents (%-mEq) of anions and cations used in calculating dietary cation-anion difference	1639			

# List of illustrations

1.1	Making a diagnosis . . . . .	23	5.4	Steps in correction of left dorsal displacement of the colon (renosplenic entrapment) . . . . .	251	15.1	The causes of porcine agalactia . . . . .	758
1.2	A decision tree for choosing between two interventions . . . . .	29	6.1	Silhouettes of the contour of the abdomen of cattle, viewed from the rear, with different diseases of the abdominal viscera . . . . .	302	21.1	Possible pathways after exposure to BVL virus (percentage figures indicate proportion of seroconverted animals that develop the particular form referred to) . . . . .	1214
1.3	Example of the construction and use of a decision tree . . . . .	30	6.2	Schematic illustration of the rectal findings in cattle affected with different diseases of the abdominal viscera . . . . .	306	21.2	Clinical diagnosis: frequency of predominant signs of bovine leukaemia – 1100 field cases. (By courtesy of <i>Canadian Veterinary Journal</i> ) . . . . .	1215
1.4	Examination of the herd with the objective of making a diagnosis . . . . .	33	6.3	Some common causes of physical and functional obstruction of the alimentary tract of cattle . . . . .	307	21.3	The objectives of herd testing for BVDV . . . . .	1267
2.1	Etiology and pathogenesis of dehydration . . . . .	74	6.4	Sequelae of traumatic perforation of the reticular wall . . . . .	337	21.4	Flow chart for testing a beef herd pre-breeding to detect and eliminate BVDV carrier cattle . . . . .	1268
2.2	Etiology and pathogenesis of hyponatremia . . . . .	77	6.5	Ultrasonogram and schematic of a reticular abscess in a cow with chronic traumatic reticuloperitonitis . . . . .	342	21.5	Flow chart for testing a dairy herd to detect and eliminate BVDV P1 carrier cattle . . . . .	1269
2.3	Types of dehydration . . . . .	78	6.6	Ultrasonogram and schematic of the reticulum in a cow with chronic traumatic reticuloperitonitis . . . . .	343	23.1	Annual reports of incidence of BSE in the UK (1987–1998) . . . . .	1447
2.4	Etiology and pathogenesis of hypochloremia . . . . .	78	6.7	Causes of grunting in cattle . . . . .	345	26.1	The development life cycle of <i>Babesia bigemina</i> in cattle and the ixodid tick vector <i>Boophilus microplus</i> (adapted from Mehlhorn, Shein 1984; Mackenstedt et al. 1995; gough et al. 1998) . . . . .	1486
2.5	Etiology and pathogenesis of hypokalemia . . . . .	79	6.8	Ultrasonogram and schematic of the abdomen in a cow with ileus due to obstruction of the jejunum with coagulated blood (hemorrhagic bowel syndrome) . . . . .	382	29.1	Body condition scoring chart adapted from Edmonson et al. (1989) . . . . .	1625
2.6	Etiology and pathogenesis of acidemia . . . . .	85	7.1	Classification of jaundice . . . . .	384	30.1	The four phases of copper deficiency . . . . .	1716
2.7	Etiology and pathogenesis of alkalemia . . . . .	86	7.2	Ultrasonogram and schematic of the liver in a cow with obstructive cholestasis due to fasciolosis . . . . .	388			
2.8	The interrelationships between the changes in body water, electrolytes and acid–base balance that can occur in diarrhea . . . . .	88	10.1	The causes of dyspnea . . . . .	474			
3.1	Examples of forms used to document and record historical aspects and findings on physical examination of foals less than 1 month of age . . . . .	162	10.2	Ultrasonogram and schematic of the thorax in a cow with pleuropneumonia due to infection with <i>Mannheimia haemolytica</i> . . . . .	523			
5.1	Left lateral view of abdomen of a normal horse and left dorsal displacement of the left colon . . . . .	249						
5.2	Right dorsal displacement of the colon, right lateral view . . . . .	250						
5.3	A 360° clockwise volvulus of the colon viewed from the right side . . . . .	250						

# List of Contributors

**Otto M. Radostits** CM, DVM, MS, MRCVS, DipACVIM  
Emeritus Professor, Department of Large Animal Clinical Sciences, Western College of Veterinary Medicine, University of Saskatchewan, Saskatoon, Saskatchewan, Canada

**Clive C. Gay** DVM, MVSc, FACVSc  
Emeritus Professor and Emeritus Director, Field Disease Investigation Unit, Department of Veterinary Clinical Science, College of Veterinary Medicine, Washington State University, Pullman, Washington, USA

**Kenneth W. Hinchcliff** BVSc, PhD, DipACVIM  
Professor, Equine Medicine, Department of Veterinary Clinical Sciences, College of Veterinary Medicine, Ohio State University, Columbus, Ohio, USA

**Peter D. Constable** BVSc, MS, PhD, DipACVIM  
Professor and Head, Department of Veterinary Clinical Sciences, School of Veterinary Medicine, Purdue University, West Lafayette, Indiana, USA

## Contributors:

**Stanley H. Done**, BA, BVetMed, DVetMed, Dipl ECVP, Dipl ECPHM FRCVS, FRCPath  
Visiting Professor of Veterinary Pathology, The Veterinary School, University of Glasgow, Glasgow, UK, Senior Veterinary Investigation Officer, Veterinary Laboratories Agency (VLA), Thirsk, North Yorkshire

**Dennis Jacobs** BVMS, PhD, DipEVPC FRCVS, FRCPath  
Professor, Veterinary Parasitology, Department of Pathology and Infectious Diseases, Royal Veterinary College, University of London, London, UK

**Basil Ikede** DVM, PhD, Diagn Path, FCVSN  
Professor Department of Pathology and Microbiology, Atlantic Veterinary College, Charlottetown, Prince Edward Island, Canada

**R. A. (Ross) McKenzie** BVSc, MVSc, DVSc  
Senior Lecturer, University of Queensland, and Principal Veterinary Pathologist, Queensland Department of Primary Industries, Animal Research Institute, Yeerongpilly, Queensland, Australia

**D. D. (Doug) Colwell** BSc, MSc, PhD  
Sustainable Production Systems Program, Agriculture and Agri-Food Canada, Lethbridge Research Centre, Lethbridge, Alberta, Canada

**Gary Osweiler DVM**, PhD, DABVT  
Veterinary Diagnostic and Production Animal Medicine, College of Veterinary Medicine, Iowa State University, Ames, Iowa, USA

**Rob Bildfell** DVM, MSc, DiplACVP  
Associate Professor, Department of Biomedical Sciences, College of Veterinary Medicine, Oregon State University, Corvallis, Oregon, USA

## Dedicated to Professor Douglas Charles Blood OBE, BVSc (Sydney), MVSc, FACVSc, Hon LLD (Sask), Hon LLD (Guelph), Hon Assoc RCVS

The Tenth Edition of this text, *Veterinary Medicine*, marks the passing of an era. For the first time Professor D. C. Blood, the originator of this text, is not a contributor and author. Doug Blood has had a passion for veterinary science and over the past 60 years he has made a remarkable contribution to the science of clinical veterinary medicine and to the profession of veterinary medicine. Not the least of these contributions is this text, in print for the past 45 years. He has taught clinical veterinary medicine to 40 years of veterinary students. The undergraduate education of all four of the senior authors of this edition has been profoundly impacted by Doug Blood's teaching and philosophy and the period of time of this influence ranges from the late 1950s to the early 1980s. Our postgraduate education and experience has also had significant influence from Doug Blood and we reflect on his influence on the profession and dedicate this edition to him.

As a background, Doug received his veterinary degree from the University of Sydney in 1942 and served in the Australian Army Veterinary Corps until the end of the Second World War. He then returned to teach and practice clinical veterinary medicine in the Clinical Department of the Faculty of Veterinary Science in the University of Sydney for 12 years, during which he spent a year on a Fulbright stipend at the veterinary school at Cornell University. In 1957 he joined the Department of Clinical Medicine at the Ontario Veterinary College in Guelph, then part of the University of Toronto, Canada.

In these early years Doug Blood revolutionized the teaching of clinical veterinary medicine. For those of us privileged to have been taught by him at this time he was a superlative teacher. Doug was one of the first teachers in veterinary clinical medicine to recognize that pathophysiology was the basis for teaching the disease processes in large animals. He also concentrated on its principles for the explanation of disease syndromes and in teaching clinical examination and diagnosis. This was an approach that he developed from the teaching of his mentor, the Oxford veterinary scientist, H. B. Parry, to whom this text was dedicated in the first edition. This approach to clinical teaching was in marked contrast to the rote learning that was common in many of the disciplines taught at that time and in stark contrast to the teaching in clinical examination and diagnosis, which then primarily relied on pattern recognition.

Doug Blood also taught that the method of clinical examination should be system-based, that it should be conducted in a systematic manner and that it should be conducted using all available senses and techniques. He further taught that the intellectual diagnostic rule-out process should also incorporate a consideration of the presenting epidemiology of the disease problem, the probability of disease occurrence and an examination of the environment. Although these approaches might seem obvious to recent graduates, in the 1950s and early 1960s they were revolutionary. In fact, they set the foundation for current teaching principles in large-animal clinical veterinary medicine. Students of that older vintage recall with great appreciation the understanding of clinical veterinary medicine imparted by Doug Blood and his particular contribution to their education. Throughout subsequent years in his teaching career Doug has shown the ability to inspire students and is held in respect, admiration and even veneration by the generations of students that he has taught.

The first edition of this text was published in 1960 and authored by D. C. Blood and J. A. Henderson. It was entitled *Veterinary Medicine: A Textbook of the Diseases of Cattle, Horses, Sheep, Pigs and Goats* and was based on Doug Blood's and Jim



Henderson's lectures and Doug's teaching and philosophical approach. At that time there were few textbooks in the disciplines of veterinary science and none that were either current, or published in English, that were primarily concerned with clinical veterinary medicine and diseases in agricultural animal species. The text was divided into two major sections: one, entitled General Medicine, covered system dysfunction and the other, Special Medicine, covered the specific diseases of the large animal species. This format has been followed in subsequent editions. The second edition was published in 1963 and had an additional two chapters covering parasitic diseases. Subsequently, new editions have been published approximately every 5 years with major or minor changes in format in most editions, such as the addition of new chapters dealing with new subjects or the addition of material in specific subheadings to highlight, for example, the epidemiology or zoonotic implications of disease. However, always, with each edition there was an extensive revision of disease descriptions based on current literature. Professor Henderson's involvement with the text ceased with the Fifth Edition and that edition recruited Professor O. M. Radostits as a senior author and others as contributing authors. The list of senior and contributing authors has expanded since the Fifth Edition but, until this present edition, Doug Blood has always been a major author.

In the preface to the First Edition it was stated that the book was directed primarily at students of veterinary medicine, although it was expected that the book would be of value to practicing veterinarians and field workers. The latter expectation has certainly proved true and the book has come to be

extensively used as a reference by veterinarians in large- and mixed-animal practice around the English-speaking world. Editions of the text have also been translated into French, Italian, Spanish, Portuguese, Japanese and Chinese.

In addition to his passion for the method and accuracy of diagnosis of disease in individual animals and herds, Doug Blood also has had a passion for preventive medicine and has been a firm proponent of the thesis that subclinical disease is economically more important than clinical disease in agricultural animal populations. With other colleagues at the University of Melbourne he developed, and trialed practically in private herds and flocks, health programs for dairy cattle, beef cattle and sheep. These programs were based on a whole-farm approach and centered on the concept that performance targets could be monitored by computer-based productivity monitoring to detect deviation from target performance. Doug Blood was a very early proponent of the use of computers to manage and analyze data in clinical diagnosis and herd health management. These herd health programs have been successfully commercially adopted in several countries.

Doug has stated on many formal occasions that he is immensely proud to be a member of the veterinary profession and in addition to his teaching and writing in clinical veterinary medicine he has attested this by his other outstanding contributions to the profession. In 1962 he returned to Australia to establish a Faculty of Veterinary Science within the University of Melbourne. He was appointed Professor of Veterinary Clinical Medicine and was also the Founding Dean of the current veterinary school in the university. The successful formation and funding of a new Faculty (College) within the University was a remarkable political achievement requiring cooperation with agricultural commodities, veterinarians, politicians and the public.

Doug has always been active in promoting the profession of veterinary medicine and active in organized veterinary medicine. He has actively encouraged his colleagues to have equivalent involvement and commonly would invite, pick up and transport

new graduates or new faculty to the local veterinary association meetings in Melbourne.

In the 1970s Doug was instrumental in establishing the Australian College of Veterinary Science, which continues to provide continuing education and specialty certification for practicing veterinarians in Australia and New Zealand. He has served on a large number of state and national veterinary association committees including service as President of the Victorian Veterinary Association. In recognition of his service to the veterinary profession he was awarded the Gilruth prize by the Australian Veterinary Association. This is the highest honor that the Australian Veterinary Association can bestow. Other honors include prestigious international honors such as the award of the Order of the British Empire (OBE) for outstanding service in veterinary science, the award of an Honorary Associate in the Royal College of Veterinary Surgeons in the UK and the bestowment of Honorary Doctor of Laws awarded by both the University of Guelph and the University of Saskatchewan.

With all of his activities, Doug acknowledged the strong support of his wife Marion, recently deceased, and his family of five daughters. His house was always open to students and graduate students to discuss anything from subjects in veterinary medicine to a discussion of the current book of the month, for the enjoyment of a tasting of Australian wines or to meet with an overseas veterinarian, who so often had come to meet with Doug on the visit to Australia and had ended up staying as a guest in the Blood household during the period of this visit.

Doug is currently retired in Werribee, Victoria with a continuing interest in his many past students and a major interest in ornithology and photography.

**Otto M. Radostits**  
**Clive C. Gay**  
**Kenneth W Hinchcliff**  
**Peter D Constable**

# Preface to the Tenth Edition

We are pleased to present the Tenth Edition of *Veterinary Medicine*, 45 years since the first 'Blood and Henderson' *Veterinary Medicine* was published in 1960. Because the demand for this book continues undiminished, we assume that we have a philosophy, a format and a price that is attractive and meets the demands of undergraduate veterinary students and graduate veterinarians working in the field of large-animal medicine. For this edition, significant changes were needed to keep up to date with the increasingly rapid expansion of knowledge about the diseases of large animals. The entire book was reviewed and revised as necessary, and new diseases added, based on literature published worldwide since 2000. We have attempted to ensure the book continues to have an **international scope** by including most of the diseases occurring in large animals **worldwide**.

**Professor D. C. Blood** continues to be an important inspiration and guiding light but retired from this edition of the book. We dedicate this edition to him.

**Dr Clive Gay** revised the chapters on diseases of the newborn, practical antimicrobial therapy, diseases caused by physical agents, the infectious diseases of sheep and goats, a new chapter on diseases associated with prions, and some of the metabolic and protozoan diseases and diseases of unknown etiology.

**Dr Kenneth Hinchcliff**, Ohio State University, completely revised the sections on specific equine diseases and added many newly described diseases of the horse. The section on equine colic, which had been expanded in the Ninth Edition, was completely revised for this edition. A section on care and management of the recumbent horse is a new addition. Dr Hinchcliff also revised the chapter on diseases of the respiratory system and diseases of the hemolymphatic and immune system. Dr Hinchcliff's section on the **formulary of drugs** used in large animal practice has been highly successful and useful to students, clinicians, and practitioners. It serves as a quick reference for the busy practitioner who needs to know the dosage schedule of a certain drug.

**Dr Peter Constable** has joined us a co-author. He reviewed major parts of Chapter 2, on systemic states, and revised the chapters on diseases of the cardiovascular system, the urinary system, the nervous system, and the mammary gland.

**Dr Otto Radostits** continued his role as senior author with major responsibilities for chapters in general medicine including systemic states, alimentary tract, ruminant stomachs, respiratory system, and musculoskeletal system. He also revised the chapters on metabolic diseases, nutritional diseases and most of the infectious diseases of cattle and some of the diseases of uncertain etiology.

**Professor Dennis Jacobs**, University of London, revised the chapter on diseases caused by helminths and completely reorganized the material into more distinct groups according to effects of the various helminths on body systems.

**Dr Ross A. McKenzie** revised the chapter on diseases caused by toxins in plants, fungi, cyanophytes, clavibacteria, and venoms in ticks and vertebrate animals.

**Professor Basil O. Ikede**, revised the major exotic viral and protozoan diseases and introduced some new tabular information that may be useful to the reader.

**Dr Doug Colwell** joined our book by revising the chapter on diseases caused by arthropod parasites.

**Professor Stanley Done** also joined our book as a major contributor and revised all the diseases of pigs. It was a major task given the very large literature base on infectious diseases of pigs on a worldwide basis.

**Dr Rob Bildfell**, reviewed and revised the necropsy findings for most of the specific diseases. His contribution in the Ninth Edition, **Samples for confirmation of diagnosis**, has been a successful section to serve as a guideline for the collection of samples at necropsy. The details of the guidelines are described in the section dealing with **'How to use this book'**.

Computerized word processing greatly facilitates the achievement of our long-term objective to produce an up-to-date review of the field of large-animal veterinary medicine as it is practiced, and the parallel stream of research work into the **etiology, epidemiology, pathogenesis, treatment and control** of diseases of large animals. We continue to emphasize a good understanding of **pathogenesis** of each disease, which is important in understanding the rationale for the diagnosis, treatment and control. This means that we strive to maintain an optimum balance between published research and what field veterinarians find useful in their daily work, which necessitates that our authors and contributors maintain a strong contact with clinical work, especially with the clinical techniques and treatment and control measures.

The knowledge base in **veterinary epidemiology**, particularly risk factors for disease, continues to increase and become more complex. A system of subheadings has been introduced and the material has been rearranged under them in order to simplify the reader's task in locating material in these presentations. A major change for this edition is giving special emphasis to the risk factors for disease, which are so important to the veterinarian in the clinical management and control of disease, particularly on a herd basis. We also continue to include the **zoonotic implications** of many diseases and how the large-animal veterinarian is becoming more involved in the control of diseases transmissible to humans. We also indicate those diseases of concern as agents of bioterrorism.

The use of **individual diagnostic tests**, described under clinical pathology of each disease, continues to be a challenge for all of us. A very large number of publications deal with the development of laboratory diagnostic tests but most of them have little information on their sensitivity and specificity for diagnostic purposes and will likely never be employed in routine diagnosis. There is also regional and national variation in tests that are used and it is not possible nor desirable to detail these in the book. We have chosen to concentrate on those tests that are accepted through common use, to discuss their limitations if they are known, and to provide a reference to newer tests that have future promise in diagnosis.

Restraining the size of the book has been a constant pre-occupation and a difficult task with the ever increasing volume of published information and the constantly growing list of diseases. Our intention has always been to provide information on all recorded diseases. In spite of reductions in reference lists, word paring editing made possible by word processing, and overall editing to minimize repetition, the book is still quite large. The references have been culled and those included are considered to be current. **Synopses** have been included for each disease topic for which the material exceeded approximately 1000 words. To make it easier for the reader to find particular pieces of information, long passages of prose have been divided into smaller sections using more **headings and subheadings**. **Key words, terms and phrases** have been emboldened for emphasis and to make it easier for the reader to identify important points.

Other reference books to which the readers are referred, include the 3rd edition of *Herd Health* (2001), the companion



reference to animal health management of farm animals, and the 3rd edition of *Saunders Comprehensive Veterinary Dictionary* (2006) with its complete coverage of definitions and spellings of all words used by undergraduate and graduate veterinarians.

We are satisfied that we have completed another authoritative, responsible and comprehensive review of the literature of large animal medicine, at a standard at least equal to that of the previous nine editions, and we hope that it will provide the

information necessary for the needs of students and practitioners for the next 5 years.

**O. M. Radostits**

**C. C. Gay**

**K. W. Hinchcliff**

**P. C. Constable**

**November 2006**

# Introduction

## Objectives and principles of farm animal practice

The primary objective of this book is to provide the veterinary student and the practitioner with the knowledge and information necessary to provide animal health management for farm animals. This is a commentary on the objectives and principles of veterinary practice related to the animal health and production of cattle, sheep, goats, pigs and horses.

### FOOD-PRODUCING ANIMALS

Food-producing-animal veterinary practice provides service primarily to the owners of the meat-, milk- and fiber-producing animals such as dairy and beef cattle, pigs, sheep and goats. Veterinarians also provide service to owners of captive ungulates, such as red deer, elk and bison, that are being raised under farm conditions for the production of meat and byproducts such as hides. While some commercially processed horsemeat is consumed by humans, the market is small compared to beef and pork, and horses are not usually included in discussions about food-producing animal veterinary practice. Poultry, fish and rabbits are also important sources of human food but are not the subject of this book.

For the past several decades, the major activity in food-producing-animal practice, and a major source of income for veterinarians, was the provision of **emergency veterinary service** to the owners of herds or flocks in which a single animal was affected with one of the common diseases. Occasionally, outbreaks of disease affecting several animals occurred. In addition, routine elective veterinary services such as castration, vaccination, dehorning, deworming, the testing for diseases such as brucellosis and tuberculosis and the dispensing of veterinary drugs, pharmaceuticals and biologicals accounted for a significant source of revenue for the veterinarian. Since about the early 1970s, there has been a shift from emphasis and dependence on emergency veterinary medicine and routine procedures to more attention being paid by the veterinarian and the producer to **planned animal health and production management** using the whole-farm approach. Livestock producers are now much more knowledgeable about animal agriculture and are concerned about the cost-effectiveness and the scientific basis of the recommendations made by veterinarians and agricultural advisors. More and more producers are doing the routine elective procedures themselves. From firsthand experience and extension courses provided for them they have also learned how to diagnose and treat many of the common diseases of farm livestock. Many veterinary pharmaceuticals antimicrobials and biologicals can now be purchased by producers from either veterinary or nonveterinary sources.

### INDUSTRIALIZED ANIMAL AGRICULTURE

The intensification of animal agriculture has created complex animal health and production problems for which there are no simple and reliable therapeutic and preventive procedures, and this has made the task of the veterinarian much more challenging. For example, acute undifferentiated respiratory disease is a common disease of feedlot cattle that is difficult to treat and control effectively because the etiology and epidemiology are complex. Acute diarrhea of calves under 30 days of age may be caused by several different enteropathogens but a knowledge of the risk factors or epidemiological determinants such as colostrum

immunity and population density is probably more important for effective clinical management and control of the disease. The rearing of pigs intensively and in complete confinement has exaggerated a number of disease problems, many exacerbated by inadequacies of the environment.

Suboptimal reproductive performance due to a variety of management and environmental factors is common, and pneumonia in growing and finishing pigs may be almost impossible to eradicate unless the herd is depopulated and repopulated with minimal-disease breeding stock. Infectious diseases such as porcine reproductive and respiratory syndrome are difficult to control. The solutions to these complex problems are not always readily apparent, in part because of insufficient research on etiology and epidemiology and different control strategies in the herds where the problems are occurring. The veterinarian must be knowledgeable and skillful in the principles of epidemiology, applied nutrition and animal housing, the education and training of animal attendants and the analysis of production indices, including profit and loss, which includes the use of computers, in addition to being skilled in the traditional veterinary disciplines of medicine, reproduction, pharmacology and pathology. Thus, the food-producing-animal practitioner must become more skilled in the simultaneous management of animal health and production; the modern livestock producer is cost-conscious and anything veterinarians do or recommend must be cost-effective.

### COMPANION ANIMAL PRACTICE

In contrast, developments in companion animal medicine (small animals) have followed in the footsteps of human medicine with an ever-increasing emphasis and reliance on extensive use of clinical pathology for the in-depth evaluation of the hematology, clinical chemistry, enzymology, immune status and many other body functions of the individual animal.

Diagnostic techniques such as ultrasonography, endoscopy, nuclear imaging and computed tomography are being used both in veterinary teaching hospitals and in referral veterinary practices. These in-depth 'diagnostic workups' presumably lead to a greater understanding of the etiology and pathophysiology of disease, with the ultimate aim of a more accurate and early diagnosis that allows much more effective medical and surgical therapy than is economically possible or necessary in food-producing animals. There is not the same emphasis on the efficiency of production, epidemiology and cost-effectiveness that constantly faces the food-producing-animal practitioner. More and more companion animal owners, because of the sentimental value of their animals and the growing importance of the human-companion-animal bond, are willing to pay for the costs associated with extensive laboratory and sophisticated diagnostic tests and intensive and prolonged veterinary hospital care. Palliative care for dogs and cats affected with diseases that may not be curable over the long term is now a recognized fact in small-animal practice.

### EQUINE PRACTICE

Equine practice has evolved along similar lines to small-animal practice. Some aspects of it, such as reproduction, intensive clinical care of the newborn foal and the treatment of medical and surgical diseases of valuable athletic and competitive horses, have advanced a great deal. The great strides that have been made in our understanding of the diagnosis, prognosis and medical and surgical therapy of colic in the horse are due to the in-depth diagnostic laboratory work and the medical and surgical

expertise that have been used. Our improved understanding of the prognosis of equine colic has in part been due to prospective studies of the clinical and laboratory findings in horses with colic. However, the large advances in improvement in survival made in the early years of surgical and intensive medical treatment of colic have not continued, and there is an urgent need for appropriately designed prospective clinical trials to determine optimal treatment regimes in these horses. The same is true for intensive treatment of sick foals. In addition to the advanced diagnostic and therapeutic procedures being done on valuable horses at veterinary teaching hospitals, there are now many privately owned equine veterinary centers that provide the same service. Undoubtedly the high financial value of some horses has provided the impetus for the development of these services.

While the increasingly sophisticated diagnostic and therapeutic techniques used in equine practice are readily noted, advances in the understanding of infectious and contagious diseases of horses has also increased markedly. This is particularly true for economically important diseases that have the potential to affect large numbers of horses, consequently causing disruption to important athletic events, sales and shipment of horses. These diseases are typically the infectious respiratory diseases and those diseases, such as African horse sickness, that are exotic to most of the horse population worldwide. The economic incentive to control these diseases has resulted in considerable increases in knowledge of their etiology (and consequently vaccinology), epidemiology, immunology, diagnosis and prevention. Few advances have been made in treatment of what are for the most part self-limiting diseases with low case fatality rates.

## CONTRASTING OBJECTIVES

It is clear that there are major differences between the objectives and principles of companion-animal practice and those of food-producing-animal practice. In companion-animal practice, the objective is the restoration of the clinically ill animal to a normal state, if possible, or in some cases a less than normal state is acceptable providing it is a quality life, using all the readily available diagnostic and therapeutic techniques that can be afforded by the client. In sharp contrast, in food-producing-animal practice, the objective is to improve the efficiency of animal production using the most economical methods of diagnosis, treatment and control, including the disposal by culling or slaughter of animals that are difficult to treat and are economic losses.

This growing dichotomy in the delivery of veterinary services to the food-producing-animal owner and to the companion-animal owner prompted us to present a short introductory commentary on the objectives and principles of food-producing animal practice.

## The objectives of food-producing animal practice

### EFFICIENCY OF LIVESTOCK PRODUCTION

The most important objective in food-producing-animal practice is the continuous improvement of the efficiency of livestock production by the management of animal health. This involves several different but related activities and responsibilities, which include the following:

- **Providing the most economical method of diagnosis and treatment** of sick and injured animals and returning them to an economically productive status, or to a point where slaughter for salvage is possible in the shortest possible time.

The financially conscious producer wants to know the probability of success following treatment of a disease in an animal and to minimize the costs of prolonged convalescence and repetitive surgery

- **Monitoring animal health and production** of the herd on a regular basis so that actual performance can be compared with targets and the reasons for the shortfalls in production or increases in the incidence of disease can be identified as soon as possible, so that appropriate and cost-effective action can be taken. The routine monitoring of production records and the regular monitoring of bulk tank milk somatic cell counts in dairy herds are examples
- **Recommending specific disease control and prevention programs** such as herd biosecurity, vaccination of cattle against several important infectious diseases that occur under a variety of conditions, and the strategic use of anthelmintics in cattle and sheep
- **Organizing planned herd and flock health programs** for the individual farms with the objective of maintaining optimum productivity through animal health management. This subject is presented in the companion volume to this book, *Radostits OM Herd Health: Food Animal Production Medicine*, 3rd edn. WB Saunders, 2001
- **Advising on nutrition, breeding and general management practices.** Food-producing-animal practitioners must be interested in these matters when they affect animal health. It is a large part of production-oriented health management, and it is now common for veterinarians to expand their health-oriented animal husbandry advisory service to include an animal production advisory service. To do so is a matter of individual preference, an option that some veterinarians take up and others do not. Some veterinarians will rely on consultation with agricultural scientists. However, veterinarians still require a working knowledge of the relevant subjects, at least enough to know when to call in the collaborating advisor for advice. Members of both groups should be aware of the extensive list of subjects and species-oriented textbooks on these subjects, which should be used to support this kind of service.

## ANIMAL WELFARE

Encouraging livestock producers to maintain standards of animal welfare that comply with the views of the community is emerging as a major responsibility of the veterinarian. The production of food-producing animals under intensified conditions has now become an animal welfare concern that practitioners must face and in which they must become proactive.

## ZOOSES AND FOOD SAFETY

Promoting management practices that ensure that meat and milk are free of biological and chemical agents capable of causing disease in humans must also become a preoccupation for food-producing-animal veterinarians. This is because the general public is concerned about the safety of the meat and milk products it consumes and the most effective way to minimize hazards presented by certain infectious agents and chemical residues in meat and milk is to control these agents at their point of entry into the food-chains, namely, during the production phase on the farm. Veterinarians will undoubtedly become involved in the surveillance of the use of antimicrobial compounds and other chemicals that are added to feed supplies to promote growth or prevent infections, and will be expected to minimize the risk of the occurrence of zoonotic disease agents in farm animal populations.

## Principles of food-producing animal practice

### REGULAR FARM VISITS

A unique feature of a food-producing animal veterinary practice is that most of the service is provided by the veterinarian who makes emergency or planned visits to the farm. In some areas of the world, where veterinarians had to travel long distances to farms, large-animal clinics were established and producers brought animals that needed veterinary attention to the clinic. For the past 25 years these clinics have provided excellent facilities in which, for example, surgical procedures such as cesarean sections could be done and intensive fluid therapy for dehydrated diarrheic calves could be administered much more effectively and at a higher standard than on the farm. However, much less veterinary service is being provided in these clinics now because of the high operating costs of providing hospital care and the limited economic returns that are possible for the treatment of food-producing animals, which have a fixed economic value. Producers have also become less enthusiastic about transporting animals to and from a veterinary clinic because of the time and expertise involved.

### CLINICAL EXAMINATION AND DIAGNOSIS

The diagnosis, treatment and control of diseases of food-producing animals are heavily dependent on the results of the clinical examination of animals on the farm and the careful examination of the environment and management techniques. This means that the veterinarian must become highly skilled in obtaining an accurate and useful history on the first visit to an animal or group of animals and in conducting an adequate clinical examination in order to make the best diagnosis possible, and economically so that the treatment and control measures can be instituted as soon as possible. On the farm, during the day or in the middle of the night, the veterinarian will not have ready access to a diagnostic laboratory for the rapid determination of a cow's serum calcium level if milk fever is suspected. The practitioner must become an **astute diagnostician** and a skillful user of the physical diagnostic skills of visual observation, auscultation, palpation, percussion, succussion, ballottement and olfactory perception. On the farm, the clinical findings, including the events of the recent disease history of an animal, are often much more powerful, diagnostically, than laboratory data. It therefore becomes increasingly important that the clinical examination should be carefully and thoughtfully carried out so that all clinically significant abnormalities have been detected.

An outline of the clinical examinations of an animal and the different methods for making a diagnosis are presented in Chapter 1. Becoming efficient in clinical examination requires the diligent application of a systematic approach to the task and, most importantly, evaluation of the outcome. A most rewarding method of becoming a skillful diagnostician is to retrospectively correlate the clinical findings with the pathology of those cases that die and are submitted for necropsy. The correlation of the clinical findings with the clinical pathology data, if available, is also an excellent method of evaluation but is not routinely available in most private practices. The food-producing-animal practitioner must also be a **competent field pathologist** and be able to do a useful necropsy in the field, usually under less than desirable conditions, and to make a tentative etiological diagnosis so that additional cases in the herd can be properly handled or prevented. Doing necropsies on the farm or having them done by a local diagnostic laboratory can be a major activity in a specialty pig or beef feedlot practice, where clinical examination

of individual animals is done only occasionally, compared with dairy practice.

### EXAMINATION OF THE HERD

The clinical examination of the herd in which many animals may be affected with one or a number of clinical or subclinical diseases or in which the owner's complaint is that performance is suboptimal but the animals appear normal, has become a major and challenging task. This is particularly true in large dairy herds, large pig herds, beef feedlots, lamb feedlots and sheep flocks where the emphasis is on health management of the herd. Intensified animal agriculture may result in an increased frequency of herd **epidemics** or **outbreaks** of diseases such as pneumonic pasteurellosis, bloat, acute diarrhea in beef calves and peracute coliform mastitis in dairy cattle. Such well known diseases are usually recognizable and a definitive etiological diagnosis can usually be made and in some cases the disease can be controlled by vaccination. However, in some cases of herd epidemics of respiratory disease, salmonellosis, Johne's disease, for example, the veterinarian may have to make repeated visits to the herd in order to develop effective treatment and control procedures. The steps involved in the examination of the herd affected with a clinical disease or suboptimal performance are presented in Chapter 1.

### VETERINARY TECHNICIANS

Veterinary technicians are now employed by veterinary practices to assist in a wide variety of tasks. They can collect and computerize animal health and production records from individual herds, collect laboratory samples and assist in the preparation of reports. Under the veterinary supervision they can do routine elective surgical procedures such as dehorning, castration, foot-trimming and vaccinations. The veterinarian is thus provided with more time to pursue the diagnosis and correction of health and production problems in the herd. In large commercial beef feedlots, veterinary technicians commonly identify and treat cattle affected with acute undifferentiated respiratory disease and the veterinarian will analyze the therapeutic responses, do necropsies and interpret the data, which have been stored in a computer.

### VETERINARY EPIDEMIOLOGY

As animal agriculture continues to intensify, an increasing number of herd problems are evolving that have a multifactorial etiology and we are entering the era of the **epidemiological diagnosis**, in which the definitive etiology may not be determined but removal or modification of the risk factors may successfully and economically control the disease. For example, recent epidemiological observations revealed that certain skeletal abnormalities of beef calves were associated with the use of grass or clover silage as the sole diet of pregnant beef cows during the winter months in Canada. The precise etiology was undetermined but in a controlled clinical trial, supplementation of the silage with grain eliminated the abnormality. This is an example of a modern-day epidemiological diagnosis comparable to the observation by John Snow that cholera in humans was associated with the use of the community water pump, long before the causative bacterium was identified. Bovine spongiform encephalopathy, first recognized in the UK in 1986, has resulted in some excellent research in veterinary epidemiology, which has demonstrated its power in the investigation of a disease that has such important zoonotic implications.

It is clear that the next wave of development in food-producing-animal practice will be associated with the increased use of **applied and analytical epidemiology**. The tools of

epidemiology are now readily available to allow the veterinarian to identify and quantify the risk factors associated with the disease, to provide a more accurate prognosis, to accurately assess treatment responses and not depend on clinical impressions, to scientifically evaluate control procedures and to conduct response trials. There is a large and challenging opportunity for veterinarians to become involved in clinical research in the field where the problems are occurring. It will require that they become knowledgeable about the use of computerized databases. These now provide an unlimited opportunity to capture and analyze data and generate useful information, which heretofore was not considered possible. The technique of decision analysis is also a powerful tool for the veterinarian who is faced with making major decisions about treatment and control procedures.

### **COLLECTION AND ANALYSIS OF ANIMAL HEALTH DATA**

With the shift in emphasis to the problems of the herd, the collection, analysis and interpretation of animal health and production data will be a major veterinary activity. Livestock producers must keep and use good records if the veterinarian is to make informed decisions about animal health and production. The once tedious and unpopular work of recording and analyzing animal health and production data is now done by the computer. Veterinarians will have to move in the direction of developing a computer-based animal health and production profile of each herd for which they are providing a service. Veterinary colleges will also have to provide leadership and provide undergraduate and graduate student education in the collection, analysis and interpretation of animal health data. This activity will include methods of informing the producer of the results and the action necessary to correct the herd problem and to improve production.

### **PUBLIC HEALTH AND FOOD SAFETY**

Veterinarians have a major responsibility to ensure that the meat and milk produced by the animals under their care are free from pathogens, chemicals, antimicrobials and other drugs that may be harmful to humans. The prudent use of antimicrobials, including adherence to withdrawal times for meat and milk, are becoming major concerns of the veterinary associations such as the American Association of Bovine Practitioners and Swine Practitioners. Traditionally, veterinary public health was not an attractive career for veterinarians because it was perceived as an unimportant activity. However, because of the recent concern about the contamination of meat supplies by pathogens and **xenobiotics** (any substance foreign to an animal's biological system), and the potentially serious economic effects of such contamination on the export markets of a country, it is now clear that veterinarians, using a variety of testing techniques, will become involved in monitoring the use of veterinary drugs so that treated animals are not placed in the food-chain until the drugs have been excreted. The same principles apply to the contamination of milk supplies with antimicrobials, a major responsibility of the veterinarian.

### **ECONOMICS OF VETERINARY PRACTICE**

The successful delivery of food-producing-animal practice will depend on the ability of the veterinarian to provide those services that the producer needs and wants at a price that is profitable to both the producer and veterinarian. Several constraints interfere with this successful delivery. Maximizing net profit is not a high priority for many farmers. Being independent and making a living on the farm are commonly ranked higher. Consequently,

when veterinarians make recommendations to control a disease their subsequent enthusiasm for giving advice may be dampened if farmers do not adopt the control procedures even though the advice is based on good information about expected economic returns.

The frustrations that many veterinarians experience in attempting to get dairy producers to adopt the principles of an effective and economical mastitis control program are well known. In some cases, producers do not use modern methods of production and disease control because they are unaware of their importance. The variable financial returns that farmers receive for their commodities, particularly the low prices received during times of oversupply of meat and milk, may also influence whether they purchase professional veterinary service or attempt to do the work themselves.

### **VETERINARY EDUCATION**

We have described our views on the state of food-producing-animal medicine and what it requires of veterinarians who practice it. Traditionally, veterinary colleges have provided undergraduate students with the knowledge and clinical skills necessary to enter veterinary practice and begin to engage in food-producing-animal practice. Field service units and large-animal in-clinics devoted to clinical teaching were an integral part of most veterinary colleges. The clinical caseload is for the students, clinicians and the paraclinical sciences such as microbiology, toxicology, clinical pathology and pathology. However, recently, it seems that veterinary colleges have not maintained their farm-animal teaching clinics and, in fact, some of these teaching clinics have ceased to exist. The demise of in-house food animal practice in veterinary teaching hospitals, as opposed to the care of agricultural animals from hobby farms, is contributed to by the increasing use of stringent biosecurity measures on medium- and large-scale operations. Animals brought to veterinary teaching hospitals for diagnosis and possible treatment cannot be returned to the farm because of the fear of introducing infectious disease. Regardless, the demise of in-house food-animal practice in universities should be of major concern to the veterinary profession, which should have an obligation to serve the veterinary needs of animal agriculture. Some veterinary colleges have developed extensive programs in which undergraduate students spend time in private veterinary practice to gain clinical experience. However, the failure to maintain and support viable farm-animal teaching clinics will diminish the clinical experience of clinicians and the paraclinical sciences, who have a primary responsibility for teaching. In addition, the lack of clinical cases will adversely affect the clinical research activities of clinicians. Clinicians must experience a critical number of clinical cases in order to maintain credibility as a veterinary scholar.

*To study the phenomena of disease without books is to sail an unchartered sea, while to study books without patients is not to go to sea at all.*

Sir William Osler,  
Books and Men. *Boston Surgical Journal*. 1901

The practicing veterinarian must become knowledgeable about various aspects of **farm animal management**, especially those that cause or contribute to clinical or subclinical disease and impaired animal production. Such veterinarians will become **species-industry specialists** who can provide totally integrated animal health and production management advice either to the dairy herd, the beef cow-calf herd, the beef feedlot, the pig herd or the sheep flock. To be able to do this veterinarians will need to undertake a postgraduate clinical residency program or develop the expertise on their own by diligent self-education in a

veterinary practice that is committed to the concept of a total animal health management and allows the veterinarian the time and the resources to develop the specialty.

### **OPTIMAL UTILIZATION OF THE FOOD-PRODUCING-ANIMAL PRACTITIONER**

All that we have said in this introduction is related to enhancing and improving the performance of the professional food-producing-animal veterinarian. In developed countries this could mean greater utilization of each veterinarian by farmers and improved financial viability of their farming enterprises. In developing countries it could mean a greater volume of production at a time when malnutrition appears to be the fate of so many groups of the world community. These could be the

outcomes if the world's agricultural situation was a stable one. As it is, there is currently a great upheaval in agriculture; developed countries are heavily overproduced and there is a sharp decline in farming as an industry and way of life. In developing countries, the decisions governing the health and welfare of animals and the people that depend on them often seem to depend more on political expediency than on the basic needs of humans and their animals. In these circumstances we do not feel sufficiently courageous and farsighted to predict our individual futures but with the hindsight of how far the human population and their attendant agricultural and veterinary professions have come in the past 50 years we are confident that you will have an opportunity to properly pursue the objectives and principles that we have described.



# How to use this book

We would like you to get the most out of this book. To do that you should follow the directions below. And if you keep doing this every time you use the book you will develop a proper diagnostic routine of going from:

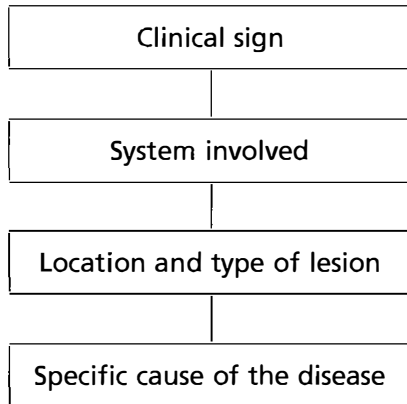

... and become what we wish for every one of you: a thinking clinician.

## FOR EXAMPLE

A yearling bull has a sudden onset of dyspnea, fever, anorexia, abnormal lung sounds and nasal discharge.

**Step 1** The bull's problem is dyspnea. Go to the index and find the principal entry for dyspnea.

**Step 2** The discussion on dyspnea will lead you to respiratory tract dyspnea and cardiac dyspnea.

**Step 3** Via the index consult these and decide that the system involved is the respiratory system and that the lungs are the location of the lesion in the system.

**Step 4** Proceed to diseases of the lungs and decide on the basis of the clinical and other findings that the nature of the lesion is inflammatory and is pneumonia.

**Step 5** Proceed to pneumonia, and consult the list of pneumonias that occur in cattle. Consult each of them via the index and decide that pneumonic pasteurellosis is the probable specific cause.

**Step 6** Proceed to the section on pneumonic pasteurellosis determine the appropriate treatment for the bull and the chances of saving it.

**Step 7** Don't forget to turn to the end of the section on pneumonic pasteurellosis and remind yourself of what to do to protect the rest of the herd from sharing the illness.

## Guidelines for selection and submission of necropsy specimens for confirmation of diagnosis

In this edition we continue with the subheading *Samples for confirmation of diagnosis* to serve as a rough guideline for the collection of samples at necropsy. Several points must be emphasized with regard to this section. First and foremost, **collection of these samples is not advocated as a substitute for a thorough necropsy examination.** Furthermore, the samples listed are selected in order to confirm the diagnosis but

a conscientious diagnostician should also collect samples that can be used to rule out other disease processes. Even the best of practitioners can make an incorrect tentative diagnosis but it is an even more humbling experience if there are no samples available to pursue alternate diagnoses. Also, recall that some diseases may be the result of several different etiological factors (e.g. neonatal diarrhea of calves) and the veterinarian who samples to confirm one of these factors, while not attempting to investigate others, has not provided a good service to the client.

A huge variety of veterinary diagnostic tests have been developed but each veterinary diagnostic laboratory (VDL) offers only a selected panel, chosen after consideration of a number of factors. Such factors may include: cost, demand, reliability, sensitivity and specificity, and the availability of appropriate technology at the lab. The array of diagnostic tests is constantly improving and it is beyond the scope of this text to list all the tests available for a given disease, or to recommend one test method to the exclusion of others. Under the samples for confirmation of diagnosis section we have merely listed some of the more common tests offered. Advances in molecular biology are providing exciting avenues for disease diagnosis, but many of these tests have limited availability in VDLs at present. For optimal efficiency in the confirmation of a diagnosis at necropsy, the practitioner must contact their VDL to determine what tests are offered and to obtain the preferred protocol for sample collection and submission to that particular laboratory. Most VDLs publish user guidelines, which include the tests available and the samples required. The guidelines listed below are broad, and individual VDLs may have very specific requirements for sample handling.

Several general statements can be made with regard to the submission of samples to VDLs:

- The samples should be accompanied by a clearly written and concise clinical history, including the signalment of the animal, as well as feeding and management information. Failure to provide this information deprives the owner of the full value of the expertise available from the laboratory staff
- If a potentially zoonotic disease is suspected, this should be clearly indicated in a prominent location on the submission form
- All specimens should be placed in an appropriate sealed, leakproof container and clearly labeled with a waterproof marker to indicate the tissue/fluid collected, the animal sampled and the owner's name. At some VDLs, pooling of tissues within a single bag or container is permitted for specific tests (such as virus isolation), but in general all fresh samples should be placed in separate containers. When packaging samples for shipment recall that condensation from ice packs and frozen tissues will damage any loose paper within the package; the submission sheet should be placed within a plastic bag for protection or taped to the outside of the shipping container
- Samples for histopathology can be pooled within the same container of 10% neutral-buffered formalin. An optimal tissue sample of a gross lesion should include the interface between normal and abnormal tissue. For proper fixation, tissue fragments should not be more than 0.5 cm in width and the ratio of tissue to formalin solution should be 1:10. If necessary, large tissues such as brain can be fixed in a larger container and then transferred to a smaller one containing only a minimal quantity of formalin for shipping to the laboratory. To speed fixation and avoid artifactual changes,

formalin containers should not be in direct contact with frozen materials during shipment.

In the *Samples for confirmation of diagnosis* section, the tests are listed under various discipline categories (bacteriology, virology, etc.). The appropriate sample(s) is noted, followed by the types of test that might be applied to these samples. The following is a list of these different tests, including any abbreviation used in this section of the text. A brief discussion of how the samples collected for each test should be handled is also provided. Again, it must be emphasized that this is by no means a complete listing of diagnostic tests available, and that different VDLs often have differing sample handling procedures.

- **Aerobic culture** = (CULT). These samples should generally be kept chilled during shipment. If a transit time of greater than 24 hours is anticipated the samples should be frozen, then packaged appropriately so that they are still frozen upon arrival at the VDL. Various bacterial species cannot be recovered using routine culture techniques and most of these are highlighted in the text by the phrase 'special culture requirements'
- **Agar gel immunodiffusion** = (AGID). A type of serological test. Chilled or frozen serum may be submitted
- **Anaerobic culture** = (ANAEROBIC CULT). Confirmation of the diagnosis requires that any swabs be transported in special transport media and that the VDL attempts to grow bacteria from the samples under anaerobic culture conditions. Transport requirements are as for (CULT) (aerobic culture) specimens
- **Analytical assay** = (ASSAY). This refers to a broad range of tests in which a substance is quantitatively measured. The substance to be assayed is listed in brackets, e.g. (ASSAY (Ca)) denotes a test for calcium levels. The method used to perform the assay is not listed but in general frozen samples may be submitted for most of these analytical assays.
- **Blood urea nitrogen** = (BUN). A useful test to determine degree of renal compromise. Sample can be shipped chilled or frozen
- **Bioassay** = (BIOASSAY). This typically refers to tests in which the sample material is administered to an animal under experimental conditions. Preserved material is inappropriate and some bioassays cannot be performed using samples which have been frozen. The VDL performing the test should be contacted for instructions prior to sample collection
- **Complement fixation** = (CF). A serological test. Ship chilled or frozen serum
- **Cytology** = (CYTO). Air-dried impression smears are usually adequate. Keep dry during transport
- **Direct smear** = (SMEAR). The type of test is usually given in brackets (e.g. (Gram)). Air-dried smears are usually adequate but must be kept dry during shipment
- **Enzyme-linked immunosorbent assay** = (ELISA). Chilled or frozen samples are usually acceptable. There are many variants of ELISA (e.g. antigen-capture, kinetic, indirect, direct, etc.) and the specific type used is not specified in this portion of the text

- **Electron microscopic examination** = (EM). Appropriate sample collection and handling varies with the specimen being examined. Most of the diagnostic specimens submitted to VDLs for EM are fecal samples, and these do not require any special preservative
- **Fecal floatation** = (FECAL). Sample can be fresh, chilled or frozen
- **Fluorescent Antibody Test** = (FAT). This may refer to either a direct or indirect method of antigen detection. Generally, cryostat sections are utilized and therefore the tissue received by the laboratory should still be frozen upon arrival to provide the best results. Freeze/thaw cycles should be avoided. If impression smears are being shipped, they should be kept dry
- **Fungal culture** = (FCULT). Special media is required. Transport as per (CULT) specimens
- **Immunohistochemical testing** = (IHC). Many of these tests can be performed on formalin-fixed material but in some instances frozen tissues must be delivered to the laboratory. In such instances the test is listed under a heading distinct from histology (e.g. virology, bacteriology, etc.)
- **Indirect hemagglutination** = (IHA). A serological test. Ship chilled or frozen serum
- **In-situ hybridization** = (IN-SITU HYBRID). Samples should be shipped chilled although some test methods can use formalin-fixed material. These tests utilize nucleic acid probes which bind with complementary nucleic acid sequences in the specimen. Although not widely used in routine diagnostics at present, these methods may gain more prominence as their use is refined
- **Virus isolation** = (ISO). Samples should be kept chilled during shipment or maintained in a frozen state if prolonged transit times are anticipated
- **Latex agglutination** = (LATEX AGGLUTINATION). Fresh, chilled or frozen samples are acceptable
- **Light microscopic examination** = (LM). Formalin-fixed tissues are preferred. The shipment of fresh tissues to the VDL permits more tissue autolysis prior to fixation, resulting in less useful specimens. If Bouin's fixative is available, it is the preferred preservative for eye globes.
- **Microagglutination test** = (MAT). A type of serologic test. Ship chilled or frozen serum.
- **Mycoplasmal culture** = (MCULT). These types of organism have specific growth requirements that are usually not met by standard bacteriological culture techniques. Transport as per (CULT) specimens. Culture swabs cannot be submitted in media containing charcoal or glycerol
- **Polymerase chain reaction** = (PCR). Tissues should be frozen and maintained in that state until arrival at the VDL. Swabs and fluids submitted for PCR testing should be chilled but not frozen. These tests are capable of detected minute quantities of nucleic acid, so if multiple animals are tested the samples should be 'clean' in order to avoid false-positives through cross-contamination (i.e. blood/tissue from one animal contaminating the sample from another)
- **Virus neutralization** = (VN). A serological test. Ship chilled or frozen serum.

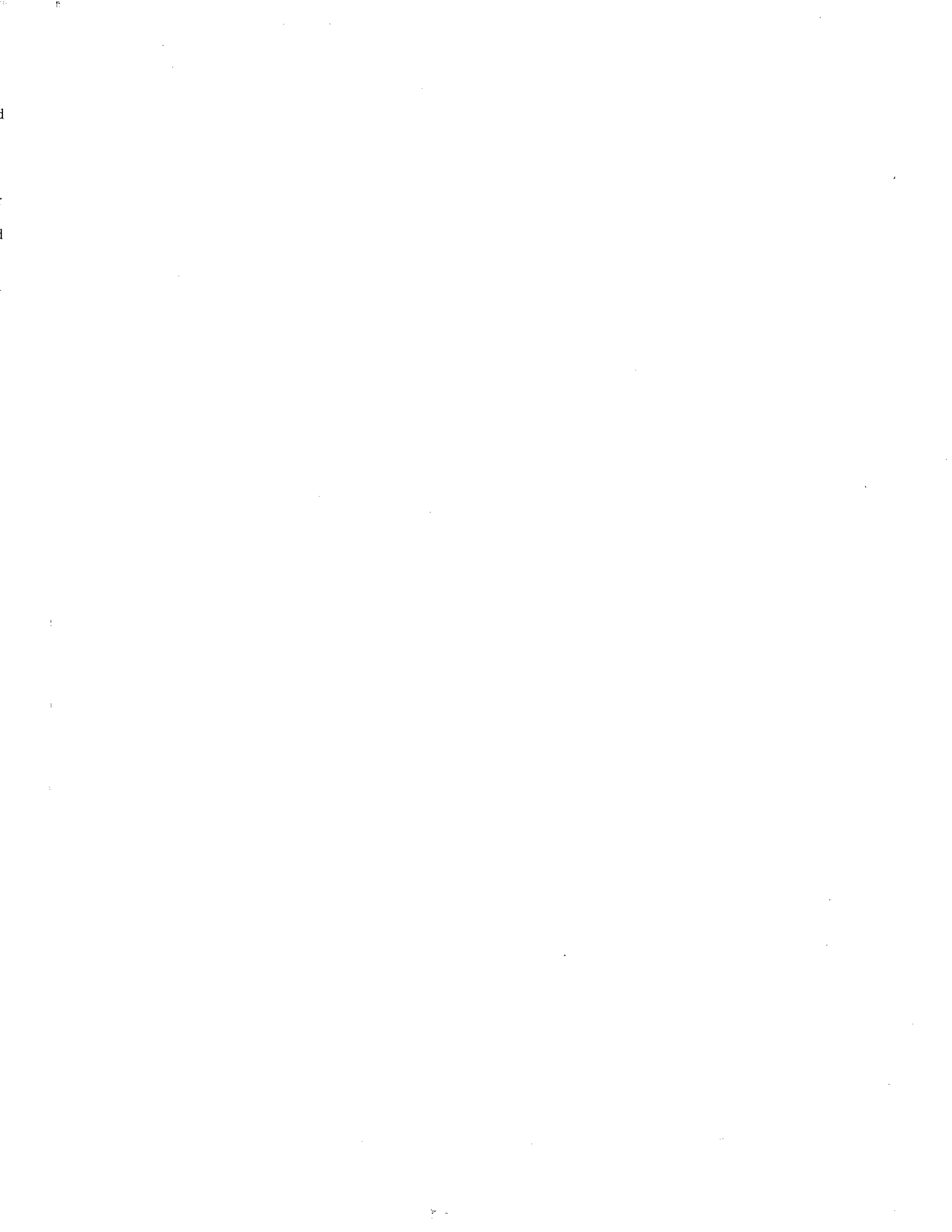

# PART 1

## GENERAL MEDICINE

# Clinical examination and making a diagnosis

## INTRODUCTION 3

### CLINICAL EXAMINATION OF THE INDIVIDUAL ANIMAL 3

History-taking 3

Examination of the environment 7

Examination of the patient 7

## MAKING A DIAGNOSIS 22

Diagnostic methods 22

Interpretation of laboratory data 25

Computer-assisted diagnosis 28

## PROGNOSIS AND THERAPEUTIC DECISION-MAKING 29

Decision analysis 29

## EXAMINATION OF THE HERD 31

Approach to herd examination 31

Techniques in examination of the herd or flock 35

## Introduction

The focal point of any investigation of animal disease is the making of a diagnosis, and the critical part in making that decision is the clinical examination of the individual animal or group of animals. Therefore, it is appropriate that the first chapter of this book deals with this important subject.

However, before we begin that exercise, it is important that we be quite clear and agree upon what we mean by 'disease'. Let us assume that disease can be defined as 'inability to perform physiological functions at normal levels even though nutrition and other environmental requirements are provided at adequate levels'. When this definition is accepted, then not only does a clinically ill animal come into the area of examination but so also do those animals or herds that are not clinically ill but that do not perform as expected. As veterinarians working with food-producing animals and horses, we are required to recognize individual animals that are affected with a particular, recognizable pathological lesion, or biochemical or metabolic deficit, or nutritional deficiency, that results in recognizable clinical signs such as fever, dyspnea, convulsions or lameness. This is traditional veterinary medicine based on a transposition of attitudes and behavior from human medicine. However, it is also necessary for us to investigate disease that the owner recognizes simply as failure to perform or to reach predetermined objectives. This is not necessarily subclinical disease: it is recognizable clinically but perhaps only as poor performance, such as unthriftiness, without any specific system-oriented clinical signs. In other situations, the owner may not recognize any abnormality unless productivity is measured, e.g. milk production or growth rate per day.

There has been considerable emphasis on the clinical and laboratory examination of individual animals affected with

clinical disease or that have not performed normally and the large body of information now available in laboratory medicine testifies to this preoccupation. Its greatest importance is in animals, such as companion and racing animals, that are kept as singles and, unless the diagnosis is simple and readily obvious, if a laboratory is available there may be a tendency to make one or more laboratory examinations. The more valuable the animal, the greater the tendency towards some laboratory work. Many biochemical, hematological and biophysical examinations of each body system can yield valuable clues about system or organ function, which usually lead to more accurate and detailed examination of that system or organ. In animals kept in herds or flocks these laboratory tests are also important but are equalled in importance overall by epidemiological investigations. There is little to be gained by this form of examination in animals kept as singles.

With a herd of animals affected with clinical disease, or which is failing to achieve expected objectives, an epidemiological investigation, in addition to the clinical examination of individual animals, may make a valuable contribution to the making of a diagnosis. This is not to suggest that clinical and laboratory examinations are de-emphasized in the examination of herd problems. In some instances, the clinical and laboratory examinations assume major importance to ensure that animals in a herd that is not performing normally are in fact not clinically ill. But when the presenting complaint is poor performance, it is necessary to collect all the pertinent epidemiological data, including accurate production measurements, and to decide whether or not an abnormality is present and, if so, its magnitude. It is at this point that veterinarians become the arbiters of what is 'health' and what is 'illness'. In herd health programs this is a continuing and positive service provided by veterinarians to farmer clients.

In this chapter on clinical examination and making a diagnosis, we have described

the standard procedure for the clinical examination of an individual animal followed by some guidelines for the examination of the herd. The level of the examination set out is sufficient to enable the clinician to determine the nature of the abnormality and the system involved. For more detailed examination it is recommended that subsequent chapters, which deal with individual systems, be consulted. Each of them sets out a method for a special examination of the particular system.

## Clinical examination of the individual animal

A clinical examination has three parts:

- The animal
- The history
- The environment.

Inadequate examination of any of these may lead to error. The examination of the affected animal represents only a part of the complete investigation. Careful questioning of the owner or attendant can yield information about the diet or the prior diet, about recent vaccinations or surgery or about the introduction of animals into the group, that will provide the clues to a successful diagnosis. However, in certain instances, for example in lead poisoning of cattle, the most detailed examination of the animal and the most careful questioning of the owner may fail to elicit the evidence necessary for a correct diagnosis. Only a careful physical search of the environment for a source of lead can provide this information. Thus neglect of one aspect of the clinical examination can render valueless a great deal of work on the other aspects and lead to an error in diagnosis.

## HISTORY-TAKING

In veterinary medicine, history-taking is often the most important of the three aspects of a clinical examination. The significance of the results obtained by

examination of the patient and the environment is liable to be modified by a number of factors. Animals are unable to describe their clinical symptoms; they vary widely in their reaction to handling and examination, and a wide range of normality must be permitted in the criteria used in a physical examination. These variations are much greater in some species than in others. Dairy cattle, horses, sheep and goats are usually easy to examine while beef cattle and pigs may be difficult to examine adequately under some conditions. A satisfactory examination of the environment may prove difficult because of lack of knowledge of the factors concerned or because of the examiner's inability to assess their significance. Problems such as the measurement of the relative humidity of a barn and its importance as a predisposing factor in an outbreak of pneumonia or the determination of pH of the soil with reference to the spread of leptospirosis can present virtually insuperable difficulties to the veterinarian in the field. On the other hand, a search for a specific factor such as a known poison may be relatively simple.

Nevertheless, history-taking is an important key to accurate diagnosis in veterinary medicine, and to be worthwhile it must be accurate and complete. Admittedly, human fallibility must be taken into consideration; there may be insufficient time, the importance of particular factors may not be appreciated, and there may be misunderstanding. Although these are excusable up to a point, failure to recognize the importance of the history can lead only to error. To avoid being misled, it is essential that the veterinarian assesses the accuracy of the history by careful examination of what the owner relates about his or her animals.

The history should suggest not only the diagnostic possibilities but also the probabilities. A 1-year-old heifer is unlikely to have clinical Johne's disease; an adult cow is more likely to have parturient paresis than a first-calf heifer, which in turn is more likely to have maternal obstetric paralysis than is the adult cow. The history may often indicate that special attention should be paid to the examination of a particular system in the animal, or a particular factor in the environment. For example, in hypovitaminosis-A in beef calves from 6–10 months of age, the animals may be seen when they are clinically normal and the only means of reaching a diagnosis may be a consideration of the history of the clinical findings and the nutritional status.

#### HISTORY-TAKING METHOD

Successful history-taking involves many veterinarian–client relationships, which

must be learned by experience. Some suggestions are presented here as guidelines that may prove useful to the clinician.

The veterinarian should introduce himself or herself to the owner, and the usual greetings of the day will help to establish a veterinarian–client relationship. Asking the owner 'How can I help you today?' is an effective opening question, which provides the owner the opportunity to relate his or her concerns about the animals.

The owner or attendant must be handled with diplomacy and tact. The use of nontechnical terms is essential, since livestock owners are likely to be confused by technical expressions or reluctant to express themselves when confronted with terms they do not understand. Statements, particularly those concerned with time, should be tested for accuracy. Owners, and more especially herdsman and agents, may attempt to disguise their neglect by condensing time or varying the chronology of events. If a detailed cross-examination of the owner seems likely to arouse some antagonism, it is advisable for the veterinarian to forego further questioning and be content with his or her own estimate of the dependability of the history. The clinician must try to separate owners' observations from their interpretations. A statement that the horse had a bout of bladder trouble may, on closer examination, mean that the horse had an attack of abdominal pain in which it assumed a posture usually associated with urination. Often, however, it is impossible to avoid the use of leading questions – 'Did the pigs scour?', 'Was there any vomiting?' – but it is necessary to weigh the answers in accordance with the general veracity of the owner.

Absence of a sign can only be determined by inquiring whether or not it occurred. Simply to ask for a complete history of what has happened almost invariably results in an incomplete history. The clinician must, of course, know the right questions to ask; this knowledge comes with experience and familiarity with disease. Owners seldom describe clinical signs in their correct time sequence; part of the clinician's task is to establish the chronology of events.

For completeness and accuracy in history-taking the clinician should conform to a set routine. The system outlined below includes patient data, disease history and management history. The order in which these parts of the history are taken will vary. In general it is best to take the disease history first. The psychological effect is good: the owner appreciates the desire to get down to the facts about his or her animal's illness.

#### PATIENT DATA

If records are to be kept at all, even if only for financial purposes, accurate identification of the patient is essential. An animal's previous history can be referred to, the disease status of a herd can be examined, specimens for laboratory examination can be dispatched with the knowledge that the results can be related to the correct patient. Accurate records are also necessary for the submission of accounts for veterinary services rendered and the details of the owner's address and of the animals examined and treated must be accurate. These points may have no importance in establishing the diagnosis but they are of primary importance in the maintenance of a successful practice.

The relevant data include:

- Owner's name and initials
- Postal address and telephone number
- Species, type, breed (or estimate of parentage in a crossbred)
- Sex, age, name or number, body weight
- If necessary, a description, including color markings, polledness and other identifying marks, of the patient.

Such a list may appear formidable but many of the points, such as age, sex, breed, type (use made of animal, e.g. beef, dairy, mutton, wool), are often of importance in the diagnosis. A case history of a particular animal may suggest that further treatment is likely to be uneconomic because of age, or that a particular disease is assuming sufficient importance in a herd for different control measures to be warranted.

Computers are now being used extensively in veterinary practices for recording the details of farm calls, the animals examined and treated, the amounts charged for travel and professional services, the costs of laboratory services, the drugs used and dispensed, and the diseases that occur on a particular farm on an ongoing basis. It is now possible for veterinary practices to provide regular and annual health reports to herd owners so that planned health management programs can be assessed and evaluated. The ability to retrieve and summarize this information on an individual farm basis is a major step forward in providing optimal veterinary service to livestock herds regardless of their size and complexity.

#### DISEASE HISTORY

History-taking will vary considerably depending on whether one animal or a group of animals is involved in the disease problem under examination. As a general rule, in large animal work, all disease states should be considered as herd problems until proved to be otherwise.



It is often rewarding to examine the remainder of a group and find animals that are in the early stages of the disease.

### Present disease

Attempts should be made to elicit the details of the clinical abnormalities observed by the owner in the sequence in which they occurred. If more than one animal is affected, a typical case should be chosen and the variations in history in other cases should then be noted. Variations from the normal in the physiological functions such as intake of food or drink, milk production, growth, respiration, defecation, urination, sweating, activity, gait, posture, voice and odor should be noted in all cases. There are many specific questions that need to be asked in each case but they are too numerous to list here and for the most part they are variations on the questions already suggested.

If a number of animals are affected, information may be available from clinical pathological examinations carried out on living animals or necropsy examinations on fatal cases. The behavior of animals before death and the period of time elapsing between the first observable signs and death or recovery are important items of information. Prior surgical or medical procedures such as castration, docking, shearing or vaccination may be important factors in the production of disease.

### Morbidity, case fatality and population mortality rates

The morbidity rate is usually expressed as the percentage of animals that are clinically affected compared with the total number of animals exposed to the same risks. The case fatality rate is the percentage of affected animals that die. The population mortality rate is the percentage of all exposed animals that die. The estimates may be important in diagnosis because of the wide variations in morbidity, case fatality and population mortality rates that occur in different diseases. An equally important figure is the proportion of animals at risk that are clinically normal but show abnormality on the basis of laboratory or other tests.

### Prior treatment

The owner may have treated animals before calling for assistance. Exact details of the preparations used and doses given may be of value in eliminating some diagnostic possibilities. They will certainly be of importance when assessing the probable efficiency of the treatment and the significance of clinical pathological tests, and in prescribing additional treatment. Drug withdrawal regulations now require that treated animals or their products,

such as milk, be withheld from slaughter or market for varying lengths of time to allow drug residues to reach tolerable limits. This necessitates that owners reveal information about the drugs that they have used.

### Prophylactic and control measures

It should be ascertained whether preventive or control procedures have already been attempted. There may have been clinical pathological tests, the introduction of artificial insemination to control venereal disease, vaccination, or changes in nutrition, management or hygiene. For example, in an outbreak of bovine mastitis careful questioning should be pursued regarding the method of disinfecting the cows' teats after each milking, with particular reference to the type and concentration of the disinfectant used and whether or not back-flushing of teat cups is practiced. Spread of the disease may result from failure of the hygiene barrier at any one of a number of such points. When written reports are available they are more reliable than the memory of the owner.

### Previous exposure

The history of the group relative to additions is of particular importance. Is the affected animal an established member of the group, or has it been introduced, and if so how long ago? If the affected animal has been in the group for some time, have there been recent additions? Is the herd a 'closed herd' or are animals introduced at frequent intervals? Not all herd additions are potential carriers of disease – they may have come from herds where control measures are adequate, they may have been tested before or after sale or kept in quarantine for an adequate period after arrival, or they may have received suitable biological or antibiotic prophylaxis. Herd additions may have come from areas where a particular disease does not occur, although a negative history of this type is less reliable than a positive history of derivation from an area where a particular disease is enzootic.

A reverse situation may occur where imported animals have no resistance to endemic infection in the home herd, or have not become adapted to environmental stressors such as high altitudes, high environmental temperatures and particular feeding methods, or are not accustomed to poisonous plants occurring in the environment.

### Transit

The possibility of infection during transit is always a potential risk and pre-sale certificates of health may be of little value if an animal has passed through a sale barn, a show or communal trucking yards

while in transit. Highly infectious diseases may be transmitted via trucks, railroad cars or other accommodation contaminated by previous inhabitants. Transient introductions, including animals brought in for work purposes, for mating or on temporary grazing, are often overlooked as possible vectors of disease. Other sources of infection are wild fauna that graze over the same area as domestic livestock and inanimate objects such as human footwear, car tires and feeding utensils.

### Culling rate

There may be considerable significance in the reasons for culling, and the number of animals disposed of for health reasons. Failure to grow well, poor productivity and short productive life will suggest the possible occurrence of a number of chronic diseases, including some associated with infectious agents, by nutritional deficiencies or by poisons.

### Previous disease

Information elicited by questioning on previous history of illness may be helpful. If there is a history of previous illness, inquiries should be made on the usual lines, including clinical observations, necropsy findings, morbidity, case fatality rates, the treatments and control measures used and the results obtained. If necessary, inquiries should be made about herds from which introduced animals have originated and also about herds to which other animals from the same source have been sent.

### MANAGEMENT HISTORY

The management history includes nutrition, breeding policy and practice, housing, transport and general handling. It is most important to learn whether or not there has been any change in the prevailing practice prior to the appearance of disease. The fact that a disease has occurred when the affected animals have been receiving the same ration, deriving from the same source over a long period, suggests that the diet is not at fault, although errors in preparation of concentrate mixtures, particularly with the present-day practice of introducing additives to feeds, can cause variations that are not immediately apparent.

### Nutrition

The major objective in the examination of the nutritional history is to determine how the quantity and quality of the diet which the animals have been receiving compares with the nutrient requirements that have been recommended for a similar class of animal. In some situations it may be necessary to submit feed and water samples for analyses to assess quality.

### Livestock at pasture

Pastured livestock present a rather different problem from those being stall-fed in that they receive a diet that is less controlled and thus more difficult to assess. The risk of parasitic infestation and, in some cases, infectious disease is much greater in grazing animals. Inquiries should be made about the composition of the pasture, its probable nutritive value with particular reference to recent changes brought about by rain or drought, whether rotational grazing is practiced, the fertilizer program and whether or not minerals and trace elements are provided by top-dressing or mineral mixtures. The origin of mineral supplements, particularly phosphates, which may contain excess fluorine, and homemade mixtures, which may contain excessive quantities of other ingredients, should receive attention. Actual examination of the pasture area is usually more rewarding than a description of it.

### Hand-fed/stall-fed animals

Hand-fed or stall-fed animals are subjected to a more or less controlled feed supply but, because of human error, they are frequently exposed to dietary mistakes. Types and amounts of feeds fed should be determined. Examples of disease caused by inadequate hand-fed diets include: osteodystrophia fibrosa in horses on diets containing excess grain; azoturia in the same species when heavy-carbohydrate diets are fed during periods of rest, and lactic acid indigestion in cattle introduced to high-level grain diets too rapidly. The sources of the dietary ingredients may also be of importance. Grains from some areas are often much heavier and contain a much greater proportion of starch to husk than grains from other areas so that when feed is measured, rather than weighed, overfeeding or underfeeding may occur.

Because the digestive enzyme capacity of newborn farm animals is most efficient in the digestion of whole milk, the use of non-milk sources of carbohydrates and proteins in the formulation of milk replacers may result in indigestion and nutritional diarrhea.

Exotic diseases may be imported in feed materials: anthrax, foot-and-mouth disease and hog cholera are well-known examples.

Variations in the preparation of ingredients of rations may produce variable diets. Overheating, as in pelleting or the cooking of feeds, can reduce their vitamin content; contamination with lubricating oil can result in poisoning by chlorinated naphthalene compounds; pressure extraction of linseed can leave considerable residues of hydrocyanic acid in the residual oil cake.

Feeding practices may in themselves contribute to the production of disease. Pigs fed in large numbers with inadequate trough space or calves fed from communal troughs are likely to be affected by overeating or inanition, depending on their size and vigor. High-level feeding and consequent rapid growth may create deficiency states by increasing the requirement for specific nutrients.

In both hand-fed and grazing animals changes in diet should be carefully noted. Movement of animals from one field to another, from pasture to cereal grazing, from unimproved to improved pasture may all precipitate the appearance of disease. Periods of sudden dietary deficiency can occur as a result of bad weather or transportation, or during change to unfamiliar feeds. Rapid changes are more important than gradual alterations, particularly in pregnant and lactating ruminants when metabolic diseases, including those caused by hypocalcemia, hypoglycemia and hypomagnesemia, are likely to occur.

The availability of **drinking water** must be determined: salt poisoning of swine occurs only when the supply of drinking water is inadequate.

### Reproductive management and performance

In the examination of a single animal the breeding and parturition history may suggest or eliminate some diagnostic possibilities. For example, pregnancy toxemia occurs in sheep in late pregnancy while acetonemia in dairy cows occurs primarily 2–6 weeks after parturition. Acute septic metritis is a possibility within a few days after parturition in any species but unlikely several weeks later.

#### Breeding history

The breeding history may be of importance with regard to inherited disease. The existence of a relationship between sires and dams should be noted. Hybrid vigor in crossbred animals should be considered when there is apparent variation in resistance to disease between groups maintained under similar environmental conditions. A general relationship between selection for high productivity and susceptibility to certain diseases is apparent in many breeds of animal and even in certain families. The possibility of genotrophic disease, i.e. the inheritance of a greater requirement than normal of a specific nutrient, should be considered.

#### Reproductive history

The examination of the herd reproductive history involves comparing past and present reproductive performance with certain optimum objectives. The mean length of the interval between parturition and conception, the mean number of

services per conception and the percentage of young animals weaned relative to the number of females that were originally exposed for breeding (calf or lamb crop, pigs weaned) are general measures of reproductive performance and efficiency.

Using cattle as an example, certain other observations may assist in determining the cause of failure to reach reproductive performance objectives. These are:

- Percentage of abortions
- Length of breeding season
- Percentage of females pregnant at specified times after the onset of breeding period
- Bull/cow ratio
- Size and topography of breeding pastures
- Fertility status of the females and males at breeding time.

The percentage of females that need assistance at parturition and the percentage of calves that die at birth are also indices of reproductive performance that are indicative of the level of reproductive management provided.

### Climate

Many diseases are influenced by climate. Foot rot in cattle and sheep reaches its peak incidence in warm, wet summers and is relatively rare in dry seasons. Diseases spread by insects are encouraged when climatic conditions favor the propagation of the vector. Internal parasites are similarly influenced by climate. Cool, wet seasons favor the development of hypomagnesemia in pastured cattle. Anhidrosis in horses is specifically a disease of hot, humid countries. The direction of prevailing winds is of importance in many disease outbreaks, particularly in relation to the contamination of pasture and drinking water by fumes from factories and mines and the spread of diseases carried by insects.

### General management

There are so many items in the proper management of livestock that, if neglected, can lead to the occurrence of disease that they cannot be related here; animal management in the prevention of disease is a subject in its own right and is dealt with in all parts of this book. Some of the more important factors include:

- Hygiene, particularly in milking parlors and in parturition and rearing stalls
- Adequacy of housing in terms of space, ventilation, draining, situation and suitability of troughs
- Opportunity for exercise
- Proper management of milking machines to avoid udder injury.

The class of livestock under consideration is also of importance; for example, enterotoxemia is most common in finishing lambs and pigs, parturient paresis in milking cows, obstructive urolithiasis in lambs and steers in feedlots and pregnancy toxemia in ewes used for fat lamb production.

## EXAMINATION OF THE ENVIRONMENT

An examination of the environment is a necessary part of any clinical investigation because of the possible relationship between environmental factors and the incidence of disease. A satisfactory examination of the environment necessitates an adequate knowledge of animal husbandry and, with the development of species specialization, it will be desirable for the veterinarian to understand the environmental needs of a particular species or class of farm animal.

Depending on the region of the world, some animals are kept outside year round, some are housed for part of the year during the winter months, and some are kept under total confinement. For animals raised on pasture, the effects of topography, plants, soil type, ground surface and protection from extremes of weather assume major importance. For animals housed indoors, hygiene, ventilation and avoiding overcrowding are of major concern. Some of these items will be briefly presented here as guidelines. Each observation should be recorded in detail for preparation of reports for submission to the owners. Detailed records and even photographs of environmental characteristics assume major importance when poisonings are suspected and where litigation proceedings appear possible.

### OUTDOOR ENVIRONMENT

#### Topography and soil type

The topography of grasslands, pastures and wooded areas can contribute to disease or inefficient production and reproduction. Flat, treeless plains offering no protection from wind predispose cattle to lactation tetany in inclement weather. Low, marshy areas facilitate the spread of insect-borne diseases and soil-borne infections requiring damp conditions, such as leptospirosis; Johne's disease and diseases associated with liver fluke infestation and lungworm pneumonia are more prevalent in such areas. Rough grasslands with extensive wooded areas can have an adverse effect on reproductive performance in beef herds because of the difficulty the bulls have in getting to the females during peak periods of estrus activity.

The soil type of a district may provide important clues to the detection of

nutritional deficiencies; copper and cobalt deficiencies are most common on littoral sands and the copper deficiency/molybdenum excess complex usually occurs on peat soils. The surface of the ground and its drainage characteristics are important in highly intensive beef feedlots and in large dairy herds where fattening cattle and dairy cows are kept and fed under total confinement. Ground surfaces that are relatively impermeable and/or not adequately sloped for drainage can become a sea of mud following a heavy rainfall or snowstorm. Constant wetting of the feet and udders commonly results in outbreaks of foot rot and mastitis. Dirty udders increase the time required for udder washing prior to milking and can seriously affect a mastitis control program.

In some regions of the world, beef cows are calved in outdoor paddocks in the spring when it is wet and cold with an excess of surface water; this increases the spread of infectious disease and results in a marked increase in neonatal mortality. A lack of sufficient protection from the prevailing winds, rain, snow or the heat of the sun can seriously affect production and can exacerbate an existing disease condition or precipitate an outbreak. Dusty feedlots during the hot summer months may contribute to an increase in the incidence of respiratory disease or delay the response to treatment of disease such as pneumonia.

#### Stocking rate (population density)

Overcrowding is a common predisposing cause of disease. There may be an excessive buildup of feces and urine, which increases the level of infection. The relative humidity is usually increased and more difficult to control. Fighting and cannibalism are also more common in overcrowded pens than when there is adequate space for animals to move around comfortably. The detection and identification of animals for whatever reason (illness, estrus) can be difficult and inaccurate under crowded conditions.

#### Feed and water supplies

##### Pasture and feed

On pastures the predominant plant types, both natural and introduced, should be observed as they are often associated with certain soil types and may be the cause of actual disease; the high estrogen content of some clovers, the occurrence of functional nervous diseases on pastures dominated by *Phalaris aquatica* (syn. *P. tuberosa*) and perennial rye grass and the presence of selective absorbing 'converter' plants on copper-rich and selenium-rich soils are all examples of the importance of the dominant vegetation. The presence of specific poisonous plants, evidence of

overgrazing and the existence of a bone-chewing or bark-chewing habit can be determined by an examination of the environment.

Vital clues in the investigation of possible poisoning in a herd may be the existence of a garbage dump or ergotized grass or rye in the pasture, or the chewing of lead-based painted walls in the barn, or careless handling of poisons in the feed area. The possibility that the forage may have been contaminated by environmental pollution from nearby factories or highways should be examined. In some cases the physical nature of the pasture plants may be important; mature, bleached grass pasture can be seriously deficient in carotene, whereas lush young pasture can have rachitogenic potency because of its high carotene content or it may be capable of causing hypomagnesemia if it is dominated by grasses. Lush legume pasture or heavy concentrate feeding with insufficient roughage can cause a serious bloat problem.

The feed supplies for animals raised in confinement outdoors must be examined for evidence of moldy feed, contamination with feces and urine and excessive moisture due to lack of protection from rain and snow. Empty feed troughs may confirm a suspicion that the feeding system is faulty.

#### Water

The drinking water supply and its origin may be important in the production of disease. Water in ponds may be covered with algae containing neurotoxins or hepatotoxic agents and flowing streams may carry effluent from nearby industrial plants. In a feedlot, water may suddenly become unavailable because of frozen water lines or faulty water tank valves. This should not go unnoticed if one recognizes the anxiety of a group of cattle trying to obtain water from a dry tank.

#### Waste disposal

The disposal of feces and urine has become a major problem for large intensified livestock operations. Slurry is now spread on pastures and may be important in the spread of infectious disease. Lagoons can provide ideal conditions for the breeding of flies, which can be troublesome to a nearby livestock operation. The inadequate disposal of dead animals may be an important factor in the spread of certain diseases.

### INDOOR ENVIRONMENT

There are few aspects of livestock production that have aroused more interest, development and controversy in the last few years than the housing and environmental needs of farm animals. Several textbooks on the subject have been

written and only some of the important items will be mentioned here, with the aid of some examples. The effects of housing on animal health have not received the consideration they deserve, partly because of insufficient knowledge of animals' environmental needs and partly because there has been a failure to apply what is already known.

As a general statement, it can be said that inadequate housing and ventilation, overcrowding and uncomfortable conditions are considered to have detrimental effects on housed animals that make them not only more susceptible to infectious disease but also less productive. Moreover, this reduction in productive efficiency may be a greater cause of economic loss than losses caused by infectious disease. For this reason, the veterinarian must learn to examine and assess all aspects of an indoor environment, which may be the primary cause of, or a predisposing factor to, disease. By way of illustration, the major causes of preweaning mortality of piglets are chilling and crushing of piglets in the first few days of life, and not infectious disease. These physical causes are commonly related to a combination of poorly designed farrowing crates, slippery floors, inadequate heating and perhaps overcrowding of the farrowing facilities.

### Hygiene

One of the first things to observe is the level of sanitation and hygiene, which is usually a reliable indicator of the level of management; poor hygiene is often associated with a high level of infectious disease. For example, the incidence of diarrhea in piglets may be high because the farrowing crates are not suitably cleaned and disinfected before the pregnant sows are placed in them. A similar situation applies for lambing sheds, calving pens and foaling boxes. An excessive buildup of feces and urine with insufficient clean bedding will result in a high level of neonatal mortality. The methods used for cleaning and disinfection should be examined carefully. The removal of dried feces from animal pens that have been occupied for several months is a difficult and laborious task and often not done well. Undue reliance may be placed on the use of chemical disinfectants.

The total length of time that animals have occupied a pen without cleaning and disinfection (occupation time) should be noted. As the occupation time increases, there is a marked increase in the infection rate and the morbidity and mortality from infectious disease often increase.

### Ventilation

Inadequate ventilation is considered to be a major risk factor contributing to the

severity of swine enzootic pneumonia in finishing pigs. The primary infection has a minimal effect on the well-housed pig, but inadequate ventilation results in overheating of the barn in the summer months and chilling and dampness during the winter months, commonly resulting in subclinical and clinical pneumonia, which severely affects productive efficiency. Similarly, in young calves, which are raised indoors in most of the temperate zones of the world, protection from the cold during the winter is necessary. The effects of enzootic pneumonia of housed calves are much more severe when ventilation is inadequate than when the calves are comfortable and have clean, fresh air.

The evaluation of the adequacy of ventilation of a farm animal barn that is filled to economic capacity with animals is a difficult task and a major subject. Ventilation is assessed by a determination of the number of air changes per unit of time, the relative humidity during the day and night, the presence or absence of condensation on the hair coats of the animals or on the walls and ceilings, the presence of drafts, the building and insulation materials used, the positions and capacities of the fans and the size and location of the air inlets. The measurement of the concentration of noxious gases in animal barns, such as ammonia and hydrogen sulfide, may be a valuable aid in assessing the effectiveness of a ventilation system.

Animals raised indoors are frequently overcrowded, which may predispose to disease, and measurements of population density and observations of animal behavior in such conditions assume major importance. When pigs are raised indoors in crowded conditions with inadequate ventilation, their social habits may change drastically and they begin to defecate and urinate on the clean floor and on their pen-mates rather than over the slatted floor over the gutter. This can result in outbreaks of diseases that are transmitted by the fecal-oral route.

### Flooring

The quality of the floor is often responsible for diseases of the musculoskeletal system and skin. Poorly finished concrete floors with an exposed aggregate can cause severe foot lesions and lameness in adult swine. Recently calved dairy cows are very susceptible to slipping on poor floors in dairy barns, a common cause of the downer cow syndrome. Loose-housing systems, particularly those with slatted floors, have resulted in a new spectrum of diseases of the feet of cattle because of the sharp edges of some of the slats. The quality and quantity of bedding used

should be noted. Bedding is now rarely used in intensified swine operations. The use of sawdust or shavings in loose-housing systems for dairy cattle may be associated with outbreaks of coliform mastitis. Wet bedding, particularly during the winter months, is commonly associated with endemic pneumonia in calves.

### Floor plan

The floor plan and general layout of an animal house must be examined for evidence that the routine movements of animal attendants, the movements of animals and feeding facilities may actually be spreading disease. Communal gutters running through adjacent pens may promote the spread of disease through fecal or urinary contamination. The nature of the partitions between pens, whether solid or open grid type, may assist the control or spread of infectious disease. The building materials used will influence the ease with which pens, such as farrowing crates and calf pens, can be cleaned and disinfected for a new batch of piglets or calves.

### Lighting

The amount of light available in a barn should be noted. With insufficient light it may be difficult to maintain a sufficient level of sanitation and hygiene, sick animals may not be recognized early enough, and in general errors in management are likely to occur.

In the investigation of a herd problem of mastitis in dairy cattle the veterinarian should visit the farm at milking time and observe how the cows are prepared for milking, examine the teats and udders before and after they are washed, observe the use of the milking machine, and the level of sanitation and hygiene practiced. Several successive visits may be necessary to reveal possible weakness in a mastitis control program.

## EXAMINATION OF THE PATIENT

A complete clinical examination of an animal patient includes, in addition to history-taking and an examination of the environment, physical and laboratory examinations. A complete clinical examination of every patient is unnecessary because of the simplicity of some diseases. However, a general clinical examination of every patient is necessary and the inexperienced clinician should spend as much time and effort as is practicable and economical in carrying it out. This will help to avoid the sort of embarrassing error in which a calf is operated on for umbilical hernia when it also has a congenital cardiac defect.

As **learned** experience develops, the clinician will know the extent to which a

clinical examination is necessary. All the laboratory tests that are likely to be informative and that are practical and economical should be used. Because of the cost of laboratory tests, the clinician must be selective in the tests used. The most economical method is to examine the patient and then select those laboratory tests that will support or refute the tentative clinical diagnosis. In this section a system for the examination of a patient is outlined in a general way. There is a great deal of difference between species in the ease with which this examination is done and the amount of information that can be collected. Additional detailed examination techniques are described under the individual body systems.

The examination of a patient consists of a **general inspection** done from a distance (the **distant examination**, and the particular **distant examination of body regions**), followed by a **close physical examination** of all body regions and systems. Only the major body systems that are routinely examined are presented here as part of the general examination.

#### GENERAL INSPECTION (DISTANT EXAMINATION)

The importance of a distant examination of the animal cannot be overemphasized, and yet it is often overlooked. Apart from the general impression gained from observation at a distance, there are some signs that can best be assessed before the animal is disturbed. The proximity of the examiner is particularly disturbing to animals that are unaccustomed to frequent handling.

#### Behavior and general appearance

The general impression of the health of an animal obtained by an examination from a distance should be assessed according to the following.

##### Behavior

Separation of an animal from its group is often an indication of illness. The behavior is also a reflection of the animal's health. If it responds normally to external stimuli, such as sound and movement, it is classified as **bright**. If the reactions are sluggish and the animal exhibits relative indifference to normal stimuli, it is said to be **dull** or **apathetic**. Cattle with carbohydrate engorgement are commonly reluctant to move unless coaxed. A pronounced state of indifference in which the animal remains standing and is able to move but does not respond at all to external stimuli is the **'dummy' syndrome**. This occurs in subacute lead poisoning, listeriosis and some cases of acetonemia in cattle, and in encephalomyelitis and hepatic cirrhosis in horses. The terminal stage of apathy or depression is **coma**, in

which the animal is unconscious and cannot be roused.

##### Excitation states

Excitation states vary in severity. A state of anxiety or apprehension is the mildest form: here the animal is alert and looks about constantly but is normal in its movements. Such behavior is usually expressive of moderate constant pain or other abnormal sensation, as in early parturient paresis or in recent blindness. A more severe manifestation is restlessness, in which the animal moves about a good deal, lies down and gets up and may go through other abnormal movements such as looking at its flanks, kicking at its belly and rolling and bellowing. Again, this demeanor is usually indicative of pain.

More extreme degrees of excited demeanor include **mania** and **frenzy**. In mania, the animal performs abnormal movements with vigor. Violent licking at its own body, licking or chewing inanimate objects and pressing forward with the head are typical examples. In frenzy, the actions are so wild and uncontrolled that the animals are a danger to anyone approaching them. In both mania and frenzy there is usually excitation of the brain, as in rabies, acute lead poisoning and some cases of nervous acetonemia.

##### Voice

Abnormality of the voice should be noted. It may be hoarse in rabies or weak in gut edema; there may be continuous lowing in nervous acetonemia or persistent bellowing indicative of acute pain. Soundless bellowing and **yawning** are commonly seen in rabid cattle and yawning is a common sign in animals affected with hepatic insufficiency.

##### Eating

The appetite of the animal can be assessed by observing its reaction to the offering of feed or by the amount of feed available that has not been eaten. It is important to determine the total amount of feed that the animal is eating per day. In a patient that has retained its appetite, there may be abnormality of **prehension**, **mastication** or **swallowing** and, in ruminants, of belching and regurgitation.

Prehension may be interfered with by inability to approach feed, paralysis of the tongue in cattle, in cerebellar ataxia, osteomyelitis of cervical vertebrae and other painful conditions of the neck. When there is pain in the mouth, prehension may be abnormal and affected animals may be able to take only certain types of feed. Mastication may be slow, one-sided or incomplete when mouth structures, particularly teeth, are affected. Periodic cessation of chewing when feed is still in the mouth occurs commonly in the

'dummy' syndrome, when there are space-occupying lesions of the cranium or an encephalomyelitis exists.

Swallowing may be painful because of inflammation of the pharynx or esophagus, as is found in strangles in the horse, in calf diphtheria, and where improper use of bailing and drenching guns or bottles has caused laceration of the pharyngeal mucosa. Attempts at swallowing followed by coughing up of feed or regurgitation through the nostrils can also be the result of painful conditions but are most likely to be due to physical obstructions such as esophageal diverticula or stenosis, a foreign body in the pharynx, or paralysis of the pharynx. It is important to differentiate between material that has reached the stomach and ingesta regurgitated from an esophageal site. Partial esophageal obstruction resulting in difficult swallowing is usually manifested by repeated swallowing movements, often with associated flexion of the neck and grunting.

In ruminants there may be abnormalities of **rumination** and **eructation**. Absence of cudging occurs in many diseases of cattle and sheep; violent efforts at regurgitation with grunting suggests esophageal or cardiac obstruction. There may be inability to control the cud – 'cud-dropping' – due to pharyngeal paralysis or painful conditions of the mouth. Failure to eructate is usually manifested by the appearance of bloat.

##### Defecation

In constipation and rectal paralysis or stenosis, the act of defecation may be difficult and be accompanied by straining or tenesmus. When there is abdominal pain or laceration of the mucocutaneous junction at the anus, defecation may cause obvious pain. Involuntary defecation occurs in severe diarrhea and when there is paralysis of the anal sphincter. Consideration of frequency, volume and character of feces is given later under the section on special examination of the digestive tract. Constipation must not be mistaken for scant feces, particularly in mature cattle with diseases of the fore-stomachs and failure of movement of ingesta in a caudad direction.

##### Urination

This may be difficult when there is partial obstruction of the urinary tract, and painful when there is inflammation of the bladder or urethra. In cystitis and urethritis, there is increased frequency with the passage of small amounts of fluid, and the animal remains in the urination posture for some time after the flow ceases. Incontinence, with constant dribbling of urine, is usually due to partial obstruction of the urethra or paralysis of its sphincter. If the animal urinates during

the visual inspection, a sample of urine should be obtained, examined grossly and submitted for urinalysis.

### Posture

Abnormal posture is not necessarily indicative of disease, but when associated with other signs it may indicate the site and severity of a disease process. One of the simplest examples is resting of a limb in painful conditions of the extremities; if a horse continually shifts its weight from limb to limb it may indicate the presence of laminitis or early osteodystrophia fibrosa. Arching of the back with the limbs tucked under the body usually indicates mild abdominal pain; downward arching of the back and 'saw horse' straddling of the legs is characteristic of severe abdominal pain, usually spasmodic in occurrence; a 'dog-sitting' posture in the horse associated with rolling and kicking at the belly is usually associated with abdominal pain and pressure on the diaphragm, such as occurs in acute gastric dilatation after engorgement on grain. This posture is commonly adopted by normal cattle but will occur in painful conditions of the pelvic limbs such as degenerative osteoarthritis in young cattle. Abduction of the elbows is usually synonymous with chest pain or difficulty in breathing. Elevation and rigidity of the tail, and rigidity of the ears and limbs, are good indications of tetanus in animals. The carriage of the tail in pigs is a useful barometer of their state of health. Sheep that are blind, as in early pregnancy toxemia, are immobile but stand with the head up and have an expression of extreme alertness.

When the animal is recumbent, there also may be abnormalities of posture. In cattle affected by dislocation of the hip or by sciatic nerve paralysis, the affected limb is not held flexed next to the abdomen but sticks straight out in an awkward position; unilateral pain in the chest may cause an animal to lie habitually on the other side; a weak hindleg may be kept under the animal. The head may be carried around towards the flank in parturient paresis in cows and in colic in horses. Sheep affected with hypocalcemia, and cattle with bilateral hip dislocation, often lie in sternal recumbency with the hindlegs extended behind in a frog-like attitude. Inability or lack of desire to rise are usually indicative of muscle weakness or of pain in the extremities as in enzootic muscular dystrophy or laminitis.

### Gait

Movements of the limbs can be expressed in terms of rate, range, force and direction of movement. Abnormalities may occur in one or more of these categories. For example, in true cerebellar ataxia all

qualities of limb movement are affected. In louping-ill in sheep it is the range and force that are excessive, giving a high-stepping gait and a bounding form of progression; in arthritis, because of pain in the joints, or in laminitis, because of pain in the feet, the range is diminished and the patient has a shuffling, stumbling walk. The direction of progress may be affected. Walking in circles is a common abnormality and is usually associated with rotation or deviation of the head; it may be a permanent state as in listeriosis or occur spasmodically as in acetonemia and pregnancy toxemia. Compulsive walking or walking directly ahead regardless of obstructions is part of the 'dummy' syndrome mentioned earlier and is characteristic of encephalomyelitis and hepatic insufficiency in the horse.

### Body condition

The animal may be in normal bodily condition, or obese, thin or emaciated. The difference between thinness and emaciation is one of degree: the latter is more severe but there are additional signs that are usually taken into consideration. In an emaciated (cachectic) animal the coat is poor, the skin is dry and leathery and work performance is reduced. Thin animals, on the other hand, are physiologically normal. The difference between fatness and obesity is of the same order. Most beef cattle prepared for the showing are obese. In order to inject some degree of numerical assessment it is now customary in all farm animal species and in horses to use body condition on a scale of 1–5 or preferably 1–10.

### Body conformation

The assessment of conformation or shape is based on the symmetry and the shape and size of the different body regions relative to other regions. An abdomen that is very large relative to the chest and hindquarters can be classified as an abnormality of conformation. To avoid repetition, points of conformation are included in the description of body regions.

### Skin

Skin abnormalities can usually be seen at a distance. They include changes in the hair or wool, abnormal sweating, the presence of discrete or diffuse lesions, evidence of soiling by discharges and of itching. The normal luster of the coat may be absent: it may be dry as in most chronic debilitating diseases or excessively greasy as in seborrheic dermatitis. In debilitated animals the long winter coat may be retained past the normal time. Alopecia may be evident: in hyperkeratosis it is diffuse; in ringworm it may be diffuse but more commonly occurs in discrete

areas. Sweating may be diminished, as in anhidrosis of horses; patchy as in peripheral nerve lesions; or excessive as in acute abdominal pain. Hypertrophy and folding of the skin may be evident, hyperkeratosis being the typical example. Discrete skin lesions range in type from urticarial plaques to the circumscribed scabs of ringworm, pox and impetigo. Diffuse lesions include the obvious enlargements due to subcutaneous edema, hemorrhage and emphysema. Enlargements of lymph nodes and lymphatics are also evident when examining an animal from a distance.

### INSPECTION OF BODY REGIONS (PARTICULAR DISTANT EXAMINATION)

As a general rule, as much of a clinical examination as possible should be carried out before the animal is handled. This is partly to avoid unnecessary excitement of the patient but also because some abnormalities are better seen at a distance and in some cases cannot be discerned at close range. The general appearance of the animal should be noted and its behavior assessed. Some time should also be devoted to an inspection of the various body regions – a particular distant examination.

### Head

The facial expression may be abnormal. The rigidity of tetanus, the cunning leer or maniacal expression of rabies and acute lead poisoning are cases in point. The symmetry and configuration of the bony structure should be examined. Doming of the forehead occurs in some cases of congenital hydrocephalus and in chondrodysplastic dwarfs, and in the latter there may be bilateral enlargement of the maxillae. Swelling of the maxillae and mandibles occurs in osteodystrophia fibrosa; in horses swelling of the facial bones is usually due to frontal sinusitis; in cattle enlargement of the maxilla or mandible is common in actinomycosis. Asymmetry of the soft structures may be evident and is most obvious in the carriage of the ears, degree of closure of the eyelids and situation of the muzzle and lower lip. Slackness of one side and drawing to the other are constant features in facial paralysis. Tetanus is accompanied by rigidity of the ears, prolapse of the third eyelid and dilatation of the nostrils.

The carriage of the head is most important: rotation is usually associated with defects of the vestibular apparatus on one side, deviation with unilateral involvement of the medulla and cervical cord; opisthotonos is an excitation phenomenon associated with tetanus, strychnine poisoning, acute lead poisoning, hypomagnesemic tetany, polioencephalomalacia and encephalitis.

The eyes merit attention. Visible discharge should be noted; protrusion of the eyeball, as occurs in orbital lymphomatosis, and retraction of the bulb, as occurs commonly in dehydration, are important findings; spasm of the eyelids and excessive blinking usually indicate pain or peripheral nerve involvement; prolapse of the nictitating membrane usually characterizes central nervous system derangement, generally tetanus.

Dilatation of the nostrils and nasal discharge suggest the advisability of closer examination of the nasal cavities at a later stage. Excessive salivation or frothing at the mouth denotes painful conditions of the mouth or pharynx or is associated with tremor of the jaw muscles due to nervous involvement. Swellings below the jaw may be inflammatory, as in actinobacillosis and strangles, or edematous, as in acute anemia, protein starvation or congestive heart failure. Unilateral or bilateral swelling of the cheeks in calves usually indicates necrotic stomatitis.

### Neck

If there is enlargement of the throat this region should be more closely examined later to determine whether the cause is inflammatory and whether lymph nodes, salivary glands (or guttural pouches in the horse) or other soft tissues are involved. Goiter leads to local enlargement located further down the neck. A jugular pulse, jugular vein engorgement and edema should be looked for and local enlargement due to esophageal distension should be noted.

### Thorax

The respiration should be examined from a distance, preferably with the animal in a standing position, as recumbency is likely to modify it considerably. Allowance should be made for the effects of exercise, excitement, high environmental temperatures and fatness of the subject: obese cattle may have respiratory rates two to three times that of normal animals. The rate, rhythm, depth and type of respiration should be noted.

#### Respiratory rate

In normal animals under average conditions the rate should fall within the following limits:

- Horses, 8–16/min
- Cattle, 10–30/min
- Sheep and pigs, 10–20/min
- Goats, 25–35/min.

An increased respiratory rate is designated as polypnea, decreased rate as oligopnea and complete cessation as apnea. The rate may be counted by observation of rib or nostril movements, by feeling the nasal

air movements or by auscultation of the thorax or trachea. A significant rise in environmental temperature or humidity may double the normal respiratory rate. Animals that are acclimatized to cold outdoor temperatures are susceptible to heat stress when exposed suddenly to warmer temperatures. When brought indoors the respiratory rate may increase to six or eight times the normal, and panting open-mouth breathing may be evident within 2 hours.

#### Respiratory rhythm

The normal respiratory cycle consists of three phases of equal length: inspiration, expiration and pause; variation in the length of one or all phases constitutes an abnormality of rhythm. The breathing pattern of the neonatal foal is markedly different from that of the adult horse, and similar to that of other neonates. It has a higher respiratory rate, a higher airflow rate, and a higher minute ventilation on a body weight basis. In addition, in the standing neonatal foal, both the inspiratory and expiratory airflow patterns are essentially monophasic, whereas the adult horse typically has a biphasic inspiratory and expiratory airflow pattern. The transition from monophasic to biphasic flow patterns occurs within the first year of life.

#### Prolongation of phases

Prolongation of inspiration is usually due to obstruction of the upper respiratory tract; prolongation of the expiration is often due to failure of normal lung collapse, as in emphysema. In most diseases of the lungs there is no pause and the rhythm consists of two beats instead of three. There may be variation between cycles: Cheyne–Stokes respiration, characteristic of advanced renal and cardiac disease, is a gradual increase and then a gradual decrease in the depth of respiration; Biot's breathing, which occurs in meningitis affecting the medullary region, is characterized by alternating periods of hyperpnea and apnea, the periods often being of unequal length. Periodic breathing also occurs commonly in animals with electrolyte and acid–base imbalances – there are periods of apnea followed by short bursts of hyperventilation.

#### Respiratory depth

The amplitude or depth of respiratory movements may be reduced in painful conditions of the chest or diaphragm and increased in any form of anoxia. Moderate increase in depth is referred to as hyperpnea and labored breathing as dyspnea. In dyspnea, the accessory respiratory movements become more prominent: there is extension of the head and neck, dilatation of the nostrils, abduction of the elbows and breathing through the mouth

plus increased movement of the thoracic and abdominal walls. Loud respiratory sounds, especially grunting, may also be heard.

#### Type of respiration

In normal respiration there is movement of the thorax and abdomen. In painful conditions of the thorax, e.g. acute pleurisy, and in paralysis of the intercostal muscles, there is relative fixation of the thoracic wall and a marked increase in the movements of the abdominal wall; there also may be an associated pleuritic ridge caused by thoracic immobility with the thorax expanded. This syndrome is usually referred to as an abdominal-type respiration. The reverse situation is thoracic-type respiration, in which the movements are largely confined to the thoracic wall, as in peritonitis, particularly when there is diaphragmatic involvement.

#### Thorax symmetry

This can also be evaluated by inspection. Collapse or consolidation of one lung may lead to restriction of movements of the thoracic wall on the affected side. The 'rachitic rosary' of enlarged costochondral junctions is typical of rickets.

#### Respiratory noises or stridors

These include:

- Coughing – due to irritation of the pharynx, trachea and bronchi
- Sneezing – due to nasal irritation
- Wheezing – due to stenosis of the nasal passages
- Snoring – when there is pharyngeal obstruction, as in tuberculous adenitis of the pharyngeal lymph nodes
- Roaring – in paralysis of the vocal cords
- Grunting – a forced expiration against a closed glottis, which happens in many types of painful and labored breathing.

An important part of the clinical examination of a horse that produces an externally audible noise, usually a grunt, while working is to determine when the noise occurs in the respiratory cycle. This can be related to limb movements, expiration occurring as the leading foot hits the ground at the canter or gallop. Flexion of the head by the rider will exacerbate the noise.

#### Abdomen

Variations in abdominal size are usually appreciated during the general inspection of the animal. An increase in size may be due to the presence of excessive feed, fluid, feces, flatus or fat, the presence of a fetus or a neoplasm. Further differentiation is usually possible only on close examination. In advanced pregnancy, fetal movements may be visible over the right

flank of cattle. In severe distension of the intestines with gas, the loops of intestine may be visible in the flank, especially in calves. Intestinal tympany usually results in uniform distension of the abdomen whereas fluid tends to result in increased distension ventrally.

The term 'gaunt' is used to describe an obvious decrease in the size of the abdomen. It occurs most commonly in starvation, in severe diarrhea and in many chronic diseases where appetite is reduced. An umbilical hernia, omphalophlebitis, or dribbling of urine from a previous urachus may be apparent on visual inspection of the ventral abdominal wall. Ventral edema is commonly associated with approaching parturition, gangrenous mastitis, congestive heart failure, infectious equine anemia, and rupture of the urethra due to obstructive urolithiasis. A grossly enlarged asymmetrical swelling of the flank may suggest herniation of the abdominal wall. Ruminal movements can be seen in the left paralumbar fossa and flank of cattle but a complete examination of the rumen requires auscultation, palpation and percussion, which are described later.

#### External genitalia

Gross enlargements of the preputial sheath or scrotum are usually inflammatory in origin but varicocele or tumors can also be responsible. Degenerative changes in the testicles may result in a small scrotum. Discharges of pus and blood from the vagina indicate infection of the genitourinary tract.

#### Mammary glands

Disproportionate size of the udder suggests acute inflammation, atrophy or hypertrophy of the gland. These conditions can be differentiated only by further palpation and examination of the milk or secretions.

#### Limbs

General abnormalities of posture and gait have been described. Symmetry is important and comparison of the various aspects of pairs of limbs should be used when there is doubt about the significance of an apparent abnormality. Enlargement or distortion of bones, joints, tendons, sheaths and bursae should be noted and so should any enlargement of peripheral lymph nodes and lymphatic vessels.

### CLOSE PHYSICAL EXAMINATION

Some of the techniques used in making a close physical examination are set out below.

#### Palpation

Direct palpation with the fingers or indirect palpation with a probe is aimed at determining the size, consistency,

temperature and sensitivity of a lesion or organ. Terms used to describe palpation findings include the following:

- Doughy – when the structure pits on pressure, as in edema
- Firm – when the structure has the consistency of normal liver
- Hard – when the consistency is bone-like
- Fluctuating – when the structure is soft, elastic and undulates on pressure but does not retain the imprint of the fingers
- Tense – when the structure feels like a viscus distended with gas or fluid under some considerable pressure
- Emphysematous – when the structure is puffy and swollen, and moves and crackles under pressure because of the presence of gas in the tissue.

#### Percussion

In percussion, the body surface is struck so as to set deep parts in vibration and cause them to emit audible sounds. The sounds vary with the density of the parts set in vibration and may be classified as follows:

- Resonant – the sound emitted by organs containing air, e.g. normal lung
- Tympanitic – a drum-like note emitted by an organ containing gas under pressure such as a tympanitic rumen or cecum
- Dull – the sound emitted by solid organs such as heart and liver.

Percussion can be performed with the fingers using one hand as a plexor and one as a pleximeter. In large animals a pleximeter hammer on a pleximeter disk is recommended for consistency.

The quality of the sound elicited is governed by a number of factors. The strength of the percussion blow must be kept constant as the sound volume increases with stronger percussion. Allowances must be made for the thickness and consistency of overlying tissues. For example, the thinner the thoracic wall, the more resonant the lung. Percussion on a rib must not be compared with percussion on an intercostal space. The size and body condition score of the animal are also important considerations. The technique may be relatively ineffective in a fat animal. Pigs and sheep are of a suitable size but the fatness of the pig and the wool coat of the sheep plus the uncooperative nature of both species make percussion impracticable. In mature cattle and horses the abdominal organs are too large and the overlying tissue too thick for satisfactory outlining of organs or abnormal areas, unless the observer is highly skilled. The lungs of cattle and

horses can be satisfactorily examined by percussion but this requires practice and experience to become skillful and accurate.

Percussion is a valuable aid in the diagnosis of diseases of the lungs and abdominal viscera of all large animals. Increased dullness over the thorax indicates consolidation of the lung, a pleural effusion, or space-occupying lesion such as tumor or abscess. Increased resonance over the thorax suggests emphysema or pneumothorax.

#### Ballottement

Ballottement is a technique used to detect floating viscera or masses in the abdominal cavity. Using the extended fingers or the clenched fist the abdominal wall is palpated vigorously with a firm push to move the organ or mass away and then allow it to rebound on to the fingertips. Ballottement of a fetus is a typical example; the fetal prominences can be easily felt by pushing the gravid uterus through the abdominal wall over the right flank in pregnant cattle. Impaction of the abomasum, large tumors and abscesses of the abdominal cavity may also be detected by ballottement. Ballottement and auscultation of the flanks of cattle is also useful to detect fluid-splashing sounds. Their presence on the left side suggests carbohydrate engorgement and excessive quantities of fluid in the rumen, or left-side displacement of the abomasum. Over the right flank, fluid-splashing sounds may indicate intestinal obstruction, abomasal volvulus, cecal dilatation and torsion, and paralytic ileus.

Ballottement and auscultation of the abdomen of the horse with colic may elicit fluid-splashing sounds indicative of intestines filled with fluid, as in intestinal obstruction or paralytic ileus. A modification of the method is tactile percussion, when a cavity containing fluid is percussed sharply on one side and the fluid wave thus set up is palpated on the other. The sensation created by the fluid wave is called a fluid thrill. It is felt most acutely by the palm of the hand at the base of the fingers. Diseases that cause ascites and accumulation of fluid in the peritoneal cavity are examples where this technique is useful.

#### Auscultation

Direct listening to the sounds produced by organ movement is performed by placing the ear to the body surface over the organ. Indirect auscultation by a stethoscope is the preferred technique. A considerable amount of work has been done to determine the most effective stethoscopic equipment, including investigation of such things as the shape and proportions of bell chest pieces, the thickness of rubber tubes and the diameter



and depth of phonendoscope chest pieces. A comparatively expensive unit from a reputable instrument firm is a wise investment. For large animal work, a stethoscope with interchangeable 5 cm diameter phonendoscope and rubber (to reduce hair friction sounds) bell chest pieces is all that is required. The details of the sounds heard on auscultations of the various organs are described in their respective sections. Auscultation is used routinely to assess heart sounds, lung sounds and gastrointestinal sounds.

### Percussion and simultaneous auscultation of abdomen

Percussion and simultaneous auscultation of the left and right sides of the abdomen is a useful technique for examination of the abdomen of large animals. The stethoscope is placed over the area to be examined and the areas around the stethoscope and radiating out from it are percussed. This is a valuable diagnostic aid for the detection and localization of a gas-filled viscus in the abdomen of cattle with left-side displacement of the abomasum, right-side dilatation and volvulus of the abomasum, cecal dilatation and torsion, intestinal tympany associated with acute obstruction or paralytic ileus, or pneumoperitoneum.

Simultaneous percussion and auscultation of the abdomen of the horse with colic is useful to detect pings indicative of intestinal tympany associated with intestinal obstruction or paralytic ileus. In diaphragmatic hernia the presence of gas-filled intestines in the thorax may be determined by this method. To elicit the diagnostic 'ping', it is necessary to percuss and auscultate side by side and to percuss with a quick, sharp, light and localized force. The obvious method is a quick tap with a percussion hammer or similar object. Another favored method is a 'flick' with the back of a forefinger suddenly released from behind the thumb. A gas-filled viscus gives a characteristic clear, sharp, high-pitched 'ping' which is distinctly different from the full, low-pitched note of solid or fluid-filled viscera. The difference between the two is so dramatic that it is comparatively easy to define the borders of the gas-filled viscus.

The factors that determine whether a 'ping' will be audible are the force of the percussion, the size of the gas-filled viscus and its proximity to the abdominal wall. The musical quality of the ping is dependent on the thickness of the wall of the viscus (e.g. rumen, abomasum, small or large intestines) and the amount and nature of the fluid and gas in the intestines or viscus.

### Succussion

This technique, which involves moving the body from side to side to detect the

presence of fluid, is an adaptation of the above method. By careful auscultation while the body is moved, free fluid in the intestines or stomach will result in fluid-splashing or tinkling sounds.

### Other techniques

Special physical techniques including biopsy and paracentesis are described under special examination of the various systems to which they apply. With suitable equipment and technique, one of the most valuable adjuncts to a physical examination is a radiographic examination. The size, location and shape of soft tissue organs are often demonstrable in animals of up to moderate size. Radiology, other than of limbs and neonates, is not commonly practiced in larger animals. Ultrasound appears to have much more general application but will require its own textbook.

### SEQUENCE USED IN THE CLOSE PHYSICAL EXAMINATION

The close physical examination should be performed as quietly and gently as possible to avoid disturbing the patient and thus increasing the resting heart and respiratory rates. At a later stage it may be necessary to examine certain body systems after exercise, but resting measurements should be carried out first. If possible the animal should be standing, as recumbency is likely to cause variation in heart and pulse rates, respiration and other functions.

The sequence used in the close physical examination will vary with the species being examined, the results of the distant examinations, the history obtained, and the diagnostic hypotheses that the clinician has generated. The various parts of the close physical examination that are described here can be modified according to individual circumstances but it is important to do a thorough clinical examination based on the circumstances.

Following the distant examination, and the particular distant examination, it is recommended that the vital signs be determined before the animal is handled for examination of body regions such as the oral cavity.

In general, an appropriate sequence for the close physical examination would be as follows:

- Vital signs: temperature, heart and pulse rates, respirations, state of hydration
- Thorax: heart sounds (rate, rhythm, intensity); lung sounds
- Abdomen: nasogastric intubation
- Head and neck: including eyes, oral cavity, facial structures, and the jugular veins
- Rectal examination
- Urinary tract

- Reproductive tract
- Mammary gland
- Musculoskeletal system
- Nervous system
- Skin: including ears, hooves and horns.

The important principle is to determine the vital signs before handling and examining other body systems, which may distort the vital signs. The sequence that follows taking the vital signs can vary, based on individual circumstances, the urgency of the case, if any, and the ease of doing the particular examinations. For example, it may be very important to pass a nasogastric tube as one of the first diagnostic techniques in a horse with severe colic associated with gastric distension. When presented with a lactating dairy cow with peracute mastitis, the sequence will be recording the temperature, heart rate and sounds, respirations and status of the lungs, status of the rumen, followed by careful examination of the mammary gland. The close physical examination of each body region or body systems is outlined below.

### Vital signs

#### Temperature

Normally the temperature is taken per rectum. When this is impossible the thermometer should be inserted into the vagina. Ensure that the mercury column is shaken down, moisten the bulb to facilitate entry and, if the anus is flaccid or the rectum full of hard feces, insert a finger also to ensure that the thermometer bulb is held against the mucosa. When the temperature is read immediately after defecation, or if the thermometer is stuck into a ball of feces or is left in the rectum for insufficient time, a false, low reading will result.

As a general rule the thermometer should be left in place for 2 minutes. If there is doubt as to the accuracy of the reading, the temperature should be taken again. The normal average temperature range for the various species at average environmental temperature is as shown in Table 1.1.

The reference values in Table 1.1 indicate the average resting temperature

Table 1.1 Normal average temperatures with critical points

Species	Normal temperature	Critical point
Horse	38.0°C (100.5°F)	39.0°C (102.0°F)
Cattle	38.5°C (101.5°F)	39.5°C (103.0°F)
Pig	39.0°C (102.0°F)	40.0°C (103.5°F)
Sheep	39.0°C (102.0°F)	40.0°C (104.0°F)
Goat	39.5°C (103.0°F)	40.5°C (105.0°F)

Temperature conversions are approximate.

for the species and the critical temperature above which hyperthermia can be said to be present. Normal physiological variations occur in body temperature and are not an indication of disease: a diurnal variation of up to 1°C (2°F) may occur, with the low point in the morning and the peak in the late afternoon. There may be a mild rise of about 0.6°C (1°F) in late pregnancy, but a precipitate although insignificant decline just before calving is not uncommon in cows and ewes and lower temperatures than normal occur just before estrus and at ovulation – the degree of change (about 0.3°C; 0.6°F) is unlikely to attract clinical attention.

In sows the body temperature is subnormal before farrowing and there is a significant rise in body temperature coinciding with parturition. This rise is commonly high enough to exceed the critical temperature of 40°C and may be considered erroneously as evidence of disease. The elevation of temperature that occurs in sows at the time of parturition, of the order of 1°C, is maintained through lactation and disappears at weaning.

High environmental humidity and temperature and exercise will cause elevation of the temperature; the deviation may be as much as 1.6°C (3°F) in the case of high environmental temperatures and as much as 2.5–3°C (4.5°F) after severe exercise; in horses, after racing, 2 hours may be required before the temperature returns to normal.

If animals that have been acclimatized to cold outside temperatures are brought indoors to a warmer temperature their body temperatures may exceed the critical temperature within 2–4 hours. Marked temperature variations are an indication of a pathological process:

- **Hyperthermia** is simple elevation of the temperature past the critical point, as in heat stroke
- **Fever or pyrexia** is the state where hyperthermia is combined with toxemia, as in most infectious diseases
- **Hypothermia**, a subnormal body temperature, occurs in shock, circulatory collapse (as in parturient paresis and acute rumen impaction of cattle), hypothyroidism and just before death in most diseases.

#### Pulse

The pulse should be taken at the middle coccygeal or facial arteries in cattle, the facial artery in the horse and the femoral artery in sheep and goats. With careful palpation a number of characters may be determined, including rate, rhythm, amplitude, tone, maximum and minimum pulse pressures and the form of the arterial pulse. Some of these characters are more properly included in special

**Table 1.2** Resting pulse rates

Species	Pulse rate per minute
Adult horses	30–40
Foals up to 1 year	70–80
Adult cattle	60–80
Young calves	100–120
Sheep and goats	70–90

examination of the circulatory system and are dealt with under that heading.

#### Rate

The pulse rate is dependent on the heart alone and is not directly affected by changes in the peripheral vascular system. The pulse rate may or may not represent the heart rate; in cases with a pulse deficit, where some heartbeats do not produce a pulse wave, the rates will differ. Normal resting rates (per minute) for the various species are shown in Table 1.2.

Although there are significant differences in rate between breeds of dairy cow, and between high- and low-producing cows, the differences would not be noticeable to a clinician performing a routine examination. In newborn thoroughbred foals the pulse rate is 30–90 in the first 5 minutes, then 60–200 during the first hour, and then 70–130 during the first 48 hours after birth. Draught horses have heart rates slightly higher than those quoted, which are based on a light horse population. The pulse is not readily palpable in the pig but the comparable heart rate is 60–100 per minute. The same techniques are used in intensive clinical examinations for horses afflicted with the poor performance syndrome.

**Bradycardia**, or marked slowing of the heartbeat, is unusual unless there is partial or complete heart block, but it does occur in cases of space-occupying lesions of the cranium, in cases of diaphragmatic adhesions after traumatic reticulitis in cattle, or when the rumen is much emptier than normal.

**Tachycardia**, or increased pulse rate, is common and occurs in most cases of septicemia, toxemia, circulatory failure and in animals affected by pain and excitement. Counting should be carried out over a period of at least 30 seconds.

#### Rhythm

The rhythm may be regular or irregular. All irregularities must be considered as abnormal except sinus arrhythmia, the phasic irregularity coinciding with the respiratory cycle. There are two components of the rhythm, namely the time between peaks of pulse waves and the amplitude of the waves. These are usually both irregular at the one time, variations in diastolic filling of the heart causing vari-

ation in the subsequent stroke volume. Regular irregularities occur with constant periodicity and are usually associated with partial heart block. Irregular irregularities are due to ventricular extrasystoles or atrial fibrillation. Most of these irregularities, except that due to atrial fibrillation, disappear with exercise. Their significance lies chiefly in indicating the presence of myocardial disease.

#### Amplitude

The amplitude of the pulse is determined by the amount of digital pressure required to obliterate the pulse wave. It is largely a measure of cardiac stroke volume and may be considerably increased, as in the 'water hammer' pulse of aortic semilunar valve incompetence, or decreased, as in most cases of myocardial weakness.

#### State of hydration

The state of hydration is assessed by inspection of the eyes for evidence of dehydration and evaluating the elasticity of the skin. Dehydration is characterized by sunken eyes of varying degrees, and the skin will 'tent' when lifted with the fingers and remain tented for varying lengths of time.

### EXAMINATION OF BODY REGIONS

After the examination of the temperature, pulse and respirations the physical examination proceeds with an examination of the various body regions.

#### Thorax

Examination of the thorax includes palpation, auscultation and percussion of the cardiac area (precordium) and the lung area. The wide variations between species in the thickness of the thoracic wall, the size of the animal and the respiratory rate require careful and methodical examination. For example, in the adult horse the thick thoracic wall and the normally slow respiratory rate contribute to an almost soundless respiration on auscultation of the thorax. There is, too, the need to detect minor pulmonary lesions, which may reduce the work performance of the horse only slightly but, because of the importance of perfect fitness in a racing animal, may have major significance. Another important factor that emphasizes the care that must be taken with the examination of the respiratory system of the horse is the ability of racing animals to compensate for even major pulmonary lesions from their immense functional reserve. Because of this, one is likely to encounter horses with massive pulmonary involvement and yet with little obvious impairment of respiratory function.

#### Cardiac area

Auscultation of the heart is aimed at determining the character of normal heart

sounds and detecting the presence of abnormal sounds. Optimum auscultation sites are the fourth and fifth intercostal spaces and, because of the heavy shoulder muscles that cover the anterior border of the heart, the use of a flat phonendoscope chest piece pushed under the triceps muscles is necessary. Extension of the forelimb may facilitate auscultation if the animal is quiet. Areas where the various sounds are heard with maximum intensity are not directly over the anatomical sites of the cardiac orifices, because conduction of the sound through the fluid in the chamber gives optimum auscultation at the point where the fluid is closest to the chest wall.

The first (systolic) sound is heard best over the cardiac apex, the tricuspid closure being most audible over the right apex and mitral closure over the left apex. The second (diastolic) sound is heard best over the base of the heart, the aortic semilunar closure posteriorly and the pulmonary semilunar anteriorly, both on the left side.

In auscultation of the heart, the points to be noted are the rate, rhythm, intensity and quality of sounds and whether abnormal sounds are present. Comparison of the heart and pulse rates will determine whether there is a pulse deficit due to weak heart contractions failing to cause palpable pulse waves; this is most likely to occur in irregular hearts. Normally the rhythm is in three time and can be described as

*LUBB – DUPP – pause,*

the first sound being dull, deep, long and loud and the second sound sharper and shorter. As the heart rate increases the cycle becomes shortened, mainly at the expense of diastole and the rhythm assumes a two-time quality. More than two sounds per cycle is classified as a 'gallop' rhythm and may be due to reduplication of either the first or second sounds. Reduplication of the first sound is common in normal cattle and its significance in other species is discussed under diseases of the circulatory system.

The rhythm between successive cycles should be regular except in the normal sinus arrhythmia associated with respiration. With irregularity, there is usually variation in the time intervals between cycles and in the intensity of the sounds – louder sounds coming directly after prolonged pauses and being softer than normal sounds after shortened intervals, as in extrasystolic contractions. The intensity of the heart sounds may vary in two ways, absolutely or relatively: absolutely when the two sounds are louder than normal, and relatively when one sound is increased compared to the other

in the cycle. For example, there is increased absolute intensity in anemia and in cardiac hypertrophy.

The intensity of the first sound depends on the force of ventricular contraction and is thus increased in ventricular hypertrophy and decreased in myocardial asthenia. The intensity of the second sound depends upon the semilunar closure, i.e. on the arterial blood pressure, and is therefore increased when the blood pressure is high and decreased when the pressure is low.

Abnormal sounds may replace one or both of the normal sounds or may accompany them. The heart sounds are muffled when the pericardial sac is distended with fluid. Sounds that are related to events in the cardiac cycle are murmurs or bruits and are caused mainly by endocardial lesions such as valvular vegetations or adhesions, by insufficiency of closure of valves and by abnormal orifices such as a patent interventricular septum or ductus arteriosus. Interference with normal blood flow causes the development of turbulence with resultant eddying and the creation of murmurs. In attempting to determine the site and type of the lesion it is necessary to identify its time of occurrence in the cardiac cycle: it may be presystolic, systolic or diastolic and it is usually necessary to palpate the arterial pulse and auscultate the heart simultaneously to determine accurately the time of occurrence. The site of maximum audibility may indicate the probable site of the lesion, but other observations, including abnormalities of the arterial pulse wave, should be taken into account. In many cases of advanced debility, anemia and toxemia, soft murmurs can be heard that wax and wane with respiration (hemic murmurs) and are probably due to myocardial asthenia. In cases of local pressure on the heart by other organs, for example in diaphragmatic hernia in cattle, loud systolic murmurs may be heard, probably due to distortion of the valvular orifices.

Abnormal sounds not related to the cardiac cycle include pericardial friction rubs, which occur with each heart cycle but are not specifically related to either systolic or diastolic sounds. They are more superficial, more distinctly heard than murmurs and have a to-and-fro character. Local pleuritic friction rubs may be confused with pericardial sounds, especially if respiratory and cardiac rates are equal.

Palpation of the heart beat has real value: the size of the cardiac impulses can be assessed and palpable thrills may on occasion be of more value than auscultation of murmurs. It is best carried out with the palm of the hand and should be performed on both sides. An increased

cardiac impulse, the movements of the heart against the chest wall during systole, may be easily seen on close inspection of the left precordium and can be felt on both sides. It may be due to cardiac hypertrophy or dilatation associated with cardiac insufficiency or anemia or to distension of the pericardial sac with edema or inflammatory fluid. Care should be taken not to confuse a readily palpable cardiac impulse due to cardiac enlargement with one due to contraction of lung tissue and increased exposure of the heart to the chest wall.

Normally, the heart movements can be felt as distinct systolic and diastolic thumps. These thumps are replaced by thrills when valvular insufficiencies or stenoses or congenital defects are present. When the defects are large the murmur heard on auscultation may not be very loud but the thrill is readily palpable. Early pericarditis may also produce a friction thrill. The cardiac impulse should be much stronger on the left than the right side and reversal of this situation indicates displacement of the heart to the right side. Caudal or anterior displacement can also occur.

Percussion to determine the boundaries of the heart is of little value in large animal work because of the relatively large size of the heart and lungs and the depth of tissue involved. The area of cardiac dullness is increased in cardiac hypertrophy and dilatation and decreased when the heart is covered by more than the usual amount of lung, as in pulmonary emphysema. More detailed examination of the heart by electrocardiography, radiographic examination, test puncture and blood pressure are described under diseases of the heart.

#### Lung area

**Auscultation, percussion and palpation** are the major methods used for examination of the lungs.

The lung area available for satisfactory auscultation is slightly larger than that available for percussion. The normal breath sounds are heard over most of the lungs, particularly in the middle third anteriorly over the base of the lung, and consist of a soft, sipping VEE-EFF, the latter, softer sound occurring at expiration. The sounds are heard with variable ease depending on the thickness of the chest wall and the amplitude of the respiratory excursion. In well-fleshed horses and fat beef cattle the sounds may not be discernible at rest. The amplitude or loudness of the breath sounds is increased in dyspnea and in early pulmonary congestion and inflammation. The amplitude of the breath sounds is decreased or totally inaudible when there is pleural effusion, and in space-occupying lesions

in the lung or pleural cavity. Abnormal lung sounds include crackles, wheezes and pleuritic friction rubs. They are the result of interference with the free movement of air in and out of the lungs, and of the presence of lesions that interfere with the normal movement of the lung and thus create additional respiratory sounds, which are an indication of disease. The descriptions and interpretations of the normal and abnormal lung sounds, and other respiratory noises are described in Chapter 10.

The intensity of abnormal lung sounds may be increased and their clarity improved by measuring the rate and depth of respirations with forced mild exercise such as walking for a few minutes followed by immediate auscultation. If exercise is undesirable the occlusion of both nostrils for 30–45 seconds will be followed by some deep inspirations and accentuation of abnormal lungs. An alternative maneuver which is effective in both horses and cattle is to pull a plastic bag over the muzzle and lower face. When respiratory movements become exaggerated the bag is removed and the lungs auscultated immediately.

Sounds of peristalsis are normally heard over the lung area on the left side in cattle and in horses. In cattle, these sounds are due to reticular movement and in horses to movements of the colon. Their presence is not of much significance in these species unless there are other signs. In cattle, too, sounds of swallowing, eructation and regurgitation may be confused with peristaltic sounds; ruminal movements and the esophagus should be observed for the passage of gas or a bolus to identify these sounds. Other techniques for examination of the thorax are described under diseases of the respiratory system (Ch. 10).

Palpation of the thoracic wall may reveal the presence of a pleuritic thrill, bulging of the intercostal spaces when fluid is present in the thoracic cavity, or narrowed intercostal spaces and decreased rib movement over areas of collapsed lung.

Percussion may be by the usual direct means, or indirectly by tracheal percussion when the trachea is tapped gently and the sound is listened for over the lung area. By direct percussion within the intercostal spaces the area of normal lung resonance can be defined and abnormal dullness or resonance detected. Increased dullness may indicate the presence of a space-occupying mass, consolidated lung, edematous lung or an accumulation of fluid. In a pleural effusion the upper limit of the area of dullness can be determined by percussion and the **fluid line** can be delineated and identified and used to assess the progress of therapy.

An overloud normal percussion note is obtained over tissue containing more air than usual, e.g. emphysematous lung. A definite tympanic note can be elicited over pneumothorax or a gas-filled viscus penetrating through a diaphragmatic hernia. For percussion to be a satisfactory diagnostic aid, affected areas need to be large with maximum abnormality, and the chest wall must be thin.

### Abdomen

Clinical examination of the abdomen includes:

- **Visual inspection** of the abdominal contour for evidence of distension or gauntness
- **Auscultation** of the gastrointestinal sounds
- **Palpation and percussion** through the abdominal wall
- **Rectal palpation**
- **Passage of the nasogastric tube**
- **Paracentesis** of the abdomen.

#### Auscultation

Auscultation of the abdomen is an essential part of the clinical examination of cattle, horses and sheep. It is of limited value in pigs. The intestinal or stomach sounds will indicate the nature of the intraluminal contents and the frequency and amplitude of gastrointestinal movements, which are valuable aids in clinical diagnosis. The intensity, duration and frequency of the sounds should be noted. All these characteristics will be increased in animals that have just eaten or immediately following excitement.

#### *Auscultation of the rumen of cattle and sheep*

This is a very useful part of the clinical examination. In normal animals there are 1–2 primary contractions per minute, involving the reticulum and the dorsal and ventral sacs of the rumen; the frequency depends on the amount of time that has elapsed since feeding and the type of food consumed. Secondary contractions of the dorsal and ventral sacs of the rumen occur at about 1 per minute and are commonly associated with eructation. The examination is made in the left paralumbar fossa and a normal sequence of sounds consists of a lift of the flank with a fluid gurgling sound, followed by a second more pronounced lift accompanied by a booming, gassy sound. Auscultation over the lower left ribs will reveal the fainter fluid sounds of reticular contractions just prior to the contractions of the dorsal and ventral ruminal sacs described above. The reticular and ruminal sounds are the predominant abdominal sounds in the normal ruminant.

A grunt, detectable by auscultation over the trachea, may occur during the

reticular contraction phase of a primary contraction in cattle with traumatic reticuloperitonitis. The factors that result in a decrease in the intensity and frequency of ruminal sounds are discussed in detail in Chapter 6.

The intestinal sounds that are audible on auscultation of the right flank of cattle and sheep consist of frequent faint gurgling sounds, which are usually difficult to interpret. The contraction of the abomasum and the intestines result in a mixture of sounds that are difficult to distinguish.

#### *Intestinal sounds of the horse*

These sounds are clearly audible and their assessment is one of the most vital parts of the clinical examination and surveillance of the horse with suspected abdominal disease. Over the right and ventral abdomen there are the loud, booming sounds (borborygmi) of the colon and cecum, which are at peak intensity about every 15–20 seconds. Over the left abdomen there are the much fainter rushing fluid sounds of the small intestines. An increase in the intensity and frequency of sounds with a distinct fluid quality are heard in enteritis and loud, almost crackling, sounds in spasmodic colic. In impaction of the large intestine there is a decrease in the intensity and frequency of the borborygmi, and in thromboembolic colic due to verminous aneurysm and infarction of the colon there may be complete absence of sounds. In intestinal obstruction the intestinal sounds due to peristalsis are markedly decreased and usually absent and fluid tinkling sounds occur infrequently. In intestinal stasis in the horse, auscultation in the right flank often detects the tinkling sound of fluid dropping from the ileocecal valve through gas into the dorsal sac of the cecum.

#### Palpation and percussion through the abdominal wall

Because of the thickness and weight of the abdominal wall in mature cattle and horses, deep palpation of viscera and organs through the abdominal wall has limited value in these species compared to its usefulness in small animals. No viscera or organ, with the exception of the fetus, can be palpated with certainty through the abdominal wall in the horse. In cattle, the rumen and its contents can usually be palpated in the left paralumbar fossa. Ruminal distension is usually obvious while an inability to palpate the rumen may be due to a small, relatively empty rumen or to medial displacement, as in left-side displacement of the abomasum.

### *Percussion and simultaneous auscultation*

In left-side displacement of the abomasum, percussion and simultaneous auscultation over the upper third of the costal arch between the 9th and 12th ribs of the left side will elicit the typical high-pitched musical-quality sounds or ping. These may be mistaken for similar sounds present in ruminal atony. A markedly enlarged liver in a cow may be palpable by ballottement immediately behind the right costal arch. Using a combination of palpation, percussion and simultaneous auscultation over the right paralumbar fossa and caudal to the entire length of the right costal arch it may be possible to detect any of the following in cattle:

- Dilatation and torsion of the abomasum
- Cecal dilatation and torsion
- Impaction of the abomasum and omasum
- Intestinal obstructions, including torsion of the coiled colon.

Percussion and auscultation over viscera that are distended with fluid and gas may be undertaken and the size and location of the tympanic area will provide some indication of the viscera likely to be involved.

### *Tactile percussion of the abdomen*

This technique aids detection of an excessive quantity of fluid in the peritoneal cavity: ascites due to a ruptured bladder, transudate in congestive heart failure and exudate in diffuse peritonitis. A sharp blow is struck on one side of the abdomen and a fluid wave, a 'blip' or undulation of the abdominal wall, can be seen and felt on the opposite side of the abdomen. The peritoneal cavity must be about one-third full of fluid before a fluid wave can be elicited.

### *Abdominal pain*

The location of abdominal pain may be located by deep external palpation of the abdominal wall in cattle. Deep palpation with a firm uniform lift of the closed hand or with the aid of a horizontal bar held by two people under the animal immediately caudal to the xiphoid sternum is a useful aid for the detection of a grunt associated with traumatic reticuloperitonitis in cattle. Superficial pain may be elicited by a firm poke of the hand or extended finger in cattle or horses. In cattle, pain may be elicited over the right costal arch when there are liver lesions or generally over the abdomen in diffuse peritonitis.

The response to palpation of a focus of abdominal pain in cattle is a 'grunt' which may be clearly audible without the aid of a stethoscope. However, if there is doubt about the audibility of the grunt, the

simultaneous auscultation of the trachea will detect a perceptible grunt when the affected area is reached. In calves with abomasal ulceration, a focus of abdominal pain may be present on deep palpation over the area of the abomasum.

In cases of severe abdominal distension (ruminal tympany in cattle, torsion of the large intestine) it is usually impossible to determine, by palpation and percussion, the viscera that are distended. Pneumoperitoneum is rare and thus gross distension of the abdomen is usually due to distension of viscera with gas, fluid or ingesta. A combination of rectal examination, passage of a stomach tube, paracentesis and exploratory laparotomy may be necessary to determine the cause.

The abdomen of pigs is difficult to examine by palpation because pigs are seldom sufficiently quiet or relaxed and the thickness of the abdominal wall limits the extent of deep palpation. In late pregnancy in sows the gravid uterus may be ballotted but it is usually not possible to palpate fetal prominences.

In sheep, the rumen, impacted abomasum and the gravid uterus are usually palpable through the abdominal wall. Positioning the sheep on its hindquarters will shift the viscera to a more easily palpable position.

### *Nasogastric intubation*

An important part of the examination of the abdomen and gastrointestinal tract of large animals, especially cattle and horses, is the passage of the nasogastric tube into the rumen of cattle and into the stomach of horses. Gastric reflux occurs commonly in the horse with colic and it is important to determine if the stomach is distended with fluid and to relieve it as necessary. This topic is presented in detail in the chapter dealing with equine colic. In cattle, when disease of the rumen is suspected, the nasogastric tube is passed into the rumen to relieve any distension and to obtain a sample of rumen juice for determination of rumen pH and the presence or absence of rumen protozoa.

## **Head and neck**

### *Eyes*

Any discharge from the eyes should be noted: it may be watery in obstruction of the lacrimal duct, serous in the early stages of inflammation and purulent in the later stages. Whether the discharge is unilateral or bilateral is of considerable importance; a unilateral discharge may be due to local inflammation, a bilateral discharge may denote a systemic disease. Abnormalities of the eyelids include abnormal movement, position and thickness. Movement may be excessive in painful eye conditions or in cases of nervous irritability including hypo-

magnesemia, lead poisoning and encephalitis. The lids may be kept permanently closed when there is pain in the eye or when the eyelids are swollen, as for instance in local edema due to photosensitization or allergy. The membrana nictitans may be carried across the eye when there is pain in the orbit or in tetanus or encephalitis. There may be tumors on the eyelids.

### *Examination of the conjunctiva*

This examination is important because it is a good indicator of the state of the peripheral vascular system. The pallor of anemia and the yellow coloration of jaundice may be visible, although they are more readily observed on the oral or vaginal mucosa. Engorgement of the scleral vessels, petechial hemorrhages, edema of the conjunctiva as in gut edema of pigs or congestive heart failure, and dryness due to acute pain or high fever are all readily observable abnormalities.

### *Corneal abnormalities*

These include opacity, varying from the faint cloudiness of early keratitis to the solid white of advanced keratitis, often with associated vascularization, ulceration and scarring. Increased convexity of the cornea is usually due to increased pressure within the eyeball and may be due to glaucoma or hypopyon.

### *Size of the eyeball*

Eyeball size does not usually vary but protrusion is relatively common and when unilateral is due in most cases to pressure from behind the orbit. Periorbital lymphoma in cattle, dislocation of the mandible and periorbital hemorrhage are common causes. Retraction of the eyeballs is a common manifestation of reduction in volume of periorbital tissues, e.g. in starvation when there is disappearance of fat and in dehydration when there is loss of fluids.

### *Abnormal eyeball movements*

Abnormal movements occur in nystagmus due to anoxia or to lesions of the cerebellum or vestibular tracts. In nystagmus there is periodic, involuntary movement with a slow component in one direction and a quick return to the original position. The movement may be horizontal, vertical or rotatory. In paralysis of the motor nerves to the orbital muscles there is restriction of movement and abnormal position of the eyeball at rest.

### *Examination of the deep structures*

Assessment of the deep structures of the eye necessitates an ophthalmoscope but gross abnormalities may be observed by direct vision. Pus in the anterior chamber, hypopyon, is usually manifested by yellow to white opacity often with a

horizontal upper border obscuring the iris. The pupil may be of abnormal shape or abnormal in position due to adhesions to the cornea or other structures. An abnormal degree of dilatation is an important sign, unilateral abnormality usually suggesting a lesion of the orbit.

Bilateral excessive dilatation (mydriasis) occurs in local lesions of the central nervous system affecting the oculomotor nucleus, or in diffuse lesions including encephalopathies, or in functional disorders such as botulism and anoxia. Peripheral blindness due to bilateral lesions of the orbits may have a similar effect. Excessive constriction of the pupils (miosis) is unusual unless there has been overdose with organic phosphatic insecticides or parasympathomimetic drugs. Opacity of the lens is readily visible, especially in advanced cases.

#### Vision tests

Several tests of vision and of ocular reflexes are easily carried out, and when warranted should be done at this stage of the examination. Tests for blindness include the menace reflex and an obstacle test. In the former a blow at the eye is simulated, care being taken not to cause air currents. The objective is to elicit the eye preservation reflex manifested by reflex closure of the eyelids. This does not occur in peripheral or central blindness and in facial nerve paralysis there may be withdrawal of the head but no eyelid closure. An obstacle test in unfamiliar surroundings should be arranged and the animal's ability to avoid obstacles assessed. The results are often difficult to interpret if the animal is nervous. A similar test for night-blindness (nyctalopia) should be arranged in subdued light, either at dusk or on a moonlit night. Nyctalopia is one of the earliest indications of avitaminosis-A. Total blindness is called amaurosis, partial blindness is called amblyopia. The pupillary light reflex – closure and dilatation of the iris in response to lightness and darkness – is best tested with a strong flashlight.

#### Nostrils

Particular attention should be paid to the odor of the nasal breath. There may be a sweet sickly smell of ketosis in cattle or a fetid odor, which may originate from any of a number of sources including gangrenous pneumonia, necrosis in the nasal cavities or the accumulation of nasal exudate. Odors originating in the respiratory tract are usually constant with each breath and may be unilateral. The sour smell of alimentary tract disturbance is detectable only periodically, coinciding with eructation. Odors originating in the mouth from bad teeth or from necrotic ulcers associated with *Fusobacterium*

*necrophorum* in calves may be smelled on the nasal breath but are stronger on the oral breath.

In certain circumstances it may be important to note the volume of the breath expelled through the nostrils: it may be the only way of determining whether the animal is breathing and, in some cases, of counting the respiratory rate. Variation in volume between nostrils, as felt on the hands, may indicate obstruction or stenosis of one nasal cavity. This can be examined further by closing off the nostrils one at a time; if obstruction is present in one nostril, closure of the other causes severe respiratory embarrassment.

Any nasal discharge that is present should receive special attention and its examination should be carried out at the same time as an inspection of the nasal mucosa. Discharges may be restricted to one nostril in a local infection or be bilateral in systemic infection. The color and consistency of the exudate will indicate its source. In the early stages of inflammation the discharge will be a clear, colorless fluid, which later turns to a white to yellow exudate as leukocytes accumulate in it. In Channel Island cattle the color may be a deep orange, especially in allergic rhinitis. A rust or prune juice color indicates blood originating from the lower respiratory tract, as in pneumonia and in equine infectious anemia in the horse. Blood clots derived from the upper respiratory tract or pharynx may be present in large quantities, or appear as small flecks. In general, blood from the upper respiratory tract is unevenly mixed with any discharge, whereas that from the lower tract comes through as an even color.

The consistency of the nasal discharge will vary from watery in the early stages of inflammation, through thick, to cheesy in longstanding cases. Bubbles or foam may be present. When the bubbles are coarse it signifies that the discharge originates in the pharynx or nasal cavities; fine bubbles originate in the lower respiratory tract. In all species, vomiting or regurgitation caused by pharyngitis or esophageal obstruction may be accompanied by the discharge of food material from the nose or the presence of food particles in the nostrils. In some cases the volume of nasal discharge varies from time to time, often increasing when the animal is feeding from the ground, leading to infection of cranial sinuses.

Inflammation of the nasal mucosa varies from simple hyperemia, as in allergic rhinitis, to diffuse necrosis, as in bovine malignant catarrh and mucosal disease, to deep ulceration as in glanders. In hemorrhagic diseases variations in

mucosal color can be observed and petechial hemorrhages may be present.

#### Mouth

Excessive salivation, with ropes of saliva hanging from the mouth and usually accompanied by chewing movements, occurs when a foreign body is present in the mouth and also in many forms of inflammation of the oral mucosa or of the tongue. Actinobacillosis of the tongue, foot-and-mouth disease and mucosal disease are typical examples. Excessive salivation may also occur in diseases of the central nervous system, as in acute lead poisoning in young cattle. Hyper-salivation is a characteristic sign in epidermic hyperthermia associated with the mycotoxins of *Acremonium coenophialum* and *Claviceps purpurea* and by the fungus *Rhizoctonia leguminicola* sometimes found on red clover. Dryness of the mouth occurs in dehydration and poisoning with belladonna alkaloids, or when high levels of urea are fed.

Abnormalities of the buccal mucosa include local lesions, hemorrhages in purpuric diseases, the discolorations of jaundice and cyanosis and the pallor of anemia. Care must be taken to define the exact nature of lesions in the mouth, especially in cattle; differentiation between vesicles, erosive and ulcerative lesions is of diagnostic significance in the mucosal diseases of this species.

#### Teeth

Examination of the teeth for individual defects is a surgical subject but a general examination of the dentition can yield useful medical information. Delayed eruption and uneven wear may signify mineral deficiency, especially calcium deficiency in sheep; excessive wear with mottling and pitting of the enamel is suggestive of chronic fluorosis.

#### Tongue

The tongue may be swollen by local edema or by inflammation as in actinobacillosis of cattle, or shrunken and atrophied in post-inflammatory or nervous atrophy. Lesions of the lingual mucosa are part of the general buccal mucosal response to injury.

#### Pharynx

Examination of the pharyngeal region in large animals requires some dexterity and the use of a speculum of appropriate size. The oral cavity and pharynx of calves, lambs and goat kids is examined by holding the mouth open, depressing the base of the tongue with the fingers or a tongue depressor and viewing the pharynx, the glottis and the proximal part of the larynx and arytenoid cartilages. In adult cattle, a metal or Plexiglass cylindrical speculum, 45 cm in length and 4 cm in diameter,

placed in the oral cavity and over the base of the tongue will allow viewing of the pharynx and the larynx. Foreign bodies, diffuse cellulitis and pharyngeal lymph node enlargement can also be detected by this means. The use of a speculum wedged between the upper and lower molar teeth in cattle allows manual exploration and evaluation of lesions of the pharynx and proximal part of the larynx. In the horse, the pharynx cannot be viewed from the oral cavity and manual exploration of the pharynx requires general anesthesia. Endoscopy is a useful method of examination in this species, and the modern fiberoptic scope has made it possible to visualize lesions in the posterior nares and pharynx-esophagus, larynx-trachea in the standing, conscious horse or ox.

#### Submaxillary region

Abnormalities of the submaxillary region that should be noted include enlargement of lymph nodes due to local foci of infection, subcutaneous edema as part of a general edema, local cellulitis with swelling and pain, enlargement of salivary glands or guttural pouch distension in the horse. Thyroid gland enlargement is often missed or mistaken for other lesions, but its site, pulsation and surrounding edema are characteristic.

#### Neck

The most important part of the examination of the neck of cattle and horses is to determine the state of the jugular veins. Bilateral engorgement of the jugular veins may be due to obstruction of the veins by compression or constriction, or to right-side congestive heart failure. A jugular pulse of small magnitude moving up the jugular vein about one-third of the way up the neck is normal in most animals but it must be differentiated from a transmitted carotid pulse, which is not obliterated by compression of the jugular vein at a lower level. Variations in size of the vein may occur synchronously with deep respiratory movements but bear no relation to the cardiac cycles. When the jugular pulse is associated with each cardiac movement it should be determined whether it is physiological or pathological. The physiological pulse is presystolic and due to atrial systole, and is normal. The pathological pulse is systolic and occurs simultaneously with the arterial pulse and the first heart sound; it is characteristic of an insufficient tricuspid valve.

Local or general enlargement of the esophagus associated with vomiting or dysphagia occurs in esophageal diverticulum, stenosis and paralysis, and in cardiac obstructions. Passage of a stomach tube or probang can assist in the examination of esophageal abnormalities.

Tracheal auscultation is a useful diagnostic aid. Normally, the sounds that are audible are louder and more distinct than breath sounds audible over the lung. In upper respiratory tract disease such as laryngitis and tracheitis, the sounds are louder and harsher and may be whistling in the presence of stenosis. Very loud stenotic tracheal sounds are characteristic of calves with tracheal collapse. Abnormal tracheal sounds, regardless of their cause, are usually transferred down the major bronchi and are audible on auscultation over the thorax, primarily during inspiration. They are commonly confused with abnormal lung sounds due to pneumonia, but in pneumonia the abnormal sounds are usually present both on inspiration and on expiration.

#### Rectal examination

Rectal exploration of the abdomen is a vital part of the complete examination of the abdomen of large animals, especially cattle and horses. Abnormalities that are completely unexpected may be present and may be the cause of illness in animals in which no other significant clinical abnormalities were detected on clinical examination. Special care is necessary to avoid injuring the patient and causing it to strain. Suitable lubrication and avoidance of force are the two most important factors. Rectal examination enables observations to be made on the alimentary, urinary and genital tracts and on the vessels, peritoneum and pelvic structures. The amount and nature of the feces in the rectum should be determined.

Palpable abnormalities of the digestive tract include paralysis and ballooning of the rectum, distension of the loops of the intestine with fluid or gas, the presence of hard masses of ingesta as in cecal and colonic impactions in the horse, and intestinal obstruction due to volvulus, intussusception or strangulation. The detection of tight bands of mesentery leading to displacement segments may be a valuable guide. In cattle, the caudal sacs of the rumen are readily palpable. When the rumen is distended as in bloat or vagus indigestion they may push well into the pelvis or be only just within reach when the rumen is empty. A distended abomasum may be felt in the right half of the abdomen in cases of abomasal torsion and occasionally in vagus indigestion. In healthy animals there is little to feel because of the space occupied by normal intestines. Palpable objects should be carefully examined.

The left kidney in the cow can be felt in the midline and distinct lobulations are evident. In the horse, the caudal pole of the left kidney is easily palpable, but the right kidney is not. There may be abnor-

malities of size in pyelonephritis, hydro-nephrosis and amyloidosis, and pain on pressure in pyelonephritis. The ureters are not normally palpable nor is the empty bladder. A distended bladder or chronic cystitis with thickening of the wall can be felt in the midline at the anterior end of the pelvic cavity. Abnormalities of the bladder and ureters in cattle are also palpable through the ventral aspects of the vagina. Large calculi have a stone-like hardness and are occasionally observed in horses in the same position. Pain with spasmodic jerking of the penis on palpation of the urethra occurs in urinary obstruction due to small calculi, cystitis and urethritis. Enlarged, thickened ureters such as occur in pyelonephritis can be felt between the kidney and the bladder.

On the peritoneum and mesentery one may feel the small, grape-like lesions of tuberculosis, the large, irregular, hard masses of fat necrosis and the enlarged lymph nodes of lymphomatosis. The abdominal aorta is palpable, and in horses the anterior mesenteric artery and some of its branches can be felt. This may be an important examination if a verminous aneurysm is suspected, in which case the vessels are thickened but still pulsate, have an uneven rough surface and may be painful. In horses the caudal edge of the spleen is usually palpable in the left abdomen. During a rectal examination in a horse it is advantageous in some cases to palpate the inguinal ring from inside the abdomen and, by pushing the other hand between the horse's thighs, to palpate the external ring simultaneously. It is then easier to decide whether any abnormal structures are passing through the ring.

#### Feces and defecation

Examination of the feces may provide valuable information on the digestive and motor functions of the tract. They should be examined for volume, consistency, form, color, covering, odor and composition. Note should be made of the frequency and the time taken for material to pass through the tract. Laboratory examinations may be advisable to detect the presence of helminth eggs, occult blood, bile pigments, pathogenic bacteria or protozoa.

The volume of feces is usually described scant, normal or copious but, in certain circumstances, it may be advisable to weigh or measure the daily output. The normal output for each species is as follows:

- Horses: 15–20 kg/day
- Cattle: 25–45 kg/day
- Pigs: 1–2.5 kg/day
- Sheep and goats: 0.5–1 kg/day



There is an increased bulk when much fiber is fed or during attacks of diarrhea. The consistency and form of the feces varies with each species and varies widely within a normal range, depending particularly on the nature of the food. Variations in consistency not explainable by changes in the character of the feed may indicate abnormalities of any of the functions of the tract. The consistency is more fluid in diarrhea and less fluid than normal in constipation. The consistency and form of the feces may provide some indication of the location of the dysfunction of the gastrointestinal tract. In general, large quantities of liquid feces suggest a dysfunction of the small intestine where normally most of the fluid is absorbed. If the feces contain large quantities of undigested feed this suggests over-feeding, incomplete mastication, a digestive enzyme deficiency or an acute disorder of the small intestine or stomachs. Large quantities of soft feces that contain well-digested ingesta suggest a dysfunction of the large intestine. However, these are only guidelines and are subject to error.

**Color of the feces** This also varies widely with the color of the food, but feces of a lighter color than normal may be caused by an insufficient secretion of bile or by simple dilution of the pigments, as occurs in diarrhea. The effect of blood on the appearance of feces has already been described. Discoloration by drugs should be considered when the animal is undergoing treatment.

**Fecal odor** This depends largely on the nature of the food eaten but in severe enteritis the odor is characteristically one of putrefaction.

**Composition** The composition of the feces should be noted. In herbivorous animals, there is always a proportion of undigested fiber but excessive amounts suggest incomplete digestion due to, for example, bad teeth and faulty mastication. Excessively pasty feces are usually associated with a prolonged sojourn in the tract such as occurs in vagal indigestion or abomasal displacement in cattle. Foreign material of diagnostic significance includes sand or gravel, wool, and shreds of mucosa. Mucus is a normal constituent but, in excessive amounts, indicates either chronic inflammation, when it is associated with fluid, copious feces, or constipation when the feces are small in volume and hard. Mucosal shreds or casts always indicate inflammation.

**Frequency of defecation** Frequency and the length of sojourn in the gastrointestinal tract are usually closely allied, increased frequency and decreased sojourn

occurring in diarrhea and the reverse in constipation. Most animals defecate eight to 12 times a day but the sojourn varies widely with the species. Omnivores and carnivores with simple stomachs have an alimentary sojourn of 12–35 hours. In ruminants it is 2–4 days and in horses 1–4 days, depending on the type of feed.

#### *Other observations*

Observation of other acts associated with the functions of the alimentary tract may provide information of diagnostic value. Prehension, mastication, swallowing, vomiting and defecation should be observed and an attempt made to analyze the behavior of the animal when there is evidence of abdominal pain.

#### Paracentesis of the abdomen

Paracentesis of the abdomen includes obtaining a sample of peritoneal fluid when peritonitis or inflammation of the serosae of the intestines or other viscera of the abdomen is suspected. Aspiration of fluid from a distended abdominal viscus is also possible and may aid in the diagnosis.

#### Urinary system

Examination of the urinary tract consists of observations of the **act of urination**, evidence of **difficult and painful urination**, **abnormal urine**, collection of urine and urinalysis, and, depending on the species, **palpation of the kidneys, bladder and urethra**. Details of the examination of the urinary tract are presented in Chapter 11.

#### Reproductive tract

Examination of the reproductive tract is usually carried out at this stage but is not discussed here because it is dealt with adequately in texts on diseases of the genital system. In the immediate post-partum period, the vagina, cervix and uterus should be examined thoroughly for evidence of gross abnormalities such as metritis, retained placenta and ruptured uterus, which may be the cause of illness not obvious on examination of other body systems.

#### Mammary gland

The mammary gland(s) of all species is examined by inspection and palpation of the udder and teats, and gross examination of the milk or abnormal secretions of the glands. Details of this examination are presented in Chapter 15.

#### Musculoskeletal system and feet

Examination of the musculoskeletal system and feet is necessary when there is lameness, weakness, or recumbency. Inspection of the gait during the walk and trot is used to determine the origin of the lameness. The muscles, joints, ligaments, tendons, and bones are inspected and

palpated to determine abnormalities associated with lameness, weakness or recumbency. The feet are examined by inspection, palpation and the trimming of hooves in farm animals to identify lesions associated with lameness. Medical imaging is commonly used to define lesions not readily recognizable by routine clinical examination. Details of examination of the musculoskeletal system and feet are presented in Chapter 13.

#### Nervous system

In routine veterinary practice, veterinarians will commonly include several components of a neurological examination in a complete clinical examination. Most often a diagnosis and differential diagnosis can be made from consideration of the history and the clinical findings. However, if the diagnosis is uncertain it may be necessary to conduct a complete neurological examination, which may uncover additional clinical findings necessary to make a diagnosis and give a prognosis.

A complete neurological examination includes examination of the mental status, head and posture, cranial nerve function, gait and posture, function of the neck and forelimbs, function of the trunk and hindlimbs, palpation of the bony encasement of the central nervous system, examination of cerebrospinal fluid, medical imaging of the bony skeleton of the head and vertebral column. The details of the neurological examination are presented in Chapter 12.

#### Skin including ears, hooves and horns

A systematic method for the examination of the skin is necessary to avoid misinterpretation of the lesions. Inspection of the behavior of the animal and of the skin and hair, and palpation and smelling of the skin are the most common physical methods used for clinical examination of the skin. The important prerequisites for an adequate examination of the skin are good lighting such as natural light or day-type lamps, clipping the animal's hair when necessary to adequately visualize lesions, magnification of the lesions with a hand lens to improve visualization of the changes, and adequate restraint and positioning of the animal. Palpation can be used to assess the consistency of lesions, the thickness and elasticity of skin, and to determine the presence of pain associated with diseases of the skin.

**Close inspection and palpation** of the skin and hair coat are necessary to identify and characterize lesions. Magnifying spectacles or an illuminated magnifying glass may prove useful. The dorsal aspect of the body is inspected by viewing it from the rear, as elevated hairs and patchy alopecia may be more obvious from that



angle. All parts of the head including the nose, muzzle and ears are examined. The lateral trunk and the extremities are then examined. The feet of large animals need to be picked up to examine the interdigital clefts and parts of the coronary bands. The skin of the udder and teats of cattle, sheep and goats, and horses must be observed. The ventral aspect of the body is carefully examined using a source of light to illuminate the underside of adult cattle and horses. The external and internal aspects of the ears, and the hooves and horns must be examined by inspection and palpation.

Every centimeter of the skin needs to be examined for the presence of lesions in different stages of development. The **visual, tactile and olfactory senses** are used to see, feel and smell the lesions. The presence or absence of some ectoparasites can be determined by direct inspection. For example, lice and ticks of cattle are usually easily visible. The odor of the skin in some diseases may be abnormal; dermatophilosis in cattle is characterized by a foul and musty odor. Parting the hairs with the fingers or by gently blowing them is necessary to evaluate the length of the hair shafts. Broken hairs, changes in hair color and the accumulation of exudative material on hair shafts are noted. The texture and elasticity of the skin must be assessed by rolling the skin between the fingers. Careful digital palpation of the hair coat which appears normal on visual inspection may reveal underlying lesions such as pustules which may be covered by the hair coat. In some cases, tufts of hairs may be seen protruding through an accumulation of exudate. A combination of visual inspection of the wool coat of sheep is done carefully and systematically by parting the wool coat and evaluating the condition of the wool fibers and the underlying skin. The hair coat should not be clipped, groomed or washed before the lesions have been identified and characterized.

### DIAGNOSTIC ULTRASONOGRAPHY

Diagnostic ultrasonography in animals is the continuation of the clinical examination

Ultrasonography has developed into a valuable imaging technique in almost all animal species because of the rapid development of technically improved portable units and their potential use at any given location, which is important in farm animals not being examined in a veterinary clinic. It is indeed a continuation of the clinical examination.<sup>1</sup>

The ultrasonographic examination is unique in its patient application because it is a dynamic examination technique with no risk to the patient or the sonographer. It is a continuation of the clinical

examination. Ultrasonography is non-invasive, and well tolerated in unsedated animals. It enables serial examinations to monitor the progression of an abnormality or response to treatment. Ultrasonography requires considerable skill and experience to make a diagnosis. Some practitioners may hesitate before investing considerable resources in an ultrasound machine if they feel it will not be used regularly and if they believe they do not have enough time for the examination. Continuing education courses and workshops are becoming more common and they provide excellent training and the latest concepts. When employed correctly, ultrasonography is of great benefit to every veterinary clinician and practitioner in continuing the clinical examination. Ultrasonography can be valuable in examining the contents of cavitory lesions, synovial cavities, cysts or other fluid-filled lesions for the presence of liquid, semisolid or solid contents and/or effusion. Centesis of synovial cavities or body cavities, and biopsy of organs such as liver or kidney are now frequently done as part of the clinical examination. Ultrasonography enables accurate needle placement following ultrasonographic examination of the designated structure, assisting with the measurement of the distance from the skin surface to the structure when, for example, a freehand biopsy technique is to be performed.

The literature on the history of the development, advances and application of ultrasound in animals has been reviewed.<sup>2</sup>

When a pulse of ultrasound is directed into a substance, varying amounts are reflected back to the source according to the material encountered and the returning signal conveys information regarding the structures it has penetrated. Real-time brightness or 'B' mode imaging is currently the form of ultrasound most commonly used. Examination of moving structures such as the heart required a technique known as time motion or 'M' mode ultrasound.

During a routine ultrasound examination, real-time B mode provides information regarding the physical form and structure of tissues, allows subjective assessment of movement such as peristaltic contractions within the intestine and provides an overview that guides the application of other ultrasound modes. M mode is now an integral part of echocardiographic examinations and all modern ultrasound machines are equipped with this capability.

The benefits of ultrasound as a veterinary diagnostic imaging procedure are numerous.<sup>2</sup> Routine examinations have no harmful biological effects. It is a safe procedure for the animal, the operator

and nearby personnel, allowing it to be done in any location without the need for specific safety precautions.

The ability of ultrasound to distinguish fluid from soft tissue and differentiate between soft tissues on the basis of their composition makes it more suited than radiography for examining soft tissue structures. Ultrasonography can often provide information that was previously only available through exploratory laparotomy. Ultrasound is limited by its inability to penetrate gas-filled or bony structures; therefore 'acoustic windows' must be found that avoid the interposition of bone or gas between the transducer and the region of interest, although this can often be achieved by judicious positioning of the patient. Transcutaneous examinations in animals require removal of the hair overlying the region of interest by clipping, as the beam cannot penetrate the air trapped between the hairs.

Examples of the use of ultrasonography in bovine practice include the diagnosis of gastrointestinal disease,<sup>3</sup> diseases of the mammary gland,<sup>4</sup> thoracic disease,<sup>5</sup> splenic disease,<sup>6</sup> ruptured gall bladder in cows<sup>7</sup> and the blood flow patterns in the common carotid artery and external jugular vein for cardiac and blood vessel disease.<sup>8</sup>

The use of ultrasonography as a reproductive management aid in dairy cattle practice represents a major advance in understanding reproductive biology in cattle.<sup>9</sup> The literature on the veterinary ultrasound equipment, imaging the bovine ovary (ovarian follicles, corpora lutea, ovarian cysts), the bovine uterus (early pregnancy diagnosis, early embryonic loss, identification of cows carrying twins, determination of fetal sex) and the diagnostic limitations of ultrasonographic imaging has been reviewed.<sup>9</sup> Because nonpregnancy can be established 7–14 days earlier after artificial insemination (AI) using ultrasound compared with rectal palpation, nonpregnant cows can be detected earlier and returned to AI service, thereby improving the pregnancy rate through an increased AI service rate.

The use of ultrasonography to examine various body systems is described briefly in their respective chapters in the General Medicine part of the textbook. Readers are encouraged to consult the publications listed under Review Literature and References, and textbooks dealing with ultrasonography. Short courses and laboratory workshops are now commonplace and readily available and highly recommended. The development of extension education programs to train bovine practitioners is a critical step toward rapid implementation of this technology into the dairy industry.

## REVIEW LITERATURE

- Braun U (ed.), Fluckiger M, Kahn W et al. Atlas und Lehrbuch der Ultraschalldiagnostik beim Rind. Berlin: Parey Buchverlag im Blackwell Wissenschafts-Verlag, 1997.
- Radostits OM, Mayhew IG, Houston DM. Veterinary clinical examination and diagnosis. London: WB Saunders, 2000.
- Braun U. Ultrasonography in gastrointestinal disease in cattle. *Vet J* 2003; 166: 112–124.
- King AM. Development, advances and applications of diagnostic ultrasound in animals. *Vet J* 2006; 171: 408–420.
- Kofler J. Diagnostic ultrasonography in animals – Continuation of the clinical examination? *Vet J* 2006; In press.

## REFERENCES

1. Kofler J. *Vet J* 2006; 171:393.
2. King AM. *Vet J* 2006; 171:408.
3. Braun U. *Vet J* 2003; 166:112.
4. Flock M, Winter P. *Vet J* 2006; 171:314.
5. Flock M. *Vet J* 2004; 167:272.
6. Braun U, Sicher D. *Vet J* 2006; 171:513.
7. Braun U et al. *Vet Rec* 2005; 156:351.
8. Braun U et al. *Am J Vet Res* 2005; 66:962.
9. Fricke PM. *J Dairy Sci* 2002; 85:1918.

## Making a diagnosis

The practice of clinical veterinary medicine consists of two major facets: the making of a diagnosis and the provision of treatment and control measures. For treatment and control to be of optimum value the diagnosis must be as accurate as possible, so that diagnosis is the crux of all medical problems.

A diagnosis is the identification of the disease affecting the patient, and to be complete should include three parts:

- The specific cause
- The abnormality of structure or function produced by the causative agent, and which is inimical to normal body processes
- The clinical manifestation of that abnormality produced by the causative agent.

For recording purposes the animal species should also be included, for example, 'equine *Rhodococcus equi* pneumonia and lung abscess'. Many diagnoses fall short of this objective because of lack of confirmatory laboratory assistance. So clinical signs (such as bovine chronic diarrhoea) or necropsy lesions (such as bovine polioencephalomalacia) are often used.

## DIAGNOSTIC METHODS

At least five distinctly recognizable methods are used and they are presented here in order of increasing complexity. As a general rule the experienced clinician uses more of the simpler strategies, the novice clinician more of the complex ones. This is because the simple method

omits several steps in the clinical reasoning process – the sort of appropriate and safe 'cutting of corners' that it is possible to carry out with confidence only after gaining wide experience and after paying a good deal of attention to assessing one's own personal competence as a clinician and especially as a diagnostician.

### METHOD 1: THE SYNDROME OR PATTERN RECOGNITION

In the first few moments of viewing the patient, e.g. the pain-generated behavior of a horse with abdominal pain or the skin lesions of ecthyma in a sheep or papillomatosis in a cow, the diagnosis is made instantaneously and reflexly. The same experience may occur while taking the history: one may have to rely entirely on the history in the case of a cow having an epileptic seizure to be able to diagnose it. This recognition is based on the comparison of the subject case and previous cases in the clinician's memory and the one is recognized as a replica of the other. There is no need to seek further supporting advice and the definitive diagnosis is made then and there. In the hands of the wise and experienced clinician the method is quick and accurate.

### METHOD 2: HYPOTHETICO-DEDUCTIVE REASONING

As soon as the client begins to relate the presenting signs, usually commencing with the key clinical sign, the clinician begins to draw up a short list of diagnostic possibilities, usually three or four. This is the process of generating multiple plausible **hypotheses** from initial cues. The clinician then begins to ask questions and conduct clinical examinations that test the hypotheses. The questions and examinations may be directed at supporting or discounting the tentative diagnoses (the confirm/exclude technique) but they may lead to the addition of more hypotheses and the deletion of some others. (The questions used here are search ones, aimed at supporting a hypothesis, and are distinctly different from scanning questions, which are 'fishing' expeditions looking for more key signs about which to ask search questions.) This process of hypothesis and deduction is continued until one diagnosis is preferred to the others. The original list of hypotheses may be expanded but not usually to more than seven, and in the final stages is usually reduced to two or three. These are then arranged in order of preference and become the list of **diagnostic possibilities**.

In farm animal medicine there is usually a general absence of both hard primary data and ancillary data such as clinical pathology, so that the clinician may be in the position of having to provide treatment for two or three

possible illnesses. An example is the parturition syndrome of recently calved dairy cows in which the treatment of subacute mastitis, metritis and acetonemia is standard procedure because the clinician is uncertain about which disease is most accountable for the illness. In the more resourceful arena of a veterinary teaching hospital it may still be necessary to proceed in this way in the first instance but then to narrow down the list of hypotheses when additional information is received from the laboratory. This polypharmacy approach has a number of disadvantages, among which are included the additional expense and the increased possibility of contamination of food products of animal origin by medications, especially antibiotics and sulfonamides, and with resistant strains of bacteria.

One of the important characteristics of this strategy is the dependence on the selection of a critical or key clinical sign or cue on which to base the original hypotheses. The selection of the key sign and additional supporting clinical findings is done instinctively by experienced clinicians on the basis of prior experience in similar situations. For novice clinicians it may be necessary to examine two or more key signs.

### METHOD 3: THE ARBORIZATION OR ALGORITHM METHOD

This is really an extension of method 2 but the hypothetico-deductive reasoning method is formalized and carried out according to a preplanned program. The hypothetico-deductive reasoning method depends on the clinician remembering and being aware of an all-inclusive list of diagnostic possibilities in the case under consideration. Because memory is unreliable and impressionistic the method is subject to error by omission. The arborization or algorithmic method similarly approaches a listed series of diagnoses and examines each one in turn with supporting or disproving questions; if they pass the proving test they stay in, if they fail it they are deleted. For example, a key sign of red urine in a cow promotes the question: *Has the cow had access to plant substances that color the urine red?* If the answer is no, the next question is: *Is the red color caused by hemoglobinuria or hematuria?* If the answer is hemoglobinuria, all the diagnoses on the hematuria branch of the algorithm are deleted and the questioner proceeds to the next question, which will attempt to determine whether the cow has postparturient hemoglobinuria or any one of a number of diseases characterized by intravascular hemolysis.

Provided that the list of possible diagnoses is complete and is frequently updated

as new diagnoses become available – and, just as importantly, as new ways of supporting or discounting each hypothesis are added as soon as they are published – the method works well. These algorithms are eminently suited to computerization and can be made available by the supply of floppy disks or by access to a central database via a modem, the online database, or dial-up information system.

The arborization method is well suited to the clinician who has not had the necessary experience for the memorization of long lists of potential diagnoses and the critical tests that confirm or exclude each of them. Because the algorithms are likely to include **all** the recorded diagnoses that have that particular key sign, error by omission is not a risk. Thus they are also valuable to the specialist, who is less able to afford an omission than the general practitioner and certainly cannot really afford to miss even the most obscure and unlikely diagnosis. Another major advantage is that they provide a system of tests that should be performed and clinical findings that should be searched for – which is really a form of clinical protocol, acting as a reminder of

the sequential diagnostic steps to be taken. The arrangement of the algorithm represents the clinical reasoning of the person who designed it and it should have considerable merit, assuming that the designer was an expert. This characteristic does arouse the comment that the method does away with the need for the clinicians to do their own clinical reasoning. That may be so, but the interests of optimum clinical care of patients are probably better served by having first-year interns apply the clinical reasoning of a specialist and as a consequence achieve significantly better results.

#### METHOD 4: THE KEY ABNORMALITY METHOD

This is a more time-consuming method than the previous ones and requires that clinicians rely on their knowledge of normal structure and function to select the key abnormality or clinical cue. The method consists of five steps and is summarized in Figure 1.1.

##### Determination of the abnormality of function present

Disease is abnormality of function which is harmful to the animal. The first step is

to decide what abnormality of function is present. There may of course be more than one and some clinically insignificant abnormalities may be present, e.g. a physiological cardiac murmur in a newborn foal. Definition of the abnormality is usually in general terms such as paralysis, state of the alimentary tract, hypoxia, respiratory insufficiency, nervous shock and so on. These terms are largely clinical, referring to abnormalities of normal physiological function, and their use requires a foreknowledge of normal physiology. It is at this point that the pre-clinical study of physiology merges into the clinical study of medicine.

The necessary familiarity with the normal, combined with observation of the case in hand, makes it possible to determine the physiological abnormality that may be, e.g. hypoxia. The next step is to determine the body system or body as a whole or organ involved in the production of the hypoxia.

##### Determination of the system or body as a whole or organ affected

Having made a careful physical examination and noted any abnormalities, it is

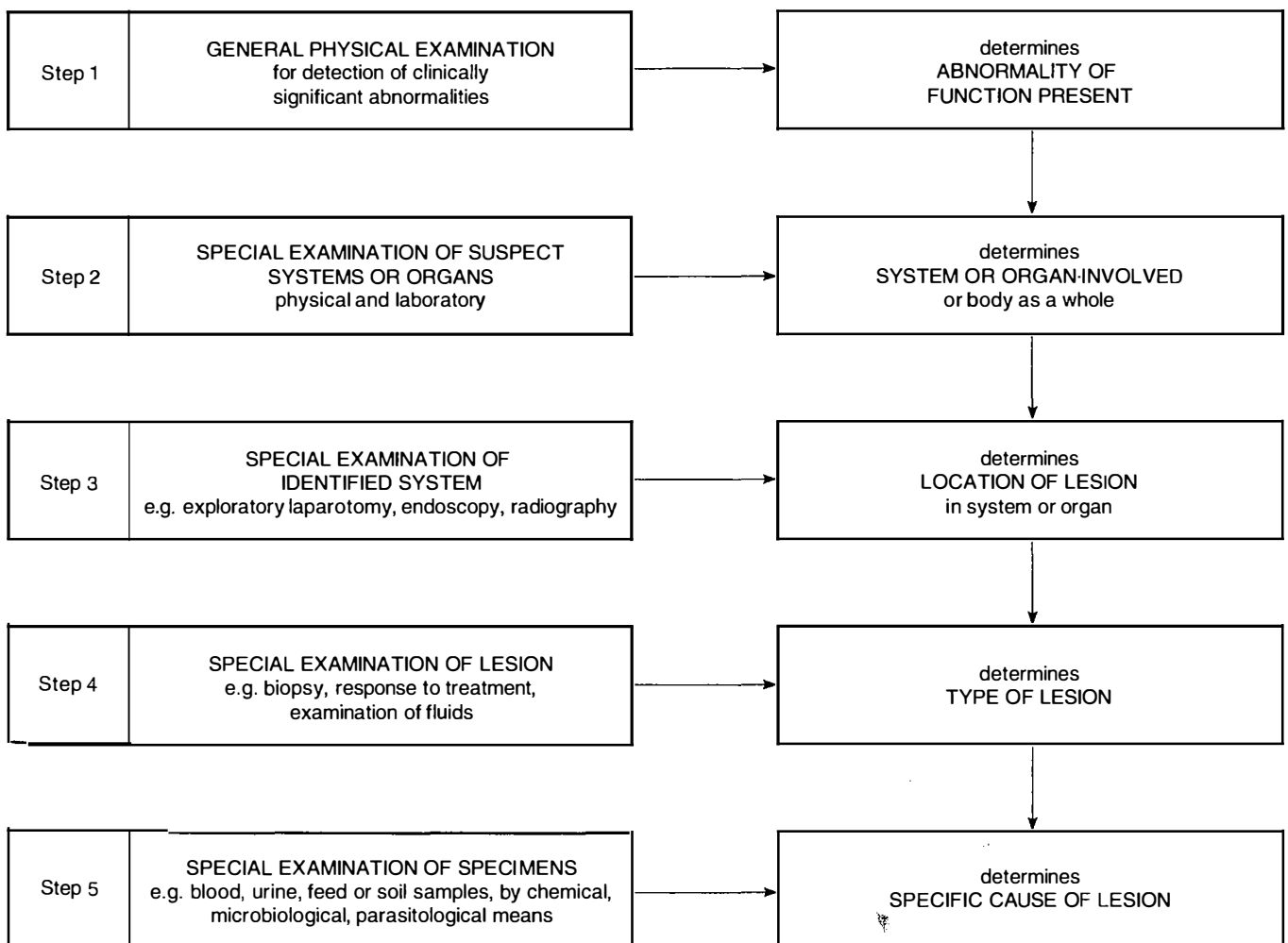

Fig. 1.1 Making a diagnosis.

then possible to consider which body system or organ is the cause of the abnormality. In some cases the body as a whole may be involved. This may not be difficult with some systems: for example, hypoxia may be due to failure of the respiratory or circulatory systems and examination of these is not difficult. However, special problems arise when attempting to examine the nervous system, the liver, kidney, endocrine glands, spleen and hemopoietic systems. Here, routine physical examination by palpation, auscultation and percussion is not very rewarding: special ancillary examination techniques with the aid of a laboratory are usually necessary. These are described under special examination methods for the various systems. As a guiding principle, all functions of the organ under examination should be observed and any abnormalities noted. For example, if the integrity of the central nervous system is to be examined, the clinician would look for abnormalities of mental state, gait, posture, muscle and sphincter tone and involuntary movements, abnormal posture and paralysis. Knowing the normal physiological functions of systems, one looks for aberrations of them.

When only simple physical examination is available it may be extremely difficult to choose between two or more systems as the possible location of the abnormality. For example, in an animal that is unable to rise from the recumbent position it may be difficult to decide whether the nervous system or the musculoskeletal system or generalized weakness from a systemic illness is the origin of the clinical recumbency. If special diagnostic techniques and laboratory evaluations are inconclusive or not available, it may be necessary to resort to probability as a guide. For example, paresis due to diseases of the muscles is most common in young calves, lambs and foals and generally uncommon in mature farm animals, with the exception of the myopathy associated with the downer cow syndrome in dairy cattle. However, paresis is common in mature cows affected with parturient hypocalcemia, peracute coliform mastitis and acute diffuse peritonitis.

#### **Determination of the location of the lesion within the system or organ affected**

The location of the lesion within the body system involved is not always obvious and may require special physical and laboratory examination techniques. For example, a detailed neurological examination may be necessary to localize the lesion in an animal with manifestation of disease of the nervous system. This may

be combined with radiographic techniques such as myelography. An exploratory laparotomy with or without biopsy techniques may be necessary to determine the location of an intestinal lesion thought to be the cause of chronic diarrhea. Endoscopy is rapidly becoming standard practice for the localization of lesions of the respiratory tract of the horse. Radiography is often necessary to localize lesions of the musculoskeletal system and diseases of the feet of horses and cattle.

#### **Determination of the type of lesion**

The abnormality observed may be produced by lesions of different types. In general, lesions can be divided into anatomical or physical lesions and functional disturbances. The physical lesions can be further subdivided into inflammatory, degenerative or space-occupying. These classifications are not mutually exclusive, as a lesion may be both inflammatory and space-occupying: abscesses in the spinal cord or lung are typical examples. In these circumstances it is necessary to modify the diagnosis and say that such and such a lesion is space-occupying and may or may not be inflammatory.

The differentiation between functional disturbances and physical lesions is often extremely difficult because the abnormalities produced may be identical. For example, in a case of hypomagnesemia in a cow there is no physical lesion but differentiation from the encephalitis of furious rabies may be impossible. As a rule, functional disturbances are transient, often recurrent or fluctuating and are readily reversible by treatment, whereas structural lesions cause changes that are relatively static or at least change slowly and are affected only gradually by treatment. This is by no means a regular rule: the acute abdominal pain of intestinal obstruction usually fluctuates but the lesion is a physical one, whereas the paralysis of parturient paresis in cattle is static but the disturbance is functional only.

Differentiation between inflammatory, degenerative and space-occupying lesions is usually simpler. The latter produce signs characteristic of pressure on surrounding organs and can often be detected by physical means. Inflammatory lesions are characterized by heat, pain, swelling and a local or general leukocytosis and, in severe cases, a systemic toxemia. A total white blood cell count and differential is a **sensitive** but **nonspecific** test for the presence of an infection. A leukopenia, neutropenia and a degenerative left shift suggests a severe infection. A neutrophilia and regenerative shift suggests an active chronic infection. The most common infections of cattle, which are often not

readily obvious, are in the thoracic and abdominal cavities (pleuritis, pulmonary abscesses, pericarditis and peritonitis). Degenerative lesions produce the same loss or abnormality of function as lesions of the other types but are not usually accompanied by evidence of inflammation unless they are extensive. If the lesion is accessible, biopsy should be considered as a means of determining its nature.

#### **Determination of the specific cause of the lesion**

If in the system involved, the nature of the abnormality and the type of lesion can be satisfactorily determined, it then remains to decide on the specific causative agent. If, for example, it could be said that a particular case of paralysis in a calf was caused by a degenerative lesion of the musculature, only a few specific etiological agents would have to be considered to make a final diagnosis. In many, if not most cases it is impossible to go beyond this stage without additional techniques of examination, particularly laboratory examinations, and it is a general practice to make a diagnosis without this confirmatory evidence because of limitations of time or facilities.

It is at this stage that a careful history-taking and examination of the environment show their real value. It is only by a detailed knowledge of specific disease entities, the conditions under which they occur, the epidemiology and the clinical characteristics of each disease that an informed judgment can be made with any degree of accuracy. If the diagnostic possibilities can be reduced to a small number, confirmation of the diagnosis by laboratory methods becomes so much easier because there are fewer examinations to be made and confirmation by response to treatment is easier to assess. If it is necessary to treat with a great many drugs serially or in combination to achieve a cure, the expense is greater and the satisfaction of both the client and the veterinarian is diluted in proportion to the range of treatments. Accuracy in diagnosis means increased efficiency, and this is the final criterion of veterinary practice.

#### **METHOD 5: THE DATABASE METHOD**

The basis of this method (also called the **Weed** or **problem-oriented method**), is to conduct a complete clinical and clinicopathological examination of the patient in order to acquire a comprehensive patient database. The problems (key signs) in this database are then matched with the diagnostic database, in which collections of signs or syndromes are labeled with diagnoses, to select the best fit with the patient's data.

This method also uses the **problem-oriented veterinary medical record**

**system**, which is an excellent system for the daily recording of clinical and laboratory data in an orderly, systematic and consistent manner that can be easily followed by clinicians and their colleagues. This system is now used widely by veterinary teaching hospitals. The system has four components based on the four phases of veterinary medical action:

- Database
- Problem list
- Initial plans
- Progress notes.

The progress notes are created daily and divided into four parts known collectively by the acronym SOAP to designate:

- S: subjective information
- O: objective data
- A: assessment of problem
- P: plans, which may include diagnostic, therapeutic or client education.

The method requires that clinicians be very painstaking in their examination and recording. It places great demands on the time spent by clinicians and clinical pathologists, on laboratory resources and on clinical record storage. Much of the data has no diagnostic significance because the diagnostic decisions are made largely on the presence or absence of relatively few key signs. It also has the disadvantage that there is a tendency to make the patient fit a category. It is the opposite of the **key abnormality** method, in which only the signs and other indicants relevant to the proposed diagnosis are sought and recorded. Because of its requirement of time and data recording and storage this method is not suitable for use in food animal medicine, where speed is a vital component of the diagnostic process. As mentioned earlier, however, it is an excellent system for the teaching of clinical veterinary medicine.

The method is really an expanded version of the hypothetico-deductive method, where the hypotheses are made sequentially as further information becomes available. In the database method all the hypotheses are pursued in parallel because all the possible data have been collected into the patient's database. The source of error in the method is the possibility of undue importance being attached to a chance abnormality in, say, the clinical biochemistry. If the abnormality cannot be matched to a clinical sign, it should be weighted downwards in value or marked for comment only. The same error may result from inclusion of a sign that is important, e.g. diarrhea, but that happens to be present at low intensity.

## INTERPRETATION OF LABORATORY DATA

### WHEN TO COLLECT LABORATORY DATA

Collection of a full history and performance of a purposeful physical examination are the most powerful tools available to the veterinarian in determining the nature of an animal's disease and its likely cause. However, laboratory data, including results of clinical, biochemical, hematologic, serologic, radiographic, electrocardiographic, ultrasonographic and other examinations, are often obtained from individual animals or groups of animals. The reasons for collecting laboratory data can be summarized as:

- To confirm the presence or cause of a disease
- To assess the severity of a disease
- To predict the clinical course of a disease or to determine a prognosis
- To estimate the likely response to therapy
- To determine the response to therapy or monitor progression of a disease
- To satisfy regulatory requirements
- To determine the disease or immune status of an animal, herd or flock.

Collection of laboratory data should not be viewed as a fishing expedition performed in the hope that 'something will turn up'. The decision to collect laboratory data should always be made with one or more of the above aims, with the intention that the data collected will answer a particular, clearly stated question. It is very easy, when faced with a sick animal with clinical signs that are not clearly diagnostic or indicative of the organ system involved, to request a 'serum biochemical profile' and complete blood count without having a clear idea of the usefulness of the information provided by the results of these tests. While the usefulness of these tests in most cases is very clear, the results of the tests are most informative when used to address a particular question, for instance: does the animal have evidence of kidney disease?

A test should never be performed unless one can anticipate all the likely results and provide a meaningful interpretation for each. Collecting laboratory data for the sake of running a test or as an act of diagnostic desperation is wasteful of resources and will not, in all likelihood, contribute to management of the animal or group of animals. It is more likely that the results of the test will be uninterpretable and will muddy the diagnostic picture.

### PROPERTIES OF DIAGNOSTIC TESTS

The following properties of a test, and of the population to which it is applied,

should be known before it is considered to be reliable:

- The test should be developed and validated in the population of interest. Tests developed in one population might not be valid in an animal from another population. For instance, tests developed for use in one species might not be reliable if used in another species
- You should know how accurate the test is in the situation in which you intend to use it
- The **specificity** of the test, i.e. the ability of a positive result of the test to rule in the disease of interest, should be known. While this is a property of the test that is usually independent of the prevalence of the disease in the population being tested, this might not always be the case
- The **sensitivity** of the test, i.e. the ability of a negative result of the test to rule out the disease of interest, should be known. While this is a property of the test that is usually independent of the prevalence of the disease in the population being tested, this might not always be the case
- The pre-test likelihood of the disease in the population should be known. This permits calculation of post-test odds of the animal having (**positive predictive value**) or not having (**negative predictive value**) the disease for which it is being tested
- The likelihood ratios of the various test results should be known for the population of animals being tested
- The reliability of the laboratory performing the test should be known. There should be considerable confidence in the quality control of the laboratory such that test results are repeatable and reliable
- Are the reference ranges (values in animals without the disease or condition of interest) known and with what certainty are they known? The meaning of an abnormal test result should be clear
- The test should allow you to rule in or rule out one of the differential diagnoses, in the instance in which a test is being used for diagnostic, as opposed to monitoring or other purposes
- All test results should be interpretable. In other words, all results should provide information that will be of use in diagnosis or monitoring.

### Utility

To be useful, a diagnostic test must be accurate. An accurate test reliably

differentiates between normal and diseased animals, thereby contributing to effective management of the animal or its disease. Inaccurate diagnostic tests provide unreliable data, which in the best scenario are useless and in the worst scenario cause mismanagement of the animal or its disease. The diagnostic accuracy of a test should be known before it is used extensively and a test of unknown diagnostic accuracy should be assumed to be inaccurate until proven otherwise.

The usefulness of a test to a veterinarian depends on a number of factors. Firstly, the test must be accurate, as discussed above. Secondly, it should be technically feasible and reliable, i.e. the test must be readily performed and its characteristics (listed above) must be known. A test that cannot be readily performed has minimal usefulness and unreliable tests are inaccurate. For testing of analytes, such as serum biochemical analysis or serology, it is important that the analysis yields results that are accurate and precise. Laboratory tests that are accurate yield results that are the same (or very close to) the true value of the variable being measured. Precise tests yield results that have very little variability around the expected value. Note that a test can be precise without being accurate, i.e. it has little variability but yields a value that is different from the actual value. Tests that are inaccurate or are highly variable (have poor precision) are not useful because the results are unreliable.

Thirdly, the test must have diagnostic utility in that the results of the test should enable the veterinarian to make a decision that will affect the subsequent management of the animal or its disease. If the results of the test will not alter the animal's management or treatment of its disease nor improve its production or prognosis, then the test has no diagnostic utility and should not be performed. The diagnostic utility depends on the characteristics of the test in the population of animals being tested. The important characteristics, which should be known before the test is widely used, are the sensitivity and specificity of the test and the likelihood ratios associated with the possible results, in the population in which it will be used. That a test has sensitivity and specificity implies that there is a range of values expected in normal animals, the so-called 'reference range'.

### Reference range (Interval)

An important aspect of evaluating laboratory data is to decide whether or not the result of a test is consistent with the animal being healthy or diseased. Healthy animals are assumed to have values

within a certain range, whereas diseased animals may have values that differ from that expected in a healthy animal. The range of values in healthy animals is often referred to as being the 'normal range' although, because of the statistical connotation of this term, 'reference range' or 'reference interval' is preferred.

The reference range represents the range of values of a test that are expected in a group of healthy animals. Animals with values outside the reference range are at increased risk of having the disease, compared to animals with values within the reference range. The actual increase in risk of being diseased depends on the way in which the reference range was determined, the sensitivity and specificity of the test and the prevalence of the disease in the population from which the animal was selected. Calculation of likelihood ratios, both positive and negative, is a useful means of quantitatively assessing the results of a test.

The reference range for a particular test is usually developed by collecting values from a large number of healthy or 'normal' animals and performing a statistical analysis of the values. For variables that have a range of possible values (e.g. serum urea nitrogen concentration), as opposed to being either present or absent (e.g. seropositive or seronegative for antibodies to a disease), the range of values in normal animals will have a characteristic spread. For the range of values of the variable in normal animals, an upper and a lower value are chosen that represent the upper and lower limits of the reference range. These values are usually chosen to include 95% of the values from normal animals, calculated as the mean value for the population of normal animals plus or minus 2 standard deviations, or as the 2.5–97.5 percentile range.

### Problems with reference ranges

There are problems with using the reference range of normal animals to diagnose diseased animals. Firstly, 5% of normal animals will have values for the test that are outside the reference range and may be incorrectly diagnosed as being diseased (**false positive**). Although a 5% false-positive rate is very low, the error is compounded when batteries of tests are run at the same time. This is a potentially serious problem when interpreting data from a serum biochemical profile analysis, in which 20 or more analytes may be measured simultaneously from one animal. The risk of the value of any one analyte being outside the normal range is only 5%, but when 20 analytes are measured simultaneously the chance of finding one analyte of the 20 with a

value outside the reference range is almost 66% ( $100(1-0.95^{20})$ ).

This problem can be mitigated in several ways. Firstly, serum biochemical profiles often contain more than one variable that is indicative of a particular disorder. If disease affecting a particular organ system is present, then there should be appropriate changes in all variables indicative of disease in this system. For instance, most serum biochemical profiles measure both serum creatinine and urea nitrogen concentrations. An elevation in the serum urea nitrogen concentration may be indicative of renal disease, but if the serum creatinine concentration is not also increased, then the likelihood of important renal dysfunction is much less than if both analytes were above the reference range. Secondly, disease may be associated only with marked increases in value of the variable such that unusually low values could be disregarded. For example, a serum creatinine concentration below the reference range is very unlikely to indicate the presence of renal disease, and a serum creatinine activity below the reference range has almost no diagnostic value. Thirdly, the extent to which the variable is outside the reference range should be considered. A small difference from the reference range is much less likely to indicate the presence of disease than is a much larger difference – calculation of likelihood ratios is one way of expressing this effect of variables that are markedly abnormal.

Another problem with using the reference range to detect disease is that not all diseased animals will have a value for the variable of interest that is outside the normal range. Some diseased animals will have values of useful variables that are within the reference range and these animals may be falsely diagnosed as not having the disease (**false negative**). This problem can be mitigated by reducing the size of the reference range, although this will increase the false-positive rate, or by measuring other variables that are also useful in detecting the suspected disease. For instance, an animal with liver disease may have a value of the serum activity of a hepatic enzyme that is within the reference range suggesting the lack of liver disease (a false-negative result). However, the same animal may have marked increases in serum bilirubin and bile acid concentrations, findings strongly suggestive of liver disease.

### Sensitivity and specificity

The sensitivity of a test is a measure of the test's ability to detect animals that are diseased and its numerical value represents the proportion of animals with

**Table 1.3** Method for determining sensitivity, specificity, likelihood ratio for positive and negative tests, positive predictive value and negative predictive value of a test

	True disease status	
	Disease present	Disease absent
Test positive	True positive (TP)	False positive (FP)
Test negative	False negative (FN)	True negative (TN)

$Sensitivity = (TP / (TP + FN)) \times 100$   
 $Specificity = (TN / (FP + TN)) \times 100$   
 $Likelihood\ ratio\ positive\ test = Sensitivity / (1 - Specificity)$   
 $Likelihood\ ratio\ negative\ test = Specificity / (1 - Sensitivity)$   
 $Positive\ predictive\ value = TP / (TP + FP)$   
 $Negative\ predictive\ value = TN / (TN + FN)$

the disease that are detected by the test (Table 1.3). A test with high sensitivity will detect most diseased animals within a population.

The specificity of a test is a measure of the test's ability to detect animals that are not diseased and its numerical value represents the proportion of normal animals detected by the test. A highly specific test will rule out the disease in most normal animals. Stated another way, a negative result for a test with high sensitivity effectively rules out the disease being tested for, whereas a positive test result for a test of high specificity effectively rules in the disease for which the animal is being tested.

Sensitivity and specificity are intrinsic properties of the test and their values are not influenced by the likelihood before the animal is tested that it has the disease for which it is being tested. The ability of a test to detect whether an animal has a particular disease depends on the likelihood that the animal has the disease at the time it is tested (the prevalence of disease in the population from which the animal being tested is drawn) as well as on the sensitivity and specificity of the test. The sensitivity and specificity can be combined to produce a single number, the likelihood ratio.

#### Likelihood ratio

The likelihood ratio is an overall measure of the efficiency of the diagnostic test, combining both sensitivity and specificity (Table 1.3) and permitting the calculation of post-test odds of the disease from the pre-test odds of disease. The likelihood ratio is a quality of the test and is not influenced in most instances by the prevalence of the disease in the population. The likelihood ratio is useful for quantifying the post-test odds of an animal having the disease. For instance, in hospitalized neonatal foals, a positive stall-side test for failure of transfer of passive immunity has a likelihood ratio of 4.86. A foal with pretest probability of having the disease of 50% that has a positive test (i.e. indicative of lack of passive immunity)

therefore has a post-test probability of having the disease of 81%.<sup>1</sup>

#### Positive and negative predictive value

The combined effects on the ability of the test to correctly detect diseased or healthy animals of (a) the prevalence of the disease and (b) the sensitivity and specificity of the test can be calculated and are called the positive predictive value (PPV) and negative predictive value (NPV) respectively. These are important values because they determine the usefulness of the test in detecting diseased, or normal, animals. The positive predictive value is the likelihood that a positive test is from an animal with the disease. The negative predictive value is the likelihood that a negative test is from an animal that does not have the disease.

Both the PPV and NPV are inextricably linked to the prevalence of the disease in the population being tested. Reports of the PPV and NPV are therefore only useful for populations of animals similar to those in which the values of these variables was determined, especially with regard to the prevalence of the disease in the population. The prevalence of the disease can also be viewed as the probability that an animal selected at random from the population has the disease – it is the pretest probability of disease in the animal. For a test of given sensitivity and specificity, the likelihood that a positive

test correctly predicts the presence of disease (the PPV) increases as the proportion of diseased animals in the population increases (the disease has higher prevalence). Conversely, the NPV increases as the prevalence of the disease decreases.

The effect of changes in prevalence on the PPV and NPV of two tests with differing sensitivities and specificities is illustrated in Table 1.4. The probability that either test will detect the presence of disease in an animal with a high pretest likelihood of having the disease is very high. Similarly, the probability that a negative result is indicative of the absence of disease in an animal from a population with very low prevalence of disease is also very high. Importantly, the ability of a very good test (sensitivity and specificity both 95%) to correctly predict the presence of disease in an animal with a positive test from a population with a low prevalence (1% of animals affected) of the disease is very poor. Applied to an individual animal, this means that even a very good test is likely to yield an incorrect result in an animal that is unlikely to have the disease.

Conversely, although the test result is very unlikely to be incorrect, a positive result in an animal with a very high pretest probability of having the disease yields little further information. The test result does not increase the likelihood of the animal having the disease by very much. The diagnostic test has its greatest utility when the pretest probability of disease is approximately 50% and the increase in PPV and NPV is much greater for a test with higher sensitivity and specificity.

The pre-test probability of disease, and thus the positive predictive value of the test, can be increased by selecting animals to be tested through careful physical examination and collection of an appropriate history. The PPV of a test in an animal that has signs of the disease being tested for is much higher than the PPV of a test in an animal without signs of the disease. Testing clinically normal animals

**Table 1.4** Effect of changes in prevalence (pretest probability of disease) on the positive predictive value (PPV) and negative predictive value (NPV) of tests with 95% sensitivity and specificity (Test A) and 60% sensitivity and specificity (Test B)

Prevalence or pretest probability of disease (%)	Test A PPV (%)	NPV (%)	Test B PPV (%)	NPV (%)
1	17	99	1	99
10	67	99	14	92
25	85	98	33	82
50	95	96	60	60
75	98	86	83	31
90	99	65	94	12
99	99	19	99	1



is more likely to yield false-positive than true-positive results and such indiscriminate testing is not wise.

## REVIEW LITERATURE

Sackett DL et al. *Clinical epidemiology. A basic science for clinical medicine.* Boston: Little, Brown & Co., 1991: 3–170

Cockcroft P, Holmes M. *Handbook of evidence-based veterinary medicine.* Oxford: Blackwell, 2003.

## REFERENCE

1. Metzger N et al. *J Vet Intern Med* 2006; 20:382.

## COMPUTER-ASSISTED DIAGNOSIS

In the 1980s there was considerable interest in computer-assisted diagnosis. The entry of the clinical and laboratory data from a patient into a computer program could yield a differential diagnosis list of diseases in order of highest to lowest probability. However, despite over 20 years of activity and interest in the use of computers for diagnosis, the impact of computer-assisted diagnosis in medical practice has been slight. Computerized programs have been useful in circumscribed areas such as the differential diagnosis of abdominal pain in humans and the diagnosis and treatment of meningitis. However, no program developed for use in a specific localized area of the body has been successfully adapted for generalized use. Theoretically, the computer could be expected to be useful to aid the clinician with the workup in order to make multiple and complex diagnoses.

Research on clinical decision-making has confirmed the importance of creating the list of differential diagnoses or diagnostic hypotheses. A clinician faced with a diagnostic problem must use clinical findings to develop a list of possible diagnoses. With a knowledge of the epidemiological and clinical characteristics of each disease, the veterinarian can confirm or exclude certain diagnostic possibilities. Diagnostic acumen depends on the ability to recognize the most important clinical abnormalities and to generate a list of differential diagnoses – a task that becomes more efficient with experience.

Specialists can generate many differential diagnoses in a narrow area of expertise, but the breadth of knowledge required in general practice makes it difficult for generalists to keep current on rare or unusual conditions. If a disease is not considered by the clinician faced with a presenting problem, it is frequently overlooked as a possibility and may not be 'stumbled-on' during the diagnostic process. This problem is complicated in veterinary education by the common practice of teaching according to disease entity. All the nosology of a disease is presented in a standard format but the

information must then be used in reverse order in clinical practice: the clinician generates a list of diseases based on the history and clinical findings. Textbooks that feature lists of differential diagnoses for animals with similar clinical findings assist in this task, but rapidly become outdated because of the many major and minor clinical findings that can be associated with a disease. The large storage capacity of computer databases and the ease of access to stored data makes the computer useful for handling this sort of information.

The success of a computer-assisted diagnosis will depend first on the clinician determining the important finding or **forceful feature** or **pivot** of the case, which can be useful in separating possible look-alike diseases. The second most important requirement is to know the propensity for a certain clinical finding to occur in a disease syndrome. The algorithm is the center of a computer-aided diagnostic system. Statistical algorithms calculate the most likely diagnosis from explicit statistical analysis of disease probabilities and the frequency of clinical findings in a particular disease.<sup>1</sup> A statistical algorithm is based on the Bayes theorem. The posterior probability that an animal has a given disease can be calculated if one has access to:

- The incidence (prior probability) of the disease
- The probability of a given clinical finding if the animal has the disease
- The probability of the same clinical finding occurring if the animal has the disease.

After receiving the data, the computer uses this theory to calculate the likelihood of various diseases. However, a major problem of a Bayesian system is the non-availability of an order of probabilities of the incidence of diseases and clinical findings associated with them. There is a need in veterinary medicine to generate comprehensive databases from which the probabilities of incidence and clinical finding for each disease can be determined from actual clinical practice.

In spite of these limitations, some progress is being made in the development of computer-assisted diagnosis in veterinary medicine. One computer-assisted diagnostic system for veterinary medicine was developed at the College of Veterinary Medicine, Cornell University, Ithaca, NY. The CONSULTANT program designed by M. E. White and J. Lewkowicz<sup>2</sup> is available on the Internet at: <http://www.vet.cornell.edu>. The Web version of the CONSULTANT program is based on the 1996 database. Direct access to the most current database of

CONSULTANT at the College is possible using dial-in or telnet.

The data bank contains a description of several thousand diseases of dogs, cats, horses, cattle, sheep, pigs and goats. For each disease, there is a short description, including information on diagnostic testing, a list of current references, and a list of the clinical findings that might be present in the disease. The clinician enters one or more of the clinical findings present in a patient. The computer supplies a list of the diseases in which that clinical finding or combination of clinical findings are present. The complete description can be retrieved for any disease in the list of differential diagnoses. The program is available by long-distance telephone and a modem. A major limitation of the program to date is that the list of differential diagnoses is not in order of probability from highest to lowest. This is because the program does not include the probability of incidence and clinical findings for each disease, information that, as mentioned earlier, is not yet available.

Experience with the Cornell CONSULTANT program has shown that computer-assisted diagnosis is not used in day-to-day management of routine cases but is used primarily when faced with an unusual problem, to provide assurance that a diagnosis was not overlooked. Computerized databases also offer a mechanism for the generalist to search through a complete list of differential diagnoses compiled from the recorded experience of many specialists and kept current as new information is published. Practitioners feel that having access to CONSULTANT is also a significant part of continuing education and a source of references. Experience with a computer-assisted diagnostic system has also confirmed the importance of an accurate history and an adequate clinical examination. If an important clinical finding is not detected, or not adequately recognized – for example, mistaking weakness of a limb for lameness due to musculoskeletal pain – the computer program will be ineffective. Disagreement between observers about the meaning of a clinical finding will also continue to be a problem as computer-assisted diagnosis becomes more widely used.

At the present time, the most important service the computer can provide in making a diagnosis is the generation of a hypothesis through the generation of a list of differential diagnoses, and access to further information. Computers will probably not be able to make a definitive etiological diagnosis but they are able to remind the user of diagnoses that should be considered and to suggest the collection



of additional data that might have diagnostic value.

## Prognosis and therapeutic decision-making

The dilemma of whether or not to administer a certain drug or perform a certain operation in an animal patient with or without an established diagnosis, or when the outcome is uncertain, is familiar to veterinarians. Owners of animals with a disease, or merely a minor lesion, expect to receive a reasonably accurate prediction of the outcome and the cost of treatment, but often considerable uncertainty exists about the presence or absence of a certain disease, or its severity, because confirmatory diagnostic information is not available.

The information required for a reasonably accurate prognosis includes:

- The expected morbidity and case fatality rates for the disease
- The stage of the disease
- Whether or not a specific treatment or surgical operation is available or possible
- The cost of the treatment.

If success is dependent on prolonged and intensive therapy, the high cost may be prohibitive to the owner, who then may select euthanasia of the animal as the optimal choice. Veterinarians have an obligation to keep their clients informed about all the possible outcomes and the treatment that is deemed necessary, and should not hesitate to make strong recommendations regarding the treatment or disposal of a case. There are also different levels of outcome, which may affect the prognosis and therapeutic decision-making. In the case of breeding animals, mere survival from a disease is insufficient and treatment is often not undertaken if it is unlikely that it will result in complete recovery and return to full breeding capacity. Slaughter for salvage may be the most economical choice. In other cases, e.g. a pleasure horse, the return of sufficient health to permit light work may satisfy the owner.

### DECISION ANALYSIS

Veterinarians must routinely make decisions that have economic consequences for the client and the veterinarian. Questions such as whether to vaccinate or not, whether to treat an animal or recommend slaughter for salvage value, whether or not to perform surgery, or even which surgical procedure to use to correct a case of left-side displacement of the abomasum, are com-

mon.<sup>3</sup> Many of these questions are complex, requiring several successive decisions, and each decision may have more than one outcome. Clinical decisions are not only unavoidable but also must be made under conditions of uncertainty. This uncertainty arises from several sources and include the following:

- Errors in clinical and laboratory data
- Ambiguity of clinical data and variations in interpretations
- Uncertainty about the relationships between clinical information and presence of disease
- Uncertainty about the effects and costs of treatment
- Uncertainty about the efficacy of control procedures such as vaccination or the medication of feed and water supplies in an attempt to control an infectious disease.

The process of selecting a management plan from a range of options involves a mental assessment of the available options and their probable outcomes. Decision analysis provides a framework for handling complex decisions so that they can be more objectively evaluated. Decision analysis is a systematic approach to decision-making under conditions of uncertainty. Because the technique can be so useful in sorting out complex questions associated with the treatment and control of disease in individual animals and in herds, it is almost certain to become more commonly used by large-animal practitioners.

Decision analysis involves identifying all available choices and the potential outcomes of each, and structuring a model of the decision, usually in the form of a decision tree. Such a tree consists figuratively of nodes, which describe choices and chances, and outcomes. The tree is used to represent the strategies available to the veterinarian and to calculate the likelihood that each outcome will occur if a particular strategy is employed. A probability value must be assigned to each possible outcome, and the sum of the probabilities assigned to the branches must equal 1.0. Objective estimates of these probabilities may be available from research studies or from a veterinarian's own personal records or it may be necessary to use subjective estimates. The monetary value associated with each possible outcome is then assigned, followed by calculation of the expected value at each node in the tree. At each decision node the value of the branch with the best expected value is chosen and that becomes the expected value for that node. The expected value establishes a basis for the decision. An example of a decision tree without probability values assigned is shown in Figure 1.2.<sup>4</sup>

In the decision tree, choices such as the decision to use intervention no. 1 or intervention no. 2 are represented by squares, called **decision nodes**. Chance events, such as favorable or unfavorable outcomes, are represented by circles called **chance nodes**. When several

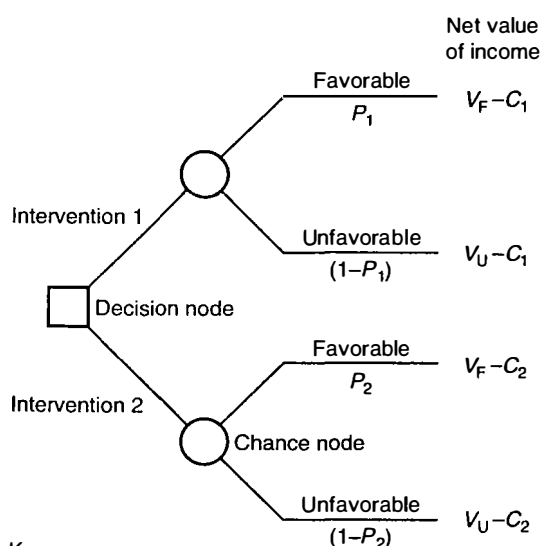

#### Key

- $P_1$  = Prognosis for a favorable outcome following intervention 1
- $P_2$  = Prognosis for a favorable outcome following intervention 2
- $V_F$  = Revenue obtained from a favorable outcome
- $V_U$  = Revenue obtained from an unfavorable outcome
- $C_1$  = Cost of intervention 1
- $C_2$  = Cost of intervention 2

Fig. 1.2 A decision tree for choosing between two interventions. (With permission from Fetrow J et al. J Am Vet Med Assoc 1985; 186:792-797.)

decisions are made in sequence, the decision nodes must be placed from left to right in the same order in which the decisions would have to be made, based on information available at that time. The tree may become very complicated, but the basic units of choice and chance events represented by squares and circles remain the same. Lines, or **branches**, follow each node and lead to the next event. The branches following each decision node must be exhaustive; for example, they must include all possible outcomes, and the outcomes must be mutually exclusive.<sup>3</sup> After each chance node there is a probability that an event occurs. The probabilities following a chance node must add up to 1.0. The probabilities are placed on the tree following the chance node. The expected outcomes ( $V_F$  and  $V_U$  in Fig. 1.2) are entered at the far right of the tree. The outcomes represent the value that would result if the events preceding them on the tree were to take place, and must include the costs of the intervention.

When a complete tree accurately representing the problem has been constructed, the next step is to solve it for the best decision to follow. This is done by starting at the right of the tree, where outcome values are multiplied by the probabilities of outcome at the preceding chance node. The figures derived from this procedure are added together to obtain the equivalent of a weighted average value at the chance node, known as the **expected value**, which by convention is circled with an oval. This procedure is repeated from right to left on the tree at each chance node. When a decision node is reached when moving from right to left, the most profitable path is chosen and a double bar is drawn across the branches leading to the lesser cost-effective decisions. When the first decision node at the left of the tree is reached, a single path will remain that leads from left to right and has not been blocked by double bars. This path represents the best way to handle the problem according to the available information, including the outcome at the end of that path.

An example of the construction and use of a decision tree to assist in deciding at what day postpartum an ovarian cyst should be treated, as opposed to waiting for spontaneous recovery, is illustrated in Figure 1.3.<sup>4</sup> In structuring the problem, over time, the clinician knows that the cyst can be treated or left to be treated later. Retreatment is possible if the first treatment is ineffective. The structure must include all alternatives. The other information needed to solve the problem includes:

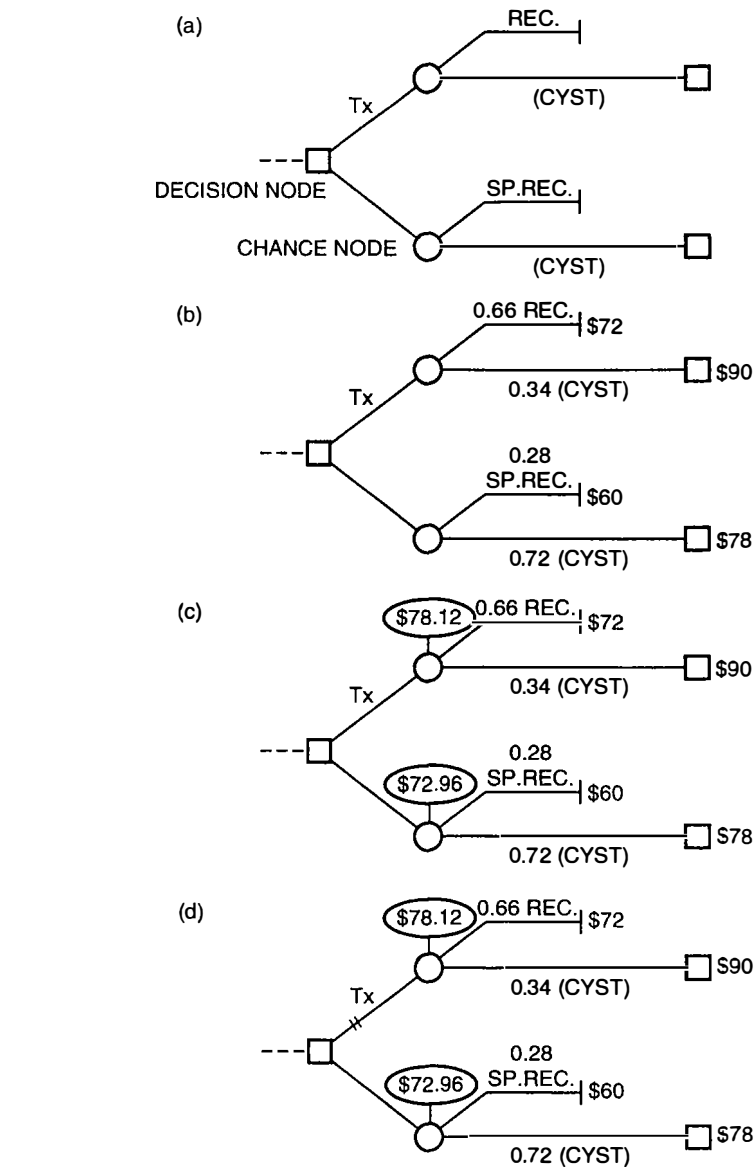

**Fig. 1.3** Example of the construction and use of a decision tree. The sources of probabilities and dollar values are discussed in the text. (a) The skeleton of the decision tree with a decision (treat Tx versus do not treat) and chance outcomes (recovery (REC) or spontaneous recovery (SPREC) versus continued cyst (CYST)). (b) Probabilities and previously calculated outcome values are placed on the tree. (c) Expected costs of decision alternatives have been calculated and written in balloons above the chance nodes. (d) At this decision node, the correct choice is no treatment because it is cheaper (\$72.96 v \$78.12). Double bars mark the pathway that is not chosen (treatment). The value \$72.96 is then the outcome cost for this decision node. The value is used in the calculation of the best alternative to the previous decision node, as the process is repeated from right to left (not shown). (With permission from White ME, Erb HN. *Comp Cont Educ Pract Vet* 1982; 4:5426-5430.)

- The incidence or chances of spontaneous recovery
- The response to treatment, both initially and following repeated treatments
- When the response occurs
- The cost of treatment and the cost of the disease.<sup>4</sup>

The critical factor in each tree is the probability value for each possible outcome. The monetary value of each outcome

can be estimated on a daily basis but, unless the probability of the outcome can be assessed as accurately as possible, the decision analysis will be unreliable. Decision analysis has been used to determine the cost-effectiveness of heat mount detectors, the time at which to treat bovine ovarian cysts, the effectiveness of three alternative approaches to the control of *Haemophilus meningoenephalitis* in feedlot cattle, the

economically optimal control strategy among several alternatives for the control of infection with *Brucella ovis* in a sheep flock<sup>5</sup> and the relative merits of testing or not testing calves entering a feedlot as predictors of performance in the feedlot. Decision analysis can now be done on microcomputers which makes the process highly suitable for assisting the veterinarian in daily decision-making.

The details of the steps used in decision analysis of several different problems in food-animal practice have been described and the reader is referred to the publications for further information.<sup>4</sup> There are some limitations to using decision analysis in animal health programs:<sup>6</sup> the technique requires time and effort, which practitioners are reluctant to provide unless the benefits are obvious. The estimates of the probabilities associated with the respective branches of the tree are seldom readily available.

A number of techniques that can be used to derive these probabilities and incorporate them in decision-making have been recorded. The rapidly developing use of analytical veterinary clinical epidemiology can now provide the tools to generate the numerical data necessary to make reliable decisions. There is a need to apply epidemiological principles to prospective clinical studies to determine the most effective therapy or the efficacy of control procedures for the commonly occurring economically important diseases of food-producing animals. The inputs and outputs of a given strategy may not have a market value, or the market value may not be an appropriate measure, or they may not be tangible or measurable in the usual monetary units. For example, the market value of a dairy cow may not represent the true or real value of the cow to the farmer. The farmer may consider the value of the cow in relation to cattle replacement determinants such as herd size, the availability of replacements and the genetic potential of the animal. The final selection of one option or the other is usually a complex process that will also vary from individual to individual depending on the decision criterion used.

In summary, decision analysis provides a systematic framework for making rational decisions about major questions in animal health and it is hoped that some veterinarians will adopt the technique for field use.

## REVIEW LITERATURE

Sackett DL et al. Clinical epidemiology. A basic science for clinical medicine. Boston: Little, Brown & Co., 1991: 3-170.

Wilson J. Physical examination. Vet Clin North Am Food Anim Pract 1992; 8:1-433.

Farver TB. Concepts of normality in clinical biochemistry. In: Kaneko JJ, Harvey JW, Bruss M (eds). Clinical biochemistry of domestic animals, 5th ed. San Diego, CA: Academic Press, 1997: 1-19.

## REFERENCES

1. Sackett DL et al. Clinical epidemiology. A basic science for clinical medicine. Toronto: Little, Brown & Co., 1985.
2. White ME. J Am Vet Med Assoc 1985; 187:475.
3. Fetrow J et al. J Am Vet Med Assoc 1985: 186:792.
4. White ME, Erb HN. Compend Contin Educ Pract Vet 1982; 4:S426.
5. Carpenter TE et al. J Am Vet Med Assoc 1987; 190:983.
6. Ngategize PK et al. PrevVet Med 1986; 4:187.

## Examination of the herd

The examination of the herd assumes importance where there are outbreaks of disease or problems of herd productivity due to subclinical disease. The purpose of a herd examination is to define the exact nature of the problem and to identify those dysfunctions within the herd environment that are associated with its occurrence. The ultimate objective in the examination of a herd is to establish strategies for the treatment, correction and control of the disease problem at the herd level. This may involve strategies to increase the resistance of the animals or strategies that change adverse factors in the herd environment.

There are a number of ways in which these objectives can be achieved and they are not mutually exclusive. The methods for examination of the herd include:

- Initial definition of the problem to be examined
- Clinical examination of individual animals in the herd
- Analysis of records of performance and disease
- Examinations of the environment of the herd
- Laboratory examination of animal; nutritional and environmental sampling
- Necropsy examinations of dead or sacrificed animals
- Descriptive and analytical epidemiological examinations.

Methods for correction of the problem include:

- Treatment of individual sick animals
- Selective or strategic prophylactic medication of the impacted group
- Immunoprophylaxis
- Alterations to the nutrition, the environment or the management of the herd or of selected groups within it.

One, or several, of these methodologies may be used in dealing with herd prob-

lems depending upon the nature of the disease under consideration.

Herd examinations can be expensive and in clinical settings the depth of investigation must be justified by the degree of economic importance of the problem. Some diseases are well defined, they are easily and definitively recognized by clinical or postmortem examination, their determinants are well established, and there are established effective methods for their control. In these instances a herd examination in a clinical setting would be limited to the initial examinations that establish the diagnosis and to the implementation of corrective strategies.

Other diseases are less well defined. There may be several determinants of their occurrence and consequently all facets of the examination methods may be needed to determine the most appropriate method for control. It is for this type of disease that **epidemiological investigations** are of particular importance and, where there is an economic justification, an in-depth epidemiological investigation should be considered in order to determine the appropriate method of intervention.

## APPROACH TO HERD EXAMINATION

The previous sections have discussed the approach to clinical examination of the individual animal and the methods for determining the presence of system dysfunction and of reaching a diagnosis as to cause. Basically, these consist of a physical examination to assess the function of each body system coupled with laboratory or other ancillary diagnostic methods and information that can assist in this assessment and in the establishment of cause. In the individual animal, disease is usually diagnosed and classified by the system involved and the inciting agent as, for example, pneumonia associated with *Histophilus somni*, myopathy caused by a deficiency of selenium. Subsequent treatment is based on this knowledge and usually consists of therapy directed against the cause and therapy aimed at correcting the system dysfunction.

The approach to the examination of the herd has a similar logical and systematic approach but it is obviously expanded beyond the examination of individual animals and involves different systems. It also involves different approaches to the cause of disease. Herd examinations are conducted because there is an outbreak of disease or a problem of production inefficiency. By definition this involves a group or a population of animals. Most outbreaks of disease and problems of production inefficiency in

groups of animals result from faults or dysfunctions in the complex of interactions that occur within groups of animals and between the groups of animals and their management, environment and nutrition. The characteristics of the group of animals that are affected thus become a focus of the examination and the management, environment and nutrition are the broad systems that are examined in relation to this group of animals. In the examination of the herd one is asking the following questions:

- What is the disease problem that is present?
- What are the characteristics of the animals that are involved?
- Why has this group of animals developed the disease?
- Why are they at increased risk in relation to others within the herd?
- What are the factors in their management, nutrition or other environment that have led to this increased risk?
- What intervention strategies can be used to correct the problem?

A major objective of the examination is to establish a diagnosis of cause. In particular, the objective is to establish a diagnosis of cause that can be altered by an intervention. The diagnosis of cause in a herd disease problem is often different from the diagnosis of cause established in the examination of an individual. Disease occurrence in groups of animals is often multifactorial in cause and the result of the interaction of several risk factors, which may be characteristics of the animals, their environment or of an inciting agent. In the context of the herd the cause or 'etiology' of a disease can be a management fault. In making a diagnosis of cause, the clinician establishes and ranks the major determinants of the problem from among the various risk factors.

#### Examples of multifactorial etiology of a disease

The examination of an individual animal that is representative of a group of young calves with respiratory disease may lead to a diagnosis of pneumonia associated with *Histophilus somni*. The diagnosis of the cause of the same problem following a herd examination that evaluates the numerous risk factors for pneumonia in calves might be:

- Inadequate ventilation in the calf house
- Failure of adequate passive transfer of colostral immunoglobulins
- Most probably, a combination of the above two, plus other additional factors.

In making a diagnosis of cause, the clinician establishes and ranks the major determinants of the problem from among the various risk factors.

With many diseases one progresses to an examination of cause in the herd using knowledge of recognized risk factors for the disease. These risk factors usually have a logical relation to the disease being examined, as with the example of calf pneumonia. With other diseases the logic of these relationships may be less apparent. This occurs particularly with newly developing or recently recognized diseases, where the pathogenesis of the disease is poorly understood but epidemiological examinations have established certain relationships that have a causal association. The definition of circumstances of occurrence for a disease can lead to a method of control even though the cause of the disease, in the traditional sense, is not known and the relationship between the inciting or associated circumstance and the disease is obscure. A current example would be the developing recognition of an association between dry cow nutrition in dairy cattle and metabolic and infectious diseases that occur early in lactation.

#### Example of the control of a disease without knowledge of its etiological cause

It is now known that facial eczema in sheep is a toxicosis from fungal toxins produced on pastures. However, long before the toxic nature of this disease was fully understood, the epidemiological circumstances of its occurrence were defined and it was prevented by removing sheep from pastures that had risk for the disease during predicted risk periods factors.

Problems of disease and production inefficiency encountered in herds can present a considerable challenge in diagnosis and correction. In part this is because disease in groups or herds is commonly multifactorial in cause and, for this reason, in an examination of the herd, all the factors that influence the behavior of a disease in that herd assume importance. The obvious approach is a quantitative definition of the disease and a quantitative examination of the relative importance of these risk factors. However, this approach can be difficult in practice.

In clinical settings there is usually no difficulty in achieving a quantitative definition of the animals affected and their characteristics. In large, well-recorded herds it is usually possible to conduct a quantitative examination of risk factors if

the records contain information that relates to them. In small herds, a quantitative examination of the relative importance of risk factors may be limited by low numbers of animals. Knowledge of risk factors and their relative importance in disease causation is improving with epidemiological research studies that involve large numbers of animals and several herds. The role of the clinician in the approach to a herd disease problem is to know and to be able to detect these established influences, to be able to quantify them where possible, and to be able to choose from among them those that are most subject to correction by intervention from both a practical and an economic standpoint.

#### EXAMINATION STEPS

There is no single protocol that can be used for the examination of the herd as this will depend both upon the type of disease problem and the type of herd. For example the methods of examination that would be used in the examination and definition of a problem of ill-thrift in a flock of weaned lambs would be different from those used for a problem of lameness in dairy cattle. Most herd investigations will follow certain broad principles and steps, and these are outlined in Figure 1.4. A given herd examination would not necessarily follow all the steps in this illustration nor would it necessarily proceed in the exact order given. However, the general principles apply to most investigations.

#### Step 1: Defining the abnormality

It is essential first to define the abnormality in either clinical or subclinical terms. This definition must be accurate, as this step of the examination determines the focus of the examination and the types of cases that will be included in the examination and analytical procedures. A **case** is defined as an animal or a group of animals that have the characteristics of the disease or a defined deviation from targets of production. With some investigations the problem will have obvious clinical manifestations and the primary definition of cases will be made by clinical examination of affected individuals. With others the primary complaint may be lowered production in the absence of clinical disease. An apparent problem in production efficiency can be focused by the examination of records. In many herds this will prove to be an immediate major limitation to the investigation because of a lack of sufficient records on reproduction, production and associated management to define the complaint. In these circumstances the criteria of the production inefficiency that will be

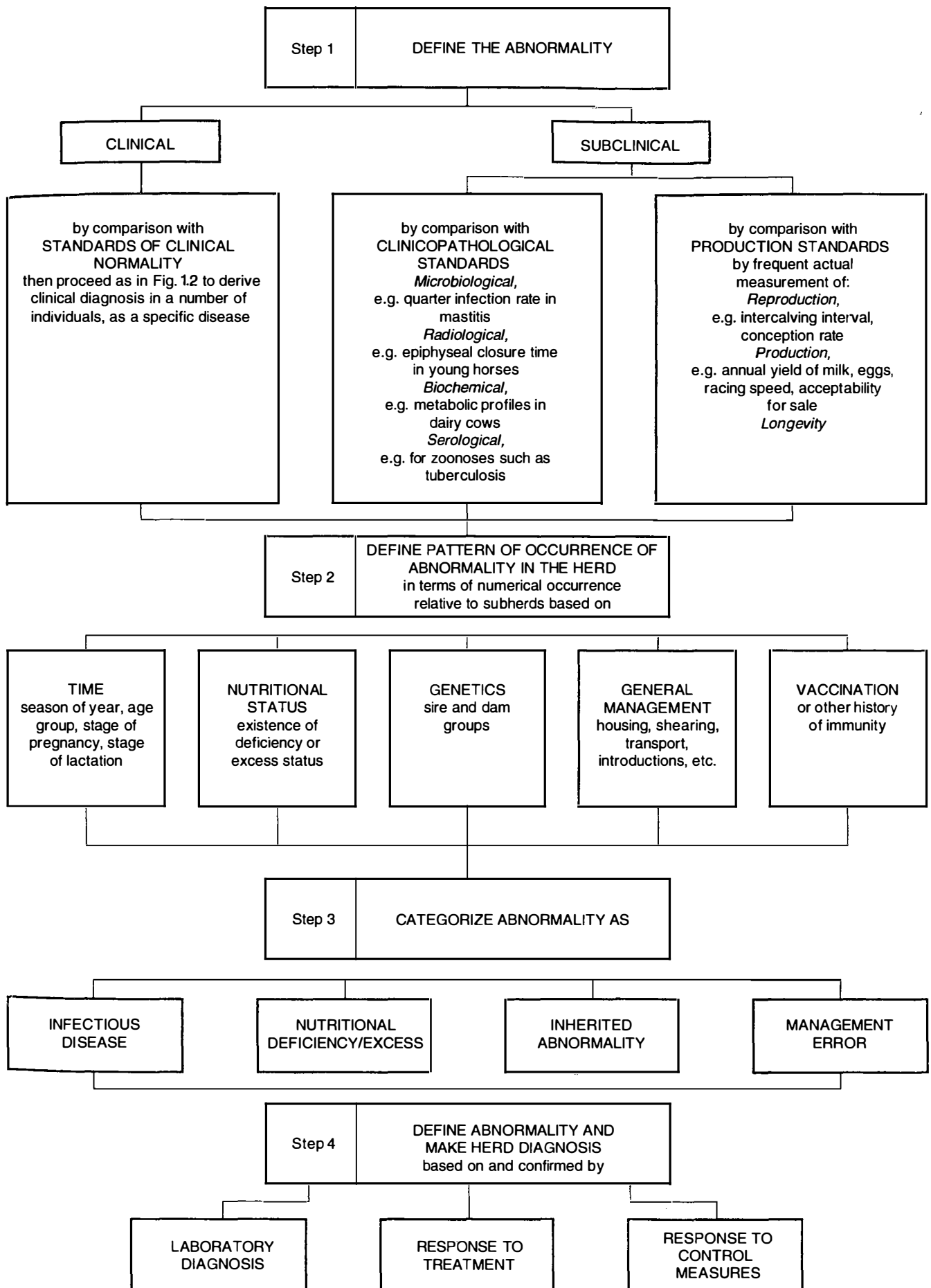

Fig. 1.4 Examination of the herd with the objective of making a diagnosis.

considered in the examination will need to be determined and some form of measurement established.

### Step 2: Defining the pattern of occurrence and risk factors

This step of the examination is often conducted in conjunction with step 1 above. It has the purpose of defining the characteristics of the animals that are affected in the disease problem and that have been established as cases, and of determining differences between them, as individuals or as a group, and the non-affected animals within the herd. These differences may be attributes of the animals themselves or of environmental influences that affect them.

The initial examination is usually directed towards the determination of the characteristics of the animals involved and the **temporal** (when) and **spatial** (where) patterns of the disease. In general, the information that allows these examinations is collected at the same time and consists of such factors as:

- A listing of the cases that have occurred
- The date when disease was first observed in each case
- The age, breed and other individual information for each case, which may include such information as source, family association, vaccination history, previous medication
- Management group membership, which may be pen membership, milking string, pastoral group, etc.
- Type of ration and nutritional data
- Management and other environmental information that is relevant to the problem.

In order to compute **risk group analysis** the number of animals present in both sick and well groupings must be recorded, as must be any similarities and differences in their management and environment. After the identity of the abnormality has been established, all the available clinical, production and laboratory data are examined according to the affected sub-groups in the herd and according to time occurrence, management differences, nutritional and environmental influences and factors such as vaccination history.

In most herd examinations the analysis of these data is restricted to a cross-sectional study. Prevalence rates within the various groups are calculated and the population at risk can be determined. Animals or groups can be examined as those with and without disease and those with and without hypothesized risk factors, using a  $2 \times 2$  contingency table generated for each variable. Relative risk, odds ratios or rate ratios can be calculated

as a measure of association of the variable with chi-square and Mantel-Haenszel procedures used for evaluation of the significance of the risk. This attempts to determine if any associations exist between certain groups of animals and those factors that can influence the behavior of disease.

In some herds, where there has been extensive historical recording, it may be possible to examine the nature of the problem on the basis of a case-control study. However, in most herds this will not be possible because of the paucity of recording of factors of importance to the definition of the disease problem. With problems that are of obvious continuing importance to the economic viability of the herd it may be necessary to establish recording systems that allow a prospective examination of the problem.

#### Temporal pattern

The temporal pattern of distribution of a disease in a population can be of importance in suggesting the type of disease that is occurring and its possible causes. Temporal recording and graphing of cases is of value in indicating possible portals of entry of an infectious agent or sources of a toxic influence. For this analysis the temporal occurrence of the disease is determined by the collection and graphing of the time of onset of clinical cases (hours, days, weeks) and by relating this information to management or environmental changes.

Generally two types of epidemic curve are graphed. A **point source** epidemic curve is characterized by a rapid increase in the number of cases over a short period of time. This type of epidemic curve occurs when all the animals in a population are exposed at the one time to a common agent. Generally this will be a poison or a highly infectious agent, with many animals becoming affected at approximately the same time and, depending on the variation in the incubation period, a sharply rising or a bell-shaped curve of short time duration. The graphing of a sporadic outbreak suggests the occasional introduction of a disease agent into a susceptible population or the sporadic occurrence of factors suitable to the clinical manifestation of an endemic agent, as opposed to the relatively continual occurrence of an endemic disease.

When the infection has to be transferred from animal to animal after undergoing multiplication in each, delay results and the epidemic curve develops a flatter bell-shaped occurrence of much longer duration and with varying peaks depending upon temporal differences in, and opportunities for, transmission. This is known as a **propagative** epidemic.

Whereas the occurrence and identification of an index case has considerable value in epidemiological examinations of this nature, it commonly cannot be identified in veterinary clinical settings.

#### Spatial examination

The spatial examination of a disease problem requires the gathering of information on affected and nonaffected animals in relation to areas of the housing environment, or pastures, or animal movements. A cluster of cases associated with a specific area may indicate the source of the problem. This is best analyzed by plotting the frequency of cases on maps of the environment that include possible risk factors such as pen locations within buildings, buildings themselves, water sources, pastures, rubbish dumps, roads, implement storage areas, etc. When spatial associations are established, further detailed examination of the location is indicated.

### Step 3: Defining the etiological group

Following characterization of the abnormality according to groups within the herd, and having made comparisons of the prevalence rates between groups, it may be possible to discern to which etiological category the abnormality most logically belongs. In many instances considerable difficulty may be encountered in deciding in which of the general areas of etiology the major determinant is located. In so many cases herd problems are not the result of a single error but are multifactorial, with several determinants contributing to a greater or lesser degree, and the problem may fall in several categories.

An example might be a problem of mortality in calves where examinations have determined that population mortality rates are highest in the winter period, that most mortality occurs between 4 days and 1 month of age, that calves that die early in this period have septicemia, or have scours associated with rotavirus and cryptosporidial infections, that the body condition scores of the calves fall during the third and fourth weeks of life and that calves that die later in the time period appear to die of starvation. Probable causes include improper feeding of colostrum, a poor environment leading to a high infection pressure and possibly also to excess cold exposure, malnutrition resulting either from the residual effects of enteric disease on intestinal absorption of nutrients or from an inadequate caloric intake or both. This complex could be placed in the categories of infectious disease, nutritional disease and also in the category of management error; further definition is the next step.

The use of **path models** that summarize current knowledge of the causality of the disease under consideration can help in this aspect of the herd examination. Path models specific to the problem at hand can be constructed and can show the interrelationships between various risk factors and give some indication of the dependence of any one factor on the occurrence of another. This information can be used to estimate the relative contributions of the various etiological categories and to give guidance as to the area where intervention is most likely to be effective.

#### Step 4: Defining the specific etiology

The final step is to select the probable most important determinant or combination of determinants from within one or more of the general areas and to make corrective interventions based on this diagnosis. In many instances the primary cause may be clear and the correction, be it alterations in nutrition, alterations in management, vaccination, etc., can be made at this stage. In other cases further prospective examinations may be conducted for a better definition before an intervention is attempted. In the example above, failure of passive transfer of colostrum immunoglobulins and inadequate caloric intake would have been suspect or even identified as underlying determinants of the problem. However, with most farm recording systems there is likely to be no available data that would help delineate the specific reasons, and the specific management deficiencies that require correction, and so a prospective study to establish these would need to be established.

It can be very difficult to obtain a clearly defined diagnosis of cause of disease in a herd, because of its complexity, but the known important relationships are given for the individual diseases in the special medicine section. Methods for practical clinical quantitative assessment of the level of management expertise or, more importantly, the intensity with which it is applied, are not available. Consequently this must be assessed qualitatively for most management practices. Surrogates such as the percentage of cows presented for pregnancy diagnosis but not pregnant, bulk tank somatic count, rates of failure of passive transfer of colostrum immunoglobulins, etc., can give some indication.

#### TECHNIQUES IN EXAMINATION OF THE HERD OR FLOCK

Set out below are some of the techniques used in examining a group or herd of animals. Any one or combination of the techniques may be used at the one time,

depending on the nature of the problem, the availability of support facilities such as diagnostic laboratories and data analysis laboratories, and their cost.

#### CLINICAL EXAMINATION

A clinical examination is essential if clinical illness is a feature of the disease; a representative sample of animals should be examined. The importance of this component of the examination cannot be overemphasized. Where there is clinical disease an accurate definition by clinical examination may lead to a diagnosis of a disease with known and specific determinants and further examination of the herd can focus specifically on these factors. Where clinical examination does not lead to a finite definition of the cause of the disease but gives a diagnosis of a disease of multifactorial determinants, the examination will still lead to the identification of risk factors that need to be included in the herd examination.

Recording the findings is important and is greatly assisted by a structured report form so that the same clinical features are recorded for each animal. Commonly, clinically affected animals are enrolled as cases in an investigation on the basis of the presence of certain defined signs or clinical abnormalities and a recording form aids in this selection. This is especially important where several veterinarians in a practice may be involved in the herd examination over time.

Selection of the animals to be examined is vital. This should not be left to the farmer because that selection may be biased to include the sickest, the thinnest and the oldest, and not necessarily the animals that are representative of the disease under examination. This is particularly important if a group of animals is to be brought from the farm to a central site for detailed clinical examination as part of the workup of the problem. Strict instructions should be given to the owner to select 10–12 animals as a minimum. The groups should include eight sick animals, if possible four advanced and four early cases, and four normal animals as controls. If the situation permits it, the inclusion of animals that can be sacrificed for necropsy examination is an advantage. Ideally, unless facilities will not allow it, the clinical examinations should be on the farm and the veterinarian should select the animals for examination.

In outbreaks of disease where there is mortality, necropsy examination and associated sampling is an extremely valuable investigative and diagnostic tool. Necropsy examination should not be ignored as the primary method of establishing a diagnosis of problems of

disease or production inefficiency in larger herds and flocks. With many diseases in swine herds and larger sheep flocks the costs associated with the sacrifice of a few animals for this purpose are by far outweighed by the benefits of an early and accurate diagnosis and the ability to intervene quickly with corrective strategies. Even in cattle herds, owners are willing to sacrifice affected cattle if by so doing they can facilitate a more accurate definition of their problem. It must also be recognized that some diseases cannot be accurately defined on the basis of their clinical manifestation and epidemiology and a necropsy is required as part of the examination system.

#### SAMPLING AND LABORATORY TESTING

Laboratory examination is conducted for a number of legitimate reasons. It may be conducted to aid in the establishment of a diagnosis or it may be conducted following the establishment of a diagnosis to aid in the definition of risk factors or in the evaluation or the efficacy of treatment and control strategies.

The validity of laboratory testing in the investigation of disease is only as good as the quality and relevance of the samples that are submitted. The samples submitted must be appropriate to the question that is being asked of them. Frequently samples that can be most conveniently obtained are not the best for this purpose and a **sampling strategy** specifically directed to the question may need to be established.

Laboratory analysis of samples is expensive and should not be undertaken unless there is a specific objective. Before submitting samples for examination the following questions should be asked:

- Is the sampling strategy structured to answer specific questions or is it a random 'fishing expedition'?
- Have you established a sampling strategy that will allow a comparison of animals in your 'at risk' category with those believed not at risk for the disease or the exposure factor?
- Is there a 'gold standard' for the analysis and its interpretation?
- What information will be gained from the results of the laboratory examination that could not be gained by other examinations or logically inferred without these examinations?
- What are the specific steps to be taken that depend upon the results of these examinations, or will the steps be taken regardless of the results?

This type of questioning of sampling for laboratory examination may limit it to situations where it is cost-effective.

Laboratory examination of samples taken in association with clinical examination is usually conducted to help establish the presence and severity of organ dysfunction – which generally cannot establish cause. The value and use of laboratory examinations in the assessment of organ function is discussed in the sections in this text that deal with system diseases. Similarly the nature and value of sampling to establish the etiological association of toxic or infectious agents with disease is discussed under specific disease headings.

Laboratory testing can also be conducted to determine risk and exposure factors. When used for this purpose the sampling strategy must be directed and should be conducted after the preliminary diagnosis has been made. It must be aimed at answering the specific questions above, otherwise it will be inordinately expensive. An example would be the examination of specific feeds that have been implicated as potential sources for a toxin following the epidemiological examination and risk factor analysis in a herd where a specific toxicity was established as the cause of mortality. Without this prior epidemiological examination a mass sampling of the herd and its environment for the presence of the toxin would be extremely expensive and of limited value.

At the time of the initial farm visit, it is advisable to collect samples that are pertinent to the problem and its differential diagnosis but are not of primary analytical significance in the initial definition of the problem. These can be stored and, depending upon the results of initial laboratory examinations, may be discarded or used to further define the problem. Duplicates of some samples with storage is often desirable so that second thoughts on tests can be accommodated. This is particularly important in serological work where the hindsight may be at a long time interval and a serum bank is most profitable when one is attempting a retrospective examination of prevalence.

In many outbreaks it is usually wise to collect samples from 'controls' that are established specifically to evaluate the problem under investigation. These may be clinically normal animals that have not experienced the suspect exposure factor, animals that are clinically normal but that have been exposed and are possibly in an incubation or subclinical stage, and from a third group of clinically affected animals. This system approximates the protocol for the Compton Metabolic Profile, which is described in detail in Chapter 28.

The other consideration is the number of animals to be included in each

sampling group. The sample size required for the detection of an attribute varies with the confidence of detection that is desired, with the size of the population and the prevalence or frequency of the attribute in that population. Obviously there can be no set recommendation even for one disease. For example, the sample size required to confirm a diagnosis of copper deficiency in a group of animals with overt clinical deficiency disease will be much smaller than that which is required to establish a developing deficiency state or the risk for clinical disease in the face of deficient intakes on pasture. Unfortunately, cost severely limits the size of the sample that can be tested in most circumstances and the small size that is common can place severe restrictions on any meaningful interpretation. The commonly recommended 10 animals or 10% of the group would appear to have little validity in most examinations.

#### Numerical assessment of performance

Productivity indexes can be used as indicators of health; they can also be used to measure response to treatment or control measures. More and more they are being used as guides to husbandry and management questions to meet the present-day farmer's concerns with costs and returns. If recording systems are present on the farm they can be invaluable data sources in the investigation of herd problems with disease. Monitors of production efficiency are used extensively in performance or production management veterinary practice and are detailed in texts on that subject in the reference literature section.

#### Intervention strategies and response trials

As the result of a herd examination, a clinician formulates a hypothesis concerning the disease. This may include hypotheses on the population of animals at risk, the determinants of the disease, the source of the problem and its methods of transmission or propagation. There may be sufficient confidence in these hypotheses that they may result in **intervention strategies** to correct the problem without further analysis. In other outbreaks the hypotheses may be less secure and may require further examination of response trials.

**Response trials** are often used in an approach to herd disease problems and problems of production inefficiency. They have several purposes: they may be used to establish or confirm a diagnosis, and when used for this purpose it is usually because of the difficulty in confirming the diagnosis by other methods. This may result from the lack of a suitable labor-

atory test or because the result of the test is supportive for the diagnosis but not confirmatory. Response trials can also be used to determine the degree of intervention that is required and the efficacy of the level of intervention that has been used.

#### Example of reason for response trials

The finding of hypocupremia in a group of poorly growing calves would support a diagnosis of growth retardation due to copper deficiency but does not confirm it, as calves with normal growth can also be hypocupremic. The only way to confirm the association and the diagnosis is to conduct a response trial with copper treatment as the variable.

#### An example of monitoring efficacy of interventions

Response trials can be used to determine the degree of intervention that is required and the efficacy of the level of intervention that has been used. Copper deficiency in grazing calves may occur as a simple deficiency or as a conditioned deficiency. Simple copper deficiency can usually be prevented by a single subcutaneous treatment of copper glycinate and this may protect for several months. On the other hand, a conditioned copper deficiency may require treatment every 4–6 weeks.

Some prediction as to the required treatment frequency can be made by pasture element analysis but a response trial with 6-week-interval monitoring of blood copper concentrations and weight gain can monitor the efficacy of the treatment that has been decided upon and also allow a corrective intervention, if indicated. In the absence of a treatment response trial, a nonresponse due to an incorrect decision on treatment frequency could result in the discarding of the correct diagnosis.

There are many limitations to conducting response trials in clinical situations in private herds and their structure may not always meet the strict requirements of those conducted in research. It is not always possible to establish a controlled response trial in clinical practice but the efficacy of intervention strategies should still be monitored. The ultimate interest is in whether the disease or production problem is corrected; however, the efficacy of the individual strategies should be specifically monitored where possible. In the earlier example of calf mortality a decision might have been made to change the method of feeding colostrum and to improve the caloric intake of the calves. There can be various ways that either of these changes could be achieved. The overall efficacy of these changes will be



determined by improved survival of the calves. However, the efficacy of the colostrum management change in improving passive transfer should be determined specifically by measurements of serum immunoglobulin concentrations in the serum of a proportion of calves and the efficacy of caloric improvement by weight measurements. Should calf mortality drop, these latter measures are of limited value but if it does not, then there are measures of whether the failure was due to misdiagnosis of the problem or due to poor efficacy of the suggested corrective strategies in correcting their respective target areas.

A diagnosis made on the basis of a response trial is often presumptive and it has become customary to couch the diagnosis in terms of response to a treatment, for instance, 'selenium-responsive infertility' in sheep. This is not a diagnosis in terms of satisfying the original concepts of Koch's postulates, although it does satisfy the subsequent modifications of these postulates that are now generally accepted and have been based on a broader interpretation of disease causation. In populations of animals, diseases are largely the result of a number of interacting factors of different genres, including management, nutrition and environmental factors, interacting with traditional agent-causes of disease, including microbiological and toxic agents. The answer for the practical problem may be most economically derived by finding

the cure rather than the cause. This is especially desirable if that course is cost-effective and finding the cause is more expensive than the wastage caused by the disease.

A simple example would be mortality in a group of cattle that followed a change of feed to a more concentrated ration. An epidemiological examination, including a temporal examination of cause or determinants, might closely link the mortality to the change in ration. This should be sufficient to indicate that the ration should be withdrawn or its method of feeding modified. The alternative approach would be to defer any decision for correction of the problem until the exact problem with the ration was established. This could involve a ration analysis and an examination for unknown toxic components. These examinations would take considerable time, would involve considerable costs, and could well give no additional information that would modify the immediate initial intervention strategy.

#### **The role of the planned animal health and production program**

Properly conducted herd health programs and planned animal health and production programs maintain accurate records on all matters of production and health. These are maintained against a background of epidemiological data, including number of animals in the herd, numbers of animals in the reproductive cycle segment group or age group that are

therefore at risk. In many instances all the data required to effectively diagnose a disease or monitor its prevalence are already at hand in the records of these herds. It does put the veterinarian and the farmer in the position of almost being able to do a herd examination simply by consulting the records. This approach is detailed in texts on herd health and production medicine.

#### **REVIEW LITERATURE**

- Kahrs RF. Techniques for investigating outbreaks of livestock disease. *J Am Vet Med Assoc* 1978; 73: 101-103.
- Blood DC. The clinical examination of cattle. Part 2: Examination of the herd. In: Proceedings of the 14th Annual Convention of the AABP, 1981: 14-21.
- Cannon AR, Roe RT. Livestock disease surveys. A field manual for veterinarians. Canberra: Australian Government Publishing Co., 1982.
- Dohoo IR, Waltner-Toews D. Observational studies and interpretation of results. *Comp Cont Educ Pract Vet* 1985; 7:S605-S613.
- Thrushfield MV, Aitken CGG. An introduction to veterinary observational studies. Edinburgh: University of Edinburgh Press, 1985: 35.
- Thrushfield MV. Veterinary epidemiology. London: Butterworths, 1986: 165.
- Martin SW, Meek AH, Welleberg P. Veterinary epidemiology. principles and methods. Ames, IA: Iowa State University Press, 1987: 343.
- Lessard PR, Pery BD. Investigation of disease outbreaks and impaired productivity. *Vet Clin North Am, Food Anim Pract* 1988; 4:1-212.
- Smith RD. Veterinary clinical epidemiology. A problem oriented approach. Boston, MA: Butterworth-Heinemann, 1991: 234.
- Radostits OM. Herd health. Food animal production medicine, 3rd ed. Philadelphia, PA: WB Saunders, 2001.

## General systemic states

**HYPOTHERMIA, HYPERTHERMIA, FEVER 39**

- Body temperature 39
- Hypothermia 40
- Hyperthermia (heat stroke or heat exhaustion) 47
- Fever (pyrexia) 49

**SEPTICEMIA/VIREMIA 51****TOXEMIA AND ENDOTOXEMIA 53****TOXEMIA IN THE RECENTLY CALVED COW 60**

- Postpartum septic metritis in cattle 60

**HYPOVOLEMIC, HEMORRHAGIC, MALDISTRIBUTIVE AND OBSTRUCTIVE SHOCK 63****ALLERGY AND ANAPHYLAXIS 69**

- Anaphylaxis and anaphylactic shock 69
- Other hypersensitivity reactions 71

**EDEMA 72****DISTURBANCES OF FREE WATER, ELECTROLYTES AND ACID-BASE BALANCE 73**

- Dehydration 74
- Acute overhydration (water intoxication) 76
- Electrolyte imbalances 76
- Acid-base imbalance 82
- Acidemia 84
- Alkalemia 86
- Naturally occurring combined abnormalities of free water, electrolyte and acid-base balance 87

**PAIN 102****STRESS 107****LOCALIZED INFECTIONS 110****DISTURBANCES OF APPETITE, FOOD INTAKE AND NUTRITIONAL STATUS 112**

- Polyphagia 112
- Anophagia or aphagia 112
- Pica or allotriophagia 112

- Starvation 113
- Inanition (malnutrition) 113
- Thirst 114

**WEIGHT LOSS OR FAILURE TO GAIN WEIGHT (ILL-THRIFT) 115****SHORTFALLS IN PERFORMANCE 116****PHYSICAL EXERCISE AND ASSOCIATED DISORDERS 117**

- Poor racing performance and exercise intolerance in horses 118
- Exercise-associated diseases 119

**DIAGNOSIS AND CARE OF RECUMBENT ADULT HORSES 120****SUDDEN OR UNEXPECTED DEATH 124**

- Sudden or unexpected death in single animals 124
- Sudden death in horses 124
- Sudden or unexpected death in a group of animals 124
- Procedure for investigation of sudden death 124

There are several general systemic states that contribute to the effects of many diseases. Because the systemic alterations are common to many diseases they are considered here as a group in order to avoid unnecessary repetition. Hyperthermia, fever, septicemia and toxemia are closely related in their effects on the body, and an appreciation of them is necessary if they are not to be overlooked in the efforts to eliminate the causative agent. Likewise, hypovolemic, hemorrhagic, maldistributive, obstructive and anaphylactic shock are best examined together. This chapter will also present the disturbances of free water, electrolytes and acid-base balance, and briefly introduce pain and stress as it relates to disease. Syndromes of poor performance, decreased appetite and sudden and unexpected death are also covered.

**Hypothermia, hyperthermia, fever**

Hypothermia, hyperthermia and fever – characterized by significant changes in body temperature – are presented here together, along with an introduction to thermoregulation mechanisms of the body.

**BODY TEMPERATURE**

Farm animals maintain a relatively constant body core temperature, **homeothermy**,

during extreme ranges of thermal environments. This **homeothermic** state is achieved by physiological and behavioral mechanisms that modify either rates of heat loss from the body or the rate at which heat is produced by metabolism of feed or body energy reserves. For the body temperature to remain constant in changing thermal environments, the rate of heat loss must equal the rate of heat gain. The body temperature is a reflection of the balance between **heat gain** from the environment (radiation, conduction, convection) or due to metabolic activity (maintenance, exercise, growth, lactation, gestation, feeding) and **heat loss** to the environment (radiation, conduction, convection, evaporation) or due to metabolic activity (milk removal, fecal elimination, urinary elimination). Absorption of heat from the environment occurs when the external temperature rises above that of the body.

**HEAT PRODUCTION**

Heat production occurs as a result of metabolic activity and the digestion of feed, muscular movement and the maintenance of muscle tone. **Shivering thermogenesis** is a response to sudden exposure to cold and is a major contributor to enhanced heat production. **Nonshivering thermogenesis** is also induced by exposure to cold and is the mechanism in which heat is produced by

the calorogenic effect of epinephrine and norepinephrine, which are released into the blood in increased amounts. In the neonate, heat is produced by the metabolism of brown adipose tissue, which is present in newborn farm animals and is a particularly important mechanism of heat production to prevent neonatal hypothermia.

**HEAT LOSS**

Heat is transferred to or from an animal by the four standard physical phenomena of **convection, conduction, radiation and evaporation**. Convection is a transfer of heat between two media at different temperatures, such as the coat surface and the air. As such, convective heat transfer depends on the temperature gradient between the coat surface and air, the surface area and the air speed over the surface. Conduction is the transfer of heat between two media that are in direct contact, such as the skin and water. Radiation is the absorption or emission of electromagnetic radiation at the body surface, and depends on the skin surface temperature and area. Evaporative heat transfer is a process whereby heat is lost by the evaporation of water, and is dependent on the water vapor pressure gradient between the epithelial surface and the environment and the air speed over the surface.

Evaporation occurs by sweating, salivation and respiration, with the relative

importance varying between species. Losses by evaporation of moisture vary between species depending upon the development of the sweat gland system and are less important in animals than in humans, beginning only at relatively high body temperatures. Horses sweat profusely, but in pigs, sheep and European cattle sweating cannot be considered to be an effective mechanism of evaporative heat loss. In Zebu cattle the increased density of cutaneous sweat glands suggests that sweating may be more important. Profuse salivation and exaggerated respiration, including mouth breathing, are important mechanisms in the dissipation of excess body heat in animals. The tidal volume is decreased and the respiratory rate is increased so that heat is lost but alkalemia due to respiratory alkalosis is avoided.

#### BALANCE BETWEEN HEAT LOSS AND GAIN

The balance between heat gain and heat loss is controlled by the heat-regulating functions of the hypothalamus. The afferent impulses derive from peripheral hot and cold receptors and the temperature of the blood flowing through the hypothalamus. The efferent impulses control respiratory center activity, the caliber of skin blood vessels, sweat gland activity and muscle tone. Heat storage occurs and the body temperature rises when there is a decrease in rate and depth of respiration, constriction of skin blood vessels, cessation of perspiration and increased muscle tone. Heat loss occurs when these functions are reversed. These physiological changes occur in, and are the basis of, the increment and decrement stages of fever.

#### BREED DIFFERENCES

Differences exist between breeds and races of cattle in coat and skin characters that affect heat absorption from solar radiation and heat loss by evaporative cooling; differences also exist in the metabolic rate, which influences the basic heat load. Interest in this subject has been aroused by the demands for classes of animal capable of high production in the developing countries of the tropical zone. Detailed information on the physiological effects of, and the mechanisms of adaptation to, high environmental temperatures are therefore available elsewhere.

These findings are of greater interest in more temperate climates where the demand for more economic animal husbandry methods has led to investigation of all avenues by which productivity might be increased. Such subjects as the provision of shelter in hot weather, the use of tranquilizers to reduce activity, and therefore heat increment, and the

optimum temperature in enclosed pig houses are subjects of vital importance to the farming economy but are not dealt with in this book because they appear to have little relation to the production of clinical illness.

**Hypothermia**, caused by exposure to low environmental temperatures, and **hyperthermia (heat stroke or heat exhaustion)**, caused by exposure to high environmental temperatures, are the major abnormalities of body temperature associated with extremes of environmental temperatures. **Anhidrosis**, occurring primarily in horses in hot humid climates and associated with the inability to sweat, is described in Chapter 35.

#### HYPOTHERMIA

Hypothermia is a lower than normal body temperature, which occurs when **excess heat is lost or insufficient is produced**. Neonatal hypothermia is a major cause of morbidity and mortality in newborn farm animals within the first few days of life. Cold injury and frostbite are presented under that heading in Chapter 30.

#### ETIOLOGY

##### Excessive loss of heat

Exposure to excessively cold air temperatures causes heat loss if increased metabolic activity, shivering and sustained muscular contraction and peripheral vasoconstriction are unable to compensate.

##### Insufficient heat production

Insufficient body reserves of energy and insufficient feed intake result in insufficient heat production.

Hypothermia also occurs secondary to many diseases in which there may be a decrease in the ability to shiver and skeletal muscle contraction associated with decreased cardiac output, decreased peripheral perfusion and shock. Examples include parturient paresis, acute ruminal acidosis (grain overload), and during anesthesia and sedation, and the reduction of metabolic activity that occurs in the terminal stages of many diseases. A sudden fall in body temperature in a previously febrile animal, the so-called premortal fall, is an unfavorable prognostic sign.

##### Combination of excessive heat loss and insufficient heat production

A combination of excessive heat loss and insufficient heat production is often the cause of hypothermia. Insufficient energy intake or starvation of newborn farm animals in a cold environment can be a major cause of hypothermia. This may not occur under the same environmental conditions if the animals receive an adequate energy intake. Fatal hypothermia may also occur in other circumstances,

such as in certain breeds of pig (pot-bellied) following general anesthesia or sedation with higher doses of azaperone.<sup>1</sup> Mature pot-bellied pigs deprived of feed and kept outdoors during cooler months of the year may develop hypothermia, which would not normally occur in these conditions if the pigs were receiving adequate food.<sup>2</sup>

#### EPIDEMIOLOGY

##### Neonatal hypothermia

Newborn farm animals are prone to hypothermia in cool environments and hypothermia is a major cause of neonatal mortality. The neonates cannot maintain their rectal temperatures at normal values during the first few hours after birth under cold environmental conditions. Hypothermia and environmental thermoregulatory interactions are of particular importance in piglets and lambs because of their surface to volume ratio but are also relevant in calves and sick foals.

At birth, the neonatal ruminant moves from a very stable thermal environment, of similar temperature to its core body temperature, to a variable and unstable thermal environment that is 10–50°C colder than its core temperature. The coat is wet with placental fluids and energy loss is increased by evaporation and the low insulative value of a wet coat. The newborn calf becomes hypothermic in the first 6 hours after birth and only limited tissue substrates are available as energy sources. Neonates also are exposed to a variety of environmental pathogens against which they have little specific immunity. Thus the neonatal period is one of the most critical to the survival of an animal and during this period the morbidity and mortality can be high under adverse environmental conditions.

The continued emphasis in modern agriculture on the production of neonates throughout the year, including times of inclement weather and limited feed (late winter and early spring calving in beef herds in northern climates), the emphasis on short calving seasons, the use of high stocking densities, the production of animals with high muscle growth potential, which may be associated with an increased incidence of dystocia resulting in decreased vitality of newborn animals at birth, all appear to combine to increase the incidence of mortality due to hypothermia and related diseases of the neonate.

In lambs, more than 30% of deaths occur in the first few days of life and mortalities may be greater than 10%, with more than half of the losses due to hypothermia from either exposure or starvation. In calves, approximately 50% of deaths occur within 48 hours of birth

and most losses are either directly due to, or follow, dystocial parturitions where stillbirths and early postnatal mortality rates are about 20% compared with less than 5% in calves born without dystocia (eutocia).<sup>3</sup>

### Thermoregulation in neonatal farm animals

#### Response to cold stress

Neonatal ruminants, compared with many altricial neonatal mammals, are precocial in their development, with well developed thermoregulatory mechanisms that allow them to maintain homeothermy in many environments.<sup>3</sup> Prolonged exposure to heat or cold induces hormonal and metabolic changes specific to each stress. This involves secretion of glucocorticoid hormones and increased activity of the sympathetic nervous system augmented by increased secretion of catecholamines. The principal metabolic effect of these increases is greater availability and utilization of substrates (fat, glycogen and protein) for catabolism, with increased production of heat.

#### Cold-induced thermogenesis

This is achieved by shivering thermogenesis in skeletal muscle tissue and non-shivering thermogenesis in brown adipose tissue. **Shivering thermogenesis** consists of involuntary, periodic contractions of skeletal muscle. Heat is produced during contraction of muscle bundles in skeletal muscle tissue that has increased in tone as well as in skeletal muscle contracting in overt tremors. Increased heat production in neonatal calves in the first several hours after birth can be significant when the animals first stand for 10 minutes; this effect is reproduced later when the calves are stronger and stand for longer periods. The principal site of cold-induced non-shivering thermogenesis in animals is brown adipose tissue, which is present in neonatal lambs, kids and calves but not in piglets. In neonatal lambs, approximately 40% of the thermogenic response during summit metabolism is attributed to **non-shivering thermogenesis**, with the balance of about 60% attributed to shivering thermogenesis.

#### Control of heat loss

The insulative nature of the external hair coat and cutaneous tissues to resist non-evaporative heat loss during cold exposure is critical in maintaining homeothermy. Total thermal insulation is the sum of tissue insulation and external insulation.

**Tissue insulation.** This is the resistance of cutaneous tissue to conductive heat loss from the body core to the skin surface. Tissue insulation is influenced by subcutaneous fat depth, which is minimal in neonates, and by vasoconstriction. Tissue insulation increases with age.

**External insulation.** This is the thermal resistance of the hair coat and air interface to radiative, convective and conductive heat losses from the skin surface to the environment. External insulation is a function of length and type of hair coat and the air interface. When exposed to dry, cold, still air environmental conditions, external insulation as a proportion of total thermal insulation in neonatal calves ranges from 65–75%. Moisture and mud in the coat decrease the value of external insulation; wind and rain can also decrease external insulation.

The neonate's total thermal resistance to heat loss is a function of the physical properties of the skin and hair coat and the ability to induce vasoconstriction of cutaneous blood vessels and piloerection of the hair coat. Neonatal calves are remarkably cold-tolerant in a dry, still air environment. The thermal demand of an outdoor cold environment is a function of **wind and precipitation** as well as **ambient temperature**.

**Conductive heat loss** is controlled by sympathetic regulation of blood vessels that supply cutaneous tissues, especially the ears and lower extremities. In response to cold, vessels constrict, peripheral blood flow diminishes and heat transfer is limited. Vasoconstriction of cutaneous vessels during cold exposure occurs first in the ears, followed by the lower extremities and then the skin surrounding the trunk. **Phasic vasodilation** in the skin of the ears and distal extremities at a point near freezing occurs by the sudden opening of arteriovenous anastomoses to permit **intermittent warming** (called the **hunting reaction**). Phasic vasodilation does not occur on the skin of the trunk.

#### Thermoregulating mechanisms

Heat exchange between any homeotherm and the environment is the result of:

- Heat production by metabolism
- Insensible heat loss by evaporation of moisture from the respiratory tract and skin
- Sensible heat transfer by conduction, convection and radiation.

There is a range in the effective thermal environment, called the **thermoneutral zone**, over which an animal maintains body temperature with minimal metabolic effort. Within this zone, body temperature is maintained primarily by varying blood flow to the body surface, piloerection of the hair coat, behavioral and postural changes. These responses adjust the physical processes of heat transfer to balance the body's heat production. The lower limit of the thermoneutral zone – the **lower critical temperature** – is the minimum tempera-

ture that an animal can tolerate without actually increasing its rate of metabolic heat production to maintain thermal balance.<sup>4</sup> The lower critical temperature of an animal is determined by the animal's ability to resist heat loss (thermal insulation) and the animal's resting, thermoneutral heat production through metabolism. An increase in thermal insulation or an increase in thermoneutral metabolic rate decreases the lower critical temperature, improving cold tolerance.

Estimates of lower critical temperatures of calves during the first day of life are not available but some estimates for older calves include 13°C for 2-day-old Ayrshire calves and 8–10°C for dairy and crossbred calves at 1–8 weeks of age. In lambs, estimates are 37°C and 32°C for light (2 kg) and heavy (5 kg) birth weights immediately after birth while still wet with amniotic fluid, and 31°C and 22°C when these lambs are more than 1 day old.<sup>4</sup>

Older cattle are much more cold tolerant, with lower critical temperatures of 0°C for 1-month-old calves and –36°C for finishing feedlot cattle. At the lower border of the cold zone is the **cold lethal limit** – the ambient temperature below which the calf is unable to generate sufficient heat to offset heat losses required to maintain thermal balance, and at which hypothermia begins. Prolonged periods of exposure below the cold lethal limit will result in death. The cold lethal limit also can be defined as the ambient temperature below which heat loss exceeds the animal's summit or maximal metabolism.

Because published values for lower critical temperatures assume **still air, dry clean coats, standard radiation** and a **standing animal given a maintenance level of feeding**, there are limitations to their use. Insulation of extremities decreases, and heat loss increases, at temperatures below freezing. Thus some lower critical temperatures for cattle are too low, which means that neonates may be affected by cold temperatures not normally considered harmful. External insulation can change because of changes in air velocity and long-wave radiation. Behavioral changes of animals may occur to minimize heat loss. For example, animals may orient towards the wind to decrease their profile, and they may seek shelter, huddle and change their posture. Solar radiation varies throughout the daylight hours depending on the quantity of cloud. In general, radiation balance is positive in the day, while at night, when the skies are clear, the radiation balance is usually negative. Heat production varies with the time of day, time since the last meal and physical activity. Rain will often depress intake of feed and illness and

hypothermia severely depress feed intake, whereas cold stimulates intake.

#### Heat production

Heat produced by metabolism varies directly with the level of feed intake. The more an animal eats, the greater the heat increment of feeding. Animals subjected to cold will increase their feed intake if given the opportunity. In adults, proportionate dry matter increases of up to 35% are typical. This increased feed intake is accompanied by decreased retention time in the intestine and a decrease in digestibility of approximately 2.5 g/kg per 8°C decrease in environmental temperature. Heat is also generated from physical activity. When newborn calves stand for the first time and are able to stand for 10 minutes, the energy expenditure is increased proportionately 30–100%. As calves become stronger and are able to stand for more than 30 minutes, heat production increases by 40%.

#### Cold thermogenesis

The major source of heat in cold thermogenesis, whether it is induced by either shivering thermogenesis or by nonshivering thermogenesis, is lipid. Glycogen is also important for maximum metabolic rates and for lipid metabolism. For the neonate, in the first 24 hours there is little digestion of colostrum proteins and little catabolism of amino acids.

**Shivering thermogenesis.** This is the most obvious sign of increased heat production of cold thermogenesis.

**Nonshivering thermogenesis.** Functional brown adipose tissue is present in newborn calves, lambs and kids, and its primary function is to generate heat by nonshivering thermogenesis. The release of norepinephrine during cold exposure in neonatal ruminants stimulates increased blood flow to brown adipose tissue. Thyroid hormones also have an essential role in regulating cold thermogenesis. Glucocorticoids are essential for cold thermogenesis through the mobilization of lipid and glycogen to supply energy substrates. Large deposits of brown adipose tissue are present in the abdominal cavity (perirenal), around large blood vessels and in the inguinal and pre-scapular areas. In calves, 20 g/kg body weight (BW) may be present and in lambs from well-fed ewes, 6 g/kg BW. At parturition, marked changes occur in both the neonate's supply and demand for nutrients. In utero the fetal ruminant is provided with high levels of carbohydrate and low levels of fat, whereas after birth it is provided with colostrum high in fat and low in carbohydrate. Before colostrum is fed, the neonatal ruminant depends on mobilization of tissue glycogen and lipids to provide energy substrates for basal

metabolism as well as thermogenesis in shivering muscle tissue and in brown adipose tissue. The major sources of energy substrates for thermogenesis in neonatal ruminants include glycogen and lipid in liver and muscle because protein catabolism is minimal during the early postnatal period.

**Summit metabolism.** This is the maximal rate of metabolism which occurs in response to cold without a decline in body temperature. The time for which summit metabolism can be maintained is usually short, e.g. a few minutes in neonatal lambs. It is approximately five times resting metabolic rate and is associated with increased sympathetic activity and development of metabolic acidosis and increased plasma concentrations of glucose, glycerol, free fatty acids and lactate. Parturition hypoxia is likely associated with postpartum depression of sympathetic nervous activity and of thermogenic responses to cold.

**Birth weight and summit metabolism.** The principal factor which determines an animal's resting, thermoneutral metabolism is body size. In newborn animals, thermoneutral metabolic rates and summit metabolic rates are proportional to  $W^1$  rather than  $W^{0.75}$ , which means that summit metabolism per unit of  $W$  is similar for all neonates regardless of size, but lightweight animals have more surface area per unit of  $W$  than heavyweight neonates. Therefore, lightweight neonates have a lower summit metabolic rate per unit of surface area and, as a consequence, lightweight neonates will be less cold-tolerant than heavyweight neonates. Summit metabolism can be 33% higher in a 55 kg newborn calf compared to a 32 kg calf. Thus lightweight neonates have a more difficult time maintaining thermal balance during cold stress because of a lower cold-induced thermogenic rate per unit of skin surface area than heavier animals. This, in part, explains the higher incidence of neonatal mortality in smaller piglets and lambs, and in smaller calves born to first-calf heifers, and even to mature cows.

#### Factors affecting cold thermogenesis

Several factors affect the ability of the newborn calf to avoid hypothermia. Prompt activation of thermogenic mechanisms must occur immediately after birth when the demand for heat production is usually highest. The development of functional brown adipose tissue must occur in fetal life in order to enable calves to have maximal nonshivering thermogenesis during the early postnatal period. Most of the functional brown adipose tissue is deposited in late gestation in lambs and calves.

Ambient temperature and nutrition during pregnancy can affect cold thermogenesis of lambs. Maternal cold exposure by winter shearing of sheep increases lamb birth weight independent of changes in prepartum feed intake. Lambs from cold-exposed (winter sheared) ewes were 15% heavier at birth, and had 21% more perirenal adipose tissue that was 40% more thermogenically active than lambs from unshorn ewes. Thus newborn lambs from cold-exposed ewes were more cold-tolerant. Acute cold exposure during late gestation increases glucose supply to the fetus, which stimulates insulin secretion which in turn promotes fetal growth; recruitment and proliferation of brown adipose tissue occurs to enhance cold tolerance of the newborn lamb. There is some evidence that prepartum exposure of pregnant cows to a cold environment may result in heavier calf weights.

**Malnutrition of the dam during late gestation.** This can adversely affect neonatal calf survival. Parturition energy restriction beginning at day 90 of gestation of ewes can also reduce the proportional weight of perirenal adipose tissue and reduce the nonshivering ability of newborn lambs. The influence of parturition nutritional restriction on cold thermogenesis in newborn calves is unknown but parturition protein restriction during the last trimester reduced thermoneutral thermogenic rates by 12% without affecting birth weights, resulting in an estimated increase in the lower critical temperature. Maternal malnutrition also adversely affects the availability of energy substrates required by the neonate for cold thermogenesis. Nutritional restriction of pregnant ewes reduces total body lipid in fetal lambs but not muscle or liver glycogen. Thus, nutritional restriction of the fetus impairs cold tolerance of the neonate by reducing body substrate reserves available for cold thermogenesis and reduces nonshivering thermogenic capabilities.

European or British breeds of cattle are also more cold-tolerant and more adaptable to temperate climates, whereas Zebu cattle are more adaptable to subtropical climates because of greater heat tolerance.<sup>4</sup> The lack of cold tolerance of the newborn *Bos indicus* calf is associated with a higher mortality rate in purebred Brahman herds in the USA. These calves are less cold-tolerant and more susceptible to the weak calf syndrome.

#### Postnatal changes in cold thermogenesis

As calves and lambs grow during the early postnatal period, heat loss per unit of body weight declines because of improved thermal insulation and a decrease in the ratio of skin surface area to body weight. Nonshivering thermogenesis

decreases during the first month of age in lambs and calves, which is associated with a decrease in summit metabolism. This coincides with the conversion of brown adipose tissue to white adipose tissue by about 10 days after birth. Post-natal exposure to cold delays the disappearance of brown adipose tissue, which enhances cold tolerance of the lamb and calf by delaying the normal decline in nonshivering thermogenesis.

### Risk factors for neonatal hypothermia

#### Calves

Beef calves born outdoors during cold weather are susceptible to hypothermia. Wind, rain and snow decrease the level of insulation and increase the lower critical temperature. Dairy calves born indoors are not usually exposed to cold environments that cause hypothermia. Hypothermia (<37°C) has been recognized in calves reared outdoors in cold climates and in some calves affected with enteritis.<sup>3</sup>

Dystocia can affect cold thermogenesis. During a normal delivery, fetal hypoxemia may occur, causing anaerobic glycolysis, the production of lactic acid and a mixed respiratory–metabolic acidosis that the calf can usually compensate for within hours after birth. In prolonged dystocia, a metabolic acidosis may occur, which will inhibit nonshivering thermogenesis and impair cold tolerance immediately after birth. Dystocia may result in a weak calf that has weak teat-seeking activity, a poor suck reflex and a poor appetite for colostrum, resulting in colostrum deprivation and hypogammaglobulinemia.

**Colostrum** supplies **passive immunity** to the calf and the **nutrients** to meet energy demands during the immediate postpartum period. In order for the calf to maintain thermal balance during cold exposure, it is critical that the calf ingests colostrum early to provide enough energy reserves to sustain cold thermogenesis. Thus it is important that newborn calves consume adequate colostrum to ensure adequate passive immunity and to aid in the maintenance of thermal stability during the early postnatal period when rates of heat loss are greatest. The limited availability of energy substrates from body reserves also requires that adequate quantities of colostrum are ingested during long periods of cold exposure, especially in neonatal calves at higher risk for developing hypothermia. The thermoneutral maintenance requirements of a 40 kg calf can be met with about 2.4 L of cow colostrum; an additional 125 mL of colostrum are required to supply the energy requirements for every 1°C decrease in effective environmental temperature below the lower critical temperature.<sup>3</sup>

Young calves to be reared for veal are usually transported for 1–2 days during the first 2 weeks of life. These calves are prone to cold stress because they are very young and are being fed at a low level directly after transport. Veal calves arriving in a veal calf unit are dependent on body reserves to meet their energy requirement because of limited feed allowances, and ambient temperatures should not be below 14°C immediately after arrival, to prevent extra mobilization of energy reserves.<sup>5</sup> The thermal requirements of these calves are higher during standing than during lying and the provision of bedding that stimulates lying will have a positive effect on thermal requirements.<sup>6</sup>

Survival of beef calves born in the USA can be influenced by ambient temperature.<sup>7</sup> Calving late in spring, compared with earlier calving during cold winter months, results in a decreased mortality, especially in calves born to 2-year-old dams.

#### Lambs

Cold exposure resulting in hypothermia is a primary cause of lamb mortality, as seen when large numbers of lambs die during or soon after periods of a few hours of low temperatures (<5°C) with wind and rain, or after prolonged rain. Deaths in 'bad' weather cannot necessarily be attributed with certainty to exposure as a primary cause, because lambs debilitated for other reasons, such as starvation, are highly susceptible to chilling and conditions such as low birth weight, birth injury and sparse hair coat all predispose lambs to cold exposure; under less harsh conditions such lambs may survive.

**Colostrum intake** is also critical in lambs. Under field conditions in the UK it is estimated that lambs require 180–210 mL colostrum per kg BW in the first 18 hours after birth to provide sufficient energy substrate for heat production.<sup>3</sup> This colostrum requirement exceeds that for adequate transfer of colostrum immunoglobulins. The thermoneutral and summit metabolic rates are much higher in lambs fed colostrum compared with unfed lambs at 4–5 hours of age. The increased metabolic rates are attributed to increased availability of energy substrates from colostrum: plasma concentrations of glucose and non-esterified free fatty acids are doubled from birth to 4 hours of age in colostrum-fed lambs but remain unchanged in colostrum-deprived lambs.

The heaviest losses in Australian sheep flocks, which occur in the form of 'outbreaks' when the weather is very bad, are due to hypothermia. The high mortality rates in newborn lambs due to the effects of cold exposure and starvation occur because many of these lambs are born during the late winter and early

spring, when adverse conditions are most likely to occur. This is also true in the northern USA and Canada. The lambs are often born outdoors in unprotected pens designed to accommodate a large number of ewes. Under these circumstances, the lambs may be severely cold-stressed because the ambient air temperatures outside and within the lambing sheds are often 15°C or less, which is considerably lower than the critical temperatures described for heavy- (32°C) and light-weight (37°C) lambs. Cold-stressed lambs often become hypothermic because of excessive heat loss from exposure to inclement weather and because of heat production due to severe hypoxia at birth or to starvation.<sup>8</sup> Factors that further increase the susceptibility of lambs to hypothermia include:

- Lambs from ewes in poor condition
- Lambs from young or aged ewes
- Lambs from multiple births
- Lambs from dystocias
- Lambs with a low birth weight or born prematurely
- Breed differences in susceptibility to cold
- Length of the birthcoat
- Wetting of the birthcoat
- Exposure to wind.

The effects of experimental cold stress (0°C and –10°C) on pregnant ewes during the last weeks of gestation and their lambs of up to 3 days of age have been examined.<sup>9</sup> In general, ewes were unaffected by treatment. Cold-induced changes in lambs included physical weakness, depression and poor nursing response. Serum concentrations of glucose and insulin decreased and cortisol increased. The mortality rate was 40% in stressed lambs and 10% in lambs kept at the warmer temperatures.<sup>9</sup> Cold-exposed lambs had reduced amounts of adipose tissue in perirenal areas and extensive subcutaneous hemorrhages and edema in the distal portions of the thoracic and pelvic limbs.

**Wetness of the fleece** is a major factor in determining whether or not lambs become hypothermic. Wet lambs suffer a reduction in coat insulation, primarily as a result of reduced coat depths, but this effect is small compared with the increase in evaporative heat loss which occurs as a result of wetting. Lambs exposed to experimental air movement from a fan produce more body heat than those in still air, and differences in resistance to cold stress between single and twin lambs are largely caused by the corresponding differences in body weight and coat depth.

The relative importance of environmental and maternal factors is not easy to

determine. Inclement weather kills many lambs, probably more than would otherwise die, but principally those that are at risk because of reduced vigor – dependent upon poor preceding nutrition – or because of poor mothering – itself as dependent on poor nutrition of the ewe as on her inherited lack of mothering ability. The vigor of the lamb, principally manifested as ‘sucking drive’, is reduced by lack of reward, so that a vicious cycle is created if the ewe will not stand. Vigor is also greatly reduced by cold discomfort, giving inclement weather two points at which it influences lamb survival rates. The lamb dies of hypothermia and inanition.

#### Piglets

At birth, the newborn piglet experiences a sudden and dramatic 15–20°C decrease in its thermal environment. Because the newborn pig is poorly insulated, maintenance of homeothermia depends almost exclusively on its capacity to produce heat. Unlike most other mammals the newborn pig does not possess brown adipose tissue.<sup>10</sup> Consequently, neonatal pigs are assumed to rely essentially on muscular thermogenesis for thermoregulatory purposes. Newborn pigs shiver vigorously from birth because it is the main heat-producing mechanism and the thermogenic efficiency of shivering increases during the first 5 days of life.<sup>10</sup>

Thermoregulation in the newborn piglet is important in the first 2 days.<sup>11</sup> Metabolic heat production and rectal temperature increase and the development of adequate thermal insulation helps to withstand the effects of a cold environment. Body reserves are important for the piglet to survive in the first few hours and glycogen and fat reserves are utilized as major energy substrates for heat production within the first 12–24 hours. Thus ingestion of colostrum is crucial. Coldness impairs the development of thermostability and induces hypothermia, which diminishes the vigor of the piglet and reduces colostrum intake and immunoglobulins. Thus the need for a high ambient temperature for piglets in the first several days of life.

#### Foals

Newborn foals that are premature, dysmature or affected with neonatal maladjustment syndrome cannot maintain their rectal temperatures at normal values during the first few hours after birth under the environmental conditions usually encountered within foaling boxes in the UK.<sup>12</sup> Their overall mean metabolic rate is about 25% below the mean value for recumbent healthy foals.

This difference in resting metabolic rate affects the lower critical temperature – the

air temperature below which heat loss exceeds resting heat production. The lower critical temperature for healthy foals is estimated to be about 10°C and for sick foals is about 24°C. When wet with amniotic fluid, the lower critical temperature probably will be much higher. Covering these foals with rugs and providing thermal radiation using radiant heaters would increase the lower critical temperature.

Premature foals are the most compromised compared to dysmature and those with neonatal maladjustment syndrome. They have small body masses, the lowest rates of metabolism and the lowest rectal temperature. Premature foals are also likely to be deficient in energy reserves and thermal insulation, in addition to immaturity of organ systems, which could limit further energy availability. **Colostrum intake** is also crucial to their survival.

#### Post-shearing hypothermia in sheep

Sudden unpredicted summer rainfall can cause high mortality due to hypothermia in newly shorn sheep.<sup>13</sup> A fall in body weight in the period immediately preceding shearing is another major risk factor. It is estimated that in Australia 0.8 million sheep die annually during the first 14 days after shearing and many of the deaths are associated with cold, wet, windy weather. Overall, crude mortality rates can range from 12–34% for sheep up to 28 days after shearing. In outbreaks in Australia in January the mean temperature can be 10°C, with a high rainfall and high wind velocity, accounting for a **wind chill factor** (a function of temperatures, rain and wind velocity). Other factors that increase heat loss include sunshine versus cloud, and the depth of the wool cover. The speed of the wind at the location of the animals varies greatly depending on the presence of protective windbreaks such as trees.

#### Cold environments and animal production

Farm animals maintain a relatively constant body core temperature during exposure to the extreme range of thermal environments experienced in countries such as Canada.<sup>14</sup> The severity of the winter is particularly challenging. Homeothermy is achieved by physiological and behavioral mechanisms that modify either rates of heat loss from the body or the rate at which heat is produced by metabolism of feed or body energy reserves. Despite the extremely cold temperatures that occur in most of the agricultural regions of Canada, the effective severity of extremely cold temperatures is reduced because of the dryness of the frozen environment and the effective

external insulation of the animal's hair coat. The influence of wind can add to cold stress and the provision of shelter from wind by natural tree shelter belts or manmade structures such as porosity fences is required.

Prolonged exposure to cold results in subtle adaptation of hormonal and metabolic responses. Acclimatization to cold and winter conditions generally has little long-term effect on energy metabolism but increases thermal insulation and appetite. During prolonged exposure of cattle and sheep to cold environments down to –10 to –20°C there is a reduction in the apparent digestibility of the diet.<sup>14</sup> To offset the lowered digestibility, the animals would accordingly need to consume more feed to achieve a similar digestible energy intake when kept outdoors during winter than if they were kept in a heated barn.

#### PATHOGENESIS

Sudden exposure of neonatal animals at birth and during the first few days of life to cold ambient temperature results in subnormal body temperature, shivering and decreased cardiac output, heart rate and blood pressure. This results in muscular weakness and mental depression, respiratory failure, recumbency and a state of collapse and, eventually, coma and death. The entire body, especially the extremities, becomes cold and the rectal temperature is below 37°C and may drop to 30°C in neonates. Cold injury or frostbite of the extremities may occur in extremely cold conditions. Nonshivering induced thermogenesis may occur, resulting in depletion of brown adipose tissue deposits. The neurological signs of convulsions seen in some cases of hypothermia have not been adequately explained.<sup>15</sup> The nervous signs observed in piglets with an inadequate intake of milk and exposed to cold environmental temperature are probably due to a marked hypoglycemia.

In newborn lambs carbohydrate and lipid are the major energy substrates for heat production because protein catabolism is minimal during the first day after birth.<sup>16</sup> Liver glycogen concentrations increase markedly during the last few days before normal parturition. The amount of liver and skeletal muscle glycogen available in the newborn lamb at birth determines how long it can avoid hypoglycemia and hypothermia if not fed. The amount of lipid present in the newborn lamb can also affect the duration of the glycogen reserves. In growth-retarded lambs, lipid availability is decreased and glycogen exhaustion occurs earlier than normal. Such lambs are highly susceptible to hypothermia but this can be minimized by the early ingestion of colostrum, which

is rich in lipid and extends the availability of glycogen.

Deaths are the result of excessive body cooling due to low temperature, driving winds and starvation. Wetness may or may not be involved. The starvation results indirectly from poor mothering by the ewe, either because she is a poor mother, because the weather interferes with mothering or because the lamb is weak owing to poor antepartum nutrition. These lambs often walk after birth but at postmortem examination there is little to see. They may have sucked but there is little digestion and the intestine on the recumbent side is flaccid. There are also subcutaneous hemorrhages of the limbs and depletion of brown fat stores.

Hypothermia secondary to other diseases is due to failure of the thermoregulation mechanism and is usually accompanied by varying degrees of shock and the inability to invoke shivering thermogenesis.

#### CLINICAL FINDINGS

A decrease in body temperature to below 37°C represents hypothermia for most farm animal species. Weakness, decreased activity, cold extremities and varying degrees of shock are common. Bradycardia, weak arterial pulse and collapse of the major veins are characteristic. The mucous membranes of the oral cavity are cool and there is a lack of saliva.

#### Neonatal hypothermia

Body temperatures may be as low as 35°C in neonatal calves, piglets, lambs and foals exposed to a cold environment within hours after birth or following 12–24 hours of profuse diarrhea accompanied by marked dehydration and acidosis. However, acute dehydration in a thermoneutral environment is accompanied by a mild increase in rectal temperature. In the early stage of hypothermia, affected animals may be shivering and trembling and the skin of their extremities and ears feels cool to touch. Hypothermic piglets will attempt to huddle together, are lethargic, do not suck and eventually become recumbent and die. Hypothermic calves exposed to a cold environment will assume sternal recumbency, lie quietly, will have a weak suck reflex and will die in a few hours. In later stages, further weakness leading to coma is common. The mucous membranes of the oral cavity are cool and may be dry. The heart rate is commonly slower than normal and the intensity of the heart sounds decreased. Death is common when the body temperature falls below 35°C but field observations indicate that the temperature may fall below 30°C and animals still survive if treated intensively.

#### Shorn sheep hypothermia

Sheep with hypothermia associated with recent shearing and inclement weather have a range of body temperatures from 35–38°C. They huddle in tight groups and the animals that cannot maintain sufficient heat will become weak, recumbent and die within a few hours. They may be found in lateral or sternal recumbency, with their heads back over their shoulders. Palpebral reflexes are decreased, skin and extremities are cold, mucous membranes are pale to white and generalized weakness similar to circulatory collapse is common.

#### Hypothermia secondary to other diseases

The hypothermia secondary to other diseases is usually not marked and there are clinical findings related to the underlying illness. Hypothermia is common in diseases such as milk fever in cattle but returns to normal within a few hours after successful treatment with calcium salts. Successful treatment of the primary disease will usually return the temperature to within the normal range.

#### CLINICAL PATHOLOGY

Clinical pathological examinations are usually not done because the diagnosis is frequently obvious and the variability in biochemical changes make them of limited value in reaching a diagnosis of hypothermia. The serum concentrations of glucose, non-esterified fatty acids and immunoglobulins are commonly reduced, and hypoglycemia may be profound. However, the glucose concentration depends on the level of starvation that coexisted with the hypothermia. In starvation-induced depletion of body lipid and glycogen reserves, there is a depression in cold thermogenesis and subsequent hypothermia. In neonatal calves and lambs with hypothermia caused by excessive heat loss during short cold exposure, the serum concentrations of glucose, non-esterified fatty acids and immunoglobulins may be at adequate levels. Hemoconcentration, azotemia and metabolic acidosis may occur.

#### Necropsy findings

Lesions associated with hypothermia depend on the duration and severity of the hypothermia. Fatal hypothermia in lambs and calves is characterized by an absence of lesions. A relative absence of milk in the abomasum is common. Experimental cold stress may result in subcutaneous edema of the ventral body wall and subcutaneous edema and hemorrhages of the extremities. Marked reductions in the amount of perirenal adipose tissue may be obvious. However, intense cold exposure of short duration may cause death of calves with no signifi-

cant changes in the visual appearance of perirenal, pericardial or cardiac adipose tissue depots.

#### TREATMENT

##### Hypothermic newborn lambs

A system for the detection and treatment of hypothermia in newborn lambs can improve the survival rate.<sup>17</sup> Most lambs become hypothermic within 5 hours or at more than 12 hours after birth. Hypothermia in the first 5 hours of life is most commonly caused by a high rate of heat loss from the wet newborn lamb, whereas a depressed rate of heat production consequent to starvation is the most common cause in the older lamb. Twin and triplet lambs are more susceptible to hypothermia than singles because of lower body energy reserves; the ewe takes longer to lick dry two or three lambs, and the milk requirement of two or three lambs is higher than that of a single lamb and starvation is more likely.

Using an electronic thermometer, the body temperature of any weak or suspect lamb is taken.<sup>18</sup> Lambs of any age with mild hypothermia (37–39°C) are dried off if necessary to reduce heat loss, given ewe or cow colostrum by stomach tube and placed in a sheltered pen with the ewe. Lambs less than 5 hours of age with severe hypothermia (<37°C) are dried off and given an intraperitoneal injection of 20% glucose at a temperature of 39°C. A large lamb (>4.5 kg) is given 50 mL, a medium lamb (3.0–4.5 kg) 35 mL and a small lamb (<3.0 kg) 25 mL. Hypothermic lambs are then placed in warming pens, measuring 2 × 2 m and made of horizontally laid straw bales, two bales high. The pen is divided horizontally into two chambers by a sheet of weld mesh upon which the lambs lie. Warm air, at 38–40°C, is blown into the lower chamber from a domestic heater, and a sheet of polythene fitted over the entire pen retains the heat. When the lamb's temperature reaches 37°C, it is removed from the warmer and immediately fed ewe or cow colostrum by stomach tube at a rate of 50 mL/kg BW. Any lamb that is vigorous and able to suck is returned to its ewe in a sheltered pen and monitored over the next several hours. Colostrum can be hand milked from the ewe after administration of oxytocin.

The immersion of hypothermic lambs in water at 38°C can result in the recovery to an eutermic state in about 28 minutes at a reduced expense in metabolic effort by lambs. However, this requires extra labor and lambs must be quickly dried, otherwise the heat loss is exaggerated after removal from water because of the wet fleece.



### Hypothermic newborn calves

Clinical management of hypothermic newborn calves is similar to that of lambs. Supplemental heat must be provided immediately. Rewarming can be done in small, enclosed boxes bedded with blankets and heat provided by infrared heat lamps. Colostrum or milk should be warmed to 40°C and intubated using an esophageal feeder. Fluids given intravenously must be warmed; one practical method requires submersion of the intravenous line in a sustained source of warm water. Intravenous dextrose (1 mL of 50% dextrose/kg BW) should be routinely administered to all hypothermic calves because most have moderate to severe hypoglycemia. This dosage rate of 50% dextrose will increase the serum glucose concentration of the calf by approximately 100 mg/dL, assuming that the extracellular fluid space is 50% of the calf's body weight. The rectal temperature should be taken every 30 minutes during treatment to assess progress.

A more aggressive rewarming technique involves the repeated administration of warm (40°C) 0.9% NaCl enemas via a flexible soft tube; a 20–30F Foley catheter works well in this regard when it is advanced through the anus and the bulb inflated to maintain the catheter in the rectum. Rectal fluid should be aspirated before infusing additional fluid volumes via the Foley catheter in order to maximize the warming ability of enema fluids. Use of enema fluids as part of the rewarming protocol makes it more difficult to monitor the increase in body temperature. Whether immersion of hypothermic calves in water at 38–40°C is beneficial has not been determined, but immersion presents practical difficulties.

### Hypothermic newborn foals

The clinical management of sick foals that are prone to hypothermia is presented below under Control.

### Hypothermic newborn piglets

Hypothermic piglets must be placed in a warming box with a heat lamp and treated with intraperitoneal administration of glucose for the hypoglycemia. The subject is presented in additional detail in Chapter 3.

### CONTROL

Control and prevention of hypothermia is dependent on providing the necessary surveillance at the time of parturition in animals being born in cold environments. Early recognition and treatment of animals with diseases leading to hypothermia is also necessary.

### Lambs and calves

Prevention of hypothermia in calves depends on the planning and implemen-

tation of effective management strategies that will limit the risk factors known to predispose newborn calves to hypothermia and starvation. Management strategies to prevent hypothermia from excessive heat loss are most important in the first 24 hours after birth. They include changing the calving season to a warmer time of the year to minimize exposure to severe weather. Measures to minimize excessive heat loss include providing a dry, draft-free environment for calving and lambing. Providing a protective shelter for beef cow/calf pairs for calving and during the first week after birth can reduce mortality from hypothermia. In extensive beef cow/calf herds, calf huts large enough for 8–10 calves provide excellent shelter from wind, rain and snow.

The provision of adequate surveillance and assistance at the time of lambing or calving is necessary to minimize the incidence of dystocia and its consequences for the neonate. The ingestion of adequate quantities of colostrum, beginning as soon after birth as possible, is important in order to provide immunoglobulins and energy sources for the neonate.

### Piglets

The newborn piglet requires an adequate intake of colostrum within a few hours after birth, continued intake of milk after the colostrum period, a warm external environment of 30–34°C for at least the first 3 days of life (with heat lamps) and protection from traumatic injuries such as crushing by the sow. Sows do not instinctively remove the amniotic fluid from the surface of piglets; it is removed by contact with other surfaces or by evaporation. Smaller than normal or weak piglets should be dried manually to minimize excessive heat loss. Cross-fostering is used when gilts or sows have large litters that they cannot nurse adequately.

### Sick foals

Sick foals are prone to hypothermia but cold stress can be reduced by good management procedures, including the following:<sup>12</sup>

- The foal should be housed in an environment with minimal drafts, in which the air temperature is controlled at a steady value, set according to the foal's needs. Air temperature should be at, or a few degrees above, the lower critical temperature. This temperature may exceed 24°C for a sick, uncovered, recumbent foal. Radiant heaters are useful but should not be placed too close to the foal
- Excessive moisture should be removed from the foal's hair coat

immediately after birth. A sick foal that cannot increase its metabolic rate is particularly susceptible to cold stress when wet with amniotic fluid<sup>19</sup>

- Additional insulation with foal rugs and leg bandages will reduce heat loss from the dry body surface. The dry sick foal needs an additional 10 mm of insulation for each 10°C decline in air temperature below 24°C. Because sick foals are recumbent, they should lie on a heated pad or on thick bedding material to minimize heat loss by conduction to the floor
- Energy intake should be sufficient to sustain resting metabolism and can be given by the oral or parenteral route
- Frequent monitoring of both rectal and air temperature, as well as energy intake, will assist in the diagnosis of thermal stress, so that appropriate action can be taken. A lack of shivering does not indicate an absence of cold stress.

### REVIEW LITERATURE

- Close WH. Thermoregulation in piglets: environmental and metabolic consequences. In: Neonatal survival and growth. Occasional Publications No. 15. London: British Society of Animal Production, 1992: 25.
- Rowan TG. Thermoregulation in neonatal ruminants. In: Neonatal survival and growth. Occasional Publication No. 15, British Society of Animal Production, 1992: 13–24.
- Christopherson RJ. Overcoming climatic constraints. In: Martin J (ed.) Animal production in Canada. Edmonton, Alberta: University of Alberta Press, 1993: 173–190.
- Carstens GE. Cold thermoregulation in the newborn calf. In: Perinatal mortality in beef herds. Vet Clin North Am, Food Anim Pract 1994; 10: 69–106.

### REFERENCES

1. Duran O. Vet Rec 1997; 140:240.
2. Arbuckle JBR. Vet Rec 1995; 136:156.
3. Rowan TG. In: Varley MA, ed. Neonatal survival and growth. Occasional Publication No. 15. Penicuik: British Society of Animal Production, 1992: 13–24.
4. Carstens GE. Vet Clin North Am FoodAnim Pract 1994; 10:69.
5. Schrama JW et al. J Anim Sci 1993; 71:1761.
6. Schrama JW et al. J Anim Sci 1993; 71:3285.
7. Azzam SM et al. J Anim Sci 1993; 71:282.
8. Hancock RD et al. Trop Anim Health Prod 1996; 28:266.
9. Olson DP et al. Can Vet J 1987; 28:181.
10. Berthon D et al. J Therm Biol 1994; 19:413.
11. Close WH. In: Varley MA, ed. Neonatal survival and growth. Occasional Publication No. 15. Penicuik: British Society of Animal Production, 1992: 25.
12. Ousey JC et al. Vet J 1997; 153: 185.
13. Glass MH, Jacob RH. Aust Vet J 1992; 69:142.
14. Christopherson RJ. In: Martin J (ed.) Animal production in Canada. Edmonton, Alberta: University of Alberta Press, 1993: 173.
15. Green SL. Equine Vet Educ 1994; 6:44.
16. Mellor DJ, Cockburn F. Q J Exp Physiol 1986; 71:361.
17. Eales FA et al. Vet Rec 1984; 114:469.
18. Eales FA et al. Vet Rec 1982; 110:118.
19. McArthur AJ, Ousey JC. J Therm Biol 1996; 21:43.

## **HYPERTHERMIA (HEAT STROKE OR HEAT EXHAUSTION)**

Hyperthermia is the elevation of body temperature due to excessive heat production or absorption, or to deficient heat loss, when the causes of these abnormalities are purely physical. Heat stroke (heat exhaustion) is the most commonly encountered clinical entity.

### **ETIOLOGY**

The major causes of hyperthermia are the physical ones of high environmental temperature and prolonged, severe muscular exertion, especially when the humidity is high, the animals are fat, have a heavy hair coat or are confined with inadequate ventilation, such as on board ship or during road transportation. Fat cattle, especially British beef breeds, can be overcome by the heat in feedlots. Brahman cattle in the same pen may be unaffected. Angora goats are much more sensitive to high environmental temperatures than sheep, especially when they are young.<sup>1</sup> The original concept of sunstroke as being due to actinic irradiation of the medulla has now been discarded and all such cases are now classed as heat stroke.

### **High environmental temperature**

The upper border of the thermoneutral zone – the **upper critical temperature** – is the effective ambient temperature above which an animal must increase heat loss to maintain thermal balance. The upper critical temperature in sheep with a light wool coat on board ship appears to be 35°C (95°F) at a humidity of 33–39 mmHg (4.4–5.2 kPa) vapor pressure. Differences between breeds of animal in their tolerance to environmental high temperatures, exposure to sunlight and exercise are important in animal management and production. Water buffalo have been shown to be less heat-tolerant than Shorthorn steers, which were less tolerant than Javanese Banteng and Brahman crossbreds – the last two appear to be equally tolerant. The differences appear to be at least partly due to capacity to increase cutaneous evaporation under heat stress.

There are similar differences in heat tolerance between lactating and non-lactating cows; lactating animals show significantly greater increases in rectal temperature and heart and respiratory rates when the environmental temperature is raised. This is primarily a result of the greater dry matter intake and heat of fermentation in dairy cattle that must be dissipated. Heat stress is therefore an important production-limiting disease when dairy cattle are kept in conditions of high heat and humidity.

Rested, hydrated horses are well able to maintain homeothermy in the hottest

environmental conditions. Their most efficient mechanism in ensuring that body temperature is kept low is their capacity for heavy sweating.

### **Other causes of hyperthermia**

- Neurogenic hyperthermia – damage to hypothalamus, e.g. spontaneous hemorrhage, may cause hyperthermia or poikilothermia
- Dehydration – due to insufficient tissue fluids to accommodate heat loss by evaporation
- Excessive muscular activity – e.g. strychnine poisoning
- Miscellaneous poisonings, including levamisole and dinitrophenols
- Malignant hyperthermia in the porcine stress syndrome
- Hyperkalemic periodic paresis in horses
- Fescue toxicity in ruminants and horses
- Cattle with hereditary bovine syndactyly
- Administration of tranquilizing drugs to sheep in hot weather
- Specific mycotoxins, e.g. *Claviceps purpurea*, *Acremonium coenophialum*, the causes of epidemic hyperthermia. Bovine idiopathic hyperthermia in cattle in Australia may be due to *Claviceps purpurea*<sup>2</sup>
- Iodism
- Sylade (possibly) poisoning.

### **PATHOGENESIS**

The means by which hyperthermia is induced have already been described. The physiological effects of hyperthermia are important and are outlined briefly here.

Unless the body temperature reaches a critical point, a short period of hyperthermia is advantageous in an infectious disease because phagocytosis and immune body production are facilitated and the viability of most invading organisms is impaired. These changes provide justification for the use of artificial fever to control bacterial disease. However, the metabolic rate may be increased by as much as 40–50%, liver glycogen stores are rapidly depleted and extra energy is derived from increased endogenous metabolism of protein. If anorexia occurs because of respiratory embarrassment and dryness of the mouth, there will be considerable loss of body weight and lack of muscle strength accompanied by hypoglycemia and a rise in nonprotein nitrogen.

There is increased thirst due in part to dryness of the mouth. An increase in heart rate occurs due directly to the rise in blood temperature and indirectly to the fall in blood pressure resulting from peripheral vasodilatation. Respiration increases in rate and depth due directly to

the effect of the high temperature on the respiratory center. An increased respiratory rate cools by increasing salivary secretion and the rate of air flow across respiratory epithelial surfaces, thereby increasing the rate of evaporative cooling. Urine secretion is decreased because of the reduced renal blood flow resulting from peripheral vasodilatation, and because of physicochemical changes in body cells that result in retention of water and chloride ions.

When the critical temperature is exceeded, there is depression of nervous system activity and depression of the respiratory center usually causes death by respiratory failure. Circulatory failure also occurs, due to myocardial weakness, the heart rate becoming fast and irregular. If the period of hyperthermia is unduly prolonged, rather than excessive in degree, the deleterious effects are those of increased endogenous metabolism and deficient food intake. There is often an extensive degenerative change in most body tissues but this is more likely to be due to metabolic changes than to the direct effects of elevation of the body temperature.

### **CLINICAL FINDINGS**

An elevation of body temperature is the primary requisite for a diagnosis of hyperthermia and in most species the first observable clinical reaction to hyperthermia occurs when the rectal temperature exceeds 39.5°C (103°F). In most instances the temperature exceeds 42°C (107°F) and may reach 43.5°C (110°F). An increase in heart and respiratory rates, with a weak pulse of large amplitude, sweating and salivation occur initially, followed by a marked absence of sweating. The animal may be restless but soon becomes dull, stumbles while walking and tends to lie down.

In the early stages there is increased thirst and the animal seeks cool places, often lying in water or attempting to splash itself. When the body temperature reaches 41°C (106°F) respiration is labored and general distress is evident. Beyond this point the respirations become shallow and irregular, the pulse becomes very rapid and weak and these signs are usually accompanied by collapse, convulsions and terminal coma. Death occurs in most species when the core temperature exceeds the normal value by approximately 5°C (8°F). Abortion may occur if the period of hyperthermia is prolonged and a high incidence of embryonic mortality has been recorded in sheep that were 3–6 weeks pregnant. In cattle, breeding efficiency is adversely affected by prolonged heat stress and in intensively housed swine a syndrome known as

summer infertility, manifested by a decrease in conception rate and litter size and an increase in anestrus, occurs during and following the hot summer months in most countries. Sudden exposure of cattle that are acclimatized to cold temperatures (–20°C; –4°F) to warmer temperature (20°C; 68°F) results in heat stress. The respiratory rate may increase from 20 to 200 breaths/min within 1 hour, the heart rate will increase by 10–20 beats/min and the temperature will undergo an increase of 0.5–1.0°C (33–34°F). The respiratory rate is the most practical indicator of heat stress, and a respiratory rate above 70 breaths/min indicates that animals are suffering heat stress. It is not uncommon in hot humid climates to see cattle open-mouth breathing with respiratory rates exceeding 80 breaths/min during periods of heat stress. In summary, the progression of changes in cattle with heat stress is increased respiratory rate, rectal temperature and heart rate, followed by decreased urine concentration (due to increased water intake) and finally decreased appetite and milk production.

Affected horses are fatigued and have profound fluid and electrolyte losses, characterized by hypotonic dehydration due to excessive sweating. The resultant clinical signs include decreased performance, depression, weakness, increased heart and respiratory rates, and marked increases in rectal temperature (usually exceeding 42°C). Because of the hyponatremia, affected horses may lose the stimulus to drink, thereby exacerbating their dehydration. In advanced cases, the skin is dry and hot because sweating is impaired. Hyperthermic horses that have been participating in an endurance event may have synchronous diaphragmatic flutter as a result of hypocalcemia and metabolic alkalosis. Coma and death can occur in extreme cases of hyperthermia that are not identified and treated until the condition is advanced.

### CLINICAL PATHOLOGY

No important clinicopathological change is observed in simple hyperthermia. However, horses with advanced hyperthermia typically have hyponatremic dehydration and azotemia. Horses with synchronous diaphragmatic flutter are typically hypocalcemic.

### Necropsy findings

At necropsy there are only poorly defined gross changes. Peripheral vasodilatation may be evident, clotting of the blood is slow and incomplete, and rigor mortis and putrefaction occur early. There are no constant or specific histopathological changes.

### TREATMENT

The presence of adequate drinking water is essential and together with shade and air movement is of considerable assistance when multiple animals are exposed to high air temperature.

If treatment of individual animals is necessary because of the severity or duration of the hyperthermia, affected animals should be immediately placed in the shade and hosed on the midline of the back with cold water so that their coats are saturated. Fans should be immediately placed in front of the animal to promote evaporative cooling, and cooled water, with and without added electrolytes, should be made available for the animal to drink. In severe cases of hyperthermia where large volumes of water are not available, very cold water (2–8°C) should be applied and immediately scraped off because the water becomes warm almost immediately. The application of very cold water does not induce a clinically relevant degree of peripheral vasoconstriction and has not been associated with clinically relevant side effects. Water applied by hose does not need to be scraped off because heat is conducted to the applied water stream. Placement of wet sheets or towels over the head or neck is not recommended as they provide unneeded insulation.

The rectal temperature should be monitored frequently during cooling, and water application should be stopped when the rectal temperature has returned to normal. Because affected animals may not be interested in or capable of drinking, the intravenous administration of fluids such as 0.9% NaCl is indicated in animals that are weak, recumbent or dehydrated. Horses often need 20–40 L of intravenous fluids over the first few hours of treatment. Horses with synchronous diaphragmatic flutter should be treated with intravenous calcium.

Fluids can also be administered orally to horses, but care should be taken to ensure that gastrointestinal motility is not impaired. A practical oral electrolyte solution is obtained by dissolving 20 g of table salt (NaCl) and 20 g of Litesalt (NaCl and KCl) in 5 L of water; this provides 107, 28, and 132 mmol/L of sodium, potassium and chloride, respectively. Five L of this fluid can be administered to an adult horse each hour by nasogastric tube.

### CONTROL

Shade alone is a most important factor in maintaining the comfort of livestock and preventing heat stress. Shade reduces the heat gain from solar radiation and can be provided by trees or artificially by roofs or shades made from cloth or artificial

material. Shades should be placed over feed and where the producer wants the animals to spend their time. The efficiency of metal shades can be increased by painting metal shades white on the topside and black on the underside. A north–south orientation will permit drying under the shades as the shaded area moves throughout the day; this may be helpful in decreasing the incidence of coliform mastitis if sprinklers are used under the shades and cattle prefer to lie under the shades than in freestalls.

In dairy and feedlot cattle, the following measures should be taken to manage heat stress:

- Provide cool clean water and plenty of trough space for drinking
- Use shades and intermittent sprinkler systems (wet time of 1–2 min with an adequate dry off time of 20–30 min); continuous application of water increases the local humidity and decreases the effectiveness of evaporative cooling
- Enhance airflow by fans or by providing mounds for cattle to stand on
- Adjust rations and feed a larger percentage of the ration in the evening when it is cooler
- Minimize handling during periods of greatest heat stress
- Select cattle based on breed and coat characteristics, and house the most susceptible cattle (heavy, black) on east-sloping lots with the most shade.

In exercising horses, periodic rests in the shade with fans and water sprinklers and maintaining a normal hydration status can be very helpful in preventing heat stress. Monitoring the heart rate is a useful and practical method of assessing the degree of heat stress in horses, in that heart rates remain elevated for a longer period of time in horses undergoing heat stress.

If animals have to be confined under conditions of high temperatures and humidity, the use of tranquilizing drugs has been recommended to reduce unnecessary activity. However, care is needed because blood pressure falls and the animals may have difficulty losing heat if the environment is very hot, and in some cases may gain heat. Chlorpromazine, for example, has been shown to increase significantly the survival rate of pigs exposed to heat and humidity stress.

### REVIEW LITERATURE

- Stokka GL, Smith J, Kuhl G, Nichols D. Compend Contin Educ Pract Vet 1996; S296–S302.
- Foreman JH. The exhausted horse syndrome. Vet Clin North Am Equine Pract 1998; 14:205–219.
- Guthrie AJ, Lund RJ. Thermoregulation. Base mechanisms and hyperthermia. Vet Clin North Am Equine Pract 1998; 14:45–59.

## REFERENCES

1. McGregor B. *Aust Vet J* 1985; 62:349.
2. Jessep TM et al. *Aust Vet J* 1987; 64:353.

## FEVER (PYREXIA)

Fever is an elevation of core body temperature above that normally maintained by an animal and is independent to the effects of ambient conditions on body temperature. It is important to realize that fever is a combination of hyperthermia and infection or inflammation that results from an elevated set-point for temperature regulation.

### ETIOLOGY

Fevers may be septic, the more common type, or aseptic, depending on whether or not infection is present.

#### Septic fevers

These include infection with bacteria, viruses, protozoa or fungi as:

- Localized infection such as abscess, cellulitis, empyema
- Intermittently systemic, as in bacteremia, endocarditis
- Consistently systemic, as in septicemia.

#### Aseptic fevers

- Chemical fevers, caused by injection of foreign protein, intake of dinitrophenols
- Surgical fever, due to breakdown of tissue and blood
- Fever from tissue necrosis, e.g. breakdown of muscle after injection of necrotizing material
- Severe hemolytic crises (hemoglobinemia)
- Extensive infarction
- Extensive necrosis in rapidly growing neoplasms such as multicentric lymphosarcoma in cattle
- Immune reactions – anaphylaxis, angioneurotic edema.

## PATHOGENESIS

Most fevers are mediated through the action of endogenous pyrogens produced by granulocytes, monocytes and macrophages. The most important and best known **endogenous pyrogen** is interleukin-1, produced by monocytes and macrophages. The febrile response is initiated by the introduction of an **exogenous pyrogen** to the body. Exogenous pyrogens include pathogens such as bacteria, viruses, bacterial endotoxins, antigen-antibody complexes, hemoglobinemia in a hemolytic crisis, and many inorganic substances. In hypersensitivity states, soluble antigen-antibody complexes may act as mediators. One of the most potent exogenous pyrogens is the lipopolysaccharide of Gram-negative bacteria.

## Endogenous pyrogens

Endogenous pyrogens are proteins released from monocytes and, to a lesser extent, lymphocytes. These proteins were originally designated as **monokines** and **lymphokines** respectively, but are now more commonly referred to under the more general term of **cytokines**. One of the pyrogenic cytokines is interleukin-1, formerly known as lymphocyte activating factor. **Interleukin-1** stimulates T-lymphocyte proliferation in the presence of antigen and thereby enhances the immune response. The mediators between endogenous pyrogen and the hypothalamus appear to be prostaglandins and the level of calcium in the hypothalamus appears to regulate its activity.

Interleukin-1 initiates fever by inducing an abrupt increase in the synthesis of **prostaglandins**, particularly prostaglandin  $E_2$ , in the anterior hypothalamus. The elevated prostaglandin levels in the hypothalamus raise the thermostatic set point and induce the mechanisms of heat conservation (vasoconstriction) and heat production (shivering thermogenesis) until the blood and core temperature are elevated to match the hypothalamic set point.

Prostaglandin precursors are believed to be the chemical mediators of fever according to the following sequence:

1. Endogenous pyrogens cause the release of arachidonic acid, with subsequent synthesis of prostaglandins
2. Arachidonic acid breakdown products modulate the hypothalamic thermoregulatory mechanism, resulting in an increase in the set point value
3. Prostaglandin synthetase-inhibitor antipyretics lower fever by blocking the synthesis of prostaglandins or prostaglandin precursors from arachidonic acid.

A cytokine known as **tumor necrosis factor (TNF)- $\alpha$**  reproduces many of the physiological derangements observed in septic shock and mediates many of the deleterious effects of Gram-negative bacterial infection, including fever.

In addition to their pyrogenic activity, cytokines mediate the **acute phase response**, which is a term now being used to describe the reaction of animals to pathogen invasion, tissue injury, immunological reactions and inflammatory processes. During the acute phase response, the liver increases the synthesis of certain proteins, whereas albumin synthesis is reduced. Haptoglobins, fibrinogen, ceruloplasmin and proteinase inhibitors have been examined in cattle with the acute phase response.<sup>1</sup> In this

response, the serum iron concentration decreases during fever, which inhibits the growth of certain bacteria that require iron. Blood concentrations of zinc also decrease, with a simultaneous increase in serum copper concentrations.<sup>2</sup> Measurement of acute phase proteins may provide a basis for monitoring the severity of some infections and act as an aid in making a diagnosis. The concentration of fibrinogen can be a useful addition to routine hematological determination in animals.<sup>3</sup>

The physiological mechanisms involved in the production of fever after stimulation by pyrogens must be matured or sensitized by previous exposure to pyrogen. Injection of pyrogens into newborn lambs does not cause fever but subsequent injections do.

## Effect of pyrogens on the hypothalamus

The effect of bacterial and tissue pyrogens is exerted on the thermoregulatory center of the hypothalamus so that the thermostatic level of the body is raised. The immediate response on the part of organs involved in heat regulation is the prevention of heat loss and the increased production of heat. This is the period of **increment**, or chill, which is manifested by cutaneous vasoconstriction, resulting coldness and dryness of the skin and an absence of sweating. Respiration is reduced and muscular shivering occurs, while urine formation is minimal. The extremities are cold to the touch and the rectal temperature is elevated and the pulse rate increased. When the period of heat increment has raised the body temperature to a new thermostatic level the second period of fever, the **fastigium**, or period of constant temperature, follows. In this stage the mechanisms of heat dissipation and production return to normal. Cutaneous vasodilatation causes flushing of the skin and mucosae, sweating occurs and may be severe, and diuresis develops. During this period there is decreased forestomach motility in ruminants, metabolism is increased considerably to maintain the body temperature, and tissue wasting may occur. There is also an inability to maintain a constant temperature when environmental temperatures vary.

When the effect of the pyrogenic substances is removed, the stage of **decrement**, or fever defervescence, appears and the excess stored heat is dissipated. Vasodilatation, sweating and muscle flaccidity are marked and the body temperature falls. The fall in body temperature after the initial rise is accompanied by a decline in plasma zinc and plasma total iron concentrations. If the toxemia

accompanying the hyperthermia is sufficiently severe, the ability of tissues to respond to heat production or conservation needs may be lost and as death approaches there is a precipitate fall in body temperature.

### Febrile response

The febrile response, and the altered behavior that accompanies it, are thought to be part of a total mechanism generated to conserve the resources of energy and tissue being wasted by the causative infection. The febrile response has major effects on immune mechanisms. Endogenous pyrogens stimulate T-cell proliferation. The increased body temperature causes increases in leukocyte mobility, leukocyte bactericidal and phagocytic activities, lymphocyte transformation, and also enhances the effects of interferon and interleukin-1.

Some possible adverse effects of fever include anorexia, which can lead to excessive catabolism if prolonged. Rarely, extremely high fevers can result in disseminated intravascular coagulation and effects on the central nervous system that may lead to convulsions.

### CLINICAL FINDINGS

The effects of fever are the combined effects of hyperthermia and infection or inflammation. There is elevation of body temperature, an increase in heart rate with a diminution of amplitude and strength of the arterial pulse, hyperpnea, wasting, oliguria often with albuminuria, increased thirst, anorexia, scant feces, depression and muscle weakness. The temperature elevation is always moderate and rarely goes above 42°C (107°F).

The **form of the fever may vary**. Thus the temperature rise may be:

- Transient
- Sustained, without significant diurnal variation
- Remittent, when the diurnal variation is exaggerated
- Intermittent, when fever peaks last for 2–3 days and are interspersed with normal periods
- Atypical, when temperature variations are irregular.

A biphasic fever, consisting of an initial rise, a fall to normal and a secondary rise, occurs in some diseases, e.g. in strangles in the horse and in erysipelas in swine. The outstanding example of intermittent fever in animal disease is equine infectious anemia.

In farm animal practice the most common cause of a fever is the presence of an inflammatory process such as pneumonia, peritonitis, mastitis, encephalitis, septicemia, viremia and the like. The clinical abnormalities that are typical

of the particular disease must be detected and differentiated in the process of making a diagnosis. In the absence of physical causes of hyperthermia, the presence of a fever indicates the presence of inflammation, which is not always readily apparent. A **fever of unknown origin** occurs commonly in farm animals and requires repeated clinical and laboratory examinations to elucidate the location and nature of the lesion.

In **horses**, a **fever of unknown origin** is characterized by prolonged, unexplained fever associated with nonspecific findings such as lethargy, inappetence and weight loss. In a series of horses with fever of unknown origin, the cause was found to be infection in 43%, neoplasia in 22%, immune-mediated in 7% and miscellaneous diseases in 19%. The cause remained undetermined in 10%.<sup>4</sup>

The **magnitude of the fever** will vary with the disease process present and it is often difficult to decide at what point the elevated temperature is significant and represents the presence of a lesion that requires specific treatment. This is especially true when examining groups of animals with nonspecific clinical findings including an elevated temperature. The typical example is a group of feedlot cattle affected with depression, inappetence, dyspnea and fever ranging from 39.5–40.5°C. The suspected disease may be pneumonic pasteurellosis but it may be impossible to make that diagnosis based on auscultation of the lungs of all the affected animals. Some of the animals may have a fever of unknown origin from which they will recover in a few days and specific therapy is not required. Under these circumstances and based on clinical experience, the tendency is to make a diagnosis of '**acute undifferentiated bovine respiratory disease**' or '**undifferentiated fever**' in animals with a temperature  $\geq 40.5^\circ\text{C}$  for 2 days in succession. This emphasizes the need to select an upper threshold value that indicates a clinically and physiologically significant fever.

### CLINICAL PATHOLOGY

There are no clinicopathological findings that are specific for fever. The hemogram will reflect the changes associated with the cause of the fever. Inflammation is characterized by marked changes in the total and differential leukocyte count characteristic for each disease. A wide variety of tests can be performed to identify the location and nature of the lesion causing the fever. The most commonly used include:

- Microbiologic testing of blood samples
- Analysis of serous fluids from body cavities

- Cerebrospinal fluid analysis
- Milk sample analysis
- Reproductive tract secretion analysis
- Joint fluid analysis
- Biopsies
- Exploratory laparotomy.

Medical imaging may be necessary to detect deep abscesses.

### Necropsy findings

The necropsy findings will be characteristic of the individual disease process and are commonly characterized by varying degrees of peracute, acute and chronic inflammation depending on the severity of the disease, the length of illness and whether or not treatment had been given. In the case of longstanding fevers the above findings are still characteristic but they may fluctuate in severity daily or over longer periods.

Fever must be differentiated from hyperthermia due to a physical cause such as **heat stroke** or **exhaustion** or **malignant hyperthermia**. In **fever of unknown origin**, the history, physical examination, laboratory findings and epidemiological setting should be reviewed. Localizing clinical findings may provide a clue to the body system or organ involved. Common inflammatory processes include:

- **Abscesses of the peritoneum, pleura and lungs**
- **Septic metritis**
- **Endocarditis**
- **Polyarthritits**
- **Pyelonephritis**.

Many animals are placed in the category of fever of unknown origin because the veterinarian overlooks, disregards or rejects an obvious clue. No algorithms or computer-assisted diagnostic programs are likely to solve the diagnostic challenge. In order to improve the diagnostic accuracy, veterinarians will have to work harder. This requires obtaining a detailed history, repeated physical examinations, reconsideration of the epidemiological characteristics of the affected animal, requesting consultations from colleagues, and the investment of time to consider the diagnosis and the circumstances.

### TREATMENT

#### Antimicrobial agents

The most important aspects of the clinical management of fever should be directed at its cause. The main objective is to identify and treat the primary disease. Antimicrobial agents are indicated for the treatment of bacterial infections. The selection of antimicrobial, the route of administration and the duration of treatment depend on the cause of the infection, its severity and the accessibility

of the lesion to the drug. The use of antimicrobial agents to prevent secondary bacterial infections in animals with viral diseases (e.g. viral interstitial pneumonia) is controversial and of doubtful benefit.

In animals with a **fever of unknown origin**, broad-spectrum antimicrobial agents seem rational. However, blind therapy is not recommended because it may lead to drug toxicity, superinfection due to resistant bacteria, and interference with subsequent accurate diagnosis by cultural methods. In addition, the fall of the temperature following treatment may be interpreted as a response to therapy, with the conclusion that an infectious disease is present. If such a trial is begun the response should be monitored daily to determine effectiveness and continued efforts should be made to determine the cause of the fever. In some cases it may be necessary to surgically remove by drainage techniques the source of the infection located in abscesses or body cavities such as the pleural cavity.

### Antipyretics

Since fever ordinarily does little harm and usually benefits the animal's defense mechanism, antipyretic agents are rarely essential and may actually obscure the effect of a specific therapeutic agent or of the natural course of the disease. If the fever is high enough to cause discomfort or inappetence, or is so high that death due to hyperthermia is possible, then nonsteroidal anti-inflammatory drugs (NSAIDs) should be administered. Most NSAIDs, such as flunixin meglumine, are inhibitors of prostaglandin synthesis and act centrally to lower the thermoregulatory set point. Rectal temperatures start to decline within 30 min of parenteral NSAID administration but usually do not completely return to within the normal physiological range.

### REVIEW LITERATURE

- Dinarelo CA. Interleukin-1 and the pathogenesis of the acute phase response. *N Engl J Med* 1984; 311:1413-1418.
- McMillan FD. Fever: pathophysiology and rational therapy. *Comp Cont Educ Pract Vet* 1985; 7:845-855.
- Eckersall PD, Conner JG. Bovine and canine acute phase proteins. *Vet Res Commun* 1988; 12:169-178.

### REFERENCES

- Eckersall PD, Conner JG. *Vet Res Commun* 1988; 12:169.
- Auer DE et al. *Vet Rec* 1989; 124:235.
- Hawkey CM, Hart MG. *Vet Rec* 1987; 121:519.
- Mair TS et al. *Equine Vet J* 1989; 21:260.

## Septicemia/viremia

**Septicemia** is the acute invasion of the systemic circulation by pathogenic bacteria accompanied by sepsis or septic shock

with possible bacterial localization in various body systems or organs if the animal survives. Septicemia is a common cause of morbidity and mortality in newborn farm animals which have not received a sufficient quantity of colostrum in the first 24 hours after birth. **Bacteremia** is different from septicemia in that bacteremia is not accompanied by sepsis or septic shock. The difference between septicemia and bacteremia is one of degree. In bacteremia, bacteria are present in the bloodstream for only transitory periods and do not produce clinical signs; for example, a clinically unimportant bacteremia probably occurs frequently after rectal examination or other manipulations in which mucosa is disturbed. In septicemia, the pathogen is present throughout the course of the disease and is directly responsible for initiation of the disease process.

**Viremia** is the invasion of the systemic circulation by pathogenic viruses with localization in various body tissues and in which the lesions produced are characteristic of the specific virus. Many infections associated with rickettsias, protozoa and fungi are also spread hematogenously throughout the body but do not initiate a systemic inflammatory response syndrome.

### ETIOLOGY

Many different infectious agents can result in septicemia or viremia. Some of the notable examples of septicemias and viremias are outlined below.

#### All species

Anthrax, pasteurellosis and salmonellosis are found in all species of food animal.

#### Neonatal septicemias

Neonatal septicemias are caused most commonly by Gram-negative bacteria.

#### Calves

Bacteremia and septicemia are often associated with *Escherichia coli* and *Salmonella* spp. *E. coli* is most frequently isolated from the blood of calves<sup>1</sup> but Gram-positive infections may be found in 10% of septicemic calves and polymicrobial infections in 28%.<sup>2</sup> Calf septicemia is infrequently caused by an *Actinobacillus-suis*-like bacteria.<sup>3</sup> Thirty percent of severely ill calves with or without diarrhea are bacteremic, with the risk of bacteremia being higher in calves with failure of transfer of colostral immunoglobulins.<sup>1,4,5</sup>

#### Piglets

Septicemia due to *E. coli* is possible, also septicemia with localization in the joints, endocardium and meninges associated with *Streptococcus suis* type 1.

#### Foals

Septicemia with localization associated with *E. coli*, *Actinobacillus equuli*, *Klebsiella*

*pneumoniae*,  $\alpha$ -hemolytic *Streptococcus*, and *Salmonella* spp. are seen.

#### Lambs

Septicemia associated with *E. coli* occurs most frequently.

#### Cattle

*Histophilus sommi*, *Pasteurella multocida*, *Mannheimia haemolytica*, *Pasteurella (Yersinia) pseudotuberculosis*, acute and chronic infections with bovine virus diarrhea virus and bovine malignant catarrh are encountered.

#### Sheep (young lambs)

*Histophilus sommi* is the main pathogen.

#### Pigs

Hog cholera and African swine fever viruses and *Erysipelothrix insidiosa* are encountered.

#### Horses, donkeys, mules

African horse sickness and *M. haemolytica* infection are implicated.

#### Secondary septicemias

The principal cause of death in subacute radiation injury is septicemia resulting from loss of leukocyte production because of injury to bone marrow. Septicemia may also result when there is a congenital defect in the immune system or when immunosuppression occurs in older animals as a result of corticosteroid therapy or toxin such as bracken.

### EPIDEMIOLOGY

Systemic infections associated with bacteria, viruses, rickettsia, protozoa and other pathogens occur in animals of all ages and under many different circumstances. The epidemiological characteristics for each entity are presented under each disease described in this book. The risk factors for each infectious disease are categorized according to:

- **Animal risk factors**
- **Environmental risk factors**
- **Pathogen risk factors.**

For example, colostrum-deprived newborn animals are highly susceptible to septicemia.<sup>6</sup> Failure of transfer of passive immunity in foals is defined by serum IgG<sub>1</sub> levels of  $\leq 400$  mg/dL; partial failure of transfer of passive immunity between 400 and 800 mg/dL. Serum IgG concentrations of  $\geq 800$  mg/dL are less frequently associated with sepsis in foals and this is considered the threshold concentration for prophylaxis in foals.

### PATHOGENESIS

Two mechanisms operate in septicemia: the **exotoxins** or **endotoxins** produced by the infectious agents initiate a profound toxemia and high fever because of their initiation of the release of host mediators and because of the rapidity

with which the agents multiply and spread to all body tissues (see also Toxemia and Shock). The clinical manifestations are the result of the effect of the pathogens on monocytes and lymphocytes, which initiate the **systemic inflammatory response syndrome**. TNF- $\alpha$  is associated with clinical septicemia in newborn foals<sup>7</sup> and calves,<sup>8</sup> with plasma TNF- $\alpha$  concentration being associated with the severity of clinical signs.

Localization of certain pathogens occurs in many organs and may produce severe lesions in animals that survive the toxemia. Direct endothelial damage and hemorrhages may also be caused. The same general principles apply to a viremia, except that toxins are not produced by viruses. It is more likely that the clinical manifestations are the result of direct injury of the cells invaded by the virus. **Transplacental infection** can occur, resulting in fetal **mummification, abortion, or infection of the fetus that may be carried to term**.

#### Disseminated intravascular coagulation

Disseminated intravascular coagulation (DIC) is common in severe septicemic disease, especially that which terminates fatally. It is initiated by vascular injury with partial disruption of the intima, caused by the circulation of foreign materials such as bacterial cell walls, antigen-antibody complexes and endotoxin, with subsequent platelet adherence and the formation of platelet thrombi. Once coagulation proceeds, the initial hypercoagulable state changes to hypocoagulation, as clotting factors and platelets are consumed. The activation of the fibrinolysis system can be a major cause of the hemorrhagic diathesis present in this syndrome.

#### CLINICAL FINDINGS

The major clinical findings in septicemia are **fever, cardiovascular dysfunction and shock, and submucosal and subepidermal hemorrhages** that are usually petechial and occasionally ecchymotic. The hemorrhages are best seen under the conjunctiva and in the mucosae of the mouth and vulva. Tachycardia, tachypnea and shock-induced organ dysfunction with cardiovascular hypotension, myocardial asthenia and respiratory distress may occur in severe cases if the pathogen initiates the release of the host mediators, causing the **systemic inflammatory response syndrome (SIRS)**. These features are described under Toxemia and Shock.

Specific signs may occur as the result of localization of the infection in joints, heart valves, meninges, eyes or other

organs. The clinical findings characteristic of each disease in which septicemia and viremia occur are presented under each disease heading in this book.

#### Neonatal septicemia

Neonatal septicemia is common in all farm animal species from a few hours up to several days of age. The following features are common:

- Recumbency
- Depression
- Absence or marked depression of the suck reflex
- Dehydration
- Fever
- Diarrhea
- Injected or congested mucous membranes
- Weakness
- Rapid death.

Colostrum-deprived foals are commonly very ill and become comatose and die within several hours. Localized infections in the joints and lungs are frequent in foals that survive for several days. Septic polyarthritis is common and is characterized by heat, pain, synovial distension and lameness. Pneumonia is often observed and is characterized by dyspnea and abnormal lung sounds. The survival rate of foals with confirmed septicemia in one series was 70%.<sup>9</sup>

In calves under 30 days of age with septicemia clinical findings can include evidence of shock with cold extremities, dehydration, weak pulse, prolonged capillary refill time, weakness and recumbency.<sup>2</sup> Findings indicative of localization include ophthalmitis, neurological abnormalities, omphalophlebitis and polyarthritis.

#### Clinical sepsis score

A **clinical sepsis score** for the early diagnosis of septicemia in newborn foals has been evaluated and validated.<sup>10</sup> It should be recognized that application of such scoring systems is statistically flawed, as it assigns equal weights to predictors and equal weights to change in severity within a given predictor. Nevertheless, such sepsis scores have been adopted by some and do have the value of facilitating the identification of neonates at risk for being septicemic. A score for predicting bacteremia in neonatal dairy calves from 1–14 days of age has also been suggested to predict clinically whether a sick calf has bacteremia.<sup>11</sup> The calves are scored according to degrees of **hydration status, fecal appearance, general attitude, appearance of scleral vessels and umbilical abnormality**. However, the sensitivity, specificity and positive predictive value are too low to be of diagnostic value.<sup>5</sup>

## CLINICAL PATHOLOGY

### Blood culture

Isolation of the causative bacteria from the bloodstream should be attempted by culture. Ideally, blood cultures should be obtained just before the onset of fever and from a major vein or any artery. The standard is three blood cultures or animal inoculation at the height of the fever. A minimum of 10 mL of blood (preferably 30 mL) should be collected anaerobically after aseptic preparation of the venipuncture site by clipping and scrubbing with povidone iodine scrub. Blood samples should be inoculated into a broth medium with the ratio of blood to broth being 1:10 to 1:20,<sup>12</sup> and the culture bottles should be examined for growth daily for up to a week.<sup>13</sup> Growth is manifest as turbidity and possibly by the presence of hemolysis.

### Hemogram

The presence of **leukopenia** or **leukocytosis** is an aid in diagnosis and the type and degree of leukocytic response may be of prognostic significance.

Plasma fibrinogen concentrations may be increased.<sup>2</sup> Consumption coagulopathy is detected by falling platelet counts, prothrombin and fibrinogen values, and also by the presence of fibrin degradation products.

### Immunoglobulin status

Low levels of serum protein and immunoglobulins are associated with failure of transfer of colostral immunoglobulins in newborn farm animals with consequent septicemia due, most commonly, to Gram-negative bacteria.

### Serology

Serological tests are available for most infectious diseases described in this book.

### Necropsy findings

The lesions will reflect the specific disease causing the septicemia. Subserous and submucosal hemorrhages may be present, together with embolic foci of infection in various organs accompanied by the lesions typical of the specific pathogen.

## TREATMENT

The principles of treatment are similar to those described for the treatment of toxemia, fever and shock, and treatment should focus on broad-spectrum antimicrobial agents and general supportive measures. For neonatal septicemia the provision of a source of immunoglobulins by plasma or blood transfusion is necessary when there is failure of transfer of passive immunity. Whether such treatment alters the mortality rate is uncertain. Intensive care of the newborn with septicemia, as described in Chapter 3. The frequency of bacteremia (approximately 30%) is sufficiently high in calves



with diarrhea that are severely ill (as manifest by reduced suckle reflex, > 6% dehydration, weakness, inability to stand, or clinical depression) that affected calves should be routinely treated for bacteremia, with emphasis on treating potential *E. coli* bacteremia.<sup>1,4,5</sup> Strict hygienic precautions to avoid spread of infection are also necessary.

## REFERENCES

1. Fecteau G et al. *Can Vet J* 1997; 38:95.
2. Aldridge BM et al. *J Am Vet Med Assoc* 1993; 203:1324.
3. DeBey BM et al. *J Vet Diagn Invest* 1996; 8:248.
4. Lofstedt J et al. *J Vet Intern Med* 1999; 13:81.
5. Constable PD. *J Vet Intern Med* 2004; 18:8.
6. Robinson JA et al. *Equine Vet J* 1993; 25:214.
7. Morris DD, Moore JN. *J Am Vet Med Assoc* 1991; 199:1584.
8. Basoglu A et al. *J Vet Intern Med* 2004; 18:238.
9. Raisis AL et al. *Aust Vet J* 1996; 73:137.
10. Brewer BD, Koterba AM. *Equine Vet J* 1988; 20:18.
11. Fecteau G et al. *Can Vet J* 1997; 38:101.
12. Kasari TR, Roussel AJ. *Compend Contin Educ Pract Vet* 1989; 11:655.
13. Hariharan, H. et al. *Can Vet J* 1992; 33:56.

## Toxemia and endotoxemia

Toxemia is a clinical systemic state caused by widespread activation of host defense mechanisms to the presence of toxins produced by bacteria or injury to tissue cells. Toxemia does not include the diseases caused by toxic substances produced by plants or insects or ingested organic or inorganic poisons. Theoretically, a diagnosis of toxemia can be made only if toxins are demonstrable in the bloodstream. Practically, toxemia is often diagnosed when the syndrome described below is present. In most cases there is contributory evidence of a probable source of toxins, which in many cases are virtually impossible to isolate or identify.

The most common form of toxemia in large animals is **endotoxemia**, caused by the presence of lipopolysaccharide cell-wall components of Gram-negative bacteria in the blood, and characterized clinically by abnormalities of many body systems. Because of the overwhelming importance of endotoxemia in large animals with Gram-negative bacterial infections, the focus of this discussion will be on endotoxemia. The abnormalities of endotoxemia include:

- Marked alterations in cardiopulmonary function
- Abnormalities in the leukon (neutropenia and lymphopenia) and thrombocytopenia that may lead to coagulopathies
- Increased vascular permeability
- Decreased organ blood flow and metabolism, leading to heart and renal failure

- Decreased gastrointestinal motility
- Decreased perfusion of peripheral tissues, leading to shock
- The need for intensive and complex therapy
- A high case fatality rate.

Current therapeutic regimens are only moderately successful.

Gram-negative bacteria such as *E. coli*, *Salmonella* spp., *Pasteurella* spp. and *Histophilus somni*, as examples, cause many diseases of ruminants in which endotoxemia is common.<sup>1</sup> Varying degrees of severity of toxemia occur in diseases such as mastitis, peritonitis, pneumonia and pleuritis, pericarditis, septic metritis, septicemia of neonates, myositis, meningoencephalitis and some enteritides. Endotoxemia is also one of the commonest causes of death in horses affected with gastrointestinal disease due to a physical obstruction causing strangulation and ischemic necrosis.

## ETIOLOGY OF TOXEMIA AND ENDOTOXEMIA

Toxins can be classified as antigenic or metabolic.

### Antigenic toxins

These are produced by bacteria and to a lesser extent by helminths. Both groups of pathogens act as antigens and stimulate the development of antibodies. Antigenic toxins are divided into exotoxins and endotoxins.

### Exotoxins

These are protein substances produced by bacteria that diffuse into the surrounding medium. They are specific in their pharmacological effects and in the antibodies that they induce. The important bacterial exotoxins are those produced by *Clostridium* spp., for which commercial antitoxins are available. They may be ingested preformed, as in botulism, or produced in large quantities by heavy growth in the intestines, such as in enterotoxemia, or from growth in tissue, as in blackleg and black disease.

### Enterotoxins

These are exotoxins that exert their effect principally on the mucosa of the intestine, causing disturbances of fluid and electrolyte balance. The most typical example is the enterotoxin released by enterotoxigenic *E. coli*, which causes a hypersecretory diarrhea in neonatal farm animals.

### Endotoxins

The endotoxins of several species of Gram-negative bacteria are a major cause of morbidity and mortality in farm animals. The endotoxins are lipopolysaccharides found in the outer wall of the bacteria. Endotoxins are released into the immediate surroundings when the

bacteria undergo rapid proliferation with production of unused sections of bacterial cell wall or, most commonly, when the bacterial cell wall breaks. Endotoxin gains access to the blood when there is a severe localized infection, such as a coliform mastitis in dairy cattle, or a disseminated infection, such as coliform septicemia in newborn calves.

Gram-negative bacteria are present in the intestinal tract as part of the normal microflora and endotoxins are also present. The endotoxins are not ordinarily absorbed through the intestinal mucosa unless it is injured, as in enteritis or more particularly in acute intestinal obstruction. Ordinarily, small amounts of endotoxin that are absorbed into the circulation are detoxified in the liver but, if hepatic efficiency is reduced or the amounts of toxin are large, a state of endotoxemia is produced. Endotoxins may also be absorbed in large amounts from sites other than intestine including the mammary gland, peritoneum, abscesses and other septic foci, or from large areas of injured or traumatized tissue. The best known endotoxins are those of *E. coli*, which have been used extensively as models for experimental endotoxemia, and *Salmonella* spp.

The most common causes of endotoxemia in horses are associated with diseases of the gastrointestinal tract including colitis, intestinal strangulation or obstruction and ileus.<sup>2</sup> Complications associated with foaling and grain overload are also common causes.

### Metabolic toxins

These may accumulate as a result of incomplete elimination of toxic materials normally produced by body metabolism, or by abnormal metabolism. Normally, toxic products produced in the alimentary tract or tissues are excreted in the urine and feces or detoxified in the plasma and liver. When these normal mechanisms are disrupted, particularly in hepatic dysfunction, the toxins may accumulate beyond a critical point and the syndrome of toxemia appears. In obstruction of the lower alimentary tract there may be increased absorption of toxic phenols, cresols and amines that are normally excreted with the feces, resulting in the development of the syndrome of auto-intoxication. In ordinary circumstances in monogastric animals these products of protein putrefaction are not absorbed by the mucosa of the large intestine but when regurgitation into the small intestine occurs there may be rapid absorption, apparently because of the absence of a protective barrier in the wall of the small intestine.

In liver diseases, many of the normal detoxification mechanisms, including



oxidation, reduction, acetylation and conjugation with such substances as glycine, glucuronic acid, sulfuric acid and cysteine, are lost and substances which are normally present in insufficient quantity to cause injury accumulate to the point where illness occurs. The production of toxins by abnormal metabolism is taken to include the production of histamine and histamine-like substances in damaged tissues. Ketonemia due to a disproportionate fat metabolism, and lactic acidemia caused by acute ruminal acidosis (grain overload), are two common examples of toxemia caused by abnormal metabolism.

### **PATHOGENESIS OF ENDOTOXEMIA**

The specific effects of the particular bacterial exotoxins and metabolic toxins are presented in the relevant sections of specific diseases in the Special Medicine section of this book. The principles of the effects of bacterial endotoxemia will be presented here.

The total toxic moiety of the lipopolysaccharide molecule is generally similar regardless of the bacterial source. Endotoxemia results in an extraordinary array of pathophysiological effects, involving essentially all body systems. Of the endotoxins produced by bacteria most is known of those produced by *E. coli*.

**Endotoxins are normally present in the intestine** and although the intestinal mucosa provides a highly efficient barrier, limiting transmural movement of endotoxins, small quantities are absorbed into the portal blood. These endotoxins are removed by the liver and do not reach the peripheral blood. In hepatic failure the level of endotoxins in plasma is increased. Significantly greater quantities of endotoxins escape the intestine when the mucosal barrier is disrupted by intestinal ischemia, trauma, ionizing radiation, bacterial overgrowth, reduced luminal pH or inflammatory intestinal disease.<sup>3</sup> These conditions not only temporarily overwhelm the capacity of the liver to remove endotoxin from the portal circulation but also allow transmural movement of endotoxins into the peritoneal cavity from which they reach the peripheral blood.

**Endotoxemia** may also occur when Gram-negative bacteria gain access to tissues and/or blood. Most of these organisms liberate endotoxin during rapid growth and gain access to the blood from primary foci of systemic or superficial tissue infections. An example is coliform septicemia in newborn farm animals. Once the endotoxins gain access to the blood, they are removed from the circulation by the mononuclear phagocyte system, and the response of these phagocytes to the lipopolysaccharides determines the severity of the clinical illness.

### **Biochemical mediators**

Endotoxins do not cause their effects via direct toxic effect on host cells but rather induce the production of soluble and cell-bound mediators from a broad range of host cells, including endothelial and smooth muscle cells, polymorphonuclear granulocytes, platelets, thrombocytes and cells of the monocyte/macrophage lineage. These cells release a series of phlogistic biochemical mediators, which include cytokines, platelet-activating factor, thromboxane A<sub>2</sub>, prostaglandins, leukotrienes, proteinases, toxic oxygen metabolites and vasoactive amines. Macrophages become highly activated for enhanced secretory, phagocytic and cidal functions by the lipopolysaccharide. The cytokines derived from the macrophages are responsible for many of the pathophysiological consequences of endotoxemia. Pulmonary intravascular macrophages are the most important producers of cytokines in large animals.

Animals have evolved to recognize and respond to the lipopolysaccharide of Gram-negative bacteria. Although lipopolysaccharide may directly injure the host tissue, many of its effects are indirectly mediated through inappropriate activation of host defense mechanisms, culminating in multiple-organ dysfunction and failure. Importantly, the response to endotoxin can be attenuated with certain substances. Experimentally, the use of detergents, such as a nonionic surfactant, can attenuate the response of the horse given endotoxin.<sup>4</sup> The literature on the pathophysiological effects of endotoxemia and Gram-negative bacteremia in swine has been reviewed.<sup>5</sup>

There is a large individual variability in the response to endotoxin administration, with much of the variability still being unexplained. Circulating lipopolysaccharide forms complexes in plasma with high density lipoproteins or a unique plasma protein termed **lipopolysaccharide-binding protein (LBP)** and bound lipopolysaccharide is cleared from plasma within a few minutes by fixed and circulating macrophages in the bovine lung and liver that recognize the lipopolysaccharide-LBP complex. The lipopolysaccharide-LBP complex binds to a membrane-bound receptor (mCD14) on mononuclear cells via a secreted linking protein called MD-2 and then attaches to a **toll-like receptor 4 (TLR4)** on the mononuclear cell membrane; the lipopolysaccharide-LBP-mCD14-MD-2 complex is then internalized and lipopolysaccharide is thought to be destroyed in the process. Internalization of lipopolysaccharide activates the intracellular signaling pathway via nuclear factor kappa B (**NF-κB**), which translocates to

the nucleus and causes the transcription of many cytokine genes and release of proinflammatory cytokines, of which **TNF-α**, **interleukin-1** and **interleukin-6** are the most important. Some of the genes activated include those that code for cyclooxygenase 2 (**COX-2**, the inducible form of cyclooxygenase), inducible nitric oxide (**iNOS**), **endothelial adhesion molecules**, which promote the adhesion of neutrophils to endothelial surfaces, and chemokines.

The plasma concentrations of the **arachidonic acid metabolites**, **thromboxane A<sub>2</sub>** and **prostacyclin**, increase in several species during endotoxemia, and these eicosanoids are probably responsible for the hemodynamic abnormalities caused by endotoxin. Endotoxin initiates cellular events that activate a cell-membrane enzyme known as phospholipase A<sub>2</sub>. Activation of this enzyme leads to the hydrolysis of membrane-bound phospholipids; arachidonic acid is released from the phospholipid portion of damaged mammalian cell membranes.<sup>6</sup> The enzyme cyclooxygenase converts arachidonic acid into intermediate endoperoxides, which are substrates for the formation of prostaglandins, thromboxane and prostacyclin, by specific synthetases. Platelets are the principal source of thromboxane, which acts as a potent vasoconstrictor and induces platelet aggregation. Most prostacyclins are synthesized in vascular endothelial cells and cause vasodilation and inhibit platelet aggregation. The generalized endotoxin-induced production of cyclooxygenase products may contribute to the multisystemic organ dysfunction, shock and disseminated coagulopathy that culminates in death.

**TNF-α** is released by macrophages early in the course of endotoxemia and circulating TNF-α activity correlates with the severity and outcome of disease. Infusion of TNF induces an endotoxemic-shock-like syndrome and TNF-α blockade confers marked protection against the effects of Gram-negative sepsis and lipopolysaccharide administration. Experimentally, pretreatment of horses with monoclonal antibody to TNF-α can reduce the hematological and clinical effects of endotoxin-induced TNF activity<sup>7</sup> and interleukin-6 activity can be reduced by neutralization of TNF-α.<sup>8</sup> Interleukin-1 release is proinflammatory and leads to pyrexia and the hepatic acute phase response. Interleukin-6 contributes to the hepatic acute phase response and promotes B-lymphocyte proliferation. Interleukin-6 may have value as a prognostic indicator, as its plasma concentration appears to be a better predictor of mortality in humans than TNF-α or interleukin-1.

The systemic effects of endotoxemia can be demonstrated experimentally by parenteral injection of purified endotoxin, TNF- $\alpha$  or interleukin-1. In naturally occurring disease, however, the total effect includes those of bacterial toxins plus those of mediators produced by tissues in response to the toxins, and the counterbalancing effects of anti-inflammatory molecules that are also secreted during sepsis, such as interleukin-4, interleukin-10, interleukin-11, interleukin-13, and soluble CD14 receptors. The pathophysiological effects of endotoxemia associated with Gram-negative bacteria are summarized here according to their effects on various body systems or functions.

### Cardiopulmonary function

The hemodynamic effects of endotoxemia are manifested in two phases.<sup>9</sup> In the early stages, heart rate and cardiac output commonly increase, although systemic blood pressure remains near or slightly less than normal. This is known as the **hyperdynamic phase** of endotoxemia. Oxygen demands of peripheral tissues are increased during the hyperdynamic phase, resulting in compensatory mechanisms that increase blood flow in an attempt to meet the increased metabolic demands. However, despite the absolute increase in cardiac output and oxygen delivery during this hyperdynamic phase, blood flow still may be inadequate to meet the needs of tissues in a hypermetabolic state. During the hyperdynamic state, affected animals hyperventilate and have decreased capillary refill time and red, congested mucous membranes. Microcirculatory shunting of blood continues in organs such as the gastrointestinal tract and kidney. Ischemia of intestinal mucosa is manifested clinically by ileus and diarrhea may occur. Decreased renal perfusion will result in decreased urine output.

With uncontrolled endotoxemia, the hyperdynamic phase progresses to the **hypodynamic phase** of shock. Changes include decreased cardiac output, systemic hypotension, increased peripheral resistance and decreased central venous return. Hypothermia, rapid irregular pulses, prolonged capillary refill time, pale to cyanotic mucous membranes, acidemia and hypoxemia provide clinical evidence of this advanced stage of endotoxemia. The skin and extremities are cool. Severe pulmonary edema and increasing pulmonary hypertension occur. In horses, administration of endotoxin at high dosages can induce circulatory shock with increased heart rate, decreased cardiac output and stroke volume, and concomitant increases in peripheral vascular resistance. The slow intravenous infusion

of low dosages of endotoxin into conscious horses results in pulmonary hypertension without causing hypotensive, hypovolemic shock.<sup>10</sup> Intestinal vasoconstriction occurs as part of the compensatory response to endotoxemia following slow infusion of low dosages of endotoxin.

Infusion of endotoxin into swine induces widespread changes including intense pulmonary vasoconstriction and hypertension, bronchoconstriction, increased vascular permeability, hypovolemia, systemic hypotension, pulmonary edema, hypoxemia, granulocytopenia and thrombocytopenia.<sup>5</sup> The vascular changes in endotoxemia include increased vascular permeability, changes in vascular tone and microvascular obstruction. Increased capillary permeability promotes transmural movement of albumin and other colloids, which carry water to the interstitial space. The result is hypoalbuminemia, hypoproteinemia, interstitial edema, pulmonary edema, relative hypovolemia, decreased return to the heart and further decreases in cardiac output. Arterial and arteriolar vasoconstriction develops in the systemic and pulmonary circulations. Prolonged infusion of endotoxin into sheep causes systemic hypotension, pulmonary hypertension and acute lung injury with progressive respiratory failure.<sup>11</sup>

Endotoxemia causes an acute and severe neutropenia, which precedes neutrophilia and hemoconcentration. Neutropenia is due mainly to leukocyte margination and sequestration; persistence of severe neutropenia is a poor prognostic indicator. Hemoconcentration is due to movement of fluid from the vascular to extravascular spaces. Endotoxin administration causes an immediate accumulation, margination and activation of leukocytes in the microcirculation, particularly in the alveolar capillaries. This is followed by degranulation and leukocyte migration into the interstitium and endothelial cell damage. Pulmonary sequestration of neutrophils is preceded by endotoxin uptake by pulmonary intravascular macrophages, indicating that the pulmonary macrophage response is pivotal to the subsequent inflammatory response. Leukopenia appears to be an immediate response to endotoxin administration, and is observed as early as 5 min after infusion. The rebound leukocytosis is caused by humoral effects on the bone marrow; a neutrophil-releasing factor that promotes release of neutrophils from bone marrow, and macrophage-colony-stimulating factor, which stimulates granulopoiesis. Colostrum-fed calves have a greater neutrophilia in response to endotoxin than colostrum-deprived calves, possibly because of absorption of a

granulopoietic factor from colostrum. Endotoxemia also induces a lymphopenia that is secondary to the release of endogenous corticosteroids and redistribution of lymphocytes from peripheral blood and the spleen to lymphatic tissue.

Thrombocytopenia is consistently observed after endotoxin administration, but occurs later than neutropenia, although it is sustained for a longer period of time. Endotoxin affects platelet function by a number of different mechanisms.

### Hemostatic system

Endotoxins cause endothelial injury directly or indirectly, and thereby expose subendothelial collagen and tissue thromboplastin, initiating the intrinsic and extrinsic coagulation cascades, respectively.<sup>3</sup> Endotoxin can initiate the coagulation cascade directly by activation of factor XII or by inducing platelet release of thromboxane and other procoagulant substances. Endotoxin may induce coagulopathy indirectly by endothelial damage with secondary factor XII activation, or through the effects of complement activation. Macrophages and leukocytes have been shown to release a procoagulant substance in response to endotoxin, which functions similarly to factor VII and may also have a role in perpetuating coagulopathy in endotoxemia via the extrinsic pathway.

Disseminated coagulopathy is the cause of diffuse microvascular thrombosis and eventual organ failure subsequent to endotoxemia. The experimental injection of endotoxin can cause diffuse microthrombosis in multiple or organ systems. The principal clinical finding of DIC in horses is petechial and/or ecchymotic hemorrhages on mucous membranes and sclerae with a tendency to bleed from venepuncture sites. Spontaneous epistaxis or prolonged hemorrhage after nasogastric intubation may also occur. The result of exaggerated thrombin formation during DIC is widespread fibrin deposition in the microcirculation causing circulatory obstruction and organ hypoperfusion that may lead to ischemic necrosis and failure. The ultimate consequences are multiple organ failure and death.

### Thermoregulation

Bacterial endotoxins are potent stimulators of macrophage interleukins, which belong to a family of polypeptides functioning as key mediators of various infectious, inflammatory and immunological challenges to the host. Interleukin-1 induces fever, an increase in the number and immaturity of circulating neutrophils, muscle proteolysis through increased prostaglandin E<sub>2</sub> production, hepatic acute phase protein production, and

reduced albumin synthesis. Interleukin-1 participates in the acute phase response, which is characterized by fever, hepatic production of acute phase proteins, neutrophilia and procoagulant activity.<sup>9</sup>

Endotoxins commonly cause a fever followed by hypothermia. Serum interleukin-6 concentrations are lower in endotoxin-induced colostrum-deprived foals and take longer to reach peak levels compared to colostrum-fed foals.<sup>12</sup> The higher and more rapid concentrations in colostrum-fed foals may be part of a resistance factor in equine neonates. Interleukin-6 plays a key role in host defense, regulating antigen-specific immune responses, hematopoiesis, cellular differentiation and the acute phase reaction subsequent to an inflammatory insult. Serum TNF- $\alpha$  responds in a similar pattern in colostrum-deprived and colostrum-fed foals given endotoxin and the mean rectal temperature in colostrum-deprived foals is significantly less than in colostrum-fed foals.<sup>12</sup>

#### Gastrointestinal function

Endotoxemia can cause a profound inhibition of gastrointestinal motility, including the stomach, small and large intestine. Postoperative ileus is a frequent and serious complication of equine colic surgery and there is a good correlation between the incidence of ileus and the presence of ischemic intestine. Low doses of endotoxin infused into ponies produced profound disruption of normal fasting intestinal motility patterns, with an inhibition of gastric contraction amplitude and rate, left dorsal colon contraction product and small-colon spike rate.<sup>13</sup> In the small intestine, there is an increase in abnormally arranged regular activity and a decrease in irregular activity. Experimental endotoxemia in the horse causes cecal and proximal colonic hypomotility (ileus) by a mechanism involving  $\alpha$ -adrenergic receptors, which is reversible by yohimbine.<sup>14</sup> Numerous mediators may interact with the sympathetic nervous system to induce this effect.

The administration of endotoxin to adult dairy cows can reduce the frequency of reticulorumen contractions; this is caused by endotoxin-induced mediators<sup>15</sup> and the effect can be abolished by flunixin meglumine. Endotoxemia also decreases the abomasal emptying rate in cattle and is suspected to play a role in the development of left displaced abomasum.

#### Carbohydrate metabolism

The effects on carbohydrate metabolism include a fall in plasma glucose concentration, the rate and degree varying with the severity of endotoxemia, a disappearance of liver glycogen and a decreased glucose tolerance of tissues so

that administered glucose is not used rapidly. Endotoxic shock can result in lactic acidemia and both hyper- and hypoglycemia responses. **Hyperglycemia** occurs early and transiently in endotoxic shock, is accompanied by increased rates of glucose production and is dependent on mobilization of hepatic glycogen.

**Hypoglycemia** is very common in prolonged or severe endotoxemia. Experimental infusion of endotoxin into sheep results in transient hyperglycemia associated with increased hepatic glucose production followed by hypoglycemia 3–8 hours later, when hepatic glucose production decreases. Sympathetic activation occurs early in endotoxemia and is probably responsible for the initial hyperglycemia and glycogenolysis. Blood pyruvate and lactate concentrations increase as a result of poor tissue perfusion and the anaerobic nature of tissue metabolism. By extrapolation from the known pathogenesis of endotoxic shock in horses, it is likely that the resulting accumulation of lactate has significant effects in causing mental depression and poor survival.

#### Protein metabolism

There is an increase in tissue breakdown (catabolism) and a concomitant increase in serum urea nitrogen concentration. The changes observed include alterations in individual plasma amino acid concentrations, increased urinary nitrogen excretion and increased whole-body protein turnover. The time-course changes in the concentrations of plasma amino acids and other metabolites during and after acute endotoxin-induced fever in mature sheep have been described. Rapid and extensive changes occur in the patterns of tissue protein metabolism in the ruminant in response to endotoxin administration, and these changes may contribute to economic losses incurred during infectious disease outbreaks. There is also an alteration in the aminogram (the relative proportions of the amino acids present in blood) and the electrophoretic pattern of plasma proteins. The globulins are increased and albumin decreased as part of the acute phase reaction.

#### Mineral metabolism

Negative mineral balances occur. These include hypoferremia and hypozincemia as part of the acute phase reaction as the animal attempts to sequester these microminerals from invading bacteria, but blood copper concentrations are commonly increased concurrently with an increase in blood ceruloplasmin levels.

#### Reproduction and lactogenesis

Endotoxemia can cause pregnancy failure in domestic animals, particularly when

pregnancy is corpus-luteum-dependent. In horses and cattle, experimentally induced endotoxemia causes an immediate and pronounced release of prostaglandin  $F_{2\alpha}$ . The intravenous administration of endotoxin may influence luteal function by the activation of the arachidonic acid cascade, by a direct effect of prostaglandin  $F_{2\alpha}$  on the corpus luteum. The administration of endotoxin to mares pregnant 21–35 days results in a decrease in progesterone and fetal death, which can be prevented by daily treatment with a progesterone compound.<sup>16</sup> Similar results have been produced in pregnant dairy cows during the first 150 days of lactation, and coliform mastitis in the first 5 months of lactation is becoming an increasingly important cause of early embryonic death and return to estrus. The uterus of the early postpartum cow is capable of absorbing endotoxin, which may provoke changes in the serum concentrations of prostanoids<sup>17</sup> and is thought to contribute substantially to the systemic signs of toxic metritis in cows. Endotoxin has a negative effect on the genital functions of the ram; the changes in luteinizing hormone (LH) and testosterone are similar to those seen after heat-induced stress.

In recently farrowed swine with the mastitis-metritis-agalactia syndrome, it is suggested that the endotoxin from the mammary glands affected with mastitis may be important in the pathogenesis of theagalactia.

#### Combined effects on body systems

The combined effects of the hypoglycemia, hyper L-lactatemia and acidemia interfere with tissue enzyme activity and reduce the functional activity of most tissues. Of these factors, acidemia is probably the most important in adult animals; in neonates glucose levels are probably as important as acidemia because profound hypoglycemia is more commonly encountered in neonatal animals. Experimental endotoxemia in calves at 24–36 hours of age causes severe hypoglycemia, lactic acidemia and hypotension commonly associated with moderate to severe sepsis.<sup>18</sup> The myocardium is weakened, the stroke volume decreases and the response to cardiac stimulants is diminished. There is dilatation and in some cases damage to capillary walls, so that the effective circulating blood volume is decreased; this decrease, in combination with diminished cardiac output, leads to a fall in blood pressure and the development of circulatory failure. The resulting decline in the perfusion of tissues and oxygen consumption contributes greatly to the animal's decline and to the clinical signs, such as the dark red coloration of the oral

mucosa. Respiration is little affected except in so far as it responds to the failing circulation.

There is decreased liver function, and the damage to renal tubules and glomeruli causes a rise in blood nonprotein nitrogen and the appearance of albuminuria. The functional tone and motility of the alimentary tract is reduced and the appetite fails; digestion is impaired, with constipation usually following. A similar loss of tone occurs in skeletal muscle and is manifested by weakness and terminally by prostration.

Apart from the effects of specific toxins on the nervous system, such as those of *Clostridium tetani* and *Clostridium botulinum*, there is a general depression of function attended by dullness, depression and finally coma. Because of the suspected role of *E. coli* in the etiology of edema disease of swine, it is noteworthy that some of the characteristic nervous system lesions of that disease are missing from experimentally induced porcine colitoxicosis. Changes in the hemopoietic system include depression of hemopoiesis and an increase in the number of leukocytes – the type of cell that increases often varying with the type and severity of the toxemia. Leukopenia may occur but is usually associated with aplasia of the leukopoietic tissue associated with viruses or specific exogenous substances such as radioactive materials. Most of these pathophysiological effects of endotoxemia have been produced experimentally, and it is apparent that very small amounts of endotoxin can contribute greatly to the serious effects of intestinal disease, especially in the horse.

#### Endotoxin tolerance

The repeated administration of lipopolysaccharide results in attenuation of the host response, known as endotoxin tolerance. This refractoriness to endotoxin-mediated effects comprises two phases. Early phase tolerance is transient, occurs within hours or days and is not associated with anti-endotoxin antibody production. Late phase tolerance requires several days to develop and is long lasting, antigen specific and the result of antibody production. By this mechanism it is possible for individual animals to survive a dose of endotoxin lethal to the nontolerant individual. Experimentally, horses develop endotoxin tolerance following sequential sublethal infusions of endotoxin.<sup>19</sup>

#### Hypersensitivity

A secondary effect produced by some toxins is the creation of a state of hypersensitivity at the first infection so that a second infection, or administration of the same antigen, causes anaphylaxis or an allergic phenomenon such as

purpura hemorrhagica. Also, a generalized Schwartzmann reaction can be induced in pigs by an injection of *E. coli* endotoxin, especially if there are two injections properly spaced (in time). Pigs on a vitamin-E-deficient diet are much more severely affected than pigs on a normal diet. Vitamin E is protective; selenium is not.

#### Other infectious toxins

In mycoplasmosis (*Mycoplasma mycoides* var. *mycoides*), at least part of the toxic effect is attributable to galactans contained in the toxins. These have a noticeably local effect in causing hemorrhages in alveolar ducts and pulmonary vessel walls so that pulmonary arterial blood pressure rises as systemic blood pressure falls. Later lesions are pulmonary edema and capillary thrombosis, which are characteristic of the natural disease of pleuropneumonia. Disseminated intravascular coagulation is also a characteristic of the lesions associated with the toxin of *Pseudomonas* spp.

### CLINICAL FINDINGS OF TOXEMIA AND ENDOTOXEMIA

#### Acute toxemia

The clinical findings of acute toxemia in most nonspecific toxemias are similar. The syndrome varies with the speed and severity of the toxic process but the variations are largely of degree. **Depression, anorexia and muscular weakness** are common in acute endotoxemia. **Calves do not suck voluntarily** and may not have a suck reflex. Scant feces are common but a low-volume diarrhea may also occur. The heart rate is increased and initially the intensity of the heart sounds is increased, but later as the toxemia worsens the intensity may decrease. The pulse is weak and rapid but regular. A **fever** is common in the early stages of endotoxemia but later the temperature may be normal or subnormal. In neonatal calves, foals and lambs a fever may not occur because of failure of thermoregulation or deprivation of colostrum. Terminally, there is muscular weakness to the point of collapse and death occurs in a coma or with convulsions.

#### Endotoxemia

When toxin formation or liberation into the circulation is rapid and the toxicity of the toxin high enough, the onset of cardiovascular collapse is rapid enough to cause a state of 'toxic' or 'septic' shock. The remarkable clinical findings are:

- Severe **peripheral vasodilatation** with a consequent fall in blood pressure
- **Pallor of mucosa**
- **Hypothermia**
- **Tachycardia**

- **Pulse of small amplitude**
- **Muscle weakness.**

The syndrome is discussed also in the section on Shock. Endotoxemia is most commonly associated with bacteremia or septicemia due to infection with Gram-negative organisms, especially *E. coli*.

The clinical findings of severe endotoxemia include:

- Depression
- Hyperthermia followed by hypothermia
- Tachycardia followed by decreased cardiac output
- Decreased systemic blood pressure
- Cool skin and extremities
- Diarrhea
- Congested mucosae with an increased capillary refill time
- Muscular weakness, leading to recumbency.

Renal failure is common and is characterized by anuria. If DIC develops, it is characterized by petechial and ecchymotic hemorrhages on mucous membranes and sclerae with a tendency to bleed from venepuncture sites.

#### Chronic toxemia

Lethargy, separation from the group, inappetence, failure to grow or produce and emaciation are characteristic signs of chronic toxemia.

#### Localized infection

With localized infections there are, in addition to the general signs of toxemia, the clinical effects of the space occupation by the lesion. These are presented under Localized infections.

### CLINICAL PATHOLOGY OF ENDOTOXEMIA

#### Hematology

Changes in total and differential leukocyte numbers occur in endotoxemia. Leukocytosis and neutrophilia occur with mild endotoxemia and leukopenia, neutropenia and lymphopenia increase in severity and duration with increasing severity of endotoxemia. Endotoxin-induced rebound neutrophilia may occur and is attributed to an accelerated release of neutrophils from the bone marrow reserve into the circulation through generation of the neutrophil releasing factor.

In experimental sublethal endotoxemia in foals 3–5 days of age, there is leukopenia followed by leukocytosis, hypoglycemia, increased prothrombin time and partial thromboplastin time, and mild hypoxemia.<sup>20</sup>

#### Serum biochemistry

A low plasma glucose concentration, high serum urea concentration (nonprotein

nitrogen), and a low serum albumin and total protein concentration are usually present in acute endotoxemia. Decreased albumin and total protein concentrations are in response to increased capillary permeability, whereas the azotemia reflects a decreased glomerular filtration rate. Adult herbivores have a mild hypocalcemia, hypomagnesemia and hypokalemia, and hypophosphatemia,<sup>21</sup> which most likely reflects inappetence and decreased gastrointestinal tract motility.

In more chronic toxemic states, a high serum total protein concentration, with globulins noticeably increased on electrophoretic examination, is more common.

### Endotoxin

Endotoxin can be detected in the whole blood of horses using a whole blood hemagglutination inhibition assay.<sup>22</sup> However, sensitivity, specificity and predictive values are not high enough to be of routine use.

### NECROPSY FINDINGS OF TOXEMIA AND ENDOTOXEMIA

Gross findings at necropsy are limited to those of the lesion that produces the toxin. Microscopically, there is degeneration of the parenchyma of the liver, the glomeruli and tubules of the kidney and of the myocardium. There may also be degeneration or necrosis in the adrenal glands.

### TREATMENT OF ENDOTOXEMIA

The principles of treatment of endotoxemia or septic shock include: 1) removal of the foci of infection; 2) administration of antimicrobial agents with a Gram-negative spectrum; 3) aggressive fluid and electrolyte therapy to combat the relative hypovolemia, hypoglycemia, and electrolyte and acid-base disturbances; and 4) NSAIDs or glucocorticoids for the inhibition of products of the cyclooxygenase pathway. These four treatments are routinely applied. Other treatments that may be applied in selected cases include the administration of inotropic agents or vasopressors, intravenous or intramammary administration of polymyxin B, and hyperimmune plasma containing antibodies directed against core lipopolysaccharide antigens. Potential therapeutic agents under investigation (such as pentoxifylline, dimethyl sulfoxide, tyloxapol and insulin) cannot be currently recommended for treating endotoxemic animals.

Endotoxemic or septic shock occurs when the animal is overwhelmed by an infection or endotoxemia. This is a complex disease that requires a rapid and comprehensive treatment plan, including the following.

### Removal of foci of infection

Removal of endotoxin before it can be absorbed is an important cornerstone of treatment in foals and calves with omphalophlebitis, horses with ischemic or necrotic bowel and lactating dairy cattle with coliform mastitis.

### Antimicrobial agents

**Bactericidal Gram-negative antimicrobial agents** are always indicated whenever there is evidence of septicemia or a localized infection causing endotoxemia. The choice and route of administration will depend on the pathogens suspected of causing the infection and endotoxemia and the site of infection. The speed of kill of Gram-negative bacteria may be an important clinical issue, as antimicrobial agents with a rapid kill (such as moxalactam) can produce a bolus release of endotoxin into the blood stream by punching multiple holes in the bacteria, causing a rapid explosion of the bacteria due to osmotic fluid shifts and bolus release of endotoxin. Antimicrobial agents that alter the cell wall of Gram-negative bacteria can theoretically produce a bolus release of endotoxin when administered to animals with Gram-negative septicemia. On this basis,  $\beta$ -lactam antibiotics effective against Gram-negative bacteria should theoretically be avoided, however, clinical experience has not indicated deleterious effects following administration of  $\beta$ -lactam antibiotics. Moreover, coadministration of aminoglycosides blocks the potential bolus release of endotoxin by  $\beta$ -lactam antibiotics.<sup>23</sup> However, it is clinically prudent to ensure that whenever antimicrobial treatment is initiated in endotoxemic animals, that NSAIDs are administered concurrently.

### Aggressive fluid therapy

The intravenous infusion of large quantities of fluids and electrolytes is a high priority in the management of endotoxemia.<sup>24</sup> Maintenance of peripheral perfusion is essential to any therapeutic regimen for treatment of endotoxic shock. Large volumes of isotonic fluids have been standard practice. Lactated Ringer's solution or other balanced electrolyte solution must be given by intravenous infusion over several hours. A beneficial response is noted by the following:

- Correction of peripheral vasoconstriction
- Restoration of an acceptable pulse quality
- Return of urine output
- Increase in the central venous pressure
- Restoration of arterial blood pressure
- Restoration of cardiac output

- Restoration of oxygen delivery to acceptable levels.<sup>24</sup>

It may be necessary to deliver fluids in amounts equivalent to 0.5–1.0 times the estimated blood volume of the animal over a period of several hours. Glucose should always be included in the infusion fluids because hypoglycemia, increased glucose utilization and inappetence are usually present.

### Hypertonic solutions

The use of hypertonic saline, 7.5% NaCl, may enhance tissue perfusion and decrease the volume of subsequent fluids required for a beneficial response.<sup>25</sup> Experimentally, the use of hypertonic saline in sublethal *E. coli* endotoxemia in mature horses was associated with a more effective cardiovascular response than was an equal volume of isotonic saline solution. Cardiac output is increased and peripheral vascular resistance is decreased compared to results for isotonic saline controls. Hypertonic saline rapidly expands the plasma volume and increases preload by acting as an effective osmotic agent in the extravascular compartment, causing a translocation of fluid from the intracellular space and gastrointestinal tract.

Hypertonic sodium bicarbonate is widely used for the initial treatment of metabolic acidosis in endotoxemic adult horses. However, in horses with experimental endotoxemia, hypertonic sodium bicarbonate did not normalize blood pH, and it increased blood L-lactate concentrations and caused hypokalemia, hypernatremia and hyperosmolality.<sup>26</sup>

### Nonsteroidal anti-inflammatory drugs

Nonsteroidal anti-inflammatory drugs (NSAIDs) have been in general use for the treatment of endotoxemia because of their analgesic, anti-inflammatory and antipyretic properties. NSAIDs suppress production of thromboxane and prostaglandins and reduce the acute hemodynamic response to endotoxemia. Although NSAIDs are routinely administered to endotoxemic animals, a large-scale study in humans with severe sepsis failed to demonstrate an effect of ibuprofen on mortality, despite improvement in a number of clinical indices and decreased production of arachidonic acid metabolites.<sup>27</sup>

**Flunixin meglumine** is the NSAID most commonly used in the treatment of endotoxemia in horses and cattle<sup>28</sup> and remains the NSAID of choice for treating this condition. Flunixin meglumine is a potent inhibitor of cyclooxygenase and its action on this enzyme to inhibit the synthesis of eicosanoids such as prostaglandin E<sub>2</sub> may explain the anti-

inflammatory action of the drug. Flunixin meglumine also modulates the acute hemodynamic changes and hyper L-lactatemia commonly seen during endotoxemia, which may increase survival rate. Endotoxin-stimulated production of thromboxane B<sub>2</sub> (a metabolite of thromboxane) and prostaglandin F<sub>1α</sub> are blocked by flunixin meglumine at 0.25 and 0.10 mg/kg respectively,<sup>29</sup> which resulted in a widespread clinical use of an 'anti-endotoxemic' dose of 0.25 mg/kg. However, the term 'anti-endotoxemic effect' should be discouraged as it is misleading, and a dose rate of 1.1 mg/kg BW every 12 hours is recommended in horses. Care should be taken to ensure adequate hydration in endotoxemic animals receiving multiple doses of flunixin meglumine. Flunixin meglumine is usually given intravenously or intramuscularly in cattle at 1.1–2.2 mg/kg BW every 24 hours.<sup>30</sup> The oral administration of flunixin meglumine at 2.2 mg/kg BW prior to experimentally induced endotoxemia in cattle exerted an effect equal to that after intravenous administration by minimizing the fever and prostaglandin F<sub>2α</sub> metabolite concentration induced by the endotoxin administration. However, flunixin meglumine did not prevent the decrease in peripheral mononuclear cells and polymorphonuclear leukocytes seen after endotoxin administration. The bioavailability of flunixin meglumine in cattle ranges from 53–60% in cattle and 80–86% in horses.<sup>30</sup>

Flunixin meglumine was superior to prednisolone and dimethylsulfoxide in providing protection and mitigating the effects of experimental endotoxemia in calves but was only partially protective against the hypotension and hyper L-lactatemia and failed to alter the hypoglycemic effect.<sup>31</sup> Although flunixin meglumine is the most widely used NSAID in endotoxemia, there is little experimental evidence demonstrating its efficacy over other NSAIDs. Ketoprofen, flunixin meglumine, ketorolac and phenylbutazone have been compared for treating experimental endotoxemia in calves.<sup>32</sup> Each drug modified the response to endotoxin but none was clearly superior to the others in modulating the clinical signs. Phenylbutazone given to calves at 5 mg/kg BW/day intravenously for 5 days suppressed the clinical response to experimental endotoxin in neonatal calves with progressively increasing amounts of endotoxin until large amounts were given.<sup>32</sup> There were no significant differences between ketoprofen and flunixin meglumine in *in vitro* studies of the effects of the drugs on equine peripheral blood monocytes.<sup>33</sup> An interesting finding in adult dairy cows with experimentally induced endotoxemia was

that flunixin meglumine and phenylbutazone delayed the plasma clearance of endotoxin by 2–3 and 6–12 times respectively,<sup>34</sup> suggesting that both NSAIDs may prolong the clinical signs of endotoxemia in cattle, possibly by interfering with hepatic metabolism. The clinical significance of this finding is unknown.

### Glucocorticoids

Glucocorticoids (corticosteroids) have been used extensively in the past for the treatment of endotoxemia and shock. The rationale for the use of glucocorticoids includes:

- Organelle and cell-membrane stabilization
- Improved cellular metabolism and gluconeogenesis
- Improved microcirculation
- Decreased production of endogenous toxins such as myocardial depressant factor
- Decreased leukocyte activation and degranulation
- Minimal reticuloendothelial depression and histologic organ damage.<sup>24</sup>

The corticosteroids most commonly used in endotoxic shock were hydrocortisone, prednisolone, methylprednisolone and **dexamethasone**. However, these corticosteroids have been most beneficial therapeutically when given as a pre-treatment in experimental situations. Published evidence, based on controlled clinical trials, that corticosteroids are efficacious in naturally occurring cases of endotoxemic shock in farm animals appears to be lacking.

Glucocorticoids improve capillary endothelial integrity and tissue perfusion, decrease activation of complement and the clotting cascade, decrease neutrophil aggregation, stabilize lysosomal membranes, protect against hepatic injury and improve survival rate. However, there are concerns about their use in septicemic animals because they may cause immunosuppression. Large doses are required, which are cost-prohibitive in farm animals where they are used most commonly in acute cases and in doses such as 1 mg/kg BW of dexamethasone intravenously every 24 hours. It is currently believed that glucocorticoids, if they are to be clinically effective, **must be given as early as possible** to endotoxemic animals. Glucocorticoids are less frequently administered to endotoxemic animals as a result of a number of studies supporting the use of NSAIDs.

### Inotropic agents and vasopressors

Critically ill neonates and adults may require the administration of positive

inotropic agents and vasopressor agents. Inotropic agents increase cardiac contractility, thereby increasing cardiac output and oxygen delivery. Vasopressor agents increase systemic arterial blood pressure. Inotropic and vasopressive agents are usually administered for short periods of time during anesthesia or recovery from anesthesia.

**Dobutamine** (0.5–1.0 µg/kg BW/min in adults and 1–3 µg/kg BW/min in neonates) is the inotropic agent of choice.<sup>35</sup> Dobutamine should be diluted in 0.9% NaCl, 5% dextrose or lactated Ringer's solution and the dose carefully titrated by monitoring heart rate and rhythm and blood pressure. **Norepinephrine** (0.01–1 µg/kg BW/min) is the vasopressor agent of choice in hypotensive animals that have not responded to intravenous fluid loading or dobutamine.<sup>35</sup> Norepinephrine should be diluted in 5% dextrose and the dose titrated as there is marked individual variability in the response to norepinephrine administration.

### Polymyxin B

**Polymyxin B** is a cationic antibiotic that has an appropriate charge distribution to stoichiometrically bind to the lipid A moiety of lipopolysaccharide. Parenteral administration of antimicrobial doses of polymyxin can lead to nephrotoxicity, neurotoxicity and ototoxicity but lower, non-nephrotoxic doses are effective in ameliorating the effects of endotoxin in horses. Specific endotoxin binding agents such as intravenous polymyxin B are therefore theoretically of benefit and have shown efficacy in endotoxemic horses when administered at a recommended dose of 5000 U/kg administered at 8–12-hour intervals<sup>36,37</sup> but definitive efficacy studies have not been completed in endotoxemic calves or horses with naturally acquired endotoxemia. In particular, because the efficacy of polymyxin B is focused against circulating lipopolysaccharide before it is bound to lipopolysaccharide binding protein, it is currently believed that polymyxin B, like glucocorticoids, must be given as early as possible to endotoxemic animals if they are to be clinically effective. Attractive features of polymyxin B are its shelf life and ease of storage, ease of administration (intravenous bolus) cost and 8–12-hour duration of effect.<sup>37</sup>

### Antiserum

**Hyperimmune serum** is commercially available for the treatment of endotoxemia in the horse. The rationale is that anti-lipid A antibodies bind circulating lipopolysaccharide, thereby preventing the subsequent inflammatory cascade. However, on theoretical grounds it is difficult for an antibody to competitively

inhibit the strong binding affinity and high specificity between lipopolysaccharide and lipopolysaccharide binding protein. There are also difficulties with spatial hindrance between immunoglobulin (Ig)G and the R-core subfraction of lipopolysaccharide that contains lipid A. It is therefore difficult to believe that antiserum against core lipopolysaccharide antigens will ever be therapeutically successful in animals with naturally acquired endotoxemia, and large-scale studies in septic humans have failed to observe a decrease in mortality following the administration of hyperimmune core-lipopolysaccharide plasma. However, the administration of antiserum has many theoretical advantages separate from those of endotoxin neutralization, and it may be that plasma transfusion alone is beneficial.

The use of antiserum to the rough mutant of *E. coli* 0111:B4(J-5) as a treatment of experimental or naturally acquired endotoxemia has been demonstrated in some, but not all, studies in adult horses<sup>38,39</sup> but not in foals and calves.<sup>40</sup> One study in foals indicated that administration of hyperimmune serum resulted in a worsening of the clinical signs and augmented release of TNF- $\alpha$  and interleukin-6.<sup>41</sup> Antiserum does not appear as rational a treatment for neutralizing circulating lipopolysaccharide as polymyxin B and, for this reason, the administration of hyperimmune serum should probably be reserved for animals that fail to improve after polymyxin B administration.

### Anticoagulants

Disseminated intravascular coagulation (hypercoagulable states) can be treated with heparin in an attempt to impair intravascular coagulation. Much of the knowledge regarding DIC in endotoxemia has been extrapolated from species other than large animals, and there is little objective information available to guide the clinical use of anticoagulants in endotoxemic large animals. Instead, the focus of treatment should be aggressive intravenous fluid administration in order to maximize microcirculation.

### CONTROL OF ENDOTOXEMIA

The hallmarks of a control program are to decrease the risk or prevent neonatal septicemia, institute early and aggressive treatment of Gram-negative bacterial infections and ensure prompt surgical removal of ischemic and damaged intestine. Vaccines based on core lipopolysaccharide antigens are widely used in North America to decrease the incidence and severity of Gram-negative mastitis in lactating dairy cows (see Ch. 15) and Gram-negative infections in pigs, but

similar vaccination protocols have not been developed for horses, small ruminants and New World camelids, which are also at risk of endotoxemia.

### REVIEW LITERATURE

- Morris DD. Endotoxemia in horses. A review of cellular and humoral mediators involved in its pathogenesis. *J Vet Intern Med* 1991; 5:167-181.
- Cullor JS. Shock attributable to bacteremia and endotoxemia in cattle: clinical and experimental findings. *J Am Vet Med Assoc* 1992; 200:1894-1902.
- Olson NC, Kruse-Elliott KT, Dodam JR. Systemic and pulmonary reactions in swine with endotoxemia and Gram-negative bacteremia. *J Am Vet Med Assoc* 1992; 200:1870-1884.
- Roy M. Sepsis in adults and foals. *Vet Clin North Am Equine Pract* 2004; 20:41-61.
- Southwood LL. Postoperative management of the large colon volvulus patient. *Vet Clin North Am Equine Pract* 2004; 20:167-197.
- Sykes BW, Furr MO. Equine endotoxemia - a state of the art review of therapy. *Aust Vet J* 2005; 83:45-50.

### REFERENCES

- Cullor JS. *J Am Vet Med Assoc* 1992; 200:1894.
- Shuster R et al. *J Am Vet Med Assoc* 1997; 210:87.
- Morris DD. *J Vet Intern Med* 1991; 5:167.
- Longworth KE et al. *Am J Vet Res* 1996; 57:1063.
- Olson NC et al. *J Am Vet Med Assoc* 1992; 200:1870, 1884.
- Bottoms GD, Adams HR. *J Am Vet Med Assoc* 1992; 200:1842.
- Cargile JL et al. *Am J Vet Res* 1995; 56:1451.
- Cargile JL et al. *Am J Vet Res* 1995; 56:1445.
- Green EM, Adams HR. *J Am Vet Med Assoc* 1992; 200:1834.
- Clark ES et al. *Equine Vet J* 1991; 23:18.
- Perkowski SZ et al. *J Appl Physiol* 1996; 80:564.
- Robinson JA et al. *Am J Vet Res* 1993; 54:1411.
- King JN, Gerring EL. *Equine Vet J* 1991; 23:11.
- Eades SC, Moore JN. *Am J Vet Res* 1993; 54:581.
- Eades SC. *J Dairy Sci* 1993; 76:414.
- Gossett KA et al. *J Am Vet Med Assoc* 1990; 51:1370.
- Gilbert RO et al. *Theriogenology* 1990; 33:645.
- Gerros TC et al. *Can J Vet Res* 1995; 59:34.
- Allen GK et al. *Equine Vet J* 1996; 28:269.
- Daels PF et al. *Am J Vet Res* 1991; 52:282.
- Toribio RE et al. *J Vet Intern Med* 2005; 19:223.
- Smith NL. *J Equine Vet Sci* 1993; 13:433.
- Bentley AP et al. *Am J Vet Res* 2002; 63:660.
- Haskins SC. *J Am Vet Med Assoc* 1992; 200:1915.
- Tyler JW et al. *Am J Vet Res* 1994; 55:278.
- LeGrand EK. *J Am Vet Med Assoc* 1990; 197:454.
- Bernard GR et al. *New Engl J Med* 1997; 336:912.
- Moore JN, Morris DD. *J Am Vet Med Assoc* 1992; 200:1903.
- Semrad SD et al. *Equine Vet J* 1987; 19:201.
- Odensvik K, Magnusson U. *Am J Vet Res* 1996; 57:201.
- Semrad SD. *Am J Vet Res* 1993; 54:1517.
- Semrad SD. *Am J Vet Res* 1993; 54:1339, 1511.
- Jackman BR et al. *Can J Vet Res* 1994; 58:138.
- Haubro Andersen P et al. *J Vet Med A* 1996; 43:93.
- Corley KTT. *Vet Clin North Am Equine Pract* 2004; 20:77.
- Parviainen AK et al. *Am J Vet Res* 2001; 62:72-76.
- Barton MH et al. *Equine Vet J* 2004; 36:397.
- Garner HE et al. *Equine Pract* 1988; 10:10.
- Spier SJ et al. *Circ Shock* 1989; 28:235.
- Boosman R et al. *Vet Rec* 1990; 127:11.
- Durando MM et al. *Am J Vet Res* 1994; 55:921.

## Toxemia in the recently calved cow

A special occurrence of toxemia of major importance in food-animal practice is that caused by several diseases in the period immediately after calving in the dairy cow. The syndrome is characterized clinically by lack of appetite, marked reduction in milk yield, reduced ruminal and intestinal activity, dullness, lethargy and a fever. The term 'parturition syndrome' is often used but is not recommended because its general adoption could dissuade clinicians from seeking more accurate identification of the component disease.

The diseases commonly included in the broad category of periparturient toxemia are:

- Acetonemia
- The fat cow syndrome and pregnancy toxemia
- Mastitis
- Peritonitis
- Septic metritis.

A brief account of septic metritis in cattle is provided here because of the common occurrence of septic metritis and the profound nature of the systemic signs of illness in affected cattle. All the other diseases are described under their respective headings in this book.

### POSTPARTUM SEPTIC METRITIS IN CATTLE

Postpartum septic metritis occurs primarily in dairy cows within 2-10 days of parturition and is characterized clinically by severe toxemia and a copious, foul-smelling uterine discharge, with or without retention of the fetal membranes.

### ETIOLOGY

The etiology is multifactorial. It is assumed that a combination of impaired neutrophil function, abnormal postpartum uterine involution, often with retained fetal membranes, and infection of the uterus precipitates the disease. A mixed bacterial flora is common, which includes organisms such as *Arcanobacterium* (*Actinomyces* or *Corynebacterium*) *pyogenes*, *Bacteroides* spp., *Fusobacterium necrophorum*; these commonly predominate as a mixed flora in cows with retained placenta and postpartum metritis,<sup>1,2</sup> particularly after 5-7 days post partum. Other observations found that *E. coli* predominates in cows with retained placenta,<sup>3</sup> particularly in the first 5-7 days post partum. *Staphylococcus* spp., *Streptococcus* spp., *Pseudomonas aeruginosa*, *Proteus* spp. and occasionally *Clostridium* spp. are also present; the last can occasionally result in tetanus if *C. tetani* proliferates.



## EPIDEMIOLOGY

The disease occurs in cows of all ages but is most common in mature dairy cows within 2–4 days of parturition. Factors strongly associated with an increased incidence of metritis include:

- Large herds
- Dystocias
- Retained fetal membranes
- Overconditioning or underconditioning of cows.<sup>4</sup>

Septic metritis is most common in cows with fetal membranes retained for more than 24 hours following parturition. Several cause and effect relationships have been implicated for retained placenta in cattle,<sup>5</sup> with impaired neutrophil function being the most likely underlying cause.

Retention of fetal membranes is associated most commonly with abortion, dystocia and multiple births. The most commonly used definition is the presence of fetal membranes 12 hours or more following parturition but retention for more than 6–8 hours is the time limit set, particularly in older cows.<sup>5</sup> Approximately 10% of dairy cows have retained fetal membranes for longer than 6 hours after parturition.<sup>6</sup> The incidence between herds ranges from 3 to 27%. In single calvings the incidence is about 10%; in twin calvings 46%. Metritis occurs in about 50% of cows with retained placenta, and metritis is 25 times more likely to occur with retained placenta than without. Other less common risk factors for retained placenta include:

- Old age
- Increased gestation length
- Hormone-induced parturition
- Fetal anasarca
- Uterine prolapse
- Fetotomy.

The factors that are associated with retention of the placenta are indirectly associated with the development of postpartum metritis. The forceful removal of retained placenta, particularly in the first 4 days post partum, is also considered to be a major predisposing factor to septic metritis. Recent work indicates that the fundamental cause of retained placenta is impaired neutrophil function, whereby the ability of the maternal immune system to recognize the placenta as 'foreign' tissue is impaired.<sup>7</sup> In other words, retained placenta is an indication of an impaired immune system.

Uncomplicated cases of retained fetal membranes in cattle have no significant effect on subsequent fertility and the calving-to-conception interval. However, the calving-to-conception interval is significantly increased in cows that develop

clinical metritis as a sequel to retained fetal membranes. Vitamin E and selenium deficiency, placentitis and vitamin A deficiency have also been suggested as factors.

## PATHOGENESIS

Failure of normal uterine involution combined with retention of the fetal membranes and infection of the uterus with a mixed bacterial flora results in acute metritis and a severe toxemia. There is diffuse necrosis and edema of the mucosa and wall of the uterus. There is marked accumulation of foul-smelling fluid in the uterus and enlargement of the uterus. Absorption of toxins results in severe toxemia, particularly in fat cows, which may develop irreversible fatty degeneration of the liver.

## CLINICAL FINDINGS

Affected cows become acutely anorexic and toxemic within 2–10 days after parturition. There is a marked drop in milk production. The temperature is usually elevated, in the range 39.5–41.0°C, but may be normal in the presence of severe toxemia. The heart rate is usually elevated and may range from 96–120 beats/min. The respiratory rate is commonly increased to 60–72 breaths/min and the breath sounds may be louder than normal. Rumen contractions may be markedly depressed or absent. A foul-smelling fluid diarrhea may occur. Mild to moderate dehydration is common because affected cows do not drink normally.

Retention of the fetal membranes is common, and manual examination of the vagina reveals the presence of copious quantities of foul-smelling, dark brown to red fluid containing small pieces of placenta pooled in the vagina. When the fetal membranes are retained and protruding through the cervix, the hand can usually be inserted through the cervix and into the uterus. Manual exploration of the uterine cavity will usually reveal the state of adherence of the fetal membranes. Often the fetal cotyledons are firmly attached to the maternal caruncles, but occasionally they have separated from the caruncles and the placenta can be removed by simple traction.

Rectal examination usually reveals that the uterus is large, flaccid and lacks the longitudinal ridges that indicate involution. In large cows the enlarged, flaccid uterus may be situated over the pelvic brim extending into the ventral part of the abdomen and thus may not be easily palpable and examined. This is an important finding because the fetal membranes may be fully retained in the uterus and no evidence of their presence may be detectable on examination of the vagina and the cervix, which may be almost

closed, making examination of the uterus impossible.

The presence of viscid, nonodoriferous mucus in the cervix and anterior part of the vagina usually, but not always, indicates that the fetal membranes have been expelled. When evidence of a retained placenta and septic metritis cannot be found on examination of the reproductive tract, either by rectal palpation or vaginal examination, and if the history indicates some uncertainty about the disposition of the placenta, a retained placenta and septic metritis should be considered until proven otherwise. Persistent toxemia, tachycardia (100–120 beats/min), anorexia and rumen stasis that cannot be explained by any other disease should arouse suspicion of septic metritis until proved otherwise.

Tenesmus occurs most commonly when the fetal membranes are retained and this causes irritation in the vagina. Manual examination of the vagina may also stimulate tenesmus.

The course of the disease varies from 2–10 days. Those cases with retained fetal membranes may be toxemic and not return to normal appetite until the membranes are fully expelled, which may take up to 10 days. Necrotic pieces of placenta may be passed for 10–14 days after treatment is begun.

## CLINICAL PATHOLOGY

### Hematology

A leukopenia, neutropenia and degenerative left shift occur in acute cases and the degree of change parallels the severity of the disease and reflects the absorption of endotoxin from the uterine lumen.

### Vaginal/uterine fluid

**Samples of fluid from the vagina and uterus** reveal a mixed bacterial flora including *E. coli*, *Proteus* spp., *A. pyogenes*, *Staphylococcus* spp. and *Streptococcus* spp., with the predominant bacteria varying mainly with time since parturition. In general, *E. coli* predominates in the first 5 days after parturition, whereas *A. pyogenes* and *F. necrophorum* predominate after the first 5 days in cattle with retained placenta.<sup>8,9</sup> Uterine lochia of cattle with retained placenta had a much higher endotoxin concentration in the first 2 days post partum than did lochia of healthy cattle or cattle that had undergone a dystocia but did not have retained placenta. Endotoxin was not detected in the plasma of cattle with high lochial endotoxin concentrations, indicating effective systemic clearance.<sup>8</sup>

### Other samples and tests

**Ketonuria** may occur in animals that are overconditioned and mobilize excessive quantities of depot fat, resulting in ketosis. **Liver function tests** reveal a



decrease in liver function, which may be irreversible in excessively fat cows.

### NECROPSY FINDINGS

The uterus is enlarged, flaccid and may contain several liters of dark brown, foul-smelling fluid with decomposed fetal membranes. The uterine mucosa is necrotic and hemorrhagic and the wall of the uterus is thickened and edematous. In severe cases, fibrin may be present on the serosal surface of the uterus. The liver may be enlarged and fatty and there is usually mild degeneration of the myocardium and kidneys.

### The fat cow syndrome

This is characterized by excessive body condition, anorexia to inappetence, ketonuria, a marked loss in milk production, decreased rumen movements and delayed involution of the uterus. The temperature is usually normal but the heart and respiratory rates may be increased. The prognosis is poor in cows that are totally anorexic; those that are inappetent will usually recover after 5–7 days of supportive therapy.

### Acute diffuse peritonitis

This may occur in cows within a few days postpartum and is characterized by anorexia, toxemia, a spontaneous grunt or one that can be elicited by deep palpation, rumen stasis, fever and the presence of an inflammatory exudate in the peritoneal fluid.

### Peracute and acute mastitis

This occurs in cows within a few days after parturition and is characterized by severe toxemia, swelling of the affected quarters and abnormal milk.

## TREATMENT

### Conservative therapy

Uncomplicated cases of retained fetal membranes without any evidence of clinical toxemia usually do not require parenteral or intrauterine treatment. The placenta will usually be expelled within 4–6 days. Cows with retained fetal membranes and tenesmus should be examined vaginally to ensure that there is no evidence of injury to the vagina or cervix. In cows with tenesmus, if the placenta is detached and loose it should be removed by careful traction. Forceful removal of the placenta should be avoided.

### Antimicrobial agents

Cows with retained fetal membranes but **without systemic illness** should be monitored but treatment with antimicrobial agents is not indicated. Antibiotic treatment with oxytetracycline (10 mg/kg BW, daily) before placental shedding delays detachment of the placenta; this finding is consistent with the concept that intrauterine bacterial infection facilitates placental detachment.<sup>9</sup>

Cows with retained fetal membranes **complicated by septic metritis and toxemia** should be treated with antimicrobial agents daily for several days or until recovery occurs. Death can occur in untreated animals. Because of the mixed bacterial flora in the postpartum uterus with a retained placenta, broad-spectrum antimicrobials are recommended. Intramuscular procaine penicillin (22 000 U/kg BW every 24 h), subcutaneous ceftiofur (2.2 mg/kg BW every 24 h), intramuscular ampicillin (10 mg/kg BW) and intravenous oxytetracycline (11 mg/kg BW every 24 h) are commonly administered for several days until recovery is apparent.<sup>10,11</sup> Ceftiofur increases the cure rate and milk yield, and decreases rectal temperature, when administered to dairy cows with fever and vaginal discharge or dystocia.<sup>12</sup> Subcutaneous administration of ceftiofur (1 mg/kg BW) achieved concentrations of ceftiofur derivatives in uterine tissue and lochial fluid that exceeded the reported minimal inhibitory concentrations for common metritis pathogens.<sup>13</sup> Ampicillin increased the pregnancy rate and decreased the cure rate, compared to ceftiofur, in cattle that were also treated with intrauterine ampicillin and cloxacillin.<sup>14</sup> In general, oxytetracycline use should be confined to the first 5–7 days post partum when *E. coli* predominates, as it is likely to be ineffective against *A. pyogenes* in the endometrium. Oxytetracycline at 30 mg/kg BW intravenously as a single dose in cows with retained fetal membranes resulted in concentrations of the antimicrobial in uterine secretions, placenta and cotyledon for 32–36 hours.<sup>15</sup> Two intramuscular injections of oxytetracycline at 25 mg/kg BW resulted in lower peak concentrations, but these were maintained for 144 hours. Parenteral oxytetracycline appears to decrease endotoxin production, as indicated by the severity of leukopenia in cattle with retained placenta.<sup>9</sup>

In **severely affected cases**, large amounts of balanced isotonic crystalloid fluids, electrolytes and glucose by continuous intravenous infusion may be necessary and often result in a marked beneficial response within 24–48 hours. The uterus should always be examined by palpation per rectum and vaginally to determine the degree of uterine involution, the thickness of the uterine wall, the volume of the uterus, the nature of the luminal contents and the degree of attachment of the placenta to the cotyledons. This can be done daily to assess progress. Uterine fluids should be drained by creating a siphon, if sufficiently liquid in nature, although care must be taken to ensure that the tube does not penetrate a friable uterine wall.

If parenteral antimicrobial and supportive therapy is provided the placenta will invariably be expelled within 6–8 days and usually within 4–6 days. The use of antimicrobial agents must be accompanied by appropriate withdrawal periods for the milk produced by treated animals.<sup>16</sup>

### Intrauterine medication

The necessity for intrauterine medication is controversial. There is limited evidence, if any, that the intrauterine infusion of antimicrobial agents with or without lytic enzymes and estrogens has any beneficial effect in the treatment of postpartum septic metritis. Nevertheless, a wide variety of antimicrobial agents have been used for intrauterine medication for retained placenta and metritis in cows, although in general,  $\beta$ -lactam-resistant antibiotics should be administered because the uterine lumen can contain  $\beta$ -lactamase-producing bacteria. Intrauterine infusion of 0.5 g of the first-generation cephalosporin cephapirin improved the reproductive performance, but only when administered after 26 days in milk.<sup>17,18</sup> Intrauterine infusion of 1 g of the third-generation cephalosporin ceftiofur in 20 mL of sterile water once between 14 and 20 days of lactation had no effect on reproductive performance but decreased the risk of culling and increased the time to culling.<sup>19</sup> Tetracycline products (5–6 g) are commonly used but should be administered as a powder dissolved in an appropriate volume of 0.9% NaCl, as vehicles such as propylene glycol can irritate the endometrium. Infusion of oxytetracycline decreases lochial odor and the incidence of fever in cattle with retained placenta.<sup>20</sup> In cattle with retained placenta, intrauterine administration of a povidone-based oxytetracycline solution (5 g daily until expulsion) combined with fenprostalene (1 mg subcutaneously) did not alter the time to detachment of the placenta but increased the frequency of pyometra;<sup>21</sup> this finding was consistent with the concept that intrauterine bacterial infection facilitates placental detachment.<sup>9</sup> Milk from cows treated by intrauterine infusion of antimicrobial agents should be discarded for an appropriate period of time in order to avoid illegal residues.<sup>16</sup>

Intrauterine administration of antiseptics (povidone iodine, chlorhexidine, hypertonic saline) has been done but studies demonstrating efficacy are lacking.

### Ancillary treatment and control

Portions of retained placenta protruding from the vagina should be wrapped in a plastic rectal sleeve to minimize wicking of fecal bacteria after defecation, although this supposition has not been verified. Alternatively, protruding remnants of

placenta can be excised, although this may prolong to the time to expulsion because the decreased weight may interfere with traction on the remaining placenta in the uterine lumen. Complete manual removal is often requested by the producer but is not recommended because studies have not demonstrated its efficacy.

The infusion of collagenase solution (200 000 U dissolved in 1 L of 0.9% NaCl containing 40 mg calcium chloride and sodium bicarbonate) into the umbilical arteries within 12 hours of parturition is an effective treatment for retained placenta. Collagenase injection therefore provides an effective method for preventing septic metritis in cattle with retained placenta. However, the collagenase solution is expensive, not widely available and the technique is difficult in some animals because of difficulty in identifying intact umbilical arteries for injection. As a result, collagenase injection is rarely performed in clinical veterinary practice. The efficacy of umbilical artery infusion with antimicrobial agents has not been adequately evaluated.

Ecbolic drugs have been proposed for the prevention and treatment of retained placenta in cattle. These include prostaglandins, ergot derivatives, oxytocin and  $\beta_2$ -adrenoceptor antagonists.<sup>22</sup> The rationale for their use is that they stimulate uterine contractions and physically aid in the expulsion of the fetal membranes. In general, the consensus is that they are ineffective after the diagnosis of a retained placenta is recognized. However, their use may be effective if used immediately after calving. In particular, the frequent intramuscular administration of oxytocin appears to provide the most effective means of preventing metritis, with a recommended protocol of 20 IU every 3 hours for postpartum days 0–3, 30 IU every 2 hours for postpartum days 4–6 and 40 IU every 2 hours for postpartum days 7–10.<sup>23</sup> A large study found that intramuscular injection of oxytocin (30 IU) immediately after parturition and 2–4 hours later decreased the incidence of retained placenta and the calving-to-conception interval.<sup>24</sup> Fenprostalene at 1 mg subcutaneously, 25 mg dinoprost tromethamine intramuscularly, or 20 IU oxytocin given to a large number of dairy cows in five commercial dairy herds did not reduce the incidence of retained fetal membranes or improve reproductive performance.<sup>6</sup> A detailed review failed to identify any evidence supporting the use of estrogen or prostaglandins in the first 7–10 days post partum.<sup>23</sup>

The finding that retained placenta can be caused by neutrophil dysfunction at calving<sup>7</sup> provides the basis for epidemiological evidence that deficiency of trace minerals or vitamins (such as

selenium and vitamin E) is associated with an increased incidence of retained placenta. In regions deficient in selenium, supplementation of the diet up to 0.3 ppm can decrease the incidence of retained placenta in herds that are fed a total mixed ration. Selenium can also be administered by intraruminal boluses or parenteral administration of vitamin E/selenium preparations during the dry period.

#### IDENTIFICATION OF AFFECTED COWS

Cows affected with retained placenta and metritis should be identified and recorded in the records system and examined 30–40 days after parturition for evidence of further complications such as pyometra.

#### REVIEW LITERATURE

- Laven RA, Peters AR. Bovine retained placenta: etiology, pathogenesis and economic loss. *Vet Rec* 1996; 139:465–471.
- Peters AR, Laven RA. Treatment of bovine retained placenta and its effects. *Vet Rec* 1996; 139:535–539.
- Frazer GS. Hormonal therapy in the postpartum cow – days 1 to 10 – fact or fiction? *AABP Proc* 2001; 34:109.

#### REFERENCES

1. Bekana M et al. *Acta Vet Scand* 1996; 37:251.
2. Cohen RO et al. *J Vet Med B* 1996; 43:193.
3. Ziv G et al. *Israel J Vet Med* 1996; 51:63.
4. Kaneene JB, Miller R. *Prevent Vet Med* 1995; 23:183.
5. Laven RA, Peters AR. *Vet Rec* 1996; 139:465.
6. Stevens RD, Dinsmore RP. *J Am Vet Med Assoc* 1997; 211:1280.
7. Kimura K et al. *J Dairy Sci* 2002; 85:544.
8. Dohmen MJW et al. *Theriogenology* 2000; 54:1019.
9. Konigsson K et al. *Reprod Dom Anim* 2001; 36:247.
10. Bretzlaff KN et al. *Am J Vet Res* 1983; 44:764.
11. Smith BI et al. *J Dairy Sci* 1998; 81:1555.
12. Zhou C et al. *J Am Vet Med Assoc* 2001; 219:805.
13. Okker H et al. *J Vet Pharmacol Ther* 2002; 25:33.
14. Drillich M et al. *J Dairy Sci* 2001; 84:2010.
15. Cohen RO et al. *Israel J Vet Med* 1993; 48:69.
16. Dinsmore RP et al. *J Am Vet Med Assoc* 1996; 209:1753.
17. Leblanc SJ et al. *J Dairy Sci* 2002; 85:2237.
18. McDougall S. *New Zealand Vet J* 2001; 49:150.
19. Scott HM et al. *J Am Vet Med Assoc* 2005; 226:2044.
20. Callahan CJ et al. *Bovine Pract* 1988; 23:21.
21. Stevens RD et al. *J Am Vet Med Assoc* 1995; 207:1612.
22. Peters AR, Laven RA. *Vet Rec* 1996; 139:535.
23. Frazer GS. *AABP Proceedings* 2001; 34:109.
24. Mollo A et al. *Anim Reprod Sci* 1997; 48:47.

## Hypovolemic, hemorrhagic, maldistributive and obstructive shock

#### Synopsis

**Etiology** Shock due to a reduction in venous return (circuit failure) secondary to hypovolemia, hemorrhage, maldistribution of blood or obstruction to venous return

**Clinical findings** Depression and weakness, subnormal temperature, elevated heart rate with weak thready pulse, cold skin and extremities, prolonged capillary refill time. Progressive development without aggressive fluid therapy and collapse and death from irreversible shock

**Clinical pathology** Increased blood or plasma L-lactate concentration, decreased venous oxygen tension, evidence of multiple organ dysfunction. Decreased central venous pressure, low mean arterial blood pressure terminally. Changes in heart rate, activity level and blood or plasma L-lactate concentration indicate the efficacy of treatment

**Necropsy findings** None specific for hypovolemic or maldistributive shock; the source of hemorrhage may be apparent in hemorrhagic shock

**Diagnostic confirmation** Clinical signs, blood or plasma L-lactate concentrations, venous oxygen tension

**Treatment** Aggressive fluid therapy based on intravenous isotonic crystalloid solutions and possibly colloid solutions. Blood transfusion or stroma-free hemoglobin administration for hemorrhagic shock. Initial treatment by rapid infusion with small-volume hypertonic saline solutions gives rapid but transient resuscitative effect. Antimicrobial agents and non-steroidal anti-inflammatory drugs in maldistributive shock due to endotoxemia

#### ETIOLOGY

The circulatory system consists of a pump (the heart) and a circuit (the vasculature). Circulatory shock can result from abnormal functioning of the pump or circuit, or both. It is clinically very important to differentiate **pump failure** (cardiogenic shock due to acute or chronic heart failure) from **circuit failure**, because the diagnosis and treatment of cardiogenic shock is vastly different to that of circuit shock. Circulatory shock is covered in detail in Chapter 8, whereas circuit failure is addressed in the following section.

Circuit failure occurs whenever the cardiac output is reduced below a critical point because of inadequate venous return to the heart. There are four main ways that circuit failure occurs:

- **Hypovolemic shock** occurs when there is a reduction in circulating blood volume due to plasma or free water loss
- **Hemorrhagic shock** occurs when there is a reduction in circulating blood volume due to rapid blood loss
- **Maldistributive shock** occurs when there is a reduction in circulating blood volume due to increased capillary permeability, pooling of blood in capacitance

vessels (such as the veins in the splanchnic circulation), or pooling of plasma in a large third space such as the thoracic or abdominal cavities

- **Obstructive shock** occurs when there is an acute reduction in venous return due to a mechanical obstruction, such as pericardial tamponade or pulmonary artery thrombosis. Obstructive shock is extremely rare in large animals.

Regardless of the initiating cause for circuit failure and inadequate venous return, tissue hypoperfusion results, leading to impaired oxygen uptake and anaerobic metabolism. The end result of inadequate tissue perfusion is the development of multiple organ failure, L-lactate acidemia, and strong ion (metabolic) acidosis, manifest as the **hypodynamic stage** of shock. Hypovolemia and poor tissue perfusion results in cold extremities, elevated heart rate, a weak thready pulse, decreased capillary refill times and altered mental status. Cardiac arrhythmias may occur because of myocardial ischemia and electrolyte and acid-base disturbance. There is anorexia and gastrointestinal stasis. Signs of renal failure include anuria or oliguria and azotemia.

Common causes of circuit failure in large animals are as follows.

#### Hypovolemic shock

- Fluid loss and dehydration, such as in neonatal calf diarrhea and burn injury, especially when fluid loss is severe and rapid
- Fluid loss into the gastrointestinal tract due to acute intestinal obstruction.

#### Hemorrhagic shock

Acute hemorrhage with loss of 35% or more of total blood volume, equivalent to an acute blood loss of 2.8% of body weight (assuming blood volume is 8% of body weight) will lead to clinical signs of severe hemorrhagic shock. In contrast, acute hemorrhage with loss of less than 10% of total blood volume (equivalent to an acute blood loss of less than 0.8% of body weight) produces minimal detectable clinical changes.

Traumatic injury or spontaneous rupture of large blood vessels are the common reasons for acute hemorrhage. Any sort of minor surgical wound, e.g. castration, dehorning, may lead to excess hemorrhage where there is a hemorrhagic tendency due to defects of clotting. Some of the more common causes of hemorrhagic shock areas follow.

Cattle and sheep

- Spontaneous pulmonary hemorrhage associated with caudal vena caval syndrome
- Abomasal ulcer, sometimes originating from a bovine viral leukosis lesion (cattle)
- Enzootic hematuria with bleeding from a bladder lesion (cattle)
- Pyelonephritis with bleeding from a renal lesion (cattle)
- Intra-abdominal hemorrhage as a result of arterial aneurysm, possibly associated with copper deficiency (cattle)
- Laceration of arteries in the wall of the vagina as a result of dystocia
- Ruptured middle uterine artery during prolapse or torsion of uterus
- Cardiac tamponade due to rupture of coronary artery or ventricular chamber, rupture of aorta (see Chapter 1)
- Rupture of liver associated with dystocia in lambs, and in older lambs possibly associated with vitamin E deficiency.

Horses

- Ethmoidal hematoma<sup>1</sup>
- Exercise-induced pulmonary hemorrhage<sup>2</sup>
- Rupture of the middle uterine, utero-ovarian (especially right side) or iliac artery associated with parturition, more commonly in aged mares<sup>3</sup>
- Nasal bleeding from hemorrhage into the guttural pouch, from carotid or maxillary arteries with guttural pouch mycosis or associated with rupture of the longus capitis muscle following trauma<sup>4</sup>
- Rupture of mesenteric arteries secondary to strongyle larval migration
- Splenic hematoma<sup>5</sup> or rupture following blunt trauma
- Rupture of liver with hyperlipemia
- Hemangioma, hemangiosarcoma and other neoplasia
- Persistent bleeding from the vulva in association with ulcerated varicose veins on the dorsal wall of the vagina<sup>6</sup>
- Congenital venous aneurysm (rare).<sup>7</sup>

Pigs

- Esophagogastric ulceration
- Proliferative hemorrhagic enteropathy
- Rupture of liver in hepatosis dietetica
- Congenital neonatal bleeding, e.g. umbilical hemorrhage.

#### Maldistributive shock

- Endotoxemia in neonatal septicemia, salmonellosis, coliform mastitis in lactating dairy cattle, toxic metritis in cattle
- Septic shock due to Gram-positive bacterial septicemia<sup>8-10</sup>

- Too sudden reduction of pressure in a body cavity, e.g. by rapid withdrawal of ascitic fluid.

#### Obstructive shock

- Pericardial tamponade.

#### PATHOGENESIS

##### Hypovolemic shock

When cardiac output falls as a result of decreased venous return, the carotid and aortic baroreceptors stimulate the sympathetic nerves and adrenal medulla to release catecholamines resulting in vasoconstriction in vessels with alpha-adrenergic receptors.<sup>8,11</sup> Vasoconstriction leads to **decreased renal perfusion**, which activates the renin-angiotensin-aldosterone system, thereby inducing sodium and water retention. The decrease in renal perfusion can result in renal ischemia and nephrosis if the ischemia is sufficiently severe and prolonged (see Chapter 11). Hypovolemia also stimulates the release of antidiuretic hormone (vasopressin). There is contraction of the spleen and venous capacitance vessels, an increased peripheral vascular resistance and an increase in heart rate in an attempt to maintain cardiac output and blood perfusion through the coronary and cerebral blood vessels.

Water shifts from the interstitial space to the vascular space in response to the contraction of precapillary arterioles. In the initial stages of hypovolemic failure the primary signs are those of interstitial fluid depletion and dehydration, with dry mucous membranes, sunken eyes and decreased skin turgor. Peripheral vasoconstriction in the face of continued hypovolemia and falling cardiac output results in the opening of arteriovenous shunts and decreased perfusion of organ systems, with resultant damage from hypoxia and tissue acidosis and the development of clinical signs of peripheral vascular failure and shock. Arterial blood pressure falls terminally, and a decrease in mean arterial pressure indicates a complete lack of cardiovascular reserve. The rate at which hypovolemia develops profoundly affects the outcome because compensatory mechanisms are more readily overcome by acute than chronic changes.

##### Hemorrhagic shock

The major effects of hemorrhage are loss of blood volume (hypovolemic shock), loss of plasma protein (decreased plasma oncotic pressure), and loss of erythrocytes (decreased oxygen-carrying capacity).

With acute and severe hemorrhage, the rapid loss of blood volume results in hypovolemic shock and the loss of erythrocytes in anemic anoxia. The combination of these two factors is

termed hemorrhagic shock and is often fatal. With less severe hemorrhage, the normal compensatory mechanisms, including release of blood stored in the spleen and liver and the withdrawal of fluid from the tissue spaces, may maintain a sufficient circulating blood volume, but the anemia is not relieved and the oncotic pressure of the blood is reduced by dilution of residual plasma protein. The resulting anemia and edema are repaired with time provided the blood loss is halted.

### Maldistributive shock

In normal animals the healthy intestinal mucosa is an effective barrier to the absorption of endotoxin that is present in the gut and the small amounts of endotoxin that are absorbed into the portal blood are cleared by the liver and do not reach the systemic circulation. When the integrity of the intestine is compromised by factors such as ischemia, trauma or inflammation, sufficient endotoxin can be absorbed to overwhelm the clearance mechanisms of the liver, and endotoxin may also leak to the peritoneal cavity and thereby gain access to the systemic circulation. Endotoxin can also be absorbed from sites of local infection, as with diffuse peritonitis, coliform mastitis and toxic metritis, or released from Gram-negative bacteria in the blood stream. Intestinal mucosal integrity is lost in the terminal stages of circulatory shock due to tissue hypoxia, and endotoxin translocation from the intestinal tract is markedly increased in the terminal stages of shock, independent of the initiating cause.

Endotoxin and other bacterial toxins cause direct endothelial damage.<sup>11</sup> Endotoxin also activates macrophages and neutrophils provoking the release of a multitude of **inflammatory mediators**, including TNF, interleukin-1, interleukin-6 and platelet activating factor, which lead to endothelial damage, leaky vessels, hypotension and vasculitis and eventually decreased intravascular volume.<sup>12</sup> Inadequate perfusion of tissue with appropriately oxygenated blood impedes oxidative cellular metabolism and leads to the release of arachidonic acid, which is metabolized by the cyclooxygenase pathway to yield prostaglandins and thromboxane A<sub>2</sub> or by the lipoxygenase pathway to yield leukotrienes.<sup>13,14</sup> These **eicosanoids** are potent vasoactive compounds. They can act locally or be carried in the circulation to act at distant sites to further adversely affect vascular reactivity and vascular permeability.<sup>11</sup> Endotoxin itself also provokes increased synthesis and release of eicosanoids<sup>13</sup> and many of the early effects of endotoxin are

mediated by these metabolites of arachidonic acid.<sup>15</sup>

A further consequence to tissue hypoxia is damage to endothelium with exposure of collagen; tissue thromboplastin can initiate the intrinsic and extrinsic coagulation cascades, leading to damage to other organ systems and further complications from the development of DIC,<sup>11</sup> which may be central to the development of irreversible shock.

In the early **hyperdynamic stage** of endotoxemia and sepsis there is an increased oxygen demand by peripheral tissue and an increase in heart rate and cardiac output with pulmonary and systemic vasoconstriction.<sup>16</sup> Pulmonary hypertension increases transvascular fluid filtration in the lung and pulmonary edema can develop when hypertension is accompanied by increased vascular permeability.<sup>17</sup> There is hypoxemia and, despite the increase in cardiac output, blood flow may be inadequate to meet the needs of tissue in a hypermetabolic state.<sup>11</sup> The **late hypodynamic stage** of endotoxemia and sepsis is characterized by decreased venous return, cardiac contractility, cardiac output and mean arterial pressure.

### Obstructive shock

In severe pericardial tamponade, the rapid increase in pericardial fluid volume impedes diastolic filling of the heart and therefore results in decreased cardiac output. A similar response occurs in advanced traumatic reticulopericarditis in cattle that have ingested a wire; however, in the latter condition the obstruction is slow to develop.

### CLINICAL FINDINGS

Depression, weakness and listlessness are accompanied by a fall in temperature to below normal. The skin is cold and skin turgor is decreased. The mucosae are pale gray to white and dry, and capillary refill time is extended beyond 3–4 s.

There is an increase in heart rate to 120–140 beats/min in horses and cattle, with abnormalities of the pulse including small and weak pressure amplitudes (a 'thready' pulse). Cardiac arrhythmias are present terminally. Venous blood pressure is greatly reduced in hypovolemic and hemorrhagic shock and the veins are difficult to raise. Arterial blood pressure, measured either directly by arterial puncture or by indirect oscillometric methods, is decreased terminally and fails to provide an early indicator of the severity of the circulatory failure.

Anorexia is usual but thirst may be evident and there is anuria or oliguria. Nervous signs include depression, listlessness and obtusion, and coma in the terminal stages.

**During the early hyperdynamic stage** of maldistributive shock the temperature is normal or elevated, mucous membranes are injected and brick-red in color, there is tachycardia but normal capillary refill time, and the extremities (particularly ears) are cool to the touch. Whereas these signs are not specific for shock, the recognition of this stage in animals that are at risk for maldistributive shock, such as the neonate or animals with early signs of acute intestinal accident, can allow the early institution of therapy, which will frequently result in a better outcome than therapy instituted when the later stages of shock are manifest.

**Therapeutic reversal** of maldistributive shock in its later stages is difficult. In contrast, circulatory failure that is a result of hypovolemic or hemorrhagic shock is relatively easily treated and can be successfully reversed even at stages of profound depression.

### CLINICAL PATHOLOGY

The use of clinical pathology is directed at determining the cause and severity of shock and at monitoring the effectiveness of therapy. Volume expansion and restoration of tissue perfusion will usually correct acid–base and strong ion (metabolic) acidosis in the majority of animals with shock and abnormalities are addressed once fluid balance is established.<sup>18</sup>

Examination of the blood for hematocrit and plasma protein concentration are valuable in indicating the magnitude of the blood loss in hemorrhagic shock and provide a clinically useful index to the progress of the disease. However, there can be a **delay in the fall** of the hematocrit following hemorrhage for up to 4–6 hours because splenic contraction temporarily augments circulating red cell numbers. The hematocrit and plasma protein concentrations usually fall to their lowest levels 12–24 hours following hemorrhage, and determination at this time provides a clinically useful index of the amount of blood lost. Signs of a regenerative response (increased hematocrit, presence of reticulocytes, increased red blood cell volume) should be seen within 4 days of an acute hemorrhage in ruminants and pigs but cannot be used as a guide in the horse. In general, the hematocrit increases by 1% per day following acute hemorrhage in ruminants.

**Abdominocentesis, thoracocentesis and ultrasound** are used to identify sites of internal bleeding. **Thrombocyte and clotting factor** examinations are indicated in cases in which unexplained spontaneous hemorrhages occur.

### Monitoring in shock

**Clinical parameters** of heart rate, pulse character, mucous membrane color,

temperature of the extremities (particularly the ears) and activity level provide extremely useful guides to the efficacy of treatment when performed serially over time. The single most valuable index is the **heart rate**, although, in animals housed in a stable ambient temperature, **peripheral skin temperature** is also a useful clinical guide but not during rapid intravenous fluid administration because a thermal lag of at least 30 minutes before increased blood and heat flow to the periphery is manifest as an increase in skin surface temperature.<sup>19</sup> Blood or plasma **L-lactate concentration** and **venous oxygen tension** provide the most useful measures of the adequacy of oxygen delivery and tissue perfusion, and therefore the efficacy of treatment. These two laboratory parameters are much more informative than measurement of **central venous pressure** or **mean arterial blood pressure**, and blood pressure measurement is discussed mainly for historical interest.

**Blood or plasma L-lactate concentration**, preferably measured in arterial blood or blood from a large vein such as the jugular vein, provides an indication of prognosis and an even more valuable serial measure of the efficacy of treatment. In general terms, plasma L-lactate concentrations are normally less than 1.5 mmol/L and fluctuate slightly depending on diet and time since feeding. Plasma L-lactate concentrations of more than 4 mmol/L indicate the presence of widespread anaerobic metabolism and the need for aggressive therapy, and plasma L-lactate concentrations above 10 mmol/L are associated with a high mortality in humans, pigs and horses.<sup>20</sup> Blood L-lactate concentrations are increased in cows with abomasal volvulus (3.8 mmol/L,<sup>21</sup> 7.3 mmol/L;<sup>22</sup> 4.8 mmol/L<sup>23</sup>); however, blood lactate concentration did not provide an accurate prognostic indicator for survival. In general, it is the **change in plasma L-lactate concentration after initiation of therapy** that provides the most useful guide to treatment. In particular, failure to decrease the plasma L-lactate concentration despite aggressive and appropriate therapy is a poor prognostic sign.

**Venous blood oxygen tension ( $P_{O_2}$ )**, preferably measured in a large vein such as the jugular vein, provides an indication of the adequacy of oxygen delivery and is a useful guide to the efficacy of treatment. In general terms, venous  $P_{O_2}$  is normally 35–45 mmHg, arterial  $P_{O_2}$  is normally 90 mmHg and the difference between the venous and arterial  $P_{O_2}$  depends on the amount of oxygen extracted by tissues. Whenever tissues receive inadequate blood flow and therefore oxygen delivery,

their oxygen extraction ratio increases, resulting in a greater difference between arterial  $P_{O_2}$  and venous  $P_{O_2}$  and a lower value for venous  $P_{O_2}$ . **Venous  $P_{O_2}$  below 30 mmHg** indicates inadequate oxygen delivery and the need for aggressive therapy; hemoglobin in erythrocytes or stroma free solution in hemorrhagic shock, plasma volume expansion in hypovolemic and maldistributive shock. A venous  $P_{O_2}$  below 25 mmHg indicates severe abnormalities in oxygen delivery, and venous  $P_{O_2}$  below 20 mmHg indicates impending death. Aggressive resuscitation should always increase venous  $P_{O_2}$  to more than 40 mmHg, and failure to substantially increase venous  $P_{O_2}$  despite aggressive and appropriate therapy is a poor prognostic sign.

**Central venous pressure (CVP)** is another measure of hypovolemia but individual measurements can be misleading and serial measurements should be used. By definition, central venous pressure can only be measured by a catheter placed in a blood vessel within the thorax (typically the cranial vena cava), as this permits measurement of negative values for central venous pressure. 'Central venous pressure' is frequently measured in the jugular vein through a short intravenous catheter; this pressure is more correctly termed jugular venous pressure and, because it cannot be negative, is of much less clinical value than measuring CVP in shocked animals. The normal CVP of the standing horse referenced to the point of the shoulder (scapulohumeral joint) is  $12 \pm 6$  cmH<sub>2</sub>O ( $1.2 \pm 0.6$  kPa) and is markedly influenced by factors such as head position and excitement.<sup>24</sup> In contrast, the normal CVP of a standing calf is  $0.6 \pm 0.8$  cmH<sub>2</sub>O ( $0.06 \pm 0.08$  kPa), with only a small decrease in CVP to  $-1.9 \pm 1.0$  cmH<sub>2</sub>O ( $0.19 \pm 0.10$  kPa) being present in hypovolemic calves that were severely dehydrated (14% body weight).<sup>25</sup> A general rule of thumb in horses is to administer fluids as long as the CVP remains below 2 cmH<sub>2</sub>O (0.2 kPa), and to immediately discontinue fluid administration whenever CVP exceeds 15 cmH<sub>2</sub>O (1.5 kPa). The main clinical utility of CVP measurement is ensuring that volume overload is not occurring.

**Mean arterial blood pressure** is an insensitive but specific method for determining the severity of shock and the efficacy of therapy, in that mean arterial blood pressure only decreases in the terminal stages of shock, indicating a complete lack of cardiovascular reserve.

### NECROPSY FINDINGS

In **hemorrhagic shock** there is extreme **pallor** of all tissues and a thin **watery appearance of the blood** may be

accompanied by large extravasations of blood if the hemorrhage has been internal. Where the hemorrhage has been **chronic**, anemia and edema are characteristic findings. In obstructive shock there is a large increase in pericardial fluid (usually blood), or the presence of a large thrombus in the cranial or caudal vena cava or pulmonary circulation, or evidence of severe abdominal distension (such as in ruminal tympany). There are **no specific findings** in hypovolemic or maldistributive shock, although in maldistributive shock the capillaries and small vessels of the splanchnic area may be congested and there may be evidence of pulmonary edema. With death from septic shock the major findings relate to the changes associated with the infectious disease. Dehydration is evident in animals dying from hypovolemic shock.

### DIFFERENTIAL DIAGNOSIS

Circulatory failure due to a circuit abnormality can be diagnosed when there is no detectable primary cardiac abnormality, and when a primary cause such as hemorrhage, dehydration, or endotoxemia is known to be present. Ideally, endotoxemic or septic shock should be diagnosed in its early hyperdynamic stage and aggressively treated at this stage. This requires a knowledge of the risks for shock with various conditions in each of the animal species. Hypovolemic, hemorrhagic, or maldistributive shock should be anticipated:

- In septicemic disease, especially of the neonate
- In acute localized infections
- With intestinal disease, but especially with those in the horse that have acute intestinal accident as part of the differential diagnosis
- When severe trauma occurs
- Where there is severe fluid loss for any reason
- Where decompression of an area is to be practiced (i.e. removal of fluid from a body cavity)
- When there is to be a significant surgical procedure.

### TREATMENT

#### Identification of cause

The identification and, if possible, the immediate elimination of the precipitating cause of the shock is important in cases where circulatory failure is initiated by conditions that are amenable to surgical correction. Prompt surgical intervention coupled with aggressive fluid therapy may save an animal, whereas delaying surgery until shock is advanced is almost always followed by fatality. This requires a full clinical examination and often ancillary laboratory examination to accurately identify the cause.

The identification of cause will also give some indication of the likelihood of success in treatment. In general there is greater success in the treatment and management of hypovolemic and hemorrhagic shock, especially if treatment is instituted early in the clinical course. Effective treatment and management of maldistributive shock is less successful unless the sepsis can be controlled and the source of the endotoxemia eliminated.

### Hypovolemic and maldistributive shock

The rapid administration of intravenous fluids is the single most important therapy in animals with hypovolemic or maldistributive shock. The goal is to increase venous return and thereby restore circulatory function and tissue perfusion. Crystalloid solutions (fluids that contain electrolytes) and colloid solutions (fluids that increase the plasma oncotic pressure and expand plasma volume) can be used. The general principles and practice of fluid therapy are extensively discussed in the section on disturbances of free water, electrolytes and acid-base balance.

#### Isotonic crystalloid solutions

These are the least expensive and most commonly used treatment for hypovolemic and maldistributive shock in large animals. Balanced electrolyte solutions, such as lactated Ringer's solution, are preferable to 0.9% NaCl solutions.<sup>26</sup> Fluids for the restoration of the extracellular fluid volume must contain sodium but glucose solutions (fluids that provide free water when the glucose is metabolized) are not indicated in the treatment of shock. **Large volumes** of isotonic crystalloid fluids are required. There is no set dose and each case needs to be assessed individually; an initial administration of 100 mL/kg by rapid intravenous infusion is not unusual and 50 mL/kg is probably the minimum. Isotonic crystalloid solutions expand the interstitial fluid volume and promote urine flow; however, beneficial responses are absent shortly after the cessation of fluid administration unless the syndrome is resolved.<sup>17,27</sup>

More fluids are administered as required on the basis of clinical response and the monitoring measures discussed above; in general this involves continuous intravenous infusion during the clinical course. In calves, ruminants and horses the re-establishment of adequate tissue perfusion by intravenous fluid therapy can often be sustained by oral administration of large volumes of electrolyte solutions.<sup>28</sup>

The disadvantages of the use of isotonic crystalloid solutions are the large volume required for treatment, the requirement for repeated treatment, and a

sustained increase in pulmonary artery pressure with the risk for production of pulmonary edema in animals with maldistributive shock due to endotoxemia.<sup>29</sup> Moreover, the delivery of large volumes of isotonic fluid to large animals takes time and is difficult to accomplish in the field. This has led to the widespread use of **small-volume hypertonic saline solutions** for the initial resuscitation of shocked animals. The intravenous administration of small volumes of hypertonic salt solutions results in a transcompartmental and transcellular shift of fluid into the vascular compartment, with an increase in the circulating volume, cardiac contractility and stroke volume and an increase in blood pressure with a reduction in peripheral and pulmonary vascular resistance.<sup>17,26,27,29,30</sup> However, there is little improvement in renal function, the improvement in hemodynamic function is very **short-lived** and their use must be followed by intravenous isotonic crystalloid fluids.

#### Hypertonic saline solution

This has been used successfully in fluid therapy of hypovolemic, maldistributive and hemorrhagic shock and is of value for the rapid resuscitative effect and the lower risk for induction of pulmonary edema in animals with endotoxemia.<sup>27,29-31</sup> Small volumes (4-5 mL/kg) of hypertonic saline (7.2%, 2400 mosmol/L) are infused intravenously over 4-5 min. Too rapid an infusion will result in vasodilation and death and too slow an infusion will diminish the resuscitative effect. There is a risk of phlebitis if there is perivascular deposition of hypertonic fluid.

#### Colloids

The intravenous administration of colloid solutions (dextran, gelatin polymers, hexastarch) induces a more sustained increase in plasma volume than crystalloid solutions and smaller volumes are required for therapy, but colloid solutions are expensive and are rarely used in cattle and occasionally used in horses, with the exception of blood transfusion. Colloid solutions also have a risk for the induction of pulmonary edema<sup>28</sup> and may also increase risk for coagulopathy.<sup>11</sup> For horses, equine plasma is available commercially but is expensive. The use of hypertonic saline in combination with colloids or infusions containing albumin gives a more sustained response and hypertonic saline-dextran solution (2400 mosmol/L sodium chloride with 6% Dextran-70) at a dose of 5 mL/kg is more effective than hypertonic saline alone.<sup>17,31</sup>

### Hemorrhagic shock

The source of the hemorrhage should be determined and the cause corrected. The

other immediate concern is to replenish the blood volume and a decision must be made if this will be with fluids, whole blood or stroma-free hemoglobin solutions. Blood transfusion replaces all elements of the blood and in cases of severe hemorrhage blood transfusion is the most satisfactory treatment. However, a **decision for blood transfusion** should not be made lightly as the procedure is time-consuming, costly and carries some risk.<sup>32</sup> The collection of blood for transfusion and its administration is covered in detail in Chapter 9. The decision to use whole blood in addition to fluids for treatment is based on the need to replace erythrocytes. The hematocrit can be a guide, in combination with clinical assessment, if the hemorrhage started at least 4 hours previously. With acute hemorrhage (<4h), transfusion is indicated solely on the basis of the severity of clinical signs.

In the period immediately following hemorrhage a hematocrit of 20% is indicative of a significant loss of erythrocytes and the hematocrit should be monitored over the next 24-48 hours. If there is a fall to less than 12%, a transfusion of blood is indicated, but a stable packed cell volume (PCV) between 12% and 20% is not usually an indication for transfusion.<sup>33</sup>

Blood should be administered intravenously with an in-dwelling catheter through an in-line filter. Administration of the blood at too rapid a rate may cause overloading of the circulation and acute heart failure, particularly in animals with both circuit and pump failure. A gallon (4.5 L) of blood usually requires an hour to administer to a cow and comparable rates in the smaller species are advisable; and an infusion rate of 10-20 mL/kg/h is recommended for the horse,<sup>32</sup> with faster rates (40 mL/kg/h) for foals.<sup>33</sup>

**Hypertonic saline** solution is recommended in the initial treatment of hemorrhagic shock and has been shown to be effective in the treatment of experimental hemorrhagic shock in large animals.<sup>17,18,24</sup> Hypertonic saline can be of particular value to the ambulatory clinician, as this therapy can be used in emergency situations for the initial resuscitation of cases of hemorrhagic shock pending transfusion.<sup>17,18</sup> A further advantage to the ambulatory clinician is the ease of portability of this fluid. The use of hypertonic saline is contraindicated where the hemorrhage has not been controlled, as its use in these cases will result in more protracted bleeding.

Drugs to assist coagulation and arrest hemorrhage are used in some cases but there is limited information on their efficacy. Aminocaproic acid (10 g in 1 L of saline for an adult horse, administered

intravenously) has been recommended<sup>34</sup> for the management of hemoperitoneum in the horse. Formalin has traditionally been used to control hemorrhage and 10–30 mL of buffered neutral formalin in 500 mL of saline administered rapidly intravenously through an intravenous catheter has been recommended for the control of postparturient hemorrhage in mares.<sup>35</sup> Ergonovine maleate, 1–3 mg intramuscularly at 3-hour intervals has also been used to control hemorrhage in the postparturient mare.<sup>36</sup>

Animals should be kept quiet and in a dark stall to minimize excitement and the risk of further hemorrhage. Analgesic drugs should be given with hemorrhagic disease where there is pain, such as rupture and hemorrhage of the broad ligament of the uterus.

### Obstructive shock

The source for the obstruction should be identified and specific remedies applied. This is a rare cause of shock in large animals.

### Ancillary treatment

A large number of drugs have been shown to influence various components of the inflammatory response in septic shock but none has been shown to alter the eventual outcome and the interference of one aspect of the inflammatory cascade triggered by endotoxin should not be expected to improve overall survival.<sup>11</sup> The specific treatment of maldistributive shock has been discussed earlier.

### Corticosteroids

There is considerable controversy over the use of corticosteroids in shock. Experimental studies have shown that they may have value in the prevention of maldistributive shock but for this to occur corticosteroids must be given prior to the bacterial or endotoxin challenge. There is little evidence that they are of value in the treatment of hypovolemic, hemorrhagic or maldistributive shock in animals once clinical signs have developed.<sup>11,26,37,38</sup> Despite this, corticosteroids are frequently used in the treatment of shock in animals.<sup>26</sup> The dose that is used is considerably higher than that used for other indications, for example a dose of 1–2 mg/kg BW of dexamethasone intravenously.

### Cyclooxygenase inhibitors

The use of cyclooxygenase inhibitors such as flunixin meglumine (0.25 mg/kg BW) and ketoprofen (0.5–2.2 mg/kg BW) has attractions in that they inhibit the production of the vasoactive prostaglandins and thromboxane A<sub>2</sub>. This may not be entirely advantageous as the alternate path of metabolism of arachidonic acid is

to leukotrienes, which are also potent mediators of inflammation. Treatment of horses with endotoxemia with cyclooxygenase inhibitors does result in a better maintenance of blood pressure and tissue perfusion but does not influence the eventual mortality.<sup>11</sup> Tirilazad mesylate suppresses eicosanoid production and TNF activity and has been shown to be of benefit in the treatment of experimental endotoxemia in calves.<sup>39</sup>

### Antibiotic therapy

With maldistributive shock the appropriate antibiotic therapy should be immediately instituted. Antibiotic therapy will not counteract the immediate effects of endotoxin and may theoretically increase the release of endotoxin in the short term but this should not be a contraindication to antibacterial therapy. Pending the result of bacterial culture and susceptibility testing a broad-spectrum bactericidal antibiotic, or a combination of antibiotics to achieve a broad spectrum, should be used. Gram-negative septicemia in calves or foals, or acute-diffuse peritonitis, must be treated with antibiotics as well as by aggressive fluid therapy if there is to be any chance of survival.

### Vasoconstrictors and vasodilators

The administration of vasoconstrictors and vasodilators in cases of shock remains problematic unless the patient's cardiovascular status is accurately known and can be continuously monitored. In general, their use is not currently recommended. The administration of a vasoconstrictor substance in a case of low-pressure distributive shock might seem rational because blood pressure would be elevated but it could reduce tissue perfusion still further.  $\alpha$ -Adrenergic blockers improve tissue perfusion and cardiac function once the circulating blood volume has been restored but if hypotension is already present it will be further exacerbated.<sup>40</sup> Dopaminergic agonists may be useful in the early stages of maldistributive shock as long as monitoring is adequate.<sup>26</sup> This is seldom possible in large animal ambulatory practice and their use in large animals is confined to referral hospitals.

### Immunotherapy

Immunotherapy with antibody directed against the **core lipopolysaccharide antigens** of Gram-negative bacteria may be of value in the therapy or prevention of shock produced by endotoxin in some diseases but not in others. Immunotherapy has shown some promise in the treatment of shock associated with experimental endotoxemia in horses but none for the control of maldistributive

shock associated with Gram-negative sepsis in the neonate.<sup>41–43</sup> Hyperimmune serum is available commercially and may be indicated in those cases where endotoxemia is a risk, in which case it is given before the onset of severe signs.<sup>44</sup> Vaccination with these antigens has proved of value in the reduction of clinical disease produced by endotoxemia and in a reduction of the occurrence of endotoxin-induced shock associated with Gram-negative mastitis in cows, although it does not reduce the occurrence of infection of the udder.<sup>45,46</sup>

### REVIEW LITERATURE

- Wagner AE, Dunlop CI. Anesthetic and medical management of acute hemorrhage during surgery. *J Am Vet Med Assoc* 1993; 203:40–45.
- Durham AE. Blood and plasma transfusions in horses. *Equine Vet Educ* 1996; 8:8–12.
- Constable PD. Hypertonic saline. *Vet Clin North Am Food Anim Pract* 1999; 15:559–585.
- Constable PD. Fluids and electrolytes. *Vet Clin North Am Food Anim Pract* 2003; 19:1–40.
- Roy M. Sepsis in adults and foals. *Vet Clin North Am Equine Pract* 2004; 20:41–61.
- Sykes BW, Furr MO. Equine endotoxemia – a state of the art review of therapy. *Aust Vet J* 2005; 83:45–50.

### REFERENCES

- Laing JA, Hutchins DR. *Aust Vet J* 1992; 69:57.
- Weiss DJ, Smith CM. *Equine Vet J* 1998; 30:7.
- McCarthy PF et al. *Vet Med* 1994; 89:147.
- Sweeney CR et al. *J Am Vet Med Assoc* 1993; 202:1129.
- Dyke TM, Friend SCE. *Equine Vet J* 1988; 20:138.
- Foster RA et al. *Can Vet J* 1997; 38:375.
- Hilbert BJ, Rendano VT. *J Am Vet Med Assoc* 1975; 167:394.
- Natanson C et al. *J Clin Invest* 1989; 83:243.
- Kenny K et al. *J Clin Microbiol* 1993; 31:706.
- Rapoport E et al. *Israel J Vet Med* 1994; 49:127.
- Morris DD. *J Vet Intern Med* 1991; 5:171.
- Koterba AM. *Equine Pract* 1992; 14:28.
- Bottoms GD, Adams HR. *J Am Vet Med Assoc* 1992; 200:1842.
- Welch RD et al. *J Vet Intern Med* 1992; 6:29.
- Moore JN, Morris DD. *J Am Vet Med Assoc* 1992; 200:1903.
- Green EM, Adams HR. *J Am Vet Med Assoc* 1992; 200:1834.
- Constable PD et al. *Am J Vet Res* 1991; 52:981.
- Mandell DC, King LG. *Vet Clin North Am* 1998; 28:623.
- Constable PD et al. *Am J Vet Res* 1998; 59:874.
- Lagutnick MS. *J Vet Emerg Crit Care* 1998; 6:83.
- Constable P et al. In: *Proceedings of the 20th World Buiatrics Congress, Sydney 1998; vol 1: 121.*
- Hjortkjær RK, Svendsen CK. *NordVet Med* 1979; 31(suppl 2):1.
- Wittek T et al. *Am J Vet Res* 2004; 65:597.
- Schatzmann U, Battier B. *Dtsch Tierärztl Wochenschr* 1987; 4:137.
- Walker FG et al. *Can J Vet Res* 1998; 62:205.
- Weeren PR, Muir WW. *J Am Vet Med Assoc* 1992; 200:1859.
- Bertone JJ. *Comp Cont Educ Pract Vet* 1991; 13:665.
- Mitchell AR. *Ir Vet J* 1988; 17.
- Constable P et al. *Am J Vet Res* 1991; 5:981.
- Cambier C et al. *Vet Res Commun* 1997; 21:303.
- St Jean G et al. *Agri-Practice* 1993; 14(7):6.
- Morris DD. *Equine Pract* 1989; 115:34.



33. Durham AE. *Equine Vet Educ* 1996; 8:8.
34. Jeffery SC. *Vet Med* 1996; 91:850.
35. Hooper RN et al. *Vet Med* 1994; 89:57.
36. Rosedale PD. *Equine Vet Educ* 1994; 6:135.
37. Cohn LA. *J Vet Intern Med* 1991; 5:95.
38. Ewart K et al. *Am J Vet Res* 1985; 46:140.
39. Semrad SD, Dubielzig R. *Can J Vet Res* 1994; 58:67.
40. Hardie EM, Krues-Elliott K. *J Vet Intern Med* 1990; 4:306.
41. Spier SJ et al. *Circ Shock* 1989; 28:235.
42. Morris DD et al. *Am J Vet Res* 1986; 47:544.
43. Morris DD et al. *Am J Vet Res* 1986; 47:2554.
44. Murray R. *In Practice* 1998; 20(2):88.
45. Hogan JS et al. *J Dairy Sci* 1992; 75:78.
46. Cullor JS. *J Am Vet Med Assoc* 1992; 200:1894.

## Allergy and anaphylaxis

When exposure of an animal to an antigen produces a state of increased reactivity of the animal's tissues to that antigen, a state of specific immune responsiveness is achieved. In most animals these responses are defensive and beneficial but, on occasion, they can be detrimental to the host. In these cases a state of hypersensitivity is said to exist, which is clinically recognizable as allergy. When the reaction is sudden and clinically severe it is called anaphylaxis and if sufficiently severe it may result in anaphylactic shock.

There are a number of immune reactions that can be harmful to tissues but in large animals the immediate hypersensitivity reactions, especially those that result in severe anaphylaxis, pulmonary (potentially recurrent airway obstruction (RAO) horses) and dermatological diseases (such as Queensland itch) are most important. There are other immediate hypersensitivity reactions that should be noted. They include isoimmune erythrolysis of foals – a specific cytotoxic hypersensitivity – and the more generalized formation of circulating immune complexes, which cause vasculitis, thrombosis, hemorrhage and consequent tissue damage. Purpura hemorrhagica is probably the best example.

There are four major mechanisms for the induction of a hypersensitivity response. They are classified as types I–IV based on the immune mechanism that elicits the disease state.<sup>1</sup> Types I–III are antibody-mediated responses to antigen and include such conditions as systemic anaphylactic shock (type I), autoimmune hemolytic anemia (type II) and the local Arthus reaction (type III). Type IV hypersensitivity is caused by the induction of sensitized T lymphocytes and thus has a cell-mediated mechanism.<sup>1</sup>

### TYPE I

In **immediate hypersensitivity reactions** the antigen, or allergen, reacts with

antibody, which may be either circulating or cell-bound, to set in train a series of complex biochemical and pharmacological reactions that culminate in the release of pharmacologically active mediators. There are a number of recognized mediators and the importance of any one varies with the host species and possibly the nature of the hypersensitivity reaction. In general they act to contract smooth muscle and increase capillary permeability. These agents may act immediately at the site of antigen-antibody reaction or they may be carried in the blood to produce effects in susceptible tissues at sites remote from the primary focus. The difference in manifestation of acute, immediate-type hypersensitivity reactions between species appears to depend largely on differences in the tissue site of antibody binding and the distribution of susceptible smooth muscle, as well as differences in the major pharmacological mediators of the reaction. The high incidence of atopic hypersensitivity with familial predisposition seen in humans and dogs does not occur in large animals.

The literature on immunoglobulin-E-mediated hypersensitivity in food-producing animals has been reviewed and the details are available.<sup>1</sup>

Immunological injury in the absence of significant release of pharmacological mediators also occurs but it is rarely approached from the clinical standpoint as a primary allergy and is generally considered in the disease complex in which it is occurring. The anemia and glomerulitis that accompany equine infectious anemia is an example. Serum sickness is rare in large animals.

### TYPE II

**Autoimmune reactions** are uncommon in farm animals. They contribute to the formation of spermatocytic granulomas. Isoimmune hemolytic anemia and thrombocytopenic purpura could be considered as examples and are dealt with elsewhere under those headings.

### TYPE III

**Arthus-type reaction** or the **Arthus phenomenon** is the development of an inflammatory lesion, with induration, erythema, edema, hemorrhage and necrosis, a few hours after intradermal injection of antigen into a previously sensitized animal producing precipitating antibody; it is classed as a type III hypersensitivity reaction in the Gell and Coombs classification of immune responses. The lesion results from the precipitation of antigen-antibody complexes, which causes complement activation and the release of complement fragments that are chemotactic for neutrophils; large numbers of neutrophils

infiltrate the site and cause tissue destruction by release of lysosomal enzymes.

### TYPE IV

**Cell-mediated or delayed hypersensitivity** is of importance in the tuberculin and other long-term skin sensitivity tests, but similar delayed reactions to topically applied antigens are not common in farm animals. Queensland and sweet itch are probably examples. Delayed hypersensitivity reactions may contribute to the pathology of many diseases such as mycoplasmal pneumonia in swine, but those are considered clinically under their initiating etiology.

### TREATMENT

The **treatment of allergic states** is by the use of functional antagonists which have opposing effects to those of the allergic mediators, and the specific pharmacological antagonists, especially antihistamines and corticosteroids. The functional antagonists include the sympathomimetic drugs, those related to epinephrine and, to a less extent, the anticholinergic drugs. Of the sympathomimetic drugs there is a choice between those with an alpha-response (vasoconstriction and maintaining vascular permeability) and those with a beta-response (bronchodilatory and cardiac-stimulatory). Of the pharmacological antagonists, antihistamines have very limited usefulness, being effective only when the allergic mediator is histamine, the corticosteroids have very wide applicability, and the NSAIDs, including acetylsalicylic acid, phenylbutazone and meclofenamic acid, all inhibit prostaglandin synthesis and thus reduce inflammation.

## ANAPHYLAXIS AND ANAPHYLACTIC SHOCK

Anaphylaxis is an acute disease caused by antigen-antibody reaction. If severe it may result in anaphylactic shock.

### ETIOLOGY

Most commonly, severe anaphylactic reactions are seen in farm animals following the parenteral administration of a drug or biological product.<sup>1</sup> Other routes of entry of the allergen, such as via the respiratory or gastrointestinal tract, may also result in anaphylactic reactions. The reaction may occur at the site of exposure or in other areas.

In general the reaction is due to sensitization to a protein substance entering the bloodstream and a second exposure to the same substance. In veterinary practice such incidents are not uncommon, although the sensitizing substance cannot always be isolated.

Although severe anaphylactic reactions occur usually after a second exposure to a



sensitizing agent, reactions of similar severity can occur with no known prior exposure. In large-animal practice this is most likely to occur after the injection of sera and bacterins, particularly heterologous sera and bacterins in which heterologous serum has been used in the culture medium.

Hypersensitivity reactions are sometimes observed at a higher incidence than normal in certain families and herds of cattle.

Anaphylactic reactions can occur in the following circumstances:

- Repeated intravenous injection of biological preparations such as glandular extracts
- Repeated blood transfusions from the same donor
- Repeated injections of vaccines, e.g. those against foot-and-mouth disease and rabies
- Rarely, after a first injection of a conventional drug such as penicillin, usually procaine or benzathine penicillin, or a test agent such as bromsulphalein. The reaction is reminiscent of 'serum sickness' in humans because there has been no known previous exposure to the product, but occurs much earlier. It may in fact be immediate and is usually within a few hours after injection
- Similar rare occurrences after the injection of lyophilized *Brucella abortus* strain 19 vaccine and *Salmonella* vaccine. These, like the preceding group, are really anaphylactoid reactions because there has been no apparent previous exposure to the sensitizing antigen
- Assumed anaphylactic reaction to ingested protein occurs in animals at pasture or in the feedlot
- Cows, especially Channel Island cattle, may develop anaphylaxis when milking is stopped because the cows are being dried off – severe urticaria and respiratory distress occur 18–24 hours later
- A systemic reaction after *Hypoderma* spp. larvae are killed in their subcutaneous sites may be anaphylactic, but is more likely to be a toxic effect from breakdown products of the larvae
- Anaphylactic like reactions can be produced experimentally in calves by injecting the endotoxin-like extract of ruminal contents. Acute toxemia develops about 30 minutes later, but an anaphylactic reaction occurs when the same extract is injected 15 days later. This response is more correctly termed endotoxemic shock.

## PATHOGENESIS

Anaphylactic reactions occur as the result of antigen reacting with circulating or cell-bound antibody. In humans and dogs a specific class of reaginic antibody, IgE, has been identified and has particular affinity for fixed tissue mast cells.<sup>1</sup> The tissue distribution of mast cells in part accounts for the involvement of certain target organs in anaphylactic reactions in these species. Homocytotropic antibody has been detected in farm animals but the classes of antibody involved in anaphylactic reactions have not been fully identified and are likely to be diverse. Anaphylactic antibodies may be transferred via colostrum.

Antigen-antibody reactions occurring in contact with, or in close proximity to fixed tissue mast cells, basophils and neutrophil leukocytes result in the activation of these cells to release pharmacologically active substances that mediate the subsequent anaphylactic reaction. These substances include biogenic amines such as histamine, serotonin and catecholamines; vasoactive polypeptides such as kinins, cationic proteins and anaphylatoxins; vasoactive lipids such as prostaglandins and slow reacting substance of anaphylaxis (SRS-A); and others. Knowledge of the type and relative importance of pharmacological mediators of anaphylaxis in farm animals rests with studies of severe anaphylactic reactions that have been induced experimentally, but it is likely that these mediators are also of significance in less severe reactions. From these studies it appears that histamine is of less importance as a mediator in farm animals than in other species and that prostaglandins and SRS-A are of greater importance. Bradykinin and 5-hydroxytryptamine (5-HT) are also known to act as mediators in cattle but the reactions in all species are complex and involve a sequence of mediator effects.

**In the horse**, there are four phases in the development of the anaphylactic response. The **first is acute hypotension** combined with pulmonary arterial hypertension 2–3 minutes after the injection of the triggering agent; it coincides with histamine release. In the **second phase, blood plasma 5-HT levels rise, and central venous blood pressure rises** sharply at about 3 minutes and onward. The **third phase** commences at about 8–12 minutes, and is largely reflex and **manifested by a sharp rise in blood pressure**, and alternating apnea and dyspnea. Finally, there is a second and more protracted systemic hypotension due to prostaglandin and SRS-A influence which persists until the return to normality.

**In cattle**, there is a similar diphasic systemic hypotension with marked pulmonary venous constriction and pulmonary artery hypertension. An increase in mesenteric venous pressure and mesenteric vascular resistance causes considerable pooling of blood on the venous side of the mesenteric vessels. In both cattle and horses these reactions are accompanied by severe hemoconcentration, leukopenia, thrombocytopenia and hyperkalemia.

**Sheep and pigs** also show a largely pulmonary reaction.

In horses and cattle the marked changes in vascular tone coupled with increased capillary permeability, increased secretion of mucous glands and bronchospasm are the primary reactions leading to the development of severe pulmonary congestion, edema and emphysema and edema of the gut wall. Death is due to anoxia.

Less severe reactions are also dependent upon the effect of mediators on capillary permeability, vascular tone and mucous gland secretion. The major manifestation depends on the distribution of antibody-sensitized cells and of susceptible smooth muscle in the various organs. In cattle, reactions are generally referable to the respiratory tract but the alimentary tract and skin are also target organs. Sheep and pigs show largely a pulmonary reaction and horses manifest changes in the lungs, skin and feet.

Sensitization of a patient requires about 10 days after first exposure to the antigen, and persists for a very long time: months or years.

## CLINICAL FINDINGS

### Cattle

In cattle, initially there is a sudden onset of severe dyspnea, muscle shivering and anxiety. In some cases there is profuse salivation, in others moderate bloat and yet others diarrhea. After an incompatible blood transfusion, the first sign is often hiccough. Additional signs are urticaria, angioneurotic edema and rhinitis. Muscle tremor may be severe and a rise in temperature to 40.5°C (105°F) may be observed. On auscultation of the chest there may be increased breath sounds, crackles if edema is present, and emphysema in the later stages if dyspnea has been severe. In most surviving cases the signs have usually subsided within 24 hours, although dyspnea may persist if emphysema has occurred.

In natural cases the time delay after injection of the reagent intravenously is about 15–20 min but in experimentally induced cases a severe reaction may be evident within 2 min and death within 7–10 min of the injection. Clinical signs

include collapse, dyspnea, wild paddling, nystagmus, cyanosis, cough and the discharge of a creamy, frothy fluid from the nostrils. Recovery, if it occurs, is complete in about 2 hours.

### Sheep and pigs

In sheep and pigs, **acute dyspnea is common**. Laminitis also occurs rarely in ruminants.

### Horses

In the horse, naturally occurring anaphylactic shock is manifested by severe dyspnea, distress, recumbency and convulsions. Death may occur within less than 5 min but it usually requires about an hour. Laminitis and angioneurotic edema are also common signs in the horse. Experimentally induced anaphylaxis may be fatal but not in such a short time. Within 30 min of injecting the reagin the horse is showing anxiety, tachycardia, cyanosis and dyspnea. These signs are followed by congestion of conjunctival vessels, increased peristalsis, fluid diarrhea, generalized sweating and erection of the hair. If recovery occurs it is about 2 hours after the incident began. Death, if it occurs, takes place about 24 hours after the injection.

### Pigs

In pigs, experimentally produced anaphylactic shock can be fatal within a few minutes, with systemic shock being severe within 2 min and death occurring in 5–10 min. The disease appears to occur in only one phase, in contrast to the four fairly distinct states in horses. Labored respiration, severe cyanosis, vomiting and edema of the larynx, stomach and gallbladder are the usual outcome.<sup>9</sup>

### CLINICAL PATHOLOGY

Blood histamine levels may or may not be increased and few data are available on blood eosinophil counts. Tests for sensitivity to determine the specific sensitizing substance are rarely carried out for diagnostic purposes but their use as an investigation tool is warranted. Serological tests to determine the presence of antibodies to plant proteins in the diet have been used in this way.

Some significant changes occur during immediate anaphylaxis in cattle and horses but whether they have diagnostic importance is uncertain. There is a marked increase in packed cell volume, a high plasma potassium concentration and a neutropenia.

### NECROPSY FINDINGS

In acute anaphylaxis in young cattle and sheep the necropsy findings are confined to the lungs and are in the form of severe pulmonary edema and vascular engorgement. In adult cattle there is edema and

emphysema without engorgement. In protracted anaphylaxis produced experimentally in young calves, the most prominent lesions are hyperemia and edema of the abomasum and small intestines. In pigs and sheep pulmonary emphysema is evident and vascular engorgement of the lungs is pronounced in the latter. Pulmonary emphysema and widespread petechiation in the horse may be accompanied by massive edema and extravasations of blood in the wall of the large bowel. There may also be subcutaneous edema and lesions of laminitis.

### DIFFERENTIAL DIAGNOSIS

- A diagnosis of anaphylaxis can be made with confidence if a foreign protein substance has been injected within the preceding hour, but should be made with reservation if the substance appears to have been ingested.
- Characteristic signs as described above should arouse suspicion and the response to treatment may be used as a test of the hypothesis.
- Acute pneumonia may be confused with anaphylaxis, but there is usually more toxemia and the lung changes are more marked in the ventral aspects; in anaphylaxis there is general involvement of the lung.

### TREATMENT

Treatment should be administered immediately; a few minutes' delay may result in the death of the animal. Epinephrine is the most effective treatment for anaphylaxis and anaphylactic shock. Epinephrine administered intramuscularly (or one-fifth of the dose given intravenously) is often immediately effective, the signs abating while the injection is being made. Corticosteroids potentiate the effect of epinephrine and may be given immediately following the epinephrine. Antihistamines are in common use but provide variable results due to the presence of mediators other than histamine. Atropine is of little value.

The identification of mediators other than histamine in anaphylactic reactions in farm animals has led to studies of the effectiveness of drugs more active against these mediators than antihistamines. Acetylsalicylic acid, sodium meclofenamate and diethylcarbamazine have all shown ability to protect against experimentally induced anaphylaxis in cattle and horses and warrant trial in anaphylactic reactions in these species. One of the important clinical decisions, especially in horse practice, is to decide whether an animal is sufficiently hypersensitive to be at risk when being treated. An acute anaphylactic reaction, and even death, can

occur soon after intravenous injection of penicillin into a horse. In suspect cases it is customary to conduct an intradermal or a conjunctival test for hypersensitivity with a response time of about 20 minutes, but these tests have their limitations. The types of sensitivity are not necessarily related and there is no sure relationship between anaphylactic sensitivity and either skin (or conjunctival) sensitivity or circulating antibody, and the test often gives false negatives. The reason why some animals develop systemic hypersensitivity and some develop cutaneous hypersensitivity does not appear to be related to the nature of the reagin but may be related to the size of the sensitizing dose.

### OTHER HYPERSENSITIVITY REACTIONS

These reactions include anaphylaxis of a less severe degree than anaphylactic shock and cases of cell-mediated delayed hypersensitivity. The resulting clinical signs vary depending on the tissues involved, but are usually localized and mild.

### ETIOLOGY

Exposure to any of the etiological agents described under anaphylaxis may result in this milder form of hypersensitivity. Exposure may occur by injection, by ingestion, by inhalation or by contact with the skin.

### PATHOGENESIS

In anaphylactic reactions the clinical signs may depend on the portal of entry. Thus ingestion may lead to gastrointestinal signs of diarrhea, inhalation to conjunctivitis, rhinitis, and laryngeal and bronchial edema. Cutaneous lesions can result from introduction of the reagin via any portal. They are usually manifested by angioedema, urticaria or a maculopapular reaction. All the lesions result from the liberation of histamine, serotonin (5-HT) and plasma kinins as in anaphylactic shock.

### CLINICAL FINDINGS

In ruminants inhalation of a sensitizing antigen may cause the development of allergic rhinitis. On ingestion of the sensitizing agent there may be a sharp attack of diarrhea and the appearance of urticaria or angioneurotic edema; in ruminants mild bloat may occur. Contact allergy is usually manifested by eczema. In farm animals the eczematous lesion is commonly restricted to the skin of the lower limbs, particularly behind the pastern, and at the bulbs of the heels, or to the midline of the back if the allergy is due to insect bites. In many cases of allergic disease the signs are very transient

and often disappear spontaneously within a few hours. Cases vary in severity from mild signs in a single system to a systemic illness resembling anaphylactic shock. On the other hand, cases of anaphylaxis may be accompanied by local allergic lesions.

### DIFFERENTIAL DIAGNOSIS

The transitory nature of allergic manifestations is often a good guide, as are the types of lesion and sign encountered. The response to antihistamine drugs is also a useful indicator. Skin test programs as applied to humans should be utilized when recurrent herd problems exist. The differential diagnosis of allergy is discussed under the specific diseases listed above.

### TREATMENT

A combination of epinephrine, antihistamines and corticosteroids is usually highly effective. Skin lesions other than edema may require frequent local applications of lotions containing antihistamine substances. Continued exposure to the allergen may result in recurrence or persistence of the signs. Keeping the animals indoors for a week often avoids this, probably because the allergen occurs only transiently in the environment. Hypo-sensitization therapy, as it is practiced in human allergy sufferers, may have a place in small animal practice but is unlikely to be practicable with farm animals.

### REVIEW LITERATURE

Black L. Hypersensitivity in cattle, Pt 1. Mechanism of causation; Pt 2. Clinical reactions; Pt 3. Mediators of anaphylaxis. *Vet Bull* 1979; 49:77, 303.

Gershwin LJ. Immunoglobulin E-mediated hypersensitivity in food-producing animals. *Vet Clin North Am Food Anim Pract* 2001; 17:599-619.

### REFERENCE

1. Gershwin LJ. *Vet Clin North Am Food Anim Pract* 2001; 17:599.

## Edema

### ETIOLOGY

Edema results from four causes: **increased hydrostatic pressure** in capillaries and veins due to chronic (congestive) heart failure or obstruction to venous return; **decreased plasma oncotic pressure**; **increased capillary permeability** in endotoxemia, part of the allergic response, vasculitis and damage to the vascular endothelium; or **obstruction to lymphatic flow**.

#### Increased hydrostatic pressure

- Symmetric ventral edema in chronic (congestive) heart failure, symmetric pulmonary edema in acute heart failure
- Generalized edema in enzootic calcinosis of cattle

### Synopsis

**Etiology** Increased hydrostatic pressure (chronic (congestive) heart failure or obstruction to venous return), decreased plasma oncotic pressure (hypoalbuminemia), increased capillary permeability (endotoxemia) or decreased lymphatic drainage (obstruction to lymph flow) result in accumulation of fluid in the interstitial space

**Clinical findings** Pitting, cool, usually dependent, subcutaneous swelling and fluid accumulation in peritoneal and pleural cavities. Distribution of edema varies with animal species

**Clinical pathology** Hypoalbuminemia except with obstruction to venous return or lymph flow. Examinations aimed at establishing the organ principally responsible for edema formation (commonly heart, kidney, gastrointestinal tract, and liver) and at the cause of the organ failure

**Necropsy findings** Fluid accumulation in tissues and body spaces. Specific changes with cause

**Diagnostic confirmation** Clinical findings coupled with clinical pathology

**Treatment** Diuretics (furosemide) and colloid replacement fluid therapy using blood, plasma, or plasma volume expanders. Correction of specific cause

- Local symmetric ventral edema in udder edema in late pregnancy from compression of veins and lymphatics by the developing mammary gland (and possibly the enlarging fetus and uterus), causing mammary or ventral edema in cows (particularly heifers), mares and occasionally ewes.<sup>1</sup> Sodium and potassium intakes and cation-anion differences in the diet contribute to the severity of udder edema.<sup>2</sup> Edema resolves 5-10 days following parturition
- Local edema by compressive lesions on veins (as in thymic lymphosarcoma with compression of the cranial vena cava)<sup>3</sup> draining other anatomic locations
- Local edema in portal hypertension due to hepatic fibrosis causing ascites (rare in large animals).

#### Decreased plasma oncotic pressure

Decreased total protein concentration in plasma, and particularly decreased plasma albumin concentration, will result in symmetric ventral edema. Hypoalbuminemia is more important than hypoglobulinemia in inducing edema formation because albumin provides the largest contribution to plasma oncotic pressure. Hypoalbuminemia can result from **increased loss** (due to blood-sucking parasites or across the gastrointestinal tract, kidneys or into a large third space such as the pleural or peritoneal

cavities), **decreased production** (as in chronic hepatic failure) or **decreased intake**:

- Chronic blood loss, especially in heavy infestations with blood-sucking parasites such as *Strongylus* sp. in the horse, *Fasciola* sp. in ruminants, *Haemonchus* sp. in ruminants of all ages, especially goats, and *Bunostomum* sp. in calves
- Protein-losing gastroenteropathies as in Johne's disease and amyloidosis in adult cattle, right dorsal colitis in horses; heavy infestation with nematode parasites in ruminants, particularly *Ostertagia* sp. in young cattle and cyathostomiasis in horses
- Glomerulonephropathies, such as amyloidosis in adult cattle, inherited glomerulonephritis in Finnish Landrace lambs
- Chronic liver damage causing failure of plasma protein synthesis (rare and terminal in large animals)
- Terminally in prolonged malnutrition with low dietary protein intakes, e.g. ruminants at range in drought time.

#### Increased capillary permeability

- Increased capillary permeability due to endotoxemia
- Allergic edema as in urticaria and angioneurotic edema caused by local liberation of vasodilators
- Toxic damage to vascular endothelium or vasculitis - in anthrax, gas gangrene and malignant edema in ruminants, edema disease of pigs, mulberry heart disease in pigs, equine viral arteritis, equine infectious anemia, purpura hemorrhagica in horses, and heartwater (cowdriosis) in ruminants.

#### Obstruction to lymphatic flow

- Part of the edema caused by tumors or inflammatory swellings is lymphatic obstruction. Extensive fluid loss also originates from granulomatous lesions on serous surfaces. Ascites or hydrothorax may result
- Congenital in inherited lymphatic obstruction edema of Ayrshire and Hereford calves
- Sporadic lymphangitis (bigleg) of horses
- Edema of the lower limbs of horses immobilized because of injury or illness.

### PATHOGENESIS

Edema is the excessive accumulation of fluid in the interstitial space of tissue caused by a disturbance in the mechanism of fluid interchange between capillaries, the interstitial space and the lymphatic vessels. At the arteriolar end of the

capillaries the hydrostatic pressure of the blood is sufficient to overcome its oncotic pressure and fluid tends to pass into the interstitial space. At the venous end of the capillaries the position is reversed and fluid tends to return to the vascular system. The pressure differences are not great, but there is a large area for exchange, and a small increase in hydrostatic pressure or a small decrease in oncotic pressure leads to failure of the fluid to return to the capillaries.

Increased fluid passage into the interstitial space can also occur where there is increased vascular permeability due to vascular damage. Under these circumstances, fluid accumulates in the interstitial space when the fluid flux across the endothelium is greater than the ability of the lymphatic system to drain it. Alternatively, capillary hydrostatic pressure, oncotic pressure and vascular permeability might be normal, but fluid and vascular permeability can accumulate in the interstitial space when lymphatic drainage is occluded.

Edema of the lower limbs of immobilized horses ('filling') is usually ascribed to poor lymphatic or venous return due to inactivity of the 'foot pump'. Lower limb edema in horses may also be related to changes in the hematocrit and plasma protein concentration in the distal limb vasculature as a result of inactivity.

#### CLINICAL FINDINGS

Accumulation of edematous transudate in subcutaneous tissues is referred to as **anasarca**, in the peritoneal cavity as **ascites**, in the pleural cavities as **hydrothorax** and in the pericardial sac as **hydro-pericardium**. Anasarca in large animals is usually confined to the ventral wall of the abdomen and thorax, the brisket and, if the animal is grazing, the intermandibular space because of the large hydrostatic pressure gradient between the submandibular space and heart. Intermandibular edema may be less evident in animals housed such that they do not have to lower their heads to feed. Edema of the limbs is uncommon in cattle, sheep and pigs but occurs in horses quite commonly when the venous return is obstructed or there is a lack of muscular movement. Hydrothorax is not common with generalized edema and is usually an indication of an obstructive intrathoracic lesion. Local edema of the head in the horse is a common lesion in African horse sickness and purpura hemorrhagica.

Edematous swellings are **soft, painless and cool to the touch**, and **pit on pressure**. In ascites there is distension of the abdomen and the fluid can be detected by a fluid thrill on tactile percussion, fluid sounds on succussion and

by paracentesis. A level top line of fluid may be detectable by any of these means. In the pleural cavities and pericardial sac the clinical signs produced by the fluid accumulation include restriction of cardiac movements, embarrassment of respiration and collapse of the ventral parts of the lungs. The heart sounds and respiratory sounds are muffled, and the presence of fluid may be ascertained by percussion and thoracocentesis or pericardiocentesis.

More localized edemas cause more localized signs: pulmonary edema is accompanied by respiratory distress and in some cases by an outpouring of froth from the nose; cerebral edema is manifested by severe nervous signs of altered mentation. A not uncommon entity is a large edematous plaque around the umbilicus in yearling horses. The plaque develops rapidly, causes no apparent illness and subsides spontaneously after about 7 days. Thrombophlebitis is a common cause of localized edema, particularly of the head in horses and cattle with thrombophlebitis of both jugular veins. Head edema usually occurs in affected animals only when there is rapid and complete occlusion of both jugular veins by thrombophlebitis; a slower rate of jugular vein occlusion permits development of collateral veins for venous drainage of the head.

#### CLINICAL PATHOLOGY

Cytological examination of a sample of fluid reveals an absence of inflammatory cells where edema is the result of increased hydrostatic pressure, decreased plasma oncotic pressure (hypoalbuminemia), increased vascular permeability or obstruction to lymphatic flow. Thoracocentesis or abdominocentesis is useful to differentiate the causes of fluid accumulation, in conjunction with measurement of serum albumin concentration and central venous pressures.

Examinations should always be directed towards determining the mechanism for hypoalbuminemia; in particular, the renal and gastrointestinal systems and liver are examined for evidence of disease and altered function. In general, the serum albumin concentration is usually less than 15 g/L in animals with generalized edema due to decreased plasma oncotic pressure. Generalized edema should always be expected whenever serum albumin concentration is less than 10 g/L.

#### NECROPSY FINDINGS

The nature of the accumulation of fluid in most cases is obvious on gross post-mortem examination but the determination of the cause of the disease that has resulted in hypoalbuminemia may require further histological and cultural exam-

ination. Necropsy findings for the specific diseases where edema is a feature are given in the individual disease sections.

#### DIFFERENTIAL DIAGNOSIS

- Rupture of urethra or bladder for differentiation of ascites
- Peritonitis or pleuritis for accumulation of fluid in abdominal or pleural cavities
- Cellulitis for local edema

#### TREATMENT

The treatment of edema should be aimed at correcting the cause, whether it is increased hydrostatic pressure, decreased plasma oncotic pressure, increased endothelial permeability, or obstruction to lymphatic drainage. Chronic (congestive) heart failure may need to be treated with digoxin and thrombophlebitis of the jugular veins may need specific treatment (see Ch. 8). Hypoalbuminemia may require the administration of plasma or plasma substitutes, although this is only a short-term measure and is expensive. Parasitic gastroenteritis requires administration of the appropriate anthelmintic, obstructive edema requires removal of the physical cause, and increased permeability edema requires resolution of the cause of endothelial damage.

Ancillary nonspecific measures include restriction of the amount of salt in the diet and the use of diuretics. Diuretics may relieve the effects of pressure temporarily but the primary cause needs to be addressed for a satisfactory outcome. Aspiration of edema fluid is rarely successful and is not routinely recommended. Aspiration usually provides temporary relief because the fluid rapidly accumulates.

#### REFERENCES

1. Block E. *J Dairy Sci* 1994; 77:1437.
2. Al-Ani FK, Vestweber JGE. *Vet Bull* 1986; 56:763.
3. Alexander AN et al. *J Vet Intern Med* 1996; 10:275.

## Disturbances of free water, electrolytes and acid-base balance

There are many diseases of farm animals in which there are disturbances of body fluids (free water), electrolytes and acid-base balance. A disturbance of body water balance in which more fluid is lost from the body than is absorbed results in reduction in circulating blood volume and in **dehydration** of the tissues. In contrast, the rapid ingestion of large quantities of water can lead to overhydration (**water intoxication**).

**Electrolyte imbalances** occur commonly as a result of loss of electrolytes,

shifts of certain electrolytes or relative changes in concentrations due to loss of water. Common electrolyte imbalances include hyponatremia, hypokalemia, hypocalcemia and hypochloremia.

**Acid–base imbalances**, either **acidemia** or **alkalemia**, occur as a result of the addition of acid and depletion of alkali reserve, or the loss of acid with a relative increase in alkali reserve.

Under most conditions, the above disturbances of fluid and electrolyte balance will occur simultaneously, in varying degrees, depending on the initial cause. Each major abnormality will be described separately here with emphasis on etiology, pathogenesis, clinical pathology and treatment. However, it is important to remember that actual disease states in animals in which treatments with fluids and electrolytes are contemplated are rarely caused by single abnormalities. In most cases it is a combination of dehydration together with an electrolyte deficit, and often without a disturbance of the acid–base balance, that necessitates treatment.

## DEHYDRATION

### ETIOLOGY

There are two major causes of dehydration:

- Inadequate water intake
- Excessive fluid loss.

Deprivation of water, a lack of thirst due to toxemia, and the inability to drink water as in esophageal obstruction, are examples of dehydration due to inadequate water intake. The most common cause of dehydration is when excessive fluid is lost. Diarrhea is the most common reason for excessive fluid loss, although vomiting, polyuria and loss of fluid from extensive skin wounds or by copious sweating may be important in sporadic cases. Severe dehydration also occurs in acute carbohydrate engorgement in ruminants, acute intestinal obstruction and diffuse peritonitis in all species, and in dilatation and volvulus of the abomasum. In most forms of dehydration, deprivation of drinking water being an exception, the serious loss, and the one that needs correction, is not the fluid but the electrolytes (Fig. 2.1).

The ability to survive for long periods without water in hot climates represents a form of animal adaptation that is of some importance. This adaptation has been examined in camels and in Merino sheep. In the latter, the ability to survive in dry, arid conditions depends on a number of factors, including insulation, the ability to carry water reserves in the rumen and extracellular fluid space, the ability to adjust electrolyte concentrations in several fluid locations, the ability of the kidney to conserve water and the ability

to maintain the circulation with a lower plasma volume. Dehydrated mammals in hot environments can save water by reducing the rate of panting and sweating and regulating body temperature above hydrated levels. Sweating is a significant avenue of evaporative heat loss in goats when they are hydrated and exposed to high ambient temperatures above 40°C.

Observations of drinking behavior of cattle transported to the abattoir indicate that those animals that had been sold in livestock markets prior to arrival at the abattoir are more thirsty and more tired than cattle sent directly from farms.<sup>1</sup> This indicates inadequate water intake and dehydration.

### PATHOGENESIS

Two factors are involved in the pathogenesis of dehydration:

- Depression of tissue water content with resulting interference in tissue metabolism
- Reduction in the free water content of blood.

The initial response to negative water balance is the withdrawal of fluid from the tissues and the maintenance of normal blood volume. The fluid is drained primarily from the intracellular and interstitial fluid spaces. Essential organs including the central nervous system,

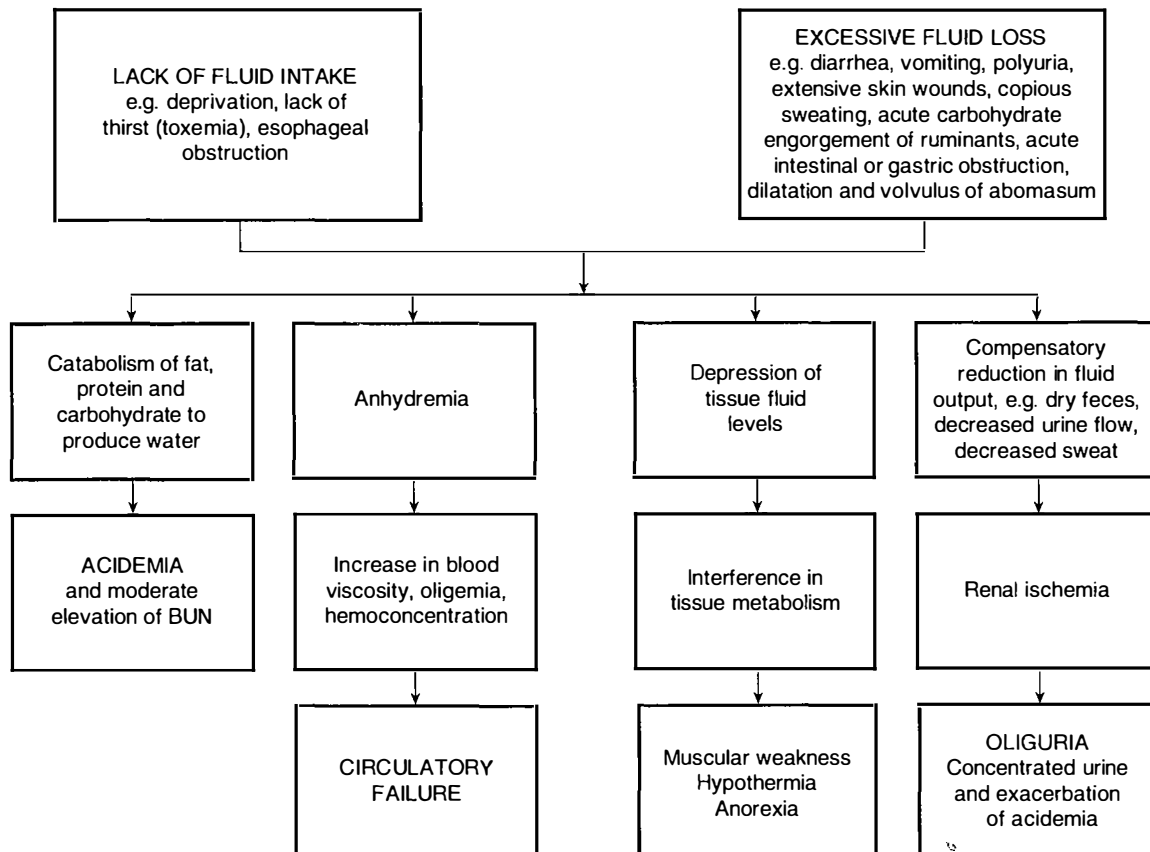

Fig. 2.1 Etiology and pathogenesis of dehydration.

heart and skeleton contribute little and the major loss occurs from connective tissue, muscle and skin. The loss of fluid from the interstitial and intracellular spaces results in loss of skin elasticity, dryness of the skin and mucosa, and a reduction and retraction of the eyeball (enophthalmia) due to reduction in the volume of the postorbital fat deposits. In the goat, total body water may be reduced as much as 44% before death occurs.

The secondary response to continued negative water balance is a reduction in the fluid content of the blood causing a reduction in circulating blood volume (**volume depletion**) and an increase in the concentration of the blood (**hemoconcentration**). Because of the hemoconcentration, there is an increase in the viscosity of the blood, which impedes blood flow and may exacerbate peripheral circulatory failure. The loss in circulating blood volume also contributes to the mental depression of dehydrated animals, which is also due to varying degrees of acidemia and toxemia depending on the cause of the dehydration. In deprivation of water and electrolytes or in deprivation of water alone or inability to consume water in an otherwise normal animal (e.g. esophageal obstruction), the dehydration is minimal because the kidney compensates effectively by decreasing urine output and increasing urine osmolality. In addition, water is preserved by reduced fecal output and increased absorption, which results in dehydration of the contents of the rumen and large intestine, which in turn results in dry, scant feces.

In calves with acute diarrhea there is increased fecal output of water compared to normal calves but the total water losses are not much greater than in normal calves. In the diarrheic calf the kidney compensates very effectively for fecal water loss, and the plasma volume can be maintained if there is an adequate oral fluid intake. Urine excretion decreases, the urine becomes progressively more concentrated and the renal insufficiency may accentuate pre-existing acidemia and electrolyte imbalance, hence the importance of restoring renal function. The newborn calf is able to concentrate urine at almost the same level as the adult. This illustrates the importance of oral fluid and electrolyte intake during diarrhea to compensate for continuous losses. However, it is possible for metabolic acidosis to occur in diarrheic calves and goat kids that are not dehydrated.<sup>2,3</sup>

Goats are more sensitive to water deprivation during pregnancy and lactation than during anestrus. Water deprivation for 30 hours causes a marked increase in the plasma osmolality and plasma sodium concentration in pregnant

and lactating goats. Pregnant and lactating goats drink more than goats in anestrus.

The dehydration in horses used for endurance rides is hypotonic, in which both sodium and water are lost through sweating. This may account for the lack of thirst in some dehydrated horses with the exhaustion syndrome. Weight losses of 10–15 kg/h may occur in horses exercising in high environmental temperatures exceeding 32°C (89°F) and a horse weighing 450 kg can lose 45 L of fluid in a 3-hour ride.

Dehydration exerts important effects on tissue metabolism. There is an increase in breakdown of fat, then carbohydrate and finally protein, to produce water of metabolism. The increased endogenous metabolism under relatively anaerobic conditions results in the formation of acid metabolites and the development of metabolic acidosis. Urine formation decreases because of the restriction of renal blood flow and this, together with the increased endogenous metabolism, causes a moderate increase in blood levels of nonprotein nitrogen.<sup>4</sup> The body temperature may increase slightly initially – dehydration hyperthermia – because of insufficient fluid to maintain the loss of heat by evaporation. The onset of sweating in steers after exposure to high environmental temperatures has been shown to be delayed by dehydration.

Dehydration may cause death, especially in acute intestinal obstruction, vomiting and diarrhea, but it is chiefly a contributory cause of death when combined with other systemic states, such as acidosis, electrolyte imbalances, toxemia and septicemia.

### CLINICAL FINDINGS

The first and most important clinical finding in dehydration is **dryness and wrinkling of the skin**, giving the body and face a shrunken appearance. The eyes recede into the sockets and the skin subsides slowly after being picked up into a fold. The dehydration is usually much more marked if water and electrolyte losses have been occurring over a period of several days. Peracute and acute losses may not be obvious clinically because major loss will have occurred from the intravascular compartment and only minor shifts have occurred from the interstitial spaces. Sunken eyes and inelastic skin are not remarkable clinical findings of dehydration in the horse.

The best indicator of hydration status in calves has been demonstrated to be the **degree of recession of the eye into the orbit**. Hydration status is assessed by gently rolling the lower eyelid out to its normal position and estimating the

distance of eye recession in millimeters. This distance is multiplied by 1.7 to provide an estimate of the degree of dehydration as a percentage of euhydrated body weight.<sup>5</sup> The second best indicator of hydration status in calves is the elasticity of the skin of the neck and lateral thorax, which are assessed by pinching the skin between the fingers, rotating the skin fold 90° and noting the time required after release of the skin fold for the skin fold to disappear (normally < 2 s). The elasticity of the skin fold on the upper or lower eyelid is a poor indicator of hydration status in calves and is not recommended. The best methods for assessing hydration status in adult cattle and other large animals has not been determined but it is likely that eye recession and skin tent duration in the neck region provide the most accurate and sensitive methods for estimating hydration status.

In diarrheic calves, the severity of dehydration, hypothermia and metabolic acidosis are associated with the degree of mental depression.<sup>6</sup> The combined effects of acidemia and dehydration also contribute to hypothermia.

Loss of body weight occurs rapidly in dehydration and muscular weakness and inappetence or anorexia are common. In horses deprived of water for 72 hours there is a mean body weight loss of about 15%, and 95% of the animals have a urine specific gravity of 1.042, a urine osmolality of 1310 mosmol/kg and a urine osmolality/serum osmolality ratio of 4:14. Prerenal azotemia also develops.

The degree of thirst present will depend on the presence or absence of other diseases causing an inflammatory response or endotoxemia. In primary water deprivation, dehydrated animals are very thirsty when offered water. In dehydration secondary to enteritis associated with severe inflammation, acidemia and electrolyte imbalance, there may be no desire to drink. Horses that become dehydrated in endurance rides may refuse to drink and the administration of water by oral intubation and enemas may be necessary. In cattle on pasture and deprived of water for up to 9 days and then given access to water, there will be staggering, falling, convulsions and some death – signs similar to salt poisoning in pigs. Experimental restriction of the water intake in lactating dairy cattle for up to 4 days may reduce milk yield by 75% and decrease body weight by 14%. A 10% reduction in water intake causes a drop in milk production that may be difficult to detect. Behavioral changes are obvious: cows spend considerable time licking the water bowls. In cold climates, cattle are often forced to eat snow as a source of

water. The snow must be soft enough so that it can be scooped up by the cattle and 3–5 days are necessary for the animals to adjust to the absence of water and become dependent on snow. During this time there is some loss of body weight. Lactating ewes relying on snow as a source of free water reduce their total water turnover by approximately 35%.

### CLINICAL PATHOLOGY

Dehydration is characterized by an increase in the packed cell volume and total serum protein concentration, although the latter response may be modified by the presence of severe enteritis, peritonitis, or proteinuria.

### REFERENCES

1. Jarvis AM et al. *Appl Anim Behav Sci* 1996; 50:83.
2. Tremblay RRM, Butler DG. *Can Vet J* 1991; 32,308.
3. Lorenz I. *Vet J* 2004; 168:323.
4. Groutides CP, Michell AR. *Br Vet J* 1990; 146:205.
5. Constable PD et al. *J Am Vet Med Assoc* 1998; 212:991.
6. Naylor JM. *Can Vet J* 1989; 30:577.

## ACUTE OVERHYDRATION (WATER INTOXICATION)

### Synopsis

**Etiology** Rapid ingestion of large quantities of water

**Epidemiology** Access to water by thirsty calves, or calves that have been marginally deprived of water for some time

**Clinical findings** Dark red urine, weakness and depression

**Clinical pathology** Hemoglobinuria, hemoglobinemia, hypo-osmolality, hyponatremia, hypochloremia

**Necropsy findings** Hemoglobinuria and renal cortical necrosis

### Diagnostic confirmation

Epidemiologic, presence of hyponatremia and hypochloremia; rule out other causes of intravascular hemolysis

**Treatment** Time, possibly intravenous hypertonic saline but usually too late to be effective

The rapid ingestion of large amounts of water by young calves with normal serum sodium concentrations may result in intravascular hemolysis, hemoglobinemia and hemoglobinuria. In contrast, water ingestion in hypernatremic animals may result in cerebral edema but does not produce hemoglobinuria. The cerebral edema syndrome is described in sodium chloride poisoning. Water intoxication (acute overhydration) is described here.

### ETIOLOGY

The ingestion of excessive quantities of water when animals are very thirsty may result in overhydration, which is also called water intoxication. The primary cause of acute overhydration is a rapid

decrease in the osmolality of the small intestinal contents, which are normally isotonic to plasma. Such a rapid decrease in luminal osmolality occurs within 5 minutes of water ingestion<sup>2</sup> because thirsty calves close their esophageal groove when drinking. This results in a large volume of water in the abomasum, which is subsequently emptied into the duodenum. Free water rapidly moves from the small intestinal lumen into the intravascular compartment because of the large surface area for absorption in the small intestine and development of an osmotic gradient between the small intestinal lumen and intestinal capillary bed. The end result is a rapid decrease in plasma osmolality and expansion and rupture of erythrocytes, leading to intravascular hemolysis, hemoglobinemia, hemoglobinuria, hyponatremia, hypochloremia and a decrease in plasma protein concentration from preingestion values.

### EPIDEMIOLOGY

The syndrome has been reported from several countries but is uncommon. Calves 2–4 months of age are most commonly affected but the disease is also recorded in adult cattle,<sup>1</sup> sheep<sup>3</sup> and pygmy goats.<sup>4</sup> Water intoxication occurs in calves in normal husbandry systems when animals that have had limited access to water are suddenly given free access. Commonly water intoxication occurs when calves previously fed a milk replacer diet but no other fluid, or weaned calves that have been on a starter diet but limited water, are turned out to pasture or to yards where water is freely available. Calves that are not fed supplementary salt or that have lost salt as a result of severe exercise or high environmental temperatures may be at higher risk<sup>5</sup> but the syndrome also occurs where salt has not been restricted. The majority of calves show clinical signs within minutes to hours of access to water.

The condition has been reproduced in calves by gavage with water at 12% of body weight.<sup>6</sup>

### CLINICAL FINDINGS

Hemoglobinuria as a result of intravascular hemolysis is prominent and there may be a moderate to severe hemolytic anemia. Dark red urine is passed shortly following access to water. Additional signs include tachycardia and hypothermia if the temperature of the water ingested is below body temperature. Affected animals are usually depressed and weak.

### CLINICAL PATHOLOGY

Hemoglobinuria and hemoglobinemia are evident and there is hypo-osmolality, hyponatremia and hypochloremia.<sup>5</sup> Serum

total protein and albumin concentration may be decreased but are usually within the normal range because animals are usually mildly dehydrated and thirsty before ingesting large volumes of water.

### Postmortem findings

There is marked pallor of the carcass and renal cortical necrosis due to hemoglobinemic nephrosis may be evident histologically.<sup>7</sup>

### DIFFERENTIAL DIAGNOSIS

Other causes of intravascular hemolysis and hemoglobinuria.

### TREATMENT

Treatment of affected animals is usually not attempted as the hypo-osmotic lysis has already occurred when clinical signs are manifest and serum osmolality is usually gradually increasing as the distal convoluted tubules eliminate excessive free water. Hypertonic saline (7.2% NaCl, 5 mL/kg BW over 5 min intravenously) is usually administered to correct the hyponatremia and hypochloremia but treatment is not necessary in mild cases. Case fatality is low and hemoglobinuria persists for only a few hours.

### CONTROL

Water intoxication does not occur commonly and can be avoided by preventing thirsty animals from having unlimited access to water. Calves should have free access to water by the end of the first week of life.

### REVIEW LITERATURE

Angelos SM, van Metre DC. Treatment of sodium balance disorders: water intoxication and salt toxicity. *Vet Clin North Am Food Anim Pract* 1999; 15:609–618.

### REFERENCES

1. Bianca W. *Br Vet J* 1970; 126:121.
2. Shimizu Y et al. *Jpn J Vet Sci* 1979; 41:583.
3. Abdelrakim AI et al. *Rev d'Elevage Med Vet Pay Trop* 1985; 38:180.
4. Middleton JR et al. *J Vet Intern Med* 1997; 11:382.
5. Gilchrist F. *Can Vet J* 1996; 37:490.
6. Slalina L et al. *Vet Med Prague* 1993; 38:459.
7. Njoroge EM et al. *Onderstepoort J Vet Res* 1997; 64:111.

## ELECTROLYTE IMBALANCES

Most electrolyte imbalances are due to a net loss of electrolytes associated with diseases of the alimentary tract. Sweating, exudation from burns, excessive salivation and vomiting also result in electrolyte losses, but are of minor importance in farm animals, with the exception of sweating in the horse and dysphagia in ruminants. The electrolytes of major concern are sodium, chloride, potassium,

calcium and phosphorus. Losses of bicarbonate are presented under acid–base imbalance.

### HYPONATREMIA

Sodium is the most abundant ion in the extracellular fluid and is chiefly responsible for the maintenance of osmotic pressure of the extracellular fluid. The most common cause of hyponatremia is increased loss of sodium through the intestinal tract in enteropathies (Fig. 2.2). This is particularly marked in the horse with acute diarrhea and to a moderate extent in calves with acute diarrhea. The sodium is lost at the expense of the extracellular fluid. In calves with acute diarrhea due to enterotoxigenic *E. coli* the sodium concentration of the intestinal fluid secreted in response to the enterotoxin is similar to that of plasma, and hyponatremia usually occurs (**hypotonic dehydration**). Animals affected with diarrhea of several days' duration continue to lose large quantities of sodium and the hyponatremia may become severe. Hyponatremia can become severe when sodium-free water or 5% dextrose are used as the only fluid therapy in animals already hyponatremic. Hyponatremia can also occur in animals with proximal tubular dysfunction.

Hyponatremia causes an increase in the renal excretion of water in an attempt to maintain normal osmotic pressure, which results in a decrease in the extra-

cellular fluid space, leading to a decreased circulating blood volume, hypotension, peripheral circulatory failure and ultimately renal failure. Muscular weakness, hypothermia and marked dehydration are common findings.

**Isotonic dehydration** occurs when there is a parallel loss of sodium and water. **Hypertonic dehydration**, which is uncommon, occurs when there is a loss or deprivation of water with minor losses or deprivation of sodium. Hypertonic dehydration can occur in animals that are unable to consume water because of an esophageal obstruction. The dehydration in isotonic and hypertonic dehydration is mild compared to the marked clinical dehydration that can occur in hypotonic dehydration accompanied by marked loss of water and concentration of the extracellular space (Fig. 2.3).

There are no clinical signs that are characteristic of hyponatremia. There is usually dehydration, muscular weakness and mental depression, which occur with other disturbances of both water and electrolytes and with acid–base imbalance. Similarly, there are no clinical signs characteristic of hypochloremia. However, hyponatremia affects the osmotic pressure of the extracellular fluid, and hypochloremia promotes the reabsorption of bicarbonate and further development of alkalosis. Polyuria and polydipsia occur in cattle with dietary sodium chloride deficiency.

### HYPOCHLOREMIA

Hypochloremia occurs as a result of an increase in the net loss of the electrolyte in the intestinal tract in acute intestinal obstruction, dilatation and impaction and volvulus of the abomasum and in enteritis (Fig. 2.4). Normally a large amount of chloride is secreted in the abomasum by the mucosal cells in exchange for bicarbonate, which moves into the plasma. The hydrogen, chloride and potassium ions secreted in gastric juice are normally absorbed by the small intestine. Failure of abomasal emptying and obstruction of the proximal part of the small intestine will result in the sequestration of large quantities of chloride, hydrogen and potassium ions which leads to a **hypochloremic, hypokalemic metabolic alkalosis**. A severe hypochloremia can be experimentally produced in calves by feeding them a low chloride diet and daily removal of abomasal contents. Clinical findings include anorexia, weight loss, lethargy, mild polydipsia and polyuria. A marked metabolic alkalosis occurs, with hypokalemia, hyponatremia, azotemia and death.

### HYPOKALEMIA

Hypokalemia may occur as a result of decreased dietary intake, increased renal excretion, abomasal stasis, intestinal obstruction and enteritis, and repeated administration of corticosteroids with

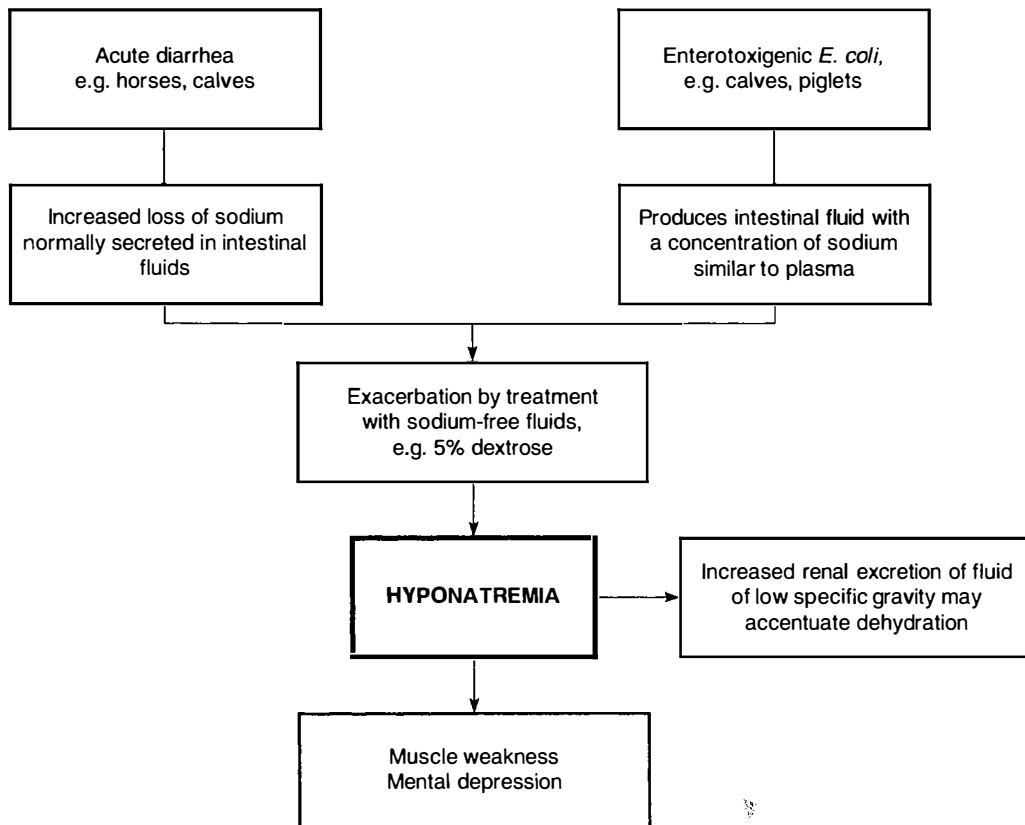

Fig. 2.2 Etiology and pathogenesis of hyponatremia.



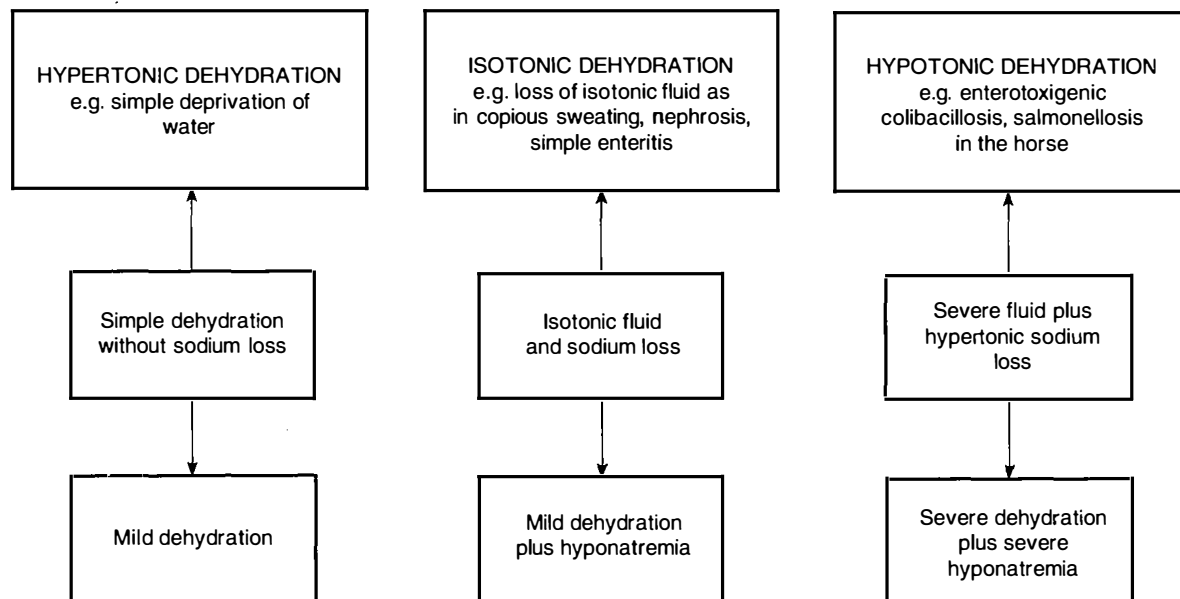

Fig. 2.3 Types of dehydration.

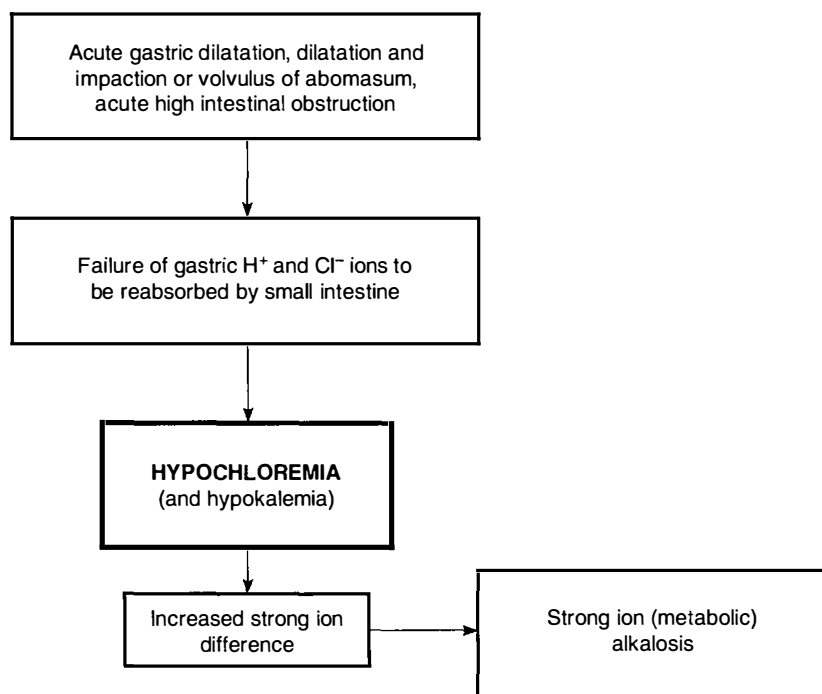

Fig. 2.4 Etiology and pathogenesis of hypochloremia.

mineralocorticoid activity (Fig. 2.5). The prolonged use of potassium-free solutions in fluid therapy for diarrheic animals may result in excessive renal excretion of potassium and hypokalemia. Alkalosis may result in an exchange of potassium ions for hydrogen ions in the renal tubular fluid, resulting in hypokalemia. Hypokalemia can cause muscle weakness, prolonged unexplained recumbency, inability to hold up the head, anorexia, muscular tremors and, if severe enough, coma. The treatment of ketosis in lactating dairy cows with multiple dosages of isoflupredone, a glucocorticoid with some mineralocorticoid activity, can

cause hypokalemia and recumbency, with a high case fatality rate.<sup>1</sup>

The most common occurrence of hypokalemia in ruminants is in diseases of the abomasum that cause stasis and the accumulation of fluid in the abomasum. Potassium becomes sequestered in the abomasum along with hydrogen and chloride, resulting in **hypokalemia, hypochloremia** and **metabolic alkalosis**.

Metabolic alkalosis and hypokalemia in cattle are often accompanied by muscular weakness and paradoxical aciduria. Hypokalemia causes muscle weakness by lowering the resting potential of mem-

branes, resulting in decreased excitability of neuromuscular tissue. Thus, the differential diagnosis of the animal with muscle weakness should always include hypokalemia.

Hypokalemia and alkalosis also are often directly related because of the renal response to either. Hypokalemia from true body deficits of potassium will cause decreased intracellular concentration of this ion. The intracellular deficit of potassium and excess of hydrogen will cause hydrogen secretion into the urine when distal sodium reabsorption is required. This situation exists in metabolic alkalosis, where sodium bicarbonate

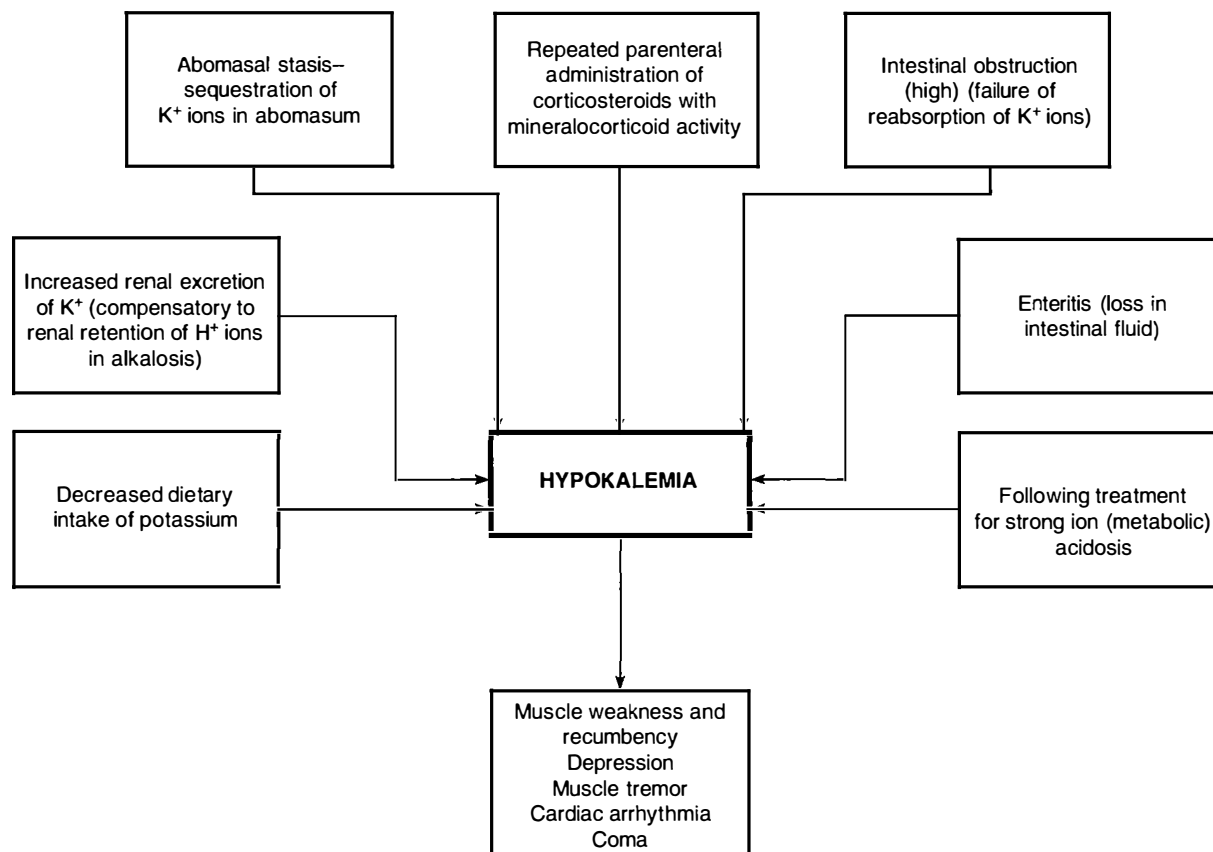

Fig. 2.5 Etiology and pathogenesis of hypokalemia.

reabsorption in the proximal nephron is decreased because of the excess of plasma bicarbonate. Distal nephron avidity for sodium is increased to protect extracellular fluid volume, and the increased distal sodium reabsorption is at the expense of hydrogen secretion, although it is contrary to the need of acid retention in the presence of alkalosis. In other words, the kidney prioritizes maintenance of plasma volume above that of acid-base balance, presumably because respiratory compensation can usually keep blood pH within the normal physiological range. Because electroneutrality of extracellular fluid must be maintained by reabsorbing an equivalent charge of cations and anions, the reabsorption of chloride and of bicarbonate in the kidneys are inversely proportional to each other. Thus, with excess trapping of chloride in the abomasum, the kidneys will compensate for the resulting hypochloremia by increasing bicarbonate reabsorption, which may proceed until metabolic alkalosis develops.

The **treatment of hypochloremic, hypokalemic alkalosis** requires correction of extracellular fluid volume and sodium and chloride deficits with 0.9% NaCl infusions and oral KCl. Providing adequate chloride ion allows sodium to be reabsorbed without bicarbonate. Increased proximal reabsorption of sodium will decrease distal acid secretion because less

sodium is presented to the distal nephron. As less bicarbonate is reabsorbed and less acid secreted, the metabolic alkalosis is resolved. Specially formulated solutions containing potassium are necessary in cases of severe hypokalemia and small-intestinal obstruction.

Hypokalemia also occurs following treatment of the horse affected with metabolic acidosis and hyponatremia, and probably reflects whole-body potassium depletion. Horses used for endurance rides may be affected by hypokalemia, hypocalcemia and alkalosis due to loss of electrolytes during the competition. Synchronous diaphragmatic flutter also occurs, which may be the result of the electrolyte imbalance (particularly hypocalcemia) causing hyperirritability of the phrenic nerve.

Since potassium is the major intracellular cation, the measurement of plasma or serum potassium is not a reliable indication of whole-body potassium status. Extremely low levels or high levels are usually indicative of a potassium imbalance, often associated with other electrolyte and acid-base imbalances. In severe alkalosis, for example, potassium leaves the extracellular space and becomes concentrated in the cells. This may result in low serum potassium levels when, in fact, there might not be potassium depletion of the body. Conversely, in severe metabolic

acidosis of calves with acute diarrhea, the potassium leaves the cells and moves into the extracellular fluid. This results in hyperkalemia in some cases where the body potassium is normal or even decreased. When changes occur in the concentration of intracellular and extracellular potassium, the ratio of intracellular to extracellular potassium may decrease by as much as 30–50%, which results in a decrease in the resting membrane potential. This is thought to be the explanation for the effects of hypokalemia and hyperkalemia on muscle function.

The potassium concentration of red blood cells may be a more accurate indicator of whole-body potassium deficit in diarrheic horses and provides a basis for a calculated oral dose of potassium chloride in horses with diarrhea, which is a safe therapeutic procedure.

Potassium should be administered intravenously or orally. The intravenous route is used only for the initial treatment of recumbent ruminants with severe hypokalemia and rumen atony, as it is much more dangerous and expensive than oral treatment. The most aggressive **intravenous treatment** protocol is an isotonic solution of KCl (1.15% KCl), which should be administered at less than 3.2 mL/kg per hour, equivalent to a maximal delivery rate of 0.5 mEq of K<sup>+</sup>/kg BW per hour. Higher rates of potassium

administration run the risk of inducing hemodynamically important arrhythmias, including ventricular premature complexes that can lead to ventricular fibrillation and death. A less aggressive intravenous treatment is an isotonic equimolar mixture of NaCl (0.45% NaCl) and KCl (0.58% KCl), and the least aggressive intravenous treatment is the addition of 10 mmol of KCl/L of Ringer's solution, which will increase the solution osmolarity to 329 mosmol/L. Clinical experience with oral administration of KCl has markedly decreased the number of adult ruminants treated with intravenous KCl.

**Oral administration of potassium** is the method of choice for treating hypokalemia. Inappetent adult cattle should be treated with 30–60 g of feed grade KCl twice with a 12-hour interval, with the KCl placed in gelatin boluses. Adult cattle with severe hypokalemia (< 2.5 mEq/L) should initially be treated with 120 g of KCl, followed by two 60 g KCl treatment at 8-hour intervals, for a total 24-hour treatment of 240 g KCl. Higher doses have been administered to dairy cows but these are accompanied by diarrhea, and oral administration of 0.58 g KCl/kg BW was toxic in 6-month-old Holstein calves, manifest by excessive salivation, muscular tremors of the legs and excitability, and a peak plasma  $[K^+]$  of 9.0 mEq/L. Extrapolating this toxic dose in normokalemic calves to hypokalemic 600 kg cows suggests that a daily dose of 240 g KCl approaches the upper limit of safety. The recommended doses are empirical but are effective in rapidly increasing serum  $[K^+]$  and  $[Cl^-]$ . Inappetent horses often have whole-body potassium depletion and would benefit from supplementary dietary potassium (25–50 g/d KCl).

### HYPERKALEMIA

Hyperkalemia is not as common in farm animals as hypokalemia, occurring most commonly in severe metabolic acidosis. The classic description for the development of hyperkalemia in metabolic acidosis involves a purported redistribution of potassium from the intracellular space to the extracellular space because a large proportion of the excess hydrogen ions are buffered intracellularly. Thus potassium is supposedly exchanged with hydrogen ions across the cell membrane in order to maintain electroneutrality. A more likely mechanism is that metabolic acidosis is accompanied by acidemia and a decreased intracellular pH; during intracellular acidosis the function of all enzyme systems is decreased. As a direct result of the intracellular acidosis, the Na-K-ATPase activity is decreased, with potassium leaving the cell down its concentration gradient.

Hyperkalemia is potentially more life-threatening than hypokalemia. Hyperkalemia (when over 7–8 mmol/L) has a profound effect on cardiac function. There is usually marked bradycardia and arrhythmia and sudden cardiac arrest may occur. The electrocardiogram (ECG) changes in experimentally induced hyperkalemia in the horse have been described. The changes include four successive stages as hyperkalemia increased. There was a widening and lowering of amplitude followed by inversion and disappearance of the P wave, an increase in the amplitude of the T wave, an increase in the QRS interval, with some irregularity in the ventricular rate, and periods of cardiac arrest that became terminal or were followed by ventricular fibrillation. The minimum plasma potassium concentration required to induce ECG changes was 6–7 mmol/L and severe cardiotoxic effects occurred at levels between 8–11 mmol/L. The effects of hyperkalemia on the ECG are exacerbated by the presence of hyponatremia.

Hyperkalemia has traditionally been treated by intravenous administration of sodium bicarbonate, glucose, insulin and sometimes calcium. Hypertonic saline is just as effective as is hypertonic sodium bicarbonate in decreasing hyperkalemia and hyperkalemia-associated bradyarrhythmias, as a result of sodium-induced intracellular movement of potassium, extracellular volume expansion and the strong ion effect of increasing the serum concentration of a strong cation. The long-held myth regarding the need to administer glucose and insulin to 'drive' potassium into the cells during hyperkalemia needs to be re-evaluated. Calcium counteracts the effect of hyperkalemia on the resting membrane potential by increasing the threshold potential to a higher value, thereby returning an appropriate difference between resting and threshold potentials. Calcium can be administered intravenously at 0.2–0.4 mL of a 23% calcium gluconate solution/kg BW. The focus of treatment in hyperkalemia should be correction of acidemia, plasma volume expansion and increasing the serum sodium concentration. Glucose and insulin are not routinely needed to correct hyperkalemia.

**Hyperkalemic periodic paralysis** occurs in heavily muscled Quarterhorse. Affected horses become weak, may stand base-wide and are reluctant to move. Sweating commonly occurs and generalized muscle fasciculations are apparent. Affected horses remain bright and alert but may yawn and do not eat or drink. Some horses become recumbent and may appear to be in a state of flaccidity. Attacks may occur in a rest

period following exercise or at random. During the episode the serum potassium concentration is elevated by up to twofold and returns to normal values when the animal recovers. Treatment consists of sodium bicarbonate, hypertonic saline or 5% dextrose given intravenously, possibly with insulin.

### HYPOCALCEMIA

Hypocalcemia or milk fever may occur in recently calved mature dairy cows that have been inappetent or anorexic for a few days. Hypocalcemia can be due to a reduction in dry matter intake because of illness or it may be the earliest stages of hypocalcemic parturient paresis. The clinical findings include anorexia, mild tachycardia with a reduction in the intensity of the heart sounds and occasionally an arrhythmia, a decrease in the frequency and amplitude of rumen contractions or complete ruminal stasis, and a decrease or complete absence of feces, which may last from 6–36 hours if untreated.

Hypocalcemia cases often mimic intestinal obstruction and create problems in the differential diagnosis. Affected cattle may not exhibit any evidence of muscular weakness and the detection of the hypocalcemic state can be elusive. The total serum calcium concentrations range from 1.5–2.0 mmol/L and the response to intravenous therapy is usually good, although recovery may require several hours before the appetite returns to normal and feces are passed.

Calcium should be administered by the intravenous, subcutaneous, or oral route. **Calcium gluconate** and **calcium borogluconate** are the preferred forms for intravenous and subcutaneous administration because  $CaCl_2$  causes extensive necrosis and sloughs of tissue when administered perivascularly. Compared to calcium gluconate, calcium borogluconate has improved solubility and shelf life. Plasma ionized calcium concentrations are increased to a greater extent following  $CaCl_2$  treatment when high equimolar solutions of  $CaCl_2$  and calcium gluconate are administered, leading to more cardiac arrhythmias during  $CaCl_2$  administration. A typical treatment to an adult lactating dairy cow with periparturient hypocalcemia is 500 mL of 23% calcium borogluconate by slow intravenous injection with cardiac auscultation, this provides 10.7 g of calcium. Although the calculated calcium deficit in a recumbent periparturient dairy cow is 4 g calcium, additional calcium should be provided to overcome the continued loss of calcium in milk. A field study comparing the effectiveness of different doses of calcium for treating periparturient milk fever determined that

9 g of calcium was superior to 6 g. A good rule of thumb for administering 23% calcium borogluconate solutions (2.14 g calcium/100 mL) to cows with periparturient hypocalcemia is therefore to administer 1 mL/kg BW. There do not appear to be any clinically important advantages to slow administration of the solution over 6 h, when compared to 15 min.<sup>2</sup>

The normal cardiac response to **intravenous calcium administration** is an increase in the strength of cardiac contraction and a slowing of the heart rate. Intravenous administration is continued until the first arrhythmia is detected (a bradyarrhythmia such as a prolonged pause); the rate of intravenous administration is then slowed until a second arrhythmia is detected, at which time intravenous administration is discontinued and the remainder of the solution is placed subcutaneously over the lateral thorax. This treatment method titrates the calcium dose required for each animal. Auscultation of the heart is an absolute requirement during treatment: visual monitoring of the jugular pulse at the base of the neck does not allow the early detection of bradyarrhythmias, making it more likely that the cow will receive a toxic and possibly lethal dose of calcium. The maximum safe rate of calcium administration in cattle is 0.07 mEq of  $\text{Ca}^{2+}$ /kg BW/min, which is equivalent to 0.065 mL 23% calcium borogluconate/kg BW/min. For a 500 kg normocalcemic dairy cow, this corresponds to a maximum safe rate of administration of 33 mL/min. Typical rates of administration through a 14-gauge needle are 50 mL/min; this rate of administration is safe for cows with hypocalcemia, provided that cardiac auscultation is performed during administration.

**Subcutaneous administration** of calcium solutions has been practiced for many years. To facilitate absorption, it is preferable to administer no more than 125 mL at a site. A 14-gauge needle is placed subcutaneously over the lateral thorax, 125 mL is administered, the needle is redirected and another 125 mL is administered. The process is then repeated on the other side of the cow. Although the effectiveness of subcutaneous administration of calcium has been documented in healthy normal cows, there do not appear to be any reports documenting the rapidity by which subcutaneous calcium is absorbed by cows with periparturient hypocalcemia. Subcutaneous administration of calcium gluconate is not recommended in recumbent cows because poor peripheral blood flow is suspected to lead to slow absorption from the subcutaneous site. Calcium chloride is not recommended for

subcutaneous administration because of extensive tissue damage; the addition of dextrose to the administered calcium is also not recommended because it increases the tonicity of the solution and propensity for bacterial infection and abscessation. Rectal calcium administration is not recommended because it causes severe mucosal injury and tenesmus but does not increase plasma concentrations of calcium.

**Oral administration** of calcium has also been practiced for many years, usually by ororuminal intubation of calcium borogluconate solutions designed for parenteral administration. Over the past decade there has been increased interest in improving the efficacy of oral calcium formulations. The results of a number of studies indicate that oral calcium salts are effective at increasing plasma calcium concentration; orally administered calcium is absorbed by a dose-dependent passive diffusion process across ruminal epithelium and a dose-independent calcium-binding protein mechanism in the small intestine that is modulated by vitamin D. Rapid correction of hypocalcemia by oral calcium administration is predominantly by passive ruminal diffusion, as small intestinal absorption is too slow to be of clinical value.

Two calcium formulations are currently recommended for oral administration to ruminants;  $\text{CaCl}_2$  and calcium propionate, but most commercially available products contain 50 g of  $\text{CaCl}_2$ . Calcium chloride has the advantage of low cost and low volume (because of its high solubility), but  $\text{CaCl}_2$  can severely damage the pharynx and esophagus in ruminants with reduced swallowing ability, can lead to necrosis of the forestomach and abomasum when administered in high doses, and can lead to aspiration pneumonia when administered as a drench. Calcium propionate has the advantage that it is less irritating while providing a gluconeogenic substrate (propionate), but the disadvantages of higher volumes and cost. Oral calcium solutions should only be administered to cattle that have normal swallowing ability, precluding their administration to animals with advanced clinical signs of hypocalcemia. Higher plasma calcium concentrations are obtained more quickly when calcium solutions are drenched after administration of vasopressin to induce esophageal groove closure, or when the calcium solution is administered as a drench instead of ororuminal intubation. Calcium solutions are suspected to have a higher likelihood of aspiration pneumonia than calcium gels (with a consistency similar to toothpaste), although this supposition does not appear

to have been verified. Commercially available formulations of calcium gels contain 50 g of  $\text{CaCl}_2$  and increase plasma calcium concentrations within 30–60 minutes and for at least 6 hours. Retreatment at 12-hour intervals (if needed) therefore appears indicated and provide 100 g of  $\text{CaCl}_2$  and 37 g of calcium over 24 hours, but more aggressive treatment protocols are not recommended.

## **HYPOPHOSPHATEMIA**

Hypophosphatemia also occurs in cattle under conditions similar to those of hypocalcemia. A decrease in feed intake or alimentary tract stasis will result in a decrease in serum inorganic phosphate. Acute recumbency in lactating dairy cattle may be associated with marginal phosphorus deficiency,<sup>3</sup> although a cause and effect relationship between hypophosphatemia and recumbency has not been established.<sup>4</sup> However, many inappetent and weak cows have marginal hypophosphatemia and clinically appear to benefit from normalization of their plasma concentration of phosphate. As such, it is currently recommended that ruminants with marked hypophosphatemia and signs of illness should be treated with phosphorus-containing solutions.

Almost all commercially available intravenous solutions for treating hypophosphatemia use **phosphite** ( $\text{PO}_2^{2-}$ ) or **hypophosphite** ( $\text{PO}_3^{3-}$ ) salts as the source of phosphorus because these salts are very soluble, even in the presence of calcium and magnesium. However, the phosphorus in phosphite and hypophosphite is unavailable to mammals, meaning that the vast majority of 'phosphate'-containing solutions have no efficacy in treating hypophosphatemia. Instead, the **monobasic monophosphate form of sodium phosphate** ( $\text{NaH}_2\text{PO}_4$ ) should be administered. The pH of the solution should be mildly acidic (pH 5.8) to maintain phosphate solubility in cold weather but is not needed in warm ambient temperatures. A recommended treatment to an adult lactating dairy cow with severe hypophosphatemia is 300 mL of 10%  $\text{NaH}_2\text{PO}_4$  (monohydrate) solution by slow intravenous injection; this provides 7 g of phosphate and increases plasma phosphate concentrations for at least 6 hours. Human enema formulations that contain a mixture of monobasic sodium phosphate monohydrate and dibasic sodium phosphate heptahydrate in a buffered solution have also been administered to cattle with hypophosphatemia but are not recommended. This human enema solution is extremely hypertonic and must therefore be diluted before administration. A major drawback with intravenous administration of

phosphate solutions is that they should not be administered within 2 hours of intravenous calcium administration, because of concerns that calcium-phosphate precipitates may be formed in the plasma of cattle with treatment-induced hypercalcemia and hyperphosphatemia. This has traditionally been evaluated by calculating the calcium-phosphorus product, whereby metastatic calcification may occur if the product of serum calcium concentration and serum phosphate concentration (both in mg/dL) exceeds 70.

Hypophosphatemia is more safely treated by administration of **oral monosodium phosphate**, and this is the preferred method of administration in ruminants with rumen motility. Oral administration also results in a more prolonged increase in plasma phosphorus concentration. Recommended dose is 200 g of feed grade monosodium phosphate (contains 50 g of phosphate) administered in gelatin boluses, drench, or by ororumenal intubation. Phosphorus in other feed grade minerals (such as bone meal or dicalcium phosphate) is poorly available and is not recommended for the treatment of hypophosphatemia.

#### HYPOMAGNESEMIA

Magnesium is usually administered parenterally only when a ruminant exhibits clinical signs of hypomagnesemia. Treatment of hypomagnesemia is more dangerous (to the animal and clinician) and less satisfying than treatment of periparturient hypocalcemia; the response to treatment is much slower in hypomagnesemia presumably because magnesium concentrations must be normalized in cerebrospinal fluid, which turns over at approximately 1% per minute.

Treatment of hypomagnesemia has historically used 25% Epsom salts solution (magnesium sulfate heptahydrate;  $\text{MgSO}_4 \cdot 6\text{H}_2\text{O}$ ); this solution concentration was selected because it provided approximately 1 mmol of magnesium per liter. It should be noted that 25% Epsom salts solution is markedly hypertonic (2028 mosmol/L). A typical treatment for an adult cow has been slow intravenous administration (over at least 5 min) of 100 mL of the 25% Epsom salts solution, this provides 2.5 g of magnesium (25 mg of magnesium/mL of solution). More recently, hypomagnesemia has been treated using commercially available combined calcium and magnesium solutions; 500 mL of these solutions typically contain 1.6–2.7 g of magnesium in the form of a borogluconate, chloride or hypophosphite salt. Although the calculated extracellular deficit in a cow with hypomagnesemia is 2 g of magnesium,

we should provide additional magnesium to correct presumed intracellular deficiencies and to overcome the anticipated urinary loss of magnesium. Combined calcium and magnesium solutions are preferred for intravenous administration to 25% Epsom salts solution because ruminants with hypomagnesemia frequently have hypocalcemia, and hypercalcemia provides some protection against the toxic effects of hypermagnesemia. Moreover, administration of solutions containing magnesium as the only cation increases the risk of developing cardiac and respiratory failure during treatment. The maximum safe rate of administration of magnesium in cattle is 0.08 mEq  $\text{Mg}^{2+}$ /kg BW per minute, which is equivalent to 0.04 mL 25% Epsom salts/kg BW per minute. For a 500 kg beef cow with hypomagnesemia, this corresponds to a maximum safe rate of administration of 20 mL/min.

Magnesium-containing solutions (such as 25% Epsom salts solution) can also be administered subcutaneously, although this frequently leads to necrosis of the skin, particularly when 50% Epsom salts solution is administered. Only combined calcium and magnesium solutions should therefore be administered subcutaneously.

The oral bioavailability of magnesium is low and much lower than that of calcium. Accordingly, oral administration of magnesium is not recommended for the treatment of hypomagnesemia, but is essential for the prevention of hypomagnesemia. Magnesium absorption from the rumen is facilitated by volatile fatty acids but decreased by potassium and the ammonium ion.

Rectal administration may be the only practical and safe method for treating a convulsing hypomagnesemic beef cow. After evacuating the rectal contents, an enema containing 60 g of Epsom salts (magnesium sulfate heptahydrate) or magnesium chloride in 200 mL of water can be placed in the descending colon (and not the rectum) and the tail held down for 5 minutes; this increases plasma magnesium concentrations within 10 minutes. However, enema solutions can be prematurely evacuated, eliminating the chance for therapeutic success, and some degree of colonic mucosal injury is expected because of the high osmolarity of 30% solutions (approximately 2400 mosmol/L). The safety of this treatment protocol does not appear to have been evaluated, although a 50 mL enema of a 30%  $\text{MgCl}_2 \cdot 6\text{H}_2\text{O}$  solution rapidly and effectively increased serum magnesium concentration in 7–10-week-old calves and relieved clinical signs of hypomagnesemia.

Oral administration of magnesium hydroxide and magnesium oxide excess-

ively alkalinizes the rumen and can create a severe metabolic alkalosis (strong ion alkalosis), as absorption of magnesium leads to hypermagnesemia and increased plasma strong ion difference. Because oral administration of sodium bicarbonate causes expansion of the plasma volume and creates a metabolic alkalosis (strong ion alkalosis) without hypermagnesemia, it is likely that oral sodium bicarbonate is a more effective treatment for grain overload in ruminants.

#### REVIEW LITERATURE

- Angelos SM, van Metre DC. Treatment of sodium balance disorders: water intoxication and salt toxicity. *Vet Clin North Am Food Anim Pract* 1999; 15:609–618.
- Goff JP. Treatment of calcium, phosphorus, and magnesium balance disorders. *Vet Clin North Am Food Anim Pract* 1999; 15:619–640.
- Sweeney RW. Treatment of potassium balance disorders. *Vet Clin North Am Food Anim Pract* 1999; 15:609–618.
- Constable PD. Fluids and electrolytes. *Vet Clin North Am Food Anim Pract* 2003; 19:1–40.

#### REFERENCES

- Seilman ES et al. *J Am Vet Med Assoc* 1997; 210:240.
- Braun U et al. *Vet Rec* 2004; 154:336.
- Gerloff BJ, Swenson EP. *J Am Vet Med Assoc* 1996; 208:716.
- Metzner M, Klee W. *Tier Umschau* 2005; 60:13.

#### ACID-BASE IMBALANCE

The pH of mammalian blood is maintained within the normal range of 7.35–7.45 by its buffer systems, of which hemoglobin is the most important, because it has the greatest buffering capacity. However, because the blood hemoglobin concentration is regulated on the basis of oxygen delivery instead of acid–base balance, and because rapid changes in hemoglobin concentration occur only with marked changes in hydration status or splenic contraction associated with exercise, the **bicarbonate system** has traditionally been considered to be the most important buffer. Other buffers in blood are plasma proteins and phosphate. The addition of relatively large amounts of acid or alkali to the blood is necessary before its buffering capacity is exhausted and its pH changed. Changes from normal acid–base balance towards alkalemia or acidemia occur commonly in sick animals and make a significant contribution to the observed clinical signs.

**The traditional approach for assessing acid–base balance** focuses on how plasma carbon dioxide tension ( $P_{\text{CO}_2}$ ), plasma bicarbonate concentration ( $[\text{HCO}_3^-]$ ), the negative logarithm of the apparent dissociation constant ( $\text{pK}'_1$ ) for plasma carbonic acid ( $\text{H}_2\text{CO}_3$ ), and the plasma solubility of  $\text{CO}_2$  ( $S$ ) interact to determine plasma pH. This relationship is most commonly expressed as the

**Henderson–Hasselbalch equation:**  $\text{pH} = \text{pK}'_1 + \log([\text{HCO}_3^-]/S \times \text{PCO}_2)$ . The evaluation of acid–base balance using the Henderson–Hasselbalch equation has historically used pH as an overall measure of acid–base status,  $\text{PCO}_2$  as an independent measure of the respiratory component of acid–base balance, and extracellular base excess, actual  $\text{HCO}_3^-$  concentration or standard  $\text{HCO}_3^-$  as a measure of the nonrespiratory (also called metabolic) component of acid–base balance.

When using the traditional Henderson–Hasselbalch approach, **four primary acid–base disturbances** can be distinguished: **respiratory acidosis** (increased  $\text{PCO}_2$ ), **respiratory alkalosis** (decreased  $\text{PCO}_2$ ), **metabolic acidosis** (decreased extracellular base excess or actual  $\text{HCO}_3^-$  concentration) and **metabolic alkalosis** (increased extracellular base excess or actual  $\text{HCO}_3^-$  concentration). The anion gap is easily calculated from the results of serum biochemical analysis and is used to determine whether unmeasured anions are present. The Henderson–Hasselbalch equation has a long history of use and remains widely and routinely used in the clinical management of acid–base disorders. These advantages should not be overlooked. The principal disadvantage of the Henderson–Hasselbalch equation is that it is more descriptive than mechanistic, decreasing the value of the approach in explaining the cause of acid–base changes during disease. This is because the Henderson–Hasselbalch equation fails to distinguish between the effects of independent and dependent variables on plasma pH.

**Actual plasma  $\text{HCO}_3^-$  concentration** in units of mmol/L is not measured but calculated using the Henderson–Hasselbalch equation and measured values for pH and  $\text{PCO}_2$ , whereby:

$$[\text{HCO}_3^-] = S \times \text{PCO}_2 \times 10^{(\text{pH} - \text{pK}'_1)}$$

The values for  $\text{pK}'_1$  and  $S$  at 37°C are 6.12 and 0.0307/mmHg respectively for normal mammalian plasma. The equation at 37°C is therefore:

$$[\text{HCO}_3^-] = 0.0307 \times \text{PCO}_2 \times 10^{(\text{pH} - 6.12)}$$

Because actual  $\text{HCO}_3^-$  concentration is calculated from pH and  $\text{PCO}_2$ , it can never provide an independent measure of the nonrespiratory component of an acid–base disturbance. A primary decrease in  $\text{PCO}_2$  (respiratory alkalosis) at normal pH always is accompanied by a decrease in plasma  $\text{HCO}_3^-$  concentration (which would be interpreted as a metabolic acidosis). Likewise, a primary increase in  $\text{PCO}_2$  (respiratory acidosis) at normal pH always produces an increase in plasma  $\text{HCO}_3^-$  concentration (which would be

interpreted as a metabolic alkalosis). In both cases, the actual  $\text{HCO}_3^-$  concentration is dependent upon the pH and  $\text{PCO}_2$ , thereby providing no additional information as to the cause of the acid–base imbalance than that obtained by knowledge of the pH and  $\text{PCO}_2$ . It is therefore illogical to use actual  $\text{HCO}_3^-$  concentration to define the non-respiratory (metabolic) component of an acid–base disturbance.

The current use of actual  $\text{HCO}_3^-$  concentration in the evaluation of acid–base status results from Van Slyke's work in 1924, where pH and total  $\text{CO}_2$  (which is highly correlated with actual  $[\text{HCO}_3^-]$ ) could be measured more accurately than  $\text{PCO}_2$ . This led to the graphical depiction of the curvilinear  $\text{HCO}_3^-$ –pH relationship, the so-called Davenport diagram, to represent acid–base disturbances. With the later development of accurate and practical laboratory methods in the 1950s to measure  $\text{PCO}_2$ , acid–base derangements were graphically depicted as approximately linear  $\log(\text{PCO}_2)$ –pH relationships. This development led directly to the **base excess** concept.

The normal range of plasma bicarbonate in large animals is 24–30 mmol/L (this should be compared to the normal range in humans, which is 22–24 mmol/L). In mild metabolic acidosis the bicarbonate concentration is in the range of 20–24 mmol/L, moderate metabolic acidosis is 14–18 mmol/L, and in severe cases the values are below 10 mmol/L and carry a grave prognosis. The levels of  $\text{PCO}_2$ ,  $\text{PO}_2$ , plasma bicarbonate and blood pH can be used to determine the degree of compensation, if any, which has taken place. In metabolic acidosis there may be a compensatory decrease in  $\text{PCO}_2$  due to hyperventilation; in metabolic alkalosis there may be an increase in  $\text{PCO}_2$  due to hypoventilation. In respiratory acidosis due to severe pneumonia the arterial  $\text{PO}_2$  will be markedly decreased.

The **base excess** value directly expresses the amount (usually expressed in units of mEq/L) of strong base (or acid) added per liter of blood or plasma, when the normal mean base excess value is arbitrarily fixed at zero. As such, the base excess is defined as the amount of strong acid (such as HCl) needed to titrate the pH of 100% oxygenated human blood to 7.40 at 37°C and at a  $\text{PCO}_2$  of 40 mmHg. By definition, the normal base excess value for humans is 0 mEq/L (range is –2 to +2 mEq/L), and a base excess of more than +2 mEq/L indicates metabolic alkalosis, whereas a value of less than –2 mEq/L (negative base excess value or base deficit) reflects metabolic acidosis. The **normal range of base excess** in large animals is 0–6 mmol/L.

Mathematical formulas and nomograms are available to calculate base excess from measured pH,  $\text{PCO}_2$  and blood hemoglobin concentration. Base excess is usually expressed as  $\text{BE}_{\text{ECF}}$  (also called **standard base excess** or **in vivo base excess**). Extracellular base excess is the preferred measurement as this formulation provides the best clinical estimate of the required mmol/L of  $\text{HCO}_3^-$  required to correct metabolic acidosis, as it assumes a fixed hemoglobin concentration of 5 g/dL. Clearly, the  $\text{BE}_{\text{ECF}}$  value will be incorrect when applied to animals with anemia or polycythemia; however, the error introduced by this approximation is small and usually clinically insignificant.

Most blood gas analyzers calculate base excess in units of mEq/L using Siggaard-Andersen's empirical equation derived from his nomogram with hemoglobin concentration [Hb] and actual  $\text{HCO}_3^-$  concentrations in mmol/L:

$$\text{BE}_{\text{blood}} = (1 - 0.023 \times [\text{Hb}]) \times ([\text{HCO}_3^-] - 24.4 + (7.7 + 2.3 \times [\text{Hb}]) \times (\text{pH} - 7.40)),$$

which is equivalent to the following expression when [Hb] = 3.1 mmol/L = 5 g/dL:

$$\text{BE}_{\text{ECF}} = 0.93 \times ([\text{actual HCO}_3^-] - 24.4 + 14.83 \times (\text{pH} - 7.40)).$$

The calculated  $\text{BE}_{\text{ECF}}$  value assumes normal serum protein concentration (7.2 g/dL) and therefore provides an inaccurate estimate of the magnitude of a metabolic acidosis or alkalosis in domestic animals with hypoproteinemia or hyperproteinemia. The ability of **extracellular base excess** ( $\text{BE}_{\text{ECF}}$ ) and actual  $\text{HCO}_3^-$  concentration to accurately characterize the metabolic component of acid–base status has been controversial for many years, although  $\text{BE}_{\text{ECF}}$  has advantages compared to actual  $\text{HCO}_3^-$  concentration. The major advantages of the base excess approach are that  $\text{BE}_{\text{ECF}}$  is theoretically related to strong ion difference and is independent of respiratory activity. On this basis, when using the traditional Henderson–Hasselbalch approach to acid–base balance, the recommended approach is to use pH as an overall index of acid–base status,  $\text{PCO}_2$  as an index of the respiratory component and standard (in vivo) base excess as an index of the nonrespiratory (metabolic) component.

The **strong ion approach** to acid–base balance provides a revolutionary method to assess acid–base balance that is becoming more widely adopted. This strong ion approach differs in three important areas from the traditional bicarbonatecentric application of the Henderson–Hasselbalch equation:

1) acid–base balance is examined using a systems approach; 2) a clear conceptual distinction is made between dependent variables (such as pH and  $[\text{HCO}_3^-]$ ) and the independent variables; and 3) the effects of protein concentration on acid–base balance are considered.

The strong ion approach reduces the chemical reactions in plasma to that of simple ions in solution. This assumption can be made because the quantitatively important plasma cations ( $\text{Na}^+$ ,  $\text{K}^+$ ,  $\text{Ca}^{2+}$ ,  $\text{Mg}^{2+}$ ) and anions ( $\text{Cl}^-$ ,  $\text{HCO}_3^-$ , protein, lactate, sulfate, ketoacids) bind each other in a salt-like manner. Plasma ions (such as  $\text{Cu}^{2+}$ ,  $\text{Fe}^{2+}$ ,  $\text{Fe}^{3+}$ ,  $\text{Zn}^{2+}$ ,  $\text{Co}^{2+}$  and  $\text{Mn}^{2+}$ ) that enter into oxidation–reduction reactions, complex ion interactions and precipitation reactions are not categorized as simple ions but are assumed to be quantitatively unimportant in determining plasma pH, primarily because their plasma concentrations are low.

Simple ions in plasma can be differentiated into two main types, nonbuffer ions (strong ions or strong electrolytes) and buffer ions. Strong ions are fully dissociated at physiological pH and therefore exert no buffering effect. Strong ions do, however, exert an electrical effect because the sum of completely dissociated cations does not equal the sum of completely dissociated anions. Stewart termed this difference the **strong ion difference (SID)**. Because strong ions do not participate in chemical reactions in plasma at physiological pH, they act as a collective positive unit of charge.

In contrast to strong ions, **buffer ions** are derived from plasma weak acids and bases that are not fully dissociated at physiological pH. The conventional dissociation reaction for a weak acid (HA), conjugate base ( $\text{A}^-$ ) pair is:

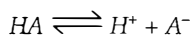

and, at equilibrium, an apparent weak acid dissociation constant ( $K_a$ ) can be calculated adopting the accepted convention regarding hydrated solutes as  $K_a = [\text{H}^+][\text{A}^-]/[\text{HA}]$ . For a weak acid to act as an effective buffer, its  $\text{p}K_a$  (defined as the negative logarithm of the weak acid dissociation constant  $K_a$ ) lies within the range of  $\text{pH} \pm 1.5$ .

Conceptually, the buffer ions can be subdivided into volatile buffer ions ( $\text{HCO}_3^-$ ) and nonvolatile buffer ions (non- $\text{HCO}_3^-$ ). Bicarbonate is considered separately because this buffer system is an open system in arterial plasma; rapid changes in carbon dioxide tension and hence arterial plasma  $\text{HCO}_3^-$  concentration can be readily induced through alterations in respiratory activity. In contrast, the non- $\text{HCO}_3^-$  buffer system is a closed system containing a fixed quantity of buffer.

Another important physiological distinction between these two buffer systems is that an open buffer system such as  $\text{HCO}_3^-$  can be effective beyond the limits of  $\text{pH} = \text{p}K_a \pm 1.5$ . Finally, it should be appreciated that  $\text{HCO}_3^-$  is a homogeneous buffer ion while the nonvolatile buffer ion ( $\text{A}^-$ ) represents a diverse and heterogeneous group of plasma buffers (albumin, globulin and phosphate) that is being modeled as a single buffer. Another assumption in Stewart's strong ion model is that HA and  $\text{A}^-$  do not take part in plasma reactions that result in the net destruction or creation of HA or  $\text{A}^-$ . This is because when HA dissociates, it ceases to be HA (therefore decreasing plasma  $[\text{HA}]$ ) and becomes  $\text{A}^-$  (therefore increasing plasma  $[\text{A}^-]$ ). The sum of  $[\text{HA}]$  and  $[\text{A}^-]$  (called  $\text{A}_{\text{TOT}}$ ) therefore remains constant through conservation of mass, whereby:  $[\text{A}_{\text{TOT}}] = [\text{HA}] + [\text{A}^-]$ .

In summary, the strong ion approach assumes that plasma ions act as either strong ions, volatile buffer ions ( $\text{HCO}_3^-$ ) or nonvolatile buffer ions ( $\text{A}^-$ ). Plasma therefore contains three types of charged entity: SID,  $\text{HCO}_3^-$  and  $\text{A}^-$ . The requirement for electroneutrality dictates that at all times the SID equals the sum of bicarbonate buffer ion activity ( $\text{HCO}_3^-$ ) and nonvolatile buffer ion activity ( $\text{A}^-$ ), such that:  $\text{SID} - \text{HCO}_3^- - \text{A}^- = 0$ . This equation obviously assumes that all ionized entities in plasma can be classified as either a strong ion (SID), a volatile buffer ion ( $\text{HCO}_3^-$ ) or a nonvolatile buffer ion ( $\text{A}^-$ ).

An equation **relating plasma pH to three independent variables ( $\text{PCO}_2$ , SID,  $\text{A}_{\text{TOT}}$ )** and three constants ( $K_a$ ,  $K_b$ ,  $S$ ) has been developed based on these assumptions. The most important factors that determine plasma pH are  $\text{PCO}_2$ , SID and the concentrations of individual nonvolatile plasma buffers (albumin, globulins, phosphate). A change in any one of these variables will produce a direct and predictable change in plasma pH. Using the strong ion approach, **six primary acid–base disturbances can be distinguished**, instead of the four primary acid–base disturbances (respiratory acidosis, respiratory alkalosis, metabolic acidosis, metabolic alkalosis) differentiated when using the traditional Henderson–Hasselbalch approach. The strong ion approach indicates that acidemia results from an increase in  $\text{PCO}_2$  and nonvolatile buffer concentration, or from a decrease in SID. Alkalemia results from a decrease in  $\text{PCO}_2$  and nonvolatile buffer concentration, or from an increase in SID. The unmeasured strong anion concentration is quantified by calculating the strong ion gap (SIG).

## ACIDEMIA

### ETIOLOGY

The traditional Henderson–Hasselbalch approach to acid–base balance indicates that general causes of nonrespiratory (**metabolic**) acidosis can be divided into three categories on the basis of pathogenesis (Fig. 2.6):

- Excessive loss of base (bicarbonate)
- Accumulation of endogenous or exogenous acid
- Combination of both of the above processes.

For comparison, the strong ion approach indicates that general causes of nonrespiratory (metabolic) acidosis can be divided into **two categories: strong ion acidosis** due to a decrease in strong cation concentration (hyponatremia) or increase in strong anion concentration (hyperchloremia, hyper L-lactatemia, hyper D-lactatemia, ketoacidosis), and **nonvolatile buffer ion acidosis** due to an increase in albumin, globulin and phosphate concentration.

Some common specific causes include acute diarrhea in newborn animals, acute enteritis in adult cattle and horses and carbohydrate engorgement in ruminants and horses. Metabolic acidosis without dehydration, which is probably due to hyper D-lactatemia, has been described in neonatal goat kids<sup>1</sup> and neonatal calves.<sup>2</sup> Respiratory acidosis also occurs where there is retention of carbon dioxide in the blood as a result of interference with normal respiratory exchange. Thus pneumonia, severe pulmonary emphysema, depression of the respiratory center and left-sided heart failure may all be accompanied by respiratory acidosis. Metabolic acidosis occurs in the newborn at the time of parturition if this is prolonged and difficult. It is also common in shock with peripheral circulatory failure and anaerobic oxidation. A decrease in renal excretion of acid in renal insufficiency or renal failure also contributes to a metabolic acidosis. The administration of excessive quantities of acidifying solutions for the treatment of metabolic alkalosis also may cause acidosis. Acute intestinal obstruction in the horse is commonly accompanied by metabolic acidosis, whereas in other species alkalosis occurs, at least initially.

### PATHOGENESIS

The traditional Henderson–Hasselbalch approach indicates that metabolic acidosis is characterized by a low arterial blood pH and a reduced plasma bicarbonate concentration, following the loss of bicarbonate or the addition of hydrogen ions. Extra- and intracellular buffering and respiratory compensation minimize the change in

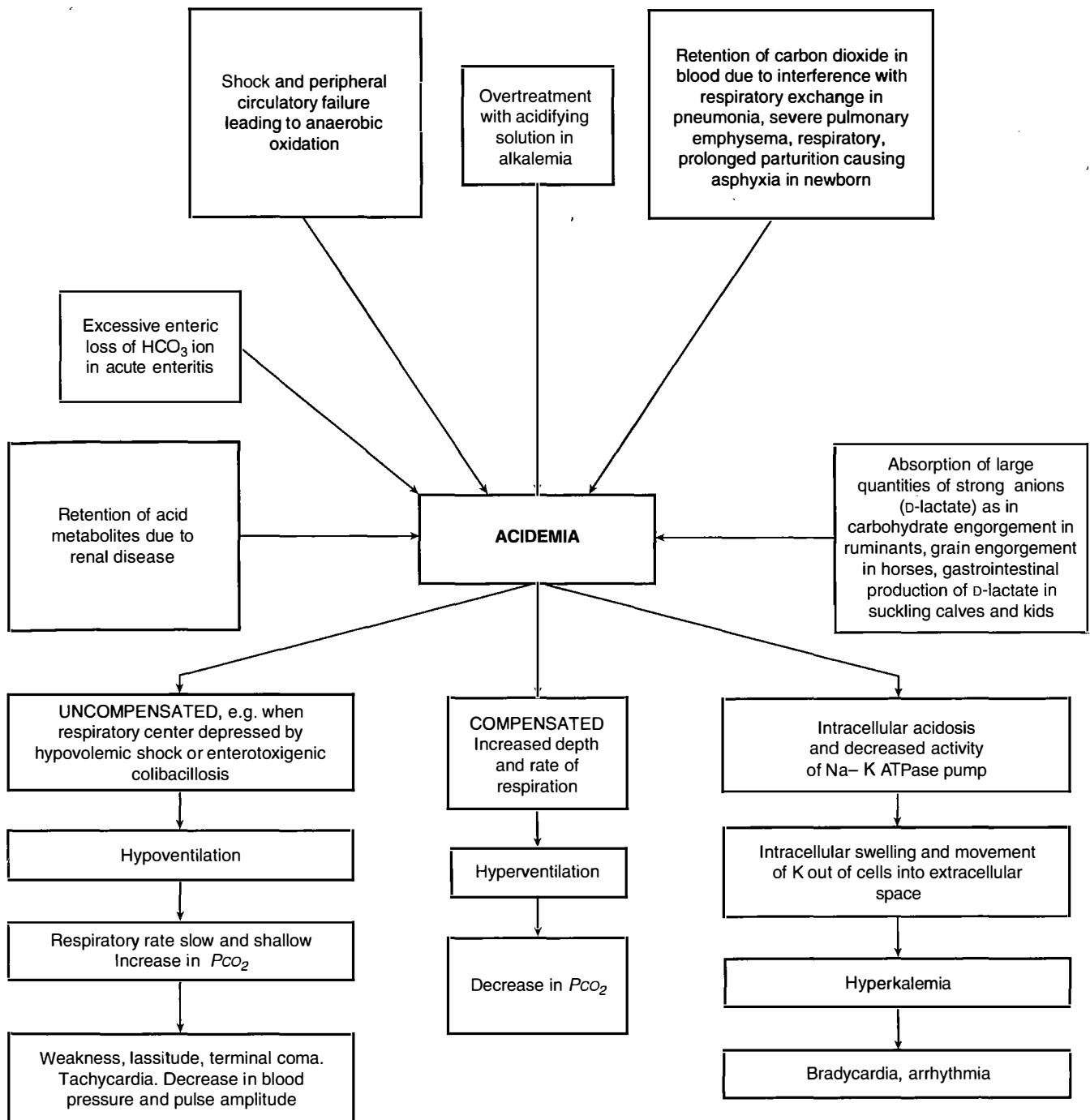

Fig. 2.6 Etiology and pathogenesis of acidemia.

pH until the kidney can excrete sufficient hydrogen ions to correct the acid-base imbalance.<sup>3</sup> In general, the body will tolerate a pH range of 7.0–7.6, although survival has been reported at pH values beyond these limits for short periods, particularly in neonatal animals with diarrhea.

Acidemia generally depresses cardiac contractility and cardiac output in the denervated heart. In the intact animal, however, activation of the sympathetic nervous system in response to acidemia causes increased cardiac contractility, increased heart rate and increased cardiac output. In acidemia, the myocardial

response to catecholamines is not depressed until the blood pH is decreased to below 7.0–7.1.<sup>4</sup> The increased carbon dioxide tension of the blood and depletion of bicarbonate causes an increase in the depth and then the rate of respiration by stimulation of the respiratory center (Kussmaul breathing). However, when hypovolemic shock is severe enough, there is often depressed respiratory function, resulting in the additional accumulation of hydrogen ions, and so the acidemia is accentuated.

Acidemia causes varying degrees of depression of the central nervous system and muscular weakness.<sup>1,5</sup> Central nervous

abnormalities may develop in neonatal foals that develop severe respiratory compromise, resulting in hypoxemia and hypercapnia, because of the reduced ability of the cerebrospinal fluid to buffer acid-base changes.<sup>6</sup> Carbon dioxide concentration within the central nervous system (CNS) may have an effect on respiratory rate, neurotransmitter activity, CNS activity, cerebral blood flow and cerebral extracellular fluid volume. If the blood-CSF and brain-CSF interfaces in the neonate are immature and unable to adequately compensate for vascular changes in  $CO_2$ , the hypercapnia may contribute to the CNS abnormalities that



are often seen in sick newborn foals. The increased cerebral blood flow may be associated with cerebral edema, resulting in the depression of cerebral activity observed in these sick foals.

The increased urinary excretion of acids in acidosis also causes polyuria, which may be sufficiently severe to cause dehydration or accentuate concomitant dehydration.

### CLINICAL FINDINGS

The major clinical manifestation of metabolic acidosis is mental depression and varying degrees of muscular weakness. Newborn calves and goat kids with metabolic acidosis are depressed, weak and reluctant to suck.<sup>5</sup> In severe acidemia, affected animals may be in lateral recumbency and appear to be in a state of coma. The depth and rate of respirations may be increased because of the increased  $PCO_2$ . Respiratory compensation is normally evident when the bicarbonate level is diminished to 50% of normal. Calves affected with severe acidemia and dehydration due to acute diarrhea may be unable to compensate because of

depressed respiratory function. Their respiratory rate will be much slower and the depth of respiration much more shallow than normal. There is usually tachycardia, which becomes worse as the acidosis becomes more severe, and the amplitude of the pulse and blood pressure both decrease. A concomitant hyperkalemia will cause bradycardia, heart block, sudden collapse and rapid death. This is particularly evident when animals with acidosis and hyperkalemia are transported and handled for treatment. The increased muscular activity appears to accentuate the abnormalities and sudden death is not uncommon. Weakness, lassitude and terminal coma are frequent observations.

A syndrome of metabolic acidosis with minimal signs of dehydration or diarrhea has been described in calves from 1–4 weeks of age.<sup>2,7</sup> Affected calves are depressed, weak and ataxic, and the suck and menace reflexes may be weak or absent. Some calves appear comatose. On succussion of the abdomen fluid-splashing may be audible, which suggests that the syndrome may be related to diarrhea,

which most of the calves may have had but from which they appeared to recover. The same abnormality has also occurred in goat kids with no apparent history of previous diarrhea.<sup>1</sup> The abnormal laboratory findings include a reduced venous blood pH,  $PCO_2$  and bicarbonate ion concentration, marked hyper D-lactatemia, elevated blood urea nitrogen, increased anion gap and a neutrophilic leukocytosis with a left shift. Many of the clinical signs appear to be primarily the consequence of hyper D-lactatemia.<sup>2</sup> The intravenous administration of 2.5–4.5 L of isotonic (1.3%) sodium bicarbonate solution, the amount depending on the severity of the condition,<sup>7</sup> is necessary.

### ALKALEMIA

#### ETIOLOGY AND PATHOGENESIS

Alkalemia is caused by an increased absorption of alkali, excessive loss of acid or a deficit of carbon dioxide (Fig. 2.7). Abomasal atony due to dilatation, impaction or torsion of the abomasum is one of the commonest causes of alkalemia in cattle. There is continuous secretion of

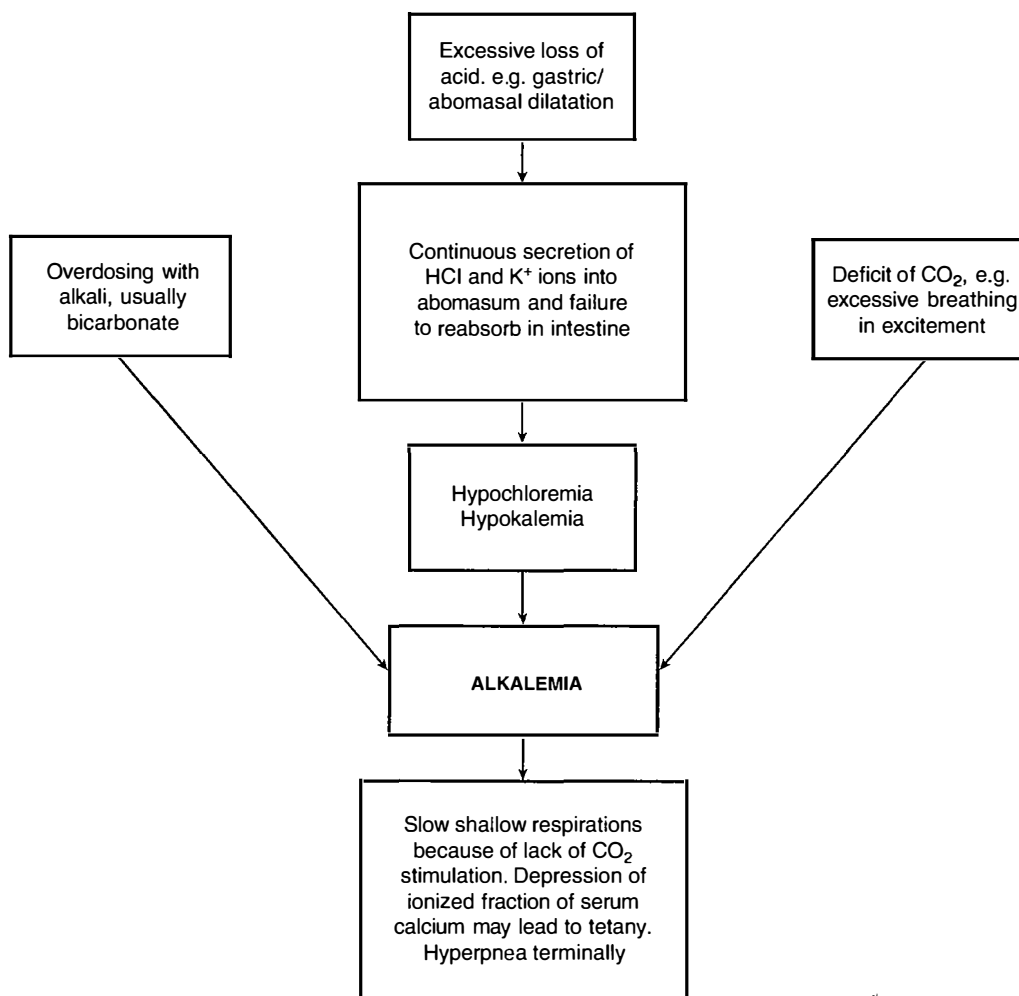

Fig. 2.7 Etiology and pathogenesis of alkalemia.

hydrochloric acid and potassium into the abomasum, with failure of evacuation of the abomasal contents into the duodenum for absorption. Sequestration of hydrochloric acid and potassium occurs in the abomasum, along with reflux into the rumen, all of which results in a hypochloremic, hypokalemic alkalosis. In metabolic alkalosis, potassium will shift from the extracellular to the intracellular space, resulting in a hypokalemia when in fact there may not be depletion of total body potassium. In cattle with metabolic alkalosis there is a paradoxical aciduria, which is not well understood but may be due to severe electrolyte depletion placing limits on the kidney to regulate acid–base balance. Paradoxical aciduria must be differentiated from postparturient aciduria, which has been reported to occur in dairy cows.

Metabolic alkalosis has been recorded in cows with severe coliform mastitis but the pathogenesis is unknown.<sup>8</sup>

### CLINICAL FINDINGS

The clinical findings of alkalosis are not characteristic enough to be recognized reliably. Alkalosis results in slow, shallow respirations in an attempt to preserve carbon dioxide. Muscular tremors and tetany with tonic and clonic convulsions may occur because of depression of the ionized fraction of serum calcium. Hyperpnea and dyspnea may also occur in the terminal stages.

### REVIEW LITERATURE

Constable PD. Clinical assessment of acid–base status: strong ion difference theory. *Vet Clin North Am Food Anim Pract* 1999; 15:447–471.

Constable PD. Clinical assessment of acid–base status: comparison of the Henderson–Hasselbalch and strong ion approaches. *Vet Clin Path* 2000; 29:115–128.

Constable PD. Fluids and electrolytes. *Vet Clin North Am Food Anim Pract* 2003; 19:1–40.

### REFERENCES

1. Tremblay RRM, Butler DG. *Can Vet J* 1991; 32:308.
2. Lorenz I. *Vet J* 2004; 168:323.
3. Lunn DP, McGuirk SM. *Vet Clin North Am Food Anim Pract* 1990; 6:1.
4. Brobst D. *J Am Vet Med Assoc* 1983; 183:773.
5. Naylor JM. *Can Vet J* 1989; 30:577.
6. Geiser DR et al. *Am J Vet Res* 1996; 57:1483.
7. Kasari TR, Naylor JM. *Can J Vet Res* 1986; 50:502.
8. Ohtsuka H et al. *J Vet Med Sci* 1997; 59:471.

### NATURALLY OCCURRING COMBINED ABNORMALITIES OF FREE WATER, ELECTROLYTE AND ACID–BASE BALANCE

These abnormalities are seldom primary and usually secondary to a serious disease state such as abomasal volvulus, rumen overload or acute intestinal obstruction – diseases that are in themselves life-threatening. Fluid and electrolyte abnormalities are also life-threatening and

simple correction of the primary abnormality, for example removal of a large section of a horse's small intestine, is valueless unless the dehydration, hyponatremia and acidosis are also corrected. The variation that can occur in these naturally occurring errors of fluid, electrolyte and acid–base balance is what makes their diagnosis and treatment so difficult. If it were possible to have instant clinicopathological advice on what the abnormalities were, and how they were progressing as determined by constant laboratory monitoring, there would be little challenge in it. However, under normal clinical circumstances these services are not readily available and it is necessary to have an understanding of the basic physiology and pathology of these diseases to be able to predict by clinical examination and examination of the history, the likely deficiencies and imbalances and their degrees of severity.

In the preceding paragraphs the individual abnormalities of fluid and electrolyte homeostasis were described. In most naturally occurring diseases, the abnormalities are complex. In example, the probable events in a case of acute diarrhea are set out diagrammatically in Figure 2.8. It is important to remember that the variation in fluid and electrolyte imbalance is **dynamic** as a result of the compensatory changes occurring in various organs, especially the respiratory and circulatory systems and the kidneys. It is this volatility which makes clinical pathological monitoring so important. Some generalizations on the dynamics of fluid and electrolyte status are as follows:

- The body water and electrolytes are maintained at a homeostatic level by the buffering system of the blood, the lungs and the kidney
- In disturbances of body water and electrolytes, the changes that occur are also dynamic, and there is constant reaction by the homeostatic mechanism to restore the water and electrolyte relationship to normal
- With some exceptions, it is unusual to find an uncompensated alkalemia or acidemia. A partial compensation in the opposite direction of the primary acid–base imbalance is usually in progress and it is important to determine the nature of the primary disturbance for the selection of rational therapy
- Often, the nature of the primary disturbance can be determined from a consideration of the history and the clinical findings
- The dehydration caused by deprivation of water and electrolytes (lack of water or inability to drink) is

mild and animals may appear only mildly dehydrated even after several days of water deprivation. The feces are hard and dry, the rumen contents are firm and dry and urine volume is considerably decreased

- With the exception of clinical dehydration, the clinical findings of electrolyte and acid–base imbalances are not characteristic
- Without laboratory evaluation, the nature and degree of electrolyte and acid–base imbalance must be assumed and estimated based on the history of the affected animal and the changes that are most likely to have occurred.

### NATURE OF THE DISEASE AND HISTORY

The **history of the case**, the **length of time** the animal has been affected and the **tentative diagnosis** will provide a clinical assessment of the possible nature and degree of electrolyte and acid–base imbalance. Animals affected with acute diarrhea due to infectious enteritis are likely to be in a state of metabolic acidosis and hyponatremia. In intestinal obstruction of the horse, there are varying degrees of dehydration and metabolic acidosis. Obstruction of the upper intestinal tract, or abomasal stasis, is characterized by varying degrees of dehydration, and metabolic alkalosis with hypochloremia and hypokalemia. A combination of the clinical assessment and the available laboratory evaluation will allow the clinician to make the most rational approach to treatment.

The information on the duration of illness must be accurate or it will be misleading. The sequence of clinical findings in the history may indicate the trend in severity. Animals that have had a profuse watery diarrhea for 18–24 hours may be severely acidemic. Acute intestinal obstruction in cattle is not as severe as in the horse. Acute gastric or intestinal rupture in the horse or in cattle is usually rapidly fatal. Acidosis in grain overload in cattle may be fatal in 24–48 hours; acidosis in the horse with grain overload may be much more rapidly fatal as electrolyte disturbances are more severe in the horse.

### CLINICAL FINDINGS

**Dehydration** is usually obvious clinically and determination of the PCV and total serum solids will improve the assessment.

A normal **temperature** is not a good prognostic guide but a subnormal temperature suggests a worsening situation.

A gradually progressive **tachycardia** indicates that the patient is deteriorating. In general, in the horse, a heart rate up to 60 beats/min suggests a minor lesion (but not always), a heart rate between

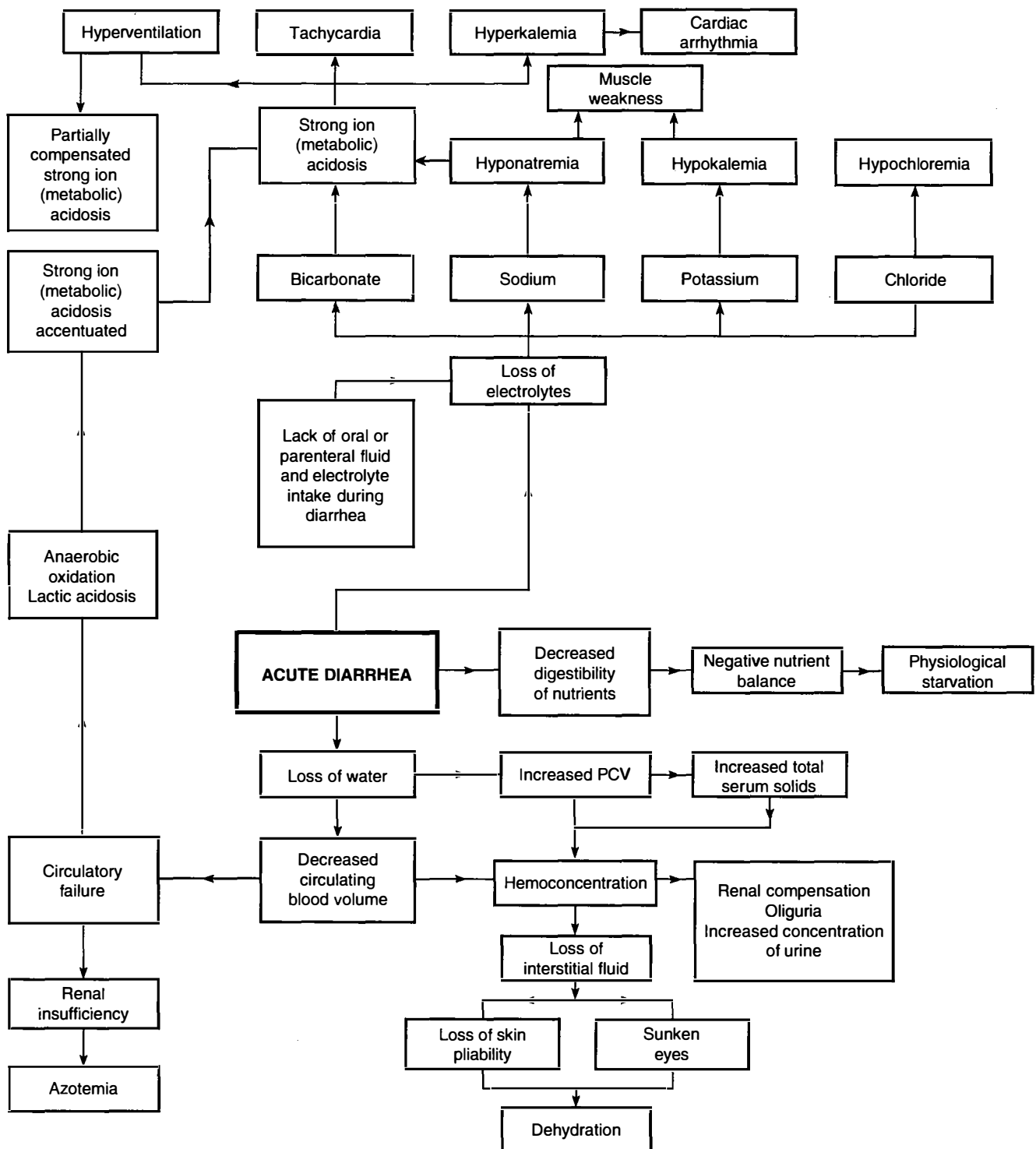

Fig. 2.8 The interrelationships between the changes in body water, electrolytes and acid-base balance that can occur in diarrhea.

60–80 beats/min is in the danger area, 80–100 beats/min is serious; more than 100 beats/min is commonly premortal (except in intestinal tympany that may be relieved).

A cold clammy skin that remains tented for more than 30 seconds suggests severe dehydration. Cyanosis of the oral mucous membranes and a capillary refill time of more than 4 s suggests a poor prognosis, as does rapid respiration (three to four times normal) with intermittent hyperpnea and apnea.

**Muscular tremors and leg buckling are grave signs in the horse** and are commonly followed by collapse and death. The inability of any dehydrated animal to stand (other reasons being eliminated) is ominous. Severe depression and dullness are commonly observed in acute conditions, and coma is usually terminal.

**Metabolic acidosis** is characterized by varying degrees of mental depression, weakness and ataxia. Some of the depression and weakness will be due to

dehydration. In newborn animals with metabolic acidosis associated with diarrhea, a failure to suck and the lack of a suck reflex are common.

#### CLINICAL PATHOLOGY

Some representative laboratory values in examples of body water and electrolyte disturbances are given in Table 2.1.

#### Packed cell volume and total serum solids

The PCV and the total serum proteins or total serum solids will indicate the

Table 2.1. Representative laboratory values (mean  $\pm$  SD) in body water and electrolyte disturbances

Clinical pathology	Acute diarrhea in horse	Acute diarrhea in calf	Metabolic alkalosis due to abomasal dilatation impaction/volvulus in cattle	Acute intestinal obstruction in horse	Acute carbohydrate engorgement in ruminants
Packed cell volume (%)	60 $\pm$ 7	45.3 $\pm$ 7.0	42 $\pm$ 6	64 $\pm$ 5	45 $\pm$ 6
Total serum solids (g/dL)	10 $\pm$ 2	8.6 $\pm$ 1.5	8.2 $\pm$ 1.5	11.5 $\pm$ 1.5	8.5 $\pm$ 1.8
Blood pH (venous)	7.10 $\pm$ 0.15	7.08 $\pm$ 0.12	7.49 $\pm$ 0.15	7.15 $\pm$ 0.04	7.10 $\pm$ 0.05
Plasma bicarbonate (mmol/L)	12 $\pm$ 3	13.7 $\pm$ 4.2	35.4 $\pm$ 5.7	18 $\pm$ 6	12.5 $\pm$ 3.5
Partial pressure of carbon dioxide (mmHg)	45 $\pm$ 8	46.8 $\pm$ 6.4	46.4 $\pm$ 7.5	48 $\pm$ 6	40 $\pm$ 6
Serum sodium (mmol/L)	126 $\pm$ 3	138 $\pm$ 9.4	138.5 $\pm$ 5.4	135 $\pm$ 5	132 $\pm$ 4
Serum chloride (mmol/L)	99 $\pm$ 3	101.4 $\pm$ 7.5	88.6 $\pm$ 12.8	98 $\pm$ 4	93 $\pm$ 3
Serum potassium (mmol/L)	3.0 $\pm$ 1.2	7.4 $\pm$ 1.6	3.4 $\pm$ 0.6	3.8 $\pm$ 0.6	5.0 $\pm$ 2.5
Blood urea nitrogen (mg/dL)	60 $\pm$ 30	50.1 $\pm$ 30.5	40 $\pm$ 15	65 $\pm$ 35	55 $\pm$ 25

severity of water loss. Anemic animals and those affected with diseases causing hypoproteinemia may provide misleading values.

The normal range depends on the age and species of animal, previous excitement and the presence of anemia or hypoproteinemia. A packed cell volume of 30–40% is considered normal; between 40% and 50%, fluid therapy may or may not be necessary; between 50% and 60%, fluids are necessary for recovery and above 60% intensive fluid therapy is necessary and the prognosis is unfavorable. A total serum solids of 6.0–7.5 g/dL is usually considered normal; at 8–10 g/dL fluids are needed and the prognosis is favorable and above 12 g/dL the prognosis is unfavorable.

### Blood pH and blood gases

#### Sample collection and analysis

A useful screening test for acid-base status in animals without evidence of respiratory disease is the total CO<sub>2</sub>. Total CO<sub>2</sub> is defined as the amount of total carbon dioxide in plasma that can be liberated with a strong acid, and can be calculated from the results of routine blood gas analysis as: total CO<sub>2</sub> = [HCO<sub>3</sub><sup>-</sup>] + dissolved CO<sub>2</sub> + [H<sub>2</sub>CO<sub>3</sub>]. The [HCO<sub>3</sub><sup>-</sup>] is calculated using the Henderson-Hasselbalch equation, the dissolved CO<sub>2</sub> is equal to  $S \times P_{CO_2}$ , whereas [H<sub>2</sub>CO<sub>3</sub>] is negligible.

Many automatic serum biochemical analyzers directly measure total CO<sub>2</sub> (instead of calculating its value from the results of blood gas analysis) but for total CO<sub>2</sub> measurement it is important that blood collection tubes are completely filled before serum is harvested: failure to completely fill the blood tubes promotes escape of CO<sub>2</sub> from serum into the partial vacuum above, thus resulting in measured total CO<sub>2</sub> values that underestimate true serum total CO<sub>2</sub>.<sup>1</sup> Because changes in total CO<sub>2</sub> reflect changes in actual [HCO<sub>3</sub><sup>-</sup>], total CO<sub>2</sub> can never provide an independent measure of the nonrespiratory component of an acid-base disturbance. Total CO<sub>2</sub> does, however, provide a useful

screening test for the presence of acid-base disturbances in domestic animals without clinical evidence of respiratory disease. In the absence of respiratory disease, a decrease in total CO<sub>2</sub> indicates a metabolic acidosis, whereas an increase in total CO<sub>2</sub> indicates metabolic alkalosis. Total CO<sub>2</sub> has historically been measured using the Harleco apparatus,<sup>2</sup> although this methodology is no longer used due to the availability of point-of-care analyzers.

If the primary clinical interest is acid-base assessment, then a jugular venous blood sample should be anaerobically obtained in a 3 mL plastic syringe that has been previously coated internally with sodium heparin (by drawing sodium heparin into the syringe barrel and then expelling all heparin from the syringe into the barrel before blood collection). Three mL of air should then be drawn into the syringe and forcibly expelled; this process is repeated three times. Evacuating the syringe in this manner ensures that minimal heparin is retained to dilute the blood sample but a sufficient quantity is still present to prevent coagulation.<sup>3</sup> After blood collection, the air bubbles should be removed from the blood in the syringe, the end should be corked to prevent loss of CO<sub>2</sub> and addition of O<sub>2</sub> to the blood sample and the syringe should be placed on ice (4°C) until analysis. This will minimize any time-related changes in pH, P<sub>CO<sub>2</sub></sub> and base excess that occur when blood is held at room temperature (20°C), particularly in blood samples with high white blood cell concentrations. The change in pH, P<sub>CO<sub>2</sub></sub> and base excess per hour at 22–24°C are -0.024, +2.5 and -0.5 respectively.<sup>3</sup> A portable blood gas analyzer for equine venous blood is available and provides reproducible and acceptable analysis.<sup>4</sup>

If the primary interest is evaluation of the respiratory system, an arterial blood sample should be obtained in the same manner but the sample should be kept at body temperature (preferable) or room temperature before blood gas analysis, which should be performed as soon as

possible. This is because keeping 3 mL plastic syringes on ice (4°C) facilitates oxygen diffusion through the plastic syringe barrel, causing an increased P<sub>O<sub>2</sub></sub>.<sup>5</sup>

Use of point-of-care clinical analyzing systems has greatly facilitated routine evaluation of acid-base status in domestic animals. Thorough assessment of acid-base status requires blood gas analysis and serum biochemical analysis, with blood samples being obtained from a major vein or any artery. If serum total protein, albumin and phosphate concentrations are approximately normal, then acid-base status should be evaluated using blood pH, P<sub>CO<sub>2</sub></sub> and extracellular base excess concentration. This is the traditional Henderson-Hasselbalch approach. The presence of unidentified anions should be investigated by calculating the anion gap. If serum total protein, albumin, and phosphate concentrations are markedly abnormal, then acid-base status should be evaluated using blood pH, P<sub>CO<sub>2</sub></sub>, measured [SID<sup>+</sup>] and [A<sub>TOT</sub>]. This is the simplified strong ion approach. The presence of unidentified strong ions should be investigated by calculating the SIG.

#### Blood pH and acid-base interpretation

**Normal blood pH** varies from 7.35 to 7.45 (venous blood). The degree of acidemia encountered includes moderate acidemia (pH 7.30–7.25), severe acidemia (pH 7.25–7.20), grave (and commonly fatal except in neonates) acidemia (pH 7.10–7.00). Horses with volvulus or strangulation of the intestines generally have blood lactate levels over 75 mg/dL (8.2 mmol/L) whereas cases of impaction have levels of 5–9 mg/dL (0.55–1.0 mmol/L). The normal value is 6.0 mg/dL (0.78 mmol/L) with a range of 4–12 mg/dL (0.44–1.33 mmol/L). The survival rate in a series fell from 85% to 0% as the lactate concentration increased from 75 to 155 mg/dL (8.3 to 17.2 mmol/L).

#### Serum electrolytes

**Serum electrolyte** concentrations indicate the severity of the electrolyte losses

and the necessity for replacement with either balanced electrolyte solution or specific electrolyte solution. Serum concentrations of **sodium, chloride and potassium** are usually determined. The total deficit for each electrolyte can be estimated using the standard formula presented under calculation of electrolyte requirements.

Serum electrolyte concentrations depend on the initial cause and the severity of the disease. For example, in most cases of acute diarrhea there is hyponatremia and metabolic acidosis, which are usually marked in the horse with acute diarrhea. The serum levels of chloride may be normal or subnormal in acute diarrhea. The serum levels of potassium will be below normal initially but as acidosis develops and becomes severe, **hyperkalemia** may occur. In diseases causing **abomasal atony** there will be **hypochloremic, hypokalemic and metabolic alkalosis**.

**Water and electrolyte abnormalities** are classified into three types based on the measurement of electrolytes and osmolality:

- **Hypertonic dehydration** (true dehydration/desiccation): osmolality greater than 300 mosmol/kg (300 mmol/kg), associated with water deprivation, some acute gastrointestinal problems and some types of diarrhea
- **Hypotonic dehydration** (acute desalting water loss): osmolality less than 260 mosmol/kg (260 mmol/kg), associated with acute diarrhea, particularly secretory diarrheas, such as salmonellosis
- **Isotonic dehydration**: normal electrolyte and osmolality levels, as in horses losing electrolytes and water in almost equal proportions.

### Urea nitrogen and creatinine

**Plasma urea nitrogen and plasma creatinine** are metabolic breakdown constituents that can be used to assess the degree of dehydration and to distinguish between prerenal, renal and postrenal uremia. The plasma urea nitrogen and creatinine concentration will be elevated, depending on the severity of the dehydration and decrease in circulating blood volume. Following treatment with fluids and electrolytes in prerenal uremia, the levels of plasma urea and creatinine will decline.

### Total leukocyte and differential counts

A marked leukopenia and neutropenia with a degenerative left shift carries an unfavorable prognosis. A regenerative left shift with a neutrophilia is a favorable

prognosis. A marked lymphopenia indicates severe stress and the prognosis may be unfavorable.

### Blood glucose

Blood glucose concentration can be determined using conventional laboratory techniques, which require the submission of heparinized blood samples as soon as possible to avoid erroneous results due to hemolysis or erythrocyte glycolysis. A quantitative, rapid method of determining blood glucose concentrations in mature cattle and calves is available and the results correlate with the conventional, laboratory-based method.<sup>6</sup> The laboratory-based plasma glucose levels were 10–15% higher than the blood glucose levels determined by the rapid field method. The field method is based on the glucose oxidase reaction and uses impregnated test strips and a pocket-sized, digital readout reflectance meter to measure colorimetric change.

### Anion, strong ion and osmolal gaps

Acid–base balance has traditionally been evaluated by using the Henderson–Hasselbalch equation to characterize four primary acid–base disturbances (i.e. respiratory acidosis and alkalosis, metabolic acidosis and alkalosis) and by calculating the **anion gap** to estimate the unmeasured anion concentration. Evaluation of the anion gap has become routine in many medical institutions. The calculation takes little time, is essentially without cost and is valuable in assessing a variety of clinical conditions in which electrolyte imbalances occur.

The anion gap (AG) represents the difference between the concentration of unmeasured anions [UA] and unmeasured cations [UC] in serum, which can be expressed in the equation:<sup>7</sup>

$$[Na^+] + [K^+] + [UC] = [Cl^-] + [HCO_3^-] + [UA],$$

which can be rearranged to:

$$[UA] - [UC] = AG = ([Na^+] + [K^+]) - ([Cl^-] + [HCO_3^-]).$$

A change in [UA] or [UC] will cause a change in the AG. Under normal circumstances, approximately two-thirds of the AG originates from the net negative charge of serum proteins, and the remainder represents the serum concentration of phosphate and strong anions, such as lactate, sulfate,  $\beta$ -OH butyrate, acetate and anions associated with uremia.<sup>7</sup> The normal range for AG depends on the age and species. The normal range for 2–3-week-old foals is 9–22 mEq/L which is higher than that for 2-year-old horses (range 8–13 mEq/L). The range of AG (mean  $\pm$  2 SD) for adult animals varies for different species:

8–13 mEq/L (horse), 14–20 mEq/L (cow) and 17–29 mEq/L (sheep). AG values greater than 30 mEq/L have been seen in critically ill cattle, with the increase being attributed to an increase in blood lactate and ketoacid concentration as well as to anions associated with uremia.

A potentially valuable clinical use for the AG is in estimating the plasma L-lactate concentration, which provides information about the adequacy of oxygen delivery to the tissues, thereby providing a means for assessing the severity of cardiovascular or pulmonary dysfunction, monitoring the response to treatment and formulating a prognosis for survival. The normal plasma L-lactate concentration is generally considered to be less than 1.5 mmol/L. Increases in plasma L-lactate concentration have been categorized as mild (2.5–4.9 mmol/L), moderate (5.0–9.9 mmol/L) and severe ( $\geq$  10 mmol/L), with L-lactate concentrations greater than 10 mmol/L being associated with a high mortality in humans, pigs and horses.<sup>7</sup>

Because lactate determinations may not be available in some laboratories, calculation of the AG can be considered a 'poor man's plasma lactate'. The correlation between AG and L-lactate concentrations is excellent in horses with intestinal disease. The AG of neonatal calves with experimental diarrhea was  $28.6 \pm 5.6$  mEq/L, and the blood lactate concentration ranged from 1.1–2.9 mmol/L; the AG was significantly correlated with serum phosphate and creatinine concentration. The AG of adult cattle with abomasal volvulus was  $20.5 \pm 7.8$  mEq/L and the blood L-lactate concentration ranged from 0.6–15.0 mmol/L. The AG in adult cattle is only moderately correlated with L-lactate concentrations and is similarly correlated with serum phosphate and creatinine concentrations in neonatal calves and adult cattle, as well as with serum albumin and total protein concentrations in adult cattle. Anion gap determination is of limited usefulness in predicting blood L-lactate concentration in sick cattle, whereas the correlation between AG and serum concentration in sick cattle suggests that an increased AG should suggest the potential presence of uremic anions.<sup>7</sup>

In summary, the determinants and utility of the anion gap in predicting hyperlactatemia are as follows.<sup>7</sup>

- The AG in critically ill cattle is influenced by at least three factors: blood L-lactate concentration and the serum concentrations of phosphate and creatinine
- There is a substantial quantity of unmeasured anions in sick cattle

(approximately 7 mEq/L), which implies that either unidentified cations or anions other than chloride, bicarbonate, L-lactate, pyruvate,  $\beta$ -OH butyrate or phosphate are present in critically ill cattle or that the formula used to assign protein charge was inaccurate

- The correlation coefficient between AG and blood L-lactate concentration is similar to that observed in human patients and less than that seen in sick horses
- The AG appears to predict blood L-lactate concentration more accurately in neonatal calves with experimental diarrhea than that in adult cattle with spontaneously occurring abomasal volvulus.

#### Strong ion gap

The **strong ion gap** represents the concentration of unmeasured strong ions in plasma and is more specific in detecting the presence of unmeasured strong ions in plasma than the anion gap. The SIG concept is a logical extension of the AG concept and was developed using the strong ion difference approach in order to express SIG in terms of other factors:  $SIG = A_{TOT}/(1 + 10^{(pK_a - pH)}) - AG$ , where SIG represents the difference between unmeasured strong cation concentration and unmeasured strong anion concentration in plasma or serum.<sup>8</sup> Calculation of the SIG requires species-specific values for the total plasma concentration of nonvolatile weak acids ( $A_{TOT}$ ; i.e. the total concentration of plasma nonvolatile buffers; albumin, globulin and phosphate) and the negative logarithm to the base 10 ( $pK_a$ ) of the effective dissociation constant ( $K_a$ ) for plasma nonvolatile buffers. Values for  $A_{TOT}$  and  $pK_a$  have been determined for the plasma of horses ( $A_{TOT}$ , 15.0 mmol/L = 0.22 mmol/g of total protein or 0.47 mmol/g of albumin;  $pK_a$ , 6.66) and calves ( $A_{TOT}$ , 23.1 mmol/L = 0.41 mmol/g of total protein or 0.75 mmol/g of albumin;  $pK_a$ , 7.08).<sup>8,10</sup>

The normal SIG value is -5 to +5 mEq/L. An increase in SIG to above 5 mEq/L (a rare occurrence) therefore reflects an increase in unmeasured strong cations or a decrease in unmeasured strong anions. A decrease in SIG to below -5 mEq/L (a common occurrence) reflects a decrease in unmeasured strong cations or, more likely, an increase in unmeasured strong anions.

The SIG offers a more accurate approach to identifying unmeasured strong ions in plasma than does the AG. The critical difference between the AG and SIG is that the SIG provides an estimate of the difference between unmeasured strong cations and strong anions, whereas AG

provides an estimate of the difference between unmeasured cations and anions (including strong ions and nonvolatile buffer ions such as albumin, globulins, and phosphate). A change in SIG therefore provides a more specific method for detecting a change in unmeasured strong ions (such as lactate) than a change in AG.

#### Osmolal gap

**Evaluation of the osmolal gap** is a means of detecting an increased amount of abnormal osmotically active solute in the blood. The osmolal gap is the difference between the measured plasma osmolality and the osmolality calculated from the plasma concentration of normally measured solutes. Sodium and potassium and their associated anions, along with glucose and urea, constitute the majority of normal osmotically active solutes. The following formula is recommended, although many clinicians disregard the contribution of serum urea nitrogen (SUN) because it is an ineffective osmole that easily crosses cell membranes:

$$1.86 \times ([Na^+] + [K^+]) + (glucose/18) + (SUN/2.8) + 8.6.$$

Examination of the triad of **calculated osmolality**, **measured osmolality** and the **osmolal gap** is beneficial in the diagnosis and prognosis of a number of diseases.

The effects of acidemia on the anion gap and electrolytes can vary depending on the cause of the acidosis and the species involved. Experimentally in horses, the infusion of L-lactic acid and D- and L-lactic acid results in acidosis with a high anion gap.<sup>11</sup> An infusion of hydrochloric acid causes metabolic acidosis with a decreased anion gap. Saline infusions cause mild acidosis with no significant change in anion gap. The plasma potassium was decreased by the infusions of the organic acids but not by hydrochloric acid. Hypophosphatemia occurred with the saline and hydrochloric acid infusions but not with the organic acids. These results indicate that large changes in plasma potassium and serum inorganic phosphate can occur in acidosis in the horse and are probably not the direct result of acidemia. High-intensity exercise in the horse results in a progressive rise in plasma potassium and lactate.<sup>12</sup>

#### Arterial blood pressure

Arterial blood pressure and central venous pressure are not measured routinely but are occasionally measured in referral centers where the technical assistance and instrumentation are readily available. Mean arterial blood pressure provides a rough guide for the presence and severity of terminal shock but not for the severity or extent of the initiating lesion.

#### Jugular or central venous pressure

This is more useful as a monitor during fluid replacement. Normal pressure is 2–10 cmH<sub>2</sub>O (0.3–1.0 kPa), referenced to the point of the shoulder (scapulohumeral joint). Below 2 cmH<sub>2</sub>O (0.3 kPa) requires fluid therapy; above 15 cmH<sub>2</sub>O (1.5 kPa) indicates cardiac failure and volume overload.

#### Total body water

Total body water can be measured in horses before and after exercise using orally administered deuterium oxide followed by a series of blood samples taken for analysis.<sup>13</sup> Mean total body water content is about 62%. It is not determined clinically.

#### PRINCIPLES OF FLUID AND ELECTROLYTE THERAPY

The most important principle is to prevent or minimize dehydration and electrolyte loss whenever possible. This means the provision of an adequate water supply, adequate drinking space and a continuous supply of salt and the necessary minerals. The next most important principle is to treat potential losses of fluid and electrolytes as quickly as possible to minimize the degree of dehydration and acid-base imbalance that may occur in animals with diseases in which losses are occurring.

The **major therapeutic objectives** are to **correct the abnormalities** that already exist and to monitor and **provide maintenance therapy** until the animal has recovered. Correction of the abnormalities may require 4–6 hours and maintenance therapy may be necessary for 2–4 days, depending on the cause of the disease. There are at least four possible abnormalities that could exist at the same time and must be corrected:

- **Fluid volume deficit**
- **Plasma osmolar deficits**
- **Specific electrolyte imbalances**
- **Acid-base imbalance.**

The two major problems are to determine the nature and degree of the abnormalities present and to decide which fluid and electrolyte replacement solution should be used.

The ideal situation would be to make both a clinical and laboratory evaluation of the animal as described above. The history and the diagnosis will suggest the possibility of acidemia or alkalemia and the electrolyte imbalances that are likely to be present. The degree of dehydration can usually be recognized clinically. Severe dehydration and acidemia should be treated as quickly as possible. A summary of the disturbances of fluid and electrolyte balance that occur in some common diseases of cattle and horses,

and the suggested fluid therapy, is presented in Table 2.2.

**Calculation of electrolyte requirements**

The electrolyte deficits can be estimated using the serum electrolyte values of the affected animal. The total deficit of the electrolyte in milliequivalents (mEq) is the product of the deficit of the electrolyte in mEq per liter ( $\Delta\text{mEq/L}$ ) and the distribution space for the electrolyte. For sodium, chloride and bicarbonate, the distribution space is the extracellular fluid volume, which approximates 30% of BW in normally hydrated adults and 50% in normally hydrated neonates. In other words, for sodium, chloride and bicarbonate, the total milliequivalent deficit =  $(\Delta\text{mEq/L}) \times (\text{estimated euhydrated body weight in kg}) \times (0.3 \text{ or } 0.5)$ .

There is less certainty about the size of the potassium space because potassium is mainly an intracellular ion.

**Types of intravenous fluid**

Fluids are categorized on the basis of their physical nature (**crystalloid** or **colloid**) and osmolarity (**hypotonic**, **isotonic** or **hypertonic**). Isotonic or slightly hypotonic crystalloid solutions are most commonly administered parenterally, although under specific circumstances hypertonic crystalloid solutions or isotonic colloid solutions are preferred.

**Crystalloid solutions**

A crystalloid is a substance that forms a true solution and is capable of being crystallized. Examples of crystalloid solutions are Ringer's solution, lactated Ringer's solution, acetated Ringer's solution, 0.9% NaCl, 7.2% NaCl (hypertonic saline), 1.3%  $\text{NaHCO}_3$ , 8%  $\text{NaHCO}_3$ , calcium gluconate and 50% dextrose. Sodium chloride is the classic crystalloid solution, as table salt (NaCl) exists as a crystal but dissolves completely when placed in water. Because crystalloids dissolve completely in water, crystalloid solutions containing sodium distribute throughout the entire extracellular fluid space and are therefore not confined to the intravascular space. Sodium-containing crystalloid solutions are always indicated in hypovolemia (circuit problem) but are contraindicated in congestive heart failure (pump problem) because they provide an additional sodium load, and animals with heart failure have already retained too much sodium. Sodium-containing crystalloid solutions are also contraindicated in the presence of severe hypoalbuminemia because sodium-containing crystalloids will further decrease plasma albumin concentration and oncotic pressure, resulting in movement of fluid into the interstitial spaces and exacerbating tissue edema.

Crystalloid solutions are characterized in terms of the number of molecules (numerator) per volume of solution

(denominator). The number of molecules is expressed in moles (abbreviated as mol), where 1 mol of compound is equivalent to the molecular weight of the compound in grams (formula weights for NaCl,  $\text{NaHCO}_3$  and KCl are 58.5 g, 85 g and 74 g respectively). Because body fluids are dilute, we express moles as millimoles (mmol = mol/1000) to facilitate readability.

Crystalloid solutions are commonly expressed in terms of the number of charged components (numerator) per volume of solution (denominator). The number of charged components is expressed in equivalents (abbreviated as Eq), where 1 Eq is the number of each charged component that combines with or replaces 1 mol of hydrogen ion (this means that Eq is always a positive number). Because body fluids are dilute, equivalents are expressed as milliequivalents (mEq = Eq/1000). To calculate the number of mEq from mmol, we simply multiply the number of millimoles by the valence (charge), whereby:  $\text{mEq/L} = (\text{mmol/L}) \times \text{valence}$ . For instance, 1 mmol of NaCl in solution provides 2 mEq: 1 mEq of  $\text{Na}^+$  ( $1 \times 1$ ) and 1 mEq of  $\text{Cl}^-$  ( $1 \times 1$ ), assuming that NaCl acts as a strong electrolyte in water (i.e. it completely dissociates into  $\text{Na}^+$  and  $\text{Cl}^-$  in water). In comparison, 1 mmol of  $\text{CaCl}_2$  in solution provides 4 mEq: 2 mEq of  $\text{Ca}^{2+}$

**Table 2.2 Summary of disturbances of body water, electrolytes and acid-base balance in some common diseases of cattle and horses, and suggested fluid therapy.**

Disease	Major abnormalities and deficits	Fluid and electrolyte requirements
Neonatal calf diarrhea (including piglets and lambs)	Metabolic acidosis, low plasma bicarbonate, severe dehydration, loss of sodium, hyperkalemia when acidosis severe	Equal mixtures of isotonic saline and isotonic sodium bicarbonate with 5% dextrose. Balanced electrolytes too, IV and PO. See Colibacillosis, Ch. 18, for details
D-lactic acidosis (carbohydrate engorgement of ruminants)	Metabolic acidosis, low plasma bicarbonate, severe dehydration	Sodium bicarbonate initially followed by balanced electrolytes, IV. See Acute carbohydrate engorgement of ruminants, Ch. 6, for details
Acute diffuse peritonitis	Dehydration. Slight metabolic alkalosis due to paralytic ileus	Balanced electrolyte solutions in large quantities IV for hydration and maintenance
Right-side dilatation/abomasal volvulus of cattle, abomasal impaction (dietary or vagal nerve injury)	Metabolic alkalosis, marked hypochloremia, hypokalemia, severe dehydration	Balanced electrolyte solutions or high-potassium and chloride-acidifying solution, IV. May give acidifying solutions orally. See Right-side displacement of abomasum Ch. 6, for details; can also use mixture of 2 L of isotonic saline (0.9%), 1 L isotonic potassium chloride (1.1%) and 1 L isotonic dextrose (5%)
Peracute coliform mastitis	Severe dehydration, mild electrolyte deficits including mild hypocalcemia. Metabolic acidosis if diarrhea present	Balanced electrolyte solutions IV in large quantities for hydration and maintenance for 24–48 hours (100–150 mL/kg B W/24 h)
Acute diarrhea in the horses (enteric salmonellosis)	Severe dehydration, marked hyponatremia, metabolic acidosis. Hypokalemia occurs following bicarbonate therapy	Hypertonic sodium bicarbonate (5%) 3–5 L/500 kg BW followed by high-sodium, high-potassium alkalizing solution to correct hypokalemia following bicarbonate therapy. All by the IV route
Acute grain engorgement in the horse	Metabolic acidosis, dehydration and shock	Hypertonic sodium bicarbonate (5%) 3–5 L/500 kg BW followed by balanced electrolytes IV
Water and electrolyte deprivation. Esophageal obstruction in horses	Moderate dehydration	Balanced electrolytes IV. When obstruction relieved, provide electrolyte solution orally
Acute intestinal obstruction	Metabolic acidosis or alkalosis dependent on level of obstruction. Severe dehydration in horse, moderate in cow	Isotonic sodium bicarbonate initially, 3–5 L/500 kg BW followed by balanced electrolytes IV. Horses may develop hypokalemia following bicarbonate therapy and must be given potassium chloride

(1 × 2) and 2 mEq of Cl<sup>-</sup> (2 × 1), and 1 mmol of dextrose provides 0 mEq, because dextrose does not dissociate into charged components in water.

The principal reason we define constituents of plasma in terms of mEq instead of mmol is because electro-neutrality must be preserved at all times; the difference between the charge assigned to all strong cations (Na<sup>+</sup>, K<sup>+</sup>, Ca<sup>2+</sup>, Mg<sup>2+</sup>) and strong anions (Cl<sup>-</sup>, lactate, sulfate, ketoacids, non-esterified fatty acids, etc.) in plasma is called the **strong ion difference** and this factor independently and directly alters blood pH and therefore acid-base status. The normal SID of plasma is approximately 40 mEq/L, although there are species differences in the actual value. Electrolyte solutions with an effective SID of more than 40 mEq/L are therefore alkalinizing because they create a strong ion alkalosis. Electrolyte solutions with an effective SID = 0 are acidifying because they create a strong ion acidosis. Electrolyte solutions of intermediate SID may be alkalinizing or acidifying, depending upon the change in plasma SID relative to the decrease in plasma protein concentration (which is alkalinizing) (Table 2.3).

#### Isotonic, hypertonic, and hypotonic crystalloid solutions

The tonicity of the solution is an important clinical issue. Complete understanding of the tonicity concept requires differentiation of two terms, **osmolality** and **osmolarity**. Osmolality is the number of dissolved particles per kilogram of solution and is expressed as mosmol/kg of solution. The normal plasma osmolality in large animals is approximately 285 mosmol/kg, and plasma osmolality is aggressively defended by increasing water intake (osmolality > 285 mosmol/kg) or promoting free water excretion (osmolality < 285 mosmol/kg). The correct term in plasma and extracellular fluid is osmolality, because this factor is measured in the laboratory; however, frequently the term osmolarity is used because 1 kg of plasma approximates 1 L of plasma and because osmolarity can be easily calculated from the concentration of electrolytes in the fluid solution. Osmolarity is the number of particles per liter of solution and is expressed as mosmol/L of solution.

One kg (1 L) of plasma from an adult large animal has two components, 70 g of protein and 930 g of plasma water. Accordingly, the osmolality of normal plasma (285 mosmol/kg) is equivalent to a plasma water osmolarity of 306 mosmol/L ((285 mosmol/kg)/(0.93 L/kg)). Ringer's solution, 0.9% NaCl and 1.3% NaHCO<sub>3</sub> are therefore considered isotonic solutions because they distribute in plasma

Table 2.3 Summary of effective strong ion difference (SID) and osmolarity of parenterally administered crystalloid solutions.

Solution	Effective SID (mEq/L)	Osmolarity (mosmol/L)
<b>Hypertonic solutions (&gt;312 mosmol/L)</b>		
<b>Alkalinizing</b>		
8.4% NaHCO <sub>3</sub>	1000	2000
5.0% NaHCO <sub>3</sub>	595	1190
10% NaH <sub>2</sub> PO <sub>4</sub>	145	1150
<b>Acidifying</b>		
50% dextrose	0	2500
7.2% NaCl	0	2460
25% magnesium sulfate	0	2028
23% calcium borogluconate	0	1069
<b>Isotonic solutions (300 to 312 mosmol/L)</b>		
<b>Alkalinizing</b>		
Tromethamine	210	300
1.3% NaHCO <sub>3</sub>	155	310
Carbicarb	75	300
McSherry's solution	54	312
Darrow's solution	53	312
<b>Acidifying</b>		
Ringer's solution	0	309
0.9% NaCl	0	308
1.15% KCl	0	308
<b>Hypotonic solutions (&lt;300 mosmol/L)</b>		
<b>Alkalinizing</b>		
Acetated Ringer's	27	294
Lactated Ringer's	<14	275
<b>Acidifying</b>		
5% dextrose	0	250

The effective SID is the difference between the strong cation and strong anion concentration after metabolizable anions (such as lactate or acetate) have been completely metabolized to produce bicarbonate. Electrolyte solutions with an effective SID of more than 27 mEq/L are alkalinizing because they create a strong ion alkalosis. Electrolyte solutions with an effective SID = 0 are acidifying because they create a strong ion acidosis.

water and have calculated osmolarities of 309 mosmol/L, 308 mosmol/L and 310 mosmol/L respectively.

The normal plasma osmolarity for large animals is 306 mosmol/L; solutions are defined as isotonic (300–312 mosmol/L), hypertonic (> 312 mosmol/L) or hypotonic (< 300 mosmol/L). Using this categorization, it is readily apparent that some routinely used crystalloid solutions are hypotonic; in particular, lactated Ringer's solution (275 mosmol/L) is mildly hypotonic and 5% dextrose (250 mosmol/L) is moderately hypotonic, although, as glucose is metabolized, 5% dextrose becomes an increasingly hypotonic solution. Erythrocytes are resistant to increases in plasma osmolarity, whereas they are susceptible to mild decreases in osmolarity; this is the basis of the red blood cell fragility test whereby red blood cell suspensions are placed in solutions of decreasing osmolarity. Because of hypotonic-induced hemolysis, parenterally administered fluids should be isotonic or hypertonic.

#### Hypotonic crystalloid solutions

**Lactated Ringer's solution** is a balanced, polyionic, alkalinizing, hypotonic (275 mosmol/L), crystalloid solution containing physiological concentrations of Na<sup>+</sup>, K<sup>+</sup>, Ca<sup>2+</sup>, Cl<sup>-</sup> and lactate

(CH<sub>3</sub>CH(OH)COO<sup>-</sup>). Lactated Ringer's solution alkalinizes because lactate is predominantly metabolized to the bicarbonate ion, whereby:

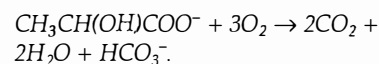

The lactate in lactated Ringer's is a racemic equimolar mixture of L-lactate and D-lactate; in healthy animals L-lactate is rapidly metabolized; however, animals have negligible D-lactate dehydrogenase activity, leading to slow clearance of D-lactate, which is primarily through the urinary system. DL-lactate solutions such as lactated Ringer's therefore have approximately half the alkalinizing ability of L-lactate solutions. The effective SID of lactated Ringer's solution is less than 14 mEq/L because L-lactate can also be used in gluconeogenesis instead of bicarbonate production. Lactated Ringer's solution is the standard intravenous fluid for neonates and adult horses because these animals tend to get acidemic when inappetent. However, lactated Ringer's solution is theoretically inferior to acetated Ringer's solution, because critically ill animals may have increased blood lactate concentrations and it is incongruous to add lactate in this situation.



**Acetated Ringer's solution** is a balanced, polyionic, alkalizing, hypotonic (294 mosmol/L), crystalloid solution. Commercially available formulations of acetated Ringer's solution contain physiological concentrations of  $\text{Na}^+$ ,  $\text{K}^+$ ,  $\text{Mg}^{2+}$ ,  $\text{Cl}^-$ , acetate ( $\text{CH}_3\text{COO}^-$ ) and gluconate ( $\text{CH}_2(\text{OH})(\text{CH}(\text{OH}))_4\text{COO}^-$ ); the gluconate is problematic because calves (and presumably all large animals) slowly metabolize gluconate.<sup>14</sup> Acetated Ringer's solution alkalizes because acetate is metabolized to the bicarbonate ion, whereby:

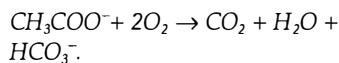

The strong ion approach to acid-base balance states that acetated Ringer's solution is alkalizing because it contains a metabolizable strong anion (acetate) that, when metabolized, increases the SID.

**Five percent dextrose** is 250 mosmol/L as administered, but plasma osmolarity decreases as the glucose is metabolized, leaving free water. Because 5% dextrose has no sodium to expand the extracellular volume and has much less energy content than 50% dextrose on a volume basis, the only application of 5% dextrose is to provide free water or as a vehicle for pharmacological agents.

#### Isotonic crystalloid solutions

**Ringer's solution** is a balanced, polyionic, nonalkalizing, isotonic, crystalloid solution that contains physiological concentrations of  $\text{Na}^+$ ,  $\text{K}^+$ ,  $\text{Ca}^{2+}$ , and  $\text{Cl}^-$ . This solution is mildly acidifying because its effective SID = 0 mEq/L. Addition of a fluid with a SID of 0 mEq/L to plasma (normal SID  $\approx$  40 mEq/L) will decrease plasma SID and therefore directly and independently decrease plasma pH because a 1 mEq/L decrease in SID decreases plasma pH by approximately 0.016. Ringer's solution is the standard intravenous fluid for adult ruminants because these ruminants tend to get alkalemic when inappetent.<sup>15</sup>

**Isotonic saline (0.9% NaCl solution)** is an isotonic crystalloid solution that has little merit in the routine treatment of sick ruminants, principally because ruminants usually develop hypocalcemia and hypokalemia when inappetent. Accordingly, the use of 0.9% NaCl should be confined to horses, the irrigation of surgical sites and wounds, or as a vehicle for adding other electrolytes and dextrose. Like Ringer's solution, 0.9% NaCl is mildly acidifying because effective SID = 0 mEq/L.

**Isotonic sodium bicarbonate (1.3%  $\text{NaHCO}_3$  solution)** is an alkalizing isotonic crystalloid solution that is used to treat severe acidemia (indicated when-

ever blood pH < 7.20 as a result of metabolic acidosis). This solution is alkalizing because it buffers hydrogen ion:  $\text{HCO}_3^- + \text{H}^+ \rightleftharpoons \text{CO}_2 + \text{H}_2\text{O}$ , and because it increases SID (effective SID = 155 mEq/L). Sodium bicarbonate is superior to sodium L-lactate and sodium acetate for the treatment of metabolic acidosis because it provides an immediate source of bicarbonate. On theoretical grounds, sodium bicarbonate ( $\text{NaHCO}_3$ ) should not be used to treat severe respiratory acidosis because additional  $\text{CO}_2$  generated may worsen the respiratory acidosis.

**Tromethamine** (Tham, tris-hydroxymethyl aminomethane, 300 mmol/L) is an isotonic solution of an organic amine that is a safe and effective buffer.<sup>16</sup> After administration, 70% of the neutral compound ( $\text{CH}_2\text{OH})_3\text{C-NH}_2$  in tromethamine is immediately protonated to the strong cation ( $\text{CH}_2\text{OH})_3\text{C-NH}_3^+$  in plasma, with the net equation being:

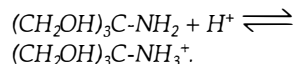

The remaining 30% of the administered tromethamine remains unprotonated and can therefore cross cell membranes and potentially buffer the intracellular compartment. Tromethamine therefore provides an alternative alkalizing agent to sodium bicarbonate; however, tromethamine does not currently appear to offer any important clinical advantages over sodium bicarbonate in spontaneously breathing animals.

Isotonic formulations are available for intravenous administration with or without electrolytes; administration of tromethamine without electrolytes leads to hyponatremia and it would appear preferable to administer tromethamine in conjunction with electrolytes.

**Carbicarb** is an isotonic buffer (300 mosmol/L) made from equimolar disodium carbonate ( $\text{Na}_2\text{CO}_3$ ) and sodium bicarbonate; carbonate avoids generation of  $\text{CO}_2$  when buffering acidemic blood.<sup>17</sup>

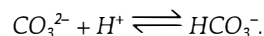

Carbicarb was suspected to decrease the incidence and magnitude of hypercapnia when rapid alkalization was needed in animals with mixed metabolic and respiratory acidosis. Despite numerous studies comparing Carbicarb to sodium bicarbonate, the potential clinical advantages of Carbicarb have only been demonstrated in animals being ventilated or with extremely limited ventilatory ability. Carbicarb has been administered intravenously to diarrheic calves; however, these studies have failed to identify a clinically important advantage over con-

ventional isotonic sodium bicarbonate administration.<sup>18</sup> Accordingly, there does not appear to be a compelling reason to prefer Carbicarb to isotonic sodium bicarbonate when rapid alkalization of conscious animals is required.

**Darrow's solution** is an isotonic polyionic solution formulated by Darrow in 1946 for use in human infants; the solution has been administered to calves.<sup>19,20</sup> Compared to other isoosmotic polyionic solutions, Darrow's solution is hyponatremic, hyperkalemic and hyperlactatemic and does not contain calcium or magnesium. As such, Darrow's solution is not recommended for administration to large animals.

**McSherry's balanced electrolyte solution** is an isotonic polyionic solution formulated by McSherry and Grinyer in 1954 for intravenous and intraperitoneal administration to dehydrated diarrheic calves.<sup>21</sup> On theoretical grounds, this is an excellent parenteral fluid for resuscitating dehydrated diarrheic calves that deserves more frequent use. Unfortunately, commercial formulations are currently unavailable.

#### Hypertonic crystalloid solutions

**Fifty percent dextrose** is 2500 mosmol/L (approximately eight times normal osmolarity). Fifty percent dextrose solutions are commonly administered to ruminants with ketosis or hypoglycemia and produce a transient increase in cardiac contractility.<sup>22</sup> Some commercially available formulations in Europe contain an equimolar mix of dextrose and fructose, although the addition of fructose does not appear to produce a more sustained increase in plasma glucose concentration than that produced by glucose alone.<sup>23</sup>

The necessity for glucose in fluid therapy has been controversial. Hypoglycemia occurs commonly in septicemic neonates and calves with diarrhea but is uncommon in most other common diseases in which there is an acute fluid and electrolyte disturbance. Dextrose will promote the movement of extracellular potassium into the cell, will provide metabolic water and is a source of carbohydrate. If glucose is indicated, large quantities of parenteral glucose are necessary to meet the maintenance energy requirements and every effort must be made to restore the animal's appetite and to provide the necessary requirements through dietary intake. The energy requirements for maintenance are calculated on the basis of metabolic body size,  $\text{kg}^{0.73}$ , which is a measure of the fasting metabolism in an animal not eating and not doing any muscular work. If 1 g of dextrose given intravenously will provide 5 kcal (2.1 kJ) of energy, the

**Table 2.4** Estimated daily energy requirements of fasting cattle.

Body weight (kg)	Metabolic body size (kg W <sup>0.73</sup> )	Metabolizable energy requirements (kcal)	Glucose 0% (L/day)
45 (1-month-old calf)	16	1760	7
90	27	2970	1.2
180	45	4950	2.0
360	74	8140	3.3
454	67	9510	3.8
544	100	12100	4.8

approximate amounts of dextrose solution needed to meet the energy needs for maintenance in cattle are shown in Table 2.4. Table 2.4 comprises a rough estimate of the requirements and should be used as a general guideline only. Every effort should be made to supply the energy needs through oral intake of energy-containing foods.

**NaCl 7.2% (Hypertonic saline)** is 2460 mosmol/L (approximately eight times normal osmolality) and is used for the rapid resuscitation of animals with hypovolemia. Hypertonic saline should be administered at 4–5 mL/kg BW intravenously over 4–5 min (1 ml/kg BW/min). Faster rates of administration lead to hemodynamic collapse due to vasodilation and decreased cardiac contractility, whereas slower rates of administration provide no advantages over isotonic crystalloid solutions. Like high-volume 0.9% NaCl, small-volume hypertonic saline consistently induces a mild strong ion acidosis as its effective SID = 0 mEq/L. In general, the decrease in pH following hypertonic saline administration is less than 0.08 pH units and rapidly dissipates with time.<sup>23</sup> The effect of hypertonic saline on acid-base balance is therefore clinically inconsequential.

The use of small volumes (4–5 mL/kg BW) of hypertonic saline solution, ranging in concentration from 7.0% to 7.5%, has been extensively evaluated for the treatment of various forms of hemorrhagic, septic and endotoxic shock.<sup>24</sup> Plasma volume is increased by the movement of free water from the intracellular space, thereby increasing cardiac output, mean arterial blood pressure, systemic oxygen delivery and glomerular filtration rate. Total peripheral vascular resistance and pulmonary vascular resistance decrease, and mean circulatory filling pressure increases. Urine output is restored and acid-base equilibrium returns towards normal in conjunction with improved tissue perfusion.

Hypertonic saline solution is widely used for the treatment of dairy cattle with endotoxic shock and endotoxemia associated with coliform mastitis. Affected cows

are given 2 L of hypertonic saline (4–5 mL/kg BW) intravenously, followed by immediate access to drinking water and other supportive therapy. The small volume of hypertonic saline followed by the oral water load increases circulatory volume rapidly, induces slight metabolic acidosis, increases renal perfusion and glomerular filtration rate, and induces homeostatic changes in serum calcium and phosphorus.<sup>25</sup> In experimental endotoxin-induced mastitis of cattle, small volumes of hypertonic saline given intravenously (7.5%, 5 mL/kg BW) resulted in expanded plasma volume and increased the cows' voluntary water intake by about 12 times compared to cows treated with isotonic saline.<sup>26</sup> The rapid intravenous administration of hypertonic saline can successfully, but only transiently, resuscitate calves in experimental endotoxic shock.<sup>27</sup> Hypertonic saline (7.2% NaCl, 2400 mosmol/L), 4 mL/kg BW intravenously over 4 min can be safely administered to endotoxic calves.<sup>28</sup> On a comparative basis, the rapid infusion of large-volume isotonic saline is superior to small-volume hypertonic saline for initial resuscitation of experimentally induced acutely endotoxemic calves.<sup>27</sup>

Hypertonic saline has been associated with greater and more prolonged improvement in cardiopulmonary function and survival in horses with experimentally induced hemorrhagic and endotoxemic shock and in halothane-induced hypotension in horses.<sup>29</sup> When given intravenously to normal conscious horses at 5 mL/kg BW, there are increases in plasma osmolality and serum sodium and chloride but clinically normal horses rapidly regulate variable sodium loads.<sup>30</sup>

**Sodium bicarbonate 8.4%** is 2000 mosmol/L (approximately seven times normal osmolality). This solution is used for rapid alkalization, particularly in the presence of severe acidemia (pH < 7.20). The solution osmolality was selected because it provides 1 mEq of HCO<sub>3</sub><sup>-</sup>/mL of solution, which facilitates calculation of the volume to be administered. The speed of intravenous adminis-

tration of 8.4% sodium bicarbonate should not exceed 1 (ml/kg BW)/min. There is one report of the intravenous administration of 8.4% sodium bicarbonate to normovolumic calves with experimentally induced mixed respiratory and metabolic acidosis; the study found that rapid administration of NaHCO<sub>3</sub> (5 mL/kg intravenously over 5 min) rapidly corrected the metabolic acidosis, increased blood pH and improved cardiovascular status without inducing paradoxical cerebrospinal fluid acidosis,<sup>31</sup> suggesting that this treatment may be of value in treating dehydrated diarrheic calves. Efficacy studies in calves with naturally acquired diarrhoea appear indicated. Hypertonic solutions of sodium bicarbonate are highly effective for the initial treatment of acidosis associated with D-lactic acidosis in calves, acute diarrhoea in calves<sup>31</sup> and strong ion (metabolic) acidosis in newborn calves.<sup>32</sup>

**Sodium bicarbonate 5%** is 1190 mosmol/L (approximately four times normal osmolality). This solution is also used for rapid alkalization in the presence of severe acidemia (pH < 7.20). The speed of intravenous administration of 5.0% sodium bicarbonate should not exceed 2 (ml/kg)/min. Three to five L of 5% sodium bicarbonate may be necessary as initial therapy to correct the severe hyponatremia and strong ion (metabolic) acidosis that occurs in the horse with acute diarrhoea. Following this initial treatment, hypokalemia characterized by muscular weakness commonly occurs, which can be treated using a high sodium, high potassium, alkalizing solution.

**Calcium gluconate 23% or calcium borogluconate** are 1069 mosmol/L (approximately three and a half times normal osmolality). Calcium borogluconate is the standard treatment for milk fever (hypocalcemia) in cattle. D-gluconate is an aldose sugar produced by oxidation of D-glucose and is the preferred salt for calcium-containing parenteral solutions because it does not cause tissue necrosis as severe as does CaCl<sub>2</sub>. Calcium gluconate should not be added to sodium bicarbonate solutions because a white precipitate (CaCO<sub>3</sub>) forms immediately that interferes with normal fluid administration. Likewise, calcium gluconate should not be administered with tetracycline antibiotics because a yellow precipitate forms.

#### Colloid solutions

A colloid is a substance that is too large to pass through a semipermeable membrane. Examples of colloid solutions administered to ruminants are whole blood, stroma-free hemoglobin, plasma, dextrans, hydroxyethyl starches and

gelatins. As a group, colloid solutions are excellent for sustained expansion of plasma volume, which is in marked contrast to the effect of crystalloid solutions. Colloid solutions are contraindicated in congestive heart failure because these animals have increased plasma volume. Colloid solutions are also contraindicated in the presence of oliguric or anuric renal failure because the sustained volume overload may lead to pulmonary edema.

**Whole blood** is the perfect balanced colloid/crystalloid solution, with great O<sub>2</sub>-carrying capacity. It has a short shelf life (< 24 h at 4°C) and is expensive to obtain. Whole blood administration runs the risk of disease transmission and allergic reactions; the latter are extremely rare in ruminants with the first blood transfusion but common enough in horses for blood typing or cross-matching to be required. Excellent descriptions for collecting, storing and administering blood are available elsewhere (Chapter 9).<sup>33</sup>

**Stroma-free hemoglobin** is a blood substitute containing a purified hemoglobin glutamer-200 solution (13 g hemoglobin/dL) derived from cattle blood. A commercially available solution has a 2-year shelf life at 20°C, an osmolarity of 300 mosmol/L and an oncotic pressure of 43 mmHg; the solution is therefore isotonic but hyperoncotic. Stroma-free hemoglobin solutions are excellent at increasing oxygen delivery and carrying capacity, while providing similar plasma volume expansion to dextrans and hydroxyethyl starches. The major theoretical concerns regarding administration of stroma-free hemoglobin solutions are potent vasoconstriction<sup>34</sup> and hemoglobinuric nephrosis. Some of the original experimental studies examining the effects of stroma-free hemoglobin administration were completed in sheep<sup>35,36</sup> and there are occasional reports of its successful administration to critically ill horses in a clinical situation. It is likely that the high cost of this product will minimize its administration to large animals.

**Plasma (fresh or frozen)** is an excellent balanced colloid/crystalloid solution. Compared with blood, plasma has a much longer shelf life (at least 1 year at -20°C) but is more expensive to obtain. Details for collection, harvesting, storing and administering plasma are available elsewhere,<sup>33</sup> and bovine, equine and New World camelid plasma is commercially available. Like blood, administration of plasma runs the risk of disease transmission and allergic reactions, although these risks are less than with blood transfusion.

Plasma is routinely administered to foals with inadequate transfer of passive

immunity. Hyperimmune plasma is occasionally administered to neonatal foals and adult horses with Gram-negative septicemia and endotoxemia. There appears to be only one report documenting the efficacy of plasma administered to neonatal calves with diarrhea, and these calves were probably colostrum-deprived. The 14-day survival rate in diarrheic calves that received 600–800 mL of bovine plasma (5 g protein/dL) and electrolytes intravenously was 93% (37/40), which was significantly greater than the survival rate of calves receiving intravenous electrolytes alone (54%, 7/13).<sup>37</sup> Another study failed to identify a beneficial effect of blood transfusion in treating diarrheic calves.<sup>38</sup> Because blood is cheaper to obtain than plasma, whole blood transfusions are usually administered when a neonatal ruminant needs plasma.

**Dextran preparations** (such as Dextran-70) are high-molecular-weight glucose polymers obtained by bacterial fermentation of sucrose; the fermentation metabolites then undergo acid hydrolysis and fractionation. The molecular weight of dextran can therefore be 'selected', and two dextran products, Dextran-70 (mean molecular weight 70 000) and Dextran-40 (mean molecular weight 40 000) are commercially available. Because the molecular weight of Dextran-70 is similar to albumin (molecular weight 65 000), there is limited diffusion of dextran into the interstitial space and Dextran-70 therefore acts clinically as a plasma volume expander; this is in contrast to isotonic crystalloid solutions, which act as extracellular fluid volume expanders. Dextran-70 has been the most widely used dextran formulation in large animals and is therefore the recommended product for administration. Dextran-70 is supplied as a 6% concentration in 0.9% NaCl; this provides a hyperoncotic but isotonic solution. Reported administration rates of Dextran-70 are 5–40 (mL/kg)/h, but it is safer to administer Dextran-70 at less than 20 (mL/kg)/h. One mL of Dextran-70 expands the plasma volume by 0.8–1.2 mL, but 50% of the administered dose is gone by 24 hours. Dextran administration runs the risk of exacerbating pre-existing coagulopathies, although the clinical significance of dextran-induced prolongation of activated partial thromboplastin time (APTT) by decreasing factor VIII:C is probably minimal. The risk of coagulopathy is dependent upon the administration rate, total dose administered (20 mL/kg is maximum 24 h dose in humans) and the molecular weight of dextran. The deleterious effects of dextrans are usually associated with large doses or prolonged administration.

The use of **hypertonic saline–dextran solution** (4 mL/kg, 2400 mosmol/L sodium chloride in 6% Dextran-70 administered intravenously once over 4 min) combined with an isotonic oral alkalinizing solution containing sodium chloride (3.22 g/L), potassium chloride (1.12 g/L), sodium acetate trihydrate (4.76 g/L) and glucose anhydrous (16.22 g/L), providing 300 mosmol/kg of water and administered at 55 mL/kg BW, was superior to either solution alone for the treatment of experimentally induced hypovolemic diarrhea in calves.<sup>39</sup> The combined treatment resulted in immediate and sustained increases in plasma volume, cardiac output and stroke volume, thereby improving tissue perfusion. Rapid and sustained rehydration after the combined treatment was indicated by improvement in hydration and clinical depression scores and decreases in hematocrit, blood lactate concentration and serum creatinine, albumin and phosphate concentrations. Resuscitation with oral electrolyte solution alone was slower but was complete within 24 hours. Resuscitation with the hypertonic saline–dextran solution alone resulted in only transient benefit.

The administration of hypertonic saline–dextran solution (7.2% NaCl solution with 6% dextran at the rate of 4 mL/kg BW, intravenously during a 4 min period, combined with oral administration of isotonic electrolyte solution at the rate of 50–60 mL/kg BW) provided a rapid and effective method for resuscitating severely dehydrated calves with experimentally induced diarrhea<sup>40</sup> or with naturally acquired diarrhea.<sup>41</sup>

**Hydroxyethyl starch preparations (hetastarch, pentastarch)** Two hydroxyethyl starch preparations are currently commercially available; hetastarch and pentastarch. Hetastarch is a high-molecular-weight glucose polymer (mean molecular weight 450 000) that is chemically synthesized from amylopectin, producing a highly branched glucose polymer with a structure similar to that of glycogen. Because the molecular weight of hetastarch is much greater than that of albumin, hetastarch decreases endothelial permeability by sealing separations of endothelial cells. Hetastarch is hydrolyzed in blood by  $\alpha$ -amylase, and the addition of hydroxyethyl groups slows hydrolysis and therefore prolongs the duration of plasma volume expansion. Hetastarch is supplied as a 6% concentration in 0.9% NaCl; this provides a hyperoncotic but approximately isotonic solution. Reported administration rates are 5–40 (mL/kg BW)/h but, like Dextran-70, it is safer to administer hetastarch at less than 20 (mL/kg BW)/h. Like Dextran-70, hetastarch administration also runs

the risk of exacerbating pre-existing coagulopathies. The risk of coagulopathy is dependent upon the administration rate and total dose administered (20 mL/kg BW is the maximum 24 h dose in humans).

Pentastarch has a mean molecular weight of 280 000 and is available as a 10% solution. Pentastarch has two important advantages over hetastarch: it has less exacerbating effect on pre-existing coagulopathies and the rate of elimination is faster. Pentastarch has rarely been administered to large animals.

**Gelatins (modified bovine collagens)** are available for veterinary use. The formulation uses gelatin with a mean molecular weight of 30 000 and is a 5.6% suspension in NaCl. Compared to dextrans and hydroxyethyl starches, gelatins have a shorter plasma half-life but appear to have less effect on coagulation. In general, gelatins have not been evaluated as completely as dextrans and hydroxyethyl starches and, on this basis, are not currently preferred.

#### Practical administration of electrolyte solutions

Under ideal conditions, with laboratory evaluation of the animal, the deficits can

be accurately assessed and fluids containing the deficient electrolytes can be formulated. However, under most practice conditions this is not possible and **polyionic crystalloid solutions** are in general use. These usually contain sodium, potassium, chloride and calcium or magnesium at a concentration similar to the electrolyte composition of extracellular fluid; the solutions may also contain lactate or acetate as bicarbonate precursors. Dextrose may be added to the solution to make an initial mildly hypertonic solution.

Polyionic crystalloid solutions are safe and can be used in large quantities without inducing electrolyte disturbances provided that circulating blood volume and renal function have been restored and are maintained. They can be used for most situations of dehydration and moderate acidemia or alkalemia and moderate electrolyte imbalances. They are not usually adequate for the treatment of severe acidemia or alkalemia, or severe hyponatremia, hypokalemia or hypochloremia.

For the treatment of severe acidemia or alkalemia, and severe hyponatremia, hypokalemia and hypochloremia, specific

electrolyte solutions are necessary. Generally, they consist of a mixture of the common simple solutions with supplemented electrolytes to correct some major abnormality. These are considered necessary to correct abnormalities quickly that could not be corrected using balanced electrolyte solutions. These solutions are summarized in Tables 2.3 and 2.5. Many intravenous solutions for fluid therapy in calf diarrhea are available and it is recommended that they should contain 150 mmol/L of sodium, 5 mmol/L of potassium and about 50 mmol/L of a mixture of bicarbonate and precursors.<sup>42</sup>

When acidemia is not present it is not necessary to use a fluid containing bicarbonate.<sup>43</sup>

Mature cattle affected with metabolic alkalosis associated with diseases of the abomasum are usually hypokalemic, hypochloremic and dehydrated. For such cases, a balanced electrolyte solution containing sodium, chloride and potassium is satisfactory. A solution containing sodium (135–155 mEq/L), chloride (150–170 mEq/L) and potassium (10–20 mEq/L) is effective.<sup>43</sup> In recently calved dairy cattle, calcium borogluconate is commonly added to the mixture.

Table 2.5 Composition (mmol/L) and indications for use of electrolyte solutions used in fluid therapy.

Solution	Na <sup>+</sup>	K <sup>+</sup>	Cl <sup>-</sup>	Mg <sup>2+</sup>	Ca <sup>2+</sup>	HCO <sub>3</sub> <sup>-</sup>	Lactate or acetate	Dextrose	Major indications
0.9% sodium chloride isotonic saline)	155		155						Expansion of circulating blood volume
1.3% sodium bicarbonate (isotonic)	155					156			Metabolic acidosis
1.3% sodium bicarbonate in 5% dextrose	155					156		5%	Metabolic acidosis
5% sodium bicarbonate (hypertonic)	600					600			Severe metabolic acidosis
Equal mixture of isotonic saline and isotonic sodium bicarbonate	155		78			78			Metabolic acidosis and dehydration
Balanced electrolyte solution (i.e. McSherry's solution)	138	12	100	5	3		50 (acetate)		Metabolic acidosis electrolyte losses and dehydration
Lactated Ringer's solution	130	4	111		3		28 (lactate)		Metabolic acidosis
High sodium, alkalinizing solution. Lactated	190	4	111			60	27 (lactate)		Metabolic acidosis and hyponatremia
Ringer's solution plus sodium bicarbonate (5 g/L)	190	18	125			60	27 (lactate)		Metabolic acidosis, hyponatremia, hypokalemia
High sodium, high potassium, alkalinizing sodium	190	18	125			60	27 (lactate)		Metabolic acidosis, hyponatremia, hypokalemia
Lactated Ringer's solution plus 1 g/L potassium chloride and 5 g/L sodium bicarbonate	154	35	189						Metabolic alkalosis, hypochloremia, hypokalemia
High-potassium acidifying solution, isotonic saline plus 2.5-g potassium chloride/L									Metabolic alkalosis, hypochloremia, hypokalemia
Mixture of 1 L isotonic potassium chloride (1.1%), 2 L isotonic saline (0.9%) and 1 L dextrose 9%									Metabolic alkalosis in cattle with abomasal disease

Solutions containing potassium have been recommended for the treatment of the potassium depletion that occurs in calves with acute diarrhea and in inappetent ruminants and horses. However, in calves with severe acidemia and hyperkalemia, it is important to expand circulating blood volume, restore renal function and correct the strong ion (metabolic) acidosis before providing additional potassium, which may be toxic. Solutions containing potassium may be indicated following correction of the acidosis and dehydration. However, if the animal's appetite is returned to normal, the oral potassium intake will usually correct any existing deficiencies.

For the treatment of hypochloremic, hypokalemic, metabolic alkalosis, acidifying solutions can be used but preferably only if constant laboratory evaluation of the animal is possible. Without laboratory evaluation, the use of Ringer's solution, 0.9% NaCl or hypertonic saline for correction of strong ion (metabolic) alkalosis in adult cattle is recommended, along with the oral administration of potassium in animals that are inappetent. In experimentally induced hypochloremic hypokalemic metabolic alkalosis in 40–50 kg BW sheep, replacement of the chloride deficit using 2 L of hypertonic saline (1.8% sodium chloride) was effective in returning plasma sodium and chloride concentrations to normal within 12 hours, and the plasma potassium concentrations and acid–base balance returned to normal within 36 hours of treatment without providing potassium.<sup>44</sup> Small volumes of hypertonic saline are also effective for the treatment of experimentally induced hypochloremic, hypokalemic metabolic alkalosis in sheep.<sup>45</sup>

In summary, four different kinds of solutions are used in large animal practice:

- **Polyionic crystalloid solutions**, such as lactated Ringer's solution and acetated Ringer's solution, are indicated for dehydration and moderate degrees of acid–base and electrolyte imbalance
- **Hypertonic saline solution and an oral water load** represent a practical and inexpensive alternative to parenteral administration of large fluid volumes
- **Hypertonic or isotonic sodium bicarbonate**, such as 8.4%, 5.0% (hypertonic) or 1.3% (isotonic) solutions of sodium bicarbonate, are used for severe strong ion (metabolic) acidosis and hyponatremia
- **Chloride-containing acidifying solutions**, such as Ringer's solution, are used for treatment of strong ion (metabolic) alkalosis.

Because cost is a major consideration in large animal fluid therapy, it may not be possible to use sterile solutions. Most of the above solutions can be formulated using the necessary salts mixed with distilled water, boiled water or ordinary tap water and are therefore prepared inexpensively.

#### Quantity of fluids required and routes of administration

The amount of fluid required depends on the degree of dehydration (an estimate of the volume losses which have already occurred), the continuous losses which are occurring during treatment, and the maintenance requirements of the animal during treatment presuming its dietary intake of water, electrolytes and nutrients is minimal. The fluids are usually given in two stages:

- **Hydration therapy** in the first 4–6 hours at a rate of 100–150 mL/kg BW intravenously
- **Maintenance therapy** (a combination of **continuous losses** and **maintenance requirements**) in the next 20–24 hours, depending on the severity and the course of the disease, at 60–80 mL/kg BW/24 hours intravenously (approximately 3–4 mL/kg BW/hour). In some cases of profuse diarrhea, the continuous losses and maintenance requirements will be about 150 mL/kg BW over a 24-hour period. The daily maintenance water requirements of adult horses range from 54–83 mL/kg BW, with a mean of 64 mL/kg BW.<sup>46</sup>

Some examples of the large quantities of fluid required for hydration and maintenance therapy in cases of acute diarrhea are outlined in Table 2.6.

#### Parenteral fluid therapy

The total amount of the estimated necessary hydration therapy should be given intravenously using indwelling intravenous catheters in the first 4–6 hours in order to expand and maintain circulating blood volume. If acidemia or alkalemia is present, it also should be

treated immediately. Thus the most important abnormalities – decreased circulating blood volume and acid–base imbalance – are treated first. Restoring circulating blood volume will restore renal function, which will assist in correcting acid–base and electrolyte balance. The immediate correction of acidemia will return the tissues to their normal physiological activity. The intravenous route is preferred for hydration therapy and for the correction of severe acid–base and electrolyte imbalances. All other routes (intraperitoneal, subcutaneous and oral) are unsatisfactory in the presence of decreased circulating blood volume.

During the intravenous administration, the animal must be monitored for clinical and laboratory evidence of improvement or deleterious effects. A **favorable response** is indicated by urination within 30–60 minutes, an improvement in mental attitude and some evidence of hydration. **Unfavorable responses** include **dyspnea** because of pre-existing pneumonia or pulmonary edema because of too rapid administration, **failure to urinate** because of renal failure or paralysis of the bladder, and **tetany** because of the excessive administration of alkali. Unusual responses such as sweating, trembling and depression within several hours following the intravenous administration of electrolytes or other substances such as commercial amino-acids may occur if the infusion is contaminated during administration.<sup>47</sup> If a laboratory is available, the determination of PCV, bicarbonate and blood pH will provide an excellent monitoring system during the administration of the fluids.

#### Rate of administration

The rate of administration will depend on the size of the animal, the severity of the illness, the type of fluids being administered and the response of the animal to the fluids. In calves, isotonic saline (0.9% NaCl) and sodium bicarbonate solutions can be given at the rate of 1–3 L/h; in a mature horse, fluids may be given at the

Table 2.6 Examples of approximate amounts of fluid required for hydration and maintenance therapy

Animal	Degree of dehydration (% of body weight)	Fluid required for:	
		Hydration (L)	Maintenance (L/24 h)
Mature horse (500 kg)	8	40	25–50
	12	60	25–50
Newborn calf (50 kg)	8	4	2.5–5
	12	6	2.5–5
Mature cow (700 kg)	8	56	35–70
	12	84	35–70

rate of 10–12 L/h. Hypertonic solutions such as 5% sodium bicarbonate can be given to a mature horse at the rate of 3–5 L/h, followed by balanced electrolytes at 10–12 L/h. Solutions containing added potassium should be given cautiously, at the rate of 3–5 L/h. In a cow with severe dehydration and acidosis due to carbohydrate engorgement, fluids may be given at the rate of 10–12 L/h.

**Adverse reactions** in all species include **sudden muscle weakness** (suggests hypokalemia) and sudden **tachycardia** and **hyperventilation**, which suggest **overhydration**. When these occur the fluids should be stopped and the clinical findings assessed. If laboratory assistance is available, the determination of blood pH and bicarbonate may provide an explanation for the reaction.

**Intravenous catheters and complications**  
The administration of large quantities of fluids intravenously to farm animals is best done with an indwelling **jugular vein** flexible catheter (10–14-gauge) that is appropriately secured to the animal's neck to prevent withdrawal from the vein. Standard aseptic technique must be used. A plastic, spring-like, coiled tube and suitable rubber tubing are used to deliver the fluids from large 20–25 L plastic containers. The coiled plastic tubing allows the animal to lie down or stand up without disrupting the catheter and tubing.<sup>48</sup> The use of a drip chamber in the rubber tubing system assists in determining the flow rate, which can be adjusted with a clamp. With a 12-gauge catheter, 25–30 L of fluids can be delivered as hydration therapy to a mature horse or cow.

#### *Auricular vein of cattle*

The short neck, thick skin and, in some breeds, pendulous dewlap of cattle make it difficult to introduce and secure indwelling jugular catheters for long-term use. The auricular vein of adult cattle can be successfully catheterized with an over-the-needle, 14-gauge catheter, 5 cm long, permitting 20 L of rehydration solution to be delivered over 4 hours.<sup>49</sup>

#### *Cecal catheters in horses*

Percutaneous cecal catheters have been used to deliver fluid solutions in ponies.<sup>50</sup> The advantages include less cost but complications include peritonitis, diarrhea, laminitis and hypocalcemia.

#### *Thrombophlebitis*

Long-term jugular vein catheterization (over a period of a few days) in adult cattle and particularly horses can result in thrombophlebitis, suppurative phlebitis, and catheter sepsis. Inspection of the affected jugular vein reveals swelling,

firmness and moderate pain. Careful digital and visual inspection are necessary to determine the patency of the vein; in about 50% of cases the vein is completely thrombosed and occluded and cannot be used for intravenous administration for 2–3 weeks. The extent and severity of the thrombophlebitis can be determined by ultrasonography of the neck and patency of the vein can be assessed by compressing the vein with the transducer head.<sup>51</sup>

The development of thrombophlebitis is dependent on the method used for skin preparation and the catheterization technique. Careful preparation of the skin and aseptic technique during insertion and placement of the catheter are crucial in preventing this complication.<sup>52</sup> Heparin subcutaneously, 150 IU/kg BW immediately after insertion of the catheter and repeated every 12 hours, has been used prophylactically<sup>52</sup> but this is not deemed necessary with good technique. Alternating catheters between jugular veins every 48–72 hours is standard practice in equine fluid therapy but despite this precaution complications occur in 20–50% of horses whose jugular veins are catheterized for 48 hours.<sup>53</sup> By using catheters made of materials that are less thrombogenic, inserting them in an aseptic manner and observing simple management practices, the duration of catheter survival increases to about 14 days. The least reactive catheter is Silastic, followed by polyurethane; polytetrafluoroethylene causes most reaction. Catheters that are soft are superior to stiff and rigid ones.

A retrospective study of the risk factors associated with vein thrombosis in horses treated with intravenous fluids in a veterinary teaching hospital found that the use of carboy fluids, diarrhea and fever were related; the incidence was lower in horses that had general anesthesia, surgery and received antimicrobial agents.<sup>54</sup> A variety of aerobic bacteria were cultured from about 50% of the intravenous catheters removed from horses.<sup>55</sup> Bacteria were isolated from 7% of skin swabs taken from the area around the catheter after surgical preparation with iodine soap and before and after removal of the catheter. However, there was no correlation between bacterial culture and the condition.

#### **Oral fluid therapy**

Whenever possible, the oral route can be used to deliver the maintenance requirements. Provided there are no abnormalities of the digestive tract that interfere with oral administration or the absorption of the fluids, the oral route is preferred for maintenance therapy. In ruminants such as adult cattle, rumen function must be

present for significant absorption of fluids and electrolytes. The oral administration of large quantities of fluid to cattle with rumen atony results in sequestration of the fluid in the rumen and the development of metabolic hypochloremic, hypokalemic alkalosis.

#### **Oral fluid therapy in calves and adult cattle**

For diarrheic calves, the total 24-hour maintenance requirement is calculated and given orally in divided doses every 2–4 hours. Compared to parenteral therapy, there is less danger from overhydration and electrolyte toxicity, and in acute diarrhea the maintenance of oral fluid and electrolyte intakes will replace continuous losses that are occurring during the diarrhea. Livestock owners should be informed of the value of providing newborn animals affected with diarrhea associated with dehydration, depression, inactivity or failure to suck with oral fluids and electrolytes as soon as possible and of the value of continuing this treatment until the animal has returned to normal. Oral electrolyte solutions and water should be made available at all times to animals affected with diarrhea and other diseases in which there are continuous losses of fluid and electrolytes. The exception is cattle affected with carbohydrate engorgement, in which the water supply should be restricted to one-half or less until the animals begin to eat.

Calves with dehydration and diarrhea absorb electrolyte solutions almost as effectively as healthy calves. The important principle underlying the efficacy of oral fluid therapy is the use of low concentrations of glucose (about 2%) to promote sodium absorption from the intestine.<sup>56</sup> Water follows passively and, because sodium is the osmotic skeleton of the extracellular fluid, fluid is held predominantly where it is needed in the extracellular space, including plasma. Amino acids, such as glycine, also act like glucose to promote sodium absorption. In enterotoxigenic colibacillosis in calves, the glucose and amino acid cotransport mechanisms for sodium transport into epithelial cells are intact.<sup>57</sup> Thus, water and salt, together with glucose and glycine, facilitate the absorption of sodium and water in calves with diarrhea.

A high-calorie hypertonic oral rehydration solution containing glutamine was more effective in correcting plasma, extracellular fluid and blood volume than conventional solutions with a lower calorie content and without glutamine.<sup>58</sup> Glutamine also promotes enteric sodium uptake and may be important in sustaining villus form and function. The higher-

calorie solution (7.5% glucose) also sustains blood glucose levels at a higher level than conventional solutions. An effective oral fluid should also contain or yield sufficient bicarbonate to correct metabolic acidosis.

A variety of oral and parenteral electrolyte replacement solutions are available commercially.<sup>59</sup> Most preparations are in the form of powders to be mixed with water. They contain sodium, chloride, potassium, glucose, glycine and bicarbonate or its precursors (acetate or propionate).

The sodium bicarbonate included in oral fluids for the acidosis in calf diarrhea is usually effective directly and quickly. There is speculation that sodium bicarbonate may interfere with milk clotting in the abomasum, which requires an acidic environment for the action of rennin.<sup>60</sup> There is no direct evidence that oral fluids containing sodium bicarbonate interfere significantly with clotting of milk in the abomasum. Nevertheless, some oral electrolyte solutions for diarrheic calves contain acetate, propionate or citrate, which, when absorbed, act as bicarbonate precursors;<sup>57</sup> it should be noted that gluconate is not metabolized in calves and probably not in other large animals. Because of their acidic pH, it is claimed that these fluids do not interfere with abomasal clotting of milk but, as already stated, there is no direct evidence to support the claim and no evidence that the final outcome in naturally occurring cases of diarrhea in calves is superior when oral fluids containing metabolizable bases (rather than bicarbonate) are used. Furthermore, the oral fluids containing the base precursors are most effective in diarrheic calves with a blood pH over 7.2 (see *Colibacillosis of calves*, Ch. 18).

The **alkalinizing effects of commercial oral electrolyte solutions** have been compared in healthy calves.<sup>61,62</sup> A sodium bicarbonate-rich solution induced the best alkalinization effect. The preparation should not be mixed with milk but given one hour before or after feeding milk because any fluid substance added to milk changes the physicochemical characteristics of milk and may interfere with optimum clotting of milk by rennin in the abomasum, although the clinical significance of this effect remains uncertain. Bicarbonate-containing oral electrolyte solutions will restore acid-base imbalance in calves with viral-induced diarrhea much more effectively than solutions without bicarbonate.

The **continued feeding of milk to diarrheic calves** while they are receiving oral fluids and electrolytes is **controversial**.<sup>61</sup> It has been conventional to withhold milk from diarrheic calves for

1–2 days and gradually reintroduce milk over the next few days when there is evidence of recovery. An extreme practice was to totally deprive the calf of milk until the diarrhea ceased. The rationale was that the ability of the calf's intestine to digest milk was impaired. It is known that lactose digestion is impaired in the rotavirus and coronavirus diarrheas of young calves. It was also thought that the presence of milk in the intestine would provide a substrate for continued growth of enteric pathogens.

Another different practice was to continue feeding milk to diarrheic calves because it resulted in more rapid recovery from diarrhea, less debilitation, continued weight gain and improved circulating plasma volume. This is based on the premise that continuous feeding provides the intestinal mucosa with nutrients.

In experimentally induced diarrhea in calves, the continued feeding of milk during the course of the diarrhea sustained growth, resulted in greater fat stores, facilitated regeneration of the intestinal mucosa and resulted in less thymic atrophy than calves deprived of milk.<sup>61</sup> However, the number of calves in the experiment was small and extrapolation of the results to the naturally occurring disease is not yet warranted. Whole milk and an acidic oral fluid therapy given to calves with naturally occurring diarrhea did not adversely affect the calves or prolong or worsen the diarrhea, and promoted body weight gain.<sup>63</sup> However, none of the calves was severely dehydrated or acidemic and treatment was begun very early in the stage of diarrhea (see also *E. coli* in Ch. 18).

#### Oral fluid therapy in horses

Intravenous fluid and electrolyte therapy has been used extensively for the treatment of dehydration and electrolyte disturbances in the horse with diarrhea. However, oral fluid therapy, as used in calves, has not been employed to the same extent. It may be an effective, practical and economical method of rehydration of horses with diarrhea that has not yet been fully explored.<sup>64,65</sup>

In the horse with acute diarrhea, several factors contribute to the nature of the fluid and electrolyte losses. There are increases in fecal sodium and water loss but the fecal potassium excretion may remain unchanged.<sup>64</sup> Experimentally induced diarrhea (castor oil) in adult horses results in dehydration, metabolic acidosis and large fecal losses of sodium and urinary losses of potassium.<sup>66</sup> Plasma volume decreased while horses were clinically dehydrated. The lack of feed intake, which affects primarily the

potassium intake, can result in losses of 2500–3000 mmol of potassium per day. Although urinary water and potassium losses are reduced, potassium depletion continues; thus potassium losses are very high and need to be replaced, especially in the anorexic horse. The large potassium deficit in diarrheic horses should also be considered when formulating the composition of oral fluids. Administration of 30–40 g potassium chloride or, if chloride administration is inappropriate, 30–40 g potassium bicarbonate in 2–4 L of water given by nasogastric tube several times daily to an inappetent horse with diarrhea can complement intravenous fluid therapy and replace the potassium deficit.

The optimum electrolyte composition of oral fluids and the amount to be used have not yet been determined for the horse. The amount given depends on the degree of dehydration. Dehydration in horses becomes clinically apparent when about 5% of body weight has been lost. In a 500 kg horse, assuming 90% water loss, the fluid deficit is about 23 L.<sup>64</sup> Abdominal discomfort may occur following the nasogastric tube administration of a series of 8–10 L doses of oral rehydration fluid.<sup>67</sup> The administration of large amounts may result in rapid transit through the stomach and intestines and decreased absorption. A slower rate of administration, such as 8–10 L every few hours, may be tolerated more effectively and the transit time in the intestine may be decreased, enhancing absorption. Volumes of 6–8 L can be given by nasogastric tube as often as every 15–20 minutes by funnel; as much as 20–30 L is possible during the first hour and 40 L is possible during a 2-hour period.<sup>68</sup> Oral fluids may also be administered through a small-diameter indwelling nasogastric tube, as is used for prolonged enteral nutrition of horses with dysphagia.<sup>65</sup>

Commercially available **oral electrolyte solutions** are inadequate for horses because the concentrations of sodium and potassium are too low to adequately replace losses. When treating horses with acute diarrhea, the ratio of sodium to chloride ions in the oral solution should be approximately 1.4:1, and the need for glucose in an oral rehydration solution for adult horses has not been clearly demonstrated. One formulation contained 5.27 g of NaCl, 0.37 g of KCl and 3.78 g NaHCO<sub>3</sub> per liter of tap water; this produced a suitable electrolyte composition for oral administration (Na 135 mmol/L; K 5 mmol/L; Cl 95 mmol/L; HCO<sub>3</sub> 45 mmol/L).<sup>69</sup>

Oral administration of bicarbonate will result in a pronounced alkalemia within 3–6 hours, with the maximum change in



pH occurring at a sodium bicarbonate dose of 1 g/kg BW (which represents 40% of normal extracellular sodium). Doses above this level do not induce additional alkalization, presumably because of limited absorption of bicarbonate from the intestinal tract. The oral administration of sodium bicarbonate to normal mature resting horses without ad libitum access to water induces metabolic alkalosis, hypernatremia, hypokalemia and hyperosmolality for at least 8 hours.<sup>70</sup> The oral doses were 0.25, 1 and 1.5 g/kg BW in 3 L water; the intravenous dose was 0.25 g/kg BW in 3 L water. The effects were dose-dependent: in the horses given the 1 and 1.5 g/kg BW oral doses, the hypercapnia persisted for 12 hours, whereas hypercapnia lasted 2 hours in horses given the 0.25 g/kg BW dose orally or intravenously. The effects of these large doses of sodium bicarbonate on the renal function of horses indicated increases in urine flow, fractional clearance of electrolytes and bicarbonate, electrolyte-free water reabsorption, urine concentrations of sodium and bicarbonate, urine excretion, clearance of sodium and bicarbonate, urine pH and anion gap.<sup>70</sup>

The temperature or glucose concentration of the fluid does not appear to be important, as the rate of fluid absorption was similar in dehydrated horses administered an oral rehydration solution at 5°C, 21°C or 37°C or containing glucose at 0%, 2.5% or 3.5%.<sup>71</sup> The tonicity of the oral rehydration solution is of minor clinical importance; however, oral administration of hypertonic solutions (628 mosmol/kg BW) to dehydrated horses caused a transient increase in plasma protein concentration that was attributed to movement of water into the bowel lumen.<sup>71</sup> A practical limitation of oral rehydration solutions in horses is that they should be ingested voluntarily rather than by nasogastric intubation. This limitation has led to recent interest in the oral administration of pastes.

The oral administration of an **electrolyte paste** has been shown to be effective in correcting mild to moderate dehydration in horses, provided animals are monitored to ensure that they drink water.<sup>72</sup> Oral electrolyte pastes may be formulated as follows: 30 g of 1:1 mixture of sodium chloride and potassium chloride, potassium chloride and sodium bicarbonate, or potassium chloride and potassium carbonate, and administered every 6 hours; 120 g of the latter mixture provides 1400 mmol or more of potassium in a 24-hour period.<sup>65</sup> Administration of higher doses of oral pastes (0.5 g of NaCl/kg BW, 0.5 g of KCl/kg BW or a mixture of 0.25 g of NaCl/kg BW and 0.25 g of KCl/kg BW) to dehydrated

horses induced a transient period of hyperhydration and apparent plasma volume expansion that lasted 12 hours.<sup>72</sup> Although the absorbed electrolytes from an oral paste are subsequently eliminated via the urine, this treatment is potentially of benefit in horses with disease processes associated with ongoing fluid losses, such as diarrhea.

There is no published information on the use of oral fluid therapy in horses that are diarrheic as a result of disease of the small intestine such as enteritis, or proximal enteritis (duodenitis). It would seem unlikely that oral fluid therapy would be indicated or effective for anterior duodenitis. In horses with colitis, the small intestinal absorptive capacity is probably intact and oral fluid therapy prior to transport of the horse to a clinical center for intensive fluid therapy may delay the onset of more serious complications. Horses with mild dehydration can be rehydrated effectively with oral fluid therapy. Horses treated with oral fluid therapy must be monitored clinically, and the hematocrit, total plasma protein concentration and serum electrolytes should be measured.

Oral fluid therapy in horses with impaction of the large colon provides an effective and inexpensive treatment and should be regarded as the initial treatment of choice. In general, 6–8 L of water can be administered by nasogastric tube and funnel (gravity flow) every 15–20 minutes;<sup>68</sup> the administered fluid is rapidly transported to the large intestine. It is generally recommended that the osmolality of the fluids should be isotonic, ranging from 280–360 mosmol/L; the upper range of tonicity which is safe to administer is unknown. Oral administration of 60 L of lactated Ringer's solution or an isotonic solution over 12 hours was superior in hydrating the contents of the right dorsal colon when compared to intravenous administration of an equivalent volume of lactated Ringer's solution or enteral administration of 1 g/kg BW of MgSO<sub>4</sub>·7H<sub>2</sub>O (Epsom's salts) or anhydrous Na<sub>2</sub>SO<sub>4</sub> as a 1 L solution.<sup>69,73</sup> Moreover, enteral administration of Epsom's salts has been associated with hypermagnesemia, and anhydrous Na<sub>2</sub>SO<sub>4</sub> has been associated with hypocalcemia.<sup>73</sup>

Fluid and electrolyte therapy in newborn piglets and lambs

The most common cause of fluid and electrolyte imbalance in newborn piglets and lambs is acute neonatal diarrhea. There is severe dehydration, acidemia, hyponatremia and, in some cases, hyperkalemia due to the acidosis. Balanced electrolyte solutions or isotonic saline and

sodium bicarbonate initially followed by balanced electrolytes are indicated and successful. These are given subcutaneously or intraperitoneally at the rate of 15 mL per piglet every 2 hours plus the same amount orally. The safe amount of sterilized porcine serum or saline and 5% dextrose that can be given to piglets is equivalent to about 8% BW intraperitoneally, in two divided doses given 8 hours apart. Lambs are also treated subcutaneously (30–40 mL) and orally (50–100 mL) every 2 hours.

### Parenteral nutrition

Parenteral nutrition is used to provide adequate nutrition intravenously, as long as necessary, when feeding by the gastrointestinal tract is impractical, inadequate or impossible. The term parenteral nutrition is preferred to total parenteral nutrition because the complete nutritional requirements of large animals are either not completely known or not addressed by intravenous fluid administration. It should be recognized that enteral nutrition represents state-of-the-art medicine because enteral nutrition supports the repair, maintenance and growth of the gastrointestinal tract to a much greater extent than does parenteral nutrition. It should also be recognized that parenteral nutrition should only be contemplated after at least 5 days of inappetence.

The technique is used to supply the nutrient requirements, most importantly protein, of the animal until it returns to normal. In calves affected with persistent diarrhea due to chronic disease of the alimentary tract, or that cannot or will not eat, total intravenous feeding may be indicated.<sup>74</sup> High concentrations of glucose, protein hydrolysates, lipid emulsions and electrolytes are given by continuous slow intravenous infusion over a period of several days. Some encouraging results in calves have been published but the cost-effectiveness of the technique has not been examined.<sup>74</sup>

Parenteral nutrition is an acceptable method of maintaining nutrition in the healthy horse over a period of 10 days.<sup>75</sup> Body weight was maintained at 94% of initial values without clinical evidence of dehydration. No problems were encountered with the long-term intravenous catheterization. The total daily amounts given are calculated on the basis of daily caloric requirement. The intravenous catheter must be inserted down into the cranial vena cava, where a large volume of blood will dilute the hypertonic concentration of the solution. The potential problems associated with parenteral nutrition include difficulty in the maintenance of a steady intravenous drip,



hypertonicity of the solutions used, venous thrombosis, excessive diuresis, catheter sepsis and bacterial contamination of the solutions.

## REVIEW LITERATURE

- McGinness SG, Mansmann RA, Breuhaus BA. Nasogastric electrolyte replacement in horses. *Comp Cont Educ Pract Vet* 1996; 18: 942-950.
- Ecke P, Hodgson DR, Rose RJ. Review of oral rehydration solutions for horses with diarrhea. *Aust Vet J* 1997; 75: 417-420.
- Schott HC. Oral fluids for equine diarrhea: an underutilized treatment for a costly disease. *Vet J* 1998; 155:119-121.
- Schott HC, Hinchcliff KW. Treatments affecting fluid and electrolyte status during exercise. *Vet Clin North Am Equine Pract* 1998; 14:175-204.
- Berchtold J. Intravenous fluid therapy of calves. *Vet Clin North Am Food Anim Pract* 1999; 15:505-532.
- Constable PD. Clinical assessment of acid-base status: Strong ion difference theory. *Vet Clin North Am Food Anim Pract* 1999; 15:447-471.
- Constable PD. Hypertonic saline. *Vet Clin North Am Food Anim Pract* 1999; 15:559-585.
- Naylor JM. Oral electrolyte therapy. *Vet Clin North Am Food Anim Pract* 1999; 15:487-504.
- Roussel AJ. Fluid therapy in mature cattle. *Vet Clin North Am Food Anim Pract* 1999; 15:545-558.
- Constable PD. Clinical assessment of acid-base status: Comparison of the Henderson-Hasselbalch and strong ion approaches. *Vet Clin Path* 2000; 29:115-128.
- Kudnig ST, Mama K. Perioperative fluid therapy. *J Am Vet Med Assoc* 2002; 221:1112-1121.
- Constable PD. Fluids and electrolytes. *Vet Clin North Am Food Anim Pract* 2003; 19:1-40.

## REFERENCES

- James KM et al. *Am J Vet Res* 1997; 58:343.
- Groutides C, Michell AR. *Vet Rec* 1990; 126:29.
- Siggaard-Andersen O. *Scand J Clin Lab Invest* 1961; 13:196.
- Mitten LA et al. *J Vet Intern Med* 1995; 9:353.
- Wu EY et al. *J Appl Physiol* 1997; 82:196.
- Roeder BL et al. *J Am Vet Med Assoc* 1996; 208:707.
- Constable PD et al. *J Vet Intern Med* 1997; 11:71.
- Constable PD et al. *Am J Vet Res* 1998; 59:881.
- Constable PD. *J Appl Physiol* 1997; 83:297.
- Constable PD et al. *J Vet Intern Med* 2005; 19:581.
- Gossett KA et al. *Am J Vet Res* 1990; 51:1375.
- Harris P, Snow DH. *Equine Vet J* 1988; 20:109.
- Andrews FM et al. *Am J Vet Res* 1997; 58:1060.
- Naylor JM, Forsyth GW. *Can J Vet Res* 1986; 50:509.
- Roussel AJ et al. *J Am Vet Med Assoc* 1998; 212:1769.
- Nahas GG. *Pharmacol Rev* 1962; 14:447.
- Rhee KH et al. *Chest* 1993; 104:913.
- Berchtold J. *Vet Clin North Am Food Anim Pract* 1999; 15:505.
- Groutides CP, Michell AR. *Res Vet Sci* 1990; 49:292.
- Watt JG. *J Am Vet Med Assoc* 1967; 150:742.
- McSherry BJ, Grinyer I. *Am J Vet Res* 1954; 15:535.
- Constable PD et al. *Am J Physiol* 1994; 267:H667.
- Goetsch DD et al. *Am J Vet Res* 1956; 17:213.
- Muir WM III. *Cornell Vet* 1990; 80:7.
- Roeder BL et al. *Am J Vet Res* 1997; 58:549.
- Tyler JW et al. *Am J Vet Res* 1994; 55:278.
- Constable PD et al. *Am J Vet Res* 1991; 52:981.
- Constable PD et al. *Am J Vet Res* 1991; 52:990.
- Schmall LM et al. *Equine Vet J* 1990; 22:278.
- Bertone JJ, Shoemaker KE. *Am J Vet Res* 1992; 53:1844.

- Berchtold J et al. *J Vet Intern Med* 2005; 19:240.
- Bleul U et al. *Vet Rec* 2005; 156:202.
- Hunt E, Wood B. *Vet Clin North Am Food Anim Pract* 1999; 15:559.
- Muir WW et al. *Vet Surg* 2000; 29:449.
- Vlahakes GJ et al. *J Thorac Cardiovasc Surg* 1990; 100:379.
- Slanetz PJ et al. *Surgery* 1994; 115:246.
- Watt JG. *Vet Rec* 1965; 77:1474.
- Buntain BJ, Selman IE. *Vet Rec* 1980; 107:245.
- Constable PD et al. *Am J Vet Res* 1996; 57:97.
- Walker PG et al. *J Am Vet Med Assoc* 1998; 213:113.
- Senturk S. *J Vet Med* 2003; 50:57.
- Groutides CP, Michell AR. *Res Vet Sci* 1990; 49:292.
- Roussel AJ. *Vet Clin North Am Food Anim Pract* 1990; 6:111.
- Fubini SL et al. *Am J Vet Res* 1991; 52:1898.
- Ward JL et al. *Am J Vet Res* 1993; 54:1160.
- Groenendyk S et al. *Equine Vet J* 1988; 20:189.
- Young DR et al. *J Am Vet Med Assoc* 1989; 195:340.
- Grove-White D. *In Pract* 1994; 16(5): 263.
- Roussel AJ et al. *J Am Vet Med Assoc* 1996; 208:905.
- Mealey RH et al. *J Vet Intern Med* 1995; 9:347.
- Pusterla N, Braun U. *Vet Rec* 1995; 137:431.
- Pusterla N, Braun U. *Vet Rec* 1996; 139:287.
- Spurlock SL et al. *J Am Vet Med Assoc* 1990; 196:425.
- Traub-Dargatz JL, Dargatz DA. *J Vet Intern Med* 1994; 8:264.
- Eitlinger JJ et al. *Vet Rec* 1992; 130:248.
- Michell AR et al. *Br Vet J* 1992; 148:507.
- Naylor JM. *Vet Clin North Am Food Anim Pract* 1990; 6:51.
- Brooks HW et al. *Vet J* 1997; 153:163.
- Frederick GS et al. *Vet Clin North Am Food Anim Pract* 1990; 6:149.
- Naylor JM. *J Am Vet Med Assoc* 1992; 201:1026.
- Heath SE et al. *Can J Vet Res* 1989; 53:477.
- Naylor JM et al. *Can Vet J* 1990; 31:753.
- Garthwaite BD et al. *J Dairy Sci* 1994; 77:835.
- Ecke P et al. *Aust Vet J* 1997; 75:417.
- Schott HC II. *Vet J* 1998; 155:119.
- Ecke P et al. *Vet J* 1998; 155:149.
- Ecke P et al. *Vet J* 1998; 155:161.
- McGuinness SG et al. *Comp Cont Educ Pract Vet* 1996; 18:942.
- Lopes MA et al. *Equine Vet J* 2002; 34:505.
- Rivas LJ et al. *Am J Vet Res* 1997; 58:658-664.
- Sosa Leon LA et al. *Equine Vet J* 1995; 20:140.
- Schott HC et al. *Am J Vet Res* 2002; 63:19.
- Lopes MA et al. *Am J Vet Res* 2004; 65:695.
- Sweeney RW, Divers TJ. *Vet Clin North Am Food Anim Pract* 1990; 6:125.
- Hansen TO et al. *Am J Vet Res* 1988; 49:122.

## Pain

### THE PROBLEM OF PAIN

Pain is a distressing sensation arising from stimulation of specific end-organs in particular parts of the body and perceived in the thalamus and cerebral cortex. Pain is basically a protective mechanism to ensure that the animal moves away from noxious (damaging) influences, but endogenous pain, arising from internal damaging influences, causes its own physiological and pathological problems that require the veterinarian's inter-

vention. In humans, there is an additional psychological parameter to pain and, although it is customary to transpose attitudes from pain in humans to animals, this is a courtesy rather than an established scientific principle.

A major difficulty with pain in animals is the difficulty of pain measurement. Pain is a subjective sensation known by experience and which can be described by illustration, but measurement of pain is an indirect activity related to its effects and is an objective phenomenon. A panel report on recognition and alleviation of pain in animals proposes a simplified classification for animal pain and distress as: pain, anxiety and fear, stress, suffering, comfort, discomfort and injury.<sup>1</sup> The recommendations are directed at academicians, teachers and researchers using laboratory animals, and the pharmaceutical industry.

Pain is assessed in animals by three methods: 1) **observation of behavior**; 2) measurement of physiological parameters, including heart rate, blood pressure, sweating and polypnea, that indicate **sympathetic activation**; and 3) measurement of the plasma concentration of factors that indicate sympathetic activation, such as plasma cortisol, epinephrine, norepinephrine and non-esterified fatty acid concentrations. Because of the lability and expense of epinephrine and norepinephrine analyses, and the poor specificity of increased plasma non-esterified fatty acid concentration for pain, the most commonly utilized laboratory measure of pain is **plasma cortisol concentration**. Cortisol concentrations have also been measured in saliva, urine and feces in order to provide a more accurate indicator of basal stress, as plasma cortisol concentrations increase rapidly in response to handling and restraint for blood sampling.

Pain in agricultural animals is a matter of ever-increasing concern. Many agricultural practices that are thought to be necessary to avoid later painful disease or injury (e.g. dehorning of cattle, sheep and goats; tail docking in lambs; the Mules operation in Merino sheep; tooth clipping in baby pigs, to improve animal production (e.g. castration, spaying) or to facilitate in animal identification (branding, eartagging, tattooing or ear notching) are carried out by producers without anesthetic. It is not our purpose to engage in a discussion on the subject of animal welfare or the prevention of cruelty.

### ADVANCES IN ATTITUDE TOWARD PAIN

There is now a greater awareness of the existence of pain in animals and the detrimental effects of pain,<sup>2</sup> which has led

to widespread implementation of post-operative pain control.<sup>3</sup> New and improved analgesics are being developed and marketed as a result of increased basic and clinical research in pain. The detrimental effects of pain include:

- Suffering and stress resulting in delayed healing
- Increased catabolism and decreased feed intake
- Prolonged recovery and longer recumbency, with a greater risk of postoperative complications
- The potential to cause ineffective respiratory ventilation with the development of respiratory acidosis and acidemia
- Self-mutilation
- The potential of acute pain to lead to chronic pain.

Pain may be clinically beneficial by acting as a protective mechanism by moving the animal away from the noxious stimulus and providing immobility of the affected part, thereby promoting healing. Pain is a valuable diagnostic aid but, once identified, it is our obligation to treat the pain and remove or modify its source if possible.

Once it is accepted that pain is detrimental it then becomes important to recognize and evaluate the severity of pain. In the past, veterinary science has used an anthropomorphological approach to the assessment of whether or not an animal is in pain. It is a reasonable elementary approach to compare the effects of pain in animals with those in humans because there are many more similarities in the neuroanatomical, physiological and behavioral data between humans and animals than there are differences. However, because of the inherent behavioral and social differences between humans and animals, this approach is limited. Current research on pain in animals includes visual and subjective assessment of pain supported by physiological and clinicopathologic measurements. These studies have increased the awareness of the problem of pain in veterinary medicine and resulted in improved information on the use of appropriate analgesics.

## ETIOLOGY

Pain sensations are aroused by different stimuli in different tissues and the agents that cause pain in one organ do not necessarily do so in another. In animals there are three types of pain:

- **Cutaneous (or superficial)**
- **Visceral**
- **Somatic (or musculoskeletal).**

The causes of each type of pain are listed below.

## Cutaneous or superficial pain

Cutaneous or superficial pain is caused by agents or processes that damage the skin, such as burning, freezing, cutting and crushing. Fire burns, frostbite, severe dermatitis, acute mastitis, laminitis, infected surgical wounds, footrot, crushing by trauma, conjunctivitis and foreign body in the conjunctival sac are all common causes of pain.

## Visceral pain

Examples of visceral pain include:

- Inflammation of serosal surfaces, as in peritonitis, pleurisy and pericarditis
- Distension of viscera, including the stomach, intestines, ureters and bladder
- Swelling of organs as in hepatomegaly and splenomegaly
- Inflammation, as in nephritis, peripelvic cellulitis and enteritis
- Stretching of the mesentery and mediastinum.

In the nervous system, swelling of the brain caused by diffuse edema, or of the meninges caused by meningitis, are potent causes of pain. Inflammation of (neuritis) or compression of (neuralgia) peripheral nerves or dorsal nerve roots are also associated with severe pain.

## Musculoskeletal (somatic) pain

Muscular pain can be caused by lacerations and hematomas of muscle, myositis and space-occupying lesions of muscle. Osteomyelitis, fractures, arthritis, joint dislocations, sprains of ligaments and tendons are also obvious causes of severe pain. Among the most painful of injuries are swollen, inflamed lesions of the limbs caused by deep penetrating injury or, in cattle, by extension from foot rot. Amputation of a claw, laminitis and septic arthritis are in the same category. Ischemia of muscle and generalized muscle tetany, as occurs in electroimmobilization,<sup>4</sup> also appear to cause pain.

The trauma of surgical wounds is a controversial topic in animal welfare, especially that associated with minor surgical procedures such as dehorning, tail docking and castration in farm animals. From clinical observation supported by some laboratory examinations, e.g. salivary cortisol concentrations after castration in calves and lambs, it appears that pain after these procedures is short-lived, up to about 3 hours.<sup>5</sup>

## PATHOGENESIS

Pain receptors are distributed as end-organs in all body systems and organs. They are connected to the central nervous system by their own sensory nerve fibers with their cell bodies in the dorsal root ganglion of each spinal nerve and via

some of the cranial nerves. Intracord neurons connect the peripheral neurons to the thalamus, where pain is perceived, and to the sensory cerebral cortex, where the intensity and localization of the pain are appreciated and the responses to pain are initiated and coordinated.

The stimuli that cause pain vary between organs. The important causes include:

- **Skin** – cutting, crushing, freezing, burning
- **Gastrointestinal tract** – distension, spasm, inflamed mucosa, stretching of mesentery
- **Skeletal muscle** – ischemia, traumatic swelling, tearing, rupture, hematoma
- **Synovial membranes and cartilage of joints** – inflammation.

Nociception is the normal physiological process by which pain is perceived. When a tissue is injured by mechanical, thermal or chemical means, **peripheral nociceptors** (specialized free nerve endings of afferent neurons) are depolarized and the initial stimulus is felt as pain.

Peripheral nociceptors are located in skin, fascia, muscles, tendons, blood vessels, joint capsules, periosteum, subchondral bone, pleura, peritoneum and viscera. Five classes of peripheral nociceptor are currently recognized: 1) thermal nociceptors activated by temperatures above 52°C or below 5°C; 2) mechanoheat nociceptors activated by pressure and temperature; 3) polymodal nociceptors; 4) visceral nociceptors; and 5) silent nociceptors. The **first pain** or initial sharp stinging following injury is due to activation of large-diameter fast-conduction myelinated nerve fibers called **Type I Aδ fibers** (thermal nociceptors) or **Type II Aδ fibers** (mechanoheat nociceptors). The **second pain** or slow pain following injury is due to activation of small-diameter unmyelinated slow-conduction fibers called **C-fibers**; these fibers transmit a painful stimulus that is perceived as a sustained burning sensation that persists past cessation of the initial sharp painful sensation. Visceral nociceptors are activated by diffuse stimulation instead of direct local noxious stimuli. Silent nociceptors are mechanoheat nociceptors that are activated when sensitized by release of proinflammatory mediators (such as bradykinin, histamine, leukotrienes, eicosanoids, serotonin, substance P, adenosine triphosphate (ATP), low tissue pH and other constituents of inflammation) into damaged tissues, thereby establishing **peripheral hyperalgesia**. The hyperalgesia during acute pain is believed to promote healing at the injured site.

### Central hypersensitivity and pre-emptive analgesia

A state of altered central processing can also occur in response to chronic activation of peripheral nociceptors, called **central hypersensitivity** or 'wind up'. This central hypersensitivity results in a modified response to subsequent afferent inputs, which last between 10 and 200 times the duration of the initiating stimulus. The net result is that stimuli previously perceived as innocuous, such as touch or pressure, become perceived as painful after the system is sensitized. Preinjury treatment with opioids or local anesthetics prevents or decreases the development of central hypersensitivity and behavioral indicators of pain but opioids and local anesthetics are less effective if administered after the injury is initiated. It is the establishment of central hypersensitivity that makes pain much more difficult to control once it is established and why analgesics are less effective at this time. Thus the combination of peripheral hyperalgesia (particularly associated with substance P) and central hypersensitivity results in what is called clinical pain.

It has been suggested that by preventing the surgical afferent stimuli from entering the spinal cord, the facilitation of spinal nociceptive processing could be prevented and this would decrease the severity of postoperative pain. This is known as the concept of **pre-emptive analgesia**. Presurgical administration of an analgesic is more effective than post-surgical administration of the same dose; this is relevant to the control of pain associated with elective surgery. Many studies (primarily in humans) have demonstrated that presurgical administration of local anesthetic agents and the administration of NSAIDs or opioids before the patient is recovered from anesthesia are appropriate methods for instituting pre-emptive analgesia.

The physiological responses to pain are described below. Normal responses include the release of the morphine-like endorphin from the brain,<sup>6</sup> providing an endogenous analgesic system, and also cortisol release from the adrenal cortex<sup>7</sup> in response to any stress. The clinical response to pain varies not only with the personality of the patient (some are more stoical than others) but also with various other influences. For example, distraction, as in walking a horse with colic, application of an alternative pain in the forced elevation of the tail of a cow (tail jack), and application of local anesthetic agents all tend to relieve pain. In agricultural animals pain elicits behavioral, physiological and clinicopathological changes. The behavioral responses can be interpreted as a form of

distraction, a displacement activity, or as providing an alternative pain. The physiological and clinicopathological responses are part of the fight or flight phenomena and reflect sympathetic activation.

### CLINICAL FINDINGS

The general clinical findings of pain are described here and the indications of pain associated with individual body systems or organs are described within each category.

#### Physiological responses

Physiological responses to pain are manifested by the following signs, the severity of the pain determining the degree of response:

- Tachycardia
- Polypnea
- Pupillary dilatation
- Hyperthermia
- Sweating.

The cardiovascular responses of tachycardia and hyperthermia may contribute to a fatal outcome in animals with reduced cardiovascular reserve, for example when dehydration, acid-base imbalance and endotoxic shock are also present.

#### Behavioral responses

These include abnormal posture and gait when the pain is musculoskeletal (e.g. somatic). The gait abnormalities include lameness, a shuffling gait and rapid shifting of weight from one leg to another. These are subjects of importance in orthopedic surgery.

The behavioral responses to pain may also include unrelated activities such as **rolling, pawing, crouching or grinding of teeth** when the pain is visceral. However, the behavioral activities may also be related to the site of the pain, e.g. the horse with colic that looks at its abdomen, or to a particular function, such as pain manifest on coughing, walking, defecating, urinating, etc. The behavioral aspects of severe pain are very important in the horse with severe unrelenting visceral pain due to colic. The rolling, falling and lunging upwards and backwards (often falling against walls) can result in severe injury and causes panic in many owners.

Generally, somatic pain is more localized and easily identified than visceral pain. Injuries to limbs are usually identifiable by fractures or localized tendon strain or muscle injury. With severe somatic pain, as with a fracture or septic arthritis, the limb is carried off the ground and no weight is taken on the limb. With lesser lesions more weight-bearing activity is undertaken.

One of the notable factors affecting pain in animals is the analgesic effect of

the animal lying on its back or of its adopting a defeated, supine posture. This may be related to the release of endorphins.<sup>7</sup>

More general behavioral responses to pain include **decreased appetite** and average daily rate of gain, adoption of an anxious expression (ears retracted), disinclination to be examined and aversion to returning to a particular location where pain has been experienced previously.

#### Moaning, grunting and grinding of the teeth

(odontoprisis or bruxism) are generally indicative of pain. If the vocalization occurs with each respiration, or each rumination, the pain appears likely to arise from a lesion in the thoracic or abdominal cavities. When teeth-grinding is associated with head-pressing it is thought to indicate increased intracranial pressure such as occurs with brain edema or lead poisoning. Grinding of the teeth as a sole sign of pain is usually associated with subacute distension of segments of the alimentary tract. More extreme kinds of vocalization caused by pain include moderate bellowing by cattle, bleating in sheep and goats, and squealing in pigs.

#### Elicitation of pain by the veterinarian

This is an essential part of a clinical examination. The techniques include the following:

- Pressure by palpation, including firm ballottement with the fist and the use of a pole to depress the back in a horse or to arch the back upwards from below in a cow
- Pressure by compression, as with hoof testers for detecting the presence of pain in the hoof
- Movement by having the animal walk actively or by passively flexing or extending limbs or neck
- Stimulation of pain related to coughing by eliciting the cough reflex
- Relief of the pain by correction of the lesion.

#### Periodicity and duration of pain

Limited duration of pain can be the result of natural recovery or of surgical or medical correction of the problem. Constant pain results from a static state whereas periodic or intermittent pain is often related to periodic peristaltic movement. In humans and in companion animals some importance also attaches to observing the time of onset of pain, whether it is related to particular functions or happenings and whether the patient gains relief by adopting particular postures or activities. These factors are unlikely to be of importance as an aid to a diagnosis in agricultural animals.

## TREATMENT

Several aspects concerning the relief of pain in agricultural animals are important. Cost has always been a deterrent to the use of local anesthetics and analgesics. However, with changing attitudes towards animal pain, this issue is more frequently examined. Treatment of the causative lesion is a major priority, but the treated lesion may remain painful for varying lengths of time. Relief and the control of pain should be a major consideration and the following principles require consideration:

- Relief of pain is a humane act. Improved, less painful methods of castration, dehorning, tail-docking, Mules operation in sheep, spaying cattle and treating painful lesions of the hooves of farm animals must be explored and implemented. Surgical operations such as laparotomies must be performed using appropriate analgesia
- Analgesia may obscure clinical findings that may be necessary to observe, properly diagnose or maintain surveillance of a case. This is of major importance in equine colic
- Control of pain is necessary to prevent animals from inflicting serious self-injury associated with uncontrollable behavior as a result of severe visceral pain (see Equine colic)
- Analgesics for visceral pain are readily available and relatively effective
- A major problem in the clinical management of pain is for cases of severe, slowly healing, infected traumatic wounds of the musculoskeletal system. Pain is likely to be very severe, continuous and to last for periods of up to several weeks. Affected animals cannot bear weight with the affected limb, have great difficulty in moving, lose much weight and prefer prolonged recumbency. At the present time, there are no effective analgesics available that can be administered easily and daily for a few weeks without undesirable side-effects. The development of such products is urgently required.

## Analgesia

The analgesic agents and techniques available include the following:

- Surgical procedures, e.g. neurectomy by section of peripheral nerves, as practiced in horses
- Local destruction of peripheral nerves by chemical means, e.g. the epidural injection of agents such as ethyl alcohol may prevent straining
- Local destruction of peripheral nerves by thermal means, e.g. cautery of the

wound edge after gouge dehorning in calves<sup>8</sup>

- Analgesia using nonopiate drugs when sedation is not required or is contraindicated
- Opiate analgesics (narcotic analgesics).

## Analgesic agents

There are five main types of analgesic agent administered parenterally or topically to large animals: 1) **local anesthetic agents** such as lidocaine, mepivacaine and bupivacaine; 2) **nonsteroidal anti-inflammatory drugs (NSAIDs)** such as flunixin meglumine, ketoprofen, phenylbutazone and meloxicam; 3)  **$\alpha_2$ -agonists** such as xylazine and detomidine; 4) **opioids** such as morphine, fentanyl, butorphanol and buprenorphine; and 5) **vanilloids** such as capsaicin. In general, local anesthetic agents,  $\alpha_2$ -agonists and opioids are used to provide short-term analgesia (hours), and parenteral NSAIDs and topical vanilloids are used to provide long-term analgesia (days to months). Standard anesthesiology texts should be consulted regarding techniques for local analgesia using regional or peripheral nerve blocks and local anesthetic agents, or for general analgesia using  $\alpha_2$ -agonists and opioids.

## Local anesthetic agents

Lidocaine, mepivacaine and bupivacaine exert their analgesic effect by addressing both the first pain and second pain after injury by blocking the voltage-gated sodium channels in peripheral nerves, thereby preventing propagation of depolarization. Type IA $\delta$ , type IIA $\delta$  and C-fibers are blocked before other sensory and motor fibers, meaning that it is possible (but sometimes a clinical challenge) to selectively block pain while leaving the animal able to maintain normal motor function. The main advantages of local anesthetic agents are their cost and predictable and local effect, the main disadvantage is short duration of action. Topical formulations of lidocaine (2.5%) and prilocaine (2.5%) are available that appear to be useful for transdermal administration of a local anesthetic in large animals prior to intravenous catheter placement, venipuncture, arthrocentesis or collection of cerebrospinal fluid.<sup>9</sup>

## Nonsteroidal anti-inflammatory drugs

These drugs appear to exert most of their analgesic effect by addressing the **second pain** (slow pain) due to sensitization of C-fibers by eicosanoids; NSAIDs are not currently believed to exert a central analgesic effect. Animals receiving NSAIDs should be normally hydrated in order to minimize potential renal effects such as tubular nephrosis and papillary necrosis (see diseases of the kidney).

## Flunixin meglumine

This NSAID has excellent anti-inflammatory, antipyretic and analgesic properties, and is the preferred NSAID for acute soft tissue or visceral pain, although it is also efficacious against musculo-skeletal pain. Flunixin meglumine provides excellent analgesia in equine colic and postsurgical pain. In a comparison of three NSAIDs used to minimize postsurgical pain in horses, flunixin meglumine (1 mg/kg BW), phenylbutazone (4 mg/kg BW) or carprofen (0.7 mg/kg BW) were administered once intravenously.<sup>10</sup> All three NSAIDs were effective in controlling postsurgical pain but the duration of clinical effect was longer for flunixin meglumine (12.8 h) than carprofen (11.7 h) or phenylbutazone (8.4 h).

The usual loading dose is 1.1–2.2 mg/kg BW (ruminants) or 1.1 mg/kg BW (horses) followed by a maintenance dose of 1.1 mg/kg BW every 24 hours,<sup>11</sup> although some studies have administered repeated injections at 8–12 hours. Flunixin meglumine is usually administered once or twice a day for its analgesic effect and is usually administered parenterally (preferably intravenously because of the rare instances of myonecrosis following intramuscular injections, particularly in horses), although oral formulations exist. Intramuscular doses are rapidly absorbed, with the maximal concentration occurring within 1 hour. Large doses given to individual ponies may, however, be toxic.<sup>12</sup> Toxic effects are similar to those with phenylbutazone and include ulceration of the colon, stomach and mouth; the latter two are most evident when administered orally.

## Ketoprofen

This NSAID has anti-inflammatory, antipyretic and analgesic properties, and is labeled in Europe for the treatment of pain in cattle associated with mastitis, lameness and trauma (3.3 mg/kg BW, intravenously or intramuscularly, every 24 h for 3 d). Oral formulations are also available in Europe for the treatment of suckling calves. On theoretical grounds, ketoprofen may have superior analgesic properties to currently available NSAIDs because it blocks both the cyclooxygenase and 5-lipoxygenase branches of the arachidonic acid cascade as well as potentially having antibradykinin activity. However, the latter two effects have not been demonstrated in large animals at recommended dose rates.<sup>13</sup> Ketoprofen has been shown to provide analgesia for several hours after gouge dehorning of calves<sup>14</sup> and surgical castration of calves.<sup>15</sup>

## Phenylbutazone

This NSAID is used extensively as an analgesic for horses, especially for

musculoskeletal pain. It is most effective for the relief of mild to moderate musculoskeletal pain. The half-life of the drug in plasma is about 3.5 hours so that repeated treatment is recommended. A plasma concentration of 20 µg/mL appears to be clinically effective in horses, whereas a plasma concentration of 60–90 µg/mL appears to be clinically effective in cattle.<sup>16</sup>

After oral use in horses the peak levels in plasma are reached at 2 hours, but after intramuscular injection this does not occur until after 6 hours, so that the oral or intravenous routes are the usual routes of administration. Unless care is taken to inject the drug slowly when using the intravenous route, severe phlebitis, sometimes causing complete obstruction of the jugular vein, may result. For horses the recommended dose rate is 4.4 mg/kg BW daily for 5 days orally or intravenously. Treatment on day 1 may be at 4.4 mg/kg BW twice, constituting a loading dose.<sup>17</sup> Treatment beyond 5 days may be continued at minimal effective dose rates. However, prolonged use, especially in ponies, at a dose of 10–12 mg/kg BW daily for 8–10 days, may be followed by ulceration of alimentary tract mucosa, including the oral mucosa, and fatal fluid retention due to hypoproteinemia.<sup>18</sup> The pathogenesis of these lesions is thought to be due to a widespread phlebopathy.<sup>19</sup> Phenylbutazone should not be used if there is pre-existing gastrointestinal ulceration, clotting deficits or cardiac or renal dysfunction. Its use should be under close veterinary supervision so that the dose rate may be kept to a minimal effective level and so that it is used only when there is a clear clinical indication to do so. It should be withdrawn if there is no indication of a therapeutic response or if signs of toxicity appear. If there is doubt about toxicity or a prolonged course is advised, periodic hematological examinations are recommended.

For cattle, the recommended oral dose is 10–20 mg/kg BW initially followed by daily doses of 4–6 mg/kg BW or every other dose of 10–14 mg/kg BW.<sup>16,20</sup> Clearance is slowed in neonates, so the dosage protocol would need to be adjusted in suckling calves.<sup>21</sup> Phenylbutazone is moderately effective in cattle with painful conditions of the limbs. In most countries phenylbutazone is not approved for use in food-producing animals because of the risk of drug residues in the food chain and the known toxicity of phenylbutazone in humans.

#### Salicylates

Aspirin or acetylsalicylic acid is the most commonly administered analgesic in cattle but is not very effective and there is limited clinical evidence of its efficacy. The

recommended dose rate is 100 mg/kg BW orally every 12 hours,<sup>22</sup> and oral administration is most common. Because there may be limited absorption from the small intestine, the salicylates may be given intravenously (35 mg/kg BW every 6 h in cattle; 25 mg/kg BW every 4 h in horses), but this is no longer practiced with the widespread availability of flunixin meglumine and phenylbutazone.

#### Carprofen

This is the safest NSAID, because of its weak inhibition of peripheral prostaglandins.

#### Diclofenac

This NSAID, when given to lambs before castration with bloodless castrators, significantly reduced the time spent trembling or in abnormal postures following the castration procedure.<sup>23</sup>

#### Xylazine

Xylazine was shown to be the most effective analgesic for the relief of experimentally induced superficial, deep and visceral pain in ponies when it was compared to fentanyl, meperidine (pethidine), methadone, oxymorphone and pentazocine.<sup>24</sup> However, its short duration of action and the accompanying sedation and decreased gastrointestinal motility and increased urine formation limit its use to short-term analgesia.

#### Narcotic analgesics

Meperidine (Demerol, pethidine) is extensively used as an analgesic for visceral pain in the horse. Methadone hydrochloride and pentazocine are also used, to a limited extent, and their use is detailed in the treatment of colic in the horse. Butorphanol, a synthetic narcotic used alone<sup>25</sup> or in combination with xylazine,<sup>26</sup> provides highly effective analgesia in horses. In general, narcotic analgesics are not as effective in ruminants because they have a different distribution of mu and kappa receptors to monogastric animals.

Narcotic agents are used in somatic pain in humans and may have wider applicability in animals. A recent clinical application has been transdermal delivery of fentanyl, which is a potent mu and kappa agonist opioid analgesic drug that is highly lipid-soluble. Fentanyl patches have been applied to the skin of horses, pigs, sheep, goats and llamas. The rate and magnitude of uptake is dependent on core temperature and environmental temperature (and therefore blood flow to the skin at the site of the patch), thickness of the skin at the site of the patch and adherence of the patch to the skin.<sup>27</sup> A significant limitation to the use of opioids is their addictive nature in humans, necessitating storage under strict control

with written records of their usage required in most countries.

#### Vanilloids

Capsaicin is derived from hot chili peppers (*Capsicum annuum*) and is the main vanilloid used in horses; these agents are characterized by their ability to activate a subpopulation of nociceptor primary afferent neurons. Capsaicin induces a transient primary hyperalgesia that is followed by a sustained period of desensitization that is species-, age-, dose- and route-of-administration-dependent. The sustained desensitization is responsible for capsaicin's efficacy as an analgesic agent. Capsaicin therefore has dual effects: initial transient primary hyperalgesia (manifest as a burning sensation) and long-term desensitization. Topical application of capsaicin ointment over the site of the palmar digital nerves has been used in horses as an adjunctive method of analgesia in equine laminitis, with demonstrated efficacy.<sup>28</sup> The major clinical disadvantage of using capsaicin is the initial transient primary hyperalgesia.

#### Balanced analgesia

Because multiple mechanisms for pain modulation all act together, the concept of **balanced analgesia** has been proposed, similar to the way in which the use of different combinations of sedative and anesthetic agents results in the best aspects of each agent producing balanced anesthesia.<sup>2</sup> Among horses receiving NSAIDs at the end of an anesthetic, those that received butorphanol during surgery required less additional analgesia compared to those that did not receive any opioid. Thus, combinations of drugs can be used to produce sequential blocks in nociceptive pathways.

#### Administration routes

The main routes used for administration of analgesics have been local infiltration, subcutaneous, intramuscular and intravenous. Other routes, including the **oral, epidural, intra-articular** and **topical**, are now being explored.<sup>2</sup>

**Xylazine** and **lidocaine** given as **epidural analgesia** abolished pain and tenesmus in cows with acute tail-head trauma which was characterized by acute, intense pain and discomfort, severe tenesmus and a limp tail.<sup>29</sup> Extended pain relief was required for up to 3 weeks. Xylazine in the epidural space has also been used to provide analgesia for the castration of bulls.<sup>30</sup> In the horse epidural analgesia using a combination of butorphanol and local anesthetics has been used to provide perineal analgesia.<sup>2</sup>

#### Supportive therapy

The application of moist heat to a local lesion causing pain is effective and makes

medical sense. Its value depends on how frequently and for how long it can be applied.

Providing adequate bedding is important for an animal that is recumbent for long periods or that is likely to injure itself while rolling. A thick straw pack is most useful if it can be kept clean and densely packed. Sawdust is most practical but has the problem that it gets into everything, especially dressings and wounds. Rubber floors and walls, as in recovery wards, are effective but are usually available only for short periods.

The provision of adequate amounts and quality of feed and water is essential, especially if the animal is immobilized and because appetite is often poor.

Distracting a horse with colic by walking it continuously is a common practice to prevent the animal from behavioral activities such as rolling, which may cause self-inflicted injuries. It is valuable, but has obvious limitations.

#### REVIEW LITERATURE

- Cunningham FM, Lewes P. Advances in anti-inflammatory therapy. *Br Vet J* 1994; 150:115-134.
- Lascelles BDX. Advances in the control of pain in animals. *Vet Annu* 1996; 36:1-15.
- Lamont LA, Tranquilli WJ, Grimm KA. Physiology of pain. *Vet Clin North Am Small Anim Pract* 2000; 30:703-728.
- Muir WW, Woolf CJ. Mechanisms of pain and their therapeutic implications. *J Am Vet Med Assoc* 2001; 219:1346-1356.
- Underwood WJ. Pain and distress in agricultural animals. *J Am Vet Med Assoc* 2002; 221:208-211.

#### REFERENCES

- Kitchen H et al. *J Am Vet Med Assoc* 1987; 191:1186.
- Lascelles BDX. *Vet Annu* 1996; 36:1.
- Johnson CB et al. *Vet Rec* 1993; 133:336.
- Rushen J, Congdon P. *Aust Vet J* 1986; 63:373.
- Fell RL et al. *Aust Vet J* 1986; 63:16.
- Van Ree JM. *Tijdschr Diergeneesk* 1985; 110:3.
- Schoental R. *Vet Rec* 1986; 119:223.
- Sylvester SP et al. *Aust Vet J* 1998; 76:118.
- Erkert RS, MacAllister CG. *J Am Vet Med Assoc* 2005; 226:1990.
- Johnson CB et al. *Vet Rec* 1993; 133:336.
- Hardee GE et al. *Res Vet Sci* 1985; 39:110.
- Trillo MA et al. *Equine Pract* 1984; 6(3):21.
- Landoni MF et al. *Vet Rec* 1995; 137:428.
- McMeekan CM et al. *Res Vet Sci* 1998; 64:147.
- Earley B, Crowe MA. *J Anim Sci* 2002; 80:1044.
- Williams RJ et al. *Am J Vet Res* 1990; 51:371.
- Taylor JB et al. *Vet Rec* 1983; 113:183.
- Snow DH et al. *Am J Vet Res* 1981; 42:1754.
- Meschter CL et al. *Cornell Vet* 1984; 74:282.
- De Backer P et al. *J Vet Pharm Ther* 1980; 3:29.
- Semrad SD et al. *Am J Vet Res* 1993; 54:1906.
- Davis LE. *J Am Vet Med Assoc* 1980; 176:65.
- Molony V et al. *Vet J* 1997; 153:205.
- Pippi NL, Lumb WV. *Am J Vet Res* 1979; 40:1082.
- Kalpravidh M et al. *Am J Vet Res* 1984; 45:211.
- Robertson JT, Muir WW. *Am J Vet Res* 1983; 44:1667.
- Grubb TL et al. *Am J Vet Res* 2005; 66:907.
- Seino KK et al. *J Vet Intern Med* 2003; 17:563.
- Shaw JM. *Vet Rec* 1997; 140:23.
- Caulkett NA et al. *Comp Cont Educ Pract Vet* 1993; 15:1155.

## Stress

Stress is a systemic state that develops as a result of the long-term application of stressors. It includes pain, which is discussed above. **Stressors** are environmental factors that stimulate homeostatic, physiological and behavioral responses in excess of normal. The most objective measure of the presence and magnitude of stress is the plasma cortisol concentration. The importance of stress is that it may:

- Lead to the development of psychosomatic disease
- Increase susceptibility to infection
- Represent an unacceptable level of consideration for the welfare of animals
- Reduce the efficiency of production.

**The general adaptation syndrome**, described in humans, has no counterpart in our animals and it is lacking in accurate definitions, precise pathogenesis and general credibility.

#### CAUSES OF STRESS

For animals, a satisfactory environment is one that provides thermal comfort, physical comfort, control of disease and behavioral satisfaction. An environment that is inadequate for these factors will lead to stress. The environmental influences that elicit physiological responses from animals are outlined below and some can be classified as stressors. The effects of most of these influences on production or performance indices have been measured quantitatively and many of them have been equated with blood levels of adrenal corticosteroids, which quantify them as stressors in the different species:

- **Road transportation** for prolonged periods, especially during inclement weather and when overcrowded, is considered to be a major stress associated with an increased incidence of infectious disease in all farm animal species. The effects of prolonged road transportation have been measured in young calves,<sup>1</sup> cattle,<sup>2</sup> sheep<sup>3,4</sup> and horses<sup>5</sup>
- **Climate**, especially temperature, either as excessive heat or cold, is a stressor. In particular, a change of climate places great pressure on heat production and conservation mechanisms in, for example, conditions of sudden wind and rain, which affect the comfort of animals
- **Excessive physical effort**, as in endurance rides for horses, struggling in restrained animals, fear, and the excitement and fear in capture myopathy syndrome in wildlife, are all potential stressors

- **Pain**, especially analgesia-masked pain in severe colic in horses, is a stressor. The pain of dehorning and castration of farm animals is also a transient stressor, depending upon the species and method used
- **Crowding** – temperature, humidity, the physical exhaustion associated with standing up for long periods, being walked on, difficulty in getting to food and water, etc. are relevant. Two other factors could be important. One is the effect of crowding on behavior. For example, pigs in overcrowded pens appear to bite one another more than when they are housed at lower densities, and are more restless than normal when temperatures in the pens are high. The biting is much more severe between males than between females. Also, it is known that pigs bite each other when establishing precedence in a group, e.g. after mixing of batches, and that this is more severe when feed is short. The other possible factor that might affect the animal's response to crowding is a psychological appreciation of the unattractiveness of crowding (or of isolation). This, however, is an unknown phenomenon in animals
- **Presence or absence of bedding**. This is a comfort factor separate from temperature and wetness. Whether comfort affects physiological mechanisms is not currently known
- **Housing** generally includes the matter of comfort as well as that of maintaining moderate temperatures, but whether there is a factor other than the physical is not known
- **Nutritional deficiencies** including lack of energy, bulk and fluid
- **Quietness versus excitement**. Harassment by humans or other animals sufficient to cause fear does elicit stress response in animals and this is thought to be one of the significant causes of stress-related diseases in animals. Thus, transportation, entry to saleyards, feedlots, fairs and shows, and simply the mixing of several groups so that competition for superiority in the social order of the group is stimulated, are causes of stress. Entry to an abattoir, which has the additional fear-inspiring factors of noise and smell, is likely to be very stressful for those reasons, but it is unlikely that a fear of impending death is relevant. Such situations are stressful to the point of causing marked elevation of plasma epinephrine concentrations

### Herding and flocking instincts.

Animal species that are accustomed to be kept as herds or flocks may be distressed for a period if they are separated from the group.

### PATHOGENESIS

Stress is thought to develop when the animal's mechanisms concerned with adapting its body to the environment are extended beyond their normal capacities. The daily (circadian) rhythm of homeostatic and physiological changes in response to normal daily changes in environment requires the least form of adaptation. Marked changes in environment, such as a dramatic change in weather, on the other hand, place a great strain on adaptation and are classified as stressors.

The body systems that are principally involved in the process of adaptation to the environment are the endocrine system for the long-term responses and the nervous system for the sensory inputs and short-term responses. The endocrine responses are principally the adrenal medullary response, related to the 'flight or fight' situation, which requires immediate response, and the adrenal cortical response, which becomes operative if the stressful situation persists.

In humans, a large part of the 'stress' state is the result of stimuli arising in the cerebral cortex and is dependent on the capacity to develop fear and anxiety about the effect of existing or anticipated stressful situations. Whether or not these psychological inputs play any part in animal disease is important, but undecided. The evidence seems to suggest that psychic factors do play such a part but that it is relatively minor.

The critical decision in relating 'stress' to disease is to decide when an environmental pressure exceeds that which the animal's adaptive mechanisms can reasonably accommodate – in other words, to define when each of the pressures outlined above does, in fact, become a stressor. There is a great dearth of definition on the subject. Probably the most serviceable guideline is: 'Stress is any stimulus, internal or external, chemical or physical or emotional, that excites neurons of the hypothalamus to release corticotrophin-releasing hormone at rates greater than would occur at that time of the day in the absence of the stimulus'. This definition uses 'stress' where 'stressor' would have been more common usage. Other than that, it is acceptable. The critical threshold of stress occurs in the adrenal cortex, and its physical determination is subject to a chemical assay of adrenocorticotrophic hormone (ACTH). This was the basis of the original 'Stress and the general adaptation

syndrome' as set down by Selye. The original concept is still attractive because of its simplicity and logic. However, evidence supporting the hypothesis remains limited. The importance of the concept for our animals is unproven. The deficiency in evidence is that of obtaining a standard response to a standard application of a stimulus. There is a great deal of variation between animals, and stimuli that should be significant stressors appear to exert no effect at all on adrenocortical activity.

### Stress and road transportation

The response of different farm animal species to the effects of road transportation has been examined. In unaccustomed cattle that are forced to run and are then herded together, there are increases in the hematocrit and blood concentrations of catecholamines, cortisol, total lipid, glucose and lactose.<sup>6</sup> Transportation of calves, 4–6 months of age, for only 4 hours results in a leukocytosis with neutrophilia, a decrease in T-lymphocyte population, a suppression of lymphocyte blastogenesis and enhancement of neutrophil activity.<sup>7</sup> The effects of road transportation on cattle varies according to age: the transportation of 1–3-week-old calves for up to 18 hours was not as stressful as in older calves.<sup>1,2</sup> The lack of response of the younger calves to transport may be due to their lack of physiological adaptation to coping with the transportation.<sup>1</sup> During transportation, plasma cortisol concentrations and serum creatine kinase activities increase. There is clinical evidence of dehydration and increases in serum non-esterified fatty acid,  $\beta$ -hydroxybutyrate and urea concentrations, which reflect changes in normal feeding patterns.<sup>2</sup> Based on the physiological measurements and subjective measurements of behavior, a 15-hour transportation period under good conditions is not unacceptable with regard to animal welfare.<sup>2</sup> Transportation is exhausting and causes dehydration but lairage facilitates recovery from both.<sup>8</sup> When sheep are subjected to a journey of up to 24 hours it is best to be done as an uninterrupted trip, because it is the initial stages of loading and transport that are most stressful.<sup>3,4</sup> In a 15-hour road journey in sheep, the major change in hormone release occurs during the first 3-hour period and is much less in the remaining 12 hours.<sup>9</sup>

The effects of road transport on indices of stress in horses have been examined.<sup>5</sup> A road journey lasting up to 24 hours is not particularly stressful for horses, if they are healthy, accustomed to the trailer and their travel companions, permitted to stop at least as frequently as every 3.75 hours

and traveling in a well-ventilated trailer.<sup>5</sup> There was no indication that road transport was a risk factor for pulmonary disease; however, confinement of horses with their heads elevated for up to 24 hours (similar to during transportation) results in bacterial colonization and multiplication within the lower respiratory tract.<sup>10</sup> Horses are also less physically stressed when facing backwards in a trailer.<sup>11</sup>

Based on plasma cortisol concentrations, confinement of young bulls on a truck and motion are considered stressful factors in road transport.<sup>12</sup> Transport stress increases fecal, urine and tissue losses, with most of the increased loss taking place during the first 5–11 hours of transport.<sup>13</sup> During transportation of feeder calves (195 kg) the major portion of transport stress occurs during the early phases of transport; longer periods may not add significantly to the overall stress imposed on the calf. It is possible that the major stress may be related to the handling of the animals during loading and unloading.<sup>2</sup>

### Other possible sources of stress

Dehorning dairy calves at 8 weeks of age resulted in an increase in plasma cortisol concentration within 1 hour after the procedure but there was no evidence of prolonged stress.<sup>14</sup>

The effects of maternal dietary restriction of protein and/or metabolizable energy on the humoral antibody response in cows and the absorption of immunoglobulins by their cold-stressed calves indicates that there were no major or sustained differences compared to controls.

Different types of stress also result in distinctive changes in the plasma concentrations of metabolites and hormones.<sup>15</sup> An environmental stress, such as noise, will stimulate a hypothalamic–adrenal–cortex response; while a sympathetic–adrenal–medulla response occurs with a stressor such as transportation.<sup>15</sup>

### CLINICAL PATHOLOGY

The direct criterion of stress is the assay of plasma ACTH; stress may be indirectly assayed using plasma cortisol concentration, which is a less expensive and more widely available assay. Salivary cortisol concentration is a good indicator of stress in sheep. Saliva samples are easy to collect and the laboratory assay is simple to perform. It needs to be remembered that elevation of plasma and saliva cortisol concentrations are a normal physiological response and do not necessarily imply the existence of a damaging state in the environment.

During prolonged periods of road transportation of cattle and sheep, there



are significant changes in serum concentrations of total proteins, non-esterified fatty acids (NEFAs), glucose, creatine kinase,  $\beta$ -hydroxybutyrate and urea. These changes can be used to assess the degree of stress and the deprivation from feed and water during transportation.<sup>16</sup> Prolonged feed deprivation reduces liver glycogen stores and increases concentrations of NEFAs and ketones in the plasma. Dehydration will elevate the concentrations of plasma proteins and the osmolality of the blood. Physical stress such as fatigue or exercise will result in increases in creatine kinase. Psychological stressors such as fear result in elevations of cortisol and corticosterone.

## STRESS SYNDROMES

### Stress-related psychosomatic disease

In humans there is a significant neuronal input from the cerebral cortex to the hypothalamus in response to the psychological pressure generated by stress. Inability to monitor anxiety and feelings of harassment in our animals makes it impossible to determine the presence or otherwise of psychological stress in them. However, psychosomatic diseases as they occur in humans are almost unknown in farm animals. The pathogenesis of psychosomatic disease appears to be based on the ability of the cerebral cortex to effectively override the normal feedback mechanisms by which the pituitary gland regulates the secretion of corticosteroids from the adrenal cortex. In other words, the normal adaptive mechanisms do not operate and hyperadrenocorticism and adrenal exhaustion develop.

### Stress and susceptibility to infection

Field observations support the view that stress reduces resistance to infection. This seems to be logical in the presence of higher than normal adrenocortical activity. The most intensively explored relationship of this kind has been that of exposure of calves to weaning and transportation and their subsequent susceptibility to shipping fever. The prevalence appears to be increased and is still further enhanced by the introduction of other stress factors.

### Stress and animal welfare

The harassment of domesticated animals by humans has become a matter of great concern for the community at large. Intensive animal housing has become an accepted part of present-day agribusiness but the consuming public is inclined to the view that these practices are cruel. The literature that has built up around the argument sets out to demonstrate that environmental stress in the shape of intensive housing, debeaking, tail docking and so on is sufficient to cause a stress

reaction as measured by increased corticosteroid secretion. Such has not turned out to be the case and this is understandable in the light of the known variation among animals in their response to environmental circumstances requiring their physiological adaptation. If it could be shown that this relationship did exist and that the increased adrenocortical activity caused reduction in resistance to infection, the task of the responsible animal welfare person would be much easier. The absence of this experimental data makes the continuing argument less resolvable, but it is now generally accepted that producers have a responsibility to their animals and to society generally to maintain an acceptable standard of humane care of animals. These arguments are usually expressed as codes of animal welfare, to which most concerned people conform. However, they are not statutory directives and are not capable of active enforcement. Some courts of law accept them as guidelines on what the human-animal relationship in agriculture should be. Many aspects of the codes are arbitrary and are understandably heavily sprinkled with anthropomorphic sentiments. The study of ethology, which has expanded greatly during the recent past, may eventually provide some answers to this active, often bitterly fought-over field.

The status of animals used in experiments has always been a bone of contention between the experimenters and some sections of the general public. In general, these arguments revolve around anthropomorphic propositions that animals are subject to fear of pain, illness and death in the same way as human beings. There is no consistent evidence in physiological terms that supports these views. However, the public conscience has again achieved a good deal of acceptance to its view that animal experimentation should be controlled and restricted, and carefully policed to avoid unnecessary experiments and hardship in animals under our control.

### Stress and metabolic disease

There is an inclination to label any disease caused by a strong pressure from an environmental factor as a 'stress' disease, for instance hypocalcemia of sheep and hypomagnesemia of cattle in cold weather, acetonemia and pregnancy toxemia of cattle and sheep on deficient diets, white muscle disease of calves and lambs after vigorous exercise. These diseases do have environmental origins, but their causes are much simpler than a complex interaction of the cerebral-cortical-hypothalamic-adrenocortical axis. They can be prevented and cured without any

intervention in the 'stress' disease pathogenesis. This is not to say that there is no adrenocortical basis for the pathogenesis of the above-listed diseases, but attempts to establish the relationship have so far been unsuccessful.

### Stress and its effect on economic performance

The constant struggle for domination of other animals in an animal population is most marked in chickens and pigs and the relationship between status in the hierarchy and productivity in these species has been established, with the low-status animals producing less well. It is also known that birds that are highly sensitive and easily startled are poor producers; they are easily identified and culled.

The relationship between stress and production appears to be a real one. For example, heat stress in the form of high environmental temperatures reduces roughage intake and hence milk production in lactating dairy cows and the relationships between stress and infertility and stress and mastitis in cattle are also well documented. The sensitivity of animals to environmental stress is greatest at times when they are already affected by metabolic stresses, e.g. during late pregnancy and early lactation. The adoption of a policy of culling erratic, excitable animals appears to have an economic basis.

## MANAGEMENT OF STRESS

The widespread public debate about the welfare of food-producing domestic animals dictates that veterinarians, animal scientists and the livestock industry must develop systems of handling and housing that will minimize stressors and provide an environment that makes the animals most contented and at the same time most productive. In civilized human society it should be realistic to expect that the animals that we use for food production or as companions should live their lives free from abuse or adverse exploitation. It will be necessary to determine how best to monitor the wellbeing of animals and determine whether or not they are under stress. Guidelines dealing with codes of practice for livestock production are available in many countries. In addition to housing, handling and experimental intervention, it will also be important to give due care to the appropriate selection and use of anesthetics and analgesics when pain is being inflicted, as in dehorning and castration. The effects of sedatives such as acepromazine and xylazine on the stress response in cattle has been examined but the results are inconclusive.<sup>17</sup>

The welfare of animals during transportation is a major issue that has



resulted in legislation governing the transport of animals and to define acceptable and unacceptable procedures.<sup>16</sup> Many countries now have codes of practice for the handling and transportation of animals. Welfare is determined by the length of the trip and the conditions under which animals are transported, including stocking density, ventilation, temperature and humidity, noise and vibration. Prolonged deprivation of feed and water during long transportation results in hunger and thirst, and methods to minimize these consequences must be examined.<sup>16</sup>

## REVIEW LITERATURE

- Howard JL, ed. Stress and disease in cattle. *Vet Clin North Am Food Anim Pract* 1988; 4:441-618.
- Griffin JFT. Stress and immunity: a unifying concept. *Vet Immunol Immunopathol* 1989; 20:263-312.
- Wariss PD. The welfare of animals during transport. *Vet Annu* 1996;36: 73-85.

## REFERENCES

- Knowles TG et al. *Vet Rec* 1997; 140:116.
- Wariss PD et al. *Vet Rec* 1995; 136:319.
- Knowles TG et al. *Vet Rec* 1996; 139:335.
- Knowles TG et al. *Vet Rec* 1995; 136:431.
- Smith BL et al. *Equine Vet J* 1996; 28:446.
- Hattingh J et al. *J South Afr Vet Assoc* 1989; 60:219.
- Murata H et al. *Br Vet J* 1987; 143:166.
- Atkinson PJ. *Vet Rec* 1992; 130:413.
- Broom DM et al. *Br Vet J* 1996; 152:593.
- Raidal SL et al. *Aust Vet J* 1995; 72:45.
- Waran NK et al. *Vet Rec* 1996; 139:7.
- Kenny FJ, Tarrant PV. *Appl Anim Behav Sci* 1987; 17:209.
- Cole NA et al. *Am J Vet Res* 1988; 49:178.
- Laden SA et al. *J Dairy Sci* 1985; 68:3062.
- Mitchell G et al. *Vet Rec* 1988; 123:201.
- Wariss PD. *Vet Annu* 1996; 36:73.
- Brearley JC et al. *J Vet Pharmacol Ther* 1990; 13:367.

## Localized infections

Localized infections are common in farm animals and many are bacterial infections secondary to traumatic injuries. Because most of them have a surgical outcome, by incision and drainage or by excision or amputation, they are not usually included in medical textbooks. They are presented briefly here because of their importance in the differential diagnosis of causes of toxemia and also because of their space-occupying characteristics, causing compression of other structures. Also, the initial treatment is often medical, especially if the location of the lesion cannot be identified.

## ETIOLOGY

Abscesses and similar aggregations of pyogenic material in certain anatomical locations are described elsewhere in this book. The common ones include: pharyngeal, retroperitoneal, hepatic, splenic, pulmonary, cerebral, pituitary,

spinal cord and subcutaneous abscesses. Other similar lesions include embolic nephritis, guttural pouch empyema, lymphadenitis, pharyngeal phlegmon, osteomyelitis tooth root abscesses and infections of the umbilicus and associated vessels.

More widespread accumulations of necrotic/toxic pyogenic debris occur and are described under the headings of: pericarditis, pleurisy, peritonitis, metritis, mastitis, meningitis and pyelonephritis.

Other pyogenic lesions worthy of note include the following:

- **Inguinal abscess in horses.** Some of these probably originate as postcastration infections, but some obviously have other origins, possibly as a lymphadenitis arising from drainage of a leg with a chronic skin infection
- **Traumatic cellulitis and phlegmon in soft tissue,** especially skeletal muscle. The neck is a common site of infection in the horse, with lesions resulting from infected injection sites or the injection of escharotic materials, e.g. iron preparations intended only for intravenous administration. Penetrating traumatic wounds, often severely infected, are among the serious occurrences to the legs and hooves of horses and cattle. These commonly penetrate joint capsules, bursae and tendon sheaths, and under-run periosteum. In cattle, the common causes are agricultural implements, in horses they are more commonly caused by running into protruding objects, including stakes and fencing material
- **Abscessation and cellulitis of the tip or the proximal part of the tail.** Occurs in steers in feedlots and rarely extends to the hindquarters and the scrotum;<sup>1</sup> the cause is presumed to originate from the presence of an aggregate of feces on the tip of the tail (manure ball) which gets caught in fencing material. Bacterial isolated from the lesion indicates a mixed infection
- **Perirectal abscess** occurs in horses, caused usually by minor penetrations of the mucosa during rectal examination. Some of these rupture into the peritoneal cavity, causing acute, fatal peritonitis. Others cause obstruction of the rectum and colic because of the pain and compression that result.<sup>2</sup> They are readily palpable on rectal examination
- **Perivaginal abscess** occurs in heifers and cows, caused by vaginal tears during parturition, particularly after dystocia. Occasionally these rupture

into the peritoneal cavity, causing acute, fatal peritonitis. More commonly, the abscess causes obstruction of the rectum and urethra, with the animal exhibiting signs of abdominal pain and stranguria because of the pain and compression that results. Perivaginal abscesses are readily palpable on rectal and vaginal examination

- **Urachal abscess** – see omphalitis
- **Pituitary abscess** occurs in cattle as a single entity or in combination with other lesions.<sup>3</sup> Pituitary abscesses cause a wide range of signs with emphasis on dysphagia due to jawdrop, blindness and absence of a pupillary light reflex, ataxia and terminal recumbency with nystagmus and opisthotonos.<sup>4</sup> A high-quality *Arcanobacterium* (*Actinomyces* or *Corynebacterium*) *pyogenes* vaccine against the disease is reported to have performed well<sup>5</sup> but theoretically should provide minimal to no efficacy against pituitary abscesses.
- **Facial abscess in cattle and goats.** Facial abscesses secondary to injury of the cheek mucosa caused by plant awns are common in beef cattle being fed hay containing a variety of awns that may penetrate the oral mucosa. *A. pyogenes* is the commonly isolated bacterium. Localized abscesses of the face and neck are common in some flocks of goats.<sup>6</sup> *A. pyogenes* is most commonly isolated, followed by *Corynebacterium pseudotuberculosis* and *Staphylococcus* spp. The abscesses are most common on the jaw and sternal, facial and cervical regions
- **Tooth root abscesses in llamas, alpacas, goats and sheep.** Tooth root abscesses are a common dental disease of llamas and alpacas. Tooth root abscesses can arise without a known cause or may result from trauma, foreign body migration (such as grass seeds), malocclusion and abnormal tooth wear, and periodontal disease.<sup>7</sup> *Fusobacterium necrophorum* and *A. pyogenes* are most commonly isolated from tooth root abscesses in New World camelids. Tooth root abscesses are most frequently found in mandibular molar teeth in New World camelids, the mandibular incisors in pigs and the first maxillary molar in horses.<sup>7</sup>

## Bacterial causes of localized infection

These include those bacteria that are common skin contaminants in animals, including *A. pyogenes*, *F. necrophorum*, streptococci and staphylococci. Clostridial infections are common but occur sporadically. They are described under

Malignant edema. *C. pseudotuberculosis* is common as a cause of local suppuration in horses and is the specific cause of caseous lymphadenitis of sheep. *Rhodococcus equi* also causes pulmonary and subcutaneous abscesses in horses and cervical lymphadenitis in pigs. Strangles, *R. equi* infection in foals, melioidosis and glanders are all characterized by extensive systemic abscess formation. *Histophilus somni* causes systemic abscess formation in sheep. *Mycobacterium phlei* and other atypical mycobacteria are rare causes of local cellulitis and lymphadenitis/lymphangitis manifesting as 'skin tuberculosis' in cattle. Streptococcal cervical abscess in pigs is another specific abscess-forming disease.

#### PORTAL OF ENTRY

Most localized infections begin as penetrating wounds of the skin, caused accidentally or neglectfully because of failure to disinfect the skin adequately before an injection or incision, as in castration, tail docking, etc.

Metastatic implantation from another infectious process, especially endocarditis, carried by blood or lymph, is the next most common cause. In this way a chain of lymph nodes can become infected. Cranial and caudal vena caval syndromes produce similar embolic showers in the lungs.

#### PATHOGENESIS

The local infection may take the form of a circumscribed aggregation of bacterial debris and necrotic tissue, known as an **abscess**. This may be firmly walled off by a dense fibrotic capsule or be contiguous with normal tissue. When such an abscess occurs in a lymph node, it is a **bubo**. When the infective material is purulent but diffusely spread through tissues, especially along fascial planes, it is known as a **phlegmon**, and when it is inflammatory but not purulent the same lesion is a **cellulitis**.

The species of bacteria in the abscess determines the type of pus present and its odor. Staphylococci produce large quantities of thick yellow pus, streptococci produce less pus and more serous-like exudates. Pus associated with *A. pyogenes* is deep-colored, yellow or green in color and very thick and tenacious. The pus of *F. necrophorum* is very foul-smelling and usually accompanied by the presence of gas.

Deposition of bacteria in tissues is sufficient to establish infection there in most instances. Conditions that favor abscess development include ischemia, trauma and the presence of a cavity or a hematoma. A continuing process of pus formation results in enlargement to the stage of pointing and rupturing of an abscess, or spread along the path of least

resistance into a nearby cavity or vessel, or discharge to the exterior through a sinus. Continuing discharge through a sinus indicates the persistence of a septic focus, usually a foreign body, such as a grass seed, a sequestrum of necrotic bone or an osteomyelitis lesion.

#### CLINICAL FINDINGS

The clinical signs of abscesses and other local aggregations of pyogenic lesions are described under each of the headings listed under etiology. General clinical findings which suggest the presence of a localized infection, which is not readily obvious clinically, include the following:

- Fever, depression, lack of appetite – the signs of toxemia
- Pain resulting in abnormal posture, e.g. arching of the back, or gait abnormality, including severe lameness
- Weight loss, which can be dramatic in degree and rapidity
- Obstruction of lymphatic and venous drainage, which can cause local swelling and edema. Sequels to these developments include extensive cellulitis if there is a retrograde spread of infection along lymph drainage channels, and phlebitis and thrombophlebitis when there is stasis in the veins
- Careful palpation under anesthesia or heavy sedation may be necessary to overcome the muscle spasm caused by pain. Calves with extensive abscessation emanating from the navel, and horses with inguinal abscesses, can only be satisfactorily examined by deep abdominal and rectal palpation
- Radiological examination may elicit evidence of osteomyelitis, and examination of a fistulous tract may be facilitated in this way, especially if a radiopaque material is infused into the track.

#### CLINICAL PATHOLOGY

##### Hemogram

A complete blood count is helpful in supporting a diagnosis of local abscess. Unless the infection is completely isolated by a fibrous tissue capsule or is small in size relative to the size of the animal (tooth root abscess or osteomyelitis), there will be a leukocytosis with a left shift and an elevation of polymorphonuclear leukocytes in acute lesions or of lymphocytes and monocytes in more chronic ones. A moderate normochromic anemia is usual in chronic lesions, and mild proteinuria is common.

##### Sample of lesion for culture and staining

Attempts to identify the presence of an infectious agent and to establish its

identity are usually undertaken but care is necessary to avoid spreading infection from a site in which it is presently contained. Techniques used include paracentesis, careful needle aspiration from an abscess, blood culture (with the chances of isolation of bacteria being very small unless there is phlebitis or endocarditis) and aspiration of cerebrospinal fluid.

The isolation of bacteria from a well-contained abscess may be difficult because of the paucity of organisms. Special techniques may be necessary and examination of a smear stained with Gram stain, and perhaps also with Ziehl-Neelsen stain if the circumstances suggest it, is an essential part of the examination. Determination of sensitivity of the bacteria to antibiotics is usually undertaken.

#### Necropsy findings

The presence and location of the local infection can be demonstrated at necropsy.

#### TREATMENT

##### Drainage of abscesses

Surgical drainage of readily accessible intact abscesses is the treatment of choice and in most cases the only effective method of therapy. A needle aspirate may be indicated when the nature of the lesion is uncertain. The site is prepared surgically and the abscess is drained, flushed and topically medicated. If the abscess has not yet pointed with a soft spot, hot fomentations and hydrotherapy may aid in the maturation of a superficial abscess. An analgesic may be required during this stage of therapy. Tooth root abscesses require extraction of the affected tooth to effect a cure.<sup>7</sup>

#### Antimicrobial agents

Antimicrobial agents given parenterally can be used for the treatment of deep abscesses not readily accessible to surgical drainage. Ideally, a sample of the contents of the abscess should be cultured and antimicrobial susceptibility determined. The agent must achieve high plasma concentrations to facilitate penetration into an abscess and daily treatment for several days is usually necessary. However, antimicrobial agents alone may be ineffective, even if the organism appears sensitive to the drug in vitro in cases where the abscess is surrounded by a dense capsule – presumably the capsule prevents diffusion of the drug into the abscess cavity. Lipophilic antibiotics, such as rifampin, florfenicol or macrolides, are theoretically advantageous in penetrating into abscesses. Rifampin should be administered with another antimicrobial agent in order to delay the development of antibiotic resistance.

## REFERENCES

1. Buczek J et al. *MedWet* 1984; 40:643, 707.
2. Sanders-Sharis M. *J Am Vet Med Assoc* 1985; 187:499.
3. Taylor PA, Meads EB. *CanVet J* 1963; 4:208.
4. Ferdrizet JA. *Comp Cont Educ Pract Vet* 1986; 8:S311.
5. Cameron CM et al. *Onderstepoort J Vet Res* 1976; 43:97.
6. Gezon HM et al. *J Am Vet Med Assoc* 1991; 198:257.
7. Cebra ML et al. *J Am Vet Med Assoc* 1996; 209:819.

## Disturbances of appetite, food intake and nutritional status

**Hunger** is a purely local subjective sensation arising from gastric hypermotility caused in most cases by lack of distension by food.

**Appetite** is a conditioned reflex depending on past associations and experience of palatable foods, and is not dependent on hunger contractions of the stomach. The term appetite is used loosely with regard to animals and really expresses the degree of hunger as indicated by the food intake. When we speak of variations from normal appetite we mean variations from normal food intake, with the rare exception of the animal that demonstrates a desire to eat but fails to do so because of a painful condition of the mouth or other disability. Variation in appetite includes increased, decreased or abnormal appetite.

**Hyperorexia**, or increased appetite, due to increased hunger contractions, is manifested by **polyphagia** or increased food intake. Partial absence of appetite (**inappetence**) and complete absence of appetite (**anorexia**) are manifested by varying degrees of decreased food intake (**anophagia**).

Abnormal appetites include cravings for substances, often normally offensive, other than usual foods. The abnormal appetite may be perverted, a temporary state, or depraved, the permanent or habit stage. Both are manifested by different forms of **pica** or **allogotriophagia**.

## POLYPHAGIA

Starvation, functional diarrhea, chronic gastritis and abnormalities of digestion, particularly pancreatic deficiency, may result in polyphagia. Metabolic diseases, including diabetes mellitus and hyperthyroidism, are rare in large animals but are causes of polyphagia in other species. Internal parasitism is often associated with poor growth response to more than adequate food intakes.

Although appetite is difficult to assess in animals it seems to be the only

explanation for the behavior of those that grossly overeat on concentrates or other palatable feed. The syndromes associated with overeating are dealt with under the diseases of the alimentary tract (Chs 5 and 6).

## ANOPHAGIA OR APHAGIA

Decreased food intake may be due to physical factors, such as painful conditions of the mouth and pharynx, or to lack of desire to eat. Hyperthermia, toxemia and fever all decrease hunger contractions of the stomach. In species with a simple alimentary tract a deficiency of thiamin in the diet will cause atony of the gut and reduction in food intake. In ruminants a deficiency of cobalt and a heavy infestation with *Trichostrongylidae* helminths are common causes of anophagia, and low plasma levels of zinc have also been suggested as a cause. In fact alimentary tract stasis due to any cause results in anophagia. Some sensations, including severe pain, excitement and fear, may override hunger sensations and animals used to open range conditions may temporarily refuse to eat when confined in feeding lots or experimental units. Some sheep that have been at pasture become completely anophagic if housed. The cause is unknown and treatment, other than turning out to pasture, is ineffective.

A similar clinical sign is feed aversion, seen most commonly in pigs, which is rejection of particular batches of feed that are contaminated by fungal toxins, e.g. *Fusarium* spp., or by the plant *Delphinium barbeyi*.

One of the important aims in veterinary medicine is to encourage an adequate food intake by sick and convalescing animals. Alimentary tract stimulants applied either locally or systemically are of no value unless the primary disease is corrected first. To administer parasymphomimetic drugs parenterally when there is digestive tract atony due to peritonitis is unlikely to increase food intake. In cattle, the intraruminal administration of 10–20 L of rumen juice from a normal cow will often produce excellent results in adult cattle that have been anorexic for several days, provided the primary cause of the anorexia is corrected. The provision of the most palatable feed available is also of value.

Parenteral or oral fluid and electrolyte therapy is indicated in animals that do not eat or drink after a few days. For animals that cannot or will not eat, or in those with intractable intestinal disease, the use of total intravenous feeding (parenteral nutrition) may be indicated. The subject of

therapeutic nutrition for farm animals that cannot or will not eat appears to have been ignored. However, in most cases farm animals will begin to eat their normally preferred diets when the original cause of the anophagia or aphagia is removed or corrected. Intensive fluid therapy may be necessary during the convalescence stage of any disease that has affected feed intake and that may result in a mild depression of serum electrolytes.

A reduced feed intake in high-producing dairy cattle during the first few days or weeks of lactation and in fat beef cattle in late pregnancy may result in fatty infiltration and degeneration of the liver and high mortality. Treatment with glucose parenterally and propylene glycol orally to minimize the mobilization of excessive amounts of body fat is indicated.

In nervous anophagia the injection of insulin in amounts sufficient to cause hypoglycemia without causing convulsions is used in human practice, and in animals the use of tranquilizing drugs may achieve the same result.

In ruminants the effects of blood glucose levels on food intake are controversial, but it seems probable that neither blood glucose nor blood acetate levels are important factors in regulating the appetite. The anorexia that is characteristic of acetonemia and pregnancy toxemia of ruminants appears to be the result of the metabolic toxemia in these diseases. Electrolytic lesions in the hypothalamic region can stimulate or depress food intake depending on the area affected. This indicates the probable importance of the hypothalamus in the overall control of appetite.

## REVIEW LITERATURE

Langhans W, Scharrer E. Pathophysiology of inappetence. *J Vet Med Assoc* 1986; 33:401–413, 414–421.

## PICA OR ALLOTRIOPHAGIA

**Pica** is the ingestion of materials other than normal food and varies from licking to actual eating or drinking. It is associated in most cases with dietary deficiency, either of bulk or, in some cases, more specifically fiber, or of individual nutrients, particularly salt, cobalt or phosphorus. It is considered as normal behavior in rabbits and foals, where it is thought to be a method of dietary supplementation or refection of the intestinal bacterial flora. Boredom, in the case of animals closely confined, often results in the development of pica. Chronic abdominal pain due to peritonitis or gastritis and central nervous system disturbances, including rabies and nervous acetonemia, are also causes of pica.

The type of pica may be defined as follows: **osteophagia** is the chewing of bones; **infantophagia** is the eating of young; **coprophagia** is the eating of feces. Other types include wood-eating in sheep, bark-eating, the eating of carrion and cannibalism. Salt hunger can result in coat-licking, leather-chewing, earth-eating and the drinking of urine. Urine drinking may also occur if the urine is mixed with palatable material such as silage effluent. Bark-eating is a common vice in horses, especially when their diet is lacking in fiber, e.g. when they are grazing irrigated pasture.

### Cannibalism

**Cannibalism** may become an important problem in housed animals, particularly swine, which bite one another's tails, often resulting in severe local infections. Although some cases may be due to protein, iron or bulk deficiency in the diet, many seem to be the result of boredom in animals given insufficient space for exercise. A high ambient temperature and generally limited availability of food also appear to contribute. Male castrates are much more often affected than females and the bites are also much more severe in males. Provision of larger pens or a hanging object to play with, removal of incisor teeth and the avoidance of mixing animals of different sizes in the same pen are common control measures in pigs. In many instances only one pig in the pen has the habit and his removal may prevent further cases. One common measure that is guaranteed to be successful in terms of tail-biting is surgical removal of all tails with scissors during the first few days of life, when the needle teeth are removed. Unfortunately the cannibalistic tendency may then be transferred to ears. As in all types of pica, the habit may survive the correction of the causative factor.

### Infantophagia

**Infantophagia** can be important in pigs in two circumstances. In intensively housed sows, especially young gilts, hysterical savaging of each pig as it is born can cause heavy losses. When sows are grazed and housed at high density on pasture it is not uncommon to find 'cannibal' sows who protect their own litters but attack the young pigs of other sows. This diagnosis should be considered when there are unexplained disappearances of young pigs.

### Significance of pica

Pica may have serious consequences: cannibalism may be the cause of many deaths; poisonings, particularly lead poisoning and botulism, are common sequelae; foreign bodies lodging in the

alimentary tract or accumulations of wool, fiber or sand may cause obstruction; perforation of the esophagus or stomach may result from the ingestion of sharp foreign bodies; grazing time is often reduced and livestock may wander away from normal grazing. In many cases the actual cause of the pica cannot be determined and corrective measures may have to be prescribed on a basis of trial and error.

### STARVATION

Complete deprivation of food causes rapid depletion of glycogen stores and a changeover in metabolism to fat and protein. In the early stages there is hunger, increase in muscle power and endurance, and a loss of body weight. In sheep there is often a depression of serum calcium levels sufficient to cause clinical hypocalcemia. The development of ketosis and acidosis follows the increased fat utilization. A marked reduction in feed intake in pony mares in late pregnancy is often a precursor of hyperlipemia, a highly fatal disease discussed in Chapter 28 on metabolic diseases. The most pronounced biochemical change in ponies occurring as a result of experimental food deprivation is a lipemia, which reaches a peak by the eighth day of fasting but quickly returns to normal when feeding is resumed. This degree of change in blood lipids appears to be a characteristic of ponies and horses; it is much higher than occurs in pigs.

In lactating cows, a short period of starvation results in depression of plasma glucose and an increase in plasma lipid concentrations. Milk yield falls by 70%. On refeeding most levels return to normal in 5 days but blood lipid and milk yield may take as long as 49 days to recover to normal levels. In horses, fecal output falls to zero at day 4 and water intake is virtually nil from that time on, but urine volume is maintained. In spite of the apparent water imbalance there is no appreciable dehydration, plasma protein levels and PCV staying at normal levels. A significant loss of skin turgor (increase in skin tenting) due to the disappearance of subcutaneous fat as cachexia develops may occur. Muscular power and activity decrease and the loss of body weight may reach as high as 50–60%. The metabolic rate falls and is accompanied by a slowing of the heart and a reduction in stroke volume, amplitude of the pulse and blood pressure. The circulation is normal as indicated by mucosal color and capillary refill.

In the final stages, when fat stores are depleted, massive protein mobilization occurs and a premortal rise in total

urinary nitrogen is observed, whereas blood and urine ketones are likely to diminish from their previous high level. Great weakness of skeletal and cardiac musculature is also present in the terminal stages and death is due to circulatory failure. During the period of fat utilization there is a considerable reduction in the ability of tissues to utilize glucose and its administration in large amounts is followed by glycosuria. In such circumstances readily assimilated carbohydrates and proteins should be given in small quantities at frequent intervals but fatty foods may exacerbate the existing ketosis. Diets for animals that have been through a period of great nutritional stress because of deprivation of food or because of illness are described below under inanition.

**Starvation of farm livestock is an animal welfare issue** with economic and ethical considerations. When starving animals are identified by a neighboring farmer or veterinarian they are commonly reported to the appropriate authorities, which may be provincial or state appointed inspectors (animal care officers) who have the authority to take appropriate action. The animals are examined and corrective action is taken, including possession of the animals and relocating them to a commercial feeding facility.<sup>1</sup> Predicting survival of starved animals is a major challenge. Economics becomes an important aspect because the financial costs of stabilizing a group of starved horses may exceed their free market price. Responsible management of chronically starved commercial animals should include options for immediate euthanasia. Ethical considerations include deciding if certain severely starved animals should be euthanized. In some cases, enforcement officers may be reluctant to recommend mass euthanasia of otherwise healthy horses based on personal aversion.<sup>1</sup>

Chronically starved horses lose body weight, become weak and their body condition score may decline to below 2 on the basis of 1–9, and death is common, especially during cold weather.<sup>1</sup> Chronically starved horses frequently respond poorly to refeeding. About 20% of severely malnourished horses can be expected to die in spite of attempts at refeeding.<sup>2</sup> Recovery of severely malnourished horses to an average body condition score may require 6–10 months.<sup>3</sup>

### INANITION (MALNUTRITION)

Incomplete starvation – inanition or malnutrition – is a more common field condition than complete starvation. The diet is insufficient in quantity; all essential nutrients are present but in suboptimal

amounts. The condition is compatible with life, and in general the same pattern of metabolic change occurs as in complete starvation but to a lesser degree. Thus ketosis, loss of body weight and muscular power and a fall in metabolic rate occur. As a result of the reduction in metabolic activity there is a fall in body temperature and respiratory and heart rates. In addition there is mental depression, anestrus in cows but not ewes, and increased susceptibility to infection. This increased susceptibility to infection that occurs in some cases of malnutrition cannot be accepted as a general rule. In the present state of knowledge it can only be said that 'some nutritional influences affect resistance to some forms of infection'.

A significantly reduced food intake also increases susceptibility to some poisons, and this has been related to the effects of starvation on hepatic function. In ruminants, the effects of starvation on the activity of liver enzymes is delayed compared to the effects in monogastric animals, due apparently to the ability of the ruminal store of feed to cushion the effect of starvation for some days. The most striking effect of short-term malnutrition in sheep and cattle compared to rats was the very rapid and large accumulation of neutral fat in hepatocytes. If there is a relative lack of dietary protein over a long period of time, anasarca occurs, particularly in the intermandibular space.

Malnutrition makes a significant contribution to a number of quasi-specific diseases, 'weaner ill-thrift' and 'thin sow syndrome' among them, and these are dealt with elsewhere.

Controlled malnutrition in the form of providing submaintenance diets to animals during periods of severe feed shortage is now a nutritional exercise with an extensive supporting literature. For pastured animals it is a fact of economic life that significant loss of body weight is planned and tolerated for some parts of each year because the well-known phenomenon of compensatory growth enables the animal to make up the lost weight, with no disadvantage, during the times of plenty. Animals fed on submaintenance diets undergo metabolic changes reflected in blood and tissue values as well as the more significant changes in weight. Experimental restriction of feed intake to 65% of normal levels in nonlactating, nonpregnant heifers does not cause significant falls in serum calcium and phosphorus levels, nor in plasma glutamic oxaloacetic transaminase (GOT), aspartate transferase (AST), lactate dehydrogenase (LDH) or creatine phosphokinase (CPK) activities. Serum alkaline phosphatase (AP)

activity was also maintained. In sheep that are losing weight because of under-nutrition there is a significant decrease in plasma creatinine concentration.

Experimental feed restriction, followed by fasting, followed by ad libitum access to feed, such as might occur in nature, had no serious ill-effects on goats. The goats lost weight significantly but did not overeat on being allowed access to feed.

A deficiency of one or more specific dietary essentials also causes a form of partial starvation and is dealt with in Chapter 30.

**Outbreaks of incomplete starvation may occur in cattle, sheep and horses** that are kept outdoors during the cold winter months in regions of the northern hemisphere. The feed usually consists of poor-quality grass hay or cereal grain straw and no grain supplementation. During prolonged exposure to the cold environment the animals will increase their daily intake in an attempt to satisfy maintenance requirements and, in cattle, abomasal impaction with a high case mortality may occur. Animals affected with severe inanition are usually weak and recumbent and may or may not eat when offered a palatable feed.

**Malnutrition and starvation may occur in calves** under 1 month that are fed poor-quality milk replacers containing excessive quantities of nonmilk carbohydrates and proteins. The diet is not well digested by young calves and chronic diarrhea and gradual malnutrition occur. Affected calves recover quickly when fed cows' whole milk for several days. At necropsy there is a marked reduction in muscle mass, lack of depot fat and serious atrophy of fat. Starvation may also occur in beef calves sucking poorly nourished heifer dams with an insufficient supply of milk. The mortality will be high during cold weather when the maintenance requirements are increased. Affected calves will initially suck vigorously and persistently, they will attempt to eat dry feed, drink surface water and urine and bawl for several hours. Eventually they lie in sternal recumbency with their head and neck turned into their flanks and die quietly. The response to therapy is usually unsatisfactory and the case fatality rate is high. The convalescence period in survivors is prolonged and treatment is usually uneconomic. Affected animals must be brought indoors and kept warm and well bedded during treatment and realimentation. Initially, fluid therapy using balanced electrolyte solutions containing glucose and amino acids may be necessary to restore the animal's strength and appetite. This is followed by the provision of controlled amounts of a highly palatable digestible diet. High-

quality legume hay is excellent, small amounts of ground grain are of value and the daily administration of a multiple B vitamin and mineral mixture will replenish those lost during inanition. Skim-milk powder is an excellent source of carbohydrate and protein for young animals that have been partially starved. Adult animals cannot digest large quantities of milk powder because of the relative lack of the appropriate digestive enzymes.

Horses that have been ill with a poor appetite should be tempted with green grass first, and failing that tried with good-quality hay – preferably alfalfa. It is best to dilute it with good grass hay to begin with, and increase the mix to 100% legume hay over a week. An average horse will require 1.5–2 kg BW/day. Grain can be added, mixed with molasses or as a mash. Low-fiber diets are recommended to ensure maximum digestibility. A supplement of B vitamins may be advantageous until full appetite and intake are regained. Horses with broken jaws or that are unable to eat at all for some reason can be allowed to go without food for 3 days, but beyond that time they should be fed by stomach tube. A suitable ration is:

- Electrolyte mixture (NaCl, 10 g;  
NaHCO<sub>3</sub>, 15 g; KCl, 75 g;  
K<sub>2</sub>HPO<sub>4</sub>, 60 g; CaCl<sub>2</sub>, 45 g;  
MgO, 24 g) 210 g
- Water 21 L
- Dextrose, increased from  
300 g/d in 7 days to 900 g
- Dehydrated cottage cheese,  
increased from 300 g/day in  
7 days to 900 g

The ration is divided into two or three equal amounts and fed during one day. Adult horses that are weak and recumbent may be supported in a sling to avoid decubitus ulceration and other secondary complications associated with prolonged recumbency.

## THIRST

Thirst is an increased desire for water manifested by excessive water intake (polydipsia). There are two important causes of thirst: dryness of the pharyngeal and oral mucosae increases the desire for water, irrespective of the water status of body tissues; in addition, cellular dehydration due to a rise in blood osmotic pressure causes increased thirst. Specific observations in ponies have shown that water intake is increased in response to either an increase in the osmotic pressure of tissue fluid or a decrease in the volume of their body fluids.

Cellular dehydration occurs commonly in many cases of dehydration due to

vomiting, diarrhea, polyuria and excessive sweating. Increased thirst in early fever is due to changes in cell colloids leading to increased water retention. A marked polydipsia and polyuria occur in salt deficiency in lactating dairy cattle, in addition to weight loss, a fall in milk production and salt hunger. Salivary sodium levels are best used for diagnosis. A similar syndrome occurs in the 'thin sow syndrome'.

In humans, several other factors appear to exert some effect on water intake: a deficiency of potassium and an excess of calcium in tissue fluid both increase thirst; an increased thirst also occurs in uremia irrespective of the body's state of hydration. It has been suggested that these chemical factors may cause direct stimulation of the thirst center in the hypothalamus. Clinically, diabetes insipidus produces by far the most exaggerated polydipsia.

The clinical syndrome produced by water deprivation is not well defined. Animals supplied with saline water will drink it with reluctance and, if the salinity is sufficiently great, die of salt poisoning. Cattle at pasture that are totally deprived of water usually become quite excited and are likely to knock down fences and destroy watering points in their frenzy. On examination they exhibit a hollow abdomen, sunken eyes and the other signs of dehydration. There is excitability with trembling and slight frothing at the mouth. The gait is stiff and uncoordinated and recumbency follows. Abortion of decomposed calves, with dystocia due to failure of the cervix to dilate, may occur for some time after thirst has been relieved and cause death in survivors. At necropsy there is extensive liquefaction of fat deposits, dehydration and early fetal death in pregnant cows.

Experimental water deprivation has been recorded in camels and lactating and nonlactating dairy cows. In camels death occurred on the seventh to ninth day of total deprivation; body weight loss was about 25%. Lactating cows allowed access to only 50% of their regular water supply become very aggressive about the water trough, spend more time near it and lie down less. After 4 days milk yield is depressed to 74% and body weight to 86% of original figures. There is a significant increase in serum osmolality with increased concentrations of urea, sodium, total protein and copper. The PCV is increased, as are activities of creatinine kinase and serum AST. With complete deprivation for 72 hours, the changes are similar but there are surprisingly few clinical signs at that time. The composition of the milk does not change markedly and blood levels return

to normal in 48 hours. After deprivation of half of their water intake, cattle reduced their water loss by all routes, but plasma and total blood volumes were unchanged.

Sheep, even pregnant ewes, are capable of surviving even though access to water is limited to only once each 72 hours, but there is a significant loss (26%) of body weight. Deprivation of water that allows access to water only once every 96 hours is not compatible with maintaining the pregnancy.

#### REFERENCES

1. Whiting TL et al. *Can Vet J* 2005; 46:320.
2. Kronfeld DS. *J Equine Vet Sci* 1993; 13:298.
3. Poupard DP. *J Equine Vet Sci* 1993; 13:304.

### Weight loss or failure to gain weight (ill-thrift)

This section is concerned with the syndrome of weight loss in the presence of an adequate food supply and a normal appetite. In the absence of any primary disease, an animal or group of animals that presents with this as the problem is a major diagnostic dilemma. Several poorly identified diseases in this category are 'weaner ill-thrift', 'thin sow syndrome', 'thin ewe syndrome', 'weak calf syndrome' (see Ch. 36).

Errors by the owner in the estimation of body weight can lead to inadequate feeding if the ration is based on the requirements needed for growth and maintenance per unit of body weight. Scales are rarely available and estimations by weight-bands are generally inaccurate and subject to too much variability. A reasonably satisfactory alternative used in cattle, sheep and horses is a body condition score estimated on the basis of the amount of body covering of muscle, fat and connective tissue.

Detailed below is a checklist of causes that should be considered when an animal has a weight loss problem in the absence of signs indicative of a primary wasting disease.

#### NUTRITIONAL CAUSES

'Hobby farm malnutrition' is a surprisingly common cause, especially in companion horses. Inexperienced owners keep their animals where they are not able to graze pasture and are entirely dependent on stored feed, but underfeed for economy's sake. A knowledge of the animals' needs and of the approximate energy and protein values of feeds are necessary to prepare an appropriate ration. In a hospital situation any horse presented with a weight loss problem and without a potential diagnosis on first examination should be weighed, fed an energy-rich diet *ad libitum* for 4 days,

then re-weighed. A horse that has previously been underfed will gain 3–5 kg in weight per day.

The feed must be inspected. Mature meadow hay may be efficient only as a filler, and poorly filled oat grain may be very poorly nutritive on a weight basis. Gentle animals that are fed in a group with others may be physically prevented from getting a fair share of available feed, especially if **trough space** is inadequate.

This problem is also common when urban people try to raise a few veal calves or sheep to help defray the costs of their rural acreage. It is common in these circumstances to equate rough meadow grass with proper nutrition for young or pregnant ruminants.

Other considerations are as follows:

- Diets that are inadequate in total energy because they cannot replace the energy loss caused by the animal's level of production can be important causes of weight loss in heavy-producing animals. This subject is discussed under the heading of production disease. An example is acetonemia of high-producing cows in which body stores of fat and protein are raided to repair the energy deficiency of the diet
- Malnutrition as a result of a ration that is deficient in an essential trace element is unusual in the management situation being discussed. A nutritional deficiency of cobalt does cause weight loss in ruminants but is likely to have an area effect rather than cause weight loss in single animals. Copper, salt, zinc, potassium, selenium, phosphorus, calcium and vitamin D deficiencies are also in this category. Experimental nutritional deficiencies of riboflavin, nicotinic acid, pyridoxine and pantothenic acid in calves and pigs can also be characterized by ill-thrift
- Inadequate intake of an adequate supply of feed is dealt with under diseases of the mouth and pharynx and is not repeated here, but it is emphasized that the first place for a clinician to look in a thin animal is its mouth. The owner may have forgotten just how old the animal is and one often finds a cow without any incisor teeth attempting to survive on pasture
- Other factors that reduce an animal's food intake when it is available in adequate amounts include anxiety, the excitement of estrus, new surroundings, loss of newborn, bad weather, tick or other insect worry and abomasal displacement.

## EXCESSIVE LOSS OF PROTEIN AND CARBOHYDRATES

- **Glucose loss in the urine** in diabetes mellitus or chronic renal disease, the former indicated by hyperglycemia and both by glycosuria, are obvious examples of weight loss as a result of excessive metabolic loss of energy
- **Protein loss in the feces.** Cases of protein-losing gastroenteropathy are unusual and are difficult to identify without access to a radioactive isotope laboratory. The loss may occur through an ulcerative lesion, via a generalized vascular discontinuity or by exudation through intact mucosa as a result of hydrostatic pressure in blood vessels, e.g. in verminous aneurysm, or lymphatics in cases of lymphangiectasia of the intestine. The identification of a neoplasm (lymphosarcoma or intestinal or gastric adenocarcinoma are the usual ones) or of granulomatous enteritis is not possible without laparotomy and biopsy of the alimentary segment. One is usually led to the possibility of this as a diagnosis by either a low serum total protein or low albumin level in a normal total protein level, and in the absence of other protein loss as set out below
- **Proteinuria** for a lengthy period can cause depletion of body protein stores, resulting in weight loss. Chronic glomerulonephritis is the usual cause. Examination of the urine should be part of every clinical examination of a patient, but is not commonly so in horses because of the difficulty of obtaining a specimen without recourse to catheterization. Moving the horse into a box stall with fresh straw, or the intravenous injection of furosemide, are possible methods when straightforward collection is not possible. The latter provides an abnormally dilute sample
- **Internal and external parasitoses** in which blood sucking is a significant pathogenetic mechanism can result in severe protein loss, as well as anemia per se.

## FAULTY DIGESTION, ABSORPTION OR METABOLISM

Faulty digestion and absorption are commonly manifested by diarrhea, and diseases that have this effect are dealt with under the heading of malabsorption syndromes (see Enteriti). In grazing ruminants, the principal causes are the nematode worms *Ostertagia*, *Nematodirus*, *Trichostrongylus*, *Chabertia*, *Cooperia* and *Oesophagostomum* and the flukes *Fasciola*

and *Paramphistomum*. In cattle there are, in addition, tuberculosis, coccidiosis, sarcosporidiosis and enzootic calcinosis. In sheep and goats there are John's disease, viral pneumonia without clinical pulmonary involvement, and hemonchosis. In horses there are strongylosis, habronemiasis and heavy infestations with botfly larvae. In pigs there are stephanuriasis, hyostroglylosis (including the 'thin sow syndrome'), infestation with *Macracanthorhynchus hirudinaceus*, and ascariasis. Gastrointestinal neoplasia must also be considered as a possible cause

- Chronic villous atrophy occurs most severely with intestinal parasitism or as a result of a viral infection
- Other lesions caused by parasitic invasion that affect digestion and absorption are gastric granuloma associated with *Habronema* spp. in horses and verminous arteritis, also in horses
- Abnormal physical function of the alimentary tract, as in vagus indigestion of cattle and grass sickness in horses, can be a potent cause of failure to absorb nutrients, but the syndrome is usually manifested by poor food intake and grossly abnormal feces
- Inadequate utilization of absorbed nutrients is a characteristic of chronic liver disease. It is usually distinguishable by a low serum albumin level, by liver function tests and by serum enzyme estimations. A clinical syndrome including edema, jaundice, photosensitization and weight loss is a common accompaniment
- Neoplasia in any organ. The metabolism of the body as a whole is often unbalanced by the presence of a neoplasm so that the animal wastes even though its food intake seems adequate
- Chronic infection, including specific diseases such as tuberculosis, sarcocystosis, East Coast fever, trypanosomiasis (nagana), maedi-visna, caprine arthritis-encephalitis, enzootic pneumonia of swine and nonspecific infections such as atrophic rhinitis of pigs, abscess, empyema and chronic peritonitis have the effect of reducing metabolic activity generally as well as reducing appetite. Both effects are the result of the toxemia caused by tissue breakdown and of toxins produced by the organisms present. Less well understood are the means by which systemic infections, e.g. equine infectious anemia, scrapie in sheep and other slow viruses,

- produce a state of weight loss progressing to emaciation
- Food refusal is a well-recognized syndrome in pigs, due in some cases to mycotoxins in the feed, and 'off feed effects' are similarly encountered in feedlot cattle on rations containing a large proportion of wheat grain
- Many diseases of other systems, e.g. congestive heart failure, are manifested by weight loss because of inadequate oxygenation of tissues.

Determination of the **specific cause of weight loss in an individual animal** depends first on differentiation into **one of the three major groups**:

- Nutritional causes, diagnosed by assessment of the animal's total food intake
- Protein or carbohydrate loss in the animal's excretions, diagnosed by clinicopathological laboratory tests
- Faulty absorption of the food ingested, diagnosed by tests of digestion as set out in Chapter 5.

## Shortfalls in performance

The present-day emphasis on the need for economically efficient performance by farm animals introduces another set of criteria, besides freedom from disease, to be taken into consideration when deciding an animal's future. The same comment applies, and much more importantly, when a herd's productivity is being assessed. This is usually done by comparing the subject herd's performances to that of peer herds, or animals in similar environmental and management conditions.

It is usual to use the production indexes that are the essential outputs of the particular enterprise as the criteria of productivity. Thus, in dairy herds the criteria could be:

- Milk or butterfat production per cow per lactation (liters per cow or liters per hectare)
- Reproductive efficiency as mean intercalving interval
- Percentage calf survival to 1 year of age
- Longevity as percentage mortality per year or average age of cows in herd plus culling rate per year
- The culling rate needs to differentiate between sale because of disease or poor production and sale as a productive animal
- Acceptability of product at sale – as indicated by bulk tank milk somatic



cell count, rejection of milk because of poor-quality, low-fat content, low solids-not-fat content.

If it is decided that performance falls too far short of the target, an investigation is warranted. Some targets for productivity in each of the animal industries are available, but they vary a great deal between countries depending on the levels of agriculture practiced and the standards of performance expected. For this reason, they are not set down here; nor is the degree of shortfall from the target that is acceptable – this depends heavily on the risk aversion or acceptability in the industry in that country. For example, if the enterprise is heavily capitalized by high-cost housing and land, the standard of performance would be expected to be higher than in a more exploitative situation where cattle are pastured all year. In the latter, a reasonable flexibility could be included in the assessment of productivity by permitting it to fall within the scope of 2 SD of the mean productivity established by peer herds.

If it is decided that performance is below permissible standards an investigation should be conducted and should include the following groups of possible causes:

- Nutrition – its adequacy in terms of energy, protein, minerals, vitamins and water
- Inheritance – the genetic background of the herd and the quality of its heritable performance
- Accommodation – to include protection from environmental stress by buildings for housed animals and terrain and tree cover for pastured animals; also consideration of population density as affecting access to feed, water and bedding areas
- General managerial expertise – the degree of its application to the individual flock or herd. This is difficult to assess and then only indirectly, e.g. the efficiency of heat detection, achievement of planned calving pattern
- Disease wastage – as clinical disease or, more particularly, subclinical disease. The latter may include such things as quarter infection rate as an index of mastitis, fecal egg counts relative to parasite burden, metabolic profile relative to metabolic disease prevalence rate, etc.

These investigations tend to require special techniques in addition to the clinical examination of individual animals. They are mostly self-evident, but attention is drawn to the section on exam-

ination of a herd or flock in Chapter 1. It will be apparent that there is a great deal of merit in having herds and flocks under constant surveillance for productivity and freedom from disease, as is practiced in modern herd health programs. Monitoring performance and comparing it with targets is the basis of that system.

The specific syndromes that fall within this category of disease, and which are dealt with elsewhere in this book are ill-thrift of weaner sheep, 'thin sow syndrome', 'weak calf syndrome', 'poor performance syndrome' of horses, 'low butterfat syndromes' and 'summer slump' of milk cows. Two performance shortfalls encountered commonly by field veterinarians are ill-thrift in all species and poor performance syndrome in horses, presented in the two sections following. More specialized problems are dealt with in *Herd health* (details below).

#### REVIEW LITERATURE

Radostits OM. Herd health. Food animal production medicine, 3rd ed. Philadelphia, PA: WB Saunders, 2000.

## Physical exercise and associated disorders

### EXERCISE PHYSIOLOGY

The act of performing physical work requires expenditure of energy at rates above the resting metabolic rate. Increases in metabolic rate can be supported by anaerobic metabolism through the use of intramuscular adenosine triphosphate stores and conversion of glycogen or glucose to lactate for short periods of time. Ultimately, however, all energy is derived by aerobic metabolism and is limited by the rate of delivery of oxygen to tissue and its utilization in mitochondria. To support the increased energy expenditure required to perform work such as racing, carrying a rider or pulling a cart, the metabolic rate is increased. Increases in metabolic rate are supported by increases in oxygen delivery to tissue and carbon dioxide removal. Increased oxygen consumption is dependent upon an increase in oxygen delivery to tissues which is possible by increases in cardiac output, muscle blood flow and, in horses, an increase in hemoglobin concentration with a concomitant increase in the oxygen-carrying capacity of blood. The increased transport of oxygen from the air to the blood is accomplished principally by increases in respiratory rate and tidal volume. Factors that affect oxygen transport from the air to the mitochondria have the potential to impair performance. For instance, laryngeal hemiplegia reduces

minute ventilation and exacerbates the normal exercise-associated hypoxemia in horses, atrial fibrillation decreases cardiac output and hence oxygen delivery to tissues and anemia reduces the oxygen-carrying capacity of the blood.

The increase in cardiac output with exercise of maximal intensity in horses is very large – horses have a cardiac output of about 75 (mL/min)/kg at rest and 750 (mL/min)/kg (300 L/min for a 400 kg horse) during maximal exercise. Associated with the increase in cardiac output are increases in right atrial, pulmonary arterial and aortic blood pressures. Systemic arterial blood pressure during exercise increases as the intensity of exercise increases with values for systolic, mean and diastolic pressures increasing from 115, 100 and 80 mmHg (15.3, 13.3 and 10.6 kPa) at rest to 205, 160 and 120 mmHg (27.3, 21.3 and 16 kPa), respectively, during intense exercise.

Pulmonary artery pressure increases from a mean of approximately 25 mmHg (3.3 kPa) to almost 100 mmHg (13.3 kPa) during intense exercise. The increase in pulmonary artery pressure with exercise may contribute to exercise-induced pulmonary hemorrhage.

The increase in metabolic rate during exercise causes a marked increase in metabolic heat generation with a subsequent increase in body temperature. The increase in body temperature is dependent on the intensity and duration of exercise and the ability of the horse to dissipate heat from the body. Intense exercise of short duration is associated with marked increases in body temperature but such increases rarely cause disease. However, prolonged exercise of moderate intensity, especially if performed in hot and humid conditions, may be associated with rectal temperatures in excess of 42.5°C (108.5°F). Heat is dissipated primarily by evaporation of sweat from the skin surface. Sweating results in a loss of body water and electrolytes, including sodium, potassium, calcium and chloride. The size of these losses can be sufficient to cause dehydration and abnormalities of serum electrolyte concentrations and also impaired cardiovascular and thermoregulatory function.

Recovery from exercise is influenced by the fitness of the individual, with fitter horses recovering more rapidly, the intensity and duration of the exercise bout, and activity during recovery. Horses allowed to walk after a bout of intense exercise recuperate more quickly than do horses that are not allowed to walk. Recovery is delayed if the horse cannot drink to replenish body water or in hot and humid conditions.



## REVIEW LITERATURE

Hinchcliff KW, Kaneps AJ, Geor RJ. Equine sports medicine and surgery: basic and clinical sciences of the equine athlete. Edinburgh, UK: Saunders, 2004.

## POOR RACING PERFORMANCE AND EXERCISE INTOLERANCE IN HORSES

The definition of poor racing performance is difficult. Horses that have a proven record of performing well and that then fail to perform at their previous level are readily apparent and a physical cause of the reduction in performance can often be identified. More difficult are the horses that do not have a history of satisfactory performance and are best labeled as 'failure to perform to expectation'. Horses in this group may indeed have a clinical abnormality but commonly the reason is lack of innate ability or inadequate training – both causes that must be raised with the owner and trainer carefully and tactfully, and only after a thorough examination of the horse.

Exercise intolerance in race horses is best defined as the inability to race at speeds previously attained by that horse or attained by peers. In its most extreme form exercise intolerance is evident as failure to complete the race, whereas its mildest form is evident as a slight decrement in performance, such as losing a race by several lengths or one or two seconds, or failure to perform to expectation.

### APPROACH TO THE HORSE WITH EXERCISE INTOLERANCE

Horses with a history of a recent decrement in performance or those that are not performing to expectation should be examined in a systematic fashion.

#### History

A detailed history should be collected that focuses on documenting the reduction in performance, its time course and the presence and evolution of any clinical signs. This can be accomplished by asking the following questions of the owner or trainer:

- **What evidence is there of poor performance?** This query should focus on providing objective evidence of a reduction in performance through examination of race times or results. This also allows the severity of the reduction in performance to be documented
- **What is the horse's training schedule?** The training regimen should be appropriate for the horse's level of competition
- **Describe the horse's exercise intolerance.** Does it start the race strongly and 'fade' in the last part of the race, or is it unable to maintain a

suitable speed for the complete race? Is the horse slow to recover its normal respiratory rate after exercise? Can it sweat? Does it consistently veer or 'pull' towards one side?

- **Is there any history of illness in this horse or other horses in the same stable or at the race track?** Has the horse had a fever or been inappetent? Is the horse on any medication? Specific attention should be paid to any history of respiratory disease
- **Does the horse make an unusual noise associated with respiration when running?** Horses with upper airway obstructions almost always make an abnormal noise during exercise
- **Does the horse cough either at rest, during or after exercise?** Coughing may be an indication of lower respiratory tract disease
- **Has the horse ever had blood at the nostrils after exercise or has it been diagnosed as having exercise-induced pulmonary hemorrhage?**
- **Is the horse lame?** Does it ever show signs of muscle stiffness or abnormal gait?
- **What is the history of anthelmintic administration?**

#### Clinical examination

A thorough clinical examination should be performed. The physical examination should include a detailed examination of the musculoskeletal, cardiovascular and respiratory systems and may include the collection of samples of body fluids for laboratory analysis. Ancillary testing, such as radiography, endoscopy, nuclear scintigraphy and stress testing, may be available at larger centers.

The horse should be examined at rest for evidence of musculoskeletal disease and then should be observed at the walk and trot for signs of lameness. Subtle lameness that is sufficient to impair performance may be difficult to detect in a horse slowly trotting, and other examinations, such as observation during and after high-speed running at a track, radiography and nuclear scintigraphy, may be necessary. The major muscle groups, including the quadriceps, should be palpated for firmness or pain suggestive of rhabdomyolysis.

The heart should be auscultated carefully for evidence of valvular incompetence or arrhythmias. Mild (grade II–III/VI) systolic ejection murmurs heard loudest on the left thorax are common in fit race horses and should not be mistaken for evidence of valvular disease. Electrocardiography to diagnose abnormalities of rhythm or echocardiography to demon-

strate the extent of valvular lesions are indicated if abnormalities are detected on cardiac auscultation.

The respiratory system should be carefully examined by auscultation of the thorax in a quiet area. The thorax should be auscultated initially with the horse at rest; if no abnormalities are detected the horse's tidal volume should be increased by rebreathing air from a large bag held over its nose, or by exercise. Radiography of the thorax may demonstrate changes consistent with exercise-induced pulmonary hemorrhage, recurrent airway obstruction or pneumonia. Aspirates of tracheal fluid or bronchoalveolar lavage fluid should be examined for evidence of inflammation or hemorrhage. The upper respiratory tract, including pharynx, larynx, trachea and carina, should be examined with a flexible endoscope.

#### Laboratory testing

Collection of blood and urine samples for laboratory analysis are indicated if specific abnormalities are detected on physical examination. For instance, exercise-associated rhabdomyolysis can be confirmed by measurement of serum creatine kinase and aspartate aminotransferase activity. However, blood samples are often submitted for analysis as a matter of routine. Specific attention should be paid to the hemogram, in particular the white blood cell count, for evidence of inflammation and the hematocrit for evidence of anemia. Care should be taken to not assign minor abnormalities an undue significance until corroborating evidence is obtained. Tracheal or bronchoalveolar lavage fluid may provide evidence of lower respiratory tract disease. Examination of feces for helminth ova may demonstrate parasitism.

#### Exercise stress testing

Examination of horses during and after high-speed exercise on a treadmill is now routine in many referral centers. Values of a number of performance-related variables have been determined for Standardbred and Thoroughbred race horses, with better athletes having greater aerobic capacity. However, at this time the main use of high-speed exercise testing is detection of exercise-induced arrhythmia, such as paroxysmal ventricular tachycardia or atrial fibrillation, rhabdomyolysis and upper airway obstruction. Upper airway obstruction is a common cause of poor performance that can often be diagnosed by rhinologyngoscopic examination of horses at rest or after brief nasal occlusion. However, some causes of obstruction are best diagnosed using rhinologyngoscopy during exercise.

## CAUSES OF EXERCISE INTOLERANCE OR POOR PERFORMANCE

Any disease that adversely affects the normal function of a horse has the potential to impair performance. Listed below are some common causes of exercise intolerance in race horses.

### Musculoskeletal system

- Lameness is a common cause of poor performance. Subtle lameness may be difficult to detect but may be sufficient to cause a decrement in performance. Causes and diagnosis of lameness are discussed in textbooks on that topic and are not further covered here
- Rhabdomyolysis.

### Cardiovascular system

Poor performance attributable to cardiovascular disease may be caused by:

- Atrial fibrillation, usually readily diagnosed by electrocardiographic examination. Paroxysmal atrial fibrillation induced by exercise that resolves soon after exercise ceases causes poor performance and is difficult to diagnose
- Ventricular arrhythmias
- Valvular incompetence, such as mitral or tricuspid regurgitation secondary to acquired or congenital disease. Endocarditis is rare in horses
- Congenital anomalies including ventricular septal defect
- Myocarditis or myocardial disease (rare)
- Aorto-iliac thrombosis.

### Respiratory system

Upper airways (see Obstructive diseases of the equine larynx)

- Laryngeal hemiplegia
- Intermittent dorsal displacement of the soft palate
- Epiglottic entrapment
- Epiglottic hypoplasia
- Arytenoid chondritis
- Pharyngeal cysts
- Upper air obstruction associated with hyperkalemic periodic paralysis
- Guttural pouch empyema
- Retropharyngeal abscesses
- Redundant or flaccid alar folds.

Lower airways

- Pneumonia secondary to influenza virus or equine herpesvirus-1 or -4 infection
- Parasitic pneumonia due to *Dictyocaulus arnfieldi*
- Severe exercise-induced pulmonary hemorrhage
- Lower airway inflammatory disease and recurrent airway obstruction
- Granulomatous pneumonia.

## Hematologic and biochemical abnormalities

Anemia

- Parasitism, especially caused by *Strongylus* sp. and cyathostomes
- Chronic disease, such as the presence of an abscess
- Equine infectious anemia
- Piroplasmosis
- Gastric ulceration (anemia is an unusual manifestation of this disease)
- Iron deficiency
- Administration of inhibitors of folic acid synthesis or prolonged oral administration of inactive folic acid
- Phenylbutazone toxicity
- Excessive phlebotomy
- Gastric squamous cell carcinoma
- Administration of recombinant human erythropoietin.

Hypoproteinemia

- Parasitism, especially caused by *Strongylus* sp. and cyathostomes
- Malnutrition, especially inadequate protein intake
- Protein losing enteropathy such as lymphosarcoma or granulomatous enteritis

Electrolyte abnormalities

- Hypokalemia and hyponatremia secondary to excessive losses in sweat and inadequate intake.

### Nervous system disease

- Spinal ataxia caused by cervical compressive myelopathy (static or dynamic, equine protozoal myeloencephalitis, and equine degenerative myelopathy
- Sweeney
- Stringhalt.

### Miscellaneous

- Hypothyroidism (very rare)
- Pituitary tumor (equine Cushing's disease
- Iatrogenic hypoadrenocorticism
- Hepatic disease of any cause, but beware of iron overload
- Renal disease
- Secondary nutritional hyperparathyroidism
- Malnutrition
- Performance-altering drug administration such as  $\beta$ -adrenergic antagonists or sedatives.

## TREATMENT

Treatment should be directed towards correcting the underlying disease. Routine administration of hematinics to horses with a normal hemogram is unnecessary. If after careful and comprehensive examination an organic cause for the poor performance is not found, attention should be given to the horse's training program. Training programs for

horses are described elsewhere (see below).

## REVIEW LITERATURE

Hinchcliff KW, Kaneps AJ, Geor RJ. Equine sports medicine and surgery: basic and clinical sciences of the equine athlete. Edinburgh, UK: Elsevier Health Sciences 2004.

## EXERCISE-ASSOCIATED DISEASES

Many exercise-induced diseases are associated with specific activities. For instance, heat stroke and exhaustion are very rare in Standardbred and Thoroughbred horses raced over distances of up to 3 miles (5 km) but common in horses participating in endurance races (50–100 km) or the second day of three-day event competitions. Conversely, exercise-induced pulmonary hemorrhage occurs only in horses that race at high speed. The exercise-associated diseases exertional rhabdomyolysis, synchronous diaphragmatic flutter, hyperthermia and exercise-induced pulmonary hemorrhage are dealt with in other sections of this book.

## EXHAUSTION

All physical work, if of sufficient intensity and duration, causes fatigue. The mechanisms underlying fatigue vary with the type of work or exercise performed. Thus fatigue in a race horse running 3 km at high speed has a different genesis from fatigue in an endurance horse that has run 100 km at low speed. Typically, Standardbred and Thoroughbred racehorses recover quickly and exhaustion rarely occurs. However, horses performing endurance exercise require longer to recover, and the processes associated with fatigue may progress to the extent that recovery is delayed or impossible without treatment. The failure to recover and the clinical and clinicopathologic signs associated with this have been labeled 'exhausted horse syndrome'.

The exhausted horse syndrome is associated with endurance races, three-day eventing, trail riding and fox and bird hunting – all activities in which there is prolonged submaximal exercise. The likelihood of the disorder is increased in unfit horses or when horses are exercised in hot and humid conditions, especially if they are not accustomed to such conditions.<sup>1</sup>

## Pathogenesis

The pathogenesis of exhaustion is complicated but probably involves depletion of body glycogen and electrolytes, especially sodium, chloride and potassium, hypovolemia due to large losses of water in sweat, hyperthermia and acid-base disturbances. Endurance exercise is associated with the production of large

amounts of heat, which are dissipated primarily by evaporation of sweat.<sup>2</sup> Approximately 11 L of sweat are lost each hour during submaximal exercise, and this loss causes a significant decline in total body water, sodium, potassium and chloride content and serum concentrations of these ions.<sup>3</sup> Loss of chloride causes a metabolic alkalosis. Hypovolemia impairs thermoregulation by reducing blood flow to the skin and probably results in a reduction in gastrointestinal blood flow contributing to intestinal ischemia and development of ileus.<sup>4</sup> Body temperature increases to dangerous levels (43°C, 109°F) and the horse cannot continue to exercise. If the exercise-induced abnormalities are sufficiently severe then the combination of hyperthermia and dehydration may initiate a cascade of events terminating in shock, multiple organ failure and death.<sup>1</sup>

### Clinical signs

The clinical signs of the exhausted horse syndrome include failure to continue to exercise, depression, weakness, failure to eat and drink, delayed return of heart rate and rectal temperature to normal values, poor skin turgor and capillary refill time, a stiff stilted gait consistent with rhabdomyolysis, and decrease or absent borborygmi.<sup>1</sup> Urine is concentrated and the horse ceases to urinate.

Clinicopathologic examination reveals hemoconcentration, hypochloremia, hypokalemia and variable changes in serum sodium concentration. There is usually a metabolic alkalosis (increased blood bicarbonate concentration), although some severely affected horses will also have a metabolic acidosis associated with increased blood lactate concentration. Serum creatinine and urea nitrogen concentrations are increased because of dehydration and/or renal disease. Serum creatine kinase activity may be markedly increased in horses with rhabdomyolysis.

### Treatment

Treatment consists of rapid restoration of hydration status, correction of electrolyte and acid-base abnormalities and reduction in body temperature. Fluid therapy is addressed in detail elsewhere. Suitable fluids for administration to exhausted horses are Ringer's solution, isotonic sodium chloride with added potassium chloride (10 mEq/L) and calcium gluconate (10–20 mL of 24% solution per liter), or lactated Ringer's solution. Theoretically, lactated Ringer's solution should not be given to horses with metabolic alkalosis, but clinical experience indicates its safety and efficacy.<sup>1</sup>

Horses should be aggressively cooled by application of cold water or water and ice. In spite of folk lore to the contrary, application of ice cold water to hyperthermic horses is not dangerous or associated with rhabdomyolysis.<sup>5</sup> NSAIDs, for pain relief and prophylaxis of the effects of endotoxemia, can be given when the horse is no longer hypovolemic.

### Prevention

Prevention rests in ensuring that participating horses are adequately trained for the event and acclimated to the environmental conditions. Horses should be healthy, preferably as determined by a veterinary examination before the race, and should be monitored during the event for signs of excessive fatigue, dehydration or hyperthermia.

### REFERENCES

1. Foreman JH. *Vet Clin North Am Equine Pract* 1998; 14:205.
2. Hodgson DR et al. *J Appl Physiol* 1991; 74:1161.
3. Schott HC et al. *Am J Vet Res* 1997; 58:303.
4. Schott HC et al. *Compend Cont Educ Pract Vet* 1996; 18:559.
5. Williamson L et al. *Equine Vet J Suppl* 1995; 18:337.

## Diagnosis and care of recumbent adult horses

Diagnosis and management of adult horses that are recumbent can be challenging. The large size of adult horses, the variety of conditions that can cause recumbency, the difficulty in performing a thorough clinical examination and the need for prolonged and intensive care all present formidable obstacles to management of recumbent horses. Causes of prolonged (> 8 h) recumbency in horses are listed in Table 2.7. Other causes of acute recumbency of shorter duration are usually obvious on initial examination and include septic or hemorrhagic shock, such as occurs in horses with colic or internal or external hemorrhage.

### EXAMINATION OF THE RECUMBENT HORSE

#### History

Careful questioning of the horse's attendants can reveal valuable information regarding the cause of recumbency. Causes such as observed trauma, foaling and excessive unaccustomed exercise are readily determined from the history. In addition to inquiries about the cause of the recumbency, estimates of the duration of recumbency should be obtained from the attendants. This can often be best elicited by asking when the horse was last observed to be standing. A history of recent illness, abnormal behavior or unusual use immediately before the horse

became recumbent is useful. The horse's age, sex, breed and use should be determined. Information regarding management, vaccination and deworming status, feeding and health of other horses can be revealing. Outbreaks of recumbency suggest either an infectious (equine herpesvirus-1) or toxic (botulism, ionophore) cause. Questions should be directed toward discerning the cause of the horse's recumbency rather than collecting information.

### Physical examination

Physical examination of recumbent horses is challenging but should be as complete as practical and safe. The examination should begin with a general assessment of the horse and its surroundings and can be directed at answering a series of questions:

- Are the surrounding conditions safe for the horse and people? Is the footing sound?
- Is there evidence of the horse struggling or thrashing?
- Has the horse defecated and urinated recently?
- Is there evidence of exposure to toxins or physical evidence of the reason for recumbency?

Examination of the horse should begin with measurement of heart rate, respiratory rate and temperature (rectal temperature might not be accurate if there is dilation of the anus), examination of mucous membranes and an assessment of its hydration, body condition and level of consciousness. The horse should be thoroughly examined for evidence of trauma. Although the examination should be complete, initial examination of cases for which the cause of recumbency is not immediately obvious should focus on the nervous and musculoskeletal systems.

- Is the horse alert and able to sit in sternal recumbency or is it unconscious and in lateral recumbency? Can the horse rise with assistance?
- Is the horse's mentation normal?
- Are there any spontaneous voluntary or involuntary movements?
- Can the horse eat and drink?
- Are the cranial nerves normal?
- Is there evidence of trauma to the head or neck?
- Is there evidence of paresis or paralysis? Are only the hind limbs involved or are both the hind limbs and forelimbs involved?
- Are the peripheral reflexes normal (withdrawal, patellar, cervicofacial, cutaneous, anal, penile)?

Table 2.7 Causes and diagnostic features of recumbency of more than 3 hours duration in adult horses

Cause	Clinical signs and diagnosis	Treatment	Prognosis and comments
<b>Neurologic disease</b>			
Botulism	Horse alert. Flaccid paralysis, dysphagia, weak corneal or palpebral reflex. Often multiple animals affected. Toxin isolation in mice	Administration of specific antitoxin or multivalent antitoxin. Supportive care	Can require prolonged treatment. Prognosis poor for recumbent horses
Tetanus	Horse alert. Rigid paralysis. Signs worsened by stimuli. Often history of recent wound and lack of vaccination	Tetanus antitoxin (IV or intrathecally). Penicillin. Wound debridement. Sedation (acepromazine, chloral hydrate). Minimize stimulation (dark, quiet stall)	Guarded prognosis
Trauma – vertebral	Alert horse. Signs depend on site of lesion. Can be difficult to detect vertebral fractures in adult horses. Radiography	None specific	Poor prognosis
Trauma – cranial	Unconscious or severely altered mentation. Seizures. Head wounds. Blood from ears and nostril. Imaging (radiography, CT, MRI)	Anti-inflammatory drugs including flunixin meglumine, phenylbutazone, corticosteroids. Drugs to reduce swelling (mannitol and hypertonic saline). Control of seizures (diazepam, midazolam, barbiturates). Heroic craniotomy	Very poor prognosis
Cervical vertebral instability	Alert horse. Acute-onset ataxia and recumbency. Young horse (< 4 years old). Radiography and myelography	Anti-inflammatory drugs. Rest. Surgical vertebral stabilization	Poor prognosis
Vestibular disease	Normal to depressed, depending on cause. Signs of vestibular disease include circling and falling to one side, head tilt and nystagmus. Diagnosis by endoscopic examination of guttural pouches, radiography of skull and examination of CSF	Antibiotics, anti-inflammatory disease. Surgical or medical treatment of guttural pouch disease	Poor to guarded prognosis
Equine herpesvirus-1 myoencephalopathy	Usually alert horse. Recumbency follows period of posterior ataxia with fecal and urinary incontinence. Fever in early stages of disease. CSF xanthochromic. Viral isolation or detection of virus by PCR. Serology. Often multiple horses affected	Supportive care	Guarded prognosis. Affected horses can be infectious
Arboviral encephalitis (Eastern, Western, West Nile, Japanese B)	Alert horse or altered mentation, depending on the disease. CSF consistent with inflammation. Viral isolation or detection by PCR. Serology	Supportive care. Dexamethasone for West Nile encephalitis	Epidemiology is characteristic. Prognosis is poor for recumbent horses. Vaccines available
Migrating parasite larvae (Table 35.2)	Mentation depends on anatomic site of parasite. Eosinophils in CSF	Ivermectin 400 µm/kg orally. Corticosteroids	Sporadic disease
Neoplasia (melanoma, lymphosarcoma, cholesterol granuloma, Table 35.2)	Alert horse. Signs of spinal cord compression. Diagnosis by imaging (radiography, myelography, CT). CSF usually normal	No specific treatment	Hopeless prognosis
Equine motor neurone disease	Alert horse. Good appetite. Profound muscle weakness and atrophy. Prolonged periods of recumbency but usually able to stand when stimulated	Supportive care. Vitamin E	Guarded to poor prognosis. Lifelong disease
Equine protozoal myeloencephalitis	Variable mentation and signs of neurologic disease. Diagnosis based on neurologic examination and results of Western blot of CSF or serum	Antiprotozoal medications	Guarded to fair prognosis
Rabies	Variable mentation. Protean signs of neurologic disease. Important zoonosis. Diagnosis by immunofluorescent antibody testing of brain	No treatment. If suspected then appropriate barrier isolation measures must be instituted until the horse dies or recovers, or another diagnosis is confirmed	Rare cause of recumbency in horses
Postanesthetic myelopathy	Acute-onset posterior paresis evident on recovery from general anesthesia	Supportive care	Poor to hopeless prognosis

Table 2.7 (Cont'd) Causes and diagnostic features of recumbency of more than 8 hours duration in adult horses

Cause	Clinical signs and diagnosis	Treatment	Prognosis and comments
<b>Musculoskeletal disease</b>			
Acute rhabdomyolysis (exertional, atypical)	Alert horse. History of unaccustomed or strenuous exercise. Painful. Sweating. Firm painful muscles. Pigmenturia. High CK and AST in serum	Fluid diuresis. Pain control. Supportive care	Guarded to fair prognosis. Can recur. Can progress to acute renal failure
Laminitis	Alert horse. Assumes sternal recumbency easily. Bounding digital pulses. Pain on application of hoof tester to feet	Pain control. Corrective shoeing	Guarded to poor prognosis for long-term care
Fracture of long bone or pelvis	Horse usually able to stand on three legs. Bilateral fracture of femurs. Diagnosis by physical examination and radiography	Euthanasia	
Foaling paralysis (obturator nerve paresis)	Dystocia. Mare unable to stand after difficult foaling. Legs excessively abducted	Supportive care. Anti-inflammatory drugs. Sling horse	Guarded prognosis
Bilateral femoral nerve paresis	Occurs in horses suspended by the hind limbs during anesthesia	Supportive care	Guarded prognosis
Hyperkalemic periodic paralysis	Alert horse. Anxious. Muscle fasciculations. Muscle weakness. High serum potassium concentration. Electromyography. Unusual for recumbency to persist for < 1–2 h. Diagnosis by detection of appropriate genome	Administration of dextrose or calcium solutions. Prevention by administration of acetazolamide, feeding low K <sup>+</sup> diet and selective breeding	Guarded to good prognosis. Lifelong care needed
<b>Environmental</b>			
Heat stress/exhaustion	Depressed mentation. Compatible history of exercise in hot and humid conditions or exposure to extreme heat. Hyperthermia	Rapid cooling. Administration of fluids	Guarded to poor prognosis. Death often associated with DIC
Hypothermia <sup>1</sup>	Depressed mentation. History of exposure to extreme cold. Hypothermia	Warming. Prolonged care necessary	Guarded to poor prognosis
Lightning strike	Horses at pasture. History of electrical storm activity. One or more horses can be affected. There can be evidence of burns, fractures of long bones or the axial skeleton, or vestibular disease	Supportive care. Euthanasia for animals with severe disease	
Gunshot wounds	Horses at pasture. Often during hunting season. Can be malicious. Physical examination variable. Entry hole, and exit hole, can be difficult to identify	Supportive care, depending on site of wound	Horses that have been shot and are recumbent have a poor prognosis
<b>Metabolic</b>			
Starvation, inanition	Alert horse. Grade 1 or 2 of 9 body condition score	Careful refeeding and supportive care	Poor to fair prognosis
Hypocalcemia, hyponatremia	Depressed mentation. Seizures. Confirmed by measurement of serum electrolyte concentrations. Unusual cause of recumbency in adult horses	Correction of electrolyte deficit. Gradual correction of hyponatremia	Good prognosis
Liver disease	Depressed, seizures, head pressing. Jaundice. Elevated serum concentrations of bilirubin, ammonia, and bile acids and increased activity of gammaglutamyl transpeptidase, sorbitol dehydrogenase	Supportive care. Provision of hydration and nutrition. Correction of hypoglycemia. Administration of lactulose	Poor prognosis. History of exposure to hepatotoxins
Hypoglycemia	Seizures. Measurement of blood glucose concentrations. Iatrogenic or malicious, associated with insulin administration. Unusual cause in adult horses	Administration of glucose intravenously	
Water deprivation	Variable mentation from normal to seizures. Associated with inadequate water intake (e.g. broken bore or dry tank supplying horses at pasture)	Judicious rehydration. Provision of unrestricted access to water can result in water intoxication	Cause is usually obvious (lack of access to water). Guarded prognosis
Senile collapse	Alert horse. Old horse. History of progressive weakness. No other causes of recumbency identified	Supportive care. Correction of metabolic abnormalities. Provision of good-quality nutrition	Poor prognosis
<b>Intoxications</b>			
Ionophores (monensin, salinomycin, etc.;	Alert. Acute-onset colic and muscle weakness. Recumbency. Diagnosis is based on history of exposure and measurement of drug concentrations in blood or tissues, and feed	Supportive. No specific treatment	Poor to guarded. Horses surviving the acute episode can have exercise intolerance due to persisting myocardial disease

AST, aspartate transferase; CK, creatine kinase; CSF, cerebrospinal fluid; CT, computed tomography; DIC, disseminated intravascular coagulation; IV, intravenously; MRI, magnetic resonance imaging; PCR, polymerase chain reaction.

- Is cutaneous sensation present in all regions? If not, what are the anatomic boundaries of desensitized areas?
- Is the position of the limbs normal? Is there evidence of crepitus, swelling or unusual shape of the limbs or axial skeleton?
- Are the horse's feet normal? Does it have laminitis? What is the response to application of hoof testers?
- Are abnormalities detected on rectal examination (fractured pelvis, distended bladder, fecal retention, pregnancy), provided that it is safe to perform one?

Other body systems should be evaluated as indicated or necessary. The heart and lungs should be auscultated, although detecting abnormal lung sounds in a recumbent horse is difficult. The horse should be rolled so that a complete examination can be performed. Assisting the horse to stand using a rope tied to the tail and thrown over a rafter, or preferably using a sling, can be useful in assessing the severity of the horse's illness (can it stand at all?) and in facilitating a complete physical examination. If there is a suspicion that the horse has colic a nasogastric tube should be placed to check for accumulation of liquid gastric contents, a rectal examination performed and peritoneal fluid collected.

**Ancillary diagnostic** testing includes radiography of limbs and/or axial spine as indicated by the history or physical examination; myelography if a compressive lesion of the cervical spinal cord is suspected; endoscopic examination of the pharynx and guttural pouches (especially in horses with a history of falling, see Rupture of the longus capitis muscle, ultrasonography of the chest and abdomen; collection of cerebrospinal fluid; and electromyography.

Hematologic abnormalities are sometimes reflective of the causative disease. Serum **biochemical abnormalities** are reflective of the causative disease and in addition are influenced by muscle damage caused by the horse being recumbent (increased creatine kinase and aspartate aminotransferase activity), inappetent (increased total and indirect bilirubin, and triglyceride concentrations), and unable to drink or gain access to water (increased serum urea nitrogen, creatinine, sodium, chloride, total protein and albumin concentrations). Cerebrospinal fluid is reflective of any inciting disease but is usually normal.

## MANAGEMENT AND CARE

The principles of care are treatment of the primary disease, prevention of further illness or injury, assisting the horse to stand, and provision of optimal nutrition and hydration.

Treatment of the primary disease is covered in other sections of this book. Similarly, maintenance of hydration and electrolyte status is covered elsewhere. Maintenance of normal hydration is sometimes problematic in recumbent horses because of limited access to water and unwillingness to drink. Provision of fresh, palatable water is essential. Intravenous or enteral (nasogastric intubation) administration of fluids and electrolyte solutions might be necessary in some recumbent horses, especially early in their illness.

Horses with diseases that cause recumbency often have problems with fecal and urinary incontinence or retention. Catheterization of the urinary bladder might be necessary to relieve distension in horses with neurogenic upper motor bladder or lower motor bladder dysfunction, or in male horses that are reluctant to urinate when recumbent. Catheterization of the bladder is often repeated. To minimize the risk of iatrogenic cystitis, the procedure should be performed aseptically. Administration of bethanechol might increase detrusor muscle tone and aid urination, and phenoxybenzamine (0.5 mg/kg intravenously over 15 min) might decrease sphincter tone in horses with upper motor neurone bladder.

Horses that can eat should be fed a balanced, palatable and nutritious diet. Tempting horses with reduced appetite with treats such as apples, carrots and horse treats might stimulate appetite for hay and grain. Horses that are unable to eat should be fed through a nasogastric tube. Slurries of alfalfa pellets or commercial diets can be administered through nasogastric tubes. The maintenance needs of a sedentary 425 kg horse are approximately 15–18 Mcal/d. The maintenance needs of a recumbent horse are unknown, but are probably less than that of normal sedentary horses.

## COMPLICATIONS – PREVENTION

A major challenge in managing recumbent horses is preventing further injury. Recumbent horses often make repeated efforts to stand, which, while encouraging to all involved, can result in further injury. Horses attempting to stand can injure their head, especially the periorbital regions, and skin over bony prominences such as over the wing of the ilium. Minimizing further injury is achieved by use of a sling or tail rope to assist horses to stand, housing in a padded stall with deep, soft bedding (although this can interfere with the horse's ability to stand), and protection of the head and distal limbs with a helmet and bandages, respectively. Recumbent horses kept in

well-grassed pasture often do well and have minimal self-inflicted trauma.

Decubital ulcers occur over pressure points such as the wing of the ilium, point of the shoulder and zygomatic arch, and can become severe. Recumbent horses that paddle can abrade the skin over limb joints with subsequent increased risk of septic arthritis. Bandages, helmets, ointments such as silver sulfadiazine paste, and soft bedding minimize but do not eliminate these abrasions. Recumbent horses that cannot or do not voluntarily move from side to side should be rolled every 2–4 hours.

Peripheral pressure neuropathy can occur in recumbent horses. The radial nerve and facial nerve are most often affected. Prevention is achieved by use of padded bedding, slings, frequent rolling and a helmet.

Recumbent horses can sustain muscle damage from pressure on large muscle groups. For large or well-muscled horses this can result in large increases in serum creatine kinase activity and myoglobinuria. Myoglobinuria can cause acute renal failure, although this degree of myoglobinuria in recumbent horses is unusual.

Pneumonia can occur as a result of recumbency. Horses that are dysphagic are at increased risk of aspiration of feed material and saliva, and hence development of aspiration pneumonia. Horses receiving corticosteroids are at increased risk of bacterial and fungal (*Aspergillus* spp.) pneumonia. While not every recumbent horse should be administered antimicrobials, this is indicated in horses at increased risk of developing pneumonia. Antimicrobials should have a broad spectrum, including activity against *Streptococcus* spp., such as a combination of penicillin and an aminoglycoside.

Slinging horses is labor-intensive and requires the use of a sling that is designed for use with horses. Horses should not be lifted using hip slings intended for use with cattle. Use of these slings to lift horses by grasping over the wing of each ilium is inhumane and unsuccessful. Horses in slings should be closely monitored and not allowed to hang in the sling. The horses should be assisted to stand in the sling every 6 or 8 hours. The sling should be used to help the horse to get up and provide some support while it is standing, but the horse should not have all its weight borne by the sling for more than a few minutes. Horses that have an excessive amount of weight borne by the sling for a prolonged period of time have trouble breathing and are likely to develop colic, rupture of the urinary bladder, diaphragmatic hernia or rectal prolapse.

Potentially catastrophic complications include septic arthritis, radial nerve injury, bladder rupture, diaphragmatic hernia, rectal prolapse, colon torsion and long bone fracture. The risk of these complications can be minimized by the practices detailed above, but cannot be eliminated.

#### REVIEW LITERATURE

- Chandler K. Clinical approach to the recumbent adult horse. In *Practice* 2000; June:308
- Davis EG et al. Treatment and supportive care of recumbent horses. *Compend Contin Educ Pract Vet* 2004; 26:216.
- Rush BR et al. *Compend Contin Educ Pract Vet* 2004; 26:256.
- Nout YS, Reed SM. Management and treatment of the recumbent horse. *Equine Vet Educ* 2005; 17:324

#### REFERENCE

1. Stephen JO et al. *J Am Vet Med Assoc* 2000; 216:725.

## Sudden or unexpected death

When an animal is found dead without having been previously observed to be ill, a diagnosis, even after necropsy examination, is often difficult because of the absence of a detailed history and clinical findings. A checklist of diseases for consideration when sudden or unexpected death occurs in a single animal or group of animals is provided below. Details of each of the diseases listed are available in other sections of this book. The list applies particularly to cattle, but some occurrences in other species are noted. It is necessary to point out the difference between 'found dead' and 'sudden death'.

When animals are observed infrequently, for example at weekly intervals, it is possible for them to be ill with obvious clinical signs for some days without being observed. In these circumstances the list of possible diagnoses is very large. It is also correspondingly large when animals are kept together in large groups and are not observed as individuals. This is likely to happen in beef cattle, especially in feedlots or as calves with dams at pasture, when the animals are unaccustomed to human presence and move away when approached. The list below refers to animals that are closely observed as individuals at least once daily.

### SUDDEN OR UNEXPECTED DEATH IN SINGLE ANIMALS

#### SPONTANEOUS INTERNAL HEMORRHAGE

This condition could be due to cardiac tamponade in cows, ruptured aorta or atrium, inherited aortic aneurysm or verminous mesenteric arterial aneurysm

in horses and esophagogastric ulcer or intestinal hemorrhagic syndrome in pigs.

#### RUPTURE OF INTERNAL CAROTID ARTERY ANEURYSM

This condition may occur secondary to mycosis of guttural pouch of the horse. In one survey of sudden deaths in horses while racing, most (68%) were undiagnosed, although it was assumed that they died of exercise-associated ventricular arrhythmias. Of those that were diagnosed, most were due to spontaneous hemorrhage.<sup>1</sup> Similar conclusions have resulted from other surveys.<sup>2</sup> Most reported cases of sudden death in the horse are the result of cardiovascular accidents.<sup>3,4</sup>

Fracture of the pelvis can result in fatal hemorrhage within the gluteal muscles of the horse<sup>5</sup> and rupture of the middle uterine artery at parturition in cattle may occur with uterine prolapse.

#### PERACUTE ENDOGENOUS TOXEMIA

This condition can arise from rupture of the stomach of horses, abomasum of cows and colon in mares at foaling. Large amounts of gastrointestinal contents are deposited rapidly into the peritoneal cavity. In newborn animals, especially foals, fulminating infections are the commonest cause.

**Peracute exogenous toxemia** in a single animal could be as a result of snakebite, but the snake would have to be very poisonous and the animal of small body weight to cause death without any observable illness.

#### TRAUMA

Trauma may cause death by either internal hemorrhage or damage to the central nervous system, especially the brain or atlanto-occipital joint sufficient to damage the medulla oblongata. In most cases the trauma is evident: there has been fighting, or a fall has occurred, or the animal has attempted to jump an obstacle. In horses a free gallop downhill may result in a serious fall or collision with, for example, a wall, especially if the ground is slippery.

Inapparent trauma usually occurs when animals are tied up by halter and rush backwards when frightened or are startled by an electric fence and the halter shank is long. Sometimes the animal will plunge forward and hit its forehead between the eyes on a protruding small object such as a bolt used in a fence. Sadism, especially by the insertion of whip handles or pitchfork handles into the anus or vulva, may also be inapparent.

#### GASTROINTESTINAL CONDITIONS

Gastric rupture in the horse may occur following overeating highly fermentable feed, administration of excessive quan-

ties of fluids by nasogastric tube, gastric impaction or when gastric motility is markedly reduced in acute grass sickness or gastric distension with fluid. Peracute enteritis in the horse can cause rapid unexpected death.

Volvulus or gastrointestinal accidents account for almost 50% of sudden deaths in sows, followed next by gastric ulceration, retained fetuses and toxemia.<sup>6</sup>

Recumbent cattle that become lodged in a small hollow in the ground may die of bloat<sup>7</sup> because the cardia becomes covered with ruminal fluid and eructation is not possible.

#### IATROGENIC DEATHS

These may be due to overdose with intravenous solutions of calcium salts in an excited cow, too-rapid fluid infusion in an animal with pulmonary edema, intravenous injection of procaine penicillin suspension, and intravenous injections of ivermectin in horses. These are not hard to diagnose and the producer or veterinarian is usually obviously embarrassed.

One of the most sudden death occurrences is the anaphylactoid reaction in a horse to an intravenous injection of an allergen such as crystalline penicillin. Death occurs in about 60 seconds. Intrarterial injections of penicillin or phenothiazine tranquilizers have also been reported to cause sudden death.<sup>3</sup>

### SUDDEN DEATH IN HORSES

An analysis was made of the causes of death in horses and ponies over 1 year of age that died suddenly and unexpectedly.<sup>8</sup> No cause of death was found in 31% of cases and 16% died from the following causes: hemorrhage in the respiratory tract, central nervous system and adverse drug reactions. Cardiovascular lesions were the cause in 14% and the remaining 3% had lesions of the gastrointestinal tract.

Sudden death in racehorses is commonly due to massive hemorrhage into the lungs, abdomen or brain.<sup>5</sup> In horses that were found dead but appeared normal when last seen, the cause of death was not determined in 33%. Lesions of the gastrointestinal tract were the cause of death in 39% and respiratory tract lesions in 9%. Lesions of both the central nervous system and cardiovascular system were the cause of death in 5%. The remaining 10% had miscellaneous causes.

### SUDDEN OR UNEXPECTED DEATH IN A GROUP OF ANIMALS

The diseases listed below could obviously affect single animals if the animals were housed or run singly.

## LIGHTNING STRIKE OR ELECTROCUTION

This usually affects a number of animals that are found together in a pile or group. Rarely, electrical current only electrifies a contact object intermittently and deaths will be intermittent. In most cases the history and an examination of the environment reveals the cause.

## NUTRITIONAL DEFICIENCY AND POISONING

At pasture, sudden death may come from the sudden exposure of the cattle to plants that cause bloat, hypomagnesemia, cyanide or nitrite poisoning, fluoroacetate poisoning, fast death factor (produced by algae in a lake or pond) or acute interstitial pneumonia. Acute myocardopathy in young animals on diets deficient in vitamin E or selenium is in this group, as is inherited myocardopathy in Herefords. Gross nutritional deficiency of copper in cattle causes 'falling disease', a manifestation of acute myocardopathy.

Acute myocardopathy and heart failure is associated with poisons in *Phalaris* spp. pasture, grass nematodes on *Lolium rigidum*, the hemlocks *Cicuta* and *Oenanthe* spp. and the weeds *Fadogia*, *Pachystigma*, *Pavette*, *Asclapius* and *Aeriocarpa*, *Crystostegia* and *Albizia*, *Cassia* spp. The trees oleander and yew (*Taxus* spp.) may also be causes, and those species containing fluoroacetate, such as the gidgee tree and the weeds *Gastrolobium*, *Oxylobium*, *Dichapetalum* and *Ixioloena* spp. may be implicated. There are a number of plants that cause cardiac irregularity and some sudden deaths, e.g. *Urginea*, *Kalanchoea* spp., but more commonly congestive heart failure is caused. Monensin, lasolocid and salinomycin toxicities are increasingly common causes in horses and, to a less extent, cows.

## ACCESS TO POTENT POISONS

Access to potent poisons may occur in housed animals or in those fed prepared feeds.

There are few poisons that cause sudden death without premonitory signs.

Cyanide is one, but is an unlikely poison in these circumstances. Monensin, mixed in a feed for cattle that is then fed to horses, or fed in excess to cattle, does cause death by heart failure. Organophosphates are more likely, but clinical signs are usually apparent. Lead is in a similar category; however, very soluble lead salts can cause death quickly in young animals.

## DISEASES ASSOCIATED WITH INFECTIOUS AGENTS

These cause septicemia or toxemia, and include anthrax, blackleg, hemorrhagic septicemia and (especially in sheep, but occasionally in cattle) peracute pasteurellosis. In pigs, mulberry heart disease and perhaps gut edema should be considered. In horses, colitis is probably the only disease that will cause sudden death. In sheep and young cattle, enterotoxemia associated with *C. perfringens* should be included and this may be involved in rumen overload in feedlot cattle on heavy grain feed. Circumstances, feeding practices, climate and season of the year usually give some clue as to the cause.

## NEONATAL AND YOUNG ANIMALS

In very young, including neonatal, animals, congenital defects that are incompatible with life – prematurity, septicemia because of poor immune status or toxemia associated with particular pathogens, especially *E. coli*, and hypothyroidism – are important causes of sudden death.

## ANAPHYLAXIS

Anaphylaxis after injection of biological materials, including vaccines and sera, is usually an obvious diagnosis, but its occurrence in animals at pasture can cause obscure deaths. In these circumstances it usually affects one animal and clinical illness is often observed. A similar occurrence is sudden death in a high proportion of piglets injected with an iron preparation when their selenium-vitamin E status is low.

## PROCEDURE FOR INVESTIGATION OF SUDDEN DEATH

This is as follows:

- Keep excellent records because of the probability of insurance enquiry or litigation
- Take a careful history, which may indicate changes of feed composition or source, exposure to poisons or administration of potentially toxic preparations
- Make a careful examination of the environment to look for potential sources of pathogens. Be especially careful of your personal welfare if electrocution is possible – wet concrete floors can be lethal when combined with electrical current unless you are wearing rubber boots
- Carefully examine dead animals for signs of struggling, frothy nasal discharge, unclotted blood from natural orifices, bloat, pallor or otherwise of mucosae, burn marks on body, especially on the feet, or signs of trauma or of having been restrained. Pay particular attention to the forehead by palpating the frontal bones – these may have been fractured with a heavy blunt object without much damage to the skin or hair
- Ensure that typical cadavers are examined at necropsy, preferably by specialist pathologists at independent laboratories, where opinions are more likely to be considered authoritative and unbiased
- Collect samples of suspect materials for analysis. Preferably, collect two samples, one to be analyzed and one to be made available to a feed company, if indicated.

## REFERENCES

1. Gelberg HB et al. J Am Vet Med Assoc 1985; 187:1354.
2. Platt H. Br Vet J 1982; 138:417.
3. Lucke VM. Equine Vet J 1987; 19:85.
4. Allen JR et al. Equine Vet J 1987; 19:145.
5. Brown CM, Mullaney TP. In Pract 1991; 13:121.
6. Sanford SE et al. Can Vet J 1994; 35:388.
7. Rafferty GC. Vet Rec 1996; 138:72.
8. Brown CM et al. Equine Vet J 1988; 20:99.



# Diseases of the newborn

## PERINATAL AND POSTNATAL DISEASES 127

- General classification 127
- General epidemiology 128
- Special investigation of neonatal deaths 131

## CONGENITAL DEFECTS 132

- Intrauterine growth retardation 137
- Neonatal neoplasia 137

## PHYSICAL AND ENVIRONMENTAL CAUSES OF PERINATAL DISEASE 138

This chapter considers the principles of the diseases that occur during the first month of life in animals born alive at term. Diseases causing abortion and stillbirth are not included. The specific diseases referred to are presented separately under their own headings.

The inclusion of a chapter on diseases of the newborn, and at this point in the book, needs explanation. The need for the chapter arises out of the special sensitivities which the newborn have:

- Their immunological incompetence
- Their dependence on adequate colostrum containing adequate antibodies at the right time
- Their dependence on frequent intake of readily available carbohydrate to maintain energy
- Their relative inefficiency in maintaining normal body temperature, upwards or downwards.

All these points need emphasizing before proceeding to the study of each of the body systems.

There are no particular aspects of a clinical examination that pertain only to or mostly to neonates. It is the same clinical examination as is applied to adults, with additional, careful examination for congenital defects and diseases, which may involve the umbilicus, the liver, the heart valves, the joints and tendon sheaths, eyes and meninges. Although one should avoid any suggestion that an examination of an adult could be cursory, it is necessary to ensure that an examination of a newborn animal is as complete as practically possible. This is partly for an emotional reason: the neonate always evokes a sentimental reaction. It is also important for the economic reason that in most species the offspring, when already on the ground, represents a very considerable part of the year's investment

- Perinatology 138
- Prematurity and dysmaturity of foals 139
- Parturient injury and intrapartum death 139
- Fetal hypoxia 140
- Hypothermia 141
- Maternal nutrition and the newborn 143
- Poor mother-young relationship 143
- Induction of premature parturition 144

## DISEASES OF CLONED OFFSPRING 145

and productivity. There is also the much greater susceptibility to infectious disease, dehydration and death, and diagnosis and treatment must be reasonably accurate and rapid. Supportive therapy in the form of fluids, electrolytes and energy and nursing care are especially important in the newborn in order to maintain homeostasis.

## Perinatal and postnatal diseases

One of the difficulties in the study of these diseases is the variation in the type of age classification that occurs between publications, which makes it difficult to compare results and assessments. The term perinatal is usually used to describe morbidity or mortality that occurs at birth and in the first 24 hours of life. The term neonatal is usually used to describe morbidity or mortality between birth and 14 days. However, there is variation in the use of these terms. To ensure that our meanings are clear, we set out below what we think is the most satisfactory classification of all the diseases of the fetus and the newborn, which is adapted from a scheme proposed for lambs. The importance of this type of classification is with the assessment of risk for a given type of disease and in the prediction of likely causes that should be investigated by further examinations. This approach is not of major importance in the assessment of disease in an individual animal, although it is of importance in helping establish the priority in diagnostic rule-outs. The classification is, however, of considerable value in the approach to perinatal morbidity and mortality in large flocks or herds where an assessment of the age occurrence of morbidity and mortality can guide subsequent examin-

## NEONATAL INFECTION 146

- Failure of transfer of colostral immunoglobulins 149
- Principles of control and prevention of infectious diseases of newborn farm animals 157
- Omphalitis, omphalophlebitis and urachitis in newborn farm animals (navel-ill) 159

## CLINICAL ASSESSMENT AND CARE OF CRITICALLY ILL NEWBORNS 160

ations to the probable group of cases, with optimal expenditure of investigative capital.

## GENERAL CLASSIFICATION

### FETAL DISEASES

These are diseases of the fetus during intrauterine life, e.g. prolonged gestation, intrauterine infections, abortion, fetal death with resorption or mummification, goiter.

### PARTURIENT DISEASES

These are diseases associated with dystocia, causing cerebral anoxia or fetal hypoxemia, and their consequences and predispositions to other diseases; injury to the skeleton or soft tissues and maladjustment syndrome of foals are also included here.

### POSTNATAL DISEASES

These are divided into early, delayed and late types:

- **Early postnatal disease** (within 48 hours of birth). Deaths that occur during this period are unlikely to be caused by an infectious disease unless it has been acquired congenitally. Most diseases occurring in this period are noninfectious and 'metabolic', e.g. hypoglycemia and hypothermia due to poor mothering, hypothermia due to exposure to cold, low vigor in neonates due to malnutrition. Congenital disease will commonly manifest during this period but may sometimes manifest later. Infectious diseases are often initiated during this period but most manifest clinically at a later age because of their incubation period; some, e.g. navel infection, septicemic disease and enterotoxigenic colibacillosis, have a short enough incubation to occur during this period

- **Delayed postnatal disease** (2–7 days of age). Desertion by mother, mammary incompetence resulting in starvation and diseases associated with increased susceptibility to infection due to failure of transfer of colostral immunoglobulins (the predisposing causes to these occur in the first 12–24 hours of life). Examples include colibacillosis, joint ill, lamb dysentery, septicemic disease, most of the viral enteric infections in young animals, e.g. rotavirus and coronavirus
- **Late postnatal disease** (1–4 weeks of age). There is still some influence of hypogammaglobulinemia, with late-onset enteric diseases and the development and severity of respiratory disease in this period, but other diseases not directly associated with failure of transfer of immunoglobulins such as cryptosporidiosis, white muscle disease and enterotoxemia start to become important.

## GENERAL EPIDEMIOLOGY

Diseases of the newborn and neonatal mortality are a major cause of economic loss in livestock production. In cattle, sheep and pigs the national average perinatal mortalities exceed by far the perinatal mortality experienced in herds and flocks with good management. In these species the identification of the management deficiencies that are the cause of a higher than acceptable mortality in a herd or a flock is a most important long-term responsibility of the practicing veterinarian and, in most instances, is more important than the identification of the causal agent or the short-term treatment of individual animals with neonatal disease. In contrast, in horses the individual is of extreme importance and the primary thrust is in the treatment of neonatal disease.

All animals must be born close to term if they are to survive in a normal farm environment. Minimal gestational ages for viability (in days) for each of the species are:

- Calf – 240
- Foal – 300
- Lamb – 138
- Piglet – 108.

## LAMBS

### Mortality rates

Neonatal lamb mortality is one of the major factors in impairment of productivity in sheep-raising enterprises around the world.<sup>1–3</sup> Mortality can obviously vary with the management system (intensive versus extensive lambing, highly supervised versus minimally

supervised, variations in the provision of shelter, etc.), and according to whether there is a particular disease problem in a given flock. Nonselective mortality surveys have shown population mortality rates in lambs, from birth to weaning, that vary from 9–35% and there are flocks that may exceed this upper figure in the face of a major problem. In well-managed flocks neonatal mortality is less than 10% and in some is below 5%. The majority of neonatal mortality is due to noninfectious disease.

### Major causes

Surveys from various sheep-raising areas in the world consistently show that the majority of lamb mortalities can be attributed to three main causes:<sup>1–4</sup>

- The complex of hypothermia/exposure/hypoglycemia/starvation
- Stillbirth and dystocia/stillbirth
- Abortion.

These syndromes have a multifactorial etiology but can account for over 65% of the mortality that occurs in the first few days of life.<sup>4,5</sup>

### Fetal disease

Infectious abortion can cause considerable fetal, parturient and postnatal mortality in infected flocks but it is a relatively minor cause of perinatal mortality overall. In contrast to other large animal species, abortion storms in sheep are often accompanied by significant mortality in liveborn animals. Many agents associated with abortion in ewes produce placentitis and cause abortion in late pregnancy. This frequently results in the birth of liveborn, growth-retarded and weak lambs that die during the first few days of life. Any investigation of perinatal mortality in sheep should also consider the presence of agents causing abortion, although abortion and the birth of dead lambs is always prominent in abortion outbreaks.

### Parturient disease

Stillbirth occurs largely as a result of prolonged birth and fetal hypoxemia. Prolonged birth and dystocia is a particular problem in large single lambs.<sup>6</sup> Higher rates of stillbirth can also occur in flocks that are in poor condition. Prolonged birth is a major risk factor for subsequent postnatal disease.<sup>4</sup>

### Postnatal disease

The **hypothermia/exposure/hypoglycemia/starvation complex** is the most important cause of postnatal disease. The determinants for the occurrence of this complex are the birth size of the lamb, the energy reserves of the lamb, and environmental factors at birth and during the following 48 hours which

influence heat loss. These include environmental temperature, wind velocity and evaporative cooling determined by the wet coat of the lamb at birth or the occurrence of rain.

### Birth size

Birth size is determined by the nutrition and genetics of the ewe, and by litter size which is also determined by the parity and genetics of the ewe. Reflecting these influences, most surveys of neonatal mortality in lambs show:

- A significant association between the body condition score or **nutrition of the late pregnant ewe** and perinatal mortality
- A relation between **birth weight** and mortality (depending upon the breed, a birth weight of less than 2.5–3.0 kg has increased risk for death)
- A higher mortality in lambs from **multiparous ewes**
- A pronounced effect of **litter size**, with mortality in lambs born as triplets being higher than in those born as twins, which in turn is higher than that in lambs born as singles.

These relationships can be confounded by an increase in mortality in large-birth-weight lambs born as singles because of dystocia and by the greater mortality in lambs born to **maiden ewes** associated with poor mothering and desertion.

### Environmental factors

Environmental factors of temperature, wetness and wind also confound the above relationships; their influence varies according to the management system.

The identification of the above determinants of mortality is of more than academic value as almost all can be changed by the identification of **at-risk groups** and the institution of special management procedures, or by the identification and mitigation of adverse environmental factors.

### Infectious disease

Infectious disease can be important in some flocks and occurs after 2 days of age. The major infectious diseases of lambs that cause mortality are enteritis and pneumonia.<sup>7</sup> Their prevalence varies with the management system – enteric disease and liver abscess are more common in shed lambing systems than with lambing at pasture.<sup>8</sup> Risk for pneumonia is greatest in very light or heavy lambs and in lambs from maiden ewes and ewes with poor milk production.<sup>9</sup>

### Other factors

Other factors can be important in individual flocks or regions. Lambs found dead or missing may account for significant losses under some conditions, such as

mountain or hill pastures.<sup>2</sup> **Predation**, or predation injury, is an important cause of loss in some areas of the world and, depending upon the region, can occur from domestic dogs, coyotes, birds or feral pigs. **Poor mothering** and an inability of the ewe to gather and bond to both lambs of twins can be a problem in Merinos and can cause permanent separation of lambs from the ewe and subsequent death from starvation.

Management at lambing can also influence the patterns of mortality. Intensive stocking at the time of lambing to allow increased supervision can allow a reduction in mortality associated with dystocia and the hypothermia/exposure/hypoglycemia/starvation complex. It can ensure the early feeding of colostrum to weak lambs but it can also result in a greater occurrence of mismothering associated with the activities of 'robber' ewes and it also increases the infection pressure of infectious agents, resulting in an increased incidence of enteric and other disease.<sup>7</sup>

Mortality rate can differ between breeds and lambs from crossbred dams may have higher survival rates.

### Recording systems

Simple systems for recording, determining and evaluating the major causes of lamb mortality in a flock, for determining the time of death in relation to birth and relating the deaths to the weather and management system are available.<sup>4,10</sup> These systems of examination are effective in revealing the extent of lamb losses and the areas of management that require improvement and are much more cost-effective than extensive laboratory examinations, which may give little information on the basic cause of the mortality. More intensive examination systems that combine these simple examinations with selected biochemical indicators of determinant factors are also described.<sup>5</sup>

## DAIRY CALVES

### Mortality rates

A 1992 review of publications on calf mortality reported mortality rates in dairy calves that varied from a low of approximately 2% to a high of 20% with mortality on individual farms varying from 0–60%.<sup>11</sup> A survey of calf mortality in 829 dairy operations in the USA showed considerable variation with region and with management system.<sup>12</sup> The best estimate for the average on-farm calf mortality rate is 6%.<sup>11</sup> This mortality is in addition to that associated with stillborn or weak-born calves which is reported to occur in 11% of primiparous and 5.7% of multiparous Holstein cows in the USA.<sup>13</sup>

The exact cause of death in these stillborn or weakborn calves is not known.

In addition to the influence of parity, dystocia has a major influence on rates and rates are also higher where gestation length was shorter than 280 days. Calving-associated anoxia may be an important contributing factor in these deaths.<sup>14</sup>

Mortality in twin-born calves is approximately three times that of single-born calves. Disease morbidity rates also vary with the farm and, as might be expected, with the disease under consideration and the age of the calf.<sup>12,15,16</sup>

### Major causes

Fetal disease and the postnatal septicemic, enteric and respiratory diseases are the most common causes of loss.

### Fetal disease

Definition of fetal loss and abortion varies between studies but the median frequencies of observed abortions is approximately 2% and of fetal loss in dairy cattle diagnosed pregnant 6.5%.<sup>17</sup> The majority of these have no diagnosed cause.

### Parturient disease

Calving in dairy cattle is usually supervised, but prolonged calving with consequent hypoxemia (and occurring with or without dystocia) and twin birth is associated with significantly higher risk for mortality in the first 21 days of life.<sup>12,18,19</sup>

### Postnatal disease

Calves are at highest risk for death in the first 2 weeks of life and especially in the first week. Septicemic and enteric disease are most common during this period, with respiratory disease being more common after 2 weeks of age.<sup>14,20,21</sup> **Failure of transfer** of colostral immunoglobulins is a major determinant of this mortality.<sup>12</sup> The economic significance of neonatal disease can be considerable and the occurrence of disease as a calf can also subsequently affect days to first calving intervals and long-time survival in the herd.<sup>14,22</sup> Death also causes a loss of genetic potential both from the loss of the calf and the reluctance of the farmer to invest in higher-price semen in the face of a calf mortality problem.

Meteorological or **seasonal influences** may have an effect on dairy calf mortality rate and this can vary with the region. In cold climates during the winter months, an increase in mortality may be associated with the effects of cold, wet and windy weather, whereas in hot climates there may be an increase in mortality during the summer months in association with heat stress.

### Management

Management is a major influence and in well managed dairy herds calf mortality

usually does not exceed 5% from birth to 30 days of age. Risk factors for disease morbidity and mortality in dairy calves relate to the **infection pressure** to the calf and factors that affect its **nonspecific** and **specific resistance** to disease. It is generally recognized that mortality is associated with the **type of housing** for calves, calving facilities, the person caring for the calves and attendance at calving. Thus calves that are born in separate calving pens have a lower risk of disease than those born in loose housing or stanchion areas<sup>23</sup> and the value of good colostrum feeding practices is apparent.<sup>11,12</sup> Studies on the role of calf housing and the value of segregated rearing of calves in reducing infection pressure generally show beneficial health results<sup>7,21,24,25</sup> but the value of this system of rearing is probably best measured by its adoption in many dairies where climatic conditions allow this to be an option for housing young calves. The quality of management will be reflected in rates of failure of transfer of passive immunity and will also affect the infection pressure on the calf during the neonatal period. Quality of management is very hard to measure but is easily recognized by veterinary practitioners.

The epidemiological observations that calf mortality is lower when females or family members of the ownership of the farm manage the calves, rather than when males or employees perform these duties, is probably a reflection of this variation in quality of management and suggests that owner-managers and family members may be sufficiently motivated to provide the care necessary to ensure a high survival rate in calves. Even so, calf health can be excellent with some hired calf-rearers and very poor with some owner calf-rearers. Besides visual assessments of hygiene an effective **measure of the quality** of calf management can be provided by a measure of rates of failure of transfer of passive immunity.

## BEEF CALVES

### Mortality rates

Mortality in beef herds is usually recorded as birth to weaning mortality and has ranged from 3–7% in surveys, with higher rates in calves born to heifers; significantly higher mortality can occur in herds with disease problems.<sup>26–31</sup> The majority of this mortality occurs within the first week of life and most of it occurs in the parturient or immediate postnatal period as a result of prolonged birth or its consequences.<sup>30–32</sup>

### Major causes

Dystocia resulting in death is common and dystocial calves, twin-born calves and calves born to heifers are at greater risk

for postnatal disease.<sup>31-34</sup> Enteric and respiratory disease occurs in outbreaks in some years and very cold weather can result in high loss from hypothermia. In a survey of 73 herds in the USA the overall mortality rate was 4.5% and causes were dystocia (17.5%), stillbirths (12.4%), hypothermia (12.2%), enteric disease (11.5%) and respiratory infections (7.6%).<sup>31</sup>

#### Fetal disease

Abortion rates appear to be lower than in dairy cattle, usually less than 1%.<sup>30</sup> The majority of these are not diagnosed as to cause but of those that are, infectious abortion is the most common diagnosis.<sup>35</sup>

#### Parturient disease

Accurate prospective and retrospective studies have shown that 50–60% of the parturient deaths in beef calves are associated with slow or difficult birth and that the mortality rate is much higher in calves born to heifers than from mature cows.<sup>26,30,32</sup> **Dystocial birth** can lead to injury of the fetus and to hypoxemia and may not necessarily be associated with fetal malposition. **Birth size** is highly heritable within all breed types of cattle<sup>36</sup> and perinatal mortality will vary between herds depending upon their use of bulls with high ease of calving ratings in the breeding of the heifer herd. Milk fever and over-fatness at calving are other preventable causes. Selective intensive supervision of calving of the heifer herd can also result in a reduction of perinatal mortality.

#### Postnatal disease

Scours and pneumonia are the next most important causes of mortality in beef calves, followed by exposure to extremely cold weather or being dropped at birth into deep snow or a gully. The incidence of diarrhea is greatest in the first 2 weeks of life and there is considerable variation in incidence between herds.<sup>37</sup> However, explosive outbreaks of diarrhea or exposure chilling can be significant causes of mortality in certain years.<sup>29</sup> The purchase of a calf for grafting, often from a market, is a significant risk for introduction of disease to a herd.

Body **condition score** of the dam can influence calf mortality, with high condition scores having a higher risk for dystocial mortality and low scores for infectious disease. Mortality from diarrhea is often higher in calves born to heifers, possibly because heifers are more closely congregated for calving supervision or because of a higher risk for failure of transfer of passive immunity in this age group. Congenital abnormalities can be an occasional cause of mortality in some herds.<sup>27</sup>

### PIGLETS

#### Mortality rates

Prewaning mortality ranges from 5–48%, with averages ranging from 12–19%, of all pigs born alive.<sup>38,39</sup> More than 50% of the preweaning losses occur before the end of the second day of life. Mortality increases as the mean litter size increases and as the mean birth weight of the pig decreases. In most herd environments the minimal **viable weight** is approximately 1 kg. The mean number of piglets weaned is related to the size of the litter up to an original size of 14 and increases with parity of sows up to their fifth farrowing. Prewaning mortality is negatively correlated with herd size and farrowing crate utilization, and positively correlated with the number of farrowing crates per room.<sup>39</sup>

#### Major causes

Surveys of neonatal mortality in piglets have repeatedly indicated that the most important causes of death in piglets from birth to weaning are noninfectious in origin.<sup>38-40</sup> The major causes are **starvation and crushing** (75–80%) (although these may be secondary to, and the result of, hypothermia), congenital abnormalities (5%) and infectious disease (6%). The major congenital abnormalities are congenital splayleg, atresia ani and cardiac abnormalities. Infectious diseases may be important on certain individual farms but do not account for a major cause of mortality.

#### Fetal disease

Fetal disease rates in most herds are low unless there is an abortion storm or poor control of endemic infections such as parvovirus. In contrast to other species, the majority of abortions are diagnosed and are infectious.

#### Parturient disease

Stillbirths account for 4–8% of all deaths of pigs born and 70–90% are type II or intraparturient deaths, in which the piglet was alive at the beginning of parturition. The viability of newborn piglets can be accurately evaluated immediately after birth by scoring skin color, respiration, heart rate, muscle tone and ability to stand. Stillbirths are more commonly born in the later birth orders of large litters and it is a relatively common practice for sows to be routinely given oxytocin at the time of the birth of the first piglet in order to shorten parturition. Controlled trials have shown that, while oxytocin administration at this time will result in a significant decrease in farrowing time and expulsion intervals there is a significant increase in fetal distress, fetal anoxia and intrapartum death and an increase in piglets born alive with ruptured umbilical cords and meconium staining.<sup>41</sup>

#### Postnatal disease

The large percentage of mortality caused by **crushing** and trampling probably includes piglets that were starved and weak and thus highly susceptible to being crushed. The estimated contribution of crushing and starvation to neonatal mortality varies from 50–80%. The body condition score of the sow at the time of farrowing, the nursing behavior of the sow, her ability to expose the teats to all piglets and the sucking behavior of the piglets have a marked effect on survival.<sup>42</sup>

Cold stress is also an important cause of loss and the provision of a warm and comfortable environment for the newborn piglet in the first few days of life is critical. The lower critical temperature of the single newborn piglet is 34°C (93°F). When the ambient temperature falls below 34°C (93°F) the piglet is subjected to cold stress and must mobilize glycogen reserves from liver and muscle to maintain deep body temperature. The provision of heat lamps over the creep area and freedom from draughts are two major requirements.

#### Management

Minimizing the mortality rate of newborn piglets will depend on management techniques, which include:

- Proper selection of the breeding stock for teat numbers, milk production and mothering ability
- The use of farrowing crates and creep escape areas to minimize crushing injuries
- Surveillance at farrowing time to minimize the number of piglets suffering from hypoxia and dying at birth or a few days later
- Batch farrowing, which allows for economical surveillance
- Fostering to equalize litter size
- Cross-fostering to equalize non-uniformity in birth weight within litters
- Artificial rearing with milk substitutes containing purified porcine gammaglobulin to prevent enteric infection.<sup>41</sup>

### FOALS

#### Mortality rates

Foals are usually well supervised and cared for as individual animals. Neonatal death is less frequent than in other species but equivalent rates of morbidity and mortality occur on some farms.<sup>43</sup> Infectious disease is important, along with structural and functional abnormalities that are undoubtedly better recognized and treated than in any of the other large animal species. In a large survey of thoroughbred mares in the UK, only 2% of newborn foals died;<sup>44</sup> only

41% of twins survived and 98% of singles survived. In contrast, a mortality rate of 22% between birth and 10 days is recorded in an extensively managed system.<sup>45</sup> Between 25–40% of mares that are bred fail to produce a live foal<sup>46</sup> and an extensive study of breeding records indicated that 10% of mares that are covered either aborted or had a non-surviving foal.<sup>47</sup>

### Fetal disease

This is a major cause of loss and in one study infections accounted for approximately 30% of abortions.<sup>46</sup> In a retrospective study of 1252 fetuses and neonatal foals submitted for postmortem examination over a 10-year period in the UK, equine herpes virus and placentitis accounted for 6.5% and 9.8% of the diagnoses respectively.<sup>48</sup> The placentitis occurred in late gestation and was concentrated around the cervical pole and lower half of the allantochorion associated with ascending chronic infections of bacteria or fungi resident in the lower genital tract.

### Parturient disease

Neonatal asphyxia, dystocia, placental edema and premature separation of the placenta, umbilical cord abnormality and placental villous atrophy are other important causes of mortality in this period. In the UK study<sup>48</sup> umbilical cord disorders accounted for 38.8% of the final diagnoses. Umbilical cord torsion usually resulted in death of the fetus in utero but the long cord/cervical pole ischemia disorder resulted in intrapartum death and a fresh fetus with lesions consistent with acute hypoxia.

Twins are at higher risk for spontaneous abortion.

### Postnatal disease

Postnatal disease causing mortality from birth to 2 months of age includes: lack of maturity 36%, structural defect 23%, birth injury 5%, convulsive syndrome 5%, alimentary disorder 12%, generalized infection 11% and other (miscellaneous) 9%. Of the **infectious diseases**, gastrointestinal and septicemic disease have greatest importance.<sup>49,50</sup> Whereas in the past many of these conditions would have been fatal, there have been significant advances in the science of equine perinatology in the 1980s and 1990s and protocols for the treatment of neonatal disease have been developed that have been based on equivalents in human medicine. These have proved of value in the management and treatment of prematurity, immaturity, dysmaturity and neonatal maladjustment syndromes in newborn foals, as well as in enteric and septicemic disease. Different levels of intensive care have been defined that

start from those that can be applied at the level of the farm and increase in sophistication, required facilities and instrumentation to those that are the province of a specialized referral hospital. Early followup studies indicate that this approach is of considerable value in foals with neonatal disease and that most surviving foals become useful athletic adults.<sup>51</sup>

### SPECIAL INVESTIGATION OF NEONATAL DEATHS

The following protocol is a generic guide to the investigation of deaths of newborn animals. It will require modification according to the species involved.

1. Determine the duration of pregnancy to ensure that the animals were born at term
2. Collect epidemiological information on the problem. Where possible, the information should include the following:
  - What is the abnormality?
  - What is the apparent age at onset and the age at death?
  - What clinical signs are consistently associated with the problem?
  - What is the prevalence and proportional risk in particular groups (maternal, paternal, nutritional, vaccinated, etc.)?
  - What is the parity of the dam that gave birth to the animal and what proportional risk does this reflect within the group?
  - What is the birth history of affected animals? Are births supervised, what is the frequency of observation and what are the criteria for intervention? What is the proportional risk associated with prolonged birth?
  - Is there an effect of litter size and what is the health of the other litter mates?
  - Has there been any difference in management of the dams of the affected animals to the group as a whole?
  - What is the farm policy for feeding colostrum?
  - What have been the environmental conditions during the past 48 hours? In housed animals the quality of the environment should be measured objectively
3. Conduct a postmortem examination of all available dead neonates. The determination of body weight is essential and measures of **crown-rump length** can also give an indication of gestational age. In order of precedence the purpose of the postmortem examination is to determine:
  - The time of death in relation to parturition (e.g. fetal disease, parturient disease, early or delayed postnatal death). This can be determined from the state of the lungs, the nature of the severed end of the umbilical artery and the presence of a clot, the state of the brown fat deposits, whether the animal has walked and if it has sucked prior to death
  - The possibility that animals born alive have died because of cold stress, hypoglycemia and starvation. An indication can be obtained from an examination of the brown fat reserves, the presence or absence of milk in the gastrointestinal tract and fat in the intestinal lymphatics. The presence of subcutaneous edema in the hind limbs is also relevant
  - The possible presence of birth injury or trauma. In addition to examination of the ribs and liver for trauma and the presenting areas for subcutaneous edema, the brain should be examined for evidence of hemorrhage
  - The presence of infectious disease. If necessary samples can be submitted for examination
  - The presence of congenital disease
4. If abortion is suspected, specimens of fetal tissues and placenta are sent for laboratory examination. Examinations requested are pathological and microbiological for known pathogens for the species of animal under consideration
5. A serum sample should be collected from the dam for serological evidence of teratogenic pathogens followed by another sample 2 weeks later. Samples from unaffected dams should also be submitted. A precolostral serum sample from affected animals may assist in the diagnosis of intrauterine fetal infections
6. Investigate management practices operating at the time, with special attention to clemency of weather, feed supply, maternalism of dam and surveillance by the owner – all factors that could influence the survival rate.<sup>51,52</sup> Where possible, this should be performed using objective measurements. For example, in calf-rearing establishments the efficacy of transfer of colostrum immunoglobulins should be established by the bleeding of a proportion of calves and actual measurement; food intake should be established by actual measurement, etc.

## REVIEW LITERATURE

- Edwards BL. Causes of death in new-born pigs. *Vet Bull* 1972; 42:249.
- Randall GCB. Perinatal mortality. Some problems of adaptation at birth. *Adv Vet Sci* 1978; 22:53.
- English PR, Morrison V. Causes and prevention of piglet mortality. *Pig News Info* 1984; 4:369-376.
- Rossdale PD, Silver M, Rose RJ. Equine perinatal physiology and medicine. *Equine Vet J* 1984; 4:255-398.
- Rook JS, Scholman G, Wing-Procter S, Shea M. Diagnosis and control of neonatal losses in sheep. *Vet Clin North Am Food Anim Pract* 1990; 6:531-562.
- Haughey KC. Perinatal lamb mortality: its investigation, causes and control. *J South Afr Vet Assoc* 1991; 62:78-91.
- Rossdale PD, McGladdery AJ. Recent advances in equine neonatology. *Vet Annu* 1992; 32:201-208.
- Kasari TR, Wikse SE. Perinatal mortality in beef herds. *Vet Clin North Am Food Anim Pract* 1994; 10:1-185.
- Edwards SA. Perinatal mortality in the pig: environmental or physiological solutions. *Livestock Prod Sci* 2002; 78:3-13.
- Herpin P, Damon M, Le Dividitch J. Development of thermoregulation and neonatal survival in pigs. *Livestock Prod Sci* 2002; 78:25-45.
- Mellor DJ, Stafford KJ. Animal welfare implications of neonatal mortality and morbidity in farm animals. *Vet J* 2004; 168:118-133.

## REFERENCES

- Purvis GM et al. *Vet Rec* 1985; 116:293.
- Morrison D, Young J. *Aust J Agric Res* 1991; 42:227.
- Gumbrell RC. *Surveillance NZ* 1985; 12:5.
- Haughey KM. *J South Afr Vet Assoc* 1991; 62:78.
- Barlow RM et al. *Vet Rec* 1987; 120:357.
- Wooliams C et al. *J Agric Sci* 1983; 100:553.
- Binns SH et al. *Prevent Vet Med* 2001; 52:287.
- Greene LE, Morgan KL. *Prevent Vet Med* 1994; 21:19.
- Nash ML et al. *Small Rumin Res* 1997; 26:53.
- Eales FA et al. *Vet Rec* 1986; 118:227.
- Bruning-Fann C, Kaneene JB. *Vet Bull* 1992; 62:399.
- Wells SJ et al. *Prevent Vet Med* 1996; 29:9.
- Szyer CL et al. *J Dairy Sci* 2000; 83:2657.
- Szenci O. *Vet Bull* 2003; 73(7):7R.
- Curtis CR et al. *Prevent Vet Med* 1988; 5:293.
- Waltner-Toews D et al. *Prevent Vet Med* 1986; 4:125, 137 & 159.
- Forar AL. *Theriogenology* 1995; 43:989.
- Szenci O et al. *Vet Q* 1988; 10:140.
- Cross S, Soede N. *Ir Vet J* 1988; 42:8.
- Sivula NJ et al. *Prevent Vet Med* 1996; 27:155.
- Svensson C et al. *Prevent Vet Med* 2003; 58:179.
- Curtis CR et al. *Prevent Vet Med* 1989; 7:173.
- Curtis CR et al. *Prevent Vet Med* 1988; 6:43.
- Quigley JD et al. *J Dairy Sci* 1995; 78:893.
- Quigley JD et al. *J Dairy Sci* 1994; 77:3124.
- Berger PJ et al. *J Anim Sci* 1992; 70:1775.
- Bellows RA et al. *Theriogenology* 1988; 28:573.
- McDermott JJ et al. *Can Vet J* 1991; 32:407, 413.
- Olson DP et al. *Bovine Pract* 1989; 24:4.
- Toombs RE. *Vet Clin North Am Food Anim Pract* 1994; 10:137.
- Wittum TE et al. *J Am Vet Med Assoc* 1993; 203:232.
- Rice L. *Vet Clin North Am Food Anim Pract* 1994; 10:53.
- Wittum TE et al. *Prevent Vet Med* 1994; 19:1.
- Vestweber JG. *Vet Clin North Am Food Anim Pract* 1997; 13:411.
- Mickelsen WD, Evermann JF. *Vet Clin North Am Food Anim Pract* 1994; 10:1.
- Burrow HM et al. *Aust J Agric Res* 1991; 42:295.

- Bendali F et al. *Vet Res* 1999; 30:61.
- English PR, Morrison V. *Pig News Info* 1984; 4:369.
- Edwards SA. *Livestock Prod Sci* 2002; 78:3-13.
- English PR. *Vet Annu* 1993; 33:107.
- Mota-Rojas D et al. *Anim Reprod Sci* 2005; 86:131.
- Weary DM. *Appl Anim Behav Sci* 1996; 49:149.
- Morley PS, Townsend HGG. *Equine Vet J* 1997; 29:290.
- Platt H. *Vet Annu J* 1975; 15:153.
- Haas SD. *Can Vet J* 1996; 37:91.
- Giles RC et al. *J Am Vet Med Assoc* 1993; 203:1170.
- Jeffcott LB et al. *Equine Vet J* 1982; 14:185.
- Smith KC et al. *Equine Vet J* 2003; 35:496.
- Morris DD. *Compend Contin Educ Pract Vet* 1986; 8:S139.
- Carter GK, Martens RJ. *Compend Contin Educ Pract Vet* 1986; 8:S256.
- Koterba AM, Drummond WH. *Equine Vet J Suppl* 1988; 5:6.
- Wikse SE et al. *Vet Clin North Am Food Anim Pract* 1994; 10:147.

## Congenital defects

### Synopsis

**Etiology** Genetic, infectious, toxic and physical causes are recognized for some defects but the etiology of most is not known

**Epidemiology** Low but significant incidence in all animals. Epidemiology depends on cause

**Clinical findings** Congenital defects can be structural or functional. Clinical signs depend on organ system(s) affected

**Clinical pathology** Specific serological and chemical tests can be used in the diagnosis and control of some congenital disease and, if available, are detailed under specific disease headings

**Necropsy findings** Specific to the particular problem  
Diagnostic confirmation Abnormalities of structure or function that are present at birth are obviously congenital defects. They may or may not be inherited, and inherited defects may or may not be manifest at birth

**Control** Avoidance of exposure to teratogenic agents. Vaccination for some teratogenic infections, identification of carriers for genetic defects

## ETIOLOGY

Congenital disease can result from defective genetics<sup>1,2</sup> or from an insult or agent associated with the fetal environment. A neonate with a congenital defect is an adapted survivor from a disruptive event of a genetic or environmental nature or of a genetic-environmental interaction at one or more of the stages in the sequences of embryonic and fetal development.<sup>3</sup>

**Genetic** abnormalities, detailed in Chapter 35, may result in a wide spectrum of disorder that can vary from severe malformations with deformation to the

presence of inborn errors of metabolism in animals that may be born apparently normal and develop storage disease later in life<sup>3</sup>

Susceptibility to injurious **environmental agents** depends upon the nature and the severity (dose size and duration of application) of the insult, and decreases with fetal age. Prior to attachment, the zygote is resistant to teratogens but susceptible to chromosomal aberrations and genetic mutations. Agents that disrupt blastula and gastrula stages and that interfere with normal apposition of the uterine mucosa are usually embryotoxic and induce early embryonic death.

The period during which an **organ system** is being established is a particularly critical period for that system and different teratogens, if applied at that time, can produce similar defects. One example would be the complex of arthrogryposis and cleft, which can occur in the calves of cattle grazing certain species of lupine,<sup>4</sup> in calves infected in utero with Akabane virus<sup>5</sup> and as an inherited disease in Charolais calves.<sup>6</sup>

Many noninherited congenital defects in animals occur in 'outbreaks', which is a reflection of the exposure of the pregnant herd to a viral, plant or other teratogen during a period of fetal susceptibility. Because this occurs in early pregnancy it is often very difficult to determine the nature of this exposure at the time the animals are born.

Some teratogens are quite **specific** in the defect that they produce and their action may be limited to a single species; a tentative diagnosis as to cause can be based on this association. Others produce a wide variety of abnormality that may also occur with other teratogens and cause is less obvious.

The exact etiology of most congenital defects is unknown. Influences that are known to produce congenital defects are presented here.

## Chromosomal abnormality and inheritance

Most chromosomal abnormalities are associated with poor fertility and early embryonic death.<sup>7</sup> A few are structural or numerical aberrations of chromosomes. The importance of chromosomal abnormality to congenital defects in farm animals has not been studied extensively but a study of 55 aborted and stillborn calves found six with an abnormal chromosome component.<sup>8</sup> Chromosomal abnormality is usually associated with multiple deformations.<sup>8-11</sup> Most chromosomal abnormalities are mutant genes and the majority are inherited as recessive traits. There are many examples among domestic animals (see Ch. 35).

### Virus and other infections

Members of the *Bunyavirus* (Akabane virus, Cache valley virus and Rift Valley fever virus), *Orbivirus* (bluetongue virus, epizootic hemorrhagic disease virus and Chuzan virus), *Pestivirus* (bovine virus diarrhea virus, border disease virus, hog cholera virus) families, Japanese B encephalitis virus and Wesselsbron virus are recognized teratogens.<sup>12</sup> Other viruses also can result in fetal death without malformation. Examples are as follows:

- Akabane virus – this infection of pregnant cattle, sheep and goats causes arthrogryposis, microencephaly and hydrocephalus.<sup>12</sup> Infection of, and disease of, the fetus depends on the stage of pregnancy and the fetus's immunological status. In cattle infected between 76–104 days of pregnancy hydranencephaly predominates; arthrogryposis predominates with infections between 104–173 days gestation and poliomyelitis after 173 days. In sheep the window of susceptibility for congenital defects is between 30 and 50 days
- Cache valley virus – congenital infection of lambs with Cache valley virus<sup>13</sup> produces disease very similar to that produced by Akabane virus in cattle. The period of susceptibility for congenital defects is 36–45 days of pregnancy
- Rift valley fever virus infection of pregnant sheep results in placentitis and abortion but attenuated vaccine strains produce arthrogryposis and brain defects
- Bluetongue virus – vaccination of ewes with attenuated vaccine virus between days 35 and 45 of pregnancy causes a high prevalence of porencephaly in lambs. Natural infections of sheep (50–80 days of gestation) and cattle (60–120 days of gestation) can result in fetal death and resorption, or the birth of stillborn and weakborn animals and animals with hydrocephalus and hydranencephaly and occasionally arthrogryposis. Similar defects are produced by Chuzan, Aino and Kasba virus infections
- Bovine virus diarrhea – infection with cytopathogenic strains before 100 days can result in abortion and mummification, cerebellar hypoplasia and optic defects, including cataracts, retinal degeneration and hypoplasia and neuritis of the optic nerves. Other defects are brachygnathia, curly coats, abortion, stillbirth and mummification. Infection of the bovine fetus between 45 and 125 days

of gestation with a noncytopathic biotype of the virus can result in the development of a persistently viremic and immunotolerant calf that is carried to term, born alive, remains persistently viremic and may later develop mucosal disease

- Border disease virus – the window of susceptibility is from 16–90 days gestation, and, depending upon the fetal age at infection and the presence of a fetal immune response, fetal infection may result in fetal death, growth retardation, the birth of persistently infected lambs or lambs born with hypomyelinogenesis, hydranencephaly and cerebellar dysplasia. Coat defects may also be seen
- Hog cholera virus – vaccination of sows with modified vaccine virus between days 15 and 25 of pregnancy produces piglets with edema, deformed noses and abnormal kidneys. Natural infection with field virus can cause reproductive inefficiency and cerebellar hypoplasia in piglets
- An unidentified virus is associated with the AII type of congenital tremor in pigs
- Congenital infection with Wesselsbron virus and with Rift Valley fever is recorded as producing central nervous system disease in cattle and sheep<sup>14</sup>
- Japanese B encephalitis virus in pigs can result in abortion or in the birth of weak, mummified or stillborn piglets and live piglets with neurological abnormalities. The window of susceptibility is from 40–60 days gestation
- Pseudorabies virus infection of the pregnant sow can result in myoclonia congenita in piglets
- Viral, bacterial and protozoal agents that produce abortion in animals can also produce intrauterine growth retardation and the birth of weakborn neonates that are highly susceptible to mortality in early life.

### Nutritional deficiency

There are many congenital defects in animals that are known to be caused by deficiencies of specific nutrients in the diet of the dam. Examples are as follows:

- Iodine – goiter and increased neonatal mortality is caused in all species; prolonged gestation occurs in horses and sheep. Congenital musculoskeletal lesions are seen in foals (congenital hypothyroid dysmaturity syndrome). Deficiency may be due to a primary deficiency, or induced by nitrate or *Brassica* spp.

Syndromes are also produced by iodine excess, often associated with feeding excess seaweed or seaweed products

- Copper – enzootic ataxia in lambs is due either to a primary copper deficiency or to a secondary deficiency where the availability of copper is interfered with by other minerals, e.g. molybdenum and iron
- Manganese – chondrodystrophy and limb deformities in calves<sup>15</sup>
- Vitamin D – neonatal rickets
- Vitamin A – eye defects, harelip and other defects in piglets
- Vitamin E and/or selenium – congenital cardiomyopathy and muscular dystrophy
- Congenital cobalt deficiency is reported to reduce lamb vigor at birth and to increase perinatal mortality because of impaired immune function in the lamb.<sup>16</sup> A similar effect on immune function in neonatal lambs and calves has been proposed with copper deficiency<sup>17</sup>
- Malnutrition of the dam can result in increased neonatal mortality and is suspected in the genesis of limb deformities<sup>17</sup> and in congenital joint laxity and dwarfism in calves<sup>18,19</sup>
- Vitamin A deficiency induced by feeding potato tops or water with high nitrate content has been associated with congenital blindness in calves.

### Poisonous plants

Their teratogenic effects have been reviewed in detail.<sup>20</sup> Some examples are given below.

- *Veratrum californicum* fed to ewes at about the 14th day of pregnancy can cause congenital cyclopia and other defects of the cranium and brain in lambs, as well as prolonged gestation.<sup>6</sup> When fed at 27–32 days of pregnancy it can produce limb abnormalities. Tracheal stenosis has been produced by feeding at 31–33 days of gestation. The alkaloid cyclopamine is the teratogenic substance<sup>20</sup>
- 'Crooked calf disease' is associated with the ingestion of *Lupinus* sp. during pregnancy. This is a major problem on some range lands in western North America. There are approximately 100 species of *Lupinus* in Canada and the USA but the disease has been mainly associated with *L. sericeus*, *L. leucophyllus*, *L. caudatus* and *L. laxiflorus*.<sup>21</sup> These are believed to be toxic because of their content of anagryne, but some piperidine alkaloids may also produce the disease.<sup>22</sup> The disease has been



reproduced by feeding anagryne-containing lupines to pregnant cattle between 40 and 90 days of gestation but can occur with later feeding in natural grazing. The syndrome is one of arthrogryposis, torticollis, scoliosis and cleft palate<sup>4</sup>

- *Astragalus* and *Oxytropis* spp. locoweeds cause limb contracture in calves and lambs, also fetal death and abortion
- Tobacco plants – ingestion of *Nicotiana tabacum* (burley tobacco) and *N. glauca* (tree tobacco) by sows between 18 and 68 days, with peak susceptibility between 43 and 55 days of gestation, can cause limb deformities in their piglets. The teratogen is the piperidine alkaloid anabasine. Cleft palate and arthrogryposis has also been produced experimentally in the fetuses of cattle and sheep fed *N. glauca* during pregnancy but the plant is not palatable and this is an unlikely cause of natural disease<sup>20</sup>
- *Conium maculatum*, poison hemlock, fed to cows during days 55–75 of pregnancy, to sheep in the period 30–60 days of pregnancy and to sows in the period 30–62 days of pregnancy will cause arthrogryposis, scoliosis, torticollis and cleft palate in the fetuses.<sup>20</sup> Cattle are most susceptible. Piperidine alkaloids coniine and –coniceine are responsible<sup>22,23</sup>
- *Leucaena leucocephala* (or mimosine, its toxic ingredient) causes forelimb polydopia (supernumerary feet) in piglets when fed experimentally to sows
- Fungal toxicosis from the feeding of moldy cereal straw has been epidemiologically linked to outbreaks of congenital spinal stenosis and bone deformities associated with premature closure of growth plates in calves.<sup>24</sup>

#### Farm chemicals

- Some benzimidazoles (parbendazole, cambendazole, oxfendazole, netobimin) are important teratogens for sheep, producing skeletal, renal and vascular abnormality when administered between 14 and 24 days of pregnancy<sup>25</sup>
- Methallibure, a drug used to control estrus in sows, causes deformities in the limbs and cranium of pigs when fed to sows in early pregnancy
- Apholate, an insect chemosterilant, is suspected of causing congenital defects in sheep
- The administration of trichlorfon to pregnant sows can result in the birth of piglets with cerebellar hypoplasia and congenital trembles<sup>26</sup>

- Organophosphates have been extensively tested and found to be usually nonteratogenic.<sup>27</sup> A supposed teratogenic effect is probably more a reflection of the very common usage of these substances in agriculture (see under poisoning by organophosphates)
- Griseofulvin given to a mare in the second month of pregnancy is suspected of causing microphthalmia and facial bone deformity in a foal.<sup>28</sup>

#### Physical insults

- Severe exposure to beta or gamma irradiation, e.g. after an atomic explosion, can cause a high incidence of gross malformations in developing fetuses
- Rectal palpation of pregnancy using the amniotic slip method between 35 and 41 days of pregnancy in Holstein Friesian cattle is associated with atresia coli in the calf at birth,<sup>29</sup> but there is also a genetic influence.<sup>30</sup> It is probable that the cause is palpation-induced damage to the developing colonic vasculature
- Hyperthermia applied to the dam experimentally causes congenital deformities, but this appears to have no naturally occurring equivalent. The most severe abnormalities occur after exposure during early pregnancy (18–25 days in ewes). Disturbances of central nervous system development are commonest. Defects of the spinal cord manifest themselves as arthrogryposis and exposure of ewes to high temperatures (42°C, 107.5°F) causes stunting of limbs; the lambs are not true miniatures as they have selective deformities with the metacarpals selectively shortened. The defect occurs whether nutrition is normal or not.<sup>31</sup> Hyperthermia between 30 and 80 days of pregnancy in ewes produces growth retardation in the fetus. Developmental abnormalities have been reproduced experimentally in explanted porcine embryos exposed to environmental temperatures similar to those that may be associated with reproductive failure due to high ambient temperatures in swine herds.<sup>32</sup>

#### Environmental influences

Currently, there is considerable interest in the possible teratogenic effects of man-made changes in the environment. The concern is understandable because the fetus is a sensitive biological indicator of the presence of some noxious influences in the environment. For example, during an accidental release of polybrominated biphenyls much of the angry commentary related to the probable occurrence of

congenital defects. The noxious influences can be physical or chemical. In one examination of the epidemiology of congenital defects in pigs, it was apparent that any environmental causes were from the natural environment; manmade environmental changes, especially husbandry practices, had little effect.<sup>33</sup> A current concern in some regions is an apparent increase in congenital defects believed to be associated with exposure to radio-frequency electromagnetic fields associated with mobile telephone networks,<sup>34,35</sup> but there is little hard data.

#### EPIDEMIOLOGY

Individual abnormalities differ widely in their spontaneous occurrence. The determination of the cause of congenital defects in a particular case very often defies all methods of examination. Epidemiological considerations offer some of the best clues but are obviously of little advantage when the number of cases is limited. The possibility of inheritance playing a part is fairly easily examined if good breeding records are available. The chances of coming to a finite conclusion are much less probable. Some of the statistical techniques used are discussed in Chapter 34 on inherited diseases. The determination of the currently known teratogens has mainly been arrived at following epidemiological studies suggesting possible causality followed by experimental challenge and reproduction of the defect with the suspected teratogen.

An expression of the **prevalence** of congenital defects is of very little value unless it is related to the size of the population at risk, and almost no records include this vital data. Furthermore, most of the records available are retrospective and based on the number of cases presented at a laboratory or hospital.

Reported prevalence rates of 0.5–3.0% for calves and 2% for lambs are comparable with the human rate of 1–3%.<sup>36</sup> A much higher rate for animals of 5–6% is also quoted.<sup>21</sup> A study of over 3500 cases of abortion, stillbirth and perinatal death in horses found congenital malformations in almost 10%.<sup>37</sup> A very extensive literature on congenital defects in animals exists and a bibliography is available.<sup>38–40</sup>

Some breeds and families have extraordinarily high prevalence rates because of intensive inbreeding. The extensive use, by artificial insemination, of certain genetics can result in a significant increase in the occurrence and nature of congenital defects when the bulls are carriers of genetic disease. The use of bulls that were carriers for the syndrome 'complex vertebral malformation' resulted in an approximately threefold increase in the presence of arthrogryposis, ventricular



septal defect and vertebral malformations in Holstein-Friesian calves submitted to diagnostic laboratories in the Netherlands between 1994 and 2000.<sup>41</sup>

In the USA an extensive registry has been established at the veterinary school at Kansas State University.

Checklists of recorded defects are included in the review literature.

### **PATHOGENESIS**

The pathogenesis of many of the congenital defects of large animals is poorly understood but it is apparent that disease produced by each teratogen is likely to have its own unique pathogenesis. Congenital defects in large animals have examples of defects induced from structural malformations, from deformations, from the destruction of tissue by extraneous agents and from enzyme deficiencies – or from a combination of these.

### **Structural malformations and deformations**

**Structural** malformations result from a localized error in morphogenesis. The insult leading to the morphogenic error takes place during organogenesis and thus is an influence imposed in early gestation. **Deformations** occur where there is an alteration in the shape of a structure of the body that has previously undergone normal differentiation. Deforming influences apply later in the early gestational period, after organogenesis.

Deformation is the cause of arthrogryposis and cleft palate produced by the piperidine alkaloids from *Conium maculatum* and *Nicotiana* spp. and by anagryne from *Lupinus* spp., which produce a chemically induced reduction in fetal movements. Ultrasound examination of the normal fetus shows that it has several periods of stretching and vigorous galloping during a 30 minute examination period. In contrast, the fetus that is under the influence of anagryne has restricted movement and lies quietly, often in a twisted position. Restricted fetal limb movement results in arthrogryptic fixation of the limbs, and pressure of the tongue on the hard palate when the neck is in a constant flexed position inhibits closure of the palate. In experimental studies there is a strong relation between the degree and duration of reduced fetal movement, as observed by ultrasound, and the subsequent severity of lesions at birth.<sup>21</sup>

Restriction in the movement of the fetus, and deformation, can also result from teratogens that produce damage and malfunction in organ systems, such as the primary neuropathy that occurs in the autosomal recessive syndrome in Charolais cattle and the acquired neuro-

pathy in Akabane infection, both of which result in arthrogryposis through absence of neurogenic influence on muscle activity.

It has been suggested, with some good evidence, that the etiology and pathogenesis of congenital torticollis and head scoliosis in the equine fetus are related to an increased incidence of transverse presentation of the fetus.<sup>42,43</sup> Flexural deformities of the limbs are also believed to be due to errors in fetal positioning and limited uterine accommodation, which may be further complicated by maternal obesity. Abnormal placental shape may also be important in the genesis of skeletal deformations.<sup>44</sup>

### **Viral teratogenesis**

Viral teratogenesis is related to the susceptibility of undifferentiated and differentiated cells to attachment, penetration and virus replication, the pathogenicity of the virus (cytopathogenic versus noncytopathogenic strains of bovine virus diarrhoea), the effects that the virus has on the cell and the stage of maturation of immunological function of the fetus at the time of infection. Viral infections can result in prenatal death, the birth of nonviable neonates with severe destructive lesions, or the birth of viable neonates with growth retardation or abnormal function (tremors, blindness). The gestational age at infection is a major influence. In sheep infected with border disease virus between 16 and 90 days of gestation, the occurrence of the syndromes of early embryonic death, abortion and stillbirth or the birth of defective and small weak lambs is related to the fetal age at infection. Certain viruses cause selective destruction of tissue and of organ function late in the gestational period and the abiotrophies are examples of selective enzyme deficiencies. The pathogenesis of the viral diseases is given under their specific headings in later chapters.

### **Inherited congenital defects**

A number of **inherited congenital defects**, some of which are not clinically manifest until later in life, are associated with specific enzyme deficiencies. Examples are maple syrup urine disease (MSUD), citrullinemia, factor XI deficiency in cattle and the lysosomal storage diseases. Inherited lysosomal storage diseases occur when there is excessive accumulation of undigested substrate in cells. In mannosidosis, it is due to an accumulation of saccharides due to a deficiency of either lysosomal  $\alpha$ -mannosidase or  $\beta$ -mannosidase. In GM<sub>1</sub> gangliosidosis, disease is due to a deficiency of  $\beta$ -galactosidase and in GM<sub>2</sub> gangliosidosis a deficiency of hexosaminidase.<sup>45</sup>

The age at development of clinical signs and their severity is dependent on the importance of the enzyme that is deficient, the biochemical function and cell type impacted and, in storage disease, the rate of substrate accumulation. Factor XI deficiency is manifest with bleeding tendencies but is not necessarily lethal. In contrast, calves with citrullinemia and MSUD develop neurologic signs and die shortly after birth, whereas the onset of clinical disease can be delayed for several months with  $\alpha$ -mannosidosis.

### **CLINICAL AND NECROPSY FINDINGS**

It is not intended to give details of the clinical signs of all the congenital defects here but some general comments are necessary. Approximately 50% of animals with congenital defects are **stillborn**. The defects are usually readily obvious clinically. Diseases of the nervous system and musculoskeletal system rate high in most published records and this may be related to the ease with which abnormalities of these systems can be observed. For example, in one survey of congenital defects in pigs, the percentage occurrence rates in the different body systems were as follows:

- Bones and joints 23%
- Central nervous system 17%
- Special sense organs 12%
- Combined alimentary and respiratory tracts (mostly cleft palate and atresia ani) 27%
- Miscellaneous (mostly monsters) 9%
- Genitourinary and abdominal wall (hernias) each 5%
- Cardiovascular system 3%.

In a survey of congenital defects in calves the percentage occurrence rates were:

- Musculoskeletal system 24%
- Respiratory and alimentary tracts 13%
- Central nervous system 22%
- Abdominal wall 9%
- Urogenital 4%
- Cardiovascular 3%
- Skin 2%
- Others 4%
- (Anomalous-joined twins and hydrops amnii accounted for 20%).

In a survey of foals the approximate percentage occurrence rates were:

- Musculoskeletal system 50%
- Respiratory and alimentary tracts 20%
- Urogenital 9%
- Abdominal wall 6%
- Cardiovascular 5%
- Eye 5%
- Central nervous system 5%.

Contracted foal syndrome and craniofacial abnormalities were the most com-

mon congenital defects in a study of stillbirth and perinatal death in horses.<sup>37,46</sup>

Many animals with congenital defects have more than one anomaly: in pigs, the average is two and considerable care must be taken to avoid missing a second and third defect in the excitement of finding the first. In some instances, the combinations of defects are repeated often enough to become specific entities. Examples are microphthalmia and cleft palate, which often occur together in piglets, and microphthalmia and patent interventricular septum in calves.

There are a number of defects that cannot be readily distinguished at birth and others that disappear subsequently. It is probably wise not to be too dogmatic in predicting the outcome in a patient with only a suspicion of a congenital defect or one in which the defect appears to be causing no apparent harm. A specific instance is the newborn foal with a cardiac murmur.

Sporadic cases of congenital defects are usually impossible to define etiologically but when the number of affected animals increases it becomes necessary and possible to attempt to determine the cause.

### CLINICAL PATHOLOGY

The use of clinical pathology as an aid to diagnosis depends upon the disease that is suspected and its differential diagnosis. The approach varies markedly with different causes of congenital defects: **specific tests** and procedures are available for some of the viral teratogens, for congenital defects associated with nutritional deficiencies and for some enzyme deficiencies and storage diseases, and the specific approach for known teratogens is covered in the individual diseases section.

When an unknown viral teratogen is suspected, precolostral blood samples should be collected from the affected neonates and also from normal contemporaries that are subsequently born in the group. Precolostral serum can be used for investigating the possible fetal exposure of the group to an agent and the buffy coat or blood can be used for attempted virus isolation. IgG and IgM concentrations in precolostral serum may give an indication of fetal response to an infecting agent even if the agent is not known and there is no serological titer to known teratogenic agents.

Enzyme-based tests have been used to virtually eradicate carriers of  $\alpha$  mannosidosis in cattle breeds in Australia and New Zealand<sup>47</sup> and DNA-based tests are used to detect and eliminate the carriers of diseases such as generalized glycosinosis in cattle.<sup>48</sup>

### DIFFERENTIAL DIAGNOSIS

- The diagnostic challenge with congenital defects is to recognize and identify the defect and to determine the cause
- Syndromes of epidemic disease resulting from environmental teratogens are usually sufficiently distinct that they can be diagnosed on the basis of their epidemiology combined with their specific clinical, pathological and laboratory findings and on the availability of exposure
- Congenital defects occurring sporadically in individual animals pose a greater problem. There is usually little difficulty in defining the condition clinically, but it may be impossible to determine what was the cause. With conditions where there is not an obvious clinical diagnosis, an accurate clinical definition may allow placement of the syndrome within a grouping of previously described defects and suggest possible further laboratory testing for further differentiation.

The examination for cause of an unknown congenital defect is usually not undertaken unless more than a few newborn animals in a herd or area are affected in a short period of time with similar abnormalities. A detailed epidemiological investigation will be necessary which will include the following:

- Pedigree analysis. Does the frequency of occurrence of the defect suggest an inherited disease or is it characteristically nonhereditary?
- Nutritional history of dams of affected neonates and alterations in usual sources of feed
- Disease history of dams of affected neonates
- History of drugs used on dams
- Movement of dams during pregnancy to localities where contact with teratogens may have occurred
- Season of the year when insults may have occurred
- Introduction of animals to the herd.

The major difficulty in determining the cause of nonhereditary congenital defects is the long interval of time between when the causative agent was operative and when the animals are presented, often 6–8 months. Detailed clinical and pathological examination of affected animals offers the best opportunity in the initial approach to determine the etiology based on the presence of lesions that are known to be caused by certain teratogens.

### REVIEW LITERATURE

- Dennis SM, Leipold HW. Ovine congenital defects. *Vet Bull* 1979; 49:233.
- Parsonson IM, Della-Porta AJ, Snowdon WA. Development disorders of the fetus in some arthropod-bovine virus infection. *Am J Trop Med Hyg* 1981; 30:600–673.
- Leipold HW, Huston K, Dennis SM. Bovine congenital defects. *Adv Vet Sci Comp Med* 1983; 27:197–271.

- Leipold HW. Cause, nature, effect and diagnosis of bovine congenital defects. In: *Proceedings of the 14th World Congress on Diseases of Cattle* 1986; 1:63–72.
- Rousseaux CG. Developmental anomalies in farm animals. I. Theoretical considerations. *Can Vet J* 1988; 29:23–29.
- Rousseaux CG, Ribble CS. Developmental anomalies in farm animals. II. Defining etiology. *Can Vet J* 1988; 29:30–40.
- De Lahunta A. Abiortrophy in domestic animals: a review. *Can J Vet Res* 1990; 54:65–76.
- Angus K. Congenital malformations in sheep. In *Pract* 1992; 14:33–38.
- Panter KE, Keeler RC, James LF, Bunch TD. Impact of plant toxins on fetal and neonatal development. A review. *J Range Manag* 1992; 45:52–57.
- Dennis SM. Congenital abnormalities. *Vet Clin North Am Food Anim Pract* 1993; 9:1–222.
- Rousseaux CG. Congenital defects as a cause of perinatal mortality of beef calves. *Vet Clin North Am Food Anim Pract* 1994; 10:35–45.
- Mee JF. The role of micronutrients in bovine periparturient problems. *Cattle Pract* 2004; 12:95–108.

### REFERENCES

1. Power M. *Adv Vet Sci* 1990; 34:131.
2. Huston K. *Vet Clin North Am Food Anim Pract* 1993; 9:1.
3. Leipold HW et al. *Adv Vet Sci* 1983; 27:197.
4. Finnell RH, Gay CC. *Handbook Nat Toxins* 1991; 6:27.
5. Konno S et al. *Vet Pathol* 1982; 19:246.
6. Russell RG et al. *Vet Pathol* 1985; 22:32.
7. McFeeley RA. *Vet Clin North Am Food Anim Pract* 1993; 9:11.
8. Schmultz SM et al. *J Vet Diagn Invest* 1996; 8:91.
9. Agerholm JS, Christensen K. *J Vet Med Assoc* 1993; 40:576.
10. Saito M et al. *J Jpn Vet Med Assoc* 1995; 48:848.
11. Oberst RD. *Vet Clin North Am Food Anim Pract* 1993; 9:23.
12. Haughey KG et al. *Aust Vet J* 1988; 65:136.
13. Chung SI et al. *Am J Vet Res* 1991; 199:337.
14. Davies FG et al. *Vet Rec* 1992; 130:247.
15. Staley GP et al. *J South Afr Vet Assoc* 1994; 65:73.
16. MacPhearson A et al. In: *Proceedings of the 6th International Trace Element Symposium* 1989; 4:1132.
17. Wikse SE et al. *Compend Contin Educ Pract Vet* 1997; 19:1309.
18. Peet RL, Creeper J. *Aust Vet J* 1994; 71:58.
19. Proulx JG, Ribble CS. *Can Vet J* 1992; 33:129.
20. Panter KE et al. *J Range Manag* 1992; 45:52.
21. Preister WA et al. *Am J Vet Res* 1970; 31:1871.
22. Panter KE, Keeler RF. *Vet Clin North Am Food Anim Pract* 1995; 9:33.
23. Panter KE. *J Nat Toxins* 1994; 3:83.
24. Ribble CS et al. *Can Vet J* 1993; 34:221.
25. Navarro M et al. *Vet Rec* 1998; 142:86.
26. Berge GN et al. *Acta Vet Scand* 1987; 28:321.
27. Bellows RA et al. *Am J Vet Res* 1975; 36:1133.
28. Schutte JG, van den Ingh TSAM. *Vet Q* 1997; 19(2):58.
29. Constable PD et al. *Bovine Pract* 1999; 33:70.
30. Syed M, Shanks RD. *Cornell Vet* 1993; 83:261.
31. Cartwright GA, Thwaites GCJ. *J Agric Sci (Cambridge)* 1976; 86:573.
32. Trujano M, Wrathall AE. *Br Vet J* 1985; 141:603.
33. Selby LA et al. *Environ Res* 1973; 6:77.
34. Loscher W. *Prakt Tierarzt* 2002; 83:260.
35. Wenzel C et al. *Prakt Tierarzt* 2003; 84:850.
36. Leipold HW et al. *Adv Vet Sci* 1972; 16:103.
37. Giles RC et al. *J Am Vet Med Assoc* 1993; 203:1170.
38. Crowe MW, Swerczek TW. *Am J Vet Res* 1985; 46:353.

39. WHO. Bibliography on congenital defects in animals. Geneva: Veterinary Public Health Unit, WHO, 1973.
40. Dennis SM. *Vet Clin North Am Food Anim Pract* 1993; 9:1–222.
41. Wbuda W, Visser IJR. *Vet Rec* 2000; 147:612.
42. Wolam DHM. *Equine Vet J* 1984; 16:399.
43. Vadeplassche M et al. *Equine Vet J* 1984; 16:419.
44. Cottrill CM et al. *J Reprod Fertil Suppl* 1991; 44:591.
45. Jolly RD. *NZ Vet J* 2002; 50(Suppl 3):90.
46. Puyalto-Moussu C et al. *Epidemiol Sante Anim* 1999; 35:87.
47. Jolly RD. *Aust Vet J* 2002; 80:284.
48. Dennis JA et al. *Aust Vet J* 2002; 80:286.

## INTRAUTERINE GROWTH RETARDATION

This is a special form of congenital defect. It is a failure to grow properly, as apposed to a failure to gain body weight, and occurs when the developmental age is less than the chronological (gestational) age. **Runt** is a common colloquial agricultural term. Normal fetal growth rate is determined by genetic and epigenetic factors and cross-breeding experiments suggest that fetal size is regulated by the embryonic/fetal genotype and also an effect of maternal genotype.<sup>1</sup> Litter size has an effect on birth weight in all species. A **genetic** association with intra-uterine growth retardation has been shown in Japanese Black calves.<sup>2</sup>

There is a strong positive association between placental mass and fetal size at birth in all species and the majority of cases of growth retardation result from inadequate placentation, disturbance in utero-placental blood flow or placental pathology.

### ETIOLOGY

There are a number of different etiologies.

**Heat stress** to ewes in the final third of pregnancy will result in intrauterine growth retardation but it is not as severe as when ewes are exposed in the second third of pregnancy – the period of placental growth.<sup>3,4</sup> Hyperthermia results in a redistribution of blood away from the placental vascular bed and a decrease in cotyledon mass with consequent reduction in birth weight. The degree of growth restriction is directly related to the degree of hyperthermia to which the ewe is exposed and her heat tolerance. The growth retardation affects fetal weight more than fetal length and, while there is some reduction in the growth of the brain, it is relatively less than that of the internal organs, resulting in an increased brain:liver weight ratio at birth.<sup>5</sup>

**Viral infections**, such as border disease and bovine virus diarrhoea in ruminants and parvovirus in pigs, produce growth-retarded neonates,<sup>6,7</sup> as do bacterial and other infections that result in placentitis.

**Inadequate placentation** is the cause of runt piglets. Runts are smaller, thinner and have disproportionately larger, domed heads than normal pigs. A deficiency in specific **trace elements** is suspect in some field cases of growth retardation in ruminants but there is no evidence for deficient trace element nutrition in runt pigs.<sup>8</sup>

**Inadequate nutrition** can result in in-utero growth retardation. Growth retardation can be produced in fetal pigs, lambs and calves by **maternal caloric undernutrition**. Nutritional restriction in ewes reduces the number of placental lactogen receptors that mediate amino acid transport in fetal liver and glycogen synthesis in fetal tissue, leading to depletion of fetal liver glycogen stores. This has been postulated as a possible cause of the fetal growth retardation that accompanies maternal caloric under-nutrition;<sup>9</sup> runt pigs have a reduced metabolic rate and lower skeletal muscle respiratory enzyme activity.<sup>10</sup> This deficiency persists after birth – runt pigs have a lower core temperature and a lessened ability to increase their metabolic rate and heat production in response to cold.<sup>11</sup>

Paradoxically, **overnourishing the adolescent ewe** will also result in placental growth restriction and in in-utero growth retardation.<sup>4,12</sup> This effect is most evident in the second third of pregnancy. This syndrome is accompanied by the birth of lambs with a shorter gestational age, commonly reduced by 3 days. It is thought that the fetal hypoxia and hypoglycemia that accompanies placental insufficiency might stimulate the maturation of the fetal hypothalamic–pituitary–adrenal axis, initiating early parturition. The growth of those lambs that survive initially lags behind that of normal lambs but there is compensatory growth and no difference in weight at 6 months-of age.<sup>13</sup>

**Measurements** that can be used to determine the presence of growth retardation in a **dead fetus** include crown–rump (anal) length, brain weight, body weight, brain to body weight ratios, long bone weight and appendicular ossification centers. Formulas are available to determine the degree of growth retardation.<sup>14</sup>

In the **live animal** the presence of radiodense lines in long bones and the examination of closure of ossification centers can provide evidence for prior stressors in pregnancy that induce fetal growth retardation, such as malnutrition or infection of the dam, that may not be found by other examinations.<sup>7,15,16</sup>

Intrauterine growth retardation is accompanied by an impaired cellular development of tissues such as the small

intestine and skeletal muscle and disproportionately large reductions in the growth of some organs such as the thymus, spleen, liver, kidney, ovary and thyroid. There is an associated impairment of thermogenesis, immune and organ function at birth.<sup>17–19</sup> In lambs there is impaired development of secondary wool follicles.

The **survival** of fetuses with growth retardation requires special nutritional care and the provision of adequate heat, and is discussed in the section on Critical care for the newborn. In large piggeries that practice batch farrowing, the survival of runts can be significantly improved by the simple practice of fostering them together in one litter on one sow so that they do not have to compete with larger-birth-size and more vigorous pigs, by ensuring adequate colostrum intake and adequate environmental warmth and by feeding using a stomach tube in the first few hours of life if indicated.

### REVIEW LITERATURE

- Fowden AL, Rossdale PD. Foetal maturation; comparative aspects of normal and disturbed development. *Equine Vet J Suppl* 1993; 14:1–49.
- Redmer DA, Wallace JM, Reynolds LP. Effect of nutrient intake during pregnancy on fetal growth and vascular development. *Domestic Anim Endocrinol* 2004; 27(3):199–217.

### REFERENCES

1. Ousy J C et al. *Equine Vet J* 2004; 36:616.
2. Ogata Y et al. *J Jpn Vet Med Assoc* 1997; 50:271.
3. McCrabb G J et al. *J Agric Sci* 1993; 120:265.
4. Wallace JM et al. *J Physiol* 2005; 565:19.
5. Wallace JM et al. *Placenta* 2000; 21:100.
6. Done J T et al. *Vet Rec* 1980; 106:473.
7. Caffrey J F et al. *Res Vet Sci* 1997; 62:245.
8. Gurtler H et al. In: *Proceedings of the 6th International Trace Element Symposium* 1989; 2:534.
9. Freemark M et al. *Endocrinology* 1989; 125:1504.
10. Dauncey M J, Geers R. *Biol Neonate* 1990; 58:291.
11. Hayashi M et al. *Biol Neonate* 1987; 51:205.
12. Wallace JM et al. *Biol Reprod* 2004; 71:1055.
13. Da Silva P et al. *Reproduction (Cambridge)* 2001; 122:375.
14. Richardson C et al. *Vet Rec* 1990; 126:279.
15. O'Connor B T, Doige C E. *Can J Vet Res* 1993; 57:25.
16. Smyth J A, Ellis W A. *Vet Rec* 1996; 139:599.
17. Greenwood P L, Bell A W. In: *Proceedings of the 6th International Symposium on Reproduction in Domestic Animals* 2003; 6:195.
18. Holdstock N B et al. *Pferdheilkunde* 2001; 17:659.
19. Da Silva P et al. *Reproduction (Cambridge)* 2003; 126:249.

### NEONATAL NEOPLASIA

Congenital neoplasia is rare, occurring at a substantially lower rate than in adults, and accounts for a minor percentage of findings in surveys of neonatal mortality.<sup>1,2</sup> It is probable that genetic rather than environmental factors influence its development.

Clinical signs depend upon the type of neoplasm and its site and they can result

in dystocia or abortion. A variety of tumors have been recorded in all large animal species and are predominantly of mesenchymal origin.<sup>2,3</sup>

In calves, malignant lymphoma is most commonly reported. It is usually multicentric and also affects the skin. Sporadic bovine leukosis of young calves may also be present at birth. Other tumors reported predominant in calves include diffuse peritoneal mesothelioma, mixed mesodermal tumor, mast cell tumor, hemangiomas and cutaneous melanoma.<sup>2,4</sup>

Melanomas (both benign and malignant) also occur in foals and piglets. Duroc Jersey, Vietnamese pot-bellied pigs and Sinclair miniature pigs have a high incidence of congenital malignant melanoma, which is fatal in approximately 15% of affected pigs but regresses spontaneously, and without recurrence, in the remainder.<sup>5,6</sup>

A breed predisposition to cardiac rhabdomyoma is recorded in Red Wattle pigs.<sup>7</sup>

Papillomatosis is rare but **lingual papillomatosis** is reported as a cause of enzootic disease of piglets in China.<sup>5</sup>

## REFERENCES

1. Giles RC et al. *J Am Vet Med Assoc* 1993; 203:1170.
2. Midsop W. *J Comp Pathol* 2002; 127:96.
3. Midsop W. *Vet Q* 2002; 24:1.
4. Yeruham I et al. *Vet Dermatol* 1999; 10:149.
5. Midsop W. *Vet Q* 2003; 25:17.
6. Morgan CD. *Vet Immunol Immunopathol* 1996; 55:189.
7. McEwen BJE. *Can Vet J* 1994; 35:48.

## Physical and environmental causes of perinatal disease

Disease in the neonate can result directly from noxious influences in the postnatal period but it can also be predisposed or produced by noxious influences in the period before and during birth.

## PERINATOLOGY

The clinical care of the newborn animal in large animal veterinary medicine has traditionally started at the time of birth but there is a growing recognition of the importance of antenatal and parturient events to the subsequent viability of the neonate. This has been particularly recognized by equine clinicians and has led to the clinical concept of perinatology.<sup>1</sup> One purpose of perinatology is to expand the care of the neonate into the antenatal and parturient period by measurements that reflect fetal health or that can predict risk to fetal viability. Measures that can be used are still being developed and evaluated but the following include those that have apparent value.<sup>2,3</sup>

### Heart rate

In the horse, **fetal heart rate** recorded by electrocardiography (ECG) or by ultrasound can be used as a measure of fetal viability, for the detection of twins and as a monitor for fetal distress during parturition. Fetal heart rate decreases logarithmically from approximately 110 beats/min at 150 days before term to 60–80 beats/min near to term.<sup>4</sup> It has been suggested that a base heart rate of 80–92 beats/min with baseline variations of 7–15 beats/min and occasional accelerations above this is normal for the fetal heart rate of equines, and that bradycardia is evidence of abnormality.<sup>2</sup> Continued monitoring traces may be needed to assess fetal distress. Cardiac arrhythmia is common at the time of birth and for the first few minutes following and is believed to result from the transient physiological hypoxemia that occurs during the birth process.<sup>5</sup>

### Ultrasound examination

The foal can be examined by **ultrasound** to establish the presentation, the presence of twins, the heart rate, the presence and quality of fetal movement, the presence of placentitis, placental thickness, the presence of echogenic particles in the amniotic fluid and an estimate of body size from the measurement of the aortic and orbit diameters. Measurements of fetal heart rate, fetal aortic diameter, uteroplacental contact, maximal fetal fluid depths, uteroplacental thickness and fetal activity have allowed the development of an objective measurement profile to assess fetal wellbeing.<sup>2,6</sup>

The examination of the **amniotic fluid** for the determination of pulmonary maturity and other measures of foal health may be limited as there is a considerable risk for abortion and placentitis, even with ultrasound-guided amniocentesis, and the technique is not recommended for routine clinical use.<sup>7,8</sup>

### Prematurity

Foals born at less than 320 days of gestational age are considered premature and those less than 310 days are at significant risk for increased mortality. Traditionally, external signs have been used to predict a premature foaling and the common signs used are the enlargement of the udder, milk flow and the occurrence of vaginal discharge. Causes of early foaling include bacterial or fungal placentitis and twin pregnancy.<sup>9</sup> Several **assays** are used as alternate methods of determining if foaling is imminent and if problems are present.

Plasma **progesterone** concentrations decline in pregnancy to reach a low around

150 days of gestation. In Thoroughbreds, they remain below 10 ng/mL until approximately 20 days prior to foaling when they start to increase but in ponies there is a greater variation.<sup>10,11</sup> Concentrations decline 24 hours before parturition. Plasma progesterone cannot be used to accurately predict the time of foaling and a single sample is not diagnostic.<sup>8</sup> There is a strong correlation between the presence of plasma progesterone concentrations above 10 ng/mL before a gestational age of 310 days and the presence of placental pathology<sup>2</sup> and a rapid drop in concentration to below 2 ng/mL that persists for more than 3 days indicates impending abortion. Current research is examining the profiles of individual progesterones during pregnancy to determine if the profile of any one can be used as a predictor of fetal distress.<sup>12</sup>

During the last week of gestation the concentration of calcium and potassium in **milk** increases and that of sodium decreases. The rise in calcium concentrations are the most reliable predictor of fetal maturity<sup>3</sup> and milk calcium concentrations above 10 mmol/L, in combination with a concentration of potassium that is greater than sodium, are indicative of fetal maturity. Milk calcium concentrations above 10 mmol/L in the earlier stages of pregnancy are suggestive of fetal compromise.<sup>2</sup> Commercial milk test strips are available for estimating mammary secretion electrolyte concentrations; however, it is recommended that testing be done in an accredited laboratory.<sup>13</sup>

## REVIEW LITERATURE

- Rossdale PD, Silver M, Rose RJ. *Perinatology. Equine Vet J Suppl* 1988; 5:1–61.
- Ellis DR. Care of neonatal foals, normal and abnormal. *In Pract* 1990; 12:193–197.
- Rossdale PD, McGladdery AJ. Recent advances in equine neonatology. *Vet Annu* 1992; 32:201–208.
- Rossdale PD. Advances in equine perinatology 1956–1996: a tribute. *Equine Vet Educ* 1997; 9:273–277.
- Davies Morel MCG, Newcombe JR, Holland SJ. Factors affecting gestation length in the Thoroughbred mare. *Anim Reprod Sci* 2002; 74:175–185.

## REFERENCES

1. Rossdale PD. *Equine Vet Educ* 1997; 9:273.
2. Rossdale PD, McGladdery AJ. *Equine Vet Educ* 1991; 3:208.
3. Vaala WE, Sertich PL. *Vet Clin North Am Equine Pract* 1994; 10:237.
4. Matsui K et al. *Jpn J Vet Sci* 1985; 47:597.
5. Yamamoto K et al. *Equine Vet J* 1992; 23:169.
6. Reef VB et al. *Equine Vet J* 1996; 28:200.
7. Schmidt AR et al. *Equine Vet J* 1991; 23:261.
8. LeBlanc MM. *Equine Vet J* 1997; 24:100.
9. Ellis DR. *In Pract* 1990; 12:192.
10. Rossdale PD et al. *J Reprod Fertil Suppl* 1991; 44:579.
11. Ousey JC et al. *Pferdheilkunde* 2001; 17:574.
12. Ousey JC et al. *Theriogenology* 2005; 63:1844.
13. Ousey J. *Equine Vet Educ* 2003; 15:164.

## PREMATURITY AND DYSMATURITY OF FOALS

Foals that are born before 300 days are unlikely to survive and foals born between 300 and 320 days of gestation are considered premature but may survive with adequate care.<sup>1,2</sup> **Premature foals** are characterized clinically by low birth weight, generalized muscle weakness, poor ability to stand, lax flexor tendons, weak or no suck reflex, lack of righting ability, respiratory distress, short silky haircoat, pliant ears, soft lips, increased passive range of limb motion, and sloping pastern axis. Radiographs may show incomplete ossification of the carpal and tarsal bones and immaturity of the lung and there may be clinical evidence of respiratory distress.

**Full term foals** born after 320 days of gestation but exhibiting signs of prematurity are described as **dysmature**.

**Premature foals** have hypoadrenal corticalism. They are neutropenic and lymphopenic at birth and have a narrow neutrophil to lymphocyte ratio.<sup>3,4</sup> In premature foals older than 35 hours the neutrophil count can be used to predict survival and foals that remain neutropenic after this time have a poor prognosis.<sup>4,5</sup> Premature foals also have low plasma glucose, low plasma cortisol and a blood pH of less than 7.25. An extensive collaborative investigation of equine prematurity has been conducted and information on foal metabolism<sup>6-9</sup> and guidelines for laboratory and clinical assessment of maturity are available.<sup>5,10</sup>

The **placenta** is critical to the fetus in the antenatal period and pregnancies involving placental pathology commonly result in foals that suffer premature-like signs at whatever stage they are delivered.<sup>11</sup> Placental edema, placental villous atrophy and premature separation of the placenta are significant causes.<sup>12,13</sup>

**Precocious lactation** of the mare can be associated with placentitis. The examination of the placenta for evidence of placentitis and for the presence of larger than normal avillous areas should be part of normal foaling management. A study of the equine placenta showed a high correlation between both allantochorionic weight and area and foal weight in normal placentas. Normal placentas had a low association with subsequent perinatal disease in the foals. In contrast, abnormal placental histology was associated with poor foal outcome (three normal foals from 32 abnormal placentas). Cords longer than 70 cm were often associated with fetal death or malformation. Edema, sacculation and strangulation are other abnormalities and can be associated with microscopic deposits of mineral within the lumen of placental blood vessels.<sup>12</sup>

## REFERENCES

1. Mee JF. *Vet Rec* 1991; 128:521.
2. Koterba AM. *Equine Vet Educ* 1993; 5:271.
3. Rossdale PD, McGladdery AJ. *Equine Vet Educ* 1991; 3:208.
4. Chavatte P et al. *J Reprod Fertil Suppl* 1991; 44:603.
5. Vaala WE. *Compend Contin Educ Pract Vet* 1986; 8:S211.
6. Wilshire T. *In Pract* 1989; 11:239.
7. Silver M et al. *Equine Vet J* 1984; 16:278.
8. Fowden AL et al. *Equine Vet J* 1984; 16:286.
9. Pipkin FB et al. *Equine Vet J* 1984; 16:292.
10. Rossdale PD. *Equine Vet J* 1984; 16:275, 300.
11. Rossdale PD et al. *J Reprod Fertil Suppl* 1991; 44:579.
12. Giles RC et al. *J Am Vet Med Assoc* 1993; 203:1170.
13. Galvin N, Collins D. *Ir Vet J* 2004; 57:707.

## PARTURIENT INJURY AND INTRAPARTUM DEATH

During parturition extreme mechanical forces are brought to bear upon the fetus and these can result in direct traumatic damage or can impair fetal circulation of blood by entrapment of the umbilical cord between the fetus and the maternal pelvis, which may lead to hypoxemia or anoxia and death of the fetus during the birth process. Neonates that suffer birth trauma and anoxia but survive are at risk for development of the neonatal maladjustment syndrome,<sup>1</sup> have reduced vigor, are slower to suck and are at increased risk for postnatal mortality.

In all species, but in ruminants in particular, the **condition of the dam** can have a marked influence on the prevalence of birth injury and its consequences. The effect is well illustrated in sheep, where the two extremes of condition can cause problems. Ewes on a high plane of nutrition produce a large fetus and also deposit fat in the pelvic girdle, which constricts the birth canal, predisposing to dystocia. Conversely, thin ewes may be too weak to give birth rapidly.<sup>2</sup> **Pelvic size** can influence the risk of birth injury and ewe lambs and heifers mated before they reach 65% of mature weight are at risk. **Pelvimetry** is used to select heifers with adequate pelvic size for breeding but the accuracy and validity is seriously questioned.<sup>3,4</sup> **Breed** is also a determinant of length and ease of labor and the subsequent quickness to time to first suckle.<sup>5</sup>

## TRAUMA AT PARTURITION

**Traumatic injuries** can occur in apparently normal births, with prolonged birth and as a result of dystocia, which may or may not be assisted by the owner. Incompatibility in the sizes of the fetus and the dam's pelvis is the single most important cause of dystocia, and birth weight is the most important contributing factor. In cattle, expected progeny differ-

ence (EPD) estimates for calf birth weight are good predictors of calving ease.<sup>3</sup> In foals, calves and lambs the chest is most vulnerable to traumatic injury but there is the chance of vertebral fracture and physical trauma to limbs with excessive external traction.

**Fractured ribs** are common in foals and can lead to laceration of the lungs and heart and internal hemorrhage.<sup>6</sup> **Rupture of the liver** is common in some breeds of sheep<sup>7,8</sup> and can also occur in calves and foals. A retrospective study of rib and vertebral fractures in calves suggests that most result from excessive traction and that as a result smaller dystocial calves are more at risk.<sup>9</sup> **Vertebral fractures** occur as the result of traction in calves with posterior presentations and in calves with hip lock. Trauma is a major cause of neonatal mortality in piglets but it occurs in the postparturient phase and is associated with being overlain or stepped on by the sow. It is possible that the underlying cause of crushing mortality in piglets is hypothermia.<sup>10</sup>

**Intracranial hemorrhage** can result in damage to the brain. A high proportion (70%) of nonsurviving neonatal lambs at, or within 7 days of birth have been shown to have single or multiple intracranial hemorrhages, the highest incidence being in lambs of high birth weight. Similar lesions have been identified in foals and calves. Experimentally controlled parturition in ewes showed that duration and vigor of the birth process affected the severity of intracranial hemorrhages and further studies indicated that these birth-injured lambs had depressed feeding activity and that they were particularly susceptible to death from hypothermia and starvation.<sup>11,12</sup>

Birth anoxia associated with severe dystocia in cattle can result in calves with lower rectal temperatures in the perinatal period than normal calves and a decreased ability to withstand cold stress.<sup>13</sup>

Intracranial hemorrhage, especially subarachnoid hemorrhage, occurs in normal full-term deliveries as the result of physical or asphyxial trauma during or immediately following delivery.<sup>14</sup> The forceful uterine contractions associated with parturition can result in surges of cerebral vascular pressure resulting in subarachnoid hemorrhage. It is also of common occurrence in foals born before full term.<sup>15</sup> In one study, the highest incidence occurred in pony foals in which parturition was induced prior to 301 days of gestation. Similar hemorrhage occurred in pony foals born by cesarean section at 270 and 280 days of gestation and appeared associated with anoxic damage.

In a prolonged birth, **edema** of parts of the body, such as the head and particularly the tongue, may also occur. This occurs particularly in the calf and the lamb, possibly because of less close supervision at parturition and also because the young of these species can sustain a prolonged birthing process for longer periods than the foal without their own death or death of the dam. The edema can interfere with subsequent sucking but the principal problem relative to neonatal disease is the effect of the often prolonged hypoxia to which the fetus is subjected. There is interference with the placental circulation and failure of the fetus to reach the external environment. The hypoxia may be sufficient to produce a stillborn neonate, or the neonate may be alive at birth but not survive because of irreparable brain damage. Intrapartum deaths due to prolonged parturition occur in piglets.

### REVIEW LITERATURE

- Kasari TR, Wikse SE. Perinatal mortality in beef herds. *Vet Clin North Am Food Anim Pract* 1994; 10(1):1-185.
- Sanderson MW, Chenoweth PJ. *Compend Contin Educ Pract Vet* 2001; 23(9 Suppl):S95.
- Szenci O. Role of acid-base disturbances in perinatal mortality of calves: a review. *Vet Bull* 2003; 73(7):7R-14R
- Redmer DA, Wallace JM, Reynolds LP. Endocrine regulation of tissue differentiation and development with focus on the importance of nutrition and IGFs. *Domestic Anim Endocrinol* 2004; 27:199-217.

### REFERENCES

- Hess-Dudan F, Rosedale PD. *Equine Vet Educ* 1996; 8:24, 79.
- Wilsmore T. *In Pract* 1989; 11:239.
- Rice LE. *Vet Clin North Am Food Anim Pract* 1994; 10:53.
- Vestweber JG. *Vet Clin North Am Food Anim Pract* 1997; 13:411.
- Dwyer CM et al. *Reprod Fertil Develop* 1996; 8:1123.
- Giles RC et al. *J Am Vet Med Assoc* 1993; 203:1170.
- Johnston WS, Maclachlan GK. *Vet Rec* 1986; 118:610.
- Greene LE, Morgan KL. *Prevent Vet Med* 1993; 17:251.
- Schuijt G. *J Am Vet Med Assoc* 1990; 197:1196.
- Edwards SA. *Livestock Prod Sci* 2002; 78:3.
- Haughey KG. *Aust Vet J* 1980; 56:49.
- Haughey KC. *Wool Technol Sheep Breed* 1984; 31:139.
- Bellows RA, Lammoglia MA. *Theriogenology* 2000; 53:803.
- Hess-Dudan F, Rosedale PD. *Equine Vet Educ* 1996; 8:24, 79.
- Palmer AC et al. *Equine Vet J* 1984; 16:383.

### FETAL HYPOXIA

Hypoxemia and hypoxia can occur as a result of influences during the birth process or because of pulmonary immaturity in premature births.<sup>1,2</sup>

**Transient tachypnea** occurs following birth and is believed to be due to transient

hypoxemia associated with the birth process and the absorption of pulmonary fluid.

**Prolonged tachypnea**, with flaring of the nostrils, open-mouth breathing, exaggerated rib retraction and paradoxical breathing patterns, is highly suggestive of primary pulmonary abnormality. Failure of respiration can occur at this stage and creates an urgent need for resuscitation measures. In the foal, **body position** can have a major effect on arterial oxygen tension.<sup>3</sup> A foal that is unable to stand or to right itself from lateral recumbency is at risk from atelectasis<sup>4</sup> and should be moved frequently. Hypoxia and hypercapnia resulting from mismatching of ventilation and perfusion are accentuated by prolonged recumbency.

Placental dysfunction or occlusion of the umbilicus in the second stage of labor can result in a much more serious situation so that the neonate is born in a state of terminal, as distinct from primary, apnea. It will be stillborn unless urgent and vigorous resuscitation is initiated immediately. Resuscitation includes:

- Establishing a patent airway by extending the head and clearing the nostrils of mucus and, if necessary, by postural drainage to clear excess fluids from the airways
- Artificial ventilation. This is easier if the foal is intubated but can also be achieved by sealing one nostril by hand and breathing forcibly into the other (or inflating with a rubber tube from an oxygen cylinder, delivering at a rate of 5 L/min). The chest wall should be moved only slightly with each positive breath. Continue at 25 ventilations/min until respiration is spontaneous
- Administering 200 mL 5% sodium bicarbonate solution intravenously to counter acidosis. However, respiratory acidosis with hypoxemia and hypercapnia should be primarily treated by assisted ventilation.

In general, the response of the neonate to hypoxemia is an increase in blood pressure and a redistribution of cardiac output with increased blood flow to the brain, heart and adrenal gland and a reduction in flow to the lungs, kidney, gastrointestinal tract and carcass.<sup>5,6</sup> These regulatory changes fail with developing hypoxia and metabolic acidosis and failure leads eventually to cerebral anoxia. The avoidance of acidemia and the maintenance of an adequate oxygen supply are essential in the care of hypoxemic and premature foals.

A special cause of hypoxia, due usually to hypovolemia in addition to inadequate oxygenation of blood, occurs in the foal as

a result of an inadequate **placental blood transfusion**, when the umbilical cord is severed too early after birth. This is one cause of the neonatal maladjustment syndrome, which is detailed in another section of this text.

Intrapartum hypoxemia due to **prolonged parturition** is common,<sup>7</sup> particularly in calves born to first-calf beef heifers, and is considered to be one cause of the 'weak calf syndrome' described in Chapter 36.

A similar syndrome has been produced experimentally by clamping the umbilical cord of the bovine fetus in utero for 6-8 minutes, followed by a cesarean section 30-40 minutes later. Calves born following this procedure may die in 10-15 minutes after birth or survive for only up to 2 days.<sup>8</sup> During the experimental clamping of the umbilical cord, there is a decline in the blood pH, PO<sub>2</sub> and standard bicarbonate levels and an increase in PCO<sub>2</sub> and lactate levels.<sup>8</sup> There is also increased fetal movement during clamping and a release of meconium, which stains the calf and the amniotic fluid. Those that survive for a few hours or days are dull, depressed, cannot stand, have poor sucking and swallowing reflexes and their temperature is usually subnormal. They respond poorly to supportive therapy. A slight body tremor may be present and occasionally tetany and opisthotonus occur before death. Calves that are barely able to stand cannot find the teats of the dam because of uncontrolled head movements. At necropsy of these experimental cases, there are petechial and ecchymotic hemorrhages on the myocardium and endocardium, an excess of pericardial fluid, and the lungs are inflated. When the experimental clamping lasts only 4 minutes, the calves usually survive.

**Meconium staining** (brown discoloration) of the coat of the newborn at birth is an important indicator that it has suffered hypoxia during or preceding the birth process; such neonates require close supervision in the early postnatal period. In lambs, severe hypoxia during birth results in death shortly following birth and there is an increased risk in those that survive for metabolic acidosis and depressed heat production capacity, which causes hypothermia.<sup>9</sup>

Fetal anoxia associated with **premature expulsion** of the **placenta** occurs in all species but may be of greatest importance in cattle.<sup>10</sup> It occurs in all parities of cow and with little relation to calving difficulty, although malpresentation is a predisposing factor. Prepartum diagnosis in cattle is hindered by the low prevalence of prepartum vaginal hemorrhage, and the majority of fetuses die during the birth process. The placenta is expelled with the

fetus. **Premature separation** of the placenta ('red bag') occurs in foals when foals experience difficulty in breaking through the cervical star region of an edematous thickened placenta. This is an emergency and requires immediate attention.

In all species the prevention of intrapartum hypoxia depends on the provision of surveillance. Universal surveillance is usually not practical for species other than the horse, and in cattle, for example, it tends to concentrate on the group at most risk so that surveillance, and assistance if necessary, is provided for first-calf heifers at the time of calving. Heifers that do not continue to show progress during the second stage of parturition should be examined for evidence of dystocia, and obstetrical assistance should be provided if necessary.

The treatment and care of foals with this syndrome is described under Critical care of the newborn later in the chapter. The monitoring, treatment and care of agricultural animals with this syndrome should follow the same principles but is usually limited by the value of the animal and the immediate access to a laboratory. Measures such as the time from birth to sternal recumbency, time from birth to standing and time from birth to first suckle have been used to grade calves and identify those that might require intervention and treatment, but the best method of evaluation is an assessment of muscle tone.<sup>11</sup> There is no effective practical treatment for calves affected with intrapartum hypoxia other than the provision of ventilation as for the foal and the correction of the acidosis. The airway should be cleared and, if physical stimulation of ventilation gives no response, then mechanical ventilation should be attempted. The practice of direct mouth-to-mouth ventilation assistance should be strongly discouraged, especially in lambs, because of the risk from zoonotic disease agents. Doxapram hydrochloride has been used in calves to stimulate respiration.<sup>11</sup>

The provision of warmth, force-feeding of colostrum and fluid therapy are logical support approaches.

## REVIEW LITERATURE

Szenci O. Role of acid-base disturbances in perinatal mortality of calves; a review. *Vet Bull* 2003; 73(7):7R-14R.

## REFERENCES

- Hess-Dudán F, Rosedale PD. *Equine Vet Educ* 1996; 8:24, 79.
- Rose R. *Equine Vet J Suppl* 1987; 5:11.
- Chavatte P et al. *J Reprod Fertil Suppl* 1991; 44:603.
- Rosedale PD, McGladdery AJ. *Vet Annu* 1992; 32:201.
- Ruark DW et al. *Am J Physiol* 1990; 258:R1108, R1116.
- Rosedale PD. *Vet Clin North Am Large Anim Pract* 1979; 1:205.

- Vestweber JG. *Vet Clin North Am Food Anim Pract* 1997; 13:411.
- Duffy J, Sloss V. *Aust Vet J* 1977; 53:262.
- Eales FA, Small J. *Res Vet Sci* 1985; 39:219.
- Mee JF. *Vet Rec* 1991; 128:521.
- Szenci O. *Vet Bull* 2003; 73:7R.

## HYPOTHERMIA

The environment of the neonate can have a profound effect on its survival. This is especially true for lambs and piglets, in which hypothermia and hypoglycemia are common causes of death. Hypothermia can also predispose to infectious disease and can adversely affect the response of neonates in coping with an exogenous endotoxin challenge. Endotoxin exposure of hypothermic pigs results in an even greater reduction in body temperature.<sup>1</sup>

## LAMBS

Lambs are very susceptible to cold and hypothermia is an important cause of mortality in the early postnatal period. **Cold stress** to neonatal lambs exists in three forms, ambient temperature, wind and evaporative cooling. The healthy newborn lamb has a good ability to increase its metabolic rate in response to a cold stress by shivering and non-shivering thermogenesis (brown adipose tissue). The energy sources in the neonatal lamb are liver and muscle glycogen, brown adipose tissue and, if it sucks, the energy obtained from colostrum and milk. The ingestion of colostrum can be essential for early thermogenesis in lambs, especially twin lambs.<sup>2</sup>

The **critical temperature** (the ambient temperature below which a lamb must increase metabolic heat production to maintain body temperature) for light birth-weight lambs is 31–37°C in the first days of life.

The risk for mortality from hypothermia is highest in lambs of small birth size. **Heat production** is a function of body mass while **heat loss** is a function of body surface area. Large-birth-size lambs have a greater body mass in relation to their surface areas and are thus more resistant to environmental cold stress. In contrast, small-birth-size lambs, with a smaller body mass relative to surface area, are more susceptible. The dramatic nature of this relationship was shown in early studies on cold stress and survival in lambs many years ago. Birth weight is lower in twins and triplets and in the progeny of maiden ewes. Susceptibility is also influenced by maternal nutrition in pregnancy (see next section), as this can both influence placental mass, birth weight and the energy reserves of the neonate, and also affect the activity of the ewe at parturition, and the resultant poor mothering behavior and mismothering can result in starvation in the lamb.

Lambs are particularly susceptible to cold stress during the first 5 days of life. During this period hypothermia can result from heat loss in excess of summit metabolism or from depressed heat production caused by intrapartum hypoxia, immaturity and starvation.<sup>3</sup>

## Heat loss in excess of summit metabolism

Low-birth-weight lambs born into a cool environment where there is wind are especially susceptible because of the evaporative cooling of fetal fluids on the fleece.<sup>4</sup> To a small newborn lamb the evaporative cooling effect of a breeze of 19 km/h (12 mph) at an ambient temperature of 13°C (55°F), common in lambing seasons in many countries, can be the equivalent of a cold stress equivalent to 25°C. The heat loss in these circumstances can exceed their ability to produce heat (summit metabolism) and progressive hypothermia and death results. Hypothermia due to heat loss in excess of summit metabolism can also occur when there is rain or just with cold and wind. This mortality occurs primarily in the first 12 hours of life.

## Hypothermia from depleted energy reserves

Hypothermia occurring in lambs after 12 hours of age is usually due to depletion of energy reserves in periods of cold stress. There are three major causes. Milk is the sustaining energy source.

One of the early manifestations of developing hypothermia is the **loss of sucking drive**; severe cold stress and developing hypothermia can result in low milk intake and depletion of energy reserves.

The second important cause is **mismothering**; the third is related to **birth injury**. Dystocia-related hypoxia results in acidemia, a reduction in summit metabolism and disturbance in thermoregulation and can result in hypothermia.<sup>5</sup> Birth-injured lambs, usually large single-born lambs, have depressed sucking and feeding activity.<sup>6,7</sup> Systems are available for the categorization of deaths based on postmortem examination.<sup>7-9</sup>

In lambs that have hypothermia associated with heat loss in excess of summit metabolism, heat is required for **therapy**, but in lambs with starvation hypothermia the administration of glucose is also necessary. Glucose is administered intraperitoneally at a dose of 2 g/kg body weight using a 20% solution. Following the administration of the glucose, the lambs should be dried with a towel if wet and rewarmed in air at 40°C (104°F). This can be done in a warming box using a radiant heater as the heat supply. Care should be taken to avoid the occurrence



of hyperthermia. Careful attention must be given to the nutrition of the lambs after rewarming otherwise relapse will occur. A feeding of 100–200 mL of colostrum will also be beneficial but lambs should not be fed before they are normothermic, as aspiration pneumonia is a risk. Experimental hypothermia in lambs has shown little direct long-term pathological effect.<sup>10</sup>

In most countries the selection of time of lambing is dictated by nutritional considerations and the seasonality of the ewes' sexual behavior and lambing occurs at a time of year when cold stress is likely. The **control** of loss from hypothermia in newborn lambs requires supervision at lambing and protection from cold. Shed lambing will reduce cold stress loss. The provision of shelter in lambing paddocks may be effective but site is important as birth sites in lambing paddocks are not randomly distributed and there is variation in the preferred sites between breeds.<sup>5</sup> Some ewes will seek shelter at lambing but many ewes in wool will not. In some flocks, sheep are shorn before lambing in an attempt to force this shelter-seeking trait.

Experimentally, there is a strong relationship between breed and the degree of hypothermia produced.<sup>10</sup> There is also convincing evidence that rearing ability is heritable in sheep, that some of this relates to traits within the newborn lamb, and that a significant reduction in neonatal mortality associated with susceptibility to hyperthermia could be achieved with a genetic approach.<sup>6,7,10–12</sup>

Lambs are also susceptible to hyperthermia and thermoregulation is not efficient at high environmental temperatures. Heat prostration and some deaths can occur in range lambs when the environmental temperature is high, especially if lambs have to perform prolonged physical exercise and if there is an absence of shade.

### CALVES

Hypothermia as a result of environmental influence is less common in full-term healthy calves than in lambs but mortality rates have been shown to increase with decreasing ambient temperature and increasing precipitation on the day of birth.<sup>13</sup> The **critical temperature** for neonatal calves is much lower than for lambs, approximately 13°C, and *Bos taurus* calves are more resistant to cold stress than *Bos indicus*.<sup>14</sup>

Experimentally produced hypothermia in calves has also been shown to cause little overt injury except for peripheral damage to exterior tissues.<sup>15,16</sup> During cooling, there can be significant peripheral hypothermia prior to any marked reduc-

tion in core body temperature. Calves have a remarkable ability to resist and overcome the effects of severe cold temperatures.<sup>14,16</sup> However, there is a relationship between the occurrence of cold weather and calf deaths, including those due to the 'weak calf syndrome', and deficiencies in thermoregulation occur in animals born prematurely and in dystocia calves. As in lambs, dystocia will reduce teat-seeking activity and sucking drive and dystocia calves have lower intakes of colostrum<sup>17</sup> and lower body temperatures and decreased ability to withstand cold stress.<sup>18</sup>

Rewarming of hypothermic calves can be by radiant heat but immersion in warm water produces a more rapid response and with minimal metabolic effort. The prevention of hypothermia requires the provision of shelter from wet and wind for the first few days of life. Cows can be calved in a shed, or alternately sheds for calves can be provided in the fields. Beef calves will use shelters in inclement weather; these may not improve their health status, although they are in common use.<sup>19</sup>

### PIGLETS

Hypothermia from heat loss and hypothermia/hypoglycemia from starvation are major causes of loss in neonatal pigs.<sup>20</sup> Newborn piglets have a reasonably good ability to increase their metabolic rate in response to cold stress but they have limited energy reserves, especially limited brown adipose tissue, and they consequently rely on a continual intake of milk for their major energy source, sucking approximately every hour. Young pigs have a good ability for peripheral vasoconstriction at birth but surface insulation is deficient because at this age there is no subcutaneous layer of fat. The **critical temperature** for young pigs is 34°C.

Thermoregulation is inefficient during the first 9 days of life and is not fully functional until the 20th day. Newborn piglets must be provided with an external heat source in the first few weeks of life. The body temperature of the sow cannot be relied upon for this and the preferred air temperature for neonatal pigs is 32°C (89.5°F) during the first day and 30°C (86°F) for the first week. In contrast, the preferred temperature for the sow is about 18°C. A **separate environment** (creep area) must be provided for the piglets. Providing there is an adequate ambient temperature to meet the requirements of the piglets, and good floor insulation, hypothermia will not occur in healthy piglets of viable size unless there is a failure of milk intake.

Birth anoxia, with resultant reduced vigor, reduced teat-seeking activity and

**risk for hypothermia**, occurs particularly in later-birth-order pigs in large litters from older sows. Failure of milk intake can also occur with small-birth-size piglets and is influenced by litter size, low number of functional teats relative to litter size and teat sucking order.

### FOALS

There have been few studies on thermoregulation in foals but the large body mass in relation to surface area renders healthy newborn foals, like healthy calves, relatively resistant to cold. Also, foals are less likely to be born in a hostile environment than other farm animals. Significant foal mortality from hypothermia as a result of starvation and exposure can occur in extensively managed herds and dystocia, low birth weight and poor mothering are contributing factors.<sup>21</sup>

Sick and **premature foals** may have difficulty in maintaining body temperature in normal environments and the metabolic rates of sick foals and premature foals are approximately 25% lower than healthy foals.<sup>22,23</sup>

The relatively larger surface area to mass ratio, lower energy reserves and lower insulation of the coat of premature foals, coupled with the lower metabolic rate, places them at particular risk for hypothermia. **Dystocia foals** also have lower metabolic rates but dysmature foals appear to thermoregulate normally.<sup>22,24</sup> Methods of investigation that allow post-mortem differentiation of placental insufficiency, acute intrapartum hypoxemia, inadequate thermogenesis and starvation as causes of mortality in foals are described.<sup>8</sup>

Hypothermia should be suspected in premature foals when the rectal temperature falls below 37.2°C (99°F) and should be corrected with external warmth, rugging or moving to a heated environment. If fluids are being administered they should be heated to normal body temperature.

### REVIEW LITERATURE

- Alexander G., Barker JD, Slee J. Factors affecting the survival of newborn lambs. A seminar in the CEC programme of coordination of agricultural research held in Brussels, January 22–23, 1985. Brussels: Commission of the European Communities, 1986.
- Rook JS, Scholman G, Wing-Proctor S, Shea M. Diagnosis and control of neonatal loss in sheep. *Vet Clin North Am Food Anim Pract* 1990; 6(3):531–562.
- Haughey KC. Perinatal lamb mortality: its investigation, causes and control. *J South Afr Vet Assoc* 1991; 62:78–91.
- Carstens GE. Cold thermoregulation in the newborn calf. *Vet Clin North Am Food Anim Pract* 1994; 10(1):69–106.
- Mellor DJ, Stafford KJ. Animal welfare implications of neonatal mortality and morbidity in farm animals. *Vet J* 2004; 168:118–133.



## REFERENCES

1. Carroll JA et al. *Am J Vet Res* 2001; 62:561.
2. Hamadeh SK et al. *Sheep Goat Res J* 2000; 16(2):46.
3. Eales FA et al. *Vet Rec* 1984; 114:469.
4. McCutcheon SN et al. *NZ J Agric Res* 1983; 26:169, 175.
5. Eales FA, Small J. *Res Vet Sci* 1985; 39:219.
6. Haughey KC. *Wool Technol Sheep Breed* 1984; 31:139.
7. Haughey KC. *J South Afr Vet Assoc* 1991; 62:78.
8. Rook JS et al. *Vet Clin North Am Food Anim Pract* 1990; 6:531.
9. Eales FA et al. *Vet Rec* 1986; 118:227.
10. Slee J et al. *Aust J Exp Agric* 1991; 31:175.
11. Alexander G et al. *Aust J Exp Agric* 1990; 30:759.
12. Nash ML et al. *Vet Rec* 1996; 139:64.
13. Azzam SM et al. *J Anim Sci* 1993; 71:282.
14. Carstens GE. *Vet Clin North Am Food Anim Pract* 1994; 10:69.
15. Olson DP et al. *Am J Vet Res* 1981; 42:758, 876.
16. Olson DP et al. *Am J Vet Res* 1983; 44:564, 572, 577, 969.
17. Vermorel M et al. *Can J Anim Sci* 1989; 69:103, 113.
18. Bellows RA, Lammoglia MA. *Theriogenology* 2000; 53:803.
19. Olson DP et al. *Bovine Pract* 1989; 24:4.
20. English PR. *Vet Annu* 1993; 33:107.
21. Haas AD. *Can Vet J* 1996; 37:91.
22. Ousey JC et al. *Vet J* 1997; 153:185.
23. Rossdale PD. *Equine Vet J Suppl* 1988; 5:19.
24. Ousey JC et al. *Equine Vet J* 2004; 36:616.

## MATERNAL NUTRITION AND THE NEWBORN

Effects on both the dam and the fetus can occur from overfeeding or underfeeding of the dam, and there can be effects from the influences of trace element deficiencies or toxic substances. Severe **undernutrition** of the dam can affect fetal size, and its thermogenic rate, with consequences mentioned earlier. Prepartum protein restriction has most effect.<sup>1</sup> Severe undernutrition of the dam can also lead to weak labor, increased rates of dystocia and can limit the development of the udder. Colostragenesis may be impaired, with a greater risk of infectious disease in the neonate, and milk production may be significantly reduced or delayed, with a risk of starvation.

Most information is available for the effects of nutrition of the pregnant ewe on fetal growth rate, udder development, the availability of energy in the body reserves of fetuses at term, and the amount and energy content of colostrum.<sup>2-4</sup> In sheep, maternal nutrition can have a significant influence on fetal growth rate and on placental size. The underfeeding of hill sheep in late pregnancy markedly reduces the term weight of the udder and the prenatal accumulation and subsequent rates of secretion of colostrum.<sup>4</sup> A low plane of nutrition in late pregnancy results in a marked decrease in fetal body lipid and brown fat reserves, and marked reductions in the total production of colostrum and in the concentration in

colostrum during the first 18 hours after parturition.<sup>4</sup> However, exposure of late pregnant ewes to cold by shearing increases lamb birth weight and lamb brown fat reserves.<sup>5,6</sup>

**Inadequate nutrition** can also result in in-utero growth retardation. Growth retardation can be produced in fetal pigs, lambs and calves by **maternal caloric undernutrition**. Nutritional restriction in ewes reduces the number of placental lactogen receptors that mediate amino acid transport in fetal liver and glycogen synthesis in fetal tissue, leading to depletion of fetal liver glycogen stores. This has been postulated as a possible cause of the fetal growth retardation that accompanies maternal caloric undernutrition. Runt pigs have a reduced metabolic rate and lower skeletal muscle respiratory enzyme activity. This deficiency persists after birth – runt pigs have a lower core temperature and a lessened ability to increase their metabolic rate and heat production in response to cold. Paradoxically, **overnourishing the adolescent ewe** will also result placental growth restriction and in in-utero growth retardation.<sup>7,8</sup> This effect is most evident in the second third of pregnancy. This syndrome is accompanied by the birth of lambs with a shorter gestational age, commonly reduced by 3 days. It is thought that the fetal hypoxia and hypoglycemia that accompanies placental insufficiency might stimulate the maturation of the fetal hypothalamic-pituitary-adrenal axis initiating early parturition.

Maximum lamb survival is achieved at intermediate lamb birth weights and the **nutritional management** of the pregnant ewe in fecund flocks is very important.<sup>9</sup> Ewes with multiple lambs can be selected using ultrasound and fed separately from those with singles. Pregnant maiden ewes should also be fed to their separate requirements. The recommendation is for a body condition score of 3.0–3.5 at mating, with a fall of 0.5 in score during the second and third months of pregnancy and a subsequent rise in score to 3.55 to the point of lambing, and with a distinct weight gain in late pregnancy. Equivalent condition scores are also appropriate for other species.

Toxic substances and trace element deficiencies can result in increased risk for fetal and neonatal mortality and are discussed under those headings. One of particular significance is agalactia, prolonged gestation and fetal distress at birth seen in mares fed grain contaminated with ergot (*Claviceps purpurea*) and in mares grazing tall fescue (*Festuca arundinacea*) containing the endophyte fungus *Acremonium coenophialum*.

## REFERENCES

1. Carstens GE. *Vet Clin North Am Food Anim Pract* 1994; 10:69.
2. Mellor DJ. *Br Vet J* 1983; 139:307.
3. Mellor DJ, Murray L. *Res Vet Sci* 1982; 32:177, 377.
4. Mellor DJ, Murray L. *Res Vet Sci* 1985; 39:230, 235.
5. Symonds ME, Lomax MA. *Proc Nutr Soc* 1992; 51:165.
6. Symonds ME et al. *J Physiol* 1992; 455:487.
7. Wallace JM et al. *J Physiol* 2005; 565:19.
8. Wallace JM et al. *Biol Reprod* 2004; 71:1055.
9. Fogarty NM et al. *Aust J Exp Agric* 1992; 32:1.

## POOR MOTHER-YOUNG RELATIONSHIP

Any examination of neonatal mortality suspected of being caused by hypothermia, starvation or infection due to failure of transfer of passive immunity, and even trauma by crushing in piglets, must take into account the possibility that poor mothering and a poor mother-young bond may be the primary cause. Inadequate maternal care leads to rapid death of the newborn under extensive conditions where there is no human intervention to correct the problem. The defect is most likely to be on the side of the dam but may originate with the offspring. A poor relationship may be genetic or nutritional and, on the part of the offspring, may be the result of birth trauma.

For both the dam and the young there is a much greater chance of establishing a good bond if the animal has been reared in a group rather than as an individual. Because sight, smell, taste and hearing are all important in the establishment of a seeking and posturing to suckle activity by the dam and a seeking, nuzzling and sucking activity by the offspring, any husbandry factor that interferes with the use of these senses predisposes to mortality. Weakness of the offspring due to poor nutrition of the dam, harassment at parturition by overzealous attendants and high growth of pasture are obvious examples. This can be a problem in cattle, pigs and sheep, and occasionally in horses, especially with extensive foaling practices.<sup>1</sup> In pigs it may be developed to an intense degree in the form of farrowing hysteria, and is dealt with under that heading. In sheep it can be a significant contributor to neonatal death from starvation, especially in highly strung breeds like the Merino.<sup>2</sup>

**Bonding** occurs rapidly after birth, although there is some minor variation between species with bonding starting within a few minutes of birth in sheep but taking up to 2–3 hours in some horses.<sup>3</sup> The strength of bonding also appears to vary between species.<sup>4</sup> The bonding of the dam to the neonate is usually quite specific, although this can be modulated by management systems, and the neonate

may be less selective and will often attempt to suck other dams. With sheep lambed under intensive lambing practices, this can lead to high rates of mismothering and subsequent abandonment, when preparturient 'robber' ewes adopt lambs from multiple births. A high degree of shepherding is required to minimize loss in these management systems, whereas in extensive systems a strong bonding is established providing the ewe and lamb are allowed to remain relatively undisturbed on the lambing site for 6 hours.<sup>2</sup>

Vaginal cervical stimulation and the central release of oxytocin are believed to be important in initiating maternal behavior<sup>5,6</sup> though caudal epidural anesthesia for delivery does not effect mothering or bonding.<sup>7</sup> Sucking is also a major determinant. Recognition is olfactory and auditory and mediated by the release of neurotransmitters.<sup>8</sup>

Bonding is often slower with primiparous dams and is also delayed where there is postpartum pain. A failure of bonding leads to rejection and abandonment of the neonate.

Maternal care is also important to neonatal survival and there is significant difference in litter mortality from crushing and injury between sows related to sow behavior and their response to piglet distress calls.<sup>9</sup> A description of normal and abnormal behavioral patterns of the mare and foal is available<sup>10</sup> and techniques for fostering are described.<sup>3,11</sup>

## REFERENCES

1. Haas SD et al. *Can Vet J* 1996; 37:91.
2. Nowak R. *Appl Anim Behav Sci* 1996; 49:61.
3. Chavatte P. *Equine Vet Educ* 1991; 3:215.
4. Hopster H et al. *Appl Anim Behav Sci* 1994; 44:1.
5. Kendrick KM et al. *Brain Res Bull* 1991; 26:803.
6. Romeyer A et al. *Physiol Behav* 1994; 55:395.
7. Scott PR, Gessert ME. *Vet Rec* 1996; 138:19.
8. Ohkura S, Kendrick KM. *J Reprod Dev* 1995; 41:143.
9. Wechsler B, Heggin D. *Appl Anim Behav Sci* 1997; 51:39.
10. Houpt KA. *Compend Contin Educ Pract Vet* 1984; 6:S114.
11. Alexander G et al. *Aust J Exp Agric* 1987; 27:771.

## INDUCTION OF PREMATURE PARTURITION

### CALVES

The medical induction of parturition by the parenteral injection of corticosteroid into pregnant cows during the last 6 weeks of pregnancy has raised the question of animal welfare and of the possible effects of prematurity on the disease resistance of the newborn calf. The induction of premature parturition in cattle has found application in five main areas:

- With pastoral-based dairy production, synchronization of the calving period has allowed maximal utilization of

seasonally available pastures by the synchronization of peak demand for dry matter intake with spring flush in pasture growth. In pastoral-based herds with breeding for seasonal calving, late-calving cows will be induced and these average approximately 8% of the herd<sup>1</sup>

- Ensuring that calving coincides with the availability of labor to facilitate observations and management of calving and to overcome the inconvenience caused by late-calving cows
- Minimizing dystocia in small heifers
- The therapeutic termination of pregnancy for various clinical reasons, including potential problems such as associated with pregnancy in feedlot heifers
- As an aid in the control of milk fever using vitamin D analogs<sup>2</sup>

A variety of short-acting and long-acting corticosteroids have been used. A single injection of a short-acting formulation is used when it is desirable to induce calving in the last 2-3 weeks of gestation. Earlier in pregnancy the long-acting formulations are more reliable. Sometimes this is followed in 5-8 days by treatment with a short-acting glucocorticoid. Parturition occurs 30-60 hours (mean 48 h) after injection.

Some reports have indicated that the **mortality rate** of induced calves was higher than expected, and that the level of serum immunoglobulins was lower because of interference with absorption by the corticosteroid. Mortality in calves born as a result of induced parturition is primarily as a result of prematurity and calf mortality is generally low when calving is induced within 12 days of parturition, although there are welfare concerns.<sup>3</sup> The calves are usually lighter in weight. The health of calves that survive is generally good, provided they receive adequate quantities of colostrum. When short-acting corticosteroids are used to induce calving close to term, the ability of the calves to absorb immunoglobulins from colostrum is not impaired. However, calves born earlier in pregnancy after using long-acting corticosteroid are lethargic, slow to stand and to suck properly and their ability to absorb immunoglobulins is impaired.<sup>2</sup> Up to 60% of calves born following induction with long-acting corticosteroids are at risk for failure of transfer of immunoglobulins. The colostrum available to such calves also has a reduced content of immunoglobulins, and there may also be a reduction in the total volume of colostrum available from the induced-calving cows.

Artificial induction of parturition is an important risk factor for retention of the placenta and the incidence is reported to vary from 20% to 100%.<sup>1,4,5</sup> Subsequent reproductive performance of induced cows can be impaired.<sup>1</sup> A risk for acute Gram-negative bacterial infections is reported in a low (0.3%) proportion of cows following induction with dexamethasone.<sup>6</sup>

When parturition is induced in large herds of beef cattle, particularly with a high percentage of heifers, increased surveillance will be necessary after the calves are born to avoid mismothering. Every attempt must be made to establish the cow-calf pair (neonatal bond) and move them out of the main calving area. Heifers that disown their calves must be confined in a small pen and be encouraged to accept the calf and let it suck - sometimes a very unrewarding chore for the cowman. Calf mortality can be very high where calving is induced earlier than 35 weeks of pregnancy.<sup>3</sup>

### FOALS

The induction of parturition in mares for reasons of economy, management convenience, concern at prolonged gestation or clinical conditions such as prepubic tendon rupture, or research and teaching is now being practiced.<sup>7,8</sup>

Foaling is induced with oxytocin and occurs within 15-90 minutes of its administration.<sup>9</sup> High doses of oxytocin are potentially dangerous to the foal and low doses (10-20 IU) are preferred. Glucocorticoids, antiprogestagens and prostaglandins that are effective in inducing pregnancy in other species are either ineffective in the mare or capricious in their efficacy, and can also be associated with adverse effects on the foal.<sup>8</sup>

Induction of parturition in the mare it is not without risk and has been associated with the birth of foals that are weak, injured or susceptible to perinatal infections. The period of fetal maturation is relatively short in the horse and is considered to be the last 2-3 days of gestation. Because spontaneous parturition in healthy mares can occur between 320 and 360 days there is the risk of delivering a foal that is premature and nonviable. Fetal maturity is the major prerequisite for successful induced parturition and the three essential criteria are:<sup>8</sup>

- A gestational length of more than 330 days
- Substantial mammary development and the presence of colostrum in the mammary gland with a calcium concentration greater than 10 mmol/L
- Softening of the cervix.

The rise in calcium concentration is the most reliable predictor of fetal maturity

and milk calcium concentrations above 10 mmol/L, in combination with a concentration of potassium that is greater than sodium, are indicative of fetal maturity. Commercial milk test strips are available for estimating mammary secretion electrolyte concentrations, however, it is recommended that testing be done in an accredited laboratory.<sup>8,10-12</sup>

In mature foals, head lifting, sternal recumbency and evidence of suck reflex occurs within 5 minutes of spontaneous full-term deliveries. The foal can stand within 1 hour and suck the mare within 2 hours. The behavior and viability of the premature foal after induced parturition have been described.<sup>13</sup> The overall survival rate of foals delivered from induced parturition before 320 days of gestation was 5%.<sup>13</sup> Four patterns of neonatal adaptation were observed on the basis of righting, sucking and standing ability. If the suck reflex was weak or absent and the foals were unable to establish righting reflexes, the prognosis of survival was poor. Foals born before 300 days of gestation did not survive for more than 90 minutes; foals born closer to 320 days of gestation had a better chance of survival and exhibited behavioral patterns of adaptation.

In addition to the potential delivery of a premature or weak foal, other adverse effects of induction can be dystocia, premature placental separation and retained placenta.

### PIGLETS

The induction of parturition of gilts and sows on days 112, 113 or 114 of gestation is highly reliable and can be achieved by a single intramuscular injection of 175 mg of cloprostenol or 5–10 mg of prostaglandin F<sub>2α</sub>.<sup>14</sup> The sows farrow approximately 20–24 hours later. The interval to onset can be decreased by the use of oxytocin.<sup>15</sup>

Induction of parturition has been used on large-scale farms to allow a concentration of labor and improve supervision and care at the time of farrowing, and to reduce the incidence of the mastitis/metritis/agalactia syndrome<sup>16</sup> and reduce the percentage of stillborn piglets. The end-day of a batch farrowing system can be fixed and weekend farrowing avoided. The subsequent fertility of the sows is not impaired. Induction on day 110 may be associated with a slight increase in perinatal mortality.

### LAMBS

The induction of parturition in sheep is not commonly practiced but it can be used to synchronize lambing in flocks where there are accurate dates of mating for individual ewes. Unless accurate dates are available there is risk of prematurity. Also, ewes that are more than 10 days

from their normal parturition date are unlikely to respond.<sup>17</sup>

Induction of parturition is also used as a therapeutic ploy to terminate pregnancies in sheep with pregnancy toxemia.

Induction is usually with dexamethasone, betamethasone or flumethazone.<sup>18,19</sup> Lambing occurs 36–48 hours later and there may be breed differences in response. Variability in lambing time can be reduced by the use of clenbuterol and oxytocin.<sup>20</sup>

### REVIEW LITERATURE

- MacDiarmid SC. Induction of parturition in cattle using corticosteroid: a review. Part 1. Reasons for induction, mechanisms of induction and preparations used. *Anim Breed Abstr* 1983; 51:403–19.
- MacDiarmid SC. Induction of parturition in cattle using corticosteroid: a review. Part 2. Effects of induced calving on the calf and cow. *Anim Breed Abstr* 1983; 51:499–508.
- Pressing AL. Pharmacologic control of swine reproduction. *Vet Clin North Am Food Anim Pract* 1992; 8:707–23.
- Hemsworth PH, Barnett JL, Beveridge L Mathews LR. The welfare of extensively managed dairy cattle: a review. *Appl Anim Behav Sci* 1995; 42:161–82.
- Ingoldby L, Jackson P. Induction of parturition in sheep. *In Pract* 2001; 23:228–31.
- Macmillan KL. Advances in bovine theriogenology in New Zealand. 1. Pregnancy, parturition and the postpartum period. *NZ Vet J* 2002; 50(3 Suppl):67–73.

### REFERENCES

- Macmillan KL. *NZ Vet J* 2002; 50(3 Suppl):67.
- MacDiarmid SC. *Anim Breed Abstr* 1983; 51:403–99.
- Morton JM, Butler KL. *Vet Rec* 1995; 72:5.
- Verkerk GA et al. *Proc NZ Soc Anim Prod* 1997; 57:231.
- Guerin P et al. *Vet Rec* 2004; 154:326.
- Browning JW et al. *Aust Vet J* 1990; 67:28.
- Camillo F et al. *Equine Vet J* 2000; 32:307.
- Ousey J. *Equine Vet Educ* 2003; 15:164.
- Macpherson ML et al. *J Am Vet Med Assoc* 1997; 210:199.
- Ousey JC et al. *Equine Vet J* 1984; 16:259.
- Leadon DP et al. *Equine Vet J* 1984; 16:256.
- LeBlanc MM. *Equine Vet J* 1997; 24:100.
- Leadon DP et al. *Am J Vet Res* 1986; 47:1870.
- Podany J et al. *Pig News Info* 1987; 8:24.
- Pressing AL. *Vet Clin North Am Food Anim Pract* 1992; 8:707.
- Scott E. *Pig J* 1994; 32:38.
- Ingoldby L, Jackson P. *In Pract* 2001; 23:228.
- Niemann H. *Reprod Domest Anim* 1991; 26:22.
- Kastelic JP et al. *Can Vet J* 1996; 37:101.
- Kiesling DO, Meredith S. *Theriogenology* 1991; 36:999.

## Diseases of cloned offspring

The successful cloning of domestic animals using somatic-cell nuclear transfer has resulted in birth of offspring with a high frequency of clinical abnormalities. Cloning of livestock and horses is achieved by transfer of nuclear material from the cell of an adult animal to the

enucleated egg of an animal of the same species (somatic-cell nuclear transfer) with subsequent implantation of the resulting embryo in a surrogate dam and birth of a live, viable offspring.<sup>1</sup> However, the use of nuclear material from somatic cells of adult animals, and from fetal cells, does not result in normal development of the embryo and placenta. The abnormal development is a consequence of altered methylation of the genome in transferred nuclear material.<sup>2</sup> In normal reproduction, the paternal genome is demethylated during passage through the oocyte and fusion with the maternal genome. Consequently, the methylation marks of the two genomes (paternal and maternal) are different at the end of the cleavage process. Transfer of somatic nuclear material into an enucleated oocyte results in exposure of both genomes to the active demethylating process in the cytoplasm of the oocyte and uniform demethylation of both genomes.<sup>2,3</sup> The loss of these parent-specific epigenetic markers results in widespread dysregulation of imprinted genes and subsequent abnormalities in the placenta, fetus and newborn.

A small proportion of transferred blastocysts develop in viable animals. For cattle, of 134 recipients that received blastocysts, 50 were pregnant 40 days after blastocyst transfer and 23 had full-term pregnancies.<sup>4</sup> For all species studied, fewer than 3% of cloned embryos result in birth of viable animals.<sup>1</sup> Abnormalities in placenta and newborn cloned animals are reported for cattle and sheep but not for pigs and equids (horses and mules).<sup>1,5</sup> Factors influencing the risks of abnormalities in newborns have not been well defined, but include the source of the nuclear material, with frequency of birth of live animals born after somatic cell nuclear transfer from well-differentiated tissue (e.g. fibroblasts) or fetal somatic cells being lower than after nuclear transfer from embryonic cells (7%, 15% and 34%, respectively).<sup>6</sup>

The cause of placental, fetal and neonatal abnormalities is abnormal expression of imprinted genes as a consequence of transfer of nuclear material from differentiated somatic cells, conditions and media used for maintenance and culture of cytoplasts and blastocysts, and techniques used for handling cells.<sup>1,7</sup> Candidate genes for large offspring syndrome include *IGF-2* and *IGFBP-2*, insulin-like growth factor (IGF) concentrations in plasma of cloned calves being higher than that of normal calves<sup>7,8</sup> although others, such as genes related to endothelin-1 production, might well be involved.<sup>9</sup>

‡ **Clinical findings** in cloned calves and lambs include abortion, placental

abnormalities, large birth size, poor extrauterine viability, respiratory disease, cardiovascular abnormalities and neurologic disease compatible with neonatal encephalopathy. Abortion occurs after day 90 of gestation in 30–50% of pregnancies in cattle resulting from transfer blastocysts containing transferred nuclear material.<sup>6</sup> Abnormalities, including hydroallantois, are present in approximately 25% of advanced pregnancies.<sup>6</sup> **Placental abnormalities** include hydroallantois, a reduction in the number of placentomes (from a normal of approximately 100 to as few as 26–70 in cloned calves),<sup>7,10</sup> abnormally large placentomes (140 g in cloned calves vs 33 g in conventional calves) and edema of the placenta.<sup>6,7,11</sup> Maternal retention of the placenta is common and occurs in most cows.<sup>11</sup> Duration of gestation is probably longer in cloned calves, although the frequent delivery of cloned calves by cesarian section makes assessment of gestational duration difficult. Cloned calves are heavier than conventional calves, often by as much as 25%, a well-recognized part of the 'large offspring syndrome' that affects calves born as a result of reproductive manipulation, including in-vitro fertilization.<sup>6,12</sup> Viability of cloned calves that are born alive (commonly by cesarian section) is less than that of conventional calves – only approximately two-thirds of cloned calves born alive survive more than 1 month,<sup>10</sup> although others report better survival.<sup>11</sup> Similar results are reported for horses.<sup>13</sup>

A high proportion of cloned calves have **clinically detectable abnormalities** at or soon after birth, including sepsis, neonatal encephalopathy, respiratory failure, umbilical abnormalities, anemia, flexure contracture, abdominal distension and renal dysfunction. Respiratory failure is a common finding and might reflect persistent fetal circulation or inadequate surfactant production, as evidenced by the high pulmonary artery pressures and signs consistent with patent ductus arteriosus. Left heart failure, which can also cause pulmonary hypertension, is reported in cloned calves.<sup>11</sup> Umbilical abnormalities are evident as abnormal umbilical cord structure (multiple arteries and veins) and large size, with a high risk of hemorrhage from the umbilical cord after birth. Cloned calves have higher body temperatures than do conventional calves.<sup>7</sup>

Hematological abnormalities include anemia and decreased mean corpuscular volume. Biochemical abnormalities include hypoxemia, azotemia and hypoglycemia. Plasma leptin and IGF-2 concentrations are higher, and thyroxine lower, in cloned calves.<sup>7</sup> Serum cortisol and ACTH stimu-

lation tests do not differ between cloned and conventional calves.<sup>7</sup>

**Necropsy** examination reveals placentomegaly, presence of excess pleural and peritoneal fluid, hepatomegaly, interstitial pneumonia or pulmonary consolidation and alveolar proteinosis, right ventricular dilation and hepatocellular vacuolation.<sup>11</sup>

**Treatment** is supportive and directed toward correcting hypoxemia and providing nutritional, fluid and environmental support (see above).

There are currently no recognized methods for preventing these abnormalities, but presumably improvements in methodology and culture techniques will result in fewer cloned offspring with these abnormalities.

## REFERENCES

1. Vanderwall DK et al. J Am Vet Med Assoc 2004; 225:1694.
2. Jaenisch R. New Engl J Med 2004; 351:2787.
3. Kang YK et al. Nat Genet 2001; 28:173.
4. Kato Y et al. J Reprod Fertil 2000; 120:231.
5. Tsunoda Y, Kato Y. Differentiation 2002; 69:158.
6. Heyman Y et al. Biol Reprod 2002; 66:6.
7. Chavette-Palmer P et al. Biol Reprod 2002; 66:1596.
8. Young LE et al. Theriogenology 1999; 51:196.
9. Wilkins PA et al. J Vet Intern Med 2005; 19:594.
10. Hill JR et al. Cloning 2001; 3:83.
11. Hill JR et al. Theriogenology 1999; 51:1451.
12. Young LE et al. Rev Reprod 1998; 3:155.
13. Galli C et al. Nature 2004; 424:635.

## Neonatal infection

### Synopsis

**Etiology** Common infections for each animal species are listed under etiology below. Most are bacterial.

**Epidemiology** Commonly predisposed by management and environmental factors that increase the exposure risk and load and decrease the resistance of the neonate.

**Clinical findings** Septicemia or bacteremia with localization is most common but signs can be specific for the infecting agent.

**Clinical pathology** White blood cell and differential counts, toxic change, serum immunoglobulin concentrations, arterial oxygen concentrations, metabolic acidosis, fibrinogen levels, blood culture.

**Necropsy findings** Specific to disease.

**Diagnostic confirmation** Specific to disease.

**Treatment** General therapy may include antibacterial therapy, blood or plasma transfusion, correction of acid-base disturbance, fluid and electrolyte therapy, and supportive treatment.

Infection is a common cause of morbidity and mortality in neonates. There are a number of specific infectious pathogens

that can cause disease. Other infectious agents, normally considered to have low virulence, can also cause disease if the immunological status of the neonate is not at an optimum level. Maternal immunoglobulins are not transferred transplacentally in ungulates and the newborns are at particular risk for infectious disease during the neonatal period because they rely on the acquisition of immunoglobulins from colostrum for passive antibody protection.

## ETIOLOGY

In domestic farm animals the common infections that can produce disease during the neonatal period are as follows. (Relative importance and prevalence statistics are not given, as these vary from area to area and with differing management systems.)

### Calves

- Bacteremia and septicemia associated with *Escherichia coli*, *Listeria monocytogenes*, *Pasteurella* spp., streptococci or *Salmonella* spp.
- Enteritis associated with enterotoxigenic *E. coli*, *Salmonella* spp., rotavirus and coronavirus, *Cryptosporidium parvum* and *Clostridium perfringens* types A, B and C; and occasionally by the virus of infectious bovine rhinotracheitis and bovine virus diarrhea.

### Pigs

- Septicemia with or without localization in joints, endocardium and meninges associated with *Streptococcus suis*, *Streptococcus equisimilis*, *Streptococcus zooepidemicus* and *L. monocytogenes*
- Bacteremia, septicemia and enteritis associated with *E. coli*
- Transmissible gastroenteritis, Aujeszky's disease, swine pox, enterovirus infections, and vomiting and wasting disease are associated with viruses
- Enteritis associated with *C. perfringens*, *Campylobacter* spp., rotavirus and *Coccidia* spp.
- Arthritis and septicemia associated with *Erysipelothrix rhusiopathiae*.

### Foals

- Septicemia with localization associated with *E. coli*, *Actinobacillus equuli*, *Klebsiella pneumoniae*,  $\alpha$ -hemolytic streptococci, *S. zooepidemicus*, *L. monocytogenes*, *Rhodococcus equi* and *Salmonella typhimurium*
- Enteritis associated with *C. perfringens* types A, B, and C., *Clostridium difficile*, *R. equi*, *Salmonella* spp., *Strongyloides westeri*, *C. parvum* and rotavirus.

### Lambs

- Septicemia or bacteremia with localization in joints and/or synovia and/or leptomeninges associated with *E. coli*, *L. monocytogenes*, streptococci, micrococci, *E. rhusiopathiae* and *Chlamydomphila* spp.
- Enteritis associated with enterotoxigenic *E. coli*, *Salmonella* spp., rotavirus and coronavirus and *C. parvum*
- Lamb dysentery associated with *C. perfringens* type B and C
- Gas gangrene of the navel associated with *Clostridium septicum*, *Clostridium novyi* and *Clostridium chauvoei*
- Pyemia associated with *Staphylococcus aureus*, *Fusobacterium necrophorum* and *Arcanobacterium pyogenes*
- Pneumonia, polyserositis and peritonitis associated with *Pasteurella multocida* and *Mannheimia haemolytica*.

The following agents are recorded as causing neonatal infections but are less common than those listed above and not of as great importance.

### Calves

*Pseudomonas aeruginosa*, *Streptococcus pyogenes*, *Streptococcus faecalis*, *S. zooepidemicus*, *Pneumococcus* spp.; enteritis due to *Providencia stuartii*, *Chlamydomphila* spp., *A. equuli*.

### Lambs

*S. aureus* (tick pyemia); enteritis due to *E. coli*, rotavirus; pneumonia due to *Salmonella abortus-ovis*.

### Foals

*Enterobacter cloacae*, *S. aureus*, *Pasteurella multocida*, *P. aeruginosa*, *A. pyogenes*, *Serratia marcescens*.

### All species

Nonspecific infections are associated with pyogenic organisms, including *Arcanobacterium pyogenes* and *Fusobacterium necrophorum*; *S. faecalis*, *S. zooepidemicus*, *Micrococcus* spp. and *Pasteurella* spp. occur in all species.

## EPIDEMIOLOGY

The occurrence of neonatal disease is broadly influenced by two main factors: the exposure or infection pressure of the infectious agent to the neonate and the ability of the neonate to modulate the infection so that disease does not occur. With some agents the organism is sufficiently virulent in its own right that an exposure can lead to disease. With others, the majority, the defenses of the host must be compromised or the infection challenge must be very high before clinical disease occurs. Management of the neonate has a great influence on both these factors and the recognition and

correction of these risks is the key to the prevention of neonatal disease in both the individual and the group.

## Sources of infection

### Postnatal infection

The vast majority of infections are acquired by the neonate after birth from the enteric or respiratory tract flora of the dam, from the environment or from close contact with other infected neonates. Depending upon the specific agent, the reservoir of infection may be in a carrier animal or in the environment. Details for the common neonatal diseases are given under the individual disease headings in the chapters on special medicine.

### Prenatal infection

Some bacterial infections that manifest with neonatal disease are acquired in utero. The majority of these are agents that cause abortion, and neonatal septicemia is only part of the spectrum of abortion and perinatal death associated with these agents. Examples would be many of the agents producing abortion in sheep.

Some septicemic infections in **foals**, particularly those associated with *A. equuli*, *S. zooepidemicus*, *Salmonella abortus-ovis* and possibly some *E. coli* septicemic infections, are acquired by prenatal infection. If the disease is intra-uterine in origin it must gain entrance via the placenta, and probably by means of a placentitis due to a blood-borne infection or an existing endometritis. In the latter case, disinfecting the uterus before mating becomes an important hygienic precaution; disinfecting the environment may have little effect on the incidence of the disease.

**Viral** infections that are acquired in utero are listed in the section on congenital disease.

## Routes of transmission

The **portal of infection** is commonly by ingestion but may occur via aerosol infection of the respiratory tract. Organisms capable of invading to produce a bacteremia and septicemia invade through the nasopharynx or through the intestinal epithelium. An alternate route of infection and invasion is via the umbilicus. Routes of **excretion** are via the feces in enteric disease and the nasal secretions, urine and sometimes the feces in septicemic disease to result in contamination of the neonatal environment.

Where neonates are in groups or in close contact, direct transmission by fecal, respiratory secretion and urine aerosols can also occur. Neonatal bull calves that are group-housed and that suck each other's navels can transmit infection by this activity.

## Risk factors and modulation of infection

### Immunity

All newborn farm animals are more susceptible to infection than their adult counterparts. The calf, lamb, piglet and foal are born without significant levels of immunoglobulins and possess almost no resistance to certain diseases until after they have ingested colostrum and absorbed sufficient quantities of immunoglobulins from the colostrum. **Failure of transfer** of colostrum immunoglobulins is a major determinant and is discussed under that heading later in this chapter.

### Immune responsiveness

All components of the immune system are present in foals and calves at birth but the immune system of the newborn animal is less mature than its adult counterpart, at least for the first 30 days of life, and does not respond as effectively to many antigens.

Immune responsiveness is age-dependent but also varies with the antigen.<sup>1</sup> In colostrum-fed animals part of the inefficiency of the newborn to produce humoral antibody following infection of antigen is the interference from circulating colostrum antibody and the downregulation by colostrum of endogenous immunoglobulin production.<sup>2-4</sup>

Colostrum-deprived calves respond actively to injected antigens and are believed to be immunologically competent at birth with respect to most antigens. Immune competence begins during fetal life and the age of gestation at which this occurs varies according to the nature of the antigen. The bovine fetus will produce antibody to some viruses, beginning at 90–120 days, and by the third trimester of gestation it will respond to a variety of viruses and bacteria.<sup>5</sup> The lamb will respond to some antigens beginning as early as 41 days and not until 120 days for others. The piglet at 55 days and the fetal foal also respond to injected antigens.

The presence of high levels of antibody in the precolostral serum of newborn animals suggests that an in-utero infection was present, which is useful for diagnostic purposes. The detection of immunoglobulins and specific antibodies in aborted fetuses is a useful aid in the diagnosis of abortion in cattle.

### Exposure pressure

The exposure pressure is a factor of the cleanliness of the environment of the neonate. The phenomenon of a 'buildup of infection' in continual-throughput housing for neonatal animals has been recognized for decades and has been translated to many observations of risk for neonatal disease associated with sub-optimal hygiene and stocking density in

both pen and paddock birthing areas. Details for the individual species are provided in the section on perinatal disease.

#### Age at exposure

With several agents that produce neonatal disease, the age of the neonate at infection and the infecting dose have a significant influence on the outcome. Examples are the importance of age with respect to susceptibility to disease associated with some enteric infections. Disease associated with enteropathogenic *E. coli* and with *C. perfringens* type B and C occurs only in young animals and if infection can be avoided by hygiene in this critical period disease will not occur regardless of subsequent exposure. Colostrum-deprived calves show significant resistance to challenge at 7 days of age with strains of *E. coli* that invariably produce septicemic disease if challenged at the time of birth and isolation of an immunocompromised neonate is an important factor in its survival. Thus the management of the neonate and its environment is a critical determinant of its health. Age at exposure also varies with the epidemiology of the pathogen and segregated early weaning is used to reduce transmission of and infection with certain pathogens in pigs.

#### Animal risk factors

Animal risk factors that predispose infection include those that interfere with sucking drive and colostrum intake, such as cold stress and dystocia. These are detailed in the preceding section on perinatal disease.

#### PATHOGENESIS

The pathogenesis varies with the neonatal infectious disease under consideration and is given for each of these in the special medicine section.

Following invasion via the nasopharynx and the gastrointestinal tract, the usual pattern of development is a bacteremia followed by **septicemia** with severe systemic signs; or a **bacteremia** with few or no systemic signs, followed by **localization** in various organs. If the portal of entry is the navel, local inflammation occurs – **navel ill** – which can be easily overlooked if clinical examination is not thorough. From the local infection at the navel, extension may occur to the liver or via the urachus to the bladder and result in chronic ill-health. Extension systemically may produce septicemia.<sup>6</sup>

**Localization** is most common in the joints, producing a suppurative or non-suppurative arthritis. Less commonly there is localization in the eye to produce a panophthalmitis, in the heart valves to cause valvular endocarditis, or in the meninges to produce a meningitis.

In some cases these secondary lesions take time to develop and signs usually appear at 1–2 weeks of age. This is especially true with some of the streptococcal infections, where bacteremia may be present for several days before localization in the joints and meninges produces clinical signs. Bacterial meningitis in newborn ungulates is preceded by a bacteremia followed by a fibrinopurulent inflammation of the leptomeninges, choroid plexuses and ventricle walls but does not affect the neuraxial parenchyma. It is proposed that the bacteria are transported in monocytes, which do not normally invade the neuraxial parenchyma.

Dehydration, acid–base and electrolyte imbalance can occur very quickly in newborn animals, whether diarrhea and vomiting (pigs) are present or not, but obviously are more severe where there is fluid loss into the gastrointestinal tract. In Gram-negative sepsis the prominent signs are those of endotoxemia.

#### CLINICAL FINDINGS

The clinical findings depend on the rapidity of growth of the organism, its propensity to localize and its potential to produce toxemia. With organisms that have a low propensity for toxemia there is fever, depression, anorexia and signs referable to localization. These include endocarditis with a heart murmur; panophthalmitis with pus in the anterior chamber of the eye; meningitis with rigidity, pain and convulsions; and polyarthritis with lameness and swollen joints. With more virulent organisms there are clinical signs of toxemia as well as bacteremia, including fever, severe depression, prostration, coma, petechiation of mucosae, dehydration, acidosis and rapid death.<sup>7,8</sup>

The clinical and clinicopathological characteristics of the septicemic foal have been detailed in an outbreak of septicemia in colostrum-deprived foals<sup>9</sup> and on the clinical records of 38 septicemic foals admitted to a referral clinic,<sup>10</sup> where the survival rate of septicemic foals, 26%, was markedly less than the rate for all other foal admissions. The major clinical findings included lethargy, unwillingness to suck, inability to stand without assistance but remaining conscious, unawareness of environment and thrashing or convulsing, diarrhea, respiratory distress, joint distension, central nervous system abnormalities, uveitis and colic. Fever was not a consistent finding.

A **sepsis score** has been developed for foals based on 14 measures related to historical, clinical and laboratory data (Table 3.6). The score derived from the collective differential scoring of these data has been found to be more sensitive and

specific for infection than any parameter taken individually.<sup>7</sup> However, a subsequent study of 168 foals presented to a university hospital found that the sepsis score correctly predicted sepsis in 58 out of 86 foals and nonsepsis in 24 out of 45 foals resulting in a sensitivity of 67%, a specificity of 75%, a positive predictive value of 84% and a negative predictive value of 55%, and it was suggested that the score system should be used with care as the low negative predictive value limited its clinical utility.<sup>11</sup>

A sepsis score, based on fecal consistency, hydration, behavior, ability to stand, state of the umbilicus and degree of injection of scleral vessels, is described for calves and has reasonable predictive value.<sup>12</sup>

The clinical findings specific to individual etiological agents are given under their specific headings in the special medicine section of this book.

#### CLINICAL PATHOLOGY

Clinical pathology is used as an integral part of the evaluation of a sick neonate and to help formulate a treatment plan. A major evaluation is to attempt to confirm the presence or absence of sepsis and this type of evaluation has been developed most successfully in the foal. **Blood culture** is part of this examination but the time for a positive result limits its value in the acutely ill neonate. Laboratory findings in foals with neonatal sepsis are variable and depend upon the severity, stage and site of infection.<sup>8</sup> **Serial examinations** are commonly used. In examinations relating to the possible presence of septicemia, particular emphasis is placed on the results of the white blood cell and differential counts, the presence of toxic change, serum immunoglobulin concentrations, arterial oxygen concentrations, presence of metabolic acidosis and fibrinogen levels.<sup>7,8,12</sup>

#### DIFFERENTIAL DIAGNOSIS

- The principles of diagnosis of infectious disease in newborn animals are the same as for older animals. However, in outbreaks of suspected infectious disease in young animals there is usually a need for more diagnostic microbiology and pathology
- With outbreaks, owners should be encouraged to submit all dead neonates as soon as possible for a meaningful necropsy examination
- In addition to postmortem examination it is necessary to identify the factors that may have contributed to an outbreak of disease in newborn calves, piglets or lambs and only detailed epidemiological investigation will reveal these

## TREATMENT

The first principle is to obtain an etiological diagnosis if possible. Ideally a drug sensitivity of the causative bacteria should be obtained before treatment is given, but this is not always possible. It may be necessary to choose an **anti-bacterial** based on the tentative diagnosis and previous experience with treatment of similar cases.

Outbreaks of infectious disease are common in litters of piglets and groups of calves and lambs, and individual treatment is often necessary to maximize survival rate. There is usually no simple method of mass-medicating the feed and water supply of sucking animals and each animal should be dosed individually as necessary. Supportive fluid and electrolyte therapy and correction of acid-base disturbances are described in detail in Chapter 2.

The provision of **antibodies** to sick and weak newborn animals through the use of blood transfusions or serum is often practiced, especially in newborn calves in which the immunoglobulin status is unknown. Whole blood given at the rate of 10–20 mL/kg body weight, preferably by the intravenous route, will often save a calf that appears to be in shock associated with neonatal diarrhea. The blood is usually followed by fluid therapy. Serum or plasma can also be given at half the dose rate. The blood should not be taken from a cow near parturition as the circulating immunoglobulins will be low from the transfer into the mammary gland.

**Plasma** is often incorporated into the therapeutic regimen in foals, both for its immunoglobulin content and for its effect on blood volume and osmotic pressure. Stored plasma can be used. A dose of 20 mL plasma/kg body weight given slowly intravenously is often used, but significantly higher doses are required to elevate circulating immunoglobulins by an appreciable amount.<sup>8</sup> Blood may be collected, the red blood cells allowed to settle and the plasma removed and stored frozen. The donor plasma should be prescreened for compatibility. Lyophilized hyperimmune equine serum as a source of antibodies may also be fed to foals within 4 hours after birth. Good nursing care is also essential.

Further information on treatment is given in the section on critical care for the newborn later in this chapter.

## CONTROL

Methods for avoidance of failure of transfer of passive immunity and the principles for prevention of infectious disease in newborn farm animals follow in this chapter. The control of individual

diseases is given under specific disease headings elsewhere in this book.

## REFERENCES

1. Watson DL et al. *Res Vet Sci* 1994; 57:152.
2. Kitching RP, Salt JS. *Br Vet J* 1995; 151:379.
3. Ellis JA et al. *J Am Vet Med Assoc* 1996; 208:393.
4. Aldridge BM et al. *Vet Immunol Immunopathol* 1998; 62:51.
5. Tierney TJ et al. *Vet Immunol Immunopathol* 1997; 57:229.
6. Staller GS et al. *J Am Vet Med Assoc* 1995; 206:77.
7. Brewer BD, Koterba AM. *Equine Vet J* 1988; 20:18.
8. Carter GK. *Compend Contin Educ Pract Vet* 1986; 8:S256.
9. Robinson JA et al. *Equine Vet J* 1993; 25:214.
10. Koterba AM et al. *Equine Vet J* 1984; 16:376.
11. Corley KIT, Furr MO. *J Vet Emerg Crit Care* 2003; 13:149.
12. Fecteau G et al. *Can Vet J* 1997; 38:101.

## FAILURE OF TRANSFER OF COLOSTRAL IMMUNOGLOBULINS

The acquisition and absorption of adequate amounts of colostrum immunoglobulins is essential to the health of the neonate as it is born virtually devoid of circulating immunoglobulin and relies on antibody acquired from colostrum for protection against common environmental pathogens. Adequate antibody transfer is the cornerstone of all neonatal preventive health programs. This has been recognized for many years and it is discouraging that a study conducted in 2002 in the USA by the National Animal Health Monitoring System found that over 40% of dairy heifer calves sampled by the National Dairy Heifer Evaluation Project had failure of transfer of colostrum immunoglobulins.<sup>1</sup>

Much of the description that follows refers to the calf because more studies on transfer of passive immunity have been conducted in calves. However, most of the information is applicable to the other species; where there are differences these are mentioned.

## NORMAL TRANSFER OF IMMUNOGLOBULINS

The major **immunoglobulin in colostrum** is IgG, but there are also significant amounts of IgM and IgA. IgG<sub>1</sub> is present in highest concentration and is concentrated in colostrum by an active, selective, receptor-mediated transfer of IgG<sub>1</sub> from the blood of the dam across the mammary secretory epithelium. This **transfer to colostrum** begins approximately 4–6 weeks before parturition and results in colostrum IgG<sub>1</sub> concentrations in first milking colostrum that are several-fold higher than maternal serum concentrations. The transfer of the other immunoglobulin classes is believed to be nonselective and lesser concentrations in colostrum are achieved.

Following **ingestion by the newborn**, a significant proportion of these immuno-

globulins in ingested colostrum is transferred across the epithelial cells of the small intestine during the first few hours of life and transported via the lymphatic system to the blood. Immunoglobulins in the blood are further varyingly distributed to extravascular fluids and to body secretions depending upon the immunoglobulin class.

These absorbed immunoglobulins protect against systemic invasion by microorganisms and septicemic disease during the neonatal period. Unabsorbed immunoglobulins and immunoglobulins resecreted back into the gut play an important role in protection against intestinal disease for several weeks following birth. In calves, passive immunity also influences the occurrence of respiratory disease during the first months of life and may be a determinant of lifetime productivity. In foals, failure of transfer of passive immunity presents a significant risk for the development of an illness during the first 3 months of life.

## Lactogenic immunity

The IgG concentration in milk falls rapidly following parturition in all species and immunoglobulin concentrations in milk are low. In the sow, the concentration of IgA falls only slightly during the same period and it becomes a major immunoglobulin of sows' milk. IgA is synthesized by the mammary gland of the sow throughout lactation and serves as an important defense mechanism against enteric disease in the nursing piglet. In the piglet, IgA in milk is an important mucosal defense mechanism whereas in the calf there is little IgA in milk but some enteric protection is provided by colostrum and milk IgG, and IgG derived from serum that is resecreted into the intestine.<sup>2,3</sup>

## FAILURE OF TRANSFER OF PASSIVE IMMUNITY

Failure of transfer of colostrum immunoglobulins is the major determinant of septicemic disease in all species.<sup>4,5</sup> It also modulates the occurrence of mortality and severity of enteric and respiratory disease in early life<sup>6</sup> and, in some studies, performance at later ages.<sup>7–9</sup> While an important determinant for neonatal disease and subsequent performance, it is not the sole determinant and it is not surprising that some studies have found only a minor relationship.

In terms of the modulation of disease, there can be **no set cut-point** for circulating immunoglobulins as the cut-point will vary according to the farm, its environment, infection pressure and also the type of disease. Figures are given as a guide. With dairy calves serum IgG<sub>1</sub> concentrations of 500 mg/dL are



associated with protection against septicemic disease and concentrations of 1000 mg/dL or more are sufficient to reduce the risk of infectious disease in most environments. With **foals**, the equivalent IgG<sub>1</sub> concentrations for protection are given as 400 mg/dL and 800 mg/dL.<sup>10,11</sup>

Rates of failure of transfer of passive immunity are high in both sucking and artificially fed dairy calves but are less in beef calves.<sup>12,13</sup> Failure rates in foals are lower and approximate 13–16%.<sup>11,14</sup> Rates in lambs are also comparatively low.

In animals that are **fed colostrum artificially**, risk for failure of transfer of passive immunity is primarily dependent upon the amount or mass of immunoglobulin present in a feeding of colostrum, the time after birth that this is fed, and the efficiency of its absorption by the calf. The mass of immunoglobulin fed is determined by the concentration of immunoglobulin in the colostrum and the volume that is fed. Feeding trials with calves suggest that a **mass of at least 100 g** of IgG<sub>1</sub> is required in colostrum fed to a 45 kg calf to obtain adequate ( $\geq 1000$  mg/dL IgG<sub>1</sub>) passive blood immunoglobulin concentrations.<sup>15</sup>

In animals that **suck colostrum naturally** such as foals, risk for failure of transfer of passive immunity is primarily dependent upon the concentration of immunoglobulin in the colostrum, the amount that is ingested and the time of first suckling. Inadequate colostrum immunoglobulin concentration and delay in ingestion of colostrum are the two important factors in failure of transfer of passive immunity in foals.<sup>16</sup>

#### Determinants of transfer of colostrum immunoglobulins

1. Amount of immunoglobulin in colostrum fed:
  - a. *Volume* of colostrum fed
  - b. *Concentration* of immunoglobulins in colostrum
2. The amount of colostrum actually suckled or fed
3. Efficiency of absorption of immunoglobulins by neonate
4. Time after birth of suckling or feeding

#### Determinants of immunoglobulin concentration in colostrum

Nominal concentrations of immunoglobulin in the first milking colostrum of cows are shown in Table 3.1. There can be **substantial variation** in the concentration of immunoglobulin in colostrum in all species and the ingestion of a 'normal' amount of colostrum that has low immunoglobulin concentration may provide an insufficient amount of immunoglobulin for protection. In a study of over 900 first-milkings colostrum from American Holstein cows, only 29% of the colostrum samples contained a sufficiently high concentration of immunoglobulin to provide 100 g IgG in a 2 L volume.<sup>17</sup> The equivalent percentages for 3 and 4 L volume feedings were 71% and 87%.

A similar situation exists with **horses**. The mean concentrations of IgG in colostrum of mares 3–28 days before foaling is greater than 1000 mg IgG/dL, while at parturition the mean concentrations may vary from 4000–9000 mg/dL. The concentrations decrease markedly to 1000 mg/dL in 8–19 hours after parturition.<sup>18</sup>

It is apparent that variation in colostrum immunoglobulin concentration can be a cause of failure of transfer of passive immunity.

Some causes of this variation are:

- The concentrations of immunoglobulin in colostrum fall dramatically following parturition. Only the **first milking** of colostrum after calving should be considered for feeding to calves for immunoglobulin transfer. The concentrations in second-milking colostrum are approximately half those in the first milking and by the fifth postcalving milking, concentrations approach those found during the remainder of lactation
- The immunoglobulin concentration of colostrum decreases after calving even when the cow is not milked. In order to facilitate early feeding of colostrum to a calf, herd policy may be to feed stored colostrum taken from a

previously calved cow rather than the newborn calf's dam. It is important that this colostrum be milked as soon as possible after parturition.

Colostrum that is collected 6 hours or later after calving has a significantly lower concentration than that collected 2 hours after calving.<sup>17,19</sup>

- Colostrum from cows or mares that have been **premilked** to reduce udder edema or from dams that **leak colostrum** prior to parturition will have low immunoglobulin concentrations and alternate colostrum should be fed for immunoglobulin transfer as there is a higher rate of failure in their foals and calves
- In cattle, **dry periods** of less than 30 days may result in colostrum of lower immunoglobulin concentration
- **Premature foaling** or the **induction of parturition** can result in colostrum with low immunoglobulin concentration and/or low volume
- In cattle, average colostrum immunoglobulin concentrations are higher in cows in third or higher **lactation groups** compared to younger cows. However, colostrum from all lactation numbers can produce adequate immunoglobulin mass. There is no scientific basis for not feeding first-milking colostrum from first-lactation cows
- Larger-volume first-milking colostrum tends to have lower immunoglobulin concentrations than smaller-volume colostrum, and **colostrum weight** can be used to select colostrum of higher immunoglobulin concentration for calf feeding (Table 3.2)
- A recent study has shown that immunoglobulin concentrations are higher in the early temporal fractions of a single milking of first-milking colostrum.<sup>20</sup> This might suggest that segregation of the first portion of the first-milking colostrum could provide colostrums with higher immunoglobulin concentration for feeding

Table 3.1: Concentrations and relative percentage of immunoglobulins in serum and mammary secretions of cattle and pigs

Animal	Immunoglobulin	Concentration (mg/mL)			Total immunoglobulin (%)		
		Serum	Colostrum	Milk	Serum	Colostrum	Milk
Cow	IgG <sub>1</sub>	11.0	47.6	0.59	50	81	73
	IgG <sub>2</sub>	7.9	2.9	0.02	36	5	2.5
	IgM	2.6	4.2	0.05	12	7	6.5
	IgA	0.5	3.9	0.14	2	7	18
Sow	IgG	21.5	58.7	3.0	89	80	29
	IgM	1.1	3.2	0.3	4	6	1
	IgA	1.8	10.7	7.7	7	14	70



Table 3.2 Immunoglobulin concentrations in the first milking of colostrum of Holstein cattle by weight of colostrum produced

Weight (lb)	% of colostrums	IgG <sub>1</sub> concentration (mg/mL)	
		Mean	Range
< 10	20	67	24–136
11–20	38	58	17–136
21–30	26	46	15–93
> 30	16	39	19–76

- There are **breed differences** in the concentration of immunoglobulins in first milking colostrum. In **cattle**, beef breeds have higher concentrations. Many dairy breeds, including American Holsteins, produce colostrum of relatively low immunoglobulin concentration, and a significant proportion of calves that suckle cows of these breeds ingest an inadequate mass of immunoglobulin. Channel Island breeds have a greater concentration of immunoglobulin in colostrum than Holsteins. **Breed differences** are also seen in **horses**, with Arabian mares having higher colostrum immunoglobulin concentrations than Standardbreds, which in turn are higher than those of Thoroughbreds. Breed differences also occur in **sheep**, with higher concentrations in meat and wool breeds than dairy breeds<sup>21</sup>
- Heat **stress** to cattle in the latter part of pregnancy results in lower colostrum immunoglobulin concentrations<sup>22</sup>
- One study found that calves from cows with **mastitis** have lower serum immunoglobulins.<sup>23</sup> Colostrum volume but not colostrum immunoglobulin concentration is reduced in mastitic quarters and it is unlikely that mastitis is a major determinant of the high rate of failure of transfer of passive immunity in dairy calves<sup>24</sup>
- There is a significant positive but weak correlation between total lactational milk and immunoglobulin concentration in that cow's colostrum.<sup>17</sup> Selection for **production** does not appear to be a negative influence on colostrum immunoglobulin concentration, although dilution by high volume production in first-milking colostrum is a factor in low colostrum immunoglobulin concentration<sup>25</sup>
- The **pooling of colostrum** in theory could avoid the variation in immunoglobulin concentration of individually fed colostrum and could provide a colostrum that reflects the antigenic experience of several cattle. In practice, colostrum pools from Holsteins invariably have low immunoglobulin concentrations

because high-volume, low-concentration colostrum dilutes the concentration of the other samples in the pool. If pools are used, the diluting influence of low-immunoglobulin-concentration, high-volume colostrum should be limited by restricting any individual cow's contribution to the pool to 9 kg (20 lb) or less. However, pooling increases the risk of disease transmission, as multiple cows are represented in a pool and the pool is fed to multiple calves. This can be important in the control of Johne's disease, bovine leukosis and *Mycoplasma bovis*

- Bacterial contamination** of colostrum can have a negative effect on transfer of passive immunity and one study<sup>26</sup> found high bacterial counts in 85% of colostrums sampled from 40 farms in the USA. Colostrum that is to be fed or stored should be collected with appropriate preparation and sanitation of the cow and of the milking equipment used on fresh cows
- Pasteurization of colostrum** (both pasteurization at 63°C for 30 min and HTST 72°C for 15 s) reduces colostrum IgG concentration. A recent study<sup>27</sup> of batch pasteurization at 63°C for 30 minutes showed that the percentage reduction in colostrum IgG concentration varied with the batch size, with a 24% reduction in 57 L batch size and a 58% reduction in a larger batch size. Calves fed 2 L of pasteurized colostrum had twofold lower serum concentrations of IgG than controls
- Old mares** (older than 15 years) may have poor colostrum immunoglobulin concentration.

#### Volume of colostrum ingested

Holstein cows

The volume of colostrum that is fed has a direct influence on the mass of immunoglobulin ingested at first feeding. The average volume of colostrum ingested by nursing Holstein calves in the first 24 hours of life is reported as 2.4 L but there is wide variation around this mean<sup>28</sup> and a significant proportion of dairy calves fail

to ingest an adequate mass of immunoglobulin in management systems that provide colostrum solely by allowing the calf to suck the dam.<sup>6,29</sup>

In **natural suckling** situations, calves may fail to ingest adequate colostrum volumes before onset of the closure process, and therefore absorb insufficient colostrum immunoglobulin. Early assisted suckling may help avoid this. In dairy calves the volume of colostrum that is ingested can be controlled in **artificial feeding systems** using nipple bottle feeders or esophageal tube feeders. **Bucket feeding** of colostrum is not recommended, as training to feed from a bucket can be associated with erratic intakes.

The **traditional recommendation** for the volume of colostrum to feed at first feeding to calves is 2 L (2 quarts). However, only a small proportion of first-milking colostrum from Holsteins contains a sufficiently high concentration of immunoglobulin to provide 100 g IgG in a 2 L volume and higher volumes of colostrum are required to achieve this mass intake.<sup>17</sup> Possibly the major cause of failure of transfer of passive immunity rests with the fact that commercial feeding bottles are made in a 2 L size and this is consequently the amount of colostrum that is fed. Some calves fed with a **nipple bottle** will drink volumes greater than 2 L but others will refuse to ingest even 2 L of colostrum in a reasonable period of time, and calf rearers may lack the time or patience to persist with nipple bottle feeding until the required volume has been ingested by all calves.

Larger volumes of colostrum can be fed by an **esophageal feeder** and single feedings of large volumes of colostrum (3.5–4.0 L per 45 kg body weight) result in the lowest percentage of calves with failure of transfer of passive immunity by allowing calves fed colostrum with relatively low immunoglobulin concentrations to receive an adequate immunoglobulin mass prior to closure.<sup>12,13,30</sup> Feeding this volume by an esophageal feeder causes no apparent discomfort to a minimally restrained calf.

Channel Island breeds

Jersey cows produce colostrum with a higher immunoglobulin content than Holsteins and the feeding of nipple bottle 2.0 L of first milking at birth and again at 12 hours of life results in excellent circulating concentrations of immunoglobulin.<sup>31</sup> Three L at each feeding is recommended where feeding is with an esophageal feeder.

Beef cows

With beef breeds very effective colostrum immunoglobulin transfer is achieved with

natural sucking. This is believed to be due to the greater vigor at birth exhibited by these calves and the higher immunoglobulin concentrations in beef colostrum, requiring a smaller volume intake to acquire an adequate mass. **Natural sucking** will give an adequate volume intake and there is no need to artificially feed colostrum unless the dam is observed to refuse nursing or the calf's viability and sucking drive are compromised.<sup>32,33</sup> The **yield of colostrum** and colostrum immunoglobulins in beef cows can vary widely<sup>32</sup> and range beef heifers may produce critically low volumes of colostrum. Differences in yield can be due to breed or to nutritional status, although undernutrition is not an effect unless it is very severe.<sup>34</sup>

#### Ewes

Colostrum yield is high in ewes in good condition at lambing but may be low in ewes with condition scores of 1.5–2.0.<sup>35</sup>

#### Sows

In sows there is also very effective colostrum immunoglobulin transfer with natural sucking and piglets average an intake of 5–7% of body weight in the first hour of life.<sup>36</sup> There is between-sow variation in the amount of colostrum and there can be a large **variation** in colostrum supply from teat to teat, which may explain variable health and performance. During farrowing and for a short period following, colostrum is available freely from the udder but thereafter it is released in ejections during mass suckling. A strong coordinated sucking stimulus is required by the piglet for maximum release of colostrum and this requires that the ambient temperature and other environmental factors be conducive to optimum vigor of the piglets. Small-birth-weight piglets, late-**birth-order** piglets and piglets sucking posterior teats obtain less colostrum.

#### All species

In all species a low-volume intake may also occur because of:

- Poor **mothering behavior**, which may prevent the newborn from sucking, occurrence of disease or milk fever
- Poor **udder and/or teat conformation** so the newborn cannot suck normally or teat seeking is more prolonged. Udder to floor distance is most critical and low-slung udders can account for significant delays in intake. Bottle-shaped teats (35 mm diameter) also significantly reduce intake<sup>37</sup>
- Delayed and **inadequate colostrum intake** frequently accompanies perinatal asphyxia or acidosis due to

the greatly decreased vigor of the calf in the first few hours of life. Perinatal asphyxia can occur in any breed and is greatly increased by matings resulting in fetal–maternal disproportion and dystocia

- The newborn may be weak, traumatized, or unable to suck for other reasons – a **weak sucking drive** can be a result of congenital iodine deficiency, cold stress or other factors
- Failure to allow newborn animals to ingest colostrum may occur under some management systems.

#### Efficiency of absorption

After ingestion of colostrum by the newborn, colostrum immunoglobulins are absorbed by the small intestine, by a process of pinocytosis, into the columnar cells of the epithelium. In the newborn calf this is a very rapid process and immunoglobulin can be detected in the thoracic duct lymph within 80–120 minutes of its being introduced into the duodenum. The **period of absorption** varies between species and with immunoglobulin class and the mechanism by which absorption ceases is not well understood but may be related to replacement of the fetal enterocyte. The region of maximum absorption is in the lower small intestine and peak serum concentrations are reached by 12–24 hours in all species. Absorption is not limited to immunoglobulins and there is a **proteinuria** during the first 24 hours of life associated with the renal excretion of low-molecular-weight proteins such as  $\beta$ -lactoglobulin.

#### Feeding methods, closure and immunoglobulin absorption

Under normal conditions complete loss of the ability to absorb immunoglobulin (closure) occurs by 24–36 hours after birth in all species and there is a significant reduction in absorptive ability (as much as 50% in some studies but minimal in others) by 8–12 hours following birth. **The time from birth to feeding** is a crucial factor affecting the absorption of colostrum immunoglobulins by all species, and any delay beyond the first few hours of life, particularly after 8 hours, significantly reduces the amount of immunoglobulin absorbed.

The recommendation is that all neonates be fed colostrum within the first 2 hours of life.

#### Natural sucking

**Natural sucking** is the desired method of intake of colostrum and is the most efficient, but it is influenced by the sucking drive and **vigor** of the calf at birth. Calves that suck colostrum can achieve very high concentrations of colostrum

immunoglobulin and the efficiency of absorption is best with this feeding method. However, natural sucking of dairy calves is commonly associated with a high rate of passive transfer failure due to **delays in sucking** coupled with low intakes. In one study 25–34% of calves failed to suck by 6–8 hours of age and 18% of calves did not suck by 18 hours of age. There may be **breed differences** in sucking ability: Jersey calves have better rates of successful transfer of passive immunity with natural sucking than do Holsteins.<sup>38</sup> Many factors influence the occurrence of delayed sucking but calf vigor and birth anoxia are the most important. Conformation of the udder is significant and the importance of this increases with parity.

#### Artificial feeding

In contrast, when calves are **fed colostrum artificially**, minimal delays from birth to the time of colostrum feeding occur and maximal colostrum immunoglobulin absorption results. In breeds like American Holsteins, where colostrum immunoglobulin concentrations tend to be quite low and maximal efficiency of absorption is necessary, the logical way to minimize the effects of closure is to feed the maximum well-tolerated colostrum volume at the first feeding within the first few hours of life. The published literature consistently reports higher calf serum IgG<sub>1</sub> concentrations and a lower rate of failures in response to larger colostrum feeding volumes.<sup>12,13</sup>

#### Other influences

Even with the best available on-farm colostrum selection methods, **large colostrum-feeding volumes are essential** to minimize failure of transfer of colostrum immunoglobulins in breeds with relatively low colostrum immunoglobulin concentrations. The method is particularly advantageous where time constraints of other farm activities limit the time available for calf feeding. The major detrimental influence on absorptive efficiency of immunoglobulins is **delayed feeding after birth**. Other factors that affect absorptive efficiency include:

- Perinatal asphyxia or acidosis may have both direct and indirect effects on colostrum immunoglobulin transfer. **Asphyxia** has a major effect on subsequent sucking drive and **acidemic** calves ingest far less colostrum than calves with more normal acid–base status at birth. In carefully controlled colostrum feeding studies, there was also significant negative correlation between the degree of hypercapnia and efficiency of absorption of colostrum

immunoglobulins, even in calves within the 'normal' newborn blood pH and  $PCO_2$  ranges.<sup>39</sup> Direct oxygen deprivation of newborn calves did not cause a similar effect.<sup>40</sup> Treatment of calves with an alkalinizing agent and a respiratory stimulant altered pH and  $PCO_2$  values towards adult normal values but did not influence immunoglobulin absorption efficiency.<sup>39</sup>

- In one early study, a **mothering effect** was reported where calves remaining with their dams absorbed colostrum immunoglobulin much more efficiently than calves removed immediately to individual box stalls. However, other studies have shown much smaller or no effects of mothering using similar experimental designs. The different results of these studies have not been reconciled
- There can be **seasonal** and **geographical** variations in transfer of immunoglobulins in calves although these are not always present on farms in the same area and their cause is unknown. Where seasonal variation occurs in temperate climates the mean monthly serum  $IgG_1$  concentrations are lowest in the winter and increase during the spring and early summer to reach their peak in September, after which they decrease. The cause is not known but an decrease in sucking drive is observed in colder months and may contribute. In subtropical climates, peak levels occur in the winter months, while low levels are associated with elevated temperatures during the summer months.<sup>41</sup> Heat stress in late pregnancy will reduce colostrum immunoglobulin concentration but high ambient temperature is a strong depressant of absorption and the provision of shade will help to obviate the problem
- The efficiency of absorption may be decreased in **premature calves** that are born following induced parturition<sup>42</sup> but the medical **induction of parturition** with short-acting corticosteroids in cattle does not interfere with the efficiency of absorption of immunoglobulins in calves
- The absorption of small volumes (1–2 L) fed by an esophageal feeder is usually suboptimal, probably due to retention of some colostrum in the immature forestomachs for several hours. The calf will feel satiated and not inclined to suck naturally for the next few hours
- A **trypsin inhibitor** in colostrum may serve to protect colostrum IgG from

intestinal degradation. It varies in concentration between colostrums. The addition of a trypsin inhibitor to colostrum improves immunoglobulin absorption<sup>43</sup>

- In a study of **mare-associated determinants of failure of transfer of passive immunity** in foals (based on serum Ig measurements), there was a trend to increase rates of failure in foals from mares aged over 12 years but no real association with age, parity or gestational age of foals over 325 days. There was an association with season with a lower incidence in the late spring compared with foals born earlier in the year and with a foal score based on a veterinary score of foal health and 'fitness'.<sup>44</sup>

Traditionally it has been considered that the **movement** of animals, either the dam just **before parturition** or the newborn animal during the first few days of life, is a special hazard for the health of the calf. The postulated reason is that the dam may not have been exposed to pathogens present in the new environment and thus not have circulating antibodies against these pathogens. The newborn animal may be in the same position with regard to both deficiency of antibodies and exposure to new infections. While this may obtain in some situations, the developing practice of contract-rearing of dairy heifers away from the farm to be brought back as close-up springers, and the practice of purchase of close-up heifers on to the farm, are not associated with appreciable increase in mortality in their calves.

#### Decline of passive immunity

Passive antibody levels fall quickly after birth and have usually disappeared by 6 months of age. In the **foal**, they have fallen to less than 50% of peak level by 1 month of age, and to a minimum level between 30 and 60 days. This is the point at which naturally immunodeficient foals are highly susceptible to fatal infection.

In **calves**, the level of IgG declines slowly and reaches minimum values by 60 days, in contrast to IgM and IgA, which decline more rapidly and reach minimum values by approximately 21 days of age. The half-lives for IgG, IgM and IgA in calves are approximately 20, 4 and 2 days respectively and half lives of IgG, IgG<sub>1</sub>, IgG<sub>2</sub>, IgG(T) and IgA in foals are approximately 18, 32, 21 and 3.5 days respectively.<sup>45</sup>

**Immunological competence** is present at birth but endogenous antibody production does not usually reach protective levels until 1 month, and maximum levels not until 2–3 months of age. The endogenous production of intestinal IgA in the piglet begins at about 2 weeks of age and

does not reach significant levels until 5 weeks of age.

Foals that acquire low concentrations of immunoglobulins from colostrum may experience a transitory hypogammaglobulinemia at several weeks of age as the levels fall and before autogenous antibodies develop. They are, as expected, more subject to infection than normal.

#### OTHER BENEFITS OF COLOSTRUM

In addition to its immunoglobulin content, colostrum contains considerably more protein, fat, vitamins and minerals than milk and is especially important in the transfer of fat-soluble vitamins. It has **anabolic effects** and lambs that ingest colostrum have a higher summit metabolism than colostrum-deprived lambs. Colostrum also contains growth-promoting factors that stimulate DNA synthesis and cell division including high concentrations of insulin-like growth factor (IGF)-1.<sup>46,47</sup>

Colostrum contains approximately 106 leukocytes/mL and several hundred million are ingested with the first feeding of colostrum. In calves 20–30% of these are lymphocytes and cross the intestine into the circulation of the calf.<sup>48</sup> It is postulated that they have importance in the development of neonatal resistance to disease but there is little tangible evidence. Calves fed colostrum depleted of leukocytes are claimed to be more poorly protected against neonatal disease than those fed normal colostrum.<sup>49</sup>

#### ASSESSMENT OF TRANSFER OF PASSIVE IMMUNITY

Because of the importance of transfer of colostrum antibodies to the health of the neonate, it is common to quantitatively estimate the levels of immunoglobulins, or their surrogates, in colostrum and in serum in order to predict risk of disease and to take preventive measures in the individual or to make corrective management changes where groups of animals are at risk.

#### Assessment in the individual animal

Where samples are taken from an individual animal to determine the risk for infection, sampling is undertaken early so that replacement therapy can be given promptly if there has been inadequate transfer. IgG is detectable in serum 2 hours following a colostrum feeding and **sampling at 8–12 hours** after birth will give a good indication of whether early sucking has occurred and has been effective in transfer.<sup>50</sup> This type of monitoring is commonly performed in foals. There are a number of different tests that can be used, some of which are quantitative and others semi-quantitative. For foals, these include commercially available

tests such as the latex agglutination, concentration immunoassay and hemagglutination inhibition tests. These are semi-quantitative and the relative value of these tests for this type of analysis has been evaluated.<sup>51,52</sup> A glutaraldehyde test for serum is available commercially for use in the horse and is reported to correlate well with radial immunodiffusion (RID) values.<sup>53</sup> In calves, sampling may be undertaken for similar reasons but the cost of replacement therapy is limiting.

#### Monitoring assessment tests on serum

Sampling to **monitor** the efficacy of a farm policy for feeding colostrum, to evaluate levels in **calves to be purchased** or to determine the **rates of failure of transfer of passive immunity** in investigations of neonatal disease can be conducted at any time in the first week of life after 48 hours with most tests. This is possible because of the relatively long half-life of IgG.

##### *Radial immunodiffusion*

This test is usually used in research studies and is the gold standard. It is available commercially but is expensive and takes longer to perform than is desirable for most clinical purposes. An enzyme-linked immunosorbent assay (ELISA) for measurement of IgG concentration in horses and in porcine plasma and colostrum suffers from the same problems.

##### *Quantitative zinc sulfate test*

This is a good predictor of mortality but requires instrumentation. It has been used for many years in calves and lambs and has been validated in horses.<sup>54</sup> Hemolyzed blood samples will give artificially high readings, and the reagent must be kept free of dissolved carbon dioxide. The suggested cut-point is 20 ZST units. Increased test solution concentrations to those traditionally used have been suggested to improve sensitivity.<sup>55</sup>

##### *Serum $\gamma$ -glutamyltransferase activity*

Serum  $\gamma$ -glutamyltransferase (GGT) activity has been used as a surrogate for determining the efficacy of transfer of passive immunity in calves and lambs. GGT concentrations are high in the colostrum of ruminants (but not horses) and serum GGT activity in calves and lambs that have sucked or been fed colostrum are 60–160 times greater than normal adult serum activity and correlate moderately well with serum IgG concentrations.<sup>56,57</sup> The half-life of GGT from colostrum is short and serum GGT activity falls significantly in the first week of life. Serum GGT values equivalent to a serum IgG concentration of 10 mg/mL are

200 IU/L on day 1 of life and 100 IU/L on day 4. Serum GGT concentrations less than 50 IU/L indicate failure of transfer of passive immunity.<sup>56,58</sup>

##### *Serum total protein*

Total protein, as measured by a refractometer, gives an indirect measure of the amount of immunoglobulin. Despite the indirect nature of the test, there is a reliable correlation between the refractometer reading and total immunoglobulin concentration (IgG and IgM) measured by RID. In healthy calves a serum total protein of 5.2 g/dL or greater is associated with adequate transfer of passive immunity.

Serum total protein has good predictive value for fate of the newborn, and the facile and practical nature of the test and its predictive ability commends it for survey studies in calves and lambs but not foals. Cut-points will vary with the environment<sup>59,60</sup> and the infection pressure to the calves. The sensitivity of the test is maximal using a cut point of 5.5 g/dL and the specificity is maximal at a cut point of 5.0 g/dL.<sup>61</sup> The refractometer can give false high values in dehydrated calves but these can be clinically identified and a cut point of 5.5 g/dL can be used.

##### *Sodium sulfite precipitation and glutaraldehyde test*

Both of these were developed as rapid field tests to evaluate the immune status of neonatal calves. An 18% test solution is used and the development of turbidity is the determinant of adequate transfer of passive immunity. The glutaraldehyde coagulation test is also available for the detection of hypogammaglobulinemia in neonatal calves but is less accurate.<sup>61</sup> Neither test is widely used.

##### *ELISA test*

An ELISA test is commercially available and used for calf-side testing.

#### Monitoring colostrum

There has long been the desire for a method to select colostrums with high immunoglobulin concentration for feeding neonates.

##### *Specific gravity*

Specific gravity can be used as a measure of immunoglobulin content of colostrum. In **mares** the concentration of immunoglobulins in colostrum is highly correlated with the specific gravity of the colostrum, which in turn is highly correlated with the serum immunoglobulin levels achieved in foals.<sup>50,62</sup> Temperature-corrected measurements are most accurate.<sup>63</sup> Measurement of colostrum specific gravity provides a rapid and easy method of identifying foals likely to be at a high risk for failure of transfer of passive immunity and the

need to provide them with colostrum of a higher Ig content. It is recommended that, to prevent failure of transfer of passive immunity, the colostrum specific gravity should be equal to or greater than 1.060 and the colostrum IgG concentration be a minimum of 3000 mg/dL.<sup>62</sup>

In **cattle** the relation of specific gravity of colostrum to colostrum immunoglobulin concentration is linear but is better in Holsteins than in Jerseys.<sup>58</sup> The measurement is simple but there is a correction for temperature, and air trapped in colostrum taken by a milking machine can give a false reading if the measurement is taken too quickly after milking. The cut-point recommended to distinguish moderate from excellent colostrum has been set at 1.048 and is based on the amount of immunoglobulin required for a 2 quart feeding. Specific gravity is not a perfect surrogate for immunoglobulin concentration with cattle colostrum. It has good negative prediction but it will falsely pass many Holstein colostrums that have low immunoglobulin concentration and is not accurate with Jersey colostrum.<sup>64,65</sup> An analysis of first-milking colostrum in midwest USA dairies found that specific gravity differed among breeds and was influenced by month of calving, year of calving, lactation number and protein yield in previous lactation and that it was more closely associated with colostrum protein concentration ( $r = 0.76$ ) than IgG<sub>1</sub> concentration ( $r = 0.53$ ).<sup>66</sup>

##### *Glutaraldehyde test*

This test for mare colostrum is available commercially and is reported to have a high predictive value for colostrums that contain more than 38 mg/mL of IgG and have a specific gravity greater than 1.060.<sup>67,68</sup>

##### *ELISA*

Recently, a cow-side immunoassay kit has become available commercially in the US. The kit provided a positive or a negative response with the cut point being a concentration of 50 g/L of IgG in colostrum and has accuracy sufficient to recommend its use for rejection of colostrums with low immunoglobulin concentration.<sup>69</sup>

#### CORRECTION OF FAILURE OF TRANSFER OF PASSIVE IMMUNITY

##### Parenteral immunoglobulins

**Blood transfusion** is commonly used and the method is described elsewhere in this text. Purified immunoglobulin preparations are an alternative and are available commercially in some countries. Large amounts are required to obtain the required high serum concentrations of immunoglobulins and intravenous infusion can be accompanied by transfusion-type reactions.

## AVOIDANCE OF FAILURE OF TRANSFER OF PASSIVE IMMUNITY

With all species, with the exception of dairy calves, the common practice is to allow the newborn to suck naturally. The policy for avoidance of failure of transfer of passive immunity with naturally sucking herds should be to provide supplemental colostrum by artificial feeding of those neonates with a high risk for failure, based on the risk factors detailed above. In the dairy calf, rates of failure with natural sucking are so high that many farms opt to remove that calf at birth and feed colostrum by hand to ensure adequate intakes.

### Colostrum

Colostrum can be stripped from the dam and fed fresh or the neonate can be fed stored (banked) colostrum.

Colostrum for banking

With **dairy cows**, first-milking colostrum from a cow with a first-milking yield of less than 10 kg should be used. The temptation for the farmer is to store the leftover from the feeding of large-volume colostrum. This should not be used as it has a high probability of containing a low immunoglobulin concentration.

Colostrum from **mares** should have a specific gravity of 1.060 or more and 200 mL can be milked from a mare before the foal begins sucking.

Storage of colostrum

Colostrum can be kept at **refrigerator temperature** for approximately 1 week without significant deterioration in immunoglobulins. Storage in plastic containers also maintains the viability of cellular components.<sup>26</sup> The addition of formaldehyde to 0.05% (wt/vol) allows maintenance at 28°C for 4 weeks without loss of immunoglobulins as detected by RID<sup>70</sup> but information on such colostrum's protection efficacy, when fed, is not available. The addition of 5 g of propionic or lactic acid per liter extends the storage life to 6 weeks<sup>30</sup> but, more commonly, colostrum is frozen for storage. **Frozen colostrum**, at -20°C, can be stored virtually indefinitely and there is no impairment to the subsequent absorption of immunoglobulins. Frozen colostrum should be stored in flat plastic bags in the amount required for a feeding, which facilitates thawing. **Thawing** should be at temperatures below 55°C. Higher temperatures and microwave thawing results in the deterioration of immunoglobulins and antibody in frozen colostrum and frozen plasma.<sup>71</sup>

### Cross-species colostrum

Colostrum from another species can be used to provide immunological protection where same-species colostrum is not

available. Bovine colostrum can be fed to a number of different species. While absorption of immunoglobulins occurs and significant protection can be achieved,<sup>72</sup> the use of cross-species colostrum is not without some risk and the absorbed immunoglobulins have a short half-life. Bovine colostrum has been successfully used for many years to improve the survival rate of hysterectomy-produced artificially reared pigs. It has also been used as an alternate source of colostrum antibody for rearing goats free of caprine arthritis-encephalitis. Colostrum from some cows can result in the development of a hemolytic anemia, occurring at around 5-12 days of age, in lambs and kids because the IgG of some cows attaches to the red cells and their precursors in bone marrow, resulting in red cell destruction by the reticulo-endothelial system.<sup>73,74</sup> Treatment of the anemia consists of a blood transfusion. Bovine colostrum can be tested for 'anti-sheep' factors by a gel precipitation test on colostrum whey but this test is not generally available. Bovine colostrum can provide some protection to newborn foals against neonatal infections and protection appears to be due to factors in addition to the immunoglobulins, which have a short half-life in foals.

### Colostrum supplements

In recent years there has been a move to develop supplements or even replacements for colostrum to feed calves. These have been attempted using IgG concentrated from bovine colostrum, milk whey, eggs or bovine serum. The search for colostrum substitutes or colostrum replacers has been prompted by the problem of the variability of IgG concentration in natural colostrum. It has also been prompted by possible limitations of availability of high-quality colostrum on dairy farms as the result of discarding colostrum from cows that test positive to disease that can transmit through colostrum, such as Johne's disease, bovine leukosis, *Mycoplasma bovis*. This problem is confounded by reports that pasteurization of colostrum can have a deleterious effect on IgG concentration in colostrum and its subsequent absorption by calves.<sup>27</sup>

Lacteal-secretion-based preparations

Colostrum supplements prepared from whey or colostrum are available commercially in many countries. Depending upon the manufacturer, they contain varying amounts of immunoglobulin but significantly less than first-milking colostrum. The amount of immunoglobulin contained varies, but the recommendations for feeding that accompany these products indicate that they will supply approximately 25% or less of the immuno-

globulin required to elevate calf serum IgG concentrations above 1000 mg/dL. There is a further problem in that the immunoglobulins in products made from colostrum or whey are poorly absorbed and trials assessing their ability to increase circulating immunoglobulins when fed with colostrum have generally shown little improvement and no improvement in health-related parameters.<sup>75-80</sup>

There is evidence that their inclusion with colostrum can impair the efficiency of colostrum immunoglobulin<sup>77</sup> and if they are fed they should be fed after normal colostrum. While these milk-protein-derived products are advertised for supplementing normal colostrum feeding, they are unfortunately often promoted as replacements and used by farmers as total substitutes for colostrum. When fed as the sole source of immunoglobulin to colostrum-deprived calves, they achieve circulating concentrations of immunoglobulin that are lower than those achieved by natural colostrum containing equivalent amounts of immunoglobulin.<sup>76</sup>

Bovine-serum-based preparations

Colostrum supplements prepared from bovine serum are also available commercially but regulations governing the feeding of blood or blood products to calves (risk reduction for bovine spongiform encephalopathy) may limit their availability in some countries. The absorption of immunoglobulin from these bovine-serum-derived commercial products appears better than from milk-protein-derived products<sup>80</sup> and consequently they are also marketed as colostrum replacers. It has been proposed that the distinction between a colostrum supplement and a colostrum replacer should be the immunoglobulin mass contained in the product, with a colostrum supplement having less than 100 g IgG per dose and a colostrum replacer having sufficient immunoglobulin mass in a dose to result in a serum IgG concentration greater than 10 mg/mL following a feeding.<sup>80</sup>

A large mass of immunoglobulin is required for acquisition of adequate circulating immunoglobulin. Calves fed a colostrum replacement containing a high mass (250 g for Holsteins) of an IgG derived from bovine serum and fed at 1.5 and again at 13.5 hours after birth, achieved equivalent serum IgG concentrations to calves fed normal colostrum and showed no difference in gain or health parameters during the first 4 weeks of life.<sup>81</sup>

The IgG in a commercially available bovine serum colostrum replacer has been shown to be effectively absorbed when fed to newborn lambs. The feeding

of 200 g of IgG in the first 24 hours of life resulted in a mean plasma concentration of 18 mg/mL.<sup>82</sup>

The published literature suggests that there is little advantage to be gained from the use of milk-protein-derived colostrum supplements and their use as colostrum replacers or substitutes is not recommended, except where there is no source of natural colostrum due to factors such as the death of the dam. The feeding of colostrum-derived supplements can result in a modest elevation of circulating IgG, sufficient to protect against experimental colisepticemia. If available, the bovine-serum-derived products would be more suitable.

The use of colostrum replacers should be confined to this type of emergency and there can be little justification for more widespread use, particularly as there are limited independent health-related publications of their efficacy. Also, as mentioned above, in addition to immunoglobulins, natural colostrum contains various substances important to neonatal physiology.

### Administration of colostrum

#### Foals

Foals should be allowed to suck naturally. The specific gravity of the mare's colostrum can be checked at foaling and, where this is less than 1.060, supplemental colostrum may be indicated. Foals that do not suck, or that have serum IgG concentrations less than 400 mg/mL at 12 hours of age, or that require supplementation for other reasons, should be fed colostrum with a specific gravity of 1.060 or more at an amount of 200 mL at hourly feedings.<sup>50,60</sup>

#### Dairy calves

##### Assisted natural sucking

Leaving the newborn dairy calf with the cow is no guarantee that the calf will obtain sufficient colostrum and a high proportion fail either to suck early or to absorb sufficient immunoglobulins from ingested colostrum. This problem can be alleviated to some extent by **assisted natural sucking** but this can fail because not all calves requiring assistance are detected. An alternate approach is to milk 2 L of colostrum from the dam, bottle-feed each calf as soon after birth as possible, then leave the calf with the cow for 24 hours and allow it to suck voluntarily. While this will not be as effective as a system based entirely on artificial feeding of selected colostrum, it is an approach that is suitable for the **smaller dairy farm**.

##### Artificial feeding systems

With **artificial feeding systems**, the calf is removed from the dam at birth and fed

colostrum by hand throughout the whole absorptive period. Nipple bottle-feeding can be used with 2 L of colostrum given every 12 hours (Holstein calves) for the first 48 hours of life. The first feeding is usually milked from the cow by hand and the remaining feedings are from the colostrum obtained from the cow after the first machine milking. If care and patience is taken with feeding, this system can result in good transfer of passive immunity in all calves except those born to dams that have very low concentrations of immunoglobulin in their colostrum. Unfortunately, with American Holsteins this can be a significant percentage. An extension from this system is to nipple bottle-feed at the same frequency but to feed stored colostrum selected for its superior immunoglobulin content. Nipple bottle-feeding of newborn calves requires considerable **patience** and its success is very much dependent on the calf feeder and on the availability of the feeder's time when faced with a calf that has a slow intake.

Where the diligence of the calf feeders is poor, or where there is a time constraint on their availability, the feeding of a large volume of colostrum (4 L to a 45 kg calf) by **esophageal feeder** at the initial feeding immediately after birth can be a successful practice. The **large-volume feeding** also allows the delivery of an adequate mass of immunoglobulin with colostrum that has low immunoglobulin concentrations and the delivery of colostrum to the gut in its early absorptive period. The practice usually uses stored colostrum and the feeding can be achieved within a few minutes. It can be supplemented by bottle-feeding of a second feeding at 12 hours of life.

The practice of feeding stored colostrum as the sole source of colostrum is limited to **larger dairy herds** but it does allow the selection of superior colostrum for feeding with selection based on weight and specific gravity as detailed above.

#### Beef calves

Beef calves should be allowed to suck naturally and force-feeding of colostrum to beef breeds should not be practiced unless there is obvious failure of sucking. Where colostrum is required, as with weak beef calves, calves with edematous tongues and calves that have been subjected to a difficult birth, it can be administered with an esophageal feeder or a stomach tube.

#### Lambs

Lambs are allowed to suck naturally but there can be competition between siblings for colostrum and one large single lamb is capable of ingesting, within a short period

of birth, all the available colostrum in the ewe's udder. Lambs require a total of 180–210 mL colostrum/kg body weight during the first 18 hours after birth to provide sufficient energy for heat production.<sup>35</sup> This amount will usually provide enough immunoglobulins for protection against infections. **Supplemental feeding** of colostrum may be advisable for lambs from multiple birth litters, lambs that lack vigor and those that have not nursed by 2 hours following birth. This can be done with a nipple bottle or an esophageal feeder.

#### Piglets

Colostrum supplementation is not commonly practiced with piglets. An immunoglobulin dose of 10 g/kg body weight on day 1 followed by 2 g/kg on succeeding days for 10 days is sufficient to confer passive immunity on the colostrum-deprived pig.

### REVIEW LITERATURE

- Norcross NL. Secretion and composition of colostrum and milk. *J Am Vet Med Assoc* 1982; 181:1057.
- Gay CC. Failure of passive transfer of colostrum immunoglobulins and neonatal disease in calves: a review. In: *Proceedings of the Fourth International Symposium on Neonatal Diarrhea*, Saskatoon, Saskatchewan, Canada. Saskatoon: University of Saskatchewan, 1983: 346–364.
- Besser TE, Gay CC. Septicemic colibacillosis and failure of passive transfer of immunoglobulin in calves. *Vet Clin North Am Food Anim Pract* 1985; 1:445–459.
- Black L, Francis ML, Nicholls MJ. Protecting young domestic animals from infectious disease. *Vet Annu* 1985; 25:46–61.
- Sheldrake RF, Husband AJ. Immune defences at mucosal surfaces in ruminants. *J Dairy Res* 1985; 52:599–613.
- Staley TE, Bush LJ. Receptor mechanism of the neonatal intestine and their relationship to immunoglobulin absorption and disease. *J Dairy Sci* 1985; 68:184–205.
- Butler JE. Biochemistry and biology of ruminant immunoglobulins. *Prog Vet Microbiol Immunol* 1986; 2:1–53.
- Carter GK. Septicemia in the neonatal foal. *Compend Contin Educ Pract Vet* 1986; 8:S256–S270.
- Morris DD. Immunologic disease of foals. *Compend Contin Educ Pract Vet* 1986; 8:S139–S150.
- Mellor D. Meeting colostrum needs of lambs. In *Pract* 1990; 12:239–244.
- Brenner J. Passive lactogenic immunity in calves: a review. *Israel J Vet Med* 1991; 46:1–12.
- Besser TE, Gay CC. Colostral transfer of immunoglobulins to the calf. *Vet Annu* 1993; 33:53–61.
- Garry F, Aldridge B, Adams R. Role of colostrum transfer in neonatal calf management: current concepts in diagnosis. *Compend Contin Educ Pract Vet* 1993; 15:1167–1175.
- White DG. Colostral supplementation in ruminants. *Compend Contin Educ Pract Vet* 1993; 15:335–342.
- Besser TE, Gay CC. The importance of colostrum to the health of the neonatal calf. *Vet Clin North Am Food Anim Pract* 1994; 10:107.
- Quigley JD, Drewry JJ. Nutrient and immunity transfer from cow to calf pre- and postcalving. *J Dairy Sci* 1998; 81:2779–2790.

Weaver DM, Tyler JW, VanMetre D, Hoeteler DE, Barrington GM. Passive transfer of colostral immunoglobulins in calves. *J Vet Intern Med* 2000; 14:569-577.

Barrington GM, Parish SM. Bovine neonatal immunology. *Vet Clin North Am Food Anim Pract* 2001; 17:463-476.

Rooke JA, Bland IM. The acquisition of passive immunity in the newborn piglet. *Livestock Product Sci* 2002; 78:13-23.

McGuirk SM, Collins M. Managing the production, storage, and delivery of colostrum. *Vet Clin North Am Food Anim Pract* 2004; 20:593-603.

## REFERENCES

- National Animal Health Monitoring System. National Dairy Heifer Evaluation Project: Dairy herd management practices focusing on preweaned heifers. Fort Collins, CO: USDA: APHIS:VS, 2002.
- Besser TE. *Vet Immunol Immunopathol* 1993; 38:103.
- Saif LJ, Smith KL. *J Dairy Sci* 1985; 68:206.
- Robinson JA et al. *Equine Vet J* 1993; 25:214.
- Gay CC et al. In: Gyles CL, ed. *Escherichia coli* in domestic animals and humans. Wallingford, Oxfordshire: CAB International, 1994:75.
- Gay CC. 1983; In: Proceedings of the Fourth International Symposium on Neonatal Diarrhea, Saskatoon, Saskatchewan, Canada. Saskatoon: University of Saskatchewan, 1983; 4:346.
- Wittum TE, Perino LJ. *Am J Vet Res* 1995; 56:1149.
- Wells SJ et al. *Prevent Vet Med* 1996; 29:9.
- Donovan GA et al. *Prevent Vet Med* 1998; 34:31.
- Ley WB et al. *Equine Vet Sci* 1990; 10:262.
- Tyler-McGowan JL et al. *Aust Vet J* 1997; 75:56.
- Besser TE, Gay CC. *Vet Clin North Am Food Anim Pract* 1994; 10:107.
- Besser TE, Gay CC. *Vet Annu* 1993; 33:53-61.
- LeBlanc MM et al. *J Am Vet Med Assoc* 1992; 200:179.
- Besser TE et al. *J Am Vet Med Assoc* 1991; 198:419.
- Chavatte-Palmer P et al. *Pferdheilkunde* 2001; 17:669.
- Pritchett L et al. *J Dairy Sci* 1991; 74:2336.
- Pearson RC et al. *Am J Vet Res* 1984; 45:186.
- Moore M et al. *J Am Vet Med Assoc* 2005; 226:1375.
- Hostetler D et al. *J Appl Res Vet Med* 2003; 1:168.
- Waelchli RO et al. *Vet Rec* 1994; 135:16.
- Nardone E et al. *J Dairy Sci* 1997; 80:838.
- Perino LJ et al. *Am J Vet Res* 1995; 56:1144, 1149.
- Maunsell FP et al. *J Dairy Sci* 1998; 81:1291.
- Guy MA et al. *J Dairy Sci* 1994; 77:3002.
- Godden SM et al. *J Dairy Sci* 2003; 86:1503.
- Stott GH et al. *J Dairy Sci* 1979; 62:1632, 1766, 1902, 1908.
- McGuirk SM, Collins M. *Vet Clin North Am Food Anim Pract* 2004; 20:593.
- Franklin ST et al. *J Dairy Sci* 2003; 86:2145.
- White DG. *Compend Contin Educ Pract Vet* 1993; 15:335.
- Jaster EH. *J Dairy Sci* 2005; 88:296.
- Petrie L et al. *Can Vet J* 1984; 25:273.
- Bradley JA, Niilo L. *Can Vet J* 1984; 25:121.
- Hough RL et al. *J Anim Sci* 1990; 68:2662.
- Mellor DJ. *In Pract* 1990; 12:239.
- Fraser D, Rushen J. *Can J Anim Sci* 1992; 72:1.
- Ventorp M, Michanek P. *J Dairy Sci* 1992; 75:262.
- Quigley JD et al. *J Dairy Sci* 1995; 78:893.
- Ayers MW, Besser TE. *Am J Vet Res* 1992; 53:83.
- Tyler H, Ramsey H. *J Dairy Sci* 1991; 74:1953.
- Mohammed HO et al. *Cornell Vet* 1991; 81:173.
- Johnston NE, Stewart JA. *Aust Vet J* 1986; 63:191.
- Quigley JD et al. *J Dairy Sci* 1995; 78:886, 1573.
- Clabough DL et al. *J Vet Intern Med* 1991; 5:335.
- Sheoran AS et al. *Am J Vet Res* 2000; 61:1099.

- Barrington GM, Parish SM. *Vet Clin North Am Food Anim Pract* 2001; 17:463.
- Blum JW, Baumruckerb CR. *Domest Anim Endocrinol* 2002; 23:101.
- Le Jan C. *Vet Res* 1996; 27:403.
- Reidel-Caspari G. *Vet Immunol Immunopathol* 1993; 35:275.
- Massey RE et al. *Proc Am Assoc Equine Pract* 1991; 36:1.
- Ley WB et al. *Equine Vet Sci* 1990; 10:262.
- Morris DD et al. *Am J Vet Res* 1985; 46:S294.
- Jones D, Brook D. *J Equine Vet Sci* 1994; 14:85.
- LeBlanc MM et al. *Equine Vet Sci* 1990; 10:36.
- Hudgens KA et al. *Am J Vet Res* 1996; 57:1711.
- Perino LJ et al. *Am J Vet Res* 1993; 54:56.
- Tessman RK et al. *J Am Vet Med Assoc* 1997; 211:1163.
- Parish SM et al. *J Vet Intern Med* 1997; 11:344.
- Tyler JW et al. *J Vet Intern Med* 1998; 12:79.
- Rea DE et al. *J Am Vet Med Assoc* 1996; 208:2047.
- Tyler JW et al. *J Vet Intern Med* 1996; 10:304.
- LeBlanc MM et al. *J Am Vet Med Assoc* 1986; 189:57.
- Dascanio JJ et al. *Equine Pract* 1997; 19:23.
- Quigley JD. *J Dairy Sci* 1994; 77:264.
- Pritchett LC et al. *J Dairy Sci* 1994; 77:1761.
- Morin DE et al. *J Dairy Sci* 2001; 84:937.
- Jones D, Brook D. *J Equine Vet Sci* 1994; 14:85.
- Jones D, Brook D. *J Equine Vet Sci* 1995; 15:269.
- Chigerwe M et al. *J Am Vet Med Assoc* 2005; 227:129.
- Mbuthia EW et al. *Anim Feed Sci Technol* 1997; 67:291.
- Orielly JL. *Aust Vet J* 1992; 70:442.
- Gomez GG et al. *J Anim Sci* 1998; 76:1.
- Winter A, Clarkson M. *In Pract* 1992; 14:283.
- Perl S et al. *Israel J Vet Med* 1995; 50:61.
- Abel Francisco SF, Quigley JD. *Am J Vet Res* 1993; 54:1051.
- Garry FB et al. *J Am Vet Med Assoc* 1996; 208:107.
- Morrin DE et al. *J Dairy Sci* 1997; 80:747.
- Arthington JD et al. *J Dairy Sci* 2000; 83:1463.
- Quigley JD et al. *J Dairy Sci* 2001; 84:2059.
- Quigley JD et al. *J Dairy Sci* 2002; 85:1243.
- Jones CM et al. *J Dairy Sci* 2004; 87:1806.
- Quigley JD et al. *Vet Therapeut* 2002; 3:262.

## PRINCIPLES OF CONTROL AND PREVENTION OF INFECTIOUS DISEASES OF NEWBORN FARM ANIMALS

The four principles are:

- Reduction of risk of acquisition of infection from the environment
- Removal of the newborn from the infectious environment if necessary
- Increasing and maintaining the nonspecific resistance of the newborn
- Increasing the specific resistance of the newborn through the use of vaccines.

The application of each of these principles will vary depending on the species, the spectrum of diseases that are common on that farm, the management system and the success achieved with any particular preventive method used previously.

## REDUCTION OF RISK OF ACQUISITION OF INFECTION FROM THE ENVIRONMENT

The animal should be born in an **environment** that is clean, dry, sheltered and con-

ducive for the animal to get up after birth, suck the dam and establish bonding.<sup>1,2</sup> Calving and lambing stalls or grounds, farrowing crates and foaling stalls should be prepared in advance for parturition. No conventional animal area can be sterilized but it can be made reasonably clean to minimize the infection rate before colostrum is ingested and during the first few weeks of life when the newborn animal is very susceptible to infectious disease.

With seasonal calving or lambing there can be buildup of infection in the birth area and animals born later in the season are at greater risk of disease. In these circumstances it may be necessary to move to secondary lambing or calving areas. In northern climates snow may constrict the effective calving area and result in a significant buildup of infection. Buildup of infection pressure must be minimized by a change to a fresh calving/lambing area and by the frequent movement of feed bunks or feed areas. Any system that concentrates large numbers of cattle in a small area increases environmental contamination and close confinement of heifers and cows around calving time is a known risk factor for calf mortality.<sup>3,4</sup> With large herds both the cow herd and heifer herd should be broken into as many subgroups as is practical. Extensive systems where cows calve out over large paddocks are optimal and with more intense systems a group size no larger than 50 has been suggested.<sup>5</sup>

Lambing sheds and calving areas for beef cattle should be kept free of animal traffic during the months preceding the period of parturition. In dairy herds, maternity pens separate from other housing functions should be provided and cleaned and freshly bedded between calvings. Certainly **they should not also be used as hospital pens.**

In swine herds, the practice of batch farrowing, with all-in all-out systems of management and disinfection of the farrowing rooms, is essential. Sows should be washed prior to entry to the farrowing area and the floor of the farrowing crate should be of the type that minimizes exposure of the piglet to fecal material at birth.

The swabbing of the **navel** with tincture of iodine to prevent entry of infection is commonly practiced by some producers and seldom by others. In a heavily contaminated environment it is recommended; ligation of umbilical vessels at the level of the abdomen using plastic clamps available for this purpose may however be more effective. The efficiency of the disinfection of the umbilicus after birth is uncertain. It is often surprising how many cases of



omphalophlebitis occur in calves in herds where swabbing or 'dunking' of the navel in a solution of tincture of iodine is a routine practice. Severance of the umbilical cord too quickly during the birth of foals can deprive the animal of large quantities of blood, which can lead to the neonatal maladjustment syndrome.

When deemed necessary, some **surveillance** should be provided for pregnant animals that are expected to give birth, and assistance provided if necessary. In large herds this attention is concentrated on the heifers and because these are more susceptible to dystocia and to neonatal disease they are preferably calved in a separate group that can be easily supervised. The major objective is to avoid or minimize the adverse effects of a difficult or slow parturition on the newborn. Physical injuries, hypoxia and edema of parts of the newborn will reduce the vigor and viability of the newborn and, depending on the circumstances and the environment in which it is born, may lead to death soon after birth.

When possible, every effort should be made to minimize exposure of the neonate to extremes of temperature (heat, cold, snow). Shelter sheds should be built if necessary. Restricting feeding to between 4 pm and 6 am can reduce the number of calves born at night.

In beef herds, the practice of purchasing dairy bulls to foster on to cows whose calves have died should be discouraged. If calves are purchased they should be from a herd whose health status is known to the veterinarian and certainly never through a market. Similarly, colostrum should be obtained from cows within the herd and stored frozen for future use. Colostrum from a dairy herd is a break in herd biosecurity and may transmit the agents of leukosis and Johne's disease. Furthermore, purchased dairy colostrum is commonly second- or third-milking colostrum and of limited immunological value. The use of a commercial colostrum supplement or replacer is possible, although they have significant limitations (see Colostrum substitutes, above).

#### REMOVAL OF THE NEWBORN FROM THE INFECTIOUS ENVIRONMENT

In some cases of high animal population density (e.g. a crowded dairy barn) and in the presence of known disease it may be necessary to transfer the newborn to a noninfectious environment temporarily or permanently. Adult cows shedding enteric pathogens are a risk for calf infection. Thus dairy calves are often removed from the dam at birth and placed in individual pens inside or outdoors in hutches and reared in these pens

separately from the main herd. This reduces the severity of neonatal diarrhea and pneumonia and risk for mortality compared to calves allowed to remain with the dam.<sup>6,7</sup> **Individual housing** in hutches is preferred because this avoids navel sucking and other methods of direct-contact transmission of disease. Humans entering these hutches should also practice interhutch hygiene. The prevalence of disease is higher in enclosed artificially heated barns than in hutches. However, despite the well-established value of individual rearing of calves, animal welfare regulations in several countries require that there be visual and tactile contact between calves. The removal of the cow-calf pair from the main calving grounds to a '**nursery pasture**' after the cow-calf relationship (neonatal bond) is well established at 2-3 days of age, has proved to be a successful management practice in beef herds.<sup>8</sup> This system moves the newborn calf away from the main calving ground, which may be heavily contaminated because of limited space. It necessitates that the producer plan the location of the calving grounds and nursery pastures well in advance of calving time. Calves that develop diarrhea in the calving grounds or nursery pasture are removed with their dams to a '**hospital pasture**' during treatment and convalescence. The all-in all-out principle of successive population and depopulation of farrowing quarters and calf barns is an effective method of maintaining a low level of contamination pressure for the neonate.<sup>9</sup>

#### INCREASING THE NONSPECIFIC RESISTANCE OF THE NEWBORN

Following a successful birth, the next important method of preventing neonatal disease is to ensure that the newborn ingests colostrum as soon as possible. As detailed above, with natural sucking the amount which the calf ingests will depend on the amount available, the vigor of the calf, the acceptance of the calf by the dam and the management system used, which may encourage or discourage the ingestion of liberal quantities of colostrum. Beef cows that calve at a condition score lower than 4 (out of 10) are at higher risk of having calves that develop failure of transfer of passive immunity and the ideal condition score at calving is 5 to 6.<sup>4</sup>

The method of colostrum delivery that is needed to optimize transfer of passive immunity to the dairy calf will vary with the breed of cow, the management level of the farm and the priority given to calf health. Owner acceptance of alternate feeding systems to natural sucking also is a consideration. The success of the farm

policy for the feeding of colostrum is easily monitored by one of the tests listed above, as is the effect of an intervention strategy.

**Newborn male dairy calves** are commonly assembled and transported to market or to **calf-rearing units** within a few days of birth. Studies have repeatedly shown high rates of failure of transfer of passive immunity in this class of calf. The high rates occur either because the original owner does not bother to feed colostrum to the calf, knowing it is to be sold, or because calves are purchased off the farm before colostrum feeding is completed. The effects of the transportation can have a further deleterious effect on the defense mechanism of the calves and they are at high risk of disease.

Calf-rearing units should preferably purchase calves directly from a farm with an established policy of feeding colostrum before the calf leaves the farm, and every effort should be made to reduce the stress of transportation by providing adequate bedding, avoiding long distances without a break and attempting to transport only calves that are healthy. In some countries there is now legislation requiring the feeding of colostrum and limiting the transport of newborn calves.

The honesty of the stated farm colostrum feeding policy can be monitored by testing the calves for immunoglobulins. Where this is not possible and **market calves** must be used, the entry immunoglobulin value should be tested; the incidence of infectious disease in low-testing calves will be high unless hygiene, housing, ventilation, management and nutrition are excellent. Low-testing calves should probably be culled. The entry immunoglobulin of calves entering veal or other calf-rearing units is a prime determinant of subsequent health and performance. The cull cut-point can be established for an individual farm by monitoring of individual immunoglobulin levels and subsequent calf fate.

Following the successful ingestion of colostrum and establishment of the neonatal bond, emphasis can then be given to provision, if necessary, of any special nutritional and housing requirements. Newborn piglets need supplemental heat, their eye teeth should be clipped and attention must be given to the special problems of intensive pig husbandry. Orphan and weak piglets can now be reared successfully under normal farm conditions with the use of milk replacers containing added porcine immunoglobulins. Heat is often provided to lambs for the first day in pen lambing systems.

**Milk replacers** for the newborn must contain high-quality ingredients. Human-grade milk products are preferred to



animal-grade products because there is less heat denaturation. Calves younger than 3 weeks are less able to digest nonmilk proteins, and the fats best used by the calf are high-quality animal source fats and slightly unsaturated vegetable oils.<sup>10,11</sup> A 22% crude protein is recommended for milk replacers comprised only of milk proteins and 24–26% in replacers that contain nonmilk protein sources. The level of fat should be at least 15%; higher fat concentration will provide additional energy which may be required in colder climates. Feeding utensils must be cleaned and disinfected between each feeding if disease transmission is to be minimized.<sup>12</sup>

With animals at pasture, the mustering and close contact associated with management procedures such as castration and docking pose a risk for disease transmission. These procedures should be performed in yards prepared for the purpose – preferably temporary yards erected for this sole purpose in a clean area.

#### INCREASING THE SPECIFIC RESISTANCE OF THE NEWBORN

The specific resistance of the newborn to infectious disease may be enhanced by vaccination of the dam during pregnancy to stimulate the production of specific antibodies which are concentrated in the colostrum and transferred to the newborn after birth. Vaccination of the dam can provide protection for the neonate against enteric and respiratory disease. Details are given under the specific disease headings in this text. The vaccination of the late fetus in utero stimulates the production of antibody but its practical application has yet to be determined.

#### REVIEW LITERATURE

- Black L, Francis ML, Nicholls MJ. Protecting young domestic animals from infectious disease. *Vet Annu* 1985; 25:46–61.
- Brenner J. Passive lactogenic immunity in calves: a review. *Israel J Vet Med* 1991; 46:1–12.
- Vermunt JJ. Rearing and management of diarrhoea in calves to weaning. *Aust Vet J* 1994; 71:33–41.
- Rogers GM, Capucille DJ. Colostrum management: keeping beef calves alive and performing. *Compend Contin Educ Pract Vet Food Anim Pract* 2000; 22(1):S6–S13.
- Larson RL, Tyler JW, Schultz LG, Tessman RK, Hostetler DE. Management strategies to decrease calf death losses in beef herds. *J Am Vet Med Assoc* 2004; 224:42–48.

#### REFERENCES

- Nowak R. *Appl Anim Behav Sci* 1996; 49:61.
- Ganaba R et al. *Prevent Vet Med* 1995; 24:31.
- Sanderson MW, Dargatz DA. *Prev Vet Med* 2000; 44:97.
- Larson RL et al. *J Am Vet Med Assoc* 2004; 224:42.
- Pence M et al. *Compend Contin Educ Pract Vet Food Anim Pract* 2001; 23(8):S73.
- Quigley JD et al. *J Dairy Sci* 1995; 78:893.
- Wells SJ et al. *Prevent Vet Med* 1996; 29:9.
- Radostits OM, Acres SD. *Can Vet J* 1980; 21:243.

- Edwards SA et al. *Br Vet J* 1982; 138:233.
- Heinrichs AJ. *Compend Contin Educ Pract Vet* 1994; 16:1605.
- Heinrichs AJ. *Compend Contin Educ Pract Vet* 1995; 17:433.
- Lance SE et al. *J Am Vet Med Assoc* 1992; 201:1197.

#### OMPHALITIS, OMPHALOPHLEBITIS AND URACHITIS IN NEWBORN FARM ANIMALS (NAVEL-ILL)

Infection of the umbilicus and its associated structures occurs commonly in newborn farm animals and appears to be particularly common in calves. The umbilical cord consists of the amniotic membrane, the umbilical veins, the umbilical arteries and the urachus. The amniotic membrane of the umbilical cord is torn at birth and gradually the umbilical vein and the urachus close, but they remain temporarily outside the umbilicus. The umbilical arteries retract as far back as the top of the bladder.

In many countries regulations govern the minimal age at which neonatal calves can be shipped or sent to market and slaughter. Commonly this can not legally be done until the calf is in its fifth day of life. The wetness or dryness of the umbilicus is used as a surrogate measure of age in welfare regulations and the requirement is that the umbilical cord at the junction with the abdominal skin should be dry and shriveled. The drying time varies from 1 to 8 days, with variation between breeds and a longer drying period in bull calves. As might be expected, this measure is only an approximate surrogate for age but approximately 90% of calves have dry navels by 4 days of age.<sup>1</sup>

Infection of the umbilicus occurs soon after birth and may result in omphalitis, omphalophlebitis, omphaloarteritis or infection of the urachus, with possible extension to the bladder, causing cystitis. The majority of infections progress to sites beyond the umbilicus.<sup>1</sup> There is usually a **mixed bacterial flora** including *E. coli*, *Proteus* spp., *Staphylococcus* spp., *A. pyogenes*, *Bacteroides* spp., *F. necrophorum* and *Klebsiella* spp.<sup>2,3</sup>

Bacteremia and localization with infection may occur in joints, bone, meninges, eyes, endocardium and end-arteries of the feet, ears and tail. The navel can also be the source of infection leading to septicemia, arthritis and fever of unknown origin in neonates with failure of transfer of passive immunity.<sup>4</sup>

#### Omphalitis

Omphalitis is inflammation of the external aspects of the umbilicus and occurs commonly in calves and other species within 2–5 days of birth and often persists

for several weeks.<sup>5</sup> The umbilicus is enlarged, painful on palpation and may be closed or draining purulent material through a small fistula. The affected umbilicus may become very large and cause subacute toxemia. The calf is moderately depressed, does not suck normally and is febrile. Treatment consists of surgical exploration and excision. A temporary drainage channel may be necessary.

#### Omphalophlebitis

Omphalophlebitis is inflammation of the umbilical veins. It may involve only the distal parts or extend from the umbilicus to the liver. Large abscesses may develop along the course of the umbilical vein and spread to the liver, with the development of a hepatic abscess that may occupy up to one-half of the liver. Affected calves are usually 1–3 months of age and are unthrifty because of chronic toxemia. The umbilicus is usually enlarged with purulent material; however, in some cases the external portion of the umbilicus appears normal-sized. Placing the animal in dorsal recumbency and deep palpation of the abdomen dorsal to the umbilicus in the direction of the liver may reveal a space-occupying mass.

**Ultrasonography** may assist in the diagnosis and can help in formulating a surgical approach.<sup>6,7</sup> Affected calves and foals are inactive, inappetent, unthrifty and may have a mild fever. Parenteral therapy with antibiotics is usually unsuccessful. Exploratory laparotomy and **surgical removal** of the abscess is necessary.<sup>8,9</sup> Large hepatic abscesses are usually incurable unless surgically removed, but the provision of a drain to the exterior and daily irrigation may be attempted if resection is not feasible.

#### Omphaloarteritis

In omphaloarteritis, which is less common, the abscesses occur along the course of the umbilical arteries from the umbilicus to the internal iliac arteries. The clinical findings are similar to those in omphalophlebitis: chronic toxemia, unthriftiness and failure to respond to antibiotic therapy. Treatment consists of surgical removal of the abscesses.

#### Urachitis

Infection of the urachus may occur anywhere along the urachus from the umbilicus to the bladder. The umbilicus is usually enlarged and draining purulent material, but can appear normal. Deep palpation of the abdomen in a dorsocaudal direction from the umbilicus may reveal a space-occupying mass. Extension of the infection to the bladder can result in cystitis and pyuria. **Contrast radiography** of the fistulous tract and the bladder will

reveal the presence of the lesion. The treatment of choice is exploratory laparotomy and surgical removal of the abscesses. Recovery is usually uneventful.

### CONTROL

The control of umbilical infection depends primarily on **good sanitation and hygiene** at the time of birth. The application of drying agents and residual disinfectants such as tincture of iodine is widely practiced. However, there is limited evidence that chemical disinfecting is of significant value. Chlorhexidine is more efficient in reducing the number of organisms than 2% iodine or 1% povidone iodine. High concentrations of iodine (7%) are most effective but are damaging to tissue.<sup>10</sup>

### REFERENCES

1. Hides SJ, Hannah MC. *Aust Vet J* 2005; 83:371.
2. Hathaway SC et al. *NZ Vet J* 1993; 41:166.
3. Goto Y et al. *J Jpn Vet Med Assoc* 2003; 56:528.
4. Vaala WE et al. *J Am Vet Med Assoc* 1988; 193:1273.
5. Virtala AM et al. *J Am Vet Med Assoc* 1996; 208:2043.
6. Ataller GS et al. *J Am Vet Med Assoc* 1995; 206:77.
7. Pokar J. *Prakt Tierarzt* 2004; 85:646.
8. Baxter GM. *Compend Contin Educ Pract Vet* 1989; 11:505.
9. Lewis CA et al. *J Am Vet Med Assoc* 1999; 214:89.
10. Lavan RP. In: *Proceedings of the 14th Conference of the American Association of Equine Practitioners* 1994, 14:37.

## Clinical assessment and care of critically ill newborns

The following discussion focuses on care and treatment of critically ill foals, although the principles are applicable to any species. The increasing availability of secondary and tertiary care for ill newborns has allowed the development of sophisticated care for newborns of sufficient emotional or financial value. This level of care, at its most intensive, requires appropriately trained individuals (both veterinarians and support staff) and dedicated facilities. True intensive care of newborns requires 24-hour monitoring. The following discussion is not a comprehensive guide to intensive care of newborns but is rather an introduction to the general aspects of advanced primary or secondary care. Sophisticated interventions, such as mechanical ventilation and cardiovascular support, are mentioned but not discussed in detail.

### CLINICAL EXAMINATION

Initial assessment of an ill newborn should begin with collection of a detailed history including the length of gestation, health of the dam, parturition and behavior of the newborn after birth,

including the time to stand and to commence nursing activity. Physical examination should be thorough, with particular attention to those body systems most commonly affected. A form similar to that in Figure 3.1 is useful in ensuring that all pertinent questions are addressed and that the physical examination is comprehensive.

Examination of ill neonates should focus on detection of the common causes of disease in this age group: sepsis, either focal or systemic; prematurity or dysmaturity; metabolic abnormalities (such as hypoglycemia or hypothermia); birth trauma; diseases associated with hypoxia; and congenital abnormalities. Detailed descriptions of these conditions are provided elsewhere in this chapter.

### Sepsis

**Sepsis** is an important cause of illness in neonates that can manifest as localized infections without apparent systemic signs, localized infections with signs of systemic illness, or systemic illness without signs of localized infection.

**Localized infections** without signs of systemic illness include septic synovitis or osteomyelitis, or omphalitis. Signs of these diseases are evident on examination of the area affected and include lameness, distension of the joint and pain on palpation of the affected joint in animals with synovitis or osteomyelitis, and an enlarged external umbilicus with or without purulent discharge in animals with infections of the umbilical structures. Specialized imaging, hematological and serum biochemical examinations (see below) are useful in confirming the infection.

**Systemic signs** of sepsis include depression, failure to nurse or reduced frequency of nursing, somnolence, recumbency, fever or hypothermia, tachypnea, tachycardia, diarrhea and colic, in addition to any signs of localized disease. Fever is a specific, but not sensitive, sign of sepsis in foals. The presence of petechia in oral, nasal, ocular or vaginal mucous membranes, the pinna or coronary bands is considered a specific indicator of sepsis, although this has not been documented by appropriate studies. A similar comment applies for injection of the scleral vessels. A scoring system ('the sepsis score') has been developed to aid in the identification of foals with sepsis.<sup>1</sup>

The '**sepsis score**' was developed with the intention of aiding identification of foals with sepsis, and thereby facilitating appropriate treatment. A table for calculation of sepsis score is provided in Table 3.3. Foals with a score of 12 or greater are considered to be septic, with a sensitivity of 94%.<sup>1</sup> However, the sepsis

score, which was widely used for over a decade, was not appropriately evaluated in other clinics until very recently. These recent studies demonstrate that the sepsis score has limited sensitivity (67%, 95% confidence interval (CI) 59–75%) and specificity (76%, 95% CI 68–83%) in foals less than 10 days of age.<sup>2</sup> The associated positive and negative likelihood ratios were 2.76 and 0.43, respectively.<sup>2</sup> Similarly, 49% of 101 foals with positive blood cultures had a sepsis score of 11 or less.<sup>3</sup> The low sensitivity of the sepsis score for detection of sepsis or bacteremia means that many foals with sepsis are incorrectly diagnosed. This is an important shortcoming of the test, as accurate and prompt identification of foals with sepsis is assumed to be important for both prognostication and selection of treatment. The sepsis score might be useful in some situations, but its shortcomings should be recognized when using it to guide treatment or determine prognosis.

### Prematurity and dysmaturity

Detection of **prematurity** is important because it is a strong risk factor for development of other diseases during the immediate postpartum period. The detection of prematurity is often based on the length of gestation. However, the duration of gestation in Thoroughbred horses varies considerably, with 95% of mares foaling after a gestation of 327–357 days<sup>4</sup> – the generally accepted 'average' gestation is 340 days. Ponies have a shorter gestation (333 days, range 315–350 days).<sup>5</sup> Therefore, a diagnosis of prematurity should be based not just on gestational age but also on the results of physical, hematological and serum biochemical examination of the newborn. Factors helping in the determination of prematurity are listed in Table 3.4. Foals that are immature (premature) at birth typically have low birth weight and small body size, a short and silky hair coat and laxity of the flexor and extensor tendons. The cranium is rounded and the pinnae lack tone (droopy ears). The foals are typically weak and have trouble standing, which is exacerbated by laxity of the flexor tendons and periarticular ligaments.

**Dysmature** (postmature) foals are typically large, although they can be thin, and have a long hair coat and flexure tendon contracture. These signs are consistent with prolonged gestation combined with inadequate intrauterine nutrition. Examination of the placenta, either by ultrasonographic examination before birth or by direct examination, including histologic and microbiologic testing, after birth is useful in identifying abnormalities that have significance for the newborn.<sup>5–7</sup>

Table 3.3 Worksheet for calculating a sepsis score for foals less than 12 days of age<sup>1</sup>

Variable	Number of points to assign					Score for this case
	4	3	2	1	0	
<b>1. Historical data</b>						
a. Placentitis, vulvar discharge before delivery, dystocia, sick dam, induced parturition		Present				Absent
b. Gestation length (days)		< 300	300–310	311–330		> 330
<b>2. Clinical examination</b>						
a. Petechiation or scleral injection (nontraumatic)		Marked	Moderate	Mild		None
b. Rectal temperature (°C)			> 38.9	< 37.8		37.9–38.7
c. Hypotonia, convulsions, coma, depression			Marked	Moderate		Mild
d. Anterior uveitis, diarrhea, respiratory distress, swollen joints or open wounds		Present				Absent
<b>3. Hemogram</b>						
a. Neutrophil count (cells × 10 <sup>9</sup> /L)		< 2.0	2.0–4.0 or 8.0–12.0			4.0–8.0
b. Band neutrophils (cells × 10 <sup>9</sup> /L)			> 12			< 0.05
c. Toxic changes in neutrophils	Marked	Moderate	Slight			None
d. Fibrinogen concentration (g/L)			> 6.0	4.1–6.0		4.0
<b>4. Laboratory data</b>						
a. Blood glucose (mmol/L)			< 2.7	2.7–4.4		> 4.4
b. IgG concentration (g/L)	< 2.0	2.0–4.0	4.1–8.0			> 8.0
c. Arterial oxygen tension (Torr)		< 40	40–50		51–70	> 70
d. Metabolic acidosis (base excess < 0)				Present		Absent
<b>Total points for this foal</b>						
<p>To calculate the sepsis score, assign foal a score corresponding to the historical, physical examination and laboratory data included in the above table. A score of 11 or less predicts the absence of sepsis correctly on 88% of cases whereas a score of 12 or higher predicts sepsis correctly in 93% of cases. For foals less than 12 hours of age that have nursed or received colostrum, assign a value of 2 for the serum immunoglobulin score. If the foal has not nursed, assign a value of 4.</p>						

Table 3.4 Criteria to assess stage of maturity of the newborn foal

Criterion	Premature	Full term
<b>Physical</b>		
Gestational age	320 d	Normally > 330 d
Size	Small	Normal or large
Coat	Short and silky	Long
Fetlock	Overextended	Normal extension
<b>Behavior</b>		
First stand	> 120 min	< 120 min
First suck	> 3 h	< 3 h
Suck reflex	Poor	Good
Righting reflexes	Poor	Good
<b>Adrenal activity</b>		
Plasma cortisol values over first 2 h postpartum	Low levels (< 30 ng/mL)	Increasing levels (120–140 ng/mL) at 30–60 min postpartum
Plasma ACTH values over first 2 h postpartum	Peak values (≈ 650 pg/mL) at 30 min postpartum and declining subsequently	Declining values from peak (300 pg/mL at birth)
Response to synthetic ACTH1-24 (short-acting Synacthen), dose 0.125 mg IM	Poor response shown by a 28% increase in plasma cortisol and no changes in neutrophil:lymphocyte ratio	Good response shown by a 208% increase in plasma cortisol and widening of neutrophil:lymphocyte ratio
<b>Hematology</b>		
Mean cell volume (fl)	> 39	< 39
White blood cell count (× 10 <sup>9</sup> /L)	6.0	8.0
Neutrophil:lymphocyte ratio	< 1.0	> 2.0
<b>Carbohydrate metabolism</b>		
Plasma glucose levels over first 2 h postpartum	Low levels at birth (2–3 mmol/L), subsequently declining	Higher levels at birth (4.1 mmol/L), maintained
Plasma insulin levels over first 2 h postpartum	Low levels at birth (8.6 μU/mL), declining	Higher levels at birth (16.1 μU/mL), maintained
Glucose tolerance test (0.5 mg/kg body weight IV)	Slight response demonstrated by a 100% increase in plasma insulin at 15 min post-administration	Clear response demonstrated by a 250% increase in plasma insulin at 5 min post-administration
<b>Renin–angiotensin–aldosterone system</b>		
Plasma renin substrate	Higher and/or increasing levels during 15–60 min postpartum	Low (< 0.6 μg/mL) and declining levels during 15–30 min postpartum
Acid–base status (pH)	< 7.25 and declining	> 7.3 and maintaining or rising
IM, intramuscularly; IV, intravenously.		

## Foal Examination Protocol (age < 1 mon)

The Ohio State University Veterinary Teaching Hospital

Special considerations:  
\_\_\_\_\_  
\_\_\_\_\_  
\_\_\_\_\_

Clinician: \_\_\_\_\_

Student: \_\_\_\_\_

Date: \_\_\_\_\_ Time: \_\_\_\_\_ AM/PM

### History

#### Mare

Age: \_\_\_\_\_ No of previous foals: \_\_\_\_\_ Problems with previous foals? \_\_\_No \_\_\_Yes \_\_\_\_\_

Uterine infections/Vaginal discharge? \_\_\_No \_\_\_Yes \_\_\_\_\_

Illness during pregnancy? \_\_\_No \_\_\_Yes \_\_\_\_\_

Milk dripping? \_\_\_No \_\_\_Yes How long? \_\_\_\_\_

Vaccinations? \_\_\_No \_\_\_Yes What/When? \_\_\_\_\_

Deworming? \_\_\_No \_\_\_Yes When? \_\_\_\_\_

Feeding: \_\_\_\_\_

Breeding date: \_\_\_\_\_ Duration of pregnancy: \_\_\_\_\_ → \_\_\_on term \_\_\_early \_\_\_overdue (\_\_\_\_ days)

Dystocia? \_\_\_No \_\_\_Yes \_\_\_\_\_

Early cord rupture? \_\_\_No \_\_\_Yes \_\_\_\_\_ Premature placental separation? \_\_\_No \_\_\_Yes \_\_\_\_\_

Placenta completely passed? \_\_\_No \_\_\_Yes Condition of placenta: \_\_\_\_\_

Meconium staining? \_\_\_No \_\_\_Yes \_\_\_\_\_

Udder: \_\_\_Normal \_\_\_Abnormal \_\_\_\_\_

Colostrum quality: \_\_\_Normal \_\_\_Low-quality \_\_\_\_\_ Amount: \_\_\_Normal \_\_\_Reduced \_\_\_\_\_

#### Foal

Spontaneous breathing? \_\_\_No \_\_\_Yes \_\_\_\_\_ Time to stand: \_\_\_\_\_ Time to nurse: \_\_\_\_\_

Nursing normally? \_\_\_No \_\_\_Yes \_\_\_\_\_ Colostrum/Milk given? \_\_\_\_\_

Behavior normal? \_\_\_No \_\_\_Yes \_\_\_\_\_ IgG tested? \_\_\_No \_\_\_Yes \_\_\_\_\_

Urination? \_\_\_No \_\_\_Yes \_\_\_\_\_ Meconium passed? \_\_\_No \_\_\_Yes \_\_\_\_\_ Enema given? \_\_\_No \_\_\_Yes \_\_\_\_\_

Medications given? \_\_\_No \_\_\_Yes \_\_\_\_\_

Umbilicus treated? \_\_\_No \_\_\_Yes \_\_\_\_\_

Presenting complaint: \_\_\_\_\_  
\_\_\_\_\_  
\_\_\_\_\_

Previous treatment: \_\_\_\_\_

The Ohio State University  
Form-209046

### Foal Examination Protocol

**Fig. 3.1** Examples of forms used to document and record historical aspects and findings on physical examination of foals less than 1 month of age.

## Physical Examination      Date: \_\_\_\_\_ Time: \_\_\_\_\_ AM/PM

Temperature: \_\_\_\_\_°F    Pulse rate: \_\_\_\_\_/min    Respiratory rate: \_\_\_\_\_/min    Body weight: \_\_\_\_\_ kg / \_\_\_\_\_ lb

### Inspection:

Behavior: \_\_\_\_\_

Signs of prematurity?  no  yes (  Haircoat  Forehead  Ears  Joints  Tendons \_\_\_\_\_ )

Skin and haircoat: \_\_\_\_\_

Body condition: \_\_\_\_\_

Suckle reflex:  good  moderate  weak  none \_\_\_\_\_

Eyes:  normal  Entropion (L)(R)  Uveitis (L)(R)  Corneal ulcer (L)(R) \_\_\_\_\_

### Cardiovascular

Pulse quality:  strong  moderate  weak /  regular  irregular \_\_\_\_\_

Mucous membranes: \_\_\_\_\_ CRT: \_\_\_\_\_ sec.    Skin turgor: \_\_\_\_\_

Jugular veins:  normal  collapsed  distended \_\_\_\_\_ Catheter  left  right

Cardiac auscultation: HR: \_\_\_\_\_ Intensity: \_\_\_\_\_ Rhythm:  regular  irregular \_\_\_\_\_

Murmurs:  no  yes \_\_\_\_\_

### Respiration

Nasal discharge:  no  yes \_\_\_\_\_ Cough:  no  yes \_\_\_\_\_

Lymph nodes:  normal: \_\_\_\_\_ Auscultation:  normal: \_\_\_\_\_

### GI tract

Colic:  no  yes \_\_\_\_\_ GL sounds: \_\_\_\_\_ Abd. distention:  no  yes \_\_\_\_\_

Fecal consistency: \_\_\_\_\_ Digital palpation/Meconium: \_\_\_\_\_

### Urogenital

Umbilicus:  normal \_\_\_\_\_

Urination:  no  yes  straining \_\_\_\_\_ Scrotum/Testes - Vulva/Vagina:  normal \_\_\_\_\_

### Musculoskeletal

Joints:  normal \_\_\_\_\_

Lameness:  no  yes \_\_\_\_\_

Deformations/Angular limb deformities:  no  yes \_\_\_\_\_

### Neurologic:

\_\_\_\_\_ normal \_\_\_\_\_

Seizures:  no  yes \_\_\_\_\_

Senior Student: \_\_\_\_\_ Attending Clinician: \_\_\_\_\_

## Foal Examination Protocol

**Fig. 3.1 (Cont'd)** Examples of forms used to document and record historical aspects and findings on physical examination of foals less than 1 month of age.

(See Prematurity, immaturity and dysmaturity of foals for a complete discussion of this topic.)

### **Hypoxia**

Hypoxia during late gestation, birth or the immediate postpartum period has a

variety of clinical manifestations depending on the tissue or organ most affected. Signs of central nervous system dysfunction, the so-called 'dummy foals' or 'barkers and wanderers' are often assumed to be a result of cerebral hypoxia during birth. Other signs suggestive of

peripartum hypoxia include colic and anuria.

### **Hypoglycemia**

Foals that are hypoglycemic because of inadequate intake, such as through mismothering, congenital abnormalities

or concurrent illness, are initially weak with rapid progression to somnolence and coma.

### DIAGNOSTIC IMAGING

Radiographic and ultrasonographic examination of neonates can be useful in determining maturity and the presence of abnormalities. Prematurity is evident as failure or inadequate ossification of cuboidal bones in the carpus and tarsus. Radiographs of the thorax should be obtained if there is any suspicion of sepsis or pneumonia, because thoracic auscultation has poor sensitivity in detecting pulmonary disease in newborns (see Table 10.2 for definition of radiographic abnormalities in foals). Severity of abnormalities in lungs of foals detected by radiographic examination is related to prognosis, with foals with more severe disease having a worse prognosis for recovery.<sup>8</sup> Abdominal radiographs may be useful in determining the site of gastrointestinal disease (see Foal colic).

**Ultrasonography** is a particularly useful tool for examination of neonates, in large part because their small size permits thorough examination of all major body cavities. Ultrasonography of the umbilical structures can identify omphalitis and abscesses of umbilical remnants<sup>9</sup> and, when available, is indicated as part of the physical examination of every sick neonate.

Examination of the **umbilical structures** can reveal evidence of infection, congenital abnormalities and urachal tears. Examination of the umbilicus can be achieved using a 7.5 MHz linear probe (such as that commonly used for reproductive examination of mares) although sector scanners provide a superior image. Examination of the umbilical structures should include examination of the navel and structures external to the body wall, the body wall, the umbilical stump as it enters the body wall and separates into the two umbilical arteries, the urachus and apex of the bladder, and the umbilical vein. The size and echogenicity of each of these structures should be determined. For foals less than 7 days of age the intra-abdominal umbilical stump should be less than 2.4 cm in diameter, the umbilical vein less than 1 cm and the umbilical arteries less than 1.4 cm (usually < 1 cm). Examination of these structures should be complete: the umbilical vein should be visualized in the umbilical stump and then followed as it courses along the ventral abdominal wall and into the liver; the umbilical arteries should be visualized in the umbilical stump and then as they separate from that structure and course over the lateral aspects of the bladder; the urachus should be visualized from

the external umbilical stump through the body wall and as it enters the bladder.

Abnormalities observed frequently in the umbilical structures include overall swelling, consistent with omphalitis, gas shadows in the urachus or umbilical stump, which are indicative of either a patent urachus allowing entry of air or growth of gas-producing bacteria, and the presence of flocculent fluid in the urachus, vein or artery, which is consistent with pus. Urachal tears can be observed, especially in foals with uroperitoneum.

Ultrasonographic examination of the **abdomen** is useful in identifying abnormalities of gastrointestinal function and structure, including intestinal distension or thickening of intestinal wall. Intussusceptions are evident as 'donut' lesions in the small intestine. Gastric outflow obstruction should be suspected in foals with a distended stomach evident on ultrasonographic examination of the abdomen. Uroperitoneum is readily apparent as excessive accumulation of clear fluid in the abdomen. Hemorrhage into the peritoneum can be detected as accumulation of echogenic, swirling fluid. Accumulation of inflammatory fluid, such as in foals with ischemic intestine, is detected by the presence of flocculent fluid.

Ultrasonographic examination of the **chest** can reveal the presence of pleural abnormalities, consolidation of lung (provided that the consolidated lung is confluent with the pleura), accumulation of fluid in the pleural space (hemorrhage secondary to birth trauma and fractured ribs, inflammatory fluid in foals with pleuritis), pneumothorax (usually secondary to lung laceration by a fractured rib<sup>10</sup>) or congenital abnormalities of the heart.

Advanced imaging modalities, such as **computed tomography (CT) and magnetic resonance imaging (MRI)**, are available at referral centers and are practical in foals and other neonates because of the small size of the animals. These modalities are useful in detection of intrathoracic and intra-abdominal abnormalities, including abscessation, gastrointestinal disease and congenital abnormalities.<sup>11,12</sup> MRI is particularly useful for diagnosis of diseases of the brain and spinal cord.<sup>13</sup>

### CLINICAL PATHOLOGY

#### Serum immunoglobulin concentration

Serum immunoglobulin G (IgG) concentration, or its equivalent, must be measured in every ill or at-risk newborn and should be repeated every 48–96 hours in critically ill neonates. A variety of tests are available for rapid detection of failure of transfer of

passive immunity in foals<sup>14–17</sup> and calves.<sup>18</sup> While measurement of serum IgG concentration is ideally performed by the gold standard test, a radial immunodiffusion, this test requires at least 24 hours to run, whereas the stall side or chemistry analyzer tests can be run in a few minutes. The sensitivity and specificity of a number of these rapid tests has been determined. Overall, most tests have high sensitivity (> 80%), meaning that the few foals that have low concentrations of IgG are missed, but poor specificity (50–70%), meaning that many foals that have adequate concentrations of immunoglobulin are diagnosed as having inadequate concentrations.<sup>15–17</sup> The exact sensitivity and specificity depends on the test used and the concentration of immunoglobulin considered adequate. The high sensitivity and low specificity of most of the available rapid tests result in a number of foals that do not need a transfusion receiving one. However, this error is of less importance than that of foals that should receive a transfusion not receiving one.

Serum or plasma concentrations of IgG should be measured after approximately 18 hours of age, and preferably before 48 hours of age – the earlier failure of transfer of passive immunity is recognized the better the prognosis for the foal. Foals that ingest colostrum within the first few hours of birth have minimal increases in serum IgG concentration over that achieved at 12 hours of age,<sup>19</sup> suggesting that measurement of serum IgG concentration as early as 12–18 hours after birth is appropriate. This early measurement of serum IgG concentration could be especially important in high-risk foals. The oldest age at which measurement of serum IgG is useful in foals is uncertain, but depends on the clinical condition of the foal. Typically, immunoglobulin concentrations of foals that have adequate concentrations of IgG within the first 24 hours reach a nadir at about 6 weeks of age and then rise to concentrations similar to adults over the next 2–3 months.

#### Hematology

It is important to recognize that the hemogram of neonates differs from that of older animals (Table 3.5), as these differences can impact on the clinical assessment of the animal. The hematologic and serum biochemical values of foals and calves can vary markedly during the first days and weeks of life and it is important that these maturational changes are taken into account when assessing results of hematological or serum biochemical examination of foals. Hematological examination can reveal evidence of hemolytic

Table 3.5 Hematological values of normal foals and calves

Variable	Foals			Calves		
	< 12 h	1 week	1 month	24 h	48 h	3-4 weeks
PCV (%)	42.5 ± 3.4	35.3 ± 3.3	33.9 ± 3.5	34 ± 6	32 ± 6	35 ± 3
(L/L)	0.43 ± 0.03	0.35 ± 0.03	0.33 ± 0.04	0.34 ± 0.06	0.32 ± 0.06	0.35 ± 0.03
Plasma protein (g/dL)	6.0 ± 0.8	6.4 ± 0.6	6.1 ± 0.5	6.4 ± 0.7	6.4 ± 0.7	6.4 ± 0.3
(g/L)	60 ± 8	64 ± 6	61 ± 5	64 ± 7	64 ± 7	64 ± 3
Fibrinogen (mg/dL)	216 ± 70	290 ± 70	400 ± 130	290 ± 105	335 ± 120	285 ± 145
(g/L)	2.16 ± 0.7	2.90 ± 0.7	4.00 ± 1.30	2.90 ± 1.05	3.35 ± 1.20	2.85 ± 1.45
Hemoglobin (g/dL)	15.4 ± 1.2	13.3 ± 1.2	12.5 ± 1.2	10.9 ± 2.1	10.5 ± 1.8	11.3 ± 1.02
(g/L)	154 ± 12	130 ± 12	125 ± 12	109 ± 21	105 ± 18	113 ± 10
Red blood cells (× 10 <sup>6</sup> /μL)	10.7 ± 0.8	8.8 ± 0.6	9.3 ± 0.8	8.17 ± 1.34	7.72 ± 1.09	8.86 ± 0.68
(10 <sup>12</sup> /L)	10.7 ± 0.8	8.8 ± 0.6	9.3 ± 0.8	8.17 ± 1.34	7.72 ± 1.09	8.86 ± 0.68
MCV (fL)	40 ± 2	39 ± 2	36 ± 1	41 ± 3	41 ± 3	39 ± 2
MCHC (g/dL)	36 ± 2	38 ± 1	37 ± 1	32.1 ± 0.8	32.6 ± 1.0	32.8 ± 1.6
(g/L)	360 ± 20	380 ± 10	370 ± 10	320 ± 8	326 ± 10	328 ± 16
MCH (pg)	14 ± 1	15 ± 1	14 ± 1			
Nucleated cells (10 <sup>6</sup> /μL)	9500 ± 2500	9860 ± 1800	8150 ± 2030	9810 ± 2800	7760 ± 1950	8650 ± 1690
(10 <sup>9</sup> /L)	9.5 ± 2.5	9.86 ± 1.80	8.15 ± 2.03	9.81 ± 2.80	7.76 ± 1.95	8.65 ± 1.69
Neutrophils (10 <sup>6</sup> /μL)	7950 ± 2200	7450 ± 1550	5300 ± 200	6500 ± 2660	4110 ± 2040	2920 ± 1140
(10 <sup>9</sup> /L)	7.95 ± 2.20	7.45 ± 1.55	5.30 ± 0.20	6.50 ± 2.66	4.11 ± 2.04	2.92 ± 1.14
Band neutrophils (10 <sup>6</sup> /μL)	24 ± 40	0	4 ± 13	310 ± 460	210 ± 450	10 ± 30
(10 <sup>9</sup> /L)	0.02 ± 0.04	0	0.00 ± 0.01	0.31 ± 0.46	0.21 ± 0.45	0.01 ± 0.03
Lymphocytes (10 <sup>6</sup> /μL)	1350 ± 600	2100 ± 630	2460 ± 450	2730 ± 820	2850 ± 880	5050 ± 800
(10 <sup>9</sup> /L)	1.35 ± 0.6	2.10 ± 0.63	2.46 ± 0.45	2.73 ± 0.82	2.85 ± 0.88	5.05 ± 0.80
Thrombocytes (10 <sup>3</sup> /μL)	266 ± 103	250 ± 70	300 ± 80			
(10 <sup>9</sup> /L)	266 ± 103	250 ± 70	300 ± 80			
Serum Fe (μg/dL)	380 ± 60	175 ± 80	138 ± 60		71 ± 60	127 ± 60
(mg/L)	3.80 ± 0.6	1.75 ± 0.8	1.38 ± 0.6		0.7 ± 0.6	1.27 ± 0.6
TIBC (μg/dL)	440 ± 50	385 ± 80	565 ± 65		420 ± 67	
(mg/L)	4.40 ± 0.5	3.85 ± 0.8	5.65 ± 0.65		4.2 ± 0.7	
UIBC (μg/dL)	55 ± 40	210 ± 100	430 ± 85			
(mg/L)	0.55 ± 0.4	2.10 ± 1.00	4.30 ± 0.85			
Iron saturation (%)	87 ± 9	46 ± 20	25 ± 12			

Sources: Harvey JW et al. *Equine Vet J* 1984; 16:347; Adams R et al. *Am J Vet Res* 1992; 53:944; Tennant B et al. *Cornell Vet* 1975; 65:543.

disease, bacterial or viral infection, or prematurity/dysmaturity (Table 3.4). Repeated hemograms are often necessary to monitor for development of sepsis and responses to treatment.

Foals with **sepsis** can have a leukocyte count in the blood that is low, within the reference range or high.<sup>20</sup> Approximately 40% of foals with sepsis have blood leukocyte counts that are below the reference range. Most foals with sepsis (approximately 70%) have segmented neutrophil counts that are below the reference range, with fewer than 15% of foals having elevated blood neutrophil counts. Concentrations of band cells in blood are above the reference range in almost all foals with sepsis. Some foals born of mares with placentitis have a very pronounced mature neutrophilia without other signs of sepsis – these foals typically have a good prognosis. Lymphopenia is present in foals with equine herpesvirus-1 septicemia or Arabian foals with severe combined immunodeficiency. Thrombocytopenia occurs in some foals with sepsis.<sup>21</sup> Hyperfibrinogenemia is common in foals that have sepsis, although the concentration might not be above the reference range in foals examined early in the disease. Hyperfibrinogenemia is com-

mon in foals born of mares with placentitis, and reflects systemic activation of the inflammatory cascade even in foals that have no other evidence of sepsis. Serum amyloid A concentrations are above 100 mg/L in foals with sepsis.<sup>22</sup> Septic foals also have blood concentrations of proinflammatory cytokines that are higher than those in healthy foals.<sup>23</sup> Indices of coagulation are prolonged in foals with sepsis, and concentrations of antithrombin and protein C antigen in plasma are lower than in healthy foals.<sup>23</sup> These abnormalities indicate that coagulopathies are common in septic foals.

**Prematurity** is associated with a low neutrophil:lymphocyte ratio (< 1.5:1) in blood and a red cell macrocytosis (Table 3.4).<sup>24</sup> A neutrophil:lymphocyte ratio above 2:1 is considered normal. Premature foals that are not septic can have low blood neutrophil counts but rarely have immature neutrophils (band cells) or toxic changes in neutrophils.

#### Serum biochemistry

Care should be taken in the interpretation of the results of serum biochemical examinations because normal values for newborns are often markedly different to those of adults, and can change rapidly during

the first days to weeks of life (Table 3.6). Serum biochemical examination can reveal electrolyte abnormalities associated with renal failure, diarrhea and sepsis. Elevations in serum bilirubin concentration or serum enzyme activities may be detected. As a minimum, blood glucose concentrations should be estimated using a chemical strip in depressed or recumbent newborns.

Markedly elevated serum **creatinine** concentrations are not uncommonly observed in foals with no other evidence of renal disease. The elevated serum creatinine in these cases is a consequence of impaired placental function during late gestation, with the consequent accumulation of creatinine (and probably other compounds). In foals with normal renal function, which most have, the serum creatinine concentration should decrease to 50% of the initial high value within 24 hours. Other causes of high serum creatinine concentration that should be ruled out are renal failure (dysplasia, hypoxic renal failure) and postrenal azotemia (uroperitoneum).

**Sepsis** is usually associated with hypoglycemia, although septic foals can have normal or elevated blood glucose concentrations. Hypoglycemia is attributable

Table 3.6 Serum biochemical values of normal foals and calves

Variable	Foals			Calves		
	< 12 h	1 week	1 month	24 h	48 h	3 weeks
Na <sup>+</sup> (mEq/L) (mmol/L)	148 ± 8	142 ± 6	145 ± 4	145 ± 7.6	149 ± 8.0	140 ± 6
K <sup>+</sup> (mEq/L) (mmol/L)	4.4 ± 0.5	4.8 ± 0.5	4.6 ± 0.4	5.0 ± 0.6	5.0 ± 0.6	4.9 ± 0.6
Cl (mEq/L) (mmol/L)	106 ± 6	102 ± 4	103 ± 3	100 ± 4	101 ± 5.0	99 ± 4
Ca <sup>2+</sup> (mg/dL)	12.8 ± 1	12.5 ± 0.6	12.2 ± 0.6	12.3 ± 0.2	12.3 ± 0.3	9.4 ± 0.6
(mmol/L)	3.2 ± 0.25	3.1 ± 0.15	3.05 ± 0.15	3.1 ± 0.1	3.1 ± 0.1	2.3 ± 0.2
PO <sub>4</sub> <sup>-</sup> (mg/dL)	4.7 ± 0.8	7.4 ± 1.0	7.1 ± 1.1	6.9 ± 0.3	7.6 ± 0.2	7.1 ± 6.4
(mmol/L)	1.52 ± 0.26	2.39 ± 0.32	2.29 ± 0.36	2.3 ± 0.1	2.5 ± 0.1	2.3 ± 1.8
Total protein (g/dL)	5.8 ± 1.1	6.0 ± 0.7	5.8 ± 0.5	5.6 ± 0.5	6.0 ± 0.7	6.5 ± 0.5
(g/L)	58 ± 11	60 ± 7	58 ± 5	56 ± 5	60 ± 7	65 ± 5
Albumin (g/dL)	3.2 ± 0.3	2.9 ± 0.2	3.0 ± 0.2			
(g/L)	32 ± 3	29 ± 2	30 ± 2			
Creatinine (mg/dL)	2.5 ± 0.6	1.3 ± 0.2	1.5 ± 0.2			
(μmol/L)	221 ± 53	115 ± 18	133 ± 18			
Urea nitrogen (mg/dL)	19.7 ± 4.4	7.8 ± 3.4	9.0 ± 3.0	12.6 (7.1–21.2)		
(mmol/L)	3.4 ± 1.6	1.6 ± 0.6	1.7 ± 0.5	2 (1.5–3.6)		
Glucose (mg/dL)	144 ± 30	162 ± 19	162 ± 22	130 ± 27	114 ± 19	70 (52–84)
(mmol/L)	8.0 ± 1.6	9.0 ± 1.0	9.0 ± 1.2	7.23 ± 1.5	6.34 ± 1.1	3.9 (2.9–4.7)
Total bilirubin (mg/dL)	2.6 ± 1.0	1.5 ± 0.4	0.7 ± 0.2	< 2.5	< 0.9	< 0.6
(μmol/L)	45 ± 17	26 ± 6	12 ± 4	< 42	< 15	< 10
Direct bilirubin (mg/dL)	0.9 ± 0.1	0.5 ± 0.2	0.3 ± 0.2	< 0.6	< 0.3	< 0.3
(μmol/L)	15 ± 2	8.5 ± 3	5 ± 3	< 10	< 5	< 5
GGT (IU/L)	47.5 ± 21.5	49.1 ± 21.2		890 ± 200	600 ± 180	70 ± 10
ALK (IU/L)	3040 ± 800	1270 ± 310	740 ± 240	< 1150	< 1000	< 770
AST (IU/L)	199 ± 57	330 ± 85	340 ± 55	< 60	< 33	< 32

Values are mean ± standard deviation.

ALK, alkaline phosphatase; AST, aspartate aminotransferase; GGT, gammaglutamyl transpeptidase.

Sources: Bauer JE et al. *Equine Vet J* 1984; 16:361; Pearson EG et al. *J Am Vet Med Assoc* 1995; 207:1466; Jenkins SJ et al. *Cornell Vet* 1982; 72:403; Dalton RG. *Br Vet J* 1967; 123:48; Wise GH et al. *J Dairy Sci* 1947; 30:983; Diesch TJ et al. *NZ Vet J* 2004; 52:256; Patterson WH, Brown CM. *Am J Vet Res* 1986; 47:2461; Thompson JC, Pauli JV. *NZ Vet J* 1981; 29:223

to failure to nurse whereas hyperglycemia indicates loss of normal sensitivity to insulin. Indicators of renal, hepatic or cardiac (troponin) damage can increase in foals with sepsis causing organ damage or failure.<sup>25</sup> Foals with sepsis tend to have elevated concentrations of cortisol in serum.

**Prematurity** is associated with low concentrations of cortisol in plasma or serum and minimal increase in response to intramuscular administration of 0.125 mg of exogenous ACTH (corticotropin).<sup>26</sup> Plasma cortisol concentration of normal, full-term, foals during the first 24 hours of life increases from a baseline value of approximately 40 ng/mL to over 100 ng/mL 60 minutes after ACTH administration, whereas plasma cortisol concentrations in premature foals do not increase from values of slightly less than 40 ng/mL.<sup>26</sup> At 2 and 3 days of age, plasma cortisol concentrations of full-term foals increase twofold after ACTH administration, albeit from a lower resting value, but do not increase in premature foals. Blood glucose concentrations of premature foals are often low, probably because of inability to nurse.

### Blood gas

Arterial blood pH, PCO<sub>2</sub> and PO<sub>2</sub> should be measured to determine the newborn's acid-base status and the adequacy of

respiratory function. Foals with hypoxemia are five times more likely to have pulmonary radiographic abnormalities.<sup>27</sup> Prolonged lateral recumbency of foals compromises respiratory function, and arterial blood samples should be collected with the foal in sternal recumbency. Repeated sampling may be necessary to detect changes in respiratory function and to monitor the adequacy of oxygen supplementation or assisted ventilation.

### Blood culture

Identification of causative organisms of sepsis in foals can aid in prognostication and potentially in selection of therapy, although there does not appear to be a relation between antimicrobial sensitivity of organisms isolated from blood, as determined by Kirby-Bauer testing, and survival of foals. Anaerobic and aerobic blood cultures should be performed as early in the disease process as possible, and preferably before initiation of antibiotic treatment, although antimicrobials should not be withheld from a newborn with confirmed or suspected sepsis in order to obtain a result from blood culture. Strict aseptic technique should be used when collecting blood for culture. Blood cultures should also be collected if there is a sudden deterioration in the newborn's condition.

Gram-negative enteric bacteria are the most common isolates from blood of newborn foals, with *E. coli* the most common isolate.<sup>3</sup> *A. equuli* is also a common isolate from foals. There are important differences in diseases produced by the various organisms, with foals with *A. equuli* septicemia being twice as likely to die, seven times more likely to have been sick since birth, six times more likely to have diarrhea, five times more likely to have a sepsis score of more than 11 and three times more likely to have pneumonia than foals with sepsis associated with other bacteria.<sup>3</sup>

### Other body fluids

Synovial fluid should be submitted for aerobic and anaerobic culture, Gram stain and cytological examination when signs of synovitis, such as lameness, joint effusion or joint pain are present.

Analysis of cerebrospinal fluid (CSF) is indicated in newborns with signs of neurologic disease. Samples of CSF should be submitted for cytological examination, measurement of total protein concentration, Gram stain and bacterial culture.

Urinalysis may provide evidence of renal failure (casts) or urinary tract infection (white blood cells).

Abdominal fluid should be collected in foals with abdominal pain or distension



and should be submitted for cytological examination and, if uroperitoneum is suspected, measurement of creatinine concentration.

### TREATMENT

The principles of care of the critically ill newborn farm animal are that:

- The newborn should be kept in a sanitary environment to minimize the risk of nosocomial infections
- Systemic supportive care should be provided to maintain homeostasis until the newborn is capable of separate and independent existence
- There should be frequent and comprehensive re-evaluations of all body systems in order to detect signs of deterioration and allow early correction
- Provision should be made to ensure adequate passive immunity to reduce the risk of secondary infections or to treat existing infections. Transfer of passive immunity should be evaluated using laboratory methods that measure serum or plasma immunoglobulin G concentration.

The level of care provided depends upon the value of the animal and the available facilities, personnel and expertise. Newborns of limited financial worth are usually treated on the farm whereas valuable foals and calves can be referred for specialist care. Referral of sick neonates to institutions and practices with expertise in provision of critical care to newborns should be timely and prompt and, when necessary, should be recommended on the first visit.

### Nursing care

The sophistication of care for critically ill newborns depends on the facilities and personnel available, with intensive management requiring dedicated facilities and trained personnel available 24 hours a day. The minimum requirement for providing basic care of ill newborns is a sanitary area in which the newborns can be protected from environmental stress. Often this means separating the newborn from its dam.

Excellent nursing care is essential for maximizing the likelihood of a good outcome. Critically ill animals might benefit from constant nursing care. Strict attention must be paid to maintaining the sanitary environment in order to minimize the risk of nosocomial infections. The newborn should be kept clean and dry and at an ambient temperature in its thermoneutral zone. Bedding should prevent development of decubital ulcers. Foals should be maintained in sternal recumbency, or at least turned every

2 hours, to optimize their respiratory function.

### Correction of failure of transfer of passive immunity

Colostrum immunoglobulin

Ideally, adequate transfer of passive immunity is achieved by the newborn nursing its dam and ingesting an adequate amount of colostrum containing optimal concentrations of immunoglobulins, principally IgG (IgGb) in foals. Foals need approximately 2 g of IgG per kilogram of body weight to achieve a plasma concentration of 2000 mg/dL (20 g/L), therefore a 45 kg foal needs approximately 90 g of IgG to attain a normal serum IgG concentration (or approximately 40 g to achieve a serum IgG concentration of 800 mg/dL (8 g/L)). Assuming that colostrum contains on average 10 000 mg/dL (100 g/L), foals must ingest at least 1 L of colostrum to obtain sufficient immunoglobulin. Because colostrum IgG concentration varies considerably (from 2000–30 000 mg/dL), specific recommendations regarding the quantity of colostrum to be fed to neonatal foals cannot be made with certainty. However, colostrum with a specific gravity of more than 1.060 has an IgG concentration of more than 3000 mg/dL (30 g/L),<sup>28</sup> suggesting that foals should ingest at least 1.5 L to achieve serum IgG concentrations above 800 mg/dL (8 g/L).

Critical plasma IgG concentrations in foals

There is some debate as to what constitutes a critical serum or plasma IgG concentration. Foals that ingest an adequate amount of colostrum typically have serum immunoglobulin concentrations during the first week of life greater than approximately 2000 mg/dL (20 g/L).<sup>29–31</sup> Both 400 mg/dL (4 g/L) and 800 mg/dL (8 g/L) have been recommended as concentrations below which foals should be considered to have increased likelihood of contracting infectious disease. However, on a well-managed farm the serum IgG concentration was not predictive of morbidity or mortality amongst foals, suggesting that serum immunoglobulin concentration in some populations of foals is not an important risk factor for infectious disease.<sup>32</sup> The foals in this study were from an exceptionally well-managed farm. Other researchers have found that foals with serum IgG concentration below 800 mg/dL (8 g/L) are at markedly increased risk of subsequent development of infectious disease, including sepsis, pneumonia and septic arthritis.<sup>33,34</sup> It is likely that there is no single concentration of IgG in serum that is protective in all situations and the concentration of IgG in serum that is desirable in an individual

foal depends on the risk factors for infectious disease of that foal. Our opinion is that a minimum serum IgG in foals free of disease and housed in closed bands on well-managed farms is 400 mg/dL (4 g/L). For foals at increased risk of disease, for instance those on large farms with frequent introduction of animals and foals that are transported or housed with foals with infectious disease, the minimum advisable serum IgG concentration is 800 mg/dL (8 g/L). Foals that have infectious disease should have serum IgG concentrations of at least 800 mg/dL and it might be advantageous for these foals to have even higher values, as indicated by the enhanced survival of foals with septic disease administered equine plasma regardless of their serum IgG concentration.<sup>35</sup> This therapeutic advantage could be because of the additional IgG, or because of other factors included in the plasma. Transfusion of plasma to sick foals improves neutrophil function, an important advantage given that oxidative burst activity of neutrophils from septic foals is reduced compared to that in healthy foals.<sup>36</sup>

### Plasma transfusion

The ability of foals to absorb macromolecules, including immunoglobulins, declines rapidly after birth, being 22% of that at birth by 3 hours of age, and 1% of that at birth by 24 hours of age.<sup>37</sup> Consequently, by the time that failure of transfer of passive immunity is recognized it is no longer feasible to increase serum IgG concentrations by feeding colostrum or oral serum products. Foals should then be administered plasma or serum intravenously. The **amount of plasma** or serum to be administered depends on the target value for serum IgG concentration and the initial serum IgG concentration in the foal. For each gram of IgG administered per kilogram of body weight of the foal, serum IgG concentration increases by approximately 8.7 mg/dL (0.87 g/L) in healthy foals and 6.2 mg/dL (0.62 g/L) in sick foals.<sup>38</sup> To achieve serum IgG concentrations above 800 mg/dL (8 g/L) in foals with serum IgG concentrations below 400 mg/dL (4 g/L), they should be administered 40 mL/kg of plasma containing at least 20 g/L of IgG. Similarly foals with serum IgG concentrations above 400 mg/dL (4 g/L) but below 800 mg/dL (8 g/L) should be administered 20 mL/kg of plasma. For 45 kg foals, these recommendations translate to administration of 1 or 2 L of plasma, respectively.

The ideal product for transfusion into foals with failure of transfer of passive immunity is **fresh frozen plasma** harvested from horses that are Aa and Qa

antigen-negative and that do not have antibodies against either or both of these red blood cell antigens (see Neonatal isoerythrolysis). The donor horses should have been vaccinated against the common diseases of horses and have tested negative for equine infectious anemia. Good-quality commercial products specify the minimum concentration of IgG in the plasma. Concentrated serum products that do not need to be frozen until use are available. These are much more convenient for field use than are plasma products that must be frozen until immediately before transfusion. However, the IgG concentration of these products is often not specified, and the manufacturer's recommendations for dosing often result in administration of inadequate amounts of immunoglobulin. Serum products can produce adequate concentrations of IgG in foals, but the dose is usually two to three times that recommended by the manufacturer. An adequate dose of concentrated serum products is approximately 1 L for some products.<sup>39</sup> The crucial point is that it is not the volume of plasma or serum that is administered that is important, but rather the quantity of immunoglobulin delivered to the foal. A total of 20–25 g of IgG is required to raise the serum IgG concentration of a 50 kg foal by 400 mg/dL (4 g/L).<sup>39</sup>

**Plasma** should be administered intravenously – oral administration is likely to be wasteful, especially in foals more than a few hours old. Frozen plasma should be thawed at room temperature or by immersion in warm (< 100°F, 37°C) water. Thawing by immersion in water at temperatures higher than body temperature can cause denaturation and coagulation of proteins with loss of efficacy of transfused immunoglobulins. Plasma should never be thawed or warmed using a microwave, as this denatures the proteins.

**Administration of plasma** should be intravenous – intraperitoneal administration, such as used in pigs or small ruminants, has not been investigated in foals. The thawed plasma should be administered through a jugular catheter using a blood administration set containing a filter (160–270 µm mesh) to prevent infusion of particulate material. Strict asepsis should be used. The foal should be adequately restrained for the procedure, with some active foals needing moderate tranquilization. Premedication with antihistamines or nonsteroidal anti-inflammatory drugs is usually not necessary. The plasma should be infused slowly at first, with the first 20–40 mL administered over 10 minutes. During this period the foal should be carefully observed for signs of transfusion reaction,

which is usually evident as restlessness, tachycardia, tachypnea, respiratory distress, sweating or urticaria. If these signs are observed the transfusion should be stopped and the foal should be re-evaluated and treated if necessary. If no transfusion reactions are noted during the first 10 minutes, the infusion can then be delivered at 0.25–1.0 mL/kg/min (i.e. about 1 L/h for a 50 kg foal). Rapid infusion can result in acute excessive plasma volume expansion with the potential for cardiovascular and respiratory distress.

Serum IgG concentration should be measured after the infusion to ensure that an adequate concentration of IgG has been achieved. Serum IgG can be measured as early as 20 minutes after the end of the transfusion.<sup>39</sup>

### Nutritional support

Provision of adequate nutrition is essential to the recovery of ill newborns. Newborn foals have estimated energy requirements of 500–625 (kJ/kg)/d (120–150 (kcal/kg)/d) and consume approximately 20% of their body weight as milk per day. The best food for newborns is the dam's milk and newborns that are able to do so should be encouraged to nurse the dam. However, if the foal is unable to nurse or the dam is not available, then good-quality milk substitutes should be used. Soy and other plant-protein-based milk replacers are not suitable for newborns. Commercial products formulated for foals, calves and lambs are available. Human enteral nutrition products supplying 0.7–1 kcal/mL (2.8–4.1 kJ/mL) can also be used for short-term (several days to a week) support of foals.

It is preferable to provide enteral, rather than parenteral, nutrition to ill newborns with normal or relatively normal gastrointestinal function. Sick neonatal foals should initially be fed 10% of their body weight as mare's milk, or a suitable replacer, every 24 hours, divided into hourly or 2-hourly feedings. If the foal does not develop diarrhea or abdominal distension, then the amount fed can be increased over a 24–48-hour period to 20–25% of the foal's body weight (or 150 (kcal/kg)/day; 620 (kJ/kg)/day). Newborns can be fed by nursing a bottle or bucket or via an indwelling nasogastric tube such as a foal feeding tube, stallion catheter, human feeding tube or enema tube. Every attempt should be made to encourage the newborn to nurse its dam as soon as the newborn can stand. Adequacy of nutrition can be monitored by measuring blood glucose concentrations and body weight.

**Parenteral nutrition (PN)** can be provided to newborns that are unable to

be fed by the enteral route. This can be achieved by administration of various combinations of solutions containing glucose (dextrose), amino acids and fat. A commercial product that does not include lipid has been used successfully for up to 12 days in foals. One product that has been used successfully for foals is a solution of amino acids (5%), dextrose (25%) and electrolytes (Clinimix E, Baxter Healthcare Corporation, Deerfield, IL). Lipid emulsion is not added to the preparation. Additional multivitamin supplements including calcium gluconate (provided 2.5 mmol/L), magnesium sulfate (6 mEq/L), B vitamin complex (thiamine 12.5 mg/L; riboflavin 2 mg/L; niacin 12.5 mg/L; pantothenic acid 5 mg/L; pyridoxine 5 mg/L; cyanocobalamin 5 µg/L), and trace elements (zinc 2 mg/L; copper 0.8 mg/L; manganese 0.2 mg/L; chromium 8 µg/L) are added.<sup>40</sup> Administration is through a catheter, a single-lumen 14-gauge over-the-wire catheter (Milacath), inserted in the jugular vein with its tip placed in the cranial vena cava. A double-T extension set is used to allow concurrent constant rate infusion of isotonic crystalloid fluids and intravenous administration of medication in one line and PN solution in the other. An infusion pump is used for continuous-rate infusion of the solutions. The PN solution should be prepared under aseptic conditions just prior to administration and used for only a period of 24 hours after preparation. A 0.22 µm filter is included in the administration line to remove all bacteria, glass, rubber, cellulose fibers and other extraneous material in the PN solution. The filters and administration sets are changed with each new bag of PN solution.

The rate of PN infusion is determined based on the weight and physical and metabolic condition of the foal. The general protocol is based on the assumption that sick foals expend approximately 50 kcal/kg body weight per day (basal rate).<sup>41</sup> The PN is started at half the basal rate for 12 hours, increasing to the basal rate over 24–48 hours, and then in some foals increased slowly to 75 (kcal/kg)/d if tolerated by the foal. The clinical condition of the foal is assessed frequently. Blood glucose concentrations should be measured every 6–8 hours during the introduction and weaning of PN until the blood glucose concentration is stabilized. Insulin can be administered during hyperglycemic crises (>>250 mg/dL) at a dose of 0.1–0.4 U/kg regular insulin intramuscularly, but this is rarely needed. When a constant rate of PN is achieved glucose concentrations should be measured every 8–12 hours, depending on the clinical condition of the foal. Foals

are weaned off the PN as their clinical condition improves and enteral feeding is gradually increased. The rate of PN is halved every 4–12 hours if blood glucose concentration is stable until half the basal rate was obtained, at which time the infusion is discontinued if the foal is bright, alert and nursing well.

PN is supplemented with isotonic fluid therapy administered intravenously. The fluid rate and composition are determined based on clinical condition, packed cell volume, total protein and serum electrolyte concentrations (Na, Cl, Ca, K and HCO<sub>3</sub>). The composition and rate are adjusted to maintain normal hydration, and electrolyte and acid–base status. During the period that foals receive PN, enteral feeding is initially withdrawn and the foals are muzzled or separated from the mare. Beginning 24 hours after the institution of PN, 20–40 mL of mare's milk ('trophic' feeding) is administered enterally every 4 hours. The trophic feeding provides nutrition to enterocytes and stimulates production of lactase in the small intestine in preparation for resumption of enteral feeding. As the foals are weaned off the PN, enteral feedings are gradually increased from small trophic feeding every 4 hours to

allowing the foal to nurse from the mare for 2–5 minutes every 2 hours and eventually unrestricted nursing from the mare.

#### Antimicrobial treatment

Normal newborns are at risk of acquiring life-threatening bacterial infections, and the risk increases when they do not ingest adequate colostrum in a timely fashion or are subjected to environmental stresses (see Neonatal infection). Newborns in which bacterial infection is suspected and those at high risk of developing an infection, such as sick newborns with failure of transfer of passive immunity, should be administered antimicrobials. Antimicrobial therapy should not be delayed pending the results of bacterial culture and antimicrobial sensitivity testing.

The choice of antimicrobial is determined by the likely infecting agent and clinical experience with antimicrobial susceptibility of local strains of pathogens. In general, broad-spectrum antimicrobials are chosen because it is almost impossible to predict, based on clinical signs, the nature of the infecting agent and its antimicrobial susceptibility. Although *Streptococcus* spp. were historically reported

to be the cause of most infections in neonatal foals, currently infections of neonatal foals are usually due to Gram-negative organisms including *E. coli*, *Klebsiella* spp. and *Salmonella* spp.<sup>3</sup> Because of the wide variety of infecting agents and their varying antimicrobial susceptibility, it is possible to make only general recommendations for antimicrobial therapy of neonates. A frequently used antimicrobial regimen is an aminoglycoside (gentamicin or, more commonly, amikacin) and penicillin.<sup>42</sup> Some commonly used drugs and their doses are listed in Table 3.7. Dosage of antimicrobials in foals differs somewhat from that of adults, and the pharmacokinetics of drugs in normal foals are often different from those of the same drug in sick foals.<sup>43,44</sup> Consequently, higher dosages administered at prolonged intervals are often indicated in sick foals, especially when concentration-dependent drugs such as the aminoglycosides are used.<sup>43,44</sup>

The response to antimicrobial therapy should be monitored, using physical examination and clinical pathology data, on at least a daily basis. Failure to improve should prompt a reconsideration of the therapy within 48–72 hours, and a

Table 3.7 Antimicrobials used in neonatal foals

Antimicrobial	Dose and route	Frequency	Comments
Amikacin sulfate	25 mg/kg, IM or IV	24 h	Excellent Gram-negative activity, potentially nephrotoxic. Use with a penicillin
Amoxicillin trihydrate	25 mg/kg, PO	6–8 h	Variable absorption decreasing with age. Limited Gram-negative spectrum
Amoxicillin–clavulanate	15–25 mg/kg, IV	6–8 h	Enhanced Gram-negative spectrum
Amoxicillin sodium	15–30 mg/kg, IV or IM	6–8 h	Limited Gram-negative spectrum. Use with an aminoglycoside. Safe
Ampicillin sodium	10–20 mg/kg, IV or IM	6–8 h	Limited Gram-negative spectrum. Use with an aminoglycoside. Safe
Ampicillin trihydrate	20 mg/kg, PO	6–8 h	Limited Gram-negative spectrum. Variable absorption decreasing with age
Cefotaxime sodium	15–25 mg/kg, IV	6–8 h	Use for bacterial meningitis. Expensive
Cefoperazone sodium	20–30 mg/kg, IV	6–8 h	Use for <i>Pseudomonas</i> sp. infections
Cefpodoxime proxetil	10 mg/kg PO	8–12 h	Broad spectrum and well absorbed by foals after oral administration
Ceftazidime sodium	20–50 mg/kg	6–8 h	Third-generation cephalosporin. Save for refractory infections
Ceftiofur sodium	10 mg/kg, IV over 15 min	6 h	Broad spectrum. Note higher dose than used in adults
Chloramphenicol palmitate	50 mg/kg, PO	6–8 h	Broad spectrum, bacteriostatic. Human health risk. Restricted use
Chloramphenicol sodium succinate	50 mg/kg, IV	6–8 h	Broad spectrum, bacteriostatic. Human health risk. Restricted use
Ciprofloxacin	5 mg/kg, IV	12 h	Broad spectrum. Potentially toxic to developing cartilage
Enrofloxacin	5–7.5 mg/kg, PO or IV	12–24 h	Broad spectrum. Potentially toxic to developing cartilage
Gentamicin sulfate	7 mg/kg, IV or IM	24 h	Good Gram-negative spectrum. Nephrotoxic. Use with a penicillin
Metronidazole	15–25 mg/kg, IV or PO	8–12 h	Active against obligate anaerobes and protozoa only
Oxytetracycline	5 mg/kg, IV	12 h	Variable Gram-negative activity. Safe. Cheap
Procaine penicillin G	20 000–40 000 IU/kg, IM	12 h	Very limited Gram-negative activity. Muscle soreness. Cheap
Sodium or potassium penicillin G	20 000–40 000 IU/kg, IV or IM	6 h	Limited Gram-negative activity. Use with an aminoglycoside
Pivampicillin	15–30 mg/kg, IV or IM	8 h	Ampicillin prodrug
Ticarcillin sodium	50 mg/kg, IV	6 h	Active against Gram-negative organisms. Expensive
Ticarcillin–clavulanate	50 mg ticarcillin/kg, IV	6 h	Extended activity. Expensive
Trimethoprim-sulfonamide	15–30 mg/kg, PO, IV	12 h	Cheap. Broad spectrum. Limited efficacy in treating septicemia in foals

worsening of the newborn's condition may necessitate changing the antimicrobial sooner than that. The decision to change antimicrobial therapy should be guided, but not determined, by the results of antimicrobial sensitivity testing of isolates from the affected newborn. These antimicrobial susceptibility patterns should be determined locally, as the results can vary geographically, although results of studies are published.<sup>45</sup> The utility of antimicrobial sensitivity testing in determining optimal antimicrobial therapy for foals has not been determined, although it is likely that, as with mastitis in cows, sensitivity to antimicrobials determined by the Kirby-Bauer method will not be useful in predicting efficacy.

### Fluid therapy

Fluid therapy of newborns differs from that of adult animals because of important differences in fluid and electrolyte metabolism in newborns.<sup>46,47</sup> The following guidelines are suggested:<sup>47</sup>

- **Septic shock** – sequential boluses of 20 mL/kg delivered over 5–20 minutes with re-evaluation after each bolus. Usually, 60–80 mL/kg is the maximum dose before use of pharmacological support of blood pressure is considered. Care should be taken to avoid fluid overload and the foal should be re-evaluated after each bolus and the need for continued fluid therapy determined. Continuous infusion of fluid is not indicated
- **Maintenance support** – this should be determined based on the ongoing losses and the clinical status of the animal. However general recommendations are:
  - First 10 kg body weight – 100 (mL/kg)/d
  - Second 10 kg body weight – 50 (mL/kg)/d
  - Weight in excess of 20 kg – 25 (mL/kg)/d

Neonates with high ongoing losses, such as those with diarrhea or gastric reflux, can have higher fluid requirements.

Care should be taken to prevent administration of **excess sodium** to foals as they have a limited ability to excrete sodium.<sup>48</sup> The recommended intake is 2–3 (mEq/kg)/d, and this includes sodium administered in parenteral fluids. One L of isotonic sodium chloride provides a 50 kg foal's sodium requirements for one day.<sup>47</sup>

A suitable maintenance fluid for foals is isotonic dextrose (5%) with supplemental potassium (10–40 mEq/L).

### Respiratory support

Respiratory failure, evidenced by elevated arterial  $PCO_2$  and decreased  $PO_2$ , may be

due to depressed central activity, weakness of respiratory muscles or lung disease. Regardless of the cause, should the hypoxemia become sufficiently severe then oxygenation must be improved by increasing respiratory drive, increasing the inspired oxygen tension, or employing mechanical ventilation. Foals should always be maintained in sternal recumbency to allow optimal respiratory function.

Provision of respiratory support should be considered when the arterial  $PO_2$  is less than 60 mmHg (8 kPa) and the arterial  $PCO_2$  is more than 60 mmHg (8 kPa) in a foal in sternal recumbency. Pharmacological respiratory stimulants have only a very short duration of action and are of limited use. Nasal insufflation of oxygen is achieved by placing a nasopharyngeal tube and providing oxygen at a rate of 5 L/min.

Mechanical ventilation is useful for maintaining oxygenation in foals with botulism, with more than 80% of foals surviving in one small study.<sup>49</sup> However, this intervention requires considerable expertise and sophisticated equipment. The prognosis is much worse for foals with diseases of the lungs that require mechanical ventilation.

### Gastrointestinal ulcer prophylaxis

Ill neonatal foals are often treated with antacid drugs in an attempt to prevent the development or progression of gastrointestinal ulcers, although the efficacy of this approach is unproven. There is a trend toward not administering antiulcer medications to foals except for those with demonstrated gastric ulceration, in part because of the recognition that critically ill foals often have gastric pH above 7.0 and administration of ranitidine does not affect this pH.<sup>50</sup> (See Gastric ulcers in foals for further discussion.)

### COMMON COMPLICATIONS

Complications of the neonate's disease or its treatment occur frequently:

- Entropion is common in critically ill foals and, although readily treated, can cause corneal ulceration if undetected
- Aspiration pneumonia occurs in weak foals, often as a result of aggressive bottle feeding or regurgitation of milk around a nasogastric tube
- Nosocomial infections can be severe and life-threatening and are best prevented by strict hygiene and asepsis
- Septic synovitis/arthritis occurs as a consequence of bacteremia and should be treated aggressively
- Omphalitis and omphalophlebitis occur and can be an undetected cause of fever and relapse. These are best

detected by ultrasonographic examination of the abdomen

- Patent urachus, evident as urine at the navel, usually resolves with time and local treatment
- Uroperitoneum as a result of urachal rupture occurs in critically ill foals and should be suspected in any ill foal that develops abdominal distension
- Angular limb deformities and excessive flexor tendon laxity occur frequently in ill neonatal foals but usually resolve with minimal symptomatic treatment as the foal recovers its strength.

### PROGNOSIS

The prognosis for critically ill neonates depends on many factors, including the nature and severity of the disease, facilities available for care and the expertise of the personnel caring for the neonate. There is a consensus that the recovery rate for severely ill foals has improved over the last decade because of provision of better care. There are reports of survival rates of around 80% for foals treated at a specialized intensive care unit.<sup>51</sup> However, the high cost of providing care for these animals has prompted studies to determine outcome, as a means of deciding whether, financially, treatment is warranted.

The increased number of foals being treated intensively has resulted in prospective studies of outcome. The prognosis for athletic activity for foals with septic arthritis is poor. Thoroughbred foals with **septic arthritis** have odds of 0.28 (95% CI of 0.12–0.62) (roughly one-quarter of the likelihood) for racing as compared with a cohort of healthy foals.<sup>52</sup> Multisystemic disease, in addition to the presence of septic arthritis, decreased the likelihood of racing to 1/10th that of healthy foals (odds ratio 0.12, 95% CI 0.02–0.90).<sup>27</sup> Affected foals that survive take almost 40% longer to race for the first time. Approximately 30–48% of affected Thoroughbred foals eventually race, compared to approximately 65% of normal foals.<sup>52,53</sup>

Attempts to determine prognostic indicators for survival of foals have been partially successful but tend to be most applicable to the intensive care unit in which they were developed.<sup>3,23,25,35,54–56</sup> The results of these studies are summarized in Table 3.8. The common theme is that sicker foals are less likely to be discharged from hospital alive. Characteristics of foals that are more likely to survive include ability to stand when first examined, normal birth, white cell count in blood that is within or above the reference range, lack of dyspnea, normal plasma fibrinogen concentration, and short duration of disease.

Table 3.8 Variables associated with survival in sick foals

Variable	Odds ratio for survival	Comments	No. foals (reference)
Dystocia	0.2	Dystocial foals have a decreased chance of survival	109 (25)
Standing at admission	12.1	Foals that are standing when first examined are much more likely to survive than recumbent foals	65(53)
Duration of clinical signs (days)	0.17	Foals with disease of longer duration are less likely to survive	65 (53)
Sepsis score	0.63	Increased sepsis score is associated with greater risk of death	68 (33)
≤ 7 days of age	8.8	Younger foals are more likely to survive	65 (53)
Respiratory rate (≥ 60 bpm)	18.8	Foals with high respiratory rates are more likely to survive	65 (53)
Dyspnea	0.25	Foals in respiratory distress are less likely to survive	109 (25)
Rectal temperature subnormal	0.19	Foals with rectal temperature below normal are less likely to survive	90 (52)
Rectal temperature above normal	0.86	Foals with rectal temperature above normal are less likely to survive	90 (52)
Heart rate below normal	0.1	Foals with heart rate below normal are less likely to survive	90 (52)
Heart rate above normal	0.49	Foals with heart rate above normal are less likely to survive	90 (52)
Radiographic evidence of diffuse lung disease	0.28	Foals with radiographic evidence of lung disease in multiple areas of the lung are less likely to survive	75 (6)
Segmented neutrophil count in blood	1.7	Increased neutrophil count in blood is associated with lower risk of death	68 (33)
Neutrophil count > 4000 $\mu$ L ( $4.0 \times 10^9$ /L)	37.5	Foals with neutrophil counts in blood > 4000 $\mu$ L ( $4.0 \times 10^9$ /L) are much more likely to survive are foals with counts < 4000 $\mu$ L ( $4.0 \times 10^9$ /L)	65 (53)
Neutrophil count below normal	0.28	Low neutrophil count in blood is associated with greater risk of death	90 (52)
Neutrophil count above normal	1.5	Increased neutrophil count in blood is associated with lower risk of death	90 (52)
IgG (mg/dL)	1.003	Foals with higher serum IgG on admission are more likely to survive	68 (33)
Plasma fibrinogen (mg/dL)	0.99	Foals with high fibrinogen concentration are less likely to survive	68 (33)
Red blood cell count	1.8	Foals with higher red cell counts are more likely to survive	68 (33)
Venous $P_{O_2}$ (mmHg)	1.1	Foals with higher venous oxygen tension are more likely to survive	56 (51)
Anion gap (mEq/L)	0.81	Foals with higher anion gap are less likely to survive	56 (51)
Serum creatinine (mg/dL)	0.20	Foals with higher creatinine concentration are less likely to survive	109 (25)

*Odds ratios > 1 are indicative of an increased probability of survival. All variables reported above were statistically significantly associated with survival in the reporting publication.*

## REVIEW LITERATURE

- McKenzie HC, Furr MO. Equine neonatal sepsis: the pathophysiology of severe inflammation and infection. *Compend Contin Educ Pract Vet* 2001; 23:661-672.
- Sanchez LC. Neonatal Medicine and Surgery. *Vet Clin North Am Equine Pract* 2005; 21:241-535.

## REFERENCES

- Brewer BD, Koterba AM. *Equine Vet J* 1988; 20:18.
- Corley KTT et al. *J Vet Emerg Crit Care* 2003; 13:149.
- Stewart AJ et al. *J Vet Intern Med* 2002; 16:464.
- Rossdale PD, Short RV. *J Reprod Fertil* 1967; 13:341.
- Rossdale PD. *Equine Vet J Suppl* 1993; 14:3.
- Schlafer DH. *Proc Am Assoc Equine Pract* 2004; 50:144.
- Renaudin CD et al. *Theriogenology* 1997; 47:559.
- Bedenice D et al. *J Vet Intern Med* 2003; 17:876.
- Reef VB et al. *J Am Vet Med Assoc* 1989; 195:69.
- Bellezzo F et al. *Equine Vet J* 2004; 36:557.
- Gull T. *Vet Rec* 2001; 149:199.
- Wion L et al. *Equine Vet J* 2001; 33:523.
- Ferrell FA et al. *Vet Radiol Ultrasound* 2002; 43:510.
- Davis DG et al. *J Vet Intern Med* 2005; 19:93.
- Metzger N et al. *J Vet Intern Med* 2006; 20:382.
- McClure JT et al. *Proc Am Assoc Equine Pract* 2003; 49:64.
- Davis R, Giguere S. *J Am Vet Med Assoc* 2005; 227:1640.
- McVicker JK et al. *Am J Vet Res* 2002; 63:247.
- Hofsaess FR. *J Equine Vet Sci* 2001; 21:158.
- Koterba AM et al. *Equine Vet J* 1984; 16:376.
- Bentz AI et al. *J Vet Intern Med* 2002; 16:494.
- Stoneham SJ et al. *Equine Vet J* 2001; 33:599.
- Barton MH et al. *J Vet Intern Med* 1998; 12:26.
- Chavatte P, Rossdale PD. *Equine Vet Educ* 1991; 3:28.
- Slack JA et al. *J Vet Intern Med* 2005; 19:577.
- Silver M et al. *Equine Vet J* 1984; 16:278.
- Bedenice D et al. *J Vet Intern Med* 2003; 17:868.
- LeBlanc MM et al. *J Am Vet Med Assoc* 1986; 189:57.
- Holznapel DL et al. *Equine Vet J* 2003; 35:620.
- Kohn CW et al. *J Am Vet Med Assoc* 1989; 195:64.
- Flamminio MJBF et al. *J Vet Intern Med* 1999; 13:206.
- Baldwin JL et al. *J Am Vet Med Assoc* 1991; 198:423.
- Raidal S. *Aust Vet J* 1996; 73:201.
- Tyler-McGowan CM et al. *Aust Vet J* 1997; 75:56.
- Peek SF et al. *J Vet Intern Med* 2006; 20:569-574.
- McTaggart C et al. *Aust Vet J* 2005; 83:499.
- Jeffcott LB. *J Comp Pathol* 1974; 84:279.
- Wilkins PA, Dewan-Mix S. *Cornell Vet* 1994; 84:7.
- McClure JT et al. *Equine Vet J* 2001; 33:681.
- Buffington T et al. *Manual of veterinary dietetics*. Philadelphia, PA: Elsevier, 2004.
- Ousey JC et al. *Am J Vet Res* 1997; 58:1243.
- Furr M, Mogg TD. *Compend Contin Educ Pract Vet* 2003; 25:302.
- McKenzie HC, Furr M. *Compend Contin Educ Pract Vet* 2003; 25:457.
- Bucki EP et al. *J Vet Intern Med* 2004; 18:728.
- Marsh PS, Palmer JE. *J Am Vet Med Assoc* 2001; 218:1608.
- Palmer J. In: *Proceedings of the International Conference on Veterinary Emergency and Critical Care, San Antonio, TX, 2002*; 8:652.
- Palmer J. In: *Proceedings of the International Conference on Veterinary Emergency and Critical Care, San Antonio, TX, 2002*; 8:665.
- Buchanan BR et al. *J Am Vet Med Assoc* 2005; 227:1123.
- Wilkins PA, Palmer JA. *J Vet Intern Med* 2003; 17:708.
- Sanchez LC et al. *J Am Vet Med Assoc* 2001; 218:907.
- Axon J et al. *Proc Am Assoc Equine Pract* 1999; 45:224.
- Smith LJ et al. *Equine Vet J* 2004; 36:452.
- Steel CM et al. *J Am Vet Med Assoc* 1999; 215:973.
- Hoffman AM et al. *J Vet Intern Med* 1992; 6:89.
- Furr M et al. *J Vet Intern Med* 1997; 11:183.
- Gayle JM et al. *J Vet Intern Med* 1998; 12:140.

# Practical antimicrobial therapeutics

## PRINCIPLES OF ANTIMICROBIAL THERAPY 173

- Identification of the infection by clinical examination 173
- Taking samples for diagnosis 174
- Antimicrobial sensitivity tests 175
- Antibiotic resistance 176

This chapter is not intended as a treatise on pharmacology, pharmacodynamics and antibacterial activity of antimicrobial agents. Other textbooks are available that deal with those subjects. However, antimicrobials are the most commonly employed group of drugs in large animal practice and their use is recommended on many occasions in the following chapters. To avoid repetition, the principles of usage and considerations for dose schedules and for the selection of antibacterial agents for certain circumstances are given here and in the formulary.

Some of the information or opinions presented are based on clinical use rather than experimental evidence. However, this is often unavoidable, because unfortunately many antimicrobial agents have in the past been released for use in large animals with minimal pharmacological or clinical evaluation in the species concerned. As a result it has been assumed, often erroneously, that information obtained from studies in laboratory animals, dogs and humans can be directly applied to the ruminant, horse and pig.

## Principles of antimicrobial therapy

The success of antimicrobial therapy depends upon maintaining, at the site of infection, a drug concentration that will result, directly or indirectly, in the death or control of the infectious organism with minimal deleterious effect to the host. In order to achieve this aim the antimicrobial agent must have activity against the organism at its **site of infection** and it must be administered in such a way as to maintain an **effective inhibitory or lethal concentration**. These principles apply to therapy in all species and dictate the choice of antimicrobial agent to be used. However, in farm animal veterinary practice there are also other important considerations

- **Cost** is critical. This consideration includes not only the primary cost of

## PRACTICAL USAGE OF ANTIMICROBIAL DRUGS 177

- Antibiotic dosage: the recommended dose 177
- Routes of administration 178
- Drug distribution 181
- Duration of treatment 181

the drug but also related factors such as the ease and frequency of administration and the duration of treatment

- **Tissue residue problems and withdrawal periods** must also be taken into consideration and are a primary determinant of treatment strategy
- **Animal welfare** becomes a consideration when a decision is made not to treat an animal because of concerns about cost or the occurrence of residues that would preclude marketing of the animal or its products in the future
- **Antimicrobial resistance** and the risk of contributing to the emergence and problem of antimicrobial resistance is a concern that has increasing attention, not so much with the therapeutic use of antimicrobials but certainly with the prolonged administration of antimicrobials in animal feeds for disease prevention.

In the theoretically ideal situation, the following steps would be taken before selecting an antimicrobial agent for therapy.

- First, the site of infection would be located and the identity of the infecting organism established by culture
- Second, the minimal inhibitory concentration (MIC) of each antimicrobial agent for the infecting organism would be identified
- Third, an initial selection would be made based on the sensitivity of the organism and the knowledge of the capacity of the individual antimicrobial agents to penetrate to the site of infection and to achieve and exceed these concentrations at nontoxic dose rates
- Fourth, the dose rates, route of administration and frequency of administration required to achieve these concentrations for each of the selected antibiotics, in the particular

- Drug combinations 181
- Additional factors determining selection of agents 182
- Drug deterioration 183
- Unfavorable response to therapy 183
- Drug withdrawal requirements and residue avoidance 183

animal species being treated, would then be considered

- Finally, selection of a particular drug would be based on a consideration of the potential toxicity to the host, on the likely relative efficiency of each drug, on the cost and ease of administration and, in food animals, on costs associated with the relative withholding periods.

It is obvious that for many clinical situations all these steps cannot be followed before therapy is instituted. It may take several days to establish the identity of the infectious agent unless it can be ascertained by clinical diagnosis. The identification of the organism helps in determining its potential sensitivity but even without identification the establishment of exact MICs by tube dilution for each antimicrobial agent also takes several days, and the results would frequently be historical by the time that they were received. Also, a knowledge, for each antimicrobial agent, of the varying tissue and organ levels achieved following varying doses given by different routes of administration is not easily remembered and therefore not easily available in large-animal field situations. Nor, unfortunately, is complete information of this type available for each antimicrobial agent in all large-animal species.

Because of this uncertainty, some expedients are adopted in clinical antimicrobial therapy. One of them is the concept of the **recommended dose** and another is the use of disk sensitivity testing, both of which are discussed later in this chapter. Regardless of these expedients, it should be recognized that rational antimicrobial therapy is based upon the principles outlined above. These important principles in antimicrobial therapy are discussed in greater detail individually.

## IDENTIFICATION OF THE INFECTION BY CLINICAL EXAMINATION

In infectious disease, clinical examination aims to identify the nature and site of the

infection and its cause. The importance of making an accurate clinical diagnosis cannot be overemphasized as the first prerequisite for successful antimicrobial therapy. The establishment of a diagnosis in many instances immediately identifies the pathogen and previous clinical experience may suggest the specific antibiotic to be used and allow a confident prediction of success of the therapy. Equally, it may indicate the likelihood of unsuccessful or prolonged therapy. For example, the diagnosis of erysipelas or Glasser's disease in pigs or strangles in horses immediately identifies the etiological cause of the infection and the type of antimicrobial agent that will be required. It also gives some indication of the likely ease or difficulty of successful therapy and of the duration of therapy that might be required.

The establishment of an accurate diagnosis is also important in animals where chemotherapeutic control of further disease may be required. Thus, in pigs, an accurate differentiation between the diarrhea of swine dysentery and that associated with coliform gastroenteritis is essential for effective prophylactic medication.

It is often not possible to establish an exact diagnosis at the first examination and yet in almost every instance it is essential that treatment be instituted at that time, not only for the wellbeing of the patient but also for the maintenance of good client relationships. The lack of a definitive etiological diagnosis should never preclude the initiation of therapy during the period when further tests are being carried out. Rational therapy in these circumstances depends very much on clinical acumen. A detailed examination leading to a determination of the site and nature of the infection can frequently allow an educated guess at the likely pathogen and allow rational therapy during the period that specific diagnosis is being determined by culture.

This approach is frequently used initially in field situations in large animal medicine but it requires good clinical knowledge. Clinicians should be familiar not only with the individual diseases of large animals but also with their **differential diagnosis** and with the **relative prevalence** of each condition in their area. They should also be familiar with the types of organism that may produce infections in various body areas with similar clinical manifestations and the relative prevalence of each of these. Thus peracute mastitis in recently calved cows is most commonly associated with infection by staphylococci but can also be associated with coliform organisms or, more rarely, *Actinomyces (Corynebacterium)*

*pyogenes* or *Pasteurella multocida*. Treatment must be initiated immediately if the gland or even the cow is to be saved. There are subtle clinical and epidemiological differences that may allow some clinical differentiation between these agents but frequently treatment must begin with no sure knowledge of which agent is involved. There are **two approaches** in this type of situation:

- Therapy may be directed at the most prevalent or likely agent and, in situations where one particular infectious agent is the most prevalent cause of the condition, this is a rational approach
- In other situations, where a disease could be associated with any one of several different organisms, each with a different sensitivity, and where clinical experience suggests that no one organism is the predominant infectious agent, it is more common to initiate therapy with a broad-spectrum antimicrobial agent or a combination that will have activity against all the possibilities. If indicated, the antibacterial agent being used for therapy may have to be changed to a more specific one once the actual pathogen and its sensitivity have been determined.

There are also clinical situations where therapy must begin when there is little knowledge of the site of infection and consequently **no knowledge of the identity** of the infecting agent. This occurs where infection, such as abscessation, occurs in deep-seated and clinically inaccessible organs such as the liver or spleen. Also in these situations it may not be possible to determine the nature and cause of the disease by laboratory examination although biochemical examinations and ultrasound may give some indication of the site. In these cases therapy is generally started with a broad-spectrum antimicrobial agent or a combination of lesser ones, and the accuracy of the selection is determined by subsequent clinical response.

#### **TAKING SAMPLES FOR DIAGNOSIS**

In teaching hospitals, there is ready access to bacteriology laboratories, which frequently contain automated and rapid systems for sensitivity testing. However, in practice the taking of samples for this purpose is generally restricted and limited by such factors as the availability of a diagnostic laboratory, and by cost. Furthermore, in many cases the results of culture and sensitivity are historical by the time they are received. Nevertheless,

information of this type is of value for future similar cases and it provides prevalence data and data of antimicrobial sensitivity that can be used for background clinical knowledge and justification for extralabel drug use in food-producing animals.

The recognition of when samples should be taken for microbiological examination and sensitivity testing comes with clinical experience. In general, the approach is different when dealing with individual sick animals from when dealing with groups of animals and a contagious disease. In individual animals, cost and the time for processing usually limit the taking of samples to valuable stud animals and to horses. They should be taken from **individual sick animals** with life-threatening conditions so that, if a response is not obtained to initial therapy, the subsequent choice of antimicrobial agent can be based on laboratory data. They should also be taken from animals with disease syndromes that may be caused by one of several agents or by an organism that may show **variable resistance patterns**. Examples would be infective arthritis in foals or Gram-negative sepsis.<sup>1</sup> The increasing emergence of variable resistance patterns in veterinary pathogens places an increasing importance on sampling and sensitivity testing and many practices have now established their own laboratories for this purpose.

Samples are also frequently taken from chronic, **poorly responsive conditions** to determine the best course of treatment. In groups of animals where there is **contagious** disease, the taking of samples to establish or confirm the etiological diagnosis and to determine the best drug for chemotherapy is most important. Where there are **a large number of animals at risk** it is important to confirm the initial choice of therapy as soon as possible so that remedial steps can be taken if this was incorrect. It is also important in these situations to have a confirmed accurate etiological diagnosis so that control measures can be instigated to prevent future problems. Thus an outbreak of diarrhea in postweaned pigs may be due to coliform gastroenteritis, salmonellosis or swine dysentery. Clinical and pathological examination may eliminate swine dysentery but not allow complete differentiation between salmonellosis and coliform gastroenteritis. An aminoglycoside could be used for the initial therapy of the outbreak but, at the same time, samples are taken for culture and sensitivity to determine the exact antimicrobial sensitivity of the infectious agent in case there is resistance to this antibiotic. Also, by this procedure the exact etiological diagnosis will be

determined, which will then determine recommendations for future control of the disease.

Consideration should be given to the **nature of the sample** for examination. In outbreaks of diarrhea there is little point in taking fecal samples from chronically scouring and runted animals. Samples should be taken from animals at the onset of diarrhea. The site of sampling can also have an influence that may affect the relevance of the results. In animals with pneumonia, the nasal flora may not reflect that in the lung and cultures are best taken as transtracheal aspirates of the lower respiratory system.<sup>2,3</sup>

Similarly, fecal *Escherichia coli* strains are not always representative of small-intestinal strains in scouring calves.<sup>4</sup>

## ANTIMICROBIAL SENSITIVITY TESTS

### RATIONALE

Antimicrobial sensitivity testing is not required with all infections because many organisms are invariably sensitive to one or more antimicrobial agents and in most cases these can be used for therapy. The clinician should be familiar not only with the spectrum of each antimicrobial drug but also with the spectrum of sensitivity for the common organisms involved in diseases of large animals. **Sensitivity testing** is generally reserved for members of those groups of organisms that show considerable variation in sensitivity to individual antimicrobial agents.

There can be considerable area-to-area variation and spatial and temporal clustering in the sensitivity patterns of individual organisms.<sup>5-7</sup> It is wise to establish the broad patterns of general sensitivity or resistance for these groups in any practice area and to monitor any change periodically so that therapy can be guided by this information. This also can provide information justifying the extralabel use of antimicrobials in food-producing animals.

The **purpose of sensitivity testing** is to attempt to determine if the organism under consideration is likely to be susceptible to the action of an antimicrobial agent at the drug levels that can be achieved using the usual therapeutic dose rates. In clinical terms, organisms are considered to be either **sensitive** or **resistant** to the action of an antimicrobial. However, with many organism-antimicrobial associations, resistance or susceptibility is **not an all-or-none phenomenon** but is dependent upon drug concentration. Organisms that may be resistant to low levels of an antimicrobial agent are frequently susceptible to its action at higher concentrations. Thus an organism

that is susceptible to the action of benzylpenicillin at a concentration of 0.1 µg/mL would be considered sensitive because equivalent levels of benzylpenicillin can be easily achieved in the blood and tissues. One that was susceptible only at a concentration above 5 µg/mL might be considered resistant, even though it is possible to achieve and maintain this concentration of benzylpenicillin in the tissues with high and frequent dosing.

### SENSITIVITY TEST METHODS

#### Tube sensitivity tests

Sensitivity tests may be quantitative or qualitative. **Tube sensitivity tests**, using serial dilutions of the antimicrobial drug against a standard dose of the test organism, provide quantitative information in terms of an exact MIC of the drug being tested. The MIC is the lowest antibiotic concentration that prevents the growth of bacteria within a defined period of time and under the conditions of the test. Tube sensitivity testing is the gold standard. With most antibiotics, a mean plasma level 2-5 times the MIC needs to be sustained through the dosing interval for effective therapy. These tests are laborious and time-consuming and are seldom used in practice situations for these reasons.

#### Disk sensitivity tests

**Disk sensitivity tests** provide more limited qualitative information. They are generally a valuable adjunct in the choice of an antimicrobial agent for therapy, particularly for systemic diseases. However, the limitations of the usual method of testing, and the limitations of interpretation should be recognized by the clinician.

The **Kirby-Bauer** technique is the most commonly used method of disk diffusion sensitivity testing. With this technique, disks are impregnated with a standard amount of antibiotic that diffuses into the media to produce a zone of inhibition of growth. With a standard concentration of antibiotic in the disk and standard antibiotic sensitivity test media and test conditions, the concentration of the diffused antibiotic at any given distance from the disk is relatively predictable and constant. There is a linear relationship between the diameter of the zone of inhibition and the log<sup>2</sup> of the MIC. For each antibiotic MIC, breakpoints have been established and corresponding zone size breakpoints established above or below which an organism is classified as resistant, susceptible or of intermediate sensitivity.

Although the Kirby-Bauer disk sensitivity testing system has a quantitative genesis the results are qualitative –

especially as used in most practice laboratories. MIC breakpoints are specific values used to assign bacteria to one of three classifications – susceptible, intermediate and resistant.

The MIC breakpoints and thus the published reference zone sizes for resistance and susceptibility are often based on the pharmacokinetic properties of each antimicrobial in humans. These frequently have limited relationship to their pharmacokinetic properties in animals, particularly ruminants.<sup>8</sup>

Also, a single antimicrobial considered to be representative of its class is used to test sensitivity to that class of antimicrobials, but commonly this representative is not the antibiotic agent present in commercially available antibiotic treatments for livestock.<sup>8</sup> Further, the use of specific zone diameters to establish resistance and susceptibility assumes a standard test with standard media and under standard conditions. These conditions are frequently not met in veterinary practice laboratories.

Despite these limitations, disk sensitivity tests can be used as a guide to the selection of antimicrobials for therapy in large-animal veterinary practice. They are of particular value in selecting a choice of antibiotic with organisms that exhibit variable patterns of resistance and where this pattern for any one antibiotic is essentially bimodal in distribution.<sup>9</sup> They may have limited value in the testing of organisms where the sensitivities are clustered around the MIC breakpoint. However, there is a lack of validation for susceptibility testing being predictive for treatment outcome in almost all large-animal diseases as the breakpoints have not been validated.<sup>8,10</sup>

There should not be over-reliance on the results of testing for sulfonamide sensitivity, as these are frequently misleading and a good clinical response can be achieved with therapy even though the sensitivity test suggests resistance.

Frequently, with disk sensitivity tests, the organism proves sensitive to a number of different antimicrobial agents. The selection of one of these for therapy is based on such factors as **ease of administration** and **cost**. The relative efficacy of any one of the agents cannot be determined by comparison of the size of the zones of inhibition.

#### Microtiter techniques

The development of semiautomated microtiter methodology for direct MIC determinations allows many reference diagnostic laboratories and teaching hospitals to determine MIC concentrations directly in bacterial sensitivity testing. The results are more directly



applicable to rational therapy and, in particular, have more relevance than disk diffusion tests for determining the sensitivity of organisms that cluster around the MIC breakpoint for a given antibiotic.<sup>9,11</sup>

### OTHER CONSIDERATIONS

The antimicrobial sensitivity of an organism can vary considerably depending upon the species of animal from which it is isolated. *E. coli* isolates from pigs generally show a greater degree of antibiotic resistance than those isolated from adult cattle. Similarly, *Campylobacter* spp. isolates from pigs show substantially different antibiotic sensitivity patterns from those isolated from sheep. Isolates from the same species may also vary significantly in sensitivity, so that *E. coli* isolated from mastitis in cattle generally have a broader sensitivity pattern than those isolated from enteric disease in calves. In addition, there are area differences and changes with time. Low levels of antibiotic fed for growth-promoting purposes may influence sensitivity patterns, and in herds where growth promoters are being used it is generally wise not to use the same drug or members of the same group for therapeutic purposes without prior testing.

### REVIEW LITERATURE

- Woolcock JB, Mutimer MD. Antibiotic sensitivity testing: caeci caecos ducentes? *Vet Res* 1983; 113:125-128.
- Prescott JG, Baggot JD. Antimicrobial susceptibility testing and antimicrobial drug dosage. *J Am Vet Med Assoc* 1985; 187:363-368.
- Baggot JD, Prescott JF. Antimicrobial selection and dosage in the treatment of equine bacterial infections. *Equine Vet J* 1987; 19:92-96.
- Wilcke JR. Therapeutic decisions. Choosing appropriate antimicrobial therapy. *Probl Vet Med* 1990; 2:279-289.
- Dow SW, Papich MG. Keeping current on developments in antimicrobial therapy. *Vet Med* 1991; 86:600-609.
- Constable PD, Morrin DE. Treatment of clinical mastitis: Using antimicrobial susceptibility testing profiles for treatment decisions. *Vet Clin North Am Food Anim Pract* 2003; 19:139-155.

### REFERENCES

1. Brewer BD, Koterba AM. *Compend Contin Educ Equine Pract* 1990; 12:1773.
2. Spurlock SL. *Equine Pract* 1989; 11:6.
3. Thomas A et al. *Vet Res Commun* 2002; 26:333.
4. Constable PD. *J Vet Intern Med* 2004; 18:8.
5. Gunn GL, Low JC. *Vet Rec* 2003; 152:537.
6. Singer RS et al. *J Am Vet Med Assoc* 1998; 212:1001.
7. Dunlop RH et al. *Prev Vet Med* 1998; 34:265, 283.
8. Constable PD. Proceedings of the 37th Annual Convention of the American Association of Bovine Practitioners 2004; 37:11.
9. Libal MC et al. *Proc Am Assoc Vet Lab Diagn* 1986; 29:9.
10. Constable PD, Morrin DE. *J Am Vet Med Assoc* 2002; 221:103.
11. Libal MC. *Am J Vet Res* 1985; 46:1200.

## ANTIBIOTIC RESISTANCE

Antimicrobial resistance is a natural biological phenomenon and the introduction of antibiotics into clinical use has almost invariably been followed by the emergence of resistance to these drugs in bacterial populations.<sup>1</sup> When a microbial population is exposed to an antibiotic, the more susceptible organisms will succumb, and antimicrobial use in human medicine and in agriculture naturally must result in the selection of antimicrobial-resistant phenotypes. This occurs in nonpathogens as well as pathogens.<sup>2</sup> Resistance is generally slow to reverse or is irreversible.

There are a number of mechanisms whereby resistance is engendered. Resistance that results from spontaneous mutation of chromosomal genes encoding a target site is probably of limited importance in clinical settings. It occurs more frequently with certain antibacterials, i.e. rifampin, and may be combated by the inclusion of a second antibacterial in the treatment regimen. Plasmid- and transposon-determined drug resistance is of much more importance in clinical situations and has led to widespread multiresistance patterns in certain bacterial populations.

Plasmids are extrachromosomal genetic elements that replicate independently of the chromosome. They can be transferred within, and in some cases between, bacterial species and may also act as vectors for transposons. They may encode for single or multiple patterns of antibiotic resistance and, increasingly, multiple patterns of resistance are emerging. With veterinary pathogens, plasmid-determined resistance is particularly important in the Enterobacteriaceae, *Staphylococcus aureus* and to some extent in *Pasteurella* spp.<sup>3-5</sup>

Virtually all antibiotics given in therapeutic doses cause marked changes in the microflora of sites in the host normally colonized by bacteria. There is suppression of the sensitive flora with subsequent selection and colonization by resistant bacteria. In pigs, there is some evidence that therapeutic use of antibiotics in individual animals does not greatly influence herd flora resistance patterns but in-feed medication of postweaned pigs selects for antibiotic resistance that maintains in finisher pigs.<sup>6</sup> The feeding of antibiotics for growth promotion and the feeding of antibiotic-treated milk to calves will select for resistance among organisms within the alimentary tract. These resistant organisms can persist in the animal and in the environment and subsequently form part of the normal colonizing flora of other animals, so that it is not unusual to isolate organisms, *E. coli* for example, that are

resistant to one or more antibiotics even though the animal from which they were isolated had never received antibiotic medication.<sup>7,8</sup>

There is a higher prevalence of antibiotic-resistant *E. coli* in the normal intestinal flora of young animals than adults.<sup>9</sup> The prevalence is higher in young animals reared intensively, such as veal calves and pigs, and in environments where antibiotic usage has exerted selection pressure. The prevalence falls with increasing age and the intestinal flora of adults generally shows a broader sensitivity pattern. Although many of these resistant organisms are not pathogens, they contribute a pool of R plasmids that can be transmitted to pathogens, and therapy decisions should take into account what antibiotics are in routine use on the farm as growth-promoting additives. Tetracyclines and neomycin are commonly incorporated in calf milk replacers with the label claim that they are growth promoters and aid in the control of calf diarrhea. However, there are no published studies that support health benefits.<sup>10</sup> There are studies that show improved growth of calves on medicated milk replacers compared with control calves but this difference is lost after weaning and not of any production benefit.

Feeding antimicrobials to livestock and poultry to reduce disease and promote weight gain has been standard practice in developed countries for several decades but is engendering increasing concern and the occurrence of antimicrobial resistance is beginning to be considered to be a societal issue. The concern is that antimicrobial use in food-producing animals may affect human health by the presence of drug residues in foods, and by promoting the presence of antibiotic-resistant strains in animals that can subsequently infect humans through food or from effluent contamination of the environment.<sup>11-13</sup> The consequences of this also include an increased risk for resistant pathogens to be transferred to humans by direct contact with animals. Although many of the growth-promoting antibiotics used in animals are not the same as those used for human therapy, antimicrobial exposure can initiate bacterial resistance to compounds of dissimilar structures.<sup>14</sup>

There is a particular risk to farmers, farm workers and veterinarians from exposure to contamination in the farm environment.<sup>13,15-17</sup> and a risk from transfer of resistant bacteria through farm food and via environmental contamination from farm effluents.<sup>18</sup>

Public and medical concern about the ways in which antimicrobials are used in

agriculture has particularly been aroused by the development of vancomycin-resistant enterococci in humans associated with the use of the related drug avoparcin as a growth-promoter in animal feeds.<sup>19</sup> In response to concerns about the emergence of antimicrobial resistance, Sweden banned all growth-promoting antibiotics in 1986. This was followed by a ban on avoparcin and virginiamycin in Denmark in 1995 and 1998. Finally, the European Union (EU) banned the use of avoparcin in 1997 and bacitracin, spiramycin, tylosin and virginiamycin for growth promotion in 1999. The effects of these bans on the antibiotic resistance of flora in animals and humans will take some time to determine. There has been an apparent reduction in vancomycin resistance in fecal enterococci isolated from humans and animals.<sup>20,21</sup> There has also been an apparent increase in morbidity and mortality among pigs, associated with enteric infections, diarrhea and chronic infections due to *Lawsonia intracellularis*. This increase in animal disease since the ban has resulted in a substantial increase in the use of therapeutic antibiotics for food animals in Europe, primarily tetracyclines, trimethoprim/sulfonamides and macrolides.<sup>21</sup>

With respect to the emergence of antibiotic resistance in zoonotic organisms, a particular concern has been plasmid-determined multiple antibiotic-resistant strains of salmonella that have emerged and caused rapidly spreading epidemics of disease in young calves in England and Europe.<sup>22</sup> These multiple resistance patterns have been associated with particular phage types and biotypes of *Salmonella typhimurium* and *Salmonella dublin*.

Preventing the spread of multiresistant organisms is not easily achieved and there are examples of spread involving virtually every major pathogenic bacterial group.<sup>23</sup> An example is the emergence and spread of *S. typhimurium* DT 104, in which multiple antibiotic resistance is chromosomally determined. A pathogen of a variety of different animal species, including humans, this organism spread globally in the 1990s. Because of the advanced salmonella surveillance system in the UK, this organism was first recognized as causing outbreaks of disease in cattle and humans in the UK and its emergence was initially attributed to the use of antimicrobials in cattle. There is however no evidence in support of this<sup>24</sup> and its spread was due to its colonizing ability, not to selection by the feeding of antimicrobials. The history of the emergence and spread of this organism, which was unrelated to the use of antimicrobials in livestock and related more to the colonizing ability of DT104, should act as a brake on proposals to use

changing patterns of antimicrobial resistance as a measure of the risk of the use of antimicrobials in livestock.

Plasmid-determined multiple patterns of resistance are likely to increase in organisms in environments where selection pressure is high as a result of frequent antibiotic usage. The use of antibiotics in agriculture is an obvious target to reduce this selection, and is frequently blamed for the problem of developing antibiotic resistance in human pathogens. Nosocomial infection with antibiotic-resistant animal pathogens is an emerging problem in veterinary hospitals and procedures for limiting their spread are available.<sup>25</sup>

Whereas the major concern has been directed at antibiotic use for growth promotion there are also moves, in some countries, to restrict the use of certain antimicrobials, e.g. fluoroquinolones, from therapeutic use in farm animals. However, a European survey of antimicrobial susceptibility among zoonotic and commensal bacteria from food-producing animals found that, although there was variation among European countries in the resistance of enteric organisms, this largely involved the older antimicrobials, and that resistance to the newer compounds used to treat humans was low.<sup>26</sup> Equally, a study of mastitis pathogens over a 7-year period in the USA showed no trend towards increased resistance and reported a reduction of resistance to beta-lactam antimicrobials for several Gram-positive mastitis pathogens.<sup>27</sup>

#### REVIEW LITERATURE

- Saunders JR. Genetics and evaluation of antibiotic resistance. *Br Med Bull* 1984; 40:54-60.
- Hinton M. The ecology of *Escherichia coli* in animals including man with particular reference to drug resistance. *Vet Rec* 1986; 119:420-426.
- Pohl P, Lintermann P. R plasmid reservoirs and circulation. In: Rico RG, ed. Drug residues in animals. *Veterinary Science and Comparative Medicine A Series*. New York: Academic Press, 1986.
- Corpet DE. Microbiological hazards for humans of antimicrobial growth promoter use in animal production. *Rev Med Vet* 1996; 147:851-862.
- National Research Council. The use of drugs in food animals: benefits and risks. Washington, DC: National Academy Press, 1998:211.
- Tallefson L, Angulo FJ, Fedorka-Cray PJ. National surveillance for antibiotic resistance in zoonotic enteric pathogens. *Vet Clin North Am Food Anim Pract* 1998; 14:141-150.
- Bailor JC, Travers K. Review of assessments of the human health risk associated with the use of antimicrobial agents in agriculture. *Clin Infect Dis* 2002; 34(Suppl 3):S135-S143.
- Wise R, Soulsby E. Antibiotic resistance - an evolving problem. *Vet Rec* 2002; 151:371-372.
- Besser TE, Hancock D, Davis M. The veterinarians role in controlling the emergence and dissemination of drug-resistant bacteria. *J Vet Med Educ* 2003; 30:136-139.
- Thiele-Bruhn S. Pharmaceutical antibiotic compounds in soils - a review. *J Plant Nutr Soil Sci* 2003; 166:145-167.

Rooklidge SJ. Environmental antimicrobial contamination from terraccumulation and diffuse pollution pathways. *Sci Total Environ* 2004; 325:1-13.

#### REFERENCES

- Kaysner FH. *Vet Microbiol* 1993; 35:257.
- Schroeder CM et al. *Emerg Infect Dis* 2002; 8:1409.
- Hinckley LS et al. *J Am Vet Med Assoc* 1985; 187:709.
- Boyce JR, Morter RL. *Am J Vet Res* 1986; 47:1204.
- Libal M et al. *J Am Vet Med Assoc* 1982; 180:908.
- Dunlop RH et al. *Prev Vet Med* 1998; 34:265, 283.
- Gellin G et al. *Appl Environ Microbiol* 1989; 55:2287.
- Hinton M et al. *J Appl Bacteriol* 1985; 58:131.
- Khachatryan AR et al. *Appl Environ Microbiol* 2004; 70:752.
- Constable PD. In: *Proceedings of the Annual Conference of the American Association of Bovine Practitioners* 2003; 37:137.
- Corper DE. *Vet Microbiol* 1993; 35:199.
- Gorbach SL. *Vet Hum Toxicol* 1993; 35(Suppl 1):13.
- Rooklidge SJ. *Sci Total Environ* 2004; 325:1.
- Courvalin P. *Emerg Infect Dis* 2001; 7:489.
- Hamscher G. *Environ Health Perspect* 2003; 111:1590.
- Haller M et al. *J Chromatogr A* 2002; 952:111.
- Meyer M et al. *Sci Total Environ* 2000; 248:181.
- Thiele-Bruhn S. *J Plant Nutr Soil Sci* 2003; 166:145.
- Lu K et al. *Emerg Infect Dis* 2004; 10:679.
- Aarestrup FM et al. *Antimicrob Agents Chemother* 2001; 45:2054.
- Casewell M et al. *J Antimicrob Chemother* 2003; 52:159.
- Threlfall EJ. *Soc Appl Bacteriol Symp Ser* 1992; 21:S96.
- Tenover FC. *Clin Infect Dis* 2001; 33 (Suppl 3):S108.
- Hancock D et al. In: Brown C, Bolin CA, eds. *Emerging diseases of animals*. Washington, DC: ASM Press, 2000; 217-243.
- Brewer BD, Koterba AM. *Compend Contin Educ Equine Pract* 1990; 12:1773.
- Bywater R et al. *J Antimicrob Chemother* 2004; 53:744.
- Makovec JA, Ruegg PL. *J Am Vet Med Assoc* 2003; 222:1582.

## Practical usage of antimicrobial drugs

### ANTIBIOTIC DOSAGE: THE RECOMMENDED DOSE

Theoretically, there is no set dose for any antimicrobial agent. The concentration of an antimicrobial drug required for effective activity against different micro-organisms varies and these requirements could be met by varying the dose rate of the drug. However, this is an impractical situation and in practice one works from the **recommended dose**. The recommended dose is one that will give blood and tissue levels that will be effective against very susceptible organisms, with minimal side effects to the host. In this respect the recommended dose should be considered as a minimum dose.

If one is dealing with organisms that require higher concentrations of the drug for therapeutic effectiveness, the recommended dose can be exceeded. With low-toxicity antibacterials this dose may be exceeded severalfold and with drugs such as benzyl penicillin this is a frequent therapeutic ploy. However, with antibacterials that have toxic potential the recommended dose should only be exceeded with caution and frequently it is wise to search for a different antimicrobial agent to which the organism is more sensitive.

Similarly, the recommended dose may be exceeded in an attempt to increase the concentration gradient in sensitive infections where necrotic tissue produces long diffusion paths. The recommended dose may also be exceeded for management reasons, as in the case of the treatment of sheep with footrot or mycotic dermatitis, where only a single treatment is administered for practical purposes.

The **label dose** is the dose stated on the label of the drug and is the legal dose that can be used for that product. The label states the required **withdrawal periods** for avoidance of tissue or milk residues. The recommended doses given in the sections on individual diseases are based on our expectations of therapeutic efficiency, and may exceed the label dose recommendations for certain drugs. The problem of persisting tissue residues should be recognized when label recommendations are exceeded and withdrawal periods should be adjusted accordingly.

Label dose levels and dose intervals for many of the antimicrobial agents used in large animals are frequently too low and too long. In many cases, there are no obvious pharmacological reasons for these dosing regimes. Unfortunately, pharmacokinetic studies of the earlier antimicrobial agents released for use in large animal species were limited at the time of their release and it would appear that in many instances the label dose established at that time was inadequate. Some estimate of the dose required for an antimicrobial drug can be obtained by a comparison of the MICs required for activity against various organisms with the blood and tissue levels of the drug obtained at various dose levels. Usually, levels 3–5 times the MIC are considered necessary for effective therapy, and it is generally considered desirable to maintain these levels over the treatment period, especially with bacteriostatic antimicrobials, although this is probably not essential.

The ultimate proof for dose levels and dose intervals of an antimicrobial is by clinical trials of its efficacy in the treatment of infectious disease. It is apparent

that antimicrobial drugs are effective in many diseases in large animals at the dose rates and intervals currently in use. Nevertheless, as the results of pharmacokinetic studies in farm animals become available it is quite probable that they will suggest changes in the dose levels and intervals for several of the antimicrobial drugs in use, which may result in more efficacious therapy and lead to label doses that have a broader spectrum of activity against disease.

## **ROUTES OF ADMINISTRATION**

### **INTRAVENOUS INJECTION**

Intravenously administered antibiotics attain high and immediate blood and tissue levels. This route should be used in the treatment of **septicemia** and other life-threatening diseases. The concentrations obtained are much higher than those obtained with equivalent doses of the same drug given intramuscularly or orally, and consequently greater **diffusion concentrations** are achieved at sites of infection. For this reason this route of administration may also be used in an attempt to increase the drug concentration in areas where the antibiotic normally achieves only low concentrations, and where areas of necrosis increase the length of the diffusion pathway. Intravenous administration may also be indicated in **chronic infections** such as corynebacterial pneumonia in foals, where high diffusion concentrations are required in order to penetrate the abscess areas and the capsular material of the organism.

An initial intravenous loading dose may combat the development of **step-wise resistant mutants**. Because of the initial higher blood and tissue levels, the intravenous route may also be used for the treatment of infections that are only moderately sensitive to the antibacterial drug being used. This is because effective concentrations may be achieved by repeated intravenous dosing which would not be achieved by equivalent doses given intramuscularly or orally.

For practical reasons the intravenous route of administration is used for **low-concentration**, high-volume antimicrobial agents such as sulfamethazine and oxytetracycline. It is also preferred to the intramuscular route in racehorses where there is a need to avoid muscular soreness. The need to avoid **muscle damage** in beef cattle close to marketing may also dictate intravenous administration.

Administration by this route is not without its dangers. Acute **toxic reactions** either to the drug or to its vehicle are more common when intravenous administration is used. Drugs specifically

formulated for intravenous use should be used, or the manufacturer's recommendations on the advisability of the use of this route for any preparation should be followed. Severely toxemic terminal cases may die immediately following injection, and in the owner's mind death may be attributed to the therapy.

Injections should be given **slowly** and not as a bolus. Therapy by repeated intravenous administration is generally restricted to hospital situations and can be expensive because of the added **cost** of the intravenous preparations. In field situations an initial **intravenous loading dose** followed by sustaining intramuscularly administered doses is frequently indicated in the treatment of infectious diseases and is sound therapeutic policy.

The jugular vein is used in all species except the pig, where the inaccessibility of superficial veins other than the ear veins makes the jugular route of administration generally impractical. **Perivascular reactions** and intravascular thrombosis are a hazard with this route, especially following the administration of irritant drugs such as sulfonamides and tetracyclines.

### **INTRAMUSCULAR INJECTION**

Intramuscular injection is the most commonly used method for antimicrobial administration in large animals. Where possible this route should be **avoided in meat-producing animals**, especially with irritant preparations. Lesions can be detected at slaughter 12 months after the intramuscular injection of long-acting tetracyclines.<sup>1</sup> If the drug must be given intramuscularly in a meat-producing animal it should be given in the **muscles of the neck**, as scar tissue and blemish are more likely to be detected at this site in the cutting process after slaughter and they can be trimmed. With certain antibiotics, drug residues may persist at these sites for long periods, and the label recommendation for withdrawal or withholding time should be followed.<sup>2</sup>

Irritant drugs should be used with care in **horses**, or avoided, as this species more commonly develops severe reactions at the site of injection. The development of such reactions is usually an indication to change to alternative therapy. Oil-based vehicles frequently produce severe reactions at the site of injection in horses and should not be used.

There is evidence, for some antibiotics at least, that the site of intramuscular administration can influence the rate of absorption, the **bioavailability** and the subsequent pharmacokinetics of the administered antibiotic. In both cattle and horses, injection in the neck gives more favorable pharmacokinetic parameters

than does injection into the gluteal or shoulder muscles.<sup>3-5</sup> Injection into the dewlap gives the poorest bioavailability. These differences presumably result from differences in the spread of the injected drug within and between the muscles and differences in blood supply. With intermuscular spread there is a greater absorption area and less compromise of capillary and lymphatic structures.<sup>5</sup> Injection into the side of the neck of horses is considered to be malpractice in some countries. When irritant preparations must be given to horses it is wise to inject them into the muscle of the chest between the forelegs, as reactions in this area have less tendency to spread and are more accessible to drainage and treatment.

At all sites, care should be taken to ensure that the injection is not inadvertently given intravascularly, by applying negative pressure to the syringe prior to injection. In adult animals no more than 10 mL should be given at any injection site. Large injection volumes can result in the formation of encapsulated antibiotic-filled cysts in muscle.<sup>2</sup> Label directions of the maximum amount to be given at any one site should not be exceeded.

With most antimicrobial drugs, excepting the repository forms and drugs of an irritant nature, peak blood concentrations are obtained within 30–120 minutes of injection. However, the bioavailability of drugs given by intramuscular injection is markedly influenced by their formulation and irritant nature. This is especially marked with oxytetracycline preparations.

### INTRAPERITONEAL INJECTION

Intraperitoneal injection is occasionally used for antimicrobial administration, especially in cattle close to market size, and where intravenous administration for various reasons may be impractical. It is also occasionally used in pigs with diarrhea, where the antibacterial drug is combined with fluids for rehydration. In cattle the injection is given in the right flank midway between the last rib and the tuber coxae and at least 10 cm ventral to the lateral processes of the lumbar vertebrae so as to avoid retroperitoneal and perirenal deposition of the drug. An aseptic injection technique should be used. Animals with peritonitis are also occasionally additionally treated by this route of injection. In horses with peritonitis the peritoneal cavity can be drained through a cannula inserted in the ventral midline as used for abdominal paracentesis, and the antimicrobial agent is injected via this route. Intraperitoneal injection may also be used for the parenteral administration of the tetracycline group in acutely toxemic animals or in animals with severe respiratory distress

where intravenous injection may result in collapse and even death.

### SUBCUTANEOUS INJECTION

Subcutaneous injection has not been commonly used in large-animal practice but concerns regarding lesions in meat following intramuscular injections is leading to a greater use of this route. Providing the drug is not deposited in a fat depot, this route provides a reasonable alternative to intramuscular injection.<sup>6</sup> With irritant preparations there is a danger of excessive reaction and the occurrence of sterile abscesses. Very small animals (piglets) are often treated by this route.

### ORAL ADMINISTRATION

Oral administration of antimicrobial agents is generally restricted to **preruminant animals, young foals** and **pigs**. The blood and tissue levels achieved following oral administration are considerably less than those achieved by an equivalent dose of the same antimicrobial agent given parenterally, and for this reason the oral dose rate is generally 2–5 times greater than the parenteral dose. Oral drugs are less reliable because **absorption characteristics** may vary with the volume of ingesta, the presence or absence of gastric and intestinal stasis or hypermotility and the nature of the ingesta, which variably bind the orally administered drug. For example, oxytetracycline and trimethoprim have a much lower **bioavailability** to calves when administered in milk, rather than in water, because of the high degree of binding to milk.<sup>7</sup> There is some evidence that the oral administration of antibiotics to calves in glucose–glycine–electrolyte solutions is associated with more favorable absorption characteristics. The aminoglycoside and polymyxin groups of antimicrobial agents are not absorbed from the alimentary tract and benzylpenicillin is largely destroyed within the stomach.

The oral route is the easiest method for administration, and where the cost of revisits is a significant consideration this route is often chosen for **continuing medication**, as it is within the capability of any owner. In general, however, systemic infections are better treated by parenteral injection and certainly treatment should be initiated by this route. The oral route is the one of choice for the treatment of enteric infections. Experimental studies have shown that the oral administration of antibiotics to healthy neonatal calves may induce villous atrophy within the intestine and a malabsorption diarrhea.<sup>8</sup> This occurred particularly with neomycin and to a lesser extent with tetracycline and ampicillin. Although this does not negate the use of antibiotics for specific

therapy of enteritis in young calves (when this is indicated), it does suggest that prophylactic use of oral antibiotics has a risk in young calves.

**Prolonged oral medication** at therapeutic levels may result in **superinfection** in all animal species. Commonly a yeast, staphylococcus or *Pseudomonas aeruginosa* is involved. It occurs most commonly in calves given courses of differing antimicrobial agents. It is more common following medication involving tetracyclines and usually a treatment period of at least 2 weeks is required for its development.

Antimicrobial drugs are seldom given orally to ruminant animals. Exceptions are the use of sulfonamides, especially as sustaining medication following initial parenteral treatment, and low-level antibiotic therapy to feedlot animals to reduce the incidence of liver abscess and respiratory disease. Blood levels following oral administration in ruminants are variable and frequently not achieved until 12–18 hours after dosing. Also, many antibacterials are destroyed or inactivated within the rumen. Orally administered antimicrobials cause a significant disruption of the ruminal flora and by itself this may result in a syndrome of ruminal stasis, anorexia and depression. If antibacterial agents are given orally to ruminants, the course should be followed by re-establishment of the ruminal flora by cud transfer.

### Contamination of feedstuffs

**Antibiotic contamination of rations** is a potential problem in feed mills that process medicated and nonmedicated feeds consecutively. The inadvertent feeding of antibiotics to cattle and horses can result in **clinical disease** and the cause may not be immediately apparent to the investigating clinician. This can occur when cattle and horses are fed medicated pig feed, but may also occur when regular rations become contaminated with antibiotics. Residual carryover of medicated material into other feedstuffs can occur with feed-mixers of various types and also via residues in conveyors, hoppers and trucks. The risk for feedstuffs being contaminated can be quite high and the most common contaminating drugs are chlortetracycline, sulfonamides, penicillin and ionophores.<sup>9</sup>

Within 24 hours of being fed medicated feed, dairy cattle show anorexia, rumen stasis and subsequently pass custard-consistency feces containing undigested fiber. There is a precipitous fall in milk production. Dullness, muscle fasciculation, ketosis, hypocalcemia and recumbency have also been observed. Affected cattle usually recover when placed on non-

medicated feed, but milk production may be adversely affected for the remainder of the lactation. Feeds contaminated with dimetridazole, lincomycin and tylosin have been incriminated,<sup>10,11</sup> although there is debate as to the role of tylosin in this syndrome.<sup>12</sup> The **carryover** of medicated material into other feeds can also create violative **tissue residues** at slaughter.<sup>9</sup> Sulfonamide contamination of swine rations is a particular problem.<sup>13</sup>

The use of orally administered antimicrobial agents in horses over 3 months of age should be approached with great care. Their use can be followed by diarrhea, which is often intractable and results in chronic debilitation or death. Clindamycin and lincomycin carry a high risk and are probably totally contraindicated but macrolides, tetracyclines, tylosin and metronidazole are also associated with risk in stressed horses.

### Water medication of pigs

The oral route is the most common and convenient one for group medication of pigs. The antibacterial agent may be incorporated in the water or in the feed. For the treatment of disease in pigs, water medication is preferred as **sick pigs may drink**, whereas they frequently will not eat. Also, water medication can usually be **started immediately**, whereas the mixing of an antibacterial agent with the diet for piggeries purchasing prepared diets may take 1–2 days. Antibiotic bioavailability is also less in pelleted feeds.<sup>14</sup>

In outbreaks of contagious disease in pigs, the sick pigs within the group are usually initially treated individually by parenteral injection followed by mass medication of the water supply. Large swine units usually have facilities for in-line medication; small swine units may not. With pigs using troughs, water medication is no problem. However, with automatic watering systems, medication must be through the header tank, if this can be isolated, or more commonly the water is turned off and medicated water is provided for the pigs via portable 200 L drums with a drinking bowl or nipple drinker inserted in the side.

In determining the **concentration of antibiotic** required in the water, the total daily dose of the drug is computed by multiplying the total weight of the group of pigs in kilograms by the daily dose of the drug in milligrams per kilogram. This dose must then be added to the amount of water that will be consumed in one day. It is obvious that this amount will vary according to climatic conditions and to the nature of the disease in the pigs. For example, diarrhetic pigs may drink more than normal quantities. In practice,

a rule of thumb of 10% body weight water consumption of pigs between weaning and market age has been found to be satisfactory, with estimates of 15% for situations in which high water consumption can be expected. The total daily dose is thus added to the number of liters of water equivalent to 10–15% of the estimated total body weight of the group. In pregnant sows, water consumption is usually 5–8 L/d, but lactating sows may drink 15–20 L/d. When there is doubt as to the exact water consumption the medication can be added to the lower estimate and, when consumed, fresh water provided for the remainder of the day. Water medication is generally continued for a period of at least 5 days. Antibiotics may deteriorate rapidly in water and a fresh mix should be prepared each day. Most drugs for water medication have label directions.

### Water medication in cattle

There are some major limitations in the mass medication of water supplies of cattle. The daily amount of water consumed is usually directly proportional to the amount of dry matter intake. Anorexia or inappetence will result in a marked decrease in water intake to mere maintenance requirements. Depending on the drug used, the palatability of the medicated water may affect intake. With large drinking water tanks that are replenished on a continuous basis, or even two or three times daily, it is difficult to determine how much drug should be added on a daily basis in order to maintain a reasonably steady concentration. On a theoretical basis, automatic in-line water medicators should provide a uniform concentration of drug in the water supply. However, some medicators are extremely unreliable and regular surveillance and servicing may be necessary. In countries where below-freezing temperatures occur during the winter months, the medication of water supplies may be difficult and impractical under certain management conditions.

### Dietary medication

This is generally used for long-term disease control. In many countries, the amount of an antimicrobial that can be added to a feed is restricted to the **approved label level** and the veterinarian has no legal right to alter this concentration. The drug is usually added at the feed mill.

### OTHER ROUTES

Other routes of administration may be used to increase the level of antibacterial drug in areas where diffusion following parenteral administration of the drug may be limited and when high local levels are

required. These include intra-articular, intrapleural and subconjunctival injection. Non-irritant preparations should be used with strict aseptic technique. In most cases these treatments should be supported by parenteral treatment. The indications are described in the special medicine section.

Intramammary infusion of drugs is dealt with under mastitis.

Intratracheal administration of antibiotics has its advocates for the treatment of pneumonia in cattle. In theory, this could result in higher levels of antibiotics at the site of infection, although with many pneumonias diffusion through the affected lung must be minimal. The antibiotics are administered in sterile physiological saline equivalent to 2.0 mL/kg body weight. An extensive study has shown variation in absorption and persistence between antibiotics administered by this route, when compared to parenteral administration, but has concluded that there is no potentially useful advantage to its use.<sup>15</sup>

The local administration of antibiotics may not always be the preferred route despite historical precedence. For example, in the treatment of the **genital tract**, it has been shown that parenteral administration of antibiotics achieves tissue concentrations of drug in all areas of the genital tract, whereas intrauterine infusion results in comparable concentrations only in the endometrium and uterine secretions. Local and/or parenteral administration may be indicated in different cases of genital tract infection.<sup>16</sup>

### REVIEW LITERATURE

George MH, Tatum JD, Smith GC, Cowman GL. Injection-site lesions in beef subprimals: Incidence, palatability, consequences and economic impact. *Compend Contin Educ Food Anim Pract* 1997; 19(2):S84–S93.

### REFERENCES

- George MI et al. *J Anim Sci* 1995; 73:3510.
- Mawhinney H et al. *Aust Vet J* 1996; 74:140.
- Hoffman B et al. *Dtsch Tierarztl Wochenschr* 1986; 93:310.
- Nouws JM, Vree TB. *Vet Q* 1983; 5:165.
- Firth EC et al. *Am J Vet Res* 1986; 47:2380.
- Gilman JM et al. *J Vet Pharmacol Ther* 1987; 10:101.
- Groothuis DG, van Miert ASJPAM. *Vet Q* 1987; 9:91.
- Mero KN et al. *Vet Clin North Am Food Anim Pract* 1985; 1:581.
- Lynas L et al. *Food Addit Contamin* 1998; 15:162.
- Crossman PJ, Payser MR. *Vet Rec* 1981; 108:285.
- Anon. *Vet Res* 1984; 114:132.
- MacKinnon JD et al. *Vet Rec* 1984; 115:278.
- Rosenburg MC. *J Am Vet Med Assoc* 1985; 187:704.
- Mevis DJ et al. *Vet Q* 1986; 8:274.
- Hjerpe CA. *Bovine Pract* 1979; 14:18.
- Gustafsson BK. *J Am Vet Med Assoc* 1984; 185:1194.

## DRUG DISTRIBUTION

### ABSORPTION

Antibiotics of the aminoglycoside group and polymyxins are not absorbed from the alimentary tract and if circulating levels of these antibiotics are required they must be given by parenteral injection. Where both intestinal and systemic levels are required, as may be the case in neonatal colibacillosis, these drugs should be given both orally and parenterally. Benzylpenicillin and methicillin are destroyed by acid pH and significant blood levels are not achieved following oral administration but blood levels are achieved with ampicillin and amoxicillin. Certain sulfonamides (phthalylsulfathiazole, phthalylsulfacetamide, sulfaguanidine and succinyl sulfathiazole) are not absorbed from the alimentary tract. The remaining antibiotics and sulfonamides are absorbed following oral administration in preruminant calves and lambs and in pigs and horses. However, in general, blood and tissue levels obtained are considerably lower than those achieved with equivalent doses given parenterally. Whey feeding (calcium) will inhibit the absorption of tetracyclines in pigs.

### DISTRIBUTION

Factors governing the distribution of antimicrobial agents in the body fluids are complex, and distribution should be considered as involving a multi-compartmental system with all body compartments being in contact directly or indirectly with the blood. The occurrence of exchange, and its rate, between the blood and the various tissue compartments is governed by the factors that influence the diffusion of solutes, such as the concentration of the drug and the volume of blood flow through the tissues and the volume of the tissue. It is also considerably influenced by the extent of protein binding of the drug in blood and in the tissues, the ionization constant of the drug, pH differences in the compartments, and the lipid solubility of the drug. Drug distribution is also influenced by age and the disease state of the animal.

In most diseases infection occurs in the extravascular tissue compartments and it is the concentration of the unbound drug at these sites that determines the efficacy of therapy. The majority of antibiotics diffuse relatively freely in extracellular fluids but sulfonamides, the chloramphenicol group, tetracyclines, fluoroquinolones and macrolides have a distribution that more closely approximates total body water, and they can enter cells.

There are several so-called **barriers** to antimicrobial diffusion and these include the brain and cerebrospinal fluid, serous

cavities, joints and synovial fluid, the eye and the placenta and fetus. In general sulfonamides, the tetracyclines and chloramphenicol have some ability to penetrate these barriers in the normal state, whereas penicillin may not. Erythromycin has the ability to penetrate intracellularly and across most barriers but will not produce effective levels in the brain or cerebrospinal fluid. Members of the aminoglycoside group of antibiotics generally achieve effective levels in synovial fluid and the pleural and peritoneal fluid but not in the brain or eye. The importance of these barriers, especially those of serous cavities and synovia, in the presence of inflammation is open to doubt and effective therapy can often be achieved by the use of antibiotics that do not in normal situations reach these areas unless they are inflamed. An exception to this rule is infections involving the eyes where, in order to achieve effective levels, high circulating levels of the antimicrobial agent are required and intravenous injection to achieve this is usually necessary. Lipophilic drugs diffuse into tears and parenterally administered erythromycin, oxytetracycline and gentamicin, for example, may achieve bacteriostatic concentrations in tears. In many areas, especially joints and the peritoneal, pleural and pericardial cavities, high levels of the required antimicrobial agent can be achieved by local administration.

Almost all antimicrobial agents are **excreted** via the kidney, and the urine usually contains high levels of them. This feature is not of great significance in large animals, where urinary tract infections are comparatively rare, but violative residue levels can persist in the kidney for long periods with drugs such as the aminoglycosides. Penicillins and tetracyclines have a significant enterohepatic cycle, and erythromycin also may obtain significant levels in bile.

### REVIEW LITERATURE

- Baggot JD. Principles of drug distribution in domestic animals. Philadelphia: WB Saunders, 1977.
- Baggot JD. Factors involved in the choice of routes of administration of antimicrobial drugs. *J Am Vet Med Assoc* 1984; 185:1076-1082.
- Koritz GD. Relevance of peak and trough concentrations to antimicrobial therapy. *J Am Vet Med Assoc* 1984; 185:1072-1075.
- Short CR, Clark CR. Calculation of dosage regimens of antimicrobial drugs for the neonatal patient. *J Am Vet Med Assoc* 1984; 185:1088-1093.
- Riviere JD. Veterinary clinical pharmacokinetics. *Compend Contin Educ Pract Vet* 1988; 10:24-30, 314-328.
- Koritz GD. Practical aspects of pharmacokinetics for the large animal practitioner. *Compend Contin Educ Pract Vet* 1989; 11:202-204.
- Prescott JF. Antimicrobial chemotherapy. In: Biberstein EL, Yuan CZ, eds. *Review of veterinary microbiology*. Boston, MA: Blackwell Scientific, 1990.

Riviere JD. Pharmacologic principles of residue avoidance for veterinary practitioners. *J Am Vet Med Assoc* 1991; 198:809-816.

### DURATION OF TREATMENT

For certain infectious diseases there is an established regimen of therapy that is known from clinical experience to be therapeutically effective. Where such regimens are known they are stated in the treatment section for the individual diseases in the Special Medicine section. As a rule of thumb in undifferentiated diseases, therapy should be continued for at least a 3-5-day period, or longer if there is evidence of chronic infectious disease with localization. An alternative rule of thumb is that treatment should be continued for at least 1 day beyond the return of body temperature to normal, especially if bacteriostatic antibiotics are being used. Chronic pyogenic processes may require treatment for a 2-4-week period or even longer.

### DRUG COMBINATIONS

Combinations of antimicrobial drugs are frequently used in veterinary practice. Combinations of antimicrobial agents are used either to achieve a **synergistic effect** in the case of a single infection, or to achieve a **broad spectrum of activity** in the case of infections involving more than one agent. Combinations may also be of value in combating the **emergence of resistant mutants** during therapy.

The combination of two drugs may result in **indifference**, where the effect is either that of the single most effective drug or is equal to the sum of the effects of the two individual drugs, or it may result in **synergism** or **antagonism**. There are, however, no hard and fast rules for combinations that will result in any of these effects. Knowledge of these effects results largely from laboratory animal studies and from some human therapeutic trials. From these trials it is evident that the occurrence of **synergism** is very much dependent on the type of infectious organism, and to some extent the site of infection, and, whereas two drugs may show a synergistic effect with one type of infection, the effect may be indifferent or even occasionally antagonistic with other infective agents. **Antagonism** is equally not easily predictable but the drugs that most commonly result in antagonistic effect when combined with others are the tetracycline group, chloramphenicol and the macrolide groups.

A traditional approach has been that combinations of bactericidal drugs will generally result in an indifferent effect or in synergism; combinations of bacteriostatic drugs generally give an indifferent effect,



**Table 4.1 Mode of action of antimicrobial drugs**

Bactericidal antimicrobials	Bacteriostatic antimicrobials
Beta-lactams	Sulfonamides – all
Penicillins	Trimethoprim
Cephalosporins	Methotrexate
Semisynthetic penicillins	Pyrimethamine
Ampicillin	Tetracyclines
Amoxicillin	Macrolides
Cloxacillin	Erythromycin
Methicillin	Oleandomycin
Carbenicillin	Spiramycin
Aminoglycosides	Tylosin
Streptomycin	Carbomycin
Neomycin	Lincomycin
Gentamicin	Chloramphenicol
Paromomycin	Florphenicol
Tobramycin	
Glycopeptides	
Vancomycin	
Rifampin	
Bacitracin	
Polymyxins	
Fluoroquinolones	

whereas combinations of a bactericidal with a bacteriostatic drug may result in antagonism (Table 4.1). This approach is, however, too general for validity as interactions are specific to individual infections and are dose-dependent.

In farm animals, **synergistic activity** between penicillin and streptomycin has been demonstrated in the therapy of mycotic dermatitis and footrot in sheep.

The synergism between aminoglycoside and beta-lactam antimicrobials is widely used in the approach to the therapy of sepsis in neonates. Carbenicillin and gentamicin in combination can be of value in therapy against *P. aeruginosa*, *Klebsiella* and *Proteus* spp., and tylosin and oxytetracycline can be of value in treating infection with *Mannheimia* and *Pasteurella* spp. Trimethoprim and sulfonamide combinations are of special value in treating several infectious diseases in large animals. Rifampin and erythromycin show in-vitro synergism against *Rhodococcus equi*, as does a combination of gentamicin and penicillin. Tiamulin and tetracycline show in-vitro synergism against several swine respiratory pathogens and herd studies show a measured response in the control of respiratory disease greater than that achieved by chlortetracycline alone.

Drug combinations are also used for **broad-spectrum therapy**. An accurate diagnosis with consequent recognition of the likely infectious organism allows specific antibacterial therapy and obviates the need for broad-spectrum antibacterial therapy. However, there are clinical situations where broad-spectrum therapy, including the possibility of combined

drug therapy, is indicated. These include such problems as the acute septicemia, where a number of different organisms, with differing antibacterial sensitivities, can produce identical clinical disease, and those infections associated with organisms that have a varying sensitivity depending upon the isolate. The requirement for immediate treatment without knowledge of the bacterial sensitivity dictates the use of antimicrobial drugs designed to obtain a broad spectrum of activity.

The availability of **broad-spectrum drugs** such as ampicillin or amoxicillin and trimethoprim-potentiated sulfonamides has lessened the need to use drug combinations but the latter may still be necessary in certain situations and are fully indicated. Although antagonism has not been demonstrated in clinical veterinary situations it is wise to avoid bacteriostatic and bactericidal drug combinations.

**Fixed-dose combinations** are available commercially for some antibiotics but they **are not recommended** for use and are gradually being withdrawn from the market or being declared not legal for use in food-producing animals. Fixed-dose combinations suffer from the deficiency that the dose level of any one of the drugs in the combination is dictated by the level of the other. Also, the excretion rates of the two drugs may be markedly different. The most common of these, fixed-dose penicillin/streptomycin combinations, suffer from this deficiency.

Where combinations of antibacterial drugs are used they should be given individually and at their respective recommended doses and repeats. Some antibiotics are **physically incompatible** when mixed together. The incompatibility may rest with the drugs or their vehicles and may be visible, as with crystalline benzylpenicillin and neomycin, or it may be inapparent, as with gentamicin and carbenicillin. The two drugs should be given separately at separate sites. Incompatibilities can also occur with antibiotics and intravenous fluid solutions – especially those containing protein hydrolysates.

Antibiotics may influence the **activity of other drugs**. In particular, chloramphenicol and tetracyclines inhibit liver microsomal metabolism and may significantly increase the half-life of drugs metabolized by this mechanism, such as digitalis or barbiturates, with resultant potential toxicity.

#### REVIEW LITERATURE

Reilly PEB, Issacs JP. Adverse drug interactions of importance in veterinary practice. *Vet Rec* 1983; 112:29–33.

Whittem T, Hanlon D. Dihydrostreptomycin or streptomycin in combination with penicillin G in

dairy cattle therapeutics: a review and re-analysis of published data. *NZ Vet J* 1997; 45:178–184, 223–229.

McKenzie HC, Furr MO. Aminoglycoside antibiotics in neonatal foals. *Compend Contin Educ Pract Vet* 2003; 25:457–469

#### ADDITIONAL FACTORS DETERMINING SELECTION OF AGENTS

In addition to the considerations of bacterial sensitivity to the antimicrobial agent, there are other important factors that dictate the selection of the antimicrobial agent to be used in a particular case. In most clinical situations several agents would be effective and a choice needs to be made amongst them.

#### COST

This is a major factor and includes not only the primary cost of the drug but also the ancillary costs that may be associated with its administration. This is a most important factor in agricultural animals but of less importance with pleasure horses. The importance of the primary cost of the drug is obvious. For example, in most countries a 5-day course of treatment with procaine benzylpenicillin will cost considerably less than one with, for example, oxytetracycline. If there is no specific indication for the use of the more expensive drug then the less expensive one should be used. The **ancillary costs** associated with repeat visits to administer the drug may also be important. The practice of dispensing drugs for continuing intramuscular therapy varies between countries and veterinary practices and has an influence on this consideration.

#### EASE OF ADMINISTRATION

This is a further factor that influences the nature of the drug and treatment used. In general, one avoids starting a course of therapy with an antibacterial such as tetracycline, which may require daily intravenous administration, in favor of one that can be administered more simply – unless there are good therapeutic reasons for choosing the former. In situations where facilities are poor, where **mustering or yarding** is difficult, or where mass medication is required, long-acting repository preparations may be indicated. Irritant preparations are avoided where possible.

#### TOXICITY

This is always a consideration when dealing with infections that may require high dose rates of antimicrobial drugs, or in chronic infections that require a prolonged course of therapy. Where a choice is available, antimicrobial agents with a low incidence of toxic side effects at high doses are chosen. As in all clinical situations involving large animals it is

essential to make an assessment of the case and to attempt a **prognosis**. The possible cost and duration of treatment should be estimated and the owner advised of this. When examined in this light the decision may be against treatment and for salvage slaughter.

### BACTERICIDAL OR BACTERIOSTATIC ANTIMICROBIALS

Antibiotics are either primarily bactericidal or primarily bacteriostatic in their activity (Table 4.1). Some of the bactericidal group are bacteriostatic at low concentration. Both classes rely on intact and **effective body defense mechanisms** for full effect. Although in terms of clinical response little if any difference can be detected between the two groups in most diseases, in certain situations it is probably advisable to choose a bactericidal antibiotic for therapy. This is especially true when dealing with acute septicemic infection where there is frequently a significant leukopenia, and quick maximal bactericidal effect is required. There is also the need to prevent subsequent localization.

Bactericidal antimicrobials are also indicated for antibacterial treatment of secondary infection in **granulocytopenic syndromes** such as bracken fern poisoning or chronic furazolidone poisoning in calves. Bactericidal antibiotics are also preferable in the treatment of heavily **capsulated organisms**, such as *Klebsiella* spp. and *R. equi*, which show anti-phagocytic activity. Infections in which significant **intracellular parasitism** occurs are a problem. The majority of antimicrobials that diffuse relatively freely into cells are bacteriostatic in activity and, although the disease may be controlled by their use, infection may still persist in a latent carrier state.

#### Antimicrobials prohibited from use in animals intended for food in the USA

- Chloramphenicol
- Dimetridazole
- Iprnidazole
- Other nitroimidazoles
- Furazolidone, nitrofurazone, other nitrofurans
- Sulfonamide drugs in lactating dairy cattle (except approved use of sulfadimethoxine, sulfabromomethazine and sulfamethoxyypyridazine)
- Fluoroquinolones
- Glycopeptides (example: vancomycin)

### DRUG DETERIORATION

Many antibacterials lose their activity rapidly when kept under adverse conditions. **Quality control** in terms of purity, efficacy and freedom from toxicity

costs money but for these reasons it is preferable to purchase from known reputable companies and follow their recommendations with respect to storage and expiration periods. The use of cheap antibacterial preparations, often purchased in bulk and simply packaged, and distributed with little consideration for factors influencing drug stability, often results in poor therapeutic results. **Crystalline** or dry preparations that require reconstitution to a solution before parenteral administration are frequently presented this way because their activity degenerates rapidly once they are in solution. Therefore, once they have been prepared they should be used immediately, or the manufacturer's recommendations should be followed regarding storage. Attention should be paid to the length of activity expected following reconstitution.<sup>1</sup> **Temperature** and exposure to **sunlight** can be important factors in antibiotic stability and become especially important in farm ambulatory practice: car cold boxes should be used to store antibiotic preparations and other sensitive drugs.

### UNFAVORABLE RESPONSE TO THERAPY

In clinical cases that do not respond to antimicrobial therapy the initial consideration should be that the wrong antimicrobial agent has been chosen for therapy. This is especially true of infectious conditions of undetermined etiology where the drug has been chosen on the basis of an educated guess. In these circumstances adequate time should be given for an evaluation of the efficacy of the treatment before a change is made. In general a **3-day period of treatment** is allowed for this evaluation provided there is no marked deterioration in the clinical state or further elevation of temperature during this period. If there is no response to initial therapy then, in the case of conditions of undetermined etiology, it is generally best to change to an entirely different class of antimicrobial agent. However, the possibility of viral or non-infectious etiology should always be considered in these cases and the case and diagnosis should be reviewed before any change is made.

In any situation where there is a poor response to therapy the usual causes of this failure should be considered in any further adjustments to therapy or future therapy of similar cases. The first and most obvious of these is that the organism is either **insensitive to the drug** or that it is **not susceptible to the level of the drug** that is being used for therapy. There are two possible approaches. The first is to

increase the dose rate and dose frequency and/or to change the route of administration so that higher and possibly effective levels will be achieved, bearing in mind the possible toxic consequences. The second, and safer, approach is to change the antimicrobial agent being used. This problem can be avoided if the organism and its potential **sensitivity** can be identified, either by clinical examination or by appropriate sampling with culture and sensitivity testing. The development of resistance during antimicrobial treatment of an individual animal is not a recognized problem in large-animal medicine.

Another common cause of poor response is that the infection is situated in an area to which the drug is **poorly accessible**. If this is associated with an area behind a barrier to the entry of the antibiotic, such as the joints or the eye, it may be necessary to resort to **higher dose rates** and frequency, or intravenous administration of the drug, or to ancillary local treatment into this area. Alternatively, another drug with **superior penetrability** may be used.

Organisms must be actively metabolizing in order for antimicrobial agents to exert their effect. This feature can result in poor response to therapy or relapse following discontinuation of therapy in **chronic infections** such as endocarditis or where there is excessive necrotic or fibrotic tissue associated with the infection. In these instances, dormant organisms and the long diffusion tracks make effective cure difficult and high antimicrobial levels sustained over longer periods are required. In **purulent conditions** surgical drainage, where possible, is an essential adjunct to antimicrobial therapy.

The importance of ancillary and **supportive therapy** to counteract the effects of shock, toxemia and dehydration that may be associated with infection cannot be overemphasized and frequently such therapy may markedly influence the outcome of a case. It is obvious, for example, that 3 mL of antibiotic will do little to counter the effects of a 4 L fluid deficit in a scouring calf.

### DRUG WITHDRAWAL REQUIREMENTS AND RESIDUE AVOIDANCE

In most countries there are requirements for the withdrawal of antimicrobial agents from the feed for specified periods prior to slaughter, and animals or their milk cannot be marketed for certain periods following antimicrobial therapy.

Antibiotic contamination of food products can be a **public health risk**,



although proven risk for toxicity or allergy from antibiotics in humans is minuscule. An example would be allergic reactions to antibiotic residues – particularly penicillin. There are also **commercial considerations** where residues of antibiotics in milk can cause considerable problems in the manufacture of milk products. Effects on starter cultures for cheese and yoghurt can be particularly deleterious and can result in downgrading or total loss of large quantities of manufacturing milk.

The purpose of withdrawal requirements is to ensure that meat and milk for human consumption is wholesome and does not contain violative residues of drugs. The public's concern for the wholesomeness of the food that it consumes will determine the food that it buys. Cooperative quality assurance programs involving both the producer and the veterinarian are a major answer to this concern.

A **withdrawal period** is the time during which the animal must be held free of the drug before it can be marketed. In the case of milk, the term **withholding period** is commonly used and defines the period during which milk cannot be sent for human consumption following the treatment of the animal with a drug. A **tolerance** for the pharmacologically active ingredient in tissues is set by regulatory authorities for each drug. The **tolerance level** is the level below which tissue concentrations must fall before they are considered safe for human consumption, and there is a large margin of safety.<sup>2</sup>

The required withdrawal and withholding periods will vary between antimicrobial agents and also with the same antimicrobial agent depending upon the amount of drug given; factors such as age and the disease state of the animal are also important. Unfortunately, the required withdrawal and withholding periods to ensure freedom of food products from violative drug residues are not known for the variety of dose concentrations and dose intervals of the various antimicrobials that could be used in clinical practice – nor are they likely to be known in the near future. In many countries this has led to regulations that limit the quantity of antibiotics in drug products. **Label instructions explaining product usage and drug withdrawal times are required.** These label instructions include what is generally called the **label dose**.

#### The label dose and extralabel use

The label dose (and dose interval) is a dose of an antimicrobial for which the specific withdrawal and withholding periods have been established, and these

are stated in conjunction with the label dose. The label dose is the officially approved or legal dose rate for that drug.

When an antimicrobial is used, it is incumbent upon the practitioner to notify the owner that the animal cannot be marketed (or milk sent for human consumption) before the accompanying withdrawal (or withholding) period has expired. The practitioner may be legally liable if a violation occurs and this notification has not been given.

In the **USA** the **label dose** of a drug also includes use only in the species of animal for which the drug is labeled, the class of animal (lactating versus non-lactating dairy cow), the disease conditions indicated by the label, the route of injection, the amount of drug to be injected at one site and the number of repeat treatments that can be given. These **label directions**, and the need to follow them, are directed primarily at lay users of these drugs and lay users may not use the drug in a nonlabel fashion. The label directions should also be followed by the veterinarian whenever possible.

#### Requirements for extralabel use of drugs in the USA

- Extralabel use of drugs (ELDU) is permitted only by or under the supervision of a veterinarian
- ELDU is allowed only for US Food and Drug Administration (FDA)-approved animal and human drugs
- A valid veterinarian–client–patient relationship is a prerequisite for all ELDU
- ELDU must be for therapeutic purposes only (animal's health is suffering or threatened), not drugs for production use
- Rules apply to dosage form drugs and drugs administered in water – ELDU in feed is prohibited
- ELDU is not permitted if it results in a violative food residue, or any residue that may present a risk to public health
- FDA prohibition of a specific ELDU precludes such use

#### Extralabel use

There are times where **extralabel use** of drugs is necessary and veterinarians can do this where they have established a proper veterinarian–client–patient relationship.<sup>3</sup> It is the intention that the label dose should be one that is therapeutically effective for that drug. However, this is not always the case, and the label dose should not be confused with the term 'recommended dose' as used elsewhere in this book. There are also circumstances where, although the label dose may be therapeutically efficient in many cases, it is not for the particular case in hand. In fact, optimal therapeutic

dose regimes often require extralabel use of the drug.<sup>4,5</sup> In these situations, antimicrobial drugs may need to be used at dose concentrations and dose intervals different from the label dose. Extralabel use of the drug may be therapeutically necessary for the successful treatment of the problem, but it is not officially approved and the establishment of the required withdrawal period is entirely incumbent upon the veterinarian. The withdrawal period in these circumstances cannot always be extrapolated from that for the label dose.<sup>2</sup>

#### Definition of valid veterinarian–client–patient relationship (American Veterinary Medical Association)

An appropriate veterinarian–client–patient relationship will exist when:

1. The veterinarian has assumed the responsibility for making medical judgments regarding the health of the animal(s) and the need for medical treatment, and the client (owner or other caretaker) has agreed to follow the instructions of the veterinarian
2. There is sufficient knowledge of the animal(s) by the veterinarian to initiate at least a general or preliminary diagnosis of the medical condition of the animal(s). This means that the veterinarian has recently seen and is personally acquainted with the keeping and care of the animal(s) by virtue of an examination of the animal(s) and/or by medically appropriate and timely visits to the premises where the animal(s) are kept, and
3. The practicing veterinarian is readily available for followup in case of adverse reactions or failure of the regimen of therapy

#### WITHDRAWAL PERIODS

**Label dose withdrawal periods** are determined from pharmacokinetic studies of excretion following administration of the label dose. However, the rate of drug elimination from the body can be influenced by drug dose and dose frequency. For example, the metabolism and excretion half-life of sulfonamides in cattle is dose-dependent. With repeated dosing of antibiotics such as tetracycline and the aminoglycosides, there is deposition of the antibiotic in certain tissues and following cessation of drug administration there is a slow release from these tissues and a long **washout period**.<sup>6,7</sup> During this washout period there are decreasing concentrations of the drug in tissues and in milk, which, although not of therapeutic importance, are sufficiently high to be violative. This presents a dilemma to the veterinarian trying to establish withdrawal periods.

The occurrence of significant washout periods following prolonged therapy with antibiotics has only recently been recognized and there are few data on their duration at different dose concentrations and dose frequencies. A further problem is that most pharmacokinetic parameters have been determined in healthy animals and altered physiology in diseased animals can markedly alter elimination half-lives; there is also considerable animal-to-animal variation.<sup>2</sup> Rather than try to guess the possible withdrawal period for an extralabel use, computer-based data information banks with easy access are established to provide this information.<sup>8</sup> One of these is the Food Animal Residue Avoidance Databank (FARAD), which provides recommendations for withdrawal intervals for extralabel drug use based on analysis of published pharmacokinetic data, foreign and domestic label drug withdrawal intervals and established maximum residue limits. Another, the Veterinary Antimicrobial Support System (VADS), aims to provide information on optimal therapeutic regimens against pathogens in cattle and swine using approved drugs and treatment regimens but also providing information on extralabel regimens that might be required in the face of a refractory pathogen.

### RESIDUE TESTING

Currently, the only way to attempt to ensure nonviolation with extralabel use of antimicrobials is to test for residues.<sup>9,10</sup> There are a very large number of testing systems becoming available, which vary in their method of detection of the presence of antibiotics.<sup>11-14</sup> Tests such as the Swab Test on Premises (STOP), Calf Antibiotic and Sulfa Test (CAST), Live Animal Swab Test (LAST), Fast Antimicrobial Screen Test (FAST) (which has a higher sensitivity and shorter analytical time and has largely replaced the use of STOP and CAST), the Delvotest-P, the Charm Inhibition Assay and the Charm Farm and Disk Assays are based on the inhibition of growth of *Bacillus stearothermophilus* var. *calidolactes* or *Bacillus stearothermophilus*. While relatively cheap and easy to perform, they have a risk for false-positive results due to inhibition of growth by inhibitory substances other than antibiotics in milk, particularly substances in milk from inflamed mammary glands.<sup>12,13,15-17</sup> They are sensitive for detecting penicillin and its derivative compounds but less sensitive to other classes of antibiotic. Other commercially available tests use a variety of different immunological detection methods and test for a single antibiotic or class of antibiotics.

### TESTING FOR COMPLIANCE

Most countries have a monitoring program to detect the occurrence of residues in meat. In the USA, sampling is such as to provide a 95% probability of finding a violative residue when 1% of the population is violative. The occurrence of violative residues in red meat is very low as the prevalence of infectious disease is low in the period before slaughter. Feedlot cattle can have a high prevalence of disease in the early feeding period but there is a substantial subsequent period on-feed before the animals are slaughtered, which exceeds the withholding period of most drugs used for treatment of disease occurring during the early feeding period. Violative drug residues occur predominantly in cull dairy cows and in bob veal calves.

The concentrations for the various antibiotics that are violative are not stated in this chapter for two reasons. First, they vary from country to country. Secondly, the violative concentrations tend to be set by the sensitivity of the detection assay used by the regulatory authority and, as assay technology improves, legally acceptable minimal concentrations will be lowered. Local regulatory publications should be consulted for current requirements.

Assay techniques can be remarkably sensitive. An example is the occurrence of violative residues of chloramphenicol in the milk, blood and urine of cows that had teat or skin lesions sprayed with a 5% chloramphenicol solution<sup>18</sup> – an illegal drug for use in animals for food in most countries.

### CAUSES OF RESIDUE VIOLATIONS IN MILK

In a retrospective study of reasons for the presence of violative antibiotic residues in milk<sup>19</sup> **failure to withhold milk** for the full withdrawal period and **accidental inclusion of treated milk** in the shipment were the most common. Accidental inclusion of treated milk can occur when there is **inadequate identification** of treated cows. The veterinarian should work with the producer to establish a system that easily identifies cows whose milk is subject to a withholding period. Colored leg markers are one system and are immediately visible to the milker.

**Contamination of recorder jars and milking equipment** with the high concentration of antibiotic secreted in milk in the first milking after treatment is a further reason for residue violations. Treated cows should be **milked last** in large dairies, or milked with separate equipment, and are preferably kept separate as a hospital string.

### Common causes of antibiotic residues in milk

- Extended usage or excessive dosage
- Failure to observe withdrawal times
- Poor records of treatment
- Prolonged drug clearance
- Failure to identify treated animals
- Contaminated milking equipment
- Milker or producer mistakes
- Products not used according to label directions
- Lack of advice on withdrawal period
- Withholding milk from treated quarters only
- Early calving or short dry periods
- Purchase of treated cows
- Use of dry cow therapy for lactating cows
- Milking dry cows

Other reasons for residue violations include **short dry periods**, where dry cow therapy has been used but the cow has calved earlier than expected. The infusion of **dry cow treatments** into the udder of heifers prior to calving for the prevention of summer mastitis has also been followed by the presence of violative residues for as long as 26 days.<sup>9</sup> A less common cause is the **accidental milking of dry cows**, where the latter are not kept as a separate group, and the withholding of milk from only treated quarters.<sup>19</sup> The use of dry cow infusion preparations for treatments during lactation can occur by mistake if drugs intended for the treatment of lactating cows are not kept in a **separate storage area** from other drugs.

The **risk** for residues is higher for farms that have higher frequency of antibiotic usage and for those that use part time labor.<sup>10</sup> The use of **records** to document treatments and the day of exit from the withholding period is an important preventive measure. Sulfonamides, tetracyclines, penicillins, aminoglycosides, cephalosporin and chloramphenicol have been found in milk in the USA.<sup>20</sup>

### CAUSES OF RESIDUE VIOLATIONS IN BEEF CATTLE

Violative drug residues occur predominantly in cull dairy cows and in bob veal calves.<sup>21</sup> In one study<sup>22</sup> the primary reasons for violations in this group were:

- Failure to observe the withdrawal periods (61%)
- Use of an unapproved drug (10%)
- The feeding to calves of milk or colostrum from a treated cow (9%). A greater risk for residues occurs in herds that feed larger volumes of colostrum, possibly reflecting contamination from dry cow therapy; waste milk, discarded from treated cows and fed to calves, is also a

risk<sup>23,24</sup> especially if extralabel doses of antimicrobials are used for udder infusions<sup>25</sup>

- Exceeding the label dose (6%).

The major drugs involved with residues in meat are neomycin, streptomycin, penicillin, oxytetracycline, gentamicin and sulfamethazine, with intramuscular injection being the route of administration in 60% of the residue cases, oral administration in 28% and intramammary infusion in 9%.<sup>21,22</sup> The use of orally administered antimicrobial boluses in calves that were subsequently slaughtered as bob veal calves is also a problem.

### CAUSES OF RESIDUE VIOLATIONS IN SWINE

Similar causes are recorded for the occurrence of violative residues in pigs but an additional problem in pigs is tissue residues resulting from **antibiotic inclusions in feeds** for growth promotion and disease control purposes. Sulfonamides are a particular problem. Nonobservance of the required withdrawal period can result in the rejection of market batches of animals with a substantial financial loss to producers. If feed inclusions have been for the purposes of medication, the prescribing veterinarian may be liable if adequate information on withdrawal periods has not been given.

There is also a problem with **sulfonamide residues** resulting from carryover of sulfonamides from medicated to nonmedicated feeds at the feed mill or on the farm.<sup>26</sup> Mistakes in **feed delivery**, **feed mixing** sequences, ingredient **contamination** and contamination within the bulk feed **distribution system**, and **delivery augers** can cause residual contamination.<sup>26,27</sup> **Carryover concentrations** of sulfamethazine (sulfadimidine) of greater than 2 g per tonne in the finisher ration can result in violative residues in the liver at slaughter.<sup>28</sup> The use of granular forms of sulfamethazine markedly reduces the potential for carryover.<sup>29</sup>

A further source of contamination in the piggery is **environmental contamination**. Manure and pooled urine from swine fed 100 g per tonne of sulfamethazine contains sufficient drug to contaminate swine to violative levels when contact with the material is maintained and this can continue for 6–7 weeks when pens are not cleaned after a drug is withdrawn from the feed.<sup>27</sup> **Dried urine** has the potential for airborne contamination of pigs. Sulfamethazine is stable in manure and flush water for long periods and **coprophagy** by pigs can lead to significant intake of the drug. In order to avoid the risk of this occurring, it is recommended that, 3 days after the medi-

cated feed has been withdrawn, the pens should be thoroughly cleaned or the pigs moved to new housing. Water medication can also lead to buildup of residues in the water delivery system, so the watering systems should be flushed. Pigs destined for slaughter can be tested on the farm prior to shipping using commercially available testing systems, which can also be used for detection of the occurrence of sulfonamides in feed and water.<sup>27</sup>

### TYPE OF THERAPY

In the USA veterinarians are responsible for a very minor proportion of detected residue violations.<sup>30</sup> Possible causes of violations resulting from veterinary therapy include the selection of an inadequate withdrawal period following extralabel use of an antimicrobial and treatment modalities that may not be considered a risk. The local infusion of antibiotic solutions into the uterus of cows may result in circulating concentrations of antibiotic and residues in body tissues and in milk. This results from the absorption of the antibiotic through the endometrium and from the peritoneal cavity following passage through the fallopian tubes.<sup>31</sup> Similarly, following infusion of antibiotic solutions into one quarter of the udder, low concentrations of the antibiotic can occur in milk secreted from the remaining quarters. Gentamicin is generally considered not to be absorbed from the mammary gland but more than 87% of an intramammary dose of gentamicin is absorbed from the *inflamed* udder.<sup>32</sup>

### APPROVED DRUGS

Whenever possible, approved antimicrobials should be used for therapy at label dose and a known withdrawal time in order to comply with regulatory requirements and to minimize the possibility of antibiotic residues in meat and milk. It may be necessary to use non-approved antimicrobial drugs in certain circumstances and in minor species. The use of an approved antibiotic in a minor species for which it is not approved constitutes an extralabel use of the drug. The legality of the use of unapproved drugs, or of approved drugs in minor species for which they are not approved, is questionable. If such use is contemplated it is probably wise to have culture and sensitivity data indicating that the use of the unapproved drug is therapeutically necessary. Certain nonapproved antibiotics are **totally banned** for use in food-producing animals in some countries (e.g. in the USA: chloramphenicol, the nitroimidazoles, sulfamethazine in dairy cattle over 20 months of age, furazolidone and the use of fluoroquinolones in an

extralabel fashion) and local regulations should be followed. The use of sulfamethazine in food-producing animals may be banned in some countries. The American Association of Bovine Practitioners has passed a voluntary moratorium on the use of aminoglycosides in cattle.

### REVIEW LITERATURE

- Bevill RF. Factors influencing the occurrence of drug residues in animal tissues after the use of antimicrobial agents. *J Am Vet Med Assoc* 1984; 185:1124.
- Bishop JR, White CH. Antibiotic residue detection in milk – a review. *J Food Pract* 1984; 47:647.
- Bishop JR et al. Retention data for antibiotics commonly used for bovine infections. *J Dairy Sci* 1984; 67:437.
- Sundlof SF. Drug and chemical residues in livestock. *Vet Clin North Am Food Anim Pract* 1989; 5:424–430.
- Riviere JD. Pharmacologic principles of residue avoidance for veterinary practitioners. *J Am Vet Med Assoc* 1991; 198:809–816.
- Payne MA. The rational use of antibiotics in dairies. *Vet Med* 1993; 88:161–169.
- Nicholls TJ et al. Food safety and residues in Australian agricultural produce. *Aust Vet J* 1994; 71:393–396.
- Hung E, Tollefson L. Microbial food borne pathogens. *Vet Clin North Am Food Anim Pract* 1998; 14:1–176.
- Sundberg P. Food safety: Antimicrobial residues. *Compend Contin Educ Pract Vet* 2000; 22(9):S118.
- Food Animal Residue Avoidance Databank Homepage. Available on line at: <http://www.farad.org/>. Accessed May 19 2005.

### REFERENCES

1. Waltner-Toews D, McEwen SA. *Prev Vet Med* 1994; 20:159.
2. Riviere JD. *J Am Vet Med Assoc* 1991; 198:809.
3. Sterner KE. *J Am Vet Med Assoc* 1991; 198:825.
4. Constable PD. Proceedings of the 37th Annual Convention of the American Association of Bovine Practitioners 2004; 37:11.
5. Constable PD, Morrin DE. *J Am Vet Med Assoc* 2002; 221:103.
6. Nouws JFM et al. *Am J Vet Res* 1986; 47:642.
7. Haddad NA et al. *Am J Vet Res* 1987; 48:21.
8. Haskell SRR et al. *J Am Vet Med Assoc* 2003; 223:1277.
9. Hogg RA et al. *Vet Rec* 1992; 130:4.
10. McEwen SA et al. *Can Vet J* 1992; 33:527.
11. Korsrud GO et al. *J AOAC Int* 1998; 81:21.
12. Katz SE, Siewierski M. *J AOAC Int* 1995; 78:1408.
13. Cullor JC. *Vet Med* 1992; 87:1235.
14. Dey BP et al. *J Environ Health B* 2003; 38:391.
15. Tyler JW et al. *J Am Vet Med Assoc* 1992; 201:1378.
16. Slennning BD, Gardner IA. *J Am Vet Med Assoc* 1997; 211:419.
17. Andrew SM. In: Torrence ME, Isaacson RE, eds. *Microbial safety in animal agriculture: current topics*. Ames, IA: Iowa State Press, 2003:397.
18. Pengov A et al. *Anal Chem Acta* 2005; 529:347.
19. Booth JM, Harding F. *Vet Rec* 1986; 119:565.
20. Kaneene JB, Miller R. *J Am Vet Med Assoc* 1992; 201:68.
21. Gibbons SN et al. *J Am Vet Med Assoc* 1996; 209:589.
22. Guest GB, Paige JC. *J Am Vet Med Assoc* 1991; 198:805.
23. Selim SA, Cullor JS. *J Am Vet Med Assoc* 1997; 21:1029.
24. Carpenter LV et al. *Prev Vet Med* 1995; 23:143.
25. Mussér JM et al. *J Am Vet Med Assoc* 2001; 219:346.

26. McCaughey WJ et al. *Ir Vet J* 1990; 43:127.
27. McKean JD. *Agri-Pract* 1988; 9:15.
28. Ashworth RB et al. *Am J Vet Res* 1986; 47:2596.
29. Rosenberg MC. *J Am Vet Med Assoc* 1985; 187:704.
30. Gibbons SN et al. *J Am Vet Med Assoc* 1996; 209:589.
31. Ayliffe TR, Noakes DE. *Vet Rec* 1986; 118:243.
32. Sweeney RW et al. *J Vet Pharmacol Ther* 1996; 19:155.

## Diseases of the alimentary tract – I

**PRINCIPLES OF ALIMENTARY TRACT DYSFUNCTION 189**

Motor function 189  
 Secretory function 191  
 Digestive function 191  
 Absorptive function 191

**MANIFESTATIONS OF ALIMENTARY TRACT DYSFUNCTION 191**

Abnormalities of prehension, mastication and swallowing 191  
 Drooling of saliva and excessive salivation 192  
 Vomiting and regurgitation 192  
 Diarrhea, constipation and scant feces 193  
 Ileus 193  
 Alimentary tract hemorrhage 194  
 Abdominal pain 194  
 Tenesmus 195  
 Shock and dehydration 195  
 Abdominal distension 195  
 Abnormal nutrition 195

**SPECIAL EXAMINATION 195**

Nasogastric intubation 195  
 Medical imaging 196  
 Endoscopy 197  
 Exploratory laparotomy (celiotomy) 197  
 Tests of digestion and absorption 197  
 Abdominocentesis for peritoneal fluid 199  
 Intestinal and liver biopsy 203

**PRINCIPLES OF TREATMENT IN ALIMENTARY TRACT DISEASE 203**

Relief of abdominal pain 203  
 Relief of distension 203  
 Replacement of fluids and electrolytes 203  
 Correction of abnormal motility 204  
 Relief of tenesmus 204  
 Reconstitution of rumen flora and correction of acidity or alkalinity 204

**Principles of alimentary tract dysfunction**

The primary functions of the alimentary tract are the **prehension, digestion and absorption of food and water** and the **maintenance of the internal environment** by modification of the amount and nature of the materials absorbed.

The primary functions can be divided into four major modes and, correspondingly, there are four major modes of alimentary dysfunction. There may be abnormality of **motility, secretion, digestion or absorption**. The procedure

**DISEASES OF THE BUCCAL CAVITY AND ASSOCIATED ORGANS 205**

Diseases of the muzzle 205  
 Stomatitis 205  
 Diseases of the teeth 207  
 Parotitis 208

**Diseases of the pharynx and esophagus 209**

Pharyngitis 209  
 Pharyngeal obstruction 210  
 Pharyngeal paralysis 211  
 Esophagitis 211  
 Esophageal obstruction 212

**DISEASES OF THE NONRUMINANT STOMACH AND INTESTINES 215**

Equine colic (adult horses) 215  
 Colic in the pregnant and postparturient mare 229  
 Colic in foals 230  
 Gastric dilatation in the horse 233  
 Gastric impaction in horses 234  
 Gastric ulcers 234  
 Gastric (gastroduodenal) ulcer in foals 234  
 Gastric ulcer in adult horses 237  
 Intestinal obstruction in horses 241  
 Small-intestinal obstruction in horses 241  
 Anterior enteritis 245  
 Diseases of the cecum 246  
 Displacement and volvulus of the large (ascending) colon 248  
 Impaction of the large intestine of the horse 252  
 Enteroliths and fecaliths 253  
 Sand colic 254  
 Right dorsal colitis 255  
 Small colon obstruction 255  
 Spasmodic colic 256  
 Intestinal tympany in horses 257  
 Vermineous mesenteric arteritis 257  
 Gastritis 258

Acute gastric dilatation in pigs 259  
 Acute gastric torsion in sows 259  
 Intestinal reflux 259  
 Intestinal obstruction in pigs 259  
 Impaction of the large intestine of pigs 259  
 Intestinal tympany in pigs 260  
 Enteritis 260  
 Acute diarrhea of adult (nonsuckling) horses 268  
 Chronic undifferentiated diarrhea of horses 272  
 Acute diarrhea of suckling foals 274  
 Intestinal hypermotility 277  
 Dietary diarrhea 277  
 Intestinal or duodenal ulceration 279  
 Diverticulitis and ileitis of pigs 279  
 Rectal prolapse 279  
 Rectal stricture 279

**CONGENITAL DEFECTS OF THE ALIMENTARY TRACT 280**

Harelip and cleft palate 280  
 Atresia of the salivary ducts 280  
 Agnathia, micrognathia and brachygnathia 280  
 Persistence of the right aortic arch 280  
 Choanal atresia 280  
 Congenital atresia of the intestine and anus 280

**NEOPLASMS OF THE ALIMENTARY TRACT 281**

Mouth 281  
 Pharynx and esophagus 281  
 Stomach and rumen 281  
 Intestines 282

**DISEASES OF THE PERITONEUM 282**

Peritonitis 282  
 Rectal tears 287  
 Retroperitoneal abscess 290  
 Abdominal fat necrosis 290  
 Tumors of peritoneum 290

in diagnosis should be to determine which mode or modes of function are disturbed before proceeding to the determination of the site and nature of the lesion and ultimately of the specific cause.

**MOTOR FUNCTION****NORMAL GASTROINTESTINAL MOTILITY**

The form and function of the small intestine of farm animals is similar between species but the stomachs and large intestines vary considerably.<sup>1</sup> The motility patterns in both the small and large intestine are similar among the

species. In the small intestine, the fundamental unit of electrical activity is the slow wave, which is a subthreshold fluctuation in membrane potential. Slow waves are constantly propagated from the stomach to the rectum. When an additional stimulus causes the membrane potential to exceed the excitation threshold, a spike or electrical response activity occurs, which is usually accompanied by contraction. Almost all spike activity in the intestine is superimposed on slow waves, which are important in controlling frequency and velocity at which spiking events occur. The spiking activity, also known as the migrating myoelectric

complex, is the myoelectric pattern in the stomach and small intestine of fasted nonruminants, fed and fasted ruminants, and pigs and horses fed ad libitum.<sup>2</sup> There are three phases of the migrating myoelectric complex:

- The **quiescent phase**, in which very little spike activity occurs
- The **irregular phase**, characterized by intermittent spike activity
- The **activity front**, characterized by intense, continuous spike activity.<sup>2</sup>

There is very little muscle contraction or transit of gut contents during the quiescent phase. During the irregular phase, contractions mix the intestinal contents and propel them in an aboral direction. The activity front is accompanied by intense muscular contraction that obliterates the lumen, preventing backflow of content as it propagates, or migrates, down the intestine. In non-ruminants, and pigs and horses fed periodically, feeding abolishes the migrating myoelectric complex for several hours. It is replaced by the fed pattern, characterized by intermittent spike activity resembling the irregular phase.

Normal cecal and colonic myoelectric activities, like those of the small intestine, are characterized by slow waves and spikes. However, unlike the small intestine, the patterns of spikes vary greatly with the species and the area of the large intestine.<sup>2</sup>

Abnormalities of stomach and intestinal motility represent the most common consequence of gastrointestinal tract disease. Disruption in gastrointestinal tract motility can result in:

- **Hypermotility or hypomotility**
- **Distension of segments of the tract**
- **Abdominal pain**
- **Dehydration and shock.**

#### **HYPERMOTILITY AND HYPMOTILITY**

The most important functions of alimentary tract motility are the peristaltic movements that move ingesta from the esophagus to the rectum, the segmentation movements that churn and mix the ingesta, and the tone of the sphincters. In ruminants these movements are of major importance in the forestomach. Prehension, mastication and swallowing are other functions of alimentary tract motility that are essential for normal function. Eructation of ruminal gases is an additional crucial function of motility in ruminants.

**Abnormal motor function** may take the form of **increased or decreased motility**. Peristalsis and segmenting movements are usually affected equally and in the same manner. Motility depends upon stimulation via the sympathetic and

parasympathetic nervous systems and is thus dependent upon the activity of the central and peripheral parts of these systems, and upon the intestinal musculature and its intrinsic nervous plexuses. Autonomic imbalance, resulting in a relative dominance of one or other system, is manifested by hypermotility or hypomotility, and can arise as a result of stimulation or destruction of hypothalamic centers, the ganglia, or the efferent or afferent peripheral branches of the system. Debility, accompanied by weakness of the musculature, or severe inflammation, such as occurs in acute peritonitis or after trauma, or infarction, results in atony of the intestinal wall. Less severe inflammation, such as occurs in mild gastritis and enteritis, may result in an increase in muscular activity and increased propulsive activity. Increased motility causes diarrhea, decreased motility causes constipation, and both have deleterious effects on digestion and absorption.

Increased irritability at a particular intestinal segment increases its activity and disturbs the normal downward gradient of activity that insures that the ingesta is passed from the esophagus to the rectum. Not only is the gradient towards the rectum made steeper, thus increasing the rate of passage of ingesta in that direction, but the increased potential activity of an irritated segment may be sufficiently high to produce a reverse gradient to the oral segments so that the direction of the peristaltic waves is reversed orally to the irritated segments.

#### **DISTENSION**

One of the major results of abnormality of motility is distension of the tract. This occurs in a number of disturbances, including the rapid accumulation or inefficient expulsion of gas, complete occlusion of the lumen by intestinal accident or pyloric or ileocecal valve obstruction, and engorgement on solid or liquid feeds. Fluids, and to a lesser extent gas, accumulate because of their failure to pass along the tract. Much of the accumulated fluid represents saliva and gastric and intestinal juices secreted during normal digestion. Distension causes pain and, reflexly, increased spasm and motility of adjoining gut segments. Distension also stimulates further secretion of fluid into the lumen of the intestine and this exaggerates the distension. When the distension passes a critical point, the ability of the musculature of the wall to respond diminishes, the initial pain disappears, and a state of paralytic ileus develops in which all muscle tone is lost.

#### **ABDOMINAL PAIN**

Visceral pain may arise in any abdominal viscus or organ but the mode of its

development is always the same and alimentary tract disease is the major cause of visceral and, more specifically, of abdominal pain. The **most important mechanism is stretching of the wall of the viscus**, which stimulates free pain endings of the autonomic nerves in the wall. Contraction does not of itself cause pain but does so by causing direct and reflex distension of neighboring segments. Thus spasm, an exaggerated segmenting contraction of one section of intestine, will result in distension of the immediately oral segment of intestine when a peristaltic wave arrives. When there is increased motility for any reason, excessive segmentation and peristalsis cause abdominal pain, and the frequent occurrence of intermittent bouts of pain depends upon the periodic increases in muscle tone that are typical of alimentary tract wall. Other factors that have some stimulating effect on the pain end organs are edema and failure of local blood supply, such as occurs in local embolism or in intestinal accidents accompanied by twisting of the mesentery. A secondary mechanism in the production of abdominal pain is the stretching and inflammation of serous membranes.

Clinically, abdominal pain can be detected by palpation and the eliciting of pain responses. However, it is unknown if the response elicited is due to involvement of underlying organs or to referred pain. It is difficult to decide if referred pain occurs in animals. In humans it is largely a subjective sensation, although often accompanied by local hyperalgesia. There are no known examples of referred pain that are of diagnostic importance in animals and a local pain response on palpation of the abdomen is accepted as evidence of pain in the serous membranes or viscera that underlie the point of palpation.

#### **DEHYDRATION AND SHOCK**

An immediate effect of distension of the stomach or small intestine by the accumulation of saliva and normal gastric and intestinal secretions is the stimulation of further secretion of fluid and electrolytes in the oral segments. The stimulation is self-perpetuating and creates a vicious cycle resulting in loss of fluid and electrolytes to the point where fatal dehydration can occur. The dehydration is accompanied by acidosis or alkalosis depending on whether the obstruction is in the intestine and accompanied by loss of alkali, or in the stomach and accompanied by a large loss of acid radicals. The net effect is the same whether the fluid is lost by vomiting or is retained in the gut.

The same cycle of events occurs in ruminants that gorge on grain but here

the precipitating mechanism is not distension but a gross increase in osmotic pressure of the ingesta due to the accumulation of lactic acid. Dehydration is also of major importance in diarrhea, irrespective of the cause. An important additional factor in the production of shock, when there is distension of alimentary segments, is a marked reflex depression of vasomotor, cardiovascular and respiratory functions. In diarrhea in calves in which there is no septicemia nor toxemia associated with bacteria, the end-point in the phase of dehydration can be cardiac failure due to severe metabolic acidosis. Renal ischemia leading to uremia may result from decreased circulating blood volume and also contribute to a fatal outcome. These matters are discussed in detail in the section in Chapter 2 on disturbances of body fluids, electrolytes and acid-base balance.

### **SECRETORY FUNCTION**

Diseases in which abnormalities of secretion occur are not generally recognized in farm animals. In humans, and to a lesser extent in small animals, defects of gastric and pancreatic secretion produce syndromes that are readily recognized, but they depend upon clinical pathological examination for diagnosis. If they do occur in farm animals, they have so far only been recognized as aberrations of motility caused by the defects of secretion. However, it is reasonable to assume that some neonates may be deficient in lactase activity, which results in dietetic diarrhea. Undigested lactose causes diarrhea by its hyperosmotic effect, and some of the lactose may be fermented in the large intestine, the products of which fermentation may exaggerate the diarrhea. A deficiency of lactase activity has been suspected in foals affected with diarrhea of undetermined origin but the definitive diagnosis has not been made. The intestinal lactase activity of foals is at its highest level at birth and gradually declines until the fourth month of age, and then disappears from adults before their fourth year.

### **DIGESTIVE FUNCTION**

The ability of the alimentary tract to digest food depends on its motor and secretory functions and, in herbivores, on the activity of the microflora that inhabits the forestomachs of ruminants or cecum and colon of Equidae. The flora of the forestomachs of ruminants is capable of digesting cellulose, of fermenting the end-products of other carbohydrates to volatile fatty acids and converting nitrogenous substances to ammonia and protein. In a number of circumstances, the

activity of the flora can be modified so that digestion is abnormal or ceases. Failure to provide the correct diet, prolonged starvation or inappetence, and hyperacidity as occurs in engorgement on grain all result in impairment of microbial digestion. The bacteria, yeasts and protozoa may also be adversely affected by the oral administration of antibiotic and sulfonamide drugs, or drugs that drastically alter the pH of the rumen content.

Diseases of the stomach of ruminants are presented in Chapter 6. Information about the digestive and absorptive capacities of the equine gut is not exhaustive but some basic data are available.<sup>1,3</sup> The rate of passage of ingesta through the stomach and intestines is rapid but varies widely depending on the physical characteristics of the ingesta, dissolved material passing more rapidly than particulate material; 75% of a liquid marker can be emptied from the stomach in 30 minutes and be in the cecum at 2 hours. Passage through the large bowel is much slower, especially in the latter part of the colon where much of the fluid is absorbed. There is an obvious relationship between the great activity of the small intestine and the effect of a complete obstruction of it: the pain is very severe and often uncontrollable with standard analgesics, fluid loss into the obstructed parts is rapid, and dehydration, loss of electrolytes and disturbances of acid-base balance are acute, severe and life-threatening.

### **ABSORPTIVE FUNCTION**

Absorption of fluids and the dissolved end-products of digestion may be adversely affected by increased motility or by disease of the intestinal mucosa. In most instances, the two occur together but, occasionally, as with some helminth infestations, lesions occur in the intestinal wall without accompanying changes in motility.

## **Manifestations of alimentary tract dysfunction**

Inanition is the major physiological effect of alimentary dysfunction when the disease is a chronic one, dehydration is the major effect in acute diseases, and shock is the important physiological disturbance in hyperacute diseases. Some degree of abdominal pain is usual in most diseases of the alimentary tract, the severity varying with the nature of the lesion. Other manifestations include abnormalities of prehension, mastication

and swallowing, and vomiting, diarrhea, hemorrhage, constipation and scant feces.

### **ABNORMALITIES OF PREHENSION, MASTICATION AND SWALLOWING**

Prehension is the act of grasping for food with the mouth (lips, tongue, teeth). It includes the ability to drink. Causes of faulty prehension include:

- Paralysis of the muscles of the jaw or tongue
- Malapposition of incisor teeth due to:
  - inherited skeletal defect (inherited displaced molar teeth, inherited mandibular prognathism, inherited congenital osteopetrosis)
  - rickets
- Absence of some incisor teeth
- Pain in the mouth due to:
  - stomatitis, glossitis
  - foreign body in mouth
  - decayed teeth, e.g. fluorosis
- Congenital abnormalities of tongue and lips:
  - inherited harelip
  - inherited smooth tongue of cattle.

A simple examination of the mouth usually reveals the causative lesion. Paralysis is indicated by the behavior of the animal as it attempts to ingest feed without success. In all cases, unless there is anorexia due to systemic disease, the animal is hungry and attempts to feed but cannot do so.

Mastication may be painful and is manifested by slow jaw movements interrupted by pauses and expressions of pain if the cause is a bad tooth, but in a painful stomatitis there is usually complete refusal to chew. Incomplete mastication is evidenced by the dropping of food from the mouth while eating and the passage of large quantities of undigested material in the feces.

Swallowing is a complex act governed by reflexes mediated through the glossopharyngeal, trigeminal, hypoglossal and vagal nerves. It has been described endoscopically and fluoroscopically in the horse. The mechanism of the act includes closure of all exits from the pharynx, the creation of pressure to force the bolus into the esophagus, and involuntary movements of the musculature of the esophageal wall to carry the bolus to the stomach. A defect in nervous control of the reflex or a narrowing of the lumen of the pharynx or esophagus may interfere with swallowing. It is difficult to differentiate clinically between physical and functional causes of dysphagia (difficulty in eating/swallowing).

Dysphagia is manifested by forceful attempts to swallow accompanied initially

by extension of the head, followed by forceful flexion and violent contractions of the muscles of the neck and abdomen. Inability to swallow is usually caused by the same lesions as dysphagia, but in a greater degree. If the animal attempts to swallow, the results depend on the site of the obstruction. Lesions in the pharynx cause regurgitation through the nostrils or coughing up of the material. In the latter instance, there is danger that some of the material may be aspirated into the lungs and cause acute respiratory and cardiac failure or aspiration pneumonia. When the obstruction is at a low level in the esophagus, a large amount of material may be swallowed and then regurgitated. It is necessary to differentiate between material regurgitated from the esophagus and vomitus: the former is usually slightly alkaline, the latter acid.

#### CAUSES OF DYSPHAGIA AND INABILITY TO SWALLOW

- Foreign body, tumor or inflammatory swelling in pharynx or esophagus
- Painful condition of pharynx or esophagus
- Esophageal dilatation due to paralysis
- Esophageal diverticulum
- Esophageal spasm at site of mucosal erosion (achalasia of cardia not encountered).

#### DROOLING OF SALIVA AND EXCESSIVE SALIVATION

Drooling saliva from the mouth, distinct from frothing such as occurs during convulsions, may be caused by pain in the mouth and by an inability to swallow. Excessive salivation is caused by stimulation of saliva production by systemic toxins, especially fungal toxins, or by hyperthermia. With systemic poisonings the increased salivation is often accompanied by lacrimation.

#### LOCAL CAUSES OF DROOLING

- Foreign body in mouth or pharynx
- Ulceration, deep erosion or vesicular eruption of the oral mucosa
- Inability to swallow (esophageal abnormality).

#### SYSTEMIC CAUSES OF EXCESSIVE SALIVATION

- Poisonous trees – *Oleander* spp., *Andromeda* spp. (rhododendron)
- Other poisonous plants – kikuyu grass (or an attendant fungus)
- Fungal toxins, e.g. slaframine and those causing hyperthermia, e.g. *Claviceps purpurea*, *Acremonium coenophialum*
- Iodism
- Watery mouth of lambs
- Sweating sickness
- Methiocarb poisoning.

## VOMITING AND REGURGITATION

### VOMITING

Vomiting is the forceful ejection of contents of the stomach and the proximal small intestine through the mouth and is a complex motor disturbance of the alimentary tract. It is a vigorously active motion signaled by hypersalivation, retching and forceful contractions of the abdominal muscles and diaphragm. Vomiting is essentially a protective mechanism with the function of removing excessive quantities of ingesta or toxic materials from the stomach. It occurs in two forms: **projectile** and **true vomiting**.

#### Projectile vomiting

This is not accompanied by retching movements and large amounts of fluid material are ejected with little effort. It is almost always a result of overloading of the stomach or forestomach with feed or fluid.

#### True vomiting

As it occurs in monogastric animals like the dog and cat, true vomiting is accompanied by retching movements including contraction of the abdominal wall and of the neck muscles and extension of the head. The movements are commonly prolonged and repeated and the vomitus is usually small in amount and of porridge-like or pasty consistency. It is most commonly a result of irritation of the gastric mucosa. Vomiting is commonly designated as being either peripheral or central in origin depending on whether the stimulation arises centrally at the vomiting center or peripherally by overloading of the stomach or inflammation of the gastric mucosa, or by the presence of foreign bodies in the pharynx, esophagus or esophageal groove. Central stimulation of vomiting by apomorphine and in nephritis and hepatitis are typical examples but vomiting occurs rarely, if at all, in these diseases in farm animals.

Vomiting may have serious effects on fluid and electrolyte balance because of the losses of gastric and intestinal contents during vomiting. Aspiration pneumonia or laryngeal obstruction are potential serious consequences of vomiting. Examination of any suspected vomitus to determine its site of origin should always be carried out.

**True vomiting is rare in farm animals** except in pigs with gastroenteritis and some systemic diseases. True vomiting does not occur in ruminants but abnormal regurgitation does occur (see below under Regurgitation). **True vomiting is not a feature of gastric disease in the horse for two reasons.** First, the strong cardiac sphincter inhibits the release of stomach contents; in horses rupture of the stomach

is more likely to occur before vomiting takes place. Secondly, the soft palate and epiglottis combine to effect a seal between the oral and nasal parts of the pharynx so that any vomited stomach contents must be discharged through the nasal cavities and not through the mouth. Spontaneous nasal regurgitation or vomiting does occur occasionally, as manifested by the production of green stomach contents at the nostrils. This suggests extreme gastric distension or a dilated esophagus and cardiac sphincter and perhaps some underlying neurological deficit. Thus vomiting of large quantities of material in the horse is usually a terminal event and suggests gastric rupture.

### REGURGITATION

Regurgitation is the expulsion through the mouth or nasal cavities of feed, saliva and other substances that have not yet reached the stomach. In most cases it is due to abnormalities of the esophagus that interfere with swallowing. A common example in large animals is the regurgitation of feed, saliva, and perhaps blood-stained fluid from the esophagus of the horse with esophageal obstruction. Esophagitis is also a common cause of regurgitation.

Ruminants regurgitate rumen contents as part of rumination but the material is not expelled from the mouth nor into the nasal cavities. The regurgitation of rumen contents through the mouth does occur in cattle occasionally, is abnormal, and is a dramatic event. It is most commonly associated with loss of tone of the cardia or inflammation of the cardia (see examples below).

**Nasogastric regurgitation or gastric reflux** occurs in the horse. Stomach contents flow into the esophagus, and usually into the nasopharynx and nasal cavities, as a result of distension of the stomach with fluid (which usually originates in the small intestine). This involuntary process is usually slow and gradual, unlike true vomiting. Gastric reflux in the horse can be elicited by nasogastric intubation. Spontaneous efflux of stomach contents is indicative of high-volume and high-pressure fluid distension of the stomach. On other occasions the presence of sequestered gastric fluids can be confirmed only by the creation of a siphon, using the nasogastric tube to infuse a volume of fluid then disconnecting its supply in order to retrieve the **nasogastric reflux**.

**Causes of vomiting and regurgitation include:**

- Terminal vomiting in horses with acute gastric dilatation
- 'Vomiting' in cattle is really *regurgitation* of large quantities of



rumen contents through the mouth.

Causes include:

- third-stage milk fever (loss of tone in the cardia)
- arsenic poisoning (acute inflammation of the cardia)
- poisoning by plants including *Eupatorium rugosum*, *Geigeria* spp., *Hymenoxis* spp., *Andromeda* spp., *Oleander* spp., *Conium maculatum*
- veterinary administration of large quantities of fluids into the rumen (regurgitation occurs while the stomach tube is in place)
- use of a large-bore stomach tube
- cud-dropping: a special case of regurgitation usually associated with abnormality of the cardia
- Vomiting in pigs may be due to:
  - transmissible gastroenteritis
  - acute chemical intoxications
  - poisoning by the fungus *Fusarium* sp., which also causes off-feed effects suspected to be analogous to nausea in humans
- Regurgitation – in all diseases causing dysphagia or paralysis of swallowing.

## DIARRHEA, CONSTIPATION AND SCANT FECES

Diarrhea and constipation are the most commonly observed abnormalities in **fecal consistency, composition and frequency of defecation**.

### DIARRHEA

**Diarrhea** is the increased frequency of defecation accompanied by feces that contain an increased concentration of water and decrease in dry matter content. The consistency of the feces varies from soft to liquid.

Abnormalities of peristalsis and segmentation usually occur together and when there is a general increase in peristaltic activity there is increased caudal flow, resulting in a decrease in intestinal transit time and diarrhea. Because of a lack of absorption of fluid the feces are usually softer than normal, the dry matter content is below the normal range, and the total amount of feces passed per day is increased. The frequency of defecation is usually also increased. Common causes of diarrhea are:

- Enteritis, including secretory enteropathy
- Malabsorption, e.g. due to villous atrophy and in hypocuprosis (due to molybdenum excess)
- Neurogenic diarrhea as in excitement
- Local structural lesions of the stomach or intestine, including:
  - ulcer, e.g. of the abomasum or stomach
  - tumor, e.g. intestinal adenocarcinoma

- Indigestible diet, e.g. lactose intolerance in foals
- Carbohydrate engorgement in cattle
- In some cases of ileal hypertrophy, ileitis, diverticulitis and adenomatosis
- Terminal stages of congestive heart failure (visceral edema)
- Endotoxic mastitis in cattle (splanchnic congestion)
- Chronic and acute undifferentiated diarrhea in horses
- Vagus indigestion in cows causes pasty feces but bulk is reduced. These cases may be mistaken initially for other causes of diarrhea.

### Malabsorption syndromes

**Malabsorption syndromes** are being recognized with increased frequency in monogastric farm animals. For example, in recently weaned pigs, there is villous atrophy with a resulting loss in secretory and absorptive function. Inefficient digestion originating in this way may or may not be manifested by diarrhea, but in malabsorption there is usually diarrhea. There is always failure to grow or maintain body weight, in spite of an apparently normal appetite and an adequate diet. In horses, the lesions associated with malabsorption, which may be with or without diarrhea, include villous atrophy, edema and/or necrosis of the lamina propria of the gut wall, and nodular tracts and aggregations of eosinophils indicating damage by migrating strongyle larvae. It is possible also that some cases are caused by an atypical reaction of tissue to unknown allergens (possibly helminths) and are probably an abnormal immunological response. A common accompaniment in the horse is thin hair coat, patchy alopecia and focal areas of scaling and crusting. The pathogenesis is unknown. Special tests are now detailed for the examination of digestive efficiency in the horse. These are listed in the next section under special tests. Increased venous pressure in the portal circuit caused by congestive heart failure or hepatic fibrosis also causes diarrhea.

The question of whether or not enteritis in animals causes intestinal hypermotility and increased peristalsis, resulting in diarrhea, remains unresolved. If hypermotility and increased peristalsis cause diarrhea, antimitility drugs may be indicated in some causes of acute infectious diarrhea. Current concepts on the pathophysiology of the common diarrheas associated with infectious agents (such as enterotoxigenic *Escherichia coli*) indicate that there is a net increase in the flow of intestinal fluid into the lumen and a decrease in outflow back into the systemic circulation, which causes distension of the intestine with fluid. The hydraulic effect of

the distension can cause diarrhœa and hypermotility is probably not necessary. In addition, because of the temporary malabsorption that exists in infectious enteritides, and the presence of infectious agents and enterotoxins in the lumen of the intestine, the emphasis should be on evacuation of the intestinal contents and not on the use of anticholinergic drugs to inhibit evacuation. Furthermore, it is unlikely that the anticholinergics will have any significant effect on the secretory-absorptive mechanisms that have been altered by an enteropathogen.

### CONSTIPATION

**Constipation** is the **decreased frequency of defecation** accompanied by feces that contain a decreased concentration of water. The feces vary in consistency from being hard to dry and of small bulk. True constipation as it occurs in humans is usually characterized by failure to defecate and impaction of the rectum with feces. When the motility of the intestine is reduced, the alimentary transit time is prolonged and constipation or scant feces occurs. Because of the increased time afforded for fluid absorption, the feces are dry, hard and of small bulk and are passed at infrequent intervals. Constipation may also occur when defecation is painful, as in cattle with acute traumatic reticuloperitonitis.

### SCANT FECES

**Scant feces** are small quantities of feces, which may be dry or soft. Scant feces occur most commonly in cattle with abnormalities of the forestomach or abomasum resulting in the movement of only small quantities of ingesta into the small and large intestines (**an outflow abnormality**). The details are available in Chapter 6. When there is complete intestinal stasis the rectum may be empty except for blood-tinged, thick, pasty material.

Common causes of constipation or scant feces are:

- Diseases of the forestomach and abomasum causing failure of outflow
- Impaction of the large intestine in the horse and the sow
- Severe debility, as in old age
- Deficient dietary bulk, usually fiber
- Chronic dehydration
- Partial obstruction of large intestine
- Painful conditions of the anus
- Paralytic ileus
- Grass sickness in horses
- Chronic zinc poisoning in cattle
- Terminal stages of pregnancy in cows.

### ILEUS (ADYNAMIC AND DYNAMIC ILEUS)

Ileus is a state of **functional obstruction** of the intestines or failure of peristalsis.

It is also known as **paralytic ileus** or **adynamic ileus**. **Dynamic or mechanical ileus** is a state of physical obstruction. In paralytic ileus there is loss of intestinal tone and motility as a result of reflex inhibition. This can occur in acute peritonitis, excessive handling of viscera during surgery, and prolonged and severe distension of the intestines as in intestinal obstruction or enteritis. Ileus can also be caused by acid-base imbalance, dehydration, electrolyte imbalances such as hypocalcemia and hypokalemia, and toxemia. Ileus can affect the stomach, causing delayed gastric emptying and subsequent dilatation with fluid and gas. The effect of ileus on the intestines is to cause failure of orocaudal movement of fluid, gas and ingesta and accumulation of these substances, which results in intestinal distension and varying degrees of abdominal pain, dehydration and a marked reduction in the amount of feces. Distension of the abdomen, fluid-tinkling, fluid-splashing sounds, and pings on percussion of the abdomen are common clinical findings. Impaction of the large intestine of horses is a form of ileus.

**Postoperative ileus** of the large intestine is a common complication of surgical treatment for colic in the horse. The clinical findings include gastric reflux because of gastric distension with fluid, absence of or minimal intestinal peristaltic sounds, an absence of feces, abdominal pain, distended loops of intestine palpable per rectum, and varying degrees of shock and dehydration as a result of intestinal fluid sequestration and a decrease in fluid absorption. **Infarction of the intestinal wall** associated with an acute mechanical obstruction of the intestine also results in ileus. In thromboembolic colic due to verminous mesenteric arteritis in the horse, large segments of the large colon and cecum can become infarcted, resulting in irreversible ileus.

The etiology and pathogenesis of ileus in farm animals are not well understood. Sympathetic hyperactivity is thought to be a factor. The gastroileal reflex is one example of the influence of the activity of one part of the digestive tract on that of another; inhibition of gastric motility when the ileum is distended is called ileogastric reflex. Immediate cessation of all intestinal movement (adynamic ileus) follows distension of an intestinal segment, rough handling of the intestine during abdominal surgery or peritoneal irritation. Adynamic ileus operates through three pathways: general sympathetic discharge of the peripheral reflex pathway through the iliac and mesenteric plexuses, and the intramural plexuses. The treatment of ileus depends on the original cause. Physical obstruction of the intestines

and torsion of the stomach must be corrected surgically. Postoperative ileus in the horse is difficult to manage and the case fatality rate is high.<sup>2</sup> Fluid therapy and gastric reflux decompression using a nasogastric tube are standard recommendations. Nonsteroidal anti-inflammatory drugs (NSAIDs) are used to control abdominal pain. Xylazine is contraindicated because of its depressant effect on gastric and intestinal motility.

### ALIMENTARY TRACT HEMORRHAGE

Hemorrhage into the stomach or intestine is a common occurrence in farm animals. The main causes are:

- Gastric or abomasal (rarely duodenal) ulcers
- Severe hemorrhagic enteritis
- Structural lesions of the intestinal wall, e.g. adenomatosis, neoplasia
- Infestation with blood-sucking nematodes, e.g. bunostomiasis
- Local vascular engorgement or obstruction as in intussusception and verminous thrombosis.

Hemorrhage into the stomach results in the formation of **acid hematin**, which makes vomitus a dark brown color like coffee grounds, and feces have a black or very dark brown, tarry appearance (**melena**). The change in appearance of the feces caused by hemorrhage into the intestine varies with the level at which the hemorrhage occurs. If the blood originates in the **small intestine**, the feces may be **brown-black**, but if it originates in the **colon or cecum**, the blood is unchanged and gives the feces an **even red color**. Hemorrhage into the **lower colon and rectum** may cause the voiding of feces containing or consisting entirely of **clots of whole blood**.

Hemorrhage into the pharynx is unusual, but when it occurs the blood may be swallowed and appear in the feces or vomitus. If there is any doubt about the presence of blood in the feces or vomitus, biochemical tests should be performed. The hemorrhage may be sufficiently severe to cause anemia and, in particularly severe cases, acute peripheral circulatory failure. In cattle the most sensitive test is one using a dilute alcoholic solution of guaiac as the test reagent. It is capable of detecting a daily blood loss into the abomasum of as small a volume as 70 mL. Transit time of blood from abomasum to rectum in normal cows varies from 7–19 hours.

### ABDOMINAL PAIN

The pain associated with diseases of the abdominal viscera causes similar signs

regardless of the viscus or organ involved and careful clinical examination is necessary to locate the site of the lesion. The manifestations of abdominal pain vary with the species, horses being particularly sensitive, but comprise largely of abnormalities of behavior and posture. Pain as a systemic state is presented in general terms in Chapter 2, including its effects on body systems and methods for its detection.

Readily identifiable syndromes of abdominal pain referable to the alimentary tract include the following.

#### Horses

- Acute pain: Pawing, flank-watching, rolling
- Subacute pain: Lesser degree of flank-watching, often excessive pawing, lying down frequently without rolling, stretching out as if to urinate, males may extrude the penis, walking backwards, dog-sitting posture, lying on back, impulsive walking
- Peritoneal pain: Rigidity of the abdominal wall, pain on palpation.

#### Cattle

- Acute pain: Downward arching of back with treading of the hind feet, lying down (rolling is uncommon). Calves will lie down and bellow with severe abdominal pain, as in abomasal torsion
- Subacute pain, including peritoneal pain: Back arched upwards, grunting on walking or lying down, grunting on deep palpation of the abdomen, immobility.

### DIFFERENTIAL DIAGNOSIS

The disease states likely to be mistaken for the above categories of alimentary tract pain are:

- Acute pain: Paresthesia, e.g. in photosensitive dermatitis of cows; pleuropneumonia in the horse; uterine torsion in the mare and cow; snakebite in horses; urticaria as in milk allergy in cows; renal and urethral colic; compulsive walking, e.g. in hepatic disease; lead poisoning; dysuria or obstruction of urinary tract generally; laminitis and lactation tetany in mares
- Subacute pain: Encephalopathy, possibly hepatic insufficiency

### COMMON CAUSES OF ALIMENTARY TRACT PAIN

#### Horses

- Acute pain: All causes of intestinal obstruction, gastric dilatation, enteritis generally, colitis X, rarely salmonellosis
- Subacute pain: Thromboembolic colic, impaction of the large intestine, ileal hypertrophy.

## Cattle

- Acute pain: Intestinal obstruction, especially by phyto bezoars; poisoning by kikuyu grass, *Andromeda* sp., *Oleander* sp., water hemlock (*Cicuta* sp.)
- Subacute pain: Traumatic reticuloperitonitis and peritonitis generally. Abomasal volvulus.

## TENESMUS

Tenesmus, or persistent straining, is common in many diseases of the organs of the pelvic cavity; therefore it is not necessarily a diagnostic sign of disease in the lower alimentary tract. It is sometimes associated with frequent defecation caused by neurological stimulation of peristalsis. Common causes of tenesmus are listed by species below.

### Cattle

- Lower alimentary tract disease, e.g. colitis and proctitis caused by coccidiosis
- Genital tract disease, e.g. severe vaginitis, retained placenta
- Estrogen toxicity in steers, e.g. estrogen implantation, fusariotoxicosis
- 4-aminopyridine poisoning, methiocarb poisoning
- Lower spinal cord lesions – spinal cord abscess, rabies
- Idiopathic.

### Horses

- Tenesmus does not usually occur except during parturition.

### Pigs

- Constipation in parturient sows; also dystocia.

## SHOCK AND DEHYDRATION

Acute rapid distension of the intestine or stomach causes reflex effects on the heart, lungs and blood vessels. The blood pressure falls abruptly, the temperature falls below normal and there is a marked increase in heart rate. In acute intestinal accidents in horses that terminate fatally in 6–12 hours, shock is the major cause of death. There appears to be some species difference in the susceptibility to shock because similar accidents in cattle rarely cause death in less than 3–4 days; acute ruminal tympany is an exception and may exert its effects rapidly, causing death in a very short time after its onset. Less severe distension, vomiting and diarrhea cause clinically recognizable dehydration and abnormalities of electrolyte concentration and acid–base balance. Determination of the relative importance of shock and dehydration in a particular case at a particular time is one of the challenges in gastroenterology. The subject is considered

in detail under the heading of equine colic and under enteritis.

## ABDOMINAL DISTENSION

Distension of the abdomen is a common manifestation of disease of the alimentary tract. Generally, abdominal distension associated with the alimentary tract is caused by **distension of viscera** with **gas** or **fluid**. The degree of abdominal distension depends on the viscera that are distended, the species involved and the age of the animal. Abdominal distension is most pronounced when large viscera of adult cattle and horses are distended. Distension of the small intestines in adult cattle and horses may not be detectable clinically. On the other hand, distension of the small intestine with fluid in calves and foals often causes noticeable abdominal distension.

Occasional cases of abdominal distension are due to **pneumoperitoneum**, which usually follows abdominal surgery. In ruminants the most common causes are distension of the rumen, abomasum, cecum and large intestine, the details of which are presented in Chapter 6. Abdominal distension in horses and pigs is usually due to distension of the large intestine. Gastric dilatation of the horse does not cause abdominal distension. Ascites is a cause in all species.

Abdominal distension may be symmetrical, asymmetrical or more pronounced dorsally or ventrally on one or both sides. The severity can vary from mild and barely detectable to so severe that the skin over the abdominal wall has sufficient tension that it cannot be picked up or 'tentled'. Determination of the cause of the distension requires careful examination of the abdomen by inspection, palpation, percussion and simultaneous auscultation. Rectal palpation is used to determine the location and nature of distended viscera. Diseases of other body systems that cause abdominal distension and must be considered in the differential diagnosis include advanced pregnancy and hydrops allantois.

The alimentary tract diseases of simple-stomached animals in which abdominal distension may be a manifestation are:

- Intestinal tympany – due to excessive gas production caused by abnormal fermentation in the large intestine of horses and pigs
- Obstruction of the large intestine – in horses and pigs as a result of their torsion or miscellaneous constrictions caused by adhesions, usually as a result of peritonitis
- Retention of the meconium – in foals. This is often accompanied by severe distension of the colon and abdomen.

Obstruction of the small intestine may cause abdominal distension but not to the degree that occurs in distension of the large intestine. In all the above diseases, acute abdominal pain is common.

## ABNORMAL NUTRITION

Failure of normal motor, secretory, digestive or absorptive functions causes impairment of nutrient supply to body tissues. Inanition or partial starvation results and the animal fails to grow, loses body weight or shows other signs of specific nutritional deficiencies. Ancillary effects include decreased appetite when gut motility is decreased; in many cases where motility is increased and there is no toxemia, the appetite is increased and may be voracious.

## Special examination

The general aspects of the clinical examination of the alimentary tract and abdomen of farm animals are described in Chapter 1 under Clinical examination. Some additional or special examination techniques and procedures are included here.

## NASOGASTRIC INTUBATION

### RUMEN OF CATTLE

Examination of the rumen contents is often essential to assist in determination of the state of the rumen environment and digesta. Passage of a stomach tube into the rumen will determine the patency of the esophagus and if there is increased intraruminal pressure associated with a frothy or free-gas bloat. In a free-gas bloat, large quantities of gas are usually released within a minute. In a frothy bloat, the ruminal end of the tube may become occluded by the froth and very little if any gas is released. Moving the tube back and forth within the rumen and blowing air into the tube to clear the ruminal end may result in the release of some gas.

When the tube is in the rumen, some **rumen juice** can be siphoned or pumped out and collected in an open beaker for field and laboratory analysis. The **color**, depending on the feed to a limited extent, will be green, olive-green or brown-green. In cattle on **pasture** or being fed good quality hay, the color is **dark green**. When **silage** or **straw** is the diet the color is **yellow-brown**. In grain overload the color is **milky-gray**, and in rumen stasis of long duration with putrefaction, the color is **greenish-black**. The **consistency of the rumen contents** is normally slightly viscid, and watery rumen content is indicative of inactive bacteria and

protozoa. **Excess froth** is associated with frothy bloat as in primary ruminal tympany or vagus indigestion. The **odor** of the rumen contents is normally aromatic and, although somewhat pungent, not objectionable to the nose. A **moldy, rotting odor** usually indicates protein putrefaction, and an intensely sour odor indicates an excess of lactic acid formation, due to grain or carbohydrate engorgement. The **pH of the rumen juice** varies according to the type of feed and the time interval between the last feeding and taking a sample for pH examination. The normal range, however, is between 6.2 and 7.2. The pH of rumen juice should be examined immediately after the sample is obtained, using a wide range pH (1–11) paper. **High pH values (8–10)** will be observed when putrefaction of protein is occurring in the rumen or if the sample is mixed with saliva. Low pH values (4–5) are found after the feeding of carbohydrates. In general, a **pH below 5** indicates **carbohydrate engorgement**; this pH level will be maintained for between 6–24 hours after the animal has actually consumed the carbohydrate diet. Microscopic examination of a few drops of rumen fluid on a glass slide with a low-power field will reveal the level of protozoan activity. Normally 5–7 protozoons are active per low-power field. In lactic acidosis the protozoa are usually absent or a few dead ones are visible.

#### DECOMPRESSION OF DISTENDED RUMEN

In adult cattle with severe abdominal distension due to gross distension of the rumen it is difficult, if not impossible, to assess the status of the abdomen. To determine if the rumen is distended and/or to relieve the pressure a large-bore stomach tube should be passed (Colorado Kingman Tube: 2 m long and 3 cm inside diameter). In vagus indigestion, the rumen may be grossly distended with fluid contents, which will gush out through a large-bore tube. In some cases 100–150 L of rumen contents may be released. If no contents are released the contents may be frothy or mushy and the rumen end of the tube will plug almost instantly. Rumen lavage may then be attempted using a water hose to deliver 20–40 L of water at a time followed by back drainage using gravity flow. After the rumen is partially emptied it is usually possible to more accurately assess the rumen and the abdomen.

#### DECOMPRESSION OF THE HORSE'S STOMACH

Attempts to pass a nasogastric tube in the horse will usually detect complete or partial obstruction of the esophagus. In gross distension of the stomach in the

horse, there is an immediate rush of fluid contents as soon as the cardia is passed (**gastric reflux**). The technique of gastric decompression is therapeutic and diagnostic. Gastric distension is a highly distressing feature of some colic cases and the mere pain relief of gastric decompression facilitates the clinical examination. The retrieval of significant volumes (2 L or more) of sequestered gastric fluid is also an extremely specific indicator of intestinal obstruction, especially small intestinal obstruction, and a reasonably specific indicator that surgical intervention is necessary.

### MEDICAL IMAGING

#### RADIOGRAPHY

Because of their large size, and the presence of substantial amounts of gas in the large intestine, abdominal radiography has not been used routinely as a diagnostic aid in mature horses with abdominal pain. Similarly, in mature cattle the sheer size of the abdomen and the gas in the rumen has not favored abdominal radiography except for identifying the presence of metal objects in the reticulum. **Esophageal radiography** is, however, useful for the diagnosis of disorders of swallowing in horses.

Foals, calves and small horses are too small to be palpated per rectum, and abdominal radiography, with and without contrast media, has been used diagnostically in colic of foals. A standard lateral abdominal radiography is a valuable diagnostic aid in the foal with colic.<sup>4</sup> The site of the lesion, whether gastric, small or large intestinal, or a combination of all three, can be determined from the radiographs. The **sensitivity of radiography** in detecting gastrointestinal lesions in neonatal foals was found to be 96%; the specificity was 71%.<sup>4</sup>

Knowledge of the radiographic appearance of the normal neonatal abdomen is important before lesions can be reliably detected. The standing lateral radiographic of the normal abdomen of the neonatal foal is characterized by:

A gas cap over fluid and ingesta in the stomach

Small collections of gas in the small intestine in the cranial and mid-central abdomen

Gas caps over fluid and ingesta in the cecum and large colon, seen in the caudodorsal abdomen

Small amounts of gas in the small colon and inconsistent gas in the rectum, seen at the pelvic inlet.

Abdominal radiography has also been used for the diagnosis of enterolithiasis and sand accumulation as causes of colic.<sup>3</sup>

The technique provides a high positive-predictive value and is cost-effective in high-prevalence areas.

#### ABDOMINAL ULTRASONOGRAPHY

Abdominal ultrasonography has been used to identify small intestine intussusceptions, large colon displacements, abdominal viscera and neoplasms. The technique may require only several minutes in the hands of an experienced clinician.

#### Horse

Abdominal ultrasonography is a diagnostic aid that is used for evaluation of equine colic and to assist in differentiation of medical from surgical colics.

It is accurate in identifying horses with abnormal small intestines.<sup>5</sup> Ultrasonographic findings of edematous small intestine without motility provides an indication of primary small-intestine disease (obstruction or strangulation) and justifies surgical intervention. Detecting increased thickness of the wall of the large intestine during ultrasonography is a reproducible and accurate preoperative test for large-colon torsion in horses with surgical colic localized to the large colon.<sup>6</sup> Strangulating lipomas and epiploic foramen entrapments were diagnosed more often than any other primary small intestine lesion. Detection of distended or edematous small intestine by rectal palpation provided a sensitivity of 50%, a specificity of 98% and a positive predictive value of 89% for small intestine strangulation obstructions.<sup>5</sup> The duodenum of the horse can be evaluated by ultrasonography.<sup>7</sup> Normally it does not contain any gas and the accumulation of fluid and gas associated with colic may be useful. The technique has been used to detect intestinal sand accumulations.<sup>8</sup> Gastrointestinal activity patterns have been evaluated in healthy horses using B mode and Doppler ultrasonography.<sup>9</sup> The anatomy and biometric analysis of the thoracic and abdominal organs in healthy foals from birth to age 6 months have been evaluated with ultrasonography.<sup>10</sup>

#### Cattle

Abdominal ultrasonography is an ideal diagnostic aid for the investigation of gastrointestinal diseases, the most common of which include traumatic reticuloperitonitis, left and right displacement of the abomasum, ileus of the small intestine, and dilatation and displacement of the cecum.<sup>11,12</sup> The various divisions of the small intestine can be differentiated from one another with the exception that the ileum cannot be differentiated from jejunum.<sup>13</sup> In normal cows, in which the intestine is full of ingesta, all parts of the intestine have a relatively large diameter.

In cows with ileus, the loops of intestine proximal to the ileus are distended and those distal to the ileus are empty.

## ENDOSCOPY

### GASTROENTEROSCOPY

**Fiberoptic gastroduodenoscopy** is a practicable procedure in a sedated horse that has had no feed for 12–24 hours. A 275 × 13.5 cm fiberoptic instrument is passed via a nostril to the stomach, which is then distended with air. The control of the objective of the endoscope is quite difficult and entry into the pylorus particularly so, so that examination of the duodenum is not possible in all horses.

### LAPAROSCOPY

In this procedure a laparoscope is passed through an incision in the abdominal wall of either the left or right paralumbar fossa.<sup>14</sup> Feed must be withheld for 36 hours, analgesia is provided during the procedure, and abdominal insufflation with carbon dioxide is required in order to separate the viscera for viewing. Laparoscopy in standing horses is a valuable diagnostic aid for examination of the structures in the dorsal regions of the abdomen. In the standing horse, the anatomic structures of importance that can be viewed in the left half of abdomen are the hepatic duct, left lateral and quadrate lobes of the liver, stomach, left kidney with associated nephrosplenic ligament, segments of the jejunum, descending colon and ascending colon, left side of the male and female reproductive tracts, urinary bladder, vaginal ring and mesorchium. The important structures observable in the right side of the abdomen are the common hepatic duct, left lateral, quadrate and right lobes of the liver, caudate process of the liver, stomach, duodenum, right dorsal colon, epiploic foramen, omental bursa, right kidney, base of the cecum, segments of jejunum, descending colon and ascending colon, urinary bladder, right half of the male and female reproductive tracts, and rectum.<sup>14</sup>

In the dorsally recumbent horse under general anesthesia, with laparoscopy the main structures of diagnostic relevance in the caudal region of the abdomen are the urinary bladder, mesorchium, ductus deferens (left and right), left and right vaginal rings, insertion of the prepubic tendon, random segments of jejunum and descending colon, the pelvic flexure of the ascending colon, body of the cecum and cecocolic fold. The main structures observed in the cranial region of the abdomen are the ventral surface of the diaphragm, falciform ligament and round ligaments of the liver, ventral portion of the left lateral, left medial, quadrate and

right lateral lobes of the liver, spleen, right and left ventral colons, sternal flexure of the ascending colon, apex of the cecum, and stomach.<sup>15</sup> Alterations in cardiovascular and respiratory functions in response to the pneumoperitoneum and various positional changes indicated a need for continuous and thorough anesthetic monitoring and support.

### EXPLORATORY LAPAROTOMY (CELIOTOMY)

An exploratory laparotomy is useful for palpating and inspecting the abdominal viscera as a diagnostic aid in cattle, sheep and horses of all ages. Cost and time are important factors but if abdominal disease is suspected and other diagnostic techniques cannot identify the location and nature of the abnormality, a laparotomy is highly desirable.

### TESTS OF DIGESTION AND ABSORPTION

Digestion and absorption of nutrients are complex, interrelated functions of the gastrointestinal tract. Failure in one or more of normal motility, enzymic digestion of food and absorption of simple sugars, fat and protein by the small intestine can result in inadequate assimilation of nutrients from the gastrointestinal tract. Tests of small intestinal digestion, absorption or both have been devised for use in monogastrics. These tests take advantage of the rapid appearance in blood of products of digestion, or of compounds that are readily absorbed without digestion.

**Indications** for these tests include:

- Weight loss of undetermined cause that is suspected to be due to failure of absorption of food by the small intestine

- Diarrhea of suckling foals that is suspected to be due to failure of the foal to digest lactose (lactase deficiency)

- Suspected protein-losing enteropathy of older foals and adult horses.

Low serum protein and albumin concentrations with small intestinal disease can be due to failure of digestion of proteins and absorption of amino acids or leakage of plasma proteins into the intestine. Regardless of the mechanism, some horses with protein-losing enteropathy have abnormal tests of intestinal digestion and absorption of sugars. **Contraindications** include the presence of obstructive lesions of the gastrointestinal tract, risk of worsening the disease process by the period of fasting required for most of the tests (such as in ponies with hyperlipemia), or known adverse reactions of the animal to any of the test substances.

**Interpretation** of the test is based on the concentration of the variable of interest (usually glucose or xylose) in blood over a period of time after administration of the test meal (usually by nasogastric intubation). Concentration of the metabolite or marker of interest in blood is plotted against time and the shape of the curve, highest concentration attained, time to attain the highest concentration, and elevation over baseline values (i.e. those measured immediately before administration of the test meal) is compared against values obtained from clinically normal horses or foals. Blood concentrations of glucose or xylose that are lower than expected (so called 'flat curve') can be indicative of alterations in gastrointestinal function that hinder propulsion, digestion or absorption of nutrients. Thus, tests of digestion and absorption alone rarely provided sufficient information to make a definitive diagnosis of the functional disorder. The exception to this rule is the modified lactose tolerance test in foals (see below). Interpretation of the results of oral tests of absorption is often confounded by factors that alter gastrointestinal function, such as feed withholding or enteritis, or conditions that alter removal of the test compound from blood, such as reduced insulin sensitivity. This is particularly the case for tests that depend on measurement of blood glucose concentration. Blood glucose concentrations are determined in the absorptive state by the difference in rates of absorption of glucose from the small intestine into blood and removal of glucose from blood by uptake into muscle, adipose tissue and metabolically active tissues. Conditions that enhance glucose uptake from the blood can result in low peak blood glucose concentrations, and conditions that decrease insulin sensitivity (as is seen in fat horses) can result in high blood glucose concentrations. The use of D-xylose as an indicator of small intestinal absorption is intended to avoid these effects of variable glucose disposal. Therefore, the values obtained with oral tests of absorption and digestion should be interpreted with caution and should be considered in light of all clinical and laboratory data available for the animal.

### GLUCOSE ABSORPTION TEST

The oral glucose tolerance test is one of the simplest tests of small intestinal absorptive capacity to perform. However, because of the many factors that affect blood glucose concentration, including factors not related to small-intestinal absorptive capacity, results of the test can on occasion be difficult to interpret.<sup>16</sup> Oral glucose tolerance testing can produce

abnormal results in horses with diseases that do not involve the small intestine, such as lower motor neurone disease or polysaccharide storage myopathy. On the other hand, the oral glucose tolerance test is often used because of the ready availability of glucose for oral administration and routine nature of measurement of blood glucose concentrations.

The main indications for performing oral glucose tolerance testing include unexplained weight loss believed to be associated with gastrointestinal disease, and suspected protein-losing enteropathy. Contraindications are those listed above. In addition, care should be exercised in performing the test in horses at increased risk of laminitis, as rapid passage of unabsorbed glucose into the large colon and cecum can cause laminitis.

Horses for oral glucose tolerance testing are first fasted for 12–18 hours. Access to water should be provided. Glucose is given by stomach tube at 1 g/kg body weight (BW) of anhydrous glucose (or comparable) as a 10–20% solution in water. Blood for measurement of glucose concentration is collected immediately before, and every 30 minutes for 4–6 hours after glucose administration. Some protocols involve less frequent (hourly) collection of blood. One protocol requires collection of blood samples before and 120 minutes after administration of glucose. This last protocol is not recommended as early or delayed peaks in blood concentration are not detected. The blood glucose concentration in the normal horse increases by at least 85% (from 90 up to 180 mg/dL (5.0 to 10.0 mmol/L)) with peak blood concentrations attained 90–150 minutes after administration of glucose. Horses with partial malabsorption have increases in blood glucose concentration of 15–85% of baseline values, and horses with complete malabsorption have no increase or less than 15% increase in blood glucose concentration by 2 hours.<sup>17</sup> Blood concentrations of glucose in normal horses return to resting values in approximately 6 hours. The shape of the curve is affected by the horse's previous diet, the curve being much lower in horses fed on stored feeds such as hay and grain compared to horses eating pasture of clover and grass.

Horses with weight loss and complete failure of absorption of glucose, are likely to have extensive infiltrative disease of the small intestine such as lymphosarcoma or granulomatous enteritis.<sup>17</sup> Of 25 horses with partial failure of glucose absorption, 18 (62%) had structural abnormalities of the small intestine. Clearly abnormal results of the oral glucose tolerance test therefore appear to be fairly specific for

severe and widespread small-intestinal disease. Care should be taken when interpreting results that deviate only marginally from normal values.

#### **STARCH DIGESTION TEST**

A suitable test for the evaluation of gastric, small-intestinal and pancreatic function is the starch digestion test. The test relies on the presence of amylase in the small intestine with subsequent cleavage of starch into glucose, which is then absorbed into the blood. The horse is fasted for 18 hours and then given corn starch (1 kg in 4 L of water or 2 g/kg BW) by stomach tube. A pretreatment blood sample is matched with others taken at 15, 30, 60, 90 and 120 minutes and then hourly to 6 hours.

In the normal horse there is an increase in blood glucose levels of about 30 mg/dL (1.7 mmol/L) (from 90 up to 120 mg/dL (5.0–6.7 mmol/L)), with the peak occurring at 1–2 hours and the curve returned to pretreatment level at 3 hours.<sup>18</sup> The test can be affected by the diet of the horse prior to testing.

#### **LACTOSE DIGESTION TEST**

Newborn animals rely on ingestion of milk sugar (lactose) as an important source of energy until weaning. Lactose is digested in the proximal small intestine by lactase, a disaccharidase present in the brush border of intestinal epithelial cells that cleaves lactose into glucose and galactose. Loss of small-intestinal production of lactase, such as occurs in some bacterial and viral enteritides including rotavirus infection, results in failure to cleave lactose and passage of the sugar to the hind gut. Fermentation of lactose in the hind gut causes acute and sometimes severe osmotic diarrhea. A prime indication for the oral lactose tolerance test is therefore acute diarrhea in neonates being fed milk. The test not only has diagnostic usefulness because a positive test (i.e. demonstration of lactose intolerance) provides a clear indication for feeding lactose-free milk or providing supplemental lactase in the animal's diet.

An oral lactose digestion test has been devised for foals. Lactose (1 g/kg BW) is given by stomach tube in a 20% solution to a foal that has been fasted for 2–4 hours. In foals and young horses up to 3 years of age there is a rise in blood glucose levels from  $86 \pm 11$  mg/dL ( $4.8 \pm 0.1$  mmol/L) up to  $153 \pm 24$  mg/dL ( $8.5 \pm 1.3$  mmol/L), with a peak achieved in 90 minutes, and the level returns to pretreatment levels in 5 hours. In foals of 1–12 weeks of age the plasma glucose concentration should rise by at least 35 mg/dL (1.9 mmol/L) and peak within 40 minutes of the administration of the lactose. With this test no changes in blood sugar levels occur in

horses over 4 years of age. Instead there is abdominal discomfort followed by diarrhea, with feces the consistency of cow feces for the next 24 hours. Sucrose and maltose are readily digested by the intestine of the adult horse, but not by newborn foals. Maximum levels of the relevant intestinal disaccharidases (sucrase and maltase) are not achieved until 7 months of age. The oral lactose digestion test is likely to be of value as a monitor of epithelial damage in young horses. In humans the ability to hydrolyze lactose is one of the first functions of the intestinal mucosa to be lost where there is epithelial damage in the gut. It is also one of the last functions to return in the recovering patient. The loss of intestinal lactase may be the pathogenetic basis of the diarrhea that occurs in rotavirus infections in neonates. Lactase digestion is impaired in calves with mild diarrhea.<sup>19</sup> Calves with acute diarrhea are in a catabolic state and respond with a larger increase in plasma glucose concentration to a given amount of glucose than do healthy calves.

A modification of the oral lactose tolerance test in foals includes a second evaluation in foals in which there is failure of blood glucose concentrations to increase by the appropriate amount after oral administration of lactose. At least 8 hours after the first test, foals are fed a meal of lactose-free milk, or of milk to which lactase has been added. Blood glucose concentrations are measured and an increase of at least 35 mg/dL (1.9 mmol/L) is interpreted as evidence of lactase deficiency. Such animals can then be maintained on a diet of lactose-free milk. Diarrhea usually resolves in 24 hours, but returns within hours of feeding milk containing lactase.

#### **XYLOSE ABSORPTION TEST**

D-xylose is used to evaluate small intestinal absorptive function because it is not metabolized by tissues, which is an advantage over the oral glucose tolerance test. D-xylose absorbed from the intestinal tract is excreted unchanged in the urine within 15 hours of dosing.<sup>20</sup> Concentrations of D-xylose in blood are therefore dependent only upon the rate of absorption from the intestine and rate of excretion into the urine. However, the compound is more expensive than glucose and measurement of D-xylose in blood requires a particular analysis that might not be readily available. Indications for the test are the same as those for the oral glucose tolerance test described above.

D-xylose, at a dose rate of 0.5 g/kg BW as a 10% solution, is administered by stomach tube after a starve of 18 hours.<sup>21</sup>

A maximum blood xylose level of 30 mg/dL (2.0 mmol/L) at 1.5 hours is a normal result in adult horses. In normal foals the peak blood concentration of xylose is reached in 30–60 minutes and the level attained varies with age, being highest (47 mg/dL (3.14 mmol/L)) at 1 month of age and lowest (19 mg/dL (1.25 mmol/L)) at 3 months (the pretreatment reading should be zero). In abnormal horses the xylose curve is flat (a peak of 7–13 mg/dL (0.5 mmol/L) at 60–210 minutes) contrasted with a peak of 20 mg/dL (1.3 mmol/L) at 60 minutes in normal horses. As an initial checking test, one postdosing sample at 2 hours is recommended.

Interpretation of the test is influenced by the customary diet of tested animals and feed deprivation. Horses receiving a high energy diet have a lower absorption curve than horses on a low energy diet. The test is also affected by the duration of deprivation of feed.<sup>20</sup> In mares deprived of feed for 72 and 96 hours, the rate of D-xylose absorption and the maximum concentrations of D-xylose in plasma were reduced.<sup>22</sup> For example, apparent low absorption can be caused by increased transit time through the gut, due perhaps to excitement.

Low blood concentrations of xylose occur in horses with small intestinal infiltrative disease, such as lymphosarcoma or granulomatous enteritis.<sup>20</sup> The test appears to be quite specific (low false-positive rate) for small intestinal disease, but the sensitivity (false-negative rate) is unknown.

A D-xylose absorption curve has been determined for cattle. The xylose (0.5 g/kg BW) is deposited in the abomasum by abomasocentesis, and a peak of blood glucose is attained in about 90 minutes.

#### SUCROSE ABSORPTION TEST

The sucrose absorption test differs from the other tests in this section in that abnormal results are associated with detection of sucrose in blood or urine of horses. Sucrose is not normally absorbed intact – it is usually cleaved by disaccharidases in the small intestine into glucose and fructose, which are then absorbed. Intact sucrose is absorbed across compromised gastric mucosa and detection of sucrose in blood or urine indicates the presence of gastric ulceration, as mammals neither synthesize nor metabolize sucrose.<sup>23,24</sup> The sucrose absorption test involves administration of 250 g of sucrose to an adult horse that has been fasted overnight. Blood samples for measurement of serum sucrose concentration are collected at 0, 15, 30, 45, 60 and 90 minutes after dosing. Alternatively, a urine sample is collected 2 hours after dosing (the bladder must be emptied immediately before dosing). Peak serum sucrose concentrations occur 45 minutes after administration and peak values correlate with the severity of gastric ulceration. Horses with minimal lesions have serum sucrose concentrations of 103 pg/μL, whereas horses with the most severe lesions have concentrations of 3400 pg/μL.<sup>24</sup>

#### RADIOACTIVE ISOTOPES

A technique used for determining whether a protein-losing enteropathy is present is based on the examination of feces for radioactivity after the intravenous administration of a radioactive agent. <sup>51</sup>Cr<sup>13</sup>C-labeled plasma protein has been used for this purpose. Similarly, administration of radioactively labeled leukocytes reveals the presence of small-intestinal inflammatory disease in horses.<sup>4,25</sup> The test is quite specific, in that false-positive tests are uncommon, but not very sensitive.

#### ABDOMINOCENTESIS FOR PERITONEAL FLUID

Peritoneal fluid reflects the pathophysiological state of the parietal and visceral mesothelial surfaces of the peritoneum. Collection of a sample of peritoneal fluid is a useful aid in the diagnosis of diseases of the peritoneum and the abdominal segment of the alimentary tract.<sup>22</sup> It is of vital importance in horses in the differential diagnosis and prognosis of colic and in cattle in the diagnosis of peritonitis.

#### EQUINE AND BOVINE PERITONEAL FLUID

Normal peritoneal fluid is a transudate with properties as summarized in Tables 5.1 and 5.2. It has functions similar to those of other tissue fluids. It contains mesothelial cells, lymphocytes, neutrophils, a few erythrocytes and occasional mono-

Table 5.1 Guidelines for the classification and interpretation of bovine peritoneal fluid

Classification of fluid	Physical appearance	Total protein g/dL	Specific gravity	Total RBC × 10 <sup>6</sup> /μl	Total WBC × 10 <sup>6</sup> /μl	Differential WBC count	Bacteria	Particulate matter (plant fiber)	Interpretation
Normal	Amber, crystal clear 1–5 mL per sample	0.1–3.1 (1.6) Does not clot	1.005–1.015	Few from puncture of capillaries during sampling	0.3–5.3	Polymorphonuclear and mononuclear cells, ratio 1:1	None	None	Increased amounts in late gestation, congestive heart failure
Moderate inflammation	Amber to pink, slightly turbid	2.8–7.3 (4.5) May clot	1.016–1.025	0.1–0.2	2.7–40.7 (8.7)	Nontoxic neutrophils, 50–90%. Macrophages may predominate in chronic peritonitis	None	None	Early stages of strangulation, destruction of intestine; traumatic reticuloperitonitis; ruptured bladder; chronic peritonitis
Severe inflammation	Sero-sanguineous, turbid, viscous 10–20 mL per sample	3.1–5.8 (4.2) Commonly clots	1.026–1.040	0.3–0.5	2.0–31.1 (8.0)	Segmented neutrophils, 70–90% Presence of (toxic) degenerate neutrophils containing bacteria	Usually present	May be present	Advanced stages of strangulation obstruction; acute diffuse peritonitis; perforation of abomasal ulcer; rupture of uterus, stomachs or intestine

Table 5.2 Characteristics of equine peritoneal fluid in selected diseases of horse

Disease	Protein concentration	Total nucleated cell count (TNCC)	Cytological comments	Other variables	Comments
Normal horse	< 2.1 g/dL < 21 g/L	< $9 \times 10^9$ cells/L < $9 \times 10^3$ cells/ $\mu$ L (TNCC is usually substantially lower in clinically normal horses)	Approximately 50% each of nondegenerate neutrophils and mononuclear cells	Lactate < 1 mmol/L (always < plasma (lactate)); Glucose < 2.0 mmol/L different from blood glucose; pH > 7.45; fibrinogen < 300 mg/dL (3 g/L) Creatinine = serum creatinine No red blood cells	Clear and slightly yellow. Not malodorous. Culture does not yield growth
Normal late-gestation mare	< 2.5 g/dL < 25 g/L	< $0.9 \times 10^9$ cells/L < 900 cells/ $\mu$ L	< 40% neutrophils. No degenerative changes. < 20% lymphocytes	Fluid usually readily obtained. Clear and slightly yellow	
Normal post-partum (< 7 d) mare	< 2.5 g/dL < 25 g/L	< $5.0 \times 10^9$ cells/L < $5.0 \times 10^3$ cells/ $\mu$ L	< 50% neutrophils. No degenerative changes. < 10% lymphocytes	Fluid usually readily obtained. Clear and slightly yellow	
Dystocia but clinically normal mare (1 d)	< 2.5 g/dL < 25 g/L	$2.7 \times 10^9$ (3.9) cells/L* $2.7 \times 10^3$ (3.9) cells/ $\mu$ L	50–90% nondegenerate neutrophils, 40% mononuclear cells and 10% lymphocytes	Fluid clear and yellow. Essentially normal fluid with small increases in TNCC and protein concentration	
Dystocia and clinically abnormal mare (uterine rupture, vaginal tear)	4.4 (1.3) g/dL* 44 (13) g/L	$27 \times 10^9$ (35) cells/L* $27 \times 10^3$ (35) cells/ $\mu$ L	70–100% neutrophils, some of which are degenerate, <10% mononuclear cells and <10% lymphocytes	Increased red blood cell count.	Fluid yellow or serosanguinous and cloudy. Can be malodorous. Culture can yield variety of bacteria. Red cell count in mares with middle uterine artery rupture is high with normal TNCC
Peritonitis, septic	5.2 (4.0–6.0) g/dL† 50 (40–60) g/L	$131 (7-700) \times 10^9$ cells/L† $131 (7-700) \times 10^3$ cells/ $\mu$ L	Almost all neutrophils, many of which have degenerative changes. Some neutrophils contain bacteria in many cases. Plant material with rupture of intestine	pH < that of blood; glucose < blood (difference < 2.0 mmol/L or 50 mg/dL); peritoneal glucose < 30 mg/dL (1.5 mmol/L); fibrinogen > 200 mg/dL (2.0 g/L)	Fluid usually dark yellow, brown, or serosanguinous. Can be green if severe rupture of intestine or stomach. Cloudy. Malodorous. Culture yields bacteria
Peritonitis, nonseptic (e.g. nonstrangulating, nonischemic obstructive lesion of the bowel)	2.7 (0.7–4.9) g/dL† 27 (7–49) g/L	$13 (0.4-516) \times 10^9$ cells/L† $13 (0.4-516) \times 10^3$ cells/ $\mu$ L	Mostly neutrophils (> 50%). Nondegenerate. No bacteria detected. No plant or foreign material	No abnormalities. pH $\geq$ that of blood	Fluid yellow and clear. Not malodorous. No bacteria isolated on culture
Strangulating intestinal lesion or ruptured intra-abdominal viscus	5.2 (4.0–6.0) g/dL† 50 (40–60) g/L	$131 (7-700) \times 10^9$ cells/L† $131 (7-700) \times 10^3$ cells/ $\mu$ L	Almost all neutrophils, many of which have degenerative changes. Some neutrophils contain bacteria in many cases. Plant material with rupture of intestine	Lactate $8.5 \pm 5.5$ mmol/L	Serosanguinous fluid. Cloudy if ruptured.
Nonstrangulating obstruction				Lactate $2.1 \pm 2.1$ mmol/L	
Peritonitis due to <i>Actinobacillus equuli</i>	2.5–8.4 g/dL 25–84 g/L	$46-810 \times 10^9$ cells/L $46-810 \times 10^3$ cells/ $\mu$ L	> 80% neutrophils most of which do not have signs of degeneration. Low numbers of Gram-negative pleomorphic rods, both intra- and extracellular		Cream, orange, brown or red fluid. Turbid. Not malodorous. Growth of <i>Actinobacillus equuli</i> on culture
Intra-abdominal abscess	> 2.5 g/dL > 25 g/L	> $10 \times 10^9$ cells/L > $10 \times 10^3$ cells/ $\mu$ L	> 80% nondegenerate neutrophils. Usually no bacteria detected on Gram stain		Yellow to white. Slightly cloudy. Culture will occasionally yield causative bacteria (usually <i>Streptococcus equi</i> )



Table 5.2 (Cont'd) Characteristics of equine peritoneal fluid in selected diseases of horses

Disease	Protein concentration	Total nucleated cell count (TNCC)	Cytological comments	Other variables	Comments
Hemoperitoneum	3.2–6.3 g/dL 32–63 g/L	$< 10 \times 10^9$ cells/L $< 10 \times 10^3$ cells/ $\mu$ L	Differential similar to blood. Mostly nondegenerate neutrophils. Erythrophages and hemosiderophages as hemorrhage resolves	High red cell count ( $2.4\text{--}8.6 \times 10^{12}$ cells/L, $2.4\text{--}8.6 \times 10^6$ cells/ $\mu$ L)	Serosanguinous to frankly bloody
Intra-abdominal neoplasia (lymphosarcoma, gastric squamous cell carcinoma)	$< 2.5$ g/dL $< 25$ g/L	$< 10 \times 10^9$ cells/L $< 10 \times 10^3$ cells/ $\mu$ L	Abnormal cells not detected in most cases. Care should be taken not to mistake reactive lymphocytes for neoplastic lymphocytes		Clear and yellow. Often subjective assessment of increased quantity (increased ease of collection of a large quantity of fluid)
Uroperitoneum	$< 2.5$ g/dL $< 25$ g/L	$\lll 10 \times 10^9$ cells/L $\lll 10 \times 10^3$ cells/ $\mu$ L	Normal differential. Might see calcium carbonate crystals in adult horses with uroperitoneum	Creatinine $>$ serum creatinine concentration Urea nitrogen $>$ serum urea nitrogen concentration Potassium $>$ serum potassium concentration	Large amount of fluid. Clear to very pale yellow. Uriniferous odor

\* mean (SD). † median (range).

Data from Frazer G, et al. *Theriogenology* 1997; 48:919; van Hoogmoed L, et al. *J Am Vet Med Assoc* 1996; 209:1280; van Hoogmoed L, et al. *J Am Vet Med Assoc* 1999; 214:1032; Pusterla N, et al. *J Vet Intern Med* 2005; 19:344; Latson KM, et al. *Equine Vet J* 2005; 37:342; Matthews S, et al. *Aust Vet J* 2001; 79:536.

cytes and eosinophils. The following general comments apply:

- It can be examined in terms of physical characteristics, especially color, translucence, specific gravity, clotting time, biochemical composition, cell volume, cell morphology and cell type
- Examination of the fluid may help in determining the presence in the peritoneal cavity of:
  - peritonitis (chemical or infectious)
  - infarction of a segment of gut wall
  - perforation of the alimentary tract wall
  - rupture of the urinary bladder
  - leakage from the biliary system
  - intraperitoneal hemorrhage
  - peritoneal neoplasia

The reaction of the peritoneum varies with time and a single examination can be dangerously misleading. A series of examinations may be necessary, in acute cases at intervals of as short as an hour

A significant reaction in a peritoneal cavity may be quite localized, so a normal sample of fluid collected at one point in the cavity may not be representative of the entire cavity. Changes in peritoneal fluid, especially its chemical composition, e.g. lactate level, may be a reflection of a systemic change. The examination of a concurrently collected peripheral blood sample will make it possible to determine whether the changes are in fact restricted to the peritoneal cavity

As in any clinicopathological examination the results must be interpreted with caution and only in conjunction with the history and clinical findings.

#### Specific properties of peritoneal fluid (normal and abnormal)

Color

**Normal fluid is crystal clear, straw-colored to yellow.** Turbidity indicates the presence of increased leukocytes and protein, which may include fine strands of fibrin.

A **green color** suggests food material; intense orange-green indicates rupture of the biliary system. A **pink-red color** indicates presence of hemoglobin, degenerated erythrocytes, entire erythrocytes and damage to vascular system by infarction, perforation or hydrostatic pressure. A **red-brown color** indicates the late stages of necrosis of the gut wall, the presence of degenerated blood and hemoglobin and damage to gut wall with hemorrhage.

**Whole blood, clear fluid streaked with blood** or heavily bloodstained fluid indicate that the sample has been collected from the spleen or a blood vessel or that there is hemoperitoneum. Rupture of the uterus or bladder or dicoumarol poisoning are also possibilities.

A **dark green sample** containing motile protozoa with very few leukocytes and no mesothelial cells indicates that the sample has been collected from the gut lumen. Enterocentesis has little apparent clinical affect in normal horses, although an occasional horse will show a transient fever. However, puncture of a devitalized loop of intestine may lead to extensive

leakage of gut contents and a fatal peritonitis. The effect of enterocentesis of normal gut on peritoneal fluid is consistently to increase the neutrophilic count, which persists for several days.

Cellular and other properties  
Surgical manipulation of the intestinal tract during exploratory laparotomy or intestinal resection and anastomosis in the horse results in a significant and rapid postoperative peritoneal inflammatory reaction.<sup>26</sup> Manipulation of the viscera causes injury to the mesothelial surfaces. Total and differential nucleated cell counts, red blood cell numbers, and total protein and fibrinogen concentrations were all elevated on the first day after the surgery and remained elevated for up to 7 days in a study of this phenomenon.<sup>26</sup>

In cattle, exploratory celiotomy and omentopexy results in an increase in the total nucleated cell count by a factor of 5–8, minor increases in specific gravity and increases in total protein concentration by a factor of up to 2. These changes appear by two days after surgery and continue to increase through to day 6.<sup>27,28</sup>

**Particulate matter** in peritoneal fluid suggests either fibrin clots/strands or gut contents caused by leakage from a perforated or ruptured gut wall.

**High specific gravity** and **high protein content** are indicative of vascular damage and leakage of plasma protein, as in peritonitis or mural infarction.

The **volume** and viscosity of fluid varies. A normal flow is 1–5 mL per sample. A continuous flow with 10–20 mL per sample indicates excess fluid due to

ruptured bladder or ascites (clear yellow), acute diffuse peritonitis (yellow, turbid), infarction or necrosis of gut wall (thin, red-tinged). The higher the protein content, as the peritoneal fluid shifts from being a transudate to an inflammatory exudate, the higher the viscosity becomes. Highly viscous fluid may clot.

#### Cells

A rapid staining method, using a modified Wright's stain, gives a stained slide ready for examination within 5 minutes. The value of the technique is in indicating the number of leukocytes and other cells present, and in differentiating the types of cell.

An **increase in total white cell count** of the fluid including a disproportionate number of polymorphonuclear cells indicates acute inflammation, which may have an infectious origin or else be sterile. An increase in mononuclear phagocytes from the peritoneum is an indication of chronic peritonitis. **Degenerate and toxic neutrophils** suggest the probability of infection being present.

An increase in the number of **mesothelial cells** with the distinctive presence of actively dividing mitotic figures suggests neoplasia.

**Bacteria** found as **phagocytosed inclusions in leukocytes**, or by culture of fluid, indicate an infective peritonitis, which may arise by hematogenous spread, in which case the infection is likely to be a specific one. If there has been leakage from a peritoneal abscess the same comment applies, but if there is leakage through a segment of devitalized or perforated bowel wall there is likely to be a mixed infection and possibly particulate matter from bowel contents.

**Entire erythrocytes**, often accompanied by some hemoglobin, indicate either hemoperitoneum, in which case there should be active phagocytosis of erythrocytes, or that the sample has been inadvertently collected from the spleen. The blood is likely to be concentrated if there has been sufficient time for fluid resorption across the peritoneum. Splenic blood has a higher packed cell volume (PCV) also, but there is no erythrophagocytosis evident in the sample. A **PCV of less than 5%** in peritoneal fluid suggests extravasation of blood from an infarcted or inflamed gut wall; one of more than 20% suggests a significant hemorrhage.

#### Abdominocentesis in horses

In the horse the recommended site for paracentesis is on the ventral midline, 25 cm caudal to the xiphoid (or midway between the xiphoid and the umbilicus). Following surgical preparation and subcutaneous infiltration of an anesthetic, a stab incision is made through the skin

and subcutaneous tissues and into the linea alba. A 9 cm long blunt-pointed bovine teat cannula, or similar metal catheter, with the tip wrapped in a sterile swab to avoid blood and skin contamination, is inserted into the wound and manipulated until the incision into the linea alba can be felt. With a quick thrust the cannula is pushed through the linea alba into the peritoneal cavity. A 'pop' is often heard on entry into the peritoneal cavity. Failure to incise into the linea alba first will cause many cannulas to bend and break.

In most horses (about 75%) a sample of fluid is readily obtained. In others it takes a moment or two before the fluid runs out, usually spurting synchronously with the respiratory movements. Applying suction with a syringe may yield some fluid if there is no spontaneous flow. Normal fluid is clear, yellow and flows easily through an 18-gauge needle. Two samples are collected, one in a plain tube and one in a tube with an anticoagulant. In case the fluid clots readily a few drops should be placed and smeared out on a glass slide and allowed to dry for staining purposes.

In peritonitis, the total leukocyte count will increase markedly, but wide variation in the total count can occur between horses with similar conditions, and in the same horse within a period of hours. Variations are due to the nature and stage of the lesion and to the total amount of exudate in the peritoneal cavity, which has a diluting effect on the total count. Total leukocyte counts ranging from 10 000–150 000  $\mu\text{L}$  have been recorded in peritonitis and in infarction of the intestine in horses. Experimentally, the intravenous injection of endotoxin into horses causes marked changes in the peripheral blood cellular components but there are no changes in the total white cell count of the peritoneal fluid.<sup>29</sup>

In **healthy foals** the reference values for peritoneal fluid are different than in adult horses.<sup>30</sup> The maximum peritoneal fluid nucleated cell counts in foals are much lower than in adult horses ( $1.5 \times 10^9/\text{L}$  versus  $5.0 \times 10^9/\text{L}$ ). Nucleated cell counts greater than  $1.5 \times 10^9/\text{L}$  should be interpreted as elevated.

Peritoneal fluid abnormalities in mares within a week of foaling should be attributed to a systemic or gastrointestinal abnormality not due to the foaling event.<sup>31</sup> The nucleated cell count, protein concentration, fibrinogen concentration and specific gravity of peritoneal fluid from recently foaled mares should be normal; however, differential cell counts may be abnormal for up to 1 week after foaling.

#### Risks

**Abdominocentesis is not without some danger**, especially the risk of introducing

fecal contents into the peritoneal cavity and causing peritonitis. This appears to be of major importance only if there are loops of distended atonic intestine situated on the ventral abdominal wall. This is a common occurrence in the later stages of intestinal obstruction that is still amenable to surgery. Puncture of a devitalized loop of intestine may cause a leakage of intestinal contents and acute diffuse peritonitis, which is rapidly fatal. Penetration of a normal loop of intestine occurs often enough to lead to the conclusion that it appears to have no ill-effects. If a sample of peritoneal fluid is an important diagnostic need in a particular case and the first attempt at paracentesis causes penetration of the gut, it is recommended that the attempt be repeated, if necessary two or three times, at more posterior sites. Repeated abdominocentesis does not cause alterations in peritoneal fluid constituents and any significant changes are likely due to alterations in the disease state present.<sup>32</sup> The technique most likely to cause bowel penetration is the use of a sharp needle instead of the blunt cannula recommended, and forcibly thrusting the cannula through the linea alba without a prior incision. When the suggested incision is made in the linea alba, the cannula can be pushed gently through whilst rotating it.

#### Abdominocentesis in cattle

The choice of sites for paracentesis is a problem because the rumen covers such a large portion of the ventral abdominal wall and avoiding penetration of it is difficult. Cattle have a low volume of peritoneal fluid, and failure to obtain a sample is not unusual.<sup>27</sup> The most profitable sites are those that, on an anatomical basis, consist of recesses between the forestomachs, abomasum, diaphragm and liver. These are usually caudal to the xiphoid sternum and 4–10 cm lateral to the midline. Another recommended site is left of the midline, 3–4 cm medial and 5–7 cm cranial to the foramen for the left subcutaneous abdominal vein. A teat cannula similar to the one described for use in the horse is recommended but, with care and caution, a 16-gauge 5 cm hypodermic needle may also be used. The needle or cannula is pushed carefully and slowly through the abdominal wall, which will twitch when the peritoneum is punctured. When this happens the fluid will usually run out into a vial without the aid of a vacuum. However, if it does not, a syringe may be used and the needle may be moved backwards and forwards in a search for fluid, with the piston of the syringe withdrawn. A further site is the right caudoventral abdominal wall medial

to the fold of the flank, using a 3.8 cm, 15-gauge needle.<sup>27</sup>

In calves, a reliable technique includes the use of sedation with intravenous xylazine hydrochloride and diazepam. The animal is placed in left lateral recumbency with the right hind limb pulled dorsally and caudally. One site slightly dorsal and caudal to the umbilicus is prepared together with another site in the center of the inguinal region. The site is prepared with local anesthetic and a 14-gauge needle is introduced and directed slightly caudally and toward the midline while keeping it parallel to the inner abdominal wall once the peritoneal cavity is entered.<sup>33</sup> A 3.5 gauge urinary catheter (1.2 mm × 56 cm sterile feeding tube) is inserted through the needle and a 3 mL sterile syringe is attached to the catheter. Gentle suction is applied. The fluid is placed in a 2 mL tube containing tri-potassium EDTA. A 14-gauge over-the-needle catheter can also be used, followed by insertion of a 3.5 French feeding tube. If fluid cannot be obtained from the first site, the inguinal site is used using the same basic technique and with the catheter directed slightly cranially toward the midline.

Failure to obtain a sample does not preclude the possibility that peritonitis may be present: the exudate may be very thick and contain large masses of fibrin, or the peritonitis may be localized. Also, animals that are dehydrated may have less peritoneal fluid than normal. Most animals from which samples cannot be obtained, however, are in fact normal. In animals in which peritonitis is strongly suspected for clinical reasons, up to four attempts at paracentesis should be made before aborting the procedure. The fluid should be collected into an anticoagulant, preferably EDTA, to avoid clotting.

Abnormal peritoneal fluid in cattle is a highly sensitive indicator of peritoneal disease, but not a good indicator of the *nature* of the disease. The most pronounced abnormalities occur in acute diseases of the peritoneum; chronic peritonitis may be accompanied by peritoneal fluid which is almost normal.

Examination of the fluid should take into account the following characteristics:

- Large amounts (10–20 mL) of serosanguineous fluid suggests infarction or necrosis of the gut wall
- Heavily bloodstained fluid, whole blood or fluid with streaks of blood through it are more likely to result from puncture of a blood vessel or from bleeding into the cavity, as in dicoumarol poisoning or with a neoplasm of the vascular system
- The same sort of bloodstained fluid as above may accompany a ruptured

uterus or bladder or severe congestive heart failure

- Large quantities of yellowish-colored turbid fluid suggests acute diffuse peritonitis. The degree of turbidity depends on the number of cells and the amount of fibrin present
- Particulate food material in the sample indicates perforation or rupture of the gut, except that penetration of the gut with the instrument during collection may be misleading. Such samples are usually heavily fecal in appearance and contain no mesothelial cells
- Laboratory examination is necessary to derive full benefit from the sample. This will include assessment of: the number and type of **leukocytes** present – the number is increased in peritonitis, neutrophils predominating in acute peritonitis and monocytes in chronic forms; the number of **erythrocytes** present; whether **bacteria** are present inside or outside the neutrophils; and **total protein** content.

The significant values for these items are included in Table 5.1.

Reference values for peritoneal fluid constituents of normal adult cattle may be inappropriate for interpretation of peritoneal fluid analysis in calves of up to 8 weeks of age.<sup>34</sup> The peritoneal fluid nucleated cell count and mononuclear cell counts are higher in calves, and the eosinophil counts are lower than in adult cows.

### **INTESTINAL AND LIVER BIOPSY**

An intestinal biopsy may be obtained from an exploratory laparotomy but is costly and time-consuming. Rectal biopsy is easily done and of low cost. It is a valuable diagnostic aid for evaluating certain intestinal diseases of the horse.<sup>35</sup> Biopsy specimens are taken using minimal restraint and unaided by proctoscopic visualization in the standing horse. A rectal biopsy forceps is used to obtain the biopsy from the floor of the rectum approximately 30 cm proximal to the anal sphincter.

The technique for liver biopsy is presented in Chapter 7.

## **Principles of treatment in alimentary tract disease**

Removal of the primary cause of the disease is essential but a major part of the treatment of diseases of the alimentary tract is supportive and symptomatic. This is aimed at relieving pain and distension,

replacement of fluids and electrolytes, correcting abnormal motility and relieving tenesmus and reconstitution of the digestive flora if necessary. Specific treatment for individual diseases is presented with each disease throughout this book. General principles are outlined here..

### **RELIEF OF ABDOMINAL PAIN**

The relief of abdominal pain is of prime importance from the humane aspect, to prevent the animal from self-injury associated with falling and throwing itself against a wall or other solid objects, and to allay the concerns of the owner. No single analgesic is completely satisfactory for every situation. Non-narcotic and narcotic analgesics are in general use and are discussed under the heading of pain, and under the individual diseases. The analgesics used in the important subject of equine colic are presented under that heading.

### **RELIEF OF DISTENSION**

The relief of distension of the gastrointestinal viscera is a critical principle in order to minimize shock and to prevent rupture of the viscus. **Relief of distension of the stomach of the horse with colic is accomplished by nasogastric intubation.** Distension due to bloat in cattle can be relieved by stomach tube or trocarization of the rumen. Relief of distension may be possible by medical means alone with the use of laxatives and purgatives when there is accumulation of ingesta without a physical obstruction. Surgical intervention is often necessary when the distension is associated with a physical obstruction. In functional distension (paralytic ileus), relief of the atony or spasm can be effected by the use of drugs such as metoclopramide. Distension due to intestinal or gastric accidents requires surgical correction.

### **REPLACEMENT OF FLUIDS AND ELECTROLYTES**

Replacement of fluid and electrolytes lost in gastrointestinal disease is one of the most important principles of treatment. In gastric or intestinal obstruction, or when diarrhea is severe, it is necessary to replace lost fluids and electrolytes by the parenteral administration of large quantities of isotonic glucose-saline or other physiologically normal electrolyte solutions. The amount of fluid lost may be very large and fluids must be given in quantities to replace losses and to support continuing losses and maintenance requirements. In acute, severe dehydration in horses, such as occurs in acute intestinal obstruction, the amount of fluid required before and

during surgery ranges from 50–100 mL/kg BW per 24 hours. It is critical that administration of fluid be commenced at the earliest possible time because of the need to maintain homeostasis and thus ameliorate the almost impossible task of restoring animals to normal before surgery is to be attempted. Details of fluid therapy are given in the section on disturbances of water, electrolytes and acid–base balance in Chapter 2.

In young animals the need is much greater still and amounts of 100 mL/kg BW, given slowly intravenously, are commonly necessary and not excessive. The treatment of shock is also presented in Chapters 2 and 9 and includes the administration of fluids, plasma or blood and NSAIDs. The use of intravenous hypertonic saline followed by the ingestion of large quantities of water by the animal is another aspect of fluid therapy in gastrointestinal disease (see Chapter 2).

## CORRECTION OF ABNORMAL MOTILITY

### INCREASED MOTILITY

When motility is increased, the administration of atropine or other spasmolytics such as dipyrone or proquamezine is usually followed by disappearance of the abdominal pain and a diminution of fluid loss. Meperidine, butorphanol and pentazocine inhibit regular cyclic myoelectric activity in the jejunum.<sup>36</sup> There is a need for some scientific clinical investigation into the desirability of treating intestinal hypermotility, if it does exist in enteritis for example, and the efficacy of anticholinergics. Loperamide has an antidiarrheal effect in experimentally induced diarrhea in calves but the mechanism of action does not involve changes in intestinal motility.

### DECREASED MOTILITY

When gastrointestinal motility is decreased, the usual practice is to administer parasympathomimetic drugs or purgatives, usually combined with an analgesic. Prokinetic drugs such as metoclopramide hydrochloride and cisapride monohydrate increase the movement of ingesta through the gastrointestinal tract.<sup>37</sup> They are useful because they induce coordinated motility patterns.

Metoclopramide

**Metoclopramide**, acting in the upper gastrointestinal tract, increases acetylcholine release from neurons and increases cholinergic receptor sensitivity to acetylcholine. It is a dopamine antagonist and stimulates and coordinates esophageal, gastric, pyloric and duodenal motor activity. It increases lower esophageal sphincter tone and stimulates gastric

contractions, while relaxing the pylorus and duodenum. This results in accelerated gastric emptying and reduced esophageal reflux. The transit time of ingested material from the duodenum to the ileocecal valve is reduced, due to increased jejunal peristalsis. It has little or no effect on colonic motility. The pharmacokinetics of metoclopramide in cattle have been studied.<sup>38</sup>

Metoclopramide crosses the blood–brain barrier, where its dopamine antagonist activity at the chemoreceptor trigger zone can result in an antiemetic effect. It can also result in involuntary activity including tremors, restlessness and aggressive behavior characterized by charging and jumping walls. This can be reversed by the use of an anticholinergic such as diphenhydramine hydrochloride intravenously at 0.5–2.0 mg/kg BW.

Indications for metoclopramide include reflux esophagitis and gastritis, chronic gastritis associated with delayed emptying, abomasal emptying defects in ruminants, gastric stasis following gastric dilatation and volvulus surgery, and **post-operative ileus**. It is contraindicated in animals with physical obstruction of the gastrointestinal tract.

In horses, the dose is 0.125–0.25 mg/kg BW diluted in multiple electrolyte solution and given intravenously over 60 minutes.<sup>37</sup> It is used for stimulating equine gastric and small intestinal activity at dose rates of 0.25 mg/kg BW per hour when there is intestinal hypomotility.<sup>39</sup> Given as continuous intravenous infusion of 0.04 (mg/kg)/h it can decrease the incidence and severity of persistent post-operative ileus following resection and anastomosis of the small intestine in horses without serious side effects.<sup>40</sup>

In cattle and sheep metoclopramide is used at 0.3 mg/kg BW subcutaneously every 6–8 hours. Metoclopramide did not alter cecocolic myoelectrical activity in cattle.<sup>41</sup>

Cisapride

**Cisapride** promotes gastrointestinal motility by enhancing the release of acetylcholine from postganglionic nerve endings of the myenteric plexus. Cisapride is more potent and has broader prokinetic activity than metoclopramide by increasing the motility of the colon as well as the esophagus, stomach and small intestine.<sup>37</sup> It does not have dopaminergic effects and does not have either the antiemetic or the extrapyramidal effects of metoclopramide. Cisapride is useful for the treatment of gastric stasis, gastroesophageal reflux and postoperative ileus. In horses, cisapride increases left dorsal colon motility and improves ileocecal junction coordination. The suggested dose is 0.1 mg/kg BW orally every 8 hours.

Cisapride may have some value in the clinical management of cecal dilatation in cattle.<sup>42</sup>

Xylazine and naloxone

While **xylazine** is used for alleviation of visceral pain in horses and cattle, it is not indicated in cecal dilatation in cattle because it reduces the myoelectric activity of the cecum and proximal loop of the ascending colon.<sup>42</sup> **Naloxone**, a widely used opiate antagonist with a high affinity for  $\mu$  receptors, is also not indicated for medical treatment of cecal dilatation when hypomotility must be reversed.

Bethanechol, neostigmine

**Bethanechol** is a methyl derivative of carbachol and classified as a direct-acting cholinomimetic drug. Its action is more specific on the gastrointestinal tract and urinary bladder. **Neostigmine**, a cholinesterase inhibitor, is an indirect-acting cholinergic drug with motor-stimulating activities but only on the gastrointestinal tract. Bethanechol at 0.07 mg/kg BW intramuscularly may be useful for medical treatment of cecal dilatation in cattle in which hypomotility of the cecum and proximal loop of the ascending colon must be reversed.<sup>41</sup> Neostigmine at 0.02 mg/kg BW intramuscularly increased the number of propagated spike sequences but they were uncoordinated.<sup>41</sup>

### RELIEF OF TENESMUS

Tenesmus can be difficult to treat effectively. Long-acting epidural anesthesia and sedation are in common use. Combinations of xylazine and lidocaine may be used. Irrigation of the rectum with water and the application of topical anesthetic in a jelly-like base are also used.

### RECONSTITUTION OF RUMEN FLORA AND CORRECTION OF ACIDITY OR ALKALINITY

When prolonged anorexia or acute indigestion occurs in ruminants, the rumen flora may be seriously reduced. In convalescence, the reconstitution of the flora can be hastened by the oral administration of a suspension of ruminal contents from a normal cow, or of dried ruminal contents, which contain viable bacteria and yeasts and the substances necessary for growth of the organisms.

The pH of the rumen affects the growth of rumen organisms, and hyperacidity, such as occurs on overeating of grain, or hyperalkalinity, such as occurs on overeating of protein-rich feeds, should be corrected by the administration of alkalinizing or acidifying drugs as the case may be.

## REVIEW LITERATURE

- Roussel AJ. Intestinal motility. *Compend Contin Educ Pract Vet* 1994; 16:1433–1442.
- Dowling PM. Prokinetic drugs: metoclopramide and cisapride. *Can Vet J* 1995; 36:115–116.
- Navarre CB, Roussel AJ. Gastrointestinal motility and disease in large animals. *J Vet Intern Med* 1996; 10:51–59.

## REFERENCES

- Roussel AJ. *Compend Contin Educ Pract Vet* 1994; 16:1433.
- Navarre CB, Roussel AJ. *J Vet Intern Med* 1996; 10:51.
- Yarbrough TB et al. *J Am Vet Med Assoc* 1994; 205:592.
- Fischer AT et al. *Vet Radiol* 1987; 28:42.
- Klohnen A et al. *J Am Vet Med Assoc* 1996; 209:1597.
- Pease AP et al. *Vet Radiol Ultrasound* 2004; 45:220.
- Kirberger RM et al. *Vet Radiol Ultrasound* 1995; 36:50.
- Korolainen R, Ruohoniemi M. *Equine Vet J* 2002; 34:499.
- Mitchell CF et al. *Can Vet J* 2005; 46:134.
- Aleman M et al. *Equine Vet J* 2002; 34:649.
- Braun U. *Vet J* 2003; 166:112.
- Braun U. *Vet J* 2002; 150:75.
- Braun U, Marmier O. *Vet Rec* 1995; 136:239.
- Galuppo LD et al. *Am J Vet Res* 1995; 56:518.
- Galuppo LD et al. *Am J Vet Res* 1996; 57:923.
- Kronfeld DS et al. *J Am Vet Med Assoc* 2005; 226:712.
- Mair TS et al. *Equine Vet J* 1991; 23:344.
- Van Amstel SR et al. *J S Afr Vet Assoc* 1984; 55:119.
- Gutzwiller A, Blum JW. *Am J Vet Res* 1996; 57:560.
- Freeman DE et al. *Am J Vet Res* 1989; 50:1609.
- Brown CM. *Br Vet J* 1992; 148:41.
- Freeman DE et al. *Am J Vet Res* 1989; 50:1609.
- O'Connor MS et al. *Am J Vet Res* 2004; 65:31.
- Hewetson M et al. *J Vet Intern Med* 2006; 20.
- Menzies-Gow NJ et al. *Vet Rec* 2003; 153:457.
- Blikslager AT et al. *J Am Vet Med Assoc* 1994; 205:1748.
- Hanson RR et al. *Am J Vet Res* 1992; 53:216.
- Anderson DE et al. *Am J Vet Res* 1994; 55:1633.
- Valadao CAA et al. *J Equine Vet Sci* 1995; 15:124.
- Grindem CB et al. *Equine Vet J* 1990; 22:359.
- Hoogmoed L et al. *J Am Vet Med Assoc* 1996; 209:1280.
- Juzwiak JS et al. *Vet Res Commun* 1991; 15:177.
- Burton S et al. *Vet Clin Pathol* 1997; 26:38.
- Anderson DE et al. *Am J Vet Res* 1995; 56:973.
- Lindberg R et al. *Equine Vet J* 1996; 28:275.
- Sojka JE et al. *Am J Vet Res* 1988; 49:527.
- Dowling PM. *Can Vet J* 1995; 36:115.
- Jones RD et al. *J Vet Pharmacol Ther* 1994; 17:1141.
- Hunt JM, Gerring EL. *J Vet Pharmacol Ther* 1989; 9:109.
- Dart AJ et al. *Aust Vet J* 1996; 74:280.
- Steiner A et al. *Am J Vet Res* 1995; 56:1081.
- Steiner A et al. *Am J Vet Res* 1995; 56:623.

## Diseases of the buccal cavity and associated organs

### DISEASES OF THE MUZZLE

The congenital defect of harelip may be contiguous with a cleft palate. Severe dermatitis with scab formation, develop-

ment of fissures, and sloughing and gangrene of the skin of the muzzle are common lesions in cattle affected with photosensitive dermatitis, bovine malignant catarrh, bovine virus diarrhoea and rinderpest.

In sheep severe lesions of the muzzle are less common, but occur in bluetongue and ecthyma.

In pigs, only the vesicular diseases – vesicular exanthema of swine, swine vesicular disease, and foot-and-mouth disease – cause such lesions on the snout and on other sites. The lesions are vesicular initially and confusion has arisen in recent years because of isolated incidents in Australia and New Zealand in which such outbreaks occurred but in which no pathogenic agent was identified.

### STOMATITIS

Stomatitis is inflammation of the oral mucosa and includes **glossitis** (inflammation of the tongue), **palatitis** (lampas) (inflammation of the palate) and **gingivitis** (inflammation of the mucosa of the gums). Clinically it is characterized by partial or complete loss of appetite, smacking of the lips and profuse salivation. It is commonly an accompaniment of systemic disease.

### ETIOLOGY

Stomatitis may be caused by physical, chemical or infectious agents, the last being the largest group of causes. The agents are listed under these group headings below.

#### Physical agents

- Trauma while dosing orally with a balling gun
- Laceration of the tongue<sup>1</sup>
- Foreign body injury
- Malocclusion of teeth
- Sharp awns or spines on plants. The commonest lesions are on the gums of cattle and sheep just below the corner incisors where tough grass is pulled around the corner of the incisor arcade. In spear grass country the alveoli are often stuffed full of grass seeds. Very young animals, e.g. 1–6-week-old lambs, are particularly susceptible to traumatic injury from abrasive feed.<sup>2</sup> Among the most dramatic lesions are those in the mouths of horses. They are large (2–3 cm long and 5 mm wide) and linear in shape. They may be caused by eating hairy caterpillars that infest pasture, or by the awns in hay or chaff made from triticale (a hybrid of wheat and rye) and a yellow bristle grass (*Setaria lutescens*). Foxtail awns can cause multiple painful nodules on the lips of horses that have eaten hay contaminated with the awns

- The strength and thickness of the awn in dwarf barley cultivars used to make silage fed to feedlot cattle in some regions is associated with mouth lesions. The incidence of tongue lesions in slaughter cattle in some areas can be about 19% and the incidence is higher in cattle finished on silage from semidwarf rough awn (29.3%) compared to normal-stem rough awn (13.5%) and normal-stem smooth awn barley (11.8%)<sup>3</sup>
- Eating frozen feed and drinking hot water are recorded, but seem highly improbable
- Ulcers of the soft palate of horses may be due to mechanical trauma associated with dorsal displacement of the soft palate.<sup>4</sup>

#### Chemical agents

- Irritant drugs, e.g. chloral hydrate, administered in overstrong concentrations
- Counterirritants applied to skin, left unprotected and licked by the animal, including mercury and cantharides compounds
- Irritant substances administered by mistake, including acids, alkalis and phenolic compounds
- Manifestation of systemic poisoning, e.g. chronic mercury poisoning. Poisoning with bracken, *Heracleum mantegazzianum*, furazolidone and some fungi (*Stachybotrys*, *Fusarium* spp. and mushrooms) cause a combination of focal hemorrhages and necrotic ulcers or erosions. They are a common cause of confusion with vesicular or erosive disease
- Lesions associated with uremia syndrome in horses.

#### Infectious agents

##### Cattle

- Oral necrobacillosis associated with *Fusobacterium necrophorum*
- Actinobacillosis of the bovine tongue is not a stomatitis, but there may be one or two ulcers on the dorsum and sides of the tongue and on the lips. Characteristically, there is initially an acute diffuse myositis of the muscle of the tongue, followed by the development of multiple granulomas and subsequently fibrosis and shrinkage
- Ulcerative, granulomatous lesions may occur on the gums in cases of actinomycosis
- Stomatitis with vesicles occurs in foot-and-mouth disease and in vesicular stomatitis
- Erosive, with some secondary ulcerative, stomatitis occurs in bovine viral diarrhoea (mucosal disease), bovine malignant catarrh, rinderpest

and rarely in bluetongue. Cases of infectious bovine rhinotracheitis in young calves may have similar lesions

- Proliferative lesions occur in papular stomatitis, proliferative stomatitis and rare cases of rhinosporidiosis and papillomatosis where the oral mucosa is invaded
- Oral mucosal necrosis in bovine sweating sickness
- Nondescript lesions varying from erosions to ulcers occur late in the stages of many of the above diseases when secondary bacteria have invaded the breaches in the mucosa. In some cases the involvement goes deeper still and a phlegmonous condition or a cellulitis may develop. Thus, lesions that were initially vesicular are converted to what look like bacterial ulcers. Secondary infection with fungi, especially *Monilia* spp., may also occur.

#### Sheep

- Erosive lesions in bluetongue, rinderpest and peste de petits ruminantes
- Vesicular lesions rarely in foot and mouth disease
- Granulomatous lesions due to ecthyma are not unusual in the mouth, especially in young lambs. Similarly, oral lesions occur in bad cases of sheep pox, ulcerative dermatosis, coital exanthema and mycotic dermatitis.

#### Horses

- Cheilitis and gingivitis (inflammatory nodules of the lips and gums caused by plant awns)
- Vesicular lesions in vesicular stomatitis
- Herpesvirus infections are commonly accompanied by small (1 mm diameter) vesicles surrounded by a zone of hyperemia. The lesions are in groups and at first glance appear to be hemorrhages
- Lingual abscess associated with *Actinobacillus* spp.

#### Pigs

- The vesicular diseases: foot and mouth disease, vesicular stomatitis, vesicular exanthema of swine and swine vesicular disease.

#### Bullous stomatitis

- Bullous stomatitis has been reported in the horse and may be associated with a paraneoplastic pemphigus syndrome.<sup>5</sup>

Many other causes of stomatitis have been suggested but the relationship of these conditions to the specific diseases listed above is unknown. It is common to

find stomatitides that cannot be defined as belonging to any of these etiological groups. An example is necrotic glossitis reported in feeder steers in the USA in which the necrotic lesions are confined to the anterior part of the tongue.

#### PATHOGENESIS

The lesions of stomatitis are produced by the causative agents being applied directly to the mucosa, or gaining entrance to it by way of minor abrasions, or by localization in the mucosa from a viremia. In the first two instances, the stomatitis is designated as primary. In the third, it is usually described as secondary because of the common occurrence of similar lesions in other organs or on other parts of the body, and the presence of a systemic disease. The clinical signs of stomatitis are caused by the inflammation or erosion of the mucosa and the signs vary in severity with the degree of inflammation.

#### CLINICAL FINDINGS

There is partial or complete anorexia and slow, painful mastication. Chewing movements and smacking of the lips are accompanied by salivation, either frothy and in small amounts, or profuse and drooling if the animal does not swallow normally. The saliva may contain pus or shreds of epithelial tissue. A fetid odor is present on the breath only if bacterial invasion of the lesion has occurred. Enlargement of local lymph nodes may also occur if bacteria invade the lesions. Swelling of the face is observed only in cases where a cellulitis or phlegmon has extended to involve the soft tissues. An increased desire for water is apparent and the animal resents manipulation and examination of the mouth.

Toxemia may be present when the stomatitis is secondary to a systemic disease or where tissue necrosis occurs. This is a feature of oral necrobacillosis and many of the systemic viremias. In some of the specific diseases, lesions may be present on other parts of the body, especially at the coronets and mucocutaneous junctions.

Several different lesions of the oral cavity may be present and their characteristic appearances are as follows. The importance of vesicular diseases such as foot-and-mouth disease means that the recognition and differentiation of these lesions assumes major importance.

**Erosions** are shallow, usually discrete, areas of necrosis, which are not readily seen in the early stages. They tend to occur most commonly on the lingual mucosa and at the commissures of the mouth. The necrotic tissue may remain in situ but is usually shed, leaving a very shallow discontinuity of the mucosa with a dark red base that is more readily seen.

If recovery occurs, these lesions heal very quickly.

**Vesicles** are thin-walled swellings 1–2 cm in diameter filled with clear serous fluid. They are very painful and rupture readily to leave sharp-edged, shallow ulcers.

**Ulcerative lesions** penetrate more deeply to the lamina propria and are painful, as in necrotic stomatitis in calves associated with *F. necrophorus*. In lambs the tongue may be swollen and contain many microabscesses infected with *Actinomyces (Corynebacterium) pyogenes*. There is an accompanying abscessation of the pharyngeal lymph nodes.<sup>2</sup>

**Proliferative lesions** are characterized by an abnormality raised above the surface of the mucous membrane as in oral papillomatosis. **Traumatic lesions** are usually solitary and characterized by a discontinuity in the mucous membrane often with evidence of healing and the presence of granulation tissue.

**Catarrhal stomatitis** is manifested by a diffuse inflammation of the buccal mucosa and is commonly the result of direct injury by chemical or physical agents. **Mycotic stomatitis** is characterized by a heavy, white, velvety deposit with little obvious inflammation or damage to the mucosa.

**Deformity of or loss of tissue at the tip of the tongue** may result in a chronic syndrome of chewing and swallowing food in such a way that food is always oozing from between the lips. In sheep this may cause permanent staining of the hair around the mouth, creating an appearance similar to that of a tobacco-chewer. Loss of the tip is usually the result of predator attack on a newborn or sick lamb.

**Laceration of the tongue** can result in complete or partial severance of the organ, with the severed portion protruding from the oral cavity. In cattle, glossectomy interferes with prehension and the animal is unable to eat. Excessive loss of saliva is common because of interference with swallowing.

**Ulceration of the soft palate** of horses may occur in 16% of horses with dorsal displacement of the soft palate and is characterized clinically by reduced exercise tolerance, respiratory noise during light exercise or racing, dysphagia and coughing after exercising.<sup>4</sup> The ulcers can be viewed by upper respiratory airway video-endoscopy. **Bullous stomatitis** in the horse is characterized by intact or ruptured vesicles on the peripheral margin of the tongue, the sublingual region and the mucosa of the oral cavity and lips.

#### CLINICAL PATHOLOGY

Material collected from lesions of stomatitis should be examined for the presence of

pathogenic bacteria and fungi. Transmission experiments may be undertaken with filtrates of swabs or scrapings if the disease is thought to be due to a viral agent.

### NECROPSY FINDINGS

The oral lesions are easily observed but complete necropsy examinations should be carried out on all fatally affected animals to determine whether the oral lesions are primary or are local manifestations of a systemic disease.

### DIFFERENTIAL DIAGNOSIS

- Particularly in cattle, and to a less extent in sheep, the diagnosis of stomatitis is most important because of the occurrence of oral lesions in a number of highly infectious viral diseases. The diseases are listed under etiology and their differentiation is described under their specific headings elsewhere in this book
- Careful clinical and necropsy examinations are necessary to define the type and extent of the lesions if any attempt at field diagnosis is to be made
- In cattle, lymphoma of the ramus of the mandible may spread extensively through the submucosal tissues of the mouth causing marked swelling of the gums, spreading of the teeth, inability to close the mouth and profuse salivation. There is no discontinuity or inflammation of the buccal mucosa but gross enlargement of the cranial lymph nodes is usual
- The differentiation of causes of hypersalivation must depend on a careful examination of the mouth (the causative gingivitis is often surprisingly moderate in horses) and an awareness of the volume of increased saliva output caused by toxic hyperthermia, e.g. in fescue and ergot poisonings
- Poisoning by the mycotoxin slaframine also causes hypersalivation

### TREATMENT

Affected animals should be isolated and fed and watered from separate utensils if an infectious agent is suspected. Specific treatments are described under the headings of the individual diseases. Nonspecific treatment includes frequent application of a mild antiseptic collutory such as a 2% solution of copper sulfate, a 2% suspension of borax or a 1% suspension of a sulfonamide in glycerin. Indolent ulcers require more vigorous treatment and respond well to curettage or cauterization with a silver nitrate stick or tincture of iodine.

In stomatitis due to trauma, the teeth may need attention. In all cases, soft, appetizing food should be offered and feeding by stomach tube or intravenous alimentation may be resorted to in severe, prolonged cases. If the disease is infec-

tious, care should be exercised to insure that it is not transmitted by the hands or dosing implements.

### REFERENCES

1. Mohammed A et al. *Vet Rec* 1991; 128:355.
2. Rossiter DL et al. *J Am Vet Med Assoc* 1984; 185:1552.
3. Karren DB et al. *Can J Anim Sci* 1994; 74:571.
4. Gille D, Lavoie JP. *Equine Pract* 1996; 18:9.
5. Williams MA et al. *J Am Vet Med Assoc* 1995; 207:331.

### DISEASES OF THE TEETH

Surgical diseases of the teeth of animals are presented in textbooks of surgery. Some of the medical aspects of diseases of the teeth of farm animals are described here.

#### ETIOLOGY

The causes may be congenital or acquired.

#### Congenital defects

- Inherited
  - Malocclusion of sufficient degree to interfere with prehension and mastication
  - Red-brown staining of inherited porphyria of cattle
  - Defective enamel formation on all teeth combined with excessive mobility of joints in inherited defect of collagen metabolism in Holstein/Friesian cattle identified as bovine osteogenesis imperfecta. The teeth are pink and obviously deficient in substance. This defect is also recorded in a foal with severe epitheliogenesis imperfecta.<sup>1</sup>

#### Dental fluorosis

The teeth are damaged before they erupt and show erosion of the enamel. See the section on fluorosis.

#### Enamel erosion

The feeding of acidic byproduct feed such as sweet potato cannery waste, which is acidic because of the presence of lactic acid, can cause erosion of the enamel of the incisors of cattle.<sup>2,3</sup> Exposure of incisor teeth in vitro to a supernatant of cannery waste or lactic acid at pH 3.2 results in removal of calcium from the surface enamel of bovine teeth. Neutralizing the cannery waste to a pH of 5.5 does not cause detectable etching of the teeth. Feeding cattle with heavily compacted silage is also associated with loss of incisor enamel and severe incisor wear.<sup>4</sup>

#### Premature wear and loss of teeth in sheep (periodontal disease)

Premature loss of incisor teeth or 'broken mouth' causes concern because of the early age at which affected sheep have to be culled. Broken mouth is a chronic inflammatory disease of the tissue supports of the tooth.<sup>5</sup> Between 60% and

70% of ewes sold at slaughter in England and Scotland have loose or missing incisor teeth.<sup>6</sup> Broken mouth is geographically specific and it seems that once the disease is established on a particular farm, the animals are permanently susceptible.<sup>7</sup> Many sheep are culled before the end of their useful reproductive life because of broken mouth. The problem is particularly severe in New Zealand and the hill country in Scotland.<sup>8</sup> The cause is uncertain but environmental factors that result in periodontal disease are probably important. *Bacteroides gingivalis*, an organism that is found in plaque from sheep's teeth, has been found with increased frequency in diseased compared to unaffected animals.<sup>8</sup> The depths of the gingival crevice of sheep are heritable and it is possible that deeper crevices may already be harboring greater numbers of periodontally pathogenic bacteria so that when the animals are exposed to a broken-mouth environment they may be more prone to the changes.<sup>9</sup> While nutrition and mineral deficiencies influence dental development and tooth eruption of sheep, there is no significant difference in calcium or phosphorus status between control and affected populations of sheep. Low planes of nutrition have delayed eruption of the permanent dentition and retarded mandibular growth but these changes are not seen in broken mouth in sheep. The occurrence of this periodontal disease is higher on some soil types than on others. The ingestion of irritating materials such as sand and spiny grass seeds<sup>10</sup> has been suggested as causes, but they are considered to be secondary complications in a pre-existing disease.

Another dental disease of sheep is also recorded on an extensive scale in New Zealand.<sup>11</sup> There is excessive wear of deciduous incisors but no change in the rate of wear of the molar teeth. The incisor wear is episodic and is not due to any change in the supportive tissues, nor is there any change in the intrinsic resistance to wear of the incisor teeth.<sup>12</sup> The disease is not related to an inadequate dietary intake of copper or vitamin D and is thought to be caused by the ingestion of soil particles.<sup>13</sup> The two New Zealand diseases do not occur together and have no apparent effect on body condition score.<sup>14</sup>

Dentigerous cysts have been described in ewes in the South Island of New Zealand with a prevalence of 0.91%.<sup>15</sup>

#### PATHOGENESIS

There are some limitations to the use of number of incisors for determining age in sheep.<sup>16</sup> In mixed-age female sheep flocks, the median age when two, four, six and eight incisors come into wear is 15,



23, 30 and 42 months of age, respectively.<sup>16</sup> Errors will be made by assuming that all sheep gain a pair of permanent incisors at annual intervals between 1.5 and 4.5 years of age.

In periodontal disease or broken-mouth disease of sheep the primary lesion is an acute gingivitis around permanent incisors and premolars at the time of their eruption. This subsides leaving a chronic gingivitis and an accumulation of subgingival plaque. On some farms, for reasons not understood, this gingivitis penetrates down into the alveoli, causing a severe periodontitis and eventual shedding of the teeth.<sup>17</sup> The severity of the gingivitis can vary between farms.<sup>18</sup> The disease is episodic in nature, with discrete acute inflammatory incidents leading to periodontal injury that may resolve by healing.<sup>8</sup> The balance between repair and the various short- and long-term acute episodes probably accounts for the large variation in incidence and age onset of tooth loss both within and between flocks.<sup>4</sup> The inflammatory periodontal disease markedly affects the tooth's mobility.<sup>19</sup> Collagen fibrils supporting the tooth become abnormal. The deepened periodontal pocket resulting from inflammation removes the major area of support for the tooth and abnormal loads are applied to fibers deeper within the tissue.<sup>20</sup> While the incisor teeth are usually most severely affected, the cheek teeth are also involved.<sup>5</sup> In some unusual circumstances the gingivitis appears to arise from heavy deposits of dental calculus.<sup>21</sup> In the Scottish disease there is local alveolar bone loss but no accompanying general skeletal deficiency.<sup>6</sup>

#### CLINICAL FINDINGS

The most obvious evidence of broken-mouth disease is incisor tooth loss, which usually occurs when sheep are between 3.5 and 6.6 years; normal sheep without broken mouth will retain their teeth beyond 7 years of age. Several dental health indices can assist to assess the amount of gingivitis, tooth movement, gum recession and pocketing.<sup>5</sup> Gingivitis is characterized by redness and edema of the attached gingiva. Bleeding from the gingivae is also a feature. Clinical gingivitis is evident as soon as the permanent teeth erupt. Chronic gingivitis results in a downward retreat of the gum margin, loss of its normal, scalloped shape and fibrosis of the gingiva. Within a year prior to tooth loss, tissue damage around the incisors leads to deepening of the gingival sulcus and the formation of pockets which are readily detected by the use of graduated dental measuring probes. The normal sulcus is 0.5–1.0 mm deep labially and up to 4 mm deep lingually;

pockets may be over 1.0 cm in depth prior to tooth loss. Crown lengthening, protrusion, hemorrhages, loosening and lingual periodontitis are characteristic. If sheep affected with broken mouth periodontal disease are examined over a 12-month period, only a few animals undergo clinically significant destruction.<sup>8</sup> The relationship between periodontal disease and body condition score in sheep is variable.<sup>14</sup>

Secondary starvation occurs even with a plentiful feed supply. Inspection of the mouth may reveal the worn or damaged incisor teeth but the molar teeth are not easily inspected in the living animal and tooth lesions can be missed. Since it is common to find that both incisors and molars are all affected, damage to incisors should lead the clinician to suspect that molar disease is also present.

Cattle fed sweetpotato cannery waste develop black, stained teeth with severe enamel erosion.<sup>3</sup>

An abattoir survey of dental defects in cull cows, all over 30 months of age found that 14.6% had one or more missing incisors, most of which were acquired losses.<sup>22</sup> Rotation and overlapping of rostral teeth were common, as was attrition. Congenitally absent first lower premolars, other missing teeth, large and often multiple interdental spaces and a few cases of macrodontia, cavitation, multiple defects and fractures were observed in cheek tooth arcades. There were also some unusual patterns of premolar and molar attrition, often attributable to malocclusion, one result of which was the formation of a hook at the posterior extremity of the third maxillary molar.

#### CLINICAL PATHOLOGY

On bacteriological examination spirochetes and *Fusobacterium* spp. are present.

#### TREATMENT AND CONTROL

There is no reliable treatment and control for broken mouth in sheep. The use of dental prosthetics glued to the incisors when the ewe has three pairs of incisors in place is being investigated. The use of antimicrobials has been proposed to control the gingivitis but there is no apparent effect on the periodontal disease. Cutting the incisor teeth of ewes to control premature tooth loss has been explored but the practice has been banned in the UK.<sup>23</sup>

#### REVIEW LITERATURE

- Spence JA, Aitchison GU. Early tooth loss in sheep: a review. *Vet Annu* 1985; 25:125–133.  
Spence J, Aitchison G. Clinical aspects of dental disease in sheep. *In Pract* 1986; 8:128.

#### REFERENCES

- Dubielzig RR et al. *Vet Pathol* 1986; 23:325.
- Rogers GM et al. *Am J Vet Res* 1997; 58:498.
- Rogers GM et al. *J Am Vet Med Assoc* 1999; 214:681.

- Smith AJ et al. *Vet Rec* 1992; 130:352, 455, 479.
- Spence JA et al. *Res Vet Sci* 1988; 45:324.
- Aitchison GU, Spence JA. *J Comp Pathol* 1984; 94:285, 95:505.
- Friskin KW et al. *Res Vet Sci* 1989; 46:147.
- Laws AJ et al. *NZ Vet J* 1988; 36:32.
- Laws AJ et al. *Res Vet Sci* 1993; 54:379.
- Anderson BC et al. *J Am Vet Med Assoc* 1984; 184:737.
- Thurley DC. *NZ Vet J* 1984; 32:25, 33:25, 157.
- Erasmuson AF. *NZ Vet J Agric Res* 1985; 28:225.
- Millar KR et al. *NZ Vet J* 1985; 33:41.
- Orr MB, Chalmers M. *NZ Vet J* 1988; 36:171.
- Orr MB, Gardner DG. *NZ Vet J* 1996; 44:198.
- Bray A et al. *Proc NZ Soc Anim Prod* 1989; 49:303.
- Morris PL et al. *NZ Vet J* 1985; 33:87, 131.
- Thurley DC. *J Comp Pathol* 1987; 97:375.
- Moxham BJ et al. *Res Vet Sci* 1990; 48:99.
- Shore RC et al. *Res Vet Sci* 1998; 47:148.
- Baker JR, Britt DP. *Vet Rec* 1984; 115:411.
- Ingham B. *Vet Rec* 2001; 148:739.
- Barber DML, Waterhouse A. *Vet Rec* 1988; 123:598.

### PAROTITIS

Parotitis is inflammation of any of the salivary glands.

#### ETIOLOGY

Parotitis may be parenchymatous, when the glandular tissue is diffusely inflamed, or it may be a local suppurative process. There are no specific causes in farm animals, cases occurring only sporadically and due usually to localization of a blood-borne infection, invasion up the salivary ducts associated with stomatitis, irritation by grass awns in the duct, or salivary calculi.<sup>1</sup> Avitaminosis A often appears to be a predisposing cause.

Local suppurative lesions are caused usually by penetrating wounds or extension from a retropharyngeal cellulitis or lymph node abscess. Neoplasia of the parotid glands of cattle examined at slaughter has been described.<sup>2</sup>

#### PATHOGENESIS

In most cases only one gland is involved. There is no loss of salivary function and the signs are restricted to those of inflammation of the gland.

#### CLINICAL FINDINGS

In the early stages, there is diffuse enlargement of the gland accompanied by warmth and pain on palpation. The pain may interfere with mastication and swallowing and induce abnormal carriage of the head and resentment when attempts are made to move the head. There may be marked local edema in severe cases. Diffuse parenchymatous parotitis usually subsides with systemic and local treatment within a few days, but suppurative lesions may discharge externally and form permanent salivary fistulae.

#### CLINICAL PATHOLOGY

Bacteriological examination of pus from discharging abscesses may aid the choice of a suitable antibacterial treatment.



## NECROPSY FINDINGS

Death occurs rarely and necropsy findings are restricted to local involvement of the gland or to primary lesions elsewhere in the case of secondary parotitis.

## DIFFERENTIAL DIAGNOSIS

- Careful palpation is necessary to differentiate the condition from lymphadenitis, abscesses of the throat region and metastases to the parotid lymph node in ocular carcinoma or mandibular lymphoma of cattle
- Acute phlegmonous inflammation of the throat is relatively common in cattle and is accompanied by high fever, severe toxemia and rapid death. It may be mistaken for an acute parotitis but the swelling is more diffuse and causes pronounced obstruction to swallowing and respiration

## TREATMENT

Systemic treatment with sulfonamides or antibiotics is required in acute cases, especially if there is a systemic reaction. Abscesses may require draining and, if discharge persists, the administration of enzymes either parenterally or locally. A salivary fistula is a common sequel.

## REFERENCES

1. Misk NA, Nigam JM. *Equine Pract* 1984; 6:49.
2. Bundza A. *J Comp Pathol* 1983; 93:629.

## Diseases of the pharynx and esophagus

### PHARYNGITIS

Pharyngitis is inflammation of the pharynx and is characterized clinically by coughing, painful swallowing and a variable appetite. Regurgitation through the nostrils and drooling of saliva may occur in severe cases.

### ETIOLOGY

Pharyngitis in farm animals is usually traumatic. Infectious pharyngitis is often part of a syndrome with other more obvious signs.

### Physical causes

- Injury while giving oral treatment with balling or drenching gun<sup>1</sup> or following endotracheal intubation.<sup>2</sup> The administration of intraruminal anthelmintic coils to calves under a minimum body weight have also been associated with pharyngeal and esophageal perforation<sup>3</sup>
- Improper administration of a reticular magnet, resulting in a retropharyngeal abscess
- Accidental administration or ingestion of irritant or hot or cold substances

- Foreign bodies, including grass and cereal awns, wire, bones, gelatin capsules lodged in the pharynx or suprapharyngeal diverticulum of pigs.

### Infectious causes

#### Cattle

- Oral necrobacillosis, actinobacillosis as a granuloma rather than the more usual lymphadenitis
- Infectious bovine rhinotracheitis
- Pharyngeal phlegmon or intermandibular cellulitis is a severe, often fatal, necrosis of the wall of the pharynx and peripharyngeal tissues without actually causing pharyngitis. *F. necrophorum* is a common isolate from the lesions.

#### Horses

- As part of strangles or anthrax
- Viral infections of the upper respiratory tract, including equine herpesvirus-1, Hoppengarten cough, parainfluenza virus, adenovirus, rhinovirus, viral arteritis, influenza-1A/E1 and 1A/E2, cause pharyngitis
- Chronic follicular pharyngitis with hyperplasia of lymphoid tissue in pharyngeal mucosa giving it a granular, nodular appearance with whitish tips on the lymphoid follicles. An exaggerated form of the disease is a soft tissue mass hanging from the pharyngeal roof and composed of lymphoid tissue.

#### Pigs

- As part of anthrax in this species and in some outbreaks of Aujeszky's disease.

### PATHOGENESIS

Inflammation of the pharynx is attended by painful swallowing and disinclination to eat. If the swelling of the mucosa and wall is severe, there may be virtual obstruction of the pharynx. This is especially so if the retropharyngeal lymph node is enlarged, as it is likely to be in equine viral infections such as rhinovirus.

In balling-gun-induced trauma of feedlot cattle treated for respiratory disease with boluses of sulfonamides, perforations of the pharynx and esophagus may occur with the development of periesophageal diverticulations with accumulations of ruminal ingesta, and cellulitis.<sup>1</sup> Improper administration of a magnet to a mature cow can result in a retropharyngeal abscess.<sup>4</sup>

Pharyngeal lymphoid hyperplasia in horses can be graded into four grades (I-IV) of severity based on the size of the lymphoid follicles and their distribution over the pharyngeal wall.

### CLINICAL FINDINGS

The animal may refuse to eat or drink or it may swallow reluctantly and with evident

pain. Opening of the jaws to examine the mouth is resented and manual compression of the throat from the exterior causes paroxysmal coughing. There may be a mucopurulent nasal discharge, sometimes containing blood, spontaneous cough and, in severe cases, regurgitation of fluid and food through the nostrils. Oral medication in such cases may be impossible. Affected animals often stand with the head extended, drool saliva and make frequent, tentative jaw movements. Severe toxemia may accompany the local lesions, especially in oral necrobacillosis and, to a less extent, in strangles. Empyema of the guttural pouches may occur in horses. If the local swelling is severe, there may be obstruction of respiration and visible swelling of the throat. The retropharyngeal and parotid lymph nodes are commonly enlarged. In 'pharyngeal phlegmon' in cattle there is an acute onset with high fever (41-41.5°C, 106-107°F), rapid heart rate, profound depression and severe swelling of the soft tissues within and posterior to the mandible to the point where dyspnea is pronounced. Death usually occurs 36-48 hours after the first signs of illness.

In **traumatic pharyngitis in cattle**, visual examination of the pharynx through the oral cavity reveals hyperemia, lymphoid hyperplasia and erosions covered by diphtheritic membranes. Pharyngeal lacerations are visible, and palpation of these reveals the presence of accumulated ruminal ingesta in diverticulae on either side of the glottis.<sup>1</sup> External palpation of the most proximal aspect of the neck reveals firm swellings, which represent the diverticula containing rumen contents. A retropharyngeal abscess secondary to an improperly administered magnet can result in marked diffuse painful swelling of the cranial cervical region.<sup>4</sup> Ultrasonographic examination of the swelling may reveal the magnet within the abscess.<sup>4</sup>

**Palpation of the pharynx** may be performed in cattle with the use of a gag if a foreign body is suspected, and endoscopic examination through the nasal cavity is possible in the horse.

Most acute cases recover in several days but chronic cases may persist for many weeks, especially if there is ulceration, a persistent foreign body or abscess formation. Pharyngitis has become one of the most commonly recognized diseases of the upper respiratory tract of the horse. Chronic pharyngitis after viral infections is relatively common and results in a break in training, which is inconvenient and costly. On endoscopic examination there may be edema in early and relatively acute cases. In long-standing cases there is lymphoid infiltration and follicular hyperplasia. This is more common and

more severe in young horses, who also suffer more attacks of upper respiratory tract disease. The condition does not appear to diminish racing performance or respiratory efficiency. If secondary bacterial infection is present a purulent exudate is seen on the pharyngeal mucosa and in the nostrils. Affected horses cough persistently, especially during exercise, are dyspneic and tire easily. Guttural pouch infections may occur secondarily. An occasional sequel is aspiration pneumonia.

#### CLINICAL PATHOLOGY

Nasal discharge or swabs taken from accompanying oral lesions may assist in the identification of the causative agent. *Moraxella* spp. and *Streptococcus zooepidemicus* can be isolated in large numbers from horses with lymphoid follicular hyperplasia grades III and IV.

#### NECROPSY FINDINGS

Deaths are rare in primary pharyngitis and necropsy examinations are usually undertaken only in those animals dying of specific diseases. In 'pharyngeal phlegmon' there is edema, hemorrhage and abscessation of the affected area and on incision of the area a foul-smelling liquid and some gas usually escape.

#### DIFFERENTIAL DIAGNOSIS

- Pharyngitis is manifested by an acute onset and local pain
- In pharyngeal paralysis, the onset is usually slow
- Acute obstruction by a foreign body may occur rapidly and cause severe distress and continuous, expulsive coughing – but there are no systemic signs
- Endoscopic examination of the pharyngeal mucous membranes is often of diagnostic value

#### TREATMENT

The primary disease must be treated, usually parenterally, by the use of antimicrobials. 'Pharyngeal phlegmon' in cattle is frequently fatal and early treatment, repeated at short intervals, with a broad-spectrum antimicrobial is necessary.

Pharyngeal lymphoid hyperplasia is not generally susceptible to antimicrobials or medical therapy. Surgical therapy including electrical and chemical cautery is indicated and has been successfully applied.

#### REFERENCES

1. Adams CP, Radostits OM. *Can Vet J* 1988; 29:389.
2. Brock KA. *J Am Vet Med Assoc* 1985; 187:944.
3. West HJ et al. *Vet Rec* 1996; 139:44.
4. Braun U et al. *Vet Radiol Ultrasound* 1999; 40:162.

#### PHARYNGEAL OBSTRUCTION

Obstruction of the pharynx is accompanied

by stertorous respiration, coughing and difficult swallowing.

#### ETIOLOGY

Foreign bodies or tissue swellings are the usual causes.

#### Foreign bodies

These include bones, corn cobs and pieces of wire. While horses are considered discriminating eaters in comparison to cattle, they will occasionally pick up pieces of metal while eating.<sup>1</sup>

#### Tissue swellings

##### Cattle

- Retropharyngeal lymphadenopathy or abscess due to tuberculosis, actinobacillosis or bovine viral leukosis
- Fibrous or mucoid polyps. These are usually pedunculated because of traction during swallowing and may cause intermittent obstruction of air and food intake.

##### Horses

- Retropharyngeal lymph node hyperplasia and lymphoid granulomas as part of chronic follicular pharyngitis syndrome
  - Retropharyngeal abscess and cellulitis
  - Retropharyngeal lymphadenitis caused by strangles
  - Pharyngeal cysts in the subepiglottic area of the pharynx, probably of thyroglossal duct origin, and fibroma; also similar cysts on the soft palate and pharyngeal dorsum, the latter probably being remnants of the craniopharyngeal ducts
  - Dermoid cysts and goitrous thyroids.
- Pigs
- Diffuse lymphoid enlargement in the pharyngeal wall and soft palate
  - Food and foreign body impaction in the supratharyngeal diverticulum.

#### PATHOGENESIS

Reduction in caliber of the pharyngeal lumen interferes with swallowing and respiration.

#### CLINICAL FINDINGS

There is difficulty in swallowing and animals may be hungry enough to eat but, when they attempt to swallow, cannot do so and the food is coughed up through the mouth. Drinking is usually managed successfully. There is no dilatation of the esophagus and usually little or no regurgitation through the nostrils. An obvious sign is a snoring inspiration, often loud enough to be heard some yards away. The inspiration is prolonged and accompanied by marked abdominal effort. Auscultation over the pharynx reveals loud inspiratory stertor. Manual examination of the pharynx may reveal

the nature of the lesion but an examination with a fiberoptic endoscope is likely to be much more informative. When the disease runs a long course, emaciation usually follows. Rupture of abscessed lymph nodes may occur when a nasal tube is passed, and can result in aspiration pneumonia.

In horses with metallic foreign bodies in the oral cavity or pharynx, the clinical findings include purulent nasal discharge, dysphagia, halitosis, changes in phonation, laceration of the tongue and stertorous breathing.<sup>1</sup> In case studies, most horses were affected with clinical signs for more than 2 weeks and had been treated with antimicrobials with only temporary improvement.<sup>1</sup>

#### CLINICAL PATHOLOGY

A tuberculin test may be advisable in bovine cases. Nasal swabs may contain *S. equi* when there is streptococcal lymphadenitis in horses.

#### NECROPSY FINDINGS

Death occurs rarely and in fatal cases the physical lesion is apparent.

#### DIFFERENTIAL DIAGNOSIS

- Signs of the primary disease may aid in the diagnosis in tuberculosis, actinobacillosis and strangles
- Pharyngitis is accompanied by severe pain and commonly by systemic signs and there is usually stertor
- It is of particular importance to differentiate between obstruction and pharyngeal paralysis when rabies occurs in the area. Esophageal obstruction is also accompanied by the rejection of ingested food but there is no respiratory distress. Laryngeal stenosis may cause a comparable stertor but swallowing is not impeded. Nasal obstruction is manifested by noisy breathing but the volume of breath from one or both nostrils is reduced and the respiratory noise is more wheezing than snoring
- Radiography is useful for the identification of metallic foreign bodies<sup>1</sup>

#### TREATMENT

Removal of a foreign body may be accomplished through the mouth. Treatment of actinobacillary lymphadenitis with iodides is usually successful and some reduction in size often occurs in tuberculous enlargement of the glands but complete recovery is unlikely to occur. Parenteral treatment of strangles abscesses with penicillin may effect a cure. Surgical treatment has been highly successful in cases caused by medial retropharyngeal abscess.

#### REFERENCE

1. Kiper ML et al. *J Am Vet Med Assoc* 1992; 200:91.

## PHARYNGEAL PARALYSIS

Pharyngeal paralysis is manifested by inability to swallow and an absence of signs of pain and respiratory obstruction.

### ETIOLOGY

Pharyngeal paralysis occurs sporadically, due to peripheral nerve injury, and in some encephalitides with central lesions.

#### Peripheral nerve injury

- Guttural pouch infections in horses
- Trauma to the throat region.

#### Secondary to specific diseases

- Rabies and other encephalitides
- Botulism
- African horse sickness
- A series of unexplained fatal cases in horses.

### PATHOGENESIS

Inability to swallow and regurgitation are the major manifestations of the disease. There may be an associated laryngeal paralysis, accompanied by 'roaring'. The condition known as 'cud-dropping' in cattle may be a partial pharyngeal paralysis as there is difficulty in controlling the regurgitated bolus, which is often dropped from the mouth. In these circumstances, aspiration pneumonia is likely to develop.

### CLINICAL FINDINGS

The animal is usually hungry but, on prehension of food or water, attempts at swallowing are followed by dropping of the food from the mouth, coughing and the expulsion of food or regurgitation through the nostrils. Salivation occurs constantly and swallowing cannot be stimulated by external compression of the pharynx. The swallowing reflex is a complex one controlled by a number of nerves and the signs can be expected to vary greatly depending on which nerves are involved and to what degree. There is rapid loss of condition and dehydration. Clinical signs of the primary disease may be evident but, in cases of primary pharyngeal paralysis, there is no systemic reaction. Pneumonia may follow aspiration of food material into the lungs and produces loud gurgling sounds on auscultation.

In 'cud-dropping' in cattle, the animals are normal except that regurgitated boluses are dropped from the mouth, usually in the form of flattened disks of fibrous food material. Affected animals may lose weight but the condition is usually transient, lasting for only a few days. On the other hand, complete pharyngeal paralysis is usually permanent and fatal.

### CLINICAL PATHOLOGY

The use of clinicopathological examinations is restricted to the identification of the primary specific diseases.

## NECROPSY FINDINGS

If the primary lesion is physical, it may be detected on gross examination.

### DIFFERENTIAL DIAGNOSIS

- In all species, often the first clinical impression is the presence of a foreign body in the mouth or pharynx and this can only be determined by physical examination
- Pharyngeal paralysis is a typical sign in rabies and botulism but there are other clinical findings that suggest the presence of these diseases
- Absence of pain and respiratory obstruction are usually sufficient evidence to eliminate the possibility of pharyngitis or pharyngeal obstruction
- Endoscopic examination of the guttural pouch is a useful diagnostic aid in the horse

### TREATMENT

Treatment is unlikely to have any effect. The local application of heat may be attempted. Feeding by nasal tube or intravenous alimentation may be tried if disappearance of the paralysis seems probable.

## ESOPHAGITIS

Inflammation of the esophagus is accompanied initially by clinical findings of spasm and obstruction, pain on swallowing and palpation, and regurgitation of bloodstained, slimy material.

### ETIOLOGY

Primary esophagitis caused by the ingestion of chemical or physical irritants is usually accompanied by stomatitis and pharyngitis. Laceration of the mucosa by a foreign body or complications of nasogastric intubation may occur.<sup>1</sup> Nasogastric intubation is associated with a higher risk of pharyngeal and esophageal injury when performed in horses examined for colic.<sup>1</sup> This may be related to the use of larger-diameter nasogastric tubes to provide more effective gastric decompression, the longer duration of intubation in some horses, or the presence of gastric distension resulting in increased resistance to tube passage at the cardia.<sup>1</sup> In a series of six horses with esophageal trauma the lesions were detected 5 and 20 cm from the cranial esophageal opening.<sup>1</sup>

The administration of sustained-release anthelmintic boluses to young calves that are not large enough for the size of the bolus used may cause esophageal injury and perforation.<sup>2,3</sup> The boluses are 8.5 cm in length and 2.5 cm in diameter and the calves 100–150 kg. The minimum body weight for these boluses is 100 kg but in the study some calves

were younger than the recommended age and were also fractious when handled, which may have contributed to the injury.<sup>2</sup> Death of *Hypoderma lineatum* larvae in the submucosa of the esophagus of cattle may cause acute local inflammation and subsequent gangrene.

Inflammation of the esophagus occurs commonly in many specific diseases, particularly those that cause stomatitis, but the other clinical signs of these diseases dominate those of esophagitis.

### PATHOGENESIS

Inflammation of the esophagus combined with local edema and swelling results in a functional obstruction and difficulty in swallowing. Traumatic injury to the esophagus results in edema, hemorrhage, laceration of the mucosa and possible perforation of the esophagus, resulting in periesophageal cellulitis, which spreads proximally and distally along the esophagus in fascial planes from the site of perforation. Perforation of the thoracic esophagus can result in severe and fatal pleuritis. There is extensive edema and accumulation of swallowed or regurgitated ingesta along with gas. The extensive cellulitis and the presence of ingesta results in severe toxemia, and dysphagia may cause aspiration pneumonia.

### CLINICAL FINDINGS

In the acute injury of the esophagus, there is salivation and attempts to swallow, which cause severe pain, particularly in horses. In some cases, attempts at swallowing are followed by regurgitation and coughing, pain, retching activities and vigorous contractions of the cervical and abdominal muscles. Marked drooling of saliva, grinding of the teeth, coughing and profuse nasal discharge are common in the horse with esophageal trauma with complications following nasogastric intubation.<sup>1</sup> Regurgitation may occur and the regurgitus contains mucus and some fresh blood. If the esophagitis is in the cervical region, palpation in the jugular furrow causes pain and edematous tissues around the esophagus may be palpable. If perforation has occurred, there is local pain and swelling and often crepitus. Local cervical cellulitis may cause rupture to the exterior and development of an esophageal fistula, or infiltration along fascial planes with resulting compression obstruction of the esophagus, and toxemia. Perforation of the thoracic esophagus may lead to fatal pleurisy. Animals that recover from esophageal traumatic injury are commonly affected by chronic esophageal stenosis with distension above the stenosis. Fistulae are usually persistent but spontaneous healing may occur. In specific diseases such as mucosal disease and bovine malignant catarrh, there are

no obvious clinical findings of esophagitis, the lesions being mainly erosive.

Endoscopy of the esophagus will usually reveal the location and severity of the lesion. Lateral cervical radiographs may reveal foreign bodies and extensive soft tissue swelling with pockets of gas.

### CLINICAL PATHOLOGY

In severe esophagitis of traumatic origin a marked neutrophilia may occur, suggesting active inflammation.

### NECROPSY FINDINGS

Pathological findings are restricted to those pertaining to the various specific diseases in which esophagitis occurs. In traumatic lesions or those caused by irritant substances, there is gross edema, inflammation and, in some cases, perforation.

### DIFFERENTIAL DIAGNOSIS

- Esophagitis must be differentiated from pharyngitis, in which attempted swallowing is not as marked and coughing is more likely to occur. Palpation may also help to localize the lesion; however, pharyngitis and esophagitis commonly occur together
- When the injury is caused by a foreign body, it may still be in the esophagus and, if suitable restraint and anesthesia can be arranged, the passage of a nasogastric tube or endoscope may locate it. Complete esophageal obstruction is accompanied by bloat in ruminants, by palpable enlargement of the esophagus and by less pain on swallowing than in esophagitis, although horses may show a great deal of discomfort
- In cattle perforation of the esophagus is not uncommon. There is a persistent, moderate toxemia, a moderate fever and a leukocytosis. Edema and swelling are prominent in surrounding fascial planes, but may cause only slight physical enlargement, which is easily missed on a routine examination

### TREATMENT

Feed should be withheld for 2–3 days and fluid and electrolyte therapy may be necessary for several days. Parenteral antimicrobials are indicated, especially if laceration or perforation has occurred. Reintroduction to feed should be monitored carefully and all feed should be moistened to avoid the possible accumulation of dry feed in the esophagus, which may not be fully functional.

### REFERENCES

1. Hardy J et al. *J Am Vet Med Assoc* 1992; 201:483.
2. Mannion PA et al. *Vet Rec* 1997; 140:331.
3. West HJ et al. *Vet Rec* 1996; 139:44.

### ESOPHAGEAL OBSTRUCTION

Esophageal obstruction may be acute or chronic and is characterized clinically by

inability to swallow, regurgitation of feed and water, continuous drooling of saliva, and bloat in ruminants. Acute cases are accompanied by distress. Horses with choke commonly regurgitate feed and water and drool saliva through the nostrils because of the anatomical characteristics of the equine soft palate.

### ETIOLOGY

Obstruction may be **intraluminal** by swallowed material or **extraluminal** due to pressure on the esophagus by surrounding organs or tissues. Esophageal paralysis may also result in obstruction.

### Intraluminal obstructions

These are usually due to ingestion of materials that are of inappropriate size and that then become lodged in the esophagus:

- Solid obstructions, especially in cattle, by turnips, potatoes, peaches, apples, oranges, etc.
- 15 g gelatin capsules in Shetland ponies<sup>1</sup>
- The most common type of esophageal obstruction in horses is simple obstruction due to impaction of ingesta.<sup>2</sup> Feedstuffs are a common cause of obstruction in horses allowed to eat immediately after a race or workout. Improperly soaked sugarbeet pulp, inadvertent access to dry sugarbeet pulp and cubed and pelleted feed are especially risky for horses when eaten quickly. The horse eats ravenously and swallows large boluses without properly insalivating them. The bolus lodges at the base of the neck or the cardia. Similar obstructions occur when horses are turned into stalls containing fresh bedding, including shavings
- Foreign bodies in horses include pieces of wood, antimicrobial boluses and fragments of nasogastric tubes.<sup>3</sup> A nasogastric tube inserted into a horse may break if the animal is startled and jumps, or in some cases the tube becomes weakened from overuse and breaks if left in place over a period of time<sup>3</sup>
- A trichobezoar caused esophageal obstruction in a cow;<sup>4</sup> it may have been regurgitated rather than ingested because of the lack of teeth marks on the trichobezoar.

### Extraluminal obstructions

- Tuberculous or neoplastic lymph nodes in the mediastinum or at the base of lung
- Cervical or mediastinal abscess
- Persistent right aortic arch
- Thymoma.

### Esophageal paralysis

This may be due to **congenital or acquired**

**abnormalities of the esophagus** and there are many examples of such abnormalities, which interfere with swallowing and cause varying degrees of obstruction, even though it may be possible to pass a stomach tube through the esophagus into the stomach or rumen.

**Esophageal paralysis**, diverticulum or megaesophagus has been recorded in horses and in cattle.<sup>5</sup> Congenital hypertrophy of esophageal musculature and esophagotracheal fistula has been found in calves. Congenital esophageal ectasia is recognized in foals,<sup>6</sup> caused by degeneration of musculature and reduced ganglion cells in the myenteric plexus. Congenital esophageal dysfunction has also occurred in foals with no detectable histopathological lesion but with prolonged simultaneous contractions throughout the esophagus.

### Megaesophagus

Megaesophagus is a dilatation and atony of the body of the esophagus usually associated with asynchronous function of the esophagus and the caudal esophageal sphincter. It occurs sporadically in cattle, and in horses with pre-existing esophageal disease.<sup>2</sup> It is usually a congenital condition, causing regurgitation and aspiration pneumonia. A mild esophagitis has been observed in some cases and congenital stenosis of the esophagus in a foal has been associated with megaesophagus.<sup>7</sup>

### Esophageal strictures

These arise as a result of cicatricial or granulation tissue deposition, usually as result of previous laceration of the esophagus. They may occur in the adult horse with a history of previous obstruction. Esophageal strictures resulting in obstruction occur in foals from 1–6 months of age without any history of foreign body.<sup>8</sup> An esophageal stricture has also been described in a goat.<sup>9</sup>

### Other causes of obstruction

- **Carcinoma of stomach** causing obstruction of cardia
- Squamous cell carcinoma of the esophagus of a horse<sup>10</sup>
- Esophageal hiatus hernia in cattle
- Paraesophageal cyst in a horse<sup>11</sup>
- Combined esophageal and tracheal duplication cyst in a young horse<sup>12</sup>
- Esophageal duplication in a horse<sup>12</sup>
- Tubular duplication of the cervical portion of the esophagus in a foal<sup>13</sup>
- Cranial esophageal pulsion (pushing outward) diverticulum in a horse<sup>14</sup>
- Esophageal phytobezoar in a horse<sup>15</sup>
- Esophageal mucosal granuloma<sup>11</sup>
- Traumatic rupture of the esophagus from an external injury (e.g. a kick) or during treatment using a nasogastric tube

- Esophageal paralysis may also be associated with lesions of encephalitis, especially in the brain stem.<sup>16</sup>

### PATHOGENESIS

An **esophageal obstruction** results in a physical inability to swallow and, in cattle, inability to eructate, with resulting bloat. In acute obstruction, there is initial spasm at the site of obstruction and forceful, painful peristalsis and swallowing movements. Complications of esophageal obstruction include laceration and rupture of the esophagus, esophagitis, stricture and stenosis, and the development of a diverticulum.

**Acquired esophageal diverticula** may occur in the horse. A traction diverticulum occurs following periesophageal scarring and is of little consequence. An esophageal pulsion diverticulum is a circumscribed sac of mucosa protruding through a defect in the muscular layer of the esophagus. Causes that have been proposed to explain pulsion diverticula include excessive intraluminal pressure from impacted feed, fluctuations in esophageal pressure and external trauma.<sup>15</sup> Complications associated with esophageal diverticula include peridiverticulitis, pulmonary adhesions, abscesses and mediastinitis. Esophageal stricture and subsequent obstruction secondary to impaction of a diverticulum may also occur.

In **megaesophagus**, the esophagus is dysfunctional, dilated and filled with saliva, feed and water. This results in regurgitation and may lead to aspiration pneumonia. It may be congenital or secondary to other lesions and has been associated with gastric ulceration in a foal.<sup>17</sup>

Using esophageal manometry, the normal values for esophageal pressure profiles in healthy horses, cows and sheep have been recorded.<sup>18</sup> The body of the equine and bovine esophagus has two functionally different regions: the caudal portion and the remainder of the esophageal body (cranial portion).

### CLINICAL FINDINGS

#### Acute obstruction or choke

##### Cattle

The obstruction is usually in the cervical esophagus just above the larynx or at the thoracic inlet. Obstructions may also occur at the base of the heart or the cardia. The animal suddenly stops eating and shows anxiety and restlessness. There are forceful attempts to swallow and regurgitate, salivation, coughing and continuous chewing movements. If obstruction is complete, bloating occurs rapidly and adds to the animal's discomfort. Ruminal movements are continuous and forceful and there may be a systolic murmur audible on auscultation

of the heart. However, rarely is the bloat severe enough to seriously affect the cardiovascular system of the animal, as occurs in primary leguminous bloat.

The acute signs, other than bloat, usually disappear within a few hours. This is due to relaxation of the initial esophageal spasm and may or may not be accompanied by onward passage of the obstruction. Many obstructions pass on spontaneously but others may persist for several days and up to a week. In these cases there is **inability to swallow, salivation** and **continued bloat**. Passage of a nasogastric tube is impossible. Persistent obstruction causes pressure necrosis of the mucosa and may result in perforation or subsequent stenosis due to fibrous tissue construction.

##### Horse

In the horse with esophageal obstruction due to feed, the obstruction may occur at any level of the esophagus from the upper cervical region all the way to the thoracic portion. The ingestion of large quantities of grain or pelleted feed can cause obstruction over a long portion of the esophagus.

The clinical findings vary with the location, nature, extent and duration of the obstruction. Typically the major clinical finding is **dysphagia with nasal reflux of saliva, feed and water**. Affected horses will usually not attempt further eating but will drink and attempt to swallow water. External palpation of the **cervical esophagus** may reveal a **firm cylindrical swelling** along the course of the neck on the left side when the esophagus is obstructed with feed. In cases of foreign body obstruction such as a piece of wood, there may be no palpable abnormality.

Horses with acute esophageal obstruction are commonly difficult to handle because they are panicky and make forceful attempts to swallow or retch. They may vigorously extend and flex their necks and stamp their front feet. In some horses it may be difficult to pass a nasogastric tube because they resist the procedure. During these episodes of hyperactivity they may sweat profusely, tachycardia may be present and they may appear to be in abdominal pain. Such clinical findings on first examination may resemble colic but attempted passage of a nasogastric tube as part of the examination of a horse with colic reveals the obstruction.

**Passage of a nasogastric tube** is necessary to make the diagnosis and to assess the level of the obstruction.<sup>19</sup> The level of obstruction can be approximated by the amount of tube that has been passed. Care must be taken not to push

the tube more than gently to avoid injury to the esophagus. Occasionally, a foreign body or bolus of feed will move distally into the stomach as the tube is gently advanced.

The nature of the obstruction can be assessed more adequately with a fiberoptic endoscope but visualization of the entire esophagus of an adult horse requires an endoscope of 2.5 m length. The endoscope allows determination of the rostral but not the distal limit of the obstruction. If radiographic equipment is available, standing lateral radiographs of the cervical and thoracic esophagus along with contrast media may be required to determine the extent and nature of an obstruction.

Persistent obstruction may occur in the horse and death may occur in either species from subsequent aspiration pneumonia or, when the obstruction persists, from dehydration. In **foals** with esophageal obstruction the clinical findings include **nasal reflux of saliva, feed and milk, reluctance to eat solid feed and dyspnea** if aspiration pneumonia has occurred.<sup>8</sup> Unthriftiness occurs if the obstruction has been present for a few weeks. Affected foals may have had several episodes of choke within the previous few weeks from which they appeared to recover spontaneously.<sup>8</sup> Passage of a nasogastric tube may be possible in some and not in others.

#### Chronic obstruction

No acute signs of obstruction are evident and in cattle the earliest sign is chronic bloat, which is usually of moderate severity and may persist for several days without the appearance of other signs. Rumen contractions may be within the normal range. In horses and in cattle in which the obstruction is sufficiently severe to interfere with swallowing, a characteristic syndrome develops. Swallowing movements are usually normal until the bolus reaches the obstruction, when they are replaced by more forceful movements. Dilatation of the esophagus may cause a pronounced swelling at the base of the neck. The swallowed material either passes slowly through the stenotic area or accumulates and is then regurgitated. Projectile expulsion of ingested material occurs with esophageal diverticula, but water is retained and there is no impedance to the passage of the stomach tube. In the later stages, there may be no attempt made to eat solid food but fluids may be taken and swallowed satisfactorily.

When there is **paralysis of the esophagus**, as in megaesophagus, regurgitation does not occur but the esophagus fills and overflows, and saliva drools from the mouth and nostrils. Aspiration into

the lungs may follow. Passage of a stomach tube or probang is obstructed by stenosis but may be unimpeded by paralysis.

### Complications following esophageal obstruction

Complications following an esophageal obstruction are most common in the horse and include esophagitis, mucosal ulceration in long-standing cases, esophageal perforation and aspiration pneumonia. Mild cases of esophagitis heal spontaneously. Circumferential full-thickness mucosal ulceration may result in a stricture, which will be clinically evident in 2–5 weeks and may require surgical correction. Esophageal perforation may occur and is characterized by diffuse cellulitis of the periesophageal tissues, often with subcutaneous emphysema. A fistula may develop.

### CLINICAL PATHOLOGY

Laboratory tests are not used in diagnosis although radiographic examination is helpful to outline the site of stenosis, diverticulum or dilatation, even in animals as large as the horse. Radiological examination after a barium swallow is a practicable procedure if the obstruction is in the cervical esophagus. Viewing of the internal lumen of the esophagus with a fiberoptic endoscope has completely revolutionized the diagnosis of esophageal malfunction. Biopsy samples of lesions and tumor masses can be taken using the endoscope.<sup>10</sup> Electromyography has been used to localize the area of paralysis of the esophagus in a cow with functional megaesophagus.<sup>20</sup>

### TREATMENT

#### Conservative approach

Many obstructions will resolve spontaneously and a careful conservative approach is recommended. If there is a history of prolonged choke with considerable nasal reflux having occurred, the animal should be examined carefully for evidence of foreign material in the upper respiratory tract and the risk of aspiration pneumonia. It may require several hours of monitoring, re-examination and repeated sedation before the obstruction is resolved. During this time, the animal should not have access to feed and water.

#### Sedation

In acute obstruction, if there is marked anxiety and distress, the animal should be sedated before proceeding with specific treatment. Administration of a sedative may also help to relax the esophageal spasm and allow passage of the impacted material. For sedation and esophageal relaxation in the horse, one of the following is recommended:

- Acepromazine 0.05 mg/kg BW intravenously

### DIFFERENTIAL DIAGNOSIS

- The clinical findings of acute esophageal obstruction in cattle and horses are usually typical but may be similar to those of esophagitis, in which local pain is more apparent and there is often an accompanying stomatitis and pharyngitis
- The excitement, sweating, and tachycardia observed in acute choke in the horse often suggests colic. Passage of the nasogastric tube reveals the obstruction. The use of a fiberoptic endoscope will usually locate the obstruction for visualization and obstructions are easiest to see when the endoscope is being withdrawn rather than advanced

#### Chronic obstruction

- Differentiation of the causes of chronic obstruction may be difficult. A history of previous esophagitis or acute obstruction suggests cicatricial stenosis. Contrast radiography of the esophagus is valuable in the investigation of horses with dysphagia, choke and nasogastric reflux.<sup>21</sup> The use of the sedative detomidine can affect the function of the esophagus and make interpretation of barium swallowing studies difficult<sup>22</sup>
- Persistent right aortic arch is rare and confined to young animals
- Mediastinal lymph node enlargement is usually accompanied by other signs of tuberculosis or lymphomatosis
- Chronic ruminal tympany in cattle may be caused by ruminal atony, in which case there is an absence of normal ruminal movements
- Diaphragmatic hernia may also be a cause of chronic ruminal tympany in cattle and is sometimes accompanied by obstruction of the esophagus with incompletely regurgitated ingesta. This condition and vagus indigestion, another cause of chronic tympany, are usually accompanied by a systolic cardiac murmur but passage of a stomach tube is unimpeded. Dysphagia may also result from purely neurogenic defects. Thus, an early paralytic rabies 'choke' is often suspected, with dire results for the examining veterinarian
- Equine encephalomyelitis and botulism are other diseases in which difficulty is experienced with swallowing
- Cleft palate is a common cause of nasal regurgitation in foals

- Xylazine 0.5–1.0 mg/kg BW intravenously
- Detomidine 0.01–0.02 mg/kg BW intravenously
- Romifidine 0.04–0.12 mg/kg intravenously.<sup>19</sup>

For esophageal relaxation, analgesia and anti-inflammatory effect hyoscine: dipyron 0.5:0.22 mg/kg BW intravenously can be used and for analgesia and anti-inflammatory effect flunixin meglumine 1.1 mg/kg BW intravenously or phenyl-

butazone 2–4 mg/kg intravenously are suggested. For analgesia butorphanol 0.02–0.1 mg/kg intravenously may be administered.

#### Pass a stomach tube and allow object to move into stomach

The passage of the nasogastric tube is always necessary to locate the obstruction. Gentle attempts may be made to push the obstruction caudad but care must be taken to avoid damage to the esophageal mucosa. A fiberoptic endoscope can be used to determine the presence of an obstruction, its nature and the extent of any injury to the esophageal mucosa.

If the above simple procedures are unsuccessful it is then necessary to proceed to more vigorous methods. In cattle, it is usual to attempt further measures immediately, partly because of the animal's distress and the risk of self-injury and partly because of the bloat. However, rarely is the bloat associated with esophageal obstruction life-threatening. The important decision is whether to proceed and risk damaging the esophagus or wait and allow the esophageal spasm to relax and the obstruction to pass spontaneously. This problem is most important in the horse. Attempts to push the obstruction too vigorously may injure the mucosa, causing esophagitis and even esophageal perforation. Alternatively, leaving a large obstruction in place may restrict the circulation to the local area of mucosa and result in ischemic necrosis. Complications such as strictures and diverticula may occur but are uncommon. As a guide in the horse it is suggested that conservative measures, principally sedation, waiting and lavaging the esophagus, be continued for several hours before attempting radical procedures such as general anesthesia and manipulation or esophagotomy.

#### Removal by endoscope

If a specific foreign body, such as a piece of wood, is the cause of the obstruction, it may be removed by endoscopy. The foreign body must be visible endoscopically and suitable forceps or a snare through the scope are required. In some cases, impacted feed anterior to the foreign object must be lavaged out before the object is retrieved.

#### Manual removal through oral cavity in cattle

Solid obstructions in the upper esophagus of cattle may be reached by passing the hand into the pharynx with the aid of a speculum and having an assistant press the foreign body up towards the mouth. Because of slippery saliva, it is often difficult to grasp the obstruction sufficiently strongly to be able to extricate it from the

esophagus. A long piece of strong wire bent into a loop may be passed over the object and an attempt made to pull it up into the pharynx. The use of Thygesen's probang with a cutting loop is a simple and effective method of relieving choke in cattle that have attempted to swallow beets and other similar-sized vegetables and fruits. If both methods fail, it is advisable to leave the object in situ and use treatments aimed at relaxing the esophagus. In such cases in cattle it may be necessary to trocarize the rumen and leave the cannula in place until the obstruction is relieved. However, this should not be undertaken unless specifically required.

### General anesthesia in the horse

In horses, attempts to manually remove solid obstructions from the cranial portion of the esophagus require a general anesthetic, a speculum in the mouth and a manipulator with a small hand. The fauces are much narrower in the horse than in the cow and it is only with difficulty that the hand can be advanced through the pharynx to the beginning of the esophagus. Fragments of nasogastric tubes have been retrieved from the esophagus of horses using sedation with xylazine and butorphanol intravenously and the use of a fiberoptic endoscope.<sup>23</sup>

### Esophageal lavage in the horse

Accumulations of feedstuffs, which occur most commonly in the horse, can be removed by careful lavage or flushing of the obstructed esophagus. Lavage may be performed in the **standing horse** or in **lateral recumbency under general anesthesia**. Small quantities of warm water, 0.5–1 L each time, are pumped through a nasogastric tube passed to the point of obstruction, and then the tube is disconnected from the pump and the liquid material is allowed to siphon out through the tube by gravity flow. Return of the fluid through the oral cavity and nostrils is minimized by ensuring that the tube is not plugged by returning material and by using only small quantities of fluid for each input of the lavage. Throughout the procedure, the tube is gently manipulated against the impaction. The use of a transparent tube assists in helping to see the amount and nature of the material coming through the tube. This is repeated many times until the fluid becomes clear. This procedure may require a few hours but perseverance will be successful. After each lavage the tube can be advanced caudad a few centimeters and eventually all the way to the stomach. Following relief of the obstruction the horse will become relaxed and phonate its pleasure. Care must be taken to avoid overflowing

the esophagus and causing aspiration into the lungs. This is a constant hazard whenever irrigative removal is attempted and the animal's head must always be kept as low as possible to avoid aspiration. Following relief of obstruction the horse can be offered water to drink, and a wet mash of feed for a few days.

In the recumbent horse under general anesthesia, lavage is similar. A cuffed endotracheal tube is used to maintain an airway and to prevent aspiration of foreign material. Lavage under general anesthesia provides relaxation of the esophagus, which may enhance the procedure and allow a greater volume of water to be used.

### Surgical removal of foreign bodies

Surgical removal by esophagostomy may be necessary if other measures fail. Gastrotomy may be necessary to relieve obstructions of the caudal portion of the esophagus adjacent to the cardia.<sup>24</sup> Although stricture or fistula formation is often associated with esophageal surgery, complications do not occur in every case; healing by secondary intention is common.<sup>6</sup>

### Repeated siphonage in chronic cases

In chronic cases, especially those due to paralysis, repeated siphonage may be necessary to remove fluid accumulations. Successful results are reported in foals using resection and anastomosis of the esophagus and in a horse using esophagomyotomy, but the treatment of chronic obstruction is usually unsuccessful.

### Cervical esophagostomy alimentionation

Alimentation of horses with esophageal ruptures can be attempted by various means. Maintenance of nasogastric tubes through the nostrils is difficult but possible. Tube feeding through a **cervical esophagostomy** has some disadvantages, but it is a reasonably satisfactory procedure in any situation where continued extraoral alimentionation is required in the horse. However, the death rate is higher than with nasogastric tube feeding. When the obstruction is due to circumferential esophageal ulceration, the lumen is smallest at about 50 days and begins to dilate at that point so that it is normal again at about 60 days.

### REFERENCES

1. Undvall RL, Kingrey BW. *J Am Vet Med Assoc* 1985; 133:75.
2. Felge K et al. *Can Vet J* 2000; 41:207.
3. Baird AN, True CK. *J Am Vet Med Assoc* 1989; 194:1098.
4. Patel JH, Brace DM. *Can Vet J* 1995; 36:774.
5. Bargai U et al. *Vet Radiol* 1991; 32:255.
6. Wilmot L et al. *Can Vet J* 1989; 30:175.
7. Clabough DL et al. *J Am Vet Med Assoc* 1991; 199:483.

8. Knottenbelt DC et al. *Vet Rec* 1992; 131:27.
9. Fleming SA et al. *J Am Vet Med Assoc* 1989; 195:1598.
10. Campbell-Beggs CL et al. *J Am Vet Med Assoc* 1993; 202:617.
11. Shiroma JT et al. *Vet Radiol Ultrasound* 1994; 35:158.
12. Peek SI et al. *Equine Vet J* 1995; 27:475.
13. Gaughan EM et al. *J Am Vet Med Assoc* 1992; 201:748.
14. Murray RC, Gaughan EM. *Can Vet J* 1993; 34:365.
15. MacDonald MH et al. *J Am Vet Med Assoc* 1987; 191:1455.
16. Scott PR et al. *Vet Rec* 1994; 135:482.
17. Murray MJ et al. *J Am Vet Med Assoc* 1988; 192:381.
18. Clark ES et al. *Am J Vet Res* 1987; 48:547.
19. Hillyer M. *In Pract* 1995; 17:450.
20. Pearson EG et al. *J Am Vet Med Assoc* 1994; 205:1767.
21. Greet TRC. *In Pract* 1989; 11:256.
22. Watson TDG, Sullivan M. *Vet Rec* 1991; 129:67.
23. DiFranco B et al. *J Am Vet Med Assoc* 1992; 201:1035.
24. Orsini JA et al. *J Am Vet Med Assoc* 1991; 198:295.

## Diseases of the nonruminant stomach and intestines

Only those diseases that are accompanied by physical lesions, such as displacement or strangulation, or disturbances of motility, such as ileus, are presented. Diseases associated with functional disturbances of secretion are not recognized in animals. Deficiencies of biliary and pancreatic secretion are dealt with in the chapter on diseases of the liver. Those diseases of the stomach and intestines peculiar to ruminants are dealt with separately in Chapter 6.

### EQUINE COLIC (ADULT HORSES)

#### GENERAL PRINCIPLES

Gastrointestinal disease causing signs of abdominal pain in horses is commonly referred to as colic. Colic is a frequent and important cause of death and is considered the most important disease of horses encountered by practicing veterinarians. It is estimated to cost the horse industry in the USA approximately \$115 000 000 annually.<sup>1-3</sup>

#### ETIOLOGY

Several classification systems of equine colic have been described including a disease-based system (Table 5.3) classifying the cause of colic as:

- **Obstructive**
- **Obstructive and strangulating**
- **Nonstrangulating infarctive**
- **Inflammatory** (peritonitis, enteritis).

Colic cases can also be classified on the basis of the duration of the disease: **acute** (< 24–36 h), **chronic** (> 24–36 h) and **recurrent** (multiple episodes separated



**Synopsis**

**Etiology** See Tables 5.4, 5.5, 5.6 and 5.7

**Epidemiology** Incidence of 2–30 cases per 100 horse years, mortality of 0.5–0.7 cases per 100 horse years and case fatality rate of 7–13%. Any age predisposition is weak, although certain diseases (e.g. meconium impaction, strangulation by pedunculated lipoma) have specific age distributions. Consumption of a diet high in concentrate increases the risk of colic, as does a poor parasite control program

**Clinical signs** Signs of abdominal pain include agitation, flank watching, flank biting, pawing, frequent lying down, kicking at the abdomen, frequent attempts to urinate or defecate, and rolling. Tachycardia is common. Normal gut sounds are absent and replaced by tympanitic sounds. Abdominal distension may develop. Reflux through a nasogastric tube may occur. Rectal examination may reveal abnormalities

**Clinical pathology** Few changes have diagnostic significance but many are used to monitor the severity of the disease. Hemoconcentration, azotemia and metabolic acidosis are frequent findings. Peritoneal fluid may have increased protein and leukocyte concentration

**Lesions** Consistent with the particular disease

**Diagnostic confirmation** Physical examination, exploratory laparotomy, necropsy

**Treatment** Analgesia (Table 5.7), correction of fluid, acid–base and electrolyte abnormalities (Ch. 2), gastric decompression via nasogastric intubation, administration of fecal softeners or lubricants (Table 5.8), surgical correction of the lesion

**Control** Parasite control. Ensure adequate roughage in the diet

by periods of > 2 days of normality). Another classification system is anatomically based and is listed in Table 5.4. Regardless of the classification system used, some estimates are that fewer than 20% of colic cases seen in the field have a definitive diagnosis.<sup>2,4</sup> Horses with acute transient colic relieved by analgesics are often referred to as having 'spasmodic colic'.<sup>5</sup> Spasmodic or gas colic was the cause of 35% of horses with colic examined in the field by veterinarians.<sup>6</sup> Large-colon impaction (20%) and undiagnosed (13%) were the other largest diagnostic categories.<sup>6</sup>

**EPIDEMIOLOGY**

Most studies of the epidemiology of colic do not provide details of specific diseases but rather consider colic as one disease. This inclusion of many diseases into one category, while maximizing the statistical power of the studies, is unfortunate because it can obscure important details regarding the occurrence and risk factors of individual diseases. Furthermore, much of the information related to incidence, treatments and outcome of horses with colic is derived from studies of horses examined at referral centers. Horses examined at these centers are in all likelihood not representative of horses with colic that are not referred for examination by specialists, this being the majority of horses with colic. Details of the epidemiology of specific etiological entities are included under those headings. Only general principles are included here.

**Occurrence**

Equine colic occurs worldwide, although there are regional differences in the types of colic, and is a common and important disease of horses. For cases of equine colic recognized in the field, as distinct from those referred for specialized treatment, the **incidence** rate ranges between 3.5 and 10.6 cases per 100 horse years, although individual farms may experience rates as high as 30 or more cases per 100 horse years.<sup>2,3,7,8</sup> **Mortality** due to colic ranges between 0.5 and 0.7 deaths per 100 horse years, representing 28% of overall horse deaths (2.5 deaths per 100 horse years).<sup>2,4,8</sup> The **case fatality rate** is 6–13% of field cases.<sup>2–4,8</sup> Approximately 1–2% of colic events in the USA and the British Isles result in surgery.<sup>3,8</sup> It should be borne in mind that these estimates of incidence and mortality are highly influenced by the population of horses studied and may be biased or unduly influenced by inclusion of farms or groups of horses with an extremely high, or low, incidence of colic.

**Risk factors**

Risk factors for colic can be categorized as: 1) intrinsic horse characteristics; 2) those associated with feeding practices; 3) management; 4) medical history, and; 5) parasite control.<sup>9</sup>

**Horse characteristics****Age**

There are conflicting results of studies that examine the association of colic and age. The conflicting results might be the result of varying study populations, study design, presence of varying confounding

Type of colic	Etiology	Lesion	Typical clinical signs	Diagnosis
Simple obstruction (not infarctive)	Luminal obstruction	Impaction of stomach, ileum or large intestine with dry ingesta Concretion-type body, e.g. fecalith, meconium, phytobezoar, enterolith, foreign body, sand colic, congenital atresia	Mild to moderate pain, heart rate mildly increased initially, moderate dehydration Mild to moderate pain, moderate dehydration	Usually subacute course. Diagnosis on rectal exam or imaging. Exploratory celiotomy Subacute to acute course. Diagnosis on rectal exam or imaging. Exploratory celiotomy
	Mural blockage	Hematoma, neoplasm, idiopathic muscular hypertrophy	Pain, moderate dehydration	Rectal exam, reflux through nasogastric tube. Exploratory celiotomy
	Extramural blockage	Large colon displacement	Mild to moderate pain, mild dehydration, abdominal distension	Rectal exam. Exploratory celiotomy
	Functional	Spasm (spasmodic colic) Paralytic ileus Gastric reflux (acute gastric dilatation, gastric ulcer, anterior enteritis)	Moderate to severe pain, moderate to severe signs of hypovolemia	Rectal exam, gut sounds, nasogastric intubation, ultrasonographic examination
Inflammation (irritation of peritoneal pain receptors)	Infectious (e.g. <i>Salmonella</i> spp., <i>Actinobacillus equuli</i> ), chemical irritation (urine, ingesta)	Peritonitis Enteritis	Mild pain, fever, toxemia, tachycardia, hypovolemia	Leukocytosis, abdominal paracentesis, diarrhea



Table 5.3 (Cont'd) Etiological classification of equine colic

Type of colic	Etiology	Lesion	Typical clinical signs	Diagnosis
Simple infarction (no obstruction)	Infarction. Ischemia	Thromboembolic colic (verminous arteritis), arterial occlusion (pedunculated lipoma around mesentery), detachment of mesentery (traumatic or congenital)	Mild to severe pain, toxemia. Possibly blood loss	Abdominal paracentesis, total white cell count. Exploratory celiotomy
Obstruction plus infarction	Intestinal accidents	Intussusception Torsion Strangulation (epiploic foramen, diaphragmatic, inguinal hernias, mesenteric tear or congenital defect, pedunculated lipoma)	Intractable pain followed by profound depression, toxemia, severe tachycardia, hypovolemia	Rectal exam. Abdominal paracentesis, PCV, total white cell count, nasogastric intubation, ultrasonographic examination

Table 5.4 Disorders of the equine gastrointestinal tract causing colic, by anatomical site

Site	Disorder
<b>Stomach</b>	Gastric dilatation Primary Secondary to outflow obstruction, pyloric stenosis, ileus or anterior enteritis Gastric impaction Gastroduodenal ulceration
<b>Small intestine</b>	Volvulus Intussusception Ileocecal Jejunojunal Infarction or ischemia Thromboembolic disease Disruption of blood supply by mesenteric tear Strangulation, including entrapment through the epiploic foramen, mesenteric rents (including cecocolic fold, splenic ligament, uterine ligaments, spermatic cord), Merkel's diverticulum and hernias (diaphragmatic, inguinal/scrotal, umbilical). Strangulation by pedunculated lipoma Luminal obstruction Foreign bodies Ascarids Luminal compression Lipomas Intramural masses such as <i>Pythium</i> spp. and neoplasms (adenocarcinoma, lymphoma, eosinophilic enteritis) Adhesions
<b>Cecum</b>	Enteritis Impaction Rupture and perforation Intussusception Cecocolic Cecocecal Cecal torsion Infarction (thromboembolic disease, necrotizing enterocolitis) Typhilitis
<b>Ascending (large) colon</b>	Tympany Impaction Intestinal tympany Volvulus Displacement, including left dorsal (reno- or nephrosplenic), right dorsal, cranial displacement of pelvic flexure Infarction (verminous mesenteric arteritis, necrotizing enterocolitis) Luminal obstruction Sand accumulation Enterolith Right dorsal ulcerative colitis Colitis
<b>Descending (small) colon</b>	Necrotizing enterocolitis Impaction Luminal obstruction Fecalith Enterolith Luminal compression Pedunculated lipoma Intramural hematoma Perirectal abscess Perirectal tumor (melanoma) Avulsion of mesocolon and rectal prolapse in mares at parturition Strangulation

factors, and interpretation of data. Confounding factors are those that alter with the age of the horse, such as use, feeding and management of horses, and mask an effect of age or give the impression of an effect of age when in fact such an effect is not present.<sup>9,10</sup> Horses 2–10 years of age are 2.8 times more likely to develop colic than horses less than 2 years.<sup>11</sup> One large-scale study reported that foals less than 6 months of age had an incidence of 0.2 cases of colic per 100 horses per year, while horses more than 6 months of age had incidence of approximately 4–6 colic-affected horses per 100 horse years, with the incidence varying to a limited extent among older age groups.<sup>3</sup> Other studies have not found a similar effect of age.<sup>4</sup> However, each age group has a particular set of diseases unique or common to it. New-born foals may have congenital colon or anal atresia, or meconium impaction (see Colic in foals), diseases that do not affect older horses, whereas strangulating or obstructive lesions caused by pedunculated lipomas are found only in older horses.<sup>12</sup>

#### Sex

There is no overall effect of sex on risk of colic<sup>4,11</sup> but certain diseases are restricted by sex. For instance, inguinal hernias occur only in males, whereas entrapment of intestine in the mesometrium is restricted to mares, for obvious reasons.

#### Breed

There is a consistent finding that Arabian horses are at increased risk of colic, but the reason for this apparently greater risk has not been determined.<sup>4,6,9,10</sup> Thoroughbreds are reported to be at increased risk of colic, independent of their use.<sup>3,11</sup>

#### Diet and feeding practices

Horses at pasture are at a lower risk of developing colic than are **stabled horses** fed concentrate feeds.<sup>11,13,14</sup> The risk of colic increases with the amount of concentrate fed, such that a horse fed 5 kg of concentrated feed per day has 6 times as great a risk of developing colic as a horse not fed concentrate.<sup>11</sup> However, another report did not detect an effect of diet composition on risk of colic.<sup>6</sup> Changes to the horse's diet through changes in quantity and quality of feed, feeding frequency, or time of feeding increase the risk of colic by 2–5 times.<sup>6,11,13,15</sup>

#### Management

##### Watering

Horses without constant **access to water** are at increased risk of developing colic,<sup>14</sup> whereas horses with access to ponds or dams have a reduced risk of colic compared to horses provided with water from buckets or troughs.<sup>11,14</sup> This

might represent a confounding effect of pasturing, in that horses with access to dams are probably at pasture and benefit from the lower risk of colic associated with that management practice. Alternatively, horses provided with water from buckets may be at greater risk of having periods when water is not available.<sup>14</sup>

##### Housing

Increased duration of stabling per day is associated with an increased risk of colic.<sup>6,13</sup> Horses cared for by their owner and horses in stables with large numbers of horses are less likely to develop colic.<sup>8</sup>

##### Exercise

Overall, there appears to be an increased risk of colic among horses that are undertaking physical activity or that have a recent change in the amount of physical activity. However, the finding of this association should be considered in the context of other differences that exist between active and inactive horses, such as in feeding practices, housing (stabling versus pasture), and transportation.

##### Weather and climate

Despite the widespread belief that colic is associated with changes in weather, particularly thunderstorms, there is no conclusive evidence of such an association.<sup>9,10</sup>

##### Medical history

Horses with a history of colic are more likely to have another episode, and horses that have had colic surgery are approximately five times more likely to have another episode of colic than are horses that have not had colic.<sup>6,15</sup> There is no association between dental care and incidence of colic or recent vaccination and colic.<sup>6,9</sup>

##### Parasite control

Inadequate parasite control programs have been estimated to put horses at 2–9 times greater risk of developing colic,<sup>7</sup> although other studies have not demonstrated a relationship between anthelmintic administration and colic.<sup>8,15</sup> The presence of tapeworms is associated with a 3 times greater risk of ileal impaction.<sup>16</sup> A recent large-scale study in the USA found an increased incidence of colic in horses on farms on which rotation of anthelmintics was practiced.<sup>3</sup> This apparently paradoxical finding may be because farms with a higher incidence of colic are more likely to alter rotate anthelmintics as a result of having more horses with colic.<sup>3</sup>

The apparently conflicting results of some of the epidemiologic studies should not deter veterinarians from recommending effective parasite control programs for horses, given the clear association at an individual level of presence of tapeworms,

cyathostomes and/or large strongyles and ileocecal disease, diarrhea and ill thrift, and verminous arteritis, respectively.

#### Importance

Losses caused by colic in horses are due almost entirely to death of the patient. However, the cost of treatment and the emotional trauma to the owners of their horse being afflicted with a potentially fatal disease are important considerations. A 1989 survey of veterinarians in the USA rated colic the most serious medical disease in horses, ahead of viral respiratory disease<sup>1</sup> and recent studies estimated the cost of colic to the horse industry in the USA at \$115 000 000 annually.<sup>3</sup>

#### PATHOGENESIS

The pathogenesis of equine colic is variable depending on the cause and severity of the inciting disease. A horse with a strangulating lesion involving 50% of its small intestine has a much more rapidly evolving disease, with severe abnormalities, than does a horse affected with mild spasmodic colic or impaction of the pelvic flexure of the large colon. While equine colic often involves changes in many body systems, notably the gastrointestinal, cardiovascular, metabolic and endocrine systems, there are several features and mechanisms that are common to most causes of colic and that depend only on the severity of the disease for the magnitude of their change. The features common to severe colic, and often present to a lesser degree in milder colics, are pain, gastrointestinal dysfunction, intestinal ischemia, endotoxemia, compromised cardiovascular function (shock) and metabolic abnormalities.

#### Pain

Pain is the **hallmark of gastrointestinal disease** in horses and is attributable to distension of the gastrointestinal tract and stimulation of stretch receptors in the bowel wall and mesentery, stretching of mesentery by displaced or entrapped bowel, and inflammation and irritation of the bowel, peritoneum or mesentery. The **intensity of the pain** is often, but not always, related to the severity of the inciting disease. Horses with mild impaction (< 24 h) often have very mild pain, whereas a horse with a strangulating lesion of the small intestine will have very severe pain.

Gastrointestinal pain has an inhibitory effect on normal gastrointestinal function, causing a feedback loop in which the pain inhibits normal gut motility and function, allowing accumulation of ingesta and fluid, resulting in distension and further pain. Horses can respond very violently to

abdominal pain and may injure themselves when rolling or thrashing.

### Gastrointestinal dysfunction

Colic is almost invariably associated with impaired gastrointestinal function, usually alterations to **motility** or **absorptive** function. Gastrointestinal motility may be increased, as is presumed to be the case in spasmodic colic, altered in its character or coordination, as in some cases of impaction colic, or absent, such as in ileus secondary to inflammation or ischemia of the bowel or to the presence of endotoxemia. Increased or uncoordinated gastrointestinal motility probably causes pain through excessive contraction of individual segments of bowel or distension of bowel because of the loss of normal propulsive activity. **Ileus** is associated with fluid distension of the small intestine and stomach and fluid and gas distension of the large colon, both of which cause severe pain and can lead to gastric or colonic rupture. The absorptive function of the intestine may be decreased by inflammation or ischemia, which results in distension of the small intestine or large colon, pain and potentially rupture of the stomach or colon.

Impairment of the **barrier function** of the gastrointestinal mucosa by inflammation or ischemia can result in leakage of endotoxin into peritoneal fluid and endotoxemia<sup>17</sup> (see Endotoxemia).

### Ischemia of the intestinal wall

Ultimately, most forms of lethal colic involve some degree of ischemia of the intestine, with subsequent loss of barrier function, evident in its most extreme form as rupture of the viscus, endotoxemia, bacteremia, cardiovascular collapse and death. Ischemia may be the result of impaired blood flow to or from the intestine because of torsion or volvulus of the intestine, entrapment of the intestine and associated mesentery in rents or hernias, strangulation such as by a pedunculated lipoma, or thromboembolic disease. Ischemia may also result from severe gastrointestinal distension, such as occurs in the terminal stage of severe colon impaction. Mild ischemia probably impairs normal intestinal motility and function. The role of reperfusion injury in pathogenesis of ischemic disease is uncertain at this time.

### Endotoxemia

Death in fatal cases of colic in which the affected viscus ruptures secondary to distension, or when ischemia and/or infarction damages a segment of bowel wall, is due to the absorption of endotoxins from the gut lumen into the systemic circulation.<sup>17</sup> (See Endotoxemia). Endotoxin absorption causes increased

concentrations of tumor necrosis factor and interleukin 6 in peritoneal fluid and blood concentrations<sup>17</sup>

Rupture of the stomach or intestine is also a characteristic termination of distension of the intestine in the horse. The resulting deposition of large quantities of highly toxic ingesta or fecal contents into the peritoneal cavity causes profound shock and death within a few hours.

### Shock

The usual cause of death in severe colic is cardiovascular collapse secondary to endotoxemia and hypovolemia. In less severe colic, hypovolemia and cardiovascular dysfunction may contribute to the development of the disease, and rapid correction of hypovolemia is central to the effective treatment of colic.

**Hypovolemia** is due to the loss of fluid and electrolytes into the lumen of the gastrointestinal tract or loss of protein from the vascular space with subsequent reduction in the circulating blood volume. Hypovolemia impairs venous return to heart and therefore cardiac output, arterial blood pressure and oxygen delivery to tissues. Not surprisingly, measures of circulatory status are good predictors of the outcome of colic (see Prognosis, below).

Cardiorespiratory function is impaired if there is severe distension of gut, such as in large-colon torsion, because of restricted respiration by pressure on the diaphragm and reduced venous return to the heart because of pressure on the caudal vena cava.

### Coagulation and fibrinolysis

Severe colic, especially that involving ischemia or necrosis of intestine, is associated with abnormalities in coagulation and fibrinolysis characterized by hypercoagulation of blood and decreases in rate of fibrinolysis.<sup>18-21</sup> Disseminated intravascular coagulation is common among horses with ischemia or necrosis of the gut and is a good prognostic indicator of survival.<sup>19,20</sup> Changes in coagulation and fibrinolysis include decreases in anti-thrombin activity and fibrinogen concentration and increases in prothrombin time, activated partial thromboplastin time and concentration of thrombin-antithrombin complexes in plasma.<sup>19-21</sup>

### Overview of the pathogenesis of common colics

Simple obstructive

Simple obstructive colics are those in which there is obstruction to the aboral passage of ingesta but no ischemia or strangulation of bowel. In the terminal stages there is often ischemia caused by distension of the intestine.

**Small-intestinal obstructive** lesions include ileal hypertrophy, ileocecal

intussusception and foreign-body obstruction of the lumen. The course of the disease is often 24-72 hours, and sometimes longer depending on the extent of the obstruction, partial obstructions having much less severe signs and disease of longer duration. The principal abnormality is reduced aboral flow of ingesta, with subsequent distension of intestine cranial to the obstruction, causing pain and, if the distension is severe, gastric rupture.

**Large intestinal obstructive** lesions include impaction and simple (non-strangulating) displacements of the large colon. The course of disease is prolonged, often more than 72 hours. Signs of abdominal pain are due to distension of the bowel. There is progressive distension with fluid and gas and ultimately ischemia of the bowel and rupture.

### Obstructive and strangulating

Diseases that cause both obstruction and strangulation as an initial event, such as torsion of the small intestine or volvulus of the large colon, result in severe and unrelenting pain that is little relieved with analgesics. Obstruction causes distension and strangulation causes ischemia, loss of barrier function and endotoxemia. These diseases have a short course, usually less than 24 hours and sometimes as short as 6 hours, and profound clinical signs. Endotoxemia and cardiovascular collapse are characteristic of these diseases.

### Infarctive

Infarctive diseases, such as thromboembolic colic, are characterized by ischemia of the intestinal wall with subsequent alterations in motility and absorptive and barrier functions. Ileus causes distension of the intestines and stomach and altered barrier function causes endotoxemia. The course of the disease is usually less than 48 hours and is terminated by cardiovascular collapse and death.

### Inflammatory

Inflammation of the intestine or peritoneum alters gastrointestinal motility and absorptive function leading to accumulation of fluid and ingesta, distension and abdominal pain.

### CLINICAL FINDINGS

The bulk of the following description is generally applicable to severe acute colic. Clinical findings characteristic of each etiological type of colic are dealt with under their individual headings. The purposes of the clinical examination are **diagnostic** – to determine whether the pain is due to gastrointestinal tract disease and, if so, to determine the nature of the lesion – and **prognostic**, to provide some estimate of the likely outcome of

the disease. Veterinary clinicians are able to accurately predict the site of lesions (small versus large intestine), type of lesion (simple obstructive versus strangulating or infarctive) and outcome.<sup>22</sup> The ability to predict these events increases with training and experience.<sup>22</sup>

**Accurate diagnosis** of the cause of the colic has some prognostic usefulness, but assessment of the horse's physiological state by measurement of heart and respiratory rates, mucous membrane color and refill time, arterial blood pressure, hematocrit and serum total protein concentration, and other measures, allows more accurate prognostication. Furthermore, the cause of colic is determined in only approximately 20% of field cases.

### Visual examination

#### Behavior

Pain is manifested by **pawing, stamping or kicking** at the belly or by restlessness evident as pacing in small circles and repeatedly getting up and lying down, often with exaggerated care. Other signs are looking or nipping at the flank, **rolling**, and lying on the back. Often the penis is protruded without urinating or with frequent urination of small volumes. Continuous playing with water without actually drinking (sham drinking) is common.

**Pain** may be continuous or, more commonly, intermittent with bouts of pain lasting as long as 10 minutes interspersed with similar periods of relaxation. In general the intensity of the pain is of about the same severity for the duration of the illness; sudden exacerbations may indicate a change in the disease status or the development of another abnormality, such as a horse with impaction of the large colon developing a displacement of the colon or horses with diarrhea developing necrotizing enteritis. Horses in the terminal phase of the disease may have a marked diminution of pain associated with relief of pressure after rupture of distended bowel and depression caused by toxemia and shock. Pain responses in colic may be so severe, and uncontrolled movements so violent, that the horse may do itself serious injury. Other causes of pain, such as pleuritis or rhabdomyositis, can be confused with colic, although a horse that goes down and rolls almost certainly has alimentary tract colic.

#### Posture

The posture is often abnormal, with the horse standing stretched out with the forefeet more cranial and the hindfeet more caudal than normal – the so-called 'saw-horse' stance. Some horses lie down on their backs with their legs in the air,

suggesting a need to relieve tension on the mesentery.

#### Abdomen size

**Distension** of the abdomen is an uncommon but important diagnostic sign. **Symmetrical, severe distension** is usually caused by distension of the colon, sometimes including the cecum, secondary to colon torsion, or impaction of the large or small colon and subsequent fluid and gas accumulation. If only the cecum is distended the abdomen may show an **asymmetrical enlargement** in the right sublumbar fossa. Maximum distension of stomach or small intestines does not cause appreciable distension of the abdomen.

#### Vomiting

Projectile vomiting or regurgitation of intestinal contents through the nose is very unusual in the horse and is a serious sign suggesting severe gastric distension and impending rupture.

#### Defecation and feces

Defecation patterns can be misleading. It is often mistakenly assumed that there is no complete obstruction because feces are still being passed. But in the very early stages of acute intestinal obstruction there may be normal feces in the rectum, and the animal may defecate several times before the more usual sign of an empty rectum with a sticky mucosa is observed.

### Physical examination

#### Heart and respiratory rates

The **heart rate** is a useful indicator of the severity of the disease and its progression but has little diagnostic usefulness. Horses with heart rates less than 40/min usually have mild disease whereas horses with heart rates above 120/min are usually in the terminal stages of severe disease. Horses with obstructive, non-strangulating disease often have heart rates between 40 and 60/min, whereas horses with strangulating disease or necrotic bowel will usually have heart rates over 80/min. However, heart rate is not an infallible indicator of disease severity, as horses with torsion of the colon can have heart rates of 40–50/min.

The **respiratory rate** is variable and may be as high as 80/min during periods of severe pain.

#### Mucous membranes and extremities

**Mucous membranes** of normal horses and of horses without significantly impaired cardiovascular function are pink, moist and regain their normal color within 2 seconds after firm digital pressure is removed. Dehydrated horses have dry mucous membranes, although the capillary refill time and color are

normal. Horses with impaired cardiovascular function have pale, dry mucous membranes with delayed capillary refill (> 2 s). Endotoxemic horses will often have bright red mucous membranes with normal or delayed capillary refill. As the disease becomes more severe the mucous membranes develop a bluish tint and capillary refill is longer than 3 seconds. **Terminal** stages of disease are associated with cold, purple, dry mucous membranes with a capillary refill time of more than 3 seconds; necrosis of the mucosa of the gingival margins of the gums, the so-called 'toxic line', is often seen.

**Cool extremities** may be indicative of compromised cardiovascular function but should be interpreted with caution and only in the context of the rest of the clinical examination. **Sweating** is common in horses with severe abdominal pain and, when present in a horse with cool extremities and signs of cardiovascular collapse, is indicative of a poor prognosis.

#### Auscultation; percussion

**Auscultation** of the abdomen can provide useful diagnostic and prognostic information and should be performed thoroughly and without haste. All four quadrants (dorsal and ventral, left and right sides) of the abdomen should be examined for at least 1 minute at each site. Attention should be paid to the intensity, frequency and characteristics of the spontaneous gut sounds (borborygmi). Repeated observations are often necessary to detect intermittent or rapid changes in the character of the borborygmi.

**Continuous, loud borborygmi** distributed in all or most quadrants are indicative of intestinal hypermotility and consistent with spasmodic colic, impending diarrhea or the very early stages of a small-intestinal obstructive/strangulating lesion. The **absence of sounds**, or the presence of occasional high-pitched, brief sounds, sometimes with a splashing character, is consistent with ileus. These sounds should not be mistaken for the rolling, prolonged sounds of normal peristalsis.

**Combined percussion and auscultation** is a valuable procedure for defining the presence of extensive gas caps; a flick or abrupt tap with a finger while auscultating with a stethoscope will elicit a 'pinging' sound similar to that made by flicking an inflated balloon. The detection of such sounds indicates the presence of tightly gas-distended bowel near the body wall. Such bowel is almost always large colon or cecum and is consistent with gas distension secondary to ileus, small or large colon impaction, gas colic or colon displacement, including torsion.

### Rectal examination

A careful rectal examination is probably the most important part of the clinical examination in colic and should not be neglected. The examiner must know the anatomy of the posterior abdomen in order to make reasonably accurate decisions about the location of various organs. Recognition that an important abnormality exists is a critical factor in the decision to refer the horse for specialized evaluation and care.

### Normal anatomy

The horse should be restrained so that the examination can be performed with minimal risk to both the examiner and patient. Fractious or painful horses should be tranquilized. A twitch should be applied to all but the most cooperative horses to minimize straining and the chance of kicking. Rectal examination in small or unruly horses should be approached with caution.

Only approximately 40% of the abdomen can be examined in a mature horse, the cranial and ventral structures being

outside the reach of the examiner. In the normal 425 kg (1000 lb) horse there should not be any distended intestine nor should the small intestine be palpable. The **cecum** is readily palpable in the right caudal abdomen, with its ventral band running from the dorsal right quadrant ventrally and slightly to the left. The base of the cecum may be palpable as a soft, compressible structure containing fluid and gas. The caudal border of the **spleen** is readily palpable as it lies on the left side of the abdomen against the body wall. There should be no bowel between the spleen and the body wall although occasionally small colon can be detected dorsal to the spleen. Dorsal and medial to the spleen the **left kidney** should be readily palpable, as should the **nephrosplenic ligament** and **space**. There should be no bowel in the nephrosplenic space, although some horses have portions of small colon in the region of the nephrosplenic space. Portions of **large colon**, especially the pelvic flexure, can be palpated in the caudal ventral abdomen if they contain ingesta. The inguinal rings

may be palpated in males. The **ovaries** and **uterus** can be palpated in mares. The bladder can be palpated if it contains urine.

### Abnormal findings

Abnormalities associated with specific diseases are discussed under those headings (Table 5.5). One should be able to recognize gas and fluid distension of the cecum and colon, fluid distension of the small intestine, impaction of the large and small colon, and displacement of the large colon.

**Small intestinal distension** is evident as loops of tubular structures of up to 10–15 cm diameter that may extend as far caudally as the pelvic canal. The structure is often compressible, akin to squeezing a fluid-filled tubular balloon, and slightly moveable. The presence of distended small intestine is an important sign suggestive of a small-intestinal obstructive lesion or anterior enteritis.

**Colonic distension, impaction and displacement.** Gas and fluid distension of the **large colon** is evident as large (> 20 cm) taut structures often extending

Table 5.5 Rectal findings and associated causes of equine colic

Rectal abnormality	Disease	Clinical characteristics	Treatment
Distended small intestine	Anterior enteritis	Small intestine mildly to moderately distended. Voluminous gastric reflux. Marked pain relief on gastric decompression. Normal peritoneal fluid in most cases	Supportive. Repetitive decompression of stomach
	Strangulating intestinal lesion. Small intestinal volvulus or entrapment	Severe, tight distension of small intestinal. Gastric reflux. Severe pain not relieved by gastric decompression. Abnormal peritoneal fluid	Surgery
	Ileal impaction	Mild and progressive pain. Gastric reflux only late in disease. Impaction occasionally palpable per rectum	Medical initially, then surgery if no resolution
	Ileal hypertrophy	Mild to moderate chronic pain occurring after feeding. Hypertrophy may be palpable	Surgical resection
Large colon distension	Ileocecal intussusception	Moderate to severe pain. Gastric reflux later in disease. Usually young horse	Surgical correction
	Colon torsion	Tenia dorsal in some cases. Cecum displaced medially. Severe pain. Abdominal distension. No gastric reflux. Short disease course	Surgical correction
	Left dorsal colon displacement (renosplenic entrapment)	Mild to moderate pain. Bands on rectal examination leading to renosplenic space. Ultrasonographic confirmation	Replacement by rolling horse. Surgery
	Right dorsal displacement of colon	Moderate to severe pain. Bands leading ventral to right dorsal quadrant. Colon lateral to base of cecum	Surgical correction
	Impaction of large colon	Impaction palpable per rectum	Fecal softeners and lubricants, oral and intravenous fluids. Surgery in refractory cases
	Enterolith	Obstruction usually of right dorsal or transverse colon. Not palpable rectally. Refractory pain. Radiography	Surgical removal
	Gas colic	Gas distension of large colon. Pain readily relieved with analgesics. Short course with rapid recovery. Major differential is colon torsion	Analgesics, mineral oil
Cecal distension	Sand colic	Mild to moderate pain. Sand auscultable in ventral abdomen. Sand in feces. Occasional watery feces	Analgesics, psyllium orally
	Cecal impaction	Mild to moderate pain, course of several days with sudden deterioration when cecum ruptures	Analgesics, lubricants, fecal softeners. Surgical correction
Displaced spleen	Cecal torsion	Acute, severe pain. Rare	Surgical removal or correction
	Renosplenic entrapment of large colon	See above	
Intra-abdominal masses	Large colon displacement	Mild to moderate pain. Ultrasonographic diagnosis	Analgesics. Surgery
	Mesenteric abscess	Fever, mild chronic or intermittent abdominal pain. Increased leukocyte numbers in blood and peritoneal fluid	Long term antibiotics
	Neoplasia	Neoplastic cells in peritoneal fluid. Exploratory laparotomy	None

into the pelvic canal. Tenial bands are often not palpable because of the distension. The distended bowel may extend into the pelvic canal, preventing examination of the caudal abdomen. **Impaction** is evident as columns of firm ingesta in the large or small colon. The most common site is the pelvic flexure in the caudoventral abdomen and the inlet to the pelvic canal. The impacted material remains indented when pressed with the finger tips.

**Distension of the small colon** is detectable as loops of tubular structures in the caudal abdomen. The loops of intestine have a prominent antimesenteric band, a feature not present on small intestine.

**Displacement** of the large colon is evident rectally as tight bands extending from the ventral abdomen cranially, dorsally and to the left or cranially, dorsally and to the right in left and right displacements of the colon, respectively. Displacement of the colon, if it obstructs aboral flow of ingesta and gas, may cause distension.

#### Nasogastric intubation

Passage of a nasogastric tube is an essential part of the examination of a horse with colic because of the diagnostic information it provides and because relief of gastric distension may be life-saving.

The nasogastric tube **must** be passed into the stomach. This is usually evident by the release of a small amount of sweet-smelling gas as the stomach is entered. The tube should then be advanced further into the stomach and, if reflux of material does not occur spontaneously, a siphon should be established by filling the tube with approximately 500 mL of water and rapidly dropping the end of the tube below the level of the horse's stomach. This procedure should be repeated at least three or four times if reflux is not obtained. If **reflux** is obtained, its volume and character should be noted. The volume should be measured – anything more than 2 L of net reflux is likely important. If reflux is obtained, the nasogastric tube should be left in place or replaced frequently (1 h intervals) until the colic resolves. If there is no reflux but the horse remains colicky, then repeated attempts should be made to obtain reflux.

**Oral medications**, such as mineral oil, should not be given to horses with nasogastric reflux.

#### Ancillary diagnostic techniques

##### Ultrasonography

Ultrasonographic examination of the abdomen of adult horses is useful in identifying a number of abnormalities, including small-intestinal distension, ileocecal intussusception, gastric disten-

sion, gastric squamous cell carcinoma, diaphragmatic hernia, peritoneal effusion and other conditions.<sup>23</sup> The abdomen should be examined in a systematic fashion with a 2.0–3.5 MHz transducer. Ultrasonographic examination is useful to detect small-intestinal distension (such as occurs with anterior enteritis or small intestinal accidents), reduced motility (anterior enteritis, enteritis, obstruction), thickening of intestinal wall (> 4 mm, enteritis, right dorsal colitis), volume and characteristics of peritoneal fluid (peritonitis, hemoperitoneum), abnormalities in intestinal contents (such as presence of sand or excessively fluid ingesta), presence of sacculations of the ventral colon (absence indicates distension), abnormalities in intestinal architecture (intussusceptions) and presence of abnormal structures (neoplasia, abscess). Ultrasonographic detection of small-intestinal distension is more sensitive than rectal examination.<sup>24</sup> Ultrasonographic examination reveals colon with a mural thickness of 9 mm or greater in horses with colon torsion. The test has a sensitivity of approximately 67% (i.e. correctly predicts the presence of colon torsion in two-thirds of horses that have the disease) and specificity of 100% (correctly rules out the diagnosis in 100% of horses that do not have the disease).<sup>25</sup>

##### Radiology

The large size of the adult horse precludes detailed radiographic examination of intra-abdominal structures. However, enteroliths and sand accumulation can be detected with reasonable certainty provided suitable radiographic equipment is available.<sup>18</sup> Diaphragmatic hernias can be detected on radiographic examination of the thorax.

##### Arterial blood pressure

Arterial blood pressure is a very good indicator of the degree of shock in colic, and the availability of a simple technique makes it a practical aid in assessing prognosis in a clinical case. If normal systolic pressure is about 100 mmHg (13.3 kPa), a pressure below 80 mmHg (10.6 kPa) indicates a critical situation (it can be as low as 50 mmHg, 6.6 kPa). In horses with very severe pain but not shock, the systolic pressure is likely to be very high, up to 250 mmHg (33.3 kPa).

##### Course of the disease

The course of the disease depends upon its cause and the severity of the associated lesions. Spasmodic and gas colic usually resolves within hours of onset. Horses with strangulating lesions have severe clinical signs and usually die within 24 hours of the onset of signs. Horses with nonstrangulating obstructive lesions

have longer courses, often 48 hours to 1 week, and die when distension causes bowel to become devitalized and rupture.

When intestinal rupture does occur, there is a sudden onset of shock and toxemia, the acute pain that preceded it disappears and the horse becomes quiet and immobile. The terminal stages after rupture of the intestine or stomach, or due to profound endotoxemia, are very distressing. The horse may be recumbent but most continue to stand until the last few minutes, when they literally drop dead. The respiration is sobbing and there is gross muscle tremor and profuse sweating, and there is often a delirious, staggering wandering. Euthanasia should be performed before this stage is reached.

#### CLINICAL PATHOLOGY

Examination of various clinical pathology variables is useful in assessing the severity of the changes occurring as a consequence of the disease rather than in providing a definitive diagnosis. Therefore, some of these variables have prognostic significance (Prognostication) and should be monitored repeatedly in severe cases.

##### Hematology and serum biochemistry

Measurement of **hematocrit** and **plasma total protein** concentration is useful in assessing hydration status (see Chapter 2). Hematocrit increases as a consequence of splenic contraction or dehydration, making the use of this variable as a sole indicator of hydration status unreliable. However, increases in both hematocrit and total protein concentration indicate dehydration, and these variables can be used as crude estimates of response to fluid therapy. Plasma total protein concentrations may decline if there is significant loss of protein into the gut lumen or peritoneal space.

Measurement of the **blood leukocyte** count has little diagnostic significance, with the exception that the combination of leukopenia and a left shift are consistent with the endotoxemia that accompanies devitalized bowel, enteritis or peritonitis.

Horses with severe colic often have abnormalities in coagulation, with non-surviving horses and horses with strangulating lesions having the most severe changes, characterized by low anti-thrombin activity and prolonged prothrombin and activated partial thromboplastin times.<sup>18,26</sup>

Measures of **serum electrolyte concentration** are important in providing an assessment of the horse's electrolyte status and in tailoring fluid therapy (see Chapter 2). The nature of the abnormalities depends to some extent on the

cause of the disease, but is more markedly affected by the severity of the disease. Mild hyponatremia is not uncommon but is clinically insignificant. **Hyperkalemia** is common in horses with severe acidosis and large sections of devitalized intestine. **Hypokalemia** is common in horses with more long-standing colic, for instance impaction of the large colon, that have not eaten for several days. **Hypocalcemia** and **hypomagnesemia** are common in horses with colic, especially horses with severe colic. Measurement of total concentrations (ionized plus non-ionized) can be misleading in that reductions in concentration of the physiologically important ionized component can be present in horses with normal concentrations of the total ion.<sup>27,28</sup> Hospitalized horses with colic or diarrhea are more likely to have hypomagnesemia than are horses with other diagnoses.<sup>29</sup>

Serum enzyme activities are rarely useful in aiding diagnosis or treatment of horses with colic, with the exception that **serum gamma glutamyl transferase (GGT)** activity is elevated in approximately 50% of horses with right dorsal displacement of the colon, whereas such elevations are rare in horses with left dorsal displacement.<sup>30</sup> The elevated GGT, and less commonly serum bilirubin concentration, in horses with right dorsal displacement is attributable to compression of the common bile duct in the hepatoduodenal ligament by the displaced colon.<sup>30</sup> Serum and peritoneal **alkaline phosphatase** activities are higher in horses with ischemic or inflammatory bowel disease than in horses with other forms of colic, although the differences are not sufficiently large as to be useful diagnostically.<sup>31</sup> Serum creatine kinase activity above the normal range (385 U/L) is associated with a fourfold increase in the likelihood that a horse with colic has small intestinal ischemia.<sup>32</sup>

Serum **urea nitrogen** and **creatinine** concentrations are useful indicators of hydration status and renal function. Prerenal azotemia is common in horses with colic, and may progress to acute renal failure in severe cases of colic.

High plasma concentrations of intestinal fatty acid binding protein (> 100 pg/mL) are associated with increased need for surgery in horses with colic.<sup>32</sup>

Horses that die of colic have higher circulating concentrations of epinephrine, cortisol and lactate than do horses that survive, indicating the greater degree of sympathetic and adrenal cortical activation in these horses.<sup>33</sup>

#### Acid–base status

Most horses with severe colic have **metabolic acidosis**, although respiratory

acidosis and metabolic alkalosis also occur. Horses with less severe disease, such as simple obstructive disease or spasmodic colic, might not have abnormalities in acid–base status. Metabolic acidosis, when severe, is attributable to L-lactic acidosis.<sup>34</sup> An estimate of the plasma **lactate** concentration can be obtained by calculating the anion gap:

$$\text{Anion gap} = (\text{sodium} + \text{potassium}) - (\text{bicarbonate} + \text{chloride}).$$

If bicarbonate concentrations are not available, total serum carbon dioxide can be substituted. Anion gaps of less than 20 mEq/L (mmol/L) are associated with 81% survival, 20–24.9 mEq/L (mmol/L) with 47% survival, and 25 mEq/L (mmol/L) or more with 0% survival.<sup>35</sup>

#### Abdominocentesis

Analysis of peritoneal fluid is an important component of the complete examination of a horse with colic.<sup>36</sup> Details of the technique and interpretation of the results were discussed previously but, briefly, if there is an increase in the total protein concentration, a change in the color to red or blood-tinged, and an increase in the leukocyte count in peritoneal fluid, it is likely that there is some insult to intra-abdominal structures.<sup>32,36</sup> **Total protein concentration** increases when there is an insult to the gastrointestinal tract that compromises the serosal surface of the bowel, for instance strangulating lesions of the small intestine or in the terminal stages of an impaction colic in which the bowel wall is devitalized.<sup>32,36</sup> The presence of intracellular bacteria, plant material and degenerate neutrophils is indicative of gastrointestinal rupture provided that one is *certain* that the sample came from the peritoneal space and not from the bowel lumen (by inadvertent enterocentesis).

#### PROTOCOL FOR EVALUATING A COLIC PATIENT

When evaluating a horse with colic the aims are:

- Determine the nature and cause of the lesion
- Establish a prognosis
- Determine the most appropriate therapy, including consideration of euthanasia
- Determine the need for referral for specialized care, including surgery.

The suggested protocol for evaluating a horse with colic is set down below. The time intervals between repeated examinations depend on a number of factors, including severity of the disease and the accessibility of the horse. For a horse with a possible intestinal obstruction this should be every hour; for a horse with

probable colonic impaction examinations every 4 hours are adequate; for a chronic colic with ileal hypertrophy an examination every day is usual. The following observations should be made.

#### Behavior

The following should be assessed: severity of pain, frequency and duration of attacks, whether food is taken, amount and character of feces, and frequency of urination.

#### Clinical and clinicopathological observations

- **Elevated pulse rate** with a fall in **pulse amplitude** are among the most reliable indicators of the state of dehydration or shock. They can be temporarily misleading in a horse that is excited because it is in strange surroundings, or separated from its dam, foal or close companion. They may also be marginally influenced by a bout of pain. A rate of more than 60/min and a steady climb in heart rate of about 20 beats/min at each hour in a series of monitoring examinations signal a deterioration in prognosis. A high rate that continues to worsen during a period of analgesia as a result of medication also indicates a bad outcome. A small-amplitude, 'thready' pulse characterizes severe shock
- **Mucous membrane color and capillary refill time** are assessed. Deep congestion (dark red) or cyanosis (purple) and capillary refill times much longer than 2 seconds are indicators of peripheral circulatory failure
- **Temperature** is infrequently taken unless there is some positive indication, such as suspicion of peritonitis, to do so
- **Respiratory rate**, also of minor importance except as an indicator of severity of pain, or in terminal stages of endotoxic shock or dehydration, when it becomes gasping
- **Intestinal sounds.** The disappearance of intestinal sounds indicates ileus. Hypermotility is usually a sign of less serious disease, except in the very early stages of a small intestinal accident. The development of a 'ping' on auscultation–percussion indicates accumulation of gas under some pressure
- **Rectal findings.** The development of palpable abnormalities is an ominous finding. A decision to intervene surgically is often made at this point. The inherent inadequacy of the rectal examination is that only the caudal half of the abdominal cavity can be

reached. Therefore large bowel and terminal ileal problems are more easily detected. With anterior abdomen small-intestinal lesions, distended loops do not usually come into reach until 6 hours after colic commences. They may reach back as far as the pelvis by 18 hours

- Amount and nature of **feces** is important. Failure to defecate within 12 hours of treatment is a bad sign. The empty rectum with a dry, tacky feel, or with a smear of mucus and degenerated blood some hours after the last defecation, presages a completely blocked intestine. The passage of oil but no feces suggests a partial blockage of large bowel that will permit the passage of oil but not fecal balls
- **Reflux** through a nasogastric tube. Acute gastric dilatation or small intestinal regurgitation of fluid sufficient to cause reflux of fluid via the stomach tube is a grim development. Large-bowel distension is also associated with fluid accumulations in the stomach. A negative test in a case suggestive of small intestinal obstruction should be followed by repeated tests; reflux from a lesion well down in the small intestine may take some hours to reach the stomach. In ileocecal valve impaction gastric reflux may not develop until 24 hours after the commencement of the colic
- **Abdominal paracentesis.** Repeated examinations are without serious risk and can herald the development of infarction and necrosis of gut wall, leakage and the development of peritonitis, or rupture and death due to endotoxic shock
- Visible **distension** of the abdomen
- **PCV and plasma protein.** A rise in PCV of 5% (i.e. from 55 to 60%) in an hour is a serious sign. A rise in PCV with a stable or declining serum protein concentration is often indicative of loss of capillary integrity and leakage of vascular proteins into extravascular spaces, such as the intestinal lumen. This is a sign of a poor prognosis
- **Skin tenting** on its own can be a very misleading indicator of the state of a horse's dehydration, but significant changes from one examination to another are likely to confirm deductions made on the basis of heart rate and mucosal color
- **Arterial blood pressure** is one of the most reliable prognostic indicators in cases of colic
- Response to **analgesics.** Diminution in the relief of pain after administration of detomidine,

xylazine, butorphanol or flunixin meglumine can be interpreted as a serious decline in the status of the affected intestine.

#### When to refer the patient

The decision to refer a horse for specialist care and evaluation is often difficult. Most referrals occur because of the need for specialized medical or surgical treatment and therefore involve considerable expense and inconvenience to the owner. However, early referral is critical because of the improved chances of survival associated with early medical and surgical therapy of horses with severe colic.

The criteria for referral include:

- Severe persistent pain without identifiable cause for more than 24 hours. Referral should be sooner if there is evidence of compromised cardiovascular function, or any of the signs described below
- Recurrent attacks of colic over a period as long as several months
- Failure of an efficient analgesic to provide analgesia or relief for at least 20 minutes
- A rectally palpable lesion including distended small intestine, large colon, or small colon, or impaction of the large colon that does not resolve in 24 hours
- Reflux of more than 4 L of fluid through a nasogastric tube
- Abdominal distension
- Blood-tinged, high-protein peritoneal fluid with a high white cell count
- A rapid worsening of the pain and vital signs during a period of 2–4 hours.

Not all of these criteria need to be fulfilled to warrant a decision to refer and in most cases the presence of one of these findings is sufficient to justify a recommendation to the owner to refer the horse for further evaluation and specialized care.

Important in the decision to refer, or to perform a laparotomy, is the client's understanding of the **costs** involved and the **likely outcomes**. Because decisions to refer are often complicated by the emotional pressures on the owner and the need to make a decision quickly, it is important to take the time to fully inform the owner of the likely costs and outcomes before a final commitment is made to refer.

#### If there is doubt – refer it!

##### Surgery

The **decision to perform surgery** is best made by trained specialists and is usually based on a variety of clinical and clinicopathological findings with most weight given to the presence of severe unrelenting or intermittent pain, severe

abdominal distension, large quantities of reflux through a nasogastric tube, intestinal distension palpable per rectum, serosanguinous peritoneal fluid, evidence of cardiovascular compromise including a high (> 60/min) and increasing heart rate, poor capillary refill, discolored mucous membranes and the absence of borborygmi.<sup>37,38</sup> Presence of abnormal abdominal fluid (turbid or serosanguinous) and peritoneal fluid with an elevated total protein concentration has good sensitivity (92%) and moderate specificity (74%) for the need for surgery.<sup>36</sup> Formal modeling of the need for surgery in horses with colic at referral institutions provides a numerical estimate of the need for surgery, but is seldom used in most referral practices.<sup>39,40</sup>

##### Prognosis

Given the enormous emotional and financial costs of having a severely ill horse with colic, there is an obvious need for accurate prognostication. Overall best predictors of survival are those clinical and clinicopathological factors that assess cardiovascular and metabolic status. The important factors include arterial blood pressure or its clinical correlates, pulse pressure and/or capillary refill time, pulse rate, mucous membrane color, indicators of hydration status (hematocrit, serum urea nitrogen concentration), blood lactate concentration and anion gap.<sup>33,41–44</sup>

**Arterial systolic pressure** is one of the best predictors of survival, with horses with systolic pressures of 90 mmHg (12 kPa) having a 50% chance of survival while fewer than 20% of horses with a pressure below 80 mmHg (10.6 kPa) survive.

**Capillary refill time**, the clinical manifestation of arterial blood pressure, is also a good predictor of the probability of survival. Capillary refill times of 3 seconds or more are associated with a survival rate of 30%. Similarly, increasing **heart rate** is associated with diminishing chances of survival – a horse with a heart rate of 80/min has a 50% chance of survival whereas one with a heart rate of 50/min has a 90% chance of surviving. Increasing blood lactate concentration and anion gap (see under Clinical pathology, above) are associated with increased chance of death. Measures of hydration status are also good indicators of prognosis. A **hematocrit** of 50% (0.50 L/L) is associated with a 50% chance of survival, while the chance of surviving drops to 15% when the hematocrit is 60% (0.60 L/L). Horses with high circulating epinephrine, cortisol or lactate concentrations are at greater risk of death.<sup>33</sup>

While individual variables may be good prognostic indicators, their predictive



utility improves when they are combined<sup>40,43,44</sup> although this introduces the need for either remembering models or keeping the model close at hand, something often not easily accomplished in the field. Furthermore, these models have been developed from cases at specific referral institutions and may not be applicable to field cases or even cases at other referral sites. However, the general principles probably apply in all circumstances even if the precise weighting appropriate for each variable does not.

## NECROPSY FINDINGS

The nature of the necropsy findings depends on the underlying disease.

### DIFFERENTIAL DIAGNOSIS

The following diseases may be mistaken for colic:

- Laminitis
- Pleuritis
- Enterocolitis
- Rhabdomyolysis
- Obstructive urolithiasis
- Uroperitoneum
- Foaling and dystocia
- Uterine torsion
- Peritonitis
- Cholelithiasis
- Ovulation and ovarian pain
- Esophageal obstruction
- Anterior enteritis
- Gastric ulceration
- Anthrax
- Testicular torsion
- Lactation tetany
- Tetanus
- Rabies
- Botulism
- Grass sickness
- Purpura hemorrhagica
- Clostridial myonecrosis (gas gangrene)
- Psychogenic colic

The clinical characteristics of common causes of equine colic are summarized in Table 5.6.

## TREATMENT

### Medical treatment

The specific treatment of each case of colic varies and depends on the nature of the lesion and the severity of the disease. However several principles are common to the treatment of most colic:

- Provision of analgesia
- Correction of fluid, electrolyte and acid-base abnormalities
- Gastrointestinal lubrication or administration of fecal softeners
- Treatment of underlying disease.

### Analgesia

Analgesia is important in that it relieves the horse's discomfort, minimizes the physiological consequences of pain,

including the pain-induced reduction in gastrointestinal motility, permits a thorough clinical examination and reduces the likelihood of the horse injuring itself while rolling or thrashing. Analgesics can be divided into NSAIDs, sedating analgesics and spasmolytics. The doses of these drugs are provided in Table 5.7.

The analgesic and its dose rate should be chosen such that the horse's pain is relieved but signs of progressive cardiovascular compromise indicative of the need for more aggressive therapy or surgery are not masked. **Acupuncture** does not provide effective analgesia in horses with colic and should not be used in these animals.<sup>45</sup>

### Nonsteroidal anti-inflammatory drugs

**Flunixin meglumine** is a potent, long-acting analgesic with the ability to mask signs of surgical disease, with the consequence that surgery may be delayed and the chance of recovery diminished. Flunixin meglumine should only be used to control pain when the diagnosis is clear or when surgical intervention is not an option. It should not be used routinely in horses being monitored for progression of disease unless such monitoring is frequent and thorough, which may not be the situation in field colics. A horse that remains painful 30 minutes after the administration of flunixin meglumine is likely to have severe gastrointestinal disease and should be further evaluated.

Comments similar to flunixin meglumine apply to **ketoprofen** but not to **phenylbutazone**, which has relatively weak analgesic effects in colic patients (as opposed to its potent analgesic effects in musculoskeletal disease). **Dipyron** is a weak analgesic that is useful in treatment of mild cases of colic.

Flunixin meglumine and etodolac retard recovery of equine jejunum and barrier function and flunixin inhibits electrical activity in the ventral colon.<sup>46,47</sup> However, these effects detected in vitro have not been demonstrated to have practical relevance to treatment of horses with colic with NSAIDs. Horses in pain should not, based on current information, be deprived of these drugs.

### Alpha-2 agonists

The **alpha-2 agonists** (xylazine, detomidine, romifidine) provide potent analgesia, especially when combined with the opiate **butorphanol**. Duration is relatively short (up to 90 min for detomidine), which means that signs of progressive disease are readily detectable. The effect of alpha-2 agonists in reducing gastrointestinal motility is not clinically important in most colic cases and should not discourage use of these very useful drugs.

### Opiates

**Opiates**, including butorphanol, meperidine (pethidine), morphine and pentazocine, are potent analgesics useful in the management of abdominal pain in the horse. These drugs are often combined with an alpha-2 agonist. Morphine and meperidine can cause excitement or urticaria in some horses. All are drugs with the potential for human abuse and the consequent limitation on their availability limits their use in horses.

### Other agents

**Acetylpromazine** has almost no analgesic properties, although it is a potent sedative, and should not be used in the routine treatment of colic. Acetylpromazine is a potent hypotensive agent and should not be administered to any horse that is dehydrated or has compromised cardiovascular function.

**Hyoscine butylbromide**, a parasympatholytic drug, is widely used in certain parts of the world as the drug of choice in the initial treatment of field cases of colic. It is often combined with dipyron and is effective in the field treatment of mild, uncomplicated colic.

**Atropine** causes gastrointestinal stasis in horses and should not be used in the routine treatment of colic.<sup>48</sup>

**Lidocaine** (Table 5.7) is a potent analgesic when administered systemically, but must be given by constant intravenous infusion. Overdosing results in central nervous system excitement.

### Prophylaxis and treatment of endotoxemia

Treatment of endotoxemia has been recently reviewed.<sup>49</sup> Administration of plasma from horses **hyperimmunized** with *Salmonella typhimurium* or *E. coli* reduces the severity of clinical signs and shortens the duration of disease in horses with endotoxemia secondary to enterocolitis or colic.<sup>50</sup> **Polymyxin** (5000 IU/kg intravenously every 8–12 h) attenuates the effect of endotoxin in experimental disease and is used for the prevention and treatment of endotoxemia in hospitalized horses.<sup>51</sup> Its efficacy in clinical settings has not been determined. **Aspirin** (10 mg/kg orally every 48 h) is administered to diminish platelet aggregation around intravenous catheters. **Flunixin meglumine** (1 mg/kg intravenously every 8–12 h) or **phenylbutazone** (2.2 mg/kg intravenously every 12 h) is given for analgesia and to prevent endotoxin-induced increases in plasma prostaglandins. **Pentoxifylline** (8 mg/kg orally every 8 h) is administered for its putative effective in attenuating the effects of endotoxemia. The efficacy of these treatments in a clinical setting and their effect on measures of outcome of disease, such

Table 5.6 Differential diagnosis of noninfectious colic

	Epidemiology and history	Clinical findings	Clinical pathology	Response to treatment
Acute gastric dilatation	Feeding on grain or whey. Outflow obstruction. Lipoma at pylorus.	Acute severe pain, gut sounds negative, rectal negative. Voluminous reflux through nasogastric tube and relief of pain. Regurgitation	Depends on underlying disease. No diagnostic changes	Good to relief of gastric distension. Prognosis guarded and depends on underlying disease
Acute obstruction and infarction of small intestine	Reflux with proximal enteritis Sporadic	Acute, severe intractable pain, no gut sounds, rectal exam reveals distended loops small intestine, tight bands of mesentery at 12 h. No feces after 12 h. Nasogastric reflux	Hypovolemia. Toxemia late in disease. PCV more than 50% after 12 hours. Blood-tinged peritoneal fluid	Pain intractable. Surgical correction
Acute obstruction of large intestine	As above	As above except abdomen visibly distended. Rectal exam impeded by large loops of distended large colon	As above	As above
Ileocecal valve impaction	Feed includes finely chopped oat straw, or sorghum, Sudan grass, coastal Bermuda grass. Infestation with <i>A. perfoliata</i>	Subacute pain for 24 hours as small intestine descends. Then as for small intestinal obstruction. Impaction palpable rectally	PCV normal first 24 h. No characteristic changes	Medical therapy initially, then surgery for refractory cases
Spasmodic/tympenic colic	Sporadic. Increased incidence with poor worm control	Acute moderate pain but heart rate up to 80. Loud and gassy gut sounds. Rectal exam and feces normal, recovers spontaneously, lasts only 1-2 h	Normal	Xylazine, detomidine, butorphanol, hyoscine all effective. Mineral oil orally
Impaction of large intestine	Old horse, debilitated, poor teeth, indigestible feed. Inadequate access to water. Excessive consumption of low-energy grass	Moderate pain, depressed or absent gut sounds, rectally long columns of dry hard fecal material, distinct from individual balls	Normal	Responds well to standard analgesics, mineral oil, fecal softeners and fluid therapy
Vermineous mesenteric arteritis (thromboembolic colic)	Poor worm control. Rare	Subacute pain continues for 3-4 d. No gut sounds. Rectally slightly distended loops; paralytic ileus	Slight leukocytosis and shift to left. Paracentesis yields bloody fluid	Irreversible even if surgery performed. Prevention - adequate parasite control
Enteroliths, colonic foreign bodies, phytozoars	Endemic in some areas	Subacute or recurrent colic of moderate severity only. Masses palpable in small colon	No changes	Surgery only
Subacute obstruction of small intestine (adhesions neoplasm, idiopathic muscular hypertrophy of ileum, etc.*	History of recurrent moderate or persistent mild colic	Moderate pain. Distended loops of small intestine on rectal exam. Point of obstruction may be palpable. Gut sounds normal to loud	No changes	Excellent to surgery
Sand colic	Access to polluted feed. Grazing on sandy country when feed sparse. Salt deficiency or boredom leading to soil-eating or licking Mostly on succulent green feed. Some secondary to physical obstruction of large intestine Sporadic	May be severe pain with acute impaction or chronic mild pain, often with intermittent bouts of diarrhea. May palpate impacted loops containing sand. Auscultate sand in ventral abdomen. Radiography. Ultrasonography Severe acute pain. Visibly distended abdomen. Loud gut sounds present early. Rectal exam difficult because of size of loops	Normal. Mixture of feces and water allowed to stand shows heavy sand sediment	Analgesia and psyllium orally. Prevent ingestion sand
Flatulent colic			Not recorded	Trocarization through right flank or exploratory laparotomy if time and analgesia not successful
Dorsal displacement left colon (nephrosplenic ligament entrapment)		Intractable moderate pain continues for days. Pelvic flexure of colon missing, spleen displaced medially	No changes	Rolling of anesthetized patient to replace colon very successful. Jogging with or without administration of phenylephrine
Small intestine or colon strangulation by lipoma	Only horses older than 10 years Sudden onset	Sudden onset moderate pain without toxemia. May be palpable per rectum	No changes No changes	Surgery

The clinical picture varies with time: descriptions relate to clinical signs at 12-24 h of illness.

\*Chronic intussusception, terminal ileal hypertrophy, constructive adhesions, Meckel's diverticulum, fibroma at the root of the mesentery

Table 5.7 Analgesics and spasmolytics for use in equine colic

Drug class	Drug	Dose	Comments
NSAIDs	Flunixin meglumine	0.25–1.0 mg/kg, IV or IM every 8–24 h	Potent analgesic for up to 12 h. May mask signs of surgical disease
	Ketoprofen	2.2 mg/kg, IV every 12 h	Potent analgesic for up to 12 h
	Phenylbutazone	2.2–4.4 mg/kg, IV or PO every 12 h	Weak analgesic for gastrointestinal pain. Minimal effect on motility
	Dipyrone	10 mg/kg, IV or IM every 4–6 h	Weak analgesic. Often combined with hyoscine in commercial preparations (Buscopan compositum)
Opiates	Butorphanol	0.025–0.1 mg/kg, IV or IM as required	Potent analgesia for 30–90 min. Safe. Often combined with an alpha-2 agonist. May cause ataxia
	Meperidine (pethidine)	0.2–2.0 mg/kg, slowly IV or IM as required	Moderate analgesia for 0.5–4 h. Can cause excitement and/or ataxia
	Pentazocine	0.5–1.0 mg/kg, IV or IM as required	Moderate analgesia. May cause ataxia
Alpha-2 agonists	Morphine sulfate	0.05–0.01 mg/kg slowly IV or IM as required	Potent analgesia. Can cause excitement
	Xylazine	0.1–1.0 mg/kg, IV or IM, as needed	Potent analgesia and sedation for up to 30 min. Decreases intestinal motility. Often combined with butorphanol
	Detomidine	10–40 µg/kg, IV or IM as needed	Potent analgesia and sedation for up to 120 min
	Romifidine	0.04–0.08 mg/kg, IV or IM	Potent analgesia and sedation
	Medetomidine	0.01–0.02 mg/kg, IV or IM.	Potent analgesia for up to 120 min. Sedation
Spasmolytics	Atropine	0.01–0.04 mg/kg IV or IM	Do not use because of induction of ileus
	Hyoscine butylbromide	0.1–0.4 mg/kg, IV or IM every 6–12 h	Reduces gastrointestinal motility. Mild analgesic. Often combined with dipyrone
Other	Acetylpromazine	0.02–0.04 mg/kg, IV or IM every 6–24 h	No analgesia but marked sedation. Potent hypotensive agent. Do not use
	Lidocaine	1.5 mg/kg IV loading dose followed by 0.05 (mg/kg)/min IV infusion	Substance P inhibitor. Analgesic, anti-inflammatory, promotility agent

IM, intramuscularly; IV, intravenously; NSAIDs, nonsteroidal anti-inflammatory drugs; PO, orally.

as duration of illness, case fatality rate or incidence of complications, has not been determined, with the exception of hyper-immune plasma or serum.<sup>50</sup>

**Antibiotics** are often administered to horses with severe colic and evidence of toxemia because of presumed bacteremia. The antibiotics of choice should have a broad spectrum including Gram-negative and positive and anaerobic bacteria. A suitable regimen includes an aminoglycoside and a penicillin, possibly combined with metronidazole. NSAIDs are administered to prevent the increased production of prostaglandins induced by endotoxin and the associated clinical abnormalities including fever, malaise and tachycardia. However, the effect of NSAIDs in improving survival or shortening the duration of treatment has not been demonstrated.

#### Fluid and electrolyte therapy

Horses with evidence of dehydration, compromised cardiovascular function or electrolyte imbalances should be administered fluids intravenously, preferably a balanced, isotonic, polyionic fluid such as lactated Ringer's solution. Horses with severe colic and signs of cardiovascular collapse may require urgent resuscitation by intravenous administration of large quantities of fluids or administration of hypertonic saline followed by

administration of isotonic fluids. Horses with hypoproteinemia may benefit from administration of plasma or colloidal fluids such as hetastarch. (See Chapter 2 for details on fluid therapy and the section on Shock for a discussion of the treatment of this syndrome.)

#### Intestinal lubricants and fecal softeners

The intestinal lubricant of choice is **mineral oil** (Table 5.8). It should be given only through a nasogastric tube as its aspiration is associated with severe and usually fatal pneumonia. Mineral oil is useful in cases of mild impaction colic and is often administered when the cause of the colic is not known, provided that there is no reflux of gastric contents through the nasogastric tube.

**Diocetyl sodium sulfosuccinate** (DSS) is a fecal softener with the potential to be toxic at therapeutic doses and its use is now not generally recommended.<sup>52</sup>

**Magnesium sulfate** is an effective fecal softener useful in the treatment of impaction colic.<sup>52</sup> However, it can cause hypermagnesemia and toxicity characterized by depression and signs of central nervous system dysfunction.<sup>53</sup> **Sodium sulfate** is a safe and effective fecal softener, although it may induce mild hyponatremia and hypokalemia.<sup>54</sup>

Other treatments

**Promotility agents** (Table 5.8) may be

used in cases of ileus or large colon impaction. Postoperative ileus is a common complication of surgical colic and should be treated by maintenance of hydration and electrolyte status and administration of promotility agents.<sup>55</sup> **Cisapride** is apparently effective in reducing the incidence of postoperative ileus and may be useful in the treatment of ileus of other cause.<sup>56</sup> The clinical efficacy of other putative promotility agents has not been demonstrated.

**Heparin** and low-molecular-weight heparins have been recommended for the treatment and prevention of coagulopathies associated with severe colic.<sup>21</sup> The use of heparin or low-molecular-weight heparin is associated with increased risk of hemorrhage and heparin use causes a decrease in hematocrit.<sup>21</sup> The efficacy of this treatment in improving survival has not been demonstrated.

#### Trocarization

Occasionally in severe cases of flatulent (gas) colic or in cases of colon torsion in which the abdominal distension is impairing respiration, it may be necessary to relieve the gas distension of the colon or cecum by trocarization. Trocarization is usually performed through the **right paralumbar fossa** immediately caudal to the last rib. The exact place for trocarization can be located by simultaneous flicking

Table 5.3 Promotility agents, lubricants and fecal softeners for use in horses with colic

Drug group	Drug	Dose	Comments
Lubricants	Mineral oil	10–15 mL/kg, via nasogastric tube, every 12–24 h	Safe. Lubricant only, does not soften feces. Usually passed in 12–36 h*
Fecal softeners	Diocetyl sodium sulfosuccinate (DSS)	12–25 mg/kg, via nasogastric tube, every 24 h	No more than 2 doses. Toxic at higher doses*
	Magnesium sulfate	0.5–1.0 g/kg, via nasogastric tube, in water	Osmotic cathartic. Toxic (CNS signs due to hypermagnesemia) with repeated dosing*
	Sodium sulfate	1.0 g/kg, via nasogastric tube, in water, every 12 h	Osmotic cathartic. Mild hypernatremia. Safe*
Promotility agents	Psyllium	1 g/kg, orally, every 24 h	Bulk laxative. Used for treatment of sand accumulation. Efficacy uncertain but widely used*
	Lidocaine	1.5 mg/kg slow IV, then 0.05 mg/kg infusion	Analgesic, anti-inflammatory, promotility. Used to treat ileus. Toxicity evident as CNS signs
	Metoclopramide	0.25 mg/kg IV slowly over 30 min every 12 h	Toxic. Minimally effective
	Erythromycin	0.1 (mg/kg)/h IV	Questionable efficacy. May induce colitis
	Cisapride	0.1 mg/kg, IV every 8 h	Effective in prevention and treatment of postoperative ileus. May prolong cardiac Q–T interval (importance unknown)
	Neostigmine	0.02 mg/kg, IM or SC, every 8–12 h	Increases large-colon motility, decreases small-intestine motility. May cause colon rupture around hard impaction

\*None of these agents should be given if there is reflux through the nasogastric tube. CNS, central nervous system; IM, intramuscularly; IV, intravenously; SC, subcutaneously.

the body wall with a finger and listening with a stethoscope. The area of loudest ping will indicate the point of insertion of the trocar. A suitable trocar is a 12.5–15 cm 14–16-gauge needle. The needle is inserted through the skin and advanced into the abdomen until there is an audible expulsion of gas through the trocar. The trocar should be kept in position as long as gas is escaping. It may need to be replaced as the bowel is decompressed and moves away from the trocar. The procedure is reasonably safe but will cause inflammatory changes in the peritoneal fluid. The major danger is laceration of the colon or cecum and leakage of ingesta. It is advisable to administer systemic antibiotics to horses that have been trocarized.

### Management of field colic

Initial treatment of field cases of colic that do not have signs indicative of the need for referral or surgery usually includes administration of an analgesic and an intestinal lubricant. Analgesics suitable for the initial treatment of colic in the field are an alpha-2 agonist, such as xylazine, hyoscine butylbromide, dipyrrone, butorphanol or phenylbutazone. If there is no reflux through the nasogastric tube, then mineral oil should be administered. Fluids should be administered intravenously if there are signs of dehydration, cardiovascular compromise or electrolyte imbalance. The response to this therapy should be monitored as described under Protocol for evaluating a colic patient. Further doses of analgesic can be given as required and the horse should be monitored for any evidence of deterioration. If referral is contemplated, the

referral institution should be contacted for advice on analgesia during transportation. Horses should be transported with a nasogastric tube in place.

### Surgery

The only definitive treatment for many causes of equine colic is surgical correction or removal of the lesion. The availability of surgical facilities staffed by appropriately trained personnel has increased over the past two decades and there is often the opportunity to refer horses for examination by personnel with specialist training. Gastrointestinal surgery should not be attempted by those untrained or inexperienced in the necessary techniques or without the facilities to provide postoperative care.

The decision to perform an exploratory laparotomy on a horse with colic is based on a number of factors, including the provisional diagnosis, findings on physical and laboratory examination and degree of pain. Horses with severe pain refractory to treatment with analgesics should have an exploratory laparotomy even if no other significant abnormalities can be detected. Algorithms for the decision to perform surgery have been developed, but are not perfect and do not replace the opinion of an appropriately trained and experienced examiner.<sup>40</sup> Examination of peritoneal fluid contributes to the decision to perform surgery.<sup>36</sup> The survival rate for horses undergoing surgical correction of lesions depends on the nature and location of the underlying disease and its duration.<sup>57</sup> However, survival rates range from 50–75%, with approximately two thirds of horses returning to their intended use.<sup>58–60</sup> The

survival rate of horses with small-intestinal lesions is less than that of horses with large-intestinal disease, and the survival rate for horses with strangulating disease is much less than that of horses with nonstrangulating disease.<sup>58</sup>

### Prevention

Minimization of colic episodes depends on management factors, including ensuring adequate parasite control, feeding large quantities of forage and minimizing the amount of concentrate fed, and providing dental care. However, most cases of colic not attributable to parasites or dietary factors cannot be prevented.

### REVIEW LITERATURE

- Johnston M. Equine colic – to refer or not to refer. In *Pract* 1992; 14:134–141.
- Hay WP, Moore JN. Management of pain in horses with colic. *Compend Contin Educ Pract Vet* 1997; 19:987–990.
- Singer ER, Smith MA. Examination of the horse with colic: is it medical or surgical? *Equine Vet Educ* 2002; 14:87.
- Cohen ND. Colic by the numbers. *Equine Vet J* 2003; 35:343.

### REFERENCES

- Traub-Dargatz JL et al. *J Am Vet Med Assoc* 1991; 198:1745.
- Tinker MK et al. *Equine Vet J* 1997; 29:448.
- Traub-Dargatz JL et al. *J Am Vet Med Assoc* 2001; 219:67.
- Kaneene JB et al. *Prev Vet Med* 1997; 30:23.
- Proudman CJ. *Equine Vet J* 1991; 24:90.
- Cohen ND et al. *J Am Vet Med Assoc* 1999; 215:53.
- Uhlinger C. *Equine Vet J* 1990; 22:251.
- Hillyer MH et al. *Equine Vet J* 2001; 33:380.
- Goncalves S et al. *Vet Res* 2002; 33:641.
- Cohen ND. *Equine Vet J* 2003; 35:343.
- Tinker MK et al. *Equine Vet J* 1997; 29:454.
- Freeman DE et al. *J Am Vet Med Assoc* 2001; 219:87.

13. Hudson JM et al. *J Am Vet Med Assoc* 2001; 219:1419.
14. Reeves MJ et al. *J Prevent Med* 1996; 26:285.
15. Cohen ND et al. *J Am Vet Med Assoc* 1995; 206:667.
16. Proudman CJ et al. *Equine Vet J* 1998; 30:194.
17. Barton MH et al. *J Vet Intern Med* 1999; 13:457.
18. Prasse KW et al. *J Am Vet Med Assoc* 1993; 203:685.
19. Monreal L et al. *Equine Vet J Suppl* 2000; 32:19.
20. Fiege K et al. *J Vet Med A* 2003; 50:30.
21. Fiege K et al. *Equine Vet J* 2003; 35:506.
22. Blikslager AT, Roberts MC. *J Am Vet Med Assoc* 1995; 207:1444.
23. Freeman S. *In Pract* 2002; May:262.
24. Klohnen A et al. *J Am Vet Med Assoc* 1996; 209:1597.
25. Pease AP et al. *Vet Radiol Ultrasound* 2004; 45:220.
26. Collatos C et al. *J Vet Intern Med* 1995; 9:18.
27. Garcia-Lopez JM et al. *Am J Vet Res* 2001; 62:7.
28. Van der Kolk JH et al. *Equine Vet J* 2002; 34:528.
29. Johansson AM et al. *J Vet Intern Med* 2003; 17:860.
30. Gardner RB et al. *J Vet Intern Med* 2005; 19:761.
31. Saulez M et al. *J Vet Intern Med* 2004; 18:564.
32. Nieta JE et al. *Am J Vet Res* 2005; 66:223.
33. Hinchcliff KW et al. *J Am Vet Med Assoc* 2005; 227:276.
34. Nappert G, Johnson PJ. *Can Vet J* 2001; 42:703.
35. Bristol DG. *J Am Vet Med Assoc* 1982; 181:63.
36. Matthews S et al. *Aust Vet J* 2002; 80:132.
37. Edwards GB. *Equine Vet Educ* 1991; 3:19.
38. Baxter GM. *Vet Med* 1992; 87:1012.
39. Reeves MJ et al. *Am J Vet Res* 1991; 52:1903.
40. Thoenes MB et al. *Can Vet J* 2003; 67:20.
41. Parry BW et al. *Equine Vet J* 1983; 15:211.
42. Puotunen-Reinert A. *Equine Vet J* 1986; 18:275.
43. Furr MO et al. *Vet Surg* 1995; 24:97.
44. Reeves MJ et al. *Prev Vet Med* 1990; 9:241.
45. Merritt AM et al. *Am J Vet Res* 2002; 63:1006.
46. Tomlinson JE et al. *Am J Vet Res* 2004; 65:761.
47. Freeman DE et al. *Am J Vet Res* 1997; 58:915.
48. Sykes BW, Furr MO. *Aust Vet J* 2005; 83:45.
49. Ducharme NG, Fubini SL. *J Am Vet Med Assoc* 1983; 182:229.
50. Spier SJ et al. *Circ Shock* 1989; 28:235.
51. Barton MH et al. *Equine Vet J* 2004; 36:397.
52. Freeman DE et al. *Am J Vet Res* 1992; 53:1347.
53. Henninger RW, Horst J. *J Am Vet Med Assoc* 1997; 211:82.
54. Lopes MAF. *Am J Vet Res* 2004; 65:695.
55. Hoogmoed LM. *Vet Clin North Am Equine Pract* 2003; 19:729.
56. Velden MA, Klein WR. *Vet Q* 1993; 15:175.
57. Van der Linden MA et al. *J Vet Intern Med* 2003; 17:343.
58. Phillips TJ, Walmsley JP. *Equine Vet J* 1993; 25:427.
59. Hunt JM et al. *Equine Vet J* 1986; 18:264.
60. Blikslager AT et al. *J Am Vet Med Assoc* 1994; 205:1748.

## COLIC IN THE PREGNANT AND POSTPARTURIENT MARE

Diagnosis and management of colic in pregnant and immediately postparturient mares is challenging because of the variety of conditions that can cause the disease, the difficulty in examination of intra-abdominal organs in late term mares and concern about the viability of the fetus. There are also substantial technical challenges in surgical correction of abnormalities of either the gastrointestinal tract or reproductive tract in the

presence of a gravid uterus. Colic in late term mare can be caused by any of the causes of colic in adult horses (Table 5.4) but some disorders occur more commonly in late term mares and in addition abnormalities of the reproductive tract can cause signs of colic. Causes of colic in the late term mare include:<sup>1-3</sup>

- Idiopathic, chronic or recurrent, low-grade colic
- Large colon torsion
- Large colon impaction
- Incarceration of small intestine through a mesenteric rent
- Rupture of the cecum or colon
- Uterine torsion
- Uterine rupture
- Middle uterine or utero-ovarian artery rupture
- Abdominal wall hernia
- Diaphragmatic hernia
- Dystocia
- Hydrops
- Imminent foaling.

A common presentation of colic in late term mares is chronic or recurrent, low-grade abdominal pain that is not associated with any signs of compromised cardiovascular or gastrointestinal function. It is assumed that the large gravid uterus interferes with normal motility or positioning of bowel, with subsequent pain. Severe colic in late term mares is rarely associated with the uterus, with the exception of uterine torsion.

Colic in immediately post-parturient mares (< 24 h after foaling) include:<sup>1-3</sup>

- Cramping associated with uterine contractions and involution, often coincident with nursing or administration of oxytocin
- Rupture of the cecum or colon
- Incarceration of the small intestine through a mesenteric rent
- Rupture of the mesocolon with segmental ischemia of the small colon
- Rectal prolapse
- Uterine tear, with or without prolapse of intestine
- Uterine prolapse
- Inversion of uterine horn
- Bladder prolapse through urethra
- Hemorrhage from uterine or utero-ovarian artery
- Retained fetal membranes
- Uroperitoneum, usually secondary to rupture of the bladder.

Colic in postparturient mares that is anything more than transient and associated with passage of placenta or nursing of the foal should be considered important and the mare should be examined closely and, if the colic does not resolve, repeatedly.

**Survival rates** for colic associated with anatomical abnormalities in late

term or postparturient mares is 50% and 30%, respectively.<sup>3</sup>

**Clinical examination** of late-term or postparturient mares with colic uses the same principles as apply to examination of nonpregnant adult horses with colic. Monitoring of vital signs, passage of a nasogastric tube, rectal examination and collection of peritoneal fluid should all be performed as indicated. However, the presence of a gravid uterus in late-term mares impairs rectal examination of the abdomen and often makes collection of peritoneal fluid impossible. Manual and visual, through a speculum, examination of the vagina and cervix should be performed.

**Rectal examination** should be performed and careful attention should be paid to examination of the uterus, including position and viability of the fetus, and broad ligaments. Uterine torsion can be detected by examination of the broad ligaments, which in mares with uterine torsion will be taut and spiral in the direction of the torsion. Hemorrhage into the broad ligament, which can extend into the uterus and perivaginal regions, is detectable as swelling in these structures. Additionally, affected mares will have signs of hemorrhagic shock, including tachycardia, sweating and pallor of mucous membranes. Palpation of gastrointestinal structures per rectum is limited in the late-term mare, although the cecum and small colon should be palpable. The spleen and left kidney can be palpated in almost all normal late-term mares.

The reduced uterine size in postparturient mares permits more thorough per rectum examination of the caudal abdomen. Again, careful attention should be given to palpation of the uterus and associated structures for evidence of hemorrhage, prolapse or rupture. **Rectal prolapse** and eversion of the small colon in a postparturient mare is an ominous finding as it is usually associated with rupture of the mesocolon and ischemic necrosis of the small colon, a condition that is almost always fatal. Prolapse of small amounts of anal or perirectal tissue is not a serious concern.

The **abdominal silhouette** should be examined for evidence of abdominal distension, such as can occur with colon torsion or uterine hydrops, and abnormalities in contour caused by rupture of the prepubic tendon and herniation of abdominal contents.<sup>4</sup>

**Vaginal and cervical examination** can reveal discharge associated with impending abortion or parturition. Vaginal examination for uterine torsion is of limited value as the torsion almost always occurs cranial to the cervix so that, unlike the cow, the torsion is not apparent as

deformation of the cervix. Manual examination of the vagina, cervix and uterus of postparturient mares with colic is important to detected uterine, cervical and vaginal trauma, uterine inversion and retained fetal membranes.

**Ultrasonographic examination** of the abdomen in the late-term mare, both per rectum and percutaneously, allows examination of structures not palpable per rectum. The presence and any abnormalities in structure, location and motility of bowel should be noted. For example, small-intestinal distension caused by entrapment through a mesenteric rent may not be palpable per rectum but can be imaged. Peritoneal fluid should be examined for quantity and echogenicity. Intra-abdominal hemorrhage caused by uterine artery rupture is evident as large quantities of echogenic fluid that has a characteristic swirling pattern similar to turbulent blood flow imaged ultrasonographically in the cardiac ventricles of some horses. The position, number and viability of the fetus or fetuses should be ascertained. The nature of allantoic fluid should be noted.

Collection of **peritoneal fluid** from late-term mares can be difficult because of contact between the gravid uterus and the ventral abdominal wall. Ultrasonographic examination can be useful in locating pockets of fluid for collection. Collection of peritoneal fluid is more readily accomplished in the postpartum mare. Peritoneal fluid from late-term and postpartum mares, even those with assisted vaginal delivery, should have protein and cell concentrations within the reference range of normal horses.<sup>5,6</sup> Abnormalities in peritoneal fluid in late-term or postparturient mares should be considered to be indicative of intra-abdominal disease.<sup>6</sup>

The **differential diagnosis** of colic is similar to that of nonpregnant horses except as indicated above.

**Treatment** of colic depends on its cause. Horses with low-grade to moderate, recurrent colic respond to administration of low doses of NSAIDs, mineral oil or fecal softeners.

The **risk of abortion** in mares with colic is partially dependent on the severity of colic and especially the presence of toxemia.<sup>1,2,7</sup> Severely ill mares with signs of toxemia have abortion rates of almost 70%<sup>7</sup> while mares with less severe disease have abortion rates of 12–18%, which is not markedly different from the rate in mares without colic.<sup>3</sup> Approximately 40% of mares with uterine torsion abort.<sup>1</sup>

## REVIEW LITERATURE

Steel CM, Gibson KT. Colic in the pregnant and postparturient mare. *Equine Vet Educ* 2001; 13:94.

## REFERENCES

- Boening KJ, Leendertse IP. *Equine Vet J* 1993; 25:518.
- Santschi EM et al. *J Am Vet Med Assoc* 1991; 199:374.
- Steel CM, Gibson KT. *Equine Vet Educ* 2001; 13:94.
- Hanson RR, Todhunter RJ. *J Am Vet Med Assoc* 1986; 189:790.
- Van Hoogmoed L et al. *J Am Vet Med Assoc* 1996; 209:1280.
- Frazer GS et al. *Theriogenology* 1997; 48:919.
- Slone DE. *Compend Contin Educ Pract Vet* 1993; 15:117.

## COLIC IN FOALS

### Synopsis

**Etiology** See Table 5.9

**Epidemiology** Sporadic. Some are congenital, others heritable. Inguinal and scrotal hernias occur only in males

**Clinical signs** Abdominal pain evidenced by kicking at the abdomen, flank-watching, repeated tail movements as if chasing flies, repeated aborted attempts to suck, frequent lying down and standing within a short period, rolling and lying in dorsal recumbency. Abdominal distension in some diseases and straining to defecate with meconium impaction. Radiography and ultrasonography are useful in identifying affected bowel

**Clinical pathology** None diagnostic

**Lesions** Of the causative disease

**Diagnostic confirmation** Physical examination, radiography, ultrasonography, laparotomy, necropsy

**Treatment** Pain control, fluid therapy, treatment of causative disease

## ETIOLOGY

Diseases that cause colic in horses less than 1 year of age include both congenital and acquired conditions and are listed in Table 5.9.

## EPIDEMIOLOGY

The congenital conditions are discussed under those headings in Chapter 34, but it is notable that some, such as **ileo-colonic aganglionosis** in white progeny of Overo spotted horses, are clearly heritable. Other conditions occur sporadically, although **meconium impaction** is more common in colt foals and occurs only in the newborn foal, **intussusceptions** are most common in foals of 3–5 weeks of age and particularly those with diarrhea or extraintestinal illness, and impaction of the small colon by **fecaliths** is common in miniature horse foals.<sup>3,4</sup> **Inguinal and scrotal hernias** occur only in male foals.<sup>5</sup>

Among neonatal Thoroughbred foals 50% of foals subjected to exploratory laparotomy had nonstrangulating lesions and 30% had enteritis.<sup>6</sup> Among foals 2 weeks to 6 months of age, 30 of foals

subjected to exploratory laparotomy had gastric ulcer disease, 27% strangulating lesions, 21% nonstrangulating lesions and 17% enteritis.<sup>6</sup>

## PATHOPHYSIOLOGY

The pathophysiology of colic in foals does not differ qualitatively from that of adult horses (see Equine colic, above). The importance of pain, gastrointestinal distension, motility and absorptive disturbances and loss of barrier function are all similar in foals and adults. Additionally, in young foals gastrointestinal disease may prevent nursing and ingestion of colostrum, causing failure of transfer of passive immunity to the foal. Failure to nurse also results in hypoglycemia and dehydration, which may exacerbate the abnormalities induced directly by the disease causing colic.

## CLINICAL FINDINGS

Pain is the cardinal feature of gastrointestinal disease of foals. Foals with mild **abdominal pain** are apprehensive and walk continuously with frequent but brief (< 1 min) periods of sternal or lateral recumbency. Affected foals make frequent attempts to nurse but do not continue to suckle and may butt the mare's udder even though there is let-down of milk. The foal vigorously moves its tail as if chasing flies, looks at the abdomen and may nip at its flanks. There are often frequent attempts to urinate or defecate but without passage of significant quantities of urine or feces. Severely affected foals will roll, often violently, and may spend considerable periods of time in dorsal recumbency, often propped up against walls or fences.

Severely affected foals are **tachycardic** (> 100/min) and **tachypneic** (< 40/min) (recall that young foals have higher heart and respiratory rates and rectal temperature than do older foals and adults). **Mucous membrane color** and **capillary refill time** are similar to that of adult horses, and changes can be interpreted in the same manner as for adults.

The **external abdomen** should be examined closely for the presence of inguinal, scrotal or umbilical hernias. Abdominal distension in foals can be the result of large-colon or small-intestinal distension (or uroperitoneum), although the abdominal distension is greater with large-colon distension. Abdominal circumference should be monitored frequently by direct measurement to detect changes in the degree of abdominal distension.

**Auscultation** of the abdomen may reveal increased or decreased borborygmi and, if there is gas distension of the large colon or cecum, pinging sounds on simultaneous flicking and auscultation of the abdomen.

Table 3.9 Diseases causing colic in foals

Congenital anomalies	Anal atresia	
	Colonic atresia	
	Rectal atresia	
	Ileocolonic agangliosis	
	Myenteric hypogangliosis	
	Inguinal hernia	
	Diaphragmatic hernia	
	Umbilical hernia	
	Scrotal hernia	
	Gastrointestinal obstruction with or without infarction	Meconium impaction
		Ileus, secondary to extraintestinal disease including neonatal hypoxia
		Small-intestinal volvulus
		Large-intestinal volvulus
		Intussusception
		Jejuno-jejunal
		Ileocecal
		Small colon obstruction
		Fecalith
Impaction		
Meconium		
Entrapment in hernia, mesenteric rents		
Large colon obstruction		
Impaction		
Intussusception		
Torsion		
Necrotizing enterocolitis		
Adhesions		
Colonic stricture		
Ileal impaction – foreign body		
Ascarid impaction – small intestine		
Other	Phytobezoar	
	Gastric ulcer	
	Duodenal ulcer	
	Abdominal abscess	
	Umbilical abscess	
	Peritonitis	
	Tyzzler's disease ( <i>Clostridium piliforme</i> ) <sup>1</sup>	
	Uroperitoneum	
	Enteritis	
	Ovarian torsion <sup>2</sup>	

**Rectal examination** in foals is limited to exploration of the rectum with one or two fingers. The presence or absence of feces should be noted. Lack of fecal staining of the rectum suggests a complete obstruction such as intestinal agenesis.

**Nasogastric intubation** should be performed. The presence of more than 300 mL of reflux in a foal is significant and suggestive of gastric dilatation secondary to an outflow obstruction or regurgitation of small intestinal fluid into the stomach because of a small intestinal obstruction.

Meconium is usually passed within the first 10–12 hours (usually 3 hours) after birth. **Retention of meconium** is evident as signs of colic and the presence of firm meconium in the rectum. Palpation of the caudal abdomen may reveal firm material in the small colon. Enemas (see under Treatment, below) usually provide rapid relief and confirmation of the diagnosis.

#### Ancillary diagnostic tests

Diagnostic imaging<sup>7</sup>

**Radiography** is useful in the evaluation of foals with colic although it seldom

provides a definitive diagnosis, with the possible exception of meconium impaction and contrast studies of foals with lesions of the small or large colon, or gastric outflow obstructions.<sup>8,9</sup> **Retrograde contrast radiography** of the lower gastrointestinal tract of foals less than 30 days old is a sensitive technique for detection of anatomic anomalies such as **atresia coli** and obstruction of the **small colon**.<sup>9</sup> The technique is performed by the intrarectal infusion of up to 20 mL/kg of barium sulfate (30% w/v) in sedated, laterally recumbent foals. **Meconium impaction** may be evident as a mass of radio-opaque material in the caudal abdomen with accumulation of fluid and gas oral to the obstruction. Upper gastrointestinal contrast radiography is useful to detect abnormalities of the stomach and small intestine, in particular gastric outflow obstructions.<sup>10</sup>

**Ultrasonographic examination** of the foal abdomen can demonstrate intussusceptions,<sup>11</sup> the presence of excessive peritoneal fluid (such as urine or blood), edematous intestine, hernias

and colonic impaction. The presence of atonic, distended small intestine suggests the presence of ileus, possibly secondary to a small intestinal strangulating lesion. However, ultrasonographic differentiation of ileus secondary to enteritis from that accompanying a strangulating lesion is difficult.<sup>12</sup>

#### Endoscopy

**Endoscopic examination** of the stomach is indicated in any foal with recurrent or continuous mild to moderate colic, bruxism or ptyalism suggestive of gastric or duodenal ulceration. Gastrosopy reveals the presence of any ulcers and their extent and severity.<sup>12</sup>

#### CLINICAL PATHOLOGY

There are few changes detected by routine hematological or serum biochemical examination of foals with colic that provide a definitive diagnosis. However, changes in the hemogram and serum biochemical profile are useful in evaluating the physiological state of the foal and the severity of the disease. Principles used in the evaluation of these variables in adult horses apply to foals. It should be appreciated that the normal range of values for many clinical pathology variables in foals is age-dependent and markedly different from that of adult horses (see Tables 3.5, 3.6).

Profound leukopenia is more likely to be indicative of enteritis and colic secondary to ileus than of small-intestinal strangulating obstructions. Similarly, hyponatremia is uncommon with strangulating obstructions but is a common finding in foals with enteritis.

Newborn foals with colic should have the adequacy of transfer of passive immunity examined by measurement of serum immunoglobulin G concentration, or an equivalent test.

Examination of abdominal fluid is useful in the assessment of colic in foals, as it is in adults. The normal values for abdominal fluid in foals differs from that of adult horses<sup>13</sup> and white cell counts greater than 1500 cells/ $\mu$ L ( $1.5 \times 10^9$  cells/L) should be considered abnormal.

#### NECROPSY FINDINGS

The findings on necropsy examination depend on the nature of the disease.

#### TREATMENT

The principles of treatment of foals with colic are the same as those for adult horses: relief of pain, correction of fluid and electrolyte abnormalities, and treatment of the underlying disease. In addition, foals with **failure of transfer of passive immunity** should receive plasma.

Foals with gastrointestinal disease that cannot eat may require **parenteral**

### DIFFERENTIAL DIAGNOSIS

Diagnostic features of common causes of colic in foals are listed in Table 5.10. The principal differential diagnoses for gastrointestinal disease of foals with abdominal pain are:

- Enteritis due to rotavirus infection, salmonellosis intestinal clostridiosis (*Clostridium perfringens* or *Clostridium difficile* or other causes)
- Uroperitoneum
- Peritonitis
- Gastroduodenal ulcer disease

**nutrition** to insure adequate caloric intake.

**Meconium impaction** can be treated by administration of an enema of soap and warm water, commercial enema preparations or acetylcysteine. Soap and

water enemas can be administered at a rate of 5 mL/kg through a soft Foley catheter inserted into the rectum. **Acetylcysteine** (8 g in 200 mL of water with 20 g sodium bicarbonate) has the advantage of actually dissolving part of the meconium, thereby enhancing passage of the meconium. Affected foals may require analgesics to control pain, intravenous fluids to correct or prevent dehydration, oral laxatives such as mineral oil (300 mL via nasogastric tube) and plasma to correct failure of transfer of passive immunity. Surgical correction of the impaction is rarely required.

### Surgical treatment

The proportion of foals surviving varies with the disease and age of the foal. Younger foals (< 6 months of age) appear to have a worse prognosis after surgical correction of intestinal lesions than do older foals.<sup>6,14</sup> Fewer foals having surgery

for colic live to race than do their normal cohorts, although affected foals that do race have similar racing careers.<sup>6</sup> Foals with nonstrangulating lesions and enteritis are more likely to survive than foals with gastric ulcer disease or strangulating lesions.<sup>6</sup> Suckling foals are at greatest risk of development of post-operative adhesions and need for repeated celiotomy.<sup>6</sup>

### PREVENTION

Although not proven, the suspected association between diarrhea and small-intestinal surgical lesions in foals suggests that measures to reduce the incidence of enteritis in foals may reduce the incidence of colic. Adequate deworming programs that reduce or eliminate infestation with parasites should be implemented. Care should be taken when deworming foals with heavy infestations of *Parascaris equorum*, as rapid killing of the ascarids

Table 5.10 Differential diagnosis of common foal colics

Disease	History	Clinical findings	Clinical pathology	Treatment
Intestinal atresia or hypoganglionosis	White progeny of Overo horses. Otherwise sporadic. Newborn foals < 4 days old	Failure to pass feces. Abdominal distension pain	None specific	None
Small-intestinal volvulus	Any age but more common at 3–6 months. Abrupt-onset abdominal pain. Diarrhea	Severe pain. Nasogastric reflux. Abdominal distension. Ultrasonography – distended, atonic intestine. Radiography – gas and fluid distension of small bowel	Increased protein and leukocytes in abdominal fluid	Surgical. Low survival rate
Small-intestinal intussusception	Any age, but usually 3–6 weeks. Diarrhea	Severe pain, abrupt onset. Nasogastric reflux. Ultrasonography – intussusception. Radiography – gas and fluid distension of small bowel	Increased protein and leukocytes in abdominal fluid	Surgery. 40% survival rate
Ascarid impaction	More than 3 months of age. Recent history (< 3 d) of anthelmintic administration	Severe pain. Nasogastric reflux. Ultrasonography – distended, atonic bowel, ascarids	None specific	Medical therapy. Lubricants and analgesics. Surgery
Meconium impaction	Newborn. No passage of meconium. More common in males	Mild pain initially, becoming more severe. Abdominal distension. Ultrasonography – distended large colon, may see impaction. Radiography – contrast may outline impaction	None specific	Warm soapy enemas. Acetylcysteine. Mineral oil orally. Surgery for refractory cases
Large-colon torsion	Sporadic	Severe pain and abdominal distension. Ultrasonography – gas distended colon. Radiography – gas distended colon	None specific	Surgery. 20% recovery rate
Large-colon impaction	Sporadic. Poor diet, eating sand-polluted feed	Mild to moderate pain initially. Progressive abdominal distension. Ultrasonography – distended colon with impacted material	None specific	Medical treatment of lubricants, fecal softeners and analgesics. Surgery
Small-colon impaction	Common in Miniature horses	Moderate to marked pain. Lack of feces. Abdominal distension. Ultrasonography – gas distended colon. Radiography – impaction of small colon	None specific	Medical as above. Surgery
Gastroduodenal ulcer	Common in foals with other disease or stress	Usually clinically inapparent. Colic, inappetence, teeth grinding, excessive salivation, diarrhea. Gastroscopy diagnostic	None diagnostic	Antacids and antiulcer compounds (Table 5.11). Rarely surgery to correct gastric outflow obstruction



may lead to impaction and obstruction of the small intestine.<sup>14</sup>

## REVIEW LITERATURE

- Neal, HN. Foal colic: practical imaging of the abdomen. *Equine Vet Educ* 2003; 15:263-270.  
Bernard W. Colic in the foal. *Equine Vet Educ* 2004; 16:319-323.

## REFERENCES

1. St Denis KA et al. *Can Vet J* 2000; 41:491-492.
2. Valk N et al. *J Am Vet Med Assoc* 1998; 213:1454-1456.
3. Chaffin MK, Cohen ND. *Vet Med* 1995; 90:765.
4. McClure JT et al. *J Am Vet Med Assoc* 1992; 200:205.
5. Spurlock GH, Robertson JT. *J Am Vet Med Assoc* 1988; 193:1087.
6. Santischi EM et al. *Equine Vet J* 2000; 32:32-36.
7. Neal HN. *Equine Vet Educ* 2003; 15:263-270.
8. Fischer AT et al. *Vet Radiol* 1987; 28:42.
9. Fischer AT et al. *J Am Vet Med Assoc* 1995; 207:734.
10. Campbell ML et al. *Vet Radiol* 1987; 25:194.
11. Bernard WV et al. *J Am Vet Med Assoc* 1989; 194:395.
12. Chaffin MK, Cohen ND. *Vet Med* 1995; 90:770.
13. Grindem CB et al. *Equine Vet J* 1990; 22:359.
14. Vatisas NJ et al. *Equine Vet J* 1996; 28:139.

## GASTRIC DILATATION IN THE HORSE

**Etiology** Gastric outflow obstruction. Idiopathic. Ingestion of excess fluid or feedstuffs

**Epidemiology** Sporadic. No age, breed or sex predilection

**Clinical signs** Colic. Reflux from nasogastric tube. Gastric rupture, acute severe peritonitis and death

**Clinical pathology** None diagnostic. Inflammatory cells and ingesta in peritoneal fluid of horses with gastric rupture

**Diagnostic confirmation** Nasogastric reflux without other identifiable cause

**Lesions** Gastric dilatation. Gastric rupture with hemorrhage at margins of rupture

**Treatment** Gastric decompression. Treat underlying disease

**Control** Prevent overeating. Control inciting diseases

## ETIOLOGY

Chronic gastric dilatation can be caused by:

- Outflow obstruction, such as cicatricial constriction of the pylorus secondary to gastroduodenal ulceration or pressure by a tumor.<sup>1,2</sup>
- Gastric atony in older horses or wind-sucking (aerophagic) horses.

Acute gastric dilatation is associated with:

- Reflux of intestinal contents secondary to acute intestinal obstruction, e.g. anterior enteritis, small intestinal strangulation or ileus
- Ingestion of excess fluid or feedstuffs such as whey or grain
- Acute idiopathic dilatation after racing.

## EPIDEMIOLOGY

The incidence of gastric rupture, the most severe sequela to gastric dilatation, in horses with colic is approximately 5%, although in horses subjected to exploratory laparotomy the rate may be as high as 11%.<sup>3,4</sup> There is no detectable effect of age, breed or season on the risk of gastric rupture. Risk factors for gastric dilatation include consumption of excess grain, although horses routinely fed grain are at lower risk;<sup>3</sup> ingestion of palatable fluids such as whey has been implicated. **Acute idiopathic dilatation** of the stomach occurs sporadically and is a common cause of gastric rupture, representing between 16% and 60% of cases of gastric rupture.<sup>3,4</sup> **Chronic dilatation** secondary to pyloric obstruction due to a tumor is a sporadic occurrence in older horses,<sup>4</sup> whereas cicatricial obstruction secondary to gastroduodenal ulceration is more common in younger horses and those at risk of developing gastroduodenal ulcers.

Acute dilatation occurs secondarily to acute obstruction of the small intestine.

## PATHOGENESIS

Acute obstruction results in gastric dilatation associated with severe pain and signs of shock, including elevated heart rate, sweating and delayed mucosal capillary refill time. Gastric rupture can occur within hours and death shortly thereafter. Chronic dilatation results from partial obstruction and delayed gastric emptying. The disease is more prolonged and clinical signs may be related to the primary disease.

The obstruction may be as aboral as the ileocecal valve. Gastric distension with fluid also occurs late in the course of impaction of the large or small colon, and in cases of large intestinal volvulus. The accumulation of fluid in these cases appears to be in response to tension on the duodenocolic fold.<sup>5</sup>

Gastric distension causes severe pain and there is often dehydration and hypochloremia as a result of sequestration of gastric secretions. Ingestion of material that putrefies and damages gastric mucosa may result in toxemia and development of associated signs of shock.

Engorgement of a readily fermentable carbohydrate, such as wheat, glucose or calf feeds, results in a syndrome characterized by shock, ileus and laminitis. Gastric dilatation can occur secondary to grain engorgement but the clinical signs of the gastric dilatation are often masked by the more severe signs secondary to endotoxemia.

## CLINICAL FINDINGS

The clinical findings in gastric distension depend in large part on the underlying

disease. However, horses with primary gastric distension have abdominal pain, often of 12-36 hours duration, that progressively worsens. The heart and respiratory rates increase progressively as the distension worsens, and the horse may sweat and exhibit signs of increasingly severe abdominal pain. Paradoxically, some horses with gastric distension, especially that which develops over several days or in horses recovering from intestinal surgery and being treated with analgesics, may not exhibit any but the most subtle signs until rupture of the stomach occurs.

**Vomition** in horses is very rare, is always associated with gastric distension and is usually a terminal event.

In **grain engorgement dilatation** abdominal pain is usually severe. Dehydration and shock develop rapidly, often within 6-8 hours of ingestion of the grain, and may be severe. Death from gastric rupture can occur within 18 hours.

**Passage of a nasogastric tube** usually results in the evacuation of large quantities of foul-smelling fluid, except in cases of grain engorgement, where the fluid is absorbed by the grain. However, significant and life-threatening gastric dilatation can be present even though there is no reflux through a nasogastric tube. If gastric dilatation is suspected then repeated, persistent efforts should be made to obtain reflux. The nasogastric tube should be left in situ until the disease has resolved.

**Acute post-race dilatation** occurring immediately after racing is accompanied by more serious and acute signs. There is abdominal distension, coughing and dyspnea. Tympany is also detectable on percussion of the anterior abdomen and large amounts of foul-smelling gas, and usually fluid, are passed via the stomach tube. This immediately relieves the animal's distress.

In **chronic dilatation** there is anorexia, mild pain, which is either continuous or recurrent, scanty feces and gradual loss of body weight persisting for a period of months. Vomiting and bouts of pain may occur after feeding but they are not usually severe. Dehydration may be present but is usually only of moderate degree.

The distended stomach cannot be palpated on **rectal examination**, but the presence of distended loops of small intestine should alert the clinician to the probability of gastric distension. Rupture of the stomach, or other viscus, is characterized during rectal examination by a negative pressure in the abdomen and the presence of particulate matter on the serosal surface of intestine.

**Ultrasonographic** examination will reveal a distended stomach containing

large quantities of fluid or ingesta and can reveal evidence of the predisposing lesion, such as presence of distended small intestine.<sup>6</sup> **Radiographic examination**, with or without a barium meal, may be of diagnostic value in young animals with chronic outflow obstruction. **Gastroscopy** performed after the stomach has been emptied can reveal lesions consistent with obstructed outflow, such as gastric squamous cell carcinoma or pyloric abnormalities secondary to gastric ulcer disease in foals.

### CLINICAL PATHOLOGY

Horses with severe gastric dilatation often, but not always, have slightly **low serum chloride concentrations**.<sup>4</sup> Metabolic alkalosis, metabolic acidosis or mixed disturbances can be present.<sup>4</sup> Other abnormalities depend on the underlying disease.

**Abdominal fluid** of horses with gastric dilatation is normal whereas that of horses with gastric rupture is characterized by an elevated total protein concentration (> 2.5 g/dL, 25 g/L) and leukocyte count (> 10000 cells/ $\mu$ L,  $10 \times 10^9$  cells/L) which is predominantly composed of degenerate neutrophils. Microscopic examination of the fluid reveals intra- and extracellular bacteria and plant material.

### NECROPSY FINDINGS

After grain engorgement in horses, the stomach is distended with a doughy, malodorous mass of ingesta. In acute gastric dilatation due to other causes, the stomach is grossly distended with fluid and the wall shows patchy hemorrhages. Rupture, when it occurs, is usually along the greater curvature and results in gross contamination of the abdominal cavity with ingesta.

### DIFFERENTIAL DIAGNOSIS

See Table 5.6.

### TREATMENT

**Relief of the gastric distension** should be considered an **emergency** as gastric rupture invariably causes death. Passage of a nasogastric tube, important in diagnosing the accumulation of fluid within the stomach, also provides a means for relieving the distension. Repetition and persistence may be needed to relieve the gastric distension. Passage of the nasogastric tube through the cardia may be difficult in horses with gastric distension. Blowing into the tube to dilate the esophagus or instillation of lidocaine (20 mL of 2% solution) may facilitate passage of the tube. If there is no spontaneous reflux of material, a siphon should

be formed by filling the tube with 500 mL of water and rapidly lowering the end of the tube below the level of the horse's stomach. The nasogastric tube should be left in place until there is no longer clinically significant quantities of reflux (1–2 L every 3 h for an adult 425 kg horse).

Gastric dilatation caused by overeating of grain, bread or similar material may be impossible to resolve through a nasogastric tube because of the consistency of the material. Gastric lavage using water or isotonic saline administered through a large bore nasogastric tube may aid in removal of inspissated ingesta. Surgical decompression may be attempted in refractory cases, but is technically demanding because of the position of the stomach in the adult horse.

The underlying disease should be treated to restore normal gastric emptying or stop reflux from the small intestine. Supportive therapy, including restoration of hydration and normal electrolyte and acid–base status, should be provided (see Chapter 2). Horses at risk of inhalation pneumonia should be treated with broad-spectrum antibiotics for at least 3 days.

### REFERENCES

1. Boy MG. J Am Vet Med Assoc 1992; 200:1363.
2. Laing JA, Hutchins DR. Aust Vet J 1992; 69:68.
3. Kiper ML et al. J Am Vet Med Assoc 1990; 196:333.
4. Todhunter RJ et al. Equine Vet J 1986; 18:288.
5. Harrison IW. Vet Surg 1988; 17:77.
6. Freeman S. In Pract 2002; May: 262.

### GASTRIC IMPACTION IN HORSES

Primary gastric impaction is characterized by enlargement of the stomach, subacute pain, which may exacerbate if fluid is administered by nasogastric tube, minor fluid reflux if a tube is passed, and regurgitation of fluid and ingesta from the nostrils in some cases. At exploratory laparotomy the stomach is enlarged with dry, fibrous feed material but is not grossly nor acutely distended, and the intestines are relatively empty.<sup>1</sup> Gastric impaction occurs secondary to hepatic fibrosis and insufficiency associated with poisoning with *Senecio jacobea*.<sup>2</sup> Persimmon (*Diospyros virginiana*) causes gastric impaction, ulceration and rupture in horses.<sup>3,4</sup> There is usually a history of a diet of mature grass, alfalfa hay, corn, sorghum fodder or ensilage.<sup>5</sup> Other causes include insufficient access to water, poor teeth causing poor digestion, or the atony of old age. Long-term signs include weight loss, intermittent colic, anorexia, dullness and small amounts of hard, dry feces.<sup>4</sup> Treatment with an oral administration of normal saline or mineral oil is commonly applied but is not usually satisfactory because the oil does not

moisten the impacted mass and is likely to bypass it. The patient may require exploratory laparotomy because of the absence of satisfactory diagnostic tests.<sup>6</sup> Rupture of the stomach is a potential sequel.

### REFERENCES

1. Owen RR et al. Vet Rec 1987; 121:102.
2. Milne EM et al. Vet Rec 1990; 126:502.
3. Cummings CA et al. J Vet Diagn Invest 1997; 9:311.
4. Kellman LL et al. J Am Vet Med Assoc 2000; 216:1279.
5. Kiper ML et al. J Am Vet Med Assoc 1990; 196:333.
6. Barclay WP et al. J Am Vet Med Assoc 1982; 181:682.

### GASTRIC ULCERS

Gastric ulcers occur in cattle (Abomasal ulceration), swine (Esophagogastric ulceration), foals and horses. The etiology varies among the species but the condition is characterized by the development of ulcers in the nonglandular and, less frequently, glandular sections of the stomach or abomasum. Common factors in the development of gastric ulcers in all species are the presence of gastric fluid of low pH and mechanical disruption or dysfunction of the mechanism protecting gastric mucosa from damage by acid and pepsin. The clinical manifestations vary with the species affected but include hemorrhage, anemia and the presence of melena or occult blood in the feces in pigs, cattle and, rarely, foals.

### GASTRIC (GASTRODUODENAL) ULCER IN FOALS

#### Synopsis

**Etiology** Unknown in most cases. NSAID intoxication

**Epidemiology** Foals from 1 day of age. 50% of normal foals have gastric mucosal ulceration. Clinical disease in 0.5% of foals. More severe ulceration in stressed foals or foals with other diseases

**Clinical signs** None in most foals. Teeth grinding, excessive salivation, colic, diarrhea, inappetence and weight loss. Sudden death with perforation. Ulcers present on gastroduodenoscopy

**Clinical pathology** None diagnostic

**Lesions** Gastric mucosal ulceration, duodenal ulceration and stenosis, esophagitis. Peracute septic peritonitis

**Diagnostic confirmation** Gastroscopic demonstration of ulcers in foals with appropriate clinical signs

**Treatment** Ranitidine 6.6 mg/kg, orally every 8–12 hours, or cimetidine 6.6–20 mg/kg orally or intravenously every 6 hours, or omeprazole 2–4 mg/kg orally or intravenously every 24 hours

**Control** Minimize occurrence of inciting or exacerbating diseases

## ETIOLOGY

There is no established etiology, although there is an association with stress (see below). There is no evidence of an infectious etiology, for instance *Helicobacter* sp.

## EPIDEMIOLOGY

### Occurrence

Gastric ulcers are reported in foals in North America, Europe and Australia and probably occur worldwide. The prevalence of erosion and ulcers of the gastric glandular and nonglandular mucosa, detected by gastroscopic examination, averages 50% in foals less than 2 months of age that do not have signs of gastric ulcer disease.<sup>1,2</sup> Lesions of the squamous mucosa are present in 45% of foals, while lesions in the glandular mucosa occur in fewer than 10% of foals less than 4 months of age.

Disease attributable to gastric or duodenal ulcers occurs in approximately 0.5% of foals<sup>3</sup> although the prevalence is greater in foals with other diseases such as pneumonia and septicemia.<sup>4</sup> Duodenal ulceration was present in 4.5% of foals examined post mortem<sup>5</sup> but this is probably a gross overestimation of the prevalence in normal foals.

Estimates of case fatality rate are not available.

### Risk factors

#### Age and sex

Age is an important risk factor for ulceration of the squamous epithelium, with 88% of foals less than 9 days of age affected compared to 30% of foals more than 70 days of age.<sup>1,2</sup> Gastric lesions occur in fewer than 10% of foals over 90 days of age.<sup>4</sup> There does not appear to be an effect of age on prevalence of ulceration of the gastric glandular mucosa, a much more clinically significant lesion. There is no effect of sex on the prevalence of ulcers.<sup>6</sup>

#### Stress/disease

Stress and disease are important risk factors for development of ulcers of the glandular mucosa.<sup>1,2</sup> Lesions of the gastric glandular mucosa occur in 27% of foals with another disease but in 3% of otherwise healthy foals.<sup>4</sup>

## PATHOGENESIS

The pathogenesis of gastric ulceration in foals has not been definitively determined and much is extrapolated from the disease in humans and other animals. It is assumed that ulcers occur because of an imbalance between the erosive capability of the **low gastric pH** and the **protective mechanisms** of the gastric mucosa.<sup>7</sup> Low gastric pH is essential for the development of a gastric ulcer and foals as young as 2 days of age have a gastric pH of less than 4.<sup>8</sup> Preservation of adequate mucosal

blood flow and the presence of an intact, bicarbonate-rich layer of mucus over the epithelium are essential to maintaining the resistance of the epithelium to digestion by gastric acid and pepsin. Mucosal blood flow and bicarbonate secretion into the protective mucus layer are dependent in part on normal prostaglandin E concentrations in the mucosa. Factors that inhibit prostaglandin E production, such as NSAIDs and ischemia, contribute to the development of ulcers. Trauma to the gastric epithelium may disrupt the protective layer and allow an ulcer to develop, as may the presence of compounds in duodenal fluid, such as bile salts, that intermittently reflux into the stomach of normal foals.

Normal foals develop the capacity for secretion of gastric acid and ability to achieve gastric pH less than 4 within 1–2 days of birth.<sup>8</sup> Ingestion of milk increases gastric pH and it is a generally held belief that frequent ingestion of milk provides a protective effect against the adverse effects of low pH on gastric mucosa.<sup>8</sup> However, development of gastric lesions in foals is not solely a result of prolonged exposure to low pH, although this might be a necessary factor, as ill neonatal foals that are at high risk of gastric erosion or ulceration have gastric pH that is often greater than 5–6.<sup>9</sup> The elevated pH, which may be alkaline in severely ill foals at greatest risk of death,<sup>9</sup> is not consistent with development of gastric lesions.

Most ulcers do not produce clinical signs. **Severe ulceration** is associated with delayed gastric emptying, gastric distension, gastroesophageal reflux and subsequent reflux esophagitis and pain. Ulcers may perforate the stomach wall and cause a peracute, septic peritonitis or erode into a large blood vessel with subsequent hemorrhage and occasional exsanguination. Ulcers and the attendant inflammation and pain might cause gastroparesis and delay gastric emptying and chronic lesions can result in both functional and physical obstructions to gastric emptying with subsequent gastric dilatation and reflux esophagitis.

## CLINICAL FINDINGS

There are six syndromes associated with gastroduodenal ulcers in foals:

- Ulceration or epithelial desquamation of the squamous mucosa of the greater curvature and area adjacent to the margo plicatus. These lesions are very common in foals less than 60 days of age and usually do not cause clinical signs. The lesions heal without treatment
- Ulceration of the squamous epithelium of the lesser curvature and

fundus. This is more common in older foals (> 60 days) and is usually associated with clinical signs including diarrhea, inappetence and colic

- Ulceration of the glandular mucosa, sometimes extending into the pylorus. This lesion occurs in foals of any age and is most common in foals with another disease. Clinical signs due to the ulcer can be severe and include teeth grinding, excessive salivation, inappetence, colic, and diarrhea. There is often reflux esophagitis
- Gastric outflow obstruction due to pyloric or duodenal stricture secondary to pyloric or duodenal ulceration. This occurs in 2–5-month-old foals and is evident as colic, inappetence, weight loss, gastric dilatation, gastroesophageal reflux, excessive salivation and teeth grinding
- Peracute peritonitis secondary to gastric perforation. This usually occurs in foals that do not have a history of signs of gastric ulceration. Clinical signs include unexpected death, shock, dehydration, sweating and an increased respiratory rate
- Hemorrhagic shock secondary to blood loss into the gastrointestinal tract from a bleeding gastric ulcer.<sup>10</sup> This is an unusual presentation.

The typical signs of gastric ulcers in foals include depression, teeth grinding, excessive salivation and abdominal pain that can range in intensity from very mild to acute and severe, similar to that of a foal with an acute intestinal accident. Diarrhea, with or without mild to moderate abdominal pain, is often associated with gastric ulcer disease in foals. Treatment with antiulcer drugs is sometimes associated with resolution of diarrhea and signs of gastric ulcer disease. There may be pain evinced by deep palpation of the cranial abdomen but this is not a reliable diagnostic sign.<sup>11</sup>

Definitive diagnosis is provided by **gastroscopic examination**. The endoscope should be 2 m in length, although a 1 m endoscope may allow partial examination of the stomach of young or small foals. Diameter of the endoscope should be less than 1 cm. Foals can usually be examined without sedation, although sedation may facilitate examination in larger or fractious foals. Ideally, older foals should have food withheld for 12 hours before the examination but this may be neither necessary nor advisable in sick foals. Young foals (those relying on milk intake for their caloric needs) should have food withheld for 1–2 hours. Adequate examination of the nonglandular stomach can usually be achieved without fasting,

especially in younger foals, but thorough examination of the glandular mucosa and pylorus requires fasting.

**Nasogastric intubation** may cause pain and cause affected foals to gag. Foals with gastric outflow obstruction, due either to pyloric or duodenal stricture or to gastroparesis, will have reflux of material through a nasogastric tube.

Contrast **radiographic** examination is useful in defining gastric outflow obstruction and may demonstrate filling defects in the gastric wall that are consistent with ulcers. The principal use of radiography is to establish delays in gastric emptying. Normal foals have complete emptying of barium sulfate (10–20 mL/kg BW administered through a nasoesophageal or nasogastric tube) from the stomach within 2 hours of administration. Gastric ulcers are occasionally apparent as filling defects, but contrast radiography is not sufficiently sensitive to justify its routine use for diagnosis of gastric ulceration.

#### CLINICAL PATHOLOGY

There are no diagnostic changes in the histogram or serum biochemical profile. Serum pepsinogen values are of no use in diagnosing gastric ulcers in foals.<sup>12</sup> Testing for fecal occult blood is neither sensitive nor specific for gastric ulceration in foals. Foals with perforation of the stomach have changes consistent with septic peritonitis.

#### NECROPSY FINDINGS

Gastric ulcers and erosions are common findings in foals dying of unrelated disease and their presence should not be overinterpreted. The gross characteristics of the gastric lesions are described above. Foals dying of gastric ulcer disease do so from peracute diffuse peritonitis, exsanguination or starvation secondary to the gastric outflow obstruction.

#### DIAGNOSTIC CONFIRMATION

The combination of compatible clinical signs, endoscopic demonstration of gastric ulcers, a favorable response to antacid therapy and the elimination of other diseases permits a diagnosis of gastric ulcer disease.

#### DIFFERENTIAL DIAGNOSIS

The combination of teeth grinding, excessive salivation, depression, inappetence and colic in foals is virtually diagnostic of gastric ulcer disease. Other causes of colic in foals are listed in Table 5.9.

#### TREATMENT

The principles of treatment of gastroduodenal ulcer disease in foals are:

- Promotion of healing by reducing gastric acidity and enhancing mucosal protection
- Enhancement of gastric emptying
- Provision of nutritional and metabolic support
- Treatment of other disease.

**Reduction of gastric acidity** is achieved by administration of one of several drugs that reduce secretion of gastric acid and increase gastric pH (Table 5.11).<sup>13</sup> These drugs are either histamine type 2 (H<sub>2</sub>) receptor antagonists or inhibitors of the proton pump in the gastric parietal cells. Administration of ranitidine (6.6 mg/kg orally every 8 h) effectively increases gastric pH in normal neonatal foals but does not affect gastric pH in hospitalized neonates.<sup>8,9</sup> Omeprazole (4 mg/kg orally every 24 h), a proton pump inhibitor, increases gastric pH within 2 hours of administration and for 24 hours in clinically normal neonatal foals.<sup>14</sup> However, similarly to ranitidine, the efficacy of omeprazole in ill neonatal foals has not been determined. Omeprazole does enhance healing of spontaneous ulcers in foals older than 28 days and does not

have important or frequent adverse effects.<sup>15,16</sup> Sucralfate is used to provide protection of denuded gastric epithelium, although its efficacy in preventing lesions or enhancing healing of existing lesions in foals with spontaneous disease is doubted.

A common **treatment protocol** involves administration of a H<sub>2</sub> antagonist or omeprazole. Treatment should begin as soon as the presence of a clinically significant ulcer is suspected and should continue for at least 1 week after the resolution of clinical signs or until there is endoscopic confirmation of healing. Foals are often treated for 2–6 weeks.

Foals with gastroparesis secondary to severe gastroduodenal ulceration or gastritis may benefit from the administration of bethanechol (Table 5.11) to increase gastric motility and enhance gastric emptying. Surgical bypass of pyloric or duodenal strictures may be necessary in foals with physical obstructions to gastric emptying.<sup>17</sup>

**Nonsteroidal anti-inflammatory drugs** such as phenylbutazone or flunixin meglumine are ulcerogenic and should be used sparingly in sick foals, and should not

Table 5.10 Drugs used in the treatment of gastroduodenal ulcer disease of foals and adult horses

Drug class	Drug	Dose, route and frequency	Comments
H <sub>2</sub> antagonists	Cimetidine	6.6–20 mg/kg PO every 6 h	Potent acid suppression. Short elimination half-life necessitates frequent administration. Preferably use at the higher dose rate
	Cimetidine	6.6 mg/kg IV every 6 h	Rapid and potent acid suppression. Use when oral administration is not feasible or rapid effect is required
	Ranitidine	6.6–8.8 mg/kg IV or PO every 8–12 h	Potent acid suppression and rapid resolution of clinical signs
Proton pump inhibitor	Omeprazole	4 mg/kg PO as paste every 24 h	Potent, rapid onset and long-lasting acid suppression
Pantoprazole		1.5 mg/kg ivq 12–24 h	Potent acid suppression in foals
Protectants	Sucralfate	40 mg/kg PO every 6 h	Can be given at the same time as inhibitors of acid secretion
Prostaglandin analogues	Misoprostol	5 µg/kg PO every 12 h	Causes diarrhea and mild colic. Effective as a prophylactic for NSAID-induced ulcers in humans but minimal efficacy in enhancing healing of existing ulcers
Antacids	Aluminum hydroxide	1–2 g PO every 4–6 h	Ineffective. Do not use
	Magnesium hydroxide	1–2 g PO every 4–6 h	Ineffective. Do not use
	Calcium carbonate	1–2 g PO every 4–6 h	Ineffective. Do not use
Promotility agents	Bethanechol	0.025 mg/kg SC every 6 h	Enhances gastric motility with minimal increased gastric acid secretion. Used to treat gastroparesis. Contraindicated if physical outflow obstruction exists

H<sub>2</sub>, histamine type 2 receptor; IV, intravenously; NSAID, nonsteroidal antiinflammatory drug; PO, orally; SC, subcutaneously.

be given to foals with gastric or duodenal ulcers unless absolutely necessary.<sup>18</sup>

Nutritional and metabolic support should be provided as necessary to foals that are unable to eat or drink or that have abnormalities of fluid and electrolyte status.

### CONTROL

Control of diseases that predispose foals to gastroduodenal ulcer may reduce the incidence or severity of ulcer disease. Prophylactic treatment of sick or stressed foals with H<sub>2</sub> antagonists, sucralfate or omeprazole is widely practiced. However, the efficacy of pharmacological prophylaxis in prevention of disease or death due to gastric ulceration has not been demonstrated. Indeed, suppression of gastric acidity (increasing gastric pH) in either sick or normal foals may be unwise because of the protective effect of low gastric pH on gastric colonization of bacteria.

### REVIEW LITERATURE

Murray MJ. Gastroduodenal ulceration in foals. *Equine Vet Educ* 1999; 11:199-207.

### REFERENCES

- Murray MJ et al. *J Am Vet Med Assoc* 1990; 196:1623.
- Murray MJ et al. *Equine Vet J* 1990; 22:6.
- Sweeney HJ. *Equine Vet Educ* 1991; 3:80.
- Murray MJ. *J Am Vet Med Assoc* 1989; 195:1135.
- Wilson JH. In: *Proceedings of the 2nd Equine Colic Research Symposium* 1986:126.
- Sandin A et al. *Acta Vet Scand* 1999; 40:109-120.
- Murray MJ. *Equine Vet J Suppl* 1992; 13:63.
- Sanchez LC et al. *J Am Vet Med Assoc* 1998; 212:1407.
- Sanchez LC et al. *J Am Vet Med Assoc* 2001; 218:907-911.
- Traub-Dagartz J et al. *J Am Vet Med Assoc* 1985; 186:280.
- Becht JL, Byars TD. *Equine Vet J* 1986; 18:307.
- Wilson JH, Pearson MM. In: *Proceedings of the 31st Annual Convention of the American Association of Equine Practitioners*, Toronto, Canada, 1985:149.
- Geor RJ, Papich MG. *Compend Contin Educ Pract Vet* 1990; 12:403.
- Sanchez LC et al. *Am J Vet Res* 2004; 65:1039-1041.
- Murray MJ et al. *Equine Vet J Suppl* 1999; 29:67-70.
- MacAllister CG et al. *Equine Vet J Suppl* 1999; 29:77-80.
- Campbell-Thompson ML et al. *J Am Vet Med Assoc* 1986; 188:840.
- Carrick JB et al. *Can J Vet Res* 1989; 53:195.

## GASTRIC ULCER IN ADULT HORSES

### ETIOLOGY

The etiology of the most common occurrence of gastric ulcers in the horse is unknown but several risk factors have been identified, which are described under epidemiology. The disease is common in horses undertaking regular exercise and might be related to decreased

### Synopsis

**Etiology** Unknown in most cases. NSAID intoxication

**Epidemiology** Common in Thoroughbred, Standardbred and Quarter horses in racing or training, and horses used for endurance racing. Occasionally associated with colic

**Clinical signs** None in most horses. Poor appetite, failure to bloom, mild colic in some horses. Ulcers or erosions present on gastroduodenoscopy

**Clinical pathology** None diagnostic

**Necropsy lesions** Gastric ulceration.

Rarely a cause of death

**Diagnostic confirmation** Gastroscopic demonstration of ulcers

**Treatment** Omeprazole 1-4 mg/kg orally once daily. Ranitidine and cimetidine are used but are less efficacious and convenient

**Control** Minimize risk factors, including confinement and intermittent feeding. Prolonged administration of omeprazole to symptomatic horses

stomach volume and subsequent exposure of the squamous mucosa of the proximal parts of the stomach to acid during exercise (see Pathogenesis, below).

Individual cases of gastric ulcers are associated with parasitic gastritis, such as in horses infested with *Gasterophilus* spp., and *Habronema megastoma* larvae. Tumors of the stomach, such as gastric squamous cell carcinoma or lymphosarcoma, may cause ulceration of the gastric mucosa. Gastric phytobezoars and persimmon seeds (*D. virginiana*) have been associated with gastric impaction, ulceration and perforation of the glandular portion of the stomach of a horse.<sup>1</sup> There is no evidence that infection by *Helicobacter* sp. or similar organisms is associated with gastric ulcer disease in horses.

### EPIDEMIOLOGY

#### Occurrence

The occurrence of gastric ulceration is detected by either postmortem examination or gastroscopic examination. The frequency with which gastric ulcers are detected depends the method of examination, the group of horses examined and the reasons for examining them. Studies reporting on incidence of gastric ulceration in horses with clinical abnormalities or at necropsy examination revealed a high frequency of gastric lesions in horses with colic and in race horses.<sup>2-5</sup> More recent studies have examined large numbers of horses without clinical signs of gastric ulcer disease but from populations at risk and have demonstrated a high prevalence in horses undertaking strenuous exercise on a regular basis.<sup>6-10</sup>

Gastric ulcer disease in horses is a recently recognized disease, with most

reports originating after 1990 and coinciding with the widespread availability of endoscopes of sufficient length to permit examination of the stomach of adult horses. However, a longitudinal study of horses submitted for postmortem examination in Sweden demonstrated that horses have been affected with gastric ulcers since 1924.<sup>3</sup>

The condition is common in race horses and other breeds of horse used for athletic events and this population represents the most important occurrence of the disease.<sup>6-10</sup>

**Thoroughbred and Standardbred** horses in training or racing have a high prevalence of gastric lesions. Gastroscopic studies of convenience samples of clinically normal Thoroughbred race horses in training reveal a prevalence of lesions of the gastric mucosa of 82-93%.<sup>8,9</sup> Gastric lesions are detected in 63-87% of Standardbred horses in training and actively racing.<sup>6,7</sup> Postmortem examination of Thoroughbred race horses in Hong Kong, where many horses that retire from racing are examined post mortem, reveals a prevalence of gastric lesions of 66%, with the prevalence increasing to 80% when only horses that had raced recently were considered.<sup>5</sup> Among race horses selected for gastroscopic examination because of clinical abnormalities, including inappetence, failure to race to expectation, poor hair coat or poor body condition, lesions of the gastric mucosa were detected in 86-90%.<sup>2,11</sup>

There were lesions of the gastric mucosa in approximately 20 of 30 **endurance horses** examined immediately after racing 50-80 km.<sup>10</sup> Eight horses had lesions of the gastric glandular mucosa. Gastric lesions were present in 58% of **show horses** that had competed in the 30 days prior to gastroscopic examination.<sup>12</sup>

#### Risk factors

Risk factors for gastric lesions in horses include being in training for an athletic event, exercise and the amount of time exercising, and colic. Suspected risk factors include the disposition of the horse (nervous horses are at greater risk), diet, feeding practices, housing (pasture vs stall), stress (although the definition of stress is often not clear) and administration of NSAIDs such as phenylbutazone.<sup>13</sup> While each of these risk factors can be considered separately, it is likely that many are related and act in concert to increase the risk of development of lesions of the gastric mucosa. For instance, being in training often coincides with confined housing, intermittent feeding, daily bouts of strenuous exercise and administration of

NSAIDs. The combination of these factors, even without NSAID administration, reliably induces ulcers in Thoroughbred race horses.<sup>14</sup> Young horses (2 years old) that had arrived at the track within the month before first gastroscopic examination had a marked increase in severity of lesions at the time of a second gastroscopic examination 1 month later.<sup>10</sup>

#### Animal risk factors

Among adult horses, age and sex are only weak risk factors, if at all, for presence of gastric lesions.<sup>6-8</sup> Gastric lesions tend to be more severe in older horses.<sup>6,7,9</sup> Among Standardbred race horses, trotters are twice as likely as pacers to have gastric lesions.<sup>7</sup> Horses with a nervous disposition are considered to be at greater risk of developing gastric lesions but objective evidence is not available to support this observation.<sup>8</sup> NSAIDs are ulcerogenic and often administered to horses in training. However, among Thoroughbred race horses there is no clear association between administration of these drugs and risk of having gastric lesions.<sup>8</sup>

**Colic** is associated with presence of gastric lesions, although a cause and effect relationship is often not clear in individual cases. In a series of 111 horses with clinical evidence of abdominal discomfort of varying duration and severity, 91 had endoscopic evidence of gastric ulceration.<sup>4</sup> Other abnormalities of the gastrointestinal tract or abdominal viscera were not found in 57 of the 91 horses with gastric ulcers. Thus gastric ulceration was the primary cause of colic, based on lack of concurrent abnormalities, clinical response to treatment with H<sub>2</sub> antagonists, and confirmation of improvement or resolution of gastric ulceration by endoscopy.<sup>4</sup> However, 34 of the 91 horses with gastric ulceration had concurrent abnormalities of the gastrointestinal tract, demonstrating that gastric lesions can develop in horses with colic. Thus, colic can cause gastric lesions and gastric ulcers can cause colic.

#### Management and environmental risk factors

Race horses in **training** have a higher prevalence of ulcers than do race horses that are spelling (not in active training)<sup>5,7,9</sup> and horses that are racing regularly have a higher prevalence than resting horses or horses in training but not racing.<sup>7</sup> Standardbred race horses in training are 2.2 times more likely to have gastric lesions, and those racing regularly are 9.3 times more likely to have gastric lesions, than are horses not training or racing.<sup>7</sup> Although, as discussed above, many factors can contribute to the likelihood of a horse having gastric lesions,

exercise is strongly associated with development of gastric lesions in horses. This is probably through the increase in intragastric pressure and decrease in pH in the proximal (nonglandular) stomach that occurs during exercise.<sup>14</sup>

**Feed withholding** causes gastric ulcers in horses, probably because of the lack of buffering of acid produced during periods when the stomach is empty.<sup>15</sup> It is likely that the intermittent access to feed that occurs in many stables results in periods of time during each day when horses do not have feed within the stomach. The loss of buffering is due to lack of feed material in the stomach and to decreased production of saliva, which normally buffers gastric acid. Horses grazing at pasture eat frequently and have food in the stomach almost all the time.

**Diet** is suggested to be a risk factor for development of gastric ulcers, but definitive studies are lacking. Horses in training for racing are usually fed diets high in concentrated rations and this is suspected to predispose these horses to gastric ulcers. Feeding of alfalfa hay and grain was associated with fewer gastric lesions in six research horses than was feeding brome grass hay.<sup>16</sup>

**Confinement** to stalls is associated with an increased prevalence of gastric lesions, whereas gastric lesions are uncommon to rare in horses at pasture. Horses with gastric lesions during confinement have healing of these lesions when they are pastured. Again, there is considerable confounding among the various risk factors, as housing at pasture is associated with constant access to feed, and therefore no periods of feed withholding, changes in diet from that rich in concentrates to that predominated by grasses, and, often, cessation of forced exercise.

#### PATHOGENESIS

The equine stomach is comparatively small relative to the size of the gastrointestinal tract. The stomach mucosa is divided into two parts. The proventricular part is glistening white in color, is composed of thick **stratified squamous epithelium** and contains no glands. It covers approximately one-third of the mucosal area and ends abruptly at the margo plicatus, a slightly raised irregular serrated border with the glandular mucosa. Most gastric lesions in horses occur in squamous mucosa.

The **glandular mucosa** has a velvet-like structure and is usually covered by a thick layer of viscous mucus. The mucosa contains three main gland types: mucus-secreting cardiac glands; fundic glands, which contain mucus-secreting cells, hydrochloric-acid-producing parietal cells

and pepsinogen-secreting chief cells; and pyloric glands, which consist largely of mucus-secreting cells. The stratified squamous epithelial mucosa has minimal resistance to gastric acid. The glandular epithelium has elaborate mechanisms, including the mucus-bicarbonate barrier, prostaglandins, mucosal blood flow and cellular restitution, to protect itself from peptic injury. Hydrochloric acid and pepsinogens, which are converted to the proteolytic enzyme pepsin in an acidic environment, are secreted in the glandular mucosa by parietal cells and chief cells, respectively. The horse is a continuous, variable hydrochloric acid secretor, and the pH of equine gastric contents in the pylorus and antrum is often less than 2.0. Gastric pH is lowest, and acidity highest, when horses have been deprived of feed or have voluntarily stopped eating, often for as little as 2 hours. Thus there are periods during the day when gastric acidity is high. Periods of prolonged high gastric acidity (pH < 2.0) can be induced in horses by intermittent deprivation of feed, which often results in severe ulceration in the gastric squamous epithelial mucosa. Concurrent administration of the H<sub>2</sub> antagonist ranitidine during feed deprivation substantially reduces the area of lesion in the gastric squamous epithelial mucosa.<sup>17</sup>

The pathogenesis of gastric ulcer is uncertain. Exposure of squamous mucosa to acid is probably involved in the development of ulcers in most horses. During exercise intragastric pressure increases from approximately 14 mmHg at rest to as high as 50 mmHg, stomach volume decreases and the acidity of fluid within the proximal part of the stomach declines from 5-7 to 2-4.<sup>14</sup> The combination of reduced blood flow and exposure to low pH increases the likelihood of mucosal damage, loss of protective mechanisms and development of gastric mucosal lesions.

Other factors, including physical injury to gastric mucosa, reflux of bile acids from the duodenum<sup>18</sup> and presence of volatile fatty acids in the stomach all may contribute to the development of gastric lesions,<sup>19</sup> but the definitive roles, if any, of each of these factors have not been determined.

#### CLINICAL FINDINGS

The vast majority of horses with lesions of the gastric mucosa, including ulceration, do not have clinical signs. Among race horses, signs of poor performance, feed refusal, fussy eating (not consuming all of the meal at a constant rate) and poor body condition have been associated with presence of gastric ulcers. Of these signs only poor hair coat and poor body condition have been proved to be

associated with gastric ulcers.<sup>7,8</sup> The high prevalence of both some of the clinical signs, for instance failure to perform to expectation, and gastric ulcers means that there is a high likelihood that horses with a given clinical sign will have an ulcer by chance. However, clinical experience indicates that horses with more extensive or severe lesions will have more severe clinical signs, including colic.

**Colic** is associated with presence of lesions of the gastric mucosa, including ulceration. Ulceration can result from lesions elsewhere in the gastrointestinal tract, probably because of feed withholding or feed refusal by horses with colic. Alternatively, gastric ulceration can cause colic. The four criteria to determine whether gastric ulceration is the primary cause of colic in horses are:

- Endoscopic confirmation of gastric ulceration
- Absence of another alimentary tract abnormality
- Clinical response to treatment that effectively suppresses or neutralizes gastric acidity
- Confirmation of improvement or complete healing of gastric lesions.<sup>4</sup>

Most gastric ulcers in horses are not associated with hemorrhage and so signs of anemia or melena are unusual in horses. Horses with severe gastric ulceration and reflux esophagitis often have bruxism and retching. Rupture of gastric ulcers, perforation and subsequent peritonitis, and exsanguination from a bleeding ulcer are rare in adult horses.

Involvement of the spleen in the horse with a perforating gastric ulcer, a rare event, results in fever, anorexia, toxemia, pain on deep palpation over the left flank and leukocytosis with a left shift.

**Gastroscopic** examination is the only means of demonstrating gastric lesions and assessing their extent and severity. Gastroscopic examination of the adult horse requires an endoscope of at least 2.5 m in length, although 3 m is preferable. Presence of feed material within the stomach prevents complete examination of the gastric mucosa, and in particular of the pylorus and antrum. The horse should be prepared by having feed withheld for at least 12 hours and water withheld for 4 hours before examination. If the horse is stabled on edible material such as straw or shavings, it should be muzzled to prevent it eating this material. The horse may need to be sedated before examination (xylazine hydrochloride 0.1–0.3 mg/kg intravenously) and a twitch applied. The gastric mucosa is examined in a systematic fashion. As the end of the endoscope passes through the cardia, the greater curvature and margo plicatus are

examined. The endoscope is then advanced and rotated so that the lesser curvature and cardia are examined. The stomach should be inflated with air during the procedure. Excess fluid in the pylorus and antrum can be aspirated to allow better visualization of these regions. Careful attention should be paid to the margo plicatus as this is the most common site for lesions. The gastric glandular mucosa should be examined carefully for lesions as they are easily missed in this region.<sup>20</sup> Material adherent to the mucosa should be washed away by flushing water through the endoscope. The endoscope can be passed into the duodenum to permit complete examination of the antrum. Endoscopic examination usually underestimates the number of gastric ulcers, compared to necropsy examination, and does not accurately predict the severity or depth of ulcers.<sup>20</sup>

Grading systems for description of gastric lesions in horses are:<sup>20</sup>

#### Gastric ulcer number score

Score	Number of lesions
0	No lesions
1	1–2 localized lesions
2	3–5 localized lesions
3	6–10 lesions
4	> 10 lesions

#### Gastric ulcer severity score

Score	Description
0	No lesions
1	Appears superficial
2	Deeper structures involved (deeper than #1)
3	Multiple lesions and variable severity
4	Same as #2 and in addition presence of hyperemia or darkened lesion crater
5	Same as #4 but hemorrhage or blood clot adherent to ulcer

A simplified scoring system recommended for use in practice is:<sup>21</sup>

Score	Description
0	Intact mucosal epithelium
1	Intact mucosal epithelium with reddening or hyperkeratosis
2	Small single or small multifocal lesions
3	Large single or large multifocal lesions or extensive superficial lesions
4	Extensive often coalescing lesions with areas of apparent deep ulceration

Most lesions in race horses are in the gastric squamous mucosa with less than 20% of lesions being in the glandular mucosa. The situation is different in hospitalized adult horses, in which lesions in the squamous and glandular mucosa occur with about the same frequency (58%).<sup>22</sup> Most lesions in the glandular mucosa of hospitalized horses occur in the antrum or pylorus, as opposed to the glandular mucosa of the body of the stomach.<sup>22</sup>

Idiopathic gastroesophageal reflux disease occurs sporadically and rarely in adult horses.<sup>23</sup> Affected horses have bruxism and ptyalism that can be severe. Endoscopic examination reveals ulceration and erosion of the esophagus that is more severe in the distal esophagus. Often there is no evidence of impaired gastric outflow, as is common in foals with this disease.

#### CLINICAL PATHOLOGY

There are no specific laboratory tests for gastric ulceration. Horses with gastric ulcers have higher concentrations of creatinine and activity of alkaline phosphatase in serum than do unaffected horses, but these differences are not sufficient to be clinically useful.<sup>8</sup> Horses with gastric ulcer disease are typically not anemic. A test using concentrations of sucrose greater than 0.7 mg/dL in urine after intragastric administration of 10% sucrose (1 g/kg orally after feeding) solution has a sensitivity and specificity of 83% and 90%, respectively, for detection of gastric ulceration.<sup>24</sup> Sucrose is absorbed intact across the damaged gastric mucosa and excreted in urine, whereas that entering the small intestine is degraded to fructose and glucose.

#### NECROPSY FINDINGS

Ulcers may be singular or multiple and are most commonly located in the squamous epithelial mucosa adjacent to the margo plicatus along the lesser curvature of the stomach. They may be linear or irregular in shape; with the exception of those in the glandular mucosa, they are rarely circular in appearance. Ulcers in the squamous mucosa often have slightly raised brown-stained keratinized borders and contain small amounts of necrotic material at their base; frank blood is uncommon. Ulcers in the glandular zone are less common and are usually circular or oval depressions surrounded by an intense zone of inflammation.

When perforation has occurred, there is an area of local peritonitis, the stomach wall is adherent to the tip of the spleen and an extensive suppurative splenitis may be present. In some cases, especially when the stomach is full at the time of



perforation, a long tear develops in the wall and large quantities of ingesta spill into the peritoneal cavity. Tumor masses may be present and accompanied by several glandular ulcers.

#### DIFFERENTIAL DIAGNOSIS

Gastric ulceration of adult horses must be differentiated from the common causes of recurrent colic.

#### TREATMENT

The goals of treatment of horses with gastric ulcer disease are: healing of the ulcer, suppression of pain and prevention of ulcer recurrence. The principle underlying treatment of gastric ulcers in horses is suppression of gastric acidity (increase intragastric pH). This can be achieved by inhibiting acid production or increasing buffering of acid. Mucosal protectants are administered with the aim of preventing exposure of damaged mucosa to acid. Management changes may reduce the risk of horses developing disease.

#### Acid suppression

The agents available to suppress acid production are compounds including omeprazole and lansoprazole that block the proton pump on the luminal surface of gastric parietal cells, and H<sub>2</sub> receptor antagonists including cimetidine, ranitidine and famotidine.

#### Omeprazole

Omeprazole is currently the favored treatment for gastric ulcer disease in horses. The pharmacokinetics, pharmacodynamics, safety, and efficacy of the drug have been extensively investigated in horses under a variety of conditions and management systems. Omeprazole (4 mg/kg body weight orally every 24 h) as a commercial suspension (Gastrogard®) is very effective in promoting healing of ulcers in horses that continue to train or race, a situation in which ulcers will not heal spontaneously.<sup>21,25,26</sup> Omeprazole is safe and no adverse effects from its administration have been reported. Original studies were conducted using omeprazole at a high dose (4 mg/kg), whereas more recent evidence suggests that it may be effective at lower doses (1 mg/kg orally every 24 h), especially when administered as acid-resistant enteric-coated granules.<sup>27</sup> A frequently used treatment regimen is omeprazole 4 mg/kg once daily for 14 days followed by maintenance therapy of 1–2 mg/kg once daily for as long as the horse is at risk of developing gastric ulcers. Omeprazole paste administered at 1 mg/kg orally once daily is effective in both preventing development of ulcers in

horses entering race training and preventing recurrence of ulcers in horses in which ulcers have healed during treatment with a higher dose of omeprazole.<sup>28,29</sup>

The composition of the excipients and form of omeprazole is important in determining efficacy. Forms of omeprazole other than that in the commercial preparation are associated with reduced or nil efficacy.<sup>30,31</sup> Omeprazole is more effective than cimetidine (20 mg/kg orally every 8 h) for treatment of gastric ulcers in race horses.<sup>32,33</sup>

#### Cimetidine

Cimetidine is the prototypical H<sub>2</sub> receptor antagonist. It acts by blocking action of histamine on the basilar membrane of the gastric parietal cells. It is used for treatment of gastric ulcer disease in horses, for which it must be administered frequently and in high doses (20–25 mg/kg orally every 6–8 h). The drug has variable absorption after oral administration to horses.<sup>34</sup> It is usually cheaper than omeprazole, but is less effective.<sup>32,33</sup> Cimetidine can be administered intravenously (7 mg/kg every 6 h) if rapid action is needed or the animal cannot take medication orally (e.g. a horse with colic).

#### Ranitidine and famotidine

Ranitidine (6.6 mg/kg orally every 8 h) effectively suppresses gastric acidity and prevents development of ulcers in horses deprived of feed.<sup>35</sup> Commercial preparations for use in horses are marketed in some countries. It is effective in preventing ulcers induced in experimental horses, but its efficacy in field situations is not reported.

Famotidine is an H<sub>2</sub> receptor antagonist marketed for use in humans. It is effective in suppressing gastric acidity in horses (3 mg/kg orally every 12 h or 0.3 mg/kg intravenously every 12 hours) but is expensive.

#### Gastric antacids

Gastric antacids given orally neutralize stomach acid to form water and a neutral salt. They are not absorbed and decrease pepsin activity, binding to bile salts in the stomach, and stimulate local prostaglandin. One oral dose of 30 g of aluminum hydroxide and 15 g magnesium hydroxide can result in a significant increase in gastric pH for up to 4 hours.<sup>36</sup> The short duration of action, minimal and transient effect on gastric pH and need for administration of large volumes orally render these products less than optimal. Moreover, there is evidence that antacids are not effective in treatment of gastric ulcers in race horses.<sup>32</sup>

#### Protectants

**Sucralfate** is an antiulcer drug with

cytoprotective effect on the gastric mucosa. Sucralfate dissociates in gastric acid to sucrose octasulfate and aluminum hydroxide. The aluminum hydroxide acts as an antacid and the sucrose octasulfate polymerizes to a viscous, sticky substance that creates a protective effect by binding to ulcerated mucosa. This prevents back diffusion of hydrogen ions, inactivates pepsin and absorbs bile acid. Sucralfate is administered to horses (22 mg/kg orally every 8 h) but is not effective in promoting healing in induced disease nor associated with a lower risk of gastric ulcers in race horses administered the compound.<sup>32</sup>

Pectin–lecithin complexes are not effective in treatment of gastric ulcer disease in horses.<sup>37</sup>

#### Management changes

Horses with gastric ulcers experience spontaneous healing when removed from training and kept at pasture. These management changes are not appropriate in most instances, and emphasis should be placed on feeding diets that have a low ulcerogenic potential (such as alfalfa hay) and using feeding practices that minimize or eliminate periods when the horse does not have access to feed. Hay should be constantly available to horses, if at all possible.

#### Overview of treatment

The usual approach to treatment is to promote healing of the ulcer by administration of effective agents (omeprazole or possibly ranitidine) at high dose until the ulcer has healed, as demonstrated by gastroscopy. The horse is then administered omeprazole at a lower dose (1–2 mg/kg orally every 24 h) for the duration of time that it is at risk of developing gastric ulcers. Changes in management, including importantly feeding practices and diet, should be instituted at the start of treatment. While not statistically associated with risk of gastric ulceration, use of phenylbutazone or other NSAID should be minimized in horses at high risk of disease.

#### CONTROL

Prevention of gastric ulcer disease in athletic horses centers upon minimizing the effect of factors that promote ulcer development. This may involve the chronic administration of omeprazole (1 mg/kg orally once daily),<sup>29</sup> but should include attention to dietary and feeding practices (discussed above) that minimize the time that horses have no feed in their stomach. Ideally, horses at risk would be kept at pasture, but this is not feasible under many management or husbandry systems. All horses in athletic training and confined to stalls should be considered at high risk of development of gastric ulcers and should be managed



accordingly. Horses at pasture, such as brood mares, are at minimal risk of development of gastric ulcer disease and no specific control measures are indicated.

## REVIEW LITERATURE

Equine Gastric Ulcer Council. Recommendations for the diagnosis and treatment of equine gastric ulcer syndrome. *Equine Vet Educ* 1999; 11:262.

Various authors. Equine gastric ulceration. *Equine Vet J Suppl* 1999; 29:1.

Buchanan BR, Andrews FM. Treatment and prevention of equine gastric ulcer syndrome. *Vet Clin North Am Equine Pract* 2003; 19:575.

## REFERENCES

- Cummings CA et al. *J Vet Diagn Invest* 1997; 9:311.
- Johnson JH et al. *Equine Vet Educ* 2001; 13:221.
- Sandin A et al. *Equine Vet J* 2000; 32:36.
- Murray MJ. *J Am Vet Med Assoc* 1992; 201:117.
- Hammond CJ et al. *Equine Vet J* 1986; 18:284.
- Rabuffo RS et al. *J Am Vet Med Assoc* 2002; 221:1156.
- Dionne RM et al. *J Vet Intern Med* 2003; 17:218.
- Vatistas NJ et al. *Equine Vet J Suppl* 1999; 29:34.
- Murray MJ et al. *Equine Vet J* 1996; 28:368.
- Nieto JE et al. *Vet J* 2004; 167:33.
- Begg LM, O'Sullivan CBAustVet J 2003; 81:199.
- McClure SR et al. *J Am Vet Med Assoc* 1999; 215:1130.
- Meschter CL et al. *Vet Pathol* 1990; 27:244.
- Lorenzo-Figueras M, Merritt AM. *Am J Vet Res* 2002; 63:1481.
- Murray MJ. *Dig Dis Sci* 1994; 12:2530.
- Nadeau JA et al. *Am J Vet Res* 2000; 61:784.
- Murray MJ, Eichorn ES. *Am J Vet Res* 1996; 57:1599.
- Berschneider HM et al. *Equine Vet J Suppl* 1999; 29:24.
- Nadeau JA et al. *Am J Vet Res* 2003; 64:413.
- Andrews FM et al. *Equine Vet J* 2002; 34:475.
- Equine Gastric Ulcer Council. *Equine Vet Educ* 1999; 11:262.
- Murray MJ et al. *J Vet Intern Med* 2001; 15:401.
- Baker SJ et al. *J Am Vet Med Assoc* 2004; 224:1967.
- Hewetson M et al. *J Vet Int Med* 2006; 20:388.
- Buchanan BR, Andrews FM. *Vet Clin North Am Equine Pract* 2003; 19:575.
- Murray MJ et al. *Equine Vet J* 1997; 29:425.
- Andrews FM et al. *Am J Vet Res* 1999; 60:929.
- McClure SR et al. *J Am Vet Med Assoc* 2005; 226:1681.
- McClure SR et al. *J Am Vet Med Assoc* 2005; 226:1685.
- Merritt AM et al. *Equine Vet J* 2003; 35:691.
- Nieto JE et al. *J Am Vet Med Assoc* 2002; 221:1139.
- Orsini JA et al. *J Am Vet Med Assoc* 2003; 223:336.
- Nieto JE et al. *Equine Vet Educ* 2001; 13:260.
- Smyth GB et al. *Equine Vet J* 1990; 22:48.
- Murray MJ, Schusser GF. *Equine Vet J* 1993; 25:417.
- Vatistas NJ et al. *Equine Vet J Suppl* 1999; 29:44.
- Murray MJ, Grady TC. *Equine Vet J* 2002; 34:195.

## INTESTINAL OBSTRUCTION IN HORSES

Intestinal obstruction is an important cause of colic in horses, and can involve the small intestine, cecum, large (ascending) colon, or small (descending) colon. Because the clinical characteristics of obstruction of the various bowel segments are quite different, intestinal obstruction is discussed based on the site

affected (small intestine, cecum, large or small colon).

## SMALL-INTESTINAL OBSTRUCTION IN HORSES

### Synopsis

**Etiology** Volvulus; intussusception; incarceration and strangulation in epiploic foramen, Meckel's diverticulum, mesenteric rents, or umbilical, inguinal or diaphragmatic hernia, or by pedunculated lipoma; obstruction due to foreign bodies, intramural tumors including hematomas, neoplasms and abscesses; ileal hypertrophy; ileal impaction

**Epidemiology** Mostly sporadic diseases, although the age affected can vary with the disease

**Clinical signs** Strangulating lesions cause acute, severe disease with intense pain, tachycardia, dehydration and hemoconcentration, and usually distended loops of small intestine palpable rectally. Death occurs in untreated horses within 48 hours. Obstructive, nonstrangulating lesions cause less severe pain and clinical abnormalities and have a longer course until death

**Clinical pathology** None diagnostic. Hemoconcentration and azotemia are indicative of dehydration. Leukopenia and left shift are consistent with endotoxemia and peritonitis. Peritoneal fluid may be serosanguinous with infarcted intestine

**Lesions** Consistent with the disease

**Diagnostic confirmation** Surgical exploration or necropsy

**Treatment** Surgical correction of lesion. Analgesia. Correction of fluid, electrolyte and acid-base abnormalities

## ETIOLOGY

A working classification is outlined below.

### Obstruction with infarction

- Volvulus or torsion of the mesentery
- Incarceration in or strangulation by:
  - Mesenteric rents<sup>1</sup>
  - Epiploic foramen<sup>2</sup>
  - Meckel's diverticulum<sup>3</sup>
  - Pedunculated lipoma<sup>4</sup>
  - Adhesions
  - Inguinal hernia<sup>5</sup>
  - Umbilical hernia<sup>6</sup>
  - Diaphragmatic hernia<sup>7</sup>
  - Rents in mesentery or intra-abdominal ligaments (e.g. gastrosplenic) or spleen<sup>8</sup>
  - Spermatic cord in geldings<sup>9</sup>
  - Developmental defects in mesentery<sup>10</sup>

### Obstruction without infarction

- Intussusception:
  - Jejunojunal, ileoileal, and other small intestinal<sup>11,12</sup>
  - Acute and chronic ileocecal<sup>13,14</sup>
- Foreign body:
  - Wood chip or fencing material

impaction of duodenum or jejunum<sup>15</sup>

- Phytobezoars
- Linear foreign bodies such as string or baling twine
  - Impaction of the duodenum or jejunum by molasses-containing feedblocks<sup>16</sup>
- Impaction of *Parascaris equorum*<sup>17</sup>
- Impaction of the terminal ileum<sup>18</sup>
- Muscular hypertrophy of the terminal ileum<sup>19</sup>
- Intramural masses such as neoplasms (intestinal adenocarcinoma, focal lymphosarcoma, leiomyoma),<sup>20</sup> hematomas,<sup>21</sup> abscesses and fungal infections (intestinal pythiosis), focal eosinophilic enteritis<sup>22</sup> and *Lawsonia intracellularis* proliferative enteropathy
- Compression of intestine by intra-abdominal masses including abscesses and neoplastic tumors.

### Functional obstruction

- Anterior enteritis
- Postoperative ileus
- Myenteric ganglioneuritis<sup>23</sup>
- Intestinal ischemia of any cause (thromboembolic colic, mesenteric accidents, post-exertional ileus.<sup>24</sup>

The classification used above should be used only as a guide, as the actual clinical presentation may vary. For instance, intussusceptions usually result in infarction of the intussuscepted segment but, because this segment is effectively isolated from the body, the clinical signs are often not characteristic of a horse with an infarctive lesion. Similarly, horses with small intestine entrapped in the epiploic foramen often have less severe clinical signs than anticipated for the severity of the lesion.

## EPIDEMIOLOGY

The epidemiology of colic is covered in a previous section. There are no recognized risk factors for small-intestinal volvulus and for many small-intestinal accidents. Epidemiological information is available for some small-intestinal obstructive diseases and is presented below. Obstructive diseases of the small intestine compromise approximately 20% of colic cases referred for further evaluation and treatment.<sup>25</sup> For small-intestinal diseases requiring surgical correction, the case fatality rate is 100% if surgery is not performed. Short-term survival of horses undergoing surgical correction of small intestinal obstruction is 34–74%.<sup>26,27</sup> Mortality rate is greatest in the perioperative period.<sup>27</sup> Survival rates vary depending on the nature and severity of the lesion, with long-term survival rates being lower for horses that require

resection of intestine, especially for resections of more than 2 m or more than one surgery.<sup>28,29</sup>

### Intestinal herniation through the epiploic foramen

This occurs in approximately 5% of horses with small intestinal disease requiring surgery.<sup>2</sup> Geldings are four times more likely than mares to be affected. Thoroughbreds were over-represented in two studies, suggesting a breed predisposition, and there was no effect of age on incidence.<sup>2,30</sup> There appears to be an increased incidence of the disease between October and March in Britain.<sup>30</sup> The **case fatality rate** for horses subjected to surgery was between 30% and 40%,<sup>2,24,30</sup> although older reports of the disease had a much higher case fatality rate. Horses with colic that crib (a behavioral abnormality in which horses grasp a fixed object such as a fence rail or post with the incisors, flex the neck and draw air into the esophagus) are 8–34 times more likely to have herniation of the small intestine through the epiploic foramen than are horses that do not crib.<sup>30,31</sup> The reason for this association is not known but may be related to factors that predispose horses to both cribbing and intestinal herniation through the epiploic foramen, such as diet, exercise or housing. Alternatively, cribbing might cause changes in intra-abdominal pressure that favor herniation.<sup>31</sup> There is no age predisposition to development of this disorder.<sup>26</sup>

### Pedunculated lipomas

The prevalence of colic caused by pedunculated lipoma is 1–2.6% of horses with colic and 1–17% of all horses that have a celiotomy because of small intestinal disease.<sup>4,26</sup> The prevalence varies depending on the population of horses studied. The proportion of horses with colic due to pedunculated lipomas increases with age, with the median age of affected horses being 19 years.<sup>26</sup> Pedunculated lipomas cause small intestinal obstruction in older horses (> 8 years) with geldings (2 ×) and ponies (4 ×) being at increased risk.<sup>4</sup> Pedunculated lipomas occasionally (5 of 75 cases) cause strangulating obstructive lesions of the small colon.<sup>4</sup> The case fatality rate for horses subjected to surgery is over 60%.

### Inguinal hernias

**Inguinal hernias** occur only in males. **Congenital inguinal hernias** are usually self-limiting, do not require medical or surgical therapy and resolve by the time foals are 3–6 months of age. Congenital inguinal hernias rarely cause a strangulating lesion of the small intestine (see Colic in foals). **Acquired inguinal hernias** occur almost exclusively in stallions, the

disease being rare in geldings.<sup>5</sup> There is no apparent breed or age predilection. The case fatality rate for horses subjected to surgery is 25%.

### Intussusception

**Small-intestinal intussusception** occurs more commonly in young horses and foals but also occurs in adult horses.<sup>11,12</sup> Approximately 50% of intussusceptions in adult horses are associated with a luminal or mural mass, whereas this is not the case in younger horses and foals.<sup>11,12</sup> The case fatality rate of horses subjected to surgery is 25–60%.

Both acute and chronic **ileocecal intussusceptions** occur more commonly in young (6–30 months) horses, although they are rare in foals.<sup>13,14</sup> There is no breed or sex predilection. The disease is acute in approximately 70% of cases and chronic in the remainder.<sup>13</sup> Ileocecal intussusceptions constitute approximately 75% of all intussusceptions involving the small intestine, and 60% of all intussusceptions.<sup>13</sup> The **case fatality rate** for horses with acute ileocecal intussusception when surgery is available is approximately 70%, whereas that for chronic intussusception is less than 10%.<sup>13,14</sup> There is strong evidence of an association between tapeworm (*Anoplocephala perfoliata*) infestation and ileocecal disease causing colic in horses.<sup>32,33</sup>

### Foreign body

**Foreign body obstructions** occur most frequently in foals and yearlings, possibly because of their tendency to explore and eat unusual items. Impaction by *Parascaris equorum* occurs in foals between 3 and 18 months of age and is often associated with the administration of anthelmintics to previously untreated foals.<sup>17</sup> Small-intestinal obstruction by feedblocks containing molasses is associated with ingestion of large quantities of the material.<sup>26</sup>

### Impaction

**Ileal impaction** occurs more commonly in mares and only in animals over 1 year of age.<sup>18</sup> The disease represented 7% of surgical colic cases in one series.<sup>34</sup> The case fatality rate of animals treated at a referral institution was 64%.<sup>20</sup> The disease is attributed to the feeding of finely ground, high-fiber feed such as Bermuda hay.<sup>35</sup> Horses with colic that have been fed coastal Bermuda hay are approximately three times more likely to have ileal impaction than are horses with colic that have not been fed this feedstuff.<sup>35</sup> Similarly, lack of administration of a compound effective against tapeworms is associated with a three-times greater risk of ileal impaction among horses with

colic,<sup>35</sup> and tapeworm infestation is associated with an increased incidence of spasmodic colic and ileocecal impaction in Thoroughbred race horses.<sup>36</sup>

### Mesenteric rents

Incarceration of small intestine through mesenteric rents is a cause of colic in approximately 2% of colic patients undergoing exploratory celiotomy.<sup>1</sup> The long-term survival rate is approximately 40%. There are no identified age, breed or sex predilections.

### PATHOGENESIS

The effects of intestinal obstruction and the particular influence of the related endotoxemia in horses have been detailed earlier. The type of lesion is important, depending on whether the blood supply to a large section of intestine is occluded or whether effective circulation is maintained. Obstructions that do not cause widespread intestinal ischemia, such those caused by focal external pressure, such as occurs with some forms of disease caused by pedunculated lipomas, or caused by internal foreign bodies such as phytobezoars, are less acutely lethal and do not cause as severe signs as do volvulus and forms of intussusception that result in ischemia of large sections of intestine. In the latter case, endotoxins from the gut lumen pass through the devitalized tissues of the gut wall into the circulation, resulting in signs of toxemia and cardiovascular collapse.

### CLINICAL FINDINGS

#### Acute disease – infarctive lesions

In acute, complete obstructions of the small intestine, with intestinal ischemia due to volvulus, intussusception or strangulation, there is usually an almost immediate onset of severe abdominal pain. The pain may be minimally or only transiently responsive to administration of analgesics. During this early stage intestinal sounds may still be present and feces still passed. The pulse rate increases to 60–80/min, the respiratory rate may be as high as 80/min, and sweating begins in many horses. It may be 8–12 hours before distended loops of intestine are palpable on rectal examination and it is about the same time that clinical and laboratory evidence of hypovolemia is first apparent. Depending on the site of the obstruction there may be reflux of fluid on passage of a nasogastric tube. More proximal lesions result in distension of the stomach earlier in the course of the disease. Small-intestinal distension is readily detected by percutaneous or rectal ultrasonographic examination. The sensitivity and specificity of ultrasonographic examination for detecting small-intestinal distension (98% and 84%, respectively) is greater

than that of rectal examination (50% and 98%, respectively).<sup>37</sup>

In the period 12–24 hours after obstruction commences, the pulse rate rises to 80–100/min, loops of distended intestine can be palpated per rectum, gut sounds and defecation cease, and the rectum is empty and sticky to the touch. Abdominal paracentesis yields blood-stained fluid. From 24 hours onwards, signs of hypovolemia and toxic shock become marked but the pain may not worsen. The horse will often appear depressed and poorly responsive to external stimuli. Sweating may persist. The heart rate increases to 100–120/min, intestinal loops are easily palpable, and reflux filling of the stomach occurs, with much fluid being evacuated via the stomach tube; the horse may vomit. Death due to endotoxemia or rupture of the intestine usually occurs within 48 hours. The terminal stage is one of severe endotoxic shock, with or without intestinal rupture and peracute diffuse peritonitis.

#### Subacute cases – noninfarctive lesions

If there is no vascular involvement in the small-intestinal obstruction, the pain is less severe than for horses with infarctive lesions, it is usually responsive to analgesics and the heart rate is only mildly elevated (50–60 bpm). The pain may be low-level continuous or intermittent with moderate attacks of pain alternating with periods of uneasiness without signs of overt pain. Pain is usually responsive to administration of analgesics. The duration of colic in these cases may be several days to several weeks. Palpable intestinal distension and clinical and laboratory evidence of hypovolemia may be evident. Surgical intervention becomes an option because of the failure of the patient to improve.

#### Intussusception of the small intestine

This may cause a syndrome of acute, subacute or chronic colic, depending on the degree of involvement of the blood supply. Horses with **acute ileocecal intussusception** have an abrupt onset of moderate to severe abdominal pain, tachycardia, reflux through a nasogastric tube, complete absence of borborygmi, and tightly distended small intestine evident on rectal palpation. The course of the disease is usually less than 24 hours. Horses with **chronic ileocecal intussusception** have a history of chronic, intermittent colic occurring after feeding, weight loss and reduced fecal volume.<sup>13,14</sup> The abdominal pain is mild and intermittent and the horses are not dehydrated or tachycardic. Rectal examination may

reveal the presence of mildly distended small intestine, especially after a meal, and in approximately 25% of cases the intussusception can be palpated per rectum. Mild abdominal pain may be present for weeks without an abdominal crisis occurring. Ultrasonographic examination may reveal the intussusception in the right flank.

#### Volvulus of the small intestine

This presents a typical syndrome of acute intestinal obstruction and infarction. The onset of signs is abrupt and there is severe pain, tachycardia, sweating and a rapid deterioration in the horse's clinical condition.

#### Strangulated inguinal hernia

This entity is often missed in the early stages because the distension of the scrotum is easily missed unless a specific examination of that area is performed. Severe pain in an entire male, even when distended loops of small intestine are not palpable, should prompt a thorough examination of the scrotum and, per rectum, the internal inguinal rings.

#### Strangulated diaphragmatic hernia

When acquired after birth, this lesion may have no distinguishing characteristics and may be identified only on thoracic radiography or exploratory laparotomy. There is often a history of trauma, such as dystocia or, in adults, a fall or being hit by a car. The clinical course is characteristic of any acute, strangulating intestinal lesion. Small intestine or large colon may herniate into the thoracic cavity and be evident on radiographic or ultrasonographic examination of the thorax.<sup>7</sup>

#### Epiploic foramen entrapment

Entrapment of small intestine in the epiploic foramen is associated with an array of clinical signs, some of which are subtle. Strangulation of small intestine through the epiploic foramen typically causes signs of acute abdominal pain with reflux of material through a nasogastric tube.<sup>2,38</sup> However, approximately 40% of affected horses do not have signs of abdominal pain when examined at a referral center and 52% do not have nasogastric reflux.<sup>2</sup> Horses with less severe clinical signs presumably have shorter lengths of incarcerated small intestine or incomplete obstructions to passage of luminal material or blood flow. Herniation of the parietal (antimesenteric) margin of the small intestine is sometimes associated with incomplete obstruction of the small intestine and signs of mild disease.<sup>39</sup> Because of the anterior location of the lesion, distended small intestine cannot usually be palpated per rectum and is not identifiable without ultrasonographic examination or surgical

intervention. A fatal complication of epiploic foramen herniation is rupture of the portal vein, leading to sudden death from internal hemorrhage. Tension by the incarcerated section of gut on the portal vein causes tearing of its wall and subsequent hemorrhage.<sup>34</sup> Hemoperitoneum in a horse with colic should prompt consideration of entrapment of small intestine in the epiploic foramen as a cause of the disease. The outcome of this combination of diseases is almost always fatal.

#### Functional obstruction

Functional obstructions due to anterior enteritis, intestinal ischemia or post-operative ileus can be difficult to discriminate from obstructive lesions of the small intestine that require surgical correction. Postoperative ileus is characterized by continued pain and reflux through a nasogastric tube after surgical correction of an intestinal lesion. The ileus is probably a result of the diffuse peritonitis and inflammation of the intestine that results from surgical exploration of the abdomen. If sufficient doubt exists over the cause of a horse's signs of intestinal obstruction, then laparotomy or repeat laparotomy should be performed.

#### Foreign body

Foreign body impaction of the duodenum by agglomerations of chewed wood or cracked corn kernels cause signs of acute obstruction but without the endotoxemia caused by infarction.<sup>15</sup>

#### Ileocecal valve impaction

Impaction of the ileocecal valve is manifest as an initial period of 8–12 hours of subacute abdominal pain with mild increases in heart rate. Intestinal sounds are increased in frequency and intensity. Rectal examination may reveal the enlarged, impacted ileum in the upper right flank at the base of the cecum in approximately 10% of cases.<sup>35</sup> It is easily confused with an impaction of the small colon. Reflux on nasogastric intubation occurs in approximately 50% of cases. After 24–36 hours the pain increases in severity. There is severe depression, patchy sweating and coldness of the extremities and the animal stands with its head hung down, sits on its haunches and rolls and struggles violently. The abdominal pain becomes severe and continuous, the pulse rate rises to between 80–120/min and the pulse is weak. The abdominal sounds are absent and there is reflux of sanguineous fluid through a nasogastric tube. On rectal examination the small intestine is tightly distended with gas and fluid. Death usually occurs within 36–48 hours after the onset of illness without surgical or effective medical intervention.

### Idiopathic muscular hypertrophy (terminal ileal hypertrophy)

This causes a long-term chronic or mild intermittent colic, with reduced appetite and weight loss, which persists over a period of weeks, sometimes months, in horses more than 5 years and up to 18 years old.<sup>19</sup> Colic pain is associated with feeding. On rectal examination the greatly thickened ileum can be palpated at the base of the cecum, and there may also be distended loops of thick-walled ileum.

Difficulty can be experienced in differentiating ileal hypertrophy from chronic intussusception, especially of the terminal ileum into the cecum. Fluid ingesta can pass the much constricted lumen of an intussusception so that mural hypertrophy occurs orally. A similar clinical picture results from stenosis of the small intestine by adhesions, usually resulting from verminous migration. In all three diseases there is increased motility of the small intestine and there is no interference with the blood supply.

### Caudal abdominal obstructions

Obstructive lesions of small intestine in the caudal abdomen, and therefore more likely to be palpable, include strangulation through tears in the mesentery, through a defect in the gastrosplenic ligament, entrapment behind the ventral ligament of the bladder or through a tear in the broad ligament of the uterus.

**Radiography** is not useful in diagnosing the cause of small-intestinal obstruction in adult horses, but **ultrasonographic** examination of the abdomen is rewarding and has greater sensitivity for detection of distended loops of small intestine than does rectal examination.<sup>2,37</sup> If available, ultrasonographic examination is indicated in the initial or second examination of all horses with colic. Ultrasonographic examination can detect, in addition to distended small intestine, reductions in or absence of motility associated with ileus, thickening of the intestinal wall, intussusceptions, increased volume of peritoneal fluid and abnormalities in the echogenicity of peritoneal fluid.<sup>40</sup>

### CLINICAL PATHOLOGY

While laboratory examinations of animals with intestinal obstruction may not be used in the diagnosis of the obstruction, they are useful in assessing its severity. In general, the laboratory findings in acute intestinal obstruction include the following:

- Hemoconcentration (the PCV usually exceeds 50%)
- Increase in serum creatinine concentration (depending on severity of the decrease in circulating blood volume)

- Decreases in plasma bicarbonate and pH, with increases in lactate concentration and anion gap
- Leukopenia and neutropenia. This is due to devitalization of infarcted intestine and the development of endotoxemia and, in some cases, peritonitis
- An increase in the total number of leukocytes, erythrocytes and the protein concentration in the peritoneal fluid obtained by paracentesis. In acute intestinal obstruction with infarction, the peritoneal fluid will be bloodstained. As necrosis and gangrene develop there is an increase in the total number of leukocytes with an increase in the number of immature neutrophils. As devitalization proceeds, but prior to perforation of the gut wall, intra- and extracellular bacteria may be seen in the fluid. Peritoneal fluid from horses with intestinal infarctive lesions has a higher alkaline phosphatase activity than fluid from horses with nonstrangulating obstructions.<sup>41</sup>

### NECROPSY FINDINGS

The physical lesions are characteristic of the disease.

### DIFFERENTIAL DIAGNOSIS

Other diseases that may mimic pain caused by gastrointestinal disease are listed under Differential diagnosis in equine colic. Gastrointestinal causes of colic that must be differentiated from small intestinal obstructive disease include:

- Enteritis and acute diarrhea
- Equine monocytic ehrlichiosis
- Anterior enteritis
- Gastric ulcer in foals and adults
- Disorders of the large or small colon
- Intestinal tympany (gas colic)
- Thromboembolic colic.

See also Table 5.6.

### TREATMENT

The principles of treatment of horses with small intestinal obstructive lesions are similar to those of any colic and are set out in detail under Equine colic, above.

Every attempt should be made to relieve the horse's pain using appropriate doses of effective analgesics (see Table 5.7). Care should be taken when using flunixin meglumine that signs of a lesion requiring surgical correction are not masked until the severity of the disease makes successful treatment unlikely.

**Almost all obstructive lesions of the small intestine require surgical correction.** In addition to surgery, attention should be paid to maintaining the horse's fluid, acid-base and electrolyte status, as discussed under Equine colic and in Chapter 2. Treatment of postoperative ileus should be aggressive and include correction of acid-base, fluid and electrolyte abnormalities, continued gastric decompression through a nasogastric tube and administration of promotility drugs such as cisapride, lidocaine, erythromycin and metoclopramide (Table 5.8).

Ileal impactions can be treated medically by the administration of intravenous fluids, gastric decompression and administration of mineral oil.<sup>42</sup> Horses treated medically should be closely monitored as prompt surgical intervention may be necessary if the horse's condition deteriorates.

### REFERENCES

1. Gayle JM et al. *J Am Vet Med Assoc* 2000; 216:1446.
2. Vachon AM, Fischer AT. *Equine Vet J* 1995; 27:373.
3. Hooper RN. *J Am Vet Med Assoc* 1989; 194:943.
4. Edwards GB, Proudman CJ. *Equine Vet J* 1994; 26:18.
5. Schneider RK et al. *Am J Vet Res* 1982; 180:317.
6. Rijkenhuijzen ABM et al. *Equine Vet Educ* 1997; 9:3.
7. Santschi EM et al. *Vet Surg* 1997; 26:242.
8. Helie P et al. *Can Vet J* 1999; 40:657.
9. Moll HD et al. *J Am Vet Med Assoc* 1999; 215:824.
10. Steenhaut M et al. *Vet Rec* 1992; 129:54.
11. Gift LJ et al. *J Am Vet Med Assoc* 1993; 202:110.
12. Greet TRC. *Equine Vet J* 1992; 24:81.
13. Ford TS et al. *J Am Vet Med Assoc* 1990; 196:121.
14. Hackett MS, Hackett RP. *Cornell Vet* 1989; 79:353.
15. Green P, Tong JM. *Vet Rec* 1988; 123:196.
16. Mair TS. *Equine Vet J* 2002; 34:532.
17. Southwood L et al. *Compend Contin Educ Pract Vet* 1998; 20:100.
18. Parks AH et al. *Cornell Vet J* 1989; 79:83.
19. Chaffin MK et al. *Equine Vet J* 1992; 24:372.
20. Kasper C, Doran R. *J Am Vet Med Assoc* 1993; 202:769.
21. Van Hoogmoed L, Snyder JR. *J Am Vet Med Assoc* 1996; 209:1453.
22. Southwood LL et al. *Vet Surg* 2000; 29:415.
23. Burns GA et al. *Cornell Vet* 1990; 80:53.
24. Schott HC, Charlton MR. *Compend Contin Educ Pract Vet* 1996; 18:559.
25. Van der Linden MA et al. *J Vet Intern Med* 2003; 17:343.
26. Freeman DE, Schaeffer DJ. *J Am Vet Med Assoc* 2001; 219:87.
27. Van der Boom R, van der Velden MA. *Vet Q* 2001; 23:109.
28. Freeman DE et al. *Equine Vet J Suppl* 2000; 32:42.
29. Morton AJ, Blikslager AT. *Equine Vet J* 2002; 34:450.
30. Archer DC et al. *Vet Rec* 2004; 155:793.
31. Archer DC et al. *J Am Vet Med Assoc* 2004; 224:562.
32. Proudman CJ et al. *Equine Vet J* 1998; 30:194.
33. Pearson GR et al. *Vet Rec* 1993; 132:179.
34. Emberston RM et al. *J Am Vet Med Assoc* 1985; 186:570.
35. Little D, Blikslager AT. *Equine Vet J* 2002; 34:464.
36. Proudman CJ, Hodlstock NB. *Equine Vet J* 2000; 32:37.

37. Klohnen A et al. J Am Vet Med Assoc 1996; 209:1597.  
 38. Engelbert TA et al. Vet Surg 1993; 22:57.  
 39. Hammock PD et al. J Am Vet Med Assoc 1999; 214:1354.  
 40. Freeman S. In Pract 2002; May:262.  
 41. Saulez MN et al. J Vet Intern Med 2004; 18:564.  
 42. Hanson RR et al. J Am Vet Med Assoc 1996; 208:898.

## ANTERIOR ENTERITIS (DUODENITIS – PROXIMAL JEJUNITIS, PROXIMAL ENTERITIS)

### Synopsis

**Etiology** Unknown

**Epidemiology** Sporadic disease. Case fatality rate of 6–75%

**Clinical signs** Colic, voluminous reflux on nasogastric intubation, mild fever, resolution of pain on gastric decompression

**Clinical pathology** None diagnostic

**Lesions** Duodenitis, proximal jejunitis.

Gastric and small intestinal distension

**Diagnostic confirmation** None.

Resolution of disease

**Treatment** Gastric decompression.

Correction of fluid and electrolyte abnormalities

### ETIOLOGY

The etiology of anterior enteritis is unknown. *C. difficile* might be involved<sup>1</sup> Experimental intoxication with culture media of *Fusarium moniliforme* produces histological, but not clinical, signs consistent with the disease.<sup>2</sup>

### EPIDEMIOLOGY

The disease is reported from the USA and Europe.<sup>2,3</sup> There is no apparent effect of age, with the exception that the disease is not reported in horses less than 1 year of age and is uncommon in horses less than 2 years of age.<sup>4</sup> There is no breed or sex predilection for the disease. There are anecdotal reports of farms with a high incidence of the disease, especially among brood mares. Similarly, some consider feeding of large amounts of concentrated feeds to horses to be a risk factor for the disease. Anterior enteritis occurs more commonly in the warmer months.<sup>4</sup> There are no reports of the incidence, morbidity/mortality of anterior enteritis. The case fatality rate varies from 6% to 75%.<sup>4,5</sup>

### PATHOGENESIS

The primary lesion is inflammation and edema of the duodenum and jejunum with sloughing of villus epithelium and villus atrophy.<sup>5</sup> These lesions are probably associated with ileus and failure of small intestinal absorptive function. Fluid accumulation in the atonic small intestine causes distension and pain and reflux of

alkaline small-intestinal contents into the stomach. Sequestration of fluid, electrolytes and bicarbonate in the stomach and small intestine causes a reduction in blood volume, shock and metabolic acidosis. Gastric and small intestinal distension and hypovolemia cause tachycardia. Disruption of the small intestinal mucosal barrier allows absorption of toxins, including endotoxins, that further compromise cardiovascular and metabolic function. Death in untreated cases results from acute, diffuse peritonitis secondary to gastric rupture, or shock and metabolic disturbances secondary to hypovolemia and endotoxemia.

### CLINICAL FINDINGS

The onset of clinical signs is usually abrupt and characterized by mild to severe colic. Affected horses are **depressed, dehydrated** and have prolonged capillary refill time and heart rates between 50 and 80/min. The respiratory rate is variable. The horse may sweat profusely and there are muscle fasciculations in severely affected cases. **Borborygmi are absent** although there may be tinkling sounds of gas bubbling in fluid-filled atonic intestine. **Rectal examination** usually reveals the presence of multiple loops of moderately to severely distended small intestine. **Reflux of fluid** through a nasogastric tube is a consistent finding, and usually results in marked relief of pain and resolution of tachycardia. The fluid is often sanguineous, malodorous, alkaline and of large (10–12 L) volume.<sup>4</sup>

Gastric decompression and administration of intravenous fluids results in marked improvement of clinical signs, although affected horses may continue to have nasogastric reflux for 24 hours to 10 days. Most cases resolve within 5 days. If untreated, horses develop severe gastric distension with subsequent rupture and death from peracute, diffuse peritonitis, or die as a result of hypovolemia and toxemia. A common sequela is the development of laminitis. Approximately 10% of horses with anterior enteritis have cardiac arrhythmias, including ventricular depolarizations and atrio-ventricular conduction disturbances.<sup>6</sup> Arrhythmia resolves with resolution of the anterior enteritis.

### CLINICAL PATHOLOGY

There is hemoconcentration with hematocrits as high as 0.70 L/L (70%) and total serum protein as high as 96 g/L (9.6 g/dL) in severely affected horses. The leukogram is variable and not diagnostic – leukocytosis and left shift are common.<sup>5</sup> Serum potassium concentration may be mildly low and blood bicarbonate concentration and pH are low in most cases. Horses with anterior enteritis have serum bilirubin concentrations and serum

gamma-glutamyl transpeptidase, aspartate aminotransferase and alkaline phosphatase activities higher than horses with small intestinal infarctive lesions.<sup>7</sup> However, the differences are not sufficiently large for these variables to be useful in the differentiation of horses with anterior enteritis from horses with small-intestinal infarctive lesions.

Peritoneal fluid has a normal nucleated cell count in 65% of cases; in the remaining cases it is increased.<sup>4</sup> Peritoneal fluid protein concentration is often normal in cases sampled early in the disease but may be increased in more severe or prolonged disease and is a useful prognostic indicator.<sup>8</sup>

### NECROPSY FINDINGS

Gross lesions are restricted to the stomach, duodenum and jejunum in most cases. The affected stomach and small intestine are distended and the serosal surface has numerous petechial and ecchymotic hemorrhages.<sup>5</sup> The mucosa is deep red and contains petechial hemorrhages and occasional foci of necrosis and ulceration. Histological changes include neutrophilic inflammation, edema, hyperemia, epithelial sloughing and villus atrophy. There is necrosis of mucosa, fibrin-rich edema and heavy neutrophil infiltration of the submucosa, and extensive hemorrhage in the tunica muscularis and serosa.<sup>5</sup> A proportion of horses with anterior enteritis have biochemical and histological evidence of liver disease, including hepatocellular vacuolization and neutrophilic inflammation.<sup>7</sup> Some horses with anterior enteritis have myocarditis.<sup>6</sup>

### DIFFERENTIAL DIAGNOSIS

The most important differential diagnosis is a small intestinal obstructive lesion.

### DIAGNOSTIC CONFIRMATION

Horses with small-intestinal obstructive lesions require urgent surgical correction, while horses with anterior enteritis respond well to medical therapy. The differentiation of anterior enteritis and a small-intestinal obstructive lesion on clinical grounds is difficult and there is no one variable that allows the distinction to be made reliably. Horses with anterior enteritis have a lower heart rate, higher rectal temperature (fever), lower volume of gastric reflux and less turgid small intestine on rectal examination than do horses with obstructive lesions,<sup>4</sup> although others report that horses with anterior enteritis have a higher volume of reflux at first examination and during the first

24 hours of disease.<sup>7</sup> However, these differences are not sufficiently great to be conclusive. Horses with anterior enteritis more often have normal peritoneal fluid than do horses with small-intestinal obstructive lesions. The response to gastric decompression and intravenous fluid therapy is useful in discriminating between diseases as horses with anterior enteritis have marked resolution of abdominal pain and tachycardia within minutes of gastric decompression, whereas horses with small-intestinal obstruction have minimal or no resolution of these signs. In general, horses with a heart rate below 60/min after gastric decompression, mildly to moderately distended loops of small intestine, resolution of abdominal pain after gastric decompression and normal peritoneal fluid probably have anterior enteritis. However, horses should be examined frequently for changes in clinical condition. Worsening pain and cardiovascular status in the face of adequate fluid therapy warrant reconsideration of a diagnosis of anterior enteritis.

## TREATMENT

The principles of treatment of anterior enteritis are gastric decompression, correction of fluid, acid–base and electrolyte abnormalities and provision of maintenance fluid and electrolytes, relief of pain, and prophylaxis of laminitis.

**Gastric decompression** is an urgent need in affected horses and can be accomplished by nasogastric intubation. The nasogastric tube should be left in place, or replaced frequently, for as long as there is reflux of clinically significant quantities of fluid (more than 2–4 L/4 h in a 425 kg horse). Discontinuation of gastric siphonage should be approached cautiously and the horse should be patient monitored for any increase in heart rate or development of abdominal pain that may indicate recurrence of gastric distension. After the nasogastric tube is removed, the horse should be reintroduced cautiously to oral fluids and food. Small amounts (1–2 L) of water should be offered frequently (every 1–2 h) during the first 12–24 hours. Horses should not be given immediate access to ad libitum water as some horses in the early convalescent period from anterior enteritis will consume a large quantity of water and develop gastric dilatation and colic. Feed should be reintroduced gradually over 24–48 hours.

Complications of prolonged or repeated gastric siphonage through a nasogastric tube are pharyngitis, esophagitis, esophageal stricture and esophageal perforation with subsequent cellulitis.

**Fluid, electrolyte and acid–base abnormalities** should be corrected by the administration of intravenous fluid.

Isotonic, polyionic fluids such as lactated Ringer's solution are suitable. Affected horses may lose considerable chloride and potassium in reflux fluid necessitating supplementation of fluids with potassium (up to 20 mEq/L).

**Analgesia** can be provided by administration of any of a number of drugs, including flunixin meglumine or ketoprofen (Table 5.7). If the diagnosis of anterior enteritis is uncertain, potent analgesics such as flunixin meglumine should not be used until there is no possibility that a lesion requiring surgical correction exists.

**Promotility agents** such as lidocaine and cisapride (Table 5.8) and antacids such as cimetidine (Table 5.11) are sometimes administered, although their efficacy has not been determined.<sup>9</sup>

**Antibiotics**, such as penicillin and an aminoglycoside, are often administered to affected horses because of the presumed bacteremia associated with the disease.

**Surgical treatment** of the disease is described<sup>3,5</sup> but most cases resolve without surgical intervention.<sup>4</sup>

## REVIEW LITERATURE

Paradis MR. Prokinetic drugs in the treatment of proximal enteritis. *Compend Contin Educ Pract Vet* 1999; 21:1147–1149.

Freeman DE. Duodenitis – proximal jejunitis. *Equine Vet Educ* 2000; 12:322–332.

## REFERENCES

1. Arroyo LG et al. *Proc Am Assoc Equine Pract* 2005; 51:38.
2. Schumacher J et al. *Vet Hum Toxicol* 1995; 37:39.
3. Huskamp B. *Equine Vet J* 1985; 17:314.
4. Johnson JK, Morris DD. *J Am Vet Med Assoc* 1987; 191:849.
5. White NA et al. *J Am Vet Med Assoc* 1987; 190:311.
6. Cornick JL, Seahorn TL. *J Am Vet Med Assoc* 1990; 197:1054.
7. Davis JL et al. *J Vet Intern Med* 2003; 896.
8. Seahorn TL et al. *J Vet Intern Med* 1992; 6:307.
9. Paradis MR. *Compend Contin Educ Pract Vet* 1999; 21:1147.

## DISEASES OF THE CECUM

### ETIOLOGY

- Cecal impaction
- Cecal rupture
- Cecocolic and cecocolic intussusceptions
- Cecal torsion
- Cecal tympany
- Cecal infarction.

There is strong support for a role of *Anoplocephala perfoliata* infestation in cecal disease of horses.<sup>1–3</sup> Infestation with *A. perfoliata* results in edema, hyperemia and hemorrhagic foci in the ileocecal valve mucosa with light parasitism through regional necrotizing enteritis, with extension of lesions to the muscularis mucosa and eosinophilic inflammation around arterioles and submucosal neural plexus with heavy parasitism.<sup>3</sup>

### Synopsis

**Etiology** Cecal impaction, perforation, cecocolic and cecocolic intussusceptions, cecal torsion and cecal tympany

**Epidemiology** Sporadic diseases. Cecal impaction and cecal perforation are reported in horses hospitalized for unrelated conditions. Cecal rupture occurs in mares during parturition

**Clinical signs** Cecal impaction is evident as mild, intermittent colic that may not be noticed by a casual observer. Cecal perforation or rupture is evident as acute shock, sweating and tachycardia secondary to diffuse peritonitis. Cecocolic intussusception causes acute severe colic while cecocolic intussusception causes mild, intermittent colic

**Clinical pathology** None diagnostic  
**Lesions** Gross lesions consistent with the disease

**Diagnostic confirmation** Physical examination, exploratory laparotomy, or necropsy examination

**Treatment** Cecal impaction treated medically with overhydration, fecal softeners and analgesics. No treatment for cecal rupture or perforation. Surgical correction of some cecal impactions and all cecocolic and cecocolic intussusceptions

Larval cyathostomiasis is also associated with cecocolic and cecocolic intussusception in young horses.<sup>4</sup> Other causes include intramural and extramural masses, including cecal abscesses, and alterations in cecal and colonic motility.

Disturbed cecal motility or dehydration of cecal contents secondary to dietary changes are thought to be the cause of most cases of cecal impaction and rupture.<sup>5</sup> Horses with recurrent cecal impaction have lower neurone densities in muscle layers of the base of the cecum and cecal body than do normal horses, supporting the hypothesis that disturbed motility secondary to neuronal abnormalities is a cause of the disease.<sup>6</sup> Administration of drugs that interfere with cecal motility or secretory function has the potential to increase the risk of cecal disease.

### EPIDEMIOLOGY

Cecal disease accounts for approximately 4–10% of colic in horses examined for abdominal pain at referral centers.<sup>7,8</sup>

### Cecal impaction

**Cecal impaction** is the cause of colic in approximately 5% of horses treated for colic in referral institutions. This estimate probably reflects a selection bias, with horses with less severe disease not being referred for further examination. Cecal impaction is therefore probably much less common as a cause of colic in field cases. Cecal impaction is the most common cause of cecal disease.<sup>7</sup> There is no sex predisposition to the disease but Arabians,

Morgan and Appaloosa breeds might be at greater risk of developing cecal impactions.<sup>9</sup> Older horses are disproportionately affected, with horses over 15 years at increased risk compared to horses less than 7 years of age.<sup>9,10</sup> The disease occurs sporadically but is reported in horses hospitalized for unrelated disease, and it is speculated that anesthesia, surgery and/or administration of NSAIDs are risk factors for the disease.<sup>10</sup> Fasting, poor dentition, poor-quality feed and restricted water intake might also be risk factors for the disease. The **case fatality rate** is approximately 50%.<sup>10</sup>

### Cecal rupture

**Cecal rupture** at parturition occurs in 0.1% of mares.<sup>11</sup> Cecal rupture represents approximately 27% of cecal disease in horses, that associated with concurrent but apparently unrelated disease being the most common (13%).<sup>7</sup> Cecal rupture or perforation is otherwise a sporadic disease that is often, but not always, a sequela to cecal impaction.<sup>12</sup> The case fatality rate is 100%.<sup>12</sup> Cecal rupture, often without recognized pre-existing disease, is recognized as a complication of anesthesia and phenylbutazone administration.<sup>9,12,13</sup> As with other cecal diseases, infestation with *A. perfoliata* has been implicated as a cause of cecal rupture, although not all horses with cecal rupture have tapeworms.<sup>9</sup>

### Cecocolic or cecocolic intussusceptions

Cecocolic and cecocolic intussusceptions are the cause of 1% of colic cases treated surgically and approximately 3–7% of cecal disease.<sup>7,14</sup> The case fatality rate is approximately 50–70%.<sup>14,15</sup> There are no recognized epidemiological patterns to the occurrence of **cecal or cecocolic intussusceptions**, with the exception that younger horses (<3 years) and Standardbreds are disproportionately affected.<sup>14,15</sup> Infestation with tapeworm (*A. perfoliata*) is suspected to increase the risk of cecal intussusceptions, although this suspicion is not universal.<sup>15,16</sup>

### Cecal torsion

**Cecal torsion** occurs rarely and is associated with hypoplasia of the cecocolic fold in some but not all cases.<sup>7,17</sup>

Primary **cecal tympany** is rare. Cecal infarction is caused by thromboembolic disease secondary to *Strongylus vulgaris* arteritis or necrotizing enterocolitis.<sup>18</sup>

### PATHOGENESIS

Cecal impaction is probably a result of impaired or altered cecal motility, with resultant reduced cecal emptying into the right ventral colon.<sup>5</sup> Accumulation of feed material causes cecal distension and excessive tension in the wall of the cecum

with ischemia, necrosis and rupture. Infestation by tapeworms, including *A. perfoliata*, cause disruption of the cecal mucosa and submucosa, necrosis and inflammation, changes that could contribute to cecal dysfunction.<sup>3</sup> Death results from peracute diffuse peritonitis.

Cecal rupture at parturition is probably the result of high intra-abdominal pressures associated with expulsion of the fetus. The pathogenesis of cecal rupture without cecal impaction is unknown.

### CLINICAL FINDINGS

#### Cecal distension and impaction

**Cecal distension** occurs as two clinical syndromes. Cases in which the cecum is **impacted** and distended with inspissated feed material usually have signs of mild to moderate abdominal pain that is often intermittent over a 1–4-day period. The signs of pain may be sufficiently mild as to be missed by a casual observer. Affected horses are usually mildly depressed and have a diminished appetite. The heart rate is 40–60/min, borborygmi are reduced and there may be mild dehydration. Nasogastric intubation yields reflux fluid only late in the course of the disease. Rectal examination reveals a doughy mass in the right caudal abdomen. The ventral, and occasionally the medial, tenia of the cecum are palpable, as is firm feed material in the base and body of the cecum. The mass extends cranially, ventrally and across the midline of the abdomen. If not treated, the cecum ruptures, causing an acute onset of tachycardia, sweating, delayed capillary refill and shock, with death occurring in hours. It is not unusual for the initial signs of the disease to be missed and the problem to be recognized only after the cecum ruptures.

Horses with chronic, **recurrent cecal impaction** have a mild disease characterized by recurrent subtle to moderate signs of colic, reduced food intake, weight loss and loose feces.<sup>19</sup>

**Cecal distension** also occurs as a syndrome in which **fluid** accumulates in the cecum. This disease has a much more acute course and is characterized by severe abdominal pain, tachycardia and signs consistent with toxemia. Rectal examination demonstrates a cecum tightly distended with fluid ingesta. Without surgical intervention the outcome is cecal rupture and death.

#### Perforation

**Cecal perforation** may occur secondary to cecal distension or as a primary entity. There are usually only very mild premonitory signs and the disease becomes apparent when the cecum ruptures and acute diffuse peritonitis develops. Detection of serosa with a gritty feel and free

gas in the abdomen on rectal examination is diagnostic of a ruptured viscus and diffuse peritonitis.

### Intussusception

**Cecocolic intussusception** may present as an acute severe colic or as a mild intermittent colic, depending on the degree of involvement of the apex of the cecum. Small intussusceptions that cause little obstruction and no infarction of the invaginated section cause only mild pain.

**Cecocolic intussusception** causes acute and severe pain and has a short course. Rectal examination may reveal a mass in the right dorsal quadrant, lack of a cecum and pain on palpation of the right dorsal quadrant. Ultrasonographic examination of the right flank reveals the presence of the cecum in the colon, apparent in cross-section as a 'target-like' pattern or taurus.<sup>20</sup>

### CLINICAL PATHOLOGY

Cecal impaction with feed material is usually associated with mild hemococoncentration. Cecal perforation results in severe leukopenia and left shift, hemococoncentration (hematocrit > 50%, 0.50 L/L) and azotemia.

**Peritoneal fluid** from horses with cecal impaction is usually normal. However, if the cecum becomes ischemic, then the fluid is sanguineous with an elevated white blood cell count (> 8000 cells/ $\mu$ L,  $8 \times 10^9$  cells/L) and protein concentration (> 2.5 g/dL, 25 g/L).<sup>10</sup> Cecal perforation is evident as a high proportion of degenerate neutrophils, intra- and extracellular bacteria and plant material.

### NECROPSY FINDINGS

The distended cecum and diffuse peritonitis are readily apparent. Cases of cecal perforation without distension will have diffuse peritonitis but the cause is only apparent on close examination of the intestinal tract. There is usually no underlying disease apparent on histologic examination.

### DIFFERENTIAL DIAGNOSIS

Causes of colic are set out in Table 5.6.

### TREATMENT

Treatment of cecal impaction involves control of pain (Table 5.7), restoration of normal fluid, acid–base and electrolyte status (see Ch. 2), and administration of fecal softeners such as sodium sulfate (Table 5.8). Mineral oil, although frequently used, may not be sufficient alone to facilitate passage of the impaction because it does not cause fecal softening.

**Intravenous administration of fluid** at 2–3 times maintenance needs is often



used in an attempt to hasten fecal softening by increasing secretion of water into the impaction. **Oral administration** of large quantities of water (4 L every 2 h for 24 h) may soften the impaction.

Horses with cecal impaction should be **closely monitored** for signs of deterioration, and especially of cecal ischemia, by frequent physical examinations and repeated abdominocentesis. Lack of resolution within 24 hours or signs of deterioration should prompt surgical exploration with typhlotomy and evacuation of the cecum and possible partial cecal bypass.<sup>12,21</sup>

Horses with **cecal perforation** always die and should be euthanized without delay.

**Cecocolic and cecocolic intussusceptions** must be corrected surgically.

## REVIEW LITERATURE

- Dabareiner RM, White NA. Diseases and surgery of the cecum. *Vet Clin North Am Equine Pract* 1997; 13:303–315.
- Dart AJ et al. Caecal disease. *Equine Vet Educ* 1999; 11:182–188.

## REFERENCES

- Proudman CJ et al. *Equine Vet J* 1998; 30:194.
- Pearson GR et al. *Vet Rec* 1993; 132:179.
- Rodriguez-Bertos A et al. *J Vet Med A* 1999; 46:261.
- Mair TS et al. *Equine Vet J Suppl* 2000; 32:77.
- Gerard MP et al. *J Am Vet Med Assoc* 1996; 209:1287.
- Schusser GF et al. *Equine Vet J Suppl* 2000; 32:69.
- Dart AJ et al. *Equine Vet Educ* 1999; 11:182.
- Van der Linden MA et al. *J Vet Intern Med* 2003; 17:343.
- Dart AJ et al. *Aust Vet J* 1997; 75:552.
- Collatos C, Romano S. *Compend Contin Educ Pract Vet* 1993; 15:976.
- Littlejohn A, Ritchie JD. *J S Afr Vet Med Assoc* 1975; 46:87.
- Ross MW et al. *J Am Vet Med Assoc* 1985; 187:249.
- Edwards JF, Ruoff WW. *J Am Vet Med Assoc* 1991; 198:1421.
- Gaughan EM, Hackett RP. *J Am Vet Med Assoc* 1990; 197:1373.
- Martin BB et al. *J Am Vet Med Assoc* 1999; 214:80–84.
- Owen RR et al. *Vet Rec* 1989; 124:34–37.
- Harrison IW. *Cornell Vet* 1989; 79:315.
- Saville WA et al. *J Vet Intern Med* 1996; 10:265.
- Huskamp B, Scheidemann W. *Equine Vet J Suppl* 2000; 32:65–68.
- Taintor J et al. *J Am Vet Med Assoc* 2004; 225:1829–1830.
- Roberts CT, Slone DE. *Equine Vet J Suppl* 2000; 32:74–76.

## DISPLACEMENT AND VOLVULUS OF THE LARGE (ASCENDING) COLON

Syndromes: nephrosplenic entrapment, renosplenic entrapment, left dorsal displacement of the large colon, right dorsal displacement of the large colon.

### ETIOLOGY

- Left dorsal displacement of the large colon (renosplenic or nephrosplenic

### Synopsis

**Etiology** Unknown, probably involves disturbance of colonic motility  
**Epidemiology** Volvulus is more common in mares during late gestation or after parturition. Left dorsal displacement (renosplenic entrapment) may be more common in large male horses  
**Clinical signs** Left displacement of the large colon causes signs of mild to moderate colic. Rectal examination reveals large colon in the renosplenic space and ultrasonographic examination confirms the diagnosis. Right dorsal colon displacement causes mild to moderate colic. Rectal examination reveals colon lateral to the base of the cecum. Volvulus of the large colon causes mild to extremely severe abdominal pain, tachycardia, shock and abdominal distension. Rectal examination reveals the distended, displaced colon  
**Clinical pathology** None diagnostic  
**Lesions** Displaced large colon  
**Diagnostic confirmation** Physical examination, laparotomy, necropsy examination  
**Treatment** Volvulus and right dorsal displacement should be treated by surgical correction. Left dorsal displacement can be corrected by rolling the anesthetized horse or jogging the horse after administration of phenylephrine

entrapment and entrapment of the large colon lateral to the spleen)

- Right dorsal displacement of the large colon
- Volvulus (both strangulating and nonstrangulating).

The etiology of these conditions is unknown but presumably involves some disturbance to normal colonic motility. Other causes of obstruction of the large colon include congenital abnormalities of the right ventral colon,<sup>1</sup> cystic duplication of the ascending colon,<sup>2</sup> defects in the mesocolon<sup>3</sup> and incarceration in epiploic foramen or gastrosplenic ligament.<sup>4,5</sup> Intussusception of the large colon causes infarction and severe colic.<sup>5</sup>

The term volvulus refers to rotation of the segment of bowel about the long axis of its mesentery, while torsion refers to rotation about the long axis of the bowel. Because of the anatomical arrangement of the mesocolon, either term may be correctly used to describe displacements of the large intestine.<sup>5</sup>

### EPIDEMIOLOGY

**Left dorsal displacement of the large colon** (Fig. 5.1) is the cause of 2–10% of colic cases referred for specialist treatment.<sup>6</sup> There is no breed, age or sex predisposition, although some authors suggest that males and large horses are more likely to be affected. The case fatality

rate is approximately 5% for horses treated correctly.<sup>7–10</sup>

**Right dorsal displacement** of the large colon (Fig. 5.2) occurs sporadically and without recognized risk factors. The case fatality rate is reported to be as high as 43%.<sup>10</sup>

Risk factors for noninfarctive displacement of the large colon include cribbing or wind sucking (odds ratio (OR) = 90), number of hours stabled per day (OR for 24 h stabling = 35), lack of regular exercise (OR = 3.3), change in exercise program (OR = 9), lack of anthelmintic administration (OR = 13) and history of transport in the previous 24 hours (OR = 17).<sup>11</sup>

**Volvulus of the large colon** is the cause of colic in 11–17% of colic cases in which abdominal surgery is performed.<sup>12</sup> The disease occurs commonly in mares, especially those late in gestation or having recently foaled.<sup>13,14</sup> The disease has a recurrence rate of up to 15% in brood mares.<sup>15</sup> The disease occurs in horses from 2 days of age and there does not appear to be an effect of breed on occurrence of the disease.<sup>16</sup> The **case fatality rate** varies depending on the extent of the volvulus, with lesser degrees of volvulus (< 270°) having a 30% fatality rate and volvulus of 360° or more having a 65% fatality rate.<sup>13</sup>

Ingestion of large quantities of grain, such as might be fed to horses in heavy work, is associated with changes in plasma electrolyte concentrations, presence of dehydrated, foamy and homogeneous right dorsal colon contents, and fetid, less formed feces.<sup>17</sup> These effects of a high-grain diet may be associated with colonic disease in horses.<sup>17</sup>

### PATHOGENESIS

Proximate factors leading to volvulus or displacement are unknown, although risk factors have been identified (see above). A plausible scenario is that altered colonic motility and subsequent distension with gas or ingesta predisposes the colon to displacement, either spontaneously or as a result of the horse rolling or lying down in response to abdominal pain.

**Left dorsal and right dorsal** displacements of the colon rarely compromise colon blood flow and represent non-strangulating obstructive lesions. Pathogenesis in equine colic section). The displacement of the large colon (Figs 5.1 & 5.2) impedes aboral movement of ingesta and gas and may result in colonic distension. Should the distension become sufficiently severe, colon blood flow will be impaired and cause ischemia and necrosis of the colon. The obstruction to blood flow is predominantly in venous drainage, resulting in hemorrhagic strangulating



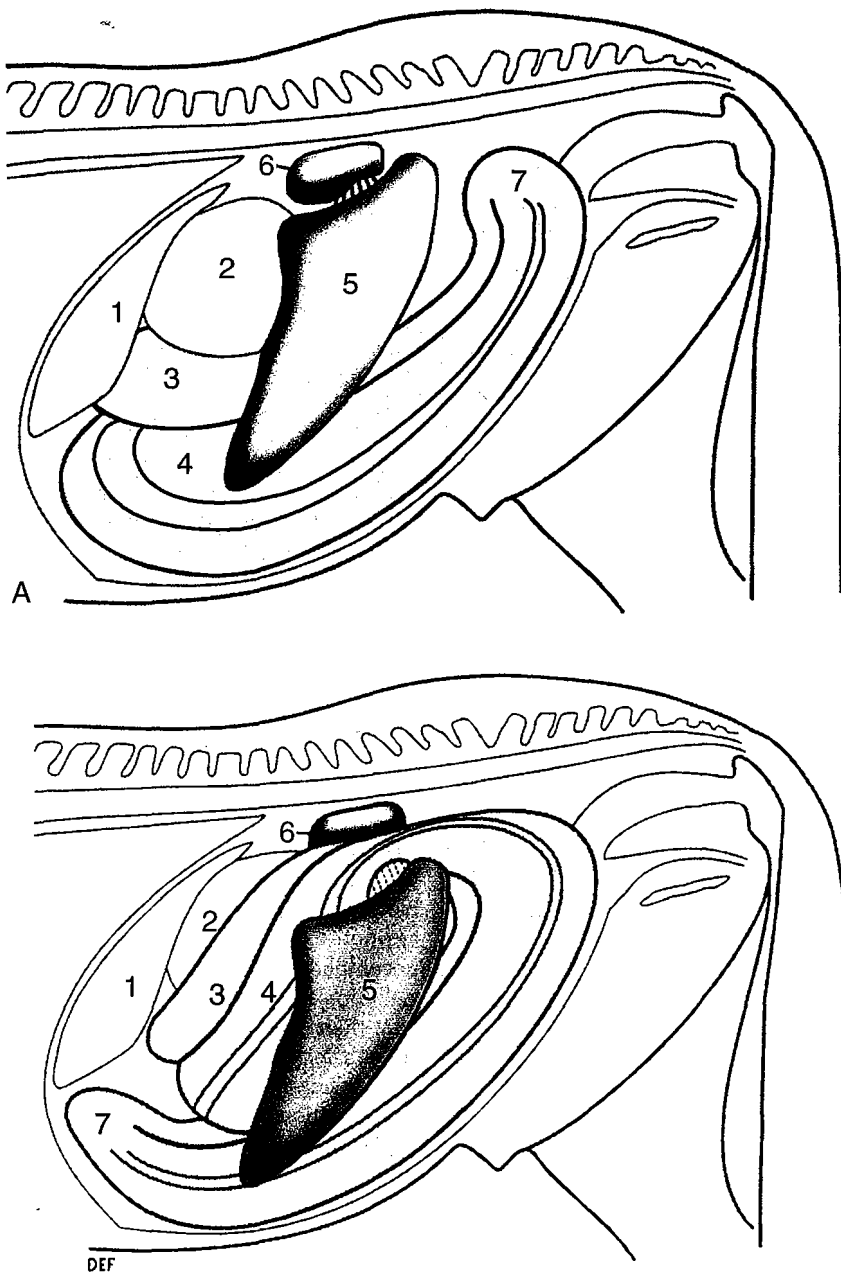

**Fig. 5.1** **A** Left lateral view of abdomen of a normal horse. **B** Left dorsal displacement of the left colon, left lateral view. The left ventral and dorsal colon is displaced lateral and dorsal to the spleen and occupies the renosplenic space. 1 = liver, 2 = stomach, 3 = left dorsal colon, 4 = left ventral colon, 5 = spleen, 6 = left kidney and renosplenic ligament, 7 = pelvic flexure. (With permission from Johnston JK, Freeman DE. *Vet Clin North Am Equine Pract* 1997; 13:317.)

obstruction with progressive development of intramural edema, extravasation of red blood cells, microvascular thrombosis, mesothelial cell loss from the serosal surface, and mucosal necrosis with loss of colonic epithelium.<sup>18</sup>

**Volvulus** of the large colon of less than 270° does not compromise blood supply but does impede aboral movement of ingesta and gas.<sup>13</sup> Volvulus of 360° or more causes ischemia through occlusion of both arterial and venous circulation of the involved large colon

with rapid loss of colonic mucosal integrity and colon viability. Irreversible mucosal damage occurs after 3–4 hours of ischemia. Loss of mucosal integrity impairs normal barrier function and permits toxins and substances normally confined to the colonic lumen to enter the systemic circulation. Additionally, loss of barrier function allows leakage of vascular proteins and in severe cases red blood cells into the colonic lumen. Subsequent signs are typical of strangulating obstruction (see Equine colic) with development

of toxemia, cardiovascular collapse and death within 12–18 hours.

The most common displacement is medial and dorsal movement of the ventral colon to complete a 360° volvulus of the large intestine (Fig. 5.3).<sup>16</sup> Lateral and dorsal displacement of the ventral colon is much less common. The volvulus is usually at the level of the cecocolic fold, although volvulus involving the cecum or at the diaphragmatic and sternal flexures does occur.

#### CLINICAL FINDINGS

##### Left dorsal displacement (renosplenic entrapment)

The disease usually has an acute onset and a duration of up to 4 days, although it can be a cause of chronic, recurrent colic.<sup>6,9</sup> Abdominal pain in the initial stages is mild to moderate and becomes progressively more severe as distension of the large colon develops. The heart rate is usually between 50 and 70/min, but may be as low as 30/min. Rectal temperature is within normal limits. Mucous membrane color and refill time are usually normal provided that there is no ischemia of the colon. **Abdominal distension** is appreciable in some affected horses.<sup>6</sup> There is more than 2 L of reflux from a **nasogastric tube** in approximately 28% of cases, although rarely is there profuse reflux.<sup>9</sup> **Rectal examination** reveals the presence of bowel in the renosplenic space in approximately 70% of cases with the typical finding of taenia of the ventral colon being traced into that space. Distension of the large colon may impair detection of bowel in the nephrosplenic space. The spleen is usually displaced caudally, medially and ventrally from its normal position against the left body wall (Fig. 5.1).

**Ultrasonographic** demonstration of colon in the renosplenic space confirms the diagnosis with an accuracy of 88%.<sup>19</sup> Gas in the displaced colon obscures the left kidney and dorsal border of the spleen normally visible on ultrasonographic examination of the left paralumbar region.<sup>19</sup>

Approximately 8% of horses with nephrosplenic entrapment have an additional lesion.<sup>9</sup> Entrapment in which the sternal and diaphragmatic flexures are displaced cranial to the stomach and liver occurs in less than 3% of cases.<sup>9</sup>

##### Right dorsal displacement

Severity of colic varies from mild to severe in horses with right dorsal displacement of the colon. Tachycardia (50–80/min) and mild abdominal distension are characteristic provided that the entrapped bowel is not ischemic. There is usually no reflux from a nasogastric tube, although as the disease progresses gastric distension may occur. **Rectal examination** reveals the presence of large colon lateral to the base

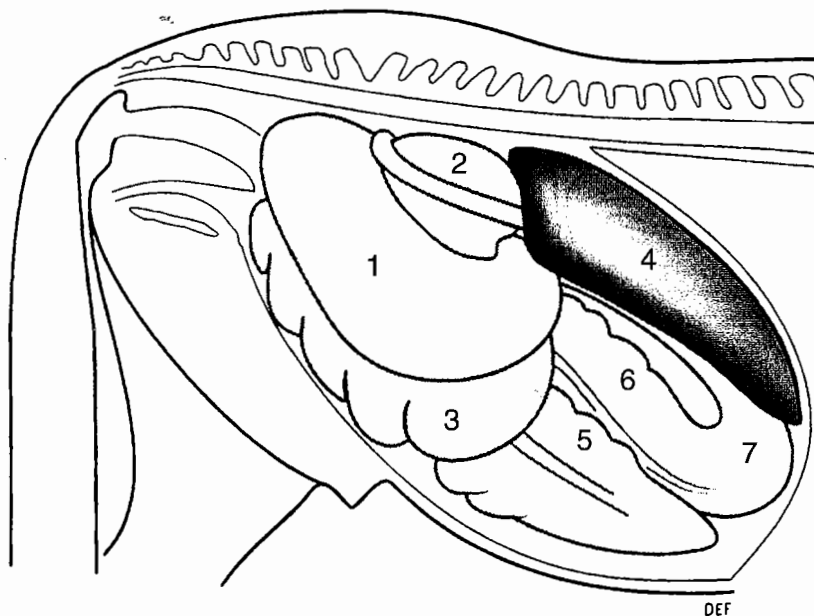

**Fig. 5.2** Right dorsal displacement of the colon, right lateral view. The colon has passed lateral to the cecum, the pelvic flexure is displaced cranially and the sternal and diaphragmatic flexures are displaced caudally. 1 = right dorsal colon, 2 = base of cecum, 3 = right ventral colon, 4 = liver, 5 = cecum, 6 = left ventral colon, 7 = pelvic flexure. (With permission from Johnston JK, Freeman DE. *Vet Clin North Am Equine Pract* 1997; 13:317.)

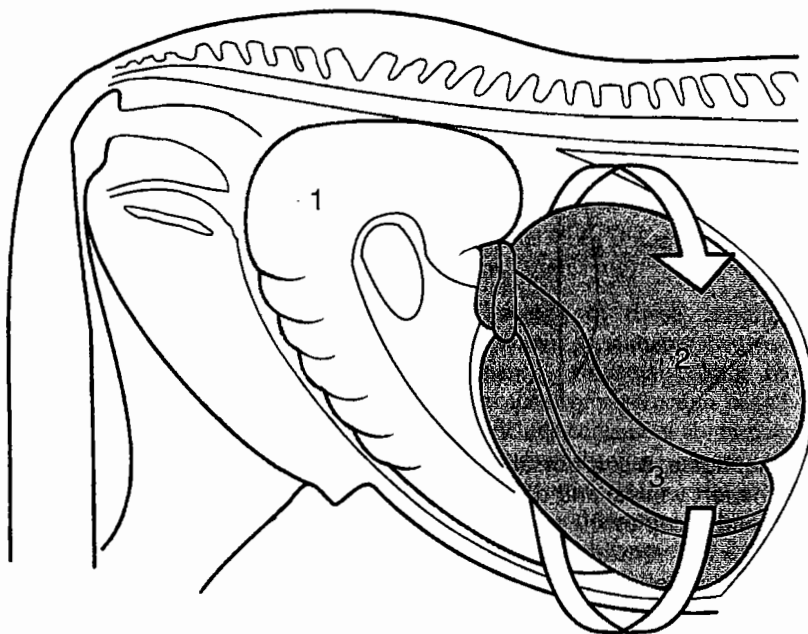

**Fig. 5.3** A 360° clockwise volvulus of the colon viewed from the right side. The volvulus has occurred in the direction of the arrow. 1 = cecum, 2 = right dorsal colon, 3 = right ventral colon. (With permission from Johnston JK, Freeman DE. *Vet Clin North Am Equine Pract* 1997; 13:317.)

of the cecum, although colonic distension may make detection of the displaced bowel difficult. Right dorsal displacement is a not uncommon sequel to impaction of the pelvic flexure.

#### Volvulus

The onset of pain is abrupt and the duration of the disease ranges from hours, in horses with strangulating lesions, to days in horses with torsion of less than 270°.

The pain ranges from mild to severe and intractable, with the horse violently throwing itself to the ground. Pain in horses with volvulus of 360° or greater is often unresponsive to any analgesics. Heart rate is variable and may be less than 40/min in horses with severe disease, although usually it is more than 60/min and increases with severity of the disease. Rectal temperature is within the normal range. The mucous membranes are dark

red to blue and capillary refill time is more than 3 seconds in severely affected horses. Abdominal distension is marked, usually severe, and may impair respiration in horses with 360° or greater volvulus. **Auscultation** of the abdomen reveals a lack of borborygmi and the presence of high-pitched, tympanitic 'pings' on simultaneous percussion and auscultation. The pings are due to the presence of gas in tightly distended large colon or cecum. There is usually no reflux through a nasogastric tube. **Rectal examination** may be limited by the distended, gas-filled colon occupying the caudal abdomen. In untreated cases death occurs within 12–24 hours from cardiovascular collapse. **Ultrasonographic** examination reveals colon with a mural thickness of 9 mm or greater in horses with colon torsion. The test has a sensitivity of approximately 67% (i.e. correctly predicts presence of colon torsion in two-thirds of horses that have the disease) and specificity of 100% (correctly rules out the diagnosis in 100% of horses that do not have the disease).<sup>20</sup>

#### CLINICAL PATHOLOGY

Changes in the hemogram, serum biochemical profile and peritoneal fluid are non-existent to mild in horses with uncomplicated left dorsal displacement, right dorsal displacement and volvulus of less than 270°. Horses with ischemic colon as a result of strangulation usually have a leukopenia with left shift, hemoconcentration and increased anion gap.<sup>16</sup>

**Serum gamma glutamyl transferase (GGT)** activity is elevated in approximately 50% of horses with right dorsal displacement of the colon, whereas such elevations are rare in horses with left dorsal displacement.<sup>21</sup> The elevated GGT, and less commonly serum bilirubin concentration, in horses with right dorsal displacement is attributable to compression of the common bile duct in the hepatoduodenal ligament by the displaced colon.<sup>21</sup>

Horses with large-colon volvulus have a high prevalence of abnormalities in hemostatic variables, including thrombin-antithrombin concentration, D-dimer concentration, antithrombin activity, prothrombin time and platelet count. Nonsurviving horses have lower platelet counts, increased prothrombin time and reduced antithrombin activity.<sup>22</sup>

Peritoneal fluid often has an increased total protein concentration (> 25 g/L, 2.5 g/dL) and white blood cell count (> 8000 cells/ $\mu$ L,  $8 \times 10^9$  cells/L) in horses with compromised bowel. Examination of peritoneal fluid is often not necessary to achieve a diagnosis in horses with colon torsion, although it does have prognostic value in that horses with blood-tinged

peritoneal fluid have a poor prognosis. The risk of inadvertent enterocentesis is increased in horses with severe distension of the colon and abdominocentesis should be attempted with caution in such cases. Use of a bovine teat cannula or similar blunt instrument is preferred to the use of a needle.

### NECROPSY FINDINGS

The colon is displaced as described above for each of the diseases. Death usually results from ischemic necrosis of the colon and the associated peritonitis, endotoxemia and shock. Histological lesions in horses dying of colon volvulus are more severe than of those that survive and are characterized by hemorrhage into the lamina propria, edema and loss of the mucosal cells and crypt architecture.<sup>13</sup>

### DIFFERENTIAL DIAGNOSIS

See Table 5.6. Less common conditions of the large colon include:

- Entrapment of the pelvic flexure in the epiploic foramen<sup>23</sup>
- Colocolic intussusceptions<sup>24</sup>
- Colonic adenocarcinoma<sup>25,26</sup>

### TREATMENT

Treatment should consist of pain control, correction of fluid, acid-base and electrolyte abnormalities, support of cardiovascular function and correction of the underlying disease (Equine colic). Decompression by trocarization of gas-distended

colon or cecum may be beneficial. Correction of colon volvulus or right dorsal displacement of the colon requires surgical exploration of the abdomen and manual correction of the displacement.

### Left displacement

Correction of left dorsal displacement can be achieved by either nonsurgical or surgical means. **Nonsurgical correction** is achieved by rolling the anesthetized horse in a particular sequence that causes the displaced colon to return to its normal position in the abdomen. Nonsurgical correction is successful in approximately 80% of cases,<sup>7,27</sup> although complications are reported,<sup>28</sup> and is recommended as the initial definitive treatment for horses with uncomplicated left dorsal displacement.<sup>27</sup> The sequence of events following diagnosis of the condition is depicted in Figure 5.4.<sup>29</sup> **Phenylephrine** (0.02–0.04 mg/kg, intravenously as a 10 min infusion) causes splenic contraction and is thought to increase the chances of the colon returning to its normal position. The horse is anesthetized within 10 minutes of phenylephrine administration and placed in right lateral recumbency. The horse is then slowly rolled into dorsal recumbency and the abdomen is vigorously massaged in an attempt to cause the colon to move ventrally and medially. If a hoist is available the horse can be lifted into dorsal recumbency. The sequence ends with the horse being rolled into left lateral recumbency and a rectal or ultrasound

examination being performed to determine the position of the colon.

An alternative means of nonsurgical correction involves administration of phenylephrine (0.01 mg/kg, intravenously, slowly) and then jogging the horse.<sup>30,31</sup> This technique was successful in correcting the displacement in 11 of 12 horses.<sup>31</sup> It may be advantageous to relieve large-colon distension by percutaneous trocarization before jogging.<sup>9</sup>

Cases that are refractory to nonsurgical treatment require laparotomy (ventral midline or left flank) and manual correction of the displacement. Recurrence of the displacement occurs in 3–7% of cases.<sup>7</sup> Horses with recurrent disease may benefit from surgical ablation of the nephrosplenic space.<sup>32</sup>

### Right dorsal displacement and colon volvulus

These diseases require surgical correction of the anatomical abnormality.

### REVIEW LITERATURE

Burba DJ, Moore RM. Renosplenic entrapment: a review of clinical presentation and treatment. *Compend Contin Educ Pract Vet* 1997; 9:180–184.

Johnston JK, Freeman DE. Diseases and surgery of the large colon. *Vet Clin North Am Equine Pract* 1997; 13:317–340.

Gibson KT, Steel CM. Strangulating obstructions of the large colon in mature horses. *Equine Vet Educ* 1999; 11:234–242.

Lopes MA, Pfeiffer CJ. Functional morphology of the equine pelvic flexure and its role in disease. A review. *Histol Histopathol* 2000; 15:983–91.

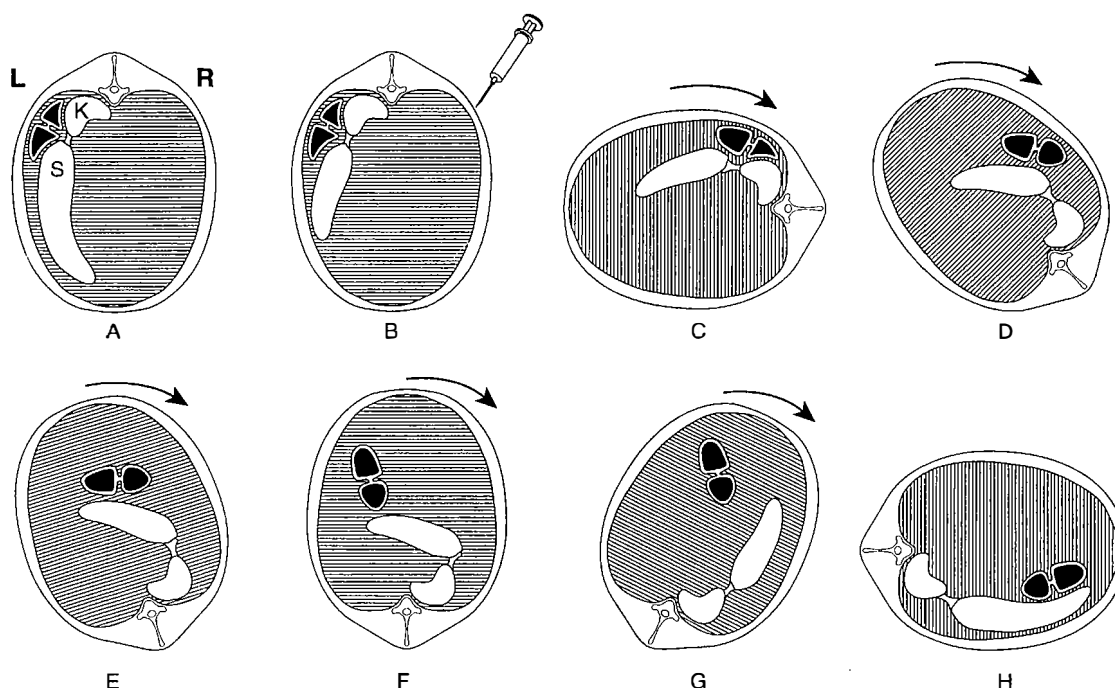

**Fig. 5.4** Steps in correction of left dorsal displacement of the colon (renosplenic entrapment). **A** Caudal view of abdomen of horse with left dorsal displacement of the colon. Entrapped colon is shown in black; K = left kidney, S = spleen. **B** Injection of phenylephrine and contraction of spleen. **C** Horse anesthetized and placed in right lateral recumbency. **D–H** Horse rolled through dorsal recumbency to left lateral recumbency. Entrapped colon moves ventrally and then medially to the contracted spleen. (Modified with permission from Kalsbeek HC. *Equine Vet J* 1989; 21:442.)

## REFERENCES

- Mair TS. *Vet Rec* 2002; 151:152.
- Bassage LH et al. *Equine Vet J* 2000; 32:565.
- Latimer FG et al. *Equine Vet Educ* 1999; 11:229.
- Segura D et al. *Equine Vet Educ* 1999; 11:227.
- Gibson KT, Steel CM. *Equine Vet Educ* 1999; 11:234.
- Livesey MA et al. *Can Vet J* 1988; 29:135.
- Baird AN et al. *J Am Vet Med Assoc* 1991; 198:1423.
- Knottenbelt DC, Hill FWG. *Vet Annu* 1989; 29:161.
- Hardy J et al. *Equine Vet J Suppl* 2000; 32:95.
- Van der Linden MA et al. *J Vet Intern Med* 2003; 17:343.
- Hillyer MH et al. *Equine Vet J* 2002; 34:455.
- Fisher AT, Meagher DM. *Compend Contin Educ Pract Vet* 1985; 8:S25.
- Snyder JR et al. *J Am Vet Med Assoc* 1989; 195:757.
- Moore JN, Dreesen DW. *Proc Am Assoc Equine Pract* 1993; 38:99.
- Hance SR, Emberstson RM. *J Am Vet Med Assoc* 1992; 201:782:787.
- Harrison IW. *Vet Surg* 1988; 17:77.
- Lopes MA, F et al. *Am J Vet Res* 2004; 65:687.
- Snyder JR et al. *Am J Vet Res* 1988; 49:801.
- Santschi EM et al. *Vet Surg* 1993; 22:281.
- Pease AP et al. *Vet Radiol Ultrasound* 2004; 45:220.
- Gardner RB et al. *J Vet Intern Med* 2005; 19:761.
- Dallap BL et al. *J Vet Emerg Crit Care* 2003; 13:215.
- Steenhaut M et al. *Equine Vet J* 1993; 25:550.
- Dyson S, Orsini JA. *J Am Vet Med Assoc* 1983; 182:720.
- Roy MF et al. *Equine Vet J* 2002; 34:102.
- Harvey-Micay J. *Can Vet J* 1999; 40:729–730.
- Abutarbush SM, Naylor JM. *J Am Vet Med Assoc* 2005; 227:603.
- Markel MD et al. *J Am Vet Med Assoc* 1985; 187:1379.
- Kalsbeek HC. *Equine Vet J* 1989; 21:442.
- Johnston JK. *Vet Surg* 1996; 25:13.
- Van Harreveld PD et al. *NZ Vet J* 1999; 47:109–111.
- Zekas LJ et al. *J Am Vet Med Assoc* 1999; 214:1361–1363.

## IMPACTION OF THE LARGE INTESTINE OF THE HORSE

### Synopsis

**Etiology** Idiopathic, often associated with restricted exercise, poor-quality diet or restricted access to water

**Epidemiology** Sporadic, more common in mares. Accounts for approximately 10–15% of colics at referral institutions. Case fatality rate of 20%

**Clinical signs** Mild to moderate colic often of several days duration. Rectal examination reveals impacted, distended large colon

**Clinical pathology** No diagnostic changes

**Lesions** Impaction of large colon, usually pelvic flexure or right dorsal colon

**Diagnostic confirmation** Physical examination

**Treatment** Pain control. Administration of fecal softeners (sodium sulfate). Overhydration by oral or intravenous administration of isotonic fluids at 3–5 times maintenance needs

### ETIOLOGY

The cause of most impactions of the large colon is unknown. Known or speculated causes include:

- Poor dentition, such as occurs in older horses
- Poor feeding regimens, such as infrequent feeding of stalled horses
- Horses not fed, in preparation for surgery or racing, and then given unrestricted access to feed or allowed to eat bedding materials
- Horses fed diets too high in fiber, e.g. mature sorghum or maize plants, or even mature Bermuda grass (*Cynodon* spp.) meadow hay, especially if their water intake is limited;<sup>1</sup> ingestion of large volumes of indigestible seeds, e.g. *Crataegus crusgalli* (cockspur hawthorn), may cause outbreaks of impaction of the right dorsal colon<sup>2</sup>
- Horses that come into loose boxes and are offered hard feed after being on soft grass on pasture are also likely to develop impaction colic
- American miniature horses develop impaction of the colon<sup>3</sup>
- General debility
- Enteroliths and fiber balls may also cause obstruction of the large intestine and usually result in recurrent attacks of colic
- Amitraz, a formamidine acaricide for cattle, causes impaction colic in horses<sup>4</sup>
- Retention of the meconium in foals (see Colic in foals)
- Administration of NSAIDs, which alter colonic motility and might predispose to impaction,<sup>5</sup> although epidemiological support of this etiology is not available
- Restricted water intake, such as during winter when watering points freeze or water is unpalatable.

### EPIDEMIOLOGY

The disease occurs in horses of any age and is more common in females.<sup>6</sup> There does not appear to be a breed predisposition. The disease represented 13% of colics treated at a referral facility.<sup>6,7</sup> An important risk factor is a change in management, especially one that involves a reduction in exercise and change in diet.<sup>6</sup> Risk factors for nonstrangulating disease of the large colon, including pelvic flexure impaction, include cribbing or wind sucking, stabling with the risk increasing with the number of hours stabled per day, change in regular exercise program, travel within the previous 24 hours and lack of anthelmintic administration.<sup>8</sup> The **case fatality rate** is approximately 1–20%.<sup>6,7</sup>

### PATHOGENESIS

Development of impaction of the large colon is frequently attributed to abnormal colonic motility.<sup>9</sup> Other factors, including mild dehydration as a result of limited water intake or ingestion of poorly digestible material, cause impaction in many instances. Ingestion of large quantities of grain, such as might be fed to horses in heavy work, is associated with changes in plasma electrolyte concentrations, presence of dehydrated, foamy and homogenous right dorsal colon contents, and fetid, less formed feces.<sup>10</sup> These effects of a high grain diet may be associated with colonic disease in horses.<sup>10</sup> The end result is accumulation of a large mass of inspissated feed material in the large colon. Material usually accumulates first at the pelvic flexure or right dorsal colon, presumably because of the reduction in lumen diameter at those points. **Accumulation of inspissated material** causes distension of the colon and prevents aboral passage of ingesta. **Distension** causes pain and changes in colonic motility that exacerbate or perpetuate the impaction. If the distension is sufficiently severe or prolonged the colon may become ischemic and necrotic with subsequent rupture, peracute diffuse peritonitis and death.

### CLINICAL FINDINGS

Moderate abdominal pain is the typical sign in affected horses and pulse rate and respiration are relatively normal. This often continues for 3–4 days and sometimes for as long as 2 weeks. The horse is not violent, the principal manifestation of pain being stretching out and lying down and the bouts of pain are of moderate severity occurring at intervals of up to a half-hour. There is anorexia and the feces are passed in small amounts and are hard and covered with thick, sticky mucus. Intestinal sounds are absent or much decreased in intensity. The pulse rate is usually less than 50/min.

On **rectal examination** impaction of the pelvic flexure of the large colon is the commonest site and the distended, solid loop of the intestine often extends to the pelvic brim or even to the right of the midline. Lying on the floor of the abdomen, it is easily palpated, the fecal mass can be indented with the fingers and the curvature and groove between the dorsal and ventral loops of the left colon can be easily discerned. Impaction of the right dorsal colon cannot usually be palpated per rectum and the only abnormality may be distension of the colon with soft ingesta that has accumulated behind the obstruction.

## CLINICAL PATHOLOGY

Hemogram, blood chemistry and peritoneal fluid are normal until the colon becomes ischemic at which time there is a leukopenia with left shift, and an increase in the white blood cell count and protein concentration in peritoneal fluid.

## NECROPSY FINDINGS

The large intestine is packed full of firm, dry fecal material and rupture may have occurred.

## DIFFERENTIAL DIAGNOSIS

See Table 5.6.

- Impaction of the pelvic flexure is readily diagnosed on rectal examination
- A clinical similar syndrome is produced by strictures of the large colon<sup>11</sup>

## TREATMENT

The principles of treatment are pain control, correction of fluid and electrolyte abnormalities and softening of ingesta to facilitate its passage. Pain control is discussed in Table 5.7. Fluid therapy is discussed in Chapter 2.

**Softening of ingesta** is achieved by rehydrating the inspissated material and providing lubrication to hasten its passage.

**Fecal softeners** (Table 5.8) such as magnesium sulfate or sodium sulfate can be given to increase the fecal water content and soften the impacted, inspissated ingesta. Magnesium sulfate is associated with a small risk of hypermagnesemia and neurologic signs<sup>12</sup> whereas sodium sulfate causes a mild hypernatremia and hypokalemia.<sup>13</sup> Oral administration of a balanced, polyionic electrolyte solution is associated with the greatest increase in colonic water content and no change in serum electrolyte concentrations.<sup>13</sup> Enteral administration of 10 L/h (to a 500 kg horse) of a balanced, isotonic, polyionic electrolyte solution is more effective than intravenous administration of the same quantity of fluid in combination with oral administration of MgO<sub>4</sub> in hydrating colonic contents in normal horses.<sup>14</sup> Mineral oil (Table 5.8) is a lubricant and may not penetrate the impacted ingesta sufficiently to soften the material although it is frequently given to horses with colon impaction.

**Overhydration** by oral administration of polyionic, isotonic fluids at 3–5 times maintenance needs (approximately 10 L/h) is the **treatment of choice** for colon impaction.<sup>6,13</sup> Water can be given by nasogastric tube at a rate of 4–10 L for a 450 kg horse every 1–2 hours until the impaction softens. However, some horses develop decreased small intestinal motility or ileus with the disease, have delayed

gastric emptying and have reflux of fluid through the nasogastric tube. Such horses should not be administered any medication or water through the nasogastric tube until reflux has resolved. Alternatively, isotonic fluids can be given intravenously at 10 mL/kg/h until the impaction is passed.

**Promotility agents** such as neostigmine are usually contraindicated because of the risk of rupture of the distended colon when vigorous contractions are induced pharmacologically.

Horses may need to be treated for 1–6 days until the impaction resolves and should **not be fed** during this time. When feed is again provided it should be easily digestible and initially be of limited volume. Horses recovered from impaction of the large intestine have a higher than expected rate of recurrence of colic (30%).<sup>6</sup>

**Surgical treatment** may be needed for refractory cases (about 15%) but is associated with a poor prognosis because of the risk of iatrogenic rupture of the colon during attempts to exteriorize it from the abdomen during surgery.<sup>6</sup> Impaction of the right dorsal colon is more likely to require surgical treatment.<sup>15</sup>

## REVIEW LITERATURE

White NA, Dabareiner RM. Treatment of impaction colics. *Vet Clin North Am Equine Pract* 1997; 13:243–259.

## REFERENCES

1. Pugh DG, Thompson JT. *Equine Pract* 1992; 14:9.
2. Rook JS et al. *Equine Pract* 1991; 13:28.
3. Ragle CL et al. *J Am Vet Med Assoc* 1992; 201:329.
4. Roberts MC, Seawright AH. *Aust Vet J* 1979; 55:553.
5. Van Hoogmoed LM et al. *Am J Vet Res* 2000; 61:1259–1263.
6. Dabareiner RM, White NA. *J Am Vet Med Assoc* 1995; 206:679.
7. Van der Linden MA et al. *J Vet Intern Med* 2003; 17:343.
8. Hillyer MH et al. *Equine Vet J* 2002; 34:155.
9. Sellers AF, Lowe JE. *Equine Vet J* 1986; 18:261.
10. Lopes MAF et al. *Am J Vet Res* 2004; 65:687.
11. Rose PL et al. *Vet Surg* 1991; 20:260.
12. Henninger RW, Horst J. *J Am Vet Med Assoc* 1997; 211:82.
13. Lopes MAF et al. *Am J Vet Res* 2004; 65:695.
14. Lopes MAF et al. *Equine Vet J* 2002; 34:505.
15. Mezerova J et al. *Vet Med Czech* 2001; 46:293.

## ENTEROLITHS AND FECALITHS

### ETIOLOGY

**Enteroliths** are rock-like concretions, which are either spherical or tetrahedral, that form in the large colon of horses, usually around a foreign body.<sup>1</sup> Most enteroliths in the large colon of horses are of two major types: magnesium phosphates/struvite and magnesium vivianite.<sup>1,2</sup> There is wide variability in macrotexture and ionic concentrations between and within enteroliths of am-

monium magnesium phosphate (struvite).<sup>1</sup> Affected horses often have more than one enterolith and the enteroliths can weigh up to 12 kg.

**Fecaliths** are aggregations of indigestible material, such as fencing, plastic or rope, that often have an irregular shape.

### EPIDEMIOLOGY

**Enteroliths** occur sporadically in horses in most regions of the world but there is a greater than expected incidence in certain areas, such as California.<sup>3</sup> Equids with enterolithiasis represented 15.1% of patients admitted for treatment colic, and 27.5% of patients undergoing celiotomy for treatment of colic in a study from California but less than 2% of horses with colic examined at a referral center in Texas.<sup>4,5</sup> Arabians and Arabian crosses, Morgans, American Saddlebreds and donkeys are over-represented, and Thoroughbreds, Standardbreds, warm-bloods and stallions are under-represented in some studies, suggesting a predilection of these breeds for the disease.<sup>3–5</sup> Enteroliths rarely occur in horses less than 4 years of age and are more common in older horses (> 11 years).<sup>4,6</sup> The disease is reported in American Miniature Horses.<sup>7</sup> Feeding alfalfa hay and stabling for more than 12 hours a day are associated with increased risk of enterolithiasis.<sup>5,8</sup> The mean pH of colonic contents from horses with enterolithiasis is significantly higher than for control horses and horses with enterolithiasis have a significantly lower percentage of dry matter in colonic fecal samples and higher mean mineral concentrations than controls.<sup>8</sup> About 15% of cases examined at referral institutions that see large numbers of cases develop a ruptured viscus caused by the enterolith and die. The long-term survival rate of horses treated surgically is approximately 90%.<sup>4</sup>

**Fecaliths** occur sporadically and appear to be more common in younger horses, perhaps because of their propensity to dietary exploration and ingestion of foreign materials.

### PATHOGENESIS

The mechanism underlying enterolith formation is not known. Enteroliths are formed in the large colon and, rarely, the cecum. They are clinically inapparent, even if quite large, until they cause obstruction of aboral passage of ingesta, usually by occluding the right dorsal or transverse colon. Occasional enteroliths pass into the small colon. Obstruction of the colon causes mild to moderate, often intermittent, colic, presumably when the enterolith or fecalith obstructs the colon, with the pain resolving when the enterolith moves and the obstruction

clears. Complete obstruction results in obstruction of aboral movement of ingesta, accumulation of gas and ingesta proximal to the obstruction and distension of the large colon. There is no loss of integrity of the colon early in the disease but with time and distension there is ischemia and necrosis of the colon, with subsequent perforation, development of acute peritonitis, and death.

### CLINICAL FINDINGS

The most common historic manifestation of enterolithiasis in horses is recurrent, intermittent colic (about one-third of cases), often with passage of enteroliths in feces (about 10% of cases).<sup>4,9</sup> Horses with acute obstruction have signs typical of obstructive, nonstrangulating disease of the large colon, including mild to moderate colic with failure to pass feces. The heart rate is 50–70/min, borborygmi are decreased but not absent, and there is mild abdominal distension. **Rectal examination** may reveal mildly distended large colon but the offending enterolith is never palpable, except on the rare occasion that the enterolith or fecalith is lodged in the small colon. Over a period of 6–12 hours the severity of pain increases and there is readily apparent distension of the large colon. There is usually no reflux through a nasogastric tube. The terminal phase, which may take 72 hours to occur and is due to rupture of a viscus, is marked by moderate to severe pain, abdominal distension, tachycardia (> 80/min), decreased capillary refill time and discolored mucous membranes, sweating, muscle fasciculations and death. Rupture of a viscus and acute peritonitis occurs in approximately 15% of cases.<sup>4</sup>

**Radiography** of the abdomen is useful in identifying enteroliths in horses with colic.<sup>10,11</sup> The accuracy of the diagnosis is approximately 80% for enteroliths in the large colon and 40% for those in the small colon.<sup>11</sup> The most common reason for not detecting an enterolith is poor imaging of the abdomen because of inadequate penetration by the X-ray beam,<sup>11</sup> emphasizing the need for appropriate radiographic equipment.

### CLINICAL PATHOLOGY

There are no diagnostic changes in the hemogram, serum biochemical profile or examination of peritoneal fluid. Horses with enteroliths have higher serum bilirubin concentrations on examination at referral centers, but this change is not sufficiently large to be useful as a diagnostic aid.<sup>5</sup> Similarly, horses with enteroliths have higher protein and white cell counts in peritoneal fluid than do horses with other forms of colic but again these differences are too small to be of diagnostic significance.<sup>5</sup> Changes in

hematological and biochemical variables during the terminal phases of the disease are characteristic of acute, diffuse peritonitis and include leukopenia with left shift, hemoconcentration and azotemia.

### NECROPSY FINDINGS

Enteroliths are frequent incidental findings at necropsy examination of mature horses and their presence should not be overinterpreted. Obstructive disease caused by an enterolith is characterized by colon distension, presence of an enterolith in the right dorsal, transverse or small colon and, in cases dying of the disease, acute diffuse peritonitis resulting from colon rupture or perforation at the site of the enterolith. Tetrahedral enteroliths with sharp points are believed to be more dangerous than are spherical enteroliths.<sup>6</sup>

### DIFFERENTIAL DIAGNOSIS

See Table 5.6.

The main differential diagnosis is colon impaction, which may be difficult to differentiate from enterolith obstruction in the absence of radiographic examination of the abdomen.

### TREATMENT

The definitive treatment is surgical removal of the enterolith. Supportive care including analgesia and fluid therapy should be provided as described under Equine colic.

### CONTROL

Prevention of ingestion of foreign bodies, such as small pieces of metal, may decrease the incidence of the disease.<sup>3</sup> Strategies that decrease fecal pH and mineral content of feces might also decrease the incidence of the disease.<sup>8</sup>

### REFERENCES

1. Blue MG, Wittkopp RW. *J Am Vet Med Assoc* 1981; 179:79.
2. Hassel DM et al. *Am J Vet Res* 2001; 62:350.
3. Lloyd K et al. *Cornell Vet* 1987; 77:172.
4. Hassel DM et al. *J Am Vet Med Assoc* 1999; 214:233.
5. Cohen ND et al. *J Am Vet Med Assoc* 2000; 216:1787.
6. Evans DR et al. *Compend Contin Educ Pract Vet* 1981; 3:S383.
7. Ragle CA et al. *J Am Vet Med Assoc* 1992; 201:329.
8. Hassel DM et al. *J Vet Intern Med* 2004; 18:346.
9. Colgan SA et al. *Aust Vet J* 1997; 75:100.
10. Rose JA, Rose EM. *Proc Am Assoc Equine Pract* 1987; 33:95.
11. Yarbrough TB et al. *J Am Vet Med Assoc* 1994; 205:592.

### SAND COLIC

Sand colic is a disease of horses grazing sandy fields with short pasture, fed on sandy ground or provided with feed contaminated with sand. It is often associated with underfeeding. Horses of all ages are

affected, including foals, which acquire the sand while eating dirt. The **case fatality rate** for horses treated by surgical removal of sand is 20–40%.<sup>1,2</sup> The disease is attributable to sand accumulation in the right dorsal or transverse colon, or pelvic flexure, causing obstruction. Sand in the ventral colon does not cause obstruction but is associated with colon volvulus and displacement.

**Clinical signs** are of mild to moderate, chronic colic with **diarrhea** and anorexia. The colic is often very mild unless there is colon torsion or volvulus, in which case the signs are typical of that disease. The diarrhea is watery but not profuse or malodorous. **Auscultation** over the cranial ventral abdomen just caudal to the xiphoid reveals sounds similar to those made when a paper bag is partially filled with sand and rotated.<sup>3</sup> This sound is diagnostic of sand accumulation in the ventral colon. **Rectal palpation** may reveal sand impaction in the ventral colon, but more frequently colon distension with gas is present.<sup>1,2</sup> Rectal palpation will not detect sand accumulation in the transverse colon. **Radiography** will demonstrate sand in the ventral and dorsal colons and can be used to monitor the efficacy of treatment.<sup>4–6</sup>

**Ultrasonography** has good sensitivity (88%) and specificity (88%) compared to radiography for detection of sand in the ventral colon.<sup>7</sup> Ultrasonography is not as effective at detecting sand in the right dorsal or transverse colon.<sup>7</sup> Abdominal fluid is normal except when there is ischemia or necrosis of the colon or when peritonitis is present.<sup>4</sup> Sand will settle out when feces is mixed with water in a clear plastic rectal sleeve and hung for 30 minutes.

**Treatment** consists of pain relief, correction of fluid and electrolyte abnormalities, prevention of continued ingestion of sand and removal of the sand. In horses with acute obstruction of the right dorsal or transverse colon by sand, surgical removal is indicated. **Medical treatment** to effect sand removal is indicated in less acute cases. A widely used medical treatment is administration of **psyllium mucilloid** (0.5–1 g/kg orally every 12 h for 4–8 weeks) administered via a nasogastric tube or as a dressing on feed. However, in an experimental model of the disease this treatment was no more effective than no specific treatment in removal of sand from the cecum and colon.<sup>8</sup> Mineral oil (1 mL/kg) or MgSO<sub>4</sub> (1 g/kg) orally may hasten sand removal.<sup>6</sup> Pasturing of horses with sand accumulation housed in stables aids removal of the sand.<sup>6</sup> Control of the disease is by preventing ingestion of sand by feeding horses hay and grain from clean feeding

bins, providing adequate roughage in the diet, pasturing horses in fields with adequate grass cover, and perhaps, in areas where sand ingestion is unavoidable, daily administration of psyllium mucilloid.

#### FURTHER READING

Walesby HA et al. Equine sand colic. *Compend Contin Educ Pract Vet* 2004; 26:712.

#### REFERENCES

1. Specht TE, Colahan PT. *J Am Vet Med Assoc* 1988; 193:1560.
2. Ragle CA et al. *Vet Surg* 1989; 18:48.
3. Ragle CA et al. *J Vet Intern Med* 1989; 3:12.
4. Bertone JJ et al. *J Am Vet Med Assoc* 1988; 193:1409.
5. Rose JA, Rose EM. *Proc Am Assoc Equine Pract* 1987; 33:95.
6. Ruohoniemi M et al. *Equine Vet J* 2001; 33:59.
7. Korolainen R, Ruohoniemi M. *Equine Vet J* 2002; 34:499.
8. Hammock PD et al. *Vet Surg* 1998; 27:547.

#### RIGHT DORSAL COLITIS

This is a chronic disease caused by ulcerative colitis of the right dorsal colon. The disease is associated with prolonged administration of NSAIDs, such as phenylbutazone, in most, but not all, cases.<sup>1</sup> The case fatality rate is greater than 50%, although descriptions of large numbers of affected horses are not available.

The **pathogenesis** involves inhibition of mucosal prostaglandin synthesis and consequent decreases in water, chloride and bicarbonate secretion by mucosa of the right dorsal colon and apoptosis (programmed cell death) of mucosal cells.<sup>2</sup> Loss of secretion of bicarbonate might be associated with failure of alkalization of right dorsal colon contents and subsequent development of mucosal lesions. The right dorsal colon is the only section of the colon with net water secretion, and this unique activity may predispose this section of colon to disease. Exposure of mucosal cells to phenylbutazone can occur both from the lumen and from blood. Luminal exposure may be related to release of phenylbutazone from ingesta in the right dorsal colon.<sup>3</sup> Ulceration of the colonic mucosa allows leakage of plasma constituents into the colonic lumen, resulting in hypoalbuminemia and loss of electrolytes, and entry of colonic substances such as endotoxin into the systemic circulation, with consequent signs of endotoxemia and systemic inflammatory response (leukopenia, hyperfibrinogenemia, fever). Chronic and extensive mucosal ulceration causes growth of granulation tissue and fibrosis of the right dorsal colon with subsequent loss of secretory function, stricture and partial obstruction.<sup>4</sup>

**Clinical signs** include depression, anorexia, mild fever (38.6–39.5°C,

101.5–103°F), mild intermittent colic, ventral edema, weight loss and occasionally mild diarrhea. There is almost always a history of administration of a NSAID. The disease can persist for weeks and often prompts inappropriate administration of nonsteroidal anti-inflammatory drugs. Rectal examination is unremarkable. **Ultrasonography** is useful in the diagnosis of right dorsal colitis by detecting the presence of a hypoechogenic submucosal layer and permitting measurement of the wall thickness of the right dorsal colon.<sup>5</sup> The hypoechogenic layer in the wall of the right dorsal colon corresponds with edema and cellular infiltrates observed histologically. The right dorsal colon in adult horses has a maximal thickness of 6 mm while that in horses with right dorsal colitis is greater than 8 mm and can be as great as 16 mm.<sup>5</sup> Additionally, the ratio of right dorsal colon to right ventral colon wall thickness is up to 1.6 in normal horses and greater than 2.0 in affected horses.<sup>5</sup> **Scintigraphic** detection of right dorsal colitis is achieved by administration of technetium-<sup>99m</sup> hexamethylpropyleneamine-oxime-labeled white blood cells.<sup>6</sup> Images obtained 20 hours after administration of labeled white cells demonstrate uptake of cells into the right dorsal colon (right cranioventral abdomen).

There is often mild **peritonitis** (neutrophilia in peritoneal fluid). Leukopenia with left shift and hypoproteinemia are characteristic. **Serum biochemical abnormalities** include hypoalbuminemia, hyponatremia (<135 mEq/L), hypochloremia (<90 mEq/L) and azotemia (serum creatinine >2 mg/dL, 170 µmol/L).<sup>1,7</sup>

Necropsy examination reveals ulcerative colitis of the right dorsal colon. In chronic cases there may be stricture of the right colon with subsequent impaction of ingesta and colon rupture.<sup>1</sup>

**Treatment** is often unrewarding although successful treatment by feeding of a low residue diet, such as a complete pelleted ration fed 4–6 times daily, is reported.<sup>8</sup> Psyllium (120 g once daily) for 3–6 weeks might enhance healing of the colon. Administration of misoprostol (Table 5.11) has been suggested but has no demonstrated efficacy. Surgical excision of the lesion is difficult because of its location in the abdomen but bypass of the right dorsal colon may be beneficial. **Control** involves minimizing the amount of NSAIDs administered to horses.

#### FURTHER READING

Bueno AC et al. Diagnosis and treatment of right dorsal colitis in horses. *Compend Contin Educ Pract Vet* 2000; 22:173.

#### REFERENCES

1. Karcher LF et al. *J Vet Intern Med* 1990; 4:247.

2. Richter R et al. *Am J Vet Res* 2002; 63:934.
3. Lees P et al. *Res Vet Sci* 1988; 44:50.
4. Hough ME et al. *Aust Vet J* 1999; 77:785.
5. Jones SL et al. *J Am Vet Med Assoc* 2003; 222:1248.
6. East LM et al. *Vet Radiol Ultrasound* 2000; 41:360.
7. Cohen ND et al. *Vet Med* 1995; 90:687.
8. Cohen ND et al. *J Vet Intern Med* 1995; 9:272.

#### SMALL COLON OBSTRUCTION

##### ETIOLOGY

- Small colon impaction<sup>1,2</sup>
- Obstruction by enterolith or fecalith<sup>1</sup>
- Meconium retention (see Foal colic)
- Atresia coli (see Foal colic)
- Strangulation by pedunculated lipoma,<sup>3</sup> volvulus, intussusception,<sup>4</sup> herniation through mesenteric rents including the mesocolon or gastrosplenic ligament<sup>5,6</sup> or enlarged ovary<sup>7</sup>
- Neoplasia (intramural)
- Hematoma
- Rectal prolapse
- Rupture of mesocolon<sup>8</sup>
- Colonic lipomatosis<sup>9</sup>
- Perirectal abscess.

##### EPIDEMIOLOGY

Small colon disease is present in approximately 2.5–5% of horses treated for colic at referral institutions and small colon impaction represents approximately 2% of horses with colic.<sup>1,2,10</sup> Aged female horses are most commonly affected although the conditions can occur in horses of any age.<sup>3</sup> Arabians, ponies and Miniature horses are reported to be at increased risk of small colon disease although others have not detected this apparent predilection.<sup>3,10</sup> Rupture of the mesocolon occurs during parturition.<sup>4</sup> The **case fatality rate** depends on the condition and is 30–40% for impaction of the small colon.<sup>2,10</sup> Small colon impaction can occur as limited outbreaks in a number of horses on a single farm over a period of days to weeks, without obvious predisposing causes or inciting events.

##### PATHOGENESIS

Obstruction of the small colon causes accumulation of ingesta and gas in the small colon aboral to the obstruction and in the large colon, with subsequent distension, pain and reduced motility. Distension of the small colon may impair blood flow with subsequent ischemia, necrosis and rupture or perforation of the small colon. Incarceration of the small colon results in ischemia of the entrapped segment and restriction of flow of ingesta. Subsequent signs are characteristic of toxemia and intestinal obstruction. The high proportion of affected horses from which *Salmonella* spp. are isolated suggests a role for colitis in the pathogenesis of small colon impaction.<sup>2,10</sup>



## CLINICAL FINDINGS

### Nonstrangulating lesions

**Nonstrangulating lesions** manifest as mild to moderate colic that may persist without a change in severity for up to 36 hours. The heart rate depends on the severity of the colic but averages 60/min with a range of 30–110/min.<sup>2</sup> There is mild dehydration. **Abdominal distension** is usually mild initially but increases as the disease progresses. Borborygmi are reduced and tympanitic sounds may develop as the large colon and cecum become distended. **Rectal examination** reveals the presence of distended large colon but no evidence of colon displacement.

**Small colon impaction** is palpable as a tubular column of material in the small colon although it may be missed if the impaction is in the cranial section of the small colon. Approximately 30% of cases have diarrhea and 13% strain to defecate.<sup>10</sup> Complete examination per rectum may be difficult because of large colon distension and accumulation of feces in the distal small colon. There is reflux through the nasogastric tube in approximately 30% of cases.<sup>2</sup>

### Strangulating lesions

**Strangulating lesions** that interfere with small colon blood supply usually present as acute colic of moderate to severe intensity. There is tachycardia and evidence of toxemia. Abdominal distension is usually marked and there is an absence of borborygmi. Rectal examination reveals distension of the large colon and occasionally soft, compressible distension of the small colon.

Avulsion of the mesocolon occurs during parturition and is often evident as a **rectal prolapse** in the mare. Avulsion results in ischemia of the distal colon. Initially the mare does not display signs of pain but, as the section of the colon from which the mesocolon has avulsed becomes necrotic, signs of toxemia develop.

## CLINICAL PATHOLOGY

There are no characteristic changes in the hemogram or serum biochemical profile. Peritoneal fluid is normal until the viability of the small colon is compromised, at which time the protein concentration and white blood cell count increase. *Salmonella* spp. are isolated from approximately 20% of cases of small colon impaction, suggesting a role for colitis in the pathogenesis of the disease.<sup>10</sup>

## NECROPSY FINDINGS

Small colon impaction is evident as a tubular column of firm ingesta in the small colon with large colon distension. Small colon accidents, such as rupture of

the mesocolon at parturition and intussusception, are readily apparent.<sup>4,8</sup>

## DIFFERENTIAL DIAGNOSIS

See Table 5.6.

## TREATMENT

### Small-colon impaction

The principles of treatment of small-colon impaction are relief of pain and of the impaction. Horses with signs of mild to moderate colic easily controlled with analgesics should be treated medically. Horses with intractable pain or progressively worsening pain, abdominal distension or abnormal peritoneal fluid should be treated surgically. Horses treated surgically have a worse prognosis than do horses treated medically, probably because the former group has more severe disease.<sup>2,10</sup>

**Medical treatment** of small-colon impaction involves administration of analgesics (see Table 5.7), correction of fluid, electrolyte and acid-base abnormalities, and administration of fecal softeners (Table 5.8). Treatments to hasten softening and passage of the impaction include overhydration, administration of sodium or magnesium sulfate and a lubricant such as mineral oil, and occasionally administration of an enema to the standing horse. Overhydration should be achieved by either intravenous or oral administration of polyionic fluids at 3–5 times maintenance (10 mL/kg/h). Administration of enemas to standing horses is controversial and should be done with care so as not to rupture the small colon. Trocarization of the large colon or cecum may be necessary in horses with severe abdominal distension.

**Small-colon accidents** including strangulation and intussusception require surgical correction. Surgical correction of rupture of the mesocolon is not available because of limited surgical access to the site of the lesion.

## REVIEW LITERATURE

- Edwards GB. A review of 32 cases of small colon obstruction in the horse. *Equine Vet J Suppl* 1992; 13:42–47.
- Edwards GB. Diseases and surgery of the small colon. *Vet Clin North Am Equine Pract* 1997; 13:359–375.
- Schumacher J, Mair TS. Small colon obstructions in the mature horse. *Equine Vet Educ* 2002; 14:19.

## REFERENCES

- White NA, Lessard P. *Proc Am Assoc Equine Pract* 1986; 23:637.
- Ruggles AJ, Ross MW. *J Am Vet Med Assoc* 1991; 199:1762.
- Dart AJ et al. *J Am Vet Med Assoc* 1992; 200:971.
- Ross MW et al. *J Am Vet Med Assoc* 1988; 192:372.
- Booth TM et al. *Aust Vet J* 2000; 78:603.

- Rhoads WS, Parks AH. *J Am Vet Med Assoc* 1999; 214:226.
- Mair TS. *Equine Vet Educ* 2002; 14:17.
- Dart AJ et al. *J Am Vet Med Assoc* 1991; 199:1612.
- Henry GA, Yamini B. *J Vet Diagn Invest* 1995; 7:578.
- Rhoads WS et al. *J Am Vet Med Assoc* 1999; 214:1042.

## SPASMODIC COLIC

### ETIOLOGY

Spasmodic colic occurs sporadically and causative factors are not usually identified. Suggested causes include excitement, such as occurs during thunderstorms, preparations for showing or racing, and drinks of cold water when hot and sweating after work, although epidemiologic evidence of these associations is lacking. Presence of a heavy burden of tapeworms is associated with a high incidence of spasmodic (undiagnosed) colic.<sup>1</sup> Mucosal penetration and submucosal migration of *Strongylus vulgaris* larvae are known to cause changes in ileal myoelectrical activity that could lead to the development of colic in horses.<sup>2</sup> Psychogenic colic occurs rarely in horses.<sup>3</sup>

### EPIDEMIOLOGY

The condition is sporadic. It affects horses of all ages but is not recognized in young foals. No apparent breed or sex predisposition is noted.

### PATHOGENESIS

The hypermotility of spasmodic colic in horses is thought to arise by an increase in parasympathetic tone under the influence of the causative factors mentioned above.

## CLINICAL FINDINGS

Spasmodic colic of horses is characterized by **brief attacks of abdominal pain**. The pain is intermittent, the horse rolling, pawing and kicking for a few minutes, then shaking itself and standing normally for a few minutes until the next bout of pain occurs. Intestinal sounds are often audible some distance from the horse and loud, rumbling borborygmi are heard on auscultation. The pulse is elevated moderately to about 60/min and there may be some patchy sweating, but rectal findings are negative and there is no diarrhea. Rectal examination is usually unremarkable. The signs usually disappear spontaneously within a few hours.

## CLINICAL PATHOLOGY AND NECROPSY FINDINGS

Laboratory examinations are not used in diagnosis and the disease is not fatal.

## DIFFERENTIAL DIAGNOSIS

See Table 5.6.



## TREATMENT

Acute hypermotility as manifested by spasmodic colic is usually transient and the use of specific spasmolytics is not necessary. Detomidine, xylazine or butorphanol are effective analgesics. Administration of hyoscine is effective. Affected horses are often administered mineral oil (1 mL/kg) by nasogastric intubation.

## REFERENCES

1. Proudman CJ, Holdstock NB. *Equine Vet J* 2000; 32:37.
2. Berry CR et al. *Am J Vet Res* 1986; 47:27.
3. Murray MJ, Crowell-Davis SL. *J Am Vet Med Assoc* 1985; 186:381.

## INTESTINAL TYMPANY IN HORSES

### ETIOLOGY

The cause of most cases of idiopathic intestinal tympany is unknown, although the ingestion of highly fermentable green feed is considered to be a risk factor. Feeding of rations rich in grains is associated with changes in colonic contents that might predispose to tympany.<sup>1</sup> Intestinal tympany occurs secondary to obstructive diseases that prevent aboral passage of ingesta and gas.

### PATHOGENESIS

The excessive production of gas or its retention in a segment of bowel causes distension and acute abdominal pain. Intestinal distension reduces intestinal motility and may contribute to the course of the disease. Severe tympany may interfere with normal respiration and cardiovascular function (see Pathogenesis of equine colic).

### CLINICAL FINDINGS

Abdominal distension is evident and pain is acute and severe. Peristaltic sounds are reduced but fluid may be heard moving in gas-filled intestinal loops, producing a tinkling, metallic sound. Pinging sounds consistent with tightly distended viscus may be heard on simultaneous flicking and auscultation of the abdomen. On rectal examination, gas-filled loops of intestine fill the abdominal cavity and make proper examination of its contents impossible. In primary tympany much flatus is passed. It is important to differentiate primary tympany from that occurring secondary to obstructive diseases such as enterolithiasis and displacement of the colon.

### CLINICAL PATHOLOGY

Laboratory examinations are of no value in diagnosis.

### NECROPSY FINDINGS

In cases of secondary tympany, the causative obstruction is evident. In primary

cases, the intestines are filled with gas and the feces are usually pasty and loose.

## DIFFERENTIAL DIAGNOSIS

See Table 5.6.

## TREATMENT

The principles of treatment are the relief of pain and distension, maintenance of hydration and reduction of gas production. In secondary tympany the primary disease should be identified and treated.

Pain should be relieved by administration of xylazine, detomidine or butorphanol, or similar agents (Table 5.7). Distension of the bowel should be relieved by trocarization but trocarization should only be performed if there is no or minimal response to analgesic medication and no return of normal peristaltic activity. Normal hydration should be restored by intravenous administration of polyionic fluids. Intestinal gas production should be minimized by the administration of mineral oil or a similar laxative (Table 5.8).

## REFERENCE

1. Lopes MAF et al. *Am J Vet Res* 2004; 65:687.

## VERMINOUS MESENTERIC ARTERITIS (VERMINOUS ANEURYSM, THROMBOEMBOLIC COLIC)

### ETIOLOGY

Unknown, although it is presumed to result from thromboemboli originating at sites of verminous arteritis in the cranial mesenteric artery.

### EPIDEMIOLOGY

The disease is assumed to be more prevalent among horses on poor parasite control programs; however, except in extreme cases that die and have a necropsy examination or exploratory laparotomy, the diagnosis is not confirmed. Therefore accurate measures of its incidence are not available. Cases may occur in foals as young as 3–6 months.<sup>1</sup> The incidence of the disease has decreased remarkably with the advent of effective broad-spectrum anthelmintics and almost complete prevention of *Strongylus* spp. infection in horses in developed countries.

### PATHOGENESIS

Migration of the larvae of *Strongylus vulgaris* into the wall of the **cranial mesenteric artery** and its branches occurs commonly in horses and may cause thromboemboli that restrict blood supply to the intestines, with subsequent ischemia and dysfunction.<sup>2</sup> The recurrent

colic of verminous arteritis is possibly due to impairment of the vascular and nerve supply to the intestine. The disease is basically an infarction of bowel wall without displacement of the bowel. The small intestine, colon and cecum can be affected. The disease has been associated with larval cyathostomiasis.<sup>3</sup>

## CLINICAL FINDINGS

Signs vary depending on the severity of the disease. It is assumed that **mild, intermittent colics** that respond to analgesics in the short term and anthelmintics in the long term are due to verminous arteritis. Affected horses are often depressed and spend long periods recumbent. Weight loss and inappetence are features of the disease in some horses. The disease can have a course of weeks to months.

**Acute, severe cases** of the disease are due to infarction of parts or all of the small intestine, cecum or colon. Affected horses have an acute onset of severe abdominal pain, tachycardia (> 100/min) and sweating. Auscultation reveals decreased borborygmi. There is mild distension of small intestine or large colon, depending on the segment of bowel affected, on rectal examination. There are rarely signs of intestinal obstruction. Palpation of the cranial mesenteric artery may reveal thickening and pain but is not a useful diagnostic sign for the acute disease. **Death** is due to peritonitis secondary to devitalization of the intestine, usually within 24 hours of the onset of signs.

## CLINICAL PATHOLOGY

There are no diagnostic changes in the hemogram or serum biochemical profile. Peritoneal fluid in mild cases may have mild elevations in protein concentration and white blood cell count. In severe cases, peritoneal fluid protein concentration is increased (> 25 g/L, 2.5 g/dL) as is white blood cell count (9000–100 000 cells/ $\mu$ L,  $9\text{--}100 \times 10^9$  cells/L).<sup>4</sup>

## NECROPSY FINDINGS

Infarction of the colon and cecum is most common and evident as either gangrene of large sections of the organ or multifocal mottled lesions that are red and edematous. Histological examination rarely reveals the presence of thrombi. There may be verminous arteritis of the cranial mesenteric artery, evident as thickening of the intima and narrowing of the lumen.

## DIFFERENTIAL DIAGNOSIS

See Table 5.6.

## TREATMENT

Mild, recurrent cases are treated with analgesics such as flunixin meglumine (Table 5.7), laxatives such as mineral oil (Table 5.8), and anthelmintics (ivermectin 200 µg/kg orally once; or fenbendazole 50 mg/kg orally every 24 h for 3 d).

Severe cases are treated with analgesics (Table 5.7), intravenous fluids (Ch. 2) and supportive care. Usually the severity of the colic prompts surgical exploration of the abdomen with resection of small lesions. Most severe cases do not survive.

## REVIEW LITERATURE

White NA. Thromboembolic colic in horses. *Compend Contin Educ* 1985; 7:S156–S161.

## REFERENCES

1. DeLay J et al. *Can Vet J* 2001; 42:289.
2. Sellers AF et al. *Cornell Vet* 1982; 72:233.
3. Mair TS, Pearson GR. *Equine Vet J* 1995; 27:154.
4. White NA. *J Am Vet Med Assoc* 1981; 178:259.

## GASTRITIS (INFLAMMATION OF THE MONOGASTRIC STOMACH, ABOMASITIS)

Inflammation of the stomach is manifested clinically by vomiting and is commonly associated with enteritis in gastroenteritis.

## ETIOLOGY

Gastritis may be acute or chronic but both forms of the disease may be caused by the same etiological agents acting with varying degrees of severity and for varying periods. The inflammation may be associated with physical, chemical, bacterial, viral or metazoan agents.

### Cattle and sheep

Diseases of the rumen and abomasum are presented in Chapter 6. For comparative purposes the causes of abomasitis are listed here. For sheep there is no information other than about parasites. They are listed with cattle for convenience sake.

#### Physical agents

Physical agents such as frosted feeds affect only the rumen. In calves, gross overeating and the ingestion of foreign materials may cause abomasitis. In adults, there is a very low incidence of foreign bodies in the abomasum,<sup>1</sup> half the cases being associated with traumatic reticulitis.

#### Chemical agents

All the irritant and caustic poisons, including arsenic, mercury, copper, phosphorus and lead, cause abomasitis. Fungal toxins cause abomasal irritation, especially those of *Fusarium* spp. and *Stachybotris alternans*. Acute lactic acidosis due to engorgement on carbohydrate-rich food causes rumenitis with some run-off into the abomasum and the development of some abomasitis/enteritis.

#### Infectious agents

Only the viruses of rinderpest, bovine virus diarrhoea and bovine malignant catarrh cause abomasal erosions. Bacterial causes are very rare – sporadic cases of extension from oral necrobacillosis, hemorrhagic enterotoxemia due to *C. perfringens* types A, B, C, rarely as an adjunct to colibacillosis and its enteric lesion in calves. Fungi, e.g. *Mucor* spp. and *Aspergillus* spp. complicate abomasal ulcer due to other causes.

#### Metazoan agents

Nematodes – *Trichostrongylus axei*, *Ostertagia* spp., *Haemonchus* spp. larval paramphistomes migrating to the rumen.

## Pigs

#### Physical agents

Foreign bodies, bedding, frosted feeds, moldy and fermented feeds are all possible causes.

#### Chemical agents

As listed under cattle, these are also possible causes of gastritis in pigs.

#### Infectious agents

Venous hyperemia and infarction of the gastric mucosa occur in erysipelas, salmonellosis, swine dysentery and acute colibacillosis in weaned pigs. Similar lesions occur in swine fever, African swine fever and swine influenza. Fungal gastritis also occurs secondarily.

#### Metazoan agents

The red stomach worm, *Hyostrogylus rubidus*, and the thick stomach worms *Ascarops strongylina* and *Physocephalus sexalatus* are of low pathogenicity but cannot be disregarded as causes of gastritis in pigs.

## Horses

Physical and chemical agents as listed under cattle may cause gastritis rarely. Infectious causes of gastritis are rare in the horse but emphysematous gastritis associated with *C. perfringens* has been recorded.

Metazoan agents causing gastritis in horses include massive infestation with botfly larvae (*Gasterophilus* spp.); *Habronema muscae* and *Habronema microstoma* infestation; *Habronema megastoma* causes granulomatous and ulcerative lesions and may lead to perforation and peritonitis.

## PATHOGENESIS

Gastritis does not often occur in animals without involvement of other parts of the alimentary tract. Even in parasitic infestations where the nematodes are relatively selective in their habitat, infestation with one nematode is usually accompanied by infestation with others, so that gastroenteritis is produced. It is dealt with as a specific entity here because it may

occur as such, and enteritis is common without gastric involvement. The net effects of gastroenteritis can be determined by a summation of the effects of gastritis and enteritis.

The reactions of the stomach to inflammation include increased motility and increased secretion. There is an increase in the secretion of mucus, which protects the mucosa to some extent but also delays digestion and may allow putrefactive breakdown of the ingesta. This abnormal digestion may cause further inflammation and favors spread of the inflammation to the intestines. In acute gastritis, the major effect is on motility; in chronic gastritis, on secretion. In acute gastritis there is an increase in motility, causing abdominal pain and more rapid emptying of the stomach, either by vomiting or via the pylorus in animals unable to vomit. In chronic gastritis, the emptying of the stomach is prolonged because of the delay in digestion caused by excessive secretion of mucus. This may result in chronic gastric dilatation. The motility is not necessarily diminished and there may be subacute abdominal pain or a depraved appetite due to increased stomach contractions equivalent to hunger pains.

## CLINICAL FINDINGS

### Acute gastritis

When the inflammation is severe, pigs and, rarely, horses and ruminants vomit (or ruminants regurgitate excessive quantities of rumen contents). In monogastric animals, such as pigs, the vomitus contains much mucus, sometimes blood, and is small in amount, and vomiting is repeated, with forceful retching movements. The appetite is always reduced, often absent, but thirst is usually excessive and pigs affected with gastroenteritis may stand continually lapping water or even licking cool objects. The breath has an offensive odor and there may be abdominal pain. Diarrhoea is not marked unless there is an accompanying enteritis but the feces are usually pasty and soft. Additional signs are usually evident when gastritis is part of a primary disease syndrome. Dehydration and alkalosis with tetany and rapid breathing may develop if vomiting is excessive.

### Chronic gastritis

Chronic gastritis is much less severe. The appetite is depressed or depraved and vomiting occurs only sporadically, usually after feeding. The vomitus contains much viscid mucus. Abdominal pain is minor and dehydration is unlikely to occur, but the animal becomes emaciated through lack of food intake and incomplete digestion.

Anorexia, tympanites, gastritis, pyloric stenosis and gastric ulcers are the clinical

manifestations of abomasal foreign body in cattle.

### CLINICAL PATHOLOGY

Specimens taken for laboratory examination are usually for the purpose of identifying the causative agent in specific diseases. Estimations of gastric acidity are not usually undertaken but samples of vomitus should be collected if a chemical poison is suspected.

### NECROPSY FINDINGS

The signs of inflammation vary in severity from a diffuse catarrhal gastritis to severe hemorrhagic and ulcerative erosion of the mucosa. In the mucosal diseases there are discrete erosive lesions. In parasitic gastritis there is usually marked thickening and edema of the wall if the process has been in existence for some time. Chemical inflammation is usually most marked on the tips of the rugae and in the pyloric region. In severe cases the stomach contents may be hemorrhagic; in chronic cases the wall is thickened and the contents contain much mucus and have a rancid odor suggestive of a prolonged sojourn and putrefaction of the food.

It is important to differentiate between gastritis and the erythematous flush of normal gastric mucosa in animals that have died suddenly. Venous infarction in the stomach wall occurs in a number of bacterial and viral septicemias of pigs and causes extensive submucosal hemorrhages, which may easily be mistaken for hemorrhagic gastritis.

### DIFFERENTIAL DIAGNOSIS

- Gastritis and gastric dilatation have many similarities but in the latter the vomitus is more profuse and vomiting is of a more projectile nature, although this difference is not so marked in the horse, in which any form of vomiting is severe
- Gastritis in the horse is not usually accompanied by vomiting but it may occur in gastric dilatation
- In esophageal obstruction, the vomitus is neutral in reaction and does not have the rancid odor of stomach contents
- Intestinal obstruction may be accompanied by vomiting and, although the vomitus is alkaline and may contain bile or even fecal material, this may also be the case in gastritis when intestinal contents are regurgitated into the stomach
- Vomiting of central origin is extremely rare in farm animals
- Determination of the cause of gastritis may be difficult but the presence of signs of the specific diseases and history of access to poisons or physical agents listed under etiology above may provide the necessary clues
- Analysis of vomitus or food materials may have diagnostic value if chemical poisoning is suspected

### TREATMENT

Treatment of the primary disease is the first principle and requires a specific diagnosis. Ancillary treatment includes the withholding of feed, the use of gastric sedatives, the administration of electrolyte solutions to replace fluids and electrolytes lost by vomiting, and stimulation of normal stomach motility in the convalescent period.

In horses and pigs, gastric lavage may be attempted to remove irritant chemicals. Gastric sedatives usually contain insoluble magnesium hydroxide or carbonate, kaolin, pectin or charcoal. Frequent dosing at intervals of 2–3 hours is advisable. If purgatives are used to empty the alimentary tract, they should be bland preparations such as mineral oil to avoid further irritation to the mucosa.

If vomiting is severe, large quantities of electrolyte solution should be administered parenterally. Details of the available solutions are given under the heading of disturbances of body water. If the liquids can be given orally without vomiting occurring, this route of administration is satisfactory.

During convalescence, the animal should be offered only soft, palatable, highly nutritious foods. Bran mashes for cattle and horses and gruels for calves and pigs are most suitable and are relished by the animal.

### REFERENCE

1. Weldon AD et al. *Cornell Vet* 1991; 81:51.

### ACUTE GASTRIC DILATATION IN PIGS

In the pig, **simple gastric distension** is usually readily relieved by vomiting.

### ACUTE GASTRIC TORSION IN SOWS

This is a much more serious problem.<sup>1</sup> Torsion is thought to occur because the sow eats a large, sloppy meal very quickly. The occurrence is specifically related to intense excitement and activity occurring at feeding time. Death occurs 6–24 hours after the pig's last meal. At necropsy the stomach is enormous (50–60 cm diameter), with engorgement of vessels and hemorrhagic effusion into the stomach, which contains much gas and usually a lot of food. Rotation varies in degree from 90–360° and is usually to the right. The spleen is markedly displaced, the liver is bloodless and the diaphragm encroaches deeply into the chest.<sup>2</sup>

### INTESTINAL REFLUX

Acute dilatation also occurs in pigs secondarily to acute obstruction of the small intestine. The obstruction may be as

far down as the ileocecal valve. The oral segment of intestine dilates and fills with fluid, and refluxes into the stomach, filling it. In the pig vomiting follows. The outcome depends on whether sufficient gastric motility returns to evacuate the stomach.

### DIAGNOSIS

The vomiting in gastric dilatation is more profuse and projectile than that of gastritis or enteritis but may be simulated by that of obstruction of the upper part of the small intestine.

### REFERENCES

1. Blackburn PW et al. *Vet Rec* 1974; 94:578.
2. Senk L. *Vet Glasnik* 1977; 31:513.

### INTESTINAL OBSTRUCTION IN PIGS

#### ETIOLOGY

Some causes of intestinal obstruction are:

- Torsion of the coiled colon about its mesentery occurs in adult pigs
- Obstruction of the terminal small colon in young piglets causes very hard fecal balls, or barley chaff used as bedding may be implicated in obstruction
- Heavy feeding on lactose<sup>1</sup> causes a dilatation and atony of the intestine in the same way as grain feeding does in ruminants.

#### CLINICAL FINDINGS

In pigs, distension of the abdomen, absence of feces and complete anorexia are evident. The distension may be extreme in young pigs when the terminal colon is obstructed. Death usually occurs in 3–6 days.

### IMPACTION OF THE LARGE INTESTINE OF PIGS

#### ETIOLOGY

- In pigs impaction of the colon and rectum occurs sporadically, usually in adult sows that get little exercise and are fed wholly on grain. The disease also occurs in pigs that are overcrowded in sandy or gravelly outdoor yards
- A special occurrence in young weaned pigs causes obstruction of the coiled colon
- A presumed inherited megacolon of fattening pigs is reported as a cause of abdominal distension, constipation and wasting. There is no anal stricture.<sup>1</sup>

#### CLINICAL FINDINGS

In impaction of the large intestine the effects appear to be due largely to auto-intoxication, although the commonly occurring posterior paresis seems more likely to be due to pressure from inspissated fecal material.

Retention of the meconium has no specific signs. There is anorexia and dullness and the pig is recumbent much of the time. Feces passed are scanty, very hard and covered with mucus. Weakness to the point of inability to rise occurs in some cases. Hard balls of feces in the rectum are usually detected when a thermometer is inserted.

In paralysis of the rectum there is inability to defecate and usually some straining. The anus and rectum are ballooned and manual removal of the feces does not result in contraction of the rectum. Spontaneous recovery usually occurs 3–4 days after parturition.

#### REFERENCE

1. Shearer IJ, Dunkin AC. NZ J Agric Res 1968; 11:923.

### INTESTINAL TYMPANY IN PIGS

#### ETIOLOGY

- Primary tympany occurs with ingestion of excess whey. Recorded in adult dry sows. Distension of proximal colon causes rupture with death from endotoxic shock<sup>1</sup>
- Secondary large bowel tympany – usually secondary to acute intestinal obstruction.

#### REFERENCE

1. McCausland IP, Southgate W. Aust Vet J 1980; 56:190.

### ENTERITIS (INCLUDING MALABSORPTION, ENTEROPATHY AND DIARRHEA)

The term enteritis is used to describe inflammation of the intestinal mucosa resulting in diarrhea and sometimes dysentery, abdominal pain occasionally, and varying degrees of dehydration and acid–base imbalance, depending on the cause of the lesion, its severity and location. In many cases, gastritis also occurs together with enteritis.

There are several diseases of the intestines of farm animals in which diarrhea and dehydration are major clinical findings, but classical inflammation of the mucosa may not be present. The best example of this is the diarrhea associated with enterotoxigenic *E. coli*, which elaborate an enterotoxin that causes a large net increase of secretion of fluids into the lumen of the gut, with very minor, if any, structural changes in the intestinal mucosa. This suggests that a word other than enteritis may be necessary to describe alterations in the intestinal secretory and absorptive

mechanisms that result in diarrhea but in which pathological lesions are not present. However, with the above qualifications, we have chosen, for convenience, to continue to use the term enteritis to describe those diseases in which diarrhea is a major clinical finding due to malabsorption in the intestinal tract.

#### ETIOLOGY AND EPIDEMIOLOGY

There are many causes of enteritis or malabsorption in farm animals and the disease varies considerably in its severity depending upon the causative agent. Enteropathogens include bacteria, viruses, fungi, protozoa and helminths. Many chemicals and toxins can also cause enteritis (Tables 5.12–5.15). In addition to the primary etiological agents of enteritis, there are many epidemiological characteristics of the animal and the environment that are important in facilitating or suppressing the ability of the causative agent to cause enteritis. Thus newborn calves and piglets that are deficient in colostral immunoglobulins are much more susceptible to diarrhea, and with a high mortality rate from diarrhea, than animals with adequate levels. Enteric salmonellosis is commonly precipitated by the stressors of transportation or deprivation of feed and water. The stress

Table 5.12 Epidemiological and clinical features of diseases of cattle in which diarrhea is a significant clinical finding

Etiological agent or disease	Age and class of animal affected and important epidemiological factors	Major clinical findings and diagnostic criteria
<b>Bacteria</b>		
Enterotoxigenic <i>E. coli</i>	Newborn calves < 3–5 days of age, colostral immune status determines survival. Outbreaks common	Acute profuse watery diarrhea, dehydration and acidosis. Culture feces for enteropathogenic type
<i>Salmonella</i> spp.	All ages. Outbreaks occur. Stress-induced	Acute diarrhea, dysentery, fever and high mortality possible. Culture feces
<i>Clostridium perfringens</i> types B and C	Young well nourished calves < 10 days of age	Severe hemorrhagic enterotoxemia, rapid death. Fecal smear
<i>Mycobacterium avium</i> subsp. <i>paratuberculosis</i>	Mature cattle, sporadic, single animal	Chronic diarrhea with loss of weight, long course. No response to therapy. Special tests
<i>Proteus</i> spp. and <i>Pseudomonas</i> spp.	Calves treated for diarrhea with prolonged course of antibiotics	Chronic to subacute diarrhea, poor response to treatment, progressive loss of weight. Culture feces
<b>Fungi</b>		
<i>Candida</i> spp.	Young calves following prolonged use of oral antibacterials	Chronic diarrhea, no response to treatment. Fecal smears
<b>Viruses</b>		
Rotavirus and coronavirus	Newborn calves, 5–21 days old, explosive outbreaks	Acute profuse watery diarrhea. Demonstrate virus in feces
Winter dysentery ( <i>Coronavirus</i> )	Mature housed cows, explosive outbreaks	Acute epizootic of transient diarrhea and dysentery lasting 24 hours. Definitive diagnosis not possible currently
Bovine virus diarrhea (mucosal disease)	Young cattle 8 months to 2 years. Usually sporadic but epidemics occur	Erosive gastroenteritis and stomatitis. Usually fatal. Virus isolation
Rinderpest	Highly contagious, occurs in plague form	Erosive stomatitis and gastroenteritis. High morbidity and mortality
Bovine malignant catarrh	Usually mature cattle, sporadic but small outbreaks occur	Erosive stomatitis and gastroenteritis, enlarged lymph nodes, ocular lesions, hematuria and terminal encephalitis. Transmission with whole blood
<b>Helminths</b>		
Ostertagiasis	Young cattle on pasture	Acute or chronic diarrhea, dehydration and hypoproteinemia. Fecal examination. Plasma pepsinogen
<b>Protozoa</b>		
<i>Eimeria</i> spp.	Calves over 3 weeks old and cattle up to 12 months of age. Outbreaks common	Dysentery, tenesmus, nervous signs. Fecal examination diagnostic
<i>Cryptosporidium</i> spp.	Calves 5–35 days of age	Diarrhea. Fecal smear and special stain

Table 5.12 (Cont'd) Epidemiological and clinical features of diseases of cattle in which diarrhea is a significant clinical finding

Etiological agent or disease	Age and class of animal affected and important epidemiological factors	Major clinical findings and diagnostic criteria
<b>Chemical agents</b> Arsenic, fluorine, copper, sodium chloride, mercury, molybdenum, nitrates, poisonous plants, mycotoxicoses	All ages, history of access to substance. Outbreaks occur	All severities of diarrhea, dysentery, abdominal pain, in some cases nervous signs, dehydration, toxemia. Fecal and tissue analyses
<b>Physical agents</b> Sand, soil, silage, feed containing lactic acid (sour brewers' grains)	Usually mature cattle, history of access. Outbreaks occur	Acute, subacute diarrhea and toxemia. See sand in feces. Rumen pH
<b>Nutritional deficiency</b> Copper deficiency, conditioned by excess molybdenum	Usually mature cattle on pasture with high levels of molybdenum	Subacute and chronic diarrhea, osteodystrophy, no systemic effects, hair color changes. Liver and blood analyses
<b>Dietary</b> Overfeeding	Young calves overfed on milk	Mild diarrhea, feces voluminous and pale yellow. Clinical diagnosis
Simple indigestion	Change of ration of mature cows (hay to silage) or grain to feedlot cattle	Subacute diarrhea. Normal in 24 hours. Clinical diagnosis usually sufficient
Inferior milk replacers	Heat-denatured skim milk used in manufacturing of milk replacers for calves	Subacute to chronic diarrhea, progressive emaciation, no response to conventional treatment except cow's whole milk. Clotting tests on milk replacer
<b>Miscellaneous or uncertain etiology</b> Intestinal disaccharidase deficiency	May occur in young calves. Sporadic	Subacute diarrhea unresponsive to usual therapy except withdrawal of milk. Lactose digestion tests
Congestive heart failure	Sporadic. Mature cattle.	Profuse watery diarrhea associated with visceral edema.
Toxemia (peracute coliform mastitis)	Sporadic	Acute diarrhea due to endotoxemia from peracute mastitis. Culture milk

Table 5.13 The epidemiological and clinical features of horses with diarrhea

Etiological agent or disease	Age and class of animal affected and important epidemiological factors	Major clinical findings; diagnostic criteria
<b>Bacteria</b> <i>Salmonella</i> spp.	Young foals; mature horses, following stress	Acute profuse diarrhea, severe dehydration, foul-smelling feces; <i>leukopenia and neutropenia, culture feces, hyponatremia</i>
<i>Rhodococcus equi</i>	Foals 2–5 months of age, some with history of respiratory disease	Diarrhea associated with <i>R. equi</i> pneumonia; <i>culture respiratory tract</i>
<i>Clostridium perfringens</i> or <i>C. difficile</i>	Mature horses administered antibiotics. Young foals	Profuse, watery diarrhea, hypovolemia, hyponatremia. <i>Fecal culture and demonstration of toxin in feces</i>
<i>Aeromonas</i> spp.	Adult horses, tends to be more common in summer. Often isolated from horses with diarrhea. Definitive etiological role not proved	Febrile, acute diarrhea. <i>Culture feces</i>
<b>Viruses and rickettsia</b> <i>Neorickettsia risticii</i> (formerly <i>Ehrlichia risticii</i> )	Endemic to certain regions in North and South America and Europe. Ingestion of organism spread by insects (mayflies)	Profuse watery diarrhea, fever, laminitis. <i>IFA, PCR</i>
<b>Parasites</b> Cyathostomes and large strongyles	Individual horses. Poor deworming history. Seasonal occurrence of larval cyathostomiasis	Acute to chronic diarrhea. <i>Patent infections evident by fecal examination for parasite eggs</i>
<b>Physical</b> Sand accumulation	Individual horses or farm problem. Ingestion of sand or gravel	Watery diarrhea, not malodorous, not profuse. <i>Abdominal radiography or ultrasonography, examination of feces</i>
Overdosing of cathartics (DSS, MgSO <sub>4</sub> , NaSO <sub>4</sub> , castor oil)	Treated animals	Moderate to profuse diarrhea. <i>Historical confirmation of administration of compounds</i>
<b>Miscellaneous or unknown</b> Colitis X	Single animal. Adult horses. High death rate	Acute, pyrexia diarrhea, hypovolemia, leukopenia. <i>Post mortem examination</i>
Granulomatous or eosinophilic colitis	Single animal. Adults	Chronic diarrhea. <i>Necropsy or colonic biopsy</i>
Right dorsal colitis/phenylbutazone toxicity	Administration of NSAIDs in large doses or prolonged administration	Mild diarrhea. Low grade fever. Mild colic. Hypoproteinemia, hyponatremia. <i>Necropsy, surgery</i>
Antibiotic-induced diarrhea	History of antimicrobial administration. High case fatality rate	Acute onset diarrhea with or without fever. Leukopenia, hypovolemia. <i>History</i>

DSS, dioctyl sodium sulfosuccinate; IFA, indirect fluorescence antibody test; NSAIDs, nonsteroidal anti-inflammatory drugs; PCR, polymerase chain reaction.

Table 5.14: Epidemiological and clinical features of diseases of the pig in which diarrhea is a significant clinical finding

Etiological agent or disease	Age and class of animal affected and important epidemiological factors	Major clinical findings and diagnostic criteria
<b>Viruses</b>		
Classical and African swine fever	Hemorrhagic diarrhea at any age	Many other signs(pyrexia) variety of lab tests (isolation, ELISA, PCR etc.)
Transmissible gastroenteritis (TGE)	Explosive outbreaks in newborn piglets. High morbidity and mortality	Acute diarrhea, vomiting, dehydration and death. No response to treatment (lab tests include virus isolation, ELISA, EM, FATs)
Rotavirus and coronavirus (Epidemic diarrhea)	Outbreaks in newborn piglets and weaned piglets. May occur in well-managed herds	Acute diarrhea and dehydration. May continue to suck the sow. Death in 2–4 days. Virus isolation and pathology of gut, EM, FATs (PED), PAGE for rotavirus
<b>Bacteria</b>		
Enterotoxigenic <i>E. coli</i>	Common disease of newborn, 3-week-old and weaned piglets. Outbreaks. Colostral immune status important	Acute diarrhea, dehydration. Responds to early treatment. Fecal culture and serotype. Virulence factor determination
<i>Salmonella</i> spp.	All ages. Most common in feeder pigs	Acute septicemia or chronic diarrhea. Responds to early treatment. Culture and serotyping
<i>Clostridium perfringens</i> type C	Newborn piglets. High mortality	Acute and peracute hemorrhagic enterotoxemia. Toxin demonstration and culture
<i>Clostridium perfringens</i> type A	Slightly older pigs, first week of life, lower mortality	As above
<i>Clostridium difficile</i>	Diarrhea in preweaned pigs	Smears of colon wall, culture, FAT, PCR
<i>Brachyspira hyodysenteriae</i> (swine dysentery)	Usually feeder pigs. Outbreaks common	Dysentery, acute to subacute, fever. Responds to treatment. Culture, FATs, PCR on mucosal smears
<i>Lawsonia intracellularis</i> (PIA, PHE)	Growing and mature pigs. Outbreaks common	Acute dysentery and death. MZN on mucosal smears, PCR, silver-stained sections
<i>Brachyspira pilosicoli</i>	Usually weaned pigs	PCR
<b>Protozoa</b>		
<i>Isospora</i> spp.	Newborn piglets 5–14 days of age. High morbidity, low mortality	Acute diarrhea. Poor response to therapy with amprolium. Fecal examination for oocysts
Other species ( <i>Eimeria</i> )	In older pigs	Histology of gut sections
<b>Parasites</b>		
<i>Ascaris suum</i> and <i>A. lumbricoides</i>	Young pigs	Mild diarrhea for few days. Worm egg count
<i>Trichuris suis</i>	All ages, usually older pigs	Diarrhea, dysentery and loss of weight. Fecal examination and gross pathology
<b>Nutritional deficiency</b>		
Iron deficiency	Young piglets 6–8 weeks. Not common in well managed swine herds	Mild diarrhea and anemia

ELISA, enzyme-linked immunoassay; EM, electron micrograph; FATs, fluorescence antibody transfer; MZN, Modified ziehl-neilson; PAGE, Poly acrylamide gel electrophoresis; PCR, polymerase chain reaction; PED, Porcine epidemic diarrhea.

of weaning in pigs is a risk factor for postweaning diarrhea. The prolonged use of antimicrobials orally in all species may alter the intestinal microflora and allow the development of a superinfection by organisms that would not normally cause disease.

The salient epidemiological characteristics and clinical findings of the diseases in which diarrhea, due to enteritis or malabsorption, is a principal clinical finding in each species are summarized by species in Tables 5.12–5.15. There are many other diseases in which diarrhea may be present but in which it is only of minor importance.

## PATHOGENESIS

### Normal intestinal absorption

Under normal conditions, a large quantity of fluid enters the small intestine from the saliva, stomach, pancreas, liver and intestinal mucosa. This fluid and its electrolytes and other nutrients must be absorbed, mainly by the small intestines, although large quantities move into the large intestine for digestion and absorption, especially in the horse. The brush

border membrane of the villous epithelial cells is of paramount importance for the absorption of water, electrolytes and nutrients.

Details of the physiology and pathophysiology of epithelial secretion in the gastrointestinal tract are becoming clear, leading to new models of the mechanisms underlying diarrhea.<sup>1</sup> The enteric nervous system is a critical component of the mechanism regulating fluid secretion in the normal intestine and a key element in the pathophysiology of diarrhea. Neural reflex pathways increase epithelial fluid secretion in response to several enteric pathogens of veterinary importance such as *Salmonella* spp., *Cryptosporidium parvum*, rotavirus and *C. difficile*. The enteric nervous system also has an important role in epithelial secretion triggered by products of activated leukocytes during inflammation.

### Mechanisms of diarrhea

Any dysfunction of the intestines will result in failure of adequate absorption and diarrhea. Depending on the causative agent, intestinal malabsorption may be

the result of at least four different mechanisms:

#### Osmotic diarrhea Exudative diarrhea Secretory diarrhea Abnormal intestinal motility.

##### Osmotic diarrhea

There may be an osmotic effect when substances within the lumen of the intestine increase the osmotic pressure over a greater than normal length of intestine, resulting in an osmotic movement of an excessive amount of fluid into the lumen of the intestine. The fluid is not reabsorbed and accumulates in the lumen. Examples include **saline purgatives, overfeeding, indigestible feeds and disaccharidase deficiencies**. A deficiency of a disaccharidase leads to incomplete digestion and the accumulation of large quantities of undigested material, which acts as a hypertonic solution.

Malabsorption is associated with several epitheliotropic viruses that affect the villous absorptive cells, causing a disaccharidase deficiency. Examples include the TGE (transmissible gastroenteritis)

Table 5.15 Epidemiological and clinical features of the diseases of sheep and goats in which diarrhea is a significant clinical finding

Etiological agent or disease	Age and class of animal affected and important epidemiological factors	Major clinical findings and diagnostic criteria
<b>Bacteria</b>		
Enterotoxigenic <i>Escherichia coli</i> (colibacillosis)	Newborn lambs in crowded lambing sheds. Cold chilling weather. Outbreaks. Inadequate colostrum. Mismothering problems. Poor udder development	Acute diarrhea (yellow feces), septicemia and rapid death. Culture feces for enterotoxigenic <i>E. coli</i>
<i>Clostridium perfringens</i> type B (lamb dysentery)	Newborn lambs up to 10 days of age. Overcrowded lambing sheds	Sudden death, diarrhea, dysentery, toxemia. Fecal smear
<i>Clostridium perfringens</i> type D (enterotoxemia)	Adult lactating does	Peracute, acute and chronic forms occur. Enterocolitis. Watery diarrhea with feces containing blood and mucus, weakness, abdominal colic
<i>Salmonella</i> spp.	Newborn lambs. Adult sheep in pregnancy	Acute diarrhea and dysentery in lambs. Acute toxemia, diarrhea in ewes followed by abortion. Fecal culture and pathology
<i>Mycobacterium paratuberculosis</i>	Mature sheep and goats; several animals may be affected	Loss of weight, chronic diarrhea, long course, no response to therapy. Serological tests
<b>Viruses</b>		
Rotavirus and coronavirus	Newborn lambs. Many lambs affected	Acute profuse watery diarrhea. No toxemia. Usually recover spontaneously if no secondary complications. Virus isolation
<b>Parasites</b>		
<i>Nematodirus</i> spp.	Lambs 4–10 weeks of age on pasture. Sudden onset. Outbreaks. Ideal environmental conditions for parasite are necessary	Anorexia, diarrhea, thirsty, 10–20% of lambs may die if not treated. Fecal examination
<i>Ostertagia</i> spp.	Lambs 10 weeks of age and older lambs and young ewes on grass. Types I and II	Many lambs develop diarrhea, weight loss. Abomasitis
<i>Trichostrongylus</i> spp.	Older lambs 4–9 months of age	Dull, anorexic, loss of weight and chronic diarrhea. Fecal examination
<b>Protozoa</b>		
<i>Eimeria</i> spp.	Overstocking on pasture and overcrowding indoors, poor sanitation and hygiene. Commonly occurs following weaning and introduction into feedlot	Acute and subacute diarrhea and dysentery. Loss of weight. Mortality may be high. Fecal examination
<i>Cryptosporidium</i>	Lambs 7–10 days of age	Dullness, anorexia, afebrile, diarrhea, may die in 2–3 days, survivors may be unthrifty. Examination of feces and intestinal mucosa. No specific treatment

virus in newborn piglets, and rotavirus and coronavirus infections in newborn calves and other species. The usual pathogenetic sequence of events is selective destruction of villous absorptive cells, villous atrophy, loss of digestive and absorptive capacities (malabsorption), diarrhea, crypt hyperplasia and recovery. Recovery depends on the severity of the lesion, the relative injury done to the villous cells and crypt epithelium, and the age of the animal. Newborn piglets affected with TGE commonly die of dehydration and starvation before there is sufficient time for regeneration of the villous cells from the crypt epithelium. In contrast, older pigs have greater capacity for regeneration of the villous cells and the diarrhea may be only transient.

#### Exudative diarrhea

Acute or chronic inflammation or necrosis of the intestinal mucosa results in a net increase in fluid production, inflammatory products, including loss of serum proteins, and a reduction in absorption of fluids and electrolytes. Examples include many of the diseases associated with bacteria, viruses, fungi, protozoa, chemical agents and tumors that are summarized in Tables 5.12–5.15. The classic example is enteric salmonellosis, in which there is

severe inflammation with the production of fibrinous, hemorrhagic enteritis. Other notable examples include swine dysentery, bovine virus diarrhea and inorganic arsenic poisoning.

#### Secretory diarrhea

A **secretory-absorptive imbalance** results in a large net increase in fluid secretion with little if any structural change in the mucosal cells. The enterotoxin elaborated by enterotoxigenic *E. coli* results in intestinal hypersecretion. The villi, along with their digestive and absorptive capabilities, remain intact. The crypts also remain intact; however, their secretion is increased beyond the absorptive capacity of the intestines, resulting in diarrhea. The increased secretion is due to an increase in cyclic adenosine monophosphate, which in turn may be stimulated by prostaglandins. The integrity of the mucosal structure is maintained and the secreted fluid is isotonic, electrolyte-rich, alkaline and free of exudates. This is useful diagnostically in enterotoxic colibacillosis.

An important therapeutic principle can be applied in secretory diarrhea disease. Whenever possible, because of the cost of parenteral fluid therapy, fluids and electrolytes should be given orally. The

mucosa remains relatively intact and retains normal absorptive capacity. Fluid replacement solutions containing water, glucose and amino acids can be given orally and are absorbed efficiently. Glucose and amino acids enhance the absorption of sodium and water, thus replacing or diminishing fluid and electrolyte losses.

There is also evidence that active electrolyte secretion occurs in enterocolitis due to salmonellosis in several species of animal. In diseases such as swine dysentery, the permeability of the colon may remain normal or even decrease, but the absorption of water and electrolytes is decreased. This suggests that the primary cause of fluid and electrolyte loss in some diseases of the colon may be failure of the affected epithelium to absorb fluids and electrolytes.

#### Abnormal intestinal motility

Hyperexcitability, convulsions and the stress of unexpected sudden confinement may result in diarrhea, which may be due to increased peristalsis, resulting in 'intestinal hurry' and reduced intestinal absorption due to rapid passage of intestinal fluids in an otherwise normal intestine. This can occur in animals that are being assembled for transportation and during transportation.

### Location of lesion

The location of the lesion in the intestinal tract may also influence the severity of the enteritis or malabsorption. Lesions involving the small intestine are considered to be more acute and severe than those in the large intestine because approximately 75–80% of the intestinal fluids are absorbed by the small intestine and much lesser quantities by the large intestine. Thus, in general, when lesions of the large intestine predominate, the fluid and electrolyte losses are not as acute nor as severe as when the lesions of the small intestine predominate. However, the horse is an exception. The total amount of fluid entering the large intestine from the small intestine, plus the amount entering from the mucosa of the large intestine, is equal to the animal's total extracellular fluid volume, and 95% of this is reabsorbed by the large intestine. This illustrates the major importance of the large intestine of the horse in absorbing a large quantity of fluid originating from saliva, the stomach, liver, pancreas, small intestine and large intestine. Any significant dysfunction of the absorptive mechanism of the large intestine of the horse results in large losses of fluids and electrolytes. This may explain the rapid dehydration and circulatory collapse that occurs in horses with colitis-X. Moderate to severe ulcerative colitis of the right dorsal colon in horses treated with phenylbutazone results in marked dehydration, endotoxic shock and death.<sup>2</sup>

### Dehydration, electrolyte and acid-base imbalance

The net effect of an increase in the total amount of fluid in the intestinal lumen and a reduction in intestinal absorption is a loss of fluids and electrolytes at the expense of body fluids and electrolytes and the normal intestinal juices. The fluid that is lost consists primarily of water, the electrolytes sodium, chloride, potassium and bicarbonate, and varying quantities of protein. Protein is lost (protein-losing enteropathy) in both acute and chronic inflammation, leading to hypoproteinemia in some cases. The loss of bicarbonate results in **metabolic acidosis**, which is of major importance in acute diarrhea. The loss of sodium, chloride and potassium results in **serum electrolyte imbalances**. In the horse with enteric salmonellosis, there is severe dehydration and marked hyponatremia. In the calf with neonatal diarrhea there are varying **degrees of dehydration** and a moderate loss of all electrolytes. With acute severe diarrhea, there is severe acidosis and reduced circulating blood volume, resulting in reduced perfusion of the liver and kidney and of peripheral tissues. This results in

uremia, anaerobic oxidation and lactic acidosis, which accentuates the metabolic acidosis. Hyperventilation occurs in some animals in an attempt to compensate for the acidosis.

In acute diarrhea, large quantities of intestinal fluid are lost in the feces and large quantities are present in the intestinal lumen (**intraluminal dehydration**), which accounts for the remarkable clinical dehydration in some affected animals. The fluid moves out of the intravascular compartment first, then out of the extravascular compartment (interstitial spaces), followed lastly by fluid from the intracellular space. Thus in acute diarrhea of sudden onset the actual degree of dehydration present initially may be much more severe than is recognizable clinically; as the diarrhea continues, the degree of clinical dehydration becomes much more evident.

### Chronic enteritis

In chronic enteritis, as a sequel to acute enteritis or developing insidiously, the intestinal wall becomes thickened and mucus secretion is stimulated, the absorption of intestinal fluids is also decreased but not of the same magnitude as in acute enteritis. In chronic enteritis there is a negative nutrient balance because of decreased digestion of nutrients and decreased absorption, resulting in body wasting. The animal may continue to drink and maintain almost normal hydration. In some cases of chronic enteritis, depending on the cause, there is continuous loss of protein, leading to clinical hypoproteinemia. Intestinal helminthiasis of all species, Johne's disease of ruminants, and chronic diarrheas of the horse are examples. Lymphocytic plasmacytic enteritis causing chronic weight loss occurs in the horse.<sup>3</sup>

**Regional ileitis** is a functional obstruction of the lower ileum associated with granulation tissue proliferation in the lamina propria and submucosa, with or without ulceration of the mucosa, and a massive muscular hypertrophy of the wall of affected areas of the intestine. It has been recognized with increased frequency in recent years in pigs, horses and lambs. The lesion undoubtedly interferes with normal digestion and absorption but diarrhea is not a common clinical finding.

### Replacement of villous epithelial cells

The villous absorptive epithelial cells of the small intestine are involved in almost every type of enteritis or malabsorptive syndrome. These cells that line the villi and face the lumen of the intestine contain important digestive enzymes such as the disaccharidases. They are also involved

in absorption of fluids, electrolytes, monosaccharides such as glucose, and amino acids, and in the transport of fat micelles. Their replacement time is up to several days in the newborn calf and piglet, and only a few days when these animals are older (at 3 weeks). This may explain the relatively greater susceptibility of the newborn to the viral enteritides, such as TGE in piglets and rotavirus infection in all newborn farm animal species. Almost any noxious influence can increase the rate of extrusion of these cells, which are then replaced by cells that are immature and not fully functional. The villi become shortened (villous atrophy) and chronic malabsorption similar to the 'sprue gut' of humans may be the result. The destruction of villous epithelial cells explains the long recovery period of several days in some animals with acute enteritis and the chronic diarrhea in others with chronic villous atrophy.

The literature on the mechanisms of intestinal mucosal repair has been reviewed.<sup>4</sup>

### Role of neutrophils in intestinal mucosal injury

Neutrophils are critical elements of the cascade of events that culminates in mucosal injury in many inflammatory diseases of the gastrointestinal tract, including ischemia and reperfusion injury.<sup>5</sup> Neutrophils mediate their detrimental actions by several mechanisms, especially physical disruption of the epithelium. These findings have resulted in consideration of strategies to attenuate neutrophil-mediated mucosal injury by preventing neutrophil transendothelial migration into the intestinal mucosa and subsequent activation during inflammation. Newer pharmacological drugs that inhibit beta-2-integrin activation, and therefore beta 2-integrin function, may be useful clinically to inhibit neutrophil-mediated injury during inflammation.<sup>5</sup>

### Intestinal motility in enteritis

The motility of the intestinal tract in animals with enteritis has not been sufficiently examined and little information is available. It was thought for many years that intestinal hypermotility, and increased frequency and amplitude of peristalsis, was present in most enteritides as a response to the enteritis and that the hypermotility accounted for the reduced absorption. However, when the pathogenesis of the infectious enteritides is considered, for example the unique secretory effect of enterotoxin, it seems more likely that, if hypermotility is present, it is a response to the distension of the intestinal lumen with fluid rather than a response to irritation. With a fluid-filled intestinal lumen, very little intestinal



peristalsis would be necessary to move large quantities of fluid down the intestinal tract. This may explain the fluid-rushing sounds that are audible on auscultation of the abdomen in animals with enteritis. It is possible that the intestines may be in a state of relative hypomotility rather than hypermotility, which makes the use of antimotility drugs for the treatment of enteritis questionable.

### Concurrent gastritis

Gastritis commonly accompanies enteritis but does not cause vomiting except perhaps in the pig. Gastritis (or abomasitis) may also be the primary lesion, resulting in a profuse diarrhea without lesions of the intestines. Examples are ostertagiasis and abomasal ulceration in cattle. Presumably the excessive amount of fluid secreted into the affected abomasum cannot be reabsorbed by the intestines.

### Effects of enteritis on pharmacodynamics of drugs

Enteritis may alter the pharmacodynamics of orally administered drugs. In acute diarrheal states there is delayed or impaired absorption, resulting in subtherapeutic plasma concentration. In chronic malabsorption states, decreased, increased or delayed absorption may occur, depending on the drug. Also, gastric antacids, anticholinergic drugs and opiates, administered orally for the treatment of diarrhea, may impair absorption of other drugs by altering solubility or delaying gastric emptying time.

### CLINICAL FINDINGS

The major clinical finding in enteritis or malabsorption is **diarrhea**. **Dehydration**, **abdominal pain**, **septicemia** and **toxemia** with **fever** occur commonly and their degree of severity depends on the causative agent, the age and species of the animal and the stage of the disease.

In **acute enteritis**, the feces are soft or fluid in consistency and may have an unpleasant odor. They may contain blood (**dysentery**), fibrinous casts and mucus or obvious foreign material such as sand. The color of the feces will vary considerably: they are usually pale yellow because of the dilution of the brown bile pigments but almost any color other than the normal is possible and, with the exception of frank blood (**hematochezia**) or **melena (black tarry feces)**, the color of the feces is usually not representative of a particular disease. When the feces are watery, they may escape notice on clinical examination. Some indication of the nature of the enteritis may be obtained from the distribution of the feces on the animal's perineum. Thus, in calves, the smudge pattern may suggest coccidiosis when both the staining that accompanies

it and the feces are smeared horizontally across the ischial tuberosities and the adjoining tail, or helminth infestation when there is little smearing on the pinbones but the tail and insides of the hocks are liberally coated with feces. Straining may occur, especially in calves, and be followed by rectal prolapse, particularly when the lesions are present in the colon and rectum. Intussusception may occur when the enteritis involves the small intestine.

There are a number of diseases in which **dysentery** with or without toxemia occurs and death may occur rapidly. These include lamb dysentery, hemorrhagic enterotoxemia of calves, acute swine dysentery and hemorrhagic bowel syndrome of pigs.

**Acute intraluminal hemorrhage** due to ulceration of unknown etiology in the small intestine has been recorded in adult cows.<sup>6</sup> Duodenal ulceration may also occur in cattle in association with left-side displacement of the abomasum.<sup>7</sup>

### Systemic effects

The **systemic effects in enteritis** vary considerably. Septicemia, toxemia and fever are common in the infectious enteritides. An increased body temperature may return to normal following the onset of diarrhea or if circulatory collapse and shock are imminent. **Dehydration** will vary from being just barely detectable at 4–6% of body weight up to 10–12% of body weight, when it is clinically very evident. The degree of dehydration can be best assessed by tenting the skin of the upper eyelid or neck and determining the time taken for the skin fold to return to normal. The degree of recession of the eyeball is also a useful aid. In the early stages of acute enteritis, the degree of clinical dehydration may be underestimated because of the time required for fluid to shift from the interstitial and intracellular spaces to the intravascular space to replace fluids already lost. Dehydration is usually evident by 10–12 hours following the onset of acute enteritis and clinically obvious by 18–24 hours. Peripheral circulatory collapse (**shock**) occurs commonly in acute and peracute cases. There may be tachycardia or bradycardia and arrhythmia depending on the degree of acidosis and electrolyte imbalance. In acute enteritis, there may be severe abdominal pain, which is most severe in the horse and is often sufficient in this species to cause rolling and kicking at the abdomen. Abdominal pain in enteritis is unusual in the other species although it does occur in heavy inorganic metal poisonings, such as arsenic and lead, and in acute salmonellosis in cattle. Some severe cases of enteric colibacillosis

in calves are characterized by abdominal pain evidenced by intermittent bouts of stretching and kicking at the abdomen. The passage of intestinal gas also occurs commonly in horses with acute and chronic diarrhea.

### Intestinal sounds in enteritis

Auscultation of the abdomen usually reveals sounds of **increased peristalsis** and **fluid-rushing sounds** in the early stages of acute enteritis. Later there may be **paralytic ileus** and an absence of peristaltic sounds with only fluid and gas tinkling sounds. The abdomen may be distended in the early stages because of distension of intestines and gaunt in the later stages when the fluid has been passed out in the feces. Pain may be evidenced on palpation of the abdomen in young animals.

### Chronic enteritis

In **chronic enteritis**, the feces are usually soft and homogeneous in consistency, contain considerable mucus and usually do not have a grossly abnormal odor. Progressive weight loss and emaciation or 'runting' are common and there are usually no systemic abnormalities. Animals with chronic enteritis will often drink and absorb sufficient water to maintain clinical hydration but there may be laboratory evidence of dehydration and electrolyte loss. In parasitic enteritis and abomasitis there may be hypoproteinemia and subcutaneous edema. In terminal ileitis, there is usually chronic progressive weight loss and occasionally some mild diarrhea. The lesion is usually recognized only at necropsy. Intestinal adenomatosis of pigs, rectal strictures in pigs, granulomatous enteritis of horses and lymphosarcoma of the intestine of horses are examples of enteric disease causing chronic anorexia and progressive weight loss, usually without clinical evidence of diarrhea. These are commonly referred to as malabsorption syndromes.

### CLINICAL PATHOLOGY

The laboratory testing of animals to obtain an etiological diagnosis of enteritis can be a complex and expensive procedure, which requires careful consideration of the history, the clinical findings and the number of animals affected. In outbreaks of enteric syndromes, it may be important to submit samples from both affected and normal animals. The details of the sampling techniques and the tissues required for the diagnosis of diseases of the digestive tract caused by feeding mismanagement, infections, toxins and other agents have been outlined and this is recommended as a reference.<sup>8</sup>

### Fecal examination

Examination of the feces to determine the presence of causative **bacteria, helminths, protozoa, viruses** and **chemical agents** is described under specific diseases throughout this book. It is important that fecal specimens be taken as the differentiation of the etiological groups depends on laboratory examinations. In outbreaks of diarrhea, fecal samples should also be taken from a representative number of normal animals in the same group as the affected animals. Comparison of the fecal examination results between affected and normal animals will improve the accuracy of interpretation.

Fecal samples can be examined for the presence of leukocytes and epithelial cells, which occur in exudative enteritis.

### Intestinal tissue samples

In outbreaks of diarrhea, especially in neonates, it may be useful to do necropsies on selected early untreated cases of acute diarrhea. The lesions associated with the enteropathogens are well known and a provisional etiological diagnosis may be possible by gross and histopathological examination of the intestinal mucosa.

### Hematology and serum biochemistry

With increasing sophistication in diagnostic laboratories and in large-animal practice, it is becoming common to do considerable laboratory evaluation to determine the actual changes that are present, for purposes of a more rational approach to therapy. For each specific enteritis there are changes in the hemogram and serum biochemistry that aid in the diagnosis and differential diagnosis. In bacterial enteritis, such as acute enteric salmonellosis in the horse, there may be marked changes in the total and differential leukocyte count, which is a useful diagnostic aid. In most cases of acute enteritis there is hemoconcentration, metabolic acidosis, an increase in total serum solids concentration, a decrease in plasma bicarbonate, hyponatremia, hypochloremia and hypokalemia. However, abnormalities in body fluid compartments caused by diarrhea depend on the pathogenetic mechanisms involved and the duration of the diarrhea. In horses with diarrhea of less than 6 days' duration, the most common abnormality may be a combined anion gap, metabolic acidosis and metabolic alkalosis characterized by hyponatremia, hypochloremia and hyperkalemia. The **acid-base imbalances** may vary considerably from case to case and it is suggested that optimal fluid therapy should be based on laboratory evaluation of the animal's blood gas and electrolytes. **Hyperkalemia** may occur in severe acidosis. An increase

in serum creatinine may be due to inadequate renal perfusion associated with the dehydration and circulatory failure.

### Digestion/absorption tests

**Digestion and absorption tests** are available for the investigation of chronic malabsorptive conditions, particularly in the horse. Intestinal biopsy may be necessary for a definitive diagnosis of chronic intestinal lesions that cannot be determined by the usual diagnostic tests. Examples include intestinal lymphosarcoma, granulomatous enteritis and perhaps Johne's disease. Serum electrophoresis and the administration of radioactively labeled albumin may be necessary to determine the presence of a protein-losing enteropathy.

### NECROPSY FINDINGS

The pathology of enteritis or malabsorption varies considerably depending on the cause. There may be an absence of grossly visible changes of the mucosa but the intestinal lumen will be fluid-filled or relatively empty, depending on the stage of examination in enterotoxigenic colibacillosis. When there is gross evidence of inflammation of the mucosa there will be varying degrees of edema, hyperemia, hemorrhage, foul-smelling intestinal contents, fibrinous inflammation, ulceration and necrosis of the mucosa. With acute necrosis there is evidence of frank blood, fibrinous casts and epithelial shreds. The mesenteric lymph nodes show varying degrees of enlargement, edema and congestion, and secondary involvement of spleen and liver is not unusual. In chronic enteritis, the epithelium may appear relatively normal but the wall is usually thickened and may be edematous. In some specific diseases there are lesions typical of the particular disease.

### DIFFERENTIAL DIAGNOSIS

#### Approach

- The approach to the diagnosis of diarrhea requires a consideration of the epidemiological history and the nature and severity of the clinical findings. With the exception of the acute enteritides in newborn farm animals, most of the other common enteritides have reasonably distinct epidemiological and clinical features
- In some cases, a necropsy on an untreated case of diarrhea in the early stages of the disease can be very useful
- If possible, a hemogram should be obtained to assist in determining the presence or absence of infection

### Appearance of feces

- The gross appearance of the feces may provide some clues about the cause of the diarrhea. In general, the diarrheas caused by lesions of the small intestine are profuse and the feces are liquid and sometimes as clear as water. The diarrheas associated with lesions of the large intestine are characterized by small volumes of soft feces, often containing excess quantities of mucus
- The presence of toxemia and fever-marked changes in the total and differential leukocyte count suggest bacterial enteritis, possibly with septicemia. This is of particular importance in horses and cattle with salmonellosis
- The presence of frank blood and/or fibrinous casts in the feces usually indicates a severe inflammatory lesion of the intestines. In sand-induced diarrhea in horses the feces may contain sand

### Weight loss

- A chronic diarrhea with a history of chronic weight loss in a mature cow suggests Johne's disease
- Chronic weight loss and chronic diarrhea, or even the absence of diarrhea, in the horse may indicate the presence of granulomatous enteritis, chronic eosinophilic gastroenteritis, alimentary lymphosarcoma, tuberculosis and histoplasmosis

### Dietary diarrhea and toxicities

- In dietary diarrhea the feces are usually voluminous, soft and odoriferous, the animal is usually bright and alert and there are minimal systemic effects. An examination of the diet will usually reveal if the composition of the diet or irregular feeding practices are responsible for the diarrhea. Analysis of samples of new feed may be necessary to determine the presence of toxic chemical agents
- Arsenic poisoning is characterized by dysentery, toxemia, normal temperature and nervous signs
- Copper deficiency conditioned by an excess of molybdenum causes a moderately profuse diarrhea with soft feces, moderate weight loss and there is usually normal hydration and possibly depigmentation of hair

### Parasitism

- Intestinal helminthiasis such as ostertagiasis causes a profuse diarrhea and marked loss of weight; the temperature is normal and there is no toxemia

### Miscellaneous causes

- In cattle, the oral cavity must be examined for evidence of lesions characteristic of viral diseases
- Many diseases of the stomach, including ulceration, parasitism, gastritis and tumors, may result in diarrhea and must be considered in the differential diagnosis of chronic diarrhea
- The soft scant feces associated with some cases of incomplete obstruction of the digestive tract of cattle affected with the complications of traumatic reticuloperitonitis must not be confused with diarrhea

## TREATMENT

The principles of treatment of enteritis are:

- Removal of the causative agent
- Alteration of the diet
- Fluids and electrolytes
- Intestinal protectants and adsorbents
- Antidiarrheal drugs.

### Removal of causative agent

Specific treatment is usually directed at intestinal helminthiasis with anthelmintics, antiprotozoan agents against diseases such as coccidiosis and antimicrobial agents against the bacterial enteritides. There are no specific treatments available for the viral enteritides in farm animals.

While considerable investigations have been done on the enteritides on farm animals, the emphasis has been on the immunology, pathology, microbiology and body fluid dynamics, each with different emphasis in different species. For example, there is considerable information on the microbiology and immunology of the common enteritides in calves and piglets in addition to the extensive knowledge of the body fluid dynamics in calves. In the horse there is some information on body fluid dynamics but the microbiology of the diarrheas is not well understood. In none of the species is there sufficient information on the effects of antibiotics on the intestinal microflora.

### Antimicrobials

The use of antimicrobials, either orally or parenterally, or by both routes simultaneously, for the treatment of bacterial enteritides is a controversial subject in both human and veterinary medicine. Those who support their use in acute bacterial enteritis claim that they are necessary to help reduce the overgrowth of pathogenic bacteria responsible for the enteritis and to prevent or treat bacteremia or septicemia that may occur secondary to an enteritis. Those who suggest that they are contraindicated or unnecessary in bacterial enteritis suggest that the drugs may eliminate a significant proportion of the intestinal flora in addition to the pathogenic flora. This may reduce the effect of competitive antagonism in the intestine, which in turn may permit the development of a superinfection (the appearance of bacteriological and clinical evidence of a new infection during the chemotherapy of a primary one). Also, the use of antimicrobials in infectious enteric disease allows the development of **multiple drug resistance**, which is a major public health concern. The use of antimicrobials may also increase the length of time over which affected animals excrete the organisms which, for example, may occur in enteric salmonellosis.

Many different antimicrobial preparations for both oral and parenteral administration are available. The choice will depend on previous experience, the disease suspected and the results of culture and drug sensitivity tests. Parenteral preparations are indicated in animals with acute diarrhea, toxemia and fever. Many antimicrobials, when given parenterally, are excreted by the liver into the lumen of the intestine and oral preparations may not be necessary. In cases of subacute diarrhea with minimal systemic effects, the use of an oral preparation may be sufficient. However, oral preparations should not be used for more than 3 days to avoid a superinfection. The preparations and doses of the antimicrobials commonly used in bacterial enteritides are described under each disease.

### Mass medication of feed and water supplies

Mass medication of the drinking water supply with antimicrobials for the treatment of outbreaks of specific infectious enteritides in animals is used commonly and with success. One of the best examples is the use of antimicrobials in the drinking water of pigs affected with swine dysentery. However, not all affected animals will drink a sufficient quantity of the medicated water and daily intake must be monitored carefully. Severely affected animals in an outbreak need individual treatment.

### Alteration of the diet

If the cause of the diarrhea is dietary in origin the feed should be removed until the animal has fully recovered; feed should then be replaced by another source or reintroduced gradually. The question of whether or not a normally digestible diet should be removed temporarily or the total daily intake reduced in animals with acute enteritis is a difficult one. The rationale is that in acute enteritis the digestibility of nutrients is reduced considerably and undigested feed provides a substrate for fermentation and putrefaction to occur, the products of which may accentuate the malabsorptive state. However, temporary withdrawal of feed presents practical problems, especially in the young. For example, the temporary removal from the sow of newborn piglets affected with acute enteritis presents practical problems and is of doubtful value; similarly with beef calves nursing cows on pasture. With foals it is relatively easy to muzzle them for 24 hours. With weaned piglets affected with weaning diarrhea and feeder pigs with swine dysentery, it is common practice to reduce the normal daily intake by half for a few days until recovery is apparent. Mature

horses affected with diarrhea should not have access to any feed for at least 24 hours. During the period of temporary starvation, the oral intake of fluids containing glucose and electrolytes is desirable and necessary to assist in maintaining hydration. In newborn calves with diarrhea, if oral fluid intake is maintained, the total loss of water from feces and through the kidney is not significantly greater than in normal calves because in diarrheic calves the kidney will effectively compensate for fecal losses. When recovery is apparent, the animal's usual diet may be reintroduced gradually over a period of a few days.

### Fluids and electrolytes

The initial goals of fluid and electrolyte therapy for the effects of enteritis are: the restoration of the body fluids to normal volume, effective osmolality, composition and acid-base balance. The quality and quantity of fluids required to achieve these goals depend on the characteristics of the dehydration and acid-base electrolyte imbalance. Under ideal conditions when a laboratory is available, the determination of packed cell volume, total serum proteins, plasma bicarbonate, blood pH, serum electrolytes and a hemogram would provide the clinician with a laboratory evaluation initially and throughout the course of therapy, to assess the effectiveness of the treatment. However, such laboratory service is expensive and usually not readily available. The clinician must therefore assess the degree of clinical dehydration and, based on the history and clinical findings, estimate the degree of acidosis and electrolyte deficits that are likely to be present. A practical approach to fluid therapy in the horse has been described. Fluids should be given orally whenever possible to save time and expense and to avoid the complications that can arise from long-term parenteral fluid therapy. Also, fluids should be given as early as possible to minimize the degree of dehydration. With good kidney function there is a wider safe latitude in the solution used.

The three major abnormalities of **dehydration**, **acidosis** and **electrolyte deficit** are usually corrected simultaneously with fluid therapy. When severe acidosis is suspected, this should be corrected immediately with a hypertonic (5%) solution of bicarbonate given intravenously at the rate of 5–7 mL/kg BW at a speed of about 100 mL/min. This is followed by the administration of electrolyte solutions in quantities necessary to correct the dehydration. With severe dehydration, equivalent to 10% of BW, large amounts of fluids are necessary.

Animal	Dehydration (%)	Fluid deficit (L)
500 kg horse	10	50
75 kg foal	10	7.5
45 kg calf	10	4.5

The initial hydration therapy should be given over the first 4–6 hours by continuous intravenous infusion, followed by maintenance therapy for the next 20–24 hours, or for the duration of the diarrhea if severe, at a rate of 100–150 mL/kg BW/24 h. Horses with acute enteritis have severe hyponatremia and following fluid therapy may become severely hypokalemic, as evidenced by weakness and muscular tremors. The hypertonic solution of sodium bicarbonate will assist in correcting the hyponatremia but potassium chloride may need to be added to the large quantity of fluids given for dehydration; 1 g of potassium chloride added to each liter of fluid will provide an additional 14 mosmol/L (14 mmol/L) of potassium. In preruminant calves with diarrhea, the fluids and electrolytes required for maintenance may be given orally in divided doses every few hours. In the early stage of acute diarrhea and for animals that are not severely dehydrated, the oral route can also be used successfully to correct dehydration and prevent it from becoming worse. The formulae of oral glucose–electrolyte solutions are given in the section under colibacillosis. Piglets and lambs affected with dehydration are most effectively treated using balanced electrolyte solutions given subcutaneously at the dose rates of 20 mL/kg BW every 4 hours and orally at 20 mL/kg BW every 2 hours. Details of the treatment of fluid and electrolyte disturbances are given under that heading in Chapter 2.

### Intestinal protectants and adsorbents

Kaolin and pectin mixtures are used widely to coat the intestinal mucosa, inhibit secretions and increase the bulk of the feces in animals with enteritis. In children with diarrhea, kaolin and pectin will result in formed rather than watery feces, but the water content of the feces is unchanged. It is not possible at this time to make a recommendation on their use in animals.

### Antidiarrheal drugs

#### Antimotility drugs

Anticholinergic drugs and opiates are available to decrease intestinal motility. The anticholinergic drugs block the action of acetylcholine on smooth muscle and glands. This results in decreased gastric secretion and emptying and a reduction on both segmental and propulsive movements of the intestines. Dosages of anticholinergics necessary to produce

effectiveness may also cause side effects such as xerostomia, photophobia, tachycardia, urinary retention and neuromuscular paralysis. The opiates function by producing an increase in segmentation while reducing propulsive movements in the intestine. The net effect is an increase in resistance to passage of intestinal contents and more complete absorption of both water and nutrients occurs with a subsequent decrease in the frequency of defecation. There are no published reports of clinical trials using antimotility drugs for the treatment of diarrhea in farm animals and at the present time, therefore, they cannot be recommended with any assurance of effectiveness.

#### Antisecretory drugs

Antisecretory drugs are also available for the treatment of diarrhea due to the hypersecretory activity of enterotoxin produced by bacteria such as enterotoxigenic *E. coli*. Loperamide hydrochloride given orally to calves with experimentally induced diarrhea can delay the onset of diarrhea by its inhibition of fluid secretion. Antisecretory drugs include chlorpromazine, opiates, atropine and prostaglandin inhibitors. These have not yet been adequately evaluated and the provision of balanced fluids and electrolytes, containing sodium chloride, sodium bicarbonate, potassium chloride and glucose, given both parenterally and orally, are considered to be adequate and effective for treating the effects of the hypersecretion.

Because prostaglandins have an important reparative role in the intestine, NSAIDs may retard recovery of ischemic-injured intestine and are contraindicated.<sup>9</sup>

### CONTROL

The control and prevention of enteritis in farm animals is a major topic and activity of large-animal practice. The control of each specific enteritis is presented under each specific disease in Part II of this book. The principles of control include the following:

- Reduce infection pressure by controlling population density
- Ensure adequate nonspecific resistance by adequate colostrum intake of neonatal farm animals and maintaining adequate nutritional status
- Vaccinate for those diseases for which there is an effective vaccine
- Minimize managerial and environmental stressors
- Monitor morbidity and mortality and ensure that a diagnosis is obtained so that control measures for newly introduced diseases into a herd can be instituted.

### REVIEW LITERATURE

- Blikslager AT, Roberts MC. Mechanisms of intestinal mucosal repair. *J Am Vet Med Assoc* 1997; 211:1437–1441.
- Blanchard PC. Sampling techniques for the diagnosis of digestive disease. *Vet Clin North Am Food Anim Pract* 2000; 16:23–36.
- Waters WR. Immunology of inflammatory diseases of the bowel. *Vet Clin North Am Food Anim Pract* 2001; 17:517–534.
- Jones SL, Blikslager AT. Role of the enteric nervous system in the pathophysiology of secretory diarrhea. *J Vet Intern Med* 2002; 16:222–228.
- Tomlinson J, Blikslager A. Role of nonsteroidal anti-inflammatory drugs in gastrointestinal tract injury and repair. *J Am Vet Med Assoc* 2003; 222:946–951.

### REFERENCES

1. Jones SL, Blikslager T. *J Vet Intern Med* 2002; 16:222.
2. Karcher LF et al. *J Vet Intern Med* 1990; 4:247.
3. MacAllister CG et al. *J Am Vet Med Assoc* 1990; 196:1995.
4. Blikslager AT, Roberts MC. *J Am Vet Med Assoc* 1997; 211:1437.
5. Gayle JM et al. *J Am Vet Med Assoc* 2000; 217:498.
6. Ruggles AJ et al. *Cornell Vet* 1992; 82:181.
7. West HJ, Baker JR. *Vet Rec* 1991; 129:196.
8. Blanchard PC. *Vet Clin North Am Food Anim Pract* 2000; 16:23.
9. Tomlinson J, Blikslager A. *J Am Vet Med Assoc* 2003; 222:946.

## ACUTE DIARRHEA OF ADULT (NONSUCKLING) HORSES

**Etiology** *Salmonella* spp., *Strongylus* spp., cyathostomes, *Neorickettsia* (*Ehrlichia*) *risticii*, *Clostridium* spp., antibiotic administration, idiopathic

**Epidemiology** Usually a sporadic disease of young horses, often temporally associated with mild respiratory disease or a stressful event such as transport. Helminthiasis has a seasonal distribution and can occur as a herd problem. *N. risticii* has a defined geographical distribution

**Clinical signs** Acute onset of profuse watery diarrhea. Depression, fever, dehydration and anorexia are common

**Clinical pathology** Leukopenia, hemoconcentration, hyponatremia, hypokalemia or hyperkalemia, metabolic acidosis. IFA or PCR for *N. risticii*, fecal culture of *Salmonella* spp. may be positive. Fecal culture for *Clostridium* spp. and ELISA to demonstrate toxin in feces

**Lesions** Colitis with or without enteritis

**Diagnostic confirmation** Cause is frequently not confirmed

**Treatment** Intense supportive care including maintenance of hydration and correction of acid–base and electrolyte abnormalities. Oxytetracycline for equine monocytic ehrlichiosis. Metronidazole for *C. difficile*-associated diarrhea

**Control** None

### ETIOLOGY

Causes are as follows:

- **Salmonellosis:** Various *Salmonella* spp.

- **Helminthiasis:** *Strongylus* sp., cyathostomes
- **Equine monocytic ehrlichiosis** (Potomac horse fever Equine neorickettsiasis): *Neorickettsia risticii*
- **Antibiotic administration:** macrolides (lincomycin, tylosin, erythromycin), tetracyclines, ciprofloxacin, trimethoprim-sulfonamide combination, penicillin, aminoglycosides, ceftiofur, and others
- **Intestinal clostridiosis:** *C. perfringens* (types A and C),<sup>1</sup> toxigenic strains of *C. difficile*<sup>2</sup> and possibly *Clostridium cadaveris*
- **Aeromonas spp.:** Isolated from horses with diarrhea, definitive role as a causative agent has not been demonstrated<sup>3</sup>
- **Colitis-X:** Idiopathic.

*E. coli* does not appear to be an important cause of diarrhea in adult horses.<sup>4</sup>

In most cases (65%) of acute diarrhea in horses the cause is not determined, or if the cause is determined it is frequently at necropsy examination or after the horse has recovered.<sup>5</sup>

## EPIDEMIOLOGY

### Occurrence

The syndrome of acute diarrhea occurs **worldwide** in adult horses of all breeds and both sexes. The pattern of occurrence of the syndrome is dependent on the causative factors, with **equine monocytic ehrlichiosis** (equine neorickettsiasis), associated with *N. risticii*, having a geographical distribution and **acute cyathostomiasis** having a seasonal distribution. Salmonellosis can occur sporadically or as outbreaks in stables, barns and veterinary hospitals. *C. difficile* enterocolitis is associated with hospitalization and/or antibiotic administration to adult horses.<sup>2</sup> The disease also occurs in foals.

**Colitis-X** is usually a sporadic disease, but multiple cases can occur in a barn or racing stable over a period of weeks and cause considerable economic hardship. With the exception of salmonellosis, equine monocytic ehrlichiosis, strongylosis and colitis-X, the syndrome is characterized by a **sporadic** distribution. Estimates of incidence, morbidity and mortality are not available for all diseases.

The **case fatality rate** for the spontaneous disease can be 25–50% even in intensively treated horses.<sup>5–8</sup> The case fatality rate is higher for horses with *C. difficile*-induced diarrhea than for horses with acute diarrhea of other causes<sup>2</sup> and for horses with antibiotic-induced diarrhea.<sup>8</sup> The prognosis is worse in horses with tachycardia, severe dehydration (PCV > 45% (0.45 L/L)), azotemia,

metabolic acidosis, low serum albumin concentration or higher immature neutrophil (band cell) count in peripheral blood.<sup>6–8</sup>

### Risk factors

The risk factors for salmonellosis, equine monocytic ehrlichiosis and strongylosis are addressed under those topics.

### Stress

Stressful episodes, such as shipping or racing, hospitalization, surgery, administration of antibiotics or mild respiratory disease, frequently precede the onset of diarrhea.<sup>6</sup>

### Celiotomy

Celiotomy for colic is associated with an incidence of severe diarrhea of up to 27% in surviving horses.<sup>9</sup> The risk of diarrhea is greatest in horses with large-colon disease or with enterotomy, but is not influenced by the type of antibiotic administered after surgery.<sup>9</sup>

### Antibiotic administration

Antibiotic administration is associated with acute diarrhea in horses. The macrolide antibiotic **lincomycin** causes acute, often fatal, disease of horses even when administered at relatively low doses, such as that resulting from horses ingesting medicated pig feed.<sup>10</sup> **Tetracyclines** have been associated with the development of acute diarrhea but, when given intravenously at therapeutic doses (6.6 mg/kg every 12–24 h) are probably no more likely to cause diarrhea than other broad-spectrum antibiotics. Tetracycline contamination of feed causes outbreaks of diarrhea on horse farms.<sup>11</sup> **Ciprofloxacin** might be a cause of diarrhea in horses.<sup>12</sup> The combination of **trimethoprim and sulfadiazine** given orally causes diarrhea in 7% of hospitalized horses, whereas pivampicillin, a prodrug of ampicillin, causes diarrhea in 3%.<sup>13</sup> However, horses treated with trimethoprim-sulfadiazine combinations are not at greater risk of developing diarrhea than horses treated with penicillin.<sup>14</sup> Almost all adult horses with diarrhea from which *C. difficile* or its toxin can be isolated were administered antibiotics before onset of diarrhea.<sup>15</sup>

### PATHOGENESIS

Diarrhea is the result of abnormalities in colonic water and electrolyte metabolism. Approximately 90 L of isotonic fluid enters the colon of an adult (450 kg) horse every 24 hours, and any disruption to the normal absorption of this fluid results in increased fecal water and electrolyte excretion. Colitis results from physical, chemical or infectious causes that induce inflammation in the colon. The proximate causes vary with the etiology of the disease. For example, colitis due to infection by

toxigenic strains of *C. perfringens* type C is attributable to binding of beta-2 toxin to colonic mucosa,<sup>16</sup> whereas colitis due to salmonellosis is associated with invasion of the organism and loss of colonic mucosa. Colitis is associated with increased production of inflammatory cytokines, including tumor necrosis factor, in the colon,<sup>17</sup> and with impaired mucosal absorptive function. Additionally, bacterial toxins and inflammation result in an increase in mucosal permeability with loss of plasma proteins into the colonic lumen and systemic absorption of toxins, including endotoxin. Loss of plasma proteins causes a reduction in plasma colloidal oncotic pressure with subsequent extravasation of water and electrolytes and development of edema and decreased effective intravascular volume (hypovolemia). The effect of the decrease in oncotic pressure becomes most apparent in horses that are treated aggressively with fluids. These horses, which often receive excessive amounts of sodium, rapidly develop edema of the ventral body wall and colon, among other tissues. Loss of other plasma proteins, including antithrombin III, and absorption from the gut of activators of coagulation, fibrinolysis or inflammation, may contribute to the disseminated intravascular coagulation often observed in horses with enterocolitis.

The large volume of diarrhea in horses causes a reduction in body water and electrolyte content. Hypovolemia, hyponatremia, hypochloremia and hypoproteinemia develop. Derangements in acid-base and electrolyte status impair gastrointestinal motility. Hypovolemia impairs perfusion of peripheral tissues, which, combined with absorption of endotoxin through the damaged colonic mucosa, results in toxemia, lactic acidosis and death.

### CLINICAL SIGNS

The onset of clinical signs is usually abrupt, although in some horses diarrhea may be presaged for up to several days by inappetence, mild depression and a mild fever. The disease varies in severity from short-lived with mild to moderate diarrhea and minimal systemic signs of disease to a fulminant disease with death in hours. The description here is of the more severe forms of the disease. Once diarrhea occurs there is **rapid progression**, with some horses dying within 12 hours of initial clinical signs, although most survive at least 24 hours. In a peracute form of the disease horses die, often within 6 hours, before developing diarrhea.

Typically horses are often severely depressed and stand with their heads down. They may play in water, but rarely eat or drink. Horses are usually mildly

pyrexia (101.5–103°F, 38.6–39.5°C) but markedly tachycardic (80–100 bpm), tachypneic (30–40 bpm) and dehydrated (8–12%). There is slow capillary refill of mucous membranes, which are usually bright red initially and then become bluish-purple as toxemia and dehydration become severe. The development of a purple line at the gingival margins is a sign of a poor prognosis. Most horses are oliguric.

The diarrhea is profuse and watery. **Abdominal pain** is usually present but mild; the onset of severe abdominal pain is often associated with necrosis of the large colon or cecum and impending death. **Rectal examination** reveals large amounts of fluid feces with minimal distension of the large colon.

**Complications** of acute, severe enterocolitis include laminitis, thrombophlebitis of the jugular veins, **thrombosis** of vessels including arteries in the limbs,<sup>18</sup> renal failure, pulmonary aspergillosis<sup>19–21</sup> and necrotizing enterocolitis.<sup>22</sup> Laminitis develops within 1–3 days of onset of diarrhea in approximately 10% of cases and can occur in any horse with enterocolitis, but is most common in horses with Potomac horse fever (equine monocytic ehrlichiosis). Thrombophlebitis, which may or may not be septic, usually affects veins, usually jugular, that have or have had catheters placed or are the site of frequent intravenous injections. Thrombosis of the vein can occur several days to a week after removal of the catheter, although most occur while the catheter is in place. Renal failure occurs as a result of the combined insults of hypovolemia, endotoxemia and administration of nephrotoxic drugs, including aminoglycosides and NSAIDs. Pulmonary aspergillosis is usually clinically inapparent.<sup>20</sup> Clinically affected horses have rapidly progressive toxemia, respiratory distress, hypoxemia and blood-tinged, frothy nasal exudates. Fatal necrotizing enterocolitis of horses is characterized by a brief course, most horses dying within 48 hours of onset of diarrhea, profound dehydration, electrolyte derangements, severe metabolic acidosis and, terminally, severe abdominal pain.<sup>22</sup>

Most horses that survive have resolution of diarrhea in about 7 days, although a small but clinically important proportion develop chronic diarrhea.

#### CLINICAL PATHOLOGY

**Hematological** examination reveals an increased hematocrit (45–60%), variable changes in plasma protein concentration and neutropenia with a marked left shift. As the disease progresses and horses are treated by intravenous administration of

fluids, plasma protein concentrations and plasma oncotic pressure decline. Plasma or serum albumin concentration may be as low as 1.2 g/dL (12 g/L). Changes in **coagulation and fibrinolysis** are evident as increases in one or more of one-stage prothrombin time, activated partial thromboplastin time and concentration of fibrin degradation products, variable changes in plasma fibrinogen concentration and a reduction in blood platelet concentration.<sup>23</sup> Approximately one-third of horses hospitalized for treatment of severe diarrhea have subclinical evidence of disseminated intravascular coagulation,<sup>23</sup> which carries a reduced likelihood of recovery.

**Serum biochemical analysis** usually reveals hyponatremia, hypochloremia, variable changes in serum potassium concentration, hypocalcemia (both concentrations of ionized and total calcium<sup>24</sup>), azotemia (increased serum urea nitrogen and creatinine concentrations), hyperphosphatemia and increased activities of enzymes indicative of muscle (creatinine kinase) or intestinal damage (aspartate aminotransferase and alkaline phosphatase).

**Blood gas analysis** often reveals a severe metabolic acidosis, and the more negative the base excess the worse the prognosis.<sup>7</sup> Interpretation of acid–base status in horses with severe enterocolitis is difficult because of the opposing effects of hypoproteinemia and combination of lactic acidosis and electrolyte loss on blood pH. Hypoproteinemia causes a metabolic alkalosis whereas increases in plasma lactate concentration and hyponatremia cause metabolic acidosis. The presence of hypoproteinemia therefore tends to diminish the effect of lactic acidosis on blood pH, which underestimates the severity of the acidosis. Acid–base status in horses with severe abnormalities in plasma protein concentration should be ascertained by examination of base excess, strong ion gap or strong ion difference.<sup>25</sup>

Plasma endothelin concentrations are higher in horses with enterocolitis than in normal horses,<sup>26</sup> although the clinical significance of this finding is unclear.

**Abdominal fluid** is usually normal initially but becomes bloody and has an increased white blood cell count and protein concentration if intestinal necrosis occurs.

#### DIAGNOSTIC CONFIRMATION

This depends on the results of fecal culture for *Salmonella* sp., fecal examination for helminth eggs or larvae, and indirect fluorescent antibody (IFA) or polymerase chain reaction (PCR) tests for *N. risticii*. Demonstration of large numbers

of salmonellae in feces on multiple fecal samples, or in lymph nodes of horses dying of the disease, is persuasive evidence that the horse had **salmonellosis**. However, demonstration of low numbers of salmonellae in a single fecal culture is not definitive evidence that *Salmonella* sp. infection was the cause of the horse's diarrhea. **Fecal examinations** for helminth eggs may be negative in cases of **acute cyathostomiasis**, although large numbers of fourth stage larvae may be present in the feces. Diagnosis of *N. risticii* infection is based on a positive IFA test. Isolation of *Clostridium* sp. and demonstration of **clostridial enterotoxin** in feces of horses with acute diarrhea supports a diagnosis of intestinal clostridiosis, although demonstration of toxin alone is usually considered sufficient evidence for diagnosis.<sup>27</sup> **Latex agglutination tests** are available for the detection of *C. perfringens* type A and *C. difficile* toxins.<sup>1,28</sup>

#### NECROPSY

There are extensive lesions at necropsy examination, the most dramatic being in the large intestine, especially the cecum and ventral colon. These include hyperemia, extensive petechiation, and edema of the gut wall in the early stages, and later an intense, greenish black, hemorrhagic necrosis. The contents are fluid, often foamy and foul-smelling, and may be bloodstained.

Histological examination demonstrates mucosal necrosis with a fibrinohemorrhagic exudate and extensive inflammation of the mucosa and submucosa.

#### DIFFERENTIAL DIAGNOSIS

Differential diagnosis list:

- Salmonellosis
- Equine monocytic ehrlichiosis (equine neorickettsiasis) (Potomac horse fever)
- Cyathostomiasis
- Antibiotic-induced diarrhea
- *Clostridium* sp. infection (*C. difficile*)
- Colitis-X
- Intoxication with inorganic arseni, cantharidin or purgatives such as castor oil
- The incipient disease in horses before onset of diarrhea can resemble colon torsion or ischemia of the large colon secondary to verminous arteritis

#### TREATMENT

Horses with mild disease, those that do not manifest systemic signs of disease, usually recover with symptomatic treatment. However, horses with severe disease require more specific treatment and supportive care, which is often intensive and expensive.

The **principles of treatment** for horses with acute diarrhea are:

- **Restoration and maintenance of normal hydration**
- **Correction of electrolyte and acid-base abnormalities**
- **Provision of analgesia**
- **Prophylaxis and treatment of the effects of endotoxemia**
- **Prevention of absorption of toxins**
- **Correction and prevention of disseminated intravascular coagulation.**

#### Restoration of hydration

Restoration of hydration should be considered an **emergency procedure** in severely affected horses. Fluids should be administered intravenously until hydration is restored, after which hydration can be maintained by either oral (via nasogastric tube) or intravenous administration of fluids. Suitable fluids for restoration of hydration are sodium-rich, isotonic, preferably polyionic, electrolyte solutions such as **lactated Ringer's** or Ringer's solution. **Isotonic sodium chloride** is also suitable. Isotonic dextrose solutions are not suitable because they do not contain any electrolytes. After correction of dehydration, attention should be paid to sodium balance because administration of excessive quantities of sodium, especially to horses with plasma oncotic pressure that is lower than normal, may cause expansion of the extracellular fluid volume and edema.

Fluid therapy is discussed elsewhere. **Maintenance of hydration** in severely affected horses can be challenging and is best accomplished by intravenous administration of fluids. **Oral administration** of fluids to horses with diarrhea, although not providing ideal rehydration or maintenance of hydration, may be effective and less costly than intravenous administration.<sup>29-31</sup>

Horses that become hypoproteinemic may require **transfusions of plasma**. Clinical signs indicating the need for transfusion include a persistently elevated heart rate and poor peripheral perfusion in spite of administration of large quantities of fluids. Ventral edema and edema of the head and legs may develop in hypoproteinemic horses. Sufficient plasma should be administered to restore the plasma protein concentration to at least 40 g/L.

#### Electrolyte and acid-base status

**Hyponatremia and hypochloremia** will usually be corrected by administration of isotonic, sodium-rich electrolyte solutions such as lactated Ringer's solution. If this does not occur, then sodium chloride or sodium bicarbonate can be added to the

intravenous fluids, or given orally. **Hypocalcemia** can be corrected by the addition of calcium gluconate (20 mL of 23% calcium gluconate per liter of fluids) to the fluids, provided that the fluids do not contain sodium bicarbonate. The mixture of sodium bicarbonate and calcium gluconate causes calcium to precipitate out of solution. Affected horses have **total body potassium depletion**,<sup>32</sup> even though serum potassium concentrations may be normal or elevated, and maintenance fluids should contain potassium at up to 25 mEq/L. Fluids with high potassium concentration should be administered slowly. Alternatively, potassium chloride can be given orally (50–100 g per 450 kg every 12 h).

The **metabolic acidosis** in horses with acute diarrhea often resolves either partially or completely when hydration is restored. However, severe acidosis can be treated with intravenous **sodium bicarbonate**. Oral administration of sodium bicarbonate (100 g per 450 kg every 8–12 h) is often adequate in restoring and maintaining normal acid-base status. The serum sodium concentration should be monitored if large quantities of sodium bicarbonate are administered.

#### Antimicrobial therapy

Administration of tetracycline to horses with acute diarrhea associated with *N. risticii* is clearly indicated and is often curative. However, the administration of antimicrobial drugs to horses with acute diarrhea other than that associated with *N. risticii* is controversial. There is no evidence that administration of antimicrobials improves the prognosis of horses with acute diarrhea.<sup>7,33</sup> The concern with antimicrobial administration is that antimicrobials may exacerbate the diarrhea in some cases. Conversely, withholding antimicrobials from severely ill horses with damaged colonic mucosa, and therefore presumably increased risk of bacteremia, is problematic. Regardless, many clinicians chose to treat horses with acute diarrhea with broad-spectrum antibiotics such as the combination of potassium penicillin (20 000 IU/kg, intravenously every 6 h) and gentamicin (7 mg/kg intravenously or intramuscularly every 24 h) or trimethoprim and sulfadiazine (30 mg/kg intravenously or orally every 12 h). Metronidazole (15–20 mg/kg orally every 6–12 h) or vancomycin have been recommended for horses with intestinal clostridiosis, although the wisdom of veterinary use of vancomycin, a drug used for the treatment of methicillin-resistant staphylococci in humans, could be questioned.<sup>34</sup> In areas in which **equine monocytic**

**ehrlichiosis** (equine neorickettsiasis) is endemic, all suspected cases should be treated with tetracycline (6.6 mg/kg intravenously every 12 h for 3 d), or another effective antibiotic, pending confirmation of the disease. Isolates of toxigenic *C. difficile* from horses with diarrhea are almost always susceptible to metronidazole (15–29 mg/kg orally every 6–12 h).<sup>15</sup>

#### Prophylaxis and treatment of endotoxemia

Treatment of endotoxemia has been recently reviewed.<sup>35</sup> Administration of plasma from horses **hyperimmunized** with *Salmonella typhimurium* or *E. coli* reduces the severity of clinical signs and shortens the duration of disease in horses with endotoxemia secondary to enterocolitis or colic.<sup>36</sup> **Polymyxin** (5000 IU/kg intravenously every 12 h) attenuates the effect of endotoxin in experimental disease and is used for the prevention and treatment of endotoxemia in hospitalized horses.<sup>37</sup> Its efficacy in clinical settings has not been determined. **Aspirin** (10 mg/kg orally every 48 h) is administered to diminish platelet aggregation around intravenous catheters. **Flunixin meglumine** (1 mg/kg intravenously every 8–12 h) or **phenylbutazone** (2.2 mg/kg intravenously every 12 h) is given for analgesia and to prevent endotoxin-induced increases in plasma prostaglandins. **Pentoxifylline** (8 mg/kg orally every 8 h) is administered for its putative effective in attenuating the effects of endotoxemia. The efficacy of these treatments in a clinical setting and their effect on measures of outcome of disease, such as duration of illness, case fatality rate and incidence of complications, has not been determined, with the exception of hyperimmune plasma or serum.<sup>36</sup>

#### Binding of toxins

Smectite or activated charcoal are sometimes administered to horses with acute enterocolitis in an attempt to adsorb toxins, such as those produced by *Clostridium* spp., and prevent systemic absorption. There is in-vitro evidence that smectite may bind clostridial toxins and endotoxin,<sup>38</sup> but evidence of efficacy in vivo is lacking.

#### Disseminated intravascular coagulation

Prevention and treatment of disseminated intravascular coagulation includes monitoring for changes in variables indicative of coagulation and fibrinolysis including D-dimer concentration, antithrombin III activity, one-stage prothrombin and activated partial thromboplastin times, platelet count and fibrinogen concentration. Plasma can be administered to increase blood antithrombin III activity,



often in conjunction with heparin or low-molecular-weight heparin (dalteparin or enoxaparin). Doses of 50 U of dalteparin or 40 U of enoxaparin per kilogram subcutaneously every 24 hours seem to be adequate for prophylactic anticoagulatory treatment of horses. For treatment of coagulation disorders or for ill horses that are considered to be at high risk of developing thrombotic disease, dosages may need to be increased to 100 U of dalteparin or 80 U of enoxaparin per kilogram subcutaneously every 24 hours.<sup>39</sup>

### CONTROL

Specific control measures for *Salmonella* spp. infection, equine monocytic ehrlichiosis and cyathostomiasis are discussed under those headings. The incidence of antibiotic-induced colitis can be reduced by minimizing the frequency with which antibiotics are administered to horses.

### REVIEW LITERATURE

- Divers TJ. Prevention and treatment of thrombosis, phlebitis, and laminitis in horses with gastrointestinal diseases. *Vet Clin North Am Equine Pract* 2003; 19:779.
- McConnico R. Acute equine colitis. *Compend Contin Educ Pract Vet* 2003; 25:623.

### REFERENCES

- Donaldson MT, Palmer JE. *J Am Vet Med Assoc* 1999; 215:358.
- Weese JS et al. *Equine Vet J* 2001; 33:403.
- Hathcock TL et al. *J Vet Intern Med* 1999; 13:357.
- Van Duijkeren E et al. *Vet Q* 2000; 22:162.
- Mair TS et al. *Vet Rec* 1990; 126:479.
- Stewart MC et al. *Aust Vet J* 1995; 72:41.
- Staempfli HR et al. *Can Vet J* 1991; 32:232.
- Cohen ND, Woods AM. *J Am Vet Med Assoc* 1999; 214:382.
- Cohen ND et al. *J Am Vet Med Assoc* 1996; 209:810.
- Raisbeck MF et al. *J Am Vet Med Assoc* 1981; 179:362.
- Keir AAM et al. *Can Vet J* 1999; 40:718.
- Weese JS et al. *Equine Vet Educ* 2002; 14:182.
- Ensink JM et al. *Vet Rec* 1996; 138:253.
- Wilson DA et al. *J Vet Intern Med* 1996; 10:258.
- Baverud V et al. *Equine Vet J* 2003; 35:465.
- Bacciarini LN et al. *Vet Pathol* 2003; 40:376.
- Davidson AJ et al. *Res Vet Sci* 2002; 72:177.
- Brianceau P, Divers TJ. *Equine Vet J* 2001; 33:105.
- Rosenstein DS, Mullaney TP. *Equine Vet Educ* 1996; 8:200.
- Sweeney CR, Habecker PL. *J Am Vet Med Assoc* 1999; 214:808.
- Slocombe RF, Slauson DO. *Vet Pathol* 1988; 25:277.
- Saville WJ et al. *J Vet Intern Med* 1996; 10:265.
- Dolente BA et al. *J Am Vet Med Assoc* 2002; 220:1034.
- Van der Kolk JH et al. *Equine Vet J* 2002; 34:528.
- Constable PD. *Vet Clin Pathol* 2000; 29:115.
- Ramaswamy CM et al. *Am J Vet Res* 2002; 63:454.
- Weese JS et al. *Proc Am Assoc Equine Pract* 1999; 45:50.
- Traub-Dargatz JL, Jones RL. *Vet Clin North Am Equine Pract* 1993; 9:411.
- Schott HC. *Vet J* 1998; 155:119.
- Ecke P et al. *Vet J* 1998; 155:161.
- McGinniss SG et al. *Compend Contin Educ Pract Vet* 1996; 18:942.
- Muyllé E et al. *Equine Vet J* 1984; 16:450.

- Van Duijkeren E et al. *Vet Q* 1997; 18:153.
- Jang SS et al. *Clin Infect Dis* 1997; 25(Suppl 2):S266.
- Sykes BW, Furr MO. *Aust Vet J* 2005; 83:45.
- Spier SJ et al. *Circ Shock* 1989; 28:235.
- Barton MH et al. *Equine Vet J* 2004; 36:397.
- Weese JS et al. *Equine Vet J* 2003; 35:638.
- Schwarzwald CC et al. *Am J Vet Res* 2002; 63:769.

## CHRONIC UNDIFFERENTIATED DIARRHEA OF HORSES

### Synopsis

**Etiology** Common sign of many enteric and non-enteric diseases

**Epidemiology** Sporadic disease of adult horses, except for cyathostomiasis and salmonellosis, which are discussed under those headings

**Clinical signs** Passage of unformed or liquid feces, either in increased or normal quantities. Weight loss, increased appetite. Otherwise normal physical examination.

Rectal examination is usually normal

**Lesions** Colitis in most cases

**Diagnostic confirmation** Examination of feces for cyathostome larvae, rectal biopsy demonstrating lymphoma or granulomatous enteritis, *Salmonella* spp. in rectal mucosal biopsy or feces. Sand in feces or evident on abdominal radiography

**Treatment** Supportive: anthelmintics, corticosteroids, antidiarrheal preparations

**Control** As for cyathostomiasis and salmonellosis

### ETIOLOGY

Chronic diarrhea is the **final common sign** of a number of causes of colonic dysfunction in horses. Diseases that cause chronic (more than 2 weeks duration) diarrhea in horses include: cyathostomiasis, chronic idiopathic colitis, salmonellosis, alimentary lymphosarcoma, granulomatous colitis, eosinophilic colitis, ingestion of sand, chronic liver disease, peritonitis, lymphangiectasia and as a sequela to acute diarrhea. Immune deficiency, including variable adult onset B-cell deficiency, may predispose to the disease.<sup>1</sup> *Brachyspira* sp. have been implicated as a cause of chronic diarrhea in horses in Australia and Japan.<sup>2,3</sup>

There are many causes and their relative importance varies between locations. Even with concerted effort, a definitive antemortem diagnosis is achieved in fewer than 30% of cases.<sup>4</sup>

### EPIDEMIOLOGY

The occurrence is sporadic, with only single cases occurring in a group. Other horses in contact are not affected. The case fatality rate is 35–65%.<sup>5</sup> There appears to be no age-related, sex-related or breed-related variation in incidence. Older horses do not appear to be at increased risk of having chronic diarrhea.<sup>6</sup> The epidemiology of cyathostomiasis

and salmonellosis are discussed under those headings.

### PATHOGENESIS

Diarrhea is attributable to colonic dysfunction, which may result in excessive loss of electrolytes in feces and diminished absorption of nutrients from the large colon. Disease of exclusively the small intestine does not cause diarrhea in horses. Protein-losing enteropathy may be present. Colonic dysfunction may be associated with inflammatory or infiltrative lesions of the colon but in many cases an anatomical lesion is not detected. However, the colonic contents of affected horses have a greater fermentative capacity than those of normal horses, suggesting that in some horses the disease is essentially one of abnormal colonic digestion and absorption.<sup>7</sup>

### CLINICAL FINDINGS

The characteristic finding is chronic diarrhea. The feces vary in consistency from thick porridge (oatmeal), through undigested fibers in liquid, to liquid without fiber. The consistency of the feces in an individual horse may vary widely from one day to the next. The duration of the diarrhea is variable but may be lifelong. Death or euthanasia usually results from progressive weight loss. The onset of diarrhea is usually abrupt and may be associated with signs of toxemia and dehydration, as described under Acute diarrhea, above. However, often there is no toxemia or other systemic sign apart from weight loss, and affected horses are bright and alert and have a normal or increased appetite.

Rectal examination usually fails to reveal any abnormalities, although horses with granulomatous enteritis or alimentary lymphosarcoma may have enlarged mesenteric lymph nodes.

Abdominal radiography may reveal the presence of excessive amounts of sand in the large colon.

### CLINICAL PATHOLOGY

- Hematological examination may reveal a mild **neutrophilia** and **anemia**, but these changes are of little use in determining the etiology of the diarrhea
- Serum biochemical examination typically demonstrates a mild **hypoalbuminemia**, **hypoglobulinemia**, **hyponatremia** and **hypokalemia**, but again these changes are not specific for any particular disease
- Hypoalbuminemia is consistent with the presence of protein-losing enteropathies such as chronic colitis, alimentary lymphosarcoma, cyathostomiasis and granulomatous colitis



- **Hyperbilirubinemia** and elevated serum concentrations of **serum bile acids** are suggestive of liver disease
- Increases in **serum alkaline phosphatase** activity, while common, are of no diagnostic utility
- Horses with cyathostomiasis may have increased concentrations of beta-globulins, although the sensitivity of this test is low.<sup>5</sup>

**Peritoneal fluid** has a neutrophilic leukocytosis and increased (> 25 g/L) protein concentration in horses with peritonitis but is normal in most horses with chronic diarrhea, including those with alimentary lymphosarcoma or granulomatous colitis.

**Fecal examination** of horses with cyathostomiasis may reveal strongyle-type ova or fourth-stage cyathostome larvae. The presence of **sand** in feces, demonstrated by allowing feces to settle in a transparent rectal glove or similar container, suggests sand accumulation in the colon as a cause of the diarrhea. The presence of **protozoa** in feces has no diagnostic significance.<sup>8</sup> *Giardia* spp. are commonly found in feces of normal horses of all ages and, despite earlier reports of their presence in feces of horses with diarrhea, they are not associated with disease.<sup>9</sup> **Coccidiosis** is very uncommon in horses, and *Eimeria leuckarti* is probably not pathogenic.<sup>10</sup>

Demonstration of *Salmonella* spp. in feces or rectal mucosal biopsy, either by culture or PCR, is suggestive but not diagnostic of salmonellosis, given the high proportion of normal horses that shed *Salmonella* spp. in feces. Isolation of *Rhodococcus equi* from feces of young horses with diarrhea is suggestive of enteric disease associated with that organism.

An abnormal **D-xylose, glucose or starch absorption test** indicates small-intestinal disease and is suggestive of granulomatous enteritis, although most horses with this disease do not have diarrhea.

Exploratory laparotomy, either ventral midline under general anesthesia or through the left flank under local anesthesia, and **intestinal biopsy** may demonstrate alimentary lymphosarcoma, granulomatous enteritis, eosinophilic enteritis, chronic colitis and other abdominal disease. **Rectal biopsy** is less expensive and invasive but has a relatively poor sensitivity, although good specificity for granulomatous enteritis, eosinophilic enteritis and alimentary lymphosarcoma.<sup>11</sup>

#### NECROPSY FINDINGS

Necropsy findings are consistent with the underlying disease, although in many cases gross lesions are not evident. The histological changes in some cases are restricted to a mild inflammatory response

and may be difficult to correlate with the severity of clinical disease. In some of these cases the diarrhea probably reflects an imbalance in the microflora of the large bowel, and demonstration of a specific etiological agent is an unrealistic goal. Conversely, isolation of *Salmonella* spp. from the gastrointestinal tract or mesenteric lymph nodes should be interpreted with caution in the absence of histological evidence of salmonellosis.

Because of the wide variety of potential causes of chronic diarrhea of horses it is not possible to list all the samples required to 'confirm' a diagnosis. In most instances, formalin-fixed samples from the liver, mesenteric lymph nodes and numerous levels of the gastrointestinal tract comprise the minimum diagnostic material required. Regardless of what other testing is performed, it is prudent to hold back frozen segments of both large and small bowel (with content) in case other tests are deemed necessary.

#### DIFFERENTIAL DIAGNOSIS

Differential diagnosis list:

- Chronic idiopathic colitis
- Salmonellosis
- Cyathostomiasis
- Granulomatous colitis
- Sand ingestion<sup>12</sup>
- Lymphosarcoma
- Peritonitis
- Intestinal lymphangiectasia
- Hyperlipemia
- Liver disease
- Basophilic enteritis
- Eosinophilic gastroenteritis.

#### TREATMENT

The **principles of treatment** are to deal with the underlying disease, correct fluid and electrolyte disturbances, give symptomatic treatment of diarrhea and provide supportive care. Except in cases of cyathostomiasis or sand accumulation, treatment of horses with chronic diarrhea is frequently unrewarding.

#### Specific treatments

**Cyathostomiasis** should be treated with larvicidal doses of anthelmintics such as fenbendazole (50 mg/kg once, or 7.5 mg/kg daily for 3 d), moxidectin (400 µg/kg) or ivermectin (200 µg/kg). Treatment may be unrewarding if there is severe damage to the large colon.

Diarrhea secondary to **sand accumulation** in the gastrointestinal tract should be treated by preventing the horse from ingesting sand and, although the efficacy is debatable, with psyllium mucilloid (1–2 g/kg orally once daily for 4–5 weeks).

**Chronic idiopathic colitis** may be treated with corticosteroids (dexamethasone 0.2–0.4 mg/kg once daily) or prednisolone (0.5–1.0 mg/kg once daily) for 3–4 weeks and the dose reduced as clinical signs permit.

methasone 0.2–0.4 mg/kg once daily) or prednisolone (0.5–1.0 mg/kg once daily) for 3–4 weeks and the dose reduced as clinical signs permit.

**Chronic salmonellosis** has been treated with enrofloxacin (2.5–5 mg/kg orally every 12 h for 3–4 weeks), sometimes in combination with metronidazole (15–20 mg/kg orally every 6–12 h), but one should be aware of the risk of articular cartilage damage in horses treated with enrofloxacin.

Many diseases commonly associated with chronic diarrhea are not treatable.

#### Symptomatic and supportive treatments

Symptomatic treatments include **metronidazole** (7.5–20 mg/kg orally every 6–12 h) or **iodochlorhydroxyquin** (10–20 mg/kg orally once daily). While some horses have resolution of diarrhea while being treated with these compounds, there is no clear demonstration of their efficacy. **Antibiotic** administration, other than as described above, does not usually alter the course of the disease. **Antidiarrheal** preparations such as codeine phosphate, **loperamide** and **bismuth subsalicylate** often provide temporary improvement in fecal consistency. Some horses with chronic diarrhea respond to **transfaunation**, whereby 5–10 L of colonic fluid collected immediately after death from a horse without enteric disease is administered via nasogastric intubation.

Supportive treatment includes provision of supplemental electrolytes, principally sodium, potassium and bicarbonate, as a feed additive. Suitable supplements include some commercial products designed for fluid replacement in diarrhetic calves, or a mixture of potassium chloride (300 g), sodium chloride (400 g) and sodium bicarbonate (300 g). This mixture is isotonic when dissolved at the rate of 90 g/12 L, or can be given orally at the rate of 30–90 g per 400 kg horse every 24 hours. Unsupplemented water should be supplied without restriction and serum electrolyte concentrations should be monitored. **Severely affected** horses may require intravenous administration of polyionic isotonic electrolyte solutions or plasma.

Nutritional support should include provision of a diet of high-quality roughage and grain. Some trials may be needed to determine the diet that is best for individual horses, but care should be taken that the diet contains adequate energy and is nutritionally balanced. Horses should be fed to attain, and then maintain, an ideal body weight.

**Spontaneous recovery** does occur, particularly in young horses, and this, and the often lengthy duration (6–12 months) of the illness, make it difficult to decide accurately the value of the treatment.

**CONTROL**

Control of cyathostomiasis and salmonellosis is discussed under those headings. Diarrhea due to sand accumulation in the colon should be prevented by not feeding horses on the ground and by avoiding grazing of short pastures on sandy soil.

**REVIEW LITERATURE**

Merritt AM. Chronic diarrhea in horses: a summary. *Vet Med* 1994; 89:363–367.

**REFERENCES**

1. MacLeay JM et al. *Vet Immunol Immunopathol* 1997; 57:49.
2. Shibahara T et al. *J Vet Med Sci* 2002; 64:633.
3. Lester GD. *Proc Am Coll Vet Int Med Forum* 2005; 23:181.
4. Love S et al. *Vet Rec* 1992; 130:217.
5. Mair TS et al. *Equine Vet J* 1993; 25:324.
6. Brosnahan MM, Paradis MR. *J Am Vet Med Assoc* 2003; 223:99.
7. Minder HP et al. *Am J Vet Res* 1980; 41:564.
8. Ike K et al. *Jpn J Vet Sci* 1983; 45:157.
9. Xiao L, Herd RP. *Equine Vet J* 1994; 26:14.

10. Taylor MA. *Equine Vet J* 1994; 26:4.
11. Lindberg R et al. *Equine Vet J* 1996; 28:275.
12. Bertone JJ et al. *J Am Vet Med Assoc* 1988; 193:1409.

**ACUTE DIARRHEA OF SUCKLING FOALS****ETIOLOGY**

The causes of diarrhea in suckling foals are listed in Table 5.16. In a large proportion of foals the cause of diarrhea is not determined, in part because the

**Table 5.16** Epidemiological and clinical features of suckling foals with diarrhea

<b>Etiological agent or disease</b>	<b>Important epidemiological factors</b>	<b>Major clinical findings; diagnostic criteria</b>
<b>Idiopathic</b>		
Foal heat diarrhea	Foals < 2 weeks of age.	No systemic signs of disease. Diarrhea is mild and pasty. No specific diagnostic criteria
<b>Bacterial causes</b>		
Septicemia (coliforms, <i>Actinobacillus</i> sp., <i>Salmonella</i> sp., <i>Klebsiella</i> sp. and others)	Newborn foal to < 2 weeks of age. Failure of transfer of passive immunity	Signs of systemic sepsis in addition to diarrhea. Fever, depression, recumbency, failure to nurse, swollen joints, pneumonia, omphalitis or omphalophlebitis. <i>Blood culture</i>
<i>Salmonella</i> sp.	Outbreaks in newborn foals, even those with adequate passive immunity. Mare likely carrier. Hygiene at parturition may prevent disease	Acute onset diarrhea, depression, fever, toxemia. <i>Culture of blood and feces</i>
<i>Escherichia coli</i>	Not well documented disease in foals (cf. calves and piglets)	Nonfetid diarrhea. <i>Culture of feces yields heavy growth of mucoid E. coli (circumstantial evidence only)</i>
Enterococcus ( <i>Streptococcus</i> ) <i>durans</i>	Young foals. Disease is rarely reported	Diarrhea. <i>Demonstration of S. durans in feces</i>
<i>Rhodococcus equi</i>	Foals 2–5 months of age, some with history of respiratory disease	Diarrhea associated with <i>R. equi</i> pneumonia; <i>culture respiratory tract</i>
<i>Clostridium difficile</i>	< 2 weeks of age.	Colic, fever, ileus, hematochezia, toxemia, depression. <i>Fecal culture and demonstration of toxin in feces</i>
<i>Clostridium perfringens</i> type c	Neonatal foals. Sporadic disease to annual outbreaks on breeding farms. Most foals excrete <i>C. perfringens</i> type A, which rarely causes diseases in foals	Colic, fever, ileus, hematochezia, toxemia, depression. <i>Culture of C. perfringens type C in feces, demonstration of toxin in feces</i>
<i>Lawsonia intracellularis</i>	Older suckling foals and weanlings. Sporadic or outbreaks on farms	Weight loss, mild to moderate diarrhea, ventral edema, depression, hypoproteinemia. <i>Serology and PCR on feces</i>
<i>Yersinia pseudotuberculosis</i>	Suckling foals. Outbreaks on breeding farms	Watery diarrhea and suppurative pneumonia. <i>Culture of feces and lesions</i>
<i>Aeromonas hydrophila</i>	Reports of disease are uncommon. Uncertain importance	Diarrhea. <i>Culture of feces</i>
<b>Viral causes</b>		
Rotavirus	< 3 months of age. Occurs as outbreaks or endemic disease on farm. Highly contagious	Profuse watery diarrhea with variable hypovolemia and depression. <i>Detection of virus in feces by electron microscopy, IFA, ELISA</i>
Adenovirus	Immunodeficient foals (Arabians with severe combined immunodeficiency)	Diarrhea, depression. May be associated with other diseases including pneumonia. <i>Detection of virus in feces by electron microscopy</i>
Coronavirus	Young foals (age range not well defined). Apparently rare cause of diarrhea in foals	Diarrhea. <i>Detection of virus in feces by electron microscopy</i>
<b>Parasites</b>		
<i>Cryptosporidium</i> sp.	Foals of any age. May be spread from other species, including calves and cria	Inapparent infection to fulminant disease with diarrhea, hypovolemia, and collapse. Chronic diarrhea. <i>Detection of oocysts in feces, IFA</i>
<i>Strongyloides westerii</i>	Individual foals. Uncertain importance as a cause of diarrhea	Acute to chronic diarrhea. <i>Patent infections evident by fecal examination for parasite eggs</i>
<b>Other</b>		
<b>Nutritional</b>		
Lactose intolerance	Sporadic. Orphan foals fed inappropriate or poor-quality milk replacers. Nursing foals fed inappropriate supplements	Mild to moderate chronic diarrhea. Failure to thrive. <i>Feed diet intended for foals (not plant-protein- or bovine-milk-based)</i>
Overdosing of cathartics (DSS, MgSO <sub>4</sub> , NaSO <sub>4</sub> , castor oil)	Nursing foals	Moderate to profuse diarrhea. <i>Historical confirmation of administration of compounds</i>
Enema	Sporadic. Secondary to viral diarrhea. Occurs only in milk-fed foals	Moderate to severe watery, acidic diarrhea. <i>Oral lactose tolerance test or trial administration of lactase with milk feedings</i>
Antibiotic-induced	History of administration. Diarrhea short-lived	Bright alert and responsive foal with mild to moderate diarrhea. No specific diagnostic tests
	Administration of antibiotics	Mild to moderate diarrhea. May be associated with <i>Candida</i> sp. or <i>C. difficile</i> . <i>Culture of feces, examination for C. difficile toxin</i>

disease is usually sporadic, mild and transient. The more common causes of diarrhea in foals on breeding farms in Britain include *Clostridium perfringens*, rotavirus, *Salmonella*, *Cryptosporidium* sp., and *Strongyloides westerii*,<sup>1-3</sup> although the relative importance of various pathogens varies from year to year, from farm to farm and from region to region.

*C. perfringens* causes diarrhea in young foals. There are five major types of *C. perfringens* and, while the organism is clearly associated with disease, a definitive role for each of these types in causing disease has not been established, partly because toxin production for strains isolated from foals with diarrhea has not been routinely documented. However, there is clear evidence that *C. perfringens* type C causes diarrhea in foals.<sup>4</sup> *C. perfringens* types A, B, D and E might be associated with disease in foals, but definitive proof is lacking. *E. coli*, an important cause of disease in neonates of other livestock species, does not appear to be an important cause of diarrhea in foals, although some strains are pathogenic.<sup>5,6</sup> Similarly, although there are reports of coronavirus causing severe disease in foals, this does not appear to be a common cause of diarrhea in foals.<sup>7,8</sup> *Candida* spp. can cause diarrhea in critically ill foals and those administered antibiotics.<sup>9</sup> *Yersinia* spp. have been associated with diarrhea in foals but do not appear to be a common cause of disease.<sup>10</sup> *Bacteroides fragilis* is an uncommon cause of diarrheal disease in foals. The role of *Campylobacter* spp. in foal diarrhea, if there is any, is unclear.

## EPIDEMIOLOGY

Diarrhea is common in suckling foals worldwide although studies of its incidence, risk factors and outcome are exiguous. Diarrhea affects 21% of foals annually in Texas, being second only to respiratory disease (22%) as a cause of disease.<sup>11</sup> The frequency of disease varies with age: 25% of foals 0-7 days of age have diarrhea, compared to 40% and 8% of foals aged 8-31 days and 32-180 days, respectively.<sup>11</sup> While a common disease syndrome, diarrhea is not associated with a high death rate (2.6%).<sup>11</sup> Results of the Texas study may not be applicable to foals in other regions.

Among the common causes of diarrhea the highest death rates are associated with diarrhea associated with *C. perfringens*, *Salmonella* sp. and *Cryptosporidium* sp.<sup>2</sup>

**Risk factors** for development of the diarrhea vary depending on its etiology, but in general the disease is less common in foals born at pasture and at low stocking density.<sup>11</sup>

Rotavirus diarrhea is often endemic on farms and the disease occurs as outbreaks

on successive years. Affected foals range in age from less than 7 days to more than 3 months.

Diarrhea due to *Rhodococcus equi* occurs in foals with *R. equi* pneumonia and the disease is endemic on some farms. Not all foals with *R. equi* pneumonia develop diarrhea. The disease occurs in foals 2-5 months of age.

Salmonellosis also occurs as outbreaks of disease among foals less than 8 days of age on breeding farms and is associated with a carrier status in mares.<sup>12</sup>

Diarrhea associated with *C. perfringens* type C occurs in foals less than 10 days of age with most foals being less than 6 days old<sup>4</sup> and can occur as a farm problem with multiple foals affected on each of several successive years.<sup>13</sup> Farm risk factors include presence of other livestock, stock-horse-type foals, foals born on dirt, and stall or dry lot confinement for the first few days of life.<sup>14</sup> *C. perfringens* type A is excreted in feces of most normal foals, whereas *C. perfringens* type C is rarely isolated from feces of normal foals.<sup>15</sup> *Clostridium difficile* causes diarrhea in foals not administered antibiotics,<sup>16</sup> in contrast to the situation in adult horses, and usually affects foals less than 14 days of age, although foals up to 120 days of age may be affected.<sup>17</sup> Failure of transfer of passive immunity is not a risk factor for *C. perfringens* or *C. difficile* enteritis in foals.

*Lawsonia intracellularis* causes mild to moderate diarrhea in older suckling or weaned foals. The disease occurs as outbreaks on breeding farms. There are no recognized foal or farm risk factors.

## PATHOGENESIS

The pathogenesis of diarrhea varies somewhat depending on the inciting cause (see appropriate sections of this text for discussion of pathogenesis), although if sufficiently severe all cause excessive loss of fluid and electrolytes in feces and subsequent hypovolemia, electrolyte abnormalities, metabolic acidosis and weakness. Although not demonstrated in foals, diarrhea in calves causes metabolic acidosis through loss of sodium and other cations in feces, which results in a decrease in the strong ion difference in blood, causing acidosis. Bicarbonate loss, per se, is not a cause of the metabolic acidosis, at least in calves. Infectious agents generally cause enteritis, although rotavirus infection is associated with loss of villus cells and subsequent loss of enzyme activity derived from the mature epithelial cell. The loss of enzyme activity, including that of disaccharidases, causes malabsorption of nutrients in milk and other feed. Failure to absorb nutrients in the small intestine causes them to be

delivered to the cecum and large intestine where they are fermented. Subsequent reductions in colonic pH and increases in osmotic activity of the colon contents results in excretion of large quantities of fluid and electrolytes. *C. difficile* and *C. perfringens* produce enterotoxins that cause damage to intestinal cells and accumulation of hemorrhagic fluid in the intestine.<sup>16</sup> *L. intracellularis* causes an infiltrative and proliferative enteropathy with subsequent protein loss and, possibly, malabsorption.

## CLINICAL SIGNS

Clinical signs vary from mild, pasty diarrhea that adheres to the perineum and causes no detectable systemic signs of disease to profuse water diarrhea with rapid development of loss of suckling, depressed mentation, tachycardia, increased skin tent, ileus and recumbency.

Signs of systemic disease include failure to nurse, increased frequency or prolonged duration of recumbency, foals at pasture may fail to follow the mare, fatigue, less frequent urination, production of concentrated urine (urine from normal foals is normally dilute) and weakness. Affected foals often have depressed mentation, tachycardia, fever (depending on the cause of the diarrhea), decreased capillary refill time, dry mucous membranes, increased skin tent and eyes that are retracted into the orbit (consistent with dehydration). Depending on the cause of the diarrhea, foals may have colic, which can range from mild with intermittent flank watching or biting and restlessness, through profound agitation, rolling and dorsal recumbency. Severely affected foals may have seizures as a result of profound hyponatremia.<sup>18</sup>

Chronic diarrhea and that due to nutritional imbalance or lactose intolerance causes rapid weight loss, failure to thrive, poor hair coat and lethargy. Chronic fecal contamination of the perineum and escutcheon causes excoriation and loss of hair.

Diarrhea associated with foal heat is usually mild and transient and not associated with systemic signs of disease. However, diarrhea due to infectious agents is often severe and accompanied by systemic signs of disease.

Diseases associated with *Clostridium* sp. are often severe with rapid onset of signs of toxemia, colic, hypovolemia and death. Diarrhea is usually present and is often bloody, although it may be watery and profuse. Severely affected foals may have signs of colic, toxemia and ileus and not develop diarrhea before dying. Salmonellosis can present as septicemia, with subsequent development of diarrhea, although in older foals diarrhea is a common presenting sign.

## CLINICAL PATHOLOGY

Diarrhea in foals with systemic signs of disease cause hyponatremia, hyperkalemia, hypochloremia, metabolic acidosis, hypoproteinemia and azotemia. The magnitude of abnormalities varies with the cause of disease and its severity. Hyponatremia may be profound ( $< 100$  mEq/L). Hypoproteinemia may be a result of loss of protein from the inflamed intestine or a reflection of failure of transfer of passive immunity. All young foals with diarrhea should have serum or plasma immunoglobulin concentrations measured or some other test for transfer of passive immunity performed.

Viral causes of diarrhea can be diagnosed by examination of feces by electron microscopy. However, more rapid and sufficiently sensitive and specific tests exist for diagnosis of rotaviral disease (ELISA, IFA). Culture of feces will demonstrate *Salmonella* spp in most cases if they are the cause of disease. Fecal culture yielding *C. perfringens* or *C. difficile* is insufficient for diagnosis of clostridial enterocolitis as these organisms can be recovered from normal foals. Confirmation of the diagnosis is achieved by demonstration of clostridial toxins in feces, which can be problematic given that the toxins are very labile.

## DIAGNOSTIC CONFIRMATION

For diagnostic criteria for specific diseases, see the appropriate sections in this text.

## LESIONS

Lesions associated with diarrhea in foals depend on the inciting cause. Characteristically in severe cases there is enteritis and colitis with ulceration of intestinal mucosa. Foals with rotavirus diarrhea, most of which survive, have flattening of small-intestinal epithelium.

## TREATMENT

The principles of treatment are:

- Correction and maintenance of hydration, acid–base and electrolyte status
- Ensuring adequate transfer of passive immunity
- Ensuring adequate nutrition
- Preventing complications of disease, including bacteremia.

Correction of hypovolemia and electrolyte abnormalities should follow the general guidelines presented elsewhere in this text. Mildly affected foals, such as those with no systemic signs of disease, might not require administration of fluids orally or parenterally. More severely affected foals might require oral supplementation with balanced, isotonic electrolyte rehydration solutions, such as those marketed for use in calves. The amount

and frequency will depend upon the size of the foal, severity of disease and response to treatment. Foals that have clear signs of hypovolemia should be administered fluids intravenously. These fluids should ideally be selected based on the foal's serum electrolyte concentrations, but in most instances a balanced, polyionic, isotonic fluid such as lactated Ringer's solution is appropriate. Correction of hyponatremia in some but not all foals requires administration of hypertonic (7%) sodium chloride intravenously. However, rapid correction of hyponatremia, especially if it is long-standing (more than 24 h) might be associated with an increased risk of cerebral demyelination. Correction of hyponatremia will resolve seizure activity.

Correction of acid–base usually occurs with correction of fluid and electrolyte abnormalities. Provision of fluids that are sodium-rich and have a high strong ion gap, for instance lactated Ringer's solution, will usually correct the metabolic acidosis common in foals with diarrhea. However in some foals the rate of fecal loss of cations including sodium, and perhaps bicarbonate, prevents resolution of metabolic acidosis without administration of sodium bicarbonate. Sodium bicarbonate can be administered intravenously or orally. Oral administration has the advantages that it is convenient and does not require administration of large amounts of fluid or of hypertonic solutions. The dose of sodium bicarbonate can be calculated from the foal's body weight and base deficit. As a guideline, a 40 kg foal that is not hypovolemic but has continued profuse watery diarrhea and metabolic acidosis should receive 30 g sodium bicarbonate orally every 6 hours. Serum sodium and bicarbonate concentrations should be measured at least daily and doses of sodium bicarbonate should be adjusted on the basis of these values. Overdosing, or continued dosing when diarrhea has resolved, results in hypernatremia and metabolic alkalosis.

Foals with diarrhea should have serum immunoglobulin concentrations measured. Hypogammaglobulinemic foals should be administered plasma intravenously (20–40 mL/kg BW).

Ensuring that foals affected by diarrhea continue to ingest sufficient calories is critical to the foal's survival. Foals require up to 150 (kcal/kg)/d for growth but can maintain weight on as little as 50 (kcal/kg)/d, especially if the nutrients are provided intravenously. Foals with mild to moderate diarrhea should be permitted to nurse at will. If there is concern that the foal is not nursing sufficiently, a feeding tube can be

placed and the foal's diet supplemented with mare's milk, milk substitute lactose-free milk. Lactase is sometimes added to the milk on the assumption that enteritis causes lactase deficiency (for details of lactose tolerance testing in foals).

Foals with severe diarrhea benefit from parenteral administration of nutrition and gastrointestinal rest. Feed withholding results in a marked reduction in fecal volume and the extent of electrolyte and acid–base abnormalities. However, it is critical for foal recovery that complete feed withholding be accompanied by partial parenteral nutrition.

Antibiotics are usually administered to foals with severe diarrhea on the presumption that such foals are more likely to have bacteremia. Although there is no evidence that parenteral administration of antibiotics reduces morbidity or case fatality rate, the precaution has merit, as it does in calves.<sup>19</sup> Oral administration of antimicrobials to foals with diarrhea is common but is not recommended because of the risk of exacerbating the disease, and unknown efficacy. Foals with suspected clostridial enterocolitis should be administered metronidazole (15–20 mg/kg, intravenously or orally, every 6–12 h).

Drugs that affect gastrointestinal motility, such as loperamide, parasympatholytics and narcotics, have no demonstrated efficacy in reducing morbidity or case fatality rate and their use is not recommended.

## CONTROL

Control of foal diarrhea is problematic because it is very common, many cases are mild and transient, a definitive diagnosis is frequently not available in a timely fashion, and it can be associated with a wide variety of infectious and non-infectious agents. Basic principles include ensuring adequate transfer of passive immunity, reducing exposure to pathogens and minimizing the effect of other risk factors.

Of the important causes of disease, in terms of morbidity and case fatality rate, control of diarrhea associated with rotavirus and clostridial species is most important. Control of rotaviral diarrhea is discussed elsewhere. Control of clostridial diarrhea on farms with an endemic problems includes vaccinating of mares, administration of metronidazole to at-risk foals and supplementation of passive immunity with antitoxins to clostridial toxins. Vaccination of mares with toxoids (*C. perfringens* type c and d toxoid) prepared for use in other species has been practiced, but there are no reports of safety or efficacy. Administration of antitoxin raised against *C. perfringens* C, D and E

may provide protection against the alpha, beta and epsilon toxins that have the potential to affect foals. The antiserum, which is intended for use in ruminants, is administered orally (50–100 mL per foal) soon after birth. The efficacy of this practice has not been determined. Foals at risk may also be administered metronidazole (10 mg/kg every 12 h) for the first 4–5 days of life. Again, the efficacy of this practice has not been determined.

Administration of a probiotic containing *Lactobacillus pentosus* WE7 did not confer any protection against development of diarrhea in foals, and was associated with an increased risk of clinical disease, including diarrhea.<sup>20</sup>

## REVIEW LITERATURE

Jones RL. Clostridial enterocolitis. *Vet Clin North Am Equine Pract* 2000; 16:471.

## REFERENCES

1. Grinberg A et al. *Vet Rec* 2003; 153:628.
2. Netherwood T et al. *Epidemiol Infect* 1996; 117:375.
3. Browning GF et al. *Equine Vet J* 1991; 23:405.
4. East LM et al. *J Am Vet Med Assoc* 1998; 212:1751.
5. Holland RE et al. *Vet Microbiol* 1996; 52:249.
6. Holland RE et al. *Vet Microbiol* 1996; 48:243.
7. Guy JS et al. *J Clin Microbiol* 2000; 38:523.
8. Davis E et al. *J Vet Diagn Invest* 2000; 12:153.
9. De Bruijn CM, Wijnberg ID. *Vet Rec* 2004; 155:26.
10. Czernomysy-Furowicz D. *Zentralbl Bakteriol* 1997; 286:542–546.
11. Cohen ND. *J Am Vet Med Assoc* 1994; 204:1644.
12. Walker RL et al. *Vet Diagn Invest* 1991; 3:223.
13. MacKay RJ. *Compend Contin Educ Pract Vet* 2001; 23:280.
14. East LM et al. *Prev Vet Med* 2000; 46:61.
15. Tilloston K et al. *J Am Vet Med Assoc* 2002; 220:342.
16. Arroyo LG et al. *J Vet Intern Med* 2004; 18:734.
17. Magdesian KG et al. *J Am Vet Med Assoc* 2002; 220:67.
18. Lakritz J. *J Am Vet Med Assoc* 1992; 200:1114.
19. Constable PD. *J Vet Intern Med* 2004; 18:8.
20. Weese JS, Sousseau J. *J Am Vet Med Assoc* 2005; 226:2031.

## INTESTINAL HYPERMOTILITY

A functional increase in intestinal motility seems to be the basis of a number of diseases of animals. Clinically there is some abdominal pain and, on auscultation, an increase in alimentary tract sounds and, in some cases, diarrhea. Affected animals do not usually die and necropsy lesions cannot be defined but it is probable that the classification as it is used here includes many of the diseases often referred to as catarrhal enteritis or indigestion.

The major occurrence of intestinal hypermotility is spasmodic colic of the horse. Other circumstances in which hypermotility and diarrhea occur without evidence of enteritis include allergic and anaphylactic states and a change of feed to lush pasture.

## DIETARY DIARRHEA

Dietary diarrhea occurs in all species and all ages but is most common in neonatal animals that ingest too much milk or a diet that is indigestible.

### ETIOLOGY

#### Milk replacers

The use of inferior-quality milk replacers in young calves under 3 weeks of age is one of the commonest causes of dietary diarrhea. The quality of the milk replacer may be affected by the use of skim-milk powder that was heat-denatured during processing, resulting in a decrease in the concentration of noncasein proteins. This results in ineffective clotting in the abomasum and reduced digestibility. The use of excessive quantities of nonmilk carbohydrates and proteins in milk replacers for calves is also associated with a high incidence of diarrhea, loss of weight, emaciation and starvation. The use of large quantities of soybean protein and fish protein concentration in milk replacers for calves will result in chronic diarrhea and poor growth rates.

Most attempts to raise calves on diets based on large amounts of certain soybean products, such as heated soybean flour, have been unsuccessful because the animals developed diarrhea, loss of appetite and weight or inferior growth rate. Preruminant calves develop gastrointestinal hypersensitive responses to certain soybean products because major proteases of the digestive tract do not denature soluble antigenic constituents of the soybean protein.<sup>1</sup>

Diarrhea of nutritional origin has become one of the most important problems where large numbers of calves are raised under intensive conditions. Because of the relatively high cost of good-quality skim-milk powder, large quantities of both nonmilk proteins and carbohydrates are used in formulating milk replacers. While some calves in these large units can satisfactorily digest the nutrients in these milk replacers, many cannot and this leads to a high incidence of diarrhea and secondary colibacillosis and enteric salmonellosis.

Milk replacers made from bovine milk and milk byproducts used to feed orphan piglets, lambs and foals may cause nutritional diarrhea for the same reasons as given above. In milk-replacer-fed calves, increasing the total daily fluid intake as a percentage of body weight causes a greater incidence of loose feces, dehydration and dullness than lower levels of fluid intake and higher dry matter concentration. This suggests that a greater amount of fluid intake increases the passage rate of dry matter and decreases absorption. The concentration

of solids in the liquid diet should range between 10% and 13% and should be offered at 8% of body weight in calves fed milk replacer once daily and allowed free access to calf starter.

### Overfeeding of milk

The feeding of excessive amounts of cows' whole milk to hand-fed calves will result in large amounts of abnormal feces but usually not a profuse watery diarrhea with dehydration and loss of weight. This suggests that simple overfeeding of milk may not be a cause of acute neonatal diarrhea of calves. However, it may predispose to secondary colibacillosis. There is some limited evidence that dietary diarrhea may occur in nursing beef calves ingesting milk that does not clot properly. Only the milk from cows with diarrheic calves showed evidence of impaired clotting in an in-vitro test.

The ingestion of excessive quantities of sows' milk by piglets at 3 weeks of age is thought to be a contributory cause of 3-week diarrhea of piglets. This may be due to the sow reaching peak production at 3 weeks.

Beef calves sucking high-producing cows grazing on lush pasture are often affected with a mild diarrhea at about 3 weeks of age. The cause is thought to be simple overconsumption of milk. Similarly, vigorous lambs sucking high-producing ewes may develop diarrhea.

Foals commonly have diarrhea at about 9 days of age, which coincides with the foal heat of the mare. It has been thought for many years that the cause was a sudden change in the composition of the mare's milk but this has not been supported by analyses of mares' milk at that time. The fecal composition in foal heat diarrhea suggests that the diarrhea is a secretory-type hypersecretion of the small intestine mucosa, which may not be controlled by an immature colon.<sup>2</sup>

There is considerable interest in the optimal conditions for feeding liquid diets to young calves. The temperature of the liquid when fed, feeding once or twice daily and the amount of dry matter intake can affect the performance of calves. However, there is a range of safety in which the performance of the calves will not be significantly affected if management is good.

### Change of diet

Dietary diarrhea also occurs in all species following a sudden change in diet, but particularly in animals at weaning time. This is particularly important in the pig weaned at 3 weeks of age and not adjusted to the postweaning ration. Diarrhea occurs commonly when animals are moved from a dry pasture to a lush pasture and when first introduced to

liberal quantities of concentrates containing a large percentage of the common cereal grains.

## PATHOGENESIS

### Digestion of milk

In calves, the ingestion of excessive quantities of cows' whole milk after several hours of no intake causes gross distension of the abomasum and possibly of the rumen. Under these conditions, the milk-clotting capacity of the abomasum may be limited, resulting in incomplete clotting. The flow of nutrients from the abomasum is more uniform in calves fed twice daily than once daily, which suggests that twice-daily feeding allows for more effective clotting and digestion.

Under normal conditions, the milk clot forms in the abomasum within minutes after feeding, and the whey moves to the duodenum 5–10 minutes later. The dilution of cows' whole milk will result in increased clotting time when treated with rennin (chymosin). Overfeeding could result in whole milk or excessive quantities of whey entering the duodenum, which cannot digest whole milk or satisfactorily digest and hydrolyze the substrates in whey. The presence of excessive quantities of such substrate, especially lactose, in the intestinal lumen would serve as a hydragogue and result in a large increase in intestinal fluid, failure of complete absorption and abnormal feces. The speed of drinking is probably also important. Prolongation of drinking time results in dilution of the milk with saliva and the production of a more easily digested milk clot. Failure of the esophageal reflex in pail-fed calves may also be important. The milk enters the rumen, where it undergoes putrefaction.

### Milk replacers and diarrhea

The pathogenesis of diarrhea in calves fed inferior-quality milk replacers is well known. In calves fed low-heat-treated skim-milk powder milk replacer, curd formation in the abomasum, compared with no curd formation, slows down the passage of total abomasal content (retained matter from the last feeding, residual matter from the penultimate feeding, saliva, and gastric secretions), dry matter, crude protein and fat from the abomasum to the intestine.<sup>3</sup> Heat-denatured skim-milk powder is incompletely clotted in the abomasum, leading to reduced digestibility.

Nonmilk carbohydrates and nonmilk proteins are not well digested by preruminant calves under 3 weeks of age because their amylase, maltase and sucrase activities are insignificant, and their pepsin-HCl activity is not well developed until at least 3 weeks of age. Following the ingestion of these nutrients, there is reduced digestibility, malabsorption

and diarrhea. This results in a negative nutrient balance, loss of body weight and gradual starvation, all of which are reversible by the feeding of cows' whole milk. The digestion of fat is particularly affected, resulting in varying degrees of steatorrhea. Preruminant calves fed milk replacer containing corn oil will have diarrhea and not do well because of inadequate dispersion of the oil.<sup>4</sup>

The mechanism for the diarrhea, which may occur in all species following a sudden change in diet, is not well understood. However, several days may be necessary for the necessary qualitative and quantitative changes to occur in the digestive enzyme capacity. Not much is known about the development of intestinal enzymes in the fetus and newborn, but this is likely to be of importance in individual animals. In calves, lactase activity is fully developed at birth and in the period between birth and weaning there are significant changes in enzyme activity, some of them influenced by the presence or absence of dietary substances.

In dietary diarrhea, the presence of undigested substrate in the intestine may result in marked changes of the bacterial flora, which may result in excess fermentation of carbohydrates and putrefaction of protein, the products of which accentuate the malabsorption. If enteropathogenic *E. coli* or *Salmonella* spp. are present they may colonize, proliferate in large numbers and cause enteric colibacillosis and salmonellosis.

## CLINICAL FINDINGS

### Nursing beef calves

Dietary diarrhea of beef calves 3 weeks of age on pasture is characterized by the passage of light yellow feces that are foul-smelling and soft. The perineum and tail are usually smudged with feces. The calves are bright and alert and usually recover spontaneously without treatment in a few days.

### Hand-fed dairy calves

When overfed on cow's whole milk these animals are usually dull, anorexic and their feces are voluminous, foul-smelling and contain considerable mucus. The abdomen may be distended because of distension of the abomasum and intestines. Secondary enteric colibacillosis and salmonellosis may occur, resulting in severe dehydration. Most uncomplicated cases will respond to oral fluid therapy and withdrawal from or deprivation of milk.

### Milk replacer diarrhea

In calves fed inferior-quality milk replacers, there will be a chronic diarrhea with gradual weight loss. The calves are bright and alert, they usually drink normally,

appear distended after drinking and spend considerable time in recumbency. Not uncommonly, many treatments will have been tried unsuccessfully. The diarrhea and weight loss continues and in 2–4 weeks emaciation is evident and death from starvation may occur. Affected calves will often have a depraved appetite and eat bedding and other indigestible materials, which further accentuates the condition. When large numbers of calves are involved, the incidence of enteric colibacillosis and salmonellosis may become high and the case mortality very high. This is a common situation in veal-calf-rearing units.

Alopecia occurs occasionally in calves fed a milk replacer, but the cause is unknown.

## CLINICAL PATHOLOGY

Laboratory evaluation of the animals with dietary diarrhea is usually not necessary other than for elimination of other possible causes of the diarrhea. When milk replacers are being used the determination of the rennet-clotting time of the milk replacer compared with whole milk is a useful aid in assessing the quality of the skim-milk powder for calves.

## NECROPSY FINDINGS

Emaciation, an absence of body fat, dehydration and serous atrophy are present in calves which have died from diarrhea and starvation while being fed inferior quality milk replacers.

## DIFFERENTIAL DIAGNOSIS

- Dietary diarrhea occurs following a change in diet, the consumption of too much feed at once, or poor quality feed. There are usually no systemic signs and recovery occurs spontaneously when the dietary abnormality is corrected or the animal adapts to a new diet
- Dietary diarrhea must be differentiated from all other common causes of diarrhea in a particular age group within each species
- Examination of the recent dietary history and examination of the diet and its components will usually provide the evidence for a dietary diarrhea

## TREATMENT

### Alter diet of hand-fed calves

In hand-fed calves affected with dietary diarrhea, milk feeding should be stopped and oral electrolyte solutions given for 24 hours. Milk is then gradually reintroduced. If milk replacers are being used their nutrient composition and quality should be examined for evidence of indigestible nutrients. Occasional cases of dietary diarrhea in calves will require intensive fluid therapy and antibacterials

orally and parenterally. The feeding practices should be examined and the necessary adjustments made.

The care and management of hand-fed calves to minimize the incidence of dietary diarrhea is an art. Much has been said about the use of slow-flowing nipple bottles and pails to reduce dietary diarrhea but they are not a replacement for good management. Calves that are raised for herd replacements should be fed on whole milk if possible for up to 3 weeks. When large numbers of calves are reared for veal or for feedlots the milk replacer used should be formulated using the highest quality milk and milk by-products that are economically possible. The more inferior the milk replacer the more impeccable must become the management, which is difficult given today's labor situation.

#### Monitor beef calves with dietary diarrhea

Beef calves affected with dietary diarrhea while sucking the cow and running on pasture do not usually require treatment unless complications develop. They must be observed daily for evidence of dullness, anorexia, inactivity and profuse watery diarrhea, at which point they need some medical care.

#### Muzzle foals

Foals with dietary diarrhea should be muzzled for 12 hours, which may require hand-stripping of the mare to relieve tension in the udder and to prevent engorgement when the foal begins to suck again. Antidiarrheal compounds containing electrolytes, kaolin and pectin with or without antibiotics are used commonly but are probably not any more effective than oral electrolyte solutions for 24 hours.

#### REFERENCES

1. Lalles JP, Dreau D. *Res Vet Sci* 1996; 60:111.
2. Masri MD et al. *Equine Vet J* 1986; 18:301.
3. Cruywagen CW et al. *J Dairy Sci* 1990; 73:1578.
4. Jenkins KJ. *J Dairy Sci* 1988; 71:3013.

### INTESTINAL OR DUODENAL ULCERATION

Intestinal ulceration occurs in animals only as a result of enteritis and clinically with manifestations of enteritis. As far as is known there is no counterpart of the psychosomatic disease that occurs in humans. Ulceration does occur in many specific erosive diseases listed elsewhere, and in salmonellosis and swine fever, but the lesions are present in the terminal part of the ileum, and more commonly in the cecum and colon.

Duodenal ulcers in cattle and horses have a similar epidemiological distribution to gastric ulcers and also resemble

them clinically. Occasionally they perforate, causing subacute peritonitis. A perforated duodenal ulcer in a foal is recorded as causing acute, fatal peritonitis manifested by pain, dyspnea and vomiting. Moderate to severe ulceration of the mucosa of the cecum and colon is described in phenylbutazone toxicity in ponies. The dose rate of phenylbutazone was 12 mg/kg BW per day for 8 days. There is significant hypoproteinemia due to protein loss from the gut. A similar hypoproteinemia has been produced in Thoroughbred horses, but there was no clinical illness.

### DIVERTICULITIS AND ILEITIS OF PIGS (PROLIFERATIVE ILEITIS)

In this disease there is thickening of the wall of the ileum, particularly in the terminal portion, so that the intestine becomes thick and rigid. There is a close clinical similarity to Crohn's disease in humans and the etiology of both conditions is obscure. Familial predisposition is probable in humans and has been suggested in pigs.

The signs are those of acute peritonitis due to ulceration and, sometimes, perforation of the affected ileum. Illness occurs suddenly with loss of appetite, excessive thirst, dullness and disinclination to rise. The temperature is subnormal, the respiration is distressed and there is a bluish discoloration of the skin. Death occurs in 24–36 hours. Acute cases occur in young pigs up to 3 months of age, and chronic cases, due to ulceration and chronic peritonitis, in the 7–8-month age group.

At necropsy there may be diffuse peritonitis due to leakage of alimentary tract contents through perforating ileal ulcers. Gross thickening of the ileal wall with nodular proliferation of the ileal mucosa and enlargement of the mesenteric lymph nodes are common accompaniments. Although the macroscopic findings are similar to those of Crohn's disease in man, the histopathological findings differ markedly. There is an obvious and significant protein loss through the intestinal lesion and a marked hypoproteinemia.

### RECTAL PROLAPSE

Prolapse of the rectum occurs commonly in pigs, is an occasional occurrence in cattle and is rarely seen in the other species. In a prospective study of rectal prolapse in a commercial swine herd, 1% of the pigs prolapsed between 12 and 28 weeks of age, with a peak incidence occurring at 14–16 weeks of age.<sup>1</sup> Prolapse rates were highest during the winter and autumn months. Other risk factors included:

- Male – relative risk 2.3
- Birth weight less than 1000 g – relative risk 3.4
- A particular Yorkshire boar – relative risk 2.8
- Dams of litter number 1 – relative risk 14.9; number 2 – relative risk 8.2; number 3 – relative risk 9.8.

There was no evidence to support the hypothesis that diarrhea and coughing are factors associated with a risk of prolapse. Feeding rations with lysine concentrations in excess of the requirements is considered a risk factor for rectal prolapse in swine.<sup>2</sup>

The common causes include enteritis with profuse diarrhea, violent straining such as occurs in coccidiosis in young cattle, in rabies sometimes, in spinal cord abscess and also when the pelvic organs are engorged. The use of estrogens as a growth stimulant and access to estrogenic fungal toxins predispose to rectal prolapse for this reason. It has been suggested that mycotoxins in swine rations are a cause of rectal prolapse but there is insufficient evidence to make such a claim.

Treatment is surgical.<sup>3</sup>

#### REFERENCES

1. Gardner IA et al. *Vet Rec* 1988; 123:222.
2. Amass SF et al. *Vet Rec* 1995; 137:519.
3. Douglas RGA. *Vet Rec* 1985; 117:129.

### RECTAL STRICTURE

There are two notable occurrences: as part of an inherited rectovaginal constriction in Jersey cattle and a syndrome of acquired rectal stricture that occurs in feeder pigs at about 2–3 months of age. Although the latter is generally classed as a sequel to enteric salmonellosis associated with *Salmonella typhimurium*, it has been suggested that there is an inherited component in the etiology. The presumed pathogenesis is that a prolonged enterocolitis with ulcerative proctitis results in an annular cicatrization of the rectal wall 2–5 cm anterior to the anorectal junction. This results in colonic dilatation and compression atrophy of the abdominal and thoracic viscera. Clinically there is progressive abdominal distension, inappetence, emaciation, dehydration and watery to pasty feces. The stricture of the rectum can be palpated on digital examination of the rectum. Most affected pigs die or are destroyed but a surgical technique for relief of the condition is described. Some pigs with incomplete strictures are unaffected clinically. The disease can be reproduced experimentally with *S. typhimurium* or the surgical manipulation of the rectal arterial blood supply, resulting in ischemic ulcerative proctitis.



At necropsy there is a low-grade peritonitis and dilatation of the colon, and sometimes the terminal ileum also. A stricture is present 2–5 cm from the anus, and may be so severe that it exists as a scirrhous cord with or without a narrow luminal remnant in the center. Histologically there is necrotic debris and granulation tissue at the site of the stricture.

## Congenital defects of the alimentary tract

### HARELIP AND CLEFT PALATE

Harelip may be unilateral or bilateral and may involve only the lip or extend to the nostril. It may be associated with cleft palate and cause dysphagia and nasal regurgitation of milk and food, and a risk of inhalation pneumonia. It may be inherited or result from poisoning of lambs with *Veratrum californicum*. Cleft palate is difficult to correct surgically, especially in foals, in which it is a common congenital defect. Cleft palate (palatoschisis) is a common inherited defect in calves and is described under that heading.

### ATRESIA OF THE SALIVARY DUCTS

Congenital atresia of salivary ducts usually results in distension of the gland followed by atrophy. Rarely the gland may continue secreting, resulting in a gross distension of the duct.

### AGNATHIA, MICROGNATHIA AND BRACHYGNATHIA

These are variations of a developmental deficiency of the mandible, relatively common in sheep. The mandible and its associated structures are partially or completely absent. Single cases of a similar defect, combined with cleft palate, are recorded in calves.<sup>1</sup>

**Brachygnathia** is an abnormal shortening of the mandible, resulting in malocclusion of the maxillary and mandibular dental arcades and creating the appearance of a maxillary overbite.<sup>2</sup> It is considered to be a congenital abnormality but may be acquired within the first few months of life. The incisive malocclusion is of little consequence to the nursing foal but can affect the ability to prehend and masticate as the animal matures. It is not known to spontaneously regress and surgical intervention is necessary to correct the malocclusion.

The cause may be genetic or environmental. Some reports indicate a genetic influence but the mode of inheritance is

controversial. One report suggests that brachygnathia in Angus calves was transmitted by a single autosomal recessive gene but such mode of inheritance has not been supported in other studies.<sup>2</sup> In a series of 20 horses with brachygnathia the amount of disparity between the mandible and premaxilla varied between 0.75 and 3.0 cm. Surgical correction of the abnormality resulted in improved incisive occlusion. Complete correction of the malocclusion was more likely to occur if foals were treated before 6 months of age.

### PERSISTENCE OF THE RIGHT AORTIC ARCH

Persistence of the right aortic arch as a fibrous band may occlude the esophagus and cause signs of obstruction, particularly chronic bloat in young calves.

### CHOANAL ATRESIA

Failure of the buccal membrane to rupture during fetal life prevents the animal breathing through the nostrils. The membrane separates the alimentary tract and the nasal cavities in the pharynx. It is incompatible with life in foals and lambs, the two species in which it is identified.<sup>3</sup> The defect is usually bilateral; a unilateral lesion is tolerable. Surgical correction is likely to be only partially effective.

### CONGENITAL ATRESIA OF THE INTESTINE AND ANUS

**Congenital intestinal atresia** is characterized by the complete closure of some segment of the intestinal tract. Intestinal atresia has been reported in calves, lambs, foals and piglets and the affected newborn usually dies of autointoxication within a few days of birth. The incidence of intestinal atresia in 31 Irish dairy herds monitored over 1 year was 0.3% of all calves born.<sup>4</sup>

### ATRESIA OF THE ANUS

This is recorded as a congenital defect in pigs, sheep and calves.<sup>5</sup> Its occurrence is usually sporadic and no genetic or management factors can be indicated as causes. In other circumstances the occurrence can be suggestive of conditioning by inheritance, or be at such a rate as to suggest some environmental cause. Atresia of the ileum and colon is probably conditioned by inheritance in Swedish Highland cattle. Congenital atresia of the intestine can be differentiated from retention of meconium in foals, and rarely calves, by the passage of some fecal color in the latter. Affected animals die at about 7–19 days of age unless the defect is corrected surgically. The intestine is grossly distended by then and the abdo-

men is obviously swollen as a result. There is marked absence of feces. When the rectal lumen is quite close to the perineum, surgical intervention is easy and the results, in terms of salvaging the animals for meat production, are good. These animals can usually be identified by the way in which the rectal distension bulges in the perineum where the anus should be; pressure on the abdomen provokes a tensing or further distension of this bulge. Other signs include tenesmus with anal pumping and inability to pass a proctoscope or other instrument.

### INTESTINAL ATRESIAS

**Intestinal atresias** have been classified into type I – membrane atresia caused by a diaphragm or membrane; type II – cord atresia caused by blind ends joined by a small cord of fibrous or muscular tissue or both, with or without mesentery; and type III – blind-end atresia, caused by absence of a segment of the intestine, with disconnected blind ends and a gap in the mesentery, and often a short small intestine.<sup>6</sup>

### ATRESIA OF THE TERMINAL COLON

This occurs in foals,<sup>7</sup> especially those of the Overoo breed; the ileum and colon are affected in calves<sup>8</sup> and the small intestine in lambs. Atresia coli has been reported in Holstein, Ayrshire, Shorthorn, Simmental, Hereford, Angus and Maine Anjou breeds and in crossbred cattle. In one dairy herd over a 10-year period, the overall incidence of atresia coli in calves was 0.76%.<sup>9</sup> All the affected calves were related to one another, some were inbred and the frequency was higher in males than females. Some affected calves were aborted or born dead at term. More calves were born with atresia coli from dams in which pregnancy was diagnosed prior to 41 days of gestation than from dams diagnosed as pregnant at a later date.

It is suggested that atresia coli in calves has an inherited basis and that affected calves are homozygous recessives for the defective allele for atresia coli. This is supported by planned matings between putative carrier sires and putative carrier dams.<sup>10</sup> The estimated minimum gene frequency of atresia coli in cattle is 0.026 and it is thought that the defective allele for atresia coli is at high frequency in Holstein cattle in the USA. It is also plausible that early pregnancy diagnosis by palpating the amniotic sac before 40 days of gestation may be a contributing factor, but it is not essential for all cases.<sup>11</sup> Intestinal atresia can be produced experimentally by terminating the mesenteric blood supply to some parts of the intestine during development.

In atresia coli, the abdomen may be grossly distended before birth when the



defect is in the small intestine and the distension may interfere with normal parturition. In defects of the large intestine, distension usually occurs after birth. In these the anus is normal and the part of the intestine caudal to the obstructed section may be normal or absent. The principal clinical findings are depression, anorexia and abdominal distension. Frequently the owner has not seen the calf pass meconium or feces. Thick mucus may be passed through the anus if it is patent or through the vagina in heifers with concomitant rectovaginal fistula. In many cases the animal has not sucked since the first day and 5-6-day-old animals are very weak and recumbent. The intestine may rupture and acute diffuse peritonitis develop. Intestinal segmental atresia has been produced experimentally by occluding the blood supply to the intestine in fetal lambs. In one large series of congenital defects in calves the most common site of atresia was the mid-portion of the spiral loop of colon.<sup>12</sup> The passage of a rectal tube or the infusion of barium and radiography may assist in the detection of atresia of the intestine. There are usually large quantities of thick tenacious mucus in the rectum with no evidence of meconium or feces. In the latter case only exploratory laparotomy can reveal the extent and nature of the defect.<sup>13</sup> The differential diagnosis of atresia coli in calves includes acute intestinal obstructions such as volvulus and intussusception, diffuse peritonitis and septicemia. **The presence of feces in the rectum rules out the presence of atresia coli.**

Surgical repair appears to be a satisfactory outcome in 30-50% of cases.<sup>14</sup> In a series of intestinal atresia in calves admitted to a veterinary teaching hospital over a period of 10 years, the survival rate was influenced by the atretic segments affected.<sup>15</sup> In a series of 58 cases of intestinal atresia in calves, seven of 18 cases corrected surgically made a satisfactory recovery; the remaining 40 calves were euthanized for different reasons.<sup>16</sup>

The incidence of **atresia coli in foals** has been reported at 0.44% of foals under 2 weeks of age admitted to veterinary teaching hospitals over a period of 27 years.<sup>17</sup> Clinical findings included progressive abdominal distension, colic, lack of feces and lack of response to enemas. A neutropenia may reflect the presence of toxemia. The large transverse and/or small colon is commonly involved. Agenesis of the mesocolon in a 1-month-old foal with colic has been described.<sup>18</sup> The prognosis for most cases is grave and surgical correction is usually unsuccessful.

The common causes of colic in newborn foals include ileus with or without

gas distension, intussusception, diaphragmatic hernia, gastroduodenal ulcers, necrotizing enterocolitis, small and large intestinal strangulation, large intestine displacement, intraluminal obstruction other than meconium, ruptured bladder and congenital abnormalities of the gastrointestinal tract.

#### MULTIPLE ORGAN DEFECTS

In many animals the congenital defects of the intestine are accompanied by defects in other organs,<sup>8,12</sup> especially the lower urinary tract, so that reparative surgery is not possible. For example multiple gut and urogenital defects are recorded in one calf<sup>19</sup> and gut defects plus defects of the pancreas and gallbladder in another.<sup>20</sup>

Congenital constriction of the anus and vagina is an inherited defect of Jersey cattle and is recorded under that heading. The defect may be combined with rectovaginal fistula manifested by the passage of feces via the vulva or penile urethra.<sup>21</sup>

#### REVIEW LITERATURE

Syed M, Shanks RD. *Cornell Vet* 1993; 83:261.

#### REFERENCES

1. Griffith JW et al. *J Comp Pathol* 1987; 97:95.
2. Gift LJ et al. *J Am Vet Med Assoc* 1992; 200:715.
3. Crouch GM et al. *Compend Contin Educ* 1983; 5:S706.
4. Mee JF. *Irish Vet J* 1994; 47:63.
5. Cho DY, Taylor HW. *Cornell Vet* 1986; 76:11.
6. Young RL et al. *Equine Vet J* 1992; 24:60.
7. Vanderfecht SL et al. *Vet Pathol* 1983; 20:65.
8. Anderson WL et al. *Cornell Vet* 1987; 97:119.
9. Syed M, Shanks RD. *J Dairy Sci* 1992; 75:1357.
10. Syed M, Shanks RD. *J Dairy Sci* 1992; 75:1105.
11. Syed M, Shanks RD. *Cornell Vet* 1993; 83:261.
12. Ducharme NG et al. *Can Vet J* 1988; 29:818.
13. Constable PD et al. *J Am Vet Med Assoc* 1989; 195:118.
14. Smith DF et al. *J Am Vet Med Assoc* 1991; 199:1185.
15. Dryfuss DJ, Tulleners EP. *J Am Vet Med Assoc* 1989; 195:508.
16. Martens A et al. *Vet Rec* 1995; 136:141.
17. Nappert G et al. *Equine Vet J Suppl* 1992; 13:57.
18. Steinhaut M et al. *Vet Rec* 1991; 129:54.
19. Dunham BM et al. *Vet Pathol* 1989; 26:94.
20. Kramme PM. *Vet Pathol* 1989; 26:346.
21. Kingston RS, Park RD. *Equine Pract* 1982; 4:32.

## Neoplasms of the alimentary tract

### MOUTH

Oral neoplasms in ruminants, other than viral papillomas, may be associated with heavy bracken intake. The tumors are usually squamous cell carcinomas arising from the gums and cause interference with mastication. They occur most commonly in aged animals and probably arise from alveolar epithelium after periodontitis has caused chronic hyperplasia. Sporadic occurrences of other tumors, e.g. adeno-

carcinoma, cause obvious local swelling and dysphagia.

### PHARYNX AND ESOPHAGUS

Papillomas sometimes involve the pharynx, esophagus, esophageal groove and reticulum and cause chronic ruminal tympany in cattle. A high incidence of malignant neoplasia affecting the pharynx, esophagus and rumen has been recorded in one area in South Africa. The tumors were multicentric in origin and showed evidence of malignancy on histological examination. The clinical disease was chronic and confined to adult animals with persistent, moderate tympany of the rumen and progressive emaciation as typical signs. A similar occurrence has been recorded in cattle in western Scotland and related to the long-term consumption of bracken. The tumors were squamous cell carcinoma in the pharynx and dorsal esophagus. The principal clinical abnormality was difficulty in eating and swallowing. Many of the carcinomas arise in pre-existing papillomas, which are associated with a virus infection. The carcinomas occur only in cattle more than 6 years of age.

### STOMACH AND RUMEN

Squamous cell carcinomas occasionally develop in the mouth and stomach of horses and the rumen of cattle. In the stomach of the horse, they occur in the cardiac portion and may cause obscure indigestion syndromes, lack of appetite, weight loss, anemia, obstruction of the lower esophagus,<sup>1</sup> dysphagia, colic and occasionally chronic diarrhea. Or a tumor may ulcerate to terminate with perforation of the stomach wall and the development of peritonitis. Metastases may spread to abdominal and thoracic cavities with fluid accumulating there. Subcutaneous edema is a common accompanying sign. There may also be pleural effusion due to metastases in the pleura.<sup>2</sup> Metastases in the female genital tract have also been noted. Most affected animals are euthanized because of anorexia and chronic weight loss. Large masses of metastatic tumor tissue may be palpable on rectal examination. In such cases an examination of paracentesis fluid sample cells should be valuable.

Lymphosarcoma in horses is often manifested by chronic diarrhea due to massive infiltration of the intestinal wall. There is severe weight loss, even in the absence of diarrhea in some cases, usually a large appetite and often severe ascites, and anasarca and sometimes colic. The same signs are recorded in a case of mesothelioma in a horse. The oral glucose absorption test is abnormal with a poor

absorption response. Rectal examination may reveal large masses of hard nodular tissue and hematological examination may be of assistance in diagnosis. Paracentesis and examination of cells in the fluid for the presence of mitotic figures is an essential part of an examination in suspected cases of neoplasia in the abdominal cavity. Nasal fibergastroscopy is an obvious technique for visualizing this tumor but suffers the limitation that standard instruments are not long enough.<sup>3</sup> The course of this disease in horses is very variable, with the period of illness lasting from 3 weeks to 3 months.

Ruminal tumors may obstruct the cardia and cause chronic tympany. In lymphomatosis of cattle, there is frequently gross involvement in the abomasal wall causing persistent diarrhea. Ulceration, hemorrhage and pyloric obstruction may also occur.

## INTESTINES

A higher than normal rate of occurrence of carcinoma of the small intestine has been recorded in sheep in Iceland, Norway<sup>4</sup> and New Zealand and in cows only in New Zealand.<sup>5</sup> A series of intestinal carcinomas is also recorded in Europe, and another series in Australia.<sup>6</sup> The tumors in the Australian series were located at abattoirs and were causing intestinal stenosis. Metastasis to regional lymph nodes occurred readily. In New Zealand there appeared to be a much higher prevalence in British-breed ewes (0.9–0.15%) compared to Merino and Corriedale ewes (0.2–0.4%), and significantly higher tumor rates were observed in sheep that had been pastured on foodstuffs sprayed recently with phenoxy or picolinic acid herbicides.<sup>7</sup> The use of the herbicides 2,4-D, 2,4,5-T, MCPA, piclorum and clopyralid has been associated with an increased incidence of these tumors. A higher prevalence in sheep kept at higher stocking rates was also suggested.

Occasional tumors of the intestine are recorded in abattoir findings but they can cause clinical signs such as chronic bloat and intermittent diarrhea<sup>8</sup> in cattle, persistent colic due to partial intestinal obstruction in horses<sup>9</sup> and anorexia and a distended abdomen in sheep.<sup>10</sup> A series of cases of lymphoma in horses were characterized by malabsorption without diarrhea but with anemia in some.<sup>11</sup>

Occasional tumors recorded as causing colic in horses include an intramural ganglioneuroma occluding the jejunum,<sup>12</sup> an intraluminal leiomyoma causing an intussusception of the small colon,<sup>13</sup> a granulosa cell tumor of an ovary causing external pressure and occlusion of a small

colon.<sup>14</sup> A juvenile granulosa cell tumor in a weanling filly caused a fatal volvulus and severe continuous colic.<sup>15</sup> Anorexia, weight loss, abdominal distension, constant chewing and swallowing movements are the prominent signs in gastric leiomyoma<sup>16</sup> and squamous cell carcinoma.<sup>17</sup> Metastases in the peritoneal cavity are palpable in some cases. Leiomyosarcomas have caused chronic intermittent colic due to constriction of the duodenum and partial intestinal obstruction.<sup>18</sup> A colonic adenocarcinoma has caused weight loss, intermittent colic, poor appetite and scant feces and a mass palpable in the abdomen.<sup>19</sup>

Tumors of the anus are rare: a mucoepidermoid carcinoma is recorded in a goat<sup>20</sup> but most tumors of the perineal area are anogenital papillomata.

## REFERENCES

1. Tennant B et al. *Equine Vet J* 1982; 14:238.
2. Wrigley RR et al. *Equine Vet J* 1981; 13:99.
3. Keim DP et al. *J Am Vet Med Assoc* 1982; 180:940.
4. Ulvund M. *NZ Vet J* 1983; 31:177.
5. Johnstone AC et al. *NZ Vet J* 1983; 31:147.
6. Ross AD. *Aust Vet J* 1980; 56:25.
7. Newell KW et al. *Lancet* 1984; 2:1301.
8. Cho DY, Archibald LF. *Vet Pathol* 1985; 22:639.
9. Wright JA, Edwards GB. *Equine Vet J* 1984; 16:136.
10. Anderson BC. *J Am Vet Med Assoc* 1983; 183:1467.
11. Platt H. *J Comp Pathol* 1987; 97:1.
12. Allen D et al. *Cornell Vet* 1989; 79:133.
13. Mair TS et al. *Vet Rec* 1992; 132:403.
14. Wilson DA et al. *J Am Vet Med Assoc* 1989; 194:681.
15. Hultgren BD et al. *J Comp Pathol* 1987; 97:137.
16. Boy MG et al. *J Am Vet Med Assoc* 1992; 200:1363.
17. Olsen SN. *Vet Rec* 1992; 131:170.
18. Mair TS et al. *J Comp Pathol* 1990; 102:119.
19. Rottman JB et al. *J Am Vet Med Assoc* 1991; 198:657.
20. Turk JR et al. *Vet Pathol* 1984; 21:364.

## Diseases of the peritoneum

### PERITONITIS

Inflammation of the peritoneum is accompanied by abdominal pain, fever, toxemia and a reduction in the amount of feces. Symptoms vary in degree with the severity and extent of the peritonitis.

### ETIOLOGY

Peritonitis may occur as a primary disease or secondarily as part of an etiologically specific disease. As a primary disease it results most commonly from injury of the serosal surfaces of the alimentary tract within the abdomen, allowing gastrointestinal contents to enter the peritoneal cavity. Less commonly there is perforation of the abdominal wall from the exterior from traumatic injury, perforation of the reproductive tract, or the introduction of pathogens or irritating substances as result of injections into the peritoneal

cavity or exploratory laparotomy. Some of the more common individual causes are as follows.

### Cattle

- Traumatic reticuloperitonitis
- Secondary to ruminal trocarization
- Perforation or leakage of abomasal ulcer
- Concurrent abomasal displacement and perforating ulcer<sup>1</sup>
- Necrosis and rupture of abomasal wall after abomasal volvulus
- Rumenitis of cattle subsequent to acute carbohydrate indigestion
- Complication of caesarean section
- Rupture of vagina in young heifers during violent coitus with a young, active bull
- Deposition of semen into the peritoneal cavity by any means
- Injection of sterile hypertonic solutions, e.g. calcium preparations for milk fever. The chemical peritonitis that results may lead to formation of constrictive adhesions between loops of the coiled colon
- Transection of small intestine that becomes pinched between the uterus and the pelvic cavity at parturition
- Intraperitoneal injection of nonsterile solutions
- Spontaneous uterine rupture during parturition, or during manual correction of dystocia
- Sadistic rupture of vagina
- Spontaneous rupture of rectum at calving<sup>2</sup>
- As part of specific diseases such as tuberculosis.

### Horses

Peritonitis in horses is usually secondary to infectious, chemical, or parasitic peritoneal injuries, and can be a major complication after abdominal surgery.<sup>3</sup>

Rupture of dorsal sac of cecum or colon<sup>4</sup> at foaling, usually related to a large meal given just beforehand

Cecal rupture in foals subjected to anesthesia and gastric endoscopy<sup>5</sup>

Administration of NSAIDs causing cecal stasis and dilatation and eventually perforation<sup>6</sup>

Rectal rupture or tear during rectal examination, predisposed to by inflammation of mucosa and overenthusiasm by the operator; this subject is presented separately under the heading of **rectal tear**

Extension from a retroperitoneal infection, e.g. *Streptococcus equi* after an attack of strangles, *Rhodococcus equi* in foals under 1 year of age, both probably assisted by migration of *Strongylus vulgaris* larvae

- Gastric erosion or rupture related to ulceration associated with larvae of *Gasterophilus* or *Habronema* spp.
- Colonic perforation associated with aberrant migration of *Gasterophilus intestinalis*<sup>7</sup>
- Leakage from a cecal perforation apparently associated with a heavy infestation of *Anoplocephala perfoliata* tapeworms
- Spontaneous gastric rupture
- *Actinobacillus equuli* infection by unknown means.<sup>8,9</sup> Septicemia and peritonitis due to *A. equuli* infection in an adult horse has been described.<sup>10</sup>

#### Pigs

- Ileal perforation in regional ileitis
- Glasser's disease associated with *Haemophilus suis*.

#### Sheep

- Spread from intestinal wall abscess following infestation with *Esophagostomum* sp. larvae
- Serositis-arthritis associated with *Mycoplasma* sp.

#### Goats

- Serositis-arthritis associated with *Mycoplasma* sp.

#### All species

- Traumatic perforation from the exterior of the abdominal wall by horn gore, stake wound
- Faulty asepsis at laparotomy, peritoneal injection, trocarization for tympany of rumen or cecum
- Leakage through wall of infarcted gut segment
- Spread from subperitoneal sites in spleen, liver, umbilical vessels.

#### PATHOGENESIS

At least six factors account for the clinical findings and the various consequences of peritonitis. They are toxemia or septicemia, shock and hemorrhage, abdominal pain, paralytic ileus, accumulation of fluid exudate and the development of adhesions.

#### Toxemia and septicemia

Toxins produced by bacteria and by the breakdown of tissue are absorbed readily through the peritoneum. The resulting toxemia is the most important factor in the production of clinical illness and its severity is usually governed by the size of the area of peritoneum involved. In **acute diffuse peritonitis**, the toxemia is profound; in local inflammation, it is negligible. The type of infection present is obviously important because of variations between bacteria in their virulence and toxin production.

With rupture of the alimentary tract wall and the spillage of a large quantity of gut contents into the peritoneal cavity, some acute peritonitis does develop, but

death is usually too sudden, within 2–3 hours in horses, for more than an early lesion to develop. These animals die of endotoxic shock due to absorption of toxins from the gut contents. In acute diffuse peritonitis due solely to bacterial contamination from the gut, the reaction depends on the bacteria that gain entry and the capacity of the omentum to deal with the peritonitis, and the amount of body movement that the animal has to perform. Cows that suffer penetration of the reticular wall at calving have lowered immunological competence, a greater than normal negative pressure in the peritoneal cavity, are invaded by *F. necrophorum*, *Corynebacterium* spp. and *E. coli*, and are required to walk to the milking parlor, to the feed supply and so on. They are likely to develop a massive diffuse purulent peritonitis and a profound toxemia and die within 24 hours. By contrast, horses that develop acute peritonitis due to streptococci or *A. equuli* show little toxemia and manifest only abdominal pain due to the inflammatory reaction of the peritoneum.

#### Shock and hemorrhage

The shock caused by sudden deposition of gut contents, or infected uterine contents, into the peritoneal cavity, plus the hemorrhage resulting from the rupture, may be significant contributors to the common fatal outcome when an infected viscus ruptures. Following rupture of the uterus in cows, the shock and hemorrhage may be minor and peritonitis may not develop if the uterine contents are not contaminated. Failure of the uterus to heal or be repaired may be followed by peritonitis several days later.

#### Abdominal pain

Abdominal pain is a variable sign in peritonitis. In acute, diffuse peritonitis, the toxemia may be sufficiently severe to depress the response of the animal to pain stimuli, but in less severe cases the animal usually adopts an arched-back posture and shows evidence of pain on palpation of the abdominal wall. Inflammation of the serous surfaces of the peritoneum causes pain, which may be severe enough to result in rigidity of the abdominal wall and the assumption of an abnormal humped-up posture.

#### Paralytic ileus

Paralytic ileus occurs as a result of reflex inhibition of alimentary tract tone and movement in acute peritonitis. It is also an important sequel to intestinal obstruction and to traumatic abdominal surgery, in which much handling of viscera is unavoidable. Rarely, it arises because of ganglionitis and a loss of neural control of peristalsis, similar to the idiopathic intes-

tinal pseudo-obstruction of humans.<sup>11</sup> The net effect is **functional obstruction of the intestine**, which, if persistent, will increase the likelihood of death. The end result is a complete absence of defecation, often with no feces present in the rectum.

#### Accumulation of fluid exudate

Accumulation of large quantities of inflammatory exudate in the peritoneal cavity may cause visible abdominal distension and, if severe enough, interfere with respiration by obstruction of diaphragmatic movement. It is a comparatively rare occurrence but needs to be considered in the differential diagnosis of abdominal distension.

#### Adhesions

Trauma to the peritoneum results in a serosanguineous exudate, which contains two closely bound proteins: fibrinogen and plasminogen. **Fibrinogen** is converted by thrombin to fibrin, forming an early fibrinous adhesion. **Plasminogen** may be converted by plasminogen activators to plasmin, a specific fibrinolytic enzyme favoring lysis of the early adhesion. Peritoneal mesothelial cells are a source of plasminogen activators and each species of domestic animal has its own baseline peritoneal plasminogen activity. Cattle have a high capacity to respond to trauma with fibrin deposition.<sup>6</sup> Intra-abdominal fibrin deposition and adhesion formation is the most important factor in localizing peritonitis after peritoneal trauma from penetrating foreign bodies or abomasal ulcers. However, these adhesions can cause mechanical or functional intestinal obstruction.

In **chronic peritonitis**, the formation of adhesions is more important than either of the two preceding pathogenetic mechanisms. Adhesions are an essential part of the healing process and are important to localize the inflammation to a particular segment of the peritoneum. If this healing process is developing satisfactorily and the signs of peritonitis are diminishing, it is a common experience to find that vigorous exercise causes breakdown of the adhesions, spread of the peritonitis and return of the clinical signs. Thus, a cow treated conservatively for traumatic reticuloperitonitis by immobilization may show an excellent recovery by the third day but, if allowed to go out to pasture at this time, may suffer an acute relapse. The secondary adverse effects of adhesions may cause partial or complete **obstruction of the intestine** or stomach, or by fixation to the body wall interfere with normal gut motility. Adhesions are important in the pathogenesis of vagus indigestion in cattle.

## CLINICAL FINDINGS

Peritonitis is common in cattle, less common in horses and rarely, if ever, identified clinically in sheep, pigs or goats. There are general signs applicable to all species and most forms of the disease in a general way. In addition, there are special findings peculiar to individual species and to various forms of the disease.

### Acute and subacute peritonitis

Inappetence and anorexia

Inappetence occurs in less severe and chronic cases, and complete anorexia in acute diffuse peritonitis.

Toxemia and fever

Toxemia, usually with a fever, is often present but the severity varies depending on the area of peritoneum involved, the identity of the pathogens and the amount of tissue injury. For example, in cattle with acute local peritonitis the temperature will be elevated (39.5°C; 103°F) for the first 24–36 hours, but then return to normal even though the animal may still be partly or completely anorexic. A high fever (up to 41.5°C; 106°F) suggests an acute diffuse peritonitis, but in the terminal stages the temperature usually falls to subnormal. It is most noteworthy that a normal temperature does not preclude the presence of peritonitis. In horses with peritonitis, the temperature will usually exceed 38.5°C but the fever may be intermittent.<sup>12</sup> There is usually a moderate increase in heart and respiratory rates, the latter contributed to by the relative fixation of the abdominal wall because of pain. In some cases there is spontaneous grunting at the end of each expiratory movement.

Feces

The amount and composition of feces is usually abnormal. The transit time of ingesta through the alimentary tract is increased and the dry matter content of the feces increases. The amount of feces is reduced, although in the early stages there may be transient period of increased frequency of passage of small volumes of soft feces, which may give the false impression of increased fecal output. In some horses with peritonitis, periods of diarrhea may occur but the feces are usually reduced in amount.<sup>12</sup> Feces may be completely absent for periods of up to 3 days, even in animals that recover, and the rectum may be so dry and tacky, because of the presence of small amounts of tenacious mucus, that it is difficult to do a rectal examination. This may suggest a complete intestinal obstruction.

In pastured cattle with peritonitis the feces are characteristically scant, dark and like small fecal balls accompanied by thick, jelly-like mucus. The feces may alter-

natively have a thick, sludge-like consistency, be tenacious and difficult to remove from a rubber glove, and have a foul smell.

Alimentary tract stasis

As well as absence of feces, there are other indicators of intestinal stasis. In cows with acute peritonitis ruminal contractions are reduced or absent; in chronic peritonitis the contractions may be present but are weaker than normal. In the horse, intestinal stasis is evidenced by an absence or reduction of typical intestinal peristaltic sounds on auscultation, although the tinkling sounds of paralytic ileus may be audible. It is very important to differentiate the two.

Abdominal pain evidenced by posture and movement

In cattle with acute peritonitis there is a disinclination to move, disinclination to lie down, lying down with great care and grunting with pain. The posture includes a characteristically arched back, the gait is shuffling and cautious, with the back held rigid and arched. Grunting at each step and when feces or urine are passed is common, and when urine is eventually passed it is usually in a very large volume. Sudden movements are avoided and there is an absence of kicking or bellowing or licking the coat.

**In horses** these overt signs of peritonitis that characterize the condition in cattle are uncommon, which makes the diagnosis difficult. In the horse peritonitis is often manifested as an episode of abdominal pain including flank watching, kicking at the belly and going down and rolling, which suggests colic caused by intestinal obstruction.<sup>8,11</sup>

In a series of 51 cases of peritonitis associated with *A. equuli* in horses, most had tachycardia, increased respiratory rates, fever and reduced intestinal borborygmi.<sup>9</sup> Affected horses were depressed, lethargic and inapparent. Mild to moderate abdominal pain was manifested as reluctance to move, pawing on the ground, lying down or splinting of the abdominal musculature. The onset of clinical signs was acute (<24 h) in 30 horses, 1–4 days in 8 horses, or longer and associated with weight loss in 3 horses. In 10 horses, there was no record of the duration of clinical signs.

Abdominal pain as evidenced by deep palpation

In cattle, deep firm palpation of the abdominal wall elicits an easily recognized pain response. It may be possible to elicit pain over the entire abdominal wall if the peritonitis is widespread. If it is localized the response may be detectable over only a very small area. Increased tenseness of

the abdominal wall is not usually detectable in the cow, although it is responsible for the characteristic arched-back posture and apparent gauntness of the abdomen, because the wall is already tightly stretched anyway.

**Several methods are used to elicit a grunt in cattle** with abdominal pain. In average-sized cows with acute local peritonitis (most commonly traumatic reticuloperitonitis), while listening over the trachea with a stethoscope, a controlled upward push with the closed fist of the ventral body wall caudal to the xiphoid sternum is most successful. In large bulls, especially if the peritonitis is subsiding, it may be difficult to elicit a grunt with this method. In these cases, the best technique is to use a heavy pole held horizontally under the area immediately caudal to the xiphoid sternum to provide a sharp lift given by assistants holding the pole on either side. **Pinching of the withers** while auscultating over the trachea is also used and with some clinical experience is highly reliable.

**In horses** with acute or subacute peritonitis, it is usually easy to elicit a pain response manifested by the animal lifting its leg and turning its head with anger when its lower flank is firmly lifted, but not punched. The abdominal wall also feels tense if it is lifted firmly with the heel of the hand. In all cases of peritonitis in all species a pain response is always much more evident in the early stages of the disease and severe chronic peritonitis can be present without pain being detected on palpation.

Rectal examination

The general absence of feces is characteristic. In cattle, it may be possible to palpate slightly distended, saggy, thick-walled loops of intestine in some cases. Also, it may be possible to feel fibrinous adhesions separating as the intestines are manipulated. Adhesions are not often palpable and their absence should not be interpreted as precluding the presence of peritonitis. Only adhesions in the caudal part of the abdomen may be palpable. Tough, fibrous adhesions may be present in long-standing cases. In horses, there are no specific rectal findings, other than a reduced fecal output, to indicate the presence of peritonitis. Distension of segments of both the small and large intestines may provide indirect evidence of paralytic ileus. However, there is a lack of clarity as to what can be felt in chronic cases because of the presence of fibrin deposits and thickening of the peritoneum. There may also be more than usual pain when an inflamed area is palpated or a mesenteric band or adhesion is manipulated.

In rupture of the rectum associated with a difficult dystocia, the rupture is usually easily palpable rectally in the ventral aspect of the rectum deep in the abdomen.<sup>2</sup> Distended loops of intestine may become entrapped in the rectal tear.

### Peracute diffuse peritonitis

In those cases in which profound toxemia occurs, especially in cows immediately after calving or when rupture of the alimentary tract occurs, the syndrome is quite different. There is severe weakness, depression and circulatory failure. The animal is recumbent and often unable to rise, depressed almost to the point of coma, has a subnormal temperature of 37–37.5°C (99–100°F), a high heart rate (110–120/min) and a weak pulse. No abdominal pain is evidenced spontaneously or on palpation of the abdominal wall. In mares that rupture the dorsal sac of the cecum during foaling, the owner observes that the mare has been straining and getting results when suddenly she stops making violent muscular contractions, and progress towards expelling the foal ceases.<sup>13</sup> Moderate abdominal pain followed by shock are characteristic developments. Death follows 4–15 hours after the rupture.

The outcome in cases of acute, diffuse peritonitis varies with the severity. Peracute cases accompanied by severe toxemia usually die within 24–48 hours. The more common, less severe cases may be fatal in 4–7 days, but adequate treatment may result in recovery in about the same length of time.

In a series of 31 cases of generalized peritonitis in cattle most cases occurred peripartum.<sup>14</sup> The most consistent clinical findings were depression, anorexia, decreased fecal output and varying degrees of dehydration. The duration of illness ranged from 1–90 days with a median of 4 days. In 19 animals, the duration of clinical disease was less than 1 week and in 12 cases the duration of illness was more than 1 week. All animals died or were euthanized.

### Chronic peritonitis

#### Cattle

The development of adhesions, which interfere with normal alimentary tract movements, and gradual spread of infection as adhesions break down combine to produce a chronic syndrome of indigestion and toxemia that is punctuated by short, recurrent attacks of more severe illness. The adhesions may be detectable on rectal examination but they are usually situated in the anterior abdomen and are impalpable. If partial intestinal obstruction occurs, the bouts of pain are usually accompanied by a marked increase in alimentary tract sounds and palpable

distension of intestinal loops with gas and fluid. The course in chronic peritonitis may be several weeks and the prognosis is not favorable because of the presence of physical lesions caused by scar tissue and adhesions. In some cases there is marked abdominal distension with many liters of turbid-infected fluid present. This may be restricted in its location to the omental bursa.<sup>15</sup> Detection of fluid in the peritoneal cavity of a cow is not easy because of the fluid nature of the ruminal contents. Results obtained by testing for a fluid wave should be interpreted cautiously. Collection of fluid by paracentesis abdominis is the critical test.

#### Horses

Horses with chronic peritonitis usually have a history of ill-thrift for a period of several weeks. Weight loss is severe and there are usually intermittent episodes of abdominal pain suggesting intestinal colic. Gut sounds are greatly diminished or absent, and subcutaneous edema of the ventral abdominal wall occurs in some cases. There may also be a contiguous pleurisy. Identification of the cause of the colic depends on the examination of a sample of peritoneal fluid.

### Diagnostic medical imaging

In cattle with traumatic reticuloperitonitis, inflammatory fibrinous changes, and abscesses can be imaged<sup>16</sup> (see also Ch. 6).

In cattle, standing reticular radiography is a useful aid for the diagnosis and management of traumatic reticuloperitonitis.<sup>5</sup> It can accurately detect the presence of a foreign body and in most instances if that foreign body is perforating the reticular wall.

## CLINICAL PATHOLOGY

### Hematology

The total and differential leukocyte count is a useful aid in the diagnosis of peritonitis and in assessing its severity. In acute diffuse peritonitis with toxemia there is usually a leukopenia, neutropenia and a marked increase in immature neutrophils (a degenerative left shift). There is 'toxic' granulation of neutrophils. In less severe forms of acute peritonitis of a few days' duration there may be a leukocytosis due to a neutrophilia with the appearance of immature neutrophils. In acute local peritonitis, commonly seen in acute traumatic reticuloperitonitis in cattle, there is commonly a normal total leukocyte count, or a slight increase, with regenerative left shift. In chronic peritonitis, depending on the extent of the lesion (diffuse or local), the total and differential leukocyte count may be normal, or there may be a leukocytosis with a marked neutrophilia and occasionally an increase in the total numbers of lymphocytes and

monocytes. The plasma fibrinogen levels in cattle, in general, tend to increase as the severity of acute peritonitis increases and may be a useful adjunct to the cell counts for assessing severity.<sup>5</sup>

In horses with peritonitis associated with *A. equuli*, there was hemoconcentration, hypoproteinemia and a neutrophilia count with a left shift.

### Abdominocentesis and peritoneal fluid

Examination of peritoneal fluid obtained by paracentesis is a valuable aid in the diagnosis of peritonitis and in assessing its severity. It may also provide an indication of the kind of antibacterial treatment required. The values in healthy horses, and horses with various intestinal or peritoneal diseases are provided in Table 5.2. The maximum peritoneal fluid nucleated cell counts in healthy foals is much lower than reported maximum values for adult horses<sup>17</sup> and similarly for calves. Particular attention should be paid to:

- The ease of collection of the sample as a guide to the amount of fluid present
- Whether it is bloodstained, indicating damage to a wall of the viscus
- The presence of feed or fecal material, indicating intestinal ischemic necrosis or rupture
- Whether it clots and has a high protein content, indicating inflammation rather than simple transudation
- The number and kinds of leukocytes present, as an indication of the presence of inflammation, and also its duration
- Microbiological examination.

When these results are available they should be interpreted in conjunction with the history, clinical signs and other results, including hematology, serum chemistry and possibly radiology. In particular, it must be noted that failure to obtain a sample does not preclude a possible diagnosis of peritonitis.

Interpretation of peritoneal fluid is also influenced by simple manipulation of the abdominal viscera and the response is greater than that following opening and closing of the abdomen without manipulation of the viscera. Surgical manipulation results in a significant and rapid postoperative peritoneal inflammatory reaction.<sup>11</sup>

In peritonitis in horses associated with *A. equuli*, the peritoneal fluid was turbid and had an abnormal color in 98% of cases. The protein content was elevated above normal in 50 samples (range 25–84 g/L, mean 44 g/L, normal < 20 g/L).

Total nucleated cell-count was elevated in all samples (range 46–810 × 10<sup>9</sup> cells/L, mean 230 × 10<sup>9</sup> cells/L, normal < 10 × 10<sup>9</sup> cells/L). A nucleated cell count above 100 × 10<sup>9</sup> cells/L, was present in 88% of animals.<sup>9</sup> Pleomorphic Gram-negative rods were seen on cytology in 53% of samples, and a positive culture of *A equuli* was obtained in 72% of samples.

Experimentally, resection and anastomosis of the small colon in healthy horses causes a different inflammatory response than does manipulation. Absolute values in the peritoneal fluid for cell count, total protein and differential count are inadequate to differentiate between a normal surgical reaction and a postoperative infection. Cytological examination of peritoneal fluid is necessary to demonstrate degenerative cell changes and the presence of bacteria and ingesta. The peripheral leukon and fibrinogen concentration should always be compared with the peritoneal fluid for evidence of post-surgical infection. The nucleated cell and red blood counts of peritoneal fluid are commonly elevated for several days in horses following open castration.<sup>15</sup> These elevated counts may be mistaken for peritonitis.

Septic peritonitis in the horse

Diagnosis of septic peritonitis is routinely made on the basis of physical examination and hematologic findings, and peritoneal fluid analysis.<sup>18</sup> After abdominal surgery, differentiation between septic peritonitis and other postoperative complications can be difficult using physical and hematological findings alone. As a result of the exploratory process itself, diagnosis of septic peritonitis is often complicated in horses after surgery because the total nucleated cell count and protein concentration in the peritoneal fluid are often high. Consequently, identification of bacteria on cytological evaluation or isolation of bacteria from peritoneal fluid is a more definitive indicator of septic peritonitis, but sometimes there are false-negative results. Although bacterial cultures are considered the standard criterion for the diagnosis of sepsis, positive results may not always be obtained and results may be delayed by a minimum of 24 hours for aerobic organisms and up to 10–14 days for anaerobic organisms. Thus ancillary tests such as pH, glucose concentrations and lactate dehydrogenase (LDH) activity in equine pleural and synovial fluid have been used to detect sepsis with the potential advantages of speed, ease of measurement and lower cost relative to bacterial cultures.<sup>18</sup>

Horses with septic peritonitis have significantly lower peritoneal fluid pH and glucose concentrations than horses

with nonseptic peritonitis and healthy horses.<sup>18</sup> Compared with other tests, serum-to-peritoneal fluid glucose concentration differences of more than 50 mg/dL had the highest diagnostic use for detection of septic peritonitis. Peritoneal fluid pH below 7.3, glucose concentration below 30 mg/dL and fibrinogen concentration above 200 mg/dL were also highly indicative of septic peritonitis.

#### NECROPSY FINDINGS

In acute diffuse peritonitis, the entire peritoneum is involved but the most severe lesions are usually in the ventral abdomen. Gross hemorrhage into the subserosa, exudation and fibrin deposits in the peritoneal cavity and fresh adhesions that are easily broken down are present. In less acute cases, the exudate is purulent and may be less fluid, often forming a thick, cheesy covering over most of the viscera. In cattle, *F. necrophorum* and *Actinomyces (Corynebacterium) pyogenes* are often present in large numbers and produce a typical, nauseating odor. Acute local peritonitis and chronic peritonitis are not usually fatal and the lesions are discovered only if the animal dies of intercurrent disease such as traumatic pericarditis or intestinal obstruction.

#### DIAGNOSIS

The diagnosis of peritonitis can be difficult because the predominant clinical findings are often common to other diseases. The clinical features that are the most reliable as indicators of peritonitis are:

- Abnormal feces – in amount and composition
- Alimentary tract stasis based on auscultation and evaluation of the passage of feces
- Abdominal pain evinced as a groan with each respiration or on light or deep percussion of the abdomen
- Abnormality of intestines on rectal palpation
- Fibrinous or fibrous adhesions on rectal palpation
- Abnormal peritoneal fluid with an increased leukocyte count collected by paracentesis
- A normal or low blood leukocyte count with a degenerative left shift
- The peritonitis may be chemical, so that, although microbiological examination usually yields positive results, these are not essential to a diagnosis of peritonitis.

#### PROGNOSIS

##### Case fatality rate in horses

Peritonitis in the horse is a potentially life-threatening disease that must be treated promptly and aggressively.<sup>20</sup>

#### DIFFERENTIAL DIAGNOSIS

The diseases which could be considered in the differential diagnosis of peritonitis are as follows.

##### Cattle

- **Acute local peritonitis** – Traumatic reticuloperitonitis, acute intestinal obstruction, splenic or hepatic abscess, simple indigestion, abomasal displacement (right and left), postpartum metritis, ketosis
- **Acute diffuse peritonitis** – Parturient paresis, coliform mastitis (peracute form), acute carbohydrate indigestion, perforation of or rupture at abomasal ulcer, acute intestinal obstruction, uterine rupture, postpartum metritis
- **Chronic peritonitis** – Vagus indigestion, lipomatosis or extensive fat necrosis of the mesentery and omentum, persistent minor leakage from an intestinal lesion, large accumulations of fluid as in ascites, rupture of bladder, chronic pneumonia and chronic toxemias due to a great variety of causes
- **Ascites** associated most commonly with primary or secondary cardiac disease, cor pulmonale with chronic pneumonia, endocarditis, thrombosis of the caudal vena cava, and diffuse abdominal epithelioid mesothelioma<sup>19</sup>

##### Horses

- **Acute and subacute peritonitis** – Acute intestinal obstruction and thromboembolic colic
- **Chronic peritonitis** – Repeated overeating causing colic, internal abdominal abscess (retroperitoneal or mesenteric abscess) may be classified as chronic peritonitis but is dealt with separately under the heading of retroperitoneal abscess. Horses with both intra-abdominal neoplasms and abscesses will have clinical findings including anorexia, weight loss, fever, colic and depression.<sup>13</sup> Both groups may also have peritoneal fluid that can be classified as an exudate

##### Pigs, sheep and goats

Peritonitis is not usually diagnosed antemortem in these species.

Therapy must be aimed at reducing systemic shock and hypovolemia, correction of the primary cause, antibiotic therapy, and abdominal drainage and lavage. The reported case fatality rates for peritonitis in horses range from 30–67%. In a series of 67 cases of peritonitis in horses, of those which developed peritonitis after abdominal surgery the case fatality was 56%.<sup>3</sup> Peritonitis not associated with intestinal rupture or abdominal surgery had a lower case fatality rate of 43%. Horses that died had higher heart rates, red blood cell count, serum creatinine concentration, PCV and anion gap; lower venous blood pH; and a greater number of bacterial species

cultured from the peritoneal fluid compared with survivors. Those that died were more likely to have clinical evidence of abdominal pain, shock and bacteria in the peritoneal fluid.

### TREATMENT

The specific cause must be treated in each case and the treatments used are described under the specific diseases listed above. An exploratory laparotomy may be indicated to determine the cause of the peritonitis and to effect repair. The literature on the treatment of peritonitis in horses has been reviewed.<sup>20</sup>

### Antimicrobials

**Broad-spectrum antimicrobials** given intravenously or intramuscularly are indicated for the infection and toxemia. However, there are no published reports of clinical trials to evaluate the effectiveness of various antimicrobials for the treatment of peritonitis in cattle or horses. Thus the recommendations are empirical. In general, **peritonitis in cattle** is commonly treated with any of the broad-spectrum antimicrobials, with the choice dependent on ease of administration and drug withdrawal times necessary in lactating dairy cattle. Treatment for traumatic reticuloperitonitis has commonly been restricted to the use of antimicrobials; supportive therapy has not been indicated with the exception of diffuse peritonitis.

**Peritonitis in horses** associated with abdominal surgery or rupture of the gastrointestinal tract is likely to be accompanied by a mixed flora of bacteria, and broad-spectrum antimicrobials are necessary. They must be given at doses high enough to achieve high blood and tissue levels and maintained daily until recovery has occurred. In a series of cases of peritonitis in horses, the most commonly used antimicrobials were gentamicin at 2.2–3.3 mg/kg BW intravenously every 8–12 hours; penicillin at 22 000 IU/kg BW intravenously or intramuscularly every 6–12 hours. Metronidazole given orally at 15–25 mg/kg BW has also been used in horses with peritonitis.<sup>3</sup>

Horses with peritonitis associated with *A. equuli* respond quickly to treatment with penicillin at 20 mg/kg BW intramuscularly twice daily for 5 days to 2 weeks.<sup>9</sup> Most isolates of the organism are sensitive to penicillin but some are resistant and gentamicin sulfate at 6.6 mg/kg BW intravenously once daily for 5 days to 2 weeks in combination with the penicillin has also been used successfully.<sup>9</sup> In a series of 51 cases in horses, the recovery rate following treatment with penicillin and gentamicin and supportive therapy was 100%.<sup>9</sup> Most

horses responded favorably within 48 hours following commencement of treatment.

**Administration of antimicrobials into the peritoneal cavity** has been attempted on the basis that higher levels of the drug may be achieved at the site of the inflammation. However, there is no scientific evidence that it is superior to daily parenteral administration and there is some danger of causing adhesions and subsequent intestinal obstruction.

### Fluid and electrolytes

Intensive intravenous fluid and electrolyte therapy is a vital part of treatment of peritonitis when accompanied by severe toxemia and shock, especially during the first 24–72 hours following abdominal surgery in the horse. It is continued until recovery is apparent and the animal is drinking water voluntarily; water can then be supplemented with electrolytes. (See Ch. 2 for details of fluid and electrolyte therapy for the treatment of dehydration and toxemia.)

### Nonsteroidal anti-inflammatory drugs

Flunixin meglumine is recommended at 0.25–1.1 mg/kg BW intravenously every 8–12 hours when the peritonitis is accompanied by shock. However, no information is available on efficacy.

### Lavage

**Peritoneal lavage** with large volumes of fluid containing antimicrobials is rational and has been attempted when large quantities of exudate are present. However, it is not easy to maintain the patency of drains, especially in cattle. Also, peritoneum is highly susceptible to inflammation and chemical peritonitis is common following the introduction of certain materials into the peritoneal cavity. Peritoneal lavage of ponies with saline and antimicrobials induces a mild, transient inflammatory response with minimal change visible at necropsy.<sup>21</sup> Solutions containing povidone-iodine induced chemical peritonitis, which was severe when 10% povidone-iodine solution was used. A 3% solution also causes peritonitis and the use of these solutions is not recommended. Extreme caution is required when foreign materials are introduced into the cavity in order to avoid exacerbating the existing inflammation. The peritoneum is also a very vascular organ and toxic material is rapidly absorbed from it.

An **active intra-abdominal drain** has been used successfully to treat abdominal contamination in horses.<sup>22</sup> Closed-suction abdominal drains were placed, mostly under general anesthesia. Abdominal lavage was done every 4–12 hours and

about 83% of the peritoneal lavage solution was retrieved.

### Prevention of adhesions

No attempt is made to prevent the development of adhesions.

### REVIEW LITERATURE

- Dyson S. Review of 30 cases of peritonitis in the horse. *Equine Vet J* 1983; 15:25–30.  
Davis JL. Treatment of peritonitis. *Vet Clin North Am Equine Pract* 2003; 19:765–778.

### REFERENCES

- Cable CS et al. *J Am Vet Med Assoc* 1998; 212:1442.
- Tyler JW et al. *Vet Rec* 1998; 143:280.
- Hawkins JF et al. *J Am Vet Med Assoc* 1993; 203:284.
- Platt H. *J Comp Pathol* 1983; 93:343.
- Edwards JF, Ruoff W W. *J Am Vet Med Assoc* 1991; 198:1421.
- Ross MW et al. *J Am Vet Med Assoc* 1985; 187:249.
- Lapointe JM et al. *Vet Pathol* 2003; 40:338.
- Fubini SL et al. *J Am Vet Med Assoc* 1990; 197:1060.
- Matthews S et al. *Aust Vet J* 2001; 79:536.
- Patterson-Kane JC et al. *Vet Pathol* 2001; 38:230.
- Hanson RR et al. *Am J Vet Res* 1992; 53:216.
- Mair TS et al. *Vet Rec* 1990; 126:567.
- Zicker SC et al. *J Am Vet Med Assoc* 1990; 196:1130.
- Ebeid M, Rings DM. *Bovine Pract* 1999; 33:144.
- Schumacher J et al. *J Vet Intern Med* 1988; 2:22.
- Braun U. *Vet J* 2003; 166:112.
- Grinden CB et al. *Equine Vet J* 1990; 22:359.
- Van Hoogmoed L et al. *J Am Vet Med Assoc* 1999; 214:1032.
- Milne MH et al. *Vet Rec* 2001; 148:341.
- Davis JL. *Vet Clin North Am Equine Pract* 2003; 19:765.
- Schneider RK et al. *Am J Vet Res* 1988; 49:889.
- Nieto JE et al. *Vet Surg* 2003; 32:1.

### RECTAL TEARS

Iatrogenic tears of the equine rectum are a serious problem in equine practice. They are a leading cause of malpractice suits for the veterinarian, comprising approximately 7% of insurance claims against veterinarians in equine practice in the USA,<sup>1</sup> and can be a large economic loss for the owner. Occurrence of rectal tears is often an emotionally charged event because they are unexpected and they usually occur in otherwise healthy horses being subjected to routine rectal examination. Prompt diagnosis and vigorous treatment, along with frank disclosure of the event to the horse's owner or handler, is essential in increasing the likelihood of a good outcome both for the horse and for the veterinarian–client relationship.

### ETIOLOGY

The etiology of rectal tears is usually readily apparent, with the vast majority of rectal tears in horses being iatrogenic. Iatrogenic rupture occurs during rectal examination by veterinarians or laypersons for reproductive management (brood mares), or examination of other



intra-abdominal structures, for example during evaluation of a horse with colic.<sup>2</sup> Spontaneous or non-iatrogenic rupture can occur associated with infarctive lesions of the distal small colon or rectum, injuries during parturition or coitus, and malicious trauma caused by insertion of foreign objects by attendants.<sup>3</sup> It is important that rectal tears should not be assumed to be iatrogenic until a thorough evaluation of the animal and the history has been performed.

### EPIDEMIOLOGY

**Risk factors** for rectal tears in horses have not been well quantified but include:

- Age – young animals appear to be at increased risk, perhaps because they are smaller and less accepting of rectal palpation
- Sex – stallions and geldings have a smaller pelvic inlet than do mares and appear to have a rectum of smaller diameter than mares, thus increasing the risk of tension on the wall of the rectum, with subsequent tearing
- Breed – Arabian horses appear to be at increased risk of iatrogenic rectal tears
- Size – smaller animals can be at increased risk
- Inadequate restraint – horses must be adequately restrained for rectal examination (see Prevention, below)
- Inadequate preparation of the rectum – the rectum and distal small colon should be emptied of feces before an examination of the reproductive organs or gastrointestinal tract is performed
- The experience of the examiner is not a factor in the risk of rectal tears in horses<sup>4</sup>
- The use of ultrasonographic probes per rectum does not appear to increase the risk of rectal tears.<sup>4</sup>

The **case fatality rate** varies depending on the type of tear (see Clinical signs, below). Horses with grade I or II tears almost all survive, whereas the survival rate for horses with grade III tears treated appropriately is 60–70%.<sup>5</sup> Almost all horses with Grade IV rectal tears die.

### PATHOGENESIS

Rectal tears occur in horses because the rectum of the horse is so sensitive and fragile and powerful contractions occur during rectal palpation. In contrast, the bovine rectum is relatively durable and, while often traumatized, is rarely ruptured. Tears occur because of excessive tension on the rectal wall. This usually occurs in horses by peristalsis and contraction of the rectum over the examiner's hand, with splitting of the rectum often occurring over the back (knuckles) of the hand.

Complete rupture of the peritoneal portion of the rectum results in fecal contamination of the abdomen and rapid onset of septic peritonitis and death. Tears in the nonperitoneal portion of the rectum (that is, caudal to the peritoneal reflection) cause perirectal cellulites and abscessation.

### CLINICAL SIGNS

The prominent clinical sign of the occurrence of a rectal tear is the presence of blood on the rectal sleeve of the examiner. Slight blood staining of mucus or lubricant is usually not associated with rectal tears (although this should be verified by repeat examination) whereas the presence of frank hemorrhage on the sleeve is usually indicative of a rectal tear. The rectum in an adult, 450 kg horse, is approximately 30 cm long and is partially within the abdomen, where it is covered by peritoneum, and partially in the pelvic canal, where it is not surrounded by peritoneum but is supported by thick connective tissue and muscle. The peritoneal portion of the rectum is supported dorsally by the mesorectum (mesocolon). Most iatrogenic rectal tears in horses occur within 25–30 cm of the anus, but can occur up to 60 cm from the anus, in the peritoneal portion of the rectum. The tears are almost always in the dorsal or dorsolateral wall and are longitudinal (parallel to the long axis of the rectum). It is speculated that the dorsal wall of the rectum is weaker than other segments because it is not covered by serosa, and blood vessels perforate the muscularis layers, thereby weakening it.<sup>5</sup>

Rectal tears in the horse have been classified according to the layers of the rectal wall disrupted. The classification is also a useful guide to the clinical signs to be expected and the treatment that is indicated (see under "Treatment" for management of each grade of tear):

- Grade I – Disruption of the mucosa only, or the mucosa and submucosa. There are usually no clinical signs other than some blood on the examiner's sleeve. Most of these injuries occur to the mucosa of the ventral aspect of the rectum<sup>5</sup>
- Grade II – Disruption of the muscular layer of the rectal wall with the mucosal and serosal surfaces intact. This is a rarely recognized form of tear. There are minimal clinical signs
- Grade IIIa – Tear includes mucosa, submucosa and muscularis but the serosal surface is intact. This degree of tear usually causes septic peritonitis. If the tear is caudal to the peritoneal reflection the pelvic fascia becomes infected, but the infection may remain contained within it for 7–10 days,

forming a local cellulitis or abscess. During this period, the horse is likely to be affected by mild chronic peritonitis, with mild abdominal pain, fever and mild toxemia. At the end of this time, the infection can erode through the peritoneum and cause an acute, severe, diffuse peritonitis, or rupture through the perianal tissue causing a fistula

- Grade IIIb – Tear is on the dorsal wall and includes the mucosa, submucosa and muscularis. Because there is no serosa at this position, the tear extends into the mesocolon. There is usually septic peritonitis
- Grade IV – Complete rupture with leakage of fecal material into the peritoneal space. Clinical signs of septic peritonitis are severe and death is inevitable.

Horses with a rectal tear will not display any immediate signs of discomfort. However, if there is grade III or grade IV tear, the horse will have signs of septic peritonitis, including elevated heart and respiratory rates, sweating, colic, increased capillary refill time and discolored mucus membranes, within 1–2 hours.

### CLINICAL PATHOLOGY

Hematological and serum biochemical changes in horses with grade III and grade IV tears are consistent with acute septic peritonitis. These changes include leukopenia and neutropenia, increased band cell count, elevated hematocrit and total protein concentration initially, after which serum total protein concentration can decline as protein leaks into the abdomen. Peritoneal fluid has a high white blood cell count and protein concentration. Cytological examination reveals the presence of degenerate neutrophils, intra- and extracellular bacteria and plant material.

### PROGNOSIS

The prognosis depends of the size, grade and location of the tear and the time between occurrence and treatment. All horses with grade I or II lesions survive, approximately 60–70% of horses with grade III lesions survive, and almost all horses with grade IV lesions die.<sup>5</sup>

### TREATMENT

If the person doing the rectal examination feels the mucosa tear, if there is blood on the rectal sleeve, or if a horse that has had a rectal examination up to 2 hours previously starts to sweat and manifest abdominal pain, a rectal tear should be suspected. A thorough examination should be conducted immediately but great care is necessary to avoid damaging the rectum further. The principles of care are to: verify the presence of a tear,



determine its severity, prevent leakage of fecal material into the peritoneum or tissues surrounding the tear, treat for septic peritonitis, prevent extension of the tear and provide pain relief.

Immediate care<sup>6</sup>

**If a rectal tear is suspected the horse should be appropriately restrained and examined immediately. There should be no delay in conducting this examination.** The client should be informed of the concern about a rectal tear. First aid measures taken at the time of a grade III or IV tear can have a marked influence on the outcome.<sup>2,5</sup> Horses with grade III or IV rectal tears should receive first aid treatment and then be referred for further evaluation and treatment.

The existence of a tear should be determined and its severity assessed. This is best achieved by sedating the horse, providing local analgesia of the rectal mucosa and anus, and careful manual and visual examination of the rectal mucosa. Sedation can be achieved by administration of adrenergic agonists (xylazine, romifidine, detomidine) with or without a narcotic drug (butorphanol, meperidine, pethidine, morphine). Analgesia of the rectum and anus can be induced by epidural anesthesia (lidocaine or xylazine) or local application of lidocaine gel or lidocaine enema (10–15 mL of 2% lidocaine in 50–60 mL of water infused into the rectum). Peristalsis can be reduced by administration of hyoscine (*N*-butylscopolammonium bromide, 0.3 mg/kg intravenously).

Manual or visual examination of the rectum can then be performed. Manual examination is performed after generous lubrication of the anus and examiner's hand and arm. Some authorities prefer to use bare hands, rather than gloves or a rectal sleeve, for this examination because of the decreased sensitivity when wearing gloves. However, one should be aware of the health risks to the examiner of not using barrier protection (gloves) during a rectal examination. The rectum should be evacuated of feces and a careful and thorough digital examination should be performed. If a tear is detected, the position, distance from the anus, length and depth of the tear should be determined. Gentle digital examination should be used to determine the number of layers involved and if there is rupture of the rectum and communication with the peritoneal space.

Alternatively, the rectum can be examined visually through a mare vaginal speculum, or using an endoscope. Both these approaches are likely to minimize the risk of further damage to the rectum. These examinations can be impaired by the presence of fecal material.

If a grade III or IV rectal tear is detected, then the horse should be administered broad-spectrum antibiotics (penicillin, aminoglycoside and possibly metronidazole) and NSAIDs, and referred for further evaluation. Some, but not all, authorities recommend placement of a rectal pack to prevent further contamination of the rectal tear. This is formed from a 3 inch (7.5 cm) stockinette into which is inserted a roll of cotton (approximately 250 g) The roll is moistened with povidone-iodine solution, lubricated and inserted into the rectum in the region of the tear. Epidural anesthesia will prevent expulsion of the roll in the short term.

Prompt referral and care is essential for maximizing the likelihood of a good outcome in horses with grade III and IV tears.

#### Grade I and grade II tears

Treatment of these tears is medical. Horses should be administered broad-spectrum antibiotics and feces should be softened by the administration of mineral oil. These wounds heal in 7–10 days.

#### Grade III tears

Both medical and surgical treatments are effective in approximately 60–70% of cases of grade III tears.<sup>7–9</sup> The choice of treatment depends on the expertise and experience of the attending clinician and financial constraints imposed by the horse's owner. Surgical treatment includes direct repair of the tear (for those lesions that can be readily exposed via the anus), placement of a rectal sheath by ventral laparotomy and placement of a loop colostomy. Surgical repair is in addition to aggressive treatment of peritonitis.

Medical treatment includes administration of broad-spectrum antibiotics (such as penicillin, aminoglycoside and metronidazole), anti-endotoxin drugs (such as hyperimmune serum or polymyxin sulfate), NSAIDs, crystalloid fluids, colloidal fluids (hetastarch, plasma) and heparin, and other care. Peritoneal lavage might be indicated. Manual evacuation of the rectum at frequent intervals (every 1–2 hours for 72 hours and then 4–6 times daily for a further 7 days) was suggested to improve the prognosis,<sup>9</sup> although others caution against manual evacuation of the rectum because of the risk of worsening the tear.<sup>8</sup>

#### Grade IV tears

Tears of this severity require immediate surgical intervention to minimize fecal contamination of the peritoneum. However, the grave prognosis and high cost of treatment, and poor success of surgical intervention in these cases, means that most horses are euthanized. If surgical care is attempted, there should also be

aggressive medical treatment of the peritonitis.

#### PREVENTION

As noted above, rectal tears can occur during examination by even the most experienced operators. Ideally, the owner should be informed of the risks of rectal palpation and explicit consent to perform the examination should be obtained. This is especially important for animals that are at increased risk of rectal tears.

The examination should be performed only when there is a clear clinical reason for performing a rectal examination, when the animal is a suitable candidate for rectal examination, and when the animal can be adequately restrained to permit a thorough examination to be performed in relative safety for both the examiner and the animal.

The examiner should proceed cautiously with the examination. The gloved hand and arm of the examiner should be well lubricated with a water-based lubricant. The anus should be gently dilated by using fingers shaped into a cone. Feces should be evacuated from the rectum such that the rectum is empty to the most cranial extent of the region to be examined. If the horse is anxious and straining, or if there is excessive peristalsis, then the animal should be sedated and anti-peristaltic drugs (such as hyoscine) should be administered. The examination should be halted if the horse begins to struggle or resist the examination excessively. Application of a nose twitch often facilitates the examination.

During the examination care should be exercised not to resist peristaltic waves – the hand should be withdrawn in front of these advancing waves and reinserted as peristalsis passes. The fingers should not be opened widely during the examination and care should be taken not to put excessive pressure on a small region of rectum, such as might occur when trying to grasp an ovary or loop of distended intestine.

A rectal tear in a horse is a common cause of a malpractice suit and the veterinarian involved with the case is advised to recommend to the owner that a second opinion be solicited from another veterinarian in order to minimize any misunderstanding.

#### REFERENCES

1. Bliklager AT, Mansmann RA. *Compend Contin Educ Pract Vet* 1996; 18:1140.
2. Watkins JP et al. *Equine Vet J* 1989; 21:186.
3. Guglick MA et al. *J Am Vet Med Assoc* 1996; 209:1125.
4. Sloet van Oldruitenborgh-Oosterbaan MM et al. *Tijdschr Diergeneesk* 2004; 129:624.
5. Eastman TG et al. *Equine Vet Educ* 2000; 12:263.
6. Sayegh AI et al. *Compend Contin Educ Pract Vet* 1996; 18:1131.

7. Alexander GR, Gibson KT. Aust Vet J 2002; 80:137.
8. Mair TS. Equine Vet J Suppl 2000; 32:104.
9. Katz LM, Ragle CA. J Am Vet Med Assoc 1999; 215:1473.

### RETROPERITONEAL ABSCESS (INTERNAL ABDOMINAL ABSCESS, CHRONIC PERITONITIS, OMENTAL BURSITIS)

A recognized form of chronic or rarely intermittent colic is associated with an abscess in the abdominal cavity. The abscesses are usually **retroperitoneal**, sometimes involving the omental bursa, and chronic leakage from them into the peritoneal cavity causes chronic or recurrent peritonitis. Complete recovery is difficult to effect and there is a high failure rate in treatment. These abscesses result from any of the following:

- Infection of a **verminous aneurysm**, especially in young horses
- **Post-strangles infection** localizing anywhere, but particularly in pre-existing lesions such as verminous aneurysms
- **Minor perforations of intestinal wall** allowing minimal leakage of intestinal contents so that omental plugging is possible
- Erosion through a **gastric granuloma** associated with *Habronema* sp. or a squamous cell carcinoma of stomach wall
- In **mares**, development of an abscess in the pelvic fascia commonly results after **tearing of the rectal wall during pregnancy diagnosis**.

**Clinical findings** suggestive of the disease include persistent or intermittent chronic colic and weight loss. A **fever** is common and **varying degrees of anorexia** are typical. In cases with a concurrent chronic peritonitis or an omental bursitis the amount of inflammatory exudate may be large enough to cause abdominal distension. When the abscess is perirectal and in the pelvic fascia there may be straining and constipation due to voluntary retention of feces.

On **rectal examination** it may be possible to feel an abscess, or adhesions to one. They are often multiple and quite large and adherent to one another, so that tight bands of mesentery can be felt that will lead the hand to the site of the abscess. Pain is usually elicited by rectal palpation of the infected sites and by firm palpation of the external abdominal wall. Ultrasonography through the abdominal wall has been used to locate large retroperitoneal abscesses in a foal.

The **hemogram**, especially in acute cases, is characterized by a neutrophilia, which may be as high as 30 000/ $\mu$ L with a left shift. **Chronic anemia** due to bone

marrow depression may occur and increased **plasma fibrinogen** and **hypoalbuminemia** occur. Abdominocentesis may yield turbid fluid with a protein content greater than 2.5 g/dL and an increase in leukocytes. If culture is possible the causative bacteria are usually *S. equi*, *S. zooepidemicus*, *C. equi*, *Corynebacterium pseudotuberculosis* or mixed infections if there has been intestinal leakage. It is common, even when there is an active infection in a retroperitoneal abscess, to fail to grow bacteria from a peritoneal effusion.

**Intra-abdominal abscesses** must be differentiated from **abdominal neoplasms** in the horse.<sup>1</sup> Anorexia, weight loss, fever, colic and depression are common to both syndromes. The laboratory findings in both groups are similar but cytological examination of the peritoneal fluid may yield an accurate diagnosis in the case of neoplasms.<sup>1</sup>

Leakages from stomach wall may result in adhesions to the spleen and development of splenic abscesses. In these animals a sharp pain response can be elicited on firm palpation of the abdomen in the left flank just behind the last rib. Abscesses in liver are not so easily located. Abscesses in pelvic fascia are usually not very discrete but are instantly noticeable on inserting the hand into the rectum.

### TREATMENT

**Treatment** with broad-spectrum antimicrobials is indicated and the initial response is good but often transitory if the usual course of treatment is only 3–5 days' duration. The prognosis is usually tentative because of the difficulty of completely eliminating the infection. Treatment must be continued for at least 2 weeks and in some cases for a period of 2 to even 4–5 months. Surgical treatment may be possible but is usually ineffectual because of the deformity of the area by adhesions and the usual outcome of tearing the intestine and spillage into the peritoneal cavity while attempting to exteriorize the lesion.

### REFERENCE

1. Zicker SC et al. J Am Vet Med Assoc 1990; 196:1130.

### ABDOMINAL FAT NECROSIS (LIPOMATOSIS)

The **hard masses of necrotic fat** that occur relatively commonly in the peritoneal cavity of adult cattle, especially the Channel Island breeds and possibly Aberdeen Angus, are commonly mistaken for a developing fetus and can cause intestinal obstruction. The latter usually develops slowly, resulting in the appearance of attacks of moderate abdominal

pain and the passage of small amounts of feces. Many cases are detected during routine rectal examination of normal animals. The lipomatous masses are located in the small omentum, large omentum and mesentery in cattle and more diffusely to other parts of the body in sheep and goats.<sup>1</sup> The composition of the fatty deposits is identical with the fat of normal cows and there is no suggestion that the disease is neoplastic. Sporadic cases are most common but there are reports of a herd prevalence as high as 67%.<sup>2</sup> The cause is unknown but there appears to be a relation between such high prevalence and the grazing of tall fescue grass,<sup>2</sup> and an inherited predisposition is suggested. The rate of occurrence increases with age, the peak occurrence being at 7 years of age. It has been suggested that excessive fattiness of abdominal adipose tissue may predispose cattle to fat necrosis.<sup>3</sup> An unusual form of the disease with many lesions in subcutaneous sites has been recorded in Holstein-Friesian cattle and is regarded as being inherited. There is no treatment and affected animals should be salvaged. A generalized steatitis has been reported in pony foals.

**Pedunculated lipomas** provide a special problem especially in older horses. Their pedicles may be 20–30 cm long and during periods of active gut motility these pedicles can become tied around a loop of intestine anywhere from the pylorus to the rectum. At the pylorus they cause acute intestinal obstruction with gastric dilatation. At the rectum they cause subacute colic and a characteristic inability to enter the rectum with the hand. This is accompanied by a folded coning-down of the mucosa, not unlike that in a torsion of the uterus. Early diagnosis and surgical intervention can produce a resolution but delay is disastrous because the blood supply is always compromised: it is always a loop and its blood supply that are strangulated. The pedicle is always tied in a very tight knot.

### REFERENCES

1. Xu LR. Acta Vet Zootechnol Sinica 1986; 17:113.
2. Stuedemann JA et al. Am J Vet Res 1985; 46:1990.
3. Katamoto H et al. Res Vet Sci 1996; 61:214.

### TUMORS OF PERITONEUM

Disseminated peritoneal leiomyomatosis has been reported occurring in a mature Quarter horse.<sup>1</sup> Clinical findings included inappetence, weight loss, intermittent fever, chronic abdominal pain and enlargement of the abdomen. Rectal examination revealed a prominent, firm, smooth-walled mass in the ventral aspect of the abdomen. Transabdominal ultrasonography was used to detect the mass,

which was a friable, polycystic structure occupying a large portion of the abdominal cavity and weighing 34 kg. The mass was removed and recovery was complete.

Mesothelioma has been reported in cattle, predominantly in the peritoneal cavity, but mesothelioma can also occur in the pleural cavity and the vagina of adult cattle. The cause of mesothelioma in cattle is unknown but pleural mesothelioma in humans is associated with asbestos exposure. One report suggested that the frequency of diagnosis in cattle is increasing.<sup>2</sup> All ages of cattle can be affected with peritoneal mesothelioma, but affected animals are typically young, with fetal and neonatal cases also being

reported.<sup>3,4</sup> Calves and adult cattle most frequently present with moderate abdominal distension.<sup>5</sup> Other presenting signs include scrotal edema in intact males<sup>5</sup> and ventral pitting edema. Occasionally, small 2–20 mm, well demarcated 'bumps' can be felt on all serosal surfaces during palpation per rectum in adult cattle. Peritoneal fluid is easily obtained by ventral abdominal paracentesis and has the characteristics of a modified transudate with a moderate to marked increase in phagocytically active mesothelial cells. Definitive diagnosis is made during a right-sided exploratory laparotomy, where numerous raised, white, well demarcated masses are palpated on all

serosal surfaces, with copious abdominal fluid being present. Biopsy of these masses and microscopic examination confirms the presumptive diagnosis of mesothelioma. Extensive peritoneal mesothelioma is fatal and there is no known treatment. All cases reported to date are sporadic and there is no apparent association with asbestos or other toxic agent in cattle.

#### REFERENCES

1. Johnson PJ et al. *J Am Vet Med Assoc* 1994; 205:725.
2. Pizarro M et al. *J Vet Med A* 1992; 39:476.
3. Klopfer U et al. *Zentralbl Vet Med B* 1983; 30:785.
4. Anderson BC et al. *Vet Med* 1984; 79:395.
5. Wolfe DF et al. *J Am Vet Med Assoc* 1991; 199:486.

## Diseases of the alimentary tract – II

**DISEASES OF THE FORESTOMACH OF RUMINANTS 293**

Anatomy and physiology 293  
Ruminant gastrointestinal dysfunction 297

**SPECIAL EXAMINATION OF THE ALIMENTARY TRACT AND ABDOMEN OF CATTLE 301**

History 301  
Systemic state, habitus and appetite 301  
Oral cavity and esophagus 301  
Inspection of the abdomen 301  
Examination of rumen fluid 304  
Rectal palpation of abdomen 305  
Gross examination of feces 305  
Detection of abdominal pain 307  
Clinical examination of the digestive tract and abdomen of the calf 308  
Laparoscopy 308  
Diagnostic imaging 308  
Exploratory laparotomy (exploratory celiotomy) 309

**DISEASES OF THE RUMEN, RETICULUM AND OMASUM 311**

Simple indigestion 311  
Rumen impaction in sheep with indigestible foreign bodies 313  
Indigestion in calves fed milk replacers (ruminal drinkers) 314  
Acute carbohydrate engorgement of ruminants (ruminal lactic acidosis, rumen overload) 314  
Ruminal parakeratosis 325  
Ruminal tympany (bloat) 325  
Traumatic reticuloperitonitis 337  
Vagus indigestion 346  
Diaphragmatic hernia 350  
Traumatic pericarditis 351  
Traumatic splenitis and hepatitis 352  
Impaction of the omasum 352

**DISEASES OF THE ABOMASUM 353**

Clinical examination of the abomasum 353  
Applied anatomy and pathophysiology of the abomasum 353  
Abomasal reflux 354

Left-side displacement of the abomasum 354  
Right-side displacement of the abomasum and abomasal volvulus 362  
Dietary abomasal impaction in cattle 367  
Abomasal impaction in sheep 369  
Abomasal phytobezoars and trichobezoars 370  
Abomasal ulcers of cattle 370  
Abomasal bloat (distension) in lambs and calves 374  
Omental bursitis 374

**DISEASES OF THE INTESTINES OF RUMINANTS 375**

Cecal dilatation and volvulus in cattle 375  
Intestinal obstruction in cattle 376  
Hemorrhagic bowel syndrome in cattle (jejunal hemorrhage syndrome) 380  
Intestinal obstruction in sheep 382  
Terminal ileitis of lambs 382

**Diseases of the forestomach of ruminants**

Forestomach motility of ruminants, especially cattle, is of major concern to the veterinarian. Evaluation of forestomach motility is an integral part of the clinical examination and differentiation of forestomach abnormalities into primary and secondary causes and is essential for diagnosis and accurate therapy. Application of the knowledge of the physiology of normal reticulorumen motility can improve the diagnosis, prognosis and therapy for diseases of the forestomach.<sup>1,2</sup> A brief review of the clinical aspects of the motility of the reticulorumen is presented here.

**ANATOMY AND PHYSIOLOGY**

The ruminant forestomach compartments, consisting of the reticulum, rumen and omasum, is like a fermentation vat. The animal exerts some control over the fermentation process by selecting the feed, adding a buffer-like saliva, and providing continual agitation and mixing with specialized contractions of the forestomach. Reticulorumen motility insures a consistent flow of partially digested material into the abomasum for further digestion.

The forestomach can be divided into primary structures: the **reticulorumen**

and the **omasum**; they are functionally separated by a sphincter: the **reticulo-omasal orifice**. The reticulorumen of an adult cow occupies almost the entire left half of the abdominal cavity and has a capacity of up to 90 kg of digesta. Because of its large size and ease of clinical examination, rumen motility is considered to represent digestive functions in the ruminant.

Both parasympathetic and sympathetic nerves supply the reticulorumen but only the former nerves stimulate motility. Parasympathetic innervation occurs through the vagus nerve, which is predominantly sensory from the forestomach. Sympathetic innervation to the forestomach consists of numerous fibers from the thoracolumbar segment; these fibers join at the celiac plexus to form the splanchnic nerve. The splanchnic nerve can inhibit motility, but normally there is little or no tonic sympathetic drive to the forestomach.

**RETICULORUMEN MOTILITY**

Four different specialized contraction patterns can be identified in the forestomach:

- Primary or mixing cycle
- Secondary or eructation cycle
- Rumination (associated with cud chewing and associated with the primary cycle)
- Esophageal groove closure (associated with sucking of milk).

It is important for the clinician to understand the motility pattern of each cycle. Specific diseases of the forestomach have characteristic alterations in motility, which aid in the diagnosis and prognosis.

**Primary contraction cycle**

The primary cyclic activity results in the mixing and circulation of digesta in an organized manner. The primary contraction in cattle begins with a **biphasic contraction of the reticulum**. The first reticular contraction forces ingesta dorsal and caudad into the rumen, as does the much stronger second reticular contraction. The dorsal ruminal sac then begins to contract as the ventral sac relaxes, thereby causing digesta to move from the dorsal to the ventral sac. Sequential contractions of the caudo-ventral, caudodorsal and ventral ruminal sacs force digesta back into the reticulum and cranial sac. After a brief pause the contraction sequence is repeated. During each reticular contraction fluid and food particles, particularly heavy grain, pass into the reticulo-omasal orifice and into the omasum and abomasum.

Reticulorumen motility results in stratification of ruminal contents, with firmer fibrous material floating on top of a more fluid layer. Solid matter remains in the rumen until the particle size is sufficiently small (1–2 mm in sheep,

2–4 mm in cattle) to pass through the reticulo-omasal orifice. The size of digested plant fragments in ruminant feces can therefore be considered an indirect measurement of forestomach function.

Identification of ruminal contractions requires both auscultation and observation of the left paralumbar fossa. Sound is produced when fibrous material rubs against the rumen during contraction. Only slight sound is produced when the rumen contains small quantities of fibrous material.

External palpation of the rumen is valuable in determining the nature of ruminal contents. The normal rumen feels doughy in the dorsal sac and more fluid ventrally; the difference in consistency is attributable to stratification of ruminal contents. Very liquid ruminal contents that splash and fluctuate on ballottement (fluid-splashing sounds) are suggestive of lactic acidosis, vagal indigestion, ileus or prolonged anorexia.

Rumen hypomotility or hypermotility is usually associated with a change in the type of sounds heard during auscultation, with gurgling, bubbling or distant rustling sounds replacing the normal crescendo-decrescendo crackling sounds. The rumen can be examined and evaluated using a combination of auscultation and simultaneous ballottement or percussion, by palpation through the left flank and by rectal examination. Inspection and laboratory analysis of rumen contents is also possible.

#### Control of primary contractions

The primary contraction cycle of the reticulorumen is a complex and organized contraction initiated, monitored and controlled by the gastric center in the medulla oblongata. These cycles are mediated by the vagus nerve. The reticulorumen is under extrinsic nervous control compared to the remainder of the gastrointestinal tract. It is also affected by hormones and smooth muscle tone.

The gastric center is bilaterally paired and located in the dorsal vagal nucleus in the medulla. The gastric center has no spontaneous rhythm of its own but acts as a processor and integrator of afferent information. Various excitatory and inhibitory inputs are brought together to determine both the rate and strength of contraction.

#### Ruminal atony

**Ruminal atony**, seen in lactic acidosis and endotoxemia, can be attributed to one or more of the following factors:

- Direct depression of the gastric center, usually associated with generalized depression and severe illness (toxemia)

- Absence of excitatory inputs to the gastric center
- Increase in excitatory inhibitory inputs to the gastric center
- Failure of vagal motor pathway (Table 6.1).

#### Hypomotility

**Hypomotility** is a reduction in the frequency or strength of extrinsic contractions, or both, and usually is caused by either a reduction in the excitatory drive to the gastric center or an increase in inhibitory inputs.

#### Properties of contractions

The **frequency** of primary contractions is determined from information accumulated during the quiescent phase of motility. Frequency provides a rough estimate of the overall health of a ruminant. In cows, the frequency of primary contractions averages 60 cycles per hour but decreases to 50 cycles per hour during rumination and even lower when the cow is recumbent. Feeding increases the rate to up to 105 cycles per hour. Because of this variability, the clinician should auscultate the rumen for at least two minutes before determining the frequency of contractions.

The **strength** and **duration** of each contraction are determined by information obtained just before and during the contraction and are therefore more dependent on the nature of the forestomach contents than is frequency of contraction. The strength of contraction is subjectively determined by observing the movement of the left paralumbar fossa and assessing the loudness of any sounds associated with ruminal contraction.

The distinction between frequency and strength is important clinically, particularly in reference to therapy of reticulorumen hypomotility. When feed is withheld from sheep for 4 days, the rate of forestomach contractions remains unchanged but the strength of contractions progressively decreases because of changes in ruminal contents.

#### Extrinsic control of primary contractions

##### Excitatory inputs to the gastric center

Tension and chewing movements are two major excitatory inputs to the gastric center. Low-threshold tension receptors deep in the circular smooth muscle layer detect reticulorumen distension. The greatest density of receptors is found in the medial wall of the reticulum and dorsal ruminal sac. These low-threshold tension receptors send afferent impulses along the dorsal or ventral vagus nerve to the gastric center, where they excite extrinsic reticulorumen contractions. Prolonged anorexia, leading to a smaller reticulorumen volume, decreases this

excitatory input. Feeding increases reticulorumen volume, thus leading to a prolonged increase in forestomach motility.

Buccal receptors, which are stimulated during feeding, are also excitatory to the gastric center. These are mechanoreceptors, and their effect is mediated by the trigeminal nerve. This reflex increases the rate of primary contractions only but is short-lived and wanes with time. The stimulatory response of feeding also has a higher brain center component: the sight of feed can increase the frequency of primary contractions by 50% during a period of 4–5 minutes. Rumination, in comparison with feeding, is accompanied by a lower than normal primary contraction rate.

Other relatively minor excitatory inputs to the gastric center include milking, environmental cold and a decrease in abomasal pH. Milking or udder massage of dairy goats markedly increases the frequency and strength of primary contractions. In a cold environment, the ruminant increases the frequency of forestomach contractions, thereby maximizing the fermentation rate and helping to maintain body temperature.

#### Inhibitory inputs to the gastric center

The four most important inhibitory inputs to the gastric center are fever, pain, moderate to severe rumen distension and increased ruminal volatile fatty acid concentrations.

#### Fever

**Fever** has been associated with decreased rumen motility. Endogenous pyrogens may cause prolonged forestomach hypomotility or atony often seen in cattle with endotoxemia due to bacterial infections. Pyrogens directly affect the gastric center in the hypothalamus, and opioid receptors mediate their action.

#### Endotoxemia

**Endotoxemia** is common in cattle and often associated with fever, anorexia and rumen atony. Inhibition of forestomach motility during endotoxemia is thought to be a combination of two different pathways: a prostaglandin-associated mechanism and a temperature-independent mechanism. The former can be attenuated by administration of nonsteroidal anti-inflammatory drugs (NSAIDs). Therapy for endotoxin-induced hypomotility or atony includes the use of antimicrobials for the underlying cause of the inflammation and NSAIDs for the effects of the endotoxemia.

#### Pain

**Pain** may be associated with rumen hypomotility or atony. Painful stimuli act

Table 6.1 Effects of some common clinical excitatory and inhibitory influences on primary cycle movements of the reticulorumen

Clinical afferent input	Clinical findings and responses to treatment
<b>Excitatory inputs</b>	
<b>Low threshold reticular tension receptors</b>	
Increased reticular tension	Increases frequency, duration and amplitude of primary cycle contractions and mixing promotes fermentation
After feeding	
Mild ruminal tympany	Decreases frequency, duration and amplitude of primary cycle contractions and decreases fermentation
Decreased reticular tension	
Starvation	Cause hypomotility of rumen contractions and may be explanation for atony in some cases of vagus indigestion. Some cases are characterized by erratic hypermotility
Anorexia	
Lesions of medial wall of reticulum	Cause hypomotility of rumen contractions and may be explanation for atony in some cases of vagus indigestion. Some cases are characterized by erratic hypermotility
Chronic induration and fibrosis due to traumatic reticuloperitonitis	
Acid receptors in abomasum	Increase primary cycle movements, which increases flow of ruminal contents into abomasum to maintain optimum volume and to decrease acidity
Increases in abomasal acidity following emptying of organ	
Buccal cavity receptors	Increased reticulorumen activity
Following eating	
<b>Inhibitory inputs</b>	
<b>High-threshold reticular tension receptors</b>	
Peak of reticular contraction	Depression of primary cycle movements, ruminal hypomotility, depression of fermentation because of failure of mixing
Severe ruminal tympany	
Ruminal impaction with forage, hay, straw (not necessarily grain overload)	Abomasal impaction, dilatation and torsion may result in complete ruminal stasis. Left-side displacement of abomasum usually does not cause clinically significant hypomotility
<b>Abomasal tension receptors</b>	
Impaction, distension or displacement of abomasum	Moderate to total inhibition of reticulorumen movements possible with visceral pain. The degree of inhibition from pain elsewhere will vary
<b>Pain</b>	
Visceral pain due to distension of abomasum or intestines. Severe pain from anywhere in body	Inhibition of primary and secondary cycle movements and of eructation, resulting in ruminal tympany
<b>Depressant drugs</b>	
Anesthetics, central nervous system depressants	Inhibition of primary and secondary cycle movement and lack of fermentation. Cud transfer promotes return to normal activity
Prostaglandin E	
<b>Changes in rumen content</b>	
Marked decrease (< 5) or increase (> 8) in pH of ruminal fluid. Engorgement with carbohydrates or protein-rich feeds.	Inhibition of primary and secondary cycle movement and lack of fermentation. Cud transfer promotes return to normal activity
Absence of protozoa in ruminal acidosis and in lead and other chemical poisoning	
<b>Changes in body water, electrolytes and acid-base balance</b>	
Hypocalcemia	Inhibition of primary and secondary cycle movements and of eructation, resulting in ruminal tympany which responds to treatment with calcium
Dehydration and electrolyte losses, acidosis, alkalosis	
<b>Peritonitis</b>	
Traumatic reticuloperitonitis	Inhibition of primary and secondary cycle movements and of eructation, resulting in ruminal tympany. Return of primary movements is good prognostic sign. Lesions must heal without involvement of nerve receptors or adhesions that will interfere with normal motility
<b>Toxemia/fever</b>	
Peracute coliform mastitis	Inhibition of primary and secondary cycle movements, which return to normal with treatment of toxemia
Acute bacterial pneumonia	
<b>Ruminal distension</b>	
Early ruminal tympany	Increased frequency of secondary cycle movements and of eructation
Covering of cardia (fluid or form)	
Ruminal tympany	Cardia does not open; failure of eructation, resulting in ruminal tympany. Clearance of cardia results in eructation
Recumbent animal	

Most of the sensory inputs are transmitted to gastric centers in the dorsal vagal nerve nuclei from which the efferent outputs originate and pass down the vagal motor nerve fibers.

Source: modified from Leek BF. Vet Rec 1969; 84:238.

directly on the gastric center, although modification of reticulorumen motility in response to painful stretching of viscera can be partially attributed to catecholamine release. The sympathetic nervous system response to pain can also stimulate splanchnic motor nerves, thereby directly inhibiting reticulorumen motility.

Because of their stoic nature, the only clinical evidence of pain in ruminants

may be anorexia and depressed forestomach motility. Prostaglandins have been implicated in increasing the sensitivity to pain both locally and centrally, and NSAIDs are indicated for alleviation of pain associated with inflammation. Other analgesics are of limited usefulness in the treatment of pain-induced forestomach hypomotility. Xylazine, an excellent sedative-analgesic for ruminants,

causes a dose-dependent inhibition of reticulum contractions.

#### *Distension of forestomach*

Moderate to severe forestomach distension exerts an inhibitory influence on reticulorumen motility. Epithelial receptors located in the ruminal pillars and papillae of the reticulum and cranial rumen sac respond to mechanical stimulation (stretch)

as well as changes in ruminal volatile fatty acid concentration. These receptors, also known as high-threshold tension receptors, are stimulated continuously during severe rumen distension. The opposing actions of low- and high-threshold tension receptors help to control the fermentation process and maintain an optimum reticuloruminal volume. A good example of their activities is the motility changes evident with some forms of vagus indigestion.

#### *Ruminal volatile fatty acids*

The ruminal volatile fatty acid concentration also influences forestomach motility. Epithelial receptors detect the concentration of nondissolved volatile fatty acids in ruminal fluid, which is normally high enough to produce a tonic inhibitor input to the gastric center. Volatile fatty acids in the reticulorumen exist in both the dissociated and non-dissociated forms, with the degree of ionization being governed by the rumen pH and the pKa of each particular acid. Ruminal atony in animals with lactic acidosis results from elevated levels of nondissociated volatile fatty acids in ruminal fluid, with the decrease in rumen pH changing more of the volatile fatty acids into a nondissociated form. Systemic acidosis does not appear to contribute to ruminal atony, although increased volatile fatty acid concentrations in the abomasum may reduce forestomach motility.

#### *Abomasal disease*

Diseases of the abomasum influence forestomach motility. Abomasal distension may contribute to the decreased forestomach motility often observed with abomasal volvulus, impaction or right-sided dilatation. Abomasal tension receptors detect overfilling and reflexly decrease reticuloruminal movements, thus reducing the rate of flow of ingesta into the abomasum. Ruminal hypomotility is not always observed in left-side displacement of the abomasum even though appetite may be decreased.

#### *Effect of depressant drugs*

General anesthetics and other depressant drugs acting on the central nervous system also inhibit reticulorumen motility by a direct effect on the gastric center.

#### *Acid-base imbalance and blood glucose*

Reticulorumen activity can be inhibited by alterations in blood pH, electrolyte imbalances, deprivation of water and hyperglycemia.

#### *Hormonal control of primary contractions*

Forestomach motility can be influenced by the action of hormones. Both cholecystokinin and gastrin can reduce feed

intake and forestomach motility observed in sheep with certain intestinal nematodes.

#### **Intrinsic control of primary contractions**

The contribution of intrinsic smooth muscle tone to forestomach motility is not well understood. Intrinsic contractions are involved in maintaining normal reticulorumen tone, directly influencing the discharge of low-threshold tension receptors to the gastric center. Calcium is required for smooth muscle contraction and hypocalcemia will usually cause ruminal atony. The administration of calcium borogluconate to cattle, sheep and goats with hypocalcemia will restore rumen motility and eructation commonly occurs after the intravenous administration of the calcium.

#### **Treatment of forestomach hypomotility**

Anorexia and forestomach hypomotility usually exist together. Reduced feed intake reduces the two primary drives for reticulorumen activity: moderate forestomach distension and chewing activity. A wide variety of drugs have been used for many years to induce forestomach motility with the aim of stimulating anorexic cattle with forestomach hypomotility to begin eating. Most if not all of these drugs have been unsuccessful. Ruminatorics such as nux vomica, ginger, gentian and tartar given orally have not been effective. Parasympathomimetics, such as neostigmine or carbamylcholine, should not be used to treat forestomach atony. Neostigmine requires vagal activity to be effective and therefore cannot incite normal primary contractions in atonic animals. Neostigmine may increase the strength of a primary contraction without altering rhythm or coordination. Carbamylcholine causes hypermotility in sheep but the contractions are uncoordinated, spastic and functionless.

Any effective drug must be able to induce forestomach motility in a coordinated sequence so that the ingesta moves through the reticulo-omasal orifice, into the omasum, out of the omasum, and into the abomasum, and out of the abomasum into the small intestine. This means that there must be a coordinated sequence of contractions and relaxations of sphincters. Experimentally, metoclopramide increases the rate of ruminal contractions and therefore might be beneficial in rumen hypomotility or motility disturbances associated with vagal nerve damage.

#### **Secondary cycle contraction and eructation**

Secondary cycles are contractions that involve only the rumen and are associated

with the **eructation of gas**. They occur independently of the primary cycle contractions and usually less frequently, about once every 2 minutes. The contraction rate depends on the gas or fluid pressure in the dorsal sac of the rumen. Secondary cycles can be inhibited by severe distension of the rumen.

Normally, the dorsal sac of the rumen contains a pocket of gas composed of CO<sub>2</sub>, N<sub>2</sub> and CH<sub>4</sub>. Gas is produced at a maximum rate of 1 L per minute in cattle, with the rate depending on the speed of microbial degradation of ingesta. Eructation occurs during both primary and secondary contraction cycles but most gas is removed during the latter. Eructation is capable of removing much larger quantities of gas than is produced at the maximum rates of fermentation and therefore free gas bloat does not occur because of excessive gas production but rather from insufficient gas elimination.

Ruminal contractions are essential for eructation. Tension receptors in the medial wall of the dorsal ruminal sac initiate the reflex by means of the dorsal vagus nerve. Contractions begin in the dorsal and caudodorsal ruminal sacs and spread forward to move the gas cap ventrally to the cardia region. Contraction of the reticuloruminal fold is necessary to stop fluid from moving forward to the reticulum and covering the cardia. Receptors in the cardia region detect the presence of gas; the cardia remains firmly closed if fluid or foam (as in frothy bloat) contacts it. Injury to the dorsal vagal nerve decreases the efficiency of eructation but either the ventral or dorsal vagus nerve alone can initiate enough eructation activity to prevent bloat.

Despite the presence of normal secondary contractions, eructation may not occur in recumbent animals when the cardia is covered with fluid. Bloat is often observed in ruminants in lateral recumbency. Eructation occurs after the animal stands or attains sternal recumbency as fluid moves away from the cardia. Bloat can also result from peritonitis, abscesses or masses that distort the normal forestomach anatomy and preventing active removal of fluid from the cardia region. Esophageal obstructions associated with intraluminal, intramural or extraluminal masses are a common cause of free gas bloat. Passage of a stomach tube usually identifies these abnormalities, and forestomach motility is unimpaired unless the vagal nerve is damaged.

Bloat is often observed in cattle with tetanus. Distension of the rumen is usually not severe and can be accompanied by strong and regular ruminal contractions. Because the ruminant esophagus is composed of striated muscle through-

out its length, tetanus-associated bloat may be due to spasm of the esophageal musculature.

Persistent mild bloat is often observed in ruminants that have rumen atony or hypomotility secondary to systemic disease. Although the fermentation rate is lower than normal in these cases, ruminal contractions are not strong enough to remove all the gas produced. The bloat usually requires no treatment and resolves with return of normal forestomach motility.

Secondary contractions cannot be distinguished from primary contractions by auscultation of the left paralumbar fossa only, unless a synchronous belch of gas is heard. However, primary contractions can be identified by simultaneous palpation of the left paralumbar fossa and auscultation with the stethoscope over the left costochondral junction between the seventh and eighth ribs. Reticular contractions indicating the beginning of a primary contraction can be heard followed by contraction of the dorsal sac and lifting of the paralumbar fossa.

Secondary contractions are relatively autonomous and are not subject to the same central excitatory and/or inhibitory influences as are primary contractions. Agents that inhibit reticulorumen motility by a central action have a lesser effect on eructation than on primary contraction cycles. However, high doses of xylazine can inhibit secondary contractions and the duration of inhibition is dose-dependent.

No drugs are yet available to improve secondary contractions as a means of treating bloat. Severe bloat usually arises from mechanical or diet-related causes, and therapy should be directed specifically to those causes.

### Rumination

Rumination is a complex process and consists of:

- **Regurgitation**
- **Remastication**
- **Insalivation**
- **Deglutition.**

Rumination is initiated by the rumination center close to the gastric center in the medulla oblongata. Rumination allows further physical breakdown of feed with the addition of large quantities of saliva and is an integral part of ruminal activity. The time devoted to rumination is determined by the coarseness of ruminal contents and the nature of the diet. Rumination usually commences 30–90 minutes after feeding and proceeds for 10–60 minutes at a time, resulting in up to 7 hours per day spent on this activity.

The epithelial receptors located in the reticulum, esophageal groove area, reti-

culorumen fold and ruminal pillars detect coarse ingesta and initiate rumination. The receptors can be activated by increases in volatile fatty acid concentration, stretching and mechanical rubbing.

An intact dorsal or ventral vagus nerve is necessary for regurgitation to proceed. Regurgitation is associated with an extra contraction of the reticulum immediately preceding the normal reticular biphasic contraction of the primary cycle. The glottis is closed, and an inspiratory movement lowers the intrathoracic pressure. The cardia then relaxes, and the distal esophagus fills with ingesta. Reverse peristalsis moves the bolus up to the mouth, where it undergoes further mastication.

The usual causes for a reduction or absence of rumination are:

- Reticulorumen hypomotility or atony
- Central nervous system depression
- Excitement, pain or both
- Liquid ruminal contents such as a high-concentrate diet with no coarse fiber
- Mechanical injury to the reticulum (peritonitis).

Other less common causes include chronic emphysema (difficulty in creating a negative thoracic pressure) and extensive damage to the epithelial receptors that incite the reflex, as occurs in rumenitis.

Reticulorumen motility is required for rumination to proceed. The extra reticular contraction is not essential for regurgitation because fixation or removal of the reticulum does not prevent rumination from occurring. Rumination can be easily inhibited by higher brain centers, as disturbance of a ruminating cow often stops the process and is absent when animals are stressed or in pain. Milking commonly elicits rumination in cows and goats.

Pharmacologic stimulation of regurgitation is not attempted.

### Esophageal groove closure

The esophageal groove reflex allows milk in the sucking preruminant to bypass the forestomach, and directs milk from the esophagus along the reticular groove and omasal canal into the abomasum. Milk initiates the reflex by chemical stimulation of receptors in the oral cavity, pharynx and cranial esophagus. Once the reflex is established in neonatal ruminants, sensory stimuli (visual, auditory, olfactory) can cause esophageal groove closure without milk contacting the chemoreceptors. This occurs in calves teased with milk or given water in an identical manner to which the calf previously received milk. The esophageal groove reflex continues to operate during and after the development of a functional rumen, provided the animal continues to receive milk.

Liquid administered to calves with an esophageal feeder (tube) does not cause groove closure. In calves younger than 3 weeks of age, overflow of liquid from the rumen into the abomasum begins when 400 mL of liquid are given. Thus if the goal of oral feeding is to insure that fluid administration by esophageal tube rapidly enters the abomasum, more than 400 mL of liquid must be given.

Closure of the esophageal groove in cattle younger than 2 years of age can be induced by solutions of sodium chloride, sodium bicarbonate or sugar. From 100–250 mL of 10% solution of sodium bicarbonate induces esophageal groove closure in 93% of cattle immediately and it lasts for 1–2 minutes. Any other oral solution administered during this time is directed into the abomasum to avoid dilution in the rumen. Closure of the groove may be used to treat abomasal ulcers if magnesium hydroxide or kaolin-pectin solutions are given orally immediately after a sodium bicarbonate solution.

### RUMINANT GASTROINTESTINAL DYSFUNCTION

The clinical findings which suggest primary ruminant gastrointestinal dysfunction include the following:

- Inappetence to anorexia, failure to ruminate
- Dropping regurgitated cuds occurs occasionally and is associated with straw impaction of the rumen, vagus indigestion, esophageal dilatation and rumenitis
- Visible distension of the abdomen, which may be asymmetrical or symmetrical, dorsal or ventral or both. Distension of the left dorsal abdomen because of ruminal tympany is most common
- The abdomen may appear gaunt or empty
- The rumen may feel abnormal on palpation through the left paralumbar fossa. It may feel more doughy than normal, distended with gas, fluid filled, or it may not be palpable
- Ruminal atony or hypermotility observed visually and detectable on auscultation and palpation
- Abdominal pain, usually subacute and characterized by humping of the back, reluctance to move or acute colicky signs of kicking at the abdomen and stretching. Pain may also be detectable on deep palpation of the abdomen if there is peritonitis, either local or diffuse
- Abnormal feces. The feces may be absent, reduced in amount or voluminous, and the composition may be abnormal. In carbohydrate



engorgement the feces are usually increased in amount and are sweet-sour smelling. In most other diseases of the ruminant stomachs the feces are reduced in amount (scant), are pasty and foul-smelling and appear overdigested because of the increased transit time in the alimentary tract. A complete absence of feces for 24–48 hours is not uncommon with diseases of the ruminant stomach and may be confused with an intestinal obstruction or the earliest stages of hypocalcemia in a recently calved mature cow

- The temperature, heart rate and respirations are variable and may be within normal ranges. With an inflammatory lesion such as acute peritonitis, a fever is usually present. In acute diffuse peritonitis with toxemia, the temperature may be normal or subnormal; in subacute and chronic peritonitis the temperature is

usually normal. In most other diseases of the ruminant stomachs except carbohydrate engorgement and abomasal torsion, where dehydration, acidosis and gastric infarction occur, vital signs may be within the normal range.

The differential diagnosis of the diseases associated with gastrointestinal dysfunction in cattle is summarized in Table 6.2.

In contrast with most other parts of the ruminant alimentary tract, and with the stomach of nonruminants, specific lesions of the mucosa of the forestomachs are uncommon. Penetration of the reticular wall by metallic foreign bodies is a common disease and is dealt with below under the heading of traumatic reticuloperitonitis, but it is the peritonitis that causes interference with ruminal motility. Rarely, there are actinomycotic or neoplastic lesions at the fundus of the reticulum that interfere with the proper

functioning of the esophageal groove and lead to a syndrome of vagus indigestion described later. Rumenitis does occur commonly but only as a secondary change in acute carbohydrate engorgement and it is this that has such damaging effects on gut motility and fluid and electrolyte status and eventually kills most cows. The rumenitis may have a long-term effect on ruminal motility but its main significance is as a portal for infection leading to the development of hepatic abscesses. Ingested animal hairs, plant spicules and fibers are also credited with causing rumenitis but no clinical signs have been associated with the lesions. Because of the high prevalence of rumenitis lesions in cattle on heavy concentrated feed, especially when the feed is awned barley, the awns have been incriminated as traumatic agents. In acute arsenic poisoning there is an early post-mortem dehiscence of the ruminal mucosa but no apparent lesions during life.

Table 6.2 Differential diagnosis of causes of gastrointestinal dysfunction of cattle

Disease	Epidemiology and history	Clinical findings	Clinical pathology	Response to treatment
Simple indigestion	Dietary indiscretion, too much of a palatable, or indigestible, or change of, or damaged, or frozen food. Can be outbreak. Consumption of excessive quantities of finely chopped straw	Simple gastrointestinal atony. Voluminous feces during recovery. Gross distension of the rumen and abdomen in straw impaction	All values normal. Slight changes in ruminal acidity, should be self-buffered	Simple indigestion. Excellent just with time. Usually a mild purgative. Rumenotomy necessary in case of straw impaction
Carbohydrate engorgement	Access to large amount of readily fermentable carbohydrate when not accustomed. Enzootic in high-grain rations in feedlots	Severe gastrointestinal atony with complete cessation of ruminal activity. Fluid splashing sounds in rumen. Severe dehydration, circulatory failure. Apparent blindness, then recumbency and too weak to rise. Soft odoriferous feces	Hemoconcentration with severe acidosis, pH of rumen juice < 5, serum phosphorus levels up to 3–5 mmol/L, serum calcium levels depressed. No living protozoa in rumen	Intensive intravenous fluid and electrolyte therapy necessary for survival. Rumenotomy or rumen lavage may be necessary. Alkalinizing agents
Ruminal tympany	Frothy bloat on lush legume pasture or low-roughage feedlot ration, especially lucerne hay. Free gas bloat secondary, occasionally primary on preserved feed	Gross distension of abdomen, especially high up on left. Sudden onset. Severe pain and respiratory distress. Rumen hypermotility initially. Liquid feces. Resonance on percussion over rumen	Nil	Excellent if in time; stomach tube for free gas. Froth-dispersing agent in frothy bloat. Severe cases may require trocarization or emergency rumenotomy
Acute traumatic reticuloperitonitis	Exposure to pieces of metal. Sporadic. Usually adult cattle	Sudden-onset reticulorumen atony, mild fever. Pain on movement and deep palpation of ventral abdomen caudal to xiphoid. Reduced amount of feces. Lasts 3 days, then improvement begins	Neutrophilia and shift to left	Good response to antimicrobials for 3 days, magnet, immobilize in stall. If no recovery after 3 days consider rumenotomy
Chronic traumatic reticuloperitonitis	Previous history of acute local peritonitis	Inappetence to anorexia; loss of weight; temperature, heart rate and respirations normal; rumen small and atonic, chronic moderate bloat common, feces scant, grunt may be detectable on deep palpation over xiphoid, reticular adhesions on laparotomy	Hemogram depends on stage and extent of inflammation	Antimicrobials for several days. Consider rumenotomy. Small percentage will respond

Table 6.2 (Cont'd) Differential diagnosis of causes of gastrointestinal dysfunction of cattle

Disease	Epidemiology and history	Clinical findings	Clinical pathology	Response to treatment
Vagus indigestion	May or may not have history of acute local peritonitis. Inappetence and progressive distension of abdomen during late pregnancy and no response to treatment with laxatives	Progressive distension of abdomen, scant soft sticky feces containing undigested feed, anorexia, rumen distended with well-macerated and frothy contents, persistent moderate bloat, hypermotile initially and atonic later, temperature normal, heart rate variable, large L-shaped rumen rectally, abomasal impaction in some, marked loss of weight, eventual recumbency, dehydration and weakness	Varying degree of dehydration, alkalosis, hypochloremia and hypokalemia; increase in rumen chloride	Inadequate response to treatment medically or surgically. Mild cases near term may respond spontaneously following parturition
Hemorrhagic jejunitis	Sporadic cases, sometimes several in one herd over few months. History of sudden death or decreased milk production, anorexia, dark tarry feces, abdominal distension. High-producing lactating dairy cattle, and beef cows. <i>Clostridium</i> sp. may be factor	Anorexia, abdominal discomfort, depression, abdominal distension, ping or fluid splashing sounds on ballottement over right abdomen, melena and distended loops of intestines on rectal examination. Black tarry feces	Dehydration, hypochromia, hypokalemia	Neither surgical nor medical treatment has been successful and the prognosis of affected cows is very poor. Intensive fluid and electrolyte therapy and surgery to remove the intestinal clot are recommended
Rumen collapse syndrome	Diseases causing complete anorexia, fever, toxemia for several days	Rectangular-shaped 'pung' (low-pitched tympanitic sound) in left paralumbar fossa; rumen pack not easily palpable through abdominal wall; on rectal examination can feel collapsed dorsal sac of rumen	Nil	Treat primary disease causing anorexia and ruminal stasis
Early hypocalcemia	Usually within 48 h following parturition in mature dairy cow	Anorexia, rumen hypotonic or atonic, scant or absence of feces for 12–24 h, temperature normal, heart rate increased and possibly arrhythmia, still milking and may appear normal in all other aspects	Total serum calcium < 1.5 mmol/L	Good response to calcium administered intravenously or subcutaneously. May require several hours to return to normal
Abomasal impaction (dietary)	Excessive intake of poor-quality roughage during cold weather. Outbreaks. Cattle eating crops contaminated with sand or small stones	Anorexia, moderate abdominal distension, weight loss, scant feces, weak, recumbent. Abomasum palpable through abdominal wall or rectally	Alkalosis, hypochloremia, hypokalemia and dehydration	High case fatality rate. Fluids, laxatives. Slaughter for salvage may be indicated
Left-side displacement of abomasum (LDA)	High-level grain diets, immediately postpartum, dairy cows, inactivity	Acetonemia in cow within days after parturition, inappetence, feces soft and amount variable (usually reduced). Ketonuria. Rumen sounds present but faint. Ping on percussion and auscultation of left upper abdomen between 9th and 12th ribs and paralumbar fossa	Ketonuria	Good response following surgical correction
Right-side displacement of abomasum (RDA)	Usually 2–4 weeks postpartum	Anorexia, scant feces, reduced milk production, moderate dehydration, rumen sluggish, fluid-filled viscus under right costal arch, ping over large area; tense viscus palpable per rectum in right lower quadrant, progressive and commonly results in torsion	Alkalosis, hypochloremia, hypokalemia	Some recover spontaneously with medical therapy. Give calcium borogluconate intravenously and hay diet. Surgery may be required. Prognosis good if treated early. Fluid therapy

(cont'd)

Table 6.2 (Cont'd) Differential diagnosis of causes of gastrointestinal dysfunction of cattle

Disease	Epidemiology and history	Clinical findings	Clinical pathology	Response to treatment
Torsion of abomasum	Sequel to RDA	History of RDA followed by sudden onset of acute abdominal pain, distension of right abdomen, loud 'ping'. Distended tense abomasum palpable per rectum in right lower quadrant, marked circulatory failure, weakness, bloodstained feces, death in 48–60 h if not treated surgically	Dehydration alkalosis, hypochloremia	Laparotomy, abomasotomy and drainage. Survival rate about 75% if treated early. Fluid therapy required
Primary acetonemia (wasting form)	Insufficient intake of energy in early lactation	Dullness, anorexia, reduced feces, lose body condition, milk yield down. Rumen activity depressed	Ketonuria and hypoglycemia	Dextrose intravenously and propylene glycol orally, or intramuscular corticosteroids. Usually excellent response
Acute intestinal obstruction	May be heightened activity, e.g. during sexual activity. Often no particular history	Sudden onset, short period acute abdominal pain. Kicking at belly, rolling. Complete anorexia, failure to drink and alimentary tract stasis. Progressive dehydration. Distended loops of intestine may be palpable. Gray to red foul-smelling rectal contents	Progressive dehydration and hemoconcentration over 3–4 days	Surgery is necessary
Idiopathic paralytic ileus	Few days postpartum, may be change in diet	Anorexia, complete absence of feces for 24–48 h; may detect ping over right flank	Nil	Usually recover spontaneously
Obstruction of small intestine by phytobezoar	Single animal usually. Area prevalence may be high some years. Depends on frequency of fibrous plants, e.g. <i>Romulea</i> spp.	Sudden onset acute abdominal pain. Attack brief, often missed. Then anorexia, ruminal stasis, heart rate increases to 120/min over 3–4 days. Abdomen distends moderately, splashing sounds and tympany right flank. Rectal examination – distended loops of intestine if obstruction in distal small intestine, may feel 5–6 cm diameter fiber ball, feces pasty, gray-yellow, foul-smelling, small amount only. Untreated and fatal cases have course of 4–8 days	Hypochloremia, hypokalemia, severity depends on location	Depends on nature of phytobezoar: dense fiber balls require surgery, crumbly masses may pass after mineral oil for several days
Abomasal ulcer	Soon after (2 weeks) parturition. High producers on heavy grain feed. In intensive feeding systems disease is becoming enzootic in some areas	Gastrointestinal atony with melena and pallor. May be sufficient blood loss to cause death; prompt recovery after 4 days more likely. Perforation and rupture of ulcer leads to death in a few hours	Melena or occult blood in feces. On perforation with local peritonitis may be leukocytosis and left shift Anemia due to hemorrhage	Alkalinizing agents orally. Surgery if medical treatment unsuccessful
Pregnancy toxemia of beef cattle	Fat beef cattle deprived of feed in last month of pregnancy. Commonly have twin pregnancy	Complete anorexia, rumen stasis, scant feces, ketonuria, weak and commonly recumbent	Ketonia, increase in nonesterified fatty acids, ketonuria, increase in liver enzymes	Poor response to therapy. Fluids, anabolic steroids, insulin
Fatty liver (fat cow) syndrome	Fat dairy cow, few days following parturition or may have had LDA for several days	Complete anorexia, rumen stasis, almost no milk yield, ketonuria initially but may have more later	Ketonemia, increase in liver enzymes	Poor response to therapy. Glucose, insulin, anabolic steroids
Cecal dilatation and/or torsion	Single case. Dairy cow, early lactation, inappetence, feces may be scant. Severe cases have history of mild abdominal pain	Systemically normal. Rumen only slightly hypotonic, high-pitched ping on percussion over right upper flank, which may be distended. Rectally enlarged cylindrical movable cecum with blind end can be felt	Nothing diagnostic, but has hemoconcentration, compensated hypochloremia, hypokalemia and alkalosis	Good response to surgical correction. Unfavorable prognosis with severe torsion and gangrene of apex

(cont'd)

Table 6.2 (Cont'd) Differential diagnosis of causes of gastrointestinal dysfunction of cattle

Disease	Epidemiology and history	Clinical findings	Clinical pathology	Response to treatment
Acute diffuse peritonitis	Following acute traumatic reticuloperitonitis, uterine rupture at parturition, rupture of rectum, postsurgical	Acute toxemia, fever followed by hypothermia, weakness, tachycardia, recumbency, groaning, moderate distension scant feces, palpate fibrinous adhesions rectally	Leukopenia, neutropenia, degenerative left shift. Hemoconcentration. Paracentesis positive	Usually die
Chronic ruminal tympany in feeder calves	Beef calves 6–8 months of age following weaning; feeder cattle after arrival in feedlot	Chronic free-gas bloat, relapses after treatment, no other clinical findings	Nil	Good response to surgical ruminal fistula or insertion of corkscrew-type trocar and cannula left in place for few weeks
Omasal impaction	Uncommon. Single cases in pregnant cows with vagus indigestion. Feedlot cattle with abomasal impaction dietary in origin	Inappetence to anorexia. Scant feces, abdominal distension. Rectally, large distended round hard viscus below kidney can be felt	Nil	Slaughter for salvage. Treat for abomasal impaction

Other lesions of the forestomachs are parakeratosis, discussed below, and villous atrophy, sometimes encountered in weanling ruminants on special diets low in fiber, even succulent young pasture, but these are not known to influence stomach function or motility. The factors that principally affect ruminal motility are those chemical and physical characteristics of its contents that are dealt with in simple indigestion and acute carbohydrate engorgement. Lesions in, and malfunctioning of, the abomasum are much more akin to abnormalities of the stomach in monogastric animals.

Some of the physiological factors that affect reticulorumen function and the clinical factors which cause reticulorumen dysfunction are summarized in Table 6.1. When reticulorumen hypomotility is present the problem is to decide if the cause is directly associated with the forestomach and abomasum, or both, or other parts of the alimentary tract, or if the cause is due to an abnormality of another system. Differentiation requires a careful clinical examination, including simple laboratory evaluation of the rumen contents.

The factors that affect the motility of the rumen are presented in the section on simple indigestion, as are the principles of treatment in cases of ruminal atony.

## REVIEW LITERATURE

Constable PD, Hoffsis GF, Rings DM. The reticulorumen: normal and abnormal motor function. Part I. Primary contraction cycle. *Compend Contin Educ Pract Vet* 1990; 12:1008–1014.

Constable PD, Hoffsis GF, Rings DM. The reticulorumen: normal and abnormal motor function. Part II. Secondary contraction cycles, rumination, and esophageal groove closure. *Compend Contin Educ Pract Vet* 1990; 12:1169–1174.

## REFERENCES

1. Constable PD et al. *Compend Contin Educ Pract Vet* 1990; 12:1008.
2. Constable PD et al. *Compend Contin Educ Pract Vet* 1990; 12:1169.

## Special examination of the alimentary tract and abdomen of cattle

When gastrointestinal dysfunction is suspected, a complete special clinical and laboratory examination may be necessary to determine the location and nature of the lesion. A systematic method of examination is presented here.

### HISTORY

A complete history, with as much detail as is available, should be obtained. The stage of the pregnancy–lactation cycle, days since parturition, the nature of the diet, the speed of onset and the duration of illness may suggest diagnostic possibilities. An accurate description of the appetite will suggest whether the disease is acute or chronic. The previous treatments used and the response obtained should be determined. Any evidence of abdominal pain and its characteristics should be determined. The nature and volume of the feces may suggest enteritis or alimentary tract stasis.

### SYSTEMIC STATE, HABITUS AND APPETITE

The vital signs indicate the severity of the disease and suggest whether it is acute, subacute or chronic. In acute intestinal obstruction, abomasal torsion, acute diffuse peritonitis and acute carbohydrate engorgement, the heart rate may be 100–120/min and dehydration is usually obvious. **Pallor of the mucous membranes** is an indicator of alimentary tract hemorrhage, especially if there is concurrent **melen**a. If cattle with any of the above diseases are recumbent and unable to stand, the prognosis is usually unfavorable. A marked increase in the rate and depth of respirations associated

with alimentary tract disease usually indicates the presence of fluid or electrolyte disturbances and possible subacute pain. **Grunting or moaning** suggests abdominal pain associated with distension of a viscus or acute diffuse peritonitis.

The **appetite** and the **presence or absence of rumination** are very reliable indicators of the state of the alimentary tract, including the liver. Complete anorexia persisting for more than 3–5 days is unfavorable. The return of appetite and rumination with chewing of the cud following medical or surgical treatment for alimentary tract disease is a favorable prognostic sign. Persistent inappetence suggests a chronic lesion, usually with an unfavorable prognosis.

### ORAL CAVITY AND ESOPHAGUS

The oral cavity is easily examined by inspection and manual palpation with the aid of a suitable mouth speculum. The patency of the esophagus is determined by passage of a stomach tube into the rumen through the oral cavity, with the aid of a cylindrical metal speculum, or through the nasal cavity.

### INSPECTION OF THE ABDOMEN

The **contour** or **silhouette of the abdomen** should be examined from the rear, and each lateral region viewed from an oblique angle. Examination of the contour can assist in determining the cause of abdominal distension. **Abdominal distension** may be **unilateral, bilaterally symmetrical** or **asymmetrical** or more prominent in the dorsal or ventral half. Recognition of the anatomical region of maximum distension suggests diagnostic possibilities, which are set out in Figure 6.1. The differential diagnosis of abdominal distension of cattle is summarized in Table 6.3.

## SPECIAL EXAMINATION OF THE ALIMENTARY TRACT AND ABDOMEN OF CATTLE

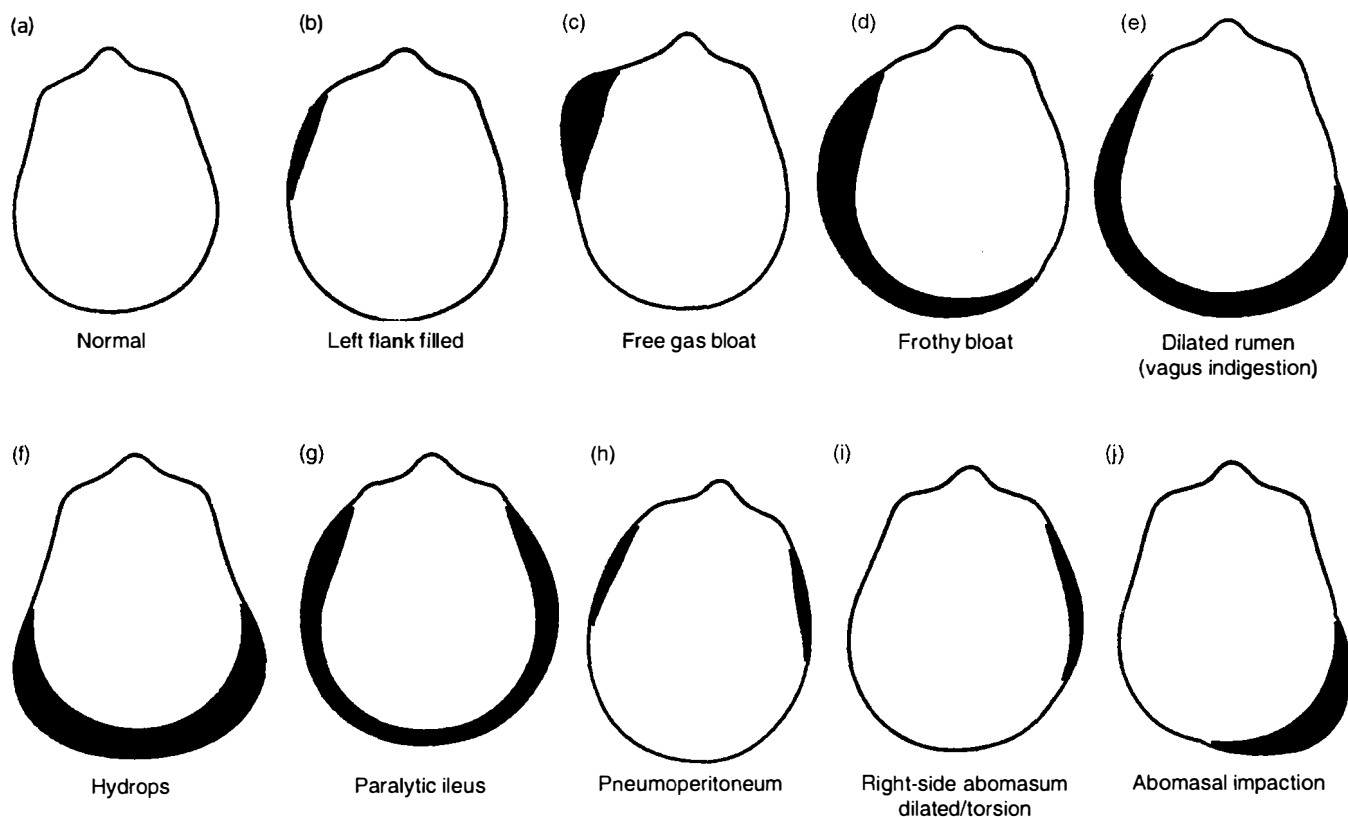

Fig. 6.1 Silhouettes of the contour of the abdomen of cattle, viewed from the rear, with different diseases of the abdominal viscera. (After Stober M, Dirksen G. *Bovine Pract* 1977; 12:35–38.)

Table 6.3 Differential diagnosis of abdominal distension in cattle

Cause	Major clinical findings and methods of diagnosis
<b>Distension of rumen</b>	
Acute ruminal tympany	Marked distension of left abdomen, less of right. Very tense distended left paralumbar fossa, dull resonance on percussion. Pass stomach tube and attempt to relieve gas or froth
Vagus indigestion	Marked distension of left abdomen, less of right 'apple-shaped' abdomen. Fluctuating rumen on palpation. Excessive rumen activity or complete atony. Large L-shaped rumen on rectal examination. Pass large-bore stomach tube to remove contents to aid in diagnosis
Grain overload	Moderate distension of left flank, less of right. Rumen contents are doughy or fluctuate. Fluid-splashing sounds may be audible on ballottement. Rumen static and systemic acidosis. Rumen pH below 5
Simple indigestion	Moderate distension of left flank; rumen pack easily palpable and doughy. Contractions may be present or absent depending on severity. Systemically normal. May be dropping cuds
<b>Distension of abomasum</b>	
Right displacement of abomasum and torsion (volvulus)	Right flank and paralumbar fossa normal to severely distended. Ping. Rectal palpation of fluctuating or tense viscus in right lower quadrant
Abomasal impaction	Right lower flank normal to moderately distended. Doughy viscus palpable caudal to costal arch. Rectal palpation feel doughy viscus in right lower quadrant
Left displacement of abomasum	Abdomen usually gaunt. Occasionally distended left paralumbar fossa due to displaced abomasum. Ping on percussion over upper aspects of ribs 9–12
Abomasal trichobezoars	Older calves (2–4 months). Right lower flank distended. Fluid-splashing sounds. Painful grunt on deep palpation. Confirm by laparotomy and abomasotomy
<b>Distension of intestines</b>	
Enteritis	Slight to moderate distension of right abdomen. Fluid-rushing and splashing sounds on auscultation and ballottement. Diarrhea and dehydration
Intestinal obstruction	Slight to moderate distension of right abdomen. Fluid tinkling, percolating and splashing sounds on auscultation and ballottement. May palpate distended loops of intestine or intussusception rectally. Scant dark feces. Paracentesis abdominis
Paralytic ileus	Slight to moderate distension of right abdomen. Tinkling sounds on auscultation. Tympanitic ping on percussion. Loops of distended intestine palpable per rectum. Scant feces but recover if no physical obstruction
Cecal dilatation and torsion	Right flank may be normal or moderately distended. Ping present in right paralumbar fossa. Palpate movable blind end cecum on rectal examination. Confirm by laparotomy
<b>Enlargement of uterus</b>	
Physiological	Gross distension of both flanks, especially right. Normal pregnancy with more than one fetus. May palpate rectally

Table 6.3 (Cont'd) Differential diagnosis of abdominal distension in cattle

Cause	Major clinical findings and methods of diagnosis
<b>Pathological</b>	
Hydrops amnion	Gradual enlargement of lower half of abdomen in late gestation. Flaccid uterus, fetus and placentomes are easily palpable per rectum
Hydrops allantosis	Gradual distension of lower half of abdomen in late gestation. Palpable uterus rectally, cannot palpate placentomes or fetus
<b>Fetal emphysema</b>	History of dystocia or recent birth of one calf, twin in uterus and emphysematous. Diagnosis obvious on vaginal and rectal examination
<b>Fluid accumulation in peritoneal cavity</b>	
<b>Ascites</b>	
Congestive heart failure, ruptured bladder	Bilateral distension of lower abdomen. Positive fluid waves. Paracentesis abdominis. May feel enlarged liver behind right costal arch
<b>Pneumoperitoneum</b>	
Perforated abomasal ulcer, postsurgical laparotomy	Not common. Bilateral distension of dorsal half of abdomen. Ping both sides

## DISTENSION OF THE ABDOMEN

The cause of distension of the abdomen of cattle is determined by a combination of the following examinations:

- Inspection of the contour or silhouette of the abdomen to determine the region of maximum distension
- If necessary, relief of rumen contents with a stomach tube to determine if the distension is due to an enlarged rumen. The ruminal contents can also be examined grossly at the same time
- Percussion or ballottement and simultaneous auscultation to detect fluid-splashing sounds indicating the presence and location of gas- and fluid-filled viscera
- Rectal examination to feel any obvious enlargements or abnormalities
- Abdominocentesis to determine the nature and amount of peritoneal fluid, which may indicate the presence of ischemic necrosis of intestines or peritonitis
- Trocarization of severely gas-filled distended regions, such as an abomasal volvulus in a calf.

## LAVAGE OF DISTENDED RUMEN

In adult cattle presented with severe abdominal distension due to gross distension of the rumen it is difficult, if not impossible, to assess the status of the abdomen. To determine if the rumen is distended and/or to relieve the pressure, a large-bore stomach tube should be passed into the rumen. In vagus indigestion, the rumen may be grossly distended with fluid contents that will gush out through a large-bore tube. In some cases 100–150 L of rumen contents may be released. If no contents are released the contents may be frothy or mushy and the rumen end of the tube will plug almost instantly. Rumen lavage may then be attempted using a water hose to deliver 20–40 L of water at a time, followed by

back drainage by gravity flow. After the rumen is partially emptied it is usually possible to more accurately assess the rumen and the abdomen.

## LEFT SIDE OF ABDOMEN AND RUMEN

### Inspection and palpation

The **primary and secondary cycle contractions** of the reticulorumen are identified by simultaneous auscultation, palpation and observation of the left paralumbar fossa and the left lateral abdominal region. During contractions of the rumen there is an alternate rising and sinking of the left paralumbar fossa in conjunction with **abdominal surface ripples**. The ripples reflect reticulorumen contractions and occur during both the **primary** (or mixing) cycle contraction and the **secondary** (or **eructation**) cycle contractions.<sup>1</sup> As the left paralumbar fossa rises during the first part of the primary cycle contraction there are two horizontal ripples that move from the lower left abdominal region up to the paralumbar fossa. When the paralumbar fossa sinks, during the second part of the primary cycle, the ripple moves ventrally and fades out at the lower part of the left abdominal region. Similar ripples follow up and down after the rising and sinking of the paralumbar fossa associated with the secondary cycle movements.

In **vagus indigestion**, there may be three to five vigorous incomplete contractions of the reticulorumen per minute. These contractions may not be audible because the rumen contents are porridge-like and do not cause the normal crackling and rustling sounds of the rumen containing coarse fibrous ingesta. **However, the contractions are visible and palpable as waves of undulations of the left flank. If reticulorumen motility is assessed only on the basis of inspection and palpation, the results will be misleading.**

### Nature of rumen contents

The nature of the rumen contents can be assessed by palpation of the rumen through the left paralumbar fossa. In the roughage-fed animal, the rumen contents are doughy and pit on pressure. In cattle that have consumed large quantities of unchopped cereal grain straw, the rumen is large and the contents feel very firm but not hard; they always pit on pressure. In the dehydrated animal the contents may feel almost firm. In the grain-fed animal the contents may be soft and porridge-like. When the rumen contains excessive quantities of fluid, the left flank fluctuates on deep palpation. In the atonic rumen distended with excess gas the left flank will be tense, resilient and tympanitic on percussion.

In mature cattle that have been anorexic for several days, the rumen may be smaller than normal and the dorsal sac will be collapsed (**rumen collapse**). There will be a '**ping**' (low-pitched ping) in the left upper abdomen extending dorsally to the transverse processes of the lumbar vertebrae, lack of abdominal distension, absence of fluid upon succession of the area of the ping, and on rectal palpation the dorsal sac of the rumen will feel collapsed.<sup>2</sup>

### Auscultation of the rumen and left flank

In the normal animal on a roughage diet there are two independent contraction sequences of the reticulorumen. The **primary cycle** recurs approximately every minute and consists of a **diphasic contraction of the reticulum** followed by a **monophasic contraction of the dorsal ruminal sac** and then by a **monophasic contraction of the ventral ruminal sac**. These movements are concerned primarily with 'mixing' the rumen contents and with assisting the passage of rumen contents into the omasum.

The **secondary cycle** movements occur at intervals of about 2 minutes and

are confined to the rumen and consist of a **contraction of the dorsal sac** followed by a **contraction of the ventral sac**. The former causes the fluid contents of the dorsal sac to be forced ventrally and the gas layer to be forced cranially to the region of the cardia where eructation takes place. Contractions of the dorsal and ventral sacs cause undulations of the left paralumbar fossa and lower flanks that are readily visible and palpable.

The clinical recognition of the presence or absence of either the primary cycle or secondary cycle contractions or both may aid in determining the cause and severity of the disease and the prognosis. These are outlined in Table 6.1.

#### Auscultation of rumen

To auscultate the rumen, the stethoscope is placed in the middle of the left paralumbar fossa. After two complete contractions have occurred, the stethoscope is moved cranially in the fossa and cranial to the fossa over the dorsal third of the 10th–13th ribs to determine if rumen contractions are audible in the region, which commonly becomes occupied with a left-side displacement of the abomasum. In the normal animal, ruminal contractions are audible in this region.

The **type, strength and frequency of rumen movements should be noted**. The rumen sounds of the normal animal consuming roughage are rasping, rustling, exploding and booming-crackling sounds. When the rumen contains less coarse roughage or primarily grain, the sounds may be much less distinct but still possess a crackling characteristic.

**Fluid-tinkling or fluid-splashing sounds.** The presence of fluid-tinkling or fluid-splashing sounds over the left paralumbar fossa, usually along with an atonic rumen, suggests the presence of excessive quantity of liquid contents in the rumen, and that the coarse ingesta is not floating on the fluid layer of the rumen contents as in the normal animal. Fluid-splashing sounds suggest diseases such as grain overload, or an atonic rumen associated with prolonged anorexia (chronic diffuse peritonitis, abomasal or omasal impaction). Fluid-splashing and -tinkling sounds can also be elicited by ballottement and simultaneous auscultation of the left lower flank in left-side displacement of the abomasum, because of its liquid contents. To assist in the differential diagnosis, the outline of the rumen can be auscultated and percussed to observe a much wider area of metallic sound than is normally expected in left-side displacement of the abomasum.

In **vagus indigestion** with an enlarged hypermotile rumen, the contractions of the rumen occur more frequently than

normal, at 3–6/min, and are easily visible as prominent abdominal ripples over the left flank. But characteristically, the **ruminal sounds are usually not audible** or barely so because the rumen contents are homogeneous and porridge-like as a result of prolonged maceration in the rumen. The absence of coarse fiber in the ingesta and the lack of coordinated reticulorumen primary and secondary contractions minimizes the intensity of the ruminal sounds. The lack of effective secondary cycle contractions and eructation results in frothy bloat. Complete atony and gross distension of the rumen is characteristic of advanced vagus indigestion.

**Percussion and simultaneous auscultation** of the left paralumbar fossa over an area extending from the mid-point of the ninth rib to the 13th rib is used to detect the presence of a 'ping' or high-pitched metallic tympanic sound associated with left-side displacement of the abomasum. Percussion is performed with a flick of the flexed finger or most reliably with a percussion hammer. The **causes of 'pings' on percussion of the left abdomen in mature cattle** include **left-side displacement of the abomasum, atonic rumen** and, rarely, **pneumoperitoneum**. The tympanic sound associated with an atonic rumen is lower-pitched than that associated with a left-side displacement of the abomasum and may be called a 'pung'.

For special investigations of reticulo-rumen motility radiotelemetry capsules can be placed in the rumen.<sup>3</sup>

#### RIGHT SIDE OF ABDOMEN

The contour of the right side of the abdomen should be examined by **inspection** for evidence of distension, which may be due to a **viscus filled with fluid, gas or ingesta, ascites** or a **gravid uterus**. In severe distension of the rumen, the ventral sac may also distend the lower half of the right flank.

A combination of deep palpation, ballottement and simultaneous percussion and auscultation, and succussion (slightly rocking the animal from side to side) is used to detect the presence of viscera that are distended with gas and/or fluid, or ingesta.

The causes of 'pings' audible on auscultation and percussion over the right abdomen include:

- Right-sided dilatation and volvulus of the abomasum
- Cecal dilatation and torsion
- Torsion of the coiled colon
- Gas-filled descending colon and rectum in a cow with persistent tenesmus
- Intestinal tympany of unknown etiology

- Torsion of the root of the mesentery in young calves
- Intussusception causing intestinal tympany
- Pneumoperitoneum
- Postpartum intestinal tympany, which occurs in the postparturient cow (for the first few days following parturition).

The causes of **fluid-splashing sounds on ballottement and auscultation of the right flank** include:

- **Fluid-filled intestines in acute intestinal obstruction and enteritis**
- **Fluid-filled abomasum in right-sided dilatation.**

**Palpation of a firm viscus in the right flank** caudal or ventral to the right costal arch may be due to:

- **Omasal impaction**
- **Abomasal impaction**
- **Enlarged ventral sac of the rumen, which extends over to the right abdominal wall**
- **Enlargement of the liver.** The liver must be grossly enlarged before it is palpable caudal to the right costal arch.

A **rectal examination** is necessary to identify the distended viscus associated with these abnormal sounds, and often a laparotomy is required.

#### EXAMINATION OF RUMEN FLUID

Examination of the rumen fluid is often essential to establish an accurate diagnosis of diseases of the forestomach. Rumen fluid can be obtained with a stomach tube passed into the rumen, the fluid being withdrawn with the vacuum of a stomach pump. The major difficulty is avoiding contamination of the sample with saliva, which can be avoided if a free flow of fluid is obtained. Specialized stomach tubes are available that are weighted and can be directed into the ventral sac to collect up to 500 mL of fluid.<sup>4</sup> Rumen fluid samples can also be obtained by percutaneous aspiration of the ventral sac of the rumen on the lower left ventrolateral abdominal quadrant, horizontal with the patella and 20 cm caudal to the last rib. The site is prepared, xylazine sedation given and a 12–15 cm 16-gauge needle is thrust firmly and quickly perpendicular to the skin into the rumen. Rumen fluid is withdrawn with a syringe and pH is measured immediately with a portable pH meter or wide-range pH paper (pH values of 2–12).

#### ANALYSIS OF RUMEN FLUID

The **color**, depending on the feed to a limited extent, will be a green, olive green or brown green. At pasture, the color is

very green; with root crops the color tends to be gray; and with silage or straw the color is mostly yellow-brown. The color of the rumen contents is milky-gray in grain overload and greenish-black in cases where rumen stasis is of long duration and where putrefaction is occurring within the rumen.

The **consistency** of the rumen fluid is normally slightly viscid, and watery rumen contents are indicative of inactive bacteria and protozoa. **Excess froth** is associated with frothy bloat as in primary ruminal tympany or vagus indigestion. The odor is normally aromatic and, although somewhat pungent, not objectionable to the nose. A **moldy, rotting odor** usually indicates protein putrefaction, and an intensely sour odor indicates an excess of lactic acid formation, due to grain or carbohydrate engorgement.

The **pH of the rumen fluid** varies according to the type of feed and the time interval between the last feeding and taking a sample for pH examination. The **normal range, however, is between 6.2 and 7.2. High pH values (8–10)** will be observed when putrefaction of protein is occurring in the rumen or if the sample is mixed with saliva. **Low pH values (4–5)** are found after the feeding of carbohydrates. In general, a value below 5 indicates carbohydrate engorgement and this pH level will be maintained for 6–24 hours after the animal has actually consumed the carbohydrate diet.

For experimental purposes, continuous monitoring of the pH of the rumen contents is possible with a pH probe containing a commercial microelectrode and a reference-electrode with a pressure-equalizing system placed in the reticulum.<sup>5</sup> By feeding diets with changing composition it is possible to provoke marked changes in rumen pH. The probes are programmed to sample pH and temperature every 30 seconds.

**Microscopic examination** of a few drops of rumen fluid on a glass slide with a low-power field will reveal the level of protozoan activity. Normally 5–7 protozoons are active per low-power field. In lactic acidosis the protozoa are usually absent or a few dead ones are visible. The rumen fluid can be stained with Gram stain to determine the predominant bacterial flora, which are normally Gram-negative but in grain overload become Gram-positive.

**Chloride** concentration can be determined by centrifuging the fluid and analyzing the supernatant for chloride levels. These are normally 10–25 mEq/L in cattle and <15 mEq/L in sheep. Elevated rumen chloride concentrations result from abomasal reflux, ileus or high salt intake.

## RECTAL PALPATION OF ABDOMEN

Some of the specific abnormalities of the digestive tract, which are commonly palpable on rectal palpation, include the following, which relates to Figure 6.2 (a–l), illustrating the abnormalities through a transverse section of the abdomen.

- (a) Normal
- (b) L-shaped rumen: occurs commonly in vagus indigestion and other diseases of the rumen characterized by gradual distension of the rumen
- (c) Cecal torsion: commonly palpable as long distended organ, usually movable, may feel the blind end
- (d) Abomasal torsion: commonly palpable as tense viscus in lower right half of abdomen
- (e) Abomasal impaction: not usually palpable in late pregnancy
- (f) Left-side displacement of the abomasum: usually cannot palpate the displaced abomasum but can often feel rumen, which is usually smaller than normal
- (g) Intussusception: not always palpable, dependent on location of intussusception and the size of the animal
- (h) Mesenteric torsion: usually palpable
- (i) Intestinal incarceration: commonly palpable
- (j) Peritonitis: only palpable if peritoneum of posterior aspect of abdomen affected
- (k) Lipomatosis: commonly palpable as 'lumps' in the abdomen and pelvic cavity
- (l) Omental bursitis: not common.

In Figure 6.2 (m–p) are included for the differential diagnosis of the diseases each represents.

As part of the differential diagnosis of digestive tract disease in the postparturient cow, the uterus should be examined carefully for evidence of retained placenta and metritis. Both vaginal and rectal examinations should be performed. The toxemia caused by retained fetal membranes and postpartum metritis may cause anorexia, rumen stasis, paralytic ileus, scant feces and sometimes an **idiopathic postpartum 'ping' in the right flank**, all of which may be misinterpreted as a primary digestive tract disease.

## GROSS EXAMINATION OF FECES

The gross appearance of the feces of cattle is not only an indicator of disease of the digestive tract but can provide valuable

clues for the differential diagnosis of disease elsewhere.

## AMOUNT

In adult cattle, the passage of ingesta through the digestive tract takes 1.5–4 days. Mature cattle generally pass some feces every 1.5–2 hours, amounting to a total of 30–50 kg/day in 10–24 portions.

A **reduction in the bulk of feces** can be due to a decrease in feed or water intake or a retardation of the passage through the alimentary tract. In diarrhea, the feces are passed more frequently and in greater amounts than normal and contain a higher water content (>90%) than normal.

## ABSENCE OF OR SCANT FECES

Failure to pass any feces for 24 hours or more is abnormal and the continued absence of feces may be due to a physical intestinal obstruction. However, in many cases the intestine is not physically obstructed but rather there is a functional obstruction. Diseases causing disturbances of motility of the rumen and abomasum often result in a relative absence of feces. Paralytic ileus of the intestines due to peritonitis or idiopathic intestinal tympany also result in a marked reduction in feces, sometimes a complete absence, for up to 3 days. The marked reduction of feces that occurs in functional obstruction is a major source of diagnostic confusion because it resembles physical obstructions of the intestines. The causes of physical and functional obstruction of the alimentary tract of cattle are summarized in Figure 6.3.

## COLOR

The color of the feces is influenced by the nature of the feed, the concentration of bile in the feces and the passage rate through the digestive tract. Calves reared on cows' milk normally produce gold-yellow feces, which become pale brown when hay or straw is eaten. The feeding of milk substitutes adds a gray component to a varying degree.

The feces of adult cattle on green forage are dark olive-green, on a hay ration more brown-olive, while the ingestion of large amounts of grain produces gray-olive feces. A retardation of the ingesta causes the color to darken. The feces become ball-shaped and dark brown with a shining surface due to the coating with mucus. Diarrheic feces tend to be paler than normal because of their higher water content and lower concentration of bile.

The presence of large amounts of bile produces a dark olive-green to black-green color such as in cattle with hemolytic anemia. In cattle with obstruction of the common bile duct, the feces are pale olive-green because of the absence of bile pigments.



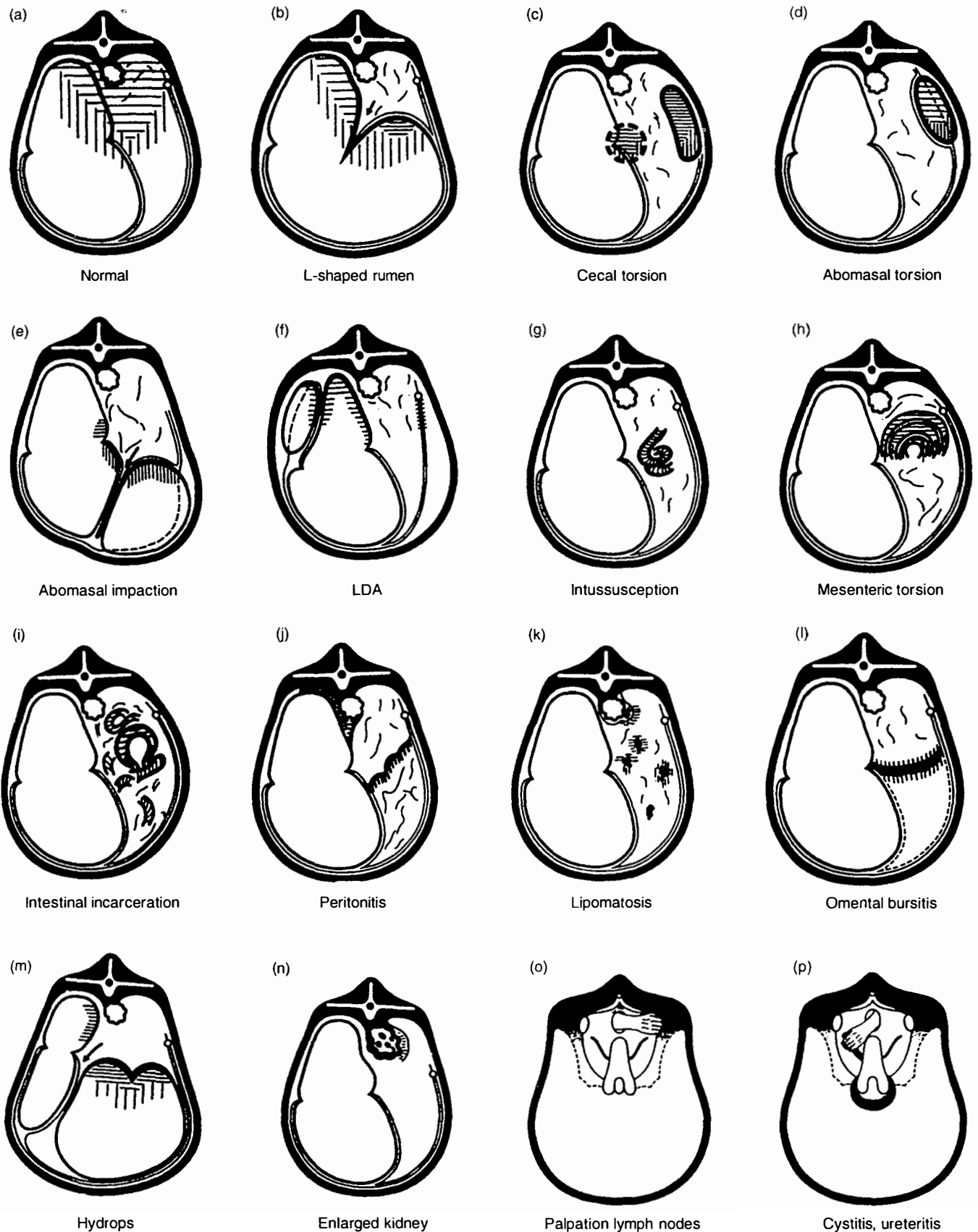

Fig. 6.2 Schematic illustration of the rectal findings in cattle affected with different diseases of the abdominal viscera. (After Stober M, Dirksen G. *Bovine Pract* 1977; 12:35-38.)

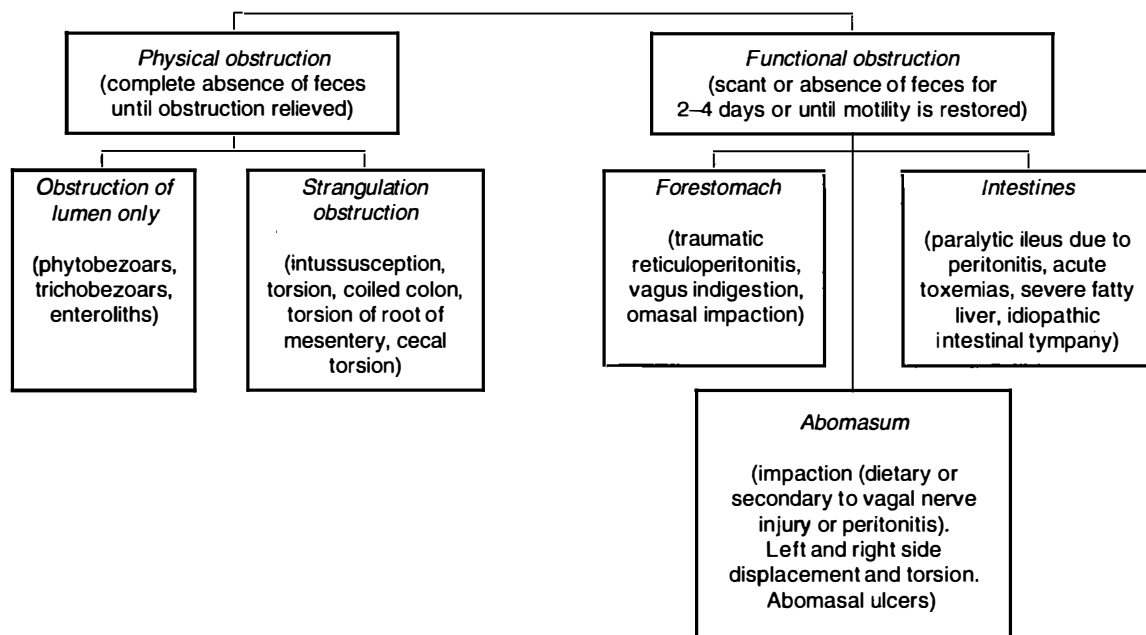

Fig. 6.3 Some common causes of physical and functional obstruction of the alimentary tract of cattle.

**Blood** in the feces may originate from the following locations:

- Hemorrhage into the abomasum: acute hemorrhage usually appears as black, tarry feces (**melena**); chronic hemorrhage as occult blood
- Hemorrhagic enteritis of small intestines: the feces are uniformly dark red
- Hemorrhagic enteritis of the large intestines: in the cecum or colon, blood appears evenly distributed throughout the feces (**dysentery**); in the rectum, blood appears as streaks or chunks of frank blood unevenly distributed throughout the feces (**hematochezia**)
- 'Occult blood' is not visible grossly; the color of the feces may be normal or dark. An occult blood test (Hemetest tablets) is required to determine its presence. Occult blood occurs most commonly when there are only small quantities of blood in the alimentary tract, as with minimal hemorrhage insufficient to result in melena. It also may be due to the swallowing of blood coughed up from pulmonary hemorrhage.

#### ODOR

Fresh bovine feces are not normally malodorous. Objectionable odors are usually due to putrefaction or fermentation of ingesta, usually associated with inflammation. For example, the feces in cattle with salmonellosis may be fetid while in advanced pericarditis with visceral edema due to passive congestion the feces are profuse but not odoriferous.

#### CONSISTENCY

The consistency of the feces is dependent on the water content, the type of feed and the length of time the ingesta has remained in the digestive tract. Normally, milk-fed calves excrete feces of a medium to firm porridge-like consistency. After transition to a plant diet, the first solid particles begin to appear. Normal bovine feces are of a medium porridge-like consistency. A moderate thickening leads to the passage of fecal disks of a more solid consistency and severe dehydration causes the formation of firm balls of feces arranged in facets inside the rectum, the surfaces of which are dark and coated with mucus. The feces of cows with left-side displacement of the abomasum are commonly pasty in appearance. Sticky and tenacious feces are commonly seen in obstruction of the forestomachs (vagus indigestion, chronic peritonitis).

#### DEGREE OF DIGESTION

The proportion of poorly digested plant particles in the feces is dependent on the duration and adequacy of rumination and the rate of passage of ingesta through the forestomach and abomasum. The length of time the ingesta is in the post-ruminal digestive tract seems to have no appreciable influence on its digestion. Inadequate digestion indicates failure in rumination and/or accelerated passage of ingesta through the forestomach. Thus in some cattle with acute traumatic reticuloperitonitis, the feces may contain small walnut-sized chunks of undigested plant fibers that have escaped the cellulose digestive processes of the forestomachs. The presence of large numbers of kernels

of grain in the feces is associated with the ingestion of large quantities of unprocessed grain such as whole wheat or barley.

#### OTHER SUBSTANCES IN THE FECES

##### Mucus

The presence of excessive mucus on the surface of feces suggests increased transit time of the ingesta in the large intestine. The presence of a plug of mucus in the rectum is suggestive of a functional obstruction (paralytic ileus). In enteritis, large quantities of clear, watery mucus may be passed, which sometimes clot to form gelatinous masses.

##### Fibrin

In fibrinous enteritis, fibrin may be excreted in the form of long strands, which may mold into a print of the intestinal lumen (**intestinal fibrinous casts**).

#### DETECTION OF ABDOMINAL PAIN

Cattle with acute local or diffuse peritonitis may grunt spontaneously with almost every expiration; this is usually exaggerated in the recumbent position. However, **grunting** may also be caused by **severe pneumonia, pleurisy** and **severe pulmonary emphysema**. Careful auscultation and percussion of the lungs is therefore necessary to exclude the presence of pulmonary disease.

Not all grunts occur spontaneously. **Deep palpation of the cranial part of the abdomen using the closed hand or knee is often necessary to elicit a grunt in cattle.** Auscultation over the trachea is often necessary to hear the grunt. The grunt is best elicited if pressure is applied to the abdomen at the end of inspiration

and the beginning of expiration. The inspiratory and expiratory sounds are noted for 6–8 respirations by auscultation over the trachea and then, without warning to the animal, firm palpation is applied to the abdomen. A grunt indicates the presence of a peritoneal lesion (stretching or inflammation of the peritoneum regardless of cause). The absence of a grunt does not preclude the presence of a peritoneal lesion. In acute traumatic reticuloperitonitis the grunt may be present for only 3–5 days after the initial penetration of the reticulum.

A rigid bar or wooden pole may be necessary to apply pressure in large cattle (large cows and bulls). The bar is held by two people in a horizontal position just behind the xiphoid sternum while a third person auscultates over the trachea when the bar is lifted firmly up into the abdomen. Simultaneous auscultation over the trachea insures that the grunt is heard. Several attempts should be made to elicit a grunt before concluding the absence of one. The ventral aspect and both sides of the abdomen should be examined beginning at the level of the xiphoid sternum and moving caudally to approximately the umbilicus. This will insure that the cranial and caudal aspects of the abdomen are examined for the presence of **points of abdominal pain**.

**Pinching of the withers is also used to elicit a grunt.** In the average-sized cow, pinching of the withers causes the animal to depress its back. In an animal with a painful lesion of the peritoneum, depression of its back will commonly result in a grunt, which is clearly audible by auscultation over the trachea and is often audible without the use of the stethoscope.

The term **anterior abdominal pain** is used to characterize the pain associated with several diseases of anterior abdomen of cattle, which would include **traumatic reticuloperitonitis, hepatic abscesses, abomasal ulcers** and **intestinal obstruction**. The differential diagnosis of the anterior abdominal pain would include diseases that cause thoracic pain such as pleuritis, pericarditis and severe pulmonary disease.<sup>6</sup>

### CLINICAL EXAMINATION OF THE DIGESTIVE TRACT AND ABDOMEN OF THE CALF

Clinical examination of the digestive tract and abdomen of the calf may be more difficult than in the adult animal. The rumen in the preruminant calf is not yet functional, and thus cannot be used as an indicator of the state of the alimentary tract as in adult cattle. Also, rectal examination is not usually possible until the animal is about 10–12 months of age,

depending on the breed. A digital examination of the rectum of young calves is useful to determine the nature and amount of feces. This may provide an indication of the presence of impending diarrhea. A complete absence of feces suggests the presence of an acute intestinal obstruction, acute diffuse peritonitis or atresia coli.

The oral cavity of the calf is easily examined and should be part of the clinical examination of every sick calf.

### ABDOMINAL DISTENSION IN CALVES

Abdominal distension occurs commonly in calves under 2 months of age. If the distension is symmetrical it may be difficult to determine if it originates in the rumen, abomasum, intestines or peritoneal cavity.

Examination of the abdomen of the young calf includes inspection of the contour of the abdomen to determine the maximum area of any distension, deep palpation and ballottement of each flank to determine the presence of fluid-splashing sounds that indicate a fluid-filled viscus, and percussion and auscultation to determine the presence of a gas-filled viscus. Placing the calf's hindquarters on the ground and allowing the viscera to move to the caudal part of the abdomen may allow visual inspection and palpation of a distended abomasum below the xiphoid sternum. With the calf in lateral recumbency, careful palpation and simultaneous auscultation may reveal the location of the distended viscus. However, it is often necessary to do an exploratory laparotomy to determine the cause. A stomach tube should always be passed into the rumen to relieve any pressure caused by the accumulation of gas or fluid. In the case of severe distension of the abdomen accompanied by severe abdominal pain (kicking, bellowing, rolling, getting up and lying down) it may be necessary to relieve pressure with a large-gauge needle (12–14-gauge, 75–100 mm; 3–4 in). The most common cause of severe abdominal distension in a young calf that can be relieved by trocarization is abomasal torsion.

Abdominocentesis is easily done in the calf and at least three punctures should be attempted before concluding the absence of fluid. To avoid puncture of the abomasum, sites that are caudal to the umbilicus are used. (See Abdominocentesis in Ch. 5.)

The differential diagnosis of the common causes of abdominal distension in the calf is set out in Table 6.4.

### LAPAROSCOPY

Endoscopy of the abdomen through the right paralumbar fossa, left paralumbar fossa<sup>7</sup> and cranioventral midline provides

a safe alternative to exploratory celiotomy in cattle.<sup>8</sup> Feed and water are withheld for 24 hours and the animals are sedated with acepromazine for both right and left paralumbar fossa laparoscopies and xylazine for the cranioventral approach. For laparoscopy through the fossae, the sites are prepared aseptically and a 2 cm incision is made through the skin and abdominal musculature after infiltration with 2% lidocaine. Each incision is made 8 cm ventral to the tip of the transverse process of the third lumbar vertebra and 5 cm caudal to the caudal aspect of the last rib. The laparoscope is introduced by standard technique and carbon dioxide gas is used to insufflate the abdominal cavity, after introduction of the trocar and cannula and prior to introduction of the laparoscope. The abdominal cavity is insufflated to a pressure of 20–24 mmHg. Each examination is completed by directing the laparoscope cranially then moving counterclockwise to examine the caudal portion of the abdomen. After the laparoscopy, the abdomen is passively deflated through the cannula and the skin is closed with sutures.

Cranioventral laparoscopy is performed with the animal positioned in dorsal recumbency. The incision for entry is made on the midline, through the linea alba, 10 cm caudal to the xiphoid process. Examination of the cranioventral portion of the abdomen is begun at the central aspect of the diaphragm then circularly moving the laparoscope counterclockwise.

Right paralumbar fossa laparoscopy provides excellent viewing of the caudal and right cranial portions of the abdomen for evaluation of diseases involving the right kidney, liver, diaphragm, small intestine, cecum, colon, reproductive tract and cranial part of the pelvic canal. Inadvertent penetration of the greater omentum or mesoduodenum may be avoided by careful placement of the trocar and periodic examination with the laparoscope to assess proper positioning of the cannula. Left paralumbar fossa laparoscopy provides excellent viewing of the left cranial portion of the abdomen and is appropriate for evaluation of diseases involving the left kidney, rumen, spleen and diaphragm.<sup>8</sup>

The cranioventral midline laparoscopy provides excellent visibility of the cranioventral portion of the abdomen. It allows evaluation of diseases involving the abomasum, liver, reticulum, spleen and diaphragm.<sup>8</sup>

### DIAGNOSTIC IMAGING

**Radiography of the cranial abdomen and reticulum of mature cattle** is now being performed more frequently. Radiological examination of the reticulum with the animal in dorsal recumbency

**Table 6.4 Differential diagnosis of diseases of the digestive tract and abdomen of young calves presented with distension of the abdomen**

Disease	History, clinical and laboratory findings, treatment
Abomasal torsion (volvulus)	Always acute to peracute, 1 week to 6 months of age, acute abdominal pain, bellowing, up and down, severe tight distension of abdomen, loud ping and fluid-splashing right side, emergency surgery necessary; recovery about 50% if recognized and corrected early
Abomasal dilatation (fluid, milk, hair balls and often abomasal ulcers)	Chronic or acute onset, calves 1–6 months of age, history of abnormal feces, may be unthrifty, mild to moderate abdominal distension and pain, fluid-splashing sounds over right flank, dehydration, negative peritoneal fluid, laparotomy and abomasotomy required
Perforated abomasal ulcers	Acute onset, sudden collapse, calves 2 weeks to 3 months, hand-fed or nursing calves, weakness, recumbency, tachycardia, mild to moderate abdominal distension, mild or no abdominal pain, abdominal splinting occasionally, <i>positive paracentesis</i> , feces variable. Laparotomy required; survival about 25%
Torsion of root of mesentery	Sudden onset, found in state of collapse, abdominal pain common, moderate abdominal distension, distended loops of intestine visible and palpable over right flank, bloodstained peritoneal tap, fluid-splashing sounds on palpation and auscultation, scant feces, emergency surgery
Acute diffuse peritonitis (not due to perforated abomasal ulcer)	Usually in calves under 3 weeks of age. Toxemia, temperature variable, weak, may be grunting, splinting of abdominal wall, mild abdominal distension, scant feces, fluid-splashing sounds over right flank (due to paralytic ileus), <i>positive paracentesis</i> , commonly associated with enteric colibacillosis, polyarthritis and umbilical and urachal abscess. Exploratory laparotomy. Prognosis poor
Atresia coli	Calf usually under 10 days of age, progressive distension of abdomen, bright and alert for first few days then becomes depressed, no feces only thick mucus from rectum, insertion of tube into rectum may lead to blind end but often blind end is near spiral colon. Surgery indicated but often unrewarding
Intussusception	May have history of diarrhea, now scant bloodstained feces, depressed, will not suck or drink, dehydrated, contour of abdomen may appear normal or slightly distended, fluid-splashing sounds and small 'ping' may be audible, bloodstained peritoneal fluid, presurgical diagnosis often difficult, surgery necessary. Recovery rate good if diagnosis early
Peracute to acute enteritis	Usually in calves under 3 weeks of age, acute onset of abdominal pain (kicking, stretching), won't suck or drink, may not yet appear dehydrated, temperature variable, mild to moderate abdominal distension, fluid-splashing sounds on auscultation and succussion of abdomen, continuous loud peristaltic sounds on auscultation, diarrhetic feces may not be present on first examination, digital examination of rectum may stimulate defecation of foul-smelling, soft, watery feces, peritoneal tap negative
Omphalitis, omphalophlebitis, umbilical abscess	Single calf, usually 2–6 weeks of age. May be unthrifty, chronic toxemia. Large, painful swelling of umbilicus that may be obvious externally or deep palpation dorsal to umbilicus reveals firm swellings directed towards liver or bladder. Surgical excision required
Gastrointestinal tympany of dietary origin	Calves under 10 days of age. Nursing calves sucking good cows. May be due to ingestion of excessive quantities of milk and excessive gas formation in abomasum and large intestine. Abdominal pain (kicking at abdomen), and pain on palpation of abdomen. Marked to severe abdominal distension. At laparotomy there is gaseous distension of the abomasum and cecum. Recovery is usually good
Intestinal hairball	Calves 3–8 weeks of age. Sudden onset of failure to suck. Normal vital signs. Total absence of feces. Slight to moderate distension of the abdomen, fluid-splashing sounds over right abdomen, normal peritoneal fluid. Will remain anorexic, and fail to pass any feces for up to several days. Hemogram normal. Metabolic alkalosis with hypokalemia, and hypochloremia may occur. Laparotomy and surgical removal of hairball required

(dorsal reticulography) is an accurate diagnostic method for the evaluation of cattle with suspected traumatic reticuloperitonitis, and the techniques used are presented under that heading.

**Ultrasonography** is a suitable method for investigation of reticular contractions

in healthy ruminants and in cattle for the diagnosis of traumatic reticuloperitonitis.<sup>9</sup> In contrast to radiography, ultrasonography provides more precise information about the contour of the reticulum and reticular motility. It is an ideal diagnostic aid for the examination of gastro-

intestinal diseases of cattle including left and right displacement of the abomasum, abnormal motility of the small and large intestines, and cecal dilatation.<sup>9</sup> It is done on the standing nonsedated animal using a 3.5 MHz linear transducer. The techniques used are presented under that heading.

### INTERPRETATION OF CLINICAL FINDINGS

A guide to the interpretation of the clinical findings associated with diseases of the digestive tract and abdomen of cattle is summarized in Table 6.5. In conjunction with the history and the laboratory findings, a differential diagnosis list can be generated.

### EXPLORATORY LAPAROTOMY (EXPLORATORY CELIOTOMY)

An exploratory laparotomy can usually assist in the diagnosis of diseases of the digestive tract or abdomen. Identification and evaluation of the abnormality allows for a more accurate diagnosis, prognosis and rational treatment. However, because a properly done laparotomy is time-consuming and expensive, the veterinarian would like to minimize the number of laparotomies in which no significant lesions are present. The challenge is, therefore, to improve the accuracy of diagnosis and to evaluate the prognosis as much as possible before doing a laparotomy unnecessarily.

There are some well-recognized diseases in which, if a clinical diagnosis can be made, a laparotomy is indicated (Table 6.6). (In some cases slaughter for salvage may be more economical.)

Other than the rumenotomy for the treatment of grain overload and the cesarean section, the most common indication for a laparotomy in cattle is for the surgical correction of displacement or obstruction of parts of the digestive tract (i.e. abomasal displacement, abomasal dilatation and volvulus, intussusception and volvulus, torsion of the root of the mesentery, torsion of spiral colon, cecal dilatation and torsion). If any of these diagnoses can be made, a laparotomy or slaughter is indicated.

In other cases, the diagnosis may be suspected, but is not obvious and the indications for a laparotomy, slaughter, euthanasia or conservative medical treatment are not clear. The major question is, 'Under what conditions is a laparotomy indicated if the history and clinical and laboratory findings suggest an obstruction (strangulation obstruction or functional) but the obstruction cannot be located on clinical examination?'

Some examples of diseases that may elude diagnosis before laparotomy and

**Table 6.5 Pathogenesis and interpretation of clinical findings associated with diseases of the digestive tract and abdomen of cattle**

Clinical findings	Pathogenesis, interpretation
Anorexia, inappetence	Toxemia, distension of intestines and stomachs, enteritis, peritonitis
Scant feces, includes small-volume diarrhea	Reduced feed intake, functional obstruction of forestomachs and abomasum, paralytic ileus, strangulation obstruction or obstruction of lumen of intestine with phytobezoar or trichobezoar
Large-volume diarrhea	Profuse, watery diarrhea usually associated with enteritis, simple indigestion or carbohydrate engorgement
Dehydration	Failure to drink adequate amounts of water (due to toxemia or lesions of oral cavity), malabsorption due to enteritis, diseases of the forestomachs interfering with absorption of water, e.g. vagus indigestion
Tachycardia	Toxemia, acid-base imbalance, abdominal pain, distension of intestines
Polypnea	Acid-base imbalance (torsion of the abomasum, severe enteritis, vagus indigestion), distension of the abdomen due to gas- or fluid-filled intestines
Weakness and recumbency	Toxemia, severe dehydration, severe distension of abdomen, peritonitis
Colic (abdominal pain)	Sudden onset of distension of forestomachs, abomasum or intestines. Stretching of mesenteric bands. Strangulation of intestine in mesenteric tear or scrotal hernia
Grunting with every respiration	Diffuse peritonitis (also pleuritis, pulmonary emphysema and advanced pneumonia), distension of stomachs or intestines
Presence of grunt on deep palpation of ventral abdominal wall	Presence of peritoneal lesion (stretching of the peritoneum, inflammation, edema, recent adhesions)
Abdominal distension	Most commonly due to gas- or fluid-filled intestines and/or forestomachs and abomasum. Rarely due to pneumoperitoneum. Also due to ascites and hydrops allantois/amnion
Rumen distension	May be distended with gas, fluid or ingesta. Primary dietary ruminal tympany and grain overload. Secondary ruminal tympany due to peritonitis, vagus indigestion
Rumen stasis	Toxemia, metabolic (hypocalcemia), fever, ruminal acidosis, distension of omasum or abomasum, peritonitis, vagal nerve injury
Hyperactive rumen	Early stages of primary dietary ruminal tympany; vagal nerve injury
Acidic rumen pH	Ruminal acidosis associated with carbohydrate engorgement; almost no other cause known
Alkaline rumen pH	Ruminal alkalosis associated with accidental consumption of high-protein diet, urea poisoning
Reduced or absent rumen protozoan activity	Ruminal acidosis (lactic acid inactivates protozoa); primary starvation lasting more than 2–3 days; ingestion of lead, arsenic and other poisonous substances
Abnormal foul-smelling rumen contents	Putrefaction of rumen contents in static and defaunated rumen
Presence of 'ping' or 'pung' over left flank	Left displacement of abomasum (ping), atonic rumen with a gas cap (pung), pneumoperitoneum (rarely)
'Ping' over right flank	Right-side dilatation displacement and torsion of the abomasum, cecal dilatation and torsion, torsion of the spiral colon, gas in distended colon and rectum
Presence of low-pitched 'pings' not clearly distinct over right flank	Tympany of right paralumbar fossa in recently calved cows (2–3 days). Gas in distended colon and rectum. Fluid- and gas-filled intestines with enteritis
Distended upper right flank	Dilatation and torsion of abomasum. Cecal dilatation and torsion. Torsion of spiral colon
Distended lower right flank	Impaction of the abomasum. Enlarged L-shaped rumen and distension of ventral sac to the right flank. Advanced pregnancy
Fluid-splashing sounds on ballottement of abdomen or succussion	Fluid-filled intestines or forestomachs or abomasum. Usually associated with enteritis, paralytic ileus, or obstruction. Fluid-splashing sounds are rarely due to fluid in the peritoneal cavity. Perculating fluid sounds audible over right flank are common in cattle with acute intestinal obstruction
Dropping cuds	Cattle rarely regurgitate uncontrollably (dropping cuds). It is usually associated with chronic inflammatory lesions of the reticulum and cardia resulting in lack of control of regurgitation and a larger than normal bolus of rumen contents being regurgitated that cannot be controlled by the animal. Also occurs in certain heavy-metal poisonings such as arsenic poisoning. Cattle affected with straw impaction of the rumen will also drop large, dry, fibrous cuds

that are or may be amenable to surgical correction include the following.

### INTUSSUSCEPTION AND OTHER STRANGULATION OBSTRUCTIONS OF THE SMALL INTESTINES

An intussusception may be located in the anterior part of the abdomen and not palpable per rectum. A clinical history of acute onset of colic, absence of feces and serosanguineous exudate on peritoneal tap are indications for a laparotomy. However, phytobezoars and trichobezoars can cause acute intestinal obstruction which may not be palpable rectally and which becomes progressively more severe with time, and only minimal, if any, changes may occur in the peritoneal fluid. A progressively worsening systemic state warrants a laparotomy.

### 'ATYPICAL' LEFT-SIDE DISPLACEMENT OF THE ABOMASUM (ATYPICAL LDA)

A small percentage of cases are difficult to detect on auscultation and percussion. When the typical LDA 'ping' cannot be detected after several examinations over a period of a few days, a presumptive diagnosis may be made on the basis of ketosis in a recently calved cow (within the last week), the presence of rumen contractions, but reduced intensity, normal vital signs (unless fatty liver is present) and spontaneous fluid-gurgling sounds audible over the left flank or fluid-splashing sounds on ballottement and auscultation of the lower left flank.

### TRAUMATIC RETICULOPERITONITIS

In traumatic reticuloperitonitis with a persistently penetrating foreign body, conservative medical treatment of immobilization in a stanchion, antimicrobials and a magnet may be unsuccessful even after several days of antimicrobial therapy. Diagnosis depends on continued anorexia, mild fever, grunt, rumen stasis, a hemogram indicating infection and peritoneal fluid containing exudate.

The guidelines for the indications of an exploratory laparotomy when a tentative diagnosis is not made are set out in Table 6.7.

### REVIEW LITERATURE

- Braun U, ed. Atlas und Lehrbuch der Ultraschall-diagnostik beim Rind. Berlin: Parey Buchverlag 1997:1–279.
- Braun U. Ultrasonography in gastrointestinal disease in cattle. *Vet J* 2003; 166:112–124.
- Cockcroft P, Jackson P. Clinical examination of the abdomen in adult cattle. In *Pract* 2004; June: 304–317.
- Ivany JM, Rings DM, Anderson DE. Reticuloruminal disturbances in the bovine. *Bovine Pract* 2002; 36:56–64.
- Radostits OM. Clinical examination of the alimentary system: Ruminants. In: Radostits OM, Mayhew IGJ, Houston DM, eds. *Veterinary clinical examination and diagnosis*. London: WB Saunders 2000:409–468.

**Table 6.6** Diseases of the digestive tract and abdomen of cattle in which a laparotomy is indicated if the diagnosis can be made

Disease	Major clinical findings
Left displacement of the abomasum (LDA)	'Ping' over ribs 9–12 and other well-recognized findings
Right displacement (RDA) and torsion of the abomasum	Distension of upper right flank, 'ping' on percussion over ribs 9–12, viscus palpable per rectum
Cecal dilatation and torsion	Distension of upper right flank, 'ping' in right paralumbar fossa, long cylindrical mass palpable per rectum
Torsion of spiral colon	Distension of upper right flank, 'ping', distended loops of intestine easily palpable
Intussusception	Abdominal pain, absence of feces, distended loops of intestine, palpable intussusception
Phytobezoars or trichobezoars	Scant feces, subacute abdominal pain, distended loops of intestine and hard lumps palpable rectally
Severe life-threatening ruminal tympany	Severe distension of rumen, skin over rumen cannot be picked up, animal grunting, is lying down, mouth breathing, cannot relieve with stomach tube or trocar
Unidentifiable lumps palpable on rectal examination, i.e. fat necrosis	Chronic gastrointestinal atony, scant feces, large hard lumps palpable per rectum
Peracute grain overload	Weakness, recumbency, dehydration, tachycardia, rumen pH 5 (see Table 29.1 for guidelines in the treatment of grain overload)

**Table 6.7** Clinical and laboratory indications for an exploratory laparotomy in cattle when the diagnosis is not obvious

Parameter/criterion	Significance and interpretation of criteria
History	Does the history suggest an acute surgically correctable condition?
Abdominal distension	Laparotomy indicated if distension of abdomen caused by distension of abomasum, cecum or intestines with fluid and gas
Volume and nature of feces	Scant or absence of feces for more than 36–48 h indicates a <i>physical</i> or <i>functional</i> obstruction. In <i>functional obstruction</i> (i.e. peritonitis) some dark feces are usually present. In <i>physical obstruction</i> (intussusception) feces are very scant and dark red due to leakage of blood into intussusceptum. Laparotomy indicated unless can determine that cause of absence of feces is not surgically correctable (diffuse peritonitis or impaction of abomasum or omasum)
Rectal findings	Distended viscera other than rumen (abomasum, cecum, small and large intestines) warrant laparotomy. Palpable 'bread and butter' fibrinous inflammation in caudal part of abdomen suggests acute diffuse peritonitis and laparotomy would not be rewarding
Peritoneal fluid and hemogram	Bloodstained peritoneal exudate and a degenerative left shift in the leukocyte count suggest leakage of the intestinal wall and warrants laparotomy if history and clinical findings suggest a strangulation obstruction
Abdominal pain (colic) and grunting	Behavioral and postural signs of acute abdominal pain (colic) such as kicking at the belly, stretching the body, suggest acute distension of the stomachs or intestines with fluid and gas. Spontaneous grunting with each respiration, which usually becomes pronounced in sternal recumbency, or the presence of a grunt on deep palpation of the abdomen suggests inflammation or stretching of the peritoneum

**Synopsis**

**Etiology** Excessive feed intake (grain, silage); indigestible roughage  
**Epidemiology** Usually in hand-fed dairy cattle and stall-fed beef cattle  
**Signs** Inappetence, drop in milk production, lack of rumination, rumen usually full and reticulorumen contractions decreased or absent, vital signs are normal. Spontaneous recovery in 12–24 hours  
**Clinical pathology** None needed except to rule out differential diagnoses. Lesions not fatal  
**Diagnostic confirmation** Spontaneous recovery  
**Differential diagnosis list** Early parturient hypocalcemia, acetonemia, traumatic reticuloperitonitis, carbohydrate engorgement, left-side displacement of the abomasum, right-side dilatation of abomasum, abomasal volvulus, vagus indigestion, phytobezoars, secondary ruminal atony in toxemia  
**Treatment** None required  
**Control** Feeding management and provision of digestible feeds

feed consumed. It is not commonly observed in pastured beef cattle or sheep because they are less heavily fed. The common causes are dietary abnormalities of minor degree including indigestible roughage, particularly when the protein intake is low, moldy, overheated and frosted feeds, and moderate excesses of grain and concentrate intake.

Cases occur under excellent feeding regimens and are usually attributed to overfeeding with grain. Although the difference between simple indigestion and carbohydrate engorgement (grain overload) is one of degree, their separation can be justified by the marked clinical difference between the two syndromes. Gross overfeeding usually occurs when cattle or sheep gain accidental access to large quantities of grain or are suddenly introduced to high-grain diets in feedlots. Indigestion is more common when heavily fed cows are fed a little more concentrate than they can digest adequately. A sudden change to a new source of grain, especially from oats to wheat or barley, may have the same effect.

**Indigestible roughage** may include straw, bedding or scrub fed during drought periods. It is probable that limitation of the available drinking water may contribute to the occurrence of the disease during dry seasons. Depraved appetite may also contribute to the ingestion of coarse indigestible material. Although good-quality ensilage cannot be considered an indigestible roughage, cases of indigestion can occur in cattle that are allowed unlimited access to it. This is most likely to happen in heavy-producing cows running outside in cold

**REFERENCES**

- McCarthy PH. *Am J Vet Res* 1981; 42:255.
- Rebhun WC. *Cornell Vet* 1987; 77:244.
- Kath GS et al. *Am J Vet Res* 1985; 46:136.
- Geishauser T. *Bovine Pract* 1994; 28:109.
- Enemark JMD et al. *J Vet Med A* 2003; 50:62.
- Henninger RW, Mullaney PC. *Compend Contin Educ Pract Vet* 1984; 6:S453.
- Wilson AD, Ferguson JG. *Can Vet J* 1984; 25:229.
- Anderson DE et al. *Am J Vet Res* 1993; 54:1170.
- Braun U. *Vet J* 2003; 166:112.

**Diseases of the rumen, reticulum and omasum****SIMPLE INDIGESTION****ETIOLOGY**

The disease is common in dairy cattle and stall-fed beef cattle because of the variability in quality and the large amounts of

weather whose hay and grain rations are limited. It is not uncommon for large Holstein cows to eat 45–50 kg of ensilage daily in such circumstances and the high intake of acetate and acetic acid may be sufficient to depress their appetite. Prolonged or heavy oral dosing with antimicrobials may cause indigestion due to inhibition of the normal ruminal flora. An unusual circumstance is the feeding of a special diet to produce milk, and dairy products, with a high content of polyunsaturated fats for special diets in humans. Fats in the diet are protected against hydrogenation in the rumen by a coating of formalin. The efficiency and safety of the diet depends on a thorough mixing of the formalin with the concentrates. If this is not done the free formalin causes severe rumenitis.

### PATHOGENESIS

Primary atony caused by dietary abnormality is difficult to explain. Changes in the pH of its contents markedly affect the motility of the rumen and in cases caused by overeating on grain an increase in acidity is probably of importance. High-protein diets, including the feeding of excessively large quantities of legumes or urea, also depress motility because of the sharp increase in alkalinity that results. Atony that occurs after feeding on damaged feeds may have the same basis or be due to other unidentified agents in the food. The simple accumulation of indigestible food may physically impede ruminal activity. Putrefaction of protein may also play a part in the production of atony. The toxic amides and amines produced may include histamine, which is known to cause ruminal atony when given intravenously and to be reversed by the administration of antihistamine drugs. Histamine may contribute to the ruminal atony that occurs in allergy, or after heavy grain feeding, but the absorption of histamine from the forestomachs in any circumstances is probably very limited.

A marked fall in milk yield occurs, caused probably by the sharp decrease in volatile fatty acid production in a hypotonic reticulorumen. Rumen contractions appear to play the same role as hunger contractions in simple stomachs and the decreased food intake is probably due to the ruminal atony.

### CLINICAL FINDINGS

A reduction in appetite is the first clinical finding, followed closely in milking cows by a slight drop in milk production. Both occur suddenly; the anorexia may be partial or complete but the fall in milk yield is relatively slight. The animal's posture is unaffected but there is mild depression and dullness. Rumination

ceases and the ruminal movements are depressed in frequency and amplitude and sometimes are almost absent. The rumen may be larger than normal if the cause is sudden access to an unlimited supply of palatable feed. There may be moderate tympany, especially with frozen or damaged feeds or in allergy, but the usual finding is a firm, doughy rumen without obvious distension. The feces are usually reduced in quantity and are drier than normal on the first day. However, 24–48 hours later the animal is commonly diarrhetic; the feces are softer than normal, voluminous and commonly malodorous.

There is no systemic reaction and the heart rate, temperature and respirations are usually within normal ranges. Pain cannot be elicited by deep palpation of the ventral abdominal wall, although cows that have consumed an excessive quantity of a highly palatable feed such as silage, after not having had any for a long period of time, will have a grossly distended rumen, and mild abdominal discomfort may be present for several hours. The discomfort usually resolves when the rumen movements return to normal and the rumen returns to its normal size. Most cases recover spontaneously or with simple treatments in about 48 hours.

### CLINICAL PATHOLOGY

Examination of the urine for ketone bodies is usually necessary to differentiate indigestion from acetonemia.

Two simple laboratory tests have been introduced to assess the activity of the ruminal microflora. The sediment activity test is carried out on aspirated ruminal fluid strained to remove coarse particles. The strained fluid is allowed to stand in a glass vessel at body temperature and the time required for flotation of the particulate material is recorded. The time in normal animals varies between 3 minutes, if the animal has just been fed, and 9 minutes, if the last feeding has occurred some time previously. Settling of the particulate material indicates gross inactivity, less severe degrees being manifested by prolongation of the time required for flotation. The cellulose digestion test is also performed on aspirated rumen fluid and depends upon the time required to digest a thread of cotton. A bead is tied to the end of the thread to indicate when separation occurs. Digestion times in excess of 30 hours indicate abnormality.

The rumen juice can be examined for pH using wide-range indicator paper. Values between 6.5 and 7.0 are considered normal. In cattle on grain diets, the pH may range from 5.5–6.0 normally but in cattle that have been on roughage diets

such low values should arouse suspicion of lactic acidosis and careful monitoring is necessary.

### NECROPSY FINDINGS

The disease is not a fatal one.

### DIFFERENTIAL DIAGNOSIS

Simple indigestion must be differentiated from all the diseases of the forestomachs and abomasum in which ruminal atony is a common clinical finding, and from diseases of other body systems that cause secondary ruminal atony:

- **Acetonemia:** the appetite and milk production decrease over a few days, there is ketonuria and the rumen contractions are present but weaker than normal
- **Traumatic reticuloperitonitis:** there is a sudden onset of anorexia and agalactia, a mild fever, a painful grunt on deep palpation of the xiphoid sternum, and the rumen is static with an increase in the size of the gas cap
- **Carbohydrate engorgement:** characterized by depression, dehydration, tachycardia, staggering, recumbency, diarrhea and ruminal stasis with the presence of fluid-splashing sounds, and the pH of the ruminal fluid is usually below 6 and commonly down to 5
- **Left-side displacement of the abomasum (LDA):** usually occurs within a few days after parturition and the rumen is usually smaller than normal, the contractions are usually reduced in amplitude, there is a ping on percussion over the lower left flank, and ketonuria
- **Right-side dilatation of abomasum:** occurs most commonly in dairy cows 2–4 weeks post partum, there is inappetence, reduced feces, ruminal atony, reduced milk production and a ping over the right flank, and a distended viscus is palpable per rectum in the lower right quadrant
- **Abomasal volvulus:** anorexia, depression, reduced feces, dehydration, tachycardia, a ping over the right flank and a distended viscus in the lower right quadrant are common
- **Vagal indigestion:** characterized by gradual distension of the abdomen due to distension of the rumen over a period of several days, progressive dehydration and scant feces. Initially there is hypermotility of the rumen and the development of secondary frothy bloat. This is commonly followed by ruminal atony
- **Phytobezoars:** cause inappetence to anorexia, scant feces, and on rectal examination distended loops of intestine and the firm masses may be palpable
- **Secondary ruminal atony:** occurs in many diseases in which septicemia or toxemia (coliform mastitis) are present but there are usually additional clinical findings to indicate their presence



- Ruminal atony with mild bloat is common in the early stages of hypocalcemia, which may last for 6–18 hours, and is usually accompanied by anorexia and a decreased amount of feces. The ruminal motility and appetite return to normal following treatment with calcium borogluconate
- The rumen is also atonic in allergic and anaphylactic states and returns to normal following treatment.

## TREATMENT

### Spontaneous recovery

Most cases of simple indigestion recover spontaneously. Small quantities of fresh, good-quality, palatable hay should be provided several times daily to encourage eating and to stimulate reticulorumen motility. Because anorexia and forestomach hypomotility usually exist together the objective is to stimulate both appetite and motility. Reduced feed intake reduces the two primary drives for reticulorumen activity: moderate forestomach distension and chewing activity.

### Rumenatorics

A wide variety of oral preparations containing rumenatorics were available for many years and is was conventional to administer these to stimulate reticulorumen motility and to stimulate appetite. These preparations contained nux vomica, ginger and tartar emetic in powder form to be added to water and pumped into the rumen. However, there is no evidence that they are effective and they are not recommended.<sup>1,2</sup> The routine use of magnesium hydroxide for rumen disorders is not recommended unless there is evidence of ruminal acidosis.

Magnesium hydroxide is a potent alkalinizing agent for use in ruminants as an antacid and mild laxative. It can significantly decrease rumen microbial activity and should be used only in cattle with rumen acidosis and not for symptomatic therapy of idiopathic rumen disorders or hypomagnesemia. The oral administration of boluses of magnesium hydroxide (162 g) or a powdered form (450 g) dissolved in 3.5 L of water daily for 3 days resulted in a significant increase in rumen pH after 48 and 24 hours, respectively.<sup>3</sup> Both the boluses and the powder forms of magnesium hydroxide decreased rumen protozoal numbers and increased methylene blue reduction times compared with baseline values. There was no change in blood pH, bicarbonate or base excess values.

### Parasympathomimetics

These agents have also been used to stimulate reticulorumen activity but have the disadvantage of inducing undesirable

side effects and being very transitory in effect. Large doses depress reticulorumen activity but small doses repeated at short intervals increase ruminal activity and promote vigorous emptying of the colon in normal animals. The normal flow of rumen contents from the reticulorumen to the abomasum is the result of a complex of synchronized contractions and relaxations of various parts of the forestomachs, orifices and abomasum occurring simultaneously. One of the major limitations of injectable parasympathomimetics used as rumenatorics is that they do not provide these synchronized movements and therefore little movement of ingesta can occur. Carbamylcholine chloride, physostigmine and neostigmine are most commonly used. Neostigmine is the most effective at a dose of 2.5 mg/45 kg body weight (BW). Carbamylcholine acts on the musculature only and causes uncoordinated and functionless movements. These drugs are not without danger, especially in very sick animals or those with peritonitis, and are specifically contraindicated during late pregnancy.

Experimentally, metoclopramide increases the rate of ruminal contractions and therefore might be beneficial in rumen hypomotility or motility disturbances associated with vagal nerve damage.<sup>1,2</sup>

Epsom salts (0.5–1.0 kg per adult cow) and other magnesium salts are reasonably effective and have the merit of simplicity and cheapness.

### Alkalinizing and acidifying agents

If an excessive quantity of grain is the cause of the simple indigestion, the use of alkalinizers, such as magnesium hydroxide, at the rate of 400 g per adult cow (450 kg BW), is recommended when the rumen contents are excessively acid. Magnesium oxide or hydroxide should be used only if ruminal acidosis is present. The administration of 400 g of magnesium oxide to normal, mature, nonfasted cattle weighing 450 kg can cause metabolic alkalosis and electrolyte disturbances for up to 24 hours following treatment. A sample of rumen fluid can be readily obtained and the pH determined. If the rumen contents are dry, 15–30 L of water should be administered by stomach tube.

Acetic acid or vinegar, 5–10 L, is used when the rumen contents are alkaline as a result of the ingestion of high-protein concentrates.

### Reconstitution of ruminal microflora

In cases of indigestion that have run a course of more than a few days, and in animals that have been anorexic for prolonged periods, there will be significant loss of ruminal microflora, especially if

there have been marked changes in pH. Reconstitution of the flora by the use of cud transfers from normal cows is highly effective. An abattoir is the best source of rumen contents (especially rumen fluid) but it can be obtained from live animals by reaching into the mouth during rumination when the bolus is regurgitated. Rumen fluid may also be removed by siphoning from the rumen with a stomach tube or by vacuum withdrawal with a special pump. Best results are obtained if 20–30 L of water is pumped into the rumen and then allowed to siphon by gravity flow (rumen lavage). The rumen fluid to be transferred should be strained and administered as an oral drench or by stomach tube. Repeated dosing is advisable. The infusion will keep for several days at room temperature. Commercial products comprising dried rumen solids are available and provide some bacteria and substrate for their activity.

When affected animals resume eating they are best tempted by good, stinky meadow or cereal hay. Good-quality alfalfa (lucerne) or clover hay, green feed and concentrate may be added to the diet as the appetite improves.

## REVIEW LITERATURE

Constable PD, Hoffsis GF, Rings DM. The reticulorumen: normal and abnormal motor function. Part I. Primary contraction cycle. *Compend Contin Educ Pract Vet* 1990; 12:1008–1014.

Constable PD, Hoffsis GF, Rings DM. The reticulorumen: normal and abnormal motor function. Part II. Secondary contraction cycles, rumination, and esophageal groove closure. *Compend Contin Educ Pract Vet* 1990; 12:1169–1174.

## REFERENCES

1. Constable PD et al. *Compend Contin Educ Pract Vet* 1990; 12:1008.
2. Constable PD et al. *Compend Contin Educ Pract Vet* 1990; 12:1169.
3. Smith GW, Correa MT. *J Vet Intern Med* 2004; 18:109.

## RUMEN IMPACTION IN SHEEP WITH INDIGESTIBLE FOREIGN BODIES

Rumen impaction in sheep with indigestible foreign bodies has been described in a semi-arid region of Nigeria.<sup>1</sup> The sheep had visited refuse dumps around a town. Only certain breeds of sheep, the Yankasa, Uda and their crossbreeds, were found feeding on refuse dumps. Rumen-indigestible foreign bodies were present in 19.3% of the sheep slaughtered in the local abattoir. The foreign bodies were polythene/cellophane materials, ropes, dry seeds, caked sand, metallic objects, paper, fiber and hair balls. The polythene/cellophane materials were present in 81.6% of the sheep. Clinically, the rumen impaction was characterized by



emaciation, abdominal distension and symmetry, lack of feces in the rectum, foamy salivation, recumbency and inappetence.

At necropsy, the foreign bodies were usually loosely matted together and impacted with rumen ingesta.

Hyperglycemia, alkalosis, hyponatremia, hypochloridemia, hypocalcemia, hypoproteinemia and hypoalbuminemia occurred in some cases. The impaction was related to the sheep scavenging on refuse dumps and the blood biochemical changes, along with the clinical signs, might be of some diagnostic significance.

#### REFERENCE

1. Igbokwe IO et al. *Small Rumin Res* 2003; 49:141.

### INDIGESTION IN CALVES FED MILK REPLACERS (RUMINAL DRINKERS)

A form of indigestion known as ruminal drinking occurs in veal calves and is characterized clinically by recurrent ruminal tympany, inappetence, unthriftiness and the production of clay-like feces.<sup>1</sup> The disease occurs most commonly in calves 5–6 weeks after being placed on a milk diet and being fed with a bucket.

The cause is insufficient closure of the reticular groove while drinking milk. The ingested milk enters the rumen in large quantities instead of flowing directly into the abomasum. The experimental intraruminal administration of milk to calves at 6 weeks of age induces changes in the rumen similar to those seen in spontaneous cases of the disease.<sup>2</sup> The pH of the rumen decreases and lactate concentrations increase rapidly. The daily oral administration of untreated whole milk via stomach tube into calves 5–23 days of age results in a D-lactic metabolic acidosis within a few days.<sup>3</sup> The onset of ruminal acidosis occurred quickly and mean pH values fell from 6.7 to 4.9 after the first feeding. In the following days the rumen pH values varied between 4 and 5. During ruminal acidosis, both L- and D-lactic acid are produced abundantly by bacterial fermentative activity. Both isomers of lactic acid are absorbed from the rumen, or from the intestines, where they exert an acidotic effect. The L-lactate can be metabolized quickly by the body and does not accumulate despite the continuous influx into the blood. However, D-lactate cannot be metabolized at the same rate because of a lack of specific metabolic pathway, and it accumulates with the consequence of the risk of hyper-D-lactatemia.<sup>3</sup>

There is marked ruminal hyperkeratosis. Villous atrophy occurs in proximal jejunum accompanied by a reduction in brush border enzyme activities.<sup>4</sup> Clinical recovery occurs within several days after

returning to normal feeding practices, with restoration of villous length and brush border enzyme activities in 3–4 weeks.

On clinical examination the temperature, heart rate and respiratory rates are within normal range. The abdominal contour is increased in size, especially over the ventral half of the abdomen. Distension is more obvious on the left side. Ballottement of the left abdominal wall commonly reveals fluid-splashing sounds.<sup>5,6</sup> Auscultation of the left paralumbar fossa while the calf is drinking reveals loud fluid-splashing sounds. Large volumes of foul- or acid-smelling, grayish-white fluid can be siphoned off from the rumen. Examination of the rumen contents after calves have consumed milk reveals the presence of a casein clot. Radiological examination reveals that ingested milk enters the rumen and reticulum and is only slowly moved on to the abomasum.

Affected calves remain unthrifty while they continue to drink milk. Esophageal groove reflex dysfunction may be a complication in some milk-fed calves affected with diarrhea.<sup>5</sup> Weaning on to hay and concentrates returns the calf to normal very quickly. Rumen movements, via eructation reflex, and ruminations become normal within 1–2 weeks.

The administration of colostrum and other fluids to calves using an esophageal feeder does not induce the esophageal groove reflex. However, colostrum and other fluids administered directly into the rumen with a feeder does move from the forestomachs into the abomasum within 3 hours.<sup>7</sup> Feeding colostrum to newborn calves by means of an esophageal feeder is a labor-saving and effective method of obtaining optimum levels of serum immunoglobulins. This is particularly useful in large dairy herds because colostrum can be given to calves immediately after birth.

At necropsy the rumen is enlarged and there are varying degrees of hyper- and parakeratosis. Villous atrophy is prominent in the small intestine, which is partially restored to normal when the reticular groove reflex is restored.<sup>8</sup>

Affected calves can be treated by inducing them to suck on the herdsman's fingers while they are being fed a small quantity of cows' whole milk or milk replacer.

#### REFERENCES

1. Breukink H et al. *Vet Q* 1988; 10:126.
2. Van Buisman WK et al. *J Anim Physiol Anim Nutr* 1990; 63:255.
3. Gentile A et al. *J Vet Med A* 2004; 51:64.
4. Van Buisman WK et al. *Vet Res Commun* 1990; 14:129.
5. Dirksen G, Din L. *Bovine Pract* 1989; 24:53, 54–60.
6. Dirksen G, Garay F. *Compend Contin Educ Pract Vet* 1987; 9:140, 173.

7. Laleur-Rowet HJM et al. *Vet Q* 1983; 5:68.

8. Ivan Buisman WK et al. *Vet Q* 1988; 10:164.

### ACUTE CARBOHYDRATE ENGORGEMENT OF RUMINANTS (RUMINAL LACTIC ACIDOSIS, RUMEN OVERLOAD)

#### ETIOLOGY

The sudden ingestion of toxic doses of carbohydrate-rich feed, such as grain, is the most common cause of the acute form

#### Synopsis

**Etiology** Sudden ingestion of large amounts of highly fermentable carbohydrates

**Epidemiology** Accidental consumption by ruminating cattle of excessive quantities of highly digestible feeds such as cereal grains, corn, baker's bread, grapes, apples and the like. Subacute ruminal acidosis is considered an important problem in dairy herds. In beef and lamb feedlots the rapid introduction of high-level grain diets is a major risk factor. Outbreaks occur when animals gain access to a large quantity of grain. High mortality rate when large quantity of grain ingested

**Signs** Anorexia, depression, dehydration, ruminal stasis, profuse diarrhea with sweet-sour odor of feces, which may contain undigested kernels, weakness and ataxia leading to recumbency. Rumen may or may not feel full but atonic and fluid-splashing sounds audible on ballottement. Laminitis, mycotic rumenitis are complications

**Clinical pathology** Ruminal fluid pH below 5, rumen protozoa absent or inactive in rumen fluid; hemoconcentration, blood lactate increased, hypocalcemia

**Lesions** Acute congested and inflamed rumenitis, sloughing ruminal mucosa; mycotic inflammation and necrosis of forestomach and fungal hepatitis if disease lasts several days

**Diagnostic confirmation** Ruminal fluid pH below 5

**Differential diagnosis list** Simple indigestion, parturient hypocalcemia, peracute coliform mastitis, acute diffuse peritonitis

**Treatment** Triage to determine which animals need medical treatment, rumen lavage or rumenotomy. Correct ruminal and systemic acidosis with alkalizing agents parenterally or orally depending on severity. Fluid and electrolyte therapy as necessary. Restore forestomach and intestinal motility by providing palatable hay

**Control** Prevent accidental access to grain. Gradual introduction to high-level grain diets in feedlots. Total mixed rations containing chopped roughage and grain to insure controlled intake of carbohydrates. Careful feeding management of dairy cattle during late pregnancy and early lactation. Use of ionophores in feed alter rumen metabolism and potentially can control ruminal acidosis

of the disease.<sup>1,2</sup> Less common causes include engorgement with apples, grapes, bread, baker's dough, sugar beet, mangels, sour wet brewers' grain that was incompletely fermented in the brewery, and concentrated sucrose solutions used in apiculture. **Subacute ruminal acidosis (SARA)** in dairy cattle is a disorder of ruminal fermentation in dairy cattle caused by the ingestion of large amounts of concentrates and inadequate amounts of fiber administered in order to increase milk production in early lactation.<sup>3,4</sup>

## EPIDEMIOLOGY

### Occurrence

All types of **ruminant** cattle and sheep are susceptible but the disease occurs most commonly in feedlot cattle and dairy cattle fed on high-level grain diets. The disease also occurs in lamb feedlots and has been recorded in goats, wild deer and farmed ungulates.

### Previous diet and change of ration

Because the type and level of ration consumed by a ruminant affects the numbers and species of bacteria and protozoa in the rumen, a change from one ration to another requires a period of microbial adaptation, which is a variable interval of time before stabilization occurs. Animals being fed a low-energy ration are most susceptible to a rapid change to a high-energy ration because satisfactory adaptation cannot occur quickly enough. This results in the rapid onset of abnormal fermentation.

### Accidental consumption of excess carbohydrates

The disease occurs commonly following accidental consumption of toxic amounts of grain by cattle gaining sudden access to large quantities of grain. A single animal or a group of hungry cows may break into a grain storage bin or find a large supply of unprotected grain, as not uncommonly happens on a mixed cattle-grain farm. Another common occurrence is when cattle are left under the care of an assistant who, being unaware of the feeding schedule, gives the cattle an unaccustomed quantity of grain. Outbreaks have occurred in dairy herds following malfunction of automatic feeders, which delivered many times more than the usual amount of grain. In a similar outbreak, recently calved cows consumed an excessive amount of feed delivered by an automatic feeder but not eaten by other cows because of hot weather.

Outbreaks have occurred when cattle have been turned into unripe, green corn standing in the field, when cattle or sheep have been placed on stubble fields in which considerable grain lost by the harvester was available on the ground,

and following the irregular feeding of large quantities of other less common animal feeds and byproducts, such as bread, baker's dough and wet brewers' grain. Problems usually arise with these feeds when a larger than usual amount is fed to cattle either for the first time or because the usual supplementary feed is in short supply.

### Dairy cattle herds

**Subacute ruminal acidosis** occurs in dairy cattle herds fed high-grain, low-fiber rations in early lactation.<sup>3,5</sup> It is considered of major economic importance because of the possible association with laminitis in dairy herds.<sup>2,6</sup>

The transition from the pregnant, nonlactating state to the nonpregnant, lactating state is the period during which the majority of metabolic diseases occur in the dairy cow. During this period, which ranges from 3 weeks before until 3 weeks after calving, the cow is changed from a high-fiber, low-concentrate diet to a diet that is higher in concentrate feeds and lower in fiber. Cows that have not adapted to these high-grain diets are particularly susceptible to ruminal acidosis. Subacute ruminal acidosis is characterized by repeated bouts of depressed rumen pH between 5.2 and 5.6. The abnormality often results from a large intake of rapidly fermentable carbohydrates that leads to the accumulation of organic acids in the rumen. Up to 20% of commercial dairy farm cows in early to mid-lactation have a rumen pH of less than 5.5, indicative of subacute ruminal acidosis.<sup>6</sup> The economic losses associated with SARA have been estimated at \$1.12 per cow per day.<sup>7</sup>

Field observations suggest that periparturient cows are at risk of subacute ruminal acidosis because of the time required for the rumen microflora and papillae to adapt to increased intakes of concentrates immediately before parturition and during early lactation when feed intake increases rapidly to meet the energy needs of high-producing dairy cows. The adaptation of the ruminal microflora and papillae from a system appropriate for forage to a system capable of utilizing high-energy lactation rations requires a gradual change during a period of 3–5 weeks.<sup>6</sup>

The need for individual cows to adapt to high-energy rations and the common practice of feeding dairy cows as groups results in periparturient cows being at risk of developing subacute ruminal acidosis. For practical reasons, as total mixed rations have become more common, many dairy herds limit the number of rations to a single dry-cow ration and a single lactating-cow ration, because of the time and labor required to mix each

ration. This system has made it difficult to introduce concentrates to individual cows in the first few weeks after calving. If the dry-cow ration has not resulted in adaptation of the ruminal microflora required for high-energy rations, acidosis may occur when the cow is fed the lactating-group ration. The net energy of a ration can be safely increased in 10% increments. For example, a change from an energy density of 0.70 Mcal/lb NE<sub>1</sub> (net energy, lactation) to 0.77 Mcal/lb NE<sub>1</sub> would be considered safe. The National Research Council recommends that dry-cow total mixed rations have 0.57 Mcal/lb NE<sub>1</sub> and that a high-production lactation cow ration have 0.78 Mcal/lb NE<sub>1</sub>.<sup>8</sup> Using the 10% guideline for gradual energy change would require at least two intermediate rations.<sup>5</sup>

Dairy producers attempt to minimize the **negative energy balance** of lactating cows in early lactation by maximizing concentrate intake early in the period after parturition. The early lactation period is a high-risk period for lactating dairy cows if they are fed rations as separate components, for three reasons:

- Concentrates are consumed by the cow in preference to forage
- Forage consumption is not usually measured on an individual cow basis and is commonly assumed to approximate the herd average
- Dry matter intake of periparturient cows is lower than commonly thought and is very dynamic through this period.<sup>5</sup>

Thus high-producing lactating dairy cows consuming large quantities of high-energy grains are susceptible to subacute ruminal acidosis during early lactation.<sup>9</sup>

Field recommendations for feeding component-fed concentrates during the first 3 weeks of lactation are usually excessive.<sup>3,5</sup> Feeding excessive quantities of concentrate and insufficient forage results in a fiber-deficient ration likely to cause subacute acidosis. The same situation may occur during the last few days before parturition if the ration is fed in separate components; as dry matter intake drops before calving, dry cows will preferentially consume too much concentrate and insufficient fiber, and develop acidosis.

Subacute ruminal acidosis may also be caused by formulation of rations that contain excessive amounts of rapidly fermentable carbohydrates, a deficiency of fiber, or errors in delivery of the rations. Recommendations for the fiber content of dairy rations are available in the National Research Council (Nutrient Requirements of Dairy Cattle).<sup>8</sup> Dry-matter content errors in total mixed rations are

commonly related to a failure to adjust for changes in moisture content of forages.<sup>5</sup>

In a survey in Denmark, dairy cattle practitioners were asked to retrospectively report on the occurrence and relative importance of SARA in dairy herds compared to the actual number of cases reported to the national computer-based dairy herd health recording system.<sup>10</sup> The most common diagnoses believed to occur were ketosis (26%), rumen acidosis (22%), abomasal disorders (16%), sub-clinical hypocalcemia (15%) and milk fever (15%). Subclinical rumen acidosis was considered to be a commonly occurring underlying condition with significant importance as a cause of reduced appetite, and inadequate feeding strategies were given as the main cause. However, according to the national dairy health recording system, SARA was rarely reported as a diagnosis. The practitioners were reluctant to imply that feeding management was a problem. The clinical signs of SARA were unclear to the practitioners, and the diagnostic tests necessary, such as rumenocentesis, were considered time consuming and unreliable because of the small size of the herds.<sup>10</sup>

#### Feedlot cattle

The occurrence of grain overload in feedlot cattle, however, has gained the most attention, presumably because of its economic impact. Digestive disorders account for approximately 25–35% of deaths in feedlot cattle and may contribute to decreased performance and efficiency of production.<sup>11</sup> The economics of feedlot beef production dictate that cattle should gain weight at their maximum potential rate and this usually involves getting them on to a full feed of a high concentration of grain quickly. Economics also favor the processing of grain by one of several methods available that will increase the availability of starch and thereby increase the rate of degradation in the rumen. All these factors set the stage for a high incidence of grain overload in feedlot cattle.<sup>12</sup>

There are some critical periods during which grain overload occurs in feedlot cattle. When starting cattle on feed, animals with previous experience of eating grain will commonly consume a toxic dose if offered a ration with a high percentage of grain. The disease occurs commonly in feedlot cattle in which the total daily feed intake has been brought up to what is considered the same feed on an ad libitum basis; they gorge themselves. When increasing the concentration of grain in the ration from one level to another, if the increment is too high the total amount of grain consumed by some cattle will be excessive. Rapid changes in

barometric pressures may affect the voluntary intake of cattle. A rapid change to cold weather may result in a moderate increase in feed intake in animals that are fed ad libitum and outbreaks of grain overload may occur. When rain is involved and feed becomes wet and possibly even moldy, feed intake will drop, but when fresh dry feed is offered again there may be a marked increase in feed intake that results in grain overload.

The disease also occurs when cattle that have been on a high-level grain ration (full feed) have become hungry because they have been out of feed for 12–24 hours as a result of a breakdown in the feed mill or handling facilities. Offering an unlimited supply of feed to these cattle will often result in severe cases of grain overload. In large feedlots, where communications can be a problem, the accidental feeding of a high-level grain ration to cattle that are on a high-level roughage ration is a common cause of the disease.

The ruminal lesions of rumenitis and ruminal hyperkeratosis, which are commonly present in feedlot cattle at slaughter, are thought to be associated with the continuous feeding of grain. These lesions are often remarkable at slaughter in well-nourished cattle and their effect on live weight gain and feed conversion is not known.

#### Beef breeding herds

Cows in beef cow-calf herds may develop acute ruminal acidosis if offered a high-energy grain ration during the winter feeding period without a period of adjustment.

#### Lamb feedlots and liquid-fed calves

Outbreaks of the disease occur in lamb feedlots in which lambs are started on a high-level grain ration without a period of adjustment. The disease is not as common in lambs as in cattle, perhaps because lambs are usually fed on oats.

Rumenitis and metabolic acidosis have also been reported when newborn calves were force-fed liquid feeds or nutrient-electrolyte solutions containing easily digestible carbohydrates.<sup>13</sup>

#### Morbidity and case fatality rates

Outbreaks of the disease occur in cattle herds kept on grain farms and in feedlots. Depending on the species of grain, the total amount eaten and the previous experience of the animals, the morbidity will vary from 10–50%. The case fatality rate may be up to 90% in untreated cases, while in treated cases it still may be up to 30–40%.

#### Types and toxic amounts of feeds

Wheat, barley and corn grains are the most toxic when ingested in large

quantities. Oats and grain sorghum are least toxic. All grains are more toxic when ground finely or even crushed or just cracked – processes that expose the starch component of the grain to the ruminal microflora. The experimental feeding of unprocessed barley to cattle did not result in rumenitis, whereas feeding rolled barley was associated with ruminal lesions. An unrestricted supply of stale bread can cause outbreaks.

The amount of a feed required to cause acute illness depends on the species of grain, previous experience of the animal with the grain, its nutritional status and body condition score, and the nature of the ruminal microflora. Dairy cattle accustomed to high-level grain diets may consume 15–20 kg of grain and develop only moderate illness, while beef cows or feedlot cattle may become acutely ill and die after eating 10 kg of grain to which they are unaccustomed. Amounts of feed that are lethal range from 50–60 g of crushed wheat/kg BW in undernourished sheep to 75–80 g/kg BW in well-nourished sheep, and in cattle doses ranging from 25–62 g/kg BW of ground cereal grain or corn produced severe acidosis.

#### PATHOGENESIS

The details of the pathogenesis of ruminant lactic acidosis have been reviewed.<sup>1</sup> A summary of the events that occur in the rumen and the systemic effects on the animal is presented here. The disease is a good example of metabolic acidosis in ruminants.

#### Changes in rumen microflora

The ingestion of excessive quantities of highly fermentable feeds by a ruminant is followed within 2–6 hours by a marked change in the microbial population in the rumen. There is an increase in the number of *Streptococcus bovis*, which utilize the carbohydrate to produce large quantities of lactic acid. In the presence of a sufficient amount of carbohydrate (a toxic or a lethal amount) the organism will continue to produce lactic acid, which decreases the rumen pH to 5 or less, which results in the destruction of the cellulolytic bacteria and protozoa. When large amounts of starch are added to the diet, growth of *S. bovis* is no longer restricted by energy source and it multiplies faster than any other species of bacteria.

#### Volatile fatty acids and lactic acid in the rumen

The concentration of volatile fatty acids increases initially, contributing to the fall in ruminal pH. The low pH allows lactobacilli to use the large quantities of carbohydrate in the rumen to produce excessive quantities of lactic acid, resulting in **ruminal lactic acidosis**. Both

D and L forms of the acid are produced, which markedly increases ruminal osmolality, and water is drawn in from the systemic circulation, causing hemoconcentration and dehydration. Ruminal osmolality increases from a normal of 280 mosmol/L to almost 400 mosmol/L.<sup>1</sup>

Some of the lactic acid is buffered by ruminal buffers but large amounts are absorbed by the rumen and some moves into and is absorbed further down the intestinal tract. Lactate is a 10 times stronger acid than the volatile fatty acids, and accumulation of lactate eventually exceeds the buffering capacity of rumen fluid. As the ruminal pH declines, the amplitude and frequency of the rumen contractions are decreased and at about a pH of 5 there is ruminal atony. The increased ruminal levels of unassociated volatile fatty acids may be more important than increased lactic acid or increased hydrogen ion concentration in causing ruminal atony. Experimentally, increased molar concentration of butyrate, not the lactic acid, causes ruminal stasis.<sup>1</sup> Inhibition of ruminal activity may also be due to lactic acid entering the duodenum and exerting a reflex inhibitory action on the rumen. Experimentally, ruminal atony occurs in sheep within 8–12 hours after grain engorgement but the precise pathophysiological mechanism for loss of forestomach motility is uncertain. The diarrhea is considered to be due to the reduction in net absorption of water from the colon.

### Systemic lactic acidosis

The absorbed lactic acid is buffered by the plasma bicarbonate buffering system. With nontoxic amounts of lactic acid, the acid–base balance is maintained by utilization of bicarbonate and elimination of carbon dioxide by increased respirations. In those which survive the acute form of the disease, this compensatory mechanism may overcompensate, resulting in alkalosis. In severe cases of lactic acidosis the reserves of plasma bicarbonate are reduced, the blood pH declines steadily, the blood pressure declines, causing a decrease in perfusion pressure and oxygen supply to peripheral tissues and resulting in a further increase in lactic acid from cellular respiration. Lactic acid given intravenously to cattle causes hypertension, increased responses to norepinephrine, slight bradycardia and slight hyperventilation.

Both D- and L-lactic acids are produced. The L-lactic acid is utilized much more rapidly than the D-isomer which accumulates and causes a severe D-lactic acidosis. If the rate of entry of lactic acid into body fluids is not too rapid, compensatory mechanisms are able to

maintain the blood pH at a compatible level until the crisis is over, and recovery is usually rapid. This may explain the common observation that feedlot cattle may be ill for a few days after being introduced to a grain ration but quickly recover, while in other cases when the rate of entry is rapid the compensatory mechanisms are overcome and urgent treatment is necessary.

In experimental lactic acidosis using sucrose in sheep, feed intake does not resume until rumen pH has returned to 6.0 or higher and lactic acid is no longer detectable in the rumen. Renal blood flow and glomerular filtration rate are also decreased, resulting in anuria. Eventually there is shock and death. All these events can occur within 24 hours after engorgement of a lethal dose of carbohydrate; with toxic doses the course of events may take 24–48 hours.

### Chemical and mycotic rumenitis

The high concentration of lactic acid in the rumen causes chemical rumenitis, which is the precursor for mycotic rumenitis in those that survive; this occurs about 4–6 days later. The low pH of the rumen favors the growth of *Mucor*, *Rhizopus* and *Absidia* spp. which invade the ruminal vessels, causing thrombosis and infarction. Inoculation of *Absidia corymbifera* orally into sheep with experimental ruminal acidosis produced with barley causes desquamation of the superficial layers of the mucosae and focal necrosis from lamina propria to muscular layers. Severe bacterial rumenitis also occurs. Widespread necrosis and gangrene may affect the entire ventral half of the ruminal walls and lead to the development of an acute peritonitis. The damage to the viscus causes complete atony and this, together with the toxemia resulting from the gangrene, is usually sufficient to cause death. Mycotic omasitis and rumenitis may also occur without a history of grain engorgement in cattle. Anorexia and forestomach atonicity associated with a primary illness in other body systems may predispose the mucosae to fungal infection because of abomasal reflux of acid and the prolonged use of antimicrobials.

Chronic rumenitis and ruminal hyperkeratosis are common in cattle fed for long periods on grain rations, and the lesions are attributed to the chronic acidosis, but it is possible that barley awns and ingested hair may contribute to the severity of the lesions.

### Hepatic abscesses

In uncomplicated chemical rumenitis, the ruminal mucosa sloughs and heals with scar tissue and some mucosal regeneration. Hepatic abscesses commonly occur as a

complication as a result of a combination of rumenitis caused by lactic acidosis and allowing *Fusobacterium necrophorum* and *Arcanobacter (Corynebacterium) pyogenes* to enter directly into ruminal vessels and spread to the liver, which may have also undergone injury from the lactic acidosis. Severe diffuse coagulation necrosis and hyperplasia of the bile duct epithelium and degeneration of renal tubules may also be present histologically.

In cattle being placed on a grain ration, even with control of the daily intake, hepatic cell damage and liver dysfunction occur even though dietary adaptation may have occurred in 2–3 weeks. The biochemical profile indicates that complete metabolic adaptation requires at least 40 days following the start of grain feeding.

### Laminitis

Laminitis occurs in acute, subclinical and chronic forms associated with varying degrees of severity of ruminal acidosis. The association between acidosis and laminitis appears to be associated with altered hemodynamics of the peripheral microvasculature. Vasoactive substances (histamine and endotoxins) are released during the decline of rumen pH and the bacteriolysis and tissue degradation. These substances cause vasoconstriction and dilation, which injure the microvasculature of the corium. Ischemia results, which causes a reduction in oxygen and nutrients reaching the extremities of the corium. Ischemia causes physical degradation of junctures between tissues that are structurally critical for locomotion. The insidious rotation of the distal phalanx (pedal bone) can result in permanent anatomical change. Manifestations of subclinical laminitis are sole hemorrhages and yellowish discoloration. Other clinical manifestations include double soles, heel erosion, dorsal wall concavity and ridging of the dorsal wall.<sup>2</sup>

### Other toxic substances produced

Several toxic substances other than lactic acid have been suggested as contributory to the disease. Increased concentrations of histamine have been found in the rumen of experimentally engorged cattle, but its possible role in the disease remains unknown. Histamine is not absorbed from the rumen except at abnormally high pH values, but is absorbed from intestinal loops. Laminitis occurs in some cases of rumen overload but the pathogenesis is unknown.

Other substances that have been recovered from the rumen in grain overload include a suspected endotoxin, ethanol and methanol. In experimental lactic acidosis induced in cattle with 70 g barley/kg BW, endotoxin and arachidonic

acid metabolites are produced and may be important. However, the role of the endotoxin is uncertain. Endotoxin administered into the intestine of lactic acidotic sheep is not absorbed. *Clostridium perfringens* and coliform bacteria have also been found in increased numbers but their significance is uncertain. The electrolyte changes that occur include a mild hypocalcemia due to temporary malabsorption, loss of serum chloride due to sequestration in the rumen, and an increase in serum phosphate due to renal failure.

#### Experimental lactic acidosis

The disease can be reproduced in cattle and sheep with a variety of grains, fruits, sugars and pure solutions of lactic acid. The oral administration of sucrose at 18 g/kg BW to goats can cause lactic acidosis. In cattle the sucrose is used to induce rumen lactic acidosis experimentally.<sup>14</sup> The severity of the experimental disease and the magnitude of the pathophysiological changes vary depending on the substance used, but changes similar to the natural disease occur.

Lesions in the brain have been recorded in the experimental disease in sheep and naturally occurring cases in cattle, but their pathogenesis and significance are uncertain. There are detectable changes in the cellular and biochemical composition of the cerebrospinal fluid, which suggests that the blood-brain barrier may be affected. Experimentally, sublethal doses of volatile fatty acids, lactate and succinate have an effect on liver function. Toxic and lethal doses of butyrate can cause sudden flaccid paralysis and death from asphyxia.

#### Adaptation to grain-based diets in beef cattle

The health and ruminal variables during adaptation to grain-based diets in beef cattle have been examined experimentally. Successive diets with forage-to-grain ratios of 75:25 (diet 1), 50:50 (diet 2), 25:75 (diet 3) and 10:90 (diet 4) were each fed for 7 days. The health variables such as rectal temperature, heart rate, respiratory rate, rumen motility rates, fecal consistency, demeanor, blood pH, and blood glucose and L<sup>-</sup>-lactate concentrations remained within reference range limits throughout the adaptation period. Blood pH continually decreased during feeding of the four diets. The pH of the ruminal contents decreased progressively from 6.8 to 5.3. By the end of the period, the ruminal contents were acidic (pH < 5.5) and, on the basis of the amounts of ruminal glucose and DL-lactate, it was concluded that ruminal microbial equilibrium had not yet been achieved. In addition, an increase in the heart and

respiratory rates in animals fed diets 2 and 4 indicated stress. During normal fermentation, glucose is not detectable in ruminal fluid because its production is closely linked with its assimilation. In general, changing from a high-roughage to low-roughage diet is stressful for cattle and their resident ruminal microflora.

#### Subacute ruminal acidosis (dairy cattle)

The pathogenesis of SARA in lactating dairy cows is not as well understood as acute ruminal acidosis associated with the sudden ingestion of large amounts of readily fermentable carbohydrates, for example, most commonly in beef cattle that gain accidental access to large quantities of grain. In early-lactating dairy cows, SARA is usually caused by the consumption of diets with high levels of rapidly fermentable carbohydrates and/or marginal, often deficient, levels of physically active fiber.<sup>8</sup>

The biochemical changes that occur in lactating dairy cows in early lactation that are affected with SARA have not been examined in detail. In SARA, fermentation of nonstructural carbohydrates leads to the production of large quantities of volatile fatty acids and lactate, which accumulate in the rumen and subsequently decrease rumen pH. It has been difficult to reproduce SARA in early-lactation dairy cows even with diets such as high-moisture corn, cracked dried corn grain and rolled barley.<sup>7</sup> These feeds did not induce SARA, either because of an inability of the feeds to depress the rumen pH rapidly enough or because of the cow's refusal to consume them.

Wheat/barley pellets were readily consumed by lactating dairy cows and did result in a sustained reduction in rumen pH.<sup>7</sup> When cows with experimental SARA are given a choice between alfalfa hay and alfalfa pellets, cows will choose the alfalfa hay more strongly, which implies that dairy cows would increase their dietary preference for a feed of longer particle size when given the appropriate choice during a bout of SARA.<sup>7</sup> As intake of long hay will result in more saliva production and rumen buffering than intake of pelleted alfalfa, this indicates that cows select feeds with high rumen buffering capacity in an attempt to prevent SARA. When cows with SARA were offered sodium bicarbonate ad libitum, they did not select the compound in order to attenuate the ruminal acidosis.<sup>15</sup> When cows with SARA were offered a choice between two test pellets, one containing 4% sodium bicarbonate and the other 4.5% sodium chloride, the intake of the sodium bicarbonate pellets increased over time, but the

intake of sodium chloride pellets remained unaltered.<sup>16</sup>

There is some evidence that lactic acid is not the causal reason for the prolonged reduction in pH of the ruminal contents. Studies have shown only low lactate levels between 0.45 mmol/L and 0.74 mmol/L in cows with suspected SARA. Excessive volatile fatty acid production may be a more important contributor to SARA in lactating dairy cows.

The induction of SARA by excess feeding of wheat/barley pellets reduces the rumen digestion of neutral detergent fiber from grass hay, legume hay and corn silage.<sup>17</sup> It is thought that SARA affects the productivity of dairy cows by reducing the fiber digestion, because low pH negatively affects cellulolytic bacteria. The induction of SARA in lactating dairy cows by replacing 25% of the total mixed ration intake with pellets consisting of 50% wheat and 50% barley reduced the in-situ dry matter and neutral detergent fiber digestion of mixed hay. Disappearance of neutral detergent fiber was reduced from 39.5% to 30.9%.<sup>18</sup>

In experimentally induced SARA, lipopolysaccharide concentration in the rumen increases during periods of grain feeding compared with times when only hay is fed.<sup>19</sup> The concentration of serum amyloid-A and serum haptoglobin indicate a systemic inflammatory response.

Rumen pH drops considerably in dairy cows after calving when the diet is changed. Monitoring rumen pH throughout the transition period of dairy cows in which the concentrate to forage ration was changed from 70:30 to 55:45 at calving found that 1 week prior to calving the average daily pH was 6.83, average daily time with rumen pH below 6 was 25.5 minutes and average daily time with rumen pH below 5.6 was 5.6 minutes. During the first week after calving, average daily pH was 6.51, and average daily time with rumen pH below 6 and 5.6 were 312 and 59.6 minutes respectively.<sup>18</sup> The drop in rumen pH is associated with an increase in the rate of production of volatile fatty acids, which temporarily increases the concentration of volatile fatty acids in the rumen, until the absorptive capacity of the rumen mucosa for volatile fatty acids has been increased.

The pathogenesis of rumenitis, hepatic abnormalities and laminitis associated with SARA is considered to be similar to those described above for acute ruminal acidosis.

#### CLINICAL FINDINGS

##### Speed of onset and severity

The speed of onset of the illness varies with the nature of the feed, being more rapid with ground feed than with whole

grain. The severity increases with the amount of feed eaten. If cattle are examined clinically within a few hours after engorgement, the only abnormalities that may be detectable are a **distended rumen and abdomen**, and occasionally some abdominal discomfort, evidenced by kicking at the belly. In the **mild form**, affected cattle are anorexic and still fairly bright and alert, and the feces may be softer than normal. Rumen movements are reduced but not entirely absent. Affected cattle do not ruminate for a few days but usually begin to eat on the third or fourth day without any specific treatment.

In **outbreaks of the severe form**, within 24–48 hours some animals will be recumbent, some staggering and others standing quietly alone. Most affected cattle are anorexic, apathetic and depressed. Teeth grinding may occur in about 25% of affected sheep and goats. Once they are ill they usually do not drink water, but cattle may gorge themselves on water if it is readily available immediately after consuming large quantities of dry grain. In an outbreak, inspection of the feces on the ground will usually reveal many spots of soft to watery feces.

#### Individual animals

**Depression, dehydration, inactivity, weakness, abdominal distension, diarrhea and anorexia** are typical. The temperature is usually below normal, 36.5–38.5°C (98–101°F), but animals exposed to the sun may have temperatures up to 41°C (106°F). In sheep and goats, the rectal temperatures may be slightly higher than normal. The heart rate in cattle is usually increased and continues to increase with the severity of the acidosis and circulatory failure. In general, the prognosis is better in those with heart rates below 100/min than those with rates up to 120–140/min. In sheep and goats, the heart rate may be higher than 100/min. The respirations are usually shallow and increased up to 60–90/min. A mucopurulent discharge is common because animals fail to lick their nares.

**Diarrhea is almost always present** and usually profuse, and the feces are light-colored with an obvious sweet-sour odor. The feces commonly contain an excessive quantity of kernels of grain in grain overload, and pips and skins when grapes or apples have been eaten. An absence of feces is considered by some veterinarians as a grave prognostic sign but diarrhea is much more common. The **dehydration is severe and progressive**. In mild cases, the dehydration is about 4–6% BW, and with severe involvement up to 10–12% BW. Anuria is a common

finding in acute cases and diuresis following fluid therapy is a good prognostic sign.

**Careful examination of the rumen is important.** The rumen contents palpated through the left paralumbar fossa may feel firm and doughy in cattle that were previously on a roughage diet and have consumed a large amount of grain. In cattle that have become ill on smaller amounts of grain, the rumen will not necessarily feel full but rather resilient because the excessive fluid contents are being palpated. Therefore, the findings on palpation of the rumen may be deceptive and a source of error. The primary contractions of the reticulorumen are usually totally absent, although **low-pitched tinkling and gurgling sounds** associated with the excessive quantity of fluid in the rumen are commonly audible on auscultation of the rumen. The ruminal fluid is a milky green to olive brown color and has a pungent acid smell. Collection of a sample of ruminal fluid in a glass beaker will reveal an absence of foam. The **pH of the rumen fluid is usually below 5**.

**Severely affected animals have a staggering, drunken gait and their eyesight is impaired.** They bump into objects and their palpebral eye preservation reflex is sluggish or absent. The pupillary light reflex is usually present but slower than normal. Acute laminitis may be present and is most common in cases that are not severely affected and appear to be good treatment risks. Affected animals are lame in all four feet, shuffle while they walk slowly and may be reluctant to stand. The lameness commonly resolves if the animals recover from the acute acidosis. Evidence of chronic laminitis may develop several weeks later.

**Recumbency usually follows after about 48 hours** but may occur earlier. Affected animals lie quietly, often with their heads turned into the flank, and their response to any stimulus is much decreased so that they resemble **parturient paresis**. A rapid onset of recumbency suggests an unfavorable prognosis and the necessity for urgent treatment, because death may occur in 24–72 hours after the ingestion of the feed. Evidence of improvement during this time includes a fall in heart rate, rise in temperature, return of ruminal movement and passage of large amounts of soft feces.

The clinical findings described above are most common but when a group of animals have been exposed to over-feeding there are all degrees of severity from simple indigestion, cases of which recover spontaneously, to the severe cases that need intensive therapy. The prognosis varies with the severity, and the

clinical variables that are useful in deciding on a course of treatment or action are summarized in Table 6.8.

#### Mycotic rumenitis

Some animals appear to recover following treatment but become severely ill again on the third or fourth day. Mycotic rumenitis is common in these animals and is characterized by a fluid-filled atonic rumen, dehydration in spite of fluid therapy, diarrhea, anorexia, weakness leading to recumbency and death in 2–3 days due to acute diffuse peritonitis.

#### Complications

**Chronic laminitis** may occur several weeks or months later. This is particularly important in dairy cattle herds affected with subacute acidosis.<sup>5</sup>

**Abortions** may occur 10 days to 2 weeks later in pregnant cattle that survive the severe form of the disease.

#### Subacute ruminal acidosis in dairy cattle

Subacute ruminal acidosis (SARA) is being recognized with increased frequency in dairy herds.<sup>3–5</sup> However, the case definition is not yet well described. Clinical findings include laminitis, intermittent diarrhea, suboptimal appetite or cyclic feed intake, a high herd culling rate, loss of body condition in spite of adequate energy intake, liver abscesses, and hemoptysis and epistaxis associated with venal caval thrombosis and pulmonary hemorrhage. Milk-fat depression and suboptimal milk production in the second- and subsequent-lactation cows compared to the first-lactation cows may occur.<sup>3</sup>

A decrease in dry matter intake is commonly reported in herds with SARA.<sup>4</sup> The causes of a lowered dry matter intake are uncertain but may be related to weaker rumen motility during low pH phases, bacterial endotoxins and changes in the osmolarity of the rumen contents.

The laminitis is characterized by ridges in the dorsal hoof wall, sole ulceration, white line lesions, sole hemorrhages and misshapen hooves.<sup>20</sup> It is suggested that when the incidence of laminitis exceeds 10% of the herd, it should be considered a herd problem related to the feeding program.

#### CLINICAL PATHOLOGY

The severity of the disease can usually be determined by clinical examination, but field and laboratory tests are of some additional value.

#### Ruminal fluid pH

The pH of the ruminal fluid obtained by stomach tube or by rumenocentesis through the left paralumbar fossa can be measured in the field using wide-range

Table 6.3. Guidelines for the use of clinical findings in assessing the severity of grain overload in cattle for the selection of the treatment of choice

Clinical parameters							
Degree of illness	Mental state and muscular strength	Degree of dehydration (% of body weight)	Abdominal distension	Heart rate (min)	Body temp. (°C)	State of rumen; fullness, consistency of contents, movements and pH	Treatment
Peracute	Severely depressed, weak, in lateral recumbency, unable to stand, apparent blindness, pupils dilated and slow response	8–12	Prominent	110–130	35.5–38.0	Distended with fluid and soft rumen contents, complete stasis, sweet–sour smelling fluid contents. Rumen juice pH below 5 and usually about 4. No protozoa	Rumenotomy. Sodium bicarbonate 5 L (5%) IV in 30 min (for 450 kg BW) followed by isotonic balanced fluids and electrolytes at 150 mL/kg BW for 6–12 h. Consider immediate slaughter. Rumen lavage or rumenotomy. Sodium bicarbonate and fluids IV as in peracute case. Feed hay. Magnesium hydroxide 500 g/450 kg BW into rumen. Fluids if indicated. Feed hay. Should begin eating 24–36 h
Acute	Depressed, still able to walk but ataxic, complete anorexia, may want to drink water, pupils slightly dilated and slow response	8–10	Moderate	90–100	38.5–39.5	Distended with fluid, complete stasis, sweet–sour smelling fluid contents. Rumen pH between 5 and 6. No protozoa	Rumen lavage or rumenotomy. Sodium bicarbonate and fluids IV as in peracute case. Feed hay
Subacute	Fairly bright and alert. Able to walk. No ataxia. May eat, usually wants to drink. Pupils normal	4–6 (just barely detectable clinically)	Mild or none	72–84	38.5–39.0	Moderate distension with fluid, some doughy ruminal ingesta palpable, some weak ruminal contractions, rumen pH between 5.5 and 6.5. Some protozoa alive	Feed hay and observe for 48 h. Watch for anorexia.
Mild	Bright and alert. Able to walk, no ataxia, eats and drinks normally	Not detectable clinically	Not significant	Normal	Normal 38.5–39.0	No detectable distension, ruminal contents palpable; ruminal contractions still present but not as strong as normal, rumen pH 6.5–7. Almost normal protozoal activity	

BW, body weight; IV, intravenously.



pH (2–12) indicator paper. The ruminal fluid must be examined immediately because the pH will increase upon exposure to air. Cattle that have been fed a roughage diet will have a ruminal pH of 6–7; for those on a grain diet it will be 5.5–6. A ruminal pH of 5–6 in roughage-fed cattle suggests a moderate degree of abnormality but a pH of less than 5 suggests severe grain overload and the need for energetic treatment. Feedlot cattle that have been on grain for several days or weeks and are affected with grain overload usually have a pH below 5.

Rumenocentesis has become a commonly used diagnostic test for subacute ruminal acidosis.<sup>13,20</sup> A hypodermic needle of 1.6 (outer diameter) × 130 mm (length) is inserted into the ventral rumen and rumen contents aspirated with a syringe. Landmarks for the puncture site are the left side, on a horizontal line level with the top of the patella about 15–20 cm posterior to the last rib. The hair of the site is clipped and prepared using a standard scrub. The cow is restrained in a stanchion or head-gate and one assistant elevates the tail of the cow while another assistant inserts a 'nose leader' and pulls the cow's head to the right side. The needle will usually become obstructed by ingesta, which is cleared by forcing a small amount of air or fluid back through the needle. When the needle becomes obstructed it is important to avoid creating a negative pressure within the syringe, as carbon dioxide will leave the fluid and increase the pH. Typically, 3–5 mL of rumen fluid can be collected with minimal difficulty.

The pH is measured immediately using a pH meter with a digital readout. Samples should be collected when the pH is likely to be near the lowest point of the day. If the ration is fed as separate components, rumenocentesis should be performed 2–4 hours after the cows are fed the primary concentrate of the day. If the ration is fed as a total mixed ration, the samples should be collected 4–8 hours later. A pH of 5.5 is recommended as the cut-point between normal and abnormal.<sup>20</sup> At least 12 or more cows should be sampled from any group in which acidosis is suspected. If 30% of 10 or more sampled cows are below 5.5, the group is classified as in a state of ruminal acidosis. A subsample of 12 cows from a herd or diet group and a critical number of three cows with a ruminal pH less than or equal to 5.5 may effectively differentiate between herds with 15% or less or greater than 30% prevalence of cows with a low ruminal pH.<sup>13</sup>

#### Ruminal protozoa

Microscopic examination of a few drops of ruminal fluid on a glass slide (with a

coverslip) at low power will reveal the absence of ruminal protozoa, which is a reliable indicator of an abnormal state of the rumen, usually acidosis. The predominantly Gram-negative bacterial flora of the rumen is replaced by a Gram-positive one.

#### Serum biochemistry

The degree of hemoconcentration, as indicated by hematocrit, increases with the amount of fluid withdrawn from the extracellular fluid space into the rumen. The hematocrit rises from a normal of 30–32% to 50–60% in the terminal stages and is accompanied by a fall in blood pressure. **Blood lactate and inorganic phosphate** levels rise and **blood pH and bicarbonate** fall markedly. In almost all cases there is a **mild hypocalcemia**, which is presumably due to a temporary malabsorption. Serum levels may drop to between 6–8 mg/dL (1.5–2 mmol/L).

The **serum enzyme activities** of cattle fed on barley for several months has been measured and suggest that hepatocellular damage occurs during the early stages of feeding grain but that recovery occurs after about 1 month.

#### Urine pH

The urine pH falls to about 5 and becomes progressively more concentrated; terminally there is anuria.

#### NECROPSY FINDINGS

In acute cases where the animal dies in 24–48 hours the contents of the rumen and reticulum are thin and porridge-like and have a typical odor suggestive of fermentation. The cornified epithelium may be mushy and easily wiped off, leaving a dark, hemorrhagic surface beneath. This change may be patchy, caused probably by the production of excess lactic acid in pockets where the grain collects, but is generally restricted to the ventral half of the sacs. Abomasitis and enteritis are also evident in many cases. The abomasum may contain large quantities of grain. There is a pronounced thickening and darkening of the blood and the visceral veins stand out prominently.

In cases that have persisted for 3–4 days the wall of the reticulum and rumen may be gangrenous. This change is again patchy but may be widespread. In affected areas the wall may be three or four times the normal thickness, show a soft black mucosal surface raised above surrounding normal areas and have a dark red appearance visible through the serous surface. The thickened area is very friable and on cutting has a gelatinous appearance. Histological preparations show infiltration of the area by fungal mycelia and a severe hemorrhagic necrosis. A fungal hepatitis is common in those with fungal

rumenitis. In the nervous system, in cases of 72 hours or more duration, demyelination has been reported. A terminal ischemic nephrosis is present in varying degrees in most fatal cases of more than several days' duration.

If the examination takes place less than an hour after death, estimation of ruminal pH may be of value in confirming the diagnosis but after 1 hour the pH of the rumen contents begins to increase and its measurement may not be reliable. A secondary enteritis is common in animals that have been ill for several days.

#### DIFFERENTIAL DIAGNOSIS

When outbreaks of the disease with an appropriate history are encountered, the diagnosis is usually readily obvious and confirmed by the clinical findings and examination of the ruminal fluid for pH and rumen protozoa.

When the disease occurs in a single animal without a history of engorgement, the diagnosis may not be readily obvious. The anorexia, depression, ruminal stasis with gurgling fluid sounds from the rumen, diarrhea and a staggy gait with a normal temperature are characteristics of rumen overload.

Acute and subacute carbohydrate engorgement must be differentiated from:

- **Simple indigestion.** The consumption of large quantities of palatable feed, such as ensiled green feed offered to cattle for the first time, may cause simple indigestion, which may resemble grain overload. The rumen is full, the movements are reduced in frequency and amplitude, there may be mild abdominal pain due to the distension, but the ruminal pH and protozoan numbers and activity are normal
- **Parturient paresis.** Severe cases that are recumbent may resemble parturient paresis, but in the latter the feces are usually firm and dry, marked dehydration does not occur, the absolute intensity of the heart sounds is reduced and the response to calcium injection is favorable
- **Toxemias.** Common toxemias of cattle that may resemble ruminal overload include peracute coliform mastitis and acute diffuse peritonitis, but clinical examination will usually reveal the cause of the toxemia
- **Subacute ruminal acidosis** must be differentiated from diseases of dairy cows in early lactation in which there is reduced appetite and milk production. These include simple indigestion, left-side displacement of the abomasum, ketosis and other causes of suboptimal milk production in dairy cows in early lactation.<sup>21</sup> Feeding management problems such as poor-quality forage or poor feeding bunk management are common causes of suboptimal performance in lactating dairy cows that are not affected with SARA



## TREATMENT

The principles of treatment are:

- Correct the ruminal and systemic acidosis and prevent further production of lactic acid
- Restore fluid and electrolyte losses and maintain circulating blood volumes
- Restore forestomach and intestinal motility to normal.

There are at least two common clinical situations encountered. One is when cattle have been found accidentally eating large quantities of grain, are not yet ill and all appear similar clinically except for varying degrees of distension depending on the amount each animal has consumed. In the other situation, the engorgement occurred 24–48 hours previously and the animals have clinical evidence of lactic acidosis.

**When cattle are found engorging themselves, the following procedures are recommended:**

- Prevent further access to feed
- Do not provide any water for 12–24 hours
- Offer a supply of good-quality palatable hay equal to one-half of the daily allowance per head
- Exercise all animals every hour for 12–24 hours to encourage movement of the ingesta through the digestive tract.

Those cattle that have consumed a toxic amount of grain will show signs of anorexia, inactivity and depression in approximately 6–8 hours and should be identified and removed from the group for individual treatment. Those cattle that did not consume a toxic amount are usually bright and alert and will usually begin eating hay if it is offered. Not all cattle found engorging themselves with grain will have consumed a toxic dose and careful monitoring over a 24–48-hour period will usually distinguish between those that need treatment and those that do not.

After 18–24 hours, those cattle that have continued to eat hay may be allowed free access to water. Those with clinical evidence of grain overload must be identified and treated accordingly. They will engorge themselves with water if allowed free access to it. The rumen becomes grossly distended with fluid and affected cattle may die 18–24 hours later from electrolyte disturbances and acid-base imbalance.

In certain situations, if feasible and warranted by economics, such as when finished beef cattle have accidentally engorged on grain, **emergency slaughter** may be the most economical course of action.

## Triage

The recommendations for treatment given in Table 6.8 are guidelines. In an outbreak, some animals will not require any treatment while severely affected cases will obviously need a rumenotomy. For those that are not severely affected, it is often difficult to decide whether to treat them only medically with antacids orally and systemically or to do a rumenotomy. Each case must be examined clinically and the most appropriate treatment selected. The degree of mental depression, muscular strength, degree of dehydration, heart rate, body temperature, and rumen pH are clinical parameters that can be used to assess severity and to determine the treatment likely to be most successful.

## Rumenotomy

In severe cases, in which there is recumbency, severe depression, hypothermia, prominent ruminal distension with fluid, a heart rate of 110–130/min and a rumen pH of 5 or below, a rumenotomy is the best course of action. The rumen is emptied, washed out with a siphon and examined for evidence of and the extent of chemical rumenitis, and a cud transfer (10–20 L of rumen juice) is placed in the rumen along with a few handfuls of hay. The rumenotomy will usually correct the ruminal acidosis and an alkalizing agent in the rumen is not necessary. A large quantity of the lactic acid and its substrate can be removed. The oral or intraruminal administration of compounds such as magnesium oxide or magnesium hydroxide to cattle following complete evacuation of the rumen may cause metabolic alkalosis for up to 24–36 hours. Not all of the feed consumed will be removed because considerable quantities may have moved into the omasum and abomasum, where fermentation may also occur. The major disadvantages of a rumenotomy are time and cost, particularly when many animals are involved.

## Intravenous sodium bicarbonate and fluid therapy

The systemic acidosis and the dehydration are treated with intravenous solutions of 5% sodium bicarbonate at the rate of 5 L for a 450 kg animal given initially over a period of about 30 minutes. This will usually correct the systemic acidosis. This is followed by isotonic sodium bicarbonate (1.3%) at 150 mL/kg BW intravenously over the next 6–12 hours. Cattle that respond favorably to the rumenotomy and fluid therapy will show improved muscular strength, begin to urinate within 1 hour and attempt to stand within 6–12 hours.

## Rumen lavage

In less severe cases, in which affected cattle are still standing but are depressed,

their heart rate is 90–100/min, there is moderate ruminal distension and the rumen pH is between 5 and 6, an alternative to a rumenotomy is rumen lavage if the necessary facilities are available. A large 25–28 mm inside-diameter rubber tube is passed into the rumen and warm water is pumped in until there is an obvious distension of the left paralumbar fossa; the rumen is then allowed to empty by gravity flow. The rumen can be almost completely emptied by 10–15 irrigations. With successful gastric lavage, alkalizing agents are not placed in the rumen but the systemic acidosis is treated as described above.

## Intraruminal alkalizing agents

In moderately affected cases, the use of 500 g of magnesium hydroxide per 450 kg BW, or magnesium oxide in 10 L of warm water pumped into the rumen and followed by kneading of the rumen to promote mixing will usually suffice.

Magnesium hydroxide is a potent alkalizing agent for use in ruminants as an antacid and mild laxative. It can significantly decrease rumen microbial activity and should be used only in cattle with rumen acidosis and not for symptomatic therapy of idiopathic rumen disorders or hypomagnesemia.<sup>22</sup> The oral administration of boluses of magnesium hydroxide (162 g) or a powdered form (450 g) dissolved in 3.5 L of water daily for 3 days resulted in a significant increase in rumen pH after 48 and 24 hours, respectively. Both the boluses and the powder forms of magnesium hydroxide decreased rumen protozoal numbers and increased methylene blue reduction times compared with baseline values. There was no change in blood pH, bicarbonate or base excess values. Serum magnesium values were significantly increased in cows receiving the powder.

## Ancillary therapy

Ancillary treatment has included anti-histamines for laminitis, NSAIDs for shock therapy, thiamin or brewer's yeast to promote the metabolism of lactic acid, and parasympathomimetics to stimulate gut motility. Their efficacy has been difficult to evaluate and it is unlikely that any of them would be of much value. Calcium borogluconate is used widely because there is a mild hypocalcemia and a beneficial but temporary response does occur, but it is of doubtful value.

Orally administered antimicrobials including penicillin and the tetracyclines have been used to control growth of the bacteria that produce lactic acid, but appear to be of limited value.

## Monitor response to therapy

Regardless of the treatment used, all cases must be monitored several times daily

until recovery is obvious, for evidence of unexpected deterioration. Following treatment, cattle should begin eating hay by the third day, some ruminal movements should be present, large quantities of soft feces should be passed and they should maintain hydration. In those that become worse, the heart rate increases, depression is marked, the rumen fills with fluid and weakness and recumbency occur. During treatment, the water supply should be restricted because some cattle, either immediately after they have engorged themselves or once they become ill, appear to have an intense thirst and will drink excessive quantities of water and die precipitously within a few hours.

The fungal rumenitis that may occur about 3–5 days after engorgement is best prevented by early effective treatment of the ruminal acidosis.

### CONTROL AND PREVENTION

Cattle can be started, grown and finished on high-level grain rations successfully, providing they are allowed a **gradual period of adaptation** during the critical period of introduction. The important principle of prevention is that the ruminant can adapt to an all-concentrate ration. For animals that have just arrived in the feedlot, the length of the adaptation period required will depend on the immediate nutritional history of the animals, their appetite and the composition of the ration to be used.

#### Total mixed rations

One of the safest procedures is to feed a milled mixed ration, consisting of 50–60% roughage and 40–50% grain, as the starting ration for 7–10 days and monitor the response. If results are satisfactory, the level of roughage is decreased by 10% every 2–4 days down to a level of 10–15% roughage, with the remainder grain and vitamins–mineral–salt supplement. The use of roughage–grain mixtures insures that cattle do not gorge themselves on grain, and adaptation can occur in about 21 days.

#### Small incremental increases in concentrate

Another method is to begin with small amounts of concentrate 8–10 g/kg BW, which is increased every 2–4 days by increments of 10–12%. A source of roughage is supplied separately. The disadvantages of this system are that hungry or dominant cattle may eat much more than their calculated share and there is no assurance that sufficient roughage will be consumed. In this system, on a practical basis, the cattle are usually fed twice daily and brought up to a daily intake of concentrate that satisfies their appetite and then the concentrate

ration is offered free-choice from self-feeders. Unless there is sufficient feeding space in the self-feeders, competitive and dominant animals will often overeat and careful monitoring is necessary.

#### Feedlot starter rations

Feedlot starter rations consisting of a mixture of roughage and grain, offered free-choice along with hay and gradually replaced by a finishing ration have successfully adapted cattle in 10 days. The starter ration contains about 2500 kcal (10 460 kJ) DE (digestible energy) per kg of feed. The finishing ration contains about 3100 kcal (12 970 kJ), and controlling the rate of increase of DE concentration of the ration was a major factor in getting cattle on feed.

A comparison of the effect of rapid or gradual grain adaptation on subacute acidosis and feed intake by feedlot cattle indicates a range of individual responses to grain challenge and current management strategies for preventing acidosis in pens of cattle are based on responses of the most susceptible individuals.<sup>23</sup> Using this approach requires consideration of individual animal responses. The data suggest that most cattle can be rapidly adapted to high-grain diets in few incremental steps; minimizing acidosis in the most susceptible individuals requires decreasing the pace of grain adaptation for the entire group.

#### Dietary buffers

The incorporation of buffers, such as sodium bicarbonate, into the ration of feedlot cattle has been studied extensively but to date the results are inconclusive and reliable recommendations cannot be made. A level of 2% dietary sodium bicarbonate, sodium bentonite or limestone provided some protection from acidosis during the early adaptation phase of high-concentrate feeding; but they were no more effective than 10% alfalfa hay. Buffers have been most effective in reducing acidosis early in the feeding period and have little or no effect later. They may be associated with an increased incidence of urinary calculi, bloat and vitamin deficiencies. The experimental results to date are conflicting. Some trials indicate that buffers maintain a Gram-negative rumen flora in sheep fed grain compared to a shift to Gram-positive rumen flora in animals not fed buffers. Liveweight performance is also improved in some trials but not in others fed 0.75, 1.0 or 2.25% of diet as sodium bicarbonate.

The potential efficiency of products for the control of ruminal acidosis has been examined through the measurement of the increase in buffer capacity and acid-consuming capacity.<sup>24</sup> Sodium bicarbonate

provided the highest increment in buffering capacity and acid-consuming capacity compared to calcium carbonate. Magnesium oxide provided higher acid-consuming capacity but had no effect on buffer capacity.

Dietary supplementation of sodium bicarbonate at a level of 1.5% for 90 days in high-concentrate diets fed to lambs improved cellulose digestibility, ciliate protozoal number, ruminal pH and total nitrogen concentration, resulting in improved growth of lambs maintained on a high-concentrate diet.<sup>25</sup>

#### Ionophores

The ionophores salinomycin, monensin and lasalocid have been compared for their protective effects, and salinomycin is more effective than the other two; monensin also shows some promise. Laidlomycin propionate does not prevent ruminal acidosis but may reduce the severity of ruminal acidosis during adaptation to a 100% concentrated diet. Monensin supplementation did not affect dry matter intake, milk yield and composition, and ruminal pH characteristics in experimentally induced SARA.<sup>16</sup> The rates of ruminal forage fiber degradability were similar between control and monensin-treated cows; however, monensin supplementation increased total digestive tract fiber digestion, especially at post-ruminal sites. Thus monensin could be used for the improvement of nutrient digestion during grain-induced SARA in dairy cows.<sup>26</sup>

#### Subacute ruminal acidosis in dairy cattle

The basic principles of preventing SARA in dairy herds include:

- Limiting the intake of rapidly fermentable carbohydrates
- Providing adequate ruminal buffering
- Allowing for ruminal adaptation to high-grain diets.<sup>27</sup>

Prevention of subacute ruminal acidosis includes **proper adaptation of rumen papillae during the prepartum period, adequate intake of forage in early lactation, and adequate fiber nutrition throughout lactation**. Successful management of energy balance through the **periparturient transition period** depends on providing adequate energy density in the prepartum diet. Increasing energy density of the prepartum diet also promotes dry matter intake before and after calving. The energy density in the prepartum diet should be 1.54–1.63 Mcal/kg NE<sub>j</sub>.

Dry cows should be fed according to their needs; cows in the early and middle portion of the dry period (far-off cows) and cows in the final 3 weeks prior to calving (pre-fresh cows) have different

nutritional requirements in order to achieve optimal milk production and maintain the health and fertility of early-lactation cows.

Prepartum diets should be offered, starting at least 3 weeks prior to calving. Because of the different calving dates of dry cows fed in groups, the use of a prepartum diet over a prepartum feeding period of 21 days will usually allow each cow to consume the diet for a minimum of 5 days. The nutrient requirements for pre-fresh dry cows is controversial. The National Research Council does not provide recommendations for pre-fresh cows and it is recommended that a dairy cattle nutritionist be consulted for formulation of such rations. In general, a pre-fresh diet will provide about 0.50–0.75% BW per day as concentrates. Pre-fresh diets should be similar to early lactation diets so that the transition occurs effectively. The forages fed in the pre-fresh diet should be similar to those fed in early lactation.

Dairy cows are usually fed total mixed rations, where the concentrates and forages are mixed and fed as a total ration, or separate component rations in which the concentrates and forage are fed independently. In herds using separate component diets, the concentrates in the pre-fresh diet should be gradually introduced over a period of 3–5 days, and preferably fed individually. Forages should also be fed individually so that intake can be evaluated.

Limiting the intake of rapidly fermentable carbohydrates

As a guideline, cows should not receive more than 8–12 lb (3–5 kg) of dry matter from grain in the first week after calving.<sup>27</sup> Grain feeding should then increase by about 0.25–0.50 lb (110–220 g) per cow per day until peak grain feeding is reached at 6–8 weeks post calving.

The physical form of the feed ingredients is as important as their chemical composition in determining how rapidly and completely they are fermented in the rumen. Grains that are finely ground, steam-flaked, extruded and/or very wet will ferment more rapidly and completely in the rumen than unprocessed or dry grains. Starch from wheat or barley is more rapidly and completely fermented than starch from corn (maize). Corn silage that is very wet, finely chopped or kernel-processed is also a greater risk for SARA than drier, coarsely chopped, or unprocessed corn silage. Particle size analysis of grains is a useful adjunct test when assessing the risk for SARA in a dairy herd. Grain particle size length can be determined using metal sieves.

Providing adequate ruminal buffering  
Ruminal buffering includes dietary and endogenous buffering.<sup>27</sup>

**Dietary buffering** is the inherent buffering capacity of the diet and is dependent on cation–anion difference (DCAD). Diets high in sodium and potassium relative to chloride and sulfur have higher DCAD concentrations, tend to support higher ruminal pH, and increase dry matter intake and milk yield. Optimal DCAD for early lactation diets is approximately +400 mEq/kg of (Na + K) – (Cl + S). Mid-lactation cows have an optimal DCAD of +275 to +400 mEq/kg. Formulating diets with a high DCAD requires the addition of buffers such as sodium bicarbonate. Alfalfa forages have a higher DCAD than corn (maize) silage, depending on the mineral composition of the soil. Concentrate feeds typically have a low or negative DCAD, which adds to their already high potential to cause ruminal acidosis because of their high fermentable carbohydrate content.

**Endogenous buffers** are produced by the cow and secreted into the rumen via saliva. The amount of physical fiber in the diet determines the extent of buffer production by the salivary glands. Coarse, fibrous feeds contain more effective fiber and stimulate more saliva production during eating than do finely ground feeds or fresh pasture. Coarse, fibrous feeds also make up the mat layer of the rumen, which is the stimulus for rumination. Fiber particles must be at least 4 cm in length in order to contribute to mat layer formation. Rumination promotes much chewing activity and the secretion of large amounts of saliva into the rumen. Ruminal pH increases during bouts of rumination.

The ability of a diet and feeding program to promote maximal amounts of ruminal buffering must be evaluated in herds with SARA. Wet chemistry analysis of a carefully collected total mixed ration bunk sample can be used to determine the actual DCAD of the diet actually consumed by the cows. Diets with measured DCAD values below +275–400 mEq/kg of (Na + K) – (Cl + S) should be supplemented with additional buffers to provide more Na or K relative to Cl and S.

Endogenous buffering can be estimated by observing the number of cows ruminating (a goal is at least 40% of cows ruminating at any given time) and by measuring the particle length of the total mixed ration actually consumed by the cows using the Pennsylvania State Forage Particle Separator.<sup>27</sup> Diets with less than 7% long particles render cows at increased risk of SARA, especially if the diets are also borderline or low in chemical fiber content. Diets with excessive (over 15%)

long forage particles can paradoxically increase the risk of SARA if the long particles are unpalatable and sortable. Sorting of the long particles occurs soon after delivery of the feed, resulting in the cows consuming a diet low in physically effective fiber after feeding. The diet consumed later in the feeding period is then excessively high in physically effective fiber and low in energy. Socially dominant cows are particularly susceptible to SARA in this situation because they are likely to consume more of the fine total mixed ration particles soon after delivery of the feed. Cows lower on the social order then consume a very low-energy diet. Limiting feed bunk space to less than 75 cm per cow exacerbates the effect of total mixed ration sorting in a group of cows.

Allowing for ruminal adaptation to high-grain diets<sup>27</sup>

Cows in early lactation are susceptible to SARA if they are poorly adapted for the lactation diet. Ruminal adaptation to diets high in fermentable carbohydrates depends on microbial adaptation (particularly the lactate-utilizing bacteria, which grow more slowly than the lactate-producing bacteria) and the length of the ruminal papillae (longer rumen papillae promote greater volatile fatty acid absorption and thus lower ruminal pH).

In herds with total mixed rations, the pre-fresh diets can be offered to pre-fresh cows as they approach calving, usually with success. With total mixed rations, cows cannot eat excessive quantities of concentrate at the expense of forage. Cows that have become adapted on a well-formulated pre-calving total mixed ration during the prepartum period can go directly on to the high-producing lactating total mixed ration after calving without any further adaptation.

In summary, one of the most challenging aspects of diet formulation for lactating dairy cows is balancing for carbohydrates. Adequate effective fiber must be provided to stimulate chewing and secretion of salivary buffers. However, effective fiber is more filling than other nutritional components of the diet and the filling effect often limits the energy intake of high-producing cows. Therefore, diets for high-producing cows should be balanced to provide adequate effective fiber with the least filling effect. A balance must also be attained for ruminal carbohydrate fermentation, which is desirable to provide nutrients for microbial growth and protein. However, the fermentability of the diet must be limited to prevent excessive production of acids of fermentation.<sup>28</sup>

Feeding management in early lactation

This consists of ensuring that concentrates are introduced gradually, and

preferably at the same rate as dry matter intake increases in the first 6 weeks of lactation. Formulation strategies for feeding concentrates in the first 6 weeks of lactation without compromising fiber nutrition have been developed. Weekly dry matter predictions were used and the proper increase in concentrate feeding is only 0.9–1.6 kg/week. At the same time, it is necessary to insure that cows receive adequate dietary energy to prevent primary acetonemia.

Routine monitoring of the dry-matter content of feed ingredients is an important strategy in preparing total mixed rations for dairy cattle. Electronic silage testers are available and recommended.

**Ionophores**, such as monensin sodium, alter rumen metabolism and have the potential to control ruminal acidosis in dairy cattle, increase milk production, modify milk composition and improve health. Monensin alters the volatile fatty acid profile in the rumen towards increased propionate production, which induces gluconeogenesis. Milk production is increased but the percentage of milk fat is depressed, which is effective in reducing the incidence of ketosis. Monensin decreases the population of *S. bovis* in the rumen, resulting in a reduction in the production of lactic acid; it increases the clearance of lactate from the rumen and increases ruminal pH. This has the potential to reduce the incidence of subacute ruminal acidosis in dairy cattle and the sequelae of rumenitis, laminitis and hepatic abscessation. Monensin also decreases ruminal methanogenesis, ruminal ammonia and blood levels of ketone bodies. Thus monensin has the potential to improve health of dairy cows and prevent ruminal acidosis during the transition period of the periparturient cow as described above. Ionophores have not yet been approved for use in lactating dairy cows in North America but extensive studies are under way.

### Vaccination against lactic acidosis

Some preliminary research has investigated the immunization of cattle against lactic-acid-producing bacteria, *S. bovis* and *Lactobacillus*. Immunization induced high levels of persistent saliva antibody responses against *S. bovis* and *Lactobacillus*, which reduced the risk of lactic acidosis in cattle.<sup>29</sup>

### REVIEW LITERATURE

- Galyean ML, Rivera JD. Nutritionally related disorders affecting feedlot cattle. *Can J Anim Sci* 2003; 83:13–20.
- Kleen JL, Hooijer GA, Rehage J, Noordhuizen JPTM. Subacute ruminal acidosis (SARA): a review. *J Vet Med A* 2003; 50:406–414.
- Loerch SC, Fluharty FL. Physiological changes in digestive capabilities of newly received feedlot cattle. *J Anim Sci* 1999; 77:113–1119.

National Research Council. Nutrient requirements of dairy cattle, 7th ed. Washington DC: National Academy Press, 2001.

- Nocek JE. Bovine acidosis: implications on laminitis. *J Dairy Sci* 1997; 80:1005–1028.
- Nordlund K. Sore feet, sour rumens, clinical quandaries. In: Proceedings of the 33rd Annual Meeting of the American Association of Bovine Practitioners. Opelika, AL: AABP, 2000:58–64.
- Nordlund K. Factors that contribute to subacute ruminal acidosis. In: Preconvention Seminar 7: Dairy Herd Problem Investigation Strategies. American Association of Bovine Practitioners 36th Annual Conference, September 15–17 2003, Columbus, OH. Available on line at: <http://www.vetmed.wisc.edu/dms/fapm/fapmtools/2nutr/sara2aabp.pdf>
- Nordlund K. Herd-based diagnosis of subacute ruminal acidosis. In: Preconvention Seminar 7: Dairy Herd Problem Investigation Strategies. American Association of Bovine Practitioners 36th Annual Conference, September 15–17 2003, Columbus, OH. Available on line at: <http://www.vetmed.wisc.edu/dms/fapm/fapmtools/2nutr/sara2aabp.pdf>
- Oetzel GR. Clinical aspects of ruminal acidosis in dairy cattle. In: Proceedings of the 33rd Annual Meeting of the American Association of Bovine Practitioners. Opelika, AL: AABP, 2000:46–53.
- Oetzel GR. Introduction to ruminal acidosis in dairy cattle. In: Preconvention Seminar 7: Dairy Herd Problem Investigation Strategies. American Association of Bovine Practitioners 36th Annual Conference, September 15–17 2003, Columbus, OH. Available on line at: <http://www.vetmed.wisc.edu/dms/fapm/fapmtools/2nutr/sara1aabp.pdf>
- Oetzel GR. Nutritional management and subacute ruminal acidosis. In: Preconvention Seminar 7: Dairy Herd Problem Investigation Strategies. American Association of Bovine Practitioners 36th Annual Conference, September 15–17 2003, Columbus, OH. Available on line at: <http://www.vetmed.wisc.edu/dms/fapm/fapmtools/2nutr/sara3aabp.pdf>
- Owens FN, Secrist DS, Hill WJ, Gill DR. Acidosis in cattle: a review. *J Anim Sci* 1998; 76:275–286.

### REFERENCES

- Owens FN et al. *J Anim Sci* 1998; 76:275.
- Nocek JE. *J Dairy Sci* 1997; 80:1005.
- Oetzel GR. In: Proceedings of the 33rd Annual Meeting of the American Association of Bovine Practitioners. Opelika, AL: AABP, 2000:46.
- Kleen JL et al. *J Vet Med A* 2003; 50:406–414.
- Nordlund K. In: Proceedings of the 33rd Annual Meeting of the American Association of Bovine Practitioners. Opelika, AL: AABP, 2000:58.
- Oetzel GR. 2003: <http://www.vetmed.wisc.edu/dms/fapm/fapmtools/2nutr/sara1aabp.pdf>.
- Keunen JE et al. *J Dairy Sci* 2002; 85:3304.
- National Research Council. Nutrient requirements of dairy cattle, 7th ed. Washington, DC: National Academy Press, 2001.
- Nordlund K. 2003: <http://www.vetmed.wisc.edu/dms/fapm/fapmtools/2nutr/sara2aabp.pdf>.
- Enemark JMD, Jorgensen RJ. *Vet Q* 2001; 23:206.
- Galyean ML, Rivera JD. *Can J Anim Sci* 2003; 83:13.
- Loerch SC, Fluharty FL. *J Anim Sci* 1999; 77:1113.
- Garrett EF et al. *J Dairy Sci* 1999; 82:1170.
- Otolari EL. *Vet Hum Toxicol* 1995; 37:462.
- Keunen JE et al. *J Dairy Sci* 2003; 86:954.
- Cumby JL et al. *Can J Anim Sci* 2001; 81:149.
- Krajarski-Hunt H et al. *J Dairy Sci* 2002; 85:570.
- Plaizer JC et al. *Can J Anim Sci* 2001; 81:421.
- Gozho GN et al. *J Dairy Sci* 2005; 88:1399.
- Nordlund K. 2003: <http://www.vetmed.wisc.edu/dms/fapm/fapmtools/2nutr/sara2aabp.pdf>.

- Steen A. *Acta Vet Scand* 2001; 42:219.
- Smith GW, Correa MT. *J Vet Intern Med* 2004; 18:109.
- Bevans DW et al. *J Anim Sci* 2005; 83:1116.
- Zammarreno AM et al. *J Sci Food Agric* 2003; 83:1607.
- Santra A et al. *Small Rumin Res* 2003; 47:203.
- Osborne JK et al. *J Dairy Sci* 2004; 87:1840.
- Oetzel GR. 2003: <http://www.vetmed.wisc.edu/dms/fapm/fapmtools/2nutr/sara3aabp.pdf>.
- Allen M. In: Proceedings of the 33rd Annual Meeting of the American Association of Bovine Practitioners. Opelika, AL: AABP, 2003:1.
- Shu Q et al. *Res Vet Sci* 1999; 67:65.

### RUMINAL PARAKERATOSIS

Parakeratosis of the ruminal epithelium does not, as far as is known, cause clinical illness but opinions on its effect on weight gain and productivity vary. There is evidence that the development of parakeratosis increases and then reduces the absorption of volatile fatty acids from the rumen and that the addition of volatile fatty acids to a calf starter increases the incidence of the condition. The abnormality has been observed most commonly in cattle and sheep fed high-concentrate rations of alfalfa pellets that have been subjected to heat treatment, and does not occur in cattle fed on rations containing normal quantities of unpelleted roughage. The incidence of the disease does not appear to be related to the feeding of antibiotics or protein concentrates.

In affected rumens the papillae are enlarged, leathery, dark in color and often adhered to form clumps. Histologically there is an increase in thickness of the cornified portion of the ruminal epithelium and a persistence of nuclei in the cornified cells. Some of the affected cells contain vacuoles. The greatest severity of lesions is present on the dorsal surface of the rumen about the level of the fluid ruminal contents. It is thought that they are caused by the lowered pH and the increased volatile fatty acid content in the rumen liquor. The fact that unprocessed, whole grain – on which animals gain weight as readily as on processed grain – does not lead to the development of the disease is probably related to the higher pH and higher concentration of acetic versus longer-chain volatile fatty acids in the ruminal liquor. The incidence of affected animals in a group may be as high as 40%.

### RUMINAL TYMPANY (BLOAT)

Ruminal tympany is abnormal distension of the rumen and reticulum caused by excessive retention of the gases of fermentation, either in the form of a persistent foam mixed with the rumen contents or as free gas separated from the ingesta. Normally, gas bubbles produced in the rumen coalesce, separate from the

rumen contents to form pockets of free gas above the level of the contents and finally are eliminated by eructation.

### Synopsis

**Etiology** Ingestion of bloating forages or interference with eructation mechanism

**Epidemiology** Primary ruminal tympany (frothy bloat) is a major problem in cattle pastured on bloating forages (legumes) and in feedlot cattle fed high-level grain rations with minimal roughage. Occurs within few days after turning into bloating pasture. High morbidity and mortality possible and cost of control makes pasture bloat an economically important disease. Bloating forages most dangerous in prebloom stage and when covered with dew in the morning. Feedlot bloat common when feed contains 80% grain and is ground fine. Secondary ruminal tympany (free-gas bloat) occurs in single animals due to interference with eructation because of physical obstruction of esophagus or eructation mechanism, as in reticular adhesions

**Clinical signs** Cattle may be found dead on pasture. Mild to marked distension of left abdomen, which is tympanic; when severe, distends right abdomen also. Severe distress, dyspnea, protrusion of tongue. Passage of stomach tube in frothy bloat reveals froth and failure to release significant amount of gas; in secondary free-gas bloat, large quantities of gas released with ease. If severe, animal may die in few hours or less if tympany not relieved

**Lesions** Marked congestion and hemorrhages of tissues of cranial aspect of body (tongue, nasal sinuses, lymph nodes and proximal part of esophagus - bloat line) compared to caudal because of ruminal tympany. Distended rumen, frothy contents if examined early; later the froth dissipates

**Diagnostic confirmation** Excessive quantity of froth or free-gas in rumen

**Differential diagnosis** Primary bloat is easily recognizable and there are no other diseases of the reticulorumen that result in ruminal tympany. Secondary bloat must be differentiated from causes of failure of eructation, including esophageal obstruction, chronic reticuloperitonitis, vagus indigestion and tetanus

**Treatment** Remove animals from bloating pasture. In severe cases, emergency rumenotomy. In less severe cases, passage of stomach tube or trocar and cannula to release rumen gas. Antifoaming agents into rumen

**Control** Pasture bloat Management strategies to reduce rate of rumen fermentation. Use of grass-legume mixtures. Delay grazing each day until dew is off; feed hay before grazing. Feed forage supplements prior to grazing. Strategic use of antifoaming agents to pastured cattle. Sustained-release antifoaming agents such as monensin. Feedlot bloat Use total mixed rations containing chopped roughage and grain

## ETIOLOGY

### Primary ruminal tympany (frothy bloat)

Primary ruminal tympany or frothy bloat is caused by the production of a stable foam that traps the normal gases of fermentation in the rumen. The essential feature is that coalescence of the small gas bubbles is inhibited and intraruminal pressure increases because eructation cannot occur.

Pasture and feedlot bloat

**Leguminous or pasture bloat** is due to the foaming qualities of the soluble leaf proteins in bloating legumes and other bloating forages ingested by cattle on pasture. Alfalfa hay may also cause bloat. **Feedlot bloat** is caused by feeding finely ground grain, which promotes frothiness of rumen contents; the cause is not clear.<sup>1</sup> The feeding of large quantities of grain to cattle results in marked changes in the total numbers and proportions of certain ruminal protozoa and bacteria. Some species of encapsulated bacteria increase in numbers and produce a slime which may result in a stable foam.<sup>2</sup>

Feedlot bloat may also be of the free-gas type based on the observations that gas may be easily released with a stomach tube. Feedlot cattle are susceptible to esophagitis, ruminal acidosis, rumenitis, overfill and ruminal atony each of which can interfere with eructation and cause secondary ruminal tympany and free-gas bloat.

Frothy rumen contents

Frothiness of the ruminal contents is the vital factor in **pasture bloat**. The froth in the rumen contents is not a true foam but rather a dispersion of gas and particles in liquid.<sup>3</sup> The liquid lamellae between the bubbles are wide, and fragments of chloroplast membranes are dispersed in the fluid. The stable dispersion of small feed particles is primarily responsible for the frothiness of the rumen fluid. The concentration of chloroplast membrane particles (measured as chlorophyll) is higher in frothy rumen fluid than in nonfrothy liquid.

The soluble leaf cytoplasmic proteins were once considered to be the principal foaming agents but their role is now questioned.<sup>3</sup> It is now accepted that bloat-causing legumes are more rapidly digested by rumen microflora than non-bloat-causing forages and that rupture of leaf mesophyll cells leads to the release of chloroplast particles. These particles are readily colonized by rumen microflora and gas bubbles are trapped among the particles, which prevent coalescence of bubbles by preventing drainage of rumen fluid from the liquid lamellae between the bubbles. The higher foam production in

bloat-prone cattle is attributed to slower rates of passage of the liquid phase of ruminal contents.<sup>4</sup> The slower clearance enhances microbial activity and promotes gas production, which contributes to stable foam formation. Rapid clearance decreases microbial gas production, enhances protein bypass and reduces the probability of bloat.

**In general, bloat-causing legumes are susceptible to rapid digestion by rumen microflora, while bloat-safe legumes are digested more slowly.**

The condition of the rumen prior to feeding is an important factor in the immediate susceptibility of an animal to pasture bloat.<sup>3</sup> **A predisposed rumen is characterized by an excess of dispersed particulate matter with adherent microbes, which provides an active inoculum for the fermentation of incoming feedstuffs.** The soluble leaf protein may contribute to the frothiness but is not the primary foaming agent. The chloroplast particles in the rumen have a slower rate of clearance from the rumen in bloating animals than in nonbloating ones. It is also known that bloating animals have larger rumen volumes than nonbloating animals. Since chloroplast particles are negatively charged, it is possible that the concentrations of ions such as sodium, potassium, calcium and magnesium in the rumen fluid prior to feeding are associated with the onset of bloat.<sup>3</sup>

The **froth in feedlot bloat** is associated with high-level grain diets. The viscosity of the ruminal fluid is markedly increased because of the production of insoluble slime by certain species of bacteria that proliferate to large numbers in cattle on a high-carbohydrate diet. The slime may entrap the gases of fermentation. The delay in occurrence of feedlot bloat suggests that a gradual change in the microbial population of the rumen may be an important factor in explaining the cause. The physical form of a grain ration appears to be related to grain bloat. As in frothy legume bloat, where a rapid release of leaf nutrients is important in producing bloat, it seems likely that the small particle size of ground feed could have the same effect.

Fine particulate matter can markedly increase foam stability. The feeding of ground grain of fine particle size (geometric mean particle size 388  $\mu\text{m}$ ) was associated with more rumen froth than the use of a coarse particle size (715  $\mu\text{m}$ ). The pH of the rumen contents also plays an important part in the stability of the foam (maximum stability occurs at a pH of about 6) and the composition of the diet and the activity and composition of the rumen microflora are known to influence this factor.

### Role of saliva

The rate of flow and composition of the saliva has an effect on the tendency for bloat to occur. Saliva may have a buffering effect on the pH of the rumen contents or it may influence the contents because of variation in its content of mucoproteins. The physical effects of dilution of ruminal ingesta by saliva may also be important. There is a negative correlation between the moisture content of the feed and the incidence of bloat. Feed of a low fiber and high water content depresses the volume of saliva secreted. Also, bloat-susceptible cows secrete significantly less saliva than nonsusceptible cows and there are differences in the composition of saliva that are genetically determined.<sup>3</sup>

In summary, primary frothy pasture bloat occurs when there is rapid digestion of leaf material by rumen microorganisms, leading to the release of chloroplast particles into the liquid phase of the rumen contents, which prevents the coalescence of the gas bubbles. In addition, there is a slower rate of clearance of these particles from the rumen in bloating cows, which also have larger rumen volumes. In primary frothy feedlot bloat, the fine particle size of the feed and the presence of rumen microorganisms that produce slime may be important factors.

### Secondary ruminal tympany (free-gas bloat)

Physical obstruction to eructation occurs in esophageal obstruction caused by a foreign body, by stenosis of the esophagus, by pressure from enlargements outside the esophagus, such as tuberculous lymphadenitis or bovine viral leukosis involvement of bronchial lymph nodes, or by obstruction of the cardia. Interference with esophageal groove function in vagus indigestion and diaphragmatic hernia may cause chronic ruminal tympany and the condition also occurs in tetanus, particularly in young animals and in poisoning with the fungus *Rhizoctonia leguminicola*, probably as a result of spasm of the esophageal musculature. Carcinoma, granulomatous lesions associated with *Actinomyces bovis* near the esophageal groove and in the reticular wall, and papillomata of the esophageal groove and reticulum are less common causes of obstructive bloat. Tetanus in cattle is usually accompanied by secondary free-gas bloat due to spasm of the esophagus and inability to eructate normally.

Interference with the nerve pathways responsible for maintenance of the eructation reflex may also occur. The receptor organs in this reflex are situated in the dorsal aspect of the reticulum and can discriminate between gas, foam and liquid. The afferent and efferent nerve

fibers are contained in the vagus nerve but the location of the central coordinating mechanism has not been defined. Depression of this center or lesions of the vagus nerve can interrupt the reflex, which is essential for removal of gas from the rumen.

Normal tone and motility of the musculature of the rumen and reticulum are also necessary for eructation. In anaphylaxis, bloat occurs commonly because of ruminal atony and is relieved by the administration of epinephrine or antihistamine drugs. A sudden marked change in the pH of the rumen contents due to either acidity or alkalinity causes ruminal atony but the tympany that results is usually of a minor degree only, probably because the gas-producing activity of the microflora is greatly reduced. Hypocalcemia in milk fever of cattle is commonly associated with secondary free-gas bloat due to ruminal atony, which is reversible following treatment with calcium salts.

While most cases of feedlot bloat associated with outbreaks are of the frothy type (primary) and cannot be easily relieved with a stomach tube, sporadic cases are of the free-gas type, which suggests that they are secondary. Possible causes of the ruminal atony and failure of eructation include: **esophagitis, acidosis, rumenitis and failure of rumination because of an all-grain diet.** Feedlot cattle on high-level grain diets for long periods will not ruminate normally and their rumen movements are significantly reduced.

### Chronic ruminal tympany

**Chronic ruminal tympany** occurs in calves up to 6 months of age. Persistence of an enlarged thymus, continued feeding on coarse indigestible roughage, and the passage of unpalatable milk replacer into the rumen, where it undergoes fermentation and gas production, instead of into the abomasum, have all been suggested as causes but the condition usually disappears spontaneously in time and in most cases the cause is undetermined.<sup>5</sup> Necropsy examination of a number of cases has failed to detect any physical abnormality, although a developmental defect appears to be likely because of the age at which it occurs. Unusual postures, particularly lateral recumbency, are commonly characterized by secondary tympany. Cattle may die from secondary tympany if they become accidentally cast in dorsal recumbency in handling facilities, crowded transportation vehicles, irrigation ditches and other restrictive positions.

In some cases of vagus indigestion characterized by ruminal hyperactivity the

secondary bloat may be of the frothy type because of ruminal hyperactivity.<sup>7</sup>

## EPIDEMIOLOGY

### Occurrence

#### Pasture bloat

Pasture bloat occurs in both dairy and beef cattle that graze pastures consisting of bloating forages. The incidence is highest when the pasture is lushest. Spring and autumn are the most dangerous seasons, when the pastures are lush and young and the leaves of the plants contain a high concentration of soluble proteins. Dry hot conditions and matured plants, and thus midsummer, are the forerunners of a decline in incidence. Sheep can also be affected but appear to be much less susceptible than cattle.<sup>6</sup>

#### Feedlot bloat

Feedlot bloat occurs in feedlot cattle during the 50–100 days when cattle are fed large quantities of grain and small quantities of roughage. In some cases the use of pelleted, finely ground feed has been associated with outbreaks of feedlot bloat. High-producing dairy cows that are fed 12–22 kg of grain daily may also develop grain bloat.

### Morbidity and case fatality

#### Pasture bloat

Reliable current field data on the incidence of pasture bloat in cattle are not available. Canadian observations in 1975 indicated that cattle fed fresh alfalfa typically bloat on 35% of the feeding days and 10% of the total animal days. Frothiness of rumen contents, observed in fistulated cattle, occurs on about 50% of the feeding days and 25% of the animal days.<sup>3</sup> In dairy herds in New Zealand, the average death rate due to legume pasture bloat has ranged from 0.3–1.2%. A survey of 312 dairy farms in New Zealand over a period of 2 months revealed that 87% of all farms experienced bloat, ranging from mild to severe.<sup>7</sup> The percentage of lactating cows dying of bloat in spring of 1986 averaged 0.83%. The highest death rate of milking cows in an individual herd was 16% and in young stock 48%.<sup>7</sup> The majority of variation among farms in bloat severity was not accounted for by any of the management, soil or pasture factors measured.

#### Feedlot bloat

In a survey of Kansas feedlots (60 lots totalling 450 000 head of cattle) the incidence of deaths due to bloat was 0.1%; 0.2% of cattle had severe bloat and 0.6% moderate bloat. In a Colorado feedlot, during one full year, bloat was the cause of 3% of all mortalities. In the same study, bloat was among the four most common causes of sudden death or of cattle found dead without having been

seen ill. Outbreaks of feedlot bloat are usually of the frothy type (primary), while the sporadic cases are of the free-gas type and secondary to lesions that cause dysfunction of eructation.

### Risk factors that influence the occurrence of primary ruminal tympany

Several risk factors have an influence on the occurrence of primary bloat and possibly contribute to its causation. Dietary, weather and animal factors have received most attention.

#### Dietary risk factors

##### Bloating forages

Alfalfa (*Medicago sativa*), red clover (*Trifolium pratense*) and white clover (*Trifolium repens*) are the principal bloat-causing legumes.

Alfalfa has been recognized for its superior yield and quality in seeded pastures. Alfalfa is the most productive and most widely adapted forage species and is considered the 'queen of forages'.

Sweet clover and alsike clover are also bloat-causing forages.

Bloat also occurs occasionally when cattle are grazed on cereal crops, rape, cabbages, leguminous vegetable crops, including peas and beans, and young grass pasture with a high protein content. An increasing occurrence of bloat is noted when cattle are grazed on young green cereal crops such as **winter wheat**, especially if it is heavily fertilized and irrigated.

Frothy bloat may also occur in cattle fed alfalfa hay, even when mixed with cereal grains and another hay. Outbreaks are commonly associated with particular lots of hay, often containing fine particles. Alfalfa hay produces a frothy bloat with a typical viscous consistency of the rumen contents but it is commonly more sub-acute and chronic rather than acute and peracute as in pasture bloat.

##### Nonbloating forages

Bird's foot trefoil (*Lotus corniculatus*), cicer milk vetch (*Astragalus cicer*), arrowleaf clover (*Trifolium vesiculosum*), sainfoin (*Onobrychis viciifolia*), and crown vetch (*Coronilla varia*) are the bloat-safe forages. The bloat-safe forages contain tannins that bind with soluble proteins and inhibit microbial digestion.<sup>3</sup>

**Condensed tannins** (CTs) or pro-anthocyanidins comprise polymerized flavan-3-ol-units, and those occurring in temperate forages have a relative molecular mass of 2000–4000, comprising 10–12 units condensed together.<sup>8</sup> Tannins normally occur in plant vacuoles. CTs from *L. corniculatus* (bird's foot trefoil) and *Lotus pedunculatus* (big trefoil) differ considerably in their chemical structures.

Table 6.9 Condensed tannin content of legumes, grasses and herbs fed to ruminants in temperate grazing systems

Forage	Total (g/kg DM)
<b>Legumes</b>	
Big trefoil ( <i>Lotus pedunculatus</i> )	77
Bird's foot trefoil ( <i>Lotus corniculatus</i> )	47
Sulla ( <i>Hedysanum coronarium</i> )	45
Sainfoin ( <i>Onobrychis viciifolia</i> )	29
Red clover ( <i>Trifolium pratense</i> )	1.7
Alfalfa ( <i>Medicago sativa</i> )	0.5
<b>Grasses</b>	
Perennial ryegrass ( <i>Lolium perenne</i> )	1.8
<b>Herbs</b>	
Chicory ( <i>Chicorium intybus</i> )	4.2
Sheep's burnet ( <i>Sanguisorba minor</i> )	3.4

Source: modified from Barry & McNabb.<sup>8</sup>

The levels of CTs in big trefoil and bird's foot trefoil are 45 times greater than in red clover (*T. pratense*) and 150 times greater than in alfalfa (*Medicago sativa*).<sup>8</sup> The protein-precipitating properties of grazing CT-containing legumes has long been known to eliminate bloat. The minimum plant CT concentration needed to make forage bloat-safe has not been discovered but 5 g CT/kg dry matter (DM) or greater has been proposed. Most common legumes and grasses used in temperate agriculture have CT concentrations well below this value, and both conventional plant breeding and genetic engineering techniques are being examined to increase these levels (Table 6.9).

##### Crop maturity

The maturity of the forage is the major plant factor affecting the incidence of pasture bloat.<sup>4</sup> Grazing very succulent pasture – immature, rapidly growing legumes in the prebloom stage – is the biggest single risk of bloat in cattle.<sup>4</sup> The bloat potential of alfalfa varies significantly with the phenological stage of the plant. The greatest risk to cattle occurs during the vegetative stage of growth, and the risk declines during the bud stage and may be absent during the bloom stage.<sup>9</sup> Feeding cattle freshly chopped alfalfa herbage daily at different stages of growth resulted in animal-days of bloat of 62, 10 and 0, respectively, for the vegetative, bud and bloom stages of the alfalfa.<sup>9</sup> The leaf:stem ratio decreased from 1.2 to 0.5 and 1.5 to 0.4 in two different years as the crop matured from vegetative to bloom stage.<sup>9</sup> The absence of bloat during bloom can be attributed to the much lower leaf:stem ratio at that stage. As most chloroplasts are within the leaves, the lower leaf:stem ratio at bloom

would reduce the concentration of these fragments. A leaf:stem ratio of less than 0.5 (1:2) could be used as an indicator of a low potential for bloat in alfalfa.

The rapid rate of digestion of the immature bloating forages results in the production of a foam. In the summer months, especially under irrigated conditions when the growth rate of alfalfa is rapid, bloat occurs in cattle fed alfalfa herbage at the **vegetative to prebud stages of growth**. Alfalfa's potential for causing bloat is highest when moisture conditions are optimal for vegetative growth. Under these conditions the stems become turgid and fleshy but not fibrous; the leaves are soft and easily crushed between the fingers. In autumn, the growth rate of alfalfa is slower because of lower temperatures. A rapid rate of growth of the alfalfa is a necessary condition for bloat. Field observations of the relationship between plant factors to alfalfa bloat found that the percentages of dry matter and acid detergent fiber were lower, and the concentration of chlorophyll, total nitrogen and soluble nitrogen were higher on days when bloat occurred.<sup>10</sup>

**Ingestion of the more succulent parts of plants** and avoidance of the more mature portions can be a precipitating factor and tympany is less likely to occur if the crop is harvested and fed than if it is grazed. Restriction of the grazing area has a similar effect, by forcing the cattle to eat the entire plants. A high incidence is recorded when pasture is wet but this is probably due to the rapid growth of the plants during heavy rainfall periods rather than to the physical wetness of the crop. Under experimental conditions the production of tympany is not influenced by the water content of clover or by wilting. Other plant factors that are known to be associated with an increased tendency to bloat are liberal administration of urea to the pasture, a high intake of glucose, calcium and magnesium, and a high nitrogen intake.

A high herbage potassium to sodium ratio can increase the risk of bloat in cattle, which may be caused by digestion rate.<sup>11</sup> There is some indication that sodium fertilizer can affect the digestion rate of perennial ryegrass and white clover.<sup>11</sup> Sodium fertilizer increased maximum gas output from grass and rate of production, which was associated with an increase in grass digestibility; however, in clover it had the opposite effect, thereby potentially reducing bloat in cows fed a high-legume diet.

Results from two decades of bloat research (1973–1993) at Kamloops have been reviewed.<sup>4</sup> Every cultivar of alfalfa tested in its vegetative to early bloom stages of growth caused bloat. The dry



matter disappearance over the first 6–8 hours was highest in alfalfa that is bloat-inducing.<sup>12</sup> Lower rates of dry matter disappearance were found in sainfoin, bird's foot trefoil and cicer milk vetch, which confirms the bloat-safe features of these alternative legume forages.<sup>4</sup> Bloat was positively associated with the level of fraction 1 protein and total soluble protein in alfalfa, supporting the concept of a decreased probability of bloat with advancing stages of plant maturity. To maintain a high incidence of bloat at the research station, it was necessary to harvest the forage at vegetative to early bloom stages of growth. The risk of bloat was twice as great when the forage height was less than 25 cm than when it was more than 50 cm.<sup>4</sup>

The risk of bloat was reduced by waiting until the dew was off the alfalfa before allowing cattle to graze.<sup>13</sup> This confirms the practice of many cattlemen of delaying morning grazing 'until the dew has dried'. Bloat was observed 2–17 times more often when cattle were fed between 0700 and 0800 hours than when they were fed 4 hours later in both grazing and feedlot trials. Ruminal chlorophyll was higher before the early feeding than before the late feeding, suggesting that feeding later in the morning reduced the predisposition of cattle to bloat by increasing particle clearance from the rumen.

The risk of bloat was also reduced when cattle grazed alfalfa continuously than when grazing was interrupted and cattle were allowed to graze for only 6 hours daily. Pasture management systems that promote continuous and rapid ruminal clearance (more bypass, less gas production) are most likely to reduce the incidence of bloat.

#### Weather risk factors

The relationship of weather conditions to the occurrence and incidence of pasture bloat has been examined under Canadian conditions.<sup>10</sup> Under ordinary grazing conditions, bloat occurs sporadically over large parts of the growing season. The occurrence of pasture bloat was not associated with a simple, unique weather variable.<sup>4</sup> The effect of temperature on the incidence of bloat is complex. Bloat seems to occur when moderate daytime temperatures (20–25°C) permit optimum vegetative growth. Cool overnight temperatures in combination with moderate daytime temperatures may induce bloat in the fall. Cool temperatures delay maturation and extend the vegetative growth phase of forage crops, and optimize conditions for bloat. On a daily basis, bloat tended to be preceded immediately by nights and days that were

cooler than usual. Bloat can also occur after a killing frost.<sup>10</sup>

#### Feedlot bloat

This occurs in hand-fed cattle confined in feedlots and barns when insufficient roughage is fed or the feed is too finely ground. Two separate sets of circumstances conducive to feedlot bloat have been identified. In one, the cattle are being fed a **high-level grain finishing ration** in which grain comprises more than 80% of the weight of the ration. The effect of these rations on the rumen is a tendency to acidity and a shortage of rumen-stimulating roughage, which may interfere with motility and eructation. In the other situation, grain comprises 30–70% of the ration, with the same but less marked effect as above, but the **roughage component is alfalfa hay** with its own bloat-inducing capacity.<sup>3</sup>

#### Animal risk factors

Cattle vary in their susceptibility to primary ruminal tympany, especially that caused by legumes, and this individual susceptibility may be inherited. Cows can be classified according to their susceptibility to pasture bloat into **high or low susceptibility** and their progeny are similar.<sup>3,14</sup> Total exchange of rumen contents between high-susceptibility and low-susceptibility animals produces a temporary exchange of susceptibilities that lasts about 24 hours. A number of inherited characteristics are related to bloat.<sup>3,14</sup> They include ruminal structure and motility, composition of salivary proteins, rate of salivation and the greater capacity of the rumen contents of high-susceptibility animals to degrade mucoproteins that would either reduce antifoaming activity or increase foam-stabilizing activity.<sup>3,14</sup> A salivary protein, bSP30, is correlated with susceptibility to bloat in cattle herds selected for high or low bloat susceptibility.<sup>15</sup> One obvious application for such a protein marker for bloat would be to screen cattle to eliminate highly susceptible herds. Blood and urinary metabolites in cattle have also differed with respect to susceptibility to bloat.<sup>16</sup>

There may also be differences between animals in the rate and extent of physical breakdown of feed in the rumen and the rate of passage of solids out of the rumen.<sup>17</sup> However, neither differences in gas production nor foam production nor the stability of the foam are important factors in distinguishing between high-susceptibility and low-susceptibility cows.<sup>18</sup>

One major physiological difference between high and low susceptibility is volume of rumen fluid.<sup>19</sup> It is suggested that low-susceptibility cows do not bloat

because they have a lower relative volume of rumen digesta than high-susceptibility cows.

Under experimental conditions the production of tympany is not influenced by the rate of intake or the total intake of dry matter. Susceptibility increases with time when a tympany-producing diet is fed for a relatively short period. However, animals accustomed over very long periods to grazing bloating pastures may be less susceptible than other animals. Accordingly the mortality rate in young cattle is much higher than in mature animals.

There may be a common biological basis for partial preference for grass and clover in sheep and cattle. Dairy heifers select between 50% and 65% white clover when given a free choice between adjacent ryegrass and white clover monocultures.<sup>20</sup> There is also a diurnal pattern to preference, with a stronger preference for clover in the morning, with the preference for grass increasing towards evening. Providing animals with anti-bloat treatment (slow-release monensin capsules) did not have any effect on the proportion of clover selected.

#### Economic importance

Primary ruminal tympany causes heavy losses through death, severe loss of production and the strict limitations placed on the use of some high-producing pastures for grazing. For example, it is estimated that bloat costs the dairy industry in New Zealand \$50 million annually. The incidence of the disease has increased markedly with the improvement of pastures by heavy applications of fertilizers and the use of high-producing leguminous pasture plants, and losses in cattle at times have reached enormous proportions.

The most obvious form of loss is sudden death. Although this is the dramatic loss, especially when a large number of cattle are unexpectedly found dead, an equivalent loss occurs as the result of reduced food intake. For example, on clover-dominant pasture (60–80% white clover) where bloat was common the weight gains of cattle grazing it were 20–30% less than normal. It has been argued that the returns achieved by good bloat prevention in pastured cattle would not compensate for the costs incurred, but the opposite view is strongly held.

#### PATHOGENESIS

Normally, gas bubbles produced in the rumen fluid coalesce, separate from the rumen contents to form pockets of free gas above the level of the contents, and are finally eliminated by eructation. Much of the gas of fermentation and acidification



of bicarbonate will be eructated. A grass-fed cow can produce 100 L during the first hour of feeding. A cow maintained on a legume diet may produce 200 L per hour.<sup>21</sup>

The composition and kinetics of the gas in the rumen headspace of lactating dairy cattle grazing white clover and perennial ryegrass pastures has been determined.<sup>22</sup> Before grazing, rumen headspace gas was composed of carbon dioxide 65%, methane 31% and nitrogen 4%; 1 hour after grazing, the headspace gas was composed of carbon dioxide 76%, methane 22% and nitrogen 2%. The composition of the headspace gas was not affected by antibloat capsules that release 250 mg/d of monensin. The headspace gas from bloated cows contained slightly less carbon dioxide and slightly more nitrogen than that from nonbloated cows.

In **frothy bloat**, the gas bubbles remain dispersed throughout the rumen contents, producing an abnormal increase in the volume of the ruminoreticular contents and, consequently, **inhibiting eructation**. The characteristic frothiness of ruminal contents is caused by **inadequate coalescence of gas bubbles**.

In **free-gas bloat** the gas bubbles coalesce and separate from the rumen fluid but the animals cannot eructate the pockets of free gas because of abnormalities of the reticulorumen or esophagus.

Most cases of naturally occurring pasture or feedlot bloat are not accompanied by ruminal atony. In the early stages there is unusually pronounced hypermotility. Most of the gas is mixed with the solid and fluid ruminal contents to form a dense, stable froth. Some free gas is present but the amount that can be removed by a stomach tube or trocar and cannula does little to relieve the distension of the rumen. In general, free-gas bloat characterized by the accumulation of free gas is due to esophageal obstruction or ruminal atony.

If the **eructation reflex is functional**, the experimental introduction of very large amounts of gas does not cause tympany, since eructation removes the excess. Bloat-producing forages do not produce more gas than safe feeds and the simple production of excessive gas is known not to be a precipitating factor.

**Frothiness of the ruminal contents** interferes with **the function of the cardia** and inhibits the eructation reflex. Rumen movements are initially stimulated by the distension and the resulting hypermotility exacerbates the frothiness of the ruminal contents. Terminally there is a loss of muscle tone and ruminal motility.

The most distinctive aspect of bloated cattle is abdominal distension, particularly the left abdomen, due to distension of the

rumen. Experimentally there is a relationship between reticulorumen volume, intraruminal pressure and the abdomen of cows fed fresh alfalfa.<sup>21</sup> The volumes of gas in a bloated cow are large, 50–70 L, and there is an exponential increase in intraruminal pressure with increasing rumen volume, especially as the potential for further increases in the abdomen diminishes. Most severely bloated cows will attempt to urinate and defecate when intraruminal pressures exceeds 25 cmH<sub>2</sub>O but some cows can tolerate pressures in excess of 50 cmH<sub>2</sub>O. As the intraruminal pressure increases, occlusion of the vena cava occurs, causing congestion of the caudal part of the body. In addition, the pressure exerted by the distended rumen on the diaphragm is very high, which results in reduced lung capacity and death from hypoxia.

### CLINICAL FINDINGS

#### Primary pasture or feedlot bloat

Bloat is a common cause of **sudden death** (or **found dead**) in cattle. **Pastured beef cattle** that die of bloat are usually found dead because they are not observed as regularly as dairy cattle. **Feedlot cattle** that die of bloat are commonly found dead in the morning, which may be due to their relative inactivity during the night or to the lack of observation, detection and treatment. **Dairy cattle** that are being milked and observed regularly will commonly begin to bloat within 1 hour after being turned into a bloat-producing pasture. There is commonly a lag period of 24–48 hours before bloating occurs in cattle that have been placed on a bloat-producing pasture for the first time. They may bloat on the first day but more commonly they bloat on the second and third days. A similar situation has been observed in pastured beef cattle, which have been on a particular pasture for several days or weeks before bloat occurs. This is always a surprise to the owner and the veterinarian, who find it difficult to explain why bloat suddenly becomes a problem on a pasture that cattle have grazed safely for some time.

In **primary pasture bloat**, obvious distension of the rumen occurs quickly, sometimes as soon as 15 minutes after going on to bloat-producing pasture, and the animal stops grazing. The distension is usually more obvious in the upper left paralumbar fossa but the entire abdomen is enlarged. There is discomfort and the animal may stand and lie down frequently, kick at its abdomen and even roll. Frequent defecation and urination are common. Dyspnea is marked and is accompanied by mouth breathing, protrusion of the tongue, salivation and extension of the head. The respiratory rate

is increased up to 60/min. Occasionally, projectile vomiting occurs and soft feces may be expelled in a stream.

In **mild bloat**, the left paralumbar fossa is distended, the animal is not in distress, and 5–7 cm of skin over the left paralumbar fossa may be easily grasped and 'tented', which provides a measure of the degree of abdominal distension and tautness of the skin.

In **moderate bloat**, a more obvious distension of the abdomen is evident, the animal may appear anxious and slightly uncomfortable, and the skin over the paralumbar fossa is usually taut but some can be grasped and tented.

In **severe bloat**, there is prominent distension of both sides of the abdomen, the animal may breathe through its mouth and protrude the tongue. It is usually uncomfortable, anxious and may be staggering. The skin over the left flank is very tense and cannot be grasped and tented.

Ruminal contractions are usually increased in strength and frequency in the early stages and may be almost continuous, but the sounds are reduced in volume because of the frothy nature of the ingesta. Later, when the distension is extreme, contractions are decreased and may be completely absent. The low-pitched tympanic sound produced by percussion over the rumen is characteristic. Before clinical tympany occurs, there is a temporary increase in eructation, but this disappears in the acute stages. The course in ruminal tympany is short but death does not usually occur in less than 3–4 hours of the onset of clinical signs. Collapse and death almost without struggle occur quickly.

If animals are treated by **trocarization or the passage of a stomach tube, only small amounts of gas are released** before froth blocks the cannula or tube. In a group of affected cattle, some will be bloated and the remainder have mild to moderate distension of the abdomen. These animals are uncomfortable, graze for only short periods and their milk production is decreased. The drop in production may be caused by depression of food intake or by failure of milk letdown.

#### Secondary bloat

In secondary bloat, the excess gas is present as a **free gas cap** on top of the ruminal contents, although frothy bloat may occur in vagus indigestion with increased ruminal motility (see vagus indigestion). There is usually an increase in the frequency and strength of ruminal movements in the early stages followed by atony. Passage of a stomach tube or trocarization results in the release of large

quantities of gas and subsidence of the ruminal distension. If an esophageal obstruction is present it will be detected when the stomach tube is passed.

### Dyspnea and tachycardia in severe bloat

In both severe primary and secondary bloat there is dyspnea and a marked elevation of the heart rate up to 100–120/min in the acute stages. A systolic murmur may be audible, caused probably by distortion of the base of the heart by the forward displacement of the diaphragm. This murmur has been observed in ruminal tympany associated with tetanus, diaphragmatic hernia, vagus indigestion and esophageal obstruction and disappears immediately if the bloat is relieved.

### CLINICAL PATHOLOGY

Laboratory tests are not necessary for the diagnosis of ruminal tympany.

### NECROPSY FINDINGS

In cattle that have died from bloat within an hour previously there is protrusion and congestion of the tongue, marked congestion and hemorrhages of lymph nodes to the head and neck, epicardium and upper respiratory tract, friable kidneys and mucosal hyperemia in the small intestine. The lungs are compressed and there is congestion and hemorrhage of the cervical portion of the esophagus but the thoracic portion of the esophagus is pale and blanched. In general, congestion is marked in the front quarters and less marked or absent in the hindquarters. The rumen is distended but the contents are much less frothy than before death. A marked erythema is evident beneath the ruminal mucosa, especially in the ventral sacs. The liver is pale because of expulsion of blood from the organ. Occasionally, the rumen or diaphragm have ruptured. In animals dead for several hours there is subcutaneous emphysema, almost complete absence of froth in the rumen, and exfoliation of the cornified epithelium of the rumen with marked congestion of submucosal tissues.

### TREATMENT

The approach to treatment depends on the circumstances in which bloat occurs, whether the bloat is frothy or due to free gas, and whether or not the bloat is life-threatening.

#### First-aid emergency measures

Emergency rumenotomy

It is often necessary to advise an owner to use some first-aid measures before the veterinarian arrives on the farm. All animals should be removed immediately from the source of the bloating pasture or feed. In severe cases in which there is

### DIFFERENTIAL DIAGNOSIS

When presented with ruminating cattle with a distended abdomen and with marked distension of the left paralumbar fossa the most obvious diagnosis is ruminal tympany.

- **Primary bloat** is likely if the dietary conditions are present and the passage of a stomach tube reveals the presence of froth and the inability to release gas
- **Secondary bloat** is likely if the history indicates that distension of the abdomen and left flank has been present for a few days or if the bloat has been intermittent within the last several days. Passage of a stomach tube will detect esophageal obstruction or stenosis, both of which are accompanied by difficult swallowing and, in acute cases, by violent attempts at vomiting
- In secondary bloat associated with **vagus indigestion**, the history usually indicates that distension of the abdomen has been progressive over the last several days or few weeks with loss of weight and scant feces. In addition, the rumen is grossly enlarged and the ventral sac is commonly enlarged and distends the right lower flank
- **Tetanus** is manifested by limb and tail rigidity, free-gas bloat, prolapse of the third eyelid and hyperesthesia
- **Carcinoma** and **papillomata** of the esophageal groove and reticulum and actinobacillosis of the reticulum cannot usually be diagnosed antemortem without exploratory rumenotomy
- **Animals found dead.** One of the difficult situations encountered in veterinary practice is the postmortem diagnosis of bloat, especially in animals found dead at pasture in warm weather. **Blackleg, lightning strike, anthrax** and **snakebite** are common causes of cattle being found dead and the necropsy findings are characteristic. A diagnosis of bloat must depend on an absence of local lesions characteristic of these diseases, the presence of marked ruminal tympany in the absence of other signs of postmortem decomposition, the relative pallor of the liver and the other lesions described above

gross distension, mouth-breathing with protrusion of the tongue and staggering, an emergency rumenotomy is necessary to save the life of the animal. Once the animal falls down death occurs within a few minutes and many animals have died unnecessarily because owners are unable or reluctant to do an emergency rumenotomy. Using a sharp knife, a quick incision 10–20 cm in length is made over the midpoint of the left paralumbar fossa through the skin and abdominal musculature and directly into the rumen. There will be an explosive release of rumen contents and marked relief for the

animal. There is remarkably little contamination of the peritoneal cavity, and irrigation and cleaning of the incision site followed by standard surgical closure usually results in uneventful recovery with only occasional minor complications.

#### Trocar and cannula

The trocar and cannula have been used for many years for the emergency release of rumen contents and gas in bloat. However, the standard-sized trocar and cannula does not have a large enough diameter to allow the very viscous stable foam in peracute frothy bloat to escape quickly enough to save an animal's life. A larger-bore instrument (2.5 cm in diameter) is necessary and an incision with a scalpel or knife must be made through the skin before it can be inserted into the rumen. If any size of trocar and cannula fails to reduce the intraruminal pressure and the animal's life is being compromised by the pressure, an emergency rumenotomy should be performed. If the trocar is successful in reducing the pressure, the antifoaming agent of choice can be administered through the cannula, which can be left in place until the animal has returned to normal in a few hours. Owners should be advised on the proper use of the trocar and cannula, the method of insertion and the need for a small incision in the skin, and the care of cannulas left in place for several hours or days.

A corkscrew-type trocar and cannula has been recommended for long-term insertion in cases of chronic bloat that occur in feedlot cattle and in beef calves following weaning. The etiology of these is usually uncertain; insertion of a cannula for several days or use of a rumen fistula will often yield good results.

#### Promote salivation

For less severe cases, owners may be advised to tie a stick in the mouth like a bit on a horse bridle to promote the production of excessive saliva, which is alkaline and may assist in denaturation of the stable foam. Careful drenching with sodium bicarbonate (150–200 g in 1 L of water) or any nontoxic oil as described below is also satisfactory.

#### Stomach tube

The passage of a stomach tube of the largest bore possible is recommended for cases in which the animal's life is not being threatened. The use of a Frick oral speculum and passage of the tube through the oral cavity permits the passage of tubes measuring up to 2 cm in diameter, whereas this may not be possible if passed through the nasal cavity. In free-gas bloat, there is a sudden release of gas and the intraruminal pressure may return

to normal. While the tube is in place, the antifoaming agent can be administered. In frothy bloat, the tube may become plugged immediately on entering the rumen. A few attempts should be made to clear the tube by blowing through the proximal end of the tube and moving it back and forth in an attempt to locate large pockets of rumen gas that can be released. However, in frothy bloat it may be impossible to reduce the pressure with the stomach tube and the antifoaming agent should be administered while the tube is in place.

If the bloat cannot be relieved but an antifoaming agent has been administered, the animal must be observed closely for the next hour to determine if the treatment has been successful or if the bloat is becoming worse, which requires an alternative treatment.

### Feedlot bloat

In an outbreak of feedlot bloat, the acute and peracute cases should be treated individually as necessary. There may be many 'swellers', which are moderate cases of bloat that will usually resolve if the cattle are coaxed to walk. After a few minutes of walking they usually begin to eructate. Shaking of experimentally reproduced foam results in loss of stability of foam and coalescence into large bubbles and the movement of walking has the same effect. If walking is effective in reducing the foam, the animals should be kept under close surveillance for several hours for evidence of continued bloating, which is unusual.

### Antifoaming agents

Details of the oils and synthetic surfactants used as antifoaming agents in treatment are described in the section on control because the same compounds are used in prevention. Any nontoxic oil, especially a mineral one that persists in the rumen, not being biodegradable, is effective and there are no other significant differences between them. Their effect is to reduce surface tension and foam. A dose of 250 mL is suggested for cattle but doses of up to 500 mL are commonly used. An emulsified oil or one containing a detergent such as dioctyl sodium sulfosuccinate is preferred because it mixes effectively with ruminal contents. Of the **synthetic surfactants, poloxalene** is the one in most general use for leguminous bloat and a dose of 25–50 g is recommended for treatment. It is not as effective for feedlot or grain bloat. Alcohol ethoxylates are a promising new group of compounds for use as bloat remedies and both poloxalene and the ethoxylates are more effective and faster than oil, which is relatively slow and better suited to prevention than treatment. All three are

recommended as being satisfactory for legume hay bloat, but poloxalene is not recommended for feedlot bloat. All of them can be given by drench, stomach tube or through a ruminal cannula. The effect of all is enhanced if they are thoroughly mixed with the ruminal contents; if rumen movements are still present mixing will occur. If the rumen is static it should be kneaded through the left flank.

Alfasure (a water-soluble pluronic detergent) is effective for the treatment of alfalfa bloat when 30 mL is given intraruminally using a 6 cm 14-gauge hypodermic needle directly into the rumen through the abdominal wall in the middle of the paralumbar fossa.<sup>23</sup> The median time of disappearance after treatment was 25 minutes; the swelling returned to normal within 52 minutes.

### Return to pasture or feed

Following the treatment of the individual cases of bloat the major problem remaining is the decision about whether or not, or when, or under what conditions, to return the cattle to the bloat-producing pasture or to the concentrate ration in the case of feedlot cattle. The possible preventive measures are presented under control but, unless one of the reliable ones can be instituted, the cattle should not be returned until the hazardous period has passed. This is difficult on some farms because the bloat-producing pasture may be the sole source of feed.

### CONTROL

#### Pasture bloat

Management strategies to reduce rate of rumen fermentation

The prevention of pasture bloat is difficult. Grazing management strategies are the principal methods used for the prevention of pasture bloat, along with controlling pasture yields and quality.<sup>24</sup> Several different management practices have been recommended, including the prior feeding of dry, scabrous hay, particularly sudan grass, cereal hay and straw, restricting the grazing to 20 minutes at a time or until the first cow stops eating, harvesting the crop and feeding it in troughs, and strip grazing to insure that all available pasture is utilized each day.

**The principle of each of these strategies is to decrease the rate of rumen fermentation.** These methods have value when the pasture is only moderately dangerous but may be ineffective when the bloat-producing potential is high. In these circumstances the use of simple management procedures is unreliable because the occurrence of bloat is unpredictable. In other cases, the strategies such as limited grazing are impractical. Generally, the farmer does not know if

the pastures are dangerous until bloat occurs and, once effective prophylactic methods are being used, it is difficult to know when they are no longer required. The bloat-producing potential of a pasture can change dramatically almost overnight and the management strategy can be quickly nullified.

#### Stage of growth

The probability of legume bloat decreases with advancing stages of plant maturity due to a decrease in the soluble protein content of the legume. Alfalfa at the vegetative stage of growth results in the highest incidence of bloat compared with the bud and bloom stages, with moderate and no bloat, respectively.<sup>25</sup> These results indicate the potential for grazing management through selection of plant phenology (periodic phases of plant growth) as a method of bloat control. In practice, it would be essential to recognize the predominant stage of growth of the stand before turning cattle into the pasture. The leaf:stem ratio should also be considered as a factor.

#### Choice of forages

Seeding cultivated pastures to grass-legume mixtures is the most effective and least costly method of minimizing pasture bloat, particularly for beef herds grazing over large areas under continuous grazing systems. In a grass-legume mixture, a legume content of 50% is suggested as the maximum bloat-safe level. However, this ratio may be impractical for large areas, especially on rolling terrain, where it is impossible to maintain a uniform 50:50 stand. If cattle have a tendency to avoid the grass and select the legume, the potential for bloat increases. Bloat can occur in mixed pastures where the proportion of legume is less than 15%, possibly because of selective grazing.

Because of the potential for causing bloat, grasses alone or nonbloating forages may be used. Sainfoin, bird's foot trefoil, cicer milk vetch and crown vetch are useful bloat-safe legumes in regions where they are adapted. However, their yield, vigor, regrowth, winter-hardiness and persistence are well below the superior growth and production characteristics of alfalfa. Seeding grasses alone avoids the problem of bloat but the benefits of including a legume in the mixture include much greater production, higher protein and nutritional value and lower fertilization costs. A decision to use grass with or without bloat-safe legumes should be based on the economic benefits of the greater protein from alfalfa or clover compared with the possible losses from bloat.

At present, a pasture comprising equal quantities of clovers and grasses comes

closest to achieving this ideal but with available pasture plants and current methods of pasture management this clover:grass ratio is not easy to maintain. Research work in this area is directed towards selecting cattle that are less susceptible to bloat. More practical are the moves being made to breed varieties of legume that are low on bloat-producing potential.

The incidence of frothy bloat can be substantially reduced if alfalfa herbage contains as little as 25% orchardgrass.<sup>26</sup>

#### Condensed tannins in forages

Proanthocyanidins, also known as CTs, are phenolic plant secondary compounds widely distributed through the plant kingdom, especially in woody plants and in certain forages.<sup>27</sup> In ruminants fed high-quality fresh forage diets (25–35 g nitrogen (N)/kg DM) and 10–11 MJ of metabolizable energy (ME)/kg DM) most proteins are rapidly solubilized and release between 56% and 65% of the N concentration in the rumen during mastication; consequently large losses of nitrogen occur (250–25%) as ammonia is absorbed from the rumen. Thus, the inefficient use of nitrogen by ruminants needs research to focus on improving nitrogen retention by the animal and natural plant compounds with known ability to reduce proteolysis, such as CTs, which exert their effects by complexing with proteins.

Forages containing moderate concentrations of CTs can exert beneficial effects on protein metabolism in sheep, slowing degradation of dietary protein to ammonia by rumen microflora and increasing protein outflow from the rumen, thus increasing absorption of amino acids in the small intestine of the animal. This can result in increases in lactation, wool growth and live weight gain, without changing voluntary feed intake. Dietary CTs can also contribute to improved animal health by reducing the detrimental effects of internal parasites in sheep and the risk of bloat in cattle. In contrast, high dietary CT concentrations (6–12% DM) depress voluntary feed intake, digestive efficiency and animal productivity.<sup>27</sup>

The literature on the effect of CTs on the nutrition and health of ruminants fed fresh temperate forages has been reviewed.<sup>28</sup> Forages containing substantial amounts of CTs are nonbloating because of the protein-precipitating properties of CTs.<sup>8,28</sup> CTs interact with proteins in feed, saliva and microbial cells, with microbial exoenzymes and with endogenous proteins and other feed components, which alters digestive processes compared with diets free from CT.<sup>29</sup> Tannin levels exceeding 40–50 g/kg DM in forages may

reduce protein and DM digestibility of the forages by ruminants. At low to moderate levels, CTs increase the quantity of dietary protein, especially essential amino acids, flowing to the small intestine. Unlike alfalfa, legumes that contain CTs do not cause bloat. Dietary CTs may provide a means to beneficially manipulate protein digestion and/or prevent pasture bloat in ruminants.

White clover and alfalfa (lucerne) contain only trace amounts of CTs in their leaves but are used extensively in animal production because of their high nutritive value. A minimum concentration of 5 g/kg DM of CTs is necessary for a high probability of preventing bloat. The transfer of DNA coding for CT production in leaves from plant species such as lotus, sulla and sainfoin into legumes such as white clover and alfalfa that normally only express low levels of CTs in leaf tissue has been proposed. Investigations to produce alfalfa and white clover containing 5 g CT/kg DM using gene transfer technology have been conducted in Australia and Canada with the objective of producing a nonbloating alfalfa cultivar.<sup>30</sup> Concentrations of 0.75–1.25 g CT/kg DM have been achieved but are well below the value of 5 g/kg DM estimated to reduce bloat.

#### Alternative temperate forages

The literature on the use of alternative temperate forages to improve the sustainable productivity of grazing ruminants, relative to grass-based pastures has been reviewed.<sup>30</sup>

Forages comprise a major proportion of the diet in most ruminant animal production systems. Grazed forages are used especially during the late spring, summer and early autumn in many countries, while in some regions such as Australasia and South America, ruminant animal production is based on year-round grazing of forages, with no indoor housing. Grazing systems are generally based on swards of which the major portion consists of grasses (perennial ryegrass (*Lolium perenne*) in the case of New Zealand), with a legume (white clover (*T. repens*) in the case of New Zealand) forming a minor portion (approximately 20%), mainly to fix atmospheric nitrogen and to provide a higher-quality feed. Different grasses and legumes form the grazed pastures in other countries. The grazing of alternative forages is being developed for the sustainable control of internal parasites, with reduced anthelmintic use, for increasing reproductive performance in sheep and the growth rate in young animals, and for reducing the incidence of bloat in cattle.<sup>30</sup>

It has been long accepted in ruminant nutrition that the feeding value of legumes is greater than that of grasses, owing to their more rapid particle breakdown, faster rumen fermentation, lower rumen mean retention time and consequently greater voluntary feed intake. Despite these advantages, legumes have never attained their true potential in many grazing systems because of three principal disadvantages: legumes generally grow slowly in winter, producing less feed per hectare than grasses; rumen frothy bloat in cattle is caused by rapid solubilization of protein in many legumes; and the presence in some legumes of estrogenic substances depresses reproductive performance when grazed by ewes during the breeding season. Thus the identification of legumes that could overcome these limitations would offer major advantages. The herb chicory (*Chicorium intybus*) and the CT-containing legumes bird's foot trefoil (*L. corniculatus*) and sulla (*Hedysarum coronarium*) offer the most advantages.<sup>30</sup> Chicory and sulla promoted faster growth rates in young sheep and deer in the presence of internal parasites, and showed reduced methane production. Grazing on *L. corniculatus* was associated with increases in reproductive rate in sheep, increases in milk production in both ewes and dairy cows and reduced methane production, effects that were mainly due to its content of CTs. The risk of frothy bloat in cattle grazing legumes is reduced when the forage contains 5 g CT/kg DM or greater.

The degree to which sulla, chicory and bird's foot trefoil are adopted by livestock farmers will depend upon their agronomy under grazing, as well as their nutritive and feeding values. All three have no means of vegetative propagation under grazing and thus plant density declines with time. With careful management, such as not grazing during wet winter weather, stands of chicory can last 4–6 years under New Zealand conditions and is gaining acceptance by farmers. Chicory is often seeded with a legume such as red clover, which has a similar lifespan and fixes nitrogen. *L. corniculatus* is best suited to hot, dry summer climates and warm winter climates and stands will persist for 3–4 years under these conditions, indicating a role in future dryland grazing systems. When grown in environments that have regular summer rainfall, a stand of *L. corniculatus* lasts only 2 years, as a result of competition from grasses, volunteer legumes and weeds.<sup>30</sup> Sulla is biennial, with a life of one winter and two grazing seasons; it has a specialized requirement for inoculation with *Rhizobium* bacteria. These factors and the lack of commercial seed supply have reduced the

acceptance of sulla by livestock producers in New Zealand, despite its obviously high nutritive value and high feeding value.

#### *Nonbloating alfalfa cultivars*

Based on research initiated in western Canada in the 1970s, alfalfa cultivars have been selected with a low potential for bloating based on low initial rates of digestion.<sup>25</sup> In field trials, a new alfalfa cultivar (AC Grazeland) reduced the incidence and severity of bloat on pasture compared with the control cultivar Beaver.<sup>31</sup> The initial rate of digestion was 85% of unselected alfalfa, and the incidence of bloat at three locations over 3 years was significantly reduced.<sup>32</sup> However, the new cultivars are not bloat-safe; they are bloat-reduced cultivars.<sup>24</sup>

#### *Field management*

Fertilization and grazing management may be used to maintain a 50:50 mixture of grass and alfalfa. Nitrogen fertilizer and heavy or frequent grazing promote grass growth at the expense of alfalfa. In areas where the incidence of bloat is high, the critical upper limit of alfalfa may be as low as 25–30%. In addition to seeding alfalfa to form 25–30% of the total stand, mixtures grown in sandy areas, which are more prone to drought than heavy soils, are less likely to produce bloat. Although alfalfa–grass mixtures may be seeded to produce the desired proportion of alfalfa and grass, selective grazing and variation in the terrain of the field may allow excessive intake of alfalfa, resulting in bloat. The period following mechanical harvesting or intensive grazing of alfalfa–grass mixtures may pose a potential risk of bloat, because alfalfa generally recovers faster than grass after cutting.

The ideal companion grass should have the same seasonal growth pattern and regrowth characteristics as alfalfa. Smooth brome grass is widely grown in a mixture with alfalfa but its regrowth after grazing or cutting is lower than alfalfa. Consequently, pasture bloat may occur when an alfalfa–brome grass mixture is used in rotational grazing systems. Sufficient time must elapse between rotations to allow regrowth of the brome grass.

Meadowgrass has faster regrowth than smooth brome grass. Similarly, orchardgrass and timothy have fast regrowth characteristics and are the best choices in areas where they are adapted.

#### *Grazing management*

Uniform and regular intake is the key to managing cattle on legume pastures. Waiting until the dew is off before placing animals on pasture is a common practice and is probably useful when animals are first exposed to a legume pasture. Before

animals are placed on a legume pasture they should be fed coarse hay to satiety. This prevents them from gorging themselves and overeating the fresh and lush legume forage. Thereafter, they should stay on the pasture. Mild bloat may occur on first exposure, but the problem should disappear in a few days because animals usually adapt to legume pastures with continuous grazing. If the legume pasture continues to have a high bloat potential, the animals should be removed until the legume becomes more mature and less bloat-provoking.

#### *Forage supplements prior to grazing*

The effect of feeding a forage supplement such as chopped straw combined with cane molasses and soyabean meal to dairy cattle prior to being placed on a clover pasture twice daily has been examined as a strategy to reduce the incidence of bloat.<sup>33</sup> The energy and protein content were varied by the content of molasses and soyabean meal. A high-energy, high-protein supplement increased the incidence of bloat, and a low-energy, high-protein supplement reduced the incidence compared to grazing alone. The feeding of silage prior to grazing reduced the incidence of bloat among cows grazing both tall and short swards. The most suitable forages to feed when there is a risk of bloat are those that are slowly fermented in the rumen but are eaten in sufficient quantity to reduce periods of rapid forage intake.

#### *Grazing patterns and strip grazing*

Bloat is often associated with discontinuous grazing such as removal of animals from the legume pasture for a period of time, e.g. overnight. Similarly, outbreaks may occur when grazing is interrupted by adverse weather, such as storms, and by biting flies or other insect pests. These factors alter normal grazing habits, generally resulting in more intensive, shorter feeding periods that may increase the incidence of bloat.

In **strip grazing** the field is grazed in strips that are changed every 1–3 days. This is done by careful placement of an electric fence so that the grazing strip is moved further and further away from the entrance. In this way the animals are forced to graze a greater proportion of the entire plant, which increases the dry matter intake and proportionately decreases the intake of soluble protein, which results in a decrease in the rate of digestion in the rumen. In some situations, the most reliable methods for the prevention of bloat in dairy cows are either strip grazing of pasture sprayed daily with oil or pluronics, or twice-daily drenching with the same preparations.

#### *Swathing and wilting*

The frequency of alfalfa bloat can be decreased by grazing pastures that have been swathed and wilted. Wilting swathed alfalfa for 24 hours produces changes in the protein configuration of the sulfhydryl and disulfide content of the proteins.<sup>25</sup> Compared with feeding a fresh swath, wilting a swath for 24 or 48 hours reduces the incidence of alfalfa bloat. The reduction is greatest by 48 hours and may be eliminated after 48 hours. A reduction in moisture content during wilting may be sufficient to eliminate the risk of bloat. Alfalfa silage is virtually bloat-free because of protein degradation by proteolysis during ensiling.

#### *Alfalfa hay bloat prevention*

The bloat-potential of alfalfa hay is unpredictable. The best indicators are leafy, immature hay with soft stems. Hay grown under cool, moist conditions is more likely to cause bloat than hay produced in hot, dry areas. Reports of bloat on damp, moldy hay are common but not documented and are unexplained. Since fine particles and leaves are especially dangerous, chopping hay can increase the incidence of bloat.

When alternative roughages are available, a coarse grass hay, cereal grain hay or straw can be substituted for a portion of the bloat-causing hay. In dairy herds, alfalfa hay can be fed in the morning and grass hay in the evening. Animals should be adjusted gradually to new lots of alfalfa hay; old and new lots should be mixed for the first 5 days of feeding.

Rations containing a 50:50 mixture of alfalfa hay and grain are most dangerous but the risk of bloat is low when grain consists of less than 35% of the mixture.

#### *Antifoaming agents*

One satisfactory strategy for the prevention of pasture bloat is the administration of antifoaming agents.

#### *Oils and fats*

Oils and fats have achieved great success for the control of pasture bloat in New Zealand and Australia.

#### *Individual drenching*

Individual drenching is sometimes practiced but because of the time and labor involved it is most suited to short-term prophylaxis. It is popular as an effective standard practice in pastured cattle in New Zealand. The common practice is to administer the antifoaming agent (antibloat drench) at the time of milking using an automatic dose syringe that is moved up and down to reach each cow in the milking parlor. Cows become conditioned quickly and turn their heads to the operator to receive their twice-daily dose of 60–120 mL of the oil. The duration of the foam-preventing effect is short,

lasting only a few hours, and increasing the dose does not significantly lengthen the period of protection.

The combined use of sodium chloride and antibloat drenching of lactating dairy cows in New Zealand may stimulate the closure of the reticular groove, causing the swallowed fluid to by-pass the reticulo-rumen, rendering the drenching with the antibloat solution ineffective.<sup>34</sup> The proportion of antibloat-sodium-chloride fluid bypassed was considered to be of no practical significance to the protection from bloat in most animals. However, there may be decreased protection in 10–15% of drenched cows. Thus, cows should be drenched with these compounds at separate times, morning for one, evening for the other, or, if drenching at the same milking, drench with the antibloat solution first, followed by a separate drench with sodium chloride.

#### *Application of oil to pasture*

If the oil or fat is emulsified with water it can be sprayed on to a limited pasture area that provides part or all of the anticipated food requirements for the day. Backgrazing must be prevented and care is required during rainy periods when the oil is likely to be washed from the pasture. The method is ideal where strip-grazing is practiced on irrigated pasture but is ineffective when grazing is uncontrolled.

#### *Addition to feed and water*

The oil can be administered at the rate of 120 g per head in concentrates fed before the cattle go on to the pasture or by addition to the drinking water to make a 2% emulsion. Oil can be added to water in all available troughs, turning off the water supply and refilling the troughs when they are emptied. However, the actual intake of the oil cannot be guaranteed. Climatic conditions also cause variations in the amount of water that is taken, with consequent variation in the oil intake. Thus it is best to make provision for a daily intake of 240–300 g of oil per head during those periods when the risk of bloating is highest. The recommended procedure is to provide an automatic watering pump that injects antifoaming agents into all the drinking water supplies in amounts that will maintain a concentration of 1% of the antifoaming agent. Hand replenishment means that the preparation must be added twice daily. Surfactants are preferred to oils because of their faster action, the smaller dose rates (5–8 mL in 10–20 mL of water) and their longer period of effectiveness (10–18 h).

#### *Application to flanks*

Antifoaming agents can be applied with a large paint brush to the flanks of cows as

they go out of the milking shed. A preparation that is palatable to cattle and encourages them to lick their flanks is preferred. This has been a popular method of controlling bloat in dairy cows in Australia, but failures are not infrequent, especially in individual cows.

#### *Types of oil*

Many different oils have been used and most vegetable oils, mineral oil and emulsified tallow are effective. The choice of oil to be used depends on local availability and cost. If the oils are to be used over an extended period, some consideration must be given to the effects of the oil on the animal. Continued administration of mineral oil causes restriction of carotene absorption and reduces the carotene and tocopherol content of the butter produced. Linseed oil, soya oil and whale oil have undesirable effects on the quality and flavor of the milk and butter. Peanut oil and tallow are the most satisfactory. In most areas the tympany-producing effect of pasture is short-lived and may last for only 2–3 weeks. During this time the pasture can be grazed under the protection of oil administration until the bloat-producing period is passed.

#### *Water-soluble feed supplements*

Commercially available sources of CTs, and plant extracts of *Yucca schidigera* (yucca) are a natural source of steroidal saponins.<sup>35</sup> Both compounds were ineffective in preventing bloat in cattle fed fresh alfalfa herbage when used as a water-soluble feed supplement added to the drinking water or given as a top-dressing.

#### *Synthetic non-ionic surfactants*

##### *Poloxalene*

**Poloxalene** is a non-ionic surfactant (surface active agent) that has been used successfully for the prevention of leguminous bloat for 25 years.<sup>36</sup> It is a polyoxyethylene polyoxypropylene block polymer and highly effective for use in cattle grazing lush legume pasture or young cereal crops such as wheat pasture. Poloxalene moderates the ingestive behavior of cattle grazing immature alfalfa.<sup>37</sup> In cattle the recommended daily level of poloxalene for prevention of bloat is 2 g/100 kg BW. In high-risk situations it may be advisable to administer the drug at least twice daily. Poloxalene is unpalatable and its use in drinking water was not possible until the introduction of the pluronic L64, which is suitable for mixing with drinking water and is effective. It needs to be introduced to the cattle several weeks before the bloat season commences. It is commonly used as an additive to grain mixtures, in feed pellets and in mineral blocks. The use of

pluronic administered by mixing with molasses to be licked from a roller drum was popular for a short period of time for the control of bloat in pastured beef cattle but consumption was erratic and control of bloat unreliable. The alternative of mixing pluronic with the drinking water is also not dependable. Pluronic poisoning has occurred in grass- and milk-fed young calves given a pluronic-type detergent bloat drench because the attendant thought the calves were mildly bloated.<sup>38</sup> Dyspnea, bellowing, convulsions and death in 24 hours occurred.

#### *Alfasure*

Alfasure, a polyoxypropylene-polyoxyethylene glycol surfactant polymer, is very effective for the prevention of bloat when used at 0.05% in drinking water of cattle fed fresh alfalfa herbage and when added as a top dressing.<sup>35</sup> An Alfasure spray on pasture is completely effective in eliminating the occurrence of bloat in cattle grazing alfalfa at the vegetative to bud stage of growth.<sup>23</sup>

#### *Alcohol ethoxylate detergents*

These products are known to have equal foam-reducing qualities to poloxalene and have the advantage of better palatability so that they can be administered by a voluntary intake method such as medicated blocks. Small-scale field trials show that these blocks are palatable and attractive and should be satisfactory in reducing the severity and prevalence of bloat. Not all cattle visit them voluntarily, so some cases of bloat are likely to occur. The blocks contain 10% of the alcohol ethoxylate, known as Teric, and a daily consumption of 17–19 g of it is usual. Application of Teric to the flanks of cows has not been as successful as a bloat prevention as has similar application of oils.

Alcohol ethoxylate and pluronic detergents controlled the occurrence of bloat in sheep fed freshly harvested alfalfa in confinement and in grazing studies wherein the products were added to the water supply.<sup>39</sup> In cattle grazing early to late bud alfalfa stands, the addition of the products to the water supplies prevented the occurrence of bloat.

#### *Ionophores*

Rumen modifiers such as the ionophore monensin have been used to control bloat using controlled-release capsules and liquid formulations.<sup>40</sup>

#### *Controlled-release monensin capsules*

Sustained-release capsules containing antifoaming agents are available for the control of pasture bloat. The capsule is administered into the rumen, where it opens, exposing an antifoaming agent, which diffuses slowly from a matrix.

Monensin, a polyether ionophore antibiotic, is potentially an important agent for bloat relief in dairy cows grazing legume-based pasture.<sup>17</sup> A monensin controlled-release intraruminal capsule is available that releases approximately 300 mg/head per day for 100 days.<sup>17</sup> Experimental and field studies indicate that monensin can reduce the severity of bloat and increase milk production in dairy cows grazing legume pastures.<sup>17</sup> In dairy farms in Australia, sustained-release monensin capsules were effective in reducing the incidence of clinical bloat in pasture-fed cattle.<sup>41</sup> There was also a significant decrease in the use of pasture spraying, drinking water administration and flank-spraying of antifoaming agents on the farms using the capsules, with no compensatory rise in the use of other bloat-prevention techniques.

A controlled-release monensin capsule reduced the incidence of bloat by about 50% in experimental steers fed alfalfa at the vegetative to early bud stages of growth.<sup>42</sup>

#### *Liquid formulation of monensin*

Oral drenching with a liquid formulation of monensin is effective in reducing bloat in milking cows grazing white-clover-ryegrass or red-clover pastures.<sup>40</sup> A daily dose of 300 mg per cow given as an oral drench in a volume of 100 mL daily provided protection for 24 hours.

#### **Feedlot bloat**

##### Roughage in ration

Feedlot high-level grain rations should contain at least 10–15% roughage, which is cut or chopped and mixed into a complete feed. This ensures that cattle will consume a minimum amount of roughage. The roughage should be a cereal grain straw or grass hay. The use of leafy alfalfa hay may be hazardous. The roughage may be fed separately in the long form as a supplement to the grain ration but this practice is dangerous because the voluntary intake of roughage will very considerably. The more palatable the grain ration, the less total roughage will be eaten and outbreaks of feedlot bloat may occur.

##### Consistency of grain

Best results in feedlot bloat are achieved by the incorporation of nonbloating roughages in the grain ration at a level of at least 10%, and avoiding fine grinding of the grain. Grains for feedlot rations should be only rolled or cracked, not finely ground. If the grain is very dry, the addition of water during processing will prevent pulverization to fine particles. The use of pelleted rations for feedlot cattle cannot be recommended because a fine grind of the grain is normally necessary to

process a solid pellet. When the pellet dissolves in the rumen, a fine pasty rumen content forms, which may be associated with the development of a stable foam. In addition, it is difficult to incorporate a sufficient quantity of roughage into a pellet.

##### Antifoaming agents

The use of dietary antifoaming agents for the prevention of feedlot bloat has had variable success. The addition of tallow at the level of 3–5% of the total ration has been successful, judged empirically, but controlled trials did not reduce bloat scores.<sup>17</sup> If animal fats are effective in preventing feedlot bloat they would be useful as a source of energy and for the control of dust in dusty feeds. Poloxalene is ineffective for the prevention of feedlot bloat.

##### Dietary salt

The addition of a 4% salt to feedlot rations has been recommended when other methods are not readily available. However, feed intake and rate of body weight gain will be reduced. A high salt diet increased water intake, causes an alteration in the proportion of disrupted cells in the forage due to changes in fermentation, and increases the rate of flow of particulate material out of the rumen. Other management factors considered to be important in the prevention of feedlot bloat generally include: **avoid overfeeding after a period of temporary starvation**, e.g. after bad weather, machinery failure, transportation or feed handling failure, and **insure that the water supply** is available at all times.

#### **Genetic control of pasture bloat**

Because of the high costs of bloat from deaths, lost production, treatment costs and extra labor, one possible long-term solution is to breed cattle with reduced susceptibility to bloat.<sup>14</sup> Bloat score on a single day is heritable but the required testing procedures are expensive in labor and can put the lives of otherwise valuable animals at risk. Selection on bloat score has been achieved successfully in an experimental herd, and genetic markers and candidate genes for bloat susceptibility are now being explored.<sup>14</sup> The ultimate aim is to assist the dairy industry to identify bloat-susceptible animals, so that they can be culled or used less frequently as parents in the national herd. Work in New Zealand suggests that the prospects are good for providing the dairy industry with a means of removing bloat-susceptible cattle. Carrier sires could be identified, using a marker, and these sires could be withheld from the teams of widely used proven sires available for commercial use. The use of non-

carrier artificial insemination sires in the dairy cattle industry could minimize the bloat problem in one generation, by removing all homozygous bloat-susceptible progeny from the population.<sup>14</sup> There has been no recent research on this aspect of bloat in cattle.

#### **General comments**

Apart from the impressive reduction in clinical and fatal cases of ruminal tympany resulting from the prophylactic use of oils, there are the added advantages of being able to utilize dangerous pasture with impunity and the reduction of subclinical bloat and its attendant lowering of food intake. Production may rise by as much as 25% in 24 hours after the use of oil. Nevertheless, these preventive methods should be considered as temporary measures only. The ultimate aim should be the development of a pasture of high net productivity where the maximum productivity is consistent with a low incidence of bloat and diarrhea.

#### **REVIEW LITERATURE**

- Howarth RE, Cheng KJ, Majak W, Costerton JW. Ruminant bloat. In: Milligan LP, Grovum WL, Dobson A, eds. Control of digestion and metabolism in ruminants. Proceedings of the 6th International Symposium on Ruminant Physiology, Banff, Canada, September 10–14 1984. Englewood Cliffs, NY: Prentice-Hall, 1986:516–527.
- Mathison GW. Effects of processing on the utilization of grain by cattle. *Anim Feed Sci Technol* 1996; 58:113–125.
- Cheng KJ, McAllister TA, Popp JD et al. A review of bloat in feedlot cattle. *J Anim Sci* 1998; 76:299–308.
- Aerts RJ, Barry TN, McNabb WC. Polyphenols and agriculture: beneficial effects of proanthocyanidins in forages. *Agric Ecosystem Environ* 1999; 75:1–12.
- Barry TN, McNabb WC. The implications of condensed tannins on the nutritive value of temperate forages fed to ruminants. *Br J Nutr* 1999; 81:263–272.
- Berg BP, Majak W, McAllister TA et al. Bloat in cattle grazing cultivars selected for a low initial rate of digestion: a review. *Can J Plant Sci* 2000; 80:493–502.
- Coulman B, Goplen B, Majak W et al. A review of the development of a bloat-reduced alfalfa cultivar. *Can J Plant Sci* 2000; 80:487–491.
- McMahon LR, McAllister TA, Berg BP et al. A review of the effects of forage condensed tannins on ruminal fermentation and bloat in grazing cattle. *Can J Plant Sci* 2000; 80:469–485.
- Popp JD, McCaughey WP, Cohen RDH, McAllister TA, Majak W. Enhancing pasture productivity with alfalfa: a review. *Can J Plant Sci* 2000; 80:513–519.
- Galyean ML, Rivera JD. Nutritionally related disorders affecting feedlot cattle. *Can J Anim Sci* 2003; 83:13–20.
- Min BR, Barry TN, Attwood GT, McNabb WC. The effect of condensed tannins on the nutrition and health of ruminants fed fresh temperate forages: a review. *Anim Feed Sci Technol* 2003; 106:3–19.
- Ramirez-Restrepo CA, Barry TN. Alternative temperate forages containing secondary compounds for improving sustainable productivity in grazing ruminants. *Anim Feed Sci Technol* 2005; 120:179–201.



## REFERENCES

1. Gaylean ML, Rivera JD. *Can J Anim Sci* 2003; 83:13.
2. Cheng KJ et al. *J Anim Sci* 1998; 76:299.
3. Howarth RE et al. In: Milligan LP, Grovum WL, Dobson A, eds. *Control of digestion and metabolism in ruminants. Proceedings of the 6th International Symposium on Ruminant Physiology, Banff, Canada, September 10-14 1984.* Englewood Cliffs, NY: Prentice-Hall, 1986:516-527.
4. Majak W et al. *J Anim Sci* 1995; 73:1493.
5. Doll K. *Bovine Pract* 1989; 24:49.
6. Colvin HW, Backhus RC. *Compend Biochem Physiol* 1988; 91:635.
7. Carruthers VR et al. In: *Proceedings of the 4th Seminar of the Dairy Cattle Society.* Wellington: NZ Veterinary Association, 1987:11.
8. Barry TN, McNabb WC. *Br J Nutr* 1999; 81:263.
9. Thompson DJ et al. *Can J Anim Sci* 2000; 80:725.
10. Hall JW, Majak W. *Can J Anim Sci* 1991; 71:861.
11. Phillips CJC et al. *Vet J* 2001; 161:63.
12. Hall JW et al. *Can J Anim Sci* 1994; 74:451.
13. Hall JW, Majak W. *Can J Anim Sci* 1995; 75:271.
14. Morris CA et al. *Proc NZ Soc Anim Prod* 1991; 57:1997.
15. Rajan GH et al. *Anim Genet* 1996; 27:407.
16. Carruthers VR, Morris CA. *Proc NZ Soc Anim Prod* 1994; 54:289.
17. Lowe LB et al. *Aust Vet J* 1991; 68:17.
18. Cockrem FRM et al. *Anim Prod* 1987; 45:37.
19. Cockrem FRM et al. *Anim Prod* 1987; 45:43.
20. Rutter SM et al. *Appl Anim Behav* 2004; 85:1.
21. Waghorn GC. *NZ J Agric Res* 1991; 34:213.
22. Moate PJ et al. *J Agric Sci (Camb)* 1997; 129:459.
23. Majak W et al. *Can J Anim Sci* 2005; 85:111.
24. Popp JD et al. *Can J Plant Sci* 2000; 80:513.
25. Majak W et al. *J Range Manage* 2001; 54:490.
26. Majak W et al. *Can J Anim Sci* 2003; 83:827.
27. Aerts RJ et al. *Agric Ecosystem Environ* 1999; 75:1.
28. Min BR et al. *Anim Feed Sci Technol* 2003; 106:3.
29. McMahon LR et al. *Can J Plant Sci* 2000; 80:469.
30. Ramirez-Restrepo CA, Barry TN. *Anim Feed Sci Technol* 2005; 120:179.
31. Berg BP et al. *Can J Plant Sci* 2000; 80:493.
32. Coulman B et al. *Can J Plant Sci* 2000; 80:487.
33. Phillips CJC et al. *Vet Rec* 1996; 139:162.
34. McLeay LM et al. *NZ Vet J* 2002; 50:77.
35. Majak W et al. *Can J Anim Sci* 2004; 84:155.
36. Hall JW et al. *Can Vet J* 1994; 35:702.
37. Dougherty CT et al. *Grass Forage Sci* 1992; 47:180.
38. Teague WR. *NZ Vet J* 1986; 34:104.
39. Stanford K et al. *J Dairy Sci* 2001; 84:167.
40. Agnew KEW et al. *New Z Vet J* 2000; 48:74.
41. Cameron AR, Malmo J. *Aust Vet J* 1993; 70:1.
42. Hall JW et al. *Can J Anim Sci* 2001; 81:281.

### TRAUMATIC RETICULOPERITONITIS

Perforation of the wall of the reticulum by a sharp foreign body initially produces an acute local peritonitis, which may spread to cause acute diffuse peritonitis or remain localized to cause subsequent damage, including vagal indigestion and diaphragmatic hernia. The penetration of the foreign body may proceed beyond the peritoneum and cause involvement of other organs resulting in pericarditis, cardiac tamponade, pneumonia, pleurisy and mediastinitis, and hepatic, splenic or diaphragmatic abscess. These sequelae of traumatic perforation of the reticular wall are set out diagrammatically in Figure 6.4.

This complexity of development makes diagnosis and prognosis difficult, and the possibility that a number of syndromes may occur together further complicates the picture. All these entities except endocarditis are dealt with together here, even though many of them are diseases of other systems.

### ETIOLOGY

Traumatic reticuloperitonitis is caused by the penetration of the reticulum by metallic foreign objects that have been ingested in prepared feed. Baling or fencing wire that has passed through a chaff-cutter, feed chopper or forage harvester is one of the most common causes. In one series of 1400 necropsies, 59% of lesions were caused by pieces of wire, 36% by nails and 6% by miscellaneous objects. The metal objects may be in the roughage or concentrate or may originate on the farm when repairs are made to fences, yards and in the vicinity of feed troughs.

The wire from motor vehicle radial tires may be the cause.<sup>1-3</sup> Used tires are commonly used to hold down plastic sheeting over silage piles. The wire is gradually released from the tires, which are in a state of deterioration, and is mixed with the feed supply, or the tires may be inadvertently dropped into a feed mixer wagon and become fragmented, mixing the pieces of wire throughout the ration.

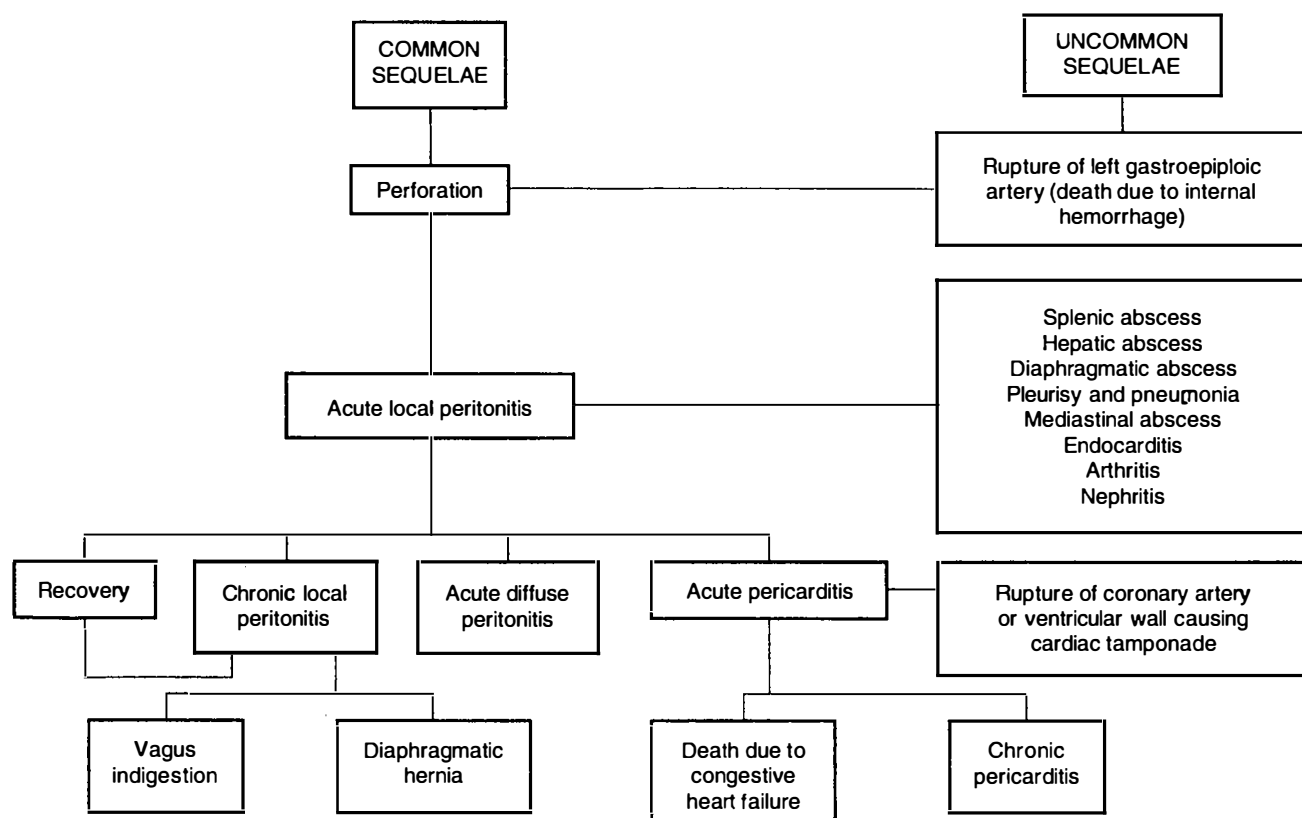

Fig. 6.4 Sequelae of traumatic perforation of the reticular wall.



### Synopsis

**Etiology** Penetration of reticulum by metallic foreign objects such as nails and pieces of wire, including tire wire, that were ingested by the animal and located in the reticulum

**Epidemiology** Most common in adult dairy cattle fed prepared feeds

**Signs** Sudden anorexia and fall in milk yield, mild fever, ruminal stasis and local pain in the abdomen. Rapid recovery may occur, or the disease may persist in a chronic form or spread widely to produce an acute, diffuse peritonitis

**Clinical pathology** In acute local peritonitis, neutrophilia and regenerative left shift; in chronic form, leukopenia and degenerative left shift. Peritoneal fluid contains marked increase in nucleated cells and total protein. Plasma protein concentration increased. Radiography and ultrasonography of abdomen

**Lesions** Localized reticuloperitonitis and varying degrees of locally extensive fibrinous adhesions. Abnormal peritoneal fluid. Abscesses and adhesions possible throughout the peritoneal cavity

#### Diagnostic confirmation

Reticuloperitonitis and metallic foreign body

#### Differential diagnosis list:

- *Acute local traumatic reticuloperitonitis* must be differentiated from: simple indigestion, acute carbohydrate engorgement, acute intestinal obstruction, abomasal volvulus, pericarditis, acute pleuritis, perforated abomasal ulcer, postpartum septic metritis, pyelonephritis acute hepatitis, acetonemia
- *Acute diffuse or generalized peritonitis* must be differentiated from those diseases causing severe toxemia or acid-base imbalance, dehydration, and shock which include the following: carbohydrate engorgement, acute intestinal obstruction, advanced vagus indigestion, abomasal volvulus, perforated abomasal ulcer, and miscellaneous causes of generalized peritonitis
- *Chronic traumatic reticuloperitonitis* must be differentiated from early stages of vagus indigestion, hepatic abscessation, traumatic splenitis, chronic pneumonia and pleuritis, and miscellaneous causes of chronic peritonitis such as peritoneal abscesses secondary to intraperitoneal injections

**Treatment** Antimicrobials daily for several days, reticular magnet and immobilization in stall to promote adhesions.

Rumenotomy to remove foreign body if medical treatment unsuccessful or in valuable animal

**Control** Prevent exposure of cattle to metallic foreign objects that can be ingested. Feed processing equipment should be equipped with magnets to remove metallic foreign bodies

In an abattoir survey of the gastrointestinal tract of 1491 slaughter cows in Denmark, foreign bodies were found in 16% of the cows. Of 286 foreign bodies, 11% were tire wires, 14% fencing wires, 5% screws, 9% nails, 37% mixed pieces of metal, 2% copper and 22% remnants of boluses containing antiparasitic drugs.<sup>3</sup> A significant association was found between the type of foreign body and the presence of lesions, and a significant association between the cross-section of the foreign body and the presence of lesions. There was also an association between the end shape of the foreign body and the presence of lesions. Tire wire was the most common traumatizing foreign body, as 81% of all lesions were associated with tire wires.

### EPIDEMIOLOGY

#### Occurrence

Adult dairy cattle are most commonly affected because of their more frequent exposure but cases occur infrequently in yearlings, beef cattle, dairy bulls, sheep and goats. In the series of 1400 referred to above, 93% were in cattle over 2 years old and 87% were in dairy cattle. In the Danish abattoir survey of cows (see Etiology), foreign body lesions were present in 10% of the cows.<sup>3</sup> Magnets, one or two, were found in only 7% of the cows. All magnets collected iron filings and fencing wire (30%), and 'other pieces of metal' (39%) were the predominant contents of the magnet. There were no lesions in 97% of the cows with magnets, and a significant association was found between the use of magnets and the absence of lesions.

The disease is much more common in cattle fed on prepared feeds, especially those fed inside for part of the year. It is almost unknown in cattle fed entirely on pasture. Accordingly, it is much more common in the winter months in the northern hemisphere. The incidence is low in sheep and goats.

The incidence is usually sporadic but outbreaks have occurred when sources of wire have become mixed into feed supplies, as in the case of perforation of the alimentary tract by pieces of tire wire.<sup>2</sup> Over a period of 6 months, 30% of 170 lactating dairy cows in one herd exhibited clinical signs suggestive of hardware disease associated with the ingestion of tire wire in the feed supplies.

#### Risk factors

There are few studies of the epidemiology of traumatic reticuloperitonitis. The effects of 23 veterinary diagnoses, host characteristics and production were examined on the risks of ruminal acidosis and traumatic reticuloperitonitis.<sup>4</sup> The lactational incidence risk for the disease in Finnish Ayrshire dairy cattle was 0.6%,<sup>4</sup>

which is similar to observations made in Holstein-Friesian cows.<sup>5</sup> The risk of the disease in the former study increased with early metritis, nonparturient paresis, ketosis, acute and chronic mastitis, and foot and leg problems. It is unknown how metritis and mastitis could be risk factors for traumatic reticuloperitonitis. The median day of occurrence was on 113 days after calving, which makes it unlikely that calving was a risk factor. Similarly, dystocia was not found to be a risk factor.

When several or more cases occur in a cluster outbreak, the nature of the feed supply should be considered as a risk factor. The use of used tires to secure plastic sheeting over silage piles may be an important risk factor.

#### Economic importance

The disease is economically important because of the severe loss of production it causes and the high mortality rate. Many cases go unrecognized and many more make spontaneous recoveries. In industrialized countries, metallic foreign bodies may be present in the reticulum in up to 90% of normal cattle and residual traumatic lesions may be present in as many as 70% of dairy cows. Among the clinically affected animals, about 25% develop incurable complications. The other 75% can be expected to recover completely with conservative treatment or routine surgical intervention.

### PATHOGENESIS

#### Ingestion of foreign body

Lack of oral discrimination by cattle leads to the ingestion of foreign bodies that would be rejected by other species. Swallowed foreign bodies may lodge in the upper esophagus and cause obstruction or in the esophageal groove and cause vomiting, but in most instances they pass to the reticulum. Radiological examination of goats that have been fed foreign bodies experimentally indicate that they may first enter various sacs of the reticulorumen before reaching the reticulum. Many lie there without causing harm but the honeycomb-like structure of the reticulum provides many sites for fixation of the foreign body, and contractions of the reticulum are sufficient to push a sharp-pointed object through the wall.

#### Penetration of reticulum

Most perforations occur in the lower part of the cranial wall of the reticulum but some occur laterally in the direction of the spleen and medially towards the liver.

If the reticular wall is injured without penetration to the serous surface no detectable illness occurs, and the foreign body may remain fixed in the site for long periods and gradually be corroded away.

A piece of wire can disappear in 6 weeks but certain nails last much longer and are unlikely to corrode away in less than 1 year. The ease with which perforation occurs has been illustrated by the artificial production of the disease. Sharpened foreign bodies were given to 10 cows in gelatin capsules. Of 20 pieces of wire and 10 nails, 25 were found in the reticulum. Of the 20 pieces of wire 18 had perforated or were embedded in the wall or plicae. Only one of the nails was embedded. Complete perforations were caused by 13 foreign bodies and incomplete by six. All cows suffered at least one perforation, showed clinical signs of acute local peritonitis and recovered after surgical removal of the foreign bodies.

Many foreign bodies may not remain embedded but are commonly found free in the reticulum if surgery is carried out about 72 hours after illness commences. This may be due to necrosis around the penetrating object and the reticular contractions moving the foreign body back into the reticulum. Objects that are deeply embedded or have kinks, barbs or large diameters tend to remain in situ and cause persistent peritonitis.

#### Acute local peritonitis

The initial reaction to perforation is one of acute local peritonitis and, in experimentally induced cases, clinical signs commence about 24 hours after penetration. The peritonitis causes ruminal atony and abdominal pain. If the foreign body moves back into the reticulum spontaneous recovery may occur.

**Resolution of acute fibrinous local peritonitis** is characterized by the development of **fibrous adhesions**, which gradually become long, stringy strands over a period of weeks and months; **motility of the reticulum is restored** and the animal may recover fully. Follow-up ultrasonographic examinations of cows with traumatic reticuloperitonitis in which rumenotomies were done found that the adhesions disappeared in most of the animals by 6 months.<sup>6</sup>

Depending on the severity of the local peritonitis, the ventral aspect of the reticulum becomes adherent to varying degrees to the abdominal floor and diaphragm. This results in **decreased reticular motility**. Ultrasonography of cows with traumatic reticuloperitonitis reveals that the **biphasic contractions of the reticulum are slower than normal or indistinct and the number of contractions are reduced**.<sup>7</sup> **Reticular abscesses are common complications** and may be located between the reticulum and the ventral body wall, between the reticulum and the right thoracic wall and between the reticulum

and the spleen.<sup>8</sup> **Persistent local peritonitis** with or without abscesses results in reduced reticulorumen motility, inappetence to anorexia, a capricious appetite (may eat hay not concentrate), chronic ruminal tympany, persistent mild fever, abdominal pain on deep palpation, and changes in the hemogram and feces. Immobilization of the reticulum impairs the clearance function of the reticulum, which results in the passage of poorly comminuted feces characterized by an increased proportion of large particles.<sup>9</sup>

#### Generalized peritonitis and extension of disease

Spread of the inflammation causing **generalized or diffuse peritonitis** may occur in cows that calve at the time of perforation and in cattle that are forced to exercise. Immobility is a prominent clinical finding and may be a protective mechanism so that adhesions are able to form and localize the peritonitis. Animals made to walk or transported long distances frequently suffer relapses when these adhesions are broken during body movements. Generalized peritonitis results in toxemia, alimentary tract stasis, dehydration and shock.

During the initial penetration of the reticulum, the foreign body may penetrate beyond the peritoneal cavity and into the **pleural or pericardial sacs**. This may occur more commonly in cows in advanced pregnancy than in nonpregnant cows, because of the gravid uterus, although this is uncertain. Complications such as pericarditis occur most commonly in cows after the sixth month of pregnancy.

Details of the pathogenesis of the more common complications are presented under **traumatic pericarditis, vagus indigestion, diaphragmatic hernia and traumatic abscess of the spleen and liver**. Less common sequelae include rupture of the left gastroepiploic artery causing sudden death due to internal hemorrhage and the development of a diaphragmatic abscess, which infiltrates tissues to the ventral abdominal wall at the xiphoid process, rupturing to the exterior and sometimes discharging the foreign body. Hematogenous spread of infection from a diaphragmatic abscess or chronic local peritonitis is a common cause of endocarditis and its sequelae of polysynovitis and arthritis, nephritis and pulmonary abscessation. Penetration into the pleural cavity causes acute **suppurative pleurisy and pneumonia**. In rare cases the infection is localized to the mediastinum causing abscessation, which causes pressure on the pericardial sac and congestive heart failure. Rarely, the foreign body penetrates to the abomasum, causing abomasitis, pyloric stenosis and abomasal

ulceration. Even more rarely, puncture of the reticular vein by a migrating metal wire may lead to fatal hemorrhage causing sudden death.<sup>10</sup>

#### CLINICAL FINDINGS

##### Acute local peritonitis

Characteristically, the onset is sudden with **complete anorexia** and a **marked drop in milk yield**, usually to about a third or less of the previous milking. These changes occur within a 12-hour period and their abrupt appearance is typical. **Subacute abdominal pain** is common in most cases. The animal is reluctant to move and does so slowly. Walking, particularly downhill, is often accompanied by grunting. Most animals prefer to remain standing for long periods and lie down with great care; habitual recumbency is characteristic in others. **Arching of the back** occurs in about 50% of cases, along with the appearance of tenseness of the back and the abdominal muscles so that the animal appears gaunt or 'tucked-up'. **Defecation and urination cause pain** and the acts are performed infrequently and usually with grunting. This results in constipation, scant feces and in some cases retention of urine. Rarely, acute abdominal pain with kicking at the belly and stretching occurs. In others there is recumbency and reluctance to stand.

A **moderate systemic reaction is common** in acute localized peritonitis. The temperature ranges from 39.5–40°C (103–104°F), rarely higher, the heart rate is about 80/min and the respiratory rate about 30/min. Temperatures above 40°C (104°F) accompanied by heart rates greater than 90/min suggest severe complications. The respirations are usually shallow and, if the pleural cavity has been penetrated, are painful and accompanied by an audible expiratory grunt.

**Rumination is absent and reticulorumen movements** are markedly depressed and usually absent. The rumen may appear to be full because of the presence of a **free-gas bloat** with moderate distension of the left paralumbar fossa. On palpation of the fossa, the ruminal gas cap is usually larger than usual and the rumen contents more doughy than normal. Deep palpation of the gas cap in the fossa may be required to feel the rumen pack below the gas cap.

**Pain can be elicited by deep palpation of the abdominal wall** just caudal to the xiphisternum. Palpation is done using short, sharp pushes with the closed fist or knee over an imaginary band about 20 cm wide covering the ventral third of the abdomen from the left to the right side with the cranial border of the band being the point just caudal to

the xiphisternum. This area should be probed with at least six deep palpations on both sides of the abdomen while listening with a stethoscope over the trachea for evidence of a grunt. Pinching the withers to cause depression of the back and eliciting a grunt is also an effective diagnostic aid, except in large adult cows and bulls; for these the sharp elevation of a solid rail held horizontally under the abdomen is a useful method for eliciting a grunt. A positive response to any of these tests is a grunt of pain, which may be audible some distance away but is best detected by auscultation of the trachea. Rarely, a grunt may also be audible by auscultation over the trachea when infrequent reticulorumen contractions occur.

The course of acute local peritonitis is short and the findings described above are most obvious on the first day; in most cases they subside quickly and may be difficult to detect by the third day. In these cases, in addition to persistent anorexia and ruminal atony, the most constant finding is the abdominal pain, which may require deep palpation for its demonstration. In cases that recover spontaneously or respond satisfactorily to conservative treatment there may be no detectable signs of illness by the fourth day.

#### Chronic local peritonitis

In chronic peritonitis the appetite and milk yield do not return to normal after prolonged therapy with antimicrobials. The body condition is usually poor, the feces are reduced in quantity and there is an increase in undigested particles. In some cases, the temperature may be within the normal range, which makes the diagnosis uncertain. A persistent slightly elevated temperature is supportive evidence of the presence of a chronic inflammatory lesion. The grunt test may be positive or negative; often it is uncertain. The gait may be slow and careful and, occasionally, grunting may occur during rumination, defecation and urination. Rumination activities are infrequent, the rumen is usually smaller than normal, chronic moderate bloat is common and there is ruminal atony or some moderate reticulorumen activity.

**Reticular abscesses** in cows are characterized by poor body condition, a relatively full rumen but with reduced ruminal contractions or almost complete ruminal atony, persistent mild bloat, an arched back with a tense abdomen and a grunt indicating abdominal pain, and undigested particles in the feces. Most have a clinical history of not responding to prolonged therapy with antimicrobials. These can be diagnosed with radiography and ultrasonography.

#### Rectal examination

**Rectal examination** of cattle with acute or local traumatic reticuloperitonitis may cause a painful grunt when the animal strains during the examination. The feces are usually dry and firm and covered by a thin coating of mucus because of prolonged retention. In acute localized peritonitis the rumen may feel larger than normal and the gas cap is easily palpable. In acute and chronic generalized peritonitis, fibrinous adhesions may be palpable between the rumen and the left abdominal wall or between loops of intestine, or in the pelvic cavity.

#### Acute diffuse (generalized) peritonitis

Acute diffuse peritonitis is characterized by the appearance of profound toxemia within a day or two of the onset of local peritonitis. Alimentary tract motility is reduced, mental depression is marked and the temperature is elevated or subnormal in severe cases, especially those that occur immediately after calving. The heart rate increases to 100–120/min and a painful grunt may be elicited by deep digital palpation at almost any location over the ventral abdominal wall. This stage is usually followed by rapid collapse and peripheral circulatory failure and an absence of pain responses. Terminally, recumbency and depression are common.

#### Sudden death

There is a record of sudden death in a 20-month-old pregnant heifer in which the reticular vein was punctured by a migrating piece of metal wire, causing fatal hemorrhage into the reticulum. At necropsy, a large blood clot was present in the reticulum, the rumen contents were red brown and no reticular adhesions were present.<sup>10</sup>

#### Iatrogenic reticulitis

There is a record of iatrogenic reticulitis that occurred as a result of the oral administration of intraruminal anthelmintic boluses, which may have lodged in the reticulum and become filled with other foreign objects ingested by the animal, resulting in a syndrome similar to acute traumatic reticuloperitonitis.<sup>11</sup> Inappetence, reduced milk production, reduced reticulorumen motility, abdominal pain and scant feces were present. On exploratory rumenotomy the reticulum contained two cylindrical boluses filled with stones, nuts and bolts. Removal of the boluses was followed by prompt recovery.

#### CLINICAL PATHOLOGY

##### Hemogram

The total and differential leukocyte counts provide useful diagnostic and prognostic data. The differential leukocyte count is usually considerably more indi-

cative of acute peritonitis than the total count.

In **acute local peritonitis** a neutrophilia (mature neutrophils above 400/ $\mu$ L) and a left shift (immature neutrophils above 200/ $\mu$ L) are common. This is a **regenerative left shift**. Both the neutrophilia and the left shift will be increased on the first day and will last for up to 3 days, when in uncomplicated cases the count begins to return to normal. In chronic cases the levels do not return completely to normal for several days or longer periods and there is usually a moderate leukocytosis, neutrophilia and a monocytosis.

In **acute diffuse peritonitis** a leukopenia (total count below 4000/ $\mu$ L) with a greater absolute number of immature neutrophils than mature neutrophils (**degenerative left shift**) occurs, which suggests an unfavorable prognosis if severe. The degree of lymphopenia (lymphocyte count below 2500–3000/ $\mu$ L) is an indication of a stress reaction to inflammation.

#### Plasma protein and fibrinogen

There is a significant difference in total plasma protein levels between cattle with traumatic reticuloperitonitis and those with other diseases of the gastrointestinal tract that might be confused with the former.<sup>12</sup> The mean plasma protein concentrations, measured before surgery, were  $88 \pm 13$  g/L for traumatic reticuloperitonitis and  $77 \pm 12$  g/L for controls. In severe diffuse peritonitis the fibrinogen levels may be increased up to 10–20 g/L.<sup>12</sup>

Cut-off points for total plasma protein (TPP) and plasma fibrinogen (PF) were determined to differentiate between traumatic reticuloperitonitis and other gastrointestinal diseases with similar clinical findings.<sup>13</sup> There was moderate negative dependence between sensitivities of TPP and PF at the 8.82 g/dL and 766 mg/dL cut-off points, and mild negative dependence between their specificities at the 7.78 g/dL and 691 mg/dL cut-off points, respectively.<sup>13</sup> Acceptable accuracy (98% or 86% specificity with 62% or 88% sensitivity, respectively) was obtained with serial interpretation of the tests.

#### Abdominocentesis and peritoneal fluid

Abdominocentesis and analysis of peritoneal fluid can be a valuable diagnostic aid. The best site for abdominocentesis is uncertain because the rumen occupies a large portion of the ventral abdominal wall and avoiding penetration of it is difficult. Cattle have a low volume of peritoneal fluid and failure to obtain a sample is not unusual. Empirically, the best sites are those in which, on an anatomical basis, there are recesses

between the forestomachs, abomasum, diaphragm and liver. These are usually 10–12 cm caudal to the xiphisternum and 10–15 cm lateral to the midline. A blunt-ended teat cannula is recommended but with care and caution a 16-gauge 5 cm hypodermic needle may also be used. The hair of the site is clipped, the skin is prepared aseptically and a local anesthetic is applied. The skin is incised with a stab scalpel and the cannula is pushed carefully and slowly through the abdominal wall. The latter will twitch and a 'pop' will be felt when the peritoneum is punctured. When the cannula is in the peritoneal cavity the fluid may leak out without the aid of a vacuum. If it does not, a syringe may be used to apply a vacuum while the needle is manipulated in an attempt to locate some fluid.

If no fluid can be obtained, a trocar and cannula 80 mm long and with a 4 mm internal diameter can be used with success. The trocar and cannula are inserted into the abdomen, the trocar is removed and an 80 cm long 10 French gauge infant feeding tube is inserted into the abdomen through the cannula, leaving about 10–20 cm outside. The tube acts as a wick and within several minutes fluid can be collected into vials. At least three different sites should be attempted to obtain peritoneal fluid. Peritonitis in cattle is characterized by a marked fibrinous response and localization of a lesion, and the amount of exudative fluid available at the abdominocentesis sites may be minimal. Thus the failure to obtain fluid does not preclude the presence of peritonitis.

**Laboratory evaluation of peritoneal fluid** consists of determinations of total white blood cell count, differential cell count, total protein and culture for pathogens. The interpretation of the analysis of the peritoneal fluid can be unreliable because to date only a few correlations have been made between the laboratory findings and the presence or absence of peritoneal lesions. A nucleated cell count above 6000 cells/ $\mu$ L and total protein above 3g/dL is consistent with the diagnosis of peritonitis in 80% of cases. Using a differential cell count, a relative neutrophil count more than 40% and a relative eosinophil count less than 10% was frequently associated with the diagnosis of peritonitis.

#### METAL DETECTION

**Metal detectors** were used at one time to aid in the diagnosis of traumatic reticuloperitonitis. Ferrous metallic foreign bodies can be detected with metal detectors but the instruments are of limited use because most normal dairy cows are positive for metal over the reticular area.

#### LAPAROSCOPY

Right flank laparoscopy using a flexible fiberoptic laparoscope, 14 mm diameter and 1120 mm working length, is a reliable diagnostic aid for the presence of traumatic reticuloperitonitis.

#### RADIOGRAPHY OF CRANIAL ABDOMEN AND RETICULUM

Radiological examination of the reticulum with the animal in dorsal recumbency (dorsal reticulography) is an accurate diagnostic method for the evaluation of cattle with suspected traumatic reticuloperitonitis.<sup>14</sup> However, the lack of adequate radiographic equipment in private veterinary practices precludes its routine use. Also, the technical difficulties of positioning the animal and the increased potential for personnel exposure associated with manual restraint suggests that it may not be practical except for valuable animals that may warrant referral to a veterinary medical center.

The **cranioventral abdomen of cattle** can be evaluated using two cranial abdominal and one caudal thoracic radiographs. An X-ray machine with a capacity of 1000–1250 mA and 150 kV is necessary, which is usually only available in veterinary teaching hospitals. However, such techniques may be appropriate in valuable animals in which an accurate diagnosis and prognosis for surgical treatment may be desirable.<sup>15</sup> In a consecutive series of standing lateral cranial abdominal radiographs, the sensitivity and specificity for detecting traumatic reticuloperitonitis or pericarditis was 83% and 90%, respectively.<sup>16</sup> These values are higher than those achieved with dorsal recumbency. In standing lateral radiographs, an enlarged reticulum was associated with a final diagnosis of vagal indigestion. Alteration in reticulo-diaphragmatic separation does not correlate with any specific disease process. The presence of focal perireticular gas collections and reticular foreign bodies greater than 1 cm in length unattached to a magnet were good indicators of traumatic reticuloperitonitis. Radiography is best suited for identification of radiodense foreign bodies in and outside the reticulum (these cannot be visualized ultrasonographically).<sup>14</sup>

Features found to be reliable in the diagnosis of traumatic reticuloperitonitis using lateral radiographs of the reticulum include:

- **Atypically positioned foreign bodies**
- **Abnormal gas shadows in the region of the reticulum**
- **Depressions in the cranioventral margin of the reticulum.**<sup>17</sup>

The reticulum is commonly markedly displaced caudally from the diaphragm or dorsally or caudodorsally from the ventral abdominal wall. Space-occupying masses of the density of soft tissue, with or without gas inclusions, gas shadows and gas-fluid interfaces in the region of the reticulum, were highly predictive of peritonitis (specificity 97%, positive predictive value 96%).

#### ULTRASONOGRAPHY OF THE RETICULUM

Ultrasonography is a suitable method for investigation of reticular contractions in healthy ruminants and in cattle for the diagnosis of traumatic reticuloperitonitis.<sup>18,19</sup> The literature on the use of ultrasonography as a diagnostic aid in gastrointestinal disease in cattle has been reviewed.<sup>20</sup> The reader is referred to an excellent atlas and textbook on the use of ultrasonography in cattle.<sup>19</sup>

The reticulum and adjacent organs of cows can be examined with ultrasonography using a 3.5 MHz linear transducer applied to the ventral midline of the thorax over the sixth and seventh intercostal spaces and from the left and right sides of the midline.<sup>21,22</sup> It may not be possible to image the reticulum in large cows in good body condition because of the high proportion of fat in the muscle layers. In older cows, calcification of the xiphisternum may interfere with imaging. The most common reason for being unable to visualize the reticulum in sick animals is the displacement of the reticulum by a markedly distended rumen or by space-occupying lesions such as abscesses and fibrin-containing effusions. The pattern, number, amplitude and duration of the interval between contractions can be visualized.<sup>21</sup> The contour of reticulum, the reticular contractions and the organs adjacent to the reticulum can be imaged. The biphasic reticular contractions can be visualized at the rate of 4 during a 4-minute period.<sup>21,22</sup> During the first incomplete contraction, the reticulum contracts by a mean of about 7.2 cm and during the second contraction the reticulum disappears from the screen.

#### Ultrasonography for traumatic reticuloperitonitis

In contrast to radiography, ultrasonography provides more precise information about the contour of the reticulum and reticular motility.<sup>7,22</sup> In cattle with traumatic reticuloperitonitis, ultrasonography can be used to identify morphological changes in the region of the cranial, ventral or caudal reticular wall.<sup>20</sup> The caudoventral reticular wall is the most frequently affected, often in

association with the craniodorsal blind sac of the rumen. The changes in the contour of the reticulum depend on the severity of the inflammatory changes.

The reticulum can be visualized in more than 90% of cows in spite of interference by the ribs and sternum. In cows with disturbed reticular motility, biphasic contractions are slower than normal, or indistinct, and the number of contractions is reduced. Fibrinous material appears as echogenic deposits, sometimes accompanied by hypoechoic fluid. Reticular abscesses have an echogenic capsule with a hypoechoic center. Involvement of the spleen, omasum, liver and abomasum may also be imaged. Neither magnets nor foreign bodies can be visualized by ultrasonography.<sup>22</sup>

Reticular activity is almost always affected in cattle with traumatic reticuloperitonitis. The frequency, amplitude or velocity of contractions, singly or combined, may be abnormal. The frequency can be reduced from 3 to 2, 1 or no contractions per 3 minutes. The reduction in the amplitude of contractions varies: when formation of adhesions is extensive, reticular contractions appear indistinct. Although the pattern of biphasic contraction is often maintained, the reticulum contracts only 1–3 cm. The velocity of reticular contractions may be normal but can be markedly reduced. In cattle with reticulo-omasal obstruction due to a foreign body, the frequency of reticular contractions may be increased.<sup>23</sup>

Reticular abscesses associated with traumatic reticuloperitonitis can be visualized by ultrasonography<sup>8</sup> (Fig. 6.5). The amplitude of reticular contractions is reduced, the reticulum is displaced from the ventral body wall, and the abscesses have hypoechoic centers and echogenic capsules.

Peritoneal effusion is visible as an accumulation of fluid without an echogenic margin and restricted to the reticular area. Depending on the fibrin and cell content, the fluid may be anechoic or hypoechoic. Fibrinous deposits are easily identified in the fluid and bands of fibrin are sometimes seen within the effusion. Occasionally, the peritoneal effusion is considerable and extends to the caudal abdomen.

The spleen, particularly its distal portion, is often affected. Fibrinous changes are frequently seen as echogenic deposits of varying thickness, often surrounded by fluid, between the spleen and reticulum or rumen. The spleen may be covered by fibrinous deposits. Occasionally, one or more splenic abscesses are visible, and the vasculature may be dilated, indicating splenitis.<sup>20</sup>

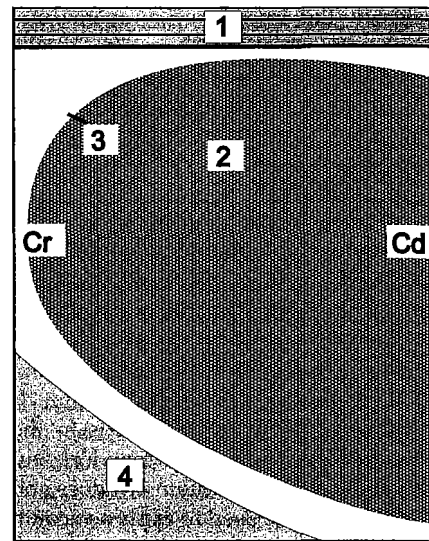

**Fig. 6.5** Ultrasonogram and schematic of a reticular abscess in a cow with chronic traumatic reticuloperitonitis. The abscess is between the reticulum and the ventral abdominal wall. The ultrasonogram was obtained from the sternal region with a 5.0 MHz-linear transducer. 1 = Ventral abdominal wall; 2 = Abscess; 3 = Capsule of the abscess; 4 = Reticulum. Cr, Cranial; Cd, Caudal. (Reproduced with kind permission of U. Braun.)

#### Ultrasonography and radiography of cattle with traumatic reticuloperitonitis

These two techniques have been compared in cows with traumatic reticuloperitonitis. The major advantages of radiography are that metallic foreign bodies can be visualized and their position determined. It has a specificity of 82%, a positive predictive value of 88% and a sensitivity of 71%.<sup>24</sup> Abnormal gas shadows or gas–fluid interfaces observed on radiographs are highly diagnostic for the disease and have a specificity of 97% and positive predictive value of 88%. However, they are seldom seen on radiographs and their sensitivity is only 19%. The position of the reticulum is a good criterion for the diagnosis of traumatic reticuloperitonitis, with a specificity of 80% and a positive predictive value of 82%. Thick-walled changes or abscessation should be suspected when the reticulum is displaced caudodorsally from the sternum. Changes in the contour of the reticulum such as indentations are highly suggestive of inflammation, with a specificity of 95% and positive predictive value but a low sensitivity of only 34%.

The major advantage of ultrasonography is being able to visualize and assess reticular motility.<sup>19,22,24</sup> Even in the presence of severe adhesions and abscessation, the reticulum may maintain its basic contractile rhythm, but much reduced. Abscesses have an echogenic capsule of varying width and a central cavity filled with hypoechoic material. Purely fibrous deposits are echogenic, and

fibrinous deposits containing an accumulation of fluid from inflammatory processes are echogenic interspersed with hypoechoic accumulations of fluid (Fig. 6.6).<sup>24</sup> Radiography and ultrasonography complement each other and the combined results can be used to decide whether an exploratory laparotomy is indicated, if the animal should be treated conservatively with antibiotics, or if it should be slaughtered for salvage.<sup>22</sup>

#### NECROPSY FINDINGS

Localized traumatic reticuloperitonitis is characterized by varying degrees of locally extensive fibrinous adhesions between the cranioventral aspects of the reticulum and the ventral abdominal wall and the diaphragm. Adhesions and multiple abscesses may extend to either side of the reticulum involving the spleen, omasum, liver, abomasum and ventral aspects of the rumen. Large quantities of turbid, foul-smelling peritoneal fluid may be present, containing fibrinous clots. Some cases of reticular abscesses are solitary and there are adhesions between the reticulum, diaphragm and ventral body wall, which are strictly localized. The size of the abscess varies. It may be from 5–10 cm in diameter or else a single one may be irregularly shaped and measure 30 × 10 × 10 cm, along with multiple smaller ones measuring around 3 × 3 × 3 cm.<sup>24</sup> The foreign body can usually be found perforating the cranioventral aspect of the reticulum, although it may have fallen back into the reticulum, leaving only the perforation site and its surrounding

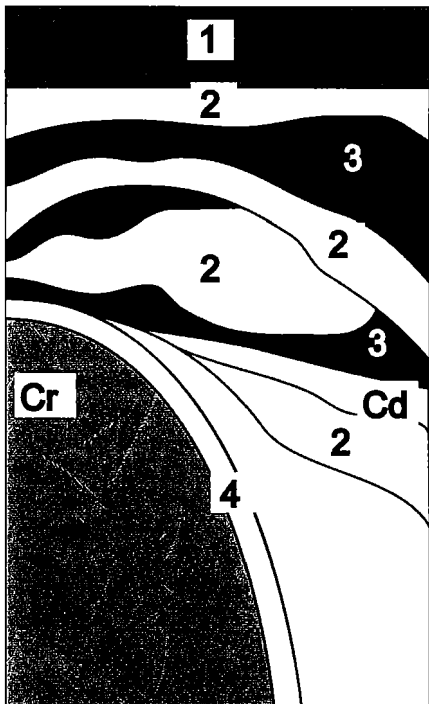
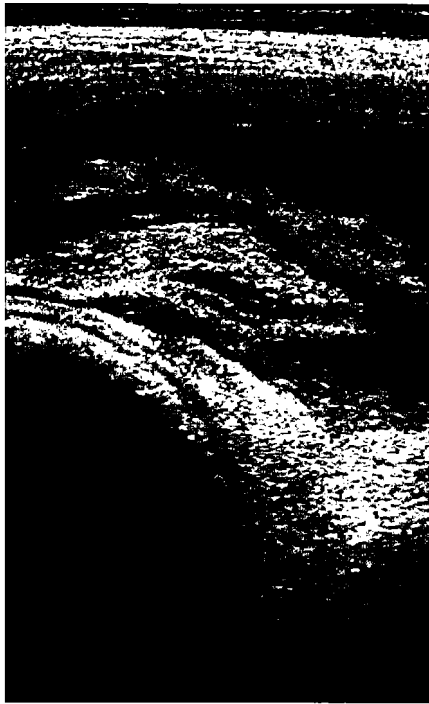

**Fig. 6.6** Ultrasonogram and schematic of the reticulum in a cow with chronic traumatic reticuloperitonitis. The reticulum is covered with fibrinous deposits. The ultrasonogram was obtained from the sternal region with a 5.0 MHz-linear scanner. 1 = Lateral abdominal wall; 2 = Fibrinous deposits; 3 = Anechoic fluid; 4 = Reticulum. Cr, Cranial; Cd, Caudal. (Reproduced with permission from U. Braun.)

inflammation as evidence of the site of penetration. A reticular magnet with many pieces of metallic foreign bodies stuck to it may be present in the

reticulum, the mucosa of which is usually normal.

In **acute diffuse peritonitis** a fibrinous or suppurative inflammation may affect almost the entire peritoneal cavity with extensive fibrinous adhesions of various stages of development involving the forestomach, abomasum, small and large intestines, liver, bladder, reproductive tract and pelvic cavity. Large quantities of turbid, foul-smelling fluid containing clots of fibrin are usually present. Loops of intestine and omenta are commonly stuck together by thick layers of fibrin.

#### DIFFERENTIAL DIAGNOSIS

Typical acute traumatic reticuloperitonitis is characterized by a sudden onset of complete anorexia, marked drop in milk production, mild fever, ruminal atony, pain on deep palpation of the ventral abdomen, an elevated leukocyte count with a left shift in the hemogram and a peritoneal fluid sample that indicates inflammation.

However, the times at which cases of traumatic reticuloperitonitis are seen varies from day 1, when the syndrome is typical, to day 3 or 4, by which time the acuteness has subsided so much clinically that confusion with other diseases is a significant possibility. The sudden onset of anorexia and marked drop in milk production will usually be noted in lactating dairy cattle but not in dry dairy cattle or beef cattle, including mature bulls whose feed intake and behaviors are not monitored daily. In these animals the clinical findings can change in a few days and be characterized by anorexia to inappetence, normal temperature, ruminal hypotonicity or atony and no evidence of abdominal pain on deep palpation of the abdomen.

The clinician must review the history carefully, conduct a thorough clinical examination and attempt to intensify the diagnostic efforts on those abnormalities that are present.

The differential diagnosis of gastrointestinal dysfunction of cattle is summarized in Table 6.2. An algorithm for the causes of grunting in cattle is shown in Fig. 6.7.

#### Acute local traumatic reticuloperitonitis

Acute local traumatic reticuloperitonitis must be differentiated from those diseases in which sudden anorexia, sudden drop in milk production, ruminal atony, abdominal pain and abnormal feces are common. They include the following:

- **Simple indigestion** characterized by sudden anorexia or inappetence, normal mental state, full rumen but atonic, perhaps uncomfortable if ingested large quantities of palatable feed like fresh silage, normal vital signs, abnormal feces and spontaneous recovery in 24 hours are typical

- **Obstruction of reticulo-omasal orifice** with a foreign body such as a roll of polyethylene twine causes intermittent inappetence, a slightly enlarged rumen with normal motility, slight reduction in the amount of feces, a decrease in milk yield for 24–48 hours followed by a return to normal and then subsequent relapses. A grunt is not present, the temperature, heart and respiratory rates are normal and the hemogram is normal. Obstruction of the reticulo-omasal orifice with foreign bodies such as rope can cause distension and hypermotility of the rumen and persistent vomiting.<sup>23</sup> A rumenotomy must be done to make the diagnosis

- **Acute carbohydrate engorgement** characterized by sudden anorexia, diarrhea and dehydration, weakness, tachycardia, staggering, ruminal distension and atony, fluid-splashing sounds in the rumen with a rumen pH of less than 5 and a history of access to grain

- **Acute intestinal obstruction** characterized by sudden anorexia, mild abdominal pain perhaps with kicking at the abdomen and stretching, ruminal atony, mild dehydration, scant feces or complete absence of feces, straining on rectal examination, dark blood-stained feces and perhaps distended loops of intestine palpable on rectal examination

- **Abomasal volvulus (following right-side dilatation)** characterized by anorexia, dehydration, tachycardia, distended right abdomen, ping audible over right flank, distended viscus palpable on rectal examination. Usually in lactating dairy cows a few weeks after parturition and following the clinical findings of right-side dilatation of the abomasum that lasts several days culminating in the volvulus but may occur spontaneously in some cows with no immediate history of previous illness

- **Pericarditis.** Continued high fever, toxemia, anorexia, tachycardia and muffled heart sounds suggest pericarditis, which is marked by markedly elevated total leukocyte and neutrophil counts. In pericarditis, the heart sounds are muffled and the typical to and fro fluid-splashing sounds are audible. The jugular veins are engorged and other signs of congestive heart failure such as anasarca are present.

- **Pericardiocentesis** to obtain foul-smelling, turbid fluid is diagnostic
- **Acute pleuritis** is characterized by a fever, toxemia, anorexia, painful respirations that may be accompanied by a grunt, pain on digital palpation of intercostal spaces, ruminal atony, and abnormal and muffled lung sounds. Fluid on thoracentesis

- **Perforated abomasal ulcer** causes acute local peritonitis characterized by marked pain on palpation over a much larger area of the abdominal wall and in the early stages is most marked on the right-hand side. If, as is usual, the peritonitis becomes diffuse the syndrome cannot be distinguished

clinically from that caused by traumatic reticuloperitonitis. Extension from a metritis to involve the peritoneum is suggested by other signs of the primary disease

- **Postpartum septic metritis** occurs a few days after parturition and is characterized by anorexia, fever, tachycardia, ruminal hypotonicity to atony, reduced amount of feces and foul-smelling vaginal discharge, and retained placenta may be present. Very important to examine the uterus vaginally for the presence of the placenta, which may be protruding through the cervix
- **Acute local peritonitis** due to penetration of the uterine wall by a catheter or of the rectal wall by a foreign body thrust sadistically into the rectum may be difficult to differentiate unless the painful area of the peritoneum can be determined. Acute local peritonitis can be differentiated from indigestion, acute ruminal impaction and acetonemia by the presence of fever, local abdominal pain and the abrupt fall in milk yield and appetite
- **Pyelonephritis** is occasionally accompanied by mild abdominal pain but can be distinguished by the presence of pus and blood in the urine
- **Acute hepatitis or severe hepatic abscess** is characterized by anorexia, fever, decreased ruminal movements, reluctance to move, a painful grunt on deep palpation over the cranial aspects of the right lower flank, icterus if obstruction of the bile ducts has occurred, and a poor response to therapy. A marked neutrophilia is typical of hepatic abscessation secondary to traumatic reticuloperitonitis
- **Acetonemia.** Traumatic reticuloperitonitis usually causes a secondary acetonemia when it occurs during early lactation and the presence of ketonuria should not be used as the sole basis for differentiation of the diseases. Differentiation may be extremely difficult if the peritonitis is of 3–4 days' duration. Response to treatment may also serve as a guide. The history is often helpful; the appetite and milk yield fall abruptly in traumatic reticuloperitonitis but slowly over a period of several days and not to the same degree in acetonemia

#### **Acute diffuse or generalized peritonitis**

**Acute diffuse peritonitis** is characterized by anorexia, fever, toxemia, tachycardia, dehydration, weakness leading to recumbency, distended abdomen, ruminal atony, spontaneous grunting or a grunt on deep palpation over the abdomen, fluid-splashing sounds and pings on auscultation and percussion or ballottement of the abdomen due to ileus, scant feces, perhaps palpable fibrinous adhesions on rectal palpation, profuse quantities of abnormal peritoneal fluid and marked changes in the hemogram. It must be differentiated from those diseases causing severe toxemia or

acid–base imbalance, dehydration and shock, which include: carbohydrate engorgement, acute intestinal obstruction, advanced vagus indigestion, abomasal volvulus, perforated abomasal ulcer and miscellaneous causes of generalized peritonitis.

#### **Chronic reticuloperitonitis**

The clinical findings of chronic traumatic reticuloperitonitis are not typical. Each chronic case may have a different combination of clinical findings, which makes the diagnosis uncertain. The clinical findings that may be present include inappetence to anorexia, mild fever, loss of body condition, lack of rumination, ruminal hypotonicity to atony, moderate bloat, scant feces containing increased amounts of undigested feed particles, possibly a grunt on deep palpation of abdomen, and changes in the hemogram. The presence of abnormal peritoneal fluid is highly supportive. It must be differentiated from early stages of vagus indigestion, hepatic abscessation, traumatic splenitis, chronic pneumonia and pleuritis, and miscellaneous causes of chronic peritonitis such as peritoneal abscesses secondary to intraperitoneal injections.

#### **TREATMENT**

Two methods of treatment are in general use: conservative treatment with or without the use of a magnet, and rumenotomy. Both have advantages and each case must be considered when deciding on the form of treatment to be used.

#### **Conservative medical therapy**

Conservative treatment comprises immobilization of the animal, administration of antimicrobials for the inflammation and the oral administration of a magnet to immobilize the foreign body. The cow is tied, stanchioned or confined in a box stall for several days. Immobilization of the animal facilitates the formation of adhesions.

#### **Antimicrobials**

Penicillin or broad-spectrum antimicrobials given parenterally daily for 3–5 days are widely used with empirical success. Because of the high probability that a mixed gastrointestinal flora is the cause of the lesion it is more rational to use a broad-spectrum antimicrobial such as the tetracyclines or trimethoprim-potentiated sulfonamides rather than penicillin, which is commonly used because of cost and a short withdrawal period in the event that the animal does not respond favorably in a few days. For lactating dairy cattle, those antimicrobials with a short milk withdrawal period are desirable. However, there are no published clinical trials to indicate the preferential value of any particular antimicrobial. The general effect appears to be good and a high rate of recovery is recorded with antimicrobials parenterally

combined with immobilization provided treatment is begun in the early stages of the disease. Cows past their sixth month of pregnancy are unlikely to recover completely and commonly relapse.

#### **Rumenotomy**

Surgical removal of the foreign body through a rumenotomy incision is widely used as a primary treatment. It has the advantage of being both a diagnostic procedure in the first instance and a satisfactory treatment. The recovery rate varies, depending on when the surgery is done relative to the time of initial penetration, but is approximately the same as that obtained with the conservative treatment described above. In both instances 80–90% of animals recover compared with about 60% in untreated animals. Failure to improve is usually due to involvement of other organs or to the development of locally extensive peritonitis and reticular abscesses associated with persistent penetration of the foreign body or, uncommonly, generalized peritonitis.

Based on follow-up ultrasonography of cows that had surgery for traumatic reticuloperitonitis, the inflammatory adhesions resolved and disappeared in the majority of animals by 6 months.<sup>6</sup> As a consequence, reticular function normalizes. In animals with severe adhesions, there is a marked disturbance of digesta passage and, in these animals, extensive abscesses are present.

Persistent penetration by the foreign body necessitates removal for optimum results but a rumenotomy is necessary to determine the extent of the lesion. Radiography and ultrasonography as described above may assist in determining the presence and location of the foreign body. A single preoperative dose of antimicrobial such as potassium penicillin G at 10 million IU given intravenously is recommended to avoid complications after a rumenotomy in cattle.

The recovery rate after surgery is likely to be much lower if only complicated cases are selected for rumenotomy and conservative treatment is given to the early mild cases. In one series the recovery rate in the cases treated conservatively was 84% and in those difficult cases treated surgically it was 47%.

#### **Drainage of reticular abscesses**

Reticular abscesses may be drained through an ultrasound-guided transcuteaneous incision.<sup>8</sup>

#### **Choice of treatment**

The choice of treatment is largely governed by economics and the facilities and time available for surgery. A rumenotomy, satisfactorily performed, is the best treatment but is unnecessary in many cases because of the tendency of



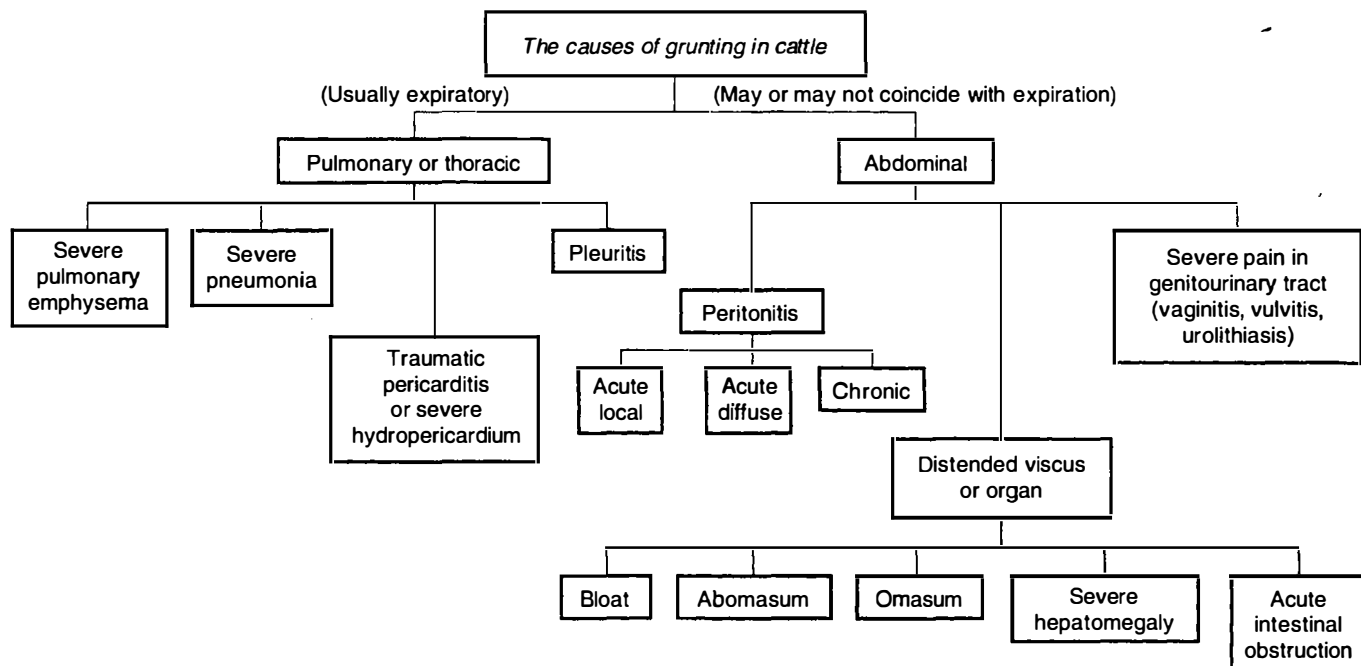

Fig. 6.7 Causes of grunting in cattle.

the foreign body to return to the reticulum. A commonly used practice is to treat the animal conservatively for 3 days and if marked improvement has not occurred by that time to consider a rumenotomy. A rumenotomy is highly desirable in cows in the last 3 months of pregnancy if severe sequelae are to be avoided. Movement of the cow during the early stages of the disease is undesirable because of the risk of disrupting the adhesions that localize the infection.

Cases of chronic traumatic reticulo-peritonitis are best treated by rumenotomy because of the probability that the foreign body is still embedded in the wall. Acute diffuse peritonitis is highly fatal but if detected early daily treatment with broad-spectrum antimicrobials may be effective.

#### PREVENTION

All processed feed should be passed over magnets to remove metallic material before being fed to cattle. The use of synthetic string instead of wire has resulted in a major decrease in the incidence of the disease.

#### Reticular magnets

Small cylindrical or bar magnets, 7.5 cm long by 1.0–2.5 cm diameter with rounded ends, are used to prevent the disease but are also used in acute cases to minimize penetration of the foreign body. When given orally to normal healthy animals the magnets locate in the reticulum within a few days, where they remain indefinitely and maintain their magnetic pull. The magnets attract foreign bodies, which then do not penetrate the reticular wall as easily as when they are free. The

extensive prophylactic use of these magnets in a dairy herd has reduced the incidence of the disease and its complications by 90–98%. The magnets are given to herd replacement heifers at 18 months to 2 years of age as part of a herd health program.

The effects of magnets in traumatic reticulitis was examined in the Danish study of cows at slaughter (see under Etiology).<sup>3</sup> Two magnets tested were cylindrical cage magnets with different fields of attraction of force. Magnet I had a magnetic force of attraction of 110 mT; magnet II had a force of 210 mT. Magnets were found in only 7% of the cows. There were no lesions in 97% of the cows with magnets. Magnet II was superior to magnet I in attracting all types of foreign bodies, including tire wires. Thus the prophylactic use of magnets should be promoted to reduce the occurrence of foreign body lesions.<sup>3</sup>

It is unlikely that magnets will extract a firmly embedded foreign body from the wall of the reticulum but loosely embedded ones with long free ends may be returned to the reticulum and loose foreign bodies will be immobilized. The position of the foreign body within the reticulum greatly influences the efficacy of treatment with a magnet. A foreign body at an angle to the ventral aspect of the reticulum of more than 30° is less likely to become attached to a magnet than a foreign body situated horizontally on the ventral aspect of the reticulum.<sup>25</sup> There have been only a few reports of physical injury to the wall of the reticulum being caused by the magnets or the foreign bodies that may be attached to them. A compass can be

used to locate the presence and position of the magnet.

#### REVIEW LITERATURE

- Braun U. Atlas und Lehrbuch der Ultraschall-diagnostik beim Rind. Berlin: Blackwell Wissenschafts-Verlag, 1997.
- Braun U. Ultrasonography in gastrointestinal disease in cattle. *Vet J* 2003; 166:112–124.
- Braun U. Ultrasound as a decision-making tool in abdominal surgery in cows. *Vet Clin North Am Food Anim Pract* 2005; 21:33–53.

#### REFERENCES

- Harwood D. *Vet Rec* 2004; 154:574.
- Monies R. *Vet Rec* 2004; 154:735.
- Cramers T et al. *Vet Rec* 2005; 157:287.
- Grohn YT, Bruss ML. *J Dairy Sci* 1990; 73:655.
- Dohoo IR et al. *Prev Vet Med* 1984; 2:655.
- Herzog K et al. *Dtsch Tierarztl Wochenschr* 2004; 111:57.
- Braun U et al. *Vet Rec* 1993; 133:416.
- Braun U et al. *Vet Rec* 1998; 142:184.
- Rehage J et al. *J Am Vet Med Assoc* 1995; 207:1607.
- Hailat N et al. *Can Vet J* 1993; 34:698.
- Sheldon IM. *Vet Rec* 1995; 136:126.
- Ward JL, Ducharme NG. *J Am Vet Med Assoc* 1994; 204:874.
- Jafarzadeh SR et al. *Prev Vet Med* 2004; 65:1.
- Farrow CS. *Vet Clin North Am Food Anim Pract* 1999; 15:397.
- Fubini SL et al. *J Am Vet Med Assoc* 1990; 197:1060.
- Partington BP, Biller DS. *Vet Radiol* 1991; 32:155.
- Braun U et al. *Vet Rec* 1993; 132:103.
- Kaske M et al. *J Vet Med A* 1994; 41:748.
- Braun U. Atlas und Lehrbuch der Ultraschall-diagnostik beim Rind. Berlin: Blackwell Wissenschafts-Verlag, 1997.
- Braun U. *Vet J* 2003; 166:112.
- Braun U, Gotz M. *Am J Vet Res* 1994; 55:325.
- Braun U. *Vet Clin North Am Food Anim Pract* 2005; 21:33–53.
- Braun U. *Vet Rec* 2002; 150:580.
- Braun U et al. *Vet Rec* 1994; 135:470.
- Braun U et al. *Am J Vet Res* 2003; 64:115.



## VAGUS INDIGESTION

### Synopsis

**Etiology** Reticular adhesions from traumatic reticuloperitonitis and failure of passage of ingesta from reticulorumen and abomasum resulting in accumulation in forestomach and abomasum. Abomasal emptying defect in sheep (uncertain etiology)

**Epidemiology** Primarily mature dairy cattle; also in mature beef cows and bulls. Also occurs in sheep as abomasal emptying defect of uncertain etiology

**Signs** Gradual distension of abdomen, especially left upper abdomen and bilateral aspects of ventral abdomen. Inappetence to anorexia and scant feces containing undigested long particles. Large L-shaped rumen viewed from rear. Rumen hypermotility or atony. Dehydration

**Clinical pathology** Hemoconcentration, metabolic alkalosis with hypochloremia and hypokalemia, increased ruminal chloride levels

**Lesions** Reticular adhesions. Enlarged rumen containing pasty and frothy material or fluid contents. Abomasum impacted with semi-dry ingesta

**Differential diagnosis** *Ruminal distension with hypermotility*: indigestion of late pregnancy, obstruction of the reticulo-omasal orifice. *Ruminal distension with atony*: chronic traumatic reticuloperitonitis. *Abomasal impaction*: abomasal impaction, dietary in origin. *Omasal impaction*: phytobezoars blocking the abomasal pylorus, abomasal ulceration without melena

**Treatment** Fluid and electrolyte therapy, rumen lavage, rumenotomy, drain reticular abscess, slaughter for salvage

**Control** Prevent traumatic reticuloperitonitis

### ETIOLOGY

The etiology has been controversial but has been divided into two major sub-categories of complications of traumatic reticuloperitonitis: vagal nerve injury and reticular adhesions. In addition there are some **other causes**.

### Complications of traumatic reticuloperitonitis

Vagal nerve injury and dysfunction

Historically, it was thought that vagus indigestion was caused by vagal nerve dysfunction due to vagal nerve injury associated with complications of traumatic reticuloperitonitis. It was hypothesized that the inflammatory and scar tissue lesions affected vagal nerve fibers supplying the forestomach and abomasum. The naturally occurring syndrome was similar to the Hoflund syndrome created by experimentally sectioning the vagus nerves and thus the term 'vagus indigestion' was coined.

The prevailing explanation was that dorsal vagal nerve injury resulted in **achalasia of the reticulo-omasal orifice (anterior stenosis)** and inhibited the passage of ingesta from the reticulorumen into the omasum and abomasum, resulting in an enlarged rumen with abnormal rumen contents. Similarly, injury of the pyloric branch of the ventral vagus nerve resulted in **achalasia of the pylorus (posterior stenosis)** and inhibited the flow of ingesta from the abomasum resulting in abomasal impaction. Both abnormalities resulted in scant feces containing undigested long feed particles.

However, while in many cases of vagus indigestion there are extensive adhesions between the reticulum and adjacent organs, there is little evidence of vagal nerve injury. It is also known that the syndrome can occur without any gross evidence of inflammation of the serosa of the forestomach and abomasum over which the vagus nerves are located. In the absence of gross lesions, it has been suggested that microscopic lesions of the medial reticular wall where vagal tension receptors are located may interfere with forestomach motility and esophageal groove reflexes.

New information based on clinical-pathological examination of clinical cases has questioned the long-held view that vagal nerve injury is an important cause of this syndrome.

Reticular adhesions

Mechanical impairment of reticular motility and esophageal groove dysfunction as a result of reticular adhesions is probably the most important cause of the syndrome.<sup>1</sup> An examination of 42 dairy cows with complications of traumatic reticuloperitonitis found that the primary mechanism was a **disturbance in particle-separation processes in the reticulorumen attributable to mechanical inhibition of reticular motility associated with extensive inflammatory parareticular adhesions**.<sup>1</sup> Based on examination of necropsy tissue grossly and histologically, there was no evidence of vagal nerve injury. Perireticular abscesses near the reticulo-omasal orifice of cattle can cause the disease.<sup>2</sup>

### Other causes

Several causes unrelated to traumatic reticuloperitonitis have been recorded. Actinobacillosis of the rumen and reticulum is a less common cause. In sheep, peritonitis associated with *Sarcosporidia* and *Cysticercus tenuicollis* may be a cause. **Fibropapillomas of the cardia** can mechanically occlude the distal esophagus and cause interference with forestomach motility.<sup>3</sup> **Abomasal impaction in sheep** has been recorded but the etiology and

pathogenesis have not been determined. Disturbances similar to those that occur under natural conditions have been produced by sectioning the vagus nerve. Following surgery for right-sided abomasal displacement or volvulus, some cattle develop a vagus-indigestion-like syndrome characterized by anorexia, scant feces, ruminal distension and abdominal distension. It has been suggested that distension of the abomasum and thrombosis of its vessels may have caused injury to the ventral vagus nerve.<sup>4</sup>

**Pyloric achalasia** is described as part of a secondary indigestion due to septicemia and toxemia but this is not well documented. There is also ruminal distension with fluid material, abomasal reflux into the reticulorumen, dehydration, hypochloremia, hypokalemic metabolic alkalosis and uremia.

**Indigestion of late pregnancy of cows** is considered a type of vagus indigestion in which the rumen and abomasum are grossly distended, but the cause is uncertain.<sup>5</sup> There is no evidence that the effects of an advanced pregnancy alone will cause a vagus-indigestion-like syndrome.

**Peripheral nerve sheath tumors**, such as a **solitary schwannoma** have been described causing a syndrome similar to vagus indigestion in a mature cow.<sup>6</sup>

A **vagal indigestion-like syndrome may be a postsurgical complication of right abomasal displacement**.<sup>7</sup> Gastric wall injury, peritonitis and vagal nerve lesions may be causative factors. It occurs in 14–21% of cases, and only 12–20% of cases return to normal production. (See under Right-side displacement of the abomasum and abomasal volvulus.)

### EPIDEMIOLOGY

The syndrome occurs most commonly in dairy cows that have a history of traumatic reticuloperitonitis, which may have occurred several weeks or a few months previously. The disease is not restricted to dairy cows – it also occurs in beef cattle and in mature bulls.

### PATHOGENESIS

The syndrome of vagus indigestion is characterized by disturbances in the passage of ingesta through the reticulo-omasal orifice (**failure of omasal transport, anterior functional stenosis**) and disturbances in the passage of ingesta through the pylorus (**pyloric stenosis, posterior functional stenosis**). *Stenosis* is a misnomer because there is no evidence of stenosis but achalasia of the sphincters may occur. The characteristic clinical findings are distension of the rumen with pasty and/or frothy contents because of increased time and maceration – in the reticulorumen, alterations in

reticulorumen motility, with consequences such as dehydration, an increase in undigested particles in the feces, scant feces, acid–base imbalance and secondary starvation. It is an **outflow abnormality of the reticulorumen and abomasum**.

Based on careful clinicopathological observations of 42 cows with complications of traumatic reticuloperitonitis including ‘vagus indigestion’, it is now proposed that the disturbances in the flow of ingesta are associated with particle-separation in the reticulorumen caused by mechanical inhibition of reticular motility associated with extensive adhesions of the reticulum.<sup>1</sup> Experimentally impaired reticular contractions in sheep support the central role of reticular motility for the separation of particles in the forestomach, the outflow of digesta from the reticulorumen and transpyloric digesta flow.<sup>8</sup>

Normally, reticulorumen motility results in **stratification of ruminal contents into three layers of ingesta** in addition to the most dorsal gas pocket. The **top layer**, consisting of firm fibrous material of **low-density** particles (coarse hay), floats on the **middle layer** of liquid ingesta, consisting of particles of **medium density**; the **bottom layer** consists of fine particles of **high density**. The solid material remains in the rumen and is digested until the particle size is sufficiently small (1–4 mm in cattle) to pass through the reticulo-omasal orifice. The size of the digested plant fragments in ruminant feces can be considered an indirect measurement of forestomach function. In cows, the presence of large plant particles (> 0.5 cm) in the feces indicates inadequate rumination or abnormalities in forestomach motility.<sup>9</sup>

In normal cattle, the mean retention time of particles in the reticulorumen depends on particle size and density. The density of large feed particles is low because of their air-filled interior. During biphasic reticular contractions, most of these large, light particles are pushed caudodorsally in the rumen. Thus, large particles are retained in the reticulorumen, because outflow through the reticulo-omasal orifice occurs mainly during the maximum portion of the second reticular contraction. Feed particles with a high density (small and well digested) are moved out of the reticulorumen preferentially, because the majority of them remain in the reticulum during the biphasic contraction.

If **reticular motility is inhibited**, the balance of particle retention time and particle outflow in the reticulorumen is disturbed. Immobilization of the reticulum experimentally causes a decrease in feed intake, an increase in ruminal volume, a decrease of mean retention time of light

plastic particles, a four-fold increase in mean retention time of heavy plastic particles, a marked increase in the amount of large particles in the feces, and an increase in abomasal volume. Such changes reflect the changes occurring in naturally occurring vagus indigestion. An increase in the amount of large particles in the feces of cows with traumatic reticuloperitonitis is indicative of inhibited clearance function of the reticulum.

Liquid consistency of the abomasal contents is important to insure physiological transpyloric flow. In cows with uncomplicated traumatic reticuloperitonitis, the process of particle separation in the reticulorumen is disturbed, which results in an increase in the amount of large particles in the feces. In uncomplicated traumatic reticuloperitonitis, the reticulorumen is not large and the abomasum is not impacted because the fluid outflow is probably adequate to flush even large particles out of the abomasum.

In cows with pyloric stenosis and an increase in the size of the abomasum, the rumen contents are homogeneous and pasty and not stratified. Thus, consistency of rumen outflow contents changes markedly. Normally, transpyloric digesta flow depends predominantly on hydrodynamic factors, especially viscosity. Even small increases in viscosity of abomasal contents may cause a marked decrease in abomasal outflow.

Disturbances of the passage of digesta in cows with traumatic reticuloperitonitis develop in three phases.

- In the **first phase**, reticulorumen motility is decreased because of immobilization of the reticulum caused by the inflammation, pain and fever. Immobilization of the reticulum impairs clearance function of the reticulum, resulting in poorly comminuted feces
- The **second phase** occurs when the adhesions are extensive enough to cause additional impairment of reticular motility. Particle distribution within the reticulorumen is changed, resulting in a loss of stratification. Although feed intake decreases, the volume of the reticulorumen increases because rumen outflow is decreased. During the second phase, comparatively small amounts of rumen outflow contents can exit the abomasum, because the dry-matter content of the material is similar to that of a clinically normal cow. During this phase, the rumen may become hypermotile because of excitation of low-threshold tension receptors as a consequence of moderate rumen distension

- The **third phase** is characterized by a further change in the consistency of rumen contents, resulting in a homogeneous pasty mass of relatively high viscosity. The increase in dry-matter content of the rumen outflow material inhibits transpyloric digesta flow. The abomasum enlarges, and reflux of abomasal contents may occur. It is suggested that the primary underlying process of reflux of abomasal contents in cows with posterior stenosis is a disturbance of ruminal outflow.<sup>1</sup>

In summary, the current hypothesis for the pathogenesis indicates that disturbances of the passage of ingesta consists of two phases of the same syndrome. Pyloric stenosis represents the phase with the most severe clinical consequences. The prognosis is poorer for cows with anterior stenosis than for those with uncomplicated traumatic reticuloperitonitis and is poorer for cows with posterior stenosis than for those with anterior stenosis. Only a small percentage of cows with traumatic reticuloperitonitis develop disturbances of digesta passage through the reticulo-omasal orifice and not all cows with anterior stenosis develop posterior stenosis. The extent and location may determine the course of the syndrome and how rapidly it develops. In cows with acute traumatic reticuloperitonitis the consistency of the adhesions changes from a widespread fibrous type to a stringy type after several months, and with time the reticulum may regain sufficient motility to provide its clearance function.

#### **Anterior functional stenosis (achalasia)**

This is characterized by accumulation of ingesta in the reticulorumen, known also as failure of omasal transport. If the ruminal wall is atonic the ingesta accumulates without bloat occurring; if it has normal motility the ruminal wall responds to the distension by increased motility and the production of frothy bloat. Ruminal motility will be almost continuous (3–6/min) but the contractions are ineffective in propelling the ingesta into the omasum. As a result the rumen enlarges to fill the majority of the abdomen, which accounts for the gross distension of the abdomen. The dorsal sac of the rumen enlarges to the right of the midline, and the ventral sac enlarges to fill most or all of the right lower quadrant of the abdomen; this results in the ‘L-shaped’ rumen as viewed from the rear of the animal. The continuous rumen contractions also result in frothy rumen contents, which can be fatal if progressive and not relieved. Occasionally there is free gas

bloat. Bradycardia occurs commonly and has been attributed to increased vagal tone of the injured nerve, causing parasympathetic slowing of the heart, but this has not been documented.

Obstruction of the reticulo-omasal orifice by foreign bodies such as polyethylene twine ingested by the animal may cause a syndrome indistinguishable from anterior functional stenosis.<sup>10</sup>

**Posterior functional stenosis (achalasia)**

This is characterized by failure of transpyloric outflow resulting in abomasal impaction with large particles. Abomasal fluid containing hydrochloric acid may reflux into the rumen if the fluid does not move from the abomasum into the small intestines.<sup>11</sup> This is known as the **abomasal reflux syndrome**. The chloride concentrations in the rumen fluid increase and there is a hypochloremia and hypokalemia. Bile acids may also reflux from the duodenum into the rumen of animals with an ileus of the small intestine.<sup>12</sup> Associated with pyloric achalasia there is in some cases an apparent failure of the esophageal groove to permit the passage of ingesta into the rumen, this organ containing only fluid. The syndrome observed depends on the stage of the disease at which the animal is first examined.

**Metabolic alkalosis, abomasal reflux**

Depending on the location and severity of the functional obstruction and distension or impaction, there will be varying degrees of dehydration and a tendency towards a **metabolic hypochloremic, hypokalemic alkalosis**. In pyloric stenosis with abomasal impaction there is sequestration of abomasal fluid in the abomasum and a reflux of abomasal contents into the rumen, resulting in a ruminal chloride concentration of more than 20 mmol/L. In anterior stenosis, the abomasal fluid can pass into the duodenum and neither metabolic alkalosis nor dehydration can be expected.

**Postsurgical complication in right-side displacement of the abomasum or abomasal volvulus**

A vagus-indigestion-like syndrome may occur in cattle treated for right-side displacement of the abomasum or abomasal volvulus.<sup>7</sup> Possible mechanisms include vagus nerve injury, overstretching of the abomasal wall during prolonged distension resulting in neuromuscular junction alterations and autonomic motility modification, thrombosis and abomasal wall necrosis, and peritonitis.

**Abomasal impaction in sheep**

Abomasal emptying defects associated with dilatation and impaction of the abomasum in Suffolk sheep have been

reported.<sup>13,14</sup> The electrolyte imbalances that occur in cattle with abomasal impaction do not occur in sheep.

**CLINICAL FINDINGS**

Three similar but separate clinical syndromes have been recognized, with some clinical findings characteristic of all three, including:

- **Inappetence for several days** or complete anorexia with evidence of **loss of body weight**
- An enlarged 'papple'-shaped abdomen (pear-shaped on the right and apple-shaped on the left) with or without bloat. The upper left abdomen is distended and the lower half of the abdomen is distended bilaterally
- **Dehydration** and electrolyte imbalance with metabolic alkalosis
- **Enlarged rumen** palpable on rectal examination
- **Scant feces** with an increase in undigested particles
- **Enlarged ingesta-impacted or fluid-distended abomasum** palpable through right flank or on rectal examination (except cannot be easily palpated in advanced pregnancy)
- Vital signs within the normal range
- Inadequate response to treatment.

**Ruminal distension with hypermotility**

The occurrence of this type is not particularly related to pregnancy or parturition. Moderate to severe bloat is common. There is evidence of loss of body weight. The animal has usually been inappetent or anorexic intermittently for the past few weeks. The abdomen is prominently distended and the rumen movements represented by the **abdominal ripples** are often unusually prominent and may occur at the rate of **4-6 per minute**. The sounds of the rumen contractions are often reduced or almost absent in spite of hyperactivity because the rumen contents are pasty and frothy. Initially, this contradiction is misleading because the hyperactivity of the rumen tends to indicate normal reticulorumen activity. Fluid-splashing sounds may be audible on ballottement of the left and right flanks if the rumen is distended with excessive quantities of fluid. The feces are scant and pasty and contain undigested particles. The temperature is usually normal and bradycardia (44-60 beats/min) may be present. A systolic murmur that waxes and wanes with respiration, being loudest at the peak of inspiration, may be present because of the ruminal distension and tympany causing compression of the heart and distortion of the valves. The murmur disappears when the tympany is relieved.

**Ruminal distension is obvious on rectal examination.** The dorsal sac of the rumen is grossly distended to the right of the midline and is pushed back against the brim of the pelvis; the ventral sac is also enlarged and occupies much of the right lower quadrant of the abdomen. This may be difficult to appreciate in advanced pregnancy. Viewed from the rear the enlarged rumen is **L-shaped**, giving an external silhouette with the left flank distended from top to bottom and the right flank distended only in the lower half - the 'papple'-shaped abdomen.

An important aspect of the clinical history of 'vagus indigestion' cases is that standard treatments for ruminal tympany and impaction usually have no effect on the course of the disease. If the acid-base imbalances can be corrected and hydration maintained and adequate nutritional status maintained until parturition occurs in these cows, the prognosis is favorable and the recovery rate is high.

**Ruminal distension with atony**

This type occurs most commonly in late pregnancy and may persist after calving. The cow is clinically normal in all respects except that she is anorexic, passes only scant amounts of soft pasty feces, has a distended abdomen and will not respond to treatment with purgatives, lubricants or parasympathetic stimulants. Ruminal movements are seriously reduced or absent and there may be persistent mild bloat. Fluid-splashing sounds may also be audible on ballottement of the left and right flanks if the rumen is distended with excessive quantities of fluid. The temperature and heart rate are usually normal. There is no pain on deep palpation of the ventral abdomen. On rectal examination the primary abnormality is gross distension of the rumen, which may almost block the pelvic inlet. The animal loses weight rapidly, becoming weak and recumbent. At this stage the heart rate increases markedly. The animal dies slowly of inanition.

**Pyloric obstruction and abomasal impaction**

Most cases of abomasal impaction also occur late in pregnancy and are manifested by anorexia and a reduced volume of pasty feces. There may be no abdominal distension and no systemic reaction until the late stages, when the heart rate rises rapidly. The distended and impacted abomasum may be palpable in the lower right abdomen as a heavy, doughy viscus. On rectal examination the impacted abomasum may be palpable as a doughy viscus that pits on pressure in the right lower quadrant. If the animal is in advanced pregnancy the impacted abomasum may not be palpable through the

abdominal wall or by rectal palpation but the gravid uterus may feel as if it is displaced into the pelvic cavity by the enlarged abomasum. Rumen movements are usually completely absent. As in the first type, affected animals usually become weak and recumbent and die slowly of inanition and electrolyte and acid-base imbalances. In some cases, the impacted abomasum may rupture and cause death in a few hours.

Combinations of these types may occur; in particular, distension of the rumen with atony combined with abomasal impaction is the most commonly observed syndrome.

**Indigestion of late pregnancy** in cattle characterized by distension and hypermotility of the rumen with distension of the abomasum has been described but is probably not due to advanced pregnancy alone.<sup>5</sup> In late pregnancy, the abomasum is difficult to examine clinically either through the abdominal wall or by rectal examination. The presence of fluid-splashing sounds on ballottement and auscultation over the right lower flank is indirect evidence of distension of the abomasum with fluid. The distended abomasum can be palpated and evaluated by left or right side laparotomy (celiotomy).

## CLINICAL PATHOLOGY

### Hemogram

In most cases there are no abnormalities on hematological examination although a moderate neutrophilia, a shift to the left and a relative monocytosis may suggest the presence of chronic traumatic reticuloperitonitis. Hemoconcentration is common, associated with the clinical dehydration. Total plasma protein concentrations may be increased, similar to traumatic reticuloperitonitis.

### Peritoneal fluid

This may be indicative of a chronic reticuloperitonitis.

### Serum biochemistry

In abomasal impaction there is metabolic hypochloremic, hypokalemic alkalosis.

### Ruminal chloride concentrations

These are normally below 30 mmol/L and increased in posterior stenosis to levels above 40 mmol/L due to abomasal reflux.<sup>1</sup> Levels of 66 mmol/L have been recorded in cows with indigestion of late pregnancy.<sup>5</sup>

## NECROPSY FINDINGS

The rumen is grossly enlarged and the contents are pasty and may be frothy. The contents may have undergone some putrefaction. In some cases the rumen is grossly distended with liquid rumen contents containing floating large particles of ingesta. The reticulum and omasum are usually grossly enlarged and the reticulo-

omasal orifice is commonly dilated and filled with rumen contents. The omasum may be almost twice its normal size and is firmer than normal. Sectioning of the omasum reveals rumen contents impacted between its leaves. The abomasum may be up to twice its normal size and firm on palpation. The abomasum is impacted and grossly distended with semi-dry partially digested ingesta that resembles partially dried rumen contents. Erosions and ulcers may be present in the pyloric part of the abomasum. The intestines may be relatively empty and the feces in the large intestine are pasty, containing an increased amount of undigested particles.

Lesions between the reticulum and ventral abdominal floor and the diaphragm vary considerably from thick fibrinous suppurative adhesions to multiple abscesses containing a foreign body or non-inflammatory fibrous bands and strings.

## DIFFERENTIAL DIAGNOSIS

The salient clinical features of vagus indigestion in cattle are inappetence for several days leading to anorexia, a gradually enlarging abdomen, especially on the left side, scant feces, failure to respond to common medical therapy, loss of body condition and varying degrees of dehydration. Obtaining an accurate history is of paramount importance. Most cases of vagus indigestion have been affected for at least several days or a few weeks. The diagnosis can be perplexing in those cases that occur in late pregnancy because the animal has usually been housed and fed with other dry cows and daily observation of feed intake and fecal output have not been made, so it is difficult to obtain an accurate and helpful history. The clinical examination should focus on the state of the rumen and the abomasum. In valuable animals a left-side exploratory laparotomy and rumenotomy will often be necessary in order to make a diagnosis. This will allow the determination of the presence of reticular adhesions, obstructions of the reticulo-omasal orifice and the state of the abomasum.

The various forms of vagus indigestion must be differentiated from diseases of the forestomach and abomasum resulting in distension and hypermotility or atony of the rumen and enlargement of the abomasum.

- **Ruminal distension with hypermotility** is typical of vagus indigestion and, if accompanied by anorexia, dehydration, scant and abnormal feces, and a large L-shaped rumen on rectal examination, it must be differentiated from:
  - *Indigestion of late pregnancy*, characterized by anorexia, lethargy, dehydration, grossly distended papple-shaped abdomen, ruminal distension with hypermotility, abomasal distension with fluid, elevated ruminal chloride levels and hypochloremic, hypokalemic alkalosis
- **Obstruction of the reticulo-omasal orifice** by ingested baling twine, plastic sleeves and bags may cause distension of the rumen indistinguishable from vagus indigestion.<sup>10</sup> The rumen is moderately distended but its size will vary daily and reticulorumen motility is normal. The animal is bright and alert, but the feed intake, amount of feces and milk production varies daily from normal to subnormal for no obvious reason. Rumenotomy is the only method of making the diagnosis. The ruminal foreign body will be floating in the rumen or may be partially lodged in the reticulo-omasal orifice
- **Ruminal distension with atony** must be differentiated from diseases of the forestomach and abomasum in which there is failure of passage of ingesta. These include:
  - **Chronic traumatic reticuloperitonitis**, which is characterized by inappetence to anorexia, a usually smaller than normal rumen with atony – but in some cases the rumen feels larger than normal with free-gas bloat, loss of body weight, persistent slight fever, perhaps the presence of a grunt, an absence of rumination, scant feces with an increased amount of undigested particles, and changes in the hemogram indicating chronic inflammation
  - **Abomasal impaction in vagus indigestion**, characterized by a papple-shaped abdomen, perhaps prominent enlargement of the right lower abdomen, ruminal distension with hypermotility or atony, the presence of a palpable heavy viscus in the right lower abdomen, scant feces with long undigested particles of ingesta, loss of body weight, dehydration and hypochloremic, hypokalemic alkalosis. The gravid uterus is easily palpable on rectal examination and the fetus may be displaced into the pelvic cavity because of the impacted and enlarged abomasum. Ruminal chloride levels are elevated
  - **Abomasal impaction dietary in origin** due to ingestion of straw or sand occurs in cattle with unlimited access to chopped straw during cold weather or consuming tuber crops contaminated with sand. The rumen is grossly distended with coarse ruminal ingesta or liquid contents and is atonic. Ballottement of the rumen elicits fluid-splashing sounds. The right flank is distended and the impacted abomasum can be palpated as a heavy, firm viscus in the right lower flank (except in late pregnancy when it cannot be palpated). Hypochloremic, hypokalemic alkalosis is present
  - **Omasal impaction** occurs sporadically and commonly part of the vagus indigestion syndrome but its cause is uncertain. Anorexia, ruminal distension and atony, scant inadequately digested feces

- **Phytobezoars** blocking the abomasal pylorus causes loss of body weight, abomasal distension with fluid-splashing sounds on ballottement over the right lower flank, ruminal distension and hypotonicity, anorexia and hypochloremic, hypokalemic alkalosis. Right flank laparotomy and abomasotomy is necessary to make the diagnosis
- **Abomasal ulceration without melena** is uncommon but occurs in dairy cows with a history of chronic inappetence and decreased milk production. There is distension of the abomasum with fluid-splashing sounds on ballottement, ruminal hypotonicity, inappetence and loss of body weight, occult blood and moderate dehydration. Diagnosis is only made surgically or at necropsy
- **Peripheral nerve sheath tumors** of the vagus nerve may cause a syndrome similar to vagus indigestion. Clinically, there is chronic ruminal stasis and tympany, persistently distended loops of intestine palpable per rectum, inappetence to anorexia and progressive loss of body weight. The diagnosis cannot be made clinically; lesions are present on the vagus nerve above the base of the heart

## TREATMENT

The prognosis in most cases is unfavorable but also unpredictable. The problem is to determine the location and extent of the lesion, which may be difficult or impossible even on exploratory laparotomy or rumenotomy.

### Rumen lavage

If the rumen is grossly distended with fluid or mushy rumen contents, it can be emptied using a large-bore (25 mm inside diameter) stomach tube followed by flushing warm water into the rumen and lavaging it by gravity flow. The contents are usually well macerated and foul-smelling. Emptying the rumen not only relieves the pressure but allows for easier examination of the abdomen.

### Fluid and electrolyte therapy and laxatives

Some cases respond beneficially following fluid and balanced electrolyte therapy for 3 days combined with the oral administration of mineral oil (5–10 L) daily for 3 days or dioctyl sodium sulfosuccinate as described under the treatment of abomasal impaction of dietary origin. Other cases do not respond but there is no reliable method of knowing which ones will respond other than by attempting treatment for a few days. Valuable pregnant cows near parturition may be maintained on fluid and electrolyte therapy for several days or until near

enough to term to induce parturition and hopefully obtain a live calf. Some cows will recover following parturition but the syndrome may recur in the next pregnancy. The use of hypertonic saline solution, 1.8%, is effective for the correction of experimentally induced hypochloremic metabolic alkalosis in sheep and could be of beneficial value for use in cattle.<sup>15</sup>

### Rumenotomy

Rumenotomy and emptying of the rumen is usually followed by slow recovery over a period of 7–10 days when there is ruminal hypermotility. The creation of a permanent ruminal fistula to permit the escape of gas in cases where gas retention is a problem may cause dramatic improvement. Surgical correction of abomasal distension or impaction by abomasotomy is usually unsatisfactory because the motility of the abomasum does not return. Surgical drainage of perireticular abscesses into the reticulum or omasum at the site of the lesion through a rumenotomy incision has been successful in prolonging survival of affected cattle for at least 1 year.<sup>2</sup> Reticular abscesses may be drained successfully by ultrasound-guided transcuteaneous incision.<sup>16</sup> For some cases of vagus indigestion, the most satisfactory procedure may be to recommend slaughter for salvage. In suspected cases of obstruction of the reticulo-omasal orifice by rope or twine, an exploratory rumenotomy is required to remove the foreign object.

### PREVENTION

This is dependent on preventing traumatic reticuloperitonitis through management of the environment and the administration of reticular magnets.

### REFERENCES

1. Rehage J et al. *J Am Vet Med Assoc* 1995; 207:1607.
2. Fubini SL et al. *J Am Vet Med Assoc* 1989; 194:811.
3. Gordon PJ. *Vet Rec* 1997; 140:69.
4. Rebhun WC et al. *Compend Contin Educ Pract Vet* 1988; 10:387.
5. Van Mere DC et al. *J Am Vet Med Assoc* 1995; 206:625.
6. Bradshaw J et al. *Vet Rec* 2003; 153:784.
7. Sattler N et al. *Can Vet J* 2000; 41:777.
8. Kaske M, Midasch A. *Br J Nutr* 1997; 78:97.
9. Constable PD et al. *Compend Contin Educ Pract Vet* 1990; 12:1008, 1169.
10. Braun U. *Vet Rec* 2002; 150:580.
11. Braun U et al. *Vet Rec* 1990; 126:107.
12. Braun U et al. *Vet Rec* 1989; 124:373.
13. Kopcha M. *J Am Vet Med Assoc* 1988; 192:783.
14. Ruegg PL et al. *J Am Vet Med Assoc* 1988; 193:1534.
15. Fubini SL et al. *Am J Vet Res* 1991; 52:1898.
16. Braun U et al. *Vet Rec* 1998; 142:184.

## DIAPHRAGMATIC HERNIA

Herniation of a portion of the reticulum through a diaphragmatic rupture causes

chronic ruminal tympany, anorexia and displacement of the heart.

### ETIOLOGY

Most cases occur because of weakening of the diaphragm by lesions of traumatic reticuloperitonitis, but diaphragmatic rupture can occur independently of a foreign body and congenital defects of the diaphragm may be a cause in some animals. An unusually high incidence of herniation of the reticulum through the diaphragm, sometimes accompanied by the abomasum, has been recorded in buffalo in India.

### PATHOGENESIS

The usual syndrome is similar to that of vagus indigestion in which ruminal hypermotility is present. It seems probable that there is either achalasia of the reticulo-omasal sphincter due to involvement of the vagus nerve or impairment of function of the esophageal groove caused by the fixation of the reticulum to the ventral diaphragm. The disturbance of function in the forestomachs suggests that food can get into the rumen but cannot pass from there to the abomasum. The hypermotility is thought to be due to overdistension of the rumen and to be the cause of the frothy bloat.

There is usually no interference with respiration without major herniation but displacement and compression of the heart occur commonly.

### CLINICAL FINDINGS

There is a capricious appetite and loss of condition for several weeks before abdominal distension due to accumulation of fluid and froth in the rumen, persistent moderate tympany of the rumen, occurs. Grinding of the teeth may occur and the feces are pasty and reduced in volume. Rumination does not occur but occasionally animals regurgitate when a stomach tube is passed.

The temperature is normal and bradycardia may be present (40–60/min). Breathing is usually normal. A systolic murmur may be present and the intensity of the heart sounds may suggest displacement of the heart, usually anteriorly or to the left. Reticular sounds are audible just posterior to the cardiac area in many normal cows and they are not significantly increased in diaphragmatic hernia.

A more severe syndrome is recorded in cases where viscera other than a portion of the reticulum is herniated. Peristaltic sounds may be audible in the thorax and there may be interference with respiration and signs of pain with each reticular contraction. Affected animals usually die from inanition in 3–4 weeks after the onset of bloat.

## CLINICAL PATHOLOGY

Laboratory examinations are of no value in diagnosis. Radiological examination after a barium meal has facilitated diagnosis.

## NECROPSY FINDINGS

The majority of cases are complications of traumatic reticuloperitonitis and a fistulous tract is often found in the vicinity of the diaphragmatic rupture which is usually 15–20 cm in diameter. A portion of the reticulum protrudes into the right pleural cavity to form a spherical distension usually 20–30 cm in diameter, but more extensive in some cases. The reticulum is very tightly adherent to the hernial ring which is thickened by fibrous tissue. The omasum and abomasum are relatively empty but the rumen is overfilled with frothy, porridge-like material which contains very little fiber. Less common cases are those in which part of the reticulum, the omasum and part of the abomasum are herniated.

## DIFFERENTIAL DIAGNOSIS

- Other causes of chronic bloat must be considered in the differential diagnosis, especially vagus indigestion with hypermotility, which is also often accompanied by a systolic murmur. The two can only be differentiated by rumenotomy but there is the hazard that cases of diaphragmatic hernia are not relieved by the operation and tympany returns rapidly, sometimes necessitating a permanent ruminal fistula
- Passage of a stomach tube is usually necessary to determine whether or not a physical obstruction is present in the esophagus. Regurgitation is likely to occur in cases of diaphragmatic hernia and this occasionally causes blockage of the esophagus with ingesta, simulating choke
- Causes of diaphragmatic hernia other than traumatic reticuloperitonitis include violent trauma to the abdomen and straining at parturition. In both instances there is probably a primary weakness of the diaphragm. In buffalo this is thought to be an anatomical characteristic of the species, the weakness being located in the right half of the diaphragm

## TREATMENT

Most recorded attempts at surgical repair in cattle have been unsuccessful and treatment has not usually been recommended. The animals could not be left as they were, so salvage by slaughter has been the usual outcome.

The ruminal contents are frothy, and trocarization or passing a stomach tube has virtually no effect in reducing the tympany, nor have standard antifrothing agents. The tympany is usually not sufficiently severe to require emergency rumenotomy. The signs may be partly

relieved by keeping the animal confined with the forequarters elevated.

## TRAUMATIC PERICARDITIS

Perforation of the pericardial sac by a sharp foreign body originating in the reticulum causes pericarditis with the development of toxemia and congestive heart failure. Tachycardia, fever, engorgement of the jugular veins, anasarca, hydrothorax and ascites, and abnormalities of the heart sounds are the diagnostic features of the disease.

### Synopsis

**Etiology** Perforation of pericardial sac by foreign body originating from the reticulum

**Epidemiology** Usually mature cattle; may have had history of traumatic reticuloperitonitis

**Signs** Depression, toxemia, fever, inappetence to anorexia, engorged jugular veins, brisket edema, heart sounds muffled and accompanied by pericardial friction rubs and to-and-fro fluid movement sounds

**Clinical pathology** Marked neutrophilia. Pericardiocentesis yields foul-smelling and turbid fluid

**Lesions** Distension of pericardial sac, foul-smelling, grayish fluid containing fibrin. Adhesions and sinus tracts to reticulum

### Diagnostic confirmation

Pericardiocentesis

**Differential diagnosis** Common causes of congestive heart failure in cattle include endocarditis, myocardopathy (lymphomatosis), congenital cardiac defect

**Treatment** Antimicrobials. Prognosis unfavorable. Euthanasia commonly recommended

## ETIOLOGY

Traumatic pericarditis is caused by penetration of the pericardial sac by a migrating metal foreign body from the reticulum. The incidence is greater during the last 3 months of pregnancy and at parturition than at other times. Approximately 8% of all cases of traumatic reticuloperitonitis will develop pericarditis. Most affected animals die or suffer from chronic pericarditis and do not return to completely normal health.

## PATHOGENESIS

The penetration of the pericardial sac may occur with the initial perforation of the reticular wall. However, the animal may have had a history of traumatic reticuloperitonitis some time previously, followed by pericarditis, usually during late pregnancy or at parturition. In this case it is probable that the foreign body remains in a sinus in the reticular wall after the initial perforation and penetrates the pericardial sac at a later date. Physical penetration of

the sac is not essential to the development of pericarditis, infection sometimes penetrating through the pericardium from a traumatic mediastinitis.

Introduction of a mixed bacterial infection from the reticulum causes a severe local inflammation, and persistence of the foreign body in the tissues is not essential for the further progress of the disease. The first effect of the inflammation is hyperemia of the pericardial surfaces and the production of friction sounds synchronous with the heart beats. Two mechanisms then operate to produce signs: the toxemia due to the infection and the pressure on the heart from the fluid which accumulates in the sac and produces congestive heart failure. In individual cases one or other of these two factors may be more important. Depression is characteristic of the first and edema of the second. Thus an affected animal may be severely ill for several weeks with edema developing only gradually, or extreme edema may develop within 2–3 days. The rapid development of edema usually indicates early death.

If chronic pericarditis persists there is restriction of the heart action due to adhesion of the pericardium to the heart. Congestive heart failure results in most cases but some animals may recover. An uncommon sequel after perforation of the pericardial sac by a foreign body is rupture of a coronary artery or the ventricular wall. Death usually occurs suddenly due to acute, congestive heart failure from compression of the heart by the hemopericardium, and often without premonitory illness.

## CLINICAL FINDINGS

Depression, anorexia, habitual recumbency and rapid weight loss are common. Diarrhea or scant feces may be present and grinding of the teeth, salivation and nasal discharge are occasionally observed. The animal stands with the back arched and the elbows abducted. Respiratory movements are more obvious, being mainly abdominal, shallow, increased in rate to 40–50/min and often accompanied by grunting. **Engorgement of the jugular veins, and edema of the brisket and ventral abdominal wall are common** and in severe cases there may even be edema of the conjunctiva with grape-like masses of edematous conjunctiva hanging over the eyelids. A prominent jugular venous pulse is usually visible and extends proximally up the neck.

**Pyrexia** (40–41°C, 104–106°F) is common in the early stages and an increase in the heart rate to 100/min and a diminution in the pulse amplitude are constant. Rumen movements are usually present but depressed. Pinching of the withers to

depress the back or deep palpation of the ventral abdominal wall behind the xiphoid sternum commonly elicits a marked painful grunt. A grunt and an increased area of cardiac dullness can also be detected by percussion over the precordial area, preferably with a pleximeter and hammer.

**Auscultation of the thorax reveals the diagnostic findings.** In the early stages before effusion commences, the heart sounds are normal but are accompanied by a **pericardial friction rub**, which may wax and wane with respiratory movements. Care must be taken to differentiate this from a pleural friction rub due to inflammation of the mediastinum. In this case the rub is much louder and the heart rate will not be so high. Several days later when there is marked effusion, the **heart sounds are muffled** and there may be **gurgling, splashing or tinkling sounds**. In all cases of suspected pericarditis, careful auscultation of the entire precordium on both sides of the thorax is essential as abnormal sounds may be audible only over restricted areas. This is especially so in chronic cases.

Most affected animals die within a period of 1–2 weeks, although a small proportion persist with chronic pericarditis. The obvious clinical findings in the terminal stages are **gross edema, dyspnea, severe watery diarrhea, depression, recumbency and complete anorexia. Enlargement of the liver** may be detectable by palpation behind the upper part of the right costal arch in the cranial part of the right paralumbar fossa. Death is usually due to asphyxia and toxemia.

Animals which have recovered from an initial pericarditis are usually affected by the chronic form of the disease. Body condition is poor, the appetite is variable, there is no systemic reaction and the demeanor is bright. Edema of the brisket is usually not prominent but there is jugular engorgement. Auscultation reveals variable findings. The **heart sounds are muffled and fluid splashing sounds** may be heard over small discrete areas corresponding to the loculi of fluid in the sac, or there may be irregularity of the heart beat. The heart rate is rapid (90–100/min) and the pulse is small in amplitude. These animals remain unthrifty and are unlikely to withstand the stress of another pregnancy or lactation.

#### CLINICAL PATHOLOGY

##### Hemogram

A pronounced leukocytosis with a total count of 16 000–30 000/ $\mu$ L accompanied by a neutrophilia and eosinopenia is usual although less dramatic changes are recorded in one series of cases.

#### Pericardiocentesis

When gross effusion is present the pericardial fluid may be sampled by centesis with a 10 cm 18-gauge needle over the site of maximum audibility of the heart sound, usually in the fourth or fifth intercostal space on the left side. In mid-stage pericarditis the fluid is usually easily obtained, and is **foul-smelling and turbid, which is diagnostic for pericarditis**. In chronic pericarditis only small amounts may be present and a sample may not be obtainable.

#### NECROPSY FINDINGS

In acute cases there is gross distension of the pericardial sac with foul-smelling, grayish fluid containing flakes of fibrin, and the serous surface of the sac is covered by heavy deposits of newly formed fibrin. A cord-like, fibrous sinus tract usually connects the reticulum with the pericardium. Additional lesions of pleurisy and pneumonia are commonly present. In chronic cases the pericardial sac is grossly thickened and fused to the pericardium by strong fibrous adhesions surrounding loculi of varying size which contain pus or thin straw-colored fluid.

#### DIFFERENTIAL DIAGNOSIS

The typical clinical findings in pericarditis are chronic illness, toxemia, fever, congestive heart failure and muffled heart sounds. The major causes of congestive heart failure in cattle are pericarditis, endocardial disease, myocardiopathy and cor pulmonale (pulmonary hypertension due to chronic pulmonary disease). Endocarditis, lymphomatosis with cardiac involvement and congenital cardiac defects are all likely to be confused with traumatic pericarditis because of the similarity of the abnormal heart sounds.

- **Endocarditis** is usually associated with a suppurative process in another organ, particularly the uterus or udder, and, although the abnormal heart sounds are typical bruits rather than pericardial friction sounds, this may be difficult to determine when extensive pericardial effusion has occurred
- **Lymphomatosis** is usually accompanied by lesions in other organs or the presence of a marked leukocytosis and lymphocytosis
- **Congenital cardiac defects** may not cause clinical abnormality until the first pregnancy but can be diagnosed by the presence of loud murmurs, a pronounced cardiac thrill and an absence of toxemia
- Less common causes of abnormal heart sounds include thoracic tumors and abscesses, diaphragmatic hernia and chronic bloat, which cause distortion of the atria and atrioventricular orifices. They are associated with other diagnostic signs, particularly displacement of the heart

- In severely debilitated animals or those suffering from severe anemia a hemic murmur which fluctuates with respiration may be audible
- Occasional cases of hematogenous pericarditis are encountered, and in some cases of pasteurellosis a fibrinous pericarditis may be present, but there is usually serious involvement of other organs and the pericarditis is only secondary

#### TREATMENT

The results of treatment are usually unsatisfactory but salvage of up to 50% of cases can be achieved by long-term treatment with antimicrobials. Rapid onset of generalized edema represents a poor prognosis. Drainage of the pericardial sac may temporarily relieve the edema and respiratory embarrassment but relapse usually occurs within a few days. Selected cases of traumatic pericarditis have been treated satisfactorily by pericardiectomy.

#### PREVENTION

Prevention depends on preventing traumatic reticuloperitonitis through management of the environment and the administration of reticular magnets.

#### TRAUMATIC SPLENITIS AND HEPATITIS

Traumatic splenitis and hepatitis occur relatively uncommonly as sequelae to traumatic reticuloperitonitis and are manifested either by continuation of the illness caused by the initial perforation or by apparent recovery followed by relapse several weeks later. The prominent clinical findings include fever (39.5–40.5°C, 103–105°F), tachycardia, gradual decrease in feed intake and milk yield but ruminal movements may be present and may be normal. Percussion of the abdomen over the site usually used to detect the pain of traumatic reticuloperitonitis gives a negative response although deep, forceful palpation may elicit a mild grunt. The diagnostic sign is pain on palpation with the thumb in the last two intercostal spaces halfway down the abdomen on the right side when there is hepatic involvement, and on the left side when the spleen is affected.

The total leukocyte count is elevated (above 12 000/ $\mu$ L) with a marked neutrophilia and a left shift. Rumenotomy is not usually undertaken except for diagnostic purposes. Treatment with antibacterial drugs is effective if commenced sufficiently early. Oral treatment with sulfadimidine has been effective in some cases.

#### IMPACTION OF THE OMASUM

Omasal impaction as a clinical entity is difficult to define and is usually



diagnosed at necropsy when the omasum is enlarged and excessively firm. It seems unlikely that it could cause death and is frequently observed in animals dying of other disease. It is reputed to occur when feed is tough and fibrous, particularly alfalfa stalks and loppings from fodder trees, or under drought feeding conditions in sheep that are fed on the ground. In the latter, the impaction is due to the accumulation of soil in the omasum. Chronic recurrent bouts of indigestion occur and are manifested by decreased rumen motility, infrequent and scanty feces, refusal to eat grain and a negative ketone test. Pain may be elicited and the hard distended viscus palpated on deep pressure under the right costal arch or in the seventh to ninth intercostal spaces on the right side. It may also be palpable per rectum as a large, round, firm mass with a checkered surface to distinguish it from the smooth surface of the abomasum. Repeated dosing with mineral oil is recommended as treatment.

At necropsy, the omasum is grossly distended; patches of necrosis may be present on the leaves and peritonitis may be evident. Necrosis of the ruminal lining may also be present. Clinically the disease is manifested by complete anorexia, cessation of defecation, an empty rectum and subacute abdominal pain with disinclination to move or lie down.

## Diseases of the abomasum

Diseases of the abomasum associated with metabolic disease, lactational stress and nutritional inadequacies are common in dairy cattle. The common diseases of the abomasum are:

- **Left-side displacement of the abomasum (LDA)**
- **Right-side displacement of the abomasum (RDA)**
- **Abomasal torsion (volvulus)**
- **Abomasal ulcers**
- **Impaction associated with vagus indigestion**
- **Dietary abomasal impaction.**

Their recognition is due in part to improved diagnostic techniques and increased awareness of their occurrence, but perhaps there is also an increase in their frequency because of intensified cattle production. Dairy cattle are being selected for high milk production and are being fed large quantities of grain and kept more commonly in total confinement where exercise is limited – all of which may contribute to abomasal atony, which is the precursor of abomasal displacements. A review of abomasal displacement in cattle is available.<sup>1</sup>

A number of general comments are summarized here that apply to most diseases of the abomasum.

## CLINICAL EXAMINATION OF THE ABOMASUM

### PHYSICAL EXAMINATION

The normal abomasum cannot usually be examined by the standard techniques of clinical examination except indirectly by auscultation and paracentesis. In **LDA**, the tympanitic sounds (**pings**) audible on auscultation and percussion between the middle to upper third of the ninth and 13th ribs and over the left paralumbar fossa are characteristic. In **RDA** the tympanitic sounds (**pings**) audible on auscultation and percussion between the lower third of the ninth and 13th ribs and extending into the right paralumbar fossa, and the **fluid-splashing sounds** audible on auscultation and ballottement of the right lower to middle third of the abdomen, are characteristic. An enlarged abomasum may be palpable on rectal examination deep in the right lower quadrant of the abdomen depending on the size of the animal and the size of the distended abomasum, and provided the animal is not in advanced pregnancy.

In abomasal volvulus, the clinical findings are similar to right-side displacement but much more severe. On rectal palpation a fluid-filled abomasum feels tense; an impacted abomasum pits on digital pressure. (**An impacted enlarged omasum is usually situated slightly to the right of midline deep in the abdomen below the palpable kidney; it feels firm and does not pit on pressure.**) In abomasal impaction, the enlarged, firm, doughy viscus can usually be palpated behind the lower aspect of the right costal arch but the gravid uterus of later pregnancy commonly makes this difficult. Following parturition the abomasum is more readily detectable by palpation through the abdominal wall or rectally.

### ULTRASONOGRAPHY OF ABOMASUM

The abomasum can be visualized by ultrasonography over the ventral midline caudal to the xiphoid process and from both left and right paramedian regions lateral to the midline site. The abomasum can be clearly differentiated from adjacent viscera because of its contents, which appear as a heterogeneous, moderately echogenic structure with echogenic stippling.<sup>2</sup> Abomasal motility cannot be observed but the relative size of the abomasum can be detected. Ultrasonographic examination of the abomasum of neonatal lambs provides an immediate indication of whether or not the lambs have sucked and may be useful in investigations of neonatal mortality.<sup>3</sup>

## ABOMASOCENTESIS

Centesis of abomasal contents is a safe procedure if done carefully.<sup>4,5</sup> Percutaneous ultrasound-guided abomasocentesis can be done to evaluate the nature and chemical composition of abomasal contents.<sup>5</sup> The procedure is done at a site where the abomasum is large and no other viscera are located. The optimum site for abomasocentesis is 10–27 cm caudal to the xiphoid process and on the ventral midline, or up to 10 cm caudal and to the right of it. A spinal needle (0.12 × 9.0 cm) with a stylet is guided by ultrasonography through the skin and abdominal wall and into the abomasum. Abomasal fluid is assessed for color, smell and the presence of blood, and pH. Normally, the color ranges from olive green to gray, and the fluid has a sour smell. The pH varies from 1.38–4.50. Higher values occur with abomasal hemorrhage, the presence of bile or chronic abomasitis due to ostertagiasis.

### INTUBATION OF ABOMASUM

The abomasum of young calves can be intubated for experimental purposes.<sup>6</sup>

## APPLIED ANATOMY AND PATHOPHYSIOLOGY OF THE ABOMASUM

In a healthy, nonpregnant cow, the abomasum is positioned below the rumen in the ventral part of the abdomen and is orientated towards the left side of the animal. During pregnancy, the enlarging uterus forces the abomasum into a more cranial position. This change is assumed to contribute to the development of an LDA, which generally occurs during the first 3 weeks after parturition.<sup>7</sup>

The anatomical position of the abomasum in cows during the last weeks of pregnancy and through the first 6 weeks after calving has been examined using ultrasonography.<sup>5,7</sup> The uterus was always located on the ventral abdominal wall and the rumen had no contact with the ventral abdominal wall. During the last weeks of pregnancy, the abomasum was located in a small region of the left ventral side of the abdominal cavity. At parturition, the abomasum was positioned high on the left side and then descended. The abomasum was furthest from the midline immediately after calving. The position of the abomasum changed in a circadian rhythm. Eating and ruminating can influence its position. A pocket of the abomasum, the piriform sac of the fundus, was detectable on the left side and was more pronounced when the abomasum was larger. Its position was related to the interval after calving, the feed intake and the pH and osmotic pressure of the rumen fluid.<sup>7</sup> These findings explain, in



part, the high incidence of LDA in the first weeks after parturition. The pronounced lateral orientation of the abomasum predisposes the cow to development of left-side displacement.

The flow of rumen fluid into the abomasum can result in the production of carbon dioxide and methane gases, which when their absorption or the motility of the abomasum is decreased, are unable to escape from the blind pocket in the abomasum and may be a major factor in the pathogenesis of left side displacement. This may explain why 80% of displaced abomasums occur towards the left side.

The size of the blind pocket after calving may determine the development of a displacement on the left side. Cows with their abomasum in a high position would be expected to be at increased risk of a displacement. There is considerable variation between individual cows and having the abomasum in a high position was negatively associated with the animal's feed intake after calving. Feed intake immediately after calving is negatively associated with body condition score during the dry period. High feed intakes were associated with a low position of the abomasum, which is probably a result of increased rumen filling: an enlarged rumen caused by a high feed intake forces the abomasum downwards. Thus inadequate feed intake is associated with displaced abomasum.

**Diseases of the abomasum that cause stasis and accumulation** of ingesta, fluid and gas in the viscus result in varying degrees of dehydration, metabolic alkalosis, hypochloremia and hypokalemia. The metabolic alkalosis and hypokalemia are often accompanied by muscular weakness and paradoxical aciduria. When these changes are severe, as in right-side dilatation, abomasal torsion and abomasal impaction, intensive fluid therapy is necessary for a favorable response. However, in spite of exhaustive efforts, because of irreversible abomasal atony the recovery rate is low.

**Abomasal luminal pressure** is increased in left-side displacement and in volvulus of the abomasum.<sup>8</sup> This may be associated with the pathogenesis of ulceration in long-standing cases of LDA and with the prognosis of survival in abomasal volvulus. The luminal pressure is high in abomasal volvulus and higher in cattle that die or are sold for slaughter than in cattle that survive and are retained in the herd. Thus measurement of luminal pressure during surgery for volvulus may be of value in formulating prognosis for survival.

Abomasal hypomotility and a decreased rate of abomasal emptying are thought to be important factors in the etiology and

pathogenesis of several diseases of the abomasum of adult cattle and calves. Because abomasal hypomotility has been associated with hypocalcemia, endotoxemia, acidosis and alkalosis, hyperinsulinemia and hyperglycemia, the approach in treatment of suspected abomasal hypomotility in adult cattle and calves has been the correction of acid-base and electrolyte imbalances, control of the effects of endotoxemia and elimination of Gram-negative bacterial infections.<sup>9</sup> Neostigmine, metoclopramide or erythromycin have been used in ruminants for the treatment of abomasal hypomotility on the basis that these drugs have a prokinetic effect in other animals. Prokinetic agents have the ability to stimulate, coordinate and restore gastric, pyloric and small-intestinal motility.

Erythromycin is an effective prokinetic agent in healthy sucking milk-fed calves similar to its effects in humans, dogs and horses.<sup>9</sup> Intramuscular administration of erythromycin at 8.8 mg/kg increased the frequency of abomasal luminal pressure waves and the mean abomasal luminal pressure and decreased the half-time of abomasal emptying by 37%.<sup>9</sup> Metoclopramide, neostigmine and low-dose (0.88 mg/kg) erythromycin did not alter abomasal motility, mean luminal pressure or emptying rate.

Abomasal emptying rate and volume in calves has been determined using nuclear scintigraphy and acetaminophen absorption methods.<sup>10</sup> Ultrasonography has also been used to evaluate abomasal volume, location and emptying rate in sucking calves.<sup>11</sup>

### ABOMASAL REFLUX

Reflux of abomasal fluid into the omasum and reticulorumen occurs when the abomasal fluid fails to move normally through the pylorus into the small intestine. This occurs most commonly in diseases of the abomasum, left-side displacement, right-side dilatation and vagus indigestion. Reflux may also occur in peritonitis, compression of the abomasum in advanced pregnancy, intussusception and toxemias. The rumen chloride levels increase from a normal of 10–25 mmol/L to 80–100 mmol/L and the buffering capacity of the rumen is decreased from 80–110 mmol/L to less than 50 mmol/L. Hypochloremic, hypokalemic metabolic alkalosis occurs. Treatment consists of removing excessive quantities of fluid from the rumen and the administration of large quantities of balanced electrolytes or simply saline intravenously. The intravenous administration of hypertonic saline solution, 1.8%, is effective for the correction of

experimental hypochloremic metabolic alkalosis in sheep.<sup>12</sup>

**Duodenal-abomasal reflux** occurs normally in cattle and may increase during abomasal displacement; the influx is lower in LDA than in RDA. The concentration of bile acids in the abomasum is twice as high in LDA and RDA as in healthy cattle.<sup>13</sup>

A series of abomasal emptying defects in sheep were characterized by weight loss, anorexia, variable degrees of abdominal distension, increased concentrations of rumen chloride and grossly enlarged abomasum.<sup>14</sup> No explanation for the emptying defect was found at necropsy.

The administration of apomorphine to sheep causes expulsion of acidic abomasal contents back into the preabomasal compartments without expulsion of gastric contents through the mouth – 'internal vomiting'. In sheep, it is estimated that approximately 280 g of sodium bicarbonate given orally would be necessary to return the ruminal pH to the neutral range.

### REFERENCES

1. Geishauser T. *J Vet Med A* 1995; 42:229.
2. Braun U et al. *Vet Rec* 1997; 140:93.
3. Scott PR et al. *Vet Rec* 1997; 141:524.
4. Braun U et al. *Vet Rec* 1997; 140:599.
5. Braun U. *Vet J* 2003; 166:112.
6. Chapman HW. *Can J Vet Res* 1986; 50:291.
7. Van Winden SCL et al. *Vet Rec* 2002; 151:446.
8. Constable PD et al. *J Am Vet Med Assoc* 1992; 201:1564.
9. Witteck T et al. *Am J Vet Res* 2005; 66:545.
10. Marshall TS et al. *Am J Vet Res* 2005; 66:364.
11. Witteck T et al. *Am J Vet Res* 2005; 66:537.
12. Fubini SL et al. *Am J Vet Res* 1991; 52:1898.
13. Geishauser T, Seeh C. *J Vet Med A* 1996; 43:445.
14. Rings DM et al. *J Am Vet Med Assoc* 1985; 185:1520.

### LEFT-SIDE DISPLACEMENT OF THE ABOMASUM

#### ETIOLOGY

The cause of LDA in cattle is multifactorial but is related primarily to feed intake before and after calving. The transition period occurring 2 weeks prepartum through 2–4 weeks postpartum is the major risk period in the etiology of LDA. The prepartum depression of feed intake and the slow postpartum increase in intake are risk factors causing decreased ruminal fill, reduced forage to concentrate ratio and increased incidence of other postpartum diseases. Excessive amounts of concentrate during the prepartum period increase the risk of left displaced abomasum, which may occur from the decreased ruminal fill caused by greater prepartum intake depression and reduced forage to concentrate ratio, decreased ruminal motility from lower ruminal fill and higher volatile fatty acid concentration, and decreased abomasal

### Synopsis

**Etiology** Gaseous distension and hypomotility of abomasum possibly due to feeding high levels of concentrate to dairy cattle in late pregnancy

**Epidemiology** High-producing dairy cows within 6 weeks of calving. Insufficient crude fiber and roughage in ration. Concurrent disease such as hypocalcemia and ketosis may be risk factors but this is uncertain

**Signs** Inappetence, ketosis, decreased milk production, abdomen usually smaller than normal, reticulorumen movements not clearly audible or absent, rumen pack not easily palpable, ping over left paralumbar fossa and cranial to it. Fatty liver and abomasal ulcers are possible complications

**Clinical pathology** Ketonemia, ketonuria. Normal hemogram

**Lesions** Not usually fatal

**Diagnostic confirmation** Laparotomy to confirm displacement

**Differential diagnosis** LDA must be differentiated from those common diseases of the forestomach and abomasum that cause inappetence to anorexia, ketosis, reduced or abnormal reticulorumen motility, and abnormal sounds on percussion and auscultation of the left abdomen. They are: simple indigestion, primary ketosis, traumatic reticuloperitonitis, vagus indigestion, fat cow syndrome

**Treatment** Open and closed surgical techniques to replace abomasum and secure in normal position

**Control** Avoid negative energy balance prepartum, avoid overconditioning of cows prepartum, provide optimal feed bunk management, maximize dry matter intake in late pregnancy

emptying.<sup>1</sup> The feeding of high levels of concentrate to dairy cattle results in a decrease in abomasal motility and increased accumulation of abomasal gas.

### EPIDEMIOLOGY

#### Occurrence

LDA occurs most commonly in large, high-producing adult dairy cows immediately after parturition. Approximately 90% of cases occur within 6 weeks following parturition. Occasional cases occur a few to several weeks before parturition. The disease is common in the UK and North America, where dairy cattle are fed grain for high milk production and the animals are usually housed for part of the year or kept under confinement (zero grazing, loose housing). The disease is uncommon in Australia and New Zealand, where much less concentrate is fed to dairy cattle and the animals are usually on pasture for most of the year. However, it can occur in pasture-fed dairy cattle.<sup>2</sup> The importance of exercise in the etiology of LDA has not been explored. The incidence of LDA is higher during the

winter months, which may be a reflection of either a higher frequency of calving or relative inactivity.

#### Calves

The disease has been recorded in calves up to 6 months of age and, rarely, in heifer calves 4 and 8 weeks of age in which abomasal ulceration perforation and peritonitis, and perforation of the abdominal wall occurred.<sup>3</sup> It was not possible to determine if the ulceration led to the atony with subsequent displacement of the abomasum, or if the displacement facilitated the ulceration.

#### Lactational incidence rate

The lactational incidence risk of LDA for dairy herds in Ontario, Canada is about 2%.<sup>4</sup> In one survey of the prevalence of disease in dairy herds, during a 3-year period, 24% of herds reported at least one case of LDA and there was a prevalence of 1.16% among the affected herds and 0.35% when all herds surveyed were considered. The mean rate of occurrence in a cow population over a period of years in Denmark was 0.62% with a range of 0.2–1.6%. In Norway 88% of the abomasal displacements are left-sided and 12% are right-sided.

#### Case fatality

In one series of observations, the case fatality rate was much higher (21%) in cows with LDA and diarrhea than in cows with LDA and normal feces (8%).

#### Risk factors

##### Dietary risk factors

##### *Prepartum nutrition and management*

Based on observations in dairy herds, significant associations were found between negative energy balance prepartum, as reflected by increased non-esterified fatty acid concentrations, and the occurrence of LDA.<sup>5</sup> High body condition scores, suboptimal feed bunk management, prepartum diets containing more than 1.65 Mcal of NE<sub>e</sub>/kg of DM, winter and summer seasons, high genetic merit and low parity were significant risk factors. Cows fed these high-energy diets during the dry period may become obese, which may result in a **decline in dry matter intake** before calving. Calving during hot summer months also decreases dry matter intake. It is suggested that hepatic lipidosis may be an important risk factor for LDA. Herds with a high mean predicted transmitting ability (PTA) were associated with a high occurrence of LDA.

Ketosis diagnosed prior to the occurrence of LDA has been implicated as a risk factor. Ketosis is associated with low dry matter intake, which would reduce rumen fill and volume, reducing forestomach motility and, potentially, abomasal

motility. A low rumen volume also offers less resistance to LDA.

##### *High-level grain feeding*

LDA is a disorder of throughput because of its relationship to diseases associated with high milk production and concentrate feeding. The practice of beginning to feed concentrates to high-producing dairy cattle during the last few weeks of the dry period in preparation for the transition to lactation after parturition (**lead feeding**) may be a high risk factor for LDA. Cows dried off in high body condition scores are at increased risk of LDA because of inadequate dry matter intake around the time of parturition.<sup>6</sup>

High-level grain feeding increases the flow of ruminal ingesta to the abomasum, which causes an increase in the concentration of volatile fatty acids, which can inhibit the motility of the abomasum.<sup>5-7</sup> This inhibits the flow of digesta from the abomasum to the duodenum so that ingesta accumulates in the abomasum. The large volume of methane and carbon dioxide found in the abomasum following grain feeding may become trapped there, causing its distension and displacement. However, the role of an increase in abomasal volatile fatty acid concentration as the cause of the abomasal atony is controversial.

##### *Dietary crude fiber*

A crude fiber concentration of less than 16–17% in the diet of dairy cows was considered a significant risk factor for LDA. Some initial epidemiological studies indicated that cows affected with LDA were higher producers than their herd-mates, and they were from higher-producing herds than herds without LDAs. The affected cows were also older and heavier than the average for cows examined in the survey.

The feeding of an experimental **completely pelleted ration** to dairy cattle resulted in an increased incidence of LDA: 17% compared to 1.6% in cows receiving loose alfalfa hay, sorghum silage and an 18% crude protein concentrate. The pelleted ration was finely ground and the short length of the dietary fiber may have been a risk factor by increasing volatile fatty acid and gas production.

**In summary, feeding rations high in carbohydrates, inadequate levels of roughage and crude fiber levels below 17% during the last few weeks of pregnancy are probably important dietary risk factors.**

##### *Animal risk factors*

A hospital-based case-control study of LDA and abomasal volvulus in cattle based on the medical records of 17 North American veterinary teaching hospitals

over a period of 10 years compared risk factors for the two diseases.<sup>8</sup>

#### *Breed and age of cow*

LDA occurs predominantly in Holstein-Friesian, Guernsey and Jersey cows. The breed disposition for LDA has been controversial. Some studies have found higher risk of LDA occurring in Holstein-Friesian cattle and a lower risk in Brown Swiss cattle compared with the risk in Simmental-Red Holstein cross cows in Switzerland.<sup>9</sup> In other studies, a breed disposition for displaced abomasum was found in Ayrshire, Canadienne, Guernsey, Holstein-Friesian and Jersey cattle. In-vitro studies of contractile activity of the abomasal wall of healthy cows of different breeds did not find any differences between breeds of cattle.<sup>9</sup>

The ratio of LDA to abomasal volvulus cases was 7.4 to 1. The risk for the two diseases increased with age with **greatest risk at 4–7 years of age**. Dairy cattle were at higher risk of developing LDA than beef cattle, with an odds ratio of 95. Female cattle were at a higher risk of developing LDA than male cattle, with an odds ratio of 29.

#### *Season of the year*

The odds of both diseases varied considerably throughout the year, with the lowest number of cases in the autumn. The **odds of abomasal volvulus and LDA were highest in January and March**, respectively. The **greater incidence of the disease in the spring** may also be related to the depletion of roughage supplies on farms in the Midwest region of the USA. In other regions of the world, the disease occurs throughout the year independently of the incidence of parturition.

#### *Influence of weather*

The possible effects of weather on the incidence of abomasal displacement has been examined.<sup>10</sup> In a study over a period of 2 years, on 26 farms with a total of 6500 Holstein-Friesian lactating cows, 373 cases of abomasal displacement occurred. A change from sunny, warm and dry days to cool, overcast and humid days was associated with an increased incidence of displacement. There were no effect of either wind velocity or atmospheric pressure.

#### *Milk production*

The relationship between high milk yield or high milk yield potential and LDA has been examined in several studies and the results are inconclusive. In some observations, a higher incidence of the disease occurred in high-yielding cows. Later studies found no difference in herd milk yield between high- and low-incidence herds. Genetic correlations between LDA

and production of milk and protein are very small and should be independent for selection. In some studies, dairy herds with a high mean PTA milk index were associated with a high occurrence of LDA.

#### *Late pregnancy*

Because parturition appears to be the most common precipitating factor, it has been postulated that during late pregnancy the rumen is lifted from the abdominal floor by the expanding uterus and the abomasum is pushed forward and to the left under the rumen. Following parturition, the rumen subsides, trapping the abomasum, especially if it is atonic or distended with feed, as it is likely to be if the cow is fed heavily on grain.

Proportionately fewer cases of abomasal volvulus than LDA occurred during the first 2 weeks after parturition – 28% and 57%, respectively.<sup>8</sup> Because proportionately fewer cases of abomasal volvulus develop in the immediate postpartum period it is suggested that the rumen volume may directly influence the direction of abomasal displacement. On the basis of the findings, it is suggested that abomasal atony is a prerequisite for abomasal volvulus and LDA, and that existence of a less than full abdomen because of reduced rumen volume is a major risk and facilitates development of abomasal volvulus and LDA.<sup>8</sup> It is suggested that normal rumen volume is an effective barrier against LDA and that the high incidence of LDA in lactating dairy cattle is the result of the additive effects of decreased rumen volume, increased **abdominal void** immediately after parturition and increased exposure to factors that induce abomasal atony. Additional indirect evidence for the rumen barrier hypothesis is that feeding a high-roughage diet, containing at least 17% crude fiber, immediately prior to parturition is a commonly recommended and successful strategy for minimizing the incidence of LDA.

#### *Concurrent diseases*

Cows with an LDA are more likely to have had retained placenta, ketosis, stillborn calf, metritis, twins or parturient paresis than control cows.<sup>11,12</sup> Concurrent diseases were present in 30% of abomasal volvulus cases and 54% of LDA cases. The greater incidence of concurrent disease in LDA suggests that inappetence and anorexia results in decreased rumen volume, which would predispose to displacement. Diseases of the wall of the abomasum (secondary ulcer) and ketosis and fatty liver are common concurrent diseases in dairy cows with LDA.<sup>8</sup>

#### *Pre-existing subclinical ketosis*

Ketosis is one of the most common complications of LDA but whether or not pre-existing subclinical ketosis is a risk factor for LDA has been controversial. Some clinical studies have reported that subclinical ketosis is a risk factor for LDA.<sup>4,13</sup> The serum concentrations of aspartate transaminase (AST), the serum and milk beta-hydroxybutyrate and milk fat to protein ratio may be used in dairy cows during the first and second weeks after parturition as tests to predict the subsequent diagnosis of LDA.<sup>13,14</sup> AST values between 100–180 U/L, and beta-hydroxybutyrate values between 1000–1600  $\mu\text{mol/L}$  were associated with increased odds ratio and likelihood ratio of LDA. When cutoff values were increased, sensitivity decreased and specificity increased. The evaluation of two milk ketone tests as predictors of LDA in dairy cows within 2 weeks of parturition (median of 6 days postpartum and 12 days prior to the diagnosis of LDA) found high specificity but low sensitivity for prediction of subsequent occurrence of LDA.<sup>5</sup> Increased ketone body concentration in milk is claimed to be a significant risk factor for LDA. This correlates with an increased fat to protein ratio in the first milk dairy herd improvement test as a predictor of subsequent LDA.<sup>15</sup> However, the studies that conclude that pre-existing subclinical ketosis occurs before the occurrence of LDA, and is a risk factor (cause and effect relationship), do not provide evidence that the cause of the ketosis was not a pre-existing LDA. It is possible for the LDA to develop over a period of several days to a few weeks in susceptible cows, which would affect feed intake and contribute to the pathogenesis of ketosis. In addition, the sensitivity and specificity of the clinical diagnostic techniques (auscultation and percussion) are unknown and it is plausible that some cases of LDA are not recognized in their very early stages when the fundus of the abomasum has moved only a small distance up along the left lateral abdominal wall (see Anterior displacement under Clinical findings). The studies did not describe how the diagnosis of LDA was made. Cows with LDA are also twice as likely to have another disease than cows without LDA<sup>4</sup> and the presence of those diseases could be risk factors for ketosis.

#### *Hypocalcemia*

Hypocalcemia, which occurs commonly in mature dairy cows at the time of parturition, has been suggested as an important contributing factor in LDA. Blood calcium levels affect abomasal motility; motility is normal down to a

threshold value of 1.2 mmol total calcium/L and below that level abomasal motility is absent. In a series of 510 dairy cows, those with hypocalcemia 12 hours before parturition (serum ionized calcium concentrations < 4.0 mg/dL or total serum calcium concentration < 7.9 mg/dL) had a 4.8 times greater risk of developing LDA than did normocalcemic cows. Other studies concluded that hypocalcemia is not an important risk factor for LDA.<sup>13</sup> In cows with LDA, the ionized calcium is not significantly different from controls.

#### *Metabolic predictors of left side displacement of abomasum*

There is a predictive association of prepartum non-esterified fatty acids (NEFA) and postpartum beta-hydroxybutyrate concentrations with LDA.<sup>12</sup> In cows with subsequent LDA, mean NEFA concentrations began to diverge from the means of cows without LDA 14 days before calving, whereas mean serum NEFA concentrations did not diverge until the day of calving. Prepartum, only NEFA concentration was associated with the risk of subsequent LDA. Between 0 and 6 days before calving, cows with NEFA concentration of 0.5 mEq/L or less were 3.6 times more likely to develop LDA after calving. Between 1 and 7 days postpartum, retained placenta, metritis and increasing serum concentration of beta-hydroxybutyrate and NEFA were associated with increased risk of subsequent LDA. Serum beta-hydroxybutyrate was a more sensitive and specific test than NEFA concentration. The odds of LDA were eight times greater in cows with serum beta-hydroxybutyrate levels of 1200 µmol/L or higher. Cows with milk beta-hydroxybutyrate concentration of 200 µmol/L or higher were 3.4 times more likely to develop LDA. Serum calcium concentration was not associated with LDA. In summary, the strategic use of metabolic tests to monitor transition dairy cows should focus on NEFA in the last week prepartum and beta-hydroxybutyrate in the first week postpartum.<sup>12</sup>

#### *Genetic predisposition*

An inherited and breed predisposition to LDA has been suggested and examined but the results are inconclusive. The data of 7416 Canadian Holstein cows were examined to estimate genetic parameters for the most common diseases of dairy cows.<sup>7</sup> The heritability of displaced abomasum across lactations was 0.28 and the estimates between displaced abomasum and production traits were small.<sup>7</sup> In the hospital-based study in North America, the odds of LDA in Guernsey cattle were higher than in Holstein cattle.<sup>8</sup>

#### *Miscellaneous animal risk factors*

Unusual activity, including jumping on other cows during estrus, is a common history in cases not associated with parturition. Occasional cases occur in calves and bulls but the disease occurs only rarely in beef cattle. Retained fetal membranes, metritis and mastitis occur commonly with LDA but a cause-and-effect relationship has been difficult to establish. In one retrospective study the disease was associated in terms of increased relative risk with periparturient factors such as stillbirth, twins, retained placenta, metritis, aciduria, ketonuria and low milk yield in the previous lactation.

#### **Economic importance and effects on production and survivorship**

The economic losses from the disease include lost milk production during the illness and postoperatively, and the cost of the surgery. The effects of LDA on test-day milk yields from 12 572 cows from parities 1–6 over a 2-year period were evaluated.<sup>16</sup> From calving to 60 days after diagnosis, cows with LDA yielded on average 557 kg less milk than cows without LDA and 30% of the losses occurred before diagnosis.<sup>16</sup> Milk loss increased with parity and productivity and milk losses were greatest in highest-yielding cows. Cows with LDA were nearly twice as likely to have another disease as were cows without LDA. Cows with LDA are more likely to be removed from the herd at any point in time after the diagnosis than their herdmates.<sup>17</sup> Cows with LDA survived a median of 18 months, and control cows survived a median of 27 months. Low milk production is a common reason for removal of cows with an LDA and the probability of removal increased as lactation number increased.

#### **PATHOGENESIS**

In the nonpregnant cow, the abomasum occupies the ventral portion of the abdomen very nearly on the midline, with the pylorus extending to the right side caudal to the omasum. As pregnancy progresses, the enlarging uterus occupies an increasing amount of the abdominal cavity. The uterus begins to slide under the caudal aspects of the rumen, reducing rumen volume by one-third at the end of gestation. This also forces the abomasum forward and slightly to the left side of the abdomen, although the pylorus continues to extend across the abdomen to the right side. After calving, the uterus retracts caudally towards the pelvic inlet, which under normal conditions allows the abomasum to return to its normal position.<sup>18</sup>

During LDA, the pyloric end of the abomasum slides completely under the rumen to the left side of the abdomen.

The relative lack of rumen fill and abomasal atony allows the abomasum to distend and move into the left side of the abdomen.

A decline in plasma concentration of calcium around the time of parturition may contribute to the abomasal atony.

Normally, the abomasum contains fluid and is located in the ventral part of the abdomen. In postpartum cows, the abomasum may shift to the left without causing any clinical signs.<sup>19</sup> Abomasal atony and gaseous distension are considered to be the primary dysfunctions in LDA.<sup>20</sup> The existence of abomasal atony precedes distension and displacement of the abomasum. The gas accumulated in the abomasum consists mainly of methane (70%) and carbon dioxide.<sup>7</sup> In a normal abomasum, the gas production is equal to the clearance in an oral or aboral direction. When motility of the abomasum is inadequate, accumulation of gas occurs. The origin of the excess gas is uncertain but there is evidence that the gas in the abomasum originates from the rumen in association with increased concentrate feeding and an increase in volatile fatty acid concentrations in the abomasum. A high-grain, low-forage diet can promote the appearance of volatile fatty acids in the abomasum by reducing the depth of the ruminal mat or raft (consisting primarily of the long fibers of forages). Physical reduction of forage particle length by chopping forages too finely prior to ensiling or overzealous use of mixer wagons also can contribute to loss of rumen raft.<sup>1</sup> The rumen raft captures grain particles so that they are fermented at the top of the ruminal fluid. The volatile fatty acids produced at the top of the ruminal fluid are generally absorbed from the rumen with little volatile fatty acid entering the abomasum. In cows with an inadequate rumen raft, grain particles fall to the ventral portion of the rumen and reticulum, where they are fermented or pass on to the abomasum. The volatile fatty acids produced in the ventral rumen can pass through the rumenoreticular orifice to enter the abomasum before the rumen can absorb them. A thick ruminal raft is generally present during the dry period, when cows are fed a high forage diet, but the depth of the raft is rapidly reduced in early lactation, especially if dry matter intake decreases. Also, when cows are fed a higher grain ration, there is less regurgitation of the cud and mastication, and less saliva produced, which affects buffering of the rumen.

The amount of effective fiber determines the consistency and depth of the rumen raft and stimulates rumen contractions.

Total mixed rations that are easily sorted by cows may affect the ratio of

forage to concentrate of total feed consumed, which contributes to the development of an LDA.

The atonic gas-filled abomasum becomes displaced under the rumen and upward along the left abdominal wall, usually lateral to the spleen and the dorsal sac of the rumen. It is primarily the fundus and greater curvature of the abomasum that becomes displaced, which in turn causes displacement of the pylorus and duodenum. Based on epidemiological observations presented earlier, it is hypothesized that a reduced rumen volume in the immediate postpartum period when there is some abdominal void allows this displacement to occur. The omasum, reticulum and liver are also displaced to varying degrees. The displacement of the abomasum invariably results in rupture of the attachment of the greater omentum to the abomasum. In some cases, the LDA resolves spontaneously; such cases are known as 'floaters'.

Insulin resistance is common in cows with an LDA.<sup>20</sup> High insulin concentrations associated with hyperglycemia but independent of ketosis are common in cows with LDA. In-vitro studies of abomasal motility indicate that the contractions of the longitudinal muscle from the pyloric myenteric plexus of cows with an LDA or RDA are significantly reduced compared to muscle from normal cows. In cows with an LDA and high concentrations of blood glucose and insulin, the myoelectrical activity of the abomasum was reduced, but increased following surgical correction along with a decrease in the concentrations of glucose and insulin.<sup>20</sup>

Compression by the rumen of the impounded part of the abomasum causes a great decrease in the volume of the organ and interference with normal movements. There is probably some interference with the function of the esophageal groove due to slight rotation of all the stomachs in a clockwise direction, and this impedes forward passage of digesta. The obstruction of the displaced segment is incomplete and, although it contains some gas and fluid, a certain amount is still able to escape and the distension rarely becomes severe. There is no interference with blood supply to the trapped portion so that effects of the displacement are entirely those of interference with digestion and movement of the ingesta, leading to a state of chronic inanition. In occasional cases the abomasum becomes trapped anteriorly between the reticulum and diaphragm – **anterior displacement of the abomasum**.

A mild metabolic alkalosis with hypochloremia and hypokalemia are common,

probably because of the abomasal atony, continued secretion of hydrochloric acid into the abomasum and impairment of flow into the duodenum. Affected cattle usually develop secondary ketosis which, in fat cows may be complicated by the development of the fatty liver syndrome. Endotoxemia does not occur in LDA or RDA.<sup>21</sup>

#### **Abomasal luminal gas pressure, volume and perfusion in cows with LDA or abomasal volvulus**

The luminal pressure in LDA is increased (median 8.7 mmHg; range 3.5–20.7 mmHg),<sup>22</sup> which may contribute to the pathogenesis of abomasal ulceration. Abomasal luminal pressure and volume is higher in cattle with an abomasal volvulus than in cattle with an LDA.<sup>23</sup> Abomasal perfusion decreases as luminal pressure increases in cattle with an abomasal volvulus or LDA.

#### **Perforating abomasal ulceration**

Perforating abomasal ulceration and acute local peritonitis with fibrinous adhesions also occur in some cases of LDA.<sup>24</sup> Abdominal pain and pneumoperitoneum are common sequelae. The ulcers may perforate acutely and cause rapid death due to acute diffuse peritonitis. Duodenal ulceration has also been associated with LDA.

### **CLINICAL FINDINGS**

#### **General appearance and ketosis**

Usually within a few days or a week following parturition there will be inappetence, sometimes almost complete **anorexia**, a marked **drop in milk production** and varying degrees of **ketosis**, based on ketonuria and other clinical findings of ketosis. It is not uncommon to diagnose an LDA that was treated for ketosis, improved for a few days and then relapsed.

On inspection of the abdomen, the left lateral abdomen appears '**slab-sided**' because the rumen is smaller than normal and displaced medially. The temperature, heart rate and respirations are usually within normal ranges. The feces are usually reduced in volume and softer than normal but periods of profuse diarrhea may occur.

#### **Status of reticulorumen and spontaneous abomasal sounds**

Ruminal movements are commonly present but decreased in frequency and intensity, and sometimes inaudible even though there are movements of the left paralumbar fossa indicating rumen motility. In some cases, the rumen pack is palpable in the left paralumbar fossa, and the rumen contractions and sounds can be detected in the fossa as in normal cows. However, the rumen sounds may

not be audible over an area anterior to the fossa where they are also audible in normal cows. The absence of normal ruminal sounds in the presence of abdominal ripples suggests the presence of an LDA.

Auscultation of an area below an imaginary line from the center of the left paralumbar fossa to just behind the left elbow reveals the presence of **high-pitched tinkling sounds**, which often have a progressive peristaltic character. These are **abomasal sounds** and may occur several times per minute or infrequently (as long as 5 min apart). They are not related in occurrence to ruminal movements and this can be ascertained by simultaneous auscultation over an area between the upper third of the ninth and 12th ribs and palpation of the left paralumbar fossa for movements of the dorsal sac of the rumen. While auscultating over the same area and ballotting the left lower abdomen just below the fossa, high-pitched fluid-splashing sounds of the LDA are commonly audible.

#### **Pings of the left-side displacement of the abomasum**

**Percussion**, using a flick of the finger or a plexor, and **simultaneous auscultation over an area between the upper third of the ninth and 12th ribs of the abdominal wall** commonly elicits the high-pitched tympanitic sounds (**pings**) that are characteristic of LDA. These pings may not be present if the cow has just previously been transported to a clinic for surgery but they will commonly reappear in 24–48 hours. Occasionally, careful, repeated, time-consuming examinations using percussion and simultaneous auscultation are necessary to elicit the pings.

#### **Acute left-side displacement of the abomasum**

In rare cases there is initially a sudden onset of anorexia accompanied by signs of moderate abdominal pain and abdominal distension. These are the acute cases, which are uncommon. An obvious bulge caused by the distended abomasum may develop in the anterior part of the upper left paralumbar fossa and this may extend up behind the costal arch almost to the top of the fossa. The swelling is tympanitic and gives a resonant note on percussion. In acute cases the temperature may rise to 39.5°C (103°F) and the heart rate to 100/min but in the more common subacute cases the temperature and pulse rate are normal. The appetite returns but is intermittent and selective, the animal eating only certain feeds, particularly hay. There may be transitory periods of improvement in appetite and disappearance of these sounds, especially after transport or vigorous exercise.

### Concurrent perforating abomasal ulceration

Perforating abomasal ulceration occurs concurrently in some cases of LDA, resulting in localized peritonitis and pneumoperitoneum.<sup>24</sup> Affected cattle have the ping over the left abdomen typical of an LDA, but a ping over both the right and left paralumbar fossae due to pneumoperitoneum is also common. Abdominal pain due to the local peritonitis is characterized by tensing of the abdominal wall, grunting and arching of the back on deep palpation over the abomasal area. The peritonitis is associated with a fever. The prognosis in these cases is unfavorable.

### Other clinical features

#### Ultrasound examination

Ultrasound examination can assist in the diagnosis of abomasal displacements.<sup>25</sup> In cattle with LDA the abomasum is seen between the left abdominal wall and the rumen. It contains fluid ingesta ventrally and a gas cap of varying size dorsally. Occasionally, the abomasal folds are seen in the ingesta. In cattle with RDA, the liver is displaced medially from the right abdominal wall by the abomasum, which has an ultrasonographic appearance similar to that described for left displacement.

#### Rectal examination

On rectal examination a sense of emptiness in the upper right abdomen may be appreciated. The rumen is usually smaller than expected and only rarely is the distended abomasum palpable to the left of the rumen. Occasionally, there is chronic ruminal tympany.

#### Secondary ketosis and fatty liver

Cows in fat body condition at parturition commonly have severe ketosis and the fatty liver syndrome secondary to LDA. The disease is not usually fatal but affected animals are usually less than satisfactory production units.

#### Anterior displacement of abomasum

In anterior displacement, the distended abomasum moves in a cranial direction and becomes trapped between the reticulum and the diaphragm. In one series of 161 cases of abomasal displacement, anterior displacement accounted for 12% of all cases.<sup>26</sup> The clinical findings are similar to those described above except that the characteristic LDA pings cannot be elicited over the typical region. Normal rumen contractions can be heard in the usual position and gurgling sounds characteristic of a distended abomasum may be audible just behind and above the heart and on both sides of the thorax.<sup>26</sup> It is necessary to auscultate over the ventral left abdominal wall, especially over an

area extending from the middle of the sixth to eighth ribs, above and below an imaginary line drawn between the point of the elbow and the tuber coxae. If a rumenotomy is done the distended abomasum can be felt between the reticulum and diaphragm.

#### Atrial fibrillation

A paroxysmal atrial fibrillation is present in some cases, which is considered to be caused by a concurrent metabolic alkalosis. Following surgical correction the arrhythmia usually disappears.

#### Course of left-side displacement of the abomasum

The course of an LDA is highly variable. Undiagnosed cases usually reach a certain level of inanition and may remain at an equilibrium for several weeks or even a few months. Milk production decreases to a small volume and the animal becomes thin, with the abdomen greatly reduced in size.

#### Unusual cases of left-side displacement

Occasional cases occur in cows that are clinically normal in all other respects. In one case, a cow had an LDA, which was confirmed at necropsy, for 1.5 years, during which time she calved twice and ate and produced milk normally.

#### Left-side displacement of the abomasum in calves

In calves, the clinical findings include inappetence, reduced weight gain, recurrent distension of the left paralumbar fossa and a metabolic ping and fluid-splashing sounds on auscultation and percussion of the left flank.

## CLINICAL PATHOLOGY

### Hemogram

There are no marked changes in the hemogram unless there is intercurrent disease, particularly traumatic reticuloperitonitis or abomasal ulcer. A moderate to severe ketonuria is always present but the blood glucose level is within the normal range. There is usually a mild hemoconcentration evidenced by elevations of the packed cell volume (PCV), hemoglobin and total serum protein. A mild metabolic alkalosis with slight hypochloremia and hypokalemia may also be present.

### Serum biochemistry

Ketosis is the most common complication of LDA and severe cases of ketosis are commonly accompanied by fatty liver. The blood levels of **AST** and **beta-hydroxybutyrate** can be measured in dairy cows during the first and second weeks after parturition as possible tests to predict the subsequent diagnosis of LDA.<sup>14</sup> AST values between 100–180 U/L and beta-hydroxybutyrate values between

1000–1600  $\mu\text{mol/L}$  were associated with increased odds ratio and likelihood ratio of LDA.

In cows with fatty liver, plasmal lipoprotein concentrations are decreased. In addition to those of lipoprotein lipids, concentrations of **apolipoprotein B-100 (apo-100)**, the major apoprotein in very low-density lipoproteins and low-density lipoproteins, and **apolipoprotein A-1 (apoA-1)**, the predominant protein constituent of high-density lipoprotein, also are reduced in cows with fatty liver. Decreased serum levels of apo-100 and apoA-I occur in cows with ketosis and LDA and may be used during the stages of nonlactation and early lactation to predict cows susceptible to ketosis and LDA.<sup>27</sup> Dairy cows with LDA also have low plasma and liver  $\alpha$ -tocopherol, and plasma vitamin E values may decrease in cows with increased liver triglyceride content.<sup>28</sup>

A mild hypocalcemia is usually present but parturient hypocalcemia is uncommon.

### Cowside tests of milk and urinary ketones

**Milk ketone** tests can also be used as predictors of LDA in dairy cows within 2 weeks of parturition.<sup>4</sup> In the first week of lactation, the Pink test liquid and the Ketolac test strip were highly sensitive for the detection of subclinical ketosis when used in milk.<sup>29</sup> The Ketotest (a milk beta-hydroxybutyrate test strip) is also highly sensitive for the detection of subclinical ketosis.<sup>30</sup>

**Urine ketones:** the Ketostix (urine nitroprusside strip detecting acetoacetate) can be used on a regular basis to detect subclinical ketosis.<sup>30</sup>

### Metabolic predictors of left side displacement of abomasum

Metabolic tests to predict the occurrence of LDA can be used strategically in the last week prepartum and the first week postpartum<sup>12</sup> (details under Metabolic predictors of left side displacement of abomasum, in Animal risk factors, under Epidemiology, above).

### Liver function

Cows with LDA may have varying degrees of fatty liver.<sup>31,32</sup> In liver biopsy samples, more about 55% of cows with LDA, fatty degeneration may be present.<sup>31</sup> In some cows with LDA, liver biopsies found 31% fat infiltration and in those same animals, serum AST and gamma-glutamyl transferase levels were increased.<sup>32</sup>

### Abomasocentesis

Centesis of the displaced abomasum through the 10th or 11th intercostal space in the middle third of the abdominal wall may reveal the presence of fluid with no protozoa and a pH of 2. Ruminal fluid will

have protozoa and a pH of between 6 and 7. Fluid is not always present in appreciable quantity in the abomasum and a negative result on puncture cannot be interpreted as eliminating the possibility of abomasal displacement.

### NECROPSY FINDINGS

The disease is not usually fatal but carcasses of affected animals are sometimes observed at abattoirs. The displaced abomasum is trapped between the rumen and the ventral abdominal floor and contains variable amounts of fluid and gas. In occasional cases it is fixed in position by adhesions, which usually arise from an abomasal ulcer. Fatty liver is common in cows that died from complications of LDA within a few days of parturition or following surgery.

### DIFFERENTIAL DIAGNOSIS

Left-side displacement of the abomasum occurs most commonly in cows within a few days of parturition and is characterized by gauntness, a relatively slab-sided left abdomen and secondary ketosis. The characteristic pings can usually be elicited by percussion and auscultation. The presence of secondary ketosis in a cow immediately after parturition should arouse suspicion of the disease. Primary ketosis usually occurs in high-producing cows 2–6 weeks after parturition. The response to treatment of primary ketosis is usually permanent when treated early, while the response to treatment of the ketosis due to LDA is temporary and a relapse in a few days is common.

Left-side displacement of the abomasum must be differentiated from those common diseases of the forestomach and abomasum that cause inappetence to anorexia, ketosis, reduced or abnormal reticulorumen motility, and abnormal sounds on percussion and auscultation of the left abdomen.

#### Common differentials

- **Simple indigestion** is characterized by normal vital signs, inappetence to anorexia, history of change of feed, reduced milk production, a relatively full rumen with reduced frequency and intensity of contractions, the absence of pings and spontaneous recovery in 24 hours
- **Primary ketosis** is characterized by inappetence, decline in milk production, strong ketonuria, normal vital signs, full rumen with reduced frequency and intensity of contractions, dry but normal amount of feces and response to therapy with dextrose and propylene glycol in 12–24 hours
- **Traumatic reticuloperitonitis** in its acute form is characterized by ruminal stasis, mild fever, a grunt on deep palpation over the xiphoid sternum and a slight neutrophilia with a regenerative left shift. However, in subacute and chronic traumatic reticuloperitonitis a

painful grunt may be absent, the temperature and hemogram may be normal and on auscultation and percussion the atonic rumen may be mistaken for an LDA. The tympanic sounds of an atonic rumen occur over a larger area than with LDA and are not as high-pitched as those of LDA – they have been called 'pungs'. An exploratory laparotomy may be necessary to distinguish between the two, although laparoscopy, ultrasonography and abdominocentesis are alternatives

- **Vagus indigestion** is characterized by progressive abdominal distension due to a grossly distended rumen with or without an enlarged abomasum, and is more common before parturition. Dehydration is also common
- **Fat cow syndrome** at parturition is characterized by excessive body condition, inappetence to anorexia, ketonuria, reduced to absent reticulorumen motility, but usually no pings over the rumen

### TREATMENT

Surgical correction is now commonly practiced and several techniques have been devised with emphasis on avoidance of recurrence of the displacement.

#### Open surgical techniques

**Right paramedian abomasopexy** and **right paralumbar fossa omentopexy** are the most widely used means of correcting left displacement of the abomasum. The right paralumbar fossa omentopexy is popular because the animal is standing and the surgeon can work alone without assistance. More skill is required than for the right paramedian abomasopexy. The right paramedian abomasopexy requires less manipulation because the abomasum usually returns to its normal position when the cow is placed in dorsal recumbency. The major disadvantage is the number of people required to restrain the animal in dorsal recumbency. There is little difference in the cost of doing a right paramedian abomasopexy compared to a right paralumbar fossa omentopexy, of which there are modifications from the original description. Based on field studies there is also no difference in either the reproductive performance or incisional complications following surgery. Based on milk yield at 1 month after surgery, some results indicate a slight preference for a right paramedian abomasopexy.

#### Closed suture techniques

A few closed suturing abomasopexy techniques have been advocated because they are rapid and inexpensive but the complications that can occur indicate that

laparotomy and omentopexy are desirable. In the blind suture technique, the precise location of insertion of the sutures is unknown. Complications include peritonitis, cellulitis, abomasal displacement or evisceration, complete forestomach obstruction and thrombophlebitis of the subcutaneous abdominal vein.

#### Roll-and-toggle-pin suture procedure

The roll-and-toggle-pin suture, a modification of the closed suture technique, is also available and has been compared with right paralumbar fossa pyloro-omentopexy. The roll-and-toggle technique, as with other closed repositioning and stabilization techniques, is generally less expensive and provides results comparable with the open surgical techniques.

Advantages of the closed suture technique include confirmation of suture placement in the abomasum by identification of abomasal gas, and deflation of the abomasum during correction.

Cows with LDA corrected by toggle-pin suture procedure produced less milk than control cows, and all the decrease in production occurred in the first 4 months of lactation.<sup>33</sup> The occurrence of LDA did not affect the period from calving to conception, nor did it affect subsequent conception rate, but it was associated with an extended period between calving and first postpartum artificial insemination. A higher proportion of LDA cattle were sold or died. Death and culling were more pronounced immediately after the diagnosis of LDA and the toggle-pin suture procedure.

#### Survivorship following surgery to correct left-side displacement of the abomasum

In a series of 564 cases of displaced abomasum (466 LDA, 98 RDA), survival after surgery was evaluated after 10 days and 15 months.<sup>34</sup> More LDA than RDA cows were discharged as cured (82% vs 74%). However, survival after the early postsurgical period was similar for RDA and LDA cows. In LDA cows, the factors associated with a favorable prognosis were a short duration of disease, an undisturbed general condition, good appetite, normal feces, a higher body weight, lower hematocrit, hemoglobin and erythrocyte counts, lower urea, AST and bilirubin, and higher serum sodium, potassium and chloride concentrations compared with cows with an unfavorable prognosis.<sup>34</sup> A thorough clinical and laboratory examination with special emphasis on general physical condition, liver function and dehydration status are important in determining the prognosis of abdominal surgery in LDA.



### Treatment of ketosis

Parenteral dextrose and oral propylene glycol are necessary for treatment of the ketosis and to avoid fatty liver as a complication. Postsurgical convalescence of cows with LDA is clearly related to disturbances in energy metabolism and fatty liver.<sup>35</sup> During convalescence, in cows with no fatty liver or moderate fatty liver, the feed intake and daily milk production increases steadily. In cows with severe fatty liver feed intake remains low. This emphasizes the need for effective treatment of excessive lipomobilization, ketosis and fatty liver along with surgical correction of the LDA. All cases of LDA should be corrected as soon as possible to minimize the incidence of peritoneal adhesions and abomasal ulcers, which may perforate and cause sudden death.

### Rumen transfaunation following surgery for left-side displacement of the abomasum

The administration of 10 L of rumen fluid via a stomach tube immediately after surgical correction of an LDA, and on the next day, resulted in a beneficial effect characterized by a greater feed intake, less degree of ketonuria and higher milk yield compared to control cows given water.<sup>36</sup>

### CONTROL

The transition period occurring 2–3 weeks before and after calving is a major risk period in the etiology of LDA. The prepartum depression of dry matter intake and the slow postpartum increase in dry matter intake are risk factors causing lower ruminal fill, reduced forage to concentrate ratios (in nontotal mixed ration feeding systems) and increased incidence of other postpartum diseases.<sup>37</sup> Retained fetal membranes, metritis and either clinical or subclinical ketosis and hypocalcemia are probable risk factors for LDA. Excessive amounts of concentrate, or too rapid an increase in concentrate feeding during the peripartum period, increases the risk of LDA, as higher volatile fatty acid concentration in the abomasal contents leads to decreased abomasal motility and emptying and excess gas in the abomasum. (See further details of importance of crude fiber in the rumen and its effect on the abomasum under Pathogenesis, above.)

### Prepartum nutrition and management

Reduction of the incidence of LDA in a dairy herd can be achieved by optimal nutrition and management during the dry period.<sup>6,38</sup> The following principles are important:

- Avoid a negative energy balance prepartum by avoiding

overconditioning and by providing optimal feed bunk management to cows in late gestation

- Feed some concentrates prior to calving to insure development of ruminal papillae
- Maximize dry matter intake in the immediate postpartum period
- Ensure palatable feed and water available to periparturient cows at all times
- Feed bunk management must ensure that cows have adequate access to fresh feed at all times to maximize dry matter intake in late pregnancy and thus improve energy balance
- Energy density of prepartum diets should not exceed 1.65 Mcal of NE<sub>l</sub>/kg of DM.

Every effort should be made to minimize dietary alterations near parturition that could result in indigestion. The amount of grain and corn (maize) silage fed prepartum should be kept at a minimum, while other forages are fed ad libitum.

Several experiments have shown no response in production to feeding large quantities of grain or concentrates (lead feeding) before parturition when cows were in good condition at drying-off and were fed well following parturition. Consequently, there seems little reason to continue the practice of steaming-up cows before parturition.

### Crude fiber intake

Ensuring an adequate intake of a high-fiber diet to dairy cows during the 'far-off' and 'close-up' periods in late pregnancy and the immediate 'postfreshening' period is of critical importance to the prevention of this disease.<sup>6</sup> The high-fiber diet will physically expand the rumen and provide a barrier against abomasal migration.<sup>8</sup> The basic principle is to maintain adequate ruminal filling before and after calving.<sup>38</sup> This requires careful **analysis and implementation** of the dry cow feeding program.<sup>6</sup> Readers are referred to National Research Council, 2001 (see Review literature) for details on feeding programs for dairy cattle.

The emphasis in the dry cow feeding program must be on increasing dry matter intake, increasing particle length and effective fiber content of the ration. Feeding a high-roughage diet is consistent with one of the most commonly recommended and successful management strategies for minimizing LDA during the postparturient period. This means insuring adequate fiber content of at least 17%. An adequate level of fiber will also aid in the control of subacute ruminal acidosis, which may occur when dairy cows are fed grain in the latter part

of the dry period in preparation for lactation.

### Monensin in controlled-release capsule prepartum

Monensin is an ionophore antibiotic that alters volatile fatty acid production in the rumen in favor of propionate, which is a major precursor for glucose in the ruminant. A monensin controlled-release capsule is available as an aid in the prevention of subclinical ketosis in lactating dairy cattle. The device delivers 335 mg of monensin per day for 95 days. A monensin controlled-release capsule has been shown to decrease the incidence of subclinical ketosis, displaced abomasum and multiple illnesses when administered to dairy cows 3 weeks before calving.<sup>39</sup> It is likely that these effects on clinical health are mediated by improved energy balance in monensin-supplemented cows. There are improvements in energy indicators such as increased glucose and decreased beta-hydroxybutyrate after calving.

The administration of a monensin controlled-release capsule to cows 3 weeks prepartum significantly decreased NEFA and beta-hydroxybutyrate and significantly increased concentrations of serum cholesterol and urea in the week immediately precalving.<sup>39</sup> No effect of treatment was observed for calcium, phosphorus or glucose in the precalving period. After calving, concentrations of phosphorus were lower and beta-hydroxybutyrate tended to be lower, and cholesterol and urea were higher in monensin-treated cows. There was no effect of treatment on NEFA, glucose or calcium in the first week after calving. Monensin treatment administered precalving significantly improved indicators of energy balance in both the immediate precalving and postcalving periods. The prevalence of subclinical ketosis as measured by cow-side tests was lower in monensin-treated cows. These findings indicate more effective energy metabolism in monensin-treated cows as they approach calving, which is important for the prevention of retained placenta, clinical ketosis and displaced abomasum. In general, a 40% reduction in both LDA and clinical ketosis can be expected with precalving administration of monensin controlled-release capsules.<sup>40</sup> In addition, a 25% decrease in retained placenta may occur.

### Genetic selection

There is some evidence that LDA is a moderately heritable trait and that the incidence may be lowered by genetic selection.<sup>41</sup> However, this has not been explored on a practical basis.



## REVIEW LITERATURE

- Geishauser T. Abomasal displacement in the bovine – a review on character, occurrence, etiology and pathogenesis. *J Vet Med A* 1995; 42:229–251.
- Shaver RD. Nutritional risk factors in the etiology of left displaced abomasum in dairy cows: a review. *J Dairy Sci* 1997; 80:2449–2453.
- Geishauser T, Leslie K, Duffield T. Prevention and prediction of displaced abomasum in dairy cows. *Bovine Pract* 2000; 34:51–55.
- Geishauser T, Leslie K, Duffield T. Metabolic aspects in the etiology of displaced abomasum. *Vet Clin North Am Food Anim Pract* 2000; 16:255–265.
- National Research Council. Nutrient requirements of dairy cattle, 7th ed. Washington, DC: National Academy Press, 2001.
- Van Winden SCL, Kuiper R. Left displacement of the abomasum in dairy cattle: recent developments in epidemiological and etiological aspects. *Vet Res* 2003; 34:47–56.
- Braun U. Ultrasonography in gastrointestinal disease in cattle. *Vet J* 2003; 166:112–124.

## REFERENCES

- Shaver RD. *J Dairy Sci* 1997; 80:2449.
- Jubb TK et al. *Aust Vet J* 1991; 68:140.
- Mueller K et al. *Vet J* 1999; 157:95.
- Geishauser T et al. *J Dairy Sci* 1997; 80:3188.
- Van Winden SCL et al. *Vet Rec* 2004; 154:501.
- National Research Council. Nutrient requirements of dairy cattle, 7th ed. Washington, DC: National Academy Press, 2001:196–197.
- Van Winden SCL, Kuiper R. *Vet Res* 2003; 34:47.
- Constable PD et al. *Am J Vet Res* 1992; 53:1184.
- Zulaf M et al. *Am J Vet Res* 2002; 63:1687.
- Da Silva C et al. *Dtsch Tierarztl Wochenschr* 2004; 111:49.
- Rohrbach BW et al. *J Am Vet Med Assoc* 1999; 214:1660.
- LeBland SJ et al. *J Dairy Sci* 2005; 88:159.
- Geishauser T et al. *Vet Clin North Am Food Anim Pract* 2000; 16:255.
- Geishauser T et al. *Am J Vet Res* 1997; 58:1216.
- Geishauser T et al. *Can J Vet Res* 1998; 62:144.
- Detilleux JC et al. *J Dairy Sci* 1997; 80:121.
- Geishauser T et al. *J Dairy Sci* 1998; 81:2346.
- Van Winden SCL et al. *J Dairy Sci* 2003; 86:1465.
- Van Winden SCL et al. *Vet Rec* 2002; 151:446.
- Pravettoni D et al. *Am J Vet Res* 2004; 65:1319.
- Wittek T et al. *J Vet Intern Med* 2004; 18:574.
- Constable PD et al. *J Am Vet Med Assoc* 1992; 201:1564.
- Wittek T et al. *Am J Vet Res* 2004; 65:597.
- Cable CS et al. *J Am Vet Med Assoc* 1998; 212:1442.
- Braun U. *Vet J* 2003; 166:112.
- Zadnik T. *Vet Rec* 2003; 153:24.
- Oikawa S et al. *Am J Vet Res* 1997; 58:121.
- Mudron P et al. *J Vet Med A* 1997; 44:91.
- Geishauser T et al. *J Dairy Sci* 2000; 83:296.
- Carrier J et al. *J Dairy Sci* 2004; 87:3725.
- Komatsu Y et al. *J Vet Med A* 2002; 49:482.
- Sevinc M et al. *Rev Med Vet* 2002; 153:477.
- Raizman EA, Santos JEP. *J Dairy Sci* 2002; 85:1157.
- Rohn M et al. *J Vet Med A* 2004; 51:294–300.
- Rehage J et al. *Schweiz Arch Tierheilkd* 1996; 38:361.
- Rager KD et al. *J Am Vet Med Assoc* 2004; 225:915.
- Barrett SC. *Cattle Pract* 2003; 11:127.
- Stengarde LU, Pehrson BG. *Am J Vet Res* 2002; 63:137.
- Duffield T et al. *J Dairy Sci* 2003; 86:1171.
- Duffield T et al. *J Dairy Sci* 2002; 85:397.
- Geishauser T et al. *Bovine Pract* 2000; 34:51.

## RIGHT-SIDE DISPLACEMENT OF THE ABOMASUM AND ABOMASAL VOLVULUS

## Synopsis

**Etiology** Abomasal atony associated with high-level grain feeding. Cause in calves unknown

**Epidemiology** Mature dairy cows within a few weeks of calving. Abomasal volvulus usually preceded by right-side displacement of abomasum but not a necessary precursor. Occurs in calves spontaneously

**Signs** Inappetence to anorexia, depression, absence of rumination, scant abnormal feces, distension of right abdomen, ping over right flank, fluid-splashing sounds on ballottement of right flank, distended abomasum may be palpable rectally.

**Abomasal volvulus** manifested by anorexia, abdominal pain, tachycardia, absence of feces, ping, fluid-splashing sounds, severe dehydration and shock, and distended and tense abomasum rectally. High case fatality rate unless surgically corrected

**Clinical pathology** Hypokalemia, hypochloremia, metabolic alkalosis, severe dehydration

**Lesions** Gross distension and/or torsion of abomasum

**Diagnostic confirmation** Laparotomy

**Differential diagnosis** *Dilatation and displacement of abomasum*: impaction of abomasum in vagus indigestion, abomasal ulceration with dilatation, cecal torsion, chronic or subacute traumatic reticuloperitonitis. *Abomasal volvulus*: intestinal obstruction, acute diffuse peritonitis. *Pings in right abdomen*: Right-side displacement of abomasum, abomasal volvulus, cecal dilatation, intestinal obstruction, dilatation of descending colon and rectum, pneumoperitoneum

**Treatment** Medical treatment if detected early. Deflation of distended abomasum. Surgical correction. Fluid and electrolyte therapy. Oral fluid and electrolyte therapy

**Control** Nothing reliable

## ETIOLOGY

The etiology of right-side displacement of the abomasum (RDA) is not well understood but it is probably similar to LDA. **Abomasal atony is thought to be the precursor of dilatation and displacement, and consequently abomasal volvulus.** The cause of the abomasal atony and gaseous distension is thought to be related to the feeding of grain and the production of excessive quantities of gas and volatile fatty acids.<sup>1</sup> The dilatation is thought to be the result of primary distension of the abomasum occurring because of either obstruction of the pylorus or primary atony of the abomasal musculature. In adult cattle with RDA, there is no obstruction of the pylorus and atony of the abomasum seems to be the more likely cause. In calves, there may be an obstruction of the pylorus resulting in dilatation.

## EPIDEMIOLOGY

## Occurrence and incidence

## Lactating dairy cows

Dilatation, RDA and abomasal volvulus occurs primarily in adult dairy cows, usually within the period 3–6 weeks after calving.<sup>2</sup> The disease is being recognized with increased frequency because of improvements in diagnostic techniques and perhaps because more cows are being fed intensively for milk production. Incidence data based on individual dairy herds are not available but based on cases of abomasal disease admitted to a veterinary teaching hospital the ratio of abomasal volvulus to LDA was 1 to 7.4.<sup>2</sup>

## Beef cattle

Abomasal displacement and volvulus has been described in beef cattle breeds from 1 month to 6 years of age with a median age of 10 months.<sup>3</sup> The typical case was under 1 year of age.

## Calves

Abomasal volvulus occurs in young calves from a few weeks of age up to 6 months, usually without a history of previous illness, which suggests that the cause may be accidental. Abomasal bloat occurs in calves with no apparent predisposing cause.

## Mature bulls and pregnant cows

Abomasal volvulus has also occurred in bulls and pregnant cows but to a much lesser degree.

## Risk factors

There is little information available on the epidemiology of right-side displacement of the abomasum and abomasal volvulus. Most of the risk factors described for LDA are relevant to RDA and abomasal volvulus. The feeding of high levels of grain to high-producing dairy cows in early lactation is considered to be a major risk factor. However, there are no good reliable data to support this cause-and-effect relationship. Why the disease occurs in a small percentage of high-producing dairy cattle being fed high-level grain rations is unknown.

When this disease was originally described, the incidence appeared to be higher in Scandinavian countries than elsewhere. The risk factors in those situations were not identified but it was thought that indoor winter feeding and the shift of the acid–base balance to an alkalotic state during the winter months might be important factors. In Denmark, the ingestion of large quantities of soil particles on unwashed root crops used as feed is considered to be significant. This may be the reason for the higher incidence of the disease in the later part of the winter. However, attempts to reproduce the condition by feeding large

quantities of sand have been unsuccessful. Because atony is often associated with vagus indigestion, a relationship between the two has been suspected but there are usually no lesions affecting the reticulum or vagus nerves.

A hospital-based epidemiological study of the risk factors for abomasal volvulus and FDA was performed using the medical record abstracts derived from the veterinary teaching hospitals of 17 North American veterinary schools.<sup>2</sup> The risk for abomasal volvulus increased with increasing age, with a greater risk in dairy cows 4–7 years of age. Dairy cattle were at a much higher risk than beef cattle. Approximately 28% of cases of abomasal volvulus occurred within the first 2 weeks and 52% within 1 month following parturition. This indicates that proportionately fewer cases of abomasal volvulus than left displacement occur during the first 2 weeks following parturition. The hospital case fatality rate for abomasal volvulus and LDA was 23.5%, and 5.6%, respectively.<sup>2</sup>

It is suggested that abomasal atony is a prerequisite for the development of right-side displacement and abomasal volvulus, and that following parturition the abdominal void facilitates such development. The direction of the displacement could be influenced predominantly by the volume of the forestomach. Immediately after parturition, displacement occurs to the left because of a reduction in the size of the rumen volume. Several weeks later the dilated abomasum moves caudally and dorsally in the right abdomen because the volume of the forestomach is much larger thereby providing an effective barrier (rumen barrier).

Abomasal volvulus has also occurred following correction of LDA by casting and rolling.<sup>4</sup>

## PATHOGENESIS

### Dilatation and displacement phase

In RDA, abomasal atony occurs initially, resulting in the accumulation of fluid and gas in the viscus leading to gradual distension and displacement in a caudal direction on the right side (dilatation phase). During the dilatation phase, which commonly extends over several days, there is continuous secretion of hydrochloric acid, sodium chloride and potassium into the abomasum, which becomes gradually distended and does not evacuate its contents into the duodenum. This leads to dehydration and metabolic alkalosis with hypochloremia and hypokalemia. These changes are typical of a functional obstruction of the upper part of the intestinal tract and occur in experimental RDA and experimental obstruction of the duodenum in calves.

The **abomasal luminal pressure** in naturally occurring abomasal volvulus is increased (median 11.7 mmHg; range 4.1–32.4 mmHg).<sup>5</sup> Increased luminal pressure in abomasal volvulus could cause mucosal injury by local vascular occlusion and affect the prognosis. Among cattle with abomasal volvulus, the abomasal luminal pressure was significantly higher in those that died or were sold following surgery (median 20.6 mmHg) than in cattle that recovered and were retained in the herd (median 11.0 mmHg). Calculation of likelihood ratios suggest that selecting cattle with a value of 16 mmHg for luminal pressure optimized the distribution of cattle into productive and nonproductive groups.

The abomasal luminal gas pressure and volume were higher in cattle with an abomasal volvulus than in cattle with an LDA.<sup>6</sup> As luminal gas pressure increases, abomasal perfusion decreases, resulting in varying degrees of ischemia to the abomasal mucosa. In cows with an abomasal volvulus, lactate concentration in the gastroepiploic vein was greater than that in the jugular vein, whereas no difference in lactate concentrations was detected in cows with an LDA. This indicates that cattle with a large and tensely distended abomasum associated with a volvulus or LDA should have the viscus decompressed as soon as possible to minimize the potential for ischemia-induced injury to the abomasal mucosa, which may result in ulcers and perforations.

An **experimental model of hypochloremic metabolic alkalosis** by diversion of abomasal outflow in sheep has been described.<sup>7,8</sup> A similar model in adult lactating dairy cows resulted in weakness and depression in 10–12 hours, dehydration, hypochloremia, hypokalemia, hypocalcemia and a milk alkalosis.<sup>9</sup>

Up to 35 L of fluid may accumulate in the dilated abomasum of a mature 450 kg cow, resulting in dehydration, which will vary from 5–12% of body weight. In uncomplicated cases, there is only slight hemoconcentration and a mild electrolyte and acid–base imbalance, with moderate distension of the abomasum. These cases are reversible with fluid therapy. In complicated cases there is severe hemoconcentration, hypovolemia and dehydration<sup>10</sup> and marked metabolic alkalosis with a severely distended abomasum. The degree of dehydration is a reliable preoperative prognostic aid. The hypovolemia, compression of the caudal vena cava and stimulation of the sympathetic nervous system in response to distension and twisting of the abomasum results in tachycardia, which is also a reliable preoperative prognostic aid.<sup>10</sup>

In cattle with severe and prolonged abomasal volvulus, a metabolic acidosis may develop and be superimposed on the metabolic alkalosis, leading to a low base excess concentration of extracellular fluid. In the experimental disease in sheep, the metabolic acidosis observed terminally, was associated with an increase in plasma lactate concentration probably due to hypovolemic shock and anaerobic metabolism.<sup>7</sup> These severe cases require surgery and intensive fluid therapy. A paradoxical aciduria may occur in cattle affected with metabolic alkalosis associated with abomasal disease. This may be due to the excretion of acid by the kidney in response to severe potassium depletion or to the excretion of acid metabolites as a result of starvation, dehydration and impaired renal function. In the experimental model in sheep, renal net acid excretion decreases and sodium excretion increases initially, followed by increased net acid excretion and decreased sodium excretion resulting in aciduria and marked sodium conservation.<sup>8</sup>

### Volvulus phase

Following the dilatation and displacement phase, the distended abomasum may twist in a clockwise or anticlockwise (viewed from the right side) direction in a vertical plane around a horizontal axis passing transversely across the body in the vicinity of the omasoabomasal orifice. The volvulus will usually be of the order of 180–270° and causes a syndrome of acute obstruction with local circulatory impairment and ischemic necrosis of the abomasum. Detailed examinations of necropsy specimens of volvulus of the abomasum indicate that the displacements can occur in a dual axial system. One system relates to displacements of the abomasum on a pendulum model, the point of suspension being situated on the visceral surface of the liver and the arms consisting of parts of the digestive tract adjacent to the abomasum. The other system comprises axes centered on the abomasum, about which this organ is able to rotate without changing its position in the abdomen. A theoretical analysis of the types of displacement of the abomasum that can occur is described.

In some cases the abomasum and omasum are greatly distended and form a loop with the cranial part of the duodenum. This loop may twist up to 360° in a counterclockwise direction as viewed from the rear or from the right side of the cow. The reticulum is drawn caudally on the right side of the rumen by its attachment to the fundus of the abomasum. The probable mode of rotation is in a sagittal plane. Abomasal volvulus with involvement of the omasum and reticulum

does occur but represents only about 5% of cases. Pressure and tension damage to the ventral vagal nerve trunk and to the blood vessels are in part responsible for the poor prognosis in severe cases, even after successful surgical correction.

There is speculation that violent exercise and transportation may be contributory factors in the pathogenesis of acute abomasal volvulus, which occurs occasionally in mature cows and young calves without a history of immediate previous illness associated with the dilatation phase. The metabolic changes that occur are similar to those described above.

#### Postsurgical complication in right-side displacement of the abomasum or abomasal volvulus

A vagus-indigestion-like syndrome may occur in cattle treated for RDA or abomasal volvulus.<sup>11</sup> Possible mechanisms include: vagus nerve injury, overstretching of the abomasal wall during prolonged distension resulting in neuromuscular junction alterations and autonomic motility modification, thrombosis and abomasal wall necrosis, and peritonitis.

#### CLINICAL FINDINGS

##### Dilatation and displacement phase

In right-side dilatation and displacement there is usually a history of calving within the last few weeks with inappetence and decreased milk production; the feces are reduced in amount and are abnormal. The cow may have been treated for an uncertain disorder of the digestive tract within the last several days. Anorexia is usually complete when the abomasum is distended. There is usually depression, dehydration, no interest in feed, perhaps increased thirst and sometimes muscular weakness. Affected cows will commonly sip water continuously. The temperature is usually normal, the heart rate will vary from normal to 100/min, and the respirations are usually within the normal range. The mucous membranes are usually pale and dry. The reticulorumen is atonic and the rumen contents (the rumen pack) feel excessively doughy. The distended abomasum may be detectable as a tense viscus on palpation immediately behind and below the right costal arch. Ballottement of the middle third of the right lateral abdomen immediately behind the right costal arch along with simultaneous auscultation will reveal fluid-splashing sounds suggesting a fluid-filled viscus. In many cases the dilatation continues and after 3–4 days the abdomen is visibly distended on the right side and the abomasum can be palpated on rectal examination. It may completely fill the right lower quadrant of the abdomen and feel tense and filled with fluid and gas. **Percussion and simul-**

**taneous auscultation over the right middle to upper third of the abdomen commonly elicits a characteristic high-pitched ping.**

##### Volvulus phase

Abomasal volvulus usually develops several days after the onset of dilatation of the abomasum but it is usually not possible to distinguish precisely the stages of the disease. However, in abomasal volvulus, the clinical findings are usually much more severe than during the dilatation phase. The abdomen is visibly distended, depression and weakness are marked, dehydration is obvious, the heart rate is 100–120/min and respirations are increased. Recumbency with a grossly distended abdomen and grunting may occur and represents a poor prognosis. A rectal examination is very important at this stage. In the dilatation stage the partially distended abomasum may be palpable with the tips of the fingers in the right lower quadrant of the abdomen. It may not be palpable in large cows. In the volvulus phase, the distended tense viscus is usually palpable in the right abdomen anywhere from the upper to the lower quadrant.

The feces are usually scant, soft and dark in color. The soft feces must not be mistaken for diarrhea, as is commonly done by the owner of the animal. Cattle with abomasal volvulus usually become recumbent within 24 hours after the onset of the volvulus. Death usually occurs in 48–96 hours from shock and dehydration. Rupture of the abomasum may occur and cause sudden death.

##### Acute abomasal volvulus (adult cattle)

In acute abomasal volvulus in adult cattle there is a sudden onset of abdominal pain with kicking at the abdomen, depression of the back and crouching. The heart rate is usually increased to 100–120/min, the temperature is subnormal and there is peripheral circulatory failure. The animal feels cool and the mucous membranes are pale, dry and cool. The abdomen is grossly distended on the right side and auscultation and percussion reveal the tympanitic sounds of a gas-filled viscus. Fluid-splashing sounds are audible on percussion. Paracentesis of the distended abomasum will usually reveal large quantities of blood-tinged fluid with a pH of 2–4. The distended abomasum can usually be palpated on rectal examination but the torsion may have moved it in a cranial direction and not uncommonly these are not as readily palpable as when only dilated. The feces are scant, soft and dark in color and become blood-stained or melanic in the ensuing 48 hours if the cow lives long enough. In some cases there is profuse watery diarrhea.

##### Acute abomasal volvulus (calves)

In calves with acute abomasal volvulus, there is a sudden onset of anorexia, acute abdominal pain with kicking at the belly, depression of the back, bellowing and straining. The heart rate is usually 120–160/min, the abdomen is distended and tense, and auscultation and percussion over the right abdomen reveal distinct high-pitched pings. Palpation behind the right costal arch reveals a tense viscus that is painful on even moderate palpation.

##### Abomasal displacement and volvulus in beef cattle

Abdominal distension, anorexia and colic are common historical findings.<sup>3</sup> Clinically, there is abdominal distension, tachycardia and colic, and a high-pitched ping is audible on percussion over the right side of the abdomen. A distended gas-filled viscus is commonly palpable on rectal examination. The course of the disease in beef cattle appears to be more protracted than in dairy cattle.

##### Postsurgical complication in abomasal volvulus

The most frequent complication encountered following surgical correction of RDA and abomasal volvulus resembles vagus indigestion, which occurs in 14–21% of cases.<sup>11</sup> The case fatality rate is high, with only 12–20% of affected animals returning to normal production. In affected cattle, there is ruminal distension, rumen hypermotility or atony, and abnormal feces (usually scant and dry).

#### CLINICAL PATHOLOGY

##### Serum biochemistry

There are varying degrees of hemococoncentration (increased PCV and total serum proteins), metabolic alkalosis, hypochloremia and hypokalemia.

The severity of volvulus can be classified, and the prognosis evaluated, according to the amount of fluid in the abomasum and the concentration of serum chloride and the heart rate:

- Group 1 – abomasum distended principally with gas
- Group 2 – abomasum distended with gas and fluid, and surgical reduction possible without removal of fluid
- Group 3 – abomasum distended with gas and fluid, 1–29 L of fluid removed before reduction of abomasum
- Group 4 – abomasum distended with gas and fluid, more than 30 L of fluid removed before reduction of torsion.

The serum chloride levels and heart rates before surgery are also valuable prognostic aids. Cows classified as group 3 or 4 or those having presurgical chloride levels equal to or below 79 mEq/L (79 mmol/L)

or pulse rates of 100/min or more have a poor prognosis.

The base excess concentration of the extracellular fluid can be a useful prognostic and diagnostic indicator in cows with abomasal volvulus or right displacement of the abomasum. In one retrospective study cows with a base excess of  $\pm 5.0$  mEq/L (5.0 mmol/L) had abomasal torsion rather than displacement. The survival rate of cows with abomasal volvulus was 50% with a base excess  $\pm 0.1$  mEq/L (0.1 mmol/L), whereas it was 84% if the base excess was  $+ 10.0$  mEq/L (10.0 mmol/L).

A cross-sectional study of the serum electrolyte and mineral concentrations in dairy cows with abomasal displacement or volvulus at the time of on-farm diagnosis found lower serum calcium, phosphorus, magnesium, potassium and chloride levels and an increase in the anion gap compared to controls.<sup>12</sup>

### Urinalysis

Paradoxical aciduria may also be present.

### Hemogram

The total and differential leukocyte count may indicate a stress reaction in the early stages, and in the later stages of volvulus there may be leukopenia with a neutropenia and degenerative left shift due to ischemic necrosis of the abomasum and early peritonitis.

### Abomasocentesis

Centesis of the distended abomasum will yield large quantities of fluid without protozoa and a pH of 2–4. The fluid may be serosanguineous when volvulus is present.

### PROGNOSTIC INDICATORS

Several clinical and laboratory findings have been examined as prognostic indicators of cows affected with RDA and abomasal volvulus. In one series of 458 cows with right displacement or abomasal volvulus, a decreased temperature and tachycardia when first examined indicated a poor prognosis.<sup>13</sup> Using multiple logistic regression of three admission variables (heart rate, base excess and plasma chloride) and five surgical variables (heart rate, base excess, diagnosis, method of decompression and appearance of abomasal mucosa), it was possible to predict the outcomes with a high degree of accuracy.<sup>14</sup> In another series of 80 cattle with abomasal volvulus, the heart rate, hydration status, period of inappetence and serum alkaline phosphatase were the best preoperative prognostic indicators.<sup>10</sup> An anion gap of 30 mEq/L was indicative of a poor prognosis and was more accurate than either serum chloride or base excess values.<sup>15</sup> The surgical and postoperative

findings in cattle with abomasal volvulus are good prognostic indicators of outcome.<sup>16</sup> Cattle with omasal–abomasal volvulus have a worse prognosis than those without omasal involvement. Large abomasal fluid volume, venous thrombosis and blue or black abomasal color before decompression are all indicative of a poor prognosis.

The evaluation of the degree of circulatory insufficiency, dehydration and levels of base excess and blood lactate are also used but are less reliable. Postoperatively decreased gastrointestinal motility is an unfavorable prognostic sign.

### NECROPSY FINDINGS

In abomasal dilatation the abomasum is grossly distended with fluid and some gas. The rumen may contain an excessive amount of fluid. In some cases there may be impaction of the pylorus with particles of soil or sand and there may be an accompanying pyloric ulcer. In abomasal volvulus the abomasum is grossly distended with brownish, sanguineous fluid and is twisted usually in a clockwise direction (viewed from the right side), often with displacement of the omasum, reticulum and abomasum. In complete volvulus the wall of the abomasum is grossly hemorrhagic and gangrenous and may have ruptured.

### DIFFERENTIAL DIAGNOSIS

The diagnosis and differential diagnosis of right-side dilatation, displacement and volvulus of the abomasum is dependent on consideration of the presence or absence of pings in the right abdomen, the findings on rectal examination and the other clinical findings, including the history. Detecting a ping on percussion and auscultation of the right abdomen must be accompanied by a rectal examination to determine the presence and nature of a gas-filled viscus to account for the ping.

#### Dilatation and displacement of abomasum

The characteristic features of dilatation and right-sided displacement of the abomasum are: recent calving, a vague indigestion since calving, soft scant feces, a ping over the right abdomen and the presence of the distended tense viscus in the right lower abdomen. It must be differentiated from the following:

- **Impaction of the abomasum associated with vagus indigestion** is characterized by an enlarged abomasum that pits on digital palpation and feels like a doughy mass behind the lower aspect of the costal arch, situated on the floor of the abdomen, whereas most cases of dilatation are situated more dorsally adjacent to the right paralumbar fossa. Pings are not present in abomasal impaction. A laparotomy may be required to distinguish between them

- **Subacute abomasal ulceration with moderate dilatation** of the abomasum in a recently calved cow may not be distinguishable clinically from RDA. The presence of melena suggests abomasal ulcers but these may be present as secondary complications in dilatation and RDA
- **Cecal torsion** is characterized by distension of the right flank, tympanitic sounds on auscultation and percussion, and the cecum can usually be palpated and identified tentatively, on rectal examination, as a long (60–80 cm), usually easily movable, cylindrical, tense tube (10–20 cm in diameter), with a blind sac
- **Fetal hydrops** is characterized by bilateral distension of the lower abdomen and an enlarged gravid uterus palpable on rectal examination
- **Chronic or subacute traumatic reticuloperitonitis** may resemble abomasal dilatation but in the former there may be a grunt on deep palpation, the feces are usually firm and dry, the abdomen is gaunt and a mild fever may be present. However, a laparotomy may be necessary to make the diagnosis. Abdominocentesis may be useful
- **Abomasal volvulus** is characterized by abdominal distension of the right side, pings on percussion and auscultation, dehydration, weakness and shock with a heart rate up to 120/min. The distended viscus can usually be palpated in the right lower quadrant of the abdomen. It must be differentiated from the following:

- **Intestinal obstruction** is characterized by a history of sudden onset of anorexia, abdominal pain, scant feces, which may be blood-tinged, and the affected portion of the intestines or loops of distended intestine may be palpable rectally
- **Acute diffuse peritonitis** as a sequel to local peritonitis in a cow soon after calving may be indistinguishable from acute abomasal volvulus. There is severe toxemia, tachycardia, dehydration, abdominal distension, grunting, weakness, recumbency and rapid death. Paracentesis of the peritoneal cavity will assist in the diagnosis

#### Pings over the right abdomen

Diseases resulting in pings over the right abdomen include dilatation and distension of the abomasum, cecum, cranial duodenum, parts of the small intestine, descending colon and rectum and pneumoperitoneum.

The evaluation of a ping is dependent upon the size of the area and location of the sound elicited by percussion and simultaneous auscultation. The common clinical characteristics of these pings are as follows:

- **Dilatation and right-side displacement of the abomasum:** the ping is usually audible between the ninth and 12th ribs extending from the costochondral junction of the ribs to their proximal third aspects. Rarely will the ping extend into the paralumbar fossa in right-side dilatation and displacement

- **Abomasal volvulus:** the area of the ping is typically larger than that of the RDA and extends more cranially and caudally, often extending into the right paralumbar fossa but not completely filling the fossa. Also, the ventral border of the ping area in an abomasal volvulus is variable, often horizontal because of the level of fluid within the abomasum
- **Cecal dilatation:** the ping is usually confined to the dorsal paralumbar fossa and caudal one or two intercostal spaces. In dilatation and torsion of the cecum the ping usually fills the paralumbar fossa and extends cranially and caudally the equivalent of two rib spaces. The ascending colon is often involved in a torsion of the cecum, which will result in an enlarged ping area extending from the paralumbar fossa. In dilatation of the ascending colon the ping may be centered over the proximal aspects of the 12th and 13th ribs
- **Intestinal obstruction:** the presence of multiple, small areas of ping that vary in pitch and intensity is characteristic of dilatation of the jejunoleum caused by intussusception or intestinal volvulus
- **Dilatation of descending colon and rectum:** a ping in the right caudal abdomen just ventral to the transverse processes of the vertebrae indicates dilatation of the descending colon and rectum, which is commonly heard following rectal examination
- **Pneumoperitoneum:** pings may be audible over a wide area of the dorsal third of the abdomen bilaterally. In one study, the sensitivity and predictive values of abomasum as the source of the ping were 98% and 96% respectively; for cecum and/or ascending colon, the sensitivity and predictive values were both 87%

## TREATMENT

The prognosis in right-side dilatation, displacement and volvulus is favorable if the diagnosis is made within a few days after the onset of clinical signs and before large quantities of fluid accumulate in the abomasum. Slaughter for salvage may be the best course of action for cattle of commercial value. Cows with considerable economic worth can be treated as outlined here. Not all cases require surgical correction: medical treatment is possible in mild cases.

### Medical therapy for mild cases

In mild cases of dilatation and minimal displacement with a mild systemic disturbance, empirical treatment with 500 mL of 25% calcium borogluconate intravenously may yield good results. The rationale for the calcium administration is to improve abomasal motility. Affected cows are also offered good-quality hay but no grain for 3–5 days and monitored daily. Surgical correction may not be necessary if the appetite and movements

of the alimentary tract return to normal in a few days. The ping in the right abdomen may gradually become smaller in 2–3 days and eventually disappear.

In mild cases of dilatation with only slight hemoconcentration and metabolic alkalosis, early treatment with fluids and electrolytes intravenously and orally will often yield good results. The fluid therapy is essential to restore motility of the gastrointestinal tract, particularly the abomasum, which is distended with fluid and must begin evacuating its contents into the duodenum for absorption of the electrolytes to occur. The cow will usually not regain her appetite until the abomasal atony has been corrected.

A combination of hyoscine–butyl bromide and dipyrone and fasting has been recommended based on field experience.<sup>17</sup> Recovery occurred in about 77% of affected cows within 48 hours.

### Deflation of distended abomasum in calves

Gas can be removed from a grossly distended (bloated) abomasum of calves as an emergency measure prior to surgical correction<sup>18</sup> by laparotomy. The calf is placed in dorsal recumbency and the abdomen is punctured with a 16-gauge 12 cm hypodermic needle at the highest point of the distended abdomen between the umbilicus and the xiphoid. After the distension is relieved and fluid therapy is begun, the need for a laparotomy can be assessed and performed if necessary.

### Surgical correction

In the more advanced cases of dilatation, displacement and volvulus, a right flank laparotomy for drainage of the distended abomasum and correction of the volvulus if present is necessary. The surgical techniques in common use have been described. Intensive fluid therapy is usually necessary preoperatively and for several days postoperatively to correct the dehydration and metabolic alkalosis and to restore normal abomasal motility. Electromyographic studies of the postoperative abomasal and duodenal motility reveal loss of motility, some retrograde motility and loss of spike activity. Cholinergics have been used to help restore motility but are not reliable. Rumen transplants to restore rumen function and appetite will provide a more effective stimulus to restore gastrointestinal tract motility.

Postsurgical complications resembling a vagus-indigestion-like syndrome have been described<sup>11</sup> (see under Clinical findings, above).

### Fluid and electrolyte therapy

The composition of the fluids and electrolyte solutions that are indicated in RDA and abomasal volvulus has been a

subject of much investigation. There are varying degrees of **dehydration, metabolic alkalosis, hypochloremia and hypokalemia**. With the aid of a laboratory it is possible to monitor the serum biochemistry during administration of the fluids and electrolytes and to correct certain electrolyte deficits by adding ('spiking') the appropriate electrolytes to the fluids. Without a laboratory, the veterinarian has no choice but to use the solutions that are considered safe and judicious. **Balanced electrolyte solutions containing sodium, chloride, potassium, calcium and a source of glucose will commonly suffice.** A mixture of 2 L of isotonic saline (0.85%), 1 L of isotonic potassium chloride (1.1%) and 1 L of isotonic dextrose (5%) given at the rate of 4–6 L/h intravenously is also recommended and reliable. Experimentally induced hypochloremic, hypokalemic metabolic alkalosis in sheep has been corrected using 0.9 (300 mosmol/L), 3.6 (1200 mosmol/L) and 7.2% (2400 mosmol/L) of sodium chloride solutions given intravenously<sup>19</sup> over a 2-hour period with the administered volume determined by the estimated total extracellular fluid chloride deficit. Significant difference was not found among treatments, with all solutions resulting in return of clinicopathologic variables to pre-experimental values within 12 hours. It is suggested that rapid intravenous replacement of chloride with small volumes of hypertonic saline solution is safe and effective for correction of experimentally induced hypochloremic, hypokalemic metabolic alkalosis in sheep. Clinical trials are needed to evaluate the efficacy of hypertonic saline solution (7.2%) for the correction of naturally occurring right-side displacement and volvulus of the abomasum.

### Acidifying solutions

Isotonic solutions of potassium chloride and ammonium chloride (KCl 108 g, NH<sub>4</sub>Cl 80 g, H<sub>2</sub>O 20 L) will provide a source of potassium and chloride and will correct the alkalosis. This solution can be given intravenously at the rate 20 L over 4 hours to a 450 kg cow. This may be followed by the use of balanced electrolyte solutions at the rate of 100–150 mL/kg BW over a 24-hour period. However, acidifying solutions such as potassium chloride and ammonium chloride must be used carefully and ideally the serum biochemistry should be monitored every hour to insure that acidosis does not occur. The above solutions are considered safe when given as described. Normal saline is also effective and potassium solutions may not be necessary unless there is severe hypokalemia.

## Oral therapy

**Oral electrolyte therapy** has been recommended, particularly in the post-operative period following surgical drainage of the distended abomasum. A mixture of sodium chloride (50–100 g), potassium chloride (50 g) and ammonium chloride (50–100 g) is given orally daily postoperatively along with the parenteral fluids as necessary. Treatment with potassium chloride (50 g/day) orally can be continued daily until the cow resumes her normal appetite.

## CONTROL

No reliable information is available on the control of right-side dilatation, displacement and volvulus of the abomasum. Because its pathogenetic mechanism is similar to LDA it would seem rational to recommend feeding programs that are used for the control of LDA.

## REVIEW LITERATURE

Geishauser T. Abomasal displacement in the bovine – a review on character, occurrence, etiology and pathogenesis. *J Vet Med A* 1995; 42:229–251.

## REFERENCES

- Geishauser T. *J Vet Med A* 1995; 42:229.
- Constable PD et al. *Am J Vet Res* 1992; 53:1184.
- Roussel AJ et al. *J Am Vet Med Assoc* 2000; 216:730.
- St Jean G et al. *Cornell Vet* 1989; 79:345.
- Constable PD et al. *J Am Vet Med Assoc* 1992; 201:1564.
- Wittek T et al. *Am J Vet Res* 2004; 65:597.
- Smith DF et al. *Am J Vet Res* 1990; 51:1715.
- Lunn DP et al. *Am J Vet Res* 1990; 51:723.
- Ward JL et al. *Can J Vet Res* 1994; 58:13.
- Constable PD et al. *J Am Vet Med Assoc* 1991; 198:2077.
- Sattier N et al. *Can Vet J* 2000; 41:777.
- Delgado-Lecaroz R et al. *Can Vet J* 2000; 41:301.
- Fubini SL et al. *J Am Vet Med Assoc* 1991; 198:460.
- Grohn YT et al. *Am J Vet Res* 1990; 51:1895.
- Garry FB et al. *J Am Vet Med Assoc* 1988; 192:1107.
- Constable PD et al. *J Am Vet Med Assoc* 1991; 199:892.
- Buchanan M et al. *Vet Rec* 1991; 129:111.
- Kumper H. *Bovine Pract* 1995; 29:80.
- Ward JL et al. *Am J Vet Res* 1993; 54:1160.

## DIETARY ABOMASAL IMPACTION IN CATTLE

Dietary abomasal impaction occurs in cattle in the prairie provinces of western Canada during the cold winter months, and elsewhere with similar circumstances, when the animals are fed poor-quality roughage. The disease is most common in pregnant beef cattle which increase their feed intake during extremely cold weather in an attempt to meet the increased needs of a higher metabolic rate.<sup>1</sup> The disease has also occurred in feedlot cattle fed a variety of mixed rations containing chopped or ground roughage (straw, hay) and cereal grains and in late pregnant dairy cows on similar feeds.

## Synopsis

**Etiology** Ingestion of large quantities of low-quality roughage during cold weather

**Epidemiology** Pregnant primiparous beef cattle during cold weather consuming low-quality roughage

**Signs** Anorexia, scant feces, distension of abdomen, loss of body weight. Normal vital signs initially. Rumen full and atonic. Right lower flank distended and may be able to palpate abomasum through abdominal wall and rectally. Gradually become weak and recumbent

**Clinical pathology** Metabolic alkalosis, hypochloremia, hypokalemia

**Lesions** Gross enlargement of abomasum impacted with dry, rumen-like contents

**Diagnostic confirmation** Laparotomy

**Differential diagnosis** Impaction of abomasum associated with vagus indigestion, impaction of omasum, diffuse peritonitis, intestinal obstruction

**Treatment** Slaughter for salvage. Medical treatment with diethyl sodium sulfosuccinate. Abomasotomy

**Control** Provide nutrient requirements for pregnant beef cattle during cold weather

## ETIOLOGY AND EPIDEMIOLOGY

The consumption of excessive quantities of poor-quality roughage which are low in both digestible protein and energy is the primary cause.<sup>1</sup> Impaction of the abomasum with sand can also occur in cattle if they are fed hay on sandy soils or root crops that are sandy or dirty.<sup>2</sup> Outbreaks of impaction with sand have occurred in which up to 10% of cattle at risk were affected.

The disease occurs most commonly in young pregnant beef cows that are kept outdoors year-round, including during the cold winter months, when they are fed roughages consisting of either grass or legume hay or cereal straw, which may or may not be supplemented with some grain. In these circumstances cows commonly lose 10–15% of their total body weight from October to May and even more during very cold winters. In one retrospective study of the necropsy reports of cattle that died with abomasal impaction, 20% of the animals had lesions of traumatic reticuloperitonitis, 60% were thought to be due to the ingestion of too much poor-quality roughage without a supplement of concentrate, and 20% did not fit into either category.<sup>3</sup>

When large quantities of long roughage without sufficient grain are fed during very cold weather, the cattle cannot eat sufficient feed to satisfy energy needs, so that the roughage is then provided in a chopped form. The chopped roughage is commonly mixed with some grain in a mix mill but usually at an insufficient level to meet the energy requirements. Cattle

can and do eat more of these chopped roughage–grain mixtures than of long roughage because the smaller particles pass through the forestomachs at a more rapid rate. But impaction of the abomasum, omasum and rumen may occur because of the relative indigestibility of the roughage. Outbreaks may occur affecting up to 15% of all pregnant cattle on individual farms when the ambient temperature drops to –5 to –10°C (14 to –22°F) for several days.

Omasal and abomasal impaction has occurred in a group of beef suckler cows in late gestation housed in straw yards and fed solely on pea haulum.<sup>4</sup> The disease has also occurred in feedlot cattle fed similar rations (e.g. 80% roughage, 20% grain) in an attempt to reduce the high cost of grain feeding and to satisfy beef grading standards that put the emphasis on producing a smaller amount of fat cover. With these constraints and the increased emphasis on roughage feeding, it is possible that the incidence of abomasal impaction may increase in feedlot cattle. The feeding of almond shells to dairy replacement heifers has also resulted in abomasal impaction.<sup>5</sup>

The ingestion of gravel (stones) by dairy cattle kept in dry-lot facilities can result in complete, nonstrangling intraluminal obstruction of the abomasum and duodenum.<sup>6</sup> The gravel, consisting of sand and small stones, may be inadvertently mixed with the feed when it is being scraped from bunker silos. It is also possible that some cows may ingest the gravel through pica.

## PATHOGENESIS

Chopped roughage and finely ground feeds pass through the forestomachs of ruminants more quickly than long roughage and perhaps in this situation the combination of low digestibility and excessive intake leads to excessive accumulation in the forestomachs and abomasum.

When large quantities of sand are ingested, the omasum, abomasum, large intestine and cecum can become impacted. The sand that accumulates in the abomasum causes abomasal atony and chronic dilatation.

Once impaction of the abomasum occurs, a state of subacute obstruction of the upper alimentary tract develops. The hydrogen and chloride ions are continually secreted into the abomasum in spite of the impaction and atony and an alkalosis with hypochloremia results. Varying degrees of dehydration occur because fluids are not moving beyond the abomasum into the duodenum for absorption. Potassium ions are also sequestered in the abomasum, resulting



in a hypokalemia. Almost no ingesta or fluids move beyond the pylorus, and dehydration, alkalosis, electrolyte imbalance and progressive starvation occur. The impaction of the abomasum is usually severe enough to cause permanent abomasal atony.

### CLINICAL FINDINGS

Complete anorexia, scant feces and moderate distension of the abdomen are the usual presenting complaints given by the owner. The onset is usually slow and progressive over a period of several days. Cattle that have been affected for several days have lost considerable weight and are too weak to rise. The body temperature is usually normal but may be subnormal during cold weather, which suggests that the specific dynamic action of the rumen is not sufficient to meet the energy needs of basal metabolism. The heart rate varies from normal to 90–100/min and may increase to 120/min in advanced cases where alkalosis, hypochloremia and dehydration are marked. The respiratory rate is commonly increased and an expiratory grunt due to the abdominal distension may be audible, especially in recumbent cattle. A mucoid nasal discharge usually collects on the external nares and muzzle, which is usually dry and cracking because of the failure of the animal to lick its nostrils and the effects of the dehydration.

The rumen is usually static and full of dry rumen contents, or it may contain an excessive quantity of fluid in those cattle that have been fed finely ground feed. The pH of the ruminal fluid is usually within the normal range (6.5–7.0). The rumen protozoan activity ranges from normal to a marked reduction in numbers and activity as assessed on a low-power field. The impacted abomasum is usually situated in the right lower quadrant of the abdomen on the floor of the abdominal wall. It usually extends caudally beyond the right costal arch but may or may not be easily palpable because of the gravid uterus, but an impacted omasum may also be palpable. It may be impossible, however, to distinguish between an impacted abomasum and an impacted omasum. In feedlot steers and non-pregnant heifers the impacted abomasum and omasum may be easily palpable on rectal examination. Deep palpation and strong percussion of the right flank may elicit a 'grunt' as is common in acute traumatic reticuloperitonitis, and this is probably due to overdistension of the abomasum and stretching of its serosa.

The course of the disease depends on the extent of the impaction when the animal is first examined and the severity of the acid-base and electrolyte imbalances.

Severely affected cattle will die in 3–6 days after the onset of signs. Rupture of the abomasum has occurred in some cases and death from acute diffuse peritonitis and shock occurs precipitously in a few hours. In sand impaction, there is considerable weight loss, chronic diarrhea with sand in the feces, weakness, recumbency and death within a few weeks.

Severe impaction and distension of the rumen and the abomasum can occur in cattle given access to large quantities of finely chopped straw during the cold winter months. There is gross distension of the abdomen, anorexia, scant dry feces, and affected animals will drop large, dry, fibrous cuds. The rumen is grossly distended and usually static.

Cows fed solely on pea haulm are dull and anorexic with grossly distended abdomens and varying degrees of bloat.<sup>4</sup> Cattle with obstruction of the abomasum and duodenum with gravel are anorexic, depressed and weak.<sup>6</sup> The abdomen may be distended and rumen hypomotility or atony is present. The feces are scant. The obstruction cannot usually be felt on rectal examination and a right flank laparotomy is necessary to make the diagnosis. A marked hypochloremic, hypokalemic metabolic alkalosis is characteristic.

### CLINICAL PATHOLOGY

A metabolic alkalosis, hypochloremia, hypokalemia, hemoconcentration and a total and differential leukocyte count within the normal range are common.

### NECROPSY FINDINGS

At necropsy the abomasum is commonly grossly enlarged to up to twice normal size and impacted with dry rumen-like contents. The omasum may be similarly enlarged and impacted with the same contents as in the abomasum. The rumen is usually grossly enlarged and filled with dry ruminal contents or ruminal fluid. The intestinal tract beyond the pylorus is characteristically empty and has a dry appearance. Varying degrees of dehydration and emaciation are also present. If rupture of the abomasum occurs, lesions of acute diffuse peritonitis are present. Abomasal tears, ulcers, and necrosis of the walls of the rumen, omasum or abomasum may occur.<sup>3</sup>

### TREATMENT

#### Salvage or treatment?

The challenge in treatment is to be able to recognize the cases that will respond to treatment and those that will not and should therefore be slaughtered immediately for salvage. Those that have a severely impacted abomasum and are weak with a marked tachycardia (100–120/min) are poor treatment risks

### DIFFERENTIAL DIAGNOSIS

The clinical diagnosis of impacted abomasum depends on the nutritional history, the clinical evidence of impaction of the abomasum and the laboratory results. The disease must be differentiated from abomasal impaction as a complication of vagus indigestion, omasal impaction, diffuse peritonitis and acute intestinal obstruction due to intestinal accidents or enteroliths and lipomas.

- **Impaction of the abomasum as a complication of traumatic reticuloperitonitis** usually occurs in late pregnancy, commonly only in one animal; a mild fever may or may not be present and there may be a grunt on deep palpation of the xiphoid. The rumen is usually enlarged and may be atonic or hypermotile. Depending on the lesion present a neutrophilia may be present, suggestive of a chronic infection. A hypochloremia is common, as in dietary impaction. In many cases it is impossible to distinguish between the two causes of impacted abomasum and a laparotomy may be necessary to explore the abdomen for evidence of peritoneal lesions. Cattle with abomasal impaction as a complication of traumatic reticuloperitonitis are usually a single incident and have usually been ill for several days, whereas those with dietary impaction have usually been ill for only a few days and more than one may be affected<sup>3</sup>
- **Impaction of the omasum** occurs in advanced pregnancy and is characterized by anorexia, scant feces, normal rumen movements, moderate dehydration and an enlarged omasum that may be palpable per rectum or behind the right costal arch. The serum electrolytes may be within normal limits if the abomasum is normal
- **Diffuse peritonitis** is characterized by anorexia, toxemia, dehydration, scant feces and a grunt on deep palpation and percussion. However, in peracute cases the abdominal pain may be absent. Fibrinous adhesions may be palpable on rectal examination, and paracentesis may yield some diagnostic peritoneal exudate, but a negative result cannot rule out peritonitis. The presence of a marked leukopenia and neutropenia or a neutrophilia may assist in the diagnosis, but it is often necessary to perform an exploratory laparotomy to confirm the diagnosis
- **Intestinal obstructions** due to intestinal accidents or enteroliths result in anorexia, scant feces, dehydration and abdominal pain, and the abnormality may be palpable on rectal examination. The rumen is usually static and filled with doughy contents. Fluid and gas accumulations in the intestines anterior to the obstruction may be detectable as fluid-splashing sounds by using simultaneous auscultation and succussion of the abdomen

and should be slaughtered. Rational treatment would appear to consist of correcting the metabolic alkalosis, hypochloremia, hypokalemia and dehydration and attempting to move the impacted material with lubricants and cathartics, or surgically emptying the abomasum. Balanced electrolyte solutions are infused intravenously on a continuous basis for up to 72 hours at a rate of 100–150 mL/kg BW over a 24-hour period. Some cases will respond remarkably well to this fluid therapy and begin ruminating and passing feces in 48 hours. The use of acidifying isotonic solutions of mixtures of ammonium chloride and potassium chloride at a rate of 20 L per 24-hour period for a 450 kg animal as described under the treatment for RDA is also recommended.

**Dioctyl sodium sulfosuccinate** is administered into the rumen by stomach tube at a dose rate of 120–180 mL of a 25% solution for a 450 kg animal repeated daily for 3–5 days. It is **mixed with 10 L of warm water and 10 L of mineral oil**. The amount of mineral oil can be increased to 15 L/d after the third day and for a few days until recovery is apparent. A beneficial response cannot be expected in less than 24 hours and most cattle that do respond will show improvement by the end of the third day after treatment begins. Cholinergics such as neostigmine, physostigmine and carbamylcholine have been used but appear not to alter the outcome.

### Surgery

**Surgical correction consists of an abomasotomy** through a right paramedian approach and removal of the contents of the abomasum. The results are often unsuccessful, probably because of abomasal atony that exists and that appears to worsen following surgery.<sup>7</sup> An alternative approach may be to do a rumenotomy, empty the rumen and infuse dioctyl sodium sulfosuccinate directly into the abomasum through the reticulo-omasal orifice in an attempt to soften and promote the evacuation of the contents of the abomasum. The placement of a nasogastric tube into the omasal groove and into the abomasum through a rumenotomy procedure is described. Mineral oil can then be pumped into the abomasum at the rate of 2 L/day for several days. Recovery should occur within 5–7 days. A rumenotomy and emptying of the rumen is necessary in the case of severe straw impaction of the rumen.

The induction of parturition using 20 mg of dexamethasone intramuscularly may be indicated in affected cattle that are within 2 weeks of term and in which the

response to a few days' treatment has been unsuccessful. Parturition may assist recovery as a result of a reduction in intra-abdominal volume. In sand impaction, affected cattle should be moved off the sandy soil and fed good hay and a grass mixture containing molasses and minerals. Severely affected cattle should be treated with large daily doses of mineral oil – at least 15 L/d.

**Gravel obstruction of the abomasum and duodenum** can be corrected surgically by right flank laparotomy.<sup>6</sup>

### CONTROL

#### Provision of nutrient requirements during cold weather

Prevention of the disease is possible by providing the necessary nutrient requirements for wintering pregnant beef cattle with added allowances for cold windy weather when energy needs for maintenance are increased. When low-quality roughage is to be used for wintering pregnant beef cattle, it should be analyzed for crude protein and digestible energy. Based on the analysis, grain is usually added to the ration to meet the energy and protein requirements.<sup>1</sup> Pregnant beef cows fed a diet of 94% barley straw for 83 days during the cold winter months may consume only 70% of their energy requirements.<sup>1</sup> Such straw-based diets must be supplemented with protein and energy.<sup>1</sup> During prolonged periods of cold weather, wintering pregnant beef cattle should be given additional amounts of feed to meet the increased feed requirement for maintenance, which has been estimated to be 30–40% greater during the colder months than during the warmer months. These increased requirements are due almost equally to the effects of reduced feed digestibility and the increased maintenance requirements.<sup>8</sup>

#### Nutrient requirements for beef cattle

The published nutrient requirements of beef cattle are guidelines for the nutrition of cattle under average conditions and higher nutrient levels than those indicated may be necessary to provide for maintenance requirements, particularly during periods of cold stress.<sup>9</sup> **Adequate amounts of fresh drinking water** should be supplied at all times and the practice of forcing wintering cows to obtain their water requirements from eating snow while on low-quality roughage is extremely hazardous. The question of whether or not low-quality roughages should be chopped or ground for wintering pregnant beef cattle is controversial. The daily voluntary intake of low-quality roughage can be increased by chopping or grinding but neither processing method increases quality or digestibility; in fact digestibility is usually decreased. If

increased consumption during cold weather exceeds physical capacity and the nutrient requirements are still not satisfied, impaction of the abomasum may occur. Thus during the coldest period of the winter low-quality roughages must be supplemented with concentrated sources of energy such as cereal grains.<sup>10</sup>

#### Avoid excessive fiber

Omasal and abomasal impaction due to the provision of excessive poor-quality roughage is preventable by supplementation with appropriate sources of energy and protein.

### REFERENCES

1. Mathison GW et al. *Can J Anim Sci* 1981; 61:375.
2. Hunter R. *J Am Vet Med Assoc* 1975; 166:1179.
3. Ashcroft RA. *Can Vet J* 1983; 24:375.
4. Simkins KM, Nagele MJ. *Vet Rec* 1997; 141:466.
5. Mitchell KJ. *J Am Vet Med Assoc* 1991; 198:1408.
6. Cebra CK et al. *J Am Vet Med Assoc* 1996; 209:1294.
7. Blikslager AT et al. *Compend Contin Educ Pract Vet* 1993; 15:1571.
8. Christopherson RJ. *J Anim Sci* 1976; 56:201.
9. National Research Council. *Nutrient requirements of beef cattle*, 7th ed. Washington, DC: National Academy of Sciences, 1996.
10. Christopherson RJ et al. In: Martin J et al, eds. *Animal production in Canada*. Edmonton, Alberta: University of Alberta, Faculty of Extension, 1993.

### ABOMASAL IMPACTION IN SHEEP

Abomasal dilatation and impaction in sheep as a result of an emptying defect has been reported in Suffolk sheep<sup>1</sup> and in the Dorset breed.<sup>2</sup> Affected sheep are ewes, usually 2–6 years of age and in late gestation or recently lambed. The duration of illness varies from several days to a few months and affected animals may become emaciated. The diets fed to affected animals consisted of grain and good-quality hay. Rams have also been affected. Clinically, they are characterized by progressive weight loss, anorexia, variable degrees of distension of the right lower abdomen, palpable masses in the right lower abdomen, increased concentrations of rumen chloride and a grossly enlarged and impacted abomasum.<sup>1</sup> Hypochloremia, hypokalemia and metabolic alkalosis are common<sup>1</sup> and ruminal chloride levels are increased up to 38.5 mmol/L, suggesting reflux from the abomasum.<sup>2</sup> Treatment has been ineffective and the case fatality rate may exceed 90%. At necropsy, the abomasum is grossly enlarged and commonly contains rumen-like contents, which are dry and doughy. In some cases the abomasum contains an excessive quantity of fluid.

There is a report of abomasal impaction with anorexia causing high mortality in young lambs.<sup>3</sup> Affected lambs developed anorexia, dullness and reluctance to walk. Sudden death occurred in lambs less than



1 month of age, and progressive loss of body condition and dehydration occurred in older lambs. Affected animals did not suck their dams normally. It is suggested that the ewes had insufficient milk for the lambs, which consequently forced them to begin consuming solid feed at an early age. The impaction was associated with the presence of phytobezoars, trichophytobezoars and coagulated, rubber-like milk clots in the abomasum, commonly at the entrance to the pylorus.

Abdominal enlargement due to abomasal dilatation and impaction associated with multiple adenomata of the abomasal mucosa has been recorded in an adult ewe.<sup>4</sup>

#### REFERENCES

1. Smith RM et al. *Vet Rec* 1992; 130:468.
2. Gabb K et al. *Vet Rec* 1992; 131:127.
3. Njau BC et al. *Vet Res Commun* 1988; 12:491.
4. Andrews AH. *Vet Rec* 1994; 134:605.

### ABOMASAL PHYTOBEZOARS AND TRICHOBEZOARS

A velvety form of abomasal phytobezoar occurs in goats and sheep in the arid regions of southern Africa and causes significant economic loss.<sup>1,2</sup> The composition of the bezoars resembles that of pappus hairs and stems of the Karoo bushes. They have a striking velvety appearance. Phytobezoars have been experimentally reproduced in goats and sheep by feeding the mature flowers or seeds and pappus hairs of Karoo bushes.<sup>2</sup>

Rumenoabomasal lesions have been reported to occur in steers 20–24 months of age with a history of inappetence and weight loss, and licking their own and other animals' haircoat.<sup>3</sup> Numerous hairs (0.5–1.5 cm in length) were found implanted in the abomasal mucosa, especially in the region of the torus pyloricus. Areas of hair implantation were frequently accompanied by scattered and severe abomasitis, erosions and ulcers. Thickening of the rugae and plicae of the pylorus was present. In the rumen, rumenitis and hyperkeratosis, characterized by short, reddish edematous ruminal papillae containing small numbers of trapped hairs, were present. The severity of the lesions increased with the number of hairs implanted in the mucosa.

#### REFERENCES

1. Bath GF et al. *J S Afr Vet Assoc* 1992; 63:103.
2. Bath GF et al. *J S Afr Vet Assoc* 1992; 63:108.
3. Tanimoto T. *Vet Pathol* 1994; 31:280.

### ABOMASAL ULCERS OF CATTLE

Abomasal ulceration occurs in mature cattle and calves and may cause acute abomasal hemorrhage with indigestion, melena and sometimes perforation, resulting in a painful acute local perito-

nitic or acute diffuse peritonitis and rapid death, or a chronic indigestion with only minimal abomasal hemorrhage. Some calves have abomasal ulceration at necropsy or slaughter that was subclinical.

#### Synopsis

**Etiology** Cause of primary ulceration unknown. Many ulcers occur secondary to lymphoma, LDA and viral diseases

**Epidemiology** Mature lactating dairy cattle, hand-fed calves, nursing beef calves. Risk factors not understood. Presence of hair balls not a risk factor in calves

**Signs** Melena, pallor due to anemia, abdominal pain, acute local peritonitis due to perforation

**Clinical pathology** Melena, occult blood in feces, anemia

**Lesions** Ulceration of mucosa, blood in abomasum. Acute local peritonitis if perforated

#### Diagnostic confirmation

Abomasotomy

**Differential diagnosis** Duodenal ulceration, acute and chronic traumatic reticuloperitonitis if ulcer perforated, acute diffuse peritonitis if perforated, right-side dilatation of abomasum

**Treatment** Antacids. Blood transfusions. Kaolin and pectin. Surgical excision

**Control** Nothing reliable

#### ETIOLOGY

##### Primary ulceration

While many different causes of primary abomasal ulceration have been suggested the cause is unknown. Possible causes that have been considered but for which there is no reliable evidence of a cause and effect relationship include:

- **Abomasal hyperacidity** in adult cattle – but there is no direct evidence to support the hypothesis
- **Mechanical abrasion** of the pyloric antrum due to the ingestion of coarse roughage, such as straw, or the presence of trichobezoars
- **Bacterial infections** such as *Clostridium perfringens* type A or unidentified fungi
- **Trace mineral deficiencies** such as copper deficiency
- **Concurrent stress** as in cattle with severe inflammatory processes or in severe pain
- **Abomasal hyperacidity** in calves nursing their dams or calves hand-fed milk or milk-replacers has also been proposed as a cause of primary ulceration<sup>1</sup> but there is no direct evidence.

##### Secondary ulceration

Abomasal ulceration secondary to other diseases occurs. Examples include lymphoma of the abomasum and erosions of the abomasal mucosa in viral diseases

such as bovine virus diarrhoea, rinderpest and bovine malignant catarrh.

#### EPIDEMIOLOGY

##### Primary abomasal ulcers

Primary abomasal ulcers occur in lactating dairy cows, mature bulls, hand-fed calves, veal calves and sucking beef calves. The epidemiological circumstances for each of these groups are presented here.

##### Lactating dairy cows

Some observations have found that acute hemorrhagic abomasal ulcers occur in high-producing mature dairy cows in early lactation, while others have found that most acute bleeding ulcers occurred in cows 3–6 months after parturition. The close relationship of the disease to parturition suggests that a combination of the stress of parturition, the onset of lactation and high-level grain feeding is associated with acute ulceration in dairy cows.

However, epidemiological observations of acute hemorrhagic abomasal ulceration in cattle have found no association with the stress of calving. The incidence was highest in dairy cows during the summer months when the animals were grazing on pasture. There was also a direct association between amount of rainfall, amount of fertilizer used, and stocking rate, and the amount of milk produced by affected cows. This suggests that some factor in grass may be a risk factor in the acute disease in mature dairy cattle.

Mature high-producing dairy cows in **early lactation** may develop acute hemorrhagic ulceration of the abomasum following a prolonged illness such as pneumonia or after having been to a cattle show and sale. This suggests that **stress** may be an important contributing cause.

The prevalence of abomasal ulcers in mature cattle varies depending on the population of animals surveyed. Of cattle admitted to a veterinary teaching hospital over a 4-year period, 2.17% had confirmed abomasal ulcers. In surveys at abattoirs the prevalence may reach 6%. The case fatality rate for mature cattle with confirmed abomasal ulcers is about 50%, for those with severe blood loss or diffuse peritonitis the case fatality rate is usually 100%. Type I nonperforating abomasal ulcers were found in 21% of cows examined at the abattoir and there was no clinical evidence of the ulcers before slaughter, but 32% of the animals were anemic and 44% were hyperproteinemic, which could be expected in cattle with chronic blood loss.<sup>2</sup>

##### Mature bulls and feedlot cattle

Acute bleeding ulcers occur occasionally in mature dairy and beef bulls, particularly

following long transportation, prolonged surgical procedures and in painful conditions such as a fractured limb or rupture of the cruciate ligaments of the stifle joint. Abomasal ulcers have also been the cause of sudden death in yearling feedlot cattle. Examination of a random sample of the abomasa of feedlot cattle revealed that erosions were present in up to 33% of the animals, depending on their origin.<sup>3</sup> It is hypothesized that the feeding of high levels of grain in feedlot cattle may be a risk factor associated with abomasal erosions.

#### Hand-fed calves

Ulcers of the abomasum are common in hand-fed calves when they are weaned from milk or milk replacer and begin consuming roughage. The causes of the acute ulceration are unknown but by association it appears that some calves are susceptible when they are changing from a diet of low dry matter content (milk or milk replacer) to one of a higher dry matter content (grass, hay, grain). Most of these ulcers are subclinical and nonhemorrhagic. The incidence of abomasal ulcers in milk-fed veal calves is higher when the animals have access to roughage than when roughage is not provided.<sup>4</sup> The type of roughage may also be a factor: pellets produced from corn silage were associated with more lesions than pellets produced from barley straw or alfalfa hay.<sup>4</sup> Occasionally, milk-fed calves under 2 weeks of age are affected by acute hemorrhagic abomasal ulcers, which may perforate and cause rapid death.

Perforating abomasal ulcers have occurred in calves up to 6 months of age, with the majority between 6 and 12 weeks of age.<sup>5,6</sup> **Left-side displacement of the abomasum** was present in 70% of the cases.

#### Veal calves

Abomasal ulceration is a common finding in veal calves slaughtered at 3–5 months of age. The incidence and severity of lesions are greatest in loose-housed calves with access to straw and fed milk substitute ad libitum. There was no evidence that erosions and ulcers found in the majority of veal calves affected their growth rate or welfare. No relationship was found between the presence of abomasal erosions and ulcers and the behavior of crated veal calves fed milk for 22–24 weeks.

#### Sucking beef calves

Well-nourished sucking beef calves, 2–4 months of age, may be affected by acute hemorrhagic and perforating abomasal ulcers while they are on summer pasture. Abomasal trichobezoars

are commonly present in these calves, but whether the hair balls initiated the ulcers or developed after the ulcers is uncertain.

Abomasal ulcers and abomasal tympany occurs in range beef calves from 3–12 weeks of age in beef herds in the north central region of the USA, along the eastern slopes of the Rocky Mountains and in Alberta.<sup>7</sup>

In a retrospective study of 46 abomasotomies in young beef calves in western Canada, in affected herds the average incidence was 1.0% with a range among herds from 0.2–5.7%.<sup>8</sup> In 80% of surgeries of the abomasum, abomasal ulcers were found, and hairballs were present in the abomasum of 76%, but this does not necessarily mean that hairballs are a causative agent (see below). Calves housed in pens or on stubble fields were nearly three times as likely to receive surgery for abomasal disease than those kept on pasture.

On-farm investigations of western Canadian beef herds that had reported **abomasal ulcers in calves** found that the average number of suspected and confirmed cases of fatal abomasal ulcers were 2.4 and 1.9 per farm, respectively.<sup>9</sup> Most producers reported that the affected calves had died without exhibiting any clinical signs and that the affected calves were average or above average in growth performance. Most (85.6%) of the ulcers occurred in calves under 2 months of age. Most (93.3%) of the fatal ulcers were perforating, the remainder (6.7%) were hemorrhagic ulcers.<sup>10</sup> The peak number of cases occurred in April and May but this seasonal incidence reflects the age structure of the calf population in Canada, where most beef calves are born during the late winter and early spring months. There was no sex predilection and no evidence of breed predisposition. There was no evidence to suggest that *C. perfringens* type A, *Helicobacter pylori* or *Campylobacter* spp. were involved in ulcer formation.<sup>11</sup>

The relationship between the **abomasal hairballs** and perforating abomasal ulcers in unweaned beef calves under 4 months of age has been examined.<sup>12</sup> For many years it was thought that the presence of hairballs in the abomasum abraded the mucosa, initiating an ulcerogenic process, eventually culminating in a perforating ulcer. However, finding hairballs in the abomasum of nursing beef calves with perforating ulcers does not necessarily mean that the hairballs caused the ulcer. Hairballs are present in the abomasum of the same class of calves that die from other diseases unrelated to the abomasum. Calves under 1 month of age dying of an ulcer were almost four times more likely to have an abomasal

hairball than were calves dying of all other diseases. But this relationship did not exist in older calves over 30 days of age, in which about 60% of all calves, regardless of the cause of death, had an abomasal hairball. The prevalence of hairballs in the young and old ulcer calves was 57.7% and 56.7%, respectively; in the old nonulcer calves it was 63.3%. The prevalence of hairballs in the young nonulcer calves was 20.1%.

Two factors may account for the lower prevalence in young nonulcer calves. First, more than half (55%) of the nonulcer calves died in the first few weeks of life, compared with only 12.5% of the ulcer calves. Thus calves in the ulcer group had more time to develop an abomasal hairball. Second, the majority (68%) of the calves died of enteritis and sepsis, making them less likely to engage in normal nursing behavior, which involves muzzling and licking the udder, resulting in the ingestion of hair. Only 57% of calves dying of perforating ulcer had a hairball, indicating that the hairballs are not necessary for an ulcer to develop. This is supported by field observations of pathologists, who report that only 25% of calves with a perforating ulcer had an abomasal hairball.<sup>12</sup> Another argument against the hairball theory is that 89% of perforations occurred in the body of the abomasum, a region that has a poorly developed musculature and is incapable of producing strong peristaltic contractions. It is suggested that the weak frictional forces generated in this region could exert an abrasive action upon the mucosal surfaces. In summary, it is suggested that abomasal hairballs are not necessary for abomasal ulcers to develop in nursing beef calves.<sup>12</sup>

#### *Dietary factors in calves fed milk or milk replacer*

The cause of the high prevalence of abomasal ulceration in nursing beef calves is unknown. A low abomasal luminal pH due to the diet has been proposed as a possible factor. Experimentally, feeding dairy calves (17 days of age) cow's whole milk, resulted in lower abomasal luminal pH compared to the feeding of two different milk replacers (an all milk protein or combined milk and soy protein milk replacer).<sup>1</sup> It has been hypothesized that the sucking of cow's whole milk results in a lower mean abomasal luminal pH and, because fasting or infrequent sucking of milk replacer results in a sustained period of low abomasal luminal pH, this may provide evidence for primary abomasal ulceration in nursing beef calves.<sup>13</sup> This may be related to the occurrence of abomasal ulceration in nursing beef calves after a period of

inclement weather, during which time the frequency of nursing may be decreased.

#### Captive white-tailed deer

Abomasal ulceration has been described in 32 of 200 captive white-tailed deer examined by necropsy over a period of 3.5 years.<sup>14</sup> Ulceration was most common in the abomasal pylorus and at the abomasal-duodenal junction. All deer had intercurrent disease, including bacterial pneumonia, enterocolitis, intussusception, chronic diarrhea, capture myopathy and experimentally induced tuberculosis. The anatomical distribution of abomasal ulcers resembled that seen in veal calves.

#### Secondary abomasal ulcers

Abomasal ulcers occur secondary to left- and right-side abomasal displacements, abomasal impaction or volvulus, lymphomatosis and vagus indigestion, or unrelated to other diseases.

#### PATHOGENESIS

Any injury to the gastric mucosa allows diffusion of hydrogen ions from the lumen into the tissues of the mucosa and also permits diffusion of pepsin into the different layers of the mucosa, resulting in further damage. There may be only one large ulcer but more commonly there is evidence of numerous acute and chronic ulcers.

A classification of abomasal ulcers in cattle is as follows.

#### Type 1: Nonperforating ulcer

There is incomplete penetration of the abomasal wall resulting in a minimal degree of intraluminal hemorrhage, focal abomasal thickening, or local serositis. Nonbleeding chronic ulcers commonly cause a chronic gastritis.

#### Type 2: Ulcer causing severe blood loss

There is penetration of the wall of a major abomasal vessel, usually in the submucosa, resulting in severe intraluminal hemorrhage and anemia. In acute ulceration with erosion of a blood vessel there is acute gastric hemorrhage with reflex spasm of the pylorus and accumulation of fluid in the abomasum, resulting in distension, metabolic alkalosis, hypochloremia, hypokalemia and hemorrhagic anemia. Usually within 24 hours there is release of some of the abomasal contents into the intestine, resulting in melena. The ruminal chloride level may increase in about 40% of cows with bleeding ulcers, which suggests abomasal reflux of acid into the rumen.<sup>15</sup>

Plasma gastrin activity increases significantly in cattle with bleeding abomasal ulcers.<sup>16</sup>

#### Type 3: Perforating ulcer with acute, local peritonitis

There is penetration of the full thickness of the abomasal wall, resulting in leakage

of abomasal contents. Resulting peritonitis is localized to the region of the perforation by adhesion of the involved portion of abomasum to adjacent viscera, omentum or the peritoneal surface. Omental bursitis and empyema may develop, with the accumulation of a large quantity of exudate and necrotic debris in the omental cavity.

Abomasal-pleural fistula associated with cranial displacement of the abomasum and abomasal ulceration has been described in a 11-month-old bull.<sup>17</sup>

#### Type 4: Perforating ulcer with diffuse peritonitis

There is penetration of the full thickness of the abomasal wall, resulting in leakage of abomasal contents. Resulting peritonitis is not localized to the region of the perforation; thus digesta is spread throughout the peritoneal cavity.

In nursing beef calves, about 90% of perforated abomasal ulcers occur in the body of the abomasum, with a propensity for the greater curvature.<sup>12</sup>

In some calves the ulcers are subclinical and the factors that determine how large or how deep an ulcer will become are unknown. Based on abattoir studies it is evident that abomasal ulcers will heal by scar formation.

#### CLINICAL FINDINGS

The clinical syndrome varies depending on whether ulceration is complicated by hemorrhage or perforation. The important clinical findings of hemorrhagic abomasal ulcers in cattle are **abdominal pain, melena** and **pale mucous membranes**. At least one of these clinical findings is present in about 70% of cattle with abomasal ulcers. The case fatality rates for cattle with types 1, 2, 3 or 4 are 25, 100, 50 and 100%, respectively. In the common clinical form of bleeding abomasal ulcers there is a **sudden onset of anorexia, mild abdominal pain, tachycardia (90–100/min), severely depressed milk production and melena**. Acute hemorrhage may be severe enough to cause death in less than 24 hours. More commonly there is subacute blood loss over a period of a few days with the development of hemorrhagic anemia. The feces are usually scant, black and tarry. There are occasional bouts of diarrhea. Melena may be present for 4–6 days, after which time the cow usually begins to recover or lapses into a stage of chronic ulceration without evidence of hemorrhage.

**Melena is almost a pathognomonic sign of an acute bleeding ulcer of the abomasum.** However, the presence of normal-colored feces does not preclude the presence of chronic nonbleeding ulcers, which may be the cause of an intractable indigestion. The use of an

**occult blood test on the feces** will aid in differentiating those that are equivocal. Abomasal ulceration secondary to lymphoma of the abomasum is characterized by chronic diarrhea and melena. The ulcer does not heal.

In some cases the **abomasum is grossly distended** and **fluid-splashing sounds** are audible on succussion similar to those in RDA. Moderate dehydration is common and affected cows commonly sip water continuously and grind their teeth frequently.<sup>15</sup> The prognosis in chronic ulceration is poor because of the presence of several ulcers and the development of chronic abomasal atony. Some cows improve temporarily but relapse several days later and fail to recover permanently. Duodenal ulceration and abdominal abscesses have also been described.<sup>18</sup>

#### Perforation of ulcer

Perforation of an ulcer is usually followed by **acute local peritonitis** unless the abomasum is full and ruptures, when **acute diffuse peritonitis** and shock result in death in a few hours. With the development of local peritonitis, with or without omental adhesions, there is a chronic illness accompanied by a fluctuating fever, anorexia and intermittent diarrhea. This is common in dairy cows in the immediate postpartum period. Pain may be detectable on deep palpation of the abdomen and the distended, fluid-filled abomasum may be palpable behind the right costal arch. Periaomasal abscess formation from a perforated ulcer also occurs and is similar to local peritonitis.

In calves with a perforated abomasal ulcer, abdominal distension and abdominal pain are common.<sup>5</sup>

Perforation of an abomasal ulcer and the development of an abomasal-pleural fistula has been described in an 11-month-old bull.<sup>17</sup> Pleuritis, pericarditis, unilateral pneumothorax and pulmonary abscessation were present.

#### Nursing beef calves

Calves with abomasal ulceration may have a distended gas-filled and fluid-filled abomasum that is palpable behind the right costal arch. Deep palpation may reveal abdominal pain associated with local peritonitis due to a perforated ulcer. Unless an abomasal ulcer has extended to the serosa it is unlikely that it can be detected by deep palpation. Many cases of abomasal ulcers, particularly in calves, cause no apparent illness.

#### CLINICAL PATHOLOGY

##### Melena

The dark brown to black color of the feces is usually sufficient indication of gastric

hemorrhage but tests for occult blood may be necessary. Results from experiments simulating abomasal hemorrhage indicate that the transit time for blood to move from the abomasum to the rectum ranges from 7–19 hours. The available fecal occult blood tests may not detect slow abomasal hemorrhage at any one sampling. This can be overcome by testing several fecal samples over a 2–4-day period and reading multiple smears per specimen. The sensitivity of the occult blood tests increases after the fecal samples have been stored at room temperature for 2 days. The predictive value of the occult blood test may be a more reliable diagnostic indicator of abomasal disease than abdominal pain or the presence of anemia. When perforation has occurred, with acute local peritonitis, there is neutrophilia with a regenerative left shift for a few days, after which time the total leukocyte and differential count may be normal.

### Hemogram

In acute gastric hemorrhage there is acute hemorrhagic anemia.

### Plasma gastrin activity

Plasma gastrin concentration increases significantly in cattle with bleeding abomasal ulcers. The mean plasma gastrin concentration in healthy cattle was 103.2 pg/mL; in cattle with bleeding abomasal ulcers the mean was 1213 pg/mL.<sup>16</sup>

### NECROPSY FINDINGS

Ulceration is most common along the greater curvature of the abomasum. There is a distinct preference for most of the ulcers to occur on the most ventral part of the fundic region with a few on the border between the fundic and pyloric regions. The ulcers are usually deep and well defined but may be filled with blood clot or necrotic material and often contain fungal mycelia, which may be of etiological significance in calves. The ulcers will measure from a few millimeters to 5 cm in diameter and are either round or oval with the longest dimension usually parallel to the long axis of the abomasum. In bleeding ulcers the affected artery is usually visible after the ulcer is cleaned out.

Most cases of perforation in cattle are walled off by omentum, with the formation of a large cavity 12–15 cm in diameter in the peritoneal cavity that contains degenerated blood and necrotic debris. Material from this cavity may infiltrate widely through the omental fat. Adhesions may form between the ulcer and surrounding organs or the abdominal wall (omental bursitis and omental emphysema). Multiple phytozoars are

commonly present in the abomasum of beef calves with abomasal ulcers. The mucosal changes associated with abomasal ulceration in veal calves reveal an increase in the depth of the mucosa with a loss of mucins in the region of erosions and ulcers.

Abomasal ulcers in captive white-tailed deer were characterized by focal to multifocal, sharply demarcated areas of coagulation necrosis and hemorrhage extending through the mucosa, with fibrin thrombi in mucosal blood vessels of small diameter. Visible bacteria were not associated with ulcerative lesions.<sup>14</sup>

### DIFFERENTIAL DIAGNOSIS

- **Acute abomasal ulceration** in mature cattle is characterized by abdominal pain, melena and pallor. The melena may not be evident for 18–24 hours after the onset of hemorrhage. Examination of the right abdomen may reveal a distended abomasum and a grunt on deep palpation over the abomasum, caudal to the xiphoid sternum on the right side. Tachycardia is common
- **Duodenal ulceration** may cause melena and a syndrome indistinguishable from hemorrhagic abomasal ulceration
- **Chronic abomasal ulceration** in mature cattle is difficult to diagnose clinically if the hemorrhage is insufficient to result in melena. The clinical findings of chronic ulceration are similar to several other diseases of the forestomach and abomasum of mature cattle. An illness of several days duration with inappetence, ruminal hypotonicity, scant feces and dehydration are common to many of those diseases. The presence of occult blood in the feces of hemorrhagic anemia suggests ulceration. The hemorrhage may be intermittent and repeated fecal tests for occult blood may be necessary. A positive result for occult blood may also be due to abomasal volvulus, intestinal obstruction or blood-sucking helminths
- **Abomasal ulceration with perforation and local peritonitis** is indistinguishable from acute traumatic reticuloperitonitis unless hemorrhage and melena occur. However, the abdominal pain elicited on deep palpation is most intense over the right lower abdomen and lateral aspect of right lower thoracic wall
- **Abomasal ulceration with perforation in sucking beef calves** is characterized by sudden onset of weakness, collapse, moderate abdominal distension shock and rapid death. It must be differentiated from other causes of diffuse peritonitis and intestinal obstruction
- **Chronic abomasal ulceration in sucking beef calves** associated with hair balls and chronic abomasitis from eating sand and dirt cannot usually be diagnosed as a separate entity

### TREATMENT

The conservative medical approach is usually used for the treatment of abomasal ulcers in cattle.

### Blood transfusions

Blood transfusions and fluid therapy may be necessary for acute hemorrhagic ulceration. The most reliable indication for a blood transfusion is the clinical state of the animal.<sup>15</sup> Weakness, tachycardia and dyspnea are indications for a blood transfusion. A hematocrit below 12% warrants a transfusion. In the case of severe blood loss, a dose of 20 mL/kg BW may be necessary.

### Coagulants

Parenteral coagulants are used but are of doubtful value.

### Antacids

The goal of antacid treatment is to create an environment that is favorable to ulcer healing. This can be done by decreasing acid secretion (oral or parenteral administration of histamine type-2 receptor antagonists [H<sub>2</sub> antagonists] and proton pump inhibitors) or neutralizing secreted acid (oral administration of magnesium hydroxide and aluminum hydroxide).<sup>19</sup> The elevation of the pH of the abomasal contents would abolish the proteolytic activity of pepsin and reduce the damaging effect of the acidity on the mucosa.

### Histamine type-2 receptor antagonists

These compounds increase gastric pH through selective and competitive antagonism of histamine at the H<sub>2</sub>-receptor on the basolateral membrane of parietal cells, thereby reducing acid secretion. H<sub>2</sub>-receptor antagonists are characterized pharmacologically by their ability to inhibit gastric acid secretion and kinetically by their similarity in absorption, distribution and elimination.

Cimetidine and ranitidine are synthetic H<sub>2</sub> antagonists that inhibit basal as well as pentagastrin- and cholinergic-stimulated gastric acid secretion. Both have been used extensively to treat gastric ulcers in many species, including horses, dogs and humans. Oral and parenteral administration of cimetidine and ranitidine increases abomasal pH in sheep and cattle. High doses of cimetidine (20 mg/kg BW intravenously, or 50–100 mg/kg orally) increase abomasal pH in weaned lambs for more than 2 hours. Daily oral administration of cimetidine (10 mg/kg BW for 30 d) to veal calves may facilitate healing of abomasal ulcers. Because ranitidine is three to four times more potent than cimetidine, results of studies in ruminants suggest that oral administration of cimetidine (50–100 mg/kg) and ranitidine

(10–50 mg/kg) should increase abomasal pH in milk-fed calves.

Experimentally, the oral administration of cimetidine (50 or 100 mg/kg every 8 h) and ranitidine (10 or 50 mg/kg every 8 h) to normal calves fed milk-replacer caused a significant dose-dependent increase in mean 24-hour abomasal luminal pH.<sup>19</sup> However, the effects of these agents have not been examined in calves with known abomasal ulcers.

### Alkalinizing agents

Compounds such as magnesium hydroxide and aluminum hydroxide are weak bases that have a direct effect on gastric acidity by neutralizing secreted acids. Aluminum hydroxide directly absorbs pepsin, thereby decreasing the proteolytic activity of pepsin in the stomach. Both compounds bind bile acids, thereby protecting against ulceration induced by bile reflux.

Experimentally, the oral administration of commercially available preparations containing aluminum hydroxide and magnesium hydroxide to calves being fed milk-replacer resulted in a short-term increase in abomasal luminal pH.<sup>20</sup> However, as with the synthetic H<sub>2</sub> antagonists, the efficacy of these weak bases to aid in the treatment of calves with abomasal ulcers has not been determined.

Magnesium oxide (500–800 g/450 kg BW weight daily for 2–4 d) has been successful empirically in some cases of abomasal ulceration in mature cattle. The injection or infusion of the antacid directly into the abomasum would probably be much more effective but injections of the abomasum through the abdominal wall are not completely reliable. An abomasal cannula placed through the abdominal wall may provide a means of ensuring the infusion of antacids directly into the abomasum.

### Kaolin and pectin

Large doses of liquid mixtures of kaolin and pectin (2–3 L twice daily for a mature cow) to coat the ulcer and minimize further ulcerogenesis have been suggested, and used with limited success.

### Surgical excision

Surgical excision of abomasal ulcers has been attempted, with some limited success. The presence of multiple ulcers may require the radical excision of a large portion of the abomasal mucosa and hemorrhage is usually considerable. A laparotomy and exploratory abomasotomy are required to determine the presence and location of the ulcer. The diagnostic criteria for deciding to do surgery have not been described, which makes it difficult to select cases with a favorable prognosis. Valuable animals with clinical evidence of chronic ulceration or those that relapse

should be considered for surgical correction. Surgical correction of perforated abomasal ulcers in calves is possible and may be successful.

### PREVENTION

Recommendations for the prevention of abomasal ulceration in cattle cannot be given because the etiology is so poorly understood.

### REFERENCES

1. Constable PD et al. *J Vet Intern Med* 2005; 19:97.
2. Braun U et al. *J Vet Med A* 1991; 38:357.
3. Jensen R et al. *Am J Vet Res* 1992; 53:110.
4. Wensing T et al. *Vet Res Commun* 1986; 10:1985.
5. Von Rademacher G, Lorch A. *Tierarztl Umsch* 2001; 56:563.
6. Lorch A, von Rademacher G. *Tierarztl Umsch* 2001; 56:572.
7. Mills KW et al. *J Vet Diagn Invest* 1990; 2:208.
8. Katchnik R. *Can Vet J* 1992; 33:459.
9. Jelinski MD et al. *Agri-Practice* 1995; 16:16.
10. Jelinski MD et al. *Prev Vet Med* 1996; 26:9.
11. Jelinski MD et al. *Can Vet J* 1995; 36:379.
12. Jelinski MD et al. *Can Vet J* 1996; 37:23.
13. Ahmed AF et al. *J Dairy Sci* 2002; 85:1502.
14. Palmer MV et al. *J Comp Pathol* 2001; 125:224.
15. Braun U et al. *Vet Rec* 1991; 129:279.
16. Ok M et al. *J Vet Med A* 2001; 48:563.
17. Costa LRR et al. *Can Vet J* 2002; 43:217.
18. Weaver AD. *J Am Vet Med Assoc* 1989; 195:1603.
19. Ahmed AF et al. *Am J Vet Res* 2001; 62:1531.
20. Ahmed AF et al. *J Am Vet Med Assoc* 2002; 220:74.

### ABOMASAL BLOAT (DISTENSION) IN LAMBS AND CALVES

Abomasal bloat or severe distension occurs in lambs and calves fed milk-replacer diets. Feeding systems that allow lambs to drink large quantities of milk replacer at infrequent intervals predispose them to abomasal bloat. This situation can occur under ad libitum feeding when the supply of milk replacer is kept at about 15°C (59°F) or higher, and particularly if it is not available for several hours. Lambs fed warm milk replacer to appetite twice daily appear to be very susceptible to abomasal bloat. Ad libitum feeding of cold milk replacers containing few or no insoluble ingredients, and adequately refrigerated, results in little or no bloating. The pathogenesis of the abomasal tympany is thought to be associated with a sudden overfilling of the abomasum followed by the proliferation of gas-forming organisms, which release an excessive quantity of gas that cannot escape from the abomasum. The severe distension causes compression of the thoracic and abdominal viscera and blood vessels leading to them. This results in asphyxia and acute heart failure. Affected lambs and calves will become grossly distended within 1 hour after feeding and die in a few minutes after the distension of the abdomen is clinically obvious. At necropsy, the abomasum is grossly

distended with gas, fluid and milk replacer, which is usually not clotted. The abomasal mucosa is hyperemic.

Abomasal bloat also occurs in Norway in lambs 15–30 days of age just prior to being turned on to pasture.<sup>1</sup> Housing these lambs on floors with built-up litter when silage is used as a roughage is a predisposing epidemiological factor. It is postulated that affected lambs eat bedding contaminated with feces, which may result in the growth of an abnormal gas-producing microflora in the abomasum.

Abomasal bloat, hemorrhage and ulcers occur in young lambs in Norway.<sup>1</sup> Affected lambs are 3–4 weeks of age. The major clinical findings are tympany and colic. There is severe abdominal pain, such as stretching of the hind legs, lifted tails, repeated attempts to defecate and anorexia. Untreated lambs die within a few hours but some lambs are found dead without having shown any clinical signs. Some lambs are anemic and have melena.

Affected lambs, approximately 1 week before developing abomasal bloat, had significantly lower serum iron levels than unaffected lambs.<sup>2</sup> The administration of iron dextran to lambs during their first week of life reduced the incidence of abomasal bloat, suggesting that iron deficiency may be a predisposing factor.

At necropsy, there is abomasal tympany, abomasal hemorrhage and ulceration.<sup>1</sup> Lambs with ulcers had a higher frequency of trichophytobezoars than the cases without ulcers or the controls. *Sarcinia*-like bacteria were found in sections of and smears from the abomasum in 79% of cases.<sup>3</sup> *Clostridium fallax* and *Clostridium sordelli* were also cultured from some cases, but their causative significance is uncertain.

### REFERENCES

1. Vatn S, Ulvund MJ. *Vet Rec* 2000; 146:35.
2. Vatn S, Torsteinbo WO. *Vet Rec* 2000; 146:462.
3. Vatn S et al. *J Comp Pathol* 1999; 122:193.

### OMENTAL BURSTITIS

Inflammation of the omental bursa occurs rarely, usually in dairy cattle. The causes include perforated abomasal ulcers of the medial wall of the abomasum, penetration of the ventral wall of the blind sac of the rumen, penetration of the reticulum by a foreign body, spread of an umbilical infection to the greater omentum, extension of an abdominal abscess and localized peritonitis, with subsequent spread to the omental bursa secondary to postpartum parametritis. Inflammation of the bursa results in the accumulation of inflammatory exudate in the bursal cavity, which enlarges beyond its normal capacity. There may also be rupture of the

leaves of the greater omentum, resulting in diffuse peritonitis, ileus or functional obstruction of the intestines.

Clinical findings include anorexia of several days' duration, chronic toxemia, dehydration and abdominal distension, particularly of the right lower flank. Fluid-splashing sounds may be audible on auscultation and percussion of the right flank. On rectal examination a large, amorphous, spongy mass may be palpable anterior to the pelvic brim in the right upper quadrant of the abdomen. The peritoneal fluid may reveal evidence of a chronic suppurative inflammation. A neutrophilia and an increase in the serum fibrinogen are common. There may also be a metabolic alkalosis with hypochloremia and hypokalemia.

Treatment consists of surgical drainage and long-term therapy with antimicrobials. At necropsy there is diffuse fibrinous and necrotizing peritonitis and a large accumulation of purulent exudate in the omental bursa.

## Diseases of the intestines of ruminants

### CECAL DILATATION AND VOLVULUS IN CATTLE

Cecal dilatation occurs primarily in dairy cattle in the first few months of lactation. The cecum may be dilated with gas or distended with ingesta, and volvulus may occur. Clinically it is characterized by inappetence, drop in milk production, decreased amount of feces, a ping over the right upper flank and a distended, easily recognizable viscus on rectal palpation. The prognosis is usually good if the diagnosis is made early.

#### ETIOLOGY

The etiology is uncertain. Experimentally, a rise in the concentration of volatile fatty acids in the cecum can result in cecal atony. Dietary carbohydrates not completely fermented in the rumen are fermented in the cecum, resulting in an increase in the concentration of volatile fatty acids, a drop in pH and cecal atony. Butyric acid has the greatest depressant effect on cecal motility while acetic has the least. Inhibition of cecal motility may lead to accumulation of ingesta and gas in the organ and consequently dilatation, displacement and possible volvulus.

The concentrations of absolute and undissociated acetic, propionic, butyric, i-valerianic and n-valerianic acids, and total volatile fatty acids are significantly higher in samples collected from the cecum and proximal loop of the ascending colon of cows with cecal dilatation or dislocation

compared with concentrations in control cows.<sup>1</sup> However, the role of increased concentrations of volatile fatty acids in the etiology and pathogenesis of cecal dilatation or dislocation is uncertain.

#### EPIDEMIOLOGY

Dilatation and volvulus of the cecum occurs in well-fed, high-producing dairy cows 3–5 years of age during the first 12 weeks after parturition.<sup>2</sup> The disease occurs throughout the year but most commonly during the calving season in North America and Europe. There is a record of five cases occurring in lactating dairy cows on one farm within 9 days.<sup>3</sup> The cows were pastured day and night on grass dominated by white clover and received a 22% crude protein concentrate in the milk parlor twice daily in addition to silage. Cecal volvulus has also been described in sheep.<sup>4</sup>

Atony or hypotonicity affecting the cecum and proximal loop of the ascending colon is thought to initiate the disease, leading to dilatation and displacement, including volvulus. The feeding of grain increases the concentration of volatile fatty acids in the cecum, lowering the pH of cecal contents and inhibiting cecal motility.

#### PATHOGENESIS

The pathogenesis of cecal dilatation, displacement and volvulus is thought to be similar to that which occurs in dilatation and displacement of the abomasum. The combination of intestinal gas and decreased cecal motility results in accumulation of fluid and gas in the cecum followed by dilatation and displacement of the cecum into the pelvic inlet. This results in a mild indigestion, or the dilatation may be subclinical and may be detected incidentally when the cow is examined for other purposes. There may be volvulus or torsion of the cecum but the outcome is probably the same.

In cecal volvulus, the apex of the cecum is rotated cranially and the cecal body becomes distended.<sup>2,5</sup> The viscus and the first few segments of the proximal loop of the ascending colon twist about the mesentery, causing incarceration and eventually strangulation obstruction of the affected portions of the intestine. Torsion is a condition in which the cecum is twisted on its longitudinal axis; it may occur cranial to the ileocecolic junction, at the ileocecolic junction, or caudal to the junction. Torsion of the cecum may occur to the left or right and in each case involves the proximal loop of the ascending colon.<sup>6</sup> The net effect is partial or total obstruction of the intestinal tract, accumulation of gas and/or ingesta in the cecum, varying degrees of paralytic ileus, reduced amount of feces and necrosis-of

the cecum because of ischemia. Cecal impaction is characterized by gross distension of the viscus with dry ingesta and in a mature cow the cecum may measure 90 cm in length by 20 cm in diameter.<sup>7</sup> The severity of the disease depends primarily on the degree of twisting of the cecum and its adjacent spiral colon, which results in ischemic necrosis. Rarely, a prolapse of the small intestine through a tear in the mesentery of the small intestine near its root may also pull the cecum cranially by the ileocecal fold and cause an anti-clockwise volvulus as viewed from the right side of the animal.<sup>8</sup>

It has been postulated that hypomotility of the cecum and proximal loop of the ascending colon may be responsible for the delayed recovery from and recurrence of cecal dilatation and displacement that occur following surgical evacuation of the cecum. However, the myoelectric activity of the cecum and proximal loop of the ascending colon in cows after spontaneous dilatation and displacement of the cecum indicates that delayed recovery is not caused by hypomotility.<sup>9</sup> The myoelectrical activity of the cecum is well coordinated with the ileum and the proximal loop of the ascending colon.<sup>10</sup>

#### CLINICAL FINDINGS

In **cecal dilatation without volvulus**, there are varying degrees of anorexia, mild abdominal discomfort, a decline of milk production over a period of a few days and a decreased amount of feces.<sup>2,5</sup> In some cases there are no clinical signs and the dilated cecum is found coincidentally on rectal examination. In simple dilatation, the temperature, heart rate and respirations are usually within normal ranges. A distinct ping is detectable on percussion and simultaneous auscultation in the right paralumbar fossa, extending forward to the 10th intercostal space.<sup>5</sup> Simultaneous ballottement and auscultation of the right flank may elicit fluid-splashing sounds. There may be slight distension of the upper right flank but in some cases the contour of the flank is normal.

In **cecal volvulus**, anorexia, ruminal stasis, reduced amount or complete absence of feces, distension of the right flank, dehydration and tachycardia are evident, depending on the severity of the volvulus and the degree of ischemic necrosis. There may be some evidence of mild abdominal pain characterized by treading of the pelvic limbs and kicking at the abdomen. The ping is centered over the right paralumbar fossa and may extend to the 10th and 12th intercostal spaces. Fluid-splashing sounds are usually audible on ballottement and auscultation of the right flank.

On **rectal examination** the distended cecum can usually be palpated as a long, cylindrical, movable organ measuring up to 20 cm in diameter and 90 cm in length. Palpation and identification of the blind end of the cecum directed towards the pelvic cavity is diagnostic. In **simple dilatation**, with minimal quantities of ingesta, the cecum is enlarged and easily compressible on rectal palpation. In **cecal volvulus**, the viscus is usually distended with ingesta and feels enlarged and tense on rectal palpation. The blind end of the cecum may be displaced cranially and laterally or medially, and the body of the cecum is then felt in the pelvic cavity. Varying degrees of distension of the colon and ileum may occur, depending on the degree of displacement or volvulus present. Rupture of the distended cecum may occur following rectal palpation or transportation of the animal. This is followed by shock and death within a few hours.

#### Ultrasonographic examination of the cecum

The cecum and proximal and spiral ansa of the colon can be visualized ultrasonographically using a 3.5 MHz linear transducer in mature cows.<sup>11</sup> The cecum can be visualized from the middle region of the abdominal wall. It extends caudocranially, varies in diameter from 5.2–18.0 cm and is situated immediately adjacent to the abdominal wall. The lateral wall of the cecum appears as a thick, echogenic, crescent-shaped line. It can be visualized as far cranially as the 12th intercostal space. Although its junction cannot be identified, the proximal ansa of the colon is recognizable on the basis of its anatomical position and its diameter, which is smaller than that of the cecum. The spiral ansa of the colon and the descending colon are situated dorsal to the cecum and can be identified by moving the transducer horizontally along the abdominal wall to the last rib. The spiral ansa of the colon is situated ventral to the descending colon, and its walls appear as thick echogenic lines. In a contracted state, the spiral colon has the appearance of a garland.

The ultrasonographic findings in cows with dilatation, torsion and retroflexion of the cecum have been described and compared with the findings on laparotomy.<sup>12</sup> The wall of the proximal ansa of the colon and of the dilated cecum closest to the abdominal wall is visible in all cows and appears as an echogenic semicircular line immediately adjacent to the peritoneum. The contents of the cecum and of the proximal and spiral ansa of the colon are not always visible because of gas. In some cows, the contents are hypoechogenic to echogenic in appearance. The dilated

cecum can be imaged from the right abdominal wall at the level of the tuber coxae. The cecum can be imaged from the 12th, 11th and 10th intercostal spaces in some cows, and in other cows the cecum and proximal ansa of the colon are situated immediately adjacent to the right abdominal wall by the liver and/or gall bladder. The diameter of the cecum, measured at various sites, varies from 7.0–25.0 cm. Cecal dilatation can be diagnosed on the basis of the results of rectal examination in most cows but in all cows ultrasonographically. Dilatation and caudal displacement of the cecum and dilatation and craniodorsal retroflexion of the cecum can be visualized. In some cows, the direction of the retroflexed cecum cannot be determined.

#### CLINICAL PATHOLOGY

A mild degree of dehydration may be present and a compensated hypochloremia and hypokalemia occur.<sup>13</sup> Hematological values are normal in most affected cattle unless there is necrosis of the cecum accompanied by peritonitis.<sup>13</sup>

#### DIFFERENTIAL DIAGNOSIS

- **Cecal dilatation and volvulus** must be differentiated from right-side dilatation and volvulus of the abomasum. The ping in cecal dilatation and volvulus is usually centered in the paralumbar fossa; in abomasal dilatation and volvulus it is usually centered over the last few ribs and lower in the middle third of the right abdomen. The distended cecum is usually easily palpable rectally in the upper part of the abdomen and is readily identified as the cecum because it is movable. In dilatation and volvulus of the abomasum, the distended viscus is usually palpable in the right lower quadrant of the abdomen much further forward than a dilated cecum and not movable. In many cases, the distended abomasum can barely be touched with the tips of the fingers, while the distended cecum can be palpated easily
- **Intestinal obstruction** of the small intestines or other parts of the large intestine are characterized by subacute abdominal pain, absence of feces, more marked systemic signs such as dehydration and tachycardia, and perhaps the presence of distended loops of intestine on rectal examination

#### TREATMENT

The method of treatment depends on the severity of the case and whether there is uncomplicated dilatation and displacement caudally or if volvulus is present.

#### Medical therapy

Mild cases of uncomplicated gaseous dilatation may be treated conservatively by feeding good-quality hay and recovery

can occur in 2–4 days. The use of parasympathomimetic drugs such as neostigmine given subcutaneously every hour for 2–3 days has been recommended<sup>14</sup> but controlled trials were not done. Xylazine is contraindicated for the abdominal pain associated with cecal dilatation because it reduces myoelectrical activity of the cecum and proximal loop of the ascending colon.<sup>15</sup> Cisapride at 0.08 mg/kg BW shows some promise.<sup>15</sup> Bethanechol at 0.07 mg/kg BW and neostigmine at 0.02 mg/kg BW increased the frequency of cecocolic spike activity, the duration of cecocolic spike activity and the number of cecocolic propagated spike sequences every 10 minutes.<sup>16</sup> Bethanechol is considered superior to neostigmine because it induces more pronounced coordinated and aborally propagated spike activity.<sup>16</sup>

#### Surgical correction

For torsion and volvulus with the accumulation of ingesta and the possibility of necrosis of the cecum, the treatment of choice is surgical correction and the prognosis is usually good.<sup>5,14</sup> The recurrence rate of cecal dilatation and displacement ranges from 11–13% within the first week after surgery, whereas the long-term recurrence rate is about 25%.<sup>9</sup> In severe cases with necrosis of the cecum, partial resection or total typhlectomy may be necessary. Extensive cecal necrosis requires total typhlectomy, which can be successful and lactating dairy cows may thrive and their milk production may be excellent in the current lactation.<sup>17</sup>

#### REFERENCES

1. Abegg R et al. *Am J Vet Res* 1999; 60:1540.
2. Braun U et al. *Vet Rec* 1989; 125:265.
3. Leonard D. *Vet Rec* 1996; 139:576.
4. Modransky PD et al. *J Am Vet Med Assoc* 1989; 194:1726.
5. Fubini SL et al. *J Am Vet Med Assoc* 1986; 189:96.
6. Geishauser T, Pfander C. *Dtsch Tierarztl Wochenschr* 1996; 103:205.
7. Desrochers A, St-Jean G. *Can Vet J* 1995; 36:430.
8. Kemble T et al. *Vet Rec* 1994; 134:521.
9. Stocker S et al. *Am J Vet Res* 1997; 58:961.
10. Meylan M et al. *Am J Vet Res* 2002; 63: 78.
11. Braun U, Amrein E. *Vet Rec* 2001; 149:45.
12. Braun U et al. *Vet Rec* 2002; 150:75.
13. Braun U et al. *Vet Rec* 1989; 125:396.
14. Braun U et al. *Vet Rec* 1989; 125:430.
15. Steiner A et al. *Am J Vet Res* 1995; 56:623.
16. Steiner A et al. *Am J Vet Res* 1995; 56:1081.
17. Green MJ, Husband JA. *Vet Rec* 1996; 139:233.

#### INTESTINAL OBSTRUCTION IN CATTLE

Intestinal obstructions in cattle include volvulus, intussusception and strangulation. The characteristic clinical findings are anorexia, abdominal pain, absence of feces, the passage of dark fecal blood and mucus, dehydration and acid–base imbalance



and death if physical obstructions are untreated.

### Synopsis

**Etiology** Physical obstruction of intestine due to intussusception, volvulus, strangulation, mesenteric torsion, luminal blockages

**Epidemiology** Uncommon, but do occur

**Signs** Abdominal pain (treading of hindlegs, stretching, kicking at abdomen), scant or absence of feces, feces may be bloodstained, rumen stasis, distension of abdomen (later stages), distended loops of intestine, progressive dehydration and toxemia leading to shock and recumbency

**Clinical pathology** Hypochloremic, hypokalemic, metabolic alkalosis, hemoconcentration

**Lesions** Intussusception, volvulus, strangulation, peritonitis

**Diagnostic confirmation** Laparotomy

**Differential diagnosis** Adult cattle: diffuse peritonitis, acute local peritonitis, abomasal ulcers, right-side displacement and volvulus of abomasum, grain overload, duodenal ileus, urethral obstruction in male ruminants. Calves under 2 months of age: abomasal dilatation – dietary in origin, abomasal volvulus, perforated abomasal ulcers, intussusception, torsion of root of mesentery, acute diffuse peritonitis, peracute to acute enteritis

**Treatment** Surgical correction

**Control** Nothing reliable

### ETIOLOGY AND EPIDEMIOLOGY

The commonest causes are the intestinal accidents – volvulus, intussusception and strangulation – in which there is **physical occlusion of the intestinal lumen**. A **functional obstruction** occurs with local or general paralytic ileus – the lumen remains physically patent but there is no passage of ingesta along it.

There are three common groups of causes:

- Physical obstruction of the intestinal lumen along with infarction of the affected section of intestine – **intestinal accidents**
- Physical obstruction of the intestinal lumen – **luminal blockages**
- Functional obstructions with no passage of intestinal contents but with the lumen still patent – **paralytic ileus**.

#### Intestinal accidents

##### Volvulus

Volvulus of the small intestine is rare and sporadic in cattle and occurs more commonly in dairy cattle than beef cattle.<sup>1,2</sup> It is not more common in calves than in adults but there may be a decreased risk in cattle over 7 years of age compared to calves under 2 months of age.<sup>1</sup>

##### Mesenteric torsion

This is most common in calves and young cattle, e.g. coiled colon on its mesentery.

As in cecal torsion, the colon may be dilated before torsion develops. A case has been described in a mature cow, which recovered following surgery.<sup>3</sup>

#### Intussusception

Intussusceptions are rare in cattle and most common in calves under 2 months of age.<sup>4</sup> The high prevalence of diarrhea due to enteritis in calves suggests that enteritis may be a risk factor in this age group.

**Four types of intussusception** are recognized in cattle:<sup>5</sup>

- The **enteric type** involves one segment of the small intestine, usually the distal jejunum or ileum, invaginating into another. The enteric type is most common in adults, with the distal jejunum most commonly affected due to the length and mobility of its mesenteric attachments. The high incidence of **jejunojejunal intussusception** in cattle has been attributed to the length and mobility of the jejunal mesenteric attachments, especially the distal third
- In the **ileocecocolic type**, the ileum invaginates into the cecum or into the proximal colon at the cecocolic junction
- The **cecocolic type** occurs with invagination of the cecal apex into the proximal colon
- In the **colonic type**, invagination of the proximal colon, or sometimes the spiral colon, occurs into a more distal segment.

The latter three do not occur commonly in adult cattle, presumably because the mesenteric fat deposits and the ileo-cecocolic ligament stabilize the intestine. In calves, the incidence of intussusception is more uniformly distributed among the four types, presumably because of the thin, fragile nature of the mesentery, which may be more susceptible to tearing under tension and allowing increased movement of adjacent segments of intestine. A series is recorded in cows with intestinal polyposis: polyps in the mucosa dragged a section of intestine into an invagination in the next section. There is also intussusception of colon into spiral colon; and intussusception of the spiral colon has been described in an adult bull.<sup>6</sup> One recorded intussusception has been associated with a transmural adenocarcinoma in an aged cow.

#### Strangulation

Strangulation may occur through a mesenteric tear or behind a persistent vitelloumbilical band, the ventral ligament of the bladder, through the lateral ligament of a bull's bladder, or via an

adhesion, especially one between the omentum and an abscess of the umbilical artery in a young animal. Rupture of the small intestinal mesentery and strangulation of the intestine has been described in adult postparturient cows.<sup>7</sup> A persistent urachus can also cause intestinal strangulation in mature cattle. Herniation of distal jejunum into a partially everted urinary bladder of a mature cow has been reported.<sup>8</sup> Strangulation of the duodenum by the uterus during late pregnancy in cows has been described.<sup>9</sup> The whole of the uterus had passed through a gap between the mesoduodenum and duodenum and with increasing weight had led to strangulation of the duodenum. The mesoduodenum and both walls of the greater omentum adjacent to its caudal edge were not connected with the duodenum, probably as a result of a congenital inhibitory malformation.

**Gut tie** has been described in male cattle that have recently been castrated using the open method and traction of the spermatic cord.<sup>10</sup> When the spermatic cord is pulled and broken during castration, it may recoil through the inguinal ring and become entangled around small intestine, causing a physical obstruction. It is also possible that traction of the spermatic cord may tear the peritoneal fold of the ductus deferens that attaches the ductus to the abdominal wall, permitting loops of intestine to pass through this hiatus and resulting in incarceration.

#### Compression stenosis

This may arise from a blood clot from an expressed corpus luteum site on an ovary, or traumatic duodenitis caused by migration of a metallic foreign body.

#### Cecal dilatation

This can be followed by cecal volvulus (see Cecal dilatation and volvulus, above).

#### Incarceration of small intestine

Incarceration by remnants of the ductus deferens is recorded.<sup>8</sup>

#### Luminal blockages

##### External pressure

External pressure by fat necrosis of mesenteries and omenta, and also lipomas may occur.

##### Ileal impaction in cows

Ileal impaction in Swiss Braunvieh cows in Switzerland has been described.<sup>11</sup> The cause is uncertain but may be related to seasonal influences and winter feeding with a hay-based ration.

##### Fiber-balls or phytobezoars

These may be common in areas where fibrous feeds, e.g. *Romulea bulbocodium* or tree loppings, form a large part of the diet. The ability of *R. bulbocodium* to survive dry



autumns and dominate the pasture insures that many fiber balls develop in the abomasum in autumn. Obstructions do not occur until the next spring when pasture is lush. The disease is common in late pregnancy or the first 2 weeks of lactation or after a period of activity such as estrus. Bezoars pass at this time from the abomasum into the first part of the duodenum, where they stick fast.

Trichobezoars (hairballs)

In cold climates a more common obstruction is by trichobezoars. Cattle confined outside have long shaggy hair coats and licking themselves and others probably leads to ingestion of the hair. Hairballs causing obstruction of the small intestine of young beef calves has been described.<sup>12</sup>

'Rectal paralysis'

In cows near parturition, an apparent rectal paralysis leading to constipation may occur. The cause is unknown but is considered to be the result of pressure by the fetus or fetuses on pelvic nerves.

Duodenal ileus

**Duodenal ileus** caused by obstruction or compression of the duodenum has been described in mature cows.<sup>13</sup> The lumen may be obstructed by phytobezoars, blood clots, or compression from or adhesion to a liver abscess.

#### Functional obstructions

Peritonitis and hypocalcemia are two common causes of functional obstruction in cattle.

### PATHOGENESIS

#### Physical obstruction

**Physical obstruction of the small intestines of cattle** results in an absence of feces, distension of the intestine cranial to the obstruction with fluid and gas, acute abdominal pain and a hypochloremic, hypokalemic metabolic alkalosis and dehydration. The alkalosis results from small-intestinal and abomasal reflux into the rumen, with chloride and hydrogen ion sequestration in the abomasum. Ileus of the small intestines is one of the most common consequences of obstruction, resulting in distension and hypomotility cranial to the obstruction. The myoelectric activity patterns occurring during small intestinal obstruction are disorganized in the segment oral to the obstruction, characterized by rapidly migrating, prolonged, high-amplitude spikes that sometimes occur in clusters.<sup>14</sup> This probably accounts for the intermittent abdominal pain.

**Ileal impaction** in Swiss Braunvieh cows in Switzerland is characterized clinically by anorexia, sudden drop in milk production and some evidence of colic, including shifting of weight from leg to

leg and occasional kicking at the abdomen. The ventral aspect of abdomen was enlarged and pear-shaped, and a tense abdominal wall was present in some cows. A ping could be elicited over the right abdomen in most cows. The feces in the rectum may be reduced in amount or there may be none. On rectal palpation, dilated loops of both small and large intestine are usually palpable. On laparotomy, the impaction was situated at the ileocecal valve, and the ileum proximal to ileocecal junction was impacted with ingesta for up to 15 cm in length. The color of the serosa of the ileum and distal part of the jejunum was normal.

#### Volvulus and intussusception

**Volvulus of the small intestine** is a rotation of the entire small intestine, with or without the cecum and spiral colon, or of only the distal third of the jejunum and the proximal portion of the ileum about its mesenteric axis. The volvulus results in intestinal distension, vascular compromise, intestinal necrosis and eventually death unless surgically corrected.<sup>1</sup>

**Intussusception** is the invagination of one portion of the intestine into the lumen of an adjacent segment of intestine. Jejunojejunal intussusception is the most common form in cattle, although isolated cases of ileocecal, ileocecolic, cecocolic and colocolic intussusception also occur. In most cases the intussusception is single, but doubles do occur. There are reports of cattle surviving after sloughing of an intussusceptum but these are rare and death usually occurs 5–8 days after the onset of clinical findings if surgical correction is not carried out.

In general, the effects of intestinal accidents in cattle are not as remarkable as in the horse. Neither the abdominal pain nor the cardiovascular collapse is as severe in adult cattle as in horses with similar lesions. The exception is in calves, in which the effects are more marked and more rapid. Distension of the abdomen occurs much more frequently in calves than in adult cattle.<sup>15</sup> Involvement of large segments of intestine as in torsion of the root of the mesentery may result in metabolic acidosis because of the rapid onset of shock. Ischemic necrosis of the intestinal wall results in various degrees of severity of peritonitis and abnormal peritoneal fluid containing erythrocytes, leukocytes and increased serum proteins.

Hemorrhage into the intestinal tract at the level of the obstruction results in the passage of small quantities of dark blood, which may be almost black if the obstruction is high up in the small intestinal tract. Distension of intestines with fluid and gas cranial to the obstruction may cause some mild distension of

the abdomen but primarily if the large intestine is obstructed as in torsion of the coiled colon. The longer duration of the disease and the profound depression that develops suggest that endotoxemia, as in horses, may be the lethal agent, but the course is much slower than in the horse.

The effect of myoelectric activity of the cecum and proximal loop of the ascending colon on motility of this segment of intestine in experimental obstruction of the large intestine in cattle has been examined.<sup>14</sup> Obstruction of the colon results in prestenotic hypermotility (colic motor complex) or prolonged propulsive peristaltic waves directed toward the obstruction site. This may represent an effort of the intestine to overcome the obstruction in order to re-establish the continuity of the passage of ingesta.

Patterns of myoelectric activity in the small and large intestine of cows oral and aboral to an obstruction site have been measured.<sup>16</sup> Myoelectric activity in the ileum immediately oral to the occlusion was characterized by abolition of the migrating myoelectric complex and a constant pattern of strong bursts of long duration. Organized cyclic activity occurred in the large intestine despite complete disruption of the small-intestinal migrating myoelectric complexes, indicating the presence of mechanisms able to initiate and regulate coordinated myoelectric patterns in the large intestine independently of the small intestine.<sup>16</sup>

#### Duodenal ileus

In **duodenal ileus** caused by obstruction of the lumen by phytobezoars or compression of the duodenum by a liver abscess associated with traumatic reticuloperitonitis in mature cows, there is abomasal and duodenal reflux into the rumen resulting in metabolic alkalosis with hypochloremia and increased ruminal chloride.<sup>13</sup> The obstruction caused by phytobezoars and liver abscesses may occur at almost any segment of the duodenum.<sup>13</sup> The ileus results in a marked reduction in gastrointestinal motility and distension of the forestomach and abomasum due to the accumulation of excessive quantities of fluid, which results in dehydration. Abdominal pain is associated with the distension of the duodenum. The ileus results in marked decrease in movement of ingesta and the feces are markedly reduced in quantity. Duodenal obstruction caused by malposition of the gallbladder in a heifer has been described.<sup>17</sup>

#### Functional obstruction

In **functional obstruction**, there is paralytic ileus and an increase in the transit time of ingesta and feces. The feces are scant and do not contain blood.

Sequestration of fluids in the intestines may result in varying degrees of dehydration and a metabolic alkalosis with hypochloremia and hypokalemia.

## CLINICAL FINDINGS

### General findings

There is an initial attack of acute abdominal pain in which the animal kicks at its abdomen, treads uneasily with the hindlegs, depresses the back and may groan or bellow from pain. The pain occurs spasmodically and at short, regular intervals and may occasionally be accompanied by rolling. This stage of acute pain usually passes off within a few (8–12) hours and during this time there is anorexia and little or no feces are passed. The temperature and respiratory rates are relatively unaffected and the heart rate may be normal or elevated, depending on whether or not blood vessels are occluded. If there is infarction of a section of intestine there will be signs of endotoxic shock, including low blood pressure, very rapid heart rate, and muscle weakness and recumbency. These signs are absent in cases where the blood supply of the intestine is not compromised. For example, in cecal torsion the heart rate may be normal. In all cases, as the disease progresses and dehydration becomes serious the heart rate rises and may reach as high as 100/min just before death.

When the acute pain has subsided, the cow remains depressed, does not eat nor ruminate and passes no feces. The circulation, temperature and respirations are usually within normal limits and ruminal activity varies. In most cases there is complete ruminal stasis but, in exceptional cases, movements will continue, though they are usually greatly reduced. The rumen pack feels dry and firm on palpation through the abdominal wall.

### Abdomen

The abdomen is slightly distended in all cases. Where there is distension of loops of intestine, as in ileus due to dietary error, there may be some distension of the right abdomen. Fluid-splashing sounds can be elicited by ballottement and simultaneous auscultation over the right abdomen in most cases and in a minority of cases over the left abdomen. With obstruction of the pylorus the splashing sounds can be elicited only on the right side, just behind the costal arch and approximately halfway down its length. Regurgitation of fluid ingesta through the nose is common.

### Feces

The character of the feces is highly variable. In the early stages they will be

normal but passed frequently and in small amounts. It may be necessary to carry out a rectal examination because the feces may not be passed from the anus. In some cases they will be hard, turd-like lumps, usually covered with mucus. Blood is often present, not as melena but as altered red blood, in the form of a thick red slurry, leaving dried flakes of it around the anus, especially in intussusception. The last fecal material is more mucoid and may consist entirely of a plug of mucus. In some cases of obstruction caused by fiber balls the fecal material is pasty, evil-smelling and yellow-gray in color.

### Rectal examination

When there is intussusception or volvulus of the small intestine, the affected segment is usually felt in the lower right abdomen but the site varies with the nature of the obstruction. It is important to appreciate that not all intestinal obstructions can be palpated on rectal examination. It depends on the location of the affected segment of intestine: those in the anterior part of the abdomen are not palpable, those in the caudal part of the abdomen may be palpable. In addition, the affected segment may or may not be palpable, and the adjacent segments cranial to the obstruction may be palpable as distended segments of intestine.

In intussusception the affected segment may be palpable, usually as an oblong, sausage-shaped mass of firm consistency, but if a long length of intestine is involved a spiral develops and is palpable as such. In volvulus the intestinal loop may be small, soft and mobile. In many cases, it is possible to follow tightly stretched mesenteric bands coursing dorsoventrally in the middle part of the abdomen.<sup>1</sup> Palpation of distended loops of intestine may cause distress, especially in the early stages, and distension of a number of loops may increase intra-abdominal pressure to the point where entry of the hand beyond the pelvis is difficult. Within a few days, the rectum is empty except for tarry mucus and exudate and insertion of the arm usually causes pain and vigorous straining. Distension of loops of intestine is not nearly as obvious as in horses with intestinal obstruction and may not occur unless the colon or cecum is involved.

### Duodenal ileus

**Duodenal ileus** in mature cows is characterized by anorexia, depression, dehydration, abdominal pain (treading, kicking and stretching, frequent lying down and standing up), rumen distension and hypotonicity, moderate bloat in some cases, scant feces and the presence of

fluid-splashing sounds on auscultation and ballottement of the right abdomen.<sup>13</sup> Rectal examination may reveal no abnormal findings or an enlarged L-shaped rumen and distended loops of small intestine. Ultrasonography can be used to visualize the distended duodenum in the 10th to 12th intercostal spaces.<sup>18</sup> If only one loop of intestine is visible, it indicates distension of the duodenum; when several loops of intestine are visible it indicates ileus of the jejunum or ileum. Duodenal obstruction caused by malposition of the gallbladder in cattle can be diagnosed using abdominal ultrasonography and laparotomy.<sup>17</sup>

### Torsion of the coiled colon (mesenteric root torsion)

This can cause death in less than 24 hours. It is characterized by distension of the right abdomen and a number of distended loops of intestine can be palpated. When there is torsion or dilatation of the cecum, there is usually one grossly distended intestinal loop extending horizontally across the abdomen just cranial to the pelvis and caudally or medially to the rumen. It may be possible to palpate the blind end of the cecum, and in cases which have been affected for several days the organ may be so distended with fluid and gas that it can be seen through the right flank, or fluid sounds can be produced by ballottement or simultaneous percussion and auscultation. Rarely, the distended cecum may be located in the left paralumbar fossa between the rumen and the abdominal wall, in a position reminiscent of an LDA. The disease is likely to recur in the same cow in subsequent years, and a case of chronic dilatation that persisted for 10 months is recorded.

### Lipomas and fat necrosis

These abnormalities are usually easily palpable as firm, lobulated masses that can be moved manually. They may encircle the rectum. An obstructing phytobezoar may be palpable on rectal examination in the right anterior abdomen. It is usually 5–15 cm in diameter and so mobile that when touched it may immediately pass out of reach. Affected cattle may remain in this state for 6–8 days but during this time there is a gradual development of a moderate, pendulous, abdominal enlargement, profound toxemia and an increase in heart rate. The animal becomes recumbent and dies at the end of 3–8 days.

## CLINICAL PATHOLOGY

Clinicopathologic findings are generally nonspecific and of limited assistance in making a diagnosis or assessing prognosis preoperatively.

### Serum biochemistry

Hypochloremia, hyponatremia, azotemia, and hyperglycemia are common.<sup>1</sup>

### Hemogram

Hemoconcentration, a mild left shift and an inverted neutrophil-to-lymphocyte ratio are common in cases of intussusception.<sup>4</sup>

### NECROPSY FINDINGS

In small-intestinal volvulus, gross changes are consistent with vascular thrombosis and intestinal necrosis.<sup>1</sup> Serosal, omental and mesenteric hemorrhages of varying degrees of transmural necrosis are common. Intestinal contents include gas, ingesta and various amounts of blood. In both intussusception and volvulus extensive intestinal necrosis and diffuse peritonitis are common.

### TREATMENT

**Slaughter for salvage** may be the most economical option for the disposition of animals which are of commercial value. If the diagnosis of intestinal obstruction requiring surgery can be made early in the course of the disease, the animal will usually pass pre-mortem and post-mortem inspection at a slaughter house. When diffuse peritonitis secondary to vascular thrombosis and intestinal necrosis has developed, the animal should be destroyed and disposed of accordingly.

### Surgical correction

Surgical correction of physical obstructions of the intestine is the only method of treatment for animals in which survival and recovery are desirable. Right side paralumbar fossa celiotomy is the most common approach. The methods for surgical correction are presented in textbooks dealing with large-animal surgery. Survival rates for correction of volvulus of the entire small intestine have been 44%; 86% for volvulus of the distal jejunum and ileum.<sup>1</sup> Survival rates were much higher in dairy cattle (63%) than beef cattle (22%).<sup>1</sup> Survival rates for intussusception in cattle were about 50%.<sup>4</sup> In ileal impaction in cattle, the postoperative outcome following laparotomy and massage of the contents of the impacted ileum into the cecum is excellent.<sup>11</sup>

### Fluid therapy

**Fluid and electrolyte therapy** given intravenously may be necessary pre-operatively and always postoperatively (see Ch. 2). Multiple electrolyte solutions or normal saline are effective even though metabolic alkalosis with hypochloremia and hypokalemia may be present.

### Antimicrobials

Antimicrobials pre- and postoperatively are recommended for the control of peritonitis, which is inevitable.

### DIFFERENTIAL DIAGNOSIS

- **Acute intestinal obstruction in mature cattle** is characterized by sudden onset of anorexia, reticulorumen atony, usually moderate abdominal pain, scant feces, fluid-splashing sounds over the right abdomen, possibly distended loops of intestine on rectal palpation, and a progressively worsening course. It must be differentiated from other diseases of the forestomach and abomasum that result in scant feces, reduced reticulorumen activity, abdominal pain, and distended loops of intestine on rectal examination (see Table 6.2). Those diseases include: vagus indigestion with or without abomasal impaction, diffuse peritonitis, RDA, abomasal ulcers, duodenal ileus (see Table 6.2)
- **Hemorrhagic jejunitis syndrome** of dairy cattle is a sporadic disease characterized by sudden anorexia and loss of milk production, moderate abdominal distension, weakness leading to recumbency, bloody to dark feces (melena), fluid-splashing sounds on ballottement over the right abdomen, tachycardia and distended firm loops of small intestine palpable on rectal examination. The case fatality rate is high. At necropsy there is severe necrohemorrhagic enteritis or jejunitis with intraluminal hemorrhage or blood clots
- **Cecal dilatation and volvulus** is characterized by gastrointestinal atony with inappetence, possibly distension of the right abdomen, a high-pitched ping on auscultation and percussion of the right paralumbar fossa, and the cecum is easily identifiable by rectal examination
- **Renal and ureteric colic** may simulate intestinal obstruction but occur rarely. Acute involvement of individual renal papillae in pyelonephritis in cattle is also thought to cause some of these attacks of colic
- **Urethral obstruction in male ruminants** causes abdominal pain but there are additional signs of grunting, straining, distension of the urinary bladder and tenderness of the urethra. Defecation is not affected
- **Photosensitive dermatitis** in cattle is also accompanied by kicking at the belly but the skin lesions are obvious and there are no other alimentary tract signs
- **Acute intestinal obstruction in calves** under 2 months of age must be differentiated from abomasal dilatation – dietary in origin, abomasal volvulus, perforated abomasal ulcers, intussusception, torsion of the root of mesentery, acute diffuse peritonitis, peracute to acute enteritis and gastrointestinal tympany – dietary in origin. The salient features of each of these diseases is summarized in Table 6.4

### Nonsteroidal anti-inflammatory drugs

NSAIDs have also been used for their anti-inflammatory and antiendotoxic effects.

### REFERENCES

1. Anderson DE et al. J Am Vet Med Assoc 1993; 203:1178.
2. Fubini SL et al. Vet Surg 1996; 15:150.
3. Simkins KM. Vet Rec 1998; 142:48.
4. Constable PD et al. J Am Vet Med Assoc 1997; 210:531.
5. Horne MM. Can Vet J 1991; 32:493.
6. Strand E et al. J Am Vet Med Assoc 1993; 202:971.
7. Garber JL, Madison JB. J Am Vet Med Assoc 1991; 198:864.
8. Peter AT et al. Can Vet J 1989; 30:830.
9. Koller U et al. Vet J 2001; 162:33.
10. Scott PR et al. Vet Rec 1997; 140:559.
11. Nuss K et al. Vet J 2005; 169:In press.
12. Abutarbush SM, Radostits OM. Can Vet J 2004; 45; 324.
13. Braun U et al. Schweiz Arch Tierheilkd 1993; 135:345.
14. Steiner A et al. J Vet Med A 1994; 41:53.
15. Naylor JM, Bailey JV. Can Vet J 1987; 28:657.
16. Meylan M et al. J Vet Intern Med 2003; 17:571.
17. Boerboom D et al. J Am Vet Med Assoc 2003; 223:1475.
18. Braun U et al. Vet Rec 1995; 137:209.

### HEMORRHAGIC BOWEL SYNDROME IN CATTLE (JEJUNAL HEMORRHAGE SYNDROME)

Hemorrhagic bowel syndrome, also known as jejunal hemorrhage syndrome, is a recently recognized disease of cattle characterized clinically by a syndrome similar to obstruction of the small intestine causing abdominal distension, dehydration and shock due to necrohemorrhagic enteritis affecting primarily the small intestine. At necropsy there is segmental necrohemorrhagic enteritis of the small intestine and large intraluminal blood clots. In spite of intensive medical and surgical therapy, the prognosis is unsatisfactory and the case fatality rate is almost 100%.

### ETIOLOGY

The etiology is unknown. *C. perfringens* type A has been isolated from the intestines of naturally occurring cases but its significance is uncertain. Because *C. perfringens* type A can be found in the intestinal tracts of healthy cattle and is able to proliferate quickly after death, the role of the organism in the pathogenesis of hemorrhagic jejunitis is uncertain.

### EPIDEMIOLOGY

The disease occurs sporadically, primarily in mature lactating dairy cows in North America.<sup>1,2</sup> Individual cases have occurred in beef cows.<sup>3</sup> In Germany, the disease occurs in Simmental cattle.<sup>4</sup>

The morbidity is low but the case fatality rate is almost 100%.<sup>3</sup>

Investigations of herds with cases have failed to identify any reliable possible risk factors.<sup>2</sup> Most cases occur in lactating dairy cows in the first 3 months of lactation. In a single dairy herd, 22 cases occurred in a period of 4 years. Affected cows ranged from 2–8 years of age and the time since parturition ranged from 9–319 days.

A mail and conference survey of dairy cattle veterinarians in Minnesota found that the disease occurred with greatest frequency in lactating dairy cows in early lactation under a wide variety of management systems, in varying herd sizes and in both free-stall and tie-stall housing systems.<sup>1</sup> The incidence appeared to be higher in herds of more than 100 cows and in herds using total mixed rations.

As part of the National Animal Health Monitoring System's Dairy 2002, information was collected about hemorrhagic jejunitis in dairy cattle in the USA.<sup>5</sup> The disease was observed in 9.1% of herds within the previous 5 years and in 5.1% of herds during the preceding 12 months. Risk factors found to be associated with the disease during the preceding 12 months were large herd size, administration of bovine somatotrophin and routine use of milk urea nitrogen concentration to determine ration composition. Use of pasture as part of the lactating cow ration during the growing season was associated with decreased odds of the disease in herds with a rolling herd average milk production of 20 000 lb or less, whereas in herds with higher milk production, use of pasture was not associated with the occurrence of the disease. For individual cows with signs consistent with the disease, the third lactation was the median of the parity distribution and the median time between parturition and the onset of clinical signs was 104 days. In summary, management practices implemented to achieve high milk production may increase the risk of developing the disease in dairy cattle. Increased consumption of high-energy diet seems to be the most plausible common pathway of all the risk factors that have been described.<sup>5</sup>

Feeding rations high in soluble carbohydrates has been suggested as a possible risk factor by providing the intestinal environment for *C. perfringens* type A to proliferate and produce enterotoxins, similar to the situation that may cause hemorrhagic enteritis, abomasitis and abomasal ulceration in calves.<sup>6</sup>

#### **PATHOGENESIS**

The primary lesion is an acute localized necrotizing hemorrhagic enteritis of the small intestine leading to the development of an intraluminal blood clot, which causes a physical obstruction of the

intestine, and ischemia and devitalization of the wall of the affected segment of the intestine.<sup>6</sup> The lesion is similar to hemorrhagic enterotoxemia associated with *C. perfringens* in young rapidly growing calves, lambs or piglets.

There is gastrointestinal stasis with accumulation of intestinal gas and fluids proximal to the obstructed intestine, resulting in distended loops of intestine, hypochloremia, hypokalemia, dehydration and varying degrees of anemia. The serum biochemistry changes are those of an obstruction of the upper small intestine and sequestration of abomasal secretions, with resultant hypokalemia and hypochloremia. The hemorrhagic enteritis is progressive, with the ischemia and necrosis extending through the intestinal wall, and within 24–48 hours there is marked fibrinous peritonitis, dehydration, continued electrolyte imbalance, marked toxemia and death.

#### **CLINICAL FINDINGS**

Common historical findings include sudden anorexia and depression, marked reduction in milk production, abdominal distension, weakness progressing to recumbency, bloody to dark-red feces or dry scant feces, dehydration and abdominal pain, including bruxism, vocalization, treading and kicking at the abdomen.<sup>6</sup> Sudden death without prior clinical findings has been reported.<sup>6</sup>

On clinical examination there is depression, dehydration, the body temperature may be normal to slightly elevated, the heart rate is increased to 90–120 beats/min, the mucous membranes are pale and the respiratory rate is increased. The abdomen is usually distended moderately over the right side. The rumen is usually atonic. Fluid-splashing sounds are commonly audible by succussion over the right abdomen. In some cases, a ping can be elicited over the right abdomen.

On rectal examination, the feces are black-red, jelly-like and sticky, and smell like digested blood.<sup>4</sup> On deep palpation of the right abdomen, distended loops of intestine may be palpable, some of which are firm (those loops containing the blood clot) while others may be resilient, representing loops of intestine proximal to the blood clot obstruction that contain excessive fluid and gas and in which the intestine is in a state of ileus.

The course of the disease in most cases is 2–4 days. Even with intensive fluid and electrolyte therapy, affected animals continue to worsen progressively, become weak, recumbent and die, or euthanasia is chosen.

On laparotomy, the abomasum is commonly distended with fluid. Up to

60–100 cm of small intestine may be distended and firm to touch, with a markedly dark red to purplish hemorrhagic serosal surface covered with fibrin tags. The mesenteric band may be too tense to allow exteriorization of the affected intestine. Manipulation of the affected intestine may lead to its rupture because of its thin and fragile intestinal wall due to ischemia and devitalization. The small intestine proximal to the affected segment is usually distended with fluid and gas and compressible; that distal to the affected segment is usually relatively empty.

#### **CLINICAL PATHOLOGY**

##### **Hematology**

The hemogram is variable and not diagnostic. Leukocytosis and mature neutrophilia with increased band neutrophils and increased fibrinogen concentrations are common but neutropenia with a left shift may also occur.<sup>7</sup> The PCV and plasma protein concentrations are variable.

##### **Serum biochemistry**

Metabolic alkalosis with compensatory respiratory acidosis, hypokalemia and hypochloremia are common, which is consistent with abomasal outflow obstruction due to the obstruction caused by the clotted blood or ileus.<sup>7</sup>

##### **NECROPSY FINDINGS**

The abdomen is moderately distended as a result of marked dilatation of the small intestine, which is dark red, hemorrhagic and commonly covered by fibrinous exudate. The affected segment of intestine, especially the jejunum and ileum, may be 1 m or more in length and contains a firm blood clot, adherent to the mucosa, which is necrotic and hemorrhagic over the entire length of the affected portion.

Histologically, there is multifocal submucosal edema and neutrophil infiltration, segmental necrosis, ulceration, and mucosal and transmural hemorrhage (hematoma) of the jejunum. Frequently, the epithelium is completely sloughed and, in the area of attachment of the blood clot, the mucosa is absent.<sup>7</sup> Extensive fibrin and neutrophil infiltration occur on the serosal surface and fibrinous peritonitis is common.

*C. perfringens* type A has been isolated from the intestinal contents of typical cases but its significance is unknown.

##### **TREATMENT**

No specific treatment is available. For valuable animals, intensive fluid and electrolyte therapy is indicated. Because of the possibility of clostridial infection, penicillin is indicated if treatment is attempted. Laparotomy and resection of the affected segment of the intestine and anastomosis is indicated but has been unsuccessful to date.

### DIFFERENTIAL DIAGNOSIS

The disease must be differentiated from other causes of acute physical or functional obstruction of the small intestine causing distended loops of intestine, fluid-splashing sounds on ballottement of the abdomen and dehydration and electrolyte imbalances. These include intussusception, cecal dilatation and volvulus and diffuse peritonitis (causing ileus). In ileal impaction in mature cows, distended loops of intestine are palpable on rectal examination but on laparotomy the abnormalities consist of ileal impaction and distended loops of intestine which are amenable to treatment.

Diseases causing melena and dysentery include bleeding abomasal ulcers, acute salmonellosis and coccidiosis.

Transabdominal ultrasonography (Fig. 6.8) can be used to detect ileus of the small intestine and distension of loops of small intestine with homogeneous echogenic intraluminal material compatible with intraluminal hemorrhage and clot formation.<sup>2</sup>

### CONTROL

No control or prevention strategies have been developed.

### REFERENCES

1. Godden S et al. *Bovine Pract* 2001; 35:97.
2. Dennison AC et al. *J Am Vet Med Assoc* 2002; 221:686.
3. Abutarbush SM et al. *Can Vet J* 2004; 45:48.
4. Von Rademacher G et al. *Tierarztl Umsch* 2002; 57:399.
5. Berghaus RD et al. *J Am Vet Med Assoc* 2005; 226:1700.
6. Kirkpatrick MA et al. *Bovine Pract* 2001; 35:104.
7. Abutarbush SM, Radostits OM. *Can Vet J* 2005; 46:711.

### INTESTINAL OBSTRUCTION IN SHEEP

Intestinal obstructions are not commonly observed in sheep unless a series of them causes a noticeable mortality. Some notable occurrences have been:

- Heavy infestation with nodular worm (*Oesophagostomum columbianum*) leading to high prevalence of intussusception occlusion by adhesion

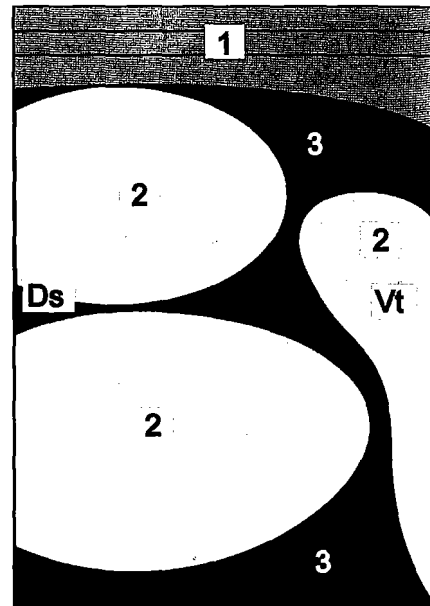

**Fig. 6.8** Ultrasonogram and schematic of the abdomen in a cow with ileus due to obstruction of the jejunum with coagulated blood (hemorrhagic bowel syndrome). The jejunal loops are dilated and there is anechoic fluid (transudate) between the dilated loops. The ultrasonogram was obtained from the right side abdominal wall last rib using a 5.0 MHz-linear scanner. 1 = Lateral abdominal wall; 2 = Dilated jejunal loops; 3 = Anechoic fluid between the jejunal loops. Ds, Dorsal; Vt, Ventral. (Reproduced with kind permission of U. Braun.)

- High incidence of intussusception in traveling sheep for no apparent reason
- Cecal torsion (red-gut) in sheep grazing lush pastures of alfalfa or clover in New Zealand. Affected lambs survive only a few hours and up to 20% of a flock are affected. The outstanding postmortem lesion is a distended, reddened cecum and/or colon that has undergone torsion. The rumen is smaller and the large intestine larger than normal because of the high digestibility of the diet. All ages, except sucking lambs, are affected and the mortality rate may be as high as 20%. Sheep that are seen alive have a distended abdomen, show abdominal pain and have tinkling sounds on auscultation of the right flank.

### TERMINAL ILEITIS OF LAMBS

This disease causes poor growth in lambs 4–6 months old. The circumstances usually suggest parasitism or coccidiosis. The terminal 50–75 cm of the ileum is thickened and resembles the classical lesion of Johne's disease. Chronic inflammation is evident and there are some shallow ulcers in the epithelium. The terminal mesenteric lymph node is enlarged. Histopathological examination of affected ileal wall shows mucosa thickened by epithelial hyperplasia, leukocytic infiltration and connective tissue infiltration. The cause is unknown, and the course of the disease has not been identified because most affected lambs are likely to be culled for ill-thrift.

# Diseases of the liver and pancreas

## DISEASES OF THE LIVER – INTRODUCTION 383

### PRINCIPLES OF HEPATIC DYSFUNCTION 383

Diffuse and focal hepatic disease 383  
Hepatic dysfunction 383  
Portal circulation 383

### MANIFESTATIONS OF LIVER AND BILIARY DISEASE 384

Jaundice 384  
Nervous signs (hepatic  
encephalopathy) 385  
Edema and emaciation 386  
Diarrhea and constipation 386  
Photosensitization 386

Hemorrhagic diathesis 386  
Abdominal pain 386  
Alteration in size of the liver 386  
Displacement of the liver 386  
Rupture of the liver 386  
Black livers of sheep 386

### SPECIAL EXAMINATION OF THE LIVER 387

Palpation and percussion 387  
Biopsy 387  
Medical imaging of the liver 387  
Laboratory tests for hepatic disease and  
function 388

### PRINCIPLES OF TREATMENT IN DISEASES OF THE LIVER 391

### DIFFUSE DISEASES OF THE LIVER 391

Hepatitis 391

### FOCAL DISEASES OF THE LIVER 395

Hepatic abscess 395  
Telangiectasis of the bovine liver  
(‘sawdust liver’) 395  
Tumors of the liver 395  
Diseases of the biliary system 396

### DISEASES OF THE PANCREAS 396

Diabetes mellitus 396  
Pancreatic adenocarcinoma 397  
Pancreatic adenoma 397  
Pancreatitis 397

## Diseases of the liver – introduction

Primary diseases of the liver, with the exception of the fat cow syndrome of cows in early lactation, seldom occur in farm animals except as a result of poisoning. Liver metabolism in late pregnancy and early lactation in dairy cows is under a great deal of stress. The metabolic demands at these times are much increased and require that the liver synthesize more glucose from non-carbohydrate precursors, metabolize butyrate and, because the cow is so often in negative energy balance, mobilize body fat, resulting in an increase in deposition of fat in the liver; a fatty liver and the fat cow syndrome may result (see Ch. 28).

Secondary disease of the liver, arising as part of a generalized disease process or by spread from another organ, occurs more commonly. In primary hepatic disease the clinical manifestations are caused solely by the lesions in the liver while in secondary involvement the syndrome may include clinical signs unrelated to the hepatic lesions. This chapter is devoted to a consideration of primary diseases of the liver and to those aspects of other diseases in which manifestations of hepatic involvement occur.

Diseases of the liver are in general neglected by agricultural animal clinicians and clinical descriptions of them are meager.

## Principles of hepatic dysfunction

### DIFFUSE AND FOCAL HEPATIC DISEASE

The liver has a large reserve of function and approximately three-quarters of its parenchyma must be rendered inactive before clinical signs of hepatic dysfunction appear. Diffuse diseases of the liver are more commonly accompanied by signs of insufficiency than are focal diseases, which produce their effects either by the toxins formed in the lesions or by pressure on other organs, including the biliary system. The origin of a toxemia is often difficult to localize to the liver because of the physical difficulty of examining the organ.

Diffuse diseases of the liver can be classified as hepatitis and hepatosis according to the pathological change that occurs, and the classification also corresponds roughly with the type of causative agent. Clinically the differences between these two diseases are not marked, although some assistance can be obtained from clinicopathological examination.

### HEPATIC DYSFUNCTION

There are no specific modes of hepatic dysfunction. The liver has several important functions and any diffuse disease of the organ interferes with most or all of the functions to the same degree. Variations occur in the acuteness and severity of the damage but the effects are the same and

the clinical manifestations vary in degree only. The major hepatic functions that, when disordered, are responsible for clinical signs include:

- The maintenance of normal blood glucose levels by providing the source as glycogen
- The formation of some of the plasma proteins
- The formation and excretion of bile salts and the excretion of bile pigments
- The formation of prothrombin
- The detoxification and excretion of many toxic substances, including photodynamic agents.

The clinical signs produced by interference with each of these functions are dealt with under manifestations of hepatic dysfunction. A rather special aspect is the role of the liver in the genesis of primary ketosis of cattle.

### PORTAL CIRCULATION

The portal circulation and the liver are mutually interdependent, the liver depending upon the portal vein for its supply of nutrients and the portal flow depending upon the patency of the hepatic sinusoids. The portal flow is unusual in that blood from the gastro-splenic area and the lower part of the large intestine passes to the left half of the liver and the blood from the two intestines to the right half, without mixing of the two streams in the portal vein. The restriction of toxipathic hepatitis to one

half of the liver and the localization of metastatic abscesses and neoplasms in specific lobes results from the failure of portal vein blood from different gut segments to mix. The localization of toxipathic hepatitis may be because of selective distribution of the toxin or of protective metabolites. The passage of blood from the portal circuit through the liver to the caudal vena cava is dependent upon the patency of the hepatic vascular bed, and obstruction results in damming back of blood in the portal system, portal hypertension, interference with digestion and absorption, and in the final stages the development of ascites.

## Manifestations of liver and biliary disease

### JAUNDICE

Jaundice is a clinical sign that often arises in diseases of the liver and biliary system but also in diseases in which there are no lesions of these organs. It does not always occur and may be conspicuously absent in acute hepatitis. Although jaundice is a result of the accumulation of bilirubin, the staining is much more pronounced with conjugated (direct) bilirubin than with unconjugated (indirect) bilirubin. Thus the jaundice is more intense in cases of obstructive and hepatocellular jaundice than in hemolytic jaundice. The levels of bilirubin in blood also affect the intensity of the jaundice, the obstructive form often being associated with levels of bilirubin

that are ten times higher than those commonly seen in hemolytic anemia. The staining of jaundice is due to staining of tissues, especially elastic tissue, and not to accumulation in tissue fluids, so that it is best detected clinically in the sclera, and jaundice that may be detectable easily at necropsy may not be visible on clinical examination. Many classifications have been suggested but the simplest is that proposed by Popper and Schaffner, illustrated in Figure 7.1.

The primary differentiation has to be made between jaundice with and without impairment of bile flow. Some indication of the type of jaundice can be derived from clinical examination. Thus jaundice is usually much more severe when impairment of flow occurs and when bile pigments are absent from the feces. However, obstructive jaundice can occur with only partial occlusion of hepatic flow provided at least half the bile flow is obstructed. In such cases jaundice may occur even though bile pigments are still present in the feces. With lesser obstruction the portion of the liver and biliary tract that is functioning normally excretes the extra load of bile pigments. The only accurate basis for the differentiation between jaundice with impaired bile flow and jaundice without impaired flow is the examination of the urine for the presence of bilirubin and urobilinogen and the determination of the relative amounts of conjugated and unconjugated bilirubin present in the serum. Unconjugated (indirect) bilirubin that has not passed through hepatic cells is not excreted by the kidney, so that in hemolytic jaundice

the indirect bilirubin content of serum is increased markedly and, although the urine contains an increased amount of urobilinogen, no bilirubin is present. In those cases in which jaundice is caused by impairment of bile flow there is a marked increase in the serum level of conjugated (direct) bilirubin, and the bilirubin content of the urine is greatly increased. The amount of urobilinogen varies depending on whether any bilirubin reaches the intestine to be metabolized to urobilinogen and reabsorbed. In complete extrahepatic biliary obstruction urobilinogen is not present in the urine.

### OVERPRODUCTION OR HEMOLYTIC JAUNDICE

Hemolytic jaundice is common in animals and may be associated with bacterial toxins, invasion of erythrocytes by protozoa or viruses, inorganic and organic poisons and immunological reactions. Diseases in which bacterial toxins cause intravascular hemolysis are bacillary hemoglobinuria of cattle and leptospirosis, although the mechanism by which hemolysis is produced in the latter disease does not seem to have been accurately determined. The common protozoan and viral diseases in which hemolysis occurs include babesiosis, anaplasmosis, eperythrozoonosis and equine infectious anemia. Chronic copper poisoning, selenium poisoning in sheep, phenothiazine poisoning in horses, pasturing on rape and other cruciferous plants and bites by some snakes are other common causes. Postparturient hemoglobinuria has an uncertain etiology but is usually attributed to a deficiency of

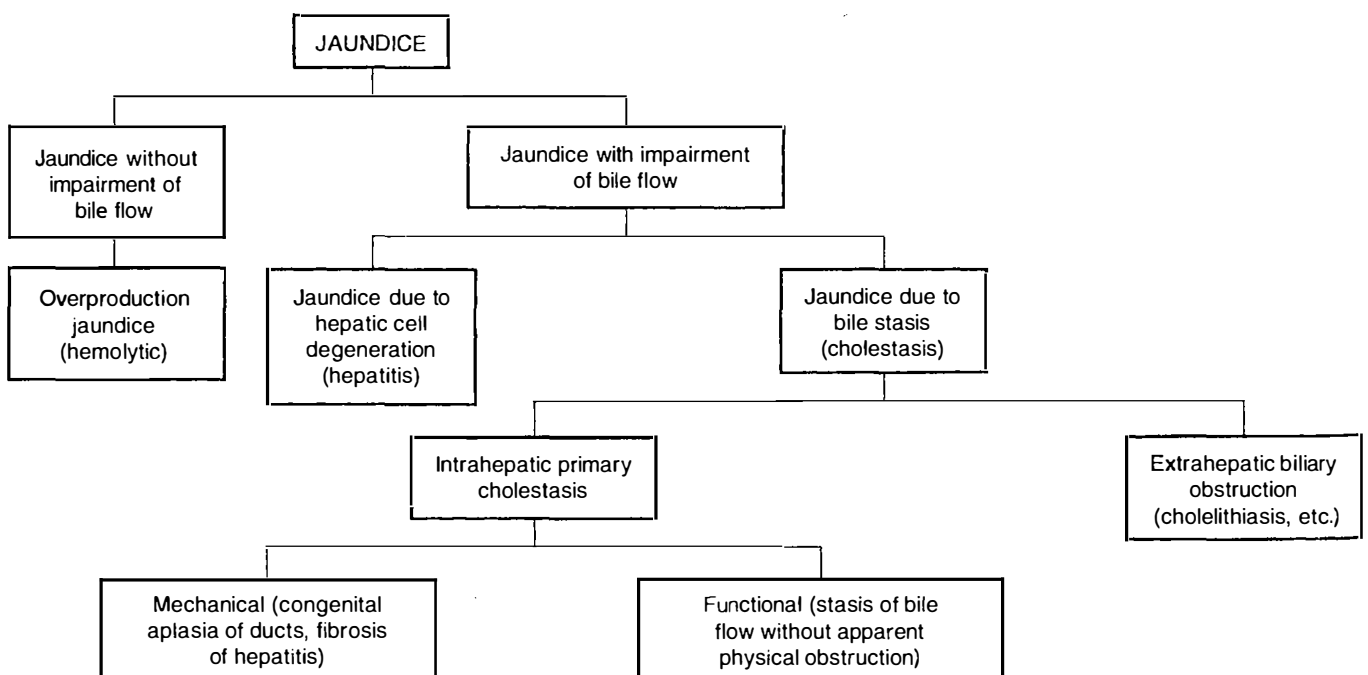

Fig. 7.1 Classification of jaundice.

phosphorus in the diet and the feeding of cruciferous plants. Isoimmunization hemolytic anemia of the newborn is caused by an immunological reaction between the sensitized cells of the newborn and antibodies in the colostrum of the dam. The occurrence of acute hemolytic anemia and jaundice in calves that drink large quantities of cold water may also be of the nature of an immunological response.

Neonatal jaundice is relatively common in babies and is regarded as a benign condition. It is rarely, if ever, observed clinically in newborn animals but may be noticeable at necropsy. Although it is generally stated that the jaundice is hemolytic and results from the destruction of excess erythrocytes when postnatal life begins, it appears more probable that it is due to retention of bile pigments because of the immaturity of the hepatic excretion mechanism. It does occur in foals and is an important differential diagnosis from isoerythrolysis.

**Hemolytic jaundice** is characterized clinically by a moderate degree of yellowing of the mucosae, and by the presence of hemoglobinuria in severe cases. Clinicopathological findings indicate the presence of anemia, an increase in urobilinogen and an absence of bilirubin in the urine, and a preponderance of indirect bilirubin in the serum.

#### JAUNDICE DUE TO HEPATIC CELL DEGENERATION

The cause may be any of those diffuse diseases of the liver that cause degeneration of hepatic cells, which are listed under hepatitis. Because there is only partial obstruction of biliary excretion, the changes in serum and urine lie between those of hemolytic jaundice and extrahepatic biliary obstruction. Serum levels of total bilirubin are increased because of retention of direct bilirubin, which also passes out in the urine, causing an elevation of urine levels. The urobilinogen levels in the urine also rise.

#### EXTRAHEPATIC BILIARY OBSTRUCTION

Obstruction of the bile ducts or common bile duct by biliary calculi or compression by tumor masses is a rare occurrence in farm animals. Commonly listed causes are obstruction of the common duct by nematodes and inflammation of the bile ducts by extension from an enteritis or by infestation with trematodes.

A significant number of pigs die with biliary obstruction and purulent cholangitis secondary to invasion of the ducts by *Ascaris lumbricoides*. Parasitic cholangitis and cholecystitis also occur due to fascioliasis and infestation with *Dicrocoelium dentriticum*. In horses an ascending cholangitis may develop from a parasitic

duodenal catarrh and cause signs of biliary obstruction.

Obstruction is usually complete and results in the disappearance of bile pigments from the feces. Serum levels of conjugated bilirubin rise, causing a marked elevation of total bilirubin in the serum. Excretion of the conjugated bilirubin in urine occurs on a large scale but there is no urobilinogen because of the failure of excretion into the alimentary tract. Partial obstruction of the common bile duct or occlusion of a number of major bile ducts may cause variations in serum and urine similar to those observed in complete obstruction, except that the feces do contain bile pigments and urobilinogen appears in the urine. In this circumstance it is difficult to differentiate between partial extrahepatic biliary obstruction and jaundice caused by hepatic cell degeneration (see above).

#### JAUNDICE DUE TO INTRAHEPATIC PRIMARY CHOLESTASIS

The mechanical stasis of biliary flow caused by fibrous tissue constriction and obliteration of the small biliary canaliculi may occur after hepatitis and in many forms of fibrosis. Cholelithiasis, the formation of biliary calculi, is frequently reported as a cause of cholestasis in humans and has been reported in horses<sup>1</sup> and cattle.<sup>2</sup> Functional stasis is a major problem in hepatic disease in humans but has not been defined in animals. In both instances the defect is the same as in extrahepatic biliary obstruction and the two diseases cannot be differentiated by laboratory tests.

#### NERVOUS SIGNS (HEPATIC ENCEPHALOPATHY)

Nervous signs include:

- **Hyperexcitability**
- **Convulsions**
- **Muscle tremor and weakness**
- **Dullness**
- **Yawning**
- **Compulsive walking**
- **Head-pressing**
- **Failure to respond to signals**
- **Mania** in some cases.

These are common with any severe hepatocellular insufficiency or major circulatory bypass of the liver. Terminally, **hepatic coma** may occur. The biochemical and anatomical basis for these signs is not well understood. Many factors, including hypoglycemia and failure of normal hepatic detoxification mechanisms, leading to the accumulation of excess amino acids and ammonia, or of acetylcholine, and the liberation of toxic breakdown products of liver parenchyma, have all been suggested as causes and -it is

probable that more than one factor is involved.

One of the primary effects of severe, acute liver damage is a precipitate fall in blood glucose accompanied by nervous signs, including **hyperexcitability, convulsions** and **terminal coma**. If the hepatic damage occurs more slowly the **hypoglycemia is less marked and less precipitous** and is accompanied by: **inability to perform work, drowsiness, yawning** and **lethargy**. With persistent hypoglycemia, structural changes may occur in the brain (hypoglycemic encephalopathy) and these may be the basis for the chronically drowsy animals or dummies.

However, hypoglycemia does not always occur in acute hepatitis and cannot be considered to be the only or even the most important factor in producing the cerebral signs.

**High blood levels of ammonia** occur in pyrrolizidine poisoning in sheep, and are reflected in the development of spongy degeneration in the brain and the clinical signs of hepatic encephalopathy.

**Status spongiosa** has also been reproduced experimentally in sheep and calves by the intravenous infusion of ammonia. This role of ammonia as a cerebrototoxicant can be important in hepatopathies in which the detoxicating function of the liver is lost, and also in congenital defects of hepatic vasculature in which blood is bypassed around the liver. In the latter case ammonia and similar toxic byproducts of protein degradation in the large intestine avoid the detoxication filter of the liver. Blood ammonia levels are increased and sulfobromophthalein sodium (BSP) dye clearance is delayed.

The most common cause of hyperammonemia and encephalopathy in the horse is a depression of hepatic function due to acute or chronic liver disease. The severity of encephalopathy clinically correlates well with the degree of hepatic functional compromise but only poorly with the degree of hyperammonemia. Other factors, such as hypokalemia, alkalosis, short-chain volatile fatty acids, and false and true neurotransmitters, may be important in the pathogenesis of hepatic coma in cattle and horses.<sup>3,4</sup>

Neurological disease was reported in a 13-year-old horse with hyperammonemia and no gross or histological evidence of disease.<sup>5</sup> The ammonia level was 475  $\mu\text{mol/L}$  (normal 7–60  $\mu\text{mol/L}$ ). Neurological signs included apparent blindness, ataxia, falling, dysphagia, bruxism, circling, head pressing, muscle fasciculations, yawning and depression.

Plasma ammonia levels are also significantly elevated in cattle with



hepatic disease. Clinical signs of hepatic encephalopathy such as blindness, head pressing, excitability, ataxia and weakness, together with fever and jaundice, are grave prognostic signs.<sup>4</sup>

An intrahepatic porto-systemic shunt causing hepatoencephalopathy has been reported in a 3-month-old goat.<sup>6</sup>

### **EDEMA AND EMACIATION**

Failure of the liver to anabolize amino acids and protein during hepatic insufficiency is manifested by tissue wasting and a fall in plasma protein. This may be sufficiently severe to cause edema because of the lowered osmotic pressure of the plasma. Hepatic edema is not usually very marked and is manifested most commonly in the intermandibular space (bottle jaw). If there is obstruction to the portal circulation, as may occur in hepatic fibrosis, the edema is much more severe but is largely limited to the abdominal cavity.

### **DIARRHEA AND CONSTIPATION**

In hepatitis, hepatic fibrosis and obstruction or stasis of the biliary system, the partial or complete absence of bile salts from the alimentary tract deprives it of the laxative and mildly disinfectant qualities of these salts. This, together with the reflex effects from the distended liver in acute hepatitis, produces an alimentary tract syndrome comprising anorexia, vomiting in some species and constipation punctuated by attacks of diarrhea. The feces are pale in color and, if there is an appreciable amount of fat in the diet, there is steatorrhea.

### **PHOTOSENSITIZATION**

Most photosensitizing substances, including phyloerythrin, the normal breakdown product of chlorophyll in the alimentary tract, are excreted in the bile. In hepatic or biliary insufficiency excretion of these substances is retarded and photosensitization occurs.

### **HEMORRHAGIC DIATHESIS**

In severe diffuse diseases of the liver there is a deficiency in prothrombin formation and a consequent prolongation of the clotting time of the blood. Abnormality of the prothrombin complex is not the only defect, deficiencies of fibrinogen and thromboplast also occurring. Prothrombin and other factors in the prothrombin complex depend upon the presence of vitamin K for their formation and an absence of bile salts from the intestine retards the absorption of this fat-soluble vitamin. Parenteral administration of vitamin K is advisable before surgery is

undertaken in patients with severe hepatic dysfunction.

### **ABDOMINAL PAIN**

Two mechanisms cause the pain in diseases of the liver: distension of the organ with increased tension of the capsule, and lesions of the capsule. Acute swelling of the liver occurs as a result of engorgement with blood in congestive heart failure and in acute inflammation. Inflammatory and neoplastic lesions of the capsule, or of the liver parenchyma just beneath the capsule, cause local irritation to its pain end organs. The pain is usually subacute, causing abnormal posture, particularly arching the back, and disinclination to move. Tenseness of the abdominal wall and pain on deep palpation over the liver area may also be detected in the majority of cases.

### **ALTERATION IN SIZE OF THE LIVER**

Great variation in the size of the liver is often seen at necropsy but clinical detection is not easy unless the liver is grossly enlarged. This is most likely to occur in advanced congestion of the liver due to congestive heart failure, in some plant poisonings in horses and when multiple abscesses or neoplastic metastases occur. In acute hepatitis the swelling is not sufficiently large to be detected clinically and in terminal fibrosis the liver is much smaller than normal.

Atrophy of the right lobe of the liver occurs in the horse and may be related to chronic distension of adjacent segments of the intestinal tract.<sup>7</sup> The normal equine liver is anatomically bisected into two approximately equal halves by the umbilical interlobar fissure; and additional interlobular fissures divide the liver into four distinct lobes in the foal: right, left, quadrate and caudate. In horses with right lobe atrophy, the capsule of the right lobe is wrinkled and thick when atrophy is severe. In clinically normal horses, the right lobe constitutes half of the total liver weight while the right lobe in horses with atrophy ranges from 11.0–38.8% of the total liver weight.<sup>7</sup> This is thought to be due to long-term, insidious compression of this portion of the liver by abnormal distension of the right dorsal colon and base of the cecum.

### **DISPLACEMENT OF THE LIVER**

The liver may be displaced from its normal position and protrude into the thoracic cavity through a diaphragmatic hernia, causing respiratory distress and abnormal findings on percussion of the chest. Torsion of a lobe of the liver has

been recorded in aged sows in the early part of lactation.<sup>8</sup> Inappetence, uneasiness and unwillingness to suckle the young were followed by severe, prolonged vomiting, acute abdominal pain and dyspnea. The twisted lobe was greatly increased in size and in one case the capsule was ruptured, leading to severe internal hemorrhage.

### **RUPTURE OF THE LIVER**

Rupture of the liver is an occasional accident in animals, occurring usually as a result of trauma. In most instances rupture results in death from hemorrhage, although small breaks in the capsule may heal. Horses used for the production of serum frequently develop hepatic amyloidosis, presumably as a reaction to repeated injection of foreign protein, and the death rate from rupture of the liver is relatively high in this group.<sup>9</sup> Amyloidosis is essentially a space-occupying lesion, which results in a liver with a friable texture. The amyloid masses exert pressure on liver cell cords and sinusoids, gradually causing pressure atrophy, ischemic degeneration and necrosis of hepatic parenchyma.

A high prevalence of liver rupture is recorded in newborn lambs of the North Country Cheviot breed. Losses resulting from the condition were 12.5% of all neonatal deaths in purebred lambs, and varied from 6.4–24.7% on individual farms. The lambs are stillborn, or are born alive but become anemic and weak and die within 12 hours of birth from internal hemorrhage. It is thought that the cause of the fatal anemia is an inherited short sternum, which exposes the liver to compression and rupture of its capsule. Vitamin E deficiency in the ewes and lambs may also be a factor.<sup>10</sup>

### **BLACK LIVERS OF SHEEP**

Dark brown to black pigmentation of the liver and kidneys occurs commonly in sheep in certain parts of Australia. No illness is associated with the condition but the livers are not used for human consumption for esthetic reasons and extensive financial loss may result. Commonly referred to as 'melanosis', the pigmentation has been determined to be the result of deposition of the pigment lipofuscin at various stages of oxidation. Areas in which the disease occurs carry many mulga trees (*Acacia aneura*), the leaves of which are fed to sheep in drought times.

The above condition should not be confused with the black livers found in a mutant strain of Corriedales in California. In these mutant sheep there is photosensitization following retention of

phylloerythrin. The darkening of the liver is due to melanin.

## Special examination of the liver

When disease of the liver is suspected after a general clinical examination, special techniques of palpation, biopsy and biochemical tests of function can be used to determine further the status of the liver.

### PALPATION AND PERCUSSION

In cattle, the liver is well concealed by the rib cage on the right-hand side and its edge cannot be palpated. A general impression of the size of the liver can be obtained by percussion of the area of liver dullness but accurate definition is not usually attempted. Deep percussion or palpation to detect the presence of hepatic pain can be carried out over the area of liver dullness in the posterior thoracic region on the right-hand side. Percussion over the entire area is necessary, as the pain of a discrete lesion may be quite localized.

If the liver is grossly enlarged in cattle, its edge can be felt on deep palpation behind the costal arch and the edge is usually rounded and thickened compared to the more defined edge of the normal liver. In cattle, the liver may be enlarged and palpable in advanced right-sided congestive heart failure, multiple liver abscesses and diffuse hepatitis. This type of palpation is relatively easy in ruminants but is unrewarding in horses and pigs because of the thickness of the abdominal wall and the shortness of the flank.

### BIOPSY

Biopsy of the liver has been used extensively as a diagnostic procedure in infectious equine anemia, poisoning by *Crotalaria* spp. and other species of plants, and experimental work on copper and vitamin A deficiency. The technique requires some skill and anatomical knowledge.

The most satisfactory instrument is a long, small-caliber trocar and cannula to which is screwed a syringe capable of producing good negative pressure. The sharp point of the instrument is introduced in an intercostal space on the right-hand side (the number depending on the species) and advanced across the pleural cavity so that it will reach the diaphragm and diaphragmatic surface of the liver at an approximately vertical position. The point of insertion is made high up in the intercostal space so that the liver is punctured at the thickest part of its edge.

For example, in cattle the biopsy is made in the 11th intercostal space at a point on an imaginary line between the right elbow and tuber coxa. The instrument is rotated until the edge of the cannula approximates the liver capsule; the trocar is then withdrawn, the syringe is attached and strong suction is applied; the cannula is twisted vigorously and advanced until it reaches the visceral surface of the liver. If its edge is sufficiently sharp the cannula will now contain a core of liver parenchyma and if the instrument is withdrawn with the suction still applied a sample sufficient for histological examination and microassay of vitamin A, glycogen or other nutrient is obtained.

Details of the technique for cattle,<sup>11,12</sup> sheep<sup>13</sup> and horses<sup>14</sup> are available. A disposable biopsy needle suitable for use in animals is available and a needle has also been designed that includes a device that ensures that the core of tissue in the cannula is in fact detached from the parenchyma of the organ.<sup>14</sup>

A system to score liver biopsies as a prognostic aid in horses with suspected liver disease is highly reliable.<sup>15</sup> Horses with scores of 0 or 1 were equally likely to survive up to 6 months with a combined mortality of 4%. Horses with biopsy scores between 2 and 6 had a combined mortality of 33% and were at a 12-fold increased risk of nonsurvival within 6 months compared to horses with a biopsy score of 0. Horses with biopsy scores between 7 and 14 had a combined mortality of 86% and were at a 46-fold increased risk of nonsurvival compared to horses with a biopsy score of 0. The evidence indicates that liver biopsy is the one antemortem test of greatest value in the absence of noninvasive tests that are able to reliably distinguish horses with significant liver disease from those without. Examination of liver biopsies may establish the presence of liver disease, provide a specific diagnosis, guide therapeutic choice and also help determine prognosis in cases of suspected liver disease.

Multiple liver biopsies can be done safely in neonatal calves from 4–28 days of age.<sup>16</sup>

The major deficiency of the method lies in the small sample that is obtained, and unless the liver change is diffuse the sample may not be representative. The procedure has been repeated many times on one animal without injury. The principal danger is that if the direction of the instrument is at fault it may approach the hilus and damage the large blood vessels or bile ducts. If the liver is shrunken or the approach too caudal no sample is obtained. Fatal hemorrhagic peritonitis may result if a hemorrhagic

tendency is present and peritonitis may occur if the liver lesion is an abscess containing viable bacteria. Biliary peritonitis results if a large bile duct is perforated. It seems possible that the technique could precipitate a fatal attack of 'black disease', but many thousands of biopsies are performed without such an incident.

Compared to the human patient, who can voluntarily restrain respiratory movements, the animal patient will traumatize its diaphragm and liver if the needle is not withdrawn quickly.

### MEDICAL IMAGING OF THE LIVER

#### ULTRASONOGRAPHY

Ultrasonography of the liver is now being used as an aid to diagnosis of diseases of the liver of large animals. A complete ultrasonographic assessment of the liver can provide detailed information about the size, position and parenchymal pattern of the liver. Ultrasonographic examinations of the liver of normal cattle<sup>17</sup> and sheep<sup>18</sup> have now been described and represent the basis for use of the technique in diagnosis of liver disease. In cattle, the liver, caudal vena cava, portal vein and gallbladder can be visualized.<sup>17</sup> Ultrasonography is the only practical method for the diagnosis of thrombosis of the caudal vena cava.<sup>19</sup>

#### Ultrasonographic technique

Examination of the liver of cattle is done with a 3.5 MHz linear transducer on the right side of the abdomen while the cows are standing. The hair is clipped and the skin shaved between the sixth intercostal space and a hand's breadth behind the last rib. After application of transmission gel to the transducer the cows are examined, beginning caudal to the last rib and ending at the sixth intercostal space. Each intercostal space is examined dorsally to ventrally, with the transducer held parallel to the ribs. The texture and the visceral and diaphragmatic surface of the liver are scanned, and the hepatic and portal veins, caudal vena cava and biliary system are examined.<sup>20</sup> Breed and age of cow does not influence the ultrasonographic appearance of the liver, particularly position, size, and vasculature of the liver and gallbladder.<sup>21</sup> During pregnancy, the diameter of the caudal vena cava increases slightly and that of the portal vein decreases. Ultrasonography has been used to detect thrombosis of the caudal vena cava in a cow with ascites<sup>22</sup> and cholelithiasis in horses.<sup>23</sup>

**Percutaneous ultrasound-guided cholecystocentesis** in cows is an excellent method of obtaining samples of bile for demonstration of *Fasciola hepatica* and *Dicrocoelium dendriticum* eggs and for

determination of bile acids. The procedure is done on the right side in the ninth, 10th or 11th intercostal space.<sup>24</sup>

**Percutaneous ultrasound-guided portocentesis** in cows is an excellent method for measuring the composition of hepatic portal blood and comparing it with peripheral blood.<sup>25</sup>

**Ultrasonography and digital analysis** can be used for the diagnosis of hydropic degeneration of the liver of cows instead of biochemical analysis.<sup>8</sup> Diffuse hepatocellular disease such as fatty liver in dairy cows can also be detected and evaluated.<sup>26</sup> Ultrasonography has been used to evaluate the liver-kidney contrast in the diagnosis of fatty liver infiltration in dairy cattle.<sup>27</sup>

#### Cholestasis

Cholestasis in cows can be diagnosed using ultrasonography (Fig. 7.2) to visualize dilatation of the extrahepatic and intrahepatic bile ducts, and dilatation of the gallbladder.<sup>28</sup> The presence of jaundice and bilirubinuria combined with the ultrasonographic findings supports the diagnosis of jaundice due to obstruction.<sup>29</sup>

#### Hepatic abscesses

Hepatic abscesses in cows and feedlot cattle can be visualized using ultrasonography.<sup>20,30</sup> The abscesses may vary in location from the caudodorsal aspect of

the liver in the 11th and 12th intercostal spaces to the cranioventral aspect of the liver in the sixth, seventh and eighth intercostal spaces.<sup>20</sup> Those on the left side of the liver cannot be detected. The medical imaging of the abscesses was more diagnostic than laboratory evaluation of liver tests, which was not useful.<sup>30</sup> The diameter of the abscesses in cows may vary in size from 5–15 cm and the presence of the abscesses can be confirmed by centesis and aspiration of the contents.

#### RADIOGRAPHY

Lateral abdominal radiography can be used to determine the size and location of the liver in foals.<sup>27</sup> Fluoroscopy and contrast media injected into the mesenteric vein have been used to detect the presence of portosystemic shunts in foals and calves.<sup>26,27</sup>

#### LABORATORY TESTS FOR HEPATIC DISEASE AND FUNCTION

Hepatic disease is difficult to diagnose based on clinical findings alone and the use of laboratory tests is necessary. The results and interpretation of such tests, however, depend on the nature of the lesion, the duration and severity of the disease, and species variations. Specific tests that identify the exact nature of the lesion are not available, and a combi-

nation of tests is usually necessary to make a diagnosis. For example, it is suggested that testing for serum bile acids, arginase and gamma-glutamyl transferase (GGT) gives a sensitive indicator of cholestasis and/or hepatocellular necrosis, and a liver biopsy would form the minimum combination of tests for the diagnosis and prognosis of hepatic disease in the horse.<sup>31,32</sup> Total serum bile acids, plasma glutamate dehydrogenase, GGT and liver biopsy are useful in the horse with liver disease.<sup>33</sup> Based on experimentally induced liver disease in cattle, it is suggested that the serum activities of sorbitol dehydrogenase (SDH), GGT and aspartate aminotransferase (AST, formerly known as SGOT), and the BSP clearance test, provide sensitive indicators of hepatocellular injury in cattle.

All laboratory tests are aids to diagnosis and must be carefully interpreted in conjunction with clinical and other available data. This is particularly important in the laboratory investigation of liver disease in the horse.<sup>34</sup> No one test will provide sufficient information, and a combination of tests is necessary. Depending on the time of sampling in relation to the pathological processes developing and the presence of complicating or secondary pathology, there may be elevations in alkaline phosphatase (ALP) and GGT. A horse with chronic hepatic lesions may have a leukocytosis and neutrophilia, hypoalbuminemia, hyperbetaglobulinemia, increased ALP and GGT and, depending on other factors, there may be increases in AST, SDH, total lactate dehydrogenase and others. None of these individual tests are specific for hepatic disease and there is no direct relationship between the magnitude of the serum enzyme level and the degree of liver injury. For these reasons, it is often necessary to take a liver biopsy.

The laboratory tests for the diagnosis of hepatic disease and to evaluate hepatic function in farm animals can be divided into those that measure:

- Excretory rate of parenterally administered substances such as BSP
- Ability of the liver to remove substances from the serum and detoxify them
- Serum levels of liver enzymes that increase following hepatic injury
- Indirect assessment of hepatic function such as blood glucose, serum proteins, clotting factors and urinalysis.

#### HEPATIC FUNCTION

The **sulfobromophthalein sodium clearance test** has been used in cattle, sheep

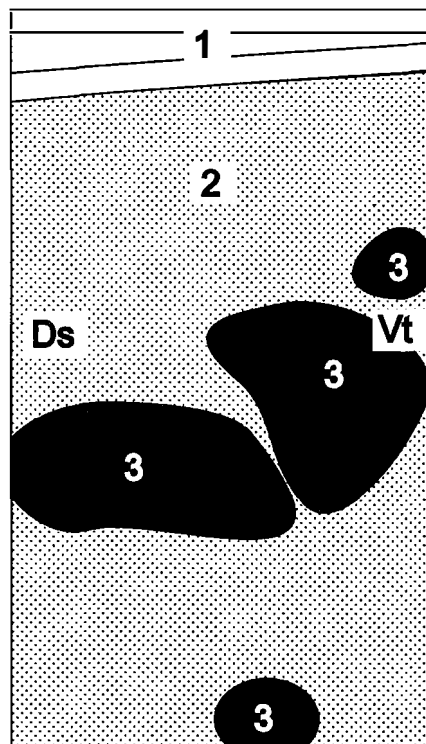

**Fig. 7.2** Ultrasonogram and schematic of the liver in a cow with obstructive cholestasis due to fasciolosis. The intrahepatic bile ducts are dilated. Normally, they are not visible. The ultrasonogram was obtained from the 11th intercostal space of the right side using a 5.0 MHz linear transducer. 1 = Lateral abdominal wall; 2 = Liver; 3 = Dilated intrahepatic bile ducts. Ds, Dorsal; Vt, Ventral. (Reproduced with kind permission of U. Braun.)

and horses, and although little information is available the test appears to have diagnostic value. The single injection technique has the advantage of being noninvasive, repeatable and suitable for conscious animals.<sup>35</sup> The time required by the normal liver to reduce the plasma concentration of BSP to half the initial concentration is taken as the standard BSP half-life and in cattle is 2.5–5.5 minutes, in sheep 2.0 minutes<sup>36</sup> and in normal horses about 2.0 minutes.<sup>35</sup> All horses with confirmed liver disease have a reduction in plasma BSP clearance against time.<sup>35</sup> The results are modified by the ability of the liver to excrete BSP via the biliary system and to store it in hepatocytes. Factors other than liver disease that increase the half-life significantly are starvation in horses, competition with bilirubin for excretory capacity, and youth, foals less than 6 months of age having a significantly slower clearance time. Precise timing of samples is needed because of the rapid excretion rate.

In sheep, where severe hepatic dysfunction is accompanied by a steep rise in blood ammonia levels, and where this is reflected in the development of spongy degeneration in the brain, the level of glutamine in the cerebrospinal fluid is also elevated. Glutamine is a byproduct of the metabolism of ammonia in brain cells. Acute ammonia toxicity is manifested by tetany, ataxia and pulmonary edema, and affected animals are likely to die before the effects of subacute poisoning, hepatic encephalopathy, are seen.

### ICTERIC INDEX

Measurement of the icteric index of plasma, by comparing its color with a standard solution of potassium dichromate, cannot be considered to be a liver function test but it is used commonly as a measure of the degree of jaundice present. The color of normal plasma varies widely between species depending upon the concentration of carotene. Horse, and to a less extent cattle, plasma is quite deeply colored, but sheep plasma is normally very pale. The color index needs to be corrected for this factor before the icteric index is computed. Hyperbilirubinemia occurs in many diseases of cattle and in most cases is related to a failure of the liver to remove unconjugated bilirubin from the serum rather than to a failure of the liver to excrete conjugated bilirubin.<sup>37</sup> The cause may be associated with anorexia, which resembles the hyperbilirubinemia associated with fasting in sick horses.

**Adult cattle with hepatic disease do not consistently have high serum bilirubin concentrations** and visible jaundice does not occur frequently in cattle with hyperbilirubinemia. Total

bilirubin concentrations in adult cattle should be 0.4 mg/dL but young healthy calves may have mean concentrations 0.87 mg/dL and even higher, up to 1.7 mg/dL.<sup>38</sup> The use of high bilirubin concentrations as an indicator of liver disease in calves is unreliable because the sensitivity is only about 66%. This is similar to results in adult cattle in which serum bilirubin concentrations are neither a specific nor a sensitive test for chronic liver disease.

**Persistent hyperbilirubinemia** has been reported in a healthy Thoroughbred horse that was not related to feed intake and not associated with increased hemolysis or acquired hepatic disease.<sup>39</sup> Inappropriate conjugation of bilirubin rather than any abnormality in bilirubin uptake or excretion is considered a possibility similar to the human syndrome associated with a familial deficiency of bilirubin-uridine diphosphate glucuronyl transferase.

### SERUM HEPATIC ENZYMES

The determination of serum levels of hepatic enzymes is used commonly for the detection and evaluation of hepatic disease. The interpretation of elevated values of enzymes in plasma is dependent not only on the tissue and site of origin but also on the half-time of clearance of the enzyme.

- **Sorbitol dehydrogenase (also called L-iditol dehydrogenase (ID))** is almost completely selective as an indicator of liver damage and is the preferred test for hepatic damage in sheep and cattle
- **Lactate dehydrogenase (LDH)** is abundant in liver, kidney, muscle and myocardium
- **Aspartate aminotransferase or L-alanine aminotransferase (ALT, previously known as SGPT)** are of some value as an indicator of liver damage because of their high content in liver but are generally considered to be too nonspecific to be of great diagnostic value
- **Arginase** is a specific indicator of hepatic disease because it is not found in appreciable quantities in other organs. Arginase has a short blood half-life, which makes it useful for the diagnosis of acute hepatic disease but not for less severe forms<sup>31</sup>
- **Gamma-glutamyl transferase** is an enzyme widely distributed in a variety of equine tissues. Specific activity of GGT in the horse is highest in the kidney, pancreas and liver. Serum GGT activity is used as a diagnostic criterion for hepatobiliary diseases in cattle, sheep and horses. In the horse, increases in serum GGT may be associated with hepatocellular –

damage and liver necrosis in a variety of natural and experimentally induced liver diseases. These include bile duct ligation, carbon disulfide toxicity, carbon tetrachloride toxicoses, cholestasis, iron hepatotoxicosis, *Senecio* poisoning<sup>40</sup> and hyperlipidemia in ponies. GGT is a sensitive indicator of liver damage in horses affected with pyrrolizidine alkaloids in the early stages of the disease but values do not correlate with the increase in the severity of the lesions observed on liver biopsy samples collected later in the chronic phase of the disease.<sup>40</sup> GGT has sufficient sensitivity (75%) and specificity (90%) to function as a primary screening test for subclinical liver disease in horses exposed to pyrrolizidine alkaloids. In horses that had consumed hay contaminated with *Senecio vulgaris*, the GGT values fluctuated widely: some horses with high levels did not die, whereas others had values slightly above reference values at the initial sample collection and died. GGT is a practical routine test for the evaluation of liver amyloidosis status in serum-producing horses.<sup>41</sup> In foals during the first month of life values were 1.5–3 times higher than the upper physiological reference values for healthy adult horses.<sup>42</sup> In neonatal foals, the serum ALP, GGT and SDH activities were increased during the first 2 weeks of life<sup>43</sup>

- **Glutamate dehydrogenase (GD)** occurs in high concentration in the serum of ruminants and horses with liver disease
- **Ornithine carbamoyl-transferase (OCT)** levels are also elevated even in chronic diseases, but only when there is active liver necrosis and not when the lesions are healing
- **Alkaline phosphatase** levels are used as a test of hepatic excretory function in the horse and are of value in that species but variations in normal cattle have such a wide range that results are difficult to interpret. Of the tests available for testing of biliary obstruction the serum ALP test is preferred. However, there is a similar response to damage in other tissues.

### Hepatic enzyme profile according to species

The serum hepatic enzymes considered to be most useful as an aid in the diagnosis of liver disease in the different species are as follows.

#### Cattle

In adult cattle, **GGT, ALP, SDH, AST** and **GD** are most useful in identifying

animals with chronic hepatic disease.<sup>38</sup> The dehydrogenases (SDH and GD) have the shortest half-lives in serum and may not increase in cattle with chronic liver disease.

In the **early stages of hepatic dysfunction in cattle**, SDH is the most efficient and sensitive test. In the later stages when tests of biliary excretion are more applicable, estimations of serum bilirubin and BSP test are indicated.

#### Calves

In **neonatal calves** under 6 weeks of age, none of the common tests for assessment of liver damage or function in adult cattle are useful for detection of hepatic disease.<sup>38</sup> The serum activity of most enzymes, total bilirubin concentration and sulfobromophthalein sodium clearance half-time are significantly higher in newborn calves than in 2-week-old calves.<sup>38</sup> In calves less than 6 weeks of age with suspected liver disease, several tests should be used to assess liver damage, which includes GD activity and total serum bile acid concentration. The concentrations of direct bilirubin may be of more value than determination of total bilirubin for assessing liver damage. It is suggested that percutaneous liver biopsy may provide the most information.

#### Horses

The clinicopathological features of primary liver disease in the horse have been examined in several case studies.<sup>15,33,34,44-46</sup> Total serum bile acids, GD, GGT and liver biopsy are helpful in studying different types of hepatic disease in the horse.<sup>3</sup> In one series of primary hepatic disease all horses had high activities of serum GGT and most had high activities of serum GD and high concentrations of bile acids.<sup>44</sup> Horses that were euthanized or died had significantly higher concentrations of GGT, GD and bile acids than survivors. Horses with signs of hepatic encephalopathy had plasma ammonia levels greater than 90  $\mu\text{mol/L}$  but this was not correlated with the clinical severity of the disease. Half of the cases with hepatic encephalopathy were hyperglycemic, none was hypoglycemic, and none had abnormally low levels of plasma urea.<sup>44</sup>

In a series of 82 cases in horses, 61 were confirmed to have significant liver disease and 12 were not.<sup>46</sup> Only serum concentrations of GGT, globulins and ALP were found to be significantly different between the two groups of horses.

Clinical and ultrasonographic data were found, when present, to be good indicators of the presence of liver disease.

The single positive test results of greatest diagnostic value were the presence of hepatic encephalopathy, increased GGT,

hypoalbuminemia, increased ALP, increased total bile acids and increased total bilirubin. Increased AST and increased GD were also good diagnostic value but only when used in combination with the above tests. No single combination or sequential test was able to fully discriminate between horses with and without biopsy-confirmed liver disease and reliance on the use of noninvasive tests for the prediction of the presence or absence of significant liver disease may lead to frequent diagnostic errors. Certain positive results did reliably predict the presence of liver disease but negative test results were invariably unsatisfactory predictors of absence of liver disease.

In the early stages of hepatic dysfunction, SDH is preferred. Plasma ammonia concentrations may be significantly elevated compared to clinically normal horses but are not always accompanied by a decline in plasma urea concentration. A fall in plasma glucose concentration represents a poor prognosis.

The most useful noninvasive prognostic test in cases of suspected liver disease in adult horses is the severity of clinical signs.<sup>34</sup>

#### SERUM BILE ACIDS

The concentration of total serum bile acids has been reported as a sensitive and specific indicator of hepatobiliary disease in humans and animals.<sup>47</sup> Abnormalities of bile acid metabolism may be detectable in animals with liver disease that have little evidence of hepatic dysfunction as determined by other common liver function tests. Bile acids are the end-products of the metabolism of cholesterol by the liver. They are excreted in the bile and reabsorbed from the intestine either unchanged or after further transformation by bacterial action. In experimental chronic copper poisoning in sheep, the total bile acid concentration in the plasma is a more sensitive indicator of hepatic damage than the concentration of plasma bilirubin or the activity of transaminases. The rise in total serum bile acid concentration usually correlates well with the severity of liver disease. In cattle, there is extreme variability among all types and ages of animals and the variation is even greater in beef cattle than in dairy cattle.<sup>48</sup> Values for calves 6 weeks of age and for 6-month-old heifers are significantly lower than values for lactating dairy cows.

The 5th–95th percentile range of values ( $\mu\text{mol/L}$ ) were:

- For beef cattle, 9–126
- For lactating dairy cattle, 15–88
- For 6-month-old dairy heifers, 11–64.

In order to be specific for liver damage in cattle, the value determined for a single

sample would have to be more than 126  $\mu\text{mol/L}$  in beef cattle, or more than 88  $\mu\text{mol/L}$  in lactating dairy cattle. There are hour-to-hour fluctuations in serum bile acid concentrations in cattle, which makes interpretation difficult.<sup>49</sup> Feeding practices and stage of lactation can also affect the serum bile acid concentrations.

The serum bile acid concentrations in dairy cattle with hepatic lipidosis were compared with liver fat content and sulfobromophthalein (BST) half-life.<sup>47</sup> Because of the large variability in serum bile acid concentrations in fed cows and the lack of correlation of measured values with liver fat content, bile acid determinations are not reliable as an indicator of subclinical hepatic lipidosis.<sup>47</sup>

In cattle, total serum bile acids are more specific and sensitive indicators of a wide variety of hepatic disease and are significantly correlated with the degree of illness compared to other tests of hepatic function. Some diurnal variations in total serum bile acids occur in normal cattle. In horses, total serum bile acid concentrations are also a sensitive indicator of several hepatic diseases and are most useful when combined with other tests of hepatic disease.<sup>41</sup>

#### Blood ammonia levels

The microbial deamination of amino acids in the intestinal tract is the major source of ammonia which is absorbed by the intestine into portal venous blood and converted into urea by the liver. The concentration of blood ammonia can be an indication of functional hepatic mass. Generally, plasma ammonia concentration is a sensitive and specific indicator of hepatic disease in the horse, although it may fluctuate widely even on the same day and the concomitant low plasma urea concentration anticipated because of the liver's reduced synthetic ability is often not apparent.<sup>3</sup>

In cattle with hepatic disease, plasma ammonia levels are significantly elevated compared to normal animals but not always accompanied by a decline in plasma urea concentrations. In healthy cattle, the plasma ammonia:urea concentration ratio is 9:1 and the plasma ammonia:glucose concentration 11:1. In hepatic disease, a plasma ammonia:glucose ratio 40:1 or plasma ammonia:urea ratio 30:1, particularly with a rising total ketone body concentration and a declining glucose concentration, represents a guarded prognosis.<sup>4</sup>

Most cases of portosystemic shunts are accompanied by marked increases in blood ammonia levels.<sup>50</sup>

Careful handling of the blood samples is critical to obtain reliable results. Blood samples with species and preferably

age-matched controls should be collected, transported on ice, and evaluated immediately.

## REVIEW LITERATURE

- West HJ. The evaluation of hepatobiliary disease in horses and cattle. FRCVS thesis, London, 1994.
- McGorum BC, Murphy D, Love S, Milne EM. Clinicopathological features of equine primary hepatic disease: a review of 50 cases. *Vet Rec* 1999; 145:134–139.
- Pearson EG. Liver disease in the mature horse. *Equine Vet Educ* 1999; 11:87–96.

## REFERENCES

- Johnston JK et al. *J Am Vet Med Assoc* 1989; 194:405.
- West HJ, Hogg R. *Vet Rec* 1988; 122:251.
- West HJ. *Equine Vet J* 1996; 28:146.
- West HJ. *Vet Res Commun* 1997; 21:169.
- Mair TS, Jones RD. *Vet Rec* 1995; 137:642.
- Humann-Ziehanek E et al. *Small Rumin Res* 2001; 42:157.
- Jakowski RM. *J Am Vet Med Assoc* 1994; 204:1057.
- Acorda JA et al. *Vet Radiol Ultrasound* 1995; 36:322.
- Abdelkader SV et al. *J Comp Pathol* 1991; 105:203.
- Smart ME. *Compend Contin Educ Pract Vet* 1985; 7:5327.
- Green LE et al. *Vet Rec* 1995; 136:197.
- Buckley WT et al. *Can J Anim Sci* 1986; 66:1137.
- Harvey RB et al. *Cornell Vet* 1984; 74:322.
- Simpson JW. *Vet Rec* 1985; 117:639.
- Durham AE et al. *Equine Vet J* 2003; 35:534.
- Swanson KS et al. *J Anim Sci* 2000; 78:2459.
- Braun U. *Am J Vet Res* 1990; 51:1522.
- Braun U, Hausammann K. *Am J Vet Res* 1992; 53:198.
- Braun U et al. *Vet Rec* 2002; 150:209.
- Braun U et al. *Vet Rec* 1995; 137:284.
- Braun U, Gerber D. *Am J Vet Res* 1994; 55:1201.
- Braun U et al. *Schweiz Arch Tierheilkd* 1992; 134:235.
- Reef VB et al. *J Am Vet Med Assoc* 1990; 196:1836.
- Braun U, Gerber D. *Am J Vet Res* 1992; 53:1079.
- Braun U et al. *Vet Rec* 2000; 147:623.
- Acorda JA et al. *Vet Radiol Ultrasound* 1994; 35:196.
- Acorda JA et al. *Vet Radiol Ultrasound* 1994; 35:400.
- Braun U et al. *Vet Rec* 1995; 137:537.
- Braun U et al. *Schweiz Arch Tierheilkd* 1994; 136:275.
- Liberg P, Jonsson G. *Acta Vet Scand* 1993; 34:21.
- Hoffmann WE et al. *Am J Vet Res* 1987; 48:1343.
- Pearson EG. *Equine Vet Educ* 11:1999; 87.
- West HJ. *Equine Vet J* 1996; 28:146.
- Durham AE et al. *Equine Vet J* 2003; 35:542.
- West HJ. *Res Vet Sci* 1988; 44:343.
- West HJ. *Res Vet Sci* 1989; 46:258.
- McSherry BJ et al. *Can J Comp Med* 1984; 48:237.
- Pearson EG et al. *J Am Vet Med Assoc* 1995; 207:1466.
- Divers TJ et al. *Cornell Vet* 1993; 83:237.
- Curran JM et al. *Aust Vet J* 1996; 74:236.
- West HJ. *Res Vet Sci* 1989; 46:264.
- Patterson WH, Brown CM. *Am J Vet Res* 1986; 47:2461.
- Bauer JE et al. *Am J Vet Res* 1989; 50:2037.
- McGorum BC et al. *Vet Rec* 145:1999; 134.
- Smith MRW et al. *Equine Vet J* 2003; 35:549.
- Durham AE et al. *Equine Vet J* 2003; 35:554.
- Garry FB et al. *J Vet Intern Med* 1994; 8:432.
- Craig AM et al. *Am J Vet Res* 1992; 53:1784.
- Pearson EG et al. *Am J Vet Res* 1992; 53:1780.
- Fortier LA et al. *Vet Surg* 1996; 25:154.

## Principles of treatment in diseases of the liver

In diffuse diseases of the liver no general treatment is satisfactory and the main aim should be to remove the source of the damaging agent. The most that can be attempted in acute hepatitis is to tide the animal over the danger period of acute hepatic insufficiency until the subsidence of the acute change and the normal regeneration of the liver restores its function. Death may occur during this stage because of hypoglycemia, and the blood glucose level must be maintained by oral or intravenous injections of glucose. Because of the danger of guanidine intoxication an adequate calcium intake should be insured by oral or parenteral administration of calcium salts.

There is some doubt as to whether protein intake should be maintained at a high level, as incomplete metabolism of the protein may result in toxic effects, particularly in the kidney. However, amino acid mixtures, especially those containing methionine, are used with apparently good results. The same general recommendations apply in prevention as in the treatment of acute diffuse liver disease. Diets high in carbohydrate, calcium and protein of high biological value and a number of specific substances are known to have a protective effect against hepatotoxic agents.

In chronic, diffuse hepatic disease fibrous tissue replacement causes compression of the sinusoids and is irreversible except in the very early stages, when removal of fat from the liver by the administration of lipotropic factors including choline and maintenance on a diet low in fat and protein may reduce the compressive effects of fibrous tissue contraction. A high-protein diet at this stage causes stimulation of the metabolic activity of the liver and an increased deposit of fat, further retarding hepatic function.

Local diseases of the liver require surgical or medical treatment depending upon the cause, and specific treatments are discussed under the respective diseases.

## Diffuse diseases of the liver

### HEPATITIS

The differentiation of hepatic diseases into two groups of hepatitis and hepatosis has not achieved general acceptance and nonspecific terms such as hepatic injury have been suggested to avoid the connotation of inflammation associated with the word hepatitis. To facilitate ease of reading, the word hepatitis is used

throughout this chapter to include all diffuse, degenerative and inflammatory diseases that affect the liver. It is used here also to include the common pathological classification of cirrhosis. Clinically the syndrome caused by fibrosis of the liver is the same as that caused by hepatitis and the etiology is the same, the only difference being that the onset of the disease is slower and less acute than in hepatitis.

### ETIOLOGY AND EPIDEMIOLOGY

Although there is an extensive list of causes of hepatitis there are still a number of unknown factors. At least there are many sporadic cases of hepatic insufficiency, especially in horses, in which the cause is not determined. In most cases the clinical disease has an acute onset and a fatal outcome but the lesion is of a much longer duration.

In a case-control study of cases of equine hepatic disease admitted to the Liphook Equine Hospital in the UK, ponies were more likely to develop hepatic disease than light riding horses but neither age nor gender were significant factors.<sup>1</sup> Overall the case fatality was low (25.9%); horses with unclassified hepatopathies had the lowest fatality rate and horses with cholangiohepatitis, pyrrolizidine alkaloid toxicity and chronic active hepatitis had significantly higher fatality rates by comparison. None of age, breed or gender had any detectable effect on outcome.

In a series of 50 cases of equine primary hepatic disease in England, 37 cases were in ponies;<sup>2</sup> 25 cases were caused by pyrrolizidine alkaloid toxicity and 11 cases classified as undifferentiated nonmegalocytic cirrhosis on the basis of histopathological findings.

The literature on primary liver disease in the horse has been reviewed.<sup>3</sup>

### Toxic hepatitis

The common causes of toxic hepatitis in farm animals are:

- Inorganic poisons – copper, phosphorus, arsenic, possibly selenium
- Organic poisons – carbon tetrachloride, hexachloroethane, Gossypol, creosols and coal tar pitch, chloroform and copper diethylamine quinoline sulfonate.

Ferrous fumarate administered in a digestive inoculate to newborn foals is also recorded as a cause.<sup>4</sup>

Poisonous plants

These include the following:

- Weeds, including *Senecio*, *Crotalaria*, *Heliotropium*, *Amsinckia* and *Tribulus* spp., *Encephalartos lanatus* and *Trachyantra* spp.

- Pasture and cultivated plants – *Panicum effusum*, lupins, alsike clover,<sup>5</sup> water-damaged alfalfa hay<sup>6</sup>
- Trees and shrubs – lantana (*Lantana camara*); yellow wood (*Terminalia oblongata*); ngaio tree (*Myoporum laetum*); Australian boobialla (*Myoporum tetrandrum*); seeds of cycads (*Zamia* spp.)
- Fungi – *Pithomyces chartarum*, *Aspergillus flavus*, *Penicillium rubrum*, *Phomopsis leptostromiformis*, *Fusarium* spp., *Myrothecium* spp., *Periconia* spp.
- Algae – the slow death factor
- Insects – ingestion of sawfly larvae (*Lophyrotoma interrupta*).

#### Miscellaneous farm chemicals

These include dried poultry waste, cottonseed cake, herring meal.

#### Toxemia perfusion hepatitis

Moderate degrees of hepatitis occur in many bacterial infections regardless of their location in the body and the hepatitis is usually classified as toxic; whether the lesions are caused by bacterial toxins or by shock, anoxia or vascular insufficiency is unknown. Hepatic failure may occur in dairy cattle following mastitis or metritis; it is thought that the hepatic dysfunction may have been the result of endotoxemia.<sup>7</sup> The same position applies in hepatitis associated with extensive tissue damage occurring after burns, injury and infarction.

#### Infectious hepatitis

Diffuse hepatic lesions in animals are rarely associated with infectious agents. The significant ones are:

- The virus of Rift Valley fever
- *Bacillus piliformis*, associated with Tyzzer's disease in foals
- The equid herpesvirus 1 of viral rhinopneumonitis as a cause of abortion in horses
- *Deltaproteobacterium* associated with epizootic abortion of cattle in California
- Postvaccinal hepatitis of horses, also known as **serum hepatitis, idiopathic acute hepatic disease, Theiler's disease and acute liver atrophy**, is the most common cause of acute hepatic failure in the horse.<sup>8</sup> The disease is commonly associated with the administration of biologics of equine origin, usually tetanus antitoxin.<sup>9</sup>

A series of four fatal cases of serum hepatitis associated with the administration of commercial plasma in the horse has been reported.<sup>10</sup> The prevalence in one veterinary teaching hospital has been recorded as 0.4%.<sup>10</sup>

A large number of cases of equine hepatic encephalopathy occurred in France

between 1992 and 1997<sup>11</sup> and the cause remains unknown.

- Severe cases of equine viral arteritis manifest signs of hepatitis
- Systemic mycoses, e.g. histoplasmosis, may be accompanied by multiple granulomatous lesions of the liver
- Other diseases in which hepatic lesions may be common at necropsy, but in which there are no overt signs of clinical disease during life. Some of these are infectious equine anemia, salmonellosis, septicemic listeriosis, leptospirosis in aborted foals<sup>12</sup>
- Infectious necrotic hepatitis associated with *Clostridium novyi* has been described in a 9-year-old mare.<sup>13</sup>

#### Parasitic hepatitis

- Acute and chronic liver fluke infestation
- Migrating larvae of *Ascaris* sp.
- Fibrosing granulomas of liver in horses with chronic shistosomiasis<sup>14</sup>
- Hepatic sarcocystosis in a horse.<sup>15</sup>

#### Nutritional hepatitis (trophopathic hepatitis)

Selenium and vitamin E deficiency are factors in dietary hepatic necrosis in pigs. A multiple dietary deficiency has also been suggested as the cause of a massive hepatic necrosis observed in lambs and adult sheep on trefoil pasture in California. Hepatic lipidosis and hyperlipemia occurs most commonly in pregnant Shetland pony mares on a falling plane of nutrition.<sup>16</sup> The fat cow syndrome occurs in beef and dairy cattle in late pregnancy or within days after parturition and is associated with excess energy intake in pregnancy followed by a sudden mobilization of body depot fat in late pregnancy or at the onset of lactation.<sup>17</sup> The fatty infiltration of the liver that occurs in most dairy cattle in late pregnancy and early lactation is functional and reversible and related to the metabolic demands of those periods in the production cycle.<sup>17</sup>

**White liver disease** is a well-identified clinical entity occurring in young sheep in the warmer parts of New Zealand. The cause is unknown but the disease affects only cobalt-deficient sheep. The disease occurs on leafy pastures with lots of leaf litter, and in spring and early summer. Affected sheep show photosensitivity, anorexia, weight loss, sometimes jaundice and blindness. At necropsy there is a very much enlarged, light-colored, fatty liver. Most deaths occur in a chronic phase after the acute signs have passed. A similar disease, suspected to be caused by a mycotoxin, has been observed in Norway.

#### Idiopathic hepatosis and cirrhosis

**Hepatic cirrhosis and hemochromatosis in horses** has been recorded.<sup>18</sup> There is

cirrhosis with increased iron stores in the parenchymal cells of the liver. Hepatic **fatty cirrhosis (hard yellow liver)** in sheep and cattle has occurred in isolated areas of western and southern Texas during years of maximal rainfall.<sup>19</sup> The cause is unknown but the high incidence during periods of heavy rainfall suggests the possibility of either a mycotoxin or nutritional deficiency.<sup>20</sup>

#### Congestive hepatopathy

Increased pressure in the sinusoids of the liver causes anoxia and compression of surrounding hepatic parenchyma. Congestive heart failure is the common cause and leads to centrilobular degeneration.

Inherited hepatic insufficiency occurs in Southdown and Corriedale sheep (see Ch. 34, Inherited photosensitization).

#### Portosystemic vascular anomaly

Portosystemic shunts in large animals have been recorded occasionally in foals and calves.<sup>12,21</sup> There is altered blood flow through the liver and hepatic insufficiency secondary to hepatic atrophy.

#### PATHOGENESIS

Hepatitis may be associated with a number of agents but the clinical effects are approximately the same in all instances as described under clinical manifestations earlier in the chapter. The usual lesion in **toxipathic hepatitis** is centrilobular and varies from cloudy swelling to acute necrosis with a terminal veno-occlusive lesion in some plant poisonings. If the necrosis is severe enough or repeated a sufficient number of times, fibrosis develops. The effects of endotoxin on the liver include multifocal hepatocellular necrosis, decreased hepatic gluconeogenesis and decreased hepatic blood flow.<sup>7</sup> It is possible that endotoxin may cause the Kupffer cells to release lysosomal enzymes, prostaglandins and collagenase, which can damage hepatocytes. Endotoxin not detoxified by the Kupffer cells may interact directly with the hepatocytes, causing lysosomal damage and decreased mitochondrial function, leading to necrosis. In infectious hepatitis the lesions vary from necrosis of isolated cells to diffuse necrosis affecting all or most of the hepatic parenchyma.

**Serum hepatitis in the horse** is characterized by severe central lobular necrosis following the administration of biologics of equine origin such as tetanus antitoxin, commercial equine plasma and other products.<sup>10</sup>

**In parasitic hepatitis** the changes depend upon the number and type of migrating parasites. In massive fluke infestations sufficient damage may occur to cause acute hepatic insufficiency, manifested particularly by submandibular



edema. In more chronic cases extension from a cholangitis may also cause chronic insufficiency.

**Trophopathic hepatitis** is characterized by massive or submassive necrosis. Hepatic lipidosis is characterized by fatty infiltration of hepatocytes progressing to development of fatty cysts.

**Congestive hepatitis** is characterized by dilatation of central veins and sinusoids with compression of the parenchymal cells. **Hepatic fibrosis** develops particularly if there is massive hepatic necrosis that destroys entire lobules. Degeneration is not possible, as it is when the necrosis is zonal, and fibrous tissue replacement occurs. Thus fibrosis is a terminal stage of hepatitis that may have developed acutely or chronically and is manifested by the same clinical syndrome as that of hepatitis except that the signs develop more slowly. Fibrosis may also develop from a cholangitis.

The term **cirrhosis** has been avoided because it carries connotations from human medicine that may be misleading when applied to animals. **Hepatic fatty cirrhosis** occurs in sheep and cattle and is characterized at necropsy by ascites, hydropericardium and acquired hepatic vascular shunts.<sup>20</sup> There is progressive fatty change of the liver leading to cirrhosis. Fibrosis begins in the peri-acinar zone associated with ruptured fatty cysts and continues until there is widespread bridging peri-acinar fibrosis. No lesions of hepatic encephalopathy occur.<sup>20</sup>

**In portsystemic vascular anomalies** the increased levels of ammonia, short-chain fatty acids and amino acids in the peripheral circulation are the cause of the depression and neurological abnormalities that are typical of hepatic encephalopathy.<sup>22</sup> These high levels of metabolites are the result of failure of the hepatic metabolism and detoxification of substances absorbed from the intestines, which are normally delivered to the liver via the portal vein before they enter the peripheral circulation.

### Liver disease and liver failure

The liver has vast reserves of function, an almost embryonic capacity to regenerate itself, and it can perform adequately despite often extensive pathological damage to its integrity. This is best exemplified in liver abscesses in cattle, where rarely is clinical disease evident in the presence of large abscesses.

Liver disease is usually diagnosed by identifying clinical signs produced by failure of some of its functions.<sup>23</sup> There is often liver disease prior to failure of function and laboratory tests may detect disease before there is actual failure. The liver has a reserve of about 70–80% and

this must be compromised before some of its functions fail. Some functions fail before others, which explains the progression of clinical signs.

### Intravascular hemolysis in equine liver disease

Intravascular hemolysis with prominent hemoglobinuria has occurred in horses with severe and advanced liver disease.<sup>24</sup> Neutrophil hypersegmentation of undetermined cause was present in one horse with liver disease and intravascular hemolysis.

### CLINICAL FINDINGS

The cardinal signs of hepatitis are anorexia, mental depression – with excitement in some cases, muscular weakness, jaundice and in the terminal stages somnolence, recumbency and coma with intermittent convulsion. Hemoglobinuria is also a variable sign in horses. The hemolytic crisis with which it is associated is always a precursor to a fatal outcome. Animals that survive the early acute stages may show photosensitization, a break in the wool or hair leading to shedding of the coat and susceptibility to metabolic strain for up to a year.

The clinical findings of **hepatic disease in the horse** are generally nonspecific but the most useful noninvasive prognostic test in cases of suspected liver disease in adult horses is the severity of clinical signs.<sup>25</sup> Regardless of the cause, consistent clinical findings include weight loss, anorexia, dullness and depression. Other findings include jaundice, tachycardia, intermittent fever, abdominal pain, ventral body wall edema, clotting deficiency, muscle fasciculations and diarrhea or constipation.<sup>16</sup> Jaundice is a constant feature in acute hepatic necrosis. Dysphagia, photosensitization, encephalopathy and hemorrhages tend to occur terminally, particularly in horses with cirrhosis. In chronic liver disease, the course is several months.

The initial anorexia is often accompanied by constipation and punctuated by attacks of diarrhea. The feces are lighter in color than normal and if the diet contains much fat there may be steatorrhea.

In a series of 50 cases of primary hepatic disease in horses, the following occurrence of clinical signs was observed (%): dull demeanor (68); anorexia (56); abdominal pain (50); encephalopathy (50); weight loss (50); jaundice (42); abnormal intestinal motility (42); abnormal fecal consistency (28); dehydration (18); photosensitization (16); bilateral laryngeal paralysis (14); clinical coagulopathy (10); dermatitis and pruritus (8); peripheral edema (6); oral ulceration (6); tenesmus (4); penile prolapse (2); and rectal impaction (2).<sup>2</sup>

The **nervous signs** are often pronounced and vary from ataxia and lethargy with **yawning**, or **coma**, to **hyperexcitability with muscle tremor, mania**, including **aggressive behavior**, and **convulsions**. A characteristic syndrome is the **dummy syndrome**, in which affected animals push with the head, do not respond to normal stimuli and may be blind. There may be subacute abdominal pain, usually manifested by arching of the back, and pain on palpation of the liver. The enlargement of the liver is usually not palpable.

Jaundice and edema may or may not be present and are more commonly associated with the less acute stages of the disease. Photosensitization may also occur but only when the animals are on a diet containing green feed and are exposed to sunlight. A tendency to bleed more freely than usual may be observed. In chronic hepatic fibrosis the signs are similar to those of hepatitis but develop more slowly and persist for longer periods, often months. Ascites and the dummy syndrome are more common than in hepatitis.

**Serum hepatitis (Thelie's disease)** is the most common cause of acute hepatic failure in the horse.<sup>9</sup> Typically, clinical findings become apparent several weeks after administration of tetanus antitoxin. Lactating mares appear to be at a higher risk than other horses but this may be due to the administration of the antitoxin to mares at the time of parturition. In a group of affected horses, the illness may begin with an unexplained death in a horse after a short illness. Clinical findings include sudden anorexia, marked lethargy, stiff gait, subcutaneous edema of the distal aspects of all four limbs and body wall, blindness, head pressing, circling, bruxism, abdominal pain, tachycardia, icterus and a marked reduction in gastrointestinal sounds. Death in a few days is common.<sup>9</sup>

Serum hepatitis following the transfusion of commercial plasma into horses may cause severe unresponsive colic, lethargy and sudden death 41–60 days later.<sup>10</sup> Severe encephalopathy has also been described.

**Hepatic disease in cattle** is characterized by weight loss, dullness and depression.<sup>26</sup> Signs of hepatic encephalopathy include blindness, head pressing, excitability, ataxia and weakness. The presence of fever and jaundice represents a poor prognosis.

**Hepatic fatty cirrhosis** in ruminants in Texas is characterized by failure to gain weight, progressive emaciation, loss of wool crimp, ascites, depression, head pressing, and walking with the head held high. In the terminal stages, animals



become immobile and die in a state of coma.<sup>7</sup> Morbidity may reach 80–100% and mortality varies from 10–60%. Mortality increases during each succeeding month following October, climaxes in January and February, and then decreases in the months thereafter.

### Portosystemic shunts

In young animals with **portosystemic shunts** the clinical findings include stunted growth, ascites and variable neurological abnormalities resulting from hepatic encephalopathy. Calves and foals may be a few weeks to a few months of age before they are presented for examination. Apparent cortical blindness, circling and dementia are common. Persistent tenesmus is common in calves.<sup>13</sup> Recurrent episodes of unexplained neurological clinical findings in a young foal suggest the presence of a portosystemic shunt. A tentative diagnosis may be made using clinicopathological results but a definitive diagnosis requires portovenography.<sup>22</sup> Blood ammonia levels are markedly increased and serum bile acids are also increased but the serum levels of hepatic derived enzymes may be normal.<sup>21</sup>

### CLINICAL PATHOLOGY

The clinicopathological features of primary liver disease have been examined<sup>12,27</sup> and are summarized in the section dealing with laboratory tests for hepatic disease and function.

Scoring liver biopsies of the horse with suspected liver disease is highly predictive of the severity of the lesion and of prognosis.<sup>28</sup>

In a series of 82 cases in horses, 61 were confirmed to have significant liver disease and 12 were not.<sup>29</sup> Only serum concentrations of GGT, globulins and ALP were found to be significantly different between the two groups of horses.

Clinical and ultrasonographic data were found, when present, to be good indicators of the presence of liver disease.

The single positive test results of greatest diagnostic value were the presence of hepatic encephalopathy, increased GGT, hypoalbuminemia, increased ALP, increased total bile acids and increased total bilirubin. Increased AST and increased GD were also good diagnostic value but only when used in combination with the above tests. No single combination or sequential test was able to fully discriminate between horses with and without biopsy-confirmed liver disease and reliance on the use of noninvasive tests for the prediction of the presence or absence of significant liver disease may lead to frequent diagnostic errors. Certain positive results did reliably predict the presence of liver disease but negative test

results were invariably unsatisfactory predictors of absence of liver disease.

The most useful noninvasive **prognostic** test in cases of suspected liver disease in adult horses is the severity of clinical signs.<sup>25</sup> A significantly poorer prognosis was found in association with clinical signs suggestive of liver disease, presence of hepatic encephalopathy, ultrasonographic abnormalities, increased globulins, increased total bile acids, increased ALP, increased GGT, erythrocytosis, leukocytosis, low serum albumin and low serum urea. The literature on liver disease in the mature horse has been reviewed.<sup>23</sup>

### NECROPSY FINDINGS

The liver in hepatitis is usually enlarged and the edges swollen but the appearance of the hepatic surface and cross-section varies with the cause. In acute toxic and trophopathic hepatitis the lobulation is more pronounced and the liver is paler and redder in color. The accentuation of the lobular appearance is caused by engorgement of the centrilobular vessels or centrilobular necrosis. There may be accompanying lesions of jaundice, edema and photosensitization. In infectious hepatitis the lesions are inclined to be patchy and even focal in their distribution. Parasitic hepatitis is obviously traumatic, with focal hemorrhages under the capsule and the necrosis and traumatic injury definable as tracks. Congestive hepatitis is marked by severe engorgement of the liver, a greatly increased content of blood and marked accentuation of the lobular pattern caused by vascular engorgement and fatty infiltration of the parenchyma. In hepatic fibrosis the necropsy findings vary widely depending on the causative agent, the duration of its action and on its severity. The liver may be grossly enlarged or be much reduced in size with marked lobulation of the surface.

**Hepatic encephalopathy** associated with portosystemic shunt is characterized by spongiform changes and gliosis of white matter in all levels of the brain.<sup>30</sup> The liver may be of normal size or small and firm, with a prominent reticular pattern visible on the capsular and cut surfaces,<sup>22</sup> and the portal veins may be absent.

### TREATMENT

The principles of treatment of hepatitis have already been outlined. Results are seldom good. Protein and protein hydrolysates are probably best avoided because of the danger of ammonia intoxication. The diet should be high in carbohydrate and calcium and low in protein and fat, but affected animals are usually completely anorectic. Because of the failure of detoxification of ammonia and other

### DIFFERENTIAL DIAGNOSIS

Hepatitis is easily misdiagnosed as an encephalopathy unless jaundice or photosensitization is present. The nervous signs are suggestive of:

- Encephalomyelitis
- Encephalomalacia
- Cerebral edema.

Congestive hepatitis is usually not manifested by nervous signs and, being a secondary lesion in congestive heart failure, is usually accompanied by ascites and edema in other regions and by signs of cardiac involvement. Hepatic fibrosis may produce ascites without evidence of cardiac disease.

Acute diseases affecting the alimentary tract, particularly engorgement on grain in cattle and horses, may be manifested by signs of nervous derangement resembling those of acute hepatic dysfunction but the history and clinical examination usually suggest a primary involvement with the alimentary tract. Anorexic hepatic insufficiency may be mirrored by an adenocarcinoma of the pancreas, which is unlikely to be diagnosed during life.

nitrogenous substances by the damaged liver and their importance in the production of nervous signs, the oral administration of broad-spectrum antibiotics has been introduced in humans to control protein digestion and putrefaction. The results have been excellent with neomycin and chlortetracycline, the disappearance of hepatic coma coinciding with depression of blood ammonia levels. Purgation and enemas have also been used in combination with oral administration of antibiotics but mild purgation is recommended to avoid unnecessary fluid loss. Supplementation of the feed or periodic injections of the water-soluble vitamins are desirable. Hepatic fibrosis is considered to be a final stage in hepatitis and treatment is not usually undertaken.

### REVIEW LITERATURE

- Ross MA. The relationship of hepatic drug metabolism to hepatotoxicity with some examples in sheep. *Vet Annu* 1982; 22:129–134.
- McGorum BC, Murphy D, Love S, Milne EM. Clinicopathological features of equine primary hepatic disease: a review of 50 cases. *Vet Rec* 1999; 145:134–139.
- Pearson EG. Liver disease in the mature horse. *Equine Vet Educ* 1999; 11:87–96.
- Olsman AF, Sloet van Oldruitenborgh-Oosterbaan MM. Primary liver disease in the horse. *Tijdschr Diergeneesk* 2004; 129:510–522.

### REFERENCES

1. Smith MRW et al. *Equine Vet J* 2003; 35:549.
2. McGorum BC et al. *Vet Rec* 1999; 145:134–139.
3. Olsman AF, Sloet van Oldruitenborgh-Oosterbaan MM. *Tijdschr Diergeneesk* 2004; 129:510.
4. Mullaney TP, Brown CM. *Equine Vet J* 1988; 20:119.
5. Nation PN. *Can Vet J* 1991; 32:602.
6. Putnam MR et al. *J Am Vet Med Assoc* 1986; 189:77.

7. Sweeney RW et al. J Vet Intern Med 1988; 2:80.
8. Messer NT, Johnson PJ. J Am Vet Med Assoc 1994; 204:1934.
9. Messer NT, Johnson PJ. J Am Vet Med Assoc 1994; 204:1790.
10. Aleman M et al. J Vet Intern Med 2005; 19:120.
11. Zentara S et al. Vet Rec 1994; 134:18.
12. Wilkie IW et al. Can Vet J 1988; 29:1003.
13. Sweeney HJ, Greig A. Equine Vet J 1986; 18:150.
14. Buergelt CD, Greener EC. J Vet Diagn Invest 1995; 7:102.
15. Davis CR et al. J Parasitol 1999; 85:965.
16. West HJ. Equine Vet J 1996; 28:148.
17. West HJ. Bovine Pract 1990; 25:127.
18. Pearson EG et al. J Am Vet Med Assoc 1994; 204:1053.
19. Helman RG et al. J Am Vet Med Assoc 1993; 202:129.
20. Helman RG et al. Vet Pathol 1995; 32:635.
21. Fortier LA et al. Vet Surg 1996; 25:154.
22. Hillyer MH et al. Vet Rec 1993; 132:457.
23. Pearson EG. Equine Vet Educ 11:1999; 87-96.
24. Ramaiah SK et al. J Vet Intern Med 2003; 17:360.
25. Durham AE et al. Equine Vet J 2003; 35:542.
26. West HJ. Vet Res Commun 1997; 21:169.
27. West HJ. Equine Vet J 1996; 28:146.
28. Durham AE et al. Equine Vet J 2003; 35:534.
29. Durham AE et al. Equine Vet J 2003; 35:554.
30. Gill PA, Townsend WL. Aust Vet J 1993; 70:69.

## Focal diseases of the liver

### HEPATIC ABSCESS

Local suppurative infections of the liver do not cause clinical signs of hepatic dysfunction unless they are particularly massive or extensively metastatic. They do cause significant losses in feedlot and grain-fed cattle because of the frequency of rumenitis in those cattle leading to hepatic abscess formation and the rejection of the affected livers at the abattoir. In feedlot cattle in North America the incidence of liver abscesses averages about 16% but ranges from about 8% to 40% or even higher, up to 78%.<sup>1</sup>

In a 2-year study of bovine hepatic abscessation in 10 abattoirs in Ireland, the livers of 6337 12-16-month-old heifers were examined.<sup>2</sup> The frequency of gross lesions was 5.8%, of which 1.9% had abscesses. Only 1.17 had scarring, and 0.7% telangiectasis. Of the livers with abscesses, 44% had a single large abscess, 35% had a single small abscess and 19% had more than two abscesses; in 16% the abscesses were resolving and in 8.3% the abscesses were ruptured. A total of 43% of the livers with abscesses had adhesions to the diaphragm and diaphragmatic lung lobes, 2.5% had adhesions to other abdominal organs, 10% also had scarring and 1.7% also had lesions attributable to the liver fluke. Clinical signs attributable to the abscesses were observed in only one animal.

Cattle started on feed in November and January in North America, and cattle housed in confinement or outside with-

out overhead shelter, had higher incidences of liver abscesses.<sup>1</sup> Virginiamycin at 16.5-19.3 mg/kg DM in the diet reduced the incidence of liver abscesses in feedlot cattle.<sup>3</sup> Occasional cases occur in dairy cows and cause severe illness.<sup>4</sup> The toxemia of traumatic hepatitis is usually due to toxins from *Arcanobacterium pyogenes*, *Streptococcus* and *Staphylococcus* spp. and *Fusobacterium necrophorum*, which are implanted in the lesions by the perforating foreign body; of the *F. necrophorum* isolates most will be of the A biotype, although the B biotype does occur usually in combination with other bacteria.<sup>5</sup>

Hepatic abscesses in goats have been described.<sup>6</sup> Out of 658 necropsies of goats, 2.5% had hepatic abscesses. The abscesses occurred most commonly in adults. All the affected animals were in poor bodily condition. The organisms isolated included *Corynebacterium pseudotuberculosis* (58.9%), *Escherichia coli* (11.8%), *Corynebacterium* spp. (11.8%), *Mannheimia haemolytica* (5.0%), *Proteus* sp. (5.9%) and *Staphylococcus aureus* (5.9%).

Omphalophlebitis, ruminal parakeratosis or rumenitis may also lead to hepatic invasions by *F. necrophorum* or other organisms and abscessed livers are common in cattle fed heavily on concentrates. Black disease is a profound toxemia caused by the liberation of potent exotoxin from *C. novyi*. *Clostridium sordellii* is associated with hepatic abscesses in neonatal lambs and bacillary hemoglobinuria by a toxin from *Clostridium haemolyticum* with focal hepatic necroses. A focal bacterial hepatitis, identified as 'Tyzzer's disease' and associated with *Bacillus piliformis*, and yersiniosis associated with *Yersinia pseudotuberculosis* are listed elsewhere. Occasional cases of strangles that develop bacteremic spread may also develop hepatic abscesses, as may septicemia in lambs associated with *Histophilus somni*.

The fungus *Mortierella wolfii* has been isolated from a liver abscess in a cow in Australia.<sup>7</sup> The liver abscess was grossly indistinguishable from other common bacterial abscesses, such as those associated with *A. pyogenes* or *F. necrophorum*.

The clinical signs of these specific diseases are included under the discussion of each disease and the only finding common to all is local pain on palpation or percussion over the liver.

A most important relationship is that between liver abscess and caudal vena caval syndrome. Sudden death, or any death, of cattle due to pulmonary hemorrhage should be examined with this possibility in mind. Liver abscesses have been produced experimentally in cattle by injecting *F. necrophorum* into the hepatic

portal vein. They are characterized by an elevation of blood levels of sialic acid and mucoprotein. High concentration of alpha-1 acid glycoprotein ( $\alpha_1$ -AG) present in naturally occurring cases is correlated with sialic acid concentration.<sup>8</sup>

### Hepatic abscesses in horses

Hepatic abscesses in horses are characterized clinically by a history of weight loss, fever, inappetence and depression. The etiology and pathogenesis are unknown. Clinicopathological abnormalities are consistent with a diagnosis of chronic bacterial infection such as leukocytosis with a mature neutrophilia, thrombocytosis, hyperglobulinemia, hypoalbuminemia and a markedly decreased albumin-to-globulin concentrations ratio.<sup>9</sup> Ultrasonography is a useful diagnostic aid. Secondary immune-mediated complications may develop in young adult horses with hepatic abscesses. The prognosis is very unsatisfactory, in spite of intensive antibiotic and supportive therapy, and euthanasia is recommended.

### TELANGIECTASIS OF THE BOVINE LIVER ('SAWDUST LIVER')

Telangiectasis of the bovine liver accounts for about 10% of all bovine liver condemnations in federally inspected slaughter facilities in the USA.<sup>10</sup> Condemnation is based on aesthetics. The lesion is usually easily diagnosed by inspectors but its biological significance is undetermined. Affected livers contain more bacteria than normal livers but telangiectasis cannot be linked to an infectious process. In some affected livers, *E. coli* O157 was present, which is a potential zoonotic risk.<sup>10</sup> It is believed that *E. coli* O157 in meat at slaughter is an external contaminant and, experimentally in cattle, there is no evidence that the organism translocates from the alimentary tract to deeper tissues. The morphological, immunohistochemical and ultrastructural studies of pretelangiectasis and telangiectasis of the bovine liver have been examined.<sup>11</sup>

### TUMORS OF THE LIVER

Metastatic lesions of lymphomatosis in calves are the commonest neoplasms encountered in the liver of animals, although primary adenoma, adenocarcinoma and metastases of other neoplasms in the area drained by the portal tract are not uncommon, especially in ruminants. For the most part, they produce no signs of hepatic dysfunction but they may cause sufficient swelling to be palpable, and some abdominal pain by stretching of the liver capsule. Primary tumors of the gallbladder and bile ducts also occur rarely and do not generally

cause clinical signs. A primary hepatic fibrosarcoma in a goat has caused loss of body weight, although appetite was maintained, anemia and jaundice.<sup>12</sup> Hepatic biliary cystadenoma has been described in a 10-year-old horse.<sup>13</sup> It is regarded as a morphological variant of biliary cystadenoma of domestic animals.

A series of 66 primary hepatic tumors of cattle has been examined and classified using modern criteria.<sup>14</sup> Fifty hepatocellular tumors (10 adenomas and 40 carcinomas), 10 cholangiocellular tumors, two cavernous hemangiomas, two hemangioendothelial sarcomas, one fibroma and one Schwannoma were diagnosed. An association with cirrhosis was not found. A bile duct hamartoma in a calf has been reported.<sup>15</sup>

## REFERENCES

1. Harman BR et al. *J Anim Sci* 1989; 67:311.
2. O'Sullivan EN. *Vet Rec* 1999; 145:389.
3. Rogers JA et al. *J Anim Sci* 1995; 73:9.
4. Cahill LW. *Bovine Pract* 1993; 27:171.
5. Scanlan CM, Hathcock CL. *Cornell Vet* 1983; 73:288.
6. Rosa JS et al. *Br Vet J* 1989; 145:73.
7. Uzal FA et al. *Vet Rec* 1999; 145:260.
8. Matoi Y et al. *Am J Vet Res* 1992; 53:574.
9. Sellon DC et al. *J Am Vet Med Assoc* 2000; 216:882.
10. Stotland EL et al. *J Am Vet Med Assoc* 2001; 219:36.
11. Marcato PS et al. *J Comp Pathol* 1998; 119:95.
12. Higgins RJ et al. *Vet Rec* 1985; 116:444.
13. Salvaggio A et al. *Vet Pathol* 2003; 40:114.
14. Bettini G, Marcato PS. *J Comp Pathol* 1992; 107:19.
15. De Bosschere H, Ducatelle R. *Vet Rec* 1999; 144:210.

## DISEASES OF THE BILIARY SYSTEM

Cases of biliary tract disease with clinical manifestations are uncommon in food animals and horses. Occasional cases of cholangitis occur in cattle and horses. Associated clinical signs include fever, pain over the liver, jaundice and photosensitization. There is usually an accompanying leukocytosis and a left shift. In horses a sequel to cholangitis may be a diffuse bacterial hepatitis with signs of hepatic insufficiency. Septic cholangiohepatitis and cholangiocarcinoma have been recorded in a horse.<sup>1</sup>

Concretions in the biliary system of cattle are usually a sequel to fascioliasis.<sup>2</sup> Mild cases show anorexia and pain over the liver. Severe cases show recurrent attacks of severe abdominal pain, alimentary tract stasis and pain on percussion over the liver. Jaundice occurs only in the terminal stages of fatal cases and is accompanied by recumbency, depression and coma.<sup>3</sup> The frequency of pigment gallstones is high in sheep and associated with high total bilirubin concentration in

the bile.<sup>4</sup> Other causes of biliary tract disease include gallbladder empyema and a bile duct carcinoma. In the latter case there was severe loss of body weight and signs referable to metastases in other organs but there were no clinical or post-mortem signs of biliary malfunction. Biliary atresia in young foals is manifested by an early period of normality for 2–3 weeks after birth followed by the development of listlessness, anorexia, the passage of gray, pasty feces and jaundice. Death occurs about a week later.

Obstructive cholelithiasis in horses may cause intermittent colic or continuous pain and sometimes jaundice. A series of 10 cases in horses is reported.<sup>5</sup> Clinical findings included fever, icterus, mild intermittent colic and weight loss. Laboratory findings included leukocytosis, hyperproteinemia and hyperfibrinogenemia. GGT and lactate dehydrogenase were also elevated.

## Cholangiohepatitis in horses

A series of nine cases was reported of cholangiohepatitis and cholelithiasis in mature horses with a median age of 13 and a range of 4–18 years.<sup>6</sup> Clinical signs that prompted referral of each horse to a veterinary teaching hospital included anorexia, depression, weight loss, colic, intermittent fever and icterus. In all horses, the GGT and ALP were elevated, and there was hyperbilirubinemia. Trans-abdominal ultrasonography was used to evaluate the size and nature of the liver and to obtain liver biopsy for histopathology and culture. The ultrasonographic findings included increased hepatic echogenicity, hepatomegaly, enlarged distended bile ducts and occasional calculi as the salient features. Neutrophilic cholangiohepatitis consistent with an infectious cause was a feature of biopsy material from each horse.

The etiology and pathogenesis of cholangiohepatitis and cholelithiasis in horses is uncertain. Retrograde bacterial infection from the small intestine is considered probable. Culture of liver biopsy material yielded *E. coli* and *Bacteroides vulgatus* from only a small number of affected animals. Long-term parenteral Gram-negative antibiotics daily for a median of 51 days (range 17–124) was associated with survival in 7/9 horses. Supportive intravenous fluid therapy is also necessary. Progress can be monitored by evidence of clinical improvement and declining levels of GGT.

Cholangiohepatitis in a 2-month-old calf was characterized clinically by depression, fever and diarrhea.<sup>7</sup> There was marked leukocytosis and neutrophilia. The GGT and ALP were markedly elevated and total bilirubin was elevated. Ultra-

sonographic examination of the liver revealed gross abnormality and liver biopsy results indicated neutrophilic hepatitis and multifocal hyperplasia of the biliary epithelium suggesting cholangiohepatitis. Culture of liver tissue yielded *E. coli* sensitive to amikacin, cefazolin and ceftiofur. Supportive fluid therapy and antibiotics may be successful.

Suppurative cholangiohepatitis and cholelithiasis associated with enteritis has been described occurring in adult horses.<sup>8</sup> Clinical findings included nonresponsive colic, fever, depression, severe abdominal pain, tachycardia, dehydration, gastric fluid accumulation and absence of abdominal sounds over all four quadrants. Distended loops of small intestine were palpable on rectal examination and the peritoneal fluid was serosanguinous. Azotemia, hyperbilirubinemia, increased ALP and GGT were present and persisted for several days. Cases were associated with severe inflammation of the small intestine and hypotensive shock.

Cholangiohepatitis and pancreatitis secondary to gastroduodenal ulceration in a 2-month-old foal was characterized clinically by colic unresponsive to surgical treatment.<sup>9</sup> At necropsy, gastric ulceration, segmental duodenal stenosis and severe chronic cholangiohepatitis and pancreatitis were present.

Cholelithiasis attributable to a foreign body in a horse is recorded.<sup>10</sup> Clinical signs suggestive of biliary disease in adult horses may be due to neoplasia of the pancreas (see below). A case of congenital hepatic fibrosis in a newborn calf is recorded.<sup>11</sup>

## REFERENCES

1. Durando MM et al. *J Am Vet Med Assoc* 1995; 206:1018.
2. West HJ, Hogg R. *Vet Rec* 1988; 122:251.
3. Lechtenberg KF et al. *Am J Vet Res* 1988; 49:58.
4. Catallini A et al. *Am J Vet Res* 1991; 52:2043.
5. Johnston JK et al. *J Am Vet Med Assoc* 1989; 194:405.
6. Peek SF, Divers TJ. *Equine Vet J* 2000; 32:301.
7. Coombs DK et al. *Vet Rec* 2002; 150:551.
8. Davis JL, Jones SL. *J Vet Intern Med* 2003; 17:583.
9. Buete M. *Can Vet J* 2003; 44:746.
10. Gerros TC et al. *J Am Vet Med Assoc* 1993; 202:301.
11. Yoshikawa H et al. *Vet Pathol* 2002; 39:1.

## Diseases of the pancreas

Pancreatic disease in large animals is rare and only a few comments are presented here.

## DIABETES MELLITUS

Lesions of the pancreas causing diabetes mellitus are recorded in cows<sup>1</sup> and horses and donkeys.<sup>2</sup> The clinical syndrome in horses includes weight loss, polydipsia,

polyuria, intense hyperlipidemia and high blood levels of cholesterol, triglycerides and glucose. Clinical observations suggest that the disease is most likely to occur in old horses and may be due to pancreatic injury related to migration of strongyle larvae.<sup>3</sup> Diabetes mellitus resulting from pancreatic beta-cell failure is rare in the horse but has been reported in a domesticated Spanish Mustang.<sup>4</sup> In cows there is afebrile emaciation, polydipsia, ketonuria, glucosuria and hyperglycemia.

### **PANCREATIC ADENOCARCINOMA**

The pancreatic duct of the horse is anatomically close to the common bile duct and it is not unexpected that a tumor mass should cause a syndrome of biliary

duct pathology,<sup>5,6</sup> although there is a surprising absence of jaundice at some stages of the disease. There is emaciation, concomitant moderate abdominal pain and variable fecal texture up to diarrhea. GGT and blood ammonia levels are greatly increased.

### **PANCREATIC ADENOMA**

Convulsions due to hypoglycemia have been recorded in a pony with a pancreatic adenoma.<sup>7</sup> It is assumed that the hypoglycemia resulted from hyperinsulinism generated by the beta-cell adenoma.

### **PANCREATITIS**

Pancreatitis is rare in farm animals. Inflammatory and degenerative changes

are detected post mortem in some cattle but are rarely diagnosed clinically because of a lack of clinical and laboratory findings. Ultrasonographic imaging of experimentally induced pancreatitis in cattle has been described.<sup>8</sup>

### **REFERENCES**

1. Mostaghni K, Ivoghli B. *Cornell Vet* 1977; 67:24.
2. Moore JN et al. *Endocrinology* 1979; 104:576.
3. Bulgin MS, Anderson BC. *Compend Contin Educ Pract Vet* 1983; 5:S482.
4. Johnson PJ et al. *J Am Vet Med Assoc* 2005; 226:584.
5. Kerr OM et al. *Equine Vet J* 1982; 14:338.
6. Church S et al. *Equine Vet J* 1987; 19:77.
7. Ross MW et al. *Cornell Vet* 1983; 73:151.
8. Mohamed T et al. *Vet J* 2003; 165:314.

# Diseases of the cardiovascular system

## PRINCIPLES OF CIRCULATORY

### FAILURE 399

- Heart failure 399
- Circuit failure 399
- Cardiac reserve and compensatory mechanisms in heart failure 399
- Cardiac enlargement 401

## MANIFESTATIONS OF CIRCULATORY

### FAILURE 401

- Chronic (congestive) heart failure 401
- Acute heart failure 404

## SPECIAL EXAMINATION OF THE CARDIOVASCULAR SYSTEM 405

- Physical examination 405
- Measurement of jugular venous pressure 407
- Exercise tolerance 407
- Electrocardiography 407

- Serum cardiac troponin I concentration 409
- Phonocardiography 409
- Cardiac output 410
- Measurement of arterial blood pressure 410
- Echocardiography 411
- Cardiac catheterization 411
- Radiographic and angiocardiographic examination 412

## ARRHYTHMIAS 412

- Sinus tachycardia, sinus bradycardia and physiological dysrhythmias 413
- Arrhythmias with normal heart rates or bradycardia 414
- Arrhythmias with tachycardia 416

## DISEASES OF THE HEART 420

- Myocardial disease and

- cardiomyopathy 420
- Rupture of the heart and acute cardiovascular accidents 422
- Cor pulmonale 422
- Valvular disease and murmurs 423
- Endocarditis 427

## DISEASES OF THE PERICARDIUM 429

- Pericarditis 429
- Congenital cardiac defects 431

## CARDIAC NEOPLASIA 433

## DISEASES OF THE BLOOD VESSELS 433

- Arterial thrombosis and embolism 433
- Venous thrombosis 435
- Hemangioma and hemangiosarcoma 436

## Principles of circulatory failure

The primary function of the cardiovascular system is to ensure an adequate circulation of blood so that nutrients are delivered, waste products are removed and a homeostatic milieu is maintained at the organ and cellular level. An inadequate circulation interferes with nutrient delivery and waste product removal, and ultimately leads to circulatory failure, the primary concept in diseases of the cardiovascular system.

The two functional units of the cardiovascular system are the heart and the blood vessels; these two units are best characterized as a pump (the heart) and a circuit (the blood vessels and blood). The pump and circuit may fail independently of each other, giving rise to two forms of circulatory failure – heart failure and circuit failure. In heart failure the primary problem is inadequate pump performance, whereas in circuit failure the deficiency is in the vascular system, which fails to return an adequate volume of blood to the heart. Circuit failure can also result from decreased circulating blood volume.

## HEART FAILURE

The failure of the heart as a pump can result from a defect in filling of the heart, an abnormality in the generation or conduction of the electrical wave of depolarization, an abnormality in contractile function, excessive workload or a combination of one or more abnormalities.

### Causes of cardiovascular dysfunction

- Cardiac arrhythmia
- Obstructed flow
- Regurgitant flow
- Contractile dysfunction (systolic failure)
- Inadequate filling (diastolic filling)
- Loss of blood

It is usual to divide heart failure into two types, **acute heart failure** and chronic (**congestive**) heart failure. However, a complete range of syndromes occurs and some of them do not fit neatly into one or other category. Circulatory equilibrium is not maintained when cardiac output is deficient. If this develops sufficiently slowly, compensatory mechanisms, plus the failure of the heart itself as a pump, result in an increase in venous pressure and congestive heart failure. If on the other hand there is an acute reduction of cardiac output, as is caused by sudden cessation of the heart beat, the effect is to deprive tissues of their oxygen supplies and the syndrome of acute heart failure develops.

Heart failure can be **left-sided**, **right-sided** or both **left- and right-sided**. Left-sided heart failure causes an increase in left ventricular end diastolic pressure, mean left atrial pressure and pulmonary venous pressure. Depending upon the magnitude and rate of the increase in pressure, left-sided heart failure results in interstitial edema in the lungs and, if severe enough, pulmonary edema, dyspnea and death. Right-sided heart failure causes an increase in right ventricular end-diastolic pressure, mean

right atrial pressure and jugular venous pressure. Depending upon the magnitude and rate of the increase in pressure, right-sided heart failure results in symmetric venous distension (most readily detected in the jugular veins), an increase in pleural, pericardial and abdominal fluid (ascites), and hepatomegaly.

## CIRCUIT FAILURE

In circuit failure the effective blood volume is decreased because of loss of fluid from the vascular system (hypovolemic shock) or by pooling of blood in peripheral vessels and increased capillary permeability (maldistributive shock). The failure of venous return results in incomplete filling of the heart and a reduction in cardiac output, although there is no primary defect in pump performance. The effects of circuit failure are the same as those of chronic (congestive) heart failure in that the supply of nutrients to the tissues and the removal of waste products from the tissues are reduced.

## CARDIAC RESERVE AND COMPENSATORY MECHANISMS IN HEART FAILURE

The normal heart has the capacity to increase its output severalfold in response to normal physiological demands created by exercise and to a lesser extent by pregnancy, lactation, digestion and hot ambient temperatures. Collectively, these compensatory responses comprise the **cardiac reserve**. Similar compensatory responses are utilized by the failing heart in an attempt to maintain cardiac output.

Cardiac reserve and its response in heart failure have not been studied extensively in large domestic animals and consequently its description must rely heavily on studies on cardiac failure in small domestic animals and studies of the effect of exercise on cardiovascular performance in the horse.<sup>1-6</sup> Clinical observations on cardiac insufficiency and cardiac failure in large animals suggest that the processes are very similar to those in small animals and humans.

The major mechanisms whereby the blood flow to an organ can be increased are:

- Increase in heart rate
- Increase in stroke volume
- Redistribution of blood flow to vital organs, or organs with particularly high metabolic requirements.

All of these mechanisms act synergistically and are interrelated. Heart rate and stroke volume are the determinants of cardiac output (cardiac output is the product of heart rate and stroke volume).

#### CARDIAC RESERVE AND HEART RATE

There is a great deal of cardiac reserve in the heart rate, and an elevation of heart rate alone is a significant factor in increasing cardiac output in the exercising horse. There is a limitation to heart rate reserve because with increasing heart rates there is a decrease in diastolic filling time, and stroke volume falls at excessive heart rates. Effective heart rate reserve can be increased with exercise training, and maximum heart rate in trained exercising horses is six to seven times resting values.<sup>7</sup> This large increase in heart rate reflects the metabolic scope of trained horses. In contrast, cattle can only increase their heart rate to two to four times their resting values. An increase in heart rate is also used to maintain cardiac output by the failing heart. With cardiac insufficiency in the horse and the cow it is rare for the heart rate to exceed 120/min, and rates higher than this are frequently due to tachyarrhythmias that require immediate treatment.

#### CARDIAC RESERVE AND STROKE VOLUME

Stroke volume is variable and depends upon the amount of shortening that the myocardial fibers can attain when working against arterial pressure. It is determined by an interplay of four factors:

- Ventricular distending or filling pressure (preload)
- Contractility of the myocardium (inotropic state)
- The tension that the ventricular myocardium must develop during

contraction and early ejection (afterload)

- The sequence of atrial and ventricular depolarization.

An increase in ventricular distending pressure (end-diastolic pressure or volume) will increase ventricular end-diastolic fiber length, which, by the Frank-Starling mechanism and stretch-dependent calcium sensitization, will result in increased stroke work and a larger stroke volume. Ventricular distending pressure is influenced by atrial contraction and is greatly augmented by increased venous return associated with exercise and increased sympathetic activity. Contractility is most influenced by adrenergic activity and circulating catecholamines. An increase in stroke volume is achieved primarily by an increase in the ejection fraction and a reduction in the end-systolic volume but can also be achieved by a decrease in afterload, which is primarily a function of aortic or pulmonary impedance (the resistance and reactance of the vasculature to ejection).

#### CARDIAC RESERVE AND MIXED VENOUS OXYGEN TENSION

In normal animals at rest, the oxygen tension of mixed venous blood is above 40 mmHg (5.3 kPa), which represents a considerable reserve. Increased extraction of oxygen from the blood by various tissues, with a subsequent decrease in mixed venous oxygen tension and a corresponding increase in arterial venous oxygen difference, occurs during exercise and in pump and circuit failure.<sup>4</sup> In uncompensated heart failure, where stroke volume is reduced, the mixed venous oxygen tension falls below 40 mmHg, reaching 15–25 mmHg in severe shock states, and the arterial venous oxygen difference is large. There is also a redistribution of blood flow to vital organs. In the horse the splenic storage capacity for erythrocytes is large and the spleen may contain one-third of the total red cell volume. Maximal emptying of the spleen under adrenergic activity can significantly influence the oxygen-transporting capacity of the blood and, in the horse, the splenic reservoir contributes significantly to cardiovascular reserve.

#### CARDIAC RESERVE AND AUTONOMIC NERVE ACTIVITY

It is evident that increased sympathetic nerve activity also plays a significant role in compensating for the failing ventricle, but one that is not readily determined clinically. An increase in sympathetic activity acts to augment cardiac output by increasing the heart rate, by improving the contractility of the myocardium and by augmenting venous return to the

heart. Autonomic nerve activity also regulates blood flow to more essential organs even when faced with insufficient cardiac output.

#### CARDIAC RESERVE IN CARDIAC INSUFFICIENCY

In cardiac insufficiency the principal defect is in the contractile state of the myocardium, and ventricular performance at any given end-diastolic volume or pressure is diminished. In early failure, cardiac output may still be maintained in the normal range by an increase in filling pressure and, through utilization of stretch-dependent calcium sensitization and the Frank-Starling principle, the ventricles can eject a normal stroke volume despite the depression in contractility. Thus, early in the course of cardiac failure, the end-diastolic pressure may be elevated only during periods with heavy demands on the heart, such as during exercise. However, as myocardial function becomes increasingly impaired, this mechanism is increasingly utilized for lesser work demands until end-diastolic pressure is elevated even at rest or with normal activity.

Ventricular filling pressure is augmented by increased venous return associated with contraction of the venous capacitance vessels under increased sympathetic tone, and by an increase in blood volume as the result of salt and water retention by the kidney. Decreased renal perfusion results in the release of renin by the juxtaglomerular cells in the kidney and the activation of the **renin-angiotensin-aldosterone system**. Renin causes the conversion of angiotensinogen to angiotensin I and angiotensin I in turn is converted to angiotensin II in the lungs. Angiotensin II is a powerful vasoconstrictor and promotes the effect of norepinephrine. Angiotensin II also stimulates the release of aldosterone from the adrenal cortex, which acts to increase sodium retention by the kidney with consequent expansion of the interstitial fluid and blood volumes.

Although the increase in ventricular end-diastolic pressure acts to maintain cardiac output, it is associated with a marked increase in systemic or pulmonary venous pressure, producing secondary effects that result in many of the clinical abnormalities associated with congestive heart failure. Where the contractile state of the heart is markedly reduced, the increased end-diastolic pressure is unable to maintain normal stroke volume, even at normal activity, and cardiac output is reduced even at rest – the state of uncompensated heart failure, which is clinically manifest as pump failure.

## MEASUREMENT OF CARDIAC RESERVE

From a clinical standpoint it would be desirable to be able to detect incipient cardiac insufficiency at a very early stage.

A clinical estimation of cardiac reserve based on physical examination is important when a prognosis is to be made for an animal with heart disease. Some of the important criteria used in making this assessment include the heart rate, the intensity of the heart sounds, the size of the heart, the characteristics of the pulse and the tolerance of the animal to exercise. A resting heart rate above normal indicates loss of cardiac reserve. The absolute intensity of the heart sounds suggests the strength of the ventricular contraction, soft sounds suggesting weak contractions and sounds that are louder than normal suggesting cardiac dilatation and possibly hypertrophy, although this is a very crude and insensitive measure. The interpretation of variation in intensity must be modified by recognition of other factors, such as pleural and pericardial effusion, that interfere with audibility of the heart sounds.

Pulse characteristics are of value in determining the cardiac reserve but they are greatly affected by factors other than cardiac activity. An increased amplitude of the pulse occurs when the cardiac stroke volume is increased, but a decreased amplitude may result from reduced venous return as well as from reduced contractile power of cardiac muscle.

Exercise tolerance is an excellent guide to cardiac reserve and the least expensive and most practical method for quantifying cardiovascular reserve. Exercise tolerance is best assessed by measuring the maximum heart rate attained after a standard exercise test, and the speed with which the heart rate returns to normal.<sup>1,3,4</sup>

## REFERENCES

1. Flaminio MJBF et al. *Vet Clin North Am Equine Pract* 1996; 12:565.
2. El Aguera EI et al. *J Equine Vet Sci* 1995; 15:532.
3. Physick-Sheard PW. *Vet Clin North Am Equine Pract* 1 1985; 2:383.
4. Evans DL, Rose RJ. *Pflugers Arch* 1988; 411:316.
5. Hinchcliff KW et al. *Am J Physiol* 1990; 258:R1177.
6. Seeherman HJ, Morris EA. *Equine Vet J Suppl* 1990; 9:20.
7. Harkins JD, Kamerling SG. *J Equine Vet Sci* 1991; 11:237.

## CARDIAC ENLARGEMENT

The ratio of heart weight to body weight is greater in athletic animals than in

nonathletic animals, and the heart:weight ratio in horses can be modestly increased during training as a result of physiological hypertrophy. Cardiac enlargement is also a compensatory response to persistent increased workloads that are associated with cardiovascular disease. The heart may respond by dilatation, hypertrophy or a combination of both.

**Cardiac hypertrophy** (concentric hypertrophy) is the usual response to an increased pressure load, and there is hypertrophy of individual fibers with an increase in the number of contractile units (sarcomeres) and an increase in total muscle mass. However, cardiac hypertrophy is usually accompanied by decreased capillary density and increased intercapillary distance and, in states of cardiac insufficiency, coronary blood flow reserve places limitations on this compensatory mechanism.

**Cardiac dilatation** (eccentric hypertrophy) is the usual response to an increased volume load and probably results from fiber rearrangement. Contractions occurring in a dilated chamber can eject a larger volume of blood per unit of myocardial shortening. However, the limitation to this compensatory mechanism is evident in the law of Laplace, which shows that in the dilated chamber greater myocardial wall tension is required to produce an equivalent elevation of intrachamber pressure during ejection.

The significance of finding cardiac enlargement on clinical examination is that it indicates the presence of a significant volume or flow load on the heart, or the presence of myocardial disease and a reduction of cardiac reserve. The detection of cardiac enlargement on physical examination is aided by careful auscultation of the heart, palpation of the apex beat and rarely by thoracic percussion. A palpable and audible increase in the apex beat and area of audibility, backward displacement of the apex beat, increased visibility of the cardiac impulse at the base of the neck and behind the elbow and increased area for the cardiac shadow during thoracic percussion are all suggestive of cardiac enlargement. Care must be taken that the abnormalities observed are not due to displacement of the heart by a space-occupying lesion of the thorax such as thymic lymphosarcoma, or to collapse of the ventral part of the lung and withdrawal of lung tissue from the costal aspects of the heart. Echocardiography should be used to quantify the magnitude of the enlargement whenever the results of physical examination suspect the presence of cardiac enlargement.

## Manifestations of circulatory failure

The manifestations of circulatory failure depend on the rapidity of its onset, the magnitude of its severity, and on its duration. Chronic (congestive) heart failure and acute heart failure are discussed below.

## CHRONIC (CONGESTIVE) HEART FAILURE

**Etiology** Diseases of the endocardium, myocardium and pericardium that interfere with the flow of blood into or away from the heart, or that impair myocardial function, may result in congestive heart failure

**Clinical findings** Generalized venous distension and edema in right-sided failure. Pulmonary edema and respiratory distress in left-sided failure

**Clinical pathology** Increased serum concentration of cardiac troponin I, a cardiac-specific enzyme

**Necropsy findings** Subcutaneous edema, ascites, hydrothorax and hydropericardium; enlargement and engorgement of the liver with right-sided failure. Pulmonary edema with left-sided failure

**Diagnostic confirmation** Clinical

**Treatment** Treatment of specific cause, often unsuccessful. Diuretics, salt restriction, minimize activity, possibly digoxin

## ETIOLOGY

Causes of chronic (congestive) heart failure can be broadly characterized as follows.

### Valvular disease

- Endocarditis resulting in either valvular stenosis or valvular insufficiency
- Congenital valvular defects – most commonly valvular stenosis
- Rupture of valve or valve chordae.

### Myocardial disease

- Myocarditis – bacterial, viral, parasitic or toxic
- Myocardial degeneration – nutritional or toxic
- Congenital or hereditary cardiomyopathy
- Toxins affecting cardiac conduction.

### Congenital anatomical defects producing shunts

- Cardiac defects, such as ventricular or atrial septal defects, tetralogy of Fallot
- Vascular abnormalities producing shunts, such as patent ductus arteriosus.

### Hypertension

- Pulmonary hypertension – high altitude disease, cor pulmonale
- Systemic hypertension – undocumented cause of congestive heart failure in large animals.

### Pressure load

Pressure loads occur with lesions that produce an obstruction to outflow such as aortic or pulmonary valve stenosis, where the heart is required to perform more work to eject an equivalent amount of blood. Pressure loads are not necessarily associated with lesions in the heart. For example, pulmonary hypertension, such as occurs in high altitude disease of cattle due to an increase in pulmonary vascular resistance, may result in cardiac insufficiency. In general, the left ventricle can tolerate a pressure load to a much greater extent without overt signs of cardiac insufficiency than the right ventricle.

### Volume load

Volume loads (flow loads) occur commonly with both acquired and congenital heart defects. In aortic valve insufficiency and mitral valve insufficiency the volume of blood delivered to the tissues does not differ significantly from normal. However, in order to achieve a normal cardiac output, the forward stroke volume of the ventricle is markedly increased and the heart is much more inefficient for the same amount of effective work. In a similar manner a patent ductus arteriosus or an interventricular septal defect with a large left-to-right shunt of blood can place a considerable flow load on the left ventricle. In general, the right ventricle is more capable of sustaining a flow load than the left ventricle.

### Pumping defects (systolic failure)

Cardiac insufficiency may occur without any increase in workload if there is a primary weakness in the myocardium or defect in its rhythmic and coordinated contraction. Myocarditis, cardiomyopathy and neoplasms of the heart, especially bovine viral leukosis lesions of the right atrium, are the common causes. Arrhythmias are a rare cause of congestive heart failure but a common cause of acute heart failure.

### Filling defects (diastolic failure)

Pericardial diseases such as pericarditis and pericardial tamponade can result in cardiac insufficiency by interfering with diastolic filling. Filling of the ventricle is determined by the complex interaction of a number of factors, including mean circulatory filling pressure, mean right atrial pressure, stiffness of the ventricular chamber (which is determined, in part, by

mean arterial blood pressure) and the pressure gradient across the ventricular wall. The latter is markedly affected by increases in pericardial fluid pressure that are present in pericarditis and pericardial tamponade.

### PATHOGENESIS

Cardiac reserve and compensatory mechanisms in heart failure are described in the preceding section. In the early stages of cardiac disease circulatory equilibrium may be maintained. However, cardiac reserve is reduced and the animal is not able to cope with circulatory emergencies as well as a normal animal. This is the stage of waning cardiac reserve in which the animal is comparatively normal at rest but is incapable of performing exercise – the phase of poor exercise tolerance – or responding appropriately to a physiological stressor such as late gestation or being housed in hot ambient temperatures. Congestive heart failure develops when these compensatory mechanisms reach their physiological limit and the heart is unable to cope with the circulatory requirement at rest.

Failure may manifest as primarily being right-sided, left-sided or both left- and right-sided. Many of the clinical signs that appear during the development of cardiac insufficiency, as well as those associated with decompensated heart failure, are the consequence of congestion or edema due to increased venous hydrostatic pressure. A decreased cardiac output also contributes to the clinical signs by the production of tissue hypoxia.

### Right-sided congestive heart failure

Venous congestion is manifest in the systemic circulation. The increase in mean right atrial pressure increases the mean capillary pressure and the net force for filtration of fluid across the capillary bed is therefore greatly increased. This results in the production of **edema** in dependent subcutaneous body areas and in body cavities. In the kidneys the increase in hydrostatic pressure is offset by the reduced flow of blood and urine output is reduced. The increased back pressure to the glomerulus causes increased permeability and escape of plasma protein into the urine. **Venous congestion** in the portal system is an inevitable sequel of hepatic congestion and is accompanied by impaired digestion and absorption and terminally by diarrhea.

### Left-sided congestive heart failure

Increased pulmonary venous pressure results in venous congestion, decreased compliance of the lung and an increase in respiratory rate, an increase in the work of breathing, and exercise intolerance. Similarly, bronchial capillary congestion

and edema result in encroachment on airways and a decrease in ventilatory efficiency. Where venous hydrostatic pressure is exceptionally high, the net force for filtration of fluid across the pulmonary capillary bed is greatly increased. This can result in **pulmonary edema**, with the presence of fluid around the septal vessels and in the alveolar spaces accompanied by marked impairment of gas exchange. The development of clinically detectable pulmonary edema depends to some extent on the rapidity of the onset of cardiac failure. In chronic failure syndromes, the development of a capacious lymphatic drainage system limits the occurrence of clinical pulmonary edema and, in large animals, pulmonary edema is usually limited to acute heart failure where there is a relatively sudden onset of a volume load on the left ventricle.

### CLINICAL FINDINGS

The specific findings on auscultation and other examinations are described under the specific causes of congestive cardiac failure.

In the very early stages when cardiac reserve is reduced but decompensation has not yet occurred there is respiratory distress on light exertion. The time required for return to the normal respiratory and pulse rates is prolonged. In affected animals there may be evidence of cardiac enlargement and the resting heart rate is moderately increased. There may be a loss of body weight.

### Right-sided congestive heart failure

The **heart rate is increased** and there is venous distension and subcutaneous edema. The **superficial veins** are engorged. In ruminants there is **subcutaneous edema** occurring in the brisket region, under the jaw and along the ventral midline, and **ascites** as indicated by the presence of an abdominal fluid wave on ballottement with palpation and less frequently by the presence of abdominal distension with a pear-shaped abdomen. Ascites needs to be differentiated from other causes of abdominal distension, and the detection by palpation per rectum of viscera floating in a fluid medium and the presence of a fluid wave on abdominal ballottement are highly suggestive of ascites. Care must be taken to differentiate ascites from uroabdomen and hydrops conditions of the uterus. Hydrothorax and hydropericardium may also be clinically detected in animals with ascites. In horses, edema is initially more prominent in the pectoral region between the front limbs, the ventral abdominal wall, the prepuce and the limbs. Ruminants and camelids do not get edema in their legs in right-sided heart failure because



their comparatively thicker skin acts as an antigravity suit ('G' suit), minimizing the extent of hydrostatic pooling of blood in the limbs.

The **liver** is enlarged and, in cattle, may be palpable, protruding beyond the right costal arch with a thickened and rounded edge. In both horses and cattle liver enlargement may be detected by ultrasound examination. The **respiration** is deeper than normal and the rate may be slightly increased. Urine flow is usually reduced and the urine is concentrated and contains a small amount of protein. The **feces** are usually normal at first but in the late stages diarrhea may be evident. Body weight may increase because of edema but the appetite is poor and condition is lost rapidly. Epistaxis may occur in the horse but is rare in other species. The attitude and behavior of the animal is one of listlessness and depression; exercise is undertaken reluctantly and the gait is shuffling and staggery through weakness.

#### Left-sided congestive heart failure

The **heart rate is increased** and there is an increase in the rate and depth of **respiration** at rest, with **cough**, the presence of crackles (discontinuous sounds) at the base of the lungs and increased dullness on percussion of the ventral borders of the lungs. Terminally there is severe dyspnea and cyanosis.

The **prognosis** in congestive heart failure varies to a certain extent with the cause but in most cases in large animals it is poor to grave. The possibility of recovery exists with an arrhythmia, pericardial tamponade or pericarditis, but when the epicardium, myocardium or endocardium are involved complete recovery rarely if ever occurs, although the animal may survive with a permanently reduced cardiac reserve. Uncomplicated defects of rhythm occur commonly in the horse and these defects are more compatible with life than are extensive anatomical lesions.

#### CLINICAL PATHOLOGY

Clinicopathological examinations are usually of value only in differentiating the causes of congestive heart failure and in differentiating from other diseases. Aspiration of fluid from accumulations in any of the cavities may be thought necessary if the origin of the fluid is in doubt.<sup>1</sup> The fluid is an edematous transudate except in pericardial tamponade (serosanguinous) or pericarditis (effusion) when it may be septic or nonseptic.<sup>2</sup> In most cases protein is present in large amounts because of leakage of plasma from damaged capillary walls. Proteinuria is often present because of pressure-induced damage to the glomerulus. The

serum concentration of **cardiac troponin I** provides an excellent cardiac biomarker in large animals, providing a sensitive and persistent indicator of cardiac injury.<sup>3</sup>

#### NECROPSY FINDINGS

Lesions characteristic of the specific cause are present and may comprise abnormalities of the endocardium, myocardium, pericardium, lungs or large vessels. Space-occupying lesions of the thorax may constrict the cranial vena cava and interfere with venous return. The lesions that occur in all cases of congestive heart failure, irrespective of cause, are: pulmonary congestion and edema if the failure is left-sided; anasarca, ascites, hydrothorax and hydropericardium and enlargement and engorgement of the liver, with a 'nutmeg' pattern of congested red centers of liver lobules surrounded by paler fatty peripheral regions, if the failure is right-sided. It is important to characterize the heart failure as being left-sided, right-sided or both left- and right-sided at necropsy, because this information will help in prioritizing the likely cause.

#### DIFFERENTIAL DIAGNOSIS

- Causes of edema
- Causes of dyspnea

#### TREATMENT

The treatment of animals with clinical signs of congestive heart failure due to pericarditis or pericardial tamponade focuses on removing the pericardial fluid and preventing its return. In animals with pump failure, the treatment of congestive heart failure initially focuses on the reduction of the effects of increased preload by administering diuretic agents and restricting sodium intake, reducing the demands on cardiac output by restricting activity, and improving contractility by the administration of positive inotropic agents such as cardiac glycosides.

#### Diuretics

Diuretic treatment, furosemide, acetazolamide or chlorothiazide, is an important component of treatment in that it mobilizes and eliminates excess body fluids. Furosemide is most commonly used because it is the most potent diuretic available, is inexpensive and pharmacokinetic parameters have been determined for large animals. Furosemide should be administered at an initial intravenous dose of 0.25–1.0 mg/kg for horses and 2.5–5.0 mg/kg for cattle for the treatment of congestive heart failure.<sup>4,5</sup> Multiple doses of furosemide will induce a hypokalemic, hypochloremic metabolic alkalosis, so it is important to monitor

serum potassium and chloride concentrations during treatment. Access to free salt should be stopped, although it is usually impractical to formulate a salt-restricted diet.

#### Stall rest

Stall rest in a thermoneutral environment is also an important treatment requirement. Parturition may be electively induced in late gestation in order to prevent in-utero fetal hypoxia and abortion, and to decrease the additional demand placed by placental blood flow on the cardiac output.

#### Cardiac glycosides

Digoxin is the most commonly used cardiac glycoside. In horses it can be administered either intravenously or orally but in ruminants it must be given intravenously or after induction of esophageal groove closure because digoxin is destroyed in the rumen. Digoxin should not be given intramuscularly in any species as it causes severe muscular necrosis and this is also reflected in erratic plasma digoxin concentrations following intramuscular administration. Treatment with digoxin results in an increase in cardiac contractility and a decrease in heart rate with increased myocardial oxygen consumption, increased cardiac output and a decrease in cardiac size.<sup>4</sup> The improvement in cardiac output promotes diuresis and the reduction and elimination of edema.

The half-life of digoxin in the **horse** is 17–23 hours.<sup>6,7</sup> and a plasma therapeutic range for digoxin of 0.5–2.0 ng/mL has been suggested.<sup>6</sup> Pharmacokinetic studies suggest that therapeutic but nontoxic plasma concentrations of digoxin in the horse will be achieved by an initial intravenous loading dose of 1.0–1.5 mg/100 kg followed by a maintenance dose of 0.5–0.75 mg/100 kg every 24 hours.<sup>7</sup> In the horse the bioavailability of powdered digoxin given orally is low, being less than 20% of the administered dose. An oral loading dose of 7 mg/100 kg, followed by a daily oral maintenance dose of 3.5 mg/100 kg is suggested by pharmacokinetic studies.<sup>6</sup>

The half-life of digoxin in **cattle** is 5.5–7.2 hours,<sup>8,9</sup> requiring more frequent dosing than in horses, and an initial intravenous loading dose of 2.2 mg/100 kg followed by 0.34 mg/100 kg every 4 hours has been suggested.<sup>8</sup> An alternative is to give digoxin as a continual infusion at 0.086 mg/100 kg.<sup>5</sup> There is no established dose for digoxin administration in **sheep** but the half-life is similar to that in cattle.<sup>10</sup>

No dosing regimen is absolute and the dose may need adjustment based on clinical response, evidence of toxicity, or by measuring the plasma digoxin

concentration. Dose rates other than those above have been used successfully.<sup>11,12</sup> Toxicity with digoxin treatment is reported and may occur because the clearance of digoxin in some animals with congestive heart failure differs from that of normal animals on which the suggested doses have been based.<sup>13</sup>

If treated animals are not eating, the daily oral administration of KCl (cattle 100 g, horses 30 g) is recommended<sup>5</sup> and it is recommended that **serum potassium concentrations** be monitored because the toxic effects of digoxin are impacted by the serum potassium concentration. Because of the necessity for frequent dosing in cattle and the ineffectiveness of oral treatment, digoxin therapy has major limitations in ruminants, especially since the primary pathology that leads to congestive heart failure in cattle is commonly not correctable. Unless myocardial damage is transient, administration of the digoxin in all species will probably have to be continued for life, and this is rarely practical.

#### REVIEW LITERATURE

- Muir MW, McGuiRK SM. Pharmacology and pharmacokinetics of drugs to treat cardiac disease in horses. *Vet Clin North Am Equine Pract* 1985; 1:335-352.
- Muir MW, McGuiRK S. Cardiovascular drugs. Their pharmacology and use in horses. *Vet Clin North Am Equine Pract* 1987; 3:37-57.
- McGuiRK SM. Treatment of cardiovascular disease in cattle. *Vet Clin North Am Food Anim Pract* 1991; 7:729-746.

#### REFERENCES

- Milne MH et al. *Vet Rec* 2001; 148:341.
- Jesty SA et al. *J Am Vet Med Assoc* 2005; 226:1555.
- Phillips W et al. *J Vet Intern Med* 2003; 17:597.
- Muir MW, McGuiRK S. *Vet Clin North Am Equine Pract* 1987; 3:37.
- McGuiRK SM. *Vet Clin North Am Food Anim Pract* 1991; 7:729.
- Button C et al. *Am J Vet Res* 1980; 41:1388.
- Brumbaugh GW et al. *J Vet Pharmacol Ther* 1983; 6:163.
- Koritz GD et al. *J Vet Pharmacol Ther* 1983; 6:141.
- Garry FB, Klee W. *Tierarztl Umsch* 1990; 45:750.
- Dix LP et al. *Am J Vet Res* 1985; 46:470.
- Staudacher G. *Berl Munch Tierarztl Wochenschr* 1989; 102:1.
- Stewart GA et al. *Aust Vet J* 1990; 67:187.
- Pearson EG et al. *Compend Contin Educ Pract Vet* 2(1987; 1):1.

### ACUTE HEART FAILURE

#### ETIOLOGY

Acute heart failure can occur when there is a severe defect in filling, when there is failure of the heart as a pump, either due to severe tachycardia, bradycardia or arrhythmia, and where there is a sudden increase in workload. The sudden occurrence of tachyarrhythmias in association with excitement and severe enough to cause acute heart failure presumably results from the exacerbating influence of catecholamines.<sup>1,2</sup> These are released in

**Etiology** Sudden onset of a severe arrhythmia, rupture of a heart valve or vessel, pericardial tamponade

**Clinical findings** Sudden loss of consciousness, falling with or without convulsions, severe pallor of the mucosae and either death or complete recovery from the episode

**Clinical pathology** Increased serum cardiac troponin I concentrations, but clinical course usually too short for examination

**Diagnostic confirmation** Clinical

**Necropsy findings** Pulmonary congestion and edema. Findings related to specific cause

**Treatment** Treatment of specific cause, often unsuccessful

association with episodes of excitement and act to heighten the discharge potential of ectopic excitatory foci associated with myocardial disease.

Acute heart failure can also occur in the absence of primary cardiac disease under the influence of pharmacological agents that affect cardiac conduction. These are associated with the ingestion of certain poisonous plants.

The many causes of acute heart failure are listed in greater detail under myocardial diseases. Some examples are as follows:

- Disorders of filling
  - Pericardial tamponade – atrial and ventricular rupture
  - Aortic and pulmonary artery rupture
- Tachyarrhythmia
  - Myocarditis, e.g. encephalomyocarditis virus, foot-and-mouth disease
  - Nutritional deficiency myopathy, e.g. copper or selenium deficiency
  - Plant poisoning, e.g. *Phalaris* spp., white snake root
  - Electrocutation and lightning strike
- Bradycardia
  - Iatrogenic, e.g. intravenous calcium gluconate or borogluconate administration, xylazine, tolazoline, concentrated solutions of potassium chloride
  - Plant poisoning, e.g. *Taxus* spp.
- Increase in workload
  - Rupture of aortic valve
  - Acute anaphylaxis.

Arrhythmias and cardiac arrest may occur during the induction of anesthesia with barbiturates in the horse and may also occur without premonitory signs in horses under halothane anesthesia.

#### PATHOGENESIS

With excessive tachycardia the diastolic period is so short that filling of the ven-

tricles is impaired and cardiac output is grossly reduced. In ventricular fibrillation no coordinated contractions occur and no blood is ejected from the heart. The cardiac output is also seriously reduced when the heart rate slows to beyond a critical point because cardiac output is the product of heart rate and stroke volume, and stroke volume cannot be markedly increased. In all these circumstances there is a precipitate fall in cardiac output and a severe degree of tissue ischemia. In peracute cases the most sensitive organ, the brain, is affected first and the clinical signs are principally neurological. Pallor is also a prominent sign in acute heart failure because of the reduction in blood flow.

In less acute cases respiratory distress is more obvious because of pulmonary edema and although these can be classified as acute heart failure they are more accurately described as acute congestive heart failure.

#### CLINICAL FINDINGS

The acute syndrome may occur while the animal is at rest but commonly occurs during periods of excitement or activity. The animal usually shows **dyspnea**, staggering and **falling**, and **death** often follows within seconds or minutes of the first appearance of signs. There is marked **pallor** of the mucosae. Although clonic convulsions may occur they are never severe and consist mainly of sporadic **incoordinate movements** of the limbs. Death is usually preceded by deep, **asphyxial gasps**. If there is time for physical examination, weakness or absence of a palpable pulse and bradycardia, tachycardia or absence of heart sounds are observed. The specific findings in the heart and vascular system depend upon the arrhythmia and are detailed in the section on arrhythmias later in this chapter.

Horses with sudden onset of tachyarrhythmias due to atrial fibrillation or multiple ventricular extrasystoles, or with rupture of the aortic or mitral valve chordae show a syndrome where sudden onset of **respiratory distress** is the prominent manifestation. However, examination of the heart will allow a diagnosis of the underlying cause.

Acute heart failure is the cause of death in a significant proportion of horses that die suddenly and unexpectedly during training or racing.<sup>3</sup> The diagnosis is based primarily on the findings of significant pulmonary hemorrhage and edema, although myocardial pathology is absent in most cases. Severe arrhythmic disturbances secondary to pre-existing myocardial injury and the concurrent presence of catecholamines, hyperkalemia and metabolic acidosis are likely causes.

## CLINICAL PATHOLOGY

In general, there is insufficient time available in which to conduct laboratory tests before the animal dies. The demonstration of elevated serum troponin I concentrations, a sensitive and specific marker of myocardial damage, strongly supports the presence of myocardial disease. Laboratory tests may also be used to elucidate the specific etiology.

## NECROPSY FINDINGS

In typical acute cases engorgement of visceral veins may be present if the attack has lasted for a few minutes but there may be no gross lesions characteristic of acute heart failure. Microscopic examination may show evidence of pulmonary congestion and early pulmonary edema. In more prolonged cases, venous engorgement with pulmonary congestion and edema are evident along with hydrothorax but these are more accurately described as acute congestive heart failure. The primary cause may be evidenced by macroscopic or microscopic lesions of the myocardium.

## DIFFERENTIAL DIAGNOSIS

Acute heart failure should always be a major consideration as a cause of sudden and unexpected death in large animals, especially when death is associated with exertion or excitement. Acute heart failure may be mistaken for primary disease of the nervous system but is characterized by excessive bradycardia or tachycardia, pallor of mucosae, weakness or absence of the pulse and the mildness of the convulsions. Epilepsy and narcolepsy are usually transient and repetitive and have a characteristic pattern of development.

## TREATMENT

Treatment of acute heart failure is not usually possible or practical in large animals because of the short course of the disease. Deaths due to sudden cardiac arrest or ventricular fibrillation while under anesthesia can be avoided to a limited extent in animals by external or internal cardiac compression or electrical conversion-stimulation but these techniques are generally restricted to sophisticated institutional surgical units. Also, the electrical energy required for defibrillation of animals larger than a sheep or goat is beyond the capabilities of conventional defibrillators unless the paddles are placed directly across the pericardium or transvenous electrodes are used. Intracardiac injections of very small doses of epinephrine in conjunction with external cardiac compression by jumping up and down on the thorax with the knees can be tried, with occasional success.

## REFERENCES

1. Van Vleet JF et al. *Am J Vet Res* 1977; 38:991.
2. Rona G. *J Mol Cell Cardiol* 1985; 17:291.
3. Gelberg HB et al. *J Am Vet Med Assoc* 1985; 187:1354.

## Special examination of the cardiovascular system

The more commonly used techniques of examination of the heart and pulse are described in Chapter 1. A more detailed clinical examination of the system that gives greater attention to nuances of location and intensity of heart sounds and arterial and venous pulse characteristics is conducted whenever cardiovascular disease is suspect.

Special techniques of examination are also available which may be of value in some cases. With the exception of jugular venous pressure measurement, assessment of exercise intolerance, electrocardiography and indirect methods for measuring arterial blood pressure, many of these techniques have limited application in general practice as they require sophisticated and expensive equipment. The use of specialized diagnostic equipment is generally confined to teaching hospitals and investigative units.

## PHYSICAL EXAMINATION

In the examination of animals suspected to have heart disease, it is important to determine the rate, rhythm and intensity of the individual heart sounds and the rate, rhythm and amplitude of the arterial pulse, examine for the presence of venous pulsation at the jugular inlet, and identify the point of maximal intensity and timing of murmurs within the cardiac cycle.

## HEART SOUNDS

In the horse it is not uncommon to hear four heart sounds on auscultation, whereas two to three heart sounds are heard in ruminants and camelids.

### First heart sound

The first heart sound (S1) signals the onset of ventricular systole, is synchronous with the apex beat and is temporally associated with closure of the mitral and tricuspid valves. The area for maximal audibility of the **mitral valve** in the horse is on the left fifth intercostal space, at a level midway between a horizontal line drawn through the point of the shoulder and one drawn at the sternum at the caudal edge of the triceps muscle. With cattle, sheep, goats and swine the sound is located at a similar level but at the fourth intercostal space. The area for maximal audibility of the **tricuspid valve** is on the right side of the chest slightly

ventral to the equivalent level for the mitral valve and at the fourth intercostal space in the horse; and at the level of the costochondral junction at the third intercostal space for the other species.

### Second heart sound

The second heart sound (S2) is associated with aortic and pulmonic valve closure and is synchronous with the end of systole and the beginning of cardiac diastole. The **aortic component** is most audible just ventral to a horizontal line drawn through the point of the shoulder and in the left fourth intercostal space in horses and the left third in the other species. The **pulmonic component** is most audible ventral and anterior to the aortic valve area in the left third intercostal space in horses and the left second or third intercostal space close to the costochondral junction in the other species. These two components of the second heart sound have the same temporal occurrence on auscultation but tonal differences can frequently be detected at the two areas of maximal audibility. Splitting of the second sound in the horse can be detected on phonocardiographic examination but cannot be detected on auscultation and there is no respiratory-associated splitting, as occurs with some other species.

### Third heart sound

The third heart sound (S3) is associated with rapid filling of the ventricle in early diastole and is heard as a dull thudding sound occurring immediately after the second sound. It is usually most audible on the left side just posterior to the area of maximal audibility of the first heart sound. However it is frequently heard over the base and also over the area of cardiac auscultation on the right side. Phonocardiographically there are two components to this heart sound but these are not usually detectable on clinical auscultation.

The third heart sound is very common in horses and can be detected in the majority of fit racing animals. It is more audible at heart rates slightly elevated above resting normal. The third heart sound is very common in slightly excited cattle (heart rates 80–100 beats/min) but becomes more difficult to hear when the heart rate exceeds 100 beats/min.

### Fourth heart sound

The fourth heart sound (S4) is associated with atrial contraction. It is also called the 'a' sound. It occurs immediately before the first heart sound and is a soft sound most audible over the base of the heart on the left- and right-hand side. It is also common in horses but its clear separation from the first heart sound is dependent

upon the length of the **P-R interval**, which varies between horses. At resting heart rates the S4 sound is detectable on clinical examination in at least 60% of horses.

The interval between the S4 and S1 frequently varies in the same horse at rest in association with variation in the P-Q interval and results in a clear separation in some beats with slurring of the two sounds together in other beats. The fourth heart sound or a split S1 is also commonly heard in young cattle, but phonocardiographic studies have not been undertaken.

#### Sequence of heart sounds

The sequence of heart sound occurrence is thus 4-1-2-3. The intensity of the third and fourth sounds is less than that of the first and second and the complex can be described as du LUBB DUP boo. In some horses, the third or fourth sound may be inaudible so that 1-2, 4-1-2 and 1-2-3 variations occur. The name **gallop rhythm** is frequently applied when these extra sounds occur. Gallop rhythms also occur in cattle and may be due to the occurrence of a fourth or third sound or to true splitting of the components of the first heart sound. In sheep, goats and pigs only two heart sounds are normally heard. The occurrence of a third or fourth heart sound in horses and cattle is not an indication of cardiovascular abnormality, as it is in other species.

#### Variation in heart sound intensity

Change in the intensity of the generation of sound by the heart or change in the transmission of the sounds between the heart and the stethoscope can result in variation in the intensity of heart sounds normally heard on auscultation.

- A **decrease** in the intensity of heart sound generation occurs in disease where there is poor venous return and decreased strength of cardiac contractility, such as in terminal heart failure, in hypocalcemia in cattle or in circulatory failure in all species
- Conversely the intensity of the heart sounds may **increase** with anemia, cardiac hypertrophy and metabolic diseases such as hypomagnesemia. However, the intensity of the heart sounds is most often increased by sympathetic activation as a result of exercise, fear and excitement.

**Muffling** of the heart sounds suggests an increase in tissue and tissue interfaces between the heart and the stethoscope. This can be due to a shift in the heart due to displacement by a mass, changes in the pericardium (increased fluid or fibrous tissue), changes in the pleural space or increased subcutaneous fat. Heart sounds are detectable by auscultation on the left

side in animals of all condition scores but heart sounds may become inaudible on the right side where the condition score approaches 5/5.

#### Heart rate

The **relative temporal occurrence** and the **intensity** of the third and fourth heart sounds changes with **heart rate**. At moderately elevated heart rates the third heart sound becomes more audible. At faster heart rates the third sound may merge and sum with the fourth sound or the fourth sound may merge with the first sound if the P-R interval decreases. During periods of a rapid change in heart rate, such as during the increase in rate that occurs following sudden noise or similar stimuli in excitable horses or the subsequent decrease in rate, the variation in the occurrence and the intensity of the third and fourth sound coupled with the variation in intensity of the first and second sound during this change can give the impression of a gross arrhythmia. Such impressions should be ignored if they occur only at times of rapid change of rate that is obviously induced by external influences and if there is no arrhythmia at the resting rate or the intervening stable elevated rate. Examination of the pulse during these periods of rapid change is also of value.

Variations in the intensity of the individual heart sounds or complete absence of some of them can occur in **conduction disturbances** and **arrhythmic heart disease** and can provide valuable clinical information. In several of these disturbances there is variation in the intensity of the first and third heart sounds associated with variation in the time of the preceding diastolic period and variations in diastolic filling. The intensity of the first heart sound may also vary with variations in the P-R interval or where there is complete atrioventricular dissociation. In several of the arrhythmias there is absence of one or more of the heart sounds. These findings are detailed below under the specific abnormalities.

#### EXAMINATION OF THE ARTERIAL PULSE

In arrhythmic heart disease the arterial pulse should be examined in more detail than that applied during routine clinical examination.

#### Pulse rate

The pulse rate should be examined over a period to determine if there is any sudden change in rate such as can occur with a shift in pacemaker to an irritable myocardial focus. At some stage during the examination of animals with tachyarrhythmias the heart rate and pulse rate should be taken synchronously to

determine the presence of a pulse deficit (auscultation of S1 but a weak or absent S2 accompanied by a weak or absent pulse). A convenient artery for this purpose is located on the posterior medial aspect of the radius and carpus in the horse and cow. However, the best artery to determine the pulse rate, rhythm and amplitude is the descending aorta; this artery should be palpated during rectal examination in horses and cattle.

#### Pulse rhythm

Pulse rhythm is carefully examined. When a 'dropped pulse' or arrhythmia is detectable in the pulse the basic underlying rhythm should be established in order to determine if the heart is under regular pacemaker influence. This is best done by mentally or physically tapping out the basic rhythm of the heart and continuing this rhythm when irregularity occurs. With conditions such as second-degree heart block where there is a basic underlying rhythm initiated by the sinoatrial node, it is possible to tap through the irregularity and re-establish synchrony with the pulse. However, in conditions such as atrial fibrillation where there is no regular pacemaker it is not possible to establish any basic rhythm. This examination of rhythm can alternatively be conducted by auscultation and allows an immediate categorization of the arrhythmia into one of the two basic group, those superimposed on a regular pacemaker influence (occasionally irregular) and those in which there is no regular pacemaker (irregularly irregular).

#### Amplitude

The amplitude of the pulse should also be carefully examined. Variations in pulse amplitude are associated with those arrhythmias that produce a variation in diastolic filling period within the heart. The extreme of this is a pulse deficit (decrease in intensity or absence of a pulse associated with heart sounds).

#### EXAMINATION OF THE JUGULAR VEIN

In the normal adult horse and cow, the jugular vein will be distended with blood some 5-8 cm above the level of the base of the heart when the animal is standing with its head in a normal, nonfeeding, alert position. There is a rapid but minor fall in the level of jugular distension associated with the fall of blood into the ventricle during the period of rapid filling during ventricular diastole followed by a slower rise in the level of jugular filling to its original point. Superimposed on this, and immediately preceding the fall, is a small wave or retrograde distension associated with **atrial contraction** ('a' wave) and a second smaller retrograde

wave ('c' wave) associated with bulging of the atrial ventricular valves into the atrium during ventricular systole. These pulsations can be observed in most horses and cattle by careful observation of the jugular vein at its entrance into the thorax and can be timed in conjunction with auscultation of the heart.

Observation of the presence or absence of the atrial 'a' wave is an aid in the clinical differentiation of first- and second-degree heart block. Cannon atrial waves occur periodically in complete heart block when atrial contractions occur against a closed atrioventricular valve. An accentuated 'c' wave occurs with tricuspid valve insufficiency.

### MEASUREMENT OF JUGULAR VENOUS PRESSURE

The jugular veins are symmetrically distended in chronic (congestive) right-sided heart failure. This distension is accompanied by an increased jugular venous pressure that can be subjectively assessed by palpation or objectively determined by measuring jugular venous pressure.

This underutilized technique can be easily and rapidly performed. The equipment required is a 14–16-gauge needle attached to a three-way stopcock. A 20 mL syringe containing heparinized 0.9% NaCl is attached directly opposite the needle, and a flexible rigid wall fluid administration line is attached to the remaining port on the three-way stopcock. The stopcock is turned so that the needle is in the off position, the needle is threaded down the jugular vein towards the heart, the syringe is pushed to fill the first 10 cm of the flexible fluid line with heparinized 0.9% NaCl, and the stopcock is turned so that the syringe is in the off position.<sup>1</sup> Blood will flow into the flexible tube and the vertical distance (in cm) between the top of the column of 0.9% NaCl supported by the jugular venous pressure and the point of the shoulder (scapulohumeral joint), which approximates the position of the right atrium,<sup>2</sup> is a direct measure of jugular venous pressure.

### REFERENCES

1. Sellers AF, Hemingway A. *Am J Vet Res* 1951; 12:90.
2. Amory H et al. *Vet Res Commun* 1992; 16:391.

### EXERCISE TOLERANCE

Dyspnea, fatigue and a prolonged elevation in heart rate following exercise are signs suggestive of cardiac insufficiency. Frequently, animals with suspect cardiac disease are exercised in an attempt to elicit these signs and to get an estimate of exercise tolerance.<sup>1,2</sup> In most practice situations the assessment of exercise

tolerance is subjective. There is obviously a considerable difference in the amount of exercise that a beef bull and a trained racehorse can tolerate under normal conditions, and the amount of exercise given to any one animal is determined by the clinician's judgment. The rate of fall in heart rate following exercise and the time required to reach resting levels depend upon the severity of the exercise, even in fit horses. Heart rate falls rapidly over the first minute and then more slowly over the ensuing 10–15-minute period.

**More objective tests** have been developed for the horse, which include evaluation by means of telemetry from horses timed over a measured distance on race tracks<sup>3</sup> or the use of a treadmill<sup>1,4</sup> to provide a defined amount of exercise. The amount and intensity of exercise can be varied by the speed and incline of the treadmill and by the duration of the exercise period. The treadmill allows the recording of a variety of cardiorespiratory measurements in the exercising horse<sup>5,6</sup> and can be used for evaluating the significance of cardiopulmonary disease and for establishing the cause of poor racing performance.

There are many noncardiac causes of exercise intolerance and, in a report on the evaluation of 275 horses, 84% were found to have more than one problem leading to poor athletic performance.<sup>7</sup>

Criteria for cardiovascular performance in endurance rides are described and the rapidity of heart rate decline following completion of each section of the ride can be used for field assessment of this function.<sup>1,8,9</sup>

### REFERENCES

1. Parente EJ. *Vet Clin North Am Equine Pract* 1996; 12:421.
2. Mitten LA. *Vet Clin North Am Equine Pract* 1996; 12:473.
3. Gati L, Holmes JR. *Equine Vet Educ* 1990; 2:28.
4. Scheffer CWJ et al. *Vet Rec* 1995; 137:371.
5. Seeherman HJ, Morris EA. *Equine Vet J Suppl* 1990; 9:20.
6. Evans DL, Rose RJ. *Equine Vet J* 1988; 20:94.
7. Morris EA, Seeherman HJ. *Equine Vet J* 1991; 23:169.
8. Poggendoel RG. *Equine Vet J* 1988; 20:224.
9. Rose RJ et al. *Equine Vet J* 1979; 11:56.

### ELECTROCARDIOGRAPHY

The electrocardiogram (ECG) provides a record and measure of the time varying potential difference that occurs over the surface of the body as the result of electrical activity within the heart. This is associated with depolarization and repolarization of the myocardium. At any one instant during depolarization and repolarization there are generally several fronts of electrical activity within the heart. However, at the body surface the potential difference is generally the sum

of this activity and at any one instant the electrical activity in the heart registers as a single dipole vector that has polarity, magnitude and direction.

The polarity is determined by the charge on the surface of the cells while the magnitude and direction is determined by the mass of muscle being depolarized or repolarized and the sum of the instantaneous vectors. Thus a wave of depolarization or repolarization over a muscle mass such as the atria or the ventricles is presented at the body surface as a sequence of instantaneous vectors with changing magnitude and direction.

### THE ELECTROCARDIOGRAPH

The electrocardiograph is used to detect these characters. In simple terms it can be considered as a voltmeter consisting of two input terminals, an amplifier to allow the recording of low input signals and a galvanometer with an attached recording device such as a heated stylus on heat sensitive paper or an ink pen or ink squitter. When a potential difference exists across the input terminals (electrodes), current flows through the coils of the electromagnet suspended between the poles of the permanent magnet to cause a deflection of the recording pen. The electrocardiograph can therefore detect the polarity of the cardiac electrical vectors and by calibration of the machine and appropriate placement of electrodes on the body surface it can detect their magnitude and direction.

**Calibration** of most electrocardiographs is such that an input of 1 mV produces a 1 cm deflection of the recording pen. Recording speeds are generally 25 or 50 mm/s. In recording an ECG, certain standard electrode positions are used for recording.

- A **lead** is the recording or circuit between two recording points. Depending upon the wiring within the electrocardiograph the same potential difference across a lead could result in an upward or downward deflection of the recording pen
- In order to allow standard recording and comparison between recordings the **polarity** of the electrodes for standard leads has been established by convention and the leads are always recorded at these polarities
- The electrodes of a lead are commonly called positive or negative
- A **positive electrode** in a lead is one that, when electrically positive relative to the other, due to a potential difference between them, yields an upward or positive deflection of the recording pen.

## DEPOLARIZATION AND REPOLARIZATION

In the normal heart, depolarization and repolarization of the myocardium occurs in a definite pattern and sequence and the electrocardiography can be used to measure and time these events. Thus discharge of the sinoatrial node results in a wave of depolarization over the atria to produce a P wave in the ECG. The delay in conduction at the AV node is registered by no electrical activity at the body surface and an isoelectric P–R interval on the ECG (isoelectric means zero voltage difference between the two leads). Depolarization of the ventricles occurs with several sequential fronts to produce the QRS complex, which is followed by another isoelectric period before repolarization represented by the T wave.

In dogs, cats and humans the electrocardiogram can be used to assess the cardiac rhythm and the size of the cardiac chambers. However, the **order of ventricular activation** in horses, cattle, sheep and swine **differs** from that of humans and dogs in that ventricular depolarization is represented by only two fronts of activity. Depolarization of a large proportion of the myocardial mass in large animals is not recognized by the surface electrocardiogram because the Purkinje fibers penetrate much more deeply in these species and depolarization occurs over multiple minor fronts that tend to cancel out, rather than over a large single front as in dogs. For this reason, the detection of chamber enlargement by vector analysis of the electrocardiogram is, in general, not possible in large animals. Consequently, electrocardiography is confined to a simple base–apex lead system to examine for **conduction disturbances** and **arrhythmias**, which are detected by measurement of the various waveforms and intervals in the ECG that represent depolarization and repolarization in the heart, and by observation of their absence or abnormality.

## LEAD SYSTEMS

The base–apex lead system provides the best method for electrocardiography in large animals, with the only exception being fetal electrocardiography. All other lead systems are clinically superfluous or inferior, or have only a research application.

**Traditional lead systems** are based on Einthoven's triangle as used in humans, and the standard bipolar limb leads (I, II and III) and the augmented unipolar limb leads (aVR, aVL, aVF) are commonly used in conjunction with an exploring unipolar chest lead. Variations in the position of the feet may produce changes in ECG

waveforms with this lead system and recordings should be taken with the animal standing square or with the left front foot set slightly in advance of the right front foot. This lead system is quite satisfactory for the detection of conduction disturbances and arrhythmic heart disease but is subject to movement artefact. There are, however, deficiencies associated with its use for the detection of change in the magnitude and direction of electrical vectors in the heart of large animals.<sup>1,2</sup> Nevertheless, traditional lead systems have been used extensively for this purpose.

**Vector-based lead systems.** There have been several studies to determine if it is possible to detect changes in cardiac chamber size in large animals. Many of these have examined alternative lead systems, recognizing that the standard limb leads are not particularly suited for detection of vector changes associated with changes in chamber dimensions. The standard limb leads are primarily influenced by vectors in the frontal plane (longitudinal and transverse) whereas early and late forces in the myocardium are significantly directed in the vertical direction. Furthermore, the heart is not electrically equidistant from the electrodes of each lead and distortion of recorded vector loops can result.<sup>1,3</sup> A partial correction of these deficiencies can be made by recording a lead using an exploring electrode at the V10 position over the dorsal spinous processes in addition to the standard limb leads. However, for proper representation of the vector changes associated with electrical activity within the heart, completely different electrode placement is required. A number of systems have been proposed. The electrode placement varies and is quite complicated but electrocardiographic studies using these methods are available for horses,<sup>3–5</sup> cattle,<sup>6,7</sup> pigs<sup>8</sup> and sheep.<sup>9</sup> In general, a three lead system consisting of leads I, aVf and V10 provides semiorthogonal axes suitable for three-dimensional reconstruction of depolarization and repolarization.

The **base–apex lead system** is most commonly used as it records the major electrical forces in the heart of large animals with consistently clear and large-amplitude waveforms. Animal movement also has minimal effect on the quality of the ECG. The most commonly used **bipolar** lead placement in horses and cattle consists of two electrodes, one positive and one negative, in a format called the **base–apex** lead. The positive electrode of lead I (left arm) is attached to the skin of the left thorax at the fifth intercostal space immediately caudal to the olecranon, and the negative electrode

(right arm) is placed on the jugular furrow in the caudal third of the right neck. This is the most common lead placement, although some investigators place the negative electrode on the left side of the neck instead of the right side. With **sheep**, where wool interferes with placement on the neck, the negative electrode can be placed on the midline of the poll. When using the base–apex lead system, the ground electrode is placed remote from the heart, and the location of the ground is not important. The electrodes are usually placed using alligator clips and a 70% isopropyl alcohol or gel contact, although disposable human stick-on type electrodes can be used in horses after clipping of the skin and cleaning with alcohol before application of the gel. In order to ensure good adherence to the skin, the skin should be shaved and cleaned with alcohol prior to the application of the gel. The ECG is recorded with the animal in a standing position with minimal restraint. Normal values for cattle, horses, and pigs are summarized in Table 8.1.

## FETAL ELECTROCARDIOGRAPHY

The fetal ECG may be recorded, and can be of value in determining if the fetus is alive, the presence of a **singleton or twins**, and as a monitor for **fetal distress** during difficult or prolonged parturition. A modified bipolar lead system is required, with the RA electrode being placed on the right ventral abdomen and the LA electrode below placed on the ventral midline in front of the udder. The ground lead can be situated anywhere. The bipolar lead should be recorded using increased sensitivity with meticulous attention to obtaining the best electrical connection to the skin. The animal needs to be electrically isolated (standing on a rubber mat) and muscular activity must be minimized.

Table 8.1 Base–apex electrocardiographic parameters in cattle and horses (mean  $\pm$  SD)

	Duration (ms) Cattle	Horses	Sows
P	80 $\pm$ 10	100 $\pm$ 32	82 $\pm$ 0
P–R	200 $\pm$ 20	136 $\pm$ 7	
QRS	60 $\pm$ 10	91 $\pm$ 10	75 $\pm$ 6
Q–T	370 $\pm$ 30	485 $\pm$ 52	276 $\pm$ 6
T	90 $\pm$ 10		

Values are obtained from 600 healthy Holstein–Friesian female cattle aged 1 or more years (Rezakhani A et al. *Vet Arch* 2004; 74:351), 17 healthy male and female horses aged 6 months to 8 years (P. Constable, personal communication) and 467 healthy sows (Takemura N et al. *J Jpn Vet Med Assoc* 1988; 41:398).

Fetal electrocardiography has been used in cattle to monitor fetal viability, but the fetal ECG signal is very weak and suffers from interference from the maternal ECG, the electromyogram and motion artifacts caused by gastrointestinal movement.<sup>10</sup> For these reasons, the position of the bipolar recording leads on the abdomen should be moved to provide the optimal recording site for each cow. Digital processing of the fetal ECG signal can assist in detection of fetal heart rate<sup>10,11</sup> at more than 157 days of gestation. Fetal heart rates for calves tend to decrease with advancing gestation, approximating 140 beats/min from 160–190 days of gestation and 120 beats/minute at 250–280 days of gestation.<sup>10</sup>

The foal fetal heart rate decreases logarithmically from approximately 110 beats/min at 150 days before term to 75 beats/min near to term.<sup>12</sup> Continued monitoring traces may be needed to assess fetal distress. Fetal heart rate and heart rate variability has also been measured as an indicant of hypoxia and fetal distress during parturition in cattle.<sup>13,14</sup> Cardiac arrhythmia is common at the time of birth and is believed to result from the transient physiological hypoxemia that occurs during the birth process.<sup>15</sup> Following birth and during early growth of the foal there are age-dependent increases in the electrocardiographic intervals and changes in the orientation of the mean electrical axis.<sup>16</sup>

#### OTHER USES OF THE ELECTROCARDIOGRAM

- Changes in the electrocardiogram occur with some **electrolyte imbalances** in large animal species
- There is an approximately linear correlation between the heart-rate-corrected Q-T interval and plasma ionized calcium concentration in cattle, with elongation of the interval in hypocalcemic and shortening in hypercalcemic states
- Decreased amplitude and flattening of the P wave, widening of the QRS complex and an increased symmetry and amplitude of the T wave are seen with hyperkalemia<sup>18</sup>
- Estimates of heart size of the horse have been made from measurements of the QRS duration on the electrocardiogram and the resultant **heart score** is used to assess potential racing performance<sup>19</sup>
- **Exercise and postexercise** electrocardiograms frequently deliver information additional to that of the resting ECG, and can be recorded by radiotelemetry or Holter monitor systems<sup>20–22</sup>

- **Heart rate variability** has received recent interest as a research method to evaluate the relative contributions of sympathetic and parasympathetic tone to the cardiovascular system. Heart rate variability has been assessed in cattle using time domain<sup>23</sup> and frequency domain procedures.<sup>24</sup>

#### REVIEW LITERATURE

- Hamlin RL, Smith CR. Categorization of common domestic mammals based upon their ventricular activation process. *Ann NY Acad Sci* 1965; 12:195–203.
- Kanagawa H, Too K, Kawata K, Ono H. Fetal electrocardiogram in dairy cattle II. Diagnosis for twin pregnancy. *Jpn J Vet Res* 1965; 13:111–119.
- Too K, Kanagawa H, Kawata K. Fetal electrocardiogram in dairy cattle. I. Fundamental studies. *Jpn J Vet Res* 1965; 13:71–83.
- Robertson SA. Practical use of the ECG in the horse. *In Pract* 1990; 12:59–67.
- Amory H et al. Bovine vector cardiography: a comparative study relative to the validity of four tridimensional systems. *J Vet Med A* 1992; 39:453–469.

#### REFERENCES

1. Nielsen K, Vibe Petersen G. *Equine Vet J* 1980; 12:81.
2. Fregin GF. *Vet Clin North Am Equine Pract* 1985; 1:419.
3. Miller PJ, Holmes JR. *Res Vet Sci* 1984; 36:370.
4. Miller PJ, Holmes JR. *Res Vet Sci* 1984; 37:334.
5. Deegen E, Reinhard HJ. *Dtsch Tierarztl Wochenschr* 1974; 81:257.
6. Schultz RA, Pretorius PJ. *Onderstepoort J Vet Res* 1972; 39:209.
7. Amory H et al. *J Vet Med A* 1993; 40:81.
8. Thielscher HH. *Zentralbl Vet Med* 1969; 16A:370.
9. Torio R. *Small Rumin Res* 1997; 24:239.
10. Chen W et al. *Anim Sci J* 2002; 73:545.
11. Chen W et al. *Anim Sci J* 2004; 75:471.
12. Matsui K et al. *Jpn J Vet Sci* 1985; 47:597.
13. Jonker FH et al. *Am J Vet Res* 1996; 57:1373.
14. Steffen S et al. *Schweiz Arch Tierheilkd* 1995; 137:432.
15. Yamamoto K et al. *Equine Vet J* 1992; 23:169.
16. Lombard CW et al. *Equine Vet J* 1984; 16:342.
17. Stewart JH et al. *Equine Vet J* 1984; 16:332.
18. Spier SJ et al. *J Am Vet Med Assoc* 1990; 197:1009.
19. Blakely JA, Blakely AA. *N Z Vet J* 1995; 43:57.
20. Jacobson LH, Cook CJ. *Vet J* 1998; 155:205.
21. Scheffer CJW, Sloet van Oldruitenborgh-Oosterbaan MM. *Vet Q* 1996; 18:2.
22. Scheffer CJW et al. *Vet Rec* 1995; 137:371.
23. Minero M et al. *Vet* 2001; Rec 149 772.
24. Bømfret CJD et al. *Vet Rec* 2004; 154:687.

#### SERUM CARDIAC TROPONIN I CONCENTRATION

The serum concentration of **cardiac troponin I** provides an excellent cardiac biomarker in large animals, providing a sensitive and persistent indicator of cardiac injury.<sup>1</sup> Troponin I, T and C are components of the tropomyosin-troponin complex in cardiac and skeletal muscle, with cardiac troponin I and T having different amino-acid sequences at the N-terminal end compared to skeletal muscle troponin I and T. This means that an immunoassay directed at the

N-terminal end will be able to differentiate between cardiac and skeletal muscle isoforms and therefore the site of injury.<sup>2</sup> Myocardial tissue from horses, cattle, sheep and pigs has high reactivity for cardiac troponin I when tested using a human immunoassay, and this reactivity is selective for the myocardium, being more than 1000-fold higher in cardiac tissue than in skeletal muscle.<sup>1</sup> Cardiac troponin I has greater myocardial selectivity than cardiac troponin T, and is therefore preferred as a biomarker of cardiac injury.<sup>1,2</sup> 3–8% of cardiac troponin I and T are found in the myocardial cytosol; damage to the myocardial cell membrane causes cytosolic troponin I and T to escape into the interstitial fluid, thereby increasing serum cardiac troponin I concentrations.

Serum activities of cardiac isoenzymes of creatine kinase (creatine kinase isoenzyme MB (**CK-MB**)) and lactate dehydrogenase (isoenzymes 1 and 2) have been used in the past as indices of cardiac disease in horses. However, only 1.5% of the total CK activity in the equine heart is attributable to CK-MB (compared to 20% in the human heart);<sup>3</sup> therefore CK-MB is an insensitive indicator of cardiac disease in the horse. Isoenzymes of lactate dehydrogenase suffer from a similar lack of specificity for cardiac disease. Cardiac troponin I is the preferred biomarker for detecting and quantifying cardiac disease in animals,<sup>4</sup> and healthy horses have cardiac troponin I concentrations below 0.11 ng/mL using the human immunoassay.<sup>1,5,6</sup> Healthy neonatal foals have cardiac troponin I concentrations of less than 0.49 ng/mL.<sup>7</sup> Healthy cattle have cardiac troponin I concentrations below 0.04 ng/mL.<sup>8</sup>

#### REFERENCES

1. O'Brien PJ et al. *Clin Chem* 1997; 43:12.
2. Cornelisse CJ et al. *J Am Vet Med Assoc* 2000; 217:231.
3. Argiroudis SA et al. *Equine Vet J* 1982; 14:317.
4. Wallace KB et al. *Toxicol Pathol* 2004; 32:106.
5. Smith GW et al. *Am J Vet Res* 2002; 63:538.
6. Phillips W et al. *J Vet Intern Med* 2003; 17: 597.
7. Slack JA et al. *J Vet Intern Med* 2005; 19:577.
8. Jesty SA et al. *J Am Vet Med Assoc* 2005; 226:1555.

#### PHONOCARDIOGRAPHY

Phonocardiography allows the recording and measurement of heart sounds. A special microphone is placed directly over the various areas of the thorax used for heart auscultation and the heart sounds are recorded graphically on moving paper or on an oscilloscope. Prior to recording, the heart sounds are usually passed through high-pass, low-pass or band-pass **filters** to allow better discrimination of the individual sounds and to allow a crude frequency examination. Phono-



cardiograms are usually recorded in conjunction with an electrocardiogram and chamber pressure measurements, which permits timing of their occurrence in relationship to the electrical activity within the heart.

Phonocardiograms can provide considerable information on heart sounds additional to that acquired by stethoscopic examination. In the horse, up to 11 sound events can be detected in each cardiac cycle and figures of the occurrence and duration of normal heart sounds in large animals are available.<sup>1-3</sup> In conjunction with an electrocardiogram, the phonocardiogram can be used to measure systolic time intervals, which may be altered in congenital and acquired cardiovascular abnormalities.<sup>4</sup>

Phonocardiograms have been infrequently used for the characterization and timing of murmurs in animals with cardiovascular disease, especially at fast heart rates where simple stethoscopic examination may not allow this. However, phonocardiography has been rarely used as a clinical diagnostic tool, and the widespread availability of echocardiographs make the clinical application of phonocardiography less likely in the future.

#### REFERENCES

1. Vanselow B et al. *Aust Vet J* 1978; 54:161.
2. Welker FH, Muir WW. *Equine Vet J* 1990; 22:403.
3. Leurada AA et al. *Am J Vet Res* 1970; 31:1695.
4. Miller PJ, Holmes JR. *Equine Vet J* 1985; 17:181.

#### CARDIAC OUTPUT

There are several techniques available for the measurement of cardiac output but the one almost universally applied in large animals is the indicator dilution technique using thermodilution (injection of iced 5% dextrose) or indicator dyes such as Evans blue, indocyanine green or lithium chloride.<sup>1,2</sup> With dye dilution, an exact amount of dye is injected into the jugular vein or pulmonary artery via a catheter and the serial collection of blood samples is performed from a suitable proximally located artery that has been catheterized. Cardiac output is most commonly measured using thermodilution<sup>3</sup> but can also be calculated from a dye dilution curve by determining the mean concentration of the dye and the time taken for one circulation through the heart.<sup>1</sup> Automated cardiodensitometers are also available for this estimation. Cardiac output is expressed as liters per minute and is usually corrected to **cardiac index** on the basis of weight or body surface area.

Most domestic animals have a cardiac index of 100 (mL/kg body weight (BW))/min at rest. The cardiac index for horses, sheep and cattle at rest has been deter-

mined as  $86 \pm 13$ ,  $131 \pm 39$  and  $113 \pm 11$  (mL/kg)/min, respectively. Stroke volume can also be calculated from the measured cardiac output and simultaneously determined heart rate, whereby stroke volume = cardiac output/heart rate. In general the normal variation between animals in indexes of cardiac output is too great to allow it to be used as a diagnostic measure in individual animals suspected to have cardiac disease. Measures of cardiac output are used in experimental studies, where the effects of certain procedures can be followed within the same animal. Indicator dilution curves using dyes or thermodilution methodology can be used to detect the presence of intracardiac defects such as septal defects and to quantify their significance.

**Doppler echocardiography** can be used to estimate cardiac output and gives values equivalent to those obtained by thermodilution techniques.<sup>4,5</sup>

#### REFERENCES

1. Fisher EW, Dalton RG. *Br Vet J* 1961; 118:143.
2. Corley KIT et al. *Equine Vet J* 2002; 34:598.
3. Muir WW. *Am J Vet Res* 1976; 37:697.
4. Young LE et al. *Br J Anaesth* 1996; 77:773.
5. Blissitt KJ et al. *Equine Vet J* 1997; 29:18.

#### MEASUREMENT OF ARTERIAL BLOOD PRESSURE

Blood pressure may be determined directly by arterial puncture and pressure measurement but this is impractical in clinical cases. The development of simple methods for the indirect determination of arterial blood pressure has proved difficult in large animals because of the paucity of suitably located arteries where a pressure cuff can be applied and because there are problems in detecting pulse return by simple auscultatory or palpatory methods.

In the horse a simple and relatively inexpensive method uses oscillometric sphygmomanometry to detect arterial pulsations and therefore simultaneously determine heart rate and mean arterial pressure.<sup>1-4</sup> For adult horses, the optimal cuff width for the oscillometric method is approximately 20–35% of the tail circumference,<sup>1,2</sup> when the cuff is applied snugly to the base of the tail and the ventral coccygeal artery pressure is monitored. The mean tail circumference of an adult horse is 22 cm, therefore the optimal cuff width for horses is 5–8 cm for oscillometric pressure measurement. Because the oscillometric units were designed for use in humans, the software programs often have difficulty in measuring arterial pressure when the heart rate is less than 40 beats/min<sup>2</sup> and when arrhythmias or arterial hypotension are present<sup>3</sup>, which minimizes the clinical

utility of these units in trained or sick horses. The units are also susceptible to motion of the tail and it is therefore preferable to keep the tail still during recording. Other methods of indirect pressure measurement in the horse (modified auscultatory technique, ultrasonic Doppler methodology) appear less accurate than the oscillometric sphygmomanometry. Moreover, oscillometric techniques offer the advantage of providing systolic, diastolic and mean arterial blood pressures, whereas other indirect methods do not provide mean arterial pressure.<sup>3</sup>

Systolic and diastolic blood pressure of a large series of trained Thoroughbred horses were  $112 \pm 16$  mmHg ( $14.9 \pm 2.1$  kPa) and  $77 \pm 14$  mmHg ( $10.2 \pm 1.9$  kPa) respectively.<sup>1</sup> Equivalent values have been recorded in other breeds. These values are **coccygeal uncorrected values** and can be corrected to the correct reference level (scapulohumeral joint, which is equivalent to the right atrium) by adding 0.7 mmHg (0.09 kPa) for every centimeter in height between the scapulohumeral joint and the tail if the coccygeal artery was the recording site for indirect pressure measurement. **Posture** of the horse is important, as lowering the head significantly lowers systolic, diastolic and pulse pressure.

Hypertension has been found in association with epistaxis, laminitis in horses and painful fractures of the distal bones of the limb. Systolic blood pressure is often also elevated in obstruction of the large intestine in horses. Blood pressure measurements are of value in the assessment of the degree of shock and possibly may prove of value in the differential diagnosis of conditions such as acute salmonellosis and in assessing the prognosis of colic. Mean arterial pressure is considered the true driving pressure for blood flow and organ perfusion, therefore determination of mean arterial pressure provides one index of perfusion. However, it is important to recognize that mean arterial pressure is poorly correlated with cardiac output.

Blood pressure readings can be obtained by equivalent techniques from the tails of cattle. However, because of anatomical differences these do not always correlate well with true blood pressure. Pressures have been observed to be 100–140 mmHg (13.3–18.6 kPa) systolic and 50–85 mmHg (6.7–11.3 kPa) diastolic.

#### REFERENCES

1. Wagner AE, Brodbelt DC. *J Am Vet Med Assoc* 1997; 210:1279–1285.
2. Latshaw H et al. *Equine Vet J* 1979; 11:191–194.
3. Muir WW et al. *J Am Vet Med Assoc* 1983; 182:1230.
4. Parry BW et al. *Equine Vet J* 1984; 16:53.
5. Giguere S et al. *J Vet Intern Med* 2005; 19:571.



## ECHOCARDIOGRAPHY

Echocardiography has provided a relatively simple and noninvasive method for the examination of the heart that can give considerable information on its function. In echocardiography, high-frequency sound waves are pulsed through tissues at known velocities. When the sound waves encounter an acoustic tissue interface, echoes are reflected back to a transducer and recorded in a number of different modalities. The modalities have become increasingly sophisticated and they have largely replaced traditional invasive evaluations of cardiac function such as cardiac catheterization. The newer technologies are expensive and are currently limited to teaching hospitals and referral clinics.

Echocardiography will allow the measurement of cardiac chamber size, wall thickness, global and regional wall movement and valve structure and function.<sup>1-3</sup> Functional indices can be calculated that will allow the determination of the presence of hypertrophy or dilatation of areas of the heart and the percentage of wall thickening.<sup>4</sup> The fractional shortening of the left ventricle can be used as a sensitive index of left ventricular contraction. Quantitative studies are available for the horse,<sup>3,5-11</sup> sheep,<sup>12</sup> pigs<sup>2,13</sup> and cattle.<sup>14,14-16</sup> The measurement of the ratio of cardiopulmonary blood volume to stroke volume, determined from a radiocardiogram following the injection of technetium-99m pertechnetate, has proved a more sensitive test for cardiac insufficiency in horses than measurements of cardiac output.<sup>17</sup> Measurements of cardiac and individual chamber dimensions, vessel diameters and flow rates can be used to assess normality, indexes of contractility and effects of cardiac lesions on cardiac response and function.<sup>5,18-21</sup> They can also be used to predict the type of lesion likely to result in these changes.<sup>19</sup>

Valvular defects and endocarditis may be diagnosed by imaging abnormal valve motion, incompetent valve orifices or vegetative masses associated with the valves<sup>22</sup> and tumor masses in the heart can be detected.<sup>23</sup> Similarly, the severity of valvular regurgitation can be quantified.<sup>24</sup> Echocardiography can be of considerable value in the diagnosis of congenital cardiovascular defects<sup>1</sup> and the injection of echogenic materials such as microbubble-laden saline may aid in the detection of shunts.<sup>2,19</sup> Echocardiography can also be used to determine the presence and extent of pleural and pericardial effusion. In the examination of the vascular system, ultrasound is capable of the early detection of iliac thrombosis

in horses and is more sensitive than manual palpation per rectum.<sup>3</sup>

There is a long-held belief that horses with a large heart relative to their body size have greater athletic capacity.<sup>25</sup> An accurate and noninvasive method for determining heart weight therefore has potential utility as one method for predicting racing success. Echocardiography provides a useful estimate of heart weight that may compliment electrocardiographically determined heart score (calculated from the QRS duration) in the prediction of athletic performance. The thickness of the interventricular septum in diastole provides an **accurate prediction of heart weight**;<sup>26</sup> the predictive accuracy was such that echocardiography using this measurement has utility as an index of subsequent athletic performance<sup>27</sup> and has been used in North America, Europe and Australia in such a manner.

## REVIEW LITERATURE

- Reef VB. Advances in echocardiography. *Vet Clin North Am Equine Pract* 1991; 7:435-450.
- Bonagura JD. Echocardiography. *J Am Vet Med Assoc* 1994; 204:516-522.
- Marr CM. Equine echocardiography - sound advice at the heart of the matter. *Br Vet J* 1994; 150:527-545.
- Voros K. Quantitative two-dimensional echocardiography in the horse: a review. *Acta Vet Hung* 1997; 45:127.
- Braun U et al. Echocardiography of the normal bovine heart: technique and ultrasonographic appearance. *Vet Rec* 2001; 148:47-41.

## REFERENCES

1. Reef VB. *Equine Vet J Suppl* 1996; 19:97.
2. Kvart C et al. *Equine Vet J* 1985; 17:361.
3. Reef VB. *J Am Vet Med Assoc* 1987; 190:286.
4. Braun U et al. *Am J Vet Res* 2005; 66:962.
5. Tucker RL et al. *J Equine Vet Sci* 1995; 15:404.
6. Reef VB. *Vet Clin North Am Equine Pract* 1991; 7:435.
7. Young LE, Scott GR. *Equine Vet J* 1998; 30:117.
8. Blissitt KJ. *Equine Vet J* 1997; 29:18.
9. Seeherman HJ, Morris EA. *Equine Vet J Suppl* 1990; 9:20.
10. Harkins JD, Kamerling SG. *J Equine Vet Sci* 1991; 11:237.
11. Voros K et al. *Equine Vet J* 1991; 233:461.
12. Moses BL, Ross JN. *Am J Vet Res* 1987; 48:1313.
13. Gwathmey JD et al. *Am J Vet Res* 1989; 50:192.
14. Amory H et al. *Am J Vet Res* 1992; 53:1540.
15. Pipers FS et al. *Bovine Pract* 1978; 13:114.
16. Amory H, Lekeux P. *Vet Rec* 1991; 128:349.
17. Guthrie AJ et al. *J S Afr Vet Med Assoc* 1991; 62:43.
18. Young LE, Scott GR. *Equine Vet J* 1998; 30:117.
19. Bonagura JD. *J Am Vet Med Assoc* 1994; 204:516.
20. Marr CM. *Br Vet J* 1994; 150:527.
21. Slater JD, Herrtage ME. *Equine Vet J Suppl* 1996; 19:28.
22. Reef VB et al. *Equine Vet J* 1998; 30:18.
23. Braun U et al. *Schweiz Arch Tierheilkd* 1995; 137:187.
24. Hagio M, Otsuka H. *Jpn J Vet Sci* 1987; 49:1113.
25. Buhl R et al. *J Am Vet Med Assoc* 2005; 226:1881.
26. O'Callaghan MW. *Equine Vet J* 1985; 17:361.
27. Seder JA et al. *J Equine Vet Sci* 2003; 23:149.

## CARDIAC CATHETERIZATION

The measurement of pressure within the various chambers of the heart and in

the inflow and outflow vessels can provide diagnostic information in both acquired and congenital heart disease in large animals. Generally, pressure is determined by means of fluid-filled catheters introduced into these areas and connected to an external pressure transducer. These systems are generally satisfactory for the measurement of pressure and the detection of changes with abnormality. However, because of their transmission characteristics, they are less suitable for the precise timing of pressure events, and high-fidelity catheter tip manometers should be used for this purpose.

Catheterization of the right side of the heart is a comparatively simple procedure in large animals but is not without risk to the animal. Catheterization is done in the standing position, and descriptions are available for horses<sup>1,2</sup> and cattle.<sup>3-7</sup> Flow-directed catheters are used and can be introduced through a needle inserted into the jugular vein. Balloon-tipped catheters aid the flow of the catheter into the pulmonary artery. Catheterization of the left side of the heart is more complicated and less commonly performed. Left heart catheterization is usually performed under general anesthesia and requires the use of a stiff catheter that is introduced into the carotid or femoral artery by surgical methods and subsequently manipulated to the left ventricle.

The systematic determination of the pressure within each area of the heart and in the inflow and outflow vessels can allow a determination of the type of abnormality that is present. Valvular stenosis or incompetence is associated with abnormal pressure differences across the affected valve during systole or diastole. Cardiac hypertrophy is generally accompanied by an increase in pressure during systole of the affected chamber. With high-fidelity equipment, pressure waveforms can also have diagnostic value.

The right atrium is usually used as the reference point for pressure comparison and is arbitrarily assigned a reference pressure of zero when recording using a fluid-filled catheter system. The scapulo-humeral joint (point of the shoulder) is taken as the anatomical equivalent reference height in the standing animal.<sup>4</sup> A simultaneously recorded base-apex electrocardiogram assists in interpretation of the pressure tracings. Numerous publications have reported cardiovascular values for conscious awake horses, adult cattle and calves, and representative values are presented in Table 8.2.

During catheterization blood may be withdrawn through the catheter and subjected to blood gas analysis. In right-sided catheterization an increase in

Table 8.2. Mean ( $\pm$  SD) cardiopulmonary values for adult horses, cattle and calves and pigs.

Measured value	Adult horses <sup>9</sup>	Adult cattle <sup>7</sup>	Calves <sup>6</sup>	Pigs <sup>10</sup>
Body weight (kg)	560	540	40	43
Mean arterial pressure (mmHg)	120 $\pm$ 14	150 $\pm$ 27	92 $\pm$ 15	130 $\pm$ 12
Mean pulmonary artery pressure (mmHg)	21 $\pm$ 5	36 $\pm$ 9	18 $\pm$ 6	16 $\pm$ 2
Mean central venous pressure (mmHg)	6.9 $\pm$ 2.7	NS	2.4 $\pm$ 1.2	4.8 $\pm$ 1.2
Heart rate (beats/min)	44.4 $\pm$ 7.8	73 $\pm$ 14	114 $\pm$ 9	134 $\pm$ 10
Cardiac index ((mL/kg)/min)	93 $\pm$ 23	64 $\pm$ 14	20 $\pm$ 48	150 $\pm$ 10
Respiratory rate (breaths/min)	18 $\pm$ 7	45 $\pm$ 12	NS	19 $\pm$ 2
Arterial pH	7.41 $\pm$ 0.02	7.42 $\pm$ 0.03	7.37 $\pm$ 0.03	7.42 $\pm$ 0.04
Arterial P <sub>CO<sub>2</sub></sub> (mmHg)	40 $\pm$ 3	38 $\pm$ 3	50 $\pm$ 6	43 $\pm$ 2
Arterial P <sub>O<sub>2</sub></sub> (mmHg)	93 $\pm$ 14	109 $\pm$ 12	92 $\pm$ 10	105 $\pm$ 4

Animals are unsedated and standing with their head in a normal, nonfeeding position. Pressures are referenced to the scapulothoracic joint. NS, not stated.

oxygen saturation in the right ventricle or pulmonary artery can be diagnostic for the presence of a left-to-right shunt due to an atrial septal defect, a ventricular septal defect or a patent ductus arteriosus. The normal maximum increase in venous oxygen content between the right heart chambers and pulmonary artery in humans is 0.9 mL O<sub>2</sub>/dL from the right atrium to right ventricle and 0.5 mL O<sub>2</sub>/dL blood from the right ventricle to the pulmonary artery.<sup>3</sup> It is a reasonable assumption that similar changes in oxygen content (due to streaming of blood flow and variability in sampling site within the right atrium and ventricle) exist in large animals. Not only can blood gas analysis indicate the presence of a left-to-right shunt; sequential blood gas analysis can be used to quantify the magnitude of the shunt by calculating the pulmonary-to-systemic flow ratio and therefore assist in prognosis.

The pulmonary blood flow and systemic blood flow are approximately equivalent in healthy individuals, with the exception of a small amount of right-to-left shunt (physiological shunt) caused by venous blood from coronary and bronchial blood flow draining into the left ventricle, left atrium or pulmonary veins. The pulmonary-to-systemic flow ratio should therefore approximate 1.0.<sup>8</sup> In animals with a left-to-right shunt, the pulmonary to systemic flow ratio ( $Q_p/Q_s$ ) quantifies the magnitude of the left-to-right shunt across the defect. The pulmonary-to-systemic flow ratio is calculated using the Fick method from measurements of S<sub>a</sub>O<sub>2</sub> (oxygen content of arterial blood), MVO<sub>2</sub> (oxygen content of mixed venous blood, which is the pulmonary artery in animals without a shunt, the right ventricle in animals with a patent ductus arteriosus, the right atrium in animals with a ventricular septal defect, and the vena cava in animals with an atrial septal defect), P<sub>v</sub>O<sub>2</sub> (oxygen content of pulmonary venous blood), and P<sub>a</sub>O<sub>2</sub> (oxygen content of pulmonary artery blood), such that:

$$(Q_p/Q_s) = (S_aO_2 - MVO_2)/(P_vO_2 - P_aO_2)^8$$

This method assumes the animal is in steady state and that cardiac output does not change during blood sampling.<sup>8</sup> Oxygen content (in mL O<sub>2</sub>/dL blood) is calculated from the measured values for blood hemoglobin concentration ([Hb], in g/dL), oxygen tension and percentage O<sub>2</sub> saturation, such that O<sub>2</sub> content = [Hb]  $\times$  1.39  $\times$  O<sub>2</sub> saturation/100 + 0.003  $\times$  P<sub>O<sub>2</sub></sub>.<sup>8</sup> In clinical cases at sea level, it is assumed that that saturation of pulmonary venous blood and arterial blood = 97.5% and that P<sub>O<sub>2</sub></sub> = 90 mmHg. Application of this equation and assumptions to data from a 2-year-old Holstein-Friesian cow with a ventricular septal defect, atrial fibrillation and pulmonary hypertension (mean pressure 67 mmHg) indicated that  $(Q_p/Q_s) = (8.67 - 5.89)/(8.67 - 8.04) = 4.4$ , using the right atrial content as the mixed venous sample because the right ventricle contained a large volume of oxygenated blood from the left ventricle. This calculation indicated the presence of an extremely large left-to-right shunt (shunt =  $Q_p - Q_s = Q_p(1 - 1/4.4) = 0.77 \times Q_p$ ); in other words, 77% of the blood flowing through the lungs was from the left heart. Such a large shunt into the right ventricle was suspected based on the large step up in O<sub>2</sub> content from the right atrium to right ventricle (2.1 mL O<sub>2</sub>/dL; Table 8.3) which exceeded the maximal normal

value of 0.9 mL O<sub>2</sub>/dL. A 2 cm diameter ventricular septal defect was confirmed at necropsy.

Shunts can also be demonstrated by dye or thermodilution techniques,<sup>8</sup> but these are much more complicated to analyze than blood gas analysis of sequential blood samples obtained from a fluid-filled catheter during a pullback from the pulmonary artery through the right ventricle into the right atrium.

Echocardiography can provide information that, while different, may be of equivalent **diagnostic value** to that obtained by cardiac catheterization and, because it is noninvasive and technically a much easier procedure, echocardiography has largely supplanted cardiac catheterization in the examination of cardiac disease in large animals.

## REFERENCES

1. Brown CM, Holmes JR. Equine Vet J 10:1978; 188.
2. Brown CM, Holmes JR. Equine Vet J 10:1978; 207.
3. Manohar M et al. J Am Vet Med Assoc 1973; 163:351.
4. Amory H et al. Vet Res Commun 1992; 16:391.
5. Amory H et al. Vet Rec 1993; 132:426.
6. Constable PD. Shock 1999; 12:391.
7. Wagner AE et al. Am J Vet Res 1990; 51:7.
8. Yang SS et al. From cardiac catheterization data to hemodynamic parameters, 2nd ed. Philadelphia, PA: FA Davis, 1978:209-231.
9. Muir WW et al. Am J Vet Res 1977; 38:195.
10. Smith GW et al. Am J Vet Res 1999; Res 60:1292.

Table 8.3. Results of sequential blood gas analysis from a 2-year-old Holstein-Friesian heifer with a large ventricular septal defect. Blood was obtained from passing a fluid-filled catheter from the jugular vein through the right atrium, right ventricle, and into the pulmonary artery. The O<sub>2</sub> content of arterial and pulmonary venous blood was calculated to be 8.67 mL O<sub>2</sub>/dL blood.

Measured value	Right atrium	Right ventricle	Pulmonary artery
pH	7.42	7.47	7.48
P <sub>CO<sub>2</sub></sub> (mm Hg)	42.9	36.4	35.3
P <sub>O<sub>2</sub></sub> (mm Hg)	33.0	48.6	48.8
O <sub>2</sub> saturation (%)	64.1	87.7	91.6
Hemoglobin concentration (g/dL)	6.5	6.4	6.2
<b>Calculated value</b>			
Blood O <sub>2</sub> content (mL O <sub>2</sub> /dL blood)	5.89	7.95	8.04

## RADIOGRAPHIC AND ANGIOCARDIOGRAPHIC EXAMINATION

Because of the size of horses and cattle these methods of examination are largely confined to neonates of these species except in teaching hospitals. Angiocardiography can be a diagnostic method of examination in congenital cardiac defects where the passage of contrast media through abnormal routes can be detected.

## Arrhythmias (dysrhythmias)

Variations in cardiac rate and rhythm include tachycardia (increased rate), bradycardia (decreased rate), arrhythmia or dysrhythmia (irregularity in rate and rhythm) and gallop rhythms. The rate and rhythm of the heart is influenced primarily by the integrity of the pacemaker, the conducting system and the myocardium, and also by the influence of the autonomic nervous system. Variation in the rate and rhythm can occur in normal animals due to strong or varying **autonomic influence** but can also be a reflection of primary **myocardial disease**. Other factors such as **acid-base** and **electrolyte imbalance** can influence rate and rhythm. These factors must be taken into consideration in the assessment of apparent abnormalities detected on clinical examination of the cardiovascular system.

The majority of arrhythmias and conduction disturbances can be detected on clinical examination. However, some may be unsuspected on clinical examination and be found only on electrocardiographic examination. The occurrence of conduction and myocardial disturbances is probably more common than generally recognized, because an electrocardiogram is usually only taken from animals in which there have been prior clinical indications of conduction abnormalities. Because of the importance of electrocardiography in the diagnosis of arrhythmias the salient electrocardiographic findings are given in the sections below.

The common conduction disturbances and arrhythmias in large animals are listed in Table 8.4. A large scale cross sectional study of 952 healthy dairy cattle aged 1 or more years produced the following prevalence of arrhythmias:<sup>1</sup> sinus arrhythmia, 8.5%; first-degree atrioventricular block, 1.6%; ventricular premature complexes, 0.6%; atrial premature complexes, 0.4%; sinus bradycardia, 0.2% and ventricular escape beats, 0.1%. Atrial fibrillation was not observed in healthy cattle in this study.<sup>1</sup>

**Table 8.4** Common arrhythmias and conduction disturbances in the horse and cow

Horses	Cattle
Second-degree atrioventricular block	First-degree atrioventricular block
Atrial fibrillation	Atrial premature complexes
Atrial premature complexes	Ventricular premature complexes
Ventricular premature complexes	Atrial fibrillation
First degree atrioventricular block	
Sinoatrial block	

The treatment of arrhythmic heart disease generally relies on the treatment of the underlying clinical condition causing the problem. This may vary from electrolyte and acid-base disturbance and toxicities to primary myocardial disease resulting from myocarditis, myocardial ischemia and changes resulting from heart failure or myopathies resulting from nutritional deficiency. These are detailed in later sections in this text. Racing and work horses should be rested for periods up to 3 months following evidence of myocardial disease. Frequently a course of corticosteroids, or a nonsteroidal anti-inflammatory drug (NSAID) such as flunixin meglumine, is given to attempt to reduce the severity of myocarditis if this is not contraindicated by the initiating cause. Specific antiarrhythmic therapy may be applied in certain conditions and is detailed below.

It is important to be able to recognize those forms of arrhythmia that are not indicative of pathological heart disease but are normal **physiological variations**. These occur commonly in the horse and most can be differentiated on physical examination. It is also important to understand the difference between a **premature beat or contraction** and a **premature complex**. A beat or contraction is a mechanical event that can be clinically detected by auscultation, palpation of an artery or visual examination of the jugular venous pulse, or recorded by pressure measurements. A complex is an electrical event that is detected by an electrocardiograph. A beat is always associated with a complex; however, a complex can be unaccompanied by a beat, particularly in electromechanical dissociation. The terms beat or contraction should therefore be used to describe an arrhythmia that is detected by auscultation, palpation or recording of the arterial pulse, whereas the term complex should be used when the arrhythmia is detected electrocardiographically.

### REVIEW LITERATURE

- Hilwig RW. Cardiac arrhythmias in the horse. *J Am Vet Med Assoc* 1977; 170:153-163.
- McQuirk SM, Muir WW. Diagnosis and treatment of cardiac arrhythmias. Symposium on Cardiology. *Vet Clin North Am Equine Pract* 1985; 1:353-370.

Fregin GF. Medical evaluation of the cardiovascular system. *Vet Clin North Am Equine Pract* 1992; 8:329.

Mitten LA. Cardiovascular causes of exercise intolerance. *Vet Clin North Am Equine Pract* 1996; 12:729-746.

### REFERENCE

1. Rezakhani A et al. *Rev Med Vet* 2004; 155:159.

## SINUS TACHYCARDIA, SINUS BRADYCARDIA AND PHYSIOLOGICAL DYSRHYTHMIAS

The heart rate results from the discharge of impulses from the sinoatrial node, which has its own intrinsic rate of discharge but which is also modified by external influences, particularly the vagus nerve.

### SINUS TACHYCARDIA

The term **sinus tachycardia** or simply tachycardia is used to describe an **increase in heart rate** caused by detectable influences such as pain, excitement, exercise, hyperthermia, a fall in arterial blood pressure or the administration of adrenergic drugs. The heart rate returns to normal when the influence is removed or relieved.

It needs to be stated that sinus tachycardia indicates an increase in heart rate that is initiated by the sinoatrial node in the right atrium (hence the sinus modifier). This means that the term sinus tachycardia should be reserved for use when electrocardiography has been performed and the sinus node has been determined to be the dominant pacemaker. For comparison, the term tachycardia should be used when an increased heart rate is detected by auscultation or palpation of the pulse and the origin of the pacemaker has not been determined. In resting horses and cattle that are used to being handled heart rates are not usually elevated above 48 and 80 beats/min respectively and rates above this are usually classified as tachycardia (Figure 8.1). In the cow and horse it is rare for the causes of sinus tachycardia to elevate the heart rate above 120 beats/min in the resting animal, and at heart rates above this an intrinsic pathological tachycardia should be sought.

### SINUS BRADYCARDIA

Sinus bradycardia or simple bradycardia is used to describe a decrease in heart rate due to a decreased rate of discharge from the sinoatrial node. Sinus bradycardia is most commonly associated with highly trained, fit animals and can be differentiated from the pathological bradycardias by its abolition by exercise or the administration of atropine. Obviously sinus bradycardia, like sinus tachycardia, requires electrocardiographic confirmation that the sinus node is the dominant pacemaker.

**Bradycardia** may also occur in association with an increase in arterial blood pressure, space-occupying lesions of the cranium and increased intracranial pressure, pituitary abscess, hyperkalemia (Figure 8.1) hypothermia and hypoglycemia and following the administration of alpha-2-adrenergic agonists such as xylazine or detomidine. Bradycardia is sometimes associated with vagus indigestion and diaphragmatic hernia in cattle and also occurs in cattle deprived of food.<sup>1</sup> Bradycardia has also been reported in cattle with bovine spongiform encephalopathy,<sup>2</sup> although this probably reflects inappetence rather than damage to the vagal nucleus in the brain stem; the latter would be expected to increase, rather than decrease, heart rate. Bradycardia can be induced in young ruminants by forceful elevation of the tail. Sinus arrhythmia is usually present in animals with sinus bradycardia.

**The resting heart rate** seldom falls below 22 beats/min in adult horses and 44 beats/min in adult cattle. Rates below this are suggestive of pathological bradycardias, and hypothermia, hypothyroidism or an intrinsic cardiac problem should be suspected. However, a general rule is that resting heart rates are inversely proportional to body weight, and large, fit horses and cattle have apparently low heart rates.

### PHYSIOLOGICAL ARRHYTHMIAS

There are several dysrhythmias that can occur in the absence of heart disease and that appear to result from **excess vagal tone**. These occur especially in the horse and include:

- Sinus arrhythmia
- **Wandering pacemaker**
- **Sinoatrial block**
- First-degree and **second-degree atrioventricular block**.

These physiological arrhythmias occur in animals at rest and can frequently be induced by the application of a nose twitch in horses or by forceful elevation of the tail in young ruminants. There is some debate as to the significance of these arrhythmias in animals but it is generally

A. Normal sinus rhythm in a horse (heart rate = 33 beats/min).

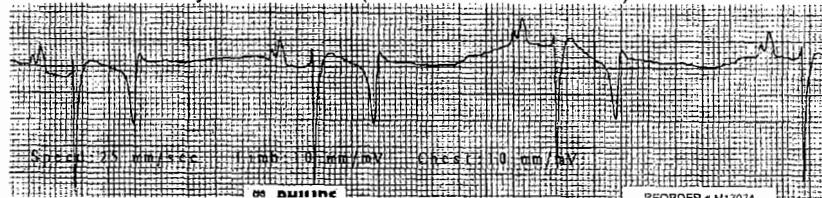

B. Normal sinus rhythm in a cow (heart rate = 68 beats/min).

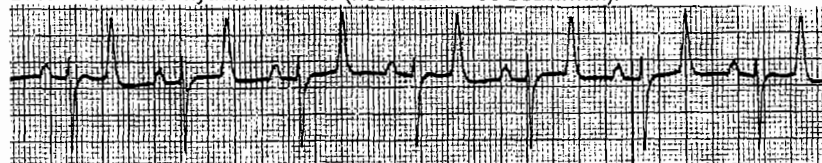

C. Atrial premature complexes in a cow (4<sup>th</sup> & 5<sup>th</sup> P waves from left).

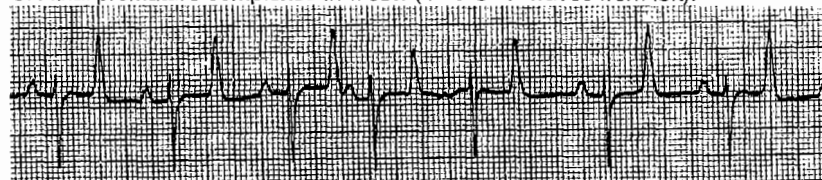

D. Paroxysmal supraventricular tachycardia in a cow.

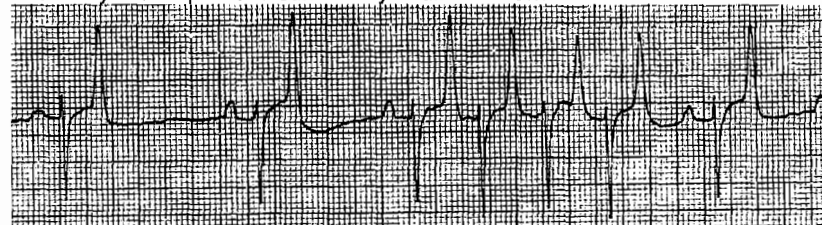

E. Atrial fibrillation in a cow (normal ventricular rate).

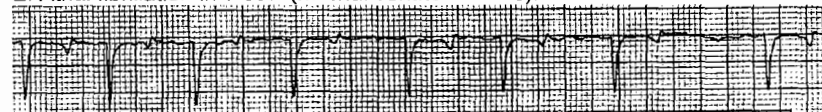

F. Atrial fibrillation in a cow (increased ventricular rate).

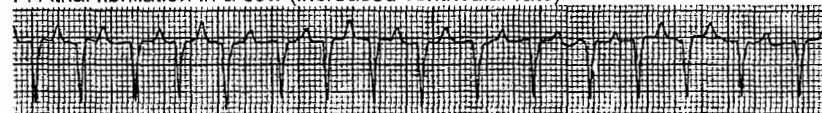

G. Atrial fibrillation in a cow (ventricular rate = 186 beats/min) with chronic (congestive) heart failure and pleural fluid accumulation leading to decreased QRS amplitude.

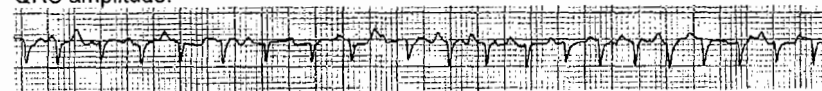

**Fig. 8.1** Base-apex electrocardiograms of large animals with normal sinus rhythm (panels A & B), supraventricular arrhythmias (panels C, D, E, F, G, & H), hyperkalemia (panels H & I) or ventricular arrhythmias (panels J, K, & L). All electrocardiograms were recorded at 25 mm/sec and 10 mm = 1 mV.

believed that if they are abolished by exercise or excitement and if there is no evidence of cardiac insufficiency they are not of pathological significance and do not require further investigation.

Perinodal myocardial fibrosis and microvascular abnormality have been reported in horses with sinoatrial and atrioventricular block, and considered as the excitatory cause.<sup>3</sup> However, because myocardial fibrosis is common in horses, being present in 79% of horse hearts examined at random,<sup>4</sup> it remains likely that these arrhythmias are physiological in horses. All animals with evidence of arrhythmic heart disease should be

examined following exercise, as should any animal in which cardiac disease is suspected.

The occurrence of **cardiac irregularities following exercise** is highly indicative of serious cardiac disease.

A high frequency of arrhythmia has been recorded in **newborn foals** immediately following birth.<sup>5</sup> 48 of 50 foals had some form of arrhythmia; atrial premature complexes were recorded in 30 foals, atrial fibrillation in 15 foals and ventricular premature complexes in 10 foals. Other arrhythmias were recorded with less frequency. It was concluded that the arrhythmias resulted from transient

H. Second degree AV block in a 3-month-old calf. The 3<sup>rd</sup> P wave is not followed by a QRS complex.

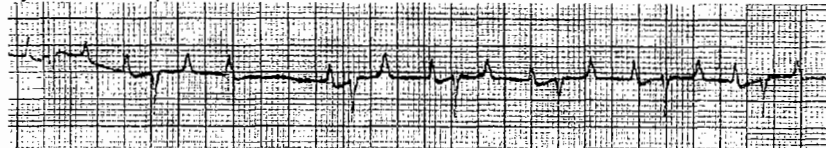

I. Bradycardia (heart rate = 58 beats/min), hyperkalemia ( $[K^+] = 8.0$  mEq/L), absence of P waves, and prolonged QRS duration in a 7-day-old calf with diarrhea and severe acidemia (jugular venous blood pH = 6.90).



J. Sinus tachycardia in a heifer (heart rate = 148 beats/min) with a premature ventricular complex.

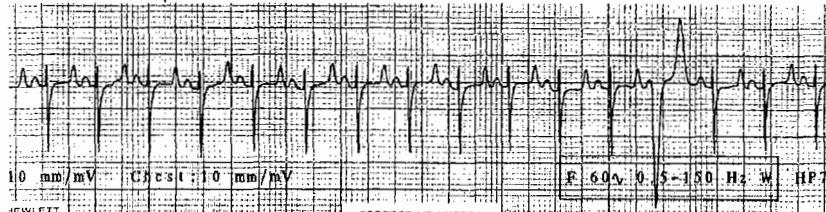

K. Ventricular premature complex in a cow. Note the markedly abnormal QRS complex that has opposite polarity to the normal complex, increased QRS duration, and a large T wave amplitude.

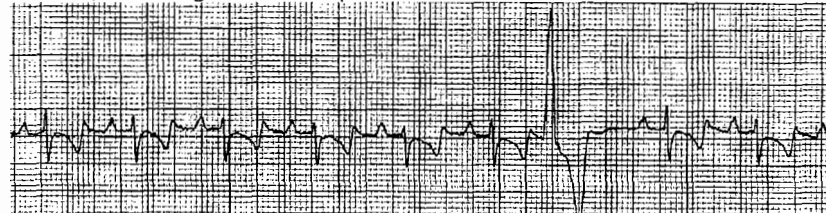

L. Ventricular arrhythmia in a cow (normal P, QRS, & T wave in 3<sup>rd</sup> complex).

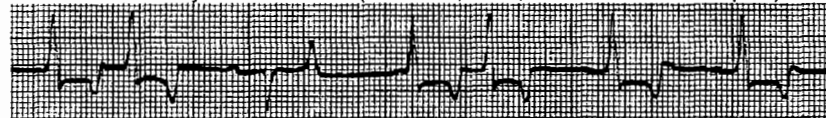

**Fig. 8.1 (Cont'd)** Base-apex electrocardiograms of large animals with normal sinus rhythm (panels A & B), supraventricular arrhythmias (panels C, D, E, F, G, & H), hyperkalemia (panels H & I) or ventricular arrhythmias (panels J, K, & L). All electrocardiograms were recorded at 25 mm/sec and 10 mm = 1 mV.

**physiological hypoxemia** during birth and that their occurrence should be considered as part of the normal adaptive process to extrauterine life, as normal sinus rhythm was recorded by 5 minutes following birth and the foals subsequently developed normally.<sup>5</sup>

Cardiac arrhythmias also occur commonly in association with **gastro-intestinal disorders** in the dairy cow<sup>6</sup> and less commonly in the horse<sup>7</sup> and resolve without specific antiarrhythmic treatment when the primary gastrointestinal disorder is corrected. Atrial premature complexes, ventricular premature complexes and atrial fibrillation have been detected in apparently healthy dairy cattle by serial monitoring,<sup>8</sup> however, ventricular premature complexes should be assumed to indicate the presence of organic heart disease.

## REFERENCES

- McQuirk SM et al. *J Am Vet Med Assoc* 1990; 196:894.
- Austin AR et al. *Vet Rec* 1997; 141:352.
- Kiri K et al. *Jpn J Vet Sci* 1985; 47:45.
- Dudan F et al. *Schweiz Arch Tierheilkd* 1985; 127:319.
- Yamamoto K et al. *Equine Vet J* 1992; 23:169.
- Constable PD et al. *J Am Vet Med Assoc* 1990; 197:1163.
- Cornick JL, Seahorn TL. *J Am Vet Med Assoc* 1990; 197:1054.
- Machida N et al. *J Vet Med A* 1993; 40:233.

## ARRHYTHMIAS WITH NORMAL HEART RATES OR BRADYCARDIA

### SINUS ARRHYTHMIA

Sinus arrhythmia is a normal physiological arrhythmia that occurs at slow resting heart rates and is associated with variation in the rate of discharge from the sinoatrial node associated with **variation**

**in the intensity of vagal stimulation.**

It is commonly **correlated with respiration** so that the discharge rate and heart rate increase during inspiration and decrease during expiration. In the horse, sinus arrhythmia unassociated with respiration also occurs. In the majority of large animals, sinus arrhythmia is much less overt than in the dog and generally it is not detected except on very careful clinical examination or examination of the electrocardiogram. Sinus arrhythmia is more clinically obvious in tame sheep and goats and in the **young of all species** and is correlated with respiration. It is abolished by exercise or by the administration of atropine.

**In the electrocardiogram** sinus arrhythmia is detected by variations in the P-P intervals (greater than 10% of the mean heart rate) with or without variation in the P-R interval and is frequently associated with a **wandering pacemaker**. This is associated with differences in the site of discharge from the sinoatrial node with subsequent minor variations in the vector of atrial depolarization with subsequent minor variations in the configuration of the P wave. In the horse there may be an abrupt change in the contour of the P wave so that the normal biphasic positive P wave in lead II, for example, changes to one with an initial negative deflection. There may or may not be a change in P-R interval. This is not pathological and is present in as many as 30% of normal horses at rest. If sinus arrhythmia is not abolished by exercise it is considered pathological. Sinus arrhythmia may be induced in the early stages of hypercalcemia during treatment for milk fever in cattle.

### SINOATRIAL BLOCK

In sinoatrial block the sinus node fails to discharge or its impulse is not transmitted over the atrial myocardium.<sup>1</sup> It is associated with the complete absence of heart sounds, of jugular atrial wave and of an arterial pulse for one beat period. The underlying rhythm is regular unless sinus arrhythmia is present. In the electrocardiogram there is complete absence of the P, QRS and T complex for one beat. The distance between the preblock and postblock P waves is twice the normal P-P interval or sometimes slightly shorter. This arrhythmia is not uncommon in fit racing horses at rest and can be induced in horses and cattle by procedures that increase vagal tone. Provided it does not persist during and following exercise it is considered as a **physiological variant** of normal rhythm.

### ATRIOVENTRICULAR BLOCK

Atrioventricular block is divided into three categories depending upon the



degree of interference with conduction at the atrioventricular node.

### First-degree atrioventricular block

This is an **electrocardiographic diagnosis** and cannot be detected clinically. It occurs when conduction is delayed at the atrioventricular node. The P–R interval is prolonged beyond normal limits (conventionally > 400 ms in the horse) and the condition may be transient because of waxing and waning vagal tone. First-degree atrioventricular block is generally considered to have little significance.

### Second-degree atrioventricular block

Also called **partial heart block**, this occurs when there is periodic interference with conduction at the atrioventricular node so that some atrial contractions are not followed by ventricular contraction (Figure 8.1). This may occur apparently at random or occur in a regular pattern, for example at every third or fourth beat. At the blocked beat there is complete absence of the first and second heart sounds and no palpable pulse. The underlying rhythm is still sinus in origin and is thus regular. In horses the presence of a **fourth heart sound** can be a valuable aid to diagnosis as with careful auscultation it can be heard during the block period in the manner of du LUBB DUPP, du ..., du LUBB DUPP. This is diagnostic for this condition. An **atrial jugular impulse** can also be detected during the block period. The intensity of the first sound in the immediate postblock beat is usually intensified.

The **electrocardiogram** shows the presence of a P wave but complete absence of the subsequent QRS and T waves at the blocked beat. There may be variations in the P–R intervals preceding and following the block. With **Mobitz type 1** (Wenkebach) second degree atrioventricular block there is a gradual increase in the PQ interval up to the point of the blocked conduction. With **Mobitz type 2** block the PQ interval remains unchanged. In most species, Mobitz type 1 is a normal physiological response reflecting changes in vagal tone, whereas Mobitz type 2 always indicates the presence of organic heart disease such as myocarditis. However, many second-degree atrioventricular blocks in horses do not fit these two categories and the PQ interval increases until the immediate preblock complex in which it may be decreased. The clinical significance of these variations in the horse has not been established.

Second-degree atrioventricular block is extremely common in horses and occurs as a **normal physiological variation** due to variations in vagal tone.<sup>1</sup> The application of a twitch to the upper lip of

a horse will frequently slow the heart rate and allow the expression of second-degree heart block. It is more common in Thoroughbreds and Standardbreds than in heavy horses and may be detected in approximately 20% of racehorses. Frequency is highest when they are examined in quiet surroundings at rest, at night or early in the morning.<sup>2</sup> Second degree atrioventricular block can be abolished by exercise or the administration of atropine.

Second-degree atrioventricular block can be associated with **myocarditis** in the horse and its presence has been associated with decreased racing performance by some clinicians. Second-degree atrioventricular block at fast heart rates has also been associated with the syndrome of duodenitis–proximal jejunitis in horses and was correlated with high serum bicarbonate concentrations in this condition.<sup>3</sup> Atrioventricular conduction disturbances can be associated with **electrolyte imbalance** in all species, overdosing with calcium salts, digoxin toxicity, cardiomyopathy and myocarditis associated with nutritional and infectious disease.

Methods for the clinical differentiation of physiological (Mobitz type 1) versus pathological (Mobitz type 2) second-degree heart block in the horse have not been established. However, the persistence of the arrhythmia at heart rates above resting normal values should be considered to be abnormal. In all other species the presence of Mobitz type 2 atrioventricular block should probably be considered as an indication of myocardial disease.

There is usually no necessity to treat this arrhythmia specifically and **treatment** is generally directed at the underlying cause. In cases where the block is frequent and syncopal episodes are likely, atropine may give some alleviation of the frequency of the block; however, this is only short-term therapy. Second-degree heart block may progress to third degree (complete) heart block.

### Third-degree or complete heart block

This occurs rarely in large animals, or perhaps is seen only infrequently because it is **almost invariably fatal**. In complete heart block there is no conduction at the atrioventricular node. The ventricle establishes a pacemaker in the nodal or conducting system and the atria and ventricles beat independently. The ventricular rate is regular but very slow. **Bradycardia** is the prominent feature and it is unresponsive to exercise or atropine. Atrial contractions are much faster than the ventricle. Atrial contraction sounds are rarely heard on auscultation but evidence of the rate may be

detected by examination of the jugular inlet. Periodically, as the atrium contracts during the period that the atrioventricular valves are closed, atrial cannon waves may occur up the jugular vein. There is usually variation in the intensity of the first heart sound due to variation in ventricular filling. Affected animals show extremely poor exercise tolerance and usually have evidence of generalized heart failure. There is frequently a history of syncopal attacks.

The **electrocardiogram** shows a slow and independent ventricular rate characterized by QRS complexes that are completely dissociated from the faster P waves.

The **prognosis** in complete heart block is extremely grave unless it is associated with a correctable electrolyte imbalance. The animal should be kept at rest in quiet surroundings while every effort is made to correct the underlying cause. Corticosteroids and dextrose are usually given intravenously in an attempt to reduce the severity of the initiating myocardial lesion. Isoproterenol (isoprenaline) may stimulate higher nodal tissue and may increase the heart rate. Isoproterenol is usually infused intravenously at a concentration of 1 mg/L of infusion fluid and the rate of infusion is adjusted to effect. This is not a practical treatment in most situations. The use of an internal pacemaker has been reported in the horse but would clearly make the animal unsuitable for athletic endeavors.

Atrioventricular block and atrioventricular dissociation may develop during anesthesia and can be associated with arrhythmogenic anesthetic drugs, hypercapnia, hypoxia and electrolyte and acid–base imbalances.<sup>4,5</sup> In these circumstances, the administration of regular doses of atropine (0.02 mg/kg) may not alleviate the arrhythmia. Dopamine HCl infusions (3–5 µg/kg per min) have been effective.<sup>6</sup>

The Wolff–Parkinson–White syndrome is recorded as a rare observation in cattle.<sup>7</sup>

### PREMATURE COMPLEXES

Premature complexes or extrasystoles arise by the discharge of impulses from irritable foci within the myocardium. They are classified according to the site of their origin as atrial, junctional and ventricular premature complexes. It is often not possible to distinguish between these by physical examination, particularly at fast heart rates. However, auscultation of an animal with premature beats usually reveals an **occasionally irregular rhythm**.

### Atrial premature complexes

These arise from the discharge of an ectopic atrial pacemaker outside the sinus node. Atrial premature contractions are

difficult to detect on physical examination if they do not affect ventricular rhythm. If the stimulus from the atrial premature complex falls outside the refractory period of the ventricle it will initiate a ventricular complex that occurs earlier than expected. Ventricular contractions initiated by atrial premature complexes have lower intensity because of lower diastolic filling, and the associated arterial pulse amplitude is decreased.

**Two main patterns** occur. In some instances the sinus node becomes reset from the atrial premature complex so that a regular rhythm is established from this contraction. In this case atrial premature complexes are characterized by the occurrence of periods of regular rhythm interrupted by beats with exceptionally short interbeat periods. In other instances the sinus node is not reset following the atrial premature complexes and if its discharge occurs during the refractory period of the atrium then no atrial or subsequent ventricular contraction will occur. This will be detected electrocardiographically as an early ventricular complex followed by a pause following which normal rhythm is continued. This character is identical to that produced by many ventricular premature complexes.

At slow heart rates the presence of atrial premature beats is suggested by periodic interruption of an underlying sinus rhythm and by the occurrence of a 'dropped pulse'. The prime differentiation is from sinoatrial block and second-degree atrioventricular block, which have distinguishing electrocardiographic characteristics.

**On the electrocardiogram** the P wave of the premature beat occurs earlier than expected from the basic rhythm and is abnormal in configuration. (Figure 8.1) QRS complexes associated with atrial premature beats are normal in configuration because this is a supraventricular arrhythmia and the pathway for ventricular depolarization is not altered.

#### Junctional premature complexes

These are also called atrioventricular nodal premature complexes arise from the region of the atrioventricular node or conducting tissue. They produce a premature ventricular contraction, which is usually followed by a compensatory pause due to the fact that the following normal discharge from the sinus node usually falls upon the ventricle during its refractory period.

Junctional premature complexes produce QRS configurations that are similar to those of normal beats but they may produce a P wave that has a vector opposite to normal.

#### Ventricular premature complexes

Ventricular premature complexes may arise from an irritable process anywhere within the ventricular myocardium. The normal rhythm is interrupted by a beat that occurs earlier than expected but the initial rhythm is established following a **compensatory pause**. This can be established by tapping through the arrhythmia as described earlier. The heart sounds associated with the premature beat are usually markedly decreased in amplitude while the first sound following the compensatory pause is usually accentuated. Occasionally, ventricular premature complexes may be interpolated in the normal rhythm and not followed by a compensatory pause. If the diastolic filling period preceding the premature beat is short the pulse associated with it will be markedly decreased in amplitude or even absent.

**On the electrocardiogram** ventricular premature complexes are characterized by bizarre QRS morphology (Figure 8.1). Conduction over nonspecialized pathways results in a complex of greater duration and amplitude to normal and the complex slurs into a T wave that is also of increased duration and magnitude. The vector orientation depends on the site of the ectopic foci initiating the contraction but it is invariably different from that of normal contractions. Electrocardiographic examination allows a differentiation of the site of origin of premature complexes and further subclassification within the categories.

Premature complexes of all site origins are indicative of **myocardial disease**, the one exception being the occurrence of atrial premature complexes accompanying cases of gastrointestinal disease in cattle. Atrial premature complexes occur commonly in cattle with **gastrointestinal disease** and their presence should be suspected whenever there is a variation in the intensity of the first heart sound with or without an underlying detectable cardiac irregularity.<sup>8</sup> Atrial premature complexes can progress to atrial fibrillation in these cases where there is excessive vagal tone.<sup>9,10</sup>

Horses in which premature beats are detected or suspected should be examined after careful exercise, which will usually increase the occurrence and severity of the arrhythmia. Premature beats are most easily detected during the period of slowing of heart rate after exercise.<sup>1</sup>

#### REFERENCES

1. Holmes JR. In *Pract* 1980; 2:15.
2. Scheefer CWJ et al. *Vet Rec* 1995; 137:371.
3. Cornick JL, Seahorn TL. *J Am Vet Med Assoc* 1990; 197:1054.
4. Greene SA et al. *J Vet Pharmacol Ther* 1988; 11:295.

5. Grubb TL et al. *J Am Vet Med Assoc* 1996; 208:349.
6. Whitton DL, Trim CM. *J Am Vet Med Assoc* 1985; 187:1357.
7. Endo Y et al. *Jpn J Vet Sci* 1990; 52:1155.
8. Constable PD et al. *J Am Vet Med Assoc* 1990; 197:1163.
9. Constable PD et al. *J Am Vet Med Assoc* 1990; 196:329.
10. Machida N et al. *J Vet Med A* 1993; 40:233.

#### ARRHYTHMIAS WITH TACHYCARDIA

An excitable focus within the myocardium may spontaneously discharge and cause depolarization of the remaining myocardium. If the discharge rate approaches or exceeds that of the sinus node the focus may transiently take over as the pacemaker of the heart.

#### PAROXYSMAL TACHYCARDIA

Paroxysmal tachycardia may arise from an irritant focus within the atria or the ventricles but in large animals ventricular paroxysmal tachycardia is more common. Atrial paroxysmal tachycardia (Figure 8.1) and atrial flutter are rare and are transients leading to atrial fibrillation.

In paroxysmal tachycardia the increase in heart rate is abrupt and the fall to normal is equally sudden. This characteristic usually serves to distinguish this arrhythmia from the transient increases in heart rate that may normally follow such factors as excitement. Also the heart rate is elevated to a rate far in excess of that which would be normally expected from such stimuli.

More commonly the excitable focus discharges repetitively over a long period of time to produce more continual ventricular tachycardia associated with ventricular extrasystoles. Sustained tachycardia is not normal and can lead to myonecrosis; three parturient dairy cows with sustained tachycardia (heart rate > 120 beats/min) had multifocal areas of necrosis throughout the myocardium characterized by myofibrillar lysis and disarray.

#### VENTRICULAR TACHYCARDIA

Ventricular tachycardia may produce either a regular heart rate or an irregular heart rate and rhythm.

When the discharge rate of the irritant focus far exceeds that of the sinoatrial pacemaker, the ectopic focus will take over completely as the pacemaker of the heart and on examination of the cardiovascular system a rapid but regular heart rate and pulse is detected and there is no irregularity of rhythm or of pulse amplitude or intensity of heart sounds. This is known as ventricular tachycardia with **atrioventricular dissociation**. This abnormality is easily overlooked clinically but

should be suspected in any adult horse or cow where the heart rate exceeds 90 beats/min<sup>1</sup> and is frequently the cause of heart rates in excess of 120 beats/min. Ventricular tachycardia should also be suspected where the heart rate is elevated to a level that is higher than that expected from the animal's clinical condition.

An **electrocardiogram** gives the diagnosis based on the occurrence of multiple regular QRS complexes with abnormal amplitude and duration of the QRS and T complexes and the T wave oriented in a direction opposite to the QRS complex (Figure 8.1).<sup>2</sup> P waves may be detected on the electrocardiogram but they have no relationship to the QRS-T complex and are frequently lost within them.

When the discharge rate of the irritant focus within the myocardium is similar to that of the sinoatrial node the ventricular tachycardia can be manifested by a gross irregularity in rhythm. This is a common manifestation in large animals. In this situation many of the discharges which originate in the sinus node are transmitted to the ventricle during a refractory period from a previous ectopic foci, but some reach the ventricle when it is not in a refractory state and are conducted normally. At some periods ventricular complexes may be initiated by the discharges from both sites.

The varying influence of each pacemaker on ventricular contraction produces a marked **irregularity** in cardiac rhythm and it is frequently not possible to establish clinically a regular pattern to the heart rhythm. Variations between beats in the degree of atrial filling and in the diastolic filling period will result in a marked variation in the intensity of the heart sounds and in the amplitude of the pulse. Frequently at fast heart rates there is a pulse deficit. Cannon atrial waves can be observed in the jugular vein when atrial contraction occurs at the same time as a ventricular extrasystole.

The **electrocardiogram** shows runs of extrasystoles interspersed with normally conducted complexes and usually the presence of fusion beats.

**Ventricular tachycardias** are evidence of **severe cardiac disease** and are usually accompanied by signs of acute heart failure. They may result from primary myocarditis, nutritional cardiomyopathy, or myocardial neoplasia<sup>3</sup> or be secondary to valvular disease and myocardial ischemia. Ventricular arrhythmias are common in certain plant poisonings and other toxicities, and in severe electrolyte and acid-base disturbance, and commonly occur in the final stages of heart failure. If uncorrected, ventricular tachycardia may lead to ventricular fibrillation and death and frequently specific antiarrhythmic

therapy is indicated during the period that the prime cause is being corrected.

#### Treatment

**Lidocaine** is the drug of first choice for treating hemodynamically important ventricular arrhythmias in large animals. Lidocaine is an antiarrhythmic agent of class 1b of Vaughan-Williams's classification, and slows intracardiac conduction by blocking the fast sodium channel while shortening the refractory period of myocardial tissue. Typically, lidocaine is given as an intravenous bolus at 0.5–1.0 mg/kg BW every 5 minutes for a total of four treatments (total dose 2–4 mg/kg BW).<sup>4,5</sup> Lidocaine has the advantages of widespread availability, low cost and low cardiovascular toxicity, with the major disadvantage being its very short duration of action (half-life is 40 minutes in the horse). The most commonly seen initial sign of lidocaine toxicity is muscle fasciculations, which occur at a serum lidocaine concentration of 1.9–4.5 mg/L.<sup>5</sup> If infusion is continued, sedation and altered visual function are apparent, the latter being manifest as rapid eye blinking, anxiety and attempts to inspect closely located objects. Temporary recumbency, excitement, sweating and convulsions occur with higher doses.<sup>4</sup>

**Quinidine sulfate** is the drug of second choice for use in **horses**. Quinidine is an antiarrhythmic agent of class 1a of Vaughan-Williams's classification, and slows intracardiac conduction by blocking the fast sodium channel and prolongs the action potential duration. An initial dose of 20 mg/kg is given orally, followed by a dose of 10 mg/kg given every 8 hours. The drug is not effective until 1–2 hours following administration. Intravenous quinidine gluconate (0.5–2.2 mg/kg BW bolus every 10 minutes to a total of 12 mg/kg BW) may be of greater value in those rare instances when oral quinidine is not indicated. Serum quinidine concentrations of 4 mg/L appear effective in treatment of **cattle** with ventricular tachycardia but serum concentrations following an oral dose of 20 mg/kg vary widely between cows and slow intravenous infusion is the preferred method of therapy.<sup>6</sup> There is a very narrow therapeutic index in cattle and death can occur in some cows at doses that are therapeutically effective in others.<sup>6</sup> Quinidine treatment in cattle should be approached with caution.

**Phenytoin sodium** is a good alternative to quinidine sulfate, and has been effective in treating ventricular arrhythmias in horses.<sup>7</sup> Phenytoin is an antiarrhythmic agent of class 1b of Vaughan-Williams's classification (same as lidocaine), and slows intracardiac conduction by blocking

the fast sodium channel while shortening the refractory period of myocardial tissue. The recommended dosage protocol for the horse requires an initial oral dose of 20 mg/kg BW every 12 hours for four doses, followed by a maintenance oral dose of 10–15 mg/kg BW every 12 hours, with monitoring of phenytoin plasma concentrations. Plasma concentrations of 5–10 mg/L appear to be effective in treatment of horses with ventricular tachycardia. High plasma phenytoin concentrations are associated with sedation, recumbency and excitement,<sup>7</sup> and the dosage protocol should be altered in horses that appear sedated. The major advantage of phenytoin over lidocaine is its long duration; conversely, its major disadvantage is the initial time required (2–6 h) to exert an antiarrhythmic effect. An intravenous form of phenytoin sodium has been administered to a pony with digitalis-induced ventricular arrhythmias, but the alkaline pH of the infused solution carries a high risk of thrombophlebitis.<sup>8</sup> **Magnesium sulfate** (0.004 mg/kg BW boluses intravenously at 5-minute intervals to a maximum dose of 0.05 mg/kg BW) has also been successful in treating ventricular arrhythmias either alone or in combination with other antiarrhythmic agents; however, clinical experience with magnesium sulfate administration in horses is minimal.

The severity of ventricular tachycardia is augmented by factors that increase sympathetic tone, and affected animals should be kept in quiet surroundings.

#### VENTRICULAR FIBRILLATION

Ventricular fibrillation is not usually observed clinically. It occurs in the terminal stages of most suddenly fatal diseases, including lightning stroke, plant poisonings such as acute *Phalaris* toxicity, overdose with anesthetics, severe toxemia and in the terminal phases of most acquired cardiac diseases. There is complete absence of the pulse and heart sounds, the blood pressure falls precipitously and the animal rapidly becomes unconscious and dies within a minute or two of onset. Treatment is usually impractical although deaths during anesthesia may be prevented by immediate and aggressive external cardiac massage. Electrical defibrillation is not feasible in large animals due to the bulk of the animal and the current required. Intracardiac injections of epinephrine are often used in acute cardiac arrest but do not correct fibrillation and are of little value.

#### ATRIAL FIBRILLATION

In atrial fibrillation atrial depolarization is characterized by numerous independent fronts of excitation that course continuously and haphazardly through the



atria. There is no synchronous atrial contraction and atrioventricular nodal stimulation occurs in an irregular and random fashion. The effects within the atria cannot be appreciated on auscultation and the clinical detection of this arrhythmia occurs through its effects on ventricular function. The random stimulation of the ventricles produces a heart rate and pulse that is **irregularly irregular**. It is not possible to establish any basic rhythm by tapping out this arrhythmia and the rate varies from period to period.

Because there is no atrial contraction, filling of the ventricles is entirely passive and very much dependent on diastolic filling time. Some contractions occur very quickly following the preceding contraction with little time for diastolic filling and this produces a marked variation in the intensity of the heart sounds and in the amplitude of the pulse. At fast heart rates there will be a pulse deficit. There is no fourth heart sound (S<sub>4</sub>) or atrial wave at the jugular inlet because there is no coordinated atrial contraction, but the third heart sound is usually grossly accentuated. The degree of cardiac insufficiency that results from this arrhythmia varies and depends upon the general rate at which the ventricles beat at rest. This is determined primarily by vagal activity.

**On the electrocardiogram** there are no P waves discernible but the baseline shows multiple waveforms (f waves) that occur with a frequency of between 300 and 600 beats/min (Figure 8.1). QRS-T complexes are normal in configuration but there is wide variation and no pattern in the Q-Q intervals. Atrial fibrillation is one of the more common arrhythmias in large animal species.

#### Atrial fibrillation in the horse

Horses with atrial fibrillation fall into two categories. In one category, sometimes called 'benign fibrillators',<sup>9</sup> there is no evidence of underlying heart disease whereas in the other, there is.

##### Benign fibrillation

In cases that are **benign fibrillators** the vagal tone may be high and conduction through the atrioventricular node is suppressed to result in heart rates in the region of approximately 26–48 beats/min. At this rate there is no cardiac insufficiency at rest and hemodynamic parameters are normal.<sup>10</sup> The horse can elevate its heart rate with exercise to allow moderate performance, although it will never perform satisfactorily as a racehorse. This is the most common manifestation in this species and it is typified by a gross irregularity in rate, rhythm and intensity of the heart sounds and by the occurrence, at rest, of occasional periods lasting for 3–6 seconds where there is no

ventricular activity. At very slow rates periodic syncope may occur.

The **benign form** of atrial fibrillation occurs not infrequently in draft horses and is also seen in racehorses. A survey of 106 cases of atrial fibrillation in horses<sup>11</sup> found the disease most commonly in Standardbred and Thoroughbred horses under 7 years of age, with a high proportion under 4 years of age, which may have been a reflection of the admissions to the clinic rather than real age incidence.

**Exercise intolerance** was the most common clinical history. All horses had an irregular heart rate and rhythm and the pulse and intensity of the heart sounds were variable. A separate study of 67 horses<sup>12</sup> showed a significantly higher prevalence in Standardbreds and Thoroughbreds than other breeds of horse and a significant difference in the mean age at diagnosis between Standardbreds (4 years) and Thoroughbreds (9 years).

**Racehorses** commonly have a history of normality at rest but poor exercise tolerance following a race in which the horse ran well for the first 200–300 m but subsequently faded badly and finished a long way behind the field. Paroxysmal atrial fibrillation has also been observed in the horse under these circumstances. Horses with paroxysmal atrial fibrillation show atrial fibrillation when examined immediately following the race, but convert to normal sinus rhythm shortly after and have normal cardiovascular function if the examination as to cause of poor racing performance is delayed. A large scale study of 39 302 racehorses undergoing 404 090 race starts estimated a minimum prevalence of atrial fibrillation of 0.29%.<sup>13</sup> The estimated prevalence was higher (1.39%) in horses that finished slowly or did not finish, and the prevalence increased markedly with age. Atrial fibrillation was paroxysmal in most horses, with 93% of horses with atrial fibrillation spontaneously converting to sinus rhythm within 24 hours of the race. Attempted conversion of horses with atrial fibrillation should therefore be delayed for at least a couple of days following a race, because most will convert spontaneously without treatment.

There is debate as to the cause of the benign form of atrial fibrillation and whether myocardial and vascular lesions are present in the atria of a significant proportion of animals with this arrhythmia. However, the high rate at which atrial fibrillation converts spontaneously or by treatment to be followed by successful racing performance suggests that this arrhythmia frequently occurs in young horses in the absence of significant atrial pathology. Benign atrial fibrillation in

young racing horses therefore has many similarities to atrial fibrillation in lactating dairy cattle with abdominal disease, in that it is likely that most cases do not have underlying heart disease. The increased prevalence of atrial fibrillation in race horses with age<sup>13</sup> suggests, however, that underlying heart disease does predispose to developing atrial fibrillation during a race.

##### Underlying disease

Horses may develop **atrial fibrillation at fast heart rates** in response to **underlying cardiovascular disease**. Commonly this is mitral valve insufficiency, tricuspid valve insufficiency or a combination of both but any acquired or congenital lesion that results in atrial hypertrophy has this risk.

Where there is underlying heart disease the ventricular rate at rest is much higher and the arrhythmia presents as a tachycardia. It has been suggested that a heart rate greater than 60 beats/min is indicative of underlying cardiac disease in cases of atrial fibrillation.<sup>12</sup> In horses with atrial fibrillation ventricular filling is impaired at heart rates above 70 beats/min<sup>4</sup> and at resting heart rates above 80–100 beats/min there is severe cardiac inefficiency and the animal rapidly develops signs of cardiac failure. At fast heart rates, atrial fibrillation presents with a syndrome clinically similar to ventricular tachycardia associated with multiple ventricular extrasystoles and electrocardiographic differentiation is required.

Primary pulmonary hypertension as a cause of atrial fibrillation is also recorded in horses, the increased resistance to right ventricular outflow leading to ventricular hypertrophy and dilatation, stretching of the right atrioventricular annulus, atrial dilatation and subsequent atrial fibrillation.<sup>14</sup>

Paroxysmal atrial fibrillation has been observed in newborn foals showing signs of respiratory distress and with birth anoxia.<sup>15</sup>

#### Atrial fibrillation in the cow

Atrial fibrillation in the cow may occur secondary to **myocardial disease** or endocarditis resulting in atrial enlargement, but more commonly is functional in occurrence and traditionally has not been associated with clinically detectable cardiac lesions.<sup>16,17</sup> However, a recent histopathological study in nine Holstein-Friesian cows with atrial fibrillation and 12 healthy controls in sinus rhythm indicated that multifocal or large areas of myocardial fibrosis were present more frequently and with greater severity in cattle with atrial fibrillation than healthy controls.<sup>18</sup> Interestingly, the atrial lesions

were largely confined to the dorsal regions of the cranial lateral and medial regions of the right atrium. Organic heart disease therefore appears to predispose cattle to the development of atrial fibrillation, and an atrial fibrillation prevalence of 2.5% was recorded in apparently healthy lactating dairy cows over an 18 month period.<sup>17</sup> In a large cross sectional study, atrial fibrillation was not observed during a 3–5 minute ECG recording in 952 of dairy cattle aged 1 or more years.<sup>19</sup>

In sick cattle, atrial fibrillation most commonly occurs in association with **gastrointestinal disease**, abnormalities causing abdominal pain and **metabolic disease**. Abnormalities as diverse as acute enteritis, left displacement of the abomasum and torsion of the uterus may be accompanied by this arrhythmia. Heightened excitation of the atria, in association with electrolyte and acid–base disturbances or due to change in vagal tone, has been postulated as a cause, and atrial premature complexes are also seen in the same types of clinical case.<sup>16,20</sup> (Figure 8.1) The administration of neostigmine to cattle with gastrointestinal disease may precipitate the occurrence of atrial fibrillation.<sup>21</sup> The arrhythmia usually converts spontaneously to sinus rhythm with correction of the abdominal disorder.

#### Atrial fibrillation in the sheep and goat

This may occur as a result of incompetence of the tricuspid or mitral valves, the presence of myocarditis or, in goats, as a sequel to interstitial pneumonia along with cor pulmonale. The presenting signs are those of respiratory distress and heart failure. Ascites is prominent and there is marked jugular distension with an irregular jugular pulse.

#### Treatment of atrial fibrillation

##### Ruminants

Ruminants with atrial fibrillation are not in general treated with specific antiarrhythmic drugs as the heart will usually revert to sinus rhythm following the correction of the underlying abdominal disorder and sufficient time (at least 1 week after return to normal physical health). However, the intravenous administration of quinidine (49 mg of quinidine sulfate/kg BW, at 0.20 (mg/kg)/min) was successful in converting seven of nine cows to normal sinus rhythm at a mean plasma quinidine concentration of 3.6 µg/mL.<sup>22</sup> Oral quinidine administration is not effective in ruminants because of the poor oral bioavailability. Side effects of intravenous quinidine administration in cattle include depression, ataxia, blepharospasm, diarrhea and increased

frequency of defecation.<sup>22</sup> Response to treatment in sheep and goats is poor, although one ram was successfully converted to normal sinus rhythm using electrical cardioversion using 360 J and paddles placed over the right heart base (behind the triceps muscles) and the left cardiac apex close to the sternum.<sup>23</sup>

##### Horses

Horses with atrial fibrillation at high heart rates are generally not treated successfully as serious cardiac pathology is usually present. Digoxin and quinidine sulfate are used. The decision to treat a horse with atrial fibrillation at low heart rates depends upon the requirement for the horse to perform work, because horses with this arrhythmia can be retired and will live for several years. They may be used successfully as brood mares.

Horses with **benign atrial fibrillation** can be converted to normal sinus rhythm with subsequent return to successful racing or other performance.<sup>24,25</sup> **Oral quinidine sulfate** is usually used. Quinidine is an antiarrhythmic agent of class 1a of Vaughan-Williams's classification, slows intracardiac conduction by blocking the fast sodium channel and prolongs the action potential duration. Several dose regimens have been used, but the administration of an oral dose of 22 mg/kg every 2 hours until conversion is achieved or toxicity is manifest has proved effective.<sup>11,24</sup> In the majority of cases, conversion will occur before the total dose exceeds 40 g. Toxicity is likely when the total dose exceeds 60 g and the decision to continue with therapy once this dose has been reached should be considered carefully. The plasma quinidine concentration required for cardioversion ranges from 2–4 µg/mL and toxicosis has been reported at 5 µg/mL.

Toxicity is not uncommon with quinidine therapy and separate studies report 48% and 28% of horses with some form of adverse reaction.<sup>11,24</sup> Depression, lassitude, anorexia, urticaria, congestion of the mucous membranes, colic and death are recorded. Prolongation of the QRS interval to 25% greater than pretreatment values has been considered a monitor for cardiovascular toxicity. The toxic effects of quinidine may be corrected by intravenous administration of sodium bicarbonate in an attempt to increase the percentage of quinidine bound to protein. Such treatment runs the risk of inducing hypokalemia, which may exacerbate quinidine toxicity. Some prefer to digitalize the horse intravenously prior to medication with quinidine in an attempt to reduce tachyarrhythmias at the point of conversion and those associated with quinidine toxicity. Nephrotoxicity with

uremia and diarrhea can occur at lower doses. Nephrotoxicity is transient and repairs rapidly following withdrawal of the drug but the serum urea nitrogen concentration and urine should be monitored during therapy in addition to cardiovascular function.

There is a much greater **success rate** with conversion in young horses and when it is attempted shortly following the onset of the arrhythmia. If the arrhythmia has been present for more than 4 months, successful conversion is much less common, and side effects with therapy are more common.<sup>24</sup> Following cardioversion the horse should be rested for 3 months. In some horses the conditions recur after a period of racing and repeated conversions with quinidine are possible. Conversion by intravenous **quinidine gluconate** is reported in the horse using an initial dose of 1.0–1.5 mg/kg, given over a period of 1 minute and repeated every 5–10 minutes until sinus rhythm is restored or the QRS interval increases 25% over baseline, ventricular rate exceeds 90 beats/min, signs of toxicity occur or a total dose of 11 mg/kg has been administered.<sup>25,26</sup> Conversion by quinidine and atrial pacing is also recorded in the horse.<sup>27</sup>

Oral and intravenous **flecainide** has been used with mixed success to convert horses in atrial fibrillation. Flecainide is an antiarrhythmic agent of class 1c of Vaughan-Williams's classification, slows intracardiac conduction by blocking the fast sodium channel and shortens the refractory period of the Purkinje fibers. Intravenous administration of flecainide acetate (1–2 mg/kg BW) infused at 0.2 (mg/kg BW)/min was effective in converting experimentally-induced atrial fibrillation in six horses and naturally occurring atrial fibrillation in two horses.<sup>28</sup> The plasma flecainide concentration at the time of conversion was 1.3 mg/L. Oral administration of flecainide acetate (4–6 mg/kg BW) also produced plasma flecainide concentrations that approximated 1.3 mg/L<sup>28</sup> for a number of hours. However, in a subsequent study in 10 horses with naturally occurring atrial fibrillation, intravenous flecainide failed to convert nine horses with long-standing atrial fibrillation to sinus rhythm, but did convert one horse who had been in atrial fibrillation for 12 days.<sup>29</sup> Orally administered quinidine sulfate subsequently converted eight of the nine horses to normal sinus rhythm. Two horses administered flecainide developed potentially dangerous ventricular arrhythmias during treatment.

One horse was converted from atrial fibrillation using rectilinear biphasic **electrical cardioversion**, which is safer

than conventional monophasic electrical cardioversion.<sup>30</sup> General anesthesia is induced using agents that produce minimal cardiovascular depression (such as intravenous induction with guaifenesin, diazepam and ketamine and maintenance with sevoflurane). The front legs of the horse were extended and cardioversion-defibrillation pads were placed over both sides of the shaved thorax, directly over the atria, the position of which had been determined ultrasonographically. The horse converted to normal sinus rhythm after delivering 200 J in conjunction with a small amount of intravenous quinidine. Three horses were converted from atrial fibrillation using transvenous electrical cardioversion via placement of a custom-length 6.5 French bipolar catheter using ultrasonographic guidance.<sup>31</sup> Catheter placement was manipulated so that one electrode was in the pulmonary artery and the other electrode in the vicinity of the right atrium. Cardioversion was accomplished at 125–300 J using a biphasic truncated exponential shock delivered to be not coincident with the T wave. Concurrent use of antiarrhythmic medications was not required. The use of electrical cardioversion should be considered in cases of atrial fibrillation refractory to oral or intravenous quinidine administration.

#### REVIEW LITERATURE

- McQuirk SM, Muir WW. Diagnosis and treatment of cardiac arrhythmias. Symposium on Cardiology. Vet Clin North Am Equine Pract 1985; 1:353–370.
- Bertone JJ, Wingfield WE. Atrial fibrillation in horses. Compend Contin Educ Pract Vet 1987; 9:763.
- Fregin GF. Medical evaluation of the cardiovascular system. Vet Clin North Am Equine Pract 1992; 8:329.
- Collatos C. Treating atrial fibrillation in the horse. Compend Contin Educ Pract Vet 1995; 17:243–245.
- Marr CM. Cardiac emergencies and problems of the critical care patient. Vet Clin North Am Equine Pract 2004; 20:217–230.

#### REFERENCES

- Nielsen IJ. Aust Vet J 1990; 67:140.
- Reimer JM et al. J Am Vet Med Assoc 1992; 201:1237.
- Delesalle C et al. J Vet Intern Med 2002; 16:612.
- Muir WW, McQuirk SM. Vet Clin North Am Equine Pract 1985; 1:335.
- Meyer GA et al. Equine Vet J 2001; 33:434.
- Takemura N et al. Jpn J Vet Sci 1989; 51:515.
- Wijnberg ID, Ververs FFT. J Vet Intern Med 2004; 18:350.
- Wijnberg ID et al. Vet Rec 1999; 144:259.
- Bertone JJ, Wingfield WE. Compend Contin Educ Pract Vet 1987; 9:763.
- Muir WW, McQuirk SM. J Am Vet Med Assoc 1986; 184:965.
- Deem DA, Fregin GF. J Am Vet Med Assoc 1982; 180:261.
- ReefVB et al. J Vet Intern Med 1988; 2:1.
- Ohmura H et al. J Am Vet Med Assoc 2003; 223:84.
- Gelberg HB et al. J Am Vet Med Assoc 1991; 198:679.

- Machida N et al. Equine Vet J 1989; 21:66.
- Brightling P, Townsend HGG. Can Vet J 1983; 24:331.
- Machida N et al. J Vet Med A 1993; 40:233.
- Machida N, Kiryu K. J Vet Med Sci 2001; 63:873.
- Rezakhani A et al. Rev Med Vet 2004; 155:159.
- Constable PD et al. J Am Vet Med Assoc 1990; 197:1163.
- Constable PD et al. J Am Vet Med Assoc 1990; 196:329.
- McGuirk SM et al. J Am Vet Med Assoc 1983; 182:1380.
- Moresco A et al. J Am Vet Med Assoc 2001; 218:1264.
- ReefVB et al. J Vet Intern Med 1988; 2:1.
- Collatos C. Compend Contin Educ Pract Vet 1995; 17:243.
- Muir WW et al. J Am Vet Med Assoc 1990; 197:1607.
- Van Loon G et al. Vet Rec 1998; 142:301.
- Ohmura H et al. J Vet Med Sci 2001; 63:511.
- Van Loon G et al. Equine Vet J 2004; 36:609.
- Frye MA et al. J Am Vet Med Assoc 2002; 220:1039.
- Kimberly M et al. J Vet Intern Med 2003; 17:715.

## Diseases of the heart

### MYOCARDIAL DISEASE AND CARDIOMYOPATHY

#### Synopsis

**Etiology** Certain bacterial, viral, parasitic infections, some nutritional deficiencies and toxic agents

**Epidemiology** Specific to causative agent

**Clinical findings** Reduction of cardiac reserve and decreased exercise tolerance, cardiac arrhythmias, congestive heart failure or acute heart failure

**Clinical pathology** Electrocardiography, echocardiography and serum cardiac troponin I concentrations. Other examinations directed at determining the specific cause

**Necropsy findings** Myocarditis, myocardial degeneration

**Treatment** For cardiac insufficiency. Specific therapy, if available, for specific cause

#### ETIOLOGY

A number of diseases are accompanied by inflammation, necrosis or degeneration of the myocardium. These include several bacterial, viral or parasitic infections and some nutritional deficiencies and toxicities. In most cases, the involvement of the myocardium is only part of the total spectrum of these diseases, although the cardiac manifestations may be clinically pre-eminent. The term cardiomyopathy is generally restricted to those diseases where myocardial damage is the prime manifestation. Causes of myocardial dysfunction include the following.

#### Bacterial myocarditis

- Following bacteremia, as in strangles or from navel-ill
- Tuberculosis – especially horses
- Tick pyemia in lambs
- Clostridium chauvoei*
- Histophilus somni*
- Extension from pericarditis, epicarditis or endocarditis.

#### Viral myocarditis

- Foot-and-mouth disease – especially young animals
- African horse sickness
- Equine viral arteritis
- Equine infectious anemia
- Equine herpesvirus-1 in fetus
- Swine vesicular disease
- Parvovirus in piglets
- Encephalomyocarditis virus infection in pigs
- PRRS virus in piglets
- Bluetongue in sheep.

#### Parasitic myocarditis

This is primarily associated with *Strongylus* spp. (migrating larvae) cysticercosis, *Sarcocystis* spp. and *Neospora caninum* (in the neonatal calf). In a postmortem study of over 2000 equine hearts, 15% showed myocardial fibrosis in association with occlusive angiopathic change.<sup>1</sup> No age association was found, but recent infarcts were more common in yearlings. It was postulated that these lesions result from thromboemboli from verminous plaques in the proximal thoracic aorta.

#### Nutritional deficiency

- Vitamin E/selenium deficiency in all large animal species
- Some forms of chronic copper deficiency in cattle (falling disease) – experimental copper deficiency in swine
- Iron deficiency in piglets and veal calves
- Copper/cobalt deficiency in lambs.

#### Toxicity

- Inorganic poisons – selenium, arsenic, mercury, phosphorus, thallium
- Gossypol from cotton seed cake
- The mycotoxin fumonisin when ingested by pigs and horses
- Fluoroacetate (1080) and poisoning by *Acacia georgina*, *Gastrolobium* and *Oxylobium* spp., *Dichapetalum cymosum*
- Plants and weeds, including members of *Ixiolena*, *Pachystigma*, *Pavetta*, *Asclepias*, *Geriocarpa*, *Cryptostigia*, *Albizia*, *Cassia*, *Digitalis*, *Urechites*, *Pimelea*, *Astragalus*, *Fadogia*, *Cicuta*, *Colchicum*, *Karwinskia*, *Vicia*, *Cicuta*, *Trigonella*, *Bryophyllum*, *Palicourea*, *Lupinus*, *Lantana*, *Kalanchoe*, *Homeria*, *Hymenoxys*, *Eupatorium* spp.

- Trees, including gidgee, yew, oleander, avocado
- Grasses, including *Phalaris tuberosa*, corynetoxins in *Lolium rigidum* infested with nematodes and *Corynebacterium* spp. (also tunicamycin in rain-damaged infected wheat, pigs), cantharidin in hay infested with blister beetles (horses)
- Drugs including succinylcholine, catecholamines, xylazine (ruminants) monensin – especially in horses, but also cattle, sheep, and pigs – lasalocid and salinomycin in horses, pigs, cattle and sheep, maduramicin in cattle and sheep fed poultry litter, and Adriamycin (used experimentally to produce cardiomyopathy). Overdosing with doxycycline in veal calves
- Vitamin D and myocardial and endocardial calcification following ingestion of *Cestrum diurnum*, *Solanum malacoxylon*, *Trisetum flavescens* (see enzootic calcinosis); calcification also occurs with hypomagnesemia in milk-fed calves.

#### Venoms

- Rattlesnake (*Crotalus* spp.) venom in horses
- *Vipera palaestinae*.

#### Embolic infarction

- Emboli from vegetative endocarditis or other embolic disease such as bracken fern poisoning in cattle.

#### Tumor or infiltration

- Viral leukosis of cattle
- Other cardiac neoplasia
- Cardiomyopathy in horses due to amyloid infiltration of the myocardium.<sup>2</sup>

#### Inherited

- Malignant hyperthermia of swine
- Hypertrophic cardiomyopathy in swine
- Congenital cardiomyopathy of Polled Hereford and Horned Hereford calves with dense curly coats, and Japanese Black calves
- Inherited cardiomyopathy in adult cattle occurring in Red Holstein–Simmental crossbred cattle in Switzerland and Austria, Red Danish dairy cattle in Denmark, Holstein–Friesian cattle in the UK, Austria, Denmark, Sweden, Japan, Canada and Australia (see cardiomyopathy – inherited as an autosomal recessive gene)
- Glycogen storage disease –  $\alpha$ -1,4-glucosidase deficiency in Shorthorn and Brahman cattle and Corriedale sheep.

#### Unknown or uncertain etiology

- Myocardial necrosis and hemorrhage secondary to acute lesions in the central nervous system<sup>3</sup>

- Exertional rhabdomyolysis of horses, capture myopathy of wild ruminants, restraint stress in swine
- Sudden death in young calves associated with acute heart failure and myocardial necrosis and precipitated by periods of intense excitement such as that experienced at feeding time<sup>4,5</sup>
- Myocardial lipofuscinosis (brown atrophy) in aged or cachectic cattle, especially Ayrshires, but often found in healthy animals at slaughter<sup>6</sup>
- Myocardial disease following mild upper respiratory disease in horses, especially when training or exercise is continued through the respiratory disease episode.

#### PATHOGENESIS

The primary effect of any myocardial lesion is to reduce cardiac reserve and limit compensation in circulatory emergencies. Minor lesions may only reduce performance efficiency while more severe lesions may produce greater clinical effect.

Most commonly, myocardial disease results in **arrhythmias** and **conduction disturbances** from primary involvement of the conduction system or establishment of excitatory foci within the myocardium. While the animal is at rest there may be minimal evidence of cardiac disease but catastrophic disturbances in cardiac conduction may occur under the adrenergic influences of **exercise** or excitement. The effects of pharmacological cardiotoxic agents in poisonous plants are frequently also initially manifest when the animals are moved or otherwise excited.

Endogenous or synthetic **catecholamines**, in their own right, can produce multifocal myocardial necrosis, especially in the left ventricle.<sup>7</sup> Sympathetic overactivity and local catecholamine release in the myocardium has been postulated as the cause of myocardial disease accompanying acute brain lesions in domestic animals and myocardial disease associated with some forms of stress and overexertion.<sup>3,8</sup>

Myocardial disease may also result in **congestive heart failure** through its primary effect on the myocardium and the function of the heart as a pump.

#### CLINICAL FINDINGS

In early cases, or cases with mild or moderate myocardial damage, a **decreased exercise tolerance** is the usual initial presenting sign. This is usually accompanied by an increase in heart rate and heart size, although the latter may only be detectable by echocardiography. There may be clinically recognizable **arrhythmia**, particularly tachyarrhythmias associated with multiple ventricular ectopic foci. The characteristics of the

pulse and heart sounds are also changed (see arrhythmias).

Animals with suspect myocardial disease but with no or minimal arrhythmic disturbances at rest can be judiciously exercised, which will frequently result in the expression of conduction or arrhythmic abnormality. Exercise or excitement should be avoided in animals with overt arrhythmias at rest.

In the late stages, or in cases with more severe myocardial damage, there may be **sudden death** or attacks of cardiac syncope due to acute heart failure, or severe dyspnea or general edema due to congestive heart failure. Details of the clinical findings associated with conduction disturbances, arrhythmias and heart failure have been given earlier.

#### CLINICAL PATHOLOGY

Electrocardiography and echocardiography are used in special examination. Hematological examination, blood culture and serology may be of value in determining the cause of myocardial disease and a full biochemical profile is advisable to determine if multisystemic problems are present. Myocardial infarction and necrosis may be associated with the release of cell enzymes into the bloodstream during the acute phase and the determination of the serum activities of lactate dehydrogenase, creatine kinase and aspartate aminotransaminase are of value.<sup>9,10</sup>

The cardiospecific isoenzyme troponin I provides the most sensitive and specific indication of cardiac necrosis (see chronic heart failure section) whereas the predictive value of serum creatinine kinase and lactate dehydrogenase activities is much lower.<sup>11,12</sup> Toxicological examination and tests for nutritional trace element deficiencies may be indicated.

#### NECROPSY FINDINGS

Bacterial infections may cause discrete abscesses or areas of inflammation in the myocardium but viral infections and degeneration due to nutritional deficiencies and poisonings usually produce a visible pallor of the muscle, which may be uniform or present as streaks between apparently normal bundles of muscle. In acute cases, there may be petechial or linear hemorrhages in the myocardium. Calcification may occur in areas of myocardial damage and with enzootic calcinosis and vitamin D toxicity. The nature and distribution of myocardial damage within the heart can vary according to the inciting agent and this can be an aid to diagnosis. The degenerated muscle may also be present in only the inner layers of the wall, leaving the external layers with a normal appearance.

In coronary thrombosis infarction of a large area of the wall may have occurred but this is not visible unless the animal survives for at least 24 hours afterwards. Careful examination of the coronary arteries is usually necessary to detect the causative embolus. In horses infarction occurs most commonly in the right atrium.

The terminal stage of myocardial degeneration or myocarditis is often fibrous tissue replacement of the damaged tissue. The heart is flabby and thin-walled and shows patches of shrunken, tough fibrous tissue. Rupture of the atrial walls may result, with sudden death occurring as a result of the pressure of blood in the pericardial sac. The lesions of lymphomatosis are characteristic of this disease: large, uneven masses of pale, firm, undifferentiated tissue with the consistency of lymphoid tissue.

Focal myocardial fibrosis, possibly resulting from microembolism from strongyle-induced endarteritis, is common in healthy horses but has also been ascribed as the predisposing factor to conduction disturbances such as atrial fibrillation and heart block.<sup>13</sup>

#### DIFFERENTIAL DIAGNOSIS

- Other cardiac causes of chronic (congestive) heart failure and acute heart failure
- Other causes of decreased exercise tolerance

The diagnosis and differential diagnosis of the specific etiology of myocardial disease rests with the epidemiological and other considerations of the individual causes and may require specific bacteriological and virological examinations, toxicological and nutritional analyses or an examination of the environment.

#### TREATMENT

The primary cause must be treated and details are given under the individual headings of the specific diseases listed above. When possible, the primary cause of the myocardial damage must be corrected or treated, and details are given elsewhere for the various etiologies listed above. The treatment of conduction disturbances, arrhythmias and heart failure is given elsewhere in this chapter.

#### REVIEW LITERATURE

Van Vleet JF, Ferrans VJ. Myocardial diseases of animals. *Am J Pathol* 1986; 124:98-178.

Van der Lugt JJ, Collett MG. Myocardial conditions of domestic animals in southern Africa. *J S Afr Vet Assoc* 1988; 59:99-105.

#### REFERENCES

1. Baker JR, Ellis CE. *Equine Vet J* 1981; 123:43 & 47.
2. NoutYS et al. *J Vet Intern Med* 2003; 17:588.
3. King JM et al. *J Am Vet Med Assoc* 1982; 180:144.
4. Rogers PAM, Poole DBR. *Vet Rec* 1978; 103:366.

5. Mee JF. *Ir Vet J* 1990; 43:61.
6. Bradley R, Duffell SJ. *J Comp Pathol* 1982; 92:85.
7. Van Vleet JF et al. *Am J Vet Res* 1977; 38:991.
8. Van Vleet JF, Ferrans VJ. *Am J Pathol* 1986; 124:98.
9. Fujii Y et al. *Bull Equine Res Inst* 1983; 20:87.
10. Züst J et al. *Vet Rec* 1996; 139:391.
11. Marr CM. *Equine Vet Educ* 1990; 2:18.
12. Preus M et al. *J Clin Chem Clin Biochem* 1989; 27:787.
13. Cranley JJ, McCullagh KC. *Equine Vet J* 1981; 13:35.

### RUPTURE OF THE HEART AND ACUTE CARDIOVASCULAR ACCIDENTS

Rupture of the heart occurs rarely in animals. It is recorded in cattle where a foreign body penetrating from the reticulum perforates the ventricular wall, and in the left atrium of horses as a consequence of chronic fibrotic myocarditis.<sup>1</sup> Rupture of the base of the aorta is not uncommon in horses and has the same effect as cardiac rupture. The pericardial sac immediately fills with blood and the animal dies of acute heart failure due to pericardial tamponade. A similar **cardiac tamponade** occurs when reticular foreign bodies lacerate a coronary artery or when foals suffer severe laceration of the epicardium during a difficult parturition.

#### RUPTURE OF THE AORTA

When the aorta ruptures it may do so through its wall just above the aortic valves. The wall may have been weakened previously by verminous arteritis associated with migrating strongyles in horses or onchocerciasis in cattle or by the development of medionecrosis. Another form of rupture occurs through the aortic ring. Death occurs very suddenly; all cases reported by one author affected stallions and coincided with the time of breeding. Cardiac tamponade may occur but the common finding is a dissecting aneurysm into the ventricular myocardium.

**Rupture of the aortic arch and the pulmonary artery** near the ligamentum arteriosum occurs occasionally in horses. The resultant **fistula** between the aorta and the pulmonary artery produces a sudden onset of cardiac failure and respiratory distress. Affected horses usually die shortly after the onset of clinical signs but can survive up to 8 days. The rupture is predisposed by abnormalities in the vasa vasorum of the vessels and may have a familial occurrence.<sup>2</sup>

**Aorticardiac fistulas** originating at the right aortic sinus are recorded in a series of older horses with sudden onset acute distress and exercise intolerance.<sup>3</sup> Five of the seven horses had a characteristic continuous murmur that was loudest at the right fourth intercostal space. Fistulas extended into the right ventricle or atrium in six horses and the left ventricle in one.

Five had dissecting tracts in the septal myocardium.

Rupture of the aorta is the usual cause of death in calves with **Marfan's syndrome**. Some have dissecting aneurysms of the aorta and pulmonary artery. Calves with Marfan's syndrome are affected from birth. They have a loud systolic murmur over the base of the heart on the left side in association with enlargement of the aortic root. There are other phenotypic abnormalities, including long thin limbs, joint and tendon laxity, and ocular abnormalities including dorsal displacement of the lens and lens opacity. The nature of the inheritance in cattle is uncertain.<sup>4</sup>

**Cranial mesenteric artery aneurysms** have been reported in cattle less than 4 years of age secondary to inherited defects in the wall of the celiac and cranial mesenteric arteries. An autosomal dominant mode of inheritance was suspected.<sup>5</sup> An aneurysm of the cranial mesenteric artery was diagnosed in a cow with severe abdominal pain and the presence of a large pulsatile mass at the root of the mesentery.<sup>6</sup>

#### RUPTURE OF HEART VALVES

Sudden death, or sudden onset of acute heart failure can also result from rupture of components of the heart valves. Rupture of the **chordae tendineae** of the **mitral valve** occurs in horses both without apparent predisposing lesions and as a sequel to endocarditis and occurs in adult horses as well as foals.<sup>7-9</sup> It is manifested by sudden onset of acute heart failure in horses apparently previously healthy or, when a complication of a pre-existing endocarditis, as a sudden onset complication of the disease or a cause of death. The rupture may involve the chordae of any of the cusps of the valve.<sup>7</sup> Rupture of the **pulmonary valve** producing right heart failure can also occur.<sup>10</sup>

#### REFERENCES

1. Haaland MA, Davidson JP. *Vet Clin North Am* 1983; 78:1284.
2. Van der Linde-Sipman JS. *Vet Pathol* 1985; 22:51.
3. Marr CM et al. *Vet Radiol Ultrasound* 1998; 39:22.
4. Potter KA, Besser TE. *Vet Pathol* 1994; 31:501.
5. Schuiringa-Sybesma AM. *Tijdschr Diergeesk* 1961; 86:1192.
6. Angelos JA et al. *J Am Vet Med Assoc* 1995; 207:623.
7. Marr CM et al. *Vet Rec* 1990; 127:376.
8. Ewart S et al. *J Am Vet Med Assoc* 1992; 200:961.
9. Reef VB. *J Am Vet Med Assoc* 1987; 191:329.
10. Reimer JM et al. *J Am Vet Med Assoc* 1991; 198:880.

#### COR PULMONALE

Cor pulmonale is the syndrome of right-sided heart failure resulting from an increase in right heart workload secondary to increased pulmonary vascular resistance

and pulmonary hypertension. The most documented cause of pulmonary hypertension in livestock is **alveolar hypoxia**. Acute alveolar hypoxia (lowered alveolar  $PO_2$ ) is a potent cause of pulmonary hypertension in several species, but cattle are especially reactive and this is the cause of the syndrome of cor pulmonale in cattle at high altitudes, **bovine brisket disease**, which is described in more detail elsewhere in this text.

An outbreak of cor pulmonale with pulmonary vascular lesions similar to those seen with high mountain disease but occurring in calves not at altitude is recorded; it was postulated but not proved to be the result of the ingestion of feed contaminated with the pyrrolizidine alkaloid monocrotaline.<sup>1</sup>

Pulmonary hypertension can also result from partial destruction of the **pulmonary vascular bed** and a reduction in its total cross-sectional area. Pulmonary thromboembolic disease can produce right heart failure by this mechanism. Chronic interstitial pneumonia and emphysema may also induce cor pulmonale by the same mechanism.<sup>2</sup>

Chronic obstructive **pneumonia**, where there is airway constriction and accumulation of fluid in distal airways, may induce pulmonary hypertension by a combination of chronic hypoxia and reduction of the pulmonary vascular bed.<sup>3</sup> Mean pulmonary artery pressures in calves with respiratory disease was 42 mmHg, compared to 22 mmHg in healthy age-matched calves. Although pulmonary hypertension and right heart hypertrophy may occur in livestock with primary pulmonary disease, clinical cardiac insufficiency is usually minor, and right heart failure rare. Nevertheless it can occur and is a cause of congestive heart failure in cattle.<sup>4,5</sup>

In goats, cor pulmonale, with right ventricular and right atrial hypertrophy secondary to interstitial pneumonia, may lead to **atrial fibrillation**,<sup>6</sup> and cor pulmonale leading to atrial fibrillation has also been recorded in horses.<sup>7</sup>

In highly conditioned feedlot cattle, increased intra-abdominal pressure resulting from excessive abdominal fat, forestomach engorgement and recumbency can lead to pulmonary hypoventilation, with decreased alveolar  $PO_2$  and subsequent right heart failure, a syndrome analogous to the Pickwickian syndrome in humans.<sup>8</sup>

Chronic severe elevations in pulmonary venous pressure can lead to constriction and hypertrophy of the vascular smooth muscle of precapillary vessels with resultant pulmonary hypertension. An elevated left ventricular filling pressure is perhaps the more common

cause and can set the stage for right heart failure in the left heart failure situations. The toxic principle in poisoning by *Pimelea* spp. appears to act in part by constricting the pulmonary venules producing pulmonary hypertension, which contributes to the clinical syndrome.

**Persistent pulmonary hypertension of the neonate** (PPHN) is a common problem in neonatal foals and calves, particularly in calves derived from somatic cell clone technology. Persistent pulmonary hypertension is characterized by persistent postnatal hypoxemia secondary to failure to adapt to extra-uterine life. An imbalance between endogenous vasoconstrictors and vasodilators is believed to play a major role in the development and maintenance of PPHN. An increase in plasma concentration of endothelin-1 (a potent vasoconstrictor) has been observed in neonatal calves with PPHN, and the source of endothelin-1 is thought to be the placenta.<sup>9</sup> Many cloned calves have abnormal placentation, characterized by a reduction in the number of established cotyledons that are enlarged and edematous. Treatment is symptomatic, focusing on intranasal oxygen administration and maintaining the calf in sternal recumbency.

## REFERENCES

1. Pringle JK et al. J Am Vet Med Assoc 1991; 198:857.
2. Panter KE et al. Vet Hum Toxicol 1988; 30:318.
3. Nuytten J et al. Zentralbl Vet Med A 1985; 32:81.
4. Angel KL, Tyler JW. J Vet Intern Med 1992; 6:214.
5. Jubbt TF, Malmo J. Aust Vet J 1989; 66:257.
6. Gay CC, Richards WPC. Aust Vet J 1984; 60:274.
7. Gelberg HB et al. J Am Vet Med Assoc 1991; 198:679.
8. Alexander AF. In: Effects of poisonous plants on livestock. New York: Academic Press, 1978:285.
9. Wilkins PA et al. J Vet Intern Med 2005; 19:594.

## VALVULAR DISEASE AND MURMURS

**Etiology** Valvular disease is acquired or congenital. Endocarditis is the commonest cause. Some murmurs are functional and not indicative of disease

**Epidemiology** Functional murmurs are common in the horse and vary with breed and training. Little information is available on the epidemiology of acquired valvular disease

**Clinical findings** Murmur defined by location, timing, character, intensity and radiation. Possibly precordial thrill, cardiac insufficiency and, in severe cases, congestive heart failure

**Clinical pathology** Blood culture echocardiography

## ETIOLOGY

### Acquired

- Endocarditis. Most common cause – see following section
- Endocardiosis. Common only in pigs
- Rupture of the chordae tendineae, either spontaneous or secondary to endocarditis<sup>1</sup>
- Laceration, detachment of aortic valve leaflets, either spontaneous or secondary to endocarditis
- Dilatation of the right atrioventricular valve annulus, such as occurs in brisket disease and secondary to some myocardial disease; may result in functional insufficiency of the valves.

### Congenital

- Pulmonic valve stenosis
- Fenestration of the aortic and pulmonic valves in horses. The cause of the lesions is unknown, although their presence in very young animals, including newborn foals, suggests that some may be congenital defects. The importance of these lesions as causes of valvular insufficiency is doubtful, although they may cause valvular murmurs if they are present close to the attachments of the cusps
- Blood cysts are common on the atrioventricular valves of cattle. They are lined with endothelium, can occur congenitally<sup>2</sup> and their incidence and size may increase with age.<sup>3</sup> They have no clinical significance. Serous cysts occur occasionally on the mitral valve of cattle.

## EPIDEMIOLOGY

There is limited information on the epidemiology and the age-specific incidence of valvular disease or murmurs in large animals, although slaughter surveys show a high prevalence of endocardial lesions. Studies at clinical centers indicate that valvular disease is often underdiagnosed in both cattle and horses and that its presence may not be detected in more than 50% of cases.<sup>4-6</sup>

### Horses

Auscultatory surveys show a high prevalence of murmurs with breed and horse-use differences. Functional (physiological) murmurs are particularly common in trained, fit racehorses. In a survey of 545 clinically normal horses in England, murmurs were heard in 68%, with a higher prevalence in flat racing and National Hunt horses than in competition and pleasure horses.<sup>7</sup> Murmurs with the characteristics of functional ejection murmurs were detected on auscultation over the left hemithorax in approximately 50% of horses and the right side in 8%. Murmurs with the characteristics of early diastolic functional

murmurs were detected on the left side in 15% and on the right side in 13%. Murmurs with the characteristics of regurgitation at the mitral, tricuspid and aortic valves were detected in 3.5, 9.2 and 2.2% of horses respectively.

An extensive abattoir survey<sup>8</sup> suggests that valvular lesions may be more common in the horse than is clinically appreciated. Approximately 25% of horses had lesions, the majority being nodular or distorting lesions on the valves or chordae tendineae of the left side and, in a significant proportion, murmurs were detected prior to slaughter. Chronic trauma of the valve leaflets was considered an important initiating factor.

### Cattle

A slaughter survey in cattle has reported endocarditis in 5.2 hearts per 10 000 animals.<sup>4</sup>

### Pigs

In a slaughter survey of pathology in the heart of pigs mitral valve endocardiosis was observed in 63% of pigs and tricuspid endocardiosis in 18% of pigs.<sup>9</sup> The prevalence and severity increases with age. These lesions can be associated with prolapse of the mitral valve and jet impact lesions. They have little significance in growing pigs but the significance of endocardiosis to clinical cardiac disease in older sows needs examination.

Bacterial endocarditis in slaughter pigs has been recorded with a prevalence of 3.1 per 10 000 animals.<sup>10</sup>

### PATHOGENESIS

The important clinical indications of valvular disease are audible murmurs and palpable precordial thrills. Murmurs may occur at any phase of the cardiac cycle and are caused by the vibrations of turbulent flow of blood transmitted to the surface of the chest. Vibrations of strong intensity may also result in palpable vibrations at the surface of the chest.

### Generation of murmurs

Blood flow is normally laminar and without turbulence. **Turbulence** in flow may be produced by a sudden change in the **diameter** of the vessel through which the blood is flowing. Its occurrence is directly related to the **velocity** of flow and inversely related to blood **viscosity**.

### Valve lesions

With murmurs associated with valvular lesions the valve lesion produces a sufficient change in stream bed diameter to result in turbulent flow. The turbulence may occur when the valves do not close properly (regurgitation or insufficiency) and blood is forced through atrioventricular orifices during ventricular systole, or through semilunar orifices during

ventricular diastole. Turbulence may also occur when the valves do not open completely (stenosis) and blood is forced through a stenotic semilunar orifice during ventricular systole or enters the ventricle through a narrow atrioventricular orifice during ventricular diastole.

The severity of the turbulence and hence the murmur can be increased with higher flow velocities such as occur with exercise and by factors that decrease blood viscosity such as anemia or hypoproteinemia.

Acquired valvular disease usually results in insufficiency of the affected valve and less commonly both insufficiency and stenosis. Congenital lesions more commonly result in stenosis of the valve.

### Murmurs without valvular disease

A change in vessel diameter such as occurs with dilatation of the aorta or pulmonary artery can produce turbulence and a murmur. A reduction in blood viscosity contributes to the frequency of murmurs occurring in anemic and hypoproteinemic states and **hemic murmurs** are common in anemic cattle, particularly over the pulmonic valve.

### Functional murmurs

Turbulent flow may occur in the absence of a change in stream bed diameter if a certain critical velocity of flow is exceeded. This is believed to be the cause of functional or ejection murmurs that occur commonly in horses and lactating dairy cows during the rapid ejection phase even at rest and especially following exercise.

### Effects of valvular disease

Stenosis of the outflow valves results in an increased **pressure load** on the heart and compensatory hypertrophy (concentric hypertrophy). Insufficiency of the semilunar valves or of the aortic or pulmonic valve produces a **volume load** on the heart and is followed by compensatory dilatation and hypertrophy (eccentric hypertrophy). If the valves on the left side of the heart are affected, especially the aortic valve, the changes in ejection of the blood from the ventricle produce changes in the character of the **peripheral pulse**. Involvement of the tricuspid valve will produce changes in the **jugular pulse**.

### Cardiac reserve

The presence of valvular lesions and murmurs may mean little except that some degree of **cardiac reserve** is lost. This may be small in degree, and moderate stenosis or incompetence can be compensated and supported for long periods. The importance of valvular lesions that do not result in cardiac insufficiency rests in their possible contribution to disease in other organs by the liberation

of emboli, and the necessity for close examination of the heart when they are present.

The purpose for which the animal is maintained also has some bearing on the significance of a murmur. Valvular lesions are of much greater importance in racing animals than in those kept for breeding purposes. The challenge to the clinician is to determine the significance of a murmur to the health and performance of the horse and to the safety of the rider.

### CLINICAL FINDINGS

Only the clinical findings referable to valvular disease are discussed here. The clinical findings in chronic (congestive) heart failure, which may coexist, are discussed elsewhere.

### Technique of examination

Auscultation is the fundamental basis of examination and a knowledge of the optimum areas of auscultation and the significance of the murmurs encountered are essential. When a murmur is detected it should be categorized according to its timing and duration, intensity, location, and character. There is room for improvement in the correct identification of heart murmurs, and specialist clinicians can more accurately identify the likely site of heart murmurs than other clinicians.<sup>11</sup>

### Timing

Timing allows a subdivision into systolic, diastolic and continuous murmurs and immediately shortens the list of possible defects present. There is little problem in differentiating systolic from diastolic murmurs at slow heart rates because of the temporal difference between the length of the systolic and diastolic period. However, where there is a murmur present at fast heart rates this distinction is less obvious and it is possible to misclassify the period of the cycle in which the murmur is occurring.

- Murmurs should be timed with reference to the **arterial pulse**, which occurs in early to mid-systole if a proximal artery is examined
- A convenient artery is on the posteromedial aspect of the carpus and radius in cattle and horses
- A less satisfactory alternative is timing with the occurrence of the **apex beat**
- Timing by relation to the **heart sounds** is unreliable as these are frequently altered in character and at fast heart rates a diastolic murmur may be mistaken for a systolic one
- **Systolic murmurs** are associated with stenosis of the outflow valves or insufficiency of the atrioventricular valves
- **Diastolic murmurs** are associated with insufficiency of the outflow



valves or stenosis of the atrioventricular valves

- A **continuous murmur** or one that occurs during both systole and diastole may be associated with both stenosis and insufficiency of the same valve or with multiple valvular lesions but more commonly results from the turbulent flow of blood from a high-pressure to a low-pressure system with no intervening valve, such as occurs with a patent ductus arteriosus.

#### Duration

Duration during systole or diastole is determined by a careful examination of the murmur with relationship to the period between the heart sounds. **Systolic murmurs** are further classified as early, late, holo- or pansystolic according to their occurrence and duration in the period between the first and the second heart sounds and **diastolic murmurs** as early (occurring between S2 and S3), holo-diastolic or presystolic (occurring between the atrial fourth heart sound and S1). Pansystolic and pandiastolic murmurs, occurring throughout the systole or diastole, have greater significance than murmurs that occur, for example, only in early systole and early diastole.

#### Intensity

Intensity or loudness of a murmur provides a guide to its significance. A system of grading the intensity of murmurs that has been found to be of clinical value is as follows:

- Grade I. The faintest audible murmur. Generally only detected after careful auscultation by an experienced clinician
- Grade II. A faint murmur that is clearly heard after only a few seconds auscultation
- Grade III. A murmur that is immediately audible as soon as auscultation begins and is heard over a reasonably large area
- Grade IV. An extremely loud murmur accompanied by a precordial thrill. The murmur becomes inaudible if the stethoscope is held with only light pressure on the chest
- Grade V. An extremely loud murmur accompanied by a precordial thrill. The murmur can still be heard when the stethoscope is held with only light pressure against the chest.

Grade I murmurs are not clinically significant whereas grade IV and V invariably are. The significance of grade II and III murmurs varies according to their cause. A system that grades on a six-grade basis is also used and differs only in a further subcategorization of moderately loud and loud murmurs.

The presence of a precordial thrill is determined by palpation over the point of maximal intensity of the murmur and palpation on the chest over other areas of the heart. A precordial thrill indicates that there is considerable energy generated by the turbulent flow and defines the intensity of the murmur in the top two grades in both grading systems.

#### Location and radiation

Location and radiation of a murmur is related to its areas of generation and transmission. The **point of maximum intensity** (PMI) is noted with reference to the areas of maximum audibility of the heart valves described earlier under the heading of examination of heart sounds. Low-intensity murmurs are generally restricted to the auscultatory area overlying their area of generation. The auscultatory areas of the heart and of the individual heart sounds have been described earlier in the section on arrhythmias. The vibrations associated with very loud murmurs may be transmitted to other auscultatory areas but generally they are most intense near the area of generation, as is any associated thrill. Murmurs and thrills can be restricted to local areas and it is essential to examine several auscultatory areas over both sides of the heart.

#### Character

Character is determined by change in intensity during the duration of a murmur and is defined as crescendo, crescendo-decrescendo, decrescendo or plateau. Murmurs may also be described according to their frequency characteristics by terms such as blowing, honking, musical and buzzing, but these interpretations are very subjective and often not repeatable between examiners. Blowing murmurs do not have a major frequency peak of harmonics and therefore do not have an easily identifiable pitch. In contrast, musical, honking and buzzing murmurs have a primary frequency and associated harmonics. Musical murmurs have a higher fundamental frequency (pitch) than honking or buzzing murmurs, whereas honking murmurs are shorter in duration than buzzing murmurs.<sup>12</sup>

#### Interpretation

Following this examination the functional defect producing the murmur and the valve involved are determined from the **characteristics** of timing and duration, location and radiation, and also any **secondary effects** that may be present in arterial or venous pulse characteristics. The severity of the lesion is judged in part on the intensity of the murmur but also on the degree of cardiac insufficiency that is present. As a rule all pansystolic mitral

and tricuspid murmurs, all holo-diastolic murmurs, all right-sided murmurs and all murmurs with a palpable precordial thrill should be considered pathological. The cause of the lesion cannot be determined from auscultation but may be determined from the results of general clinical and special pathological examinations and by a **knowledge and consideration of the common causes** of valvular disease that involve the particular valve affected in the animal species being examined.

#### Functional (innocent) murmurs

Murmurs not associated with cardiac abnormality occur in all large-animal species, but particularly the horse and the lactating dairy cow. Those associated with turbulence produced during periods of high-velocity flow are often called **functional murmurs** or **flow murmurs**; those associated with turbulence resulting from decreased viscosity and increased flow are often called **physiological murmurs**.

#### Functional systolic ejection murmurs

are very common in young, fit horses and occur occasionally in cattle, sheep and pigs. In **horses**, they are heard best over the base of the heart, usually on the left side over the aortic valve region, in some horses on the right side, but not usually on both sides in the same horse. They are early to mid systolic murmurs of low intensity (grade 1–3), and are crescendo decrescendo or decrescendo in character. In horses they are usually more audible at heart rates slightly elevated above the resting rate. Occasionally in horses, an ejection murmur is audible over the pulmonary valve.

In **cattle** they are most common at the base of the heart on the left side. A systolic ejection murmur is very common over the left anterior heart base in lactating dairy cattle and this murmur is thought to be due to turbulence at the pulmonic valves. Auscultation of this murmur requires placement of the stethoscope directly over the pulmonic valve; this murmur is usually not auscultable when the heart is auscultated at the fourth to fifth intercostal space. Holo-systolic murmurs (grade 1–3) are heard in some **calves** in the first 2–3 weeks of life. They are possibly associated with minor deformation of the atrioventricular valves by hematocysts at the edge of the valve leaflets, which are common in young calves.

An **early diastolic murmur** occurs in horses, most commonly in young Thoroughbreds and Standardbreds, and is believed to be due to vibrations associated with the rapid flow of blood into the heart in early diastole. It is a soft (grade 1–2), high-pitched, early diastolic murmur. When heard over the apex area it is probably a variation of the S3 sound.

A **presystolic murmur** of grade 1–2 intensity and rumbling sound is occasionally heard in **horses** and is probably a component of the atrial fourth heart sound.

**Recumbent cattle** commonly have a low intensity (grade 1–3) crescendo–decrescendo systolic murmur that is auscultated over the right side. It will disappear when the animal stands. A similar murmur occurs where there is **ruminal distension** and bloat.

In **newborn** calves and foals a systolic murmur is frequently audible over the base of the heart and it is believed to be due to a partial temporary patency of the closing ductus arteriosus. In newborn pigs a continuous murmur may be heard and this is often replaced by an early systolic murmur audible for the first week of life.

Insufficiency of the right atrioventricular valve

Tricuspid valve insufficiency resulting from endocarditis is the **most common** acquired valvular lesion in cattle, pigs and sheep. Insufficiency may also result from dilatation of the valve annulus in chronic anemia and with cor pulmonale in conditions such as high altitude disease in cattle. Tricuspid regurgitation can also occur with general heart failure that follows left-sided failure. Because of the association with bacterial endocarditis, tricuspid insufficiency in cattle, pigs and sheep is usually indicative of significant cardiac disease or the presence of marked pulmonary hypertension. However, in horses, the murmur of tricuspid insufficiency may be present with little evidence of impaired performance.<sup>7</sup>

There is a harsh **holosystolic** or pansystolic plateau-type murmur most audible over the tricuspid valve area. Loud murmurs project dorsally and to the cranial part of the thoracic cavity on both right and left sides. The murmur is usually accompanied by an exaggeration of the systolic component of the jugular pulse. Congestive heart failure, if it occurs, will be manifest in the greater circulation.

Insufficiency of the left atrioventricular valve

This is the **second most common** acquired valvular disease in horses, cattle and pigs. The insufficiency may result from endocarditis or rupture of the mitral valve chordae.<sup>13–15</sup> There is a loud harsh **holosystolic** or pansystolic murmur that is most intense in the mitral area. The murmur transmits dorsally and in severe cases may also be heard on the right side. There is frequently marked accentuation of the occurrence of the third heart sound, which may be mistaken for the second sound. A late systolic crescendo murmur has also been associated with mitral insufficiency.<sup>16</sup>

The **pulse characters** are unchanged until the stage of cardiac failure. Cases of mitral insufficiency may compensate at rest and may be only evidenced by decreased work tolerance. Failure, if it occurs, will be initially associated with left ventricular volume overload; however, in some cases the retrograde flow of blood through the mitral valve may lead to pulmonary hypertension and the additional occurrence of right-sided heart failure.

**Acute-onset heart failure** is usually associated with rupture of the valve chordae.<sup>17</sup> In the horse, mitral insufficiency may predispose to atrial fibrillation.<sup>18</sup>

Insufficiency of the aortic valve

This is the **most common** acquired valvular defect in horses. There is a loud **holodiastolic murmur**, frequently accompanied by a thrill caused by the reflux of blood from the aorta into the left ventricle during diastole. The murmur is generally audible over the left cardiac area and is most intense at the aortic valve area and radiates to the apex. It may modify the second heart sound or start immediately following. The murmur may be noisy or **musical** and the relative intensity varies from horse to horse. Frequently it is decrescendo in character but other variations in its intensity occur. Valvular insufficiency of a sufficient degree to have functional significance is accompanied by an arterial pulse of very large amplitude and high systolic and low diastolic blood pressures (**water-hammer pulse**). The pulse wave may be great enough to cause a visible pulse in small vessels and even in capillaries. Rarely this lesion is accompanied by a diastolic jugular pulse due to transmission of the impact of the reflex wave across the ventricular septum to the right side of the heart.

Stenosis of the aortic valve

There is a harsh **systolic** murmur, most audible high up over the base of the heart on the left side and posteriorly. The murmur replaces or modifies the first heart sound and is often crescendo–decrescendo in character. A systolic thrill may be palpable over the base of the heart and the cardiac impulse is increased as a result of ventricular hypertrophy. The stenosis has most functional significance when the pulse is abnormal, with a small amplitude rising slowly to a delayed peak reflecting the diminished left ventricular output. There may be signs of left-sided heart failure and this lesion may also be associated with syncope.

Stenosis and insufficiency of the pulmonary valve

Acquired lesions of this valve are rare in large animals. The auscultatory charac-

teristics are similar to those produced by aortic valve lesions but there are no abnormalities of the arterial pulse. Pulmonary stenosis produces a distinct murmur at the third intercostal space on the left side of the chest<sup>19</sup> but some cases of pulmonary stenosis in the horse have no murmur.<sup>15</sup> Murmurs may also be audible anterior to the aortic valve area on the left side of the chest. Heart failure, if it occurs, is right-sided.

Stenosis of the right or left atrioventricular valves

Stenosis of either atrioventricular valve is uncommon. There is a diastolic murmur caused by passage of blood through a stenosed valve during diastolic filling and audible over the base of the heart on the relevant side. The severity of the lesion will govern the duration of the murmur but there is likely to be a presystolic accentuation due to atrial contraction. Right atrioventricular valve stenosis may be accompanied by accentuation of the atrial component of the jugular pulse. Some degree of mitral stenosis may occur in acquired lesions that manifest primarily as an insufficiency.

#### CLINICAL PATHOLOGY

Clinicopathological findings will reflect the changes caused by the primary disease and are significant only when there is endocarditis. Two-dimensional echocardiography, Doppler echocardiography and color flow Doppler echocardiography are the most valuable noninvasive methods for the examination of valvular disease and allow a detection of the defect, its nature and its severity.<sup>20–24</sup> Echocardiography may detect regurgitant flow and flow through stenotic valves that is not detected by auscultation.

#### NECROPSY FINDINGS

Care is needed when the heart is opened to ensure that the valves can be viewed properly from both upper and lower aspects. Lesions of endocarditis may be visible or there may be perforations, distortion or thickening of the valves or breakage of the chordae tendineae. Endocardiosis in pigs is characterized by accumulation of glycosaminoglycans and hyaluronan and myofibroblast differentiation of fibroblasts.<sup>25</sup>

#### DIFFERENTIAL DIAGNOSIS

Murmurs must be differentiated from pericardial and pleural friction sounds and from murmurs due to congenital defects with shunts.

#### TREATMENT

There is no specific treatment for valvular disease. Methods for the treatment of

congestive heart failure and endocarditis are discussed under those headings.

## REVIEW LITERATURE

- Fregin GF. Medical evaluation of the cardiovascular system. *Vet Clin North Am Equine Pract* 1992; 8:329-346.
- Patteson MW, Cripps PJ. A survey of cardiac auscultatory findings in the horse. *Equine Vet J* 1993; 25:409-415.
- Patteson M, Blissitt K. Evaluation of cardiac murmurs in horses 1. Clinical examination. In *Pract* 1996; 18:367-373.
- Blissitt K, Patterson M. Evaluation of cardiac murmurs in horses 2. Echocardiography. In *Pract* 1996; 18:416-426.
- Reef VB. Heart murmurs in horses: determining their significance with echocardiography. *Equine Vet J Suppl* 1996; 19:71-80.

## REFERENCES

- Ewart S et al. *J Am Vet Med Assoc* 1992; 200:961.
- Kemler AG, Martin JE. *Am J Vet Res* 1972; 32:249.
- Marcato PS et al. *Vet Pathol* 1996; 33:14.
- Roussel AJ, Kasari TR. *Compend Contin Educ Pract Vet* 1989; 11:769.
- Power HT, Rebhun WC. *J Am Vet Med Assoc* 1983; 182:806.
- Ball MA, Weldon AD. *Cornell Vet* 1992; 82:301.
- Patterson MW, Cripps PJ. *J Equine Vet* 1993; 25:409.
- Else RW, Holmes JR. *Equine Vet J* 1972; 4:57.
- Guarda F, Negro M. *Dtsch Tierarztl Wochenschr* 1989; 96:377.
- Ichikawa T et al. *J Jpn Vet Med Assoc* 1991; 44:153.
- Naylor JM et al. *J Vet Intern Med* 2001; 15:507.
- Naylor JM et al. *J Vet Intern Med* 2003; 17:332.
- Holmes JR, Miller PJ. *Equine Vet J* 1984; 16:125.
- Miller PJ, Holmes JR. *Equine Vet J* 1985; 17:181.
- Maxton AD, Reef VB. *Equine Vet J* 1997; 29:394.
- Patterson M, Blissitt K. In *Pract* 1996; 18:367.
- Brown CM et al. *J Am Vet Med Assoc* 1983; 182:281.
- Reef VB et al. *Equine Vet J* 1998; 30:18.
- Nilsford L et al. *Equine Vet J* 1991; 23:479.
- McGladdery AJ, Marr CM. *Equine Vet Educ* 1990; 2:11.
- Reef VB. *Compend Contin Educ Pract Vet* 1990; 12:1312.
- Reef VB. *Vet Clin North Am Equine Pract* 1991; 7:435.
- Blissitt K, Patterson M. In *Pract* 1996; 18:416.
- Blissitt KJ, Bonagura JD. *Equine Vet J Suppl* 1995; 19:82.
- Castgnaro M et al. *Res Vet* 1997; 62:121.

## ENDOCARDITIS

### Synopsis

**Etiology** Bacterial, occasionally parasitic infection

**Epidemiology** History of ill-thrift, chronic illness, periodic milk drop, shifting lameness

**Clinical findings** Type of murmur depends on valves of species predilection. Embolic nephritis, arthritis, tenosynovitis or myocarditis

**Clinical pathology** Blood culture

**Necropsy findings** Valvular lesions, often vegetative, maybe rupture of chordae tendineae. Embolic lesions in other organs

**Diagnostic confirmation** Murmur or persistent tachycardia with evidence of bacteremia, a positive blood culture. Can be confirmed by echocardiography

**Treatment** Antimicrobial agents based on culturing causative agent. Prolonged therapy required. Case fatality uniformly high in cases that have heart failure

## ETIOLOGY

Most cases of endocarditis in farm animals are caused by bacterial infection but whether the infection gains entrance by direct adhesion to undamaged endothelium, or through minor discontinuities of the valvular surfaces, or by hematogenous spread through the capillaries at the base of the valve, is uncertain. A number of different organisms have been associated with this disease. The common infectious causes of endocarditis in animals are listed below.

### Cattle<sup>1-4</sup>

- Alpha-hemolytic streptococci
- *Arcanobacterium* (*Actinomyces* or *Corynebacterium*) *pyogenes*
- *Micrococcus* and *Staphylococcus* spp.
- *Pseudomonas* spp.
- *Clostridium chauvoei* (blackleg)
- *Mycoplasma mycoides*
- *Erysipelothrix rhusiopathiae* (*insidiosus*) (rare).

### Horses<sup>3,5-7</sup>

- *Actinobacillus equuli*
- *Streptococcus* spp., including *Streptococcus equi* and *Streptococcus zooepidemicus*
- *Pasteurella/Actinobacillus* spp.
- *Pseudomonas* spp.
- Migrating *Strongylus* spp. larvae.

### Pigs and sheep<sup>8,9</sup>

- *Erysipelothrix rhusiopathiae* (*insidiosus*)
- *Streptococcus* spp. including *Streptococcus equisimilis*, *Streptococcus dysgalactia*, *Streptococcus suis*
- *Escherichia coli*
- *A. pyogenes*.

## EPIDEMIOLOGY

There is limited information on the epidemiology of the endocarditis. (See Epidemiology, valvular disease.)

Chronic bacteremia predisposes to endocarditis. There may be a history of an ongoing septic process such as mastitis, metritis, foot abscess or traumatic reticular peritonitis, or of a procedure, such as the use of an indwelling intravenous catheter, that might lead to bacteremia. Commonly there is a history suggestive of low-grade infection. In **cattle**, ill-thrift with periodic, dramatic but temporary fall in milk production is a common history. The animals often have a lower body condition than expected for their stage of

production and there is frequently a history of intermittent lameness.<sup>4</sup> **Horses** may present with similar suggestive histories, including shifting leg lameness, intermittent joint distension, coughing, seizures, jugular vein thrombosis, colic, diarrhea, poor growth and umbilical infection.<sup>6</sup> In **sows** it is common for agalactia to develop in the first 2-3 weeks after farrowing, followed by a loss of weight, intolerance to exercise and dyspnea at rest.

## PATHOGENESIS

Endocarditis may arise from implantation of bacteria onto the endocardium from the bloodstream or by bacterial embolism of the valve capillaries. Endocarditis is **predisposed by trauma** to the endothelial surface exposing collagen and leading to binding of platelets, activation of the extrinsic coagulation cascade with deposition of fibrin and the formation of sterile platelet-fibrin deposits.

**Endothelial damage** may occur along the lines of closure of valves in association with turbulent flow and also can occur for the same reason on areas of the mural endocardium. These areas are subsequently colonized by circulating bacteria and the organisms grow in these areas enmeshed in a tight, avascular network of fibrin and platelets with further serial deposition of platelets and fibrin.<sup>10</sup> This is the mechanism of endocarditis that occurs secondary to turbulent flow in congenital heart disease and of that produced by trauma such as cardiac catheterization. Myocardial disease may lead to edema of the valves, which may also predispose to endothelial damage.

Endocarditis in large animals occurs most commonly **secondary to a chronic infection** at some distant site and a **persistent bacteremia** without predisposing lesions in the heart. Certain organisms have the ability to directly adhere to endothelium and it is probable that this is the major pathogenic factor.

**The major clinical abnormalities** associated with endocarditis result from the effect of endocarditis on **heart function** and from the effects of embolic **showering** of microorganisms, which can lead to infarction or infection at other sites in the body. The valvular lesions may be vegetative in the early stages of the disease or, more often, there may be fibrosis and shrinking, distortion and thickening of the valve cusps. Both interfere with valve function, leading to cardiac insufficiency and possibly cardiac failure. The functional defect produced by valvular endocarditis is usually, but not invariably, **valvular insufficiency**. Infected emboli most commonly produce pulmonary embolism with miliary pulmonary abscessation, or infection or abscesses in

other organs, including myocardium, kidneys and joints.

#### Valve predilection

In **cattle**, endocarditis occurs most commonly on the right atrioventricular (tricuspid) valve. The left atrioventricular (mitral) valve is the second valve of predilection, and bilateral involvement of the atrioventricular valves is not uncommon.<sup>1,4</sup> In the **horse** the most common site of infection is the aortic valve, with the left and the right atrioventricular valves being the second and the third valve sites of predilection.<sup>11</sup> Endocarditis of the pulmonary valve is uncommon, but is recorded.<sup>6,12</sup> The atrioventricular valves are the predilection sites in sheep and swine.

### CLINICAL FINDINGS

#### Cardiac signs

The important finding is a murmur on auscultation or a thrill on palpation of the cardiac area. Details of the specific findings for individual valve abnormalities can be found in the preceding section on valvular disease. A major problem with diagnosis based on the presence of murmurs is that they are not always present or detected in cases of endocarditis, particularly with right sided lesions.<sup>1,4,13</sup> Persistent tachycardia should be regarded as the most consistent clinical sign in endocarditis.

#### Embolism

Chronic bacteremia and embolic showering of microorganisms results in signs referable to infection and infarction at other sites in the body. There is a constant moderate, fluctuating fever and secondary involvement of other organs may cause the appearance of signs of peripheral lymphadenitis, embolic pneumonia, nephritis, arthritis, tenosynovitis or myocarditis. There is usually much loss of condition, pallor of mucosae and an increase in heart rate.

#### Clinical course

The clinical course in endocarditis may be as long as several weeks or months, or animals may drop dead without premonitory signs. Endocarditis is also a cause of acute heart failure and **sudden death in sows**.<sup>14</sup> Because sows are confined with minimal exercise during much of the production cycle, the presence of cardiac insufficiency from chronic endocarditis can be masked and sows with chronic endocarditis may have acute heart failure and die at times of intense exercise, such as mating or during movement to other housing.

#### Rupture of the chordae tendineae

Rupture of the chordae tendineae of the mitral valve in horses may be pre-

disposed by endocarditis<sup>15</sup> or may occur spontaneously,<sup>16,17</sup> and occurs in both adults<sup>16,17</sup> and foals.<sup>18</sup> It is manifested by **sudden onset of acute heart failure** in horses apparently previously healthy or, when a complication of a pre-existing endocarditis, as a sudden onset complication of the disease or a cause of death. There are signs of acute left failure and there is usually a prominent third heart sound.<sup>19</sup> The rupture may involve the chordae of any of the cusps of the valve.<sup>17</sup> Rupture of the medial cusp of the aortic valve to produce acute left heart failure and rupture of the pulmonary valve producing right heart failure can also occur.<sup>20</sup>

#### Cardiography

**Electrocardiographic** findings suggestive of endocarditis are sinus tachycardia and decreased QRS amplitudes in a base-apex lead;<sup>21</sup> ectopic foci may also be present.

**Echocardiographic** findings suggestive of endocarditis are hypoechoic and echogenic masses, irregular thickening of valves and rupture of the chordae tendinae.<sup>6</sup>

### CLINICAL PATHOLOGY

A nonregenerative anemia, leukocytosis, neutrophilia, hyperfibrinogenemia and hyperglobulinemia are common but **not specific** for endocarditis. In chronic cases, where the lesions are due largely to scarring of the valves, hematological findings may be normal. Hypergammaglobulinemia is the most common and consistent finding and an indication of chronic bacterial infection. Where there is passive hepatic congestion there may be an increase in serum alkaline phosphatase and gamma-glutamyltransferase activity. Repeated examination of the urine may reveal transient episodes of proteinuria and the shedding of bacteria associated with renal embolization and infarction.

**Blood cultures** should be attempted. The avoidance of skin contamination is important and the site should be adequately prepared by initial skin cleansing with 70% alcohol followed by 1% povidone-iodine applied in a circular pattern around the intended venepuncture site. A contact time of at least 2 minutes should be allowed before obtaining blood for culturing.<sup>10</sup> The ratio of blood to broth culture medium should be 1:10-1:20, and the broth should be incubated at 37°C for 24 hours before being examined for the presence of turbidity and plated on to traditional blood agar plates. Blood culture is frequently negative and it is recommended that three samples be obtained from separate venepuncture sites during a

1-hour period.<sup>10</sup> Sampling at the start of a fever is preferred but clearly impossible; however in animals with a more constant bacteremia, repeat culturing without regard to fever is successful.<sup>2,11</sup> Determination of the susceptibility of the organism to antimicrobial agents may aid in treatment.

### NECROPSY FINDINGS

The lesions are termed vegetative when they are large and cauliflower-like and verrucose when they are small and wart-like. The former are present on the valves in most fatal cases. In the later stages the valves are shrunken, distorted and often thickened along the edges. This stage of recovery is rare in farm animals but may be observed in the semilunar valves in horses. Spontaneous healing is rare and in most cases treatment is commenced at too late a stage.

Embolic lesions may be present in any other organ. Culture of the valvular lesions should be undertaken but in many cases no growth is obtained. The examination of direct smears should always be undertaken.

### DIFFERENTIAL DIAGNOSIS

- Pericarditis
- Brisket disease (cattle)
- Cardiac lymphosarcoma

### TREATMENT

Treatment is not highly successful because of the difficulty in controlling the infection. The thickness of the lesions prevents adequate penetration of antimicrobial agents and unless the susceptibility of the causative organism is known a range of antibacterial drugs may have to be tried. For this reason there should be repeated attempts at blood culture until the causative organism is cultured in order to allow drug selection on the basis of susceptibility testing. The choice of antimicrobial agent should be one that allows high concentrations in serum relative to the minimal bactericidal concentration, that has minimal side effects over a prolonged period of administration and has a prolonged half-life.<sup>12</sup>

In the absence of a positive culture the types of organism commonly isolated in cattle suggest the use of penicillin, possibly combined with gentamicin or the use of a potentiated sulfonamide.<sup>3,13</sup> The variety of causative organisms in horses recommends the use of broad-spectrum antibacterial treatment.

**Duration of treatment** needs to be prolonged. It is difficult to judge the duration of therapy required. A fall in temperature can be taken as an indication that infection is being brought under

control, but treatment needs to be continued if there is to be success in therapy.<sup>3,10,14,15</sup> A period of continual treatment for 4 months with periodic treatment continuing for 14 months in a cow has been recorded.<sup>2</sup>

**Relapse** is common. Treatment is expensive and in food animals must be extra-label and is probably uneconomic except for particularly valuable animals. Consequently the treatment of endocarditis should be approached with reservation. **Case fatality** is high if signs of congestive heart failure are present.

**The sequel** of embolic lesions in other organs and permanent distortion of valves resulting in valvular insufficiency also militate against a satisfactory outcome. The use of parenteral anticoagulants, as used in humans to prevent further deposition of material on vegetative lesions and to limit embolic disease, has questionable value<sup>21</sup> and requires monitoring that is not usually available in veterinary practice.

## REVIEW LITERATURE

- Evans ET. Bacterial endocarditis of cattle. *Vet Rec* 1957; 69:1190.
- Kasari TR, Rousell AJ. Bacterial endocarditis. Part I. Pathophysiology, diagnostic and therapeutic considerations. *Compend Contin Educ Pract Vet* 1989; 11:655-671.
- Kasari TR, Rousell AJ. Bacterial endocarditis in large animals. Part II. Incidence, causes, clinical signs, and pathologic findings. *Compend Contin Educ Pract Vet* 1989; 11:769-774.
- Fregin GF. Medical evaluation of the cardiovascular system. *Vet Clin North Am Equine Pract* 1992; 8:329-346.
- Dowling PM, Tyler JW. Diagnosis and treatment of bacterial endocarditis in cattle. *J Am Vet Med Assoc* 1994; 204:1013-1016.

## REFERENCES

- Roussel AJ, Kasari TR. *Compend Contin Educ Pract Vet* 1989; 11:769.
- Tyler JW et al. *J Am Vet Med Assoc* 1991; 198:1410.
- Brown CM. *Vet Clin North Am Equine Pract* 1985; 2:371.
- Evans ET. *Vet Rec* 1957; 69:1190.
- Bucrgell CD et al. *Vet Pathol* 1985; 22:333.
- Maxson AD, Reef VB. *Equine Vet J* 1997; 29:394.
- Travers CW et al. *J S Afr Vet Assoc* 1995; 66:172.
- Ichikawa T et al. *J Jpn Vet Med Assoc* 1991; 44:153.
- Katsumi M et al. *J Jpn Vet Med Assoc* 1998; 60:129.
- Kasari TR, Rousell AJ. *Compend Contin Educ Pract Vet* 1989; 11:655.
- Hillyer MH et al. *Equine Vet Educ* 1990; 2:5.
- Nillsford L et al. *Equine Vet J* 1991; 23:479.
- Power HT, Rebhun WC. *J Am Vet Med Assoc* 1983; 182:806.
- Drolet R et al. *Can Vet J* 1992; 33:325.
- Ewart S et al. *J Am Vet Med Assoc* 1992; 200:961.
- Brown CM et al. *J Am Vet Med Assoc* 1983; 182:281.
- Marr CM et al. *Vet Rec* 1990; 127:376.
- Reef VB. *J Am Vet Med Assoc* 1987; 191:329.
- Holmes JR, Miller PJ. *Equine Vet J* 1984; 16:125.
- Reimer JM et al. *J Am Vet Med Assoc* 1991; 198:880.
- Constable P. *J Am Vet Med Assoc* 1991; 199:299.

## Diseases of the pericardium

### PERICARDITIS

#### Synopsis

**Etiology** Traumatic, extension from other infection, as component of infections causing polyserositis, or idiopathic

**Epidemiology** Poorly defined other than for traumatic pericarditis in cattle

**Clinical findings** Friction sound initially, followed by muffling of the heart sounds, venous congestion, decreased pulse pressure and congestive heart failure

**Clinical pathology** Pericardiocentesis, echocardiography, radiography

**Necropsy findings** Inflammation, fibrin and fluid, in pericardial sac. Fibrous pericarditis

**Diagnostic confirmation** Triad of muffling of the heart sounds, venous congestion, decreased pulse pressure. Pericardiocentesis, echocardiography

**Treatment** Antimicrobials and drainage. Poor prognosis and supportive treatment

## ETIOLOGY

Pericarditis is not common but presents in three general forms; effusive, fibrinous and constrictive, although combinations of one or more of the three forms can occur. **Effusive pericarditis** is characterized by the accumulation of a protein-rich fluid within the pericardial sac. Subsequent fibrin deposition can lead to **fibrinous pericarditis**, and if fibrin within the pericardial sac matures to fibrous tissue and fibrosis of the pericardium or epicardium then **constrictive pericarditis** will result.<sup>1</sup> **Traumatic pericarditis**, perforation of the pericardial sac by an infected foreign body, occurs commonly only in cattle. Traumatic pericarditis is also recorded in the horse<sup>2</sup> and in a lamb.<sup>3</sup> Localization of a blood-borne infection occurs sporadically in many diseases. Direct extension of infection from pleurisy or myocarditis may also occur in all animals but the clinical signs of pericarditis in such cases are usually dominated by those of the primary disease.

In most cases of pericarditis in horses no causative agent is isolated.<sup>1</sup> There is commonly a history of upper or lower respiratory tract disease. Most cases are fibrinous or septic<sup>4,5</sup> but an effusive non-septic form is also described and has been called **idiopathic effusive pericarditis**.<sup>6</sup> Pericarditis in horses occurs predominantly in adults. Idiopathic effusive pericarditis has been diagnosed in two dairy cows.<sup>7</sup>

## Cattle

- *Mannheimia hemolytica*
- Black disease – if patients survive more than 24 hours

- Sporadic bovine encephalomyelitis
- *Haemophilus* spp., including *Histophilus somni*
- Tuberculosis
- *Pseudomonas aeruginosa*
- *Mycoplasma* spp.
- *Klebsiella pneumoniae*
- *Actinobacillus suis*
- Idiopathic effusive (nonseptic) pericarditis.

## Horses

- *Streptococcus* spp., including *S. equi*, *S. zooepidemicus* and *S. faecalis*
- Tuberculosis
- *Corynebacterium pseudotuberculosis*
- *Actinobacillus equuli*
- In association with EHV-1 infection
- Idiopathic effusive (nonseptic) pericarditis.

## Sheep and goats

- Pasteurellosis
- *Staphylococcus aureus*
- *Mycoplasma* spp.

## Pigs

- Pasteurellosis
- *Mycoplasma* spp. especially *Mycoplasma hyorhinis*
- *Haemophilus* spp. – Glasser's disease and pleuropneumonia
- *Streptococcus* spp.
- Salmonellosis.

## PATHOGENESIS

**In the early stages**, inflammation of the pericardium is accompanied by hyperemia and the deposition of fibrinous exudate, which produces a friction sound when the pericardium and epicardium rub together during cardiac movement. As effusion develops the inflamed surfaces are separated, the friction sound is replaced by muffling of the heart sounds, and the accumulated fluid compresses the atria and right ventricle, preventing their complete filling. Congestive heart failure follows. A severe toxemia is usually present in suppurative pericarditis because of the toxins produced by the bacteria in the pericardial sac. Gas will occur along with fluid in the sac if gas-producing bacteria are present. If sufficient gas is present, the classical washing machine sound of fluid splashing with each heart beat will be auscultated. This is not as commonly heard in clinical cases as muffling of the heart sounds.

**In the recovery stage** of nonsuppurative pericarditis the fluid is reabsorbed and adhesions form between the pericardium and epicardium to cause an adhesive pericarditis, but the adhesions are usually not sufficiently strong to impair cardiac movement.

**In suppurative pericarditis** the adhesions that form become organized, starting on day 4–6,<sup>8</sup> and may cause

complete attachment of the pericardium to the epicardium, or this may occur only in patches to leave some loculi which are filled with serous fluid.<sup>6</sup> In either case restriction of cardiac movement will probably be followed by the appearance of congestive heart failure.

### CLINICAL FINDINGS

In the **early stages** there is **pain**, avoidance of movement, abduction of the elbows, arching of the back and shallow, abdominal respiration. Pain is evidenced on percussion or firm palpation over the cardiac area of the chest wall, and the animal lies down carefully. A **pericardial friction** sound is detectable on auscultation of the cardiac area. The temperature is elevated to 39.5–41°C (103–106°F) and the pulse rate is increased. Associated signs of pleuritis, pneumonia and peritonitis may be present.

In most cases of pericarditis caused by traumatic reticuloperitonitis, hematogenous infection or spread from pleuritis, the **second stage** of effusion is manifested by **muffling** of the heart sounds, decreased palpability of the apex beat and an increase in the area of cardiac dullness with decreased amplitude of the peripheral pulse. If **gas** is present in the pericardial sac each cardiac cycle may be accompanied by splashing sounds. Signs of congestive heart failure become evident. Fever is present, the heart rate is markedly increased and toxemia is severe, although this varies with the types of bacteria present. This is the most dangerous period and affected animals usually die of congestive heart failure, or of toxemia, in 1–3 weeks.<sup>9–11</sup> Those that survive pass through a long period of chronic ill health during which the toxemia subsides relatively quickly but congestive heart failure diminishes slowly. In this stage of chronic pericarditis additional signs of myocarditis, particularly irregularity, may appear. The heart sounds become less muffled and fluid sounds disappear altogether or persist in restricted areas. Complete recovery is not common.

In the **horse**, both the idiopathic effusive and the septic forms of pericarditis present with marked muffling of the heart sounds, tachycardia, distension of the jugular veins and subcutaneous edema of the ventral body wall.<sup>4,12</sup> A nonseptic pleural effusion is also commonly present in cases of septic pericarditis in the horse<sup>9,13</sup> but not in idiopathic effusive pericarditis.<sup>14</sup>

### CLINICAL PATHOLOGY

A marked leukocytosis and neutrophilia, as well as hyperglobulinemia, are usually present in traumatic pericarditis because this has many of the characteristics of a

large internal abscess. In the other forms of pericarditis changes in the blood depend upon the other lesions present and on the causative agent. In the stage in which effusion occurs a sample of fluid may be aspirated from the pericardial sac and submitted for bacteriological examination. The technique is not without danger, as infection may be spread to the pleural cavity.

**Pericardial fluid** can also be examined cytologically but usually the smell (reminiscent of retained placenta and toxic metritis in cattle) is sufficiently diagnostic in cattle with traumatic pericarditis. In septic pericarditis the fluid represents an inflammatory response, whereas in idiopathic effusive pleuritis in horses there are very few cells in the sediment.<sup>12,15</sup> Mean right ventricular diastolic and intrapericardial fluid pressures are increased in a corresponding manner in cows with clinical signs of right-sided heart failure.<sup>10</sup> Cattle with muffled heart sounds and a large pericardial fluid volume also have a decrease in cardiac output to approximately two-thirds of normal values.<sup>10</sup>

**Electrocardiography** can aid in diagnosis. Electrocardiographic changes include sinus tachycardia and, in animals with right-sided heart failure and hydrothorax, diminished amplitude of the QRS complex.<sup>10</sup> Contrary to popular belief, hydropericardium in the absence of hydrothorax leads to an increase, and not a decrease, in QRS amplitude. Moreover, removal of large volumes of pericardial fluid does not usually result in an immediate change in QRS amplitude. Also contrary to popular belief, electrical alternans is not commonly present in dogs and humans with pericardial effusion and if present, occurs only within a narrow range of heart rates. The prevalence of electrical alternans is unknown in large animals with pericardial effusion but is suspected to be extremely low because the pericardium and heart are much more fixed in position within the thorax.

**Radiography** may be of diagnostic value, with six of seven cows having a gas–fluid interface present on standing lateral thoracic radiographs.<sup>16</sup> Radiography has the additional benefit of potentially identifying the location of the penetrating wire; this information would assist surgical removal of the wire via a rumenotomy. Radiography may also aid in the clinical differentiation of pericardial effusion from pleural effusion.

**Echocardiography** is the most valuable diagnostic procedure and will show the presence of fluid in the pericardial sac. Echocardiography usually permits differentiation of effusive and fibrinous pericarditis.<sup>5,7,9,14</sup>

### NECROPSY FINDINGS

In the early stages there is hyperemia of the pericardial lining and a deposit of fibrin. When effusion occurs there is an accumulation of turbid fluid and tags of fibrin are present on the greatly thickened epicardium and pericardium. Gas may also be present and the fluid may have a putrid odor. When the pericarditis has reached a chronic stage the pericardium is adherent to the epicardium over a greater or lesser part of the cardiac surface.<sup>6</sup> Loculi containing serous fluid often remain. Embolic abscesses may be present in other organs. Lesions typical of the specific causative diseases listed above are described under their specific headings.

### DIFFERENTIAL DIAGNOSIS

- Pleuritis
- Cardiac valvular disease
- Mediastinal abscess<sup>15</sup>
- Hydropericardium occurs in congestive heart failure, mulberry heart disease of pigs, herztod of pigs, gossypol poisoning, clostridial intoxications of sheep and lymphomatosis

### TREATMENT

Antibacterial treatment of the specific infection should be undertaken if possible on the basis of susceptibility on organisms cultured from the pericardial fluid. Where the inciting agent cannot be grown a **broad-spectrum antibiotic** or a combination to give a broad spectrum is used. A combination of penicillin and gentamicin is common and provides cover of the likely organisms associated with this infection. Pericardiocentesis, copious lavage with warmed 0.9% NaCl solution, and drainage should be conducted as required to relieve the fluid pressure in the pericardial sac, decrease the transmural pressure gradient across the atrial and ventricular walls and caudal and cranial vena cava, and thereby facilitate diastolic filling. Pericardiocentesis should be performed under ultrasonographic guidance and with electrocardiographic monitoring.

**The prognosis** varies with the etiological agent but it is generally grave in cases of septic pericarditis in **horses**<sup>4,5</sup> mainly because the stage of effusion is followed by one of fibrosis and constrictive pericarditis.<sup>17</sup> Success in treatment of a series of six cases of septic pericarditis in the horse is recorded with the use of indwelling pericardial drains to allow twice-daily lavage and drainage and the instillation of antibiotics directly into the pericardial sac. This allows high concentrations of antimicrobial agents and the twice-daily infusion of 1–2 L of fluid may

help prevent the development of constrictive pericarditis. In **cattle** thoracotomy and pericardiectomy are used to establish drainage or to allow marsupialization of the pericardium to the body wall.<sup>18</sup> Low treatment success rates are generally reported for the disease in cattle with or without surgical drainage,<sup>16,19</sup> and it is likely that cases that responded to fifth rib resection and pericardial marsupialization would have responded to pericardial drainage and intrapericardial lavage and antimicrobial administration.

There is a more favorable prognosis for the treatment of **idiopathic effusive pericarditis** in horses and cattle with aggressive therapy and the use of pericardiocentesis, pericardial lavage and corticosteroid or NSAIDs is an effective therapy.<sup>7,12,14</sup>

## REFERENCES

- Perkins SL et al. *J Am Vet Med Assoc* 2004; 224:1133.
- Bertone JJ et al. *J Am Vet Med Assoc* 1985; 187:742.
- Abo-Shekada MN et al. *Br Vet J* 1991; 147:78.
- Dill SG et al. *J Am Vet Med Assoc* 1982; 180:266.
- Buergelt CD et al. *Compend Contin Educ Pract Vet* 1990; 12:872.
- Roth L, King JM. *J Vet Diagn Invest* 1991; 3:52.
- Jesty SA et al. *J Am Vet Med Assoc* 2005; 226:1555.
- Leak LV et al. *Am J Anat* 1987; 180:373.
- Bernard W et al. *J Am Vet Med Assoc* 1990; 196:468.
- Fisher EW, Pirie HM. *Br Vet J* 1965; 121:552.
- Holmes JR. *Vet Rec* 1960; 72:355.
- Freestance JF. *Equine Vet J* 1987; 19:38.
- Bennett DG. *J Am Vet Med Assoc* 1986; 188:814.
- Worth LT, Reef VB. *J Am Vet Med Assoc* 1998; 212:248.
- Smith BP. *J Am Vet Med Assoc* 1977; 170:208.
- Ducharme NG et al. *J Am Vet Med Assoc* 1992; 200:86.
- Hardy J et al. *Equine Vet J* 1992; 24:151.
- Rings DM. *Vet Clin North Am Food Anim Pract* 1995; 11:177.
- Bernard W et al. *J Am Vet Med Assoc* 1990; 196:468.

## CONGENITAL CARDIAC DEFECTS

**Etiology** Abnormality in heart or vascular structure results in anomalous blood circulation. Cause of congenital defects unknown, some may be heritable

**Epidemiology** Sporadic occurrence. Usually present with cardiac failure shortly after birth but some defects compatible with life and detected incidentally

**Clinical and necropsy findings**  
Specific for individual defects

**Clinical pathology** Echocardiography most useful diagnostic aid

**Diagnostic confirmation**  
Echocardiography and postmortem examination

**Treatment** Surgery for some

## ETIOLOGY

An increasing number of clinical reports on congenital cardiovascular defects are appearing in the veterinary literature. However, their general importance is low.

The cause of congenital cardiac defects is unknown, but it is assumed they result from injury during development or from single recessive genes or polygenic sets that have lesion-specific effects on cardiac development.<sup>1</sup> Ventricular septal defects have been observed in twin cattle.<sup>2</sup> Heritable ventricular septal defect is recorded in miniature pigs<sup>3</sup> and suspected in cattle.<sup>4</sup>

## EPIDEMIOLOGY

Congenital cardiac anomalies occur in all species but are not common in any one of them. The prevalence is probably highest in cattle and lowest in horses.<sup>3</sup>

## Cattle

The relative frequency of individual cardiac defects in 36 calves at postmortem examination in one study<sup>5</sup> was:

- Ventricular septal defect – 14%
- Ectopic heart – 13%
- Right ventricular hypoplasia – 13%
- Left ventricular hypoplasia – 13%
- Dextroposed aorta – 10%
- Valvular hematomas – 9%
- Patent ductus arteriosus – 6%
- Patent foramen ovale – 6%
- Endocardial fibroelastosis – 4%
- Common aortic trunk – 4%
- Other cardiac defects – 10%.

The animals were neonatal calves and the relative frequencies are biased towards defects that are incompatible with longer life. In general, ventricular septal defect is the most common cardiac defect in cattle.

## Sheep

In a large series of necropsy examinations on lambs,<sup>6</sup> 1.3% had cardiac anomalies, of which approximately 90% were ventricular septal defects.

## Pigs

The relative frequency of congenital cardiac malformations in pigs<sup>7</sup> has been reported as:

- Dysplasia of the tricuspid valve – 34%
- Atrial septal defect – 25%
- Subaortic stenosis – 18%
- Ventricular septal defect – 9%
- Persistent common atrioventricular canal – 9%
- Other defects – 10%.

## Horses

A review of 82 publications on congenital cardiac defects in horses showed the following prevalence in the total cases:<sup>8</sup>

- Ventricular septal defect – 28%
- Tetralogy of Fallot – 16%

Truncus arteriosus – 8.5%

Aortic, pulmonary or mitral valve abnormalities – 13.2%

Tricuspid atresia – 14.6%

Abnormality of the aorta – 4.8%

Patent ductus arteriosus – 3.7%

Atrial septal defects – 1.2%.

Other lesions account for the remainder.

## PATHOGENESIS

Congenital cardiac defects may result in a pressure load or a volume (flow) load in one or more chambers of the heart. In general the left ventricle can tolerate a pressure load better than the right ventricle and the right ventricle can tolerate a volume load better than the left ventricle. The heart may compensate for the increase in load with minor loss in cardiac reserve or the defects may lead to cardiac failure.

## Shunts

The mixing of oxygenated and venous blood due to the presence of an anatomic abnormality that allows a shunt of blood from the pulmonary circulation to the systemic circulation in the face of high pulmonary vascular resistance is an important factor in the pathogenesis of the clinical signs of some congenital cardiac defects. The resulting anoxic anoxia causes severe dyspnea, and **cyanosis** may be marked if the right-to-left shunt is large. There is a notable absence of fever and toxemia if intercurrent disease does not develop. Cardiac enlargement is usually detectable if the animal survives past the first week of life.

## Age at manifestation

Animals with some congenital cardiac defects can survive to maturity and be productive and perform adequately. Acute heart failure or chronic (congestive) heart failure may occur when the animals are subjected to a physical stress such as the first pregnancy or activity on the range. The primary appearance of signs of cardiac disease when an animal is 2–3 years of age should not eliminate congenital defects from consideration.

## CLINICAL FINDINGS

A general description of the more common defects is given below. Some of the defects described in this section are actually defects of the vascular system but are described here for convenience. Diagnosis can be confirmed by the detection of a pressure differential across valves, the detection of shunts by dye dilution and serial blood gas analysis, and by angiocardiology. Echocardiography has developed as an important aid to diagnosis.<sup>9</sup>

## Ectopic heart

An abnormal position of the heart outside the thoracic cavity is most common in



cattle, the displacement usually being to the lower cervical region. The heart is easily seen and palpated and there is an accompanying divergence of the first ribs and a ventrodorsal compression of the sternum, giving the appearance of absence of the brisket. Affected animals may survive for periods of years, as they also may with an abdominal displacement, but those with a displacement through a defective sternum or ribs rarely survive for more than a few days.

#### Patent foramen ovale

This defect of the atrial septum is reasonably common in cattle, usually causes no clinical signs if present as an isolated defect and is detected incidentally at necropsy. Ostium secundum defects are also common in cattle.<sup>10</sup> Large defects may allow a shunt in both directions. Relative resistance to outflow from the atria is greater in the left than the right and the shunt, if it occurs, is from left to right. This induces a moderate flow load on the right side of the heart, which is well tolerated. Large flows will generally increase pulmonary vascular resistance and result in moderate right ventricular and right atrial hypertrophy. The increase in outflow resistance from the right atrium results in a decreased flow across the shunt and control of the effects of the defect. Atrial septal defects are of much greater significance when they are present with other cardiac defects and it is extremely rare for an atrial septal defect alone to cause clinical signs of circulatory failure. If these result in a severe right ventricular hypertrophy the shunt may reverse from right to left and cyanosis will occur.

#### Ventricular septal defects

These are one of the most common congenital cardiac defects in sheep, cattle and horses. They are almost invariably subaortic defects occurring high in the septum at the pars membranaceae. In the absence of other defects their presence results in the shunting of blood from the left to the right ventricle, producing a volume load on the left ventricle and left atrium.<sup>11</sup>

**On auscultation** there is a loud blowing pansystolic murmur audible over both sides of the chest. It is usually audible over a large area on both sides but most intense at the left fourth intercostal and the right third intercostal space and more intense on the right than the left side. The murmur in this defect is one of the loudest and most obvious murmurs encountered. It does not modify the heart sounds, which are usually increased in intensity. A precordial thrill is frequently palpable on both the left and the right side.

**The outcome** is determined by the magnitude of the shunt and the degree of

resistance to flow from the right ventricle as determined by pulmonary vascular resistance. With large defects the shunt of blood can be considerable and the animal may die at birth or show clinical signs at a few weeks to a few months of age. The major presenting signs during this period are of left-sided heart failure with lassitude, failure to grow well and dyspnea with moderate exercise. The shunt may be less severe and allow an apparently normal existence until maturity, when left-sided or right-sided failure can occur, or cause no apparent problem during life and be detected incidentally on necropsy or abattoir examination. Horses with this defect have raced successfully<sup>11</sup> and dairy cows have had many productive lactations.

#### Complications

An increase in pulmonary vascular resistance occurs as the result of increased pulmonary blood flow. In cattle, this increase may be sufficient to cause reversal of the shunt, and **cyanosis** develops. This syndrome, sometimes referred to as an **Eisenmenger complex**,<sup>12,13</sup> develops in young calves but also in mature animals between 1 and 3 years of age and should always be suspected where there is a sudden onset of cyanosis and exercise intolerance in an animal of this age.

The turbulence associated with flow across the defect may produce secondary changes in the valves located close to the defect, which may complicate the clinical picture. **Cattle** are prone to develop **endocarditis** in the region of the septal cusp of the right atrioventricular valve. In **horses**, endocarditis more commonly involves the medial cusp of the aortic valve.

Other complications are **prolapse of the cusps** into the septal defect due to lack of aortic root support with the development of **aortic regurgitation**.<sup>11,14</sup> **Rupture** of the valve may occur to produce a severe additional flow load on the left ventricle, with rapid onset of acute left heart failure and death.

Ventricular septal defects may occur in association with other congenital cardiac or vascular defects, and the clinical findings are varied.<sup>11,15,16</sup>

#### Prognosis

There is no practical correction for ventricular septal defects in large animals. It should be emphasized that small defects can produce dramatic auscultatory findings and, unless signs of cardiac insufficiency are present, care should be taken in giving an unfavorable prognosis in pleasure or breeding animals. Pleasure animals with this defect should never be ridden but it is possible for them to live a reasonable lifespan and to breed. Food animals can be sent for early slaughter.

There is insufficient information on the advisability of breeding animals that have this defect. An inheritable predisposition has been suspected in Hereford cattle,<sup>4</sup> and chromosomal abnormalities have been demonstrated in association with this defect in cattle.<sup>1</sup> Ventricular septal defects have high prevalence in calves and lambs with microphthalmia.

#### Tetralogy of Fallot

This is almost always a lethal defect in farm animals. The tetralogy consists of **three primary abnormalities** (ventricular septal defect, pulmonary stenosis, and dextral position of the aorta so that it overrides both ventricles) and **secondary right ventricular hypertrophy**. The marked increase in resistance to outflow into the pulmonary artery results in a shunt of blood from the right to left with the major outflow of blood through the aorta. The condition presents with clinical signs very early in life, frequently results in death at or shortly following birth and has been reported predominantly in foals and calves. Occasionally, affected animals may live for longer periods and cases are recorded in mature animals.<sup>17,18</sup>

Affected animals show lassitude and dyspnea after minor exertion such as suckling, with the clinical signs resulting primarily from **systemic hypoxemia**. **Cyanosis** may or may not be present, depending upon the degree of pulmonary stenosis, but is usually prominent, especially following exercise. On auscultation a murmur and sometimes a thrill is present and most intense in the left third or fourth intercostal space.

Other cardiac defects that result in cyanosis as a prominent sign occur when there is right-to-left shunting of blood through a patent foramen ovale, a patent ductus arteriosus or ventricular or atrial septal defects as a result of tricuspid atresia or pulmonary atresia.<sup>19-21</sup> Right-to-left shunting through these defects is rare and, if present, is usually a terminal event.

Tetralogy of Fallot should be differentiated from an even rarer condition, **double outlet right ventricle**; the latter is characterized by having both the aorta and pulmonary artery arise from a distinct conus originating from the morphologic right ventricle and from which no fibrous continuity with the atrioventricular valves can be demonstrated. Double outlet right ventricle has been diagnosed in three calves and a foal,<sup>22</sup> with clinical signs similar to tetralogy of Fallot.

#### Patent ductus arteriosus

This defect results from a failure of closure of the ductus arteriosus following birth and is probably the second most common

defect in horses after ventricular septal defect. There is some controversy over the period of time involved in normal closure in large animals. Clinically, murmurs associated with a patent ductus arteriosus are frequently heard during the first day after birth in normal foals and may persist for periods of up to 5 days. Physiological studies in foals<sup>23</sup> suggest that closure occurs before 24 hours after birth. Patent ductus arteriosus is not a common clinical cardiac defect in older animals, but can occur.<sup>24</sup> The ductus arteriosus closes within minutes of birth in calves.

Patent ductus arteriosus produces a loud **continuous murmur** associated with the left-to-right shunting of blood from the aorta to the pulmonary artery. The intensity of the murmur waxes and wanes with each cycle because of the effects of normal pressure changes on blood flow, giving rise to the name of '**machinery murmur**'. The systolic component of the murmur is very loud and usually audible over most of the cardiac auscultatory area, but the diastolic component is much softer and confined to the base of the heart. The pulse is large in amplitude but has a low diastolic pressure. Surgical correction is possible.

#### Coarctation of the aorta

Constriction of the aorta at the site of entrance of the ductus arteriosus causes a syndrome similar to that of stenosis of the aortic semilunar valves; there is a systolic murmur and a slow-rising pulse of small amplitude.

#### Persistence of the right aortic arch

Persistence of the right fourth aortic arch causes constriction of the esophagus with dysphagia and regurgitation. The aorta is situated to the right of the esophagus and trachea and the ligamentum arteriosum in its connection to the pulmonary artery encloses the esophagus in a vascular ring and compresses it against the trachea. Clinical signs are usually evident soon after birth and consist primarily of **regurgitation of milk** from the mouth and nostrils after suckling, but survival until 5 years of age has been recorded in a bull that showed **chronic bloat** and visible esophageal dilatation. Resistance to the passage of a stomach tube is encountered just behind the first rib and the diagnosis can be confirmed by radiological examination following a barium swallow. Medical treatment is concerned with the control of aspiration pneumonia, but the correction of the defect is surgical.

#### Persistent truncus arteriosus

This defect<sup>25,26</sup> and other defects of the outflow vessels, including pulmonary and aortic hypoplasia and congenital absence

of the aortic arch, have been recorded in animals but their prevalence is low.

#### Fibroelastosis

Congenital fibroelastosis has been observed in calves and pigs. The endocardium is converted into a thick fibroelastic coat and, although the wall of the left ventricle is hypertrophied, the capacity of the ventricle is reduced. The aortic valves may be thickened and irregular and obviously stenosed. The syndrome is one of congestive heart failure. The defect may cause no clinical abnormality until the animal is mature.

#### Subvalvular aortic stenosis

Stenosis of the aorta at or just below the point of attachment of the aortic semilunar valves has been recorded as a common, possibly heritable, defect in pigs<sup>27</sup> but its differentiation from other causes of heart failure is difficult. Clinically affected animals may die suddenly with asphyxia, dyspnea and foaming at the mouth and nostrils, or after a long period of ill-health with recurrent attacks of dyspnea. In the acute form death may occur after exercise or be unassociated with exertion.

#### Parachute left atrioventricular valve

This is an extremely rare congenital anomaly defined by the presence of a single papillary muscle that receives all chordae tendineae from the left atrioventricular valve. An 8-month old colt with a loud left-sided holosystolic murmur was diagnosed with this condition using echocardiography.<sup>28</sup>

#### Anomalous origin of coronary arteries

Either or both coronary arteries may originate from the pulmonary artery instead of the aorta. The resulting anoxia causes myocardial weakness in the ventricle of the affected side. Congestive heart failure usually follows. Congenital deformities of the coronary arteries have been recorded in cattle and pigs.<sup>29</sup>

#### REFERENCES

1. Tschudi P. *Schweiz Arch Tierheilkd* 1975; 117:335.
2. Besser TE, Knowlen GG. *J Am Vet Med Assoc* 1992; 200:1355.
3. Swindle MM et al. *Lab Anim Sci* 1990; 40:155.
4. Penrith ML et al. *J S Afr Vet Assoc* 1994; 65:31.
5. Gopal T et al. *Am J Vet Res* 1986; 47:1120.
6. Dennis SM, Leipold HW. *Am J Vet Res* 1968; 29:2337.
7. Hsu FS, Du SJ. *Vet Pathol* 1982; 19:676.
8. Cotterill CM, Rosedale PD. *Equine Vet J* 1992; 24:338.
9. Reef VB. *Compend Contin Educ Pract Vet* 1991; 13:109.
10. Marakami T et al. *J Jpn Vet Med Assoc* 1991; 44:696.
11. Reef VB. *Equine Vet J Suppl* 1996; 19:86.
12. Machida N. *Jpn J Vet Sci* 1986; 48:1031.
13. McLennan MW et al. *Aust Vet J* 1996; 74:22.
14. Reef VB, Spencer P. *Am J Vet Res* 1987; 48:904.
15. Wilson RB, Hoffner JC. *Cornell Vet* 1987; 77:187.

16. Ecke P et al. *N Z Vet J* 1991; 39:97.
17. Cargile J et al. *Cornell Vet* 1991; 81:411.
18. Rahal C et al. *J Equine Vet Sci* 1997; 17:604.
19. Young LE et al. *Equine Vet Educ* 1997; 9:123.
20. Anderson RH. *Equine Vet Educ* 1997; 9:128.
21. Meurs KM et al. *Equine Vet J* 1997; 29:160.
22. Prosek R et al. *J Vet Intern Med* 2005; 19:262.
23. Scott EA et al. *Am J Vet Res* 1975; 36:1021.
24. Prescott JRR et al. *Vet Rec* 1997; 74:471.
25. Sandusky GE, Smith CW. *Vet Rec* 1981; 108:163.
26. Reppas GP et al. *Aust Vet J* 1996; 73:115.
27. Van Nie CJ, Vincent J. *Vet Q* 1980; 2:160.
28. Kimberly M et al. *J Vet Intern Med* 2003; 17:579.
29. Bildfell RJ et al. *J Vet Diagn Invest* 1996; 8:500.

## Cardiac neoplasia

Primary neoplasia of the heart is exceedingly rare and cardiac disease secondary to metastatic neoplasms occurs infrequently. Aortic body adenoma, cardiac fibrosarcoma and pericardial mesothelioma are reported.<sup>1-3</sup>

Lymphosarcoma is probably the most common metastatic tumor in both cattle and horses but cardiac involvement by melanoma, hemangiosarcoma, testicular embryonal carcinoma, squamous cell carcinoma, lipoma and other tumors is also recorded.<sup>4</sup> Angiomas, benign vasoformative tumors, can occur in the heart and are recorded as obstructing blood flow and producing heart failure in a young calf.<sup>5</sup>

#### REFERENCES

1. Carnine BL et al. *Vet Pathol* 1977; 14:513.
2. Barros CSL, Santos MND. *Aust Vet J* 1983; 60:61.
3. Braun U et al. *Schweiz Arch Tierheilkd* 1995; 137:187.
4. Dill SG et al. *Equine Vet J* 1986; 18:414.
5. Watson TDG, Thompson H. *Vet Rec* 1990; 127:279.

## Diseases of the blood vessels

### ARTERIAL THROMBOSIS AND EMBOLISM

#### Synopsis

**Etiology** Arteritis leading to thrombus formation causes ischemia of the tissues supplied by the affected artery  
**Clinical findings** Reduced function or ischemic necrosis vary with the site of the obstruction. Aortic-iliac thrombosis manifest with lameness, muscular weakness, decreased pulse amplitude in affected leg  
**Clinical pathology** Leukocytosis, hyperfibrinogenemia, elevated serum concentrations of muscle enzymes in some cases. Ultrasound more sensitive for diagnosis than rectal palpation  
**Necropsy findings** Thrombosis and embolic lesions, muscle ischemia and necrosis  
**Diagnostic confirmation** Ultrasonography for aortic-iliac thrombosis  
**Treatment** Fibrinolytic enzymes. Surgical removal of thrombus

## ETIOLOGY

Injury to vascular endothelium, alteration to normal blood flow (turbulence or stasis) and alterations to the coagulability of blood can predispose thrombosis and thromboembolism.

## Coagulopathies

Coagulopathies and disseminated intravascular coagulation are important in the pathogenesis thromboembolism, which occurs in many infectious diseases.<sup>1</sup>

## Parasitic arteritis

- *Strongylus vulgaris* – horses. Migrating larvae cause arteritis of the anterior mesenteric artery, iliac arteries, base of aorta and occasionally cerebral, renal or coronary arteries. This is a major cause of arteritis and associated clinical disease in horses<sup>2</sup>
- Aortic–iliac thrombosis in horses. There is some controversy over the etiology of this disease. It may result from strongyle-related thromboembolism with organization of thrombi and their incorporation into the arterial wall with centripetal development of progressive thrombosis. Alternatively spontaneous degenerative vascular disease of unknown etiology, but particularly at the aortic quadrifurcation may result in thrombosis in the area and subsequently thromboembolism of more distal vessels
- Onchocerciasis and elaeophoriosis in cattle, sheep, goats, and horses.

## Viral arteritis

- Important in pathogenesis of several viral diseases, including malignant catarrhal fever, equine viral arteritis, African swine fever, hog cholera, bluetongue, African horse sickness.

## Bacterial arteritis

- Including septicemic salmonellosis, erysipelas, *Histophilus somni*, *Haemophilus pleuropneumoniae*, pasteurellosis.

## Embolic arteritis and thromboembolism

- From vegetative endocarditis or emboli from arterial thrombus in various sites
- Hyperlipemia and hyperlipidemia in horses
- Fat emboli following surgery
- Associated with subclinical *Salmonella dublin* infection in calves
- Rupture of abscesses into blood vessels – pulmonary embolism resulting from caudal vena caval thrombosis or jugular thrombosis
- From indwelling catheters.

## Microangiopathy

- Vitamin E/selenium deficiency

- Cerebrospinal angiopathy
- Terminal in most septicemic disease.<sup>1</sup>

## Calcification

- Enzootic calcinosis
- Vitamin D toxicity
- Chronic hypomagnesemia in calves
- Lymphosarcoma in some horses.

## Vasoconstrictive agents

- Ergot poisoning
- Fescue poisoning.

## EPIDEMIOLOGY

Clinical atherosclerosis occurs rarely in farm animals. It has been recorded in a horse in which sufficient vascular obstruction occurred to cause severe central nervous signs and a fatal outcome. Spontaneous atherosclerosis is a common necropsy finding in swine, cattle, goats, horses and wild animals but is not associated with clinical disease. Arteriosclerosis and calcification are major findings in enzootic calcinosis and occur following overdosing with vitamin D or its analogs in the prevention of milk fever in cattle and in hypomagnesemia in calves.

## PATHOGENESIS

In parasitic arteritis, inflammation and thickening of the arterial wall result in the formation of thrombi, which may partially or completely occlude the artery. The common site is in the anterior mesenteric artery, obstruction of the vessel causing recurrent colic or fatal ischemic necrosis of a segment of the intestine. Less common sites include the origin of the iliac artery at the abdominal aorta causing iliac thrombosis, the base of the aorta leading to rupture and hemopericardium, and the coronary arteries causing myocardial infarction.

With other causes of arteritis, the clinical syndrome is dependent upon the site of arteritis or embolism. Arteritis associated with bacterial and viral infections is usually widespread and several organ systems are involved. Bacterial emboli have a predilection to lodge in:

- **Vascular plexuses** in the kidney to produce **renal disease**
- The synovial membranes to produce **arthritis** and **tenosynovitis**
- The endocardium to produce **endocarditis**.

Less commonly, they may lodge in other vascular plexuses such as the rete cerebri. Large emboli that lodge in the pulmonary arteries cause anoxic anoxia. Embolism in the renal artery causes acute cortical necrosis and gross hematuria.

Vasoconstrictive alkaloids produced by *Claviceps purpurea* infestation of grass seed heads and *Acremonium coenophialium*, which infests *Festuca arundinaceae* and

*Lolium perenne*, cause arteriolar constriction and result in ischemic necrosis and gangrene of distal extremities in cattle.

## CLINICAL FINDINGS

The clinical findings in mesenteric verminous arteritis of horses and renal and myocardial infarction, gangrene associated with *C. purpurea* or endophyte infestation of grasses and other diseases listed above are described elsewhere under those headings. The clinical signs of aortic–iliac thrombosis and pulmonary embolism are described here.

## Aortic–iliac thrombosis in the horse

Aortic–iliac thrombosis<sup>3,4</sup> is reported most commonly in racehorses but occurs in other breeds. It is primarily a disease of horses of over 3 years of age. Either one or both hindlegs may be involved. The clinical manifestations vary according to the stage of progression of the disease and are associated with ischemia of the hindlimbs.

**Early mild cases** are usually detected in racehorses or horses subjected to maximal exertion where the disease may be a cause of poor performance. In early cases there is lameness only on exercise, the animal returning to normal after a short rest. If the horse is forced to work when lameness develops, the signs may increase to resemble those of the acute form. The lameness takes the form of weakness, usually of one hindlimb, which tends to give way, especially when the animal turns on it. Frequent lifting of the foot or cow-kicking may also be shown.

**In more severe cases**, lameness or refusal to work may be evident after minimal exercise.

The disease is chronic and progressive, but occasionally the onset may be acute.

**In the acute form** there is great pain and anxiety and the pulse and respiration rates are markedly increased. Profuse sweating may be evident, but the affected limb is usually dry and may be cooler than the rest of the body. The pain is often sufficiently severe to cause the animal to go down and refuse to get up.

Suspect animals should be examined following exercise.

- The affected limb is cool from the mid-gaskin distally and there is usually diminished or variable sweating over this area
- The **amplitude of the pulse** in the common digital artery is less in the affected limb than in the normal limb or the front limbs
- **Slow filling of the saphenous vein** of the affected limb can usually be detected
- Palpable abnormalities on **rectal examination** include enlargement

and firmness of the aortic quadrifurcation, irregularity and asymmetry of the internal and external iliac arteries and decreased amplitude or absence of an arterial pulse.

**Recovery** by the development of collateral circulation or shrinkage of the thrombus is unlikely to occur and the disease is usually chronically progressive with a poor prognosis.

Until recently the detection and diagnosis of the occurrence of this abnormality was limited to horses showing clinical signs and horses where abnormality could be palpated on rectal examination. **Ultrasonography** is a more sensitive method of detection than rectal palpation.<sup>5</sup> Its use as a diagnostic technique may lead to a better definition of the occurrence of this disease and ultimately its pathogenesis. Ultrasonographic measurements are available for the common carotid artery of cattle.<sup>6</sup>

Iliac thrombosis may also be associated with impotence in stallions due to failure to mount or accompanied by testicular atrophy.<sup>7</sup> It has also been associated with a syndrome of ejaculatory failure in which the stallion has excellent libido, good coupling and vigorous thrusting but a failure to ejaculate.<sup>8</sup> The reason for this manifestation is not known but it is postulated that the enlarged arteries might impinge on the caudal mesenteric plexus and the hypogastric nerve.<sup>8</sup>

#### **Aortic-iliac thrombosis in calves**

Aortic and iliac artery thrombosis is reported as an occasional disease of unknown etiology in calves less than 6 months of age.<sup>9</sup> Affected calves have a rapid onset of ataxia, paresis or paralysis of one or both hind limbs. Within 24 hours of onset the calves do not bear weight on the affected leg and, in calves affected in both hindlimbs, signs initially occur in a single limb. Affected legs are cold to touch, especially distal to the stifle, have poor muscle tone and the withdrawal reflex and deep pain sensation is absent in the distal portions. Subcutaneous swelling and crepitation is present in some. Thrombosis at the terminal part of the aorta and the iliac quadrifurcation is found at postmortem examination. The umbilical arteries arise from the iliac arteries near the iliac quadrifurcation and it is thought that thrombus formation in the iliac arteries may predispose to this disease.

#### **Pulmonary embolism**

Severe dyspnea develops suddenly and is accompanied by profuse sweating and

anxiety. The temperature and pulse rate are elevated but the lungs are normal on auscultation. In horses the signs usually pass off gradually in 12–24 hours but in cattle the hypoxemia may be more severe and cause persistent blindness and imbecility. Infected emboli may lead to more severe pulmonary embolic disease with arteritis and pulmonary abscessation. There is pulmonary hypertension, and cor pulmonale is a possible sequel. Pulmonary arteritis and aneurysm may be followed by rupture and pulmonary hemorrhage and hemoptysis.

#### **CLINICAL PATHOLOGY**

Extensive thrombus formation is usually associated with a leukocytosis and a shift to the left and there is an increase in serum fibrinogen concentration. In the majority of cases of iliac thrombosis serum aspartate aminotransferase and creatine kinase activities are within the normal range both before and after exercise<sup>7</sup> but in severe cases there may be enzymic evidence of myonecrosis with secondary hyperkalemia and uremia.<sup>10</sup> Elevated serum creatine kinase and aspartate transaminase activities are present in aortic and iliac thrombosis in calves. Angiography or ultrasonography are used for diagnostic confirmation.

#### **NECROPSY FINDINGS**

Obstruction of the affected artery is easily seen when it is opened. The thrombus or embolus is adherent to the intima and is usually laminated. Local or diffuse ischemia or infarction may be evident if the embolus has been present for some time and may have progressed to the point of abscess formation.

#### **DIFFERENTIAL DIAGNOSIS**

##### **Aortic-iliac thrombosis in the horse**

- Paralytic myoglobinuria
- Hyperkalemic periodic paralysis

##### **Aortic-iliac thrombosis in calves**

- Vertebral osteomyelitis (spinal abscess)
- White muscle disease
- Vertebral fracture
- Clostridial myositis
- Pulmonary embolism
- Pneumonia.

#### **TREATMENT**

Treatment with parenteral anticoagulants or enzymes is carried out only rarely. There are several records of good results in iliac thrombosis in horses after the intravenous injection of sodium gluconate or fibrinolytic enzymes,<sup>10</sup> and retrograde catheterization of the ventral coccygeal artery can allow the deposition of these materials at high local concentration. Stallions with ejaculatory failure have had

some success at service following treatment with phenylbutazone to reduce pain and gonadotropin-releasing hormone to maximize sexual arousal and lower the ejaculatory threshold.<sup>8</sup> Ivermectin in combination with phenylbutazone may aid recovery. A gradually increasing exercise program may improve collateral circulation. Surgical treatment is recorded by partial or complete removal of the thrombus with a thrombectomy catheter.<sup>4</sup>

#### **REFERENCES**

1. Morris DD. *Compend Contin Educ Pract Vet* 1989; 11:1386.
2. Baker JR, Ellis CE. *Equine Vet J* 1981; 13:43, 47.
3. Maxie MG, Physick-Sheard PW. *Vet Pathol* 1985; 2:238.
4. Brama PAJ et al. *Vet Q* 1996; 18(Suppl 2):S85.
5. Reef VB et al. *J Am Vet Med Assoc* 1987; 190:286.
6. Braun U, Hohn J. *Am J Vet Res* 2005; 66:962.
7. Azzie MAJ. In: *Proceedings of the 18th Annual Convention of the American Association of Equine Practitioners* 1972:43.
8. McDonnell SM. *J Am Vet Med Assoc* 1992; 200:954.
9. Morley P et al. *J Am Vet Med Assoc* 1996; 209:130.
10. Pause B et al. *Tierarztl Praxis* 1988; 16:377.

#### **VENOUS THROMBOSIS**

The development of thrombi in veins may result in local obstruction to venous drainage, in liberation of emboli that lodge in the lungs, liver or other organs, and in the development of septicemia or of endocarditis.

#### **PHLEBITIS**

Phlebitis is the common origin of thrombi and may be caused by localization of a blood-borne infection, by extension of infection from surrounding diseased tissues, by infection of the umbilical veins in the newborn and by irritant injections into the major veins.

**Thrombophlebitis of the jugular vein** is a complication of injections or catheterization in some animals and occurs in all species. It can result from damage to the vascular endothelium by cannula or indwelling intravenous catheters, inflammation caused by chemical irritation or bacterial invasion from contamination during insertion of the needle or catheter or migration along the catheter from the skin.<sup>1,2</sup> Phlebitis develops and can be detected clinically 24–72 hours after catheter insertion. A retrospective study of 46 cases in horses indicated that ongoing infectious disease was a risk factor for the development of catheter-associated thrombophlebitis<sup>3</sup> and thrombophlebitis is especially common in horses with severe gastrointestinal diseases that are accompanied by endotoxemia. Horses are also at higher risk following surgery.<sup>4</sup> Severely ill cows are also more likely to develop jugular vein thrombophlebitis than healthy cows.<sup>2</sup>

**Intravenous injections of irritating materials**, such as tetracycline, phenylbutazone, 50% dextrose, hypertonic solutions of calcium gluconate, borogluconate and chloride, or hypertonic saline (7.2% NaCl), may cause endothelial damage followed by cicatricial contraction, with or without thrombus formation. Jugular phlebitis with thrombosis is not uncommon in feedlot cattle that have received repeated intravenous antibiotic medication, and may lead to thromboembolic respiratory disease.

Accidental injection of irritating materials around the vein usually cause a marked local swelling, sometimes with necrosis and local sloughing of tissue, which may be followed by cicatricial contraction of local tissues.

### Phenylbutazone

Commonly used as an NSAID, its use in horses may be associated with toxicity, which is manifest with oral and gastrointestinal ulceration and renal medullary crest necrosis.<sup>5-7</sup> Affected horses show depression, anorexia and neutropenia with ulcers in the mouth, especially on the ventral aspect of the tongue. Ulcers in the fundic and pyloric portion of the stomach also develop but are usually subclinical, although they may be evident on gastroscopic examination or at necropsy. More severe cases show signs of colic and diarrhea in association with intestinal ulceration and duodenitis, and show evidence of renal disease. Toxicity may develop following either intravenous or oral administration of the drug. Intravenous administration is frequently associated with the development of phlebitis and jugular thrombosis at the site of injection.

Phlebitis may also develop in these animals at sites of venepuncture performed for purposes other than phenylbutazone administration. Experimental studies<sup>6</sup> suggest that a phlebopathy induced by phenylbutazone is central to the development of all these lesions, including the oral and gastrointestinal ulceration and the renal crest necrosis. The exact pathogenesis of the vein damage in phenylbutazone toxicity has not been elucidated but, experimentally, toxicity can be prevented by the concurrent administration of prostaglandin E<sub>2</sub>.<sup>7</sup> Clinical pathological examination for leukopenia and a fall in serum aspartate aminotransferase may be of value as a monitoring technique for the development of toxicity during phenylbutazone therapy of disease.

Venous thrombi are relatively common in strangles in the horse, and may affect the jugular veins or the caudal vena cava. Thrombosis of the **caudal vena cava** due to hepatic abscessation and resulting in

embolic pneumonia and pulmonary arterial lesions occurs in cows and is described together with **cranial vena caval thrombosis** in Chapter 10.

Less common examples of venous thrombosis are those occurring in the cerebral sinuses, either by drainage of an infection from the face or those caused by the migration of parasite larvae. Purpling and later sloughing of the ears which occur in many septicemias in pigs are also caused by phlebitis and venous thrombosis. Thrombosis of the tarsal vein is a complication of infections in the claw of cattle<sup>8</sup> and intravenous administration of antimicrobial agents as part of the treatment of septic arthritis or the distal interphalangeal joints.

### CLINICAL SIGNS

Clinical signs of venous thrombosis are engorgement of the vein, pain on palpation and local edema. In unsupported tissues rupture may occur and lead to fatal internal or external hemorrhage. Ultrasonographic examination assists the diagnosis and the detection of a cavitating area within the thrombus supports a diagnosis of septic thrombophlebitis.<sup>2,3,8</sup> Angiography can also assist in diagnosis. Bacteriological culture should be attempted, preferably from the tip of the removed catheter. A variety of different organisms have been isolated from different cases.<sup>3</sup> There are no typical findings on clinicopathological examination but there is often an abnormal leukogram and hyperfibrinogenemia. At necropsy the obstructed vessel and thrombus are usually easily located by the situation of the edema and local hemorrhage.

**Diagnosis** depends on the presence of signs of asymmetric local venous obstruction in the absence of obvious external pressure by tumor, enlarged lymph nodes, hematomas or fibrous tissue constriction. Pressure of a fetus may cause symmetric edema of the perineum, udder and ventral abdominal wall during late pregnancy, and can be easily differentiated from thrombophlebitis by its symmetry and lack of pain. Local edema due to infective processes such as blackleg, malignant edema and peracute staphylococcal mastitis are accompanied by fever, severe toxemia, acute local inflammation and necrosis.

### TREATMENT

**Parenteral treatment** with antimicrobial agents and hot fomentations to external veins, or treatment with a topical anti-inflammatory agent such as 50% dimethyl sulfoxide, is usually instituted to remove the obstruction or allay the swelling. If a catheter is being used it should be immediately removed. Heparin and warfarin

treatment in horses is not recommended.<sup>9</sup> Ultrasonography is useful to monitor recanalization of the thrombosed vein<sup>2</sup> and measurements of the external jugular vein are available for cattle.<sup>10</sup>

### REVIEW LITERATURE

Deem DD. Thrombophlebitis in horses: the contribution of hemostatic dysfunction to pathogenesis. *Compend Contin Educ Pract Vet* 1989; 11:1386.

### REFERENCES

1. Bayly WM, Vale BH. *Compend Contin Educ Pract Vet* 1982; 4:5227.
2. Pusterla N, Braun U. *Vet Rec* 1995; 137:431.
3. Gardner SY et al. *J Am Vet Med Assoc* 1991; 199:370.
4. Gerhards H. *Dtsch Tierarztl Wochenschr* 1987; 94:173.
5. Tobin T et al. *J Vet Pharmacol Ther* 1986; 9:1.
6. Meschter CL et al. *Cornell Vet* 1984; 74:282.
7. Collins LG, Tyler DE. *Am J Vet Res* 1985; 46:1605.
8. Kofler J et al. *Vet Rec* 1996; 138:34.
9. Deem DD. *Compend Contin Educ Pract Vet* 1989; 11:1386.
10. Braun U, Hohn J. *Am J Vet Res* 2005; 66:962.

## HEMANGIOMA AND HEMANGIOSARCOMA

Hemangioma and hemangiosarcoma are rare in large animals but are described and may be associated with hemorrhage related to the site of the tumor.

### HEMANGIOMA

Hemangiomas in the skin occur most commonly in **young animals** and may be congenital.<sup>1,2</sup> The tumors grow with age; those on the skin may ulcerate and bleed and may necessitate euthanasia because of their eventual size. Similar tumors may occur in the mouth as pedunculated pink granular masses that ulcerate and bleed. Local hemangiomas on the skin and in the mouth may respond to surgical excision, thermocautery or radiation therapy. Widespread disseminated hemangioma is also recorded in young cattle presenting with multiple skin lesions and multiorgan involvement.<sup>3,4</sup> Hemangioma has also been reported with moderate prevalence affecting the ovaries of sows.<sup>5</sup>

### HEMANGIOSARCOMA

Hemangiosarcoma occurs in **horses** but is not a common tumor. It is more prevalent in middle-aged and older animals. Affected horses may present with a bleeding subcutaneous mass or with signs of disseminated hemangiosarcoma. Disseminated hemangiosarcomas in horses cause anemia due to hemorrhage into the tumor or into body cavities. In addition there is weight loss, but good appetite, and weakness. Metastasis is extensive to lung, myocardium, brain, retroperitoneum and skeletal muscle,<sup>5-8</sup> and myocardial lesions can lead to cardiac arrhythmias. Lesions in skeletal muscle cause difficulties in movement and tumors in the nervous system

present with signs of ataxia.<sup>9</sup> The thoracic cavity is a common site for metastasis<sup>6</sup> and can also be a primary site of the neoplasm.<sup>10</sup>

A common clinical manifestation is **pleural effusion and hemorrhage**<sup>11,12</sup> and a clinical picture which requires differentiation from other causes of thoracic mass with effusion, which in the horse is more commonly mediastinal abscess, lymphosarcoma, squamous cell carcinoma or pleurisy. Hemoperitoneum, detectable by paracentesis, is present with peritoneal tumors. All the tumors are

cavitations and bleed profusely if incised. Early histopathologic diagnosis may permit a cure in animals with localized masses that can be surgically resected. If masses are not interfering with quality of life and the horse is medically stable, observation may be warranted because spontaneous resolution has been reported.<sup>8</sup>

#### **RHABDOMYOSARCOMA**

Primary cardiac rhabdomyosarcoma occurs rarely in cattle and sheep.

#### **REFERENCES**

1. Sartin EA, Hodge TG. *Vet Pathol* 1982; 19:569.
2. Lopez MJ et al. *AgriPract* 1994; 15:24.
3. Baker JC et al. *J Am Vet Med Assoc* 1982; 181:172.
4. Munroe R et al. *Vet Rec* 1994; 135:333.
5. Hargis AM, McElwain TF. *J Am Vet Med Assoc* 1984; 184:1121.
6. Johnson JE et al. *J Am Vet Med Assoc* 1988; 193:1429.
7. Delesalle C et al. *J Vet Intern Med* 2002; 16:612.
8. Johns I et al. *J Vet Intern Med* 2005; 19:564.
9. Newton-Clarke MJ et al. *Vet Rec* 1994; 135:182.
10. Freestone JF et al. *Aust Vet J* 1990; 67:269.
11. Brink P et al. *Equine Vet J* 1996; 28:241.
12. Collins MB et al. *Aust Vet J* 1994; 71:296.

# Diseases of the hemolymphatic and immune systems

## ABNORMALITIES OF PLASMA

### PROTEIN CONCENTRATION 439

Hypoproteinemia 439

Hyperproteinemia 441

### HEMORRHAGIC DISEASE 441

Diseases causing hemorrhage 443

### PURPURA HEMORRHAGICA 443

Disseminated intravascular coagulopathy and hypercoagulable states 447

Thrombosis 450

### DISORDERS OF RED CELL NUMBER OR FUNCTION 450

Anemia 450

Erythrocytosis 459

Abnormal red cell function 460

### DISORDERS OF WHITE CELLS 460

Leukopenia 460

Leukocytosis 461

Abnormal white cell function 461

Leukoproliferative disease (leukemia, lymphoma) 461

### LYMPHADENOPATHY

(LYMPHADENITIS) 464

### DISEASES OF THE SPLEEN AND THYMUS 464

Splenomegaly 465

Splenic abscess 465

Splenic hematoma, rupture or infarction 465

Congenital anomalies 466

Thymus 466

### IMMUNE DEFICIENCY DISORDERS (LOWERED RESISTANCE TO INFECTION) 466

Primary immune deficiencies 466

Secondary immune deficiencies 467

### AMYLOIDOSES 467

### PORPHYRIAS 469

## Abnormalities of plasma protein concentration

Plasma contains hundreds of proteins, including albumin, immunoglobulins, clotting factors, acute phase proteins, hormones and cytokines. The proteins in plasma are produced by the liver (albumin, acute phase proteins (fibrinogen, serum amyloid A), clotting factors) and lymphoid organs (the gamma-globulins and many cytokines). The plasma proteins serve as sources of amino acids for tissues, as carrier molecules, maintain plasma oncotic pressure, regulate immune function, and effect hemostasis and fibrinolysis. Defects or deficits of individual proteins can result in specific diseases, including immune deficiency, defective hemostasis and endocrinopathy. The individual diseases resulting from loss of activity of specific proteins are dealt with under the headings of those diseases. Provided here is an overview of hypoproteinemic and hyperproteinemic states.

## HYPOPROTEINEMIA

### ETIOLOGY

Hypoproteinemia is a plasma or serum total protein concentration that is below that expected in animals of the same age, sex, physiological state and species. Hypoproteinemia can be a result of a reduction in concentration of albumin and globulin, or a reduction in either albumin or globulin concentrations. Abnormalities in plasma protein concentration include:

- Panhypoproteinemia with hypoalbuminemia and hypoglobulinemia

- Hypoproteinemia with hypoalbuminemia and normal globulin concentration
- Hypoproteinemia with hypoglobulinemia and normal albumin
- Normal total protein concentration with hypoalbuminemia and hyperglobulinemia, and less commonly, hyperalbuminemia and hypoglobulinemia.

The specific deficiency has important diagnostic significance.

### Panhypoproteinemia

Hypoproteinemia with hypoalbuminemia and hypoglobulinemia can be either relative or absolute.

**Relative hypoproteinemia** occurs when plasma protein concentrations are lower than normal but the absolute content of protein in the vascular space is normal. This is a dilutional hypoproteinemia and is attributable to either excessive fluid therapy or excessive water intake. These causes are readily determined from a review of the history and treatment of the animal and resolve within hours of discontinuation of fluid therapy or restriction of fluid intake.

**Absolute hypoproteinemia** occurs when there is a reduction in the amount of plasma proteins in the vascular space in the presence of normal or almost normal plasma volume. The reduced protein concentration can be the result of impaired production or accelerated loss. Reduced production of all plasma proteins occurs only as part of malnutrition and starvation. Liver disease can cause a reduction in the concentration in plasma of those proteins produced by the liver (see below) but in large animals is an unusual cause of hypoproteinemia. Loss of protein is a more common cause of hypoproteinemia.

The loss of proteins can be either from the vascular space into the extravascular compartment (e.g. endotoxemia, vasculitis) or from the body (compensated hemorrhage, glomerulonephritis, protein-losing enteropathy). This situation is evident as a reduction in concentrations of both albumin and globulins, and in hemorrhagic disease by a reduction in hematocrit. Loss because of vascular leakage is usually evident as hypoproteinemia with normal or elevated hematocrit. Diseases causing panhypoproteinemia include:

- Hemorrhage – hypoproteinemia occurs when plasma volume is restored after severe hemorrhage, or in normovolemic anemia when there is persisting loss of blood (see page 451 for a list of diseases causing chronic hemorrhagic anemia). All causes of chronic blood loss can cause hypoproteinemia
- Endotoxemia – protein loss is secondary to leakage of protein from the vascular space into interstitial spaces because of increased capillary permeability
- Vasculitis – causing increased capillary permeability and leakage of protein. Evident in many systemic diseases, including African horse sickness, purpura hemorrhagica, swine fever, and malignant catarrhal fever
- Protein-losing enteropathy – the initial change is in plasma albumin concentration, but panhypoproteinemia ensues as the disease progresses. Diseases causing protein-losing enteropathy include:
  - Intestinal parasitism
  - Abomasal ulceration in cattle



- Lymphosarcoma in cattle and horses
- Granulomatous/inflammatory intestinal disease in horses (granulomatous enteritis, eosinophilic enteritis) and cattle (John's disease)
- Enteritis/colitis (salmonellosis, equine neorickettsiosis (*Neorickettsia risticii*))
- Nonsteroidal anti-inflammatory drug (NSAID) toxicosis
- *Lawsonia intracellularis* proliferative enteropathy in young horses and pigs
- Urinary tract disease including cystic calculi, pyelonephritis, glomerulonephritis
- Acute, severe inflammation of the peritoneal or pleural membranes (peritonitis, pleuritis). The hypoproteinemia occurs early in the disease but if the disease becomes chronic hypergammaglobulinemia ensues
- Chronic heart failure.

### Hypoalbuminemia

Hypoalbuminemia with normal or elevated plasma globulin concentration occurs in diseases in which there is insufficient production of albumin by the liver or excessive or selective loss of albumin compared to loss of globulin. Insufficient production of albumin occurs in diseases of the liver, although these animals might not necessarily be hypoproteinemic,<sup>1</sup> and malnutrition or starvation. Diseases of the liver that cause hypoalbuminemia are usually diffuse, severe and chronic. The prolonged half-life of albumin in cattle and horses (approximately 18 d) renders them less liable to hypoalbuminemia than smaller animals.

Albumin has a lower molecular weight than most globulins, especially the immunoglobulins, and can be lost selectively in renal or gastrointestinal disease. Diseases associated with hypoalbuminemia and normal to elevated globulin concentrations include:

- Amyloidosis – loss of albumin into urine or the gastrointestinal tract is sometimes offset, in terms of plasma protein concentration, by increases in plasma globulin concentration
- Chronic peritonitis or pleuritis – loss of albumin into the inflammatory exudate is offset, in terms of plasma total protein concentration, by increases in plasma globulin concentration
- Intestinal parasitism
- Renal disease
  - Glomerulonephritis – because of changes in the size and charge on proteins of the glomerular membrane, albumin is not prevented from entering the

ultrafiltrate and is lost in urine. Any diseases affecting the glomeruli can cause albumin loss

- Pyelonephritis.

### Hypogammaglobulinemia

Hypoglobulinemia with normal plasma albumin concentration occurs in few diseases. Notably, it is a feature of failure of transfer of passive immunity in neonates (Ch. 3). Hypoglobulinemia is an unusual isolated defect in other diseases. It can be detectable in immunodeficiencies causing decreased production of gammaglobulins, such as combined variable immunodeficiency in horses.<sup>2</sup>

### Hypofibrinogenemia

This only occurs as part of disseminated intravascular coagulation.

### PATHOPHYSIOLOGY

Panhypoproteinemia and hypoalbuminemia cause a reduction in concentration in plasma of proteins essential for a variety of functions. Overall, the reduction in plasma albumin concentration results in a low plasma oncotic pressure. Low plasma oncotic pressure allows movement of fluid from the vascular space, causing a reduction in plasma volume and increases in extravascular volume. The reduction in plasma volume lowers blood flow to tissues and can result in organ dysfunction. The increased extravascular volume is evident as edema.

Low plasma albumin concentration, in addition to the reduction in plasma oncotic pressure, reduces opportunities for transport of substances in the plasma, including hormones and electrolytes (calcium).

Hypogammaglobulinemia increases the risk of infectious disease (see Ch. 3).

### CLINICAL SIGNS

The clinical signs of hypoproteinemia are lethargy, ill-thrift and edema. The edema is usually distributed symmetrically, with some species predilection for site of accumulation – ventral edema in horses, submandibular edema in cattle and sheep. Affected animals are often tachycardic because of the reduced plasma volume.

Signs of the inciting disease will also be present (weight loss, diarrhea, melena, polyuria).

### CLINICAL PATHOLOGY

Detection of hypoproteinemia is readily achieved by routine hematologic or serum biochemical testing. The albumin to globulin (A:G) ratio can be useful in assessment of the hypoproteinemia. Hypoalbuminemia with normal globulin concentration results in a low A:G ratio, whereas panhypoproteinemia results in a normal A:G ratio. Selective deficiencies can be detected by protein electrophoresis or measurement of concen-

trations of specific proteins, such as the immunoglobulins by enzyme-linked immunosorbent assay (ELISA), radial immunodiffusion (RID), or immunoturbidimetric analysis (see Failure of transfer of passive immunity in Ch. 3).

Measurement of plasma oncotic pressure is useful in detecting low plasma oncotic pressure, which contributes to a reduction in plasma volume and increases in extravascular fluid which can lead to formation of edema. Plasma oncotic pressure is proportional to the plasma protein concentration, with the greatest correlation being with plasma albumin concentration in animals that have not received dextran solutions. Intravenous administration of dextran or hydroxyethyl starch increases plasma oncotic pressure.<sup>3</sup>

### NECROPSY

The changes are those of the inciting disease, or secondary infection in animals with hypogammaglobulinemia. Edema can be present in subcutaneous and internal connective tissues.

### TREATMENT

The principles of therapy are treatment of the inciting disease, and correction of hypoproteinemia or low plasma oncotic pressure. Correction of hypoproteinemia (hypoalbuminemia, hypogammaglobulinemia) is achieved by administration of plasma by transfusion. Unless anemia is also present, plasma transfusion is preferred over blood transfusion. The amount of plasma transfused to neonates is discussed in Chapter 3. Plasma transfusion to adult horses and cattle is often limited by the cost of the plasma. Ideally, plasma should be transfused to increase plasma albumin concentrations to more than 2.0 g/dL (20 g/L). This can be calculated as (where 0.05 is the proportion of body weight that is plasma):

$$\text{Current plasma albumin content} = \text{body weight (kg)} \times 0.05 \times (\text{plasma albumin concentration in g/L})$$

$$\text{Desired plasma albumin content} = \text{body weight (kg)} \times 0.05 \times (\text{desired albumin concentration in g/L})$$

$$\text{Amount of albumin required (g)} = \text{Desired plasma albumin content} - \text{current albumin content}$$

$$\text{Volume of plasma required (L)} = \frac{\text{Amount of albumin required (g)}}{\text{albumin concentration in transfused plasma (g/L)}}$$

A numerical example is of a 500 kg horse with a plasma albumin concentration of 1.5 g/dL (15 g/L) and a target plasma albumin concentration of 2.5 g/dL (25 g/L):

$$\text{Current plasma albumin content} = 500 \text{ (kg)} \times 0.05 \times 15 \text{ (g/L)} = 375 \text{ g}$$

*Desired plasma albumin content* =  
 $500 \text{ (kg)} \times 0.05 \times 25 \text{ (g/L)} = 525 \text{ g}$

*Amount of albumin required (g)*  
 $= 525 - 375 = 150 \text{ g}$

*Volume of plasma required (L)*  
 $= 150 \text{ (g)} / 30 \text{ (g/L)} = 5 \text{ L}$

It is a frequent observation that transfusion of the calculated volume of plasma, while improving clinical signs, does not result in the expected increase in plasma albumin concentration. This is probably because transfusion of albumin results in an increase in plasma oncotic pressure and a net movement of fluid from the extravascular space into the vascular space with subsequent expansion of the plasma volume. The expansion of plasma volume dilutes the administered albumin and attenuates the increase in plasma protein concentration.

Plasma oncotic pressure can be increased by intravenous administration of hydroxyethyl starch or high-molecular-weight dextrans. The dose is 8–10 mL/kg of 6% solution delivered intravenously over 6–12 hours.<sup>3,4</sup>

## HYPERPROTEINEMIA

### ETIOLOGY

#### Panhyperproteinemia

An increase in concentration of all plasma proteins occurs only in situations in which there is a reduction in plasma water content. This occurs in animals that are severely dehydrated through lack of access to water, inability to drink, loss of protein-poor body fluids (diarrhea, vomitus) or excessive polyuria with inadequate water intake.

#### Hyperglobulinemia

Hyperglobulinemia occurs as a consequence of chronic inflammation or abnormal production of globulins. Chronic inflammation causes a polyclonal gammopathy whereas plasma cell neoplasia (plasmacytoma, myeloid leukemia, see 'Leukoproliferative disease') causes a monoclonal gammopathy. Any chronic inflammatory disease, including those of infectious, toxic or neoplastic origin, can cause hyperglobulinemia.

#### Hyperfibrinogenemia

Fibrinogen is an acute phase protein (along with serum amyloid A, haptoglobin, C-reactive protein and others) the concentration of which increases in plasma in response to inflammation. Any disease that causes inflammation can increase plasma fibrinogen concentration.

### PATHOPHYSIOLOGY

Chronic inflammation results in chronic stimulation of the immune system with subsequent increased production of

immune globulins and acute-phase proteins. Monoclonal gammaglobulinemia occurs as a result of unrestrained production of gammaglobulins by neoplastic plasma cells.

### CLINICAL SIGNS

The clinical signs are of the underlying inflammatory disease.

### CLINICAL PATHOLOGY

Measurement of plasma protein concentration reveals hyperglobulinemia and/or hyperfibrinogenemia. Serum protein electrophoresis demonstrates whether the abnormality is a polyclonal or monoclonal gammaglobulinopathy. Measurement of specific immunoglobulins (IgG, IgA, etc.) can be useful. Fibrinogen concentration must be measured in plasma as it is consumed during the clotting process when blood is allowed to clot.

### NECROPSY

The findings are those of the underlying disease.

### TREATMENT

Treatment is directed towards the underlying disease.

### REFERENCES

1. Parrage ME et al. *J Vet Intern Med* 1995; 9:154.
2. Flaminio MJ et al. *J Am Vet Med Assoc* 2002; 221:1296.
3. Jones PA et al. *J Am Vet Med Assoc* 2001; 218:1130.
4. Jones PA et al. *Am J Vet Res* 1997; 58:541.

## Hemorrhagic disease

Hemorrhagic disease is manifest as the presence of hemorrhage of unusual duration or severity, either externally from apparently minor wounds, or into body cavities, or as the presence of petechial and ecchymotic hemorrhages in mucous and conjunctival membranes and the skin. Petechial and ecchymotic hemorrhage, spontaneous hemorrhage or excessive bleeding after minor injury may result from increased capillary fragility, disorders in platelet function or defects in the coagulation mechanism of the blood.

### Diagnosis

Diagnosis of hemorrhagic disease is based on the demonstration of abnormalities in the activity, concentration or function of components of blood coagulation and fibrinolysis. The exception is diagnosis of vasculitis, which is achieved by biopsy, usually of skin, and histologic examination and demonstration of inflammatory lesions in the walls of blood vessels.

Demonstration of prolonged **bleeding time** is achieved using devices that inflict a controlled wound on either the skin or a mucous membrane (template bleeding time). A wound is inflicted in the skin and

blood is periodically collected on to absorbent filter paper until bleeding ceases. The time from discharge of the device until bleeding stops is the 'bleeding time'. The mean template bleeding time is less than 5 minutes in most healthy animals.<sup>1</sup>

Care must be taken when **collecting specimens of blood** for measurement of factors involved in coagulation or fibrinolysis. Blood samples collected into containers that do not contain an anticoagulant will rapidly clot and the resulting serum sample will be minimally useful for any tests of clotting or fibrinolysis. The ideal anticoagulant for assays of clotting and fibrinolysis is **trisodium citrate** (1 part of 3.8% trisodium citrate to 9 parts of blood). Sodium citrate decreases the concentration of ionized calcium in blood and thereby inhibits platelet activity.<sup>2</sup> Heparin, both unfractionated (conventional) and low-molecular-weight inhibits thrombin activity and activates platelets and is not a suitable anticoagulant for measurement of clotting times or platelet activity.<sup>2</sup> Potassium ethylenediamine tetraacetic acid (EDTA) interferes with platelet function.

An integrated measure of the capacity of blood to clot is the **activated clotting time**. In this test, blood is collected into plastic syringes that do not contain an anticoagulant and then immediately injected into glass tubes containing diatomaceous earth. The tubes are gently agitated and then incubated for 1 minute in a water bath at 37°C. The tubes are then removed from the water bath and examined for clotting of blood by gently rolling the tube. The tube is then returned to the water bath and reexamined every 30–60 minutes.

The rate of **clot retraction** of blood collected into a glass tube that does not contain anticoagulants is a measure of platelet activity. The time until maximum clot retraction is 1–2 hours in most species when the blood is held at 37°C.

Measurement of **prothrombin time** (an indicator of activity of the extrinsic clotting system), **activated partial thromboplastin time** (an indicator of functionality of the intrinsic clotting system) and **thrombin time** (common pathway) are routinely performed for animals. The tests are reliable when performed properly; however, values for normal animals can vary and the recommendation is that, when submitting a sample from an animal with suspected coagulopathy, a sample from a similar healthy animal should also be examined. If prothrombin or activated partial thromboplastin time are prolonged, other tests to determine the specific factor(s) involved might be warranted.

Measurement of the activity or concentration of blood clotting factors is

routine in human medicine and many of these tests have been adapted for use in animals. **Chromogenic assays** of factors VII, VIII:C, IX and X developed for testing of human plasma are reliable when used for testing of horse plasma.<sup>3</sup> An ELISA for von Willebrand factor is available that is suitable for use in a number of species, including horses, pigs, and cattle.<sup>4</sup> While most functional assays, including chromogenic assays, are suitable for use among species, most immunologically based assays developed for use in humans are not suitable for use in animals.<sup>5</sup> It is important that assays should be validated in the species of interest before clinical use in animals.

**Fibrinogen** is an essential substrate for clot formation, and low plasma concentrations of fibrinogen, such as can be encountered in animals with disseminated intravascular coagulation, can impair blood clotting. Measurement of fibrin (fibrinogen) degradation products (FDP) has been used to detect disseminated intravascular coagulation in horses but the test has poor sensitivity and specificity. Measurement of **D-dimer** concentration has the potential to be much more useful than FDP in assessment of fibrinolysis and detection of thromboembolic disease, including disseminated intravascular coagulation and coagulopathies.<sup>6-9</sup> Performance characteristics vary among assays and kit suppliers. The FDP assays had low sensitivity (< 40%), whereas the most accurate D-dimer kit had 50% sensitivity and 97% specificity for diagnosis of disseminated intravascular coagulation in horses with colic.<sup>9</sup> The activity of **antithrombin** (previously antithrombin III), a cofactor of heparin, is measured in horses as a means of assessing the anticoagulant activity of plasma. Activity of antithrombin is reduced in animals with coagulopathies secondary to gastrointestinal disease. This factor is best measured in concert with thrombin-antithrombin complex concentration, and protein C and plasminogen activity to detect hypercoagulable states.<sup>10</sup>

**Platelet count** in blood should be evaluated in any animal with a hemorrhagic diathesis. Caution should be exercised in interpreting low platelet counts determined by automated analyzers, as clumping of platelets can cause artificially low values. This **pseudothrombocytopenia** can be a result of anticoagulant induced ex-vivo aggregation of platelets,<sup>11</sup> which can be readily detected by microscopic examination of the blood smear. Platelets counts of less than 100 000 cells/ $\mu$ L are considered abnormal, although excessive hemorrhage is usually not apparent until platelet counts are below

40 000 cells/ $\mu$ L. Determination of the proportion of platelets that stain with **thiazole orange** dye (reticulated platelets) can be useful in determining the bone marrow regenerative response in horses, and probably other species, with thrombocytopenia.<sup>12,13</sup> Reticulated platelets are those platelets that have been recently released from bone marrow. Healthy ponies have 1.3–2.8%, and horses have 1–3.4% of platelets in circulation that stain with thiazole orange. Thrombocytopenic, equine-infectious-anemia-positive ponies have 11–48% and thrombocytopenic, equine-infectious-anemia-negative horses have 2–9% thiazole-orange-staining platelets in the circulation.<sup>13</sup> **Platelet function** of horses can be evaluated using platelet function analyzers designed for use with human blood, ultrastructure and flow cytometry. Impaired platelet aggregation can be detected as a prolongation in closure time using cartridges with collagen- adenosine diphosphate (CT-ADP) and collagen- epinephrine (CT-Epi) as platelet agonists. In normal horses calculated reference ranges are 60.5–115.9 seconds and 158.5–>300 seconds for CT-ADP and CT-Epi, respectively.<sup>14</sup>

Values of the above variables in normal animals have been reported inconsistently and are available in textbooks dealing with hematology. Values in foals and calves of increasing age are reported.<sup>15,16</sup>

#### Treatment of coagulopathies

**Plasma** is often administered to animals with hemorrhagic diatheses to replace clotting factors that are deficient because of failure of production (e.g. warfarin intoxication), increased consumption (e.g. in disseminated intravascular coagulation) or dilution (e.g. in animals with severe hemorrhage treated by administration of large quantities of fluids). The actual concentration or activity of factors involved in clotting or fibrinolysis depends upon the methods used to collect and store the plasma. Fresh frozen plasma kept at  $-80^{\circ}\text{C}$  retains much of the activity of clotting factors (VII, VIII, etc.) and inhibitors of coagulation, including antithrombin, protein C, protein S and antitrypsin, for up to 1 year, whereas plasma stored at higher temperatures might not retain as much activity. The dosage varies from 2–10 mL/kg body weight (BW) intravenously, but this has not been critically evaluated. Platelet-rich plasma, which requires more sophisticated collection techniques, is useful for treatment of severe thrombocytopenic purpura. Platelet rich plasma can be prepared by centrifugation of blood at  $150 \times g$  for 20–30 minutes. Plasma is preferred over whole blood for treatment of nonanemic hemorrhagic diatheses.

**Aminocaproic acid** (30–100 mg/kg intravenously) reduces plasma fibrinogen concentration and decreases partial thromboplastin time of horses for up to 5 hours after administration. At the higher dose, alpha-2-antiplasmin activity is increased and fibrinogen concentration is decreased, consistent with an action of the drug to inhibit fibrinolysis.<sup>17</sup> The utility of aminocaproic acid to inhibit bleeding in clinical situations has not been determined.

**Tranexamic acid** inhibits fibrin degradation and is used as adjunctive treatment in animals with hemorrhagic diathesis. Its efficacy in farm animals has not been reported. **Carbazochrome** is a compound that stabilizes capillary membranes and is used for treatment of exercise-induced pulmonary hemorrhage in horses, although with undetermined efficacy.

**Formalin** has been suggested as an effective treatment of excessive hemorrhage in horses, although it does not appreciably alter bleeding time or indices of coagulation.<sup>17</sup> A common dose for an adult horse is 1 L isotonic electrolyte solution (saline or lactated Ringer's solution) with a final concentration of formalin of 0.37–0.74%. Adult goats administered a 5.5% solution of formalin in lactated Ringer's solution intravenously had a marked decrease in clotting time. However, this dose in horses is expected to be toxic.<sup>1</sup>

Administration of **aspirin** to horses inhibits platelet function in a dose-dependent fashion for 48 hours after a single dose of 12 mg/kg.<sup>18</sup> This is not the case in cattle, in which aspirin does not inhibit platelet aggregation even at doses of 100 mg/kg orally.<sup>19</sup> Aspirin irreversibly inhibits activity of thromboxane synthetase in both cattle and horses for a prolonged period (days) despite having a short plasma elimination half-life (hours). The bleeding time in horses is not restored until the affected platelets have been replaced by unaffected platelets.<sup>18</sup> Dosages of aspirin in horses range from 15–100 mg/kg orally every 8–12 hours to 10 mg/kg orally every 48 hours.

**Warfarin** reduces the concentration of vitamin-K-dependent clotting factors by inhibiting hepatic production of these compounds. Therapeutic use of warfarin was limited to treatment of navicular disease in horses, although its use for this purpose is now archaic.

**Heparin**, and the newer heparin-related compounds (low-molecular-weight heparins) **dalteparin** and **enoxaparin**, have been used in horses with, or at risk of developing, coagulopathies.<sup>20,21</sup> The low-molecular-weight heparins appear to be effective in reducing the frequency of coagulopathy in horses with colic<sup>20</sup> without the adverse effect of heparin on

hematocrit and clotting time.<sup>22</sup> Calcium heparin causes in-vivo red cell aggregation in horses, with a resultant reduction in hematocrit and hemoglobin concentration and a reduction in platelet count.<sup>21-23</sup> The low-molecular-weight heparins are dosed on the basis of anti-factor-Xa activity. At doses of these compounds that prolong factor Xa activity and thrombin time, they have a minimal effect on bleeding time or activated partial thromboplastin time in horses.<sup>20,22,24</sup> A range of doses of heparin calcium have been employed, ranging from 40 IU/kg BW intravenously or subcutaneously every 12–24 hours to 150 IU/kg BW initially followed by 125 IU/kg BW every 12 hours for 3 days and then 100 IU/kg BW every 12 hours.<sup>20,21</sup> Dalteparin (50 and 100 anti-Xa U/kg) and enoxaparin (40 and 80 anti-Xa U/kg) can be administered once daily to horses.<sup>24</sup>

**Sodium pentosan polysulfate**, a compound with heparin-like activity used for treatment of arthritis in horses, at doses of 3, 6 or 10 mg/kg, causes dose-dependent increases in partial prothrombin time that persist for 24–48 hours.<sup>25</sup> This drug is not used for treatment of coagulopathies.

**Hirudin**, an anticoagulant originally derived from leeches but now available as a recombinant compound, is a specific inhibitor of thrombin that is independent of antithrombin activity. The compound could be useful in treatment of hypercoagulable states in which there is diminished thrombin activity. Recombinant hirudin has been investigated in horses in which the maximum plasma concentration occurred at approximately 130 minutes and declined with a terminal half-life of approximately 600 minutes. A doubling of activated partial thromboplastin time occurred 1.5 hours after subcutaneous administration of 0.4 mg/kg.<sup>26</sup> The clinical efficacy of recombinant hirudin has not been determined.

**Tissue plasminogen activator** increases the activity of plasmin, thereby facilitating dissolution of clots. Its use in farm animals has not been reported, with the exception of its injection into the anterior segment of the eye to dissolve fibrin associated with uveitis in horses.

**Streptokinase** and **urokinase** have been used to facilitate dissolution of fibrin clots in farm animals, but there has been no critical analysis of their effectiveness.

## DISEASES CAUSING HEMORRHAGE

### Vasculitis

Septicemic and viremic diseases

The vasculitis is associated with endothelial damage occurring as a direct result of infection of the endothelium (e.g.

equine herpesvirus-1 myeloencephalopathy, African horse sickness) or from immune-mediated events centered on the endothelium (e.g. purpura hemorrhagica). It may be complicated by defects in blood coagulation and platelet disorders depending upon the infection. In many instances coagulation defects are a manifestation of early disseminated intravascular coagulation. Clinically, petechial and ecchymotic hemorrhages associated with septicemia are most obvious in the mucous membrane of the mouth, vulva and conjunctiva or in the sclera but they are widely distributed throughout the body on postmortem examination. Diseases causing vasculitis include:

- Systemic viral diseases: equine viral arteritis, equine infectious anemia, African horse sickness, malignant catarrhal fever, bovine ephemeral fever, bovine virus diarrhea, bluetongue, hog cholera, swine fever, equine herpesvirus-1 myeloencephalopathy
- Chlamydial and rickettsial diseases: *Anaplasma phagocytophila*
- Bacterial diseases: salmonellosis, *Histophilus somni* infection, *Actinobacillus* sp. pleuropneumonia infection, pasteurellosis, erysipelas in pigs
- Miscellaneous: aspergillosis, *Strongylus vulgaris* infection.

### Purpura hemorrhagica

This is a hemorrhagic disease of horses associated with a leukocytoclastic vasculitis. The majority of cases occur as a sequel to strangles. Cases also occur following immunization against *Streptococcus equi* and as a sequel to infection with other streptococci. The disease appears to be an immune complex-mediated disease with deposition of IgA-containing immune complexes on vessel walls.<sup>27,28</sup> Hemorrhagic tendencies in the disease include petechial and ecchymotic hemorrhages but also may result in large extravasations of blood and serum into tissues. The hemorrhage and exudation of serum may result in anemia and a depression in the circulating blood volume. Hemorrhage associated with purpura is usually treated with blood transfusions and corticosteroids. A fuller description of the syndrome is given elsewhere.

### Necrotizing vasculitis

Of unknown etiology but possibly immune mediated, this syndrome occurs in all species.<sup>29</sup> It is similar to purpura and may be local or generalized with petechial hemorrhage and serosanguineous exudation subcutaneously and into tissue spaces. Hemorrhagic tendencies associated with

vasculitis may be confused with those associated with a defect in the clotting mechanisms as the primary cause. Differentiation depends on accurate laboratory examination.

### Treatment

Treatment of vasculitis centers on removal of the inciting cause and minimizing or eliminating inflammation in the vessel. Disease-specific treatments are discussed under each of those topics. Inflammation can be reduced by administration of glucocorticoids, the selection and dose of which vary with species (see Formulary in the Appendix). General supportive treatment can include the administration of blood or plasma if severe anemia or hypoproteinemia occur.

### Coagulation defects

Coagulation defects can be either acquired or inherited. Acquired defects are usually related to exposure to compounds that interfere with production of clotting factors, or that cause depletion of these factors. Inherited defects usually present in young animals, but defects that only marginally increase clotting time might not be detected until the animal undergoes surgery or suffers trauma. Demonstration of defects in blood clotting is based on observation of signs of excessive hemorrhage, with confirmation achieved by measurement of bleeding time and laboratory examination of the activity or concentration of soluble blood clotting factors.

### Acquired hemostatic defects

Acquired clotting defects include those associated with intoxications that impair production or function of clotting factors, and those related to depletion of clotting factors. Disseminated intravascular coagulation is a common cause of hemorrhagic diathesis in animals that is discussed in detail under that heading. Protein losing nephropathy is associated with loss of antithrombin in urine and increased risk of thrombosis in cattle. Similarly, horses with protein-losing enteropathy have low plasma concentrations of antithrombin, which could contribute to the thrombotic tendency noted in these animals.<sup>30</sup>

**Reduction of vitamin K<sub>1</sub>-dependent clotting factors** II, VII, IX and X may result from coumarol poisoning following ingestion of coumarol containing plants such as *Melilotus alba*, *Anthoxanthum odoratum*, *Apium nodiflorum*, *Ferula communis* (giant fennel) or warfarin, brodifacoum and related compounds.<sup>31-33</sup> This syndrome is discussed in detail under each of those headings. Vitamin K deficiency, other than that induced by intoxication with the compounds listed above and the disorder in postweaned

pigs discussed below, has not been reported in farm animals, probably because forage contains high concentrations of this compound.

**A hemorrhagic syndrome in post-weaned pigs** is recorded from the USA, New Zealand, France, Japan, Germany, Brazil and South Africa.<sup>34-36</sup> The syndrome occurs as an outbreak with anemia, hemarthrosis, spontaneous hemorrhage under the skin of the legs and body and hemorrhage following management procedures such as castration. There is a high case fatality and the syndrome is particularly common in pigs a few weeks after weaning. There is prolongation of the prothrombin time and activated partial thromboplastin time. The outbreaks resolve promptly following the injection of **vitamin K** or its inclusion in the diet. An association has been made with housing on mesh floors.<sup>36</sup> The disease is believed to be due to a deficiency of vitamin K in the diet coupled with housing that precludes intake of vitamin K<sub>2</sub> from the feces or bedding and decreased synthesis in the gut as a result of antibiotics in the feed, especially sulfonamides.

**Snake venom** may have procoagulant or anticoagulant action.<sup>37</sup> In both cases coagulation defects may occur as procoagulant toxins result in the activation, consumption and depletion of prothrombin and fibrinogen, leading to a coagulopathy, prolonged clotting times and epistaxis.<sup>38,39</sup>

**Carcass hemorrhage** or blood splash in slaughter lambs has been associated with extended prothrombin times because of prior grazing of coumarin-producing plants. The method of electrical stunning at slaughter can also result in carcass hemorrhage.<sup>40</sup>

**Parafilaria bovicola** produces large extravasations of blood under the skin of cattle and to some extent in tissue spaces.<sup>41</sup> Bleeding from the skin may be the presenting sign of infestation.

**A number of fungal toxins** can cause hemorrhagic disease when ingested:

- Aflatoxins produced by *Aspergillus* spp. do so in association with increased prothrombin time in cattle, swine and horses
- Trichothecene toxins produced by fungal infestations of feed by *Fusarium* spp., *Myrothecium* spp., *Cephalosporium* spp.
- *Trichothecium* spp. also produce hemorrhagic disease
- Toxins associated with *Penicillium rubrum*
- Grass nematodes that infest *Lolium rigidum*.

**Hydroxyethyl starch** solution (Heta-starch), used to increase plasma oncotic pressure in animals with hypoproteinemia, prolongs cutaneous bleeding, prothrombin and activated partial thromboplastin times and decreases fibrinogen concentration and von Willebrand antigen and factor VIII:C activities in ponies, apparently by dilution of clotting factors.<sup>42</sup>

**Navel (umbilical) bleeding in newborn piglets** is a syndrome of unknown etiology. Following birth and for periods up to 2 days afterwards, blood drips or oozes from the umbilicus of affected pigs to produce severe anemia, with death frequently occurring from crushing. The navel cords are abnormally large and fleshy and fail to shrink after birth. The defect appears to be one of immaturity of collagen so that a proper platelet clot does not form. Ear-notching for identification is also followed by excessive bleeding. A variable number of piglets within the litter may be affected and the syndrome may have a high incidence on certain problem farms. The addition of vitamin K and folic acid to the sows' ration may be followed by a drop in incidence but controlled trials with menadione have shown no effect. Vitamin C given to pregnant sows for at least 6 days before farrowing appears to prevent the syndrome.

**Jejunal hemorrhage syndrome** in cattle is discussed in Chapter 5.<sup>43</sup>

Infestation of sheep by *Fasciola hepatica* shortens activated partial thromboplastin time and prolongs prothrombin and thrombin times.<sup>44</sup>

Inherited or congenital defects in hemostasis

#### *Hemophilia A*

Factor VIII:coagulant (VIII:C) deficiency, hemophilia A, is recorded in Thoroughbreds,<sup>45</sup> Standardbreds, Arabian and Quarter horse colts **foals**<sup>46</sup> and **sheep**<sup>47</sup> and is associated with a deficiency in factor VIII. The disease in the Quarter horse colt also involved deficiency of factors IX and XI. It is inherited as a sex-linked recessive trait with the defective gene located on the X chromosome. Clinically affected foals show signs of a hemorrhagic tendency within a few weeks of birth, with the development of hematomas, persistent nasal bleeding, bleeding from injection sites and sudden death from massive internal hemorrhage. Affected foals are anemic. The diagnosis is made by the finding of very low plasma factor VIII:C activity (usually < 10% of values in unaffected animals). Treatment requires fresh frozen plasma or plasma concentrates but is not recommended because of the unavailability of sufficient plasma concentrates, the recurrent nature of the problem and the poor prognosis for long-term soundness.<sup>46</sup>

#### *Von Willebrand disease (factor VIII:vWF deficiency)*

Von Willebrand factor is a large adhesive glycoprotein that mediates adhesion of platelets to exposed subendothelium and that also is a carrier for coagulation factor VIII, protecting it from degradation in the circulation. There are three variations of von Willebrand's disease – types I, II and III. Two variations of von Willebrand's disease are recorded in **pigs**<sup>47,48</sup> – both inherited as simple autosomal recessive traits. The disease in pigs is used as an experimental model for the disease in humans and the pig gene for von Willebrand factor is similar in size and complexity to its human counterpart, with affected pigs having a point mutation within the vWF gene. **Type I** von Willebrand's disease occurred in an 8-day-old Quarter horse colt that was examined because of extensive purpura.<sup>49</sup> The colt had a concentration of von Willebrand factor that was 9% of that of normal horses. The dam of the colt also had prolonged bleeding time and a concentration of von Willebrand factor 30% of that of normal animals,<sup>49</sup> suggesting a familial and possibly heritable trait. **Type II** von Willebrand disease is recorded in a Quarter horse with hemorrhage associated with trauma, prolonged bleeding, lasting several hours, at an injection site, and spontaneous conjunctival hemorrhage,<sup>50</sup> and in a Thoroughbred mare and her colt.<sup>51</sup> The hemorrhage in the Thoroughbred mare and foal was not life-threatening. **Type III** von Willebrand's disease is usually associated with low concentrations of factor VIII. Suspect factor VIII deficiency has been reported in **Hereford calves**.<sup>52</sup> The prime manifestation was death shortly following castration with bleeding from the surgical site, intra-abdominal hemorrhage and severe anemia. The disease also occurs in **sheep**, and is linked to the X chromosome.<sup>53</sup>

**Diagnosis** is based on the observation of prolonged bleeding after minor trauma or surgery, prolonged activated partial thromboplastin time, although this can be minimal, normal prothrombin time, and decreased factor VIII:C activity and von Willebrand antigen concentration.<sup>49,51</sup> The ristocetin cofactor activity of von Willebrand factor is reduced in animals with type II von Willebrand's disease.<sup>49,51</sup> An ELISA is available that is suitable for use in a number of species, including horses, pigs and cattle.<sup>4</sup> **Chromogenic assays** of factors VII, VIII:C, IX and X developed for testing of human plasma are reliable when used for testing of horse plasma.<sup>3</sup> Desmopressin increases the release of von Willebrand factor from vascular endothelium and is used for

treatment of the disease in humans. There are no reports to date of its use in farm animals or horses. The disease can be managed by housing to minimize trauma and administration of plasma before elective surgery, although this did not completely prevent excessive bleeding.

#### Factor XI deficiency

Factor XI deficiency is recorded in **Holstein-Friesian** cattle in Canada<sup>54</sup> and in Great Britain.<sup>55</sup> It is transmitted as an autosomal recessive gene and occurrence in Britain has been traced to the importation of Canadian semen, with genetic links between carriers in the two countries.<sup>56</sup> Heterozygous cattle have decreased levels of factor XI but are usually asymptomatic. The severity of clinical disease varies in homozygous cattle but they usually show prolonged or repeated bleeding episodes after trauma such as dehorning and hemorrhage following venepuncture. There are occasional deaths associated with multiple hemorrhages. Heterozygote carriers have decreased factor XI coagulant activity but measurement of factor XI activity is not a sensitive test for the carrier status, and a DNA-based test is available that accurately identifies heterozygotes.<sup>54,56-58</sup>

#### Other clotting factor disorders

**Prekallikrein deficiency** is recorded in a family of **miniature horses**.<sup>59</sup> The condition was not associated with clinical disease in these horses but blood samples failed to clot. It has also been recorded in three **Belgian horses** and was detected in this group because one hemorrhaged following castration.<sup>60</sup> The mode of transmission is not known, but the familial nature of the disease suggests that it is heritable.

**Heritable fibrinogen deficiency** was found in a Border Leicester lamb manifest with inflammation and bleeding at the umbilicus and ear tag wound at 7 weeks of age<sup>61</sup> and in Saanen goats.

#### Platelet disorders

Disorders of platelets include alterations in the number of platelets in blood (thrombocytopenia or thrombocytosis) and their function (with reduced function referred to as thrombasthenia). The physiology of platelets varies in important ways among the farm animal species. For instance, aggregation of platelets from horses, but not cattle, is inhibited by aspirin (acetylsalicylic acid), and horse platelets adhere to immobilized autologous fibrinogen while those of sheep do not.<sup>62</sup> Platelets of different species respond differently to some agonists of platelet aggregation, such as ristocetin.<sup>63</sup>

#### Thrombocytopenia

Clinical signs associated with thrombocytopenia or thrombasthenia are petechial and ecchymotic hemorrhages, prolonged bleeding after venipuncture or from injection sites, epistaxis, hyphema and melena. A combination of some or all of these clinical signs is referred to as purpura. Thrombocytopenia can result from decreased production of platelets in the bone marrow or by increased consumption, increased peripheral destruction or a combination of these factors.<sup>64</sup>

**Decreased platelet production** is commonly associated with disorders that impair bone marrow function and there is usually simultaneous suppression of granulocyte and erythrocyte production. Thrombocytopenia and neutropenia develop before anemia because of the short life span of these cells relative to erythrocytes. **Increased destruction**, that is, the abnormal consumption of platelets, is most commonly immune-mediated. **Increased consumption** also occurs with severe trauma and disseminated intravascular coagulation, both of which increase the rate at which platelets are incorporated into clots.

**Pseudothrombocytopenia** occurs as a result of aggregation of platelets after collection into a glass tube containing EDTA.<sup>11</sup> Ex-vivo aggregation can occur with other anticoagulants, including heparin. This situation can be recognized by the presence of abnormally low platelet counts in animals without evidence of excessive hemorrhage, or by the presence of clumps of platelets on microscopic examination of blood smears. Collection of blood into an anticoagulant other than EDTA or heparin, such as citrate, and measurement of a normal platelet count confirms the diagnosis of pseudothrombocytopenia.

**Differentiation** of the causes of thrombocytopenia is by clinical examination to detect underlying disease, hematology, examination for anti-platelet antibody and examination of bone marrow aspirates.

#### Decreased production

Thrombocytopenia due to decreased production, as opposed to increased destruction within the marrow, usually occurs with granulocytopenia because of the short intravascular half-life of both granulocytes and platelets.

This occurs with **poisonings** by *Pteridium* spp. (bracken fern) or *Cheilanthes seiberi* in cattle; the fungus *Stachybotrys* spp. (which produces a trichothecene) in cattle, pigs, sheep and horses; chronic furazolidone poisoning in calves; poisoning caused by trichloroethylene-extracted soybean meal; **drugs** that cause bone-

marrow suppression, and radiation injury.<sup>65,66</sup> Severe myelophthisis, such as is associated with myeloid dysplasia or myelofibrosis, causes thrombocytopenia in association with anemia and leukopenia. A familial myelofibrosis is reported in pygmy goats with anemia, granulocytopenia and thrombocytopenia.<sup>67</sup>

The syndrome is predominantly one of spontaneous hemorrhage but is complicated by bacteremia and fulminant infections facilitated by severe leukopenia. A granulocytopenic syndrome of unknown origin, occurring in all ages of cattle and manifest with a severe hemorrhagic diathesis, high morbidity and high case fatality, has been reported on various occasions in Australia.<sup>68</sup>

Familial diseases resulting in thrombocytopenia secondary to decreased production are recorded in Standardbred horses in which there is generalized bone marrow hypoplasia.<sup>69</sup> Pancytopenia secondary to bone marrow aplasia is reported in a Holstein heifer.<sup>70</sup>

#### Increased destruction

**Inflammation and infection** The most common causes of thrombocytopenia are severe gastrointestinal disease (strangling intestinal obstruction, anterior enteritis, colitis) and infectious and inflammatory disease, where a combination of increased destruction and increased consumption is the cause.<sup>64,71</sup>

**Infection** by a variety of viral, bacterial or rickettsial agents causes mild to severe thrombocytopenia. African horse sickness, equine infectious anemia, *Anaplasma phagocytophila* (equine granulocytic ehrlichiosis) and infection by *Neorickettsia risticii* (Potomac horse fever) cause mild to moderate thrombocytopenia.

Infection such as occurs in hog cholera and African swine fever can result in thrombocytopenia and contributes to the hemorrhagic tendency seen in these diseases.<sup>72</sup> Outbreaks of hemorrhagic disease due to thrombocytopenia in veal calves have been attributed to infection with bovine virus diarrhea (BVD) virus type 2 and the disease has been reproduced experimentally with noncytopathic BVD virus.<sup>73</sup> The appearance of hemorrhage was directly related to the number of circulating platelets and bleeding was seen when platelet numbers fell below 500/mL. Calves that developed thrombocytopenia had low (+ 1:32) BVD neutralizing titers. The virus infects megakaryocytes.<sup>74</sup> Thrombocytopenia with a bleeding tendency (bloody diarrhea, petechial and ecchymotic hemorrhage) is also recorded in approximately 10% of adult cattle with acute BVD infection.<sup>75</sup> Infection by *Theileria annulata* causes thrombocytopenia and prolonged

prothrombin time in cattle.<sup>76</sup> Other infectious causes in cattle include bovine leukemia virus, sarcocytosis and salmonellosis.

**Immune-mediated (idiopathic) thrombocytopenia** Most instances of thrombocytopenic purpura in the past have been described as idiopathic. However, the development of newer diagnostic tests, including flow cytometry, that can reveal the presence of antibodies on the surface of platelets has permitted the classification of many of these cases as immune-mediated.<sup>12,77</sup> Among the immune-mediated thrombocytopenias there are autoimmune and isoimmune diseases.

**Isoimmune thrombocytopenia** can be a complication in neonatal isoerythrolysis in **foals and mules** as a result of absorption of colostrum containing antiplatelet antibodies.<sup>78,79</sup> The disease also occurs as only thrombocytopenia in mule foals and is attributable to antiplatelet IgG antibodies in the mule foal's serum.<sup>80</sup> In addition to thrombocytopenia, there is also depression of platelet aggregation in these foals, probably because of binding of IgG to collagen-binding sites on the platelet surface. Thrombocytopenia and neutropenia, assumed to be isoimmune-mediated, were found in foals with ulcerative dermatitis and mucosal ulceration.<sup>81</sup> The foals had purpura and responded to supportive treatment and administration of corticosteroids.

The disease is observed in **newborn pigs** as a result of maternal isoimmunization, and has been reproduced experimentally. Piglets are normal at birth but become thrombocytopenic after suckling colostrum containing antiplatelet antibody. Clinical signs do not develop until after the fourth day of life. There is a heavy mortality rate, death being preceded by a generalized development of submucosal and subcutaneous hemorrhages, drowsiness, weakness and pallor. There is no practicable treatment. The sow should be culled. Thrombocytopenic purpura has occurred in a group of **lambs** given a single cow's colostrum and was manifest with multiple hemorrhages and death by two days of age.<sup>82</sup>

Thrombocytopenia in adult animals with normal prothrombin times and partial thromboplastin times and with no evidence of disseminated intravascular coagulation is considered most likely to develop by **autoimmune-mediated mechanisms**.<sup>83-85</sup> Immune-mediated thrombocytopenia can be induced by drugs or can be secondary to infectious or neoplastic disease<sup>64</sup> but most cases are idiopathic.<sup>83,84</sup> The disease is reported most commonly in horses but does occur in cattle.<sup>55</sup>

**Horses** of any age can be affected. The cause is usually not identified but the disease can be associated with administration of drugs, especially penicillin. The disease is caused by binding of IgG to platelets or to megakaryocytes, with subsequent impaired maturation, enhanced clearance or both, resulting in low platelet counts in blood.<sup>86</sup> Petechiation and hemorrhage may be confined to single systems, such as the respiratory system with epistaxis and hematomas in the nasal sinuses, or the genital tract producing a bloody vulval discharge, with no detectable abnormality at other mucous membranes. More generalized involvement with widespread petechiation of mucous membranes, epistaxis and melena can also occur. Diagnosis is by measurement of blood platelet concentration and elimination of disseminated intravascular coagulation or primary diseases. Demonstration of platelet-surface-bound IgG on a significant proportion of platelets is diagnostic. Fewer than 0.15% of platelets from normal horses have IgG bound to the surface, whereas more than 4% of platelets of thrombocytopenic horses have IgG on the surface.<sup>77</sup> Treatment includes the immediate removal from any medication and the administration of dexamethasone (0.040 mg/kg intramuscularly, intravenously or orally, once daily) or prednisolone (1 mg/kg orally), but not prednisone. This is usually effective in restoring platelet count and controlling hemorrhage. Resolution of hemorrhage can occur even before there are marked changes in platelet count. Treatment might need to be continued for days to weeks. Most horses do not require long-term treatment. For horses with life-threatening hemorrhage, administration of platelet-rich plasma or blood is needed. A transfusion volume of 10 mL blood per kg BW can be effective. Successful treatment with azathioprine in horses that do not respond to glucocorticoids is reported (0.5–1.5 mg/kg orally every 24 h).<sup>77,83</sup> Splenectomy has been used to treat horses with chronic, idiopathic thrombocytopenia that is refractory to medical therapy. However, surgical treatment should be undertaken only in extreme cases, and with attention to the effect of thrombocytopenia on hemostasis during surgery.

Idiopathic thrombocytopenia purpura is also recorded in a 10-month-old **bull**,<sup>87</sup> and immune-mediated thrombocytopenia and anemia occurred in a cow after vaccination with a polyvalent botulism vaccine.<sup>88</sup> Corticosteroid-responsive thrombocytopenia occurred in two beef-breed cows with subcutaneous hematomas and epistaxis.<sup>89</sup>

#### *Increased consumption*

Increased consumption of platelets occurs in animals with severe trauma or disseminated intravascular coagulation.

#### *Other causes*

Thrombocytopenia occurs in horses with lymphosarcoma or myeloproliferative disease.<sup>64</sup> Thrombocytopenia is usually associated with myelophthisic disease and is therefore a result of reduced platelet production. Heparin causes thrombocytopenia in horses, but the mechanism has not been determined.<sup>21,22</sup>

#### *Thrombasthenia*

Disorders of platelet function can result in purpura even in the presence of normal platelet counts. Disorders of platelet function can be congenital or acquired.

**Acquired defects** of platelet function are usually secondary to severe metabolic abnormalities such as uremia, liver failure or septicemia, or to administration of drugs. Among the compounds commonly administered to animals, **aspirin** is most notable in that it inhibits platelet aggregation in horses but not in cattle, despite inhibition of platelet generation of thromboxane-2 in both species.<sup>19</sup> Other NSAIDs have minimal, if any, effect on platelet function. Dextran inhibits platelet function when administered to horses.<sup>90</sup>

A bleeding tendency is present in the **Chédiak-Higashi** syndrome in cattle. A prolonged bleeding time is demonstrable despite the presence of normal soluble coagulation factors and platelet numbers, and is due to a defect in platelet aggregation.<sup>91</sup> Thrombasthenia,<sup>92,93</sup> possibly also associated with variant von Willebrand factor,<sup>94</sup> is also recorded in bleeding disorders in **Simmental** and Simmental crossbred cattle in Canada and the USA, and manifests with epistaxis in cold weather, subcutaneous hematomas and prolonged bleeding following minor procedures such as vaccination and ear-tagging.<sup>92,93</sup> Platelet dysfunction and purpura were diagnosed in a 5-day-old Simmental heifer.<sup>95</sup> **Umbilical bleeding** in calves has also been reported as an inherited condition in **Japanese black cattle**<sup>96,97</sup> with low ADP-induced platelet aggregation. Affected cattle die by 1 year of age from repeated umbilical cord hemorrhage.

Thrombasthenias are also reported in horses. **Glanzmann's disease** is reported in horses with a prolonged history of epistaxis not associated with exercise.<sup>98</sup> The horses had prolonged bleeding time, markedly delayed clot retraction and a decrease in concentration of fibrinogen receptors on the platelet surface. Treatment with glucocorticoids was not effective in preventing epistaxis. Another form of platelet defect was diagnosed in a



Thoroughbred filly with excessive hemorrhage after pin firing. The filly had prolonged bleeding time and normal clot retraction. The filly's platelets did not bind to collagen and the defect was deduced to be in calcium signaling within the platelets.<sup>99</sup>

#### *Thrombocytosis*

Thrombocytosis is not usually associated with purpura or a tendency to hemorrhage unless the platelets have abnormal function. Thrombocytosis is considered to be either primary or secondary.<sup>100,101</sup> Primary thrombocytosis is a result of excessive production of megakaryocytes in the absence of any inciting disease or increased release into the circulation. While exercise, epinephrine and vincristine can increase platelet counts, the most important cause of primary thrombocytosis is myeloproliferative disorder resulting in abnormal rate of platelet production. Primary thrombocytosis is rare in farm animal species.

**Secondary thrombocytosis** occurs in animals with severe systemic inflammatory or infectious diseases of more than several days duration, and usually of several weeks duration. Young animals appear to be more susceptible but the condition can occur in animals of any age. Detection of thrombocytosis should prompt a thorough clinical examination for a cause of chronic inflammation in the animal. Common causes in horses include pneumonia, *Rhodococcus equi* infection, septic arthritis and colitis.<sup>97</sup> Thrombocytosis with Heinz body anemia is reported in cattle fed cabbage.

### **DISSEMINATED INTRAVASCULAR COAGULOPATHY AND HYPERCOAGULABLE STATES**

There is increasing recognition that abnormalities in blood clotting and fibrinolysis exist in both subclinical and clinical forms in many diseases of farm animals, and that the presence and severity of these disorders is related to prognosis for survival. There is a spectrum of abnormalities ranging from mild changes in concentration or activity of clotting factors and indicators of fibrinolysis, through evidence of excessive coagulation or impaired fibrinolysis, to a hemorrhagic diathesis. Previously, the most extreme form of this disorder was recognized as a hemorrhagic diathesis and termed disseminated intravascular coagulation (DIC). Increasing sophistication and availability of measures of coagulation and fibrinolysis have revealed that abnormalities of hemostasis exist even in animals without clinical evidence of excessive hemorrhage. These milder

changes in hemostasis and fibrinolysis are, not surprisingly, much more common than is DIC, but are still associated with an increased case fatality rate.

### **ETIOLOGY AND EPIDEMIOLOGY**

DIC and hypercoagulable states are acquired disorders of hemostasis in animals that occur as a consequence of severe disease that induces systemic inflammation (systemic inflammatory syndrome). DIC is now regarded as a component and consequence of systemic inflammation, rather than being an isolated disorder of hemostasis.<sup>100</sup> DIC and hypercoagulable states are therefore associated with any severe disease that initiates a systemic inflammatory response. A partial listing is: colitis, enteritis, infarctive lesions of the intestines, septicemia, abomasal torsion, metritis, severe trauma, immune-mediated inflammation (e.g. purpura hemorrhagica), hyperthermia and neoplasia. A common, but not universal feature, of diseases that induce DIC or a hypercoagulable state is the presence of presumed or documented endotoxemia, although DIC can be induced by most infectious organisms. It is important to recognize that any severe disease that causes a systemic inflammatory response can incite changes in hemostatic function.

The presence of a hypercoagulable state or DIC is most well recognized in horses with gastrointestinal disease.<sup>10,102-104</sup> It also occurs in cattle with abomasal displacement and in endotoxemic calves.<sup>105,106</sup> Low plasma antithrombin concentrations occur in cows with hepatopathy, peritonitis or acute enteritis.<sup>107</sup> The disease has been reproduced experimentally in pigs, and probably occurs naturally in that species in many diseases, including African swine fever.<sup>108,109</sup> The prevalence of DIC (clinically evident hemorrhage) is uncommon, while the prevalence of a hypercoagulable state detectable only by clinicopathologic testing is much more common.<sup>30,104</sup>

The prevalence of the syndrome is not well defined, partly because of problems in achieving a confirmatory diagnosis by laboratory assessment of factors involved in coagulation or fibrinolysis because of the lack of laboratories providing the necessary assays, and partly because of lack of recognition of the disease. Five of 20 **cattle** with either left or right displacement of the abomasum had a hypercoagulable state.<sup>106</sup> Of horses examined at a referral institution for colic, 3.5% had clinical signs consistent with DIC and supportive laboratory evidence.<sup>110</sup> All these horses had severe inciting disease, with most requiring surgical intervention for infarctive intestinal disease. This study probably under-represents the proportion of horses with severe gastrointestinal

disease that have hemostatic abnormalities, given that many horses with severe gastrointestinal disease have subclinical abnormalities in hemostasis and fibrinolysis.<sup>30</sup> The survival rate among horses with colic and DIC or a hypercoagulable state was 19%, whereas that in horses with colic but no clinicopathologic evidence of a hemostatic disorder was 80%.<sup>102</sup> Twelve of 37 horses with **colitis** had clinicopathologic evidence of a hypercoagulable state, although none had clinical signs of DIC at the time of sample collection.<sup>30</sup> Of the 12 horses with a hypercoagulable state, five died, compared to two of 25 horses with colitis that did not have evidence of a coagulopathy.

Clinically relevant alternations in hemostatic and fibrinolytic indices occur in **neonatal foals** with septicemia.<sup>111</sup> Derangements in hemostatic or fibrinolytic indices were helpful in identification of septic foals with increased risk of coagulopathy, but were not helpful in predicting hemorrhage as compared to thrombus formation. Twenty-three of the 34 septic foals did not survive. Survival of septicemic foals was correlated with Gram-negative bacteremia but not with the presence of endotoxin or coagulopathy.<sup>111</sup>

### **PROGNOSIS**

The prognosis for animals with clinical signs of disseminated coagulation is very poor. Horses without physical signs of hemorrhage or defective fibrinolysis but with clinicopathologic evidence of a hypercoagulable state have a worse prognosis than horses without evidence of a hypercoagulable state.<sup>10,30,102-104</sup> When evaluating the prognosis of an animal with evidence of a coagulopathy as part of the systemic inflammatory syndrome it must be borne in mind that the coagulopathy is secondary to the initiating disease; the more severe the initiating disease the greater the likelihood that the animal will have a coagulopathy, and the more severe the initiating disease the poorer the prognosis. DIC and lesser abnormalities of hemostasis can therefore be regarded as markers of disease severity and considered accordingly when determining a prognosis. This is not to minimize the importance of DIC and hemostatic defects of lesser severity in the pathogenesis of severe disease, and the need to institute effective preventive measures and treatment.

### **PATHOPHYSIOLOGY**

DIC, or consumption coagulopathy, can develop in a number of diseases which, in themselves, are not diseases that primarily affect hemostatic mechanisms. The pathogenesis involves systemic activation of coagulation with intravascular deposition

of fibrin leading to thrombosis of small and medium-sized blood vessels with subsequent organ failure. Depletion of platelets as a result of platelet activation and binding to fibrin to form clots, and of coagulation factors, results in excessive bleeding. The systemic formation of fibrin results from increased generation of thrombin and the simultaneous suppression of anticoagulation mechanisms (which are detectable in animals as reduced concentration of antithrombin) and impaired fibrinolysis.<sup>112</sup> Products of fibrinogen activation, including fibrinopeptides A and B, contribute to systemic vasoconstriction and the hypoperfusion of some organs. The disorder, in its most extreme form, involves both excessive coagulation and, seemingly paradoxically, bleeding.

Systemic activation of coagulation is part of the systemic inflammatory response syndrome, which is dominated by interleukins 1 and 6 and tumor necrosis factor- $\alpha$ .<sup>100,112</sup> There might be a contribution of complement activation to the hypercoagulability. Activation of clotting occurs through either damage to endothelium or activation and release of tissue factor. Tissue factor expression is increased by one or more of the pro-inflammatory cytokines (interleukin-1, -6, -8 and tumor necrosis factor), which are almost universally increased in diseases that feature systemic inflammation. Generation of tissue factor results in activation of the extrinsic clotting cascade with resultant increases in thrombin. The increased activity of the coagulation cascade is temporally associated with impaired activity of anticoagulant mechanisms, demonstrable as decreases in plasma concentration of antithrombin and protein C. Further exacerbating the effect of increased rate of fibrin synthesis is impaired fibrinolysis, indicated by diminished activity of plasminogen and increased activity of plasminogen-activator inhibitor.<sup>112</sup>

In summary DIC is a hemorrhagic diathesis, characterized by an augmentation of normal clotting mechanisms that results in depletion of coagulation factors, deposition of fibrin clots in the microvasculature and the secondary activation of fibrinolytic mechanisms. The augmentation of clotting mechanisms can result in a depletion of platelets and factors V, VIII, IX, XI and XIIa, and the depletion of fibrinogen in association with the formation of fibrin clots in the microvasculature. These fibrin clots decrease tissue perfusion, which can then lead to further activation and depletion of clotting factors by the release of tissue thromboplastin as a result of tissue hypoxia. The bleeding tendency occasioned by the

depletion of these clotting factors is further accentuated by the secondary activation of the thrombolytic system with the production of fibrin degradation products that have anticoagulant properties.

Impaired capacity of the **monocyte phagocytic system** contributes to the disease. Macrophages in the reticulo-endothelial system remove fibrin degradation products and activated clotting factors from the circulation. Loss or diminution of the capacity to remove hemostatic and fibrinolytic compounds causes increases in plasma concentration of these products and exacerbation of the disease. Damage to the reticuloendothelial system, notably in the liver and spleen, resulting from damage as a consequence of the underlying disease (endotoxemia) or lack of perfusion of liver and spleen as part of DIC, decreases removal of these compounds and induces a viscous cycle of disease.

DIC can be initiated by a variety of different mechanisms.

- **Extensive tissue necrosis**, such as occurs in trauma, rapidly growing neoplasm, acute intravascular hemolysis and infective diseases such as blackleg, can cause extensive **release of tissue thromboplastin** and initiate exuberant coagulation via the extrinsic coagulation pathway
- Exuberant **activation of the intrinsic pathway** can occur when there is activation of the Hageman factor by extensive contact with vascular collagen, as occurs in disease with vasculitis, or those associated with poor tissue perfusion and tissue hypoxia with resultant endothelial damage
- Factors that initiate **platelet aggregation**, such as endotoxin, that cause reticuloendothelial blockage, such as excessive iron administration to piglets, or that cause hepatic damage to interfere with clearance of activated clotting factors, can contribute to the occurrence of disseminated intravascular coagulation.

#### CLINICAL SIGNS

As discussed above, defects in hemostasis and fibrinolysis range from those that are detectable by clinicopathologic examination but are not associated with clinical signs of excessive bleeding or coagulation, through fulminant hemorrhagic diathesis.

The presence of a hypercoagulable state that is not associated with signs of excessive bleeding or thrombosis nonetheless worsens the prognosis of severe diseases. This is probably due to DIC-induced injury to organs that is not

detectable against the background of damage caused by the primary disease but that has an important or pivotal effect on the animal's well being. The next progression of the disease is evidence of enhanced thrombosis, most evident as thrombosis of large vessels after minor damage such as that associated with intravascular catheterization or simple venipuncture. In some cases vessels can thrombose without obvious inciting cause. An example of a common manifestation of this stage of the disease is jugular vein thrombosis in horses or cattle with severe disease and low plasma concentration of antithrombin.<sup>30,107</sup>

An unusual, but severe, manifestation of DIC in horses is thrombosis of the distal limbs, resulting in ischemic necrosis of the limb and death of the animal. This clinical manifestation of DIC occurs in foals and, to a lesser extent, in adults with evidence of septicemia or severe gastrointestinal disease.<sup>113</sup>

The most severe acquired hemostatic defect in animals with systemic disease is DIC. This extreme of the clotting disorder is manifested by local or generalized bleeding tendencies that vary in severity from occurrence of petechial hemorrhages in mucous membranes to life-threatening hemorrhage or infarction of organs. Ischemic damage to a wide variety of organs is possible, with the gastrointestinal tract and kidneys being commonly affected.<sup>49</sup>

#### CLINICAL PATHOLOGY

There are a large number of hemostatic and fibrinolytic factors that can be measured in research laboratories, only a few of which are routinely available in clinical laboratories. The following measures are commonly used to detect hypercoagulable states or DIC in clinical situations:

- Platelet count. The abnormality consistent with DIC is thrombocytopenia
- Prothrombin time. This is usually prolonged in animals with DIC but can occasionally be shortened in animals with a hypercoagulable state
- Activated partial thromboplastin time. This measure of hemostasis is usually prolonged in animals with coagulopathies
- Serum markers of fibrinogen activation/fibrin degradation. FDPs have poor sensitivity and specificity for detection of DIC. Plasma D-dimer concentration is more sensitive for detection of abnormalities in hemostasis/fibrinolysis<sup>9</sup>
- Fibrinogen concentration. Classical descriptions of DIC include

hypofibrinogenemia as a common finding. However, this is uncommonly the case in horses and cattle,<sup>103,106</sup> probably because fibrinogen is an acute-phase protein the concentration of which increases in inflammatory diseases in these species. Declines in plasma fibrinogen concentration, with values remaining above the lower bound of the reference range, are often noted in horses with coagulopathy and impending death<sup>30</sup>

- Antithrombin activity is often reduced in animals with a hypercoagulable state or DIC.

A number of studies provide detailed description of the occurrence, and time course, of abnormalities in hemostatic and fibrinolytic function in **horses with gastrointestinal disease**.<sup>26,102–104,114</sup> The general pattern is that of prolonged clotting times (prothrombin (PT), activated partial thromboplastin (APTT)) with diminished activity of antithrombin and protein C, and increased plasma concentrations of fibrinogen and fibrin degradation products. D-dimer concentration has been reported to increase in horses undergoing surgery for colic<sup>115</sup> or to be lower in horses with colic than in healthy horses.<sup>102</sup> Platelet concentration is reduced in horses with colic and evidence of coagulopathy. Abnormalities in hemostatic factors are more common in peritoneal fluid than in blood of horses with colic.<sup>114</sup> Tissue plasminogen activator, plasminogen, protein C, antithrombin III, and alpha-2-antiplasmin activities and concentrations of fibrinogen and fibrin degradation products are greater in peritoneal fluid from horses with colic than in peritoneal fluid of healthy horses.

Compared to healthy **foals**, the PT, APTT and whole blood recalcification times are significantly longer in septic foals. The fibrinogen and fibrin degradation products concentrations, percentage plasminogen, alpha-2-antiplasmin and plasminogen activator inhibitor activities, and tumor necrosis factor and interleukin-6 activities are greater, and protein C antigen and antithrombin III activity are lower in septic foals.<sup>111</sup>

**Cattle** with displaced abomasum often have abnormalities in one or more of PT, APTT, thrombin time, platelet count and plasma concentration of fibrin degradation products.<sup>106</sup> **Pigs** with induced endotoxemia have increases in activity of tissue factor, plasminogen activator and plasminogen activator-inhibitor, and concentrations of thrombin-antithrombin complexes and fibrin monomer, and a decline in fibrinogen and factor VII concentrations.<sup>108</sup>

## NECROPSY EXAMINATION

It is important to differentiate the abnormalities at necropsy caused by DIC from those of the underlying disease. This can be challenging. The presence of DIC is suspected by the presence of hemorrhage in the carcass. Hemorrhage can vary from occasional petechiation to frank hemorrhage into body cavities. Horses dying of DIC usually have widespread lesions, including petechiation of mucosal and serosal surfaces, including the mesentery and pleura. There is often hemorrhage into parenchymatous organs (kidneys, adrenals), lungs and the myocardium, and infarcts in the adrenals and kidney. Microthrombi are detectable in the intestine and kidney of some horses with DIC.

## DIAGNOSTIC CONFIRMATION

The presence of a hypercoagulable state is determined by clinicopathological testing. DIC is diagnosed by the presence of clinical signs of a hemorrhagic diathesis and laboratory confirmation of abnormalities in hemostasis and fibrinolysis. A conventional definition of DIC requires the presence of clinical evidence of coagulopathy and the presence of at least three abnormal measures of coagulation or fibrinolysis. It is likely that this definition will change as our understanding of the spectrum of abnormalities and manifestations of the disorder matures.

Differential diagnoses include all of the acquired or inherited coagulopathies. However, the cardinal differentiating attribute of DIC or the lesser hypercoagulable states is the presence of severe inciting disease.

## TREATMENT

Most recommended therapies for DIC have been extrapolated from the human literature and may not be applicable to farm animals. However, generally stated, the principles of therapy are:

- Treatment of the underlying disease and correction of acid-base, inflammatory, electrolyte and perfusion abnormalities
- Restoration of normal activity or concentration of clotting factors in blood
- Halting or attenuating the increased coagulopathy
- Minimizing effect of microthrombi and thrombi on organ function.

Disseminated intravascular coagulation is invariably secondary to an initiating primary disease. Vigorous therapy should consequently be directed toward correction of the primary initiating disease. Aggressive intravenous fluid administration to maintain tissue perfusion and to

correct any acid-base and electrolyte imbalance is also very important. There should be aggressive treatment of endotoxemia and of diseases likely to induce endotoxemia. Treatment of endotoxemia is discussed elsewhere in this text, and current reviews are available.<sup>116</sup>

The plasma concentration of clotting factors should be restored, or supplemented, in horses with clinical or clinicopathological evidence of a coagulopathy. The practice of blood component therapy is well accepted in human medicine but because of technological limitations is not generally available in farm animals. However, stored **plasma**, preferably fresh frozen, can be administered to increase the concentration of clotting factors that are depleted during hypercoagulable states or DIC. Antithrombin is often readily measured and horses with low plasma antithrombin activity should be administered plasma. The dose of plasma necessary to increase blood antithrombin activity to appropriate levels has not been determined. However, many clinicians use a plasma antithrombin activity 60% of that of healthy horses as a minimal acceptable activity. This choice has not been verified empirically. Dosages of plasma vary from 2–10 mL/kg, intravenously. Platelet-rich plasma, or whole blood, can be used to treat thrombocytopenia.

Heparin and low-molecular-weight heparin is used to treat horses with hypercoagulable states<sup>2,24</sup> and its use is discussed above. The aim is to prevent formation of thrombi and microthrombi. Heparin requires antithrombin as a cofactor, and it might not exert its full therapeutic activity in horses with abnormally low blood antithrombin concentrations.

Aspirin is used to inhibit platelet activity in horses with prothrombotic states. Its efficacy in reducing morbidity or mortality has not been determined.

## REVIEW LITERATURE

- Darlen BJ. Hemostasis – a clinical review. *Equine Vet Educ* 1993; 5:33–36.
- Sellon DC, Grindem CB. Quantitative platelet abnormalities in horses. *Compend Contin Educ Pract Vet* 1994; 16:1335–1346.
- Davis EG et al. Flow cytometry: clinical applications in equine medicine. *J Vet Intern Med* 2002; 16:404–410.
- Dallap BL. Coagulopathy in the equine critical care patient. *Vet Clin North Am* 2004; 20:231–251.

## REFERENCES

1. Taylor EL et al. *Am J Vet Res* 2000; 61:1191.
2. Kingston JK et al. *Am J Vet Res* 2001; 62:547.
3. Topper MJ, Prasse KW. *Am J Vet Res* 1998; 59:538.
4. Benson RE et al. *J Lab Clin Med* 1992; 119:420.
5. Munster AB et al. *Comp Med* 2002; 52:39.
6. Heidmann P et al. *Am J Vet Res* 2005; 66:313.
7. Feige K et al. *J Vet Med A* 2003; 50:30.
8. Monreal L. *J Vet Intern Med* 2003; 17:757.
9. Stokol T et al. *Vet Clin Pathol* 2005; 34:375.

10. Topper MJ, Prasse KW. *Am J Vet Res* 1996; 57:456.
11. Hinchcliff KW et al. *J Am Vet Med Assoc* 1993; 203:1715.
12. Davis EG et al. *J Vet Intern Med* 2002; 16:404.
13. Russell KE et al. *Am J Vet Res* 1997; 58:1092.
- 13a. Segura D et al. *J Vet Int Med* 2006; 20:581.
14. Segura D et al. *Vet J* 2005; 170:108.
15. Barton MH et al. *J Vet Diagn Invest* 1995; 7:380.
16. Gentry PA et al. *Res Vet Sci* 1994; 57:336.
17. Heidmann P et al. *Am J Vet Res* 2005; 66:313.
18. Cambridge H et al. *Equine Vet J* 1991; 23:123.
19. Gentry PA et al. *Am J Vet Res* 1989; 50:919.
20. Feige K et al. *Equine Vet J* 2002; 35:506.
21. Moore BR, Hinchcliff KW. *J Vet Intern Med* 1991; 8:26.
22. Monreal L et al. *Am J Vet Res* 1995; 56:1281.
23. Moore JN et al. *Am J Vet Res* 1987; 48:68.
24. Schwarzwald CC et al. *Am J Vet Res* 2002; 63:868.
25. Dart A et al. *Aust Vet J* 2001; 79:624.
26. Fiege K et al. *Equine Vet J* 2004; 36:135.
27. Roberts MC, Kelley WR. *Vet Rec* 1982; 110:144.
28. Galan JE, Timoney JF. *J Immunol* 1985; 133:1334.
29. Werner LL et al. *J Am Vet Med Assoc* 1984; 185:87.
30. Dolente BA et al. *J Am Vet Med Assoc* 2002; 220:1034.
31. McConnico RS et al. *J Am Vet Med Assoc* 1997; 211:882.
32. Tligui N, Ruth GR. *Am J Vet Res* 1994; 55:1558.
33. Runciman DJ et al. *Aust Vet J* 2002; 80:28.
34. Sasaki Y et al. *Jpn J Vet Sci* 1985; 47:435.
35. Nuwsholme SJ et al. *J S Afr Vet Assoc* 1985; 56:101.
36. Hoppe PP. *Prakt Tierarzt* 1987; 68:32.
37. Crawford AM, Mills JN. *Aust Vet J* 1985; 62:185.
38. Meier J, Stocker K. *Crit Rev Toxicol* 1991; 21:171.
39. Dickinson CE et al. *J Am Vet Med Assoc* 1996; 208:1866.
40. Devine CE et al. *Meat Sci* 1983; 9:247.
41. Lundquist H. *Nord Vet Med* 1983; 35:57.
42. Jones PA et al. *Am J Vet Res* 1997; 58:541.
43. Abutarbusch SM, Radostits OM. *Can Vet J* 2005; 46:711.
44. Joachim A et al. *Parasitol Res* 2003; 89:53.
45. Littlewood JD et al. *Equine Vet J* 1991; 23:70.
46. Henninger RW. *J Am Vet Med Assoc* 1988; 193:91.
47. Neuenschwander S et al. *Thromb Haemost* 1992; 68:618.
48. Thiele GL et al. *J Hered* 1986; 77:179.
49. Laan MTTJ et al. *Vet Rec* 2005; 157:322.
50. Brooks M et al. *J Am Vet Med Assoc* 1991; 198:114.
51. Rathgeber RA et al. *J Vet Intern Med* 2001; 15:63.
52. Healy PJ et al. *Aust Vet J* 1984; 61:132.
53. Brachfisch W et al. *J Hered* 1994; 85:474.
54. Brush PJ, Gentry PA. *Vet Rec* 1988; 122:134.
55. Yasuda J et al. *J Vet Med Sci* 2002; 64:87.
56. Gentry PA, Brush PJ. *Can Vet J* 1987; 28:110.
57. Gentry PA, Ross ML. *Can J Vet Res* 1994; 58:242.
58. Marron BM et al. *Anim Genet* 2004; 35:454.
59. Turrentine MA et al. *Am J Vet Res* 1986; 47:2464.
60. Geor RJ et al. *J Am Vet Med Assoc* 1990; 197:741.
61. Fecteau G et al. *Can Vet J* 1997; 38:443.
62. Pelagalli A et al. *J Comp Pathol* 2003; 128:127.
63. Pelagalli A et al. *J Comp Pathol* 2002; 127:126.
64. Sellon DC. *J Vet Educ* 1998; 10:133.
65. Handagama PJ, Feldman BF. *Vet Res Commun* 1986; 10:1.
66. Jeffers M, Lenghaus C. *Aust Vet J* 1986; 63:262.
67. Cain GR et al. *Comp Haematol Int* 1994; 4:167.
68. Nicholls TJ et al. *Aust Vet J* 1985; 62:67.
69. Kohn CW et al. *J Vet Intern Med* 1995; 9:315.
70. Ammann VJ et al. *Can Vet J* 1996; 37:493.
71. Sellon DC et al. *J Vet Intern Med* 1996; 10:127.
72. Gomez-Villamandos JC et al. *J Comp Pathol* 1998; 118:1.
73. Corapi WV et al. *J Am Vet Med Assoc* 1990; 196:590.
74. Woods RD et al. *Can J Vet Res* 2004; 68:42.
75. Rebhun WC et al. *J Vet Intern Med* 1989; 3:42.
76. Singh A et al. *Vet Res Commun* 2001; 25:289.
77. McGurrin MK et al. *J Am Vet Med Assoc* 2004; 224:83.
78. Buechner-Maxwell V et al. *J Vet Intern Med* 1997; 11:304.
79. Traub-Dargatzis JL et al. *J Am Vet Med Assoc* 1995; 296:67.
80. Ramirez S et al. *J Vet Intern Med* 1999; 13:534.
81. Perkins GA et al. *J Vet Intern Med* 2005; 19:211.
82. Simpson VR, Done SH. *Vet Rec* 1994; 135:327.
83. Humber KA et al. *J Am Vet Med Assoc* 1991; 199:591.
84. Cohen ND et al. *J Am Vet Med Assoc* 1991; 199:790.
85. Sockett DC et al. *J Am Vet Med Assoc* 1987; 190:308.
86. Nunez R et al. *BMC Blood Disorders* 2001; 1:1 (available on line at: <http://www.biomedcentral.com/1471-2326/1/1>)
87. Lunn DP, Butler DG. *Can Vet J* 1991; 32:559.
88. Yeruham I et al. *Vet Rec* 2003; 153:502.
89. Hoyt PG et al. *J Am Vet Med Assoc* 2000; 217:717.
90. Heath MF et al. *Equine Vet J* 1998; 30:408.
91. Shiraishi M et al. *J Vet Med Sci* 2002; 64:751.
92. Searcy GP et al. *Can J Vet Res* 1990; 54:394.
93. Gentry PA et al. *Can J Vet Res* 1997; 61:128.
94. Sullivan PS et al. *J Am Vet Med Assoc* 1994; 205:1763.
95. Navarre CB et al. *J Vet Intern Med* 1996; 9:283.
96. Akuzawa M et al. *J Vet Med Sci* 1991; 53:107.
97. Tu CH et al. *J Jpn Vet Med Assoc* 1996; 49:237.
98. Livesey L et al. *J Vet Intern Med* 2005; 19:917.
99. Fry MM et al. *J Vet Intern Med* 2005; 19:359.
100. Dallap BL. *Vet Clin North Am* 2004; 20:231.
101. Sellon DC et al. *J Vet Intern Med* 1997; 11:24.
102. Monreal L et al. *Equine Vet J Suppl* 2000; 32:19.
103. Topper MJ, Prasse KW. *Am J Vet Res* 1998; 59:542.
104. Prasse KW et al. *J Am Vet Med Assoc* 1993; 203:685.
105. Thomson GW et al. *Can J Comp Med* 1974; 38:457.
106. Irmak K, Turgut K. *Vet Res Commun* 2005; 29:61.
107. Pusterla N et al. *Vet Rec* 1997; 140:17.
108. Kutzsche S et al. *Thromb Res* 2000; 98:517.
109. Villeda CJ et al. *Arch Virol* 1993; 133:467.
110. Welch RD et al. *J Vet Intern Med* 1992; 6:29.
111. Barton MH et al. *J Vet Intern Med* 1998; 12:26.
112. Levi M, Cate HT. *N Engl J Med* 1999; 341:586.
113. Brianceau P, Divers TJ. *Equine Vet J* 2001; 33:105.
114. Collatos C et al. *J Am Vet Med Assoc* 1995; 15:465.
115. Fiege K et al. *J Vet Med A* 2003; 50:30.
116. Sykes BW, Furr MO. *Aust Vet J* 2005; 83:45.

## THROMBOSIS (HYPERCOAGULABILITY)

Abnormal formation of thrombi is often a consequence of diminished concentrations or activity of anticoagulant factors, such as antithrombin, protein C and antiplasmin, increased concentrations of plasminogen activator-inhibitor or abnormalities of vessel walls. Thrombotic disease is usually a consequence of a primary disease that depletes anticoagulant factors and involves mech-

anisms discussed above under Disseminated intravascular coagulopathy. Thrombosis of the jugular vein is discussed elsewhere. Primary diseases involving thrombosis are thromboembolic colic in horses and aortoiliac thrombosis in horses.

An apparently **primary defect in protein C** activity in a Thoroughbred colt with a hypercoagulable state has been described.<sup>1</sup> The colt had repeated episodes of venous thrombosis and developed renal failure. Plasma concentrations of protein C were within the reference range for healthy horses, but the activity of protein C in plasma was 32% of that of healthy horses, suggesting a defect in the protein.

## REFERENCE

1. Edens LM et al. *J Vet Intern Med* 1993; 7:190.

## Disorders of red cell number or function

### ANEMIA

#### Synopsis

**Etiology** Deficiency of circulating erythrocytes associated with hemorrhage, increased destruction or the inefficient production of erythrocytes. There are a large number of specific etiologies

**Epidemiology** Specific to the underlying cause of the anemia

**Clinical findings** Pallor of mucosae, tachycardia, lethargy, exercise intolerance, arrhythmia, ileus, decreased ruminations and colic. Petechial and ecchymotic hemorrhages, icterus, hemoglobinuria, bleeding tendencies can be seen if the underlying cause is excessive hemorrhage

**Clinical pathology** Examination of erythron, bone marrow and serum total protein for nature and severity of anemia; clinical chemistry for associated organ damage. Specific tests for etiology

**Necropsy findings** Pallor of tissues. Findings specific to specific etiology

**Diagnostic confirmation** Decreased erythrocyte count or packed cell volume

**Treatment** Treatment of specific etiology. Transfusion of whole blood, packed red cells, or stromal free hemoglobin if the anemia is severe. Corticosteroids for immune-mediated anemias and supportive treatment.

## ETIOLOGY

Anemia can be classified as hemorrhagic anemia, hemolytic anemia, or anemia due to decreased production of erythrocytes. Another classification system is based on evidence of regeneration of anemia, with anemia classified as either regenerative or nonregenerative. Both classifications are useful in determining the cause, treatment and prognosis. Diseases causing

anemia in horses are listed in Table 25.2 and those causing hemolytic anemia in cattle in Table 20.4.

### Hemorrhagic anemia

Acute hemorrhage and hemorrhagic shock are discussed in Chapter 2. The diseases discussed here are those that cause **normovolemic anemia**. While anemia occurs after restitution of plasma volume in animals with severe hemorrhage, most diseases that cause normovolemic anemia do so because of the chronic loss of blood either from the body or into a body cavity. The most common route of loss is through the gastrointestinal tract. Diseases include:

- Parasitism – intestinal nematodiasis:
  - Teladorsagia circumcincta* or *Haemonchus contortus* in lambs and sheep, *Ostertagia ostertagi* in cattle, *Strongylus* sp. and cyathostomes in horses; trematodiasis including *Fasciola hepatic* in sheep and cattle; hematophagous lice and ticks, including *Linognathus vituli* in calves
- Gastrointestinal disease, including:
  - Abomasal ulceration in cattle (both spontaneous and associated with abomasal lymphoma)
  - Gastric ulceration in horses (anemia is an unusual manifestation of this disease)
  - Gastric squamous cell carcinoma in horses
  - Esophagogastric ulceration in pigs
  - Proliferative enteropathy in pigs (usually a peracute disease)
  - Bleeding from lesions in the small intestine (neoplasia, fungal infection, mural hematoma)
- Respiratory tract:
  - Guttural pouch mycosis in horses
  - Ethmoidal hematoma in horses
  - Caudal vena cava thrombosis and pulmonary embolism in cattle
- Genitourinary tract disease, including:
  - Enzootic hematuria in cattle (bladder cancer) and bladder transitional cell tumor (horse)
  - Pyelonephritis
  - Vaginal varicose vein hemorrhage in mares
  - Ureteral lesion and hematuria in geldings and stallions
  - Middle uterine artery rupture of mares (usually a peracute disease)
  - Idiopathic renal hematuria in horses
- Hemorrhage into body cavities:
  - Hemangiosarcoma
    - Juvenile bovine angiomas
- Defects in clotting (see 'Diseases causing hemorrhage')
  - Thrombocytopenia
  - Deficiency of clotting factors
  - Umbilical bleeding in piglets.

### Hemolytic anemia

Cattle and sheep

- Babesiosis, anaplasmosis, *Mycoplasma ovis comb. nov.* (formerly *Eperythrozoon ovis*) eperythrozoonosis, trypanosomiasis, nagana, theileriosis, alone or in various combinations<sup>1</sup>
- Bacillary hemoglobinuria
- Leptospirosis (*L. interrogans* serovar *pomona*)
- Bovine virus diarrhea and mucosal disease<sup>2</sup>
- Postparturient hemoglobinuria
- Associated with grazing *Brassica* spp. rape, kale, *chou moellier*, turnips, cabbages
- Associated with the excessive feeding of culled onions<sup>3</sup> or cannery offal, especially tomatoes and onions
- Poisoning by *Mercurialis*, *Ditaxis*, *Pimelia* and *Allium* spp.
- Poisoning by miscellaneous agents, including phenothiazine, guaifenesin
- Poisoning – chronic copper poisoning. In sheep secondary to pyrrolizidine alkaloids as in toxemic jaundice or primary from the feeding of diets too high in copper. Cattle are much less susceptible than sheep, although preruminant calves are very susceptible
- Treatment with long-acting oxytetracycline
- Water intoxication and drinking cold water in calves,<sup>4</sup> and in goat kids fed water from a nipple bottle<sup>5</sup>
- Inadvertent administration of hypotonic fluids intravenously
- Part of a transfusion reaction
- Rare cases of alloimmune hemolytic anemia (isoerythrolysis) in calves from vaccination of the dam with blood-derived vaccines such as anaplasma vaccine
- Autoimmune hemolytic anemia is recorded in calves but is rare.<sup>6</sup> All reported cases have occurred in calves under 6 months of age
- Immune-mediated anemia can occur in lambs that are fed cow colostrum as a source of immunoglobulin. This is not a common sequel to the feeding of cows' colostrum and occurs only with the colostrum from certain cows. Anemia is evident at 7–20 days of age but jaundice and hemoglobinuria are not usually present.<sup>7,8</sup> The syndrome must be differentiated from immune-mediated thrombocytopenia, which occurs at a younger age in some lambs fed bovine colostrum
- Rarely, in adults after vaccination<sup>9</sup>
- Congenital anemia associated with dyserythropoiesis and accompanied by dyskeratosis and progressive alopecia is recorded in Polled Hereford calves. The anemia is

present at birth and the disease is probably inherited<sup>10,11</sup>

- A congenital anemia with jaundice is recorded in Murray Grey calves and it is postulated that a defect in the red cell membrane leads to intravascular hemolysis.<sup>12</sup>

Pigs

- Eperythrozoonosis is recorded but hemolytic anemia is rare
- Isoerythrolysis, thrombocytopenia and coagulation defects are dealt with in the previous section
- Generalized cytomegalovirus infection.

Horses

- Equine infectious anemia, although the pathogenesis of the anemia is probably multifactorial, including hemolysis and decreased red cell production
- Babesiosis
- Phenothiazine poisoning. This anthelmintic is now used rarely in horses
- Red maple leaf (*Acer rubrum*) toxicity<sup>13</sup>
- Ingestion of dried garlic (> 0.2 g/kg BW) results in development of Heinz bodies and hemolytic anemia<sup>14</sup>
- Intravenous administration of hypotonic or hypertonic fluids (water, 20% dimethylsulfoxide)
- As a sequela to severe cutaneous burns.<sup>15</sup> The severity of the hemolysis correlates with the amount of skin area burned. Hemolysis is due to oxidative damage of red cell membranes that occurs within minutes of the burn. Prevention and treatment include immediate administration of polyionic fluids to prevent hemoconcentration and to prevent hemolytic uremia
- As a sequel to clostridial abscessation. The anemia occurs more than 10 days after development of the abscess and is associated with the presence of IgG or IgM on the surface of red cells<sup>16</sup>
- Alloimmune hemolytic anemia (isoerythrolysis) of foals
- Autoimmune hemolytic anemia. Not common but several series have been recorded<sup>17–20</sup>
- Immune-mediated hemolytic anemia and thrombocytopenia (Evans syndrome)<sup>21</sup>
- Penicillin-induced hemolytic anemia. This is a rare event but can occur when horses develop IgG antipenicillin antibodies. These antibodies bind to penicillin on erythrocytes with resultant red cell destruction. Penicillin-coated erythrocytes agglutinate with patient serum.<sup>22,23</sup> It is probable that other immune-mediated hemolytic anemias

in the horse are also associated with the development of antibody to therapeutic agents<sup>24</sup>

- Some snake envenomations cause intravascular hemolysis in dogs and cats<sup>25</sup> and hemolytic anemia can occur in snakebite in horses<sup>26</sup> and calves
- Lead intoxication in horses causes mild anemia, but signs of peripheral neuropathy are the more obvious manifestation
- Abnormalities in red cell function can lead to increased removal of red cells from blood (extravascular hemolysis) and are discussed under 'Abnormalities of red cell function'.

### Anemia due to decreased production of erythrocytes or hemoglobin (nonregenerative anemia)

The diseases in this group tend to affect all species so that they are divided up according to cause rather than according to animal species.

#### Nutritional deficiency

Nutritional deficiencies impair production of hemoglobin or red cells. A number of specific deficiencies that result in anemia are described:

- Cobalt and copper. These elements are necessary for all animals, but clinically occurring anemia is observed in only ruminants. Copper deficiency induced by zinc toxicity causes anemia in pigs<sup>27</sup>
- Iron, but as a clinical occurrence this is limited to rapidly growing animals, including baby pigs, young calves designated for the white veal market, housed lambs and foals. This predilection of young animals for iron deficiency is attributable to their rapid growth and hence requirement for relatively large intakes of iron (which, in addition to production of hemoglobin, is used in production of myoglobin and other iron-containing compounds), the low concentration of iron in milk, and management practices that deny access of the animals to pasture or soil from which they can obtain iron
  - Anemia in piglets can be caused by iron deficiency. The disease occurs in both housed piglets and those kept on dirt, although the disease is believed to be less common in those kept at pasture or on dirt, in part because of the availability of iron ingested in dirt<sup>28</sup>
  - Iron deficiency should be considered as a possible cause of failure to perform well in housed calves. Male calves up to 8 weeks of age and on a generally suitable diet can show less than optimum

performance in erythron levels, and the calves with subclinical anemia have deficits in growth rate and resistance to diarrhea and pneumonia.<sup>29</sup> Calves fed 20 mg Fe/kg milk replacer develop hypoferrremia and mild anemia, whereas those fed 50 mg Fe/kg do not<sup>30</sup>

- Iron deficiency anemia occurs in housed lambs and is prevented by oral or parenteral supplementation with iron.<sup>31</sup> Anemia and poor weight gain were not prevented in all lambs by a single administration of 330 mg of iron once orally at 1–5 days of age, although there was a marked increase in serum iron concentration. Treated lambs had higher hematocrit and greater weight gain than did untreated lambs
- Microcytic anemia and hypoferrremia occur in Standardbred foals kept at pasture for 12 h/d. These changes are not prevented by oral administration of four oral doses of 248 mg of iron, suggesting that higher levels of supplementation are needed.<sup>32</sup> Conversely, hypoferrremia and anemia are reported in stabled foals but not in a pastured cohort.<sup>33</sup> The stabled foals had clinical signs of anemia (lethargy) and low hematocrit, hemoglobin concentration and serum iron concentration, which were restored to normal values by iron supplementation (0.5 g iron sulfate orally once daily, 3 g of iron sulfate top dressed on cut pasture fed to the foals and their dams, and unlimited access to a lick block containing iron).<sup>33</sup> While colostrum of mares is rich in iron, milk has much lower concentrations, probably explaining the low serum iron of some nursed foals and demonstrating the need for access to iron supplements or, preferably, soil or pasture.<sup>34</sup> Supplementation of foals with iron should be undertaken cautiously because of the documented hepatotoxicity of large doses of iron given orally to newborn foals.<sup>35</sup> Toxic hepatopathy develops in newborn foals administered iron fumarate at 16 mg/kg BW within 24 hours of birth,<sup>35</sup> similar to the situation in piglets. Iron supplementation of foals should be done cautiously
- A great deal of attention is paid to providing adequate iron to racehorses, often by periodic injection of iron compounds

regularly during the racing season, or provision of hematonic supplements. Given that strongylosis is all but unknown in race horses in the current era of intensive parasite control programs and stabling of horses, anemia is exceedingly rare in healthy race horses. Supplementation with iron of horses on a balanced, complete ration is therefore unlikely to be necessary. Moreover, administration of excessive iron could be dangerous, although iron toxicity has not been documented in race horses, as it has in foals. Oral administration of 50 mg Fe/kg body weight to ponies for 8 weeks increased serum iron concentration, did not affect hematocrit and did not induce signs of disease<sup>36</sup>

- Potassium deficiency is implicated in causing anemia in calves
- Pyridoxine deficiency, produced experimentally, can contribute to the development of anemia in calves
- Folic acid deficiency is rare in horses, has not been reported as a spontaneous disease in pigs, and is unlikely to occur in ruminants because of the constant production of folic acid by rumen bacteria.<sup>37</sup> Plasma folic acid concentrations vary in pregnant mares kept at pasture, and in their foals, but there is no evidence of folate deficiency in either mares or foals.<sup>38</sup> Administration of antifolate drugs (trimethoprim, sulfonamides, pyrimethamine, methotrexate) could, theoretically, cause folate deficiency in horses. Folate deficiency causing anemia and leukopenia is reported in a horse treated for equine protozoal myelitis with antifolate drugs concurrent with oral supplementation with folic acid.<sup>39</sup> Intravenous administration of folic acid (0.055–0.11 mg/kg BW) resulted in rapid resolution of leukopenia and anemia. Paradoxically, oral administration of folic acid in monogastric animals receiving antifolate drugs impairs absorption of folic acid in the small intestine and causes folate deficiency.<sup>39</sup> Administration of folic acid, sulfonamides and pyrimethamine orally to pregnant mares results in congenital signs of folate deficiency in foals, including anemia and leukopenia.<sup>40</sup>

#### Chronic disease

Chronic inflammatory disease causes mild to moderate anemia in all species of large animals. The anemia can be difficult

to differentiate from that of mild iron-deficiency anemia. The genesis of anemia of chronic inflammation is multifactorial and includes sequestration of iron stores such that iron availability for hemato-poiesis is reduced despite adequate body stores of iron, reduced erythrocyte life span and impaired bone marrow response to anemia. The result is normocytic, normochromic anemia in animals with normal to increased serum ferritin concentrations. The clinicopathologic features of both iron deficiency anemia and anemia of chronic disease are detailed in Table 9.1.

- Chronic suppurative processes can cause severe anemia by depression of erythropoiesis
- Radiation injury
- Poisoning by bracken, trichloroethylene-extracted soybean meal, arsenic, furazolidone<sup>41</sup> and phenylbutazone, cause depression of bone marrow activity
- A sequel to inclusion body rhinitis infection in pigs
- Porcine dermatitis and nephropathy syndrome<sup>42</sup>
- Intestinal parasitism, e.g. ostertagiasis, trichostrongylosis in calves and sheep, have this effect.<sup>7</sup>

#### Red cell aplasia

- Red cell hypoplasia is a fatal syndrome of anemia, immunodeficiency and peripheral gangliopathy that develops at 4–8 weeks of age in some Fell pony foals
- Anemia in some horses follows the administration of recombinant human erythropoietin.<sup>43–45</sup> The anemia is due to pure red cell aplasia and is manifest as normocytic, normochromic anemia. The disease is attributable to injection of horses with recombinant human erythropoietin with subsequent development of substances in blood, presumably antibodies to rhEPO, that cross-react with and neutralize endogenous erythropoietin in affected horses.<sup>43,45</sup> Not all horses administered rhEPO develop anemia, but the disease is reported as an outbreak in a stable of Thoroughbred race horses administered the compound.<sup>45</sup> Severely affected horses die. Treatment of severely affected horses is futile, but mildly affected horses can recover.<sup>43</sup> Whether the recovery was spontaneous or because of administered glucocorticoids is unknown. Administration of cyclophosphamide and glucocorticoids was not effective in treatment of several severely affected horses. Blood transfusion provides temporary relief

- Pure red cell aplasia not associated with administration of rhEPO occurs but rarely in horses. The disease can be transient.

#### Myelophthitic anemia

Myelophthitic anemia, in which the bone marrow cavities are occupied by other, usually neoplastic tissues, is rare in farm animals. Clinical signs, other than of the anemia, which is macrocytic and normochromic, include skeletal pain, pathological fractures and paresis due to the osteolytic lesions produced by the invading neoplasm. Cavitation of the bone may be detected on radiographic examination.

- Lymphosarcoma with bone marrow infiltration occurs in most species
- Plasma cell myelomatosis has been observed as a cause of such anemia in pigs, calves and horses
- Infiltration of neoplastic cells, other than lymphoma or myeloma, such as melanoma in horses<sup>46</sup>
- Myelophthitic anemia due to myelofibrosis is reported in a pony<sup>47</sup> and as a familial disease in pygmy goats.<sup>48</sup>

#### PATHOGENESIS Anemic hypoxia

The most important abnormality in anemia is the hypoxemia and subsequent tissue hypoxia that results from the reduced hemoglobin concentration and oxygen-carrying capacity of blood. The anemia becomes critical when insufficient oxygen is delivered to tissue to maintain normal function.

**Oxygen delivery** is described mathematically by the Fick equation:

$$\text{Oxygen delivery} = \text{cardiac output} \times \text{arteriovenous oxygen content difference.}$$

Oxygen delivery is therefore the rate at which oxygen is delivered to the tissue – it is a combination of the rate at which oxygen arrives at the tissue in arterial blood and the proportion of that oxygen extracted from the capillary blood.

Cardiac output is determined by heart rate and stroke volume, whereas the arteriovenous difference in blood oxygen content is determined by the hemoglobin concentration, hemoglobin saturation with oxygen in both arterial and venous blood, and the extraction ratio. The extraction ratio is the proportion of oxygen that is removed from the blood during its passage through tissues. In animals with a normal hematocrit and cardiac output, oxygen delivery to tissues exceeds the oxygen requirements of the tissue by a large margin, with the result that the oxygen extraction ratio is small (< 40%). However, as the oxygen-carrying

capacity per unit of blood declines (usually expressed as mL of oxygen per 100 mL of blood) then either blood flow to the tissue or the extraction ratio must increase to maintain oxygen delivery.<sup>49,50</sup> In reality, both of these compensatory mechanisms occur during the acute and chronic responses to anemia. Heart rate increases to increase cardiac output and therefore the delivery of oxygen to tissue, and blood flow is preferentially directed to those tissue beds that are most essential for life or are most sensitive to deprivation of oxygen (heart, brain, gut, kidney). Extraction ratio increases and is evident as a decrease in venous blood hemoglobin saturation. Hemoglobin in arterial blood is usually thoroughly saturated with oxygen and the limitation to oxygen delivery to tissue is the low hemoglobin concentration and consequent low arterial oxygen content. Assessment of arterial blood oxygen tension and content is discussed in Chapter 10.

Reductions in hemoglobin concentration are compensated for by increases in cardiac output and extraction ratio so that oxygen delivery to tissue is maintained in mild to moderate anemia.<sup>49</sup> As the severity of anemia increases, these compensatory mechanisms are inadequate and oxygen delivery to tissues declines. At some point the delivery of oxygen fails to meet the oxygen needs of the tissue and organ function is impaired. It is important to realize that this is not an all-or-none phenomenon and that there is not a particular point at which decompensation occurs. In fact, with progressive anemia there are progressive increases in cardiac output and oxygen extraction ratio (evident as a progressive decline in venous hemoglobin saturation) until these compensatory mechanisms are maximal.<sup>49</sup> **Arterial pH** and **lactate concentration** are maintained until the degree of anemia cannot be compensated for by increases in cardiac output and extraction ratio, at which point blood lactate concentration rises and blood pH and base excess decline. This is the degree of anemia at which oxygen use by tissue is entirely dependent on blood flow – decreases in blood flow decrease oxygen utilization and increases in blood flow increase oxygen utilization until the point where oxygen delivery exceeds oxygen consumption.

Compensation for slowly developing anemia is more complete than for rapidly evolving anemia such that animals with chronic anemia can tolerate a degree of anemia that would be intolerable for animals with acute anemia of a similar severity. Part of this chronic compensation includes changes in the affinity of hemoglobin for oxygen, which is due in part to increases in 2,3-diphosphoglycerate concentration in red cells.



Table 9.1 Characteristics of expected changes in hematological and serum biochemical variables in anemic animals

Variable	Regenerative anemia				Nonregenerative anemia		
	Blood loss		Hemolysis		Chronic inflammation and disease	Iron deficiency (incl. prolonged chronic blood loss)	Hypoproliferative anemia, aplastic anemia, myelophthisis
	Acute hemorrhage	Chronic or normovolemic recovery phase of acute hemorrhage	Acute	Hemolysis			
Hematocrit	Normal	Low	Low	Low	Mild to moderate low	Low	Low to very low
Hemoglobin concentration in blood	Normal	Low	Normal (intravascular hemolysis) to low (extravascular hemolysis)	Normal	Low	Low	Low
Plasma total protein concentration	Normal	Low	Normal	Normal	Normal to high (increased globulins and fibrinogen)	Normal	Normal
Plasma fibrinogen	Normal	Low, normal or high	Normal or high	Normal or high	High	Normal	Normal
Reticulocytosis*	No	Yes	No	No	Unusual	Unusual	No
Mean corpuscular volume (MCV)†	Normal	High	Normal	Normal	Normal to low	Low	Normal
Mean corpuscular hemoglobin	Normal	High (because of reticulocytes)	High (because of increased concentration of free hemoglobin in plasma)	High (because of increased concentration of free hemoglobin in plasma)	Normal to low	Low	Normal
Mean corpuscular hemoglobin concentration	Normal	Decreased (because of reticulocytes)	High (because of increased concentration of free hemoglobin in plasma)	Normal	Normal to low	Low	Normal
Red cell distribution width (degree of anisocytosis)	Normal	Increased	Normal	Normal	Normal	Normal	Normal
Red cell morphology	Normocytic, normochromic	Anisocytosis, macrocytic, polychromic	Anisocytosis, spherocytosis	Anisocytosis, polychromic	Normocytic, normochromic	Microcytic, hypochromic	Normocytic, normochromic
Serum iron concentration	Normal	Normal (low if prolonged loss of red cells)	Normal to high because of release of iron from red cells	Normal	Low (to normal)	Low	Normal to high
Serum transferrin concentration (total iron-binding capacity)	Normal	High	Normal	Normal	Low to normal	Normal to increased	Low to normal
Transferrin saturation	Normal	Low to normal	NK	NK	Low to normal	Low	Normal to high
Serum ferritin concentration	Normal	Low to normal	Normal	Normal	Normal to high (note: ferritin is also an acute phase protein)	Low	Normal to high
Bone marrow iron stores	Normal	Low to normal	Normal	Normal or increased	High (or normal)	Low or absent	Normal
Bone marrow myeloid: erythroid ratio†	Normal (0.5 to 1.5)	Low (< 0.5)	Normal	Low	Normal to high	Normal	High (> 1.5)
Plasma erythropoietin concentration	Normal to high	High	Normal to high	High	Depends on underlying disease	High	Low – renal disease or decreased EPO production
Blood white cell count	Normal	Neutrophilia, thrombocytosis	Neutrophilia	Neutrophilia, thrombocytosis	Leukocytosis, thrombocytosis	Neutropenia or normal	High – bone marrow disease

The changes are those expected in most species but might not occur uniformly in all species. Normal are values within the range expected for healthy animals of that species, age, and physiological status. High and low refer to values above or below this normal range.

\* Reticulocytes are detectable in blood of horses only by use of special stains and sensitive laboratory methods. † Increases in MCV in horses are slight and difficult to detect.

‡ Values are for adult horses. < > NK, not known.

When anemia is sufficiently severe that it reduces oxygen delivery to tissue to rates that are less than the oxygen needs of tissue, tissue hypoxia develops and the proportion of energy generated by anaerobic metabolism increases. **Anaerobic metabolism** cannot be sustained for more than a short period of time (minutes) before tissue function is impaired. Impaired organ function is evident as decreased myocardial contractility, decreased cerebral function, decreased gastrointestinal motility and abnormal renal function, to list just a few of many important abnormalities. The severity of these abnormalities depends on the metabolic activity of the tissue with more metabolically active tissues (e.g. the heart) being more sensitive to hypoxia. Death usually results from acute heart failure due to arrhythmia.

The effect of anemia is also dependent on the **metabolic state** of the animal. Exertion, even mild exertion such as grazing or following a herd or flock, can increase oxygen demands above that which can be sustained by the degree of anemia. Similarly, increases in body temperature, such as with fever, increase oxygen demand noticeably – an increase in body temperature of 1°C increases oxygen need by 12%.

Anemia induces increases in plasma erythropoietin concentration, which stimulates erythropoiesis in bone marrow and, in young animals or those with extreme anemia, in extramedullary sites. The increase in plasma erythropoietin concentration is prompt, occurring within hours of the development of anemia. The compensatory erythropoietic response is slower, with new red cells being detectable in 1–2 days in most species and bone marrow reticulocytosis detectable in less than 1 week.<sup>50,51</sup>

### Autoimmune hemolytic anemia

The disease is believed to result from an aberrant production of antibodies targeted against surface antigens of the erythrocyte as a result of an alteration in the erythrocyte membrane from systemic bacterial, viral or neoplastic disease. An alternate hypothesis is the development of immunocompetent clones that direct antibody at the red cell membrane.<sup>17,24</sup> Red cells are lost by intravascular hemolysis or removal by macrophages of the reticuloendothelial system and anemia occurs when the capacity of the bone marrow to compensate for increased red cell destruction is exceeded. Autoimmune hemolytic anemia is considered to be idiopathic if it cannot be associated with an underlying disease and is considered to be secondary if associated with another condition. Often this is neoplastic

disease. The antibodies are of the IgG or IgM class, may be agglutinating or non-agglutinating and can also be temperature-dependent. The antiglobulin test has been used to confirm the diagnosis in cases of nonagglutinating autoimmune hemolytic anemia, but demonstration of immunoglobulin on the surface of red cells by immunofluorescent cell staining and flow cytometry is much more sensitive and specific.<sup>52,53</sup>

### Hemolysis

Hemolysis results from rupture of red cell membranes as a consequence of injury to the membrane or osmotic lysis when serum tonicity is lower than normal. Hemolytic disease of any cause has the potential to overwhelm the normal clearance mechanisms for hemoglobin, with the result that hemoglobin concentrations in plasma are abnormally high. This can result in hemoglobinuric nephrosis (see Ch. 11).

### Methemoglobinemia and oxidative damage

Methemoglobinemia results from oxidative damage of hemoglobin and occurs in disease such as red maple leaf toxicosis in horses and nitrate poisoning in ruminants. Methemoglobinemia is reversible but important as an indicator of oxidative damage and because methemoglobin cannot transport oxygen. Oxidative damage to red cells results in denaturation of hemoglobin with subsequent formation of Heinz bodies. Red cells damaged in this way are sensitive to osmotic lysis and fragmentation. Intravascular hemolysis and removal of damaged red cells by the reticuloendothelial system contributes to anemia.

### CLINICAL FINDINGS

The clinical signs and their severity depend on the degree of anemia. Mild anemia in animals that are not required to be physically active, such as veal calves or housed lambs, might be apparent only as failure to achieve optimal weight gain. More severe degrees of anemia, or mild anemia in animals required to be physically active, such as foals at pasture or race horses, can be evident as exercise intolerance, failure to perform athletically, or lethargy. Behavioral signs of anemia include prolonged recumbency, depressed mentation, reduced nursing, foraging or grazing and, in extreme anemia, belligerence.

Physical findings include pallor of the mucosae but appreciable degrees of anemia can occur without clinically visible change in mucosal or skin color. The mucous membranes, and skin in pale-skinned, sparsely haired animals such as pigs, can be almost white in

animals with severe anemia. Hemolytic anemia causes jaundice in most cases.

A chart for examination of conjunctival color in sheep and goats has been validated as a means of assessing severity of anemia in these species. The chart (**FAMACHA**<sup>®</sup>) was developed to aid in parasite control programs.<sup>54</sup> Conjunctival color is assessed on a scale of 1–5 in which 1 = red and 5 = white.<sup>54</sup> The correlation between FAMACHA score and hematocrit was very good ( $R = -0.52$  in sheep and  $-0.30$  in goats). The sensitivity and specificity for detection of a hematocrit below 15% for FAMACHA scores of 4 and 5 were 83% and 89% for sheep, and 83% and 71% for goats. This methodology appears to be very useful for detection of anemia in small ruminants.

The heart rate is increased, the pulse has a large amplitude and the absolute intensity of the heart sounds is markedly increased in anemic animals. Terminally the moderate tachycardia of the compensatory phase is replaced by a severe tachycardia, a decrease in the intensity of the heart sounds and a weak pulse. A hemic murmur might be heard and is likely a result of the low viscosity of blood in anemic animals combined with increased ejection velocity of blood from the heart as a consequence of increased heart rate and cardiac output.

Dyspnea is not pronounced in anemia, the most severe degree of respiratory distress appearing as an increase in depth of respiration without much increase in rate. Labored breathing occurs only in the terminal stages and at those times the animals can be severely distressed.

Other signs of decompensated anemia include anxious expression, absent rumination, ileus, colic, anuria and cardiac arrhythmia. Animals can appear quiet and comfortable unless they are forced to move or an event occurs that increases oxygen consumption and causes decompensation. An example is an animal that has compensated for its severe anemia but then develops a fever. Fever can increase whole body oxygen requirement by 12% for each 1°C increase in temperature and this can cause a finely balanced animal to decompensate.

There can be signs of the inciting disease and these can include edema, jaundice, petechial and ecchymotic hemorrhages in the mucosa and hemoglobinuria.

Adjunctive examination can include gastrointestinal, urinary or upper respiratory endoscopy; radiography of the chest or abdomen; and ultrasonographic examination of affected regions.

### CLINICAL PATHOLOGY

The clinicopathological characteristics of the common forms of anemia are provided in Table 9.1.

## Hematology

Anemia is definitively diagnosed by measurement of red cell indices and demonstration of low hematocrit, red cell count and hemoglobin concentration. Examination of various red cell indices can yield important information about the cause of anemia and evidence of regeneration. In addition to providing the diagnosis, serial monitoring of the hemogram is useful in detecting evidence of a regenerative response. At a minimum, repeated measurement of hematocrit will reveal a gradual increase when there is a regenerative response. Hematocrit of horses with induced anemia increases by approximately 1% (0.01 L/L) every 3 days.<sup>55</sup>

Red cell morphological abnormalities include variations in size, shape, and content:

- Red cell size
  - Anisocytosis is the presence of red cells of abnormal size. Abnormal cells can be either macrocytes or microcytes. See Red cell distribution width
  - Macrocytosis (high mean corpuscular volume, MCV) usually indicates a regenerative response. Ruminants have a prominent macrocytic response to anemia. The increase in MCV in horses can be so slight as to be undetectable, especially in mild to moderate regenerative anemia
  - Microcytosis (low mean corpuscular volume) is found in classic deficiency anemias such as iron deficiency
  - Red cell distribution width is a measure of the variation in red cell size in the population of red cells in blood. It is calculated by dividing the standard deviation of red cell volumes by the mean red cell volume, and multiplying the product by 100. An increase in red cell distribution width indicates the presence of anisocytosis due to macrocytosis in regenerative anemia<sup>51,55</sup>
- Red cell shape
  - Spherocytosis is found in diseases that affect the red cell membrane, such as immune-mediated anemia and red maple toxicosis
  - Schistocytes (small, irregularly shaped cells or red cell fragments) are found in diseases that cause intravascular physical injury to red blood cells, such as DIC or vasculitis with endothelial damage
  - Echinocytes are normal-sized red cells that have uniform membrane projects. They are of uncertain importance

- Eccentricocytes are cells in which hemoglobin has been damaged and accumulated eccentrically in the cell, causing variation in color density of the cell. Usually associated with diseases causing oxidative damage
- Red cell content
  - Polychromasia, the presence of erythrocytes of varying staining intensity, is usually due to the presence of reticulocytes
  - Hypochromia can be evident as reduced staining intensity and is due to a reduction in red cell hemoglobin concentration
  - The amount of hemoglobin in red cells can vary. **Mean corpuscular hemoglobin (MCH)** content increases in the presence of reticulocytes. False increases in MCH occur when there is free hemoglobin in plasma, either from in-vivo or ex-vivo hemolysis. **Mean corpuscular hemoglobin concentration (MCHC)** is reduced in the presence of reticulocytosis and hemolysis falsely increases MCHC
  - Nucleated red cells appear in the peripheral blood only in ruminants among farm animals and only in response to severe anemia
  - Howell-Jolly bodies are nuclear remnants that are common in the regenerative response in ruminants but less so in horses
  - Heinz bodies are round protrusions from the cell membrane or intracellular inclusions. The bodies are denatured hemoglobin and are found in diseases in which there is oxidative damage to red cells. Affected cells are fragile and susceptible to intravascular lysis or increased rate of removal by cells of the reticuloendothelial system
  - Parasites such as *Babesia* spp., *Theileria* spp., and *Mycoplasma* spp. (formerly *Eperythrozoon* spp.) can be detected in parasitemic animals
- Reticulocytosis
  - Reticulocytes are immature red cells released from the bone marrow. Reticulocytes contain remnants of nucleic acid and this can be detected by use of appropriate stains. Until recently, reticulocytosis in response to anemia was documented in ruminants<sup>56</sup> and pigs, but not in horses. This was because equine reticulocytes do not stain with Romanowsky and other stains used for routine examination of smears of peripheral blood.

However, use of oxazin, a stain that combines with nucleic acid, and fluorescent detection of labeled cells has revealed the presence of reticulocytes in peripheral blood of horses.<sup>51</sup> Horses develop a reticulocytosis in response to anemia, as do other species

- Reticulocyte volume and reticulocyte hemoglobin content increase in regenerative anemia in horses<sup>51</sup> but has not been evaluated in other large animals.

**Agglutination** of red cells is apparent as irregularly shaped agglomerations of red cells. The clumps of red cells do not dissociate when blood is diluted 1:4 with 0.9% saline, as happens with rouleaux. Rouleaux are normal findings in blood of horses and are apparent as rows of erythrocytes.

**Coombs testing** or use of direct **immunofluorescent flow cytometry** can provide evidence of immune-mediated hemolytic anemia.<sup>52,53</sup>

Other hematologic changes in severe anemia include leukocytosis and thrombocytosis.

## Bone marrow

Examination of bone marrow is useful for demonstrating a regenerative response, especially in horses in which a regenerative response can be difficult to detect in peripheral blood, and for determining the cause of nonregenerative anemia.

### Collection of bone marrow

Samples of bone marrow can be obtained by aspiration, with samples submitted for cytological examination, or biopsy, with core samples submitted for histological examination. Bone marrow aspirates are useful in that they provide samples in which the relative proportions of myeloid and erythroid cell lines can be determined. However, samples obtained by aspiration do not allow examination of the overall cellularity of the marrow or its architecture.

Samples of bone marrow can be obtained from the sternbrae, proximal aspects of the ribs or tuber coxae. The preferred site in adult animals, and in calves, is the cranial sternum. The procedure is performed on standing adult animals or laterally recumbent calves. Animals should be adequately restrained, which could include administration of sedatives and analgesics. A site on the ventral midline over the second or third sternbrae is clipped and aseptically prepared. Local analgesia is induced by injection of lidocaine or similar local anesthetic (5–10 mL). The local anesthetic is injected subcutaneously and to the

surface of the sternebra. A small skin incision is made and the aspiration needle or biopsy instrument is introduced. Bone marrow aspirates can be collected using a 13–15-gauge, 5–7 cm needle and stylet. Bone marrow core biopsies are performed using an 8-, 11- or 13-gauge 100–150 mm bone marrow biopsy needle (Trap-System®).

Bone marrow aspirates are collected from adult horses by advancing the needle approximately 2–3 cm into the sternebra. The stylet is then removed, a 5–10 mL syringe is attached and bone marrow is aspirated. The samples should be placed on a clean glass slide and air-dried, or put in a Petri dish containing 0.5–1.0 mL of 2% EDTA.

Core samples of bone marrow are obtained by inserting the biopsy needle 2 cm into the cortex of the sternebra. The stylet is then removed and the needle is advanced with a rotating motion. This can require considerable effort in adult animals. The needle is advanced approximately 2–3 cm and then rapidly withdrawn. A sample of bone marrow will be evident as pink to red bone. The sample should be rolled on a clean, dry glass slide (for cytological examination) and then placed in 10% neutral buffered formalin for histological examination.

#### Interpretation of bone marrow

Bone marrow is examined for overall architecture, cellularity, the ratio of myeloid to erythroid cells (M:E ratio) and the presence of inflammation, necrosis or abnormal cells. A subjective assessment of iron stores can be made by staining sections of marrow with Prussian blue stain.

A regenerative response is evident as a low M:E ratio due to erythrocyte hyperplasia, and the presence of erythroid series cells in all stages of maturity. There are increased counts of reticulocytes in bone marrow and the number of nucleated cells relative to the hematocrit increases. The MCV and reticulocyte hemoglobin content are high in regenerative bone marrow. These responses are evident as soon as 3 days after acute anemia and peak at approximately 9 days.<sup>51,57</sup>

Abnormal white cells, such as seen in myelophthisic disease caused by myeloma or lymphosarcoma, cause displacement of erythroid series cells and a high M:E ratio. Similarly, a high M:E ratio is obtained when there is primary red cell aplasia. A normal M:E ratio is obtained when there is aplasia of both myeloid and erythroid series of cells, highlighting the need to evaluate overall cellularity of the marrow. Normal marrow is approximately 50% fat and 50% combined myeloid and erythroid series cells.

### Blood gas analysis, oximetry and lactate

#### Arterial blood gas analysis

Arterial blood oxygen *tension* (mmHg, kPa) in animals with anemia is almost always within the reference range for healthy animals unless there is coexisting lung disease. Anemia does not interfere with diffusion of oxygen from the alveolus into capillary blood. However, the arterial oxygen *content* (mL O<sub>2</sub> per 100 mL blood) is reduced because of the reduced arterial blood hemoglobin concentration (see Ch. 10). Arterial carbon dioxide tension is often reduced in severe anemia as a result of alveolar hyperventilation that is a response to arterial hypoxemia. Arterial pH and base excess decline as the severity of anemia increases and compensatory mechanisms are no longer able to ensure delivery of sufficient oxygen to tissue the, indicative of metabolic acidosis resulting from tissue anaerobiosis.

#### Venous blood gas analysis

The ideal sample is mixed venous blood collected from the pulmonary artery or right atrium. However, these sites are only infrequently available for collection so samples should be collected from a major vein (jugular vein, cranial vena cava). Samples collected from small leg veins are less than ideal. Measurement of venous blood gas tensions, pH, base excess, hemoglobin saturation and oxygen content are useful in evaluating the physiological effect of anemia. As discussed under pathophysiology, reductions in oxygen content of arterial blood cause an increase in oxygen extraction ratio in an attempt to maintain oxygen delivery to tissue. The increased extraction ratio is evident as a reduction in venous oxygen tension, hemoglobin saturation and oxygen content.<sup>49</sup> When oxygen delivery to tissue is less than that needed to maintain aerobic metabolism, venous pH, bicarbonate concentration and base excess decline.

#### Methemoglobinemia

Measurement of **methemoglobin** concentration is useful in documenting the severity of diseases such red maple leaf toxicosis and nitrate poisoning. Methemoglobinemia is reversible but is a sign of oxidative damage to red cells. Oxidative damage to red cells causes Heinz body formation and eventual lysis of the cell. Methemoglobin is measured using a co-oximeter and is combined with measurement of oxygen saturation. Methemoglobin concentration in blood of healthy animals is usually less than 3%.

#### Lactate

Concentrations of lactate can be measured in blood ('whole blood lactate') or

plasma. Whole blood lactate concentrations are lower than lactate concentrations in plasma because red blood cells have lower lactate concentration than does plasma. Lactate concentrations can be measured using point-of-care analyzers, some of which have been validated for use in animals. Lactate concentration in blood or plasma increases when compensatory mechanisms are no longer effective and aerobic metabolism is impaired.

#### Serum biochemistry

Serum biochemical abnormalities are those of the inciting disease or reflect damage to organs as a result of the anemia. Severe anemia can damage many organs, resulting in increases in serum concentration or activity of urea nitrogen, creatinine, sorbitol dehydrogenase, gamma-glutamyl transpeptidase, bile acids, bilirubin, aspartate aminotransferase, creatine kinase and troponin, among others. Hemolytic anemia causes increases in plasma hemoglobin concentration (evident grossly as pink-tinged plasma or serum) and hyperbilirubinemia (unconjugated).

**Iron metabolism** in anemic animals is defined by measurement of serum iron concentration, serum transferrin concentration (total iron-binding capacity), transferrin saturation and serum ferritin concentration. Serum ferritin concentration correlates closely with whole body iron stores. Values of these variables in anemia of differing cause are provided in Table 9.1.

#### Other evaluations

**Feces** should be examined for the presence of parasites (ova, larvae or adult parasites), frank blood (hematochezia or melena) and occult blood. Detection of occult blood can be difficult and samples should be collected on multiple occasions. Samples should not be collected soon after rectal examination, as false-positive results can be found because of trauma to the rectal mucosa.

**Urine** should be evaluated for the presence of pigmenturia, red cells and casts. Pigmenturia should be differentiated into hemoglobinuria or myoglobinuria. Microscopic examination will reveal red cells, or ghost red cells, in animals with hematuria. Casts and isosthenuria can be present in urine of animals with hemoglobinuric nephrosis.

**Serum erythropoietin concentration** should be evaluated in animals with nonregenerative anemia. It is not a readily available assay. Concentrations of erythropoietin in adult horses are usually less than 37 mU/mL, but values are probably dependent on the assay used.

Tests for **specific diseases** should be performed as appropriate:

- Measurement of bleeding time, PT, APTT and platelet count should be considered in animals with evidence of excessive unexplained hemorrhage
- Examination for blood parasites
- Serological testing for infectious causes of anemia
- Toxicological testing.

### NECROPSY FINDINGS

Findings indicative of anemia include pallor of tissues, thin, watery blood and contraction of the spleen. Icterus may be evident where there has been severe hemolytic anemia and petechial and ecchymotic hemorrhages with thrombocytopenia. Necropsy findings specific to individual diseases are given under those disease headings.

### TREATMENT

The principles of treatment of anemia are ensuring adequate oxygen transport to tissues, prevention of the deleterious effects of anemia or hemolysis, and treatment of the inciting disease. The individual inciting diseases are discussed elsewhere in this text.

### Correction of anemia

**The discussion here deals with normovolemic anemia.** Acute anemia with hypovolemia (hemorrhagic shock) is dealt with in Chapter 2.

#### Transfusion

The oxygen-carrying capacity of blood should be restored in the short term to at least the level at which oxygen use by tissue is not flow-dependent, and to normal levels in the longer term. Short-term restoration of the oxygen-carrying capacity of blood is achieved by transfusion of whole blood or packed red cells, or administration of a commercial stromal free hemoglobin solution.

The decision to transfuse an anemic animal should not be undertaken lightly for a number of reasons. Transfusion of blood or packed red cells is not without risk to the recipient, there is usually considerable cost in identifying a suitable donor and collecting blood, and the process can be time-consuming. An important concern in performing a blood transfusion is the risk to the recipient. Acute reactions, include anaphylaxis and acute host versus graft reaction (hemolysis of transfused red cells), and graft versus host disease (hemolysis of recipient red cells). Development of alloantibodies in the recipient with consequent problems with repeat transfusion or development of neonatal alloimmune hemolytic anemia in progeny of female recipients is a concern. The incidence of

these adverse events has not been recorded for large animals but can be minimized by crossmatching donor and recipient.

**Crossmatching** and the mechanics of blood transfusion are discussed in Chapter 2 and elsewhere.<sup>58</sup> Briefly, both major (donor red cells and recipient plasma) and minor (donor plasma and recipient red cells) crossmatching should be performed. Ideally, blood typing and examination of plasma for alloantibodies of both donor and recipient would be performed before transfusion, but these are rarely available in an appropriate time frame.

**Indications** for transfusion are not straightforward. Because of the risk to the recipient and cost, blood transfusion should be performed only when indicated. Conversely, the severe adverse effects of anemia mean that animals should not be denied a transfusion if it is needed. There is no one variable for which a single value is a 'transfusion trigger', and the decision to provide a transfusion should not be based on hematocrit, hemoglobin concentration or red cell count alone. Rather, the decision to provide a transfusion should be based on a holistic evaluation of the animal, including the history, physical abnormalities and clinicopathological data. This information should be considered in total before a decision is made to provide a transfusion. Considerations regarding transfusion include:

- History – animals with acutely developing anemia are more likely to require transfusion at a given hematocrit than are animals with slowly developing anemia. Similarly, young animals with higher intrinsic metabolic rates might require transfusion at hematocrit values that would be tolerated by adults
- Physical findings – these are some of the most important indicators of the need for transfusion and include:
  - Changes in demeanor and activity including lethargy, belligerence, anxiousness, depressed mentation, anorexia, intolerance of minimal exercise (nursing, walking), prolonged or excessive recumbency
  - Tachycardia. There is no one value that is critical, but a heart rate that is 30–50% above the upper limit of normal is probably important. Progressive increases in heart rate are indicative of the need for transfusion
  - Sweating, cold extremities, and other signs of sympathetic activation
  - Absent rumination, ileus, gastrointestinal distension, colic

- Arrhythmias, including ventricular premature beats
- Anuria
- Clinical pathology
  - Decline in hematocrit with exacerbation of abnormalities on physical examination. Transfusion should be considered in any animal with a hematocrit below 20% (0.20 L/L). Most animals do not need a transfusion at this level, but the proportion that requires a transfusion increases at lower hematocrits. Some horses with chronic anemia and a hematocrit of 10% (0.10 L/L) do not need a transfusion, whereas others with acute anemia of 15% (0.15 L/L) need a transfusion urgently
  - Venous blood hypoxemia and declines in hemoglobin saturation. There is no one value that is critical as there are progressive and gradual declines in these variables as oxygen content of arterial blood declines. Venous blood oxygen tension of less than 25 mmHg is clinically significant and values below 20 mmHg probably represent the need for transfusion
  - Venous pH and base excess. Development of acidosis (low base excess) and acidemia (low pH) are indications of tissue anaerobiosis and the need for transfusion. Unlike venous blood oxygen tension and saturation, these values are normal until decompensation occurs
  - Lactate concentration (arterial or venous). Blood lactate concentrations rise rapidly when decompensation occurs. Blood lactate concentrations above 2 and below 4 mmol/L should be cause for concern and prompt closer monitoring, whereas values above 4 mmol/L probably indicate a need for transfusion
  - Evidence of organ damage, including increases in serum creatinine or bile acid concentration indicators of hepatocellular damage, and troponin.

Transfusion to correct anemia in normovolemic animals should be done cautiously to minimize the risk of excessive expansion of the intravascular volume. Ideally, packed red cells can be administered to reduced the extent of blood volume expansion. However, preparation of packed red cells can be difficult and time-consuming. An alternative with horses is simply to allow the collected blood to sit undisturbed for 1–2 hours,

during which time the cells will settle to the bottom. The red cells can then be siphoned off and administered to the recipient.

Details of donor selection, blood collection and blood administration are provided in Chapter 2.

An alternative to transfusion of whole blood or packed red cells is the administration of a commercial preparation of **stromal free hemoglobin**. This product is effective in increasing oxygen-carrying capacity of blood in anemic horses and has been used for support of a foal with alloimmune hemolytic anemia until a blood transfusion was available.<sup>59,60</sup> The compound is stable at room temperature and can therefore be stored for long periods of time and be readily available for use. However, it is expensive and its effect is short-lived (< 48 h and probably less). The recommended dose is 15 mL/kg BW intravenously, but lower doses have been used. The compound increases oncotic pressure of plasma and causes expansion of the plasma volume.

The efficacy of transfusion can be assessed by examination of the animal and measurement of venous blood oxygen tension and saturation, and blood lactate concentration. Venous blood oxygen tension and saturation improve promptly with transfusion of an adequate red cell mass.

#### Hematinics

Hematinic preparations are used in less severe cases and in animals with anemia due to iron deficiency or severe external blood loss (see Table of Drug Doses in Appendix). Iron is administered to prevent iron deficiency in young animals denied access to pasture or soil. The use of recombinant human erythropoietin in horses has a risk of inducing anemia.<sup>43,45</sup> Given that there are no known causes of low erythropoietin concentrations causing anemia in horses, with the exception of those horses with anemia subsequent to rHPO administration, the use of this compound in horses is specifically contraindicated.

#### Supportive care

The oxygen requirements of anemic animals should be minimized. This can be achieved by housing them individually in quiet stalls the temperature of which is maintained in the animal's thermoneutral zone, minimizing the need for exercise (such as grazing or following the mare to nurse), and maintaining a normal body temperature.

Animals with hemolytic anemia and hemoglobinuria should be administered polyionic isotonic fluids intravenously to reduce the risk of hemoglobinuric nephrosis.

#### Treatment of autoimmune hemolytic anemia

Some animals with autoimmune hemolytic anemia respond well to administration of corticosteroids.<sup>6,21,24</sup> Compounds used include prednisolone and dexamethasone. Horses with refractory aplastic anemia or hemolytic anemia have been administered cyclophosphamide (2 mg/kg intravenously every 14–21 d) in addition to glucocorticoids.

#### REVIEW LITERATURE

- Lassen ED, Swardson CJ. Hematology and hemostasis in the horse: Normal functions and common abnormalities. *Vet Clin North Am Equine Pract* 1995; 11:351.
- Durham AE. Blood and plasma transfusion in the horse. *Equine Vet Educ* 1996; 8:8–12.
- Knight R et al. Diagnosing anemia in horses. *Compend Contin Educ Pract Vet Equine Ed* 2005; October:23–33.

#### REFERENCES

- Hofmann-Lehmann R et al. *J Clin Microbiol* 2004; 42:3775.
- Braun U et al. *Vet Rec* 2005; 157:452.
- Lincoln SD et al. *J Am Vet Med Assoc* 1992; 200:1090.
- Gilchrist F. *Can Vet J* 1996; 37:490.
- Middleton JR et al. *J Vet Intern Med* 11:1997; 382.
- Fenger CK et al. *J Am Vet Med Assoc* 1992; 201:97.
- Winter A, Clarkson M. *In Pract* 1992; 14:283.
- Nappert GN et al. *Can Vet J* 1995; 36:104.
- Yeruham I et al. *Vet Rec* 2003; 153:502.
- Steffen DJ et al. *Vet Pathol* 1992; 29:203.
- Steffan DJ et al. *J Hered* 1993; 84:263.
- Nicholls TJ et al. *Aust Vet J* 1992; 69:39.
- Semrad SD. *Compend Contin Educ Pract Vet* 1993; 15:261.
- Pearson W et al. *Am J Vet Res* 2005; 66:457.
- Norman TE et al. *J Am Vet Med Assoc* 2005; 226:2039.
- Weiss DJ, Moritz A. *Vet Clin Pathol* 2003; 32:22.
- Beck DJ. *Equine Vet J* 1990; 22:292.
- Messer NT, Arnold K. *J Am Vet Med Assoc* 1991; 198:1415.
- Socket D et al. *J Am Vet Med Assoc* 1987; 190:308.
- Mair TS et al. *Vet Rec* 1990; 126:51.
- Lubas G et al. *Equine Pract* 1997; 19:27.
- Step DL et al. *Cornell Vet* 1990; 81:13.
- McConnico RS et al. *J Am Vet Med Assoc* 1992; 201:1402.
- Morris DD. *Equine Pract* 1990; 11:34.
- Meier J, Stocker K. *Crit Rev Toxicol* 1991; 21:171.
- Dickinson CE et al. *J Am Vet Med Assoc* 1996; 208:1866.
- Pritchard GC et al. *Vet Rec* 1985; 117:545.
- Szabo P, Bilkei G. *J Vet Med A* 2002; 49:390.
- Lindt F, Blum JW. *Zentralbl Veterinarmed A* 1994; 41:333.
- Moser M et al. *Zentralbl Veterinarmed A* 1994; 41:343.
- Vatn S, Framstad T. *Acta Vet Scand* 2000; 41:273.
- Kohn CW et al. *Am J Vet Res* 1990; 51:1198.
- Brommer H, van Oldruitenborgh-Oosterbaan MM. *J Vet Intern Med* 2001; 15:482.
- Grace ND et al. *Aust Vet J* 1999; 77:177.
- Mullaney TP, Brown CM. *Equine Vet J* 1988; 20:119.
- Pearson EG, Andreasen CB. *J Am Vet Med Assoc* 2001; 218:400.
- Girard CL, Matte JJ. *J Dairy Sci* 1998; 81:1412.
- Ordakowski-Burk AL et al. *Am J Vet Res* 2005; 66:1214.
- Piercy RJ et al. *Equine Vet J* 2002; 34:311.

- Toribio RE et al. *J Am Vet Med Assoc* 1998; 212:697.
- Finnie JW. *Aust Vet J* 1992; 69:21.
- Sipos W et al. *Vet Immunol Immunopathol* 2005; 107:303.
- Piercy RJ et al. *J Am Vet Med Assoc* 1998; 212:244.
- Woods PK et al. *Equine Vet J* 1997; 29:326.
- Schwarzwalz CR, Hinchcliff KW. *Proc Am Assoc Equine Pract* 2004; 50:270.
- MacGillivray KC et al. *J Vet Intern Med* 2002; 16:452.
- Angel KL et al. *J Am Vet Med Assoc* 1991; 198:1039.
- Cain GR et al. *Comp Haematol Int* 1994; 4:167.
- Widness JA et al. *J Appl Physiol* 2000; 88:1397.
- Malikides N et al. *Vet J* 2001; 162:44.
- Cooper C et al. *J Appl Physiol* 2005; 99:915.
- Wilkinson MJ et al. *J Vet Intern Med* 2000; 14:190.
- Davis EG et al. *J Vet Intern Med* 2002; 16:404.
- Kaplan RM et al. *Vet Parasitol* 2004; 123:105.
- Radin MJ et al. *Vet Pathol* 1986; 23:656.
- Harper SB et al. *ASAIO J* 1994; 40:M816.
- Malikides N et al. *Res Vet Sci* 1999; 67:285.
- Durham AE. *Equine Vet Educ* 1996; 8:8.
- Perkins GA, Divers TJ. *J Vet Emerg Crit Care* 2001; 11:141.
- Belgrave RL et al. *J Vet Intern Med* 2002; 16:396.

#### ERYTHROCYTOSIS

Erythrocytosis is an increase in erythrocyte count, hemoglobin concentration and hematocrit in blood. Polycythemia vera, a disease of humans and rarely small animals, and scarcely reported in cattle,<sup>1</sup> is due to an increase in concentration of all blood cellular elements (erythrocytes, granulocytes and platelets). Erythrocytosis, which is due solely to an increase in red cell count, is either relative or absolute.

**Relative erythrocytosis** occurs when the total body red cell mass (i.e. the total amount of red cells in the body) is not elevated above normal, but the red cell count in peripheral blood is higher than expected. This is the most common form of erythrocytosis. Relative erythrocytosis occurs both as an abnormality and as a physiological response to physical or psychological stress in animals with a capacious and capricious spleen. Abnormal relative erythrocytosis results from hemoconcentration and is evident as an increase in concentration of red cells and serum total protein. The cause is a reduction in plasma volume, which is usually associated with dehydration due either to lack of water intake or to excessive losses (diarrhea, vomiting). The diagnosis is usually obvious, based on the presence of hemoconcentration and other signs of the underlying disease. Physiological relative erythrocytosis occurs most noticeably in horse as a result of either excitement or exercise. The blood in the spleen of horses has a hematocrit much higher than that of blood (70–80%) and when relaxed the spleen contains many liters of blood. Excitement or exercise cause splenic contraction through an alpha-1-mediated event and ejection of

the red-cell-rich blood into the peripheral circulation, with subsequent marked increases in hematocrit.<sup>2,3</sup> The spleen of an adult horse can eject 5–10 L of blood into the circulation, which, together with a decline in plasma volume during exercise, increases hematocrit to 55–60% (0.55–0.60 L/L).<sup>2</sup>

**Absolute erythrocytosis** occurs because of an increase in the number of red blood cells in the body. It is classified as primary or secondary, and within secondary erythrocytosis there is a further classification of appropriate or inappropriate. **Primary erythrocytosis** is attributable to proliferation of erythroid progenitors with maturation of the red cell series in the absence of arterial hypoxemia or increases in plasma erythropoietin concentration. It is a myeloproliferative disorder. Disorders resembling primary erythrocytosis are described in horses.<sup>4,5</sup> These horses had marked increases in red cell count without evidence of diseases causing arterial hypoxemia or tissue hypoxia and without increases in serum erythropoietin concentration. A familial erythrocytosis is documented in cattle, but the disease resolved as animals matured, which is not consistent with primary erythrocytosis due to a myeloproliferative disorder.<sup>6</sup>

Secondary erythrocytosis is classified as either appropriate or inappropriate. **Appropriate secondary erythrocytosis** occurs as a consequence of diseases that cause tissue hypoxia with subsequent increases in plasma erythropoietin concentration. Tissue hypoxia is often inferred from the low arterial blood oxygen tension or content in these diseases. Tissue hypoxia can occur in the face of normal arterial blood oxygen tension when there is an abnormality in hemoglobin (such as chronic methemoglobinemia or carboxyhemoglobinemia), although this has not been reported as a cause of erythrocytosis in large animals. Diseases causing appropriate secondary erythrocytosis include chronic lung or respiratory disease, and congenital cardiac anomalies in which there is right-to-left shunting (such as Eisenmenger's complex in cattle). Physiological appropriate secondary erythrocytosis occurs in animals living at high altitude.

**Inappropriate secondary erythrocytosis** occurs in animals that do not have arterial hypoxemia or diseases causing tissue hypoxia. Plasma erythropoietin concentrations are elevated despite there being normal arterial oxygen tension and content, hence the term 'inappropriate'. The disease is usually associated with hepatic or renal neoplasia. The disease in horses is described in foals or young animals with hepatoblastoma<sup>7,8</sup>

and adults with hepatic carcinoma.<sup>9,10</sup> Erythrocytosis is recorded in a mare with a lymphoma that expressed the gene for equine erythropoietin, suggesting that anomalous production was the cause of the secondary inappropriate erythrocytosis.<sup>11</sup> Erythrocytosis also occurs in horses with liver disease.<sup>12</sup> The cause is not known, but could involve increased production of erythropoietin or decreased clearance because of reduced hepatic function. Inappropriate secondary erythrocytosis in ruminants or pigs is not reported, but probably occurs.

The **clinical signs** of secondary erythrocytosis are those of the underlying disease (dyspnea, congestive heart failure, cyanosis). In addition, the erythrocytosis can be evident as dark red or slightly purplish mucous membranes, lethargy and an increased propensity for thrombosis. These signs occur because of the increase in blood viscosity that results from marked increases in red cell concentration. **Treatment** is directed toward the inciting disease. For animals with primary erythrocytosis, repeated phlebotomy and restriction of iron intake has been used to reduce the red cell count.<sup>5</sup>

A syndrome is described in Standardbred trotters in Sweden that have normal red cell count at rest but counts during maximal exercise that are higher than expected.<sup>13</sup> The syndrome is referred to as 'red cell hypervolemia' and is associated with poor race performance. Diagnosis is based on a history of poor performance and hematocrit or red cell counts during maximal exercise or after administration of epinephrine that are higher than expected. Treatment is prolonged rest, although some horses have had phlebotomy and therapeutic bleeding.

#### REFERENCES

1. Fowler ME et al. *Cornell Vet* 1964; 54:153.
2. McKeever KH et al. *Am J Physiol* 1993; 265:R404.
3. Hardy J et al. *Am J Vet Res* 1994; 55:1570.
4. Beech J et al. *J Am Vet Med Assoc* 1984; 184:986.
5. McFarlane D et al. *J Vet Intern Med* 1998; 12:384.
6. Tennant B et al. *J Am Vet Med Assoc* 1967; 150:1493.
7. Cantile C et al. *Equine Vet J* 2001; 33:214.
8. Lennox TJ et al. *J Am Vet Med Assoc* 2000; 216:718.
9. Cook G et al. *Equine Vet J* 1995; 27:316.
10. Roby KA et al. *J Am Vet Med Assoc* 1990; 196:465.
11. Koch TG et al. *J Vet Intern Med* 2006; 20:000.
12. Durham AE et al. *Equine Vet J* 2003; 35:542.
13. Funkquist P et al. *Equine Vet J* 2001; 33:417.

#### ABNORMAL RED CELL FUNCTION

The primary function of red blood cells is to transport oxygen. Abnormal red cell function that results in anemia is dealt with under that heading. Abnormalities of red cell function can include abnormalities in red cell metabolism or the structure or function of hemoglobin.

Hemoglobinopathies are not well documented in large animals, with the exception of changes caused by ingestion of oxidants (nitrate, onions, kale, red maple leaves) that cause methemoglobinemia, or the recognition that inhalation of carbon monoxide causes carboxyhemoglobinemia. Both carboxyhemoglobinemia and methemoglobinemia decrease oxygen carriage by hemoglobin.

Reported abnormalities in red cell metabolism include:

- ◊ Diminished glucose-6-phosphate activity of red cells caused hemolytic anemia in an American Saddlebred colt<sup>1</sup>
- ◊ Flavine adenine dinucleotide deficiency is reported in a Spanish mustang with mild and variable anemia<sup>2</sup>
- ◊ Glutathione reductase deficiency causing hemolytic anemia in a horse.<sup>3</sup> Other abnormalities of glutathione metabolism, with minimal clinical expression, occur in sheep<sup>4,5</sup> and horses.<sup>6</sup>

#### REFERENCES

1. Stockham SL et al. *Vet Pathol* 1994; 31:518.
2. Harvey JW et al. *Vet Pathol* 2003; 40:632.
3. Dixon PM, McPherson EA. *Equine Vet J* 1977; 9:198.
4. Fisher TJ et al. *Biochim Biophys Acta* 1986; 884:211.
5. Tucker EM et al. *Br J Haematol* 1981; 48:403.
6. Fincham DA et al. *Res Vet Sci* 1985; 38:346.

## Disorders of white cells

### LEUKOPENIA

Leukopenia does not occur as a specific disease entity but is a common manifestation of a number of diseases. Neutropenia, often accompanied by lymphopenia, occurs with a number of acute viral diseases such as hog cholera and equine viral arteritis. It has also been observed in leptospirosis in cattle, although bacterial infections are usually accompanied by a leukocytosis. Acute local inflammation may cause a transient fall in the leukocyte count because of withdrawal of the circulating cells to the septic focus. Neutropenia occurs as part of the response to toxemia, and in particular endotoxemia, because of enhanced migration of neutrophils from blood into tissues. The emigration of neutrophils occurs at a rate faster than their entry into the peripheral blood from bone marrow. Lymphopenia occurs as part of a stress response, and as a result of administration of glucocorticoids.

Leukopenia also occurs as part of a pancytopenia in which all cellular elements of the blood are depressed. Agents that



depress the activity of the bone marrow, spleen and lymph nodes and result in pancytopenia occur in poisonings caused by trichloroethylene-extracted soybean meal, toluene, fungal toxins, e.g. fusario-toxicosis, notably that of *Stachybotrys alternans*, and bracken fern. Pancytopenia occurs also in radiation disease and in calves ascribed to furazolidone poisoning. The disease is discussed under the title of granulocytopenic calf disease. Chronic arsenical poisoning and poisoning by sulfonamides, chlorpromazine and chloramphenicol cause similar blood dyscrasias in humans but do not appear to have this effect in animals. Leukopenia in pigs can occur as a result of iron deficiency.<sup>1</sup>

Administration of glucocorticoids causes a lymphopenia and eosinopenia in most species. Lymphopenia is present in animals with immune deficiency such as severe combined immunodeficiency in Arabian foals and Fell pony foals with immunodeficiency.

The importance of leukopenia is that it may reduce the resistance of the animal to bacterial infection. Treatment of the condition should focus on the underlying disease, but broad-spectrum antibiotics are often administered because of the presumed greater risk of bacterial infection in leukopenic animals.

#### REFERENCE

1. Svoboda M et al. J Vet Med B 2004; 51:231.

#### LEUKOCYTOSIS

Leukocytosis, a white blood cell count in peripheral blood greater than expected in healthy animals, can be an appropriate physiological response to an infectious or inflammatory process, a result of white cell dysfunction or a result of leukoproliferative disease. In this last instance, a particular situation is that in which there is neoplasia of the immune cells with subsequent production of growth factors or interleukins that stimulate inappropriate proliferation of other cells types that are detectable in the peripheral blood. An example is horses with intestinal lymphosarcoma that have peripheral eosinophilia. The leukoproliferative diseases are dealt with under that heading.

Leukocytosis can be a result of an increase in concentration of all white blood cells or a result of increases in count of a particular subset. The changes include lymphocytosis, neutrophilia, eosinophilia, monocytosis and basophilia. Thrombocytosis is dealt with under that heading.

**Lymphocytosis** not related to infection by bovine leukemia virus is unusual. Chronic viral or bacterial infections can result in mild increases in lymphocyte count in blood but these changes have

little diagnostic significance. The ratio of T lymphocytes to B lymphocytes changes in some disease processes, but these subsets are seldom differentiated in routine clinical practice.

**Neutrophilia** is almost always a response to an inflammatory process, with the exception of the neutrophilia associated with stress ('stress' leukogram). Subacute to chronic bacterial disease or inflammation causes marked increases in neutrophil count in peripheral blood. The neutrophilia is variable and can reduce even in the presence of continuing disease, such as *R. equi* pneumonia. A **mature neutrophilia** is evident as a high neutrophil count in the absence of immature forms (band cells). A regenerative neutrophilia is characterized by normal to elevated neutrophil counts and the presence of an excessive number of immature neutrophils (so-called 'left shift'). The presence of a left shift suggests either rebound neutrophilia subsequent to neutropenia, or ongoing severe inflammation. Mature neutrophilia suggests inflammation of longer standing but is not definitive for this time frame. Mature neutrophilia can occur during the recovery stage from anemia, especially hemolytic anemia. Profound neutrophilia occurs in calves with **bovine leukocyte adhesion** deficiency and in some septicemic foals.

**Eosinophilia** is usually associated with allergy or parasitism. Examples include milk allergy in cows and intestinal parasitism in horses. Eosinophilia can occur in horses with intestinal lymphosarcoma or multisystemic eosinophilic epitheliotropic disease.

**Monocytosis** and **basophilia** are unusual in large animals with the exception of that occurring as part of a rebound bone marrow response to profound neutropenia.

#### ABNORMAL WHITE CELL FUNCTION

Abnormalities of white cell function can be either congenital or acquired. Congenital defects include Chédiak-Higashi syndrome and bovine leukocyte adhesion deficiency. Acquired defects include those associated with neoplasia of cells of the innate and adaptive immune systems, and dysfunction induced by disease, intoxication or deficiency (such as iron deficiency impairing neutrophil function). A wide variety of infectious diseases can impair function of a white blood cells, including phagocytosis of microorganisms by neutrophils or macrophages. Intoxicants such as some of the mycotoxins impair leukocyte function. Malnutrition, starvation and specific

deficiencies (e.g. iron) impair leukocyte function.<sup>1</sup>

#### REFERENCE

1. Svoboda M et al. J Vet Med B 2004; 51:231.

#### LEUKOPROLIFERATIVE DISEASE (LEUKEMIA, LYMPHOMA)

The leukoproliferative diseases are neoplastic diseases of the myeloid (hemapoeitic) or lymphoid tissues. The discussion here will be divided into those diseases associated with abnormal lymphoid cells (lymphoproliferative) and those associated with abnormal myeloid cells (myeloproliferative). The most common leukoproliferative diseases of large animals are lymphoma and lymphosarcoma.

#### MYELOPROLIFERATIVE DISEASES

Myeloproliferative disease is rare in large animals but granulocytic, eosinophilic, monocytic and myelomonocytic leukemias are reported:

- Acute (myelogenous) and chronic granulocytic leukemia are reported in horses<sup>1,2</sup>
- Acute granulocytic leukemia in a goat<sup>3</sup>
- Systemic mastocytosis in a goat<sup>4</sup>
- Acute myeloblastic leukemia in cattle<sup>5,6</sup> and horses<sup>7</sup>
- Myelomonocytic leukemia in a calf<sup>8</sup> and a horse<sup>9</sup>
- Malignant histiocytosis in cattle<sup>10</sup> and horses<sup>11</sup>
- Eosinophilic myeloproliferative disease in a horse.<sup>12</sup>

Cases manifest with nonspecific **clinical signs** including weight loss, poor performance, episodic ventral and lower limb edema, petechial hemorrhage, splenomegaly, and some with lymph node enlargement or palpable masses in the abdomen in some. Thrombocytopenia and anemia are common because of myelophthisis. Abnormal cells are often apparent on examination of a smear of peripheral blood. Immunohistochemistry and immunostaining of cells for fluorescent cell sorting can identify the abnormal cells.

The diagnosis is often obtained at necropsy examination. Antemortem diagnosis can be facilitated by examination of peripheral blood smears and bone marrow obtained by aspiration or biopsy.

There is no effective treatment, nor are there measures to prevent the disease.

#### REFERENCES

1. Ringger NC et al. Aust Vet J 1997; 75:329.
2. Searcy GP et al. Can Vet J 1981; 22:148.
3. Pruette M et al. J Vet Diagn Invest 1997; 9:318.
4. Khan KN et al. Vet Pathol 1995; 32:719.
5. Takayama H et al. J Comp Pathol 1996; 115:95.
6. Takahashi T et al. J Vet Med Sci 2000; 62:461.

7. Clark P et al. *Equine Vet J* 1999; 31:446.
8. Woods PR et al. *J Am Vet Med Assoc* 1993; 203:1579.
9. Mori T et al. *Vet Pathol* 1991; 28:344.
10. Anjiki T et al. *J Vet Med Sci* 2000; 62:1235.
11. Lester DG et al. *J Vet Intern Med* 1993; 25:471.
12. Morris DD et al. *J Am Vet Med Assoc* 1984; 185:993.

### LYMPHOPROLIFERATIVE DISEASE

Lymphoproliferative disease occurs in all large animal species but is common only in cattle, where it manifests as lymphoma or lymphosarcoma (bovine viral leukosis). The other lymphoproliferative disease is plasma cell myeloma, which occurs in ruminants and horses. Lymphangiosarcoma is a rare tumor of lymphoid endothelium in horses and cattle.<sup>1,2</sup>

#### Plasmacytoma (multiple myeloma)

This is a tumor of plasma cells that sometimes results in production of monoclonal globulins. The disease occurs in cattle,<sup>3</sup> sheep<sup>4</sup> and horses<sup>5-9</sup> and is characterized by proliferation of lymphoid cells that produce an immunoglobulin or immunoglobulin fragment (often referred to as M-protein). The disease characteristically, but not always, involves the bone marrow, in which case it is referred to as multiple myeloma. The tumor cells may or may not secrete abnormal protein.

**Clinical signs** are often nonspecific and include weight loss, anorexia, limb edema and recurrent infections. There can be signs of excessive bleeding as a result of minor trauma such as needle sticks. The tumor can infiltrate many tissues, accounting for the protean nature of the clinical signs. Involvement of cranial nerves can result in dysphagia<sup>8</sup> and infiltration of cervical vertebrae can result in pathological fracture and acute spinal cord compression.<sup>9</sup> Involvement of the mediastinal lymph nodes can cause signs of an anterior thoracic mass. The clinical signs can be sufficiently vague that the disease is easily overlooked in its early stages. Radiography reveals the presence of osteolytic bone lesions in some animals.<sup>5</sup>

**Anemia** is common and thrombocytopenia occurs in about 20% of affected horses.<sup>5</sup> Plasma cells can occasionally be seen in smears of peripheral blood. Hypoalbuminemia and hyperglobulinemia are common findings. Serum protein electrophoresis is useful in demonstrating the presence of a monoclonal proteinopathy in the alpha-2, beta, or gamma regions. Bence-Jones proteinuria occurs in approximately 20% of horses with myeloma.<sup>5</sup> Serum concentrations of specific immunoglobulins are often increased – there are two reports of horses with myeloma and elevated concentrations of IgA.<sup>6,7</sup> Hypercalcemia occurs in some affected horses<sup>5-7</sup> and can

be a result of increased concentrations of parathyroid-hormone-related protein.<sup>6</sup> Examination of bone marrow obtained by aspiration or biopsy can reveal the presence of an excess number of plasma cells (> 10%).

There is no effective **treatment**. Most animals present with advanced disease and die within days to weeks, but animals detected earlier in the disease process can live for more than 6 months.<sup>6,7</sup>

#### Lymphoma and lymphosarcoma

Bovine leukosis virus causes lymphoma in cattle and sheep, but with these exceptions the etiology of lymphoma in large animal species is unknown.

#### Ruminants and pigs

Lymphosarcoma occurs as four distinct clinical entities in cattle:

- Juvenile multicentric lymphosarcoma occurs at birth or in early life. It is multicentric and commonly involves the bone marrow and most lymph nodes
- Thymic lymphosarcoma develops in cattle from 3 months to 2 years of age and involves the thymus, occasionally spreads to other lymph nodes and rarely infiltrates other organs
- Cutaneous lymphosarcoma occurs primarily in cattle at 1–3 years of age
- Adult multicentric lymphosarcoma, bovine viral leukosis.

Lymphosarcoma in cattle is discussed in detail under the headings of bovine viral leukosis and sporadic bovine leukosis.

- Lymphoma associated with infection by bovine leukosis virus occurs in sheep.<sup>10</sup> The sporadic form of the disease can have a variety of presentations, including involvement of the brain, skin and joints in addition to the expected localization in lymphoid tissue.<sup>11-13</sup>
- Goats develop sporadic lymphoma including a multicentric form.<sup>14-16</sup>
- Pigs develop lymphosarcoma sporadically, with most forms being of B cells, although disease due to T cells is described.<sup>17,18</sup> There is also an inherited form of the disease.<sup>19,20</sup>

The clinical signs of lymphosarcoma are similar to those described for the disease associated with bovine leukosis virus in cattle. Lymphadenopathy and clinical abnormalities arising as a result of lymphadenopathy (dysphagia, bloat, respiratory distress) are common presentations. Radiography or ultrasonography are useful diagnostic aids.<sup>15</sup> Biopsy of lymph nodes can yield a diagnosis. Necropsy examination reveals lymphadenopathy and infiltration by neoplastic lymphocytes. There is no documented effective treat-

ment. Administration of glucocorticoids might cause transient improvement because of lympholysis. Radiotherapy is feasible in small ruminants or pigs of sufficient monetary or emotional value, but has not been reported.

#### Horses

##### *Etiology and epidemiology*

There is no recognized etiology of lymphoma or lymphosarcoma in horses. The disorder is more accurately described as neoplasia of one of many lymphoid cell lines, and with increasing sophistication of immunohistochemical staining it is possible to differentiate lymphoma by the particular cell line that is affected. Both immunohistochemistry of fixed tissue sections and fluorescent cell sorting of cells in body fluids have been used to determine the abnormal cell type.<sup>21,22</sup> An additional advantage of advanced testing is that tumors of uncertain origin (lymphoid, myeloid) can sometimes be characterized.<sup>22</sup>

The tumors in horses are most commonly of T-cell or B-cell lines. Equine B-cell lymphoma accounts for approximately 70% of equine lymphomas.<sup>21</sup> B-cell lymphomas that do not contain large numbers of T cells (which are not neoplastic) account for 40% of equine lymphoma and are characteristically tumors of the spleen and thoracic and mediastinal lymph nodes. B-cell tumors that contain large numbers of T cells (T-cell-rich B-cell lymphoma) account for approximately one third of equine lymphoma. These latter are typically tumors of the skin and subcutis.<sup>21</sup> T-cell lymphomas account for approximately 20% of equine lymphomas and typically cause disease involving mediastinal lymph nodes. Approximately 50% of equine lymphomas have cells that express progesterone receptors, but none express the estrogen receptor.<sup>23</sup>

The disease occurs in all **ages** of horse but there is no information on age-specific incidence. One study has reported cases in horses ranging from 4 months to 22 years of age<sup>24</sup> and the mean age of cases in this, and other case reviews, suggests that there is some increase in risk with increasing age. Limited slaughter surveys show a prevalence that varies from 0.7 to 3.2 cases per 100 000 animals.<sup>25</sup>

##### *Clinical signs*

**The clinical manifestation** of lymphosarcoma in horses is probably best described by the statement that the disease can manifest in a **protean** manner. Lymphosarcoma can exert an influence on the function of any organ system and this is determined by where it occurs in the body. Most cases, certainly over 50% of cases, are multicentric although they may present with signs that are

organ-specific and the multicentricity may not be recognized until further, more complete, clinical or postmortem examination.<sup>24</sup> External lymphadenopathy is usually a reflection of multicentric disease.<sup>26</sup>

**Common presenting histories** for other cases include chronic wasting and chronic diarrhea, upper respiratory distress with stertorous breathing or inspiratory dyspnea, lower respiratory abnormality, subcutaneous edema, anemia and fever of unknown origin.

Lymphosarcoma is the single most common cause of neoplasia in the **thorax** of the horse.<sup>27,28</sup> A common syndrome is that of weight loss, ventral edema of the neck and thorax, sometimes accompanied by pleural or peritoneal effusion, anemia, dyspnea, cough and abdominal masses palpable per rectum.<sup>24,25</sup> In cases where the lesions are predominantly in the thorax the syndrome is that produced by a space-occupying lesion,<sup>28</sup> manifested by pectoral edema, jugular vein engorgement but an absence of the jugular pulse and dyspnea. The heart may be displaced and there may be cardiac murmurs. If there is compression of the esophagus, dysphagia is present.

Another relatively common syndrome is chronic weight loss, with or without diarrhea, associated with infiltration of the **intestine**.<sup>29,30</sup> A case review of chronic diarrhea in horses found alimentary lymphosarcoma to be the cause in five of 51 cases.<sup>31</sup> Oral glucose tolerance tests are adversely affected by the intestinal infiltration of lymphosarcoma but an abnormal test is not pathognomonic for this disease.<sup>32</sup> Lymphosarcoma is also a cause of recurrent colic in horses.<sup>33</sup>

**Cutaneous lymphosarcoma** is a common disease in horses and might be the most common form of lymphoma in horses. The tumors can be solitary or multiple and are usually discrete, firm, nonpainful swellings. The swellings are often haired, but in the more severe disease there is loss of hair. The lesions tend to be on the head, neck and dorsal trunk, but can be anywhere on the body. The tumors sometimes metastasize but horses affected with a mild or waxing and waning disease can live for years. The tumor is usually a T-cell-rich B-cell lymphoma. Diagnosis is by excisional biopsy. Another variation is **mycosis-fungoides**, a T-cell lymphoma of the skin that appears to have a more aggressive course.<sup>34</sup> Pruritus with alopecia can occur as part of a paraneoplastic syndrome in horses with diffuse lymphoma.<sup>35</sup>

Lymphosarcoma is the final diagnosis in a significant proportion of horses with **fever of unknown origin**<sup>36</sup> and also should be considered in the differential diagnosis of horses with signs of ataxia or other signs of neurological disease.<sup>37,38</sup>

The organ systems affected by lymphosarcoma in the horse are not restricted to those mentioned above and individual horses may show involvement of virtually any body system.

Ultrasound can aid in the location of tumor masses or accumulation of pleural or peritoneal fluid, and in aspiration of material from these sites. Radiography is useful for detecting mediastinal disease. Rhinolaryngoscopy permits detection and assessment of disease of the pharynx.

#### Clinical pathology

A specific diagnosis can be obtained by cytology and **needle aspirates** or biopsy with cytological examination of affected lymph nodes is diagnostic. Samples can be obtained from enlarged lymph nodes or from bone marrow. Cytological examination of fluid obtained by thoracocentesis or abdominocentesis where there is thoracic or abdominal involvement is also frequently diagnostic.

**Anemia** is a consistent finding in horses with advanced lymphosarcoma. The anemia can be due to tumor cells occupying bone marrow,<sup>39</sup> but this is not a usual manifestation of the disease. More commonly, anemia is probably due to increased destruction of red cells or anemia of chronic disease. Only a small proportion of horses with lymphadenopathy due to lymphosarcoma have concurrent **leukemic** blood changes. Sézary-like cells have been detected in the blood of a horse with B-cell lymphoma.<sup>40</sup> **Thrombocytopenia** occurs in approximately 30% of cases.<sup>24</sup>

**Immunophenotyping** cells obtained at necropsy examination, by biopsy of affected organs or lymph nodes, or from peripheral blood can aid in determining the cell type involved.<sup>21,22</sup>

Hypergammaglobulinemia and hypoalbuminemia occur in some horses. **Hypergammaglobulinemia** in horses with lymphosarcoma is almost always due to a polyclonal globulinopathy – in contrast to horses with plasma cell myeloma – and is probably attributable to the inflammatory response to the tumor. Plasma fibrinogen concentrations can be elevated in horses with lymphosarcoma for the same reason.

Low serum immunoglobulin concentrations have been reported in horses with lymphosarcoma<sup>41</sup> but this finding is not specific for lymphosarcoma. Detection of low **serum IgM** concentration has poor sensitivity and specificity for diagnosis of lymphosarcoma.<sup>42</sup> The sensitivity and specificity of serum IgM below 60 mg/dL for diagnosis of lymphosarcoma in horses are 50% and 35%, respectively. This is not a good screening or diagnostic test for lymphosarcoma in horses.

Abnormalities in serum calcium concentration are uncommon and variable, with both hypocalcemia and hypercalcemia being reported. Hypercalcemia can be associated with elevated serum concentrations of parathyroid hormone related peptide.

#### Treatment

Treatment of lymphoma in horses is scarcely reported. Immunotherapy with cyclophosphamide and vaccinia-virus-infected autologous tumor cells resulted in some remission of disease in a stallion with cutaneous lymphosarcoma and the animal remained clinically stable for 19 months without tumor progression.<sup>43</sup> Removal of an ovarian granulosa theca cell tumor in a mare with waxing and waning cutaneous lymphosarcoma was associated with regression of the tumor.<sup>44</sup>

**Radiotherapy** of localized disease of the head and pharynx might be effective in treatment of the lymphoma in horses,<sup>45</sup> as lymphoma in other species is radiosensitive. Surgical removal of isolated masses in the skin is appropriate in some cases of cutaneous lymphosarcoma.

Administration of **oncolytic** agents has resulted in remission of disease in some horses. Drugs used include prednisolone, vincristine, cyclophosphamide and cytarabine. The glucocorticoids cause lysis of abnormal lymphocytes and can result in some improvement in clinical signs. A protocol that has met with some success involves administration of cyclophosphamide (2 mg/kg, intravenously) once weekly for 4–6 weeks, and then once every 2–3 weeks, combined with oral administration of prednisolone (0.5–1.5 mg/kg every 24–48 h). Another protocol involves administration of vincristine (0.008 mg/kg intravenously) and cyclophosphamide (2 mg/kg intravenously) once every 2 weeks for four to six treatments, combined with daily administration of prednisolone. The aim of all these treatments is to induce remission or to reduce clinical signs of the disease when these signs are due to lymphadenopathy (such as dysphagia, dyspnea). An example could be the treatment of a pregnant mare with retropharyngeal tumor that causes dysphagia, with a view to prolonging the mare's life until parturition.

#### REVIEW LITERATURE

McClure JT. Leukoproliferative disorders of horses. *Vet Clin North Am Equine Pract* 2000; 16:165–181.

#### REFERENCES

1. Ijzer J, van den Ingh TSGAM. *J Comp Pathol* 2000; 122:312.
2. Ruggles RG et al. *J Am Vet Med Assoc* 1992; 200:1987.
3. Kameyama M et al. *J Vet Diagn Invest* 2003; 15:166.

4. Perez J et al. *Vet Pathol* 2000; 37:479.
5. Edwards DF et al. *J Vet Intern Med* 1993; 7:169.
6. Barton MH et al. *J Am Vet Med Assoc* 2004; 225:409.
7. Pusterla N et al. *Vet Rec* 2004; 155:19.
8. McConkey S et al. *J Vet Diagn Invest* 2000; 12:282.
9. Drew RA et al. *Equine Vet J* 1974; 6:131.
10. Dimmock CK et al. *Immunol Cell Biol* 1990; 68:45.
11. Da Silva DL. *J S Afr Vet Assoc* 2002; 73:90.
12. Roels S, Vanopdenbosch E. *Vet Rec* 2001; 149:392.
13. Pearson GR et al. *J Comp Pathol* 1999; 120:295.
14. Guedes RM et al. *Vet Rec* 1998; 143:51.
15. Rozear L et al. *Vet Radiol Ultrasound* 1998; 39:528.
16. DiGrassie WA et al. *Can Vet J* 1997; 38:383.
17. Vo TD et al. *J Vet Med A* 2004; 51:348.
18. Hejazi R, Danyluk AJ. *Can Vet J* 2005; 46:179.
19. Head KW et al. *Vet Rec* 1974; 95:523.
20. McTaggart HS et al. *Vet Rec* 1979; 105:36.
21. Kelley LC, Mahaffey EA. *Vet Pathol* 1998; 35:241.
22. McClure JT et al. *J Vet Intern Med* 2001; 15:144.
23. Henson KL et al. *Vet Pathol* 2000; 29:40.
24. Rebhun WC, Bertone A. *J Am Vet Med Assoc* 1984; 184:720.
25. Van der Hoven R, Franken P. *Equine Vet J* 1983; 15:49.
26. Kofler J et al. *J Vet Med A* 1998; 45:11.
27. Sweeney CR, Gillette DM. *J Am Vet Med Assoc* 1989; 195:374.
28. Mair TS et al. *Equine Vet J* 1985; 17:428.
29. Wilson RG et al. *Equine Vet J* 1985; 17:148.
30. Platt H. *J Comp Pathol* 1987; 97:1.
31. Love S et al. *Vet Rec* 1992; 130:217.
32. Mair TS et al. *Equine Vet J* 1991; 23:344.
33. Mair TS, Hillyer MH. *Equine Vet J* 1997; 29:415.
34. Potter K, Anez D. *J Am Vet Med Assoc* 1998; 212:550.
35. Finley MR et al. *J Am Vet Med Assoc* 1998; 213:102.
36. Mair TS et al. *Equine Vet J* 1989; 21:260.
37. Zeman DH et al. *J Vet Diagn Invest* 1989; 1:187.
38. Williams MA et al. *Prog Vet Neurol* 1992; 3:51.
39. Lester GD et al. *J Vet Intern Med* 1993; 7:360.
40. Polk AC et al. *J Vet Intern Med* 1999; 13:620.
41. Furr MO et al. *J Am Vet Med Assoc* 1992; 201:307.
42. Perkins GA et al. *J Vet Intern Med* 2003; 17:337.
43. Gollagher RD et al. *Can Vet J* 1993; 34:371.
44. Henson KL et al. *J Am Vet Med Assoc* 1998; 212:1419.
45. Weaver MP et al. *Equine Vet J* 1996; 28:245.

## Lymphadenopathy (lymphadenitis)

Lymph nodes can be enlarged because of inflammation (lymphadenitis) or infiltration with neoplastic cells. Enlargement of peripheral nodes causes visible and palpable swellings and in some cases obstruction to lymphatic drainage and subsequent local edema, as in sporadic lymphangitis of horses. Enlargement of internal nodes may cause obstruction of the esophagus or pharynx, trachea or bronchi. Enlargement of the lymph nodes can occur as a result of infection or of neoplastic invasion. Lymphadenopathy as part of lymphoma and lymphosarcoma are discussed under 'Leukoproliferative diseases'.

**Lymphadenitis** occurs most commonly in response to infection or inflammation in

the region of the body distal to, and drained by, the lymph node. Lymphadenitis also accompanies other signs in many other diseases, including bovine malignant catarrh, sporadic bovine encephalomyelitis, the porcine reproductive and respiratory syndrome, East Coast fever, Ondiri disease and ephemeral fever.

Infection and enlargement of lymph nodes is the major presenting sign in a small number of diseases, which include:

- Caseous lymphadenitis of sheep and ulcerative lymphangitis in horses and cattle due to infection with *Corynebacterium pseudotuberculosis*
- Internal abscessation associated with *C. pseudotuberculosis* in horses<sup>1</sup>
- Anthrax, especially in the pig but also in the horse, which may initially manifest as cervical lymphadenopathy with considerable inflammation and swelling in the pharyngeal region and neck
- Strangles in horses associated with *S. equi* and lymphadenitis produced by *Streptococcus zooepidemicus*. Lymphadenopathy that causes enlargement of abdominal lymph nodes is a characteristic of infection with *S. equi* in the burro
- Anorectal lymphadenopathy in young horses, causing extraluminal rectal obstruction with colic and sometimes urinary dysfunction<sup>2</sup>
- Cervical adenitis (jowl abscess) of pigs, caused principally by group E type IV *Streptococcus* sp. but also by *Actinomyces pyogenes* and *Pasteurella multocida*
- Granulomatous cervical adenitis, which also occurs in pigs and is a common finding at slaughter. The lesions rarely cause clinical illness but are a public health concern because they may be tuberculosis. Most commonly they are associated with *R. equi* or atypical mycobacteria but *Mycobacterium tuberculosis*, *Mycobacterium avium* and *Mycobacterium bovis* are also causes
- Tularemia, infection with *Francisella tularensis*, in tick-infested sheep
- Melioidosis associated with infection with *Pseudomonas (Malleomyces) pseudomallei*
- Tick pyemia associated with *Staphylococcus aureus* in sheep infested with the tick *Ixodes ricinus*
- Retropharyngeal lymph node enlargement up to three or four times normal, and colored bright green, have been identified in cattle as resulting from infection with the algae *Prototheca* spp.<sup>3</sup>
- Tuberculosis

- Lymphadenitis in lambs associated with *P. multocida*, and in some cases of actinobacillosis
- Morel's disease of sheep associated with a micrococcus
- Bovine farcy and atypical skin tuberculosis, the latter involving the lymphatics but not associated with lymph node enlargement.

In acute lymphadenitis there may be pain and heat on palpation but the nodes are for the most part painless. Obstructions produced by enlarged lymph nodes can result in secondary signs such as respiratory difficulty with enlargement of the retropharyngeal lymph nodes and esophageal obstruction by enlarged mediastinal lymph nodes. Needle biopsy for cytology and culture can aid in the determination of the cause of lymphadenitis and can allow the differentiation between lymphadenitis and neoplastic enlargement. Ultrasound may also aid in diagnosis.<sup>4</sup> The diseases above are discussed in more detail under their specific headings.

**Absence of lymphoid tissue** occurs as a congenital defect in Arabian foals with severe combined immunodeficiency and is recorded in an Angus calf.

## REFERENCES

1. Pratt SM et al. *J Am Vet Med Assoc* 2005; 227:441
2. Magee AA et al. *J Am Vet Med Assoc* 1997; 210:804.
3. Rogers RJ et al. *J Comp Pathol* 1980; 90:1.
4. Kofler J et al. *Vet Rec* 1998; 14:425.

## Diseases of the spleen and thymus

The spleen serves a number of functions – it is a storage organ for blood, a source of extramedullary erythropoiesis in some species, a major component of the reticulo-endothelial system, and an important component of the immune system. Its function is most evident in the horse, in which an intact and functioning spleen is necessary for normal work capacity. Blood in the spleen of horses has a hematocrit much higher than that of blood (70–80%) and when relaxed the spleen contains many liters of blood. Excitement or exercise cause splenic contraction through an alpha-1-mediated event and ejection of the red-cell-rich blood into the peripheral circulation, with subsequent marked increases in hematocrit.<sup>1,2</sup> The spleen of an adult horse can eject 5–10 L of blood into the circulation and, together with declines in plasma volume during exercise, increase hematocrit to 55–60% (0.55–0.60 L/L).<sup>1</sup>

Splenectomy is performed as part of treatment of idiopathic refractory thrombocytopenia, or as a consequence of splenic infarction. Removal of the spleen (splenectomy) impairs the oxygen-carrying capacity of blood during exercise, by preventing the normal increase in hematocrit, and prevents the normal cardiovascular responses to exercise, including increases in right atrial pressure.<sup>3,4</sup>

### SPLENOMEGALY

Diffuse diseases of the spleen that result in enlargement are usually secondary to diseases in other organs. **Splenomegaly** with complete destruction of splenic function is virtually symptomless, especially if the involvement occurs gradually, and in most cases clinical signs are restricted to those caused by involvement of other organs. An enlarged spleen may be palpable on rectal examination in the horse and careful percussion may detect enlargement of the spleen in cattle, but in most instances involvement of the organ is not diagnosed at antemortem examination unless laparotomy is performed.

Left dorsal displacement of the colon in the horse is a colic in which the spleen is displaced medially and this may give the impression that the organ is enlarged.

**Rupture** of a grossly enlarged spleen may cause sudden death due to internal hemorrhage. This is sometimes the cause of death in bovine viral leukosis or equine amyloidosis.<sup>5</sup> **Moderate degrees of splenomegaly** occur in many infectious diseases, especially salmonellosis, anthrax, babesiosis, equine infectious anemia and diplococcus septicemias in calves, and in some noninfectious diseases such as copper toxicity in sheep. Animals that die suddenly because of lightning stroke, electrocution and euthanasia may also show a moderate degree of splenomegaly but the enlargement is minor compared to that observed in congestive heart failure, portal obstruction or neoplastic change.

**Neoplasms** of the spleen are not common in large animals but may include lymphosarcoma, hemangiosarcoma, myelocytic leukemia or malignant melanoma in horses.<sup>6-8</sup> Metastasis of hepatic carcinoma to the spleen of a dairy cow is reported.<sup>9</sup> The abnormality is usually readily detected by ultrasonographic examination of the spleen. They may be discovered incidentally during rectal examination or because of colic resulting from displacement of the bowel by the enlarged spleen.

### SPLENIC ABSCESS

Splenic abscess may result when a septic embolus lodges in the spleen, but is more commonly caused by extension of infection

from a neighboring organ. Perforation by a foreign body in the reticulum of cattle is the commonest cause of the disease in large animals and gastric penetration by sharp metal have caused splenitis in the horse. Perforation of a gastric ulcer or an erosion of the gastric wall caused by *Gasterophilus intestinalis*<sup>10</sup> or extension of a granuloma caused by larvae of *Habronema* sp. in horses may lead, by extension, to development of a suppurative lesion in the spleen. In those occasional cases of strangles in horses in which systemic spread occurs, splenic abscess occasionally occurs.

Splenic abscesses associated with *C. pseudotuberculosis* infection are diagnosed in horses in those parts of the world where the infection is endemic. The most common clinical signs are concurrent external abscesses, anorexia, fever, lethargy, weight loss and signs of respiratory tract disease or abdominal pain. Clinicopathological abnormalities included serum synergistic hemolysin inhibition titer of 512 or more, and leukocytosis with neutrophilia, hyperglobulinemia, hyperfibrinogenemia and anemia. Diagnosis is based on the presence of appropriate clinical signs and ultrasonographic examination of the spleen. Prolonged treatment with antimicrobials is successful in most cases.<sup>11</sup>

If the abscess is extensive and acute there are systemic signs of fever, anorexia and increased heart rate. Pain is evidenced on palpation over the area of the spleen and hematological examination reveals a marked increase in the total white cell count and a distinct shift to the left in the differential count.

**Abdominocentesis** usually provides evidence of chronic peritonitis by the presence of a large amount of inflammatory exudate. Peritonitis is often coexistent and produces signs of mild abdominal pain with arching of the back and disinclination to move. Mild recurrent colic may also occur. Anemia, with marked pallor of mucosae, and terminal ventral edema are also recorded. The spleen may be sufficiently enlarged to be palpable per rectum.<sup>12</sup>

**Treatment** of splenic abscess is often unrewarding because of the extensive nature of the lesion before clinical signs appear. The systemic signs can usually be brought under control by treatment with sulfonamides or antibiotics over a period of about 7 days but relapses are common and death is the almost certain outcome. Splenectomy is recommended if adhesions and associated peritonitis are absent.

### SPLENIC HEMATOMA, RUPTURE OR INFARCTION

Formation of a **hematoma** in the spleen or, in the more severe instance, splenic

**rupture** usually occurs as a result of trauma. The syndrome is best described in horses, occurring as a result of falling on to a stirrup or blunt trauma to the left side of the rib cage.<sup>7,13,14</sup> The clinical signs include colic, tachycardia, cold extremities and pallor of the mucous membranes – all, of which are suggestive of hemorrhagic shock. If a hematoma is present ultrasonographic examination of the abdomen will reveal an abnormally shaped spleen containing a hypoechoic mass. Rupture of the spleen will be apparent as accumulation of a large quantity of fluid within the abdomen. The fluid will have the ultrasonographic characteristics of blood (a swirling echodensity). Laparoscopy can be used to confirm the diagnosis. Hematology can reveal leukocytosis and low hematocrit. Peritoneal fluid can be serosanguinous if the hematoma has not ruptured, or bloody if the spleen is ruptured.

**Infarction** of the spleen is reported rarely in horses and so predisposing factors are not identified.<sup>15</sup> In other species splenomegaly predisposes to infarction. The clinical signs are mild to moderate colic, tachycardia and signs of hemorrhagic shock. Ultrasonography and exploratory laparotomy are diagnostic. The spleen is enlarged and has numerous zones of varying echogenicity, which is in marked contrast to the usual homogeneous echogenicity of normal spleen. There can be excessive, echogenic fluid in the abdomen consistent with blood. Treatment is surgical, although technically challenging because of the splenomegaly and risk of rupture of the spleen.

**Treatment** of a splenic hematoma is conservative, with enforced rest for a period of up to 3 months. Resolution of the hematoma can be monitored by periodic ultrasonographic examination. Horses with a ruptured spleen usually die within a short period of time. Theoretically, emergency splenectomy might be useful, but timely diagnosis and surgery is difficult to achieve because of the short time course of the disease.

### REFERENCES

- McKeever KH et al. *Am J Physiol* 1993; 265:R404.
- Hardy J et al. *Am J Vet Res* 1994; 55:1570.
- McKeever KH et al. *Am J Physiol* 1993; 265:R409.
- Kunugiya M et al. *J Vet Med Sci* 1997; 59:733.
- Pusterla N et al. *J Vet Intern Med* 2005; 19:344.
- Chaffin MK et al. *J Am Vet Med Assoc* 1992; 201:743.
- Geelen SNJ et al. *Tijdschr Diergeneesk* 1996; 121:544.
- MacGillivray KC et al. *J Vet Intern Med* 2002; 16:452.
- Jeong WI et al. *Vet Pathol* 2005; 42:230.
- Dart AJ et al. *Aust Vet J* 1987; 64:155.
- Pratt SM et al. *J Am Vet Med Assoc* 2005; 227:441.
- Spier S et al. *J Am Vet Med Assoc* 1986; 189:557.
- Dyke TM, Friend SCE *Equine Vet J* 1998; 20:138.
- Ayala I et al. *Aust Vet J* 2004; 82:479.
- Roy MF et al. *Equine Vet J* 2000; 32:174.

## CONGENITAL ANOMALIES

Abdominal situs inversus is reported in a calf.<sup>1</sup> The calf had a rumen that was on the right side of its abdomen, and two spleens, among other abnormalities. The clinical presentation was chronic bloat.

### REFERENCE

1. Fisher KR et al. *Anat Rec* 2002; 267:47.

## THYMUS

The thymus is the source of T cells in animals and is essential for development of normal immune responses. These functions occur during late gestation and in the neonate. Primary diseases of the thymus are rare in farm animals. The thymus is largest, relative to body size, in neonates and atrophies in adults to the extent that it can be difficult to identify. Aplasia or thymic hypoplasia occurs as part of severe combined immunodeficiency in Arabian foals. Aplasia of the thymus is reported in a Holstein calf.<sup>1</sup> The congenital condition results in increased susceptibility to infection. Extrathoracic thymus tissue occurs in lambs and can be mistaken for enlargement of the thyroid glands.<sup>2</sup> Neoplasia of the thymus occurs in most species. Thymic lymphomas are reported in horses,<sup>3</sup> pigs<sup>4</sup> and calves.<sup>5</sup> Thymoma and thymic carcinoma are reported in horses and cattle.<sup>6-8</sup> The clinical syndrome is that of a cranial thoracic mass. There can be compression of the cranial vena cava with obstructed blood flow and signs of congestive heart failure. The jugular veins are distended and there can be submandibular edema. There can be accumulation of excessive pleural fluid. Esophageal obstruction evident as bloat in cattle or dysphagia in cattle and horses occurs. Radiography or ultrasonography of the chest demonstrate the mass, and histological diagnosis can be achieved at necropsy or in samples obtained by fine-needle biopsy.

### REFERENCES

1. Yeruham I et al. *J Vet Med B* 2000; 47:315.
2. Kock ND et al. *Vet Rec* 1989; 124:635.
3. Van den Hoven R, Franken P. *Equine Vet J* 1983; 15:49.
4. Kadota K et al. *Zentralbl Veterinärmed A* 1990; 37:592.
5. Angel KL et al. *J Am Vet Med Assoc* 1991; 198:1771.
6. Whitely LO et al. *Vet Pathol* 1986; 23:627.
7. Norrfin RW. *Cornell Vet* 1970; 60:617.
8. Oda S et al. *J Vet Med Sci* 1999; 61:561.

## Immune deficiency disorders (lowered resistance to infection)

Increasingly, animals are encountered that are much more susceptible to infection than their cohorts. These animals

may be suffering because of a reduction in their immune function and need to be identified as such. The history and signs that should suggest the possible presence of compromised immune function are:

- Infections developing in the first 6 weeks of life
- Repeated or continuous infections that respond poorly to treatment
- Increased susceptibility to low-grade pathogens and organisms not usually encountered in immunocompetent animals
- Administration of attenuated vaccines leading to systemic illness
- Low leukocyte counts, either generally or as lymphopenia or neutropenia, perhaps within an associated low platelet count.

It is not proposed to detail the mechanisms of humoral and cellular immunity here because there is a large literature based on the subject in immunology. However, it is necessary to remember that the normal immune response is a very complicated process, including many sequential steps, and there are various sites at which defective development or function can occur.

The disorders of immunity may be **primary**, in which the animal is born with a congenital defect of one of the immune processes, or **secondary**, in which the animal has a normal complement of immunological processes at birth but suffers a dysfunction of one of them, often temporarily, during later life. Toxicological and microbiological agents can have this effect.

Immunosuppression is a state of temporary or permanent dysfunction of the immune response resulting from damage to the immune system and leading to increased susceptibility to disease agents.<sup>1</sup> In immunosuppression there is decreased immune responsiveness to all foreign antigens, whereas in immune tolerance there is a state of decreased or nonresponsiveness to one particular antigen. Immunosuppression may be associated with infectious and non-infectious agents. A review of the general aspects of immunosuppression and the various agents responsible is available.<sup>1</sup> Infectious agents include bacteria, viruses, protozoa and helminths; noninfectious causes include chemicals, hormones and some antimicrobials such as chlortetracyclines and toxins. Environmental factors such as extremes of temperature, humidity, high population density and mixing animals from different origins, and prolonged transportation have also been implicated as causes of immunosuppression but the pathogenesis of these has not been well explained.

Various laboratory methods can be used to evaluate immunosuppression. The criteria which can be used to evaluate immune functions include:

- Gross and microscopic changes in the morphology of central or peripheral lymphoid tissues
- Changes in the concentration or ratios of different classes of immunoglobulin
- Changes in serum complement concentration
- Changes in the functional activity of immunoglobulins
- Changes in functional activity of the immune response
- Interference with the results of vaccination
- Exacerbation in the course of disease associated with other agents
- Changes in the number and viability of cells from lymphoid organs.<sup>1</sup>

The development of monoclonal antibody reagents has allowed new approaches to veterinary immunopathology, particularly the identification and analysis of leukocyte subpopulations in health and disease.<sup>2</sup>

Most of the diseases associated with immunological deficiency states are dealt with in systems or other categories of disease throughout this book and only a checklist is provided here.

## PRIMARY IMMUNE DEFICIENCIES

The primary immunodeficiencies can be in either innate immunity or adaptive immunity. Deficiencies of **innate immunity** include:

- Chédiak-Higashi syndrome, an inherited defect of many animal species, including cattle. This is a defect of phagocytic capacity via the neutrophils and monocytes
- Bovine leukocyte adhesion deficiency of Holstein calves, which results from a deficiency in CD18 and accumulation of profound numbers of neutrophils in circulation but not in tissue.

Deficiencies of **adaptive immunity** include:

- Combined immunodeficiency (CID) of Arabian horses due to an inherited failure to produce and differentiate lymphoid precursor cells into B and T lymphocytes. See Table 34.2 for a listing of immunodeficiencies of horses. A similar disease is reported in an Angus calf
- Agammaglobulinemia of Standardbred and Thoroughbred horses, a probably inherited failure to produce B lymphocytes. These horses live much longer than those affected with CID

- Selective deficiencies of one or more globulins. A deficiency of IgM in Arabian horses and Quarter horses is listed.<sup>3</sup> IgM and IgA combined deficiencies with diminished but discernible levels of IgG are observed occasionally in horses. A transient hypogammaglobulinemia (absence of IgG) has been reported in one Arabian foal, which was immunodeficient until it was 3 months old and then became normal
- Selective IgG<sub>2</sub> deficiency in Red Danish cattle
- A syndrome of immunodeficiency in Fell ponies
- Common variable immunodeficiency is described in adult horses<sup>4,5</sup>
- Lethal trait A46 (inherited parakeratosis) of cattle is a primary immunodeficiency influencing T lymphocytes, with impairment of cellular immunity
- Selective IgG<sub>2</sub> deficiency of cattle causes increased susceptibility to gangrenous mastitis and other infections. It is a primary deficiency of IgG<sub>2</sub> synthesis, and is recorded in the Red Danish milk breed
- Sheep and pigs – there are as yet no recognized primary immunodeficiencies in these species.

## SECONDARY IMMUNE DEFICIENCIES

These are as follows:

- Failure of transfer of passive immunity, i.e. of antibodies from colostrum to the offspring, is well known as the commonest cause of deficient immunity in the newborn and is discussed in Chapter 3
- Atrophy of lymphoid tissue and resulting lymphopenia associated with:
  - Viral infections such as equine herpes virus in newborn foals, rinderpest, bovine virus diarrhoea, swine fever, porcine circovirus<sup>6</sup> and hog cholera. All these cause lymphatic tissue suppression and a diminished immunoresponsiveness. The pathogenesis of the immunodeficiency associated with the bovine viral diarrhoea (BVD) virus may be due to impairment of the function of polymorphonuclear cells
  - Bacterial infections such as *Mycoplasma* spp. and *Mycobacterium paratuberculosis* have approximately the same effect as the above
  - Physiological stress such as birth may cause immunosuppression in

- the fetus, making it very susceptible to infection in the period immediately after birth. There is a similar depression of immunological efficiency in the dam immediately after parturition, which, for example, leads to periparturient rise of worm infestation in ewes. Psychological stress in experimental animals does increase susceptibility to infection, but the practical importance of this to animal production is not clear
- Toxins such as bracken, tetrachlorethylene-extracted soybean meal, T<sub>2</sub> mycotoxin and atomic irradiation suppress leukopoiesis. Immunosuppression is also attributed to many environmental pollutants, including polychlorinated biphenyls, 2,4,5-T contaminants, DDT, aflatoxin and the heavy metals
  - General suppression of immune system responsiveness, e.g.:
    - Glucocorticoids administered in large doses or over long periods reduce the activity of neutrophils and the number of circulating lymphocytes, although the reduction varies widely between species. The production of antibodies is also reduced
    - Nutritional deficiency, especially of zinc, pantothenic acid, calcium and vitamin E, cause general suppression. A total caloric deficiency has a similar effect. Addition of certain trace elements such as copper, iron, zinc and selenium in animal feeds is necessary for an adequate immunity. Selenium, alone or in combination with vitamin E, can enhance antibody responses, whereas its deficiency results in immunosuppression. Selenium supplementation in animal feeds is important to enhance both antibody production and phagocytic activity of neutrophils. In cattle, copper deficiency induced by molybdenum or iron can cause an impairment in the ability of neutrophils to kill ingested *Candida albicans*.<sup>1</sup> A review of the influence of immunoenhancing vitamins in cattle is available. Nutrients that stimulate disease resistance include carotenoids, vitamins A, E, and C, zinc, manganese, copper and selenium. Neonatal calves may have low reserves of carotene and vitamins A and E and are dependent upon obtaining them from colostrum, which contains

- highly variable quantities. Administration of drugs that impair folate metabolism can induce anemia and depletion of white blood cells, with subsequent bacterial infection<sup>7</sup>
- Experimentally, a protein–energy malnutrition in neonatal calves results in loss of body weight, and decreased lymphocyte interleukin-2 activity and lymphocyte proliferation when compared to calves of similar age
  - Exposure to cold and heat stress for periods of several weeks duration
  - Events associated with parturition, in particular glucocorticoid release, that impair innate immunity.<sup>8</sup>

## REFERENCES

1. Muneer MA et al. Br Vet J 1988; 144:288.
2. MacKay CR, MacKay IR. Br Vet J 1989; 145:185.
3. Perryman LE et al. J Am Vet Med Assoc 1977; 170:212.
4. Flaminio J et al. J Am Vet Med Assoc 2002; 221:1296.
5. Pellegrini-Masini A et al. J Am Vet Med Assoc 2005; 227:114.
6. Shibahara T et al. J Vet Med Sci 2000; 62:1125.
7. Piercy RJ et al. Equine Vet J 2002; 34:311.
8. Burton JL et al. Vet Immunol Immunopathol 2005; 105:197.

## Amyloidoses

The amyloidoses are a group of diseases characterized by the deposition of an extracellular proteinaceous substance, amyloid, in the tissues with subsequent disruption of normal tissue architecture leading eventually to organ dysfunction. Amyloidosis in farm animals usually occurs in association with a chronic suppurative process elsewhere in the body and is due to accumulation of AA amyloid. Another form of the disease involves accumulation of AL amyloid, especially as localized disease in horses.

### ETIOLOGY AND EPIDEMIOLOGY

Amyloidosis occurs rarely and when it does occur it is most common in animals exposed systemically and repeatedly to antigenic substances. Examples include repeated injections of antigenic material for commercial production of hyper-immune serum and long-standing suppurative diseases or recurrent infection as in Chédiak–Higashi syndrome. Severe strongyloid parasitism in the horse has been reported as a cause. Holstein calves with bovine leukocyte adhesion deficiency have accumulation of amyloid in tissue, although this is not the primary disease. Many cases of amyloidosis in large animals are without apparent cause.

The incidence of visceral AA amyloidosis in slaughtered cattle in a group of



302 cattle older than 4 years of age in Japan was 5.0% compared with those previously reported from Japan and other countries ranging from 0.4–2.7%.<sup>1</sup> Systemic AA-amyloidosis associated with tuberculosis has been described in a European wild boar.<sup>2</sup> Systemic amyloidosis in goat kids with chronic arthritis associated with seroconversion to *Erysipelothrix rhusiopathiae* has been described.<sup>3</sup>

Out of 16 000 horses referred for clinical examination into a veterinary teaching hospital over a period of 13 years, nine horses were identified with amyloidosis.<sup>4</sup> Cutaneous amyloidosis has been associated with malignant histiocytic lymphoma in the horse.<sup>5</sup>

A case of cardiac amyloidosis causing heart failure in a 16-year-old Thoroughbred gelding has been described.<sup>6</sup> The disease was due to accumulation of AL amyloid.<sup>6</sup>

The AL form of amyloidosis is characteristically associated with unstable monoclonal immunoglobulin light chains produced by plasma cell dyscrasia and resulting in deposition of AL fibrils.<sup>6</sup>

#### **PATHOGENESIS**

How amyloid is formed is uncertain but a hyperglobulinemia is commonly present and this, together with the circumstances under which it occurs, suggest an abnormality of the antigen-antibody reaction. Amyloidoses are classified by the types of amyloid protein deposited. AA amyloid is derived from serum amyloid-A protein (SAA), which is an acute-phase reactant produced by hepatocytes.<sup>7</sup> However, increased concentrations of SAA alone are not sufficient to cause amyloidosis. AA (secondary) amyloidosis is associated with recurrent acute or chronic infections, inflammatory disease or neoplasia.

Extensive amyloid deposits may occur in the spleen, liver or kidneys and cause major enlargement of these organs and serious depression of their functions. The commonest form that is clinically recognizable in animals is renal amyloidosis. This presents as a nephrotic syndrome with massive proteinuria and a consequent hypoproteinemia and edema. Terminally, the animal is uremic, becoming comatose and recumbent. The edema of the gut wall and its infiltration with amyloid create the conditions necessary for the development of diarrhea. In horses, cases of multiple cutaneous lesions are recorded. The amyloid is present in 5–25 mm diameter nodes in the skin of the head, neck and pectoral regions.

Rare cases of involvement of the upper respiratory tract (nasal cavities, pharynx, larynx, guttural pouch and lymph nodes of the head and neck, and conjunctiva)

are also recorded in horses. The amyloid material deposited in the tissues is usually of the AL form, whereas systemic disease is almost always the AA form.

AL amyloidosis is also reported in an adult cow with bovine leukocyte adhesion deficiency.<sup>8</sup>

#### **CLINICAL FINDINGS**

Many cases of amyloidosis are detected incidentally at necropsy. The cutaneous form in horses is characterized by the presence of hard, nonpainful, chronic plaques in the skin.<sup>5</sup> Most of the lesions, which can be widespread and severe, are on the sides of the neck, shoulders and head. Respiratory tract involvement in the horse is usually limited to the nasal cavities, and this may cause dyspnea.<sup>4</sup>

Chronic heart failure due to cardiac amyloidosis secondary to systemic amyloidosis in a 16-year-old gelding was characterized clinically by weight loss, dysphagia, recurrent episodes of esophageal obstruction and anorexia of a few weeks duration.<sup>1</sup> Ventral edema, tachycardia and irregular heart rate associated with atrial fibrillation were present. The clinical findings were consistent with biventricular heart failure from ventricular dysfunction, atrial fibrillation and pulmonary hypertension. The amyloid was of the AL form.

A case of systemic AL amyloidosis associated with multiple myeloma in a horse was characterized clinically by rapid weight loss, muscle atrophy, soft unformed feces and ventral edema.<sup>9</sup>

Hemoperitoneum and acute death secondary to splenic or hepatic rupture in horses with systemic amyloidosis is reported.<sup>10</sup>

Clinical cases in cattle are characterized by emaciation and enlargement of the spleen, liver or kidneys; involvement of the kidney causes proteinuria and is often accompanied by profuse, chronic diarrhea, polydipsia and anasarca. In cattle the grossly enlarged left kidney is usually palpable per rectum. Cases may occur within 2 weeks of calving. They are characterized by anorexia, watery diarrhea, anasarca, rapid emaciation and death in 2–5 weeks.

Corpora amyloacea are small, round concretions of amyloid material found in mammary tissue of cows. They are usually inert but may cause blockage of the teat canal.

#### **CLINICAL PATHOLOGY**

An extreme, persistent proteinuria should suggest the presence of renal amyloidosis. Electrophoretic studies of serum may be of value in determining the presence of hyperglobulinemia. Alpha-globulin levels are usually elevated and albumin levels depressed. Horses with hepatic amyloidosis have elevated activities of gamma-glutamyltransferase and, to a lesser extent,

bile acids.<sup>11</sup> In cattle there is hypocalcemia, hyperfibrinogenemia, hypomagnesemia, high serum urea and creatinine concentration, low-specific-gravity urine and prolongation of the bromsulfoleïn clearance time. Biopsy of cutaneous plaques is an accurate diagnostic technique.

#### **NECROPSY FINDINGS**

Affected organs are grossly enlarged and have a pale, waxy appearance. In the spleen, the deposits are circumscribed; in the liver and kidneys they are diffuse. In a horse with systemic AL amyloidosis associated with multiple myeloma, diffuse gastrointestinal hemorrhage, thickened jejunal mucosa and splenomegaly were present.<sup>9</sup>

The pathology of AA amyloidosis in domestic sheep and goats has been described.<sup>12</sup> Most sheep had pneumonia and other sites of chronic inflammation. Amyloid was detected in all grossly affected kidneys using Congo red staining.

Deposits of amyloid in tissues may be made visible by staining with aqueous iodine. Amyloid is detected as green birefringence of Congo-Red-stained tissues viewed under polarized light. AA and AL amyloidosis can be differentiated by treatment of tissue sections with potassium permanganate. Tissue containing AA will lose its green birefringence after treatment with potassium permanganate whereas tissue containing AL will continue to appear green after Congo Red staining and viewing under polarized light.

The Shtrasburg method is now available for the identification of AA amyloid and to distinguish it from amyloid types in a large number of domestic and wild animals.<sup>13</sup>

#### **DIFFERENTIAL DIAGNOSIS**

Enlargement of parenchymatous organs associated with chronic suppurative processes should arouse suspicion of amyloidosis, especially if there is emaciation and marked proteinuria.

Pyelonephritis, nonspecific nephritis and nephrosis bear a clinical similarity to amyloidosis.

#### **TREATMENT**

There is no effective treatment of the systemic disease. The localized disease as occurs in the upper respiratory tract of horses can be treated by surgical excision, but the results are not encouraging.

#### **REVIEW LITERATURE**

Grays E. Amyloidosis in the bovine kidney. *Vet Sci Commun* 1977; 1:265.

#### **REFERENCES**

- Tojo K et al. *Amyloid* 2005; 12:103.
- Segales J et al. *J Vet Med A Physiol Pathol Clin Med* 2005; 52:135.

3. Wessels M. *Vet Rec* 2003; 152:302.
4. Van Andel ACJ et al. *Equine Vet J* 1988; 20:277.
5. Gliatto JM, Alroy J. *Vet Rec* 1995; 137:68.
6. Nout YS et al. *J Vet Intern Med* 2005; 17:588.
7. Vanhooser SL et al. *Equine Vet J* 1988; 20:274.
8. Taniyama H et al. *Vet Pathol* 2000; 37:98.
9. Kim DY et al. *Vet Pathol* 2005; 42:81.
10. Pusterla N et al. *J Vet Intern Med* 2005; 19:344.
11. Abdelkader SV et al. *J Comp Pathol* 1991; 105:203.
12. Mensua C et al. *Vet Pathol* 2003; 40:71.
13. Shtrasburg S et al. *Vet Pathol* 2005; 42:132.

---

## Porphyrias

---

Porphyria is not common in farm animals.<sup>1</sup> The congenital disease in cattle is discussed in Chapter 34.

### REFERENCE

1. Rimington D, Moore MR. *Clin Dermatol* 1985; 3:144.

## Diseases of the respiratory system

**PRINCIPLES OF RESPIRATORY INSUFFICIENCY 471**

- Definitions 471
- Hypoxia 472
- Compensatory mechanisms 473
- Carbon dioxide retention (hypercapnia) 473
- Respiratory failure 473

**PRINCIPAL MANIFESTATIONS OF RESPIRATORY INSUFFICIENCY 473**

- Abnormalities in rate, depth and ease of breathing 474
- Abnormal posture 475
- Normal and abnormal breath sounds 475
- Respiratory noises 478
- Coughing 478
- Cyanosis 479
- Nasal discharge 479
- Epistaxis and hemoptysis 480
- Thoracic pain 480

**SPECIAL EXAMINATION OF THE RESPIRATORY SYSTEM 480**

- Auscultation and percussion 481
- Endoscopic examination of the airways (rhinolaryngoscopy, tracheobronchoscopy) 481
- Radiography 482
- Scintigraphy (nuclear imaging) 483
- Ultrasonography 483
- Laboratory evaluation of respiratory secretions 484

- Pulmonary function tests 489
- Arterial blood gas analysis 490
- Venous blood gas analysis 491
- Pulse oximetry 492
- Blood lactate concentration 492
- Collection and analysis of exhaled breath condensate 492
- Lung biopsy 492
- Respiratory sound spectrum analysis 493
- Exercise testing 493

**PRINCIPLES OF TREATMENT AND CONTROL OF RESPIRATORY TRACT DISEASE 493**

- Treatment of respiratory disease 493
- Control of respiratory disease 496

**DISEASES OF THE LUNGS 498**

- Pulmonary congestion and edema 498
- Pulmonary hypertension 500
- Atelectasis 500
- Acute respiratory distress syndrome 501
- Pulmonary hemorrhage 501
- Pulmonary emphysema 507
- Pneumonia 508
- Aspiration pneumonia 515
- Caudal vena caval thrombosis (posterior vena caval thrombosis) and embolic pneumonia in cattle 516
- Cranial vena caval thrombosis 517
- Pulmonary abscess 517
- Pulmonary and pleural neoplasms 518

**DISEASES OF THE PLEURA AND DIAPHRAGM 519**

- Hydrothorax and hemothorax 519
- Pneumothorax 519
- Diaphragmatic hernia 521
- Synchronous diaphragmatic flutter in horses (thumps) 521
- Pleuritis (pleurisy) 522
- Equine pleuropneumonia (pleuritis, pleurisy) 525

**DISEASES OF THE UPPER RESPIRATORY TRACT 530**

- Rhinitis 530
- Obstruction of the nasal cavities 531
- Laryngitis, tracheitis, bronchitis 533
- Traumatic laryngotracheitis, tracheal compression and tracheal collapse 534
- Pharyngitis 534
- Upper airway obstruction in horses: laryngeal hemiplegia ('roarers') 535
- Dorsal displacement of the soft palate (soft palate paresis) 536
- Other conditions of the upper airway of horses 537
- Diseases of the guttural pouches (auditory tube diverticulum, eustachian tube diverticulum) 538
- Guttural pouch empyema 538
- Guttural pouch mycosis 540
- Guttural pouch tympany 541
- Other guttural pouch diseases 541
- Congenital defects 541

**Principles of respiratory insufficiency**

The principal function of the respiratory system is gas exchange in which oxygen is transferred from the environment to the blood and carbon dioxide is moved in the opposite direction. Other important functions include a role in thermoregulation in most species, acid-base regulation in concert with the kidney, as an endocrine organ (e.g. angiotensin-converting enzyme), in the metabolism of metabolically active substances, including eicosanoids and nitric oxide, and in the immune response to inhaled immunogens and pathogens. Capillaries in the lungs of the farm animal species and horses also possess intravascular macrophages, which are important as a reticuloendothelial organ in the processing of antigens – an action achieved by similar cells in the liver of dogs, cats, and humans. Interference with these functions can occur in a number of ways and can have a variety of manifestations

that are apparent during disease. The most readily apparent failure of the respiratory system is failure of gas exchange with resultant hypoxemia and hypercapnia. However, failure of other functions of the respiratory system can also result in clinically apparent disease.

Failure of gas exchange, and the resultant hypoxia and hypercapnia, is responsible for most of the clinical signs of respiratory disease and for respiratory failure, the terminal event of fatal cases. Death due to respiratory failure is due to hypoxia. An understanding of **hypoxia**, **hypercapnia** and **respiratory failure** is essential to the study of clinical respiratory disease.

**DEFINITIONS**

A number of terms are used to describe the function of the respiratory tract, or abnormalities that arise because of a variety of diseases. Many of these terms are described in more detail in the text that follows, but a brief definition of each is provided here:

- Hypoxia is a broad term meaning diminished availability of oxygen to tissues
- Hypoxemia is deficient oxygenation of blood, usually assessed by measurement of blood oxygen tension, or by measurement of blood hemoglobin saturation and hemoglobin concentration, and subsequent calculation of blood oxygen content
- Hypercapnia is an abnormally high carbon dioxide tension in blood
- $P_aO_2$  is the oxygen tension (partial pressure) in arterial blood
- $P_AO_2$  is the oxygen partial pressure in alveolar gas
- $P_aCO_2$  is the carbon dioxide tension in arterial blood
- $P_ACO_2$  is the carbon dioxide partial pressure in alveolar air
- $C_aO_2$  is the arterial oxygen content (milliliters of  $O_2$  per 100 mL of blood)
- $P_vO_2$  is the oxygen tension (partial pressure) in venous blood
- $P_vCO_2$  is the carbon dioxide tension in venous blood

- $C_vO_2$  is the venous oxygen content (milliliters of  $O_2$  per 100 mL of blood)
- Respiratory failure is the inability of an animal to maintain arterial blood oxygenation and carbon dioxide tension within the normal range
- Dyspnea refers to signs of respiratory distress in animals (in humans it describes the sensation of air hunger, which is a symptom and not a sign)
- Polypnea is an excessively high rate of breathing
- Tachypnea is an excessively high rate of breathing, with the implication that the breathing is shallow
- Hyperpnea is an increased minute ventilation.

## HYPOXIA

Failure of the tissues to receive an adequate supply of oxygen occurs in a number of ways and the differences are clinically relevant, in that they are associated with failure of different organ systems, different diseases, and have fundamentally different pathophysiological mechanisms

### Hypoxic (or hypoxemic) hypoxia

Hypoxic (or hypoxemic) hypoxia occurs when there is inadequate oxygenation of blood (hypoxemia) and is usually associated with disease of the respiratory tract or other causes of hypoventilation. Situations in which there is inadequate oxygenation of blood in the lungs include hypoventilation, ventilation/perfusion mismatches, diffusion impairment, low inspired oxygen tension and extrapulmonary right-to-left shunting.

**Hypoventilation** occurs in animals with depressed consciousness, such as occurs with general anesthesia and heavy sedation, or in newborns, in which the central respiratory drive is suppressed.

**Airway obstruction** caused by the presence of foreign bodies in the airway, luminal obstruction by masses, such as retropharyngeal abscesses in horses with strangles, laryngeal spasm or bronchoconstriction can cause inadequate alveolar ventilation and hypoxemia. Diseases that prevent adequate inflation of lungs cause alveolar hypoventilation and the consequent hypoxemia. These diseases include pneumothorax, pleural effusion or respiratory muscle weakness, such as can occur with botulism, tick paralysis, tetanus, strychnine poisoning or severe white muscle disease.

**Ventilation/perfusion** ( $\dot{V}/\dot{Q}$ ) mismatches occur when the distribution of blood flow in the lungs does not match the distribution of alveolar ventilation, with the result that areas of lung that are well ventilated are not adequately perfused and those areas that are well perfused by blood are not well ventilated. Ventilation/

perfusion mismatches are the most important cause of hypoxemia in many lung diseases, including pneumonia.

**Diffusion impairment** occurs when there is decreased transfer of oxygen from alveolar air that has a normal  $P_{A}O_2$  to red blood cells in alveolar capillaries because of: increased distance of diffusion through the alveolar membranes, such as might occur with pulmonary edema; decreased surface area available for diffusion, such as occurs with positional atelectasis or pulmonary embolism; or decreased transit time of red cells through the alveolar capillaries, such as occurs in horses during heavy exercise.

**Low inspired oxygen tension** occurs naturally only in animals at high altitude. It can also occur during anesthesia if there are defects in the ventilator causing low oxygen tension in the gases delivered to the animal.

**Extrapulmonary right-to-left shunting** occurs most commonly as a vascular defect (see Ch. 8).

The actual cause of hypoxemia in an individual animal or disease is often multifactorial and not simply a result of one of the mechanisms described above. For instance, cows placed in dorsal recumbency during general anesthesia become hypoxemic because of compression of the thorax by the abdominal viscera, thereby causing hypoventilation and compression atelectasis with diffusion impairment, ventilation/perfusion mismatching and reduced cardiac output because of reduced venous return.<sup>1</sup>

### Anemic hypoxia

Anemic hypoxia occurs when there is a deficiency of hemoglobin per unit volume of blood (anemia). The percentage saturation of the available hemoglobin and the oxygen tension of arterial blood are normal but as a result of the low hemoglobin concentration the oxygen-carrying capacity of the blood is reduced. Anemia due to any cause has these characteristics. The decrease in oxygen-carrying capacity caused by a 50% reduction in hemoglobin concentration from normal values (from 20 g/dL to 10 g/dL) is much greater than the decrease that results from a 50% reduction in arterial oxygen tension from normal (e.g. a reduction from 100 mmHg to 50 mmHg).

Alteration of hemoglobin to pigments, such as methemoglobin or carboxyhemoglobin, that are not capable of carrying oxygen has the same effect on oxygen content as anemia. Thus in poisoning caused by nitrite, in which hemoglobin is converted to methemoglobin, and in that due to carbon monoxide, when the hemoglobin is converted to carboxyhemoglobin, there is hypoxia due to inadequate oxygenation of blood.

### Circulatory hypoxia

Circulatory hypoxia occurs as a result of inadequate delivery of oxygen to tissue because of inadequate perfusion of tissues by blood. The blood is usually adequately oxygenated but blood flow rate to tissues is not, and therefore the rate at which it delivers oxygen to tissue is less than the amount of oxygen required to support the metabolic function of that tissue. In other words, the rate of delivery of oxygen to tissue does not match the metabolic requirements of that tissue. A common cause of this is low cardiac output, such as occurs with congestive heart failure or hypovolemic shock. It also occurs with local interruption to arterial flow such as the thrombotic emboli of thromboembolic colic of horses or compression of vessels, such as in right displacement and torsion of the abomasum.

### Histotoxic anoxia

Histotoxic anoxia occurs when oxygen delivery to tissue is adequate because both oxygen content of arterial blood and blood flow are appropriate, but the tissue is unable to utilize oxygen. Cyanide poisoning is the only common cause of this form of anoxia.

### Consequences of hypoxia

Consequences of inadequate delivery of oxygen include changes in almost all body systems. The central nervous system and heart are most susceptible to the immediate and acute effects of hypoxia, whereas clinical signs related to hypoxic damage to the gastrointestinal tract and kidneys are somewhat delayed. Central nervous system hypoxia is evident as mild changes in mentation, such as depression, progressing through decreased alertness to coma and death. Cardiac changes include a reduction in the force and efficiency of contraction due to impaired myocardial contractility, and an increased susceptibility to arrhythmia. The kidney, gut and liver are all metabolically active tissues and therefore susceptible to hypoxia. Renal function is reduced during hypoxia, with the renal medulla being most sensitive to decreases in oxygen delivery. Signs of gastrointestinal dysfunction during hypoxia include ileus, abdominal pain and abdominal distension due to accumulation of gas and liquid in the gastrointestinal tract. Liver dysfunction can be evident as decreases in blood glucose concentration and increases in serum activity of liver-derived enzymes (alkaline phosphatase, gamma-glutamyl transpeptidase, sorbitol (inositol) dehydrogenase) and metabolites (bile acids, bilirubin).

Some metabolically active tissues, when deprived of oxygen, use anaerobic metabolism to sustain energy supply for

short periods of time (depending on the tissue, but the brain cannot survive without oxygen for more than 2–3 min). Use of anaerobic glycolysis for energy causes metabolic acidosis. Animals in respiratory failure therefore often have a mixed acid–base disturbance characterized by metabolic and respiratory acidosis.

### COMPENSATORY MECHANISMS

Compensation of respiratory insufficiency occurs as both short-term and long-term events. **Short-term** compensatory mechanisms for low arterial oxygen tension or oxygen delivery to tissues occur within seconds to minutes and include respiratory, cardiovascular and behavioral responses. Stimulation of respiratory centers in the medulla oblongata by low arterial oxygen tension ( $P_aO_2$ ) and high arterial carbon dioxide tension ( $P_aCO_2$ ) causes an increase in respiratory minute volume mediated by an increase in tidal volume and respiratory frequency. Both low oxygen tension and high carbon dioxide tension in arterial blood, together or separately, are potent stimulators of these events. Inadequate tissue oxygenation also stimulates an increase in cardiac output, mainly as a result of increased heart rate and to a lesser extent by an increase in stroke volume. Splenic contraction, in those species such as the horse in which the spleen is an important reservoir of red blood cells, increases both blood volume and hemoglobin concentration, thereby increasing the oxygen-carrying capacity of blood. Hypoxemia also causes animals to attempt to decrease their oxygen requirement by decreasing physical activity, including moving and eating.

Longer-term compensatory mechanisms include an increase in erythropoietin secretion by the kidney with subsequent increases in bone marrow production of red blood cells and an increase in hemoglobin concentration in blood. This polycythemia increases the oxygen-carrying capacity of blood. Severe polycythemia, such as occurs with congenital cardiac anomalies causing chronic right-to-left shunting, increases the viscosity of blood and impairs tissue perfusion, increases the workload of the heart and the risk of thromboembolism. Longer-term compensatory mechanisms also include changes in ventilatory pattern, such as in horses with heaves, and behavior.

### CARBON DIOXIDE RETENTION (HYPERCAPNIA)

Respiratory insufficiency results in decreased elimination of carbon dioxide and its accumulation in blood and tissues. Animals breathing room air that are

hypercapnic are always hypoxemic. Increasing the oxygen tension of inspired air can alleviate the hypoxemia but, by reducing hypoxic stimulation of the respiratory center, can cause further increments in arterial  $PCO_2$ .

Acute hypercapnia causes a respiratory acidosis that reduces both blood and cerebrospinal fluid pH.<sup>2</sup> The clinical signs of acute hypercapnia are initial anxiety followed by central nervous system depression and eventual coma and death. These clinical abnormalities are attributable to declines in the pH of cerebrospinal fluid (CSF), a consequence of the ease with which carbon dioxide crosses the blood–brain barrier. Decreases in CSF pH are greater for respiratory acidosis than for a similar degree of metabolic acidosis. Severe hypercapnia also causes peripheral vasodilation, which can contribute to arterial hypotension, and cardiac arrhythmia. The acid–base effects of chronic hypercapnia are compensated by renal mechanisms that return the arterial and CSF pH to almost normal and therefore do not cause more than mild clinical disease in most instances. So long as oxygen delivery to tissue is maintained, animals can tolerate quite high arterial carbon dioxide tensions for a number of days or longer – this is referred to as ‘permissive hypercapnia’ and is sometimes an alternative to artificial or mechanical ventilation of animals with respiratory insufficiency.

### RESPIRATORY FAILURE

Respiratory movements are involuntary and are stimulated and modified by the respiratory centers in the medulla. The centers appear, at least in some species, to have spontaneous activity that is modified by afferent impulses to higher centers, including: cerebral cortex and the heat-regulating center in the hypothalamus; from the stretch receptors in the lungs via the pulmonary vagus nerves; and from the chemoreceptors in the carotid bodies. The activity of the center is also regulated directly by the pH and oxygen and carbon dioxide tensions of the cranial arterial blood supply. Stimulation of almost all afferent nerves may also cause reflex change in respiration, stimulation of pain fibers being particularly effective.

Respiratory failure is the terminal stage of respiratory insufficiency in which the activity of the respiratory centers diminishes to the point where movements of respiratory muscles cease. Respiratory failure can be paralytic, dyspneic or asphyxial, or tachypneic, depending on the primary disease.

The respiratory failure that occurs in animals with pneumonia, pulmonary

edema and upper respiratory tract obstruction is caused by combinations of hypoventilation, ventilation/perfusion mismatch and diffusion impairment, which leads to hypercapnia and hypoxemia. Hypercapnia and hypoxia stimulate the respiratory center and there is a potent respiratory drive evident as markedly increased respiratory rate and effort. As the disease progresses these changes become more marked until death occurs as a result of central nervous system or cardiac failure. Animals that die of the central nervous system effects of respiratory failure typically have dyspnea followed by periods of gasping and apnea just before death.

**Paralytic** respiratory failure is caused by depression of the respiratory centers or paralysis of the muscles of respiration. Depression of the respiratory center occurs with poisoning by respiratory center depressants, such as general anesthetics, or damage to the respiratory center, such as might occur with brainstem injury. Paralysis of respiratory muscles occurs in disease such as botulism, tetanus, strychnine poisoning, white muscle disease, severe hypocalcemia and tick paralysis. The signs of paralytic respiratory failure are a gradual or abrupt cessation of respiratory movements without preceding signs of increased respiratory effort or dyspnea. The animal is often unconscious, or unable to move, during the later stages of the disease.

The differentiation of these types of failure is of some importance in determining the type of treatment necessary. In the paralytic form of respiratory failure the optimal treatment is mechanical ventilation, along with removal of the inciting cause. Administration of respiratory stimulants is seldom effective as sole therapy. The more complex pathogenesis of respiratory failure in most diseases requires a therapeutic approach that removes each of the underlying defects. In most cases this is achieved by treating the inciting disease, for example administering antimicrobials to an animal with pneumonia or furosemide to an animal with pulmonary edema, in addition to supportive care including, potentially, nasal or pharyngeal insufflation with oxygen, or mechanical ventilation.

---

### Principal manifestations of respiratory insufficiency

---

Respiratory disease is evident as one or more of a variety of signs detectable on clinical examination. The signs vary with the etiology of the disease and its anatomic location. Diseases that impair

ventilation or gas exchange have hypoxemia and hypercapnia as prominent life-threatening abnormalities. Infectious and inflammatory diseases can cause prominent clinical abnormalities as a result of a systemic inflammatory response and toxemia. The toxemia may be so severe (e.g. in calf diphtheria, aspiration pneumonia and equine pleuritis) as to cause death even though oxygen and carbon dioxide exchange are not greatly impaired. The common signs of respiratory disease are:

- Abnormalities in the rate, depth, or ease of breathing
- Lethargy or exercise intolerance
- Abnormal posture
- Abnormal lung sounds
- Abnormal respiratory noises
- Coughing
- Cyanosis
- Nasal discharge
- Epistaxis and hemoptysis.

**ABNORMALITIES IN RATE, DEPTH AND EASE OF BREATHING**

**Polypnea** is a rate of breathing that is faster than observed in clinically normal animals of the same species, breed, age, sex and reproductive status in a similar environment.

**Tachypnea** also describes an increased rate of breathing, although with the implication that breathing is shallow (i.e. of a reduced tidal volume).

**Hyperpnea** is an abnormal increase in the rate and depth of breathing (an abnormally high minute volume) but the breathing is not labored and is not associated with signs from which one could infer represent distress on the part of the animal (i.e. the animal is not dyspneic). This assessment requires measurement of minute ventilation or arterial blood gas tensions.

**Dyspnea** is a term borrowed from human medicine, in which it refers to the *sensation* of shortness of breath or air hunger. It is used in veterinary medicine to describe labored or difficult breathing in animals that also display some signs of distress, such as anxious expression, unusual posture or stance, or unusual behavior.

Dyspnea is a physiological occurrence after strenuous exercise and is abnormal only when it occurs at rest or with little exercise. It is usually caused by hypoxia with or without hypercapnia, arising most commonly from diseases of the respiratory tract. In pulmonary dyspnea one other factor may be of contributory importance; there may be an abnormally sensitive Hering-Breuer reflex. This is most likely to occur when there is inflammation or congestion of the lungs or pleura. Rapid, shallow breathing results.

**Expiratory dyspnea** is prolonged and forceful expiration, usually associated with diffuse or advanced obstructive lower airway disease. The dyspnea of pulmonary emphysema is characteristically expiratory in form and is caused by anoxic anoxia and the need for forced expiration to achieve successful expulsion of the tidal air. It is commonly accompanied by an **audible expiratory grunt** in ruminants but less so in pigs and almost never in horses.

**Inspiratory dyspnea** is prolonged and forceful inspiration due to obstruction of the extrathoracic airways, such as with laryngeal obstruction or collapse of the cervical trachea. It may also be associated with abnormalities that restrict thoracic expansion, such as restrictive lung diseases and space-occupying lesions of the thorax. It is accompanied by a stridor or loud harsh sound on inspiration when the cause is obstruction of the

extrathoracic airways, such as is typical of laryngeal or tracheal disease.

**Open-mouth breathing** is labored breathing with the mouth held open, commonly with the tongue protruded in ruminants and most commonly associated with advanced pulmonary disease or obstruction of the nasal cavities.

**DISEASES CAUSING DYSPNEA AT REST OR LACK OF EXERCISE TOLERANCE**

Dyspnea, along with hypoxemia and hypercapnia, are the clinical and laboratory findings most likely to attract attention to the possible presence of disease in the respiratory system. A brief summary of the causes of dyspnea is outlined in Figure 10.1. It is most important, when attempting to differentiate diseases that cause dyspnea, to include diseases of systems other than the respiratory system that can result in dyspnea. Dyspnea at rest is usually, but not always, caused by respiratory tract disease, whereas exercise intolerance can be caused by disease in the respiratory, cardiovascular, musculoskeletal and other body systems.

**Respiratory tract disease**

Respiratory tract diseases interfere with normal gas transfer, through the mechanisms discussed above. Characteristics of respiratory disease that lead to dyspnea or lack of exercise tolerance include:

- **Flooding of alveoli with inflammatory cells** and/or protein-rich fluid – pneumonia and pulmonary edema
- **Atelectasis** (collapsed alveoli and small airways) – pleural effusion, hemothorax, hydrothorax, pneumothorax, chylothorax, pyothorax, prolonged recumbency of

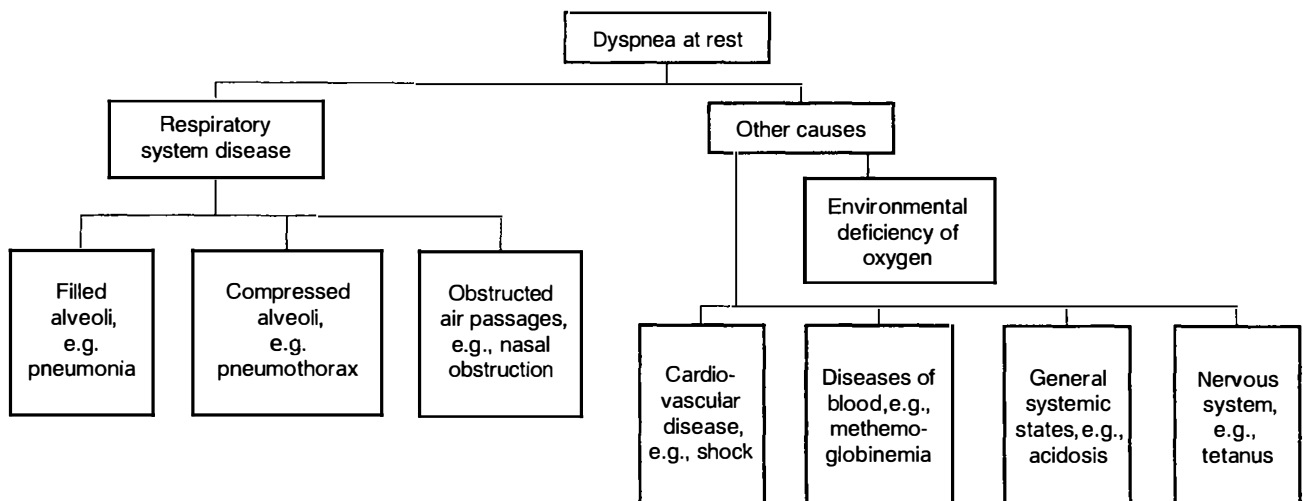

Fig. 10.1 The causes of dyspnea.

large animals and diaphragmatic hernia

- **Airway obstruction** – nasal obstruction, pharyngeal/laryngeal obstruction, tracheal/bronchial obstruction, bronchoconstriction and bronchiolar obstruction.

### Cardiovascular disease

This causes inadequate perfusion of tissues entering the lungs. There is reduced oxygen delivery to tissues, even in the presence of normal arterial oxygenation:

- **Cardiac disease.** Cardiac dyspnea results from heart failure and is multifactorial. In animals with dyspnea attributable to cardiac disease there are other readily evident signs of heart failure
- **Peripheral circulatory failure** – usually due to hypovolemic shock, although shock associated with toxemia, including endotoxemia, can cause dyspnea. There are always other prominent signs of disease.

### Diseases of the blood

These cause inadequate delivery of oxygen to tissues because of anemia or presence of hemoglobin that is unable to carry oxygen.

- **Anemia** – an abnormally low concentration of hemoglobin
- **Altered hemoglobin** – methemoglobinemia (e.g. in nitrite poisoning of cattle, red maple toxicosis of horses), carboxyhemoglobinemia.

### Nervous system diseases

Diseases of the nervous system affect respiratory function by one of several mechanisms:

- **Paralysis of respiratory muscles** occurs in tick paralysis or botulism. Tetanic spasm of respiratory muscles, such as in tetanus or strychnine toxicosis, also impairs or prevents alveolar ventilation. Both flaccid and tetanic paralysis cause hypercapnia and hypoxemia and, in extreme situations, death by suffocation
- **Paralysis of the respiratory center**, as in poisoning by nicotine sulfate, or overall central nervous system depression, causes hypoventilation because of impaired ventilatory drive
- **Stimulation of the respiratory center**, so-called neurogenic dyspnea, occurs as a result of stimulation of the center by a small irritative lesion, such as in animals with encephalitis, or administration of drugs, such as lobeline, that increase sensitivity of the respiratory center to hypoxemia or hypercapnia.

### Musculoskeletal diseases

- **Muscle diseases.** Diseases of the respiratory muscles can impair ventilation. These include white muscle disease in lambs, calves, and foals, and some congenital diseases (such as glycogen branching enzyme deficiency in foals)
- **Fatigue.** Animals with primary severe respiratory disease can develop fatigue of the respiratory muscles (intercostal, diaphragm, accessory muscles of respiration), which can further impair ventilation
- **Trauma.** Fractured ribs can impair ventilation both because of the pain of breathing and because of mechanical disruption to respiration (flail chest).

### General systemic states

Tachypnea can occur in a number of systemic states in which there is no lesion of the respiratory tract or nervous system. These include:

- **Pain** – such as in horses with colic
- **Hyperthermia** – as can occur with intense or strenuous exercise
- **Acidosis** – as a metabolic disturbance associated with any of a number of diseases but notably gastrointestinal disease that causes excessive loss of cationic electrolytes in feces.

### Environmental causes

- Low inspired oxygen tension, such as in animals at high altitude
- Exposure to toxic gases.

### Miscellaneous poisons

A number of poisons cause dyspnea as a prominent sign, but in most cases the pathogenesis has not been identified.

- Farm chemicals, including metaldehyde and dinitrophenols (probable mechanism is stimulation of respiratory center)
- Organophosphates and carbamates (probable mechanism is alteration of pulmonary epithelium), urea (probably effective as ammonia poisoning)
- Nicotine depressing the respiratory center
- Poisonous plants, including *fast-death* factor of algae, the weeds *Albizia*, *Helenium*, *Eupatorium*, *Ipomoea*, *Taxus* spp. and *Laburnum* and ironwood (*Erythrophleum* spp.); all appear to act at least in part by central stimulation.

### ABNORMAL POSTURE

Animals with respiratory disease, and especially those in respiratory distress, often adopt an unusual posture and are rarely recumbent except in the terminal stages of the disease. Animals in severe

respiratory distress will stand with the head and neck held low and extended. Animals, except horses, will often have open-mouthed breathing. Horses, except in extreme and unusual circumstances, are unable to breath through the mouth because of the anatomical arrangement of the soft palate, which effectively provides an airtight barrier between the oropharynx and nasopharynx. Cattle with severe respiratory distress and open-mouthed breathing will often drool large quantities of saliva – probably a consequence of decreased frequency of swallowing as the animal labors to breath.

The positioning of the legs is often abnormal. Severely affected animals, and those with pleuritic pain (horses or cattle with pleuritis) or severe respiratory distress, will usually stand with elbows (humeroradial joint) abducted. The animals are reluctant to move but when forced to do so can react violently. They are resistant to diagnostic or therapeutic interventions that interfere even transiently with their ability to breath.

### NORMAL AND ABNORMAL BREATH SOUNDS

Auscultation of the lungs and air passages is the most critical of the physical examinations made of the respiratory system. The examination should be performed in as quiet an environment as possible, though it is often difficult to achieve a silent listening environment in large animal practice. The animal should be adequately restrained so that the examiner can concentrate on the lung sounds, and should not be sedated or anesthetized because of the depression in lung sounds that can occur in these instances. To be effective and diagnostically reliable, auscultation must be systematic. Both the upper and lower parts of the respiratory tract must be examined in every case. It is preferable to begin the examination by auscultating the larynx, trachea and the area of the tracheal bifurcation in order to assess the rate of air flow and the volume of air sound to be heard over the lungs.

### GENERATION OF BREATH SOUNDS

The animal must be breathing to generate lung sounds. The lung sounds are generated by movement of air in the large and mid-sized airways, including the trachea and bronchi. The greater the velocity of air in the airways, the louder the noise, explaining the loud sounds that are generated in the trachea. Air movement in the bronchioles, terminal airways and alveoli is silent because of the large combined cross-sectional area of these airways and consequent low velocity of air movement and laminar character of the airflow. Sound is generated by



turbulent airflow and the degree of turbulence is affected by the velocity of airflow and the diameter of the airway. This sound is then transmitted through the lung and chest wall to the surface of the thorax, where it can be detected by use of a stethoscope.

Quiet breath sounds can be a result of low tidal volume with resultant low velocity of airflow, or impaired transmission of sounds to the surface of the chest. Sound is transmitted most readily through dense liquids such as water. Most tissue, except fat, is approximately 70% water and transmits sounds readily. Sound is reflected at the interface of two media of markedly different densities – such as air and tissue – and less sound is transmitted. Thus, in the normal lung there is marked attenuation (softening) of breath sounds because of the extensive air-tissue interfaces. This is evident by comparing the intensity of breath sounds heard over the trachea to those heard over the chest wall. However, lung sounds are more readily transmitted when areas of the lung do not contain air, such as occurs with atelectasis, pulmonary edema or infiltration of lung by inflammatory exudates. Sounds generated in the large airways are more readily transmitted through this consolidated tissue and are evident at the chest wall as louder bronchial breath sounds. The presence of bronchial breath sounds that are audible on the chest surface is dependent upon the presence of a patent bronchus with airflow to generate the lung sounds and of tissue that readily transmits the sounds generated in the bronchus. Lung sounds will not be heard if they are not generated (as a result of lack of airflow in bronchi) or are muffled by extensive accumulations of fluid or fat between the lung and the chest wall. Lung sounds are reduced in animals with airflow of low velocity in large airways, such as occurs in animals with low tidal volumes, or in which there is obliteration of the bronchial lumen by fluid or tissue. Low tidal volumes occur in animals at rest or in those in which there is rapid but shallow (low tidal volume) breathing. Obliteration of the bronchial lumen occurs in many diseases, including pneumonia.

#### REBREATHING ('BAGGING') EXAMINATION

Detection of abnormal lung sounds is optimized by increasing the animal's tidal volume, and thereby the velocity of airflow in large airways. An expeditious means of temporarily increasing the animal's tidal volume is to occlude the nostrils for a brief period (30–60 s). When the animal is again allowed to breathe it will take several large, deep breaths,

during which lung sounds can be auscultated. However, the increase in tidal volume is transient and does not permit time for detailed auscultation of the chest. A preferred technique is to place an airtight bag over the animal's muzzle such that all the air that it inhales is contained within the bag. The volume of air in the bag should exceed the anticipated stimulated tidal volume of the animal. As a rule of thumb, the volume of the bag should be sufficient to allow the animal a tidal volume of 10–15 mL of air per kilogram of body weight (BW). A 500 kg horse or cow therefore needs a bag that contains 10 L of air. Hyperventilation is stimulated by an increase in carbon dioxide content of inspired air with subsequent hypercapnia and stimulation of the respiratory center. A more refined technique has the animal inhaling gas that is 5% carbon dioxide and 95% oxygen, thereby preventing hypoxemia due to the examination. Rebreathing examinations (or 'bagging') are not indicated if abnormal lung sounds are detected on initial examination as the results of the rebreathing examination will not add any additional information. Animals in respiratory distress should not be subjected to a rebreathing examination because it might worsen the hypoxemia or hypercapnia already present, and is inhumane. Rebreathing examinations are indicated when respiratory disease is suspected but initial auscultation of the thorax does not reveal abnormal lung sounds.

#### INTERPRETATION OF BREATH SOUNDS

**Terminology** used to describe normal and abnormal lung sounds is now well established and should be used consistently so that it is a useful diagnostic aid.<sup>3,4</sup> Associations between abnormal respiratory sounds and diseases and abnormalities of respiratory function are well established. Correct identification of lung sounds, and consistency in terms used to describe them, therefore permits greater diagnostic accuracy and provides the ability to accurately and precisely describe diseases. The identification and clinical significance of respiratory sounds are summarized in Table 10.1. The clinician must carefully auscultate both the upper respiratory tract (larynx, trachea) and the entire aspects of both lung fields and interpret the sounds that are audible or not audible. The **variables that must be interpreted** include:

- **The nature of the sounds** (increased or decreased breath sounds, crackles or wheezes)
- **The timing of the sounds in the respiratory cycle**

#### ◦ Their anatomical location.

The questions that should be asked are:

- Are breath sounds audible?
- Are the breath sounds of normal intensity?
- Are the breath sounds normal or abnormal?
- If abnormal sounds are present, what are they (crackles, wheezes, stridor, stertor, etc.; see Table 10.1)?
- Are breath sounds audible over all lung fields?

Interpretation of these variables should indicate the nature of the lesion. Examples are summarized in Table 10.1. Lung sounds can be divided into normal breath sounds and abnormal breath sounds.

**Breath sounds** are produced by air movement through the tracheobronchial tree. The terms 'bronchial sounds' and vesicular sounds are not anatomically accurate or based on physiological principles and should not be used. The term 'breath sounds' should be used. These are the sounds which are audible clearly over the trachea and which are attenuated over the lungs. Breath sounds are of normal, increased or decreased intensity. Abnormally loud or soft breath sounds can be attributed to either changes in sound production in the airways by changes in flow rate or altered transmission of sound through various normal or abnormal tissues or fluids in the thorax, as discussed above.

#### Normal breath sounds

Normal breath sounds vary in quality depending on where the stethoscope is placed over the respiratory tract. They are loudest over the trachea and base of the lung and quietest over the diaphragmatic lobes of the lung. Normal breath sounds are louder on inspiration than on expiration because inspiration is active with more rapid airflow, whereas expiration is passive in normal animals and associated with lower rates of airflow. Breath sounds may be barely audible in obese animals or in the noisy surroundings common in field conditions.

**Increased loudness** of breath sounds is heard in normal animals with increased respiratory rate and depth of respiration. This can occur for physiological reasons such as exercise, excitement or a high environmental temperature. They can also occur in abnormal states such as fever, acidosis or pulmonary congestion in early pneumonia or myocardial disease.

**Decreased loudness** or an almost complete absence of breath sounds occurs in pleural effusion or pneumothorax because of almost complete reflection of the breath sounds at the pleural surface due to the mismatching of the

Table 10.1 Identification and clinical significance of breath sounds

Sounds	Acoustic characteristics	Significance and examples
Normal breath sounds	Soft blowing sounds, longer and louder on inspiration than on expiration, audible over the trachea and lungs	Normal respiratory tract
Increased audibility of breath sounds	Mild to moderate increase in loudness of breath sounds audible on inspiration and expiration over the trachea and lungs	Any factor that increases respiratory rate or depth of respirations, including fever, excitement, exercise, high environmental temperatures, lung disease. Harsh loud breath sounds are audible over the lungs with any disease resulting in collapse or filling of alveoli and leaving bronchial lumina open; pulmonary consolidation and atelectasis
Decreased audibility of breath sounds	Decreased audibility of breath sounds on inspiration and/or expiration over the lungs	Obese animal, pleural effusion, space-occupying mass of lung or pleural cavity, pneumothorax, diaphragmatic hernia, occlusive (lung) airway disease as in bronchial lumen filled with exudate
Crackles	Short duration, interrupted, nonmusical breath sounds. Coarse crackles are loud and most commonly heard over large airways in animals with pulmonary disease and may be heard during inspiration and expiration. Fine crackles are of short duration, less intense and higher pitched	Coarse crackles are caused by air bubbling through, and causing vibrations in, secretions in large airways. Fine crackles are caused by sudden explosive popping open of a series of airways closed during expiration. May be detected in early or late inspiration. Suggest the presence of secretions and exudate in airways and edematous bronchial mucosa as in exudative bronchopneumonia, tracheobronchitis, aspiration pneumonia and obstructive pulmonary disease. Loud crackles may be audible in animals with interstitial pulmonary emphysema
Wheezes	Continuous musical-type squeaking and whistling sounds audible over the lungs	Narrowing of large airways; expiratory polyphonic wheezing common in equine reactive airway disease bronchopneumonia, any species; inspiratory monophonic wheezing occurs when upper extrathoracic airways are constricted, such as in laryngeal disease
Pleuritic friction sounds	'Sandpapery' sound; grating; sound close to the surface; on inspiration and expiration; tend to be jerky and not influenced by coughing	Pleuritis; diminish or disappear with pleural effusion
Stridor	A harsh, high-pitched sound on inspiration audible with or without stethoscope over the larynx and trachea	Obstruction of upper airways, especially the larynx (due to edema, laryngitis, paralysis of vocal cord); prime example is calf diphtheria or retropharyngeal abscessation in strangles in horses or tracheal collapse in horses
Stertor	Snoring sound (low-pitched, coarse and raspy) audible without a stethoscope on inspiration and expiration over the pharyngeal and laryngeal areas	Partial obstruction of the upper respiratory tract commonly due to abnormalities of soft palate and nasopharynx
Expiratory grunting	Loud grunting on expiration, which is usually forced against a closed glottis with sudden release, audible on auscultation of the thorax, over the trachea and often audible without the aid of a stethoscope	Severe diffuse pulmonary emphysema; pleuropneumonia and pericarditis; extensive consolidation; in acute pleurisy and peritonitis; a groan indicating pain may occur
Transmitted upper respiratory tract breath sounds	Abnormal tracheal breath sounds (crackles and wheezes) audible by auscultation over the extrathoracic trachea during inspiration	Indicates presence of abnormalities of the upper respiratory tract (larynx, nasopharynx, nasal cavities and upper trachea) resulting in accumulation of respiratory secretions causing constriction of airways. Laryngitis is an excellent example
<b>Extraneous sounds heard on auscultation of respiratory tract</b>		
Crepitations in subcutaneous tissues	Loud superficial crackling sounds induced by movement of stethoscope over the skin	Subcutaneous emphysema from pulmonary emphysema in cattle; trauma to any part of respiratory tract that results in penetration of airway, allowing accumulation of air subcutaneously; gas-forming bacteria in subcutaneous tissues
Peristaltic sounds	Gurgling, grating, rumbling, squishing sounds audible over the lungs	Gastrointestinal sounds transmitted from the abdomen: ruminal sounds in cattle; stomach and intestinal sounds in horse. Does not indicate diaphragmatic hernia unless other evidence such as an absence of breath sounds is present

acoustic properties of the pleural tissues and fluids. **Space-occupying masses** between the lung and the thoracic wall also cause a relative absence of breath sounds over the site as do areas of lung that are not ventilated, such as a pulmonary abscess.

Increased loudness of breath sounds  
The normal breath sounds heard over the trachea may sound abnormally loud over the lungs because of changes in the transmission properties of the respiratory system.<sup>5</sup> This is because, when sound waves pass through structures of different

physical properties, the amount of sound transmitted depends on the matching of acoustic properties of the different structures. Consolidation results in less reflection of sound at the thoracic wall and consequently more transmission to the stethoscope. Thus, in consolidation, the breath sounds are much louder than normal. These are harsh breath sounds that approximate those heard over the trachea. They are audible on inspiration and expiration but become louder on expiration in abnormal states such as consolidation or atelectasis. Any disease

in which the bronchial lumen remains open and the surrounding lung tissue has been replaced by cells, exudate or tissues (consolidation) that transmit sound without reflection will result in increased bronchial sounds.

#### Abnormal breath sounds

Abnormal breath sounds include **crackles** and **wheezes**. Crackles are discontinuous sounds and wheezes are continuous sounds.<sup>6</sup>

**Crackles** are abnormal lung sounds described as clicking, popping or bubbling

sounds. They are caused by airways that remain closed for a portion of inspiration and then suddenly open. The crackling is caused by the sudden equalization of pressure between the proximal and distal part of the airway.<sup>6</sup> Crackles may thus be caused by the presence of exudate and secretions in the airways, and edematous bronchial mucosa. Crackling lung sounds are also audible in cattle with interstitial pulmonary emphysema. Crackling sounds may move their point of maximum intensity following coughing, presumably as a result of movement of exudate.

**Wheezes** are continuous whistling, squeaking sounds caused by vibrations of airways or air passing through a narrowed airway. They can be characterized as monophonic (single tone) or polyphonic (multiple tones) and by the timing of their occurrence in the respiratory cycle. *Inspiratory* wheezing suggests obstruction of the upper airways, usually extra-thoracic. *Expiratory* wheezing usually indicates intrathoracic airway obstruction such as bronchoconstriction with or without distal airways that are narrowed because of tenacious exudate.

**Pleuritic friction sounds** are a combination of continuous and discontinuous sounds produced by the rubbing together of inflamed parietal and visceral pleura. The sound is loud, coarse and usually not influenced by coughing. Pleuritic friction sounds are not common and their absence does not preclude the presence of pleuritis, particularly in the horse. Pleuritic friction rubs may also occur in cattle with severe diffuse pulmonary emphysema as: the relatively dry parietal and visceral surfaces rub together during the respiratory cycle.

**Absence of lung sounds** occurs when the breath sounds are reflected at the interface between the lung and thoracic wall by the presence of a medium such as a space-occupying mass, fluid or air. The common causes of the 'silent lung' include pleural effusion, space-occupying masses of the thorax, large pulmonary abscess, complete destruction of a lobe of lung including the terminal airways, such as can occur with bronchial lumen occlusion by a foreign body or tumor, and diaphragmatic hernia.<sup>6</sup>

**Extraneous sounds.** Miscellaneous unexpected sounds that are occasionally audible over the thorax include peristaltic sounds, skin and hair sounds caused by the stethoscope, crepitating sounds due to subcutaneous emphysema and muscular contractions. Subcutaneous emphysema occurs in diseases in which there is leakage of air from the lungs or airways into the subcutaneous space. This occurs with bullous lung disease in cattle, rib fractures and pneumothorax, and after

percutaneous tracheal aspirate in animals that cough. Coughing in these animals causes air to be forced out of the trachea through the hole through which the tracheal aspirate was obtained. This occurs in the period of coughing when intratracheal pressures are markedly increased just prior to the opening of the glottis.

### RESPIRATORY NOISES

Respiration may be accompanied by audible noises that indicate certain normal or abnormal occurrences in the respiratory tract such as **sneezing, snorting, stridor, stertor or snoring, wheezing, roaring, expiratory grunting and snuffling, bubbling and rattling sounds.**

**Sneezing** is a sudden, involuntary, noisy expiration through the nasal cavities caused reflexly by irritation of the nasal mucosae. Sneezing occurs in rhinitis and obstruction of the nasal cavities, and digital manipulation and examination of the nasal mucosae.

**Snorting** is a forceful expiration of air through the nostrils as in a sneeze, but a snort is a voluntary act used by horses and cattle as a device to intimidate potential predators.

**Stridor** is an inspiratory stenotic sound originating from a reduction in the caliber of the larynx, as occurs in laryngeal edema and abscess.

**Stertor or snoring** is a deep guttural sound on inspiration originating from vibrations of pharyngeal mucosa. Snoring is often intermittent, depending on the animal's posture. For example, a fat young bull will often snore when he is dozing half asleep, with his head hung down, but the snore will disappear when he is alert and his head is held up in a more normal position. Stertor can occur during expiration in horses with dorsal displacement of the soft palate.

**Wheezing** is a high-pitched sound made by air flowing through a narrow lumen, such as a stenotic or inflamed nasal cavity.

**Roaring** may occur during exercise and is caused by air passing through a larynx with a reduced lumen, e.g. laryngeal hemiplegia in horses.

**Expiratory grunting** is a clearly audible grunting noise synchronous with expiration. It is most common in cattle with diffuse pulmonary disease. A painful grunt may occur in painful diseases of the thorax such as fibrinous pleuritis and is unassociated with inspiration or expiration.

**Snuffling, bubbling or rattling sounds** may be audible over the trachea or base of the lungs when there is an accumulation of secretion, or exudate, in

the nasal cavities, larynx or trachea. These are most clearly audible on inspiration.

### COUGHING

A cough is an explosive expiration of air from the lungs. It is initiated by reflex stimulation of the cough center in the medulla oblongata by irritation of sensory receptors in one of various organs, especially the respiratory tract. The stimulus may originate in the pharynx, larynx, trachea or bronchi. Coughing may also be initiated by irritation of the esophagus, as in choking. The act of coughing consists of several stages:

- Deep inspiration followed by closure of the arytenoid cartilages (glottis)
- Compression of the air in the lungs and large increase in pressure in the thorax and airways by a forced expiratory effort against a closed glottis
- A sudden relaxation of the arytenoid adductor muscles, resulting in opening of the larynx and abrupt, vigorous and forced expiration. Coughing in horses is associated with transient dorsal displacement of the soft palate so that material in the airways caudal to the larynx is expelled through the mouth
- The sudden opening of the glottis allows an explosive expiration, during which the linear velocity attains a speed of several hundred kilometers per hour. The intrathoracic airways collapse after opening of the glottis during the forced expiration, whereas the extrathoracic airways are momentarily dilated.

The purpose of coughing is to remove the excess mucus, inflammatory products or foreign material from the respiratory tract distal to the larynx. Coughing indicates the existence of primary or secondary respiratory disease.

Coughing can be assessed according to several characteristics. Coughing is infrequent in the early stages of respiratory tract disease but can become frequent as the degree of inflammation in the larynx, trachea and bronchi becomes more severe. Assessment of the severity of coughing, at least in horses, requires prolonged observation (preferably for an hour).<sup>7</sup> Coughing is a fairly specific but not very sensitive indicator of pulmonary inflammation.<sup>8</sup> If coughing is detected then it is quite likely that the animal has inflammation of the airways, whereas failure to detect coughing does not reliably rule out the presence of clinically significant airway inflammation.<sup>8</sup> The severity of coughing in horses is closely linked to the severity of inflammation

and accumulation of mucus in the airways.<sup>7,8</sup> Race horses that cough are 10 times more likely to have more than 20% neutrophils in a tracheal aspirate, and more than 100 times more likely to have more than 80% neutrophils.<sup>8</sup> The frequency of coughing correlates well with maximal changes in pleural pressure, extent of mucus accumulation and proportion of neutrophils in bronchoalveolar lavage fluid of horses with heaves (recurrent airway obstruction).<sup>7</sup> Coughing is therefore a specific indicator of the presence of respiratory inflammation.

The frequency of coughing is an indicator of the severity of lung disease in horses<sup>7</sup> and presumably in other species. Horses that cough more than four times per hour have increased likelihood of mucus accumulation and higher pleural pressure changes during breathing than do horses that cough fewer than four times per hour.<sup>7</sup>

A cough cannot be induced in normal adult cattle and horses by manual manipulation of the larynx or trachea. If a cough can be induced in an adult horse by manual manipulation of the larynx or trachea, then this indicates airway inflammation and is a reason for further examination of the respiratory tract.

The most common causes of coughing in farm animals are due to diseases of the larynx, trachea, bronchi and lungs, which are presented under the headings of diseases of those parts of the respiratory tract later in this chapter.

## CYANOSIS

Cyanosis is a bluish discoloration of the skin, conjunctivae and visible mucosae caused by an increase in the absolute amount of reduced hemoglobin in the blood. It can occur only when the hemoglobin concentration of the blood is normal or nearly so, and when there is incomplete oxygenation of the hemoglobin. Cyanosis is apparent when the concentration of deoxygenated hemoglobin in blood is greater than 5 g/dL (50 g/L).<sup>9</sup> Cyanosis does not occur in anemic animals. The bluish discoloration should disappear when pressure is exerted on the skin or mucosa. In most cases, the oral mucous membranes are examined for evidence of cyanosis, although the skin of the pinna and the urogenital mucous membranes will suffice. Examination of vaginal mucosa is preferred in horses that have severe congestion of the oral and nasal mucosa as a result of disease affecting the head, such as cellulitis or bilateral jugular thrombophlebitis. Artificial lighting and skin pigmentation affect the ability to detect cyanosis.

**Methemoglobinemia** is accompanied by discoloration of the skin and mucosae

but the color is more brown than blue and cannot be accurately described as cyanosis.

Cyanosis is classified as central or peripheral. **Central cyanosis** is present when arterial oxygen saturation is below normal with concentration of deoxygenated hemoglobin exceeding 4–5 g/dL. **Peripheral cyanosis** occurs when there is localized desaturation of blood despite arterial oxygen saturation being normal. This usually occurs because there is diminished blood flow to tissue, with a resulting increase in oxygen extraction by the ischemic tissues and low end-capillary and venous hemoglobin saturation.

Central diseases include:

- Congenital cardiac diseases that cause right-to-left shunting
- Pulmonary diseases that cause hypoxemia. Cyanosis is not usually marked in pulmonary disease unless the degree of ventilation/perfusion mismatch is severe
- Upper airway obstruction causing hypoxemia. Cyanosis is common and is a sign of life-threatening disease in severe cases of laryngeal obstruction, as occurs in severe laryngitis in calves with necrotic laryngitis or horses with bilateral laryngeal paralysis (lead poisoning, after tracheal intubation during anesthesia, idiopathic)
- Abnormalities in hemoglobin function.

Peripheral causes of cyanosis include:

- Arterial obstruction, such as is seen in horses with aortoiliac thrombosis ('saddle thrombus') or thrombosis of distal limbs (such as can occur with severe septicemia)<sup>10</sup>
- Venous obstruction
- Severe vasoconstriction.

**Central cyanosis** is characterized by decreased arterial oxygen saturation due to right-to-left shunting of blood or impaired pulmonary function. Central cyanosis due to congenital heart disease or pulmonary disease characteristically worsens during exercise. Central cyanosis usually becomes apparent at a mean capillary concentration of 4–5 g/dL reduced hemoglobin (or 0.5 g/dL methemoglobin). Since it is the *absolute* quantity of reduced hemoglobin in the blood that is responsible for cyanosis, the higher the total hemoglobin content the greater the tendency toward cyanosis. Thus cyanosis is detectable in patients with marked polycythemia at higher levels of arterial oxygen saturation than in patients with normal hematocrit values, and cyanosis may be absent in patients with anemia despite marked arterial desaturation. Patients with congenital heart disease often have a history

of cyanosis that is intensified during exertion because of the lower saturation of blood returning to the right side of the heart and the augmented right-to-left shunt. The inspiration of pure oxygen (100% F<sub>i</sub>O<sub>2</sub>) will not resolve central cyanosis when a right-to-left shunt is present, but can resolve when primary lung disease or polycythemia is causing the cyanosis.

**Peripheral cyanosis** is caused by obstruction of blood flow to an area. This can occur as a result of arterial or venous obstruction, although it is usually more severe when arterial blood flow is obstructed. Obstruction of arterial blood flow also causes the limb to be cold and muscle and nerve function in the ischemic area to be impaired. Cyanosis can also occur as a result of cutaneous vasoconstriction due to low cardiac output or exposure to cold air or water. It usually indicates stasis of blood flow in the periphery. If peripheral cyanosis is localized to an extremity, arterial or venous obstruction should be suspected. Peripheral cyanosis due to vasoconstriction is usually relieved by warming the affected area.

Heart failure can cause cyanosis that is restricted to the extremities, probably because of reduced blood flow to extremities during this disease and the consequent markedly lower end-capillary oxygen content. Blood in the venous end of the capillaries, and in the venous bed draining these tissues, is therefore deoxygenated and cyanosis is observed. While this type of cyanosis has a peripheral distribution, its underlying cause is central.

## NASAL DISCHARGE

Excessive or abnormal nasal discharge is usually an indication of respiratory tract disease. Nasal discharges are common in all the farm animal species. Cattle can remove some or all of the nasal discharge by licking with their tongue, while horses do not remove any.

### Origin

The nasal discharge is usually obvious but the determination of its origin and significance can be difficult and elusive. The history should determine the duration of the nasal discharge and if it has been **unilateral or bilateral**.

Nasal discharges may originate from lesions in the nasal cavities, congenital defects of the hard palate such as cleft palate in the newborn, paranasal sinuses, guttural pouch in the horse, pharynx, larynx, trachea and lungs. Diseases of the esophagus and stomach that cause dysphagia and regurgitation or vomiting can also cause a nasal discharge stained with feed material.

The origin of a nasal discharge is sometimes determined by close inspection of the external nares and the visible aspects of the nasal cavities using a pointed source of light. Some important infectious diseases of the respiratory tract characterized by lesions of the nasal mucosae can be identified by examination of the external nares for the origin of a nasal discharge. If the source of the discharge is not apparent on this examination, then more detailed investigation is warranted.

### Examination

The characteristics of the discharge are noted carefully by inspection. It may be copious, serous, mucoid, purulent, caseous, streaked with blood, foul-smelling (ozena) or contain feed particles.

- A copious bilateral serous nasal discharge is characteristic of early inflammation of the nasal cavities such as in viral rhinitis
- A bilateral mucoid discharge suggests inflammation of a few days duration
- A bilateral purulent discharge can indicate inflammation in the upper or lower respiratory tract
- A copious bilateral caseous discharge suggests an allergic or bacterial rhinitis
- Foul-smelling nasal discharges are usually associated with necrosis of tissues anywhere in the nasal cavities, the guttural pouch in the horse, or severe necrotic and gangrenous pneumonia
- A bilateral foul-smelling discharge containing feed particles suggests dysphagia, regurgitation or vomiting
- In most cases, a chronic unilateral nasal discharge suggests a lesion of one nasal cavity
- A bilateral nasal discharge suggests a lesion posterior to the nasal system.

Examination of the **paranasal sinuses** for evidence of pain and facial deformity will assist in the diagnosis of sinusitis. Percussion is useful in identifying paranasal sinuses that are filled with fluid or tissue as sinuses affected in this way do not produce a resonant sound when the skin overlying the sinus is tapped. The pharynx and larynx of cattle can be examined through the oral cavity whereas a **flexible endoscope** is necessary for close examination of the upper and lower respiratory tract of horses or cattle of almost any age to determine the origin of a nasal discharge. The examination should include both nares, the region of the opening of the nasomaxillary sinus (this opening cannot be seen), the nasopharynx (in horses) or the pharynx (in other species), the guttural pouches in horses, the larynx and the trachea, preferably to

the level of the carina, although this might not be possible in large animals or when short endoscopes are used.

**Radiography** of the structures of the head and pharynx is also useful to locate lesions of the nasal cavities and paranasal sinuses that might be the origin of a nasal discharge.

### Nasal discharge and location of lesion

There is not necessarily a correlation between the characteristics of a nasal discharge and the nature of any pulmonary lesions. In exudative pneumonias in cattle, mucopus is produced and is moved up the trachea and into the pharynx by the mucociliary mechanism or by coughing. Some of it is then swallowed and some may be deposited in the nasal cavities and moved forward to the external nares by ciliary action. In the horse, with its long soft palate, most purulent material from the lungs will be deposited in the nasal cavities and appear as a nasal discharge.

### Sampling of nasal discharge

When infectious disease is suspected, nasal swabs can be collected and submitted for microbiological examination. Nasal swabs are useful only when a specific etiological agent is suspected and demonstration of its presence will confirm the cause of the disease. Examples of this include strangles (*Streptococcus equi*), influenza (equine or porcine), infectious bovine rhinotracheitis and *Mycoplasma bovis*. Submission of nasal swabs for culture yields mixed flora and the results are impossible to interpret, with the exception noted above. Organisms cultured from nasal or nasopharyngeal swabs are not representative of those cultured from lungs in individual animals but might be somewhat useful in herd outbreaks of disease.<sup>11,12</sup> Culture of trans-tracheal aspirates or, in cattle but not horses, bronchoalveolar lavage fluid, is representative of organisms causing pulmonary disease.<sup>12,13</sup> Cytological examination of the nasal discharge can reveal exfoliated cells in the case of nasal tumors or eosinophils when allergic rhinitis is present.

### EPISTAXIS AND HEMOPTYSIS

- **Epistaxis** (blood from the nostril) is in most instances a result of disease of the mucosae of the upper respiratory tract but it may originate anywhere in the upper or lower respiratory tract. Epistaxis occurring during or within several hours of intense exercise by horses is due to exercise-induced pulmonary hemorrhage
- **Hemoptysis** is the coughing up of blood. The blood usually originates

from hemorrhage in the lower respiratory tract. The presence of hemoptysis is difficult to detect in animals. Hemoptysis occurs in horses, which is perhaps unexpected given the anatomic separation of the nasopharynx and oropharynx.

Pulmonary hemorrhage, particularly in the horse, may be manifested as epistaxis. Pulmonary hemorrhage in cattle is commonly manifested as hemoptysis and epistaxis. These are described in more detail later in this chapter.

A small amount of serosanguineous fluid in the nostrils, as occurs in equine infectious anemia and infectious equine pneumonia, does not represent epistaxis, which must also be differentiated from the passage of blood-stained froth caused by acute pulmonary edema. In this instance the bubbles in the froth are very small in size and passage of the froth is accompanied by severe dyspnea, coughing and auscultatory evidence of pulmonary edema.

### THORACIC PAIN

Spontaneous pain, evidenced by grunting with each respiratory cycle, usually indicates pleural pain, such as from a fractured rib, torn intercostal muscle or traumatic injury, including hematoma of the pleura, or pleurisy. A similar grunt may be obtained by deep palpation or gentle thumping over the affected area of the thoracic wall, with a closed fist or a percussion hammer. Pain due to a chronic deep-seated lesion cannot be detected in this way. The use of a pole under the sternum, as described under traumatic reticuloperitonitis, provides a useful alternative.

### Special examination of the respiratory system

In addition to the routine clinical examination of the respiratory tract, there are a number of diagnostic techniques that can be used to aid in making a specific diagnosis, providing a reliable prognosis and formulating the most rational treatment. These techniques are being used more commonly by species specialists, particularly on valuable animals. Most equine practices have flexible endoscopes for the examination of the upper respiratory tract of horses. Medical imaging using thoracic radiography and ultrasonography of animals with suspected lung disease is now common, and the laboratory evaluation of respiratory tract secretions and exudates are commonplace. All these techniques increase the

costs of making a diagnosis, and it is therefore important to consider whether the additional diagnostic testing will improve the final outcome of the case. Techniques for advanced evaluation of the respiratory system include:

- Auscultation and percussion of the thorax
- Endoscopy of the upper airways, guttural pouch (in Equidae), trachea, bronchi and larger bronchioles
- Invasive endoscopic examination of the sinuses using rigid endoscopes
- Pleuroscopy using either rigid or flexible endoscopes
- Radiographic examination of the skull, pharynx, larynx, guttural pouch (in Equidae), trachea and thorax
- Computed tomographic and magnetic resonance imaging
- Scintigraphic examination of respiratory function
- Ultrasonographic examination of the soft tissue of the pharynx and larynx, and thorax
- Collection and evaluation of respiratory tract secretions:
  - Nasal
  - Paranasal sinus
  - Guttural pouch
  - Pharyngeal
  - Tracheobronchial (tracheal aspirates, bronchoalveolar lavage)
  - Pleural (thoracocentesis)
- Pulmonary function testing, including measurement of tidal and minute volumes, pleural pressure, forced expiratory volume, flow-volume loops, forced oscillometry, and CO<sub>2</sub> breathing
- Arterial blood gas analysis
- Venous blood gas analysis
- Blood lactate concentration
- Pulse oximetry
- Collection and analysis of exhaled breath condensate
- Lung biopsy
- Respiratory sound spectrum analysis
- Exercise testing.

## **AUSCULTATION AND PERCUSSION**

The techniques of auscultation and percussion used in examination of the thorax are discussed in Chapter 1 and references on percussion of the thorax are available.<sup>14,15</sup> Percussion of the thorax is a useful means of determining lung margins and therefore of detecting the presence of over-inflation, as occurs with heaves in horses,<sup>16</sup> or areas of consolidation. Consolidation is evident as a loss of resonance, and detection of this abnormality can reveal the presence of excessive pleural fluid or pulmonary consolidation. There is excellent agreement in the assessment of

lung margins determined by percussion and by ultrasonographic examination.<sup>16</sup> Percussion is therefore a valuable diagnostic tool, especially when ultrasonographic examination is not available.

## **ENDOSCOPIC EXAMINATION OF THE AIRWAYS (RHINOLARYNGOSCOPY, TRACHEOBRONCHOSCOPY)**

### **Horses**

Flexible endoscopes allow examination of the upper respiratory tract of horses including the nasal cavities, nasopharynx, auditory tube diverticula (guttural pouches), palatal arch, epiglottis, larynx, trachea and major bronchi. For examination to the level of the rostral trachea an endoscope of 1 m in length is suitable. However, an endoscope of 1.5 m in length is useful for examining to the level of the thoracic inlet. The endoscope is usually less than 1.5 cm in diameter. Endoscopic examinations are tolerated by most horses with the minimum of restraint (application of a nose or ear twitch). Sedation should be avoided if a purpose of the examination is to determine the functional integrity of the pharynx and larynx. Sedation depresses laryngeal function and impairs assessment of the symmetry and abductor function of the arytenoid cartilages. Sedated horses are more likely to displace the soft palate and to fail to return it to its normal position.

**Rhinolaryngoscopic** examination of horses should include a careful examination of the ventral and middle meatuses, turbinates, region of the nasomaxillary sinus opening (this cannot be visualized directly but discharge from it can be detected), ethmoidal turbinates, nasopharynx, soft palate, guttural pouches, dorsal pharyngeal recess, epiglottis and larynx. The endoscope should be used to examine both left and right nasal cavities and ethmoid turbinates. Both guttural pouches should be examined. Passage of the endoscope into the guttural pouch is best achieved by passing the endoscope through the ipsilateral nasal cavity. The guttural pouch is then entered by first introducing a thin, stiff tube, such as an endoscopic biopsy instrument, through the biopsy port of the endoscope into the guttural pouch. The endoscope is then rotated so that the entrance to the guttural pouch is opened and the endoscope is carefully advanced into the pouch. An alternative technique involves insertion of a stiff catheter, such as a Chambers mare uterine catheter, into the guttural pouch such that the entrance is dilated to enable passage of the endoscope.

Many disorders of the equine pharynx and larynx manifest only during strenuous

exercise because of the high pressures generated in the airways by the large minute ventilation of exercising horses. Pressures in the pharynx and larynx that are of similar magnitude to those occurring during intense exercise can be induced in resting horses by 60 seconds of **nasal occlusion**.<sup>4</sup> The respiratory efforts of horses during nasal occlusion can therefore be used to simulate those during exercise, thereby permitting detection of disorders of the pharynx (displacement of the soft palate) and larynx (mild laryngeal hemiplegia) that would not otherwise be apparent in a resting horse. Rhinolaryngoscopic examination can also be performed on horses running on a treadmill (see Exercise testing, below).

**Bronchoscopic examination** requires an endoscope that is at least 2 m in length and less than 1.5 cm in diameter. Horses must be sedated for bronchoscopic examination (a combination of xylazine, 0.25–0.5 mg/kg intravenously, and butorphanol, 1 mg per 40 kg intravenously, works well). Instillation of lidocaine (20 mL of 2% lidocaine diluted with 40 mL of isotonic saline or similar) minimizes coughing. The lidocaine is instilled into the trachea through the biopsy channel of the endoscope. The airways are examined in a systematic fashion and results are recorded using a system that has been described for identifying the major airways.<sup>17,18</sup> Lobar bronchi are identified on the basis of the side of the bronchial tree on which they are found and the order in which they originate from the primary bronchus.<sup>17</sup> On the right side, RB1, RB2 and RB3 refer to the right cranial lobar bronchus and subsequent right bronchi, respectively. On the left side, LB1 and LB2 refer to the left cranial lobar bronchus and the left caudal lobar bronchus, respectively. Segmental bronchi are identified by consecutive numbers in the order of origin from the lobar bronchus. The direction of the segmental bronchus is denoted by the capital letters D (dorsal), V (ventral), L (lateral), M (medial), R (rostral) and C (caudal). Subsegmental bronchi are identified in the order of origin from the segmental bronchi, using lower case letters.

### **Cattle**

The nasopharynx, pharynx and larynx of cattle can be examined by endoscopy<sup>19</sup> and this should be done without sedation if possible.<sup>20</sup> Xylazine is not recommended because it commonly interferes with normal laryngeal function. Acepromazine is recommended if necessary.<sup>20</sup>

The anatomy of the proximal portion of the respiratory tract of cattle differs from that of horses. The nasal septum does not completely separate the left and

right aspects of the nasopharynx. In cattle, the nasal septum tapers caudodorsally, allowing both ethmoturbinates to be observed from one side. The pharyngeal septum is contiguous with the nasal septum and merges with the caudodorsal wall of the pharynx. The nasopharyngeal openings of the auditory tubes are visible. The appearance of the vocal cords is similar to that observed in the horse. Cattle do not have a laryngeal sacculae and a laryngeal ventricle is not visible rostral to the vocal cords. During endoscopy, the arytenoid cartilages are maintained in fully abducted position. Constriction of the pharynx during swallowing is accompanied by rostroventral movement of the pharyngeal septum, completely occluding the nasopharynx, which differs from the situation in the horse.

### ENDOSCOPY OF PARANASAL SINUSES

The paranasal sinuses of the mature horse can be examined with a 4 mm arthroscope while standing and sedated or under general anesthesia.<sup>21</sup> The procedure is technically challenging and is usually performed by surgeons experienced in the use of arthroscopic equipment inserted through portals created by trephining holes in the sinus. The side to be examined is determined by physical, radiographic and rhinoscopic examination of the animal. Endoscopic examination is indicated in animals in which diagnosis of the disease requires collection of tissue from the sinus. Therapeutic interventions that can be performed during endoscopic examination of the paranasal sinuses include lavage, removal of accretions of inflammatory material, drainage of cysts and creation or enlargement of drainage holes.

### PLEUROSCOPY

Pleuroscopy using a rigid or flexible endoscope enables direct visual inspection of the pleural cavity for the diagnosis of pleural disease.<sup>22</sup> The technique is particularly valuable in diagnosis of diseases of the thorax that extend to the pleural surface and do not exfoliate large quantities of cells, thereby making diagnosis by examination of fluid obtained by pleurocentesis unlikely. The procedure is useful in collection of tissue samples, such as from suspected thoracic neoplasia,<sup>23</sup> or in therapeutic procedures including relief of pleural adhesions and resection of lung sections.<sup>24</sup>

The procedure is performed in standing, sedated horses restrained in stocks. Strict aseptic technique is used. The portal for insertion of the endoscope is at the level of the eighth to 12th intercostal space with optimal examination of intrathoracic structures obtained via the 10th

or 12th intercostal space. Either a rigid endoscope (10 mm diameter, 57 cm length) or flexible endoscope (10 mm diameter, 1 m length) can be used. The endoscope is inserted through a small incision in the intercostal space made under local anesthesia. The ipsilateral lung is partially collapsed by induced pneumothorax to permit visualization of intrathoracic structures. The mediastinum is intact in most horses. Inadequate collapse of the lung increases the likelihood of it being damaged during the procedure. The lung is reinflated by removal of air in the pleural space at the end of the procedure. Potential complications of the procedure include pneumothorax, hemothorax, damage to intrathoracic structures and infection.

### RADIOGRAPHY

Radiography of the head, neck and thorax is valuable in the diagnosis of diseases of the respiratory tract of animals. Examination is hindered by the large size of adult horses and cattle through the need for specialized, high-capacity equipment for obtaining radiographs, and the need for adequate restraint. Radiographic examination of adult animals in the field using portable radiographic units is very limited. However, large practices with fixed radiographic units capable of generating sufficient voltage and amperage can obtain diagnostic radiographs of the thorax of adult horses and cattle. Diagnostic films of smaller animals, including adult sheep and goats and foals and calves, can be obtained using portable units capable of generating 80–100 kVp and 15–20 mA.

Examination of the thorax of large animals is restricted to lateral radiographs because the large amount of tissue prevents adequate exposure for ventrodorsal views. Multiple films are required for complete examination of the thorax, and the exposure needed for optimal quality films varies among anatomical sites. Localization of focal lesions can be achieved by examining sets of radiographs that include images collected with the horse or cow standing first with one side to the plate and then with the other side toward the plate. The lesion will appear larger in views obtained with the lesion closer to the source of X-rays.

Radiographs of **calves and foals** can be recorded with them standing or recumbent. Images obtained with the foal or calf in lateral recumbency with the forelimbs pulled forward permit optimal examination of the cranial thorax. However, calves or foals that are recumbent for prolonged periods of time (e.g. > 30 min) can develop atelectasis of the down lung that can mimic pneumonia radiographi-

cally. Ventrodorsal views assist with localizing lesions in foals and calves. Radiographic evidence of lung disease is common in ill neonatal foals (74% having such lesions in one study),<sup>25</sup> and is not related to clinical evidence of respiratory disease or dyspnea.<sup>26</sup> The characteristics of lung lesions detected in neonatal foals are associated with likelihood of survival. Guidelines for recognition of pulmonary patterns in foals have been proposed (Table 10.2)<sup>26</sup> and these guidelines are likely to be useful aids for interpretation and description of pulmonary patterns in neonates of other species.

Radiography can assist in the recognition and differentiation of atelectasis and consolidation, interstitial and exudative pneumonias, the alveolar pattern of pulmonary disease, neoplasms, pleural effusions, pneumothorax, hydropericardium and space-occupying lesions of the thorax. Cardiomegaly, abnormalities of the cranial mediastinum, fractures of ribs and diaphragmatic hernia can also be detected.

Many pulmonary diseases do not have lesions that are readily detected on radiographic examination. Failure to detect abnormalities on radiographic examination of the thorax does not eliminate pulmonary disease. Furthermore, radiographically detectable signs of lung disease can persist after the animal has clinical and clinicopathological signs of recovery or improvement.

**Bronchography** utilizing contrast agents is of value in determining the patency of the trachea and bronchi, but general anesthesia is required to overcome the coughing stimulated by the passage of the tracheal catheter. Using a fluoroscope to determine the location of the catheter tip, the contrast agent can be deposited in each dependent lobe in turn. This technique is used infrequently. **Computed tomographic (CT)** examination of the lung is very sensitive and specific for lung disease in companion animals and is technically feasible in calves, foals and small ruminants. The technique is useful in the diagnosis of mediastinal disease in foals.<sup>27</sup>

Radiographic examination of the trachea can reveal the presence of abnormalities in shape, such as occur with tracheal collapse, or the presence of foreign bodies or exudate.

Radiographic examination of the **head** can identify diseases of the paranasal sinuses, ethmoids and pharynx. Radiographic examination is useful in defining diseases of the guttural pouches and in detecting retropharyngeal abscesses or abnormalities, such as the presence of foreign bodies. The **CT** anatomy of the head of horses and foals has been



**Table 10.2** Guidelines for radiographic pulmonary pattern recognition in foals<sup>46</sup>

<b>Alveolar lung pattern</b> (Vessels not visualized. There is displacement of air from the distal air spaces of the lung leading to a relatively homogeneous increase in soft tissue opacity. Formation of air bronchograms is usually associated with the pattern but is not always present)	
Absent	The pulmonary vessels are easily seen
Minimal alveolar component (< 10%)	No visualization of vessels in < 10% of the lung field. Usually occurs in conjunction with a moderate or severe interstitial lung pattern
Focal (> 10% to 30%)	No visualization of vessels in 11–30% of lung fields. Air bronchograms might or might not be present within < 30% of lung fields
Localized (> 30% to 50%)	No visualization of vessels in 31–50% of lung fields. Air bronchograms might or might not be present within < 50% of lung fields
Extensive (≥ 50%)	No visualization of vessels in ≥ 50% of lung fields. Air bronchograms might or might not be present throughout the entire section of lung field
<b>Interstitial lung pattern</b> (Characterization of the non-air-containing elements of the lungs including blood vessels and bronchi)	
Normal	Clear visualization of vessels. Borders are well defined
Mild increase	The pulmonary vessels appear slightly ill defined (hazy borders with loss of visualization of the fine vascular structures). Mildly lacy appearance to lung field
Moderate increase	The vessels are ill defined, resulting in moderately lacy appearance and increased opacity of the lung field
Marked increase	Significantly increased opacity; vessel borders are barely recognizable
<b>Bronchial pattern</b> (Characterized by alterations in bronchial wall thickness and density, or in bronchial lumen diameter. Note that peribronchial cuffing is a feature of interstitial not bronchial pattern)	
Normal	Bronchial structures seen in cross section appear as small, thin-walled hollow rings between paired vessels. The bronchial walls are barely distinguishable when viewed side-on and are not clearly visualized at the periphery of the lung field
Moderate increase	A few thickened bronchial walls evident in cross section ('doughnuts') at the periphery of the lung fields. Longitudinal sections appear as tram lines reaching two-thirds of the way to the lung periphery
Marked increase	Extensive bronchial thickening might be observed, extending far into the periphery of the visible lung field

described.<sup>28–30</sup> CT imaging of the nasal cavities and paranasal sinuses of horses is useful in the detection of diseases of these structures,<sup>31,32</sup> and of the teeth,<sup>33</sup> pharynx, larynx and guttural pouches.<sup>34</sup> The technique is technically feasible in ruminants and pigs, although there are few reports of its use in these species.<sup>35</sup>

**Magnetic resonance (MR) imaging** is useful in diagnosis of diseases of the head, and the anatomy as visualized on MR imaging of the head of horses has been reported.<sup>36</sup> Unfortunately, the lack of units suitable for examination of large animals precludes routine use of this imaging modality.

### SCINTIGRAPHY (NUCLEAR IMAGING)

The basis of pulmonary scintigraphy is detection at the body surface of radiation emitted from the lungs after injection or inhalation of radioactive substances.<sup>37</sup> The technique has been described in both horses and calves.<sup>37,38</sup> The technique has limited diagnostic usefulness in large animals because of the need for avail-

ability of appropriate isotopes and detection equipment. Furthermore, the large size of adult cattle and horses limits the sensitivity of the technique. The technique has been used to determine the distribution of pharmaceuticals administered by aerosolization and the presence of ventilation/perfusion mismatches. Alveolar clearance can be detected using scintigraphic examination. Currently pulmonary scintigraphy is largely a research tool.

### ULTRASONOGRAPHY

Ultrasonographic examination of the thorax of farm animals and horses is a very useful diagnostic tool. Ultrasonographic examination of the thorax provides diagnostic information that is not obtained by radiographic examination. The widespread availability of portable ultrasound units and the ability to image parts of the thorax using ultrasound probes intended for examination of the reproductive tract of mares and cows makes this a potentially valuable diagnostic aid for both field and hospital-based practitioners. Further-

more, the absence of radiation exposure and the 'real-time' nature of images obtained by ultrasonography aid in frequent assessment and monitoring of abnormalities and performance of diagnostic or therapeutic procedures such as thoracocentesis or aspiration of masses.

There are limitations to imaging imposed by aerated lung and the bones of the ribcage. Examination of the thorax is limited by the presence of ribs and aerated lungs because the sound waves used to create ultrasound images are reflected from these surfaces. Ultrasonography cannot reveal lesions of the lungs that are not confluent with the visceral pleura. Imaging windows are restricted to the intercostal spaces but this impediment can be overcome by scanning through adjacent intercostal spaces and angling of the ultrasound beam.

Ultrasonographic examination of the thorax should be performed in a consistent manner that ensures thorough examination of the thorax. Preferences for the pattern of examination differ somewhat among examiners, but one common and successful technique is to scan each intercostal space from dorsal to ventral starting at the 17th intercostal space in horses and the 12th intercostal space in cattle. The ultrasound probe is slowly moved from dorsal to ventral while the examiner studies the images. When one scanning of one intercostal space is completed, the probe is moved to the most dorsal aspect of the next intercostal space and the examination is repeated. Each side of the chest is examined in this manner. This consistent and thorough examination ensures that no important or localized abnormalities are missed. The examination is performed in adult horses and cattle with the animal standing. The rostral thorax is scanned by pulling the ipsilateral forelimb forward. This is more readily achieved in horses than in cattle. Thorough examination of the rostral thorax might require placing the animal in lateral recumbency. Calves and foals can be examined either standing or in lateral recumbency.

Ultrasound examination of the thorax is particularly useful for detecting diseases of the pleura, pleural space or lung surface. This is in addition to the well-documented utility of ultrasonographic examination of the heart and great vessels (see Ch. 8). The normal ultrasonographic anatomy of the thorax of cattle, horses and calves has been determined.<sup>39–41</sup> The following is a partial list of disorders or abnormalities detectable by percutaneous ultrasonographic examination of the thorax of farm animals or horses (excluding cardiac abnormalities):

- Excess pleural fluid
- Characteristics of pleural fluid (flocculent, bubbles, fibrin)
- Extent of pleural fluid accumulation
- Localized areas of pleural fluid accumulation
- Non-aerated lung (atelectatic, consolidated)
- Pulmonary abscesses (must be confluent with visceral pleura)
- Intrathoracic masses (thymic lymphoma, cranial thoracic mass, gastric squamous cell carcinoma)
- Pleural roughening ('comet-tail' lesions)
- Pneumothorax
- Pulmonary hematoma<sup>42</sup>
- Exercise-induced pulmonary hemorrhage
- Hemothorax
- Diaphragmatic hernia
- Fractured ribs (especially in neonates).

Ultrasonographic examination is more sensitive and specific than radiographic examination in detecting the presence of pleural fluid<sup>42</sup> and is particularly useful in the diagnosis and management of pleuritis in horses and cattle<sup>43,44</sup> and pneumonia in calves.<sup>45</sup> The extent of pulmonary lesions detected at necropsy correlates closely with the results of ultrasonographic examination of calves with pasteurellosis.<sup>46</sup> Ultrasonographic examination is useful in diagnosis of thoracic diseases of cattle.<sup>47</sup> Ultrasonography can identify pulmonary lesions in horses with infectious viral pneumonia<sup>48</sup> and is a viable alternative, though not as sensitive, to radiology in the evaluation of foals with *Rhodococcus equi* pneumonia.<sup>49</sup> Ultrasonography is very useful in identifying the presence of pleural fluid and guiding thoracocentesis to sample and drain this fluid.

## LABORATORY EVALUATION OF RESPIRATORY SECRETIONS

### SAMPLING RESPIRATORY SECRETIONS

When an inflammatory disease process of the respiratory tract is suspected, the collection of samples of secretions and exudate for microbiological and cytological examination can be considered. The objective is to obtain a sample uncontaminated with environmental flora, which are common in the upper respiratory tract, and to isolate the pathogen(s) or demonstrate inflammatory cells which may be associated with the lesion. This can be done by:

- **Swabbing the nasal cavities or the pharynx**
- **Collection of fluid from the paranasal sinus**
- **Collection of fluid from the guttural pouch of Equidae**

- **Transtracheal aspirate**
- **Tracheal lavage**
- **Bronchoalveolar lavage**
- **Thoracocentesis.**

### NASAL SWAB

A swab of the nasal cavities is a reliable method for the evaluation of the secretions associated with disease of the upper respiratory tract such as infectious bovine rhinotracheitis and allergic rhinitis. However, when attempting to assess the health status of the lungs the nasal swab can be unsatisfactory because microbiological examination usually yields a large population of mixed flora, consisting of pathogens and nonpathogens, which is difficult to interpret.

### NASOPHARYNGEAL SWABS

For more reliable results and to lessen the contamination that occurs with nasal cavity samples, swabs of the laryngeal-pharyngeal area can be collected. A swab in a long covered sheath, of the type used for collecting cervical swabs from mares, is easily passed through the nasal cavities to the pharyngeal area. Significant differences may exist between the microbial isolates from nasopharyngeal swabs and those from lung tissues, which makes nasal swabs unreliable for diagnosis. For example, at the individual animal level, nasopharyngeal swabs and bronchoalveolar lavage show only moderate agreement; at the group or herd level the isolation rates of various organisms are similar.<sup>50</sup>

For isolation of viruses associated with disease of the upper respiratory tract, nasal swabs are satisfactory provided a copious amount of nasal discharge is collected and the swabs are kept moist during transport to the laboratory. Nasal swabs sometimes contain an insufficient amount of secretion, and certain viral pathogens can become inactivated in transit.

### NASAL LAVAGE

When larger quantities of nasal discharge are required for research purposes, nasal washings are usually collected, the simplest technique being irrigation of the nasal cavities and collection into an open dish. From these samples, it is possible to isolate bacteria and viruses, and identify immunoglobulins. The development of immunofluorescent and enzyme-linked immunosorbent assay (ELISA) tests for agents of infectious disease has provided reliable systems for the diagnosis of a variety of virus diseases in the early stages of infection. A technique and apparatus are available that obtain much better samples than the conventional cotton-wool swab provides. A vacuum pump aspirates epithelial cells and secretion from the nasal passage and pharynx. Cell

smears are then prepared for microscopic examination and the mucus and cells are used for conventional microbiological isolation.

### PARANASAL SINUS FLUID

Fluid can be collected from the frontal and paranasal sinuses of most of the domestic large animals. Indications for collection of fluid include the presence or suspected presence of disease of the paranasal sinus. Medications can be administered and infected sinuses lavaged using this approach.<sup>51,52</sup> Absolute contraindications are few but include failure to be able to adequately restrain the animal. Demonstration of fluid in the paranasal sinuses is aided by radiographic examination of the skull. Fluid is collected by percutaneous centesis of the frontal or maxillary sinus and submitted for cytological and bacteriological examination (Gram stain, culture). The procedure is: restraint of the animal, which can include the induction of moderate sedation by administration of alpha-2 agonists and narcotics, or in cattle restraint in a head gate with the head secured with a halter. The area over the centesis site is prepared aseptically and the skin and subcutaneous tissues are anesthetized with local anesthetic.<sup>51</sup> A stab incision (< 1 cm) is made in the skin and subcutaneous tissues. A hole is then drilled into the sinus using a Jacob's chuck with a Steinmann pin (2–4 mm diameter). Only a short (5 mm) length of the Steinmann pin should be exposed by the chuck. The hole is drilled by applying steady pressure and making alternating clockwise and counterclockwise movements with the chuck. Entry into the sinus cavity is evident as a sudden release of tension and easy passage of the Steinmann pin. The pin is then withdrawn and sterile polyethylene tubing is inserted into the sinus cavity. Fluid can be aspirated at this time or, if none is forthcoming, 10–20 mL of sterile 0.9% saline or similar fluid can be instilled to the sinus cavity. Some of this fluid may run out the nostril if the animal's muzzle is lower than the sinus. Complications include injury to adjacent structures, including the infraorbital nerve (trigeminal nerve), nasolacrimal duct or parotid salivary duct near its entrance to the oral cavity at the level of the upper cheek teeth. Hemorrhage is usually minor and self-limiting. Subcutaneous emphysema resolves within days. Cellulitis is a risk, especially for animals with septic processes in the paranasal sinuses. Prophylactic administration of antibiotics should be considered in these cases.

### GUTTURAL POUCH FLUID

Indications for collection of fluid from the guttural pouches of equids include

bacteriological or polymerase chain reaction (PCR) examination to determine if the horse is infected by *S. equi* (the etiological agent of strangles) or to investigate the suspected presence of other inflammatory or neoplastic disease. The preferred method of collection is during endoscopic examination of the guttural pouch. During this examination, fluid can be collected through a polyethylene tube inserted through the biopsy port of the endoscope. Fluid collected in this manner is potentially contaminated by organisms in the upper respiratory tract, and results of bacteriological examination should be interpreted with caution. Usually, bacteriological examination is for the presence of *S. equi* and demonstration of its presence is all that is required for a diagnosis of infection. Fluid can also be obtained from the guttural pouch by blind passage of a firm catheter, such as a Chambers mare catheter or 10 French dog urinary catheter, into the guttural pouch. This procedure requires some skill and there is always the uncertainty that one might not have actually manipulated the catheter into the guttural pouch. A third technique involves percutaneous puncture of the guttural pouch just posterior to the ramus of the mandible and ventral to the ear. This technique has the potential to yield fluid that is uncontaminated by organisms from the upper respiratory tract, but carries with it a high risk of injury to the important vascular and neural structures in and around the guttural pouch (internal and external carotid arteries, pharyngeal branch of the vagus nerve, hypoglossal nerve, and others). Percutaneous sampling of guttural pouch fluid should not be undertaken without careful consideration of the risks and benefits of the procedure.

### TRACHEOBRONCHIAL SECRETIONS

The collection and evaluation of tracheo-bronchial secretions is a useful method for assessing lower airway disease and is widely used in the determination of the etiology of infectious pneumonia (viral, mycoplasmal, fungal, and parasitic) or the severity of disease (bronchoalveolar lavage fluid cytology in horses with heaves, exercise-induced pulmonary hemorrhage in athletic horses). It is also used as a tool in evaluating respiratory health of intensively housed animals, such as in piggeries.<sup>53</sup> Cytological examination of recovered fluid can provide valuable information about the severity, extent and etiology of disease of the lower airway. There are two methods of sampling tracheo-bronchial secretions – aspiration of tracheal fluid or lavage of bronchioles and distal airways. Each sampling method yields fluid of differing characteristics and

source and interpretation of the results of examination of these fluids depends on their source and the method of collection.

### Comparison of tracheal aspirates and bronchoalveolar lavage fluid

Examination of tracheal aspirates and bronchoalveolar lavage fluid yields different, but often complementary, information about the lower respiratory tract. The differences between tracheal aspirates and bronchoalveolar lavage fluid arise because cell populations, and types of cell, differ markedly among segments of airways. There is no correlation between cytological features of tracheal aspirates and bronchoalveolar lavage fluid of horses, and this is probably the case in other species.<sup>54</sup> Tracheal aspirates are representative of cell and bacterial populations of the large conducting airways (trachea and mainstem bronchi), which can originate in both the large and small conducting airways and the alveoli.<sup>54</sup> Secretions of more distal airways can be modified during rostral movement, such that fluid in a tracheal aspirate is not representative of processes deeper within the lung. Furthermore, disease localized to one region of the lung can alter tracheal fluid. Examination of tracheal aspirates is useful for detecting inflammation of the large airways and for isolation of microorganisms causing disease in these structures. There is no good evidence that findings on examination of tracheal aspirates correlate with abnormalities in pulmonary function, and tracheal aspirates do not accurately reflect lesions in the lungs of horses.<sup>55</sup>

Bronchoalveolar lavage is useful for sampling secretions in the more distal airways. It provides a sample of secretions that have not been contaminated by upper respiratory tract organisms or secretions before collection and the sample is therefore assumed to be more representative of small airway and, to a lesser extent, pulmonary parenchymal and alveolar secretions or exudates. Bronchoalveolar lavage is useful in the detection of widespread lung disease but not necessarily in the detection of localized disease. Tracheal aspirates, because they in theory represent a composite sample of secretions from all regions of the lung, are likely to be more sensitive in detecting focal disease, such as a pulmonary abscess. Bronchoalveolar lavage fluid composition correlates well with pulmonary function in horses.<sup>56,57</sup>

There is little agreement in cytological examination of tracheal aspirates and bronchoalveolar lavage fluid of sick and healthy horses, and this difference probably exists in other species. Typically, the proportion of cells that are neutrophils is

much higher in tracheal aspirates than in bronchoalveolar lavage fluid of both horses with heaves and normal horses.<sup>54,58</sup> Mast cells are detected more frequently, and eosinophils less frequently, in bronchoalveolar lavage fluid than in tracheal fluid of normal horses.<sup>59</sup>

### Tracheal aspirates

**Indications** for collection of tracheal aspirates include the need for microbiological and cytological assessment of tracheal fluids. The primary indication is collection of samples for microbiological diagnosis of infectious respiratory disease. Other indications include detection and characterization of inflammation of the conducting airways. **Contraindications** include severe respiratory distress, although this is not an absolute contraindication, inability to adequately restrain the animal, and severe, spontaneous coughing. Percutaneous tracheal aspirate collection performed in animals with severe coughing can result in development of severe subcutaneous emphysema as a result of the high intratracheal pressures associated with the early phase of coughing. Most animals in which percutaneous tracheal aspirates are collected subsequently have radiographic evidence of pneumomediastinum.

Tracheal aspirates can be collected either by percutaneous puncture of the trachea or through an endoscope passed through the upper airways. The advantage of percutaneous collection of tracheal aspirates is that there is minimal risk of contamination of the sample by upper respiratory tract or oropharyngeal secretions. Microbiological examination of the samples is therefore likely to accurately reflect microbes present in tracheal fluid. Collection of tracheal aspirates through an endoscope markedly increases the risk of contamination of the sample with oropharyngeal fluids, and compromises the diagnostic utility of culture of the sample. This disadvantage is partially alleviated by the use of guarded catheters inserted through the endoscope.<sup>60,61</sup> The disadvantage of percutaneous collection of tracheal fluid is that it is invasive and there is a risk of localized cellulitis and emphysema at the site of puncture. Endoscopic collection is relatively non-invasive and readily accomplished.<sup>5</sup> We prefer use of the percutaneous method when accurate microbiological assessment of samples is desired.

### Percutaneous transtracheal aspiration

This is a practical method that has been used extensively in the horse<sup>60</sup> and is adaptable to cattle,<sup>62</sup> sheep and goats. For the horse, a 60 cm no. 240–280 polyethylene tube is passed through a 9–14-gauge

needle inserted into the trachea between two rings. Commercially prepared kits for performing tracheal aspirates in horses are available that include all catheters and needles required. An alternative to polyethylene tubing is to use an 8–10 French male dog urinary catheter inserted through an appropriately sized cannula. The site for insertion of the needle or cannula is at the junction of the proximal and middle one-thirds of the ventral neck. The horse is usually sedated prior to insertion of the needle or cannula. The skin site is prepared aseptically and a short stab incision is made after the area has been anesthetized. The cannula is removed to avoid cutting the tube and the tube is pushed in as far as the thoracic inlet. Fluid typically pools in the trachea at the thoracic inlet in horses with lung disease (the tracheal lake or pool) and it is this fluid that is aspirated. Thirty to 50 mL of sterile saline (not bacteriostatic saline) is rapidly infused. The catheter or tubing should be rotated until tension is felt on aspiration by a syringe. Fluid is aspirated and submitted for cytological, microbiological or other examination.

Complications such as subcutaneous emphysema, pneumomediastinum and cellulitis can occur, which necessitates care and asepsis during the procedure. Sudden movement of the cannula during insertion of the tubing may cause part of the tube to be cut off and to fall into the bronchi, but without exception this is immediately coughed up through the nose or mouth.

#### Endoscopic sampling of tracheal secretions

The flexible fiberoptic endoscope can be used to obtain tracheal lavage samples and at the same time visualize the state of the airways.<sup>15,60</sup> The process is as for rhinolaryngoscopic examination with the addition of passage of a catheter through the biopsy port of the endoscope. Tracheal fluid is then visualized and aspirated through the catheter. The clinical advantages of the endoscopic collection include noninvasiveness, visual inspection of the airways, guidance of the catheter, and speed.<sup>60</sup> The use of an endoscope with a guarded tracheal swab minimizes contamination by oropharyngeal secretions but does not eliminate it.<sup>5,61</sup>

#### Assessment of results

Microbiological examination can yield any one or more of a variety of bacteria, depending on the species examined, the animal's age and its clinical condition. Tracheal aspirates of normal animals rarely yield any bacterial growth on culture. Growth of unusual organisms or known oropharyngeal commensal bacteria from samples obtained by endoscopic

examination should not be given undue clinical significance as they probably result from contamination of the tracheal aspirate during collection. *Pseudomonas* spp. and anaerobes isolated from tracheal aspirates collected by endoscopy are almost always contaminants and of no clinical significance.<sup>5</sup> The extent of contamination of tracheal aspirate samples by oropharyngeal bacteria can be estimated from the number of squamous epithelial cells in the sample.<sup>59</sup> There is an apparent approximate linear relationship between the number of squamous cells per milliliter of fluid and the number of colony-forming bacterial units in tracheal aspirates. Samples containing over approximately 10 squamous epithelial cells per milliliter of tracheal aspirate had markedly greater bacterial contamination.<sup>59</sup> Examination of Gram-stained smears of tracheal fluid is specific but not very sensitive for detection of bacteria, compared with culture.<sup>63</sup> In other words, if examination of a Gram-stained smear of tracheal fluid reveals bacteria, then the sample is likely to yield bacteria on culture, whereas failure to detect bacteria predicts poorly the likelihood of growth of bacteria on culture of the sample. This indicates that examination of Gram-stained samples of tracheal fluid does not reliably predict bacterial isolation, and if an infectious etiology is suspected the fluid should be cultured. Results of the microbiological examination of the tracheal fluid should be consistent with the animal's clinical condition and expected isolates.

Cytological examination of tracheal fluid is an important diagnostic tool. Various stains are available to aid identification of cell types and numbers in tracheal aspirates. Neutrophils, macrophages, lymphocytes and epithelial cells are readily identified on the basis of their classical morphology and staining using fast Romanowsky stain (Diff-Quik®), but this stain is not suitable for identifying mast cells in equine tracheal fluid and probably that of other species.<sup>59</sup> Leishman's stain is useful to identify mast cells.<sup>59</sup> Clinically normal horses typically have fewer than 20–30% of cells as neutrophils with the majority of remaining cells being macrophages, lymphocytes and epithelial cells.<sup>54,61</sup> Animals with inflammation of the airways typically have increased cell counts and proportion of neutrophils, and large amounts of mucus. Horses with inflammatory airway disease such as heaves typically have more than 20% of the cells as neutrophils (see Heaves, below), and those with infectious pneumonia often have 50–90% of cells as neutrophils. The presence of eosinophils is considered abnormal and is consistent with parasite migration (*Parascaris equorum*

in foals, *Dictyocaulus viviparus* in calves). The presence of hemosiderin-laden macrophages is evidence of prior pulmonary hemorrhage.<sup>64</sup>

#### Bronchoalveolar lavage

Bronchoalveolar lavage provides a sample of secretions and cells of the distal airways and alveoli, referred to as bronchoalveolar lavage fluid. It is a widely used procedure in horses and, to a lesser extent, cattle and calves,<sup>65–67</sup> sheep<sup>68</sup> and pigs.<sup>53,69</sup> Analyses performed on bronchoalveolar lavage fluid include measurement of cell number and type, culture (usually in pigs and cattle) and analysis of immune proteins and surfactant. It is a relatively noninvasive procedure that allows cytological and biochemical evaluations of the lower airways and alveoli, which are useful diagnostic aids when evaluating animals with lung disease. While fiberoptic bronchoscopy and tracheal aspirates permit assessment of the major bronchi and upper airways, bronchoalveolar lavage offers an extension of the diagnostic potential by sampling the terminal airways and alveolar spaces.

The primary **indication** for collection of bronchoalveolar lavage fluid is acute or chronic lung disease. This includes both infectious and noninfectious diseases, although interpretation of samples collected by passage of the collection tube through the nostrils or mouth is complicated by the inevitable contamination of the sample by oropharyngeal commensal bacteria. Despite this shortcoming, the technique has been used to detect pneumonia associated with *Mycoplasma* sp. in cattle.<sup>70</sup> **Contraindications** are few, with respiratory distress being an obvious one. **Complications** of bronchoalveolar lavage are also few, and include a mild neutrophilia in lavaged sections of lungs and changes in phagocytic function of pulmonary macrophages, and microbial content, for several days after the procedure.<sup>31,71</sup>

A shortcoming of bronchoalveolar lavage is that it lavages only a small region of the lung, with the risk that focal lung disease is not detected. This is best exemplified in pneumonia in horses, in which bronchoalveolar lavage fluid from pneumonic horses can contain large numbers and a high proportion of neutrophils or can be normal, depending on the area of lung lavaged. Therefore, the bronchoalveolar lavage procedure is a very specific but not very sensitive test for pneumonia in horses.<sup>72</sup> Abnormal lavage fluid is helpful diagnostically, whereas normal results do not exclude the presence of foci of pulmonary disease. The lavage samples may be normal in horses affected with pneumonia or pleuropneumonia and, because

of these false-negative results, this is not the best diagnostic technique to evaluate a horse with pneumonia.<sup>13</sup> In contrast, the tracheobronchial aspirates are more sensitive and most horses with pneumonia have cytological abnormalities.<sup>13</sup>

#### Endoscopic bronchoalveolar lavage

Endoscopic bronchoalveolar lavage has the advantage of permitting visual examination of the airways during the procedure and selection of the region of the lung to be lavaged. This technique does require access to sophisticated endoscopic equipment. The technique described below for horses can be modified for use in other species.<sup>73</sup>

Horses for bronchoalveolar lavage should be appropriately restrained. Sedation is usually essential and is achieved by administration of alpha-2-agonists. Coadministration of narcotics is recommended by some authorities to reduce the frequency and severity of coughing. Butorphanol tartrate 10 mg for a 400 kg horse is recommended, although this drug is not as effective as intratracheal lidocaine at reducing the frequency or severity of coughing when combined with detomidine for collection of bronchoalveolar lavage fluid.<sup>74</sup> Effective suppression of coughing during collection of bronchoalveolar lavage fluid can be achieved by instillation of lidocaine (60 mL of a 0.7% solution – made by diluting 20 mL of 2% lidocaine solution by addition of 40 mL of isotonic saline). The lidocaine solution is administered as the endoscope enters the rostral trachea. A twitch can be applied to the nares. The endoscope must be at least 2 m in length and the external diameter should be 10–15 mm. Endoscopes of 10 mm diameter will pass to about the fifth-generation bronchi, whereas endoscopes of larger diameter will not pass quite as far into the lung. The endoscope is passed until it wedges and then 300 mL of warmed (to reduced bronchospasm) isotonic saline is introduced in 5 × 60 mL aliquots. Air is infused after the last aliquot to ensure that all fluid is instilled. After the horse has taken between one and three breaths the fluid is withdrawn and the aliquots are mixed. There is no difference in the cytological composition of the first and subsequent aliquots.<sup>75</sup>

#### Blind bronchoalveolar lavage

Commercial bronchoalveolar lavage tubes are available for use in horses, and are suitable for use in adult cattle and calves.<sup>67</sup> The tubes are made of silicone and are therefore considerably more pliable than stomach tubes (which are not suitable for this procedure). The tubes are 2 m in length and have an external diameter of about 8 mm. The horse is

restrained and sedated as for endoscopic bronchoalveolar lavage and the tube is passed through one nostril into the trachea. The tube is then advanced until it wedges, evident as no further insertion of the tube with mild pressure. Continued vigorous attempts to pass the tube can result in the tube flexing in the pharynx and a loop of the tube entering the mouth. After the tube wedges, the cuff on the tube is inflated to prevent leakage of fluid around it, 300 mL of warm isotonic saline is instilled, the tube is flushed with air and fluid is aspirated. The fluid should be foamy and, if cell counts are high, slightly cloudy.

Bronchoalveolar lavage can be performed in conscious **sheep** by insertion of 1.7 mm external diameter polyethylene tubing through a cannula inserted percutaneously in the trachea.<sup>68</sup> The tubing is inserted until resistance is detected (about 40–45 cm in an adult sheep) and the lung is lavaged with 30 mL of sterile isotonic saline.

#### Laboratory assessment of tracheobronchial secretions

A problem with comparison of cell counts of bronchoalveolar lavage fluid reported by different authors is the use of inconsistent quantities of fluid to perform the lavage. The use of different volumes alters the extent of dilution of the fluid. There is a need for uniformity in technique.<sup>76</sup> An approach to this problem has been to measure substances in the bronchoalveolar lavage fluid that can provide an indication of the extent of dilution of the sample. Both endogenous (urea, albumin) and exogenous (inulin, methylene blue) markers have been used. Dilution factors using urea concentration in plasma and in bronchoalveolar lavage fluid appear to be useful.<sup>77</sup> The assumption is that urea concentrations in bronchial and alveolar secretions will be identical to that in plasma. The formula for correcting for dilution that occurs during collection of bronchoalveolar lavage fluid is:

$$\text{Dilution factor} = \frac{\text{Urea concentration in bronchoalveolar lavage fluid}}{\text{Urea concentration in plasma}},$$

where urea concentration in bronchoalveolar lavage fluid and in plasma is expressed in the same units. The volume of the pulmonary epithelial lining fluid can then be calculated:

$$\text{Pulmonary epithelial lining fluid volume} = \text{dilution factor} \times \text{volume of bronchoalveolar lavage fluid}.$$

Samples for cytology are submitted for preparation involving centrifugation of the sample to concentrate cells for preparation of slides for staining and micro-

scopic examination. At least for samples from horses, examination of smears made directly from the sample, without centrifugation, is diagnostically useful.<sup>78</sup> As for tracheal fluid, the proportion of mast cells in equine bronchoalveolar lavage fluid is underestimated if cells are stained with fast Romanowsky stain (Diff-Quik<sup>®</sup>).<sup>79</sup>

#### Diagnostic value

The aspirates from normal animals contain ciliated columnar epithelial cells, mononuclear cells and a few neutrophils with some mucus. The concentration of the cells depends on the volume of fluid infused and the disease status of the animal. Representative values for various species are listed in Table 10.3. The general pattern is that animals with inflammatory airway disease, either infectious or noninfectious, have a higher proportion of neutrophils than do disease-free animals. However, ranges of normal values vary considerably depending on the species, the age of the animal and its management (primarily housing conditions). Care should be taken not to overinterpret findings on examination of tracheal aspirates or bronchoalveolar lavage fluid. While there is good correlation between microbiological results and cell counts in bronchoalveolar lavage fluid of calves with pneumonia<sup>65</sup> and Thoroughbred race horses with inflammatory airway disease,<sup>80</sup> this association might not hold for all diseases or species.

#### Thoracocentesis (pleurocentesis)

Paracentesis of the pleural cavity is of value when the presence of pleural fluid is suspected and, in the absence of ultrasonographic examination, needs to be confirmed, and when sampling of pleural fluid for cytological and bacteriological examination is indicated. The primary indication for sampling pleural fluid is the presence of excess pleural fluid. Sampling of pleural fluid is usually accompanied by therapeutic drainage, in which case the cannula used for sampling is larger than if only collection of pleural fluid is desired. Contraindications are minimal, especially if the procedure can be performed under ultrasonographic guidance. The principal contraindication is the inability to restrain an unruly animal, as this increases the risk of laceration of the lung or a coronary vessel, or cardiac puncture. Complications include hemorrhage from lacerated intercostal or pleural vessels, pneumothorax secondary to laceration of the lung or introduction of air through the cannula, cardiac puncture and sudden death, irritation of the myocardium and ventricular arrhythmia (premature ventricular contractions), or coronary artery laceration and subsequent cardiac tamponade and death. There is a risk of cellulitis at the site

Table 10.3 Representative results of cytology of bronchoalveolar lavage fluid of cattle, sheep, pigs, and horses

Species	Disease status	Volume infused (mL)	Total nucleated cell count (cells × 10 <sup>6</sup> /L)	Neutrophil (%)	Macrophages (%)	Lymphocytes (%)	Eosinophils (mast cells) (%)	Reference
Weaner pigs	Normal	15–30	0.7 ± 0.2	2.0 ± 1.2	95.6 ± 2.7	1.7 ± 1.2	NR	53
Weaner pigs	Respiratory disease	15–30	0.9 ± 0.3	7.0 ± 4.2	87.9 ± 5.9	3.7 ± 2.0	NR	53
Adult sheep	Normal, pastured	30	NR	6.9 ± 5.8	81.1 ± 15.3	10.8 ± 15.8	1.2 ± 2.7	68
Adult sheep	Normal, housed	30	NR	21.8 ± 23.4	57.6 ± 19.6	16.1 ± 12.6	4.5 ± 9.5	68
Adult sheep	Respiratory disease	30	NR	26.8 ± 16.8	55.4 ± 20.9	11.6 ± 11.1	6.2 ± 8.6	68
Calves (2–3 months old)	Normal	240	NR	12 ± 10	86 ± 10	2 ± 1	0	66
Calves (2–3 months old)	Parasitic ( <i>Dictyocaulus viviparus</i> ) pneumonia	240	NR	20 ± 20	20 ± 10	2 ± 1	70 ± 10	66
Cattle (6–10 months old)	Healthy	180–240	1.4 ± 0.3	< 5	80–85	10	NR	145
Calves (2 months old)	Healthy	180	NR	9.1 ± 11.6 (all but one < 12)	90.7 ± 11.6	NR	NR	67
Horses (yearling)	Healthy, at pasture	300	85 ± 10.2 cells/μL	3.6 ± 0.8	39.5 ± 2.6	42.8 ± 2.4	0.8 ± 0.4 (mast cells 8.3 ± 1.7)	146
Horses (yearling)	Healthy, stabled	300	74.5 ± 7.8 cells/μL	13.2 ± 3.0	40.1 ± 2.7	39.1 ± 2.3	0.6 ± 0.2 (mast cells 4.1 ± 1.3)	146
Horses (adults)	Healthy	300	182 ± 035	8.9 ± 1.2	45 ± 2.8	43 ± 2.7	< 1	54
Standardbred racehorses	Healthy	300	153.2 ± 17.1	3.8 ± 0.3	64.8 ± 4.6	28.3 ± 2.9	1.2 ± 0.8 (mast cells 0.3)	147
Standardbred racehorses	Inflammatory airway disease	300	366 ± 16.8 cells/μL	10.4 ± 1.1	48.4 ± 1.9	36.0 ± 1.9	3.8 ± 1.5 (mast cells 1.8 ± 1.5)	147
Adult horses	Heaves	300	860 ± 324 cells/μL	60.3 ± 12.4	14.6 ± 4.8	22.7 ± 10.1	(mast cells 0.8 ± 0.6)	148
Adult horses	Remission from heaves (at pasture)	300	85 ± 15 cells/μL	17.7 ± 5.4	38.9 ± 9.1	42.4 ± 8.9	3.0 ± 0.8	148
Adult horses*	Mild heaves	250	253 (80–414)	17 (7–67)	28 (10–47)	43 (19–71)	0 (0–1) 1 (0–3)	149
Adult horses*	Moderate heaves	250	255 (117–3564)	17 (12–92)	19 (3–33)	43 (6–60)	1 (0–32) 1 (0–4)	149
Adult horses*	Severe heaves	250	286 (98–913)	25 (9–85)	34 (6–49)	31 (7–68)	0 (0–1) 1 (0–1)	149

Values are mean ± SD or median and range (\*).  
NR, not reported

of centesis, especially if indwelling cannulas are maintained for more than a day.

The procedure is performed with the animal standing. Sedation or systemic analgesia is usually not needed, unless it is medically indicated or the animal is not easily restrained. The equipment for sampling of pleural fluid from adult horses or cattle is a blunt 10–15 cm cannula of approximately 3 mm diameter (such as a bovine teat cannula) or a 7.5 cm spinal needle. The blunt-tipped cannula is preferred because use of it reduces the risk of laceration of vital structures. A three-way stopcock or similar device should be attached to the hub of the needle or cannula and closed to prevent aspiration of air when the pleural cavity is entered. The site for centesis is best identified by ultrasonographic examination of the thorax or, if that is not available, by percussion and auscultation of the chest to identify the fluid level. A commonly used site is the seventh intercostal space on the left side and the sixth intercostal space on the right side. The skin should be clipped of hair and aseptically prepared. The region can be anesthetized with approximately 10 mL of 2% lidocaine, mepiricaine or similar product. The cannula or needle should be introduced over the rib and then directed cranial to the rib (the intercostal vessels and nerves course along the caudal edge of the rib). If a cannula is used then a slight 'popping' sensation is felt as the cannula perforates the parietal pleura. A syringe is attached to the cannula or needle and fluid is aspirated from the pleural space.

Collected fluid should be examined visually. Normal pleural fluid, which is present in small quantities in normal animals, is clear and slightly yellow. Abnormal fluid can be bloody, thick and yellow, suggestive of purulent material, or flocculent. The material should be smelled – a foul odor is usually present when the pleural fluid is infected by anaerobic bacteria and is a sign of a poor prognosis. Cytological examination should be performed, including white cell count and measurement of total protein concentration. Ancillary measurements on pleural fluid include pH,  $PCO_2$ ,  $PO_2$ , bicarbonate, glucose and lactate. Sterile pleural fluid has a pH,  $PO_2$  and  $PCO_2$  and lactate, glucose and bicarbonate concentrations similar to those of venous blood.<sup>81</sup> Infected pleural fluid is acidic, hypercarbic and has an increased concentration of lactate and decreased concentrations of bicarbonate and glucose compared to venous blood.<sup>81</sup> Pleural fluid should be cultured for aerobic and anaerobic bacteria and mycoplasmas. Antimicrobial susceptibility

should be determined for isolated organisms. Fungal cultures are rarely indicated.

Ultrasound-guided needle puncture of a suspected lung abscess to determine the species of bacteria present is sometimes practiced but there is the risk that infection will be spread to the pleura by this technique. This technique is not recommended as a routine procedure as microbiological examination of tracheal aspirates will probably yield the offending bacteria.

### **PULMONARY FUNCTION TESTS**

Pulmonary function tests provide quantitative assessment of pulmonary ventilatory function through measurement of expired and inspired gas volumes, intrathoracic pressures and derivations of these variables – sometimes referred to as pulmonary mechanics. The techniques are widely used in research into pulmonary diseases, especially heaves, in horses, and have been adapted for use in ruminants.<sup>82</sup> A relatively simple assessment of pulmonary function is measurement of **pleural pressure changes** during respiration. This can be achieved by either insertion of a blunt cannula through the intercostal space or passage of a balloon catheter into the thoracic esophagus. The pressure changes during respiration are then recorded and the maximal pressure change between inspiration and expiration is calculated. The pressure change is closely correlated with airway resistance to airflow and is an excellent indicator of the severity of bronchoconstrictive diseases.

More complex measurements are made by application of an airtight face mask containing a flow meter to the animal. Combined with measures of airway pressure, air flow during tidal breathing yields measures of tidal volume, minute volume, respiratory rate, pulmonary resistance and pulmonary dynamic compliance. Measurements made with the animal at rest are relatively insensitive to small changes in pulmonary function and the sensitivity of these tests to detect heaves is low.<sup>57</sup> The sensitivity of changes in maximal pleural pressure and resistance of the lower airways are 44% and 22%, respectively.<sup>57</sup> The sensitivity of the test can be increased by measuring these variables during exercise. Measurement of pulmonary mechanics in horses with heaves is reproducible over both short (hours) and long (months) periods of time, indicating the usefulness of these techniques for monitoring of disease progression and response to therapy.<sup>83</sup>

Measurement of **flow-volume loops** has been performed for both stationary and exercising horses.<sup>84,85</sup> A number of variables are derived from these measures

and used as indicators of pulmonary function. However, the large variability in these measures in stationary horses (16–32%) severely limits the utility of this test to detect mild or subclinical respiratory disease. Similarly, flow-volume loops in exercising horses with obstructive lung disease of moderate severity do not differ markedly from those of the same horses when they do not have lung disease. Flow-volume loops have limited use in evaluation of lung function in animals.

Other tests of pulmonary function include the nitrogen dilution test and the single-breath diagram for  $CO_2$ . For the **nitrogen dilution test** concentrations of nitrogen in exhaled air are measured while the animal breathes 100% oxygen. A number of variables are calculated from the decay curve of nitrogen concentration in exhaled air, including the functional residual capacity.<sup>86</sup> There are clinically significant differences between animals with normal respiratory function and those with pulmonary disease. However, this test is not readily adapted for routine clinical use. Volumetric capnography is the graphic examination of expired breath  $CO_2$  concentrations versus expired volume to create a **single-breath diagram for  $CO_2$** .<sup>87</sup> The results are divided into phase I, which represents the relatively carbon-dioxide-free air from the proximal or oral conducting airways, phase II, which is the transitional phase, and phase III, which is the carbon-dioxide-rich air from the alveoli. Measures of pulmonary function obtained include estimates of dead space ratio, physiological dead space volume and alveolar efficiency.<sup>87</sup> The clinical utility of this test and its ability to detect mild or subclinical disease in animals have not been demonstrated.

**Impulse oscillometry** offers the potential of being a potentially clinically useful test of respiratory function in both horses and cattle.<sup>46,88,89</sup> The test measures impedance of the respiratory system and provides estimates of respiratory resistance and reactance.<sup>46</sup> The technique has the advantage of being more sensitive to changes in pulmonary function than measurement of pleural pressure changes,<sup>90</sup> is minimally influenced by respiratory rate and tidal volume<sup>91</sup> and is relatively easier to perform than more complex measures of respiratory mechanics. The test involves fitting an airtight facemask containing a pneumotachograph for measurement of respiratory volumes and tubing to a horse. The tubing is attached to a loudspeaker, which is used to generate square-wave signals containing harmonics between 0 and 10 Hz. Information from the system is analyzed using a computer program and indices of pulmonary resistance and reactance are determined.



The forced oscillation technique in feedlot cattle with naturally occurring shipping fever indicates the presence of a large increase in pulmonary resistance and a decrease in dynamic compliance with obstructive lung disease located mainly at the level of large airways but also in small airways.<sup>92</sup> The clinical utility of the technique remains to be determined.

The sensitivity of these tests can be increased by provocative tests in which animals are administered agents, such as histamine or methacholine, that cause bronchoconstriction in animals with reactive airways.<sup>90</sup>

Measurement of **forced expiratory flow–volume curves** and forced vital capacity in horses is a sensitive indicator of bronchoconstriction.<sup>57,93</sup> The test involves the heavily sedated horse having a nasotracheal tube inserted. The nasotracheal tube is then attached to a large vacuum reservoir and a valve is opened abruptly. The maximum rate of forced expiratory airflow is measured and various variables indicative of pulmonary function are calculated, including forced expiratory volume in one second (FEV<sub>1</sub>).<sup>93</sup> The clinical utility of this test of pulmonary function is limited by the extensive instrumentation of the animal and the need for sophisticated electronics.

A portable system for monitoring cardiovascular and respiratory function in large animals is available. Pulmonary function testing of cattle is also being examined and may provide some understanding of the pathophysiology of respiratory tract disease. Calves between 1 and 8 months of age with chronic respiratory disease have.<sup>82</sup>

- Significantly reduced inspiratory and expiratory times and tidal volume
- Significantly increased respiratory frequency and airway resistance
- More negative transpulmonary pressure values when compared to predicted values for the same calves.

Arterial oxygen and carbon dioxide tensions are the only variables which correlate with clinical scores.

## ARTERIAL BLOOD GAS ANALYSIS

Measurement of  $P_{aO_2}$ ,  $P_{aCO_2}$  and arterial oxygen content ( $C_{aO_2}$ ) provides valuable information about pulmonary function and oxygen delivery to tissues. The arterial oxygen tension and arterial oxygen content are not equivalent. The arterial oxygen tension ( $P_{aO_2}$ ) is a measure of the partial pressure of oxygen in arterial blood determined by the amount of oxygen dissolved in the blood (not the amount bound to hemoglobin) and the temperature of the blood – it is

not a direct measure of arterial oxygen content. Arterial oxygen content is the amount of oxygen per unit of blood and includes both dissolved oxygen and that bound to hemoglobin. The oxygen tension can be viewed as the driving force for diffusion of oxygen from capillaries into mitochondria (in which the oxygen tension is about 2 mmHg), whereas the oxygen content is the amount of oxygen delivered to tissue. Both are important measures of pulmonary function and oxygen delivery to tissue.

Measurement of **oxygen tension** in blood is achieved by analysis of an appropriately collected sample of arterial blood using a blood gas analyzer (oxygen electrode). Instruments designed for medical or veterinary clinical use measure pH,  $PO_2$  and  $PCO_2$  at a temperature of 37°C. Depending on the software included with the instrument, various derived values are also reported, including bicarbonate concentration, base excess and oxygen saturation. It is important to understand that **oxygen saturation** reported by blood gas instruments is a *calculated* value and might not be correct. Oxygen saturation is *measured* by a co-oximeter, which is different from a blood gas machine, and the amount of oxygen carried by hemoglobin is then calculated from this value and the assumption that each gram of hemoglobin, when fully saturated, carries approximately 1.34–1.39 mL of oxygen. The total **oxygen content** of blood is calculated by adding the amount carried by hemoglobin to the amount of oxygen dissolved in the aqueous phase of the blood. The formula is:

$$O_2 \text{ content} = (S_aO_2 \times 1.34 \times [Hb]) + (0.003 \times P_aO_2),$$

where  $O_2$  content is in mL/100 mL,  $S_aO_2$  is the arterial oxygen saturation (%), 1.34 is the amount of oxygen carried by fully saturated hemoglobin (mL/g), [Hb] is the concentration of hemoglobin in blood (g/100 mL), 0.003 is the amount of oxygen dissolved in the aqueous phase of 100 mL of blood for each 1 mmHg increase in  $PO_2$ , and  $P_aO_2$  is the oxygen tension in arterial blood. The appropriate substitutions can be made to calculate the oxygen content of venous blood.

The oxygen content of arterial blood is the critical factor (with cardiac output) in determining **oxygen delivery** to tissues. However, measurement of arterial oxygen content is not as readily accomplished as measurement of arterial oxygen tension. Therefore, in animals with normal hemoglobin concentration and function the arterial oxygen tension is used as a surrogate measure of arterial oxygen content. In doing so, it must be recognized that the extent of hemoglobin saturation

with oxygen is dependent on both the affinity of hemoglobin for oxygen and the oxygen tension of the blood. The oxygen tension/percentage saturation relationship is sigmoidal, with 50% saturation occurring at about 30 mmHg in most species (there are minor variations) and 80% saturation at a  $PO_2$  of 45–55 mmHg.<sup>94</sup> The sigmoidal shape of the oxygen–hemoglobin saturation curve has important clinical consequences. Small decrements in  $P_aO_2$  from normal values (usually 95–105 mmHg in animals breathing ambient air at sea level) have a minimal effect on oxygen content of blood. Many modern blood gas analyzers have software that calculates oxygen content of blood, but it must be recognized that these calculations often use an assumed, not measured, hemoglobin concentration (usually 15 g/dL) and values for the human  $SO_2$ – $PO_2$  relationship. These assumed values may not be correct for animals and one should always check the assumptions used to calculate oxygen content of blood before accepting and acting on those values. Direct measurement of blood oxygen content is restricted to research laboratories – indirect estimates gained from oxygen saturation and hemoglobin concentration are usually sufficiently accurate for clinical use.

The oxygen tension in blood is proportional to the amount of oxygen dissolved in the aqueous phase of the blood and the temperature of the blood. For a given amount of oxygen dissolved in blood, the tension varies according to the temperature of the animal. Almost all blood gas analyzers measure the  $PO_2$  at 37°C. If the animal's body temperature is markedly different from that then the reported  $PO_2$  can be erroneous. For instance, the  $P_aO_2$  of a horse with a body temperature of 40°C measured using an analyzer with a temperature of 37°C would be 80 mmHg (the  $PCO_2$  would be 35 mmHg). If the  $P_aO_2$  was adjusted for the difference between the horse's body temperature and that of the analyzer, then the reported  $P_aO_2$  would be 100 mmHg (and the  $P_aCO_2$  would be 44 mmHg). Failure to make the appropriate temperature corrections can result in errors of 6–7% per °C.<sup>95</sup> When interpreting blood gas values, attention should be paid to the temperature of the animal and consideration given to adjusting gas tension values according to the animal's body temperature. This is probably only clinically important when there are extreme deviations from normal temperature and oxygen tension. Most blood gas analyzers include software that makes the appropriate corrections.

The arterial oxygen tension is determined in the alveolus by the alveolar

oxygen tension and the alveolar-arterial difference. The alveolar oxygen tension ( $P_{AO_2}$ ) can be calculated from:

$$P_{AO_2} = F_iO_2(P_B - P_{H_2O}) - (P_aCO_2/RQ),$$

where  $F_iO_2$  is the inspired oxygen fraction (21% for ambient air),  $P_B$  is the barometric pressure (760 mmHg at sea level),  $P_{H_2O}$  is the partial pressure of water vapor in the alveolar air (47 mmHg at 37°C), and RQ is the respiratory quotient (usually assumed to be 0.8 for resting animals). The alveolar-arterial  $PO_2$  difference (A-a  $PO_2$ ) is calculated:

$$A-a PO_2 = P_{AO_2} - P_aO_2.$$

The A-a  $PO_2$  difference has clinical significance in that it is an indicator of pulmonary function that is somewhat independent of inspired oxygen fraction and is therefore useful in animals being supplemented with oxygen (there is a small increase in A-a difference with marked increases in  $F_iO_2$ ). Increases in A-a  $PO_2$  difference are indicative of ventilation/perfusion mismatches, with the A-a  $PO_2$  difference increasing with worsening ventilation/perfusion abnormalities.

### Normal values

Values obtained from clinically normal animals breathing room air at sea level vary slightly between species, with most animals having an arterial  $P_aO_2$  of 95–105 mmHg and a  $P_aCO_2$  of 35–45 mmHg. Oxygen saturation in clinically normal animals breathing air at sea level is above 98% and oxygen content of arterial blood is 16–24 mL/dL of blood (this depends on the hemoglobin concentration in blood). The difference in oxygen content of arterial and mixed venous blood is usually 4–8 mL/dL of blood. Values can be influenced substantially by changes in physiological state (exercise, hyperpnea), positioning, pulmonary disease and altitude (Table 10.4). Positioning of the animal can be important, especially in neonatal foals, in which the compliant chest wall can impair ventilation in

laterally recumbent foals – foals have lower arterial oxygen tension when in lateral recumbency than when in sternal recumbency.<sup>96</sup>

### Collection of arterial blood gas samples

Arterial samples can be collected from any of the appropriate peripheral arteries, which vary depending on species. An arterial sample is representative of aortic blood in almost all instances. Samples can be collected from the carotid, transverse facial, metacarpal and metatarsal arteries in horses and foals, and from the carotid, radial and coccygeal arteries in cattle and calves. Minimally invasive arterial access is difficult in pigs.

Samples should be collected in glass or plastic syringes in which the dead space has been filled with heparin solution. Typically, a 3 mL plastic syringe containing approximately 0.1 mL of sodium heparin and attached to a 22–25-gauge needle is used. All air should be expelled from the syringe before collection of the sample, and care should be taken to not introduce air into the syringe until blood gas tensions are measured. Air in the syringe will increase the measured oxygen tension of blood from normal animals. The sample should be measured as soon after collection as possible (within minutes). If immediate analysis is not available, the sample should be stored in iced water until analysis to prevent consumption of oxygen, production of carbon dioxide and a decrease in pH. Storage of arterial samples in plastic syringes in iced water can increase the oxygen tension from 100 mmHg to 109 mmHg in as little as 30 minutes.<sup>97</sup> This does not occur when samples are stored in glass syringes in iced water. The  $pH_a$  and  $P_aCO_2$  are not affected by the type of syringe.

### VENOUS BLOOD GAS ANALYSIS

Measurement of gas tensions in venous blood is of limited value in assessing pulmonary function because of the extensive and variable effects of passage through

the capillary beds on gas tensions. However, measurement of venous oxygen tension, saturation or content can be useful in assessment of the adequacy of oxygen delivery to tissue. The oxygen tension, saturation and content of venous blood depends on the extent of oxygenation of arterial blood, the blood flow to the tissues, the metabolic rate of the tissues drained by the veins from which blood is sampled, and the transit time of blood through capillaries. The multiplicity of these factors means that determining the precise reasons for abnormalities in venous blood gas tensions is not possible. However, some generalizations can be made about venous oxygen tension, saturation and content.

In normal, resting animals, oxygen delivery to tissues exceeds oxygen needs (demand) of the tissue, with the result that venous blood draining these tissues is only partially desaturated. Hence, venous blood from the pulmonary artery (mixed venous blood) has oxygen tension, saturation and content of approximately 35–45 mmHg, 80–90% and 12–18 mL/100 mL (the latter depending on hemoglobin concentration in addition to hemoglobin saturation). However, in situations in which oxygen delivery to tissue is decreased to levels that only just meet or do not meet the oxygen needs of tissue, there is extraction of a greater proportion of the oxygen in blood and venous oxygen tension, saturation and content decline and the arterial-venous difference in oxygen content increases. Reasons for oxygen delivery to tissue not meeting the oxygen needs of that tissue are decreased perfusion of tissue, such as can occur with shock or circulatory failure, anemia or decreased  $P_aO_2$ . Additionally, tissues with a high metabolic rate, such as exercising muscle, have high oxygen demands that can outstrip delivery.

Ideally, whole body assessment of oxygen delivery by measurement of venous blood gas tensions is best achieved by examination of mixed venous blood. Mixed venous blood represents an admixture of blood draining all tissues and is collected

Table 10.4 Changes in blood gas tensions in various disease states compared to values in normal animals breathing air at sea level

Arterial oxygen tension ( $P_aO_2$ , mmHg)	Arterial carbon dioxide tension ( $P_aCO_2$ , mmHg)	Alveolar-arterial oxygen difference (mmHg)	Physiological state or disease
↑	↓	↔	Hyperventilation (excitement, panting)
↔ or ↓	↓	↔	Low inspired $O_2$ (altitude)
↓	↑	↔	Hypoventilation
↓	↔	↑	Diffusion impairment (rarely encountered)
↓	↔ or ↑	↑	Ventilation/perfusion mismatch. ↑ $P_aCO_2$ with this disorder is uncommon
↓	↑	↑	Strenuous exercise by horses

↑, above value in normal animal breathing ambient air at sea level; ↓, below value in normal animal breathing ambient air at sea level; ↔, unchanged from value in normal animal breathing ambient air at sea level.

from the pulmonary artery (although samples collected from the right ventricle or atrium are also appropriate in most instances). While this blood is optimal for assessment of oxygen delivery to tissue, collection of mixed venous samples is not routine because of the need for catheterization of the pulmonary artery. Samples from peripheral veins are therefore used, but care should be taken when interpreting these values as venous blood gas tensions can vary considerably among veins.<sup>98</sup> For animals with normal circulatory status, blood gas tensions in jugular vein blood are likely to be reasonable estimates of mixed venous gas tensions. However, if circulatory function is not normal, then samples from peripheral veins may not be indicative of values in mixed venous blood.

Samples for venous blood gas analysis should be collected into syringes in which the dead space is filled with sodium or lithium heparin solution. The volume of heparin should not be more than 2% of the amount of blood. Samples should be processed promptly. If samples cannot be processed within an hour they should be stored in iced water. Samples stored in iced water for 24 hours have values that are minimally different from those before storage, while samples stored at 25°C change markedly in 2–3 hours.<sup>99,100</sup>

### **PULSE OXIMETRY**

Pulse oximeters are devices for measurement of blood oxygen saturation that attach to skin or mucous membranes and sense the absorption spectrum of light by hemoglobin (the same principle is used in bench top co-oximeters) in the underlying tissues. The devices are widely used for noninvasive monitoring of oxygenation in humans and have been adopted for use in animals. However, important challenges to their use exist in animals, not least of which is the presence of hair and densely pigmented skin in most farm animals. The devices have important deficiencies when used in foals and adult horses but those applied to the ear, lip or tongue of foals have good sensitivity and specificity for detecting arterial  $SO_2$  of less than 90 mmHg (12 kPa).<sup>101,102</sup> The devices consistently underestimate arterial  $SO_2$  at low saturations.<sup>101,102</sup> Care should be taken when using these devices to monitor arterial hemoglobin saturation in animals.

### **BLOOD LACTATE CONCENTRATION**

Measurement of blood lactate concentration is useful in assessing the adequacy of oxygen delivery to tissues. Hypoxia causes a shift to anaerobic metabolism and the production of lactate. Lactate production is related to the severity and

duration of hypoxia, with more severe hypoxia resulting in greater accumulation of lactate in tissues and its subsequent diffusion or transport into blood. Hypoxia also reduces the rate of removal of lactate from blood. The combination of increased production and decreased removal causes lactate to accumulate in blood. Measurement of blood lactate concentrations (which are usually lower than plasma lactate concentrations) is gaining increasing clinical usefulness as 'point-of-care' analyzers become more readily available and testing more affordable.

**Samples** for measurement of blood lactate can be collected into syringes containing heparin solution (as used for measurement of blood gas tensions) if the sample is to be analyzed within 30 minutes.<sup>103</sup> Samples should be stored in iced water until analysis. Prolonged storage at room temperature results in increases in blood lactate concentration. If sample collection is anticipated to be delayed, then samples should be collected into evacuated tubes containing sodium fluoride and potassium ethylenediamine tetraacetic acid (EDTA) – the sodium fluoride inhibits glycolysis. However, plasma lactate concentrations collected in these tubes are approximately 10% lower than in samples collected into tubes containing heparin – probably because of the osmotic effect of sodium fluoride/potassium EDTA on red cells. Samples for clinical analysis should be collected into syringes containing a heparin solution and analyzed within 30 minutes of collection. Measurement of blood or plasma lactate concentrations can be made using 'point-of-care' analyzers, although these can yield results that differ markedly from traditional analyzers, especially in animals with extreme values for hematocrit (severe anemia or polycythemia). Ideally, blood and plasma lactate concentrations should be measured only on analyzers that have been validated for the species and clinical situation being studied.<sup>104</sup>

Blood lactate and plasma lactate concentrations are not equal, with blood lactate concentration being lower because of the dilutional effect of red blood cells, which have a lower lactate concentration than plasma. However, most clinical assessments are based on blood lactate concentrations. Mixed venous or arterial blood lactate concentrations in most farm animal species are less than 2 mmol/L in normal, healthy animals. Tissue hypoxia, in addition to other conditions such as toxemia and septic shock, can increase blood lactate concentration. Blood lactate concentrations between 2 and 4 mmol/L should be interpreted with caution whereas values above 4 mmol/L are indi-

cative of clinically important disruption of oxygen transport and cellular metabolism. Repeated measurements over time can be useful for assessing progression of disease or efficacy of treatment. For instance, plasma lactate concentrations above 4 mmol/L in cattle with pneumonia are predictive of death within 24 hours.<sup>105</sup>

### **COLLECTION AND ANALYSIS OF EXHALED BREATH CONDENSATE**

Collection and analysis of exhaled breath condensate has use primarily in research studies at the current time. Breath condensate is collected and analyzed for markers of pulmonary or systemic disease. Induction of pneumonia in calves by infection with *Pasteurella multocida* causes increases in concentration of leukotriene  $B_4$  in breath condensate.<sup>106</sup> Horses with heaves have higher concentrations of hydrogen peroxide than normal horses – probably a result of the airway neutrophilia in affected animals.<sup>107</sup>

### **LUNG BIOPSY**

Percutaneous biopsy of the lung is useful in confirming diagnosis of lung disease by providing tissue for histological and microbiological examination. The procedure in cattle, sheep and horses is described.<sup>108–110</sup> Indications for the procedure include the presence of diseases of the lungs in which a diagnosis cannot be arrived at through other forms of examination, including tracheal aspiration or bronchoalveolar lavage. It can also be used for assessing the severity of histological changes and response to therapy. The procedure is best suited for widespread diseases of the lung, but can be used for diseases that produce focal lesions if the biopsy is performed with ultrasonographic guidance. Contraindications include abnormalities in clotting function, pneumothorax and severe respiratory distress. The danger in performing lung biopsy in animals in severe respiratory distress is that complications of biopsy, such as pneumothorax, hemothorax or hemorrhage into airways, could further impair lung function and cause the death of the animal.

Complications include pneumothorax, hemothorax, hemorrhage into airways with subsequent hemoptysis or epistaxis, pulmonary hematoma and dissemination of infection from infected lung to the pleural space. Pneumothorax, which is usually not clinically apparent, occurs in most horses in which the procedure is performed.<sup>108</sup> Coughing and epistaxis occur in about 20% and 10% of horses, respectively.<sup>108</sup> Life-threatening hemorrhage occurs uncommonly (≈2% of cases). Bleeding into the airways, detected

by tracheobronchoscopic examination, occurred in 16 of 50 horses after use of the manually discharged biopsy needle and in five of 50 horses after use of the automatically discharged needle.<sup>108</sup> Two of 60 cows collapsed immediately after the procedure, but subsequently stood and recovered.<sup>109</sup> The remaining cows had no clinical abnormalities detected after biopsy, although necropsy examination 24 hours later revealed small lesions in the pulmonary parenchyma at the site of biopsy.<sup>109</sup> One of 10 healthy sheep had coughing and bloody nasal discharge after lung biopsy.<sup>110</sup>

The procedure is performed in adult horses and cattle using a 14-gauge biopsy needle, either manually operated or one that discharges automatically. Such instruments yield tissue in over 95% of attempts in cattle.<sup>109</sup> The area for examination is best determined by radiographic or ultrasonographic examination of the thorax. A common site for biopsy is at the junction of the dorsal and middle thirds of the thorax at the ninth intercostal space in cattle and sheep<sup>109,110</sup> and the 13th intercostal space in horses. The procedure is best performed with the animal standing. The skin over the area should be clipped of hair and aseptically prepared and local anesthesia induced by injection of 2% lidocaine or a similar compound into the intercostal space. A 0.5 cm incision is made through the skin and the biopsy instrument is advanced through the caudal intercostal space (intercostal vessels and nerves course along the caudal aspect of the ribs) and into the lung perpendicular to the skin surface. The instrument is advanced approximately 2 cm into the lung and tissue is collected at the end of inspiration. The procedure is repeated as necessary for collection of samples for histological and microbiological examination. The skin incision is closed with a single suture if necessary. The animal is then monitored closely for 12–24 hours for signs of coughing, epistaxis, hemoptysis, fever or respiratory distress. Hemorrhage into the airways is usually evident, often within minutes of completing the procedure, by the animal coughing. Hemorrhage into the airways is often evident as hemoptysis, even in horses. Respiratory distress can be caused by pneumothorax, hemothorax or hemorrhage into airways. Treatment includes percutaneous aspiration of pleural air, administration of oxygen by insufflation or, in extreme instances, mechanical ventilation.

### RESPIRATORY SOUND SPECTRUM ANALYSIS

Analysis of respiratory sounds has utility in the diagnosis of disorders of the upper respiratory tract of horses. Respiratory

sounds can be detected by a small microphone near the horse's nostril with the recording made by a tape recorder or similar device worn on the saddle or girth strap.<sup>111,112</sup> Studies can be performed with horses running on either a treadmill or outside over ground. Dorsal displacement of the soft palate produces broad-frequency expiratory noises with rapid periodicity (rattling), whereas dynamic unilateral collapse of the arytenoid causes an increase in inspiratory broad band high-frequency noise.<sup>111–113</sup> The technique correctly identifies more than 90% of horses with dynamic collapse of the left arytenoid cartilage ('roarers').<sup>113</sup>

### EXERCISE TESTING

Exercise testing for assessment of respiratory tract function is essentially limited to horses. Such tests are usually conducted on a treadmill, although some are amenable to use in the field. Tests available for use on horses running on a treadmill include endoscopic examination of the upper airway, respiratory noise analysis, blood gas analysis and measurement of respiratory mechanics. The most important of these in a clinical setting is video-endoscopy, during exercise on a treadmill, to detect dysfunction of the upper airway of horses.<sup>114</sup> Some disorders of the upper respiratory tract, such as progressive weakness of the laryngeal abductor muscles, axial deviation of the aryepiglottic fold and epiglottic retroversion, can only be diagnosed by endoscopic examination performed during strenuous exercise.<sup>115</sup> The interested reader is referred to texts devoted to this topic.<sup>116</sup>

## Principles of treatment and control of respiratory tract disease

### TREATMENT OF RESPIRATORY DISEASE

Treatment of diseases of the lower respiratory tract depends on the cause of the disease. However, the common principles are:

- Ensure adequate oxygenation of blood and excretion of carbon dioxide
- Relieve pulmonary inflammation
- Effectively treat infectious causes of respiratory disease
- Relieve bronchoconstriction
- Supportive care to minimize demands for respiratory gas transport.

#### Respiratory gas transport

Cause of acute death in animals with respiratory disease is usually failure of transport of respiratory gases with sub-

sequent hypoxemia and hypercapnia. Treatment of failure of oxygenation of blood and excretion of carbon dioxide can be achieved through administration of supplemental oxygen or mechanical ventilation. The reasons for failure of respiratory gas transport are discussed above, and should be considered when therapy of an animal with respiratory disease and hypoxemia with or without hypercarbia is planned. Animals with hypercarbia and hypoxemia are probably hypoventilating and consideration should be given to increasing the animal's minute ventilation through relief of airway obstruction (e.g. by foreign bodies or bronchoconstriction), improvement in function of the respiratory muscles (restore hydration, maintain normal blood concentrations of electrolytes, including calcium), and positional adjustments (foals have better respiratory function when in sternal recumbency<sup>33</sup>). Artificial ventilation should be considered, but is impractical for long-term treatment in animals other than those housed in referral centers. Ventilation/perfusion abnormalities cause hypoxemia with normal to only slightly elevated  $P_aCO_2$  in most affected animals. Oxygen therapy can be useful in ameliorating or attenuating the hypoxemia due to ventilation/perfusion abnormalities.

### OXYGEN THERAPY

The principal treatment for hypoxemia caused by diseases of the lungs is the administration of oxygen. Oxygen therapy is not often used in large animals in field situations but the use of a portable oxygen cylinder may find a place in tiding animals over a period of critical hypoxia until inflammatory lesions of the lungs subside. It has been used most often in valuable calves and foals.<sup>117</sup> Oxygen therapy must be given continuously, requires constant or frequent attendance on the animal, and can be expensive. Supplemental oxygen is usually administered through a nasal cannula with the tip placed in the nasopharynx, through a mask or through a cannula inserted percutaneously in the trachea. The use of an oxygen tent is impractical.

Oxygen therapy is useful only when hypoxemia is attributable to failure of oxygen transport in the respiratory system. It is of no value when the hypoxia is due to toxins that interfere with oxygen metabolism in tissues (e.g. cyanide). Oxygen therapy will only minimally increase oxygen transport in animals with anemia, abnormal hemoglobin (methemoglobinemia) or cardiovascular shock (stagnant hypoxia). Cases of pneumonia, pleurisy, and edema and congestion of the lungs are most likely to benefit from provision of supplemental oxygen.

Oxygen is often administered to **newborn animals**, either during resuscitation after birth or in those animals with respiratory disease. The value of supplemental oxygen in increasing  $P_aO_2$  has been examined in foals, but the recommendations probably apply to newborns of other species as well. Both a facemask and nasopharyngeal tube are effective in increasing  $P_aO_2$  when oxygen is administered at 10 L/min.<sup>96</sup> The ability to elevate arterial oxygen increases with age from birth to 7 days of age because of the existence of right-to-left shunts in the newborn foal.<sup>96</sup> Maximal changes in arterial oxygen tension occur within 2 minutes of the start of supplementation. In normal foals a flow rate of 4 L/min increases arterial oxygen tension, but responses in sick foals are often attenuated as a result of positional effects on gas exchange (recumbency) and other causes of hypoventilation. **Nasal insufflation** improves arterial oxygen tensions and acid-base status in mild to moderately affected foals but may not be sufficient for oxygenation of foals with severe impairment of gas exchange. Intranasal catheters are also difficult to maintain in active sucking foals and require the use of higher oxygen flow rates to achieve beneficial effects. Oxygen should be delivered through a system that includes a humidifier so the insufflated gas is humidified and therefore drying of the respiratory mucosa is minimized.

A **transtracheal oxygen delivery system** has been used in foals with pneumonia and rapidly progressive dyspnea and hypoxemia despite intranasal oxygen therapy.<sup>117</sup> A catheter is inserted into the midcervical trachea and directly distally in the tracheal lumen for approximately 25 cm. The catheter is attached to about 6 m of oxygen tubing and suspended above the foal, allowing it to move around the stall and suck the mare for up to 6 days without dislodging the catheter. This system was more effective than nasal insufflation in increasing arterial oxygen tension, probably because the catheter tip is in the distal trachea and bypasses a significant length of dead space that would not be oxygenated were the oxygen delivered into the nasopharynx.

In foals with neonatal respiratory distress, signs of respiratory failure may be evident at birth or several hours after birth. Tachypnea, shallow and paradoxical respiration, an expiratory grunt with accentuated abdominal effort, and cyanosis are all common. Management of foals with respiratory distress includes oxygen therapy but, when the distress is severe, oxygen insufflation alone is insufficient to improve the  $P_aO_2$ , which is usually 45–60 mmHg (6.0–8.0 kPa). The atelectasis

and alveolar hypoventilation worsen, resulting in progressive hypoxemia and respiratory acidosis, which requires ventilatory assistance by the use of continuous positive airway pressure.

In cattle and adult horses the nasal tube must be inserted to the nasopharynx because passage short of this causes excessive waste of oxygen. The length of tube inserted should equal the distance from the nostril to a point one-third of the way from the lateral canthus of the eye to the base of the ear. Insertion of a nebulizer in the system permits the simultaneous administration of antibiotics and moisture to prevent drying of the pharyngeal mucosa. The volume of oxygen used should be about 10–20 mL of oxygen per min per kg of body weight. Repeated measurement of arterial oxygen tension, if available, is useful for determining the flow rate. Arterial oxygen tension responds to changes in the rate of administration of oxygen within several minutes.

Oxygen toxicity is a risk in animals breathing pure oxygen for periods exceeding 1–2 days, but this rarely occurs in veterinary medicine because supplementation with oxygen does not result in the animal breathing pure oxygen (except for animals under general anesthesia).

#### RESPIRATORY STIMULANTS

Use of respiratory stimulants, including doxapram, picROTOXIN, leptazol (Metrazol), nikethamide (Coramine), caffeine and amphetamine sulfate, which has been advocated in the past, is not useful or recommended in animals with hypoxemia due to respiratory disease. In these animals there is already maximal stimulation of the respiratory center and administration of drugs such as caffeine or doxapram is at best useless and at worst harmful, in that they can increase oxygen demand, in particular myocardial oxygen demand, thus exacerbating any oxygen deficit. The drugs might be useful in stimulating respiration in animals with pharmacological depression of the respiratory center by general anesthetics and sedatives.

#### MECHANICAL VENTILATION

**Short-term** mechanical ventilation can be achieved in neonates and small adults by use of a nasotracheal tube and a hand-operated bellows, which is usually in the form of a resilient bag equipped with a one-way valve. The animal's trachea is intubated and the bag is connected and squeezed to supply a tidal volume of approximately 5–10 mL/kg BW at a rate of approximately 20 breaths per minute. Commercial bags (Ambubag<sup>®</sup>) are available in a variety of sizes suitable for neonates and small ruminants. There is a simple device for respiratory resuscitation of newborn calves and lambs consisting

of a mouthpiece, a nonreturn valve, a flange and an oral tube.<sup>118</sup> Ventilation of larger animals requires use of compressed gases and appropriate valving systems, including a Hudson demand valve.<sup>119</sup> In an emergency situation, artificial ventilation of neonates and small ruminants can be achieved by mouth-to-nose ventilation by the veterinarian. This should be done only with an awareness of the risks of disease transmission (e.g. a weak newborn calf could be infected by *Brucella* sp. or *Leptospira* sp.).

Prolonged mechanical ventilation is an activity requiring special equipment and expertise. It is indicated for the treatment of diseases of neonates, and perhaps adults,<sup>120</sup> that cause hypoxemia and hypercarbia. There is usually a significant component of hypoventilation in these diseases and this is a prime indication for use of mechanical ventilation. An excellent example is the use of mechanical ventilation to treat foals with botulism.<sup>121</sup> In experienced hands, this technique is effective. Because of the highly technical and demanding requirements for mechanical ventilation, the interested reader is referred to more detailed sources for descriptions of the methodology.<sup>122</sup>

#### ANTI-INFLAMMATORY THERAPY

Many infectious and noninfectious diseases of the lower respiratory tract have inflammation as a major component of the tissue response to the initial insult. Primarily inflammatory diseases include heave and inflammatory airway disease of horses. Inflammation is an important component of pneumonia and some of the allergic or toxic lung diseases. Suppression of the inflammatory response is indicated when the inflammatory response is exacerbating clinical signs of the disease through obliteration of alveoli (inflammatory atelectasis), blockage of airways by inflammatory exudates and infiltration of bronchial walls, and bronchoconstriction as a consequence of inflammation increasing airway reactivity. Administration of anti-inflammatory drugs is indicated as the definitive therapy in noninfectious inflammatory airway diseases (with control achieved by environmental controls, see below). Care must be taken that suppression of the inflammatory response does not impair innate and adaptive immune responses to infectious agents.

Anti-inflammatory drugs used in the treatment of diseases of the respiratory tract include glucocorticoids and nonsteroidal anti-inflammatory drugs (NSAIDs), with other agents such as leukotriene antagonists, interferon and cromolyn sodium used in particular situations.

**Nonsteroidal anti-inflammatory drugs** are useful in the treatment of infectious respiratory disease of cattle and horses, and likely other species. The drugs act by inhibiting the inflammatory response induced by the infecting organism and tissue necrosis. Meloxicam (0.5 mg/kg subcutaneously, once), when administered with tetracycline, improves weight gain and reduces the size of lesions in lungs of cattle with bovine respiratory disease complex over those of animals treated with tetracycline alone.<sup>123</sup> NSAIDs also improve the clinical signs of cattle with respiratory disease.<sup>124</sup> Use of these drugs is routine in horses with pneumonia or pleuritis.

**Glucocorticoids** are administered for control of inflammation in a variety of inflammatory lung diseases but notably heaves of horses and interstitial pneumonia of foals. Treatment can be administered orally, by intravenous or intramuscular injection, or by inhalation. Oral, intramuscular or intravenous administration results in systemic effects of the agents. Inhalation of glucocorticoids provides therapy directed to the site of the disease and minimizes, but does not always prevent, the systemic effects of the drugs. Drugs for inhalation are usually human preparations of fluticasone, beclomethasone and flunisolide that are available as metered-dose inhalers. The compounds are administered through a mask adapted so that a large proportion of the drug is inhaled. Anti-inflammatory responses in the airways are pronounced and result in marked improvement in respiratory function in horses with heaves (see Heaves, Recurrent airway obstruction).

### IMMUNOMODULATORS

**Interferon** is used for the treatment of inflammatory airway disease in race horses and feedlot cattle with respiratory disease.<sup>125,126</sup> A dose of 50-150 IU of interferon-alpha administered orally once daily for 5 days reduced signs of airway inflammation in young Standardbred race horses.<sup>127</sup> Immune stimulation by injection of a suspension of *Propionibacterium acnes* has been investigated for treatment of chronic inflammatory airway disease in horses. The compound enhances expression of interferon-gamma and NK-lysin in peripheral blood mononuclear cells, increases the proportion of CD4<sup>+</sup> cells in peripheral blood and increases phagocytic activity of cells in peripheral blood.<sup>128,129</sup> Similar changes were detected in bronchoalveolar lavage fluid.<sup>129</sup> The effect on respiratory disease has yet to be definitively determined.

### ANTIMICROBIAL THERAPY

Bacterial infections of the respiratory tract

of all species are treated with antimicrobial agents given parenterally or, less commonly, orally. Individual treatment is usually necessary and the duration of treatment will depend on the causative agent and the severity when treatment was begun. In outbreaks of infectious respiratory disease the use of mass medication of the feed and water supplies may be advisable for the treatment of subacute cases and for convalescent therapy. The response to mass medication will depend on the total amount of the drug ingested by the animal and this is a reflection of the appetite or thirst of the animal, the palatability of the drug and its concentration in the feed or water. The choice of drug used will depend on its cost, previous experience on similar cases and the results of drug sensitivity tests if available. The individual treatment of all in-contact animals in an affected group may be useful in controlling an outbreak of respiratory disease such as shipping fever in feedlot cattle.

**Selection of antimicrobials** is based on the principles detailed in Chapter 4. Briefly, antimicrobials for treatment of bacterial respiratory disease should be active against the causative agent, should be able to achieve therapeutic concentrations in diseased lung and should be convenient to administer. The antimicrobials should be affordable and, if used in animals intended as human food, must be approved for use in such animals.

Antimicrobials for treatment of lung disease are preferably those that achieve therapeutic concentrations in diseased lung tissue after administration of conventional doses. This has been convincingly demonstrated for the macrolide (azithromycin, erythromycin, clarithromycin),<sup>130</sup> triamilide (tulathromycin)<sup>131,132</sup> and fluoroquinolone (danofloxacin, enrofloxacin)<sup>133,134</sup> antimicrobials, and florfenicol<sup>135</sup> in a variety of species. The beta-lactam antimicrobials (penicillin, ceftiofur) are effective in treatment of pneumonia in horses, pigs, and ruminants despite having chemical properties that do not favor their accumulation in lung tissue.

Routes of administration include oral (either individually or in medicated feed or water), parenteral (subcutaneous, intramuscular, intravenous) or by inhalation. Intratracheal administration of antimicrobials to animals with respiratory disease is not an effective means of achieving therapeutic drug concentrations in diseased tissue. **Aerosolization and inhalation** of antimicrobials has the theoretic advantage of targeting therapy to the lungs and minimizing systemic exposure to the drug. However, while administration by inhalation achieves good concentrations of drug in bronchial

lining fluid, it does not penetrate unventilated regions of the lungs, in which case parenteral or oral administration of antimicrobials is indicated. Aerosol administration of gentamicin to horses and ceftiofur sodium to calves with pneumonia has been investigated. Aerosol administration of gentamicin to normal horses results in gentamicin concentrations in bronchial lavage fluid 12 times that achieved after intravenous administration.<sup>136</sup> Aerosolized ceftiofur sodium (1 mg/kg) is superior to intramuscular administration in treatment of calves with *Pasteurella (Mannheimia) haemolytica*.<sup>137</sup>

### BRONCHODILATOR DRUGS

Bronchoconstriction is an important component of the increased airway resistance present in many animals with disease of the lower respiratory tract. Administration of bronchodilators can relieve respiratory distress and improve arterial blood oxygenation. Bronchodilatory drugs are beta-2-agonists (clenbuterol, albuterol/salbutamol, terbutaline), parasympatholytic drugs (ipratropium, atropine) and methylxanthines (aminophylline, theophylline).

The **indication** for the use of bronchodilators is relief of bronchoconstriction. Bronchoconstriction is an important component of the pathophysiology of many diseases of the lungs and airways. Bronchodilators are used extensively in horses with heaves and inflammatory airway disease, and less so in animals with infectious diseases. **Contraindications** are few but caution should be exercised when using these drugs in animals that are severely hypoxemic as the beta-2-agonists can transiently worsen gas exchange by increasing perfusion of nonventilated sections of the lung, and in pregnant animals, in which the tocolytic effect of the beta-2-agonists can delay parturition. The use of beta-2-adrenergic agonist bronchodilator drugs in food animals is not permitted in most countries because of the risk of contamination of foodstuffs intended for consumption by people. This is particularly the case with clenbuterol, a drug approved in many countries for use in horses that is administered to cattle illicitly as a growth promoter. People can be poisoned by clenbuterol in tissues of treated cattle.<sup>138</sup>

The **beta-2-adrenergic agonists** are potent and effective bronchodilators that can be administered orally, intravenously or by inhalation. These drugs also enhance mucociliary clearance of material from the lungs. Most administration is oral or by inhalation. Use of these drugs is restricted to horses and the drugs are discussed in the section on Heaves.

**Parasympatholytic** (anticholinergic) drugs relieve vagally mediated bronchoconstriction. Again, their use is restricted to horses. These drugs can cause tachycardia and gastrointestinal dysfunction, including ileus.

The **methylxanthines** are used in horses and have been investigated for use in cattle with respiratory disease. Their use in horses is mainly of historical interest because the availability of the more efficacious beta-2-adrenergic agonists and parasympatholytic drugs has superseded the use of methylxanthines. The use of theophylline in feedlot cattle with respiratory disease in field conditions is associated with accumulation of toxic concentrations in blood and an excessive mortality rate.<sup>139</sup>

### MUCOLYTICS, MUCOKINETIC AND ANTITUSSIVE DRUGS

Many groups of drugs are used in the therapy of respiratory diseases with the objective of improving **mucokinesis** or **effective mucociliary clearance**.<sup>140</sup> Mucokinetic agents have been divided into six groups according to their mode of action.

- Diluents, surface acting agents and mucolytics are supposed to reduce the viscosity of the respiratory secretions
- Bronchomucotropic agents, formerly called expectorants, are supposed to increase the production of a less viscous mucus
- Other agents, such as beta-adrenergic agonists and methylxanthine derivatives, promote more effective clearance of mucus and act as ciliary augmentors or bronchodilators.

The aim of mucokinetic agents is to decrease the viscosity of the respiratory secretions but in some animals with respiratory disease the excessive secretions are of low viscosity and the use of a mucolytic agent in such cases would further decrease mucokinesis. There is little or no evidence that administration of mucolytic or mucokinetic agents, with the possible exception of clenbuterol and dembexine, relieves signs of respiratory disease or hastens recovery.

Inflammation of the lower respiratory tract results in production of mucus and immigration of inflammatory cells. This accumulation of material is cleared by rostral movement into the pharynx, where it is discharged through the nostrils or swallowed. Clearance is by the mucociliary apparatus or coughing. **Mucolytics** are agents that alter the constituents of mucoid or purulent respiratory secretions and make them less viscous. Bromhexine (Bisolvon: Boehringer Ingelheim) is a popular mucolytic with

horse owners. It is said to reduce the viscosity of airway mucus and increase mucus production, although its clinical efficacy has not been determined. It may be of some value in cattle to increase mucociliary clearance. Dembexine (Sputolosin: Boehringer Ingelheim) alters the carbohydrate side chains of mucin and improves its flow properties and is reported to decrease coughing and hasten recovery in horses with respiratory disease.<sup>141</sup>

Hyperhydration, the administration of large quantities of fluids intravenously, has been suggested as being useful in the treatment of horses with accumulation of excessive amounts of mucus or mucopus in the lower airways. However, experimental trials have demonstrated that this approach is not effective in horses with heaves.<sup>142</sup>

**Bronchomucotropic agents (expectorants)** are administered with the intention of augmenting the volume of respiratory secretions by stimulating the mucus-producing cells and glands. Formerly called expectorants, they are supposed to increase the production of a less viscous mucus. These compounds include the iodides, and ammonium and glycerol guaiacolate, which are commonly found in cough mixtures. These are commonly used in farm animals, especially horses, although their efficacy is unknown.

Coughing is a common sign in animals with respiratory disease, and it is an important pulmonary defense mechanism, allowing the expulsion of mucus and foreign bodies. **Antitussive (cough suppressant)** drugs are infrequently used in large-animal medicine. These drugs should only be used when definitive therapy has been implemented for the underlying disease. Control of the underlying disease will in almost all instances resolve the coughing. It is not appropriate to use antitussive agents (butorphanol, codeine, diphenhydramine) to suppress a cough when the underlying cause is unknown or untreated.

### SURFACTANT

Surfactant is critical to normal alveolar function and a lack of this complex phospholipid results in progressive alveolar collapse.<sup>143</sup> Lack of surfactant is an important cause of respiratory disease in newborn animals, with those born prematurely being at increased risk. Attempts have been made to prevent acute respiratory disease in premature newborn foals, such as those delivered by cesarian section because of maternal disease, but the results have been disappointing.<sup>144</sup>

### SURGERY

Many conditions of the upper respiratory tract of horses are amenable to surgical

correction. Tracheostomy is often used in the emergency or urgent relief of acute upper airway obstruction, and in the removal of large amounts of tracheal debris, such as occurs in animals with smoke inhalation. Drainage of excessive or infected pleural fluid can be therapeutic in animals with pleuritis.

### GENERAL NURSING CARE

Animals with respiratory disease should have minimal or no enforced activity and environmental stressors should be minimized. One of the most important aspects of the treatment of respiratory tract disease in farm animals is the provision of a comfortable, well-ventilated environment during and after the disease episode. Affected animals should be placed in a draft-free area that is adequately ventilated and supplied with an abundance of bedding for comfort and warmth, particularly during convalescence. Feed and water should be readily available and dusty feeds avoided.

### CONTROL OF RESPIRATORY DISEASE

Infectious diseases of the respiratory tract of farm animals are caused by a combination of infectious agents and predisposing causes such as inclement weather, the stress of weaning or transportation and poorly ventilated housing, each of which can weaken the defense mechanisms of the animal. Prevention and control of these diseases include:

- Minimizing exposure to inciting agents (infectious or physical)
- Maximizing innate resistance by ensuring that the animals are in excellent general health through attention to nutrition, housing and animal welfare
- Maximizing adaptive resistance by the administration of effective vaccines such that maximal resistance is produced to coincide with the time of greatest risk of the disease.

### IMPORTANCE OF DIAGNOSIS

For some complex respiratory diseases of food animals it is becoming increasingly more difficult to obtain a definitive etiological diagnosis because some of the common diseases appear to be caused by multiple infections rather than a single one. Most of the infective agents that cause respiratory disease are ubiquitous in the environment and are present as normal residents in the nasal cavities of normal animals. This often creates difficulty with the interpretation of the microbiological findings in outbreaks of respiratory disease because the infectious agents can commonly be isolated from



both sick and well animals. Thus there may be no well-defined cause-and-effect relationship and the predisposing causes begin to assume major importance in any control program.

### MANAGEMENT TECHNIQUES

Most of the common respiratory diseases occur at certain times under certain conditions and successful control will depend on the use of management techniques before the disease is likely to occur. For example, in beef cattle, pneumonic pasteurellosis can be kept to a minimum with the use of certain management procedures that minimize stress at weaning. The incidence of pneumonia can be minimized in young bulls destined for a performance testing station if they are weaned well in advance of movement to the test center. In North America, bovine respiratory disease is most common in feedlots where young cattle from several different backgrounds have been mingled after having been transported long distances. Outbreaks of equine respiratory disease occur in young horses that are assembled at the racetrack for training or at horse shows.

### HOUSING FACILITIES

Cattle and pig barns that are overcrowded, damp and cold during the cold winter months and hot and stuffy during the summer months can predispose to a high incidence of pneumonia. The morbidity and mortality from pneumonia may be much higher when the ammonia concentration of the air is high or if it is dusty.

The incidence of pulmonary inflammation and coughing (heaves) in horses is much higher in those that are housed in barns that are dusty and not ventilated compared to horses kept outdoors. Bad stabling management as a major cause of coughing in horses was described almost 200 years ago but there is still a major emphasis on the clinical management of chronic coughing in housed horses using a wide spectrum of antibiotics, expectorants and other drugs. More consideration of good housing and ventilation is necessary.

In pigs, enzootic pneumonia is widespread but the effects of the pneumonia can be maintained at an insignificant level with adequate housing, ventilation and nutrition. Too much emphasis has been placed on the attempted eradication of *Mycoplasma* spp., which is extremely difficult, and insufficient emphasis on building design and ventilation methods.

### VACCINES

Vaccines are available for the immunization of farm animals against some of the common infectious diseases of the respiratory tract. Their advantages and disadvantages

are discussed under each specific disease. The general principles underlying use of vaccines for control of respiratory disease are that:

- The disease must be caused by a disease that is infectious
- There must be an effective vaccine suitable for use in the species and age group of animals at most risk of the disease. Ideally, this will be known from published, appropriately designed trials testing the vaccine in a group of animals identical to those in which the vaccine will be used in practice
- The vaccine must be administered to animals in such a manner (route, timing, frequency) as to optimize the immunization (adaptive immunity)
- The timing of the vaccination program should be such that maximal resistance to the anticipated diseases is achieved at the time of greatest risk of the disease
- Vaccination should be part of an on-going program of disease control and should not be regarded as a panacea with which to rectify other shortcomings in management of the animals.

### ENVIRONMENTAL CONTROL

In effect, the principles of control and prevention of airborne respiratory disease are based largely on keeping the levels of pathogens in the air at a low level. This can be accomplished by a combination of the following practices:

- The use of filtered-air positive pressure ventilation systems
- The removal of affected animals from the group
- Increasing the ventilation rate of the building unit
- Subdivision of the unit into small units, each with its own ventilation system
- A continual disinfection system where appropriate and practicable
- The provision of supplemental heat so that during cold weather the ventilation can be maintained and animals will not huddle together to keep warm and thereby increase the exposure rate of infection
- The use of vaccines for specific diseases of the respiratory tract
- Effective dust control.

### REVIEW LITERATURE

- Roudebush P. Lung sounds. *J Am Vet Med Assoc* 1982; 181:122-126.
- Kotlikoff MI, Gillespie JR. Lung sounds in veterinary medicine. Part 1: Terminology and mechanisms of sound production. *Compend Contin Educ Pract Vet* 1983; 5:634-639.
- Kotlikoff MI, Gillespie JR. Lung sounds in veterinary medicine. Part 2: Deriving clinical information

- from lung sounds. *Compend Contin Educ Pract Vet* 1983; 6:462-467.
- Curtis RA et al. Lung sounds in cattle, horses, sheep, and goats. *Can Vet J* 1986; 27:170-172.
- McGorum BC et al. Clinical examination of the respiratory tract. In: Radostits OM et al. (eds) *Veterinary Clinical Examination and Diagnosis*. Philadelphia, PA: WB Saunders, 2000:299-348.

### REFERENCES

1. Klein L, Fisher N. *Am J Vet Res* 1988; 49:1605.
2. Geiser DR et al. *Am J Vet Res* 1996; 57:1483.
3. Curtis RA et al. *Can Vet J* 1986; 27:170.
4. Holcombe SJ et al. *Am J Vet Res* 1996; 57:1258.
5. Sweeney CR et al. *J Am Vet Med Assoc* 1989; 195:1225.
6. Roudebush P. *J Am Vet Med Assoc* 1982; 181:122.
7. Robinson NE et al. *Am J Vet Res* 2003; 64:550.
8. Christley RM et al. *Vet Rec* 2001; 148:99.
9. Krotje KJ. *Compend Contin Educ Pract Vet* 1987; 9:271.
10. Brianceau P, Divers TJ. *Equine Vet J* 2001; 33:105.
11. Thomas A et al. *Vet Res Commun* 2002; 26:333.
12. Allen JW et al. *J Vet Res* 1991; 55:341.
13. Rossier Y et al. *J Am Vet Med Assoc* 1991; 198:1001.
14. Tyler JW et al. *J Am Vet Med Assoc* 1990; 197:52.
15. Roudebush P, Sweeney CR. *J Am Vet Med Assoc* 1990; 197:714.
16. Bakos Z et al. *Acta Vet Hung* 2003; 51:249.
17. Smith BL et al. *Equine Vet J* 1994; 26:283.
18. Sweeney CR et al. *Am J Vet Res* 1992; 53:1953.
19. Anderson DE et al. *Am J Vet Res* 1994; 55:901.
20. Anderson DE et al. *Am J Vet Res* 1994; 55:1196.
21. Ruggles AJ et al. *Vet Surg* 1993; 22:508.
22. Peroni JF et al. *Equine Vet J* 2001; 33:231.
23. Fry MM et al. *Equine Vet J* 2003; 35:723.
24. Lugo J et al. *Am J Vet Res* 2002; 63:1232.
25. Bedenice D et al. *J Vet Intern Med* 2003; 17:868.
26. Bedenice D et al. *J Vet Intern Med* 2003; 17:876.
27. Wion L et al. *Equine Vet J* 2001; 33:523.
28. Morrow KL et al. *Vet Radiol Ultrasound* 2000; 41:491.
29. Smallwood JE et al. *Vet Radiol Ultrasound* 2002; 43:99.
30. Cornelisse CJ et al. *Am J Vet Res* 2001; 62:1856.
31. Probst A et al. *Vet Radiol Ultrasound* 2005; 46:44.
32. Davis JL et al. *J Am Vet Med Assoc* 2002; 221:1460.
33. Kosch PC et al. *Equine Vet J* 1984; 16:312.
34. Tietje S et al. *Equine Vet J* 1996; 28:98.
35. Frame EM et al. *Vet Rec* 2000; 146:558.
36. Arencebia A et al. *Vet Radiol Ultrasound* 2000; 41:313.
37. Votion D, Lekeux P. *Equine Vet Educ* 1999; 11:300.
38. Coghe J et al. *Vet J* 2000; 160:15.
39. Braun U et al. *Am J Vet Res* 1996; 57:432.
40. Reimer JM. *Compend Contin Educ Pract Vet* 1990; 12:1321.
41. Jung C, Bostedt H. *Vet Radiol Ultrasound* 2004; 45:331.
42. Braun U. *Vet Rec* 2004; 155:92.
43. Reef VB et al. *J Am Vet Med Assoc* 1991; 198:2112.
44. Braun U et al. *Vet Rec* 1997; 141:12.
45. Rabeling B et al. *Vet Rec* 1998; 143:468.
46. Van Erck E et al. *Equine Vet J* 2004; 36:21.
47. Flock M. *Vet J* 2004; 167:272.
48. Gross DK et al. *J Vet Intern Med* 2004; 18:718.
49. Ramirez S et al. *Vet Radiol Ultrasound* 2004; 45:172.
50. Allen JW et al. *Can J Vet Res* 1991; 55:341.
51. Lindsay WA, Hedberg EB. *Vet Med* 1991; January:72.
52. Ward JL, Rehman WC. *J Am Vet Med Assoc* 1992; 201:326.
53. Mombarg MJ et al. *J Vet Med B* 2002; 49:424.

54. Dersken FJ et al. *Equine Vet J* 1989; 21:23.
55. Larson VL, Busch RH. *Am J Vet Res* 1985; 46:144.
56. Hoffman AM et al. *Am J Vet Res* 1998; 59:176.
57. Couetil LL et al. *Am J Vet Res* 2001; 62:538.
58. Malikides N et al. *Aust Vet J* 2003; 81:685.
59. Malikides N et al. *Aust Vet J* 2003; 81:681.
60. Whitwell KE, Greet TC. *Equine Vet J* 1984; 16:499.
61. Christley RM et al. *Equine Vet J* 1999; 31:197.
62. Pringle JK et al. *Can J Vet Res* 1988; 52:239.
63. Labonville M et al. *Can Vet J* 2001; 42:623.
64. McKane SA et al. *Aust Vet J* 1993; 70:401.
65. Allen JW et al. *Can J Vet Res* 1992; 56:122.
66. Hagberg M et al. *Parasitol Immunol* 2005; 27:151.
67. Lakritz J et al. *Am J Vet Res* 2004; 65:163.
68. Sheehan M et al. *Vet Rec* 2005; 157:309.
69. Hensel A et al. *Am J Vet Res* 1994; 55:1697.
70. Thomas A et al. *Vet Rec* 2002; 151:472.
71. Traub-Dargatz JL et al. *Am J Vet Res* 1988; 49:1026.
72. Hoffman AM et al. *J Am Vet Med Assoc* 1990; 196:392.
73. Silflow RM et al. *Vet Immunol Immunopathol* 2005; 103:129.
74. Westermann CM et al. *Am J Vet Res* 2005; 66:1420.
75. Pickles K et al. *Equine Vet J* 2002; 34:288.
76. Sweeney CR et al. *Am J Vet Res* 1992; 53:1376.
77. Kirschvink N et al. *Vet Res* 2001; 32:145.
78. Pickles K et al. *Equine Vet J* 2002; 34:292.
79. Leclere M et al. *J Vet Intern Med* 2006; 20:377.
80. Chaman PS et al. *Vet Rec* 2000; 146:91.
81. Brumbaugh GW, Benson PA. *Am J Vet Res* 1990; 51:1032.
82. Collie DDS. *Br Vet J* 1992; 148:33.
83. Jean D et al. *Am J Vet Res* 1999; 60:11.
84. Guthrie AJ et al. *Vet Res Commun* 1995; 19:331.
85. Connally BA, Derksen FJ. *Am J Vet Res* 1994; 55:589.
86. Gallivan GJ et al. *Can Vet J* 1990; 54:99.
87. Herholz C et al. *Vet Res Commun* 2001; 26:467.
88. Reinhold P et al. *Vet Rec* 2002 Jan 26; 150:2004; 109.
89. Uystepruyst CH et al. *Res Vet Sci* 2000; 68:47.
90. Van Erck E et al. *Am J Vet Res* 2003; 64:1414.
91. Van Erck E et al. *Vet J* 2004; 168:259.
92. Gustin P et al. *Res Vet Sci* 1990; 49:319.
93. Couetil LL et al. *J Appl Physiol* 2000; 88:1870.
94. Clerbaux Th et al. *Comp Biochem Physiol* 1993; 106A:687.
95. Fedde MR. *Equine Vet J* 1991; 23:410.
96. Stewart JH et al. *Equine Vet J* 1984; 16:329.
97. Mahoney JJ et al. *Clin Chem* 1991; 37:1244.
98. Bajcsy ACS et al. *J Vet Med A* 1999; 46:255.
99. Szenci O, Besser T. *J Am Vet Med Assoc* 1990; 197:471.
100. Assal AN et al. *Nord Vet Med* 1978; 30:354.
101. Koenig J et al. *Can J Vet Res* 2003; 67:169.
102. Chaffin MK et al. *Equine Vet J* 1996; 28:437.
103. King CM et al. *Aust Vet J* 1994; 71:382.
104. Schulman ML et al. *J S Afr Vet Assoc* 2001; 72:12.
105. Goghe J et al. *Vet J* 2000; 160:139.
106. Reinhold P et al. *Am J Vet Res* 2000; 61:742.
107. Deaton C et al. *Free Radical Res* 2004; 38:201.
108. Venner M et al. *J Vet Intern Med* 2006; 20.
109. Braun U et al. *J Am Vet Med Assoc* 1999; 215:679.
110. Braun U et al. *Vet Rec* 2000; 146:525.
111. Derksen FJ et al. *Am J Vet Res* 2001; 62:659.
112. Franklin SH et al. *Equine Vet J* 2003; 35:264.
113. Cable CS et al. *Am J Vet Res* 2002; 63:1707.
114. Dart AJ et al. *Aust Vet J* 2001; 79:109.
115. Tan RH et al. *Vet J* 2005; 170:243.
116. Hinchcliff KW et al. (eds) *Equine sports medicine and surgery: basic and clinical sciences of the equine athlete*. Edinburgh, Elsevier Health Science 2004.
117. Hoffman AM, Viel L. *Equine Vet J* 1992; 24:239.
118. Henninger W et al. *Vet Radiol Ultrasound* 2003; 44:269.
119. Johnson CB et al. *Vet Rec* 1994; 135:569.
120. Mitten LA et al. *Equine Vet J* 1994; 26:420.
121. Wilkins PA, Palmer JE. *J Vet Intern Med* 2003; 17:708.
122. Palmer JE. *Vet Clin North Am Equine Pract* 1994; 10:167.
123. Fritton GM et al. *Vet Rec* 2005; 156:809.
124. Elitok B, Elitok OM. *J Vet Pharmacol Ther* 2004; 27:317.
125. Moore I et al. *Can Vet J* 2004; 45:594.
126. Georgiades J. *Arch Immunol Ther Exp* 1993; 41:205.
127. Moore BR et al. *Equine Vet J* 1997; 29:142.
128. Davis EG et al. *Vet Ther* 2003; 4:5.
129. Flaminio MJ et al. *Vet Immunol Immunopathol* 1998; 63:303.
130. Davis JL et al. *J Vet Pharmacol Ther* 2002; 25:99.
131. Benchaoui HA et al. *J Vet Pharmacol Ther* 2004; 27:203.
132. Evans NA. *Vet Ther* 2005; 6:83.
133. Terhune TN et al. *Am J Vet Res* 2005; 66:342.
134. Apley MD, Upson DW. *Am J Vet Res* 1993; 54:937.
135. Aslan V et al. *Vet Q* 2002; 24:35.
136. McKenzie HC, Murray MJ. *Am J Vet Res* 2000; 61:1185.
137. Sustronck B et al. *Res Vet Sci* 1995; 59:267.
138. Barbosa J et al. *Food Addit Contam* 2005; 22:563.
139. McKenna DJ et al. *J Am Vet Med Assoc* 1989; 195:603.
140. Dixon PM. *Vet Rec* 1992; 131:229.
141. Matthews AG et al. *Vet Rec* 1988; 122:106.
142. Jean D et al. *Equine Vet J* 2004; 36:628.
143. Danlois F et al. *Vet J* 2003; 165:65.
144. Costa LRR et al. *Compend Contin Educ Pract Vet* 2004; 26:460.
145. Ishizaki H et al. *Vet Immunol Immunopathol* 2005; 105:67.
146. Holcombe SJ et al. *Equine Vet J* 2001; 33:244.
147. Moore RR et al. *Am J Vet Res* 1995; 56:562.
148. Robinson NE et al. *Equine Vet J* 2002; 34:17.
149. Couetil LL et al. *Am J Vet Res* 2005; 66:1665.

## Diseases of the lungs

### PULMONARY CONGESTION AND EDEMA

Pulmonary congestion is caused by an increase in the amount of blood in the lungs due to engorgement of the pulmonary vascular bed. It is sometimes followed by pulmonary edema when intravascular fluid escapes into the parenchyma and alveoli. The various stages of the vascular disturbance are characterized by respiratory compromise, the degree depending upon the amount of alveolar air space which is lost.

#### ETIOLOGY

Pulmonary congestion and edema is a common terminal event in many diseases but is frequently overshadowed by other disturbances. Congestion that is clinically apparent may be primary when the basic lesion is in the lungs or secondary when it is in some other organ, most commonly the heart.

Pulmonary edema occurs because of imbalances in the Starling forces across

the pulmonary capillary. From a clinical perspective, the common proximate causes of pulmonary edema are injury to the endothelium of the pulmonary capillary with subsequent leakage of protein-rich fluid into the interstitial spaces, elevated blood pressure in the alveolar capillaries, or low plasma oncotic pressure. Damage to pulmonary vascular endothelium can occur in infectious diseases (e.g. African horse sickness) or intoxications (endotoxemia). Physical injury, including inhalation of excessively hot air or smoke, can damage the alveolar epithelium with secondary damage to capillary endothelium. Elevated pulmonary capillary pressure occurs in left-sided heart failure (ruptured chordae tendineae of the mitral valve) and during strenuous exercise by horses. Low plasma oncotic pressure occurs in diseases causing hypoproteinemia but is rarely a cause for pulmonary edema by itself, although it contributes to the pulmonary edema in hypoproteinemic animals administered large volumes of fluids intravenously.

#### Primary pulmonary congestion

- Early stages of most cases of pneumonia
- Inhalation of smoke and fumes<sup>1</sup>
- Anaphylactic reactions
- Hypostasis in recumbent animals
- Yew (*Taxus* sp.) intoxication<sup>2</sup>
- Race horses with acute severe exercise-induced pulmonary hemorrhage.<sup>3</sup>

#### Secondary pulmonary congestion

- Congestive heart failure (cardiogenic pulmonary edema), including ruptured chordae tendineae of the mitral valve, and left-sided heart failure.

#### Pulmonary edema

Pulmonary edema as a sequel to pulmonary capillary hypertension or pulmonary microvascular damage<sup>4</sup> occurs in:

- Acute anaphylaxis
- Acute pneumonia – *Pasteurella haemolytica* produces several virulence factors that induce direct or leukocyte-mediated pulmonary endothelial cell injury<sup>4</sup>
- Gram-negative sepsis in ruminants and pigs<sup>4</sup>
- Congestive heart failure and acute heart failure, e.g. the myocardial form of enzootic muscular dystrophy in inherited cardiomyopathy of Hereford calves; ruptured mitral valve or chordae tendinae
- Inhalation of smoke or manure gas<sup>1</sup>
- Transient upper airway obstruction in the horse (negative pressure pulmonary edema)<sup>5</sup>
- After general anesthesia in horses<sup>6</sup>

- Yew (*Taxus* sp.) intoxication<sup>2</sup>
- Exercise-induced pulmonary edema in race horses<sup>3</sup>
- Fumonisin intoxication in pigs<sup>7</sup>
- Specific diseases, including: mulberry heart disease of swine; East Coast fever in cattle; the pulmonary form of African horse sickness; Hendra virus infection of horses; poisoning with organophosphates, alpha-naphthyl thiourea (ANTU) or ionophore antibiotics (monensin, salinomycin); plant poisonings by oleander, *Hymenoxis* spp. and *Phenoscadium* spp.
- Doxycycline intoxication of calves<sup>8</sup>
- *Clostridium perfringens* type D epsilon toxin in calves and sheep<sup>9,10</sup>
- The Barker syndrome in young pigs
- Semen embolism.<sup>11</sup>

### PATHOGENESIS

In **pulmonary congestion**, ventilation is reduced and oxygenation of the blood is impaired. Oxygenation is reduced by the decreased rate of blood flow through the pulmonary vascular bed. Hypoxemic anoxia develops and is the cause of most of the clinical signs that appear.

Hypoxemia occurs in **pulmonary edema** because of ventilation/perfusion abnormalities, diffusion abnormalities (although this is usually a minor contributor to the hypoxemia), and hypoventilation caused by the physical obstruction of airflow by fluid and foam in the airways. The edema is caused by damage to the capillary walls by toxins or anoxia or by transudation of fluid due to increased hydrostatic pressure in the capillaries. Filling of the alveoli, and in severe cases the bronchi, effectively prevents gaseous exchange.

**Smoke inhalation** in horses results in decreased oxygen content of inspired air and exposure of the respiratory tract tissues to various noxious gases.<sup>1</sup> Following smoke inhalation, diffuse tracheo-bronchial mucosal sloughing occurs, which, if progressive, causes separation of the epithelium and development of pseudomembranous casts, which may cause partial or complete airway obstruction. Pulmonary edema is also extensive.

### CLINICAL FINDINGS

All degrees of severity of pulmonary congestion and edema occur commonly in farm animals and only the most severe form is described here. The depth of respiration is increased to the point of extreme dyspnea with the head extended, the nostrils flared and mouth-breathing. Breathing movements are greatly exaggerated and can be best described as heaving; there is marked abdominal and thoracic movement during inspiration and expiration. A typical stance is usually

adopted, with the front legs spread wide apart, the elbows abducted and the head hung low. The respiratory rate is usually increased especially if there is hyperthermia, which occurs in acute anaphylaxis and after violent exercise as well as in the early stages of pneumonia. The heart rate is usually elevated (up to 100/min) and the nasal mucosa is bright red or cyanotic in terminal cases.

In **acute pulmonary congestion** there are harsh breath sounds but no crackles are present on auscultation.

When **pulmonary edema** develops, loud breath sounds and crackles are audible over the ventral aspects of the lungs. In long-standing cases there may be emphysema with crackles and wheezes of the dorsal parts of the lungs, especially if the lesion is caused by anaphylaxis.

Coughing is usually present but the cough is soft and moist and is not painful. A slight to moderate serous nasal discharge occurs in the early stage of congestion but in **severe pulmonary edema** this increases to a voluminous, frothy nasal discharge, which is often pink-colored due to blood.

The primary importance of pulmonary congestion is as an indicator of early pathological changes in the lung or heart. Spontaneous recovery occurs quickly unless there is damage to alveolar epithelium, or myocardial asthenia develops. Severe pulmonary edema has much greater significance and usually indicates a stage of irreversibility. Death in cases of pulmonary edema is accompanied by asphyxial respiratory failure.

Smoke inhalation in horses is characterized by:

- Polypnea and dyspnea
- Diffuse wheezes throughout the lungs
- Coughing
- A bronchointerstitial pattern radiographically
- The horse may expectorate large proteinaceous tracheobronchial casts.<sup>1</sup>

The prognosis is good if affected animals can survive the initial stages of pulmonary damage and secondary organ involvement.

### CLINICAL PATHOLOGY

Laboratory examinations are of value only in differentiating the causes of the congestion or edema. Bacteriological examination of nasal swabs and a complete hematological examination, looking particularly for the presence of eosinophilia, are the standard examinations that are carried out.

### NECROPSY FINDINGS

In acute pulmonary congestion the lungs are dark red in color. Excessive quantities of venous blood exude from the cut

surface. Similar but less marked changes occur in milder forms of congestion but are only seen in those animals that die from intercurrent disease. Histologically the pulmonary capillaries are markedly engorged and some transudation and hemorrhage into alveoli is evident.

Macroscopic findings in pulmonary edema include swelling and loss of elasticity of the lungs, which pit on pressure. They are usually paler than normal. Excessive quantities of serous fluid exude from the cut surface of the lung. Histologically there are accumulations of fluid in the alveoli and parenchyma.

### DIFFERENTIAL DIAGNOSIS

The diagnosis of pulmonary congestion and edema is always difficult unless there is a history of a precipitating cause such as an infectious disease, strenuous exercise, ingestion of toxicants, or inhalation of smoke or fumes. Pneumonia usually presents itself as an alternative diagnosis and a decision cannot be based entirely on the presence or absence of pyrexia. The best indication is usually the presence of toxemia but this again is not entirely dependable. Bacterial pneumonia is usually accompanied by some toxemia but cases of viral pneumonia are often free of it. Response to antibacterial treatment is one of the best indications, the only variable being the tendency for congestion and edema of allergic origin to recover spontaneously. In many instances there will be doubt and it is then advisable to treat the animal for both conditions.

### TREATMENT

The principles of treatment of pulmonary congestion and edema are one or more of: reduction of pulmonary capillary pressure (by reduction either of pulmonary venous or pulmonary arterial pressure); alleviation of pulmonary microvascular damage; and correction of low plasma oncotic pressure. The treatment of pulmonary congestion and edema must first be directed at correction of the primary cause as listed under etiology. Affected animals should be confined at rest in a clean, dry environment and exercise avoided.

**Pulmonary capillary pressure** can be reduced in animals with left-sided heart failure by reduction of cardiac preload, improvement in cardiac pump function or a combination of these factors. These topics are dealt with in detail in Chapter 8. Briefly, preload can be reduced by administration of furosemide and pump function improved by administration of drugs that improve myocardial function (digoxin) or decrease afterload (arterial vasodilators). The usual first step is the

administration of furosemide (1–2 mg/kg intravenously).

**Alleviation of pulmonary microvascular damage** is more difficult. Administration of anti-inflammatory drugs including NSAIDs or glucocorticoids is indicated in animals in which microvascular damage is suspected. These drugs are used to treat, among other diseases, smoke inhalation of horses.<sup>1</sup>

**Plasma oncotic pressure** can be increased by intravenous infusion of plasma (10–40 mL/kg) or synthetic colloids such as hetastarch. Administration of crystalloid solutions should be judicious and the amount of fluid administered must be monitored carefully to ensure that only sufficient fluids to meet the needs of the animal are given.

**Oxygen** should be administered to hypoxemic animals in conjunction with other specific treatments.

### Special diseases

When edema is due to **organophosphate poisoning** prompt administration of atropine may reduce fluid transudation. In these cases the animal is in considerable danger and repeated injections may be necessary. Details of the recommended treatment regimen are given in the section on treatment of poisoning by organophosphorus compounds.

**Epinephrine** is recommended in **pulmonary edema due to anaphylaxis**. It will have an immediate pharmacological effect, which may be followed by the use of a corticosteroid to maintain vascular integrity and to decrease permeability of pulmonary vessels. Antihistamines are commonly used in conjunction with epinephrine for the treatment of acute pulmonary edema due to anaphylaxis. However, recent studies of experimental anaphylaxis in cattle and horses have shown that the antihistamines may be of limited value because histamine and serotonin are of relatively limited significance as mediating substances. On the other hand, the kinins, prostaglandins and slow-release substances may be more important.

Studies in cattle have found that antihistamines and 5-hydroxytryptamine (5-HT) antagonists failed to protect cattle in experimental hypersensitivity. Sodium meclofenamate has been more successful in antagonizing experimental anaphylaxis in cattle and horses. Acetylsalicylic acid was more effective than antihistamines or antiserotonin agents in providing symptomatic relief in experimental acute interstitial pneumonia of calves.

It is difficult, however, to extrapolate the results of these studies in which the drugs were usually given before or at the same time as the experimental disease

was produced. There is a need for development of more effective antianaphylactic drugs for the treatment of acute anaphylaxis in farm animals, which invariably results in pulmonary edema and emphysema. Thus epinephrine is the drug of choice for the emergency treatment of pulmonary edema due to anaphylaxis.

### REFERENCES

1. Kemper T et al. *J Am Vet Med Assoc* 1993; 202:91.
2. Cope RB et al. *Vet Hum Toxicol* 2004; 46:279.
3. Boden LA et al. *Equine Vet J* 2005; 37:269.
4. Breider MA. *J Am Vet Med Assoc* 1993; 203:300.
5. Kollias-Baker CA et al. *J Am Vet Med Assoc* 1993; 202:1116.
6. Senior M. *Vet Anesth Analg* 2005; 32:193.
7. Gumprecht LA et al. *Toxicology* 2001; 160:71.
8. Yeruham I et al. *J Vet Med B* 2002; 49:406.
9. Uzal FA et al. *J Comp Pathol* 2002; 126:71.
10. Uzal FA et al. *J Vet Diagn Invest* 2004; 16:403.
11. Dukes TW, Balachandran V. *Can Vet J* 1994; 35:709.

### PULMONARY HYPERTENSION

Pulmonary hypertension is an increase in pulmonary arterial pressure above normal values due to structural or functional changes in the pulmonary vasculature. Primary pulmonary hypertension occurs in cattle with high-altitude disease. Chronic pulmonary hypertension results in right-side congestive heart failure due to right ventricular hypertrophy or **cor pulmonale**.

#### Causes

Hypoxemia is a potent stimulus of pulmonary arterial pressure through increased pulmonary vascular resistance induced by pulmonary vasoconstriction.<sup>1</sup> Pulmonary artery pressure can also increase in response to increases in cardiac output that are not matched by pulmonary vasodilation – the most extreme example of this being the large increase in pulmonary artery pressure of strenuously exercising horses. Alveolar hypoxia causes constriction of the precapillary pulmonary vessels, resulting in pulmonary hypertension. Conditions which may induce hypoxia include:

- Exposure to high altitude
- Respiratory impairment secondary to thoracic wall abnormalities
- Airway obstruction
- Pneumonia
- Pulmonary edema
- Emphysema
- Pulmonary vascular disease
- Heaves.

At high altitudes, the low inspired oxygen tension causes hypoxic pulmonary vasoconstriction and hypertension that are common causes of **cor pulmonale** (brisket disease) in cattle. Susceptible cattle can be identified by measurement of pulmonary artery pressure before clinical disease

develops. This test is used to select bulls for use in high-altitude pastures. Cattle grazing pastures that contain locoweed have an increased incidence of brisket disease but the pathogenesis is unknown. Although uncommon, right-sided congestive heart failure and pulmonary hypertension can occur in cows at low altitudes with primary lung disease.<sup>1</sup>

Pulmonary hypertension occurs in neonates and is a consequence of persistent fetal circulation (see Ch. 8). This is particularly a problem of cloned calves.<sup>2</sup>

An outbreak of pulmonary hypertension in a group of dairy calves 5–6 months of age has been described.<sup>3</sup> Some affected calves died suddenly. Clinical findings included lethargy, anorexia, pale mucous membranes, tachypnea, tachycardia, weakness, engorged jugular veins and loss of body condition.<sup>3</sup> Right-side cardiac catheterization revealed pulmonary hypertension. Necropsy findings revealed evidence of right-sided congestive heart failure, and periarteritis and fibrosis of the pulmonary and bronchial arteries. Lesions were characterized by variable stages of vasculitis; the airways were free of pathological changes. Ingestion of monocrotaline, a pyrrolizidine alkaloid, can cause similar pulmonary vascular lesions in rats but no evidence of such ingestion was found in affected calves.

Pulmonary hypertension occurs secondary to left-sided heart disease in horses, although the hypertension has been mistakenly identified as the primary lesion.<sup>4</sup>

### REFERENCES

1. Angel KL, Tyler JW. *J Vet Intern Med* 1992; 6:214.
2. Hill JR et al. *Theriogenology* 1999; 51:1451.
3. Pringle JK et al. *J Am Vet Med Assoc* 1991; 198:857.
4. Gelberg HH et al. *J Am Vet Med Assoc* 1991; 198:679.

### ATELECTASIS

Atelectasis is collapse of the alveoli due to failure of the alveoli to inflate or because of compression of the alveoli. Atelectasis is therefore classified as obstruction (resorption), compression or contraction. **Obstruction atelectasis** occurs secondary to obstruction of the airways, with subsequent resorption of alveolar gases and collapse of the alveoli. This disease is usually caused by obstruction of small bronchioles by fluid and exudate. It is common in animals with pneumonia or aspiration of a foreign body. **Compression atelectasis** occurs when intrathoracic (intrapleural) pressure exceeds alveolar pressure, thereby deflating alveoli. This occurs when there is excessive pleural fluid or the animal has a pneumothorax. In large animals it also occurs in the dependent lung or portions of lung in recumbent animals. Compression

atelectasis is the explanation for the large shunt fraction and hypoxemia that occurs in anesthetized horses.<sup>1</sup> Compression atelectasis and secondary bronchopneumonia can occur in horses kept in flotation tanks for up to several weeks for treatment of skeletal injuries.<sup>2</sup> **Contraction atelectasis** occurs when there is compression of parts of the lung by fibrotic changes in the pleura. **Patchy atelectasis** occurs in the absence of surfactant, such as can occur in newborns. Failure of the lung to inflate, or development of atelectasis of the lungs of the newborn, usually those born prematurely, occurs because of lack of pulmonary surfactant. The disorder can progress to hyaline membrane disease. Affected newborn animals are severely dyspneic, hypoxemic, cyanotic, weak and commonly die in a few hours.

The clinical signs of atelectasis are not apparent until there is extensive involvement of the lungs. Animals develop respiratory distress, tachypnea, tachycardia and cyanosis. Blood gas analysis reveals hypoxemia, with or without hypercapnia. Thoracic radiographs reveal pulmonary consolidation. Ultrasonographic examination of the thorax demonstrates consolidated lung.

Atelectasis is reversible if the primary obstruction or compression is relieved quickly before secondary consolidation and fibrosis occur.

## REFERENCES

1. Nyman G et al. *Equine Vet J* 1990; 22:317.
2. McClintock SA et al. *Equine Vet J* 1986; 18:462.

## ACUTE RESPIRATORY DISTRESS SYNDROME

This is a well-recognized clinical syndrome of humans characterized by acute onset of hypoxemia and pulmonary infiltrates without increases in left atrial pressure (i.e. without evidence of cardiogenic pulmonary edema). Precipitating causes include both direct and indirect lung injury, including sepsis, multiple transfusions, trauma, near-drowning, smoke inhalation, pancreatitis and more. The underlying lesion is diffuse alveolar capillary damage with secondary severe pulmonary edema. The disease occurs spontaneously in domestic animals<sup>1</sup> and, although the spontaneous disease is not extensively documented, the disease produced experimentally as a model of the human disease is better described.<sup>2</sup>

Acute respiratory distress syndrome (ARDS) in animals occurs in newborns and in adult animals. The disease in some newborn farm animals is related to lack of surfactant but except for animals born prematurely this is more the exception than the rule. Most young animals and all adult animals with ARDS have some inciting

acute lung injury that then progresses to ARDS.<sup>1,3,4</sup> The causes can be infectious (e.g. influenza virus infection), physical (smoke inhalation) or toxic (endotoxin).

The **pathophysiology** of the disease involves a common final pathway that results in damage to alveolar capillaries. The initial injury can be to either the endothelium of pulmonary capillaries or to alveolar epithelium. Damage to these structures leads to extravasation of protein-rich fluid and fibrin with subsequent deposition of hyaline membranes. The capillary injury is attributed to activated leukocytes (macrophages and neutrophils) and cytokines. Accumulation of hyaline membranes and ventilation/perfusion mismatches impair respiratory gas exchange and cause hypoxemia.

The **clinical signs** are characteristic of acute, progressive pneumonia. Animals are anxious, tachycardic, tachypneic and have crackles and wheezes on thoracic auscultation. Severely affected animals can be cyanotic. Thoracic radiographs reveal diffuse pulmonary infiltrates. Hematologic changes are characteristic of the inciting disease but usually include leukopenia. There is arterial hypoxemia.

**Treatment** includes administration of anti-inflammatory drugs (NSAIDs with or without glucocorticoids), colloids, antimicrobials and oxygen. The arterial blood gas response to oxygen therapy is often minimal in severely affected animals. If it is available, mechanical ventilation can be useful, although the prognosis is grave. Inhalation of nitric oxide is beneficial in some humans with the disease, and there are anecdotal reports that it has been used to treat foals with ARDS.

## REVIEW LITERATURE

Wilkins PA, Seahorn T. Acute respiratory distress syndrome. *Vet Clin North Am Equine Pract* 2004; 20:253-273.

## REFERENCES

1. Dunkel B et al. *Equine Vet J* 2005; 37:435.
2. Steinberg J et al. *Shock* 2005; 23:129.
3. Peek SF et al. *J Vet Intern Med* 2004; 18:132.
4. Sharp MW et al. *Vet Rec* 1993; 132:467.

## PULMONARY HEMORRHAGE

Pulmonary hemorrhage is uncommon in farm animals but does occur occasionally in cattle, and **exercise-induced pulmonary hemorrhage (EIPH)** occurs in 45-75% of exercised horses. Pulmonary hemorrhage also occurs in horses with pulmonary abscesses, tumors or foreign bodies. Tracheobronchoscopic, radiographic and ultrasonographic examinations are useful in identifying the site and cause of the hemorrhage.

### Cattle

In cattle the most common cause is erosion of pulmonary vessels adjacent to

lesions of embolic pneumonia associated with vena caval thrombosis and hepatic abscessation. The onset of hemorrhage may be sudden and affected animals hemorrhage profusely and die after a short course of less than 1 hour. Marked epistaxis and hemoptysis, severe dyspnea, muscular weakness and pallor of the mucous membranes are characteristic. In other cases, episodes of epistaxis and hemoptysis may occur over a period of several days or a few weeks along with a history of dyspnea.

## EXERCISE-INDUCED PULMONARY HEMORRHAGE OF HORSES (EIPH, BLEEDERS)

### Synopsis

**Etiology** Pulmonary hemorrhage during exercise

**Epidemiology** Present in most (> 80%) Thoroughbred and Standardbred racehorses, although clinical signs are less common. Occurs worldwide in any horse that performs strenuous exercise. Rarely causes death

**Pathogenesis** Probably associated with rupture of pulmonary capillaries by the high pulmonary vascular pressures generated during exercise. There may be a contributory role for inflammation and obstruction of small airways, and tissue damage caused by large and rapid changes in intrathoracic pressure

**Clinical signs** Epistaxis is an uncommon but very specific sign of EIPH in horses that have just exercised. Affected horses may cough or suddenly slow during a race. Endoscopic examination of the trachea and bronchi reveals blood

**Clinical pathology** Presence of hemosiderin-laden macrophages in tracheal aspirates or bronchial lavage fluid

**Lesions** Fibrosis and discoloration of the caudodorsal regions of the lungs. Fibrosis, accumulation of hemosiderin-laden macrophages in interstitial tissue, inflammation and bronchial artery angiogenesis. Horses dying acutely have blood-filled airways and heavy, wet lungs

### Diagnostic confirmation

Demonstration of blood in the trachea or bronchi by endoscopic examination, or cytological examination of tracheal aspirates or bronchoalveolar lavage fluid

**Treatment** None of demonstrated efficacy. Furosemide is used as prophylaxis

**Control** There are no specific control measures, however, prevention of environmental and infectious respiratory disease may reduce the incidence of the disease

### Etiology

EIPH occurs in horses during strenuous exercise.

### Epidemiology

EIPH is primarily a disease of horses, although it has been reported in racing camels.<sup>1</sup> EIPH occurs in horses worldwide

and there does not appear to be any geographical distribution. It is a disorder of horses that run at high speed, such as Thoroughbred or Standardbred racehorses. The disorder is uncommon in endurance horses or draft breeds, although it does occur in horses used for these activities. As a general rule, the more intense the exercise or the higher the speed attained, the greater the proportion of horses with EIPH.

The prevalence of EIPH varies with the method used to detect it and the frequency with which horses are examined, as discussed later in this section. Epistaxis associated with exercise is almost always attributable to pulmonary hemorrhage and occurs only in a small proportion of racehorses.<sup>2-5</sup> Epistaxis occurs in only 3% of horses that have blood detected in the trachea by endoscopic examination performed within 2 hours of racing.<sup>5</sup> The prevalence of epistaxis in racehorses varies between 0.1 and 9.0%, with the frequency depending on the breed, age and sex of horses selected for study, the type of racing and the timing and frequency of observation of horses after racing. Epistaxis is more common in older horses.<sup>2,3</sup> There are conflicting reports of a sex predisposition, although epistaxis may be more common in female Thoroughbreds.<sup>2,3</sup> Epistaxis is more common after races of less than 1600 m than in longer races,<sup>2</sup> although not all sources agree on this point.<sup>3,6</sup> However, horses in steeplechase races, which are typically longer than 2000 m, are at greater risk of epistaxis than are horses in flat races.<sup>2,6</sup> *Epistaxis is relatively uncommon and most horses with EIPH do not have epistaxis.*

There are a variety of other methods of detecting EIPH, including endoscopic examination of the airways and microscopic examination of tracheal aspirates or bronchoalveolar lavage fluid.

Almost all Thoroughbred racehorses in active training have hemosiderophages in bronchoalveolar lavage fluid, indicating that all have some degree of EIPH.<sup>7</sup> The prevalence of EIPH decreases when diagnosis is based on endoscopic examination of horses after exercise or racing.

Exercise-induced pulmonary hemorrhage is very common in Thoroughbred racehorses, with estimates of prevalence, based on a single endoscopic examination of the trachea and bronchi, of 43–75%.<sup>6,8-10</sup> The prevalence increases with the frequency of examination, with over 80% of horses having evidence of EIPH on at least one occasion after examination after each of three consecutive races.<sup>11</sup> The prevalence of EIPH in Standardbred racehorses is assumed to be lower, with 26–34% of horses reported to have blood

in the trachea after racing.<sup>12,13</sup> However, these studies were based on a single examination and one<sup>12</sup> only reported as positive those horses with blood covering more than one half the tracheobronchial tree. When examined after each of three races, 87% of Standardbred racehorses have evidence of EIPH on at least one occasion,<sup>14</sup> suggesting that EIPH is as common in Standardbred racehorses as it is in Thoroughbred racehorses.

Exercise-induced pulmonary hemorrhage occurs in approximately 62% of racing Quarter horses, and has been observed in Quarter horses used for barrel racing.<sup>15</sup> The disorder occurs in racing Appaloosa horses.<sup>16</sup> Approximately 11% of polo ponies are affected with EIPH.<sup>17</sup> The disease occurs in draft horses but is not well documented.

Age is considered a risk factor for EIPH, with the prevalence of the disorder being higher in older horses.<sup>8-10</sup> There is no consistent association of sex with prevalence of EIPH.<sup>8-10,13</sup> Among Thoroughbred racehorses the prevalence of EIPH increases with increasing speed,<sup>10,18</sup> being greater in Thoroughbreds after racing than after breezing (galloping). Lesions of EIPH are not detected in young Thoroughbred racehorses that have trained at speeds of less than 7 m/s.<sup>10,18</sup>

### Pathogenesis

The cause of EIPH is rupture of alveolar capillary membranes with subsequent extravasation of blood into interstitial and alveolar spaces.<sup>19</sup> The source of blood in such instances is the pulmonary circulation. Bleeding from bronchial circulation during exercise has been suggested, based on histological evidence of bronchial angiogenesis in horses that have experienced previous episodes of EIPH,<sup>20</sup> but contribution of the bronchial circulation to EIPH has not been demonstrated. Regardless of the contribution of bronchial circulation to blood in the airways, the likely initial lesion is in capillaries associated with the pulmonary circulation. Hemorrhage into the interstitial space and alveoli, with subsequent rostral movement of blood in the airways, results in blood in the trachea and bronchi.

Rupture of alveolar capillaries occurs secondary to an exercise-induced increase in transmural pressure (pressure difference between the inside of the capillary and the alveolar lumen). If the transmural stress exceeds the tensile strength of the capillary wall, the capillary ruptures.<sup>19</sup> The proximate cause of alveolar capillary rupture is the high transmural pressure generated by positive intracapillary pressures, which are largely attributable to capillary blood pressure, and the lower

intra-alveolar pressure generated by the negative pleural pressures associated with inspiration.

During exercise, the absolute magnitudes of both pulmonary capillary pressure and alveolar pressure increase, with a consequent increase in transmural pressure. Strenuous exercise is associated with marked increases in pulmonary artery pressure in horses.<sup>22-24</sup> Values for mean pulmonary arterial pressure at rest of 20–25 mmHg increase to more than 90 mmHg during intense exercise because of the large cardiac output achieved by exercising horses. The increases in pulmonary artery pressure, combined with an increase in left atrial pressure during exercise, probably result in an increase in pulmonary capillary pressure. Combined with the increase in pulmonary capillary pressure is a marked decrease (more negative) in pleural, and therefore alveolar, pressure during exercise. The pleural pressure of normal horses during inspiration decreases from approximately –0.7 kPa (–5.3 mmHg) at rest to as low as –8.5 kPa (–64 mmHg) during strenuous exercise.<sup>25</sup> Together, the increase in pulmonary capillary pressure and decrease (more negative) in intrapleural (alveolar) pressure contribute to a marked increase in stress in the alveolar wall. Although the alveolar wall and pulmonary capillaries of horses are stronger than those of other species, rupture may occur because the wall stress in the alveolus exceeds the mechanical strength of the capillary.<sup>26</sup>

Other theories of the pathogenesis of EIPH include: small-airway disease, upper airway obstruction, hemostatic abnormalities, changes in blood viscosity and erythrocyte shape, intrathoracic shear forces associated with gait, and bronchial artery angiogenesis.<sup>20,27</sup> It is likely that the pathogenesis of EIPH involves several processes, including pulmonary hypertension, lower alveolar pressure and changes in lung structure, that summate to induce stress failure of pulmonary capillaries.

Obstruction of either the upper or lower airways has been proposed as a cause of EIPH. Inspiratory airway obstruction results in more negative intrapleural, and therefore alveolar, pressures. This effect is exacerbated by exercise, with the result that alveolar transmural pressure is greater in horses with airway obstruction.<sup>28,29</sup> The higher transmural pressure in such horses may increase the severity of EIPH, although this has not been demonstrated. Moreover, while inspiratory airway obstruction may predispose to EIPH, the prevalence of this condition is much less than that of EIPH, indicating that it is not the sole factor inducing EIPH in most horses.

Horses with moderate to severe EIPH have histological evidence of inflammation of the small airways,<sup>18,30</sup> and there is a clear association between the presence of EIPH and inflammatory changes in bronchoalveolar or tracheal aspirate fluid.<sup>6</sup> However, instillation of autologous blood into the airways induces a marked inflammatory response in normal horses,<sup>31</sup> and it is therefore unclear whether inflammation alone induces or predisposes to EIPH or whether the inflammation is a result of EIPH. Theoretically, small-airway inflammation and bronchoconstriction have the potential to produce intrathoracic airway obstruction and, therefore, a more negative alveolar pressure. Given that small-airway disease is common in horses, there is the potential for an important effect of factors, such as viral infections, air pollution and allergic airway disease, to contribute to the initiation or propagation of EIPH.

The characteristic location of lesions of EIPH in the caudodorsal lung fields has led to the proposal that hemorrhage is a result of tissue damage occurring when waves of stress, generated by forelimb foot strike, are focused and amplified into the narrowing cross-sectional area of the caudal lung lobes.<sup>27</sup> According to the theory, the locomotor impact of the forelimbs results in transmission of forces through the scapula to the body wall, from where they pass into the lungs and caudally and dorsally. As the wave of pressure passes into the narrower caudodorsal regions of the lungs it generates progressively greater shearing forces that disrupt tissue and cause EIPH. However, studies of intrapleural pressures have not demonstrated the presence of a systemic pressure wave passing through the lung and do not provide support for this hypothesis.<sup>32</sup>

Horses with EIPH have been suspected of having defects in either hemostasis or fibrinolysis. However, while exercise induces substantial changes in blood coagulation and fibrinolysis, there is no evidence that horses with EIPH have defective coagulation or increased fibrinolysis.<sup>33,34</sup>

Regardless of the cause, rupture of pulmonary capillaries and subsequent hemorrhage into airways and interstitium causes inflammation of both airways and interstitium with subsequent development of fibrosis and alteration of tissue compliance. Heterogeneity of compliance within the lungs, and particularly at the junction of normal and diseased tissue, results in the development of abnormal shear stress with subsequent tissue damage. These changes are exacerbated by inflammation and obstruction of small airways, with resulting uneven inflation of

the lungs.<sup>35</sup> The structural abnormalities, combined with pulmonary hypertension and the large intrathoracic forces associated with respiration during strenuous exercise, cause repetitive damage at the boundary of normal and diseased tissue with further hemorrhage and inflammation. The process, once started, is life-long and continues for as long as the horse continues to perform strenuous exercise.<sup>20</sup>

### Clinical findings

Poor athletic performance or epistaxis are the most common presenting complaints for horses with EIPH. While poor performance may be attributable to any of a large number of causes, epistaxis associated with exercise is almost always secondary to EIPH.

Epistaxis due to EIPH occurs during or shortly after exercise and is usually first noticed at the end of a race, particularly when the horse is returned to the paddock or winner's circle and is allowed to lower its head. It is usually bilateral and resolves within hours of the end of the race. Epistaxis may occur on more than one occasion, especially when horses are raced or exercised at high speed soon after an initial episode.

Exercise-induced pulmonary hemorrhage and performance

Failure of racehorses to perform to the expected standard (poor performance) is often, accurately or not, attributed to EIPH. Many horses with poor performance have cytological evidence of EIPH on microscopic examination of tracheobronchial aspirates or bronchoalveolar lavage fluid or have blood evident on endoscopic examination of the tracheobronchial tree performed 30–90 minutes after strenuous exercise or racing.<sup>7,36</sup> However, it is important to recognize that EIPH is very common in racehorses and it should be considered the cause of poor performance only after other causes have been eliminated. Severe EIPH undoubtedly results in poor performance and, on rare occasions, death of Thoroughbred racehorses.<sup>37</sup> Thoroughbred horses with EIPH racing in Victoria, Australia have impaired performance compared to unaffected horses. Affected horses have a lower likelihood of finishing in the first three places, are less likely to be elite money earners and finish further behind the winner than do unaffected horses.<sup>5</sup>

Results of studies in Standardbred racehorses indicate either a lack of effect of EIPH on performance or an association between EIPH and superior performance. There was no relationship between presence of EIPH and finishing position in 29 Standardbred racehorses with intermittent EIPH examined on at least two

occasions,<sup>14</sup> nor in 92 Standardbred racehorses examined on one occasion.<sup>13</sup> However, of 965 Standardbred racehorses examined after racing, those finishing first or second were 1.4 times more likely (95% confidence interval 0.9–2.2) to have evidence of EIPH on tracheobronchoscopic examination than were horses that finished in seventh or eighth position.<sup>38</sup>

Physical examination

Apart from epistaxis in a small proportion of affected horses, there are few abnormalities detectable on routine physical examination of horses with EIPH. Rectal temperature and heart and breathing rates may be elevated as a consequence of exercise in horses examined soon after exercise, but values of these variables in horses with EIPH at rest are not noticeably different from horses with no evidence of EIPH. Affected horses may swallow more frequently during recovery from exercise than do unaffected horses, probably as a result of blood in the larynx and pharynx. Coughing is common in horses recovering from strenuous exercise and after recovery from exercise; horses with EIPH are no more likely to cough than are unaffected horses. Other clinical signs related to respiratory abnormalities are uncommon in horses with EIPH. Respiratory distress is rare in horses with EIPH and, when present, indicates severe hemorrhage or other serious lung disease such as pneumonia, pneumothorax or rupture of a pulmonary abscess. Lung sounds are abnormal in a small number of EIPH-affected horses and when present are characterized by increased intensity of normal breath sounds during rebreathing examination. Tracheal rales may be present in horses with EIPH but are also heard in unaffected horses.

Tracheobronchoscopy

Observation of blood in the trachea or large bronchi of horses 30–120 minutes after racing or strenuous exercise provides a definitive diagnosis of EIPH. The amount of blood in the large airways varies from a few small specks on the airway walls to a stream of blood occupying the ventral one-third of the trachea. Blood may also be present in the larynx and nasopharynx. If there is a strong suspicion of EIPH and blood is not present on a single examination conducted soon after exercise, the examination should be repeated in 60–90 minutes. Some horses with EIPH do not have blood present in the rostral airways immediately after exercise, but do so when examined 1–2 hours later. Blood is detectable by tracheobronchoscopic examination for 1–3 days in most horses, with some horses having blood detectable for up to 7 days.



Bronchoscopic examination can be used to estimate the severity of EIPH through the use of a grading system.<sup>39,40</sup> The interobserver repeatability of tracheo-bronchoscopic assessment of severity of EIPH using a 0–4 grading scale is excellent.<sup>40</sup>

- Grade 0: No blood detected in the pharynx, larynx, trachea or main stem bronchi
- Grade 1: Presence of one or more flecks of blood or  $\leq 2$  short ( $<$  quarter the length of the trachea) narrow ( $< 10\%$  of the tracheal surface area) streams of blood in the trachea or main stem bronchi visible from the tracheal bifurcation
- Grade 2: A long stream of blood ( $>$  half the length of the trachea) or  $> 2$  short streams occupying less than one-third of the tracheal circumference
- Grade 3: Multiple, distinct streams of blood covering more than one-third of the tracheal circumference. No blood pooling at the thoracic inlet
- Grade 4: Multiple, coalescing streams of blood covering  $> 90\%$  of the tracheal surface with pooling of blood at the thoracic inlet.

It is assumed that a higher score represents more severe hemorrhage, but while the repeatability of this scoring system has been established, the relationship between the amount of blood in the large airways and the actual amount of hemorrhage has not been established.

#### Radiography

Thoracic radiography is of limited use in detecting horses with EIPH. Radiographs may demonstrate the presence of densities in the caudodorsal lung fields of some horses but many affected horses have minimal to undetectable radiographic abnormalities.<sup>41</sup> Examination of thoracic radiographs of horses with EIPH may be useful in ruling out the presence of another disease process, such as a pulmonary abscess, contributing to the horse's pulmonary hemorrhage or poor athletic performance.

#### Prognosis

Horses that have experienced one episode of epistaxis are more likely to have a second episode. For this reason most racing jurisdictions do not permit horses with epistaxis to race for a period of weeks to months after the initial instance, with more prolonged enforced rest after a subsequent episode of epistaxis and retirement from racing after a third bout. The recurrence rate after one episode of epistaxis in Thoroughbred horses is approximately 13.5% despite affected horses not being permitted to

race for 1 month after the initial episode.<sup>2</sup> This high rate of recurrence suggests that the inciting pulmonary lesions have not healed.

#### Clinical pathology

Examination of airway secretions or lavage fluid

The presence of red cells or macrophages containing either effete red cells or the breakdown products of hemoglobin (hemosiderophages) in tracheal or bronchoalveolar lavage fluid provides evidence of EIPH. Detection of red cells or hemosiderophages in tracheal aspirates or bronchoalveolar lavage fluid is believed to be both sensitive and specific in the diagnosis of EIPH.<sup>7</sup> Examination of airway fluids indicates the presence of EIPH in a greater proportion of horses than does tracheobronchoscopic examination after strenuous exercise or racing. The greater sensitivity of examination of airway fluid is probably attributable to the ability of this examination to detect the presence of small amounts of blood or its residual products and the longevity of these products in the airways. While endoscopic examination may detect blood in occasional horses up to 7 days after an episode of EIPH, cellular evidence of pulmonary hemorrhage persists for weeks after a single episode.<sup>42</sup> Red blood cells and macrophages containing red cells are present in bronchoalveolar lavage fluid or tracheal aspirates for at least 1 week after strenuous exercise or instillation of autologous blood into airways and hemosiderophages are present for at least 21 days and possibly longer.<sup>42</sup>

Recent studies have reported on the use of red cell numbers in bronchoalveolar lavage fluid as a quantitative indicator of EIPH. However, this indicator of EIPH severity has not been validated nor demonstrated to be more reliable or repeatable than tracheobronchoscopic examination and visual scoring. Furthermore, considerable concern exists over the suitability of red cell counts in bronchoalveolar lavage fluid for assessment of severity of EIPH given that an unknown area, although presumably small, of the lung is examined by lavage and that there is a risk that this area of lung may not be representative of the lung as a whole, similar to the situation of examination of bronchoalveolar lavage fluid of horses with pneumonia. Bronchoalveolar lavage of sections of both lungs, achieved using an endoscope, may obviate some of these concerns.

Tracheal aspirates may be obtained any time after exercise by aspiration either during tracheobronchoscopic examination or through a percutaneous intratracheal needle. Aspirates obtained through

an endoscope may not be sterile, depending on the collection technique. Bronchoalveolar lavage fluid can be obtained through either an endoscope wedged in the distal airway or a cuffed tube inserted blindly into a distal airway. Collection of fluid through an endoscope has the advantage of permitting examination of the distal airways and selection of the area of lung to be lavaged. However, it does require the use of an endoscope that is longer (2 m) than those readily available in most equine practices. Use of a commercial bronchoalveolar lavage catheter does not require use of an endoscope and this procedure can be readily performed in field situations.

#### DIFFERENTIAL DIAGNOSIS

Epistaxis and hemorrhage into airways can occur as a result of a number of diseases (Table 10.5).

#### Necropsy

Exercise-induced pulmonary hemorrhage is a rare cause of death of racehorses, but among race horses that die during racing for reasons other than musculoskeletal injuries, EIPH is common.<sup>37</sup> Necropsy examination of horses is usually incidental to examination for another cause of death. Pertinent abnormalities in horses with EIPH are restricted to the respiratory tract. Grossly, horses examined within hours of strenuous exercise, such as horses examined because of catastrophic musculoskeletal injuries incurred during racing, may have severe petechiation in the caudodorsal lung fields. Horses with chronic disease have blue/gray or blue/brown discoloration of the visceral pleural surfaces of the caudodorsal lung fields that is often sharply demarcated, especially on the diaphragmatic surface. The discoloration affects both lungs equally with 30–50% of the lung fields being discolored in severe cases. Affected areas do not collapse to the same extent as unaffected areas and, in the deflated lung, have a spleen-like consistency. On cut surface, the discolored areas of lung are predominantly contiguous with the dorsal pleural surface and extend ventrally into the lung parenchyma. Areas of affected lung may be separated by normal lung. There is proliferation of bronchial vessels, predominantly arteries and arterioles, in affected areas. Histologically, affected areas exhibit bronchiolitis, hemosiderophages in the alveolar lumen and interstitial spaces, and fibrosis of interlobular septa, pleural and around vessels and bronchioles.

#### Treatment

Therapy of EIPH is usually a combination of attempts to reduce the severity of

Table 10.5 Causes of epistaxis in horses

Disease	Epidemiology	Clinical signs and diagnosis	Treatment and control
<b>Hemorrhage into trachea or bronchi, sometimes with epistaxis</b>			
Exercise-induced pulmonary hemorrhage (EIPH)	Horses after strenuous exercise. Most common in Thoroughbred and Standardbred racehorses	Epistaxis is a rare but very specific sign of EIPH. Only occurs after exercise. Endoscopic examination of the airways is diagnostic	Efficacy of various drugs used for treatment and control is debated. Furosemide is used extensively before racing
Trauma	Sporadic. Associated with trauma to head, neck, or chest	Physical examination reveals site and nature of the trauma. Can require endoscopic examination of upper airways	Symptomatic treatment
Pneumonia	Recent shipping or respiratory disease. Can occur as outbreaks though usually individual animals	Fever, tachypnea, abnormal lung sounds, leukocytosis, radiography demonstrates lung lesions. Cytological and microbiological examination of tracheal aspirate	Antimicrobials, NSAIDs, oxygen. Control by vaccination and prevention of respiratory disease
Lung abscess	Sporadic. Hemorrhage can occur after exercise	Sometimes no premonitory signs. Fever, depression, anorexia, cough. Hemogram demonstrates leukocytosis. Hyperfibrinogenemia. Ultrasonography or radiography demonstrates lesion. Tracheal aspirates	Antibiotics
Intrabronchial foreign body	Sporadic	Cough, hemoptysis, fever. Endoscopy or radiography reveals foreign body	Removal of foreign body – often not readily achieved
Pulmonary neoplasia	Sporadic. Often older horse, but not always. Hemangiosarcoma	Cough, hemoptysis. Demonstrate mass on ultrasonographic or radiographic examination	None
<b>Epistaxis (in addition to the above diseases)</b>			
Guttural pouch mycosis	Sporadic. Acute onset epistaxis	Severe, life-threatening epistaxis. Tachycardia, anemia, hemorrhagic shock	Surgical ligation or occlusion of arteries in the guttural pouch
Ethmoidal hematoma	Sporadic	Epistaxis not associated with exercise. Usually unilateral	Surgery or injection of mass with formaldehyde
Thrombocytopenia	Sporadic	Epistaxis, mild, intermittent. Petechiation and ecchymotic hemorrhages. Thrombocytopenia	Glucocorticoids
Neoplasia	Sporadic	Neoplasia of upper airways	None
Trauma	Sporadic	Injury to head or pharynx	Symptomatic
Sinusitis	Sporadic	Endoscopic or radiographic examination of sinus	Drainage. Antimicrobials

subsequent hemorrhage and efforts to minimize the effect of recent hemorrhage. Treatment of EIPH is problematic for a number of reasons. Firstly, the pathogenesis of EIPH has not been determined although the available evidence supports a role for stress failure of pulmonary capillaries secondary to exercise-induced pulmonary hypertension. Secondly, there is a lack of information using large numbers of horses under field conditions that demonstrates an effect of any medication or management practice (with the exception of bedding) on EIPH. There are numerous studies of small numbers of horses (< 40) under experimental conditions but these studies often lacked the statistical power to detect treatment effects and, furthermore, the relevance of studies conducted on a treadmill to horses racing competitively is questionable. Treatments for EIPH are usually intended to address a specific aspect of the pathogenesis of the disease and will be discussed in that context.

Prevention of stress failure of the pulmonary capillaries

There is interest in reducing the pressure difference across the pulmonary capillary membrane in an effort to reduce EIPH. Theoretically, this can be achieved by reducing the pressure within the capillary

or increasing (making less negative) the pressure within the intrathoracic airways and alveolus.

#### *Reducing pulmonary capillary pressure*

Furosemide administration as prophylaxis of EIPH is permitted in a number of racing jurisdictions worldwide, most notably Canada, the USA, Mexico and most of the South American countries. Within the USA and Canada, almost all Thoroughbred, Standardbred and Quarter horse racing jurisdictions permit administration of furosemide before racing.

The efficacy of furosemide in treatment of EIPH is uncertain. While field studies of large numbers of horses do not demonstrate an effect of furosemide on the prevalence of EIPH,<sup>43</sup> studies of Thoroughbred horses running on a treadmill provide evidence that furosemide reduces the severity of EIPH.<sup>44</sup> Under field conditions, based on tracheo-bronchoscopic evaluation of the severity of bleeding, furosemide has been reported to reduce or have no influence on the severity of bleeding.<sup>43,45</sup> This apparent inconsistency may be attributable to measurement of red blood cell counts in bronchoalveolar lavage fluid of horses that have run on a treadmill not being representative of effects of furosemide

under field conditions. The weight of evidence, albeit unconvincing, from field studies does not support a role for furosemide in preventing or reducing the severity of EIPH.

The mechanism by which furosemide may reduce the severity of EIPH is unknown, although it is speculated that furosemide, by attenuating the exercise-induced increase in pulmonary artery and pulmonary capillary pressure of horses, reduces the frequency or severity of pulmonary capillary rupture.

Furosemide is associated with superior performance in both Thoroughbred and Standardbred racehorses,<sup>46,47</sup> which further complicates assessment of its efficacy in treating EIPH.

An increase in pulmonary capillary pressure secondary to altered rheostatic properties of blood during exercise has been suggested as a possible contributing factor for EIPH.<sup>48</sup>

#### *Increasing alveolar inspiratory pressure*

Airway obstruction, either intrathoracic or extrathoracic, increases airway resistance and results in a more negative intrathoracic (pleural) pressure during inspiration to maintain tidal volume and alveolar ventilation. Causes of extrathoracic airway obstruction include laryngeal hemiplegia

and other abnormalities of the upper airway, whereas intrathoracic obstruction is usually a result of bronchoconstriction and inflammatory airway disease. Horses with partial extrathoracic inspiratory obstruction or bronchoconstriction and airway inflammation associated with recurrent airway obstructive disease (heaves) have pleural (and hence alveolar) pressures that are lower (more negative) than those in unaffected horses or in horses after effective treatment.

Partial inspiratory obstruction, such as produced by laryngeal hemiplegia, exacerbates the exercise-induced decrease in intrapleural pressures with a consequent increase in transmural capillary pressures.<sup>28,29</sup> These changes may exacerbate the severity of EIPH although an association between upper airway obstructive disease and EIPH has not been demonstrated. Surgical correction of airway obstruction is expected to resolve the more negative intrapleural pressure, but its effect on EIPH is unknown.

Recently, the role of the nares in contributing to upper airway resistance, and hence lowering inspiratory intrapleural pressure during intense exercise, has attracted the attention of some investigators. Application of nasal dilator bands (Flair<sup>®</sup> strips) reduces nasal resistance by dilating the nasal valve and reduces red cell count of bronchoalveolar lavage fluid collected from horses after intense exercise on a treadmill.<sup>44</sup> Furthermore, application of the nasal dilator strips to horses in simulated races reduces red cell count in bronchoalveolar lavage fluid of some, but not all, horses.<sup>49</sup>

The role of small-airway inflammation and bronchoconstriction in the pathogenesis of EIPH is unclear. However, horses with EIPH are often treated with drugs intended to decrease lower airway inflammation and relieve bronchoconstriction. Beta-adrenergic bronchodilatory drugs such as clenbuterol and albuterol (salbutamol) are effective in inducing bronchodilation in horses with bronchoconstriction, but their efficacy in preventing EIPH is either unknown or, in very small studies, is not evident. Corticosteroids, including dexamethasone, fluticasone and beclomethasone administered by inhalation, parenterally or enterally reduce airway inflammation and obstruction but have no demonstrated efficacy in preventing EIPH. Cromolyn sodium (sodium cromoglycate) has no efficacy in preventing EIPH.

Water vapor treatment (inhalation of water-saturated air) has been proposed as a treatment for EIPH because of its putative effect on small-airway disease. However, water vapor treatment has no effect on EIPH.

The use of bedding of low allergenic potential (shredded paper) to prevent EIPH has no apparent effect on prevalence of the condition.<sup>50</sup> While it is suggested that preventing or minimizing small-airway disease may reduce the severity of EIPH, studies to demonstrate such an effect have not been reported. However, optimizing the air quality in barns and stables and preventing infectious respiratory disease appear sensible precautions.

#### Interstitial inflammation and bronchial angiogenesis

Hemorrhage into interstitial tissues induces inflammation with subsequent development of fibrosis and bronchial artery angiogenesis.<sup>30,42</sup> The role of these changes in perpetuating EIPH in horses is unclear but is probably of some importance. Treatments to reduce inflammation and promote healing with minimal fibrosis have been proposed. Rest is an obvious recommendation and many racing jurisdictions have rules regarding enforced rest for horses with epistaxis. While the recommendation for rest is intuitive, there is no information that rest reduces the severity or incidence of EIPH in horses with prior evidence of this disorder.

Similarly, corticosteroids are often administered, either by inhalation, enterally or parenterally, in an attempt to reduce pulmonary inflammation and minimize fibrosis. Again, the efficacy of this intervention in preventing or minimizing severity of EIPH has not been documented.

#### Excessive bleeding

##### *Coagulopathy and fibrinolysis*

Exercise induces substantial changes in blood coagulation and fibrinolysis. However, there is no evidence that horses with EIPH have defective coagulation or increased fibrinolysis.<sup>33,34</sup> Regardless, aminocaproic acid, a potent inhibitor of fibrin degradation, has been administered to horses to prevent EIPH. The efficacy of aminocaproic acid in preventing EIPH has not been demonstrated. Similarly, estrogens are given to horses with the expectation of improving hemostasis, although the effect of estrogens on coagulation in any species is unclear. There is no evidence that estrogens prevent EIPH in horses.

Vitamin K is administered to horses with EIPH, presumably in the expectation that it will decrease coagulation times. However, as EIPH is not associated with prolonged bleeding times, it is unlikely that this intervention will affect the prevalence or severity of EIPH.

##### *Platelet function*

Aspirin inhibits platelet aggregation in horses and increases bleeding time.

Seemingly paradoxically, aspirin is sometimes administered to horses with EIPH because of concerns that increased platelet aggregation contributes to EIPH. There is no evidence that aspirin either exacerbates or prevents EIPH.

##### *Capillary integrity*

Capillary fragility increases the risk of hemorrhage in many species. Various bioflavonoids have been suggested to increase capillary integrity and prevent bleeding. However, hesperidin and citrus bioflavonoids have no efficacy in prevention of EIPH in horses. Similarly, vitamin C is administered to horses with EIPH without scientific evidence of any beneficial effect.

#### Summary of treatment options

Selection of therapy for horses with EIPH is problematic. Given that most horses have some degree of pulmonary hemorrhage during most bouts of intense exercise, the decision must be made not only as to the type of treatment and its timing but also which horses to treat. Moreover, the apparently progressive nature of the disease with continued work highlights the importance of early and effective prophylaxis and emphasizes the need for studies of factors such as air quality and respiratory infections in inciting the disorder.

The currently favored treatment for EIPH is administration of furosemide before intense exercise. Its use is permitted in racehorses in a number of countries. Increasingly persuasive laboratory evidence of an effect of furosemide in reducing red cell count in bronchoalveolar lavage fluid collected from horses soon after intense exercise supports the contention that furosemide is effective in reducing the severity of EIPH in race horses. However, it should be borne in mind that neither the relationship between severity of EIPH and red cell count in bronchoalveolar lavage fluid nor the efficacy of furosemide in reducing severity of EIPH in race horses in the field has been demonstrated. In fact, there is evidence that furosemide does not reduce the prevalence of EIPH and other evidence that it does not reduce the severity of EIPH under field conditions. The association between furosemide administration and superior performance in Standardbred and Thoroughbred racehorses should be borne in mind when recommending use of this drug.

#### Prevention and control

There are no documented preventive strategies. Rest is an obvious recommendation for horses with EIPH, but the hemorrhage is likely to recur when the horse is next strenuously exercised.

The duration of rest and the optimal exercise program to return horses to racing after EIPH is unknown, although some jurisdictions require exercise no more intense than trotting for 2 months. Firm recommendations cannot be made on duration of rest because of a lack of objective information.

Although a role for lower airway disease (either infectious or allergic) in the genesis of EIPH has not been demonstrated, control of infectious diseases and minimization of noninfectious lower airway inflammation appears prudent.

Concern about the role of impact waves in the genesis of EIPH has led to discussion of 'low-stress' training protocols, but these have not been adequately evaluated.

## REFERENCES

- Akbar SJ et al. *Vet Rec* 1994; 135:624.
- Takahashi T et al. *J Am Vet Med Assoc* 2001; 218:1462.
- Weideman H et al. *J S Afr Vet Assoc* 2003; 74:127.
- Williams R et al. *Equine Vet J* 2001; 33:478.
- Hinchcliff KW et al. *J Am Vet Med Assoc* 2005; 227:768.
- Newton JR, Wood JLN. *Equine Vet J Suppl* 2002; 34:417.
- McKane SA et al. *Aust Vet J* 1993; 70:401.
- Mason DK et al. In: Snow DH, Persson SGB, Rose RJ, eds. *Equine exercise physiology*. Cambridge: Granta, 1983:57.
- Pascoe J et al. *Am J Vet Res* 1981; 42:703.
- Raphel CF, Soma LR. *Am J Vet Res* 1982; 43:11237.
- Sweeney CR et al. *Am J Vet Res* 1990; 51:772.
- MacNamara B et al. *J Am Vet Med Assoc* 1990; 196:443.
- Speirs VC et al. *Aust Vet J* 1982; 59:38.
- Lapointe JM et al. *Equine Vet J* 1994; 26:482.
- Hillidge CJ et al. *J Equine Vet Sci* 1984; 4.
- Hillidge CJ et al. *J Equine Vet Sci* 1986; 5:351.
- Voynick BT, Sweeney CR. *J Am Vet Med Assoc* 1986; 188:301.
- Oikawa M. *J Comp Pathol* 1999; 121:339.
- West JB et al. *J Appl Physiol* 1993; 75:1097.
- Pascoe JR. *Proc Am Assoc Equine Pract* 1996; 42:220.
- West JB, Mathieu-Costello O. *Equine Vet J* 1994; 26:441.
- Birks EK et al. *J Appl Physiol* 1997; 82:1584.
- Langsetmo I et al. *Equine Vet J* 2000; 32:379.
- Manohar M et al. *Br Vet J* 1993; 149:419.
- Art T et al. *Respir Physiol* 1990; 82:279.
- Birks EK et al. *Respir Physiol* 1994; 97:235.
- Schroter RC et al. *Equine Vet J* 1998; 30:186.
- Hackett RP et al. *Am J Vet Res* 1999; 60:485.
- Ducharme NG et al. *Equine Vet J Suppl* 1999; 30:27.
- O'Callaghan MW et al. *Equine Vet J* 1987; 19:411.
- McKane SA, Slocombe RF. *Equine Vet J Suppl* 2002; 34:451.
- Jones JH et al. *Equine Vet J Suppl* 2002; 34:391.
- Bayly WM et al. In: Snow DH, Persson SGB, Rose RJ, eds. *Equine exercise physiology*. Cambridge: Granta, 1983:64.
- Johnstone JB et al. *Can J Vet Res* 1991; 55:101.
- Robinson NE, Derksen FJ. *Proc Am Assoc Equine Pract* 1980; 26:421.
- Martin BB, Jr et al. *J Am Vet Med Assoc* 1999; 214:673.
- Boden LA et al. *Equine Vet J* 2005; 37:269.
- Rohrbach BW. *J Am Vet Med Assoc* 1990; 196:1563.

- Pascoe JR et al. *Am J Vet Res* 1981; 42:703.
- Hinchcliff KW et al. *Am J Vet Res* 2005; 66:596.
- Pascoe JR et al. *Vet Rad* 1983; 24:85.
- McKane S, Slocombe R. *Equine Vet J* 1999; 30:126.
- Birks EK et al. *Equine Vet J Suppl* 2002; 34:375.
- Geor RJ et al. *Equine Vet J* 2001; 33:577.
- Pascoe JR et al. *Am J Vet Res* 1985; 46:2000.
- Gross DK et al. *J Am Vet Med Assoc* 1999; 215:670.
- Soma LR et al. *Equine Vet J* 2000; 32:334.
- Fedde MR, Erickson HH. *Equine Vet J* 1998; 30:329.
- Valdez S et al. *J Am Vet Med Assoc* 2004; 224:558.
- Mason DK et al. *Vet Rec* 1984; 115:268.

## PULMONARY EMPHYSEMA

Pulmonary emphysema is distension of the lung caused by overdistension of alveoli with rupture of alveolar walls with or without escape of air into the interstitial spaces. Overinflation describes the situation in which there is enlargement of airspaces without tissue destruction. Pulmonary emphysema is always secondary to some primary lesion which effectively traps an excessive amount of air in the alveoli. It is a common clinicopathological finding in many diseases of the lungs of all species and is characterized clinically by dyspnea, hyperpnea, poor exercise tolerance and forced expiration.

## ETIOLOGY

Pulmonary emphysema is an important lesion only in cattle, although occasional cases occur in pigs. The bovine lung is highly susceptible to the development of emphysema from many different causes, not all of them respiratory in origin. In those of respiratory origin it is common to find pulmonary emphysema when the primary lesion in the lung causes trapping of air in alveoli or terminal bronchioles. Endotoxemia, for example, can result in diffuse alveolar damage associated with thromboangiitis resulting in pulmonary edema and emphysema. Some causes of emphysema are as follows:

### Cattle

- Acute interstitial pneumonia
- Parasitic pneumonia with pulmonary edema in acute anaphylaxis
- Perforation of the lung by foreign body as in traumatic reticuloperitonitis
- Poisoning by the plants *Senecio quadridentatus*, rape, *Zieria arborescens*, *Perilla frutescens* and the fungus *Periconia* spp. are recorded as causing pulmonary emphysema in cattle
- Pulmonary abscess.

### Horses

- Bronchiolitis due to viral infection of the respiratory tract in young horses.

### All species

- Secondary to bronchopneumonia
- Poisoning by oleander, *Bryophyllum pinnatum* and moldy sweet potatoes<sup>1-3</sup>

- Acute chemical injury – as in inhalation of welding fumes
- Chlorine gas poisoning
- Local or perifocal emphysema is also a common necropsy finding around local pulmonary lesions, especially atelectasis, often with no respiratory dysfunction. In calves and pigs the emphysema is sometimes sufficiently extensive to kill the animal.

## PATHOGENESIS

Emphysema occurs because of destruction of the connective tissues of the lung, including the supporting and elastic tissue of the pulmonary parenchyma. Tissue damage resulting in emphysema in humans is caused by the action of proteases in the lung. Whether this occurs in the farm animal species is unknown but is a consideration. An initial lesion probably leads to an area of weakness from which emphysema spreads during coughing or exertion. In interstitial emphysema there is the additional factor of distension of the connective tissue with air and compression collapse of the alveoli.

The development of interstitial emphysema depends largely upon the amount of interstitial tissue that is present and is most common in cattle and pigs. Whether there is simple overdistension of alveoli or whether their walls are also ruptured is very important in prognosis and treatment. Excellent recoveries occur in simple alveolar emphysema, especially those occurring acutely at pasture. This suggests that the lesion is functional and that the alveoli are not substantially damaged.

**The pathophysiological consequences of emphysema** depend upon the inefficiency of evacuation of pulmonary air-space and failure of normal gaseous exchange in the lungs. The elastic recoil of the tissue is diminished, and when the thorax subsides during expiration incomplete evacuation occurs. Because of the increase in residual volume, the tidal volume must be increased to maintain normal gaseous exchange. Retention of carbon dioxide stimulates an increase in the depth of respiration but maximum respiratory effort necessitated by exercise cannot be achieved. Anoxia develops and metabolism of all body tissues is reduced. The characteristic effect of emphysema is to produce an increase in expiratory effort necessitated by the failure of normal elastic recoil.

Interference with the pulmonary circulation results from collapse of much of the alveolar wall area and a consequent diminution of the capillary bed. The decreased negative pressure in the chest and the abnormally wide respiratory excursion also cause a general restriction

of the rate of blood flow into the thorax. The combined effect of these factors may be sufficient to cause failure of the right ventricle especially if there is a primary defect of the myocardium. Acidosis may also result because of the retention of carbon dioxide.

### CLINICAL FINDINGS

Characteristically, diffuse pulmonary emphysema causes severe expiratory dyspnea with a grunt on expiration and loud crackling lung sounds on auscultation over the emphysematous lungs. In severe cases in cattle, the emphysema is commonly interstitial and dissection of the mediastinum and fascial planes results in subcutaneous emphysema over the withers. In severe cases in cattle, open-mouth breathing is common.

In cattle and pigs the presence of pulmonary emphysema in pulmonary disease is often not detectable clinically.

### CLINICAL PATHOLOGY

There is hypoxemia and, often, hypercapnia. Compensatory polycythemia may develop. There are no characteristic hematological findings but, if there is a significant secondary bronchopneumonia, a leukocytosis and left shift may be evident. In the appropriate location, an examination of feces for lungworm larvae may be desirable. In cases suspected of having an allergic origin, swabs of nasal secretion may reveal a high proportion of eosinophils and a hematological examination may show eosinophilia.

### NECROPSY FINDINGS

The lungs are distended and pale in color and may bear imprints of the ribs. In interstitial emphysema the interalveolar septae are distended with air, which may spread to beneath the pleura, to the mediastinum and under the parietal pleura. There may be evidence of congestive heart failure. On histopathological examination a bronchiolitis is present in most cases. This may be diffuse and apparently primary or originate by spread from a nearby pneumonia.

### TREATMENT

The treatment of pulmonary emphysema will depend on the species affected, the cause of the emphysema and the stage of the disease.

There is no known specific treatment for the pulmonary emphysema associated with acute interstitial pneumonia in cattle, which is discussed under that heading. The emphysema secondary to the infectious pneumonias will usually resolve spontaneously if the primary lesion of the lung is treated effectively. In valuable animals, the administration of oxygen may be warranted if the hypoxia is severe and life-threatening. Antihistamines,

### DIFFERENTIAL DIAGNOSIS

**Acute emphysema in cattle** is often accompanied by pulmonary edema with the presence of consolidation and crackles in the ventral parts of the lungs. It may be similar to acute pulmonary congestion and edema caused by anaphylaxis but forced expiration is not a characteristic of these latter conditions.

**Acute pneumonia** in cattle or horses is characterized by fever and localization of abnormal respiratory sounds, which are not as marked nor as widely distributed as those of emphysema.

**Chronic pneumonia** is characterized by dyspnea, chronic toxemia, crackles and wheezes and poor response to therapy.

**Pneumothorax** is accompanied by forced inspiration and an absence of normal breath sounds.

atropine and corticosteroids have been used for the treatment of pulmonary emphysema secondary to interstitial pneumonia in cattle but their efficacy has been difficult to evaluate.

### REFERENCES

1. Oryan A et al. Zentralbl Vet A 1996; 43:625.
2. Reppas GP. Aust Vet J 1995; 72:425.
3. Medeiros RM et al. Vet Hum Toxicol 2001; 43:205.

### PNEUMONIA

Pneumonia is inflammation of the pulmonary parenchyma usually accompanied by inflammation of the bronchioles and often by pleuritis. It is manifested clinically by an increase in the respiratory rate, changes in the depth and character of respirations, coughing, abnormal breath sounds on auscultation and, in most bacterial pneumonias, evidence of toxemia.

### ETIOLOGY

Pneumonia may be associated with viruses, bacteria, or a combination of both, fungi, metazoan parasites and physical and chemical agents. Most of the pneumonias in animals are bronchogenic (inhalation) in origin but some originate by the hematogenous route, such as pneumonia of foals and calves with septicemia. The pneumonias which occur in farm animals are grouped here according to species.

#### Cattle

Pneumonic pasteurellosis (shipping fever) – *M. haemolytica*, *P. multocida* with or without parainfluenza-3 virus  
*Histophilus somnus* in feedlot cattle is not necessarily associated with the septicemic form of the disease. The role of the organism as a primary pathogen in acute bovine respiratory disease is uncertain

Enzootic pneumonia of calves – parainfluenza-3, adenovirus-1, -2 and

- 3, rhinovirus, bovine respiratory syncytial virus, reovirus, bovid herpesvirus-1 (the IBR virus), plus *Chlamydia* spp., *Mycoplasma* spp., *Pasteurella* spp., *Mannheimia* spp., *Actinomyces pyogenes*, *Streptococcus* spp., *Bedsonia* sp. and *Actinobacillus actinoides*
- Pneumonia and arthritis in beef calves associated with *Mycoplasma bovis* and *Mycoplasma cali fornicum*
- Viral interstitial pneumonia in recently weaned beef calves associated with bovine respiratory syncytial virus; it may also occur in yearling and adult cattle
- Contagious bovine pleuropneumonia – *Mycoplasma mycoides*
- Acute and chronic interstitial pneumonia associated with D, L-tryptophane, moldy hay and other pneumotoxic agents
- Atypical interstitial pneumonia associated with ryegrass staggers in calves<sup>2</sup>
- Massive infestation with pig ascarid larvae
- Lungworm pneumonia – *Dictyocaulus viviparus*
- *Klebsiella pneumoniae* infection in calves and nursing cows with mastitis associated with this organism
- Sporadically in tuberculosis associated with *M. bovis*
- *Fusobacterium necrophorum* as a complication of calf diphtheria, and sporadically in feedlot cattle
- There is a preliminary report of circovirus in adult cattle with pneumonia<sup>3</sup>
- Mycotic pneumonia associated with *Mortierella wolfii* in adult cattle.<sup>4</sup>

#### Pigs

- Enzootic pneumonia – *Mycoplasma* sp. with *Pasteurella* sp. secondarily
- Pneumonic pasteurellosis – *P. multocida*
- Pleuropneumonia – *Actinobacillus pleuropneumoniae*
- Interstitial pneumonia – septicemic salmonellosis
- *Bordetella bronchiseptica*, *Salmonella choleraesuis*
- Influenza virus<sup>5</sup>
- Porcine reproductive and respiratory syndrome virus<sup>5</sup>
- *Haemophilus parasuis*<sup>5</sup>
- *Actinobacillus pyogenes*<sup>5</sup>
- Paramyxovirus causing respiratory and central nervous system disease in pigs<sup>6</sup>
- Uncommonly, lungworm pneumonia
- Anthrax by inhalation, causing pulmonary anthrax.

#### Horses

- Pleuropneumonia in mature horses due to aerobic and anaerobic

bacteria.<sup>7-9</sup> The aerobic bacteria most commonly isolated are alpha-hemolytic *Streptococcus* spp., *Pasteurella* spp., *Escherichia coli* and *Enterobacter* spp. The anaerobic bacteria most frequently isolated are *Bacteroides* spp., *Prevotella* spp., *Fusobacterium* spp. and *Clostridium* spp.<sup>9,10</sup>

- Newborn foals – *Streptococcus* spp., *E. coli*, *Actinobacillus equuli* and other agents causing septicemia in this age group
- In immunodeficient foals, pneumonia associated with adenovirus or *Pneumocystis jiroveci* (formerly *P. carinii*)<sup>11</sup>
- Immunosuppression following corticosteroid therapy for other diseases<sup>12</sup>
- Older foals – *R. equi*, equine herpesvirus-1 (the EVR virus), equine influenza virus<sup>13</sup>
- Bronchointerstitial pneumonia in foals 1–8 months of age – etiology uncertain<sup>14,15</sup>
- Eosinophilic pneumonia secondary to parasite migration (*Parascaris equorum*) or *Dictyocaulus arnfieldi* infection
- Interstitial proliferative pneumonia in foals from 6 days to 6 months of age, and the adult form in horses 2 years of age and older<sup>16</sup>  
*Nicotetella semolina* in adult horses<sup>17</sup>  
*Bordetella bronchiseptica* in adult horses<sup>18</sup>  
Pleuron pneumonia associated with pulmonary hydatidosis in a horse<sup>19</sup>  
As a sequel to strangles  
Influenza<sup>20</sup>  
Rarely, as a sequel to equine viral arteritis or equine viral rhinopneumonitis in adult animals  
Glanders and epizootic lymphangitis (*Histomonas farcinicus*) usually include pneumonic lesions  
*Paecilomyces* spp. in foals<sup>21</sup>  
Mycotic pneumonia associated with *Emmonsia crescens* (adiaspiromycosis) in adult horses<sup>22</sup>  
Strenuous exercise in very cold conditions can cause damage to the airways of horses (and probably other species).<sup>23</sup>

#### Sheep

Pneumonic pasteurellosis (*Mannheimia* spp.) as acute primary pneumonia in feedlot lambs, or secondary to parainfluenza-3 or *Chlamydia* sp. infection  
Newborn lambs – uncommonly *Streptococcus zooepidemicus*, *Salmonella abortus-ovis*  
Severe pneumonia due to *Mycoplasma* sp. in lambs – kageda in Iceland and Switzerland

- Symptomless pneumonias without secondary infection – adenovirus, respiratory syncytial virus, reovirus, *Mycoplasma* spp. (including *M. ovipneumoniae*, *M. dispar*)<sup>24</sup>
- *Corynebacterium pseudotuberculosis* – sporadic cases only
- Melioidosis (*Pseudomonas pseudomallei*)
- Lungworm (*Dictyocaulus filaria*)
- Ovine herpesvirus-2<sup>25</sup>
- Progressive interstitial pneumonia (maedi) and pulmonary adenomatosis (jaagsiekte)
- Carbolic dip toxicity.

#### Goats

- Pleuropneumonia associated with *Mycoplasma* strain F 38 or *Mycoplasma capri*, a devastating disease
- Chronic interstitial pneumonia with cor pulmonale as a common sequel may be associated with a number of *Mycoplasma* spp., but *M. mycoides* var. *mycoides* appears to be the most commonly recorded
- Parainfluenza type 3<sup>26</sup>
- Contagious ecthyma virus<sup>27</sup>
- Retrovirus infection.

#### All species

- Toxoplasmosis – rare, sporadic cases
- Systemic mycoses
- Aspiration pneumonia is dealt with as a separate entity  
Sporadic secondary pneumonia associated with *Streptococcus* sp., *Corynebacterium* sp., *Dermatophilus* sp.
- Interstitial pneumonia, pulmonary consolidation and fibrosis by toxins in plants – *Eupatorium glandulosum* in horses, *Zieria arborescens* (stinkwood) in cattle, *Astragalus* spp. in all species.

#### EPIDEMIOLOGY

In addition to the infectious agents which cause the pneumonia, there are risk factors which contribute to the susceptibility of the animal. Three **risk factors** interact in the pathogenesis of specific pneumonias:

##### Animal

##### Environmental and management

##### Pathogen.

These are of paramount importance in any consideration of pneumonia and the details of the epidemiology of each specific pneumonia are presented with each specific disease in this book. As examples, some of the commonly recognized risk factors include:

- The weaning of beef calves in northern climates
- The long transportation of beef cattle to feedlots
- The collection and mixing of animals at auction marts where they might be

deprived of feed and water for prolonged periods

- The transportation of Thoroughbred horses farther than 500 miles and viral respiratory tract disease or exposure to horses with respiratory tract disease<sup>12,28</sup>
- Housing dairy calves in poorly ventilated overcrowded barns
- Marked changes in weather.

Susceptibility to pneumonia is determined by the animal's resistance to infection by agents that cause or predispose to pneumonia. Factors that impair innate resistance or adaptive resistance (immunity) increase the animal's susceptibility to pneumonia. For instance, shipping not only increases the risk of exposure of animals to pathogens to which they have not been exposed but also can impair innate resistance through damage to the respiratory tract by airborne irritants, dehydration, food deprivation and the effects of stress. There is a distinct trend evident since 1994 of increasing mortality from respiratory disease among cattle in feedlots,<sup>29</sup> although the reasons have not been identified.

#### PATHOGENESIS

##### Pulmonary defense mechanisms

Under normal conditions the major airways and the lung parenchyma prevent the entry of and neutralize or remove injurious agents, so that the lung contains very few, if any, organisms beyond the large airways. Many infections of the respiratory tract originate from aerosolized particles carrying infectious agents that arise external to or within the respiratory tract. In order to induce an infection by the aerosol route, an etiological agent must be aerosolized, survive in the aerosol, be deposited at a vulnerable site in the respiratory tract of a susceptible host, and then multiply. Thus the pathogenesis of these respiratory infections is related to the deposition of particles and infectious agents within the respiratory tract.

Under normal conditions a complex of biochemical, physiological and immunological defense mechanisms protects the respiratory tract from inhaled particles that could be injurious or infectious. The major defense mechanisms of the respiratory tract include:

- Aerodynamic filtration by the nasal cavities
- Sneezing
- Local nasal antibody
- The laryngeal reflex
- The cough reflex
- Mucociliary transport mechanisms
- Alveolar macrophages
- Systemic and local antibody systems.

Most of the research on defense mechanisms has been done in man and in laboratory animals.

#### Respiratory mucociliary clearance

The mucociliary escalator has important functions in the lung's physical defenses against the constant challenge of inhaled pathogens.<sup>30</sup> By various physical mechanisms, mucus traps and subsequently transports inhaled particles to the pharynx, where they are normally swallowed. Mucus also protects the airways by absorbing inhaled chemicals and gases, by humidifying the inspired air and by keeping the underlying mucosa hydrated. Mucus contains antibodies, especially IgA, which together with lactoferrin and lysozyme provide immunological defense.

**Airway secretions** consist of two layers. An underlying liquid layer, known as the periciliary fluid, in which the cilia beat, originates largely from trans-epithelial osmosis. An overlying gel or mucus layer is composed of intertwined mucin strands. Airway mucus is secreted in small globules, which expand several hundredfold within seconds and are later drawn into strands and transported rostrally by ciliary activity.

The secretion of respiratory mucus is a protective mechanism by which inhaled particles touching the airway mucosa stimulate local mucus production, which then traps and transports the particle from the lung. Airway mucus is produced mainly by submucosal glands and goblet cells, also known as mucus-producing cells. Airway secretions also contain alveolar fluid, surfactant and alveolar cells, including macrophages, which are drawn into the mucociliary ladder by surface tension.

Airway mucus is a complex substance consisting of 95% water and a 5% combination of glycoproteins, proteoglycans, lipids, carbohydrates and minerals. Mucin is the main nonaqueous component. Effective mucociliary clearance or mucokinesis can occur over a range of mucus viscosity but very-low-viscosity mucus is poorly transported and tends to gravitate toward the alveoli, while excessively viscous mucus, which is also poorly transported, may lodge in the airways and become inspissated.

**In respiratory disease** mucociliary clearance is impaired through disruption of effective ciliary activity, or changes in the quantity or quality of the mucus or periciliary fluid, or all three factors. In viral pulmonary disease, ciliary activity can be disrupted because of temporary deciliation or lesions of the respiratory mucosa. The defective mucociliary clearance may also last for several weeks. In chronic obstructive pulmonary disease in the horse, metaplasia of ciliated epithelium to a

nonciliated epithelium may occur in the smaller airways.

**Changes in the quality of mucus** are common in respiratory tract disease, especially increases in viscosity with pulmonary disease. The destruction of leukocytes and respiratory epithelial cells and the release of DNA increases the viscosity. Large increases in the glycoprotein content of mucus also occur, which affects the mucokinetic properties. Purulent respiratory secretions have reduced elasticity and together with the increased viscosity affect the mucociliary clearance. Acute inflammation also results in the production of serum proteins from the airway exudate, which alters the viscoelasticity of mucus and further reduces mucokinesis.

**Yellow or green respiratory secretions** are due to the enzyme myeloperoxidase, released from leukocytes in the static secretion, or to high numbers of eosinophils.

The quantity of mucus increases in most cases of respiratory disease as a result of stimulation of goblet cells and submucosal glands by inflammatory mediators. The abnormal production can also exacerbate the original pulmonary dysfunction. Tracheal mucociliary clearance can be assessed endoscopically, in vivo, by dropping dye or small markers on the tracheal mucosa and measuring their rate of transit visually or using radioactive particles detected by scintigraphy.<sup>30</sup>

Large particles in upper respiratory tract  
Large aerosolized particles that are inhaled are removed by the nasal cavities and only small ones are able to get into the lung. In the upper respiratory tract, essentially 100% of particles more than 10 µm in diameter and 80% of particles of the 5 µm size are removed by gravitational settling on mucosal surfaces. Particles deposited between the posterior two-thirds of the nasal cavity and the nasopharynx and from the larynx to the terminal bronchioles land on airways lined by mucus-covered, ciliated epithelium and are removed by means of the mucociliary transport mechanism. The nasopharyngeal and tracheobronchial portions of the ciliated airways transport mucus toward the pharynx, where it can be eliminated by swallowing. The cilia beat most effectively in mucus at a certain elasticity, viscosity and chemical composition. Anything that interferes with the secretion and maintenance of normal mucus will interfere with the clearance of particles from the upper respiratory tract. The damaging effect of viruses on mucociliary clearance has been demonstrated in laboratory animals and in humans.

*Mycoplasma pneumoniae* infection slows tracheobronchial clearance for as

long as 1 year, suggesting a possible explanation for the predisposition to bacterial pneumonia commonly observed after these infections. Viral diseases of the upper respiratory tract of farm animals are common and a similar interference in the mucociliary transport mechanism may explain the occurrence of secondary bacterial pneumonia.

#### Cough reflex

The cough reflex provides an important mechanism by which excess secretions and inflammatory exudates from the lungs and major airways can be removed from the airways and disposed of by expectoration or swallowing. In animals with relatively normal lungs, coughing represents a very effective means of expelling inhaled foreign bodies, or excessive or abnormal respiratory secretions, down to the level of the fourth- or fifth-generation bronchi. If the airways become deciliated, the cough reflex is the main and only mucus-clearance mechanism remaining. The cough reflex is valuable for transporting the increased secretions present in equine pulmonary disease and antitussive agents should therefore not be used in horses.

In the presence of severe tracheitis and pneumonia, coughing may result in retrograde movement of infected material to the terminal respiratory bronchioles and actually promote spread of the infection to distal parts of the lung. Any process that causes airway obstruction can predispose the lung to secondary bacterial infections. Experimental obstruction of the bronchi supplying a lobe of lung in sheep allows the development of secondary bacterial pneumonia. It has been postulated that damage to small airways following viral infections may allow the accumulation of exudate and cellular debris, which may facilitate secondary bacterial infections.

#### Small particles into lower respiratory tract

Particles of 1–2 µm size settle in the lungs through the action of gravity in the alveolar spaces and particles below 0–2 µm settle through diffusion of air. The alveolar macrophage plays a major role in clearing inhaled particles from the lung. Under normal conditions, bacteria that gain entry into the alveoli are cleared quickly and effectively in a matter of hours. Experimental parainfluenza-3 (PI-3) virus infection has the greatest adverse effect on the pulmonary clearance of *M. haemolytica* administered by intranasal aerosol on the seventh day following viral infection. The effect on pulmonary clearance is much less when the bacteria are given on the third or 11th day following the initial viral infection.



The presence of pre-existing antibody to *M. haemolytica* eliminates the effect of the viral infection on pulmonary clearance. Thus there is some evidence that in domestic animals lung clearance mechanism may be affected by a concurrent viral infection. This may have major implications in the control of some of the common infectious respiratory diseases of farm animals.

### Species susceptibility

The anatomical and physiological features of the respiratory system of cattle may predispose them to the development of pulmonary lesions much more than other farm animal species. Cattle have a small physiological gaseous exchange capacity and greater resultant basal ventilatory activity. The small gaseous exchange capacity may predispose cattle to low bronchiolar or alveolar oxygen levels during exposure to high altitudes and during periods of active physical or metabolic activity. During these times, low oxygen tension or hypoxia may slow mucociliary and alveolar macrophage activity and decrease pulmonary clearance rates. The basal ventilatory activity is comparatively greater than other mammals, which results in the inspired air becoming progressively more contaminated with infectious, allergenic or noxious substances.

The bovine lung also has a higher degree of compartmentalization than other species. This may predispose to airway hypoxia peripheral to airways that become occluded. This results in reduced phagocytic activity and the retention or multiplication of infectious agents. In addition, because of the low numbers of alveolar macrophages in the bovine lung the pulmonary clearance mechanism may not be as effective as in other species. There is also a low level or atypical bioactivity of lysozyme in bovine respiratory mucus, which may make cattle more susceptible to infection of the respiratory tract than other species.

### Development of pneumonia

The process by which pneumonia develops varies with the causative agent and its virulence and with the portal by which it is introduced into the lung.

**Bacteria are introduced** largely by way of the respiratory passages and cause a primary bronchiolitis that spreads to involve surrounding pulmonary parenchyma. The reaction of the lung tissue may be in the form of an acute fibrinous process as in pasteurellosis and contagious bovine pleuropneumonia, a necrotizing lesion as in infection with *F. necrophorum* or as a more chronic caseous or granulomatous lesion in mycobacterial or mycotic infections. Spread of the lesion through the lung occurs by extension but also by

passage of infective material along bronchioles and lymphatics. Spread along the air passages is facilitated by the normal movements of the bronchiolar epithelium and by coughing. Bronchiectasis and pulmonary abscesses are complications and common causes of failure to respond to therapy. Hematogenous infection by bacteria results in a varying number of septic foci, which may enlarge to form lung abscesses. Pneumonia occurs when these abscesses rupture into air passages and spread as a secondary bronchopneumonia.

**Viral infections** are also introduced chiefly by inhalation and cause a primary bronchiolitis, but there is an absence of the acute inflammatory reaction that occurs in bacterial pneumonia. Spread to the alveoli causes enlargement and proliferation of the alveolar epithelial cells and the development of alveolar edema. Consolidation of the affected tissue results but again there is an absence of acute inflammation and tissue necrosis so that toxemia is not a characteristic development. Histologically the reaction is manifested by enlargement and proliferation of the alveolar epithelium, alveolar edema, thickening of the interstitial tissue and lymphocytic aggregations around the alveoli, blood vessels and bronchioles. This interstitial type of reaction is characteristic of viral pneumonias.

**The pathophysiology** of all pneumonias, regardless of the way in which lesions develop, is based upon interference with gaseous exchange between the alveolar air and the blood. Anoxia and hypercapnia develop, which results in polypnea, dyspnea or tachypnea. Consolidation results in louder than normal breath sounds, especially over the antero-ventral aspects of the lungs, unless a pleural effusion is present to muffle the sounds. In bacterial pneumonias there is the added effect of toxins produced by the bacteria and necrotic tissue; the accumulation of inflammatory exudate in the bronchi is manifested by abnormal lung sounds such as crackles and wheezes on auscultation. Interstitial pneumonia results in consolidation of pulmonary parenchyma without involvement of the bronchi, and on auscultation loud breath sounds predominate in the early stages.

**Extension of the pneumonia** to the visceral surface of the pleura results in pleuritis, pleuropneumonia, pleural effusion and thoracic pain. Fibrinous pleuritis is a common complication of pneumonic pasteurellosis in cattle. Pleuritis and pleural effusion secondary to pneumonia and pulmonary abscess are commonly recognized in adult horses with the pleuropneumonia complex associated with aerobic and anaerobic bacteria.<sup>10</sup> Anaerobic bacterial pleuropneumonia in

the horse is accompanied by a putrid odor of the breath, the sputum or the pleural fluid.<sup>8</sup> It is suggested that most anaerobic bacterial pulmonary infections in the horse are the result of aspiration of oropharyngeal contents, and are most commonly located in the right lung because of the proximity of the right main stem bronchus. Some horses with pleuropneumonia may develop acute hemorrhagic pulmonary infarction and necrotizing pneumonia.<sup>31</sup>

Restriction of gaseous exchange occurs because of the obliteration of alveolar spaces and obstruction of air passages. In the stage before blood flow through the affected part ceases, the reduction in oxygenation of the blood is made more severe by failure of part of the circulating blood to come into contact with oxygen. Cyanosis is most likely to develop at this stage and to be less pronounced when hepatization is complete and blood flow through the part ceases. An additional factor in the production of anoxia is the shallow breathing that occurs. Pleuritic pain causes reduction in the respiratory excursion of the chest wall but when no pleurisy is present the explanation of the shallow breathing probably lies in the increased sensitivity of the Hering-Breuer reflex. Retention of carbon dioxide with resulting acidosis is most likely to occur in the early stages of pneumonia because of this shallow breathing.

### CLINICAL FINDINGS

- **Rapid, shallow breathing** is the cardinal sign of early pneumonia
- **Dyspnea** occurs in the later stages when much of the lung tissue is nonfunctional
- **Polypnea** may be quite marked with only minor pneumonic lesions; the rapidity of the respiration is an inaccurate guide to the degree of pulmonary involvement
- **Coughing** is another important sign, the type of cough varying with the nature of the lesion.

Bacterial bronchopneumonia is usually accompanied by a moist and painful cough. In viral interstitial pneumonia the coughing is frequent, dry and hacking, often in paroxysms. Auscultation of the thorax before and after coughing may reveal coarse crackling sounds suggestive of exudate in the airways. Cyanosis is not a common sign and occurs only when large areas of the lung are affected. A nasal discharge may or may not be present, depending upon the amount of exudate present in the bronchioles and whether or not there is accompanying inflammation of the upper respiratory tract. The odor of the breath may be informative: it may have an odor of decay

when there is a large accumulation of inspissated pus present in the air passages; or it may be putrid, especially in horses affected with anaerobic bacterial pleuropneumonia.

**In acute bacterial bronchopneumonia,** toxemia, anorexia, depression, tachycardia and a reluctance to lie down are common. In the advanced stages, severe dyspnea with an expiratory grunt are common.

**In viral interstitial pneumonia,** affected animals are usually not toxemic but they may have a fever and be inappetent or anorexic. However, some cases of viral interstitial pneumonia can be diffuse and severe and cause severe respiratory distress, failure to respond to therapy and death within a few days. A severe **bronchointerstitial pneumonia of foals** aged 1–2 months of age has been described.<sup>14,32</sup> The disease was characterized clinically by sudden onset of fever and increasingly severe dyspnea with respiratory distress and no response to treatment. In **acute interstitial pneumonia of cattle,** exemplified by the acute disease seen in mature cattle moved on to a lush pasture within the previous 10 days, some animals may be found dead. Other affected animals are severely dyspneic, anxious, commonly mouth-breathing and grunting with each expiration and, if forced to walk, may collapse and die of asphyctic respiratory failure.

**Auscultation of the lungs** is a valuable aid to diagnosis. The stage of development and the nature of the lesion can be determined and the area of lung tissue affected can be outlined. In the early congestive stages of bronchopneumonia and interstitial pneumonia the breath sounds are increased, especially over the anteroventral aspects of the lungs. Crackles develop in bronchopneumonia as bronchiolar exudation increases, but in uncomplicated interstitial pneumonia, clear, harsh breath sounds are audible. In viral interstitial pneumonia, wheezes may be audible due to the presence of bronchiolitis. When complete consolidation occurs in either form, loud breath sounds are the most obvious sound audible over the affected lung but crackles may be heard at the periphery of the affected area in bronchopneumonia. Consolidation also causes increased audibility of the heart sounds. When pleurisy is also present a pleuritic friction rub may be audible in the early stages, and muffling of the breath sounds over the ventral aspects of the lungs in the late exudative stages. If a pleural effusion is present, percussion of the thorax will reveal dullness of the ventral aspects and a fluid line can usually be outlined. Consolidation can be detected also by percussion of the thorax.

**In chronic bronchopneumonia in cattle** there is chronic toxemia, rough hair coat and a gaunt appearance. The respiratory and heart rates are above normal and there is usually a moderate persistent fever. However, the temperature may have returned to within a normal range even though the animal continues to have chronic incurable pneumonia. The depth of breathing is increased and both inspiration and expiration are prolonged. A grunt on expiration and open-mouth breathing indicate advanced pulmonary disease. A copious bilateral mucopurulent nasal discharge and a chronic moist productive cough are common. On auscultation of the lungs, loud breath sounds are usually audible over the ventral half of the lungs, and crackles and wheezes are commonly audible over the entire lung fields but are most pronounced over the ventral half.

With adequate treatment in the early stages, bacterial pneumonia usually responds favorably in 24 hours but viral pneumonia may not respond at all or may relapse after an apparent initial beneficial response. The transient response may be due to control of the secondary bacterial invaders. In some bacterial pneumonias, relapses also occur that are due either to reinfection or to persistence of the infection in necrotic foci that are inaccessible to antimicrobials. The final outcome depends on the susceptibility of the causative agent to the treatments available and the severity of the lesions when treatment is undertaken. Pleurisy is a common complication of pneumonia and rarely occurs independently of it, and is described later under that heading.

**Pneumonia and pleuritis** in horses are described separately (see Equine pleuropneumonia, below).

Congestive heart failure or cor pulmonale may occur in some animals which survive a chronic pneumonia for several weeks or months.

#### Medical imaging

Thoracic radiography and ultrasonography are now commonly performed in veterinary teaching hospitals and specialty clinics. They can provide considerable diagnostic assistance in assessing the severity of the lesion and explaining certain clinical manifestations that may be difficult to interpret. Ultrasonography is a useful diagnostic aid in cattle and horses with anaerobic bacterial pleuropneumonia and pulmonary abscessation.<sup>8,33,34</sup> Gas echoes within pleural or abscess fluid were found to be a sensitive and specific indicator of anaerobic infection as was a putrid breath or pleural fluid.

In cattle with pleuropneumonia, ultrasonographic examination of both sides of

the thorax may reveal accumulations of anechogenic and hypoechoic fluid in the pleural space in the ventral aspect of the thorax.<sup>33,35</sup> In cattle, pleural effusion associated with pleuritis is usually unilateral because the pleural sacs do not communicate. Bilateral pleural effusion may indicate either bilateral pulmonary disease or a noninflammatory cause such as right-sided congestive heart failure or hypoproteinemia.

#### CLINICAL PATHOLOGY

##### Respiratory secretions

The laboratory examination of the exudates and secretions of the respiratory tract is the most common diagnostic procedure performed when presented with cases of pneumonia. Nasal swabs, tracheobronchial aspirates and bronchoalveolar lavage samples can be submitted for isolation of viruses, bacteria and fungi, cytological examination and determination of **antimicrobial sensitivity.** Tracheobronchial aspirates are considered more reliable for the cytological examination of pulmonary secretions in horses with suspected pneumonia or pleuropneumonia.<sup>36</sup> Bronchoalveolar lavage samples may be normal in horses affected with pneumonia or pleuropneumonia. In suspected cases of pleuropneumonia the collection and culture of pleural fluid is a valuable aid to diagnosis<sup>10</sup> and both anaerobic and aerobic bacteria must be considered.<sup>10</sup>

##### Thoracocentesis

When pleural effusion is suspected, thoracocentesis can be used to obtain pleural fluid for analysis.

##### Hematology

Hematological examination can indicate if the infection is bacterial or viral in nature and its severity. The hematocrit will be elevated in severely toxemic animals that are not drinking water. Severe bacterial bronchopneumonia and pleuritis is characterized by marked changes in the leukon. Serum fibrinogen concentrations are markedly elevated in horses with pleuropneumonia and pleuritis.<sup>37</sup> Some limited studies indicate that the measurement of acute-phase proteins in bovine respiratory disease may be a valuable diagnostic and prognostic aid.<sup>38</sup>

##### Serology

When viral interstitial pneumonia is suspected, acute and convalescent sera are recommended for viral neutralization titer evaluation. For specific diseases such as porcine pleuropneumonia, serum can be taken from a percentage of the herd and submitted for serotyping to determine which serotype is most prevalent in the herd.

### Fecal samples

When lungworm pneumonia is suspected, fecal samples can be submitted for detection of the larvae.

### Necropsy

In outbreaks of respiratory disease where in the diagnosis is uncertain, necropsy of selected early cases will often assist in making a diagnosis.

### NECROPSY FINDINGS

Gross lesions are usually observed in the anterior and dependent parts of the lobes; even in fatal cases where much of the lung is destroyed, the dorsal parts of the lobes may be unaffected. The gross lesions vary a great deal depending upon the type of pneumonia present. Bronchopneumonia is characterized by the presence of serofibrinous or purulent exudate in the bronchioles, and lobular congestion or hepatization.

**In the more severe, fibrinous forms** of pneumonia there is gelatinous exudation in the interlobular septae and an acute pleurisy, with shreds of fibrin present between the lobes.

**In interstitial pneumonia** the bronchioles are clean and the affected lung is sunken, dark red in color and has a granular appearance under the pleura and on the cut surface. There is often an apparent firm thickening of the interlobular septae. These differences are readily detected on histological examination.

**In chronic bronchopneumonia of cattle** there is consolidation, fibrosis, fibrinous pleuritis, interstitial and bullous emphysema, bronchi filled with exudate, bronchiectasis and pulmonary abscessation.

Lesions typical of the specific infections listed under etiology are described under the headings of the specific diseases.

### TREATMENT

#### Antimicrobial therapy

In specific bacterial infections as listed above, isolation of affected animals and careful surveillance of the remainder of the group to detect cases in the early stages should accompany the administration of specific antimicrobials to affected animals. The choice of antimicrobial will depend on the tentative diagnosis, the experience with the drug in previous cases and the results of drug sensitivity tests. The common bacterial pneumonias of all species will usually recover quickly (24–72 h) if treated with an adequate dose of the drug of choice early in the course of the disease. Animals with severe pneumonia will require daily treatment for several days until recovery occurs. Those with bacterial pneumonia and toxemia must be treated early on an

### DIFFERENTIAL DIAGNOSIS

There are two major difficulties in the clinical diagnosis of pneumonia. The first is to decide that the animal has pneumonia; the second is to determine the nature of the pneumonia and its cause. The suspected cause will influence the prognosis, the clinical management and, more particularly in infectious pneumonias, the kind of antimicrobial therapy used.

There are two kinds of errors made in the clinical diagnosis of pneumonia. One is that the pneumonia is not detected clinically because the abnormal lung sounds are apparently not obvious. The other is to make a diagnosis of pneumonia because of the presence of dyspnea that is due to disease in some other body system.

- In **bacterial pneumonia** the major clinical findings are polypnea in the early stages and dyspnea later, abnormal lung sounds, and fever and toxemia.
- In **viral interstitial pneumonia** uncomplicated by secondary bacterial pneumonia, there is no toxemia. Pulmonary edema and congestion, embolism of the pulmonary artery and emphysema are often mistaken for pneumonia but can usually be differentiated by the absence of fever and toxemia, on the basis of the history and on auscultation findings.
- **Diseases of other body systems** may cause polypnea and dyspnea. Congestive heart failure, the terminal stages of anemia, poisoning by histotoxic agents such as hydrocyanic acid, hyperthermia and acidosis are accompanied by respiratory embarrassment but not by the abnormal sounds typical of pulmonary involvement.

**If pneumonia is present** the next step is to determine the nature and cause of the pneumonia. All the practical laboratory aids described earlier should be used when necessary. This is of particular importance when outbreaks of pneumonia are encountered, in which case necropsy examination of selected cases is indicated. In single routine cases of pneumonia the cause is usually not determined. However, the age and class of the animal, the history and epidemiological findings and the clinical findings can usually be correlated and a presumptive etiological diagnosis made.

**Pleuritis** is characterized by shallow, abdominal-type respiration, by pleuritic friction sounds when effusion is minimal, a muffling of lung sounds on auscultation, the presence of dullness and a horizontal fluid line on acoustic percussion when there is sufficient pleural fluid present. Thoracocentesis reveals the presence of fluid.

In **pneumothorax** there is inspiratory dyspnea and on the affected side the abnormalities include:

- Absence of breath sounds over the lobes but still audible sounds over the base of the lung

- Increase in the absolute intensity of the heart sounds
- Increased resonance on percussion.

**Diseases of the upper respiratory tract** such as laryngitis and tracheitis are accompanied by varying degrees of inspiratory dyspnea, which is often loud enough to be audible without a stethoscope. In less severe cases, auscultation of the mid-cervical trachea will reveal moist wheezing sounds on inspiration. These sounds are transmitted down into the lungs and are audible on auscultation of the thorax. These transmitted sounds must not be interpreted as due to pneumonia. In some cases of severe laryngitis and tracheitis the inspiratory sounds audible over the trachea and lungs are markedly reduced because of almost total obliteration of these organs. In laryngitis and tracheitis there is usually a more frequent cough than in pneumonia and the cough can be readily stimulated by squeezing the larynx or trachea. In pneumonia the abnormal lung sounds are audible on both inspiration and expiration. Examination of the larynx through the oral cavity in cattle and with the aid of a rhinolaryngoscope in the horse will usually reveal the lesions.

individual basis. Each case should be identified and carefully monitored for failure to recover, and an assessment made. Clinical field trials to evaluate different antimicrobials for the treatment of acute bovine respiratory disease occurring under natural conditions are becoming more common and more meaningful, particularly under commercial feedlot conditions.<sup>39</sup>

Antimicrobial agents in a long-acting base may be used to provide therapy over a 4–6-day period instead of the daily administration of the shorter-acting preparations. However, the blood levels from the long-acting preparations are not as high as the shorter-acting preparations and treatment with these compounds are not as effective in severely affected animals.

**Selection of antimicrobials** is based on the principles detailed in Chapter 4. Briefly, antimicrobials for treatment of bacterial respiratory disease should be active against the causative agent, should be able to achieve therapeutic concentrations in diseased lung and should be convenient to administer. The antimicrobials should be affordable and, if used in animals intended as human food, must be approved for use in such animals.

Antimicrobials for treatment of lung disease are preferably those that achieve therapeutic concentrations in diseased lung tissue after administration of conventional doses. This has been convincingly demonstrated for the macrolide (azithromycin, erythromycin),<sup>40</sup> triamildide

(tulathromycin)<sup>41</sup> and fluoroquinolone (danofloxacin, enrofloxacin)<sup>42,43</sup> antimicrobials and florfenicol<sup>44</sup> in a variety of species. The beta-lactam antimicrobials (penicillin, ceftiofur) are effective in treatment of pneumonia in horses, pigs and ruminants despite having chemical properties that do not favor their accumulation in lung tissue.

Routes of administration include oral (either individually or in medicated feed or water), parenteral (subcutaneous, intramuscular, intravenous), or inhalational. Intratracheal administration of antimicrobials to animals with respiratory disease is not an effective means of achieving therapeutic drug concentrations in diseased tissue. **Aerosolization and inhalation** of antimicrobials has the theoretic advantage of targeting therapy to the lungs and minimizing systemic exposure to the drug. However, while administration by inhalation achieves good concentrations of drug in bronchial lining fluid, the drug does not penetrate unventilated regions of the lungs, in which case parenteral or oral administration of antimicrobials is indicated. Administration of gentamicin to horses and ceftiofur sodium to calves with pneumonia has been investigated. Aerosol administration of gentamicin to normal horses results in gentamicin concentrations in bronchial lavage fluid 12 times that achieved after intravenous administration.<sup>45</sup> Aerosolized ceftiofur sodium (1 mg/kg) is superior to intramuscular administration in treatment of calves with *M. haemolytica*.<sup>46</sup>

Treatment of parasitic lung disease, such as that caused by migrating larvae or lung worms, is by administration of appropriate anthelmintics such as ivermectin, moxidectin or the benzimidazoles. Refer to the sections in this book that deal with these diseases for details of the specific treatments. Treatment of *P. jiroveci* pneumonia involves the administration of a sulfonamide-trimethoprim combination or dapsone (3 mg/kg orally every 24 h).<sup>47</sup>

The antimicrobials and other drugs recommended for the treatment of each specific pneumonia listed under Etiology are presented with each specific disease elsewhere in the book. The common causes for failure to respond favorably to treatment for bacterial pneumonia include:

- **Advanced disease when treatment was undertaken**
- **Presence of pleuritis and pulmonary abscesses**
- **Drug-resistant bacteria**
- **Inadequate dosage of drug**
- **Presence of other lesions or diseases which do not respond to antimicrobials.**

There is no specific treatment for the viral pneumonias and while many of the *Mycoplasma* spp. are sensitive to antimicrobials in vitro, the pneumonias associated with them do not respond favorably to treatment. This may be due to the intracellular location of the *Mycoplasma* making them inaccessible to the drugs. Because viral and mycoplasmal pneumonias are commonly complicated by secondary bacterial infections, it is common practice to treat acute viral and mycoplasmal pneumonias with antimicrobials until recovery is apparent.

**Intensive and prolonged therapy** may be required for the treatment of diseases such as equine pleuropneumonia. It may include daily care and treatment in a veterinary clinic consisting of daily lavage of the pleural cavity including thoracostomy to drain pulmonary abscesses, and intensive antimicrobial therapy and monitoring for several weeks.<sup>48</sup>

#### Mass medication

In outbreaks of pneumonia where many animals are affected and new cases occur each day for several days, the use of mass medication of the feed and/or water supplies should be considered. Outbreaks of pneumonia in swine herds, lamb feedlots, veal calf enterprises and beef feedlots are usually ideal situations for mass medication through the feed or water. Mass medication may assist in the early treatment of subclinical pneumonia and is a labor-saving method of providing convalescent therapy to animals that have been treated individually. The major limitation of mass medication is the uncertainty that those animals that need the drug will actually get it in the amounts necessary to be effective. Total daily water intake by animals is a function of total dry matter intake and wellbeing, and the water consumption is therefore markedly reduced in toxemic animals. The provision of a reliable concentration of the drug in the water supply on a 24-hour basis is also a problem. However, with careful calculation and monitoring, mass medication can be a valuable and economical method of treating large numbers of animals. The method of calculating the amount of antimicrobials to be added to feed or water supplies is presented in Chapter 4 on antimicrobial therapy.

When outbreaks of pneumonia occur and new cases are being recognized at the rate of 5–10% per day of the total in the group, all the remaining in-contact animals may be injected with an antimicrobial in a long-acting base. This may help to treat subclinical cases before they become clinical and thus control the outbreak.

#### Other drugs

**Nonsteroidal anti-inflammatory drugs** are useful in the treatment of infectious respiratory disease of cattle and horses, and likely other species. The drugs act by inhibiting the inflammatory response induced by the infecting organism and tissue necrosis. Meloxicam (0.5 mg/kg subcutaneously, once), when administered with tetracycline, improves weight gain and reduces the size of lesions in lungs of cattle with bovine respiratory disease complex over those of animals treated with tetracycline alone.<sup>49</sup> NSAIDs also improve the clinical signs of cattle with respiratory disease.<sup>50</sup> Use of these drugs is routine in horses with pneumonia or pleuritis.

**Corticosteroids** have been used for their anti-inflammatory effect in the treatment of acute pneumonia. However, there is no clinical evidence that they are beneficial.

**Bronchodilators** have been investigated in the treatment of pneumonia in food animals. The **beta-2 adrenergic agonists** are potent and effective bronchodilators that can be administered orally, intravenously or by inhalation. These drugs also enhance mucociliary clearance of material from the lungs. Most administration is orally or by inhalation. The use of beta-2 adrenergic agonist bronchodilator drugs in food animals is not permitted in most countries because of the risk of contamination of foodstuffs intended for consumption by people. This is particularly the case with clenbuterol, a drug approved in many countries for use in horses that is administered to cattle illicitly as a growth promoter. People can be poisoned by clenbuterol in tissues of treated cattle. Theophylline has been evaluated as a bronchodilator to relieve respiratory distress in cattle with pneumonia.<sup>51</sup> When it was given orally at a dose of 28 mg/kg BW daily for 3 days, along with antimicrobial therapy, to calves with naturally acquired respiratory disease, the respiratory rate and rectal temperature decreased. However, some calves died, presumably from the accumulation of lethal concentrations of plasma theophylline. It is recommended that the drug should not be used unless plasma levels can be monitored.

#### Supportive therapy and housing

Affected animals should be housed in warm, well-ventilated, draft-free accommodation and provided with ample fresh water and light, nourishing food. During convalescence premature return to work or exposure to inclement weather should be avoided. If the animal does not eat, oral or parenteral force-feeding should be instituted. If fluids are given intravenously

care should be exercised over the speed with which they are administered. Injection at too rapid a rate may cause overloading of the right ventricle and death due to acute heart failure.

Supportive treatment may include the provision of oxygen, if it is available, especially in the critical stages when hypoxia is severe. In foals the oxygen can be administered through an intranasal tube passed back to the nasopharynx and delivered at the rate of about 8 L/min for several hours. Oxygen therapy is detailed in the general section on treatment of respiratory disease above.

## REFERENCES

- Hewicker-Trautwein M et al. *Vet Rec* 2002; 151:699.
- Pearson EG et al. *J Am Vet Med Assoc* 1996; 209:1137.
- Nayar GPS et al. *Can Vet J* 1999; 40:277.
- Gabor LJ. *Aust Vet J* 2003; 81:409.
- Loeffen WLA et al. *Vet Rec* 1999; 145:123.
- Janke BH et al. *J Vet Diagn Invest* 2001; 13:428.
- Chaffin MK, Carter GK. *Compend Contin Educ Pract Vet* 1993; 15:1642.
- Chaffin MK et al. *Compend Contin Educ Pract Vet* 16 1994; 362:1585.
- Racklyeft DJ, Love DN. *Aust Vet J* 2000; 78:549.
- Sweeney CR et al. *J Am Vet Med Assoc* 1991; 198:839.
- Prescott JF. *Equine Vet J* 1993; 25:88.
- Mair TS. *Vet Rec* 1996; 138:205.
- Peek SF et al. *J Vet Intern Med* 2004; 18:132.
- Prescott JF et al. *Can Vet J* 1991; 32:421.
- Lakritz J et al. *J Vet Intern Med* 1993; 7:277.
- Nout Y et al. *Equine Vet J* 2002; 34:542.
- Kuhnert P et al. *J Clin Microbiol* 2004; 42:5542.
- Garcia-Cantu MC et al. *Equine Vet Educ* 2000; 12:45.
- McGorum BC et al. *Equine Vet J* 1994; 26:249.
- Gross DK et al. *J Vet Intern Med* 2004; 18:718.
- Foley JE et al. *J Vet Intern Med* 2002; 16:238.
- Pusterla N et al. *Equine Vet J* 2002; 34:749.
- Davis MS et al. *Equine Vet J Suppl* 2002; 34:413.
- Alley MR et al. *N Z Vet J* 1999; 47:155.
- Li H et al. *J Vet Diagn Invest* 2005; 17:171.
- Yener Z et al. *J Vet Med A* 2005; 52:268.
- de al Concha-Bermejillo et al. *J Vet Diagn Invest* 2003; 15:423.
- Austin SM et al. *J Am Vet Med Assoc* 1995; 207:325.
- Lonergan GH et al. *J Am Vet Med Assoc* 2001; 219:1122.
- Willoughby RA et al. *Can J Vet Res* 1991; 55:315.
- Carr E et al. *J Am Vet Med Assoc* 1997; 210:1174.
- Dunkel B et al. *Equine Vet J* 2005; 37:435.
- Flock M. *Vet J* 2004; 167:272.
- Ramirez S et al. *Vet Radiol Ultrasound* 2004; 45:172.
- Braun U et al. *Vet Rec* 1997; 141:12.
- Rossier Y et al. *J Am Vet Med Assoc* 1991; 198:1001.
- Collins MB et al. *J Am Vet Med Assoc* 1994; 205:1753.
- Godson DL et al. *Vet Immunol Immunopathol* 1996; 51:277.
- Jim GK et al. *Can Vet J* 1992; 33:245.
- Davis JL et al. *J Vet Pharmacol Ther* 2002; 25:99.
- Benchaoui HA et al. *J Vet Pharmacol Ther* 2004; 27:203.
- Terhune TN et al. *Am J Vet Res* 2005; 66:342.
- Apley MD, Upson DW. *Am J Vet Res* 1993; 54:937.
- Aslan V et al. *Vet Q* 2002; 24:35.
- McKenzie HC, Murray MJ. *Am J Vet Res* 2000; 61:1185.
- Sustronck B et al. *Res Vet Sci* 1995; 59:267.
- Clark-Price SC et al. *J Am Vet Med Assoc* 2004; 224:407.
- Dechant J. *Can Vet J* 1997; 38:499.
- Friton GM et al. *Vet Rec* 2005; 156:809.
- Elitok B, Elitok OM. *J Vet Pharmacol Ther* 2004; 27:317.
- McKenna DJ et al. *J Am Vet Med Assoc* 1989; 195:603.

## ASPIRATION PNEUMONIA

Aspiration or inhalation pneumonia is a common and serious disease of farm animals. Cases occur after careless drenching or passage of a stomach tube during treatment for other illness, for example administration of mineral oil to horses with colic.<sup>1</sup> Even when care is taken these procedures are not without risk. Other causes include the feeding of calves and pigs on fluid feeds in inadequate troughing, inhalation occurring in the struggle for food. Dipping of sheep and cattle when they are weak, or keeping their heads under for too long, also results in inhalation of fluid. Vomiting in ruminants and horses may be followed by aspiration, especially in cattle with parturient paresis or during the passage of a stomach tube if the head is held high. Rupture of a pharyngeal abscess during palpation of the pharynx or passage of a nasal tube may cause sudden aspiration of infective material. Animals suffering from paralysis or obstruction of the larynx, pharynx, or esophagus may aspirate food or water when attempting to swallow. Aspiration pneumonia is the consistent lesion of crude oil poisoning in cattle and probably results from vomiting or regurgitation.<sup>2</sup>

### Lipid pneumonia

Lipid pneumonia usually results from aspiration of mineral oil (liquid paraffin) administered for gastrointestinal disease. Pneumonia is sometimes the result of inadvertent administration of the oil into the trachea through a misplaced stomach tube, or inhalation following oral administration of oil. However, aspiration of oil can occur even when it is delivered into the stomach through a nasogastric tube,<sup>3</sup> presumably because of regurgitation of oil either around the tube or after the tube has been removed. Administration of oil to sedated or severely depressed animals may increase the risk of aspiration.

Clinical signs include cough, tachypnea, tachycardia, pyrexia, respiratory distress and abnormal lung sounds. Radiographs can reveal an alveolar and interstitial pattern. Examination of tracheal aspirates reveals a neutrophilic inflammation and the presence of lipid. Lipid can be readily identified by Sudan or oil red O staining

of smears of the aspirate in acute cases. Necropsy examination reveals consolidated lungs. On cut section of these areas oil can be visible. Chronic cases have tissue necrosis and severe interstitial pneumonia. Lipid droplets can be identified in affected lung tissue after oil red O staining of sections.<sup>4</sup> The presence and nature of the lipid can be demonstrated by thin-layer chromatography and gas chromatography.<sup>4</sup> The prognosis for recovery is poor. Treatment is supportive and includes anti-inflammatory drugs, antimicrobials, and oxygen. There is no specific treatment. Prevention includes careful insertion of nasogastric tubes, verification of their placement in the stomach and not administering mineral oil to animals with a distended stomach or ones that are heavily sedated or severely depressed.

### Esophageal obstruction

Esophageal obstruction is a common and important cause of pneumonia in horses.<sup>2,5</sup> Of 18 horses with esophageal obstruction that had thoracic radiographs performed, eight had evidence of aspiration pneumonia.<sup>5</sup> Obstruction of the esophagus in horses, and in other species, leads to the accumulation of saliva and feed material in the esophagus oral to the obstruction. When the esophagus is full, this material accumulates in the pharynx with subsequent aspiration into the trachea resulting in contamination of the trachea and lower airways with feed material and oropharyngeal bacteria. Feed material is irritant and also causes obstruction of the smaller airways. Pulmonary defense mechanisms are weakened or overwhelmed by the contamination and infection and pneumonia result. The duration of esophageal obstruction is a good indicator of the risk of aspiration pneumonia, although the extent of contamination of the trachea with feed material is not.<sup>5</sup> Affected horses are pyrexia, tachycardic, and toxemic. Lung sounds can include crackles and wheezes, but the only auscultatory abnormality can be decreased breath sounds in the ventral thorax. Radiography reveals a characteristic pattern of bronchopneumonia restricted, at least initially, to the cranioventral and caudoventral lung lobes in adult horses. Ultrasonography reveals comet tail lesions in the ventral lung fields and variable consolidation. Pleuritis is a not uncommon sequel to aspiration pneumonia. Examination of tracheal aspirates demonstrates neutrophilic inflammation with presence of degenerate neutrophils, bacteria that are both intracellular and extracellular, and plant material. Culture of tracheal aspirates yields one or more of a wide variety of

bacteria including *S. zooepidemicus*, *Pasteurella* sp., *Actinobacillus* sp., *E. coli*, and anaerobes. Treatment involves prompt relief of the esophageal obstruction and administration of broad-spectrum antimicrobials such as a combination of penicillin, aminoglycoside, and metronidazole. The prognosis for recovery from aspiration pneumonia secondary to esophageal obstruction is guarded to fair, partly because the animal has to recover from two diseases – the pneumonia and the esophageal obstruction. Prevention of aspiration pneumonia in horses with esophageal obstruction includes prompt relief of the obstruction and administration of broad-spectrum antimicrobials.

### Meconium aspiration syndrome

Aspiration of meconium during parturition is associated with severe lung disease in newborns. Passage of meconium in utero, and subsequent aspiration by the fetus, is a sign of fetal distress. It is suggested that fetal distress results in expulsion of meconium into the amniotic fluid. This is followed by aspiration of contaminated amniotic fluid. The passage of meconium-contaminated amniotic fluid into the lungs may occur prior to birth when the fetus gasps for air in an attempt to correct hypoxemia or when the calf takes its first breath and aspirates meconium from the oropharynx. Normally, fetal aspiration of amniotic fluid does not occur because the inspiratory forces are insufficient to allow amniotic fluid to reach the lungs, and the lung liquid, a locally produced viscous material present in the trachea and lungs, constantly flows up the major airways to the oropharynx. The result is that the fetus is doubly challenged in that it must deal with both the cause of the fetal distress and the pneumonia induced by aspiration of meconium. Although meconium is sterile, it induces a severe inflammatory response in the lungs.

The **meconium aspiration syndrome** is best described in newborn calves,<sup>6</sup> although there are numerous reports of its experimental induction in piglets and lambs as a model of the human disease. In a series of calves under 2 weeks of age submitted to a diagnostic laboratory, 42.5% had evidence of meconium, squamous cells or keratin in the lung. Diffuse alveolitis with exudation of neutrophils, macrophages, multinucleated cells and obstruction of small airways with atelectasis were common.

Treatment of aspiration pneumonia in farm animals is not well described. Administration of antimicrobials is prudent. Anti-inflammatory drugs are indicated. Pentoxifylline is used in human neonates with meconium aspiration, but there are no reports of its use for this purpose in farm animals.

### Dusty feed

Although farm animals fed on dusty feeds inhale many dust particles and bacteria, which can be readily isolated from the lung, this form of infection rarely results in the development of pneumonia. Much of the dust is filtered out in the bronchial tree and does not reach the alveoli. However, this may be of importance in the production of the primary bronchiolitis that so often precedes alveolar emphysema in horses. The inhalation of feed particles in pigs in a very poorly ventilated environment has been demonstrated to cause foreign body pneumonia. Also, a dry, dusty atmosphere can be created in a piggery by overfrequent changing of wood shavings used as bedding, and this can lead to the production of foreign body pneumonia. Liquids and droplets penetrate to the depths of the alveoli and run freely into the dependent portions, and aspiration pneumonia often results.

### REFERENCE

1. Scarratt WK et al. *Equine Vet J* 1998; 30:85.
2. Craig DR et al. *Vet Surg* 1989; 18:432.
3. Davis JL et al. *Equine Vet Educ* 2001; 13:230.
4. Bos M et al. *Equine Vet J* 2002; 34:744.
5. Feige K et al. *Can Vet J* 2000; 41:207.
6. Lopez A, Bildfell R. *Vet Pathol* 1992; 29:104.

### CAUDAL VENA CAVAL THROMBOSIS (POSTERIOR VENA CAVAL THROMBOSIS) AND EMBOLIC PNEUMONIA IN CATTLE

Embolic pneumonia as a sequel to thrombosis of the posterior vena cava is a relatively common disease of cattle in Europe and the UK. The disease is rare in cattle less than 1 year old although it can occur at any age. A preponderance of affected animals are in feedlots on heavy grain diets and there are peaks of incidence at those times of the year when most cattle are on such diets. There is an obvious relationship between the occurrence of this disease and that of hepatic abscessation arising from lactic-acid-induced rumenitis on heavy grain diets.

The **etiology and pathogenesis** of the disease are based on the development of a thrombus in the posterior vena cava and the subsequent shedding of emboli, which lodge in the pulmonary artery causing embolism, endarteritis, multiple pulmonary abscesses, and chronic suppurative pneumonia. Pulmonary hypertension develops in the pulmonary artery, leading to the development of aneurysms, which may rupture causing massive intrapulmonary or intrabronchial hemorrhage. In most cases the thrombi in the vena cava originate from hepatic abscesses, or postdiaphragmatic abscesses. Usually there is an initial phlebitis and the subsequent thrombus extends into the thoracic part of the vessel. When the thrombus

occludes the openings of the hepatic veins into the vena cava, there is congestion of the liver and hepatomegaly, ascites, and abdominal distension in some of these cases.<sup>1</sup>

The **most common form** of the disease is characterized by manifestations of respiratory tract disease. Commonly there is a history of the disease for a few weeks or longer but some animals are 'found dead' without prior recorded illness. There is usually fever and an increase in the rate and depth of respiration, coughing, epistaxis and hemoptysis, anemia with pallor, a hemic murmur, and a low packed cell volume. Respirations are painful and a mild expiratory grunt or groan may be audible with each respiration. Subcutaneous emphysema and frothing at the mouth are evident in some. Deep palpation in the intercostal spaces and over the xiphoid sternum may elicit a painful grunt. The lung sounds may be normal in the early stages but, with the development of pulmonary arterial lesions, embolic pneumonia and collapse of affected lung, widespread rhonchi are audible on auscultation. There can be ascites.<sup>1</sup> In one series of cases the presence of anemia, hemoptysis, epistaxis, and widespread abnormal lungs sounds were characteristic features of the disease.<sup>2</sup> There are accompanying nonspecific signs of inappetence, ruminal stasis and scant feces.

About one-third of affected cattle become progressively worse over a period of 2–18 days with moderate to severe dyspnea, and die of acute or chronic anemia or are euthanized on humane grounds. Almost half of the cases die suddenly as a result of voluminous intrabronchial hemorrhage. It is probably the only common cause in cattle of acute hemorrhage from the respiratory tract that causes the animal to literally drop dead. The remainder have a brief, acute illness of about 24 hours.

Some evidence of hepatic involvement is often present, including enlargement of the liver, ascites, and melena. Chronic cor pulmonale develops in some with attendant signs of congestive heart failure.

**Radiography** of the thorax of some affected animals has found an increase in lung density and markings. These are irregular, focal or diffuse, and nonspecific. More distinct opacities are present in some and are referable to embolic infarcts and larger pulmonary hemorrhages. Radiographic abnormalities in the lungs are detected in approximately one-third of cows with caudal vena cava thrombosis.<sup>2</sup> **Ultrasonography** can be a useful diagnostic aid in detecting changes in the caudal vena cava.<sup>2,3</sup> The caudal vena cava in affected cows is round to oval rather

than the triangular shape in normal cattle,<sup>2</sup> and the hepatic, splenic, and portal veins can be dilated.

There is typically anemia and leukocytosis. Neutrophilia with a regenerative left shift and hypergammaglobulinemia due to chronic infection are common. Serum gamma-glutamyl transpeptidase activity is high in about one-third of cases.<sup>2</sup>

**The necropsy findings** include a large, pale thrombus in the posterior vena cava between the liver and the right atrium. Occlusion of the posterior vena cava results in hepatomegaly and ascites. Hepatic abscesses of varying size and number are common and often near the wall of the thrombosed posterior vena cava.<sup>2</sup> Pulmonary thromboembolism with multiple pulmonary abscesses, suppurative pneumonia and erosion of pulmonary arterial walls with intrapulmonary hemorrhage are also common. The lungs reveal emphysema, edema, and hemorrhage. A variety of bacteria including streptococci, *E. coli*, staphylococci and *F. necrophorum* are found in the abscesses in the liver.

Animals that die suddenly are found lying in a pool of blood and necropsy reveals large quantities of clotted blood in the bronchi and trachea.

The disease must be differentiated from verminous pneumonia, chronic aspiration pneumonia, pulmonary endarteritis due to endocarditis, and chronic atypical interstitial pneumonia. There is no treatment that is likely to have any effect on the disease and the principal task is to recognize the disease early and slaughter the animal for salvage if possible.

#### REFERENCE

1. Milne MH et al. *Vet Rec* 2001; 148:341.
2. Braun U et al. *Vet Rec* 2002; 150:209.
3. Braun U et al. *Schweiz Arch Tierheilkd* 1992; 134:235.

### CRANIAL VENA CAVAL THROMBOSIS

Thrombosis of the cranial vena cava occurs in cows.<sup>1</sup> Cases in young animals are also recorded and it is suggested that they arise from navel infection. Clinical signs include cough, tachypnea, muffled heart sounds, exercise intolerance, and excessive pleural fluid. As in caudal vena caval thrombosis a number of pulmonary abscesses develop. Pulmonary hypertension is not a feature as it is in the caudal lesion. However, increased jugular vein pressure, dilatation of the jugular vein and local edema may all occur. Ultrasound examination can reveal thrombosis of the cranial vena cava extending into the right atrium.<sup>1</sup>

#### REFERENCE

1. Bueno AC et al. *Vet Radiol Ultrasound* 2000; 41:551.

### PULMONARY ABSCESS

The development of single or multiple abscesses in the lung causes a syndrome of chronic toxemia, cough, and emaciation. Suppurative bronchopneumonia may follow.

#### ETIOLOGY

Pulmonary abscesses may be part of a primary disease or arise secondarily to diseases in other parts of the body.

#### Primary diseases

- *R. equi* pulmonary abscesses of foals<sup>1</sup>
- *S. zooepidemicus* and *Actinobacillus* sp. in adult horses.<sup>2</sup> One-third of infectious causes of abscesses in horses are polymicrobial, and anaerobic bacteria are isolated in 20% of cases<sup>2</sup>
- Sequestration of an infected focus, e.g. strangles in horses, caseous lymphadenitis in sheep
- Tuberculosis
- Actinomycosis rarely occurs as granulomatous pulmonary lesions
- Aerogenous infections with 'systemic' mycoses, e.g. coccidioidomycosis, aspergillosis, histoplasmosis, cryptococcosis, and moniliasis
- *Helcococcus ovis* in horses<sup>3</sup>
- *Mycoplasma bovis* in cattle.<sup>4</sup>

#### Secondary diseases

- Sequestration of an infected focus of pneumonia, e.g. bovine pleuropneumonia or pleuropneumonia in horses
- Pulmonary abscesses secondary to ovine estrosis<sup>5</sup>
- Emboli from endocarditis, caudal or cranial vena caval thrombosis, metritis, mastitis, omphalophlebitis
- Aspiration pneumonia from milk fever in cows, drenching accident in sheep – residual abscess
- Penetration by foreign body in traumatic reticuloperitonitis.

#### PATHOGENESIS

Pulmonary abscesses may be present in many cases of pneumonia and are not recognizable clinically. In the absence of pneumonia, pulmonary abscess is usually a chronic disease, clinical signs being produced by toxemia rather than by interference with respiration. However, when the spread is hematogenous and large numbers of small abscesses develop simultaneously, tachypnea occurs. In these animals the respiratory embarrassment cannot be explained by the reduction in vital capacity of the lung. However, in more chronic cases the abscesses may reach a tremendous size and cause respiratory difficulty by obliteration of large areas of lung tissue. In rare cases, erosion of a pulmonary vessel may occur, resulting in pulmonary hemorrhage and hemoptysis.

In many cases there is a period of chronic illness of varying degree when the necrotic focus is walled off by connective tissue. Exposure to environmental stress or other infection may result in a sudden extension from the abscess to produce a fatal, suppurative bronchopneumonia, pleurisy, or empyema.

#### CLINICAL FINDINGS

In typical cases there is dullness, anorexia, emaciation and a fall in milk yield in cattle. The temperature is usually moderately elevated and fluctuating. Coughing is marked. The cough is short and harsh and usually not accompanied by signs of pain. Intermittent episodes of bilateral epistaxis and hemoptysis may occur, which may terminate in fatal pulmonary hemorrhage following erosion of an adjacent large pulmonary vessel. Respiratory signs are variable depending on the size of the lesions, and although there is usually some increase in the rate and depth this may be so slight as to escape notice. When the abscesses are large (2–4 cm in diameter) careful auscultation and percussion will reveal the presence of a circumscribed area of dullness over which no breath sounds are audible. Crackles are often audible at the periphery of the lesion.

Multiple small abscesses may not be detectable on physical examination but the dyspnea is usually more pronounced. There may be a purulent nasal discharge and fetid breath but these are unusual unless bronchopneumonia has developed from extension of the abscess. Radiographic examination can be used to detect the presence of the abscess and give some information on its size and location.<sup>1</sup>

Most cases progress slowly and many affected animals have to be euthanized because of chronic ill-health; others die from bronchopneumonia or emphysema. Persistent fever, tachycardia, and polypnea are common. A rare sequel is the development of hypertrophic pulmonary osteoarthropathy.

The clinical findings of *R. equi* pulmonary abscessation in young foals are presented under that disease.

Solitary lung abscesses are not uncommon in adult horses. Presenting signs are usually low-grade fever and depression. Most horses with lung abscesses cough. There is excessive mucopurulent material in the trachea and examination of a tracheal aspirate reveals neutrophilic inflammation. Radiographic examination of the chest demonstrates the presence of one or more abscesses. Abscesses are in the caudal lung lobes in 60% of cases.<sup>2</sup> Ultrasonography can be useful in detecting the abscess provided that it is confluent with the visceral pleura. The



prognosis for life and for return to racing is excellent in horses that are treated appropriately.<sup>2</sup>

### CLINICAL PATHOLOGY

Examination of nasal or tracheal mucus may determine the causative bacteria but the infection is usually mixed and interpretation of the bacteriological findings is difficult. Culture of tracheal aspirates yields growth of pathogenic bacteria in approximately 70% of samples from horses with lung abscesses.<sup>2</sup> Hematological examination may give an indication of the severity of the inflammatory process but the usual leukocytosis and shift to the left may not be present when the lesion is well-encapsulated. In lung abscesses in foals and adult horses, hyperfibrinogenemia and neutrophilic leukocytosis are common.<sup>1</sup>

### NECROPSY FINDINGS

An accumulation of necrotic material in a thick-walled fibrous capsule is usually present in the ventral border of a lung, surrounded by a zone of bronchopneumonia or pressure atelectasis. In sheep there is often an associated emphysema. In rare cases the abscess may be sufficiently large to virtually obliterate the lung. A well-encapsulated lesion may show evidence of recent rupture of the capsule and extension as an acute bronchopneumonia. Multiple small abscesses may be present when hematogenous spread has occurred.

### DIFFERENTIAL DIAGNOSIS

The diagnosis might not be obvious when respiratory distress is minimal and especially when multiple, small abscesses are present. These cases present a syndrome of chronic toxemia which may be mistaken for splenic or hepatic abscess. Differentiation between tuberculous lesions and nonspecific infections may require the use of the tuberculin test. Focal parasitic lesions, such as hydatid cysts, may cause a similar syndrome, but are not usually accompanied by toxemia or hematological changes. Pulmonary neoplasms usually cause chronic respiratory disease, a progressive loss of weight and lack of toxemia.

### TREATMENT

Pulmonary abscesses secondary to pneumonia in cattle and pigs are usually not responsive to therapy. The daily administration of large doses of antimicrobials for several days may be attempted but is usually not effective and slaughter for salvage or euthanasia is necessary. Treatment of pulmonary abscesses in adult horses by administration of broad-spectrum antimicrobials is usually effective.<sup>1,2</sup> Most (> 80%)

racehorses with single abscesses return to racing.<sup>2</sup>

There is a report of diagnosis of pulmonary abscess and bronchopleural fistula in a filly by thoracoscopy and partial pneumonectomy.<sup>6</sup> The unusual feature of this case was the presence of a bronchopleural fistula that necessitated surgical correction. As noted above, almost all horses with solitary pulmonary abscesses recover with antimicrobial therapy.

### REVIEW LITERATURE

Roy MF, Lavoie JP. Diagnosis and management of pulmonary abscesses in the horse. *Equine Vet Educ* 2002; 14:322.

### REFERENCES

1. Lavoie JP et al. *Equine Vet J* 1994; 26:348.
2. Ainsworth DM et al. *J Am Vet Med Assoc* 2000; 216:1283.
3. Rothschild CM et al. *J Clin Microbiol* 2004; 42:2224.
4. Adegboye DS et al. *J Vet Diagn Invest* 1995; 7:333.
5. Dorchie P et al. *Vet Rec* 1993; 133:325.
6. Sanchez LC et al. *Equine Vet Educ* 2002; 14:290.

### PULMONARY AND PLEURAL NEOPLASMS

Primary neoplasms of the lungs, including carcinomas and adenocarcinomas, are rare in animals and metastatic tumors also are relatively uncommon in large animals. Primary tumors reported in lungs or pleura of the farm animal species include:

- Horses:
  - Granular cell tumors are the most common tumor arising in the pulmonary tissue of horses
  - Malignant melanomas in adult gray horses
  - Pulmonary adenocarcinoma (either primary or as metastatic disease)
  - Pulmonary leiomyosarcoma<sup>1</sup>
  - Bronchogenic carcinoma, pulmonary carcinoma, bronchogenic squamous cell carcinoma, pulmonary chondrosarcoma and bronchial myxoma are all rare tumors in lungs of horses
  - Mesothelioma arise from the visceral or parietal pleura
- Cattle:
  - Pulmonary adenocarcinoma is the most commonly reported primary lung tumor in cattle.<sup>2</sup> The ultrastructure and origin of some of these have been characterized
  - Lymphomatosis in young cattle may be accompanied by pulmonary localization
- Sheep:
  - Ovine pulmonary adenocarcinoma (jaagsiekte sheep retrovirus)

◦ Goats:

- An asymptomatic, squamous-cell type tumor, thought to be a benign papilloma, has been observed in 10 of a series of 1600 adult Angora goats. The lesions were mostly in the diaphragmatic lobes, were multiple in 50% of the cases and showed no evidence of malignancy, although some had necrotic centers.

A wide variety of tumors metastasize to the lungs and these tumors can originate in almost any tissue or organ. A series of thoracic neoplasms in 38 horses included lymphosarcoma, metastatic renal cell carcinoma, primary lung carcinomas, secondary cell carcinoma from the stomach, pleural mesothelioma, and malignant melanoma.<sup>3</sup>

The etiology of the tumors is unknown in most cases, apart from those arising from viral infections. Equine granular cell tumors arise from the Swann cells of the peripheral nervous system in the lungs.<sup>4</sup>

Characteristically, primary pulmonary or pleural tumors arise in middle-aged to old animals. The prevalence of these tumors is not well documented, although they are rare in abattoir studies of horses.<sup>5</sup> The tumors occur sporadically, with the exception of those associated with infectious agents (bovine lymphomatosis, ovine pulmonary adenocarcinoma).

The pathogenesis of pulmonary tumors includes impairment of gas exchange, either by displacement of normal lung with tumor tissue and surrounding atelectasis and necrosis, or obstruction of the large airways (e.g. granular cell tumor in horses).

### CLINICAL FINDINGS

Clinical findings are those usually associated with the decrease in vital capacity of the lungs and include dyspnea that develops gradually, cough and evidence of local consolidation on percussion and auscultation. There is no fever or toxemia and a neoplasm may be mistaken for a chronic, encapsulated pulmonary abscess. Major clinical findings included weight loss, inappetence, and dyspnea and coughing. An anaplastic small-cell carcinoma of the lung of a 6-month-old calf located in the anterior thorax caused chronic bloat, anorexia, and loss of body weight.<sup>6</sup> Some tumors, notably mesothelioma and adenocarcinoma, cause accumulation of pleural fluid.<sup>7,8</sup> Hypertrophic pulmonary osteopathy occurs in some animals with pulmonary tumors.<sup>9</sup>

**Granular cell tumors** in horses present as chronic coughing and exercise intolerance in horses without signs of infectious disease.<sup>10</sup> As the disease progresses there is increased respiratory

rate and effort and weight loss, suggestive of severe heaves. However, horses are unresponsive to treatment for heaves. The disease can progress to cor pulmonale and right-sided heart failure. A bronchial mass is evident on radiographic or endoscopic examination. There are no characteristic hematologic or serum biochemical changes.

Hemangiosarcomas of the thoracic cavities of horses occur and are evident as excess pleural fluid with a high red blood count.<sup>11,12</sup>

**Thymoma**, or **lymphosarcoma** as a part of the disease bovine viral leukosis, is not uncommon in cattle and may resemble pulmonary neoplasm but there is usually displacement and compression of the heart, resulting in displacement of the apex beat and congestive heart failure. The presence of jugular engorgement, ventral edema, tachycardia, chronic tympany and hydropericardium may cause a mistaken diagnosis of traumatic pericarditis. Mediastinal tumor or abscess may have a similar effect. Metastasis to the bronchial lymph nodes may cause obstruction of the esophagus with dysphagia, and in cattle chronic ruminal tympany. This tumor is also common in goats, many of which show no clinical illness.

**Radiographic or ultrasonographic** examination is useful in demonstrating the presence of a mass in the lungs or thorax.<sup>13</sup> **Endoscopic examination** is useful for detection of tumors that invade the larger airways, such as granular cell tumors of horses. Thoracoscopy and pleural biopsy can be useful in the diagnosis of lesions at the pleural surfaces.<sup>8</sup>

The nature of the tumor can sometimes be determined by examination of **pleural fluid**, into which some tumors shed cells, or of tumor tissue obtained by biopsy. Examination of pleural fluid for the presence of tumor cells is not very sensitive as many tumors do not shed sufficient numbers of cells to be detectable, but is quite specific in that detection of abnormal cells is diagnostic.

#### TREATMENT

There is no effective treatment with the exception of resection of localized tumors. Granular cell tumors in horses have been successfully treated by lung resection<sup>14</sup> or transendoscopic electrocauterization.<sup>15</sup>

#### REFERENCES

- Rossdale PD et al. Equine Vet Educ 2004; 16:21.
- Charan K et al. Vet Rec 1996; 138:163.
- Mair TS, Brown PJ. Equine Vet J 1993; 25:220.
- Kagawa Y et al. J Comp Pathol 2001; 124:122.
- Cotchin E et al. Vet Rec 1975; 97:339.
- Piercy DWT et al. Vet Rec 1993; 132:386.
- Foreman JH et al. J Am Vet Med Assoc 1990; 197:269.
- Fry MM et al. Equine Vet J 2003; 35:723.
- Heinola T et al. Vet Rec 2001; 149:307.
- Pusterla N et al. Vet Rec 2004; 153:530.
- Freestone JF et al. Aust Vet J 1990; 67:269.
- Rossier Y et al. J Am Vet Med Assoc 1990; 196:1639.
- Mair TS et al. Equine Vet Educ 2004; 16:30.
- Facemire PR et al. J Am Vet Med Assoc 2000; 217:152.
- Ohnesorge B et al. Vet Surg 2002; 31:375.

## Diseases of the pleura and diaphragm

### HYDROTHORAX AND HEMOTHORAX

The accumulation of edematous transudate or whole blood in the pleural cavities is manifested by respiratory embarrassment caused by collapse of the ventral parts of the lungs.

#### ETIOLOGY

Hydrothorax and hemothorax occur as part of a number of diseases.

#### Hydrothorax

- As part of a general edema due to congestive heart failure or hypoproteinemia
- As part of African horse sickness or bovine viral leukosis
- Chylous hydrothorax, very rarely due to ruptured thoracic duct
- Secondary to thoracic neoplasia
- Yellow wood (*Terminalia oblongata*) poisoning of sheep
- Dilated cardiomyopathy of Holstein-Friesian cattle.<sup>1</sup>

#### Hemothorax

- Traumatic injury to thoracic wall, a particular case of which is rib fractures in newborn foals<sup>2</sup>
- Hemangiosarcoma of pleura
- Lung biopsy
- Strenuous exercise by horses.<sup>3</sup>

#### PATHOGENESIS

Accumulation of fluid in the pleural cavities causes compression atelectasis of the ventral portions of the lungs and the degree of atelectasis governs the severity of the resulting dyspnea. Compression of the atria by fluid may cause an increase in venous pressure in the great veins, decreased cardiac return and reduced cardiac output. Extensive hemorrhage into the pleural space can cause hemorrhagic shock.

#### CLINICAL FINDINGS

In both diseases there is an absence of systemic signs, although acute hemorrhagic anemia may be present when extensive bleeding occurs in the pleural cavity. There is dyspnea, which usually develops gradually, and an absence of breath sounds, accompanied by dullness on percussion over the lower parts of the

chest. In thin animals the intercostal spaces may be observed to bulge. If sufficient fluid is present it may cause compression of the atria and engorgement of the jugular veins, and a jugular pulse of increased amplitude may be present. The cardiac embarrassment is not usually sufficiently severe to cause congestive heart failure, although this disease may already be present.

The accumulation of pleural fluid or blood is evident on radiographic or ultrasonographic examination of the thorax. Large quantities of blood in the pleural cavity have a characteristic swirling, turbulent appearance.

#### CLINICAL PATHOLOGY

Thoracocentesis may yield a flow of clear serous fluid in hydrothorax, or blood in recent cases of hemothorax. The fluid is bacteriologically negative and total nucleated cell counts are low ( $< 5 \times 10^9/L$ ,  $< 5000 \times 10^6/dL$ ). The pH,  $PCO_2$ , and lactate and glucose concentrations of pleural fluid in animals with hydrothorax are similar to those of blood.

#### NECROPSY FINDINGS

In animals that die of acute hemorrhagic anemia resulting from hemothorax, the pleural cavity is filled with blood, which usually has not clotted, the clot having been broken down by the constant respiratory movement. Hydrothorax is not usually fatal but is a common accompaniment of other diseases, which are evidenced by their specific necropsy findings.

#### DIFFERENTIAL DIAGNOSIS

Hydrothorax and hemothorax can be differentiated from pleurisy by the absence of pain, toxemia and fever and by the sterility of an aspirated fluid sample.<sup>3</sup>

#### TREATMENT

Treatment of the primary condition is necessary. If the dyspnea is severe, aspiration of fluid from the pleural sac causes a temporary improvement but the fluid usually reaccumulates rapidly. Parenteral coagulants and blood transfusion are rational treatments in severe hemothorax.

#### REFERENCES

- Nart P et al. Vet Rec 2004; 18:355.
- Schambourg MA et al. Equine Vet J 2003; 35:78.
- Perkins G et al. J Vet Intern Med 1999; 13:375.

#### PNEUMOTHORAX

Pneumothorax refers to the presence of air (or other gas) in the pleural cavity. Entry of air into the pleural cavity in sufficient quantity causes collapse of the lung and impaired respiratory gas

exchange with consequent respiratory distress.

### ETIOLOGY

Pneumothorax is defined as either spontaneous, traumatic, open, closed, or tension. Spontaneous cases occur without any identifiable inciting event. Open pneumothorax describes the situation in which gas enters the pleural space other than from a ruptured or lacerated lung, such as through an open wound in the chest wall. Closed pneumothorax refers to gas accumulation in the pleural space in the absence of an open chest wound. Tension pneumothorax occurs when a wound acts as a one-way valve, with air entering the pleural space during inspiration but being prevented from exiting during expiration by a valve-like action of the wound margins. The result is a rapid worsening of the pneumothorax. The pneumothorax can be unilateral or bilateral. The complete mediastinum of most cattle and horses means that in most instances the pneumothorax is unilateral, provided that the leakage of air into the pleural space occurs on only one side of the chest.

**Rupture of the lung** is a common cause of pneumothorax and can be either secondary to thoracic trauma, for example a penetrating wound that injures the lung, or lung disease. Most cases of pneumothorax in cattle are associated with pulmonary disease, notably bronchopneumonia and interstitial pneumonia.<sup>1</sup> Pleuropneumonia is the most common cause of pneumothorax in horses.<sup>2</sup> Pneumothorax in these instances results from 'spontaneous' rupture of weakened lung or development of bronchopleural fistula.

**Trauma to thoracic wall** can lead to pneumothorax when a wound penetrates the thoracic wall, including the parietal pleura. In cattle, the thoracic wall may be punctured accidentally by farm machinery being used around cattle, as for example when bales of hay are being moved among animals. Penetrating wounds of the thoracic wall are common causes in horses that impale themselves on fence posts and other solid objects.<sup>2,3</sup> A special case of perforating lung injury occurs in newborns in which the rib is fractured during birth and the lung lacerated by the sharp edges of the fractured rib.<sup>4</sup> Bullet and arrow wounds to the chest are not uncommon causes of pneumothorax in regions in which hunting is common.

Pneumothorax also occurs during thoracotomy, thoracoscopy or drainage of pleural or pericardial fluid. Pneumothorax can result from injury or surgery to the upper respiratory tract, presumably because of migration of air around the

trachea into the mediastinum and subsequent leakage into the pleural space.<sup>1,2,5</sup> Similarly, subcutaneous emphysema leads to pneumothorax via the mediastinum.<sup>6</sup>

### PATHOGENESIS

Entry of air into the pleural cavity results in collapse of the lung. There can be partial or complete collapse of the lung. Collapse of the lung results in alveolar hypoventilation, hypoxemia, hypercapnia, cyanosis, dyspnea, anxiety, and hyperresonance on percussion of the affected thorax. Tension pneumothorax can also lead to a direct decrease in venous return to the heart by compression and collapse of the vena cava.

The degree of lung collapse varies with the amount of air that enters the cavity; small amounts are absorbed very quickly but large amounts may cause fatal anoxia.

### CLINICAL FINDINGS

There is an acute onset of inspiratory dyspnea, which may terminate fatally within a few minutes if the pneumothorax is bilateral and severe. If the collapse occurs in only one pleural sac, the rib cage on the affected side collapses and shows decreased movement. There is a compensatory increase in movement and bulging of the chest wall on the unaffected side. On auscultation of the thorax, the breath sounds are markedly decreased in intensity and commonly absent. The mediastinum may bulge toward the unaffected side and may cause moderate displacement of the heart and the apex beat, with accentuation of the heart sounds and the apex beat. The heart sounds on the affected side have a metallic note and the apex beat may be absent. On percussion of the thorax on the affected side, a hyperresonance is detectable over the dorsal aspects of the thorax.

Affected animals are anxious, tachypneic and in variable degrees of respiratory distress. Because many cases of pneumothorax in cattle and horses are secondary to lung disease, particularly infectious lung disease,<sup>1,2</sup> there are usually signs of the inciting disease, including fever, toxemia, purulent nasal discharge and cough. Pneumothorax secondary to chest wall trauma is usually readily apparent, although fractured ribs that lacerate the lung and cause pneumothorax or hemothorax can be easily missed on physical examination, especially in newborns.

Definitive diagnosis is based on demonstration of pneumothorax by radiographic or ultrasonographic examination. Radiography permits the detection of bilateral and unilateral pneumothorax and permits identification of other air leakage syndromes, including pneumomediastinum, pneumoperitoneum, and pneumo-

pericardium.<sup>1,2</sup> Many cattle with pneumonia and pneumothorax have radiographic evidence of emphysematous bullae.<sup>1</sup> Ultrasonography is also useful in determining the extent of pneumothorax and the presence of consolidated lung and pleural fluid.

**Complications** of pneumothorax, other than respiratory distress and death, include septic pleuritis secondary to contamination of the pleural space, either secondary to trauma or from ruptured infected lung.

The **prognosis** depends on the underlying disease and its severity. Of 30 cattle with pneumothorax, mostly secondary to pneumonia, 18 survived, eight were euthanized and four died.<sup>1</sup> Of 40 horses with pneumothorax, 23 survived, 12 were euthanized and five died.<sup>2</sup> The prognosis is better for animals with traumatic pneumothorax or that secondary to surgery than for animals with pneumothorax due to pneumonia.<sup>1,2</sup>

### CLINICAL PATHOLOGY

Hematological and serum biochemical values are indicative of the underlying or concurrent disease – pneumothorax causes no specific changes in these variables. Arterial blood gas analysis reveals hypoxemia and hypercapnia.

### NECROPSY FINDINGS

The lung in the affected sac is collapsed. In cases where spontaneous rupture occurs there is discontinuity of the pleura, usually over an emphysematous bulla. Hemothorax may also be evident.

### DIFFERENTIAL DIAGNOSIS

The clinical findings are usually diagnostic. Diaphragmatic hernia may cause similar clinical signs but is relatively rare in farm animals. In cattle, herniation is usually associated with traumatic reticulitis and is not usually manifested by respiratory distress. Large hernias with entry of liver, stomach, and intestines cause respiratory embarrassment, a tympanic note on percussion and audible peristaltic sounds on auscultation.

### TREATMENT

The treatment depends on the cause of the pneumothorax and the severity of the respiratory distress and hypoxemia. Animals should receive treatment for the underlying disease. Animals with closed pneumothorax that are not in respiratory distress or hypoxemic do not require specific treatment for the pneumothorax although the animal should be confined and prevented from exercising until the signs of pneumothorax have resolved. An open pneumothorax, due to a thoracic wound, should be surgically closed.

Emergency decompression of the pleural cavity using a needle into the pleural cavity, connected to a tubing and submerged into a flask of saline or water, creates a water-seal drainage. Thoracostomy tubes attached to Heimlich thoracic drainage valves are effective in preventing aspiration of air.<sup>3</sup> Continuous suction, using thoracostomy (e.g. 24 French, 40 cm (16 in) Argyle trocar thoracic catheter) and a standard three-bottle water seal drainage system or commercial equivalent is preferable if there are large continuing air leaks that may be life-threatening.<sup>3,7</sup> Re-inflation of the lung can be monitored by repeated ultrasonic examination. The animal should be kept as quiet as possible and permitted no exercise. Prophylactic antimicrobial treatment is advisable to avoid the development of pleurisy.

#### REFERENCES

- Slack JA et al. *J Am Vet Med Assoc* 2004; 225:732.
- Boy MG, Sweeney CR. *J Am Vet Med Assoc* 2000; 216:1955.
- Laverty S et al. *Equine Vet J* 1996; 28:220.
- Nart P et al. *Vet Rec* 2004; 18:355.
- Kelly G et al. *Irish Vet J* 2003; 56:153.
- Hance SR, Robertson JT. *J Am Vet Med Assoc* 1992; 200:1107.
- Peek SF et al. *J Vet Intern Med* 2003; 17:119.

#### DIAPHRAGMATIC HERNIA

Diaphragmatic hernia is uncommon in farm animals. It occurs in cattle, especially in association with traumatic reticulo-peritonitis,<sup>1,2</sup> in which case the hernia is small and causes no respiratory distress and there may be no abnormal sounds in the thorax. Diaphragmatic hernias in horses are usually traumatic, in that there is a tear in the diaphragm, although a specific traumatic episode is not always identified. Collision with a motor vehicle can cause diaphragmatic hernia in horses. The disease is reported in a gelding after steeplechase racing and can occur in mares during or after parturition.<sup>3</sup>

#### CLINICAL FINDINGS

Clinical findings include chronic or recurrent ruminal tympany caused by herniation of reticulum preventing its normal function in eructation. Muffled heart sounds may be detectable on both sides of the thorax.

Occasional cases of acquired hernia not caused by foreign body perforation also occur in cattle and horses.

Some of the acquired diaphragmatic hernias in the horse are of long duration with an additional factor, such as the passage of a stomach tube or transportation, precipitating acute abdominal pain. In a case of traumatic hernia in a foal, a lack of exercise tolerance was the only clinical sign. Colic and dyspnea may occur as prominent clinical findings and

usually as acute episodes.<sup>3,4</sup> In some there is a history of recent thoracic trauma, although this can be severe months previously. Affected horses may have one or all of the following: tachypnea, painful or forced respirations. Colic can be sudden and severe but is usually preceded by intermittent episodes in the preceding days to months. The colic is a severe one, with the herniated intestine likely to become ischemic and necrotic. All the indications for exploratory laparotomy may be present except that the rectal findings are negative. Although the intestine may be incarcerated, abdominocentesis is likely to be negative but blood-stained fluid is present in the thoracic cavity. Clinical signs suggesting that the blood supply to the herniated intestine is compromised, but which are not accompanied by abnormal peritoneal fluid, suggest that the lesion is in the thorax, scrotum, or omental bursa.<sup>5</sup>

The presence of intestinal sounds in the thorax can be misleading; they are often present in the normal animal but their presence, accompanied by dyspnea and resonance on percussion, should arouse suspicion. Radiography, ultrasonography, thoracoscopy and exploratory laparotomy are the most useful diagnostic procedures.<sup>6</sup> Radiography reveals the presence of gas- and fluid-filled intestinal contents in the thorax, apparent in cattle as oval rounded masses over the heart.<sup>7</sup> Ultrasonography demonstrates presence of bowel in the thorax. There can be excessive pleural fluid.

**Congenital hernias** occur in all species and the defects are usually large, are in the dorsal tendinous part of the diaphragm and have thin edges. Because of the large size of the defect, much of the abdominal viscera, including liver, stomach and intestines, enters the thorax and dyspnea is evident at birth. In some cases the pericardial sac is incomplete and the diaphragm is rudimentary and in the form of a small fold projecting from the chest wall. Affected animals usually survive for a few hours to several weeks. In pigs a number of animals in each litter may be affected. Surgical repair has been performed in neonates, and successful surgical intervention is recorded in one horse, but the prognosis is usually poor.

The definitive treatment of acquired or traumatic hernia is surgical replacement of viscera in the abdomen and repair of the defect in the diaphragm. Repair of a diaphragmatic hernia through a standing thoracotomy in a cow has been described.<sup>7</sup>

#### REFERENCES

- Newton-Clarke MJ, Rebhun WC. *Cornell Vet* 1993; 83:205.
- Misk NA, Semiecka MA. *Vet Radiol Ultrasound* 2001; 42:426.
- Dabareiner RM, White NA. *J Am Vet Med Assoc* 1999; 214:1517.

- Goehring LS et al. *Equine Vet J* 1999; 31:443.
- Ethell MT et al. *J Am Vet Med Assoc* 1999; 215:321.
- Vachon AM, Fischer AT. *Equine Vet J* 1998; 30:467.
- Singh SS et al. *Vet Rec* 1996; 139:240.

#### SYNCHRONOUS DIAPHRAGMATIC FLUTTER IN HORSES (THUMPS)

Synchronous diaphragmatic flutter in horses is caused by an abrupt and powerful contraction of the diaphragm synchronous with the heart beat. Contraction of the diaphragm occurs because of stimulation of the phrenic nerve as it passes over the atria of the heart. Thumps is often associated with electrolyte abnormalities in horses. The disease occurs commonly in horses used for strenuous exercise, and in particular horses used for endurance racing. The disease occurs in Standardbred and Thoroughbred race horses, and individual animals can be affected repeatedly. This disease also occurs sporadically in adult horses and ponies that have not exercised, and peripartum mares (lactation tetany).

The syndrome is characterized by a violent hiccough occurring synchronously with every heart beat. The lateral aspect of the thorax and cranial abdomen appear to jump or 'thump' regularly in affected horses. It is often unilateral, the contraction being felt very much more strongly on one side than the other. The horse is distressed because the hiccough interferes with eating, and to an extent with respiration. In some cases there are additional signs suggestive of hypocalcemia. These include muscular rigidity and fasciculation, and a high-stepping gait. There is often hypocalcemia, hemoconcentration, alkalosis and hypokalemia, hypochloremia and elevation of creatinine phosphokinase levels in affected horses. Hypocalcemia can be profound. The disease is reported as a consequence of hypocalcemia secondary to primary hypoparathyroidism in two Thoroughbred horses.<sup>1</sup>

The principles of treatment are correction of abnormalities in blood electrolyte concentration and hydration. Treatment with calcium borogluconate slowly and intravenously has been followed by rapid recovery in many cases. Some horses require administration of balanced isotonic polyionic electrolyte solutions intravenously (e.g. Ringer's solution or 0.9% sodium chloride).

The **pathogenesis** is thought to be related to hyperirritability of the phrenic nerve caused by metabolic disturbances, including hypocalcemia, and the phrenic nerve being stimulated by each atrial depolarization to fire with each heart beat. The stimulation occurs because of the close physical proximity of the heart to the nerve in the horse. Dietary supplementation with calcium and other

electrolytes during a ride is recommended but excessive calcium feeding beforehand may reduce the activity of calcium homeostatic mechanisms, and is to be avoided.

Regular veterinary inspection of all horses at the mandatory stops of endurance rides will reveal those animals with 'thumps', which should not be allowed to proceed in the event.

## REFERENCE

1. Hudson NP et al. AustVet J 1999; 77:504.

## PLEURITIS (PLEURISY)

Pleuritis refers to inflammation of the parietal and visceral pleura. Inflammation of the pleura almost always results in accumulation of fluid in the pleural space. Pleuritis is characterized by varying degrees of toxemia, painful shallow breathing, pleural friction sounds and dull areas on acoustic percussion of the thorax because of pleural effusion. Treatment is often difficult because of the diffuse nature of the inflammation.

## ETIOLOGY

Pleuritis is almost always associated with diseases of the lungs. Pneumonia can progress to pleuritis, and pleuritis can cause consolidation and infection of the lungs. Primary pleuritis is usually due to perforation of the pleural space and subsequent infection. Most commonly this occurs as a result of trauma,<sup>1</sup> but it can occur in cattle with traumatic reticuloperitonitis and in any species after perforation of the thoracic esophagus.<sup>2</sup>

Secondary pleuritis refers to that which develops from infectious lung disease subsequent to the following conditions.

### Pigs

- Glasser's disease
- Pleuropneumonia associated with *Actinobacillus (Haemophilus) pleuropneumoniae* and *Haemophilus influenzae suis*
- The prevalence of pneumonia and pleurisy in pigs examined at slaughter represents a significant loss in production.<sup>3</sup>

### Cattle

- Secondary to *Mannheimia haemolytica* pneumonia in cattle, especially feedlot cattle, which may be related to a high percentage of fibrotic pleural lesions found in adult cattle examined at the abattoir
- Tuberculosis
- Sporadic bovine encephalomyelitis
- Contagious bovine pleuropneumonia
- *Histophilus somnus* infection
- Pleural lesions are common in veal calves examined at slaughter.

### Sheep and goats

- Pleuropneumonia associated with *Mycoplasma* spp., including *Mycoplasma mycoides* subsp. *mycoides*<sup>4</sup> and *Haemophilus* spp.
- *Streptococcus dysgalactiae* in ewes.<sup>5</sup>

### Horses

The disease in horses is discussed separately in the next section. Rare causes of pleurisy and pleural effusion in horses include lymphosarcoma and equine infectious anemia. Mesothelioma of the pleura causing persistent dyspnea, pleural effusion and death is also recorded in the horse. Thoracic hemangiosarcoma is recorded as a cause of chylothorax in the horse.<sup>6</sup>

## Other causes

**Sporadic and nonspecific diseases** may be accompanied by pleurisy. Examples include septicemias due to *Pseudomonas aeruginosa*; bacteremia with localization causing a primary septic pleural effusion. In horses, the infection is usually *S. equi* and the original disease is strangles. In goats, it is usually spread from a mycoplasmal pneumonia.

**Perforation of the diaphragm** occurs in **traumatic reticuloperitonitis** in cattle and goats. Spread into the pleural cavity can occur without actual penetration of the diaphragm, as it enters via the lymphatics. Abomasopleural fistula secondary to abomasal ulceration can cause pleuritis in cattle.<sup>7</sup>

**Chronic pleuritis** is an important cause of loss in commercial piggeries. The prevalence can be as low as 5.6% of pigs at slaughter in specific-pathogen-free piggeries and as high as 27% in conventional piggeries.<sup>8</sup>

## PATHOGENESIS

Contact and movement between the parietal and visceral pleura causes pain due to stimulation of pain end organs in the pleura. Respiratory movements are restricted and the respiration is rapid and shallow. There is production of sero-fibrinous inflammatory exudate, which collects in the pleural cavities and causes collapse of the ventral parts of the lungs, thus reducing vital capacity and interfering with gaseous exchange. If the accumulation is sufficiently severe there may be pressure on the atria and a diminished return of blood to the heart. Clinical signs may be restricted to one side of the chest in all species with an imperforate mediastinum. Fluid is resorbed in animals that survive the acute disease and adhesions develop, restricting movement of the lungs and chest wall but interference with respiratory exchange is usually minor and disappears gradually as the adhesions stretch with continuous movement.

In all bacterial pleuritis, toxemia is common and usually severe. The toxemia may be severe when large amounts of pus accumulate.

## CLINICAL FINDINGS

The clinical findings of pleuritis vary from mild to severe, depending on the species and the nature and severity of the inflammation. In peracute to acute stages of pleuropneumonia there are **fever, toxemia, tachycardia, anorexia, depression, nasal discharge, coughing, exercise intolerance, breathing distress, and flared nostrils**. The nasal discharge depends on the presence or absence of pneumonia. It may be absent or copious and its nature may vary from mucohemorrhagic to mucopurulent. The odor of the breath may be putrid, which is usually associated with an anaerobic lesion.

### Pleural pain

Pleural pain (pleurodynia) is common and manifested as pawing, stiff forelimb gait, abducted elbows and reluctance to move or lie down. In the early stages of pleuritis, breathing is rapid and shallow, markedly abdominal and movement of the thoracic wall is restricted. The breathing movements may appear guarded, along with a catch at end-inspiration. The animal stands with its elbows abducted and is disinclined to move. The application of hand pressure on the thoracic wall and deep digital palpation of intercostal spaces usually causes pain manifested by a grunt, a spasm of the intercostal muscles or an escape maneuver.

### Pleuritic friction sounds

These may be audible over the thoracic wall. They have a continuous to-and-fro character, are dry and abrasive, and do not abate with coughing. They may be difficult to identify if there is a coincident pneumonia accompanied by loud breath sounds and crackles. When the pleuritis involves the pleural surface of the pericardial sac a friction rub may be heard with each cardiac cycle and be confused with the friction sound of pericarditis. However, there is usually in addition a friction sound synchronous with respiratory movements and the pericardial rub waxes and wanes with expiration and inspiration. Pleural friction rubs are audible only during the initial stages of the disease – they are not audible when fluid accumulates in the pleural space.

### Subcutaneous edema

Subcutaneous edema of the ventral body wall extending from the pectorals to the prepubic area is common in horses with severe pleuritis but is less noticeable in other species. Presumably this edema is due to blockage of lymphatics normally drained through the sternal lymph nodes.

### Pleural effusion

In cattle, an inflammatory pleural effusion is often limited to one side because the pleural sacs do not communicate. Bilateral pleural effusion may indicate either a bilateral pulmonary disease process or a noninflammatory abnormality such as right-sided congestive heart failure or hypoproteinemia.

**Dullness on acoustic percussion** over the fluid-filled area of the thorax is characteristic of pleuritis in which there is a significant amount of pleural effusion. The dull area has a **horizontal level topline**, called a **fluid line**, which can be demarcated by acoustic percussion. As exudation causes separation of the inflamed pleural surfaces and the pleural effusion accumulates, the pain and friction sounds diminish but do not completely disappear. On auscultation there may still be pleuritic friction sounds but they are less evident and usually localized to small areas.

In the presence of a pleural effusion, both normal and abnormal lung sounds are diminished in intensity, depending on the amount of the effusion. Dyspnea may still be evident, particularly during inspiration, and a pleuritic ridge develops at the costal arch as a result of elevation of the ribs and the abdominal-type respiration. However, the degree of dyspnea is often subtle and careful clinical examination and counting of the breathing rate is necessary to detect the changes in breathing.

If the pleurisy is unilateral, movement of the affected side of the thorax is restricted as compared to the normal side. In cattle, the pleural effusion is commonly unilateral on the right side but both sides may be affected. Pain is still evident on percussion on deep palpation of the intercostal spaces and the animal still stands with its elbows abducted, is disinclined to lie down or move but is not as apprehensive as in the early stages. Toxemia is often more severe during this stage, the temperature and the heart rate are usually above normal and the appetite is poor. A cough will be present if there is a concurrent pneumonia and it is painful, short and shallow. Extension of the inflammation to the pericardium may occur. Death may occur at any time and is due to a combination of toxemia and anoxia caused by pressure atelectasis.

### Recovery

Animals with pleuritis characteristically recover slowly over a period of several days or even weeks. The toxemia usually resolves first but abnormalities in the thorax remain for some time because of the presence of adhesions and variable amounts of pleural effusion in the loculi.

Rupture of the adhesions during severe exertion may cause fatal hemothorax. Some impairment of respiratory function can be expected to persist and racing animals do not usually regain complete efficiency. Chronic pleurisy, as occurs in tuberculosis in cattle and in pigs, is usually subclinical, with no acute inflammation or fluid exudation occurring.

### Medical imaging

Radiographic examination may reveal the presence of a fluid line and fluid displacement of the mediastinum and heart to the unaffected side and collapse of the lung. However, in cattle, pleural effusion cannot be located precisely by radiography because only laterolateral radiographs of the thorax can be taken.<sup>9</sup> Ultrasonography is superior for the visualization of small volumes of pleural fluid that cannot be detected by auscultation and acoustic percussion of the thorax.

### Ultrasonography

Ultrasonography is more reliable for the detection of pleural fluid in horses and cattle than radiography.<sup>10,11</sup> Pleural fluid is easily detected as hypoechoic to anechoic fluid between the parietal pleural surface, diaphragm and lung (Fig. 10.2). Transudative pleural fluid appears homogeneously anechoic to hypoechoic. Exudative fluid is commonly present in horses and cattle with pleuropneumonia and often contains echogenic material.<sup>12</sup> Serosanguineous or

hemorrhagic fluid is also more echogenic than transudates. Fibrin appears as filmy and filamentous strands floating in the effusion with loose attachments to the pleural surfaces. Pockets of fluid loculated by fibrin are commonly imaged in horses with fibrinous pleuropneumonia. Adhesions appear as echogenic attachments between the parietal and visceral pleural surfaces; the adhesions restrict independent motion of the surfaces. The presence of small, bright echoes (gas echoes) swirling in pleural or abscess fluid is associated with anaerobic infection of the pleural cavity. Gas echoes are usually most abundant in the dorsal aspects of the pleural cavity. Other lung and pleural abnormalities that may be visualized include compression atelectasis, consolidation, abscesses and displacement of the lung as pleural effusion accumulates.

### Pleuroscopy

Pleuroscopy using a rigid or flexible fiberoptic endoscope allows direct inspection of the pleural cavity. The endoscope is introduced into the pleural cavity in the 10th intercostal space just above the point of the shoulder. The lung will collapse but pneumothorax is minimized by the use of a purse string suture placed around the stab incision and blunt dissection of the fascia and muscle layers for insertion of the endoscope. The diaphragm, costosplenic angle, aorta, mediastinal structures and thoracic wall are clearly visible. By

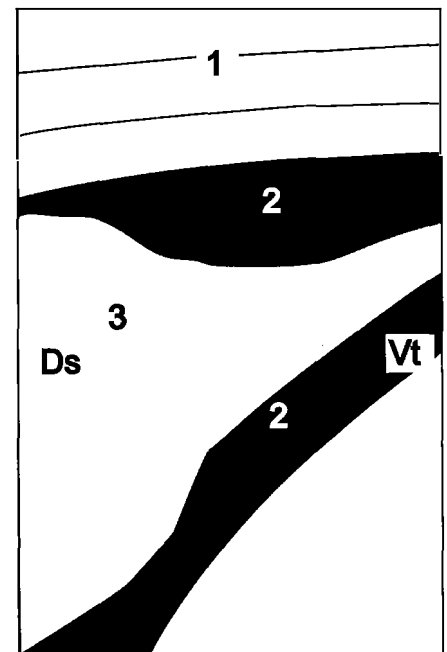
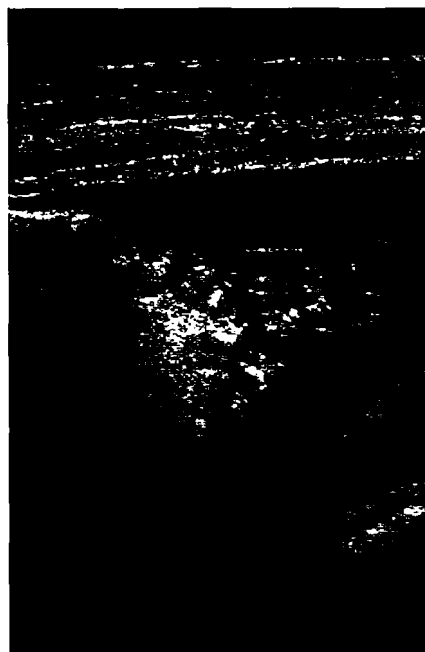

**Fig. 10.2** Ultrasonogram and schematic of the thorax in a cow with pleuropneumonia due to infection with *Mannheimia haemolytica*. There is an accumulation of anechoic pleural effusion, which compresses the lung. The ultrasonogram was obtained from the distal region of the sixth intercostal space of the left thoracic wall with a 5.0 MHz linear scanner. 1 = Thoracic wall; 2 = Anechoic fluid; 3 = Lung. Ds, Dorsal; Vt, Ventral. (Reproduced with kind permission of U. Braun.)

entering the thorax at different locations, the ventral lung, the pericardium and more of the diaphragm can be visualized. Lung and pleural abscesses and pleural adhesions may be visible.

### Prognosis

The prognosis depends on the severity and extent of the pleuritis and the presence of pneumonia. The presence of dull areas over the ventral two-thirds of the thorax on both sides and more than about 6 L of pleural fluid in the pleural cavity of a mature horse suggests an unfavorable prognosis. If the disease is in an advanced stage when first recognized and there is extensive fibrinous inflammation, the response to treatment can be protracted and extensive long-term daily care will be necessary. Also, the common failure to culture the primary causative agent, particularly in horses, makes specific therapy difficult.

### CLINICAL PATHOLOGY

#### Thoracocentesis (pleurocentesis)

Thoracocentesis to obtain a sample of the fluid for laboratory examination is necessary for a definitive diagnosis. The fluid is examined for its odor, color and viscosity, protein concentration and presence of blood or tumor cells, and is cultured for bacteria. It is important to determine whether the fluid is an exudate or a transudate. Pleural fluid from horses affected with anaerobic bacterial pleuropneumonia may be foul-smelling. Examination of the pleural fluid usually reveals an increase in leukocytes up to 40 000–100 000/ $\mu$ L and protein concentrations of up to 50 g/L (5.0 g/dL). The fluid should be cultured for both aerobic and anaerobic bacteria and *Mycoplasma* spp.

#### Hematology

In peracute bacterial pleuropneumonia in horses and cattle, leukopenia and neutropenia with toxic neutrophils are common. In acute pleuritis with severe toxemia, hemoconcentration, neutropenia with a left shift and toxic neutrophils are common. In subacute and chronic stages normal to high leukocyte counts are often present. Hyperfibrinogenemia, decreased albumin-globulin ratio and anemia are common in chronic pleuropneumonia.

### NECROPSY FINDINGS

In early acute pleurisy there is marked edema, thickening and hyperemia of the pleura, with engorgement of small vessels and the presence of tags and shreds of fibrin. These can most readily be seen between the lobes of the lung. In the exudative stage the pleural cavity contains an excessive quantity of turbid fluid containing flakes and clots of fibrin. The pleura is thickened and the central parts

of the lung are collapsed and dark red in color. A concurrent pneumonia is usually present and there may be an associated pericarditis. In the later healing stages, adhesions connect the parietal and visceral pleurae. Type I fibrinous adhesions appear to be associated with pneumonia while type II fibrinous proliferative adhesions are idiopathic.

### DIFFERENTIAL DIAGNOSIS

The diagnosis of pleuritis is confirmed by:

- The presence of inflammatory fluid in the pleural cavity
- Pleural friction sounds, common in the early stages of pleuritis and loud and abrasive; they sound very close to the surface, do not fluctuate with coughing common in the early stages and may continue to be detectable throughout the effusion stage
- The presence of dull areas and a horizontal fluid line on acoustic percussion of the lower aspects of the thorax, characteristic of pleuritis and the presence of pleural fluid
- Thoracic pain, fever and toxemia are common.

**Pneumonia** occurs commonly in conjunction with pleuritis and differentiation is difficult and often unnecessary. The increased intensity of breath sounds associated with consolidation and the presence of crackles and wheezes are characteristic of pneumonia.

**Pulmonary emphysema** is characterized by loud crackles, expiratory dyspnea, hyperresonance of the thorax and lack of toxemia unless associated with bacterial pneumonia.

**Hydrothorax and hemothorax** are not usually accompanied by fever or toxemia and pain and pleuritic friction sounds are not present. Aspiration of fluid by needle puncture can be attempted if doubt exists. A pleural effusion consisting of a transudate may occur in cor pulmonale due to chronic interstitial pneumonia in cattle.

**Pulmonary congestion and edema** are manifested by increased vesicular murmur and ventral consolidation without hydrothorax or pleural inflammation.

### TREATMENT

The principles of treatment of pleuritis are pain control, elimination of infection and prevention of complications.

#### Antimicrobial therapy

The primary aim of treatment is to control the infection in the pleural cavities using the systemic administration of antimicrobials, which should be selected on the basis of culture and sensitivity of pathogens from the pleural fluid. Before the antimicrobial sensitivity results are available it is recommended that broad-spectrum antimicrobials be used. Long-

term therapy daily for several weeks may be necessary.

### Drainage and lavage of pleural cavity

Drainage of pleural fluid removes exudate from the pleural cavity and allows the lungs to re-expand. Criteria for drainage include:

- An initial poor response to treatment
- Large quantities of fluid causing respiratory distress
- Putrid pleural fluid
- Bacteria in cells of the pleural fluid.

Clinical experience suggests that drainage improves the outcome.

Pleural fluid can be drained using intermittent thoracocentesis or indwelling chest tubes.<sup>3</sup> Intermittent drainage is satisfactory in an animal with a small amount of fluid. Small (12–20 French) chest tubes are temporarily inserted at 2–3-day intervals to remove the fluid. Aspiration may not be easy in some cases as the drainage tube may become blocked with fibrin and respiratory movements may result in laceration of the lung. Drainage may be difficult or almost impossible in cases in which adhesion of visceral and parietal pleura are extensive and fluid is loculated.

Indwelling chest tubes may be required unilaterally or bilaterally depending on the patency of mediastinal fenestration and the degree of fluid loculation. A large bore (24–32 French) chest tube is inserted and secured to prevent it from sliding out. Unidirectional drainage through the tube is facilitated by a Heimlich valve and monitored regularly. Pleural fluid is allowed to drain or drip passively, since suction often results in obstruction of the tube with fibrin or peripheral lung tissue. Loculation of fluid may interfere with proper drainage and necessitate replacement of tubes. Complications include subcutaneous cellulitis or pneumothorax.

**Pleural lavage** may assist in removal of fibrin, inflammatory debris, and necrotic tissue; it can prevent loculation, dilute thick pleural fluid and facilitate drainage. One chest tube is placed dorsally and one ventrally; 5–10 L of sterile, warm isotonic saline is infused into each hemithorax by gravity flow. After infusion, the chest tube is reconnected to a unidirectional valve and the lavage fluid is allowed to drain.

**Thoracotomy** has been used successfully for the treatment of pericarditis and pleuritis and lung abscesses in cattle.<sup>13</sup> Claims are made for the use of dexamethasone at 0.1 mg/kg BW to reduce the degree of pleural effusion. In acute cases of pleurisy in the horse analgesics such as phenylbutazone are valuable to relieve pain and anxiety, allowing the horse to eat and drink more normally.



### Fibrinolytic therapy

Pleural adhesions are unavoidable and may become thick and extensive with the formation of loculation which traps pleural fluid, all of which prevents full recovery. However, some animals will stabilize at a certain level of chronicity, will survive for long periods and may be useful for light work or as breeding animals. Fibrinolytic agents such as streptokinase have been used in human medicine to promote the thinning of pleural fluid, provide enzymatic debridement of the pleurae, lyse adhesions and promote drainage of loculi. However, these have not been evaluated in farm animals with pleuritis.

### REFERENCES

- Collins MB et al. J Am Vet Med Assoc 1994; 205:1753.
- Dechant JE et al. Equine Vet J 1998; 30:170.
- Enoe C et al. Prev Vet Med 2002; 54:337.
- Bajmocy E et al. Acta Vet Hung 2000; 48:277.
- Scott PR. Vet Rec 2000; 146:347.
- Brink P et al. Equine Vet J 1996; 28:241.
- Costa LR et al. Can Vet J 2002; 43:217.
- Cleveland-Nielsen A et al. Prev Vet Med 2002; 55:121.
- Braun U et al. Vet Rec 1997; 141:12.
- Reef VB et al. J Am Vet Med Assoc 1991; 198:2112.
- Flock M. Vet J 2004; 167:272.
- Braun U et al. Vet Rec 1997; 141:723.
- Ducharme NG et al. J Am Vet Med Assoc 1992; 200:86.

## EQUINE PLEUROPNEUMONIA (PLEURITIS, PLEURISY)

### ETIOLOGY

Pleuropneumonia of horses is almost always associated with bacterial infection of the lungs, pleura, and pleural fluid. The most common bacterial isolates from tracheal aspirates or pleural fluid of horses with pleuropneumonia are:

- Aerobes or facultative anaerobes** including: *S. equi* var. *zooeepidemicus*, *Pasteurella* spp., *Actinobacillus* spp., Enterobacteriaceae (particularly *E. coli*, *Klebsiella* spp., and *Enterobacter* spp.), *Pseudomonas* spp., *Staphylococcus* spp. and *Bordetella* spp.<sup>1-3</sup> *S. zooeepidemicus* is isolated from over 60%, Enterobacteriaceae from approximately 40% of cases, and *Pasteurella/Actinobacillus* spp. from approximately one-third of cases.<sup>2,3</sup> *Corynebacterium pseudotuberculosis* can cause septic pericarditis and pleuritis, although this is an uncommon disease.<sup>4</sup> *Mycoplasma felis* is an unusual cause of pleuritis in horses.<sup>5,6</sup> *R. equi*, usually a cause of pneumonia in foals, rarely causes pleuropneumonia in immunocompetent adult horses<sup>7</sup>
- Obligate anaerobes**, including *Bacteroides* spp. (including *B. fragilis*

### Synopsis

**Etiology** Most infections are polymicrobial combinations of *S. equi* var. *zooeepidemicus*, *Actinobacillus* sp., *Pasteurella* sp., Enterobacteriaceae and anaerobic bacteria, including *Bacillus fragilis*. Disease due to infection by a single bacterial species occurs. Other causes are *Mycoplasma felis*, penetrating chest wounds and esophageal perforation

**Epidemiology** Recent prolonged transport, racing, viral respiratory disease and anesthesia increase the likelihood of a horse developing pleuropneumonia. Aspiration of feed material secondary to esophageal obstruction or dysphagia also causes the disease

**Pathogenesis** Overwhelming challenge of oropharyngeal bacteria or reduced pulmonary defense mechanisms allow proliferation of bacteria in small airways, alveoli, and lung parenchyma. Subsequent inflammation and further spread of infection involve the visceral pleura. Impaired drainage of pleural fluid and increased permeability of pleural capillaries cause the accumulation of excessive pleural fluid, which then becomes infected. Fibrin deposition and necrosis of lung causes formation of intrathoracic abscesses. Death is due to sepsis and respiratory failure

**Clinical signs** Fever, depression, anorexia, respiratory distress, cough, nasal discharge, exercise intolerance, reduced breath sounds on thoracic auscultation and presence of pleural fluid and pneumonia on thoracic radiology and ultrasonography. Chronic disease is characterized by weight loss, increased respiratory rate, nasal discharge, and exercise intolerance

**Clinical pathology** Leukocytosis, hyperfibrinogenemia, hypoalbuminemia, hyperglobulinemia. Pleural fluid leukocytosis, hyperproteinemia and presence of intra- and extracellular bacteria. Similar findings in tracheal aspirate

**Diagnostic confirmation** Clinical signs, examination of pleural fluid

**Treatment** Systemic administration of broad-spectrum antimicrobials for weeks to months, chronic effective drainage of the pleural space, and nursing care

**Prevention** Reduce exposure of horses to risk factors including prolonged transportation and viral respiratory disease

and *B. tectum*), *Prevotella* spp., *Clostridium* spp., *Eubacterium* and *Fusobacterium* spp.<sup>1-3,8</sup> *Bacteroides* spp. are isolated from approximately 20%, *Clostridium* sp. from 10%, and *Eubacterium* sp. from 6% of horses with pleuropneumonia.<sup>2</sup> Obligate anaerobes are cultured from approximately 70% of horses with severe pneumonia.<sup>8</sup>

Equine pleuropneumonia is associated with **polymicrobial infections** of the

lungs and pleura in 50–80% of cases, although disease associated with infection with a single bacterial species occurs.<sup>1,2</sup> Infections with a single bacterial species are usually by *S. zooeepidemicus*, *Pasteurella/Actinobacillus* sp. or one of the Enterobacteriaceae, whereas almost all infections by anaerobes are polymicrobial.<sup>2</sup> Infection by obligate anaerobic bacteria is associated with disease of more than 5–7 days' duration.<sup>9</sup>

Pleuritis is also caused by penetrating chest wounds,<sup>3</sup> perforated esophagus,<sup>10</sup> and thoracic neoplasia.<sup>11</sup> Other diseases, such as congestive heart failure, may cause pleural effusion without inflammation.

### EPIDEMIOLOGY

Pleuropneumonia occurs worldwide in horses of all ages and both sexes, although most cases occur in horses more than 1 and less than 5 years of age.<sup>2</sup> Estimates of the incidence or prevalence of the disease are not available. The **case fatality rate** varies between 5% and 65%, with the higher rate reported in earlier studies.<sup>12,13</sup>

### Risk factors

The risk of a horse developing pleuropneumonia is increased by a factor of:

- 4 if the horse is a Thoroughbred racehorse
- 14 if the horse was transported more than 500 miles in the previous week
- 10 if the horse has a recent (< 2 week) history of viral respiratory tract disease or exposure to a horse with such disease
- 4 if the horse has raced within the previous 48 hours<sup>14</sup>

Other suggested risk factors include general anesthesia, surgery, disorders of the upper airway, exercise-induced pulmonary hemorrhage, esophageal obstruction, and dysphagia.

### PATHOGENESIS

Bacterial pleuropneumonia develops following bacterial colonization of the lungs with subsequent extension of infection to the visceral pleura and pleural space.<sup>9</sup> Organisms initially colonizing the pulmonary parenchyma and pleural space are those normally present in the upper airway, oral cavity, and pharynx, with subsequent infection by Enterobacteriaceae and obligate anaerobic bacteria.<sup>9</sup>

**Bacterial colonization** and infection of the lower airway is attributable to either massive challenge or a reduction in the efficacy of normal pulmonary defense mechanisms or a combination of these factors.<sup>9</sup> **Confinement** with the head elevated for 12–24 hours, such as occurs during transport of horses, decreases mucociliary transport and increases the

number of bacteria and inflammatory cells in the lower respiratory tract and probably contributes to the development of lower respiratory tract disease.<sup>14,15</sup>

**Transport** alters the composition of pulmonary surfactant, which can impair the activity of pulmonary defense mechanisms, allowing otherwise innocuous bacterial contamination to cause disease.<sup>16,17</sup>

Overwhelming bacterial challenge may occur in dysphagic horses, horses with esophageal obstruction and race horses that inhale large quantities of track debris while racing. A single bout of **exercise** on a treadmill markedly increases bacterial contamination of the lower airways.<sup>18</sup> Viral respiratory disease may decrease the efficacy of normal lung defense mechanisms.

**Bacterial multiplication** in pulmonary parenchyma is associated with the influx of inflammatory cells, principally neutrophils, tissue destruction and accumulation of cell debris in alveoli and airways. Infection spreads both through tissue and via airways. Extension of inflammation, and later infection, to the visceral pleura and subsequently pleural space causes accumulation of excess fluid within the pleural space. Pleural fluid accumulates because of a combination of excessive production of fluid by damaged pleural capillaries (exudation) and impaired reabsorption of pleural fluid by thoracic lymphatics.

**Accumulation of parapneumonic pleural effusions** has been arbitrarily divided into three stages: exudative, fibrinopurulent and organizational.<sup>19</sup>

1. The **exudative stage** is characterized by the accumulation of sterile, protein-rich fluid in the pleural space as a result of increased pleural capillary permeability
2. Bacterial invasion and proliferation, further accumulation of fluid, and deposition of fibrin in pleural fluid and on pleural surfaces occurs if the disease does not resolve rapidly and is referred to as the **fibrinopurulent stage**
3. The **organizational stage** is associated with continued fibrin deposition, restriction of lung expansion, and persistence of bacteria. The pleural fluid contains much cellular debris and bronchopleural fistulas may develop.

These categorizations are useful diagnostically and therapeutically.

### CLINICAL SIGNS OF ACUTE DISEASE

The acute disease is characterized by the sudden onset of a combination of fever,

depression, inappetence, cough, exercise intolerance, respiratory distress, and nasal discharge. The respiratory rate is usually elevated as is the heart rate.

**Nasal discharge** ranges from serosanguineous to mucopurulent, is usually present in both nares and is exacerbated when the horse lowers its head. The **breath may be malodorous**, although this is a more common finding in horses with subacute to chronic disease. Horses with pleuritis are often reluctant to cough and if they do, the cough is usually soft and gentle. Ventral edema occurs in approximately 50% of horses with pleuropneumonia.<sup>3</sup>

The horse may appear **reluctant to move** or may exhibit signs of chest pain, including reluctance to move, pawing and anxious expression, which may be mistaken for colic, laminitis, or rhabdomyolysis. Affected horses often stand with the elbows abducted.

**Auscultation** of the thorax reveals attenuation of normal breath sounds in the ventral thorax in horses with significant accumulation of pleural fluid. However, the attenuation of normal breath sounds may be mild and difficult to detect, especially in large or fat horses or in horses in which there is only slight accumulation of pleural fluid. Auscultation of the thorax with the horse's respiratory rate and tidal volume increased by having it breathe with a large airtight bag over its nostrils may reveal crackles and wheezes in the dorsal lung fields and attenuation of the breathe sounds ventrally. There is often fluid in the trachea detectable as a tracheal rattle.

**Percussion** of the chest wall may reveal a clear line of demarcation below which the normal resonant sounds are muffled. This line of demarcation represents the dorsal limit of the pleural fluid. Both lung fields should be examined to identify localized areas of consolidation. Careful percussion of the thorax is a cheap and effective way of identifying the presence and extent of pleural fluid accumulation.

**Ultrasonographic examination** of the thorax is a very sensitive technique with which to detect accumulation of pleural fluid, determine the character of the fluid, identify localized areas of fluid accumulation or pulmonary consolidation, identify sites for thoracocentesis and monitor response to treatment.<sup>20,21</sup> The examination is best performed using a 3.5–5.0 sector scanner. Linear probes, such as those used for routine reproductive examination, are adequate to identify fluid but do not allow good examination of all areas of the chest accessible with sector scanners. The entire thorax should be examined in a

systematic fashion. The presence of and characteristics of fluid within the pleural space, presence and location of pulmonary consolidation or abscessation and potential sites for diagnostic and therapeutic thoracocentesis should be identified. For horses with long-standing disease, the area cranial to the heart should be examined for the presence of cranial thoracic masses (abscesses). This examination requires that the horse's ipsilateral forelimb be placed well forward, usually with the aid of an assistant, to allow adequate visualization of the cranial thorax.

- **Excessive pleural fluid** can be detected by thorough ultrasonographic examination of both hemithoraces. Pleural fluid initially accumulates ventrally in acute cases, but may become localized dorsally in chronic cases with septation of the pleural space and trapping of fluid
- The pleural fluid may contain **small gas echoes**, an indication of infection with anaerobic bacteria and a poor prognosis,<sup>20</sup> strands of fibrin or echogenic material consistent with cellular debris. Sterile pleural effusion, such as may be present during the earliest stages of the disease, is clear and homogeneous without fibrin strands. With increasing chronicity the amount of fibrin increases, the parietal and visceral pleura become thickened, and the pleural fluid becomes echogenic consistent with the presence of cellular debris
- Regions of consolidated or **atelectatic lung** adjacent to the visceral pleura may be evident on ultrasonographic examination, but lung consolidation deeper in the lung is not evident
- Ultrasonography is more sensitive than radiographic examination in detection of small quantities of pleural fluid.<sup>21</sup>

**Radiographic examination** of horses with excessive pleural fluid reveals ventral opacity that obscures the ventral diaphragmatic and cardiac silhouettes. It is not possible on radiographic examination to differentiate accumulation of pleural fluid from consolidation of the ventral lung lobes.<sup>21</sup> Radiographic examination may be useful in demonstrating lesions, such as pulmonary abscesses or consolidation, that are not confluent with the visceral pleura and therefore not able to be detected by ultrasonographic examination.<sup>21</sup>

**Collection of pleural fluid by thoracocentesis** of both hemithoraces and of a **tracheal aspirate** is necessary to characterize the nature of the pleural fluid and determine the bacterial species present (see clinical pathology). Both

tracheal aspirates and pleural fluid should be examined in any horse with pleuropneumonia as bacteria may be recovered from one sample but not the other.<sup>2</sup> Examination of bronchiolar lavage fluid is not useful in diagnosing pleuropneumonia in horses.<sup>22</sup>

**The clinical course** of the acute form of the disease may be less than 10 days if effective therapy is instituted before the pleural effusion becomes infected or there is substantial deposition of fibrin in the pleural space. The prognosis for a return to previous function is good in horses that respond. However, most cases, even if appropriate therapy is instituted, progress to at least stage 2 of the disease process and the disease becomes chronic.

### CLINICAL SIGNS IN CHRONIC DISEASE

The chronic disease is characterized by intermittent fever, weight loss, cough, increased respiratory rate, nasal discharge, malodorous breath, exercise intolerance, and depression. Severely affected horses may display signs of respiratory distress. Signs of thoracic pain are less than in the acute disease.

**Findings on auscultation** of the chest are similar to those of the acute disease in as much as there is attenuation of normal breath sounds ventrally and the presence of crackles and wheezes dorsally. There is frequently ventral edema of the thorax.

**Ultrasonographic** examination reveals the presence of excessive pleural fluid that is very echogenic, consistent with it containing cellular debris, and containing large amounts of fibrin. The visceral and parietal pleura are thickened and there may be evidence of lung atelectasis, consolidation, or abscessation. Septation of the pleural space by fibrin and fibrous tissue results in localized accumulation of purulent pleural fluid. Air in the pleural space may indicate the presence of one or more bronchopleural fistulae.

**Radiographic examination** reveals a combination of ventral opacity, pulmonary consolidation, pneumothorax, and abscessation.

### Complications

Complications of pleuropneumonia include:

- Development of jugular thrombophlebitis (25% of cases)
- Pulmonary, mediastinal, or pleural abscesses (10–20% of cases)
- Cranial thoracic mass (5–10% of cases)
- Bronchopleural fistula (5%)
- Pericarditis (2%)
- Laminitis (1–14%).<sup>3,17–19</sup>

### Development of intrathoracic abscesses

is evident as chronic disease, weight loss, cough and fever, readily detected by a

combination of ultrasonographic and radiographic examination.

**Cranial thoracic masses** are evident as an elevation in heart rate, prominent jugular pulse, spontaneous jugular thrombosis, and forelimb pointing. The signs are referable to a mass in the cranial thorax displacing the heart caudally and to the left and impairing venous return to the heart in the cranial vena cava.<sup>23</sup> Ultrasonographic and radiographic examination reveals the presence of the mass.

**Bronchopleural fistulae** develop when a section of pulmonary parenchyma sloughs, leaving an open bronchiole that communicates with the pleural space. Mild pneumothorax develops. The bronchopleural fistula can be diagnosed by infusion of fluorescein dye into the pleural space and detecting its presence at the nares, or by pleuroscopic examination.<sup>24,26</sup>

### Prognosis

The prognosis for life for horses able to be treated aggressively is very good (60–95%)<sup>3,13</sup> and the prognosis for return to previous function if the horse survives is reasonable (60%).<sup>13</sup> The prognosis for return to previous function for horses that develop chronic disease and complications is poor (31%).<sup>13</sup>

### CLINICAL PATHOLOGY

Acute pleuropneumonia is characterized by **leukocytosis** with a mature neutrophilia, mild to moderate anemia, hyperfibrinogenemia, and hypoalbuminemia.<sup>24</sup> There are similar findings in horses with chronic disease and hyperglobulinemia is also usually present. Severely affected horses with acute disease often have hemoconcentration and azotemia.

**Pleural fluid** in acute cases is usually cloudy and red to yellow. It has an increased leukocyte number ( $> 10\,000$  cells/ $\mu$ L,  $10 \times 10^9$  cells/L) comprised principally of degenerative neutrophils, an increased protein concentration ( $> 2.5$  g/dL, 25 g/L) and may contain intracellular and extracellular bacteria.<sup>27</sup> A Gram stain of the fluid should be examined. The pleural fluid should be cultured for aerobic and anaerobic bacteria. A putrid odor suggests infection by anaerobic bacteria. Sterile pleural fluid has a pH,  $PO_2$  and  $PCO_2$  and lactate, glucose and bicarbonate concentration similar to that of venous blood.<sup>28</sup> Infected pleural fluid is acidic, hypercarbic and has an increased concentration of lactate and decreased concentrations of bicarbonate and glucose compared to venous blood.<sup>28</sup>

**Tracheal aspirates** have a leukocytosis comprised of degenerate neutrophils with intra- and extracellular bacteria. Cultures of tracheal aspirates more frequently yield growth than do cultures of pleural fluid (90% v 66%).<sup>2</sup>

### DIAGNOSTIC CONFIRMATION

The presence of excessive pleural fluid containing bacteria and degenerate neutrophils in combination with clinical signs of respiratory disease provides confirmation of the disease.

### DIFFERENTIAL DIAGNOSIS

Diseases that may cause respiratory distress and pleural effusion in horses include:

- Intrathoracic neoplasia, including mesothelioma, lymphoma, and extension of gastric squamous cell carcinoma
- Penetrating chest wounds
- Esophageal perforation
- Diaphragmatic hernia
- Congestive heart failure
- Hemangiosarcoma (causing hemothorax)
- African horse sickness
- Pulmonary hydatidosis<sup>29</sup>
- Pulmonary infarction and pneumonia<sup>30</sup>

### NECROPSY FINDINGS

The pneumonia involves all areas of the lungs but is most severe in the cranial and ventral regions. The pleura are thickened and have adherent fibrin tags and there is excessive pleural fluid. The pleural fluid contains strands of fibrin and is usually cloudy and serosanguineous to yellow. Histologically, there is a purulent, fibrinonecrotic pneumonia and pleuritis.

### TREATMENT

Given early recognition of the disease and prompt institution of appropriate therapy the prognosis for horses with pleuropneumonia is favorable. However, the long course of the disease and the associated expense often limit therapeutic options and make the outcome a decision based on economic rather than medical grounds.

**The principles of treatment** are prompt, broad-spectrum antimicrobial therapy, removal of infected pleural fluid and cellular debris, including necrotic lung, relief of pain, correction of fluid and electrolyte abnormalities, relief of respiratory distress, treatment of complications, and prevention of laminitis.

### Antimicrobial treatment

The prompt institution of **systemic, broad-spectrum antimicrobial therapy** is the single most important component of treatment of horses with pleuropneumonia. Antimicrobial therapy is almost always started before the results of bacterial culture of pleural fluid or tracheal aspirate are received and the antimicrobial sensitivity of isolated bacteria are determined. Use of antibiotics or combinations of antibiotics with a broad spectrum of antimicrobial activity is important

because of the polymicrobial nature of most infections and because the wide range of Gram-positive and Gram-negative bacteria that may be associated with the disease makes prediction of the susceptibility of the causative organisms difficult. Furthermore, superinfection with bacteria, especially Enterobacteriaceae and obligate anaerobes, commonly occurs in horses with disease initially associated with a single bacterial species. Administration of drugs that are effective in the treatment of penicillin-resistant obligate anaerobes is also important.

**Recommended doses for antimicrobials** used in the treatment of pleuropneumonia are provided in Table 10.6. Antimicrobial therapy should be broad-spectrum to include coverage of the likely bacteria involved in the disease. It should therefore provide coverage against *Streptococcus* spp., *Actinobacillus/Pasteurella* spp., Enterobacteriaceae and anaerobes, including *Bacteroides* spp. **A combination of penicillin G, an aminoglycoside and metronidazole** provides broad-spectrum coverage and is a frequently used empirical therapy until the results of bacterial culture are known. Results of bacterial culture and sub-

sequent antimicrobial susceptibility testing may aid selection of further antimicrobials. However, superinfection with Gram-negative and anaerobic bacteria is common and there is a sound rationale for continued use of a combination of antimicrobials providing broad-spectrum coverage throughout treatment of the disease.

**Antimicrobial therapy will be prolonged** in most cases, usually being required for at least 1 month and often several months. As the disease resolves it may be possible to change from parenteral antibiotics to orally administered antibiotics such as a combination of trimethoprim-sulfonamide, although the clinical response to this combination is sometimes disappointing, doxycycline or enrofloxacin.

**The decision to discontinue antimicrobial therapy** should be based on lack of fever, nasal discharge, respiratory distress or cough, lack of evidence of intrathoracic abscesses on ultrasonographic and radiographic examination of the thorax, and resolution of neutrophilia and hyperfibrinogenemia. There should be no appreciable pleural fluid on ultrasonographic examination.

### Thoracic drainage

Chronic, effective drainage of the pleural cavity and intrathoracic abscesses is critical for successful treatment of horses with pleuropneumonia.<sup>31</sup> Horses with sterile pleural fluid may require only a single drainage of pleural fluid. More severely affected horses may require intermittent drainage on each of several days, and most cases will require insertion of a tube into the pleural space to provide continuous drainage for several days to several weeks. Horses with chronic disease may benefit from a thoracotomy that provides continuous drainage and the ability to lavage the chest. Ultrasonographic examination of the chest is very useful in identifying the presence of pleural fluid, the optimal sites for drainage and the efficacy of drainage.

**Intermittent thoracic drainage** can be achieved by inserting a bovine teat cannula or similar blunt cannula into the pleural space. This should be done aseptically and under local anesthesia. If ultrasonographic examination is not available, the cannula should be placed in the sixth to eighth intercostal space on the right side or the seventh to ninth on the left side just above the level of the

Table 10.6 Antimicrobial agents and recommended doses for treatment of pleuropneumonia in horses

Drug	Dose, route and interval	Comments
Procaine penicillin G	22–44 000 IU/kg IM q 12 h	Effective against <i>Streptococcus</i> sp. and most anaerobes with the exception of <i>Bacteroides fragilis</i> . Achieves low plasma concentrations but has prolonged duration of action. Cheap. Synergistic with aminoglycosides. Should not be used as sole treatment
Sodium or potassium penicillin G	22–44 000 IU/kg IV q 6 h	Effective against Gram-positive organisms (except penicillinase-producing bacteria such as <i>Staphylococcus</i> spp.) and most anaerobes. Achieves high plasma concentrations. Synergistic with aminoglycosides. Expensive
Ampicillin sodium	11–22 mg/kg IV or IM q 6 h	Wider spectrum than penicillin G. Achieves high plasma concentrations. Synergistic with aminoglycosides
Ceftiofur sodium	2.2 mg/kg IM or IV q 12 h	Wide spectrum of action against Gram-positive and Gram-negative organisms and most anaerobes. Can be used as sole treatment, though not recommended. Clinical results sometimes disappointing
Chloramphenicol	50 mg/kg, PO q 6 h	Good spectrum of action, including anaerobic bacteria. Poor oral bioavailability and disappointing clinical efficacy. Use prohibited in some countries. Potential human health hazard. Risk of diarrhea
Gentamicin sulfate	7 mg/kg, IV or IM q 24 h	Active against <i>Staphylococcus</i> spp. and many Gram-negative organisms. Inactive against anaerobes. Poor activity against <i>Streptococcus</i> spp. Synergistic with penicillin
Enrofloxacin	7 mg/kg IV or PO q 24 h	Active against some Gram-positive and Gram-negative bacteria. Not good or reliable activity against streptococci. Contraindicated in young animals because of risk of cartilage damage
Amikacin sulfate	21 mg/kg IV or IM q 24 h	Wider spectrum of Gram-negative activity than gentamicin. Expensive
Trimethoprim-sulfonamides	15–30 mg/kg PO q 12 h	Theoretical wide spectrum of action. Disappointing clinical efficacy
Rifampin	5–10 mg/kg PO q 12 h	Penetrates abscesses well. Active against Gram-positive and some Gram-negative bacteria. Must be used in conjunction with another antibiotic (not an aminoglycoside)
Doxycycline	10 mg/kg PO q 12 h	Broad spectrum of activity, but resistance unpredictable. Only moderate blood concentrations. Suitable for prolonged therapy but not treatment of the acute disease. Risk of diarrhea
Ticarcillin-clavulanic acid	50 mg/kg IV q 6 h	Broader spectrum of Gram-negative activity than penicillin G. Expensive
Metronidazole	15–25 mg/kg PO q 6–8 h	Active against anaerobes only. Used in conjunction with other antimicrobials (especially penicillin and aminoglycosides). Neurotoxicity rare

IV, intravenously; PO, orally; IM = intramuscularly; q, dose administered every 'h' hours.

olecranon. Pleural fluid that does not contain large fibrin clots (which clog the cannula) can be drained and the cannula removed. However, the process is slow if large quantities of fluid must be removed. Intermittent drainage is indicated when the quantities of pleural fluid are small (< 5 L), relatively cell free or localized. This situation is most likely to occur in horses with acute disease.

**Insertion of large plastic chest tubes** (20–30 French, 6–10 mm outside diameter) facilitates rapid fluid removal, allows drainage of viscid fluid and provides continuous drainage. The chest tube should be inserted in an aseptic fashion under local anesthesia at sites indicated by ultrasonographic examination or as described above. A one-way valve should be attached to the external end of the tube to prevent aspiration of air and development of a pneumothorax. A balloon or condom with the end removed is an effective one-way valve. The chest tube is secured to the chest wall with a purse-string suture. The tube may be retained for several days to a week, but should be monitored frequently (every few hours) and cleared of fibrin clots as needed.

**Complications of drainage** of pleural fluid include: collapse of the animal if the fluid is removed too rapidly; pneumothorax; sudden death due to cardiac puncture or laceration of a coronary vessel; and perforation of abdominal viscera. Collapse can be prevented by administering fluids intravenously during pleural fluid drainage and by removing the fluid gradually (over a period of 30 min). Some horses develop a cellulitis around the chest tube that requires that the tube be removed.

**Thoracotomy** may be required in chronic cases to provide drainage of intrathoracic abscesses or chronic pleural effusion that is refractory to treatment with antimicrobials.<sup>31</sup> Thoracotomy is an effective intervention in many horses with advanced pleuropneumonia and should not be considered an emergency or heroic procedure.

#### Pleural lavage

Infusion and subsequent removal of 5–10 L of warm saline or balance polyionic electrolyte solution into the affected pleural space may be beneficial in the treatment of cases with viscid fluid or fluid containing large amounts of fibrin and cell debris. The fluid can be infused through the chest tube that is used to drain the pleural space. Care should be taken not to introduce bacteria with the infusion.

#### Supportive therapy

Acutely or severely ill horses may be dehydrated, azotemic, and have acid–base

disturbance. These horses should be treated with appropriate **fluids** administered intravenously.

Pleuropneumonia is a painful disease and every attempt should be made to relieve the horse's chest pain. **NSAIDs**, including flunixin meglumine (1 mg/kg, orally, intramuscularly or intravenously, every 8 h) or phenylbutazone (2.2 mg/kg, orally or intravenously, every 12 h) often provide effective analgesia and presumably reduce inflammation in the pleural space.

Horses should be provided with good nursing care, including a comfortable stall, free access to palatable water, and a good diet. Affected horses will often not eat adequately and should be tempted with fresh and nutritious fodder.

Attention should be paid to the horse's feet to detect early signs of laminitis and allow appropriate measures to be taken.

#### CONTROL

Prevention of pleuropneumonia involves reduction of risk factors associated with the disease. The main risk factors are other infectious respiratory disease and transportation. Every effort should be made to prevent and treat respiratory disease in athletic horses, including institution of effective vaccination programs. Horses with infectious respiratory disease should not be vigorously exercised until signs of disease have resolved.

Transportation of athletic horses is common and essential for their participation in competitive events. It cannot, therefore, be eliminated. Every effort should be made to minimize the adverse effects of transportation on airway health. Recommendations for transport of horses first made in 1917 are still relevant.<sup>32,33</sup> Updated, these recommendations include:

Not transporting a horse unless it is healthy. Horses with fever should not be transported

Knowledgeable staff familiar with the horse should accompany it  
Suitable periods of rest and acclimation should be provided before recently transported or raced horses are transported

The time during which horses are confined for transportation should be kept to a minimum. Horses should be loaded last and unloaded first in flights with mixed cargo

The route taken should be the most direct and briefest available

Horses should be permitted adequate time to rest at scheduled breaks. If possible, on long journeys horses should be unloaded and allowed exercise (walking) and access to hay and water

- Horses should have frequent, preferably continuous, access to feed and water during transportation
- Horses should not be exercised after arrival until they are free of fever, cough, or nasal discharge
- Horses should not be restrained during transportation such that they are unable or unwilling to lower their heads
- Air quality should be optimal in the vehicle used to transport the horse.

#### REVIEW LITERATURE

- Chaffin MK, Carter GK. Equine bacterial pleuropneumonia. Part I. Epidemiology, pathophysiology, and bacterial isolates. *Compend Contin Educ Pract Vet* 1993; 15:1642–1650.
- Chaffin MK et al. Equine bacterial pleuropneumonia: Part II. Clinical signs and diagnostic evaluation. *Compend Contin Educ Pract Vet* 1994; 16:362–378.
- Chaffin MK et al. Equine bacterial pleuropneumonia: Part III. Treatment sequelae and prognosis. *Compend Contin Educ Pract Vet* 1994; 16:1585–1595.
- Raidal SL. Equine pleuropneumonia. *Br Vet J* 1995; 151:233–262.
- Racklyeft DJ et al. Towards an understanding of equine pleuropneumonia: factors relevant for control. *Aust Vet J* 2000; 78:334–338.

#### REFERENCES

1. Sweeney CR et al. *J Am Vet Med Assoc* 1985; 187:721.
2. Sweeney CR et al. *J Am Vet Med Assoc* 1991; 198:839.
3. Collins MB et al. *J Am Vet Med Assoc* 1994; 205:1753.
4. Perkins SL et al. *J Am Vet Med Assoc* 2004; 224:1133.
5. Hoffman AM et al. *Cornell Vet* 1992; 82:155.
6. Morley PS et al. *Equine Vet J* 1996; 28:237.
7. Vengust M et al. *Can Vet J* 2002; 43:706.
8. Racklyeft DJ, Love DN *Aust Vet J* 2000; 78:549.
9. Raidal SL. *Br Vet J* 151:1995; 233–262.
10. Dechant JE et al. *Equine Vet J* 1998; 30:170.
11. Mair TS, Brown PJ. *Equine Vet J* 1993; 25:220.
12. Raphael CF, Beech J. *J Am Vet Med Assoc* 1982; 181:808.
13. Seltzer KL, Byars TD. *J Am Vet Med Assoc* 1996; 20:1300.
14. Raidal SL et al. *Aust Vet J* 1995; 72:45.
15. Raidal SL et al. *Aust Vet J* 1996; 73:45.
16. Hobo S et al. *Am J Vet Res* 1997; 58:531.
17. Hobo S et al. *Vet Rec* 2001; 148:74.
18. Raidal SL et al. *Aust Vet J* 1997; 75:293.
19. Chaffin MK, Carter GK. *Compend Contin Educ Pract Vet* 1993; 15:1642.
20. Reimer JM et al. *J Am Vet Med Assoc* 1989; 194:278.
21. Reef VB et al. *J Am Vet Med Assoc* 1991; 198:2112.
22. Rossier Y et al. *J Am Vet Med Assoc* 1991; 198:1001.
23. Byars TD et al. *Equine Vet J* 1991; 23:22.
24. Byars TD, Becht JL. *Vet Clin North Am Equine Pract* 1991; 7:63.
25. Worth LT, Reef VB. *J Am Vet Med Assoc* 1998; 212:248.
26. Mackey VS, Wheat JD. *Equine Vet J* 1985; 17:140.
27. Cowell RL et al. *Vet Clin North Am Equine Pract* 1987; 3:543.
28. Brumbaugh GW, Benson PA. *Am J Vet Res* 1990; 51:1032.
29. McCorum BC et al. *Equine Vet J* 1994; 26:249.
30. Carr EA et al. *J Am Vet Med Assoc* 1997; 210:1774.

31. Schott HC, Mansmann RA. *Compend Contin Educ Pract Vet* 1990; 12:251.
32. Watkins-Pitchford H. *Vet Rec* 1917; 73:345.
33. Racklyeft DJ et al. *Aust Vet J* 2000; 78:334.

## Diseases of the upper respiratory tract

### RHINITIS

Rhinitis (inflammation of the nasal mucosa) is characterized clinically by sneezing, wheezing, and stertor during inspiration and a nasal discharge that may be serous, mucoid, or purulent in consistency depending on the cause.

### ETIOLOGY

Rhinitis usually occurs in conjunction with inflammation of other parts of the respiratory tract. It is present as a minor lesion in most bacterial and viral pneumonias but the diseases listed are those in which it occurs as an obvious and important part of the syndrome.

#### Cattle

- Catarrhal rhinitis in infectious bovine rhinotracheitis, adenoviruses 1, 2 and 3 and respiratory syncytial virus infections
- Ulcerative/erosive rhinitis in bovine malignant catarrh, mucosal disease, rinderpest
- Rhinosporidiosis caused by fungi, the blood fluke *Schistosoma nasalis* and the supposedly allergic 'summer snuffles' also known as atopic rhinitis<sup>1</sup>
- Familial allergic rhinitis in cattle in which the progeny of affected cows are susceptible to allergic rhinitis<sup>2</sup>
- Bovine nasal eosinophilic granuloma due to *Nocardia* sp.<sup>3</sup>

#### Horses

- Glanders, strangles, and epizootic lymphangitis  
Infections with the viruses of equine viral rhinopneumonitis (herpesvirus-1), equine viral arteritis, influenza H3N8 equine rhinovirus, parainfluenza virus, reovirus, adenovirus
- Chronic rhinitis claimed to be caused by dust in dusty stables, and acute rhinitis occurring after inhalation of smoke and fumes
- Nasal granulomas due to chronic infections with *Pseudoallescheria boydii*<sup>4</sup> and *Aspergillus*, *Conidiobolus* and *Mucoraceous* fungi<sup>5</sup>  
Equine grass sickness (dysautonomia, pp 1988–1990) in the chronic form causes rhinitis sicca.

#### Sheep and goats

- Melioidosis, bluetongue, rarely contagious ecthyma and sheep pox

- *Oestrus ovis* and *Elaeophora schneideri* infestations
- Allergic rhinitis
- Purulent rhinitis and otitis associated with *P. aeruginosa* in sheep showered with contaminated wash.<sup>6</sup>

#### Pigs

- Atrophic rhinitis, inclusion body rhinitis, swine influenza, some outbreaks of Aujeszky's disease.

### PATHOGENESIS

Rhinitis is of minor importance as a disease process except in severe cases when it causes obstruction of the passage of air through the nasal cavities. Its major importance is as an indication of the presence of some specific diseases. The type of lesion produced is important. The erosive and ulcerative lesions of rinderpest, bovine malignant catarrh and mucosal disease, the ulcerative lesions of glanders, melioidosis, and epizootic lymphangitis and the granular rhinitis of the anterior nares in allergic rhinitis all have diagnostic significance.

In atrophic rhinitis of pigs the destruction of the turbinate bones and distortion of the face appear to be a form of devitalization and atrophy of bone caused by a primary, inflammatory rhinitis. Secondary bacterial invasion of facial tissue of swine appears to be the basis of necrotic rhinitis.

### CLINICAL FINDINGS

The primary clinical finding in rhinitis is a nasal discharge, which is usually serous initially but soon becomes mucoid and, in bacterial infections, purulent. Erythema, erosion, or ulceration may be visible on inspection. The inflammation may be unilateral or bilateral. Sneezing is characteristic in the early acute stages and this is followed in the later stages by snorting and the expulsion of large amounts of mucopurulent discharge. A chronic unilateral purulent nasal discharge lasting several weeks or months in horses suggests nasal granulomas associated with mycotic infections.<sup>4,5</sup>

#### 'Summer snuffles'

'Summer snuffles' of cattle presents a characteristic syndrome involving several animals in a herd. Cases occur in the spring and autumn when the pasture is in flower and warm moist environmental conditions prevail. The disease may be most common in Channel Island breeds. There is a sudden onset of dyspnea with a profuse nasal discharge of thick, orange to yellow material that varies from a mucopurulent to caseous consistency. Sneezing, irritation, and obstruction are severe. The irritation may cause the animal to shake its head, rub its nose along the ground or poke its muzzle

repeatedly into hedges and bushes. Sticks and twigs may be pushed up into the nostrils as a result and cause laceration and bleeding. Stertorous, difficult respiration accompanied by mouth breathing may be evident when both nostrils are obstructed. In the most severe cases a distinct pseudomembrane is formed that is later snorted out as a complete nasal cast. In the chronic stages multiple proliferative non-erosive nodules 2–8 mm in diameter and 4 mm high with marked mucosal edema are visible in the anterior nares.<sup>7</sup>

#### Familial allergic rhinitis

In familial allergic rhinitis in cattle, the clinical signs begin in the spring and last until late fall.<sup>2</sup> Affected animals exhibit episodes of violent sneezing and extreme pruritus manifested by rubbing their nostrils on the ground, trees, and other inanimate objects and frequently scratching the nares with their hind feet. Dyspnea and loud snoring sounds are common and affected animals frequently clean their nostrils with their tongues. The external nares contain a thick mucoid discharge and the nasal mucosa is edematous and hyperemic. The clinical abnormalities resolve during the winter months. All affected animals are positive to intradermal skin testing for a wide variety of allergens.

#### Mycotic rhinitis

Mycotic rhinitis in the horse is characterized by noisy respirations, circumferential narrowing of both nasal passages and thickening of the nasal septum. The nasal conchae and turbinates may be roughened and edematous, and the ventral meati decreased in size bilaterally. The nasal discharge may be unilateral or bilateral. Endoscopically, granulomas may be found in almost any location in the nasal cavities and extending on to the soft palate and into the maxillary sinus.<sup>5</sup> The disease is discussed in detail in Chapter 24.

### Endoscopic examination

Endoscopic examination using a flexible fiberoptic endoscope or a rigid endoscope is very useful for the visual inspection of lesions affecting the nasal mucosae of horses and cattle that are not visible externally. Radiographic or computed tomographic imaging can be used to detect atrophic rhinitis, although use of these techniques on a wide scale is clearly not practical.<sup>8</sup>

### CLINICAL PATHOLOGY

Examination of nasal swabs of scrapings for bacteria, inclusion bodies or fungi may aid in diagnosis. Discharges in allergic rhinitis usually contain many more eosinophils than normal. Nasal mucosal biopsy specimens are useful for microbiological and histopathological examination.<sup>3</sup>

## NECROPSY FINDINGS

Rhinitis is not a fatal condition, although animals may die of specific diseases in which rhinitis is a prominent lesion.

## DIFFERENTIAL DIAGNOSIS

Rhinitis is readily recognizable clinically. Differentiation of the specific diseases listed under Etiology, above, is discussed under their respective headings.

**Allergic rhinitis in cattle** must be differentiated from maduromycosis, rhinosporidiosis, and infection with the pasture mite (*Tyrophagus palmarum*). The differential diagnosis may be difficult if allergic rhinitis occurs secondary to some of these infections.

**Rhinitis in the horse** must be differentiated from inflammation of the facial sinuses or guttural pouches in which the nasal discharge is usually purulent and persistent and often unilateral, and there is an absence of signs of nasal irritation. A malodorous nasal discharge, frontal bone distortion, draining tracts at the poll, and neurological abnormalities are common in cattle with chronic frontal sinusitis as a complication of dehorning.<sup>9</sup>

## TREATMENT

Specific treatment aimed at control of individual causative agents is described under each disease. Thick tenacious exudate that is causing nasal obstruction may be removed gently and the nasal cavities irrigated with saline. A nasal decongestant sprayed up into the nostrils may provide some relief. Newborn piglets with inclusion body rhinitis may be affected with severe inspiratory dyspnea and mouth-breathing that interferes with sucking. The removal of the exudate from each nostril followed by irrigation with a mixture of saline and antimicrobials will provide relief and minimize the development of a secondary bacterial rhinitis. Animals affected with allergic rhinitis should be taken off the pasture for about a week and treated with antihistamine preparations.

## OBSTRUCTION OF THE NASAL CAVITIES

Nasal obstruction occurs commonly in cattle and sheep. The disease is usually chronic and due to:

- In sheep, infestation with *Oestrus ovis*
- In cattle, most often enzootic nasal granuloma, acute obstruction or the allergic condition 'summer snuffles'. Cystic enlargement of the ventral nasal conchae in cattle can cause unilateral<sup>10</sup> or bilateral nasal obstruction.<sup>11</sup>

Minor occurrences include the following:

- Large mucus-filled polyps developing in the posterior nares of cattle and

sheep and causing unilateral or bilateral obstruction

- Granulomatous lesions caused by a fungus, *Rhinosporidium* sp. and by the blood fluke, *Schistosoma nasalis*
- A chronic pyogranuloma due to *Coccidioides immitis* infection has occurred in the horse<sup>12</sup>
- Foreign bodies may enter the cavities when cattle rub their muzzles in bushes in an attempt to relieve the irritation of acute allergic rhinitis
- Nasal amyloidosis occurs rarely in mature horses and is characterized clinically by stertorous breathing and raised, firm, nonpainful, nodular swellings on the rostral nasal septum and floor of the nasal cavity.<sup>13</sup> Affected horses do not have any other illness and surgical removal of the lesions is recommended
- Infestation of the nasopharynx of horses by *Gasterophilus pecorum* causes obstruction of the upper airway.<sup>14</sup>

## Neoplasms

Neoplasms of the olfactory mucosa are not common but do occur, particularly in sheep, goats, and cattle, where the incidence in individual flocks and herds may be sufficiently high to suggest an infectious cause.<sup>15</sup> The lesions are usually situated just in front of the ethmoid bone, are usually unilateral but may be bilateral and have the appearance of adenocarcinomas of moderate malignancy. In cattle, the disease is commonest in 6–9-year-olds and may be sufficiently extensive to cause bulging of the facial bones. The tumors are adenocarcinomas arising from the ethmoidal mucosa, and they metastasize in lungs and lymph nodes. Clinical signs include nasal discharge, often bloody, mouth-breathing and assumption of a stretched-neck posture. There is evidence to suggest that a virus may be associated. A similar syndrome is observed in cattle with other nasal tumors such as osteoma.

Neoplasia that obstructs the nasal cavity occurs in horses with squamous cell carcinoma or adenocarcinoma of the sinus or nasal cavity, angiosarcoma and a variety of other rare tumors.<sup>16</sup> Epidermal inclusion cysts of the nasal diverticulum of horses can cause obstruction of the nasal cavity, but are not neoplasms.<sup>17</sup> Cysts of the paranasal sinuses can cause marked facial deformity and obstruction to air passages.<sup>18</sup>

## Enzootic nasal adenocarcinoma

Enzootic nasal adenocarcinoma occurs in sheep and goats.<sup>15</sup> The disease is sporadic but has occurred in related flocks, which suggests that it may be an enzootic problem. The clinical findings include a

persistent serous, mucous, or mucopurulent nasal discharge and stridor. Affected sheep progressively develop anorexia, dyspnea, and mouth-breathing and most die within 90 days after the onset of signs. The tumors originate unilaterally or occasionally bilaterally in the olfactory mucosa of the ethmoid turbinates. They are locally invasive but not metastatic. Histologically the tumors are classified as adenomas or, more frequently, adenocarcinomas. The etiology is unknown, but a retrovirus may be involved. Budding and extracellular retrovirus-like particles have been observed ultrastructurally in enzootic nasal tumors of goats.<sup>15</sup>

## Ethmoidal hematomas

Ethmoidal hematomas are encapsulated, usually expanding, insidious, potentially distorting and obstructing lesions of the nasal cavities that occur in horses.<sup>19</sup> Chronic unilateral nasal discharge is common and lesions are usually advanced at the time of diagnosis. There is stertorous breathing and upper airway obstruction in later stages of the disease. The nasal discharge is serous or mucoid and intermittently sanguineous, sanguinopurulent and usually unrelated to exercise. Diagnosis is made by endoscopy and radiography. Surgical removal is possible and successful in some cases. Multiple intralesional injection of formalin (1–100 mL of 10% neutral buffered formalin injected at 10 day intervals) through an endoscope can cure the tumor but there is the risk of serious adverse effects if the ethmoidal hematoma penetrates the cribriform plate.<sup>5,20</sup> The procedure involves the injection of a sufficient volume of 10% neutral buffered formalin to distend the lesion. The formalin is injected via an endoscope once every 10 days until the lesion resolves by sloughing. Between one and 20 injections are required. However, the prognosis for long-term resolution of the tumor is poor because of high rates of recurrence.

## CLINICAL FINDINGS

In cattle, sheep, and pigs there is severe inspiratory dyspnea when both cavities are blocked. The animals may show great distress and anxiety and breathe in gasps through the mouth. Obstruction is usually not complete and a loud, wheezing sound occurs with each inspiration. A nasal discharge is usually present but varies from a small amount of blood-stained serous discharge when there is a foreign body present to large quantities of purulent exudate in allergic rhinitis. Shaking of the head and snorting are also common signs. If the obstruction is unilateral the distress is not so marked and the difference in breath streams



between the two nostrils can be detected by holding the hands in front of the nose. The magnitude of the air currents from each nostril on expiration can be assessed with the aid of a piece of cotton thread (watching the degree of deflection). The passage of a stomach tube through each nasal cavity may reveal evidence of a space-occupying lesion. The diameter of the tube to be used should be one size smaller than would normally be used on that animal to insure that the tube passes easily. The signs may be intermittent when the obstruction is caused by a pedunculated polyp in the posterior nares.

### TREATMENT

Treatment must be directed at the primary cause of the obstruction. Removal of foreign bodies can usually be effected with the aid of long forceps, although strong traction is often necessary when the obstructions have been in position for a few days. As an empirical treatment in cattle oral or parenteral administration of iodine preparations is in general use in chronic nasal obstruction.

### REFERENCES

1. Wiseman A et al. *Vet Rec* 1982; 110:420.
2. Krahwinkel DJ et al. *J Am Vet Med Assoc* 1988; 192:1593.
3. Shibahara T et al. *Aust Vet J* 2001; 79:363.
4. Davis PR et al. *J Am Vet Med Assoc* 2000; 217:707.
5. Marriott MR et al. *Aust Vet J* 1999; 77:371.
6. Watson PJ et al. *Vet Rec* 2003; 153:704.
7. Olchoway TWJ et al. *J Am Vet Med Assoc* 1995; 207:1211.
8. Frame EM et al. *Vet Rec* 2000; 146:558.
9. Ward JL, Rebhun WC. *J Am Vet Med Assoc* 1992; 201:326.
10. Jean CS, Robertson JT. *Can Vet J* 1987; 28:251.
11. Ross MW et al. *J Am Vet Med Assoc* 1986; 188:857.
12. Hodgkin EC et al. *J Am Vet Med Assoc* 1984; 184:339.
13. Shaw J, Sautet JY. *Vet Pathol* 1987; 24:183.
14. Smith MA et al. *Vet Rec* 2005; 156:283.
15. De Las Heras M et al. *Vet Pathol* 1991; 28:474.
16. Dixon PM, Head KW. *Vet J* 1999; 157:279.
17. Frankeny RL. *J Am Vet Med Assoc* 2003; 223:221.
18. Lane J et al. *Equine Vet J* 1987; 19:537.
19. Stich KL et al. *Compend Contin Educ Pract Vet* 2001; 23:1094.
20. Frees KE et al. *J Am Vet Med Assoc* 2001; 219:950.

### EPISTAXIS AND HEMOPTYSIS

Epistaxis is bleeding from the nostrils regardless of the origin of the hemorrhage, and hemoptysis is the coughing up of blood, with the hemorrhage usually originating in the lungs. Both epistaxis and hemoptysis are important clinical signs in cattle and horses. The bleeding may be in the form of a small volume of blood-stained serous discharge coming from the nose only, or it can be a large volume of whole blood coming precipitously from both nostrils and sometimes the mouth. The first and most important decision is to determine the exact location of the bleeding point.

### ETIOLOGY

Epistaxis occurs commonly in the horse and may be due to lesions in the nasal cavity, nasopharynx, auditory tube diverticulum (guttural pouch) or lungs (see Table 10.5). **Exercise-induced pulmonary hemorrhage** is described under that heading earlier in this chapter.

Hemorrhagic lesions of the nasal cavity, nasopharynx, and guttural pouch in the horse usually cause unilateral epistaxis of varying degree depending on the severity of the lesions. **Pulmonary lesions** in the horse resulting in hemorrhage into the lumen of the bronchi also result in epistaxis. Blood originating from the lungs of the horse is discharged most commonly from the nostrils and not the mouth because of the horse's long soft palate. Also, blood from the lungs of the horse is not foamy when seen at the nose because the horizontal position of the major bronchi allows blood to flow out freely without being coughed up and made foamy. It was previously thought that upper respiratory tract hemorrhage could be distinguished from lower respiratory tract hemorrhage by the blood in the latter case being foamy. This does not apply in the horse. Froth is usually the result of pulmonary edema, in which case it is a very fine, pink, stable froth.

Bleeding from lesions of the upper respiratory tract of horses usually occur spontaneously while the horse is at rest. One of the commonest causes of unilateral epistaxis in the horse is mycotic ulceration of the blood vessels in the wall of the guttural pouch (guttural pouch mycosis).

**Other less common causes** of nasal bleeding include hemorrhagic polyps of the mucosa of the nasal cavity or the paranasal sinuses, and encapsulated hematomas, which look like hemorrhagic polyps, commencing near the ethmoidal labyrinth and expanding into the nasal cavity and the pharynx. There is respiratory obstruction, coughing, choking, and persistent unilateral epistaxis. The capsule of the hematoma is respiratory epithelium. Surgical correction has been achieved. Another cause, most uncommonly, is a parasitic arteritis of the internal carotid artery as it courses around the guttural pouch.<sup>1</sup>

Mild epistaxis is a common finding in horses and cattle with severe thrombocytopenia.<sup>2</sup>

Erosions of the nasal mucosa in glanders, granulomatous and neoplastic diseases and trauma due to passage of a nasal tube or endoscope, or from physical trauma externally, are other obvious causes.

A case of fibrous dysplasia in the ventral meatus of a horse with epistaxis is

recorded.<sup>3</sup> Similarly, in congestive heart failure and purpura hemorrhagica there may be a mild epistaxis.

Neoplasia, and notably hemangiosarcoma, of the upper or lower respiratory tract can cause epistaxis.<sup>4</sup>

Envenomation of horses by rattlesnakes in the western USA caused a clinical syndrome that includes swelling of the head, dyspnea, and epistaxis.<sup>5</sup>

**Poisoning** by bracken fern or moldy sweet clover is a common cause of spontaneous epistaxis in cattle. The epistaxis may be bilateral, and hemorrhages of other visible and subcutaneous mucous membranes are common. An enzootic ethmoidal tumor has been described in cattle in Brazil and was at one time a disease of some importance in Sweden.<sup>6</sup> The lesion occupies the nasal cavities, causes epistaxis and may invade paranasal sinuses.

**In hemoptysis in horses** the blood flows along the horizontal trachea and pools in the larynx until the swallowing reflex is stimulated and swallowing occurs; or coughing is stimulated and blood is expelled through the mouth and nostrils. In some horses repeated swallowing, without eating or drinking, can be a good indicator that bleeding is occurring. The origin of the hemorrhage is usually in the lungs and in cattle the usual cause is a pulmonary arterial aneurysm and thromboembolism from a posterior vena caval thrombosis, usually originating from a hepatic abscess.<sup>7</sup> Recurrent attacks of hemoptysis with anemia and abnormal lung sounds usually culminate in an acute intrapulmonary hemorrhage and rapid death.

**The origin** of the hemorrhage in epistaxis and hemoptysis may be obvious, as in traumatic injury to the turbinates during passage of a stomach tube intranasally or if a systemic disease with bleeding defects is present. In many other cases, however, the origin of the hemorrhage is not obvious and special examination procedures may be required. Careful auscultation of the lungs for evidence of abnormal lung sounds associated with pulmonary diseases is necessary.

### CLINICAL EXAMINATION

The nasal cavities should be examined visually with the aid of a strong, pointed source of light through the external nares. Only the first part of the nasal cavities can be examined directly but an assessment of the integrity of the nasal mucosa can usually be made. In epistaxis due to systemic disease or clotting defects the blood on the nasal mucosa will usually not be clotted. When there has been recent traumatic injury to the nasal

mucosa or erosion of a blood vessel by a space-occupying lesion such as tumor or nasal polyp, the blood will usually be found in clots in the external nares.

The nasal cavities should then be examined for any evidence of obstruction as set out in the previous section. When the blood originates from a pharyngeal lesion there are frequent swallowing movements and a short explosive cough, which may be accompanied by the expulsion of blood from the mouth. Hematological examinations are indicated to assist in the diagnosis of systemic disease or clotting defects. Radiological examinations of the head are indicated when space-occupying lesions are suspected.

In the horse, the use of the flexible fiberoptic endoscope will permit a thorough examination of the nasal cavities, nasopharynx, guttural pouch and larynx, trachea and major bronchi.

### TREATMENT

Specific treatment of epistaxis and hemoptysis depends on the cause. Hemorrhage from traumatic injuries to the nasal mucosa does not usually require any treatment. Space-occupying lesions of the nasal mucosa may warrant surgical therapy. Epistaxis associated with guttural pouch mycosis may require ligation of the affected artery. The ineffectiveness of therapy for exercise-induced pulmonary hemorrhage has been discussed above. There is no successful treatment for the hemoptysis due to pulmonary aneurysm and posterior vena caval thrombosis in cattle. General supportive therapy is as for any spontaneous hemorrhage and includes rest, blood transfusions, and hematinics.

### REFERENCES

- Owen RR. *EquineVet J* 1974; 6:143.
- Hoyt PG et al. *J Am Vet Med Assoc* 2000; 217:717.
- Livesey MA et al. *EquineVet J* 1984; 16:144.
- Southwood LL et al. *J Vet Intern Med* 2000; 14:105.
- Dickinson C.E et al. *J Am Vet Med Assoc* 1996; 208:1866.
- Tokarnia CH et al. *Pesqui Agro Bras Ser Vet* 1972; 7:41.
- Braun U et al. *Vet Rec* 2002; 150:209.

### LARYNGITIS, TRACHEITIS, BRONCHITIS

Inflammation of the air passages usually involves all levels and no attempt is made here to differentiate between inflammations of various parts of the tract. They are all characterized by cough, noisy inspiration and some degree of inspiratory embarrassment.

### ETIOLOGY

All infections of the upper respiratory tract cause inflammation, either acutely or

as chronic diseases. In most diseases the laryngitis, tracheitis, and bronchitis form only a part of the syndrome and the causes listed below are those diseases in which upper respiratory infection is a prominent feature.

#### Cattle

- Infectious bovine rhinotracheitis (bovine herpesvirus-1), calf diphtheria (necrotic laryngitis), *Histophilus somnus*
- Tracheal stenosis in feedlot cattle, 'honker cattle', etiology unknown<sup>1</sup>
- Congenital cavitation of the arytenoid may contribute to laryngeal abscess development
- Syngamus laryngeus* infests the larynx of cattle in the tropics.

#### Sheep

- Chronic infection with *Actinomyces pyogenes*.

#### Horses

- Equine herpesvirus (EVR), equine viral arteritis (EVA), equine viral influenza (EVI), strangles (*S. equi*)
- Idiopathic ulceration of the mucosa covering the arytenoid cartilages<sup>2</sup>

#### Pigs

- Swine influenza.

### PATHOGENESIS

Irritation of the mucosa causes frequent coughing, and swelling causes partial obstruction of the air passages, with resulting inspiratory dyspnea. Necrotic laryngitis in calves is associated with marked changes in pulmonary function, modifies tracheal dynamics and disturbs the growth process by increasing the energetic cost of breathing; this can result in impaired feed intake and predisposition to secondary pulmonary infection and subsequent respiratory failure from progressive exhaustion.<sup>3</sup>

### CLINICAL FINDINGS

Coughing and inspiratory dyspnea with laryngeal roaring or stridor are the common clinical signs. In the early stages of acute infections the cough is usually dry and nonproductive and is easily induced by grasping the trachea or larynx, or by exposure to cold air or dusty atmospheres. In acute laryngitis, the soft tissues around the larynx are usually enlarged and painful on palpation. In chronic affections, the cough may be less frequent and distressing and is usually dry and harsh. If the lesions cause much exudation or ulceration of the mucosa, as in bacterial tracheobronchitis secondary to infectious bovine rhinotracheitis in cattle, the cough is moist, and thick mucus, flecks of blood and fibrin may be coughed up. The cough is very painful and the animal makes attempts to suppress it.

Fever and toxemia are common and affected animals cannot eat or drink normally.

Inspiratory dyspnea varies with the degree of obstruction and is usually accompanied by a loud stridor and harsh breath sounds on each inspiration. These are best heard over the trachea although they are quite audible over the base of the lung, being most distinct on inspiration. The respiratory movements are usually deeper than normal and the inspiratory phase more prolonged and forceful. Additional signs, indicative of the presence of a primary specific disease, may also be present.

**Examination of the larynx** is usually possible through the oral cavity using a cylindrical speculum of appropriate size and a bright, pointed source of light. This is done relatively easily in cattle, sheep, and pigs but is difficult in the horse. Lesions of the mucosae of the arytenoid cartilages and the vault of the larynx are usually visible if care and time are taken. In laryngitis, there is usually an excessive quantity of mucus, which may contain flecks of blood or pus in the pharynx. Palpation of the pharyngeal and laryngeal areas may reveal lesions not readily visible through a speculum. During opening of the larynx, lesions in the upper part of the trachea are sometimes visible. The use of a fiberoptic endoscope allows a detailed examination of the upper respiratory tract.

Inflammation or lesions of the larynx may be severe enough to cause marked inspiratory dyspnea and death from asphyxia. In calves and young cattle with diphtheria the lesion may be large enough (or have a pedicle and act like a valve) to cause severe inspiratory dyspnea, cyanosis, anxiety and rapid death. The excitement associated with loading for transportation to a clinic or of a clinical examination, particularly the oral examination of the larynx, can exaggerate the dyspnea and necessitate an emergency tracheotomy.

Most cases of bacterial laryngitis will heal without obvious residual sign after several days of antimicrobial therapy. Some cases in cattle become chronic in spite of therapy due to the inflammation extending down into the arytenoid cartilages resulting in a chronic chondritis due to a sequestrum similar to osteomyelitis. Abscess formation is another common cause of chronicity. Secondary bacterial infection of primary viral diseases, or extension of bacterial infections to the lungs commonly results in pneumonia.

**Tracheal stenosis** in cattle is characterized by extensive edema and hemorrhage of the dorsal wall of the trachea, resulting in coughing (honking), dyspnea

and respiratory stertor.<sup>1</sup> Complete occlusion of the trachea may occur. Affected animals may be found dead without any premonitory signs.

### CLINICAL PATHOLOGY

Laboratory examinations may be of value in determining the presence of specific diseases.

### NECROPSY FINDINGS

Upper respiratory infections are not usually fatal but lesions vary from acute catarrhal inflammation to chronic granulomatous lesions depending upon the duration and severity of the infection. When secondary bacterial invasion occurs a diphtheritic pseudomembrane may be present and be accompanied by an accumulation of exudate and necrotic material at the tracheal bifurcation and in the dependent bronchi.

### DIFFERENTIAL DIAGNOSIS

Inflammation of the larynx usually results in coughing, and inspiratory dyspnea with a stertor and loud abnormal laryngeal sounds on auscultation over the trachea and over the base of the lungs on inspiration. Lesions of the larynx are usually visible by laryngoscopic examination, those of the trachea and major bronchi are not so obvious unless special endoscopic procedures are used. Every reasonable effort should be used to inspect the larynx and trachea. Obstruction of the nasal cavities and other parts of the upper respiratory tract may also be difficult to distinguish unless other signs are present.

### TREATMENT

Most of the common viral infections of larynx, trachea, and major bronchi will resolve spontaneously if the affected animals are **rested**, not worked and not exposed to inclement weather and dusty feeds. Secondary bacterial complications must be recognized and treated with the appropriate antimicrobial.

The bacterial infections can result in severe inflammation with necrosis and granulomatous lesions and must be treated with **antimicrobials**. Calves with calf diphtheria should be treated with a broad-spectrum antimicrobial daily for 3–5 days. Several days are usually required for the animal to return to normal. A broad-spectrum antimicrobial daily or more often for up to 3 weeks or more may be necessary for treatment of the chondritis.

**NSAIDs** such as flunixin meglumide may be used in an attempt to reduce the laryngeal edema associated with some severe cases of bacterial laryngitis in cattle.

Animals with severe lesions and marked inspiratory dyspnea may require a

**tracheotomy** and insertion of a tracheotomy tube for several days until the lesion heals. The tube must be removed, cleaned out and replaced at least once daily because of the accumulation of dried mucus plugs which interfere with respiration. The techniques of tracheotomy and permanent tracheostomy in the horse have been described.<sup>4,5</sup> Surgical excision of chronic granulomatous lesions and abscesses of the larynx may be indicated following failure of long-term antimicrobial therapy but postoperative complications of laryngeal and pharyngeal paralysis may occur. Laryngotomy as a treatment for chronic laryngeal obstruction in cattle with long-term survival of 58% has been described.<sup>6</sup>

**Tracheolaryngostomy** of calves with chronic laryngeal obstruction due to necrobacillosis has been used with a high degree of success.<sup>7</sup> Under general anesthesia and dorsal recumbency, an incision is made over the lower third of the thyroid and cricoid cartilages and the first two tracheal rings.<sup>7</sup> The larynx is easily visualized and necrotic tissue removed using a curette. The edges of the cartilages are sutured closed. A wedge-shaped piece of the first two tracheal rings is removed to create a tracheostomy, which is allowed to close after about 1 week when the postoperative swelling has subsided with the aid of daily care of the surgical site and the possible use of flunixin meglumide.<sup>7</sup> No tracheotomy tube is required.

### REFERENCES

1. Erickson ED, Doster AR. *J Vet Diagn Invest* 1993; 5:449.
2. Kelly G et al. *Equine Vet* 2003; 35:276
3. Leukeux P, Art T. *Vet Rec* 1987; 121:353.
4. Shappel KK et al. *J Am Vet Med Assoc* 1988; 192:939.
5. Dixon P. *In Pract* 1988; 10:249.
6. Gasthuys F et al. *Vet Rec* 1992; 130:220.
7. West HJ. *Vet J* 1997; 153:81.

### TRAUMATIC LARYNGOTRACHEITIS, TRACHEAL COMPRESSION AND TRACHEAL COLLAPSE

Traumatic laryngotracheal injury can occur following endotracheal intubation used for general anesthesia.<sup>1</sup> Nasotracheal intubation can result in mucosal injury to the nasal meatus, the arytenoid cartilages, the trachea, the dorsal pharyngeal recess, the vocal cords and the entrance to the guttural pouches.<sup>1</sup> The laryngeal injury is attributed to the tube pressure on the arytenoid cartilages and vocal folds and the tracheal damage is due to the pressure exerted by the inflated cuff on the tracheal mucosa.

**Tracheal collapse** occurs in calves,<sup>2,3</sup> in mature cattle,<sup>4</sup> in goats, and in horses,

including miniature horses and foals.<sup>5</sup> Dynamic collapse is a cause of exercise intolerance in race horses that is evident only by endoscopic examination of the trachea during strenuous exercise.<sup>6</sup> Restriction of the tracheal lumen and laxity of the dorsal tracheal membrane results in varying degrees of inspiratory dyspnea with stridor, coughing, and reduced exercise tolerance. A 'honking' respiratory noise is common in affected calves when coughing spontaneously or when the trachea is palpated. Tracheal collapse in calves is associated with injuries associated with dystocia and clinical signs usually occur within a few weeks after birth. In some cases the trachea is compressed at the level of the thoracic inlet in association with callus formation of healing fractured ribs attributed to dystocia. In some cases in cattle, there is no history of dystocia or pre-existing disease or previous manipulation of the trachea and the overall lumen size may be reduced to less than 25% of normal.<sup>7</sup> Auscultation of the thorax may reveal loud referred upper airway sounds. Tracheal prostheses have been used for the treatment of tracheal collapse in calves and Miniature horses.<sup>8</sup>

**Tracheal obstruction** and collapse can result from tracheitis associated with pneumonia in the horse, tracheal neoplasia, tracheal stricture, presence of foreign bodies in the trachea and compression by masses external to the trachea.<sup>5,9</sup> It is suggested that increased respiratory effort associated with pneumonia causes collapse of the soft tissue structures of the trachea, rather than collapse of the tracheal rings. Tracheal rupture due to blunt trauma in the horse may result in severe subcutaneous emphysema and pneumomediastinum.<sup>4</sup> Conservative therapy is usually successful. Tracheal compression secondary to enlargement of the cranial mediastinal lymph nodes can also cause inspiratory dyspnea<sup>10</sup> and conservative treatment with antimicrobials is successful.

### REFERENCES

1. Holland M et al. *J Am Vet Med Assoc* 1986; 189:1447.
2. Jelinski M, Vanderkop M. *Can Vet J* 1990; 31:783.
3. Fingland RB et al. *Vet Surg* 1990; 19:371.
4. Fubini SL et al. *J Am Vet Med Assoc* 1985; 187:69.
5. Fenger CK, Kohn CW. *J Am Vet Med Assoc* 1992; 200:1698.
6. Tetens J et al. *J Am Vet Med Assoc* 2000; 216:722.
7. Ashworth CD et al. *Can Vet J* 1992; 33:50.
8. Couetil LL et al. *J Am Vet Med Assoc* 2004; 225:1727.
9. Mair TS, Lane JG. *Equine Vet Educ* 2005; 17:146.
10. Rigg DL et al. *J Am Vet Med Assoc* 1985; 186:283.

### PHARYNGITIS

Pharyngitis in all species is associated with infectious diseases of the upper

airway. It is most studied in horses, probably because of the frequency of examination of the upper airway in this species. Pharyngitis in horses has many similarities to tonsillitis in children.<sup>1</sup> The disorder in horses involves follicular lymphoid hyperplasia of the pharynx and involves both the pharyngeal tonsil and the extensive and diffuse lymphoid tissue in the walls and dorsal aspect of the pharynx. These tissues form the mucosal associated lymphoid tissues and are an important component of the normal immunological response of horses.<sup>2</sup> The condition occurs in approximately 34% of Thoroughbred race horses<sup>3</sup> and is probably as common in other breeds of horse. The condition is first detectable in 2–3-month-old foals and reaches its highest prevalence and greatest severity in yearlings and 2-year-old horses in race training.<sup>4</sup> It is evident on endoscopic examination as diffuse, multiple, small, white nodules in the roof and walls of the pharynx. The nodules can be confluent and there is often excessive mucus present in severely affected horses. The clinical significance of the condition is debated. Affected race horses do not have impaired race performance.<sup>4</sup> Affected horses recover spontaneously as they age, or after treatment with topical anti-inflammatory drugs. The condition is probably a normal aging process and necessary for development of a competent immune system in young horses.<sup>1</sup>

Infestation of the nasopharynx of horses by larvae of the bot fly *Gasterophilus pecorum* causes obstruction of the upper airway and a parasitic pharyngitis.<sup>5</sup> Diagnosis is by visualization of the parasite during endoscopic examination.

## REFERENCES

1. Lunn DP. *Equine Vet J* 2001; 33:218.
2. Kumar P et al. *Equine Vet J* 2001; 33:224.
3. Sweeney CR et al. *J Am Vet Med Assoc* 1991; 198:1037.
4. Auers DE et al. *Aust Vet J* 1985; 62:124.
5. Smith MA et al. *Vet Rec* 2005; 156:283.

## UPPER AIRWAY OBSTRUCTION IN HORSES: LARYNGEAL HEMIPLEGIA ('ROARERS')

Obstruction of the upper airway is a common cause of exercise intolerance in horses and is characterized in most cases by unusual respiratory noise during heavy exercise.

### ETIOLOGY

The cause of laryngeal hemiplegia is degeneration of the recurrent laryngeal nerve with subsequent neurogenic atrophy of the cricoarytenoid dorsalis and other intrinsic muscles of the larynx.<sup>1</sup> The etiology of **neuronal degeneration** is

unknown but the pathological changes are typical of a distal axonopathy.<sup>1</sup> The disease is usually idiopathic but occasional cases are caused by guttural pouch mycosis or inadvertent perivascular injection of irritant material, such as phenylbutazone, around the jugular vein and vagosympathetic trunk. **Bilateral laryngeal paralysis** is usually associated with intoxication (organophosphate, haloxon) or trauma from endotracheal intubation during general anesthesia.

### EPIDEMIOLOGY

#### Prevalence

The disease affects large horses more commonly than ponies, and it is commonly recognized in draft horses, Thoroughbreds, Standardbreds, Warmbloods and other breeds of large horse. The **prevalence** of laryngeal hemiplegia in Thoroughbred horses in training is between 1.8 and 13%<sup>2–4</sup> depending, among other factors, on the criteria used to diagnose the condition. Among apparently normal Thoroughbred horses examined after racing, grade 4 laryngeal hemiplegia was detected in 0.3% of 744 horses, grade 3 in 0.1%, and grade 2 in 1.1%.<sup>5</sup> Male horses over 160 cm tall are at most risk of developing the disease.<sup>6</sup> There is evidence of a **familial** distribution of the disease with offspring of affected parents being more frequently affected (61%) than adult offspring of unaffected parents (40%).<sup>7</sup>

### PATHOGENESIS

Axonal degeneration causes preferential atrophy of the adductor muscles of the larynx, although both adductor (dorsal cricoarytenoid muscle) and adductor (lateral cricoarytenoid muscle) are involved.<sup>8</sup> Fiber-type grouping of laryngeal muscles, evidence of recurrent laryngeal neuropathy, is present in draft foals as young as 2 weeks of age, indicating an early onset of the disease.<sup>9</sup> The disease is progressive in some horses.<sup>10</sup>

Compromised function of the adductor muscles results in **partial occlusion of the larynx** by the arytenoid cartilage and vocal fold during inspiration. The obstruction is most severe when airflow rates through the larynx are large, such as during strenuous exercise. **Laryngeal obstruction** increases the work of breathing, decreases the maximal rate of oxygen consumption and exacerbates the hypoxemia and hypercarbia normally associated with strenuous exercise by horses.<sup>11,12</sup> These effects result in a severe limitation to athletic capacity and performance.

### CLINICAL FINDINGS

Clinical findings include exercise intolerance and production of a whistling or roaring noise during strenuous exercise.

The disease can be detected by analysis of respiratory noise.<sup>13</sup>

**Endoscopic** examination of the upper airway provides the definitive diagnosis in most cases. Examination of the larynx is performed with the horse at rest and the position and movement of the arytenoid cartilages assessed. Laryngeal function can also be observed during swallowing, brief (30–60 s) bilateral nasal occlusion, and during and after exercise. Endoscopic examination during **strenuous exercise on a treadmill** of horses with grade III disease may be beneficial in determining the severity of the disease.<sup>14,15</sup> Horses with early or mild degeneration of the recurrent laryngeal nerve and associated laryngeal musculature can have normal laryngeal function at rest. However, the loss of muscle function becomes apparent during exercise, when the laryngeal muscles of affected animals fatigue more rapidly than do those of normal animals, with the result that laryngeal dysfunction can become apparent during or immediately after exercise. Endoscopic examination during exercise is useful in differentiating the disease from **axial deviation of the aryepiglottic folds**.<sup>16</sup>

The severity of the disease is graded I through IV:

- **Grade I** is normal, there being synchronous, full abduction and adduction of both arytenoid cartilages
- **Grade II** presents as weakness of the adductors evident as asynchronous movement and fluttering of the arytenoid cartilage during inspiration and expiration, but with full abduction during swallowing or nasal occlusion
- **Grade III** has asynchronous movement of the arytenoid cartilage during inspiration or expiration; full abduction is not achieved during swallowing or nasal occlusion
- **Grade IV** implies marked asymmetry of the larynx at rest and no substantial movement of the arytenoid cartilage during respiration swallowing or nasal occlusion.<sup>17</sup>

There are no characteristic changes in the hemogram or in serum biochemical variables in resting horses. During exercise there is a marked exacerbation of the normal exercise-induced hypoxemia and the development of hypercapnia in affected horses.<sup>11,12</sup>

### NECROPSY FINDINGS

Lesions are confined to an axonopathy of the recurrent laryngeal nerves and neurogenic muscle atrophy of the intrinsic muscles of the larynx.

### DIAGNOSTIC CONFIRMATION

Diagnostic confirmation is achieved by endoscopic examination of the larynx.

**DIFFERENTIAL DIAGNOSIS**

Differential diagnoses of exercise intolerance and exercise-induced respiratory noise include:

- Dorsal displacement of the soft palate
- Subepiglottic cysts
- Arytenoid chondritis
- Aryepiglottic fold entrapment
- Axial deviation of the aryepiglottic folds<sup>16</sup>

**TREATMENT**

Treatment requires a prosthetic laryngoplasty with or without ventriculectomy. The disease is not life-threatening and horses that are not required to work strenuously or in which respiratory noise associated with mild exercise is not bothersome to the rider may not require surgery.

**REVIEW LITERATURE**

Cahill JJ, Goulden BE. The pathogenesis of equine laryngeal hemiplegia – a review. *N Z Vet J* 1987; 35:82–87.

**REFERENCES**

1. Cahill JJ, Goulden BE. *N Z Vet J* 1986; 34:161.
2. Lane JG et al. *Equine Vet J* 1987; 19:531.
3. Sweeney CR et al. *J Am Vet Med Assoc* 1991; 198:1037.
4. Hillidge CJ. *Vet Rec* 1986; 118:535.
5. Brown JA et al. *Equine Vet J* 2005; 37:397.
6. Cahill JJ, Goulden N. *N Z Vet J* 1987; 35:82.
7. Ohnesorge B et al. *Zentralbl Vet A* 1993; 40:134.
8. Duncan ID et al. *Equine Vet J* 1991; 23:94.
9. Harrison GD et al. *Acta Neuropathol* 1992; 84:307.
10. Dixon PM et al. *Equine Vet J* 2002; 34:29.
11. Christley RM et al. *Equine Vet J* 1997; 29:6.
12. King CM et al. *Equine Vet J* 1994; 26:220.
13. Cable CS et al. *Am J Vet Res* 2002; 63:1707.
14. Hammer EJ et al. *J Am Vet Med Assoc* 1998; 212:399.
15. Dart AJ et al. *Aust Vet J* 2001; 79:109.
16. King DS et al. *Vet Surg* 2001; 30:151.
17. Ducharme NG et al. *Vet Surg* 1991; 20:174.

**DORSAL DISPLACEMENT OF THE SOFT PALATE (SOFT PALATE PARESIS)**

The soft palate of equids is unique in that it provides an airtight seal between the oropharynx and nasopharynx during respiration. The horse is an obligate nasal breather except during very unusual circumstances. During swallowing the soft palate is transiently displaced dorsally as part of the normal act of deglutition to permit passage of the feed bolus. Displacement of the soft palate other than during deglutition is abnormal and can be intermittent, which is usually associated with exercise, or persistent, which is usually associated with disruption of the nerve supply to the pharynx.

**Intermittent dorsal displacement of the soft palate**

Intermittent dorsal displacement of the soft palate occurs during exercise in some horses and causes an expiratory obstruction to air flow through the larynx and pharynx. Estimates of the prevalence of the disease are unreliable because of the transient nature of the displacement and the fact that it only occurs during exercise. It is estimated to occur in 0.5–1.3% of Thoroughbred race horses.<sup>1</sup> The cause of intermittent displacement of the soft palate during exercise is unknown, although a number of mechanisms, including palatal myositis,<sup>2</sup> ulcers of the caudal border of the soft palate, caudal retraction of the larynx and lower respiratory disease, are suggested. Retropharyngeal lymphadenopathy can cause neurogenic paresis of the pharyngeal and palatal muscles, with dorsal displacement of the soft palate the most obvious sign of pharyngeal collapse during exercise.<sup>3</sup> The immediate cause of the displacement is the negative intrapharyngeal pressure generated during exercise.

Displacement of the soft palate during strenuous exercise places the soft palate dorsal to the epiglottis, a position in which it impedes flow of air during expiration.<sup>4</sup> Peak expiratory airflow, minute ventilation, tidal volume and rate of oxygen consumption are all decreased in horses with dorsal displacement of the soft palate, whereas inspiratory flow and breathing rate are not affected.<sup>4</sup>

**Clinical signs**

The clinical signs include exercise intolerance and intermittent production of a gurgling noise during strenuous exercise.

**Endoscopic examination** of resting horses usually demonstrates a normal pharynx and larynx. Brief nasal occlusion (30–60s) that induces displacement of the soft palate, in combination with a history of respiratory noise during exercise, increases the likelihood of the disorder. Endoscopic examination of affected horses during or immediately after exercise may reveal dorsal displacement of the soft palate. Radiographic examination of the pharynx may reveal a shortened epiglottis (< 7 cm) in some affected horses.

**DIFFERENTIAL DIAGNOSIS**

Differential diagnoses for exercise intolerance and respiratory noise include **laryngeal hemiplegia, subepiglottic cysts, arytenoid chondritis and aryepiglottic fold entrapment**. The important differentiating factor is that the noise occurs predominantly during expiration, and has a more gurgling sound to it than does the noise produced by horses with laryngeal hemiplegia.

**Treatment**

There is no definitive treatment. Usual methods of surgical intervention include augmentation of the epiglottis by injection of polytetrafluoroethylene (Teflon) paste, resection of the caudal edge of the soft palate or sternothyrohyoideus myectomy,<sup>5</sup> although some of these interventions may have deleterious effects on upper airway airflow.<sup>6</sup> A newer surgical technique involves the 'laryngeal tie-forward' procedure.<sup>7</sup> Reports of success of surgical treatment of the disease are not definitive, in part because horses with the disorder that went untreated are not examined. It is plausible that the response to surgical treatment could be the result of enforced rest rather than the manipulation. Treatment of retropharyngeal lymphadenopathy may be beneficial. Nonsurgical treatment includes the use of anti-inflammatory drugs, tongue-ties, a variety of bits and a laryngohyoid support apparatus.<sup>8</sup>

**Persistent dorsal displacement of the soft palate**

Persistent dorsal displacement of the soft palate is usually the result of damage to the innervation of the pharyngeal and palatal muscles as a result of:

- ◊ Guttural pouch mycosis
- ◊ Guttural pouch empyema
- ◊ Retropharyngeal lymph node abscessation
- ◊ Equine protozoal myeloencephalitis
- ◊ Otitis media
- ◊ Myositis or muscle disease, such as white muscle disease
- ◊ Botulism.

Blockade of the pharyngeal branch of the vagus nerve by injection of local anesthetic causes persistent dorsal displacement of the soft palate whereas blockade of the hypoglossal and glossopharyngeal nerves does not.<sup>9,10</sup>

**Clinical signs**

Persistent dorsal displacement of the soft palate causes dysphagia and stertorous respiration. Food material discharges from the nares and there is frequent coughing, probably secondary to the aspiration of feed material. Affected horses may develop aspiration pneumonia. If the condition persists, there is dehydration and weight loss. **Endoscopic examination** of the upper airways reveals dorsal displacement of the soft palate and may reveal other abnormalities, such as guttural pouch mycosis, that may provide a cause for the disease.

**Treatment**

Treatment should be directed toward resolution of the underlying disease, and provision of food and water. It is often

necessary to feed affected horses through a nasogastric tube.

## REFERENCES

1. Brown JA et al. *Equine Vet J* 2005; 37:397.
2. Blythe LL et al. *J Am Vet Med Assoc* 1983; 183:781.
3. Derksen FJ et al. In: *Proceedings of the Dubai International Equine Symposium 1997*:23.
4. Franklin SH et al. *Equine Vet J Suppl* 2002; 34:379.
5. Smith JJ, Emberstson RM. *Vet Surg* 2005; 34:5.
6. Holcombe SJ et al. *J Appl Physiol* 1994; 77:2812.
7. Woodie JB et al. *Equine Vet J* 2005; 37:418.
8. Woodie JB et al. *Equine Vet J* 2005; 37:425.
9. Holcombe SJ et al. *J Am Vet Med Assoc* 1998; 59:504.
10. Holcombe SJ et al. *Am J Vet Res* 1997; 58:1022.

## OTHER CONDITIONS OF THE UPPER AIRWAY OF HORSES

### Aryepiglottic fold entrapment (epiglottic entrapment)

Entrapment of the epiglottis in the fold of tissue that extends from the arytenoid cartilage to the ventrolateral aspect of the epiglottis causes exercise intolerance and respiratory noise during exercise in racehorses.<sup>1</sup> The disorder occurs in both young and mature race horses, and is found in approximately 1% of Thoroughbred race horses.<sup>2,3</sup> The entrapment is often detected during rhinolaryngoscopic examination of racehorses, although it might not be the cause of poor performance.<sup>3</sup> The presence of aryepiglottic fold entrapment causes a predominantly expiratory obstruction to air flow across the larynx during exercise. The interference with airflow, if any, does not appreciably impair performance in all horses.<sup>3</sup>

#### *Clinical signs*

Clinical signs are of exercise intolerance and respiratory noise during exercise. Acute cases can be associated with epiglottitis, whereas chronic cases are usually an incidental finding during endoscopic examination of the upper airway.

**Endoscopic examination** of the upper airway reveals the border of the epiglottis to be obscured by the aryepiglottic folds. Normally, the serrated margin of the epiglottis and dorsal blood vessels extending to the lateral margins of the epiglottis are readily apparent, but when the epiglottis is entrapped these features are no longer visible. Because of the frequently intermittent nature of the entrapment, the horse should be examined on several occasions and preferably immediately after strenuous exercise. Radiography of the pharynx reveals the entrapped epiglottis.

#### *Treatment*

Treatment consists of surgical revision of the aryepiglottic fold. However, given that the chronic condition has not been

demonstrated to adversely affect performance, and that the complication rate for surgical correction of the disorder is 60%, careful consideration should be given to not attempting surgical repair, especially in animals performing to expectation.<sup>3</sup> Entrapment associated with acute epiglottitis should include administration of antimicrobials and anti-inflammatory agents to resolve the epiglottitis.

### Epiglottitis

This is usually a disease of racehorses, although animals of any age can be affected. The clinical signs are exercise intolerance, respiratory noise and coughing. The disease can readily be mistaken for epiglottic entrapment. The epiglottis is thickened and ulcerated, and these changes are apparent on endoscopic examination. Treatment includes topical application of a mixture of nitrofurazone, dimethyl sulfoxide, glycerin and prednisolone, and systemic administration of anti-inflammatory drugs. The prognosis for recovery is excellent.<sup>4</sup>

### Subepiglottic cysts

Fluid-filled cysts in the subepiglottic, dorsal pharyngeal or soft palate tissues cause exercise intolerance and abnormal respiratory noise in exercising adult horses and mild dysphagia, chronic cough and nasal discharge in foals.<sup>5,6</sup> The cysts are usually embryonic remnants, although cysts may be acquired in adult horses by obstruction or inflammation of mucous glands.<sup>6</sup> Endoscopic examination of the upper airway reveals the presence of smooth-walled cysts. Subepiglottic cysts may only be apparent on careful examination of the epiglottis, although most will cause the epiglottis to assume a more upright posture than is normal. Treatment is surgical removal.

### Arytenoid chondritis

This is a progressive disease of the arytenoid cartilages in which there is distortion of the cartilage with consequent partial occlusion of the lumen of the larynx. The cause of the disease is not known but it is most common in racehorses in heavy work.<sup>7</sup> Distortion and swelling of the cartilage, combined with restricted abduction, increase resistance to airflow through the larynx and cause respiratory noise during exercise and exercise intolerance. In severe cases respiratory noise and increased respiratory effort may be apparent at rest. The disease can occur as a progression of idiopathic mucosal ulceration of the axial aspect of the arytenoid cartilages.<sup>8</sup>

**Endoscopic examination** reveals the cartilage to be enlarged and distorted and there may be luminal projections of

cartilage and granulation tissue. In less severe cases there is mild swelling of the cartilage and ulceration of the mucosa covering the cartilage. Bilateral disease is uncommon. The cartilage contains areas of necrosis, dystrophic mineralization and granulation tissue.

#### *Treatment*

Treatment requires surgical removal of the affected cartilage, although progression of the disease can be achieved in horses with mild lesions by administration of antimicrobials and anti-inflammatory drugs.

### Mucosal lesions of the arytenoid cartilages

Lesions of the mucosa of the axial aspect of the arytenoid cartilages are observed in Thoroughbred race horses.<sup>3,8</sup> The condition occurs in approximately 2.5% of Thoroughbred race horses and 0.6% of Thoroughbred yearlings.<sup>3,8</sup> The pathogenesis is unknown. The disorder is recognized during endoscopic examination of the horses for other reasons (before sale, examination for exercise-induced pulmonary hemorrhage). Endoscopic appearance of the lesion is that of a roughly circular lesion of the mucosa of the axial surface of the arytenoid cartilage, with or without visual evidence of inflammation, and without deformity of the underlying cartilage.<sup>8</sup> The lesions can progress to arytenoid chondritis, although most do not.<sup>8</sup> Because of the risk of progression, medical therapy including systemic or local administration of antimicrobial and anti-inflammatory drugs is indicated.<sup>8</sup> The prognosis for full recovery is excellent.

### Axial deviation of the aryepiglottic folds

This is one of the most common abnormalities detected during laryngoscopic examination of horses running on a treadmill.<sup>9</sup> The disorder can only be detected in horses by endoscopic examination of the larynx while the horse is performing strenuous exercise. Collapse of the axial portion of the aryepiglottic folds causes obstruction of the laryngeal airway during inspiration. Treatment is by transendoscopic laser ablation of the portion of the fold that collapses during exercise.<sup>10</sup>

### Epiglottic retroversion

This uncommon cause of exercise intolerance and respiratory noise during strenuous exercise is detected during endoscopic examination of exercising horses.<sup>11</sup> During exercise, the epiglottis of affected horses flips into the larynx during inspiration and back to its normal position during expiration. The cause is unknown but the condition can be

induced by injection of local anesthetic around the hypoglossal and glossopharyngeal nerves.<sup>12</sup> Treatment is rest.

### Retropharyngeal lymphadenopathy

Lymphadenopathy of the retropharyngeal lymph nodes is usually associated with *S. equi* var. *equi* infection and is often a sequel to strangles (see Strangles).<sup>13,14</sup> Shedding of *S. equi* from clinically inapparent retropharyngeal lymph node abscesses is an important source of new infections in horse barns. Retropharyngeal lymphadenopathy is also caused by trauma to the pharynx and neoplasia (predominantly lymphosarcoma). Enlargement of the retropharyngeal lymph nodes compresses the nasopharynx, increases resistance to air flow and may impair swallowing.

### Clinical signs

Clinical signs are swelling of the parotid region, although this may be slight even in horses with marked respiratory distress, pain on palpation of the parotid region, stertorous respiratory noise, respiratory distress and dysphagia evident as food material discharging from the nostrils. Affected horses are frequently depressed, inappetent and pyrexia.

**Endoscopic examination** of the upper airway will reveal ventral displacement of the dorsal wall to the pharynx and narrowing of the nasopharynx. There may be deviation of the larynx to the side away from the mass. Guttural pouch empyema often coexists with retropharyngeal lymph node infection and the guttural pouches should be examined. Radiography will reveal the presence of a soft tissue density in the retropharyngeal region with compression of the guttural pouches and pharynx. Hematological examination often demonstrates a mature neutrophilia and hyperfibrinogenemia. The serum antibody titer to the M protein of *S. equi* is usually elevated.

### Treatment

Treatment consists of administration of penicillin (procaine penicillin 20 000 IU/kg, intramuscularly every 12 h) until signs of the disease resolve, followed by administration of a combination of sulfonamide and trimethoprim (15–30 mg/kg orally every 12 h for 7–14 d). Administration of anti-inflammatory drugs such as **phenylbutazone** (2.2 mg/kg intravenously or orally every 12 h) is important in reducing inflammation and swelling and thereby allowing the horse to eat and drink. Horses that have severe respiratory distress may require a tracheotomy. Dysphagic horses may require fluid and nutritional support. Surgical drainage of the abscess is difficult and should be

reserved for cases with large, cavitating lesions evident on radiographic or ultrasonographic examination.

Control consists of preventing infection of horses by *S. equi* var. *equi* and adequate treatment of horses with strangles.

### REFERENCES

- Boles C et al. J Am Vet Med Assoc 1978; 172:883.
- Sweeney CR et al. J Am Vet Med Assoc 1991; 198:1037.
- Brown JA. Equine Vet J 2005; 37:397.
- Hawkins J, Tulleners EP. J Am Vet Med Assoc 1994; 205:1577.
- Stick JA, Boles CL. J Am Vet Med Assoc 1980; 77:62.
- Haynes PF et al. Equine Vet J 1990; 22:369.
- Haynes PF et al. J Am Vet Med Assoc 1980; 177:1135.
- Kelly G et al. Equine Vet J 2003; 35:276.
- Tan RH et al. Vet J 2004; 170:243.
- King DS et al. Vet Surg 2001; 30:151.
- Parente EJ et al. Equine Vet J 1998; 30:270.
- Holcombe SJ et al. Equine Vet J Suppl 1999; 30:45.
- Todhunter RJ et al. J Am Vet Med Assoc 1985; 187:600.
- Golland LC et al. Aust Vet J 1993; 72:161.

### DISEASES OF THE GUTTURAL POUCHES (AUDITORY TUBE DIVERTICULUM, EUSTACHIAN TUBE DIVERTICULUM)

The guttural pouches are diverticula of the auditory (or eustachian) tubes found in equids and a limited number of other species.<sup>1,2</sup> The function of the guttural pouch is unclear, although it may have a role in regulation of cerebral blood pressure, swallowing, and hearing.<sup>1</sup> It is unlikely to have a role in brain cooling.<sup>2</sup> Each guttural pouch of an adult horse has a volume of approximately 300 mL and is divided by the stylohyoid bone into lateral and medial compartments.

**The medial compartment** of the guttural pouch contains a number of important structures including the internal carotid artery and glossopharyngeal, hypoglossal, and spinal accessory nerves in addition to branches of the vagus nerve and the cervical sympathetic trunk. Retropharyngeal lymph nodes lie beneath the mucosa of the ventral aspect of the medial compartment, an important factor in the development of guttural pouch empyema.

**In the lateral compartment** the external carotid artery passes along the ventral aspect as do the glossopharyngeal and hypoglossal nerves. Involvement of any of the above-mentioned structures is important in the pathogenesis and clinical signs of guttural pouch disease, and may result in abnormalities, such as Horner's syndrome, that are not readily recognized as being caused by guttural pouch disease.

The common diseases of the guttural pouch are described below.

### GUTTURAL POUCH EMPYEMA

#### ETIOLOGY

Empyema is the accumulation of purulent material in one or both guttural pouches. Initially, the purulent material is liquid, although it is usually viscid, but over time becomes inspissated and is kneaded into ovoid masses called **chondroids**. Chondroids occur in approximately 20% of horses with guttural pouch empyema.<sup>3</sup> The condition is most commonly associated with *S. equi* var. *equi* infection and is a recognized sequel to strangles.<sup>3-5</sup> Therefore, any horse with guttural pouch empyema should be isolated and treated as if it were infected with *S. equi* var. *equi* until proven otherwise. The empyema may be associated with other conditions of the guttural pouches, especially if there is impaired drainage of the pouch through the pharyngeal opening of the eustachian tube.

#### EPIDEMIOLOGY

The epidemiology, apart from its association with strangles, has not been defined. The disease occurs in all ages of horses, including foals, and all equids, including asses and donkeys.<sup>3</sup> The case fatality rate is approximately 10%, with one-third of horses having complete resolution of the disease.<sup>3</sup> Guttural pouch empyema occurs in approximately 7% of horses with strangles.<sup>4</sup> The recovery rate for horses with uncomplicated empyema treated appropriately is generally considered to be good, although the presence of chondroids worsens the prognosis.

#### PATHOGENESIS

The pathogenesis of guttural pouch empyema is unclear although when secondary to strangles it is usually due to the rupture of abscessed retropharyngeal lymph nodes into the medial compartment. Continued drainage of the abscesses presumably overwhelms the normal drainage and protective mechanisms of the guttural pouch, allowing bacterial colonization, influx of neutrophils and accumulation of purulent material. Swelling of the mucosa, especially around the opening to the pharynx, impairs drainage and facilitates fluid accumulation in the pouch. The accumulation of material in the pouch causes distension and mechanical interference with swallowing and breathing. Inflammation of the guttural pouch mucosa may involve the nerves that lie beneath it and result in neuritis with subsequent pharyngeal and laryngeal dysfunction and dysphagia.

#### CLINICAL FINDINGS

These include:<sup>3</sup>

- Purulent nasal discharge



- Swelling of the area caudal to the ramus of the mandible and ventral to the ear
- Lymphadenopathy
- Carriage of the head with the nose elevated above its usual position
- Dysphagia and other cranial nerve dysfunction
- Respiratory stertor.

The nasal discharge is usually unilateral, as is the disease, intermittent and white to yellow. Guttural pouch empyema is not usually associated with hemorrhage, although the discharge may be blood tinged. Bilateral disease, and the resultant neuritis and mechanical interference with swallowing and breathing, may cause discharge of feed material from the nostrils, dysphagia and respiratory stertor.

**Endoscopic examination** of the pharynx reveals drainage of purulent material from the pharyngeal opening of the eustachian tube of the affected side. The guttural pouch contains a variable quantity of purulent material, although in severe cases the quantity of fluid may be sufficient to prevent adequate examination of the pouch with an endoscope.

**Radiographic examinations** demonstrate the presence of radiodense material in the guttural pouch, sometimes the presence of an air-gas interface (fluid line) within the pouch and distension of the pouch with impingement into the nasopharynx.<sup>5</sup> Chondroids are evident as multiple circular radiodensities. Passage of a **catheter** into the guttural pouch via the pharyngeal opening permits aspiration of fluid for cytology and bacterial culture.

#### CLINICAL PATHOLOGY

Hematological examination may reveal evidence of chronic infection, including a mild leukocytosis, hyperproteinemia, and hyperfibrinogenemia. Fluid from the affected guttural pouch contains large numbers of degenerate neutrophils and occasional intracellular and extracellular bacteria. Bacterial culture yields *S. equi* in approximately 30% of cases and *S. zooepidemicus* in approximately 40% of cases.<sup>3</sup>

#### NECROPSY FINDINGS

Lesions of guttural pouch empyema include the presence of purulent material in the guttural pouch and inflammation of the mucosa of the affected guttural pouch.

#### DIAGNOSTIC CONFIRMATION

Diagnostic confirmation in a horse with clinical signs of guttural pouch disease is achieved by demonstration of purulent material in the guttural pouch by endoscopic or radiographic examination and examination of the fluid.

#### DIFFERENTIAL DIAGNOSIS

Differential diagnosis of guttural pouch empyema includes:

- **Abscessation of retropharyngeal lymph nodes**
- **Guttural pouch tympany**
- **Guttural pouch mycosis.**

Guttural pouch empyema should also be differentiated from other causes of nasal discharge in horses including:

- **Sinusitis**
- **Recurrent airway obstruction (heaves)**
- **Pneumonia**
- **Esophageal obstruction**
- **Dysphagia of other cause.**

Infection by *Mycobacterium avium* complex organisms causes nasal discharge and granulomatous lesions in the guttural pouch.<sup>6</sup>

#### TREATMENT

The principles of treatment are removal of the purulent material, eradication of infection, reduction of inflammation, relief of respiratory distress and provision of nutritional support in severely affected horses.

**Removal of purulent material** may be difficult but can be achieved by repeated flushing of the affected guttural pouch. The guttural pouch can be flushed through a catheter (10–20 French, 3.3–7 mm male dog urinary catheter) inserted as needed via the nares, or a catheter (polyethylene 240 tubing) with a coiled end inserted via the nares and retained in the pouch for several days.<sup>7</sup> The pouch can also be flushed through the biopsy port of an endoscope inserted into the guttural pouch.

The choice of fluid with which to flush the guttural pouch is arbitrary but frequently used fluids include normal (isotonic) saline, lactated Ringer's solution or 1% (v/v) povidone-iodine solution. It is important that the fluid infused into the guttural pouch be nonirritating as introduction of fluids such as hydrogen peroxide or strong solutions of iodine (e.g. 10% v/v povidone iodine) will exacerbate the inflammation of the mucosa and underlying nerves and can actually prolong the course of the disease.<sup>8</sup> The frequency of flushing is initially daily, with reduced frequency as the empyema resolves.

**Infusion of antibiotics** into the guttural pouches is probably without merit. Because of the viscid nature of the empyema fluid, it is necessary to infuse large volumes of lavage solution (1–2 L) on consecutive days. It may be necessary to treat for 7–10 days. The infusion of **acetylcysteine** (60 mL of a 20% solution)

into the pouch after lavage with 1–2 L of saline has been reported to be effective in aiding the removal of purulent material.<sup>9</sup> Removal of **chondroids** usually requires surgery, although dissection and removal of chondroids through the pharyngeal opening has been described.<sup>10</sup> A stone remover inserted through the biopsy channel of the endoscope can be useful for removal of small numbers of chondroids, but is tedious if there are large numbers of them. A rule of thumb is that if the chondroids occupy more than one-third of the volume of the guttural pouch, then removal should be carried out surgically.

**Systemic antimicrobial administration** is recommended for all cases of guttural pouch empyema because of the frequent association of the disease with bacterial infection and especially *S. equi* and *S. zooepidemicus* infection of the retropharyngeal lymph nodes.<sup>3</sup> The antibiotic of choice is **penicillin G** (procaine penicillin G, 20 000 IU/kg intramuscularly every 12 h for 5–7 d), although a combination of sulfonamide and trimethoprim (15–30 mg/kg orally every 12 h for 5–7 d) is often used. **Topical application of antimicrobials** into the guttural pouch is probably ineffective because they do not penetrate the infected soft tissues of the pouch and retropharyngeal area.

**NSAIDs** such as flunixin meglumine (1 mg/kg intravenously or orally every 12 h) or phenylbutazone (2.2 mg/kg intravenously or orally every 12 h) are used to reduce inflammation and pain. Severely affected horses may require relief of respiratory distress by tracheotomy. Dysphagic horses may need nutritional support, including administration of fluids.

Chronic cases refractory to treatment might require fistulation of the guttural pouch into the pharynx.<sup>11</sup>

#### CONTROL

Prevention of guttural pouch empyema is based on a reduction in the frequency and severity of *S. equi* infection in horses (see Strangles).

#### REVIEW LITERATURE

Freeman DE. Diagnosis and treatment of diseases of the guttural pouch (Part I). *Compend Contin Educ PractVet* 1980; 2:S3–S11.

Freeman DE. Diagnosis and treatment of diseases of the guttural pouch (Part II). *Compend Contin Educ PractVet* 1980; 2:S25–S31.

#### REFERENCES

1. Baptiste KE. *Vet J* 1998; 155:139.
2. Maloney SK et al. *S Afr J Sci* 2002; 98:189.
3. Judy CE et al. *J Am Vet Med Assoc* 1999; 215:1666.
4. Sweeney CR et al. *J Am Vet Med Assoc* 1987; 191:1446.
5. Newton JR et al. *Vet Rec* 1997; 140:84.
6. Sills RC et al. *Vet Pathol* 1990; 27:133.

7. White SL, Williamson L. *Vet Med* 1987; 82:76.
8. Wilson J. *Equine Vet J* 1985; 17:242.
9. Bentz BG et al. *Equine Pract* 1996; 18:33.
10. Seahorn TL, Schumacher J. *J Am Vet Med Assoc* 1991; 199:368.
11. Hawkins JF et al. *J Am Vet Med Assoc* 2001; 218:405.

## GUTTURAL POUCH MYCOSIS

### ETIOLOGY

Mycosis of the guttural pouch is caused by infection of the dorsal wall of the medial compartment of the pouch, caudal and medial to the articulation of the stylohyoid bone and the petrous temporal bone.<sup>1</sup> The most common fungi isolated from the lesions are *Aspergillus (Emericella) nidulans*, *Aspergillus fumigatus* and, rarely, *Penicillium* spp. and *Mucor* spp., although spores of these fungi are present in the guttural pouches of normal horses.<sup>2</sup>

### EPIDEMIOLOGY

The disease occurs in horses of both genders and all breeds. Horses are affected at all ages, with the youngest recorded case being a 6-month-old foal.<sup>3</sup> The overall prevalence is low, although precise figures are lacking. The **case fatality rate** is approximately 33%.

### PATHOGENESIS

The pathogenesis of the disease is unclear, although it is likely that fungal spores gain access to the guttural pouch through the pharyngeal opening. The spores then germinate and proliferate in the mucosa of the dorsal, medial aspect of the medial compartment of the guttural pouch. The location of the lesion is consistent but the reason for the disease occurring in this particular position is unclear. Factors that predispose to the development of mycotic lesions have not been determined, although it appears unlikely that fungal infection is the initial insult to the mucosa. Invasion of guttural pouch mucosa is followed by invasion of the nerves, arteries, and soft tissues adjacent to it. Invasion of the nerves causes glossopharyngeal, hypoglossal, facial, sympathetic or vagal dysfunction. Invasion of the internal carotid artery, and occasionally the maxillary or external carotid, causes weakening of the arterial wall and aneurysmal dilatation of the artery, with subsequent rupture and hemorrhage. Death is caused by hemorrhagic shock or, in horses with dysphagia, aspiration pneumonia or starvation.

Guttural pouch mycosis is usually **unilateral**, although in approximately 8% of cases there is erosion of the medial septum and spread of infection into the other pouch.<sup>4</sup> There is no predisposition for either the left or right pouch.<sup>4</sup> Guttural pouch mycosis presents as either **epistaxis** that is not associated with exercise or as **cranial nerve disease**.

### CLINICAL FINDINGS

**Epistaxis** is usually severe and frequently life-threatening. There is profuse bleeding of bright red blood from both nostrils during an episode, and between episodes there may be a slight, serosanguineous nasal discharge. There are usually several episodes of epistaxis over a period of weeks before the horse dies. Most horses that die of guttural pouch mycosis do so because of hemorrhagic shock.<sup>3,4</sup>

**Signs of cranial nerve dysfunction** are common in horses with guttural pouch mycosis and may precede or accompany epistaxis.

- **Dysphagia** is the most common sign of cranial nerve disease and is attributable to lesions of the glossopharyngeal and cranial laryngeal (vagus) nerves. Dysphagic horses may attempt to eat or drink but are unable to move the food bolus from the oral cavity to the esophagus
- Affected horses frequently have nasal discharge that contains feed material and often develop aspiration pneumonia
- Lesions of the recurrent laryngeal nerve cause **laryngeal hemiplegia**
- **Horner's syndrome** (ptosis of the upper eyelid, miosis, enophthalmos and prolapse of the nictitating membrane) is seen when the lesion involves the cranial cervical ganglion or sympathetic nerve trunk
- **Facial nerve dysfunction**, evident as drooping of the ear on the affected side, lack of facial expression, inability to close the eyelids, corneal ulceration and deviation of the muzzle away from the affected side, also occurs.

Signs of cranial nerve and sympathetic trunk dysfunction may resolve with eradication of the infection, but are frequently permanent.<sup>4</sup>

Guttural pouch mycosis is also associated with **pain** on palpation of the parotid region, **head shyness** and **abnormal head position**. The infection may spread to the atlanto-occipital joint, causing pain on movement of the head,<sup>5</sup> or to the brain, causing encephalitis.<sup>6</sup>

**Endoscopic examination** of the guttural pouch reveals a plaque of dark yellow to black necrotic material in the dorsal aspect of the medial compartment. A sample of the material can be collected through a biopsy port of the endoscope and submitted for culture. The mycotic plaque cannot be easily dislodged by manipulation with biopsy instruments or the end of the endoscope. In cases with ongoing or recent hemorrhage, the presence of large quantities of blood may prevent identification of the mycotic plaque. Both pouches should always be

examined because of the occasional occurrence of bilateral disease or extension of the disease through the medial septum.

**Radiographic examination** of the guttural pouches may reveal the presence of a lesion in the appropriate position, but is frequently unrewarding.

### CLINICAL PATHOLOGY

There are no characteristic findings on the hemogram, nor are there serum biochemical abnormalities. Horses with repeated hemorrhage may be **anemic**. Immunoblot may identify the presence of serum antibodies specific for *A. fumigatus* in infected horses,<sup>7</sup> although the diagnostic usefulness has not been determined. **Culture** of a sample of the necrotic tissue will frequently yield one of the causative fungi.

### NECROPSY FINDINGS

Lesions of guttural pouch mycosis include the presence of a clearly demarcated, yellow-brown to black, dry plaque of necrotic tissue in the dorsal aspect of the medial compartment of the guttural pouch. The plaque of tissue is firmly adherent to underlying tissues and may perforate the medial septum and invade the other pouch. The infection may involve the adjacent nerves and blood vessels and spread to soft tissues and bone. Histological examination reveals the presence of inflammatory cells in nerves and tissues surrounding the gross lesion. There is chromatolysis and degeneration of neurones in affected nerves. The internal carotid artery may have an aneurysmal dilatation or there may be rupture of the arterial wall without dilatation. There is usually partial thrombosis of the arterial wall.

### DIFFERENTIAL DIAGNOSIS

Differential diagnoses for epistaxis not associated with exercise include **ethmoidal hematoma** or **guttural pouch empyema**, **neoplasia**, **rupture of the longus capitis muscle**<sup>8</sup> or penetration by a **foreign body**.<sup>9</sup>

### TREATMENT

Treatment of guttural pouch mycosis involves prevention of death from hemorrhage and administration of antifungal agents.

**Prevention of hemorrhage** from the internal carotid or maxillary artery is achieved by surgical ligation, transarterial coil embolization or occlusion with intra-arterial balloons of one or more of the external carotid, internal carotid or maxillary artery.<sup>10,11</sup> Because of the high rate of death from hemorrhage in horses with guttural pouch mycosis, some

authorities recommend that all horses with the disease have the internal artery ligated or occluded.<sup>4,10</sup> Medical treatment of horses with hemorrhage secondary to guttural pouch mycosis is rarely successful.<sup>10</sup>

**Administration of antifungal agents** by instillation into the guttural pouch through a catheter or endoscope has been reported, although there is disagreement about the need for such treatment in horses that have had the problematic arteries ligated or occluded.<sup>12</sup> Oral administration of antifungal agents is generally ineffective or prohibitively expensive, although itraconazole (5 mg/kg orally once daily) may be useful.<sup>13</sup> Agents reported to be usefully given by topical administration include enilconazole (60 mL of 33 mg/mL solution once daily for 3 weeks), miconazole (60 mL of 1 mg/mL solution), natamycin and nystatin.<sup>4,10,13</sup> Topical therapy is laborious because it must be continued for weeks and involves placement and maintenance of a catheter in the guttural pouch, or instillation of medication by daily endoscopy.

Horses with signs of cranial nerve or sympathetic trunk damage may not recover completely even if cured of the fungal infection because of irreparable damage to the affected nerves. Provision of supportive care, including fluid and nutrient administration to dysphagic horses and administration of antibiotics to prevent or treat aspiration pneumonia, may be indicated.

## CONTROL

There are no recognized effective measures to control or prevent the disease.

## REVIEW LITERATURE

Freeman DE. Diagnosis and treatment of diseases of the guttural pouch (Part II). *Compend Contin Educ Pract Vet* 1980; 2:S25-S31.

LePage OM et al. The mystery of fungal infection in the guttural pouches. *Vet J* 2003; 168:60.

## REFERENCES

1. Cook WR et al. *Vet Rec* 1968; 83:422.
2. Blomme E et al. *Equine Vet Educ* 1998; 10:86.
3. Cook WR. *Vet Rec* 1968; 78:396.
4. Greet TRC. *Equine Vet J* 1987; 19:483.
5. Walmsley JP. *Equine Vet J* 1988; 20:219.
6. Wagner PC et al. *Can Vet J* 1978; 27:109.
7. Guillot J et al. *Am J Vet Res* 1997; 58:1364.
8. Sweeney CR et al. *J Am Vet Med Assoc* 1993; 202:1129.
9. Bayly WM, Robertson JT. *J Am Vet Med Assoc* 1982; 180:1232.
10. Lane JG. *Equine Vet J* 1989; 21:321.
11. Leveille R et al. *Vet Surg* 2000; 29:389.
12. Spiers VC et al. *Equine Vet J* 1995; 27:151.
13. Davis EW, Legendre AM. *J Vet Intern Med* 1994; 8:304.

## GUTTURAL POUCH TYMPANY

### ETIOLOGY AND EPIDEMIOLOGY

Guttural pouch tympany refers to the gaseous distension of one, rarely both, guttural pouches of young horses. Tympany develops in foals up to 1 year of age but is usually apparent within the first several months of life. **Fillies** are more commonly affected than are colts by a ratio of 2-4:1.<sup>1</sup> The cause is not known although a polygenic cause has been proposed for Arabians.<sup>2</sup>

### CLINICAL FINDINGS

Clinical findings include marked swelling of the parotid region of the affected side with lesser swelling of the contralateral side. The swelling of the affected side is not painful on palpation and is elastic and compressible.<sup>3</sup> There are stertorous breath sounds in most affected foals due to impingement of the distended pouch on the nasopharynx. Respiratory distress may develop. Severely affected foals may be dysphagic and develop aspiration pneumonia.

**Endoscopic examination** of the pharynx reveals narrowing of the nasopharynx by the distended guttural pouch. The guttural pouch openings are usually normal. There are usually no detectable abnormalities of the guttural pouches apart from distension. Radiographic examination demonstrates air-filled pouches, and dorsoventral images permit documentation of which side is affected. There are no characteristic changes in the hemogram or serum biochemical profile.

There are no characteristic lesions and necropsy examination usually does not demonstrate a cause for the disease.

### TREATMENT

Treatment consists of surgical fenestration of the medial septum allowing drainage of air from the affected pouch into the unaffected side. The prognosis for long-term resolution of the problem after surgery is approximately 60%.<sup>1</sup>

### REFERENCES

1. McCue PM et al. *J Am Vet Med Assoc* 1989; 194:1761.
2. Blazyczek I et al. *J Hered* 2004; 95:195.
3. Freeman DE. *Compend Contin Educ Pract Vet* 1980; 2:S25-S31.

## OTHER GUTTURAL POUCH DISEASES

**Rupture of the longus capitis muscle** or avulsion of its insertion on the basisphenoid bone causes epistaxis and is

usually associated with trauma to the head, such as is caused by rearing and falling over backwards.<sup>1</sup> **Endoscopic examination** reveals:

- Compression of the nasopharynx that is asymmetric
- Blood in the guttural pouch
- Submucosal hemorrhage and swelling of the medial aspect of the medial compartment of the guttural pouch.<sup>1</sup>

**Radiographic examination** reveals ventral deviation of the dorsal pharynx and loss of the usual radiolucency associated with the guttural pouch. **Treatment is conservative** and consists of supportive care, monitoring the hematocrit, and administration of broad-spectrum antibiotics if there is concern of the development of secondary infection. The prognosis for complete recovery is guarded.

**Various neoplasms** have been recorded as involving the guttural pouches. The presenting signs are: swelling of the parotid region, epistaxis, dysphagia or signs of cranial nerve disease. Neoplasms include melanoma, lymphosarcoma, hemangiosarcoma, squamous cell carcinoma and sarcoma.<sup>2</sup> Diagnosis is made by physical, endoscopic and radiographic examination and biopsy. The prognosis is very poor to hopeless.

## REFERENCES

1. Sweeney CR et al. *J Am Vet Med Assoc* 1993; 202:1129.
2. McConnico RS et al. *Equine Vet Educ* 2001; 13:175.

## CONGENITAL DEFECTS

Primary congenital defects are rare in the respiratory tracts of animals. Hypoplasia of the epiglottis is detected occasionally in horses. Tracheal hypoplasia is recognized in calves and Miniature horses. Secondary defects, which are associated with major defects in other systems, are more common. Most of the defects in lambs are associated with defects of the oral cavity, face, and cranial vault.<sup>1</sup> Accessory lungs are recorded occasionally<sup>2,3</sup> and if their bronchi are vestigial the lungs can present themselves as tumor-like masses occupying most of the chest. Pulmonary hypoplasia is associated with congenital diaphragmatic hernia.

## REFERENCES

1. Dennis SM. *Aust Vet J* 1975; 51:347.
2. Smith RE, McEntee C. *Cornell Vet* 1974; 64:335.
3. Osborne JC, Troutt HF. *Cornell Vet* 1977; 67:222.

# Diseases of the urinary system

## INTRODUCTION 543

### PRINCIPLES OF RENAL INSUFFICIENCY 543

Renal insufficiency and renal failure 544

### CLINICAL FEATURES OF URINARY TRACT DISEASE 545

Abnormal constituents of the urine 545

Variations in daily urine flow 547

Abdominal pain, painful and difficult urination (dysuria and stranguria) 547

Morphological abnormalities of kidneys and ureters 548

Palpable abnormalities of the bladder and urethra 548

Acute and chronic renal failure 548

Uremia 548

### SPECIAL EXAMINATION OF THE URINARY SYSTEM 548

Urinalysis 548

Collection of urine samples 548

Tests of renal function and detection of renal injury 549

Diagnostic examination techniques 552

### PRINCIPLES OF TREATMENT OF URINARY TRACT DISEASE 553

#### DISEASES OF THE KIDNEY 555

Glomerulonephritis 555

Hemolytic-uremic-like syndrome 556

Nephrosis 556

Renal ischemia 556

Toxic nephrosis 557

Renal tubular acidosis 558

Interstitial nephritis 558

Embolic nephritis 558

Pyelonephritis 559

Hydronephrosis 560

Renal neoplasms 560

#### DISEASES OF THE BLADDER, URETERS AND URETHRA 561

Cystitis 561

Paralysis of the bladder 561

Rupture of the bladder (uroperitoneum) 562

Uroperitoneum in foals (uroabdomen) 562

Urolithiasis in ruminants 565

Urolithiasis in horses 570

Urethral tears in stallions and geldings 571

Urinary bladder neoplasms 571

#### CONGENITAL DEFECTS OF THE URINARY TRACT 571

Renal hypoplasia 571

Renal dysplasia 572

Polycystic kidneys 572

Ectopic ureter 572

Ureteral defect 572

Patent urachus 573

Eversion of the bladder 573

Rupture of the bladder 573

Urethral defect 573

Urethral atresia 573

Hypospadias 573

## Introduction

Diseases of the bladder and urethra are more common and more important than diseases of the kidneys in farm animals. Occasionally, renal insufficiency develops as a sequel to diseases such as pyelonephritis, embolic nephritis, amyloidosis and nephrosis. A knowledge of the physiology of urinary secretion and excretion is required to properly understand disease processes in the urinary tract. The principles of renal insufficiency presented here are primarily extrapolated from research in other species, particularly human medicine. Although, in general, these principles probably apply to farm animals, the details of renal function and renal failure in farm animals have received only limited study.

Diseases of the reproductive tract are not presented in this book and the reader is referred to textbooks on the subject. Inevitably, some of the reproductive diseases are mentioned in the differential diagnosis of the medical conditions presented here and in circumstances in which the reproductive tract is affected coincidentally. Reference to these entries in the text can be made through the index.

## Principles of renal insufficiency

The kidneys excrete the end-products of tissue metabolism (except for carbon dioxide), and maintain fluid, electrolyte and acid-base balance, by varying the volume of water and the concentration of solutes in the urine. It is convenient to think of the kidney as composed of many similar nephrons, the basic functional units of the kidney. Each nephron is composed of blood vessels, the glomerulus and a tubular system that consists of the proximal tubule, the loop of Henle, the distal tubule and the collecting duct.

The glomerulus is a semipermeable filter that allows easy passage of water and low-molecular-weight solutes but restricts passage of high-molecular-weight substances such as plasma proteins. Glomerular filtrate is derived from plasma by simple passive filtration driven by arterial blood pressure. Glomerular filtrate is identical to plasma except that it contains little protein or lipids. The volume of filtrate, and therefore its content of metabolic end-products, depends upon the hydrostatic pressure and the plasma oncotic pressure in the glomerular capillaries and on the proportion of glomeruli which are func-

tional. Because these factors are only partially controlled by the kidney, in the absence of disease, the rate of filtration through the glomeruli is relatively constant.

The epithelium of the tubules actively and selectively reabsorbs substances from the glomerular filtrate while permitting the excretion of waste products. Glucose is reabsorbed entirely, within the normal range of plasma concentration; phosphate is reabsorbed in varying amounts depending upon the needs of the body to conserve it; other substances such as inorganic sulfates and creatinine are not reabsorbed in appreciable amounts. The tubules also actively secrete substances, particularly electrolytes as they function to regulate acid-base balance. As a result of the balance between resorption and secretion, the concentration of solutes in the urine varies widely when the kidneys are functioning normally.

The principal mechanism that regulates water reabsorption by the renal tubules is antidiuretic hormone (ADH). Tissue dehydration and an increase in serum osmolality stimulates secretion of ADH from the posterior pituitary gland. The renal tubules respond to ADH by conserving water and returning serum osmolality to normal, thereby producing a concentrated urine.

Diseases of the kidneys, and in some instances of the ureters, bladder, and urethra, reduce the efficiency of the kidney's functions, resulting in: disturbances in protein, acid–base, solute and water homeostasis and in the excretion of metabolic end-products. A partial loss of function is described as **renal insufficiency**. When the kidneys can no longer regulate body fluid and solute composition, renal failure occurs.

### RENAL INSUFFICIENCY AND RENAL FAILURE

Renal function depends upon the number and functionality of the individual nephrons. Insufficiency can occur from abnormalities in:

- The rate of renal blood flow
- The glomerular filtration rate
- The efficiency of tubular reabsorption.

Of these three abnormalities, the latter two are intrinsic functions of the kidney, whereas the first depends largely on vasomotor control which is markedly affected by circulatory emergencies such as shock, dehydration, and hemorrhage. Circulatory emergencies may lead to a marked reduction in glomerular filtration but they are extrarenal in origin and cannot be considered as true causes of renal insufficiency. However, prolonged circulatory disruption can cause renal ischemia and ultimately renal insufficiency.

Glomerular filtration and tubular reabsorption can be affected independently in disease states and every attempt should be made to clinically differentiate glomerular disease from tubular disease. This is because the clinical and clinicopathological signs of renal dysfunction depend on the anatomical location of the lesion and the imbalance in function between glomeruli and tubules. Renal dysfunction tends to be a dynamic process so the degree of dysfunction varies with time. If renal dysfunction is so severe that the animal's continued existence is not possible it is said to be in a state of renal failure and the clinical syndrome of uremia will be present.

### CAUSES OF RENAL INSUFFICIENCY AND UREMIA

The causes of renal insufficiency, and therefore of renal failure and uremia, can be divided into prerenal, renal, and postrenal groups.

**Prerenal causes** include congestive heart failure and acute circulatory failure, either cardiac or peripheral, in which acute renal ischemia occurs in response to a decrease in renal blood flow. Proximal tubular function is affected by renal ischemia to a much greater extent than the glomerulus or distal tubules; this is

because of the high metabolic demands of the proximal tubules. However, those parts of the tubules within the medulla are particularly susceptible to hypoxic damage because of the low oxygen tension in this tissue, the dependency of blood flow on glomerular blood flow and the high metabolic rate of this tissue. Renal medullary necrosis is a direct consequence of these factors. In ruminants, severe bloat can interfere with cardiac output and lead to renal ischemia.

**Renal causes** include glomerulonephritis, interstitial nephritis, pyelonephritis, embolic nephritis and amyloidosis. Acute renal failure can be produced in any of the farm animal species by administration of a variety of toxins (see Toxic nephrosis, below). The disease can also occur secondary to sepsis and hemorrhagic shock. Experimental uremia has also been induced by surgical removal of both kidneys but the results, especially in ruminants, are quite different from those in naturally occurring renal failure. The clinical pathology is similar but there is a prolonged period of normality after the surgery.

**Postrenal uremia** may also occur, specifically complete obstruction of the urinary tract by vesical or urethral calculus, or more rarely by bilateral urethral obstruction. Internal rupture of any part of the urinary tract, such as the bladder, ureters, or urethra, will also cause postrenal uremia.

### PATHOGENESIS OF RENAL INSUFFICIENCY AND RENAL FAILURE

Damage to the glomerular epithelium destroys its selective permeability and permits the passage of plasma proteins into the glomerular filtrate. The predominant protein is initially albumin, because of its negative charge and a lower molecular weight than globulins; however, with advanced glomerulonephritis (such as renal amyloidosis) all plasma proteins are lost. Glomerular filtration may cease completely when there is extensive damage to glomeruli, particularly if there is acute swelling of the kidney, but it is believed that anuria in the terminal stages of acute renal disease is caused by back diffusion of all glomerular filtrate through the damaged tubular epithelium rather than failure of filtration. When renal damage is less severe, the remaining nephrons compensate to maintain total glomerular filtration by increasing their filtration rates. When this occurs, the volume of glomerular filtrate may exceed the capacity of the tubular epithelium to reabsorb fluid and solutes. The tubules may be unable to achieve normal urine concentration. As a result, an increased

volume of urine with a constant specific gravity is produced and solute diuresis occurs. This is exacerbated if the tubular function of the compensating nephrons is also impaired. The inability to concentrate urine is clinically evident as polyuria and is characteristic of developing renal insufficiency.

Decreased glomerular filtration also results in retention of metabolic waste products such as urea and creatinine. Although marked increases in serum urea concentration are probably not responsible for the production of clinical signs, because urea readily crosses cell membranes and is an effective osmole, the serum urea nitrogen concentration can be used to monitor glomerular filtration rate. However, the utility of serum urea nitrogen concentration as a measure of glomerular filtration rate is reduced because serum urea concentrations are influenced by the amount of protein in the diet, by hydration and by gastrointestinal metabolism of urea. Serum urea concentrations are higher in animals on high-protein diets and dehydration increases serum urea concentration by increasing resorption of urea in the loop of Henle, independent of effects of hydration of glomerular filtration rate. Urea is excreted into saliva of ruminants and metabolized by ruminal bacteria. In contrast, creatinine is excreted almost entirely by the kidney, creatine originates from breakdown of creatine phosphate in muscle, and serum concentrations of creatinine are a useful marker of glomerular filtration rate. The relationship between serum creatinine concentration and glomerular filtration rate is hyperbolic – a reduction in glomerular filtration rate by half results in a doubling of the serum creatinine concentration. Phosphate and sulfate retention also occurs when total glomerular filtration is reduced and sulfate retention contributes to metabolic acidosis in renal insufficiency. Phosphate retention also causes a secondary hypocalcemia, due in part to an increase in calcium excretion in the urine. In horses, the kidneys are an important route of excretion of calcium so the decreased glomerular filtration rate present in horses with chronic renal failure can result in hypercalcemia. Variations in serum potassium levels also occur and appear to depend on potassium intake. Hyperkalemia can be a serious complication in renal insufficiency in humans, where it is one of the principal causes of the myocardial asthenia and fatal heart failure that occur in uremia in this species.

Loss of tubular resorptive function is evidenced by a continued loss of sodium and chloride; hyponatremia and hypochloremia eventually occur in all cases of

renal failure. The continuous loss of large quantities of fluid due to solute diuresis can cause clinical dehydration. More often it makes the animal particularly susceptible to dehydration when there is an interruption in water availability or when there is a sudden increase in body water loss by another route – as in diarrhea.

The terminal stage of renal insufficiency – renal failure – is the result of the cumulative effects of impaired renal excretory and homeostatic functions. Continued loss of large volumes of dilute urine causes dehydration. If other circulatory emergencies arise, acute renal ischemia might result, leading to acute renal failure. Prolonged hypoproteinemia results in rapid loss of body condition and muscle weakness. Metabolic acidosis is also a contributing factor to muscle weakness and mental attitude. Hyponatremia and hyperkalemia cause skeletal muscle weakness and myocardial asthenia. Hypocalcemia may be sufficient to contribute to circulatory failure and to nervous signs. All these factors play some part in the production of clinical signs of renal failure, which are typically manifest as weakness, lethargy, inappetence and, with extensive glomerular lesions, dependent edema due to hypoproteinemia. In some cases one or other of them might be of major importance so the clinical syndrome is variable and is rarely diagnostic for renal failure. Bleeding diathesis can also be present in severely uremic animals and has been associated with a lack of antithrombin (a small protein readily lost through the damaged glomerulus), platelet factor 3, platelet dysfunction or disseminated intravascular coagulation.

Renal failure is seen as the clinical state of uremia. It is characterized biochemically by an increase in blood levels of urea and creatinine (azotemia) and by retention of other solutes as described above. Uremia can also occur in urinary tract obstruction.

## Clinical features of urinary tract disease

The major clinical manifestations of urinary tract disease are:

- Abnormal constituents of urine
- Variations in daily urine flow
- Abdominal pain, painful urination (dysuria) and difficult urination (dysuria and stranguria)
- Abnormal size of kidneys
- Abnormalities of the bladder and urethra
- Acute and chronic renal failure.

## ABNORMAL CONSTITUENTS OF THE URINE

### Proteinuria

Proteinuria can be prerenal, renal, or post renal in origin. **Prerenal proteinuria** is due to an abnormal plasma content of proteins that traverse glomerular capillary walls, with the proteins having normal permselectivity properties (such as hemoglobin, myoglobin, immunoglobulin light chains). **Renal proteinuria** is due to abnormal renal handling of normal plasma proteins, and is functional or pathological. **Functional renal proteinuria** is mild and transient as a result of altered renal physiology during or in response to a transient phenomenon, such as high-intensity exercise or fever. **Pathological renal proteinuria** is due to structural or functional lesions within the kidney, regardless of their magnitude or duration. There are three subcategories of pathological renal proteinuria: glomerular, which is due to lesions altering the permselectivity properties of the glomerular capillary wall; tubular, which is due to lesions that impair tubular recovery of plasma proteins that ordinarily traverse glomerular capillary walls having normal permselectivity properties (typically low-molecular-weight proteins); and interstitial, which is due to inflammatory lesions or disease processes (such as acute interstitial nephritis) that result in exudation of proteins from the peritubular capillaries into the urine. **Postrenal proteinuria** is due to entry of protein into the urine after it enters the renal pelvis, and is urinary or extraurinary. **Urinary postrenal proteinuria** is due to the entry of proteins derived from hemorrhagic or exudative processes affecting the renal pelvis, ureter, urinary bladder, and urethra. **Extraurinary postrenal proteinuria** is due to entry of proteins derived from the genital tract or external genitalia during voiding or in the process of collecting urine for analysis.

Normal urine contains only small amounts of protein that are insufficient to be detected using standard tests. It should be noted that the highly alkaline urine produced by herbivores produces a false-positive reaction (trace or 1+) for protein on urine dipstick tests. Prerenal proteinuria may be present in hemoglobinuria and myoglobinuria. Functional renal proteinuria is observed in normal foals, calves, kids, and lambs in the first 40 hours after they receive colostrum. Pathological renal or postrenal proteinuria and hematuria may be present when urinary tract infections are present. Postparturient cows usually have protein present in a free-catch urine sample as a result of washout of uterine fluids; this is a classic example of extra-urinary postrenal proteinuria. Demon-

stration that proteinuria originates in the kidney is easier if elements that form in the kidney, such as tubular casts, are also present in the urine, or morphological abnormalities of the kidneys are palpable per rectum or identified ultrasonographically.

Proteinuria is most accurately quantified by determining the amount of protein passed in a 24-hour period, which is impractical in clinical cases. Proteinuria is more easily quantified by indexing the protein concentration to creatinine concentration in single urine sample; this has been shown to provide an accurate representation of 24-hour protein loss in the urine.

Chronic pathological renal proteinuria may cause hypoproteinemia as in chronic glomerulonephritis and acute tubular nephrosis in horses and in amyloidosis of cattle. When proteinuria originates from pyelonephritis or cystitis other clinical and clinicopathological evidence of these diseases is usually present.

### Casts and cells

Casts are organized, tubular structures that vary in appearance depending on their composition. They occur only when the kidney is involved in the disease process. Casts are present as an indication of inflammatory or degenerative changes in the kidney, where they form by agglomeration of desquamated cells and Tamm-Horsfall protein. Casts may not form in all cases of renal disease. In addition, casts readily dissolve in alkaline urine and are best detected in fresh urine samples.

Erythrocytes, leukocytes, and epithelial cells in urine may originate in any part of the urinary tract.

### Hematuria

Hematuria can result from prerenal causes when vascular damage occurs, such as trauma to the kidney, septicemia and purpura hemorrhagica. Renal causes include acute glomerulonephritis, renal infarction, embolism of the renal artery, tubular damage as caused by toxic insult, and pyelonephritis. Postrenal hematuria occurs particularly in urolithiasis and cystitis. A special instance of hematuria is enzootic hematuria of cattle when hemorrhage originates from tumors of the urinary bladder. Hematomas of the bladder wall (cystic hematoma) cause hematuria in neonatal foals.<sup>1</sup> Typically, lesions of the kidney, bladder, and proximal urethra cause hemorrhage throughout or towards the end of urination, whereas lesions of the middle and distal urethra are responsible for bleeding at the beginning of urination.<sup>2</sup>

In severe cases of hematuria blood may be voided as grossly visible clots but

more commonly it causes a deep red to brown coloration of the urine. Less severe cases may show only cloudiness that settles to form a red deposit on standing. The hematuria may be so slight that it is detectable only on microscopic examination of a centrifuged sediment. In females, free-flow urine samples may be contaminated by blood from the reproductive tract; it may therefore be necessary to collect a sample by catheterization to avoid the chance of contamination of the urine occurring in the vagina.

Blood in urine gives positive results on biochemical tests for hemoglobin and myoglobin. Because red blood cells can be lysed in dilute urine, red-colored urine should be examined microscopically for the presence of erythrocytes. The presence of a heavy brown deposit is not sufficient basis for a diagnosis of hematuria as this may also occur in hemoglobinuria. If the bladder or urethra are involved in the process that causes hematuria, abnormalities may be detectable on physical examination. Gross hematuria persisting for long periods may result in severe blood loss anemia. Severe urinary tract hemorrhage of undetermined origin in aged mares has been recorded.<sup>3</sup> The syndrome is widely recognized, though not well documented, in Arabian mares. Endoscopic examination reveals hemorrhage in one ureter but ultrasonographic examination of the kidneys does not reveal any significant abnormalities. Surgical removal of the affected kidney is not recommended, as the hemorrhage sometimes recurs in the remaining kidney. Treatment is nonspecific. Severe hematuria can also occur in horses with pyelonephritis.<sup>4</sup>

### Hemoglobinuria

False hemoglobinuria can occur in hematuria when erythrocytes are lysed and release their hemoglobin. In this case, erythrocytes can be detected only by microscopically examining urine sediment for cellular debris.

True hemoglobinuria causes a deep red to brown coloration of urine and gives a positive reaction to biochemical tests for hemoglobin. There is no erythrocyte debris in sediment. Dipstick tests for proteinuria may not be positive unless the concentration of hemoglobin is very high.<sup>5</sup> There are many causes of intravascular hemolysis, the source of hemoglobinuria. The specific causes are listed under Hemolytic anemia.

Normally, hemoglobin liberated from circulating erythrocytes is converted to bile pigments in the cells of the reticulo-endothelial system. If hemolysis exceeds the capacity of this system to remove the hemoglobin, it accumulates in the blood

until it exceeds a certain renal threshold and then passes into the urine. Some hemoglobin is reabsorbed from the glomerular filtrate by the tubular epithelium, but probably not in sufficient amounts to appreciably affect the hemoglobin content of the urine. Hemoglobinuria will only be present when the plasma concentration exceeds the renal threshold. Consequently hemoglobin is grossly visible in plasma by the time hemoglobinuria is visible. Hemoglobin precipitates to form casts in the tubules, especially if the urine is acidic, and as a result some plugging of tubules occurs, but the chief cause of uremia in hemolytic anemia is ischemic tubular nephrosis.

### Myoglobinuria

The presence of myoglobin (myo-hemoglobin) in the urine is evidence of severe muscle damage. The only notable occurrence in animals is azoturia of horses. Myoglobinuria does not occur commonly in enzootic muscular dystrophy, possibly because there is insufficient myoglobin in the muscles of young animals. The myoglobin molecule (molecular weight 16 500) is much smaller than hemoglobin (molecular weight 64 000) and passes the glomerulus much more readily, so a detectable dark brown staining of the urine occurs without very high plasma levels of myoglobin. Detectable discoloration of the serum does not occur as in hemoglobinemia. Inherited congenital porphyria is the other disease that causes a red-brown discoloration of urine. In porphyria, the plasma is also normal in color, but urine porphyria is differentiated from myoglobinuria on the basis of a negative reaction to the guaiac test and the characteristic spectrograph. The porphyrins in inherited congenital porphyria are the only pigments that fluoresce under ultraviolet light.

The presence and type of pigment in the urine can be determined accurately by spectrographic examination, but this is rarely clinically available. Myoglobinuria is usually accompanied by clinical signs and clinical biochemistry abnormalities of acute myopathy, and clinical differentiation of myoglobinuria from hemoglobinuria is usually made on the basis of the clinical signs and serum biochemical findings, including measurement of muscle-derived enzymes such as creatine kinase. As with hemoglobin, myoglobin can precipitate in tubules and may contribute to uremia.

### Pyuria

Leukocytes or pus in urine indicates inflammatory exudation at some point in the urinary tract, usually the renal pelvis or bladder. Pyuria may occur as grossly visible clots or shreds, but is often

detectable only by microscopic examination of urine sediment. Individual cells and leukocytic casts may be present. Pyuria is usually accompanied by the presence of bacteria in urine.

### Bacteriuria

Diagnosis of urinary tract infection is based on finding a clinically relevant bacteriuria in urine collected by free catch (midstream collection into a sterile container), catheterization or cystocentesis.<sup>6</sup> In horses and adult cattle, collection of urine is limited to free catch and catheterization, because the size of the animal and intrapelvic position of the bladder prevent cystocentesis. In contrast, cystocentesis can be performed under ultrasonographic guidance in calves, small ruminants, and pigs. When culturing a urine sample obtained by catheterization, the first 20 mL or so should be discarded because of the potential for contamination from vaginal or distal urethral flora.

Reference values for urine bacterial concentrations are available for the horse; marked bacteriuria suggestive of bacterial infection may be defined as more than 40 000 colony forming units (cfu)/mL from free-catch specimens, and more than 1000 cfu/mL from catheterized specimens.<sup>6</sup>

### Crystalluria

Crystalluria should not be overinterpreted in farm animals. Crystals in the urine of herbivorous animals have no special significance unless they occur in very large numbers and are associated with clinical signs of irritation of the urinary tract. Calcium carbonate and triple phosphate crystals are commonly present in normal urine. If they occur in large numbers, it may suggest that the urine is concentrated and indicate the possible future development of urolithiasis. The presence of calcium carbonate crystals in the peritoneal fluid of a neonatal foal has been used to confirm a diagnosis of ruptured bladder.<sup>7</sup>

### Glucosuria

Glucosuria in combination with ketonuria occurs only in diabetes mellitus, an extremely rare disease in ruminants. Glucosuria might occur in association with enterotoxemia due to *Clostridium perfringens* type D and can occur after parenteral treatment with dextrose solutions, adrenocorticotrophic hormones or glucocorticoid analogs. Horses with tumor of the pars intermedia of the pituitary gland often have glucosuria. Glucosuria occurs also in acute tubular nephrosis as a result of failure of tubular resorption.

### Ketonuria

Ketonuria is a more common finding in ruminants, occurring in starvation,



acetonemia of cattle and pregnancy toxemia of ewes and does. A small amount of ketonuria is normally present in dairy cows in early lactation. As a result, it is important that the assay method used to demonstrate ketonuria is appropriate for urine, since there may be a risk for false-positive reactions on some tests. The standard test is sodium nitroprusside, which turns an intense purple color in the presence of acetate, one of the three ketoacids.

### VARIATIONS IN DAILY URINE FLOW

An increase or decrease in urine flow is often described in animals, but accuracy demands physical measurement of the amount of urine voided over a 24-hour period. This is not usually practicable in large-animal practice and it is often necessary to guess whether the flow is increased or decreased. Accurate measurement of the amount of water consumed is often easier. Care should be taken to differentiate between increased daily flow and increased frequency without increased flow. The latter is much more common. Decreased urine output rarely if ever presents as a clinical problem in agricultural animals.

Normal urine production is highly variable in large animals and is dependent to a large extent on diet, watering systems and the palatability of the water. Pregnant mares housed in tie stalls consume approximately  $53 \pm 6.2$  (SD) mL of water per kilogram body weight (BW) per day, of which  $50 \pm 8$  mL/kg is from drinking water with the remainder being water in feed.<sup>8</sup> However, most of this water is excreted in the feces with fecal and urinary water excretion being  $33.5 \pm 8$  (mL/kg)/d and  $7.6 \pm 2$  (mL/kg)/d, respectively.<sup>8</sup> Neonatal foals produce urine at an average rate of 150 (mL/kg)/d.<sup>9</sup>

#### Polyuria

Polyuria occurs when there is an increase in the volume of urine produced. Polyuria can result from extrarenal causes as when horses habitually drink excessive quantities of water (psychogenic polydipsia) and, much less commonly, in **central diabetes insipidus**, when there is inappropriate secretion of antidiuretic hormone (ADH) from the pituitary. Polyuria occurs in horses with tumors of the pars intermedia of the pituitary gland. Although the cause of the polyuria is not known it might be secondary to osmotic diuresis associated with the glucosuria, or to central diabetes insipidus. Central diabetes insipidus is reported in sibling colts.<sup>10</sup> It is extremely rare in other species but has been reported in a ram<sup>11</sup> and a cow. Another extrarenal cause is

administration of diuretic drugs including corticosteroids.

Kidney disease results in polyuria when the resorptive capacity of the remaining tubules is exceeded. Polyuria can also occur when the osmotic gradient in the renal medulla is not adequate to produce concentrated urine. Nephrogenic diabetes insipidus causes polyuria because the tubules fail to respond to ADH.

When polyuria is suspected, a urine sample should be collected to determine specific gravity or osmolality. If urine is isosthenuric with a constant specific gravity of 1.008–1.012 (the specific gravity of plasma), then the presence of renal disease should be considered. Serum urea and creatinine concentrations should be determined to evaluate glomerular filtration. If serum urea and creatinine concentrations are within normal limits, a water deprivation test can be performed to assess the animal's ability to produce concentrated urine.<sup>12</sup>

#### Oliguria and anuria

Reduction in the daily output (**oliguria**) and complete absence of urine (**anuria**) occur under the same conditions and vary only in degree. In dehydrated animals, urine flow naturally decreases in an effort to conserve water as plasma osmolality pressure increases. Congestive heart failure and peripheral circulatory failure may cause such a reduction in renal blood flow that oliguria follows. Complete anuria occurs most commonly in urethral obstruction, although it can also result from acute tubular nephrosis. Oliguria occurs in the terminal stages of all forms of nephritis. Anuria and polyuria lead to retention of solutes and disturbances of acid-base balance that contribute to the pathogenesis of uremia.

#### Pollakiuria

This is an abnormally frequent passage of urine. Pollakiuria may occur with or without an increase in the volume of urine excreted and is commonly associated with disease of the lower urinary tract such as cystitis, the presence of calculi in the bladder, urethritis and partial obstruction of the urethra. Other causes of pollakiuria include equine herpesvirus infection, sorghum cystitis and neuritis of the cauda equina in horses, neoplasia, obstructive lesions and trauma to the urethra, abnormal vaginal conformation and urachal infection.

**Dribbling** is a steady, intermittent passage of small volumes of urine, sometimes precipitated by a change in posture or increase in intra-abdominal pressure, reflecting inadequate or lack of sphincter control. Dribbling occurs in large animals with incomplete obstructive urolithiasis and from persistent urachus.

**Persistent urachus** (also called pervious or patent urachus). Failure of the urachus to obliterate at birth causes urine to dribble from the urachus continuously. Urine may also pass from the urethra. Retrograde infection from omphalitis is common, resulting in cystitis.

**Abnormalities of micturition** are classified as neurogenic or non-neurogenic. Micturition is mediated principally by the pelvic and pudendal nerves through lumbosacral spinal cord segments under the involuntary control of centers in the brain stem and voluntary control of the cerebrum and cerebellum. Reported neurogenic causes of urinary incontinence in horses include cauda equine neuritis, herpesvirus 1 myelitis, Sudan grass toxicosis, sorghum poisoning, trauma, and neoplasia. Non-neurogenic causes of urinary incontinence in horses include ectopic ureter, cystitis, urolithiasis, hypotestrogenism, and abnormal vaginal conformation.<sup>13</sup>

### ABDOMINAL PAIN, PAINFUL AND DIFFICULT URINATION (DYSURIA AND STRANGURIA)

Abdominal pain and painful urination (**dysuria**) and difficult and slow urination (**stranguria**) are manifestations of discomfort caused by disease of the urinary tract. Acute abdominal pain from urinary tract disease occurs only rarely and is usually associated with sudden distension of the renal pelvis or ureter, or infarction of the kidney. None of these conditions is common in animals, but occasionally cattle affected with pyelonephritis may have short episodes of acute abdominal pain due to either renal infarction or obstruction of the pelvis by necrotic debris. During these acute attacks of pain, the cow may exhibit downward arching of the back, paddling with the hind feet, rolling and bellowing. Abdominal pain from urethral obstruction and distension of the bladder is manifested by tail-switching, kicking at the belly and repeated straining efforts at urination accompanied by grunting. Horses with acute tubular nephrosis following vitamin K<sub>3</sub> administration might show renal colic with arching of the back, backing into corners and rubbing of the perineum and tail head.<sup>14</sup>

**Dysuria** or **painful/difficult urination** occurs in cystitis, vesical calculus, and urethritis and is manifested by the frequent passage of small amounts of urine. Grunting may occur with painful urination and the animal may remain in the typical posture after urination is completed. Differentiating pain caused by urinary disease from pain due to other causes depends largely upon the presence

of other signs indicating urinary tract involvement.

**Stranguria** is slow and painful urination associated with disease of the lower urinary tract including cystitis, vesical calculus, urethral obstruction, and urethritis. The animal strains to pass each drop of urine. Groaning and straining may precede and accompany urination when there is urethral obstruction. In urethritis, groaning and straining occur immediately after urination has ceased and gradually disappear and do not recur until urination has been repeated.

**Urine scalding of the perineum or urinary burn** is caused by frequent wetting of the skin with urine. It may be the result of urinary incontinence or the animal's inability to assume normal posture when urinating.

### MORPHOLOGICAL ABNORMALITIES OF KIDNEYS AND URETERS

Enlargement or decreased size of kidneys may be palpable on rectal examination or detected by ultrasonography. In cattle, gross enlargement of the posterior aspect of the left kidney may be palpable in the right upper flank. Abnormalities of the kidneys such as hydronephrosis in cattle may also be palpable on rectal examination. Increases in the size of the ureter may be palpable on rectal examination and indicate ureteritis or hydroureter.

### PALPABLE ABNORMALITIES OF THE BLADDER AND URETHRA

Abnormalities of the bladder that may be palpable by rectal examination include: gross enlargement of the bladder, rupture of the bladder, a shrunken bladder following rupture, and palpable abnormalities in the bladder such as cystic calculi. Abnormalities of the urethra include: enlargement and pain of the pelvic urethra and its external aspects in male cattle with obstructive urolithiasis, and obstruction of the urethral process of male sheep with obstructive urolithiasis.

### ACUTE AND CHRONIC RENAL FAILURE

The clinical findings of urinary tract disease vary with the rate of development and stage of the disease. In most cases, the clinical signs are those of the initiating cause. In horses, mental depression, colic, and diarrhea are common with oliguria or polyuria. Cattle with uremia are similar and in addition are frequently recumbent and in severe and terminal cases may have a bleeding diathesis. In chronic renal disease of all species, there is a severe loss of body weight, weakness, anorexia, polyuria, polydipsia, and ventral edema.

### UREMIA

Uremia is the systemic state that occurs in the terminal stages of renal insufficiency.

Anuria or oliguria may occur with uremia. Oliguria is more common unless there is complete obstruction of the urinary tract. Chronic renal disease is usually manifested by polyuria, but oliguria appears in the terminal stages when clinical uremia develops. The uremic animal is depressed and anorexic with muscular weakness and tremor. In chronic uremia, the body condition is poor, probably as a result of continued loss of protein in the urine, dehydration and anorexia. The respiration is usually increased in rate and depth but is not dyspneic; in the terminal stages it may become periodic in character. The heart rate is markedly increased because of terminal dehydration and myocardial asthenia but the temperature remains normal except in infectious processes and some cases of acute tubular nephrosis. An ammoniacal or uriferous smell on the breath is often described but is usually undetectable. Uremic encephalopathy occurs in a small proportion of cattle and horses with chronic renal failure.<sup>15</sup>

The animal becomes recumbent and comatose in the terminal stages. The temperature falls to below normal and death occurs quietly, the whole course of the disease having been one of gradual intoxication. Necropsy findings, apart from those of the primary disease, are nonspecific and include degeneration of parenchymatous organs, sometimes accompanied by emaciation and moderate gastroenteritis. There are rare reports of encephalopathy caused by renal insufficiency.<sup>16</sup>

Uremia has been produced experimentally in cattle by bilateral nephrectomy and urethral ligation.<sup>17,18</sup> There is a progressive increase in serum urea concentration (mean daily increase of 53 mg/dL), serum creatinine concentration (mean daily increase of approximately 3.5 mg/dL), and serum uric acid concentration. Similar findings are reported in prerenal uremia in cattle. Interestingly, serum phosphate and potassium concentrations were for the most part unchanged because of increased salivary secretion, and metabolic acidosis was not evident. Serum potassium concentrations were mildly increased after 5–7 days of bilateral nephrectomy.

### Special examination of the urinary system

Lack of accessibility limits the value of physical examination of the urinary tract

in farm animals. Rectal examination can be carried out on horses and cattle and is described in Chapter 1. In small ruminants and calves, the urinary system is largely inaccessible to physical examination although the kidneys may be palpated transabdominally.

Urinalysis and determination of blood urea and creatinine should be components of any examination of the urinary system.

### URINALYSIS

Urinalysis is an essential component of the examination of the urinary system. The reader is referred to a textbook of veterinary clinical pathology for details of the biochemical and microscopic examination of the urine. The common abnormalities of urine are discussed under manifestations of diseases of the urinary system.

### COLLECTION OF URINE SAMPLES

**Collection of urine samples can be difficult.** Free flow and catheterized samples are equally useful for routine urinalysis. Horses will often urinate a short time after they are walked into a freshly bedded box stall. Cows urinate if they are relaxed and have their perineum and vulval tip massaged upwards very gently, without touching the tail. Steers and bulls may urinate if the preputial orifice is massaged and splashed with warm water. Ewes often urinate immediately after rising if they have been recumbent for some time. Occluding their nostrils and threatening asphyxia may also induce urination just as they are released and allowed to breathe again; however, this is a stressful procedure and should not be performed in sick or debilitated sheep. An intravenous injection of furosemide (0.5–1.0 mg/kg BW) produces urination in most animals in about 20 minutes. The sample is useful for microbiological examination but its composition has been drastically altered by the diuretic. Diuretics should be used with extreme caution in dehydrated animals.

### CATHETERIZATION OF THE BLADDER

Urine samples obtained by catheterization are preferred for microbiological examination. Rams, boars, and young calves usually cannot be catheterized because of the presence of a suburethral diverticulum<sup>6</sup> and the small diameter of the urethra. A precurved catheter and fluoroscopic guidance can be used to facilitate catheterization of rams and bucks.<sup>19</sup> Ewes and sows have vulvas that are too small to allow access to the urethra. Cows can be catheterized relatively simply provided that a fairly rigid, small-diameter (0.5 cm) catheter is used. A finger can be inserted

into the suburethral diverticulum to direct the tip of the catheter over the diverticulum and into the external urethral orifice. Mares can be catheterized easily, either by blindly passing a rigid catheter into the external urethral orifice or by using a finger as a guide for a flexible catheter. Male horses can also be catheterized easily if the penis is relaxed. When urethral obstruction is present the penis is usually relaxed, but administration of an ataractic drug (acepromazine is often used) makes manipulation of the penis easier and often results in its complete relaxation. Because of the long urethra, the catheter must be well lubricated. The catheter should be rigid enough to pass through the long urethra but flexible enough to pass around the ischial arch. In all species, catheterization overcomes the natural defense mechanisms that prevent infectious organisms from ascending the urinary tract. As a result, attention to hygiene during catheterization is essential.

## TESTS OF RENAL FUNCTION AND DETECTION OF RENAL INJURY

The simplest and most important test of urinary function is the determination of whether or not urine is being voided. This can be accomplished in large animals by restraining them on a clean, dry floor which is examined periodically. Placing an absorbent cloth under recumbent foals and calves will also help determine if urine is being passed.

Renal function tests evaluate the functional capability of the kidney and, in general, assess blood flow to the kidneys, glomerular filtration and tubular function. These tests depend on whether they are based on the examination of **serum, urine** or both, and assess either **function** or the presence of **injury**. The most practical screening tests for the presence of decreased renal function are determination of serum creatinine concentration and urine specific gravity. Determination of both assists differentiation of renal azotemia from prerenal azotemia. In prerenal azotemia, tubular function remains intact and renal conservation of water is optimized, resulting in the production of a concentrated urine. Animals with prerenal azotemia therefore have increased serum concentrations of creatinine and urea, and increased urine specific gravity. For comparison, animals with some degree of renal azotemia have increased serum concentrations of creatinine and urea and a lower than expected value for urine specific gravity. Determination of urine specific gravity should therefore be routinely performed in all dehydrated animals before the initiation of treatment, because oral or

intravenous fluid therapy will directly change urine specific gravity.

### Tests of urine

Urine samples for analysis should be collected by midstream voiding, or cystocentesis in small male ruminants. Bethanechol (0.075 mg/kg subcutaneously) has occasionally been used to produce urine in reluctant individuals, but a spontaneously voided sample is preferred for initial screening. The sample should be centrifuged and the supernatant should be used for laboratory analysis and the sediment and remaining supernatant for routine urine analysis.

#### Specific gravity

Specific gravity of urine is the simplest test to measure the capacity of renal tubules to conserve fluid and excrete solute. For most species, the normal specific gravity range is 1.015–1.035, and in azotemic animals, specific gravity should be greater than 1.020 if the azotemia is prerenal in origin. In chronic renal disease the urine specific gravity decreases to 1.008–1.012 and is not appreciably altered by either deprivation of water for 24 hours or the administration of large quantities of water by stomach tube. It is important to recognize that a specific gravity of less than 1.008 indicates that the kidney can produce a dilute urine and, if sustained, indicates better renal function than a fixed urine specific gravity of 1.008–1.012.

Specific gravity can be inaccurate when other refractive particles are present in urine, such as glucose or protein. Urine specific gravity should therefore be used with caution in animals with proteinuria or glucosuria. As an alternative to specific gravity, osmolality of a fluid directly measures the concentration of solute in the fluid. Urine osmolality therefore provides a more accurate assessment of the tubule's ability to conserve or excrete solute than does specific gravity, and is the preferred test of urine concentrating ability for research studies. However, urine specific gravity is sufficiently accurate for clinical use in animals without proteinuria or glucosuria,<sup>20</sup> in that there is a linear relationship between urine specific gravity and osmolality, and that urine specific gravity explains 52% of the variation in urine osmolality, the 95% confidence interval for predicting osmolality from the specific gravity measurement being  $\pm 157$  mosmol/kg.<sup>21</sup>

#### Enzymuria

A clinically useful index of tubular injury is determining the gamma-glutamyltransferase (GGT) activity in urine. Most enzymes present in serum have a molecular weight greater than that

of albumin and are normally not detectable in the glomerular filtrate; the presence of high-molecular-weight enzymes in urine is called **parenchymatous enzymuria**. For comparison, the presence of low-molecular-weight enzymes (such as lysozyme) in urine is called **tubular enzymuria** because damage to the proximal tubule impairs its ability to reabsorb enzymes from the glomerular filtrate.<sup>22</sup>

Most of the GGT activity in urine originates from the luminal brush border of the proximal tubular epithelial cells of the kidney. High levels of GGT activity in the urine result from an increase in the rate of proximal tubular epithelial cell destruction, with GGT being released into the urine during the active phase of tissue destruction; an increase in urine GGT activity therefore reflects parenchymatous enzymuria. The activity of GGT (or other high-molecular-weight enzymes such as  $\beta$ -*N*-acetylglucosaminidase,  $\beta$ -glucuronidase, *N*-acetyl- $\beta$ -glucosaminidase) in urine can therefore be used to detect the presence of proximal renal tubular epithelial cell damage before the onset of renal dysfunction.<sup>22–24</sup> GGT is the preferred enzyme to identify the presence of parenchymatous enzymuria because the assay is inexpensive and widely available, and the kidney has the highest content of GGT of any organ in the body, thereby increasing the sensitivity of the test.

Urine GGT activity is frequently indexed to an indicator of urine concentration, such as urine creatinine concentration,<sup>22–24</sup> in order to correct for denominator effects induced by changes in urine volume, and a GGT:creatinine higher than 25 IU/g creatinine is considered abnormal in the horse. However, it may be more appropriate to calculate the fractional clearance of GGT (which compares the extent of tubular damage to the amount of functioning kidney mass) instead of the urinary GGT to creatinine ratio (which compares the amount of tubular damage to muscle mass).<sup>22,23</sup> Indexing GGT to creatinine is not physiologically valid because enzymes present in urine are not filtered through the glomerulus; using the urine GGT activity alone therefore appears to be more appropriate. Interestingly, urine GGT activity appears more sensitive as an index of tubular injury than the urine GGT to creatinine ratio in horses and sheep,<sup>25–27</sup> and appears to be the most sensitive indicator of tubular injury in animals being treated with aminoglycosides.

#### Glucosuria

Glucose is freely filtered by the glomerulus and reabsorbed from the filtrate in the

proximal tubules. Glucosuria in the face of a normal serum glucose concentration therefore indicates the presence of abnormal proximal tubular function. Glucosuria occurs early in the development of aminoglycoside-induced proximal tubule nephropathy, and may provide a useful inexpensive and practical screening test for nephrotoxicity in animals without hyperglycemia.<sup>26</sup>

#### Proteinuria

Urine protein concentrations in animals without lower urinary tract disease or hematuria are normally much lower than serum protein concentrations and similar to cerebrospinal fluid protein concentration. Glomerular filtrate normally contains low concentrations of low-molecular-weight proteins such as  $\beta_2$ -microglobulin (molecular weight 11 800) and lysozyme (molecular weight 14 400). This is because the healthy glomerulus excludes high-molecular-weight proteins such as albumin (molecular weight 65 000) and globulins from the glomerular filtrate; normally functioning proximal tubules reabsorb these low-molecular-weight proteins, leading to very low urine protein concentrations. Alterations in tubular function can therefore lead to proteinuria, but typically glomerular injury produces much larger increases in urine protein concentration than those produced by altered proximal tubule function.

Determination of urine protein concentrations requires a sensitive analytical test, such as the Coomassie brilliant blue method. Urinary protein concentrations may be indexed to the urine creatinine concentration in order to account for denominator effects of changes in urine volume. Dividing the urinary protein concentration (mg/dL) by the creatinine concentration (mg/dL) produces a unitless ratio, which provides a sensitive and reliable diagnostic method for the detection and quantification of proteinuria.<sup>28</sup> In general, increased urinary concentrations of albumin and  $\beta_2$ -microglobulin indicate **glomerular proteinuria** and **tubular proteinuria**, respectively. Proteinuria is massive and sustained in cattle and sheep with advanced renal amyloidosis and animals with advanced glomerulonephritis (glomerular proteinuria) but is mild in animals without glomerular disease but with proximal tubular injury (tubular proteinuria). A urine protein concentration to creatinine concentration ratio of less than 13 is considered to be more indicative of tubular than glomerular proteinuria.<sup>29</sup> Microalbuminuria does not appear to have been evaluated as an early and sensitive test of glomerular disease in large animals but increases in urine

albumin concentration would be expected in animals with glomerular disease.

#### Tests of serum

These tests depend on either the accumulation, in cases of renal insufficiency, of metabolites normally excreted by the kidney or the excretion of endogenous substances by the kidney. Determination of serum urea and creatinine concentration are essential components of an evaluation of the urinary system. These serum indices of function are simple estimates of glomerular filtration because urea and creatinine are freely filtered by the glomerulus. Serum concentrations of urea and creatinine do not rise appreciably above the normal range until 60–75% of nephrons are destroyed.

Serum urea and creatinine concentrations are influenced by blood flow to the kidneys and may be increased in prerenal uremia. They also suffer from the disadvantage that their serum concentrations can vary with the rate of protein catabolism and are not dependent only on renal function. In cattle, for example, serum urea concentrations caused by prerenal lesions may be higher than those resulting from renal disease, because salivary secretion of urea, rumen metabolism of urea and decreased feed intake (and therefore decreased protein intake) may lower serum urea concentration in chronic disease.

Creatinine in herbivores is essentially totally derived from endogenous creatine. Creatine is produced by the liver from amino acids and circulates in the plasma before being taken up by skeletal muscle, where it stores energy in the form of phosphocreatine. Creatine is converted to creatinine by a non-enzymatic irreversible process and is distributed throughout the body water. Creatinine is therefore released from skeletal muscle at a constant rate in animals without myonecrosis and is therefore an indirect index of muscle mass; this is the reason why serum creatinine concentrations are highest in intact males, intermediate in adult females and lowest in neonates and cachectic animals. Serum creatinine concentrations are constant within an animal because they reflect muscle mass, which does not change rapidly; an increase in serum creatinine concentration of more than 0.3 g/dL should be considered to be clinically significant.<sup>30</sup>

Serum creatinine concentration is routinely measured using the Jaffe reaction, in which a colored product is formed from creatinine and picrate in an alkaline solution. However, the alkaline picrate reaction has poor specificity, as it also detects a number of non-creatinine chromogens in serum, which do not

appear to be present in urine. In other words, the creatinine concentration may be overestimated in serum but is accurately measured in urine. The former induces some error in the calculation of fractional clearance of electrolytes. The progression of renal failure may be monitored by plotting the reciprocal of serum creatinine concentration against time. Extrapolation of the resultant linear relationship to the  $x$  axis intercept provided some clinically useful prognostic information in a horse with advanced renal failure.<sup>31</sup>

#### Glomerular filtration rate

The accepted gold standard measurement for renal function is measurement of the glomerular filtration rate using **inulin clearance**. Inulin, a metabolically inert carbohydrate, crosses freely across the glomerulus and is neither absorbed nor secreted by renal tubules. Endogenous creatinine clearance has also been used to estimate glomerular filtration rate; however, this test suffers from inaccuracies related to the presence of noncreatinine chromogens in plasma and the tubular secretion of creatinine in some species. Although the renal clearances of inulin or creatinine are the preferred research methods for measuring renal excretory function, these techniques are impractical in clinical patients and male ruminants because they require urethral catheterization, rinsing of the bladder contents and timed urine collections.

Renal excretory function is more practically assessed in clinical patients by measuring the **plasma clearance** of compounds of exogenous origin (such as **phenolsulfonphthalein** or **sodium sulfanilate**), as these techniques do not require urine collection. Plasma clearance of technetium-diethylenetriaminepentaacetic acid (Tc-DTPA) or technetium-mercaptoacetyltriglycine (Tc-MAG<sub>3</sub>) have also been evaluated in horses<sup>32,33</sup> but the technique requires measurement by a gamma camera and is therefore not suitable for use in the field. Plasma clearance tests have been evaluated in cattle, goats, sheep, and horses and provide a useful clinical test to monitor renal function in an individual animal over time.<sup>30,34–36</sup> However, the accuracy of plasma clearance techniques may not be adequate for research studies.

#### Tests of urine and serum

Urine osmolality to serum osmolality ratio

A urine:plasma osmolality ratio of 1 indicates isosmotic clearance of materials by the kidney. A ratio less than 1 indicates that the kidneys are diluting the urine, and a ratio more than 1 indicates that the urine is being concentrated. Because the plasma osmolality is much more constant

than urine osmolality, the important clinical factor is whether urine osmolality is less than, equal to, or greater than 300 mosmol/kg. Measurement of urine osmolality requires a dedicated laboratory unit and is rarely indicated in the clinical management of renal disease because of the widespread availability of hand-held refractometers. In fact, measurement of urine osmolality is needed only in research studies.

#### Water deprivation test

This can be used to assess renal concentrating ability in animals that have isosthenuria with urine specific gravity of 1.008–1.012 but do not have azotemia.<sup>12</sup> Water deprivation tests should not be performed on animals that are already azotemic and should be undertaken with extreme caution and frequent (hourly to 2-hourly) monitoring in animals that are polyuric but not azotemic. Animals that are unable to conserve water because of renal disease can rapidly become dehydrated and develop prerenal uremia as a result.

In brief, the water deprivation test monitors the animal's ability to detect an increase in serum osmolality, release antidiuretic hormone and produce a concentrated urine as a result of the action of antidiuretic hormone on the kidney. The test usually requires documentation that the animal has polyuria and polydipsia, with water consumption greater than cohorts of the same age, lactation stage and diet, when housed under the same conditions. Before conducting the water deprivation test, the animal is weighed and a Foley catheter is placed in the bladder (females), or the animal is housed in a dry stall (males). Access to water is prevented and the urine and serum are tested every 1–2 hours or when voided in males. The test should be stopped when the urine specific gravity increases to more than 1.015–1.020, when there is an increase in serum creatinine concentration of 0.3 g/dL or greater, or when there has been a decrease in body weight of 5% or more.

Animals that concentrate their urine after water deprivation are diagnosed with **psychogenic polydipsia** and their water availability is gradually decreased. Animals that fail to concentrate their urine after water deprivation are diagnosed with diabetes insipidus; **nephrogenic diabetes insipidus** can be ruled out if the animal produces a concentrated urine within a few hours of an intramuscular injection of exogenous vasopressin (0.15–0.30 U/kg BW). In the latter case, the diagnosis is **neurogenic diabetes insipidus** as a result of inadequate release of antidiuretic hormone.

Such cases are extremely rare in large animals and have been attributed to pituitary neoplasia (particularly pituitary adenoma in horses) or encephalitis.<sup>10</sup> Determination of plasma vasopressin concentrations using a radioimmunoassay may assist in differentiation of nephrogenic from neurogenic diabetes insipidus; in the former the plasma vasopressin concentration increases during the water deprivation test. However, because the assay for plasma vasopressin concentration is not widely available and has not been validated for all large animals,<sup>10</sup> the response to exogenous vasopressin is the preferred clinical test for differentiating nephrogenic from neurogenic diabetes insipidus. Two related horses have been diagnosed with nephrogenic diabetes insipidus,<sup>10</sup> suggesting that this may be inherited as an X-linked disorder.

Water deprivation tests are not needed if urine specific gravity is below 1.008, because the presence of hyposthenuria indicates that tubular function is acting to conserve solute and produce dilute urine. In other words, a specific gravity below 1.008 is a better clinical sign than a constant specific gravity of 1.008–1.012, because a low specific gravity indicates the presence of some tubular function. Low specific gravity may occur in diabetes insipidus, following excessive water intake or fluid administration, or following diuretic administration. Neonatal animals on fluid diets and lactating dairy cows often produce dilute urine.

#### Renal clearance studies

In animals with renal disease, serum creatinine and urea nitrogen concentrations are insensitive indicators of renal dysfunction and exceed the upper limit of the reference range only after extensive loss of nephron function. Increases in serum concentrations of creatinine or urea nitrogen cannot be used to distinguish between prerenal, renal, and postrenal azotemia. Urine specific gravity can be used to differentiate prerenal from renal azotemia. However, results of urinalysis do not reflect the magnitude of the disease and they are not specific for specific renal disease.

Calculation of renal clearance of creatinine, urea nitrogen, and electrolytes, along with measurement of specific enzyme activity in the urine, is a more sensitive indicator of damage to the tubules than serum biochemical analysis.<sup>37,38</sup> Urinary diagnostic indices have been used to evaluate renal function and to detect and estimate the extent of renal damage in adult cattle, calves, horses, and foals. For example, it can be clinically useful to determine the urine to serum concentration, the ratio of urinary

creatinine to urea nitrogen, the renal clearance of creatinine and urea nitrogen, the urine to serum osmolality ratio, the urine protein concentration or urine protein to creatinine ratio, the fractional clearances of electrolytes, and urine enzyme activity. Early diagnosis of renal injury facilitates initiation of appropriate treatment and reduces the incidence of irreversible renal failure. Sequential measurement of these indices can aid in the determination of prognosis and allows monitoring and evaluation of the extent of recovery of renal function.

The tests require simultaneous sampling of blood and urine.<sup>37</sup> Samples can also be collected daily for several days and weekly to determine any age-related changes, and these are available for calves from birth to 90 days of age.<sup>24</sup>

#### Fractional clearance

The fractional clearance from plasma of a given substance is calculated by comparing the amount of the substance excreted in the urine with the amount filtered through the glomerulus. The formula used to calculate fractional clearance of substance X ( $FC_X$ ) is:

$$FC_X (\%) = ([U_X]/[S_X]) \times 100 / ([U_{\text{creatinine}}]/[S_{\text{creatinine}}])$$

where  $[U_X]$  and  $[S_X]$  are the urine and serum concentrations of X, respectively, and  $[U_{\text{creatinine}}]$  and  $[S_{\text{creatinine}}]$  are the urine and serum concentrations of creatinine, respectively. Fractional clearance has been erroneously called fractional excretion; the latter term is confusing, inappropriate and has no scientific basis.<sup>39</sup> The fractional clearance provides information regarding the action of tubular transport mechanisms on the filtered substances; a value below 100% indicates net reabsorption, whereas a ratio above 100% indicates net secretion.

Sodium and inorganic phosphate are reabsorbed from the glomerular filtrate by the renal tubules; therefore, the fractional clearance of sodium and phosphate provide clinically useful indices of tubular function. Sodium retention is an important proximal tubular function and the fractional clearance of Na is usually less than 1% for animals (and often <0.2%) unless they have a high oral or intravenous sodium intake, when fractional clearance values can be increased to 4%. Renal phosphorus excretion is affected by acid–base status and body calcium and phosphate status and is therefore a less specific indicator of tubular function than fractional clearance of sodium. Values for the fractional clearance of phosphorus normally vary from 0.1–0.4%, although higher values may be seen in ruminants with high phosphate intakes. Typically,

tubular function can be adequately characterized by determining the fractional clearance of sodium alone, or sodium and phosphorus; the fractional clearance of chloride rarely adds useful information in clinical cases because it is highly correlated to the fractional clearance of sodium,<sup>40</sup> and determination of the fractional clearance of potassium is hampered by methodological limitations associated with zwitterion formation in urine. Determination of the fractional clearance of calcium can be useful when dietary intake and metabolism of calcium are being evaluated. Substantial variations in fractional clearance values are present in horses over a 24-hour period as a result of the electrolyte load ingested with feed.<sup>41</sup> Some standardization of the time of urine collection in relationship to feeding is therefore needed in research studies, but is clearly impractical in clinical cases.

Fractional clearance values for a number of electrolytes have been determined for horses,<sup>42,43</sup> foals,<sup>37</sup> cattle,<sup>40,44-46</sup> and sheep.<sup>47</sup> Renal clearance, urinary excretion of endogenous substances and urinary diagnostic indices have been measured in healthy neonatal foals.<sup>37</sup> The urine volume of neonatal foals is proportionately greater than that of calves and the normal neonatal foal produces a dilute urine.<sup>37</sup> When compared with normal values in adult horses, fractional clearance of electrolytes was similar for sodium but higher for potassium, phosphorus, and calcium. Renal function in newborn calves is similar to adult cattle within 2–3 days of birth and calves can excrete large load volumes in response to water overload and conserve water in response to water deprivation as efficiently as adult cattle.

Animals with acute renal azotemia have low urinary creatinine:serum creatinine and urine nitrogen:serum nitrogen; animals with acute prerenal azotemia have normal to high urinary creatinine:serum creatinine and urinary nitrogen:serum nitrogen. However, animals with acute renal azotemia also have a low urine specific gravity relative to the serum creatinine concentration, and it remains to be determined whether measurement of urinary creatinine and urea concentrations and serum urea concentrations provide any more information in clinical cases than that provided by urine specific gravity and serum creatinine concentration.

### Summary of renal function tests

In summary, the serum creatinine or urea concentration provides a useful screening test for the presence of urinary tract disease, with an increase in serum

creatinine concentration of more than 0.3 mg/dL over baseline providing a useful clinical test for the presence of nephrotoxicosis in normally hydrated animals being treated with potentially nephrotoxic agents. Azotemia can be prerenal, renal, or post renal in origin; the cause is most practically differentiated in azotemic animals by measuring the specific gravity of urine before any treatment has been administered. In animals suspected of having urinary tract disease, the urinary protein concentration and protein to creatinine ratio provide clinically useful indices of glomerular and tubular function and injury, the urine specific gravity and fractional clearance of sodium and phosphorus provide clinically useful indices of tubular function in animals not on intravenous or oral fluids and consuming a normal diet, and determination of urine GGT activity and analysis of urine for the presence of casts provide clinically useful and sensitive indices of tubular injury. The results of most other laboratory tests rarely provide additional information in an animal suspected to have urinary tract disease, and are not currently recommended for routine clinical use.

## DIAGNOSTIC EXAMINATION TECHNIQUES

### Ultrasonography

Transcutaneous and transrectal ultrasonography is commonly used to detect and characterize anatomical abnormalities of the kidneys, ureters, bladder, and urethra in horses, cattle, and small ruminants. Ultrasonography is an effective screening test for diagnosing obstructive conditions of the urinary tract, including hydronephrosis, hydroureter, and bladder distension, and can be used to visualize the kidney and guide the biopsy needle during renal biopsy.<sup>48</sup> Removal of the haircoat and the use of an ultrasonographic coupling gel assist in obtaining acceptable acoustic coupling, whereas saturation of a foal's haircoat with alcohol or coupling gel may be adequate when clipping is not desirable.

Techniques for ultrasonographic<sup>49</sup> evaluation of the urinary system of the horse have been described, and extensive information is available that documents age-related changes in renal dimensions.<sup>50,51</sup> Ureteral tears have been identified using transrectal ultrasonography.<sup>52</sup> Uroperitoneum is readily diagnosed in foals by ultrasonographic examination, as is the underlying lesion in the bladder or urachus. Ultrasonography has been used to visualize the renal changes in foals following administration of phenylbutazone.<sup>53</sup>

In cattle, the right kidney is easily accessible to ultrasonography from the

body surface.<sup>38</sup> Images of the right kidney are visualized best with the transducer placed in the lumbar or paralumbar region, whereas images of the left kidney are best obtained using a transrectal approach. Ultrasonographic changes in the cow with pyelonephritis include: a dilated renal collecting system, renal or ureteral calculi, echogenic material within the renal collecting system, and subjective enlargement of the kidney with acute disease or a small irregular kidney with chronic disease.<sup>54</sup> Cattle with enzootic bovine hematuria due to chronic bracken fern ingestion have a thickened bladder wall (normally <2 mm) on transrectal ultrasonography and irregular sessile masses (transitional cell papilloma) extending into the bladder lumen.<sup>55</sup>

Techniques for ultrasonographic evaluation of the urinary system of the sheep have been described.<sup>56</sup>

### Renal biopsy

Percutaneous renal biopsy can be carried out in sedated and adequately restrained cows and horses. A coagulation profile should be run before renal biopsy is attempted in animals with severe and chronic renal disease or those animals suspected to have a coagulopathy. Renal biopsy is contraindicated in animals with documented pyelonephritis because of the risk of perirenal abscessation after the biopsy procedure.

The left kidney is usually biopsied because it is more accessible. In cows, the left kidney is moved to the right paralumbar fossa and fixed in position by rectal manipulation. In horses, the left kidney is identified using transabdominal ultrasonography and fixed in position by palpation per rectum.<sup>57</sup> The skin over the biopsy site is aseptically prepared and 5–10 mL of local anesthetic is infiltrated along the proposed track for the biopsy needle. A small stab incision is made in the skin with a scalpel and a renal biopsy sample is collected by introducing a biopsy needle through the abdominal wall and manipulating it into the caudal pole of the kidney. The renal biopsy is fixed in 10% formalin and submitted for examination and histological diagnosis. Biopsy of the caudal pole minimizes the risk of trauma to the renal pelvis, renal artery, and renal vein.

Possible complications of renal biopsy are hemorrhage or abscessation in animals with pyelonephritis. Hemorrhage after renal biopsy can be extensive, and is usually perirenal but rarely life threatening. Occasionally, severe hematuria is present for hours after the biopsy procedure, but usually resolves within a few days. Because of the potential for life-threatening sequelae, renal biopsy should

only be performed when the etiology is uncertain and histologic examination will direct treatment, or when an early and accurate prognosis is desired. In animals with acute tubular injury, electron microscopic examination of the basement membrane is required to accurately prognose return to normal function.

### Endoscopy

Transurethral endoscopy can be easily performed in mares, stallions, geldings, and cows in order to examine the urethra and bladder, and flow of urine from both ureters. Horses and cows are sedated and adequately restrained for the procedure. Biopsy of diseased tissue or mechanical disruption of calculi can be attempted under endoscopic guidance. Identification of an ectopic ureter may be assisted by intramuscular administration of azo-sulfamide (1.9 mg/kg BW) or intravenous administration of sodium fluorescein (11 mg/kg BW), phenolsulfonphthalein (0.01 mg/kg BW) or indigo carmine (0.25 mg/kg BW) to color the urine being produced, 5–20 minutes before endoscopy; this assists visualization of the urine stream.<sup>58</sup>

### Cystometry and urethral pressure profile

Urodynamic tests have been evaluated in the mare that allow comparison of the normal micturition reflex with that of the incontinent patient. **Cystometry** involves measurement of luminal pressure during inflation of the bladder with measured volumes of 0.9% NaCl or carbon dioxide. The pressure–volume relationship during filling with fluid or gas provides information on bladder capacity, maximal luminal pressure during the detrusor reflex, and stiffness of the bladder wall. The **urethral pressure profile** involves measurement of pressure along the urethra while withdrawing a fluid- or gas-filled catheter at constant rate. The catheter tip pressure is graphed against distance, and the **maximum urethral closure pressure** is determined as the maximum urethral pressure minus bladder luminal pressure. The **functional urethral length** is defined as the length of the urethra in which urethral pressure exceeds bladder luminal pressure.

The test can be performed in restrained mares with or without xylazine sedation (1.1 mg/kg BW, intravenously), but sedation is recommended. Values for cystometry and urethral pressure profiles in female horses and pony mares are available.<sup>59</sup>

### Test of uroperitoneum and bladder rupture

Ultrasonographic examination of the abdomen is most useful in detecting the presence of excessive fluid, and this

examination frequently allows visualization of the lesion in the bladder or urachus. Further testing is sometimes needed to confirm that the fluid is urine. Generally, in uroperitoneum, substantial quantities of fluid can be easily obtained by abdominocentesis. Warming the fluid may facilitate detection of the urine odor, although this is a subjective and poorly sensitive diagnostic test. If there is doubt that the fluid is urine, its creatinine concentration can be compared to the serum creatinine. If creatinine in the fluid is at least twice the serum value, the fluid is confirmed as urine, although ruptured bladder should be suspected whenever the abdominal fluid creatinine concentration exceeds that of serum. In animals with uroabdomen or suspected to have uroabdomen, the administration of 30 mL of sterile 1% methylene blue into the bladder via a urethral catheter or cystocentesis has been used to confirm that the bladder is the site of urine leakage. Abdominal paracentesis is performed some minutes after administration and the fluid examined visually for the presence of a blue tinge. Absence of a blue color suggests the presence of ureteral or renal rupture.

### Radiography

Radiographic examination has limited value for the diagnosis of urinary tract disease in farm animals but contrast studies may be used to examine the lower urinary tract in neonatal animals. With the widespread availability of ultrasonography and endoscopy, the indications for radiography have become limited. A positive-contrast urethrogram was of value in diagnosing urethral recess dilatation in a bull calf,<sup>60</sup> and intravenous urography was successful in diagnosing a dilated ureter in a 4-month-old heifer calf.<sup>61</sup> Historically, excretory urography, positive contrast cystography and urethrography have been used, particularly in foals, but these tests are expensive, not widely available and time-consuming. Radiography is currently being performed on animals with equivocal results using other cheaper, faster and more widely available tests.

## Principles of treatment of urinary tract disease

### Fluid and electrolytes

Treatment of acute renal failure in all species is aimed at removing the primary cause and restoring normal fluid balance by correcting dehydration, acid–base disorders, and electrolyte abnormalities. The prognosis for acute renal failure will depend on the initiating cause and severity of the lesion. If the acute disease

process can be stopped the animal may be able to survive on its remaining functional renal tissue. When toxic nephrosis is suspected, an attempt should be made to identify and remove the initiating cause or to move the animal from the suspect environment.

**Ruminants** with chronic renal failure typically have mild to marked **hyponatremia** and **hypochloremia**; the serum calcium and potassium concentrations may be decreased because of inappetence, serum magnesium concentration may be normal or increased, and serum phosphate concentration may be normal or increased, because urine provides a route of excretion of magnesium and phosphorus. The acid–base status is characterized by **metabolic acidosis** in severely affected cases to metabolic alkalosis in mildly affected cases. Ruminants with acute renal failure have similar clinicopathological changes, although the serum phosphorus concentration is usually markedly elevated in acute renal failure because many cases are initiated by decreased renal blood flow.

**Horses** with acute or chronic renal failure have similar electrolyte changes to those in ruminants, with the marked difference being the presence of **hypercalcemia** and **hypophosphatemia** in some horses. Hypercalcemia in horses with renal disease is suspected to be due to the relatively greater efficiency of intestinal calcium absorption in the horse, with urine being the predominant route of excretion. Decreases in the function of nephrons in the horse will therefore decrease the urinary loss of calcium and result in hypercalcemia. The hypercalcemia is marked and is thought to result directly in hypophosphatemia in horses with renal failure.

Balanced electrolyte solutions or normal saline supplemented with potassium and calcium can be used to correct fluid and electrolyte deficits. The required volume of replacement fluid can be determined on the basis of clinical signs as outlined in Chapter 2. As the fluid deficit is corrected, the patient should be observed for urination. If anuria or oliguria is present, the rate of fluid administration should be monitored to prevent overhydration. If the patient has anuria or oliguria after the fluid volume deficit is corrected, a diuretic should be administered to help restore urine flow. **Furosemide** (1–2 mg/kg BW every 2 h) or **mannitol** (0.25–2.0 g/kg BW in a 20% solution) may be used, but furosemide is preferred because of its much lower cost and ease of administration. Diuretics should not be used until dehydration has been corrected. After urine flow is restored, the resulting diuresis will increase the maintenance



fluid requirement. **B vitamins** should be frequently administered because their rate of loss in the urine is anticipated to be higher than normal in animals with renal failure. Animals nonresponsive to fluid loading and diuretics could be administered low-dose ('renal dose') **dopamine** as a continuous intravenous infusion (2–5 µg/kg BW/min) with dopamine being diluted in 0.9% NaCl, 5% dextrose or lactated Ringer's solution. Dopamine is an  $\alpha_1$ ,  $\beta_1$ ,  $\beta_2$ , DA<sub>1</sub> and DA<sub>2</sub> agonist and therefore has a complex pharmacodynamic profile that is dependent upon species, organ, and cardiovascular status. Dopamine is theoretically the preferred pharmacological agent to selectively increase renal blood flow and therefore glomerular filtration rate in animals with renal failure, although low-dose dopamine infusion does not alter creatinine clearance (an index of glomerular filtration rate) in healthy adult horses and has not been shown to be of benefit in treating renal failure in humans.<sup>62</sup> At low doses (<5 µg/kg BW/min) dopamine acts primarily as an inotropic agent and at higher doses primarily as a vasopressor. The mean arterial blood pressure and electrocardiogram should therefore be monitored during dopamine administration to insure that dopamine infusion does not lead to hypertension or clinically significant cardiac arrhythmias. Although there are good theoretical grounds for use of dopamine in animals with renal failure, this is no longer the practice in human medicine because of the lack of efficacy of the drug in preventing or treating acute renal failure. Animals that remain anuric after intravenous fluid administration of furosemide/mannitol and dopamine have a grave prognosis and can only be managed with peritoneal dialysis or hemodialysis.

**Intermittent-flow peritoneal dialysis** has been used successfully in a foal with a ruptured urinary bladder.<sup>63</sup> A urinary catheter was placed in the bladder and secured to the perineal region. An area of the ventral midline was clipped and prepared for aseptic surgery. Local anesthetic was infused, and a stab incision was made in the skin with a scalpel blade. An 11 French peritoneal dialysis catheter was placed in the stab incision then forced into the abdomen. The rigid stylet was removed, the catheter was secured to the skin and the stab incision site was bandaged. Peritoneal fluid was allowed to drain; dialysis was then accomplished by infusing 2 L of a hypertonic dialysis solution, clamping the catheter for 1 hour, then opening the catheter and allowing drainage to occur for 2–3 hours. Dialysis was repeated nine times over a 36-hour period.<sup>63</sup> Intermittent-flow peritoneal

dialysis has also been used in an adult horse using a similar catheterization technique (24 French de Pezzer catheter) and infusion of 10–15 L of warmed, sterile, acetated Ringer's solution.<sup>64</sup> However, only 26–65% of the infused solution was recovered from the abdomen.

**Continuous-flow peritoneal dialysis** has been used successfully in an adult horse with azotemia refractory to intravenous fluids, furosemide, dopamine infusion and intermittent-flow peritoneal dialysis.<sup>64</sup> A 28 French indwelling thoracic tube was placed in the ventral abdomen and a 2.2 mm diameter, 15 cm long spiral fenestrated catheter was placed in the left flank via peritoneoscopy to allow for inflow of dialysate. Acetated Ringer's with 1.5% glucose was continuously infused through the catheter in the left flank at approximately 3 L/h, with abdominal fluid being collected into a sterile closed collection system from the catheter in the ventral midline of the abdomen.

**Hemodialysis** was used successfully to treat a foal with presumed oxytetracycline nephrotoxicosis.<sup>65</sup> Hemodialysis was performed under isoflurane anesthesia after surgical placement of a Teflon/Silastic arteriovenous shunt in the median artery and vein using a dialysis delivery system, a hollow-fiber artificial kidney, and acetate-base dialysate. Anticoagulation during dialysis was accomplished with a loading dose of heparin (100 U/kg BW) and then hourly boluses of 20 U/kg BW to prolong the activated clotting time. Three dialysis treatments, lasting 4–6 hours, were administered over a 4-day period, resulting in a marked reduction in azotemia. Hemodialysis is more efficient than peritoneal dialysis and requires shorter treatment intervals, but does require vascular access and anticoagulation treatment, which may predispose to hypotension.<sup>65</sup>

The treatment of chronic renal failure will depend on the stage of disease and the value of the animal. In chronic failure, therapy is aimed at prolonging life. In food-producing animals, emergency slaughter is not recommended because the carcass is usually unsuitable for human consumption. Animals in chronic failure should have free access to water and salt, unless edema is present. Stresses such as sudden environmental and dietary changes should be avoided. The ration should be high in energy-giving food and properly balanced for protein. Acute renal failure may occur in patients in chronic failure and can be treated like other cases of acute renal failure.

#### Antimicrobial agents

Selection of antimicrobial agents for the treatment of urinary tract infections

should be based on quantitative urine culture of a catheterized urine sample. A clinically relevant bacterial concentration indicative of cystitis or pyelonephritis is 1000 or 40 000 cfu/mL of urine from a catheterized or midstream free-catch sample, respectively.<sup>66</sup>

**The ideal antimicrobial for treatment of urinary tract infections** should meet several criteria. It should:

- **Be active against the causal bacteria**
- **Be excreted and concentrated in the kidney and urine**
- **Be active at the pH of urine**
- **Have low toxicity, particularly nephrotoxicity**
- **Be easily administered**
- **Be low in cost**
- **Have no harmful interactions with other concurrently administered drugs.**

Appropriate first-line antimicrobials include penicillin, ampicillin, amoxicillin, ceftiofur, and cefquinome in ruminants and trimethoprim-sulfa and ceftiofur in horses. Antimicrobial therapy for lower urinary tract infections should continue for at least 7 days; for upper urinary tract infections 2–4 weeks of treatment is often necessary. Success of therapy can be evaluated by repeating the urine culture 7–10 days after the last treatment.

Manipulation of urine pH should be considered as part of the treatment of bacterial urinary tract infections. In general, *Escherichia coli* attach best to urinary epithelial cells at pH 6.0, whereas *Corynebacterium renale* attaches best in alkaline urine. In other words, when treating an *E. coli* pyelonephritis or cystitis, the diet should be altered to ensure an alkaline urine pH. Likewise, urine pH should be acidic when treating urinary tract infections due to *C. renale*.

#### REVIEW LITERATURE

- Osbaldiston GW, Moore WE. Renal function tests in cattle. *J Am Vet Med Assoc* 1971; 159:292–301.
- Koterba AM, Coifman JR. Acute and chronic renal disease in the horse. *Compend Contin Educ Pract Vet* 1981; 3:S461–S469.
- Fetcher A. Renal disease in cattle. Part 1. *Compend Contin Educ Pract Vet* 1985; 7:S701–S707; Part 2. *Compend Contin Educ Pract Vet* 1986; 8:S338–S345.
- Kohn CW, Chew DJ. Laboratory diagnosis and characterization of renal disease in horses. *Vet Clin North Am Equine Pract* 1987; 3:585–615.
- Lees GE, Brown SA, Elliott J et al. Assessment and management of proteinuria in dogs and cats: 2004 ACVIM forum consensus statement (small animal). *J Vet Intern Med* 2005; 19:377–385.

#### REFERENCES

1. Arnold CE et al. *J Am Vet Med Assoc* 2005; 227:778.
2. Kent LLOYD KC et al. *J Am Vet Med Assoc* 1987; 194:1324.
3. Schott II HC, Hines MT. *J Am Vet Med Assoc* 1994; 204:1320.

4. Kisthardt KK et al. *Can Vet J* 1999; 40:571.
5. Jansen BS, Lumsden JH. *Can Vet J* 1985; 26:221.
6. Garrett PD. *J Am Vet Med Assoc* 1987; 191:689.
7. Morley PS, Desnoyers M. *J Am Vet Med Assoc* 1992; 200:1515.
8. Freeman DA et al. *Am J Vet Res* 1999; 60:1445.
9. Brewer B. *Equine Vet Educ* 1990; 2:127.
10. Schott HC et al. *J Vet Intern Med* 1993; 7:68.
11. Thomson JR. *J Comp Pathol* 1986; 96:119.
12. Young A. *Equine Vet Educ* 1990; 2:130.
13. Johnson PJ et al. *J Am Vet Med Assoc* 1987; 191:973.
14. Rebhun WC et al. *J Am Vet Med Assoc* 1984; 184:1237.
15. Frye MA et al. *J Am Vet Med Assoc* 2001; 218:560.
16. Summers BA et al. *Cornell Vet* 1985; 75:524.
17. Watts C, Campbell JR. *Res Vet Sci* 1970; 11:508.
18. Watts C, Campbell JR. *Res Vet Sci* 1970; 12:234.
19. Van Weeren PR et al. *Vet Q* 1987; 9:79.
20. English PB, Hogan AE. *Aust Vet J* 1979; 55:584.
21. Thornton JR, English PB. *Aust Vet J* 1976; 52:335.
22. Amodio P et al. *Enzyme* 1985; 33:216.
23. Mathur S et al. *Toxicol Sci* 2001; 60:385.
24. Sommardahl C et al. *J Am Vet Med Assoc* 1997; 211:212.
25. Bayly WM et al. *Cornell Vet* 1986; 76:306.
26. Garry F et al. *Am J Vet Res* 1990; 31:420.
27. Garry F et al. *Am J Vet Res* 1990; 31:428.
28. White JV. *J Am Vet Med Assoc* 1984; 185:882.
29. Lulich JP, Osborne CA. *Compend Contin Educ Pract Vet* 1990; 12:59.
30. Hinchcliff KW. *Am J Vet Res* 1989; 50:1848.
31. Bertone JJ et al. *J Am Vet Med Assoc* 1987; 191:565.
32. Gleadhill A et al. *Vet J* 1999; 158:204.
33. Woods PR et al. *Vet Radiol Ultrasound* 2000; 41:85.
34. Hinchcliff KW. *Am J Vet Res* 1987; 46:1256.
35. Brown SA et al. *Am J Vet Res* 1990; 51:581.
36. Danielson TJ, Taylor WG. *Am J Vet Res* 1993; 54:2179.
37. Brewer BD et al. *J Vet Intern Med* 1991; 5:28.
38. Braun U. *Am J Vet Res* 1991; 52:1933.
39. Constable PD. *J Vet Intern Med* 1991; 5:357.
40. Neiger RD, Hagemoser WA. *Vet Clin Pathol* 1985; 14:31.
41. McKenzie EC et al. *Am J Vet Res* 2003; 64:284.
42. Grossman BS et al. *J Am Vet Med Assoc* 1982; 180:284.
43. Morris DD et al. *Am J Vet Res* 1984; 45:2431.
44. Itoh N. *Vet Clin Pathol* 1989; 18:86.
45. Fleming SA et al. *Am J Vet Res* 1991; 52:5.
46. Fleming SA et al. *Am J Vet Res* 1992; 53:222.
47. Garry F et al. *Am J Vet Res* 1990; 31:313.
48. Modransky PD. *Vet Clin North Am Equine Pract* 1986; 2:115.
49. Kiper ML et al. *Compend Contin Educ Pract Vet* 1990; 12:993.
50. Aleman M et al. *Equine Vet J* 2002; 34:649.
51. Hoffmann KL et al. *Am J Vet Res* 1995; 56:1403.
52. Diaz OS et al. *Vet Radiol Ultrasound* 2004; 45:73.
53. Leveille R et al. *Can Vet J* 1996; 37:235.
54. Hayashi H et al. *J Am Vet Med Assoc* 1994; 205:736.
55. Hoque M et al. *J Vet Med A* 2002; 49:403.
56. Braun U et al. *Am J Vet Res* 1992; 53:1734.
57. Bayly WM et al. *Mod Vet Pract* 1980; 61:763.
58. MacAllister CG, Perdue BP. *J Am Vet Med Assoc* 1990; 197:617.
59. Clark ES et al. *Am J Vet Res* 1987; 48:552.
60. Anderson DE et al. *Can Vet J* 1993; 34:234.
61. Barclay WP. *J Am Vet Med Assoc* 1978; 173:485.
62. Corley KTT. *Vet Clin North Am Equine Pract* 2004; 20:77.
63. Kritchevsky JE et al. *J Am Vet Med Assoc* 1984; 185:81.
64. Gallatin LL et al. *J Am Vet Med Assoc* 2005; 226:756.
65. Vivrette S et al. *J Am Vet Med Assoc* 1993; 203:105.
66. MacLeay JM, Kohn CW. *J Vet Intern Med* 1998; 12:76.

## Diseases of the kidney

### GLOMERULONEPHRITIS

Glomerulonephritis can occur as a primary disease or as a component of diseases affecting several body systems, such as equine infectious anemia and chronic swine fever. In primary glomerulonephritis, the disease involves only the kidney, predominantly affecting the glomeruli although the inflammatory process extends to affect the surrounding interstitial tissue and blood vessels. Primary and secondary glomerulonephritis are rare causes of clinical disease in farm animals. The disease is sometimes associated with other chronic, systemic illness such as in cows with Johne's disease, bovine virus diarrhea, or leptospirosis; pigs with hog cholera or African swine fever; and horses with equine infectious anemia. Proliferative glomerulonephritis is reported as an incidental finding in normal sheep, cattle, goats, and pigs. Clinical disease from glomerulonephritis is rare in these species but has been reported in cattle<sup>1</sup> and as a congenital condition in sheep, described below. Proliferative glomerulonephritis can cause chronic renal failure in horses.<sup>2</sup> Glomerulonephritis is present in animals with amyloidosis, which is a generalized deposition of antibody-antigen complexes. Amyloidosis is discussed in detail in Chapter 9.

The immune system plays a major role in the pathogenesis of glomerular lesions. Glomerular injury can be initiated by an immune response whereby antibodies are directed against intrinsic glomerular antigens or by foreign antigens planted in the glomerulus. Alternatively, and more commonly, circulating antigen-antibody complexes may be deposited in the glomerulus. As the complexes accumulate, they stimulate an inflammatory response that damages the glomerular filtration system. Inflammatory damage to the glomerulus alters the selective permeability of the filtration system allowing plasma protein, particularly albumin, to pass into the glomerular filtrate. In horses, the glomerular lesion is thought to be caused by the deposition of circulating antigen-antibody complexes but the origin of these complexes is unknown. Infections with streptococci and equine infectious anemia virus may be involved but are not likely to be involved in all cases.

**Dermatitis-nephropathy syndrome** is a systemic necrotizing vasculitis and

glomerulonephritis syndrome of growing pigs in the UK and Canada.<sup>3</sup> The cause is unknown but an immune-mediated pathogenesis is suspected. Growing pigs are affected with a morbidity ranging from 1-3%. The skin is affected with a papular dermatopathy with a characteristic distribution of bluish red spots at least 1 cm in diameter beginning first in the perineal region and then extending to the pelvic limbs and along the ventral body wall to the neck and ears. In the glomeruli, there are extensive granular complement deposits with scattered immunoglobulins.

**Porcine dense deposit disease**, porcine membranoproliferative glomerulonephritis type II is a common cause of early loss of piglets in the Norwegian Yorkshire breed.<sup>4,5</sup> The disease is associated with extensive complement activation due to a deficiency of factor H, a plasma protein that regulates complement. Affected piglets are clinically normal at birth and for the first few weeks of life.<sup>1</sup> Thereafter they become unthrifty and die from renal failure within 72 days of birth. In the kidneys there is extensive glomerular proliferation and marked thickening of the glomerular capillary wall. Large amounts of dense deposits are consistently found within the glomerular basement membrane. This disease is inherited with a simple autosomal recessive pattern and complete penetrance. A pathogenetic mechanism of a defective or missing complement regulation protein is hypothesized. A spontaneous glomerulonephritis of unknown etiology and unrelated to any breed has been recorded in pigs.<sup>6</sup> A necrotizing glomerulonephritis is listed as occurring in pigs fed a waste product from an industrial plant producing a proteolytic enzyme. Glomerulonephritis has also been recorded in pigs in the absence of clinical illness, although an association with the 'thin sow' syndrome is suggested.

**In Finnish Landrace lambs** less than 4 months of age there is an apparently inherited disease that is remarkably similar to forms of human glomerulonephritis. Affected lambs appear to absorb an agent from colostrum that induces an immunological response, followed by the granular deposition of immune complexes and complement within the glomerular capillary walls; this initiates a fatal mesangiocapillary glomerulitis. Many affected lambs are asymptomatic until found dead. Some have signs of tachycardia, edema of the conjunctiva, nystagmus, walking in circles and convulsions. The kidneys are enlarged and tender. There is severe proteinuria and low plasma albumin. Serum urea concentration is increased (> 35 mmol/L) with hyperphosphatemia and hypocalcemia.

At necropsy the kidneys are large and pale and have multifocal pinpoint yellow and red spots throughout the cortex. On histopathological examination there are severe vascular lesions in the choroid plexuses and the lateral ventricles of the brain. The disease is thought to be conditioned in its occurrence by inheritance and to be limited to the Finnish Landrace breed. However, cases have also occurred in crossbred lambs.<sup>7</sup>

**Glomerulopathy and peripheral neuropathy in Gelbvieh calves** is a familial, and probably heritable, disease causing illness in calves of this breed of less than 13 months of age. The initial physical abnormality is posterior ataxia that progresses to generalized paresis and recumbency.<sup>8</sup> The neurological deficits include loss of conscious proprioception, diminished or absent peripheral reflexes but maintained consciousness. Affected animals continue to eat and drink normally. Serum creatinine and urea concentrations are markedly elevated. Necropsy examination reveals neuropathy, myelopathy, and glomerulopathy. The disease is terminal.

Glomerulonephritis is a common cause of chronic renal failure in horses. Several forms of glomerulonephritis are recognized in horses: membranous glomerulonephritis, post-streptococcal glomerulonephritis, membranoproliferative glomerulonephritis and focal glomerulosclerosis.<sup>9</sup> As discussed above, most are probably immune-mediated and associated with circulating antibody-antigen complexes. Over 80% of horses with equine infectious anemia have glomerular lesions, and viral antigen-antibody complexes are present in the glomerular basement membrane. Purpura hemorrhagica is associated with glomerulonephritis.

#### REFERENCES

- Hogasen K et al. *J Clin Invest* 1995; 95:1054.
- Divers TJ. *Compend Contin Educ Pract Vet* 1983; 5:S310.
- Helie P et al. *Can Vet J* 1995; 36:150.
- Jansen JH et al. *Vet Rec* 1995; 137:240.
- Jansen JH et al. *Am J Pathol* 1993; 143:1356.
- Bourgalt A, Drolet R. *J Vet Diagn Invest* 1995; 7:122.
- Dore M et al. *Can Vet J* 1987; 28:40.
- Panciera RJ et al. *Vet Pathol* 2003; 40:63.
- Biervliet JV et al. *Compend Contin Educ Pract Vet* 2002; 24:892.

#### HEMOLYTIC-UREMIC-LIKE SYNDROME

Glomerular and tubulointerstitial disease, consistent with profound microangiopathy and glomerular degeneration in humans with hemolytic-uremic syndrome, has been diagnosed in two horses. Both horses were in oliguric renal failure and

had clinicopathological evidence of intravascular hemolysis and morphological evidence of arteriolar microangiopathy and intravascular coagulation. The mortality rate is expected to be extremely high. The pathogenesis in horses is unclear, although hemolytic-uremic syndrome in humans is due to toxins produced by *E coli* O157:H7.<sup>1</sup>

#### REFERENCE

- Morris CF et al. *J Am Vet Med Assoc* 1987; 191:1453.

#### NEPHROSIS

Nephrosis includes degenerative and inflammatory lesions primarily affecting the renal tubules, particularly the proximal convoluted tubules. It can occur as a sequel to renal ischemia and following toxic insult to the kidney. Nephrosis is the most common cause of acute kidney failure. Uremia from nephrosis may develop acutely or may occur in the terminal stages of chronic renal disease.

#### RENAL ISCHEMIA

Reduced blood flow through the kidneys usually results from general circulatory failure.<sup>1</sup> There is transitory oliguria followed by anuria and uremia if the circulatory failure is not corrected.

#### ETIOLOGY

Any condition which predisposes the animal to marked hypotension and release of endogenous pressor agents potentially can initiate hemodynamically mediated acute renal ischemia and renal failure. Ischemia may be acute or chronic.

#### Acute renal ischemia

- General circulatory emergencies such as shock, dehydration, acute hemorrhagic anemia, acute heart failure. Renal failure secondary to calf diarrhea has been described<sup>2</sup>
- Embolism of renal artery, recorded in horses
- Extreme ruminal distension in cattle.

#### Chronic renal ischemia

- Chronic circulatory insufficiency such as congestive heart failure.

#### PATHOGENESIS

Acute ischemia of the kidneys occurs when compensatory vasoconstriction affects the renal blood vessels in response to a sudden reduction in cardiac output. As blood pressure falls, glomerular filtration decreases and metabolites that are normally excreted accumulate in the bloodstream. The concentration of urea in the blood increases, giving rise to the name prerenal uremia. As glomerular filtration falls, tubular resorption increases, causing reduced urine flow. Up to a certain stage, the degenerative changes

are reversible by restoration of renal blood flow, but if ischemia is severe enough and of sufficient duration, the renal damage is permanent. Acute circulatory disturbances are more likely to be followed by degenerative lesions than chronic congestive heart failure.

The parenchymatous lesions vary from tubular necrosis to diffuse cortical necrosis in which both tubules and glomeruli are affected. The nephrosis of hemoglobinuria appears to be caused by the vasoconstriction of renal vessels rather than a direct toxic effect of hemoglobin on renal tubules. Uremia in acute hemolytic anemia and in acute muscular dystrophy with myoglobinuria may be exacerbated by plugging of the tubules with casts of coagulated protein, but ischemia is also an important factor.

#### CLINICAL FINDINGS

Renal ischemia does not appear as a distinct disease and its signs are masked by the clinical signs of the primary disease. Oliguria and azotemia will go unnoticed in most cases if the circulatory defect is corrected in the early stages. However, renal insufficiency may cause a poor response to treatment with transfusion or the infusion of other fluids in hemorrhagic or hemolytic anemia, in shock or dehydration. In these cases, unexplained depression or a poor response to therapy indicates that renal involvement should be investigated. The general clinical picture is one of acute renal failure and is described under uremia.

#### CLINICAL PATHOLOGY

Laboratory tests can be used to evaluate renal function once the circulatory condition has been corrected. Urinalysis as well as serum urea nitrogen and creatinine concentrations are most commonly used as indices. Serum biochemistry on serially collected samples may also be used to monitor the response to therapy. On urinalysis, proteinuria is an early indication of damage to the renal parenchyma. The passage of large volumes of urine of low specific gravity after a period of oliguria is usually a good indication of a return of normal glomerular and tubular function.

#### NECROPSY FINDINGS

Lesions of renal ischemia are present primarily in the cortex, which is pale and swollen. There may be a distinct line of necrosis visible at the corticomedullary junction. Histologically there is necrosis of tubular epithelium and, in severe cases, of the glomeruli. In hemoglobinuria and myoglobinuria hyaline casts are present in the tubules.

#### TREATMENT

Treatment must be directed at correcting fluid, electrolyte and acid-base disturb-

## DIFFERENTIAL DIAGNOSIS

Evidence of oliguria and azotemia in the presence of circulatory failure suggests renal ischemia and the possibility of permanent renal damage. It is important to attempt to differentiate the early reversible prerenal stage from the stage when degeneration of renal parenchyma has occurred. When ischemic renal lesions are present, urinalysis may be helpful in diagnosis, particularly if urine is not appropriately concentrated in a dehydrated patient. After irreversible ischemic changes have occurred it is impossible to differentiate clinically between ischemia and other primary renal diseases such as glomerulonephritis and toxic nephrosis. History and clinical signs of chronic disease will help determine if the acute syndrome is superimposed on chronic renal disease.

ance as soon as possible. If renal damage has occurred, supportive treatment as suggested for the treatment of acute renal failure should be instituted.

## TOXIC NEPHROSIS

The kidneys are particularly vulnerable to endogenous and exogenous toxins because they receive a large proportion of the total cardiac output and because substances are concentrated in the kidney for excretion.

### ETIOLOGY

Most cases of nephrosis are caused by the direct action of toxins but hemodynamic changes may contribute to the pathogenesis.

### Toxins

- Metals – mercury, arsenic, cadmium, selenium, organic copper compounds; nephrosis can be reproduced experimentally in horses by the oral administration of potassium dichromate and mercuric chloride,<sup>3,4</sup> including topical blistering agents containing mercuric chloride
- Antimicrobials such as aminoglycosides, and overdosing with neomycin and gentamicin in treatment of calves. Treatment with tetracycline preparations accidentally contaminated by tetracycline degradation compounds and repeated daily dosing with long-acting oxytetracycline preparations may induce toxicity. Treatment with sulfonamides
- Horses treated with vitamin K<sub>3</sub> (menadione sodium bisulfite) administered by intramuscular or intravenous injection
- Horses treated with vitamin D<sub>2</sub> (ergocalciferol) and cholecalciferol (D<sub>3</sub>)

- Treatment of horses with nonsteroidal anti-inflammatory drugs (NSAIDs), including phenylbutazone and flunixin meglumine. Dose rates of more than 8.8 mg/kg BW of phenylbutazone per day for 4 days are likely to cause nephrosis. Doses of 4.4 mg/kg BW are considered to be safe but the toxicity is enhanced by water deprivation. More commonly, NSAID toxicity occurs as interstitial nephritis and renal crest necrosis. The usual presentation of NSAID toxicosis in horses is gastrointestinal ulceration, including right dorsal colitis
- Benzimidazole compounds used as anthelmintics; only some of them but including thiabendazole
- Monensin in ruminants
- Low-level aldrin poisoning in goats
- Highly chlorinated naphthalenes
- Oxalate in plants, listed under the heading of oxalate poisoning
- Oxalate in fungi, e.g. *Penicillium* spp. and mushrooms
- Oxalate in ethylene glycol or ascorbic acid, which is a metabolic precursor to oxalate
- Primary hyperoxaluria due to inherited metabolic defect in beef master calves<sup>5</sup>
- Tannins in the foliage of oak trees and acorns<sup>6</sup>
- Unidentified toxin in *Amaranthus retroflexus* in pigs and cattle in *Nartheicum asiaticum* fed to cattle and *Isotropis forrestii* in ruminants
- Mycotoxins: ochratoxins and citrinins, fumonisins in ruminants
- Ingestion of *Lophyrotoma interrupta* (sawfly) larvae by cattle
- Cantharidin in horses following ingestion of dead blister beetles in alfalfa hay and hay products
- Most nonspecific endogenous or exogenous toxemias cause some degree of temporary nephrosis.

### PATHOGENESIS

In acute nephrosis there is obstruction to the flow of glomerular filtrate through the tubules as a result of interstitial edema and intraluminal casts. If there is sufficient tubular damage, there may be back leakage of glomerular filtrate into the interstitium. There may also be a direct toxic effect on glomeruli, which decreases glomerular filtration. The combined effect is oliguria and uremia. In subacute cases, impaired tubular resorption of solutes and fluids may lead to polyuria.

### CLINICAL FINDINGS

Clinical signs may not be referable to the urinary system. In peracute cases, such as those caused by vitamin K<sub>3</sub> administered by injection, there may be colic and stranguria. In acute nephrosis there is

oliguria and proteinuria with clinical signs of uremia in the terminal stages. These signs include depression, dehydration, anorexia, hypothermia, a slow or an elevated heart rate, and weak pulse. Diarrhea may be present that is sufficiently intense to cause severe clinical dehydration. In cattle there is a continuous mild hypocalcemia with signs reminiscent of that disease, which responds, in a limited way, to treatment with calcium. Cattle with advanced and severe nephrosis may exhibit a bleeding diathesis. Polyuria is present in chronic cases.

Many systemic diseases such as septicemia cause temporary tubular nephrosis. The degree of renal epithelial loss is not sufficient to cause complete renal failure and, provided the degree of renal damage is small, complete function is regained.

### CLINICAL PATHOLOGY

In acute tubular nephrosis, urinalysis abnormalities are usually present before serum urea and creatinine concentration are increased. Proteinuria, glucosuria, enzymuria, and hematuria are initial changes on urinalysis in experimental toxic nephrosis. The earliest indication of tubular epithelial damage in experimentally induced nephrosis is the detection of the proximal tubule enzyme GGT in urine.<sup>4</sup> Hypoproteinemia may be present. In acute renal disease of horses, hypercalcemia and hypophosphatemia can be present,<sup>7</sup> although this is not the usual finding. In the chronic stages the urine is isosthenuric and may or may not contain protein. Azotemia occurs when uremia is present. Ultrasonographically, renal changes are seen in foals receiving high daily doses of phenylbutazone.<sup>8</sup>

### NECROPSY FINDINGS

In acute cases the kidney is swollen and wet on the cut surface and edema, especially of perirenal tissues, may be apparent. Histologically there is necrosis and desquamation of tubular epithelium, and hyaline casts are present in the dilated tubules. In phenylbutazone poisoning the renal lesion is specifically a renal medullary necrosis. There may also be ulcers in all or any part of the alimentary tract from the mouth to the colon if phenylbutazone was administered orally.

### TREATMENT

Treatment should be directed at general supportive care for acute renal disease as outlined above. If the toxin can be identified, it should be removed. Treatment for specific toxins may be available, as described elsewhere in the text. Hemodialysis was used successfully to treat a foal with presumed oxytetracycline nephrotoxicosis.<sup>9</sup>

## DIFFERENTIAL DIAGNOSIS

Clinical differentiation from acute glomerulonephritis is difficult but clinical signs of involvement of other organs in the toxic process may be present.

- A combination of polyuria and glycosuria is an uncommon finding in large animals and is usually caused by nephrosis
- Diabetes mellitus is rare in horses and extremely rare in ruminants
- Cushing's syndrome (chronic hyperadrenocorticism pituitary pars intermedia dysfunction) is more common in horses but this includes characteristic signs of polyuria, glycosuria, debilitation, hirsutism, polyphagia, and hyperglycemia
- Diarrhea in terminal stages of uremia in a horse can be confused with the other causes of acute diarrhea. It requires a blood urea and creatinine estimation and a urinalysis for differentiation

## REVIEW LITERATURE

Fetcher A. Renal disease in cattle, Part 1. *Compend Contin Educ Pract Vet* 1985; 7:S701-S707; Part 2 *Compend Contin Educ Pract Vet* 1986; 8:S338-S345.

Schmitz DG. Toxic nephropathy in horses. *Compend Contin Educ Pract Vet* 1988; 10:104-111.

Angus KW. Nephropathy in young lambs. *Vet Rec* 1990; 126:525-528.

## REFERENCES

1. Divers TJ et al. *Equine Vet J* 1987; 19:178.
2. Mechor GD et al. *Cornell Vet* 1993; 83:325.
3. Bayly WM et al. *Cornell Vet* 1986; 76:287.
4. Bayly WM et al. *Cornell Vet* 1986; 76:306.
5. Rhyan JC et al. *J Am Vet Med Assoc* 1992; 201:1907.
6. Ostrowski SR et al. *J Am Vet Med Assoc* 1989; 195:481.
7. Elfers RS et al. *Cornell Vet* 1986; 76:317.
8. Leveille R et al. *Can Vet J* 1996; 37:235.
9. Vivrette S et al. *J Am Vet Med Assoc* 1993; 203:105.

## RENAL TUBULAR ACIDOSIS

Renal tubular acidosis (RTA) is a rare disease of large animals that is characterized by normal glomerular function but abnormal tubular function. RTA should be suspected whenever there is a hyperchloremic strong ion (metabolic) acidosis with no discernible extrarenal cause; a common extrarenal cause of hyperchloremic strong ion acidosis is aggressive intravenous administration of 0.9% NaCl.

Four major types of tubular functional defect exist: 1) **renal diabetes insipidus**, where the tubules do not respond to antidiuretic hormone; 2) **Fanconi's syndrome**, which is a genetic defect in humans related to the tubular resorption of glucose, various amino acids, urate, and phosphate; 3) **distal RTA (type I)**, which is a defect in the ability to secrete hydrogen ions in the distal convoluted tubules against a concentration gradient;<sup>1</sup> and 4) **proximal RTA (type II)**, which is

characterized by decreased bicarbonate reabsorption in the proximal convoluted tubules.<sup>2</sup> Reabsorption of bicarbonate requires energy, therefore disease processes that lead to proximal tubular damage have the potential to result in proximal RTA.<sup>3</sup> Other causes of RTA have been described in humans but have not been documented in large animals. The urine of animals with proximal RTA (type II) is acidic, whereas the urine of animals with distal RTA (type I) is very alkaline, regardless of the serum bicarbonate concentration.

Only a few cases of RTA have been documented in horses, and these have been predominantly of the distal type. Horses with distal RTA (type I) have a profound strong ion acidosis due to hyperchloremia (normal anion gap metabolic acidosis), accompanied by an alkaline urine pH (typically > 8.0) and increased fractional clearance of sodium.<sup>1</sup> A practical diagnostic test for distal RTA involves examining the ability of the distal convoluted tubules to excrete hydrogen ions by the oral administration of ammonium chloride (0.1 g/kg BW in 6 L of water via nasogastric tube). Inability to achieve an acidic urine (pH < 6.5) after oral ammonium chloride administration is consistent with a diagnosis of distal RTA (type I). A practical diagnostic test for proximal RTA (type II) is measuring the change in urine  $PCO_2$  during oral or intravenous sodium bicarbonate administration.<sup>2</sup> Normally, urine and plasma  $PCO_2$  are similar but, during bicarbonate diuresis, urine  $PCO_2$  becomes greater than plasma  $PCO_2$ . The  $PCO_2$  gradient during intravenous sodium bicarbonate administration is therefore measured; one horse with proximal RTA developed a urine to plasma  $PCO_2$  gradient of 29 mmHg during bicarbonate loading.<sup>2</sup>

Treatment of horses with distal RTA (type I) has been symptomatic and focuses on oral or intravenous administration of sodium bicarbonate.<sup>1</sup> Spontaneous recovery has been reported in horses. Treatment of horses with proximal RTA (type II) is uncertain.<sup>2</sup>

## REFERENCES

1. Ziemer EL et al. *J Am Vet Med Assoc* 1987; 190:289.
2. Trotter GW et al. *J Am Vet Med Assoc* 1986; 188:1050.
3. Macleay JM, Wilson JH. *J Am Vet Med Assoc* 1998; 212:1597.

## INTERSTITIAL NEPHRITIS

Interstitial nephritis is rarely recognized as a cause of clinical disease in farm animals although it is a frequent post-mortem finding in some species. Interstitial nephritis may be diffuse or have a focal distribution. In calves, focal interstitial

nephritis (white-spotted kidney) is a common incidental finding at necropsy but does not present as a clinical urinary tract disease.<sup>1</sup> Focal interstitial nephritis of cattle is not associated with leptospirosis or active bacterial infection.<sup>2</sup> In pigs, diffuse interstitial nephritis is observed following infection by *Leptospira* sp. and is important clinically because of the resultant destruction of nephrons that occurs. The kidney is an important reservoir for *Leptospira* spp. in other species, particularly cattle, but renal disease is not a common clinical problem in carrier animals.<sup>3</sup>

Chronic interstitial fibrosis is a common postmortem finding in horses suffering from chronic renal failure.<sup>4</sup> This is believed to represent an end-stage condition rather than primary interstitial disease. The initiating cause of the renal disease is usually not evident but most cases are believed to begin with acute tubular nephrosis. Horses with chronic interstitial nephritis have the clinical syndrome of chronic renal failure with uremia.

## REFERENCES

1. Monaghan M. *Ir Vet J* 1985; 39:15.
2. Uzal FA et al. *Vet Microbiol* 2002; 86:369.
3. Ellis WA. *Vet Rec* 1985; 117:101.
4. Divers TJ. *Compend Contin Educ Pract Vet* 1983; 5:S310.

## EMBOLIC NEPHRITIS

Embolic lesions in the kidney do not cause clinical signs unless they are very extensive, in which case septicemia may be followed by uremia. Even though embolic nephritis may not be clinically evident, transient proteinuria and pyuria may be observed if urine samples are examined at frequent intervals.

## ETIOLOGY

Embolic suppurative nephritis or renal abscess may occur after any septicemia or bacteremia when bacteria lodge in renal tissue.

Emboli may originate from localized septic processes such as:

- Valvular endocarditis, in all species
- Suppurative lesions in uterus, udder, navel, peritoneal cavity in cattle

or be associated with systemic infections such as:

- Septicemia in neonatal animals, including *Actinobacillus equuli* infection in foals and *E. coli* septicemia in calves
- Erysipelas in pigs, *Corynebacterium pseudotuberculosis* in sheep and goats
- Septicemic or bacteremic *Streptococcus equi* infection in horses.

## PATHOGENESIS

Bacterial emboli localize in renal tissue and cause the development of focal suppurative lesions. Emboli can block larger vessels and cause infarction of portions of kidney, the size varying with the caliber of the occluded vessel. Infarcts are not usually so large that the residual renal tissue cannot compensate fully and they usually cause no clinical signs. If the urine is checked repeatedly, the sudden appearance of proteinuria, casts, and microscopic hematuria, without other signs of renal disease, suggests the occurrence of a renal infarct. The gradual enlargement of focal embolic lesions leads to the development of toxemia and gradual loss of renal function. Clinical signs usually develop only when multiple emboli destroy much of the renal parenchyma, or when there is one or more large infected infarcts.

## CLINICAL FINDINGS

Usually there is insufficient renal damage to cause signs of renal disease. Signs of toxemia and the primary disease are usually present. The kidney may be enlarged on rectal examination. Repeated showers of emboli or gradual spread from several large, suppurative infarcts may cause fatal uremia. Spread to the renal pelvis may cause signs similar to pyelonephritis. Large infarcts may cause bouts of transient abdominal pain.

## CLINICAL PATHOLOGY

Hematuria and pyuria are present but microscopic examination may be necessary to detect these abnormalities when the lesions are minor. Proteinuria is present but is also normally present in neonatal animals in the first 30–40 hours of life. Culture of urine at the time when proteinuria occurs may reveal the identity of the bacteria infecting the embolus. Hematology usually reveals evidence of an acute or chronic inflammatory process.

## NECROPSY FINDINGS

In animals that die of intercurrent disease the early lesions are seen as small gray spots in the cortex. In later stages these lesions may have developed into large abscesses, which may be confluent and in some cases extend into the pelvis. Fibrous tissue may surround long-standing lesions and healed lesions consist of areas of scar tissue in the cortex. These areas have depressed surfaces and indicate that destruction of cortical tissue has occurred. Extensive scarring may cause an obvious irregular reduction in the size of the kidney.

## TREATMENT

General information on treatment of urinary tract infections is presented in the section on treatment of urinary tract diseases. Antimicrobials should be selected

## DIFFERENTIAL DIAGNOSIS

Differentiation from pyelonephritis is difficult unless the latter is accompanied by signs of lower urinary tract infection such as cystitis or urethritis. The kidney is enlarged in both conditions and the findings on urinalysis are the same when embolic nephritis invades the renal pelvis. Many cases of embolic nephritis go unrecognized clinically because of the absence of overt signs of renal involvement.

Severely dehydrated neonatal animals may experience prerenal uremia and are susceptible to ischemic tubular nephrosis. The presence of other signs of sepsis should increase suspicion of the presence of embolic nephritis.

The sudden occurrence of bouts of acute abdominal pain in some cases of renal infarction may suggest acute intestinal obstruction, but defecation is usually unaffected and rectal examination of the intestines is negative.

on the basis of quantitative urine culture and susceptibility testing. In treating septicemic neonatal animals, particular care must be taken to avoid the use of potentially nephrotoxic drugs. Antibiotic treatment should be continued for a fairly lengthy period (7–14 d). In embolic nephritis, the primary disease must be controlled as well as the renal disease to prevent recurrence of the embolic lesions. In neonatal animals this may involve treatment for septic shock. The urine culture should be repeated at intervals after treatment is completed to insure that the infection has been completely controlled.

## PYELONEPHRITIS

Pyelonephritis usually develops by ascending infection from the lower urinary tract. Clinically it is characterized by pyuria, hematuria, cystitis, ureteritis, and suppurative nephritis.

## ETIOLOGY

Pyelonephritis may develop in a number of ways:

- Secondary to bacterial infections of the lower urinary tract
- Spread from embolic nephritis of hematological origin such as septicemia in cattle associated with *Pseudomonas aeruginosa*
- Specific pyelonephritides associated with *C. renale*, *Corynebacterium pilosum* (formerly *C. renale* type 2) and *Corynebacterium cystitidis* (formerly *C. renale* type 3) in cattle and *Corynebacterium suis* in pigs
- Secondary to anatomical abnormalities of the kidneys or distal

structures permitted ascending infection of the kidney

- In association with nephroliths, although whether the nephrolith or the pyelonephritis occurred first is uncertain.

## PATHOGENESIS

Pyelonephritis develops when bacteria from the lower urinary tract ascend the ureters and become established in the renal pelvis and medulla. Bacteria are assisted in ascending the ureters by urine stasis and reflux of urine from the bladder. Urine stasis can occur as a result of blocking of the ureters by inflammatory swelling or debris, by pressure from the uterus in pregnant females and by obstructive urolithiasis. Initially the renal pelvis and medulla are affected because they are relatively more hypoxic and localized tissue hypertonicity depresses the phagocytic function of leukocytes. Infection in advanced cases may extend to the cortex. Pyelonephritis causes systemic signs of toxemia and fever and, if renal involvement is bilateral and sufficiently extensive, uremia develops.<sup>1</sup> Pyelonephritis is always accompanied by pyuria and hematuria because of the inflammatory lesions of the ureters and bladder.<sup>1</sup>

Pyelonephritis in cattle due to *C. renale* used to be very common but clinical disease has decreased markedly, with the majority of pyelonephritis cases in cattle now being due to *E. coli*. The reason for the decrease in *C. renale* isolation from clinical cases is unclear but is probably related to a change in diet towards concentrates with an associated decrease in urine pH; other potential reasons could be the widespread use of beta-lactam antibiotics and the marked decrease in urethral catheterization in order to obtain a urine sample in cows suspected to be ketotic. *C. renale* attaches most efficiently to well-differentiated epithelial cells (transitional epithelium cells), with poor attachment at pH less than 6.8, a rapid increase in adhesion from 6.8 to 7.6, and a high rate of attachment at pH above 7.6.<sup>2</sup> *C. renale* used to be typed as 1, 2, and 3, but the latter two have been renamed *C. pilosum* (formerly *C. renale* type 2) and *C. cystitidis* (formerly *C. renale* type 3), with apparent type differences in their preferred colonization site in the vagina and urethra.<sup>2,3</sup> Uropathogenic strains of *E. coli* also attach to epithelial cells by a type 1 pili, with the optimal pH for attachment of 6.0. Attachment of bacterial to urinary epithelium appears to be an important virulence attribute.

Transmission of *C. suis* in pigs may occur after mating with infected boars, because many boars carry *C. suis* in their preputial sac fluid. Field observations

suggest that slight trauma at breeding, especially in small gilts, may be an important factor in transmission.<sup>4</sup>

### CLINICAL FINDINGS

The clinical findings in pyelonephritis vary between species. In sows there may be an initial period during which a vaginal discharge is noted but most affected animals die without premonitory illness. Characteristically, affected pigs will lose weight and eventually become emaciated.<sup>5</sup> The disease in cattle is described in detail in the section on bovine pyelonephritis.

The disease in horses is often chronic, although acute disease occurs. Gross hematuria is recognized in some horses with pyelonephritis, although this is not a common finding.<sup>5</sup> Ultrasonographic examination of the kidneys can confirm the diagnosis, based on the presence of abnormally shaped kidneys with loss of the corticomedullary gradient, hypo- or hyperechoic abnormalities in the renal cortex, and increased echogenicity. These findings should prompt examination of the urine for leukocytes, casts, protein, and bacteria.

### CLINICAL PATHOLOGY

Erythrocytes, leukocytes, and cell debris are present in the urine on microscopic examination and may be grossly evident in severe cases, particularly in horses.<sup>5</sup> Quantitative urine culture is necessary to determine the causative bacteria.

### NECROPSY FINDINGS

The kidney is usually enlarged and lesions in the parenchyma are in varying stages of development. Characteristic lesions are necrosis and ulceration of the pelvis and papillae. The pelvis is usually dilated and contains clots of pus and turbid urine. Streaks of gray, necrotic material radiate out through the medulla and may extend to the cortex. Affected areas of parenchyma are necrotic and may be separated by apparently normal tissue. Healed lesions appear as contracted scar tissue. Infarction of lobules may also be present, especially in cattle. Histologically the lesions are similar to those of embolic nephritis except that there is extensive necrosis of the apices of the papillae. Necrotic, suppurative lesions are usually present in the bladder and ureters.

### TREATMENT

General principles of treatment of urinary tract infections are presented above in the section on treatment of urinary tract disease. A specific treatment for severe asymmetric pyelonephritis is unilateral nephrectomy, but this should only be done in nonazotemic animals. An overlooked component of treatment is alteration in urinary pH, which will affect the ability of the bacteria to attach to epi-

### DIFFERENTIAL DIAGNOSIS

The presence of pus and blood in the urine may suggest cystitis or embolic nephritis as well as pyelonephritis. It may be difficult to distinguish between these diseases but renal enlargement or pain on rectal palpation of the kidney indicates renal involvement. Ultrasonographic changes associated with pyelonephritis include a dilated renal collecting system, renal or ureteral calculi, increased echogenicity, loss of corticomedullary echogenicity and subjective enlargement of the kidney with acute disease or a small irregular kidney with chronic disease.<sup>5,6</sup> Parenchymal hyperechogenicity can be caused by tubular degeneration and replacement fibrosis.

thelial cells. As a generalization, *C. renale* attaches best in alkaline urine and *E. coli* attaches best in acidic urine. Refer also to the section on bovine and porcine cystitis pyelonephritis.

### REFERENCES

1. Rebhun WC et al. J Am Vet Med Assoc 1989; 194:953.
2. Takai S et al. Infect Immunity 1980; 28:669.
3. Sato H et al. Infect Immunity 1982; 36:1242.
4. Pijoan C et al. J Am Vet Med Assoc 1983; 183:428.
5. Kistardt KK et al. Can Vet J 1999; 40:571.
6. Hayashi H et al. J Am Vet Med Assoc 1994; 205:736.

### HYDRONEPHROSIS

Hydronephrosis is a dilatation of the renal pelvis with progressive atrophy of the renal parenchyma. It occurs as a congenital or an acquired condition following obstruction of the urinary tract. Any urinary tract obstruction can lead to hydronephrosis but the extent and duration of the obstruction are important in determining the severity of the renal lesion. Urinary tract obstructions that are chronic, unilateral, and incomplete are more likely to lead to hydronephrosis. Acute obstructions of bladder or urethra that are corrected promptly are not usually associated with significant kidney damage. As a result, recurrence of the obstruction rather than renal failure is the major sequel to urolithiasis in ruminants. In cases of acute complete obstruction the clinical picture is dominated by signs of anuria, dysuria, or stranguria.

Chronic or partial obstructions cause progressive distension of the renal pelvis and pressure atrophy of the renal parenchyma. If the obstruction is unilateral, the unaffected kidney can compensate fully for the loss of function and the obstruction may not cause kidney failure. Unilateral obstruction may be detectable on palpation per rectum of a grossly distended kidney. Chronic bilateral obstruc-

tions, although they are rare in large animals, can cause chronic kidney failure. Hydronephrosis and chronic renal failure have been recorded in a steer suffering from chronic partial obstruction of the penile urethra by a urolith.<sup>1</sup> Partial obstruction of the ureters by papillomas of the urinary bladder has been recorded in a series of cows.<sup>2</sup> Compression by neoplastic tissue in cases of enzootic bovine leukosis may also cause hydronephrosis. Ultrasonography can be used as an aid to diagnosis.<sup>2</sup>

### REFERENCES

1. Aldridge BM, Garry FB. Cornell Vet 1992; 82:311.
2. Skye DV. J Am Vet Med Assoc 1975; 166:596.

### RENAL NEOPLASMS

Primary tumors of the kidney are uncommon. Carcinomas occur in cattle and horses and nephroblastomas occur in pigs. Enlargement of the kidney is the characteristic sign; in cattle and horses neoplasms should be considered in the differential diagnosis of renal enlargement. In pigs, nephroblastomas may reach such a tremendous size that they cause visible abdominal enlargement. Renal adenocarcinomas are very slow-growing but are not usually diagnosed until the disease is well advanced. The gross and histological descriptions of a series of primary renal cell tumors in slaughter cattle has been recorded.<sup>1</sup> In horses, the most common signs are weight loss, reduced appetite and intermittent bouts of abdominal pain.<sup>2,3</sup> Some affected horses have massive ascites, hemoperitoneum, or hematuria.<sup>2,3</sup> Metastasis of the tumor to the axial skeleton can result in lameness, which can be the clinical abnormality that is recognized first.<sup>4,5</sup> The tumor can also metastasize to the lungs and mouth.<sup>5,6</sup> Masses on the left kidney of horses are usually readily palpable on rectal examination.<sup>3</sup> Horses with renal carcinoma can have clinically apparent periods of hypoglycemia.<sup>7</sup> Hypoglycemia is confirmed by measurement of serum glucose concentration and is attributable to production of insulin-like growth factor by the neoplastic tissue.<sup>8</sup> Ultrasonographic examination of the kidney, and renal biopsy, confirm the diagnosis.

Metastatic neoplasms occur fairly commonly in the kidney, particularly in enzootic bovine leukosis, but they do not cause clinical renal disease. Tumor masses may be palpable as discrete enlargements in the kidneys of cattle or may involve the kidney diffusely, causing generalized enlargement of the kidney.

### REFERENCES

1. Kelley LC et al. Vet Pathol 1996; 33:133.
2. Von Mol KAC, Franssen JA. Vet Rec 1986; 119:238.



3. West HJ et al. *Equine Vet J* 1987; 19:548.
4. Rhind SM, Sturgeon B. *Equine Vet Educ* 1999; 11:171.
5. Rumbaugh ML et al. *Equine Vet J* 2003; 35:107.
6. Rhind SM et al. *J Comp Pathol* 1999; 120:97.
7. Baker JL et al. *J Am Vet Med Assoc* 2001; 218:235.
8. Swaim JM et al. *J Vet Intern Med* 2005; 19:613.

## Diseases of the bladder, ureters and urethra

### CYSTITIS

Inflammation of the bladder is usually associated with bacterial infection and is characterized clinically by frequent, painful urination (pollakiuria and dysuria) and the presence of blood (hematuria), inflammatory cells and bacteria in the urine.

### ETIOLOGY

Cystitis occurs sporadically as a result of the introduction of infection into the bladder when trauma to the bladder has occurred or when there is stagnation of the urine. In farm animals the common associations are:

- Cystic calculus
- Difficult parturition
- Contaminated catheterization
- Late pregnancy
- As a sequel to paralysis of the bladder. A special case of bladder paralysis occurs in horses grazing sudax or Sudan grass and in horses with equine herpesvirus myoencephalopathy.

In the above cases, the bacterial population is usually mixed but predominantly *E. coli*. There is also the accompaniment of specific pyelonephritides in cattle and pigs, associated with *C. renale* and *Eubacterium suis*, respectively. Many sporadic cases also occur in pigs, especially after farrowing. Common isolates from these are *E. coli*, *Streptococcus*, and *Pseudomonas* spp. *Corynebacterium matruchotii* causes encrusted cystitis in horses.<sup>1</sup>

Enzootic hematuria of cattle resembles but is not a cystitis.

### PATHOGENESIS

Bacteria frequently gain entrance to the bladder but are usually removed by the flushing action of voided urine before they invade the mucosa. Mucosal injury facilitates invasion but stagnation of urine is the most important predisposing cause. Bacteria usually enter the bladder by ascending the urethra but descending infection from embolic nephritis may also occur.

### CLINICAL FINDINGS

The urethritis that usually accompanies cystitis causes painful sensations and

the desire to urinate. Urination occurs frequently and is accompanied by pain and sometimes grunting; the animal remains in the urination posture for some minutes after the flow has ceased, often manifesting additional expulsive efforts. The volume of urine passed on each occasion is usually small. In very acute cases there may be moderate abdominal pain, as evidenced by treading with the hindfeet, kicking at the belly and swishing with the tail, and a moderate febrile reaction. Acute retention may develop if the urethra becomes blocked with pus or blood, but this is unusual.

Chronic cases show a similar syndrome but the signs are less marked. Frequent urination and small volume are the characteristic signs. In chronic cases, the bladder wall may feel thickened on rectal examination and, in horses, a calculus may be present. In acute cases no palpable abnormality may be detected but pain may be evidenced. Endoscopic examination of the bladder of affected horses reveals widespread inflammation of the cystic mucosa and occasionally the presence of a cystic calculus.

### CLINICAL PATHOLOGY

Blood and pus in the urine is typical of acute cases and the urine may have a strong ammonia odor. In less severe cases the urine may be only turbid and in chronic cases there may be no abnormality on gross inspection. Microscopic examination of urine sediment will reveal erythrocytes, leukocytes, and desquamated epithelial cells. Quantitative bacterial culture is necessary to confirm the diagnosis and to guide treatment selection.

### NECROPSY FINDINGS

Acute cystitis is manifested by hyperemia, hemorrhage and edema of the mucosa. The urine is cloudy and contains mucus. In subacute and chronic cases the wall is grossly thickened and the mucosal surface is rough and coarsely granular. Highly vascular papillary projections may have eroded, causing the urine to be bloodstained or contain large clots of blood. In the cystitis associated with Sudan grass, soft masses of calcium carbonate may accumulate in the bladder and the vaginal wall may be inflamed and coated with the same material.

### TREATMENT

Antimicrobial agents are indicated to control the infection and determination of the antimicrobial susceptibility of the causative bacteria is essential. Relapses are common unless treatment is continued for a minimum of 7 and preferably 14 days. Repeated bacterial culture of urine at least once during and again within 7–10 days after completion of treatment should be

## DIFFERENTIAL DIAGNOSIS

The clinical and laboratory findings of cystitis resemble those of pyelonephritis and cystic urolithiasis.

- **Pyelonephritis** is commonly accompanied by bladder involvement and differentiation depends on whether there are lesions in the kidney. This may be determined by rectal examination but in many cases it is not possible to make a firm decision. Provided the causative bacteria can be identified this is probably not of major importance as the treatment will be the same in either case. However, the prognosis in pyelonephritis is less favorable than in cystitis. Thickening of the bladder wall, which may suggest a diagnosis of cystitis, occurs also in enzootic hematuria and in poisoning by the yellow-wood tree (*Terminalia oblongata*) in cattle and by sorghum in horses
- **The presence of calculi** in the bladder can usually be detected by rectal examination, by ultrasonographic examination, by endoscopic examination in female ruminants and in both sexes of horses, or by radiographic examination in smaller animals
- **Urethral obstruction** may also cause frequent attempts at urination but the urine flow is greatly restricted, usually only drops are voided and the distended bladder can be felt on rectal examination

used to assess the success of therapy. Recurrence of the infection is usually due to failure to eliminate foci of infection in the accessory glands and in the bladder wall.

The prognosis in chronic cases is poor because of the difficulty of completely eradicating the infection and the common secondary involvement of the kidney. Free access to water should be permitted at all times to insure a free flow of urine.

## PARALYSIS OF THE BLADDER

Paralysis of the bladder is uncommon in large animals. Paralysis usually occurs as a result of neurological diseases affecting the lumbosacral spinal cord such as equine herpes myelopathy and cauda equina syndrome, and particularly ascending spinal meningitis in lambs after tail docking. In all species, compression of the lumbar spinal cord by neoplasia (lymphosarcoma, melanoma) or infected tissue (vertebral osteomyelitis) can cause paralysis of the bladder. Excessive tension on the tail, such as with tail ropes or use of the tail for restraint in cattle, can injure the cauda equina and cause bladder paralysis. In horses, spinal cord degeneration following consumption of sorghum can lead to bladder paralysis and posterior

ataxia. Iatrogenic bladder paralysis occurs in horses in which there has been epidural injection of an excessive quantity of alcohol. Equine protozoal myeloencephalitis can cause signs of cauda equina dysfunction in horses, as does equine polyneuritis. In some horses, idiopathic bladder paralysis and overflow incontinence may occur sporadically in the absence of other neurological or systemic signs.<sup>2</sup> When the bladder is markedly distended from a urinary tract obstruction, it may take several days after removal of the obstruction before normal bladder tone returns.

When bladder paralysis arises from spinal cord disease, other upper or lower motor neuron signs are usually present. Bladder involvement is indicated by incontinence with constant or intermittent dribbling of urine. Urine flow is often increased during exercise. The bladder is enlarged on examination per rectum and urine can be easily expressed by manual compression. In horses, chronic distension of the bladder leads to accumulation of a sludge of calcium carbonate crystals. Urine stasis produces ideal conditions for bacterial growth and cystitis is a common sequel. Treatment is supportive and aimed at relieving bladder distension by regular catheterization and lavage. During catheterization, care must be taken to avoid introducing infection. Manual or pharmacologically induced emptying of the bladder is incomplete so there is a constant risk of cystitis. Pharmacological enhancement of bladder emptying can sometimes be achieved by administration of parasympathomimetic agents such as bethanechol (parasympathetic stimulation via the pelvic nerve stimulates detrusor contraction) and sympatholytics such as prazosin and phenoxybenzamine (sympathetic stimulation via the hypogastric nerve causes detrusor relaxation and internal sphincter contraction). The administration of antimicrobial agents as a prophylaxis against the development of cystitis is advisable. The prognosis for paralysis associated with spinal cord disease depends on the prognosis for the primary disease. Paralysis in the absence of spinal cord disease has a poor prognosis.

Cattle ingesting *Cistus salvifolius*, a shrub found in the Mediterranean region, had urinary retention as the primary clinical sign.<sup>3</sup> Cattle had decreased appetites and rumen motility, weight loss, and persistent elevation of the tail head and difficulty in urination. A greatly distended urinary bladder was always detected on palpation per rectum. The mortality rate in advanced cases was high, and affected animals have severe cystitis, pyelonephritis and a marked increase in

bladder wall thickness. No evidence of neurological injury was present, and it is likely that urine retention was secondary to severe cystitis and swelling of the bladder wall that prevented normal urination.

#### REFERENCES

1. Saulez MN et al. J Am Vet Med Assoc 2005; 226:246.
2. Holt PE, Mair TS. Vet Rec 1990; 127:108.
3. Yeruham I et al. Rev Med Vet 2002; 153:627.

### **RUPTURE OF THE BLADDER (UROPERITONEUM)**

This occurs most commonly in castrated male ruminants as a sequel to obstruction of the urethra by calculi. Rare cases are recorded in cows as a sequel to a difficult parturition<sup>1-3</sup> and in mares after normal parturition,<sup>4</sup> possibly because of compression of a full bladder during foaling. In cattle, abnormal fetal position during prolonged dystocia is suspected to obstruct the urethra and distend the bladder. Subsequent manipulation within the pelvic canal during correction of the dystocia is suspected to lead to rupture of a distended bladder.<sup>3</sup> Uroperitoneum in foals is discussed in the next section.

After the bladder ruptures, uroperitoneum results in a series of abnormalities that arise from failure of the excretory process combined with solute and fluid redistribution between the peritoneal fluid and extracellular fluid. The peritoneal membrane serves as a semipermeable membrane through which low-molecular-weight solutes readily pass. High-molecular-weight compounds also diffuse across the peritoneal membrane but at a much slower rate. Urine is usually hypertonic especially in animals whose water intake is decreased by uremia. Osmotic pressure from hypertonic urine promotes movement of extracellular water into the peritoneal cavity. This movement, combined with reduced intake, results in clinical dehydration. Urine usually has a lower concentration of sodium and chloride and higher concentrations of urea, creatinine, potassium, and phosphate than plasma. Diffusion along these concentration gradients across the peritoneal membrane results in a general pattern of azotemia with hyponatremia, hypochloremia, hyperkalemia, and hyperphosphatemia.<sup>5</sup> There are minor differences between species in these general biochemical changes. In particular, the blood concentration of urea rises much more slowly in ruminants than in horses, and hyperkalemia is not as common in ruminants as in horses because excessive potassium can be excreted in the saliva and therefore eliminated in the feces.

Bladder rupture leads to gradual development of ascites from uroperitoneum, ruminal stasis, constipation, and depression. In cattle, uremia may take 1-2 weeks to develop to the point where euthanasia is necessary. The degree of uremia between individual patients can be highly variable. With therapy, the survival rate of steers in one study was 49%. The best predictor of survival among clinical pathology tests was the serum phosphate concentration: all animals with levels greater than 9.0 mg/dL (2.9 mmol/L) died.<sup>6</sup> In mature horses, clinical signs of depression, anorexia, colic, abdominal distension, and uremia develop within 1-2 days following rupture.

In cases of ascites or when urinary tract obstruction is evident, it is important in considering treatment and prognosis to determine whether the bladder has ruptured. The urea and creatinine concentrations in plasma can be compared to the values in the peritoneal fluid. The ratio of urea in peritoneal fluid to that in serum is a good guide in the early stages, but after 40 hours the ratio of the peritoneal to serum creatinine greater than 2:1 is diagnostic of uroperitoneum.<sup>7</sup> Treatment is surgical with a goal of bladder repair. To avoid the costs of laparotomy in feedlot animals, a urethrostomy is created or an indwelling catheter is placed and the rupture is allowed to repair itself.

#### REFERENCES

1. Smith JA et al. Cornell Vet 1983; 73:3.
2. LaxT, Drew RA. Vet Rec 1974; 94:615.
3. Carr EA et al. J Am Vet Med Assoc 1993; 202:631.
4. Nyrop KA et al. Compend Contin Educ Pract Vet 1984; 6:S510.
5. Sockett DC et al. Cornell Vet 1986; 76:198.
6. Donecker JM, Bellamy JEC. Can Vet J 1982; 23:355.
7. Genetzky RM, Hagemoser WA. Can Vet J 1985; 26:391.

### **UROPERITONEUM IN FOALS (UROABDOMEN)**

#### ETIOLOGY

Uroperitoneum, the accumulation of urine in the peritoneal cavity, occurs in foals as a result of a variety of situations:

- Congenital (i.e. present at birth) rupture of the bladder
- Bladder rupture associated with sepsis
- Rupture of the urachus, often secondary to sepsis
- Avulsion of the bladder from its urachal attachment, presumably as a result of trauma or strenuous exercise<sup>1</sup>
- Rarely, as embryological failure of the halves of the bladder to unite (schistocystitis)<sup>1</sup>
- Ureteral defects.

The etiology of congenital rupture is unclear, but its association with birth, markedly greater prevalence in colts, and

the traumatic nature of the lesion suggests that it occurs during birth as a result of compression of a distended bladder. Intra-abdominal pressures of the mare during parturition are large, and these compressive forces are experienced by the foal during phase 2 of parturition. Compression of a distended bladder can cause rupture. The greater prevalence in colts is speculated to be a result of the greater resistance to bladder emptying conferred by the longer urethra of male foals.

Rupture of the bladder occurs as a distinct entity in **septic foals**. The underlying reason for bladder rupture is unclear but is usually related to infection, inflammation and necrosis of the lower urinary tract.<sup>2,3</sup> This cause of uroperitoneum in foals is increasingly recognized as the most common, especially amongst hospitalized foals.

Rupture of the urachus occurs in septic foals. It is probably of similar etiology to rupture of the bladder in septic foals. The urachus of affected foals almost always has infection, inflammation and necrosis evident on histological examination.

Avulsion of the bladder from its urachal attachments is presumed to occur as a result of trauma, such as might occur with vigorous exercise. The possibility also exists that there is an underlying defect in affected foals, such as urachitis or omphalitis.

Embryological failure of the halves of the bladder to unite during organogenesis has been reported anecdotally and in case reports, although adequate documentation of its occurrence is lacking.<sup>1,2</sup> This defect would be a true congenital anomaly, arising during gestation.

Ureteral defects are an uncommon cause of uroperitoneum in foals. The defects appear to be congenital and more common in fillies. Both ureters can be affected.<sup>4</sup>

The relative frequency of these diseases is that approximately 20% of foals with uroperitoneum do so because of urachal rupture, approximately 30% because of rupture of the dorsal bladder wall, 18% because of rupture of the ventral bladder wall and the remainder because of multiple defects involving combinations of the urachus, dorsal and ventral bladder.<sup>3,5</sup>

Uroperitoneum also occurs in **calves** as a consequence of umbilical infection.<sup>6</sup>

#### EPIDEMIOLOGY

The epidemiology of uroperitoneum is not well documented. The incidence in foals appears to be approximately 0.2%, although this estimate is based on a study conducted 50 years ago.<sup>7</sup> The prevalence in hospitalized foals is 2.5%.<sup>3</sup> Male foals are at greater risk than are females for

congenital rupture, more than 80% of foals with this disease being colts.<sup>5,8</sup> In contrast, there is no sex predilection for development of uroperitoneum in foals with sepsis.<sup>2,3</sup> The age at diagnosis ranges from 2 to more than 60 days, with most cases recognized within the first 2 weeks of life. The average age at diagnosis is approximately 4–5 days, although the age at presentation depends on the underlying cause. Foals with congenital rupture of the bladder or ureteral defects are usually recognized at about 3–5 days of age, while foals with uroperitoneum secondary to sepsis are usually older (5–9 days of age, but up to 60 days).<sup>2,3,5</sup> The prognosis for survival for foals with uroperitoneum depends on the underlying cause and availability of appropriate treatment. Foals with congenital rupture of the bladder that are recognized and treated in a timely fashion have an excellent prognosis (> 80%) for survival, whereas those with uroperitoneum secondary to sepsis have a more guarded prognosis (50–60%) because of the sepsis.<sup>2,3,5</sup>

#### PATHOPHYSIOLOGY

The pathophysiology of uroperitoneum is that of postrenal azotemia. Regardless of the underlying cause of the uroperitoneum, accumulation of urine within the peritoneal cavity results in substantial electrolyte, acid–base and cardiovascular effects in affected foals. The basic principle is that affected foals are unable to excrete metabolic waste products that are normally excreted in the urine, and are unable to maintain water and electrolyte balance. Young foals derive almost all of their nutritional needs, including water, from mare's milk. Mare's milk has a low sodium concentration (approximately 12 mEq/L) and a high potassium concentration (25 mEq/L) compared to serum, and a dry matter content of 11%.<sup>9</sup> Therefore, foals ingest a diet that contains a large quantity of water and potassium but little sodium. Consequently, the urine of foals contains little sodium (7 mmol/L) and has a low osmolality (100 mosmol/kg).<sup>10,11</sup> Leakage of urine into the peritoneum, a semi-permeable membrane, results in considerable fluid and electrolyte shifts. Partial equilibration of water and electrolytes across the peritoneal membrane results from diffusion of water from the peritoneum with resultant dilution of serum and reductions in serum sodium and chloride concentrations. The low concentration of sodium in uriniferous peritoneal fluid favors diffusion of sodium from the blood into the peritoneal fluid, with the result that there is a reduction in intravascular sodium content and a consequent reduction in effective circulating

volume. Excretion of relatively large quantities of potassium in urine and accumulation of potassium-rich fluid in the peritoneum allows diffusion of potassium into the blood and an increase in plasma potassium concentration.

The peritoneal membrane is permeable to creatinine and urea, as evidenced by the efficacy of peritoneal lavage in treatment of renal failure in a variety of species, including horses. Consequently, serum creatinine and urea concentrations are higher in foals with uroperitoneum than in unaffected foals. However, equilibration of concentrations of these compounds is not complete and peritoneal fluid concentrations of urea, creatinine, and potassium are higher than those in serum.

Foals with uroperitoneum have compromised circulatory function because of reduced effective circulating plasma (blood) volume, despite having an increased total body water content. Circulatory function is further impaired by a combination of the hyperkalemia, abdominal distension and accumulation of fluid in the pleural space, with the result that foals with uroperitoneum can have signs of mild to moderate circulatory compromise.

Hyperkalemia and acidosis associated with uroperitoneum predispose affected foals to development of malignant cardiac rhythm, including ventricular tachycardia and fibrillation. This abnormal cardiac rhythm is a common cause of death of affected foals.

#### CLINICAL SIGNS

Clinical signs in foals with uroperitoneum depend in part on the underlying disease. Foals with congenital rupture or mild sepsis have progressive signs of lethargy, decreased appetite, mild abdominal discomfort, and abdominal distension. These signs usually first become apparent at 2–4 days of age. These foals do not typically have a fever. As the disease progresses and the amount of urine accumulated in the peritoneum increases, foals have progressive distension of the abdomen and make frequent attempts to urinate. Foals attempting to urinate ventroflex the back (mild lordosis) and have a wide-based stance, in contrast with foals with tenesmus, which characteristically have a narrow-based stance (all four limbs being under the body) and arch their back. Affected foals sometimes produce small quantities of urine, but usually there is lack of urination. Abdominal distension is most apparent when the foal is standing. In moderate to severe cases there is a readily appreciable fluid wave on ballotment of the abdomen. As abdominal distension increases the foal's tidal

volume is impaired and breathing becomes rapid and shallow. The extremities become cool as cardiovascular function is impaired.

Ventral edema and preputial swelling occur in some foals. Foals with a urachal rupture close to or within the abdominal wall or in the subcutaneous tissues will have subcutaneous accumulation of urine (which can be mistaken for ventral edema).

Foals with uroperitoneum secondary to sepsis usually have signs of sepsis as the initial and predominant sign of disease. These signs can range from mild fever and enlargement of the umbilical structures to septic shock and its attendant abnormalities. Initial signs of uroperitoneum in these foals are easily overlooked. As the disease develops these foals have progressive abdominal distension. Signs of cardiovascular dysfunction can be incorrectly attributed to worsening of sepsis. It is important when treating septic foals to maintain a high index of suspicion and constant vigilance for development of uroperitoneum.

Infusion of contrast agents, such as methylene blue or fluorescein, into the bladder with subsequent detection of these compounds in the peritoneal fluid has been used to diagnose uroperitoneum. However, use of this method of diagnosis is now obsolete except in those instances in which ultrasonographic examination of the foal is not possible.

### Imaging

**Ultrasonographic** examination of the abdomen of foals has simplified detection of uroperitoneum in foals and is the **preferred imaging modality for detection of excessive peritoneal fluid in foals**. The ultrasound examination is best performed with a 5 MHz sector scanner, with more detailed examination of the umbilical structures performed using a 7 MHz linear or sector scanner. However, diagnosis of the presence of excessive peritoneal fluid can be achieved using a 7 MHz linear scanner, such as is routinely used for examination of the mare reproductive tract. The examination is performed transcutaneously.

Ultrasonography reveals the presence of an excessive quantity of fluid that is minimally echogenic. Intestine, mesentery, and omentum are readily visualized floating in this fluid. The presence of a large quantity of minimally echogenic fluid in the peritoneum of foals is very specific (effectively 100%) for uroperitoneum. The procedure is also sensitive, especially if performed repeatedly to detect changes in the amount of fluid, especially when the initial examination is equivocal. The umbilical structures should be examined closely and the urachus

tracked to the bladder. Frequently a defect in the urachus or umbilicus is identified.<sup>3</sup> The thorax of affected foals should also be examined, as foals with large quantities of urine in the peritoneum often have a substantial accumulation of pleural fluid. This can be important when considering anesthesia in these foals.

**Radiographic** examination of foals with suspected uroperitoneum is rarely performed because of the utility of ultrasonographic examination in this disease. Plain abdominal radiography is of limited usefulness in the detection of uroperitoneum or localizing the source of urine. Positive contrast cystography using a 10% solution of iohexol or similar water-soluble contrast agent administered into the bladder through a Foley catheter can be useful in detection of leaks, especially small leaks that cannot be visualized on ultrasonographic examination. Care should be taken to insure that the bladder is sufficiently distended to insure that any leak is visualized. Use of barium contrast medium or negative-contrast cystography (infusion of air into the bladder) are contraindicated. Intravenous pyelography is of very limited usefulness in the detection of ureteral defects because of the difficulty in localizing the site of the leak.

**Electrocardiographic** examination can reveal cardiac arrest, atrioventricular block, presumed intraventricular block, ventricular premature complexes, ventricular tachycardia and ventricular fibrillation.<sup>5,8</sup> These abnormalities are most likely to occur in foals that are hyperkalemic at the time of induction of anesthesia.

### CLINICAL PATHOLOGY

Foals with uncomplicated uroperitoneum have hyponatremia, hypochloremia, hypobicarbonatemia (metabolic acidosis), acidemia, hyperkalemia, and azotemia. Severely affected foals can be profoundly hyponatremic (< 110 mEq/L) and hyperkalemic (> 7 mEq/L).<sup>2,5</sup> Serum creatinine and urea nitrogen concentrations are elevated. When interpreting serum urea nitrogen concentrations in foals it should be borne in mind that the urea concentration in normal foals is much lower than in adults (see Table 3.6).

Diagnosis based on serum electrolyte abnormalities is confounded in hospitalized foals that are being treated with intravenous fluids.<sup>2,3</sup> Administration of fluids prevents the development of hyponatremia and hypochloremia in septic foals that develop uroperitoneum during the course of their disease. However, fluid administration does not prevent the increases in serum creatinine or urea nitrogen concentration.<sup>2</sup>

Hematological abnormalities reflect any underlying sepsis.

Analysis of **peritoneal fluid** reveals that it has a low specific gravity (< 1.010), low total protein concentration (<< 2.5 g/dL, 25 g/L) and low white cell count (< 1000 cells/ $\mu$ L,  $1 \times 10^9$  cells/L). It can have a uriferous odor, but this is not a reliable diagnostic sign. Peritoneal fluid from foals with uroperitoneum has elevated concentrations of creatinine (usually twice that in a contemporaneous serum sample), urea nitrogen (twice that of serum) and potassium.<sup>5</sup> Microscopic examination of the fluid can reveal calcium carbonate crystals, the presence of which is diagnostic for urine.

### NECROPSY FINDINGS

Necropsy examination confirms the presence of uroperitoneum and the structural defect allowing leakage of urine into the abdomen. The defect can have signs of healing, which can make it readily confused with a malformation, because affected foals can survive for days after the rupture occurs – sufficient time for partial healing of the defect.

### DIFFERENTIAL DIAGNOSIS

Demonstration of an excessive quantity of poorly echogenic fluid in the abdomen of a foal that is passing little if any urine and that has hyponatremia and hyperkalemia is diagnostic of uroabdomen. Confirmation of the diagnosis can be achieved by measurement of creatinine concentration in the peritoneal fluid. Ultrasonographic examination greatly facilitates the diagnosis.

The principal differential diagnoses for azotemia in foals are uroperitoneum and renal disease. **Primary renal disease** in foals can cause hyponatremia, hyperkalemia, and azotemia, but there is no accumulation of fluid in the peritoneum. Additionally, in primary renal disease there are abnormalities in urine composition (presence of blood, protein, leukocytes, and casts). Hyponatremia and hyperkalemia can occur in foals with **enterocolitis**, but the other clinical signs are diagnostic of this disease. **Addison's disease** (mineralocorticoid deficiency) does occur in foals but is rare, and there is no accumulation of fluid in the abdomen.<sup>12</sup>

### TREATMENT

Definitive treatment of uroperitoneum in foals is surgical repair of the defect. However, there is no need for surgery on an emergency basis. Rather, care should be taken to correct life-threatening electrolyte and fluid abnormalities before the foal is subjected to anesthesia. Principles of medical treatment are prevention of potentially lethal cardiac arrhythmia, correction of electrolyte, fluid and acid-base abnormalities and relief of abdominal distension.

**Potentially life-threatening electrolyte abnormalities, especially hyperkalemia, should be corrected urgently and before any attempted surgical correction of the anatomical defect.**

Correction of fluid and electrolyte abnormalities is best achieved by draining the abdomen and insuring continued voiding of urine while administering isotonic fluids intravenously. Because the foal has normal kidney function, draining urine from the abdomen allows the foal to restore normal serum electrolyte concentrations and fluid balance provided that the foal is allowed to nurse and/or is administered parenteral fluids.

**Peritoneal drainage** is achieved by placement of a catheter into the abdomen. The catheter should be placed with a view to it remaining in place until the electrolyte abnormalities have been corrected and the foal is a suitable candidate for surgical repair of the anatomical defect. An ideal catheter is a Foley balloon-tipped catheter placed into the abdomen through a small (5 mm) incision in the skin and external abdominal wall. The catheter should be placed in the inguinal region and to one side of the linear alba, so as to avoid injury and contamination of a future surgical site and to minimize the chances of the catheter being plugged by omentum. The catheter is inserted under local anesthesia and the balloon is inflated to secure the catheter in the abdomen. The catheter can be further secured by a suture. Sedation or tranquilization should be avoided in foals at risk of cardiac or respiratory distress because of the electrolyte abnormalities. Urine should be allowed to drain from the catheter into a closed collection system that minimizes the chances of ascending infection of the peritoneum.

**Hyperkalemia** is usually readily corrected by peritoneal drainage and administration of potassium-free fluid, such as 0.9% sodium chloride. Serum potassium concentration declines quickly when effective peritoneal drainage is obtained and serum potassium concentrations can normalize in 8–12 hours. If emergency management of hyperkalemia is required administration of 5% dextrose either alone or, if hyponatremia is also present, in 0.9% sodium chloride, is effective in reducing serum potassium concentration. Sodium bicarbonate (1–3 mEq/kg BW, intravenously) will also decrease serum potassium concentration. Calcium gluconate antagonizes the effect of hyperkalemia on cardiac function and is useful in the treatment of hyperkalemic arrhythmias. The serum potassium concentration should be less than 5.5 mEq/L before the foal is anesthetized. Mare's milk, which is rich in potassium, should

be withheld until the serum potassium concentration is below the required level.

**Hyponatremia** is resolved by drainage of the peritoneum and administration of 0.9–1.8% sodium chloride intravenously. Serum sodium concentration, especially if markedly low, should be corrected slowly to prevent the development of hyponatremic encephalopathy. Serum sodium concentrations should be increased by approximately 1 (mEq/L)/h.

Affected foals should be administered broad-spectrum antibiotics because of the risk of peritonitis and because many foals with uroperitoneum have sepsis. The immune status of young foals should be examined by measurement of serum IgG concentration and, if it is less than 800 mg/dL (8 g/L), the foal should receive 20–40 mL/kg of plasma.

Correction of the defect in the bladder or urachus is surgical. Nonsurgical management has been described in a foal in which a Foley catheter was inserted in the bladder and left in place for 5 days. The bladder was constantly drained of urine and this allowed the tear to heal.<sup>13</sup> This technique offers an alternative to surgical repair of bladder rupture. However, surgical repair is definitive and is the recommended method of treatment.

Subcutaneous rupture of the urachus can similarly be treated by placement of a Foley catheter through the patent urachus and into the bladder. The defect in the urachus is then allowed to heal and the catheter is removed in 3–6 days.

#### PREVENTION AND CONTROL

There are no recognized means of preventing or controlling this disease. Minimizing the risk of foals developing septic disease is expected to reduce the incidence of uroperitoneum secondary to sepsis.

#### REFERENCES

1. Hardy J. *Equine Vet Educ* 1998; 10:21.
2. Dunkel B et al. *J Vet Intern Med* 2005; 19:889.
3. Kablack KA et al. *Equine Vet J* 2000; 32:505.
4. Divers TJ et al. *J Am Vet Med Assoc* 1988; 192:384.
5. Richardson DW, Kohn CW. *J Am Vet Med Assoc* 1983; 182:267.
6. Bell GJ et al. *Vet Rec* 2004; 154:508.
7. Bain AM. *Aust Vet J* 1954; 30:9.
8. Hackett RP. *Compend Contin Educ Pract Vet* 1984; 6:S488.
9. Ullrey DE et al. *J Anim Sci* 1966; 25:217.
10. Pipkin FB et al. *J Reprod Fertil Suppl* 1991; 44:736.
11. Brewer BD et al. *J Vet Intern Med* 1991; 5:28.
12. Couetill LL, Hoffman AM. *J Am Vet Med Assoc* 1998; 212:1594.
13. Lavoie JP, Harnagel SH. 1988; *J Am Vet Med Assoc* 192:1577.

#### UROLITHIASIS IN RUMINANTS

Urolithiasis is common as a subclinical disorder among ruminants raised in management systems where the ration is composed primarily of grain or where animals graze certain types of pasture. In

these situations, 40–60% of animals may form calculi in their urinary tract. Urolithiasis becomes an important clinical disease of castrated male ruminants when calculi cause urinary tract obstruction, usually obstruction of the urethra. Urethral obstruction is characterized, clinically by complete retention of urine, frequent unsuccessful attempts to urinate and distension of the bladder. Urethral perforation and rupture of the bladder can be sequelae. Mortality is high in cases of urethral obstruction and treatment is surgical. As a result, prevention is important to limit losses from urolithiasis.

#### ETIOLOGY

Urinary calculi, or uroliths, form when inorganic and organic urinary solutes are precipitated out of solution. The precipitates occur as crystals or as amorphous 'deposits'. Calculi form over a long period by a gradual accumulation of precipitate around a nidus. An organic matrix is an integral part of most types of calculus. Several factors affect the rate of urolith formation, including conditions that affect the concentration of specific solutes in urine, the ease with which solutes are precipitated out of solution, the provision of a nidus and the tendency to concretion of precipitates. These are presented under Epidemiology. Factors that contribute to the clinical syndrome of obstructive urolithiasis are dealt with separately.

#### EPIDEMIOLOGY

##### Species affected

Urolithiasis occurs in all ruminant species but is of greatest economic importance in feeder steers and wethers (castrated lambs) being fed heavy concentrate rations, and animals on range pasture in particular problem areas. These range areas are associated with the presence of pasture plants containing large quantities of oxalate, estrogens, or silica. When cattle graze pasture containing plants with high levels of silica, uroliths occur in animals of all ages and sexes.<sup>1</sup> The prevalence of uroliths is about the same in cows, heifers, bulls, and steers grazing on the same pasture and they may even occur in newborn calves. Females and bulls usually pass the calculi and obstructive urolithiasis is primarily a problem in castrated male animals.

Obstructive urolithiasis is the most common urinary tract disease in breeding rams and goats.<sup>2</sup>

There are three main groups of factors that contribute to urolithiasis:

- Those that favor the **development of a nidus** about which precipitation and concretion can occur
- Those that **facilitate precipitation of solutes** on to the nidus

- Those that favor **concretion by cementing precipitated salts** to the developing calculus.

### Nidus formation

A nidus favors the deposition of crystals about itself. A nidus may be a group of desquamated epithelial cells or necrotic tissue that may be formed as a result in occasional cases from local infection in the urinary tract. When large numbers of animals are affected it is probable that some other factor, such as a deficiency of vitamin A or the administration of estrogens, is the cause of excessive epithelial desquamation. When stilbestrol was used as a growth promoter, mortality rates of 20% due to obstructive urolithiasis were recorded in wethers receiving stilbestrol implants compared with no mortalities in a control group. Diets low in vitamin A have been suspected as a cause of urolithiasis but vitamin A deficiency does not appear to be a major causative factor.

### Precipitation of solutes

Urine is a highly saturated solution containing a large number of solutes, many of them in higher concentrations than their individual solubilities permit in a simple solution. Several factors may explain why solutes remain in solution. Probably the most important factor in preventing precipitation is the presence of **protective colloids** that convert urine into a gel. These colloids are efficient up to a point, but their capacity to maintain the solution may be overcome by abnormalities in one or more of a number of other factors. Even in normal animals, crystals of a number of solutes may be present in the urine intermittently and urine must be considered to be an unstable solution. The physical characteristics of urine, the amount of solute presented to the kidney for excretion and the balance between water and solute in urine all influence the ease of calculus formation. In most cases these factors can also be influenced by management practices.

**The pH of urine** affects the solubility of some solutes, mixed phosphate and carbonate calculi being more readily formed in an alkaline than an acid medium.

**Ammonium chloride** or phosphoric acid added to the rations of steers increases the acidity of the urine and reduces the incidence of calculi. The mechanism is uncertain but is probably related to the effect of pH on the stability of the urinary colloids or the effect of diuresis. In contrast, variations in pH between 1 and 8 have little influence on the solubility of silicic acid, the form of silica excreted in the urine of ruminants.

As a result, dietary supplementation with ammonium chloride does not consistently prevent the formation of siliceous calculi.<sup>3</sup>

**The amount of solute presented to the kidney for excretion is influenced by the diet.** Some pasture plants can contain up to 6% silica. Although ruminants grazing on these plants absorb only a small portion of the ingested silica, the kidney is the major route of excretion of absorbed silicic acid. The urine of these animals often becomes supersaturated with silicic acid, which promotes the polymerization or precipitation of the silicic acid and calculus formation.

**Feeding sodium chloride prevents the formation of silica calculi** by reducing the concentration of silicic acid in the urine and maintaining it below the saturation concentration. An excessive intake of minerals may occur from highly mineralized artesian water, or from diets containing high concentrations, particularly of phosphates in heavy-concentrate diets. Sheep with a high dietary intake of phosphorus have an increased concentration of phosphorus in their urine and an increased development of calculi. In cattle, sediment begins to appear in urine when concentrates reach 1.5% of the body weight, and urolithiasis formation begins when concentrates have been fed for 2 months at the rate of 2.5% of the animal's body weight.

**Diets high in magnesium** such as some calf milk replacers have also been associated with an increasing incidence of obstructive urolithiasis.<sup>4</sup> Supplemental calcium in the diet helps prevent calculus formation when phosphate or magnesium<sup>4</sup> intake is high.

**Ingestion of plants with a high oxalic acid** content can be a risk factor for formation of calcium carbonate calculi in sheep. Although dietary excesses contribute to certain types of urolithiasis, calculus formation can rarely be recreated experimentally by simple overfeeding. The process of formation of urinary calculi is more complex than a simple dietary excess. However, recognition of associations between diet and some types of urolithiasis has been useful in developing preventive strategies.

**Feeding practices** can influence the function of the kidney and may contribute to calculus formation. In sheep fed grain in a few large meals, there is a marked reduction in urine volume and a marked increase in urine concentration and calcium excretion at the time of feeding. These short-term changes in urine composition may be factors in the development of uroliths.

**The concentration of urine is an important determinant** of the concentration of individual solutes in the urine.

Although it is difficult to induce urolithiasis by restricting access to water, concentrated urine is a risk factor for calculus formation. Animals can be forced to produce concentrated urine because of lack of easy access to water, a particular problem in pastured animals, lack of familiarity with water delivery systems and poor quality of available water. Water deprivation can be exacerbated by heavy fluid loss by sweating in hot, arid climates.

### Factors favoring concretion

Most calculi, and siliceous calculi in particular, are composed of organic matter as well as minerals. This organic component is mucoprotein, particularly its mucopolysaccharide fraction. It acts as a cementing agent and favors the formation of calculi when precipitates are present. The mucoprotein content of urine of feeder steers and lambs is increased by heavy concentrate-low roughage rations, by the feeding of pelleted rations, even more so by implantation with diethylstilbestrol and, combined with a high dietary intake of phosphate, may be an important cause of urolithiasis in this class of livestock. These high levels of mucoprotein in urine may be the result of a rapid turnover of supporting tissues in animals that are making rapid gains in weight.

### Miscellaneous factors in the development of urolithiasis

Stasis of urine favors precipitation of solutes, probably by virtue of the infection that commonly follows, providing cellular material for a nidus. Certain feeds, including cottonseed meal and milo sorghum, are credited with causing more urolithiasis than other feeds. Alfalfa is in an indeterminate position: by some observers it is thought to cause the formation of calculi, by others to be a valuable aid in preventing their formation. Pelleting appears to increase calculi formation if the ration already has this tendency.

Attempts to produce urolithiasis experimentally by varying any of the above factors are usually unsuccessful and natural cases most probably occur as a result of the interaction of several factors. In feedlots a combination of high mineral feeding and a high level of mucoprotein in the urine associated with rapid growth are probably the important factors in most instances. In range animals a high intake of mineralized water, or oxalate or silica in plants, are most commonly associated with a high incidence of urinary calculi, but again other predisposing factors, including deprivation or excessive loss of water, may contribute to the development of the disease. Limited water intake at weaning

and in very cold weather may also be a contributory factor.

### Composition of calculi

The chemical composition of urethral calculi varies and appears to depend largely on the dietary intake of individual elements. In semi-arid areas such as the great plains of North America<sup>1</sup> and parts of Australia, the dominant pasture grasses have a high content of silica. Cattle and sheep grazing these pastures have a high prevalence of siliceous calculi. Calculi containing calcium carbonate are more common in animals on clover-rich pasture, or when oxalate-containing plants abound. Calcium, ammonium, and magnesium carbonate are also common constituents of calculi in cattle and sheep at pasture.

Sheep and steers in feedlots usually have calculi composed of struvite, magnesium ammonium phosphate. High concentrations of magnesium in feedlot rations also cause a high prevalence of magnesium ammonium phosphate calculi in lambs.<sup>5</sup> Experimental feeding of a ration with a high magnesium content increases the prevalence of calcium apatite urolithiasis in calves and can be prevented by supplementary feeding with calcium.<sup>4</sup> Oxalate calculi are extremely rare in ruminants but have been observed in goats and induced experimentally in feedlot cattle. Xanthine calculi in sheep are recorded in some areas in New Zealand where pasture is poor.

**Estrogenic subterranean clover** can cause urinary tract obstruction in wethers in a number of ways. Soft, moist, yellow calculi containing 2-benzocoumarins, isoflavones and indigotin-indirubin have been observed. Calculi or unforned sediments of benzocoumarins (urolithins) and 4'-O-methylequol, either singly or in various combinations with equol, formonentin, biochanin A, indigotin and indirubin, also occur. Obstruction is promoted by estrogenic stimulation of squamous metaplasia of the urethral epithelium, accessory sex glandular enlargement and mucus secretion. Pastures containing these plants are also reputed to cause urinary obstruction by calculi consisting of calcium carbonate. Feedlot lambs receiving a supplement of stilbestrol (1 mg/kg of feed or 2 mg per lamb daily) developed urethral obstruction believed to be caused primarily by plugs of mucoprotein. The accessory sex glands were also enlarged.

### Risk factors for obstructive urolithiasis

The risk factors important in the formation of urinary calculi are also important in the development of obstructive urolithiasis.

**The size of individual calculi and the amount of calculus material are**

both important in the development of urethral obstruction. Often the obstruction is caused by one stone, although an aggregation of many small struvite calculi often causes obstruction in sheep fed high-concentrate rations.

Once calculi form, the most important factor contributing to the occurrence of obstruction is the diameter of the urethra. Wethers (castrated lambs) and steers (castrated cattle) are most commonly affected because of the relatively small diameter of the urethra in these animals. Castration has a significant impact on the diameter of the urethra in steers. When the urethral diameter of late castrates (6 months old) was compared to early castrates (2 months), it was found to be 8% larger and would be able to expel a calculus that was 13% larger than a calculus passed by early castrates.<sup>6</sup> Bulls can usually pass calculi that are 44% larger than those that could be passed by an early castrated steer.

### Occurrence

**Urethral obstruction** may occur at any site but is most common at the **sigmoid flexure** in steers and in the **vermiform appendage** or at the sigmoid flexure in wethers or rams, all sites where the urethra narrows. Urolithiasis is as common in females as in males, but obstruction rarely if ever occurs because of the shortness and large diameter of the urethra. Repeated attacks of obstructive urolithiasis are not uncommon in wethers and steers and at necropsy up to 200 calculi may be found in various parts of the tract of one animal. However, generally, a single calculus causes obstruction in cattle whereas multiple calculi are common in sheep.

**In North America** obstructive urolithiasis due to siliceous calculi is most common in **beef feeder cattle** during the **fall and winter months**. The calves are weaned at 6–8 months and moved from pasture to a feedlot where they are fed roughage and grain. The incidence of obstructive urolithiasis is highest during the early part of the feeding period and during cold weather, when the consumption of water may be decreased.

Although the occurrence of obstructive urolithiasis is usually sporadic, with cases occurring at irregular intervals in a group of animals, outbreaks may occur affecting a large number of animals in a short time. In outbreaks it is probable that factors are present that favor the development of calculi, as well as the development of obstruction. For example, multiple cases of obstructive urolithiasis can occur in lambs within a few weeks of introducing a concentrated ration. Obstructive urolithiasis increases in occurrence with age but has

occurred in lambs as young as 1 month of age.

### PATHOGENESIS

Urinary calculi are commonly observed at necropsy in normal animals, and in many appear to cause little or no harm. Calculi may be present in kidneys, ureters, bladder, and urethra. In a few animals pyelonephritis, cystitis, and urethral obstruction may occur. Obstruction of one ureter may cause unilateral hydronephrosis, with compensation by the contralateral kidney. The major clinical manifestation of urolithiasis is urethral obstruction, particularly in wethers and steers. This difference between urolithiasis and obstructive urolithiasis is an important one. Simple urolithiasis has relatively little importance but obstructive urolithiasis is a fatal disease unless the obstruction is relieved. Rupture of the urethra or bladder occurs within 2–3 days if the obstruction is not relieved and the animal dies of uremia or secondary bacterial infection. Rupture of the bladder is more likely to occur with a spherical, smooth calculus that causes complete obstruction of the urethra. Rupture of the urethra is more common with irregularly shaped stones that cause partial obstruction and pressure necrosis of the urethral wall.

### CLINICAL FINDINGS

Calculi in the renal pelvis or ureters are not usually diagnosed antemortem although obstruction of a ureter may be detectable on rectal examination, especially if it is accompanied by hydronephrosis. Occasionally the exit from the renal pelvis is blocked and the acute distension that results may cause acute pain, accompanied by stiffness of the gait and pain on pressure over the loins. Calculi in the bladder may cause cystitis and are manifested by signs of that disease.

### Obstruction of the urethra by a calculus

This is a common occurrence in steers and wethers and causes a characteristic syndrome of abdominal pain with kicking at the belly, treading with the hind feet and swishing of the tail. Repeated twitching of the penis, sufficient to shake the prepuce, is often observed, and the animal may make strenuous efforts to urinate, accompanied by straining, grunting and grating of the teeth, but these result in the passage of only a few drops of bloodstained urine. A heavy precipitate of crystals is often visible on the preputial hairs or on the inside of the thighs. Some animals with urethral obstruction will have a dry prepuce because of the absence of urination, although this sign is not specific for urolithiasis.



The passage of a flexible catheter up the urethra, after relaxing the penis by lumbosacral epidural anesthesia, by pudendal nerve block or by administering an ataractic drug, may make it possible to locate the site of obstructions that are anterior to the sigmoid flexure. However, catheterization of the urethra from the glans penis to the bladder is almost impossible in cattle and ruminants because of the urethral diverticulum with its valve.<sup>7</sup> A precurved coronary catheter has been used to catheterize the bladder of calves and goats<sup>8</sup> but requires fluoroscopic guidance.

Cattle with incomplete obstruction – ‘dribblers’ – will pass small amounts of bloodstained urine frequently. Occasionally a small stream of urine will be voided followed by a complete blockage. This confuses the diagnosis. In these the calculus is triangular in shape and allows small amounts of urine to move past the obstruction at irregular intervals. However, these are rare.

The entire length of the penis must be palpated for evidence of a painful swelling from the preputial orifice to the scrotum, above the scrotum to locate the sigmoid flexure and proximally up the perineum as far as possible.

In rams, bucks, and wethers the urethral process of the exteriorized penis must be examined for enlargement and the presence of multiple calculi. Extrusion of the penis is difficult in prepubertal sheep and goats because of the presence of an attachment from the prepuce to the glans penis; loss of this attachment is mediated by testosterone and is usually complete by the onset of puberty,<sup>9</sup> although separation may not occur in castrated animals.<sup>10</sup> Penile extrusion is facilitated by xylazine sedation and positioning the animals with lumbosacral flexion. Abnormal urethral processes should be amputated and in many animals grit is detected during urethral transection.

**On rectal examination**, when the size of the animal is appropriate, the urethra and bladder are palpably distended and the urethra is painful and pulsates on manipulation.

**In rams** with obstructive urolithiasis, sudden depression, inappetence, stamping the feet, tail swishing, kicking at the abdomen, bruxism, anuria or the passage of only a few drops of urine are common. Clinical examination must include inspection of the ventral abdomen for edema, inspection and palpation of the preputial orifice for crystals, palpation of the penis in the area of the sigmoid flexure, and inspection and palpation of the urethral process (vermiform appendage) of the exteriorized penis.

### Rupture of urethra or bladder

If the obstruction is not relieved, **urethral rupture** or **bladder rupture** usually occurs within 48 hours. With urethral rupture, the urine leaks into the connective tissue of the ventral abdominal wall and prepuce and causes an obvious fluid swelling, which may spread as far as the thorax. This results in a severe cellulitis and toxemia. The skin over the swollen area may slough, permitting drainage, and the course is rather more protracted in these cases. When the bladder ruptures there is an immediate relief from discomfort but anorexia and depression develop as uremia develops. Two types of bladder rupture have been described; multiple pinpoint perforations in areas of necrosis or discrete tears in the bladder wall. The site of leakage is almost always on the dorsal aspect of the bladder. Complete urethral obstruction therefore results in urethral rupture or bladder rupture and never both in the same animal, because pressure is released once rupture occurs.

**A fluid wave is detectable on tactile percussion** and the abdomen soon becomes distended. The animal may continue in this state for as long as 2–3 days before death occurs. Fibrin deposition around the dorsal surface of the bladder may be palpated per rectum in steers. In rare cases death occurs soon after rupture of the bladder as a result of severe internal hemorrhage.

In rare cases calculi may form in the prepuce of steers. The calculi are top-shaped and, by acting as floating valves, cause obstruction of the preputial orifice, distension of the prepuce and infiltration of the abdominal wall with urine. These cases may be mistaken for cases of urethral perforation.

### CLINICAL PATHOLOGY

#### Urinalysis

Laboratory examinations may be useful in the diagnosis of the disease in its early stages when the calculi are present in the kidney or bladder. The urine usually contains erythrocytes and epithelial cells and a higher than normal number of crystals, sometimes accompanied by larger aggregations described as sand or sabulous deposit. Bacteria may also be present if secondary invasion of the traumatic cystitis and pyelonephritis has occurred.

#### Serum biochemistry

Serum urea nitrogen and creatinine concentrations will be increased before either urethral or bladder rupture occurs and will increase even further afterwards. Rupture of the bladder will result in uroabdomen. Because urine has a markedly low sodium and chloride concentration

and high osmolality relative to plasma, equilibration of electrolytes and free water into the abdomen will always result in hyponatremia, hypochloremia, hyperphosphatemia, and hypo-osmolality in serum, with the magnitude of the changes reflecting the volume of urine in the abdomen. Similar changes in serum biochemistry are present in steers with ruptured urethra, with the magnitude of the changes being smaller than in steers with ruptured bladder.<sup>11</sup> Interestingly, steers with ruptured bladder or urethra typically have serum potassium concentrations within the normal range;<sup>12</sup> this result most probably reflects the combined effects of increased salivary potassium loss in the face of hyponatremia and inappetence.<sup>13</sup>

#### Abdominocentesis and needle aspirate of subcutaneous tissue

Abdominocentesis is necessary to detect uroperitoneum after rupture of the bladder or needle aspiration from the subcutaneous swelling associated with urethral rupture. However, it is often difficult to identify the fluid obtained from the peritoneal cavity or the subcutaneous tissues as urine other than by appearance and smell, or by biochemical examination. Generally, in uroperitoneum, substantial quantities of fluid can be easily obtained by abdominocentesis. Warming the fluid may facilitate detection of the urine odor, although this is a subjective and poorly sensitive diagnostic test.

#### Ultrasonography

Ultrasonography is a useful aid for the diagnosis of obstructive urolithiasis in rams.<sup>12</sup> All parts of the urinary tract must be examined for urinary calculi. The kidneys are examined from the paralumbar fossa and the bladder and urethra transrectally. The kidneys are examined for enlargement, and the renal pelves, medullary pyramids and urethra for dilatation. The size of the bladder should be noted and its contents examined. A ruptured bladder does not always empty completely. In rams with obstructive urolithiasis, the urethra and bladder are markedly dilated. Because of severe cystitis, the contents of the bladder appear as multiple, tiny, uniformly distributed echoes. The renal pelves are commonly dilated. Uroperitoneum may also be visualized.

### NECROPSY FINDINGS

Calculi may be found in the renal pelvis or bladder of normal animals, or of those dying of other diseases. In the renal pelvis they may cause no abnormality, although in occasional cases there is accompanying pyelonephritis. Unilateral ureteral obstruction is usually accompanied by dilatation of the ureter and hydronephrosis. Bilateral obstruction causes fatal uremia. Calculi in

the bladder are usually accompanied by varying degrees of chronic cystitis. The urethra or urethral process may be obstructed by one or more stones, or may be impacted for up to 35 cm with a fine sabulous deposit.

When rupture of the urethra has occurred the urethra is eroded at the site of obstruction and extensive cellulitis and accumulation of urine are present in the ventral abdominal wall. When the bladder has ruptured the peritoneal cavity is distended with urine and there is mild to moderate chemical peritonitis. In areas where urolithiasis is a problem it is an advantage to determine the chemical composition of the calculi.

#### DIFFERENTIAL DIAGNOSIS

Obstruction of the urethra in ruminant animals is almost always caused by a calculus and is characterized clinically by anuria or dribbling, swishing of the tail, abdominal pain with kicking at the abdomen or stamping the feet, and a progressively worsening condition.

Nonobstructive urolithiasis may be confused with **pyelonephritis** or **cystitis**, and differentiation may be possible only by rectal examination in the case of vesical calculi or by radiographic examination in smaller animals. Subsequent development of hydronephrosis may enable a diagnosis to be made in cattle. Ultrasonographic examination is useful in sheep.

A rectal examination, if possible, may reveal distension of the bladder and dilatation and pulsation of the urethra if the bladder has not ruptured.

In adults, **rupture of the bladder** is usually the result of obstructive urolithiasis, although other occasional causes of urethral obstruction are observed.

**Rupture of the urethra** in cattle is characterized by diffuse swelling of the subcutaneous tissues of the ventral body wall and the skin is usually cooler than normal. It must be differentiated from other causes of swelling of the ventral abdominal wall, including abscesses and herniation of abdominal wall, which can be determined by close physical examination and needle aspiration.

**Dilatation of the urethral recess** in young cattle is characterized by a midline perineal swelling and may resemble pulsation of the perineal urethra in obstructive urolithiasis.<sup>8</sup> The urethral recess arises from the junction of the pelvic and spongy parts of the urethra at the level of the ischial arch. A fold of urethral mucosa proximal to the recess acts as a valve to prevent the retrograde flow of urine into the pelvic urethra. An abnormally large urethral recess has been described in a calf.<sup>8</sup> In dilatation of the urethral recess, during urination the proximal urethra pulses and the swelling may enlarge slightly. There is no urethral obstruction and urine flows passively from the penis for several minutes after the urethral pulsation ceases. The dilatation can be radiographed using contrast media.

#### TREATMENT

The treatment of obstructive urolithiasis is primarily surgical. Cattle or lambs with obstructive urolithiasis that are near the end of their feedlot feeding period and close to being marketed can be slaughtered for salvage if the result of an antemortem inspection is satisfactory. Animals in the early stages of obstruction before urethral or bladder rupture will usually pass inspection at an abattoir. The presence of uremia warrants failure to pass inspection. Rams, bucks, and wethers should all have their glans penis exteriorized and inspected, and the urethral process amputated.

It used to be thought that calculi cannot be dissolved by medical means, but recent studies suggest that administration of specific solutions into the bladder can rapidly dissolve most uroliths. Successful outcomes have occurred following instillation of 30–200 mL of an acetic acid solution (Walpole's buffer, pH adjusted to 4.3–4.8)<sup>14,15</sup> or hemiacidrin solution through a cystotomy catheter;<sup>10</sup> hemiacidrin is an acidic gluconocitrate solution with magnesium carbonate that is used for dissolution of magnesium ammonium phosphate and calcium phosphate uroliths in humans. The advantage of hemiacidrin is that it is reportedly less irritating to urothelium than other acids of similar pH.<sup>10</sup> The cystotomy tube can be placed surgically or transcatheterously, using abdominal ultrasound. The latter technique involves placement of a 12-French sleeved trocar into the lumen of the bladder, followed by removal of the trocar and placement of a 10-French silicone Foley catheter through the sleeve of the trocar into the lumen of the bladder. The balloon on the Foley catheter is then inflated using 0.9% NaCl, the trocar sleeve removed from the abdomen and the Foley catheter secured to the abdomen.<sup>10</sup> The cystotomy catheter provides an alternative route for urine to leave the bladder and is allowed to continuously drip. The cystotomy catheter is occluded for 30 minutes to 2 hours after infusion to retain the solution in the bladder and urethra, after this time the solution is drained from the bladder via the cystotomy tube.<sup>10,14,15</sup>

In early stages of the disease or in cases of incomplete obstruction, treatment with smooth muscle relaxants such as phenothiazine derivatives (aminopromazine, 0.7 mg/kg of BW) has been tried to relax the urethral muscle and permit passage of the obstructing calculus;<sup>16</sup> however treatment efficacy is unknown. Animals treated medically should be observed closely to insure that urination occurs and that obstruction does not recur. However, field observations indicate that these

relaxants are ineffective, and it is difficult to believe that smooth muscle relaxants could be efficacious given that the urethral and periurethral tissue contains very little smooth muscle.<sup>17</sup> A more rational treatment is infiltration of local anesthetic around the origin of the retractor penis muscles<sup>18</sup> or a pudendal nerve block, which would relax the retractor penis muscle and straighten the sigmoid flexure, thereby creating a wider and straighter urethral passageway.<sup>17</sup>

Normograde hydropulsion is only occasionally successful, although it is frequently used as part of the initial treatment. This technique involves catheterization of the urethral orifice with a suitably sized urinary catheter, and intermittent injection of 0.9% NaCl into the urethra in an attempt to flush out the calculi. Frequently, a gritty feeling is detected during this procedure, and one usually is left with the impression that the procedure is creating additional urethral trauma that may contribute to urethral stricture. Normograde hydropulsion may also pack small crystals more tightly into the urethra. In young ruminants, it can be difficult to exteriorize the glans penis and identify the urethral orifice. Cystotomy and retrograde hydropulsion appear to have a higher success rate than normograde hydropulsion.<sup>2</sup>

**Surgical treatment includes perineal urethrostomy** to relieve bladder pressure and for the removal of calculi. This is a salvage procedure and treated animals can be sent to slaughter for salvage when they have recovered sufficiently to pass antemortem inspection. In a series of 85 cases of surgical treatment of urethral obstruction in cattle, only 35% of animals recovered satisfactorily.<sup>7</sup> In small ruminants, which invariably have multiple calculi, amputation of the urethral process may restore urine flow but usually provides only temporary relief,<sup>2</sup> and the long-term prognosis in sheep and goats is poor<sup>19</sup> because there is a high rate of recurrence of obstruction with stricture formation at the urethrostomy site.<sup>2</sup> If perineal urethrostomy is unsuccessful, **tube cystotomy** is indicated. Urethroscopy and **laser lithotripsy** have successfully dissolved uroliths in a small number of small ruminants<sup>20</sup> and one steer<sup>21</sup> but the technique is expensive and not widely available. **Prepubic urethrostomy** has been performed in a small number of small ruminants that have undergone stricture formation following perineal urethrostomy,<sup>17</sup> whereas **urinary bladder marsupialization** offers a simpler surgical method for correction.<sup>22</sup> There is one report of erection failure in a male goat as a sequela to obstructive urolithiasis; erection failure was attributed to vascular occlusion

of the corpus cavernosum penis.<sup>23</sup> Surgical correction of urethral dilatation associated with the urethral recess in cattle has been described.<sup>24</sup>

## PREVENTION

A number of agents and management procedures have been recommended in the prevention of urolithiasis in feeder lambs and steers. First, and probably most important, the diet should contain an adequate balance of calcium and phosphorus to avoid precipitation of excess phosphorus in the urine. This is the major difficulty in controlling urolithiasis in feedlot ruminants, because their diets are grain (and therefore phosphorus)-rich. The ration should have a Ca:P ratio of 1.2:1, but higher calcium inputs (1.5–2.0:1) have been recommended. Every practical effort must be used to increase and maintain water intake in feeder steers that have just been moved into a feedlot situation. The addition of salt at the level of 4% of the total ration of feeder calves has been shown experimentally to have this effect on both steers and lambs. Under practical conditions salt is usually fed at a concentration of 3–5%, higher concentrations causing lack of appetite. It is thought that supplementary feeding with sodium chloride helps to prevent urolithiasis by decreasing the rate of deposition of magnesium and phosphate around the nidus of a calculus, but it is possible that salt-related diuresis may also play an important role. Feeding of pelleted rations may predispose to the development of phosphate calculi (such as struvite or apatite) by reducing the salivary secretion of phosphorus.<sup>15,20</sup>

The control of siliceous calculi in cattle which are fed native range grass hay, which may contain a high level of silica, is dependent primarily on increasing the water intake. The feeding of alfalfa hay is considered to increase urine flow and lower the incidence of urolithiasis but the important reason may be that it contains considerably less silica. As in feedlot animals, water intake can be promoted by supplementing the ration with salt. For yearling (300 kg) steers the daily consumption of 50 g of salt does not prevent the formation of siliceous calculi; at 200 g daily intake the occurrence of calculi is significantly reduced, and at 300 g daily calculus formation is almost eliminated. For calves on native range, providing supplements ('creep feeds') containing up to 12% salt is effective in eliminating siliceous calculi. This effect is due to the physical diluting effect of increased water intake promoted by salt supplementation. If the calves consume sufficient quantities of salt to increase the water intake above 200 g/kg BW per day the formation

of siliceous calculi will be completely suppressed. Since siliceous calculi form in the last 60 days before weaning, it is recommended that calves on range be started on creep feed without salt well before weaning and, once calves are established on the supplement, that the salt concentration be gradually increased to 12%. It is usually necessary to increase the salt gradually to this level over a period of several weeks and incorporate it in pellets to facilitate mixing.

An alkaline urine (pH > 7.0) favors the formation of phosphate-based stones (struvite, apatite) and calcium-carbonate-based stones. Feeding an agent that decreases urine pH will therefore protect against phosphate-based stones. The feeding of ammonium chloride (45 g/d to steers and 10 g daily to sheep) may prevent urolithiasis due to phosphate calculi, but the magnitude of urine acidification achieved varies markedly depending on the acidogenic nature of the diet. For this reason, urine pH should be closely monitored when adding ammonium chloride to the ration, because clinically relevant metabolic acidosis, depression and inappetence can result from over-zealous administration rates. For range animals, ammonium chloride can be incorporated in a protein supplement and fed at about two-thirds of the above dosage. An acidic urine (pH < 7.0) favors the formation of silicate stones, so ammonium chloride manipulation of urine pH is not indicated in animals at risk of developing siliceous calculi. However, ammonium chloride may prevent the formation of silica calculi in sheep,<sup>3</sup> this may have been due to the urine-diluting effects of additional chloride intake.

When the cause of urolithiasis is due to pasture exposure, females can be used to graze the dangerous pastures since they are not as susceptible to developing urinary tract obstruction. In areas where the oxalate content of the pasture is high, wethers and steers should be permitted only limited access to pasture dominated by herbaceous plants. Adequate water supplies should be available and highly saline waters should be regarded with suspicion. Sheep on lush pasture commonly drink little if any water; apparently because they obtain sufficient in the feed. Although the importance of vitamin A in the production of the disease has been decreed in recent years an adequate intake should be insured, especially during drought periods and when animals are fed grain rations in feedlots. Deferment of castration, by permitting greater urethral dilatation, may reduce the incidence of obstructive urolithiasis but the improvement is unlikely to be significant.

## REVIEW LITERATURE

- Oehme FW, Tillmann H. Diagnosis and treatment of ruminant urolithiasis. *J Am Vet Med Assoc* 1965; 147:1331–1339.
- Bailey CB. Silica metabolism and silica urolithiasis in ruminants: a review. *Can J Anim Sci* 1981; 61:219–235.
- Larson BL. Identifying, treating, and preventing bovine urolithiasis. *Vet Med* 1996; 91:366–377.
- Van Metre DC et al. Obstructive urolithiasis in ruminants: surgical management and prevention. *Compend Contin Educ Pract Vet* 1996; 18:S275–S289.

## REFERENCES

- Bailey CB. *Can J Anim Sci* 1981; 61:219.
- Haven ML et al. *Cornell Vet* 1993; 83:47.
- Stewart SR et al. *J Anim Sci* 1991; 69:2225.
- Kallfelz FA et al. *Cornell Vet* 1987; 77:33.
- Poole DBR. *Ir Vet J* 1989; 42:60.
- Marsh H, Safford JW. *J Am Vet Med Assoc* 1957; 342.
- Gasthuys F et al. *Vet Rec* 1993; 133:522.
- Anderson DE et al. *Can Vet J* 1993; 34:234.
- Ashdown RR. *J Agric Sci* 1962; 58:65, 71.
- Streeter RN et al. *J Am Vet Med Assoc* 2002; 221:546.
- Donecker JM, Bellamy JEC. *Can Vet J* 1982; 23:355.
- Braun U et al. *Can Vet J* 1992; 33:654.
- Socket D, Knight AP. *Compend Contin Educ Pract Vet* 1984; 6:S311.
- Cockcroft PD. *Vet Rec* 1993; 132:486.
- Van Metre DC et al. *Compend Contin Educ Pract Vet* 1996; 18:S275–S289.
- Scheel EH, Paton IM. *J Am Vet Med Assoc* 1960; 137:665.
- Stone WC et al. *J Am Vet Med Assoc* 1997; 210:939.
- Baxter GM et al. *J Am Vet Med Assoc* 1992; 200:517.
- Van Weeren PR et al. *Vet Q* 1987; 9:76.
- Halland SK et al. *J Am Vet Med Assoc* 2002; 220:1831.
- Streeter RN et al. *J Am Vet Med Assoc* 2001; 219:640.
- May KA et al. *Vet Surg* 2002; 31:251.
- Todhunter P et al. *J Am Vet Med Assoc* 1996; 209:650.
- Gasthuys F et al. *Vet Rec* 1996; 138:17.

## UROLITHIASIS IN HORSES

Urolithiasis occurs sporadically in horses. The prevalence is low at about 0.04–0.5% of all horse accessions or diagnoses.<sup>1</sup> Animals from about 5–15 years of age and older are most commonly affected and 76% are males (27% intact, 49% geldings) and 24% females.<sup>1</sup> The uroliths are most commonly in the bladder (cystic) although they also occur in the renal pelvis, ureters, and urethra.<sup>2</sup> In most cases, there is a single discrete stone, but a sandy sludge accumulates in cases of paralysis of the bladder. Almost all equine uroliths are composed of calcium carbonate in the form of calcite and their ultrastructure has been examined.<sup>3–5</sup>

The factors that contribute to urolith formation in horses are not understood. Urine from healthy adult horses is characterized by a substantial quantity of mucoprotein, a high concentration of

minerals, considerable insoluble sabulous material, and alkalinity. Equine urine is normally supersaturated with calcium carbonate and crystals of calcium carbonate are usually present;<sup>5</sup> this is related in some manner with the occurrence of calcium carbonate uroliths in horses. Nephrolithiasis may arise as a sequel to degenerative or inflammatory processes in the kidney in which inflammatory debris serves as a nidus for calculus formation.<sup>6</sup>

The clinical findings of urolithiasis in the horse include:

- Stranguria (straining to urinate)
- Pollakiuria (frequent passage of small amounts of urine), hematuria and dysuria (difficult urination)
- Incontinence resulting in urine scalding of the perineum in females or of the medial aspect of the hindlimbs in males
- Painful urination with hematuria associated with cystitis
- Bacterial infection is common.<sup>7</sup>

The bladder wall may be thickened and large calculi in the bladder may be palpable per rectum, just as the hand enters the rectum. Large calculi may be observed using transrectal ultrasonography<sup>6</sup> and cystoscopy. Calculi may also be palpated in the ureters, per rectum, or enlarged ureters may be present.<sup>4</sup>

In males, urethral calculi may present with signs of complete or partial obstruction that may be confused with colic of gastrointestinal origin. Horses with urethral obstructions make frequent attempts to urinate but pass only small amounts of blood-tinged urine. Unless rupture has occurred, the bladder is grossly enlarged. The calculus can be located by palpation of the penile urethra and by passage of a lead wire or catheter. If a catheter or lead wire is passed, care should be taken to prevent damage to the urethral mucosa. Bladder rupture leads to uroperitoneum but, if the rupture occurs at the neck of the bladder, urine may accumulate retroperitoneally and produce a large, diffuse, fluid swelling that is palpable per rectum. When rupture occurs acute signs disappear and are replaced by depression, immobility and pain on palpation of the abdominal wall. The heart rate rises rapidly and the temperature falls to below normal.

Urinalysis reveals evidence of erythrocytes, leukocytes, protein, amorphous debris, and calcium carbonate crystals.

Renal calculi are frequently bilateral and affected animals have often progressed to chronic renal failure by the time of diagnosis without having displayed signs of urinary tract obstruction.<sup>6</sup> A history of chronic weight loss and colic in

a horse with renal failure indicates the possible presence of renal calculi. Treatment is supportive as for all cases of chronic renal failure.

**Treatment** for cystic calculi is surgical removal of the calculus and correction of any defect in the bladder. Perineal urethrotomy has been used for removal of cystic calculi in a gelding.<sup>8</sup> Urethral calculi in males are removed through the external urethral orifice or by urethrotomy at the site of obstruction. Recurrence of cystic and urethral calculi is common in the horse, which may be related to the failure to remove all calculi. Some cystic calculi can be removed with the aid of electrohydraulic lithotripsy,<sup>9</sup> laser lithotripsy under endoscopic visualization<sup>10</sup> or surgery. In large mares with bladder calculi, it is possible to remove the calculi manually by passing a very small hand through the urethra into the bladder and retrieving the calculi after administration of epidural analgesia and sedation. Percutaneous nephrostomy of the right kidney under ultrasonic guidance has been used for short-term diversion of urine in a horse with ureteral calculi.<sup>2</sup> Ammonium chloride, at 200 mg/kg BW orally twice daily and decreased at biweekly intervals until a dosage of 60 mg/kg BW is reached, is recommended to maintain the urine pH below 7.0.

#### REFERENCES

1. Laverty S et al. *Vet Surg* 1992; 21:56.
2. Byars TD et al. *J Am Vet Med Assoc* 1989; 195:499.
3. Newman RD et al. *Am J Vet Res* 1994; 55:1357.
4. Diaz-Espineira M et al. *J Equine Vet Sci* 1995; 15:27.
5. Mair TS. *Res Vet Sci* 1986; 40:288.
6. Ehnen SJ et al. *J Am Vet Med Assoc* 1990; 197:249.
7. Johnson PJ, Crenshaw KL. *Vet Med* 1990; 85:891.
8. Hanson RR, Poland HM. *J Am Vet Med Assoc* 1995; 207:418.
9. Eustace RA et al. *Equine Vet J* 1988; 20:221.
10. Judy CE, Galuppo LD. *Vet Surg* 2002; 31:245.

#### URETHRAL TEARS IN STALLIONS AND GELDINGS

Urethral rents are lesions in the convex surface at the level of the ischial arch in geldings and stallions. The lesions communicate with the corpus spongiosum and cause hemorrhage at the end of urination in geldings or during ejaculation by stallions.<sup>1</sup> Stallions do not have hematuria, despite having a lesion identical to that in geldings, presumably because of the lower pressure in the corpus spongiosum of stallions at the end of urination compared to that in geldings.<sup>2</sup> The disease is apparently caused by contraction of the bulbospongiosus muscle at the end of urination, with a consequent increase in pressure in the corpus spongiosum and expulsion of blood through the rent. The cause of the rent

has not been determined. The diagnosis is confirmed by endoscopic examination of the urethra with visualization of the rent in the urethral mucosa. Treatment of the disease is by temporary subischial urethrostomy and sexual rest. Sexual rest alone was successful in one stallion.<sup>1</sup>

#### REFERENCES

1. Schumacher J et al. *Vet Surg* 1995; 24:250.
2. Taintor J et al. *Equine Vet J* 2004; 36:362.

#### URINARY BLADDER NEOPLASMS

Tumors of the urinary bladder are common only in cattle, where they are associated with bracken poisoning, but they do occur in other circumstances. For example, 18 cows are recorded in one series, with angioma, transitional epithelial carcinoma and vascular endothelioma being the most common tumors. Abattoir surveys in Canada, the USA, and Australia identified papillomas, lymphomas, adenomas, hemangiomas, and transitional cell tumors occurring at low frequencies in slaughter cattle.<sup>1-3</sup> Papillomas appear to be associated with the bovine papilloma-virus (BPV-5). Most bladder neoplasms develop from focal areas of hyperplasia within the transitional cell layer and approximately 80% of these can be classified as carcinomas while 17% are papillomas. Because these neoplasms arise from a common site, they can be very similar in gross and histological appearance and very difficult to differentiate.<sup>3,4</sup> The immunoenzymatic labeling of intermediate filaments in bovine urinary bladder tumors is an accurate indicator of histogenesis.<sup>5</sup>

Six cases of bladder neoplasia are also recorded in horses.<sup>6</sup> Clinical signs included hematuria, weight loss, stranguria and the secondary development of cystitis.

#### REFERENCES

1. Herenda D et al. *Can Vet J* 1990; 31:515.
2. Brobst DF, Olson C. *Am J Vet Res* 1963; 24:105.
3. Pamukcu AM. *Bull WHO* 1974; 50:43.
4. Skye DV. *J Am Vet Med Assoc* 1975; 166:596.
5. Gimeno EJ et al. *J Comp Pathol* 1994; 111:15.
6. Fischer AT et al. *J Am Vet Med Assoc* 1985; 186:1294.

#### Congenital defects of the urinary tract

Congenital defects of the urinary tract are not common in farm animals. The most common congenital defect is uroperitoneum in foals following rupture of the urinary bladder.

#### RENAL HYPOPLASIA

Developmental abnormalities of the kidneys are classified as renal agenesis, hypoplasia and dysplasia, with agenesis

and hypoplasia representing different degrees of the same condition. Renal hypoplasia is defined as a decrease in total renal parenchyma of one-third or more, with a proportionately greater loss of medullary than cortical tissue. The diagnosis of renal hypoplasia is straightforward in neonates but can be difficult to differentiate from renal dysplasia in adults.

Bilateral renal hypoplasia with or without agenesis is recorded in Large White piglets, the piglets being dead at birth or dying in the first 3 months of life.<sup>1</sup> Clinical signs exhibited by older pigs included lethargy, shivering, anorexia, diarrhea and a slow rate of growth. The disease was suspected to be inherited in a simple autosomal recessive manner and the basic defect appeared to be failure of development of mesonephric mesenchyme.

Cases of bilateral renal hypoplasia have been recorded in four horses.<sup>2</sup> The four horses were 1 day to 3 years of age and had common histories of stunting, poor growth rate, anorexia, depression, and lethargy. Evidence of chronic renal failure was present on clinicopathological examination. Transrectal and transabdominal ultrasonography revealed small kidneys and small renal medulla and pelves and was considered a useful diagnostic test.

## RENAL DYSPLASIA

Renal dysplasia is defined as disorganized development of the renal parenchyma due to anomalous differentiation. Histologically, renal dysplasia is characterized by persistence of abnormal mesenchymal structures, including undifferentiated cells, cartilage, immature collecting ductules, and abnormal lobar organization.

Renal dysplasia with benign ureteropelvic polyps associated with hydronephrosis has been recorded in a 4-month-old foal.<sup>3</sup> Renal dysplasia has also been diagnosed in two adult horses with weight loss, azotemia, hypercalcemia and increased fractional clearance of sodium. Ultrasonographic examination of the kidneys revealed a poor distinction between the cortex and medulla due to a hyperechoic medulla, which was due to fibrosis.<sup>4</sup> Histological changes in both horses were indicative of interruption of nephrogenesis after the initiation, but before the complete differentiation, of the metanephric blastema. Renal dysplasia is also reported in foals, both as an apparent spontaneous disease<sup>5</sup> and in foals born to mares treated with sulfadimidine, pyrimethamine, and folic acid during pregnancy.<sup>6</sup>

Congenital renal dysplasia has been recorded in two successive years in a

Leicester sheep flock crossbred with Suffolk and Swaledale rams.<sup>7</sup> Affected lambs were born alive, were reluctant to stand or move, sucked poorly and had wet coats. Lambs improved with nursing and provision of warmth, but none with clinical signs at birth survived beyond 5 days after birth. At necropsy, the kidneys were bilaterally small with fine intracortical cysts and distinct cortical and medullary zones. An inherited dominant trait with complete penetrance is suspected.

Renal tubular dysplasia has been diagnosed in Japanese Black cattle (wagyu) with renal failure, poor growth and long hooves.<sup>8</sup> Calves were undersized at birth and had repeated episodes of diarrhea during the neonatal period. Calves began to show signs of growth retardation from 2–5 months of age but had a normal appetite. Clinicopathological findings included azotemia, increased serum phosphorus concentrations and oliguria. At necropsy, the main lesion was dysplasia of the proximal tubule epithelial cells, with secondary interstitial fibrosis with a reduction in the numbers of glomeruli and tubules in older cattle.<sup>9</sup> An autosomal recessive mode of inheritance has been determined associated with a deletion of the paracellin-1 gene on chromosome 1.<sup>10</sup> This gene encodes a protein that is part of the tight junction of renal epithelial cells, and this gene deletion is considered to be the cause for the renal tubular dysplasia.<sup>9</sup> Heterozygotes are clinically normal and have normal renal function.

## POLYCYSTIC KIDNEYS

In most species this is a common congenital defect. If it is extensive and bilateral the affected animal is usually stillborn or dies soon after birth. In some cases, bilateral defects are compatible with life and clinical signs may not present until the residual nephron mass is gradually exhausted and the animal is adult.<sup>11</sup> If it is unilateral no clinical signs appear because of compensatory activity in the other kidney, but in an adult the enormously enlarged kidney may be encountered during rectal examination.

In adult horses, polycystic disease may also be acquired rather than congenital.<sup>12</sup> The disease is rare, but affected animals present in varying stages of chronic renal failure.<sup>13</sup>

A high incidence of renal defects has been recorded in sucking pigs from sows vaccinated during early pregnancy with attenuated hog cholera virus; bilateral renal hypoplasia has been observed as a probably inherited defect in Large White pigs.<sup>14</sup> Most polycystic kidneys in pigs appear to be inherited in a polygenic

manner<sup>15</sup> and have no effect on the pig's health or renal function. However, there is a record of the defect in newborn pigs in one herd in which it caused gross abdominal distension due to moderate ascites and gross cystic distension of the kidneys and tract. There was no evidence that the disease was inherited in this instance and a toxic origin was surmised.

Isolated cysts occur in the kidneys of all species and are of no clinical significance. The increased availability of ultrasonographic examination of the kidneys of animals facilitates antemortem identification of these cysts. The cysts are usually solitary and unilateral.

**Congenital polycystic kidney disease of lambs** occurs as an autosomal recessive trait.<sup>16</sup> The disease is recognized in Romney, Perendale, and Coopworth sheep in New Zealand. Lambs die at or shortly after birth and there is no apparent sex predisposition. Necropsy examination reveals an abdomen distended by the enlarged kidneys, which contain large numbers of fluid-filled 1–5 mm cysts. There are gross and histological abnormalities of the liver and pancreas. A pathologically similar disease is reported in a Nubian goat.<sup>17</sup>

## ECTOPIC URETER

Ectopic ureter has been recorded in cattle and horses.<sup>18</sup> The condition may be unilateral or bilateral with urinary incontinence present since birth as the major clinical manifestation. Reported neurogenic causes of urinary incontinence in horses include cauda equine neuritis, herpesvirus-1 myelitis, Sudan grass toxicosis, sorghum poisoning, trauma, and neoplasia. Nonneurogenic causes of urinary incontinence in horses include ectopic ureter, cystitis, urolithiasis, hypostrogenism, and abnormal vaginal conformation.<sup>19</sup>

The ectopic ureter opens into the urogenital tract at a place other than the bladder such as the cervix, urethra, or vagina. The condition is often complicated by ascending infections, hydronephrosis, and dilatation of the ureter. Definite diagnosis requires excretory urography or endoscopy; visualization of the ureteral openings during endoscopy can be assisted by intravenous administration of phenolsulfonphthalein (0.01 mg/kg BW) or indigo carmine (0.25 mg/kg BW) to impart a red or blue color, respectively, to the urine being produced. Surgical treatment involving ureterovesical anastomosis or unilateral nephrectomy has been successful.

## URETERAL DEFECT

Unilateral and bilateral ureteral defects have been reported in newborn foals.<sup>20</sup>

The clinical presentation is similar to rupture of the urinary bladder but ureteral defects may be more common in filly foals than in colts.<sup>21</sup>

### **PATENT URACHUS**

Failure of the urachus to close at birth occurs most commonly in foals and is very rare in other species. Patent urachus occurs as three syndromes in foals: congenital and present at birth; acquired and secondary to urachal infection or inflammation; or secondary to severe systemic illness, usually sepsis. As a result of the patent urachus, which during intra-uterine life drains urine into the allantoic fluid, urine leaks from the umbilicus. The urine flow varies from a continuous stream during micturition to constant or intermittent dribbling, or a continuous moistening of the umbilical stalk. Healthy foals with congenital patent urachus heal in several days and no specific treatment is required. Formerly, cauterization with phenol or silver nitrate was practiced, but this treatment has the potential to induce necrosis and increases susceptibility to infection.

Foals with patent urachus secondary to umbilical disease usually have an enlarged umbilicus and some have a purulent discharge. Foals that have patent urachus secondary to other umbilical disease might require surgical correction, although most respond to a 7–14-day course of antimicrobials. Foals with patent urachus secondary to systemic disease, usually sepsis, should have their other disease treated aggressively and the urachus allowed to close spontaneously, which it usually does. Ultrasonographic examination of the umbilicus of all foals with patent urachus is essential to determine the extent of disease and presence of intra-abdominal disease. As with all sick foals, the immune status of foals with patent urachus secondary to umbilical or systemic disease should be determined by measurement of serum IgG concentration and foals with low serum IgG concen-

tration should receive a transfusion. Cystitis is an occasional sequel but omphalitis and urachal abscess may also develop as complications. Patent urachus with a perforated urethra has been recorded in a lamb.<sup>22</sup>

Urachal abscess is discussed as a subgroup of umbilical abscess in Chapter 3. When the infection is localized in the urachus there are usually signs of cystitis, especially increased frequency of urination.<sup>23</sup>

### **EVERSION OF THE BLADDER**

Umbilical evagination of the bladder has been reported in a neonatal filly.<sup>24</sup> The bladder prolapsed through the umbilicus such that the mucosa of the bladder was outermost (bladder eversion). Bladder eversion through the urethra into the vagina and through the vulva occurs in mares immediately after parturition. In this instance care must be taken to not mistake the everted bladder for uterine tissue.<sup>25</sup> Correction in both instances is surgical.

### **RUPTURE OF THE BLADDER**

Rupture of the bladder is dealt with above, under other causes of uroperitoneum in foals.

### **URETHRAL DEFECT**

An anomalous vas deferens caused a chronic partial urethral obstruction in a 2-year-old Limousin bull, resulting in bilateral hydronephrosis, pyelonephritis of the left kidney, and bilateral ureteral dilatation.<sup>26</sup> There are two reports of a ruptured urinary bladder in neonatal calves apparently due to a congenital urethral obstruction that was corrected by passing a urethral catheter. Congenital urethral obstruction with subsequent hydronephrosis and uroperitoneum is reported in a lamb.<sup>27</sup>

### **URETHRAL ATRESIA**

This is recorded rarely in calves and is manifested by failure to pass urine and

distension of the patent portion of the urethra.<sup>28</sup>

### **HYPOSPADIAS**

Imperfect closure of the external male urethra in a series of newborn lambs is recorded with other neonatal defects including atresia ani and diaphragmatic hernia. No genetic influence was suspected and the cause was unidentified.<sup>29</sup>

### **REFERENCES**

1. Cordes DO, Dodd DC. *Pathol Vet* 1965; 2:37.
2. Andrews FM et al. *J Am Vet Med Assoc* 1986; 189:209.
3. Jones SL et al. *J Am Vet Med Assoc* 1994; 204:1230.
4. Ronen N et al. *Vet Rec* 1993; 132:269.
5. Zicker SC et al. *J Am Vet Med Assoc* 1990; 196:2001.
6. Toribio RE et al. *J Am Vet Med Assoc* 1998; 212:697.
7. O'Toole D et al. *J Vet Diagn Invest* 1993; 5:591.
8. Ohba Y et al. *Vet Rec* 2001; 149:115.
9. Sasaki Y et al. *Vet Rec* 2002; 150:628.
10. Ohba Y et al. *Vet Rec* 2001; 149:153.
11. Ramsay G et al. *Equine Vet J* 1987; 19:243.
12. Bertone JJ et al. *J Am Vet Med Assoc* 1987; 191:565.
13. Aguilera-Tejero E et al. *Equine Vet J* 2000; 32:167.
14. Wells GAH et al. *Vet Rec* 1980; 106:532.
15. Wijeratne WVS, Wells GAH. *Vet Rec* 1980; 107:484.
16. Johnstone AC et al. *New Zealand Vet J* 2005; 53:307.
17. Krotec K et al. *Vet Pathol* 1996; 33:708.
18. Pringle JP et al. *Can Vet J* 1990; 31:26.
19. Johnson PJ et al. *J Am Vet Med Assoc* 1987; 191:973.
20. Divers TJ et al. *J Am Vet Med Assoc* 1988; 192:384.
21. Robertson JJ, Embertson RM. *Vet Clin North Am Equine Pract* 1988; 4:359.
22. Adamu SS et al. *Vet Rec* 1991; 129:338.
23. Trent AM, Smith DF. *J Am Vet Med Assoc* 1984; 184:984.
24. Textor JA et al. *J Am Vet Med Assoc* 2001; 219:953.
25. Squire KR et al. *J Am Vet Med Assoc* 1992; 200:1111.
26. Tyler JW et al. *J Am Vet Med Assoc* 1991; 198:871.
27. Yeruham I et al. *Vet Rec* 2003; 152:540.
28. Hylton WE, Trent AM. *J Am Vet Med Assoc* 1987; 190:433.
29. Dennis SM. *Vet Rec* 1979; 105:94.

# Diseases of the nervous system

## INTRODUCTION 575

## PRINCIPLES OF NERVOUS DYSFUNCTION 576

Modes of nervous dysfunction 577

## CLINICAL MANIFESTATIONS OF DISEASE OF THE NERVOUS SYSTEM 577

Altered mentation 577

Involuntary movements 578

Abnormal posture and gait 579

Paresis and paralysis 581

Altered sensation 582

Blindness 582

Abnormalities of the autonomic nervous system 583

## SPECIAL EXAMINATION OF THE NERVOUS SYSTEM 583

The neurological examination 583

Signalment and epidemiology 583

History 583

Head 584

Posture and gait 587

Neck and forelimbs 589

Trunk and hindlimbs 590

Tail and anus 591

Palpation of the bony encasement of the central nervous system 591

Collection and examination of cerebrospinal fluid 591

Examination of the nervous system with serum biochemical analysis 593

Examination of the nervous system with imaging techniques 593

Rhinolaryngoscopy (endoscopy) and ophthalmoscopy 594

Electroencephalography 594

Electromyography 594

Brainstem auditory evoked potentials 594

Intracranial pressure and cerebral perfusion pressure 594

## PRINCIPLES OF TREATMENT OF DISEASES OF THE NERVOUS SYSTEM 594

Elimination and control of infection 595

Decompression 595

Treatment of brain injury after head trauma 595

Central nervous system stimulants 596

Central nervous system depressants 596

## PATHOPHYSIOLOGICAL MECHANISMS OF NERVOUS SYSTEM DISEASE 596

## DIFFUSE DISEASES OF THE BRAIN\* 596

Cerebral hypoxia 596

Increased intracranial pressure, cerebral edema and brain swelling 597

Hydrocephalus 599

Encephalomalacia or the degenerative diseases of the central nervous system 602

Traumatic injury to the brain 604

## FOCAL DISEASES OF THE BRAIN 606

Brain abscess 606

Otitis media/interna 607

Tumors of the central nervous system 608

Central-nervous-system-associated tumors 608

Metastatic tumors of the central nervous system 608

Central-nervous-system-associated masses 609

Coenurosis (gid, sturdy) 609

## DISEASES OF THE MENINGES 609

Meningitis 609

## TOXIC AND METABOLIC ENCEPHALOMYELOPATHIES 611

## PSYCHOSES OR NEUROSES 612

## EPILEPSY 613

## DISEASES OF THE SPINAL CORD 613

Traumatic injury 613

Spinal cord compression 615

Back pain in horses 617

Myelitis 617

Myelomalacia 617

## DISEASES OF THE PERIPHERAL NERVOUS SYSTEM 618

## CONGENITAL DEFECTS OF THE CENTRAL NERVOUS SYSTEM 619

## Introduction

This chapter presents the principles of clinical neurology and their application to large animal practice. In general, this activity has not kept pace with the study of neurology in humans and small animals, although remarkable progress has been made in equine neurology over the last 20 years. To a large extent this shortfall is due to the failure of large animal clinicians to relate observed clinical signs to a **neuroanatomical location** of the lesion. In many cases this failure has been because of adverse environmental circumstances, or the large size or nature of the animal, all of which adversely impact the quality of the neurological examination. It may be very difficult to do an adequate neurological examination on an ataxic belligerent beef cow that is still able to walk and attack the examiner. An aggressive, paretic bull in broad sunlight can be a daunting subject if one wants to examine the pupillary light reflex;

ophthalmoscopic examination of the fundus of the eye in a convulsing steer in a feedlot pen can be an exasperating task. Thus, at one end of the spectrum is the clinical examination of pigs affected with nervous system disease, which is limited to an elementary clinical examination and necropsy examination.<sup>1</sup> At the other end, neurological examination of the horse with nervous system disease is very advanced. The global occurrence of bovine spongiform encephalopathy has highlighted the importance of accurate clinical diagnosis in adult cattle with neurological abnormalities.

Discrete lesions of the central nervous system resulting in well-defined neurological signs are not common in agricultural animals. Many of the diseases are characterized by diffuse lesions associated with viruses, bacteria, toxins, nutritional disorders and embryological defects, and the clinical findings of each disease are similar. Rather than attempting to localize lesions in the nervous system, large-

animal practitioners more commonly devote much of their time to attempting to identify whether an animal has meningoencephalitis, as in *Histophilus somni* meningoencephalitis; whether it has diffuse brain edema or increased intracranial pressure, as in polioencephalomalacia; or whether the dysfunction is at the neuromuscular level, as in hypomagnesemic tetany.

Radiographic examination, including myelography, is not used routinely or available as a diagnostic aid in large-animal practice. The collection of cerebrospinal fluid (CSF) from the different species and ages of large animal without causing damage to the animal or contaminating the sample with blood is a technique that few large-animal veterinarians have mastered. However, the collection of CSF from the lumbosacral cistern is not difficult if the animals are adequately restrained, and the information obtained from analysis of CSF can be very useful in the differential diagnosis



of diseases of the brain and spinal cord.<sup>2</sup> Referral veterinary centers are now providing detailed neurological examinations of horses with nervous system disease and the clinical and pathological experience has expanded the knowledge base of large-animal clinical neurology.<sup>3</sup>

In spite of the difficulties, the large animal practitioner has an obligation to make the best diagnosis possible using the diagnostic aids available. The principles of large-animal neurology are presented in this chapter and the major objective is to recognize the common diseases of the nervous system by correlating the clinical findings with the location and nature of the lesion. Accurate neuroanatomical localization of the lesion(s) remains the fundamental requirement for creating a differential diagnosis list and diagnostic and treatment plan.

A disease such as rabies has major public health implications and it is important for the veterinarian to be able to recognize the disease as early as possible and to minimize human contact. It is also important to be able to recognize treatable diseases of the nervous system such as poliоencephalomalacia, listeriosis and nervous ketosis, and to differentiate them from untreatable and globally important diseases such as bovine spongiform encephalopathy.

The nontreatable diseases must also be recognized as such, and slaughter for salvage or euthanasia recommended if necessary. There must be a major emphasis on prognosis because it is inhumane and uneconomic to hospitalize or continue to treat an adult cow or horse with incurable neurological disease for an indefinite period. If they are recumbent the animals commonly develop secondary complications such as decubitus ulcers and other self-inflicted injuries because of repeated attempts to rise. Very few diseases of the nervous system of farm animals are treatable successfully over an extended period of time. This has become particularly important in recent years with the introduction of legislation prohibiting the slaughter of animals that have been treated with antibiotics until after a certain withdrawal period, which may vary from 5–30 days. This creates even greater pressure on the clinician to make a rapid, inexpensive and accurate diagnosis and prognosis.

Because of limitations in the neurological examination of large animals, there must be much more emphasis on the history and epidemiological findings. Many of the diseases have epidemiological characteristics that give the clinician a clue to the possible causes, thus helping to narrow the number of possibilities. For example, viral encephalomyelitis of horses

occurs with a peak incidence during the insect season, lead poisoning is most common in calves after they have been turned out on to pasture, and poliоencephalomalacia occurs in grain-fed feedlot cattle.

The functions of the nervous system are directed at the maintenance of the body's spatial relation with its environment. These functions are performed by the several divisions of the nervous system including:

- The sensorimotor system, responsible for the maintenance of normal posture and gait
- The autonomic nervous system, controlling the activity of smooth muscle and endocrine glands, and thereby the internal environment of the body
- The largely sensory system of special senses
- The psychic system, which controls the animal's mental state.

The nervous system is essentially a reactive one geared to the reception of internal and external stimuli and their translation into activity and consciousness; it is dependent upon the integrity of both the afferent and efferent pathways. This integrative function makes it often difficult to determine in a sick animal whether abnormalities are present in the nervous system, the musculoskeletal system or acid-base and electrolyte status. Accordingly, the first step when examining an animal with apparent abnormalities in the nervous system is to determine whether other relevant systems are functioning normally. In this way a decision to implicate the nervous system is often made on the exclusion of other systems.

The nervous system itself is not independent of other organs and its functional capacity is regulated to a large extent by the function of other systems, particularly the cardiovascular system. Hypoxia due to cardiovascular disease commonly leads to altered cerebral function because of the dependence of the brain on an adequate oxygen supply.

It is important to distinguish between primary and secondary diseases of the nervous system since both the prognosis and the treatment will differ with the cause.

**In primary disease** of the nervous system the lesion is usually an anatomical one with serious, long-range consequences.

**In secondary disease** the lesion, at least in its early stages, is more likely to be functional and therefore more responsive to treatment, provided the defect in the primary organ can be corrected.

The clinical findings that should arouse suspicion of neurological disturbance

include abnormalities in the three main functions of the system.

### Posture and gait

An animal's ability to maintain a normal posture and to proceed with a normal gait depend largely upon the tone of skeletal muscle but also upon the efficiency of the postural reflexes. Abnormalities of posture and gait are among the best indications of nervous system disease because these functions are governed largely by the coordination of nervous activity. Besides contributing to posture and gait, skeletal muscle tone is characteristic in its own right. However, its assessment in animals is subject to great inaccuracy because of our inability to request complete voluntary relaxation by the patient. In humans it is a very valuable index of nervous system efficiency, but in animals it has serious limitations. The most difficult step when there is a defect of gait or posture is to decide whether it originates in the skeleton, the muscles or the nerve supply.

### Sensory perceptivity

Tests of sensory perception in animals can only be objective, and never subjective as they can be in humans, and any test used in animals is based heavily on the integrity of the motor system.

### Mental state

Depression or enhancement of the psychic state is not difficult to judge, particularly if the animal's owner is observant and accurate. The difficulty usually lies in deciding whether the abnormality is due to primary or secondary changes in the brain.

## Principles of nervous dysfunction

Nervous tissue is limited in the ways in which it can respond to noxious influences. Because of its essentially coordinating function, the transmission of impulses along nerve fibers can be enhanced or depressed in varying degrees, the extreme degree being complete failure of transmission. Because of the structure of the system, in which nerve impulses are passed from neuron to neuron by relays at the nerve cells, there may also be excessive or decreased intrinsic activity of individual cells giving rise to an increase or decrease in nerve impulses discharged by the cells. The end result is the same whether the disturbance be one of conduction or discharge and these are the only two ways in which disease of the nervous system is manifested. Nervous dysfunction can thus be broadly divided into two forms, **depressed activity** and **exaggerated activity**. These can be further

subdivided into four common modes of nervous dysfunction; **excitation (irritation) signs, release of inhibition signs, paresis or paralysis due to tissue damage, and nervous shock.**

## MODES OF NERVOUS DYSFUNCTION

### Excitation (irritation) signs

Increased activity of the reactor organ occurs when there is an increase in the number of nerve impulses received either because of excitation of neurons or because of facilitation of passage of stimuli.

The **excitability** of nerve cells can be increased by many factors, including stimulant drugs, inflammation and mild degrees of those influences that in a more severe form may cause depression of excitability. Thus early or mild hypoxia may result in increased excitability while sustained or severe hypoxia will cause depression of function or even death of the nerve cell.

**Irritation phenomena** may result from many causes, including inflammation of nervous tissue associated with bacteria or viruses, certain nerve poisons, hypoxia and edema. In those diseases that cause an increase in intracranial pressure, irritation phenomena result from interference with circulation and the development of local anemic hypoxia. The major manifestations of irritation of nervous tissue are tetany, local muscle tremor, and whole body convulsions in the motor system and hyperesthesia and paresthesia in the sensory system. For the most part the signs produced fluctuate in intensity and may occur periodically as nervous energy is discharged and reaccumulated in the nerve cells.

The area of increased excitability may be local or sufficiently generalized to affect the entire body. Thus a local lesion in the brain may cause signs of excitatory nervous dysfunction in one limb and a more extensive lesion may cause a complete convulsion.

### Release of inhibition signs

Exaggeration of normal nervous system activity occurs when lower nervous centers are released from the inhibitory effects of higher centers. The classic example of a release mechanism is experimental decerebrate rigidity caused by transection of the brain stem between the colliculi of the midbrain. This results in an uninhibited extensor tonus of all the antigravity muscles. The head and neck are extended markedly in a posture of opisthotonos, and all four limbs in the quadruped are extended rigidly. The tonic mechanism or myotactic reflex involving the lower motor neuron has been released from the effects

of the descending inhibitory upper motor neuron pathways.

Cerebellar ataxia is another example of inhibitory release. In the absence of cerebellar control combined limb movements are exaggerated in all modes of action including rate, range, force, and direction. In general, release phenomena are present constantly while the causative lesion operates, whereas excitatory phenomena fluctuate with the building up and exhaustion of energy in the nerve cells.

### Paresis or paralysis due to tissue damage

Depression of activity can result from depression of metabolic activity of nerve cells, the terminal stage being complete paralysis when nervous tissue is destroyed. Such depression of activity may result from failure of supply of oxygen and other essential nutrients, either directly from their general absence or indirectly because of failure of the local circulation. Infection of the nerve cell itself may cause initial excitation, then depression of function and finally complete paralysis when the nerve cell dies.

Signs of paralysis are constant and are manifested by muscular paresis or paralysis when the motor system is affected and by hypoesthesia or anesthesia when the sensory system is involved. Deprivation of metabolites and impairment of function by actual invasion of nerve cells or by toxic depression of their activity produce temporary, partial depression of function that is completely lost when the neurons are destroyed.

### Nervous shock

An acute lesion of the nervous system causes damage to nerve cells in the immediate vicinity of the lesion but there may be, in addition, a temporary cessation of function in parts of the nervous system not directly affected. The loss of function in these areas is temporary and usually persists for only a few hours. Stunning is the obvious example. Recovery from the flaccid unconsciousness of nervous shock may reveal the presence of permanent residual signs caused by the destruction of nervous tissue.

Determining the type of lesion is difficult because of the limited range of modes of reaction to injury in the nervous system. Irritation signs may be caused by bacterial or virus infection, by pressure, by vascular disturbance or general hypoxia, by poisons and by hypoglycemia. It is often impossible to determine whether the disturbance is structural or functional. Degenerative lesions produce mainly signs of paresis or paralysis but unless there are signs of local nervous tissue injury, such as facial nerve paralysis, paraplegia or local tremor, the disturbance

may only be definable as a general disturbance of a part of the nervous system. Encephalopathy is an all-embracing diagnosis, but it is often impossible to go beyond it unless other clinical data, including signalment of the animal, epidemiology and systemic signs, are assessed or special tests, including radiographic examination and examination of the CSF, are undertaken.

Some information can be derived from a study of the **sign-time relationship** in the development of nervous disease. A lesion that develops suddenly tends to produce maximum disturbance of function, sometimes accompanied by nervous shock. Slowly developing lesions permit a form of compensation in that undamaged pathways and centers may assume some of the functions of the damaged areas. Even in rapidly developing lesions partial recovery may occur in time but the emphasis is on maximum depression of function at the beginning of the disease. Thus a slowly developing tumor of the spinal cord will have a different pattern of clinical development from that resulting from an acute traumatic lesion. Another aspect of the rapidity of onset of the lesion is that irritation phenomena are more likely to occur when the onset is rapid and less common when the onset is slow.

## Clinical manifestations of disease of the nervous system

The major clinical signs of nervous system dysfunction include:

- **Altered mentation**
- **Involuntary movements**
- **Abnormal posture and gait**
- **Paresis or paralysis**
- **Altered sensation**
- **Blindness**
- **Abnormalities of the autonomic nervous system.**

### ALTERED MENTATION

#### Excitation states

Excitation states include **mania, frenzy, and aggressive behavior**, which are manifestations of general excitation of the cerebral cortex. The areas of the cortex that govern behavior, intellect and personality traits in humans are the frontal lobes and temporal cortex. The clinical importance of these areas, which are poorly developed in animals, is not great. The frontal lobes, temporal cortex and limbic system are highly susceptible to influences such as hypoxia and increased intracranial pressure.

### Mania

In mania the animal acts in a bizarre way and appears to be unaware of its surroundings. Maniacal actions include licking, chewing of foreign material, sometimes themselves, abnormal voice, constant bellowing, apparent blindness, walking into strange surroundings, drunken gait and aggressiveness in normally docile animals. A state of delirium cannot be diagnosed in animals, but mental disorientation is an obvious component of mania as we see it.

Diseases characterized by mania include:

- Encephalitis, e.g. the furious form of rabies, Aujeszky's disease in cattle (pseudorabies, mad itch)
- Degenerative diseases of the brain, e.g. mannosidosis, early polioencephalomalacia, poisoning by *Astragalus* sp.
- Toxic and metabolic diseases of brain, e.g. nervous ketosis, pregnancy toxemia, acute lead poisoning, poisoning with carbon tetrachloride, and severe hepatic insufficiency, especially in horses.

### Frenzy

Frenzy is characterized by violent activity and with little regard for surroundings. The animal's movements are uncontrolled and dangerous to other animals in the group and to human attendants, and are often accompanied by aggressive physical attacks.

Examples of frenzy in diseases of the nervous system include:

- Encephalomyelitides, e.g. Aujeszky's disease
- Toxic and metabolic brain disease, e.g. hypomagnesemic tetany of cattle and sheep, poisoning with ammoniated roughage in cattle.

Examples of frenzy in diseases of other body systems are:

- Acute pain of colic in horses
- Extreme cutaneous irritation, e.g. photosensitization in cattle.

Apparently reasonless panic, especially in individual horses or groups of cattle, is difficult to differentiate from real mania. A horse taking fright at a botfly or a swarm of bees, a herd of cattle stampeding at night are examples.

### Aggressive behavior

Aggression and a willingness to attack other animals, humans and inert objects is characteristic of: the early stages of rabies and Aujeszky's disease in cattle; in sows during postparturient hysteria; in the later stages of chronic hypoxia in any species; and in some mares and cows

with granulosa-cell tumors of the ovary. The latter are accompanied by signs of masculinization and erratic or continuous estrus.<sup>4</sup> It is often difficult to differentiate between an animal with a genuine change in personality and one that is in pain or is physically handicapped, e.g. pigs and cattle with atlantoaxial arthroses.

### Depressive states

Depressive mental states include somnolence, lassitude, narcolepsy/catalepsy, syncope and coma. They are all manifestations of depression of cerebral cortical function in various degrees and occur as a result of those influences that depress nervous system function generally, as well as those that specifically affect behavior, probably via the limbic system. It is not possible to classify accurately the types of depressive abnormality and relate them to specific causes, but the common occurrences in farm animals are listed below.

Depression leading to coma

In all species this may result from:

- Encephalomyelitis and encephalomalacia
- Toxic and metabolic diseases of the brain such as uremia, hypoglycemia, hepatic insufficiency, toxemia, septicemia and most toxins that damage tissues generally
- Hypoxia of the brain, as in peripheral circulatory failure of milk fever
- Heat stroke
- Specific poisons that cause somnolence, including bromides, Amitraz in horses, methyl alcohol, *Filix mas* (male fern), kikuyu grass.

### Syncope

The sudden onset of fainting (syncope) may occur as a result of:

- Acute circulatory and heart failure leading to acute cerebral hypoxia
- Spontaneous cerebral hemorrhage, a most unlikely event in adult animals
- Traumatic concussion and contusion
- Lightning strike, electrocution.

### Narcolepsy (catalepsy)

Affected animals experience episodes of uncontrollable sleep and literally 'fall' asleep. The disease is recorded in Shetland ponies and is thought to be inherited in them, in other horses, and in cattle.<sup>5</sup>

### Compulsive walking or head-pressing

Head-pressing is a syndrome characterized by the animal pushing its head against fixed objects, into a corner of a pen, leaning into a stanchion or between fence posts. Head-pressing should be differentiated from compulsive walking, where affected animals put their heads

down and walk slowly while appearing blind. If they walk into an object they lean forward and indulge in head-pressing; if confined to a stall they will often walk around the pen continuously or head-press into a corner. The syndrome represents a change in behavior pattern due to an unsatisfied compulsive drive characteristic of a disorder of the limbic system. Causes include:

- Toxic and metabolic brain disease, especially polioencephalomalacia and hepatic encephalopathy
- Diseases manifested by increased intracranial pressure
- Encephalomyelitides.

### Aimless wandering

A similar but less severe syndrome to compulsive walking is aimless walking, severe mental depression, apparent blindness, with tongue protrusion and continuous chewing movements, although the animal is unable to ingest feed or drink water. Causes include:

- Toxic and metabolic diseases of brain, including poisoning by *Helichrysum* sp. and tansy mustard
- Degenerative brain diseases, e.g. nigropallidal encephalomalacia in horses, ceroid lipofuscinosis in sheep, hydrocephalus in the newborn.

### INVOLUNTARY MOVEMENTS

Involuntary movements are due to involuntary muscle contractions, which include gradations from fasciculations, shivering and tremor, to tetany, seizures or convulsions. Opisthotonos or 'backward tone' is a sustained spasm of the neck and limb muscles resulting in dorsal and caudal extension of the head and neck with rigid extension of the limbs.

### Tremor

This is a continuous, repetitive twitching of skeletal muscles, which is usually visible and palpable. The muscle units involved may be small and cause only local skin movement, in which case the tremor is described as fasciculations; or the muscle units may be extensive, the movement much coarser and sufficient to move the extremities, eyes or parts of the trunk. The tremor may become intensified when the animal undertakes some positive action, this usually being indicative of cerebellar involvement and is the counterpart of intention tremor in humans. True tremor is often sufficiently severe to cause incoordination and severe disability in gait. Examples of causes of tremor include:

- Diffuse diseases of the cerebrum, cerebellum, spinal cord
- Degenerative nervous system disease, e.g. hypomyelination of the

newborn as in congenital tremor of pigs and calves, poisoning by *Swainsona* sp.

- Toxic nervous system disease caused by a large number of poisons, especially poisonous plants and fungi, *Clostridium botulinum* toxin in shaker foal syndrome; metabolic disease such as hyperkalemic periodic paralysis in the horse; early stages of hypocalcemia in the cow (fasciculations of the eyelids and ears).

### Tics

Tics are spasmodic twitching movements made at much longer intervals than in tremor, the intervals being usually at least several seconds in duration and often much longer. The movements are sufficiently widespread to be easily visible and are caused by muscles that are ordinarily under voluntary control. They are rare in large animals but may occur after traumatic injury to a spinal nerve.

### Tetany

Tetanus is a sustained contraction of muscles without tremor. The most common cause is *Clostridium tetani* intoxication following localized infection with the organism. The degree of muscular contraction can be exaggerated by stimulation of the affected animal and the limbs are rigid and cannot be passively flexed easily – 'lead pipe' rigidity.

**Myoclonus** is a brief, intermittent tetanic contraction of the skeletal muscles that results in the entire body being rigid for several seconds, followed by relaxation. Inherited congenital myoclonus (hereditary neuraxial edema) of Polled, Horned and crossbred Hereford calves is a typical example. Affected calves are bright and alert and can suck normally but if they undertake a voluntary movement or are handled, their entire body becomes rigid for 10–15 seconds.

### Convulsions

Convulsions, seizures, fits, or ictus are violent muscular contractions affecting part or all of the body and occurring for relatively short periods as a rule, although in the late stages of encephalitis they may recur with such rapidity as to give the impression of being continuous.

Convulsions are the result of abnormal electrical discharges in forebrain neurons that reach the somatic and visceral motor areas and initiate spontaneous, paroxysmal, involuntary movements. These cerebral dysrhythmias tend to begin and end abruptly and they have a finite duration. A typical convulsion may have a prodromal phase or aura that lasts for minutes to hours, during which the animal is oblivious to its environment and seems restless. The beginning of the con-

vulsion may be manifested as a localized partial convulsion of one part of the body that soon spreads to involve the whole body, when the animal usually falls to the ground thrashing rhythmically. Following the convulsion there may be depression and temporary blindness, which may last for several minutes up to a few hours.

The convulsion may be clonic, the typical 'padding' involuntary movement in which repeated muscle spasms alternate with periods of relaxation. Tetanic or tonic convulsions are less common and are manifested by prolonged muscular spasm without intervening periods of relaxation. True tetanic convulsions occur only rarely, chiefly in strychnine poisoning and in tetanus, and in most cases they are a brief introduction to a clonic convulsion.

Convulsions can originate from disturbances anywhere in the prosencephalon, including cerebrum, thalamus or even the hypothalamus alone. However, the initiating cause may be in the nervous system outside the cranium or in some other system altogether, so that convulsions are therefore often subdivided into intracranial and extracranial types. Causes are many and include the following.

**Intracranial convulsions** are caused by:

- Encephalomyelitis, meningitis
- Encephalomalacia
- Acute brain edema
- Brain ischemia, including increased intracranial pressure
- Local lesions caused by trauma (concussion, contusion), abscess, tumor, parasitic injury, hemorrhage
- Inherited idiopathic epilepsy.

**Extracranial convulsions** are caused by brain hypoxia, as in acute circulatory or cardiac failure, and toxic and metabolic diseases of the nervous system, including:

- Hepatic encephalopathy
- Hypoglycemia (as in newborn piglets and in hyperinsulinism due to islet cell adenoma of the pancreas as described in a pony)
- Hypomagnesemia (as in lactation tetany in cows and mares)
- Inorganic poisons, poisonous plants and fungi. There are too many to give a complete list but well-known examples are the chlorinated hydrocarbons, pluronics used in bloat control in cattle, *Clostridium* spp. intoxications, e.g. *Clostridium perfringens* type D and *Clostridium sordellii*, and subacute fluoroacetate poisoning
- Congenital and inherited defects without lesions, e.g. familial convulsions and ataxia in Angus cattle.

### Involuntary spastic paresis

Involuntary, intermittent contractions of large muscle masses may result in spasmodic movements of individual limbs or parts of the body. In most, contractions occur when voluntary movement is attempted. Diseases in this category are:

- Stringhalt and Australian stringhalt of horses
- Inherited spastic paresis (Elso-heel) of cattle
- Inherited periodic spasticity (stall-cramp) of cattle
- Inherited congenital myotonia of cattle
- Inherited myotonia of goats.

## ABNORMAL POSTURE AND GAIT

### Posture

Posture is evaluated with the animal at rest. Abnormal postures may be adopted intermittently by animals in pain but in diseases of the nervous system the abnormality is usually continuous and repeatable. Deviation of the head and neck from the axial plane or rotation of the head and neck from the horizontal plane (head tilt) and drooping of the lips, eyelids, cheeks and ears, and opisthotonos and orthotonos are examples, although the latter two are often intermittent in that they occur as part of a convulsive seizure. Head-pressing and assumption of a dog-sitting posture are further examples. Abnormalities of posture and gait are the result of lesions of the brainstem, cerebellum, all levels of the spinal cord, spinal nerve roots, peripheral nerves, neuromuscular junctions and muscles. The clinical emphasis is on vestibular disease, cerebellar disease and spinal cord disease. It is important to recognize that cerebral lesions do not cause abnormalities in posture and gait.

### Vestibular disease

The vestibular system is a special proprioceptive system that assists the animal to maintain orientation in its environment with respect to gravity. The system helps to maintain the position of the eyes, trunk and limbs in relationship to movements and positioning of the head.

From the vestibular nuclei, the vestibulospinal tracts descend ipsilaterally through the length of the spinal cord. These neurons are facilitatory to ipsilateral motor neurons going to extensor muscles of the limbs, are inhibitory to ipsilateral motor flexor muscles and are inhibitory to contralateral extensor muscles. The principal effect of unilateral stimulation of this system on the limbs is a relative ipsilateral extensor tonus and contralateral flexor tonus, which promotes ipsilateral support of the trunk against gravity. Conversely, a unilateral vestibular lesion usually results in ipsilateral

flexor and contralateral extensor tonus, forcing the animal toward the side of the lesion.

The nuclei of cranial nerves III, IV, and VI, which control eye movement, are connected with the vestibular system by way of a brainstem tract – the medial longitudinal fasciculus. Through this tract, coordinated eye movements occur with changes in positioning of the head. Through these various pathways, the vestibular system coordinates movements of the eye, trunk, and limbs with head movements and maintains equilibrium of the entire body during motion and rest.

Signs of vestibular disease vary depending on whether there is unilateral or bilateral involvement and whether the disease involves peripheral or central components of the system.

The vestibular influence on balance can be affected:

- At the inner ear
- Along the vestibular nerve or
- At the vestibular nucleus in the medulla.

Unilateral excitation or loss of function can be caused by lesions at any of these points.

General signs of vestibular system dysfunction are staggering, leaning, rolling, circling, drifting sideways when walking and a head tilt, and various changes in eye position such as strabismus and nystagmus. The walking in a circle toward the affected side is accompanied by increased tone in the contralateral limbs, which is most easily observed in the contralateral forelimb. Rotation or tilt of the head occurs and severely affected animals fall to the affected side.

When the lesion affects the inner ear, as it may do in otitis media, the affected side is turned down, the animal falls to that side and there may be facial paralysis on the same side if the lesion is extensive and affects the seventh cranial nerve. In the recumbent position, the affected side is held to the ground, and if these animals are rolled over to the opposite side they quickly roll back to the affected side. When the vestibular nuclei are affected, which may occur in listeriosis, the animal falls to the affected side.

Nystagmus and forced circling are common when there is irritation of the vestibular nucleus or the medial longitudinal fasciculus.

**Causes** of vestibular disease include:

- Otitis media–interna with involvement of the inner ear
- Focal lesion at the vestibular nucleus, e.g. listeriosis
- Traumatic injury to the vestibular apparatus in the horse caused by fracture of the basisphenoid,

basioccipital and temporal bones in a traumatic injury. The clinical signs include lack of control of balance, rotation of the head, circling to the affected side, nystagmus and facial paralysis.

**In paradoxical vestibular syndrome** there is also head tilting, but circling in a direction away from the side of the lesion.<sup>6</sup> Deviation of the head and neck must be distinguished from a head tilt. Asymmetric lesions of the forebrain such as a brain abscess, some cases of polioencephalomalacia, verminous larval migration or head trauma may cause an animal to hold its head and neck turned to one side, but there is no head tilt and the circle is large in diameter. In fact, the presence of a head tilt (deviation of eyes away from a horizontal plane) accompanied by a tight circle provide clinically useful methods of differentiating a cerebral lesion from a vestibular lesion.

#### Gait

Gait is assessed when the animal is moving. Neurological gait abnormalities have two components, **weakness** and **ataxia**. Weakness (paresis) is evident when an animal drags its limbs, has worn hooves or has a low arc to the swing phase of the stride. When an animal bears weight on a weak limb, the limb often trembles and the animal may even collapse on that limb because of lack of support. While circling, walking on a slope, and walking with the head elevated, an animal frequently will stumble on a weak limb and knuckle over at the fetlock. During manipulation of the limb, the clinician will usually make the subjective observation that the muscle tone is reduced.

#### Ataxia

Ataxia is an unconscious, general proprioceptive deficit causing incoordination when the animal moves. Ataxia is manifest as a swaying from side to side of the pelvis, trunk and sometimes the whole body (truncal sway). Ataxia may also appear as a weaving of the affected limb during the swing phase of the stride. This often results in abducted or adducted foot placement, crossing of the limbs or stepping on the opposite foot.

**Hypermetria** is an increased range of movement and is seen as an overreaching of the limbs with excessive joint movement. Hypermetria without paresis is characteristic of spinocerebellar and cerebellar disease.

**Hypometria** is a decreased range of movement that is characterized by a stiff or spastic movement of the limbs with little flexion of the joints, particularly the carpal and tarsal joints.

**Dysmetria** is a term that includes both hypermetria and hypometria, with goose-stepping being the most common sign of dysmetria. Dysmetria usually is caused by a lesion in the cerebellum or cerebellar pathway.

In equine degenerative myeloencephalopathy, there is dysmetria of the hindlimbs and tetraparesis due to neuraxonal dystrophy originating in the accessory cuneate nuclei.<sup>7</sup> Severely affected horses lift their feet excessively high and stamp them to the ground.

#### Cerebellar disease

When cerebellar function is abnormal there is ataxia, which is an incoordination when the animal moves. In general terms there are defects in the rate, range and direction of movement. In typical cerebellar diseases, ataxia of the limbs is common and no weakness is evident. In true cerebellar ataxia (e.g. cerebellar hypoplasia) the affected animal stands with the legs wide apart, sways and has a tendency to fall. Ataxia of the head and neck are characterized by wide, swinging, head excursions, jerky head bobbing and an intention tremor (nodding) of the head.

The head tremor may be the most obvious sign in mild cases of cerebellar hypoplasia in young foals. The limbs do not move in unison, the movements are grossly exaggerated, muscular strength is usually preserved and there is a lack of proper placement of the feet (hypermetria and hypometria), so that falling is common. The fault in placement is the result of poor motor coordination and not related in any way to muscle weakness or proprioceptive deficit. Attempts to proceed to a particular point are usually unsuccessful and the animal cannot accurately reach its feed or drinking bowl. Examples of cerebellar disease include:

- Inherited defects of cerebellar structure or abiotrophy<sup>8</sup> in most breeds of cattle and in Arabian horses
- Congenital cerebellar defects resulting from maternal viral infections such as bovine virus diarrhea (BVD) infection in cattle
- Dysplastic disease of the cerebellum of the horse
- Traumatic injury, e.g. by parasite larvae such as *Hypoderma bovis*, which have caused unilateral cerebellar ataxia in adult cattle
- Tremorogenic mycotoxicoses and ryegrasses
- Encephalomyelitis in which other localizing signs also occur.

#### Spinal cord disease

Ataxia due to cerebellar dysfunction can be difficult to differentiate from the proprioceptive defects and partial motor

paralysis (weakness) that occur in animals with spinal cord lesions and it is most important that this differentiation be made. Spinal cord disease, causing varying degrees of weakness, and ataxia are common in large animals. The weakness is caused by damage to the upper or lower motor neurons and the proprioceptive deficit by damage to the ascending sensory neurons. With a mild or even moderate cervical spinal cord lesion in an adult cow or horse, signs of ataxia and weakness may be evident in the pelvic limbs only and it can be difficult to determine whether the thoracic limbs are involved.

Close examination of the gait, posture and postural reactions in the limbs, together with a search for localizing abnormalities, will often be productive in localizing the lesion. Signs of weakness or ataxia may be elicited by gently pushing the hindquarters to one side or pulling the tail to one side as the animal is walked (the sway response). The normal animal resists these movements or steps briskly to the side as it is pushed or pulled. The weak animal can be easily pulled to one side and may stumble or fall. The weak animal may also tend to buckle or collapse when strong pressure is applied with the hand over the withers and loin regions. The ataxic animal may sway to one side, be slow to protract a limb, cross its hindlegs or step on its opposite limb.

It is often difficult to distinguish paresis from ataxia but in most instances it is unimportant because of the close anatomical relationship of the ascending general proprioceptive and descending upper motor neuron tracts in the white matter of the spinal cord. These same abnormal sway responses can be elicited in the standing animal.

**The ataxic animal** may abduct the outside pelvic limb too far as it is pushed to one side or moved in a small circle. This may appear as a hypermetric movement similar to a stringhalt action and is assumed to be a sign of a general proprioceptive tract lesion. The pushed or circled animal may keep a clinically affected pelvic limb planted in one position on the ground and pivot around it without moving it. The same failure to protract the limb may be seen on backing. It may even force the animal into a 'dog-sitting' posture.

Examples of ataxia due to spinal cord disease include:

- Limited trauma to the spinal cord
- The early stages of a developing compression lesion in the vertebral canal
- Degenerative and inflammatory diseases of the nervous system,

especially those causing enzootic incoordination in horses and staggers in sheep (both of them dealt with under their respective headings)

- Functional diseases in toxic and metabolic diseases of the nervous system in which lesions have not yet been identified and caused mainly by poisons, especially plant materials. Typical examples are poisoning by the fungi *Claviceps paspali*, *Diplodia* spp., *Acremonium lolii*, the grass *Phalaris aquatica*, the ferns *Zamia* and *Xanthorrhoea* spp. and herbaceous plants such as *Kallstroemia*, *Vicia*, *Baccharis*, *Solanum*, *Aesculus* and *Ficus* spp.
- Nutritional deficiency especially of thiamin, occurring naturally in horses poisoned by bracken and horsetail, and experimentally in pigs
- Developmental defects including congenital abnormalities and abiotrophic abnormalities that develop some time after birth. Examples are Brown Swiss weavers and Pietrain pig creepers.

In many of these diseases incoordination and paresis are a stage in the development of tetraplegia or paraplegia.

### **PARESIS AND PARALYSIS**

The motor system comprises:

- The pyramidal tracts, which originate in the motor cortex
- The extrapyramidal system, which originates in the corpus striatum, red nucleus, vestibular nucleus and roof of the midbrain
- The peripheral nerves, which originate in the ventral horn cells.

The pyramidal tracts are of minor importance in hoofed animals (ungulates), reaching only to the fourth cervical segment. Accordingly, lesions of the motor cortex in farm animals do not produce any deficit of gait. Neither is there any paresis, although in an acute lesion weakness may be evident for the first day or two. If the lesion is unilateral the paresis will be on the contralateral side. This is in marked contradistinction to the severe abnormalities of posture and gait that occur with lesions of the pons, medulla, and spinal cord.

The main motor nuclei in these animals are subcortical and comprise the extrapyramidal system, and most combined movements are controlled by nerve stimuli originating in the tectal nuclei, reticular nuclei, vestibular nuclei and possibly red nuclei. The pyramidal and extrapyramidal tracts comprise the upper motor neurons, which reach to the ventral horn cells of the spinal cord,

which cells together with their peripheral axons form the lower motor neurons. Paralysis is a physiological end result in all cases of motor nerve injury, which if severe enough is expressed clinically. The type of paralysis is often indicative of the site of the lesion.

A **lesion of the upper motor neuron** causes:

- **Spasticity with loss of voluntary movement**
- **Increased tone of limb muscles**
- **Increased spinal reflexes.**

The spasticity of an upper motor neuron lesion usually occurs with the affected limb in extension. These are all release phenomena resulting from liberation of spinal reflex arcs from higher control.

A **lesion of the lower motor neuron** causes:

- **Paresis or paralysis with loss of voluntary movement**
- **Decreased tone of the limb muscles**
- **Absence of spinal reflexes**
- **Wasting of the affected muscle (neurogenic atrophy).**

As injuries to specific peripheral nerves are treated surgically, these are dealt with in surgical textbooks and are not repeated here.

A special form of paralysis is the **Schiff-Sherrington syndrome**, which is common in dogs but recorded rarely in large animals. It is caused by acute, severe, compressive injury of the thoracolumbar spinal cord and manifested by extensor rigidity or hypertonia of the forelimbs and hypotonic paralysis of the hindlimbs. Neurons located in the lumbar spinal cord are responsible for the tonic inhibition of extensor muscle alpha motor neurons in the cervical intumescence. The cell bodies of these neurons are located in the ventral gray column from L1-L7, with a maximum population from L2-L4. Their axons ascend to the cervical intumescence. Acute severe lesions cranial to these neurons and caudal to the cervical intumescence will suddenly deprive the cervical intumescence neurons of this source of tonic inhibition, resulting in a release of these latter neurons. This results in extensor hypertonia observed in the thoracic limbs which can function normally in the gait and postural reactions, except for the hypertonia.

**The degree of paresis or paralysis** needs to be defined. Paralysis is identified as an inability to make purposeful movements. Thus convulsive, uncontrolled movements as they occur in poliomyelomalacia may still fit a description of paralysis. Paresis, or weakness short of paralysis, can be classified into four categories:

- Animals that cannot rise, nor support themselves if helped up, but can make purposeful movements in attempting to rise
- Animals that cannot rise but can support themselves if helped up
- Animals that can rise but are paretic and can move the limbs well and stumble only slightly on walking
- Animals that move with difficulty and have severe incoordination and stumbling.

Probably the most difficult decision in farm animal neurology is whether a patient's inability to move is because of a nervous or muscular deficit. For example, the horse recumbent because of exertional rhabdomyolysis often resembles a horse with an injured spinal cord. Examples of paresis and paralysis include:

- **Focal inflammatory, neoplastic, traumatic lesions** in the motor pathway. These lesions usually produce **an asymmetric nervous deficit**
- **Toxic and metabolic diseases** of the nervous system in their most severe form, e.g. flaccid paralysis associated with tickbite (*Ixodes holocyclus*, *Ornithodoros* sp.), poisoning, botulism, snakebite. Comparable tetanic paralyzes include tetanus, lactation tetany of mares, hypomagnesemic tetany of cows and calves. In contrast to inflammatory, neoplastic and traumatic lesions in the motor pathway, toxic and metabolic lesions usually produce **a symmetric nervous deficit**.

### Neurogenic muscular atrophy

Destruction of the lower motor neurons either within the vertebral canal or peripheral to it causes neurogenic atrophy. Whether or not the atrophy is visible depends on how many neurons and therefore how many muscle fibers are affected.

### ALTERED SENSATION

Lesions of the sensory system are rarely diagnosed in animals, except for those affecting sight and the vestibular apparatus, because of the impossibility of measuring subjective responses.

Thus, although animals must experience paresthesia, as in Aujeszky's disease (pseudorabies) in cattle and sheep, the animal's response of licking or scratching does not make it possible to decide whether the diagnosis should be paresthesia or pruritus. Lesions of the peripheral sensory neurons cause hypersensitivity or decreased sensitivity of the area supplied by the nerve. Lesions of the spinal cord may affect only motor or only sensory fiber tracts or both, or may be unilateral.

Although it is often difficult to decide whether failure to respond to a normally painful stimulus is due to failure to perceive or inability to respond, certain tests may give valuable information. The test commonly used is pricking the skin with a needle, or pinching the skin with a pair of forceps, and observing the reaction. In exceptional circumstances light stroking may elicit an exaggerated response. The 'nibbling' reaction stimulated by stroking the lumbar back of sheep affected with scrapie is a striking example of hypersensitivity.

In every test of sensitivity it must be remembered that there is considerable variation between animals and in an individual animal from time to time, and much discretion must be exercised when assessing the response. In any animal there are also cutaneous areas that are more sensitive than others. The face and the cranial cervical region are highly sensitive, the caudal cervical and shoulder regions less so, with sensitivity increasing over the caudal thorax and lumbar region to a high degree on the perineum. The proximal parts of the limbs are much less sensitive than the distal parts and sensitivity is highest over the digits, particularly on the medial aspect.

**Absence of a response** to the application of a painful stimulus to the limbs (**absence of the withdrawal reflex**) indicates interruption of the reflex arc; absence of the reflex with persistence of central perception, as demonstrated by groaning or body movement such as looking at the site of stimulus application, indicates interruption of motor pathways and that central perception of pain persists. In the horse the response can be much more subtle than in other species, with movements of the ears and eyelids being the best indicators of pain perception. Increased sensitivity is described as **hyperesthesia**, decreased as **hypoaesthesia**, and complete absence of sensitivity is described as **anesthesia**. Special cutaneous reflexes include the anal reflex, in which spasmodic contraction of the anus occurs when it is touched, and the corneal reflex, in which there is closure of the eyelids on touching the cornea. The (cutaneous trunci) panniculus reflex is valuable in that the sensory pathways, detected by the prick of a pin, enter the cord at spinal cord segments T1–L3, but the motor pathways leave the cord only at spinal cord segments C8, T1, and T2. The quick twitch of the superficial cutaneous muscle along the whole back, which is the positive response (**panniculus reflex**), is quite unmistakable. Examination of the eye reflexes and hearing are discussed under examination of the cranial nerves (see below).

### BLINDNESS

Blindness is manifested as a clinical abnormality by the animal walking into objects that it should avoid.

**The menace or blink reflex** is used to test the visual pathway. A threatening gesture of the hand (or even better by the index finger in a pointing manner) toward the eye elicits immediate closure of the eyelids. The hand must come close enough to the eye without touching the tactile hairs of the eyelids or creating a wind which can be felt by the animal. Some stoic, depressed or even excited animals may not respond to a menace reflex with closure of the eyelids; others may keep the eyelids partially or almost closed. It may be necessary to alert the patient to the risk of injury by touching the eyelids first. The menace reflex is a learned reflex that is absent in neonates.

The most definitive test is to make the animal walk an **obstacle course** and place objects in front of it so that it must step over the objects easily. A similar procedure is the only way to test for **night blindness (nyctalopia)**. The area should be dimly lit but the observer should be able to see the obstructions clearly. A decision that the animal is blind creates a need for examination of the visual pathways.

### Central or peripheral blindness

Blindness may be central or peripheral. Animals with forebrain lesions are centrally blind, with depressed menace response in one or both eyes while the pupillary light reflexes are commonly intact. In peripheral blindness, such as hypovitaminosis-A, the menace reflex is absent, and the pupillary light reflexes are also absent.

Blindness can be caused by lesions along the visual pathway, from the eye to the cerebral cortex:

- **Diseases of the orbit** including keratoconjunctivitis, hypopyon, cataract, panophthalmia, mixed ocular defects inherited in white Shorthorn and Jersey cattle, night blindness in Appaloosa horses, sporadic cases of blindness due to idiopathic retinal degenerative disease in cattle
- **Diseases of the retina** including retinal dysplasia of goats, lenticular cataracts caused by poisoning with hygromycin in pigs,<sup>9</sup> congenital ocular malformations in calves after intrauterine infection with BVD virus (usually accompanied by cerebellar defects)
- **Diseases of the optic nerve and chiasma**, e.g. abscess of pituitary rete mirabile, constriction of optic nerve by diet deficient in vitamin A. Tumor of pituitary gland, injury to the optic



nerve, especially in horses after rearing and falling backwards. There is a sudden onset of unilateral or bilateral blindness with no ophthalmological change until 3–4 weeks after the injury, when the optic disc becomes paler and less vascular<sup>10</sup>

- **Metabolic or ischemic lesions of the cerebral cortex** as in polioencephalomalacia, cerebral edema, hydrocephalus
- **Localized infectious or parasitic lesions** caused by abscesses, migrating larvae
- **Functional blindness** in which there is complete, often temporary, blindness in the absence of any physical lesions. Causes are acetoneemia, pregnancy toxemia and acute carbohydrate indigestion (hyper D-lactatemia) of ruminants
- **Specific poisonings** causing blindness include *Filix mas* (male fern), *Cheilanthes* spp. (rockfern) and rape. *Stypandra* spp. cause a specific degeneration of the optic nerves. Lead poisoning in cattle.

## **ABNORMALITIES OF THE AUTONOMIC NERVOUS SYSTEM**

Lesions affecting the cranial parasympathetic outflow do so by involvement of the oculomotor, facial, vagus, and glossopharyngeal nerves or their nuclei and the effects produced are discussed under examination of the individual nerves.

In general, the lesions cause abnormality of pupillary constriction, salivation and involuntary muscular activity in the upper part of the alimentary and respiratory tracts. Lesions of the spinal sympathetic system interfere with normal function of the heart and alimentary tract. For the most part, affections of the autonomic nervous system are of minor importance in farm animals. Central lesions of the hypothalamus can cause abnormalities of heat exchange, manifested as neurogenic hyperthermia or hypothermia and obesity, but they are also of minor importance.

Some manifestations of autonomic disease are important. Autonomic imbalance is usually described as the physiological basis for spasmodic colic of horses; grass sickness of horses is characterized by degenerative lesions in the sympathetic ganglia; involvement of the vagus nerve in traumatic reticuloperitonitis of cattle can lead to impaired forestomach and abomasal motility and the development of vagus indigestion.

Defects of sphincter control and motility of the bladder and rectum may also be of importance in the diagnosis of defects of

sacral parasympathetic outflow and the spinal sympathetic system. The sacral segments of the spinal cord are the critical ones, and loss of their function will cause incontinence of urine and loss of rectal tone. The parasympathetic nerve supply to the bladder stimulates the detrusor muscle and relaxes the sphincter; the sympathetic nerve supply has the reverse function. A spinal cord lesion may cause loss of the parasympathetic control and result in urinary retention. Incontinence, if it occurs, does so from overflow. When the sympathetic control is removed incontinence occurs but the bladder should empty. Similar disturbances of defecation occur. Both micturition and defecation are controlled by medullary and spinal centers but some measure of control is regained even when the extrinsic nerve supply to the bladder and rectum is completely removed.

## **Special examination of the nervous system**

Veterinarians commonly include several components of a neurological examination in a complete clinical examination. Most often a diagnosis and differential diagnosis can be made from consideration of the history and the clinical findings. However, if the diagnosis is uncertain it may be necessary to conduct a complete neurological examination, which may uncover additional clinical findings necessary to make a diagnosis and give a prognosis.

The accuracy of clinical diagnosis of neurological diseases in the horse is high.<sup>11</sup> In a study of 210 horses in which a definitive pathological diagnosis was confirmed, the overall accuracy of clinical diagnosis for all diseases was 0.95; the accuracy ranged from 0.79–1.00, the sensitivity varied from 0.73–0.95 and the specificity varied from 0.88–1.00 for individual disease categories. Some neurological diseases are therefore underdiagnosed while others are overdiagnosed. The use of careful and thorough clinical examinations and diagnostic techniques, combined with confirmed pathological diagnoses, will result in more accurate diagnosis and therapy. Retrospective studies of series of ataxic horses, for example, will add to the body of knowledge and improve diagnosis.<sup>12</sup>

## **THE NEUROLOGICAL EXAMINATION**

The primary aim of the neurological examination is to confirm whether or not a neurological abnormality exists and to determine the neuroanatomical

location of the lesion.<sup>13</sup> A clinicoanatomical diagnosis is necessary before one can develop a list of differential diagnoses and decided whether or not treatment is possible. The format for a precise practical examination procedure that is logical in sequence, easy to remember with practice, and emphasizes the need for an anatomical diagnosis is outlined below. The rationale for the sequence is that the examination starts from a distance to assess posture and mentation, and then proceeds to a closer examination that may require placing the animal in stocks or a chute. The examination sequence is therefore suitable for minimally handled beef cattle, dairy cattle, horses, sheep, goats, and New World camelids. The results of the neurological examination should be documented and not left to memory. There are many standard examination forms available that outline each step in the examination and provide for documentation of the results.

## **SIGNALMENT AND EPIDEMIOLOGY**

The age, breed, sex, use, and value of the animal are all important considerations in the diagnosis and prognosis of neurological disease. Some diseases occur more frequently under certain conditions: for example, lead poisoning in nursing beef calves turned out to pasture in the spring of the year. *Histophilus somni* meningoencephalitis occurs most commonly in feedlot cattle from 6–10 months of age and hypovitaminosis-A occurs most commonly in beef calves 6–8 months of age after grazing dry summer pastures. In the horse there are several clearly defined diseases that affect the spinal cord including cervical stenotic myelopathy, degenerative myeloencephalopathy, protozoal myelitis, equine rhinopneumonitis myelopathy, rabies polioencephalomyelitis and equine motor neuron disease.<sup>14</sup> Some of these diseases have distinguishing epidemiological characteristics that are useful in diagnosis and differential diagnosis.<sup>9</sup> The neurological examination of the newborn foal is fraught with hazards because of the different responses elicited from those in adults. The differences relate mostly to the temporary dysmetria of gait and exaggerated responses of reflexes.

## **HISTORY**

Special attention should be given to the recording of an accurate history. The questioning of the owner should focus on the primary complaint and when it occurred and how it has changed over time (**the time–sign relationship**). The duration of signs, the mode of onset, particularly whether acute with later

subsidence, or chronic with gradual onset, the progression of involvement and the description of signs that occur only intermittently should be ascertained. When the disease is a herd problem the morbidity and mortality rates and the method of spread may indicate an intoxication when all affected animals show signs within a very short period. Diseases associated with infectious agents may have an acute or chronic onset. Neoplastic diseases of the nervous system may begin abruptly but are often slowly progressive. For some diseases, such as epilepsy, consideration of the history may be the only method of making a diagnosis.<sup>15</sup> Traumatic injuries have a sudden onset and then often stabilize or improve.

When obtaining a history of convulsive episodes an estimate should be made of their duration and frequency. The pattern is also of importance, and may be diagnostic, e.g. in salt poisoning in swine. The occurrence of pallor or cyanosis during the convulsion is of particular importance in the differentiation of cardiac syncope and a convulsion originating in the nervous system.

## HEAD

### Behavior

The owner should be questioned about the animal's abnormal behavior, which can include bellowing, yawning, licking, mania, convulsions, aggressiveness, head-pressing, wandering, compulsive walking and head-shaking.<sup>16</sup> Head-shaking may be photic in origin and can be tested by the application of blindfolds, covering the

eyes with a face mask and observing the horse in total darkness outdoors.<sup>17</sup> In one horse, head-shaking ceased with blindfolding or night darkness outdoors, and became less with the use of gray lenses. Outdoor behavior suggested efforts to avoid light.

### Mental status

Assessment of mental status is based on the animal's level of awareness or consciousness. Coma is a state of complete unresponsiveness to noxious stimuli. Other abnormal mental states include stupor, somnolence, deliriousness, lethargy and depression. Large animals that are recumbent because of spinal cord disease are commonly bright and alert unless affected with complications, which may cause fever and anorexia. Mature beef cattle that are recumbent with a spinal cord lesion and not used to being handled may be quite aggressive and apprehensive.

### Head position and coordination

Lesions of the vestibular system often result in a head tilt. Lesions of the cerebrum often result in deviation of the head and neck. In cerebellar disease, there may be jerky movements of the head, which are exaggerated by increasing voluntary effort. These fine jerky movements of the head are called intention tremors. Animals with severe neck pain will hold their neck in a fixed position and be reluctant to move the head and neck. Head-shaking in horses has been associated with ear mite infestation, otitis externa, cranial nerve dysfunction, cervical injury, ocular disease, guttural pouch mycosis, dental periapical osteitis and

vasomotor rhinitis.<sup>16</sup> However, idiopathic head-shaking in the horse is often associated with evidence of nasal irritation, sneezing and snorting, nasal discharge, coughing and excessive lacrimation.

### Cranial nerves

Abnormalities of cranial nerve (CN) function assist in localizing a lesion near or within the brainstem. Some of the information on cranial nerve dysfunction is presented in tabular form (Tables 12.1–12.6) in addition to the more detailed examination described here.

#### Olfactory nerve (CN I)

Tests of smell are unsatisfactory in large animals because of their response to food by sight and sound.

#### Optic nerve (CN II)

The only tests of visual acuity applicable in animals are testing the eye preservation (menace) reflex: provoking closure of the eyelids and withdrawal of the head by stabbing the finger at the eye; and by making the animal run a contrived obstacle course. Both tests are often difficult to interpret and must be carried out in such a way that other senses are not used to determine the presence of the obstacles or threatened injury. In more intelligent species, a good test is to drop some light object such as a handkerchief or feather in front of the animal. It should gaze at the object while it is falling and continue to watch it on the ground. The same method can be applied to young ruminants, which demonstrate normal vision by following the examiner's moving hand at an age so early that they have not yet developed a

Table 12.1 Correlation between clinical findings and location of lesions in the nervous system of farm animals; abnormalities of mental state (behavior)

Principal sign	Secondary signs	Location of lesion	Example
Mania hysteria/hyperexcitability	Continuous, leading to paralysis; aggression, convulsions	Cerebrum-limbic system	Peracute lead poisoning, rabies, encephalitis
	Intermittent, acetonuria, signs of hepatic insufficiency	Cerebrum-limbic system	Hypoglycemia, hypoxia
Coma (recumbency with no response to stimuli; dilated pupils)	Gradual development. Hypothermia, peripheral vascular collapse. Clinicopathological tests	Cerebral-brainstem reticular formation (ascending reticular activating system)	Hepatic insufficiency, uremia, toxemia, septicemia
	Sudden onset. Normal temperature, pulse/heart rate slow to normal, nose bleed, skin laceration, bruising middle of forehead or poll	Cerebral-brainstem reticular formation (ascending reticular activating system)	Accidental, severe blunt trauma with edema, concussion, contusion of brain
Narcolepsy/catalepsy. Uncontrollable sleep	With or without sudden loss of consciousness, intermittent falling due to loss of voluntary motor function	Brainstem control of cerebral cortex	Inherited in Shetland ponies, American miniature horses, and Suffolk horses
Compulsive walking and head-pressing, aggressive behavior, grinding of teeth. No ataxia	Apparent blindness, nystagmus	Cerebral-visual cortex and limbic system	Increased intracranial pressure in polioencephalomalacia
	Apparent blindness, no nystagmus, hepatic insufficiency shown on clinical pathology tests	Cerebral-visual cortex and limbic system	Hepatic insufficiency (i.e. ammonia intoxication; in pyrrolizidine poisoning)
Imbecility in neonate; lack of response to normal stimuli; can walk, stand	Blindness	Cerebral cortex absent; hydronephaly	Intrauterine infection with Akabane or bovine virus diarrhoea (BVD) virus in calves

Table 12.2. Correlation between clinical findings and location of lesion in the nervous system of farm animals: involuntary movements

Principal sign	Secondary signs	Location of lesion	Example
Tremor (continuous repetitive movements of skeletal muscles)	Moderate tetany	No specific focal lesion. Generalized disease, e.g. hypomyelinogenesis	Congenital tremor of Herefords. Hypomyelinogenesis, shaker pigs, lambs with Border disease
	Intention tremor, sensory ataxia With head rotation	Cerebellum Vestibular apparatus	Cerebellar hypoplasia Otitis media and interna. Fracture of petrous temporal bone
Nystagmus	Usually with tetraparesis, impaired consciousness, abnormal pupils, opisthotonos, facial palsy, dysphagia Pendular nystagmus	Cerebellopontine and midbrain areas No lesion	Injury, increased intracranial pressure, polioencephalomalacia, listeriosis Benign sporadic occurrence in dairy cattle, inherited in Finnish Ayrshire bulls
	Independent episodes	Focus of irritation in cerebral cortex or thalamus, with spread of excitation	Idiopathic or traumatic epilepsy
Convulsions	Continuous, leading to paralysis	Cerebral cortex	Increased intracranial pressure, encephalitis
	Intermittent, related to periods of metabolic stress	Cerebral cortex	Hypomagnesaemia (lactation tetany); hypoglycemia (e.g. of baby pigs)
Tenesmus (straining)	Later paralysis of anus, sometimes tail head. Sexual precocity in male	Caudal cord segments and cauda equina, stimulation of nerve cells, later paralysis	Rabies, subacute local meningitis
Compulsive rolling	Disturbance of balance, cannot stand, must lie on one side. Nystagmus (See Table 12.1)	Vestibular apparatus	Brain abscess, otitis media
Compulsive walking and head-pressing			

menace reflex. Ophthalmoscopic examination is an integral part of an examination of the optic nerve.

#### Oculomotor nerve (CN III)

This nerve supplies the pupilloconstrictor muscles of the iris and all the extrinsic muscles of the eyeball except the dorsal oblique, the lateral rectus and the retractor muscles. Loss of function of the nerve results in pupillary dilatation and defective pupillary constriction when the light intensity is increased, abnormal position (ventrolateral deviation) or defective movement of the eyeballs and palpebral ptosis.

The pupillary light reflex is best tested by shining a bright point source of light into the eye, which causes constriction of the iris of that eye (direct pupillary reflex). Constriction of the opposite eye (consensual pupillary light reflex) will also occur. The consensual light reflex may be used to localize lesions of the optic pathways.

Examination of the menace reflex (eye preservation reflex to a menace) and the results of the pupillary light reflex can be used to distinguish between blindness due to a lesion in the cerebral cortex (central blindness) and that due to lesions in the optic nerve or other peripheral parts of the optic pathways (peripheral blindness).

**As examples**, in polioencephalomalacia (central blindness) the menace reflex is absent but the pupillary light reflex is present. In the ocular form of hypo-

vitaminosis A (peripheral blindness) in cattle the menace reflex is also absent, the pupils are widely dilated and the pupillary light reflex is absent. In polioencephalomalacia, the optic nerve, oculomotor nucleus and oculomotor nerve are usually intact but the visual cortex is not; in hypovitaminosis A the optic nerve is usually degenerate, which interferes with both the menace and pupillary light reflexes.

**Testing** of ocular movements can be carried out by moving the hand about in front of the face. In paralysis of the oculomotor nerve there may also be deviation from the normal ocular axes and rotation of the eyeball. There will be an absence of the normal horizontal nystagmus reaction with a medial jerk of the eyeball in response to quick passive movement of the head. Failure to jerk laterally indicates a defect of the abducens nerve.

#### Trochlear nerve (CN IV)

This nerve supplies only the dorsal oblique muscle of the eye so that external movements and position of the eyeball are abnormal (dorsolateral fixation) when the nerve is injured. This is common in polioencephalomalacia in cattle, resulting in a dorsomedial fixation of the eyeball. In other words, the medial angle of the pupil is displaced dorsally when the head is held in normal extension.

#### Trigeminal nerve (CN V)

The sensory part of the trigeminal nerve supplies sensory fibers to the face and can

be examined by testing the palpebral reflex and the sensitivity of the face. The motor part of the nerve supplies the muscles of mastication and observation of the act of chewing may reveal abnormal jaw movements and asymmetry of muscle contractions. There may also be atrophy of the muscles, which is best observed when the lesion is unilateral.

#### Abducent nerve (CN VI)

Because the abducent nerve supplies motor fibers to the retractor and lateral rectus muscles of the eyeball, injury to the nerve may result in protrusion and medial deviation of the globe. This is not readily observable clinically. An inherited exophthalmos and strabismus occurs in Jersey cattle.

#### Facial nerve (CN VII)

The facial nerve supplies motor fibers for movement of the ears, eyelids, lips, and nostrils, in addition to the motor pathways of the menace, palpebral, and corneal reflexes. The symmetry and posture of the ears, eyelids, and lips are the best criteria for assessing the function of the nerve. Ability to move the muscles in question can be determined by creating a noise or stabbing a finger at the eye. Absence of the eye preservation reflex may be due to facial nerve paralysis or blindness. Facial paralysis is evidenced by ipsilateral drooping of the ear, ptosis of the upper eyelid, drooping of the lips and pulling of the filtrum to the unaffected side. There may also be drooling of saliva from the

Table 12-3 Correlation between clinical findings and location of lesion in the nervous system of farm animals: abnormalities of posture

Principal sign	Secondary signs	Location of lesion	Example
Paresis (difficulty in rising, staggering gait, easily falling)	Persistent recumbency, muscle tone and reflexes variable depending on site of lesion General loss of muscle tone including vascular, alimentary systems	Loss of function in nervous tissue, e.g. spinal cord, may be upper or motor neuron lesion Depression of synaptic or neuromuscular transmission for metabolic reasons or toxic reasons	Lymphosarcoma affecting spinal cord Milk fever, botulism, peracute coliform mastitis, tick paralysis
Flaccid paralysis (1) Pelvic limbs only	Thoracic normal. Pelvic limbs flaccid, no tone, or reflexes, no anal reflex, urinary incontinence straining initially Thoracic limbs normal. Pelvic limbs normal tone and reflexes, anal reflex normal. No withdrawal reflex caudally	Tissue destruction, myelomalacia at lumbosacral cord segments L4 to end osteomyelitis, fracture Cord damage at thoracolumbar cord segments T3–L3	Paralytic rabies. Spinal cord local meningitis, vertebral body Spinal cord local meningitis as above, damage by vertebral fracture, lymphosarcoma Fracture of vertebra lymphosarcoma, abscess
(2) Thoracic and pelvic limbs	Flaccid paralysis, normal tone and reflexes hindlimbs. Absent tone and reflexes in front limbs. Atrophy only in front. No withdrawal reflex caudally. Intact perineal reflex Flaccid paralysis all four legs and neck. Unable to lift head off ground. Normal tone and reflexes all legs. Pain perception persists. No withdrawal reflex caudally	Cord damage at cervicothoracic segments C6–T2 Cord damage at upper cervical segments C1–C5	Fracture of vertebra lymphosarcoma, abscess Injury while running or falling, abscess or lymphosarcoma
Spastic paralysis (permanent, no variation, all four limbs in extension, increased tone, exaggerated reflexes, opisthotonos) Tremor	Cranial nerve deficits trigeminal to hypoglossal. Loss of central perception of pain. Depression Tremor (fine or coarse; no convulsions)	Medulla, pons and midbrain Red nucleus and reticular apparatus and midbrain/basal ganglia area tracts	Abscess, listeriosis Congenital disease of calves, e.g. hypomyelinogenesis, neuraxial edema Tetanus
Tetany (all four limbs extended, opisthotonos). Variable intensity modifiable by treatment	Intense hyperesthesia, prolapse 3rd eyelid Exaggerated response to all external stimuli, i.e. hyperesthesia	Decreased synaptic resistance generally Increased neuromuscular transmission	Hypomagnesemia
Paralysis of anus	No anal or perineal reflex. May be straining	Damage to spinal cord at segments S1–S3	Injury or local meningitis, early rabies
Paralysis of tail	Flaccid tail with anesthesia	Injury to caudal segments	Injury or local meningitis, early rabies
Opisthotonos	With spastic paralysis, tremor, nystagmus, blindness Part of generalized tetanic state or convulsion	Cerebrum, cerebellum and midbrain Neuromuscular transmission defect, tetanus, hypomagnesemia	Polioencephalomalacia, trauma Tetanus
Falling to one side	Mostly with circling (see below). Also with deviation of tail	No detectable lesion in spinal cord	<i>Xanthorrhoea hastile</i> poisoning

commissures of the lips and in some cases a small amount of feed may remain in the cheeks of the affected side.

The common causes of damage to the nerve are fracture of the petrous temporal bone, guttural pouch mycosis and damage to the peripheral nerve at the mandible. A common accompaniment is injury to the vestibular nerve or center. A diagnosis of central, as compared to peripheral nerve involvement, can be made by identifying involvement of adjacent structures in the medulla oblongata. Signs such as depression, weakness and a head tilt would result, and are frequently present in ruminants and New World camelids with listeriosis.

#### Vestibulocochlear nerve (CN VIII)

The cochlear part of the vestibulocochlear nerve is not easily tested by simple clinical

examination, but failure to respond to sudden sharp sounds, created out of sight and without creating air currents, suggests deafness. The cochlear portion can be tested electronically (the brainstem auditory evoked response, or BAER, test) to diagnose a lesion of the auditory nerve, eliminating the possibility of a central brain lesion. Abnormalities of balance and carriage of the head (rotation around the long axis and not deviation laterally) accompany lesions of the vestibular part of the vestibulocochlear nerve, and nystagmus is usually present.

In severe cases, rotation of the head is extreme, the animal is unable to stand and lies in lateral recumbency; moving to achieve this posture is compulsive and forceful. There is no loss of strength. In some species there is a relatively common

occurrence of paralysis of the facial and the vestibular nerves as a result of otitis interna and otitis media. This does occur in the horse but less commonly than traumatic injury to the skull as a result of falling.

Pendular nystagmus should not be mistaken as a sign of serious neurological disease. Pendular nystagmus is characterized by oscillations of the eyeball that are always the same speed and amplitude and appear in response to a visual stimulus, e.g. a flashing light. Pendular nystagmus is observed most frequently in Holstein–Friesian cattle (prevalence of 0.51% in 2932 Holstein–Friesian and Jersey cows),<sup>18</sup> is not accompanied by other signs and there is no detectable histological lesion. A familial relationship was observed in Ayrshire bulls in Finland.<sup>19</sup>

Table 12.4 Correlation between clinical findings and location of lesion in the nervous system of farm animals: abnormalities of gait

Principal sign	Secondary signs	Location of lesion	Example
Circling (1) Rotation of the head	Nystagmus, circles, muscle weakness, falls easily, may roll, other cranial nerves affected	Vestibular nucleus	Brain abscess, listeriosis
	Nystagmus, walks in circles, falls occasionally, animal strong. Falls easily if blindfolded, sometimes facial paralysis	Inner ear (vestibular canals), 7th cranial nerve, facial nerve	Otitis media, otitis interna, fracture petrous temporal bone (horse)
(2) Deviation of the head	Deviation of head and gaze, compulsive walking, depression. Can walk straight. Balance may be normal	Cerebrum	Brain abscess in calf (infection from dehorning or umbilicus)
	Unable to walk straight. Facial paralysis, other cranial nerve deficits, head may be rotated	Medulla	Listeriosis
Cerebellar ataxia	Exaggerated strength and distance of movement, direction wrong. Hypermetria. Incoordination because of exaggerated movement. No paresis	Cerebellum	Inherited cerebellar hypoplasia in all species, especially Arabian horses; <i>Claviceps paspali</i> poisoning; Gomen disease a probable plant poisoning; destruction by a virus, especially BVD in cattle; hematoma in the fourth ventricle causes cerebellar displacement. Idiopathic cerebellar degeneration in adult cattle
Sensory ataxia	No loss of movement or strength but timing movement wrong, legs get crossed, feet badly placed when pivoting	Damage to sensory tracts in spinal cord	Cervical cord lesion, thoracolumbar if just pelvic limb
Sensorimotor ataxia	Weakness of movement, e.g. scuffing toes, knuckling, incomplete flexion, extension causes wobbly, wandering gait, falls down easily, difficulty in rising	Moderate lesion to spinal cord tracts	Plant poisonings, e.g. sorghum. Cervical vertebral compression of spinal cord. Degenerative myelopathy

BVD, bovine viral diarrhoea.

Glossopharyngeal nerve (CN IX) and vagus nerve (CN X)

The glossopharyngeal nerve is sensory from the pharynx and larynx, and the vagus nerve is motor to these structures. Dysfunction of these nerves is usually accompanied by paralysis of these organs with signs of dysphagia or inability to swallow, regurgitation through the nostrils, abnormality of the voice and interference with respiration.

Because of the additional role of the vagus nerve in supplying nerve fibers to the upper alimentary tract, loss of vagal nerve function will lead to paralysis of the pharynx and esophagus. Parasympathetic nerve fibers to the stomach are also carried in the vagus and damage to them could cause hypomotility of that organ. The principal clinical finding in vagus nerve injury is laryngeal and pharyngeal paralysis.

Spinal accessory nerve (CN XI)

Damage to this nerve is extremely rare and the effects are not documented. Based on its anatomical distribution loss of function of this nerve could be expected to lead to paralysis of the trapezius, brachiocephalic and sternocephalic muscles and lack of resistance to lifting the head.

Hypoglossal nerve (CN XII)

As the motor supply to the tongue, the function of this nerve can be best examined

by observing the motor activity of the tongue. There may be protrusion, deviation or fibrillation of the organ, all resulting in difficulty in prehending food and drinking water. The most obvious abnormality is the ease with which the tongue can be pulled out. The animal also has difficulty in getting it back into its normal position in the mouth, although diffuse cerebral disease can also produce this clinical sign. In lesions of some duration there may be obvious unilateral atrophy.

### POSTURE AND GAIT

The examiner evaluates posture and gait to give a general assessment of brainstem, spinal cord and peripheral nerve and muscle function. Evaluation of posture and gait consists of determining which limbs are abnormal and looking for evidence of lameness suggesting a musculoskeletal gait abnormality. Weakness and ataxia are the essential components of gait abnormality. Each limb is examined for evidence of these abnormalities. This is done while the animal is standing still, walking, trotting, turning tightly (pivoting) and backing up. To detect subtle asymmetry in the length of the stride, the observer should walk parallel to or behind the animal, step for step. If possible, the gait should also be evaluated while the animal is walking up and down a slope,

walking with the head and neck held extended, while blindfolded and while running free in an enclosure.

The best observations are made when the animal is running free, preferably at a fast gait, to avoid abnormalities resulting from being led. Also, slight abnormalities such as a high-stepping gait, slight incoordination of movement, errors of placement of feet, stumbling and failure to flex joints properly are all better observed in a free animal.

**Weakness or paresis** is evident when an animal drags its limbs, has worn hooves or has a low arc to the swing phase of the stride. When an animal bears weight on a weak limb, the limb often trembles and the animal may even collapse on that limb because of lack of support. While circling, walking on a slope and walking with the head held elevated, an animal frequently will stumble on a weak limb and knuckle over on the fetlock.

The presence of weakness in the limbs of horses or cattle can be determined by pulling the tail while the animal is walking forward. A weak animal is easily pulled to the side and put off stride. While the animal is circling, the examiner can pull on the lead rope and tail simultaneously to assess strength. Ease in pulling the animal to the side occurs because of weakness due to lesions of descending upper motor neuron pathway, the ventral

**Table 12.5** Correlation between clinical findings and location of lesion in the nervous system of farm animals: abnormalities of the visual system

Principal sign	Secondary signs	Location of lesion	Example
Blindness (bumps into objects)	Pupillary dilatation. No pupillary light reflex. No menace reflex	Optic nerve (examine fundus of eye)	Vitamin A deficiency. Pituitary reticular abscess. Congenital retinal dysplasia of goats
Peripheral blindness or night blindness		Retina	Nutritional deficiency of vitamin A Inherited defect of Appaloosa foals
Central blindness	Pupil normal size. Pupillary light reflexes normal	Cerebral cortex	Polioencephalomalacia, lead poisoning
Abnormal dilatation of pupils (mydriasis)	Absence of pupillary light reflex. Can see – does not bump into objects Absent pupillary light reflex. No vision. Retinal damage on ophthalmoscopic examination	Motor path of oculomotor nerve Retinal lesion	Snakebite, atropine poisoning, milk fever Toxoplasmosis, trauma, ophthalmitis
Abnormal constriction of pupil (miosis)	Absent pupillary light reflex. No vision. Retina normal Diarrhea, dyspnea	Optic nerve atrophy and fibrosis Failure to activate acetylcholine	Avitaminosis A in cattle Organophosphate poisoning
Horner's syndrome. Drooping upper eyelid, miosis, enophthalmos	Blindness, coma, semicomma, spastic paralysis Hemilateral sweating and temperature rise side of face and upper neck. Unilateral exophthalmos; nasal obstruction	Diffuse lesion Damage to cranial thoracic and cervical sympathetic trunk	Polioencephalomalacia, acute lead poisoning Mediastinal tumor, Guttural pouch mycosis. Neoplastic space-occupying lesions of the cranium involving the periorbit; perivascular injection around jugular vein or normal intravenous injection of xylazine hydrochloride in normal horses, melanoma at the thoracic inlet in a horse
Nystagmus Abnormal position of eyeball and eyelids	See Table 12.2 Dorsomedial deviation of eyeball Eyelid Ventrolateral fixation Protrusion and medial deviation	Trochlear (4th) Facial (7th) Oculomotor (3rd) Abducent (6th)	Polioencephalomalacia Listeriosis Abscess/tumor, e.g. bovine viral leukosis
No palpebral reflex Absence of menace response		Deficit sensory branch of 5th nerve Facial nerve (provided vision is present) Oculomotor (provided vision is present)	Trauma Listeriosis
Absence of pupillary light reflex			

**Table 12.6** Correlation between clinical findings and location of lesion in the nervous system of farm animals: abnormalities of the oropharyngeal system

Principal sign	Secondary signs	Location of lesion	Example
Inability to prehend or inability to chew	Facial (nasal septal) hypalgesia	Sensory branch of trigeminal (5th) dysfunction	Poisoning by <i>Phalaris aquatica</i> in cattle. Local medullary lesion
	Inappropriate movements of tongue	Hypoglossal (12th) nerve dysfunction	Poisoning by <i>Phalaris aquatica</i> in cattle. Listeriosis, local medullary lesion
	Inappropriate movements of lips	Facial (7th) nerve dysfunction	Traumatic injury to petrous temporal bone, otitis media and interna, listeriosis, guttural pouch mycosis
	Inadequate chewing movements of jaw	Motor branch of the trigeminal (5th) nerve dysfunction	Poisoning by <i>Phalaris aquatica</i> in cattle, listeriosis
Inability to swallow (in absence of physical foreign body; in pharyngeal paresis or paralysis)	Regurgitation through nose and mouth, inhalation into lungs causing aspiration pneumonia	Glossopharyngeal (9th) nerve dysfunction. Also vagus (10th). Nuclei in medulla	Abscess or tumor adjacent to nerve. Listeriosis, abscess in medulla
	Inappropriate swallowing movements	Globus pallidus and substantia nigra	Poisoning <i>Centaurea</i> sp.

horn gray matter level with the limb or peripheral nerves or muscle. With lower motor neuron lesions, the weakness is often so marked that it is easy to pull an animal to the side while it is standing or walking. In contrast, a weak animal with a

lesion of the upper motor neuron pathways will often fix the limb in extension, reflexly, when pulled to one side. It resists the pull and appears strong.

**Severe weakness in all four limbs**, but with no ataxia and spasticity, suggests

neuromuscular disease. Obvious weakness in only one limb is suggestive of a peripheral nerve or muscle lesion in that limb.

**Ataxia** is an unconscious, general proprioceptive deficit causing poor coordination when moving the limbs and

the body. It results in swaying from side to side of the pelvis, trunk and sometimes the entire body. It may also appear as a weaving of the affected limb during the swing phase. This often results in abducted or adducted foot placement, crossing of the limbs or stepping on the opposite foot, especially when the animal is circling or turning tightly. Circumduction of the outside limbs when turning and circling is also considered a proprioceptive deficiency. Walking an animal on a slope, with the head held elevated, often exaggerates ataxia, particularly in the pelvic limbs. When a weak and ataxic animal is turned sharply in circles, it leaves the affected limb in one place while pivoting around it. An ataxic gait may be most pronounced when an animal is moving freely, at a trot or canter, especially when attempting to stop. This is when the limbs may be wildly abducted or adducted. Proprioceptive deficits are caused by lesions affecting the general proprioceptive sensory pathways, which relay information on limb and body position to the cerebellum (unconscious proprioception) and to the thalamus and cerebral cortex (conscious proprioception).

**Knuckling the flexed foot** while the animal stands on the dorsum to determine how long the animal leaves the foot in this state before returning it to a normal position is a test for conscious proprioception in dogs and cats. The test has not been useful in horses and adult cattle but is useful in sheep, goats, New World camelids, and calves. Depressed animals will often allow the foot to rest on the dorsum for prolonged periods. Crossing the limbs and observing how long the animal maintains a crosslegged stance has been used to test conscious proprioception.

**Hypermetria** is used to describe a lack of direction and increased range of movement, and is seen as an overreaching of the limbs with excessive joint movement. Hypermetria without paresis is characteristic of spinocerebellar and cerebellar disease.

**Hypometria** is seen as stiff or spastic movement of the limbs with little flexion of the joints, particularly the carpal and tarsal joints. This generally is indicative of increased extensor tone and of a lesion affecting the descending motor or ascending spinocerebellar pathways to that limb. A hypometric gait, particularly in the thoracic limbs, is best seen when the animal is backed up or when it is maneuvered on a slope with the head held elevated. The thoracic limbs may move almost without flexing.

**Dysmetria** is a term that incorporates both hypermetria and hypometria. Animals with severe cerebellar lesions may have a high-stepping gait but have limited

movement of the distal limb joints, especially in thoracic limbs.

The degree of weakness, ataxia, hypometria and hypermetria should be graded for each limb. The types of gait abnormalities and the degree of weakness reflect various nervous and musculoskeletal lesions. Generally, with focal, particularly compressive, lesions in the cervical spinal cord or brainstem, neurological signs are one grade more severe in the pelvic limbs than in the thoracic limbs. Thus, with a mild, focal, cervical spinal cord lesion there may be more abnormality in the pelvic limbs with no signs in the thoracic limbs. The anatomical diagnosis in such cases may be a thoracolumbar, cervical, or diffuse spinal cord lesion.

A moderate or severe abnormality in the pelvic limbs, and none in the thoracic limbs, is consistent with a thoracolumbar spinal cord lesion. With a mild and a severe change in the thoracic and the pelvic limb gaits respectively, one must consider a severe thoracolumbar lesion plus a mild cervical lesion, or a diffuse spinal cord disease.

Lesions involving the brachial intumescence (spinal cord segments C6–T2) with involvement of the gray matter supplying the thoracic limbs, and diffuse spinal cord lesions may both result in severe gait abnormality in the thoracic limbs and the pelvic limbs.

A severely abnormal gait in the thoracic limbs, with normal pelvic limbs, indicates lower motor neuron involvement of the thoracic limbs; a lesion is most likely to be present in the ventral gray columns at spinal cord segments C6–T2 or thoracic limb peripheral nerves of muscle.

Gait abnormalities can occur in all four limbs, with lesions affecting the white matter in the caudal brainstem, when head signs, such as cranial nerve deficits, are used to define the site of the lesion. Lesions affecting the cerebrum cause no change in gait or posture.

## NECK AND FORELIMBS

If a gait abnormality was evident in the thoracic limbs and there was no evidence of brain involvement, then examination of the neck and forelimbs can confirm involvement of the spinal cord, peripheral nerves (spinal cord segments C1–T2) or thoracic limb muscles. The neck and forelimbs are examined for evidence of gross skeletal defects, asymmetry of the neck and muscle atrophy. The neck should be manipulated from side to side and up and down to detect any evidence of resistance or pain. Localized unilateral sweating of the neck and cranial shoulder is evidence of **Horner's syndrome**,<sup>20</sup> in

which there are varying degrees of ptosis, prolapse of the third eyelid, miosis, enophthalmos and increased temperature of the face, neck and shoulder. The syndrome is associated with lesions affecting the descending sympathetic fibers in the white matter of the spinal cord or gray matter in the cranial thoracic segments, thoracocervical sympathetic trunk, cervical vagosympathetic trunk or cranial cervical ganglion and its pre- and post-ganglionic fibers.

**Sensory perception from the neck and forelimbs** is assessed using a painful stimulus such as a blunt needle or forceps. The local responses as well as the cerebral responses are noted when the skin over the shoulders and down the limbs is pricked.

**Gait deficits** are evaluated by making the horse or halter-broken ruminant perform a series of movements. Such exercises should include walking and trotting in a straight line, in large circles, in tight circles, backing on a level ground and on a slight slope, walking and trotting over curbs or low obstacles, walking in straight lines and circles, and walking on a slope with the head held elevated. The sway reaction for the thoracic limb is assessed by pushing against the shoulders and forcing the animal first to resist and then to take a step laterally. This can be done while the animal is standing still and walking forward. Pulling the tail and lead rope laterally at the same time will assess the strength on each side of the body. Making the animal turn in a tight circle by pulling the lead rope and tail at the same time will indicate strength; an adult horse should be able to pull the examiner around and should not pivot on a limb or be pulled to the side. Pressing down with the fingers on the withers of a normal animal causes some arching, followed by resistance to the downward pressure. An animal with weakness in the thoracic limbs may not be able to resist this pressure by fixing its vertebral column but will arch its back more than normal and often buckle in the thoracic limbs.

In smaller farm animal species, other postural reactions can be performed. These include wheelbarrowing and the hopping response test. The spinal reflexes are assumed to be intact in animals that are ambulating normally.

If a large mature horse, cow or pig has a gait abnormality, it is very rare to cast the animal to assess the spinal reflexes. However, spinal reflexes are usually examined in calves, sheep, and goats.

A **recumbent animal** that can use its thoracic limbs to sit up in the dog-sitting position may have a lesion caudal to spinal cord segment T2. If a recumbent



animal cannot attain a dog-sitting position, the lesion may be in the cervical spinal cord. In lambs aged between 4 and 10 weeks with thoracic vertebral body abscesses extending into the epidural space causing spinal cord compression, the thoracic limbs are normal and the lambs frequently adopt a 'dog-sitting' position and move themselves around using the thoracic limbs only.<sup>21</sup> Lambs with a cervical spinal cord lesion are unable to maintain sternal recumbency and have paresis of all four limbs.

However, mature cattle with the downer cow syndrome secondary to hypocalcemia may be unable to use both the thoracic and pelvic limbs. If only the head, but not the neck, can be raised off the ground, there may be a severe cranial cervical lesion. With a severe caudal cervical lesion, the head and neck can usually be raised off the ground but thoracic limb function is decreased and the animal is unable to maintain sternal recumbency.

**Assessment** of limb function is done by manipulating each limb separately, in its free state, for muscle tone and sensory and motor activity. A limb that has been lain upon for some time cannot be properly evaluated because there will be poor tone from the compression. A flaccid limb, with no motor activity, indicates a lower motor neuron lesion to that limb. A severe upper motor neuron lesion to the thoracic limbs causes decreased, or absent, voluntary effort, but there is commonly normal or increased muscle tone in the limbs. This is due to release of the lower motor neuron, which reflexly maintains normal muscle tone from the calming influence of the descending upper motor neuron pathways.

**The tone of skeletal muscle** may be examined by passively flexing and extending the limbs and moving the neck from side to side and up and down. Increased muscle tone, spasticity or tetany may be so great that the limb cannot be flexed without considerable effort. If the spastic-extended limb does begin to flex but the resistance remains, this is known as 'lead-pipe' rigidity, which is seen in tetanus. If after beginning to flex an extended spastic limb, the resistance suddenly disappears ('clasp-knife release') this suggests an upper motor neuron lesion, as occurs in spastic paresis in cattle.

**Flaccidity, or decreased muscle tone**, indicates the presence of a lower motor neuron lesion with interruption of the spinal reflex arc.

Localized atrophy of muscles may be myogenic or neurogenic and the difference can be determined only by electromyography, a technique not well suited to large-animal practice. If the atrophic muscle corresponds to the distribution of a peripheral nerve it is usually assumed

that the atrophy is neurogenic. In addition, neurogenic atrophy is usually rapid (will be clinically obvious in a few days) and much more marked than either disuse or myogenic atrophy.

#### **Spinal reflexes of the thoracic limbs**

These include the flexor reflex, the biceps reflex and the triceps reflex. The flexor reflex is tested by stimulation of the skin of the distal limb and observing for flexion of the fetlock, knee, elbow, and shoulder. The reflex arc involves sensory fibers in the median and ulnar nerves, spinal cord segments C6–T2 and motor fibers in the axillary, musculocutaneous, median and ulnar nerves. Lesions cranial to spinal cord segment C6 may release this reflex from the calming effect of the upper motor neuron pathways and cause an exaggerated reflex with rapid flexion of the limb, and the limb may remain flexed for some time. A spinal reflex may be intact without cerebral perception. Cerebral responses to the flexor reflex include changes in the facial expression, head movement toward the examiner and vocalization. Conscious perception of the stimulus will be intact only as long as the afferent fibers in the median and ulnar nerves, the dorsal gray columns at spinal cord segments C6–T2 and the ascending sensory pathways in the cervical spinal cord and brainstem are intact.

**The laryngeal adductory reflex** is of special interest in the examination of ataxic horses. In normal horses a slap on the saddle region just caudal to the withers causes a flickering adductory movement of the contralateral arytenoid cartilage that is visible by an endoscope. Reflex muscle contraction can be palpated on the dorsolateral surfaces of the larynx. The reflex is absent when there is damage to afferent tracts up the spinal cord, when there is damage to the recurrent laryngeal nerves, and in tense or frightened horses. Elicitation of the reflex is called the **slap test**.

#### **TRUNK AND HINDLIMBS**

If examination of the posture, gait, head, neck or thoracic limbs reveals evidence of a lesion, then an attempt should be made to explain any further signs found during examination of the trunk and hindlimbs that could have been caused by the lesion. If there are only signs in the trunk and hindlimbs, then the lesion(s) must be either between spinal cord segments T2 and S2 or in the trunk and pelvic limb nerves or muscles. It must be remembered that a subtle neurological gait in the pelvic limbs may be anywhere between the midsacral spinal cord and the rostral brainstem.

The trunk and hindlimbs are observed and palpated for malformations and

asymmetry. Diffuse or localized sweating, the result of epinephrine release and sympathetic denervation, is often present in horses affected with a severe spinal cord injury.

**Gentle pricking** of the skin over the trunk and over the lateral aspects of the body wall on both sides, including on either side of the thoracolumbar vertebral column, will test-stimulate the cutaneous trunci reflex. The sensory stimulus travels to the spinal cord in thoracolumbar spinal nerves at the level of the site of stimulation. These impulses are transmitted up the spinal cord to spinal cord segments C8–T1, where the lateral thoracic nerve is stimulated, causing contraction of the cutaneous trunci muscle, which is seen as a flicking of the skin over the trunk. Lesions anywhere along this pathway will result in suppression or absence of this reflex caudal to the site of the lesion. Degrees of hypalgesia and analgesia have been detected caudal to the sites of thoracolumbar spinal cord lesions, especially if they are severe. In mature cattle with fractured thoracolumbar vertebrae associated with traumatic injury or vertebral body abscesses in calves, the site of the lesion may be able to be localized with this reflex. Sensory perception of pinpricking the trunk and hindlimbs may also be absent caudal to the lesion.

**The sway reaction** for the pelvic limbs involves pushing against the pelvis and pulling on the tail with the animal standing still and walking forward. An animal which is weak in the pelvic limbs will be easily pulled and pushed laterally, especially while walking. Proprioceptive deficits can be observed as overabduction and crossing of the limbs when a step is taken to the side.

**Pinching** and pressing down on the thoracolumbar or sacral paravertebral muscles with the fingers causes a normal animal to extend slightly, then fix, the thoracolumbar vertebral column. It also resists the ventral motion and usually does not flex the thoracic or pelvic limbs. A weak animal usually is not able to resist the pressure by fixing the vertebral column and thus it overextends the back and begins to buckle in the pelvic limbs.

**In the recumbent animal**, examination of the pelvic limbs includes the pelvic limb spinal reflexes, the degree of voluntary effort and the muscle tone present. Observing the animal attempting to rise on its own or following some coaxing will help to assess the pelvic limbs. The **flexor spinal reflex** is performed by pricking the skin and observing the flexion of the limb; central perception of the painful stimulus is also noted. The afferent and efferent pathways for this

reflex are in the sciatic nerve and involve spinal cord segments L5–S3.

The **patellar reflex** is evaluated by placing the animal in lateral recumbency and supporting the limb in a partly flexed position. The intermediate patellar ligament (horses) or patellar ligament (ruminants, pigs, New World camelids) is then tapped with a heavy metal plexor. This results in extension of the stifle joint. The sensory and motor fibers for this reflex are in the femoral nerve, and the spinal cord segments are L4 and L5. The patellar reflex is hyperactive in newborn farm animals. The gastrocnemius reflex and the cranial tibial reflex are not evaluated because they cannot be reliably induced.

The spinal cord of the calf has more control of basic physical functions than in humans, dogs and horses. For example, calves are able to retain control of the pelvic limb in spite of experimentally induced lesions that cause hemiplegia in dogs and humans. Also transection of the spinothalamic tract in the calf cord does not produce an area of hypalgesia or analgesia on the contralateral side as such a lesion would do in a human.<sup>22</sup>

**Skin sensation** of the pelvic limbs should be assessed independently from reflex activity. The femoral nerve is sensory to the skin of the medial thigh region, the peroneal nerve to the dorsal tarsus and metatarsus, and the tibial nerve to the plantar surface of the metatarsus.

## TAIL AND ANUS

Tail tone is evaluated by lifting the tail and noting the resistance to movement. A flaccid tail, with no voluntary movement, is indicative of a lesion of the sacrococcygeal spinal cord segments, nerves, or muscles. Decreased tone in tail can be detected with severe spinal cord lesions cranial to the coccygeal segment.

The **perineal reflex** is elicited by lightly pricking the skin of the perineum and observing reflex contraction of the anal sphincter and clamping down of the tail. The sensory fibers are contained within the perineal branches of the pudendal nerve (spinal cord segments S1–S3). Contraction of the anal sphincter is mediated by the caudal rectal branch of the pudendal nerve, and tail flexion is mediated by the sacral and coccygeal segments and nerves (spinal cord segments S1–Co). An animal with a flaccid tail and anus, due to lower motor neuron lesion, will not have an anal or tail reflex. However, it may still have normal sensation from the anus and tail provided that the sensory nerves and spinal cord and brainstem white matter nociceptive pathways are intact.

Observation of defecation and urination movements and postures contributes to knowledge of the state of the cauda equina. Thus neuritis of the cauda equina is characterized by flaccid paralysis and analgesia of the tail, anus and perineum, rectum and bladder. There is no paresis or paralysis of the hindlimbs unless lumbosacral segments of the cord are damaged.

## PALPATION OF THE BONY ENCASEMENT OF THE CENTRAL NERVOUS SYSTEM

Palpable or visible abnormalities of the cranium or spinal column are not commonly encountered in diseases of the nervous system but this examination should not be neglected. There may be displacement, abnormal configuration or pain on deep palpation. These abnormalities are much more readily palpable in the vertebral column and if vertebrae are fractured. Abnormal rigidity or flexibility of the vertebral column, such as occurs in atlanto-occipital malformations in Arabian horses and cattle, may also be detectable by manipulation.

## COLLECTION AND EXAMINATION OF CEREBROSPINAL FLUID

The collection and laboratory analysis of CSF from farm animals with clinical evidence of nervous system disease can provide useful diagnostic and prognostic information.<sup>2</sup>

CSF is formed mostly from the choroid plexuses of the lateral ventricles by the ultrafiltration of plasma and the active transport of selected substances across the blood–brain barrier. The CSF in the ventricular system flows caudally and diffuses out of the lateral aperture in the fourth ventricle to circulate around the brain and spinal cord. The presence of CSF in the subarachnoid space separates the brain and spinal cord from the bony cranium and vertebral column, which reduces trauma to the underlying delicate nervous tissue. CSF also has excretory functions with the removal of products of cerebral metabolism.

### Collection of cerebrospinal fluid

CSF can be collected from **lumbosacral cistern** with sedation (horses) or restraint (ruminants) and the **atlanto-occipital cistern (cisterna magna)** using injectable general anesthesia. For collection it is necessary to puncture the subarachnoid space in either the lumbosacral space or cisterna magna. Although there is no substantial difference between the composition of lumbosacral or cisternal CSF samples unless there is a compressive lesion of the spinal cord, the general

policy is to sample as close to the lesion as possible. CSF should be collected into a sterile tube and there is no need to add an anticoagulant, even in samples visibly contaminated with blood. Cytology should be performed as soon as possible after collection (ideally within 15 min) because the cells rapidly degenerate.

Collection from the lumbosacral cistern  
The lumbosacral site is preferred because general anesthesia is not required. CSF can be collected from the lumbosacral cistern with relative ease provided that adequate restraint can be achieved and the anatomical landmarks can be identified. CSF can be collected from the standing or recumbent animal. If recumbent, the animal should be placed in sternal recumbency with hips flexed and the pelvic limbs extended alongside the abdomen. This widens the lumbosacral space to permit correct placement of the spinal needle.

The site for collection is the midpoint of the lumbosacral space, which can be identified as the midline depression between the last palpable dorsal lumbar spine (L6 in cattle, goats and horses; L6 or L7 in sheep and pigs; L7 in New World camelids) and the first palpable sacral dorsal spine (usually S2). In well conditioned animals, these landmarks cannot always be identified; in which case the site is identified as the midpoint of a line connecting the caudal aspect of the tuber coxae. The site is clipped, surgically prepared and 1–2 mL of local anesthetic is administered subcutaneously. Sterile surgical gloves should be worn. Hypodermic spinal needles with stylettes are recommended because ordinary needles commonly plug with tissue. The length and gauge of needle depends on the size of the animal, but 15 cm (6 in) 18-gauge needles are needed for adult horses and cattle. The following guide is recommended (Table 12.7).

Provided the animal is well restrained and care is exercised in introducing the needle, little difficulty should be encountered. For collection from the lumbosacral space the needle is slowly advanced

Table 12.7 Needle length/gauge for lumbosacral cerebrospinal fluid collection

Species and body weight	Length (cm) and gauge of needle
Lambs <30 kg	2.5 and 20
Ewes 40–80 kg	4.0 and 20
Rams > 80 kg	5.0 and 20
Calves < 100 kg	4.0 and 20
Calves 100–200 kg	5.0 and 18
Cattle > 200 kg	10.0–15.0 and 18

perpendicular or up to 15° caudal to perpendicular to the plane of the vertebral column. The needle must be introduced in a perfectly vertical position relative to the plane of the animal's vertebral column because of the danger of entering one of the lateral blood vessels in the vertebral canal. Changes in tissue resistance can be felt as the needle point passes sequentially through the subcutaneous tissue, interarcuate ligament, then the sudden 'pop' due to the loss of resistance as the needle point penetrates the ligamentum flavum into the epidural space. Once the needle point has penetrated the dorsal subarachnoid space, CSF will well up in the needle hub within 2–3 seconds. Failure to appreciate the changes in resistance as the needle moves down may result in puncture of the conus medullaris, which may elicit an immediate pain response and some discomfort. Movement of the pelvic limbs may dislodge the needle point, with the risk of causing local trauma and hemorrhage in the leptomeninges, which results in blood in the sample. Repeated CSF taps of the lumbosacral space may make it more difficult to obtain an adequate sample volume because of fibrosis of epidural tissue.<sup>23</sup>

Careful aspiration with a syringe attached to the needle held between the thumb and index finger is usually required to obtain a sample of 2–3 mL, which is sufficient for laboratory analysis. This can be facilitated by firmly resting the forearms and wrists on the animal's back. Failure to obtain fluid is usually due to incorrect direction of the needle, in which the case the bony landmarks of the lumbosacral space (depression) must be rechecked and, with the needle correctly realigned, the procedure repeated. In animals with a vertebral body abscess and neurological disease confined to the hind limbs, CSF may be difficult to obtain from the lumbosacral space because flow is occluded. In these circumstances, if a sample is obtained, the CSF protein may be increased as a result of stagnation of CSF distal to the lesion with exudation or transudation of protein from the lesion (**Froin's syndrome**).<sup>24</sup>

Collection from the atlanto-occipital cistern (cisterna magna)

This site is preferred for intracranial lesions because the fluid is produced in the subarachnoid space and flows caudally down the spinal cord.<sup>25</sup> However, this site is rarely used because of the inherent risk of needle penetration of the brainstem. Xylazine at 0.20 mg/kg body weight (BW) intramuscularly is effective in providing adequate sedation and analgesia for this procedure in cattle. A general anesthetic

(such as combined intravenous administration of xylazine and ketamine) is recommended for horses.

The site is prepared as with the lumbosacral cistern. Ventriflexion of the head and neck of cattle enlarges the space of the cisterna magna and allows easy entry using a stiletted spinal needle inserted at a point created by the transection of the transverse line of the cranial rim of the wing of the atlas and the dorsal midline. The needle is advanced carefully and steadily and the tip is directed rostrally towards the symphysis of the lower jaw. The needle point goes through the skin, ligamentum nuchae and leptomeninges. In most mature cattle of body weight over 500 kg, a 20-gauge, 10 cm (4 in) spinal needle will enter the cisterna magna at 5–7 cm after going through the ligamentum nuchae, which provides some increased resistance. When the needle point punctures the leptomeninges, the animal may move its head slightly. At that point the needle is advanced only 1–2 mm and the stilette is then removed. If the end of the needle is in the cisterna magna, CSF will flow out of the needle freely and the manometer can be attached and the pressure measured.

#### Cerebrospinal fluid pressure

The CSF pressure can be determined by the use of a manometer attached to the spinal needle. Normal CSF pressures of the cisterna magna in cattle and xylazine/ketamine-anesthetized horses range from 5–15 cm (uncertain reference point) and  $28 \pm 4$  cm (referenced to the right atrium), respectively, using 0.9% NaCl solution in a manometer.<sup>26</sup> When the fluid system is properly connected, occlusion of both jugular veins causes a marked rise in CSF pressure; this is called **Queckenstedt's test**. The Queckenstedt test involves bilateral jugular vein compression; this results in a sudden increase in intracranial subarachnoid pressure that is transmitted to the cranial subarachnoid space. The resultant CSF pressure wave is transmitted to the lumbar area (when obtaining CSF from the lumbosacral space) in the absence of an obstruction in the spinal subarachnoid space, thereby resulting in an increased flow of CSF.

Variations in CSF pressure are not of much use in clinical diagnosis except in hypovitaminosis A, and measurement of CSF pressure is only indicated in animals with signs of cerebral disease (abnormal mentation). Care is needed in interpreting results because the pressure is greatly affected by voluntary movement such as tenesmus. CSF pressure is increased in a number of diseases, including poliomyelomalacia, bacterial meningitis, and

hypovitaminosis A. Xylazine given intravenously causes a decrease in intracranial pressure in healthy conscious horses.<sup>27</sup> Epidural pressure of cattle changes with change in position from standing to lateral recumbency to dorsal recumbency, and epidural pressure is positive in laterally recumbent animals.<sup>23</sup> Although the effect of epidural pressure on CSF pressure has not been evaluated in large animals, it is likely that CSF pressure is also affected by position.

#### Analysis of cerebrospinal fluid

Analysis of CSF has greater diagnostic value than hematology in animals with nervous system disease. CSF can be examined for the presence of protein, cells and bacteria.<sup>2</sup> The white blood cell count in normal animals is usually less than 5 cells/ $\mu$ L but a report exists of higher counts (12–200 cells/ $\mu$ L) in sheep.<sup>28</sup> An increase in CSF leukocyte count above 5 cells/ $\mu$ L is termed a pleocytosis and is categorized as mild (6–49 cells/ $\mu$ L), moderate (50–200 cells/ $\mu$ L), and severe (>200 cells/ $\mu$ L). The differential white cell count comprises mostly lymphocytes and monocytes; there are no erythrocytes in normal animals. Samples that show visible turbidity usually contain large numbers of cells (>500 cells/ $\mu$ L) and much protein. In cattle, protein concentrations range from 23–6 mg/dL, sodium concentrations from 132–144 mmol/L, potassium 2.7–3.2 mmol/L, magnesium 1.8–2.1 mEq/L and glucose concentrations 37–51 mg/dL.<sup>29</sup> In the horse, the reference values for CSF are similar.<sup>30</sup> Neonatal foals under 3 weeks of age have higher CSF protein concentrations than do adult horses. Glucose concentrations peak in the first 48 hours after birth, then decrease to adult values by the second week of life. Concentrations of sodium and potassium are not affected by age and are similar to values reported for adult horses and ponies.

With bacterial infections of the nervous system the CSF concentration of protein will be increased and the white blood cell count increased up to 2000 cells/ $\mu$ L with more than 70% neutrophils.<sup>28</sup> A neutrophilic pleocytosis is considered 95–100% indicative of an inflammatory process within the central nervous system.<sup>28</sup> Theoretically, the CSF glucose concentration will be decreased and CSF lactate concentration will be increased in animals with bacterial meningitis because of bacterial metabolism, but these are unreliable signs and usually do not provide additional information to that provided by determination of CSF leukocyte and protein concentrations. Bacteria may also be cultured from the CSF. Because meningoencephalitis may occur concurrently or following acute

diarrhea in calves under a few weeks of age, the evaluation of CSF should be considered in calves that remain depressed and inactive following rehydration and treatment.<sup>31</sup>

The creatine kinase and lactate dehydrogenase activities in CSF have been examined as an aid in the differentiation of some neurological diseases. However, creatine kinase activity is considered to be unreliable; contamination of the sample with epidural fat and dura may increase CSF creatine kinase activity in the horse.<sup>32</sup> Insufficient information is available to evaluate the clinical utility of CSF lactate dehydrogenase activity in large animals.

The CSF glucose concentration is usually 60–80% of serum glucose concentration; this steady state value reflects facilitated transport across the blood–brain barrier, absence of binding proteins for glucose in CSF and nervous tissue metabolism of glucose.<sup>29</sup> However, sudden changes in plasma glucose concentrations are not immediately reflected in CSF glucose concentrations, because CSF turns over at around 1% per minute. Typically, a lag time of up to 3 hours is needed for CSF glucose concentration to be in equilibrium with plasma glucose concentrations. Hyperglycemia as a result of the stress of handling and restraint may therefore not be reflected by an increased CSF glucose concentration.

Blood contamination of CSF can make interpretation difficult. A formula has been developed that 'corrects' the CSF values for the degree of blood contamination, based on the red blood cell count in CSF ( $RBC_{CSF}$ ) and blood ( $RBC_{blood}$ ), whereby the corrected value for substance  $X$  in CSF ( $X_{corrected}$ , where  $X$  is a concentration or activity) is derived from the measured value of  $X$  in CSF ( $X_{CSF}$ ) and blood ( $X_{blood}$ ) and applying the following formula:

$$X_{corrected} = X_{CSF} - (X_{blood} \times RBC_{CSF}/RBC_{blood}).^{33}$$

Calculation of a 'corrected' value rarely provides additional insight into the CSF analysis and is not commonly practiced in large animals.

Protein fractionation of CSF is not routinely performed because it requires sensitive electrophoresis methodology or species-specific radial immunodiffusion assays. However, calculation of the **albumin quotient** and **IgG index** may be informative in specific neurologic diseases.<sup>34,35</sup> Theoretically, these calculations can differentiate four blood–brain permeability patterns; normal blood–brain barrier permeability (normal albumin quotient and IgG index); intrathecal IgG production with normal blood–brain barrier permeability (normal albumin

quotient and increased IgG index); increased blood–brain barrier permeability without intrathecal IgG production (increased albumin quotient and normal IgG index) and increased blood–brain barrier permeability with intrathecal production of IgG (increased albumin quotient and increased IgG index). The albumin quotient is calculated from the albumin concentration in CSF ( $ALB_{CSF}$ ) and serum ( $ALB_{serum}$ ), whereby:

$$Albumin\ Quotient = (ALB_{CSF}) \times 100 / (ALB_{serum}).$$

The normal value for albumin quotient in the adult horse is less than 2.2<sup>34,36</sup> but the mean is 0.4 to 0.5 in cattle and adult llamas.<sup>29,35</sup> Because CSF protein is most commonly derived by disturbance of the blood–brain barrier and inflammation (resulting in an increased CSF albumin concentration), an increased CSF protein concentration is usually accompanied by an increased albumin quotient.

In animals suspected to have increased immunoglobulin production in the central nervous system (a rare occurrence, and almost always accompanied by disturbance of the blood–brain barrier), the IgG index can be calculated from the IgG concentration in CSF ( $IgG_{CSF}$ ) and serum ( $IgG_{serum}$ ), and the albumin concentration in CSF ( $ALB_{CSF}$ ) and serum ( $ALB_{serum}$ ), whereby:

$$IgG\ Index = (IgG_{CSF}/IgG_{serum}) \times (ALB_{serum}/ALB_{CSF}).$$

An IgG index of more than 0.3 is suspected to indicate intrathecal IgG production in the adult horse.<sup>34</sup>

This formula corrects the CSF IgG concentration for an increased permeability of the blood–brain barrier, and therefore theoretically provides a more sensitive method for detecting local production of IgG within the central nervous system. Calculating the albumin quotient and IgG index is expensive and rarely provides additional information to that provided by CSF protein concentration alone, and for this reason is not commonly performed in large animals.

In summary, collection and analysis of CSF from the lumbosacral region provides a practical, safe and informative diagnostic tool in conscious large animals with neurological disease. Analysis of CSF in animals with central nervous system disease has greater diagnostic value than analysis of the leukon or serum biochemical analysis. Routine assessment of CSF should include total protein concentration, erythrocyte count, leukocyte count and leukocyte differential count. Other analytical procedures on CSF can be performed in specific diseases related to the nervous system.

## EXAMINATION OF THE NERVOUS SYSTEM WITH SERUM BIOCHEMICAL ANALYSIS

### Arterial plasma ammonia concentration

In animals suspected of having hepatic encephalopathy, measurement of the arterial plasma ammonia concentration provides a clinically useful diagnostic test and a means of monitoring the response to treatment. In monogastrics, ammonia is produced by bacterial degradation of amines, amino acids, and purines in the gastrointestinal tract, by the action of bacterial and intestinal urease on urea in the gastrointestinal tract and by the catabolism of glutamine by enterocytes.<sup>37</sup> In ruminants, ammonia is derived predominantly from bacterial metabolism in the rumen and catabolism of amino acids in tissue. Absorbed ammonia is normally converted to urea by the liver and to glutamine by the liver, skeletal muscle, and brain. In the presence of hepatic dysfunction, ammonia is inadequately metabolized, resulting in high plasma ammonia concentrations. Ammonia is a direct neurotoxin that alters inhibitory and excitatory neurotransmission in the brain.

Hyperammonemia can be used as a specific indicator of hepatic dysfunction. Normal values for arterial plasma ammonia concentration are less than 29  $\mu\text{mol/L}$  in adult cattle<sup>37</sup> but may reach higher values in the immediate periparturient period. Arterial values are higher than venous values, and are preferred for analysis.

Blood gas analysis and serum electrolyte determination should be routinely undertaken in animals with clinical signs of encephalopathy, in order to rule out metabolic causes of cerebral dysfunction.

## EXAMINATION OF THE NERVOUS SYSTEM WITH IMAGING TECHNIQUES

### Radiography

Examination of the bony skeleton of the head and vertebral column to detect abnormalities which are affecting the nervous system of large animals is being used more commonly in referral centers. Conventional diagnostic radiography remains the best method for the initial evaluation of trauma to the brain and spinal cord. The injection of contrast media into the CSF system (**myelography**) is used for the detection of spinal cord compression but is rarely indicated in large animals because spinal cord depression surgery is rarely performed. In cases of peripheral nerve injury the radiograph of the appropriate limb may reveal the presence of a fracture or space-occupying lesion that has caused dysfunction of the peripheral nerve.

### Computed tomography

Computed tomography (CT) of the skull has several advantages over radiography because structures are viewed in cross section without superimposition.<sup>38</sup> The development of computer software and technology allows a large amount of information to be obtained from a CT examination. Numerous diseases of the head of the horse, including those of the brain, can be diagnosed using this technique, but the limiting factors are the weight of the patient, accessibility for large animals and the need for general anesthesia. In general, CT provides an excellent image of skeletal defects. CT has been used for the antemortem diagnosis of many conditions in foals and horses, and otitis interna in calves.<sup>39</sup>

### Magnetic resonance imaging

Magnetic resonance imaging (MRI) scanning uses nuclear magnetic resonance to create cross sectional images based on the magnetic properties of tissues. In general, MRI provides an excellent image of soft tissue defects, but the limiting factors are the weight of the patient, accessibility for large animals and the need for general anesthesia. MRI has been used for the antemortem diagnosis of many neurological conditions in foals and horses<sup>40</sup> and cerebellar hypoplasia in a calf.<sup>41</sup>

### RHINOLARYNGOSCOPY (ENDOSCOPY) AND OPHTHALMOSCOPY

Endoscopy (rhinolaryngoscopy) is now a routine technique for the examination of horses with suspected laryngeal hemiplegia.<sup>3</sup> Ophthalmoscopy for the examination of the structures of the eye is important in the diagnosis of diseases affecting the optic nerve such as in vitamin A deficiency, and the optic disc edema (**papilledema**) associated with diffuse cerebral edema.

### ELECTROENCEPHALOGRAPHY

Electroencephalography (EEG) has not been utilized to any significant degree in large animals. The EEG requires sophisticated equipment, a quiet dim environment free from electrical interference and a quiet patient that has minimal muscular activity. Because of the difficulty in obtaining quality recordings in a conscious large animal, it is preferred that the animal is anesthetized for the recording, which may confound interpretation of the EEG pattern depending on the anesthetic protocol. Electroencephalography has therefore been primarily used as an antemortem or research tool in large animals, and its use will probably remain as a complementary

test to other neurological examinations and diagnostic tests at referral institutions.<sup>42</sup>

Recommendations have been made in order to standardize EEG techniques for animals; these typically involve meticulous preparation of the recording sites on the scalp, and placement of electrodes over the left and right frontal areas, the left and right occipital areas, the vertex area and a reference electrode is placed behind the tip of the nose.<sup>20</sup> However, the addition of other recording sites increases the ability to localize a focal lesion.<sup>42</sup> Neurological disease is associated with changes in either EEG frequency or amplitude, or both, with frequency changes being a more reliable indicator of disease. In general, focal EEG abnormalities indicate a focal lesion in the cortex, whereas diffuse EEG abnormalities indicate diffuse cortical or subcortical lesions or focal subcortical lesions.

Electroencephalography has been used to study epilepsy in goats and cattle, congenital hydranencephaly and hydrocephalus in cattle, scrapie in sheep, thiamine-responsive polyencephalomalacia in cattle<sup>43</sup> and bovine spongiform encephalopathy in cattle. When performed under controlled conditions, EEG has been shown to be a useful diagnostic tool for the early diagnosis of equine intracranial diseases,<sup>42</sup> with adequate sensitivity and specificity.

### ELECTROMYOGRAPHY

Electromyographic needle examination (EMG) is a technique that records the electrical activity generated by single muscle fibers and the summated electrical activity of muscle fibers in individual motor units.<sup>44</sup> The technique involves inserting a recording needle into the muscle of interest and recording the resultant EMG. Typically, animals are unsedated and restrained in stocks or a chute. Abnormal EMG signals include short-duration and low-amplitude motor unit action potentials, which indicate diseased muscle fibers of early or incomplete reinnervation after denervation. Other abnormalities include the presence of fibrillation potentials, positive sharp waves and complex repetitive discharges that occur when the skeletal cell membrane becomes unstable because of denervation or myopathy.<sup>44</sup>

Electromyography provides a more practical diagnostic test than EEG, and is especially useful for evaluating peripheral nerve injury and diagnosing hyperkalemic periodic paresis in horses. Electromyography can discriminate between neurogenic or myogenic disorders, and nerve conduction studies can differentiate axonal loss from demyelination. In

addition, repetitive stimulation can provide information regarding neuromuscular transmission.

Electromyography has been coupled with transcranial magnetic stimulation to induce magnetic motor evoked potentials in the horse.<sup>45</sup> This provides a useful non-invasive evaluation of cervical spinal cord dysfunction in horses that evaluates the integrity of the descending motor tracts.

### BRAINSTEM AUDITORY EVOKED POTENTIALS

The brainstem auditory evoked potential (BAEP) is a recording of the electrical activity of the brainstem following an acoustic stimulation.<sup>46</sup> The use of the BAEP is well documented in human medicine as a diagnostic aid and has been used in dogs to evaluate deafness. The BAEP is obtained by recording neuro-electrical activity from generators in the auditory pathway immediately following an acoustic click stimulus, and BAEP waveforms for horses and ponies have been recorded.<sup>47</sup> Such recordings can be useful in evaluating horses suspected to have deafness, vestibular disease or brainstem disease, and to monitor the response to treatment.<sup>48</sup>

### INTRACRANIAL PRESSURE AND CEREBRAL PERFUSION PRESSURE

Intracranial pressure has been measured in neonatal foals,<sup>49</sup> although the clinical utility of such measurements has not been demonstrated. Increases in intracranial pressure can cause decreases in cerebral perfusion pressure and irreversible injury to the central nervous system.

### Principles of treatment of diseases of the nervous system

Treatment of disease of the nervous system presents some particular problems because of the failure of nervous tissue in the brain and spinal cord to regenerate and because of the impermeability of the blood-brain barrier to many antimicrobial agents, antiprotozoal agents, and anthelmintics.

When peripheral nerves are severed, regeneration occurs if the damage is not extensive but no specific treatment, other than surgical intervention, can be provided to facilitate repair. When neurons are destroyed in the brain and spinal cord no regeneration occurs and the provision of nervous system stimulants can have no effect on the loss of function that occurs. The emphasis in the treatment of diseases

of the nervous system must be on prevention of further damage. On occasion this can be done by providing specific or ancillary treatments.

## ELIMINATION AND CONTROL OF INFECTION

Most of the viral infections of the nervous system are not susceptible to chemotherapeutics. Some of the larger organisms such as *Chlamydia* spp. are susceptible to broad-spectrum antimicrobial agents such as the tetracyclines and chloramphenicol.

Bacterial infections of the central nervous system are usually manifestations of a general systemic infection as either bacteremia or septicemia. Treatment of such infections is limited by the existence of the blood–brain and blood–CSF barriers, which prevent penetration of some substances into nervous tissue and into the CSF. Very little useful data exist on the penetration of parenterally administered antibiotics into the central nervous system of either normal farm animals or those in which there is inflammation of the nervous system.

In humans it is considered that most antimicrobials do not enter the subarachnoid space in therapeutic concentrations unless inflammation is present, and the degree of penetration varies among drugs. Chloramphenicol is an exception; levels of one-third to one-half of the blood level are commonly achieved in normal individuals. The relative diffusion of Gram-negative antimicrobial agents from blood into CSF in humans is shown in Table 12.8.

The most promising antimicrobial agents for the treatment of bacterial meningitis in farm animals are the third-generation cephalosporins, trimethoprim–sulfonamide combinations and gentamicin.<sup>50</sup>

In most instances of bacterial encephalitis or meningitis in farm animals it is

likely that the blood–brain barrier is not intact and that parenterally administered drugs will diffuse into the nervous tissue and CSF. Certainly, the dramatic beneficial response achieved by the early parenteral treatment of *Histophilus somni* meningoencephalitis in cattle using intravenous oxytetracycline, intramuscular penicillin or a broad-spectrum antibiotic suggests that the blood–brain barrier may not be a major limiting factor when inflammation is present. Another example of an antibiotic that does not normally pass the blood–brain barrier well but is able to do so when the barrier is damaged is penicillin in the treatment of listeriosis. When cases of bacterial meningoencephalitis fail to respond to antimicrobial agents, to which the organisms are susceptible, other reasons should also be considered. Often the lesion is irreversibly advanced or there is a chronic suppurative process which is unlikely to respond.

Intrathecal injections of antimicrobial agents have been suggested as viable alternatives when parenteral therapy appears to be unsuccessful. However, there is no evidence that such treatment is superior to appropriate parenteral therapy. In addition, intrathecal injections can cause rapid death and therefore are not recommended.

## DECOMPRESSION

Increased intracranial pressure probably occurs in most cases of inflammation of the brain but it is only likely to be severe enough to cause physical damage in acute cerebral edema, space-occupying lesions such as abscesses, and hypovitaminosis A. In these circumstances some treatment should be given to withdraw fluid from the brain tissue and decrease the intracranial pressure.

One treatment that may be attempted is the combination of mannitol and corticosteroids used in man and in small animals. Mannitol given as a 20% solution intravenously over a 30–60-minute period is a successful intracranial decompressant with an effect lasting about 4 hours; the effect can be prolonged by the intravenous administration of dexamethasone 3 hours after the mannitol. The treatment has been used in calves with polioencephalomalacia, combined with thiamin, with excellent results to relieve the effects of acute cerebral edema. The dose rates have been those recommended for dogs and are very expensive: mannitol 2 g/kg BW, dexamethasone 1 mg/kg BW, both intravenously. There are dangers with mannitol: it should not be repeated often; it must not be given to an animal in shock; it should be given intravenously

slowly. Dexamethasone on its own is safe and has a good effect but does not decompress sufficiently. Hypertonic glucose given intravenously is dangerous because an initial temporary decompression is followed after a 4–6-hour interval by a return to pretreatment CSF pressure when the glucose is metabolized.

## TREATMENT OF BRAIN INJURY AFTER HEAD TRAUMA

The principles of treatment of animals exhibiting neurological abnormalities after a traumatic event are derived from the results of large, controlled, multicenter clinical trials in human beings. Similar studies have not been performed in large animals. The general principles are: 1) stabilize the patient by ensuring a patent airway, obtaining vascular access and attending to wounds, 2) specific treatment for hyperthermia as brain defects may result in an inability to regulate core temperature, 3) prevent or treat systemic arterial hypotension, 4) optimize oxygen delivery, 5) ensure adequate ventilation by placing in sternal recumbency whenever possible, 6) decrease pain, 7) monitor plasma glucose concentration and maintain euglycemia, and 8) prevent or treat cerebral edema by having the head elevated or by the intravenous administration of a hyperosmolar agent (hypertonic saline, 7.2% NaCl, 2 mL/kg BW every 4 hours for 5 infusions; 20% mannitol as a series of bolus infusions of 0.25 to 1 g/kg BW every 4–6 hours, the latter is an expensive treatment). Intravenous catheterization should be confined to one jugular vein and the neck should not be bandaged in an attempt to minimize promotion of cerebral edema by jugular venous hypertension. Seizures should be treated when they occur by administering diazepam, midazolam, phenobarbital, or pentobarbital.

Many anecdotal treatments have been used in large animals, but evidence attesting to their efficacy is clearly lacking. Amongst the more popular empiric antioxidant treatments are dimethyl sulfoxide (1 g/kg BW as a 10% solution in 0.9% NaCl) administered intravenously or by nasogastric tube every 12 h, vitamin E ( $\alpha$ -tocopherol, 50 IU/kg BW administered orally every day), vitamin C (ascorbic acid, 20 mg/kg BW administered orally every day), and allopurinol (5 mg/kg BW administered orally every 12 h). Corticosteroids have also been advocated; promoted treatments include an anti-inflammatory dose of dexamethasone (0.05 mg/kg BW every day) or a high dose of methylprednisolone sodium succinate (30 mg/kg BW initial bolus, followed by continuous infusion of 5.4 mg/kg BW per hour for

**Table 12.8** Relative diffusion of Gram-negative antimicrobials

Excellent with or without inflammation	Good only with inflammation
Sulfonamides	Ampicillin
Third-generation cephalosporins	Carbenicillin
(cefoperazone, cefotaxime)	Cephalothin
	Cephaloridine
Minimal or not good with inflammation	No passage with inflammation
Tetracycline	Polymyxin B
Streptomycin	Colistin
Kanamycin	
Gentamicin	

24–48 h); the latter treatment is prohibitively expensive in large animals and must be given within 8 hours of the traumatic event to be effective. Intravenous magnesium sulfate (50 mg/kg BW) in the first 5–10 L of intravenous fluids has also been advocated on the basis that it inhibits several aspects of the secondary injury cascade.

## CENTRAL NERVOUS SYSTEM STIMULANTS

These substances are used to excess in many instances. They exert only a transitory improvement in nervous function and are indicated only in nervous shock and after anesthesia or other short-term reversible anoxias such as cyanide or nitrate poisoning. It is unlikely that terminal respiratory failure caused by anoxia over a long period, and in which anoxia is likely to continue, will respond permanently to their use.

## CENTRAL NERVOUS SYSTEM DEPRESSANTS

Animals with convulsions should be sedated to avoid inflicting traumatic injuries on themselves. Most of the general anesthetic agents in common use will satisfactorily control convulsions, and allow some time to examine the animal properly, assess the diagnosis and institute specific therapy if possible.

## REVIEW LITERATURE

- Mayhew IG. Large animal neurology. A handbook for veterinary clinicians. Philadelphia, PA: Lea & Febiger, 1989.
- Summers BA., Cummings JF. de Lahunta A. Veterinary neuropathology. St Louis, MO: Mosby, 1995.
- Tucker RL, Farrell E. Computed tomography and magnetic resonance imaging of the equine head. *Vet Clin North Am Equine Pract* 2001; 17:131–144.
- Saegerman C, Claes L, Dewaele A et al. Differential diagnosis of neurologically expressed disorders in Western European cattle. *Rev Sci Tech Off Int Epiz* 2003; 22:83–102.
- Wijnberg ID, van der Kolk JH, Franssen H, Breukink HJ. Needle electromyography in the horse compared with its principles in man: a review. *Equine Vet J* 2003; 35:9–17.
- Constable PD. Clinical examination of the ruminant nervous system. *Vet Clin North Am Food Anim Pract* 2004; 20:215–230.
- MacKay RJ. Brain injury after head trauma: pathophysiology, diagnosis, and treatment. *Vet Clin North Am Equine Pract* 2004; 20:199–216.
- Scott PR. Diagnostic techniques and clinicopathologic findings in ruminant neurologic disease. *Vet Clin North Am Food Anim Pract* 2004; 20:215–230.

## REFERENCES

1. Done S. *In Pract* 1995; 17:318.
2. Scott PR. *Br Vet J* 1995; 151:603.
3. Tyler CM et al. *Aust Vet J* 1993; 70:445.
4. Perino LJ et al. *Equine Pract* 1985; 7:14.
5. Strain GM et al. *J Am Vet Med Assoc* 1984; 185:538.
6. Roeder BL et al. *Compend Contin Educ Pract Vet* 1990; 12:1175.
7. Becch J. *Am J Vet Res* 1987; 48:109.
8. De Lahunta A. *Can J Vet Res* 1990; 54:65.

9. Fayer R et al. *J Vet Intern Med* 1990; 4:54.
10. Martin L et al. *Equine Vet J* 1986; 18:133.
11. Mayhew IG. *J Vet Intern Med* 1991; 5:332.
12. Nappert G et al. *Can Vet J* 1989; 30:802.
13. Mayhew IG. Large animal neurology: A handbook for veterinary clinicians. Philadelphia, PA: Lea & Febiger, 1989.
14. Cummings JF et al. *Cornell Vet* 1990; 80:357.
15. Strain GM et al. *J Am Vet Med Assoc* 1987; 191:833.
16. Lane JG, Mair TS. *Equine Vet J* 1987; 19:331.
17. Madigan JE et al. *Equine Vet J* 1995; 27:306.
18. McConnon JM et al. *J Am Vet Med Assoc* 1983; 182:812.
19. Nurmio P et al. *Nord Vet Med* 1982; 34:130.
20. Green SL et al. *Can Vet J* 1992; 33:330.
21. Scott PR et al. *N Z Vet J* 1991; 39:105.
22. Cash WC et al. *J Vet Med A* 1986; 33:491.
23. Lee I et al. *Vet J* 2005; 169:257.
24. Scott PR, Will RG. *Br Vet J* 1991; 147:582.
25. St Jean G et al. *Can J Vet Res* 1997; 61:108.
26. Foreman JH et al. *J Vet Intern Med* 2004; 18:223.
27. Moore RM, Trims CM. *Am J Vet Res* 1992; 53:1558.
28. Scott P. *Br Vet J* 1992; 148:15.
29. Welles EG et al. *Am J Vet Res* 1992; 53:2050.
30. Furr MO, Bender H. *Am J Vet Res* 1994; 55:781.
31. Scott PR, Penny CD. *Vet Rec* 1993; 133:119.
32. Jackson C et al. *J Vet Intern Med* 1996; 10:246.
33. Wilson JW, Stevens JB. *J Am Vet Med Assoc* 1977; 171:256.
34. Andrews FM et al. *Prog Vet Neurol* 1990; 1:98.
35. Welles EG et al. *Am J Vet Res* 1994; 55:1075.
36. Foreman JH et al. *J Vet Intern Med* 2004; 18:223.
37. Mudron P et al. *Vet Med Czech* 2004; 49:187.
38. Tietje S et al. *Equine Vet J* 1996; 28:98.
39. Van Biervliet J et al. *J Vet Intern Med* 2004; 18:907.
40. Spoomakers TJP et al. *Equine Vet J* 2003; 35:146.
41. Gordon PJ, Dennis R. *Vet Rec* 1995; 137:671.
42. Lacombe VA et al. *J Vet Intern Med* 2001; 15:385.
43. Suzuki M et al. *Jpn J Vet Sci* 1990; 52:1077.
44. Wijnberg ID et al. *J Vet Intern Med* 2003; 17:185.
45. Nollet H et al. *Equine Vet J* 2004; 36:51.
46. Mayhew IG, Washbourne JR. *Br Vet J* 1992; 148:315.
47. Mayhew IG, Washbourne JR. *Vet J* 1997; 153:107.
48. Mayhew IG, Washbourne JR. *Br Vet J* 1990; 146:509.
49. Kortz GD et al. *Am J Vet Res* 1995; 56:1351.
50. Jamison JM, Prescott JF. *Compend Contin Educ Pract Vet* 1988; 10:225.

## Pathophysiological mechanisms of nervous system disease

### Etiology of nervous system disease

There are many different causes of nervous system disease in large domestic animals.

- Infectious causes include bacteria, viruses, fungi, and helminth, arthropod and protozoan parasites
- Exogenous substances such as lead, salt, selenium, organophosphate insecticides, feed additives such as urea, poisonous plants and many other chemicals are common causes
- Endogenous substances such as products of disease in other body systems or of abnormal metabolism such as bacterial toxins, ammonia and carbon dioxide can cause abnormalities of the nervous system

- Metabolic and nutritional causes include ischemia secondary to cardiopulmonary disease, hypoglycemia, hypomagnesemia, copper deficiency in pregnant animals, and hyper D-lactatemia in calves with neonatal diarrhea and adult ruminants with grain overload
- Acidemia associated with diarrhea can cause mental depression and ataxia
- Traumatic and physical injuries to the brain or spinal cord are common
- Neoplasms of the nervous system in large animals are uncommon, with the exception of spinal lymphosarcoma in adult cattle due to enzootic bovine leukosis
- Idiopathic diseases account for several diseases of the spinal cord of horses
- Malformation occurs primarily in the developing fetus and results in congenital nervous system disease, which is usually present at birth. Many different teratogens can cause congenital defects. In some cases of inherited disease, the clinical signs are not manifest until some time after birth.

### Responses of central nervous system to injury

The central nervous system may respond to injury by morphological changes that include cerebral edema and brain swelling, inflammation, and demyelination. Malformations occur when the central nervous system is affected during fetal life.

The remainder of this chapter will present the general clinical aspects of the diseases of the nervous system according to anatomical sites. The salient features of the etiology, pathogenesis, clinical findings, diagnosis, and treatment of these clinico-anatomical diseases are described. The objective is to generalize about the clinical findings that are common or typical of diseases affecting each of the major anatomical sites of the brain and spinal cord. Cerebral hypoxia and ischemia, hydrocephalus and cerebral edema are common to many diseases of the nervous system, and are described here.

## Diffuse diseases of the brain\*

### CEREBRAL HYPOXIA

Cerebral hypoxia occurs when the supply of oxygen to the brain is reduced for any reason. An acute or chronic syndrome

\* In the following discussion of diseases of the brain, the terms 'irritation', 'release', 'paralysis' and 'nervous shock' are used to describe groups of signs. These terms are used in accordance with their definitions under the principles of nervous dysfunction.



develops depending on the acuteness of the deprivation. Initially there are irritation signs followed terminally by signs of loss of function.

### ETIOLOGY

All forms of hypoxia, including anemic, anoxic, histotoxic, and stagnant forms cause some degree of cerebral hypoxia but signs referable to cerebral dysfunction occur only when the hypoxia is severe. The hypoxia of the brain may be secondary to a general systemic hypoxia or be caused by lesions restricted to the cranial cavity.

#### Cerebral hypoxia secondary to general hypoxia

- Poisoning by hydrocyanic acid or nitrite
- Acute heart failure in severe copper deficiency in cattle
- Anesthetic accidents
- Terminally in pneumonia, congestive heart failure
- During or at birth in foals, neonatal maladjustment syndrome in foals, or intrapartum hypoxia in calves and lambs due to prolonged parturition.

#### Cerebral hypoxia secondary to intracranial lesion

- In increased intracranial pressure
- In brain edema.

### PATHOGENESIS

The central nervous system is extremely sensitive to hypoxia, and degeneration occurs if the deprivation is extreme and prolonged for more than a few minutes. The effects of the hypoxia vary with the speed of onset and with the severity. When the onset is sudden there is usually a transitory period during which excitation phenomena occur and this is followed by a period of loss of function. If recovery occurs, a second period of excitation usually develops as function returns. In more chronic cases the excitation phase is not observed, the signs being mainly those of loss of function. These signs include dullness and lethargy when deprivation is moderate, and unconsciousness when it is severe. All forms of nervous activity are depressed but the higher centers are more susceptible than medullary centers and the pattern of development of signs may suggest this.

### CLINICAL FINDINGS

Acute and chronic syndromes occur depending on the severity of the hypoxia. Acute cerebral hypoxia is manifested by a sudden onset of signs referable to paralysis of all brain functions, including tetraparesis and unconsciousness. Muscle tremor, beginning about the head and spreading to the trunk and limbs, followed by recumbency, clonic convulsions and

death or recovery after further clonic convulsions is the most common pattern, although affected animals may fall to the ground without premonitory signs. In chronic hypoxia there is lethargy, dullness, ataxia, weakness, blindness and in some cases muscle tremor or convulsions. In both acute and chronic hypoxia the signs of the primary disease will also be evident. Cerebral hypoxia of fetal calves is thought to be a cause of weakness and failure to suck after birth, leading to the eventual death of the calf from starvation. Such hypoxia can occur during the birth process, especially if it is difficult or delayed, or during late pregnancy.

### CLINICAL PATHOLOGY AND NECROPSY FINDINGS

There is no distinctive clinical pathology or characteristic necropsy lesion other than those of the primary disease.

#### DIFFERENTIAL DIAGNOSIS

Clinically there is little to differentiate cerebral hypoxia from hypoglycemia or polioencephalomalacia in which similar signs occur. Irritation and paralytic signs follow one another in many poisonings including lead and arsenic and in most diffuse diseases of the brain including encephalitis and encephalomalacia. The differential diagnosis of cerebral hypoxia depends upon the detection of the cause of the hypoxia.

### TREATMENT

An increase in oxygen delivery is essential and can usually only be provided by removing the causative agent. A respiratory stimulant (such as doxapram) may be advantageous in acute cases and artificial respiration may be necessary and effective.

### INCREASED INTRACRANIAL PRESSURE, CEREBRAL EDEMA, AND BRAIN SWELLING

Diffuse cerebral edema and brain swelling usually occur acutely and cause a general increase in intracranial pressure. Cerebral edema is rarely a primary disease, but commonly an accompaniment of other diseases. Cerebral edema is commonly a transient phenomenon and may be fatal but complete recovery or recovery with residual nervous signs also occurs. It is manifested clinically by blindness, opisthotonos, muscle tremor, paralysis, and clonic convulsions.

### ETIOLOGY

Diffuse cerebral edema and brain swelling may be **vasogenic**, when there is increased permeability of capillary endothelium, **cytotoxic** when all the elements of brain tissue, glia, neurons and endothelial cells

undergo swelling. Causes include the following.

#### Vasogenic edema

- Brain abscess, neoplasm, hemorrhage, lead encephalopathy, purulent meningitis
- Minor edema after most traumatic injuries, in many encephalitides and many poisonings, including propylene glycol in the horse; probably contributes to the pathogenesis
- Accidental intracarotid injection of promazine in horses
- Leukoencephalomalacia in horses due to fumonisin consumption<sup>1,2</sup>
- Septicemia in neonatal foals.<sup>3</sup>

#### Cytotoxic edema

- Hypoxia
- Polioencephalomalacia of ruminants (thiamine deficiency or sulfur toxicosis)
- Salt poisoning of swine.

#### Interstitial edema

- Hydrocephalus.

### PATHOGENESIS

#### Cerebral edema and brain swelling

This disease is potentially life-threatening because of the limited ability for accommodation of increased volume within the confines of the dura and the cranium. The central nervous system parenchyma does not possess a lymphatic system, and the interstitial space between cells, especially in the gray matter, is much narrower than in other tissues. When central nervous system edema develops, of necessity it largely accumulates within cells, although interstitial fluid will form if cells lyse or if the edema is severe.

Cerebral edema commonly occurs to some degree in all pathological states, whether degenerative or inflammatory, traumatic or neoplastic. Edema around chronic, focal lesions such as abscesses, parasitic cysts and primary or metastatic tumors in white matter often produces marked swelling. Cerebral hemispheric swelling compresses the underlying brainstem, flattening the rostral colliculi and distorting the aqueduct. As the swollen brain expands and fills the confines of the calvaria, some regions are prone to herniation. If this occurs, the accompanying blood vessels are likely to become occluded, which may result in hemorrhage or infarction. Commonly with brain swelling, the caudal lobe of the cerebellar vermis protrudes as a flattened lip over the medulla oblongata toward the foramen magnum.

In **vasogenic edema** the primary insult is to the wall of cerebral capillaries, allowing the escape of plasma fluid and proteins under the hydrostatic pressure of the circulation. The inciting vascular

injury may be brain or spinal cord trauma, vasculitis, a neoplasm or a cerebrovascular accident. Vasogenic edema affects predominantly the white matter, where fluid accumulates within the cytoplasm of astrocytes and spreads in the interstitial spaces. Vasogenic edema moves over very long distances and from one hemisphere to the other via the corpus callosum. A chronic epidural abscess involving the frontal lobe can produce sufficient brain swelling from vasogenic edema to induce herniation of the occipital cortex beneath the tentorium cerebelli.

**Cytotoxic edema** results from an injury to a glial cell that disturbs osmoregulation of that cell by depletion of energy stores and failure of energy-dependent ionic pumps. This leads to cell swelling with fluid, and differs from edema in other tissues in which fluid accumulation is interstitial. Cytotoxic edema reflects a specific cellular insult and may result from ischemia or hypoxia, nutritional deficiency, an intoxication or an inherited metabolic abnormality. Brain swelling from cytotoxic edema is less dramatic than that seen in vasogenic edema. It may affect just the gray matter, just the white matter, or both.

The extracellular fluid volume in vasogenic edema is increased by the edema fluid, which is a plasma filtrate containing plasma protein. In cytotoxic edema it is the cellular elements themselves that increase in size. In hypoxia this is because of failure of the adenosine triphosphate (ATP)-dependent sodium pump within the cells. As a result sodium accumulates within the cells and water follows to maintain osmotic equilibrium. In polioencephalomalacia and salt poisoning the edema of the brain is primary. In salt poisoning in pigs there is an increase in concentration of cations in brain tissue with a sudden passage of water into the brain to maintain osmotic equilibrium. The cause of the edema in polioencephalomalacia of ruminants, associated with a thiamin inadequacy, is unknown. When promazine is injected accidentally into the carotid artery of the horse it produces a vasogenic edema and infarction generally, but especially in the thalamus and corpora quadrigemina on the injected side. The vasogenic edema surrounding an abscess is localized and is not evident in the white matter.

Cerebral edema and cerebellar herniation has been described in four neonatal foals admitted to an intensive care unit for treatment.<sup>3</sup> All foals had septicemia. It was suggested that hypoglycemia, hypoxia, or the alterations in cerebral blood flow associated with septicemia might have initiated injury to cell membranes, resulting in vascular damage and subsequent edema. It is

hypothesized that cerebellar herniation occurs in neonatal foals with sepsis because of the inelastic nature of the dural folds and the anatomical rigidity of the neonatal equine skull. This is in contrast to the human infant, in whom cerebral edema occurs in bacterial meningitis but cerebral or cerebellar herniation is not normally a feature. The relatively small brain of the newborn foal is only 1% of total body mass compared to the human infant which is 12% and in which the brain is enclosed within a large but relatively thin calvarium with sutures that, in the preterm infant at least, can be separated by excess internal pressure.<sup>4</sup>

An increase in intracranial pressure occurs suddenly and, as in hydrocephalus, there is a resulting ischemic anoxia of the brain due to compression of blood vessels and impairment of blood supply. This may not be the only factor that interferes with cerebral activity in polioencephalomalacia and salt poisoning. The clinical syndrome produced by the rapid rise in intracranial pressure is manifested by involuntary movements such as tremor and convulsions followed by signs of weakness. If the compression of the brain is severe enough and of sufficient duration, ischemic necrosis of the superficial layers of the cortical gray matter may occur, resulting in permanent nervous defects in those animals that recover. Opisthotonos and nystagmus are commonly observed and are probably due to the partial herniation of the cerebellum into the foramen magnum.

#### CLINICAL FINDINGS

Although the rise of intracranial pressure in diffuse edema of the brain is usually more acute than in hydrocephalus, the development of clinical signs takes place over a period of 12–24 hours and nervous shock does not occur. There is central blindness, and periodic attacks of abnormality occur in which **opisthotonos, nystagmus, muscle tremor, and convulsions** are prominent.

In the intervening periods the animal is dull, depressed, and blind, and optic disc edema may be present. The involuntary signs of tremor, convulsions, and opisthotonos are usually not extreme but this varies with the rapidity of onset of the edema. Because of the involvement of the brainstem, in severe cases muscle weakness appears, the animal becomes ataxic, goes down and is unable to rise, and the early signs persist. Clonic convulsions occur terminally and animals that survive may have residual defects of mentality and vision.

#### CLINICAL PATHOLOGY

Clinicopathological observations will depend on the specific disease causing the edema.

#### NECROPSY FINDINGS

Microscopically the gyri are flattened and the cerebellum is partially herniated into the foramen magnum with consequent distortion of its caudal aspect. The brain has a soft, swollen appearance and tends to sag over the edges of the cranium when the top has been removed. Caudal portions of the occipital lobes herniate ventral to the tentorium cerebelli.

#### DIFFERENTIAL DIAGNOSIS

Diffuse brain edema causes a syndrome not unlike that of encephalitis although there are fewer irritation phenomena. Differentiation from encephalomalacia and vitamin A deficiency may be difficult if the history does not give a clue to the cause of the disease. Metabolic diseases, particularly pregnancy toxemia, hypomagnesemic tetany of calves and lactation tetany, resemble it closely, as do some cases of acute ruminal impaction. In the history of each of these diseases there are distinguishing features that aid in making a tentative diagnosis. Some of the poisonings, particularly lead, organic mercurials and arsenicals and enterotoxemia associated with *Clostridium perfringens* type D produce similar nervous signs and gut edema of swine may be mistaken for diffuse cerebral edema.

#### TREATMENT

Decompression of the brain is desirable in acute edema. The treatment will depend in part on the cause; the edema associated with polioencephalomalacia will respond to early treatment with thiamin. In general terms, edema of the brain responds to parenteral treatment with hypertonic solutions and corticosteroids. Hypertonic solutions are most applicable to cytotoxic edema and corticosteroids to vasogenic edema. This is in addition to treatment for the primary cause of the disease. Mannitol at 2 g/kg BW and dexamethasone at 1 mg/kg BW, both intravenously, are recommended. The mannitol is given intravenously as a 20% solution followed 3 hours later by the dexamethasone, also intravenously. Diuretics usually produce tissue dehydration too slowly to be of much value in acute cases, but they may be of value as an adjunct to hypertonic solutions or in early or chronic cases. The removal of CSF from the cisterna magna in an attempt to provide relief may cause complications. In some cases the removal of 25–75 mL of CSF provides some temporary relief but the condition becomes worse later because portions of the swollen brain herniate into the foramen magnum. There is no published information available on how much fluid can be safely removed and recommendations cannot therefore be made.

## REFERENCES

1. Smith GW et al. *Am J Vet Res* 2002; 63:538.
2. Foreman JH et al. *J Vet Intern Med* 2004; 18:223.
3. Kortz GD et al. *Equine Vet J* 1992; 24:63.
4. Wigglesworth JS. *Equine Vet J* 1992; 24:6.

## HYDROCEPHALUS

Obstructive hydrocephalus may be congenital or acquired and is manifested in both cases by a syndrome referable to a general increase in intracranial pressure. Irritation signs of mania, head-pressing, muscle tremor and convulsions occur when the onset is rapid, and signs of paralysis including dullness, blindness and muscular weakness are present when the increased pressure develops slowly.

### ETIOLOGY

Obstructive hydrocephalus may be congenital or acquired but in both instances it is due to defective drainage or absorption of CSF. In the congenital disease there is an embryological defect in the drainage canals and foramina between the individual ventricles or between the ventricles and the subarachnoid space, or in the absorptive mechanism, the arachnoid villi.

### Congenital hydrocephalus

Causes are:

- Alone, with lateral narrowing of the mesencephalon
- Inherited defects of Hereford, Holstein, Ayrshire and Jersey cattle
- Inherited combined defects with chondrodysplasia, or in white Shorthorn cattle combined with hydrocephalus, microphthalmia and retinal dysplasia
- Virus infections of the fetus suggest themselves as possible causes of embryological defects in the drainage system, but there are no verified examples of this. The cavitation of brain tissue and subsequent accumulation of fluid, hydranencephaly, which occurs after infection with bluetongue virus in lambs and Akabane virus in calves, is compensatory, not obstructive
- Vitamin A deficiency may contribute
- Other occurrences, sometimes at high levels of prevalence, but without known cause.

### Acquired hydrocephalus

Causes include:

- Hypovitaminosis A in young growing calves causing impaired absorption of fluid by the arachnoid villi
- Cholesteatoma in choroid plexuses of the lateral ventricles in the horse. These may produce an acute, transient hydrocephalus on a number of occasions before the tumor reaches

sufficient size to cause permanent obstruction

- Other tumor or chronic inflammatory lesion obstructing drainage from the lateral ventricles.

### PATHOGENESIS

Increased intracranial pressure in the fetus and before the syndesmoses of the skull have fused causes hydrocephalus with enlargement of the cranium. After fusion of the suture lines the skull acts as a rigid container and an increase in the volume of its contents increases intracranial pressure. Although the increase in volume of the contents may be caused by the development of a local lesion such as an abscess, tumor, hematoma or cestode cyst, which interferes with drainage of the CSF, the more common lesion is a congenital defect of CSF drainage.

Clinical and pathological hydrocephalus has been produced experimentally in animals by creating granulomatous meningitis. The clinical signs included depression, stiffness of gait, recumbency and opisthotonus with paddling convulsions. The general effects in all cases are the same, the only difference being that local lesions may produce localizing signs as well as signs of increased intracranial pressure. These latter signs are caused by compression atrophy of nervous tissue and ischemic anoxia due to compression of blood vessels and impairment of blood supply to the brain.

In congenital hydrocephalus the signs observed are usually those of paralysis of function, while acquired hydrocephalus, being more acute, is usually manifested first by irritation phenomena followed by signs of paralysis. Edema of the optic papilla is a sign of increased intracranial pressure and may be detected ophthalmoscopically. Bradycardia occurs inconstantly and cannot be considered to be diagnostic.

### CLINICAL FINDINGS

In acquired hydrocephalus there is, in most cases, a gradual onset of general paresis. Initially there is depression, disinclination to move, central blindness, an expressionless stare and a lack of precision in acquired movements. A stage of somnolence follows and is most marked in horses. The animal stands with half-closed eyes, lowered head and a vacant expression and often leans against or supports itself upon some solid object. Chewing is slow, intermittent and incomplete and animals are often observed standing with food hanging from their mouths. The reaction to cutaneous stimulation is reduced, and abnormal postures are frequently adopted. Frequent stumbling, faulty placement of the feet and incoordination are evidenced when the

animal moves, and circling may occur in some cases. Bradycardia and cardiac arrhythmia have been observed.

Although the emphasis is on depression and paresis, signs of brain irritation may occur, particularly in the early stages. These signs often occur in isolated episodes during which a wild expression, charging, head-pressing, circling, tremor and convulsions appear. These episodes may be separated by quite long intervals, sometimes of several weeks' duration. In vitamin A deficiency in calves blindness and papilledema are the early signs and an acute convulsive stage occurs terminally.

Congenitally affected animals are usually alive at birth but are unable to stand and most die within 48 hours. The cranium is sometimes domed, the eyes protrude and nystagmus is often evident. Meningocele is an infrequent accompaniment.

### CLINICAL PATHOLOGY

Examination of the composition and pressure of the CSF will be of value. The fluid is usually normal biochemically and cytologically but the pressure is increased. A marked increase in serum muscle enzyme activity has been observed in calves with congenital hydrocephalus, due probably to an accompanying muscular dystrophy. Convulsions, if they occur, may contribute to this increase.

### NECROPSY FINDINGS

The cranium may be enlarged and soft in congenital hydrocephalus. The ventricles are distended with CSF under pressure and the overlying cerebral tissue is thinned if the pressure has been present for some time.

### DIFFERENTIAL DIAGNOSIS

Congenital hydrocephalus resembles vitamin A deficiency in newborn pigs, toxoplasmosis and hydranencephaly if there is no distortion of the cranium. Acquired hydrocephalus needs to be differentiated from other diffuse diseases of the brain, including encephalitis and encephalomalacia, and from hepatic dystrophies, which resemble it very closely. In these latter diseases there may be other signs of diagnostic value, including fever in encephalitis and jaundice in hepatic dystrophy. In most cases it is necessary to depend largely on the history and recognition of individual disease entities.

### ENCEPHALITIS

Encephalitis is, by definition, inflammation of the brain but in general usage it includes those diseases in which inflammatory lesions occur in the brain, whether there is inflammation of the nervous tissue or primarily of the vessel walls. Clinically, encephalitis is characterized initially

by signs of involuntary movements, followed by signs caused by loss of nervous function. The meninges and spinal cord may be involved in an encephalitis, causing varying degrees of meningoencephalomyelitis.

### ETIOLOGY

Many encephalitides of large animals are associated with viruses but other infectious agents are also common. Some causes are as follows.

All species

- Viral infections – rabies, pseudorabies, Japanese B encephalitis, West Nile virus encephalomyelitis
- Bacterial infections of neonatal farm animals
- Toxoplasmosis, which is not a common cause in any species
- Sarcocystosis
- Verminous encephalomyelitis – migration of larvae of parasitic species that normally have a somatic migration route, e.g. *Micronema deletrix*, *Setaria* spp. *Paraelaphostrongylus tenuis*

Cattle

- Bovine spongiform encephalopathy
- Viral infections – bovine malignant catarrh, sporadic bovine encephalomyelitis and bovine herpes virus
- Bacterial infections including *Listeria monocytogenes*, *Histophilus somni* (formerly *Haemophilus somnus*),<sup>1</sup> heartwater, clostridial infections following dehorning of calves<sup>2</sup>
- Migration of *Hypoderma bovis* occasionally to brain and spinal cord

Sheep

- Scrapie
- Viral infections – louping ill, visna (associated with Maedi-visna virus)<sup>3</sup>
- Thrombotic meningoencephalitis associated with *H. somni* (formerly *Histophilus ovis*) in lambs<sup>1,4</sup>
- Bacterial meningoencephalitis in lambs 2–4 weeks of age<sup>5</sup>
- Migration of *Oestrus ovis*

Goats

- Scrapie
- Caprine arthritis–encephalitis virus

New World camelids

- Bacterial infection due to *L. monocytogenes*

Pigs

- Bacterial infections – as part of systemic infections with *Salmonella* and *Erysipelas* spp., rarely *L. monocytogenes*
- Viral infections – hog cholera, African swine fever, encephalomyocarditis, swine vesicular disease,

hemagglutinating encephalomyelitis virus, porcine encephalomyelitis virus

Horses

- Viral infections – infectious equine encephalomyelitis, Borna disease, equine herpes virus, equine infectious anemia, eastern, western and West Nile equine encephalomyelitides, rarely louping ill virus
- Protozoal encephalomyelitis<sup>6</sup>
- Verminous encephalomyelitis due to *Strongylus vulgaris* in horses and *Draschia megastoma*. *Angiostrongylus cantonensis*, which normally migrates through the central nervous system of the rat, has been found as a cause of verminous encephalomyelitis in foals<sup>7</sup>

### PATHOGENESIS

Compared to other extraneural tissues, the inflammatory response mounted by the nervous system is unique. The central nervous system is in a sequestered and immunologically dormant state within the body. The capillary endothelial blood–brain barrier restricts free access by blood constituents. The central nervous system lacks specialized dendritic antigen-presenting cells, and the intrinsic expression by central nervous system cells of major histocompatibility complex molecules, especially class II, is low. There is no lymphatic system within nervous tissue, but cells and antigens within the central nervous system drain into the circulation and to the cervical lymph nodes.

The central nervous system has unique populations of cells consisting of parenchymal cells, which are **neurons**, and **neuroglia**. The neuroglia are supporting cells and are subdivided into macroglia and microglia: the macroglia are **astrocytes** and **oligodendrocytes**; the third glial cell type is a **microglial cell**. The brain and spinal cord are enclosed by meninges (**dura**, **arachnoid** and **pia**), which provide protection, a compartment for CSF circulation (the subarachnoid space), support for blood vessels and a sheath for the cranial and spinal nerves. Within the brain and spinal cord are the ventricular system and central canal, which are lined by **ependymal cells** and the **choroid plexuses**, which produce the CSF. Circulation of the CSF moves from the lateral, third and fourth ventricles into the central canal or through lateral apertures at the cerebellomedullary angle into the subarachnoid space of the brain. CSF in the subarachnoid space drains via specialized **arachnoid granulations** into intracranial venous sinuses, with some draining into venous plexuses associated with cranial and spinal nerves. CSF may also cross the ventricular surface into the adjacent parenchyma.

The histological characteristics of central nervous system inflammation are:

- **Perivascular cuffing**
- **Gliosis**
- **Neuronal satellitosis and neuronophagia.**

A perivascular compartment, actual or potential, exists around all central nervous system arteries, arterioles, venules and veins. A characteristic feature of central nervous system inflammation is perivascular cuffing, the accumulation of leukocytes of one or multiple types in the perivascular space. All perivascular cuffing results in vasculitis of some degree. In bacterial diseases, polymorphonuclear cells predominate with a minor component of mononuclear cells. In general, viral diseases are characterized by lymphocyte-rich cells with some plasma cells and monocytes; some arbovirus infections cause a polymorphonuclear cell response. In immune-mediated diseases, there are mixtures of polymorphonuclear and mononuclear cells. In thrombotic diseases such as thrombotic meningoencephalitis, vascular occlusion precludes the development of cuffing around injured vessels.

**Gliosis** is the increased prominence of glial cells, resulting from cytoplasmic swelling and the acquisition of more cell processes, from cell proliferation, or both. Either of the macroglia (oligodendrocytes or astrocytes) or microglia may participate in gliosis.

**Neuronal satellitosis** occurs when oligodendrocytes react and proliferate in response to degenerating neurons which may be infected by a virus.

**Neuronophagia** is the progressive degeneration of the neuron characterized by its piecemeal division and phagocytosis, eventually leaving a dense nodule of glial cells and fragments of the former neuron. Details of the form, functions and roles of astrocytes in neurological disease have been reviewed.<sup>8</sup>

**Primary demyelination** is characteristic of only a small number of inflammatory neurological diseases and is associated with only a few viruses. The inflammatory neuraxial diseases of large animals include visna in sheep and caprine arthritis–encephalitis. The demyelinating process may be initiated directly by the infectious agent alone or by an immunological response initiated by the agent.

With the exception of the viruses of bovine malignant catarrh and equine herpesvirus 1, which exert their effects principally on the vasculature, those viruses that cause encephalitis do so by invasion of cellular elements, usually the neurons, and cause initial stimulation and then death of the cells. Those bacteria that

cause diffuse encephalitis also exert their effects primarily on vascular endothelium. *L. monocytogenes* does so by the formation of microabscesses. In some diseases, such as meningoencephalitis in cattle associated with *H. somni*, the lesions may be present in the brain and throughout the spinal cord.<sup>9</sup>

**Entrance of the viruses** into the nervous tissue occurs in several ways. Normally the blood-brain barrier is an effective filtering agent but when there is damage to the endothelium infection readily occurs. The synergistic relationship between the rickettsias of tick-borne fever and the virus of louping ill probably has this basis. Entry may also occur by progression of the agent up a peripheral nerve trunk, as occurs with the viruses of rabies and pseudorabies and with *L. monocytogenes*. Entry via the olfactory nerves is also possible.

**The clinical signs** of encephalitis are usually referable to a general stimulatory or lethal effect on neurons in the brain. This may be in part due to the general effect of inflammatory edema and in part to the direct effects of the agent on nerve cells. In any particular case one or other of these factors may predominate but the tissue damage and therefore the signs are generalized. Clinical signs are often diverse and can be acute or chronic, localized or diffuse, and progressive or reversible. Because of diffuse inflammation in encephalitis, the clinical signs are commonly multifocal and asymmetric. This is not the case in listeriosis, in which damage is usually localized in the pons-medulla. Localizing signs may appear in the early stages of generalized encephalitis and remain as residual defects during the stage of convalescence. In calves with thromboembolic meningoencephalitis due to *H. somni*, prolonged recumbency may be associated with widespread lesions of the spinal cord. Visna is a demyelinating encephalitis, and caprine leukoencephalomyelitis is both demyelinating and inflammatory and also invades other tissues including joints and lung.

**In verminous encephalomyelitis**, destruction of nervous tissue may occur in many parts of the brain and in general the severity of the signs depends upon the size and mobility of the parasites and the route of entry. One exception to this generalization is the experimental 'visceral larva migrans' produced by *Toxocara canis* in pigs when the nervous signs occur at a time when lesions in most other organs are healing. The signs are apparently provoked by a reaction of the host to static larvae rather than trauma due to migration. Nematodes not resident in nervous tissues may cause nervous signs

due possibly to allergy or to the formation of toxins.

### CLINICAL FINDINGS

Because the encephalitides are associated with infectious agents they are often accompanied by fever, anorexia, depression and increased heart rate. This is not the case in the very chronic diseases such as scrapie and bovine spongiform encephalopathy. In those diseases associated with agents that are not truly neurotropic, there are characteristic signs, which are not described here.

The clinical findings that can occur in encephalitis are combinations of:

- **Subtle to marked changes in behavior**
- **Depression**
- **Seizures**
- **Blindness**
- **Compulsive walking**
- **Leaning on walls or fences**
- **Circling**
- **Ataxia.**

Bacterial meningoencephalitis in lambs 2-4 weeks of age is characterized by lack of suck reflex, weakness, altered gait and depression extending to stupor, but hyperesthesia to auditory and tactile stimuli.<sup>5</sup> Opisthotonus is common during the terminal stages.

There may be an initial period of **excitement or mania**. The animal is easily startled and responds excessively to normal stimuli. It may exhibit viciousness and uncontrolled activity including blind charging, bellowing, kicking and pawing. Self-mutilation may occur in diseases such as pseudorabies. Mental depression, including head-pressing, may occur between episodes.

Involuntary movements are variable in their occurrence or may not appear at all. When they do occur they include convulsions, usually clonic, and may be accompanied by nystagmus, champing of the jaws, excessive frothy salivation and muscle tremor, especially of the face and limbs. In cattle with malignant catarrhal fever, there is severe depression for a few days followed by the onset of tremors associated with the terminal encephalitis. Unusual irritation phenomena are the paresthesia and hyperesthesia of pseudorabies and scrapie.

**Signs caused by loss of nervous function** follow and may be the only signs in some instances. Excessive drooling and pharyngeal paralysis are common in rabies. In horses with equine encephalomyelitis, feed may be left hanging from the mouth, although swallowing may not be impaired. The loss of function varies in degree from paresis with knuckling at the lower limb joints, to

spasticity of the limbs with resultant ataxia, to weakness and recumbency. Recumbency and inability to rise may be the first clinical finding encountered as in many cases of meningoencephalitis associated with *H. somni*. Hypermetria, a staggering gait and apprehensiveness progressing to belligerency may occur in a disease such as bovine spongiform encephalopathy.

Clinical signs referable to certain anatomical sites and pathways of the brain and spinal cord are manifested by deviation of the head, walking in circles, abnormalities of posture, **ataxia** and incoordination but these are more commonly residual signs after recovery from the acute stages. Progressive ascending spinal cord paralysis, in which the loss of sensation and weakness occur initially in the hindlimbs followed by weakness in the forelimbs, occurs commonly in rabies. Residual lesions affecting the cranial nerves do not commonly occur in the encephalitides, except in listeriosis and protozoal encephalitis of horses, both infections predominating in the caudal brainstem.

An acute hemorrhagic necrotizing encephalitis following dehorning calves has been described.<sup>2</sup> Affected calves were found dead or moribund within a few days following dehorning using a gouge. A secondary clostridial infection was suspected.

In the horse with cerebral nematodiasis due to *S. vulgaris* the clinical signs are referable to migration of the parasite in the thalamus, brainstem and cerebellum. There is incoordination, leaning and head-pressing, dysmetria, intermittent clonic convulsions, unilateral or bilateral blindness and paralysis of some cranial nerves. The onset may be gradual or sudden. The clinical diagnosis is extremely difficult because examination of CSF and hematology are of limited value. A pathological diagnosis is necessary. In foals with neural angiostrongylosis, tetraparesis was the end result of progressive and multifocal neurological disease.<sup>7</sup>

### CLINICAL PATHOLOGY

Clinical pathology may be of considerable assistance in the diagnosis of encephalitis but the techniques used are for the most part specific to the individual diseases.

#### Hemogram

In the horse, complete and differential blood counts and serum chemistry profiles are recommended for most neurological cases.

#### Serology

Acute and convalescent sera can be submitted when a specific infectious disease is suspected for which a serologic diagnosis is possible.

### Cerebrospinal fluid

Laboratory examination of CSF for cellular content and pathogens may also be indicated. In bacterial meningoencephalitis of young lambs, analysis of CSF obtained from the lumbosacral space reveals a highly significant increase in protein concentration with neutrophilic pleocytosis.<sup>5</sup>

### NECROPSY FINDINGS

In some of the commonly occurring encephalitides there are no gross lesions of the brain apart from those that occur in other body systems and that are typical of the specific disease. In other cases, on transverse section of the brain, extensive areas of hemorrhagic necrosis may be visible, as in meningoencephalitis in cattle due to *H. somnus*. Histological lesions vary with the type and mode of action of the causative agent. Material for laboratory diagnosis should include the fixed brain and portions of fresh brain material for culture and for transmission experiments.

### DIFFERENTIAL DIAGNOSIS

The diagnosis of encephalitis cannot depend entirely on the recognition of the typical syndrome because similar syndromes may be caused by many other brain diseases. Acute cerebral edema and focal space-occupying lesions of the cranial cavity, and a number of poisonings, including salt, lead, arsenic, mercury, rotenone and chlorinated hydrocarbons all cause similar syndromes, as do hypovitaminosis A, hypoglycemia, encephalomalacia and meningitis.

**Fever** is common in encephalitis but is not usually present in rabies, scrapie, or bovine spongiform encephalopathy; but it may occur in the noninflammatory diseases if convulsions are severe.

Generally, the clinical diagnosis rests upon the recognition of the specific encephalitides and the elimination of the other possible causes on the basis of the history and clinical pathology, especially in poisonings, and on clinical findings characteristic of the particular disease. In many cases a definite diagnosis can only be made on necropsy. For differentiation of the specific encephalitides reference should be made to the diseases listed under Etiology, above.

Infestation with nematode larvae causes a great variety of signs depending on the number of invading larvae and the amount and location of the damage.

### TREATMENT

Specific treatments are dealt with under each disease. Antimicrobials are indicated for bacterial meningoencephalomyelitis. Generally the aim should be to provide supportive treatment by intravenous fluid and electrolyte therapy or stomach tube feeding during the acute phase. Sedation

during the excitement stage may prevent the animal from injuring itself, and nervous system stimulants during the period of depression may maintain life through the critical phase. Although there is an increase in intracranial pressure, the removal of CSF is contraindicated because of the deleterious effects of the procedure on other parts of the brain.

### REVIEW LITERATURE

Montgomery DL. Astrocytes: form, function, and role in disease. *Vet Pathol* 1994; 31: 145-167.  
Summers BA., Cummings JF, de Lahunta A. Veterinary neuropathology. St Louis, MO: Mosby, 1995.

### REFERENCES

- Ahrens AO et al. *Int J Syst Evol Microbiol* 2003; 53:1449.
- Nation PN, Calder WA. *Can Vet J* 1985; 26:378.
- Duffel SJ. *Vet Rec* 1984; 115:547.
- Cassidy JP et al. *Vet Rec* 1997; 140:193.
- Scott PR et al. *Vet Rec* 1994; 135:154.
- Boy MG et al. *J Am Vet Med Assoc* 1990; 196:632.
- Geiser DR et al. *Compend Contin Educ Pract Vet* 1988; 10:740.
- Montgomery DL. *Vet Pathol* 1994; 31:145.
- Yamaski H et al. *J Comp Pathol* 1991; 105:303.

### ENCEPHALOMALACIA OR THE DEGENERATIVE DISEASES OF THE CENTRAL NERVOUS SYSTEM

The degenerative diseases of the brain are grouped together under the name encephalomalacia. By definition encephalomalacia means softening of the brain. It is used here to include all degenerative changes. Leukoencephalomalacia and polioencephalomalacia refer to softening of the white and gray matter respectively. Abiotrophy is the premature degeneration of neurons due to an inborn metabolic error of development and excludes exogenous insults of neurons. The underlying cellular defect in most abiotrophies is inherited. The syndrome produced in most degenerative diseases of the nervous system is essentially one of loss of function.

### ETIOLOGY

Some indication of the diversity of causes of encephalomalacia and degenerative diseases of the nervous system can be appreciated from the examples which follow but many sporadic cases occur in which the cause cannot be defined.

#### All species

- Hepatic encephalopathy thought to be due to high blood levels of ammonia associated with advanced liver disease.<sup>1</sup> This is recorded in experimental pyrrolizidine alkaloid poisoning in sheep, in hepatic arteriovenous anomaly and thrombosis of the portal vein in the horse. Congenital portocaval shunts are also a cause
- Abiotrophy involving multisystem degenerations in the nervous system as focal or diffuse lesions involving

the axons and myelin of neuronal processes.<sup>2</sup> These include a multifocal encephalopathy in the Simmental breed of cattle in New Zealand and Australia,<sup>2</sup> and progressive myeloencephalopathy in Brown Swiss cattle, known as 'weavers' because of their ataxic gait (see below and Chapter on Inherited Defects)

- Poisoning by organic mercurials and, in some instances, lead; possibly also selenium poisoning; a bilateral multifocal cerebrospinal poliomalacia of sheep in Ghana
- Cerebrovascular disorders corresponding to the main categories in humans are observed in animals, but their occurrence is chiefly in pigs and their clinical importance is minor
- Congenital hypomyelination and dysmyelination are recorded in lambs (hairy shakers), piglets (myoclonia congenita) and calves (hypomyelination congenita). All are associated with viral infections in utero. Equine herpesvirus-1 infections in horses cause ischemic infarcts
- Cerebellar cortical abiotrophy in calves and lambs.<sup>2-4</sup>

#### Ruminants

- Bovine spongiform encephalopathy
- Plant poisons, e.g. *Astragalus* spp., *Oxytropis* spp., *Swainsona* spp., *Vicia* spp., *Kochia scoparia*
- Focal symmetrical encephalomalacia of sheep, thought to be a residual lesion after intoxication with *Clostridium perfringens* type D toxin
- Polioencephalomalacia caused by thiamin inadequacy in cattle and sheep and sulfur toxicosis in cattle; poliomalacia of sheep caused possibly by an antimetabolite of nicotinic acid
- Progressive spinal myelopathy of Murray Grey cattle in Australia<sup>2</sup>
- Spongiform encephalopathy in newborn polled Hereford calves similar to maple syrup urine disease<sup>2</sup>
- Neuronal dystrophy in Suffolk sheep<sup>2</sup>
- Shakers in horned Hereford calves associated with neuronal cell body chromatolysis<sup>2</sup>
- The abiotrophic lysosomal storage diseases – progressive ataxia of Charolais cattle, mannosidosis, gangliosidosis, globoid cell leukodystrophy of sheep
- The inherited defect of Brown Swiss cattle known as 'weavers', and presented elsewhere, is a degenerative myeloencephalopathy<sup>5</sup>
- Swayback and enzootic ataxia due to nutritional deficiency of copper in lambs
- Prolonged parturition of calves causing cerebral hypoxia and the weak calf syndrome

- Idiopathic brainstem neuronal chromatolysis in cattle<sup>6</sup>
- Bovine bonkers due to the consumption of ammoniated forages
- Inherited neuronal degeneration in Angora goats.<sup>2</sup>

#### Horses

- Leukoencephalomalacia caused by feeding moldy corn infested with *Fusarium moniliforme*, which produces primarily fumonisin B<sub>1</sub> and, to a lesser extent, fumonisin B<sub>2</sub>.<sup>7-10</sup>
- Nigropallidal encephalomalacia caused by feeding on yellow star thistle (*Centaurea solstitialis*)
- Poisoning by bracken and horsetail causing a conditioned deficiency of thiamin
- Ischemic encephalopathy of neonatal maladjustment syndrome of foals
- Equine degenerative myeloencephalopathy;<sup>11</sup> may be associated with a vitamin E deficiency.

#### Ruminants and horses

##### Neurotoxic mycotoxins

Swainsonine and slaframine produced by *Rhizoctonia leguminicola* cause mannose accumulation and parasympathomimetic effects. Lolitrems from *Acremonium lolii* and paspalitrems from *Claviceps paspali* are tremorgens found in grasses.<sup>7</sup>

#### Pigs

- Leukoencephalomalacia in mulberry heart disease
- Subclinical attacks of enterotoxemia similar to edema disease
- Poisoning by organic arsenicals, and salt.

### PATHOGENESIS

The pathogenesis of the degenerative diseases can be subdivided into:

- **Metabolic and circulatory disorders**
- **Intoxications and toxic-infectious diseases**
- **Nutritional diseases**
- **Hereditary, familial, and idiopathic degenerative diseases.**<sup>12</sup>

#### Metabolic and circulatory

Hepatic encephalopathy is associated with acquired liver disease and the resultant hyperammonemia and other toxic factors are considered to be neurotoxic. Disorders of intermediary metabolism result in the accumulation of neurotoxic substances such as in maple syrup urine disease of calves. Lysosomal storage diseases are caused by a lack of lysosomal enzymes which results in an accumulation of cellular substrates and affecting cell function. Central nervous system hypoxia and ischemia impair the most sensitive elements in brain tissue especially neurons. Severe ischemia results in necrosis of neurons and glial elements and areas of

infarcts. Gas-anesthesia-related neurological disease occurs in animals that have been deprived of oxygen for more than 5 minutes.

The hypoxia is lethal to neurons and upon recovery from the anesthetic affected animals are blind and seizures may occur. The typical lesion consists of widespread neuronal damage. Post-anesthetic hemorrhagic myelopathy and postanesthetic cerebral necrosis in horses are typical examples. Hypoglycemia occurs in neonates deprived of milk and in acetonemia and pregnancy toxemia and clinical signs of lethargy, dullness progressing to weakness, seizures and coma have been attributed to hypoglycemia. However, there are no studies of the central nervous system in farm animals with hypoglycemia and the effects, if any, on the nervous tissue are unknown.

#### Intoxications and toxic-infectious diseases

A large number of poisonous substances including poisonous plants, heavy metals (lead, arsenic, mercury), salt poisoning, farm chemicals, antifreeze, herbicides and insecticides can directly affect the nervous system when ingested by animals. They result in varying degrees of edema of the brain, degeneration of white and gray matter and hemorrhage of both the central and peripheral nervous system. Toxic-infectious diseases such as edema disease of swine and focal symmetrical encephalomalacia of sheep are examples of endotoxins and exotoxins produced by bacterial infections which have a direct effect on the nervous system resulting in encephalomalacia.

#### Nutritional diseases

Several nutritional deficiencies of farm animals can result in neurological disease:

- **Vitamin A deficiency** affects bone growth, particularly remodeling of the optic nerve tracts, and CSF absorption. The elevated CSF pressure and constriction of the optic nerve tracts results in edema of the optic disc and wallerian-type degeneration of the optic nerve resulting in blindness
- **Copper deficiency** in pregnant ewes can result in swayback and enzootic ataxia of the lambs. Copper is an integral element in several enzyme systems such as ceruloplasmin and lysyl oxidase, and copper deficiency affects several organ systems. The principal defect in swayback appears to be one of defective myelination probably caused by interference with phospholipid formation. However, some lesions in the newborn are more

extensive, and show cavitation with loss of axons and neurons rather than simply demyelination. In the brain, there is a progressive gelatinous transformation of the white matter, ending in cavitation that resembles porencephaly or hydranencephaly. In the spinal cord the lesions are bilateral and it is suggested that the copper deficiency has a primary axonopathic effect

- **Thiamine deficiency** in ruminants can result in **polioencephalomalacia** or **cerebrocortical necrosis**. Thiamine, mainly as thiamine diphosphate (pyrophosphate), has an important role as a coenzyme in carbohydrate metabolism especially the pentose pathway. Diffuse encephalopathy may occur characterized by brain edema and swelling, resulting in flattening of the gyri, tentorial herniation and coning of the cerebellar vermis. Bilateral areas of cerebral cortical laminar necrosis are widespread.

#### Hereditary, familial, and idiopathic degenerative diseases

A large number of neurological diseases of farm animals are characterized by abnormalities of central myelinogenesis. In most instances the underlying abnormality directly or indirectly affects the oligodendrocyte and is reflected in the production of central nervous system myelin of diminished quantity or quality or both. Many of these are inherited and are manifest from or shortly after birth. They include leukodystrophies, hypomyelinogenesis, spongy degeneration, and related disorders.<sup>12</sup> Neuronal abiotrophy, motor neuron diseases, neuronal dystrophy and degenerative encephalomyelopathy of horses and cattle are included in this group.

#### Polioencephalomalacia and leukoencephalomalacia

Polioencephalomalacia appears to be, in some cases at least, a consequence of acute edematous swelling of the brain and cortical ischemia. The pathogenesis of leukoencephalomalacia appears to be related to vasogenic edema as a result of cardiovascular dysfunction and an inability to regulate cerebral blood flow. Whether the lesion is in the gray matter (polioencephalomalacia) or in the white matter (leukoencephalomalacia) the syndrome is largely one of loss of function although as might be expected irritation signs are more likely to occur when the gray matter is damaged.

#### CLINICAL FINDINGS

Weakness of all four limbs is accompanied by:

- **Dullness or somnolence**
- **Blindness**



- Ataxia
- Head-pressing
- Circling
- Terminal coma.

In the early stages, particularly in ruminant **polioencephalomalacia**, there are involuntary signs including muscle tremor, opisthotonos, nystagmus, and convulsions.

In **equine leukoencephalomalacia**, which may occur in outbreaks, initial signs include anorexia and depression.<sup>3</sup> In the neurotoxic form, which is most common, the anorexia and depression progresses to ataxia, circling, apparent blindness, head-pressing, hyperesthesia, agitation, delirium, recumbency, seizures, and death. An early and consistent sign in affected horses is reduced proprioception of the tongue, manifest as delayed retraction of the tongue to the buccal cavity after the tongue has been extended.<sup>10</sup> In the hepatotoxicosis form, clinical findings include icterus, swelling of the lips and nose, petechiation, abdominal breathing and cyanosis. Horses with either syndrome may be found dead without any premonitory signs.

In many of the leukoencephalomalacias, the course may be one of gradual progression of signs, or more commonly a level of abnormality is reached and maintained for a long period, often necessitating euthanasia of the animal. For example, equine degenerative myeloencephalopathy is a diffuse degenerative disease of the equine spinal cords and caudal portion of the brainstem and primarily affects young horses. There is an insidious onset of symmetrical spasticity, ataxia, and paresis. Clinical signs may progress slowly to stabilize for long periods. All four limbs are affected, but the pelvic limbs are commonly more severely affected than the thoracic limbs. There is no treatment for the disease, no spontaneous recovery and, once affected, horses remain atactic and useless for any athletic function.

#### CLINICAL PATHOLOGY

There are no clinicopathological tests specific for encephalomalacia but various tests may aid in the diagnosis of some of the specific diseases mentioned above under Etiology.

#### NECROPSY FINDINGS

Gross lesions including areas of softening, cavitation and laminar necrosis of the cortex may be visible. The important lesions are described under each of the specific diseases.

#### TREATMENT

The prognosis depends on the nature of the lesion. Early cases of thiamine-deficiency-induced polioencephalomalacia can recover completely if treated with adequate

#### DIFFERENTIAL DIAGNOSIS

The syndromes produced by encephalomalacia resemble very closely those caused by most lesions that elevate intracranial pressure. The onset is quite sudden and there is depression of consciousness and loss of motor function. One major difference is that the lesions tend to be nonprogressive and affected animals may continue to survive in an impaired state for long periods.

levels of thiamin. Encephalomalacia due to sulfur-induced polioencephalomalacia and lead poisoning is more difficult to treat. Young calves with acquired in utero hypomyelinogenesis and horses with myelitis associated with equine herpesvirus-1 infection can make complete recoveries.

#### REVIEW LITERATURE

- De Lahunta A. Abiotrophy in domestic animals: a review. *Can J Vet Res* 1990; 54: 65-76.
- Summers BA, Cummings JF, de Lahunta A. *Veterinary neuropathology*. St Louis: Mosby, 1995.
- Cebra CK, Cebra ML. Altered mentation caused by polioencephalomalacia, hypernatremia, and lead poisoning. *Vet Clin North Am Food Anim Pract* 2004; 20: 287-302.

#### REFERENCES

1. Maddison JE. *J Vet Intern Med* 1992; 6:341.
2. De Lahunta A et al. *Can J Vet Res* 1990; 54:65.
3. Wilkins PA et al. *Cornell Vet* 1994; 84:53.
4. Woodman MP et al. *Vet Rec* 1993; 132:586.
5. Toenniessen JG, Morin DE. *Compend Contin Educ Pract Vet* 1995; 17:271.
6. Stewart WB. *Vet Rec* 1997; 140:260.
7. Plumlee KH, Galey FD. *J Vet Intern Med* 1994; 8:49.
8. Uhlinger C. *J Am Vet Med Assoc* 1991; 198:126.
9. Smith GW et al. *Am J Vet Res* 2002; 63:538.
10. Foreman JH et al. *J Vet Intern Med* 2004; 18:223.
11. Dill SG et al. *Am J Vet Res* 1990; 51:1300.
12. Summers BA et al. *Veterinary neuropathology*. St Louis: Mosby, 1995.

#### TRAUMATIC INJURY TO THE BRAIN

The effects of trauma to the brain vary with the site and extent of the injury but initially nervous shock is likely to occur followed by death, recovery, or the persistence of residual nervous signs.

#### ETIOLOGY

Traumatic injury to the brain may result from direct trauma applied externally, by violent stretching or flexing of the head and neck or by migration of parasitic larvae internally. Recorded causes include the following:

- Direct trauma, an uncommon cause because of the force required to damage the cranium. Accidental collisions, rearing forwards, falling over backwards after rearing are the usual reasons

- Periorbital skull fractures in horses caused by direct traumatic injury commonly from collision with gate posts<sup>1</sup>
- Cerebral injury and cranial nerve injury, accounted for in a large percentage of neurological disease in horses.<sup>2</sup> Young horses under 2 years of age seem most susceptible to injuries of the head
- Injury by heat in goat kids achieved with prolonged application of a hot iron used for debudding
- Pulling back violently when tethered causing problems at the atlanto-occipital junction
- Animals trapped in bogs, sumps, cellars, and waterholes and dragged out by the head; recumbent animals pulled on to trailers suffering dire consequences to the medulla and cervical cord, although the great majority of them come to surprisingly little harm
- The violent reaction of animals to lightning stroke and electrocution causing damage to central nervous tissue; the traumatic effect of the electrical current itself also causing neuronal destruction
- Spontaneous hemorrhage into the brain – rare but sometimes occurring in cows at parturition, causing multiple small hemorrhages in the medulla and brainstem
- Brain injury at parturition, recorded in lambs, calves, and foals and possibly a significant cause of mortality in the former.

#### PATHOGENESIS

The initial reaction in severe trauma or hemorrhage is nervous shock. Slowly developing subdural hematoma, a common development in humans, is accompanied by the gradual onset of signs of a space-occupying lesion of the cranial cavity but this seems to be a rare occurrence in animals. In some cases of trauma to the head, clinical evidence of injury to the brain may be delayed for a few days until sufficient swelling, callus formation or displacement of the fracture fragments has occurred. Trauma to the cranial vault may be classified, from least to most severe, as **concussion**, **contusion**, **laceration**, and **hemorrhage**.

#### Concussion

Concussion is usually a brief loss of consciousness which results from an abrupt head injury which produces an episode of rapid acceleration/deceleration of the brain.

#### Contusion

With a more violent force, the brain is contused. There is maintenance of structure

but loss of vascular integrity, resulting in hemorrhage into the parenchyma and meninges relative to the point of impact. Bony deformation or fracture of the calvaria result in two different kinds of focal lesions:

- Direct (**coup**) contusions immediately below the impact site
- Indirect (**contrecoup**) contusions to the brain at the opposite point of the skull. Contrecoup hemorrhages result from tearing of leptomenigeal and parenchymal blood vessels.

### Laceration

The most severe contusion is laceration where the central nervous system tissue is physically torn or disrupted by bony structures lining the cranium or by penetrating objects such as bone fragments. Focal meningeal hemorrhage is a common sequel to severe head injury. Subdural hematomas usually follow disruption of bridging cerebral veins that drain into the dural venous sinuses but subarachnoid hemorrhages are more common. The importance of these hemorrhages is that they develop into space-occupying masses that indent and compress the underlying brain. Progressive enlargement of the hematoma can result in secondary effects such as severe, widespread brain edema, areas of ischemia, herniations, midline shift, and lethal brainstem compression.

In birth injuries the lesion is principally one of hemorrhage subdurally and under the arachnoid.

### Experimental traumatic craniocerebral missile injury

Traumatic insult of the brains of sheep with a .22 caliber firearm results in a primary hemorrhagic wound track with indriven bone fragments and portions of muscle and skin.<sup>3</sup> There is crushing and laceration of tissues during missile penetration, secondary tracks due to bone and bullet fragments, widely distributed stretch injuries to blood vessels, nerve fibers and neurons as a consequence of the radial forces of the temporary cavity that develops as a bullet penetrates tissue, marked subarachnoid and intraventricular hemorrhage, and distortion and displacement of the brain. The lesions are consistently severe and rapidly fatal.

### CLINICAL FINDINGS

The syndrome usually follows the pattern of greatest severity initially with recovery occurring quickly but incompletely to a point where a residual defect is evident, this defect persisting unchanged for a long period and often permanently. This failure to improve or worsen after the initial phase is a characteristic of traumatic injury.

With severe injury there is cerebral shock in which the animal falls unconscious with or without a transient clonic convulsion. Consciousness may never be regained but in animals that recover it returns in from a few minutes up to several hours. During the period of unconsciousness, clinical examination reveals dilatation of the pupils, absence of the eye preservation and pupillary light reflexes, and a slow, irregular respiration, the irregularity being phasic in many cases. There may be evidence of bleeding from the nose and ears and palpation of the cranium may reveal a site of injury. Residual signs vary a great deal, blindness is present if the optic cortex is damaged; hemiplegia may be associated with lesions in the midbrain; traumatic epilepsy may occur with lesions in the motor cortex.

**Fracture of the petrous temporal bone** is a classic injury in horses caused by rearing and falling over backwards. Both the facial and the vestibular nerves are likely to be damaged so that at first the animal may be unable to stand and there may be blood from the ear and nostril of the affected side. When the animal does stand the head is rotated with the damaged side down. There may be nystagmus, especially early in the course of the disease. The ear, eyelid, and lip on the affected side are also paralyzed and sag. Ataxia with a tendency to fall is common. Some improvement occurs in the subsequent 2 or 3 weeks as the horse compensates for the deficit, but there is rarely permanent recovery. An identical syndrome is recorded in horses in which there has been a stress fracture of the petrous temporal bone resulting from a pre-existing inflammation of the bone. The onset of signs is acute but unassociated with trauma.

**Fracture of the basisphenoid and/or basioccipital bones** is also common. These fractures can seriously damage the jugular vein, carotid artery and glossopharyngeal, hypoglossal and vagus nerves. The cavernous sinus and the basilar artery may also be damaged and lead to massive hemorrhage within the cranium. Large vessels in the area are easily damaged by fragments of the fractured bones, causing fatal hemorrhage. A midline fracture of the frontal bones can also have this effect.

Other signs of severe trauma to the brain include opisthotonos with blindness and nystagmus and, if the brainstem has been damaged, quadriplegia. There may also be localizing signs, including head rotation, circling and falling backwards. Less common manifestations of resulting hemorrhage include bleeding into the retropharyngeal area, which may cause pressure on guttural pouches and

the airways and lead to asphyxia. Bleeding may take place into the guttural pouches themselves.

Newborn lambs affected by birth injury to the brain are mostly dead at birth, or die soon afterwards. Surviving lambs drink poorly and are very susceptible to cold stress. In some flocks it may be the principal mechanism causing perinatal mortality.

### CLINICAL PATHOLOGY

Radiography of the skull is important to detect the presence and severity of fractures, which may have lacerated nervous tissue. CSF should be sampled from the cerebellomedullary cistern and examined for evidence of red blood cells. Extreme care must be taken to ensure that blood vessels are not punctured during the sampling procedure as this would confound the interpretation of the presence of red blood cells. The presence of heme pigments in the CSF suggests the presence of pre-existing hemorrhage; the presence of eosinophils or hypersegmented neutrophils suggests parasitic invasion.

### NECROPSY FINDINGS

In most cases a gross hemorrhagic lesion will be evident but in concussion and nematodiasis the lesions may be detectable only on histological examination.

### DIFFERENTIAL DIAGNOSIS

Unless a history of trauma is available diagnosis may be difficult.

### TREATMENT

In those animals that recover consciousness within a few hours or earlier, the prognosis is favorable and little or no specific treatment may be necessary other than nursing care. When coma lasts for more than 3–6 hours the prognosis is unfavorable and slaughter for salvage or euthanasia is recommended. Treatment for edema of the brain as previously outlined may be indicated when treatment for valuable animals is requested by the owner. Animals that are still in a coma 6–12 hours following treatment are unlikely to improve and continued treatment is not warranted.

### REVIEW LITERATURE

- Summers BA, Cummings JF, de Lahunta A. Veterinary neuropathology. St Louis, MO: 1995, Mosby.  
 MacKay RJ. Brain injury after head trauma: pathophysiology, diagnosis, and treatment. *Vet Clin North Am Equine Pract* 2004; 20:199–216.

### REFERENCES

1. Wright JD et al. *Aust Vet J* 1991; 68:58.
2. Tyler CM et al. *Aust Vet J* 1993; 70:445.
3. Finnie JW. *J Comp Pathol* 1993; 108:93.

## Focal diseases of the brain

### BRAIN ABSCESS

Abscesses of the brain occur most commonly in young farm animals under 1 year of age and rarely in older animals. Brain abscesses produce a variety of clinical signs depending on their location and size. Basically the syndrome produced is one of a space-occupying lesion of the cranial cavity with some motor irritation signs. Localized or diffuse meningitis is also common, along with the effects of the abscess.

### ETIOLOGY

Abscesses in the brain originate in a number of ways. Hematogenous infections are common, but direct spread from injury to the cranium or via the nasopharynx may also occur.

#### Hematogenous spread

The lesions may be single, but are often multiple, and are usually accompanied by meningitis. The infection usually originates elsewhere.

- *Actinobacillus mallei* from glanders lesions in lung
- *Streptococcus zooepidemicus* var. *equi* as a complication of strangles in horses
- *Corynebacterium pseudotuberculosis* in a goat causing an encapsulated abscess in the left cerebellar peduncles<sup>1</sup>
- *Actinomyces bovis* and *Mycobacterium bovis* from visceral lesions in cattle
- *Fusobacterium necrophorum* from lesions in the oropharynx of calves
- *Pseudomonas pseudomallei* in melioidosis in sheep
- *Staphylococcus aureus* in tick pyemia of lambs
- Systemic fungal infections such as cryptococcosis may include granulomatous lesions in brain.<sup>2</sup>

#### Local spread

- Via peripheral nerves from oropharynx, the one specific disease is listeriosis in ruminants and New World camelids
- Multifocal meningoencephalitis associated with lingual arteritis induced by barley spikelet clusters<sup>3</sup>
- Space-occupying lesions of facial and vestibulocochlear nerves and geniculate ganglion secondary to otitis media in calves<sup>4</sup>
- Abscesses of rete mirabile of pituitary gland secondary to nasal septal infection after nose-ringing in cattle.<sup>5</sup> *Arcanobacterium* (*Actinomyces* or *Corynebacterium*) *pyogenes* is the most common isolate and several other species of bacteria that cause chronic suppurative lesions have been recovered.<sup>5</sup> Similar abscesses, usually

containing *A. pyogenes*, occur in the pituitary gland itself

- Extensions from local suppurative processes in cranial signs after dehorning, from otitis media. The lesions are single, most commonly contain *A. pyogenes* and are accompanied by meningitis.

### PATHOGENESIS

Infectious agents can invade the central nervous system by four routes:

- **Retrograde infection via peripheral nerves**
  - **Direct penetrating injuries**
  - **Extension of adjacent suppurative lesions**
  - **By way of the systemic circulation.**

Single abscesses cause local pressure effects on nervous tissue and may produce some signs of irritation, including head-pressing and mania, but the predominant effect is one of loss of function due to destruction of nerve cells. Multiple abscesses have much the same effect but whereas in single abscesses the signs usually make it possible to define the location of the lesion, multiple lesions present a confusing multiplicity of signs and variation in their severity from day to day, suggesting that damage has occurred at a number of widely distributed points and at different times.

**The pituitary abscess syndrome** has an uncertain pathogenesis. The pituitary gland is surrounded by a complex mesh of intertwined arteries and capillary beds known as the rete mirabile, which has been identified in cattle, sheep, goats, and pigs but not horses. This extensive capillary network surrounding the pituitary gland makes it susceptible to localization by bacteria that originate from other sources of infection. Nose-ringing of cattle may result in septic rhinitis, which could result in infection of the dural venous sinus system, which communicates with the subcutaneous veins of the head. Bacteria may also reach the rete mirabile by way of lymphatics of the nasal mucosa and cribriform plate. Cranial nerve deficits occur as a result of the extension of the abscess into the adjacent brainstem.

### CLINICAL FINDINGS

General signs include mental depression, clumsiness, head-pressing, and blindness, often preceded or interrupted by transient attacks of motor irritation including excitement, uncontrolled activity, and convulsions. A mild fever is usually present but the temperature may be normal in some cases.

The degree of blindness varies depending on the location of the abscess and the extent of adjacent edema and

meningoencephalitis. The animal may be blind in one eye and have normal eyesight in the other eye or have normal eyesight in both eyes. Unequal pupils and abnormalities in the pupillary light reflex, both direct and consensual, are common. Uveitis, iris bombé, and a collection of fibrin in the anterior chamber of an eye may be present in some cases of multiple meningoencephalitis in cattle.<sup>3</sup> Nystagmus is common when the lesion is near the vestibular nucleus; strabismus may also occur.

Localizing signs depend on the location of lesions and may include cerebellar ataxia, deviation of the head with circling and falling, hemiplegia or paralysis of individual or groups of cranial nerves often in a unilateral pattern. In the later stages there may be papilledema. In calves with lesions of the facial and vestibulocochlear nerves and geniculate ganglion, clinical signs may include drooping of the ears and lips, lifting of the nose, slight unilateral tilting of the head and uncontrolled saliva flow. Inability to swallow may follow and affected calves become dehydrated.

These localizing signs may be intermittent, especially in the early stages, and may develop slowly or acutely.

**Pituitary gland abscesses** are most common in ruminants, primarily cattle 2–5 years of age,<sup>5</sup> but are relatively rare. The most common history includes anorexia, ataxia, depression, and drooling from the mouth with inability to chew and swallow. The most common clinical findings are depression, dysphagia, dropped jaw, blindness, and absence of pupillary light reflexes. Terminally, opisthotonos, nystagmus, ataxia, and recumbency are common. Characteristically, the animal stands with a base-wide stance, with its head and neck extended and its mouth not quite closed; there is difficulty in chewing and swallowing, and drooling of saliva. Affected animals are usually nonresponsive to external stimuli. Cranial nerve deficits are common, usually asymmetrical, multifocal and progressive. These include reduced tone of the jaw, facial paralysis, strabismus, and a head tilt. There may also be ptosis and prolapse of the tongue. Bradycardia has been recorded in about 50% of cases.<sup>5</sup> Terminally there is opisthotonos, nystagmus, and loss of balance, followed by recumbency.

### CLINICAL PATHOLOGY

#### Cerebrospinal fluid

Leukocytes, protein, and bacteria may be present in the CSF, but only when the abscess is not contained.

#### Hematology

In pituitary gland abscessation there may be hematological evidence of chronic infection including neutrophilia, hyperproteinemia, and increased fibrinogen,<sup>5</sup>

although it is unlikely that a pituitary abscess itself is sufficiently large enough to induce these changes.

### Imaging

Radiographic examination will not detect brain abscesses unless they are calcified or cause erosion of bone. Computed tomography has been used to diagnose a brain abscess in the horse.<sup>6</sup>

### Electroencephalography

Electroencephalographic assessment of central blindness due to brain abscess in cattle has been reported.<sup>7</sup>

### NECROPSY FINDINGS

The abscess or abscesses may be visible on gross examination and if superficial are usually accompanied by local meningitis.<sup>8</sup> Large abscesses may penetrate to the ventricles and result in a diffuse ependymitis. Microabscesses may be visible only on histological examination. A general necropsy examination may reveal the primary lesion.

### DIFFERENTIAL DIAGNOSIS

Brain abscess is manifested by signs of involuntary movements and loss of function, which can occur in many other diseases of the brain, especially when local lesions develop slowly. This occurs more frequently with tumors and parasitic cysts but it may occur in encephalitis. The characteristic clinical findings are those of a focal or multifocal lesion of the brain, which include:

- Localizing signs of hemiparesis and ataxia
- Postural reaction deficit
- Vestibular signs, including head tilt and positional nystagmus
- Cranial nerve deficits.

There may be evidence of the existence of a suppurative lesion in another organ, and a high cell count and detectable infection in the CSF to support the diagnosis of abscess. Fever may or may not be present. The only specific disease in which abscess occurs is listeriosis, in which the lesions are largely confined to the medulla oblongata and the characteristic signs include circling and unilateral facial paralysis. Occasional cases may be associated with fungal infections, including cryptococcosis. Toxoplasmosis is an uncommon cause of granulomatous lesions in the brain of most species.

Many cases of brain abscess are similar to otitis media but there is, in the latter, rotation of the head, a commonly associated facial paralysis and an absence of signs of cerebral depression.

The pituitary gland syndrome in cattle must be differentiated from listeriosis, polioencephalomalacia, lead poisoning, other brain abscesses and thrombomeningoencephalitis. In sheep and goats, *Paraelaphostrongylus tenuis* infection and caprine arthritis encephalomyelitis syndrome may resemble the pituitary gland abscess syndrome.

### TREATMENT

Parenteral treatment with antimicrobials is indicated but the results are generally unsatisfactory because of the inaccessibility of the lesion, with the clear exception being listeriosis. Treatment of pituitary gland abscess is not recommended, and an antemortem diagnosis is rarely obtained.

### REVIEW LITERATURE

Perdrizet JA, Dinsmore P. Pituitary abscess syndrome. *Compend Contin Educ Pract Vet* 1986; 8:S311-S318.

Summers BA, Cummings JF, de Lahunta A. *Veterinary neuropathology*. St Louis, MO: Mosby, 1995.

Morin DE. Brainstem and cranial nerve abnormalities: Listeriosis, otitis media/interna, and pituitary abscess syndrome. *Vet Clin North Am Food Anim Pract* 2004; 20:243-274.

### REFERENCES

1. Glass EN et al. *Cornell Vet* 1993; 83:275.
2. Teuscher E et al. *Zentralbl Vet Med A* 1984; 31:132.
3. Sorden SD, Radostits OM. *Can Vet J* 1996; 37:227.
4. Van der Lugt JJ, Jordaan P. *Vet Rec* 1994; 134:579.
5. Perdrizet JA, Dinsmore P. *Compend Contin Educ Pract Vet* 1986; 8:S311.
6. Allen JR et al. *Equine Vet J* 1987; 19:552.
7. Strain GM et al. *Cornell Vet* 1987; 77:374.
8. Summers BA, Cummings JF, de Lahunta A. *Veterinary neuropathology*. St Louis, MO: Mosby, 1995.

### OTITIS MEDIA/INTERNA

Infection of the middle ear (**otitis media**) occurs in young animals of all species but especially dairy calves and pigs, to a lesser extent feedlot cattle and lambs, and rarely foals. The infection may gain entrance from the external ear (e.g. caused by ear mite infestation) or hematogenously, but the spread is chiefly an ascending infection of the eustachian tubes in a young animal from a respiratory tract infection. Extension of infection into the inner ear leads to **otitis interna**.

#### Pigs

Otitis media was present in 68% of 237 pigs that were slaughtered because of illness.<sup>1</sup> It is suggested that otitis media in pigs develops first as an acute inflammation in the auditory tube and then extends to other parts of the ear and brain. When abscesses form at the ventrum of the brainstem, the vestibulocochlear nerve is usually involved in the lesion.<sup>1</sup> Infection in the ear may extend into the brain by following the auditory nerve. Perilymph filling the scala vestibuli and scala tympani is also a possible tract for the extension of the infection because there is a communication between the perilymph-filled spaces of the bony labyrinth and the subarachnoid space.

#### Calves and lambs

The peak of occurrence in calves and lambs is 1-4 weeks of age. The highest prevalence is in suckling dairy calves

and weaned cattle and sheep in feedlots, where the disease is probably secondary to respiratory tract infection. Outbreaks of otitis media/interna have occurred in beef calves from 6-10 weeks of age on pasture with their dams; mixed cultures of *Escherichia coli*, *Pseudomonas* spp., and *Acinetobacter* spp. were isolated.<sup>2</sup> Otitis media/interna in suckling dairy calves can also occur in outbreaks, and *Mycoplasma bovis* is frequently isolated from the middle and inner ears of affected calves.<sup>3</sup>

The onset of clinical signs commonly includes dullness, fever, inappetence, tachypnea, and a purulent discharge from the affected ear accompanied by rotation of the head (in otitis interna) and drooping of the ear a few days later due to involvement of the facial nerve in the inflammation.<sup>2</sup> Deep palpation at the base of the ears may elicit a pain response.<sup>3</sup>

Rotation of the head, with the affected side down and facial paralysis may occur on the same side, and walking in circles with a tendency to fall to the affected side is common. In most cases the animals are normal in other respects, although depression and inappetence can occur in advanced cases.

#### Horses

Otitis media/interna occurs in horses<sup>4,5</sup> and two clinical syndromes have been described.

**The first syndrome** is primary otitis media characterized by abnormal behavior, including head tossing, head shaking, and ear rubbing.<sup>4</sup> Violent, uncontrollable behavior includes throwing themselves on the ground, rolling, and thrashing. This may progress to involve the bony structures of the temporal and proximal stylohyoid bones, resulting in a degenerative arthritis and eventual fusion of the temporohyoid bone.

**The second syndrome** is characterized by an acute onset of neurologic deficits. Commonly, there is vestibulocochlear nerve and often facial nerve dysfunction characterized by head tilt to the side of the lesion, nystagmus with the slow component to the affected side and weakness of the extensor muscles on the affected side resulting in an ataxia or reluctance or refusal to stand. Horses that can stand often will lean on walls for support of the affected side.

Definitive diagnosis is dependent on either a positive tympanocentesis or, in the majority of cases, bony proliferation of the temporal bone and proximal part of the stylohyoid bone, or lysis of the tympanic bulla, as determined by radiography<sup>4</sup> or computed tomography.<sup>3</sup> This can be visualized using endoscopy of

the auditory tube diverticula in horses with otitis media/interna.<sup>5</sup> In some cases, the tympanic membrane is ruptured, which can be seen using an otoscope.<sup>5</sup>

**Tympanocentesis** is done under general anesthesia in horses or sedation in ruminants by directing a 15 cm needle through the tympanic membrane visualized with the aid of an otoscope. The technique is somewhat difficult because of the long and angled external auditory canal. Sterile 0.9% NaCl (0.5–1 mL) is injected into the tympanic cavity and then, after a few seconds, withdrawn. A positive tap consists of withdrawal of a cloudy or yellow fluid, which on analysis may contain evidence of pus and can be sampled for culture and antimicrobial susceptibility.

#### DIFFERENTIAL DIAGNOSIS

The disease needs to be differentiated from otitis externa, in which the head may be carried in a rotated position, but usually intermittently, and this is accompanied by head shaking and the presence of exudate and an offensive smell in the ear canal, and from cerebral injury or abscess, and similar lesions of the upper cervical cord. All of these are characterized by deviation of the head, not rotation. At necropsy the tympanic bulla contains pus, and a variety of organisms, such as staphylococci, streptococci, *Pasteurella haemolytica*, and *Neisseria catarrhalis*, may be isolated.

#### TREATMENT

Treatment consists of broad-spectrum antimicrobials daily for 4 weeks, and anti-inflammatory agents. The prognosis with treatment with fluoroquinolones is very good in calves, although a 50% mortality rate has been reported in calves that were not treated with other antimicrobial agents.<sup>6</sup> The use of lincomycin at 6.5 mg/kg BW combined with spectinomycin at 10 mg/kg BW intravenously twice daily for 5 days has been reported to be successful for the treatment of otitis media in beef calves.<sup>2</sup> Anecdotal reports exist in cattle of the use of a knitting needle to rupture the tympanic membrane, with rapid resolution of the head tilt because of the decreased pressure in the middle ear. Bilateral tympanic bulla osteotomy has been performed in an affected calf, resulting in a rapid resolution of the head tilt.<sup>3</sup>

#### REVIEW LITERATURE

- Duarte ER, Hamdan JS. Otitis in cattle, an etiological review. *J Vet Med B* 2004; 51:1–7.
- Morin DE. Brainstem and cranial nerve abnormalities: listeriosis, otitis media/interna, and pituitary abscess syndrome. *Vet Clin North Am Food Anim Pract* 2004; 20:243–273.

#### REFERENCES

- Shimada A et al. *Vet Pathol* 1992; 29:337.
- Henderson JP, McCullough WP. *Vet Rec* 1993; 132:24.

- Van Biervliet J et al. *J Vet Intern Med* 2004; 18:907.
- Blythe LL et al. *Proc Annu Conv Am Assoc Equine Pract* 1991; 36:517.
- Hassel DM et al. *J Am Vet Med Assoc* 1995; 207:1081.
- Walz PH et al. *J Vet Intern Med* 2004; 18:907.

### TUMORS OF THE CENTRAL NERVOUS SYSTEM

Primary tumors of the central nervous system are extremely rare in farm animals. They produce a syndrome indicative of a general increase in intracranial pressure and local destruction of nervous tissue. Tumors of the peripheral nervous system are more common.

#### ETIOLOGY

The reader is referred to the review literature for a summary of available references on the tumors of the central nervous system of farm animals, which include:

- Meningeal tumors in cattle<sup>1</sup>
- Equine papillary ependymoma.<sup>2</sup>

#### PATHOGENESIS

The development of the disease parallels that of any space-occupying lesion, with the concurrent appearance of signs of increased intracranial pressure and local tissue destruction. Many lesions found incidentally at necropsy may not have had any related clinical findings.

#### CLINICAL FINDINGS

The clinical findings are similar to those caused by a slowly developing abscess and localizing signs depend on the location, size, and speed of development of the tumor. Clinical signs are usually representative of increased intracranial pressure, including opisthotonos, convulsions, nystagmus, dullness, head-pressing, and hyperexcitability. Common localizing signs include circling, deviation of the head, disturbance of balance. Lesions close to the pituitary gland may cause diabetes insipidus and Cushing's syndrome.<sup>3</sup> A 17-year-old horse with an ependymoma had an 18-month history of slowly progressive ataxia culminating in a sudden loss of ability to control the pelvic limbs, with dog-sitting, spinning, and falling.<sup>4</sup>

#### CLINICAL PATHOLOGY

There are no positive findings in clinicopathological examination which aid in diagnosis.

#### NECROPSY FINDINGS

The brain should be carefully sectioned after fixation if the tumor is deep-seated.

#### TREATMENT

There is no treatment.

#### REVIEW LITERATURE

- Summers BA, Cummings JF, de Lahunta A. *Veterinary neuropathology*. St Louis, MO: Mosby, 1995.

#### DIFFERENTIAL DIAGNOSIS

Differentiation is required from the other diseases in which space-occupying lesions of the cranial cavity occur. The rate of development is usually much slower in tumors than with the other lesions.

#### REFERENCES

- Josephson GKA, Little PB. *Can Vet J* 1990; 31:700.
- Carrigan MJ et al. *Vet Pathol* 1996; 33:77.
- Green EM, Hunt EL. *Compend Contin Educ Pract Vet* 1985; 7:S249.
- Summers BA, Cummings JF, de Lahunta A. *Veterinary Neuropathology*. St Louis, MO: Mosby, 1995.

### CENTRAL-NERVOUS-SYSTEM-ASSOCIATED TUMORS

**The pituitary gland (hypophysis)** consists of the adenohypophysis (pars distalis, intermedia, tuberalis) and the neurohypophysis (pars nervosa). Tumors of the pituitary gland occur in the horse.<sup>1</sup> Cushing's syndrome in horses almost invariably originates from an adenoma of the pars intermedia of the pituitary gland.<sup>1</sup> Initially, these animals exhibit only one remarkable sign, namely, hirsutism. Horses with Cushing's disease only do not manifest polyuria and polydipsia. Major sequelae of an adenoma of the pars intermedia of the pituitary gland are type 2 diabetes mellitus and laminitis. Diagnosis of an adenoma of the pars intermedia of the pituitary gland in the horse mainly depends on dynamic endocrinological function tests. The sensitivity of the adrenocorticotropin (ACTH) test is about 80%.<sup>1</sup>

#### REVIEW LITERATURE

- Summers BA, Cummings JF, de Lahunta A. *Veterinary neuropathology*. St Louis, MO: Mosby, 1995.

#### REFERENCE

- Van der Kolk JH et al. *Domestic Anim Endocrinol* 1995; 12:35.

### METASTATIC TUMORS OF THE CENTRAL NERVOUS SYSTEM

Many primary tumors of non-nervous tissue have the potential for metastasis to the central nervous system.

**Ocular squamous cell carcinoma** of cattle may invade the cranium through the cribriform plate

**Lymphomas** of cattle may metastasize to the central nervous system with either a multicentric distribution or occasionally as the only lesion. Most commonly bovine lymphoma occurs as an epidural mass in the vertebral canal. Intracranial lymphoma usually involves the leptomeninges or the choroid plexus. Clinical signs are related to the progressive compression of the

nervous tissue at the site of the mass. Lymphoma in the horse has occurred in the epidural space with spinal cord compression.

### CENTRAL-NERVOUS-SYSTEM-ASSOCIATED MASSES

Cholesterinic granulomas, also known as cholesteatomas may occur in up to 20% of older horses without any clinical effects.<sup>1</sup> However, they can be associated with significant neurological disease. Affected horses are commonly obese.<sup>1</sup> Cholesterinic granulomas occur in the choroid plexus of the fourth ventricle or in the lateral ventricles and mimic cerebrocortical disease. It has been suggested that cholesterol granulomas result from chronic hemorrhage into the plexus stroma but the underlying pathogenesis is unknown.

Brownish nodular thickening of the plexuses with glistening white crystals is a common incidental finding in mature and aged horses. Occasionally, deposits in the plexuses of the lateral ventricles are massive and fill the ventricular space and cause secondary hydrocephalus due to the build up of CSF behind the mass. CSF may be xanthochromic with an elevated total protein.<sup>1</sup>

**Clinical findings** include episodes of abnormal behavior such as depression and bolting uncontrollably, running into fences and walls.<sup>2</sup> Some horses exhibit profound depression, somnolence, and reluctance to move.<sup>1</sup> Seizures have also been reported.<sup>1</sup> Other clinical findings reported include decreased performance, aggression, head tilt, incoordination, intermittent convulsions, hindlimb ataxia progressing to recumbency, intermittent circling in one direction, and spontaneous twitching along the back and flank. There are often serious changes in temperament, with previously placid animals becoming violent and aggressive. In others there are outbursts of frenzied activity followed by coma. The horse may be normal between attacks and these may be precipitated by moving the head rapidly.

These signs are referable to cerebrocortical disease and the differential diagnosis of cholesterol granulomas must include diffuse cerebral encephalopathy due to abscess, tumor, toxicosis, metabolic disease, encephalomyelitis, trauma, and hydrocephalus. At necropsy, large cholesterol granulomas are present in the choroid plexus.

#### REFERENCES

1. Jackson CA et al. *Vet Rec* 1994; 135:228.
2. Duff S. *Vet Rec* 1994; 135:288.

### COENUROSIS (GID, STURDY)

Coenurosis is the disease caused by invasion of the brain and spinal cord by

the intermediate stage of *Taenia multiceps*. The syndrome produced is one of localized, space-occupying lesions of the central nervous system. In most countries the disease is much less common than it used to be and relatively few losses occur.

#### ETIOLOGY

The disease is associated with *Coenurus cerebralis*, the intermediate stage of the tapeworm *T. multiceps*, which inhabits the intestine of dogs and wild Canidae. The embryos, which hatch from eggs ingested in feed contaminated by the feces of infested dogs, hatch in the intestine and pass into the bloodstream. Only those embryos that lodge in the brain or spinal cord survive and continue to grow to the coenurid stage. *C. cerebralis* can mature in the brain and spinal cords of sheep, goats, cattle, horses, and wild ruminants, and occasionally humans, but clinical coenurosis is primarily a disease of sheep and occasionally cattle. Infection in newborn calves, acquired prenatally, has occasionally been observed.

#### PATHOGENESIS

The early stages of migration through nervous tissue usually passes unnoticed, but in heavy infections an encephalitis may be produced. Most signs are caused by the mature coenurus, which may take 6–8 months to develop to its full size of about 5 cm. The cyst-like coenurus develops gradually and causes pressure on nervous tissue, resulting in its irritation and eventual destruction. It may cause sufficient pressure to rarefy and soften cranial bones.

#### CLINICAL FINDINGS

In acute outbreaks due to migration of larval stages, sheep show varying degrees of blindness, ataxia, muscle tremors, nystagmus, excitability, and collapse. Sheep affected with the mature coenurus show an acute onset of irritation phenomena including a wild expression, salivation, frenzied running and convulsions. Deviation of the eyes and head may also occur. Some animals may die in this stage but the greater proportion go on to the second stage of loss of function phenomena, the only stage in most affected animals. The most obvious sign is slowly developing partial or complete blindness in one eye. Dullness, clumsiness, head-pressing, ataxia, incomplete mastication and periodic epileptiform convulsions are the usual signs. Papilledema may be present. Localizing signs comprise chiefly deviation of the head and circling; there is rotation of the head with the blind eye down, and deviation of the head with circling in the direction of the blind eye.<sup>1</sup>

In young animals local softening of the cranium may occur over a superficial cyst

and rupture of the cyst to the exterior may follow, with final recovery. When the spinal cord is involved there is a gradual development of paresis and eventually inability to rise. Death usually occurs after a long course of several months.

#### CLINICAL PATHOLOGY

Clinicopathological examinations are not generally used in diagnosis in animals and serological tests are not sufficiently specific to be of value. Radiological examinations are helpful in defining the location of the cyst, especially if there is a prospect of surgical intervention.<sup>1</sup>

#### NECROPSY FINDINGS

Thin-walled cysts may be present anywhere in the brain but are most commonly found on the external surface of the cerebral hemispheres. In the spinal cord the lesions are most common in the lumbar region but can be present in the cervical area. Local pressure atrophy of nervous tissue is apparent and softening of the overlying bone may occur.

#### DIFFERENTIAL DIAGNOSIS

The condition needs to be differentiated from other local space-occupying lesions of the cranial cavity and spinal cord, including abscess, tumor, and hemorrhage. In the early stages the disease may be confused with encephalitis because of the signs of brain irritation. Clinically there is little difference between them and, while clinical signs and local knowledge may lead to a presumptive diagnosis, demonstration of the metacestode is essential.

#### TREATMENT AND CONTROL

Surgical drainage of the cyst may make it possible to fatten the animal for slaughter, and surgical removal with complete recovery is possible in a majority of cases. The life cycle can be broken most satisfactorily by control of mature tapeworm infestation in dogs. Periodic treatment of all farm dogs with a tenicide is essential for control of this and other more pathogenic tapeworms. Carcasses of livestock infested with the intermediate stages should not be available to dogs.

#### REVIEW LITERATURE

Skerritt GC, Stallbaumer MF. Diagnosis and treatment of coenurosis (gid) in sheep. *Vet Rec* 1984; 115:399.

#### REFERENCE

1. Tirgari M et al. *Vet Rec* 1987; 120:173.

## Diseases of the meninges

### MENINGITIS

Inflammation of the meninges occurs most commonly as a complication of

a pre-existing disease. Meningitis is usually associated with a bacterial infection and is manifested clinically by fever, cutaneous hyperesthesia, and rigidity of muscles. Although meningitis may affect the spinal cord or brain specifically, it commonly affects both and is dealt with here as a single entity. Meningoencephalitis is common in neonatal farm animals. Primary bacterial meningitis is extremely rare in adult farm animals, with the exception of listeriosis and *Histophilus somni* (formerly *Haemophilus somnus*) infection, although the latter is more a vasculitis than a primary meningitis. The possibility of immunodeficiency should be considered in adult horses with bacterial meningitis.<sup>1</sup>

### ETIOLOGY

Most significant meningitides are bacterial, although most viral encephalitides have some meningitic component.

#### Cattle

- Viral diseases – bovine malignant catarrh, sporadic bovine encephalomyelitis
- Bacterial diseases – listeriosis, *H. somni*, chronic lesions elsewhere in the body possibly associated with meningitis in adult animals;<sup>2</sup> rarely tuberculosis.

#### Horses

- Strangles, *Pasteurella haemolytica* (also donkeys and mules), *Streptococcus suis*, *Streptococcus equi*, *Actinomyces* spp. *Klebsiella pneumoniae*, coagulase-negative staphylococci, *Sphingobacterium multivorum*, *Cryptococcus neoformans*.

#### Sheep

- Melioidosis, *S. aureus* (tick pyemia) in newborn lambs
- *Pasteurella multocida* in lambs *Mannheimia (Pasteurella) haemolytica* in lambs.

#### Pigs

Glasser's disease, erysipelas, salmonellosis; *S. suis* type 2 in weaned and feeder pigs.

#### Young animals generally

Streptococcal and coliform septicemias are probably the commonest causes of meningitis in neonatal farm animals. The infection may originate from an omphalophlebitis, bacteremia,<sup>3</sup> or bacterial translocation across the gastrointestinal tract in neonates less than 24 h of age or with enteritis. Septicemia occurs in all species, especially calves, and may be accompanied by polysynovitis, endocarditis, and hypopyon. The causative bacteria are usually a mixed flora.<sup>4</sup>

Hematogenous infection occurs from other sites also. In neonatal animals, some of the common infections are:

- **Calf** – *E. coli*. The disease occurs most commonly in calves under several days of age and can occur in less than 24 hours after birth. Failure of transfer of colostral immunoglobulins is a common contributing factor
- **Piglet** – *Streptococcus zooepidemicus*, *S. suis* type 1
- **Lamb** – *S. zooepidemicus*.

### PATHOGENESIS

Inflammation of the meninges causes local swelling and interference with blood supply to the brain and spinal cord but as a rule penetration of the inflammation along blood vessels and into nervous tissue is of minor importance and causes only superficial encephalitis. Failure to treat meningitis associated with pyogenic bacteria often permits the development of a fatal choroiditis, with exudation into CSF, and ependymitis. There is also inflammation around the nerve trunks as they pass across the subarachnoid space. The signs produced by meningitis are thus a combination of those resulting from irritation of both central and peripheral nervous systems. In spinal meningitis there is muscular spasm with rigidity of the limbs and neck, arching of the back and hyperesthesia with pain on light touching of the skin. When the cerebral meninges are affected, irritation signs, including muscle tremor and convulsions, are the common manifestations. Since meningitis is usually bacterial in origin, fever and toxemia can be expected if the lesion is sufficiently extensive.

Defects of drainage of CSF occur in both acute and chronic inflammation of the meninges and produce signs of increased intracranial pressure. The signs are general although the accumulation of fluid may be localized to particular sites such as the lateral ventricles.

### CLINICAL FINDINGS

Acute meningitis usually develops suddenly and is accompanied by fever and toxemia in addition to nervous signs. Vomiting is common in the early stages in pigs. There is trismus, opisthotonos, and rigidity of the neck and back. Motor irritation signs include tonic spasms of the muscles of the neck causing retraction of the head, muscle tremor and paddling movements. Cutaneous hyperesthesia is present in varying degrees, even light touching of the skin causing severe pain in some cases. There may be disturbance of consciousness manifested by excitement or mania in the early stages, followed by drowsiness and eventual coma.

Blindness is common in cerebral meningitis but not a constant clinical finding. In young animals, ophthalmitis

with hypopyon may occur, which supports the diagnosis of meningitis. The pupillary light reflex is usually much slower than normal. Examination of the fundus of the eyes may reveal evidence of optic disk edema, congestion of the retinal vessels and exudation.

In uncomplicated meningitis the respiration is usually slow and deep, and often phasic in the form of **Cheyne-Stokes breathing** (a breathing pattern characterized by a period of apnea followed by a gradual increase in the depth and rate of respiration) or **Biot's breathing** (a breathing pattern characterized by unpredictable irregularity). Terminally there is quadriplegia and clonic convulsions.

The major clinical finding of meningoencephalitis in calves under 2 weeks of age was depression which progressed rapidly to stupor but the mental state changed to hyperesthesia, opisthotonos and seizures in unresponsive terminal cases.<sup>3</sup> Meningoencephalitis should be considered in calves that have been treated for the effects of diarrhea with fluid therapy but fail to respond and remain depressed.

In a series of 32 cases of meningitis in neonatal calves, the mean age at admission was 6 days (range, 11 hours–30 days). The major clinical findings were lethargy (32/32), recumbency (32/32), anorexia and loss of the suck reflex (26/32), and stupor and coma (21/32).<sup>5</sup> The frequency of other clinical findings were as follows: opisthotonos (9/32), convulsions (7/32), tremors (6/32), and hyperesthesia (6/32). The case fatality rate was 100%.

Although meningitis in farm animals is usually diffuse, affecting particularly the brainstem and upper cervical cord, it may be quite localized and produce localizing signs, including involvement of the cranial or spinal nerves. Localized muscle tremor, hyperesthesia and rigidity may result. Muscles in the affected area are firm and board-like on palpation. Anesthesia and paralysis usually develop caudal to the meningitic area. Spread of the inflammation along the cord is usual. Reference should be made to the specific diseases cited under Etiology for a more complete description of their clinical manifestations.

In newborn calves, undifferentiated diarrhea, septic arthritis, omphalophlebitis and uveitis are frequent concurrent clinical findings. Bacterial meningitis has been reproduced experimentally in calves, resulting in typical clinical signs consisting of convulsions, depression, circling and falling to one side, ataxia, propulsive walking, loss of saliva, tremors, recumbency, lethargy, and nystagmus.<sup>6</sup>



## CLINICAL PATHOLOGY

### Cerebrospinal fluid

CSF collected from the lumbosacral space or cisterna magna in meningitis contains elevated protein concentrations, has a high cell count and usually contains bacteria.<sup>4,7</sup> The collection of CSF from the lumbosacral space of calves has been described under the section on Special examination of the nervous system.<sup>7</sup> Culture and determination of drug sensitivity of the bacteria is advisable because of the low concentrations of antimicrobial agents achieved in CSF. In a series of meningitis in neonatal calves, the CSF revealed pleocytosis (mean 4000 leukocytes/ $\mu$ L; range, 130–23 270 leukocytes/ $\mu$ L), xanthochromia, turbidity and a high total protein concentration.<sup>5</sup>

### Hematology

The hemogram usually reveals a marked leukocytosis, reflecting the severity of the systemic illness secondary to septicemia.

### NECROPSY FINDINGS

Hyperemia, the presence of hemorrhages, and thickening and opacity of the meninges, especially over the base of the brain, are the usual macroscopic findings. The CSF is often turbid and may contain fibrin. A local superficial encephalitis is commonly present. Additional morbid changes are described under the specific diseases and are often of importance in differential diagnosis. In neonatal calves with meningitis, lesions of septicemia are commonly present at necropsy and *E. coli* is the most commonly isolated organism.

### DIFFERENTIAL DIAGNOSIS

Hyperesthesia, severe depression, muscle rigidity, and blindness are the common clinical findings in cerebral meningitis but it is often difficult to differentiate meningitis from encephalitis and acute cerebral edema. Examination of the CSF is the only means of confirming the diagnosis before death. Analysis of CSF is very useful in the differential diagnosis of diseases of the nervous system of ruminants.<sup>7,8</sup> Details are presented under Examination of CSF in the section on Special examination of the nervous system. Subacute or chronic meningitis is difficult to recognize clinically. The clinical findings may be restricted to recumbency, apathy, anorexia, slight incoordination if forced to walk and some impairment of the eyesight. Spinal cord compression is usually more insidious in onset and is seldom accompanied by fever; hyperesthesia is less marked or absent and there is flaccidity rather than spasticity.

### TREATMENT

The infection is usually bacterial, and parenteral treatment with antimicrobial

agents is necessary. Large doses daily for several days are required. The levels of antimicrobial agents that are achieved in the meninges and CSF following parenteral administration to farm animals are not known. Presumably, the blood–brain and blood–CSF barriers are not intact in meningitis and minimum inhibitory concentrations of some drugs may be achieved.

### Antimicrobial agents

The injection of antimicrobial agents into the cerebrospinal cistern or into the lumbosacral space is not recommended. If parenteral treatment with the antimicrobial of choice, determined by a susceptibility test, does not result in a beneficial response in 3–5 days the prognosis is unfavorable.

The choice of antimicrobial agent will depend on the suspected cause of the meningitis. The common antibiotics, such as penicillin and oxytetracycline, are effective for the treatment of meningoencephalitis in cattle due to *H. somni* when treatment is begun early. Neonatal streptococcal infections also respond beneficially to penicillin when treated early before irreparable injury has occurred.

The response to therapy will depend on the causative pathogen and the severity of the inflammation present. Some cases of meningitis, such as that in swine associated with *S. suis* type 2, commonly do not respond to treatment when clinical signs are obvious. Conversely, the meningoencephalitis in cattle associated with *H. somni* will respond dramatically if treatment is begun as soon as clinical signs are apparent. The prognosis in meningitis associated with infection with *E. coli* is unfavorable. In a series of 32 cases admitted to a veterinary teaching hospital, even after intensive therapy the case fatality rate was 100%.<sup>5</sup>

### Cephalosporins

Based on recent experiences in human medicine, the most promising antimicrobials for the treatment of meningitis in farm animals, particularly the neonates, may be the new third-generation cephalosporins, which resist hydrolysis by beta-lactamases, have enhanced penetration into the CSF and are bactericidal at very low concentrations.<sup>4</sup> Clinical experience with these agents in the treatment of neonatal meningitis has been very encouraging. The aminoglycosides are also indicated in the treatment of meningitis in newborn animals.<sup>5</sup> Moxalactam and cefotaxime are used widely for the treatment of Gram-negative bacillary meningitis in human and ceftazidime is equally effective.<sup>4</sup> Trimethoprim–sulfonamide combinations, with or without gentamicin, which is

synergistic with the former, are also recommended. The principles of the pharmacotherapeutics of bacterial meningitis in farm animals have been reviewed.<sup>4</sup>

### REVIEW LITERATURE

- Fecteau G, George LW. Bacterial meningitis and encephalitis in ruminants. *Vet Clin North Am Food Anim Pract* 2004; 20:363–378.  
 Scott PR. Diagnostic techniques and clinicopathologic findings in ruminant neurologic disease. *Vet Clin North Am Food Anim Pract* 2004; 20:215–230.

### REFERENCES

1. Pellegrini-Masini A et al. *J Am Vet Med Assoc* 2005; 227:114.
2. Scott PR et al. *Vet Rec* 1993; 133:623.
3. Scott PR, Penny CD. *Vet Rec* 1993; 133:119.
4. Jamison JM, Prescott JF. *Compend Contin Educ Pract Vet* 1988; 10:225.
5. Green SL, Smith LL. *J Am Vet Med Assoc* 1992; 201:125.
6. Nazifi S et al. *J Vet Med A* 1997; 44:55.
7. Scott PR. *Br Vet J* 1992; 148:15.
8. Scott PR. *Br Vet J* 1995; 151:603.

## Toxic and metabolic encephalomyelopathies

A very large number of poisons, especially poisonous plants and farm chemicals, and some metabolic defects cause abnormalities of function of the nervous system. Those plants that cause degenerative nervous system disease are listed under encephalomalacia; those that cause no detectable degenerative change in tissue are listed here.

A partial list of toxins and metabolic errors or imbalances that can cause nervous system dysfunction are as follows.

### Abnormalities of consciousness and behavior

- Hypoglycemia and ketonemia of pregnancy toxemia (with degenerative lesions in some) and acetonemia
- Depression due to strong ion (metabolic) acidosis associated with diarrhea and dehydration, particularly in neonatal animals
- Hypomagnesemia of lactation tetany
- Hyper-D-lactatemia in neonatal calves with diarrhea and adult ruminants with grain overload
- High blood levels of ammonia in hepatic insufficiency
- Unspecified toxic substances in uremic animals
- Exogenous toxins, including carbon tetrachloride, hexachloroethane, and trichloroethylene
- Plants causing anemic and histotoxic hypoxia, especially plants causing cyanide or nitrite poisoning
- Poison plants, including *Helichrysum* spp., tansy mustard, male fern, kikuyu grass (or a fungus, *Myrothecium* sp. on the grass).

### Abnormality characterized by tremor and ataxia

- Weeds, including *Conium* spp. (hemlock), *Eupatorium* spp. (snakeroot), *Sarcostemma* spp., *Euphorbia* spp. and *Karwinskia* spp.
- Bacterial toxins in shaker foal syndrome (probably)
- Fungal toxins, e.g. *Acremonium lolii*, the fungus of ryegrass staggers.

### Convulsions

- Metabolic deficits, including hypoglycemia (piglets, ewes with pregnancy toxemia), hypomagnesemia (of whole milk tetany of calves, lactation tetany, cows and mares)
- Nutritional deficiencies of vitamin A (brain compression in calves and pigs), pyridoxine (experimentally in calves)
- Inorganic poisons, including lead (calves), mercury (calves), farm chemicals such as organic arsenicals (pigs), organophosphates, chlorinated hydrocarbons, strychnine, urea, metaldehyde
- Bacterial toxins, including *Clostridium tetani*, *Clostridium perfringens* type D
- Fungal toxins, e.g. *Claviceps purpurea*
- Grasses, including Wimmera ryegrass (*Lolium rigidum*) or the nematode on it, *Echinopogon ovatus*
- Pasture legumes – lupines
- Weeds – *Oenanthe* spp. (hemlock water dropwort), *Indigophera* spp. (in horses), *Cicuta* spp. (water hemlock), *Albizia tanganyinicus*, *Sarcostemma* spp. and *Euphorbia* spp.
- Trees – laburnum, oleander, supplejack (*Ventilago* spp.).

### Ataxia apparently due to proprioceptive defect

- Grasses – *Phalaris tuberosa* (*aquatica*) (and other *Phalaris* spp.), *Lolium rigidum*, *Echinopogon ovatus*
- Weeds – *Romulea bulbocodium*, sneezeweed (*Helenium* spp.), *Indigophera* spp., Iceland poppy (*Papaver nudicaule*), *Gomphrena* spp., *Malva* spp., *Stachys* spp., *Ipomoea* spp., *Solanum esuriale*
- Trees – *Kalmia* spp., *Erythrophloeum* spp., *Eupatorium rugosum*
- Ferns – *Xanthorrhoea* spp., *Zamia* spp. Induced thiamin deficiency caused by bracken and horsetail poisoning.

### Involuntary spastic contraction of large muscle masses

This includes, for example, Australian stringhalt caused by *Arctotheca calendula* (flatweed).

### Tremor, incoordination, and convulsions

There is an additional long list of plants that cause diarrhea and nervous signs,

especially ataxia, together, but whether the latter are due to the former or caused by neurotoxins is not identified.

The nervous signs include tremor, incoordination, and convulsions.

### Paresis or paralysis

Many of the toxic substances and metabolic defects listed above cause paresis when their influence is mild and paralysis when it is severe. Some of the items appear in both lists. Because an agent appears in one list and not the other is not meant to suggest that it does not cause the other effect. It is more likely that it occurs in circumstances that are almost always conducive to the development of a mild syndrome (or a severe one, as the case may be).

- **Disturbance of function at neuromuscular junctions** e.g.: hypocalcemia, hypomagnesemia, hypokalemia (as in downer cows), tetanus, botulism and hypoglycemia of pregnancy toxemia in cows and ewes, and tick paralysis. Hypophosphatemia has not been demonstrated to be a definitive cause of weakness in cattle
- **Nutritional deficiency**, but including only experimentally induced deficiency of nicotinic and pantothenic acids: biotin and choline, cause posterior paresis and paralysis in pigs and calves
- **Toxic diseases of the nervous system**, including disease associated with many chemicals used in agriculture, e.g.: piperazine, rotenone, 2,4-D and 2,4,5-T, organophosphates, carbamates, chlorinated hydrocarbons, propylene glycol, metaldehyde, levamisole, toluene, carbon tetrachloride, strychnine, and nicotine sulfate.

### Psychoses or neuroses

Psychoses or neuroses are extremely rare in farm animals, although the vices of crib-biting and weaving in horses could be included in this category.

### Crib-biting and windsucking

**Crib-biting** is an acquired habit in which the horse grasps an object, usually the feed box or any solid projection, with the incisor teeth, then arches the neck and, by depressing the tongue and elevating the larynx, pulls upwards and backwards and swallows air, emitting a loud grunt at the same time. This results in erosion of the incisor teeth, intermittent bouts of colic and flatulence. Crib-biting must be distinguished from chewing wood due to boredom and

from pica due to a mineral deficiency. Some horses perform similarly but do not actually seize the object with their teeth; they just rest their teeth or their chin on it.

**Wind sucking** is the vice in which the horse flexes and arches the neck and swallows air and grunts but there is no grasping of objects.

**Grasping** is the seizing of an object with the teeth but without swallowing of air.

### Kicking, pawing, circling, weaving

Persistent kicking of the stall, in the absence of pruritic lesions of the lower limbs, continuous circling of a stall, pawing of the floor with a forefoot and weaving, standing at the window looking out while rocking from one forefoot to the other and swinging the head and neck to the same side, are all neurotic vices caused by boredom in active horses. The extreme case is the animal that bites itself and causes cutaneous and subcutaneous mutilation.

### Farrowing hysteria

Hysteria in sows at farrowing is a common occurrence. This syndrome occurs most commonly in gilts. Affected animals are hyperactive and restless and they attack and savage their piglets as they approach the head during the initial teat sucking activity after birth. Serious and often fatal injuries result. Cannibalism is not a feature.

When the syndrome occurs, the remaining piglets and freshly born piglets should be removed from the sow and placed in a warm environment until parturition is finished. The sow should then be tested to see if she will accept the piglets. If not, ataractic or neuroleptic drugs should be administered to allow initial sucking, after which the sow will usually continue to accept the piglets.

Azaperone (2 mg/kg BW) is usually satisfactory and pentobarbital sodium administered intravenously until the pedal reflex is lost has been recommended. Promazine derivatives are effective but subsequent incoordination may result in a higher crushing loss of piglets. The piglets' teeth should be clipped.

Affected gilts should be culled subsequently as the syndrome may recur at subsequent farrowing. Where possible, gilts should be placed in their farrowing accommodation 4–6 days before parturition and the farrowing environment should be kept quiet at the time of parturition.

### Tail-biting, ear-chewing, snout-rubbing

The incidence of cannibalism has increased with intensification of pig rearing

and it is now a significant problem in many pig-rearing enterprises. Tail-biting is the most common and occurs in groups of pigs, especially males, from weaning to market age. Ear-chewing is less common and is generally restricted to pigs in the immediate postweaning and early growing period, although both syndromes may occur concurrently. The incidence of ear-chewing has increased with the practice of docking piglet tails at birth.

Tail-biting usually begins with one or two pigs sucking or chewing the tails of pen mates. Initially the practice causes no resentment but as the tail becomes raw and eroded, pain is shown. Rarely, if the offending agonists are removed at this stage, the problem will not progress. Generally the raw eroded tail becomes attractive to other individuals within the group and the vice spreads within the group to involve the majority of pigs. Most of the tail may eventually be removed, leaving a raw bleeding stump.

Productivity is affected by severe lesions and sequelae such as spinal abscessation with paralysis and abscessation or pyemia with partial or total carcass condemnation are not uncommon.

Ear-biting occurs in similar fashion. The lesions are usually bilateral and most commonly involve the ventral part of the ear. Lesions from bite wounds may also occur on the flanks of pigs. There is frequently an association with mange infestation with both of these vices.

A syndrome of snout-rubbing to produce eroded necrotic areas on the flanks of pigs has been described. Affected pigs were invariably colored, although both white and colored pigs acted as agonists.

**The causes** of these forms of cannibalism in pigs are poorly understood but they are undoubtedly related to an inadequate total environment. Affected groups are usually more restless and have heightened activity. Factors such as a high population density, both in terms of high pen density and large group size, limited food and competition for food, low protein and inadequate nutrition, boredom and inadequate environment in terms of temperature, draft and ventilation have been incriminated in precipitating the onset of these vices.

When a problem is encountered each of these factors should be examined and corrected or changed if necessary. **Prevention** is through the same measures. Chains or tires are frequently hung for displacement activity but are not particularly effective.

The problem may recur despite all attempts at prevention. Also for economic reasons it is not always possible to

implement the radical changes in housing and management that may be necessary to avoid the occurrence of these vices. Because of this, the practice of tipping or docking the piglets' tails at birth has become common as a method of circumventing the major manifestation of cannibalism.

## Epilepsy

Seizures occur most frequently in conjunction with other signs of brain disease. The syndrome of inherited, recurrent seizures, which continues through life with no underlying morphological disease process, is true epilepsy, which is extremely rare in farm animals. Familial epilepsy has been recorded in Brown Swiss cattle and is described under that heading in Chapter 12.

Residual lesions after encephalitis may cause symptomatic epileptiform seizures but there are usually other localizing signs. A generalized seizure is manifested by an initial period of alertness, the counterpart of the aura in human seizures, followed by falling in a state of tetany, which gives way after a few seconds to a clonic convulsion with paddling, opisthotonos and champing of the jaws. The clonic convulsions may last for some minutes and are followed by a period of relaxation. The animal is unconscious throughout the seizure, but appears normal shortly afterwards.

Some seizures may be preceded by a local motor phenomenon such as tetany or tremor of one limb or of the face. The convulsion may spread from this initial area to the rest of the body. This form is referred to as jacksonian epilepsy and the local sign may indicate the whereabouts of the local lesion or point of excitation. Such signs are recorded very rarely in dogs and not at all in farm animals. The seizures are recurrent and the animal is normal in the intervening periods.

## Diseases of the spinal cord

### TRAUMATIC INJURY

Sudden severe trauma to the spinal cord causes a syndrome of immediate, complete, flaccid paralysis caudal to the injury because of spinal shock. This is so brief in animals as to be hardly recognizable clinically. Spinal shock is soon followed by flaccid paralysis in the area supplied by the injured segment and spastic paralysis caudal to it.

### ETIOLOGY

Trauma is the most common cause of monoplegia in large animals. There are

varying degrees of loss of sensation, paresis, paralysis, and atrophy of muscle.

### Physical trauma

- Animals falling off vehicles, through barn floors
- Osteoporotic or osteodystrophic animals, especially aged brood mares and sows, spontaneously while jumping or leaning on fences
- Spondylosis and fracture of thoracolumbar vertebrae in old bulls in insemination centers
- Cervical vertebral fractures account for a large percentage of spinal cord injuries in horses<sup>1</sup>
- Trauma due to excessive mobility of upper cervical vertebrae may contribute to the spinal cord lesion in wobbles in horses
- Dislocations of the atlanto-occipital joint are being reported increasingly
- Stenosis of the cervical vertebral canal at C2-C4 in young rams, probably as a result of head-butting<sup>2</sup>
- Fracture of T1 vertebra in calves turning violently in an alleyway wide enough to admit cows
- Vertebral fractures in 7-10-month-old calves escaping under the head gate of chute and forcefully hitting their backs (just cranial to the tuber coxae) on the bottom rail of the gate<sup>3</sup>
- Vertebral fractures in neonatal calves associated with forced extraction during dystocia<sup>2,4</sup>
- Lightning strike may cause tissue destruction within the vertebral canal.

### Parasitic invasion

- Cerebrospinal nematodiasis, e.g. *Paraelaphostrongylus tenuis*, *Setaria* spp. in goats and sheep, *Stephanurus dentatus* in pigs. *P. tenuis* in moose, causing moose sickness
- *Toxocara canis* experimentally in pigs
- *Strongylus vulgaris* in horses and donkeys
- *Hypoderma bovis* larvae in cattle.

### Local ischemia of the spinal cord

- Obstruction to blood flow to the cord by embolism, or of drainage by compression of the caudal vena cava, e.g. in horses during prolonged dorsal recumbency under general anesthesia;<sup>5</sup> in pigs due to fibrocartilaginous emboli, probably originating in injury to the nucleus pulposus of an intervertebral disk.<sup>5</sup>

### PATHOGENESIS

The lesion may consist of disruption of nervous tissue or its compression by displaced bone or hematoma. Minor degrees of damage may result in local edema or hyperemia or, in the absence of macroscopic lesions, transitory injury to nerve cells, classified as concussion. The initial

response is that of spinal shock, which affects a variable number of segments on both sides of the injured segment and is manifested by complete flaccid paralysis. The lesion must affect at least the ventral third of the cord before spinal shock occurs. When the shock wears off the effects of the residual lesion remain. These may be temporary in themselves and completely normal function may return as the edema or the hemorrhage is resorbed. In sheep, extensive experimental damage to the cord may be followed by recovery to the point of being able to walk, but not sufficiently to be of any practical significance.

Traumatic lesions usually affect the whole cross-section of the cord and produce a syndrome typical of complete transection. Partial transection signs are more common in slowly developing lesions. Most of the motor and sensory functions can be maintained in 3-month-old calves with experimental left hemisection of the spinal cord.<sup>6</sup>

**In a retrospective study** of dystocia-related vertebral fractures in neonatal calves, all the fractures were located between the 11th thoracic vertebra and the fourth lumbar vertebra, with 77% occurring at the thoracolumbar junction.<sup>4</sup> All but one case was associated with a forced extraction using unspecified (53%), mechanical (28%) or manual (17%) methods of extraction. Traction is most commonly applied after the fetus has entered the pelvic canal. Manual traction varies from 75 kg pressure applied by one man to 260 kg applied by three or more men. The forces applied in mechanical traction vary from 400 kg for a calf puller to over 500 kg for a tractor. The transfer of these forces to the vertebrae and to the physal plates at the thoracolumbar junction could readily cause severe tissue damage. In a prospective study of vertebral fractures in newborn calves, all fractures were located at the thoracolumbar area, especially the posterior epiphysis of T13.<sup>2</sup>

### CLINICAL FINDINGS

**Spinal shock** develops immediately after severe injury and is manifested by flaccid paralysis (reflex loss) caudal to a severe spinal cord lesion. There is a concurrent fall in local blood pressure due to vasodilatation and there may be local sweating. Stretch and flexor reflexes and cutaneous sensitivity disappear but reappear within a half to several hours, although hypotonia may remain. The extremities are affected in most cases and the animal is unable to rise and may be in sternal or lateral recumbency. The muscles of respiration may also be affected, resulting in

interference with respiration. The body area supplied by the affected segments will eventually show flaccid paralysis, disappearance of reflexes and muscle wasting – a lower motor neuron lesion.

When the injury is caused by invasion by parasitic larvae there is no stage of spinal shock but the onset is acute, although there may be subsequent increments of paralysis as the larva moves to a new site.

Neonatal calves with dystocia-related vertebral fractures are weak immediately after birth or remain recumbent and make no effort to rise.

Sensation may be reduced at and caudal to the lesion and hyperesthesia may be observed in a girdle-like zone at the cranial edge of the lesion as a result of irritation of sensory fibers by local inflammation and edema. Because of interference with the sacral autonomic nerve outflow there may be paralysis of the bladder and rectum, although this is not usually apparent in large animals. The vertebral column should be examined carefully for signs of injury. Excessive mobility, pain on pressure, and malalignment of spinous processes may indicate bone displacements or fractures. Rectal examination may also reveal damage or displacement particularly in fractures of vertebral bodies and in old bulls with spondylosis.

Residual signs may remain when the shock passes off. This usually consists of paralysis, which varies in extent and severity with the lesion. The paralysis is apparent caudal to and at the site of the lesion. The reflexes return except at the site of the lesion. There is usually no systemic disturbance but pain may be sufficiently severe to cause an increase in heart rate and prevent eating.

Recovery may occur in 1–3 weeks if nervous tissue is not destroyed but when extensive damage has been done to a significantly large section of the cord there is no recovery and disposal is advisable. In rare cases animals that suffer a severe injury continue to be ambulatory for up to 12 hours before paralysis occurs. In such instances it may be that a fracture occurs but displacement follows at a later stage during more active movement. Recovered animals may be left with residual nervous deficits or with postural changes such as torticollis.

### Fracture of the cervical vertebrae in horses

In horses fracture/dislocation of cranial cervical vertebrae occurs fairly commonly. Affected animals are recumbent and unable to lift the head from the ground. However, they may be fully conscious and able to eat and drink. It may be possible to palpate the lesion, but a radiograph

is usually necessary. Lesions of the caudal cervical vertebrae may permit lifting of the head but the limbs are not moved voluntarily. In all cases the tendon and withdrawal reflexes in the limbs are normal to supernormal.

### Spondylosis in bulls

Old bulls in artificial insemination centers develop calcification of the ventral vertebral ligaments and subsequent spondylosis or rigidity of the lumbar area of the vertebral column. When the bull ejaculates vigorously the calcified ligaments may fracture and this discontinuity may extend upward through the vertebral body. The ossification is extensive, usually from about T2–L3, but the fractures are restricted to the midlumbar region. There is partial displacement of the vertebral canal and compression of the cord. The bull is usually recumbent immediately after the fracture occurs but may rise and walk stiffly several days later. Arching of the back, slow movement, trunk rigidity and sometimes unilateral lameness are characteristic signs. Less severe degrees of spondylosis have been recorded in a high proportion of much younger (2–3-year old) bulls, but the lesions do not appear to cause clinical signs.

### CLINICAL PATHOLOGY

Radiologic examination may reveal the site and extent of the injury. CSF obtained from the lumbosacral space may reveal the presence of red blood cells, suggesting pre-existing hemorrhage.

### NECROPSY FINDINGS

The abnormality is always visible on macroscopic examination. In neonatal calves with dystocia-related vertebral fractures, hemorrhage around the kidneys, around the adrenal glands and in the perivertebral muscles is a common finding and a useful indicator that a thoracolumbar fracture is present. In addition to the vertebral fracture, subdural and epidural hemorrhage, myelomalacia, spinal cord compression, severed spinal cord, and fractured ribs are common findings.

### DIFFERENTIAL DIAGNOSIS

Differentiation from other spinal cord diseases is not usually difficult because of the speed of onset and the history of trauma, although spinal myelitis and meningitis may also develop rapidly. Other causes of recumbency may be confused with trauma especially if the animal is not observed in the immediate preclinical period. In most diseases characterized by recumbency, such as azoturia, acute rumen impaction and acute coliform mastitis, there are other signs to indicate the existence of a lesion other than spinal cord trauma. White muscle disease in foals is characterized by weakness and the serum creatine kinase activity will be increased.

## TREATMENT

Treatment is expectant only, surgical treatment rarely being attempted. Large doses of corticosteroids or nonsteroidal anti-inflammatory agents are recommended to minimize the edema associated with the spinal cord injury. Careful nursing on deep bedding with turning at 3-hourly intervals, massage of bony prominences and periodic slinging may help to carry an animal with concussion or other minor lesion through a long period of recumbency. In cattle especially, recumbency beyond a period of about 48 hours is likely to result in widespread necrosis of the caudal muscles of the thigh and recovery in such cases is improbable. A definitive diagnosis of a vertebral fracture with paralysis usually warrants a recommendation for euthanasia.

## REVIEW LITERATURE

Divers TJ. Acquired spinal cord and peripheral nerve disease. *Vet Clin North Am Food Anim Pract* 2004; 20, 231-242.

## REFERENCES

1. Tyler CM et al. *Aust Vet J* 1993; 70:445.
2. Agerholm JS et al. *Acta Vet Scand* 1993; 34:379.
3. Edwards JF et al. *J Am Vet Med Assoc* 1995; 207:934.
4. Schuh JCL, Killeen JR. *Can Vet J* 1988; 29:830.
5. Johnson RC et al. *Cornell Vet* 1988; 78:231.
6. Troyer DL et al. *Prog Vet Neurol* 1994; 5:98.

## SPINAL CORD COMPRESSION

The gradual development of a space-occupying lesion in the vertebral canal produces a syndrome of progressive weakness and paralysis. A pre-existing inflammatory or neoplastic lesion of the vertebral body may result in spontaneous fracture of the vertebral body and compression of the spinal cord.

## ETIOLOGY

Compression of the spinal cord occurs from space-occupying lesions in the vertebral canal, the common ones being as follows.

### Tumors

**The most commonly occurring** tumor in animals is lymphomatosis, which the nerve trunks and invades the vertebral canal, usually in the lumbosacral region and less commonly in the brachial and cervical areas. This tumor is particularly common in adult cattle with multicentric lymphosarcoma due to bovine leukosis virus infection.

**Rare tumors** include: fibrosarcomas, metastases, plasma cell myeloma, angioma, melanoma in a horse,<sup>1</sup> hemangiosarcoma in a horse,<sup>2</sup> neurofibroma and lymphosarcoma, e.g. in horses, vascular hamartoma in a goat.<sup>3</sup>

### Vertebral body or epidural abscess

Vertebral body abscesses (osteomyelitis) occur most commonly in neonatal farm

animals generally in association with a chronic suppurative lesion elsewhere in the body.

- Docking wounds in lambs, bite wounds in pigs and chronic suppurative pneumonia in calves are common occurrences
- Polyarthritis and endocarditis may also be present
- Compression of the spinal cord is caused by enlargement of the vertebral body abscess into the vertebral canal and there may or may not be deviation of the vertebral canal and its contents
- The original site of infection may have resolved when the clinical signs referable to the spinal cord abscess appear
- Hematogenous spread may also occur from *Arcanobacterium (Actinomyces or Corynebacterium) pyogenes* in cattle, *Actinomyces bovis* in cattle with lumpy jaw, *Corynebacterium pseudotuberculosis* in sheep
- Epidural abscesses causing compression of the spinal cord and not associated with vertebral bodies also occur in lambs.<sup>4</sup>

### Bony lesions of vertebra

- Exostoses over fractures with no displacement of vertebral bodies
- Similar exostoses on vertebral bodies of lambs grazing around old lead mines
- Hypovitaminosis A in young growing pigs causing compression of the nerve roots passing through the vertebral foramina
- Congenital deformity or fusion of the atlanto-occipital-axial joints in calves, foals and goats (see Congenital defects, below)
- Congenital spinal stenosis of calves.<sup>5</sup>

Rarely there is protrusion of an intervertebral disc, identifiable by myelogram, and progressive paresis and ataxia also occur rarely in diskospondylitis in horses. Cervical pain is a more common sign in the latter. The degenerative lesions in disks in the neck of the horse resemble the Hansen type 2 disk prolapses in dogs.

**Adult sows and boars** may have degeneration of intervertebral disks and surrounding vertebral osteophytes. Less commonly ankylosing spondylosis, arthrosis of articular facets, defects in annulus fibrosus and vertebral end plates, and vertebral osteomyelitis or fracture. These lesions of diskospondylitis cause lameness in boars and sows rather than compression of cord and paresis/ paralysis.

These are not to be confused with the many extravertebral causes of posterior lameness or paralysis in adult pigs, which

are discussed in Chapter 13 on the musculoskeletal system.

### Vertebral subluxation

Cervicothoracic vertebral subluxation in Merino sheep in Australia.<sup>6</sup>

### Ataxia in horses

This is a major problem and is dealt with more extensively under the heading of enzootic incoordination of horses. For purposes of comparison the diseases involved are listed here:

- Nonfatal fractures of the skull (basisphenoid, basioccipital, and petrous temporal bones)
- Nonfatal cervical fractures
- Atlanto-occipital instability
- Stenosis of cranial vertebral orifice of C3-C7;<sup>7</sup> this may be effective as a compression mechanism only if the vertebrae adopt exaggerated positions
- Abnormal growth of interarticular surfaces
- Dorsal enlargement of caudal vertebral epiphyses and bulging of intervertebral disks
- Formation and protrusion of false joint capsules and extrasynovial bursae
- Spinal myelitis due to parasitic invasion or equine herpesvirus-1 virus, even louping-ill virus and probably others
- Spinal abscess usually in a vertebral body
- Cerebellar hypoplasia – most commonly the inherited version in Arabian foals
- Degenerative myelomalacia/myelopathy – cause unknown
- Fusion of occipital bone with the atlas, which is fused with the axis
- Hypoxic-ischemic neuromyopathy in aortic-iliac thrombosis
- Tumors of the meninges.

### PATHOGENESIS

The development of any of the lesions listed above results in the gradual appearance of motor paralysis or hypoesthesia, depending on whether the lesion is ventrally or dorsally situated. In most cases there is involvement of all motor and sensory tracts but care is necessary in examination if the more bizarre lesions are to be accurately diagnosed. There may be hemiparesis or hemiplegia if the lesion is laterally situated. Paraparesis or paraplegia is caused by a bilateral lesion in the thoracic or lumbar cord and monoplegia by a unilateral lesion in the same area. Bilateral lesions in the cervical region cause tetraparesis to tetraplegia (quadriplegia).

**In horses** with chronic compressive myelopathy (wobbles), compression of the spinal cord results in necrosis of white

matter, and some focal loss of neurons.<sup>8,9</sup> With time, secondary wallerian-like neuron fiber degeneration in ascending white matter tracts cranial to the focal lesion and in descending white matter tracts caudal to the lesion occurs. Astrocytic gliosis is a prominent and persistent alteration of the spinal cord of horses with chronic cervical compressive myelopathy and is associated with nerve fiber degeneration at the level of the compression and in well-delineated areas of ascending and descending nerve fiber tracts. It is possible that the persistent astrocytic gliosis may prevent, or slow, recovery of neurological function in affected horses.

**Vertebral osteomyelitis in young calves** occurs most commonly in the thoracolumbar vertebrae and less commonly in the cervical vertebrae. The abscess of the vertebral body gradually enlarges and causes gradual compression of the spinal cord, which causes varying degrees of paresis of the pelvic limbs and ataxia.<sup>10</sup> The abscess may extend into adjacent intervertebral spaces and result in vertebral arthritis with lysis of the articular facets. The onset of paresis and paralysis may be sudden in cases of abscessation or osteomyelitis of the vertebrae, which may fracture and cause displacement of bony fragments into the vertebral canal with compression and traumatic injury of the spinal cord. Vertebral body abscesses between T2 and the lumbar plexus will result in weakness of the pelvic limbs and normal flexor withdrawal reflexes of the pelvic limbs. Lesions at the site of the lumbar plexus will result in flaccid paralysis of the pelvic limbs.

#### CLINICAL FINDINGS

Varying degrees of progressive weakness of the thoracic limbs or pelvic limbs may be the initial clinical findings. With most lesions causing gradual spinal cord compression, difficulty in rising is the first sign, then unsteadiness during walking due to weakness, which may be more marked in one of a pair of limbs. The toes are dragged along the ground while walking and the animal knuckles over on the fetlocks when standing. Finally the animal can rise only with assistance and then becomes permanently recumbent. These stages may be passed through in a period of 4–5 days.

The paralysis will be flaccid or spastic depending on the site of the lesion and reflexes will be absent or exaggerated in the respective states. The 'dog-sitting' position in large animals is compatible with a spinal lesion caudal to the second thoracic vertebra segment. Calves with

vertebral osteomyelitis caudal to T2 are usually able to sit up in the 'dog-sitting' position, they are bright and alert and will suck the cow if held up to the teat. In some cases, extensor rigidity of the thoracic limbs resembles the Schiff–Sherrington syndrome and indicates a lesion of the thoracic vertebrae.

Lesions involving the lumbar plexus will result in flaccid paralysis of the pelvic limbs and an absence of the flexor withdrawal reflexes. Lesions involving the sacrococcygeal vertebrae will cause a decrease in tail tone, decreased or absent perineal reflex and urinary bladder distension.

**Pain and hyperesthesia** may be evident before motor paralysis appears. The pain may be constant or occur only with movement. In vertebral body osteomyelitis in the horse, vertebral column pain and a fever may be the earliest clinical abnormalities. With neoplasms of the epidural space, the weakness and motor paralysis gradually worsen as the tumor enlarges.

**Considerable variation** in signs occurs depending on the site of the lesion. There may be local hyperesthesia around the site of the lesion and straining to defecate may be pronounced. Retention of the urine and feces may occur. There is usually no detectable abnormality of the vertebrae on physical examination.

**In the wobbler horse**, circumduction of the limbs with ataxia is typical. The ataxia is usually pronounced in the pelvic limbs, and weakness is evident by toe dragging and the ease with which the horse can be pulled to one side while walking. Ataxia with hypometria is often evident in the thoracic limbs, especially while walking the horse on a slope and with the head elevated.

**Calves** with congenital spinal stenosis are usually unable to stand or can do so only if assisted. There are varying degrees of weakness and ataxia of the pelvic limbs. They are bright and alert and will suck the cow if assisted. Those that survive for several weeks will sometimes assume the 'dog-sitting' position.

#### CLINICAL PATHOLOGY

**Radiographic** examination of the vertebral column should be carried out if the animal is of a suitable size. Myelography is necessary to demonstrate impingement on the spinal cord by a stenotic vertebral canal. Myelography using the contrast medium Iopamidol has been done in neonatal calves for the detection of spinal cord compression causing paresis.<sup>11</sup> The contrast medium was introduced through the foramen magnum under general anesthesia.

The **cerebrospinal fluid** may show a cellular reaction if there is some invasion of the spinal canal.

#### NECROPSY FINDINGS

Gross abnormalities of the vertebrae and the bony spinal canal are usually obvious. Those diseases of the spinal cord characterized by degeneration without gross changes require histological techniques for a diagnosis.

#### DIFFERENTIAL DIAGNOSIS

Differentiation between abscess, tumor and exostosis in the vertebral canal is usually not practicable without radiographic examination. Vertebral osteomyelitis is difficult to detect radiographically, particularly in large animals, because of the overlying tissue. In bovine lymphosarcoma there are frequently signs caused by lesions in other organs. A history of previous trauma may suggest exostosis. The history usually serves to differentiate the lesion from acute trauma.

- Spinal myelitis, myelomalacia and meningitis may resemble cord compression but are much less common. They are usually associated with encephalitis, encephalomalacia and cerebral meningitis respectively
- Meningitis is characterized by much more severe hyperesthesia and muscle rigidity
- Rabies in the dumb form may be characterized by a similar syndrome but ascends the cord and is fatal within a 6-day period.

**In the newborn** there are many congenital defects in which there is defective development of the spinal cord. Most of them are not characterized by compression of the cord, the diminished function being caused in most cases by an absence of tissue. **Spina bifida**, **syringomyelia** and **dysraphism** are characterized by hindquarter paralysis or, if the animal is able to stand, by a wide-based stance and overextension of the legs when walking. Some animals are clinically normal.

**A generalized degeneration of peripheral nerves** such as that described in pigs and cattle causes a similar clinical syndrome; so does **polyradiculoneuritis**. A nonsuppurative **ependymitis**, **meningitis** and **encephalomyelitis**, such as occurs in equine infectious anemia, may also cause an ataxia syndrome in horses.

**Paresis or paralysis of one limb (monoplegia)** is caused by lesions in the ventral gray matter, nerve roots, brachial and lumbosacral plexus, and peripheral nerves and muscles of the limbs.

#### TREATMENT

Successful treatment of partially collapsed lumbar vertebra by dorsal laminectomy has been performed in a calf and in horses, but in farm animals treatment is usually not possible and in most cases slaughter for salvage is recommended.

## REVIEW LITERATURE

- Jeffcott LB, Dalin G. Bibliography of thoracolumbar conditions in the horse. *Equine Vet J* 1983; 15:155-157.
- Divers TJ. Acquired spinal cord and peripheral nerve disease. *Vet Clin North Am Food Anim Pract* 2004; 20:231-242.

## REFERENCES

- Schott HC et al. *J Am Vet Med Assoc* 1990; 196:1820.
- Newton-Clarke MJ et al. *Vet Rec* 1994; 135:182.
- Middleton JR et al. *Vet Rec* 1999; 144:264.
- Scott PR, Will RG. *Br Vet J* 1991; 147:582.
- Doige CE et al. *Vet Pathol* 1990; 27:16.
- Hill BD et al. *Aust Vet J* 1993; 70:156.
- Tomizawa N et al. *J Vet Med Sci* 1994; 56:227.
- Yovich JV et al. *Aust Vet J* 1991; 68:326.
- Yovich JV et al. *Aust Vet J* 1991; 68:334.
- Rashmir-Raven A et al. *Prog Vet Neurol* 1991; 2:197.
- Bargai U. *Vet Radiol Ultrasound* 1993; 34:20.

## BACK PAIN IN HORSES

The subject of back pain, and its relationship to lameness, is a very important one in horses. There is often a lesion in the vertebral canal and by pressing on the cord or peripheral nerves it causes gait abnormalities that suggest the presence of pain, or they actually cause pain. Spondylosis, injury to dorsal spinous processes, and sprain of back muscles are common causes of the same pattern of signs. Because these problems are largely orthopedic ones, and therefore surgical, their exposition is left to other authorities.

It is necessary in horses to differentiate spinal cord lesions from acute nutritional myodystrophy, and subacute tying-up syndrome. Those diseases are characterized by high serum creatine kinase and aspartate aminotransferase activities.

## REVIEW LITERATURE

- Jeffcott LB, Dalin G. Bibliography of thoracolumbar conditions in the horse. *Equine Vet J* 1983; 15:155-157.

## MYELITIS

Inflammation of the spinal cord is usually associated with viral encephalitis. The signs are referable to the loss of function, although there may be signs of irritation. For example, hyperesthesia or paresthesia may result if the dorsal root ganglia are involved. This is particularly noticeable in pseudorabies and to a lesser extent in rabies. Paralysis is the more usual result. There are no specific myelitides in farm animals. Listeriosis is sometimes confined in its lesion distribution to the spinal cord in sheep. Viral myelitis associated with equine herpesvirus-1 (the equine rhinopneumonitis virus) is now commonplace and equine infectious anemia and dourine include incoordination and paresis in their syndromes. In goats, caprine arthritis encephalitis is principally

a myelitis, involving mostly the white matter.

**Equine protozoal myeloencephalitis** causes multifocal lesions of the central nervous system, mostly the spinal cord.<sup>1</sup> The most accurate diagnosis is based on histological findings:

- Necrosis and mild to severe, nonsuppurative myeloencephalitis
- Infiltration of neural tissue by mononuclear cells
- Sometimes giant cells, neutrophils, and eosinophils
- Infiltration of perivascular tissue by mononuclear cells including lymphocytes and plasma cells.

Equine protozoal myeloencephalitis is caused primarily by *Sarcocystis neurona*, which has the opossum (*Didelphis virginiana*) as the definitive host, raccoons as the most likely intermediate host, with the horse acting as a dead end host.<sup>1</sup> Occasional cases of protozoal myeloencephalitis in horses are associated with *Neospora hughesi*.

Myelitis associated with *Neosporum caninum* infection in newborn calves has been described.<sup>2</sup> Affected calves were recumbent and unable to rise but were bright and alert. Histologically there was evidence of protozoal myelitis.

## MYELOMALACIA

Myelomalacia occurs rarely as an entity separate from encephalomalacia. One recorded occurrence is focal spinal poliomyelomalacia of sheep and in enzootic ataxia the lesions of degeneration are often restricted to the spinal cord. In both instances there is a gradual development of paralysis without signs of irritation and with no indication of brain involvement. Progressive paresis in young goats may be associated with the virus of caprine arthritis encephalitis and other unidentified, possibly inherited causes of myelomalacia.<sup>3</sup>

Degeneration of spinal cord tracts has also been recorded in **poisoning** by *Phalaris aquatica* in cattle and sheep, by sorghum in horses, by 3-nitro-4-hydroxyphenylarsonic acid in pigs and by selenium in ruminants; the lesion is a symmetrical spinal poliomyelomalacia. Poisoning of cattle by plants of *Zamia* spp. produces a syndrome suggestive of injury to the spinal cord but no lesions have been reported. Pantothenic acid or pyridoxine deficiencies also cause degeneration of spinal cord tract in swine.

A disease of obscure etiology in sheep with spinal cord degeneration is Murrurrundi disease. A spinal myelino- pathy, possibly of genetic origin is recorded in Murray Grey calves.<sup>4</sup> Affected animals develop ataxia of the hindlegs,

swaying of the hindquarters and collapse of one hindleg with falling to one side. Clinical signs become worse over an extended period.

Sporadic cases of degeneration of spinal tracts have been observed in pigs. One outbreak is recorded in the litters of sows on lush clover pasture. The piglets were unable to stand, struggled violently on their sides with rigid extension of the limbs and, although able to drink, usually died of starvation. Several other outbreaks in pigs have been attributed to selenium poisoning.

**An inherited lower motor neuron** disease of pigs has been recorded.<sup>5</sup> Clinical findings of muscular tremors, paresis or ataxia developed at 12-59 days of age. There is widespread degeneration of myelinated axons in peripheral nerves and in the lateral and ventral columns of lumbar and cervical segments of the spinal cord. Axonal degeneration is present in ventral spinal nerve roots and absent in dorsal spinal nerve roots when sampled at the same lumbar levels.

**Equine degenerative myeloencephalopathy** of unknown etiology affects young horses and has been recorded in the USA, Canada, the UK, and Australia.<sup>6</sup> The major clinical signs are referable to bilateral leukomyelopathy involving the cervical spinal cord. There is abnormal positioning and decreased strength and spasticity of the limbs as a result of upper motor neuron and general proprioceptive tract lesions. Hypalgesia, hypotonia, hyporeflexia, muscle atrophy, or vestibular signs are not present and there is no evidence of cranial nerve, cerebral or cerebellar involvement clinically. Abnormal gait and posture are evident, usually initially in the pelvic but eventually also in the thoracic limbs. There are no gross lesions but histologically there is degeneration of neuronal processes in the white matter of all spinal cord funiculi, especially the dorsal spinocerebellar and sulcomarginal tracts. The lesion is most severe in the thoracic segments. The disease is progressive and there is no known treatment.

**Equine motor neuron disease** affects horses from 15 months to 25 years of age of many different breeds.<sup>7,8</sup> Progressive weakness, short-striding gait, trembling, long periods of recumbency, and trembling and sweating following exercise are characteristic clinical findings. The weakness is progressive and recumbency is permanent. Appetites remain normal or become excessive. At necropsy, degeneration and/or loss of somatic motor neurons in the spinal ventral horns and angular atrophy of skeletal muscle fibers are characteristic.<sup>7</sup>



Sporadic cases of spinal cord damage in horses include hemorrhagic myelomalacia following general anesthesia<sup>9</sup> and acute spinal cord degeneration following general anesthesia and surgery.<sup>10</sup> Following recovery from the anesthesia, the horse is able to assume sternal recumbency but not able to stand.<sup>10</sup> A hemorrhagic infarct assumed to be due to cartilage emboli, and a venous malformation causing spinal cord destruction have also occurred in the horse. The disease must be differentiated from myelitis and spinal cord compression caused by space-occupying lesions of the vertebral canal, and cervical, vertebral malformation/malarticulation.

## REFERENCES

1. Fayer R et al. *J Vet Intern Med* 1990; 4:54.
2. Parish SM et al. *J Am Vet Med Assoc* 1987; 191:1599.
3. Lancaster MJ et al. *Aust Vet J* 1987; 64:123.
4. Richards RB, Edwards JR. *Vet Pathol* 1986; 23:35.
5. O'Toole D et al. *J Vet Diagn Invest* 1994; 6:230.
6. Mayhew IG et al. *J Vet Intern Med* 1987; 1:45.
7. Step DL et al. *J Am Vet Med Assoc* 1993; 202:26.
8. Cummings JF et al. *Cornell Vet* 1990; 80:357.
9. Lerche E et al. *Cornell Vet* 1993; 83:267.
10. Lam KHK et al. *Vet Rec* 1995; 136:329.

## Diseases of the peripheral nervous system

The **peripheral nervous system** consists of cranial and spinal nerve components. As such, the peripheral nervous system includes the dorsal and ventral nerve roots, spinal ganglia, spinal and specific peripheral nerves, cranial nerves and their sensory ganglia, and the peripheral components of the autonomic nervous system.<sup>1</sup>

### ETIOLOGY

There are several different causes of peripheral nervous system disease.

#### Inflammatory

**Polyneuritis equi**, also known as **neuritis of the cauda equina** or **cauda equina syndrome**, is a rare and slowly progressive demyelinating granulomatous disease affecting peripheral nerves in the horse.<sup>2</sup> Polyneuritis equi is characterized by signs of lower motor neuron lesions, primarily involving the perineal region but also affecting other peripheral nerves, especially the 5th and 7th cranial nerves. The 8th, 9th, 10th and 12th cranial nerves also may be involved. Clinical signs of perineal region paresis/paralysis predominate, manifest as varying degrees of hypotonia, hypalgesia and hyporeflexia of the tail, anus and perineal region. Degrees of urinary bladder paresis and rectal dilatation are also present. Differential diagnoses include sacral or coccygeal trauma,

equine herpes myeloencephalopathy, equine protozoal myeloencephalitis, rabies and equine motor neuron disease.<sup>2</sup>

**Cranial neuritis with guttural pouch mycosis** and empyema in the horse may cause abnormalities of swallowing, laryngeal hemiplegia and Homer's syndrome if the glossopharyngeal and vagal nerves are involved in the inflammatory process of the guttural pouch.<sup>1</sup>

#### Degenerative

**Equine laryngeal hemiplegia**, often called roaring, is a common disease of the horse in which there is paralysis of the left cricoarytenoid dorsalis muscle resulting in an inability to abduct the arytenoid cartilage and vocal fold, which causes an obstruction in the airway during inspiration. Endoscopic examination reveals asymmetry of the glottis. On exercise, inspiratory stridor develops as the airflow vibrates a slack and adducted vocal fold. The abnormality is due to idiopathic distal degeneration of axons in the left recurrent laryngeal nerve (see more details in Chapter 10).

#### Traumatic

**Injection injuries to peripheral nerves** may result from needle puncture, the drug deposited, pressure from an abscess or hematoma, or fibrous tissue around the nerve.<sup>1</sup> The sciatic nerve has been most commonly affected in cattle because historically most intramuscular injections were given deep in the hamstring muscles. Young calves were particularly susceptible because of the small muscle masses. Current recommendations in cattle are that intramuscular injections should be administered cranial to the shoulder.

**Femoral nerve paralysis in calves** occurs in large calves born to heifers with dystocia. The injury occurs when calves in anterior presentation fail to enter the birth canal because their stifle joints become engaged at the brim of the pelvis. Traction used to deliver these calves causes hyperextension of the femur and stretching of the quadriceps muscle and its neural and vascular supplies. In most cases the right femoral nerve is affected. Such calves are unable to bear weight on the affected leg within days after birth, the quadriceps muscle is atrophied and the patella can be luxated easily. The patellar reflex is absent or markedly reduced in the affected limb because this reflex requires an intact femoral nerve and functional quadriceps muscle. Varying degrees of rear limb paresis result, accompanied by varying degrees of hind limb gait abnormality.<sup>3,4</sup> Skin analgesia maybe present over the proximal lateral to cranial to medial aspect of the tibia.<sup>3</sup> At rest, the affected leg is slightly flexed and the hip on the affected side is held slightly

lower.<sup>4</sup> During walking, the animal has difficulty in advancing the limb normally because the limb collapses when weight-bearing. In severe cases of muscle atrophy, the patella is easily luxated both medially and laterally. Injury to the femoral nerve is relatively easy to clinically identify, and there is usually no need to perform electromyographic studies of atrophied quadriceps muscle in order to document denervation.

**Calving paralysis** is common in heifers that have experienced a difficult calving. Affected animals are unable to stand without assistance; if they do stand, the hind limbs are weak and there is marked abduction and inability to adduct. It has always been erroneously thought that traumatic injury of the obturator nerves during passage of the calf in the pelvic cavity was the cause of the paresis; however, detailed pathological and experimental studies have demonstrated that most calving paresis/paralysis is due to damage to the sciatic nerve.<sup>5-8</sup> Experimental transection of the obturator nerves does not result in paresis. The term obturator nerve paralysis should only be used for post-parturient cattle with an inability to adduct one or both hindlimbs, and calving paralysis in the preferred descriptive term for hind limb paresis/paralysis occurring in the immediate postparturient period.

Damage to the sciatic nerve results in rear limb weakness and knuckling of the fetlocks; the latter clinical sign is an important means for differentiating sciatic nerve damage from obturator nerve damage. The patellar reflex in ruminants with sciatic nerve damage is normal or increased, because the reflex contraction of the quadriceps muscle group by the femoral nerve is unopposed by the muscles of the hindlimb innervated by the sciatic nerve.

The peroneal nerve is most frequently damaged by local trauma to the lateral stifle, where the peroneal nerve runs in a superficial location lateral to the head of the fibular bone. Damage to the peroneal nerve leads to knuckling over of the fetlock joint due to damage to the extensor muscles of the distal limb, resulting in the dorsal aspect of the hoof resting on the ground when the animal is standing. Full weight can be borne on the affected limb when the digit is placed in its normal position, but immediately upon walking the digit is dragged. There is a loss of skin sensation on the anterior aspect of the metatarsus and digit.

Damage to the tibial nerve causes mild hyperflexion of the hock and a forward knuckling of the fetlock joint. Tibial nerve damage is very rare, and most cases described as tibial nerve damage are actually sciatic nerve damage.

**Metabolic and nutritional**

**Pantothenic acid deficiency** may occur in pigs fed diets based solely on corn (maize). Affected animals develop a goose-stepping gait due to degenerative changes in the primary sensory neurons of the peripheral nerves.

**Toxic**

**Heavy metal poisoning** including **lead and mercury poisoning in horses** has been associated with clinical signs of degeneration of peripheral cranial nerves but these are not well documented.

**Tumors**

A multicentric schwannoma causing chronic ruminal tympany and forelimb paresis has been recorded in an aged cow.<sup>9</sup> Neoplastic masses were present throughout the body and both right and left brachial plexi were involved. The peripheral nerves of each brachial plexus were enlarged. Large tumor masses were present on the serosal surfaces of the esophagus, pericardial sac and epicardium, within the myocardium, endocardium and the ventral branches of the first four thoracic spinal nerves. A large mass was present in the anterior mediastinum near the thoracic inlet.

**Autonomic nervous system**

**Grass sickness in the horse** occurs exclusively in the UK and is characterized by a peracute to chronic alimentary tract disease of horses on pasture (hence the name). Gastrointestinal stasis is partial or complete. Peracute cases are in shock and in a state of collapse with gastric refluxing. Acute, subacute and chronic cases also occur. Degenerative changes occur in the autonomic ganglia, especially the celiac-mesenteric, stellate, thoracic sympathetic chain, ciliary, cranial and caudal cervical, the craniospinal sensory ganglia and selected nuclei in the central nervous system.<sup>9</sup> The etiology is unknown.

**REVIEW LITERATURE**

Summers BA, Cummings BA, de Lahunta A. *Veterinary neuropathology*. St Louis, MO: Mosby, 1995.

Constable PD. Clinical examination of the ruminant nervous system. *Vet Clin North Am Food Anim Pract* 2004; 20:185–214.

Divers TJ. Acquired spinal cord and peripheral nerve disease. *Vet Clin North Am Food Anim Pract* 2004; 20:231–242.

**REFERENCES**

- Summers BA, Cummings BA, de Lahunta A. *Veterinary neuropathology*. St Louis, MO: Mosby, 1995.
- Vatistas N, Mayhew J. *J Pract* 1995; 17:26.
- Tryphonas L et al. *J Am Vet Med Assoc* 1974; 164:801.
- Paulsen DB et al. *Bovine Pract* 1981; 2:14–26.
- Vaughan LC. *Vet Rec* 1964; 76:1293.
- Cox VS et al. *Am J Vet Res* 1975; 36:427.
- Cox VS, Breazile JE. *Vet Rec* 1973; 93:109.
- Cox VS, Onapito JS. *Bovine Pract* 1986; 21:195.
- Reek SF et al. *Vet Rec* 1997; 140:504.

**Congenital defects of the central nervous system**

The pathogenesis of congenital defects, including those of the central nervous system, has been dealt with in general terms in Chapter 3. Inheritance, nutrition, virus infection in early pregnancy and some toxins can all play a part in the genesis of these defects and the purpose of this section is to guide the diagnostician through the recognition of the defect to the possible causes. However, many such cases occur sporadically and a specific cause cannot be identified.

Although most developmental defects are present at birth there are a few that appear later in life, especially the abiotrophic diseases, in which an essential metabolic process (essential, that is, for cellular structure and function) is missing and the tissue undergoes degeneration.

The diseases to be identified are listed under the headings of the principal clinical signs and syndromes that they produce. Many affected neonates are weak and die either during birth or soon afterwards so that they tend to be diagnoses for pathologists rather than clinicians. There may be an unintentional bias toward more clinically conspicuous diseases in the following material. The reader is referred to the review literature for details of specific congenital defects.

**Defects with obvious structural errors**

- Hydrocephalus, sporadic or inherited, with obvious enlargement of the cranium
- Meningocele with protrusion of a fluid-filled sac through the open fontanelle in the cranial vault. The defect is inherited in some pigs
- Hydrocephalus with spina bifida combination – the Arnold–Chiari syndrome – in cattle
- Hydrocephalus with congenital achondroplasia (bulldog calf syndrome)
- Cranium bifidum (may include meningocele) of pigs
- Ventral meningocele in a filly foal<sup>1</sup>
- Microphthalmia – in microcephaly the cranium is usually of normal size
- Some cases of failure of closure of neural tube, e.g. spina bifida in lambs.<sup>2</sup> There is a defect in the skin and dorsal arch of the vertebra in the lumbosacral area in some cases
- Exophthalmos with or without strabismus, an inherited form in Jersey and Shorthorn cattle does not appear until the animal is more than 6 months of age

- Neurofibromas occurring as enlargements on peripheral nerves and seen as subcutaneous swellings. They are passed from cow to calf
- Persistent cloaca and caudal spinal agenesis in calves<sup>3</sup>
- Hydranencephaly, porencephaly and other structural defects due to intrauterine infection with Akabane, Bluetongue, Cache Valley and Wesselsbron viruses.

**Diseases characterized by congenital paresis/paralysis**

- Enzootic ataxia due to nutritional deficiency of copper. It may also develop later, within the first month of postnatal life
- Inherited congenital posterior paralysis of calves, and of pigs
- Congenital spinal stenosis of calves<sup>4</sup>
- Spina bifida, sometimes accompanied by flexion and contracture and atrophy of hindlegs; most are stillborn. In rare cases the affected calf is ambulatory<sup>5</sup>
- Spinal dysraphism in Charolais and Angus calves, syringomyelia and hydromyelia in calves
- Tetraparesis, tetraplegia, progressive ataxia with head deviation in foals with congenital occipitoatlanto-axial malformations. A familial tendency to the defects occurs in Arab and non-Arabian horses. Additional signs include stiffness of the neck, palpable abnormalities at the site and a clicking sound on passive movement. Foals may be affected at birth or develop signs later. The defect is identifiable radiographically
- A congenital dysplasia of the atlanto-occipital joint with excessive mobility is recorded in Angora goats and causes a compressive myelopathy. Devon calves may be affected by the same deformity<sup>6</sup> and similar ones have been recorded in calves that were recumbent at birth<sup>5</sup> and others in which ataxia developed subsequently<sup>7</sup>
- More widespread malacic changes have been recorded in the spinal cord of calves but without the specific etiology being determined.

**Neurogenic arthrogryposis and muscle atrophy**

- Akabane virus infection of calves, kids, possibly lambs, in utero
- There are many other causes of arthrogryposis listed under congenital abnormalities of joints but they are not known to be neurogenic.

**Spasms of muscle masses**

- Inherited spastic paresis (Elso-heel) of calves

- Inherited periodic spasticity (stall-cramp).

#### Diseases characterized by cerebellar ataxia

- Inherited cerebellar hypoplasia of calves, Arabian foals, lambs
- Cerebellar hypoplasia and hypomyelination in calves from cows infected with BVD virus and possibly Akabane virus during pregnancy
- Cerebellar hypoplasia in piglets after hog cholera vaccination of dams
- Inherited cerebellar ataxia in pigs and foals
- Familial convulsions and ataxia of Angus cattle
- Mannosidosis of cattle
- Intracranial hemorrhage in newborn foals, discussed in more detail under Neonatal maladjustment syndrome
- Spinal cord hypoplasia in Akabane virus infection in ruminants.

#### Diseases characterized by tremor

- Congenital paresis and tremor of piglets
- Inherited congenital spasms of cattle
- Inherited neonatal spasticity (Jersey and Hereford cattle) develops at 2–5 days old
- Border disease (hairy shakers) in lambs due to BVD virus
- Inherited neuraxial edema (now inherited congenital myoclonus) of polled Hereford cattle and congenital brain edema of Herefords
- Myoclonia congenita as a result of infection with hog cholera or Aujeszky's disease viruses
- Tremor with rigidity due to hydranencephaly and porencephaly in calves infected in utero with BVD virus
- Shaker calves' in Herefords.

#### Disease characterized by convulsions

- Brain injury during birth in calves and lambs
- Brain compression due to hypovitaminosis A in calves and pigs

- Neonatal maladjustment syndrome (barkers and wanderers) in Thoroughbred foals
- Congenital toxoplasmosis in calves, bluetongue virus infection in lambs
- Tetanic convulsion in inherited neuraxial edema (now inherited congenital myoclonus) of Hereford calves, but only when lifted to standing position
- Inherited idiopathic epilepsy of Brown Swiss cattle
- Familial convulsions and ataxia of Angus cattle
- Inherited narcolepsy/catalepsy in Shetland ponies and Suffolk horses (not really a convulsion)
- Doddler calves.

#### Diseases characterized by imbecility

- Microencephaly in calves, probably inherited, with no abnormality of the cranium, but the cerebral hemispheres, cerebellum and brainstem are reduced in size and the corpus callosum and fornix are absent
- Microcephaly recorded in sheep; many are dead at birth, viable ones are unable to stand, blind, incoordinate and have a constant tremor
- Anencephaly in calves with absence of cerebral hemispheres, rostral midbrain, occurs sporadically in calves
- Hydranencephaly associated with Akabane virus infection of calf, kid, and possibly lamb in utero
- Congenital porencephaly in lambs after intrauterine infection with bluetongue virus.

#### Ocular abnormalities

- Spontaneous microphthalmia and anophthalmia in calves, usually of unknown cause
- Congenital lenticular cataracts in cattle and lambs
- Blindness developing after birth in gangliosidosis of cattle and ceroid lipofuscinosis of sheep

- Constriction of optic nerve by vitamin A deficiency causing blindness in calves and pigs
- Constriction of optic nerve and blindness with BVD virus infection in calves in utero
- Inherited exophthalmos with strabismus of cattle
- Familial undulatory nystagmus (pendular nystagmus).

#### Defects conditioned by inheritance but not present at birth

- Cerebellar atrophy (abiotrophy) in calves and foals; a probably inherited cerebellar abiotrophy in sheep aged 3.5–6 years
- Inherited idiopathic epilepsy of Jerseys and Shorthorns
- Mannosidosis of cattle
- Gangliosidosis of cattle
- Bovine generalized glycogenosis
- Multifocal symmetrical necrotizing encephalomyelopathy (Leigh's disease) in Angus, Simmental, and Limousin cattle<sup>7</sup>
- Globoid cell leukodystrophy of sheep
- Ceroid lipofuscinosis of sheep
- Inherited myotonia of goats
- Progressive ataxia of Charolais cattle
- Inherited citrullinemia of calves
- Inherited maple syrup urine disease.

#### REVIEW LITERATURE

- Done JT. Developmental disorders of the nervous system in animals. *Adv Vet Sci* 1976; 20:69.
- Cho DY, Leipold HW. Congenital defects of the bovine central nervous system. *Vet Bull* 1977; 47:489.
- Summers BA, Cummings JF, de Lahunta A. *Veterinary neuropathology*. St Louis, MO: Mosby, 1995.
- Washburn KE, Streeter RN. Congenital defects of the ruminant nervous system. *Vet Clin North Am Food Anim Pract* 2004; 20:413–434.

#### REFERENCES

1. Harmelin A et al. *J Comp Pathol* 1993; 109:93.
2. Davies IH. *Vet Rec* 1993; 132:90.
3. Dean CE et al. *Vet Pathol* 1996; 33:711.
4. Doige C. E et al. *Vet Pathol* 1990; 27:16.
5. Boyd JS, McNeil PE. *Vet Rec* 1987; 120:34.
6. McCoy DJ et al. *Cornell Vet* 1986; 76:277.
7. Philbey AW, Martel KS. *Aust Vet J* 2003; 81:226.

## Diseases of the musculoskeletal system

**PRINCIPAL MANIFESTATIONS OF MUSCULOSKELETAL DISEASE 621**

- Lameness 621
- Abnormal posture and movement 621
- Deformity 621
- Spontaneous fractures 625
- Painful aspects of lameness 625
- Economics of lameness in food-producing animals 625
- Examination of the musculoskeletal system 625

**DISEASES OF MUSCLES 626**

- Myasthenia (skeletal muscle asthenia) 626

- Myopathy 626
- Myositis 631

**DISEASES OF BONES 632**

- Osteodystrophy 632
- Hypertrophic pulmonary osteoarthropathy (Marie's disease, achropachia ossea) 635
- Osteomyelitis 635

**DISEASES OF JOINTS 637**

- Arthropathy (osteoarthropathy, degenerative joint disease) 637
- Arthritis and synovitis 642

**CONGENITAL DEFECTS OF MUSCLES, BONES, AND JOINTS 648**

- Fixation of joints 648
- Hypermobility of joints 648
- Weakness of skeletal muscles 648
- Congenital hyperplasia of myofiber 648
- Obvious absence or deformity of specific parts of the musculoskeletal system 648

Diseases of the organs of support, including muscles, bones, and joints, have much in common in that the major clinical manifestations of diseases that affect them are lameness, failure of support, insufficiency of movement and deformity. Insufficiency of movement affects all voluntary muscles, including those responsible for respiratory movement and mastication, but lameness and failure of support are manifestations of involvement of the limbs.

Various classifications of the diseases of the musculoskeletal system, based on clinical, pathological and etiological differences, are in use, but the simplest is that which divides the disease into degenerative and inflammatory types.

- The degenerative diseases of muscles, bones and joints are distinguished as: myopathy, osteodystrophy and arthropathy, respectively
- The inflammatory diseases are myositis, osteomyelitis and arthritis.

**Principal manifestations of musculoskeletal disease****LAMENESS**

Lameness is an abnormal gait or locomotion characterized by limping (claudication) or not bearing full weight on a leg, usually associated with pain in the musculoskeletal system. Lameness must be distinguished from **ataxia**, which is an abnormal gait characterized by lack of coordination of muscular action, usually because of a lesion of the central or peripheral nervous system.

**Weakness** is the inability to maintain a normal posture and gait, usually

because of a lesion of muscle or generalized weakness due to an abnormal systemic state such as shock, hypocalcemia, or starvation.

Because of the difficulty inherent in the differentiation of diseases causing lameness, and other abnormalities of gait and posture, a summary is presented in Table 13.1. It does not include lameness in racing horses, which is described in textbooks on lameness in horses, or diseases of the nervous system that interfere with normal movement and posture. These are discussed in Chapter 12.

**ABNORMAL POSTURE AND MOVEMENT**

As a group, diseases of the musculoskeletal system are characterized by reduced activity in standing up and moving, and the adoption of unusual postures. Abnormal movements include limpness, sagging or stiffness and lack of flexion. Abnormal postures include persistent recumbency, including lateral recumbency. There may be signs of pain on standing, moving or palpation. There is an absence of signs specifically referable to the nervous system. For example, there are no signs of brain damage and the spinal cord reflexes are present but may be only partly elicitable (the sensory pathway is intact but the motor response may be diminished). Differentiation from diseases of the nervous system and from each other may be aided by specific biochemical, radiological or hematological findings that indicate the system involved. Specific epidemiological findings may indicate the location of the lesion (which may be secondary) in muscle, bones, or joints, as set out in Table 13.1.

**DEFORMITY**

Atypical disposition, shape or size of a part of the musculoskeletal system constitutes a deformity. This may occur in a number of ways, and be caused by the following.

**Muscle and tendon defects**

- Congenital hypermobility of joints, inherited and sporadic
- Congenital flexed or stretched tendons of limbs causing contracture of joints or hyperextension
- Inherited congenital splayleg of pigs
- Muscle hypertrophy (doppelender, culard) of cattle
- Acquired asymmetric hindquarters of pigs.

**Joint defects**

- Inherited congenital ankylosis of cattle causing fixation of flexion
- Joint enlargement of rickets and chronic arthritis.

**Defects of the skeleton**

- Dwarfism – inherited miniature calves, achondroplastic dwarves; short legs of inherited congenital osteopetrosis; nutritional deficiency of manganese; acorn calves
- Giant stature – inherited prolonged gestation, not really giantism, only large at birth
- Asymmetry – high withers, low pelvis of hyena disease of cattle
- Limbs – complete or partial absence, inherited or sporadic amputates; curvature of limbs in rickets; bowie or bentleg of sheep poisoned by *Trachymene* sp.
- Head – inherited and sporadic cyclopean deformity; inherited probatocephaly (sheep's head) of

Table 13.1 Differential diagnosis of diseases of the musculoskeletal system

Disease and clinical findings	Epidemiological findings	Clinical pathology	Necropsy findings	Examples
<b>Myasthenia</b> Paresis, paralysis and incoordination	Ischemia or reduced supply of energy or electrolytes	Hypoglycemia, hypocalcemia, hypokalemia, hypomagnesemia	Reversible malfunction	iliac thrombosis, toxemia, milk fever, lactic acidosis, some poisonous plants
<b>Myopathy</b> Either stiff gait, disinclination to move, board-like muscles or weakness, pseudoparesis or paralysis, difficult rising, staggy gait, flabby muscles. Always bilateral, mostly hindlimbs	Often precipitated by sudden increase in muscular work. Usually diet-dependent on: (1) High carbohydrate intake (2) Deficiency in selenium/vitamin E intake (3) Ingestion of myopathic agents, e.g. in poison plants, cod liver oil	Marked elevations in serum levels of CPK and AST. Myoglobinemia and possibly myoglobinuria	White, waxy, swollen, 'fish flesh' muscle	<b>Horses:</b> Azoturia ('equine paralytic myoglobinuria', 'tying-up', 'equine rhabdomyolysis') Postanesthetic myositis <b>Pigs:</b> Porcine stress syndrome, selenium deficiency, inherited splaylegs <b>Cattle:</b> Selenium/vitamin E deficiency (enzootic muscular dystrophy), poisoning by <i>Cassia occidentalis</i> , <i>Karwinskia humboldtiana</i> , ischemic necrosis of recumbency <b>Sheep:</b> Approximately the same. Exertional rhabdomyolysis
<b>Myositis</b> Acute inflammation, swelling, pain, may be associated with systemic signs if infectious. Chronic manifested by atrophy, contracture of joint, incomplete extension	Related to trauma or specific infectious disease. Atrophy, pallor in chronic	As for myopathy plus hematological response when infection present	Bruising, edema and hemorrhage in acute	Blackleg, false blackleg (malignant edema), Eosinophilic myositis in beef cattle. Traumatic injury by strain of muscle or forceful impact
<b>Osteodystrophy</b> Stiff gait, moderate lameness often shifting from leg to leg, arched back, crackling sounds in joints while walking. Disinclination to move, horses affected early race very poorly. Severely affected animals disinclined to stand, recumbent much of time. Fractures common. Bones soft, e.g. frontal bones to digital pressure. Deformities of bones, e.g. bowing, pelvic collapse. Ready detachment of tendons and ligaments	Absolute deficiency and/or relative imbalance of dietary calcium, phosphorus and vitamin D. Most apparent in rapidly growing, working and heavy milk-producing animals	Radiographic evidence of osteoporosis, deformed epiphyseal lines, broadness of epiphyses. Subperiosteal unossified osteoid	Osteoporosis, subepiphyseal collapse of bone at pressure points. Fracture of soft bones. Bone ash determinations of Ca, P and Mg content of bones	<b>Cattle:</b> Phosphorus deficient or, Marie's disease. Hypovitaminosis D. Calcium deficiency. Poisoning by <i>Trachymene glaucofolia</i> (bowie or bentleg) <b>Horses:</b> Osteodystrophia fibrosa due to low calcium diet, or to poison plants containing large amounts of oxalate (see under oxalate poisoning) <b>Pigs:</b> Osteodystrophia fibrosa due to low Ca high P in diet
<b>Osteomyelitis</b> Pain, swelling (fittle), toxemia, fever, may be discharge through sinus	Only of specific disease	Radiographic evidence of rarefaction, new bone growth	Osteomyelitis	Actinomycosis, brucellosis in pigs and cattle. Necrotic and atrophic rhinitis disease in pigs
<b>Arthropathy (osteoarthritis)</b> Lameness with pain on walking, standing, palpation. Some enlargement but not gross. Slackness in joints, may be ligament rupture, creptus	(1) Inherited predisposition in cattle (2) Dietary excess of phosphorus, relative deficiency of calcium (3) Very rapid increase in body weight in young (4) Heavy milk production during many lactations	Excessive sterile brownish fluid with floccules. Radiological evidence of joint erosion, epiphyseal deformity, new bone growth peripherally	Erosion of cartilage and bone, ligament rupture, new bone growth (epiphytes) around edge of joint. Excess brownish sterile clear fluid containing floccules	<b>Cattle:</b> Degenerative joint disease (of young beef bulls) inherited osteoarthritis <b>Horses:</b> As early part of osteodystrophia syndrome. <b>Pigs:</b> Epiphyseolysis of femurs of young breeding boars. Osteochondrosis

Table 13.1 (Cont'd) Differential diagnosis of diseases of the musculoskeletal system

Disease and clinical findings	Epidemiological findings	Clinical pathology	Necropsy findings	Examples
<b>Arthritis</b> Acute: Sudden onset, severe pain, very lame, sore to touch, swelling, heat in joint Chronic: Continuous pain, recumbency, may be toxemia if infectious. Joint may be visibly swollen but may be normal appearance. Pain may be evident only when animal stands on joint	Most commonly in young via navel infection and bacteremia, or residual from septicemia of neonate	Aspiration of fluid under very sterile conditions shows leukocytes and somatic cells in large numbers. Culture may be positive but often negative. Joint fluid may appear normal in chronic case	Acute: Inflammation or suppuration, increased fluid content Chronic: Thickened synovial membrane Increased amount of clear fluid. Erosion of articular cartilage	Cattle: <i>Mycoplasma</i> sp., <i>Erysipelothrix rhusiopathiae</i> <i>Streptococcus</i> and <i>Staphylococcus</i> spp., <i>Escherichia coli</i> , <i>Salmonella</i> sp. in newborn. <i>Brucella abortus</i> , <i>Mycoplasma</i> sp. and <i>Chlamydochila</i> sp. Pigs: <i>E. Erysipelothrix rhusiopathiae</i> , <i>Mycoplasma</i> sp. Sheep: <i>Corynebacterium pseudotuberculosis</i> , <i>E. rhusiopathiae</i> , <i>Histophilus somni</i> , <i>Manheimia</i> <i>haemolytica</i> , <i>Actinobacillus seminis</i> , <i>Chlamydochila</i> sp., <i>Mycoplasma</i> sp. Horses: Foal septicemias
<b>Tenosynovitis, cellulitis, lymphangitis, bursitis</b> Inflammation of other supporting tissues. Visible, painful enlargements	Sporadic due to trauma or localization of systemic infection	Culture of aspirate from local lesion	Inflammation of affected part. Acute hemorrhagic or chronic, suppurative	Horses and cattle: Bursitis – <i>B. abortus</i> . Tenosynovitis – <i>Histophilus somni</i> , cattle, <i>Streptococcus equi</i> horse, <i>Histophilus somni</i> , sheep
<b>Interdigital dermatitis (footrot)</b> Severe foot lameness. Visible local lesion at skin-horn junction, necrotic smell, horn under-run. Allied similar conditions have less severe lesions	Severe epidemics in wet, warm weather in sheep. Infection soil-borne. Some farms have disease persistently	Culture of infectious agent, swab from depth of lesion	Necrosis of soft tissue	Sheep: Footrot – <i>Bacteroides nodosus</i> ; footscald – avirulent <i>B. nodosus</i> ; foot abscess – <i>F. necrophorus</i> ; <i>Arcanobacterium pyogenes</i> ; interdigital dermatitis – <i>F. necrophorum</i> Cattle: Footrot – <i>F. necrophorum</i> , <i>B. nodosus</i>
<b>Laminitis</b> Severe foot pain, separation of horn from sensitive laminae, rotation of the pedal bone. Metabolic, traumatic or infectious types	Sporadic except infectious type in sheep related to dipping. Possibly inherited susceptibility to metabolic laminitis in cattle	Very high blood pressure. Radiological demonstration of P <sub>3</sub> rotation	Infection or hemorrhage/edema, sensitive laminae	Sheep: <i>Erysipelothrix rhusiopathiae</i> – postdipping laminitis Horses – traumatic due to continuous pawing All species: Metabolic associated with heavy grain feeding – in mares with retained placenta and metritis
<b>Damage to horn of hoof</b> Severe foot pain if sensitive laminae affected. Horn damage obvious	Related to hard abrasive surfaces – pigs and dairy cattle; soft underfoot – cows indoors on wet bedding	Nil	Foothorn lesion only	Cattle: Stable footrot on soft footing; sole wear on rough concrete Pigs: Sole wear on rough concrete, predisposed by biotin deficiency in diet. Horses: Thrush and canker on soft wet underfoot

Table 13.1 (Cont'd) Differential diagnosis of diseases of the musculoskeletal system

Disease and clinical findings	Epidemiological findings	Clinical pathology	Necropsy findings	Examples
<p><b>Traumatic injuries of feet of newborn piglets</b></p> <p>Severe lameness in piglets 1–8 days of age. Bruising of sole, congestion and swelling followed by peeling, erosion and cracking of horn of sole; both claws and accessory digits injured more often on medial aspect and incidence in hindfeet twice that of forefeet; abrasions of skin of carpal joints common; accessory digits involved too. Ascending secondary bacterial infection resulting in tenosynovitis and septic arthritis. Most piglets recover following antibacterial therapy</p> <p><b>Coronitis dermatitis at coronet</b></p> <p>Lesions vary from granuloma through vesicles, erosions. Lameness in all, but severity varies with type of lesion. Essential to examine oral mucosa</p>	<p>Newborn piglets raised on concrete or slatted floors. Distribution of lesions related to sucking behavior of piglets, the backwards, outwards and downwards thrusting movements of the hindlegs while sucking</p>	<p>Nil</p>	<p>Erosion, necrosis, congestion, fissures and hemorrhage of horn of sole and sensitive laminae of digit. Secondary tenosynovitis and arthritis</p>	<p><i>Piglets:</i> Newborn piglets raised on concrete, expanded metal or plastic slatted floors</p>
<p><b>Coronitis dermatitis at coronet</b></p> <p>Lesions vary from granuloma through vesicles, erosions. Lameness in all, but severity varies with type of lesion. Essential to examine oral mucosa</p>	<p>Acute outbreaks of lameness due to coronitis in any species raises specter of food-and-mouth disease</p>	<p>Microbiology of material from local lesion</p>	<p>Local lesions only</p>	<p><i>Sheep:</i> Bluetongue, foot-and-mouth disease, vesicular stomatitis, ecthyma, strawberry footrot, ulcerative dermatosis, heel dermatitis (<i>B. nodosus</i>), strongyloidosis</p> <p><i>Cattle:</i> Foot-and-mouth disease, vesicular stomatitis, bovine virus diarrhoea, bovine malignant catarrh, epitheliogenesis imperfecta</p> <p><i>Pigs:</i> Foot-and-mouth disease, vesicular exanthema of swine, swine vesicular disease, vesicular stomatitis</p> <p><i>Horses:</i> Vesicular stomatitis, greasy heel, chorioptic mange</p>



calves; inherited moles, bulldog calves; acquired atrophic rhinitis of pigs.

### SPONTANEOUS FRACTURES

Spontaneous fractures occur uncommonly in farm animals and pre-existing diseases are usually present, which include the following:

- Nutritional excess of phosphorus causing osteodystrophia in horses
- Nutritional deficiency of calcium causing osteodystrophia in pigs
- Nutritional deficiency of phosphorus or vitamin D in ruminants causing rickets and/or osteomalacia; hypervitaminosis A may contribute to this
- Nutritional deficiency of copper
- Chronic fluorine intoxication.

### PAINFUL ASPECTS OF LAMENESS

**Musculoskeletal pain** can be caused by lacerations and hematomas of muscle, myositis and space-occupying lesions of muscle. Osteomyelitis, fractures, arthritis, joint dislocations, sprains of ligaments and tendons are also obvious causes of severe pain. Among the most painful of injuries are swollen, inflammatory lesions of the limbs caused by deep penetrating injury or in cattle by extension from footrot. Amputation of a claw, laminitis and septic arthritis are in the same category. Ischemia of muscle and generalized muscle tetany, as occurs in electro-immobilization, also appear to cause pain.

Research on the pathophysiology and pharmacology of pain associated with lameness in animals indicates that the thresholds to painful stimuli change in response to pain and this change is seen as an indication of an alteration in nerve function or in nociceptive processing at higher levels. In flocks of sheep with severe lameness due to foot rot, affected sheep had a lower threshold to a mechanical nociceptive stimulus than matched controls and their thresholds remained low when tested 3 months later, after the apparent resolution of the foot lesions.<sup>1</sup> Thus hyperalgesia persisted in severely lame sheep for at least 3 months. It is suggested that *N*-methyl-D-aspartate receptors are involved in the development of this long-term hypersensitivity. Similar findings have been reported in dairy heifers affected with claw lesions during the peripartum period.<sup>2</sup>

#### Relief of musculoskeletal pain

Several aspects about relieving pain in agricultural animals are important. Cost has always been a deterrent to the use of local anesthetics and analgesics but, with changing attitudes, the need to control

pain is more apparent. Treatment of the causative lesion is a major priority but the lesion may be painful for varying lengths of time. Relief and the control of pain should be a major consideration. Details on the use of analgesics are presented in Chapter 2.

### ECONOMICS OF LAMENESS IN FOOD-PRODUCING ANIMALS

Diseases of the musculoskeletal system and feet that cause lameness cause major economic losses. A survey of the incidence and prevalence of lameness in cattle on 37 dairy farms in the UK in 1989–91 found a mean annual incidence of 54.6 new cases per 100 cows (farm range 11–170%) and a mean annual prevalence of 21% (farm range 2–54%).<sup>3</sup> Loss of production occurs because animals that are in pain have difficulty moving around and do not eat and milk normally. Reproductive performance may be reduced because of failure to come into heat normally. The culling rate may be higher than is desirable because so many of the lesions of the feet and legs are incurable. The direct monetary costs for the treatment of lame animals are not high, but the actual treatment of either individual animals or groups of animals is time-consuming and laborious. The condemnation of animals to slaughter because of lesions of the musculoskeletal system also contributes to the total economic loss. When lameness is a herd problem not only are the economic losses increased but clinical management becomes very difficult.

The epidemiological factors which contribute to lameness include:

- Injuries due to floor surfaces
- Persistently wet, unhygienic ground conditions
- Overcrowding and trampling during transportation and handling
- Nutritional inadequacies
- Undesirable skeletal conformation
- Failure to provide regular foot-trimming.

Certain breeds may be more susceptible to diseases of the feet and legs than others. Osteoarthritis occurs most commonly in old animals. Diseases of the legs of dairy cattle occur most commonly at the time of parturition and during the first 50 days of lactation. Diseases of the feet of dairy cattle occur most commonly in days 50–150 of the lactation period. Often the etiology is complex and a definitive etiological diagnosis cannot be made. This makes clinical management difficult and often unrewarding.

### REFERENCES

1. Ley SJ et al. *Vet Rec* 1995; 137:85.

2. Whay HR et al. *Vet J* 1997; 154:155.

3. Clarkson MJ et al. *Vet Rec* 1996; 138:563.

### EXAMINATION OF THE MUSCULOSKELETAL SYSTEM

The clinical examination of the musculoskeletal system and the feet of farm animals would include the following special examinations.

#### Analysis of gait and conformation

Inspection of the gait of the animal is necessary to localize the site of lameness. Evaluation of its conformation may provide clues about factors that may contribute to lameness. Details on the examination of farm animals for lameness are available in textbooks on lameness in horses and cattle.

#### Close physical examination

A close detailed physical examination of the affected area is necessary to localize the lesion. This includes passive movements of limbs to identify fractures, dislocations and pain on movement. Muscles can be palpated for evidence of enlargement, pain, or atrophy.

#### Radiography

Radiography is useful for the diagnosis of diseases of bones, joints and soft tissue swelling of limbs, which cannot be easily defined by physical examination. Detailed radiographic information about the joint capsule, joint cavity or articular cartilage can be obtained using negative (air), positive or double contrast arthrography. Ultrasonographic imaging can be used to differentiate the pathological changes in the soft tissue structures of digital flexor tendon sheaths of cattle.<sup>1</sup>

#### Ultrasonography

Ultrasonography is used extensively in dogs and horses for the visualization of soft tissue structures of the joint. Most veterinary practices have an ultrasound machine that is used for small-animal imaging or transrectal pregnancy diagnosis in cattle and horses.<sup>2</sup> Ultrasonography is cheaper, faster and provides important information compared to radiography; it is also less invasive and cheaper than joint fluid aspiration and analysis.

The ultrasonographic anatomy of the elbow, carpal, fetlock, and stifle joints of clinically normal sheep using a 7.5 MHz linear transducer with a stand-off pad has been described.<sup>2</sup> The anatomical structures that could be consistently identified in normal ovine joints included bone, articular cartilage, ligaments and tendons. In sheep with chronic arthritis/synovitis, the gross thickening of the joint capsule is visible as a hyperechoic band up to 20 mm thick.

The ultrasonographic examination of the stifle region in cattle has been

described.<sup>3</sup> The homogeneously echogenic patellar and collateral ligaments, the combined tendon of the long digital extensor and peroneus tertius muscles, the popliteal tendon, the anechoic articular cartilage of femoral trochlea, the echogenic menisci and the hyperechoic bone surfaces were imaged successfully. The boundaries of the joint pouches became partially identifiable only when small amounts of anechoic fluid were present in the medial and lateral femorotibial joint pouches. The main indication for ultrasonography of the bovine stifle is evaluation of acute septic and traumatic disorders of the region, when specific radiographic signs are often nonspecific or absent. The cruciate ligaments could not be imaged in live cattle. The cruciate ligaments are identifiable in the horse, in which flexion of the hindlimb is a routine procedure necessary for identification of these structures.

The ultrasonographic examination of the carpal region in cattle has been described.<sup>4</sup> The main indication is the evaluation of septic and traumatic disorders of the carpal joints and tendon sheaths. Each tendon and tendon sheath in carpal region must be scanned separately. The use of a stand-off pad is recommended as it permits adaptation of the rigid transducer to the contours of the carpus. The carpal joint pouches and tendon sheath lumina are not clearly defined in healthy cattle. Thus the ability to image these structures indicates the presence of synovial effusion.

Ultrasonography is a valuable diagnostic aid for septic arthritis. Joint effusion, which is one of the earliest signs of septic arthritis, the accurate location of soft tissue swelling, the extent and character of joint effusion and involvement of concurrent periarticular synovial cavities or other soft tissue structures can be imaged by ultrasonography.<sup>5</sup> The ultrasonogram can image the presence of small, hyperechogenic fragments within the joint, appearing very heterogeneous. Normal synovial fluid is anechoic and appears black on the sonogram. A cloudy appearance is usually associated with the presence of pus.<sup>6</sup>

### Muscle biopsy

A muscle biopsy may be useful for microscopic and histochemical evaluations.

### Arthrocentesis

Joint fluid is collected by needle puncture of the joint cavity (arthrocentesis) and examined for the presence of cells, biochemical changes in the joint fluid and the presence of infectious agents. The techniques and application of arthrocentesis for some of the joints commonly sampled in the horse have been reviewed.

### Arthroscopy

Special endoscopes are available for inspection of the joint cavity and articular surfaces (arthroscopy). Diagnostic and surgical arthroscopy is now commonplace in specialized equine practice. Surgical arthroscopy is rapidly replacing conventional arthrotomy for the correction of several common surgical conditions of the musculoskeletal system of the horse. Accurate quantification of equine carpal lesions is possible when the procedure is performed by an experienced arthroscopist.<sup>7</sup> Convalescent time following surgery is decreased and the cosmetic appearance improved compared to arthrotomy. The arthroscopic anatomy of the intercarpal and radiocarpal joints of the horse have been described. A synovial membrane biopsy can be examined histologically and for infectious agents and may yield useful diagnostic information.

### Serum biochemistry and enzymology

When disease of bone or muscle is suspected, the serum levels of calcium, phosphorus, alkaline phosphatase and the muscle enzymes creatinine phosphokinase (CPK) and aspartate aminotransferase (AST), also known as serum glutamic oxaloacetic transaminase (SGOT), may be useful. The muscle enzymes are sensitive indicators of muscle cell damage; the serum levels of calcium, phosphorus and alkaline phosphatase are much less sensitive indicators of osteodystrophy.

### Nutritional history

Because the most important osteodystrophies and myopathies are nutritional in origin a complete nutritional history must be obtained. This should include an analysis of the feed and determination of the total amount of intake of each nutrient, including the ratio of one nutrient to another in the diet.

### Environment and housing

When outbreaks of lameness occur in housed cattle and pigs the quality of the floor must be examined to evaluate the possibility of floor injuries.

### REFERENCES

1. Kofler J. *Vet Rec* 1996; 139:36.
2. Macrae AI, Scott PR. *Vet J* 1999; 158:135.
3. Kofler J. *Vet J* 1999; 158:21.
4. Kofler J. *Vet J* 2000; 159:85.
5. Kofler J. *Br Vet J* 1996; 152:683.
6. Munroe GA, Cauvin ER. *Br Vet J* 1994; 150:439.
7. Hurtig MB et al. *Vet Surg* 1985; 14:93.

## Diseases of muscles

### MYASTHENIA (SKELETAL MUSCLE ASTHENIA)

The differential diagnosis of paresis, paralysis and incoordination should

include a consideration of skeletal muscle weakness unrelated to primary neurogenic hypotonia or to permanent muscle injury, including myopathy and myositis. Most of the syndromes that fall into this group of myasthenia have been described in detail elsewhere in this book and are referred to briefly here only to complete the list of abnormalities of skeletal muscle that affect gait and posture. Unlike myopathy and myositis, they are reversible states.

The common causes of myasthenia in farm animals are:

- **Ischemia** in iliac thrombosis in the horse and after recumbency in cows with parturient paresis. The end stage is myonecrosis and not reversible
- **Metabolic effect on muscle fibers** – causes include hypokalemia, hypocalcemia and possibly hypophosphatemia (in parturient paresis of dairy cows), hypomagnesemia (in lactation tetany), hypoglycemia of newborn pigs and lactic acidemia after engorgement on grain
- **Toxins** – general toxemia is a cause. Also, many plant toxins exert an effect on skeletal muscle activity. Although in most cases the mode of the action of the toxin is unknown, the toxins have been listed as neurotoxins.

### MYOPATHY

The term myopathy describes the non-inflammatory degeneration of skeletal muscle that is characterized clinically by muscle weakness and pathologically by hyaline degeneration of the muscle fibers. The serum levels of some muscle enzymes are elevated and myoglobinuria is a common accompaniment.

### ETIOLOGY AND EPIDEMIOLOGY

The most important myopathies in farm animals are due to nutritional deficiencies of vitamin E and selenium and the effects of unaccustomed exercise. In humans, in contrast, the muscular dystrophies occur as inherited defects of muscle or degenerative lesions caused by interruption of their nerve supply. The skeletal myopathies can be classified into primary and secondary myopathies.

A retrospective analysis of the case records in a veterinary teaching hospital over a 9-year period revealed that the most common myopathy in horses was exercise-associated muscle disorder (69%). The remainder were postexhaustion syndrome (9%), infectious myopathies (10.5%), immunological myopathy (6.0%), nutritional myopathy (4.5%) and hyperkalemic periodic paralysis (1.5%).<sup>1</sup>

The major causes of myopathy in farm animals and their epidemiological determinants are as follows.

### Enzootic nutritional muscular dystrophy

A nutritional deficiency of vitamin E and/or selenium is a common cause in young calves, lambs, foals, and piglets. Factors enhancing or precipitating onset include: rapid growth, highly unsaturated fatty acids in diet and unaccustomed exercise. The disease also occurs in adult horses.

### Exertional or postexercise rhabdomyolysis

This is not known to be conditioned by vitamin E (selenium deficiency) and occurs as equine paralytic myoglobinuria (tying-up syndrome, azoturia) in horses after unaccustomed exercise or insufficient training.<sup>1</sup> It also occurs in sheep chased by dogs, in cattle after running wildly for several minutes and as capture myopathy during capture of wildlife. An acute myopathy of undetermined etiology occurred in horses at grass in Scotland.<sup>2</sup> The horses were not in training, creatine kinase levels were elevated and the urine was dark brown; most of them died and the muscles affected were those of posture and respiration rather than movement.<sup>2</sup>

Equine polysaccharide storage myopathy is a metabolic disease being recognized with increasing frequency in many breeds of horse.<sup>3</sup> It occurs in Quarter-Horse-related breeds and more recently has been recognized in draught horse breeds. It is thought to be due to an inherited metabolic defect affecting carbohydrate metabolism (see Ch. 28).

### Metabolic

Hyperkalemic periodic paralysis occurs in certain pedigree lines of North American show Quarter Horses.

### Degenerative myopathy

This occurs in newborn calves, sheep and goats affected by Akabane virus infected in utero.

### Inherited myopathies

**The porcine stress syndrome**, which is discussed under that heading, now includes **herztod** pale, soft, exudative pork encountered at slaughter and malignant hyperthermia following halothane anesthesia. Certain blood types in pigs have been used as predictors of stress susceptibility and malignant hyperthermia in Pietrain pigs is genetically predetermined. Most of these myopathies of pigs thus have an inherited basis and the stress of transportation, overcrowding and handling at slaughter precipitates the lesion and rapid death.

**Congenital myopathy of Braunvieh-Brown Swiss calves** is thought to be inherited.<sup>4</sup> Affected calves become progressively weak and recumbent within 2 weeks of birth.<sup>4</sup>

**Doubling-muscling in cattle and splaylegs of newborn pigs** are also considered to be inherited. A **dystrophy-like myopathy** in a foal has been described and is similar to human muscular dystrophy.<sup>5</sup> **Dystrophy of the diaphragmatic muscles** in adult Meuse-Rhine-Yessel cattle is thought to be inherited. **Xanthosis** occurs in the skeletal and cardiac muscles of cattle and is characterized grossly by a green iridescence.

### Toxic agents

This is caused by poisonous plants, including *Cassia occidentalis*, *Karwinskia humboldtiana*, *Ixioloena* spp., *Geigeria* spp. and lupins. A special case is enzootic calcinosis of all tissues, especially muscle, and the principal signs are muscular. It is caused by poisoning by *Solanum malacoxylon*, *Tricetum* spp., and *Cestrum* spp.

### Ischemia

Ischemic myonecrosis occurs in the thigh muscles of cattle recumbent for about 48 hours or more and is discussed in detail under the heading Downer cow syndrome. Iliac thrombosis in horses is an important cause of ischemic myopathy and has been reported in calves.

### Neurogenic

Neurogenic muscular atrophy occurs sporadically due to traumatic injury and subsequent degeneration or complete severance of the nerve supply to skeletal muscle. The myopathy in arthrogryposis associated with the Akabane virus is thought to be due to lesions of the lower motor neurons supplying the affected muscles. It has been suggested that cattle with muscular hypertrophy may be more susceptible to the effects of exercise and the occurrence of acute muscular dystrophy. Suprascapular nerve paralysis in the horse (sweeney) is a traumatic neuropathy resulting from compression of the nerve against the cranial edge of the scapula.

### Neoplasms

Neoplasms of striated muscle are uncommon in animals. Rhabdomyosarcomas are reported in the horse, affecting the diaphragm and causing loss of body weight, anorexia and respiratory distress.

### PATHOGENESIS

#### Primary myopathy

The characteristic change in most cases of primary myopathy varies from hyaline degeneration to coagulative necrosis, affecting particularly the heavy thigh muscles and the muscles of the diaphragm. Myocardial lesions are also commonly associated with the degeneration of skeletal muscle and when severe will cause rapid death within a few hours or

days. The visible effects of the lesions are varying degrees of muscle weakness, muscle pain, recumbency, stiff gait, inability to move the limbs and the development of respiratory and circulatory insufficiency.

In primary nutritional muscular dystrophy associated with a deficiency of vitamin E and/or selenium there is lipoperoxidation of the cellular membranes of muscle fibers resulting in degeneration and necrosis. The lesion is present only in muscle fibers and the histological and biochemical changes which occur in the muscle are remarkably similar irrespective of the cause. Variations in the histological lesion occur but indicate variation in the severity and rapidity of onset of the change rather than different causes.

### Myoglobinuria

Because of the necrosis of muscle, myoglobin is excreted in the urine and **myoglobinuric nephrosis** is an important complication, particularly of acute primary myopathy. The degree of myoglobinuria depends on the severity of the lesion, acute cases resulting in marked myoglobinuria, and on the age and species of animal affected. Adult horses with myopathy may liberate large quantities of myoglobin, resulting in dark brown urine. Yearling cattle with myopathy release moderate amounts and the urine may or may not be colored; calves with severe enzootic nutritional muscular dystrophy may have grossly normal urine. In all species the renal threshold of myoglobin is so low that discoloration of the serum does not occur.

### Muscle enzymes

An important biochemical manifestation of myopathy is the increased release of muscle cell enzymes that occurs during muscle cell destruction. CPK and serum glutamic oxaloacetate transaminase are both elevated in myopathy and CPK, particularly, is a more specific and reliable indication of acute muscle damage. Increased amounts of creatinine are also released into the urine following myopathy.

### Exertional rhabdomyolysis

In exertional rhabdomyolysis in horses there is enhanced glycolysis with depletion of muscle glycogen, the accumulation of large amounts of lactate in muscle and blood and the development of hyaline degeneration of myofibers. Affected muscle fibers are richer in glycogen in the acute stage of 'tying-up' than in the late stages, suggesting an increased glycogen storage in the early phase of the disease compared with normal healthy horses. During enforced exercise there is local muscle hypoxia and anaerobic oxidation

resulting in the accumulation of lactate and myofibrillar degeneration. The pathogenesis of postanesthetic myositis in horses is uncertain.<sup>6</sup> A significant postischemic hyperemia occurs in horses that develop postanesthetic myopathy.<sup>6</sup> Postanesthetic recumbency can occur in the horse with polysaccharide storage myopathy.<sup>7</sup>

### Types of muscle fiber affected

In most animals skeletal muscle is composed of a mixture of fibers with different contractile and metabolic characteristics. Fibers with slow contraction times have been called slow twitch or type I fibers and those with fast contraction time are fast twitch or type II. Histochemically, types I and II fibers can be differentiated by staining for myofibrillar ATPase. Type II fibers can be subgrouped into type IIA and IIB on the basis of acid preincubations.<sup>8</sup> Several different characteristics of these muscle fibers have been studied in the horse. There are variations in the percentage of each type of fiber present and in composition of muscle fibers dependent on genetic background, age, and stage of training.<sup>8</sup> There are also variations in the muscle fibers within one muscle<sup>9</sup> and between different muscles.<sup>10</sup> The histochemical characteristics of equine muscle fibers have been examined:<sup>11,12</sup>

- Type I fibers are characterized by strong aerobic capacity, compared with type IIA
- Type IIA fibers are more glycolytic and have strong aerobic and moderate to strong anaerobic capacities
- Type IIB fibers are characterized by a relatively low aerobic and a relatively high anaerobic capacity and are glycolytic.<sup>11</sup>

The histochemical staining characteristics of normal equine skeletal muscle have been examined and serve as a standard for comparison with data obtained from skeletal muscles with lesions.<sup>12</sup>

### Secondary myopathy due to ischemia

In secondary myopathy due to ischemia there may be multiple focal areas of necrosis, which causes muscle weakness and results in an increase of muscle enzymes in the serum. The degree of regeneration with myofibers depends on the severity of the lesion. Some regeneration occurs but there is considerable tissue replacement. In aortic and iliac thrombosis in calves under 6 months of age the thrombosis results in acute-to-chronic segmental necrosis of some skeletal muscles and coagulation necrosis in others.<sup>13</sup>

### Neurogenic atrophy of muscle

In neurogenic atrophy there is flaccid paralysis, a marked decrease in total muscle mass and degeneration of myofibers, with failure to regenerate unless the nerve supply is at least partially restored.

### CLINICAL FINDINGS

The nutritional myopathies associated with a deficiency of vitamin E and/or selenium occur most commonly in young growing animals and may occur in outbreak form, particularly in calves and lambs. The details are presented under the heading of vitamin E and selenium deficiency.

### Primary myopathy

In general terms, in acute primary myopathy there is a sudden onset of weakness and pseudoparalysis of the affected muscles, causing paresis and recumbency and, in many cases, accompanying respiratory and circulatory insufficiency. The affected animals will usually remain bright and alert but may appear to be in pain. The temperature is usually normal but may be slightly elevated in severe cases of primary myopathy. Cardiac irregularity and tachycardia may be evident, and myoglobinuria occurs in adult horses and yearling cattle. The affected skeletal muscles in acute cases may feel swollen, hard and rubbery but in most cases it is difficult to detect significant abnormality by palpation. Acute cases of primary myopathy may die within 24 hours after the onset of signs.

### Acute nutritional myopathy

While acute nutritional myopathy in horses occurs most commonly in foals from birth to 7 months of age, acute dystrophic myodegeneration also occurs in adult horses. There is muscle stiffness and pain, myoglobinuria, edema of the head and neck, recumbency and death in a few days. A special occurrence of myopathy has been recorded in suckling Thoroughbred foals up to 5 months of age. The disease occurs in the spring and summer in foals running at pasture with their dams and is unassociated with excessive exercise. In peracute cases there is a sudden onset of dejection, stiffness, disinclination to move, prostration and death 3–7 days later. Lethargy and stiffness of gait are characteristic of less acute cases. There is also a pronounced swelling and firmness of the subcutaneous tissue at the base of the mane and over the gluteal muscles. There may be excessive salivation, desquamation of lingual epithelium and board-like firmness of the masseter muscles. The foals are unable to suck because of inability to bend their necks. Spontaneous recovery occurs in mild cases but most severely affected foals die.

Severe nutritional myopathy of the masseter muscles in a 6-year-old Quarter Horse stallion has been described.<sup>14</sup> The masseter muscles were swollen and painful, and there was exophthalmos and severe chemosis with protrusion of the third eyelids. The mouth could be opened only slightly and masticatory efforts were weak. Serum enzymology supported a diagnosis of nutritional muscular dystrophy, and the concentrations of vitamin E and selenium in the blood and feed were lower than normal.

### Tying-up

In tying-up in horses there is a very sudden onset of muscle soreness 10–20 minutes following exercise. There is profuse sweating and the degree of soreness varies from mild, in which the horse moves with a short, shuffling gait, to acute, in which there is a great disinclination to move at all. In severe cases, horses are unable to move their hindlegs, and swelling and rigidity of the croup muscles develops. Myoglobinuria is common.

### Postanesthetic myositis

In postanesthetic myositis affected horses experience considerable difficulty during recovery from anesthesia. Recovery is prolonged and when initial attempts are made to stand there is lumbar rigidity, pain and reluctance to bear weight.<sup>7</sup> Some affected horses will be able to stand in within several hours if supported in a sling.<sup>7</sup> The limbs may be rigid and the muscles firm on palpation. In severe cases the temperature begins to rise – reminiscent of malignant hyperthermia. Other clinical findings include anxiety, tachycardia, profuse sweating, myoglobinuria and tachypnea. Death may occur in 6–12 hours. Euthanasia is the only course for some horses. In the milder form of the syndrome, affected horses are able to stand, but are stiff and in severe pain for a few days.

### Exertional rhabdomyolysis

In horses, the clinical findings are **variable** and range from poor performance to recumbency and death. Signs may be mild and resolve spontaneously within 24 hours or severe and progressive.

The **usual presentation** is a young (2–5-year-old) female racehorse with recurrent episodes of stiff gait after exercise. The horse does not perform to expectation and displays a **short-stepping gait** that may be mistaken for lower leg lameness. The horse may be reluctant to move when placed in its stall, be apprehensive and anorexic, and frequently shift its weight. More severely affected horses may be unable to continue to exercise, have **hard and painful**

**muscles** (usually gluteal muscles), sweat excessively, be apprehensive, refuse to walk and be tachycardic and tachypneic. Affected horses may be hyperthermic. Signs consistent with abdominal pain are present in many severely affected horses. Deep red urine (myoglobinuria) occurs but is not a consistent finding. Severely affected horses may be recumbent and unable to rise.

Many different manifestations of equine polysaccharide storage myopathy occur.<sup>3</sup> All manifestations are related to dysfunction, which results in pain, weakness, segmental fiber necrosis, stiffness, spasm, atrophy or any combination of the above. The muscles most severely affected are the powerful rump, thigh and back muscles, including gluteals, semi-membranosus, semitendinosus and longissimus.

In exertional rhabdomyolysis in sheep chased by dogs, affected animals are recumbent, cannot stand, appear exhausted and myoglobinuria is common. Death usually follows. A similar clinical picture occurs in cattle that have run wildly for several minutes.

#### **Hyperkalemic periodic paralysis**

Initially there is a brief period of myotonia with prolapse of the third eyelid. In severe cases, the horse becomes recumbent and the myotonia is replaced by flaccidity. Sweating occurs, and generalized muscle fasciculations are apparent, with large groups of muscle fibers contracting simultaneously at random. The animal remains bright and alert and responds to noise and painful stimuli. In milder cases, affected horses remain standing and generalized muscle fasciculations are prominent over the neck, shoulder and flank. There is a tendency to stand base-wide. When the horse is asked to move, the limbs may buckle and the animal appears weak. The horse is unable to lift its head, usually will not eat and may yawn repeatedly early in the course of an episode. The serum potassium levels are elevated above normal during the episodes.

#### **Secondary myopathy due to ischemia**

In secondary myopathy due to ischemia, e.g. the downer cow syndrome, the affected animal is unable to rise and the affected hindlegs are commonly directed behind the cow in the frogleg attitude. The appetite and mental attitude are usually normal. No abnormality of the muscles can be palpated. With supportive therapy, good bedding and the prevention of further ischemia by frequent rolling of the animal, most cows will recover in a few days.

In calves with aortic and iliac artery thrombosis there is an acute onset of

paresis or flaccid paralysis of one or both pelvic limbs.<sup>13</sup> Affected limbs are hypothermic and have diminished spinal reflexes and arterial pulse pressures. The diagnosis can be defined using angiography. Affected calves die or are euthanized because treatment is not undertaken.

#### **Neurogenic atrophy**

With neurogenic atrophy there is marked loss of total mass of muscle, flaccid paralysis, loss of tendon reflexes and failure of regeneration. When large muscle masses are affected, e.g. quadriceps femoris in femoral nerve paralysis in calves at birth, the animal is unable to bear normal weight on the affected leg.

#### **Dystrophy of the diaphragmatic muscles**

In dystrophy of the diaphragmatic muscles in adult Meuse-Rhine-Yessel cattle there is loss of appetite, decreased rumination, decreased eructation and recurrent bloat. The respiratory rate is increased with forced abdominal respirations, forced movement of the nostrils and death from asphyxia in a few weeks.

Severe diaphragmatic necrosis in a horse with degenerative myopathy due to polysaccharide storage myopathy has been described.<sup>15</sup> Affected horses may have severe respiratory distress and respiratory acidosis, and do not respond to supportive therapy.

### **CLINICAL PATHOLOGY**

#### **Muscle-derived serum enzymes**

The serum levels of the muscle enzymes are characteristically elevated following myopathy due to release of the enzymes from altered muscle cell membranes. Creatine kinase (CK) is a highly specific indication of both myocardial and skeletal muscle degeneration. Plasma CK activity is related to three factors: the amount and rate of CK released from an injured muscle into plasma, its volume of distribution and its rate of elimination.<sup>16</sup> CK has a half-life of about 4–6 hours and, following an initial episode of acute myopathy, serum levels of the enzyme may return to normal within 3–4 days if no further muscle degeneration has occurred. Levels of AST are also increased following myopathy but, because the enzyme is present in other tissues such as liver, it is not a reliable indicator of primary muscle tissue degeneration.

Because AST has a longer half-life than CK, the levels of AST may remain elevated for several days following acute myopathy. The daily monitoring of both CK and AST levels should provide an indication of whether active muscle degeneration is occurring. A marked drop in CK levels and a slow decline in

AST levels suggests that no further degeneration is occurring whereas a constant elevation of CK suggests active degeneration.

In acute nutritional muscular dystrophy in calves, lambs, and foals the CK levels will increase from normal values of below 100 IU/L to levels ranging from 1000–5000 IU/L and even higher. The levels of CK in calves will increase from a normal of 50 IU/L to approximately 5000 IU/L within a few days after being placed outdoors followed by unconditioned exercise. There is some preliminary investigation into quantification of the amount of skeletal damage in cattle based on the amount of CK activity.<sup>16</sup>

The measurement of serum levels of glutathione peroxidase is a useful aid in the diagnosis of myopathy due to selenium deficiency.

In downer cows with ischemic necrosis of the thigh muscles, the CK and AST levels will be markedly elevated and will remain elevated if muscle necrosis is progressive in cows that are not well bedded and rolled from side to side several times daily to minimize the degree and extent of ischemic necrosis.

High levels of CK (1000 IU/L and greater) usually indicate acute primary myopathy. Levels from 500–1000 IU/L may be difficult to interpret in animals recumbent for reasons other than primary myopathy. This will necessitate a careful reassessment of the clinical findings, history and epidemiology.

In horses with acute exertional rhabdomyolysis (paralytic myoglobinuria) the CK levels will range from 5000–10 000 IU/L. Following vigorous exercise in unconditioned horses, the CK and AST levels will rise as a result of increased cell membrane permeability associated with the hypoxia of muscles subjected to excessive exercise. Lactate dehydrogenase (LDH) has also been used as a biochemical measurement of the degree of physical work done by horses in training. With progressive training in previously unconditioned horses there is no significant change between rest and exercise in the levels of serum CK, AST, and LDH. In horses with postanesthetic myositis the CK levels may exceed 100 000 IU/L, the serum calcium is decreased and the serum inorganic phosphorus is increased. In naturally occurring cases of exertional rhabdomyolysis in horses the most consistent acid-base abnormality may be a hypochloremia rather than metabolic acidosis as has been assumed.

#### **Muscle biopsy**

Investigation of the structural and biochemical alterations of muscle tissue in myopathy include biopsy techniques that

have been described.<sup>3,17</sup> Needle biopsies require a specialized Bergstrom muscle biopsy needle, which most practitioners do have on hand. Open biopsy is recommended in order to obtain a strip of muscle. Biopsy of either the semimembranosus or semitendinosus muscles, at a site between the base of the tail and the tuber ischium, provides an adequate sample. Muscle biopsy samples can be processed for either frozen section or routine formalin-fixed, paraffin-embedded sections. The frozen section is considered the gold standard.

Inclusions of periodic-acid-Schiff (PAS)-positive, amylase-resistant complex polysaccharide are abnormal and characteristic findings in muscle of equine polysaccharide storage myopathy.<sup>3</sup>

Histochemical techniques can be used on muscle biopsies of horses with muscular disease and animals with congenital and inherited myopathies.<sup>4</sup>

### Myoglobinuria

Myoglobinuria is a common finding in adult horses with acute paralytic myoglobinuria but is not a common finding in acute nutritional muscular dystrophy in young farm animals, except perhaps in yearling cattle with acute muscular dystrophy. The myoglobinuria may be clinically detectable as a red or chocolate brown discoloration of the urine. This discoloration can be differentiated from that caused by hemoglobin by spectrographic examination or with the use of orthotoluidine paper strips. Urine becomes dark when myoglobin levels exceed 40 mg/dL of urine. Discoloration of the plasma suggests hemoglobinuria. Both myoglobin and hemoglobin give positive results for the presence of protein in urine. Porphyria causes a similar discoloration although this may not be evident until the urine has been exposed to light for some minutes. The coloration is lighter, pink to red rather than brown, and the urine is negative to the guaiac test and fluoresces with ultraviolet light. Creatinuria accompanies acute myopathy but has not been used routinely as a diagnostic aid.

**Electromyography** is a special technique for the evaluation of the degree of neurogenic atrophy.

### NECROPSY FINDINGS

Affected areas of skeletal muscle have a white, waxy, swollen appearance like fish flesh. Commonly only linear strips of large muscle masses are affected and the distribution of lesions is characteristically bilaterally symmetrical. Histologically the lesion varies from a hyaline degeneration to a severe myonecrosis, with subsequently the disappearance of large groups of muscle fibers and replacement by con-

nective tissue. Calcification of the affected tissue may be present to a mild degree in these cases.

The lesions in exertional rhabdomyolysis in the horse are of a focal distribution and consist of hyaline degeneration with insignificant inflammatory reaction and slight calcification. The degenerative changes affect primarily the fast twitch fibers, which have a low oxidative capacity and are used when the horse trots at very close to its maximum speed.

### DIFFERENTIAL DIAGNOSIS

Most myopathies in farm animals occur in rapidly growing, young animals and are characterized clinically by a sudden onset of acute muscular weakness, and pain often precipitated by unaccustomed exercise. There may be evidence of a dietary deficiency of vitamin and selenium in the case of nutritional muscular dystrophy. A sudden onset of recumbency or stiffness in young farm animals that are bright and alert should arouse suspicion of acute muscular dystrophy. Primary myopathies are not common in adult cattle, sheep or pigs but myopathy secondary to recumbency for other reasons does occur.

Secondary myopathy due to aortic and iliac thrombosis in calves must be differentiated from other common causes of hindlimb paresis including traumatic injury to the spinal cord, spinal cord compression due to vertebral body abscess, nutritional muscular dystrophy, myositis and nerve damage due to trauma of intramuscular injections, and clostridial myositis.<sup>14</sup>

The exertional myopathies in the horse in training are usually readily obvious. The CK levels are valuable aids to diagnosis. In special circumstances, such as neurogenic myopathy, muscle biopsy and electromyography may be useful additional diagnostic aids. The histological and histochemical staining characteristics of equine muscle have been described and serve as a standard for comparison with abnormal muscle.

Myositis may present a similar syndrome but is usually present as a secondary lesion in a clinically distinguishable primary disease or is accompanied by obvious trauma or toxemia.

### TREATMENT

Vitamin E and selenium are indicated for the treatment of nutritional muscular dystrophy and the details are provided under that heading. The treatment of exertional rhabdomyolysis in horses has not been well defined because of the uncertain etiology, but enforced rest and the relief of pain, if necessary, seems logical. Supportive therapy for any case of myopathy, particularly severe cases in which there is persistent recumbency, consists of:

- Liberal quantities of thick bedding
- Removal from solid floors to softer ground
- Frequent turning from side to side to minimize secondary myopathy
- Provision of fluid therapy to prevent myoglobinuric nephrosis
- A palatable, nutritious diet.

With the exception of the sporadically occurring congenital and inherited myopathies of farm animals, all the nutritional and exertional myopathies are amenable to treatment if it is begun early and if adequate supportive therapy is provided.

In myopathies associated with systemic acidosis the use of a solution of sodium bicarbonate may be indicated. Dietary sodium bicarbonate at the rate of 2% of total dry matter intake has been used for the treatment of exertional rhabdomyolysis in a horse.<sup>18</sup> Horses with postanesthetic myositis must be considered as critical care patients for 18–24 hours. Maintenance of adequate renal perfusion is vital. Large quantities of intravenous polyionic balanced electrolyte fluids (50–100 L) must be given over a 24-hour period. Dantrolene sodium at 4 mg/kg body weight (BW) given orally immediately upon recognition of clinical signs is efficacious.

### CONTROL

The nutritional myopathies in farm animals can be satisfactorily prevented by the provision of adequate quantities of dietary vitamin E and selenium in the maternal diet during pregnancy or at the strategic times in postnatal life. The prevention of exertional myopathy in the horse depends on a progressive training program and avoidance of sudden unaccustomed exercise in animals that are in good body condition and have been inactive. Similarly, in general terms, the prevention of the porcine stress syndrome will depend on careful handling and transportation techniques combined with genetic selection of resistant pigs.

### REVIEW LITERATURE

Valentine BA. Equine polysaccharide storage myopathy. *Equine Vet Educ* 2003; 15:254–262.

### REFERENCES

1. Freestone JF, Carlson GP. *Equine Vet J* 1991; 23:86.
2. Hosie BD et al. *Vet Rec* 1986; 119:444.
3. Valentine BA. *Equine Vet Educ* 2003; 15:254.
4. Hafner A et al. *J Comp Pathol* 1996; 115:23.
5. Sarli G et al. *Vet Rec* 1994; 135:156.
6. Serteyn D et al. *Vet Rec* 1988; 123:126.
7. Bloom BA et al. *Vet Rec* 1999; 144:73.
8. Essen-Gustavsson B, Lindholm A. *Equine Vet J* 1985; 17:434.
9. Bruce V, Turek RJ. *Equine Vet J* 1985; 17:317.
10. Van den Hoven R et al. *Am J Vet Res* 1985; 46:939.
11. Van den Hoven R et al. *Am J Vet Res* 1985; 46:1755.
12. Andrews FM, Spurgeon TL. *Am J Vet Res* 1986; 47:1843.

13. Morley PS et al. *J Am Vet Med Assoc* 1996; 209:130.
14. Step DL et al. *J Am Vet Med Assoc* 1991; 198:117.
15. Valentine BA et al. *Can Vet J* 2002; 43:614.
16. Lefebvre HP et al. *Am J Vet Res* 1994; 55:487.
17. Van den Hoven R et al. *Equine Vet J* 1988; 20:46.
18. Robb EJ, Kronfeld DS. *J Am Vet Med Assoc* 1986; 188:602.

## MYOSITIS

Myositis may arise from direct or indirect trauma to muscle and occurs as part of a syndrome in a number of specific diseases including blackleg, foot-and-mouth disease, bluetongue, ephemeral fever, swine influenza, sarcosporidiosis and trichinosis, although clinical signs of myositis are not usually evident in the latter. Sporadic cases of a localized infectious myositis of skeletal muscles, associated with *Escherichia coli*, may occur in calves.<sup>1</sup> An asymptomatic eosinophilic myositis is not uncommon in beef cattle and may cause economic loss through carcass condemnation. The cause has not been determined.

### Acute myositis of limb muscles

This disease is accompanied by severe lameness, swelling, heat and pain on palpation. There may be accompanying toxemia and fever. In chronic myositis there is much wasting of the affected muscles and this is difficult to differentiate clinically from atrophy due to other causes. Biopsy of the muscles may be necessary to confirm the diagnosis.

Injury to the gracilis muscle can cause acute, severe lameness in performance Quarter Horses.<sup>2</sup> Horses competing in barrel racing may be susceptible to gracilis muscle injury because the muscle functions to adduct the hind limb. The prognosis is good for returning to athletic use after an adequate period of muscle healing and mild exercise. However, fibrotic myopathy or muscle atrophy can be a complication of the injury resulting in persistent gait deficits.

In horses traumatic myositis of the posterior thigh muscles may be followed by the formation of fibrous adhesions between the muscles (fibrotic myopathy) and by subsequent calcification of the adhesions (ossifying myopathy). External trauma can result in fibrotic myopathy but it may also be associated with excessive exercise or secondary to intramuscular injections.

Occasionally similar lesions may be seen in the foreleg. The lesions cause a characteristic abnormality of the gait in that the stride is short in extension and the foot is suddenly withdrawn as it is about to reach the ground. The affected area is abnormal on palpation.

An inherited disease of pigs, generalized myositis ossificans, is also characterized

by deposition of bone in soft tissues. In traumatic injuries caused by penetration of foreign bodies into muscle masses, ultrasonography may be used to detect fistulous tracts and the foreign bodies.

Extensive damage to or loss of muscle occurs in screwworm and sometimes blowfly infestation, although the latter is more of a cutaneous lesion, and by the injection of necrotizing agents. For example, massive cavities can be induced in the cervical muscles of horses by the intramuscular injection of escharotic iron preparations intended only for slow intravenous injection. Similarly, necrotic lesions can result from the intramuscular injection of infected or irritant substances. Horses are particularly sensitive to tissue injury, or are at least most commonly affected. Some common causes are chloral hydrate, antimicrobials suspended in propylene glycol, and even antimicrobials alone in some horses.

### Injection site clostridial infections in horses

Clostridial myositis, myonecrosis, cellulitis, and malignant edema are terms used to describe a syndrome of severe necrotizing soft tissue infection associated with *Clostridium* spp. Affected horses typically develop peracute emphysematous soft tissue swelling in the region of an injection or wound within hours of the inciting cause. It can occur following the intramuscular or inadvertent perivascular administration of a wide variety of commonly administered drugs.<sup>3</sup> In a series of 37 cases, the lesion occurred within 6–72 hours of a soft-tissue injection in most cases and most were in the neck musculature. Aggressive treatment can be associated with a survival rate of up to 81% for cases due to *Clostridium perfringens* alone; survival rates for other *Clostridium* spp. are lower. A combination of a high dose of intravenous antibiotic therapy and surgical fenestration and debridement is the recommended approach to treatment.

### Injection site lesions in cattle

Muscle lesions associated with injection sites in the cattle industry are a source of major economic loss because of the amount of trim required at slaughter. The presence of injection-site lesions in whole muscle cuts, such as the top sirloin and outside round, limits their use and value. The occurrence of injection-site lesions in muscle is among the top five quality challenges for both beef and dairy market cows and bulls.<sup>4</sup> Because injection-site lesions are concealed in muscles and/or are under subcutaneous fat, they are seldom found during fabrication at the packing plant and appear instead during wholesale/retail fabrication or at the consumer level. In 1998, the National Animal

Health Monitoring System found that 47% of producers and 37% of veterinarians administered intramuscular injections in the upper or lower rear leg of cows; the need for further educational effort is apparent.

Monitoring the frequency of injection-site lesions allows educational efforts of state and national beef quality assurance programs to evaluate, more definitively, management practices of producers that can be changed to minimize occurrence of these defects. Audits done at abattoirs between 1998 and 2000 in the USA indicate that the frequency of injection-site lesions has decreased but the need remains for educational programs and continued improvements in beef quality assurance practices among beef and dairy cattle producers.<sup>4</sup> Historically, most intramuscular injections were given in the gluteals and the biceps femoris muscles, which are prime cuts of beef. Surveys of injection sites in beef cattle in North America have found lesions in a significant percentage of prime cuts of beef.<sup>5</sup> Lesions consisting of clear scars and woody calluses are mature and probably originated in calfhood; scars with nodules or cysts are less mature, occurring later in the feeding period. It is now recommended that intramuscular injections be given in the cervical muscles. Reducing the incidence of injection site lesions requires that manufacturers of biological and antibiotic preparations develop less irritating formulations. Products should be formulated for subcutaneous use whenever possible and administered in the neck muscles, which are not prime cuts of beef.

The outcome of an intramuscular injection depends on the nature of the lesion produced. Myodegeneration following intramuscular injections of antibiotics in sheep results in full muscle regeneration within less than 3 weeks.<sup>6</sup> Necrosis following the injection results in scar formation with encapsulated debris, which persists for more than a month and leaves persistent scar tissue.

An outbreak of myositis, lameness and recumbency occurred following the injection of water-in-adjuvanted vaccines into the muscles of the left and right hips of near-term pregnant beef cattle.<sup>7</sup> Within 24 hours, some cattle were recumbent, some had nonweightbearing lameness and, within 10 days, 50% of the herd developed firm swellings up to 24 cm in vaccination sites. Histologically, granulomatous myositis with intralesional oil was present. The swellings resolved over a period of 6 months. The acute transient lameness was attributed to the use of two irritating biological vaccines in the hip muscles of cows near parturition.



## REFERENCES

1. Mills LL et al. *J Am Vet Med Assoc* 1990; 197:1487.
2. Dabareiner RM et al. *J Am Vet Med Assoc* 2004; 224:1630.
3. Peek SF et al. *Equine Vet J* 2003; 35:86.
4. Roeber DL et al. *J Dairy Sci* 2002; 85:532.
5. Van Donkersgoed J et al. *Can Vet J* 1998; 39:97.
6. Mikaelian I et al. *Vet Res* 1996; 27:97.
7. O'Toole D et al. *J Vet Diagn Invest* 2005; 17:23.

## Diseases of bones

### OSTEODYSTROPHY

Osteodystrophy is a general term used to describe those diseases of bones in which there is a failure of normal bone development, or abnormal metabolism of bone that is already mature. The major clinical manifestations include distortion and enlargement of the bones, susceptibility to fractures and interference with gait and posture.

#### ETIOLOGY

The common causes of osteodystrophy in farm animals include the following.

#### Nutritional causes

Calcium, phosphorus and vitamin D Absolute deficiencies or imbalances in calcium-phosphorus ratios in diets cause:

- Rickets in young animals, e.g., growing lambs fed a diet rich in wheat bran
- Absolute deficiencies of calcium
- Beef calves on intensive rations with inadequate supplementation<sup>1</sup>
- Osteomalacia in adult ruminants.

**Osteodystrophia fibrosa in the horse** occurs most commonly in animals receiving a diet low in calcium and high in phosphorus.

**Osteodystrophia fibrosa in pigs** occurs as a sequel to rickets and osteomalacia, which may occur together in young growing pigs that are placed on rations deficient in calcium, phosphorus and vitamin D following weaning.

#### Copper deficiency

- Osteoporosis in lambs
- Epiphysitis in young cattle.

#### Other nutritional causes

- Inadequate dietary protein and general undernutrition of cattle and sheep can result in severe osteoporosis and a great increase in ease of fracture
- Chronic parasitism can lead to osteodystrophy in young growing ruminants
- Hypovitaminosis A and hypervitaminosis A can cause osteodystrophic changes in cattle and pigs
- Prolonged feeding of a diet high in calcium to bulls can cause nutritional

hypercalcitoninism combined with replacement of trabecular bone in the vertebrae and long bones with compact bone, and neoplasms of the ultimobranchial gland

- Multiple vitamin and mineral deficiencies are recorded as causing osteodystrophy in cattle. The mineral demands of lactation in cattle can result in a decrease in bone mineral content during lactation with a subsequent increase during the dry period.

#### Chemical agents

- Chronic lead poisoning is reputed to cause osteoporosis in lambs and foals
- Chronic fluorine poisoning causes the characteristic lesions of osteofluorosis, including osteoporosis and exostoses
- Grazing the poisonous plants *Setaria sphacelata*, *Cenchrus ciliaris*, and *Panicum maximum* var. *trichoglume* causes osteodystrophia in horses
- Enzootic calcinosis of muscles and other tissues is caused by the ingestion of *Solanum malacoxylon*, *Solanum torvum*, *Trisetum flavescens* (yellow oatgrass), and *Cestrum diurnum*, which exert a vitamin-D-like activity
- Bowie or bentleg, a disease caused by poisoning with *Trachymene glaucifolia*, is characterized by extreme outward bowing of the bones of the front limbs.

#### Inherited and congenital causes

There are many inherited and congenital defects of bones of newborn farm animals, which are described, and discussed in detail in Chapter 34. In summary, these include:

Achondroplasia and chondrodystrophy in dwarf calves and some cases of prolonged gestation Osteogenesis imperfecta in lambs and Charolais cattle. There is marked bone fragility and characteristic changes on radiological examination Osteopetrosis in Hereford and Angus calves Chondrodystrophy in 'acorn' calves Inherited exostoses in horses; inherited thicklegs and inherited rickets of pigs, which are well-established entities.

**Angular deformities** of joints of long bones due to asymmetric growth plate activity are common in foals and are commonly repaired surgically.<sup>2</sup> The distal radius and distal metacarpus are most often affected, the distal tibia and metatarsal less commonly. Physiologically immature foals subjected to exercise may develop compression-type fractures of the central or third tarsal bones. Some of these

foals are born prematurely or are from a twin pregnancy. Retained cartilage in the distal radial physis of foals 3-70 days of age presents without apparent clinical signs.

**Physitis** is dysplasia of the growth plate, characterized by an irregular border between the cartilage and the metaphyseal zone of ossification, an increase in the lateromedial diameter of the physis, and distoproximally oriented fissures at the medial aspect of the metaphysis, which originate at the physis. In some cases, these may result in bilateral tibial metaphyseal stress fractures in foals.<sup>3</sup>

**Abnormal modeling** of trabecular bone has been recognized in prenatal and neonatal calves.<sup>4</sup> Abnormalities included growth retardation lines and lattices, focal retention of primary spongiosa and the persistence of secondary spongiosa. Intra-uterine infection with viruses such as bovine virus diarrhoea (BVD) may be a causative factor.<sup>4</sup>

#### Physical and environmental causes

Moderate osteodystrophy and arthropathy may occur in rapidly growing pigs and cattle raised indoors and fed diets that contain adequate amounts of calcium, phosphorus and vitamin D. Those animals raised on slatted floors or concrete floors are most commonly affected and it is thought that traumatic injury of the epiphyses and condyles of long bones may be predisposing factors in osteochondrosis and arthrosis in the pig (leg weakness) and epiphysitis in cattle. Experimentally raising young calves on metal slatted floors may result in more severe and more numerous lesions of the epiphysis than occurs in calves raised on clay floors. Total confinement rearing of lambs can result in the development of epiphysiolysis and limb deformities. However, the importance of weight-bearing injury as a cause of osteodystrophy in farm animals is still uncertain. In most reports of such osteodystrophy, all other known causes have not been eliminated.

Chronic osteodystrophy and arthropathy have been associated with undesirable conformation in the horse.

**Vertebral exostoses** are not uncommon in old bulls and usually affect the thoracic vertebrae (T2 and T12) and the lumbar vertebrae (L2-L3), which are subjected to increased pressure during the bending of the vertebral columns while copulating. The exostoses occur mainly on the ventral aspects of the vertebrae, fusing them to cause immobility of the region. Fracture of the ossification may occur, resulting in partial displacement of the vertebral column and spinal cord compression. The disease is commonly referred to as spondylitis or vertebral osteochondrosis

and also occurs less commonly in adult cows and in pigs. It is suggested that the anulus fibrosus degenerates and that the resulting malfunctioning of the disk allows excessive mobility of the vertebral bodies, resulting in stimulation of new bone formation. A similar lesion occurs commonly in horses and may affect performance, particularly in hurdle races and cross-country events. The initial lesion may be a degeneration of the intervertebral disk.

**Some types of growth plate defect** occur in young growing foals and these are considered to be traumatic in origin. Failure of chondrogenesis of the growth plate may be the result of crush injuries in heavy, rapidly growing foals with interruption of the vascular supply to the germinal cells of the growth plate. Asymmetric pressures due to abnormal muscle pull or joint laxity may slow growth on the affected side and result in limb angulation.

**Femoral fractures** occur in newborn calves during the process of assisted traction during birth.<sup>5</sup> Laboratory compression of isolated femurs from calves revealed that the fracture configurations and locations are similar to those found in clinical cases associated with forced extraction. The breaking strength of all femurs fell within the magnitude of forces calculated to be created when mechanical devices are used to assist delivery during dystocia. It is suggested that the wedging of the femur in the maternal pelvis and resulting compression during forced extraction accounts for the occurrence of supracondylar fractures of the femur of calves delivered in anterior presentation using mechanical devices in a manner commonly used by veterinarians and farmers.

#### Tumors

**Osteosarcomas** are highly malignant tumors of skeletoblastic mesenchyme in which the tumor cells produce osteoid or bone. Osteosarcomas are the most common type of primary bone tumor in animals such as dogs and cats but are rare in horses and cattle. Most tumors of bone in large animals occur in the skull. A periosteal sarcoma on the scapula has been recorded in the horse<sup>6</sup> and an osteosarcoma of the mandible in a cow.<sup>7</sup>

#### PATHOGENESIS

Osteodystrophy is a general term used to describe those diseases of bones in which there is a failure of normal bone development, or abnormal metabolism of bone that is already mature. There are some species differences in the osteodystrophies that occur with dietary deficiencies of calcium, phosphorus, and vitamin D. **Rickets and osteomalacia** occur primarily

in ruminants, osteodystrophia fibrosa in horses, and all three may occur in pigs.

#### Rickets

Rickets is a disease of young growing animals in which there is a failure of provisional calcification of the osteoid plus a failure of mineralization of the cartilaginous matrix of developing bone. There is also failure of degeneration of growing cartilage, formation of osteoid on persistent cartilage with irregularity of osteochondral junctions and overgrowth of fibrous tissue in the osteochondral zone. Failure of provisional calcification of cartilage results in an increased depth and width of the epiphyseal plates, particularly of the long bones (humerus, radius and ulna and tibia) and the costal cartilages of the ribs. The uncalcified, and therefore soft, tissues of the metaphyses and epiphyses become distorted under the pressure of weightbearing, which also causes medial or lateral deviation of the shafts of long bones. There is a decreased rate of longitudinal growth of long bones and enlargement of the ends of long bones due to the effects of weight causing flaring of the diaphysis adjacent to the epiphyseal plate. Within the thickened and widened epiphyseal plate there may be hemorrhages and minute fractures of adjacent trabecular bone of the metaphyses, and in chronic cases the hemorrhagic zone may be largely replaced by fibrous tissue. These changes can be seen radiographically as 'epiphysitis' and clinically as enlargements of the ends of long bones and costochondral junctions of the ribs. These changes at the epiphyses may result in separation of the epiphysis, which commonly affects the femoral head. The articular cartilages may remain normal or there may be subarticular collapse resulting in grooving and folding of the articular cartilage and ultimately degenerative arthropathy and osteochondrosis. Eruption of the teeth in rickets is irregular and dental attrition is rapid. Growth of the mandibles is retarded and is combined with abnormal dentition. There may be marked malocclusion of the teeth.

#### Osteomalacia

Osteomalacia is a softening of mature bone due to extensive resorption of mineral deposits in bone and failure of mineralization of newly formed matrix. There is no enlargement of the ends of long bones or distortions of long bones but spontaneous fractures of any bone subjected to weightbearing is common.

#### Osteodystrophia fibrosa

Osteodystrophia fibrosa may be superimposed on rickets or osteomalacia and occurs in secondary hyperparathyroidism.

Diets low in calcium or that contain a relative excess of phosphorus cause secondary hyperparathyroidism. There is extensive resorption of bone and replacement by connective tissue. The disease is best known in the horse and results in swelling of the mandibles, maxillae and frontal bones (the 'bighead' syndrome). Spontaneous fracture of long bones and ribs occurs commonly. Radiographically there is extreme porosity of the entire skeleton.

#### Osteoporosis

Osteoporosis is due to failure or inadequacy of the formation of the organic matrix of bone; the bone becomes porous, light and fragile, and fractures easily. Osteoporosis is uncommon in farm animals and is usually associated with general under-nutrition rather than specifically a deficiency of calcium, phosphorus, or vitamin D. Copper deficiency in lambs may result in osteoporosis due to impaired osteoblastic activity. Chronic lead poisoning in lambs also results in osteoporosis due to deficient production of osteoid. In a series of 19 lactating or recently weaned sows with a history of lameness, weakness or paralysis, 10 had osteoporosis and pathological fractures while six had lumbar vertebral osteomyelitis. Bone ash, specific gravity of bone and the cortical to total ratio were significantly reduced in sows with osteoporosis and pathological fractures.

Ovariectomized sheep that are fed a calcium-wasting diet develop osteoporosis, which is being used as a model to study the disease in humans.<sup>8</sup>

#### Osteodystrophy of chronic fluorosis

Osteodystrophy of chronic fluorosis is characterized by the development of exostoses on the shafts of long bones due to periosteal hyperostosis. The articular surfaces remain essentially normal but there is severe lameness because of the involvement of the periosteum and encroachment of the osteophytes on the tendons and ligaments.

#### Congenital defects of bone

These include complete (**achondroplasia**) and partial (**chondrodystrophy**) failure of normal development of cartilage. Growth of the cartilage is restricted and disorganized and mineralization is reduced. The affected bones fail to grow, leading to gross deformity, particularly of the bones of the head.

#### CLINICAL FINDINGS

In general terms there is weakening of the bones due to defective mineralization and osteoporosis, which results in the **bending of bones**, which probably causes pain and shifting lameness – one of the earliest clinical signs of acquired osteodystrophy.

The normal weight and tension stresses cause distortion of the normal axial relationships of the bones, which results in the bowing of long bones. The distortions occur most commonly in young, growing animals. The distal ends of the long bones are commonly enlarged at the level of the epiphyseal plate and circumscribed swellings of the soft tissue around the epiphyses may be prominent, and painful on palpation.

The effects of osteodystrophy on appetite and body weight will depend on the severity of the lesions and their distribution. In the early stages of rickets in calves and pigs the appetite and growth rate may not be grossly affected until the disease is advanced and causes considerable pain. Persistent recumbency due to pain will indirectly affect feed intake unless animals are hand-fed.

**Spontaneous fractures** occur commonly and usually in mature animals. Common sites for fractures include the long bones of the limbs, pelvic girdle, femoral head, vertebrae, ribs, and transverse processes of the vertebrae. Ordinary hand pressure or moderate restraint of animals with osteomalacia and osteodystrophia fibrosa is often sufficient to cause a fracture. The rib cage tends to become flattened and in the late stages affected animals have a slab-sided appearance of the thorax and abdomen. Separations of tendons from their bony insertions also occur more frequently and cause severe lameness. The osteoporotic state of the bone makes such separations easy. Any muscle group may be affected but, in young cattle in feedlots, separations of the gastrocnemius are the most common. Thickening of the bones may be detectable clinically if the deposition of osteoid or fibrous tissue is excessive, or if exostoses develop as in fluorosis. Compression of the spinal cord or spinal nerves may lead to paresthesia, paresis or paralysis, which may be localized in distribution. Details of the clinical findings in the osteodystrophies caused by nutritional deficiencies are provided in Chapter 30.

**Calcinosis of cattle** is characterized clinically by chronic wasting, lameness, ectopic calcifications of the cardiovascular system, lungs and kidneys, ulceration of joint cartilage and extensive calcification of bones.

#### CLINICAL PATHOLOGY

The **laboratory analyses** that are indicated include the following:

- **Serum calcium and phosphorus**
- **Serum alkaline phosphatase**
- **Feed analysis for calcium, phosphorus, vitamin D and other minerals when indicated** (such as copper, molybdenum, and fluorine)

- **Bone ash chemical analysis**
- **Histopathology of bone biopsy**
- **Radiographic examination of the skeleton**
- Single photon absorptiometry, a safe and noninvasive method for the measurement of bone mineral content, is now available.

**Radiographic examination** of the affected bones and comparative radiographs of normal bones is indicated when osteodystrophy is suspected. Radiographic examination of slab sections of bone is a sensitive method for detecting abnormalities of trabecular bone in aborted and young calves.<sup>4</sup>

**Serum calcium and phosphorus** concentrations in nutritional osteodystrophies may remain within the normal range for long periods and not until the lesions are well advanced will abnormal levels be found. Several successive samplings may be necessary to identify an abnormal trend.

**Alkaline phosphatase** levels may be increased in the presence of increased bone resorption but this is not a reliable indicator of osteodystrophy. Increased serum levels of alkaline phosphatase may originate from osseous tissues, intestine or liver, but osseous tissue appears to be the major source of activity.

**Nutritional history and feed analysis** results will often provide the best circumstantial evidence of osteodystrophy.

The definitive diagnosis is best made by a combination of chemical analysis of bone, histopathological examination of bone and radiography. The details for each of the common osteodystrophies are discussed under the appropriate headings.

#### NECROPSY FINDINGS

The pathological findings vary with the cause, and the details are described under each of the osteodystrophies elsewhere in the book. In general terms, the nutritional osteodystrophies are characterized by bone deformities, bones that may be cut easily with a knife and that bend or break easily with hand pressure and the presence in prolonged cases of degenerative joint disease. In young, growing animals the ends of long bones may be enlarged and the epiphyses may be prominent and circumscribed by periosteal and fibrous tissue thickening. On longitudinal cut sections the cortices may appear thinner than normal and the trabecular bone may have been resorbed, leaving an enlarged marrow cavity. The epiphyseal plate may be increased in depth and width and appear grossly irregular, and small fractures involving the epiphyseal plate and adjacent metaphysis may be present. Separation of epiphyses is common, particularly of the femoral head. The calluses

#### DIFFERENTIAL DIAGNOSIS

In both congenital and acquired osteodystrophy the clinical findings are usually suggestive. There are varying degrees of lameness, stiff gait, long periods of recumbency and failure to perform physical work normally, progressive loss of body weight in some cases and there may be obvious contortions of long bones, ribs, head and vertebral column. The most common cause of osteodystrophy in young growing animals is a dietary deficiency or imbalance of calcium, phosphorus and vitamin D. If the details of the nutritional history are available and if a representative sample of the feed given is analyzed, a clinical diagnosis can be made on the basis of clinical findings, nutritional history and response to treatment. In some cases, osteodystrophy may be due to overfeeding, such as might occur in rapidly growing, large foals.

However, often the nutritional history may indicate that the animals have been receiving adequate quantities of calcium, phosphorus and vitamin D, which necessitates that other less common causes of osteodystrophy be considered. Often the first clue is an unfavorable response to treatment with calcium, phosphorus and vitamin D. Examples include copper deficiency in cattle, leg weakness in swine of uncertain etiology – but perhaps there is weight-bearing trauma and a relative lack of exercise due to confinement – or chemical poisoning such as enzootic calcinosis or fluorosis. These will require laboratory evaluation of serum biochemistry, radiography of affected bones and pathological examination. The presence of bony deformities at birth suggests congenital chondrodystrophy, some cases of which appear to be inherited while some are due to environmental influences.

of healed fractures of long bones, ribs, vertebrae and pelvic girdle are common in pigs with osteodystrophy. On histological examination there are varying degrees of severity of rickets in young growing animals and osteomalacia in adult animals, and osteodystrophia fibrosa is possible in both young and adult animals.

#### TREATMENT

The common nutritional osteodystrophies due to a dietary deficiency or imbalance of calcium, phosphorus and vitamin D will usually respond favorably following the oral administration of a suitable source of calcium and phosphorus combined with parenteral injections of vitamin D. The oral administration of dicalcium phosphate, at the rate of three to four times the daily requirement, daily for 6 days followed by a reduction to the daily requirement by the 10th day, combined with one injection of vitamin D at the rate of 10 000 IU/kg BW is recommended.

Affected animals are placed on a diet that contains the required levels and ratios of calcium, phosphorus, and vitamin D. The oral administration of the calcium and phosphorus will result in increased absorption of the minerals, which will restore depleted skeletal reserves. Calcium absorption is increased in adult animals following a period of calcium deficiency; young animals with high growth requirements absorb and retain calcium in direct relation to intake. General supportive measures include adequate bedding for animals that are recumbent.

The treatment of the osteodystrophies due to causes other than calcium and phosphorus deficiencies depends on the cause. Copper deficiency will respond gradually to copper supplementation. There is no specific treatment for the osteodystrophy associated with leg weakness in pigs and slaughter for salvage is often necessary. Overnutrition in young, rapidly growing foals may require a marked reduction in the total amount of feed made available daily.

Oxytetracycline has been used for the treatment of flexural deformities of the distal interphalangeal joints of young foals.<sup>9</sup> It is postulated that oxytetracycline chelates calcium, rendering it unavailable for use for striated muscle contraction. It is considered effective for obtaining a short-term moderate decrease in metacarpophalangeal joint angle in newborn foals. Hemicircumferential periosteal transection and elevation has gained wide acceptance for correction of angular limb deformities in young foals.<sup>1</sup>

#### REFERENCES

1. Caldwell G et al. *Vet Rec* 1995; 136:80.
2. Mitten LA, Bertone AL. *J Am Vet Med Assoc* 1994; 204:717.
3. Frankney RL et al. *J Am Vet Med Assoc* 1994; 205:76.
4. O'Connor BF, Doige CE. *Can J Vet Res* 1993; 57:25.
5. Ferguson JG. *Can Vet J* 1994; 35:626.
6. Zaruby JF et al. *Can Vet J* 1993; 34:742.
7. Plumlee KH et al. *J Am Vet Med Assoc* 1993; 202:95.
8. Turner AS. *Vet J* 2002; 165: 232.
9. Madison JB et al. *J Am Vet Med Assoc* 1994; 204:246.

#### HYPERTROPHIC PULMONARY OSTEOARTHROPATHY (MARIE'S DISEASE, ACHROPACHIA OSSEA)

Although hypertrophic pulmonary osteoarthropathy is more common in dogs than in the other domestic animals it has been observed in horses,<sup>1</sup> cattle and sheep. The disease is characterized by proliferation of the periosteum leading to the formation of periosteal bone, and bilateral symmetrical enlargement of bones, usually the long bones of limbs. The enlargement is quite obvious, and in

the early stages is usually painful and often accompanied by local edema. On radiographic examination there is a shaggy periostitis and evidence of periosteal exostosis. The pathogenesis is obscure but the lesion appears to be neurogenic in origin, unilateral vagotomy causing regression of the bony changes. Stiffness of gait and reluctance to move are usually present, and there may be clinical evidence of the pulmonary lesion with which the disease is almost always associated. Such lesions are usually chronic, neoplastic or suppurative processes such as tuberculosis.

The disease is considered to be incurable, unless the thoracic lesion can be removed, and affected animals are usually euthanized. At necropsy the periostitis, exostosis and pulmonary disease are evident. There is no involvement of the joints.

#### REFERENCE

1. Mair TS et al. *Equine Vet J* 1996; 28:256.

#### OSTEOMYELITIS

##### ETIOLOGY AND PATHOGENESIS

Inflammation of bone is uncommon in farm animals except when infection is introduced by traumatic injury or by the hematogenous route. **Bacteria can reach bone by any of three routes:**

- Hematogenously
- By extension from an adjacent focus of infection
- By direct inoculation through trauma or surgery.

Focal metaphyseal osteomyelitis can occur following open fractures in the horse. Specific diseases that may be accompanied by osteomyelitis include actinomycosis of cattle and brucellosis, atrophic rhinitis and necrotic rhinitis of pigs. Nonspecific, hematogenous infection with other bacteria occurs sporadically and is often associated with omphalitis, abscesses from tail-biting in pigs or infection of castration or docking wounds in lambs. A series of 28 cases of osteomyelitis of the calcaneus of adult horses has been described.<sup>1</sup>

Foals and calves under 1 month of age and growing cattle 6–12 months of age may be affected by osteomyelitis in one or more bones. The majority of foals with suppurative polyarthritis have a polyosteomyelitis of the bones adjacent to the affected joints. In a series of cases of tarsal osteomyelitis in foals there was usually evidence of infectious arthritis.<sup>2</sup> Osteomyelitis of the pubic symphysis associated with *Rhodococcus equi* in a 2-year-old horse has been described.<sup>3</sup> The lameness was localized to the pelvis and was associ-

ated with a fever and an inflammatory leukogram.

The infections occur commonly in the metaphysis, physis, and epiphysis, which are sites of bony growth and thus susceptible to blood-borne infections. The metaphyseal blood vessels loop toward the physis and ramify into sinusoids that spread throughout the metaphyseal region. Blood flow through the sinusoids is sluggish and presents an ideal environment for propagation of bacteria. Lesions occur on both sides of the physis in both the metaphysis and the epiphysis. Multiple lesions are common and support the explanation that septic emboli are released from a central focus.

In a series of 445 cattle with bone infection of the appendicular skeleton a distinction was made between hematogenous and post-traumatic origin (wound/fracture).<sup>4</sup> Bone infection was classified into four types according to the site of infection: Type 1 is metaphyseal and/or epiphyseal osteomyelitis close to the growth plate; type 2 is primary subchondral osteomyelitis, mostly accompanied by septic arthritis; type 3 is infectious osteoarthritis with subchondral osteomyelitis, implying that infection in the subchondral bone originates from the infection. Type 4 includes bone infections that cannot be categorized in the other groups. Hematogenous osteomyelitis was 3.2 times more frequent than post-traumatic osteomyelitis. *Arcanobacterium (Corynebacterium) pyogenes* was the most common etiological agent. About 55% of the affected animals with osseous sequestration had physical evidence of lacerations, contusions, abrasions or puncture wounds from a previous traumatic event.

**Hematogenous osteomyelitis** in cattle can be of:

- Physeal type, in which an infection generally of metaphyseal bone originates at or near the growth plate, usually affecting the distal metacarpus, metatarsus, radius or tibia<sup>5</sup>
- Epiphyseal type, in which an infection originates near the junction of the subchondral bone and the immature epiphyseal joint cartilage, most often affecting the distal femoral condyle epiphysis, the patellar and the distal radius.

The epiphyseal osteomyelitis are usually due to infection with *Salmonella* spp. and are most common in calves under 12 weeks of age. The physeal infections are usually due to *A. pyogenes* and occur most commonly in cattle over 6 months of age.

#### Osseous sequestration in cattle

Osseous sequestration is a common orthopedic abnormality in cattle and

horses.<sup>6</sup> In most cases, the lesions develop in the bones of the distal portion of the limbs. Sequestration is associated with trauma that results in localized cortical ischemia and bacterial invasion secondary to loss of adjacent periosteal and soft-tissue integrity and viability. The soft tissues covering the bones that comprise the distal portions of the limbs fail to provide adequate protection and collateral blood supply to the bone.

#### Osteomyelitis secondary to trauma

In horses, osteomyelitis is a frequent sequela to wounds of the metacarpal and metatarsal bones and the calcaneus. These bones have limited soft tissue covering, which may predispose them to osteomyelitis following traumatic injury. Similarly, a portion of the lateral aspect of the proximal end of the radius has limited soft-tissue covering. Penetrating and nonpenetrating wounds in this region, therefore, may result in serious consequences even though they may initially appear to be minor. Because lesions may be an extension of septic arthritis, a thorough examination of the wound area is necessary.

Osteomyelitis of the sustentaculum tali in horses has been described.<sup>7</sup>

#### Inflammation of bone marrow

Inflammation of bone marrow in animals has been described.<sup>8,9</sup> Acute inflammation commonly accompanies bacterial sepsis, resulting in either multifocal microabscesses or perivascular infiltrates of neutrophils, fibrin, edema, and hemorrhage. The most common abnormality associated with fibrinous inflammation is disseminated intravascular coagulopathy. Discrete granulomas may occur in the marrow of animals with systemic mycotic disease, idiopathic granulomatous disease and serous atrophy of fat.

#### CLINICAL FINDINGS

The common clinical findings of osteomyelitis include:

- Lameness
- Generalized soft tissue swelling and inflammation
- Pain on palpation of the affected area
- Chronic persistent drainage
- Secondary muscle atrophy of the affected limb<sup>1</sup>

Erosion of bone occurs and pus discharges into surrounding tissues, causing a cellulitis or phlegmon, and to the exterior through sinuses, which persist for long periods. The affected bone is often swollen and may fracture easily because of weakening of its structure. When the bones of the jaw are involved, the teeth are often shed and this, together with

pain and the distortion of the jaw, interferes with prehension and mastication. Involvement of vertebral bodies may lead to the secondary involvement of the meninges and the development of paralysis. Lameness and local swelling are the major manifestations of involvement of the limb bones.

Most osseous sequestra in cattle are associated with the bones of the extremities, most commonly the third metacarpal or metatarsal bone. Cattle 6 months to 2 years of age are most likely to have a sequestrum compared with animals less than 6 months of age.<sup>6</sup>

The lesions are typically destructive of bone and cause severe pain and lameness. Those associated with *Salmonella* spp. are characteristic radiographically in foals and calves. *A. pyogenes*, *Corynebacterium* spp., and *E. coli* may also be causative agents. Affected animals are very lame and the origin of the lameness may not be obvious. A painful, discrete soft-tissue swelling over the ends of the long bones is often the first indication. The lameness characteristically persists in spite of medical therapy and the animal may become lame in two or more limbs and spend long periods recumbent.

Osteomyelitis affecting the cervical vertebrae, usually the fourth to sixth vertebra, causing a typical syndrome of abnormal posture and difficulty with ambulation. Initially there is a stumbling gait, which then becomes stiff and restricted and with a reluctance to bend the neck. Soon the animal has difficulty eating off the ground and must kneel to graze pasture. At this stage there is obvious atrophy of the cervical muscles and pain can be elicited by deep, forceful compression of the vertebrae with the fists. There is no response to treatment and at necropsy there is irreparable osteomyelitis of the vertebral body and compression of the cervical spinal cord. Radiological examination is usually confirmatory.

**Cervicothoracic vertebral osteomyelitis** in calves between 2 and 9 weeks of age is characterized by difficulty in rising with a tendency to knuckle or kneel on the forelimbs, which are hypotonic and hyporeflexic. Pain can be elicited on manipulation of the neck. The lesion usually involves one or more of the vertebrae from C6-T1.<sup>8</sup> *Salmonella dublin* is commonly isolated from the vertebral lesion.

#### CLINICAL PATHOLOGY

**Radiographic changes** include:

- Necrotic sequestrum initially
- New bone formation
- Loss of bone density.

The lesions are characteristically centered at the growth and extend into both metaphysis and epiphysis. Culture of the inflammatory exudate and necrotic sequestra removed surgically is necessary to determine the species of bacteria and their antimicrobial sensitivity.<sup>6</sup> Samples of bone obtained at surgery provide the most accurate culture results compared to specimens obtained from the draining sinuses, which may yield a mixed flora. Specimens should consist of sequestra and soft tissues immediately adjacent to bone thought to be infected. Special transport media are desirable for optimum culture results. Anaerobic bacteria are frequently associated with osteomyelitis and should be considered when submitting samples for culture.

#### NECROPSY FINDINGS

At necropsy the osteomyelitis may not be obvious unless the bones are opened longitudinally and the cut surfaces of the metaphysis and epiphysis are examined.

#### DIFFERENTIAL DIAGNOSIS

A differential diagnosis for a destructive lesion in the end of a long bone of a foal or calf would include: a healing fracture, traumatic periostitis or osteitis, bone tumor, nutritional osteodystrophy and infection of the bone due to external trauma, fracture, extension from adjacent infection or hematogenous spread. The absence of equal pathological involvement in the comparable parts of long bones and the young age of the animal will usually suggest infection of bone. The pathological features of multiple bone infection in foals are described.

#### TREATMENT

Despite advances in antimicrobial therapy and refined diagnostic techniques, the clinical management of osteomyelitis is difficult. Medical therapy alone is rarely completely successful because of the poor vascularity of the affected solid bone and the inaccessibility of the infection. In cases of long-term infection or those with extensive bone necrosis, surgery is generally recommended to remove sequestra, devitalized tissue and sinus tracts that are harboring large numbers of bacteria.<sup>1,6</sup> Good results are obtained when the affected bone is removed and the affected area is irrigated daily through a temporary drainage tube.

In septic phylitis, the implantation of homologous cancellous bone grafts following debridement of necrotic bone, and the application of a walking cast for 4-5 weeks and antimicrobial therapy for 2 weeks was highly successful.<sup>10</sup> Absolute asepsis is required for successful application of a bone graft and, after

debridement of the necrotic bone, the cavity is flushed with saline and ampicillin.

Antimicrobials are an integral part of the treatment and selection of the most appropriate drug should be based on identification of the organism. Parenteral antimicrobial therapy should be continued for 4–6 weeks following surgical curettage. However, in a series of osteomyelitis of the calcaneus of adult horses, there was no difference in the survival rate of animals between those treated surgically and those treated conservatively.<sup>1</sup> Prolonged antibiotic therapy can be successful for the treatment of osteomyelitis of the proximal end of the radius in the horse.<sup>11</sup>

Most anaerobic bacteria associated with osteomyelitis are sensitive to penicillin and the cephalosporins, but some species of *Bacteroides fragilis* and *Bacteroides asaccharolyticus* and other species of *Bacteroides* are known to produce beta-lactamases, which can inactivate penicillin and cephalosporin. Metronidazole and clindamycin will penetrate bone and can be considered.

## REFERENCES

1. MacDonald MH et al. J Am Vet Med Assoc 1989; 194:1317.
2. Firth EC, Goodegebuure SA. Vet Q 1988; 10:99.
3. Clark-Price SC et al. J Am Vet Med Assoc 2003; 222:969.
4. Verschooten F et al. Vet Radiol Ultrasound 2000; 41:250.
5. Firth EC et al. Vet Rec 1987; 120:148.
6. Valentino LW et al. J Am Vet Med Assoc 2000; 217:376.
7. Hand DR et al. J Am Vet Med Assoc 2001; 219:341.
8. Healy AM et al. Vet J 1997; 154:227.
9. Weiss DJ et al. Vet Clin Pathol 1992; 21:79.
10. Barneveld A. Vet Q 1994; 16(Suppl 2):S104.
11. Swinebroad EL et al. J Am Vet Med Assoc 2003; 223:486.

## Diseases of joints

### ARTHROPATHY (OSTEOARTHROPATHY, DEGENERATIVE JOINT DISEASE)

The terms osteoarthropathy and degenerative joint disease are used here to describe noninflammatory lesions of the articular surfaces of joints characterized by:

- Degeneration and erosion of articular cartilage
- Eburnation of subchondral bones
- Hypertrophy of bone surrounding the articular cartilage resulting in lipping and spur formation at the joint margins.

Osteochondrosis is a degeneration of both the deep layers of the articular cartilage and the epiphyseal plate – a defect in endochondral ossification – which occurs in pigs and horses and is similar to the well-recognized disease in dogs.

## ETIOLOGY AND EPIDEMIOLOGY

The etiology is not clear but in most of the commonly occurring cases the lesions are considered to be multifactorial and perhaps secondary to conformational defects resulting in excessive joint laxity, acute traumatic injury of a joint, the normal aging process and nutritional deficiencies. The etiological information is primarily circumstantial and some of the epidemiological observations that have been associated with osteoarthritis of farm animals are outlined here.

### Nutritional causes

- Secondary to, or associated with, rickets, osteomalacia, bowie and osteodystrophia fibrosa
- Coxofemoral arthropathy in dairy cattle associated with aphosphorosis
- Copper deficiency thought to be related to enlargement of limb joints in foals on pasture and pigs fed experimental copper-deficient diets
- Experimental diets deficient in manganese or magnesium causing arthropathy and joint deformity in some calves
- Experimental riboflavin deficiency in pigs.

### Poisonings

- Chronic zinc poisoning in pigs and foals
- Fluorosis in cattle
- As part of the enzootic calcosinosis syndrome caused by poisoning with *Solanum malacoxylon* and others.

### Steroid-induced

The intra-articular injection or prolonged parenteral administration of corticosteroids in horses may lead to degenerative joint disease.

### Biomechanical trauma

- **Acute traumatic injury**, e.g. injury to joint surfaces, menisci and ligaments, especially the cruciate ligaments of the stifle joints of breeding bulls, may lead to chronic progressive osteoarthritis. Injuries to the femorotibial ligaments of horses can predispose to osteoarthropathy of the stifle joint
- **Repeated subacute trauma** to joint surfaces can lead to degenerative arthropathy. This is common in young racehorses in training, which may have their joint surfaces and surrounding tissues made susceptible to injury because of conformational defects and subtle deficiencies of calcium and phosphorus. Hard running surfaces may also contribute to the onset
- **Trauma caused by movement** is suspected of contributing to the erosive lesions on the articular

surfaces of some horses affected by enzootic incoordination, the intervertebral joints of caudal thoracic and cranial lumbar vertebrae of old bulls with spondylitis, and the condition of bulls with inherited spasticity. Coxofemoral osteoarthritis may occur in aged horses with joint instability and in calves with hip dysplasia.

### Growth rate, body size, and genetic predisposition

**Degenerative coxofemoral arthropathy** occurs in **young beef bulls** as early as 9 months of age. A congenital shallow acetabulum may predispose. It may be secondary to hip dysplasia, but in some cases there is no evidence of this. The large, weightbearing joints subjected to the greatest movement and concussion appear to be most susceptible. Rapidly growing bull calves appear to be most susceptible and some of them have an inherited susceptibility.

### Osteochondrosis

**Osteochondrosis** is an important cause of lameness in horses. It is usually seen in young rapidly growing animals, and affects males more commonly than females. The predilection sites of osteochondrosis in the horse and their general order of incidence are hock, stifle, shoulder, fetlock, and cervical spine. The stifle, hock, and shoulder joints are more commonly affected, but many other joints may also be affected, including the metatarsal and metacarpal bones and rarely the acetabula of young foals.

The epidemiology, heritability and body measurements and clinical findings of osteochondrosis of hock and fetlock joints in Standardbred trotters have been examined.<sup>1</sup> The incidence of the disease is high in the Swedish Standardbred population and well developed by the age of 1.5 years. The incidence of osteochondrosis is higher in horses born later in the foaling season than earlier and the incidence was related to body size: affected horses were taller at the withers and had a greater circumference of the carpus.<sup>1</sup> This suggests that differences in body size at birth and the first few months of the foal's life are of major importance in the development of osteochondrosis. The heritability estimates of osteochondrosis in the hock and fetlock joints of 753 Standardbred trotters 6–21 months of age was 0.52 and 0.21, respectively.<sup>2</sup>

### Aging process

Degenerative arthropathy in aged dairy cows and bulls may be a manifestation of the normal aging process. Osteochondrosis, degenerative joint disease and vertebral osteophysis occur in middle-aged bulls.

Osteoarthritis of the antebrachial joint of riding horses has been described.<sup>3</sup> Affected animals were aged mares that developed osteoarthritis and ankylosis. The cause was unknown.

### Conformation and intensive animal production

Osteoarthropathy occurs in rapidly growing cattle and pigs raised in confinement on hard, usually concrete, floors and with minimal exercise. Osteochondrosis in feedlot cattle may be associated with a high-caloric diet and rapid growth rate. It is thought that weight-bearing trauma in these rapidly growing animals is sufficient to cause degenerative lesions of certain joints, especially in animals with a skeletal conformation that results in abnormal stress on certain weightbearing condyles of long bones.

In a series of 42 cases of stifle lameness in cattle, 18 had evidence of subchondral bone cyst and ranged in age from 6–18 months. It is suggested that the subchondral bone cyst is an indicator of osteochondrosis. In a series of osteochondrosis in cattle, male, purebred cattle of a mean age of 21 months were affected.<sup>4</sup>

Osteochondrosis may occur in rapidly growing bull beef calves fed a diet lacking adequate calcium, sodium, copper and vitamins A, D, and E,<sup>5,6</sup> grazing beef cattle on improved native pasture in which a common ancestral sire and gender (all males) may have been contributing factors.<sup>7</sup> Severe osteochondrosis of multiple joints but with remarkable changes in the humeral head and glenoid of both shoulder joints in 10-month-old beef calves has been described.<sup>8</sup>

Osteochondrosis similar to that seen in pigs has been recorded in purebred Suffolk lambs raised in a system designed to produce rapidly growing, high-value rams.<sup>9</sup> The disease has been recorded in a single pedigree Suffolk ram.<sup>10</sup>

**Osteochondrosis and arthritis** are considered to be major causes of 'leg weakness' in rapidly growing pigs.<sup>11</sup> Restricting the energy intake appears to decrease the prevalence and severity of osteochondrosis when gilts are examined at 100 kg. The prevalence and severity of osteochondrosis in growing pigs is probably not related to floor type.<sup>11</sup> Recent work has shown a significant relationship between body conformation and the presence of joint lesions. Pigs with a narrow lumbar region, broad hams and a large relative width between the stifle joints were highly susceptible to poor locomotor ability due to lesions in the elbow and stifle joints, the lumbar intervertebral joints and the hip joint.

This excellent work represents real progress in understanding the relation-

ship between skeletal conformation and bone and joint lesions. It is postulated that inherited weakness of muscle, ligaments, cartilage and exterior joint conformation results in local overloading in the joint and the development of osteochondrosis and arthritis. Some breeds, such as the Duroc, have more problems of structure and movement in the front legs than in the rear legs, but osteochondrosis is not responsible for the leg weakness. Osteochondrosis has been recorded in wild boar–Swedish Yorkshire crossbred pigs in which the growth rate was low.<sup>12</sup>

### Osteoarthritis of the distal tarsal joints of the horse (bone spavin)

Osteoarthritis of the distal tarsal joints (hock), commonly known as bone spavin, is common in Icelandic horses and strongly related to age.<sup>13,14</sup> In Icelandic horses aged 6–12 years and used for riding, the prevalence of radiographic signs of osteoarthritis in the distal tarsus increased from 18% in horses 6 years of age up to 54% in 12-year-old horses. The age onset of radiographic signs reflect a predisposition to bone spavin indicating a trait with medium–high heritability.<sup>13</sup> There is a high prevalence of chondronecrosis in young Icelandic horses, indicating an early onset and slow progression of disease.<sup>14</sup> The disease is the most common cause of culling due to disease in riding horses in the age group 7–17 years.<sup>15</sup>

### PATHOGENESIS

The details of the pathogenesis of degenerative joint disease have been reviewed.<sup>16</sup> A brief review of the structure and biochemistry of the normal articular joint will serve as background for understanding the pathogenesis of osteoarthropathy.<sup>17</sup>

Articular cartilage is a tissue consisting of chondrocytes scattered in a matrix of collagen fibers and an amorphous intercellular substance containing proteoglycans. Articular cartilage contains no nerves, is avascular and has a high matrix-to-cell ratio. The chondrocytes are the only living matter in cartilage, produce the fine strands of collagen and are engaged in protein and proteoglycan synthesis. The matrix of the cartilage consists of water-soluble proteoglycans interspersed with collagen fibers, which are arranged in parallel rows superficially and crisscross rows closer to the calcified layer. This enables the cartilage to withstand shearing stresses superficially and compression more deeply.

The proteoglycans are glycosaminoglycan–protein complexes, bound by a link glycoprotein to a linear hyaluronic acid molecule. The glycosaminoglycans in articular cartilage are

chondroitin 4-sulfate, chondroitin 6-sulfate and keratan sulfate. About 75% of the proteoglycans exist on aggregates that protect them from degradation and, because of their high water content, form large polyanionic complexes that have considerable elastic resistance to compression.

Nutrition of the articular cartilage is provided via the synovial fluid and is dependent on the capillary flow to the synovial membrane. Nutrients flow through the synovial fluid and diffuse through the cartilage to the chondrocytes. Proteoglycans are synthesized by the chondrocytes and secreted to the cell exterior. Proteoglycans are also degraded intracellularly by lysosomes. The normal equilibrium between anabolism and catabolism is maintained by several different low-molecular-weight proteins. When the equilibrium is disturbed and shifts toward catabolism, degeneration occurs.

### Primary osteoarthropathy

This is due to normal aging processes and ordinary joint usage. The initial lesions occur in the superficial layers of the articular cartilages where, with increasing age, there is loss of the normal resilience of the cartilage, a lowering of the chondroitin sulfate content and reduction in the permeability of the cartilaginous matrix, which results in progressive degeneration of the articular cartilage. There is grooving of the articular cartilage, eburnation of subchondral bone and secondary hypertrophy of marginal cartilage and bone, with the formation of pearl-like osteophytes. In experimentally induced arthritis in the horse the major changes include synovitis, increased synovial effusion and superficial fibrillation with chondrocyte necrosis in the articular cartilage. These are comparable to the early changes in naturally occurring degenerative joint disease.

### Secondary osteoarthropathy

This appears to be initiated by injuries or congenital conformational defects that create greater shearing stresses on particular points, in contrast to the intermittent compressive stresses typical of ordinary weightbearing. These irregular stresses result in cartilaginous erosion, increased density of subchondral bone at points of physical stress and proliferation of bone and cartilage at the articular margins.

**Following acute trauma**, the initial changes are often characterized by acute synovitis and capsulitis. As a result of the inflammatory response, leukocytes, prostaglandins, lysosomal enzymes and hyaluronidase enter the synovial fluid, which becomes less viscous and affects the nutrition of the cartilage. There is



some evidence of immune complexes associated with collagen-type-specific antibodies in horses with secondary osteoarthritis. Cytokines can be detected in the synovial fluid after racing in horses with degenerative joint disease.<sup>18</sup> The cartilage matrix undergoes a variety of changes, possibly because of chondrocyte damage with lysosomal enzyme release, or to collagen fiber injury. There is an increase in water content and loss of orientation of the collagen fibers. Proteoglycans are lost and, while increased chondrocyte activity synthesizes proteoglycans, they are of lower molecular weight and altered glycosaminoglycan composition. This leads to loss of elasticity and surface integrity of the cartilage, resulting in increased friction, blistering and ulceration. There is additional lysosomal enzyme release from the chondrocytes, resulting in matrix destruction and further proteoglycan destruction. The degrading enzymes enter the altered matrix and cause further degradation.

The first stage of matrix degradation involves discoloration, softening and blistering of the tangential layer of the cartilage surface, a process known as early fibrillation. As the fissuring extends to the radial layer, microfractures occur, with loss of cartilage fragments (detritus) into the synovial fluid. As the cartilage is destroyed the underlying bone is exposed and becomes sclerotic. Bony proliferation occurs in the floor of the cartilage lesions, while at the joint margins osteophyte formation occurs. The pathogenesis of degenerative joint disease indicates that the ideal treatment would be the use of a substance that would promote synthesis of matrix components and retard catabolic processes.

The major proteoglycan in cartilage is a high-molecular-weight aggrecan that contains chondroitin sulfate and keratin sulfate chains located on specific regions of the core protein. These macromolecules are continuously released into the synovial fluid during normal cartilage matrix metabolism. Cartilage proteoglycans are degraded early in the course of joint disease and released from the cartilage into the synovial fluid, where they can be identified.<sup>19</sup>

**In horses** with degenerative joint disease, proteoglycan fragments – glycosaminoglycans – have been determined in equine synovial fluid as indicators of cartilage metabolism in various types of arthritides.<sup>19</sup> The presence of high-molecular-weight proteoglycans and high concentrations of hyaluronate in horses with various arthritides – acute or chronic traumatic arthritis, intra-articular fracture and infectious arthritis, with and without abnormal radiographic and/or

arthroscopic findings – compared with control joints has been investigated.<sup>19</sup>

The intra-articular injection of corticosteroids depresses chondrocyte metabolism, alters the biochemical composition and causes morphological changes in the articular cartilage, which remains biochemically and metabolically impaired for several or more weeks.

**In femoral-tibial osteoarthritis of bulls** the secondary degenerative joint lesions are due to rupture of the attachments of the lateral meniscus resulting in mechanical instability in the joint with unusual mechanical stresses on the articular cartilage leading to degeneration. The cranial cruciate ligament becomes progressively worn and eventually ruptures, resulting in loss of all joint stability and the development of gross arthrosis. In cattle with severe degenerative joint disease of the coxofemoral joints, an acetabular osseous bulla may develop at the cranial margin of the obturator foramen.

### Osteochondrosis

Osteochondrosis (dyschondroplasia) is characterized by disturbance of the normal differentiation of the cells in the growing cartilage. Both the metaphyseal growth plate (the growth zone of the diaphysis) and immature joint cartilage (the growth zone of the epiphysis) are affected. The loss of normal differentiation of the cartilage cells results in failure of provisional calcification of the matrix and endochondral ossification ceases. Degeneration and necrosis of blood vessels in cartilage canals results in ischemia of an area of growing cartilage followed by chondrocyte degeneration and death. The initial lesion occurs in growing cartilage and dyschondroplasia is a more appropriate term. The primary lesion of osteochondrosis directly affects the differentiation and maturation of the cartilage cells and the surrounding matrix that are destined to become replaced by bone. This can occur at the two sites of endochondral ossification in long bones – the articular/epiphyseal cartilage complex and the metaphyseal growth plate. In osteochondrosis, the capillary buds fail to penetrate the distal region of the hypertrophic zone, which leads to a failure of the final stages of cartilage maturation and modification of the surrounding matrix. These changes lead to retention and thickening of cartilage with subsequent weakening of the articular/epiphyseal cartilage complex.

**Typical lesions in the horse** involve extensive cartilaginous and subchondral bone degeneration with flap formation and, ultimately, loose pieces in the joint. This is usually referred to as osteo-

chondritis dissecans and is associated with synovial effusion and varying degrees of synovitis. Osteochondral fracture associated with severe pathological changes to the subchondral bone occurs most commonly on the trochlear ridges and the lateral or medial malleoli of the hock. In some instances, cartilage damage weakens underlying bone and causes a bone cyst to form, usually at a site of biomechanical stress or weightbearing.<sup>11</sup>

It is suggested that osteochondrosis lesions in horses develop prior to 7 months of age and that ischemic necrosis of cartilage secondary to a defect in vascular supply is an important factor in the pathogenesis of the disease in horses.<sup>20</sup> An osteochondrotic lesion in the metaphyseal growth plate may disturb growth to such a degree that the whole shape of the bone is altered. Epiphyseolysis may also occur. Osteochondrosis of joint cartilage may lead to osteochondritis dissecans and secondary osteoarthritis. The lesion may heal and only the sequelae are present once the period of growth is over.

**In rapidly growing pigs** raised in confinement with minimal exercise, **osteochondrosis and arthrosis** are seen as degeneration of the deep layer of the articular cartilage and adjacent subchondral bone with degenerative lesions of the epiphyseal plate. Lesions in the epiphyseal plate may result in epiphyseolysis, which occurs most commonly in the femoral head. The typical lesions are usually symmetrical and commonly involve the elbow, stifle and hip joints and the distal epiphyseal plate of the ulna. Lesions also occur in the intervertebral articulations. The lesions are common in pigs when they are examined at slaughter (90–100 kg BW) and there may have been no evidence of clinical abnormality or a proportion of the pigs with severe lesions may have been affected with the leg-weakness syndrome. Osteochondrosis and *Erysipelothrix rhusiopathiae* are the most common causes of nonsuppurative joint disease of pigs examined at the abattoir. Thus not all lesions are clinical.

### CLINICAL FINDINGS

The major clinical characteristic is a chronic lameness that becomes progressively worse over a long period of time and does not usually respond to treatment. The disease is insidious and generally not clinically apparent in the early stages. A common clinical history is that the affected animal becomes progressively more lame over a period of weeks and months and prefers long periods of recumbency. The lesion may develop slowly over a period of weeks and months during the convalescent

stages of an acute traumatic injury to the joint when recovery is expected but the animal continues to be lame. Young breeding bulls in the early stages of coxofemoral arthropathy may be reluctant to perform the breeding act and yet appear to have sufficient libido. One of the first clinical abnormalities of osteochondrosis and epiphyseolysis in young breeding boars may be inability to mount the sow – impotentia coeundi.

There is usually difficulty in flexing affected joints normally, which results in a stiff and stilted gait. In cattle confined to stanchions one of the earliest and persistent signs is shifting of weight from limb to limb. In dairy cattle, as the lesions become more painful, there is a decline in appetite and milk production, prolonged recumbency and considerable difficulty in rising from the recumbent state. In the early stages there may be an apparent remission of the lameness, but relapses are common. The bony prominences of the joint eventually appear more prominent than normal, which is due to disuse muscle atrophy of the affected limbs. Distension of the joint capsule is not a characteristic, as it is in an infectious or suppurative arthritis. The joint capsule of palpable joints is usually not painful on palpation. Passive flexion of affected joints may be painful and it may be possible to elicit crepitus due to detached pieces of cartilage and bone and osteophytes surrounding the articular cartilage. However, crepitus is most common in the large movable joints, such as the stifle, and commonly in osteoarthropathy secondary to acute traumatic injury of the meniscus and cranial cruciate ligament of the joint.

Epiphyseolysis of the head of the femur occurs in young pigs from 5 months to 1 year of age. There is usually a history of slight to moderate lameness, sudden in onset and affecting one or both hindlimbs. The onset of lameness may coincide with some physical activity such as breeding, farrowing or transportation. The lameness is progressive and in about 7–10 days the animal is unable to use its hindlegs. Crepitus may be audible on circumduction of the affected limb and radiography may reveal the separation.

In **leg weakness associated with osteochondrosis and arthrosis of pigs** the common clinical findings are hyperflexion of the carpus, limb bowing, adduction of both forelegs at the level of the carpus, hyperextension of the fore and hind phalanges and anterior curvature of the tarsus. Locomotory dysfunction involves primarily the hindlegs. There is pronounced swaying of the hindquarters, and crossing the hindlegs with each step, which makes the pig appear incoordinated.

**Osteochondrosis in cattle** is characterized by chronic long-standing lameness, either with or without joint effusion.<sup>4</sup> Joint fluid analysis is usually normal or indicates nonseptic inflammation. The stifle joint is most commonly affected followed by the hock joint. In osteochondrosis in young growing bulls there is reluctance to move, stiffness, enlargement of the ends of long bones and a straightened joint. While there may be clinical evidence of lameness in less than 40% of affected cattle, radiographically, 88% of the lesions are bilateral.<sup>4</sup>

**Osteochondrosis in the horse** is characterized by a wide range of clinical signs and in some cases lesions are not accompanied by clinical signs. The most common sign of osteochondrosis is a nonpainful distension of an affected joint. In foals under 6 months of age, a tendency to spend more time lying down is common. This is accompanied by joint swelling, stiffness and difficulty keeping up with the other animals in the group. An upright conformation of the limbs may also be present. In yearlings or older animals the common clinical signs are stiffness of joints, flexion responses and varying degrees of lameness.

In the horse with osteochondrosis of the shoulder joint there is intermittent lameness, characterized by a swinging leg, shoulder lameness with pain elicited by extension, flexion or abduction of the limb. Secondary joint disease is also a common finding. In a retrospective study of osteochondrosis dissecans in 21 horses, affected animals were 8 months to 5 years of age. The usual age of onset of clinical abnormalities was 18–24 months. The common presenting complaints included joint effusion and lameness of either gradual or sudden onset. The prevalence was higher in males than in females.

## CLINICAL PATHOLOGY

### Joint fluid

The changes in the synovial fluid of joints affected with degenerative arthropathy are usually unremarkable and can be distinguished from the changes in infectious arthritis. A summary of the laboratory evaluation of synovial fluid in diseases of the joints is set out in Table 13.2. The isolation of an infectious agent from the synovial fluid of a diseased joint suggests the presence of an infectious arthritis but failure to isolate an organism must not be interpreted as the presence of a non-infectious arthritis. In well advanced cases of infectious arthritis the number of organisms may be small or they have been phagocytosed by neutrophils in the joint fluid.

**Total protein concentration and viscosity** of synovial fluid of horses can

be determined. Normal values are available<sup>21</sup> and the concentration and molecular weight distribution of hyaluronate in synovial fluid from clinically normal horses and horses with diseased joints have been compared.<sup>19,22</sup> Synovial fluid viscosity is reduced in horses with infectious and chronic arthritides and with radiographic evidence of cartilage degeneration. The synovial fluid hyaluronate concentration can be used as a diagnostic marker for chronic traumatic arthritis. However, high-molecular-weight proteoglycans or other markers in the synovial fluid cannot be used for diagnosing or monitoring degenerative joint disease.<sup>19</sup>

**Hematology and serum biochemistry** should be combined with appropriate hematology and serum biochemistry where indicated. The concentration of hyaluronic acid in synovial fluid can be determined using an assay technique. The determination of serum calcium and phosphorus may reveal the existence of a dietary deficiency or imbalance of minerals.

### Radiography

Radiography of the hock joints in a craniomedial–caudolateral oblique view and of the fetlock joints in lateromedial view are standard techniques for the diagnosis of osteochondrosis in the horse. Those joints with abnormal radiographs may be radiographed from additional perspectives. Horses with bony fragments or defects at the cranial edge of the intermediate ridge of the distal aspect of the tibia or defects at the lateral trochlea of the talus can be classified as having osteochondrosis.<sup>2</sup> The radiographic progression of femoropatellar osteochondrosis in horses under 1 year of age at the onset of clinical signs has been examined.<sup>22</sup> The full extent of the radiographic lesions may take several weeks to develop.

### Arthroscopy

Arthroscopic examination and surgery of affected joints of horses with osteochondrosis can provide considerably more information than is possible from clinical and radiographic examination alone.<sup>23</sup>

## NECROPSY FINDINGS

In **degenerative joint disease** the joint cartilage is thin or patchily absent and polished subchondral bone is evident. The articular surfaces are irregular and sometimes folded. Exposed bone may be extensively eroded and osteophytes (small bony excrescences, like pearls) may be present on the nonarticular parts of the joint on the circumference of the articular cartilage. The synovial fluid is usually only slightly increased in volume and appears

Table 18.2. Laboratory evaluation of synovial fluid in diseases of the joints

Synovial fluid analysis	Normal joint	Degenerative arthropathy	Infectious arthritis
Gross appearance	Colorless, clear	Pale yellow, may contain flocculent debris	Turbid, yellow
Total volume	—	Normal or slight increase	Usually marked increase
Clot formation	No clot	No clot	May clot within minutes after collection
Erythrocytes ( $\mu\text{L}$ )	< 4000	6000–12 000	4000–8000
Leukocytes ( $\mu\text{L}$ )	< 250	250–1000	50 000–150 000
Neutrophils (%)	7	10–15	80–90
Lymphocytes (%)	35–40	45–50	4–8
Monocytes (%)	45–50	35–40	1–3
Microbiology	—	—	May be able to culture bacteria, mycoplasma or virus, but not always
Total protein (g/dL)	1.2–1.8	1.6–1.8	3.20–4.5
Relative viscosity	—	Slightly reduced	Decreased
pH	—	—	Decreased

*Other laboratory analyses of synovial fluid include: sugar content, alkaline phosphatase activity, lactic dehydrogenase activity, aldolase activity, glutamic oxaloacetic transaminase activity, glutamic pyruvic transaminase activity, mucinous precipitate quality.*

amber-colored. Menisci, intra-articular, cartilages and ligaments may be entirely absent and there may be areas of calcification in the joint capsule and cartilages free in the synovium. When the stifle is affected, fractures of the head of the tibia occur commonly, usually a chip of the lateral condyle having become separated. In such cases, fractures of the lateral condyle of the distal end of the femur may follow. With either of these fractures, lameness is extreme and the animal may often refuse to rise.

The radiographic and pathological findings of femoral-tibial osteoarthritis in bulls is described. When the hip joint of bulls is affected, the head of the femur becomes smaller and more flattened than normal, the acetabulum is shallower and the round ligament is usually ruptured. The pathology of coxofemoral arthropathy in young bulls is described.

The pathological changes in experimentally induced osteoarthritis in the horse are similar to the early changes of naturally occurring degenerative joint disease.

**In osteochondrosis** there is splitting and invagination of articular cartilage, loss of articular cartilage, chip fractures of condyles, exposed and collapsed subchondral bone, osteophyte formation around the circumference of the articular cartilage and loose pieces of cartilage in the joint. In the epiphyseal plates (e.g., the distal ulna in pigs with leg weakness) the cartilage is uneven and thickened with hemorrhage, fibrous tissue, collapse of bone tissue in the metaphysis and epiphyseal separation. Complete separation of the epiphysis occurs most commonly at

the head of the femur. The ultrastructural appearance of nonnal epiphyseal cartilage of the articular-epiphyseal cartilage complex in growing swine has been examined and serves as a standard for comparison with the lesions in affected pigs. The lesions may be present in pigs at an early age as part of the usual growth pattern of cartilages.

**In equine osteochondrosis (dyschondroplasia)**, the histological lesions can be divided into two groups.<sup>24</sup> In one group there are accumulations of small rounded chondrocytes, areas of necrosis and chondrocyte clusters. In the second group, there are alterations in the appearance of the mineralized matrix, areas of necrosis, chondrocyte clusters and an alteration in type VI collagen immunoreactivity within the chondrocyte clusters.

#### TREATMENT

The treatment of arthropathy depends largely upon correction of the cause, but in most cases the lesions are progressive and irreparable and food-producing animals should be slaughtered for salvage. Tarsal degenerative joint disease in cattle has been treated with intra-articular injections of corticosteroids and has provided temporary relief from pain and discomfort. However, the corticosteroids do not promote healing of the joint and their use in arthropathy may actually accelerate erosion of articular cartilage, loss of joint sensation and the development of 'steroid arthropathy'. Large doses of acetylsalicylic acid may be given to reduce pain in animals that are kept for breeding purposes.

#### DIFFERENTIAL DIAGNOSIS

Osteoarthritis is characterized clinically by a chronic lameness that becomes progressively worse and usually does not respond to treatment. The gait is stiff, there is disuse muscle atrophy, the bony prominences of the joint are more apparent but usually there is no marked distension and pain of the joint capsule, as in infectious arthritis. Examination of synovial fluid may aid in differentiation from infectious arthritis.

Radiographically there is erosion of articular cartilage, sclerosis of subchondral bone and periarticular accumulations of osteophytes. In the early stages of the disease in large animals, radiographic changes may not be visible and repeated examinations may be necessary. The radiographic changes of osteochondrosis in the shoulder joint of the horse consist of:

- Alteration in the contour of the humeral head and glenoid cavity
- Periarticular osteophyte formation
- Sclerosis of the subchondral bone
- Bone cyst formation.

The literature on the medical management of **osteoarthritis** in the **horse** has been reviewed.<sup>25</sup> There are many choices available for controlling inflammation in osteoarthritis. Treatment is symptomatic and largely nonspecific.

#### Nonsteroidal anti-inflammatory agents

Several nonsteroidal anti-inflammatory drugs (NSAIDs), such as **phenylbutazone**, **flunixin meglumine**, **ketoprofen**, **naproxen**, and **carprofen**, are available treatment options. Each has associated toxicities. They are now the most commonly used drugs because of their analgesic, antipyretic and anti-inflammatory properties.<sup>25</sup> They inhibit some component of the enzyme system that converts arachidonic acid into prostaglandins and thromboxanes. All cells, including chondrocytes and synoviocytes, possess arachidonic acid as a fatty acid constituent of phospholipids. Once released, arachidonic acid is oxidized by either cyclooxygenase (COX) or 5-lipoxygenase. COX oxidation leads to prostaglandin production, while lipoxygenase oxidation leads to leukotriene formation. The effect of NSAIDs is primarily from inhibiting COX, which blocks arachidonic acid conversion to prostaglandin.

#### Intra-articular steroids

Various steroidal formulations for intra-articular administration are available and correct dosage, frequency of administration, indications and toxicity are factors to consider for each drug. They include methylprednisolone acetate, betametasone, and triamcinolone acetonide.<sup>25</sup>

### Chondroprotective agents

Various **chondroprotective** drugs such as **hyaluronic acid**, **polysulfated glycosaminoglycan**, and oral **glucosamine-chondroitin sulphate** are also used to control inflammation and provide viscosupplementation.<sup>25</sup>

There is a notable lack of treatment information based on randomized, blinded placebo-controlled clinical trials in the horse to identify the efficacy of therapeutic agents for both symptomatic and disease-modifying activity in degenerative joint disease.<sup>25</sup> Until there are validated outcome measures that can be used practically in clinical trials, there will always be uncertainty about whether these therapeutic agents have any real disease-modifying action.<sup>26</sup>

#### Hyaluronic acid

The changes in the synovia following the intra-articular injection of **sodium hyaluronate** into normal equine joints and after arthrotomy and experimental cartilage damage have been examined, but in general the results are inconclusive.

#### Polysulfated glycosaminoglycans

Polysulfated glycosaminoglycans have been reported to induce articular cartilage matrix synthesis and to decrease matrix degradation.<sup>27</sup> Experimentally, intra-articular injections of **polysulfated glycosaminoglycan** provides some protection against chemically induced articular cartilage damage but not against physical defects of articular cartilage in the horse. The polysulfated glycosaminoglycans inhibit lysosomal enzymes and neutral proteases. The allo-transplantation of synovial fluid into the joints of horses with arthropathies has been examined. A survey of the use of polysulfated glycosaminoglycans by equine practitioners for the treatment of lameness in horses found that the drug is moderately effective overall and is considered most beneficial in the treatment of subacute degenerative joint disease.<sup>28</sup> Its efficacy for incipient and chronic forms of degenerative joint disease is considered comparable to that of sodium hyaluronate.

The prevention of further trauma should be assured and possible nutritional causes corrected. The treatment of active disease, particularly in soft tissues, that is contributing to articular degeneration includes rest, immobilization, physical therapy, intra-articular injections of corticosteroids, NSAIDs, joint lavage and intra-articular injection of sodium hyaluronate, all of which have been used with variable success.<sup>29</sup>

### Other treatments

**Surgical therapy** includes curettage of articular cartilage, removal of osteophytes

and surgical arthrodesis.<sup>29</sup> In a retrospective study of stifle lameness in 42 cattle admitted to two veterinary teaching hospitals over a period of 6 years, 18 had radiographic evidence of subchondral bone cyst without radiographic evidence of degenerative joint disease. The prognosis in those with a subchondral bone cyst was favorable, 75% returning to their intended function, while in septic arthritis only 22% returned to normal.

**Chemical arthrodesis** using the intra-articular injections of monoiodoacetate (MIA) has been described as an alternative to surgical arthrodesis for the treatment of degenerative joint disease of the distal tarsal joints.<sup>30</sup> MIA causes an increase in intracellular concentration of adenosine triphosphate resulting in inhibition of glycolysis and cell deaths. It causes dose-dependent cartilage degeneration characterized by cartilage fibrillations, chondrocyte death and glycosaminoglycan and proteoglycan depletion. MIA produces reliable radiographic and histological ankylosis of the distal tarsal joints. Resolution of the lameness required 12 months and occasionally longer. Soundness was achieved in 82% and 85% of horses at 12 and 24 months, respectively. Complications of the injections were uncommon and were probably related to peri-articular injection or leakage of MIA, or to use of higher concentrations or volumes. Postinjection pain was marked in a small number of horses but was transient and managed effectively with analgesic drugs. The procedure is controversial.<sup>31</sup> Some clinicians argue that arthrodesis should only be used where lameness is localized to the tarsometatarsal and centrodistal joints with objective means such as local analgesic techniques, and when other more conservative treatments have failed.

### CONTROL AND PREVENTION

Prevention of osteoarthritis will depend upon recognition and elimination of the predisposing causes: provision of an adequate diet and the avoidance of overnutrition; regular exercise for confined animals; the provision of suitable flooring to minimize persistent concussion and the use of breeding stock that have a body conformation that does not predispose to joint lesions.

### REVIEW LITERATURE

Clegg P. Therapy for osteoarthritis in the horse – how do we know that it works? *Vet J* 2006; 171:9–10.

Goodrich LR, Nixon AJ. Medical treatment of osteoarthritis in the horse: a review. *Vet J* 2006; 171:51–69.

### REFERENCES

- Sandgen B et al. *Equine Vet J Suppl* 1993; 16:31, 38, 48.

- Grondahl AM, Dolvik NI. *J Am Vet Med Assoc* 1993; 203:101.
- Magnusson LE, Ekman S. *Acta Vet Scand* 2001; 42:429.
- Trostle SS et al. *J Am Vet Med Assoc* 1997; 211:1566.
- Davies IH et al. *Cattle Pract* 1998; 4:243.
- Davies IH, Munro R. *Vet Rec* 1999; 145:232.
- Hill BD et al. *Aust Vet J* 1998; 76:171.
- Scott PR et al. *Vet Rec* 2000; 147:608.
- Scott CA et al. *Vet Rec* 1996; 139:165.
- Doherty ML et al. *Vet Rec* 1996; 138:137.
- Ray CS et al. *Equine Vet J* 1996; 28:225.
- Uhlorn H et al. *Acta Vet Scand* 1995; 36:41.
- Arnason T, Bjornsdottir S. *Livestock Prod Sci* 2003; 79:285.
- Bjornsdottir S et al. *Equine Vet J* 2004; 36:5.
- Bjornsdottir S et al. *Acta Vet Scand* 2003; 44:161.
- Clyne MJ. *Equine Vet J* 1987; 19:15.
- Palmer JL, Bertone AL. *Equine Vet J* 1994; 26:263.
- Billinghurst RC et al. *Equine Vet J* 1995; 27:208.
- Tulamo RM et al. *Am J Vet Res* 1996; 57:932.
- Carlson CS et al. *Vet Pathol* 1995; 32:641.
- Tulamo RM et al. *Am J Vet Res* 1994; 55:710.
- Davbareiner RM et al. *Vet Surg* 1993; 22:515.
- McIlwraith CW. *Equine Vet J Suppl* 1993; 16:27.
- Henson FMD et al. *Vet J* 1997; 154:53.
- Goodrich LR, Nixon AJ. *Vet J* 2006; 171:51.
- Clegg PD. *Vet J* 2006; 171:9.
- Todhunter RJ, Lust G. *J Am Vet Med Assoc* 1994; 204:1245.
- Caron JF, Kaneene JB. *J Am Vet Med Assoc* 1996; 209:1564.
- McIlwraith CW. *J Am Vet Med Assoc* 1982; 180:239.
- Dowling BA et al. *Aust Vet J* 2004; 82:38.
- Whitton C. *Aust Vet J* 2004; 82:286.

## ARTHRITIS AND SYNOVITIS

Inflammation of the synovial membrane and articular surfaces as a result of infection occurs commonly in farm animals. It is characterized by varying degrees of lameness and a warm and swollen painful joint. The synovial fluid is usually abnormal, containing an increased leukocyte count and the pathogens causing the arthritis. The arthritis may be severe enough to cause systemic illness, and in some cases a draining sinus tract may occur.

### ETIOLOGY AND EPIDEMIOLOGY

Specific bacterial infections of the joints are most common in newborn farm animals, in which localization of infection occurs in joints following bacteremia or septicemia. Surveys of Thoroughbred studs have shown that the incidence of infectious arthritis is higher in foals with other perinatal abnormalities and in which the ingestion of colostrum was delayed for more than 4 hours after birth. Calves with hypogammaglobulinemia are particularly susceptible to bacteremia and meningitis, ophthalmitis and arthritis. Some of the important infectious causes of arthritis are as follows.

#### Calves

- Nonspecific joint-ill from omphalophlebitis associated with

*A. pyogenes*, *Fusobacterium necrophorum*, *Staphylococcus* sp.

- *Erysipelothrix rhusiopathiae* sporadically in older calves
- *Salmonella dublin*, *Salmonella typhimurium* and *Mycoplasma bovis*.

#### Lambs

- *E. rhusiopathiae* in newborn and recently tail-docked lambs
- Sporadic cases associated with *F. necrophorum*, *Staphylococcus* sp., *Corynebacterium pseudotuberculosis*, *Histophilus somni*, *Mannheimia haemolytica*
- *Chlamydophila* spp. cause polyarthritis extensively in feedlot lambs
- In tick pyemia associated with *Staphylococcus aureus*.

#### Foals

- *Actinobacillus equuli*, *Rhodococcus equi*, *Salmonella abortusovae* in the newborn
- *Chlamydophila* sp. has caused polyarthritis in foals.

#### Piglets

- Streptococci, Lancefield groups C, E, and L
- *Streptococcus suis*
- *E. rhusiopathiae* in pigs of any age. Up to 65% of joints of pigs at slaughter are affected and up to 80% of the farms from which the pigs come do not vaccinate for erysipelas. Mortality in preweaning groups of pigs may affect 18% of litters, 3.3% of the piglets with a herd mortality of 1.5%
- In a 4-year period in a swine research station, 9411 piglets were born alive and 9.8% were treated for lameness.<sup>1</sup> About 75% of the cases were observed in piglets under 3 weeks of age. The incidence of lameness was much higher in piglets born from sows of parity 3 (11.4%) compared to piglets born to sows of parity 4–7 (8%).

#### Cattle

- *Histophilus somni* is a cause of synovitis
- *Mycoplasma agalactia* var. *bovis* is a common cause of synovitis, arthritis and pneumonia in young feedlot cattle
- *Mycoplasma bovis* may cause mastitis in cows, with some animals developing arthritis
- *Mycoplasma mycoides* may cause arthritis in calves vaccinated with the organism against contagious bovine pleuropneumonia. Calves already sensitive to the organism develop an immediate-type allergic reaction of the synovial membrane
- *Brucella abortus*: occasional cows with brucellosis develop an arthrodial synovitis

- Some cases of ephemeral fever have a sterile arthritis
- BVD virus in young bulls, rarely
- Idiopathic septic arthritis in dairy heifers. The etiology is unknown
- Septic arthritis of the proximal interphalangeal (pastern) joint in cattle due to perforating wounds.<sup>2</sup> *A. pyogenes* is the most common cause in cattle.

#### Sheep and goats

- As part of melioidosis
- *Mycoplasma* sp. of serositis – arthritis
- *Streptococcus dysgalactiae* in dairy goats.

#### Pigs

- Glasser's disease
- *Mycoplasma* sp. in synovitis and arthritis of growing pigs especially in housed pigs
- *Brucella suis* commonly infects bones, especially vertebrae, and joints.

#### Horses

- Septic arthritis after penetrating wounds, intra-articular injection of corticosteroids, and surgery; young foals under 6 months of age usually associated with a septicemia; adult horses without a known etiology
- In a series of 34 cases of monoarticular infectious arthritis in adult horses admitted to a veterinary teaching hospital over a period of 10 years, 16 had a penetrating wound over the joint, four had a puncture wound of the sole and in five the infection was iatrogenic (three had received intra-articular corticosteroids, one had received intra-articular anesthesia and one had sepsis after a purulent thrombophlebitis).<sup>3</sup> In nine cases, no cause could be determined
- Spread to the joints from generalized strangles
- Rare cases of non-erosive polysynovitis in a horse, possibly immunological and immune-mediated polysynovitis in foals<sup>4</sup>
- *Acedosporium prolificans*, a newly recognized opportunistic fungus, has been associated with an incurable arthritis and osteomyelitis in a mature horse.<sup>5</sup>

#### All species

Sporadic cases are due to:

- Traumatic perforation of the joint capsule
- Spread from surrounding tissues, e.g. footrot to interphalangeal joints in cattle and pigs, interdigital abscess in sheep
- Hematogenous spread from suppurative lesions commonly in udder, uterus, diaphragmatic abscess,

infected navel or tail, castration wound.

#### PATHOGENESIS

In infectious arthritis that is hematogenous in origin there is usually a synovitis initially, followed by changes in the articular cartilages and sometimes bone. With almost any systemic infection there may be localization of the infectious agent in the synovial membrane and joint cavity. The synovial membrane is inflamed and edematous, and there are varying degrees of villous hypertrophy and deposition of fibrin. Bacteria colonize in synovial membranes, which makes treatment difficult. The synovitis causes distension of the joint capsule with fluid and the joint is painful and warm. Successful treatment and elimination of infection at this early stage of synovitis will minimize changes in articular cartilage and bone and healing will result. A progressive infectious synovitis commonly results in pannus formation between articular surfaces with erosion of articular cartilage, infection of subchondral bone and osteomyelitis. In the chronic stages there is extensive granulation tissue formation, chronic synovitis and degenerative joint disease with osteophyte formation, and ankylosis is possible. Depending on the organism, the arthritis may be suppurative or serofibrinous. Suppurative arthritis is particularly destructive of cartilage and bone and commonly there is rupture of the joint capsule. In foals with septic arthritis there may be a concurrent polyosteomyelitis, usually in either the epiphysis and/or the metaphysis of the long bones.

#### Experimental infectious arthritis in calves

Septic arthritis induced by *E. coli* is a reliable and reproducible model of infectious arthritis in laboratory animals, horses and calves.<sup>6</sup> The inoculation of *E. coli* into the tarsal joint of newborn colostrum-fed calves resulted in septic arthritis in all calves. Clinical signs of septic arthritis appeared on day 2 after infection and persisted until day 4 for all calves. *E. coli* was cultured from synovial fluid on day 2 for one calf and until day 4 for five other calves. Polymerase chain reaction (PCR) for *E. coli* was positive in the synovial fluid of all calves. Synovial fluid neutrophil and white blood cell counts were increased on days 2–4. All bacterial cultures were negative on day 8, although clinicopathological signs of inflammation persisted until day 20. Rapid recovery occurred within 1 week when an appropriate treatment was begun early in the course of the disease.

### Foals with septicemia

Septicemic foals may develop infectious arthritis and a concurrent polyosteomyelitis because of the patency of transphyseal vessels in the newborn foal; this allows spread of infection across the physes with the development of lesions in the metaphysis, epiphysis and adjacent to the articular cartilage. The syndrome is classified according to the location of the lesions:

- A foal with S-type septic arthritis-osteomyelitis has synovitis without macroscopic evidence of osteomyelitis
- Foals with E-type osteomyelitis have osteomyelitis of the epiphysis at the subchondral bone-cartilage junction
- Those with P-type have osteomyelitis directly adjacent to the physis
- The same joint may have a single type or any combination of types but most foals with the S-type have concurrent bone lesions.

### Horses

Septic arthritis has been reproduced experimentally in horses and the sequential synovial fluid changes monitored. Following intra-articular inoculation of *S. aureus*, clinical signs are evident as early as 8 hours after infection. A high and persistent neutrophilia is one of the earliest and most accurate diagnostic abnormalities. The total white blood cell count rises within 12–24 hours to a mean value of  $100 \times 10^9/L$ . Total protein also increases. Synovial fluid acidosis also occurs in infectious arthritis, which may interfere with the antibacterial activity of some antimicrobials. In experimental arthritis, the synovial pH declined from a mean value of 7.43 to 7.12. Bacteria could be detected in 40% of the smears of infected synovial fluid samples and primary cultures of the fluid were positive in 70%. The intra-articular inoculation of *E. coli* into horses induces a reliable, reproducible and controlled model of infectious arthritis consistent with the naturally occurring disease and has been used to evaluate the efficacy of gentamicin for treatment. The injection of *E. coli* lipopolysaccharide into various joints of horses can cause clinical signs of endotoxemia, and the synovial fluid total nucleated cell count and total protein are linearly responsive in increases in endotoxin.<sup>7</sup>

Endothelin (ET)-1, a 21-amino-acid polypeptide, is locally synthesized in the joints of horses with various forms types of joint disease.<sup>8</sup> It induces a potent and sustained vasoconstriction. Synovial fluid concentrations of ET-1 varies among horses with joint disease, with higher concentrations in animals with joint sepsis suggesting a pathogenetic role in septic arthritis.

Synovial fluid in infectious arthritis in the horse may contain the proteolytic enzymes collagenase and caseinase which may derive from both synovial cells and neutrophils.<sup>9</sup> These enzymes are involved in the degradation of connective tissue and loss of cartilage matrix. Lavage of affective joints is intended to remove these enzymes.

Infectious arthritis may occur following traumatic injury to a joint but the pathogenesis is obscure. Traumatic injury of the joint capsule resulting in edema and inflammation may allow latent organisms to localize, proliferate and initiate an arthritis.

### CLINICAL FINDINGS

Inflammation of the synovial membrane causes pain and lameness in the affected limb, sometimes to the point that the animal will not put it to the ground. Pain and heat are usually detectable on palpation and passive movement of the joint is resented. The joint may be swollen but the degree will depend on the type of infection. Pyogenic bacteria cause the greatest degree of swelling and may result in rupture of the joint capsule. Some enlargement of the epiphysis is usual and this may be the only enlargement in nonpyogenic infections, particularly that associated with *E. insidiosa*.

Fever, inappetence to anorexia, endotoxemia, loss of body weight and discomfort may occur in animals with only one severely affected joint or when several joints are less severely affected.

In many of the neonatal infections there will also be an accompanying omphalophlebitis and evidence of lesions in other organs, particularly the liver, endocardium and meninges. Arthritis in older animals may also be accompanied by signs of inflammation of the serous membranes and endocardium when the infection is the result of hematogenous localization.

The joints most commonly involved are the hock, stifle and knee but infection of the fetlock, interphalangeal and intervertebral joints is not uncommon. In chronic cases there may be physical impairment of joint movement because of fibrous thickening of the joint capsule, periarticular ossification and rarely ankylosis of the joints. Crepitus may be detectable in joints where much erosion has occurred.

In newborn and young animals, involvement of several joints is common. The joints may become inflamed simultaneously or serially. Lameness is often so severe that affected foals lie down in lateral recumbency most of the time and may have to be assisted to rise. Decubitus ulcerations due to prolonged recumbency

are common. The gait may be so impaired as to suggest ataxia of central origin.

The prognosis in cases of advanced septic arthritis is poor. Neglected animals may die or have to be destroyed because of open joints or pressure sores. The subsequent development of chronic arthritis and ankylosis may greatly impede locomotion and interfere with the usefulness of the animal.

### CLINICAL PATHOLOGY

#### Arthrocentesis

Aspiration of joint fluid for culture and analysis is necessary for a definitive diagnosis. Careful disinfection of the skin and the use of sterile equipment is essential to avoid the introduction of further infection.

#### Analysis of joint fluid

Total and differential cell count, total protein concentration and specific gravity are determined.

In infectious arthritis the volume of joint fluid is increased and the total leukocyte count is increased, with a high percentage (80–90%) of neutrophils. The severity of infectious arthritis may be manifested systemically by a leukocytosis with a marked regenerative left shift. In degenerative joint disease, the volume may be normal or only slightly increased and the total and differential leukocyte count may be manifested within the normal range. In traumatic arthritis there may be a marked increase in the number of erythrocytes. Special biochemical examinations of joint fluid are available that measure for viscosity, strength of the mucin clot and concentrations of certain enzymes. The laboratory findings in examination of the joint fluid are summarized in Table 13.2. The synovial fluid analysis of 130 cases in cattle compared the characteristics of animals with infectious and noninfectious arthritis.<sup>10</sup>

#### Culture of joint fluid

Joint fluid must be cultured for aerobic and anaerobic bacteria and on specific media when *Mycoplasma* sp. is suspected. It is often difficult to isolate bacteria from purulent synovial fluid. The rates of recovery of organisms vary from 40–75%. In one study of suspected infectious arthritis in 64 horses admitted to a veterinary teaching hospital over a period of 8.5 years, positive cultures were obtained from 55% of the joints sampled.<sup>11</sup> The most common organisms were *S. aureus*, *E. coli* and *Pseudomonas aeruginosa*, accounting for more than half the isolates obtained.

There is no single test that is reliable for the diagnosis of septic arthritis. Failure to isolate organisms on culture does not exclude the a bacterial cause, and

organisms are often not observed in synovial fluid smears. Poor collection, storage and laboratory techniques, prior administration of antibiotics or partial success of the immune system in containing the infection may explain the failure to detect organisms. Arthrocentesis should be done before antibiotics are given and a blood culture bottle should be inoculated immediately, a Gram stain made and culture for anaerobes included.<sup>12</sup> Positive cultures from synovial fluid can be expected in only about 65% of cases.

A biopsy sample of synovial membrane may be more reliable than synovial fluid for culture but there is little evidence based on comparative evaluations to support such a claim. PCR has been examined in in-vitro studies to detect selected bacterial species in joint fluid compared with microbial culture.<sup>13</sup> The benefits would include rapid and accurate diagnosis infectious arthritis, ability to detect bacteria in synovial fluid in the presence of antimicrobial drugs and diagnosis of infectious arthritis when culture results are inconclusive. However, initial studies found no difference between microbial culture and PCR analyses.

#### Serology of joint fluid

Serological tests may be of value in determining the presence of specific infections with *Mycobacterium mycoides*, *Salmonella* spp., *Brucella* spp., and *E. insidiosus*. Radiographic examination may aid in the detection of joint lesions and can be used to differentiate between inflammatory and degenerative changes. In foals with arthritis and suspected osteomyelitis there may be radiographic evidence of osteolysis of the metaphysis or epiphysis.

#### Radiography

Radiography of the affected joint will often reveal the nature and severity of the lesions. Typical radiographic findings of septic arthritis include osteolytic lesions of the articular cartilage, increased width of intra-articular joint space, and soft tissue swelling. Osteomyelitic changes are seen in some cases. Because radiographic changes usually appear after 2–3 weeks when destruction of subchondral bone has become extensive, it may be necessary to take a series of radiographs several days apart before lesions are detectable.

#### Ultrasonography

**Arthrosography** is an effective, fast and noninvasive complement to traditional diagnostic techniques for comprehensive evaluation of the pathology of joints of cattle.<sup>14</sup> Distension of the joint cavities can be imaged; assessing echogenicity, acoustic enhancement and ultrasonographic character of the exudate cor-

relates well with findings by arthrocentesis, arthrotomy or at necropsy. Joint effusion, which is the earliest indication of septic arthritis, can usually be detected with ultrasound by an experienced operator in the early stages. The synovial membrane, synovial fluid, ligaments, tendons and periarticular soft tissue, only inadequately imaged by radiography, can be imaged with ultrasonography. In advanced septic arthritis, ultrasonography provides accurate information on the location of the soft-tissue swelling, the extent and character of the joint effusion and involvement of concurrent periarticular synovial cavities.

#### Arthroscopy

Endoscopy is now used widely to define joint abnormalities more clearly and to gain access to the joint cavity as an aid in the treatment of septic arthritis.<sup>15</sup>

#### NECROPSY FINDINGS

The nature of the lesions varies with the causative organism. The synovial membrane is thickened and roughened and there is inflammation and erosion of the articular cartilage. There is usually an increase in the amount of synovial fluid present, varying from a thin, clear, serous, brownish fluid through a thicker, sero-fibrinous fluid to pus. There may be some inflammation of the periarticular tissues in acute cases and proliferation of the synovial membrane in chronic cases. In the latter, plaques of inspissated necrotic material and fibrin may be floating free in the synovial fluid. Infectious arthritis due to *A. pyogenes* is characterized by extensive erosion and destruction of articular cartilage and extensive suppuration. There may be a primary omphalophlebitis in newborn animals and metastatic abscesses may be present in other organs.

#### DIFFERENTIAL DIAGNOSIS

**Infectious arthritis** is characterized clinically by swollen joints which are painful and warm to touch, and lameness of varying degrees of severity. The volume of joint fluid is usually markedly increased and the leukocyte count is increased with a high percentage of neutrophils. In the early stages of synovitis and in chronic nonsuppurative arthritis, the joint may not be visibly enlarged and careful examination by palpation may be necessary to reveal abnormalities of the joint capsule. Lameness is common, however, even though only slight in some cases, and should arouse suspicion of the possibility of arthritis.

- The diseases of the musculoskeletal system that cause lameness and stiffness of gait include:
  - Degenerative joint disease
  - Osteodystrophy and epiphysitis

- Osteomyelitis
- Degenerative myopathy
- Myositis
- Traumatic injuries of tendons and ligaments
- Diseases of the nervous system, especially the peripheral nerves and spinal cord, may be confused with arthritis unless the joints are examined carefully
- Some severe cases of polyarthritis may cause recumbency that may be erroneously attributed to the nervous system.

**Degenerative joint disease** is characterized by an insidious onset of moderate lameness and stiffness of gait that becomes progressively worse over several weeks. The joint capsule is usually not grossly enlarged and not painful, and there is usually no systemic reaction. The total leukocyte count in the joint fluid is only slightly increased and the differential count may be normal. Chronic arthritis is often difficult to differentiate clinically from degenerative joint disease. Chronic arthritis is more common in young animals than in older animals such as rapidly growing yearling bulls, adult bulls, aged dairy cows and horses, in which degenerative arthropathy is most common. A sudden onset of acute lameness and marked swelling of a joint with severe pain suggests an infectious arthritis or traumatic injury to the joint. Marked swelling of several joints suggests infectious polyarthritis.

**Osteodystrophy** is characterized by:

- Lameness and stiffness of gait
- Usually an absence of joint capsule abnormalities
- Enlargements and deformities of the long bones in growing animals
- A number of animals may be affected at about the same time.

Radiography may reveal the abnormal bones and the nutritional history may explain the cause.

**Degenerative myopathy** causes acute lameness, a stiff and trembling gait, often leading to recumbency and absence of joint or bone involvement.

**Traumatic sprains of tendons or ligaments** and fractures of the epiphyses may cause lameness and local pain and, when they involve periarticular tissues, may be difficult to differentiate from arthritis.

**Arthritis is never present at birth** and apparent fixation of the joints should arouse suspicion of a congenital anomaly. The differentiation between arthritis and diseases of the peripheral nerves or spinal cord, both of which can cause lameness and/or recumbency, may be difficult if the arthritis is not clinically obvious. Diseases of the peripheral nerves cause lameness due to flaccid paralysis and neurogenic atrophy. Lesions of the spinal cord usually result in weakness of the hindlimbs, weak or absent withdrawal reflexes and loss of skin sensation.



## TREATMENT

### Parenteral antimicrobials

Acute septic arthritis should be treated as an emergency to avoid irreversible changes in the joint. The conservative approach is the use of antimicrobials given parenterally daily for several days and up to a few weeks in some cases. The selection of the drug of choice will depend on the suspected cause of the arthritis. The antimicrobial sensitivities of bacterial isolates from horses with septic arthritis/synovitis or osteomyelitis after fracture repair vary widely. A combination of cephalosporin and amikacin is recommended before culture and sensitivity results are available.

The antimicrobials that perfuse into the joint in therapeutic concentrations include the natural and synthetic penicillins, tetracycline, trimethoprim-potentiated sulfonamides, neomycin, gentamicin, and kanamycin.

Cloxacillin, methicillin, or penicillin have been used successfully for the treatment of staphylococcal septic arthritis in the horse.

Amphotericin B given intravenously daily for up to 30 days combined with joint drainage has been used for the treatment of *Candida* sp. arthritis in the horse.<sup>16</sup>

The relative efficacies of antimicrobials administered parenterally versus by intra-articular injections has been uncertain. Trimethoprim-sulfadiazine, given to calves parenterally, results in therapeutic concentrations of the drug in the synovial fluid of calves and penetrability was not enhanced nor restricted by experimental joint inflammation. Oxytetracycline and penicillin given parenterally readily penetrate the synovial membrane of both normal neonatal calves and those with experimental arthritis. Since peak synovial joint fluid levels of oxytetracycline and penicillin exceeded the minimum inhibitory concentrations for organisms such as *A. pyogenes*, the use of parenteral antimicrobials for the treatment of infectious arthritis in calves is appropriate. Ceftiofur at 1 mg/kg BW intravenously every 12 hours for 20 days, along with joint lavage, was successful in treating experimental septic arthritis associated with *E. coli*.<sup>6</sup> The duration of antibiotic therapy is empirical; 3 weeks is recommended. Cephapirin administered parenterally to normal calves or those with arthritis resulted in synovial fluid levels approximately 30% of serum levels. The use of ampicillin trihydrate in calves with suppurative arthritis, at a dose of 10 mg/kg BW intramuscularly, resulted in a peak serum concentration of 2.5 µg/mL, 2 hours after injection; the highest concentration in normal synovial fluid

was 3.5 µg/mL at 4 hours and the highest concentration in suppurative synovial fluid was 2.7 µg/mL at 2 hours.

Marbofloxacin at 4 mg/kg BW intramuscularly daily for 10 days was effective for the treatment of infectious arthritis in calves.<sup>17</sup> Amoxicillin at 40 mg/kg BW intravenously is effective for the treatment of infectious joint disease in horses.<sup>18</sup>

The administration of trimethoprim-sulfadiazine at 30 mg/kg BW orally once daily to horses with experimentally induced *S. aureus* arthritis was ineffective in maintaining adequate levels of both drugs in infected synovial fluid. The use of the same drug at 30 mg/kg BW orally given every 12 hours was effective in maintaining therapeutic concentrations of both drugs in the serum and in the joint fluid.

**In piglets at 2 weeks of age, streptococcal arthritis** is most likely and it will respond quickly to penicillin given parenterally. Likewise, acute arthritis associated with erysipelas in pigs will respond beneficially if treated early before there is pannus formation.

**Synovitis due to *Histophilus somni*** infection responds quickly to systemic treatment. However, in other specific types of infectious arthritis the response is poor and recovery, if it does occur, requires several days or a week. Mycoplasmal arthritis in cattle is relatively non-responsive to treatment and affected cattle may be lame for up to several weeks before improvement occurs and complete recovery may not occur. Chronic arthritis due to infection of pigs with *E. insidiosus* will commonly develop into a rheumatoid-like arthritis and be refractory to treatment.

**Failure to respond to conservative therapy** has been attributed to:

- Inadequate concentrations of antimicrobials achieved in the joint cavity
- Presence of excessive amounts of exudate and fibrin in the joint making the infectious agent inaccessible to the antimicrobial
- Drug-resistant infections
- The development of rheumatoid-like arthritis, which is chronic and progressive.

It is often not possible to determine which situation is responsible.

If conservative treatment is not providing sufficient improvement and the value of the animal warrants extended therapy, a joint sample should be obtained for culture and sensitivity. The most suitable antimicrobial may then be given parenterally and/or by intra-articular injection. Strict asepsis is necessary to avoid introduction of further infection.

### Intra-articular antimicrobials

The combined intra-articular and intravenous administration of gentamicin to normal horses can result in concentrations 10–100 times greater than after intravenous administration alone. In addition, gentamicin concentration in synovial fluid remained above the minimum inhibitory concentration for many common equine bacterial pathogens for at least 24 hours after treatment. The intra-articular administration of gentamicin is advantageous for the treatment of infectious arthritis in animals in which the systemic administration of the drug may be contraindicated, especially in the presence of impaired renal function or endotoxemia. Continuous infusion of gentamicin into the tarsocrural joint of horses for 5 days is an acceptable method of treating septic arthritis.<sup>19</sup>

**An antimicrobial-impregnated polymethylmethacrylate beads** have been used for the treatment of orthopedic infections involving bone, synovial structures and other soft tissues.<sup>20–22</sup> The antimicrobials diffuse from the beads in a bimodal fashion. There is a rapid release of 5–45% of the total amount of antimicrobial within the first 24 hours after implantation and then a sustained elution that persists for weeks to months, depending on the antimicrobial used. For effective diffusion, the antimicrobials must be water-soluble, heat-stable and available in powder form. Aminoglycosides and the cephalosporins have been incorporated most commonly into the beads.

**Regional limb perfusion** with antimicrobials has been used for the treatment of experimentally induced septic arthritis. The antimicrobial is infused under pressure to a selected region of the limbs through the venous system. The concentration of the antimicrobial in the septic synovial fluid will usually exceed those obtained by intravenous administration. However, there are insufficient data available to evaluate the procedure in naturally occurring cases. Therapeutic concentrations of ceftazolin are achieved in the synovial fluid of clinically normal cows when injected intravenously distal to a tourniquet and the technique could be used as an alternative to systemic administration of antimicrobials to provide adequate concentrations in a joint cavity.

### Lavage of joint

Drainage of the affected joint and through-and-through lavage of the joint is also desirable along with the systemic administration of antimicrobials. Aspiration and distension-irrigation of the joint cavity using polyionic electrolyte solutions buffered to 7.4 is recommended.<sup>6</sup> The

irrigation removes exudates and lysozymes that destroy articular cartilage. A through-and-through lavage system may also be used with drainage tubes. General or local anesthesia should be provided. The distended joint is identified by palpation, the hair is clipped short and the skin is prepared with appropriate surgical disinfection. A 2 cm 16-gauge needle is inserted into the joint cavity, avoiding direct contact with the bones of the joint. A second needle is inserted into the joint as far as possible from the first needle to cause any fluid perfused into the joint to pass through as much of the joint cavity as possible. 0.5–1 L of Ringer's solution warmed to 37°C is flushed through the joint using a hand-pumped pressure bag to keep a steady fluid flow into the joint.<sup>6</sup>

### Arthroscopy

Arthroscopy provides excellent visualization of most parts of an affected joint and can be used to access the joint for the treatment of septic arthritis.<sup>15</sup> The endoscope can be used to explore and debride the affected joint during the same intervention. Purulent exudate can be removed and necrotic areas within the synovial membrane can be debrided.

### Surgical drainage and arthrotomy

Failure to respond to parenteral and intra-articular medication may require surgical opening of the joint capsule, careful debridement and excision of synovium and infected cartilage and bone. This may be followed by daily irrigation of the joint cavity with antimicrobials and saline. A lavage system can be established and the joint cavity infused with an antimicrobial and saline daily for several days.<sup>23</sup> Arthrotomy with lavage was more effective in eliminating joint infections by providing better drainage than arthroscopy, synovectomy and lavage. However, with arthrotomy the risk of ascending bacterial contamination is greater and the major difficulty is to eliminate the infection from the joint and incision site.<sup>24</sup> Infected sequestra and osteomyelitis of subchondral bone will prevent proper healing. Curettage of septic physeal lesions in foals may be necessary.

Open drainage and intra-articular and parenteral antimicrobials has been used to treat persistent or severe septic arthritis/tenosynovitis. While joint lavage through needles is still effective in many horses with acute infectious arthritis or tenosynovitis, in those with chronic or recurring septic arthritis, open drainage is indicated to remove the inflammatory exudate from the synovial space. Infected synovial structures are drained through a small (3 cm) arthrotomy incision left open and protected by a sterile bandage. Joint lavage using antimicrobials is done daily

and parenteral antimicrobials are given intensively.

**Septic pedal arthritis in cattle** may be treated successfully by the creation of a drainage tract to promote adequate drainage. In cattle with septic arthritis of the digit, placement of a wooden block under the unaffected digit decreases weight-bearing on the affected digit and provides for earlier, less painful ambulation.<sup>25</sup>

### Arthrodesis or artificial ankylosis

Surgical arthrodesis can be used for the treatment of chronic septic arthritis in horses and calves.<sup>26,27</sup>

Septic arthritis of the distal interphalangeal joint is a common complication of diseases of the feet of cattle. Facilitated ankylosis of the joint is a satisfactory alternative to amputation of the affected digit in valuable breeding animals.<sup>28</sup> In a series of 12 cases of septic arthritis of the distal interphalangeal joint treated by use of facilitated ankylosis, the success rate was 100%.

### Physical therapy

The local application of heat, by hot fomentations or other physical means, is laborious but, if practiced frequently and vigorously, will reduce the pain and local swelling. Analgesics are recommended if there is prolonged recumbency. Persistent recumbency is one of the problems in the treatment of arthritis, particularly in foals. The animal spends little time feeding or sucking and loses much condition. Compression necrosis over bony prominences is a common complication and requires vigorous preventive measures.

### Anti-inflammatory agents

NSAIDs are used parenterally to decrease the inflammatory response and to provide analgesia. In experimental synovitis in the horse, similar to septic arthritis, phenylbutazone was more effective than ketoprofen in reducing lameness, joint temperature, synovial fluid volume and synovial fluid prostaglandin.<sup>29</sup>

### Prognosis for survival and athletic use in horses with septic arthritis

The factors affecting the prognosis for survival and athletic use in 93 foals treated for septic arthritis have been examined.<sup>12</sup> The femoropatellar and tarsocrural joints were most commonly affected. Osteomyelitis or degenerative joint disease were detected in 59% of the foals. Failure of transfer of passive immunity, pneumonia and enteritis were common. Treatment consisted of lavage, lavage and arthroscopic debridement with or without partial synovectomy, or lavage and arthrotomy to debride infected bone and parenteral antibiotics. Seventy-five foals survived and were discharged from hospital, and approximately one-third

raced. Isolation of *Salmonella* from synovial fluid was associated with an unfavorable prognosis for survival, and multisystemic disease was associated with an unfavorable prognosis for survival and ability to race. The key to successful outcome for septic arthritis is rapid diagnosis and initiation of treatment.

In a series of 507 horses treated for joint disease at one equine hospital during a period of 7 years, the risk factors affecting discharge from the hospital, of ever being sound, or of being alive after a 3-month followup were examined;<sup>30</sup> 58% of foals, 78% of yearlings and 94% of racing adults were discharged. Foals with a less severe lameness, duration of less than 1 day and infectious arthritis had increased odds of discharge.

### CONTROL

The control of infectious arthritis is of major importance in newborn farm animals. The early ingestion of adequate quantities of good-quality colostrum and a clean environment for the neonate are necessary. The prophylactic use of antimicrobials may be considered to reduce incidence. Some of the infectious arthritides associated with specific diseases can be controlled through immunization programs. For example, vaccination of piglets at 6–8 weeks of age will provide protection against both the septicemic and arthritic forms of erysipelas.

### REVIEW LITERATURE

Streppa HK, Singer MJ, Budsberg SC. Applications of local antimicrobial delivery systems in veterinary medicine. *J Am Vet Med Assoc* 2001; 219:40–48.

Sayeh AI, Moore RM. Polymethylmethacrylate beads for treating orthopedic infections. *Compend Contin Educ PractVet* 2003; 25:788–793.

### REFERENCES

- Zoric M et al. *Vet Rec* 2003; 153:323.
- Kofler J. *Berl Munch Tierarztl Wschr* 1995; 108:281.
- Peremans K et al. *J EquineVet Sci* 1991; 11:27.
- Gagnon H et al. *J Vet Pharmacol Ther* 1994; 17:31.
- Swerczek TW et al. *J Am Vet Med Assoc* 2001; 218:1800.
- Francoz D et al. *J Vet Intern Med* 2005; 19:336.
- Palmer JL, Bertone AL. *Equine Vet J* 1994; 26:492.
- De la Calle J et al. *Am J Vet Res* 2002; 63:1648.
- Spiers S et al. *Equine Vet J* 1994; 26:48.
- Rohde C et al. *Vet Surg* 2000; 4:341.
- Madison JB et al. *J Am Vet Med Assoc* 1991; 198:1655.
- Steel CM et al. *J Am Vet Med Assoc* 1999; 215:973.
- Crabill MR et al. *Vet Surg* 1996; 25:195.
- Kofler J. *Br Vet J* 1996; 152:683.
- Munroe GA, Cauvin ER. *Br Vet J* 1994; 150:439.
- Madison JB et al. *J Am Vet Med Assoc* 1995; 206:328.
- Grandemange E et al. *Ir Vet J* 2002; 55:237.
- Errecalde JO et al. *J Vet Pharmacol Ther* 2001; 24:1.
- Lescum TB et al. *Am J Vet Res* 2002; 63:683.
- Streppa HK et al. *J Am Vet Med Assoc* 2001; 219:40.
- Sayeh AI. *Compend Contin Educ PractVet* 2003; 25:788.

22. Trostle SS et al. J Am Vet Med Assoc 1996; 208:404.
23. McClure SR et al. J Am Vet Med Assoc 1993; 202:973.
24. Bertone AL et al. Am J Vet Res 1992; 53:585.
25. Guard C. Proc Am Assoc Bovine Pract 2000; 35:21.
26. Riley CB, Farrow CS. Can Vet J 1998; 39:438.
27. Groom LJ et al. Can Vet J 2000; 41:117.
28. Desrochers A et al. J Am Vet Med Assoc 1995; 206:1923.
29. Owens JG et al. Am J Vet Res 1996; 57:866.
30. Fubini SL et al. Can J Vet Res 1999; 63:253.

## Congenital defects of muscles, bones, and joints

Defects of the musculoskeletal system are among the most common congenital abnormalities in farm animals. In cattle 476 such defects are listed. Many of them are lethal, and most of the remainder are life-threatening because of interference with grazing or the prehension of food. Many of them occur in combinations so that single defects are uncommon. For example, most axial skeletal defects and cleft palates occur in calves that already have arthrogryposis.

Because of the very large volume of literature involved it is not possible to deal with all the recorded defects here, and the text is limited to those defects that are thought to be of general importance. Whether or not they are inherited or have an environmental cause is often not known so that an etiological classification is not very effective. Nor is an anatomical or pathological classification, so we are reduced to a classification based on abnormal function.

### FIXATION OF JOINTS

Because arthrogryposis, which has been used to convey the description of joint fixation, strictly means fixation in flexion, the term congenital articular rigidity has been introduced. The immobilization of the joint may be due to lack of extensibility of muscles, tendons, ligaments or other tissues around the joint, or to deformity of articular surfaces, or theoretically to fusion between the bones at the articular surface. Muscle contracture, which is the principal cause of joint fixation, has been produced experimentally, and occurs naturally, as a result of primary muscle atrophy or of atrophy resulting from denervation. Articular surface deformity is usually associated with gross deformity of the limb bones and is usually identifiable but the principal problem in the diagnosis of congenital articular rigidity is to determine what the pathogenesis might have been and, beyond that, what was the specific cause.

Congenital fixation of joints can be caused by some well known entities, as follows.

#### Cattle

- Hereditary congenital articular rigidity (HCAR) with cleft palate in Charolais
- HCAR with normal palates in Friesians, Danish Reds, Swedish, Shorthorns
- Inherited arthrogryposis
- Inherited multiple tendon contracture
- Inherited multiple ankylosis of Holstein–Friesian cattle.

Environmentally induced congenital articular rigidity caused by:

- Intrauterine infection with Akabane virus
- Ingestion of lupins
- Ingestion of *Astragalus* and *Oxytropis* spp. (locoweeds)
- Sorghum, Johnson grass, Sudan grass
- Dietary deficiency of manganese.

#### Sheep and goats

- Inherited congenital articular rigidity in Merino sheep
- Infection with Akabane virus
- Poisonous plants as for cattle
- Poisoning with parabendazole and cambendazole.

#### Piglets

- Inherited congenital articular rigidity
- Nutritional deficiency of vitamin A
- Poisonous plants, hemlock (*Conium maculatum*), *Prunus serotina*, Jimson weed (*Datura stramonium*), tobacco wastes.

#### Foals

- **'Contracted' foals** having congenital axial and appendicular contractures of joints in the us, cause unknown, not thought to be inherited. Deformities include torticollis, scoliosis, thinning of ventral abdominal wall, sometimes accompanied by eventration, asymmetry of the skull, flexion contracture in distal limb joints
- **Congenital articular rigidity** also occurs in foals from mares fed on hybrid Sudan grass pastures
- **Sporadic cases of congenital joint deformity** occur in foals and calves. They are manifested usually by excessive flexion of the metacarpophalangeal joints causing affected animals to 'knuckle' at the fetlocks and sometimes walk on the anterior aspect of the pastern. A similar defect occurs in the hindlegs. Many mild cases recover spontaneously but surgical treatment may be required in badly affected animals. The cause in these sporadic cases is unknown and necropsy examination fails to reveal lesions

other than excessive flexion of the joints caused by shortening of the flexor tendons. Rarely such fixations are associated with spina bifida or absence of ventral horn cells of the spinal cord.

### HYPERMOBILITY OF JOINTS

This is recorded as an inherited defect in Jersey cattle. Affected animals are unable to rise or stand because of the lack of fixation of limb joints. The joints and limbs are usually all affected simultaneously and are so flexible that the limbs can be tied in knots. Causes include:

- Inherited joint hypermobility in Jersey cattle
- Heredity in Holstein–Friesian cattle, which also have pink teeth due to absence of enamel
- In inherited congenital defects of collagen formation including dermatosparaxis, hyperelastosis cutis and Ehlers–Danlos syndrome in cattle
- Sporadically in newborn animals.

### WEAKNESS OF SKELETAL MUSCLES

A number of sporadic myopathies are recorded in cattle and sheep. Causes have not been determined in most of them. Splayleg in pigs has been well described and occurs in most countries.

### CONGENITAL HYPERPLASIA OF MYOFIBER

There is only one identified state; it is the inherited form of doppelender, double muscling or culard of cattle, described in Chapter 35. The principal cause of the bulging muscles is an increase in the number of myofibers in the muscle.

### OBVIOUS ABSENCE OR DEFORMITY OF SPECIFIC PARTS OF THE MUSCULOSKELETAL SYSTEM

A number of these defects are known to be inherited and are dealt with in Chapter 34. They include:

- Achondroplastic dwarfism, inherited miniature calves, bulldog calves
- Umbilical, scrotal hernia, cryptorchidism
- Tail deformity (kinking), taillessness
- Reduced phalanges, including hemimelia (individual bones missing), amputates (entire limbs missing), vestigial limbs (all parts present but limbs miniaturized). Amputates in outbreak form are recorded in cattle and produced experimentally by irradiation injury of sows, cows and ewes during early pregnancy.

- Inherited arachnomyelia (spidery limbs) of calves
  - Congenital thickleg of pigs, osteopetrosis of calves, muscular hypertrophy of calves
- Cyclopic deformity. Inherited form associated with prolonged gestation. Toxic form associated with ingestion of *Veratrum californicum*
- Displaced molar teeth, mandibular prognathism. Agnathia in lambs takes a variety of forms, including complete absence of lower jaw and tongue.

# Diseases of the skin, conjunctiva, and external ear

## INTRODUCTION 651

### PRINCIPLES OF TREATMENT OF DISEASES OF THE SKIN 653

Primary treatment 653  
Supportive treatment 653

### DISEASES OF THE EPIDERMIS AND DERMIS 654

Pityriasis 654  
Hyperkeratosis 654  
Parakeratosis 654  
Pachyderma 654  
Impetigo 655  
Urticaria 655  
Dermatitis and dermatosis 656  
Photosensitization 659

### DISEASES OF THE HAIR, WOOL, FOLLICLES, SKIN GLANDS, HORNS AND HOOVES 661

Alopecia and hypotrichosis 661  
Achromotrichia 662  
Leukoderma and leukotrichia 662  
Vitiligo 662

Seborrhea 662  
Folliculitis 663  
Diseases of hooves and horns 663

### DISEASES OF THE SUBCUTIS 664

Subcutaneous edema (anasarca) 664  
Angioedema (angioneurotic edema) 664  
Subcutaneous emphysema 665  
Lymphangitis 665  
Panniculitis 665  
Hemorrhage 666  
Necrosis and gangrene 666  
Subcutaneous abscess 666  
Cutaneous cysts 667

### GRANULOMATOUS LESIONS OF THE SKIN 667

#### CUTANEOUS NEOPLASMS 667

Papilloma and sarcoid 667  
Squamous-cell carcinoma 668  
Melanoma 668  
Cutaneous angiomatosis 668  
Lymphomatosis 668

Mast cell tumors 668  
Neurofibromatosis 668  
Histiocytoma 668  
Hemangioma and hemangiosarcoma 669  
Lipoma 669

### CONGENITAL DEFECTS OF THE SKIN 669

### CONGENITAL SKIN NEOPLASMS 669

### DISEASES OF THE CONJUNCTIVA 670

Conjunctivitis and keratoconjunctivitis 670

### CONGENITAL DEFECTS OF THE EYELIDS AND CORNEA 670

Dermoid cysts 670

### DISEASES OF THE EXTERNAL EAR 670

Otitis externa 670  
Otitis media 671

## Introduction

The major functions of the skin are:

- To maintain a normal body temperature
- To maintain a normal fluid and electrolyte balance within the animal
- To act as a sensory organ perceiving those features of the environment which are important to the subject's survival.

In general these functions are not greatly impeded by most diseases of the skin of large animals, with the exceptions of failure of the sweating mechanism, which does seriously interfere with body temperature regulation, and severe burns or other skin trauma, which may cause fatal fluid and electrolyte loss.

The major effects of skin diseases in large animals are esthetic and economic. The unsightly appearance of the animal distresses the owner. Discomfort and scratching interfere with normal rest and feeding and when the lips are affected there may be interference with prehension. There is loss of the economic coat and the sales value and acceptability of animals for transport and appearance in exhibitions, especially in other sovereign states, is greatly reduced.

### Primary/secondary lesions

Diseases of the skin may be primary or secondary in origin. In primary skin

disease the lesions are restricted initially to the skin although they may subsequently spread from the skin to involve other organs. On the other hand, cutaneous lesions may be secondary to disease originating in other organs. Differentiation between primary and secondary skin diseases should be attempted by seeking evidence that organs other than the skin are affected. If there is no such evidence produced during a complete clinical examination of the patient, it is reasonable to assume that the disease is primary. Even if involvement of other organs is diagnosed it is still necessary to determine whether the involvement constitutes the primary state or whether it has developed secondarily to the skin disease. This decision can be based on the chronology of the signs, elicited by careful history-taking, and a detailed knowledge of the individual diseases likely to be encountered.

When a careful clinical examination has been made and an accurate history taken it is then necessary to make a careful examination of the skin itself, using the proper technique of examination, especially (and essentially) histopathological examination of a biopsy specimen. It is then possible to determine the basic defect, whether it be inflammatory, degenerative or dysfunctional, and thus to define the type of lesion present.

The purpose of this chapter is to describe the basic skin lesions so that the

differential diagnosis, up to the point of defining the type and nature of the lesion, the pathoanatomical diagnosis, can be accomplished. A definitive etiological diagnosis requires further examination and is included in the discussion of the specific diseases in Part Two of this book.

### Clinical signs and special examination

A general clinical examination is followed by a special examination of the skin and must include inspection and, in most cases, palpation. Additional information can be obtained by taking swabs for bacteriological examinations, scrapings for examination for dermatophytes and metazoan parasites, and biopsy for histopathological examination.

Biopsy material should include abnormal, marginal, and normal skin. Artifacts are common in biopsy specimens, including nonrepresentative sampling, crushing the specimen by forceps or hemostat, and inadequate fixation.

Wood's lamp finds a special use in the examination of the skin for dermatophytes.

Descriptions of lesions should include size, depth to which they penetrate, geographical distribution on the body and size of the area covered. Abnormalities of sebaceous and sweat secretion, changes in the hair or wool coat and alterations in color of the skin should be noted, as should the presence or absence of pain or

pruritus and the manifestations of skin disease and the common lesions defined below.

### Lesions

An accurate definition of the lesions, summarized in Table 14.1, is an essential part of a skin patient's clinical record. The table makes a primary differentiation into discrete and diffuse lesions and these categories need to be further categorized in terms of size, e.g. they may be limited diffuse lesions or extensive localized ones.

### Abnormal coloration

This parameter includes jaundice, pallor and erythema, and these are best seen in the oral or vaginal mucosa or in the conjunctiva. In animals they are rarely visible in light-colored skins. Red-purple discoloration of the skin of septicemic,

white pigs may be dramatic but no diagnostic significance can be attached to its degree. Early erythema is a common finding where more definite skin lesions are to develop, as in early photosensitization. The blue coloration of early gangrene (e.g. of the udder and teat skin in the early stages of peracute bovine mastitis associated with *Staphylococcus aureus*) is characterized by coldness and loss of elasticity.

Hypopigmentation of the skin may be general, as in albino, pseudoalbino and lethal white animals. Local patches of hypopigmentation are characteristic of vitiligo and leukoderma.

### Pruritus

○ **Pruritus or itching** is the sensation that gives rise to scratching

- **Hyperesthesia** is increased sensitivity to normal stimuli
- **Paresthesia** is perverted sensation, a subjective sensation, and not diagnosed in animals.

All sensations that give rise to rubbing or scratching are therefore included with pruritus, more properly defined as scratching. Pruritus can arise from peripheral or central stimulation. When it is peripheral in origin it is a primary cutaneous sensation like heat, cold, pain and touch; it differs from pain because it is purely epidermal, whereas pain can still be felt in areas of skin denuded of epidermis. Thus itching does not occur in the center of deep ulcerations nor in very superficial lesions, such as those of ringworm, where only the hair fibers

Table 14.1 Terms used to identify skin lesions

Name of lesion	Nature of lesion	Relation to skin surface	Skin surface
Scales	Dry, flaky exfoliations	On surface only, no penetration of skin	Unbroken
Excoriations	Traumatic abrasions and scratches	Penetration below surface	Variable skin surface damage – depends on severity
Fissures	Deep cracks	Penetrate into subcutis	Disrupted
Dry gangrene	Dry, horny, black, avascular, shield-like	Above skin, usually all layers affected	Removed
Early, moist gangrene	Blue-black, cold, oozing serum	In plane of skin or below	Complete depth of subcutis
Keratosis	Overgrowth of dry, horny, keratinized epithelium	Above skin	Undamaged stratum corneum is retained
Acanthosis	Like keratosis but moist, soft	Above skin	Prickle cell layer swollen; is really part of skin
Hyperkeratosis	Excessive overgrowth of keratinized, epithelium-like scab	Above skin	Skin surface unbroken
Parakeratosis	Adherent to skin	Above skin	Cells of stratum corneum nucleated and retained; really part of skin
Eczema	Erythematous, itching dermatitis	Superficial layer of epidermis affected	Weeping, scabby disruption of surface
Hypermelanosis	Increased deposits of melanin, e.g. melanosis, meloderma	In epidermis or dermis	Unbroken
Hypomelanosis	Decreased deposits of melanin	In epidermis or dermis	Unbroken
<b>Discrete lesions</b>			
Vesicle, bleb, bulla, blister	Fluid (serum or lymph)-filled blister 1–2 cm diameter	Above skin surface, superficial	Unbroken but will slough
Pustule	Pus-filled blister, 1–5 mm	Above, superficial	Will rupture
Wheal	Edematous, erythematous, swellings, transitory	Above, all layers affected	Undamaged
Papules (pimples)	Elevated, inflamed, necrotic center, up to 1 cm diameter	Above surface, all layers affected	Points and ruptures
Nodules, nodes	Elevated, solid, up to 1 cm diameter. Acute or chronic inflammation. No necrotic center	Above surface, all layers	Surface unbroken
Plaque	A larger nodule, up to 3–4 cm diameter	All layers affected; raised above surface	Surface unbroken
Acne	Used synonymously with pimple but strict meaning is infection of sebaceous gland	Above surface of skin; all layers affected	May point and rupture
Comedo	Plugged (sebum, keratin) hair follicle	Raised above skin	May rupture
Impetigo	Flaccid vesicle, then pustule, then scab, up to 1 cm diameter	Raised above skin; very superficial	Upper layers destroyed
Scab (or crust)	Crust of coagulated, blood, pus and skin debris	Raised above skin	Disrupted, depth varying with original lesion
Macule (patch)	Small area of color change; patch is larger	Within superficial layers	Unbroken

<sup>1</sup>Above skin, usually all

<sup>2</sup>Pyoderma is any infection of skin; includes impetigo, acne, pustule, pimple

and keratinized epithelium are involved. Itching can be elicited over the entire skin surface but is most severe at the mucocutaneous junctions. Common causes include the following.

#### Cattle

- Sarcoptic and chorioptic mange
- Aujeszky's disease
- Nervous acetonemia
- Lice infestation.

#### Sheep

- Lice, mange, ked, blowfly and itch-mite infestations
- Scrapie.

#### Pigs

- Sarcoptic and chorioptic mange
- Lice infestation.

#### Horses

- Chorioptic mange on the legs
- Queensland (sweet) itch along the dorsum of the body
- Lice infestation
- Perianal pruritus due to *Oxyuris equi* infestation.

#### All species

- The early stages of photosensitive dermatitis
- Urticarial wheals in an allergic reaction
- 'Licking syndromes' such as occur in cattle on copper-deficient diets are accompanied by pica and the licking of others as well as themselves. They are examples of depraved appetites developed in response to nutritional deficiency and are not a response to pruritus
- **Itching of central origin** derives in the main from the scratch center below the acoustic nucleus in the medulla. It may have a structural basis, as in scrapie and pseudorabies, or it may be functional in origin, as in the nervous form of acetonemia. The only lesions observed are those of a traumatic dermatitis with removal of the superficial layers to a variable depth, breakage or removal of the hairs and a distribution of lesions in places where the animal can bite or rub easily.

#### Secretion abnormalities of skin glands

The activity of the **sweat glands** is controlled by the sympathetic nervous system and is for the most part a reflection of body temperature. Excitement and pain may cause sweating due to cerebral cortical activity. A generalized form of hyperhidrosis, apparently inherited, has been recorded in Shorthorn calves. Local areas of increased or decreased sweating may arise from peripheral nerve lesions or obstruction of

sweat gland ducts. A generalized anhidrosis is recorded in horses and occasionally in cattle.

Excess secretion of sebum by **sebaceous glands** causes oiliness of the skin or seborrhea but its pathogenesis is poorly understood.

#### Abnormalities of wool and hair fibers

Deficiency of hair or wool in comparison to the normal pilosity of the skin area is **alopecia** or **hypotrichosis**.

**Hirsutism**, abnormal hairiness, manifested by a long, shaggy, usually curly, coat is most common in aged ponies with adenomas of the pars intermedia of the pituitary gland.

The character of the fiber may also vary with variations in the internal environment. For example, in copper deficiency the crimp of fine wool fibers is lost and the wool becomes straight and 'steely'. Alternation in coat color, achromotrichia, may be generalized or segmental along the fiber.

## Principles of treatment of diseases of the skin

### PRIMARY TREATMENT

Primary treatment commences with removal of hair coat and debris to enable topical applications to come into contact with the causative agent. Accurate diagnosis of the cause must precede the selection of any topical or systemic treatment. In bacterial diseases sensitivity tests on cultures of the organism are advisable. Specific skin diseases due to bacteria, fungi and metazoan parasites are reasonably amenable to treatment with the appropriate specific remedy.

Bacterial resistance to antimicrobials used in veterinary dermatological practice is a concern.<sup>1</sup> The broad application of antimicrobials for various therapeutic and nontherapeutic purposes has accelerated the spread of pre-existing resistance genes and led to the apparent development of mechanisms by which resistance genes are spread, not only within a bacterial species, but also between bacterial species. Every veterinarian must strive to practice prudent use of antimicrobials in order to minimize the resistance problem.

Removal of the causative agent in allergic diseases and photosensitization may be impossible and symptomatic treatment may be the only practicable solution. In many cases, too, the primary disease may be confounded by the presence of a secondary agent, which can

lead to confusion in diagnosis. Treatment may be unsuccessful if both agents are not treated.

### SUPPORTIVE TREATMENT

Supportive treatment includes prevention of secondary infection by the use of bacteriostatic ointments or dressings and the prevention of further damage from scratching.

- Effective treatment of pruritus depends upon the reduction of central perception of itch sensations by the use of ataractic, sedative or narcotic drugs administered systemically or on successful restraint of the mediator between the lesion and the sensory end organ. In the absence of accurate knowledge of the pathogenesis of pain it is usual to resort to local anesthetic agents, which are shortlived in their activity, and corticosteroids, which are longer-acting and effective, provided that vascular engorgement is part of the pruritus-stimulating mechanism
- When large areas of skin are involved it is important to prevent the absorption of toxic products by continuous irrigation or the application of absorptive dressings. Losses of fluid and electrolytes should be made good by the parenteral administration of isotonic fluids containing the necessary electrolytes
- Ensure an adequate dietary intake of protein, particularly sulfur-containing amino acids to facilitate the repair of skin tissues
- Boredom contributes significantly to an animal's response to itch stimuli, and close confinement of affected animals is best avoided.

### REVIEW LITERATURE

- Pascoe RR. Equine dermatoses. University of Sydney Postgraduate Communications in Veterinary Science Review 22. Sydney: University of Sydney, 1974.
- Montes LF, Vaughan JT. Atlas of skin diseases of the horse. Philadelphia: WB Saunders, 1983.
- Mullowney PC. Symposium on large animal dermatology. Vet Clin North Am Large Anim Pract 1984; 6:1-226.
- Mullowney PC, Fadok VA. Dermatologic diseases of the horse. Compend Contin Educ Pract Vet 1984; 6:S16-S20, S22-S26.
- Scott DW. Large animal dermatology. Philadelphia: WB Saunders, 1988.
- Schwarz S, Noble WC. Aspects of bacterial resistance to antimicrobials used in veterinary dermatological practice. Vet Dermatol 1999; 10:163-176.
- Matousek JL, Campbell KL. A comparative review of cutaneous pH. Vet Dermatol 2002; 13:293-300.

### REFERENCE

1. Schwarz S, Noble WC. Vet Dermatol 1999; 10:163-176.



## Diseases of the epidermis and dermis

### PITYRIASIS

**Primary pityriasis**, excessive bran-like scales on the skin, characterized by overproduction of keratinized epithelial cells, can be caused by:

- Hypovitaminosis A
- Nutritional deficiency of B vitamins, especially of riboflavin and nicotinic acid, in pigs, or linolenic acid, and probably other essential unsaturated fatty acids
- Poisoning by iodine
- Pityriasis rosea occurs in humans and pigs and the etiology is unknown. The literature for and against an infectious etiology has been reviewed.<sup>1</sup>

**Secondary pityriasis**, characterized by excessive desquamation of epithelial cells is usually associated with:

- Scratching in flea, louse and mange infestations
- Keratolytic infection, e.g. with ringworm fungus.

Pityriasis scales are accumulations of keratinized epithelial cells, sometimes softened and made greasy by the exudation of serum or sebum. Overproduction, when it occurs, begins around the orifices of the hair follicles and spreads to the surrounding stratum corneum.

Primary pityriasis scales are superficial, accumulate where the coat is long, and are usually associated with a dry, lusterless coat. Itching or other skin lesions are not features. Secondary pityriasis is usually accompanied by the lesions of the primary disease.

Pityriasis is identified by the absence of parasites and fungi from skin scrapings.

#### DIFFERENTIAL DIAGNOSIS

- Hyperkeratosis (see below)
- Parakeratosis (see below)

#### TREATMENT

**Primary treatment** requires correction of the primary cause.

**Supportive treatment** commences with a thorough washing, followed by alternating applications of a bland, emollient ointment and an alcoholic lotion. Salicylic acid is frequently incorporated into a lotion or ointment with a lanolin base.

### HYPERKERATOSIS

Epithelial cells accumulate on the skin as a result of excessive keratinization of

epithelial cells and intercellular bridges, interference with normal cell division in the granular layer of the epidermis and hypertrophy of the stratum corneum.

Lesions may be **local** at pressure points, e.g. elbows, when animals lie habitually on hard surfaces. **Generalized hyperkeratosis** may be caused by:

- Poisoning with highly chlorinated naphthalene compounds
- Chronic arsenic poisoning
- Inherited congenital ichthyosis
- Inherited dyserythropoiesis–dyskeratosis.

The skin is dry, scaly, thicker than normal, usually corrugated, hairless and fissured in a gridlike pattern. Secondary infection of deep fissures may occur if the area is continually wet. However, the lesion is usually dry and the plugs of hyperkeratotic material can be removed, leaving the underlying skin intact.

Confirmation of the diagnosis is by the demonstration of the characteristically thickened stratum corneum in a biopsy section, which also serves to differentiate the condition from parakeratosis (see below) and inherited ichthyosis.

Primary treatment depends on correction of the cause. Supportive treatment is by the application of a keratolytic agent (e.g. salicylic acid ointment).

### PARAKERATOSIS

Parakeratosis, a skin condition characterized by incomplete keratinization of epithelial cells, can be:

- Caused by nonspecific chronic inflammation of cellular epidermis
- Associated with dietary deficiency of zinc
- Part of an inherited disease listed below.

The initial lesion comprises edema of the prickle cell layer, dilatation of the intercellular lymphatics, and leukocyte infiltration. Imperfect keratinization of epithelial cells at the granular layer of the epidermis follows, and the horn cells produced are sticky and soft, retain their nuclei and stick together to form large masses, which stay fixed to the underlying tissues or are shed as thick scales.

The lesions may be extensive and diffuse but are often confined to the flexor aspects of joints (referred to historically in horses as mallenders and sallenders). Initially the skin is reddened, followed by thickening and gray discoloration. Large, soft scales accumulate, are often held in place by hairs and usually crack and fissure, and their removal leaves a raw, red surface. Hyperkeratosis scales are thin, dry and accompany an intact, normal skin.

Confirmation of a diagnosis of parakeratosis is by the identification of imperfect keratinization in a histopathological examination of a biopsy or a skin section at necropsy.

#### DIFFERENTIAL DIAGNOSIS

- Hyperkeratosis (see above)
- Pachyderma (see below)
- Ringworm
- Inherited ichthyosis
- Inherited Adema disease in cattle
- Inherited dermatosis vegetans in pigs
- Inherited epidermal dysplasia

#### TREATMENT

**Primary treatment** requires correction of any nutritional deficiency.

**Supportive treatment** includes removal of the crusts by the use of keratolytic agent (e.g. salicylic acid ointment) or by vigorous scrubbing with soapy water, followed by application of an astringent (e.g. white lotion paste), which must be applied frequently and for some time after the lesions have disappeared.

### PACHYDERMA

Pachyderma, including scleroderma, is thickening of the skin affecting all layers, often including subcutaneous tissue, and usually localized but often extensive as in lymphangitis and greasy heel in horses. There are no specific causes, most cases being due to nonspecific chronic or recurrent inflammation.

In affected areas the hair coat is thin or absent and the skin is thicker and tougher than usual. It appears tight and, because of its thickness and reduced volume of subcutaneous tissue, cannot be picked into folds or moved easily over underlying tissue. The skin surface is unbroken and there are no lesions and no crusts or scabs as in parakeratosis and hyperkeratosis (see above).

Confirmation of the diagnosis depends on histopathological examination of a biopsy. The cells in all layers are usually normal but the individual layers are increased in thickness. There is hypertrophy of the prickle cell layer of the epidermis and enlargement of the interpapillary processes.

#### DIFFERENTIAL DIAGNOSIS

- Parakeratosis (see above)
- Cutaneous neoplasia
- Papillomatosis

#### TREATMENT

**Primary treatment** requires removal of the causal irritation but in well-established

cases little improvement can be anticipated, and surgical removal may be a practical solution when the area is small. In early cases local or systemic corticosteroids may effect a recovery.

### IMPETIGO

A superficial eruption of thin-walled, small vesicles, surrounded by a zone of erythema, that develop into pustules, then rupture to form scabs.

In humans, impetigo is specifically a streptococcal infection but lesions are often invaded secondarily by staphylococci. In animals the main organism found is usually a staphylococcus. The causative organism appears to gain entry through minor abrasions, with spread resulting from rupture of lesions causing contamination of surrounding skin and the development of secondary lesions. Spread from animal to animal occurs readily.

The only specific examples of impetigo in large animals are:

- Udder impetigo of cows
- Infectious dermatitis or 'contagious pyoderma' of baby pigs associated with unspecified streptococci and staphylococci.

Small (3–6 mm) vesicles appear chiefly on the relatively hairless parts of the body and do not become confluent. In the early stages each vesicle is surrounded by a narrow zone of erythema. No irritation is evident. Vesicle rupture occurs readily but some persist as yellow scabs. Involvement of hair follicles is common and leads to the development of acne and deeper, more extensive lesions. Individual lesions heal rapidly in about a week but successive crops of vesicles may prolong the duration of the disease.

Confirmation of the diagnosis is by culture of vesicular fluid and identification of the causative bacterium and its sensitivity.

### DIFFERENTIAL DIAGNOSIS

- Cowpox, in which the lesions occur almost exclusively on the teats and pass through the characteristic stages of pox
- Pseudocowpox, in which lesions are characteristic and also restricted in occurrence to the teats.

### TREATMENT

**Primary treatment** with antibiotic topically is usually all that is required because individual lesions heal so rapidly.

**Supportive treatment** is aimed at preventing the occurrence of secondary lesions and spread of the disease to other animals. Twice daily bathing with an

efficient germicidal skin wash is usually adequate.

### URTICARIA

An allergic condition characterized by cutaneous wheals. It is most common in horses.<sup>2</sup>

### ETIOLOGY

**Primary urticaria** results directly from the effect of the pathogen, e.g.:

- Insect stings
- Contact with stinging plants
- Ingestion of unusual food, with the allergen, usually a protein
- Occasionally an unusual feed item, e.g. garlic to a horse<sup>3</sup>
- After a recent change of diet
- Administration of a particular drug, e.g. penicillin; possibly guaifenesin or other anesthetic agent<sup>4</sup>
- Allergic reaction in cattle 8 days following vaccination for foot-and-mouth disease<sup>5</sup>
- Death of warble fly larvae in tissue
- Milk allergy when Jersey cows are dried off
- Transfusion reaction.

**Secondary urticaria** occurs as part of a syndrome, e.g.:

- Respiratory tract infections in horses, including strangles and the upper respiratory tract viral infections
- Erysipelas in pigs.

### PATHOGENESIS

The lesions are characteristic of an allergic reaction. There is degranulation of mast cells followed by liberation of chemical mediators inflammation, resulting in the subsequent development of dermal edema. A primary dilatation of capillaries causes cutaneous erythema. Exudation from the damaged capillary walls causes local edema in the dermis and a wheal develops. Only the dermis, and sometimes the epidermis, is involved. In extreme cases the wheals may expand to become seromas, when they may ulcerate and discharge. The lesions of urticaria usually resolve in 12–24 hours but in recurrent urticaria an affected horse may have persistent and chronic eruption of lesions over a period of days or months.<sup>6</sup>

### CLINICAL FINDINGS

Wheals, mostly circular, well delineated, steep-sided, easily visible elevations in the skin, appear very rapidly and often in large numbers, commencing usually on the neck but being most numerous on the body. They vary from 0.5–5 cm in diameter, with a flat top, and are tense to the touch. There is often no itching, except with plant or insect stings, nor discontinuity of the epithelial surface, exudation or

weeping. Pallor of the skin in wheals can be observed only in unpigmented skin. Other allergic phenomena, including diarrhea and slight fever, may accompany the eruption. The onset of the lesions is acute to peracute with the wheals developing within minutes to hours after exposure to the triggering agent. When associated with severe adverse systemic responses, including apnea, respiratory arrest, atrial fibrillation, cardiac arrest or sudden death, the case qualifies as one of anaphylaxis.

Subsidence of the wheals within 24–48 hours is usual but they may persist for 3–4 days because of the appearance of fresh lesions. In some very sensitive horses, dermatographism, the production of a continuous wheal following the pattern of a blunt-pointed instrument drawn across the skin, can be demonstrated about 30 minutes later.<sup>7</sup>

Urticaria lasting 8 weeks or longer is classified as chronic or recurrent urticaria, which may require testing for atopic disease using intradermal skin testing and serum testing for antigen-specific IgE.

Adverse reactions in dairy cattle following annual vaccination for foot-and-mouth disease are characterized by wheals (3–20 mm in diameter) covering most of the body, followed by exudative and necrotic dermatitis.<sup>5</sup> The affected areas become hairless and the wheals exude serum and become scabbed over. Edema of the legs is common and vesicles occur on the teats. The lesions appear 8–12 weeks postvaccination and may persist for 3–5 weeks. Loss of body weight and lymphadenopathy also occur. Pruritus, depression and a drop in milk yield are common.

### CLINICAL PATHOLOGY

Intradermal skin tests to detect the presence of hypersensitivity are of little value because many normal horses, as well as those with urticaria, will respond positively to injected or topically applied allergens. Also, reactions usually occur within the first 24 hours after the injection, but the interval is very erratic. The duration of the reaction also varies a great deal.<sup>8</sup> Intradermal tests in horses without atopy and horses with atopic dermatitis or recurrent urticaria using environmental allergens indicate a greater number of positive reactions for intradermal tests in horses with atopic dermatitis or recurrent urticaria, compared with horses without atopy. This provides evidence of type-1 IgE-mediated hypersensitivity for these diseases.<sup>6</sup>

Biopsies show that tissue histamine levels are increased and there is a local accumulation of eosinophils. Blood histamine levels and eosinophil counts may also show transient elevation.

### DIFFERENTIAL DIAGNOSIS

Urticaria is manifested by a sudden appearance of a crop of cutaneous wheals, sometimes accompanied by restlessness, mostly in horses, occasionally in cattle. Identification of the etiology is also helpful in diagnosis but is often difficult, depending on a carefully taken history and examination of the environment.

The differential diagnosis list is limited to angioedema, but in urticaria the lesions can be palpated in the skin itself. Angioedema involves the subcutaneous tissue rather than the skin and the lesions are much larger and more diffuse. The two conditions may appear in the one animal at the one time.

### TREATMENT

#### Primary treatment

A change of diet and environment, especially exposure to the causal insects or plants, is standard practice. Spontaneous recovery is common.

#### Supportive treatment

Corticosteroids, antihistamines, or epinephrine by parenteral injection provide the best and most rational treatment, especially in the relief of the pruritus, which can be annoying in some cases. One treatment is usually sufficient but lesions may recur. The local application of cooling astringent lotions such as calamine or white lotion or a dilute solution of sodium bicarbonate is favored. In large animal practice parenteral injections of calcium salts are used with apparently good results.

Long-term medical management of persistent urticaria involves the administration of corticosteroids and or antihistamines. Oral administration or prednisone or prednisolone at the lowest possible dose on alternate days is the method of choice.<sup>2</sup> The antihistamine of choice is oral hydroxyzine hydrochloride initially at 600 mg three times daily, followed by gradual reduction to a minimum maintenance dose required to keep the horse free of lesions.

### REVIEW LITERATURE

- Evans AG. Urticaria in horses. *Compend Contin Educ Pract Vet* 1997; 15:626–632.
- Stannard AA. Immunologic diseases. *Vet Dermatol* 2000; 11:163–178.
- Chuh A, Chan H, Zawar V. Pityriasis rosea—evidence for and against an infectious etiology. *Epidemiology* 2004; 132:381–390.

### REFERENCES

- Chuh A et al. *Epidemiology* 2004; 132:381.
- Stannard AA. *Vet Dermatol* 2000; 11:163.
- Miyazawa K et al. *J Vet Med Sci* 1991; 53:747.
- Matthews NS et al. *Equine Vet J* 1993; 25:555.
- Yerhuam I et al. *Vet Dermatol* 2001; 12:197.
- Lorch G et al. *Am J Vet Res* 2001; 62:1051.
- Cornick JL, Brumbaugh GW. *Cornell Vet* 1989; 79:109.
- Evans AG et al. *Am J Vet Res* 1992; 53:203.

## DERMATITIS AND DERMATOSIS

### Synopsis

**Etiology** Any disease of skin, including those characterized by inflammation. All pathogens, infectious, chemical, physical, allergic, autoimmune

**Epidemiology** Sporadic or outbreak, acute or chronic course, cosmetic to lethal, but of most importance as constraints on movement, sale or exhibition

**Clinical signs** Primarily localized to skin, including lesions varying from parakeratosis and pachyderma to weeping, through necrosis, vesicles and edema. Secondary signs of shock, toxemia, anaphylaxis

**Clinical pathology** Positive findings in the area of skin swabs or scrapings

**Necropsy lesions** Inflammatory, degenerative or vascular lesions in skin biopsy

**Diagnostic confirmation** Positive finding in skin biopsy

**Treatment** primary is removal of the pathogen; supportive includes treatment for shock, toxemia or fluid and electrolyte loss

### ETIOLOGY

Some of the identifiable occurrences of dermatitis in food animals and horses are as follows.

#### All species

- Mycotic dermatitis due to *Dermatophilus congolensis*, in horses, cattle, sheep
- *Staphylococcus aureus* is a common finding in cases in all species, either as a sole pathogen or combined with other agents
- Ringworm
- Photosensitive dermatitis
- Chemical irritation (contact dermatitis) topically
- Arsenic – systemic poisoning
- Mange mite infestation – sarcoptic, psoroptic, chorioptic, demodectic mange
- Trombidiform mite infestation (tyroglyphosis)
- Biting flies especially *Culicoides* spp. Observed most commonly in horses, but also in other species<sup>1</sup>
- *Stephanofilaria* sp. dermatitis
- *Strongyloides* (*Pelodera*) sp. dermatitis
- Infection with the protozoon *Besnoitia* spp.

#### Cattle

- Udder impetigo – *S. aureus*
- Cutaneous botryomycosis of the udder caused by a combination of trauma and infection by *Pseudomonas aeruginosa*
- Cowpox
- Ulcerative mammillitis – udder and teats only

- Lumpy skin disease – Allerton and Neethling 'strains'
- Foot-and-mouth disease – vesicles around natural orifices; vesicular stomatitis with lesions on teats and coronet
- Rinderpest, bovine virus diarrhea, bovine malignant catarrh, bluetongue – erosive lesions around natural orifices, eyes, coronets
- Sweating sickness
- Perianal vesicular and necrotic dermatitis associated with mushroom poisoning
- Dermatitis on legs – potato poisoning topical application of irritants or defatting agents, e.g. diesoline
- Dermatitis due to the ingestion of *Vicia villosa* and *Vicia dasycarpa*
- Plaque-like and cracked skin lesions on the udder, hindquarters, lips and muzzle of cattle bedded on straw heavily contaminated with *Fusarium sporotrichioides*<sup>2</sup>
- Flexural seborrhea
- Bovine exfoliative dermatitis (see below)
- Slurry heel (see below).

#### Sheep and goats

- Strawberry footrot – *Dermatophilus pedis*
- Sheep pox
- Contagious ecthyma
- Ulcerative dermatosis
- Rinderpest, peste de petits ruminants, bluetongue – as for cattle
- Foot-and-mouth disease and vesicular stomatitis
- Fleece rot – constant wetting and associated with *P. aeruginosa*<sup>3</sup>
- Lumpy wool – *D. congolensis*
- Itch-mite (*Psorergates ovis*) infestation
- Blowfly infestation (cutaneous myiasis)
- 'Cockle' (probably related to louse infestation)<sup>4</sup>
- Elaeophoriosis (*Elaeophora* sp. infestation)
- Ovine atopic dermatitis
- Caprine idiopathic dermatitis
- Postdipping necrotic dermatitis (see below).

#### Pigs

- Ulcerative granuloma – *Borrelia suilla*
- Exudative epidermitis – *Staphylococcus hyicus* (greasy pig disease)
- Pig pox
- Swine vesicular disease, vesicular exanthema of swine, foot-and-mouth disease – vesicles around natural orifices
- Contact with fresh parsnip tops, celery
- Sunburn
- Porcine necrotic ear syndrome
- Nonspecific nutritional dermatitis – experimental nutritional deficiency of

nicotinic acid, riboflavin, pantothenic acid, biotin

- Pityriasis rosea – cause unknown
- Idiopathic chronic recurrent dermatoses.

#### Horses

- *Staphylococcus hyicus* in a syndrome reminiscent of greasy heel
- *Actinomyces viscosus*
- Horsepox
- Canadian horsepox
- Viral papular dermatitis
- Vesicular stomatitis – vesicles around natural orifices
- Vesicular dermatitis around nasal area, eyes, ears in horses stabled on shavings of a tree of the *Quassia* spp.<sup>5</sup>
- Spongiotic vesicular dermatitis of unknown etiology<sup>6</sup>
- Sporotrichosis
- Dermatophytes, including ringworm, follicular dermatitis, hyphomycosis (pythiosis), tinea versicolor dermatitis
- Scald – constant wetting
- Queensland (sweet) itch – sensitivity to *Culicoides* spp. sandflies<sup>7</sup>
- Atopic dermatitis (IgE-mediated hypersensitivity)<sup>8</sup>
- Chronic eosinophilic dermatitis (see below)
- Pemphigus, lupus erythematosus, erythema multiforme, eosinophilic dermatitis and stomatitis, described separately below
- Molluscum contagiosum (see below)
- Linear hyperkeratosis (see below)
- Nodular necrobiosis (see below)
- Ear plaque (see below)
- Uasin gishu disease
- Cutaneous habronemiasis
- Tropical lichen (see below)
- Midline, ventral dermatitis due to infestation with *Hydrotaea irritans* (horn fly and buffalo fly)
- Trombidiform mites, e.g. *Pyemotes tritici* and *Acarus (Tyroglyphus) farinae*
- Ulcerative dermatitis, thrombocytopenia and neutropenia in neonatal foals (see Alloimmune hemolytic anemia of the newborn (Neonatal isoerythrolysis, isoimmune hemolytic anemia of the newborn), Ch. 33).

#### Special local dermatitides

These include dermatitis of the teats and udder, the bovine muzzle and coronet, and flexural seborrhea, and are dealt with under their respective headings.

#### PATHOGENESIS

Dermatitis is basically an inflammation of the deeper layers of the skin involving the blood vessels and lymphatics. The purely cellular layers of the epidermis are involved only secondarily. The noxious agent causes cellular damage, often to the point

of necrosis, and, depending on the type of agent responsible, the resulting dermatitis varies in its manifestations. It may be acute or chronic, suppurative, weeping, seborrheic, ulcerative or gangrenous. In all cases there is increased thickness and increased temperature of the part. Pain or itching is present and erythema is evident in unpigmented skin. Histologically there is vasodilatation and infiltration with leukocytes and cellular necrosis. These changes are much less marked in chronic dermatitis.

#### CLINICAL FINDINGS

Affected skin areas first show erythema and increased warmth. The subsequent stages vary according to the type and severity of the causative agent. There may be development of discrete vesicular lesions or diffuse weeping. Edema of the skin and subcutaneous tissues may occur in severe cases. The next stage may be the healing stage of scab formation or, if the injury is more severe, there may be necrosis or even gangrene of the affected skin area. Spread of infection to subcutaneous tissues may result in a diffuse cellulitis or phlegmonous lesion. A distinctive suppurative lesion is usually classified as pyoderma. Deep lesions which cause damage to dermal collagen may cause focal scarring and idiopathic fibrosing dermatitis (see below).

A systemic reaction is likely to occur when the affected skin area is extensive. Shock, with peripheral circulatory failure, may be present in the early stages. Toxemia, due to absorption of tissue breakdown products, or septicemia due to invasion via unprotected tissues, may occur in the later stages.

Individual dermatitides are as follows:

- **Bovine exfoliative dermatitis** in calves associated with the excretion of an unidentified agent in the dam's milk. The calves show a widespread dermatitis, including vesicles on the muzzle, scaling and hair loss, at a few days of age but recover spontaneously before 3 months of age. The dam has the same disease in a mild but chronic form<sup>9</sup>
- **Slurry heel**<sup>10</sup> is erosion and deep fissuring of the epithelium and horn of the heel of cattle housed indoors and standing continuously in slurry. The affected claws are destabilized by the disappearance of support so that the pedal bone projects downwards and through the dorsal surface of the sole; the heel sinks and the toe overgrows. Sole ulceration is a common sequel. The condition can be confused with interdigital dermatitis
- **Ovine postdipping necrotic dermatitis** is associated with *P. aeruginosa* and related to dipping in solutions containing no bacteriostatic agent.<sup>11</sup> Necrotic lesions (1–3 cm in diameter), with cellulitis down to the underlying muscle, occur only along the backline and may be related to trauma during dipping. It may be accompanied by an outbreak of fatal otitis media with *P. aeruginosa* present in the lesion
- **Ovine atopic dermatitis:** Only the wool-less parts of the skin are affected by symmetrical erythema, alopecia, lichenification and excoriation. Only occasional sheep in the flock are affected and these are affected each summer, with remission during the winter months<sup>12</sup>
- **Caprine idiopathic dermatitis:** Alopecic, exudative dermatitis of all ages and both sexes of pygmy goats<sup>13</sup> is characterized by hair loss, scaling and crusting around eyes, lips and chin, ears, poll, perineum and ventral abdomen. Histologically the lesions have a psoriasis-like form
- **Porcine dermatitis–nephropathy syndrome,** an idiopathic low morbidity but highly fatal disease of feeder pigs,<sup>14–16</sup> is characterized by papular, vascular dermatopathy, systemic necrotizing vasculitis and exudative, proliferative glomerulonephritis. Skin lesions are full-depth necrosis appearing as multiple, flat, red-blue papules up to 2 cm in diameter (which may coalesce to form large plaques) on any part of the body. Some pigs die of glomerulonephritis without skin lesions having been apparent. Many cases that show only skin lesions recover spontaneously in several weeks. The disease may disappear if the commercial grain ration used is ground more coarsely
- **Porcine necrotic ear syndrome** is an extensive necrosis of the edges of the ears. The cause is unknown but the possibility that a combination of *S. hyicus* infection and trauma by biting by pen mates is the cause seems high
- **Porcine idiopathic chronic, recurrent dermatitis** is recorded in sows in specific farrowing houses.<sup>17</sup> Boars and piglets were not affected and lesions disappeared as soon as the sows left the houses. Annular macules 11 cm diameter and patches of erythema 11 cm diameter occur only on white skin. There are no systemic signs
- **Equine staphylococcal dermatitis** is a serious disease because the lesions are intractable to treatment and are so painful to touch that the horse is hard

to handle, and the presence of the lesions under harness, where they commonly are, prevents the horse from working kindly. Harness horses are at a particular disadvantage. Individual lesions are raised nodules, 3–5 mm diameter, covered by a small, easily removed scab. When these lift they take a tuft of hair with them and a small crater is left. A little pus exudes and only a red serous fluid can be expressed. Individual lesions last a long time, at least several weeks, and fresh crops occur, causing the disease to spread slowly on the animal

- **Chronic equine eosinophilic dermatitis** is characterized by marked acanthosis and hyperkeratosis, and eosinophilic granulomas in pancreas, salivary glands and other epithelial organs. The systemic involvement is accompanied by severe weight loss. The disease is chronic, and the cause unknown
- **Spongiotic vesicular dermatitis** has been described in horses.<sup>6</sup> Lesions are characterized by a multifocal, exudative, oozing dermatitis characterized histologically by epidermal spongiotic vesicles and perivascular eosinophilic, neutrophilic and mixed mononuclear inflammation. Some horses are pruritic
- **Equine nodular necrobiosis:** Firm, small (up to 1 cm diameter) nodules, usually a number of them, occur on the sides of the trunk and neck. The cause is unknown. The lesions consist largely of an accumulation of eosinophils
- **Molluscum contagiosum** is a chronic, progressive dermatitis<sup>18</sup> characterized by raised, hairless lesions 0.5–2 cm in diameter, covered by soft keratin, that bleed profusely when the horse is groomed. The lesions are on the face, shoulders, trunk, lateral aspects of limbs, fetlocks and pasterns. Histological examination identifies the disease because of the presence of characteristic inclusions in cells. These are thought to be pox virus virions, but the virus cannot be cultivated from the lesions. There is no specific treatment
- **Systemic lupus erythematosus (SLE)** is an extensive dermatitis, manifested as a scaly, crusty dermatitis of the face, neck and trunk, with loss of hair over the lesions, edema of the limbs and a mild to moderate lymph node enlargement.<sup>7,19</sup> Multiple ulcers 11 cm in diameter are present on the oral mucosa, especially the

mucocutaneous junctions of the lips and nares, and on the tongue. There is a severe systemic reaction, including a marked loss of body weight, a temperature up to 39.5°C, heart rate 80/min, respiratory rate up to 60/min, painful swollen joints containing sterile serous fluid, stiff gait, reluctance to move, and persistent lateral recumbency. SLE is an immune-mediated disease with a characteristic histopathology including a necrotizing, lymphocytic dermatitis and focal accumulations of lymphocytes in the liver, membranous glomerulonephritis and synovioocyte hyperplasia. An antinuclear antibody test is diagnostic. No treatment is effective and the disease runs a chronic progressive course marked by remissions and exacerbations

- **Discoid lupus erythematosus** is an uncommon, benign variant of the systemic disease, with cutaneous lesions similar to those in the major disease but with no involvement of other tissues
- **Erythema multiforme** is a self-limiting skin disease of horses and cattle characterized by macular, papular, urticarial or bullous skin lesions but without any abnormality of the epidermis or loss of hair, and with no apparent itching or pain. The lesions occur symmetrically on most parts of the body, persist for long periods and increase in size up to 4–5 cm to form annular or crescent-shaped wheals. Spontaneous disappearance of the lesions after about 3 months is usual. Symptomatic treatment may be effective but is not usually necessary
- **Equine ear plaque:** Multiple white plaques, resembling papilloma and about 1 cm in diameter, develop on the inner surface of the ear pinna of horses
- **Equine tropical lichen** is an intensely irritating, papular eruption in the skin on the side of the neck, under the mane, the shoulders and at the tail head, occurring in summer and recurring annually. The disease closely resembles the cutaneous sensitivity to *Culicoides* spp. but responds dramatically to treatment with ivermectin. Microfilariae, thought to be *Onchocerca* spp., can be found in histological sections
- **Linear keratosis** is most common in horses, especially Quarter horses. One case has been recorded in cattle.<sup>20</sup> Lesions appear spontaneously in horses 1–5 years old and persist, usually for life. They appear first as isolated scaly lumps, which then

coalesce to form a ridge, usually vertical, 3–4 cm wide and up to 70 cm long, of hyperkeratotic, hairless skin. There may be one or more lesions, commonly on the sides of the neck and chest. Symptomatic treatment appears to have no effect on the lesions

- **Idiopathic fibrosing dermatitis:** The end stage of several severe dermatoses, this causes damage to dermal collagen.<sup>21</sup> Manifested by multiple fibrous plaques in the skin caused by sclerosis of the skin or subcutis, it resembles human morphea and the skin granulomas of animals.

### Pemphigus

This is an autoimmune disease of the skin, sometimes affecting mucosae and characterized by the presence of vesicles or bullae, which are usually very difficult to find, and subsequent erosions and ulcerations. There are a number of manifestations, including pemphigus vulgaris, bullous pemphigoid and pemphigus foliaceus.<sup>7</sup> It is a chronic autoimmune disease often accompanied by severe weight loss.

**Pemphigus foliaceus** is the most common autoimmune disease of the horse.<sup>7</sup> The majority of cases occur in mature horses, usually 5 years of age or older; a small number occur in horses 1 year of age or younger. The classic, but rarely seen, primary lesion is a vesicle or pustule. Usually, the earliest lesions visible are crusted papules best seen in lightly or nonhaired skin adjacent to mucocutaneous junctions – the nostrils, eyelids or lips. Lesions rapidly coalesce to form multifocal or diffuse areas of crusting. It occurs as a generalized scabby, weeping dermatitis<sup>22</sup> but it may be localized as circumscribed, circular lesions in the mouth and vulva and on the skin at mucocutaneous junctions. The lesions are subepidermal bullae from which the top layer can be pulled away, and are sore to the touch. In some cases the lesions are around the coronary bands on all limbs. Edema of the extremities, especially the hindlimbs, and the ventral abdominal region are commonly present.

The differential diagnoses include all skin diseases caused by scaling and crusting. These include dermatophytosis, dermatophilosis, systemic granulomatous disease and primary or idiopathic abnormalities of keratinization.

A direct immunofluorescence examination, consisting of a fluorescein-antihorse IgG applied to the lesion, can confirm the diagnosis. Corticosteroid or gold (aurothioglucose) therapy has been reported to effect improvement but an

inexorable deterioration is usual. Pemphigus foliaceus is recorded in goats as a widespread disease characterized by the presence of scales, sometimes in heavy crusts, and involvement of the coronets.

### CLINICAL PATHOLOGY

Examination of skin scrapings or swabs for parasitic, bacterial or other agents is essential. Culture and sensitivity tests for bacteria are advisable to enable the best treatment to be selected. Skin biopsy may be of value in determining the causal agent. In allergic or parasitic states there is usually an accumulation of eosinophils in the inflamed area. In mycotic dermatitis organisms are usually detectable in the deep skin layers although they may not be cultivable from superficial specimens.

### DIAGNOSIS

The clinical features of dermatitis are apparent. The characteristic features of the etiological types of dermatitis are described under each specific disease. **Diagnostic confirmation** is by histopathological demonstration in a biopsy specimen.

### DIFFERENTIAL DIAGNOSIS

- **Hyperhidrosis and anhidrosis** are dysfunctions of sweating and have no cutaneous lesion
- **Cutaneous neoplasm** is differentiable on histopathological examination
- **Epitheliogenesis imperfecta** is a congenital absence of all layers of skin
- **Vascular nevus** is a congenital lesion commonly referred to as 'birth mark'

### TREATMENT

**Primary treatment** must be to remove the noxious physical or chemical agent from the environment or to supplement the diet to repair a nutritional deficiency. The choice of a suitable treatment for infectious skin disease will depend upon the accurate identification of the etiological agent.

**Supportive treatment** includes both local and systemic therapy. Local applications may need to be astringent either as powders or lotions in the weeping stage or as greasy salves in the scabby stage. The inclusion of corticosteroids or antihistamine preparation is recommended in allergic states and it is desirable to prescribe sedative or anesthetic agents when pain or itching is severe.

If shock is present, parenteral fluids should be administered. If the lesions are extensive or secondary bacterial invasion is likely to occur, parenterally administered antibiotics or antifungal agents may be preferred to topical applications. To facili-

tate skin repair, a high protein diet or the administration of protein hydrolysates or amino acid combinations may find a place in the treatment of valuable animals. Non-specific remedies such as gold-containing remedies (e.g. aurothioglucose) are commonly used in autoimmune diseases such as pemphigus.

The use of vaccines as prophylaxis in viral and bacterial dermatitides must not be neglected. Autogenous vaccines may be most satisfactory in bacterial infections. An autogenous vaccine is particularly recommended in the treatment of staphylococcal dermatitis in horses and bovine udder impetigo in which long and repeated courses of treatment with penicillin produce only temporary remission. An autogenous vaccine produces a cure in many cases.

### REFERENCES

1. Yeruham I et al. Aust Vet J 1993; 70:348.
2. Wu W et al. Vet Rec 1997; 140:399.
3. El-Sukhon SN. Vet Dermatol 2002; 13:247.
4. Heath ACG et al. Vet Parasitol 1996; 67:259.
5. Campagnolo ER et al. J Am Vet Med Assoc 1995; 207:211.
6. Hargis AM et al. Vet Dermatol 2001; 12:291.
7. Stannard AA. Vet Dermatol 2000; 11:163.
8. Lorch G et al. Am J Vet Res 2001; 62:1051.
9. Bassett H. Ir Vet J 1985; 39:106.
10. Blowey RW, Done SH. Vet Rec 1995; 137:379.
11. Davies IH, Done SH. Vet Rec 1993; 93:460.
12. Scott DW, Campbell SG. Agri-practice 1987; 8:46.
13. Jefferies AR et al. Vet Rec 1997; 121:576.
14. Helie P et al. Can Vet J 1995; 36:150.
15. Vanhalderen A. J S Afr Vet Assoc 1995; 66:108.
16. Smith WJ et al. Vet Rec 1993; 132:47.
17. Scott DW et al. Agri-practice 1989; 10:43.
18. Van Rensburg IJ. J S Afr Vet Assoc 1991; 62:72.
19. Scott DW, Geor RJ. J Am Vet Med Assoc 1990; 197:1489.
20. Deprez P et al. Vet Dermatol 1995; 6:45.
21. Littlewood JD et al. Equine Vet Educ 1995; 7:295.
22. Laing JA et al. Equine Vet J 1992; 24:490.

### PHOTOSENSITIZATION

#### Synopsis

**Etiology** Caused by the sensitization of dorsally situated, lightly pigmented skin, mucosa and cornea to light. Dermatitis develops when the sensitized skin is exposed to sunlight

- Intake of primary photodynamic agents (PDAs)
- Faulty excretion of phyloerythrin (metabolic product of chlorophyll and a PDA) due to liver damage
- Inherited defects of porphyrin metabolism, producing PDAs
- Many unexplained cases and outbreaks in pastured or housed animals

**Epidemiology** Exposure to photosensitizing substances and sunlight. Similar incidence of sporadic cases and outbreaks. Always life-threatening unless exposure to sunlight can be avoided

**Clinical signs** Primary cases have cutaneous signs only (erythema, edema, necrosis, gangrene of light colored skin or mucosae exposed to sunlight). Secondary cases have also signs of hepatic dysfunction (jaundice, prostration, short course, death), or porphyrin metabolism

**Clinical pathology** Nil for evidence of photosensitivity. In secondary cases there is evidence of the primary disease

**Necropsy lesions** Only skin lesions in primary cases. Secondary cases show liver lesions or evidence of porphyrin accumulation

**Differential diagnosis** Clinical evidence of restriction of damage to white, wool-less skin on body dorsum and lateral aspects of limbs, teats, corneas and tongue and lips

**Treatment** Primary: remove from exposure to sunlight and PDA. Supportive: treat for infection, shock, toxemia

### ETIOLOGY AND EPIDEMIOLOGY

If photosensitizing substances (photodynamic agents) are present in sufficient concentration in the skin, dermatitis occurs when the skin is exposed to light. Photodynamic agents are substances that are activated by light and may be ingested preformed (and cause primary photosensitization) or be products of abnormal metabolism (and cause photosensitization due to aberrant synthesis of pigment) or be normal metabolic products that accumulate in tissues because of faulty excretion through the liver (and cause hepatogenous photosensitization). Faulty excretion through the liver may be due to hepatitis, caused in most instances by poisonous plants, or to biliary obstruction caused by crystal-associated cholangio-hepatopathy, or rarely by cholangio-hepatitis or biliary calculus.

#### Primary photosensitization

Photosensitization due to the ingestion of exogenous photodynamic agents usually occurs when the plant is in the lush green stage and is growing rapidly. Livestock are affected within 4–5 days of going on to pasture and new cases cease soon after the animals are removed. In most cases the plant responsible must be eaten in large amounts and will therefore usually be found to be a dominant inhabitant of the pasture. All species of animals are affected by photodynamic agents, although susceptibility may vary between species and between animals of the same species. Photosensitizing substances that occur naturally in plants include:

- Dianthrone derivatives – hypericin in *Hypericum perforatum* (St John's wort) and other *Hypericum* spp. and fagopyrin in seeds and dried plants of *Fagopyrum esculentum* (buckwheat)

- Furocoumarins in *Cymopterus* spp. (wild carrot), *Ammi majus* and *Thamnosma texana*
- Perloine from perennial ryegrass (*Lolium perenne*)
- Cocoa shells in feedlot rations causing photosensitization in feedlot calves<sup>1</sup>
- Gluten metabolites in dairy cattle concentrates being fed to horses<sup>2</sup>
- *Erodium moschatum*, an exotic weed in South Africa, causing photosensitization in sheep<sup>3</sup>
- Unidentified photodynamic agents in *Medicago denticulata* (burr trefoil) and the aphids that infest it, and in *Brassica* spp., *Erodium* spp., and *Trifolium* spp.
- Miscellaneous chemicals including phenothiazine (its metabolic end-product phenothiazine sulfoxide is photosensitizing to calves), rose Bengal and acridine dyes
- Cows treated with corticosteroids to induce calving may develop a photosensitive dermatitis of the teats, esutcheon and udder. Its occurrence is sporadic and does not appear to be related to a particular drug.

#### Photosensitization due to aberrant pigment synthesis

The only known example in domestic animals is inherited congenital porphyria, in which there is an excessive production in the body of porphyrins, which are photodynamic.

#### Hepatogenous photosensitization

The photosensitizing substance is in all instances phylloerythrin, a normal end-product of chlorophyll metabolism excreted in the bile. When biliary secretion is obstructed by hepatitis or biliary duct obstruction, phylloerythrin accumulates in the body and may reach levels in the skin that make it sensitive to light. Although hepatogenous photosensitization is more common in animals grazing green pasture, it can occur in animals fed entirely on hay or other stored feeds and in animals exposed to hepatotoxic chemicals e.g. carbon tetrachloride. There appears to be sufficient chlorophyll, or breakdown products of it, in stored feed to produce critical tissue levels of phylloerythrin in affected animals. The following list includes those substances or plants that are common causes of hepatogenous photosensitization. The individual plants are discussed in more detail in the section on poisonous plants.

#### Plants containing hepatotoxins

- *Pithomyces chartarum* fungus on perennial ryegrass – causing facial eczema
- *Periconia* sp. fungus on Bermuda grass

- Cyanobacteria associated with blue-green algae (water bloom) on drinking water in ponds, dams and dugouts – *Microcystis flosaquae*
- Lupins – *Lupinus angustifolius* plus the accompanying fungus, *Phomopsis leptostromiformis*
- Signal grass (*Brachiaria decumbens* and *Brachiaria brizantha*), a common component of established pastures in Brazil<sup>4</sup>
- Alligator weed (*Alternanthera philoxeroides*), a South American aquatic plant causing photosensitization in dairy cattle in Australia and New Zealand<sup>5</sup>
- Weeds including lantana (*Lantana camara*), *Lippia rehmanni*, sacahuiste (*Nolina texana*), coal oil bush (*Tetradymia* spp.), alecrim (*Holocalyx glaziovii*), ngaio (*Myoporum laetum*), *Crotalaria retusa*, ragwort (*Senecio jacobea*), *Sphenosciadium* spp.

#### Plants containing steroidal saponins

These cause crystal-related cholangio-hepatopathy.

- *Agave lecheguilla*, *Nartheicum ossifragum*, *Panicum* spp. (panic and millet grasses), *Tribulus terrestris* (caltrop, geeldikkop), plants being grazed particularly by sheep
- Alveld, a hepatogenous photosensitivity disease of sheep (lambs) grazing on pastures containing *Nartheicum ossifragum* (bog asphodel) on the west coast of Norway and in Scotland, northern England, Ireland, and the Faroe Islands.<sup>6</sup> The disease is known as alveld (literally 'elf fire') in Norway, plochteach, saut or yellowises in the British Isles and ormajuka ('worm disease') in the Faroe Islands. *Nartheicum ossifragum*-containing pastures in these countries are commonly used for grazing sheep. Photosensitization of sheep grazing this plant usually occurs in 2–6-month-old lambs and is rarely seen in adult sheep. It produces similar clinical signs to those due to facial eczema, a disease most commonly seen in New Zealand and associated with the fungal toxin sporidesmin.

#### Congenitally defective hepatic function

Inherited congenital photosensitivity in Corriedale and Southdown lambs is an inherited defect in the excretion of bile pigment.

#### Photosensitization of uncertain etiology

In the following diseases it has not been possible to ascertain whether the photo-

sensitization is primary or due to hepatic insufficiency:

- Feeding on rape or canola (*Brassica rapa*), kale, lucerne or alfalfa (*Medicago sativa*), burr medic or burr trefoil (*Medicago denticulata*), *Medicago minima*, *Trifolium hybridum* (alsike or Swedish clover), *Erodium cicutarium* and *Erodium moschatum* (lamb's tongue, plantain)
- Cattle feeding on water-damaged or moldy alfalfa hay or alfalfa silage; extensive outbreaks usually with no signs suggestive of hepatic disease
- Cattle, sheep and horses grazing lush pasture; many clinical cases occur sporadically
- Corticosteroids used systemically to terminate parturition in cows
- Phenanthridium used in the treatment of trypanosomiasis.

#### PATHOGENESIS

Penetration of light rays to sensitized tissues causes local cell death and tissue edema. Irritation is intense because of the edema of the lower skin level, and loss of skin by necrosis or gangrene and sloughing is common in the terminal stages. Nervous signs may occur and are caused either by the photodynamic agent, as in buckwheat poisoning, or by liver dysfunction.

Hepatogenous photosensitization involves production of a toxin, by a higher plant, fungus or cyanobacterium (algae), that causes liver damage or dysfunction, resulting in the retention of the photosensitizing agent phylloerythrin.

#### CLINICAL FINDINGS

##### General signs

These commence with intense irritation and the animal rubs the affected parts, often lacerating the face by rubbing it in bushes. When the teats are affected the cow may kick at them and walk into ponds to immerse the teats in water, sometimes rocking backwards and forwards as if to cool the affected parts. In nursing ewes there may be resentment towards the lambs sucking, and heavy lamb mortalities due to starvation may result.

Local edema is often severe and may cause drooping of the ears, closure of the eyelids and nostrils, causing dyspnea, and dysphagia due to swelling of the lips. An early sign is increased lacrimation, with the initially watery discharge developing into a thicker, serous discharge accompanied by blepharospasm and swelling of the eyelids. Initial erythema of the muzzle is followed by fissuring, then sloughing of the thick skin.

##### Skin lesions

Skin lesions are initially erythema, followed by edema and subsequently weeping with matting then shedding of clumps of



hair, and finally gangrene. They have a characteristic distribution, restricted to the unpigmented areas of the skin and to those parts which are exposed to solar rays. They are most pronounced on the dorsum of the body, diminishing in degree down the sides and are absent from the ventral surface. The demarcation between lesions and normal skin is very clear-cut, particularly in animals with broken-colored coats.

Predilection sites for lesions are the ears, conjunctiva, causing opacity of the lateral aspect of the cornea, eyelids, muzzle, face, the lateral aspects of the teats and, to a lesser extent, the vulva and perineum. In solid black cattle dermatitis will be seen at the lips of the vulva and on the edges of the eyelids, and on the cornea. Linear erosions often occur on the tip and sides of the tongue in animals with unpigmented oral mucosa. In severe cases the exudation and matting of the hair and local edema causes closure of the eyelids and nostrils. In the late stages necrosis or dry gangrene of affected areas leads to sloughing of large areas of skin.

#### Systemic signs

These include shock in the early stages, due to extensive tissue damage. There is an increase in the pulse rate with ataxia and weakness. Subsequently a considerable elevation of temperature (41–42°C, 106–107°F) may occur.

#### Nervous signs

These including ataxia, posterior paralysis and blindness; depression or excitement are often observed. A peculiar sensitivity to water is sometimes seen in sheep with facial eczema: when driven through water they may lie down in it and have a convulsion.

#### Liver insufficiency

Signs are described elsewhere and may accompany photosensitive dermatitis when it is secondary to liver damage.

#### CLINICAL PATHOLOGY

There are no suitable field tests to determine whether or not photosensitivity is present.

Hepatogenous photosensitization can be diagnosed by analysis of plasma phylloerythrin concentration using a spectroscopic method. Plasma or serum fluorescence can be used to measure the elevation of phylloerythrin above normal levels prior to hepatogenous photosensitization.<sup>7–9</sup> The levels of phylloerythrin in plasma of lambs grazing *Nartheicum ossifragum* are increased from a normal of less than 0.05 µg/mL to more than 0.3 µg/mL when clinical signs of photosensitization are observed.<sup>9</sup> Levels in skin are also increased.

In lambs in which facial eczema was experimentally induced by dosing with

the mycotoxin sporidesmin, the plasma concentrations of phylloerythrin were increased from a normal of less than 0.1 µmol/L to 0.3 µmol/L when clinical signs were evident.<sup>8</sup> The concentration of phylloerythrin in the skin began increasing 2–3 days later than that in the blood.

#### NECROPSY FINDINGS

In primary photosensitization, lesions are restricted to white-haired or pale-skinned areas of skin or mucosa that have been exposed to sunlight, and vary from necrosis to gangrene. Lesions characteristic of hepatic injury or metabolic defects of porphyrin metabolism are described elsewhere.

Diffuse hepatocellular hydropic degeneration and hyperplasia of the smooth endoplasmic reticulum associated with marked multifocal cholangitis in the portal triads with bile duct proliferation are characteristic of the hepatic lesions of sheep grazing *Brachiaria decumbens*.<sup>4</sup> Foam cells are present in the liver and mesenteric and hepatic lymph nodes of cattle grazing *Brachiaria* spp.<sup>10</sup> Hepatocellular degeneration is the primary event in alveld photosensitization in sheep.<sup>6</sup> High concentrations of conjugated epipapogenins are present in both liver and bile in alveld-affected lambs.

#### DIFFERENTIAL DIAGNOSIS

The diagnosis of photosensitivity depends almost entirely on the distribution of the lesions. It can be readily confused with other dermatitides if this restriction to unpigmented and hairless parts is not kept in mind.

- Mycotic dermatitis is often mistaken for photosensitization because of its tendency to commence along the back line and over the rump, but it occurs on colored and white parts alike
- Frequent wetting, as in periods of heavy rainfall, along the back in horses or cattle with a dense hair coat
- Bighead of rams associated with *Clostridium novyi* infection may also be confused with photosensitization but the local swelling is an acute inflammatory edema and many clostridia are present in the lesion
- The eye lesions in photosensitization have been confused with those of pink-eye but that disease is not accompanied by extensive dermatitis.

#### Treatment

**Primary treatment** includes immediate removal from direct sunlight, prevention of ingestion of further toxic material and the administration of laxatives to eliminate toxic materials already eaten. In areas where the disease is enzootic the use of

dark-skinned breeds may make it possible to utilize pastures that would otherwise be too dangerous.

**Local treatment** will be governed by the stage of the lesions. Nonsteroidal anti-inflammatory drugs (NSAIDs), corticosteroids or antihistamines can be administered parenterally and adequate doses maintained. To avoid septicemia the prophylactic administration of antibiotics may be worthwhile in some instances.

#### REVIEW LITERATURE

- Rowe LD. Photosensitization problems in livestock. *Vet Clin North Am Large Anim Pract* 1989; 5:301–323.
- Plumlee KH. Photosensitization in ruminants. *Vet Med* 1995; 90:605–612
- House JK et al. Primary photosensitization in cattle ingesting silage. *J Am Vet Med Assoc* 1996; 209:1604.

#### REFERENCES

1. Yeruham I et al. *Vet Hum Toxicol* 2003; 45:249.
2. Yeruham I et al. *Vet Hum Toxicol* 1999; 41:386.
3. Stroebel JC. *J S Afr Vet Assoc* 2002; 73:57.
4. Driemeier D et al. *Toxicol* 2002; 40:1027.
5. Bourke CA, Rayward D. *Aust Vet J* 2003; 81:361.
6. Wisloff H et al. *Vet Res Commun* 2002; 26:381.
7. Schie E et al. *N Z Vet J* 2003; 51:99.
8. Schie E et al. *N Z Vet J* 2003; 51:104.
9. Schie E et al. *N Z Vet J* 2002; 50:104.
10. Gomar MS et al. *J Vet Med A* 2005; 52:18.

## Diseases of the hair, wool, follicles, skin glands, horns, and hooves

### ALOPECIA AND HYPOTRICHOSIS

#### ETIOLOGY

Alopecia is complete absence of the hair or wool coat; hypotrichosis is less than the normal amount of hair or wool. Both may be caused by the following conditions.

#### Failure of follicles to develop

- Congenital hypotrichosis.

#### Loss of follicles

- Cicatricial alopecia due to scarring after deep skin wounds that destroy follicles. Cicatricial alopecia occurs following permanent destruction of the hair follicles, and regrowth of hair will not occur. Examples include physical, chemical or thermal injury, severe furunculosis, neoplasia and certain infections such as cutaneous onchocerciasis.<sup>1</sup>

#### Failure of the follicle to produce a fiber

- Inherited symmetrical alopecia
- Congenital hypotrichosis
- Hair-coat-color-linked follicle dysplasia
- Inherited dyserythropoiesis and dyskeratosis
- In baldy calves and adenohipophyseal hypoplasia

- Congenital hypothyroidism (goiter) due to iodine deficiency in the dam
- After viral infection of the dam, alopecia congenitally in the newborn, e.g. after bovine virus diarrhea in cattle and infection by a similar virus in sheep (Border disease)
- Neurogenic alopecia due to peripheral nerve damage
- Infection in the follicle
- Alopecia areata of horses and, less commonly, cows<sup>2</sup> characterized by one or more round lesions of spontaneously disappearing, non-scarring alopecia over the face, neck, shoulders and brisket. At histopathological examination normal skin contains accumulations of lymphocytes around the hair follicles.

#### Loss of preformed fibers

- Dermatomycoses – ringworm
- Mycotic dermatitis in all species due to *D. congolensis*
- Metabolic alopecia subsequent to a period of malnutrition or severe illness – ‘a break in the wool’, e.g. excessive whale, palm or soya oil in milk replacers to calves; the fibers grown during the period of nutritional or metabolic stress have a zone of weakness and are easily broken
- Traumatic alopecia due to excessive scratching or rubbing associated with louse, tick or itch-mite infestations; rubbing against narrow doors, feed troughs or tethers in confined housing, against harness in working animals
- Poisoning by thallium, selenium, arsenic, mercury or the tree *Leucaena leucocephala*
- Idiopathic hair loss from the tail-switch of well-fed beef bulls
- In sterile eosinophilic folliculitis of cattle
- Wool slip
- In many primary skin diseases, e.g. parakeratosis, hyperkeratosis, dermatitis, cutaneous neoplasia, sarcoid; pythiosis hair is lost at the site of local lesions.

#### PATHOGENESIS

Normal shedding of hair fibers is a constant but largely unexplained process, especially during significant changes in environmental temperature. The long winter coat is shed in response to warmer spring temperatures and increased hours of sunlight, and rapidly regrows as environmental temperatures fall in the autumn. In inherited hair defects there may be a reduction in follicle numbers or a reduced capacity of each follicle to produce fibers. Chemical depilation produced by cytotoxic agents, such as cyclophosphamide, occurs as a result of induced cytoplasmic degener-

ation in some of the germinative cells of the bulb of the wool follicle. The alteration in cell function is temporary, so that regrowth of the fiber should follow.

#### CLINICAL FINDINGS

When alopecia is due to breakage of the fiber, the stumps of old fibers or developing new ones may be seen. When fibers fail to grow the skin is shiny and in most cases is thinner than normal. In cases of congenital follicular aplasia, the ordinary covering hairs are absent but the coarser tactile hairs about the eyes, lips and extremities are often present. Absence of the hair coat makes the animal more susceptible to sudden changes of environmental temperature. There may be manifestations of a primary disease and evidence of scratching or rubbing.

Congenital hypotrichosis results in alopecia which is apparent at birth or develops within the neonatal period.

#### CLINICAL PATHOLOGY

If the cause of the alopecia is not apparent after the examination of skin scrapings or swabs, a skin biopsy will reveal the status of the follicular epithelium.

#### DIFFERENTIAL DIAGNOSIS

Diagnostic confirmation of alopecia is by visual recognition, the diagnostic problem being to determine the primary cause of the hair or fiber loss.

**Hypotrichosis** is a reduction in numbers of fibers instead of a complete absence. Inherited diseases of the skin are presented in Chapter 34.

#### TREATMENT

Primary treatment consists of removing the causes of trauma or other damage to fibers. In cases of faulty follicle or fiber development treatment is not usually attempted.

#### REVIEW LITERATURE

Pascoe RR. Alopecia, diagnosis and treatment. *Equine Pract* 1993; 15:8–16.

#### REFERENCES

1. Stannard AA. *Vet Dermatol* 2000; 11:191.
2. Scott DW, Guard CL. *Agri-practice* 1988; 9(4):16.

#### ACHROMOTRICHIA

Deficient pigmentation in hair or wool fiber as follows:

- Bands of depigmentation in an otherwise black wool fleece are the result of a transitory deficiency of copper in the diet
- Cattle on diets containing excess molybdenum and deficient copper show a peculiar speckling of the coat caused by an absence of pigment in a proportion of hair fibers. The

speckling is often most marked around the eyes, giving the animal the appearance of wearing spectacles

- General loss of density of pigmentation in all coat colors, e.g. Hereford cattle shade off from their normal deep red to a washed-out orange.

#### LEUKODERMA AND LEUKOTRICHIA

Several skin diseases of the horse are characterized by an acquired loss of melanin pigment in the epidermis of hair.<sup>1</sup> Melanocytes in the epidermis and those in the hair bulbs are frequently affected independently. Leukotrichia occurs when the melanocytes in the hair bulbs lose their normal amount of melanin pigment. When the melanocytes in the epidermis are affected and the skin loses normal pigmentation, the abnormality is leukoderma. The etiology and pathogenesis of leukoderma are unknown. Reticulated leukotrichia, spotted leukotrichia and juvenile Arabian leukoderma have been described.<sup>1</sup>

#### VITILIGO

Patchy depigmentation of the skin with premature graying of the local hair is not uncommon in cattle and horses. The usual manifestation is the appearance of patches of gray or white hair – ‘snowflakes’ – in an otherwise pigmented coat. The defect is esthetic only. Histopathological examination reveals a complete absence of melanocytes from affected areas but the cause is unknown in most cases. A genetic etiology is suspected in Arabian horses and Holstein–Friesian cattle. It can also be caused by:

- Application of ‘supercooled’ instruments that selectively destroy melanocytes, the basis for freeze branding
- Prolonged pressure, e.g. by poorly fitting harness
- X-irradiation
- An idiopathic state in horses, usually during a debilitating disease, with patchy depigmentation of skin appearing on the prepuce, perineum, underneath the tail, and on the face. There is no discontinuity of the skin.

#### SEBORRHEA

##### ETIOLOGY

Seborrhea is an excessive secretion of sebum on to the skin surface. In large animals it is always secondary to dermatitis or other skin irritation, e.g.:

- Exudative epidermitis of pigs associated with *S. hyicus*

- Greasy heel of horses, including infection with *S. hyicus*
- Greasy heel of cattle
- Flexural seborrhea of cattle.

### **PATHOGENESIS**

Increased blood supply to the skin and increased hair growth appear to stimulate the production of sebum, but why seborrhea is provoked in some individuals and not in others is unknown.

### **CLINICAL FINDINGS**

In primary seborrhea there are no lesions, only excessive greasiness of the skin. The sebum may be spread over the body surface like a film of oil or be dried into crusts, which can be removed easily. Sebaceous glands may be hypertrophied.

### **Flexural seborrhea**

Flexural seborrhea is most common in young, periparturient dairy cows. Severe inflammation and a profuse outpouring of sebum appear in the groin between the udder and the medial surface of the thigh, or in the median fissure between the two halves of the udder. Extensive skin necrosis follows, causing a pronounced odor of decay, which may be the first sign observed by the owner. Irritation may cause lameness and the cow may attempt to lick the part. Shedding of the oily, malodorous skin leaves a raw surface beneath; healing follows in 3–4 weeks.

### **Greasy heel of cows**

Cows grazing constantly irrigated, wet pastures, or in very muddy conditions in tropical areas may develop local swelling, with deep fissuring of the skin and an outpouring of evil-smelling exudate, on the back of the pastern of all four feet but most severely in the hind limbs. Affected animals are badly lame and their milk yield declines sharply. Removing the cows to dry land and treating systemically with a broad-spectrum antibiotic effects a rapid recovery.

### **Greasy heel of horses (scratches)**

Greasy heel occurs mostly on the hind pasterns of horses that stand continuously in wet, insanitary stables.<sup>2</sup> Some cases do occur in well managed stables. It has been suggested that secondary infections associated with either *S. aureus* and *D. congolensis* may be causative factors.<sup>2</sup> Dermatophytosis, chorioptic mange and photosensitization are also possible causative factors.

Lameness and soreness to touch are due to excoriations called 'scratches' on the back of the pastern that extend down to the coronary band. The skin is thick and greasy and, if neglected, the condition spreads around to the front and up the back of the leg; this involvement can be severe enough to interfere with normal movement of the limb.

### **CLINICAL PATHOLOGY**

The primary cause of the seborrhea may be diagnosed by a suitable examination for the presence of parasitic or bacterial pathogens.

#### **DIFFERENTIAL DIAGNOSIS**

The lesion is characteristic and diagnostic confirmation is by histopathological examination of a biopsy specimen; the principal difficulty is to determine the primary cause. All the types listed may be mistaken for:

- Injury, commonly wire cuts or rope burn
- Flexural seborrhea for injury, usually due to straddling a gate or wire fence
- Greasy heel of horses for chorioptic mange.

### **TREATMENT**

The skin must be kept clean and dry. Affected areas should be defatted with hot soap and water washes, then properly dried, and an astringent lotion, e.g. white lotion, should be applied daily. In acute cases of greasy heel the application at 5-day intervals of an ointment made up of five parts salicylic acid, three parts boric acid, two parts phenol, two parts mineral oil and two parts petroleum jelly is recommended. Long-standing cases profit from the twice-daily washing of the part and covering with an ointment containing an antibiotic, a fungistat and a corticosteroid, e.g. gentamicin, clotrimazole, betametason.

### **FOLLICULITIS**

#### **ETIOLOGY**

Infection and inflammation of hair follicles associated with suppurative organisms, including staphylococci. Identifiable forms of folliculitis as individual diseases include:

- Staphylococcal dermatitis of horses
- Contagious acne of horses
- Benign facial folliculitis of sucking lambs
- Demodectic mange
- **Bovine sterile eosinophilic folliculitis.**

#### **PATHOGENESIS**

Sebaceous gland ducts blocked by inspissated secretion and epithelial debris or by pressure become infected. Folliculitis is also a sequel to seborrhea, with hypertrophy of sebaceous glands and dilatation of their ducts.

#### **CLINICAL FINDINGS**

The sequence of lesion development is: nodules around the base of the hair, then pustules, then crusts, finally hair fiber loss. Itching may occur, but pain and rupture of pustules under pressure are more

common. Pustule rupture leads to contamination of the surrounding skin and development of further lesions.

**In bovine sterile, eosinophilic folliculitis**, the multiple lesions are crusted, alopecic, 3–5 cm diameter nodules on all parts of the body except the limbs. They are composed largely of eosinophils and are negative on culture.

### **CLINICAL PATHOLOGY**

Swabs should be taken for bacteriological and parasitological examination.

#### **DIFFERENTIAL DIAGNOSIS**

Diagnostic confirmation is by demonstration of infection of hair follicles in a biopsy specimen.

- **Udder impetigo of cattle**; lesions are superficial and confined to the udder
- **Infectious dermatitis (contagious pyoderma) of baby pigs** associated with streptococci and staphylococci; lesions are limited to face and caused by bites from needle teeth
- **Exudative epidermitis of pigs** due to *S. hyicus*, with extensive seborrheic dermatitis
- **Ulcerative dermatitis of face in adult sheep**
- **Leg dermatitis down to coronet of sheep**
- **Chronic pectoral and ventral midline abscesses in horses** due to *Corynebacterium pseudotuberculosis*; not a skin lesion but it resembles furunculosis.

### **TREATMENT**

**Primary treatment** commences with cleaning the skin by washing followed by a disinfectant rinse. Affected areas should be treated with antibacterial ointments or lotions. If the lesions are extensive the parenteral administration of antibiotics is recommended. The course of treatment should last 1 week; in chronic cases this may need to be at least 1 month; a broad-spectrum preparation such as trimethoprim-sulfadiazine is recommended. In stubborn cases an autogenous vaccine may be helpful.

**Supportive treatment** – infected animals should be isolated and grooming tools and blankets disinfected.

### **REFERENCES**

1. Stannard AA. Vet Dermatol 2000; 11:205
2. Stannard AA. Vet Dermatol 2000; 11:217.

### **DISEASES OF HOOVES AND HORNS**

Diseases of the hooves are presented in textbooks on large animal surgery and lameness in horses and cattle.

Horn cancer is covered in the section on squamous-cell carcinoma of the skin,

and hoof diseases that cause lameness are listed in Table 13.1.

### Skin diseases of the bovine digit associated with lameness

Diseases of the skin of bovine digit include digital dermatitis (hairy heel warts), interdigital necrobacillosis (foot rot), dermatitis verrucosa and interdigital hyperplasia.<sup>1</sup> These are presented in Chapters 16–20.

### Sloughing of the hooves and dewclaws (chestnuts)

Separation of the hooves from the sensitive laminae and, in severe cases, sloughing of the horn occur in:

- Severe edema of the legs, due to limb lymphangitis or from severe trauma, causing capillary dilatation and fluid effusion into the laminar tissues
- Burns in grass fires where only the undersurface of the body is burned
- Coronitis occurring as part of pemphigus in horses
- Horses poisoned by eating mushrooms
- Terminally in laminitis.

There is no treatment once the hooves have sloughed and all attempts should be made to avoid it if separation is already evident at the coronet. Reduction of the swelling in the limb is critical, requiring enhancement of lymphatic and vascular drainage from the area.

### REVIEW LITERATURE

Demirkan I, Murray RD, Carter SD. Skin diseases of the bovine digit associated with lameness. *Vet Bull* 2000; 70:149–171.

### REFERENCE

1. Demirkan I et al. *Vet Bull* 2000; 70:149–171.

## Diseases of the subcutis

### SUBCUTANEOUS EDEMA (ANASARCA)

#### ETIOLOGY

Extensive accumulation of edema fluid in the subcutaneous tissue is part of general edema and caused by the same diseases, as follows.

#### Increased hydrostatic pressure

- Congestive heart failure
- Vascular compression by tumor, e.g. anterior mediastinal lymphosarcoma, udder engorgement in heifer about to calve.

#### Hypoproteinemic edema

- In liver damage with reduced albumin production due to liver insufficiency, especially fascioliasis
- Renal damage with protein loss into urine occurs rarely in animals.

### DIFFERENTIAL DIAGNOSIS

Diagnostic confirmation is by clinical detection of serous fluid in a subcutaneous site.

- In cattle, **extravasation of urine** as a result of urethral obstruction and perforation
- **Subcutaneous hemorrhage, hematoma or seroma**, which is not necessarily dependent, nor bilaterally symmetrical
- **Ventral hernia**, usually unilateral and does not pit on pressure
- **Cellulitis**, usually asymmetric, hot, often painful, does not pit on pressure and can be sampled by needle puncture

### Renal amyloidosis

- Protein-losing enteropathy, e.g. in intestinal lymphosarcoma
- Intestinal nematodiasis
- Protein starvation

### Vascular damage

- In purpura hemorrhagica
- Anasarca in hypovitaminosis A
- Subcutaneous plaques of equine infectious anemia and dourine
- Subcutaneous plaques in dourine
- Horses standing in black walnut shavings as bedding.

### Inflammatory edema

Many bacteria cause local edema due to infection:

- *Clostridium* spp. are the most noted
- Anthrax in swine and horses
- Sporadic lymphangitis of horses
- Insect, especially bee, stings.

### Fetal anasarca

- Some pigs with congenital goiter also have **myxedema**, especially of the neck
- Sporadic cases due to unknown causes are sometimes associated with deformities, e.g. in Awassi sheep<sup>1</sup>
- Congenital absence of lymph nodes and some lymph channels causes edema to be present at birth.

### PATHOGENESIS

Alteration to the balance between the hydrostatic pressure of intravascular fluids, the blood and lymph, to the osmotic pressure of those fluids or to the integrity of the filtering mechanism of the capillary endothelium leads to a positive advantage by the hydrostatic pressure of the system and causes a flow of fluid out of the vessels into the tissues. This results in anasarca and, coincidentally, in fluid accumulations in the body cavities.

### CLINICAL FINDINGS

There is visible swelling, either local or diffuse. The skin is puffy and pits on

pressure; there is no pain unless inflammation is also present. In large animals the edema is usually confined to the ventral aspects of the head, neck and trunk and is seldom seen on the limbs.

### CLINICAL PATHOLOGY

Anasarca is a clinical diagnosis but many estimates, for example of arterial blood pressure, serum and urine protein levels, provide contributory evidence. Differentiation between obstructive and inflammatory edema can be made by cytological and bacteriological examination of the fluid.

### TREATMENT

Primary treatment requires correction of the causal abnormality. Supportive treatment includes removal of the fluid by drainage methods such as intubation or multiple incision, both likely to result in damaging infection in animals in the average farmyard situation, or by the use of a diuretic.

### REFERENCE

1. Hailat N et al. *Aust Vet J* 1997; 75:257.

## ANGIOEDEMA (ANGIONEUROTIC EDEMA)

### ETIOLOGY

Transient, localized subcutaneous edema due to an allergic reaction and caused by endogenous and exogenous allergens provokes either local or diffuse lesions. Angioedema occurs most frequently in cattle and horses on pasture, especially during the period when the pasture is in flower. This suggests that the allergen is a plant protein. Fish meal may also provoke an attack. Recurrence in individual animals is common.

### PATHOGENESIS

After an initial erythema, local vascular dilatation is followed by leakage of plasma through damaged vessels.

### CLINICAL FINDINGS

**Local lesions** most commonly affect the head with diffuse edema of the muzzle, eyelids, conjunctiva and cheeks. Occasionally only the conjunctiva is affected, so that the eyelids are puffy, the nictitating membrane swollen and protruding, and lacrimation is profuse. Affected parts are not painful to touch but shaking the head and rubbing against objects suggest irritation. Salivation and nasal discharge may be accompanying signs.

**Perineal involvement** includes vulvar swelling, often asymmetrical, and the perianal skin, and sometimes the skin of the udder, is swollen and edematous. When the **udder** is affected, the teats and base of the udder are edematous and cows may padde with the hind limbs, suggesting irritation in the teats. Edema

of the lower limbs, usually from the knees or hocks down to the coronets, is a rare sign.

**Systemic signs** are absent, except in those rare cases where angioedema is part of a wider allergic response, when bloat, diarrhea and dyspnea may occur, often with sufficient severity to require urgent treatment.

### CLINICAL PATHOLOGY

The blood eosinophil count is often within the normal range, but may be elevated from a normal level of 4–5% up to 12–15%.

### DIFFERENTIAL DIAGNOSIS

Diagnostic confirmation is found with sudden onset and disappearance of edema at the typical sites.

- **Subcutaneous edema (above) due to vascular pressure** occurs mostly in dependent parts and is not irritating
- In horses, and rarely in cattle, angioedema may be simulated by **purpura hemorrhagica**, but hemorrhages are usually visible in the mucosae in purpura.

### TREATMENT

**Primary treatment** to remove the specific cause is usually impossible but affected animals should be removed from the suspected source of allergens. Cattle running at pasture should be confined and fed on dry feed for at least a week.

**Supportive treatment** to relieve the vascular lesion is always administered even though spontaneous recovery is the rule. In acute cases with severe dyspnea epinephrine can be administered parenterally, but cautious intravenous injection is recommended. For subacute cases corticosteroids or other anti-inflammatories are preferred over antihistamines or epinephrine; usually only one injection is required.

### SUBCUTANEOUS EMPHYSEMA

#### ETIOLOGY

Emphysema, free gas in the subcutaneous tissue, occurs when air or gas accumulates in the subcutaneous tissue as a result of:

- Air entering through a cutaneous wound made surgically or accidentally
- Air entering tissues through a discontinuity in the respiratory tract lining, e.g. in fracture of nasal bones; trauma to pharyngeal, laryngeal, tracheal mucosa caused by external or internal trauma as in lung puncture by a fractured rib; a foreign body, as in traumatic reticulitis
- Rumen gases migrating from a rumenotomy or ruminal trocharization

- Extension from a pulmonary emphysema
- Gas gangrene infection.

### PATHOGENESIS

Air moves very quickly through fascial planes, especially when there is local muscular movement. For example when a lung is punctured, or in cases of severe interstitial pulmonary edema, air escapes under the visceral pleura and passes to the hilus of the lung, hence to beneath the parietal pleura, between the muscles and into the subcutis.

### CLINICAL FINDINGS

Visible subcutaneous swellings are soft, painless, fluctuating and grossly crepitant to the touch, but there is no external skin lesion. In gas gangrene, discoloration, coldness and oozing of serum may be evident. Emphysema may be sufficiently severe and widespread to cause stiffness of the gait and interference with feeding and respiration.

### CLINICAL PATHOLOGY

None is necessary except in cases of gas gangrene, when a bacteriological examination of fluid from the swelling should be carried out to identify the organism present.

### DIFFERENTIAL DIAGNOSIS

Diagnostic confirmation is based on the observation of crepitus and the extreme mobility of the swelling; these distinguish emphysema from other superficial swellings.

- **Anasarca**, dependent and pits on pressure (see above)
- **Hematoma, seroma at injury sites**, confirmed by needle puncture (see below)
- **Cellulitis** is accompanied by toxemia, confirmed by needle puncture.

### TREATMENT

**Primary treatment** is to close the entry point for the gas but this is usually impossible to locate or to close. **Supportive treatment** is only necessary when the emphysema is extensive and incapacitating, when multiple skin incisions may be necessary. Gas gangrene requires immediate and drastic treatment with antibiotics.

### LYMPHANGITIS

This is characterized by inflammation and enlargement of the lymph vessels and is usually associated with lymphadenitis.

### ETIOLOGY

Lymphangitis is due in most cases to local skin infection with subsequent spread to the lymphatic system. Common causes are as follows.

### Horse

- Glanders, epizootic lymphangitis, sporadic lymphangitis, ulcerative lymphangitis due to *C. pseudotuberculosis*
- Strangles in cases where bizarre location sites occur
- In foals ulcerative lymphangitis associated with *Streptococcus zooepidemicus*.

### Cattle

- Skin farcy associated with *Nocardia farcinica*, *Rhodococcus equi*
- Cutaneous tuberculosis associated with atypical mycobacteria, rarely *Mycobacterium bovis*.

### PATHOGENESIS

Spread of infection along the lymphatic vessels causes chronic inflammation and thickening of the vessel walls. Abscesses often develop, with discharge to the skin surface through sinuses.

### CLINICAL FINDINGS

An indolent ulcer usually exists at the original site of infection. The lymph vessels leaving this ulcer are enlarged, thickened and tortuous and often have secondary ulcers or sinuses along their course. Local edema may result from lymphatic obstruction. In chronic cases much fibrous tissue may be laid down in the subcutis and chronic thickening of the skin may follow. The medial surface of the hindlimb is the most frequent site, particularly in horses.

### CLINICAL PATHOLOGY

Bacteriological examination of discharges for the presence of the specific bacteria or fungi is common practice.

### TREATMENT

**Primary treatment** requires vigorous, early surgical excision or specific antibiotic therapy.

**Supportive treatment** is directed toward removal of fluid and inflammatory exudate and relief of pain.

### PANNICULITIS

Panniculitis is diffuse, sterile inflammation of subcutaneous fat. Deep-seated, firm and painful nodules up to 5 cm in diameter develop, often in large numbers, anywhere over the body but especially on the neck and sides, most commonly in young horses and rarely in cattle.<sup>1</sup> The lesions may fluctuate greatly in size and number, or even disappear spontaneously. In a few cases there is transient fever, reduced feed intake and weight loss. Lameness may be evident in horses with extensive lesions.<sup>2</sup>

Diagnosis is by histological examination of a biopsy specimen. At necropsy examination there are no other lesions. The

lesions reduce in size and number after the administration of dexametasone, but recur when treatment stops.<sup>3</sup>

## REFERENCES

1. Scott PR et al. *Vet Rec* 1996; 139:262.
2. Bassage EJ et al. *J Am Vet Med Assoc* 1996; 209:1242.
3. Karcher LF et al. *J Am Vet Med Assoc* 1990; 196:1823.

## HEMORRHAGE

This is extravasation of whole blood into the subcutaneous tissues.

### ETIOLOGY

Accumulation of blood in the subcutaneous tissues beyond the limit of that normally caused by trauma may be due to defects in the coagulation mechanism or to increased permeability of the vessel wall.

Common causes include:

- Dicoumarol poisoning from moldy sweet clover hay
- Purpura hemorrhagica in horses
- Bracken poisoning in cattle, and other granulocytopenic disease. These diseases are manifested principally by petechiation and the lesions are observed only in mucosae
- Hemangiosarcoma in subcutaneous sites
- Inherited hemophilia.

### PATHOGENESIS

Leakage of blood from the vascular system can cause local swellings, which interfere with normal bodily functions but are rarely sufficiently extensive to cause signs of anemia.

### CLINICAL FINDINGS

Subcutaneous swellings resulting from hemorrhage are diffuse and soft with no visible effect on the skin surface. There may be no evidence of trauma. Specific locations of subcutaneous hemorrhages include the frontal aspect of the chest – due to fracture of the first rib in collisions at full gallop and often fatal through internal hemorrhage – and perivaginal at foaling, causing massive swelling of the perineum and medial aspect of the thigh.

### CLINICAL PATHOLOGY

Visual examination of a needle aspirate confirms the existence of subcutaneous hemorrhage. Diagnosis of the primary cause is greatly assisted by platelet counts and prothrombin, clotting and bleeding times.

### TREATMENT

**Primary treatment** targets removal or correction of the cause.

**Supportive treatment:** The hemorrhages should not be opened until clotting is completed, except in the case of a

## DIFFERENTIAL DIAGNOSIS

Subcutaneous hemorrhages are usually associated with hemorrhages into other tissues, both manifestations being due to defects in clotting or capillary wall continuity.

Diagnostic confirmation is by opening the swelling, preferably by needle puncture to avoid massive blood loss and difficulty in locating the bleeding point.

massive hemorrhage that is interfering with respiration, defecation or urination. If blood loss is severe, blood transfusions may be required. Parenteral injection of coagulants can be justified if the hemorrhages are recent and severe.

## NECROSIS AND GANGRENE

Necrosis is tissue death; gangrene is sloughing of dead tissue. When either change occurs in the skin it involves the dermis, epidermis and subcutaneous tissue.

### ETIOLOGY

Severe **damage to the skin** in the following categories causes gangrene:

- Severe or continued trauma, e.g. pressure sores, saddle and harness galls, carpal or tarsal necrosis in recumbent animals
- Strong caustic chemicals, e.g. creosote
- Severe cold or heat, bushfires and stable fires being the worst offenders. Frostbite is an unusual occurrence in animals unless the patient has a circulatory deficit, e.g. in the neonate, in severe shock or toxemia
- Beta-irradiation.

**Infections**, especially:

- Erysipelas and salmonellosis in pigs
- Clostridial infections in cattle affecting subcutis and muscle
- Staphylococcal mastitis in cattle,
- Pasteurella mastitis in sheep
- Bovine ulcerative mammillitis of the udder and teats.

**Local vascular obstruction** – obstruction by thrombi or arterial spasm causes skin gangrene, but includes deeper structures also from poisoning by:

- *Claviceps purpurea*
- *Festuca arundinacea* (probably due to an accompanying fungus)
- *Aspergillus terreus*
- Mushrooms.

Similar cutaneous and deeper structure involvement occurs in systemic infections in which bacterial emboli block local vessels, e.g. in salmonellosis in calves,

and after tail vaccination of calves with *Mycoplasma mycoides*.

### Other causes

- Final stages of photosensitive dermatitis and flexural seborrhea
- Screw-worm infestation.

### PATHOGENESIS

The basic cause of gangrene is interference with local blood supply by external pressure, by severe swelling of the skin, as in photosensitization, or by arteriolar spasm or damage to vessels by bacterial toxins.

### CLINICAL FINDINGS

**If the arterial and venous systems** are closed the initial lesions will be moist and the area is swollen, raised, discolored and cold. Separation occurs at the margin and the affected skin may slough before it dries; the underlying surface is raw and weeping.

**If the veins and lymphatics remain patent**, the lesion is dry from the beginning and the area is cold, discolored and sunken. Sloughing may take a long time and the underlying surface usually consists of granulation tissue.

## DIFFERENTIAL DIAGNOSIS

Confirmation of the diagnosis is by visual recognition.

- **Gangrenous mastitis** in cows or ewes
- **Photosensitive dermatitis**
- **Claviceps purpurea poisoning.**

### TREATMENT

**Primary treatment** requires removal of the etiological insult.

**Supportive treatment** comprises the application of astringent and antibacterial ointments to facilitate separation of the gangrenous tissue and to prevent bacterial infection.

## SUBCUTANEOUS ABSCESS

Most subcutaneous abscesses are matters of purely local and esthetic concern but if sufficiently extensive and active **localized infections**, they may cause mild toxemia. Their origins include the following.

### Trauma

Most subcutaneous abscesses are the result of traumatic skin penetration with resulting infection. For example **facial subcutaneous abscesses** are common in cattle eating roughage containing foxtail grass (*Hordeum jubatum*). Several animals in a herd may be affected at one time. The awns of these plants migrate into the

cheek mucosa, causing subcutaneous abscesses containing *Arcanobacterium* (formerly *Actinomyces*) *pyogenes* and *Actinobacillus* spp. The abscesses contain purulent material, are well encapsulated and must be surgically drained and treated as an open wound. Medical therapy with parenteral antimicrobials and iodine is ineffective.

### Hematogenous

Rarely the infection reaches the site via the bloodstream, e.g. chronic pectoral abscesses of horses, infections in foals with *R. equi*, infections in all species with *Pasteurella pseudotuberculosis*, infections in lambs with *Histophilus somni* (formerly *Histophilus ovis*) or *Pseudomonas pseudomallei*.

### Extension

Abscesses may originate by **extension** from lesions of furunculosis, pyoderma or impetigo. or by **contiguous spread** by contact from an internal organ, e.g. from traumatic reticuloperitonitis.

## CUTANEOUS CYSTS

Cysts contained by an epithelial wall enclosing amorphous contents or living tissue may be congenital, inherited defects or acquired as a result of inappropriate healing of accidental wounds. They are smooth, painless, about 1.5–2.5 cm in diameter, round and usually fluctuating, although inspissated contents may make them feel quite hard. The skin and hair coat over them is usually normal, although some may leak mucoid contents on to the skin. Epidermoid cysts are lined with skin; dermoid cysts usually contain differentiated tissue such as sebaceous glands and hair follicles; dentigerous cysts contain teeth or parts of them. Acquired cysts include apocrine, sebaceous and keratin varieties.

Developmental cysts, which are present from birth, are usually located at specific anatomical sites, and include:

**Branchial cysts** in the neck, formed from an incompletely closed branchial cleft

**False nostril cysts** in horses

**Wattle cysts** in goats.

Cysts may occur anywhere on the body, but most commonly they are found near the dorsal midline.<sup>1</sup> In horses a common site is the base of the ear.

Other diseases that cause cutaneous nodules in horses include collagenolytic granuloma, mastocytosis, amyloidosis, lymphoma, sarcoid and infestation with *Hypoderma* spp.

Surgical excision for cosmetic reasons is common practice.<sup>2</sup>

## REFERENCES

1. Abraham CG, Genetzky RM. *Vet Med* 1995; 90:72.
2. Misk NA et al. *Equine Pract* 1994; 16:31.

## Granulomatous lesions of the skin

Granulomatous lesions are chronic inflammatory nodules, plaques and ulcers; they are cold, hard, progress slowly and are often accompanied by lymphangitis and lymphadenitis. In many cases there is no cutaneous discontinuity, nor alopecia. Some of the common causes in animals are as follows.

### Cattle

- *Mycobacterium* spp. especially *Mycobacterium farcinogenes*
- *Nocardia farcinica*
- *A. lignieresii*
- Infestation with *Onchocerca* sp.
- *Hypoderma* sp. larvae
- *Mucor* sp. fungi in thick-walled nodules in the skin on the posteroventral aspect of the udder
- Lechiguana, a disease of cattle in Brazil in which very large granulomata consisting of fibrous tissue and containing *Pasteurella granulomatis* develop in subcutaneous sites in any part of the body.<sup>1</sup>

### Sheep

- Strawberry footrot – *D. congolensis*
- Ecthyma
- Ulcerative lesions of lower jaw and dewlap associated with *A. lignieresii*.

### Pigs

- *Actinomyces* spp. and *B. suilla* cause lesions on the udder.

### Horses

- Tumorous calcinosis causes hard, painless, spherical granulomata, up to 12 cm in diameter, near joints and tendon sheaths, especially the stifle joint. Surgical removal is recommended
- Cutaneous amyloidosis
- Collagenolytic granuloma (nodular necrobiosis) – the most common nodular skin disease of the horse.<sup>2</sup> The etiology is unknown. There are multiple firm nodules located in the dermis ranging in size from 0.5–5 cm in diameter. The overlying skin surface and hair are usually normal. Biopsy reveals collagenolysis. Treatment consists of surgical removal and consideration of corticosteroids
- Botryomycosis, or bacterial pseudomycosis, results from bacterial infection at many sites, often accompanied by a foreign body. Lesions on the limbs, brisket, ventral

abdomen and scrotum vary in size from nodules to enormous fungating growths composed of firm inflammatory tissue riddled by necrotic tracts, leading to discharging sinuses, often containing small, yellow-white granules or 'grains'.

Surgical excision is the only practicable solution  
Equine eosinophilic granuloma – non-alopecic, painless, nonpruritic, firm nodules, 2–10 cm in diameter and covered by normal skin develop on the neck, withers and back of horses, especially in the summer. The cause is unknown and palliative treatment, surgical excision or corticosteroid administration is usually provided

- Systemic granulomatous disease (equine sarcoidosis)<sup>3</sup> – a rare disease of horses characterized by skin lesions and widespread involvement of the lungs, lymph nodes, liver, gastrointestinal tract, spleen, kidney, bones, and central nervous system
- *Actinobacillus mallei* – cutaneous farcy or glanders
- *Actinomadura* spp. and *Nocardia brasiliensis* – painless mycetomas
- *Histoplasma farciminosum* – epizootic lymphangitis
- *C. pseudotuberculosis* – ulcerative lymphangitis
- *Habronema megastoma*, *Hyphomyces destruens* as causes of swamp cancer, bursattee, Florida horse leech and blackgrain mycetoma
- Infestation with *Onchocerca* sp.
- Chronic urticaria.<sup>4</sup>

## REFERENCES

1. Riet-Correa P et al. *Vet Pathol* 1992; 29:93.
2. Stannard AA. *Vet Dermatol* 2000; 11:179.
3. Stannard AA. *Vet Dermatol* 2000; 11:163.
4. Evans AG. *Compend Contin Educ Pract Vet* 1993; 15:626.

## Cutaneous neoplasms

Many cutaneous neoplasms have been recorded in large animals but at a very low incidence. A brief description of only the more common types is given here.

### PAPILLOMA AND SARCOID

Sarcoid of horses and cutaneous papillomatosis of horses, goats, and cattle are specific diseases. The lesions are characteristically nodular growths of viable tissue and, if there is no traumatic injury, with no discontinuity of the covering epidermis.

**Aural flat warts (aural plaques)** occur commonly in the horse and are



caused by the papilloma virus.<sup>1</sup> Blackflies may serve as a vector. Lesions consist of one to several gray or white plaques involving the inner surface of the pinna. Similar lesions may occur around the anus, vulva and inguinal regions. The lesions are usually asymptomatic, may persist indefinitely, may regress spontaneously and are refractory to treatment.

### SQUAMOUS-CELL CARCINOMA

This neoplasm can occur anywhere on the skin, and also in the mouth and maxillary sinus.

- **Cancer-eye** is the commonest lesion, on the eyelids and the eyeball in horses and cattle
- **Genital squamous-cell carcinomas** affecting the glans penis and prepuce of aged horses can cause fatal metastases unless amputation is performed in the early stages. Grossly similar lesions are caused by epithelial hyperplasia, habronemiasis, and squamous papillomata. Squamous-cell carcinomas also occur on the vulva of cattle and a greater incidence has been observed on unpigmented than on pigmented vulvas
- **Vulvar squamous-cell carcinoma** appears frequently in Merino ewes as a result of excessive exposure of vulvar skin to sunlight after radical perineal surgery to help control blowfly strike<sup>2</sup>
- **Cancer of the horn core** in cattle and rarely in sheep<sup>3</sup> is a squamous-cell carcinoma arising from the mucosa of the frontal sinus and invading the horn core; it is most prevalent in aged, white, Indian breeds of cattle. In the early stages affected animals may rub the horns against a fixed object, or shake the head frequently. A bloody discharge begins from the nostril on the affected side, or from the base of the horn, and the animal holds its head down and toward one side. The horn becomes loosened and falls off, leaving the tumor exposed to infection and fly infestation. Secondary metastases are not uncommon. The high prevalence of metastases in regional lymph nodes and internal organs discourage treatment but a phenol extract of horn core tissue is immunogenic and immunotherapy may be a successful treatment technique.<sup>4</sup> Other forms of therapy are also practiced for squamous-cell carcinoma generally, including surgical excision, preferably by cryotherapy, and radiofrequency hyperthermia
- **Ear cancer** in sheep is in most cases a squamous-cell carcinoma. The lesion commences around the free edge of

the ear and then invades the entire ear, which becomes a large, cauliflower-shaped mass. A high incidence may occur in some flocks but the cause is not known; the presence of papilloma virus in many aural precancerous lesions suggests that the virus may participate in the etiology

- **Ovine skin cancer:** a high incidence of epitheliomas has been recorded in some families of merino sheep in Australia. The lesions occurred on the woolled skin and were accompanied by many cutaneous cysts. It has been suggested that predisposition to the neoplasm is inherited. Metastasis is common with both epitheliomas and squamous-cell carcinomas
- **'Brand cancer'**, which occurs as a granulomatous mass at the site of a skin fire or freeze brand, is usually considered to be of chronic inflammatory rather than neoplastic origin, but squamous cell carcinomas are recorded at branding sites in sheep and cattle<sup>5</sup>
- **In goats**, the perineum is a common site for squamous-cell carcinoma. The udder, ears, and base of the horns may also be affected. Ulceration, fly strike and matting of hair are unattractive sequels. A bilaterally symmetrical vulvar swelling due to ectopic mammary tissue that enlarges at parturition is likely to be confused with squamous-cell carcinoma. Milk can be aspirated from the swellings.

### MELANOMA

Superficially situated melanomas occur most commonly at the tail root in aged, gray horses and rarely in dark-skinned cattle, sheep and goats. Equine lesions are not usually malignant and rarely metastasize widely. The skin is intact but ulcerates in rapidly growing tumors. Bovine melanomas are usually benign. A high rate of occurrence of malignant melanomas has been observed in neonatal pigs of the Duroc-Jersey breed. Inherited melanomas and kindred neoplasms occur commonly in Sinclair miniature and NIH miniature swine but they frequently regress spontaneously.

### CUTANEOUS ANGIOMATOSIS

This condition is manifested clinically by recurrent profuse hemorrhage from small (1–1.5 cm diameter), single, inconspicuous, cutaneous lesions situated most commonly along the dorsum of the back in adult dairy cows. The lesions consist of what appears to be protruding granulation tissue and are benign. Surgical excision is effective.

A juvenile version of angiomatosis in calves<sup>6</sup> is characterized by similar lesions, but in many organs, sometimes including the skin.

### LYMPHOMATOSIS

In cattle and horses skin lesions occur as nodules in the subcutaneous tissue, most commonly in the paralumbar fossae and the perineum. In cattle the lesions are associated with the virus of epizootic bovine leukosis, and are only one manifestation of the disease, usually being accompanied by lesions in other organs. In horses there are no leukemic lesions in lymph nodes or visceral organs.

### MAST CELL TUMORS

#### Cattle

Cutaneous mastocytoma appears as a rapidly growing intradermal nodule, which may become widely disseminated if excised or, less commonly, there may be multiple tumors in the first instance. The nodules show no tendency to metastasize internally and are compatible with life provided they do not ulcerate and become repulsive.

#### Horses

Cutaneous mastocytomas (mastocytosis) is a neoplasm recorded in horses of all ages. The neonatal form is manifested by multiple cutaneous nodules up to 3 cm in diameter; in adults there are usually only single lesions. The skin surface is intact except for larger lesions, which are sometimes ulcerated. Lesions occur all over the body, but especially on the flanks. Each nodule appears, enlarges and then regresses during a period of about 30 days. Fresh lesions may appear for up to about a year. Histologically the lesions contain aggregations of mast cells. Surgical excision is recommended, few cases showing any recurrence at the surgery site.

### NEUROFIBROMATOSIS

This common lesion of nerves in cattle usually attracts attention only in abattoir specimens but can occur in a cutaneous form resembling a similar disease of humans;<sup>7</sup> a particularly high prevalence of this benign disease is recorded in breeds of European pied cattle. Clinical cases are usually recorded in calves, in which there are cutaneous lesions that appear as tumor-like lumps between the eyes and on the cheeks. They are flat, round tumors up to 8 cm in diameter and of a lumpy, elastic consistency.

### HISTIOCYTOMA

This is a very rare benign neoplasm in farm animals but is recorded as cutaneous nodules or plaques, which bleed easily, in

goats and cattle. The lesions regress spontaneously.

## HEMANGIOMA AND HEMANGIOSARCOMA

Benign cutaneous hemangiomas occur rarely in most species, including a rare occurrence in cattle<sup>8</sup> and relatively commonly on distal parts of limbs in young horses, sometimes in neonates.<sup>9</sup> The lesions are small (1–3 cm diameter), round, blue to black lumps that bleed easily and are morphologically the same as bovine cutaneous angiomas lesions. Vascular nevi in newborn foals have a very similar appearance.

Hemangiosarcomas (hemangio-epithelioma) are malignant tumors recorded relatively frequently in older horses. They are large, highly vascular, subcutaneous masses, usually associated with one or more internal lesions. The primary lesion may be internal, commonly in the spleen, or cutaneous. Recurrence after excision, extensive local infiltration and death due to anemia are common sequelae.<sup>10</sup>

## LIPOMA

External lipomas are not cutaneous neoplasms but they do occur as large subcutaneous masses and invade fascia and muscle.<sup>11</sup> They are generally susceptible to surgical removal.

## REVIEW LITERATURE

- Daniels PW, Johnson RH. Ovine squamous-cell carcinoma. *Vet Bull* 1987; 57:153–167.
- MacFadden KE et al. Squamous-cell carcinoma of horses. *Compend Contin Educ Pract Vet* 1991; 13:669–677.
- Somvanshi R. Horn cancer in Indian cattle. *Vet Bull* 1991; 61:901–911.
- Malikides N et al. Mast cell tumors in the horse. *Equine Pract* 1996; 18:12–17.

## REFERENCES

1. Stannard AA. *Vet Dermatol* 2000; 11:217.
2. Howarth S et al. *Equine Vet J* 1991; 23:53.
3. Salyari M et al. *Indian Vet* 1994; J 71:1233.
4. Batra UK et al. *Indian J Anim Sci* 1988; 58:14.
5. Yeruham I et al. *J Comp Pathol* 1996; 114:101.
6. Watson TDG, Thompson H. *Vet Rec* 1990; 127:279.
7. Sartin EA et al. *Am J Pathol* 1994; 145:168.
8. Munro R et al. *Vet Rec* 1994; 135:333.
9. Johnson GC et al. *Vet Pathol* 1996; 33:142.
10. Collins MB et al. *Aust Vet J* 1994; 71:296.
11. Dunkerley SAC et al. *J Am Vet Med Assoc* 1997; 210:332.

## Congenital defects of the skin

The common diseases are inherited. Examples are:

- Inherited parakeratosis (lethal trait A46, Adema disease, inherited nutritional zinc deficiency) of cattle

- Dermatitis vegetans of pigs
- Inherited congenital ichthyosis (fish-scale disease) of calves
- Inherited hypotrichoses and alopecias in cattle
- Congenital absence of skin (epitheliogenesis imperfecta) in all species
- Epitheliogenesis imperfecta, a rare congenital defect in foals inherited as a single autosomal recessive trait.<sup>1</sup> There are sharply demarcated areas in which there is absence of epidermis. The lesions bleed easily and secondary bacterial infection is common; death usually due to septicemia
- Epidermolysis bullosa of foals, which occurs especially the Belgian breed and may occur in American Saddlebred, is inherited as autosomal recessive.<sup>1</sup> The defect is present at birth but it may be several months before the disease is clinically apparent.<sup>2</sup> Lesions involve the skin, mucocutaneous junctions and oral mucosa and are characterized by separation of the dermal-epidermal junction beneath the basal epithelium
- Hyperelastosis cutis of newborn foals<sup>1</sup> is a group of inherited connective tissue diseases, also known as cutaneous asthenia, Ehlers-Danlos syndrome and dermatoparaxis, that is seen only in Quarter horses. The condition is characterized by sharply demarcated areas of loose skin, which is hyperfragile, tears easily and exhibits impaired healing
- Epitheliogenesis imperfecta in piglets due to ingestion of *Fusarium* spp. toxin
- Dyserythropoiesis and dyskeratosis of cattle
- Hair-coat-color-linked follicular dysplasia
- Familial acantholysis and dermatoparaxis – in familial bovine acantholysis the skin is normal at birth, but is shed later at the carpus and the coronet
- Hereditary junctional mechanobullous disease of foals, calves, lambs
- Inherited epidermolysis bullosa and inherited redfoot, both of sheep
- Dermatosparaxis, hyperelastosis cutis and the Ehlers-Danlos syndrome, all in cattle. A mild form of dermatoparaxis is recorded in sheep
- Vascular nevus: irregularly shaped, cutaneous masses, present at birth and originally covered with hair, but subsequently hairless. Individual lesions in foals are 3–4 cm in

diameter, bright pink, ulcerated and inflamed. The lesions consist of densely packed convoluted blood vessels, which bleed easily. Most lesions are on the lower limbs, especially at the coronet. Surgical excision is usually attempted

- Dermoid cysts.

## REFERENCES

1. Stannard AA. *Vet Dermatol* 2000; 11:211
2. Brounts SH et al. *Vet Dermatol* 2001; 12:219.

## Congenital skin neoplasms

Congenital tumors are defined as those existing at birth. A broader definition is that congenital tumours can be detected in fetuses, and newborns until 2 months of age.<sup>1</sup> Embryonic tumours are those that arise during embryonic, fetal or early postnatal development from a particular organ rudiment or tissue while it is still immature. Hamartomas are benign, tumor-like nodules composed of overgrowth of mature cells, which normally occur in the affected part but often with one element predominating. Hamartomas include hemangiomas, ameloblastomas and rhabdomyomas. Teratomas are true neoplasms consisting of different types of tissue not native to the area in which they occur.

### Cattle

Congenital skin neoplasms of cattle described include mast cell tumors, lymphosarcoma, myxoma and vascular hamartoma.<sup>2</sup> Benign melanomas, mastocytomas<sup>1,3</sup> hemangiomas and lymphangiomas, fibrosarcomas, neurofibromatosis, subcutaneous lipomas, multiple lipomas and retroperitoneal lipomas have also been recorded in calves.<sup>1</sup> The comparative aspects of tumors in calves have been described.<sup>4</sup>

### Pigs

The literature on congenital and hereditary tumors in piglets has been reviewed.<sup>5</sup> Spindle cell sarcoma, malignant melanoma and papillomatosis are common congenital tumors of the skin of piglets. Congenital cutaneous papillomatosis of the head and neck of a newborn piglet has been described from a pig-breeding farm where sporadic cutaneous papillomatosis of the prepuce and scrotum had previously occurred in several boars.<sup>4</sup>

### Foals

Congenital tumors in foals are rare. Congenital skin tumors are of the papillomatous, vascular and melanocytic types.<sup>6</sup> The vascular tumors are capillary hemangiomas, cavernous hemangiomas, and hemangiosarcomas.

## REFERENCES

1. Misdorp W. *Vet Q* 2002; 24:1.
2. Yeruham I et al. *Vet Dermatol* 1999; 10:149.
3. Smith BI, Phillips LA. *Can Vet J* 2001; 42:635.
4. Misdorp W. *J Comp Pathol* 2002; 127:96.
5. Misdorp W. *Vet Q* 2003; 25:17.
6. Misdorp W. *Vet Q* 2003; 25:61.

## Diseases of the conjunctiva

Some of the common diseases of the conjunctiva are listed here because they are often treated medically as they are often secondary to the presence of some other disease, and also because an examination of the conjunctiva often provides additional information on which to base a diagnosis. General practitioners need to know something of the common diseases of the eye for these reasons.

The following notes are intended only to provide guidelines to the relevant sections of Part Two, where specific forms of conjunctivitis have been described in detail.

### CONJUNCTIVITIS AND KERATOCONJUNCTIVITIS

This is inflammation of the covering membrane of the eye, including the orbit and the inner surface of the eyelids. The inflammation commonly extends to layers below the conjunctiva, hence keratoconjunctivitis.

#### ETIOLOGY

##### Specific conjunctivitis

###### Cattle

Infectious bovine keratoconjunctivitis is associated with:

- Moraxella bovis*, the only significant cause
- M. bovis* with infectious bovine rhinotracheitis virus
- Neisseria catarrhalis*
- Mycoplasma* spp.
- Chlamydomphila* spp.

###### Sheep

- Rickettsia conjunctivae* is the important infection
- N. catarrhalis*
- Mycoplasma conjunctivae*
- Acholeplasma oculi* is also listed
- Chlamydomphila* spp.

###### Goats

- R. conjunctivae*.

###### Pigs

- Rickettsia* spp.

###### Horses

There is no well-identified specific conjunctivitis in this species but *Moraxella equi* has been recorded as a cause on several occasions.<sup>1</sup> There is also infestation with *Thelazia* spp. and *Habronema* spp.

##### Specific keratitis lesions

- Thelazia* spp. in cattle and horses
- Onchocerca* spp. in cattle
- Elaeophora schneideri* in sheep and goats
- Habronema* spp. in horses
- Fungal keratomycosis in foals<sup>1</sup> and adult horses; *Aspergillus flavus* has been identified in some cases.

*Aspergillus fumigatus* is listed amongst the causes of mycotic keratitis in animals.<sup>2</sup> Most cases begin as traumatic injuries with secondary infections or begin in eyes treated for long periods with broad-spectrum antibiotics.

##### Secondary diseases in which conjunctivitis is a significant but secondary part of the syndrome

###### Cattle

- Bovine viral diarrhea
- Bovine malignant catarrh
- Rinderpest
- Infectious bovine rhinotracheitis
- Viral pneumonia due to various viruses.

###### Sheep

- Bluetongue.

###### Pigs

- Swine influenza
- Inclusion body rhinitis.

###### Horses

- Equine viral arteritis
- Equine viral rhinopneumonitis.

##### Nonspecific conjunctivitis

- Inflammation caused by foreign bodies or chemicals, or secondarily as exposure keratitis, and conjunctivitis/keratitis in paralysis of eyelids as in listeriosis. Ant-bite conjunctivitis occurs in similar circumstances.

#### CLINICAL FINDINGS

Blepharospasm and weeping from the affected eye are the initial signs. Watery tears are followed by mucopurulent, then purulent ocular discharge if the lesion extends below the conjunctiva. Varying degrees of opacity of the conjunctiva may develop, depending on the severity of the inflammation. In the severest lesions there is underrunning of the conjunctiva with pus accompanied by vascularization of the cornea. During the recovery stage there is often long-lasting, diffuse opacity of the eye and terminally a chronic white scar in some cases.

#### CLINICAL PATHOLOGY

In herd or flock outbreaks conjunctival swabs and/or scrapings should be taken for culture and examination of cells using special stains and histological techniques.

#### REFERENCES

1. Huntington PJ et al. *Aust Vet J* 1987; 64:110.

2. Grahn B et al. *Prog Vet Comp Ophthalmol* 1993; 3:2.

## Congenital defects of the eyelids and cornea

### DERMOID CYSTS

Ocular dermoid cysts are solid, skin-like masses of tissue, adherent usually to the anterior surface of the eye, causing irritation and interfering with vision. The eyelid, the third eyelid and the canthus may also be involved, and the lesions may be unilateral or bilateral. When they occur at a high frequency in a population, it is likely they are inherited, as they can be in Hereford cattle. It is also recorded in foals. The defect is sometimes associated with microphthalmos. Surgical ablation is recommended.

## Diseases of the external ear

Ear cancer is discussed in the section on squamous cell carcinoma.

### OTITIS EXTERNA

Otitis externa, inflammation of the skin and external auditory canal, can affect cattle of all ages, in isolated cases, an entire herd or in entire regions.<sup>1</sup> The literature on the causes of otitis in cattle has been reviewed.<sup>1</sup>

Arthropod parasites, foreign bodies and sporadic miscellaneous infections may cause irritation in the ear, accompanied by rubbing of the head against objects and frequent head-shaking.

In tropical and subtropical regions, parasitic otitis is more important than in other more temperate regions.<sup>1,2</sup> The mites *Raillietia auris* and *Dermanyssus avium*, the tick *Otobius magnini*, larvae (*Stephanofilaria zahaaceri*), free-living nematodes (*Rhabditis bovis*) and the blue fly (*Chrysomya bezziano*) are of importance in Europe, Africa, India and America. *Malassezia* spp., *Candida* spp., *Rhodotorula mucilaginosa*, *Aspergillus* spp. and *Micelia sterilia* are common causes of otitis externa in cattle in Brazil.<sup>3,4</sup>

When the syndrome occurs in a large number of a herd, as it does in tropical countries, it is necessary to look for a specific causative agent. *Rhabditis bovis* is the common cause. Affected animals are depressed, eat little and appear to experience pain when they swallow, and they shake their heads frequently. Both ears are affected in most cases and there is a stinking, blood-stained discharge that creates a patch of alopecia below the ear. The area is painful when touched, the external meatus of the aural canal is

obviously inflamed and the parotid lymph nodes are enlarged. Extension to the middle ear is an unusual sequel. Topical treatment with ivermectin and a broad-spectrum antibiotic is effective.

### OTITIS MEDIA

Otitis media (middle ear infection) occurs in milk-fed calves from a few days of age

up to 10 weeks and in weaned calves from 4–8 months and from 12–18 months of age.<sup>1</sup> The major bacteria that cause otitis media in calves include *Actinomyces* spp., *C. pseudotuberculosis*, *Escherichia coli*, *Histophilus somni* (formerly *Haemophilus somnus*), *Pasteurella multocida*, *Mannheimia* (formerly *Pasteurella*) *haemolytica*, *Pseudomonas* spp., *Streptococcus* spp. and *M. bovis*.

### REVIEW LITERATURE

Duarte ER, Hamdan JS. Otitis in cattle, an aetiological review. *J Vet Med B* 2004; 51:1–7.

### REFERENCES

1. Duarte ER, Hamdan JS. *J Vet Med B* 2004; 51:1–7.
2. Duarte ER et al. *Vet Parasitol* 2001; 101:45.
3. Duarte ER et al. *Med Mycol* 2003; 41:137.
4. Duarte ER et al. *J Vet Med B* 2001; 48:631.

## Diseases of the mammary gland

**INTRODUCTION 673****BOVINE MASTITIS 673****MASTITIS PATHOGENS OF CATTLE 697****MASTITIS OF CATTLE ASSOCIATED WITH COMMON CONTAGIOUS PATHOGENS 697**

*Staphylococcus aureus* 697  
*Streptococcus agalactiae* 703  
*Mycoplasma bovis* and other  
*Mycoplasma* species 705  
*Corynebacterium bovis* 708

**MASTITIS OF CATTLE ASSOCIATED WITH TEAT SKIN OPPORTUNISTIC PATHOGENS 708**

Coagulase-negative staphylococci 708

**MASTITIS OF CATTLE ASSOCIATED WITH COMMON ENVIRONMENTAL PATHOGENS 709**

Coliform mastitis associated with  
*Escherichia coli*, *Klebsiella* species and  
*Enterobacter aerogenes* 709  
 Environmental streptococci 719  
*Arcanobacterium pyogenes* 722

**MASTITIS OF CATTLE ASSOCIATED WITH LESS COMMON PATHOGENS 724**

*Pseudomonas aeruginosa* 724  
*Pasteurella* species 725  
*Nocardia* species 725

**MISCELLANEOUS CAUSES OF BOVINE MASTITIS 726**

*Bacillus* species 726  
*Campylobacter jejuni* 726  
*Clostridium perfringens* type A 726  
*Fusobacterium necrophorum* 727  
*Histophilus somni* 727  
*Listeria monocytogenes* 727  
*Mycobacterium* species 727  
*Serratia* species 727  
 Fungi and yeasts 727  
 Algae 728  
 Traumatic mastitis 728

**CONTROL OF BOVINE MASTITIS 728**

Options in the control of mastitis 729  
 Principles of controlling bovine mastitis 730  
 Mastitis control programs 730

The ten-point mastitis control program 731

Assessment of the cost-effectiveness of mastitis control 748

**MISCELLANEOUS ABNORMALITIES OF THE TEATS AND UDDER 749**

Lesions of the teat and udder skin 749  
 Lesions of the bovine teat 750  
 Lesions of the bovine teat and udder 751  
 Lesions of the bovine udder other than mastitis 751  
 Udder edema 752  
 Rupture of the suspensory ligaments of the udder 752  
 Agalactia 752  
 Neoplasms of the udder 753  
 Teat and udder congenital defects 753

**MASTITIS-METRITIS-AGALACTIA SYNDROME IN SOWS 754****MASTITIS OF SHEEP 759****MASTITIS OF GOATS 761****MASTITIS OF MARES 762****Introduction**

**Mastitis** is inflammation of the parenchyma of the mammary gland regardless of the cause. Mastitis is therefore characterized by a range of physical and chemical changes in the milk and pathological changes in the glandular tissue. The most important changes in the milk include discoloration, the presence of clots and the presence of large numbers of leukocytes. There is swelling, heat, pain and edema in the mammary gland in many clinical cases. However, a large proportion of mastitic glands are not readily detectable by manual palpation nor by visual examination of the milk using a strip cup; these quarters represent subclinical infections. Because of the large numbers of subclinical cases, the diagnosis of mastitis depends largely on indirect tests, which depend, in turn, on the somatic cell concentration (SCC) or electrolyte (sodium or chloride) concentration of milk. It seems practicable and reasonable to define mastitis as a disease characterized by the presence of a significantly increased SCC in milk from affected glands. The increased SCC is, in almost all cases, due to an increased neutrophil concentration, represents a reaction of glandular tissue to injury and is

preceded by changes in the milk that are the direct result of damage to glandular tissue. However, the exact clinical and laboratory changes that occur in the udder as a result of infection can also be caused by other factors in the absence of infection.<sup>1</sup> Until such time as it becomes common usage to define mastitis in terms of the sodium or chloride concentration of the milk (as measured by electrical conductivity) or increased permeability of the blood-milk barrier (as measured by albumin concentration) there appears to be no point in changing the current definition of mastitis based on an abnormal looking secretion or an increased SCC. Characterization of mastitis depends on the identification of the causative agent whether it be infectious or physical.

Most of the information presented here deals almost entirely with bovine mastitis because of its economic importance, but small sections on ovine, caprine, porcine and equine mastitis are included at the end of the chapter.

**Bovine mastitis****GENERAL FEATURES**

A total of about 140 microbial species, subspecies and serovars have been

**Synopsis****Etiology**

- **Contagious pathogens:**  
*Staphylococcus aureus*, *Streptococcus agalactiae*, *Mycoplasma bovis* and *Corynebacterium bovis*
- **Teat skin opportunistic pathogens:**  
 coagulase-negative staphylococci
- **Environmental pathogens:**  
 environmental *Streptococcus* spp. including *Streptococcus uberis* and *Streptococcus dysgalactiae*, which are the most prevalent; less prevalent is *Streptococcus equinus* (formerly referred to as *Streptococcus bovis*). Environmental coliforms include the Gram-negative bacteria *Escherichia coli*, *Klebsiella* spp. and *Enterobacter* spp., and *Arcanobacterium* (formerly *Actinomyces*) *pyogenes*
- **Uncommon pathogens:** many, including *Nocardia* spp., *Pasteurella* spp., *Mycobacterium bovis*, *Bacillus cereus*, *Pseudomonas* spp., *Serratia marcescens*, *Citrobacter* spp., anaerobic bacterial species, fungi and yeasts

**Epidemiology**

- Incidence of clinical mastitis ranges from 10–12% per 100 cows at risk per year. Prevalence of intramammary infection is about 50% of cows and 10–25% of quarters. Case fatality rate depends on cause of mastitis

- Contagious pathogens are transmitted at time of milking; teat skin opportunistic pathogens take any opportunity to induce mastitis; environmental pathogens are from the environment and induce mastitis between milkings
- Environmental pathogens are the most common cause of clinical mastitis in herds that have controlled contagious pathogens
- Prevalence of infection with contagious pathogens ranges from 7–40% of cows and 6–35% of quarters
- Prevalence of infection with environmental pathogens: coliforms 1–2% of quarters; streptococci less than 5%

#### Risk factors

- Animal risk factors:** prevalence of infection increases with age. Most new infections occur in dry period and in early lactation. Highest rate of clinical disease occurs in herds with low somatic cell counts (SCCs). Morphology and physical condition of teat are risk factors. Selenium and vitamin E status influence incidence of clinical mastitis. High-producing cows are more susceptible
- Environmental risk factors:** poor quality management of housing and bedding increases infection rate and incidence of clinical mastitis due to environmental pathogens
- Pathogen risk factors:** ability to survive in environment, virulence factors (colonizing ability, toxin production), susceptibility to antimicrobial agents
- Economics:** subclinical mastitis is a major cause of economic loss due to loss of milk production, costs of treatment and early culling

#### Clinical signs

- Gross abnormalities in milk** (discoloration, clots, flakes, pus)
- Physical abnormalities of udder:** acute – diffuse swelling, warmth, pain, gangrene in severe cases; chronic – local fibrosis and atrophy
- Systemic response:** may be normal or mild, moderate, acute, peracute with varying degrees of anorexia, toxemia, dehydration, fever, tachycardia, ruminal stasis, and recumbency and death

#### Clinical pathology

- Detection at the herd level:** bulk tank milk SCCs. Culture of bulk tank milk
- Detection at the individual cow level:** abnormal looking milk, culture of composite or quarter milk samples. Indirect tests include SCCs of composite or quarter milk samples, California Mastitis Test (CMT) of quarter milk samples, inline milk conductivity tests of quarter milk samples
- Use of selective media to differentiate Gram-positive and Gram-negative pathogens** in cases of clinical mastitis
- Differential diagnosis list:** other mammary abnormalities: Periparturient udder edema, rupture of suspensory ligament, and hematomas. Blood in the milk of recently calved cows

#### Treatment

- Clinical mastitis in lactating cow:** mild cases of clinical mastitis (abnormal secretion only) may not require treatment; however, all clinical mastitis episodes accompanied by an abnormal gland or systemic signs of illness should be treated with antimicrobial agents given by intramammary infusion (all cases) and parenterally (selected cases). Acute and peracute mastitis cases require also require supportive therapy (fluid and electrolytes) and nonsteroidal anti-inflammatory agents (NSAIDs). Culture milk of representative clinical cases but antimicrobial susceptibility testing has not been validated
- Dry cow therapy:** intramammary infusion of long-acting antimicrobial agents at drying-off provides the best treatment for subclinical mastitis due to contagious pathogens. Must adhere to milk withholding times after treatment with antimicrobial agents to prevent milk drug residues, which is major public health issue. Currently available cowside antimicrobial residue tests are not reliable

#### Control

- Principles of control:
  - Eliminate existing infections
  - Prevent new infections
  - Monitor udder health status
- Components of Mastitis Control Program:
  - Use proper milking management methods
  - Proper installation, function, and maintenance of milking equipment
  - Dry cow management
  - Appropriate therapy of mastitis during lactation
  - Culling chronically infected cows
  - Maintenance of an appropriate environment
  - Good record keeping
  - Monitoring udder health status
  - Periodic review of the udder health management program
  - Setting goals for udder health status

isolated from the bovine mammary gland. Microbiological techniques have enabled precise determination of the identity of many of the mastitis pathogens. Based on their epidemiology and pathophysiology, these pathogens have been further classified as causes of **contagious, teat skin opportunistic** or **environmental** mastitis.

#### Contagious mastitis pathogens

There are many contagious mastitis pathogens. The most common are *Staphylococcus aureus* and *Streptococcus agalactiae*. The usual source of contagious pathogens is the infected glands of other cows in the herd; however, the hands of milkers can act as a source of *S. aureus*. The predominant method of transmission is from cow to cow by contaminated common

udder wash cloths, residual milk in teat cups and inadequate milking equipment. Programs for the control of contagious mastitis involve improvements in hygiene and disinfection aimed at disrupting the cow-to-cow mode of transmission. In addition, methods to eliminate infected cows involve antimicrobial therapy and the culling of chronically infected cows.

In general, a conscientious mastitis control program will eradicate *S. agalactiae* from most dairy herds. It is much more difficult to deal with a herd that has a high prevalence of *S. aureus*, but *S. aureus* can be eradicated from low-prevalence herds.

*Mycoplasma bovis* is a less common cause of contagious mastitis; it causes outbreaks of clinical mastitis that do not respond to therapy and are difficult to control. Most outbreaks of *M. bovis* are associated with recent introductions of new animals into the herd. Characteristically, clinical mastitis occurs in more than one quarter, there is a marked drop in milk production and there is little evidence of systemic disease. The laboratory diagnosis of mycoplasmal mastitis requires specialized media and culture conditions. Antimicrobial therapy is relatively ineffective and culling is the predominant strategy.

#### Teat skin opportunistic mastitis pathogens

The incidence of mild clinical mastitis associated with bacterial pathogens that normally reside on the teat skin is increasing, particularly in herds that have controlled major contagious mastitis pathogens. Teat skin opportunistic pathogens have the ability to create an intramammary infection via ascending infection through the streak canal. Accordingly, their epidemiology of infections differs from those of contagious and environmental pathogens, and it is useful to consider them in a separate category. Coagulase-negative staphylococci are the most common teat skin opportunistic mastitis pathogens.

#### Environmental mastitis pathogens

Environmental mastitis is associated with three main groups of pathogens, the coliforms (particularly *E. coli* and *Klebsiella* spp.), environmental *Streptococcus* spp. and *Arcanobacterium pyogenes*. The source of these pathogens is the environment of the cow. The major method of transmission is from the environment to the cow by inadequate management of the environment. Examples include wet bedding, dirty lots, milking wet udders, inadequate premilking udder and teat preparation, housing systems that allow teat injuries, and poor fly control. Control strategies for environmental mastitis

include improved sanitation in the barn and yard areas, good premilking udder preparation so that teats are clean and dry at milking time, and fly control. Special attention is necessary during the late dry period and in early lactation.

Coliform organisms are a common cause of clinical mastitis, occasionally in a severe peracute form. Clinical cases of coliform infection are generally found in low levels in most herds and do not routinely result in chronic infections. There is increasing evidence that, as the contagious pathogens are progressively controlled in a herd, the incidence of clinical cases associated with coliform organisms increases. The pathogenesis, epidemiology, predisposing risk factors, diagnostic problems, therapy and control methods have been the subject of extensive, worldwide research efforts.

Environmental streptococci have become a major cause of mastitis in dairy cattle. Streptococcal infections are associated with many different species, however the most prevalent species are *Streptococcus uberis* and *Streptococcus dysgalactiae*. Infections with these organisms can cause clinical mastitis that is commonly mild to moderate in nature. More frequently, these organisms cause a chronic subclinical infection with an increased milk SCC. Many herds that have implemented the five-point program for mastitis control have found that environmental streptococci represent their most common mastitis problem.

*A. pyogenes* is an important seasonal cause of mastitis in dry cows and late pregnant heifers in some parts of the world. Intramammary infections with *A. pyogenes* are severe and the gland is almost always lost to milk production.

Several other pathogens are included in the environmental class of infections. These pathogens invade the mammary gland when defense mechanisms are compromised or when they are inadvertently delivered into the gland at the time of intramammary therapy. This group of opportunistic organisms includes *Pseudomonas* spp., yeast agents, *Prototheca* spp., *Serratia marcescens* and *Nocardia* spp. Each of these agents has unique microbiological culture characteristics, mechanisms of pathogenesis and clinical outcomes. These infections usually occur sporadically. However, outbreaks can occur in herds or in an entire region and are usually the result of problems with specific management of hygiene or therapy. For example, mastitis associated with *Pseudomonas aeruginosa* has occurred in outbreaks associated with contaminated wash hoses in milking parlors. Iodide germicides used in wash lines are often at too low a concentration to eliminate *Pseudomonas* spp.

Outbreaks of clinical mastitis associated with *Nocardia* spp. have been associated with the use of blanket dry cow therapy and the use of a specific neomycin-containing dry cow preparation.

The mastitis pathogens, and their relative importance, continue to evolve as new management methods and control practices are developed. Thus, there is an ongoing need for epidemiological studies to characterize the pathogens and describe their association with the animals and their environment. Improved control methods can develop only from investigations into the distribution and pathogenic nature of the microorganisms isolated.

### ETIOLOGY

Bovine mastitis is associated with many different infectious agents, commonly divided into those causing **contagious mastitis**, which are spread from infected quarters to other quarters and cows, those that are normal teat skin inhabitants and cause **opportunistic mastitis**, and those causing **environmental mastitis**, which are usually present in the cow's environment and reach the teat from that source. Pathogens causing mastitis in cattle are further divided into **major pathogens** (those that cause clinical mastitis) and **minor pathogens** (those that normally cause subclinical mastitis and less frequently cause clinical mastitis).

#### Major pathogens

Contagious pathogens

- *S. agalactiae*
- *S. aureus*
- *M. bovis*.

Environmental pathogens

Environmental *Streptococcus* species include *S. uberis* and *S. dysgalactiae*, which are the most prevalent; less prevalent is *S. equinus* (formerly referred to as *S. bovis*). The environmental coliforms include the Gram-negative bacteria *E. coli*, *Klebsiella* spp. and *Enterobacter* spp. *A. pyogenes* mastitis can be an important problem in some herds.

#### Minor pathogens

Several other species of bacteria are often found colonizing the teat streak canal and mammary gland. They rarely cause clinical mastitis and are known as **minor pathogens**. They include the **coagulase-negative *Staphylococcus* spp.** such as *Staphylococcus hyicus* and *Staphylococcus chromogenes*, which are commonly isolated from milk samples and the teat canal. *Staphylococcus xylosus* and *Staphylococcus sciuri* are found free-living in the environment; *Staphylococcus warneri*, *Staphylococcus simulans* and *Staphylococcus epidermidis* are part of the normal flora of the teat skin (and therefore are teat skin opportunistic pathogens). The prevalence of

coagulase-negative *Staphylococcus* spp. is higher in first-lactation heifers than cows, and higher immediately after calving than in the remainder of lactation. In recent studies, they have been found as teat canal and intramammary infections in nulliparous heifers.

*C. bovis* is also a minor pathogen; it is mildly pathogenic and the main reservoir is the infected gland or teat duct. However, in some herds, *C. bovis* appears to be a common cause of mild clinical mastitis. *C. bovis* spreads rapidly from cow to cow in the absence of adequate teat dipping. The prevalence of *C. bovis* is low in herds using an effective germicidal teat dip, good milking hygiene and dry cow therapy. The presence of *C. bovis* in a gland will reduce the likelihood of subsequent infection with *S. aureus*.

#### Uncommon mastitis pathogens

Many other bacteria can cause severe mastitis, which is usually sporadic and usually affects only one cow or a few cows in the herd. These include *Nocardia asteroides*, *Nocardia brasiliensis* and *Nocardia farcinica*, *Histophilus somni*, *Pasteurella multocida*, *Mannheimia* (formerly *Pasteurella*) *haemolytica*, *Campylobacter jejuni*, *B. cereus* and other Gram-negative bacteria including *Citrobacter* spp., *Enterococcus faecalis*, *Enterococcus faecium*, *Proteus* spp., *P. aeruginosa*, and *Serratia* spp. Anaerobic bacteria have been isolated from cases of mastitis, usually in association with other facultative bacteria, e.g. *Peptostreptococcus indolicus*, *Prevotella melaninogenica* (formerly *Bacteroides melaninogenicus*), *Eubacterium combesii*, *Clostridium sporogenes* and *Fusobacterium necrophorum*.

Fungal infections include *Trichosporon* spp., *Aspergillus fumigatus*, *Aspergillus nidulans* and *Pichia* spp.; yeast infections include *Candida* spp., *Cryptococcus neoformans*, *Saccharomyces* spp. and *Torulopsis* spp. Algal infections include *Prototheca trispora* and *Prototheca zopfii*.

Leptospiras, including *Leptospira interrogans* serovar. *pomona*, and especially *Leptospira interrogans hardjo*, cause damage to blood vessels in the mammary gland and gross abnormality of the milk. They are more correctly classified as systemic diseases with mammary gland manifestations, and are described under those headings in the book.

Some viruses may also cause mastitis in cattle, but they are of little importance.

### EPIDEMIOLOGY

This section deals with the general aspects of epidemiology of bovine mastitis. For information about the epidemiology of mastitis in the other animal species see the appropriate sections at the end of this chapter.



### Occurrence and prevalence of infection

**Occurrence** refers to the location of the disease and the kinds of animals affected.

**Prevalence** is the percentage of the population affected with a specific disease in a given population at a certain point in time. The **incidence** is a rate, such as the total number of new cases of clinical mastitis as a percentage of the animals at risk that occur during a certain period of time. Prevalence is a function of the incidence and the duration of infection.

#### Prevalence

In most countries, surveys in dairy herds indicate that the **prevalence of infection** of mastitis pathogens is approximately 50% of cows and 10–25% of quarters. The prevalence of infection in dairy heifers of breeding age and in pregnant dairy heifers varies widely<sup>1</sup> from 30–50% of heifers and 18% of quarters<sup>2</sup> to as high as 97% of heifers and 75% of quarters.<sup>3</sup>

#### Incidence

The **average annual incidence of clinical mastitis**, calculated as the number of clinical quarter cases per 100 cows at risk per year, including the dry period, in individual herds ranges from 10–12% in most herds<sup>4</sup> but higher incidences, ranging from 16–65%, occur in some herds.<sup>5,6</sup> The greatest risk of first acquiring mastitis occurs early in lactation, usually in the first 50 days.<sup>7</sup> The risk of clinical mastitis also increases with increasing parity.<sup>7</sup> In beef herds, 32–37% of cows and 18% of quarters may have intramammary infection, which has a significant negative effect on calf weaning weights.<sup>8</sup>

**Case fatality rates** vary widely depending largely on the identity of the causative organism. For example, *S. agalactiae* mastitis is not a fatal disease but peracute staphylococcal mastitis in a recently calved cow often may be fatal. Details of the occurrence of the different types of mastitis are presented in their individual sections in this chapter.

### Relative prevalence of infection with intramammary pathogens

The prevalence of infection with intramammary pathogens in cattle is remarkably similar in different countries. The bacteriological identification of mastitis pathogens is important because control and eradication procedures depend on the kind of infection prevalent in the herd. In addition, the validity of epidemiological investigations aiming at determining transmission patterns or the impact of environmental and managemental factors to a large extent depends on exact bacteriological diagnosis.

#### Contagious pathogens

The prevalence of infection with *S. aureus* in cows ranges widely, usually from

7–40%, but higher in some herds.<sup>9</sup> A survey of Danish dairy herds found that 21–70% of all cows and 6–35% of all quarters were infected.<sup>10</sup> *S. aureus* was isolated from 10% of quarter samples and was the most common species isolated.<sup>10</sup> The prevalence of streptococci, including *S. agalactiae*, ranges from 1–8% of cows. A relative incidence of *S. agalactiae*, other streptococci and *S. aureus* of 1:1:2 is a common finding. *S. aureus* may still assume some importance as a cause of subclinical mastitis but its prevalence has been reduced by modern mastitis control programs, leading to a higher proportion of culture-negative mastitic quarters and a corresponding, and perhaps consequent, increase in infections by *E. coli* and *Klebsiella* spp. The prevalence of infection due to *Mycoplasma* spp. varies widely.<sup>9</sup>

The prevalence of infection due to an individual pathogen, and therefore the ratio between its incidence and that of other pathogens, depends on several risk factors such as size of herd and quality of management, especially milking parlor hygiene and cleanliness of accommodation, and parity of animal (heifer or cow). For example, large, zero-grazed herds kept in drylot conditions are likely to encounter more hygiene problems than conventionally housed herds mainly because of constant soiling of the udder by inadequate or improper bedding in larger units. In those circumstances there is likely to be a much higher prevalence than usual of mastitis associated with *E. coli* and *S. uberis*.

#### Teat skin opportunistic pathogens

Coagulase-negative staphylococcal species were found in 4.1% of samples; the most frequently isolated were *S. epidermidis* (1.3%), *S. chromogenes* (1.0%) and *S. simulans* (0.7%).

#### Environmental pathogens

The prevalence of intramammary coliform infections in a dairy herd seldom exceeds 1–2%; the prevalence of intramammary environmental streptococci is less than 5% in well managed herds but may exceed 10% in some problem herds.<sup>11</sup> A characteristic of intramammary coliform infections is the short duration: 40–50% persist less than 7 days. The majority of environmental streptococci infections last less than 30 days. In a survey of Danish dairy herds, *S. dysgalactiae* (1.6%) and *S. uberis* (1.4%) were the second and third most common species isolated.

#### Heifers

Surveys of intramammary infection of heifers in regions such as Louisiana indicate variability in prevalence and duration of intramammary infection according to species of bacteria present

around the time of parturition. About 20% of heifers were infected with *S. aureus* and 70% with coagulase-negative staphylococci, the minor pathogens that are part of the normal teat skin flora of heifers.<sup>12</sup> *S. chromogenes* was isolated from 15% of all quarters of heifers before parturition but decreased shortly after parturition to 1%.<sup>13</sup> Up to 97% of breeding age and pregnant dairy heifers and 75% of their quarters may be infected with *S. aureus*, *S. hyicus* and *S. chromogenes*.<sup>3</sup> Infections with *S. simulans* and *S. epidermidis* occurred in 1–3% of quarters both before and after parturition. *S. dysgalactiae* was isolated from 4–6% of quarters before and immediately after parturition. Intramammary infections with *S. aureus* rarely occurred before parturition but increased during the first week after parturition. There was no association between the prevalence of *S. aureus* in heifers before parturition and the prevalence in lactating cows.

### Distribution of pathogens in clinical mastitis

The distribution of pathogens isolated from cases of clinical mastitis has changed with the adoption of control programs from a high frequency of isolation of *S. aureus* and *S. agalactiae* to a higher isolation rate of other pathogens, particularly environmental pathogens. For example, in 171 randomly selected dairy herds, the average annual incidence of clinical mastitis was 12.7 quarter cases per 100 cows per year. The most frequent isolates from clinical cases were *E. coli* (16%), *S. aureus* (14%), *S. uberis* (11%), and *S. dysgalactiae* (8%).<sup>4</sup> In another survey, the most common isolates from clinical cases were coagulase-negative staphylococci and *E. coli*, each at 15% of samples taken. In a 2-year observational study of 65 dairy herds in Canada, there was considerable variation in the incidence of clinical mastitis among farms.<sup>7</sup> Overall, 20% of cows experienced one or more cases of clinical mastitis during lactation. The pathogens isolated were coliforms (17%), other *Streptococcus* spp. (14%), *S. aureus* (7%), Gram-positive bacilli (6%), *C. bovis* (2%), *S. agalactiae* (1%), and other *Staphylococcus* spp. (29%). There was no growth in 18% of samples and 8% were contaminated. Clearly the main difference is that the rate of *S. aureus* in clinical cases is higher in continental Europe<sup>4</sup> and lower in England and North America.

### Source of infection

#### Contagious pathogens

*S. agalactiae* and *S. aureus* reside primarily in the udder of infected cows; the source of infection is other infected cows and exposure to uninfected quarters is limited to the milking process.

### Teat skin opportunistic pathogens

A number of species of coagulase-negative staphylococcus reside primarily on the teat skin of cattle.

### Environmental pathogens

*S. uberis*, *S. dysgalactiae*, and coliforms are common inhabitants of the cow's environment such as bedding. The exposure of uninfected quarters to environmental pathogens can occur at any time during the life of the cow, including milking time, between milkings, during the dry period and prior to first calving in heifers.

### Methods of transmission

Infection of each mammary gland occurs via the teat canal, the infection originating from either an infected udder or the environment; in dairy cattle the infection originating from infected udders is transmitted to the teat skin of other cows by milking machine liners, milkers' hands, wash cloths and any other material that can act as an inert carrier.

### Risk factors

Risk factors that influence the prevalence of infection and the incidence of clinical mastitis are outlined here. Individual factors that are of particular importance in the individual types of mastitis are described under those headings.

#### Animal risk factors

##### Age and parity

The prevalence of infected quarters increases with age, peaking at 7 years. Surveys of the prevalence of intramammary infection in dairy heifers a few days before their first parturition reveals that 45% are infected, and the quarter infection rate may be 18%.<sup>2</sup> Some studies found intramammary infections in 97% of heifers and 74% of quarters.<sup>3</sup>

##### Stage of lactation

Most **new infections** occur during the **early part of the dry period** and in the **first 2 months of lactation**, especially with the environmental pathogens. In heifers, the prevalence of infection is often high in the last trimester of pregnancy and several days before parturition, followed by a marked decline after parturition.<sup>13</sup> In dairy heifers, most of these prepartum infections are associated with the minor pathogens but some surveys have found evidence of infection by the major pathogens.<sup>2,3</sup> The mean prevalence of *S. aureus* intramammary infection in primiparous cows at first parturition in high prevalence herds can be as high as 30%, ranging from 13–65%, and in low prevalence herds it may be as low as 2%, ranging from 0–5%.<sup>14</sup> The overall prevalence of infection of *S. aureus* intramammary infection in primiparous cows at parturition was 8%, ranging from

0–27%. Of those cows with *S. aureus* intramammary infection at parturition, 43% had *S. aureus* intramammary infection at least 2 months after parturition. Primiparous cows with these infections may represent significant reservoirs of infection to uninfected animals in the herd.

Some of these differences may be related to changes in the milk as a medium for bacterial growth. For example, bacteria such as *C. bovis* grow best in milk secreted in the middle of lactation, whereas dry period secretion inhibits its growth.<sup>15</sup> During the dry period the quarter's capacity to provide phagocytic and bactericidal activities diminishes.<sup>16</sup>

##### Somatic cell count

The highest average incidence of clinical mastitis due to environmental bacteria may occur in herds with the lowest bulk tank milk SCC (< 150 000 cells/mL) and a low prevalence of subclinical infection.<sup>17</sup>

##### Breed

Generally the incidence of mastitis is greater in Holstein–Friesians than in Jerseys, but this may reflect differences in management rather than a true genetic difference. Valid comparisons between breeds have not been reported.

##### Milking characteristics and morphology of udder and teat

High milking rate and large teat canal diameter have been associated with increased SCC or risk of intramammary infection.<sup>18</sup> Milk leaking in cows in herds with a low bulk tank milk SCC has also been associated with an increased rate of clinical mastitis. Decreasing teat-end-to-floor distance is also a risk factor for clinical mastitis and may be associated with an increased incidence of teat lesions. Heritability estimates of teat-end-to-floor distance or udder height range from 0.2–0.7, which may be a consideration in the selection indices of bulls. Periparturient udder edema may also be a risk factor for clinical mastitis.

##### Physical condition of teat

The teat end is the first barrier against invading pathogens, and the efficiency of teat defense mechanisms depends on the integrity of teat tissue; its impairment leads to an increase in the risk of intramammary infection. Teat thickness is an aid to evaluating teat tissue status. Milking machine characteristics can induce a decrease or increase in teat thickness after milking compared with premilking values. Increases in teat thickness of more than 5% are significantly associated with infection and new infection, but the association was not significant when teat thickness decreased by more than 5%.<sup>19</sup> Coagulase-negative staphylococcal infec-

tions are significantly associated with both increases and decreases in teat thickness numerically greater than 5%, but there is no association between teat thickness and *S. aureus* infections.

Hyperkeratosis of the teat orifice is a commonly observed condition in the dairy cow because of machine milking; the degree of hyperkeratosis may be increased by a poor milking system.<sup>20</sup> There is wide variation in the degree of hyperkeratosis between herds; the score increases with lactational age and peaks, for any lactation, at 3–4 months after parturition, declining as the cows dry off. There is no significant relationship between mean SCC and the degree of hyperkeratosis at the herd level.

##### Udder hygiene

Dirty udders are associated with increased SCC and an increased prevalence of intramammary infection due to contagious pathogens, but surprisingly are not associated with intramammary infections due to environmental pathogens.<sup>21</sup> This suggests that udder hygiene is a proxy for general mastitis management skills, in that good mastitis control programs result in low prevalence of infection with contagious pathogens.

##### Nutritional status

Vitamins E and A and selenium may be involved in resistance to certain types of mastitis.<sup>22</sup> Early reports found that supplementation with antioxidants such as selenium and vitamin E had a beneficial effect on udder health in dairy cattle by decreasing the incidence and duration of clinical mastitis. An increase in selenium concentration in whole blood was associated with a decrease in all infections, including *S. aureus*, *A. pyogenes*, and *C. bovis*.<sup>23</sup> There was no association between different infections or SCC and concentrations of vitamin E, vitamin A, or beta-carotene, but an association existed between vitamin A concentration and SCC. The lower selenium concentration in whole blood did not increase the incidence of clinical mastitis.

##### Genetic resistance to mastitis

A variety of morphological, physiological and immunological factors contribute to a cow's resistance or susceptibility to mastitis, and each of these factors is influenced to some extent by heredity. Differences in udder depth, teat length, teat shape, and teat orifice morphology are thought to be associated with differences in mastitis. The production of keratin in the streak canal and the physical and biochemical characteristics of keratin are important contributors to mastitis resistance. Many of the defense mechanisms of the udder, including

lysozyme, lactoferrin, immunoglobulins and leukocytes, are direct products of genes and have a genetic basis. For dairy cattle, heritability estimates for clinical mastitis average about 0.05. These low heritability estimates indicate that there is very little genetic influence on clinical mastitis but a very strong environmental influence.<sup>24</sup>

**Somatic cell count** Differences in heritability between herds with high and low SCCs are not significant. However, differences among bulls' daughter groups for both clinical mastitis and SCC are reasonably large, suggesting that selection of sires can be important in mastitis control.<sup>25</sup> An analysis of the disease and breeding records of a large number of Swedish bulls siring daughters whose milk had a low SCC count found genetic correlations from 0.71–0.79 between SCC and clinical mastitis. It was concluded that it is possible to improve resistance to clinical mastitis by selecting for a low SCC.

The strong phenotypic and genetic association between SCC and mastitis indicates that breeding programs based on SCC may be effective as an indirect means of improving mastitis resistance. However, greater emphasis on SCC may decrease genetic gain in yield traits, which are economically more important.<sup>26</sup>

### Milk yield

The genetic correlation between milk yield and mastitis is about 0.2–0.3, which suggests that animals genetically above average for milk yield are more susceptible to mastitis and that low-yielding cows tend to be more resistant. However, the low correlation value suggests that this relationship is not a strong tendency. The positive correlation implies that genetic improvement for milk yield is accompanied by a slow decline in genetic resistance to mastitis. Examination of the association between milk yield and disease in a large number of dairy cows found that higher milk yield was not a factor for any disease except mastitis.<sup>27</sup> However, the association between milk yield and mastitis does not imply causation. At least two biological explanations are plausible: increased injury and leaking of milk between milkings. Improved mastitis control efforts have offset the genetic trend for increased susceptibility to mastitis. The low heritability for mastitis indicates the great importance of environmental factors in causing differences in the prevalence of infection and the incidence of clinical mastitis.

In summary, selection for milk yield alone results in increased incidence of mastitis. The positive genetic correlation between milk yield and mastitis suggests

that genes that increase milk yield tend to increase susceptibility to mastitis. Selection indices that maximize genetic improvement for net economic benefit will not decrease the incidence of mastitis, but indices that include SCC, udder depth or clinical mastitis will diminish the rate of increase in mastitis by 20–25%. Using **predicted transmitting ability** (PTA), an estimate of genetic merit, it has been found on average that daughters of bulls with high PTAs for SCC have a higher incidence of mastitis; sires with low PTA for somatic cell scores should therefore be selected. All of the economically important traits are weighted into a selection index for the selection of bulls which will improve net income over cost of production.

### Other concurrent diseases

These may be important risk factors for mastitis. Retained placentas, teat injuries and teat sores may be associated with a higher incidence of mastitis. Sole ulceration of any severity occurring in more than one digit has been associated with an approximately threefold higher risk of *S. aureus* infections in the first lactation.<sup>28</sup> It is suggested that sore feet could increase the risk of teat lesions, presumably as a result of difficulty in standing.

### Immunological function of mammary gland

The immune function of the mammary gland is impaired during the periparturient period; it is susceptible to mastitis during transition periods, such as drying off and colostrogenesis. As a result, the **incidence of new intramammary infections is highest during the early nonlactating period and the periparturient period.**

The most important components of the defense against common bacterial pathogens are blood-derived **neutrophils** and **opsonizing antibodies**. An inadequate rate of neutrophil recruitment to combat a new intramammary infection has a profound effect on the outcome of infection, in that cows with a rapid and massive recruitment of neutrophils to an infected gland clear an intramammary infection within 12–18 hours postinfection.

It is also important that an early inflammatory response in the infected mammary gland enables leakage of IgG<sub>2</sub> (opsonizing antibodies) as this facilitates neutrophil phagocytosis of bacteria. The **staggered one–two punch of peak IgG<sub>2</sub> concentrations** within 4 hours of infection and **peak neutrophil response** within 6–12 hours of infection greatly facilitates clearance of new intramammary infections.

Blood-derived neutrophils must undergo **margination, adherence** and **migration** in order to arrive in the mammary gland, where they perform **phagocytosis**,

**respiratory burst** and **degranulation**. Margination is via expression of three adhesion molecules from the selectin family, specifically L-selectin (also called CD62L) on neutrophils, E-selectin (also called CD62E), and P-selectin (also called CD62P) on vascular endothelial cells. Neutrophil L-selectin makes the initial contact between 'streaming' neutrophils in the blood stream and the vascular wall; this contact slows neutrophil movement and allows them to 'roll' along the endothelium while surveying for the presence of proinflammatory mediators at the sites of tissue infection. When the rolling neutrophils detect the presence of one or more proinflammatory mediators they immediately shed surface L-selectin (CD62L) adhesion molecules and up-regulate and activate Mac-1 (CD11b/CD18) adhesion molecules, thereby stopping neutrophil rolling and permitting tight adherence of the neutrophil to the endothelium. Once adhered, neutrophils commence diapedesis by migrating between endothelial cells to the site of infection. Neutrophil migration therefore has three components; hyperadherence (cessation of rolling), diapedesis and chemotaxis. Any delay or inhibition in this process can lead to peracute mastitis and severe clinical disease. This is best illustrated by bovine leukocyte adhesion deficiency (BLAD) in Holstein–Friesian cattle; affected calves cannot produce Mac-1 molecules and have a prominent neutrophilia because streaming neutrophils cannot migrate to the site of infection. Migration of neutrophils is slow during the first few weeks of lactation and this delay in neutrophil migration is believed to be responsible for the increased incidence and severity of intramammary infections during early lactation.

### Previous mastitis

Cows with a history of mastitis in the preceding lactation may be almost twice as susceptible to clinical mastitis in the current lactation as those without mastitis in the preceding lactation.<sup>29</sup>

### Pre-existing intramammary infections

Natural infection with minor pathogens has a **protective effect** against infections with major pathogens.<sup>30</sup> The lowest rate of infection with major pathogens has been observed in quarters infected with *C. bovis*. Elimination of these minor pathogens with postmilking teat disinfection may result in an increase in the incidence of clinical mastitis. Discontinuation of the teat dipping may be associated with an increase in the prevalence of minor pathogens, increase in the incidence of *S. aureus* infections, and decrease in the incidence of *E. coli* infections. Thus quarters already infected with

a minor or major infection are less likely to acquire a new infection than uninfected quarters.

*Use of recombinant bovine somatotropin*  
Because the risk of clinical mastitis increases as milk production increases there has been considerable scientific and public controversy over the potential effects that the use of recombinant bovine somatotropin (bST) might have on the incidence of clinical mastitis and the subsequent use of antimicrobials from therapy. In some field trials, the use of bST did not result in an increase in the incidence of clinical mastitis compared to controls. In other trials, a significant increase in the incidence of clinical mastitis occurred in treated cows compared to controls. However, the incidence of clinical mastitis was greater in treated cows compared to controls before bST was used. In trials done on well managed farms which had controlled contagious mastitis and had low rates of clinical mastitis due to environmental pathogens, the use of bST was not associated with an increase in clinical mastitis, discarded milk because of therapy or culling for mastitis.<sup>31</sup> Interpretation of a direct effect of bST on mastitis incidence is confounded by the higher incidence of mastitis in cows of higher milk production.

Environmental and management risk factors

#### *Quality and management of housing*

Factors such as climate, housing system, type of bedding and rainfall interact to influence the degree of exposure of teat ends to mastitis pathogens. Because dairy cattle spend 40–65% of their time lying down, **the quality and management of housing for dairy cattle has a major influence on the types of mastitis pathogens that infect the mammary gland, as well as the degree of infection pressure.**

The major sources of environmental pathogens are the cow's environment, including bedding, soil, feedstuffs and water supplies. Environmental pathogens multiply in bedding materials, with which the cow's teats are in close and prolonged contact. Bacterial growth in bedding depends on temperature, amount of moisture and nutrients available, and the pH. Fresh bedding can be a source of contamination even before it is used: *Klebsiella pneumoniae* can be present in green, hardwood sawdust in higher numbers than in other types of bedding and major outbreaks of environmental mastitis due to *K. pneumoniae* have occurred following the use of contaminated wood products bedding, described in detail in that section. Dry, unused bedding contains few pathogens but after being used it becomes contaminated and provides a

source in which pathogens multiply to high numbers in 24 hours. Organic bedding materials such as straw, sawdust, wood shavings and paper support the growth of pathogens. Inorganic materials such as sand retain less moisture and do not provide a supply of nutrients for the pathogens; bacterial counts in these materials are usually lower than in organic materials. Housing lactating cattle on sawdust leads to six times more *Klebsiella* bacteria and twice as much coliform bacteria on the teat ends compared to housing cattle on sand. In contrast, there were 10 times more environmental streptococci bacteria on teat ends when cows were housed on sand, compared to housing on sawdust.<sup>32</sup> Surveys indicate that herds using wood chips or sawdust as bedding material have higher rates of clinical mastitis compared to those using straw bedding.<sup>33</sup>

High humidity and high ambient temperatures favor growth of pathogens. Cows in confinement housing with organic bedding materials have the highest incidence of environmental mastitis in the warm, humid months of the year. Pasturing herds during the summer months usually reduces the incidence of coliform mastitis, although rates of environmental streptococci may remain high. In drylot systems the incidence of coliform mastitis may be associated with periods of high rainfall. Herds with more months on pasture may have a higher incidence of clinical mastitis,<sup>33</sup> which may be associated with factors such as sanitation and the stress of transition between pasture and confinement housing.

The **management and design of housing systems** influence the prevalence of intramammary infection and the incidence of clinical mastitis. Any housing factor or management system that allows cows to become dirty or damage teats or that causes overcrowding will result in an increase in clinical mastitis. This includes the size and comfort of free stalls, the size of the alleyways, ease of movement of cattle and the cleaning system. Failure to keep alleyways, cow stalls and bedding clean and dry will increase the level of contamination of the teats. Overcrowding, poor ventilation, access to dirty ponds of water and muddy areas where cows congregate are major risk factors.

The **size of the milking cow herd** may be positively associated with an increased incidence of clinical mastitis because it can be more difficult to control contagious mastitis in a herd with a greater prevalence of infection and a larger number of cow-to-cow contacts. As herd size increases, manure disposal and sanitation problems may increase exposure to environmental pathogens.

However, regional and management differences may confound the association of size with infection status. Some recent data suggest lower SCC in large herds. The use of designated maternity areas providing an isolated and clean environment for parturition<sup>33</sup> may be associated with a lower incidence of clinical mastitis.

If hygiene and bedding maintenance are neglected in the housing accommodation the prevalence of environmental forms of mastitis may increase markedly. Periodic inspection of dry cows is an essential part of mastitis control.

#### *Milking practices*

**The failure to employ established and reliable methods of mastitis control is an important risk factor.** This is a major subject, which includes efficiency of milking personnel, milking machines, high milking speed and especially hygiene in the milking parlor. Wet teats and udders are a risk factor for increased SCC, especially in the presence of teat impacts from liner slippage.<sup>33</sup> The use of a separate drying cloth for each cow is associated with a lower SCC. Effective use of a postmilking germicidal teat dip is critical for the control of contagious mastitis. Increasing person-hours spent milking per cow may be associated with a higher rate of clinical mastitis.<sup>33</sup> Contaminated milking equipment – including milk hoses, udder wash towels and teat dip products – has been associated with outbreaks of environmental mastitis from *S. marcescens* and *P. aeruginosa*. Drying off procedures at the end of lactation and an active policy on drying off treatment are equally important.

**The absence of milk quality regulations that place emphasis on SCC is also a risk factor.** Conversely, the presence of strict regulations with penalties for high SCC is an important incentive to institute mastitis control programs that improve the quality of milk. The absence of a health management program consisting of regular farm visits by the veterinarian may also be a risk factor for mastitis, which may be associated with a relative lack of awareness by the producer of the importance of the principles of mastitis control.

#### *Season of year*

The relationship between the incidence of mastitis and season of the year is variable, depending on geographical and climatic conditions. In subtropical and tropical areas the incidence may be higher during winter or spring calvings from the increase in infection pressure associated with increased humidity. In temperate climates, the incidence of mastitis is higher in autumn and winter, when calving occurs along with an extended period of housing.<sup>34</sup>

Under conditions of housing for long winter periods, infectious agents are most likely to be found in higher numbers in the bedding. In the UK there is an increased frequency of mastitis when cows are housed for the winter.

#### Pathogen risk factors

##### *Viability of pathogens*

The ability of the pathogen to survive in the cow's immediate environment (resistance to environmental influences including cleaning and disinfection procedures) is a characteristic of each pathogen. The causes of contagious mastitis are more susceptible to disinfection than the causes of environmental mastitis.

##### *Virulence factors*

There is a wide variety of virulence factors among the mastitis pathogens. These are described under specific mastitides. The influence of many bacterial virulence factors depends on the stage of lactation and severity of the intramammary infection and the effects elicited by the virulence factors on bovine mammary tissue. A few examples of the common virulence factors are noted here.

#### Colonizing ability

The ability of the pathogens to colonize the teat duct, then to adhere to mammary epithelium and to initiate mastitis is a major characteristic of the major bacterial causes of mastitis. *S. aureus* strains that cause mastitis can bind to ductular udder epithelial cells and to explant cultures of bovine mammary glands. There are differences in the adhesion characteristics among strains of the organism, which may explain the different epidemiological characteristics of the organisms in some herds. Comparison of strains isolated from different *S. aureus* mastitis cases between herds reveals that only a limited number of genotypes of *S. aureus* are most prevalent.<sup>34</sup>

#### Toxins

*E. coli* isolates that cause mastitis produce lipopolysaccharide endotoxin, which is responsible for many of the inflammatory and systemic changes observed during acute coliform mastitis. *S. aureus* isolated from intramammary infections produces many potential virulence factors, including enterotoxins, coagulase and alpha, beta, delta toxins, hemolysin, hyaluronidase and leukocidins, which are considered to be involved in the varying degrees of inflammation characteristic of staphylococcal mastitis from subclinical to peracute gangrenous mastitis. Virulence factors of *S. uberis* include hyaluronidase and the hyaluronic capsule.

#### Production and economic losses

Although mastitis occurs sporadically in all species, it assumes major economic

importance in dairy cattle and may be one of the most costly diseases in dairy herds. Mastitis results in economic loss for producers by increasing the costs of production and by decreasing productivity. The premature culling of potentially profitable cows because of chronic mastitis is also a significant loss. Because of the large economic losses, there is a potential for high returns on investment in an effective control program. The component economic losses can be divided into:

- Loss of milk production
- Discarded milk from cows with clinical mastitis and treated cows
- Replacement cost of culled cows
- Extra labor required for treatment and monitoring
- Veterinary service for treatment and control
- Cost of first trimester abortions due to clinical mastitis<sup>36</sup>
- Cost of control measures.

There are additional costs such as antimicrobial residues in milk from treated cows, milk quality control, dairy food manufacturing, nutritional quality of milk, degrading of milk supplies due to high bacteria or SCC, and interference with the genetic potential of some cows from early involuntary culling because of chronic mastitis. The total annual cost of mastitis in the dairy cattle population is estimated to be 10% of the total value of farm milk sales, and about two-thirds of this loss is due to reduced milk production in subclinically affected cows.

The production and economic losses are commonly divided into those associated with subclinical and clinical mastitis.

##### Subclinical mastitis

Total milk losses from quarters affected with subclinical mastitis have been estimated to range from 10–26%.<sup>37</sup> Lower SCCs are associated with higher milk production, and rolling herd average milk production has been estimated to decrease by 190 kg per unit increase of linear somatic cell score. Most estimates indicate that on average an affected quarter results in a 30% reduction in productivity, and an affected cow is estimated to lose 15% of its production for the lactation. This loss is sometimes expressed as a loss of about 340 kg of saleable milk, due to loss of production and the value of milk that has to be withheld from sale. The loss in production by an infected quarter may be largely compensated by increased production in the other quarters so that the net loss from the cow may be less than expected. In addition to these losses, there is an added loss of about 1% of total solids by changes in composition (fat,

casein, and lactose are reduced and glycogen, whey proteins, pH, and chlorides are increased), which interferes with manufacturing processes, and other losses include increased culling rates and costs of treatment. Comparisons between low- and high-prevalence herds always show a financial advantage of about 20% to the low-prevalence herds, the gain varying with the local price of milk or butter fat. In beef herds the losses are in the form of rare deaths of cows and failure of the calves to gain weight.

Approximately 75% of the economic loss from subclinical mastitis is attributable to loss of milk production. Other costs include discarding milk from treated cows, drug costs, veterinary costs, labor and loss of genetic potential of culled cows.

##### Clinical mastitis

Clinical mastitis results in marked decreases in milk production, which are much larger in early than late lactation. Milk production losses are also greater in cows with multiple lactations than first-lactation cows, and clinical mastitis also decreases the duration of lactation and increases the likelihood of culling. Clinical cases of brief duration that occur after the peak of lactation affect milk production very little but can induce abortion during the first 45 days of gestation.<sup>36</sup> Clinically affected quarters may not completely recover milk production in subsequent lactations but these carry-over losses are not as large as the losses from acute mastitis. In the National Animal Health Monitoring System of dairy herds in the US, clinical mastitis alone was the most costly disease identified, at a loss to the producer of \$27–50 per cow per year.<sup>37</sup>

The **costs of clinical mastitis** and mastitis prevention in dairy herds have been estimated, based on monitoring 50 dairy herds over 1 year.<sup>38</sup> Mean incidence of clinical mastitis was 39 cases/100 cow-years; each clinical case cost \$38/cow-year, with a mean cost per clinical episode of US\$107. Prevention of mastitis cost \$14.50/cow-year.<sup>39</sup> Lost milk production was estimated at \$14.85/cow-year, which does include the losses associated with subclinical mastitis.

The component causes of economic loss associated with mastitis outlined above vary according to the causative pathogen and are described under specific mastitides. In general terms *S. aureus* and *E. coli* may cause death from peracute mastitis; *A. pyogenes* causes complete loss of quarters; staphylococci and streptococci cause acute clinical mastitis, but their principal role is in causing subclinical mastitis, resulting in a reduction of milk produced and a downgrading of its

quality. Of these, *S. agalactiae* causes the greatest production loss, whereas *S. aureus* has the higher infection rate, greater resistance to treatment and longer duration of infection. At one time *S. aureus* represented the impassable barrier to mastitis control programs.

Other factors that affect the magnitude of the loss associated with mastitis include age (the loss is greatest in mature cows), and when the attack occurs in the first 150 days of lactation.

#### Zoonotic potential

With mastitis there is the danger that the bacterial contamination of milk from affected cows may render it unsuitable for human consumption by causing food poisoning, or interfere with manufacturing processes or, in rare cases, provide a mechanism of spread of disease to humans. Tuberculosis, streptococcal sore throat and brucellosis may be spread in this way. Raw (unpasteurized) milk can be a source of food-borne pathogens, and consumption of raw milk can result in sporadic disease outbreaks. For instance, sampling bulk tank raw milk in Ontario revealed the presence of *Listeria monocytogenes*, *Salmonella* spp., *Campylobacter* spp. or verocytotoxigenic *E. coli* in 2.7%, 0.2%, 0.5% and 0.9% of milk samples, respectively.<sup>40</sup> These findings emphasize the importance of continued diligence in the application of hygiene programs within dairies and the separation of raw from pasteurized milk and milk products.

#### PATHOGENESIS

Infection of the mammary gland always occurs via the teat canal and on first impression the development of inflammation after infection seems a natural sequence. However, the development of mastitis is more complex than this and can be most satisfactorily explained in terms of three stages: **invasion, infection, inflammation**. Of the three phases, prevention of the invasion phase offers the greatest potential for reducing the incidence of mastitis by good management, notably in the use of good hygienic procedures.

**Invasion** is the stage at which pathogens move from the teat end to the milk inside the teat canal.

**Infection** is the stage in which the pathogens multiply rapidly and invade the mammary tissue. After invasion the pathogen population may be established in the teat canal and, with this as a base, a series of multiplications and extensions into mammary tissue may occur, with infection of mammary tissue occurring frequently or occasionally depending on its susceptibility. Multiplication of certain organisms may result in the release of endotoxins, as in coliform mastitis, which

causes profound systemic effects with minimal inflammatory effects.

**Inflammation** follows infection and represents the stage at which clinical mastitis occurs with varying degrees of clinical abnormalities of the udder and variable systemic effects from mild to peracute; gross and subclinical abnormalities of the milk appear. Abnormalities of the udder include marked swelling, increased warmth and, in acute and peracute stages, gangrene in some cases and abscess formation and atrophy of glands in chronic stages. The systemic effects are due to the mediators of inflammation. Gross abnormalities of the milk include a decrease in milk yield, the presence of the products of inflammation and marked changes in the composition of the milk.

The most significant subclinical abnormality of the milk is the increase in the **somatic cell count**, the most common measurement of milk quality and udder health. Milk somatic cells in a healthy gland consist of several cell types, including neutrophils (<11%), macrophages (66–88%), lymphocytes (10–27%), and a smaller percentage of epithelial cells (0–7%).<sup>41</sup> Neutrophils are the predominant cell type found in mammary tissues and secretions during inflammation, in mastitis they constitute more than 90% of total mammary gland leukocytes. Once at the site of infection, neutrophils phagocytose and kill pathogens. Neutrophils exert their bactericidal effect through a respiratory burst that produces hydroxyl and oxygen radicals, important components of the oxygen-dependent killing mechanism.

In the healthy lactating mammary gland, the SCC is less than 100 000 cells/mL of milk. During intramammary infection, the glandular SCC can increase to more than 1 000 000 cells/mL of milk within a few hours because of the combined effect of an increased number of neutrophils (numerator) and a decreased glandular secretion volume (denominator). **The severity and duration of mastitis are critically related to the promptness of the neutrophil migratory response and their bactericidal activity at the site of infection.** As they colonize and multiply in the mammary gland, some bacteria release metabolic byproducts or cell-wall components (endotoxin if a Gram-negative bacteria) that serve as chemoattractants for leukocytes. If neutrophils move rapidly from the blood stream and are able to eliminate the inflammatory stimuli (bacteria), then recruitment of neutrophils ceases and the SCC returns to normal levels. If bacteria are able to survive this immediate host response, then the inflammation continues, resulting in neutrophil migration between adjacent

mammary secretory cells toward the alveolar lumen. Prolonged diapedesis of neutrophils damages mammary tissue, resulting in decreased milk production. The duration and severity of the inflammatory response therefore has a major impact on the quantity and quality of milk produced.

The major factor affecting the SCC at the herd and individual cow level is the prevalence of intramammary infection at a glandular level. Because marked increases in SCC are a result of cells being attracted to the mammary tissue because of the mediators produced during a local infection, events that do not affect udder health are unlikely to have a direct or dramatic effect on SCC. Little evidence exists that any factor other than normal diurnal variation has a major influence on SCC in the absence of intramammary infections.

The effects of mastitis on milk yield are highly variable and depend on the severity of the inflammation, the causative agents and the lesions produced, the efficiency of treatment, the production level and the stage of lactation.<sup>42</sup> Mastitis in early lactation causes a larger decrease in milk yield with long-term effects than mastitis in late lactation. Mastitis due to *S. aureus* generally evolves into persistent but moderate infections, unlike those associated with coliforms. Mastitis associated with *A. pyogenes* results in suppurative lesions, poor response to treatment and culling. *M. bovis* causes chronic induration and almost complete loss of milk production without recovery.

#### CLINICAL FINDINGS

Details of the clinical findings are provided under each specific type of mastitis. The clinical findings should be used only as a guide because different pathogens can cause chronic, subclinical, subacute, acute and peracute forms of the disease, and clinical differentiation of the different causes of mastitis is difficult. The greatest clinical accuracy achievable, even in a specialist hospital environment and after adaptation to suit local conditions, is about 70%,<sup>43</sup> which is not sufficiently accurate to be clinically useful. In other words, bacteriological culture of milk from an affected gland is required before specific pathogen-directed treatment can be implemented.

Clinical mastitis is detected using only the results of the physical examination, and a useful definition of clinical mastitis is a negative answer to the question 'would you drink this?' In other words, 'undrinkable' is a simple and generalizable concept for defining clinical mastitis, in that milk from cows with clinical mastitis is not suitable for drinking. New cases of

clinical mastitis are defined as being separated by at least 14 days.

The clinical findings in mastitis include abnormalities of secretion, abnormalities of the size, consistency and temperature of the mammary glands and, frequently, a systemic reaction. In other words, there are **three categories of clinical mastitis: abnormal milk, abnormal gland and an abnormal cow** (systemic disease). Abnormal milk is visibly abnormal (i.e. is not 'drinkable'). An abnormal gland is larger and firmer than other quarters. An abnormal cow is pyrexia, depressed or has decreased appetite or milk production. This three-part categorization scheme has excellent clinical utility, is readily understood by everyone and provides a sound pathophysiological basis for treatment. In particular, it is likely that optimal treatment protocols can be developed for the three levels of clinical mastitis. Other categorization systems have been developed, but they lack the simplicity and generalizability of the secretion, gland and cow system.

Clinical mastitis episodes are also categorized according to their severity and duration.

**Severity** is characterized as:

- **Peracute:** severe inflammation, with swelling, heat and pain of the quarter, with a marked systemic reaction, which may be fatal
- **Acute:** severe inflammation without a marked systemic reaction
- **Subacute:** mild inflammation with persistent abnormality of the milk.

**Duration** is characterized as:

- **Short-term** (as in *E. coli* and *Klebsiella* spp.)
- **Recurrent** (as in *S. aureus* and *S. dysgalactiae*)
- **Persistent** (as in *S. agalactiae* and *M. bovis*).

### Abnormal milk

Proper examination of the milk requires the use of a **strip cup**, preferably one that has a **shiny, black plate**, permitting the detection of discoloration as well as clots, flakes and purulent material. Milk is drawn on to the black plate in pools and comparisons are made between the milk of different quarters. Because the herdsman frequently has little time to examine milk for evidence of mastitis it is customary to milk the first few streams on to the floor; in some parlors black plates are set in the floor. The practice does not appear to be harmful if the floor is kept washed down.

Discoloration may be in the form of blood-staining or wateriness, the latter usually indicating chronic mastitis when the quarter is lactating. Little significance

is attached to barely discernible wateriness in the first few streams but, if this persists for 2–3 streams or more, it is an abnormality. One of the major unresolved issues in bovine mastitis is how to treat a cow with abnormal secretion on the first 1–2 streams that subsequently has normal-looking milk. Clots or flakes are usually accompanied by discoloration and they are always significant, indicating a severe degree of inflammation, even when small and present only in the first few streams. Blood clots are of little significance in a mastitis case, neither are the small plugs of wax that are often present in the milk during the first few days after calving, especially in heifers. Flakes at the end of milking may be indicative of mammary tuberculosis in cattle.

During the **dry period** in normal cows, the secretion changes from normal milk to a clear watery fluid, then to a secretion the color and consistency of honey, and finally to colostrum in the last few days before parturition. Some variation may occur between individual quarters in the one cow; if this is marked, it should arouse suspicion of infection.

The **strip cup** provides a valuable tool to detect clinical mastitis and constitutes part of the routine physical examination of the lactating cow. The most sensitive use of the strip cup is to observe the ability of milk from one quarter to mix with milk from another quarter; incomplete mixing (evidence of 'streaming') indicates that secretions from the two quarters differ and suggests the presence of an intramammary infection in one of the quarters. However, it should be remembered that the strip cup can only detect clinical mastitis, and detection of sub-clinical mastitis requires use of indirect tests such as SCC of composite milk samples from individual cows, or application of the California Mastitis Test to quarter samples or measuring the electrical conductivity of quarter samples.

### Abnormal gland

Abnormalities of size and consistency of the quarters may be seen and felt. Palpation is of greatest value when the udder has been recently milked, whereas visual examination of both the full and empty udder may be useful. The udder should be viewed from behind and the two hind quarters should be examined for symmetry. By lifting up the hind quarters, the fore quarters can be viewed. A decision on which quarter of a pair is abnormal may depend on palpation, which should be carried out simultaneously on the opposite quarter of the pair. Although in most forms of mastitis the observed abnormalities are mainly in

the region of the milk cistern, the whole of the quarter must be palpated, particularly if tuberculosis is suspected. The teats should be inspected and palpated for skin lesions, especially around the teat end. The supramammary lymph nodes should also be palpated for evidence of enlargement.

Palpation and inspection of the udder are directed at the detection of fibrosis, inflammatory swelling and atrophy of mammary tissue. Fibrosis occurs in various forms. There may be a diffuse increase in connective tissue, giving the quarter a firmer feel than its opposite number and usually a more nodular surface on light palpation. Local areas of fibrosis may also occur in a quarter; these may vary in size from pealike lesions to masses as large as a fist. Acute inflammatory swelling is always diffuse and is accompanied by heat and pain and marked abnormality of the secretion. In severe cases there may be areas of gangrene, or abscesses may develop in the glandular tissue. The terminal stage of chronic mastitis is atrophy of the gland. On casual examination an atrophied quarter may be classed as normal because of its small size, while the normal quarter is judged to be hypertrophic. Careful palpation may reveal that, in the atrophic quarter, little functioning mammary tissue remains.

### Abnormal cow (systemic response)

A systemic response including toxemia, fever, tachycardia, ruminal stasis, depression, recumbency and anorexia may or may not be present, depending on the type and severity of the infection. A systemic response is usually associated with severe mastitis associated with *E. coli*, *Klebsiella* spp. or *A. pyogenes* and occasionally with *Streptococcus* spp. or *Staphylococcus* spp. Clinical mastitis episodes due to *A. pyogenes* produces the greatest decrease in milk production. In contrast, clinical mastitis due to environmental streptococci and coagulase-negative staphylococci is associated with the smallest decrease in milk production.<sup>44</sup> Clinical mastitis episodes due to *S. aureus* are associated with the highest risk of culling.<sup>45</sup>

## DIAGNOSIS

### Detection of clinical mastitis

The initial diagnosis of clinical mastitis is made during the routine physical examination. Laboratory culturing of milk samples for bacteria and *Mycoplasma* spp., and for determining the antimicrobial susceptibility of *S. aureus* (specifically whether it produces beta-lactamase), is very useful for instituting optimal treatment protocols for cows with clinical mastitis and for instituting appropriate control measures.



However, because subclinical mastitis has the greatest influence on the cost of mastitis to the producer, it is advantageous to also diagnose subclinical mastitis, on a cow and quarter level.

#### Detection of subclinical mastitis

Culturing large numbers of milk samples, although the gold standard for intramammary infection and subclinical mastitis, is expensive and impractical for routine use. Much attention has therefore been given to the development of indirect tests to predict the presence of an intramammary infection. Currently available indirect tests detect only the presence of inflammation but are of value as screening tests; milk from quarters or cows with a positive screening test are then submitted to bacteriological culture. **Subclinical mastitis can only be detected by laboratory examination** and cannot, by definition, be detected during the routine physical examination. In other words, the secretion from a quarter with subclinical mastitis appears drinkable.

#### Detection at the herd level

The prevalence of subclinical mastitis or intramammary infection is monitored by determining the **bulk tank milk SCC** and the most likely mastitis pathogens are identified by **culturing bulk tank milk**. These two methods are recommended to diagnose the presence and prevalence of mastitis pathogens on a herd basis.

#### Bulk tank milk somatic cell counts

The SCC of bulk tank milk is an indirect measure of the prevalence of mastitis within a dairy herd. The SCC is increased primarily, but not exclusively, because of subclinical mastitis associated with Gram-positive bacterial intramammary infections. There is a good correlation between the number of streptococci (*S. agalactiae*, *S. dysgalactiae*, and *S. uberis*) colony-forming units found in bulk tank milk and its SCC. The number of colony forming units (cfu) of *S. aureus* is moderately correlated to the bulk tank milk SCC.<sup>46</sup> As contagious mastitis has become more effectively controlled, environmental mastitis pathogens have become a relatively more important cause of high SCC in bulk tank milk, especially in herds with moderate (<400 000 cells/mL) to low (<150 000 cells/mL) bulk tank milk SCC.

The association between management practices, dairy herd characteristics and SCC of bulk tank milk has been examined in about 60 000 cows in 843 herds over a 2-year period.<sup>47</sup> Results indicated that the prevalence of *S. agalactiae* and *S. aureus* intramammary infections was associated with bulk tank SCC.<sup>47</sup> In herds free of *S. agalactiae* mastitis, the prevalence of *S. aureus* and *C. bovis* intramammary

infections were correlated with bulk tank SCC. For herds without *S. agalactiae*, use of sawdust bedding was associated with a decrease in SCC in bulk tank milk, while a dirty loose housing area was associated with an increase in SCC in bulk tank milk. Increased milk production, repeated mastitis control visits and use of particular predip compounds were significantly associated with decreased SCC in bulk tank milk in all herds, regardless of whether any cows in the herd had *S. agalactiae* mastitis. In herds with *S. agalactiae* mastitis, use of iodine, chlorhexidine, peroxide or sodium chlorite-lactic acid as a predip was associated with a decrease in SCC of bulk tank milk.<sup>47</sup>

The **SCC of bulk tank milk** has become a widely used test because it provides a sensitive and specific indicator of udder health and milk quality. The sample for analysis is obtained by agitating the milk for 5–10 minutes and collecting a sample from the top of the bulk tank milk using a clean dipper. The sample should not be collected near the outlet valve because this varies from that in the rest of the tank. The SCC of bulk tank milk is widely used to regulate whether milk may be legally sold and to determine the price paid for raw milk. Premium and penalty payments are calculated on the basis of 3-month geometric mean of weekly bulk tank milk SCC measurements. Milk processing plants in most developed countries use automatic electronic somatic cell counters routinely in order to provide a monthly report of the bulk tank milk SCC. The test requires only that the sample for examination be taken randomly and not frozen, that it be prepared with the correct reagent, that the laboratory counter be set at the right calibration and that the sample be examined quickly or preserved with formalin to prevent cell losses during storage. The bulk tank milk SCC is extremely useful in creating awareness of the existence of a mastitis problem, so that when the SCC of bulk tank milk exceeds permissible limits further investigation of the herd is indicated. In a seasonal herd in which all cows are at the same stage of lactation the bulk tank milk cell count will normally be high in early lactation and just before drying off. To overcome these and other factors that are likely to transiently influence bulk tank milk SCC, it is recommended that correction factors be introduced into the estimation or that a rolling SCC, in which monthly data are averaged for the preceding 3 months, be used. Consideration of this figure will avoid too hasty conclusions on one high count caused by an extraneous factor.

Table 15.1 Estimated prevalence of infection and losses in milk production associated with bulk tank milk somatic cell count

Bulk tank milk somatic cell count (cells/mL)	Infected quarters in herd (%)	Production loss (%)
200 000	6	0
500 000	16	6
1 000 000	32	18
1 500 000	48	29

It is not possible to use the bulk tank milk SCC to determine the number of cows in a herd affected by mastitis but it is possible to estimate fairly accurately the number of infected quarters. In general, as the bulk tank milk SCC increases, the prevalence of infection increases and losses in production increase. Production losses calculated as a percentage of production expected with a count of 200 000 cells/mL are shown in Table 15.1. A bulk tank milk SCC of more than 300 000 cells/mL is considered to indicate a level of mastitis in the herd that warrants examination of individual cows. Herds with a high bulk tank milk SCC have significantly lower production levels and are less likely to use a postmilking teat dip or to have a regular program of milking machine maintenance or automatic cluster removal.<sup>46</sup>

#### Culture of bulk tank milk

Bacteria present in bulk tank milk may originate from infected udders, from teat and udder surfaces or from a variety of other environmental sources; however, despite the large number of potential sources for bacteria, culture of bulk tank milk is a useful technique for screening for major mastitis pathogens.<sup>48</sup> The culture of *S. aureus* and *S. agalactiae* from bulk tank milk is a reliable indicator of infection by those pathogens in the herd. The number of those pathogens found on culture is determined by the number of bacteria shed, the number of infected cows, the milk production level of infected cows relative to herd mates, and the severity of infection. A single culture of bulk tank milk has low sensitivity but high specificity for determining the presence of *S. agalactiae* or *S. aureus* in the herd. Thus many infected herds will be called negative but few uninfected herds will be called positive. Pathogens such as *Nocardia* spp. and *Mycoplasma* spp. have also been identified by culture of bulk tank milk. In general, the sensitivity of a single bulk tank milk culture to detect the presence of intramammary infections due to *S. agalactiae* ranges from 21–77%, for *S. aureus* it ranges from 9–58% and for *M. bovis* it is 33%.

Environmental bacteria such as *S. uberis*, *S. dysgalactiae*, and coliforms may enter milk from intramammary infections, but also from nonspecific contamination. The presence of these organisms in bulk tank milk may relate to the general level of environmental contamination and milking hygiene in the herd. Udder infections with these environmental pathogens are predominantly of short duration and characterized by clinical disease, which makes their inadvertent introduction to the bulk tank less likely.

**String sampling** or milk line sampling from the positive pressure side of the milking system is the collection of milk samples from a group of cattle instead of the entire herd, as in bulk tank milk sampling. String sampling may have some merit in identifying subgroups of cattle with the highest prevalence of infection. String sampling is thought to be more sensitive in monitoring herds for contagious pathogens than bulk tank milk sampling. If a production group tests positive on a string culture, then individual composite milk cultures can be performed to identify individual animals. Information of the culture results from string sampling should assist development of control programs; however, milk samples left in the pipeline from one string can confound the culture results of subsequent strings.

Numerous bacteriological techniques have been used to isolate and identify pathogens in bulk tank milk but none has been established as the gold standard method for the culture of milk from bulk tanks. The most suitable laboratory medium for growth and classification of the pathogens from bulk tank milk needs to be assessed. Sampling strategies have included weekly and monthly samples, but it remains to be determined which strategy is optimal relative to herd size and management, disease characteristics and practicality.

Culture of bulk tank milk has been compared to bulk tank SCC, herd summaries of SCC of individual cows and herd summaries of cultures of individual cows.<sup>48</sup> A significant correlation was found between bulk tank SCC and the frequency of isolating *S. agalactiae* from monthly samples of bulk tank milk. The correlations between *S. aureus* from bulk tank milk and SCC are lower.

**Detection at the individual cow level**  
**Abnormalities of the udder and gross abnormalities of milk** in cattle with clinical mastitis have been described above under clinical findings. In individual cows with clinical mastitis, culture of the secretion from an infected quarter can be done. In animals without clinical mas-

titis, culture of the secretion represents a direct test for subclinical mastitis. The objective is to identify cows with contagious mastitis so that they can be treated or culled, or to identify the nature and source of environmental mastitis pathogens. Fulfillment of these requirements requires bacteriological culture of milk samples so that the pathogens can be named; **identification of mastitis pathogens is central to the development of effective treatment and control programs.** Detection of infected cows requires an individual cow examination and application of an indirect (screening) test for infection, such as the SCC of a composite milk sample, followed by culture of a representative subset of cows in order to determine the most prevalent pathogen. **Indirect tests estimate the prevalence of infection and microbiological examination identifies the mastitis pathogens;** from this information an appropriate control plan can be formulated.

Culture of individual cow milk

Individual cow milk can be cultured as part of a herd examination for mastitis, or on individual quarter samples, or on composite samples including milk from all four quarters. An intramammary infection is defined as the presence of the same pathogen in duplicate samples collected immediately after each other, or the presence of the same pathogen in two of three consecutive cultures obtained on different sampling dates. **Individual quarter samples are preferred** because the costs of treatment dictate that the least possible number of quarters be treated. With this technique only affected quarters are treated; if the quarter infection rate is low the saving in treatment costs is relatively large.

Milk sampling for culture must be carried out with due attention to cleanliness since samples contaminated during collection are worthless. The technique of cleaning the teat is of considerable importance. If the teats are dirty, they must be washed and then properly dried or water will run down the teat to the teat end and infect the milk sample. The end of the teat is cleaned with a swab dipped in 70% alcohol, extruding the external sphincter by pressure to insure that dirt and wax are removed from the orifice. Brisk rubbing is advisable, especially of teats with inverted ends. The first two or three streams are rejected because their cell and bacterial counts are likely to be a reflection of the disease situation within the teat rather than within the udder as a whole. The next few streams, the premilking sample, is the approved one because of its greater accuracy. For complete accuracy a premilking and a postmilking sample are

taken. If tuberculosis is suspected, the last few streams are the critical ones. Indirect and chemical tests for mastitis can be carried out as accurately on foremilk as on later milk.

If individual quarter samples are collected, screw-cap vials are most satisfactory. During collection the vial is held at an angle to the ground in order to avoid as far as possible the entrance of dust, skin scales and hair. If there is delay between the collection of samples and laboratory examinations, the specimens should be refrigerated or frozen. Freezing of milk samples appears to have variable effects on bacterial counts, depending on the bacteria. *A. pyogenes* and *E. coli* counts are decreased by freezing, coagulase-negative *Staphylococcus* spp. counts are increased, and *Streptococcus* and *S. aureus* counts are either unaffected or increased by about 200%.<sup>49</sup>

The laboratory techniques used vary widely and depend to a large extent on the facilities available. Incubation on blood agar is most satisfactory, selective media for *S. agalactiae* having the disadvantage that other pathogens may go undetected. Smears of incubated milk are generally unsatisfactory as not all bacteria grow equally well in milk. An augmented system of culturing milk samples, which has given superior results in terms of the number of infected quarters detected, includes preculture incubation, then freezing of the milk sample, then inoculation of the medium with a larger than normal inoculum of milk.<sup>50</sup> The concern with augmented culture systems is that they may amplify contaminants obtained during sampling and therefore decrease the specificity of milk culture. Laboratory culturing techniques can be very time-consuming and expensive unless modern, prepackaged identification systems are used. They also provide the speed needed to make the examination a worthwhile one.

A milk sample is considered contaminated when more than three species of bacteria are isolated. A quarter is considered to be infected when the same bacteria is isolated in at least two out of three milk samples. A quarter is considered to be cured when bacteria, isolated at drying off, are not present in any samples 28 days after calving. An uninfected quarter at drying off that is infected at calving is considered to indicate a new intramammary infection. A quarter that is infected at drying off but infected with another bacteria at calving also indicates a new intramammary infection.

Selective culture plates, such as **biplates** (MacConkey agar and blood agar with 1% esculin), **triplates** (MacConkey agar, blood agar and TKT agar (thallium, crystal violet and staphylococcal toxin in 5%

blood agar with 1% esculin)), **Petrifilm**<sup>®</sup> plates, which are selective culture media products,<sup>51</sup> the **MASTIK**<sup>®</sup> diagnostic kit or the **ColiMast**<sup>®</sup> test can be used to differentiate between Gram-positive and Gram-negative pathogens and no growth,<sup>52</sup> and may aid in the rational and targeted use of antimicrobial agents for clinical cases of mastitis. A commercially available cowside test for endotoxin (**Limast-test**<sup>®</sup>) is available in Scandinavia. The test takes 15 minutes to run on milk samples and is able to detect the presence of endotoxin using the *Limulus* amoebocyte lysate assay. The test therefore can detect the presence or absence of Gram-negative bacteria but does not differentiate between *E. coli* and *K. pneumoniae*.<sup>53</sup> At least  $10^4$ – $10^5$  cfu of Gram-negative bacteria are necessary for a positive test result; this does not decrease the clinical utility of the test, because low bacterial counts in the milk from infected quarters usually indicates that antimicrobial agents are not required in order to clear the infection.

There is interest in developing other cowside tests to determine whether the causative pathogen is Gram-negative or Gram-positive. One such approach uses dilution of the milk sample, filtration through a membrane with a pore size that retains bacteria, and staining of the bacteria with specific stains.<sup>54</sup> The filtration procedure reportedly takes 5 minutes, but the need for microscopic examination decreases the utility of this as a cowside test.

A common diagnostic problem is a bacteriologically negative culture in cows with clinical mastitis. Even when milk samples are collected appropriately and bacteriological culture is done using routine laboratory methods, 15–40% of samples from clinical mastitis episodes are bacteriologically negative (yield no growth). Failure of these samples to yield a mastitis pathogen may be the result of spontaneous elimination of infection, a low concentration of pathogens in the milk, intermittent shedding of the pathogen, intracellular location of the pathogens or the presence of inhibitory substances in the milk. Augmented culture techniques may reduce, but do not eliminate negative culture results and may facilitate growth of contaminant organisms. Dairy producers and veterinarians therefore face a dilemma when no bacteria or bacteria commonly regarded to be of minor pathogenicity, such as *C. bovis* or coagulase-negative *Staphylococcus* spp., are cultured from the milk of cows with clinical mastitis, particularly if clinical signs persist.<sup>55</sup> Most bacteriologically negative cases of clinical mastitis appear to be caused by low-grade infections with Gram-negative bacteria.<sup>55</sup> When no bacterial pathogen can be isolated from cases of clinical mastitis using

standard culture techniques, enzyme-linked immunosorbent assays (ELISAs) may be used to detect antigens against *S. aureus*, *E. coli*, *S. dysgalactiae*, and *S. agalactiae*.<sup>56</sup> Antigens to these pathogens may be detectable using an ELISA in up to 50% of quarter samples from cows with clinical mastitis in which no pathogens were isolated but in which the SCC was more than 500 000 cells/mL. Despite these promising findings, ELISAs are not widely used in the identification of mastitis pathogens.

#### Indirect tests for subclinical mastitis

Indirect tests include SCCs using automated electronic counters, the **California Mastitis Test**, increases in **electrical conductivity** of milk, and increases in the activity of cell associated enzymes (such as **NAGase**) in milk. ELISA tests to detect neutrophil components have been developed but are not commercially available.<sup>57</sup> Of these indirect tests, **only the CMT and electrical conductivity can be used cowside**, with CMT providing a more accurate screening test than electrical conductivity.

The somatic cell count of composite or quarter samples

There is a strong relationship between the SCC of quarter samples of milk and the milk yield, with SCC increasing slightly as milk production decreases but increasing markedly with intramammary infection of the quarter. The distribution of SCC in a herd therefore reflects the distribution of intramammary infections. The most important factor affecting SCC in an individual cow is the number of quarters infected with a major or minor pathogen. In most herds, the prevalence of infection will increase through a lactation and will also increase with the age of the cow. Cell counts in the first few days of the lactation are often exceptionally high and unreliable as indicators of intramammary infection, and in uninfected cows the counts will drop to a low level within 2 weeks of calving and remain low throughout the lactation unless an intramammary infection occurs. The SCC of a cow that remains free of infection throughout her life will remain very low. However, older cows may have higher counts because the prevalence of infection is higher with age and older cows are more likely to have had previous infections with residual lesions and leaking of somatic cells into the milk. There are also consistent and significant differences in actual SCC between cows, individual cows tending to maintain the same class of count throughout their lives. Cows that have consistently low SCC do not seem to be more susceptible to mastitis than others. Attempts to base a breeding program to

reduce the prevalence of mastitis on the selection of cows with an innately low composite SCC have been discarded because of fluctuations in numbers within cows.

Healthy quarters have a SCC below 100 000 cells/mL, and **this cutpoint should be used to indicate the absence or presence of intramammary infection on a gland basis**. This cutpoint looks very solid for a gland, because many milk components differ from normal values whenever the SCC exceeds 100 000 cells/mL. Moreover, mean SCC counts for bacteriologically negative quarters, quarters infected with minor pathogens and quarters infected with major pathogens were 68 000, 130 000, and more than 350 000 cells/mL, respectively.<sup>58</sup>

Because of the time and labor saved it is now customary to do automated electronic cell counts on **composite milk samples** that have already been collected for butterfat testing. Regular reports of individual cow SCCs are therefore widely available in herds that routinely test production parameters of their cattle. An exciting new development in mastitis control is the **portable somatic cell counter**, which was designed for on farm use, thereby providing targeted and immediate SCC information for quarter or composite milk samples. Using the composite sample technique does distort the SCC; for example, the dilution of high-SCC milk from a bad quarter by low-SCC milk from three normal quarters could mean that a cow with one infected quarter might not be detected. Composite SCCs of less than 200 000 cells/mL are considered to be below the limit indicative of inflammation, even though uninfected quarters have a SCC of less than 100 000 cells/mL. Factors that affect the composite milk SCC include the number of infected quarters infected, the kind of infection (*S. agalactiae* is a more potent stimulator of cellular reaction than *S. aureus*), the strictness with which milk from cows with clinical mastitis is kept out of the bulk tank, the age of the cows (older cows have higher counts), the stage of lactation (counts are highest in the first days after calving and toward the end of lactation) and the herd's average production, the cell count reducing as milk yield increases.<sup>59</sup>

A SCC scoring system that divides the SCC of composite milk into 10 categories from 0–9, known as **linear score**, is becoming more widely used. The linear score is a base 2 logarithm of the SCC (in cells/mL), whereby linear score =  $\log_2(\text{SCC}/100\,000) + 3$ . Likewise, to calculate SCC (in cells/mL) from the linear score (LS), the following formula is used:  $\text{SCC} = 100\,000 \times 2^{(\text{LS} - 3)}$ . A SCC of

100 000 cells/mL therefore converts to a score of 3. Each 1-unit increase (or decrease) in linear score is associated with a doubling (or halving) of the SCC. For example, score 2 is equivalent to a SCC of 50 000 cells/mL, and scores of 4 and 5 correspond to 200 000 and 400 000 cells/mL. Conversion of SCC to **linear score** values is performed as shown in Tables 15.3 and 15.4. The principal reason for using the linear score is to achieve properties that are required in order to use conventional statistical methods: mean equal to median, normal distribution and uniform variance amongst samples within lactation, amongst cows within herd or among daughters within sire.

The proportion of neutrophils in the SCC is very low (< 11%) in healthy quarters but is markedly increased in quarters with intramammary infection (to > 90%). Accordingly, the percentage of neutrophils in the SCC may provide a useful indication of intramammary infection, but is not currently performed.<sup>58</sup>

Somatic cell counts can also be determined for colostrum, where they are useful in indicating the presence of intramammary infection (Table 15.2).<sup>60</sup>

The California Mastitis Test of quarter samples

**The CMT is the most reliable and inexpensive cowside test for detecting subclinical mastitis.** The CMT is also known as the Rapid Mastitis test, Schalm test or Mastitis-N-K test, was developed in 1957 and constituted a modification of

Table 15.3 Linear score calculation from the somatic cell count

- Example:* SCC = 200 000 cells/mL
- Divide the SCC by 100 000 cells/mL (200 000/100 000 = 2)
  - Determine the natural log (ln) of the results of step 1 (ln 2 = 0.693)
  - Divide this value by 0.693 (i.e. 0.693/0.693 = 1)
  - Add 3 to the result of step c = 1 + 3 = 4 linear score

the Whiteside test. The CMT reagent contains a detergent that reacts with DNA of cell nuclei, and a pH indicator (bromocresol purple) that changes color when the milk pH is increased above its normal value of approximately 6.6 (mastitis increases pH to 6.8 or above). The CMT is mixed with quarter milk samples that have been previously collected into a white container and the sample is gently swirled; the result is read within 15 seconds as a negative, trace, 1, 2, or 3 reaction depending on the amount of gel formation in the sample. Maximum gel formation actually occurs from 1–2.5 minutes, depending on the quarter SCC and continued swirling of the mixture after the time of peak viscosity produces an irreversible decrease in viscosity.<sup>61</sup> Cows in the first week after calving or in the last stages of lactation may give a strong positive reaction.

The close relationship between the CMT reaction and the SCC of milk and

the reduced productivity of affected cows is shown in Table 15.4. If the CMT is used to minimize the false negative rate (produce the highest sensitivity), then the test should be read as negative (CMT = negative) or positive (CMT = trace, 1, 2 or 3). If the CMT is used to minimize the false-positive rate (produce the highest specificity) for culling decisions, then the test should be read as negative (CMT = negative or trace) or positive (CMT = 1, 2 or 3).

CMT scores can also be determined for colostrum, where the score is useful in indicating the presence of intramammary infection (Table 15.2). The equivalent SCC for CMT scores of negative or trace are different for colostrum and milk, but the SCC for CMT scores of 1, 2 and 3 are similar for colostrum and milk.<sup>62</sup>

The NAGase test of composite or quarter samples

**The NAGase test** is based on the measurement of a cell-associated enzyme (*N*-acetyl-β-D-glucosaminidase) in the milk, a high enzyme activity indicating a high cell count. NAGase is an intracellular lysosomal enzyme derived primarily from neutrophils but also from damaged epithelial cells. The test is suited to the rapid handling of large numbers of samples because of the ease of its automation, and the test can be done on fresh milk and read on the same day.<sup>63</sup> However, because most of the NAGase activity is intracellular, samples should be frozen and thawed before analysis to induce maximal

Test result	Reaction observed	Equivalent milk SCC	Equivalent linear score	Colostrum geometric mean SCC
Negative	The mixture remains fluid without thickening or gel formation	0–200 000 cells/mL	0–4	500 000 cells/mL
Trace	A slight slime formation is observed. This reaction is most noticeable when the paddle is rocked from side to side	150 000–500 000 cells/mL	5	670 000 cells/mL
1+	Distinct slime formation occurs immediately after mixing solutions. This slime may dissipate over time. When the paddle is swirled, fluid neither forms a peripheral mass nor does the surface of solution become convex or 'domed up'	400 000–1 500 000 cells/mL	6	890 000 cells/mL
2+	Distinct slime formation occurs immediately after mixing solutions. When the paddle is swirled the fluid forms a peripheral mass and the bottom of the cup is exposed	800 000–5 000 000 cells/mL	7–8	3 400 000 cells/mL
3+	Distinct slime formation occurs immediately after mixing solutions. This slime may dissipate over time. When the paddle is swirled the surface of the solution becomes convex or 'domed up'	> 5 000 000 cells/mL	9	6 260 000 cells/mL

Table 15.4 Conversion of linear scores to somatic cell counts (cells/mL) and predicted loss of milk<sup>68</sup>

Linear score	Somatic cell count midpoint (cells/mL)	Pounds of milk lost per lactation	
		First	Second
0	12 500	0	0
1	25 000	0	0
2	50 000	0	0
3	100 000	200	400
4	200 000	400	800
5	400 000	600	1200
6	800 000	800	1600
7	1 600 000	1000	2000
8	3 200 000	1200	2400
9	6 400 000	1400	2800

NAGase activity.<sup>58</sup> The NAGase test is reputed to be the most accurate of the indirect tests and as good as SCC in predicting the infected status of a quarter. The NAGase test uses a less sophisticated reading instrument than the average automatic cell counter. If all tests are available it is best to consider the NAGase test and SCC as complementary tests and carry out both of them. Milk NAGase levels are high at the beginning and the end of lactation, as with cell counts. The test has also been validated for use with goat milk.

#### Electrical conductivity tests of quarter samples

A test that has received a lot of attention because it can be used in robotic milking systems is based on the increase in concentration of sodium and chloride ions, and the consequent increase in electrical conductivity, in mastitic milk.<sup>64</sup> The electrolyte changes in milk are the first to occur in mastitis and the test has attractions for this reason. A number of factors affect these characteristics, however, and to derive much benefit from the test it is necessary to examine all quarters and use differences between the quarters to indicate affected quarters. For greater accuracy all quarters need to be monitored each day. An experimental unit that takes all these factors into consideration has been fitted to a milking machine and, by a computer-prepared analysis, monitors variations in electrical conductivity in each quarter every day.<sup>65</sup> Electrical conductivity is attractive as a test because it measures actual injury to the udder rather than the cow's response to the damage, as SCC and NAGase activity do.<sup>66</sup> However, a meta-analysis indicated that using an absolute threshold for conductance did not provide a suitable screening test, as both sensitivity and specificity were unacceptably low.<sup>67</sup> The use of differential conductivity (within cow quarter comparison) results in improvement in test sensitivity and specificity, and is currently

the only recommended application of this indirect test.<sup>58,68</sup>

The most commonly promoted method for measuring electrical conductivity is a hand-held device with a built-in cup into which milk is squirted (foremilk is preferred). Experimentally induced clinical mastitis due to *S. aureus* and *S. uberis* was detectable by changes in electrical conductivity of foremilk: 90% of cases were detectable when clots first appeared and 55% of cases were detectable up to two milkings prior to the appearance of clots.<sup>64</sup> This suggests that clinical mastitis associated with these two major pathogens may be able to be detected earlier by electrical conductivity than by waiting for milkers to detect visible changes in the milk.

#### Comparison of indirect methods

The effects of subclinical intramammary infection on several parameters in foremilk from individual quarter milk samples have been compared.<sup>62</sup> Somatic cell count, electrical conductivity, pH, NAGase activity and the concentrations of sodium, potassium, lactose and alpha-1-antitrypsin were measured from individual quarters. Somatic cell count, NAGase activity, electrical conductivity and concentrations of sodium, alpha-1-antitrypsin and lactose were all useful indirect indicators of infection. The SCC was better able to discriminate between infected and uninfected quarters and cows than were the electrical conductivity, pH and NAGase activity.

#### Hematology and serum biochemistry

In severe clinical mastitis there may be marked changes in the leukocyte count, packed cell volume and serum creatinine and urea nitrogen concentration because of the effects of severe infection and toxemia.<sup>69</sup> In particular, clinical mastitis episodes associated with Gram-negative bacteria frequently cause a profound leukopenia, neutropenia, lymphopenia and monocytopenia as a result of the endotoxemia, as well as an increased packed cell volume.<sup>70</sup> In contrast, the leukogram in cattle with clinical mastitis associated

with Gram-positive bacteria is normal or mildly increased.

#### Ultrasonography of the mammary gland

Two-dimensional ultrasonographic images of the gland cistern, parenchymal tissue and teat are easily obtained using a 5, 7.5, or 8.5 MHz linear array transducer, and ultrasonography is becoming more widely used to guide treatment of teat and gland cistern abnormalities. However, there are few reports of the use of ultrasonography to diagnose or prognose clinical mastitis episodes, although this is likely to be a fruitful area for investigation.

The best two-dimensional images of the udder parenchyma are obtained by clipping the hair on the udder and applying a coupling gel. This minimizes air between the transducer face and skin. Imaging the normal adjacent quarter is very helpful in identifying abnormalities. Imaging should be performed in two planes, sagittal to the teat (and therefore perpendicular to the ground), and transverse to the teat (and therefore horizontal to the ground). The injection of sterile 0.9% NaCl through a teat cannula into the gland provides a practical contrast agent that can help further define the extent of any abnormalities. The superficial supermammary lymph nodes can be ultrasounded using a 7.5 MHz linear transducer, with the lymph node being well demarcated from the surrounding tissues. Mean lymph node length was 7.4 cm (range 3.5–15.0 cm) and mean depth was 2.5 cm (range, 1.2–5.7 cm). Lymph node size increased with age but was not correlated with SCC.<sup>71</sup>

Mastitis produces an increased heterogeneous echogenicity to the milk in the gland cistern, compared to an uninfected quarter. It is important to make this visual comparison without altering the contrast and brightness setting on the ultrasonographic unit.<sup>72</sup>

Three-dimensional ultrasonography of the bovine mammary gland and teat has recently been evaluated<sup>73</sup> and has many promising applications.

#### Biopsy of mammary tissue

A biopsy of mammary tissue can be used for histological and biochemical evaluation in research studies. The use of a rotating stainless steel cannula with a retractable blade at the cutting edge has been described for obtaining biopsy material from cows.<sup>74</sup> Despite some postoperative bleeding, milk yield and composition in the biopsied gland were affected only transiently.

#### NECROPSY FINDINGS

Necropsy findings are not of major interest in the diagnosis of mastitis and are

omitted here but included in the description of specific infections.

### DIFFERENTIAL DIAGNOSIS

The diagnosis of clinical mastitis is not difficult if a careful clinical examination of the udder is carried out as part of the complete examination of a cow with systemic clinical findings. Examination of the udder is sometimes omitted in a recumbent animal only for severe mastitis to be discovered later. The diagnosis of mastitis depends largely upon the detection of clinical abnormalities of the udder and gross abnormalities of the milk or the use of an indirect test like the CMT to detect subclinical mastitis.

Other mammary abnormalities that must be differentiated from clinical mastitis include **periparturient edema, rupture of the suspensory ligament, and hematoma**. These are not accompanied by abnormalities of the milk unless there is hemorrhage into the udder. The presence of stray voltage in the milking plant should not be overlooked in herds where the sudden lowering of production arouses an unfounded suspicion of mastitis.

Differentiation of the different causes of mastitis is difficult on the basis of clinical findings alone but must be attempted, especially in peracute cases where specific treatment must be given before results of laboratory examinations are available. A pretreatment sample of milk from the affected glands for culture and antimicrobial sensitivity may provide useful information about the health record of the cow and the need to consider alternative therapies, and could provide information on new infections in the herd.

### TREATMENT

The treatment of the different causes of clinical and subclinical mastitis may require specific protocols, which are described under specific mastitis pathogens later in the chapter. The general principles of mastitis treatment are outlined here.

#### Historical aspects of antimicrobial therapy for clinical and subclinical mastitis

Between about 1950 and 1990, on a worldwide basis, all forms of both clinical and subclinical bovine mastitis were treated with a wide variety of antimicrobial agents either by intramammary infusions or parenterally, and commonly by both routes in acute and peracute cases. Most veterinarians treated clinical mastitis and evaluated the response on the basis of clinical outcome. In general, it was believed that antimicrobial agents were effective for the treatment of clinical and subclinical mastitis in lactating cows. However, there are very few scientific publications based on randomized clinical trials in which the efficacy of intramammary antimicrobial agents for treat-

ment of clinical mastitis was compared to untreated controls. If antimicrobial agents were used and the animal recovered, it was assumed that treatment was efficacious. If the cow did not respond favorably, several reasons were usually enumerated for the treatment failure. However, most of these reasons, while biologically attractive, are hypothetical and have not been substantiated scientifically. Gradually, over the years, veterinarians began to doubt the efficacy of antimicrobial agents for the treatment of all cases of clinical mastitis. In addition, and of major importance, milk from treated cows had to be discarded for up to several days after the last day of treatment because of antimicrobial residues; this was a major expense. Currently, optimized treatment strategies focus on efficacy, economics, animal welfare aspects and the milk withhold time of antimicrobial treatment.

Efficacy is assessed on the basis of **clinical cure** or **bacteriological cure**. Most producers are interested in the return to normal milk (clinical cure) and are much less interested in the return to a sterile quarter (bacteriological cure). Because clinical mastitis is defined as abnormal milk, the return to normal ('drinkable') milk represents a clinical cure. Bacteriological cure represents the inability to isolate the initial pathogen 14–28 days after the start of treatment. Other important indicators of efficacy are milk production, dry matter intake, the amount of saleable milk and mortality or culling rates after treatment.

Some examples of the efficacy or inefficacy of antimicrobial agents illustrate the controversy. It is well accepted that the cure rate following intramammary treatment of clinical or subclinical mastitis due to *S. agalactiae* in the lactating cow is high (80–90%). In contrast, the cure rate of clinical and subclinical mastitis due to *S. aureus* in the lactating cow is considerably lower (40–50%), but certainly not 0%. In herds with a low prevalence of contagious mastitis, most cases of mild clinical mastitis (abnormal secretion only) in lactating cows are due to environmental streptococci and coliforms and may recover without antimicrobial therapy, although antimicrobial administration increases the clinical and bacteriological cure rate. Antimicrobial agents may be ineffective for the treatment of clinical mastitis associated with *M. bovis*, *A. pyogenes*, *Nocardia* spp., and *P. aeruginosa*.

In the 1970s dairy processing plants, veterinarians, consumer advocates, public health authorities and milk-quality regulating agencies began to express concern about antimicrobial residues in milk from cows treated for mastitis. The public health and milk industry concerns

about residues combined with the controversy about the efficacy of antimicrobial agents for clinical mastitis has also provided a stimulus to evaluate the efficacy and consequences of using antimicrobial agents. Since the early 1990s much emphasis has been placed on alternative methods of treating clinical mastitis, leading to a reduction in the use of antimicrobial agents during the lactating period.<sup>75</sup> Such strategies have been defended based on a lack of information concerning the efficacy and economics of antimicrobial therapy associated with pathogens other than *S. agalactiae*, and by the need to reduce the risk of residue violation. However, a recent study concluded that not administering antibiotics to cows with clinical mastitis was imprudent and unethical.<sup>76</sup>

There is a need for randomized controlled field trials to evaluate the use of antimicrobial agents for the treatment of clinical mastitis; the design for such trials and the statistical analysis required have been reviewed.<sup>77</sup> Well conducted clinical mastitis treatment trials represent an invaluable, although difficult and expensive, effort to evaluate efficacy of antimicrobial agents under field conditions. The use of intramammary antimicrobial agents for the treatment of clinical mastitis in lactating cows in 40 dairy herds over 4 years found an economic benefit compared to nonmedicated controls.<sup>78</sup> In the antimicrobial-treated group, the number of pathogens in the milk following treatment was reduced, the number of quarters returning to normal milk was increased, and the number of cured quarters was increased. It should be noted that the use of antimicrobial agents for the treatment of **subclinical mastitis** at the end of lactation, known as **dry cow therapy**, is accepted worldwide and is based on scientific evidence using randomized clinical trials. Dry cow therapy is one of the principles applied in the effective control of bovine mastitis, in which much progress has been made since the early 1970s.

#### Treatment strategy

The treatment strategy will depend on whether the mastitis is **clinical** or **subclinical**, and the health status of the herd, including its mastitis history. Clinical mastitis is further categorized as **abnormal milk**, **abnormal gland** or **abnormal cow**, as described under Diagnosis. If treatment is indicated, the major decision is whether to administer antimicrobial agents parenterally or by intramammary infusion.

An important aspect of treatment is the accurate positive identification of the animal(s) to be treated, the recording of the relevant clinical and laboratory information, and the treatments being

used, and monitoring the response. Useful information would include:

- Cow identification
- Quarters affected
- Date of mastitis event
- Lactation number
- Date of calving
- Identification of pathogen(s)
- Treatment used, including dose, route and duration
- Milk withholding time and time when returned to the milking string
- Most recent level of milk production.

Options for treating cows with clinical mastitis include treating all cows with antimicrobial agents, treating none of the cows with antimicrobial agents or treating only specific cows with antimicrobial agents.<sup>79</sup> Treating all cows results in increased costs for those cows with clinical mastitis associated with pathogens not susceptible to the antimicrobial agent used, especially if the signs are likely to resolve before the milk withholding period has expired. Treatment of all cows is also associated with increased risk of violative residues in the bulk milk. Treating none of the cows with antimicrobial agents has animal welfare implications, in that an effective treatment is not administered to some cattle with clinical mastitis, and nontreatment allows Gram-positive pathogens to persist, increasing the probability of a recurrence of clinical mastitis or causing a herd epidemic of mastitis. Accordingly, nontreatment of all cases of mastitis is not a viable option. Treating only specific cows with antimicrobial agents requires an accurate method of determining which animals should be treated. However, clinical judgment and predictive models are too inaccurate to distinguish between clinical mastitis associated with Gram-negative and Gram-positive pathogens.<sup>79</sup> To select cows for antimicrobial therapy on the basis of bacteriological culture is costly and delays treatment; clinical judgment would still be necessary because bacteria are not isolated from 15–40% of milk samples from cows with clinical mastitis.

Veterinarians should always ask and answer four questions related to antimicrobial therapy in bovine mastitis:

- Is antimicrobial therapy indicated?
- Which route of administration (intramammary, parenteral or both) should be used?
- Which antimicrobial agent should be administered?
- What should be the frequency and duration of treatment?

Is antimicrobial therapy indicated?

The first decision is **whether to treat** a particular case with antimicrobial agents

and whether supportive therapy is required. Therapy decisions should be made in context with the overall objectives of the lactating cow treatment protocol. The availability of approved, effective treatment products is an essential component of the program. A number of factors are important in determining which cases of mastitis should be treated during lactation. These factors include the type of pathogen involved, the type and severity of the inflammatory response, the duration of infection, the stage of lactation, and the age and pregnancy status of the cow.

#### *Type of pathogen involved*

There are marked differences in the bacteriological cure rates of the various major mastitis pathogens after therapy during lactation. The outcome of treatment during lactation is poor for cases of *S. aureus* mastitis. On the other hand, *S. agalactiae* responds extremely well to lactating cow therapy and all infected cows should be treated. Cases of mastitis associated with environmental organisms have reasonable, but variable, cure rates.

#### *Type and severity of the inflammatory response*

The predominant type of inflammatory process involved influences the objectives of the therapy program. Herds with clinical mastitis problems will aim at reducing clinical signs, returning the milk to saleable quality and avoiding residue violations. Herds with a predominance of subclinical mastitis are concerned with avoiding the spread of infection and reducing the prevalence of the major pathogens involved. Both types of herd have the primary objective of restoring the production potential.

The severity of the inflammatory response is also important in the selection of cases for mastitis therapy during lactation. Heat, pain and swelling of the quarter (abnormal gland) are clinical signs that indicate the need for antimicrobial therapy. Many producers, however, will treat any cow that shows clots in the milk (abnormal milk). There are no reports to verify that treatment of cows exhibiting abnormal milk only is efficacious and economically justifiable, although it is probable that treatment of clinical mastitis episodes of abnormal milk but normal gland due to *S. agalactiae* is efficacious and economic. Treatment success is lower in cows with high NAGase concentrations in milk compared to low NAGase concentrations.<sup>80</sup>

#### *Duration of infection*

For the contagious organisms, especially *S. aureus*, the duration of infection is an

important determinant of its susceptibility to therapy during lactation. In chronic *S. aureus* mastitis, the organism survives intracellularly in leukocytes, becomes walled-off in small abscesses of mammary ducts, and has the ability to exist in the L-form state. At this point *S. aureus* is virtually incurable during lactation. With new methods of automated detection of subclinical intramammary infection such as in-line electrical conductivity measurement, new infections may be detected much earlier. The cure rate of *S. aureus* during lactation needs to be re-evaluated when treatment is administered early in the course of infection.

#### *Stage of lactation*

The stage of lactation is an important determinant of the benefit:cost ratio of mastitis therapy during lactation. It may be uneconomical to treat even cases with a high probability of cure during late lactation.

#### *Age and pregnancy status of cow*

The probability of a cure is greater in young cows, and age should be considered in selecting cases for mastitis therapy during lactation.<sup>80</sup> The economic aspects of treatment for late-lactation, nonpregnant cows are obviously different from those for midlactation pregnant cows.

A mastitis therapy program for lactating cows should be based on a complete understanding of the mastitis status of the herd, and individual cow treatment decisions should be consistent with the overall herd mastitis therapy program. A record system for treatment should be established so that it is possible to monitor the efficacy of the mastitis treatment program.

The udder health status in a particular herd will determine whether the lactating cow mastitis therapy strategy should be targeted at the individual cow level or at the herd level. The level of emphasis should clearly reflect the objectives of the therapy program. For example, a herd with low bulk tank milk SCC and sporadic cases of environmental mastitis should target the lactating cow therapy strategy at the cow level. The primary objectives would be to alleviate clinical signs, to achieve a bacteriological cure and to restore the cow's production. On the other hand, a herd with moderate to high bulk tank milk SCCs and a significant prevalence of contagious organisms should aim the program at the herd level. In this case, the objective would be to limit the spread of infection, markedly reduce or eradicate a specific pathogen and increase herd production. A clear statement of treatment philosophy (individual cow level or herd level) in a particular



herd is needed to direct establishment of well defined treatment protocols for mastitis in lactating cows.

Intramammary infection (mastitis) is identified by the presence of clinical signs or the results of a direct test (culture of milk) or indirect tests such as SCC, CMT or electrical conductivity. The detection of clinical or subclinical mastitis does not necessarily indicate that therapy should be administered, although animal welfare issues dictate that treatment must be administered to cattle with an abnormal gland or systemic signs (abnormal cow) because these animals are undergoing pain and discomfort. A decision to use treatment during lactation should be based on the likelihood of achieving the objectives of the therapy program. Several factors are important in the selection of cows for treatment. These factors can significantly influence the cure rate achieved with therapy, or the economic benefit realized.

The herd history of udder health will indicate the probable cause of clinical mastitis. Cows with mild cases of clinical mastitis (abnormal milk only) in herds with a low prevalence of contagious mastitis pathogens are likely to be affected with environmental pathogens<sup>17</sup> and commonly return to clinically normal milk in four to six milkings.<sup>81</sup> This has led to the development of treatment algorithms based on the results of culturing clinical cases using selective media. Using this approach, milk cultures are obtained from all cattle with clinical mastitis and plated using biplates or triplates. All cattle with abnormal glands or signs of systemic illness (abnormal cow) are immediately treated with antimicrobial agents and appropriate ancillary treatment, with subsequent antimicrobial treatment based on the preliminary culture results at 18–24 hours or the final culture results at 48 hours. In contrast, treatment is initially withheld from all cattle demonstrating abnormal secretion only; antimicrobial treatment is instituted based on the culture results. One such scheme recommends using intramammary antibiotics to treat affected quarters with *S. aureus*, coagulase-negative staphylococci and environmental streptococci, infusing intramammary antibiotics into all quarters of cows with one or more quarters infected with *S. agalactiae* and not administering antibiotics to cows with coliform bacteria or no growth.<sup>82</sup> When using this delayed approach to antimicrobial treatment, it is important that cattle with abnormal milk only are closely monitored and that antimicrobial treatment is immediately instituted when signs of an abnormal gland or abnormal cow are present. The major difficulty with implementing the delayed approach is the difficulty in trans-

porting the milk sample to and receiving the results from the diagnostic laboratory in a time effective manner.

Which route of administration (intramammary, parenteral or both?)

The second decision is the route of administration. The goal of antimicrobial treatment is to attain and maintain an effective concentration at the site of infection. Three pharmacological compartments are recognized for infection by mastitis pathogens:

- Milk and epithelial lining of the ducts and alveoli
- Parenchyma of the mammary gland
- The cow<sup>83</sup> (Table 15.5).

In general, infections confined primarily to the milk and ducts (such as *C. bovis*, coagulase-negative staphylococci) are easily treated with intramammary antibiotics. In contrast, infections due to mastitis pathogens with potential for systemic infection (such as *E. coli*, *K. pneumoniae*, *M. bovis*) are best treated with parenteral antibiotics. Mastitis pathogens that are the most difficult to treat are those that are principally infections of parenchymal tissue (such as *S. aureus*, *A. pyogenes*); this is because it is more difficult to attain and maintain an effective antibiotic concentration at this anatomical site when administering antibiotics by the intramammary or parenteral routes.

Which antimicrobial agent should be administered?

The third decision is the antimicrobial agent. The selection of the antimicrobial

class for the particular mastitis pathogen has traditionally been based on culture and susceptibility testing and, although some in vivo data are now available, the choice is still largely dependent on case studies rather than on controlled experiments. Culture and antimicrobial susceptibility testing of the pathogen is not necessarily a justifiable basis for selecting the antimicrobial agent to be used in individual cows, and the response to treatment of clinical mastitis in two recent studies<sup>84,85</sup> was unrelated to the results of in vitro susceptibility tests.

Antimicrobial agents are usually selected based on availability of labeled drugs, clinical signs in the cow, milk culture results for previous mastitis episodes in the herd, experience of treatment outcome in the herd, treatment cost and withdrawal times for milk and slaughter. Many veterinarians and researchers have also recommended the use of susceptibility testing to guide treatment decisions. The validity of agar diffusion susceptibility breakpoints derived from humans in the treatment of bovine mastitis has not been established and is extremely questionable because bovine mastitic milk pH, electrolyte, fat, protein and neutrophil concentrations, growth factor composition and pharmacokinetic profiles differ markedly from those of human plasma.<sup>86</sup> Moreover, antibiotics are distributed unevenly in an inflamed gland, and high antibiotic concentrations can alter neutrophil function in vitro and therefore have the potential to inhibit bacterial clearance in vivo.

Adequate databases of in vitro minimum inhibitory concentration (MIC)

Mastitis pathogen	Pharmacological compartment		
	Milk and ducts (abnormal milk)	Parenchyma (abnormal gland)	Systemic (abnormal cow)
<b>Contagious pathogens</b>			
<i>Staphylococcus aureus</i>	+	++	-
<i>Streptococcus agalactiae</i>	++	+	-
<i>Mycoplasma bovis</i>	+	+	++
<i>Corynebacterium bovis</i>	++	-	-
<b>Teat skin opportunistic pathogens</b>			
Coagulase-negative staphylococci	++	-	-
<b>Environmental pathogens</b>			
<i>E. coli</i>	+	-	++
<i>Klebsiella pneumoniae</i>	+	-	++
Environmental streptococci	++	+	-
<i>Arcanobacterium pyogenes</i>	+	++	-
<b>Antimicrobial therapy</b>			
Intramammary	Good to excellent	Moderate	Poor
Parenteral	Poor to moderate	Moderate to excellent	Good to excellent

*Antimicrobial therapy is categorized on the basis of route of administration and likely efficacy when treating a susceptible infection*  
 ++, extensive infection; += moderate infection; -, minimal or no infection  
 Source: adapted from Erskine RJ et al. *Vet Clin North Am Food Anim Pract* 2003; 19:109.

values for clinical mastitis pathogens are currently unavailable, although adequate databases are available for subclinical mastitis isolates. Although we have a good knowledge of the pharmacokinetics of many parenteral antibiotics used to treat clinical mastitis, most pharmacokinetic data have been obtained in healthy cattle and it has not been determined whether pharmacokinetic values in healthy cows are the same as those in cows with clinical mastitis. In addition, pharmacokinetic values for many of the intramammary antibiotics used to treat clinical mastitis are unknown, and we have a limited understanding of the pharmacodynamics of antibiotics in treating mastitis. More importantly, the breakpoints currently recommended for all parenterally and almost all intramammarily administered antibiotics are based on achievable serum and interstitial fluid concentrations in humans after oral or intravenous antibiotic administration. The relevance of these breakpoints to achievable milk concentrations in lactating dairy cows after intramammary, subcutaneous, intramuscular or intravenous administration is dubious at best.<sup>86</sup>

Results from field studies are available to evaluate the validity of susceptibility breakpoints in guiding treatment of cows with clinical or subclinical mastitis. The results from these field studies suggest that the following antibiotics may have valid (but not necessarily optimal) breakpoints for treating clinical or subclinical mastitis associated with specific bacteria: parenteral penicillin G for subclinical *S. aureus* infections, intramammary cephalosporins for clinical *Streptococcus* spp. infections, and parenteral trimethoprim-sulfadiazine for clinical *E. coli* infections. Of these three antibiotics, the breakpoints for penicillin G and cephalosporins have only been validated for bacteriological cure, whereas the breakpoint for trimethoprim-sulfadiazine is validated for clinical cure.<sup>84</sup> Because duration of infection before treatment, antibiotic dosage, dosage interval and duration of treatment influence treatment outcome, many more field studies must be completed to validate the currently assigned antibiotic breakpoints for pathogens causing clinical mastitis.

To properly utilize the known pharmacokinetics of parenterally and intramammarily administered drugs, it is necessary to know something about their diffusion into mammary tissue, the degree of binding of a drug to mammary tissues and secretions, the ability to pass through the lipid phase of milk and the degree of ionization. All of these factors influence the level of the antibiotic in the mammary gland. For lactating cows the preferred treatment is one that maintains

a MIC for 72 hours without the need for multiple infusions and without prolongation of the withdrawal time. The most successful antimicrobial agents for dry period treatment are those that persist longest in the udder, preferably as long as 8 weeks. These characteristics depend on the release time from the transport agent in the formulation, and the particle size and diffusion capabilities of the antibiotic.

The formulation of the preparation will affect the duration of the maintenance of the MIC. The third-generation cephalosporins (such as ceftiofur) and fluoroquinolones are the drugs of choice for use in cases in which the infection may be associated with either a Gram-positive or Gram-negative organism; however, these antimicrobial agents may not be able to be used to treat mastitis in some countries. Mixtures of penicillin and an aminoglycoside are also in common use for this purpose. Penicillin G and penethamate are favored for Gram-positive infections.

Of special importance are the beta-lactamase-producing strains of *S. aureus*, against which beta-lactam penicillins are ineffective; cloxacillin is a commonly used and effective intramammary formulation for these strains of *S. aureus*. The drugs that have the best record of diffusion through the udder after intramammary infusion are penethamate, ampicillin, amoxicillin, erythromycin and tylosin. Those of medium performance are penicillin G, cloxacillin and tetracyclines. Poor diffusers, which have a longer half-life in the udder because they bind to protein, include streptomycin and neomycin. Streptomycin is not much used now because of the high level of resistance to it, especially by *S. uberis* and *E. faecalis*.

What should be the frequency and duration of treatment?

The fourth decision is the **frequency and duration of treatment**. The frequency of administration for parenterally administered antimicrobial agents is dependent primarily on their pharmacokinetics and pharmacodynamics. Fluoroquinolones and aminoglycosides are **concentration-dependent** antimicrobial agents where increasing concentrations at the site of infection increase the bacterial kill rate. Macrolides, beta-lactams, and lincosamides are **time-dependent** antimicrobial agents where exceeding the minimum inhibitory concentration at the site of infection for a prolonged percentage of the interdosing interval correlates with improved efficacy.<sup>87</sup> In contrast, the frequency of administration for intramammary formulations is dependent primarily on the milking schedule, in that these agents are primarily cleared by milk removal. For

example, the clearance of pirlimycin is strongly and positively correlated ( $r = 0.97$ ) to 24-hour milk production at the time of dosing.<sup>88</sup> With all intramammary formulations being licensed based on the results of studies of twice-daily milking, the recent industry trend in some parts of the world towards thrice-daily milking has created uncertainty as to whether intramammary treatment should be repeated after every milking, or even whether once-a-day intramammary administration is as efficacious as twice- or thrice-daily administration.

Recent studies have confirmed long held beliefs that **appropriate antimicrobial therapy** (commonly called **extended or aggressive antimicrobial therapy**) for 5–8 days is much more effective in treating intramammary infections than label intramammary therapy (2–3 d). In other words, increasing the duration of antimicrobial administration increases treatment efficacy.<sup>89–92</sup> Extended antimicrobial therapy is opposed by producers because such treatment may be off-label and results in a longer milk withhold time, and consequently the amount of milk that has to be discarded. Extended therapy is opposed by dairying administrators because of the inevitable increase in the number of infringements of health regulations relating to antibiotic residues in milk. The inappropriately short treatment duration for most intramammary products has been a major hindrance to developing effective antimicrobial treatment protocols.

#### Intramammary antimicrobial therapy

For reasons of convenience and efficiency, antimicrobial udder infusions are in common use for the treatment of certain causes of mastitis in lactating cows, and for dry cow therapy. For example, the cure rate of *S. agalactiae* using intramammary infusions in lactating cows exceeds 95%. Disposable tubes containing suitable antimicrobials in a water-soluble ointment base are ideal for dispensing and for the treatment of individual cows. Multiple-dose bottles containing aqueous infusions are adequate, and much cheaper per dose when large numbers of quarters are to be treated, but repeated use of the same container increases the risk of contamination. The degree of diffusion into glandular tissue is the same when either water or ointment is used as a vehicle for infusion; the duration of retention within the gland depends on the vehicle.

Most antimicrobial agents currently available in the USA in commercial intramammary infusion products are active against the staphylococci and streptococci,<sup>93</sup> with cephalosporins (a first-generation cephalosporin) having good

activity against coliform bacteria, and ceftiofur (a third-generation cephalosporin) having excellent activity against coliform bacteria.<sup>94</sup> Until recent years the emphasis was on the elimination of Gram-positive cocci from the udder, but Gram-negative infections, especially *E. coli*, have increased in prevalence to the point where a broad-spectrum preparation is almost essential for both lactation and dry period treatments.

The choice of antimicrobial agents for intramammary infusion should be based on:

- Spectrum of bacteria controlled
- Diffusibility through mammary tissue
- Cost.

Strict hygiene is necessary during treatment to avoid the introduction of bacteria, yeasts and fungi into the treated quarters; the use of a short cannula that just penetrates the external sphincter is preferred as it is less likely to introduce bacteria and leaves more of the keratin plug in place in the streak canal; the keratin plug has antimicrobial properties itself. Care must be taken to insure that bulk containers of mastitis infusions are not contaminated by frequent withdrawals and that individual, sterilized teat cannulas, usually part of commercial, single-dose ointment tubes, are used for each quarter. Bulk treatments are best avoided because of the high risk of spread of pathogens.

#### Infusion procedure

The teats must be cleaned and sanitized before infusing the quarter in order to avoid introduction of infection. The following steps are recommended:

- Clean and dry the teats
- Dip teats in an effective germicidal product. Allow 30 seconds contact time before wiping teats with an individual disposable towel (one towel/cow, use one corner of the towel for each teat)
- Thoroughly clean and disinfect each teat end with cotton soaked in 70% alcohol. Use a separate piece of cotton for each teat
- Prepare teats on the far side of the udder first, followed by teats on the near side
- Treat quarters in reverse order; near side first, far side last
- Insert only the tip of the cannula into the teat end (**partial insertion**). Do not allow the sterile cannula to touch anything prior to infusion. Most approved dry cow infusion products (and lactating tubes, too) are marketed with a dual cover that can be used for partial or full insertion
- Dip teats in a germicidal product after treatment

- Identify treated cows and remove them from the milking herd to prevent antimicrobials from entering the milk supply.

Diffusion of infused intramammary drugs is often impeded by the blockage of lactiferous ducts and alveoli with inflammatory debris. Complete emptying of the quarter by the parenteral injection of oxytocin (10–20 IU intramuscularly) followed by hand-stripping of affected quarters before infusion has been recommended in cases of clinical mastitis, but efficacy studies are lacking, the volume stripped is usually small and the procedure is painful to the cow. If stripping is performed, the intramammary infusion is given after the last stripping of the day has been done, avoiding any further milking of the gland until the next milking. Our current knowledge can be summarized by the following: 'To strip or not to strip, that is the question.'

#### Parenteral antimicrobial therapy

This should be considered in all cases of mastitis in which there is an abnormal gland or abnormal cow (fever, decreased appetite, or inappetence). The systemic reaction can usually be brought under control by standard doses of antimicrobial agents but a bacteriological cure of the affected glands is seldom achieved because of the relatively poor diffusion of the antimicrobial from the blood into the milk. However, the rate of diffusion is greater in affected than in normal quarters. Parenteral treatment is also recommended when the gland is markedly swollen and intramammary infusions are unlikely to diffuse to all parts of the glandular tissue. To achieve adequate therapeutic levels of an antimicrobial in the mammary gland by parenteral treatment it is necessary, for the above reasons, to use higher than normal dose rates daily for 3–5 days. Milk from treated cows must be withheld from the bulk tank for the stated period of time of that antimicrobial following the date of last treatment.

#### Treatment of lactating quarters

There are three situations to consider: the emergency single case of clinical mastitis requiring immediate treatment, the herd with a problem of too many clinical cases or intractable cases, but where the identity of the pathogen is known, and the cow with subclinical mastitis.

Emergency treatment when the type of infection is unknown

Cases of acute and peracute mastitis (abnormal cow) in lactating cows, and in dry cows close to calving, are serious problems for the field veterinarian. The need for treatment is urgent; it is not possible to wait for the results of labor-

atory tests to guide the selection of the most appropriate antibiotic. Clinical findings, season of the year and management practices may give a broad hint as to the specific bacterial cause, but in most such circumstances it is necessary to use a broad-spectrum approach to treatment.<sup>95</sup> Parenteral therapy with oxytetracycline (administered intravenously to increase bioavailability and therefore plasma and milk concentrations), a potentiated sulfonamide or similar broad-spectrum antimicrobial agent should be supplemented with intramammary infusion with a beta-lactamase-resistant antimicrobial such as a first-generation cephalosporin (cephapirin), a third-generation cephalosporin (e.g. ceftiofur), penicillin G–neomycin combination or other approved broad-spectrum intramammary infusion.<sup>96</sup> Parenteral ceftiofur is not effective in clinical mastitis episodes that have abnormal secretion or abnormal gland and secretion.<sup>97</sup>

Field studies show that, in herds in which clinical mastitis is often caused by environmental pathogens, intravenous administration of oxytetracycline, intramammary infusion of cephalosporin and supportive therapy (including intravenous administration of flunixin meglumine or fluids) produces a higher rate of clinical and bacteriologic cure than supportive treatment alone.<sup>96</sup> In addition, antimicrobial treatment is more effective than supportive treatment alone.<sup>86</sup> In cows with clinical mastitis caused by *E. coli* the use of procaine penicillin G IM was no more effective than not using antimicrobial agents;<sup>98</sup> this result is expected based on penicillin's Gram-positive spectrum of activity. Knowledge of the likely causative agent is therefore helpful when making decisions about therapy of clinical mastitis episodes during lactation.

Provision of other supportive therapy such as fluids and electrolytes is also crucial to the survival of the cow and minimization of the severity of the mastitis and extent of permanent injury to the udder. The efficacy of frequent stripping, with or without intramammary infusion, is uncertain. NSAIDs decrease pain associated with an abnormal gland; in addition, they enhance recovery and reduce fever in severe cases.

Treatment when the infecting organism is known

A common situation encountered by a bovine practitioner is the dairy herd that has had an outbreak of clinical mastitis or has received a warning notice from the milk processor that the bulk milk SCC or bacterial count is above acceptable limits. The situation calls for a complete mastitis control program, including conducting an

investigation to determine the causative bacteria present, the source of the infection, hygiene in the milking parlor and the importance of risk factors such as milking machine management, plus recommended antimicrobial preparations selected on the basis of the causative agent. Treatment of a number of identified subclinical cases at the commencement of the program, and of individual cases subsequently, can be based on the known common infection in the herd. Among Gram-positive cocci, the response to antimicrobial agents is excellent for streptococci. For staphylococci a cure rate of 65% is about the best that can be expected, and unless there are good reasons for doing otherwise it is recommended that treatment be postponed until the cow is dry. Standard treatments for lactating cows include penicillin alone (100 000 units) or in combination with streptomycin (1 g) or neomycin (500 mg), and a combination of ampicillin (75 mg) and sodium cloxacillin (200 mg). Acid-resistant penicillins, e.g. phenoxymethylpenicillin, are probably best not used as mammary infusions because of their ability to pass through the human stomach, thus presenting a more serious potential threat to humans drinking contaminated milk. Because of the widespread and often indiscriminate use of penicillin, a large part of the mastitis that occurs is associated with penicillin-resistant bacteria, especially *S. aureus*. Treatment programs need to take this into account when recommendations are made about the antibiotic to be used.

Intramammary infections associated with **environmental streptococci** that manifest signs of clinical mastitis are usually acute but only moderately severe. In most of these cases the streptococci are sensitive to antimicrobial agents, and they often recover spontaneously with good management and nursing care. If not, they usually respond well to therapy. Bacteriological cure rates of 60–65% can be expected following a single intramammary infusion of a cephalosporin product. In one randomized controlled field trial of clinical mastitis associated with *Streptococcus* spp. or coliform bacteria, the clinical cure rate by the tenth milking was significantly higher when intramammary cephapirin, intravenous oxytetracycline, or both, were used along with supportive therapy (oxytocin and stripping of affected glands and, in severely affected cows, the use of flunixin meglumine and fluids) compared to supportive treatment alone.<sup>99</sup> These results indicate that, in herds in which clinical mastitis is often associated with environmental pathogens, antimicrobial therapy and supportive therapy may result in a better outcome than supportive therapy alone.

#### Treatment of subclinical mastitis

It is generally considered not advisable to treat subclinical mastitis during lactation. However, it is important to consider the causative organism and the udder health status of the herd. There are several situations in which lactational therapy of subclinical mastitis is indicated; for example, herds with *S. agalactiae* infections should consider several approaches to therapy during lactation. *S. agalactiae* infections respond well to therapy during lactation, with cure rates of 80–100% expected.<sup>59</sup> All approved intramammary therapy preparations are efficacious, including penicillin, cephalosporins, cloxacillin and erythromycin. In herds with a high prevalence of *S. agalactiae* mastitis, **blitz therapy** can be used for eradication of the pathogen, increased milk production and reduced penalties for high SCCs. There is, however, a risk of residue violation, problems with disposal of milk from treated cows and considerable costs involved. It is also important to insure that standard mastitis control procedures, such as postmilking teat disinfection and blanket dry cow therapy, have been implemented. The benefit:cost ratios for various approaches to blitz therapy of *S. agalactiae* infected herds have been studied.<sup>59</sup> The prevalence of infected cows, and their stage of lactation, are important determinants of the type of program selected.

Therapy of cows with subclinical mastitis due to *S. aureus* during lactation is much less rewarding. Under field conditions, cases of *S. aureus* are difficult to cure during lactation. Reported cure rates following intramammary therapy are between 15% and 60%. Lactational therapy of subclinical *S. aureus* mastitis using intramuscular penicillin along with intramammary amoxicillin infusion, compared with the intramammary infusion alone, increased the cure rate to 40%, which represented a doubling of the cure rate with intramammary therapy alone.<sup>48</sup> If treatment by this method is used in combination with data on the age of cow, stage of lactation, duration of infection and level of SCC, the economic benefit of treating some cases of *S. aureus* mastitis during lactation may be attractive.

Subclinical infections associated with environmental streptococci, and occasionally by coliform organisms, can be found in moderate numbers in some herds.<sup>56</sup> Although spontaneous cure rates are higher with these environmental infections, individual cows may merit treatment during lactation. In these cases, the previously listed factors should be used, and are important in the selection of cases to be treated.

Prepartum antibiotic treatment of heifers is of benefit in herds experiencing

a high incidence of clinical mastitis in recently calved heifers. Coagulase-negative staphylococci are frequently isolated from late-gestation heifers, and intramammary treatment with sodium cloxacillin (200 mg) or cephapirin sodium (200 mg) 7 days before expected parturition is highly effective and economically beneficial.<sup>100</sup>

#### Anti-inflammatory agents

NSAIDs have been evaluated for the treatment of field and experimental cases of acute and peracute mastitis. NSAIDs have beneficial effects on decreasing the severity of clinical signs based on changes in rectal temperature, heart rate, rumen motility and pain associated with the mastitis, and are routinely administered as part of the initial treatment of cattle with severe clinical mastitis and marked systemic signs. On the basis of one comparative study, NSAIDs appear to ameliorate systemic abnormalities to a greater degree than corticosteroids.<sup>101</sup> The strongest evidence available to support the administration of NSAIDs is available for ketoprofen and phenylbutazone.

Ketoprofen at 2 g intramuscularly once daily combined with sulfadiazine and trimethoprim intramuscularly given daily to cows with acute clinical mastitis, and complete milking of affected quarters several times daily, significantly improved survival and milk production compared to cows not receiving the NSAID.<sup>102</sup> A re-analysis of the published results indicated that phenylbutazone at 4 g intramuscularly once daily combined with sulfadiazine and trimethoprim intramuscularly given daily to cows with acute clinical mastitis significantly improved the percentage of cows with milk production returning to more than 75% of previous levels compared to cows not receiving the NSAID.<sup>103</sup> However, intramuscular administration of phenylbutazone is not currently recommended because of the potential for myonecrosis. Dipyrone at 20 g intramuscularly once daily in the same study was not effective.<sup>103</sup>

There is no evidence that treatment of clinical cases with NSAIDs alters the inflammatory response in the udder,<sup>101</sup> although pretreatment of cattle with experimentally induced mastitis does alter the local (glandular) inflammatory response to infection. Flunixin meglumine concentrations are low in milk, which is consistent with its properties as a weak acid, which has difficulty crossing the blood-milk barrier.<sup>104</sup> Flunixin meglumine (2 mg/kg, intravenously, twice 24 h apart) did not alter the survival rate of dairy cows with severe *E. coli* or *S. uberis* mastitis compared to intravenous administration of 45 L of isotonic crystalloid fluids.<sup>105</sup> The one-time administration of

1 g of flunixin meglumine intravenously or 4 g of phenylbutazone intravenously, along with intramammary infusion of gentamicin (150 mg) at 12-hour intervals for four treatments, had no significant beneficial effect in cows with acute toxic mastitis associated with *E. coli* and *Klebsiella* spp.<sup>106</sup> However, the results of this study do not indicate a lack of effectiveness of flunixin meglumine or phenylbutazone because it is difficult for one dose of any NSAID to have a detectable effect on clinical signs in naturally occurring mastitis cases.

### Supportive therapy

Supportive treatment, including the intravenous administration of large quantities of isotonic crystalloid fluids, is indicated in cattle with severe systemic illness. Large volumes of isotonic crystalloid fluids can be rapidly administered under pressure at 0.5 L/min through a 12-gauge catheter in the jugular vein, using a 7.5 L garden weed killer spray pump.<sup>105</sup> The administration of hypertonic saline followed by immediate access to drinking water is a practical method of providing fluid therapy to cows with severe mastitis, especially peracute coliform mastitis.<sup>107</sup> A dose of 4–5 mL/kg body weight (BW) of 7.5% saline is given intravenously over 4–5 minutes.<sup>108</sup> This is usually followed by the animal consuming large quantities of water. Circulating blood volume is increased and there is mild strong ion (metabolic) acidosis, improved renal function and changes in calcium and phosphorus homeostasis when compared to cows given a similar volume of 0.9% NaCl. Fluid therapy is covered extensively in Chapter 2.

### Adjunctive therapy

Cytokines may be useful as adjunctive therapy with existing antimicrobials to improve therapeutic efficacy, particularly in lactating cows.<sup>109</sup> Cytokines are natural regulators of the host defense system in response to infectious diseases. The combination of a commercial formulation of cephapirin with recombinant interleukin-2 consistently improved the cure rate of treating *S. aureus* mastitis by 20–30% compared to use of the antimicrobial alone.<sup>109</sup>

### Magnitude of response to therapy

The treatment of some causes of mastitis can be highly effective in removing infection from the quarter and returning the milk to normal composition. However, the yield of milk, although it can be improved by the removal of congestion in the gland and inflammatory debris from the duct system, is unlikely to be returned to normal in severe clinical cases, at least until the next lactation. The degree of

response obtained depends particularly on the causative agent, the speed with which treatment is commenced, and other factors described above. A 'cure' may mean disappearance of clinical signs, elimination of the infectious cause, or both of those plus return to normal function and productivity. Which of these is the objective in any particular case or herd will influence the decisions to be made about treatment in an individual case of the disease.

**Failure to respond to therapy** of the lactating cow may be due to:

- The presence of microabscesses and inaccessibility of the drug to the pathogen
- Ineffective drug diffusion
- Inactivation of the antimicrobial by milk and tissue proteins
- Inefficient killing of the bacteria and intracellular survival of bacteria
- Increased antimicrobial resistance
- The development of L-forms of bacteria.

### Dry cow therapy

Dry cow therapy is the use of intramammary antimicrobial therapy immediately after the last milking of lactation and is an important component of an effective mastitis control program.<sup>110</sup> Intramammary infusions at drying off **decrease the number of existing infections and prevent new infections during the early weeks of the dry period.** Dry cow therapy should be routinely administered and remains one of the cornerstones of an effective mastitis control program. **Blanket dry cow therapy** is treatment of all four quarters at drying off, compared to **selective dry cow therapy** based on treatment of only those quarters that are infected. When subclinical mastitis is very low in some herds, selective dry cow therapy can be considered, but nearly all herds use blanket dry cow therapy. The problem with selective dry cow therapy is the accuracy of available indirect tests to 'select' cows for treatment or non-treatment. Currently available indirect tests are not sufficiently accurate (the exception being quarter milk cultures) to be used as a basis for selective dry cow therapy.

Intramammary infusions approved for dry cow therapy contain high levels of antimicrobial agents in a slow-release base that maintains therapeutic levels in the dry udder for long periods of time. Most dry cow therapy infusion products are intended to eliminate existing infections due to *S. aureus* and *S. agalactiae* at drying off and to prevent new infections due to the same pathogens and environmental streptococci in the early dry period.

In herds with a high prevalence of contagious mastitis, dry cow therapy has been efficacious and economically beneficial in reducing the prevalence of intramammary infections. The consistent application of effective mastitis control procedures has reduced the prevalence of contagious pathogens and the bulk tank milk SCC (<300 000 cells/mL) and owners of these herds questioned dry cow therapy because of the economics and the concerns of residues in the milk. Field trials in herds with a low prevalence of contagious mastitis indicate that dry cow therapy at the end of lactation increased 17-week milk production during the subsequent lactation and was economically beneficial compared to not treating them.<sup>111</sup> However, in the subsequent lactation, the incidence of clinical mastitis was not reduced nor were the SCCs significantly different from those of cows not treated at the end of lactation.

The most effective time to treat subclinical intramammary infections is at drying off. Dry cow therapy has the following advantages over lactation therapy:

- The cure rate is higher than that achieved by treatment during lactation
- A much higher dose of antimicrobial can be used safely
- Retention time of the antimicrobial in the udder is longer
- The incidence of new infections during the dry period is reduced
- Tissue damage by mastitis may be regenerated before parturition
- Clinical mastitis at calving may be reduced
- The risk of contaminating milk with antimicrobial residue is reduced.

Selection of a suitable dry period treatment should take into account the fact that Gram-negative infections are not common at that time because of the high concentration of lactoferrin in the dry secretions. Accordingly attention should be directed at the inclusion of a potent antibiotic against *Streptococcus* spp., beta-lactamase-producing *S. aureus*, and *A. pyogenes*. Cloxacillin, nafcillin, and cephalosporins are popular for the purpose; for example, a recommended treatment is cephapirin or sodium cloxacillin in a slow-release base with an expected cure rate of 80% against streptococci and 60% against *S. aureus*.

Most dry cow preparations maintain an adequate minimum concentration in the quarter for about 4 weeks, but some persist for 6 weeks. There is little, if any, value in treating cows again before the due calving date. There is always a possibility of introducing infection while

infusing an intramammary preparation and farmers are reluctant to break the teat canal seal, but it may be necessary to do so if summer mastitis is prevalent in the area.

### Prepartum antimicrobial therapy in heifers

Intramammary infusion of a cephalosporin dry cow therapy preparation into pregnant heifers 10–12 weeks prepartum eliminated over 90% of the intramammary infection due to *S. aureus*, *Streptococcus* spp., coagulase-negative staphylococci spp. and coliforms. The SCCs of cured quarters were comparable to uninfected control quarters after parturition.<sup>112</sup> At parturition, 24% of treated quarters were positive for the antimicrobial; however, no quarters were positive at 5 days postpartum.

### Antimicrobial residues in milk and withholding times

Label instructions must be followed to insure that drug residues do not occur, especially from cows with a shorter than normal dry period. Antibiotic residue testing of the milk of a recently calved cow can be done if there is a suspicion of residues, but this is a misuse of a test designed for bulk tank milk testing and therefore suffers from problems with sensitivity and specificity.

Treatment and control of mastitis accounts for the largest percentage of antimicrobial use on dairy farms. Following treatment by the intramammary or parenteral route, the concentration of antimicrobial agents in the milk declines over time to levels that are considered safe and tolerable for humans. The duration of time for the concentrations to decline to acceptable limits is known as the **withholding time** or the **withdrawal period** during which the milk cannot be added to the bulk tank supply but must be withheld and discarded. The presence of residues in milk is a major public health concern that adversely affects the dairy industry, the practicing veterinarian and the perception the public has of the safety of milk for human consumption. The public perception of the safety of milk is crucial and veterinarians have a responsibility to respond to these concerns through public education and quality control of milk production.

Other serious consequences of antimicrobial residues in milk are their effect on the manufacture of dairy products and the potential development of antimicrobial sensitivity syndromes in humans. In most countries the maximum intramammary dose of antimicrobial agents is limited by legislation and the presence of detectable quantities of antimicrobial agents in milk constitutes adulteration. Attention has also been directed to the excretion of anti-

microbial agents in milk from untreated quarters, after treatment of infected quarters and after their administration by parenteral injection or by insertion into the uterus. The degree to which this excretion occurs varies widely between animals and in the same animal at different points in the lactation period, and differs from one antibiotic to another. Milk from cows subjected to dry period treatment is usually required to be withheld for 4 days after calving. The use of any dry period treatments in lactating cows causes prolonged retention of the antimicrobial in milk and is a most serious violation of the legislation.

Veterinarians have the responsibility to warn farmers of the need to withhold milk, and both should be aware of the withholding times of each product, details of which are usually required to be included on its label. Marking the cow in some way to remind the farmer, by application of a leg band or placing dye on the udder, is advisable.

### Antimicrobial residue tests

Several cowside tests are available to detect antimicrobial residues in the milk of cows that have been treated for mastitis.<sup>113</sup> The goal of cowside testing is to assist in the production of high-quality, antimicrobial-residue-free milk from dairy herds. To be consistent with the intent of a quality assurance program, cowside testing would be used only on cows recently treated with antimicrobial agents and only after appropriate milk withholding times had been followed. The ideal test would have a high sensitivity and high specificity.

Most of the cowside screening tests for antimicrobial residues are imperfect because of a high rate of false-positive results when used on field samples. The direct costs to producers can be high because of the unnecessary disposal of milk and imposition of fines and penalties. False-positive results also cause the unnecessary culling of some cows, and concern about the interpretation of positive assay results, the appropriateness of withholding periods and the safety of milk creates mistrust among consumers, producers, veterinarians and regulatory personnel. The specificity of four commercially available tests ranged from 0.78–0.95.<sup>114</sup> None of the test kits has been validated to meet performance standards for sensitivity and specificity. This applies to individual cow samples, bulk tank milk samples and tanker truck samples.

The presence of naturally occurring bactericidal products in the milk of cows with acute and convalescent mastitis is the most likely cause of the false-positive

results of the tests (such as Delvo-test<sup>®</sup>) that are based on bacterial growth inhibition of beta-lactam antimicrobial agents.<sup>113</sup> Immunoglobulins, complement, lysozyme, lactoferrin and phagocytic cells are products of inflammation in the milk of cows with mastitis that can inhibit bacterial growth. The milk from cows with experimental endotoxin-induced mastitis is at increased risk for false-positive assay results using commercial residue tests.<sup>114</sup> The incidence of false-positive results is very low in milk from cows that have not had a history of mastitis or antimicrobial therapy.<sup>115</sup> Naturally occurring bactericidal products in mastitic milk can be removed by heating at 82°C for 5 minutes; this temperature does not denature antimicrobial agents present in milk.<sup>116</sup> Heat treatment therefore appears to provide a very practical way to reduce false-positive results on milk from individual cows.

A sample of milk can be submitted for antimicrobial residue testing up to three times. First, a producer may test a sample from a specific cow at the end of her withdrawal period. Second, milk is sampled at the tanker truck level. Third, should the tanker truck sample have positive results, bulk tank milk samples from each dairy herd that contributed to that tanker truck are tested.

There is a need for validation of the diagnostic assays used to detect antimicrobial residues in milk.<sup>117</sup> Acceptance of assays for regulatory purposes must be based on protocols that include field estimates of assay performance before the assays are used by the public. Three strategies have been suggested to balance public health concerns with economic concerns of dairy producers caused by false-positive results:

- Retest samples that yield positive results with a confirmatory assay of specificity close to 100%. Only those samples that also yield positive results on the second assay are considered to be positive for violative residues
- Recalibrate the assay to increase specificity. This will usually result in loss of sensitivity
- Use an alternative assay of higher specificity.<sup>117</sup>

It is suggested that regulatory monitoring of residues at a national level will be best served by use of a combination of at least two assays: initial screening with a highly sensitive and inexpensive assay followed by confirmation testing with an assay of high specificity (> 99%) that can quantify the concentration of the antimicrobial residue. All tanker samples that yield positive results with a screening assay should be rechecked with a quantitative assay. If the quantitative assay detects a concentration

greater than the safe level, safe concentration or tolerance level, only then would the milk be deemed to have violative residue and fines and penalties be imposed.<sup>117</sup> The complex dynamics of current milk residue tests discourage practitioners from recommending testing procedures to dairy producers.<sup>118</sup>

As an approximate guide, the recommended periods for which milk should be withheld from sale after different methods of antimicrobial administration are (in times after last treatment):

- Udder infusion in a lactating cow – 72 hours
- Parenteral injection, one only – 36 hours
- Parenteral injections, series of – 72 hours
- Antimicrobial agents parenterally in long-acting bases – 10 days
- Intrauterine tablet – 72 hours
- Dry cow intramammary infusion – to be administered at least 4 weeks before calving and the milk withheld for at least 96 hours afterwards.

#### Permanently drying off chronically affected quarters

If a quarter does not respond to treatment and is classified as incurable, the affected animal should be isolated from the milking herd or the affected quarter may be permanently dried off by inducing a chemical mastitis. Historically used methods, arranged in decreasing order of severity, are infusions of:

- 30–60 mL of 3% silver nitrate solution
- 20 mL of 5% copper sulfate solution
- 100–300 mL of 1:500, or 300–500 mL of a 1:2000 acriflavine solution.

If a severe local reaction occurs, the quarter should be milked out and stripped frequently until the reaction subsides. If no reaction occurs, the quarter is stripped out 10–14 days later. Two infusions of these solutions may be necessary.

The **best method for permanently drying off a quarter is infusion of 120 mL of 5% povidone-iodine solution (0.5% iodine)** after complete milk-out and administration of flunixin meglumine (1 mg/kg BW, intravenously). This causes permanent cessation of lactation in the quarter but does not alter total milk production by the cow. If the goal is chemical sterilization, then three daily infusions of 60 mL of chlorhexidine suspension should be administered after complete milk-out. The majority of treated cows (5/7) returned to milk production in the quarter in the subsequent lactation.<sup>119</sup> The infusion of 60 mL of chlorhexidine, followed by milking out at the next subsequent milking and repeat of the infusion 24 hours after the initial treatment is also effective in

making infused quarters nonfunctional within 14–63 days.<sup>120</sup> Histological evaluation of the infused quarters revealed that secretory tissues had involuted to a nonsecretory state and appeared similar to blind or nonfunctional quarters. However, as noted above, milk production may return in the gland in the subsequent lactation.

#### REVIEW LITERATURE

- Burton JL, Erskine RJ. Immunity and mastitis: some new ideas for an old disease. *Vet Clin North Am Food Anim Pract* 2003; 19:1–46.
- Constable PD, Morin DE. Treatment of clinical mastitis: using antimicrobial susceptibility profiles for treatment decisions. *Vet Clin North Am Food Anim Pract* 2003; 19:139–156.
- Erskine RJ, Wagner SA, DeGraves FJ. Mastitis therapy and pharmacology. *Vet Clin North Am Food Anim Pract* 2003; 19:109–138.
- Pyörälä S. Indicators of inflammation in the diagnosis of mastitis. *Vet Res* 2003; 34:565–578.
- Roberson JR. Establishing treatment protocols for clinical mastitis. *Vet Clin North Am Food Anim Pract* 2003; 19:223–234.
- Schukken YH et al. Monitoring udder health and milk quality using somatic cell counts. *Vet Res* 2003; 34:579–596.
- Sears PM, McCarthy KK. Diagnosis of mastitis for therapy decisions. *Vet Clin North Am Food Anim Pract* 2003; 19:93–108.

#### REFERENCES

1. Fox LK et al. *J Dairy Sci* 1995; 78:1619.
2. Pankey JW et al. *J Dairy Sci* 1991; 74:1550.
3. Nickerson SC et al. *J Dairy Sci* 1995; 78:1607.
4. Miltenburg JD et al. *Vet Rec* 1996; 139:204.
5. Firat MZ. *Livestock Prod Sci* 1993; 36:311.
6. Bartlett PC et al. *Prev Vet Med* 1992; 12:59.
7. Sargeant JM et al. *Can Vet J* 1998; 39:33.
8. Simpson RB et al. *J Anim Sci* 1995; 73:1552.
9. Fox LK, Gay JM. *Vet Clin North Am Food Anim Pract* 1993; 9:475.
10. Aarestrup FM et al. *Acta Vet Scand* 1995; 36:475.
11. Smith KL, Hogan JS. *Vet Clin North Am Food Anim Pract* 1993; 9:489.
12. Trinidad P et al. *J Dairy Sci* 1990; 73:107.
13. Aarestrup FM, Jensen NE. *J Dairy Sci* 1997; 80:312.
14. Robertson JR et al. *J Dairy Sci* 1994; 77:958.
15. Oliver SP et al. *J Dairy Sci* 1990; 73:351.
16. Paape MJ et al. *J Dairy Sci* 1992; 75:1849.
17. Erskine RJ et al. *J Am Vet Med Assoc* 1988; 192:761.
18. Slettbakk T et al. *Prev Vet Med* 1995; 24:235.
19. Zeconi A et al. *J Dairy Sci* 1996; 63:361.
20. Shearn MFH, Hillerton JE. *J Dairy Res* 1996; 63:525.
21. Schreiner DA, Ruegg PL. *J Dairy Sci* 2003; 86:3460.
22. Erskine RJ. *Vet Clin North Am Food Anim Pract* 1993; 9:551.
23. Jukola E et al. *J Dairy Sci* 1996; 79:838.
24. Shook GE, Schutz MM. *J Dairy Sci* 1994; 77:648.
25. Philipsson J et al. *Livestock Prod Sci* 1995; 41:195.
26. Schutz MM. *J Dairy Sci* 1994; 77:2113.
27. Grohn YT et al. *J Dairy Sci* 1995; 78:1693.
28. Enevoldsen C et al. *J Dairy Res* 1995; 62:69.
29. Firat MZ. *Livestock Prod Sci* 1993; 34:175.
30. Lam TJM et al. *Am J Vet Res* 1997; 58:17.
31. Judge LJ et al. *J Dairy Sci* 1997; 80:3212.
32. Zdanowicz M et al. *J Dairy Sci* 2004; 87:1694.
33. Bartlett PC et al. *J Dairy Sci* 1992; 14:195.
34. Lescourret F et al. *J Dairy Sci* 1995; 78:2167.
35. Lipman LJA et al. *Vet Microbiol* 1995; 48:51.
36. Risco CA et al. *J Dairy Sci* 1999; 82:1684.

37. DeGreaves HJ, Fetrow J. *Vet Clin North Am Food Anim Pract* 1993; 9:421.
38. Miller GY et al. *J Am Vet Med Assoc* 1993; 202:1230.
39. Hoblet KH et al. *J Am Vet Med Assoc* 1991; 199:190.
40. Steele ML et al. *J Food Prot* 1997; 60:1341.
41. Lee CS et al. *J Dairy Res* 1980; 47:39.
42. Lescourret F, Coulon JB. *J Dairy Sci* 1994; 77:2289.
43. Jones GF, Ward GE. *J Am Vet Med Assoc* 1990; 196:597.
44. Grohn YT et al. *J Dairy Sci* 2004; 87:3358.
45. Grohn YT et al. *Prev Vet Med* 2005; 71:105.
46. Fenlon DR et al. *Br Vet J* 1995; 151:17.
47. Wilson DJ et al. *J Am Vet Med Assoc* 1997; 210:1499.
48. Godkin MA, Leslie KE. *Can Vet J* 1993; 34:601.
49. Villanueva MR et al. *J Am Vet Med Assoc* 1991; 198:1398.
50. Dinsmore RP et al. *J Dairy Sci* 1992; 75:2706.
51. Walker M et al. *Proc Am Assoc Bovine Pract* 2005; 171.
52. Leslie KE et al. In: *Proceedings of the 3rd International Mastitis Seminar*, Tel Aviv, Israel 1995; (S2):66.
53. Waage S et al. *Acta Vet Scand* 1994; 35:207.
54. Yazdankhah SP et al. *J Clin Microbiol* 2001; 39:3228.
55. Morin DE, Constable PD. *J Am Vet Med Assoc* 1998; 213:855.
56. Zorah RCW et al. *Vet Rec* 1993; 132:208.
57. Gooray R. *Vet Microbiol* 1994; 42:317.
58. Pyörälä S. *Vet Res* 2003; 34:565.
59. Emanuelson U, Funke H. *J Dairy Sci* 1991; 74:2479.
60. Maunsell FP et al. *J Am Vet Med Assoc* 1999; 214:1817.
61. Whyte D et al. *J Dairy Res* 2005; 72:115.
62. Holdaway RJ et al. *Aust J Dairy Technol* 1996; 51:64, 72, 80.
63. Ball HJ, Greer D. *Vet Rec* 1991; 129:507.
64. Milner P et al. *J Dairy Sci* 1996; 79:83.
65. Maatje K et al. *Livestock Reprod Sci* 1992; 30:239.
66. Nielsen M et al. *J Dairy Sci* 1995; 78:1039, 1050.
67. Hamann J, Zeconi A. *Int Dairy Fed Bull* 1998:334.
68. Norberg E et al. *J Dairy Sci* 2004; 87:1099.
69. Sisco WM et al. *J Am Vet Med Assoc* 1997; 211:470.
70. Smith GW et al. *J Vet Intern Med* 2001; 15:394.
71. Bradley KJ et al. *Vet Rec* 2001; 148:497.
72. Trostle SS, O'Brien RT. *Compend Contin Educ Pract Vet* 1998; 20:S65.
73. Franz S et al. *Am J Vet Res* 2004; 65:1159.
74. Farr VC et al. *J Dairy Sci* 1996; 79:543.
75. Kirk JJ et al. *J Am Vet Med Assoc* 1994; 204:1152.
76. Shim EH et al. *J Dairy Sci* 2004; 87:2702.
77. Shukken YH, Deluyker HA. *J Vet Pharmacol Ther* 1995; 18:274.
78. Hallberg JW et al. In: *Proceedings of the 33rd National Mastitis Council Annual Meeting* 1994:28.
79. Morin DE et al. *J Am Vet Med Assoc* 1998; 212:1423.
80. Pyörälä S, Pyörälä E. *J Am Vet Med Assoc* 1998; 212:407.
81. Guterbock WM. *Proc Annu Conv Am Assoc Bovine Pract* 1994; 26:67.
82. Sears PM, McCarthy KK. *Vet Clin North Am Food Anim Pract* 2003; 19:93.
83. Erskine RJ et al. *Vet Clin North Am Food Anim Pract* 2003; 19:109.
84. Constable PD, Morin DE. *J Am Vet Med Assoc* 2002; 221:103.
85. Hoe FGH, Ruegg PL. *J Am Vet Med Assoc* 2005; 227:1461.
86. Constable PD, Morin DE. *Vet Clin North Am Food Anim Pract* 2003; 19:139.



87. McKellar QA et al. *J Vet Pharmacol Ther* 2004; 27:503.
88. Whittam T. *J Vet Pharmacol Ther* 1999; 22:41.
89. Oliver SP et al. *J Dairy Sci* 2004; 87:3322.
90. Oliver SP et al. *J Dairy Sci* 2004; 87:2392.
91. Deluyker HA et al. *J Dairy Sci* 2005; 88:604.
92. Hillerton JE, Kliem KE. *J Dairy Sci* 2002; 85:1009.
93. Watts JL et al. *J Dairy Sci* 1995; 78:1637.
94. Bezek DM. *J Am Vet Med Assoc* 1998; 212:404.
95. Ziv G. *Vet Clin North Am Food Anim Pract* 1992; 8:1.
96. Morin DE et al. *J Am Vet Med Assoc* 1998; 213:676.
97. Wenz JR et al. *J Dairy Sci* 2005; 88:3496.
98. Pyorala SHK, Pyorala EO. *J Am Vet Med Assoc* 1998; 212:407.
99. Sears PM et al. *Vet Clin North Am Food Anim Pract* 1993; 9:445.
100. Olover SP et al. *J Dairy Sci* 2003; 86:1187.
101. Wagner SA, Apley MD. *Am J Vet Res* 2004; 65:64.
102. Shpigel NY et al. *Res Vet Sci* 1994; 56:62.
103. Shpigel NY et al. *J Vet Med A* 1996; 43:331.
104. Rantala M et al. *J Vet Pharmacol Ther* 2002; 25:251.
105. Green MJ et al. *Vet Rec* 1997; 140:149.
106. Dascanio JJ et al. *Am J Vet Res* 1995; 56:1213.
107. Roeder BL et al. *Am J Vet Res* 1997; 58:549.
108. Tyler JW et al. *Am J Vet Res* 1994; 55:278.
109. Daley MJ et al. *J Dairy Sci* 1992; 75:3330.
110. National Mastitis Council. Dry cow therapy. Bulletin C-12254. Arlington, VA: National Mastitis Council 1995.
111. Berry SL et al. *J Am Vet Med Assoc* 1997; 211:207.
112. Owens WE et al. *J Vet Med B* 1994; 41:90.
113. Sischo WM, Burns CM. *J Am Vet Med Assoc* 1993; 202:1249.
114. Tyler JW et al. *J Am Vet Med Assoc* 1992; 201:1378.
115. Halbert LW et al. *J Food Prot* 1996; 59:886.
116. Kang JH et al. *J Dairy Sci* 2005; 88:908.
117. Gardner IA et al. *J Am Vet Med Assoc* 1996; 209:46.
118. Slenning BD, Gardner IA. *J Am Vet Med Assoc* 1997; 211:419.
119. Middleton JR, Fox LK. *J Dairy Sci* 2001; 84:1976.
120. Boddie RL, Nickerson SC. *Agri-Practice* 1994; 15:12.

## Mastitis pathogens of cattle

In the sections which follow, the special features of each mastitis associated with one or a group of pathogens will be described using the usual format of the book. Mastitis in cattle is categorized as being associated with contagious, teat skin opportunistic or environmental pathogens, and as being common or less common. The features that are unique to the diagnosis, treatment and control of each mastitis pathogen will be outlined but details applicable to all causes of mastitis have been presented above.

## Mastitis of cattle associated with common contagious pathogens

### STAPHYLOCOCCUS AUREUS

#### Synopsis

**Etiology** *Staphylococcus aureus* is a major pathogen of the mammary gland and a common cause of contagious bovine mastitis. *S. aureus* also causes mastitis in sheep and goats

**Epidemiology** Major cause of mastitis in dairy herds without an effective mastitis control program. Prevalence of infection 50–100%; prevalence of 1–10% in herds with low bulk tank milk SCCs, 50% in high-SCC herds, quarter infection rate 10–25% in high-SCC herds. Source of infection is infected udder; infection transmitted at milking. Chronic or subclinical *S. aureus* mastitis is of major economic importance

#### Clinical findings

- Chronic *S. aureus* mastitis is most common and is characterized by high SCC and gradual induration of udder, drop in milk yield and atrophy with occasional appearance of clots in milk or wateriness
- Acute and peracute *S. aureus* mastitis most common in early lactation. Acute swelling of gland with fever; milk is abnormal with thick clots and pus; gangrene of gland and teat in peracute form. Systemic reaction with anorexia, toxemia, fever, ruminal stasis

**Clinical pathology** Culture individual cow milk sample; indirect tests are high SCC and California Mastitis Test results

**Necropsy findings** Peracute, acute, and chronic (recurrent) clinical mastitis, subclinical mastitis common

**Diagnostic confirmation** Culture milk for pathogen

#### Differential diagnosis

- Peracute mastitis
- Peracute coliform mastitis
- *Arcanobacterium* (formerly *Actinomyces* or *Corynebacterium*) *pyogenes* mastitis
- Parturient paresis
- Acute and chronic mastitis. Not clinically distinguishable from other causes of mastitis. Must culture milk

#### Treatment

- **Lactating cows** – cure rates for lactating cows with subacute staphylococcal mastitis less than 50%. Intramammary infusions daily for at least 3 days, preferably 5–8 days
- **Peracute mastitis** – antimicrobial agents parenterally and intramammary that are beta-lactamase-resistant, fluid and electrolyte therapy
- **Dry cow therapy** – chronic or subclinical mastitis best treated at drying off with long-acting intramammary antimicrobial infusions that are beta-lactamase-resistant

#### Control

- Prevent new infections by early identification, culling infected cows and good milking procedures, including hygienic washing and drying of udders and teats before milking and postmilking germicidal teat dips. Regular milking machine maintenance. Consider segregation of infected cows
- Eliminate existing infections by dry cow therapy
- Immunization with vaccines may be possible in future

#### ETIOLOGY

**Coagulase-positive *S. aureus*** is a major pathogen of the bovine mammary gland

and a common cause of contagious mastitis in cattle. *S. aureus* also causes mastitis in sheep and goats.

#### EPIDEMIOLOGY

##### Occurrence and prevalence of infection

Coagulase-positive staphylococci

Historically, *S. aureus* was one of the most common causes of bovine mastitis in dairy cattle worldwide. In the last 25 years, the prevalence of infection and the occurrence of clinical mastitis due to *S. aureus* has decreased in herds using effective mastitis control measures. However, surveys indicate that 50–100% of herds may be infected. In low-SCC herds, the prevalence of infection in cows ranges from 1–10%. In other herds, especially those with high SCCs, up to 50% of cows may be infected with *S. aureus*, with quarter infection rates ranging from 10–25%. The prevalence of infection of *S. aureus* in heifers at parturition can range from 5–15%. **The majority of intramammary infections due to *S. aureus* are subclinical.** The incidence of clinical mastitis due to *S. aureus* is dependent on its prevalence of infection in the herd. With an effective mastitis control program, the most common causes of clinical mastitis are the environmental pathogens. However, in some herds with a low rolling SCC, incidence of clinical mastitis due to *S. aureus* ranges from 190–240 cases/100 cows/year, with about 47% of the clinical cases being *S. aureus*.<sup>1</sup>

##### Source of infection and method of transmission

*S. aureus* is ubiquitous in the environment of dairy cattle. The infected mammary gland of lactating cows is the major reservoir and source of the organism.<sup>2</sup> The prevalence of intramammary infection in primiparous heifers at parturition ranges from 2–50% and may represent an important reservoir of infection in herds with a low prevalence of infection. The organism may be present on the skin of the teats and external orifices of heifers, bedding materials, feedstuffs, housing materials, nonbovine animals on the farm, and equipment. In herds with a high prevalence of infection (> 10% of cows), the organism was present in bedding, the hands and noses of dairy herd workers, insects and water supplies.<sup>2</sup> Transmission between cows occurs at the time of milking by contaminated milkers' hands and teat cup liners. Although *S. aureus* can multiply on the surface of the skin and provide a source of infection for the udder, the teat skin lesions are usually infected originally from the udder,

and teat skin is a minor source of infection.

The hornfly (*Hameotobia irritans*) is an important vector for transmitting *S. aureus* mastitis in heifers, particularly in herds with scabs on the teat ends of heifers.<sup>3,4</sup> Prevention of high populations of flies in heifers is therefore needed to decrease new infections in this group.

### Risk factors

#### Animal risk factors

Several animal risk factors influence the prevalence of infection and the occurrence of clinical mastitis due to *S. aureus*.

#### Local defense mechanisms

Abrasions of the teat orifice epithelium are an important risk factor for *S. aureus* mastitis.<sup>5</sup> In experiments, teat canal infection or colonization may develop in 93% of experimentally abraded teat canal orifices compared to 53% in control quarters. Chapping of the teats and thickness of the teat barrel are correlated and significantly influence recovery of *S. aureus* from the skin.<sup>6</sup>

#### Colonization with minor pathogens

The presence of minor pathogens such as coagulase-negative staphylococci protects against new intramammary infections associated with the major pathogen *S. aureus*.<sup>7</sup> This may be the result of an elevated SCC or an antimicrobial-like substance provided by the coagulase-negative staphylococci that inhibits the growth of *S. aureus*. Conversely, quarters infected with coagulase-negative staphylococci may be more susceptible to new infections with *S. agalactiae*. Quarters that are infected with *C. bovis* are protected against *S. aureus* infection but not protected against most streptococcal species.

#### Parity of cow

The prevalence of intramammary infection and subclinical infection due to *S. aureus* increases with parity of the cow. This is probably due to the increased opportunity of infection with time and the prolonged duration of infection, especially in a herd without a mastitis control program.

#### Presence of other diseases

The presence of periparturient diseases such as dystocia, parturient paresis, retained placenta and ketosis has been identified as a risk factor for mastitis. The occurrence of sole ulcers in multiple digits may be associated with *S. aureus* in the first lactation.<sup>8</sup>

#### Heredity

Experimentally, the presence of certain bovine lymphocyte antigens increased the susceptibility to *S. aureus* infection<sup>9</sup> but heritability estimates of susceptibility

after experimental challenge were low and unstable.

#### Immune system

The infection rate of *S. aureus* is dependent on the ability of the immune system to recognize and to eliminate the bacteria.<sup>10</sup> Staphylococcal antibodies are present in the blood of infected cows but they appear to afford little protection against mastitis associated with *S. aureus*. This may be due to the low titer of the antibodies in the milk. Antibody titers in the serum rise with age and after an attack of mastitis.

The development or persistence of *S. aureus* mastitis depends on the interaction between invading bacteria and the host's defense system, principally the somatic cells in an infected gland, which are more than 95% polymorphonuclear cells. The number of bacteria isolated from milk samples of *S. aureus*-infected mammary glands is characterized by a cyclic increase and decrease concomitant with an inverse cycling of the SCC. This relationship between SCC and numbers of bacteria indicates that the cells within the mammary gland have a central role in the pathogenesis of *S. aureus* infection.<sup>11</sup> There appear to be qualitative changes in the ability of the animal's somatic cells to phagocytose the bacteria. During the period of high SCC, the cells are able to kill bacteria 9000 times more efficiently than during the low-SCC period. The relative inability of the polymorphonuclear cells to kill bacteria during the low-SCC period may explain the source of reinfection. Phagocytosis and killing of the bacteria may also be inefficient because of low concentrations of opsonins, a lack of energy source, and the presence of casein and fat globules in the milk. The function of the intramammary polymorphonuclear cell (somatic cells) may also be affected by immunosuppression induced by cortisol and dexamethasone in treated cows.<sup>12</sup>

#### Environmental and management risk factors

Several herd-level management risk factors are important for the spread of *S. aureus*.<sup>13</sup> Poor teat and udder cleaning can allow spread of the organism among quarters of the same cow, and can allow contamination of milking units, which are commonly transferred among cows without washing or rinsing. The use of high-line parlors is a risk; this may be due to the greater fluctuation in vacuum, especially when units are removed, leading to a greater occurrence of teat end impacts in which bacteria in the milking unit may enter the teat canal to establish a new udder infection.

Extensive surveys reveal that management procedures that are most effective in

reducing infection rates and cell counts associated with infections with *S. aureus* are:

- Postmilking teat dipping
- Maintaining a good supply of dry bedding for housed cows
- Thorough disinfection of the teat orifice before infusing intramammary preparations
- Milking clinical cases last.

Failure to use these management techniques will increase the risk of intramammary infection with *S. aureus*.

#### Pathogen risk factors

##### Virulence factors

*S. aureus* has several virulence factors that account for its pathogenicity and persistence in mammary tissue in spite of adequate defense mechanisms and antimicrobial therapy. **Most isolates from cattle appear to be host-adapted and different from human *S. aureus* isolates.** *S. aureus* has the ability to **colonize the epithelium** of the teat and the streak canal, and can adhere and bind to epithelial cells of the mammary gland. The specific binding is to the extracellular matrix proteins fibronectin and collagen, which can induce the epithelial cell to internalize the organism, protecting it from both exogenous and endogenous bactericidal factors. Some strains of *S. aureus* are capable of **invading bovine mammary epithelial cells** in culture, and the invasion process requires eukaryotic nucleic acid and protein synthesis as well as bacterial synthesis.<sup>14</sup>

Some strains of *S. aureus* produce **toxins**, some of which may cause **phagocytic dysfunction**. The beta toxin, or a combination of alpha toxins and beta toxins, is produced by most pathogenic strains isolated from cattle but its pathogenic significance is uncertain. The beta toxin damages bovine mammary secretory epithelial cells, increases the damaging effects of alpha toxin, increases the adherence of *S. aureus* to mammary epithelial cells and increases the proliferation of the organism.<sup>15</sup> All strains produce **coagulase** (hence the term coagulase positive *S. aureus*), which converts fibrinogen into fibrin; this appears to assist the invasion of tissues. **Leukocidin** produced by *S. aureus* may inactivate neutrophils.

Many staphylococcal strains (coagulase-negative and -positive) are able to produce an **extracellular exopolysaccharide layer** surrounding the cell wall.<sup>16</sup> This capsular structure and its production of slime have been associated with virulence against host defense mechanisms.

A major pathogenic factor is the ability of the organism to colonize and produce

microabscesses in the mammary gland so that it is protected from normal defense mechanisms, including phagocytic activity from neutrophils. The difficulty in removing staphylococci from an infected quarter is due largely to the bacteria's ability to survive in intracellular sites. There is also an ability to convert to a **nonsusceptible L-form** when exposed to antimicrobial agents, and to return to standard forms when the antimicrobial is withdrawn.

#### *Genotype of strains*

**Phage typing and ribotyping** can be used to classify strains from clinical and subclinical *S. aureus* mastitis.<sup>17</sup>

**DNA fingerprinting techniques**, using polymerase chain reaction, are also being used to differentiate various strains of the organism.<sup>18</sup> A large number of different types of *S. aureus* can be isolated from cases of bovine mastitis but a few types predominate within different countries.<sup>19</sup> Surveys have found that only a small number of genotypes cause most cases of *S. aureus* mastitis,<sup>18</sup> which may be useful information in determining the dynamics of infection in a herd and how infection spreads from cow to cow. Fine-structure molecular epidemiological analysis of *S. aureus* recovered from cows in the USA and Ireland indicates that only a few specialized clones of *S. aureus* are responsible for the majority of cases of bovine mastitis, and that these clones have a broad geographical distribution.<sup>20</sup> **A predominant strain is usually responsible for most clinical and subclinical *S. aureus* infections in a herd,**<sup>21,22</sup> and it is currently believed that *S. aureus* is a clonal organism that spreads from cow to cow. Moreover, most strains isolated from milk are different from strains isolated from the teat skin. In other words, most *S. aureus* strains isolated from mastitis demonstrate both host and site specificity.<sup>22</sup> This has important implications in the control of mastitis associated with *S. aureus*, as a rational and effective strategy for control of intramammary infections should be directed against clones that commonly cause disease.

#### **Economic importance**

The overall prevalence of mastitis due to *S. aureus* is much higher than for *S. agalactiae*, and the need for culling causes much greater economic consequences. The risk of new infections is of continuing concern. Response to treatment is comparatively poor, and satisfactory methods for the eradication of staphylococcal mastitis from infected herds have yet to be devised.

#### **Zoonotic implications**

The presence of *S. aureus* in market milk may present a degree of risk to the

consumer because of the organism's capacity to produce enterotoxins and a toxic shock syndrome toxin, which cause serious food poisoning. Mastitic milk does not constitute any large risk for *S. aureus* enterotoxin food poisoning.<sup>23</sup>

#### **PATHOGENESIS**

The disease can be reproduced experimentally by the injection of *S. aureus* organisms into the udder of cattle and sheep but there is considerable variation in the type of mastitis produced. This does not seem to be due to differences in virulence of the strains used, although strain variations do occur, but may be related to the size of the inoculum used or, more probably, to the lactational status of the udder at the time of infection. It is possible to induce *S. aureus* infection in the bovine teat cistern; the teat tissues are able to mount a marked local inflammatory response but in spite of large numbers of neutrophils that invade the teat, they are unable to control the infection, except when the numbers of bacteria are low.<sup>24</sup>

Infection during early lactation may result in the peracute form of mastitis, with gangrene of the udder. During the later stages of lactation or during the dry period new infections are not usually accompanied by a systemic reaction but result in the chronic or acute forms. Chronic *S. aureus* mastitis in cows has been converted to the peracute, gangrenous form by the experimental production of systemic neutropenia.

In the **gangrenous form** the death of tissue is precipitated by thrombosis of veins causing local edema and congestion of the udder. *S. aureus* are the only bacteria that commonly cause this reaction in the udder of the cow, and the resulting toxemia is due to bacterial toxins and tissue destruction. Secondary invasion by *E. coli* and *Clostridium* spp. contributes to the severity of the lesion and production of gas.

The pathogenesis of acute and chronic *S. aureus* mastitis in the cow is the same, the variation occurring only in degree of involvement of mammary tissue. In both forms each focus commences with an acute stage characterized by proliferation of the bacteria in the collecting ducts and, to a lesser extent, in the alveoli. In **acute** mastitis the small ducts are quickly blocked by fibrin clots, leading to more severe involvement of the obstructed area.

In the **chronic** form there are fewer foci of inflammation and the reaction is milder; the inflammation is restricted to the epithelium of the ducts. This subsides within a few days and is replaced by connective tissue proliferations around

the ducts, leading to their blockage and atrophy of the drained area. The leukocyte infiltration into the stroma, the epithelial lining and the lumina indicate an obvious deficiency of secretory and synthesizing capacity due to limitation of the alveolar lumina and the distension of the stroma area.

A characteristic of chronic *S. aureus* mastitis that is important in its diagnosis is the cyclical shedding of the bacteria from the affected quarter. Paralleling this variation is a cyclical rise and fall in the number of polymorphonuclear cells in the milk, and their capacity to phagocytose bacteria.<sup>11</sup> In some cases abscesses develop and botryomycosis of the udder, in which granulomata develop containing Gram-positive cocci in an amorphous eosinophilic mass, is also seen.

#### **CLINICAL FINDINGS**

##### **Chronic *Staphylococcus aureus* mastitis**

The most important losses are caused by the chronic form or subclinical form of mastitis. Although 50% of cattle in a herd may be affected, only a few animals will have abnormalities recognizable by the milker. Many cases are characterized by a slowly developing induration and atrophy with the occasional appearance of clots in the milk or wateriness of the first streams. The SCC of the milk is increased, as well as the CMT results of infected quarters, but the disease may go unnoticed until much of the functional capacity of the gland is lost. The infection can persist and the disease may progress slowly over a period of many months.

##### **Acute and peracute *Staphylococcus aureus* mastitis**

Acute and peracute staphylococcal mastitis are rare but do occur and can be fatal, even if aggressively treated.

**Acute *S. aureus* mastitis** occurs most commonly in early lactation. There is severe swelling of the gland and the milk is purulent or contains many thick clots. Extensive fibrosis and severe loss of function always result.

**Peracute *S. aureus* mastitis** occurs usually in the first few days after calving and is highly fatal. There is a severe systemic reaction with elevation of the temperature to 41–42°C (106–107°F), rapid heart rate (100–120 beats/min), complete anorexia, profound depression, absence of ruminal movements and muscular weakness, often to the point of recumbency. The onset of the systemic and local reactions is sudden. The cow may be normal at one milking and recumbent and comatose at the next. The affected quarter is grossly swollen, hard and sore to touch, and causes severe lameness on the affected side.

**Gangrene** is a constant development and may be evident very early. A bluish discoloration develops that may eventually spread to involve the floor of the udder and the whole or part of the teat, or may be restricted to patches on the sides and floor of the udder. Within 24 hours the gangrenous areas become black and ooze serum and may be accompanied by subcutaneous emphysema and the formation of blisters. The secretion is reduced to a small amount of bloodstained serous fluid without odor, clots or flakes. Unaffected quarters in the same cow are often swollen, and there may be extensive subcutaneous edema in front of the udder caused by thrombosis of the mammary veins. Toxemia is profound and death usually occurs unless early, appropriate treatment is provided. Even with early treatment the quarter is invariably lost and the gangrenous areas slough. Separation begins after 6–7 days, but without interference the gangrenous part may remain attached for weeks. After separation, pus drains from the site for many more weeks before healing finally occurs.

#### CLINICAL PATHOLOGY

##### Culture of individual cow milk

Bacteriological culture of milk is the best method for identifying cows with *S. aureus* intramammary infection.<sup>25</sup> A problem in the laboratory identification of *S. aureus* is that **bacteria are shed cyclically from infected quarters, so that a series of samples are necessary to increase overall test sensitivity.** The sensitivity of a single sample may be as low as 75%. Factors that have the greatest impact on the sensitivity of culture, in order of importance, are:

- The type of milk sample
- The volume of milk cultured
- The time interval between repeated milk sample collection strategies.<sup>26</sup>

Quarter samples taken on day 1 and repeated either on day 3 or 4, and cultured separately using 0.1 mL of milk for culture inoculum, were predicted to have sensitivities of 90–95% and 94–99%, respectively.<sup>26</sup> Repeated quarter samples collected daily and cultured separately gave a sensitivity of 97% and a specificity from 97–100%.<sup>27</sup> Culturing of composite milk samples instead of individual quarter samples increases the number of false-negative results in diagnosing *S. aureus* mastitis,<sup>28</sup> but the sensitivity of composite samples can be increased by using 0.05 mL of milk for inoculation. Freezing of milk samples before processing either does not affect the bacterial count or enhances it by about 200%; the latter response is attributed to fracturing of cells containing

viable *S. aureus* bacteria. Bacterial counts of more than 200 cfu/mL are commonly used as a criterion for a positive diagnosis of infection.

##### Culture of bulk tank milk

The culture of 0.3 mL of bulk tank milk for *S. aureus* using special Baird–Parker culture media is a practical method for detecting the organism in bulk tank milk and monitoring its spread in dairy herds;<sup>29</sup> the sensitivity and specificity for detection of the bacteria ranged from 90–100%.

##### Somatic cell counts and California Mastitis Test

In an attempt to decrease the cost of sampling all quarters for culture, an alternative strategy is to use the SCC as a screening test in order to identify which cows to culture for *S. aureus*. For all intramammary infections, the sensitivity and specificity of SCC range from 15–40% and 92–99%, respectively. Composite milk sample SCCs have a low sensitivity, ranging from 31–54% for detecting cows with *S. aureus*.<sup>27</sup> Individual quarter SCCs have a higher sensitivity, ranging from 71–95% depending on the study and cutpoint chosen, but quarter sampling is impractical as SCC is usually performed on a composite sample.<sup>30</sup> Both composite and quarter milk SCC testing result in an unacceptably high proportion of infected cows being missed,<sup>27,30</sup> and are therefore not currently recommended as a screening test if the goal is to identify all cows with a *S. aureus* intramammary infection in the herd.

The CMT has also been used as a screening test to identify quarters or cows to culture. Using a CMT trace, 1, 2, or 3 to indicate the presence of an intramammary infection produced a range of sensitivities from 0.47–0.96 and specificities of 0.41–0.80.<sup>30</sup>

In summary, culture of quarter milk samples (preferably) or a composite milk sample is superior to a quarter SCC or CMT for the diagnosis of *S. aureus* intramammary infection.<sup>30</sup> Culture is strongly preferred if it is important to identify all positive cows in a herd because the sensitivity of indirect tests (such as SCC, CMT) is inadequate.

##### Enzyme-linked immunosorbent assays for antibody in milk

ELISA tests for detecting *S. aureus* antibody in milk have been developed<sup>25,31</sup> but are not widely used. Rapid laboratory tests incorporating these ELISAs, including a Staph-zym test, have demonstrated 84–90% accuracy in identifying staphylococci.<sup>32</sup>

##### Acriflavine disk assay

The acriflavine disk assay is a practical, accurate method for differentiating

*S. aureus* isolates from non-*S. aureus* staphylococci.<sup>33</sup>

#### NECROPSY FINDINGS

In peracute staphylococcal mastitis, the affected quarter is grossly swollen and may contain bloodstained milk dorsally but only serosanguineous fluid ventrally. There is extreme vascular engorgement and swelling, often progressing to moist gangrene of the overlying skin. Bacteria are not isolated from the bloodstream or tissues other than the mammary tissue and regional lymph nodes. Histologically there is coagulation necrosis of glandular tissue and thrombosis of veins.

In milder forms of staphylococcal mastitis the invading organisms often elicit a granulomatous response. Microscopically, such 'botryomycotic' cases are characterized by granulomas with a central bacterial colony and by progressive fibrosis of the quarter.

##### Samples for confirmation of diagnosis

- Bacteriology – chilled mammary tissue, regional lymph node
- Histology – fixed mammary tissue.

#### DIFFERENTIAL DIAGNOSIS

Because of the occurrence of the peracute form in the first few days after parturition, the intense depression and inability to rise, the dairy producer may conclude that the cow has **parturient paresis**, which is characterized by weakness, recumbency, hypothermia, rumen stasis, dilated pupils, tachycardia with weak heart sounds and a rapid response to intravenous calcium gluconate. The mammary gland is usually normal in parturient paresis.

**Peracute *S. aureus* mastitis** is characterized by marked tachycardia, fever, weakness and evidence of severe clinical mastitis with swelling, heat, abnormal milk with serum and blood, and sometimes gas in the teat and often with gangrene of the teat up to the base of the udder. Other bacterial types of mastitis, particularly *E. coli* and *A. pyogenes*, may cause severe systemic reactions but gangrene of the quarter is less common.

**Peracute coliform mastitis** is a much more common cause of severe mastitis than *S. aureus* mastitis. The chronic and acute forms of staphylococcal mastitis are indistinguishable clinically from many other bacterial types of mastitis and bacteriological examination is necessary for identification.

#### TREATMENT

The bacteriological cure rates for the treatment of *S. aureus* mastitis with either intramammary infusion or parenteral antimicrobial administration are notoriously less than satisfactory, particularly in the lactating cow. Bacteriological cure rates after antimicrobial treatment seldom

exceed 50% and infections commonly persist throughout the lifetime of the cow. There are three likely reasons: inadequate penetration of the antimicrobial agent to the site of infection, formation of L-forms of *S. aureus*, and beta-lactamase production.

Inadequate penetration of antimicrobial agent

There is **inadequate penetration of the antimicrobial agent** into the site of intramammary infection in the lactating cow and the organism survives in phagocytes that are inaccessible. There may also be inactivation of the antimicrobial by milk and serum constituents, and the formation of L-forms of the organism during treatment, varying between 0% and 80% of bacteria.

Antimicrobial resistance

**Antimicrobial resistant strains** of *S. aureus* occur and are often beta-lactamase producers, the enzyme conferring resistance to beta-lactam antimicrobial agents such as penicillin G, penethamate, ampicillin and amoxicillin. Cloxacillin and nafcillin are effective, but only against Gram-positive bacteria; they are less effective against nonlactamase staphylococci. Clavulanic acid added to amoxicillin overcomes this beta-lactamase resistance. So does **cloxacillin** added to ampicillin, and this is made use of in a popular intramammary formulation. First- and third-generation cephalosporins and erythromycin are effective against beta-lactamase-producing staphylococci, and first- and third-generation cephalosporins are also effective against Gram-negative bacteria. A cephalosporin dry cow product administered to heifers with *S. aureus* infections resulted in bacteriological cure and left the quarters clear well into their first lactation.<sup>34</sup> Intramammary cloxacillin and ampicillin is generally considered to be the preferred initial treatment for *S. aureus* mastitis because beta-lactamase production by *S. aureus* is sufficiently common.

Antimicrobial therapy for *S. aureus* subclinical mastitis during the lactating period is not economically attractive because of low bacteriological cure rates, discarding of milk during the withholding period and the lack of an economically beneficial increase in production following treatment. Dry cow treatment at the end of lactation is much more effective, being successful in 40–70% of cases, although treatment should be attempted in heifers infected early in lactation. Cows that are infected with *S. aureus* should be appropriately identified, segregated if possible and milked last or with separate milking units.<sup>35</sup> Culling of infected cows is also an option for consideration, but a detailed economic analysis of this popular recommendation is lacking.

### Lactating cow therapy

The treatment of clinical cases of *S. aureus* mastitis using intramammary antimicrobial infusions is less than satisfactory but is often done. However, clinical recovery following therapy does not necessarily eliminate the infection and some of the published literature on cure rates has not made the distinction between clinical and bacteriological cure rates. In general, the cure rate depends on the duration of infection, the number of quarters infected, whether the strain of *S. aureus* is a beta-lactamase producer, the immune status of the cow, the antimicrobial agent administered and the duration of treatment. Current recommendations to ensure the best treatment success rate are to combine intramammary and parenteral antimicrobial treatment or **use extended intramammary treatment for 4–8 days**. Penicillin G is regarded as the antimicrobial agent of choice for *S. aureus* strains that are penicillin-sensitive.<sup>22</sup>

The following intramammary infusions, given daily at 24-hour intervals for three treatments (unless stated otherwise) have been used for the treatment of clinical cases of *S. aureus* mastitis, with expected clinical cure rates of about 30–60% in lactating cows. Subclinical cases are left until the cow is dried off

- Sodium cloxacillin (200–600 mg for three infusions)
- Tetracyclines (400 mg)
- Penicillin–streptomycin combination (100 000 units – 250 mg)
- Penicillin–tylosin combination (100 000 units – 240 mg)
- Novobiocin (250 mg per infusion for three infusions)
- Cephalosporins – most strains of *S. aureus* are sensitive to cephalosporins<sup>36</sup>
- Pirlimycin-extended therapy (two 50 mg doses, 24 hours apart, then 36-hour withhold, then cycle repeated twice, equivalent to infusing at 0, 24, 60, 84, 120, and 144 hours).

In a study of 184 cases of subclinical *S. aureus* mastitis in New York, commercially available intramammary infusions were not significantly more effective than untreated controls (43% bacteriological cure), with the following bacteriological cure rates: erythromycin (65%), penicillin (65%), cloxacillin (47%), amoxicillin (43%), and cephalosporin (43%).<sup>37</sup>

A slightly more effective treatment for subclinical *S. aureus* intramammary infection, with a cure rate of 50%, is simultaneous intramammary infusion of amoxicillin (62.5 mg) and intramuscular injection of procaine penicillin G (9 000 000 units).<sup>38</sup> This study was the first to demonstrate that combined parenteral and intramammary therapy was more effective

than intramammary infusion alone. Because of the persistence of the infection in each herd the final choice of the antimicrobial to be used should be based on a culture and susceptibility test; the latter is to determine whether the predominant *S. aureus* strain in the herd is a beta-lactamase producer; this is because **beta-lactamase-producing strains are harder to cure and require a specific antibiotic protocol**.<sup>22</sup> The bacteriological cure rate for penicillin-sensitive infections treated with parenteral and intramammary penicillin G was 76%, compared to beta-lactamase-producing strains treated with parenteral and intramammary amoxicillin–clavulanic acid (29%).<sup>22</sup>

The application of cytokines as an adjunct to antimicrobial therapy may help to increase the number of phagocytes in the mammary gland and enhance cell function. The experimental intramammary infusion of recombinant interleukin into infected or uninfected mammary glands elicited an influx of polymorphonuclear leukocytes exhibiting subsequent enhanced activity and increased the cure rate 20–30% in quarters infected with *S. aureus*.<sup>39</sup>

A novel method for decreasing the transmission of *S. aureus* within a herd is to **selectively cease lactation in infected quarters of lactating cattle**.<sup>40</sup> The best method for permanently drying off a quarter is infusion of 120 mL of 5% povidone–iodine solution (0.5% iodine) after complete milk-out and administration of flunixin meglumine (1 mg/kg BW, intravenously). Therapeutic cessation of milk production in one quarter does not alter daily milk production but does decrease individual cow SCC and its contribution to the bulk tank milk SCC. The final outcome of selectively drying off infected quarters is a decrease in the rate of new intramammary infections in the herds and a lowering in the bulk tank milk SCC.

Peracute mastitis

Early parenteral treatment of peracute cases with adequate doses of antimicrobials such as trimethoprim–sulfonamide or penicillin is deemed necessary to improve the survival rate. When penicillin is used the initial intramuscular injection should be supported by an intravenous dose of crystalline penicillin, with subsequent intramuscular doses to maintain the highest possible blood level of the antimicrobial over a 4–6-day period; tiamethicillin or penthimate hydriodide are preferred to achieve this. Intramammary infusions are of little value in such cases because of failure of the drugs to diffuse into the gland. The intravenous administration of large quantities

of electrolyte solutions is also recommended. Hypertonic saline, as recommended for peracute coliform mastitis, has not yet been evaluated but may be indicated. Frequent massage of the udder with hot wet packs and milking out the affected gland is recommended. Oxytocin is used to promote milk-down but is relatively ineffective in severely inflamed glands. Surgical amputation of the teat may be indicated to promote drainage of the gland, but only in cows with necrotic teats.

### Dry cow therapy

It has become a common practice to leave chronic *S. aureus* cases until they are dried off before attempting to eliminate the infection. The material is infused into each gland after the last milking of the lactation and left in situ. The major benefits of dry cow therapy are the **elimination of existing intramammary infections** and **prevention of new intramammary infections during the dry period**. In addition, milk is not discarded and bacteriological cure rates are superior to those obtained during lactation.

The factors associated with a bacteriological cure after dry cow therapy of subclinical *S. aureus* mastitis have been examined.<sup>41</sup> The probability of cure of an infected quarter *decreased* when:

- SCC increased
- Age of cow increased
- Another quarter was infected in the same cow
- The infection was in a hind quarter
- The percentage of samples that were positive for *S. aureus* was higher before drying off.

Cows with more than one infected quarter were 0.6 times less likely to be cured than cows with one infected quarter. The cure rate of quarters affected with *S. aureus* can be predicted using a formula which considers several cow factors and quarter factors.<sup>41</sup> The prediction of the probability of cure in an 8-year-old cow with three quarters infected with the organism and a SCC of 2300 000 is 36%. In a 3-year-old cow with one quarter infected and a SCC of 700 000, the probability of cure is 92%. This information is often available at drying off and can be used to select cows that are unlikely to be cured to be removed from the herd by designating them as 'do not breed' and culling when it is economically opportune.

Most intramammary antimicrobial infusions are satisfactory for dry cow therapy provided they are combined with slow-release bases. Bacteriological cure rates vary between herds from 25–75% and average about 50%.<sup>42</sup> The use of parenteral antimicrobials such as oxytetra-

cycline along with an intramammary infusion of cephapirin did not improve the cure rate for *S. aureus*.<sup>42</sup>

### CONTROL

Because of the relatively poor results obtained in the treatment of staphylococcal mastitis, any attempt at control must depend heavily on effective methods of preventing the transmission of infection from cow to cow. *S. aureus* is a contagious pathogen, the udder is the primary site of infection, and hygiene in the milking parlor is of major importance. To reduce the source of the organism, a program of early **identification, culling, and segregation** is important to control *S. aureus* mastitis in a dairy herd, although successful implementation of all three aspects is challenging. Satisfactory control of *S. aureus* mastitis has historically been difficult and unreliable; however, at the present time the quarter infection rate can be rapidly and profitably reduced from the average level of 30% to 10% or less.

The strategies and practices described under the control of bovine mastitis later in this chapter are highly successful for the control of *S. aureus* mastitis when applied and maintained rigorously. The control program includes:

- Hygienic washing and drying of udders before milking
- Regular milking-machine maintenance
- Teat dipping after milking. Teat dipping in 1% iodine or 0.5% chlorhexidine, either in 5–10% glycerine, is completely effective against *S. aureus* mastitis.<sup>43</sup> The program helps to eliminate infected quarters and reduces the new infection rate by 50–65% compared to controls. The disinfection of hands or use of rubber gloves provides additional advantages
  - Dry cow treatment on all cows
  - Culling cows with chronic mastitis
  - Milking infected cows last (very difficult to implement in free stall housing or pasture feeding).

An alternative but radical control strategy when all else has failed is to permanently dry off the infected quarter using iodine infusion.

Immunization against *S. aureus* mastitis has been widely researched for 100 years. Different vaccines based on cellular or soluble antigens with and without adjuvants have been given to dairy cows but protection against infection and clinical disease has been unsatisfactory when used in the field. Currently available vaccines are autogenous bacterins (made

to order using isolates from clinical cases on the farm) or contain one or more *S. aureus* strains that are believed to provide good cross-protection. The goals of such vaccines are to decrease the severity of clinical signs and increase the cure rate, particularly when administered to heifers before they calve. Vaccination has also been used simultaneously with antimicrobial therapy during lactation or at dry-off in an attempt to augment the cows immune response, with mixed success.<sup>21</sup> Development of an effective *S. aureus* vaccine remains one of the most important issues confronting control of infectious diseases in cattle.

### REVIEW LITERATURE

Sears PM. Management and treatment of staphylococcal mastitis. *Vet Clin North Am Food Anim Pract* 2003; 19:171–185.

### REFERENCES

1. Torgerson PR et al. *Vet Rec* 1992; 130:54.
2. Roberson JR et al. *J Dairy Sci* 1994; 77:3354.
3. Gillespie BE et al. *J Dairy Sci* 1999; 82:1581.
4. Owens WE et al. *Am J Vet Res* 1998; 59:1122.
5. Myllys V et al. *J Dairy Sci* 1994; 77:446.
6. Fox LK, Cummings MS. *J Dairy Res* 1996; 63:369.
7. Nickerson SC, Boddie RL. *J Dairy Sci* 1994; 77:2526.
8. Enevoldsen C et al. *J Dairy Res* 1995; 62:69.
9. Schukken YH et al. *J Dairy Sci* 1994; 77:639.
10. Daley MJ, Hayes P. *Cornell Vet* 1992; 82:1.
11. Daley MJ et al. *Am J Vet Res* 1991; 52:474.
12. Burton JL, Kehill ME Jr. *Am J Vet Res* 1995; 56:997.
13. Bartlett PC, Miller GY. *Prev Vet Med* 1993; 17:33.
14. Almeida RA et al. *J Vet Med B* 1997; 44:139.
15. Cifrian E et al. *Vet Microbiol* 1996; 48:187.
16. Baselga R et al. *Vet Microbiol* 1994; 39:195.
17. Aaerstrup FM et al. *Can J Vet Res* 1995; 59:124.
18. Lam TJGM et al. *Am J Vet Res* 1996; 57:39.
19. Aaerstrup FM et al. *Acta Vet Scand* 1995; 38:243.
20. Fitzgerald JR et al. *Epidemiol Infect* 1997; 119:261.
21. Luby CD, Middleton JR. *Vet Rec* 2005; 157:89.
22. Smith EM et al. *J Clin Microbiol* 2005; 43:4737.
23. Aaerstrup FM et al. *Acta Vet Scand* 1995; 36:273.
24. Persson K et al. *J Vet Med B* 1995; 42:435.
25. Hicks CR et al. *J Am Vet Med Assoc* 1994; 204:253.
26. Buelow KL et al. *Prev Vet Med* 1996; 25:343.
27. Buelow KL et al. *Prev Vet Med* 1996; 26:1.
28. Lam TJGM et al. *J Am Vet Med Assoc* 1996; 208:1705.
29. Ollis GW et al. *Can Vet J* 1995; 36:619.
30. Middleton JR et al. *J Am Vet Med Assoc* 2004; 224:419.
31. Matsushita T et al. *J Vet Diagn Invest* 1990; 2:163.
32. Watts JL, Washburn PJ. *J Clin Microbiol* 1991; 29:59.
33. Wallace RL et al. *J Am Vet Med Assoc* 1998; 213:394.
34. Owens WE et al. *J Dairy Sci* 1991; 74:3376.
35. Wilson DJ et al. *J Dairy Sci* 1995; 78:2083.
36. Lopes CAM, Moreno G. *Res Vet Sci* 1991; 51:339.
37. Wilson DJ et al. *J Dairy Sci* 1999; 82:1664.
38. Owens WE et al. *J Dairy Sci* 1988; 71:3143.
39. Sanchez MS et al. *J Dairy Sci* 1994; 77:1251.
40. Middleton JR, Fox LK. *J Dairy Sci* 2001; 84:1976.
41. Sol J et al. *J Dairy Sci* 1994; 77:75.
42. Erskine RJ et al. *J Dairy Sci* 1994; 77:3347.
43. Fox LK. *J Dairy Sci* 1992; 75:66.

## STREPTOCOCCUS AGALACTIAE

SV 0851

**Etiology** *Streptococcus agalactiae* is a major pathogen of the mammary gland and a common cause of contagious bovine mastitis

**Epidemiology** Major cause of mastitis in dairy herds without an effective mastitis control program. Prevalence of infection 10–50% of cows and 25% of quarters. In herds with effective control program prevalence less than 10% of cows. Can be eliminated from herd with treatment and control. Highly contagious obligate pathogen. Infection is transmitted at milking

**Clinical findings** Individual repeated episodes of subacute to acute mastitis are most common. Gland is swollen, warm, and milk is watery and contains clots. Gradual induration of udder if not treated

**Clinical pathology** Culture of individual cow milk samples or bulk tank milk samples. Latex agglutination test

**Necropsy findings** Not important

**Diagnostic confirmation** Latex agglutination test for specific identification of organism

**Differential diagnosis** Cannot differentiate clinically from other causes of acute and chronic mastitis. Must culture milk

**Treatment** Mastitis associated with *S. agalactiae* in lactating cows is sensitive to intramammary therapy with wide variety of antimicrobial agents resulting in high rate of clinical and bacteriological cures. Blitz therapy (simultaneous treatment of all positive cows in a herd) commonly used to reduce prevalence of infection in herd

**Control** Eradication is possible. Identify and treat infected quarters, cull incurable cows. Premilking teat and udder sanitation, postmilking teat dipping, and dry cow therapy

### ETIOLOGY

*Streptococcus agalactiae*. Infections with environmental streptococci are described in the next section.

### EPIDEMIOLOGY

#### Occurrence and prevalence of infection

*S. agalactiae* was the major cause of mastitis before the antimicrobial era and is still a significant cause of chronic mastitis where control procedures for contagious mastitis are not used.<sup>1</sup> Herd prevalence rates of infection range from 11–47%. Typically, in a herd infected with the pathogen, the prevalence of infection could be as high as 50% of cows, but more recent surveys indicate much lower within-herd prevalences, ranging from 8–10%.<sup>1</sup> Where good hygienic measures and the efficient treatment of clinical cases are in general use, the prevalence of infection within a herd will be less than

10% of cows. Following the use of antimicrobial agents, *S. agalactiae* was superseded by *Staphylococcus aureus* as the major cause of bovine mastitis. In herds with a high bulk tank milk SCC, the probability is high that *S. agalactiae* infection is the most prevalent pathogen.

#### Source of infection

*S. agalactiae* is a highly contagious obligate parasite of the bovine mammary gland. The main source of infection is the udder of infected cows although, when hygiene is poor, contamination of the environment may provide an additional source. The teats and skin of cattle, milkers' hands, floors, utensils and clothes are often heavily contaminated. Sores on teats are the commonest sites outside the udder for persistence of the organism. The infection may persist for up to 3 weeks on hair and skin and on manure and bricks. The importance of environmental contamination as a source of infection is given due recognition in the general disinfection technique of eradication.

#### Transmission of infection

Transmission from animal to animal occurs most commonly by the medium of milking machine liners, hands, udder cloths and possibly bedding.

The streak canal is the portal of entry, although there is doubt as to how invasion into the teat canal and then gland occurs. Suction into the teat during milking or immediately afterwards does occur, but growth of the bacteria into the canal between milkings also appears to be an important method of entry. It is difficult to explain why heifers that have never been milked may be found to be infected with *S. agalactiae*, although sucking between calves after ingestion of infected milk or contact with infected inanimate materials may be sources of infection.

#### Risk factors

There is no particular breed susceptibility but infection does become established more readily in older cows and in the early part of each lactation. Poor hygiene, incompetent milking personnel and machinery that is faulty or maladjusted are important risk factors. **The most important risk factors are the failure to use postmilking teat dip and the selective or non-use of dry cow therapy.** The use of a common wash rag or sponge is also a risk factor. Inadequate treatment of clinical cases of mastitis is also a frequent risk factor in infected herds.

*S. agalactiae* has the ability to adhere to the mammary gland tissue, and the specific microenvironment of the udder is necessary for growth of the organism. The virulence of various strains of the organ-

ism is related to differences in their ability to adhere to the mammary epithelium. Bacterial ribotyping has been used to characterize strains of the organism to determine their geographical distribution.<sup>2</sup> The physical characteristics of the teat canal may influence the susceptibility to streptococcal infection.<sup>3</sup> The mechanisms used by *S. agalactiae* to penetrate the teat canal are influenced more by the diameter of the teat canal lumen, as reflected by the peak flow rate, than by teat canal length.

#### Economic importance

The disease is of major economic importance in milk production. In individual cows, the loss of production associated with *S. agalactiae* mastitis is about 25% during the infected lactation, and in affected herds the loss may be of the order of 10–15% of the potential production. Reduction of the productive life represents an average loss of one lactation per cow in an affected herd. Deaths due to *S. agalactiae* infection rarely if ever occur and complete loss of productivity of a quarter is uncommon, the losses being incurred in the less dramatic but no less important fashion of decreased production per cow.

#### PATHOGENESIS

When the primary barrier of the streak canal is passed, if bacteria are not flushed out by the physical act of milking they proliferate and invasion of the udder tissue follows. There is considerable variation between cows in the developments that occur at each of the three stages of invasion, infection and inflammation. The reasons for this variation are not clear but resistance appears to depend largely on the integrity of the lining of the teat canal. After the introduction of infection into the teat, the invasion, if it occurs, takes 1–4 days and the appearance of inflammation 3–5 days. Again there is much variation between cows in the response to tissue invasion, and a balance may be set up between the virulence of the organism and undefined defense mechanisms of the host so that very little clinically detectable inflammation may develop despite the persistence of a permanent bacterial flora.

The **development of mastitis** associated with *S. agalactiae* is essentially a process of invasion and inflammation of lobules of mammary tissue in a series of crises, particularly during the first month after infection, each crisis developing in the same general pattern. Initially there is a rapid multiplication of the organism in the lactiferous ducts, followed by passage of the bacteria through the duct walls into lymphatic vessels and to the supra-mammary lymph nodes, and an out-pouring of neutrophils into the milk ducts. At this stage of initial tissue invasion,



a shortlived systemic reaction occurs and the milk yield falls sharply as a result of inhibition and stasis of secretion caused by damage to acinar and ductal epithelium. Fibrosis of the interalveolar tissue and involution of acini result even though the tissue invasion is quickly cleared. Subsequently, similar crises develop and more lobules are affected in the same way, resulting in a stepwise loss of secretory function with increasing fibrosis of the quarter and eventual atrophy.

The **clinico-pathological findings** vary with the stage of development of the disease. Bacterial counts in the milk are high in the early stages but fall when the SCC rises at the same time as swelling of the quarter becomes apparent. In some cases bacteria are not detectable culturally at this acute stage. The SCC rises by 10–100 times normal during the first 2 days after infection and returns to normal over the next 10 days. The febrile reaction is often sufficiently mild and shortlived to escape notice. When the inflammatory changes in the epithelial lining of the acini and ducts begin to subside, the shedding of the lining results in the clinical appearance of clots in the milk. Thus the major damage has already been done when clots are first observed. At the stage of acute swelling, it is the combination of inflamed interalveolar tissue and retained secretion in distended alveoli that causes the swelling. Removal of the retained secretion at this stage may considerably reduce the swelling and permit better diffusion of drugs infused into the quarter. Inflammatory reactions also occur in the teat wall of affected quarters.

The variations in resistance between cows and the increased susceptibility with advancing age are unexplained. Hormonal changes and hypersensitivity of mammary tissue to streptococcal protein have both been advanced as possible causes of the latter. Local immunity of mammary tissue after an attack probably does not occur but there is some evidence to suggest that a low degree of general immunity may develop. The rapid disappearance of the infection in a small proportion of cows in contrast to the recurrent crises that are the normal pattern of development suggests that immunity does develop in some animals. The antibodies are hyaluronidase inhibitors and are markedly specific for specific strains of the organism. A non-specific rise in other antibodies may occur simultaneously and this is thought to account for the field observations that coincident streptococcal and staphylococcal infections are unusual and that the elimination of one infection may lead to an increased incidence of the other.

### CLINICAL FINDINGS

In the experimentally produced disease, there is initially a sudden episode of acute mastitis, accompanied by a transient fever, followed at intervals by similar attacks, which are usually less severe. In natural cases fever, lasting for a day or two, is occasionally observed with the initial attack but the inflammation of the gland persists and the subsequent crises are usually of a relatively mild nature. These degrees of severity may be classified as **abnormal cow** when the animal is febrile and off its feed, **abnormal gland** when the inflammation of the gland is severe but there is no marked systemic reaction, and **abnormal milk** when the gland is not greatly swollen, pain and heat are absent and the presence of clots in watery foremilk may be the only apparent abnormality. Induration is most readily palpable at the udder cistern and in the lower part of the udder, and varies in degree with the stage of development of the disease.

The milk yield of affected glands is markedly reduced during each crisis but, with proper treatment administered early, the yield may return to almost normal. Even without treatment the appearance of the milk soon becomes normal but the yield is significantly reduced and subsequent crises are likely to reduce it further.

### CLINICAL PATHOLOGY

The **CAMP test**, which has served as the universally used means of identifying *S. agalactiae* for many years, has been displaced by a commercial **latex agglutination test**, which contains specific reagents necessary for the identification of *S. agalactiae* and is suitable for general laboratory use.<sup>1</sup> When used on isolates of samples from bulk tank milk, the sensitivity and specificity are 97.6% and 98.2%, respectively. An ELISA test correlates well with the bulk tank milk SCC and provides a suitable alternative.<sup>1</sup>

The critical judgment to be made is deciding when the quarter infection rate is so high that control or eradication measures are necessary. A decision can be made on the basis of the bulk tank milk SCC as an indicator of the prevalence of mastitis on a quarter basis, and on culture of the bulk tank milk sample to indicate that *S. agalactiae* is the important pathogen, but this approach is too inaccurate to be recommended. There seems to be no alternative to carrying out bacteriological culture and determining SCC on milk samples from individual cows or quarters. Milk samples collected for bacteriological examination for the presence of *S. agalactiae* can be stored in the frozen state. The number of samples that will be culturally

positive when the stored frozen samples are thawed will either be unchanged or enhanced up to 200%; the latter response is attributed to fracturing of cellular debris containing *S. agalactiae*.

### Culture from bulk tank milk samples

The presence of the organism in bulk tank milk is due to shedding of bacteria from infected quarters, with cyclic shedding being typical. The specificity of culture from bulk tank milk is very high; the sensitivity is much lower but can be increased by using selective media.

### Total bacterial count

The total bacterial count in bulk tank milk can be markedly increased due to the presence of *S. agalactiae* mastitis in the herd. Samples of bulk tank milk from infected herds commonly contain bacterial counts in the range of 20 000–100 000 cfu/mL, because a cow in the early stages of infection can shed up to 100 000 000 bacteria/mL. The standard plate count can drop from 100 000 to 2000 cfu/mL after implementation of a modified blitz therapy and control program to control *S. agalactiae*.

### Culture from individual cow samples

Composite milk samples are satisfactory, as the number of cows identified as positive does not increase by quarter sampling.<sup>1</sup> The sensitivity and specificity of a single culture from individual cows ranges between 95% and 100%.<sup>1</sup>

### Somatic cell count

*S. agalactiae* produces high SCC in individual cows, which has a significant influence on the bulk tank milk SCC.

### NECROPSY FINDINGS

The gross and microscopic pathology of mastitis associated with *S. agalactiae* are not of importance in the diagnosis of the disease.

### DIFFERENTIAL DIAGNOSIS

The clinical diagnosis of *S. agalactiae* mastitis depends entirely on the isolation of *S. agalactiae* from the milk. Differentiation from other types of acute and chronic mastitis is not possible clinically.

### TREATMENT

*S. agalactiae* is very sensitive to intramammary therapy using a wide variety of commercially available intramammary infusion preparations. Systemic therapy is also effective but offers no advantages over the intramammary route. Clinical cases should be treated whenever they occur because of the need to prevent transmission to uninfected quarters and cows. Subclinical cases identified at any stage of lactation should be treated

immediately because of the excellent response to treatment. Treatment of *S. agalactiae* mastitis with intramammary infusions will result in a high percentage of infections being eliminated economically and with few residual concerns, provided the milk withholding times are observed.

Infections at all stages of lactation have 90–100% cure rates with penicillin, erythromycin, cloxacillin and cephalosporins. Gentamicin, neomycin, nitrofurazone and polymyxin B have poor activity. Procaine penicillin G is universally used as a mammary infusion at a dose rate of 100 000 units. Higher dose rates have the disadvantage of increasing penicillin residues in the milk. A moderate increase in efficiency is obtained by using procaine penicillin rather than the crystalline product, and by using 100 000 units of penicillin in a long-acting base the cure rate (96%) is significantly better than with quick-acting preparations (83%).

To provide a broader spectrum of antimicrobial efficiency penicillin is often combined with other drugs that are more effective against Gram-negative organisms. A mixture of penicillin (100 000 units) and novobiocin (150 mg) provides a cure rate ranging from 89–98%.<sup>4</sup> It is necessary to maintain adequate milk levels for 72 hours: three infusions at intervals of 24 hours are recommended, but dosing with two infusions 72 hours apart, or one infusion of 100 000 units, in a base containing mineral oil and aluminum monostearate, gives similar results. As a general rule clinical cases should be treated with three infusions, and subclinical cases, particularly those detected by routine examination in a control program, with one infusion. Recovery, both clinically and bacteriologically, should be achieved in at least 90% of quarters if treatment has been efficient. Intramuscular administration of ceftiofur is not efficacious as a treatment to eliminate the organism, compared to intramammary infusion of penicillin (100 000 units) and novobiocin (150 mg) daily for two treatments.<sup>4</sup>

Other antimicrobial agents used in the treatment of *S. agalactiae* infections include the tetracyclines and cephalothin, which are as effective as penicillin and have the added advantage of a wider antibacterial spectrum, an obvious advantage when the type of infection is unknown. Neomycin is inferior to penicillin in the treatment of *S. agalactiae* mastitis, while tylosin and erythromycin appear to have equal efficacy. A single treatment with 300 mg of erythromycin is recommended as curing 100% of quarters infected with *S. agalactiae*. Lincomycin (200 mg) combined with neomycin (286 mg) and administered twice at 12-hour intervals also has good efficacy. In a study of 1927 cases of

subclinical *S. agalactiae* mastitis in New York, all commercially available intramammary infusions were more effective than untreated controls (27% bacteriological cure), with the following bacteriological cure rates: amoxicillin (86%), erythromycin (81%), cloxacillin (77%), cephalixin (66%), penicillin (63%), hetacillin (62%), pirlimycin (44%).<sup>5</sup>

In dry cows, one infusion is sufficient, milk levels of penicillin remaining high for 72 hours. Cloxacillin eliminated the organism from 98% and 100% of infected cows in two different studies.<sup>1</sup>

#### Blitz therapy

The prevalence of subclinical mastitis due to *S. agalactiae* can be reduced more rapidly by treatment of infected cows during lactation than by dry cow therapy and postmilking teat dipping. *S. agalactiae* is one of the few pathogens causing subclinical mastitis that can be treated economically during lactation, and can be eliminated from herds with **blitz antimicrobial therapy followed by good sanitation procedures**. All cows are sampled and those that are positive are treated simultaneously with penicillin and novobiocin. Cows not responsive to the first treatment are identified and retreated or culled. Failure to institute sanitation procedures for the control of the pathogen may result in subsequent outbreaks of mastitis.<sup>6</sup>

If blitz therapy of all infected cows is not possible because of the short-term effect of lost milk production on income, a modified treatment protocol is recommended. The herd is divided into two groups, based on a composite milk SCC of 500 000. Those cows in the high category are treated with 300 mg of erythromycin, intramammarily. When lactating cow numbers reach their lowest point, all animals are treated with the same product. At drying off, cows are treated with 500 mg cloxacillin and 250 mg ampicillin.

#### CONTROL

Eradication on a herd basis of mastitis associated with *S. agalactiae* is an accepted procedure and has been undertaken on an area scale in some countries. The control measures as outlined later in this chapter are designed especially for this disease and should be adopted in detail. If suitable hygienic barriers against infection can be introduced and if the infection can be eliminated from individual quarters by treatment, the disease is eradicable fairly simply and economically.

The control program consists of:

- **Identifying infected quarters**
- **Treating infected quarters on two occasions if necessary**
- **Culling incurable cows.**

The control program is particularly applicable in herds where an unacceptable level of clinical cases is backed by a high incidence of subclinical infections. **Pre-milking teat and udder sanitation, postmilking teat dipping, and dry cow therapy** are vital aspects of the control program.

#### Vaccination

Vaccination against *S. agalactiae* has been attempted and elicits systemic hyperimmunity but no apparent intramammary resistance. Development of an effective vaccine will be difficult because of the multiplicity of strains involved and the known variability between animals in their reaction to intramammary infection.

#### Biosecurity

As with any eradication program a high degree of vigilance is required to maintain a 'clean' status. This is particularly so with mastitis due to *S. agalactiae*. Breakdowns are usually due to the introduction of infected animals, even heifers that have not yet calved, or the employment of milkers who carry infection with them. Most dairy farms in the USA are in an ongoing process of herd expansion or replacement acquisition by the addition of purchased animals. Introduction of contagious mastitis associated with *S. agalactiae*, *S. aureus* and *M. bovis* is a common result. It has been recommended that herd additions should be screened for these important pathogens;<sup>7</sup> however, currently available screening tests do not have perfect sensitivity.

#### REVIEW LITERATURE

Keefe GP. *Streptococcus agalactiae* mastitis: a review. Can Vet J 1997; 38:429-437.

#### REFERENCES

1. Keefe GP. Can Vet J 1997; 38:429.
2. Rivas AL et al. Am J Vet Res 1997; 58:482.
3. Lacy-Hubert SJ, Hillerton JE. J Dairy Res 1995; 62:395.
4. Erskine RJ et al. J Am Vet Med Assoc 1996; 208:258.
5. Wilson DJ et al. J Dairy Sci 1999; 82:1664.
6. Boyer PJ. Vet Rec 1997; 141:55, 84, 108.
7. Wilson DJ, Gonzalez RN. In: Proceedings of 36th Annual Meeting of National Mastitis Council, 1997:127.

#### MYCOPLASMA BOVIS AND OTHER MYCOPLASMA SPECIES

##### ETIOLOGY

A number of species of *Mycoplasma*, especially *M. bovis* and occasionally *Mycoplasma* species group 7,<sup>1</sup> *Mycoplasma* F-38, *Mycoplasma arginini*, *Mycoplasma bovirhinis*, *Mycoplasma canadensis*, *Mycoplasma bovis genitalium*, *Mycoplasma alkalescens*,<sup>2</sup> *Mycoplasma capricolium*,<sup>3</sup> *Mycoplasma californicum*<sup>4,5</sup> and *Mycoplasma dispar*,<sup>6</sup> have been isolated from clinical cases. Other mycoplasmas, not usually

**Etiology** *Mycoplasma bovis*, other *Mycoplasma* spp.

**Epidemiology** A highly contagious mastitis causing outbreaks of clinical mastitis. Most common in large herds with recent introductions. Transmitted within herds by bulk mastitis treatments and poor milking hygiene. Cows of all ages and any stage of lactation but those in early lactation most severely affected

**Clinical findings** Sudden onset of clinical mastitis in many cows, usually all four quarters, marked drop in milk production and may stop lactating, swelling of the udder and gross abnormality of the milk without obvious signs of systemic illness, eventually udders atrophy and do not return to production. Can cause clinical, subclinical and chronic intramammary infections. Calves suckling milk from infected cows may develop otitis media/interna

**Clinical pathology** Special culture and staining of milk techniques

**Necropsy findings** Purulent interstitial mastitis

**Diagnostic confirmation** Identification of pathogen in milk

**Differential diagnosis** Epidemiology and clinical findings are characteristic of mycoplasma mastitis. May resemble other causes of chronic mastitis unresponsive to treatment

**Treatment** Not responsive to commonly used mastitis treatments protocols. Identify and cull affected cows for slaughter

**Control** Prevent entry of infected cows into herd. Eradicate infection by culling affected cows

associated with the development of mastitis, also cause the disease when injected into the udder. There is also evidence of mastitis associated with *Ureaplasma* spp.<sup>7</sup> A striking characteristic of the mycoplasmas is that they seem to be able to survive in the presence of large numbers of leukocytes in the milk. Antibodies to the bacteria have not been detectable in sera or whey from animals infected with some strains, but complement-fixing antibodies are present in the sera of animals recovered from infection with other strains.

*Acholeplasma laidlawii* is not a mastitis pathogen, but it has been observed that a high proportion of bulk tanks will give positive cultural tests for it, especially during wet, rainy weather. This increase is accompanied by an increase of clinical mycoplasmal mastitis due to pathogenic mycoplasma. *A. laidlawii* is considered to be a milk contaminant in these circumstances.

The group of diseases, including mastitis, that are associated with *Mycoplasma* spp. in sheep and goats are dealt with separately.

## EPIDEMIOLOGY

### Occurrence and prevalence of infection

The disease has been recorded since the mid 1960s in the USA, Canada, UK, and Israel and has been observed in Australia. The quarter infection rate in infected herds varies widely.

### Source of infection

The epidemiology of the disease has been incompletely characterized.<sup>8</sup> *Mycoplasma* mastitis occurs most commonly in large herds and in herds where milking hygiene is poor and when cows are brought in from other farms or from public saleyards. *Mycoplasma* mastitis usually breaks out subsequently after a delay of weeks or even months. The delay in development of an outbreak may be related to the long-term persistence of the organism (more than 12 months) in some quarters, and some cows become shedders of the organism without ever exhibiting signs of severe clinical mastitis. *M. bovis* was isolated from milk samples of 5–12% of cows during two lactations and two dry periods.<sup>9</sup>

*M. bovis* is capable of colonizing and surviving in the upper respiratory tract and the vagina, and extramammary colonization explains many of its epidemiological paradoxes. An interesting epidemiological observation is the detection of mycoplasmas and infectious bovine rhinotracheitis virus in affected udders at the same time. The virus could be the much sought-after unknown factor in the etiology of the disease. Outbreaks of mastitis are recorded concurrently with outbreaks of vaginitis and otitis media/interna vestibulitis.<sup>10</sup>

### Transmission

Entry of the disease to a herd is usually by the purchase of animals and their introduction without quarantine. Transmission within a herd is most commonly at milking via machine milking or the hands of milkers. Transmission can also be through the use of bulk mastitis treatments administered through a common syringe and cannula.<sup>11</sup> Although the disease occurs first in the inoculated quarter there is usually rapid spread to all other quarters.

Hematogenous spread of *M. bovis* has been demonstrated.<sup>12,13</sup> Colonization of body sites other than the mammary gland is common, and *M. bovis* isolates from the respiratory and urogenital systems are frequently the same *M. bovis* subtypes that cause mastitis.<sup>13</sup>

*Mycoplasma* spp. group 7 has also been isolated from cases of pneumonia and polyarthritis in calves fed milk from cows with mycoplasmal mastitis.

## Risk factors

Cows of all ages and at any stage of lactation are affected, cows that have recently calved showing the most severe signs and dry cows the least. There are several recorded outbreaks in dairy herds in dry cows.<sup>14</sup> One of them immediately after mammary infusions of dry period treatment that affected all quarters of all cows.

Experimental production of the disease<sup>15</sup> with *M. bovis* causes severe loss of milk production, a positive CMT reaction and clots in the milk.<sup>16</sup> Experimental infection produces little tissue necrosis but *Mycoplasma* are detectable in many tissues, including blood, vagina, and fetus, indicating that hematogenous spread has occurred. It is also apparent that spread of infection between quarters in one cow can be hematogenous. There are no significant pathological differences between mastitis produced by *M. bovis* and *M. bovis*; however, *M. bovis* remains the most common cause of mycoplasmal mastitis in dairy cattle.

## Economic importance

The disease is a disastrous one because of the high incidence in affected herds and the almost complete cessation of production for the lactation. Many cows fail ever to return to milking; as many as 75% of affected cows may have to be culled.

## PATHOGENESIS

This is a purulent interstitial mastitis. Although infection probably occurs via the streak canal, the rapid spread of the disease to other quarters of the udder and occasionally to joints suggests that hematogenous spread may occur. The presence of the infection in heifers milked for the first time also suggests that systemic invasion may be followed by localization in the udder.

## CLINICAL FINDINGS

In lactating cows, there is a sudden onset of swelling of the udder, a sharp drop in milk production and grossly abnormal secretion in one or more quarters. In most cases all four quarters are affected and a high-producing cow may fall in yield to almost nil between one milking and the next. Dry cows show little swelling of the udder. Although there is no overt evidence of systemic illness, and febrile reactions are not observed in most field cases in lactating cows, those that have recently calved show most obvious swelling of the udder and may be off their feed and have a mild fever. However, cows infected experimentally show fever up to 41°C (105.5°F) on the third or fourth day after inoculation, at the same time as the udder changes appear. The temperature returns

to normal in 24–96 hours. In some cases the supramammary lymph nodes are greatly enlarged. **The classic clinical presentation is severe clinical mastitis in multiple quarters of multiple cows with minimal systemic signs of disease.** A few cows, with or without mastitis, develop arthritis in the knees and fetlocks. The affected joints are swollen, with the swelling extending up and down the leg. Lameness may be so severe that the foot is not put to the ground. *Mycoplasma* may be present in the joint.

The secretion from affected quarters is deceptive in the early stages in that it appears fairly normal at collection; on standing, however, a deposit, which may be in the form of fine, sandy material, flakes or floccules, settles out leaving a turbid whey-like supernatant. Subsequently the secretion becomes scanty and resembles colostrum or soft cheese curd in thin serum. The secretion may be tinged pink with blood or show a gray or brown discoloration. Within a few days the secretion is frankly purulent or curdy but there is an absence of large, firm clots. This abnormal secretion persists for weeks or even months.

Affected quarters are grossly swollen. Response to treatment is very poor and the swollen udders become grossly atrophied. In infection with one strain of the *Mycoplasma*, many cows do not subsequently come back into production although some may produce moderately well at the next lactation. With other strains there is clinical recovery in 1–4 weeks without apparent residual damage to the quarter.

Mycoplasmal mastitis due to *M. bovis genitalium* may be very mild and disappear from the herd spontaneously and without causing loss of milk production.<sup>17</sup>

### CLINICAL PATHOLOGY

The causative organism can be cultured without great difficulty by a laboratory skilled in working with *Mycoplasma*. Samples for culture should be freshly collected and transported at 4°C, and concurrent infection with other bacteria is common. Diagnosis at the herd level can be made by culturing bulk tank milk or milk from cows with clinical mastitis or increased SCC. However, the sensitivity of bulk tank milk culturing is poor (33–59%).<sup>18,19</sup> A marked leukopenia, with counts as low as 1800–2500 cells/μL, is present when clinical signs appear and persists for up to 2 weeks. Somatic cell counts in the milk are very high, usually over 20 000 000 cells/mL. In the acute stages the organisms may be able to be visualized by the examination of a milk

film stained with Giemsa or Wright–Leishman stain. Species identification of *Mycoplasma* isolates is most commonly done using immunofluorescence and homologous fluorescein-conjugated antibody or an indirect immunoperoxidase test (immunohistochemistry). Speciation of the causative *Mycoplasma* species is recommended.

### NECROPSY FINDINGS

Grossly, diffuse fibrosis and granulomatous lesions containing pus are present in the mammary tissue. The lining of the milk ducts and the teat sinus is thick and roughened. On histological examination the granulomatous nature of the lesions is evident. Metastatic pulmonary lesions have been found in a few long-standing cases.

### Samples for confirmation of diagnosis

- Mycoplasmaology – chilled mammary tissue, regional lymph node (special media)
- Histology – fixed mammary tissue.

### DIFFERENTIAL DIAGNOSIS

A presumptive diagnosis can be made based on the clinical findings, but laboratory confirmation by culture of the organism is desirable. The facts that the organism does not grow on standard media and that other pathogenic bacteria are commonly present often lead to errors in the laboratory diagnosis unless attention is drawn to the characteristic field findings.

### TREATMENT

The majority of *M. bovis* strains isolated from cattle are susceptible in vitro to fluoroquinolones, florfenicol and tiamulin.<sup>20,21</sup> Approximately half of the isolates are susceptible to spectinomycin, tylosin and oxytetracycline, and very few isolates are susceptible in vitro to gentamicin, tilmicosin, ceftiofur, ampicillin, or erythromycin.<sup>20,21</sup> The clinical relevance of these in vitro susceptibility data to treating mycoplasmal mastitis remains questionable.

Cows diagnosed with mycoplasmal mastitis should be considered to be infected for life. None of the commonly used antimicrobial agents appear to be effective and oil–water emulsions used as intramammary infusions appear to increase the severity of the disease. Parenteral treatment with oxytetracycline (5 g intravenously, daily for 3 days) has been shown to cause only temporary improvement. A mixture of tylosin 500 mg and tetracycline 450 mg used as an infusion cured some quarters.<sup>22</sup> Unless treatment is administered very early in

the course of the disease, the tissue damage has already been done.

### CONTROL

Prevention of introduction of the disease into a herd appears to depend upon avoidance of introductions, or isolating introduced cows until they can be checked for mastitis. A popular bio-security recommendation is to culture the milk of all replacement cows for *M. bovis*, but the sensitivity and specificity of milk culture in cows with subclinical infections appears to be low. The disease spreads rapidly in a herd and affected animals should be culled immediately or placed in strict isolation until sale. Eradication of the disease can be achieved by culling infected cows identified by culture of milk and nasal swabs, especially at drying off and calving. When eradication is completed the bulk tank milk SCC is the best single monitoring device to guard against reinfection. An alternative program recommended for large herds is the creation of an infected subherd that is milked last. There appears to be merit in the frequent culturing of bulk milk samples as a surveillance strategy for problem herds and areas. Frequent culturing overcomes the poor sensitivity of bulk tank milk culturing. Cows with infected quarters are segregated into the subherd and cows developing clinical illness or decreased milk yield are culled.<sup>23</sup>

Intramammary infusions must be carried out with great attention to hygiene and preferably with individual tubes rather than multidose syringes. Most commercial teat dips are effective in control. Use of disposable latex gloves with disinfection of the gloved hands between cows may minimize transmission at milking.

Vaccination is a possible development but is unlikely to be a satisfactory control measure because the observed resistance of a quarter to infection after a natural clinical episode is less than 1 year. A *M. bovis* bacterin is commercially available in the USA that contains multiple strains of *M. bovis*. Autogenous bacterins have also been made for specific herds; however, no vaccine has proven efficacy for preventing, decreasing the incidence of, or decreasing the severity of clinical signs of mycoplasmal bovine mastitis.<sup>24</sup>

*Mycoplasma* are sensitive to drying and osmotic changes, but more resistant than bacteria to the effects of freezing or thawing. Amputating the teats of affected quarters may result in heavy contamination of the environment and is not recommended. Because *M. bovis* can cause respiratory disease, otitis media/interna and arthritis in calves, all colostrum and waste milk fed to calves should be pasteurized.

## REVIEW LITERATURE

- González RN, Wilson DJ. Mycoplasmal mastitis in dairy herds. *Vet Clin North Am Large Anim Pract* 2003; 19:199-221.
- Fox LK, Kirk JH, Britten A. Mycoplasmal mastitis: a review of transmission and control. *J Vet Med B* 2005; 52:153-160.

## REFERENCES

- Alexander PG et al. *Aust Vet J* 1985; 62:135.
- Jackson G et al. *Vet Rec* 1981; 108:31.
- Taoudi A, Kirchhoff H. *Vet Rec* 1986; 119:247.
- Pfutzner H et al. *Arch Exp Vet Med* 1986; 40:56.
- Mackie DP et al. *Vet Rec* 1982; 110:578.
- Hodges RT et al. *N Z Vet J* 1983; 31:60.
- Jurmanova K et al. *Arch Exp Vet Med* 1986; 40:67.
- Feenstra A et al. *J Vet Med B* 1991; 38:195.
- Gonzalez RN, Sears PM. *Proc Annu Conv Am Assoc Bovine Pract* 1994; 26:184.
- Pfutzner H et al. *Monatsh Vet Med* 1986; 41:382.
- Gonzalez RN et al. *Cornell Vet* 1992; 82:29.
- Pfutzner H, Schimmel D. *Zentralbl Vet Med A* 1985; 32:265.
- Biddle MK et al. *J Am Vet Med Assoc* 2005; 227:455.
- Mackie DP et al. *Vet Rec* 1986; 119:350.
- Ball HJ et al. *Ir Vet J* 1994; 47:45.
- Boothby JT et al. *Can J Vet Res* 1986; 50:200.
- Jackson G, Boughton E. *Vet Rec* 1991; 129:444.
- González RN et al. *J Am Vet Med Assoc* 1986; 189:442.
- González RN et al. *J Am Vet Med Assoc* 1988; 193:323.
- Rosenbusch RF et al. *J Vet Diagn Invest* 2005; 17:436.
- Thomas A et al. *Vet Rec* 2003; 153:428.
- Ball HJ, Campbell AN. *Vet Rec* 1989; 125:377.
- Brown MB et al. *J Am Vet Med Assoc* 1990; 196:1097.
- González RN, Wilson DJ. *Vet Clin North Am Large Anim Pract* 2003; 19:199.

## CORYNEBACTERIUM BOVIS

### ETIOLOGY

*Corynebacterium bovis* is a common and very contagious pathogen that is most commonly associated with subclinical infection. However, *C. bovis* has been cultured from dairy cattle with clinical mastitis in 1.7% of cases<sup>1</sup> and, in a herd that had controlled contagious mastitis pathogens, *C. bovis* was the only pathogen isolated in 22% of clinical mastitis episodes.<sup>2</sup> There is considerable debate about the significance of *C. bovis* infections for mammary gland health and cow productivity. For this reason, *C. bovis* is classified as a **minor pathogen**.

### EPIDEMIOLOGY

The main reservoir of infection appears to be infected glands and teat ducts, and *C. bovis* spreads rapidly from cow to cow in the absence of adequate teat dipping. *C. bovis* is extremely contagious and the duration of intramammary infection is long (many months). The prevalence of *C. bovis* is typically low in herds using an

effective germicidal teat dip, good milking hygiene and dry cow therapy.

In vivo and in vitro studies have demonstrated that the bacteria has a predilection for the streak canal, and this predilection has been associated with a requirement for lipids (possibly in the keratin plug) for growth.<sup>3</sup> It is possible that *C. bovis* infection in the streak canal may compete with ascending bacterial infections for nutrients and thereby decrease the new intramammary infection rate. Alternatively, the mild increase in SCC associated with *C. bovis* infection might increase the ability of the quarter to respond to a new intramammary infection.

Intramammary infection with a minor pathogen induces a higher than normal SCC and thereby increases the resistance of the colonized quarter to invasion by a major pathogen. In particular, the lowest rate of intramammary infection with major pathogens is observed in quarters infected with *C. bovis*.<sup>4</sup>

### CLINICAL FINDINGS

An intramammary infection with *C. bovis* is infrequently associated with clinical disease but usually causes a moderate increase in the SCC and a small increase in the CMT score. Milk production losses are usually not detectable, and the mastitis is typically a thicker than normal milk (abnormal milk); occasional cases also have a large firm gland (abnormal gland).<sup>2</sup> There are clear herd to herd differences in the apparent clinical pathogenicity of *C. bovis*, suggesting that strains of different virulence are present.

### TREATMENT

*C. bovis* is very susceptible to penicillin, ampicillin, amoxicillin, cephalosporin, and erythromycin, and most other commercially available intramammary infusions. There is no need for parenteral treatment. The duration of infection is prolonged (months) in animals not treated with antimicrobial agents.

### CONTROL

Long-term intensive programs of teat dipping and dry cow therapy will markedly reduce the prevalence of *C. bovis*. Because of its status as a minor pathogen, specific control measures (such as vaccination) are not indicated.

### REFERENCES

- Sargeant J et al. *Can Vet J* 1998; 39:33.
- Morin DE, Constable PD. *J Am Vet Med Assoc* 1998; 213:855.
- Black RT et al. *J Dairy Sci* 1972; 55:413.
- Lam TJGM et al. *Am J Vet Res* 1997; 58:17.

## Mastitis of cattle associated with teat skin opportunistic pathogens

### COAGULASE-NEGATIVE STAPHYLOCOCCI

Because of the intense investigation of coagulase positive staphylococcal mastitis (*S. aureus*), coagulase-negative staphylococcal intramammary infections have come under closer scrutiny and are now among the most common bacteria found in milk, especially in herds in which the major pathogens have been adequately controlled. There is considerable debate about the significance of these pathogens for the mammary gland and for cow productivity. For this reason, these pathogens are classified as **minor pathogens**.

### ETIOLOGY

Coagulase-negative staphylococci are common but minor contagious pathogens that include *Staphylococcus epidermidis*, *S. hyicus*, *S. chromogenes*, *S. simulans*, and *Staphylococcus warneri* that are normal teat skin flora, and *Staphylococcus xylosum* and *Staphylococcus sciuri* that come from an uncertain site.

### EPIDEMIOLOGY

Coagulase-negative staphylococci are teat skin opportunistic pathogens and cause mastitis by ascending infection via the streak canal. Coagulase-negative staphylococci appear to have a protective effect against colonization of the teat duct and teat skin by *S. aureus* and other major pathogens,<sup>1</sup> with the exception of *E. coli* and the environmental streptococci.

Studies in the US found that 20-70% of heifer quarters are infected before parturition with coagulase-negative staphylococci,<sup>2,3</sup> but these infections are usually eliminated spontaneously or with antimicrobial therapy during early lactation. A survey of the prevalence and duration of intramammary infection in heifers in Denmark in the peripartum period found *S. chromogenes* in 15% of all quarters before parturition, but this decreased to 1% of all quarters shortly after parturition.<sup>2</sup> In Finland, coagulase-negative staphylococci are the most commonly isolated bacteria from milk samples of heifers with mastitis.<sup>4</sup> Infections with *S. simulans* and *S. epidermidis* occurred in 1-3% of quarters both before and after parturition.<sup>2</sup> Infection with *S. simulans* persisted in the same quarter for several weeks, but intramammary infections with *S. epidermidis* were transient.

Coagulase-positive *S. hyicus* and *Staphylococcus intermedius* have been isolated from some dairy herds and can cause chronic, low-grade intramammary

infection and be confused with *S. aureus*.<sup>5</sup> The prevalence of infection with *S. hyicus* was 0.6% of all cows and 2% of heifers at parturition; the prevalence of infection of *S. intermedius* was less than 0.1% of cows.

### CLINICAL FINDINGS

Coagulase-negative staphylococci are usually associated with mild clinical disease (abnormal secretion only, occasionally abnormal gland) and are commonly isolated from mild clinical cases of mastitis and subclinical infections. For example, *Staphylococcus* spp. have been cultured from dairy cattle with clinical mastitis in 29% of cases,<sup>6</sup> and subclinical infections usually induce a moderate increase in SCC.

### CLINICAL PATHOLOGY

Intramammary infections by minor pathogens such as coagulase-negative staphylococci result in a higher than normal SCC and thereby increase the resistance of the colonized quarter to invasion by a major pathogen.<sup>7</sup> Although these bacteria are capable of causing microscopic lesions, they are not nearly as pathogenic as *S. aureus*,<sup>8</sup> and necropsy reports are lacking.

### TREATMENT

Spontaneous cure is common. Coagulase-negative staphylococci, including *S. chromogenes*, *S. hyicus* and others, are very susceptible to penicillin, ampicillin, amoxicillin, clavulanic acid, cephalosporins, erythromycin, gentamicin, potentiated sulfonamides and tetracyclines. In a study of 139 cases of subclinical coagulase-negative staphylococcal mastitis in New York, the bacteriological cure rates of commercially available intramammary infusions were similar to that of untreated controls (72% bacteriological cure), with the following bacteriological cure rates: cephalosporin (89%), amoxicillin (87%), cloxacillin (76%) and penicillin (68%).<sup>9</sup>

The use of a combination of novobiocin and penicillin, and cloxacillin as dry cow therapy for coagulase-negative staphylococci gave cure rates of over 90%.<sup>10</sup>

### CONTROL

Implementation of a mastitis control program will be very effective in decreasing intramammary infection due to coagulase-negative staphylococci. Because of its status as a minor pathogen, specific control measures (such as vaccination) are not indicated.

### REFERENCES

1. Matthews KR et al. J Dairy Sci 1991; 74:1855.
2. Aarestrup FM, Jensen NE. J Dairy Sci 1997; 80:307.
3. Erskine RJ et al. J Dairy Sci 1994; 77:3347.
4. Myllys V. J Dairy Res 1995; 62:51.
5. Roberson JR et al. Am J Vet Res 1996; 57:54.

6. Sargeant J et al. Can Vet J 1998; 39:33.
7. Fox LK et al. J Am Vet Med Assoc 1996; 209:1143.
8. Jarp J. Vet Microbiol 1991; 27:151.
9. Wilson DJ et al. J Dairy Sci 1999; 82:1664.
10. Davidson TJ et al. Can Vet J 1994; 35:775.

## Mastitis of cattle associated with common environmental pathogens

**Environmental mastitis** is associated with bacteria that are transferred from the environment to the cow rather than from other infected quarters. *E. coli*, *Klebsiella* spp. and **environmental streptococci** are the major pathogens causing environmental mastitis.

### COLIFORM MASTITIS ASSOCIATED WITH *ESCHERICHIA COLI*, *KLEBSIELLA* SPECIES AND *ENTEROBACTER AEROGENES*

#### ETIOLOGY

Many different serotypes of *E. coli*, numerous capsular types of *Klebsiella* spp.

#### Synopsis

**Etiology** Many different serotypes of *Escherichia coli*, numerous capsular types of *Klebsiella* spp. and *Enterobacter aerogenes*. These are commonly called coliform bacteria; other Gram-negative bacteria (such as *Pseudomonas aeruginosa*) can cause environmental mastitis but are not categorized as coliform bacteria.

**Epidemiology** Dairy cattle housed in total confinement or drylot; uncommon in pastured cattle. Most important mastitis problem in well managed, low-SCC herds. Quarter infection rate low at 2–4%. Incidence highest in early lactation. 80–90% of coliform infections result in clinical mastitis; 8–10% are peracute. Causes clinical mastitis rather than subclinical mastitis. Source of infection is environment between milkings, during dry period and prepartum in heifers. Isolates of *E. coli* are opportunists. Sawdust and shavings bedding contaminated with *E. coli* and *Klebsiella* spp. (particularly *K. pneumoniae*) major source of bacteria; much worse when wet (rainfall or high humidity). Coliform intramammary infection highest during 2 weeks following drying off and in 2 weeks prior to calving. Animal risk factors include:

- Low SCC
- Decrease of neutrophil function in periparturient cow
- High susceptibility in early lactation
- Contamination of teat duct
- Selenium and vitamin E status.

Outbreaks of coliform mastitis do occur, commonly associated with major change in management of the environment (introduction of sawdust for bedding may result in outbreaks of *Klebsiella* mastitis).

**Clinical findings** *Acute* – swelling of gland, watery milk with small flakes, mild systemic response, recovery in few days. *Peracute* – sudden onset of severe toxemia, fever, tachycardia, impending shock; cow may be recumbent. Quarter may or may not be swollen and warm, secretions thin and serous and contain very small flakes. May die in few days.

**Clinical pathology** Culture milk. Somatic cell count. Marked leukopenia, neutropenia and degenerative left shift. Bacteremia may occur, particularly in severely affected cattle.

**Necropsy findings** Edema, hyperemia, hemorrhages and necrosis of mammary tissue. Major changes in teat and lactiferous sinuses and ducts; invasion of organism into parenchyma not a feature of *E. coli*.

**Diagnostic confirmation.** Culture of organism from milk and high SCC.

#### Differential diagnosis

- Parturient hypocalcemia paresis
- Carbohydrate engorgement lactic acidosis

Other causes of acute and severe mastitis (must culture milk):

- Environmental streptococci
- *S. aureus* and *S. agalactiae*

**Treatment** Must consider status and requirements for each case based on severity. Use of antimicrobial agents is indicated in moderately to severely affected animals; efficacy uncertain in mild cases. Some infections become persistent if antibiotics are not administered. Severely affected cattle also need supportive fluid and electrolyte therapy (such as hypertonic saline), and possibly NSAIDs for endotoxemia.

**Control** Manage outbreaks by examination of environment. Improve sanitation and hygiene. Regular cleaning of barns. Dry bedding. Avoid crowding. Keep dry cows on pasture if possible. Replace sawdust and shavings with sand for bedding. Emphasize premilking hygiene, including premilking germicide teat dipping and keep cows standing for at least 30 minutes after milking. Core lipopolysaccharide antigen vaccine in dry period and early lactation to reduce incidence of clinical mastitis due to Gram-negative bacteria.

(most commonly *K. pneumoniae*) and *Enterobacter aerogenes* are responsible for coliform mastitis in cattle. *E. coli* isolated from the milk of cows with acute mastitis cannot be distinguished as a specific pathogenic group on the basis of biochemical and serological test reactions. The incidence of antimicrobial resistance is also low in these isolates because they are opportunists originating from the alimentary tract, from which antimicrobial resistant *E. coli* are rarely found in adults. Other Gram-negative bacteria which are

not categorized as coliforms but can cause mastitis include *Serratia*, *Pseudomonas*, and *Proteus* spp.

## EPIDEMIOLOGY

### Occurrence of clinical mastitis

The occurrence of coliform mastitis has increased considerably in recent years and is a cause for concern in the dairy industry and amongst dairy practitioners. Coliform mastitis occurs worldwide and is most common in dairy cattle that are housed in total confinement during the winter or summer months. Where cows are kept in total confinement in a drylot, outbreaks of coliform mastitis may occur during wet, heavy rainfall seasons. The disease is uncommon in dairy cattle that are continuously in pasture but it has been reported in pastured dairy cattle in New Zealand.

In contrast to contagious mastitis, environmental mastitis associated with coliform bacteria is primarily associated with clinical mastitis rather than subclinical mastitis. Clinical mastitis associated with environmental pathogens (including the environmental streptococci) is now the most important mastitis problem in well managed, low-SCC herds. In a survey of the incidence of clinical mastitis and distribution of pathogens in dairy herds in the Netherlands, the average annual incidence was 12.7 quarter cases per 100 cows per year. The most frequent isolates from clinical cases were *E. coli* (16.9%), *S. aureus* (14.4%), *S. uberis* (11.9%) and *S. dysgalactiae* (8.9%).<sup>1</sup>

The incidence of clinical coliform mastitis is highest early in lactation and decreases progressively as lactation advances.<sup>2</sup> The rate of intramammary infection is about four times greater during the dry period than during lactation. The rate of infection is also higher during the first 2 weeks of the dry period and during the 2 weeks before calving. 80–90% of coliform infections result in varying degrees of clinical mastitis in the lactating cow; approximately 8–10% of coliform infections result in peracute mastitis, usually within a few days after calving. The disease also occurs commonly in herds that concentrate calving over a short period of time.

### Prevalence of infection

The prevalence of both intramammary infection and the incidence of clinical mastitis due to coliform bacteria has increased, particularly in dairy herds with a low prevalence of infection and incidence of clinical mastitis due to *S. aureus* and *S. agalactiae* as a result of an effective mastitis control program. Compared to other causes of mastitis, coliform infections are relatively uncommon and, in data based on herd surveys, the

percentage of quarters infected with these pathogens is low. The percentage of quarters infected at any one time is generally low, at about 2–4%.

In the UK, about 0.2% of quarters of cows may be infected at any one time.<sup>3</sup> Surveillance of a dairy herd in total confinement in the USA indicated that infection with coliform bacteria by either day of lactation or day of the year never exceeded 3.5% of quarters, and this maximum was reached on the day of calving. However, coliform infections may cause 30–40% of clinical mastitis episodes. In herds with a problem, up to 8% of cows have been infected with coliform bacteria, and 80% of the cases of clinical mastitis may be due to coliform infections.<sup>4</sup>

### Duration of infection

Coliform intramammary infections are usually of short duration. Over 50% last less than 10 days; about 70% less than 30 days; and only 1.5% exceed 100 days in duration.

### Source of infection and mode of transmission

The primary reservoir of coliform infection is the dairy cow's environment (environmental pathogen); this is in contrast to the infected mammary gland, which is the reservoir of major contagious pathogens (*S. aureus* and *S. agalactiae*) and the main reservoir of infection in cattle with *M. bovis*. Exposure of uninfected quarters to environmental pathogens occur at any time during the life of the cow, including during milking, between milkings, during the dry period and before calving in heifers.

### Morbidity and case fatality

In dairy herds with low bulk tank milk SCCs the average herd incidence of clinical mastitis is 45–50 cases per 100 cows annually, with coliforms isolated from 30–40% of the clinical cases. This is similar to an average incidence of 15–20 cases of coliform mastitis per 100 cows in herds with low bulk tank milk SCCs.<sup>5</sup> Other observations indicate that the number of clinical cases of coliform mastitis varies from 3 to 32 per 100 cows per year but the average incidence in dairy herds can be as low as 6–8 per 100 cows per year.

Coliform mastitis is one of the most common causes of fatal mastitis in cattle. The case fatality rate from peracute coliform mastitis is commonly high and may reach 80% in spite of intensive therapy. Outbreaks of the disease can occur with up to 25% of recently calved cows affected within a few weeks of each other.

### Risk factors

#### Pathogen risk factors

The isolates of *E. coli* from bovine mastitic milk are simply opportunist pathogens.<sup>6</sup>

The isolates that cause coliform mastitis possess lipopolysaccharides (endotoxin), which form part of the outer layer of the cell wall of all Gram-negative bacteria. Coliform bacteria isolated from the milk of cows or from their environment have different degrees of susceptibility to the bactericidal action of bovine sera, with almost all the isolates that cause severe mastitis being serum-resistant.<sup>7</sup> Serum-sensitive organisms are unable to multiply in normal glands because of the activity of bactericidins reaching milk from the blood. Of the strains of *E. coli* isolated from cases of mastitis in cattle in England and Wales, only those that were serum-resistant were re-isolated from expressed milk following intramammary inoculation of lactating cows. Other observations indicate that serum-resistant coliforms have no selected advantage over serum-susceptible coliforms in naturally occurring intramammary infections. There are also somatic and capsular factors of coliforms that affect resistance to bovine bactericidal activity. Strains of *Klebsiella* that cause mastitis are also resistant to bovine serum. The fibronectin binding property of *E. coli* from bovine mastitis may be an important virulence factor that allows the organism to adhere to the ductular epithelium.

#### Environmental risk factors

All the environmental components that come in contact with the udder of the cow are considered potential sources of the organisms. The coliform bacteria are opportunists, and contamination of the skin of the udder and teats occurs primarily between milkings when the cow is in contact with contaminated bedding rather than at the time of milking. Feces, which are a common source of *E. coli*, can contaminate the perineum and the udder directly or indirectly through bedding, calving stalls, drylot grounds, udder wash water, udder wash sponges and cloth rags, teat cups and milkers' hands. Cows with chronic coliform mastitis also provide an important source of bacteria, and direct transmission probably occurs through the milking machine. Inadequate drying of the base of the udder and the teats after washing them prior to milking can lead to a drainage of coliform-contaminated water down into the teat cups and subsequent infection.

#### Bedding

Sawdust and shavings used as bedding that are contaminated and harbor *E. coli*, and particularly *K. pneumoniae*, are major risk factors for coliform mastitis. Cows bedded on sawdust have the largest teat end population of total coliforms and klebsiellae; those bedded on shavings have an intermediate number and those



on straw have the least. Experimentally, the incubation of bedding samples at 30–44°C (86–111°F) resulted in an increase in the coliform count; at 22°C (71°F) the count was maintained, and at 50°C (122°F) the bacteria were killed. Wet bedding, particularly sawdust and shavings, promotes the growth of coliform bacteria, especially *Klebsiella* spp.

The relationship between the bedding populations of Enterobacteriaceae was studied over a 12-month period in a dairy herd. The analyses revealed that rainfall bedding populations of *E. coli* and coliform mastitis incidence were statistically independent, while there was a strong association between rainfall and *K. pneumoniae* bedding populations and the incidence of *K. pneumoniae* mastitis. The lack of an association between bedding population of *E. coli* and coliform mastitis, along with the observation that cows are most susceptible immediately after parturition, suggest that the ability of the bacteria to penetrate the streak canal may be a factor of resistance in the cow and not a characteristic of the organism. Also, it appears that the cow in early lactation is not as susceptible to *K. pneumoniae* as to *E. coli*.

The ability of several different bedding materials to support the growth of environmental pathogens has been outlined under controlled conditions. Bedding materials vary in their ability to support growth of different pathogens, and under barn conditions it appears that high bacterial counts are influenced by factors more complex than type of bedding alone. Even clean damp bedding may support bacterial growth.

High populations of coliform bacteria on the teat end, unless accompanied by actual chronic quarter infection, are probably transitory and represent recent environmental contamination that would usually be eliminated by an effective sanitation program at milking time. However, any teat skin population, whether associated with infection in another quarter, from contaminated teat cup liners or from other environmental sources, must be considered as a potential source of new infection.

#### Animal risk factors

Factors that influence the susceptibility of cows to coliform mastitis include the SCC of the milk, the stage of lactation and the physiological characteristics and defense mechanisms of the udder (particularly the speed of neutrophil recruitment), teat characteristics, and the ability of the cow to counteract the effects of the endotoxins elaborated by the organisms.

#### Somatic cell count

Experimentally, an SCC of 250 000 cells/mL in the milk of a quarter may limit signifi-

cant growth of bacteria and development of mastitis when small inocula of coliform organisms are experimentally introduced into the gland.<sup>7</sup> Somatic cell counts of 500 000 cells/mL provided complete protection.<sup>8</sup> Thus cows in herds with a low incidence of streptococcal and staphylococcal mastitis have a low milk SCC and are more susceptible to coliform mastitis. Dairy herds with low herd bulk tank milk SCCs may have a greater incidence of severe toxic mastitis than herds with higher counts.<sup>8</sup>

#### Neutrophil recruitment and function

Increased susceptibility to coliform mastitis in the periparturient cow is primarily due to impaired neutrophil recruitment to the infected gland.<sup>9</sup> In fatal cases of peracute mastitis in cows within 1 week after parturition there may be large numbers of bacteria in mammary tissues and an absence of neutrophilic infiltration. Other observations indicate a high correlation between poor preinfection chemotactic activity of blood neutrophils and susceptibility to intramammary *E. coli* challenge exposure.<sup>10</sup> Experimentally, in periparturient cows the inability to recruit neutrophils rapidly into the mammary gland following intramammary infection is associated with an overwhelming bacterial infection and peracute highly fatal mastitis.<sup>9</sup> The periparturient cows are unable to control bacterial growth during the first few hours after bacterial inoculation and consequently the bacterial load is much higher when neutrophils finally enter the milk. The lack of neutrophil mobilization could be due to:

- Failure to recognize bacteria
- Lack of production of inflammatory mediators
- A defect in the ability of the cells to move into the milk compartment.

In ketonemic cows, experimental *E. coli* mastitis is severe, regardless of pre-infection chemotactic response.<sup>11</sup>

High levels of cytokines are present in the milk of cows that lack the ability to recruit leukocytes, which is evidence that the cells recognized the bacteria.<sup>9</sup> All of this suggests that the critical defect is in the neutrophils of the periparturient cow. Certain cell-surface receptors on leukocytes may be important defense mechanisms against *E. coli* polysaccharides.<sup>12</sup> Bovine mammary neutrophils possess cell surface C14 and C18 and lectin-carbohydrate interactions mediating non-opsonic phagocytosis of *E. coli*, which may be important in controlling these infections.

#### Selenium and vitamin E status

The positive effects of supplemental vitamin E and selenium on mammary

gland health are well established. An adequate dietary level of selenium enhances the resistance of the bovine mammary gland to infectious agents. Experimentally induced intramammary *E. coli* infections are significantly more severe, and of longer duration, in cows whose diets have been deficient in selenium than in cows whose diets were supplemented with selenium. The enhanced resistance is thought to be associated with a more rapid diapedesis of neutrophils into the gland of cows fed diets supplemented with selenium, which limits the numbers of bacteria in the gland during infection.

Vitamin E is especially important to mammary gland health during the peripartum period. Plasma concentrations of alpha-tocopherol begin to decline at 7–10 days before parturition, reach nadir at 3–5 days after calving and then start increasing.<sup>13</sup> When plasma concentrations are maintained during the peripartum period by injections of alpha-tocopherol, the killing ability of blood neutrophils is improved.<sup>14</sup> The supplementation of the diets of dry cows receiving 0.1 ppm of selenium in their diets with vitamin E at 1000 IU/d reduced the incidence of clinical mastitis by 30% compared to cows receiving 100 IU/d. The reduction was 88% when cows were fed 4000 IU/d of vitamin E during the last 14 days of the dry period.<sup>2</sup>

There are also marked effects of dietary selenium on milk eicosanoid concentrations in response to an *E. coli* infection, which may be associated with the altered pathogenesis and outcome of mastitis in a selenium-deficient state.<sup>15</sup>

#### Stage of lactation and defense mechanism

Coliform mastitis occurs almost entirely in the lactating cow and rarely in the dry cow. The disease can be produced experimentally in lactating quarters much more readily than in dry quarters.<sup>7</sup> The difference in the susceptibility may be due to the much higher SCCs and lactoferrin concentrations in the secretion of dry quarters than in the milk of lactating quarters. Cows with known uninfected quarters at drying off may develop peracute coliform mastitis at calving, suggesting that infection occurred during the dry period. New intramammary infections can occur during the nonlactating period, especially during the last 30 days, remain latent until parturition and cause peracute mastitis after parturition.

The **rate of coliform intramammary infection** is highest during the 2 weeks following drying off and in the 2 weeks before calving. The fully involuted mammary gland appears to be highly resistant to experimental challenge by *E. coli* but it becomes susceptible during the immediate

parturition period. More than 93% of *E. coli* intramammary infection associated with the nonlactating period originated during the second half of that period.<sup>16</sup>

Several physiological factors may influence the level of resistance of the nonlactating gland to coliform infection. The rate of new intramammary infection is highest during transitions of the mammary gland from lactation to involution and during the period of colostrum production to lactation. There can be a sixfold increase in coliform infections from late lactation to early involution but 50% of these new infections do not persist into the next lactation. Also, the rate of spontaneous elimination of minor pathogens is high during the nonlactating period. The difference in susceptibility or resistance to new intramammary infection may be due, in part, to changes in concentration of lactoferrin, IgG, bovine serum albumin and citrate, which are correlated with *in vitro* growth inhibition of *K. pneumoniae*, *E. coli*, and *S. uberis*.

There is also a slower increase in polymorphonuclear neutrophils in milk after new intramammary infection in early lactation than in mid and late lactation. These conditions may explain the occurrence of peracute coliform mastitis in early lactation. This suggests latent infection or, more likely, that infection occurred at a critical time just a few days before and after calving, when the streak canal became patent and the population of coliform bacteria on the teat end was persistently high because the cow was not being milked routinely and thus would not be subjected to udder washing and teat dipping. Coliform bacteria can pass through the streak canal unaided by machine milking – this may be associated with the high incidence of coliform mastitis in high-yielding older cows, which may have increased patency of the streak canal with age.

Newly calved cows can be classified as moderate or severe responders to experimentally induced coliform mastitis. Following infection there is a diversity of responses varying from very mild to very acute inflammation of the gland and evidence of systemic effects such as fever, anorexia and discomfort.<sup>17</sup> Losses in milk yield and compositional changes are most pronounced in inflamed glands and, in severe responders; milk yield and composition did not return to preinfection levels. It is proposed that the severe and long-lasting systemic disturbances in severe responders can be attributed to absorption of endotoxin.

In summary, coliform mastitis is more severe in periparturient cows because of inability to slow bacterial growth early after infection. This inability is associated

with low SCC before challenge and slow recruitment of neutrophils.<sup>9</sup> There may also be deficits in the ability of leukocytes to kill bacterial pathogens.

#### Contamination of teat duct

The sporadic occurrence of the disease may be associated with the use of contaminated teat siphons and mastitis tubes and infection following traumatic injury to teats or following teat surgery. Several teat factors are important in the epidemiology of *E. coli* mastitis. It is generally accepted that *E. coli* is common in the environment of housed dairy cows and that mastitis can be produced experimentally by the introduction of as few as 20 organisms into the teat cistern via the teat duct. However, the processes by which this occurs under natural conditions are unknown. *E. coli* does not colonize the healthy skin of the udder or the teat duct.

The teat duct normally provides an effective barrier to invasion of the mammary gland by bacteria. As a result of machine milking there is some relaxation of the papillary duct, followed by gradual reduction in the duct lumen diameter in the 2 hours following milking. This period of relaxation after milking may be a risk factor predisposing to new intramammary infection.

Experimental contamination of the teat ends with a high concentration of coliform bacteria by repeated wet contact, however, does not necessarily result in an increase in new intramammary infection. The experimental application of high levels of teat end contamination with *E. coli* after milking repeatedly led to high rates of intramammary infection, which suggests that penetration of the teat duct by *E. coli* occurs in the period between contamination and milking. Milking machines that produce cyclic and irregular vacuum fluctuations during milking can result in impacts of milk against the teat ends, which may propel bacteria through the streak canal and increase the rate of new infections due to *E. coli* and outbreaks of peracute coliform mastitis.

#### Downer cows

Cows affected with the downer cow syndrome following parturient paresis, or recently calved cows that are clinically recumbent for any reason, are susceptible to coliform mastitis because of the gross contamination of the udder and teats with feces and bedding.

#### Other defense factors

##### Lactoferrin and citrate

The failure of lactoferrin within mammary secretions to prevent new infections and mastitis near and after parturition may be due to a decrease in lactoferrin before

parturition. Lactoferrin normally binds the iron needed by iron-dependent organisms; these multiply excessively in the absence of lactoferrin. Also, citrate concentrations increase in mammary secretions at parturition and may interfere with iron-binding by lactoferrin.

#### Serum antibody to *E. coli*

The serum IgG<sub>1</sub> ELISA titers recognizing core lipopolysaccharide antigens of *E. coli* J5 in cattle are associated with a risk of clinical coliform mastitis. Titers less than 1:240 were associated with 5.3 times the risk of clinical coliform mastitis. Older cattle in the fourth or greater lactations were also at greater risk, even though titers increased with age. There is a titer-independent age-related increase in clinical coliform mastitis. Active immunization of cattle with an Rc-mutant *E. coli* (J5) vaccine resulted in a remarkable decrease in the incidence of clinical coliform mastitis.<sup>18</sup>

#### PATHOGENESIS

After invasion and infection of the mammary gland, *E. coli* proliferates in large numbers and releases endotoxin on bacterial death or during rapid growth when excess bacterial cell wall is produced. Endotoxin causes a change in vascular permeability, resulting in edema and acute swelling of the gland and a marked increase in the number of neutrophils in the milk.<sup>7</sup> The neutrophil concentrations may increase 40–250 times and strongly inhibit the survival of *E. coli*.<sup>7</sup> This marked diapedesis of neutrophils is associated with the remarkable systemic **leukopenia** and **neutropenia** that occurs in peracute coliform mastitis. The severity of the disease is influenced by:

- The degree of the pre-existing neutrophils in the milk
- The rate of invasion and total number of neutrophils that invade the infected gland
- The susceptibility of the bacteria to serum bactericidins that are secreted into the gland
- The amount of endotoxin produced.<sup>19</sup>

#### Stage of lactation

The severity of disease is dependent on the stage of lactation. Experimental infection of the mammary gland of recently calved cows with *E. coli* produces a more severe mastitis when compared with animals in midlactation. This may be due to a delay in diapedesis of neutrophils into the mammary gland of recently calved cows. Furthermore, because of this delay there may be no visible changes in the milk for up to 15 hours after infection, but the systemic effects of the endotoxin released by the bacteria are evident in the cow (fever, tachycardia, anorexia, rumen

hypomotility or atony, mild diarrhea). The net result is endotoxemia, which persists as long as bacteria are multiplying and releasing endotoxin. This persistent endotoxemia is probably a major cause of failure to respond to therapy compared to the transient endotoxemia in the experimental inoculation of one dose of endotoxin.

### Neutrophil response

The final outcome is highly dependent on the degree of neutrophil response.<sup>20</sup> If the neutrophil response is delayed and growth of the organisms is unrestricted, the high levels of toxin produced could cause severe destruction of udder tissue and general toxemia. If the animal responds quickly there is often little effect on milk yield because the injury is confined to the sinuses without involvement of secretory tissues.<sup>7</sup> The ability of the neutrophils to kill *E. coli* varies among cows. Experimental infection of the mammary gland of cows with *E. coli* results in the stimulation of a long-lasting opsonic activity for the phagocytosis and killing of the homologous strain of the organism by neutrophils. Thus it is not opsonic deficiency that is the problem in early lactation but rather a **failure of rapid migration of neutrophils into the gland cistern**.

The rapidity and efficiency of the neutrophil response are major factors in determining the outcome.<sup>21</sup> If the neutrophil response is rapid, clinical disease will be mild or go undetected, self-cure will occur and the cow returns to normal; the milk may be negative for the bacteria. This may be one important cause of an increase in the percentage of clinical mastitis cases in which no pathogens can be isolated from the milk. Failure of the cow to mount a significant neutrophil response results in the multiplication of large numbers of bacteria, the elaboration of large amounts of endotoxin and severe highly fatal toxemia. In these cases, bacteria are readily cultured from the milk. In less serious and nonfatal cases, the recruitment of neutrophils does not fail but is delayed; this results in acute clinical mastitis with progressive inflammation and permanent loss of secretory function. The bacteria are not always readily eliminated from the infected gland by the neutrophils. Coliform bacteria may remain latent in neutrophils and, in naturally occurring cases, it is not uncommon to be able to culture the organism from the mammary gland during and after both parenteral and intramammary antibacterial therapy.

### Numbers of bacteria in milk

The numbers of bacteria in the milk also influence the outcome. If bacterial num-

bers exceed  $10^6$  cfu/mL, the ability of the neutrophil to phagocytose is impaired. If the bacterial count is less than  $10^3$  cfu/mL at 12 hours postinfection, the bacteria will be rapidly eliminated and the prognosis will be favorable. This response is seen as a subacute form of the disease with spontaneous self-cure. If the neutrophil response is slow or delayed, the cow will exhibit more severe signs of coliform mastitis due to toxemia. This is most common in recently calved cows and is characterized clinically by a serous secretion in the affected quarter that later becomes watery, fever, depression, ruminal hypomotility and mild diarrhea. The prognosis in these cases is unfavorable. These more severe forms of coliform mastitis usually occur after calving and in the first 6 weeks of lactation. Cows with coliform mastitis in mid to late lactation generally generate a rapid neutrophil response rate and their prognosis is likely to be favorable.

### Experimental endotoxin-induced mastitis

In an attempt to further understand the pathogenesis of coliform mastitis, the effect of experimentally introducing *E. coli* endotoxin into the mammary gland has been examined. The intramammary infusion of 1 mg *E. coli* endotoxin induces acute mammary inflammation and transient, severe shock from which cows recover within 48–72 hours.<sup>22</sup> Udder edema is apparent within 2 hours but begins to subside in 4–6 hours. The SCC increases within 3–5 hours and at 7 hours the count is 10 times normal. A mild systemic reaction with a transient fever occurs in some cows. High concentrations of interleukin-1 and interleukin-6 are detectable in the milk of infused glands, beginning 3–4 hours after infusion.<sup>23</sup> Milk concentrations of bovine serum albumin are increased from baseline levels to peak levels within 2 hours, indicating increased vascular permeability induced by inflammatory mediators. The infusion of endotoxin into the teat cistern of cows induces a rapid local inflammatory response of short duration with an influx of neutrophils into the teat cistern.<sup>24</sup>

The intramammary infusion of endotoxin results in a sequential increase of immunoglobulin in milk whey and of phagocytosis of staphylococci by milk polymorphonuclear cells. This is consistent with spontaneous recovery of cows with acute coliform mastitis. Endotoxin infusion can also result in increases in arachidonic acid metabolites such as thromboxanes, and cytokines,<sup>23</sup> which may be involved in mediation of local quarter inflammation and the systemic signs observed in acute coliform mastitis.

Histamine, serotonin, leukotrienes and arachidonic metabolites are also released following experimental *K. pneumoniae* mastitis. There is also a marked increase in prostaglandin concentrations, which indicates that they may play a role in the pathogenesis of endotoxin-induced mastitis and that the use of NSAIDs may be of value therapeutically.

In **peracute coliform mastitis**, severe toxemia with fever, shivering, weakness leading to recumbency in a few hours, and mild diarrhea are common and probably due to the absorption of large quantities of endotoxin. For many years it was thought that bacteremia did not occur in severe cases of coliform mastitis. However, **bacteremia is present in 32–48% of naturally occurring cases of coliform mastitis.**<sup>25,26</sup> In experimental endotoxemia in cattle there is profound leukopenia (neutropenia and lymphopenia), a mild hypocalcemia and elevation in plasma cortisol concentration. Hypocalcemia also occurs in naturally occurring cases and is thought to be due to decreased abomasal emptying rate associated with the endotoxemia. Experimentally infused endotoxin is detoxified very rapidly after absorption into the circulation.

In the acute form, the systemic changes are usually less severe than in the peracute form. However, in both forms, there is marked agalactia and the secretions in the affected quarter become serous and contain small flakes. Coliform organisms are not active tissue invaders, and in affected cattle that survive the systemic effects of the endotoxin the affected quarter(s) will usually return to partial production in the same lactation, and even full production in the next. However, in some cows that survive the peracute form, subsequent milk production in the current lactation is inadequate and cows are commonly culled.

A retrospective analysis of cows with clinical and laboratory features of coliform mastitis revealed that 60% returned to produce a milk-like secretion in the affected quarters in the current lactation and 40% did not. However, only 63% of the former group and 14% of the latter group remained in the herd and produced milk in the next lactation. Some cows were culled during the current lactation for low milk production and other reasons, some died and others were culled for mastitis. Of the original 88 cows with coliform mastitis, only 38 (43%) remained in the herd and produced milk in the next lactation.<sup>27</sup>

### CLINICAL FINDINGS

**Peracute coliform mastitis** in the cow is a severe disease characterized by a sudden onset of agalactia and toxemia. The cow

may be normal at one milking and acutely ill at the next. Complete anorexia, severe depression, shivering and trembling, cold extremities (particularly the ears) and a fever of 40–42°C (104–108°F) are common. Within 6–8 hours after the onset of signs the cow may be recumbent and unable to stand. At that stage, the temperature may be normal or subnormal, all of which may superficially resemble parturient paresis. The heart rate is usually increased up to 100–120 beats/min, the rumen is static, there may be a mild watery diarrhea and dehydration is evident. Polypnea is common and in severe cases an expiratory grunt may be audible because of pulmonary congestion and edema.

The **affected quarter(s)** is usually swollen and warm but not remarkably so, and for this reason coliform mastitis may be missed on initial clinical examination. The cow may be severely toxemic, febrile and have cold extremities before there are visible changes in the mammary gland or the milk. The mammary secretion is characteristic, and changes from the consistency of watery milk initially to a thin, yellow serous fluid containing small meal-like flakes that are barely visible to the naked eye and are best seen on a black strip plate used for gross examination of milk. Additional quarters may become affected within a day or two of the initial infection.

**The course of peracute coliform mastitis is rapid.** Some cows will die in 6–8 hours after the onset of signs; others will live for 24–48 hours. Those that survive the peracute crisis will either return to normal in a few days or remain weak and recumbent for several days and eventually develop the complications associated with prolonged recumbency. Intensive intravenous fluid therapy may prolong the life of the cow for up to several days but significant improvement may not occur and eventually euthanasia may appear to be the desirable course of action.

**Acute coliform mastitis** is characterized by varying degrees of swelling of the affected gland and variable systemic signs of fever and inappetence. The secretions of the gland are watery to serous in consistency and contain flakes. Recovery with appropriate treatment usually occurs in a few days.

#### Accuracy of clinical diagnosis

Various diagnostic schemes that use clinical parameters to differentiate cows with clinical mastitis due to Gram-negative bacteria from those with clinical mastitis associated with Gram-positive bacteria have been developed.<sup>28–34</sup> In general, all these schemes predict Gram-

negative bacteria as the cause if the milk is watery or yellow, if the mastitis episode occurs in summer and if rumen motility is decreased or absent. Experienced clinicians are not much better at predicting the causative agent than inexperienced clinicians. The conclusion from all of these studies is that **clinical observations do not allow sufficiently accurate prediction of clinical mastitis pathogens** and should not be used as the sole criteria for deciding whether cows are treated with antibiotics, or even the class of antibiotic to be administered.<sup>34</sup> Even the best predictive algorithm was wrong 25% of the time if the prevalence of Gram-negative mastitis was 50%, which is too high an error rate to be used to guide treatment. For comparison, flipping a coin to attribute the causative agent as being Gram-positive or Gram-negative is wrong only 50% of the time!

An increase in the ability of a positive test to predict a Gram-negative bacterial infection as the cause for a clinical mastitis episode is provided by examining for the presence of endotoxin in milk (sensitivity (Se) = 0.72; specificity (Sp) = 0.95),<sup>35</sup> whether the segmented neutrophil count is less than 35% of the total leukocyte count (Se = 0.87; Sp = 0.71),<sup>36</sup> whether the segmented neutrophil count is less than 3200 cells/ $\mu$ L (Se = 0.93; Sp = 0.89),<sup>36</sup> and by culturing on selective media (Se = 0.60; Sp = 0.98).<sup>37</sup> The endotoxin test is a cow-side test (**Limast-test**<sup>®</sup>) that is commercially available in Scandinavia. The test takes 15 minutes to run on milk samples and requires at least 10<sup>4</sup>–10<sup>5</sup> cfu of Gram-negative bacteria for a positive test result.<sup>35</sup> Assessment of the white blood cell count and differential count is widely available in veterinary practice but is not a cow-side test and is therefore not ideal. Both the milk endotoxin test and blood neutrophil count have adequate sensitivity and specificity for use to guide treatment decisions.

**Chronic coliform mastitis** is characterized by repeated episodes of subacute mastitis, which cannot be readily clinically distinguished from other common causes of mastitis.

**Subclinical coliform mastitis** is characterized by the presence of coliform organisms in the milk samples of cows without clinical evidence of mastitis. The prevalence of intramammary infection in quarters with coliform bacteria is low relative to contagious mastitis pathogens, ranging from 0.9–1.2%.

#### CLINICAL PATHOLOGY

##### Culture of milk

Milk samples should be submitted for culture to identify the causative agent, but antimicrobial susceptibility testing has

not been validated and is currently not recommended to guide treatment decisions.<sup>38</sup> In the peracute case, the milk samples will yield a positive culture. In less acute cases, the milk sample may be negative because the neutrophils have cleared the bacteria.

#### Somatic cell count and CMT scores

In the experimental disease the SCC of milk from the inoculated quarter ranges from 14 000 000–25 000 000 cells/mL at 5 hours after inoculation. The CMT on secretions from affected quarters is usually +3.

#### Hematology

In peracute coliform mastitis there is hemoconcentration, a marked leukopenia, neutropenia and a degenerative left shift due to the margination of large numbers of neutrophils in response to endotoxin. There is also a moderate lymphopenia, monocytopenia and thrombocytopenia.<sup>36</sup> If the degenerative left shift, leukopenia and neutropenia become worse on the second day after the onset of clinical signs, the prognosis is unfavorable. An improvement in the differential white count on the second day is a good prognostic sign.

#### Endotoxin presence in milk and plasma

A commercially available cow-side test (**Limast-test**<sup>®</sup>) for endotoxin is available in Scandinavia. The test takes 15 minutes to run on milk samples and is able to detect the presence of endotoxin and therefore Gram-negative bacteria, but does not differentiate between *E. coli* and *K. pneumoniae*.

#### Serum biochemistry

The biochemical abnormalities observed in naturally occurring cases include uremia, high aspartate aminotransferase activity and strong ion (metabolic) acidosis in fatal cases, while in surviving cases there were decreased concentrations of sodium, potassium and chloride, and strong ion (metabolic) alkalosis.<sup>25,36</sup>

#### NECROPSY FINDINGS

There is edema and hyperemia of the mammary tissue. In severe cases hemorrhages are present and are accompanied by thrombus formation in the blood and lymphatic vessels; there is necrosis of the parenchyma.

A study of the progressive pathological changes in experimental and natural cases of *E. coli* mastitis in cows reveals that damage is most marked in the epithelium of the teat and lactiferous sinuses and diminishes rapidly towards the ducts. In hyperacute cases, the organisms are largely confined to the ductular and secretory lumen and there is

little invasion of the parenchyma, despite the presence of large numbers of organisms. In some cases there may be intense neutrophil infiltration, subepithelial edema and epithelial hyperplasia of the sinuses and large ducts. In hyperacute cases in the immediate postpartum period, infiltration of neutrophils may be negligible. There is now some evidence that bacteremia may occur in coliform mastitis.<sup>25</sup>

#### Samples for confirmation of diagnosis

- Bacteriology – chilled mammary tissue, regional lymph node
- Histology – formalin-fixed mammary tissue.

#### DIFFERENTIAL DIAGNOSIS

- **Peracute coliform mastitis** in cattle is characterized clinically by a sudden onset of toxemia, weakness, shivering, often recumbency, fever in the early stages followed by a normal temperature or hypothermia in several hours, and characteristic gross changes in the milk, which usually is watery and contains some particles barely visible to the unaided eye. The peracute form of the disease is most common in recently calved cows
- **Parturient hypocalcemia paresis** occurs in recently calved cows. The weakness and recumbency resembles peracute coliform mastitis but the marked increase in heart rate, and dehydration and mild diarrhea if present, are not characteristic of parturient paresis and should prompt further clinical examination, particularly of the udder. In the early stages of coliform mastitis the changes in the milk may be just barely visible. Those clinical findings which are most useful to predict peracute coliform mastitis include watery consistency of milk, shivering, firmness of udder, tachycardia, polypnea, fever, weakness and mastitis of less than 24 hours' duration.<sup>31</sup> A marked leukopenia and neutropenia are characteristic of coliform mastitis, whereas in parturient paresis there is usually a neutrophilia and stress leukon (neutrophilia, no left shift, lymphopenia, monocytosis and eosinopenia). The differential diagnosis of recumbency in the immediate postpartum period is discussed under parturient paresis
- **Carbohydrate engorgement lactic acidosis** causes rapid onset of weakness, recumbency, diarrhea, dehydration, and ruminal stasis and resembles the clinical findings of shock in peracute coliform mastitis. However, the rumen contains an excess of watery fluid and the pH is below 5
- **Acute coliform mastitis** cannot be accurately differentiated from all other common causes of acute mastitis with abnormal gland and abnormal milk, including the environmental streptococci *S. uberis* and *S. dysgalactiae*, and the contagious pathogens *S. aureus* and *S. agalactiae*. Culture of the milk is necessary

#### TREATMENT

The treatment of coliform mastitis in cattle has been controversial but recent studies have clarified the **important role that antimicrobial agents play in treating severely affected cattle**. Historically, the treatment of coliform mastitis was based on the principles of treating a bacterial infection with varying degrees of inflammation. A combination of broad-spectrum antimicrobial agents administered parenterally and by intramammary infusion, fluid and electrolyte therapy, frequent stripping out of the affected glands with the aid of oxytocin, and anti-inflammatory drugs have been used with varying degrees of success based on empirical and anecdotal experience. Only a handful of clinical trials have evaluated the efficacy of therapeutic agents used in naturally occurring cases of coliform mastitis, especially for the peracute form of the disease.

Most of the controversy has centered on the rational use of antimicrobial agents.<sup>4</sup> The use of antimicrobial agents for the treatment of coliform mastitis has been questioned for several reasons:

- Clinical signs are primarily due to the effects of endotoxin in the mammary gland, with formation of endogenous inflammatory mediators within the udder and their subsequent release into the systemic circulation<sup>39</sup>
- The severity of clinical signs are correlated with the number of bacteria in the affected gland
- Most mild cases of coliform mastitis (abnormal milk but normal gland and cow) are self-limiting and resolve without antimicrobial therapy. However, a small percentage of these mild clinical cases develop persistent infection
- There is speculation that the use of bactericidal antimicrobial agents may result in the bolus release of large quantities of lipopolysaccharides in the mammary gland associated with a rapid kill of bacteria, but this has not been observed in any study to date. In contrast, endotoxin release occurs from rapid bacterial growth alone, which will be prevented by administration of an effective antibiotic
- Many, but not all, of the broad-spectrum antimicrobial agents currently approved for use in lactating cattle do not result in high enough concentrations in the milk when given parenterally.

Most of the antimicrobial agents currently used for the treatment of coliform mastitis in lactating dairy cows are not approved for use in food-producing animals.<sup>40</sup>

Because of this extralabel use and the lack of pharmacokinetic data for adequate withholding times, the risk of drug residues in milk and meat is increased.

The prognosis in the peracute form of the disease is unfavorable if severe clinical toxemia is present. Severe depression, weakness, diarrhea and dehydration, recumbency and a heart rate over 120 beats/min are indicators of an unfavorable prognosis. The successful treatment of peracute coliform mastitis requires the earliest possible action and clinical surveillance until recovery is apparent.

#### Treatment trials using antimicrobial agents and untreated controls

Treatment trials with **experimentally induced** coliform mastitis in cattle during lactation have failed, for the most part, to demonstrate efficacy of antimicrobial therapy. This is because all experimental models used to date do not accurately reproduce the naturally occurring disease,<sup>41,42</sup> and not because antibiotics are ineffective. Accordingly, treatment efficacy should be based on the results of randomized field trials. The major considerations for antimicrobial use in coliform mastitis include:

- Early administration in order to decrease the exposure of the cow to endotoxin
- Ensuring appropriate withholding periods for milk and meat
- The benefit–cost ratio.<sup>5</sup>

The antimicrobial susceptibilities of *E. coli* isolates from coliform mastitis vary considerably; drug susceptibility determination is not routinely recommended because the breakpoints have not been validated and the bacteria come from diverse sources in the environment.

#### Parenteral antimicrobial agents

Broad-spectrum antimicrobial agents should be administered parenterally to cattle with systemic signs of disease (abnormal cow), preferably by the intravenous route initially, followed by intramuscular administration to maintain appropriate plasma concentrations. The first reason to administer parenteral antibiotics is that the **severity of clinical signs is correlated with the numbers of bacteria in milk from the affected gland**.<sup>43</sup> The second main reason to administer parenteral antibiotics is to **combat bacteremia, which is present in 32–48% of severely affected cattle**.<sup>25,26,44</sup> Based on pharmacokinetic/pharmacodynamic values, the results of experimentally induced and naturally acquired infections, and in vitro antimicrobial susceptibility testing (if this has any relevance to in vivo susceptibility), most *E. coli* isolated from the mammary glands of cattle are theoretically susceptible to

third-generation cephalosporins (such as ceftiofur), fourth-generation cephalosporins (such as cefquinome), fluoroquinolones, gentamicin, amikacin, trimethoprim-sulfonamide and oxytetracycline.

- **Ceftiofur** is a third-generation cephalosporin that is resistant to beta-lactamases and has excellent in vitro activity against *E. coli*. When given parenterally to cows with experimental coliform mastitis, ceftiofur did not produce drug concentrations in milk above the reported minimum inhibitory concentrations for coliform bacteria.<sup>45</sup> However, when administered to cows with naturally occurring coliform mastitis, ceftiofur-treated cows (2.2 mg/kg BW intramuscularly every 24 h) were three times less likely to die or be culled from the herd and had more saleable milk than nontreated cattle.<sup>44</sup>
- **Cefquinome** is a fourth-generation cephalosporin that is resistant to beta-lactamases and has excellent in vitro activity against *E. coli*. Parenteral cefquinome therapy (1 mg/kg BW intramuscularly twice at 24 h apart), with or without intramammary cefquinome (75 mg, three times at 12 h intervals), increased the bacteriological cure rate and significantly improved clinical recovery and return to milk production in experimentally induced *E. coli* mastitis.<sup>46</sup>
- **Enrofloxacin**, a fluoroquinolone with excellent in vitro activity against *E. coli*, given intravenously initially then subcutaneously (5 mg/kg BW) was effective in treating experimentally induced *E. coli* mastitis.<sup>47-49</sup> In general, parenterally administered enrofloxacin increased the rate of *E. coli* clearance from the infected mammary gland
- **Gentamicin** has been used on an extralabel basis for the treatment of acute and peracute coliform mastitis because more than 90% of isolates from milk from affected cows are sensitive in vitro.<sup>40</sup> However, the parenteral administration of gentamicin at 2 g intramuscularly every 12 hours until the appetite improved to dairy cows with mastitis predicted to be associated with Gram-negative bacteria did not result in significant improvement compared to cows with similar mastitis that did not receive an antimicrobial or received erythromycin<sup>19</sup>
- **Trimethoprim-sulfadiazine** (trimethoprim 4 g, sulfadiazine 20 g,

intramuscularly every 24 h for 3–5 d) is efficacious in treating naturally acquired cases of coliform mastitis. The recovery rate of cows with clinical mastitis due to coliform bacteria susceptible to sulfonamide-trimethoprim was 89% compared to 74% in cows infected with coliforms resistant to the combination given parenterally, combined with NSAIDs and complete milking of affected quarters several times daily.<sup>50</sup> Sulfadiazine or sulfamethazine (sulfadimidine) are preferred to sulfadoxine because the latter produces much lower milk concentrations after parenteral administration

- **Oxytetracycline** (16.5 mg/kg BW intravenously every 24 hours for 3–5 d), combined with intramammary cephalirin (200 mg) and supportive care (intravenous or oral fluids, flunixin meglumine, stripping of the mammary gland) was more effective in treating coliform mastitis than similar treatment without antibiotics in cattle with naturally acquired mastitis.

#### Intramammary antimicrobial agents

Intramammary preparations of antimicrobial agents can be infused into the affected quarters after they have been stripped out completely at the start and end of the day. The initial choice of antimicrobial will depend on previous experience of treatment efficacy in the herd.

- **Ceftiofur**: based on clinical response and the results of antimicrobial susceptibility testing of coliform isolates from cows with naturally occurring mastitis (if relevant to in vivo performance), ceftiofur is an excellent choice for intramammary infusion in suspected cases of coliform mastitis<sup>51</sup>
- **Gentamicin**: the intramammary infusion of 500 mg of gentamicin did not affect the duration or severity of experimentally induced coliform mastitis.<sup>40</sup> The numbers of *E. coli* in the milk after intramammary inoculation were not affected by the intramammary infusion of gentamicin, despite maintaining a mean minimal gentamicin concentration in milk of 181 µg/mL between dose intervals.<sup>40</sup> The infusion did not affect the body temperature or the magnitude and duration of the inflammatory process in the glands as measured by the SCCs and peak albumin and immunoglobulin concentrations in the milk. It should be noted that gentamicin is not

approved for use in the treatment of bovine mastitis and in some jurisdictions is not approved for any use.

A study of the efficacy of intramammary antibiotic therapy for the treatment of naturally occurring clinical mastitis associated with environmental pathogens found no difference in the short-term clinical or bacteriological cure rates between quarters infused with 62.5 g amoxicillin every 12 hours for three milkings or 200 mg of cephalirin every 12 hours for two milkings, and those treated with 100 units of oxytocin intramuscularly every 12 hours immediately before milking for two or three milkings alone.<sup>52</sup> However, the cost per episode of mastitis associated with the use of cephalirin was higher than the other two treatments, partly because of the longer milk withdrawal time (96 h) associated with the drug. The percentage of relapses was higher for cows in the oxytocin treatment group, especially when the mastitis-associated pathogen was an environmental *Streptococcus* sp.<sup>53</sup>

#### Stripping of affected quarter

An artificial intramammary environment has shown that milking 12 times daily could lead to elimination of *E. coli*,<sup>54</sup> suggesting that frequent stripping would be an effective treatment. Indeed, stripping (augmented by oxytocin) is a popular but largely unsubstantiated recommendation for treating severe cases of coliform mastitis.

Oxytocin at 10–20 units per adult cow given intramuscularly, followed by vigorous hand massage and hourly stripping of the affected quarter, may assist in removing inflammatory debris. Oxytocin doses higher than this are not needed, and intravenous administration is not needed because oxytocin is rapidly absorbed when injected intramuscularly. Oxytocin can be repeated and used as long as an effect is obtained.

Effective removal of coliform bacteria and endotoxin will minimize their local effects in the mammary gland and decrease the systemic signs of endotoxemia. The main problems with stripping are the labor involved, the small volumes produced, the potential for creating additional pain and discomfort for the cow (and the producer when the cow kicks!) and potential contamination of the environment if the secretion is stripped on to the ground. The role of frequent stripping, if any, in the treatment of clinical mastitis remains to be determined.

#### Fluid and electrolyte therapy

Fluid and electrolyte therapy are essential for the treatment of acute and peracute

coliform mastitis in order to counteract the effects of the endotoxemia. Isotonic polyionic electrolyte solutions (such as Ringer's solution) are given at 80 mL/kg BW for the first 24 hours by continuous intravenous infusion, and at a slower rate than that over the following days. For a mature dairy cow (400–600 kg) a total of 32–48 L is therefore needed in the first 24-hour period, with 20 L given during the first 4 hours and the remainder over the next 20 hours. A favorable response is usually clinically evident in 6–8 hours. If the animal has not improved after 5 days of intensive fluid therapy (the 5-day rule for clinical improvement), the prognosis for survival is poor.

The large amounts of isotonic fluids and electrolytes which have been advocated and used are expensive to administer by continuous intravenous infusion and require monitoring over many hours. A possible alternative is the use of small volumes of hypertonic saline, which can be transported easily and administered rapidly. **Hypertonic saline** can be safely administered to cattle with endotoxin-induced mastitis.<sup>55</sup> Hypertonic saline (7.2% NaCl) is given intravenously at 4–5 mL/kg BW intravenously over 4–5 minutes followed by immediate access to drinking water.<sup>56</sup> The changes following administration of hypertonic saline include transient expansion of the plasma volume, hypernatremia and hyperchloremia.<sup>56</sup> The intravenous administration of hypertonic saline to clinically normal cows with access to water increases circulatory volume rapidly, induces slight strong ion (metabolic) acidosis and increases glomerular filtration rate.<sup>57</sup> Fluid therapy is covered in detail in Chapter 2.

#### Anti-inflammatory agents

NSAIDs are frequently administered as adjunctive therapy in coliform mastitis, particularly in the peracute form of the disease.<sup>39</sup> **Ketoprofen** is the only currently available NSAID with documented efficacy in naturally acquired cases of coliform mastitis.

Ketoprofen has been evaluated as adjunctive therapy for the treatment of acute clinical mastitis in dairy cows, most cases of which were associated with Gram-negative pathogens.<sup>58</sup> All cases were treated with 20 g sulfadiazine and 4 g trimethoprim intramuscularly followed by one-half dose daily until recovery. Ketoprofen was given at 2 g intramuscularly daily for the duration of the antimicrobial therapy. Recovery rates for the nonblind contemporary controls and the blind placebo controls were 84% and 71%, respectively. In the nonblind controlled ketoprofen and placebo-controlled ketoprofen treatment groups, recovery

rates were 95% and 92%, respectively. The odds ratio (OR) of recovery was significantly high in the placebo-controlled study (OR = 6.8), and high but not significant in the nonblind controlled study (OR = 2.6). It was concluded that ketoprofen significantly improved recovery rate in clinical mastitis. A similar clinical field trial evaluating the efficacy of phenylbutazone and dipyron for the treatment of mastitis caused mostly by coliforms revealed a beneficial effect but no difference between the efficacies of the two drugs.<sup>59</sup> Neither phenylbutazone nor dipyron is permitted for use in lactating dairy cattle in the USA, but their use is permitted in some countries.

The anti-inflammatory effect of either flunixin meglumine or dexamethasone was evaluated compared to controls in experimentally induced coliform mastitis. Dexamethasone at 0.44 mg/kg intravenously and flunixin meglumine at 1.1 mg/kg intravenously were both given 2 hours after inoculation of the *E. coli*, which is essentially a pretreatment administration because clinical signs are not evident at this time. Flunixin meglumine was also administered once 8 hours after the initial dose. Dexamethasone reduced the rectal temperature and the mammary surface temperatures, and prevented further increase in rectal temperature above 39.2°C. The response to flunixin meglumine was less than expected, which suggested that a higher dose of 2.2 mg/kg may be necessary in lactating dairy cattle. The administration of flunixin meglumine at 2.2 mg/kg intramuscularly or flurbiprofen at 2 mg/kg intravenously before clinical signs appeared in experimental *E. coli* mastitis abolished the febrile response during the first 9 hours after infection and lessened the decrease in rumen motility. Carprofen, a long-acting NSAID, reduced the fever, tachycardia and udder swelling associated with *E. coli*-endotoxin-induced mastitis.<sup>60</sup> The long-acting properties of carprofen may be considered a therapeutic advantage over flunixin meglumine, which requires frequent dosing.

#### Combination therapy

Fluid and electrolyte therapy and flunixin meglumine, in combination and individually, have been evaluated in a 3-year study of a large number of cows with toxic mastitis.<sup>61</sup> Cows were allotted to one of three groups:

- Fluid therapy (45 L of intravenous isotonic electrolyte solution) and flunixin meglumine at 2 g
- Fluid therapy intravenously only
- Flunixin meglumine only.

All cases were treated with parenteral and intramammary antimicrobial agents,

oxytocin and calcium borogluconate. There was no significant difference in the rate of survival between the treatment groups, and 54% of the cows survived.

#### CONTROL

The control of coliform mastitis is characteristically difficult, unreliable and frustrating. Several cases of fatal peracute coliform mastitis may occur in a herd of 100 cows during a period of a year, in spite of the existence of apparently excellent management. The general principles of mastitis control that have been effective for the control of *S. aureus* and *S. agalactiae* mastitis have been unsuccessful for the control of coliform mastitis because infection of the mammary gland occurs by direct contact with the environment, usually between milkings. For the control of coliform mastitis, the emphasis is on the prevention of new infection. Core lipopolysaccharide antigen vaccines are useful and are discussed below.

#### Management of outbreaks

When an outbreak of peracute coliform mastitis is encountered the following procedures are recommended in an attempt to prevent new cases:

- Culture milk samples and obtain a definitive etiological diagnosis (in other words, **put a name to the causative pathogen**)
- Examine the bedding for evidence of heavy contamination with coliform bacteria. If sawdust or wood shavings are being used, replace with sand, if possible, or change more frequently
- Conduct a general clean-up of the stall and lounging areas
- Improve premilking hygiene
- Examine milking machine function
- Allow cows access to fresh feed immediately after milking to ensure that they remain standing for at least 30 minutes to allow time for the streak canal to close.

#### Housing and environment

The normal presence of coliform bacteria in every aspect of the cow's environment must be recognized but every effort must be made to avoid situations that allow a build-up of bacterial numbers. This is especially important in dairy herds that have been on a mastitis control program, resulting in a high percentage of cows with a low SCCs in their milk, which increases their susceptibility to coliform mastitis. The overall level of sanitation and hygiene must be improved and maintained in these herds.

#### Bedding

Most coliform infections in periparturient cows occur very early in the dry period or just before calving, and so efforts to



prevent infection should be centered on these periods. Management of the dry cow environment may provide the best opportunity for prevention of infection. While no reliable recommendations are available, cows that are housed during part or all of the day or night should be bedded on **clean** and **dry** bedding and not overcrowded, to prevent heavy fecal contamination. When possible, dry and preparturient cows are best maintained on pasture. There is an urgent need for the determination of optimum space and bedding requirements for the lounging areas of dairy cows kept under loose housing. Bedding should be kept as dry as possible. Excessively wet bedding should be removed from the back one-third of the stalls daily and replaced with fresh bedding. The addition of lime may decrease bacterial growth. Sawdust and shavings harbor more coliform bacteria than straw, and require special attention. The buildup of high numbers of coliform bacteria in the bedding of cow cubicles can be controlled by the daily removal of the sawdust from the rear of the cubicle and rebedding with clean sawdust, which is usually of low coliform count. The use of a paraformaldehyde spray on sawdust bedding reduced the coliform count for 2–3 days but it returned to its pre-disinfection level in 7 days. When outbreaks of coliform mastitis are encountered that are possibly associated with heavily contaminated sawdust or shavings, the bedding should be removed immediately and replaced with clean, fresh, dry straw. The use of sawdust or shavings as bedding should be avoided if possible. Sand is now considered to be the 'gold standard' and the most suitable alternative.

#### Regular daily cleaning of barns

This is necessary to minimize contamination of teats. In free-stall and loose-housing dairy barns, every management technique available must be used to insure that cows do not defecate in their stalls and increase the level of contamination. This requires daily raking of the bedding in free-stall barns and adjusting head rails to insure that cows do not lie too far forward in the stall and to insure that they defecate in the alleyway.

In dairy herds that are confined for all or part of the year, the level of contamination usually increases as herd size increases; commonly the ventilation is inadequate. This leads to excessively humid conditions, which promote the development of coliform bacteria in wet bedding. This will require increased attention to sanitation and hygiene.

#### Milking procedures

Postmilking teat dipping with a disinfectant has little effect on reducing the

incidence of coliform mastitis because contamination of the teats occurs between milkings rather than at milking. Thus, one logical approach to the control of coliform mastitis is to reduce environmental contamination. In the event of gross fecal contamination of the udder and teats, additional time and care will be required at milking time. Premilking udder preparation can significantly influence milk quality. Lowest bacterial counts in milk are observed when the teats of cows are cleaned with water followed by thorough drying with paper towels, or when a teat disinfectant is applied to the teats followed by drying with paper towels. In addition, premilking teat disinfection in association with good udder preparation reduces the rate of intramammary infections by environmental pathogens by about 51% compared with good udder preparation only.<sup>62</sup>

#### Premilking teat disinfection

Many dairy producers have now incorporated premilking teat disinfection into their mastitis control strategy, and many different teat dips are being used.<sup>62</sup> Premilking teat dips containing 0.25% iodine, 0.1% iodophor, 0.25% iodophor and 0.55% iodophor–1.9% linear-dodecyl benzene sulfonic acid have been evaluated and have provided consistent results. Premilking and postmilking teat disinfection, in association with good udder preparation, are significantly more effective in prevention of environmental pathogen intramammary infection than good udder preparation and postmilking teat disinfection. No chapping or irritation of teats was observed. However, premilking teat disinfection did not reduce the incidence of clinical mastitis.

#### Postmilking external teat sealant

A latex barrier teat dip that formed a physical seal between the teat and the environment reduced the incidence of new coliform intramammary infections during lactation. The efficacy of this barrier product was thought to be due to the persistency of the dip on teats between milkings; however, it was not consistently successful. A barrier teat dip containing 0.55% chlorhexidine was effective in reducing intramammary infection associated with both environmental and contagious pathogens. The incidence of *E. coli* intramammary infections was reduced but the incidence of *Serratia* spp. and *Pseudomonas* spp. was increased, while the incidence of environmental streptococcal intramammary infection was unchanged by using the experimental barrier dip compared with the results using a 1% iodophor dip.

#### Nutrition

Vitamin E or selenium deficiency decreases neutrophil chemotaxis into the mammary gland and decreases the intracellular killing of bacteria by neutrophils. It is therefore important to ensure that vitamin E and selenium intakes are adequate; this is best achieved by daily ingestion of 1000 IU vitamin E and 3 mg selenium for dry cows and daily ingestion of 400–600 IU vitamin E and 6 mg selenium for lactating cows.

#### Prevention of infection during dry period

Considerable movement of coliform bacteria can occur from the teat apex into the teat sinus in cows that are not being milked, and so cows that are due to calve should be kept on grass or moved into a clean area at least 2 weeks before calving, their udders and teats washed daily if necessary, and teat dipping with a teat disinfectant begun 10 days before calving. This is particularly necessary for older cows and those that are known to be easy milkers. The teats of those cows that are 'leakers' just before calving may have to be sealed with adhesive tape or collodion to minimize the chance of infection.

#### Recumbent cows

Cows that are recumbent and unable to stand (e.g. the downer cow) should be well bedded on clean dry straw; their udders should be kept clean and dry, and the teats should be dipped with a teat disinfectant. Strict hygiene must be practiced when using teat siphons and teat creams, and strict asepsis observed when doing teat surgery.

#### Milking machine

Irregular vacuum fluctuations in the milking machine may induce coliform mastitis in quarters exposed to a high level of contamination. The operation and sanitation of the milking machine, especially those parts in direct contact with the teats, must therefore be examined.

#### Vaccination

Core lipopolysaccharide antigen vaccine  
The vaccination of cows during the dry period and early lactation with core lipopolysaccharide antigen vaccine (such as the Re mutant *Salmonella typhimurium* or the Rc mutant *E. coli* O111:B4 (J5 vaccine)) provides one tool to reduce the incidence and severity of clinical coliform mastitis.<sup>63</sup> These vaccines are available in the USA and are based on mutated Gram-negative bacteria with exposed core antigens of lipopolysaccharide. The core antigen (lipid A component) is uniform between bacterial species possessing lipopolysaccharide and is immunogenic. On theoretical grounds, the Re mutant (*S. typhimurium*) should provide better

protection than the Rc mutant (*E. coli* J5) because the lipid A component is more accessible to the immune system; however, comparative studies of vaccine efficacy have not been performed.

The Re and Rc mutant vaccines are protective against natural challenge to Gram-negative bacteria, and in most, but not all studies, **reduce the incidence and severity of clinical Gram-negative bacterial mastitis in lactating dairy cows.** In a prospective cohort study in two commercial dairy herds, during the first 90 days of lactation, cows vaccinated with *E. coli* J5 vaccine were at five times lower risk of developing clinical coliform mastitis than unvaccinated cows. This is corroborated with the observation that cows with naturally occurring serum IgG ELISA titers higher than 1:240 against the Gram-negative core antigen of *E. coli* J5 had 5.3 times lower risk of developing clinical coliform mastitis than cows with lower titers. Vaccination reduced the severity of clinical signs following intramammary experimental challenge with a heterologous *E. coli* strain.<sup>64</sup> In cows vaccinated with the J5 bacterin at drying off, at 30 days after drying off and within 48 hours after calving, and challenged 30 days after calving with a strain of *E. coli* known to cause mild clinical mastitis, the duration of intramammary infection and local signs of mastitis were reduced compared to controls.<sup>63</sup> Also, the concentrations of bovine serum albumin in milk 24 hours after challenge were greater in control cows than in vaccinated cows.

A partial budget analysis of vaccinating dairy cattle with one core lipopolysaccharide antigen vaccine (the Rc mutant of *E. coli* or J5 strain) indicated that herd vaccination programs were predicted to be profitable when more than 1% of cow lactations resulted in clinical coliform mastitis<sup>65</sup> and predicted to be profitable at all herd milk production levels.

Core lipopolysaccharide antigen vaccines have the potential to have deleterious effects because of their endotoxin content. For instance, vaccination of late lactation and dry cattle with the *S. typhimurium* Re mutant transiently decreased leukocyte and blood segmented neutrophil concentration, but the decrease is probably clinically insignificant.<sup>66</sup> This response is typical for endotoxin administration. Vaccination of lactating dairy cattle with the *E. coli* Rc mutant decreased milk production by 7% at the second and third milkings after vaccination.<sup>67</sup> These two studies indicate that core lipopolysaccharide antigen vaccines should not be administered to diseased cattle or to healthy cattle in hot and humid weather, because of their decrease in cardiovascular

reserve. The vaccines should not be administered at the same time as other Gram-negative vaccines.

## REVIEW LITERATURE

Hogan J, Smith KL. Coliform mastitis. *Vet Res* 2003; 34:507-519.

Wilson DJ, Gonzalez RN. Vaccination strategies for reducing clinical severity of coliform mastitis. *Vet Clin North Am Food Anim Pract* 2003; 19: 187-197.

Smith GW. Supportive therapy of the toxic cow. *Vet Clin North Am Food Anim Pract* 2005; 21:595-614.

## REFERENCES

- Miltenberg JD et al. *Vet Rec* 1996; 139:204.
- Smith KL, Hogan JS. *Vet Clin North Am Food Anim Pract* 1993; 9:489.
- Shuster DE et al. *J Dairy Sci* 1991; 74:3407.
- Hogan JS et al. *J Dairy Sci* 1995; 78:2502.
- Erskine RJ et al. *J Am Vet Med Assoc* 1991; 198:980.
- Nemeth J et al. *Vet Microbiol* 1994; 40:231.
- Jones TO. *Vet Bull* 1990; 60:205.
- Green MJ et al. *Vet Rec* 1996; 138:305.
- Shuster DE et al. *Am J Vet Res* 1996; 57:1569.
- Kremer WDJ et al. *J Dairy Sci* 1993; 76:2613.
- Kremer WDJ et al. *J Dairy Sci* 1993; 76:3428.
- Paape MJ et al. *Am J Vet Res* 1996; 57:477.
- Weiss WP et al. *J Dairy Sci* 1997; 80:1728.
- Hogan JS et al. *J Dairy Sci* 1992; 65:399.
- Maddox JF et al. *Prostaglandins* 1991; 42:369.
- Todhunter DA et al. *Am J Vet Res* 1991; 52:184.
- Vandeputte-Van Messom G et al. *J Dairy Res* 1993; 60:19.
- Tyler JW et al. *North Am Food Anim Pract* 1993; *Vet Clin* 9:537.
- Jones GF, Ward GE. *J Am Vet Med Assoc* 1990; 197:731.
- Lohuis JACM et al. *J Dairy Sci* 1990; 73:333, 342.
- Hill AW. Proceedings of the 30th Annual Meeting of the National Mastitis Council. Verona, WI: National Mastitis Council, 1991:6.
- Welles EG et al. *Am J Vet Res* 1993; 54:1230.
- Shuster DE et al. *Am J Vet Res* 1993; 54:80.
- Persson K, Sandgren CH. *Acta Vet Scand* 1992; 33:283.
- Cebra CK et al. *J Vet Intern Med* 1996; 10:252.
- Wenz JR et al. *J Am Vet Med Assoc* 2001; 219:976.
- Golodetz CL, White ME. *Vet Rec* 1983; 112:402.
- White ME et al. *Can Vet J* 1986; 27:213.
- White ME et al. *Cornell Vet* 1986; 76:335.
- White ME et al. *Cornell Vet* 1986; 76:342.
- White ME et al. *Cornell Vet* 1987; 77:13.
- White ME, Montgomery ME. *Can J Vet Res* 1987; 51:181.
- Jones GF, Ward GE. *J Am Vet Med Assoc* 1990; 196:597.
- Morin DE et al. *J Am Vet Med Assoc* 1998; 212:1423.
- Waage S et al. *Acta Vet Scand* 1994; 35:207.
- Smith GW et al. *J Vet Intern Med* 2001; 15:394.
- Jansen J et al. *Proc Am Assoc Bovine Pract* 1997; 32:188.
- Constable PD, Morin DE. *J Am Vet Med Assoc* 2002; 221:103.
- Lohuis JACM. *Cornell Vet* 1990; 80:223.
- Erskine RJ et al. *Am J Vet Res* 1992; 53:375.
- Pyoral S et al. *J Dairy Sci* 1994; 77:453.
- Stempfli HR et al. In: Proceedings of the XIII World Buiatrics Congress 1994; 1:869.
- Katholm J et al. *Vet Rec* 1992; 131:513.
- Erskine RJ et al. *J Dairy Sci* 2002; 85:2571.
- Erskine RJ et al. *Am J Vet Res* 1995; 56:481.
- Shpigel NY et al. *J Dairy Sci* 1997; 80:318.
- Kutilla T et al. *J Vet Pharmacol Ther* 2004; 27:197.
- Dosogne H et al. *Inflamm Res* 2002; 51:201.
- Monfardi E et al. *Vet Immunol Immunopathol* 1999; 67:373.

- Shpigel NY et al. *Vet Rec* 1998; 142:135.
- Bezek DM. *J Am Vet Med Assoc* 1998; 212:404.
- Guterbock WM et al. *J Dairy Sci* 1993; 76:3437.
- Van Eenennaam AL et al. *J Dairy Sci* 1995; 78:2086.
- Goldberg JJ et al. *Am J Vet Res* 1995; 56:440.
- Tyler JW et al. *J Am Vet Med Assoc* 1994; 204:1949.
- Tyler JW et al. *Am J Vet Res* 1994; 55:278.
- Roeder BL et al. *Am J Vet Res* 1997; 58:549.
- Shpigel NY et al. *Res Vet Sci* 1994; 56:62.
- Shpigel NY et al. *J Vet Med A* 1996; 43:331.
- Lohuis JACM et al. *J Vet Pharmacol Ther* 1991; 14:219.
- Green MJ et al. *Vet Rec* 1997; 140:149.
- Oliver SP et al. *J Food Prot* 1993; 56:852.
- Hogan JS et al. *J Dairy Sci* 1995; 78:285.
- Hogan JS et al. *J Dairy Sci* 1992; 75:415.
- DeGraves FJ, Fetrow J. *J Am Vet Med Assoc* 1991; 199:451.
- Scott HM et al. *J Dairy Sci* 1998; 81:1928.
- Musser JMB, Anderson KL. *J Am Vet Med Assoc* 1996; 209:1291.

## ENVIRONMENTAL STREPTOCOCCI

**Etiology** *Streptococcus uberis*, *Streptococcus dysgalactiae* spp. *dysgalactiae*, other *Streptococcus* spp. most commonly; occasionally *Enterococcus* spp.

**Epidemiology** Common cause of subclinical and clinical mastitis in herds and countries that have controlled contagious mastitis. Responsible for approximately one-third of all cases of clinical mastitis in herds without contagious pathogens. Rate of infection high during first 2 weeks following drying off and 2 weeks before calving. Duration of infection usually short (<8 d). Prevalence of infection at calving: 11% of cows and 3% of quarters. Bedding materials (high in straw bedding) most important source of environmental streptococci; bacteria can be isolated from many different feedstuffs and several locations on cow (teats, rumen, feces, saliva, lips, nares). Bacterial numbers low in sand, which is bedding of choice.

**Clinical findings** Abnormal milk, abnormal gland, usually no systemic signs. Recovery in two to three milkings.

**Clinical pathology** Culture of milk

**Necropsy findings** Not applicable

**Diagnostic confirmation** Culture

bacteria from milk and milk SCC

**Differential diagnosis** Cannot differentiate from other causes of subacute and acute mastitis without culture of milk

**Treatment** Antimicrobial intramammary infusions increase bacteriological cure rate and decrease percentage of relapses.

Intramammary antibiotics should be administered to all clinical cases of mastitis due to environmental streptococci

**Control** Decrease exposure of teat end to pathogens by attention to environment, dry bedding, sand for bedding, premilking hygiene and premilking germicide teat dipping. Dry cow therapy with penicillin G, cloxacillin, erythromycin and first-generation (cephapirin) or third-generation (ceftiofur) cephalosporins. Application of an internal teat sealant of bismuth subnitrate at dry-off may decrease new infection rate in dry period

## ETIOLOGY

*Streptococcus uberis* and *Streptococcus dysgalactiae* spp. *dysgalactiae* and the enterococci are the most commonly isolated environmental streptococci from intramammary infections. Other uncommon environmental streptococci involved in bovine mastitis include *Streptococcus equi* var. *zooepidemicus*,<sup>1</sup> *Streptococcus viridans*, *S. equinus* (*S. bovis*), *Streptococcus* spp. group G, *Streptococcus pyogenes* and *Streptococcus pneumoniae*. Both *S. uberis* and *S. dysgalactiae* are widespread in the animal's environment and on the skin of the teats. Two genotypes of *S. uberis* (*S. uberis* = type I; *Streptococcus paruberis* = type II), with marked differences in their capacity to invade quarters and to cause mastitis, have been identified.<sup>2,3</sup> *Enterococcus* spp. are also a common cause of environmental intramammary infections.<sup>4</sup> The streptococcal species most commonly isolated from intramammary infections all hydrolyze esculin (*S. uberis*, *Streptococcus* spp., *Enterococcus* spp.).

## EPIDEMIOLOGY

### Occurrence and prevalence of infection

In countries where the prevalence of intramammary infections due to the contagious pathogens *S. agalactiae* and *S. aureus* has been reduced or eradicated, the proportion of intramammary infections associated with **environmental streptococci** has increased markedly; these organisms are a leading cause of both subclinical and clinical mastitis in dairy cattle worldwide.<sup>4,5</sup> *S. uberis* is now a common cause of intramammary infection occurring during the dry period, with most clinical cases occurring during the first part of lactation. Many infections acquired during the dry period persist to lactation and contribute to the incidence of clinical mastitis in early lactation. The rate of new infection due to environmental streptococci is elevated during the first 2 weeks following drying off and the 2 weeks prior to calving; the rate of new infections is greater during the first month of lactation than during the remainder of the lactation. Approximately 50% of new infections occur during the dry period and 50% in the early part of lactation. The rate of new infections during the dry period is about five times greater than during lactation.<sup>4</sup> Based on data from surveys of milk samples over a 10-year period, the point prevalence of infection of environmental streptococci was 4% of quarters and 12% of cows.<sup>6</sup> The percentage in heifers at calving is similar to that in cows. The prevalence of environmental streptococci isolation at drying off and calving was 2.5% and

3.0%.<sup>6</sup> Environmental streptococcal intramammary infections are usually short-lived (< 28 days), with only a small percentage becoming chronic.<sup>4,7</sup>

The most important change in the epidemiology of bovine mastitis over the past decade has been the rise in the importance of environmental pathogens, mainly causing clinical mastitis, relative to contagious pathogens. Remarkable increases in both the coliforms and environmental streptococci as causes of clinical mastitis have occurred.<sup>5</sup> The percentage of clinical cases of mastitis from which environmental streptococci can be isolated ranges from 14% in Ontario to 26% in the UK. When expressed as a percentage of clinical cases from which a major pathogen was isolated, environmental streptococci are isolated in 37–45% of cases.

### Source of infection

The environmental streptococci, especially *S. uberis*, have been isolated from bedding materials and the lips and tonsils of cows, with the abdominal skin of cows often harboring the largest population.<sup>8</sup> Some cows are permanently colonized with *S. uberis* and may pass large numbers of the bacteria in the feces. Fecal shedding is believed to play an important role in the maintenance of *S. uberis* populations on dairy farms, and is the likely source of large numbers of the organism in straw bedding on farms where this form of mastitis persists.<sup>9,10</sup> The numbers of environmental streptococci in organic bedding materials vary with the type of bedding. Large numbers of *S. uberis* are found in straw bedding and much lower numbers in sawdust and wood shavings. The numbers of streptococci recovered from the teats of cows bedded on sawdust are lower than those bedded on straw. Long straw used in calving box stalls or as bedding in loose housing can be a source of considerable exposure to environmental streptococci.

*S. dysgalactiae* can also be found in the environment of dairy cattle and has been isolated from the tonsils, mouth and vagina, and the mammary glands. It has characteristics of both a contagious and an environmental pathogen and some categorization schemes place it in the contagious category, although it is primarily an environmental pathogen. *S. dysgalactiae* is also associated with summer mastitis, which affects dry cows and heifers during the summer months. It has been isolated from the common cattle fly *Hydrotaea irritans*, which may be involved in the establishment and maintenance of bacterial contamination of teats. *S. dysgalactiae* may colonize the teat prior to infection with *A. pyogenes* and anaerobic bacteria such as *P. indolicus* and *F. necrophorum*.

## Risk factors

### Environmental risk factors

The major risk factor for environmental streptococci infection is **exposure of the teat end to mastitis pathogens in the environment**. Transmission is predominantly from the environment.<sup>7</sup> Exposure of uninfected teats to environmental streptococci can occur during the milking process, between milkings, during the dry period and prior to parturition in first-lactation heifers. The rate of new infections is greatest during the summer months in North America.<sup>4</sup>

Housing and management practices on dairy farms may contribute to contamination of bedding materials and exposure of teats to environmental streptococci. Housing facilities that predispose to the accumulation of feces on cows will increase the rate of exposure of the teat end to the pathogens. Straw bedding appears to increase the risk of *S. uberis* mastitis,<sup>11</sup> and an increase in *S. uberis* mastitis cases occurs when cows are housed in deep straw pack.

Pastured cattle are generally at reduced risk for environmental streptococcal mastitis when compared to cows in confinement housing. However, certain pasture conditions, such as areas under shade trees, poorly drained ground surfaces, ponds and muddy areas, may result in a high rate of exposure to the pathogens. The environmental streptococci are the most significant environmental pathogen in New Zealand dairy herds where cows spend almost 100% of their time on pasture.<sup>12</sup>

*S. dysgalactiae* is commonly isolated from heifers and cows in the dry period and is one of the most prevalent pathogens isolated from cases of summer mastitis. The spread of *S. dysgalactiae* between cows within dairy herds may occur directly or by way of the milking machine or environment.

### Animal risk factors

The risk of new infections is influenced by the stage of lactation and parity of the cow. The **rate of new infection is highest during the 2 weeks following drying off and the 2 weeks prior to calving**. The high rates of new infection following drying off may be associated with the lack of flushing action of milking, changes in the composition of the mammary secretion, which may enhance the growth of the pathogens, and the lack of a keratin plug in the streak canal. The primary defense mechanisms for *S. uberis* are the length of the teat canal and the amount of keratin in the lining.<sup>13</sup> Antimicrobial dry cow therapy reduces the infection rate in the early part of the dry period but has no or little effect on

preventing infection with *S. uberis* at the end of the dry period. The increase in susceptibility to infection just prior to parturition may be associated with the lack of milking when the gland is accumulating fluid, loss of keratin plugs from streak canals, or immunosuppression of the periparturient period. The **rate of infection is also higher in older cows** than for either heifers or cows in second lactation, and highest during the summer months for both cows in lactation and cows in the dry period. This is in contrast to contagious pathogens, where exposure occurs primarily during the milking process.

#### Pathogen risk factors

*S. uberis* is ubiquitous in the cow's environment with multiple environmental habitats.<sup>3</sup> Consequently the mammary gland is exposed continuously to the pathogen during lactation and the dry period and infections are associated with a large variety of strains. Several virulence factors of *S. uberis* and *S. dysgalactiae* have been identified that are important in the pathogenesis of environmental mastitis. Antiphagocytic factors allow *S. uberis* to infect and multiply in the gland, and to adhere to and invade the mammary tissue.<sup>14</sup> Bovine mammary macrophages are capable of phagocytosis of the organism but certain strains of *S. uberis* are capable of resisting phagocytosis by neutrophils, because of their hyaluronic acid capsule.<sup>15,16</sup> The ability of *S. uberis* to invade the bovine mammary epithelial cells could result in chronic infection and protection from host defense mechanisms and the action of most antimicrobial agents,<sup>17</sup> which may explain the intractable response to therapy in some cases. However, most 'intractable' infections are due to an inappropriately short duration of treatment.

*S. dysgalactiae* behaves like both a contagious and an environmental pathogen and can invade bovine mammary epithelial cells, which may explain the persistence of infection.<sup>18</sup> Different biotypes of *S. dysgalactiae* have been identified,<sup>19</sup> and strains can possess several antiphagocytic factors, including M-like protein, alpha-2-macroglobulin, capsule and fibronectin binding, and virulence factors, including hyaluronidase and fibrinolysin.

An existing intramammary infection due to *C. bovis* is a risk factor for environmental streptococcal infection<sup>20</sup> through an unidentified mechanism.

#### Economic importance

The major economic losses associated with environmental streptococcal mastitis are caused by clinical mastitis resulting in

lost production, milk withholding, premature culling, increased labor, and costs of therapy and veterinary services. 88% of the loss associated with clinical mastitis is attributed to loss of milk production and milk withholding. Pluriparous cows lost 2.6 times as much as first-calf heifers, and cows less than 150 days in milk lost 1.4 times more than cows more than 150 days in milk.

#### PATHOGENESIS

Infections with *S. dysgalactiae* artificially induced in goats are indistinguishable from mastitis associated with *S. agalactiae* and the pathogenesis is probably similar in all streptococcal mastitides.

In experimental infection of dairy cows with *S. uberis* there is acute inflammation, resulting in the accumulation of large numbers of neutrophils in the secretory acini in 24 hours.<sup>21</sup> After 6 days, the neutrophil response is still evident but there is cellular infiltration, septal edema, extensive vacuolation of secretory cells, focal necrosis of alveoli, small outgrowths of the secretory and ductular epithelium, and widespread hypertrophy of the ductular epithelium. The organism is present free or phagocytosed, in macrophages in the alveolar lumina, adherent to damaged secretory or ductular epithelium, in the subepithelium and septal tissue, and in lymphatic vessels and lymph nodes. The macrophage is important as the primary phagocytic cell but the marked neutrophil response may be ineffective as a defense mechanism. It is hypothesized that the marked neutrophil response following infection with *S. uberis*, rather than the organism, may be responsible for the most of the effects of the mastitis.<sup>21</sup> The current consensus is that environmental streptococci (with the possible exception of *S. dysgalactiae*) are not contagious pathogens.

#### CLINICAL FINDINGS

Approximately 50% of environmental streptococcal intramammary infections cause clinical mastitis during lactation. Clinical abnormalities occur in 42–68% of these infections in the same herd in different years.<sup>4</sup> The clinical findings are usually limited to abnormal milk or abnormal gland. In about 43% of cases the findings are limited to abnormal milk, 49% involve abnormal milk and an enlarged (abnormal) gland, and in only 8% of cases are there systemic signs with a fever and anorexia (abnormal cow). Clinical recovery commonly occurs in 24–48 hours.

#### CLINICAL PATHOLOGY

The laboratory diagnostic tests for these pathogens are the same as for *S. agalactiae*. All the environmental streptococci except

*S. dysgalactiae* hydrolyze esculin on blood agar. Species can be differentiated with reasonable success using a variety of biochemical tests, such as the API20 Strep and serological grouping using specific antisera of Lancefield groups.<sup>3</sup> However, molecular biological techniques are needed for detailed epidemiological studies.<sup>16</sup> The **HYMAST® diagnostic kit** is available as a field test to distinguish between Gram-positive and Gram-negative bacteria in the milk of dairy cows with clinical mastitis.<sup>5</sup>

#### DIFFERENTIAL DIAGNOSIS

*Streptococcus uberis* mastitis in dry cows may be sufficiently severe to resemble mastitis associated with *A. pyogenes*. Diagnosis depends on cultural examination of the milk.

#### TREATMENT

##### Antimicrobial agents

The in vitro susceptibility of environmental streptococci to antimicrobial agents is high. Most isolates of *S. uberis* and *S. dysgalactiae* are susceptible to penicillin, novobiocin, amoxicillin and cephalosporins. A high percentage (96%) are also susceptible to tetracycline, but susceptibility to aminoglycosides is much lower. Most cases of clinical mastitis associated with *S. uberis* and *S. dysgalactiae* respond well to intramammary infusions of penicillin, cephalosporins, cloxacillin, erythromycin and tetracyclines. Spontaneous cures can also occur. Clinical cases in lactating cows should be treated by at least two intramammary infusions 12 hours apart; this may produce clinical cure but fail to produce a bacteriological cure. Subclinical infections in **late lactation** may be left until the dry period. For clinical cases in the first 100 days of lactation there is substantial economic benefit from treatment. Some cases associated with strains of *S. uberis* appear intractable to treatment; extended treatment is necessary in these animals. Failure of treatment may be due to epithelial cell invasion and movement of the bacteria into subepithelial layers, possibly reducing the effectiveness of the antimicrobial. Extended therapy (for 5 or 8 days) with intramammary ceftiofur (125 mg), pirlimycin (50 mg) or penethemate hydriodide, dihydrostreptomycin sulfate and framycetin sulfate, every 24 hours, increases the bacteriological cure rate for cattle with experimentally induced *S. uberis* mastitis.<sup>10,22–24</sup> In a study of 1148 cases of subclinical environmental streptococci mastitis in New York, commercially available intramammary infusions were more effective than untreated controls (66% bacteriological cure), with

the following bacteriological cure rates: amoxicillin (90%), penicillin (82%) and cloxacillin (79%).<sup>25</sup>

Treatment using oxytocin and frequent stripping of the affected glands without intramammary antibiotic administration is not recommended because cure rates are much lower.<sup>23,26</sup> Moreover, not administering antimicrobial agents results in a higher relapse rate.<sup>27,28</sup> Many of the relapses were associated with the environmental streptococci and therefore **intramammary antimicrobial treatment should be routinely performed.** In particular, because clinical mastitis with an abnormal gland or abnormal cow induces some pain and discomfort in the cow, **withholding an effective treatment (antimicrobial agents) cannot be condoned on animal welfare grounds.**

Reinfection may occur quickly if the contributory causes are not corrected. Infections with *S. zooepidemicus* do not respond well to treatment with penicillin. Mastitis associated with *S. pneumoniae* responds well to local treatment with penicillin in large doses (300 000 units per infusion) but quarters allowed to go without treatment for any length of time suffer complete loss of function. All cases of mastitis associated with this bacteria should receive parenteral treatment with penicillin.

## CONTROL

The control of mastitis due to environmental streptococci is achieved by **decreasing the exposure of pathogens to the teat end** and by **increasing the resistance to intramammary infections.** A specific control recommendation for environmental streptococci mastitis is not to bed on straw, but this may not be a practical or economic recommendation for some producers. If straw bedding is used, a reduction in the teat end exposure to *S. uberis* can result from frequent (daily) replacement of bedding.

**Reducing the exposure of the teat end to pathogens** depends on **maintenance of a clean and dry environment.** Special attention must be directed to the dry cow and close-up heifer housing, the calving area, lactating cow housing, and the milking parlor and milking hygiene. Organic bedding materials such as straw that support large numbers of environmental pathogens should be kept dry. **Sand is the ideal bedding material** because it has the lowest number of coliform and environmental pathogens. Wet and damp areas in the back part of free stalls and tie stalls promote exposure to environmental pathogens. Milking time hygiene should emphasize milking of clean, dry teats and udder, with a properly functioning milking machine.

Predipping with a teat dip germicide may reduce environmental mastitis by as much as 50% but this reduction does not occur in all herds.

**Dry cow therapy** to prevent new infections has not been as successful for the control of all causes of environmental mastitis as it has been for contagious mastitis. However, dry cow therapy is more effective against the environmental streptococci than against coliform bacteria.<sup>29</sup> Application of an internal teat sealant of bismuth subnitrate at dry-off is effective in preventing infections associated with *S. uberis* during the dry period.<sup>30,31</sup>

A long-acting intramammary infusion dry cow therapy containing 250 mg cephalonium administered after the last milking of lactation reduced the incidence of new infections due to *S. uberis* from 12.3% to 1.2%.<sup>32</sup> Clinical infections during the dry period were most prevalent in quarters identified as having open teat canals. Fewer open teat canals were observed among treated quarters over the first 4 weeks of the dry period. It is proposed that the teat canal of treated quarters closed earlier than those of untreated quarters. Most of the new infections in the untreated controls occurred within the first 21 days of the dry period. Normally, the teat canal is dilated for up to 7 days after drying off, with a keratin plug then forming over the following 14–21 days. It is suggested that once a physical keratin seal has formed in the teat canal after drying off, an uninfected quarter has a very low risk of infection over the remainder of the dry period. Treated quarters had a lower incidence of new clinical infections during the next lactation and lower SCCs.

## Vaccination

Experimentally, multiple intramammary vaccinations with whole killed *S. uberis* cells resulted in complete protection against experimental infection in cattle.<sup>33</sup> Bacteria could not be isolated from the quarters after challenge, and protection occurred in the absence of a marked neutrophil response. Preparations containing plasminogen activator may form the basis of a vaccine against *S. uberis*.<sup>34</sup> Vaccines are presently commercially unavailable,<sup>16</sup> and vaccination is not currently recommended as part of the control program for mastitis due to environmental streptococci.

## REVIEW LITERATURE

- Leigh JA. *Streptococcus uberis*: a permanent barrier to the control of bovine mastitis. *Vet J* 1999; 157:225–238.
- Hillerton JE, Berry EA. The management and treatment of environmental streptococcal mastitis. *Vet Clin North Am Food Anim Pract* 2003; 19:157–169.

## REFERENCES

- Sharp MW et al. *Vet Rec* 1995; 137:128.
- Williams AM, Collins MD. *J Appl Bacteriol* 1990; 68:485.
- Khan IU et al. *J Vet Sci* 2003; 4:213.
- Todhunter DA et al. *J Dairy Sci* 1995; 78:2366.
- Keefe G, Leslie K. In: Proceedings of a Symposium at Ontario Veterinary College, Guelph, Ontario, June 22 1997. *Pharmacia & Upjohn*, 1997:75–86.
- Hogan JS, Smith KL. In: Proceedings of a Symposium at Ontario Veterinary College, Guelph, Ontario, June 22 1997. *Pharmacia & Upjohn*, 1997:36–41.
- McDougall S et al. *J Dairy Sci* 2004; 87:2062.
- Smith KL, Hogan JS. In: Proceedings of a Symposium at Ontario Veterinary College, Guelph, Ontario, June 22 1997. *Pharmacia & Upjohn*, 1997:42–50.
- Zadoks RN et al. *Vet Microbiol* 2005; 109:257.
- Milne MH et al. *Vet Rec* 2005; 157:245.
- Bramley AJ et al. *Br Vet J* 1979; 135:262.
- Pankey JW et al. *N Z Vet J* 1996; 44:41.
- Lacy-Hulbert SJ, Hillerton JE. *J Dairy Res* 1995; 62:395.
- Oliver SP et al. In: Proceedings of a Symposium at Ontario Veterinary College, Guelph, Ontario, June 22 1997. *Pharmacia & Upjohn*, 1997:1–35.
- Grant RG, Finch JM. *Res Vet Sci* 1997; 62:74.
- Leigh JA. *Vet J* 1999; 157:225.
- Matthews KR et al. *Infect Immun* 1994; 62:5641.
- Almeida RA, Oliver SP. *J Dairy Sci* 1995; 78:1310.
- Aarestrup FM, Jensen NE. *Vet Microbiol* 1996; 53:315.
- Hogan JS et al. *J Dairy Sci* 1988; 71:2520.
- Thomas LH et al. *Am J Vet Res* 1994; 55:1723.
- Oliver SP et al. *J Dairy Sci* 2004; 87:3322.
- Hillerton JE, Kliem KE. *J Dairy Sci* 2002; 85:1009.
- Oliver SP et al. *Vet Ther* 2003; 4:299.
- Wilson DJ et al. *J Dairy Sci* 1999; 82:1664.
- Hillerton JE, Semmens JE. *J Dairy Sci* 1999; 82:93.
- Guterbock WW et al. *J Dairy Sci* 1993; 76:3437.
- Van Eenennaam AL et al. *J Dairy Sci* 1995; 2086.
- Smith KL, Hogan JS. *Vet Clin North Am Food Anim Pract* 1993; 9:489.
- Berry EA, Hillerton JE. *J Dairy Sci* 2002; 85:2152.
- Woolford MW et al. *N Z Vet J* 1998; 46:12.
- Williamson JH et al. *N Z Vet J* 1995; 43:228.
- Finch JM et al. *Infect Immun* 1994; 62:3599.
- Leigh JA. *FEMS Microbiol Lett* 1993; 114:67.

## ARCANOBACTERIUM PYOGENES

### ETIOLOGY

*Arcanobacterium pyogenes* (formerly *Actinomyces pyogenes* and *Corynebacterium pyogenes*) causes two forms of severe clinical mastitis: sporadic cases of suppurative mastitis, mostly in housed cattle, referred to as **pyogenes mastitis**, and a clinically similar disease that occurs in outbreaks in cattle during the summer months in Europe and Scandinavia and is referred to as **summer mastitis**.<sup>1</sup> Successful transmission of infection has been performed, but the bacteria is rarely present in pure culture in the naturally occurring disease and is not the specific cause of summer mastitis. When the organism is applied to the teat skin at the end of the teat, infection of the quarter does not occur unless the teat end is injured,<sup>2</sup> when anaerobic bacteria are also involved in the infection.<sup>3</sup>

**Etiology** *Arcanobacterium pyogenes*, formerly known as *Actinomyces pyogenes* or *Corynebacterium pyogenes*

**Epidemiology** Important cause of sporadic suppurative mastitis, most common in dry cows or pregnant heifers. Outbreaks occur in Europe in summer (called summer mastitis) associated with seasonally active biting flies, such as *Hydrotoea irritans*. Other bacteria (*Streptococcus dysgalactiae* and *Peptostreptococcus indolicus*) may be required to initiate clinical mastitis

**Clinical findings** Gland is severely swollen and hard, usually only one quarter affected. Secretion from infected quarters initially watery with clots, later purulent. Initially severe systemic signs including fever, inappetence, tachycardia, depression, mortality rate up to 50%. In cattle surviving the initial infection, the affected quarter becomes abscessed, with drainage of purulent material at the base of the teat

**Clinical pathology** Culture of milk

**Necropsy findings** Abscesses in one gland and severe systemic reaction are strong presumptive necropsy findings of *A. pyogenes* mastitis

**Differential diagnosis** Cannot definitively differentiate from other causes of acute mastitis without culture of milk; however, presence of abscesses in mastitis is strongly suggestive of *A. pyogenes*

**Treatment** Responds poorly to treatment with parenteral procaine penicillin G or oxytetracycline and intramammary penicillin. Affected quarter is almost always lost for milk production

**Control** Intramammary infusion with dry cow preparation every 3 weeks during the dry period. Control fly populations. Isolate cows with draining abscesses

In summer mastitis the purulent material in the quarter usually contains *A. pyogenes* as a primary pathogen but the severity of the disease is determined by the presence of anaerobes such as *P. indolicus*, *S. dysgalactiae*, *F. necrophorum*, *P. melaninogenica*, *Fusobacterium* spp., a microaerophilic, Gram-positive coccus (Stuart-Schwan coccus)<sup>4</sup> and other Bacteroidaceae and *Micrococcus* spp. are also found. These bacterial species are found on the teats and conjunctiva and in the oral cavity of healthy cattle.<sup>5</sup> *F. necrophorum* was recovered almost exclusively from the oral cavity, *P. indolicus* and *A. pyogenes* most frequently from teat skin, and isolates of *P. melaninogenica* subsp. *levii* were evenly distributed between conjunctiva and teat tip samples. There is also a distinct seasonal pattern of the isolation of the pathogens, which corresponds closely to the seasonal activity of the fly *Hydrotoea irritans*.<sup>2</sup>

It has also been proposed that *S. dysgalactiae* is the primary cause, and the others secondary invaders,<sup>6</sup> but all

these bacteria are capable of causing suppurative mastitis when infused into the udder. *A. pyogenes* alone establishes itself readily in mammary tissue after experimental introduction but causes only a subclinical disease, but inclusion of summer mastitis exudate provokes the classical syndrome of summer mastitis.<sup>7</sup> Experimental infections with *A. pyogenes* and *P. indolicus* cause a much more serious disease, and one less responsive to treatment if the infection is introduced into a dry quarter instead of into a lactating one.<sup>8</sup> The bacterial flora in cases of summer mastitis is quite variable. In some years in the UK, many cases are apparently due to pure infections of *M. haemolytica*.<sup>9</sup> In pyogenes mastitis, *A. pyogenes* is often found in pure culture but the other bacteria listed in summer mastitis are also common accompaniments. *Actinomyces ulcerans* is an uncommon cause of a subacute mastitis.

## EPIDEMIOLOGY

### Occurrence and prevalence of infection

Bovine mastitis associated with *A. pyogenes* occurs sporadically and is most common in dry cows or pregnant heifers, although lactating cows may also be affected. A high prevalence is also recorded in heifer calves as young as 2 months.<sup>10</sup> In the UK, Japan,<sup>11</sup> northern Europe, Florida and infrequently in a group of countries scattered all over the world, there is a much higher incidence of suppurative 'summer mastitis' during the summer months when nonlactating females are left at pasture and not kept under close observation. In the UK 20–60% of farms are affected, the same herds are affected each year and about 40% of farms never experience the disease.

### Source of infection and mode of transmission

The portal of infection is unknown, although it is presumed to be via the streak canal. The method of spread is uncertain in sporadic cases but insects, especially biting ones such as *H. irritans*, appear to play an important role in outbreaks of 'summer mastitis'<sup>2,5,12</sup> in northern Europe. The prevalence of the disease is related to the peaks of the fly populations and the prevailing climate, especially the wind force and direction.

### Risk factors

The incidence is much higher in wet summers and on heavily wooded and low-lying farms when the fly population is high. Dairy breeds are the predominant target, mostly at the end of gestation or in the first few days of the lactation. Heavy fly populations are a common accompaniment of an outbreak. It has been suggested

that some triggering mechanism is needed before contamination of the teat and invasion and infection of the gland can occur.<sup>5</sup> The infection rate of *A. pyogenes* in udders is much less in housed cattle than in the same cattle at pasture. In Australia the disease occurs mostly in lactating cows and usually after injury or the development of black spot on the teat.<sup>13</sup> Outbreaks are also recorded in association with outbreaks of foot-and-mouth disease<sup>14</sup> and herpes mammillitis virus damage to the teats.

### Economic importance

Summer mastitis is a serious disease in that the mortality rate without adequate treatment is probably about 50% and the affected quarters of surviving cows are always totally destroyed. In pyogenes mastitis the mortality rate is much less but the loss of the quarter means that the cow is culled.

## PATHOGENESIS

It is suggested that the infection is carried from udder to udder by flies and that massive invasion of the mammary tissue occurs via the teat canal that is damaged. The greater part of the gland is affected at the first attack, causing a severe systemic reaction and loss of function of the entire quarter. The disease has been reproduced by inoculation of the mammary gland of pregnant heifers with *A. pyogenes*, *F. necrophorum*, and *P. indolicus*.<sup>15</sup> All animals developed moderate to severe clinical mastitis: four out of 10 animals recovered completely and had a normal lactation after calving. In six of 10 animals, the course of the disease was severe and affected quarters failed to produce milk after calving.

### CLINICAL FINDINGS

Mastitis associated with *A. pyogenes* is usually peracute with a severe systemic reaction, including fever (40–41°C, 105–106°F), rapid heart rate, complete anorexia, and severe depression and weakness. Abortion may occur during this stage. In almost all cases only one quarter is affected, most commonly a front one. The teat is swollen and inflamed and the quarter is very hard, swollen and sore; the secretion is watery with clots early and later purulent, with a typical putrid odor. Affected cows usually carry a large fly population. If the cow survives the severe toxemia, the quarter becomes extremely indurated and abscesses develop, later rupturing through the floor of the udder, commonly at the base of the teat. These may be presented as being chronic cases but they are usually residual after an acute episode. True gangrene, such as occurs in staphylococcal mastitis, rarely if ever occurs in uncomplicated infections with



*A. pyogenes* but quarters may be so severely affected that sloughing occurs. Lameness in the hindlimb on the affected side occurs in some cases, and the limb joints may be swollen. The function of the quarter is permanently lost and cows that have calved recently may go completely dry. Severe thelitis with extreme thickening and obstruction of the teat is a common sequel. Partial or complete obstruction of the teat and damage to the teat cistern can also occur independently of an acute attack of mastitis. Fetal growth retardation is thought to be a feature of calves born to cows affected by summer mastitis during pregnancy.

#### CLINICAL PATHOLOGY

Isolation of the bacteria is required. Freezing of milk samples reduces the number of samples giving a positive cultural result.<sup>16</sup>

#### NECROPSY FINDINGS

Details of the pathology of the disease are not available.

#### DIFFERENTIAL DIAGNOSIS

The seasonal incidence of the disease in some areas, the acute inflammation of the quarter, the suppurative nature of the mastitis, the development of abscesses and the severe systemic reaction make this form of mastitis one of the easiest to diagnose clinically in cattle.

#### TREATMENT

Summer mastitis normally responds poorly to treatment and the affected quarter is typically lost for milk production. Failure of therapy is due to the extensive purulent processes in the udder and not to antimicrobial resistance. Bacterial isolates from cases of summer mastitis are susceptible to penicillin G and other beta-lactam antimicrobials.<sup>17</sup> However, penicillin G has limited distribution throughout the inflamed udder. Penicillin G given parenterally to experimental cases of summer mastitis was effective in about 40% of cases if treatment was initiated within 32 hours after inoculation.<sup>18</sup> In peracute cases parenteral treatment with sodium sulfadimidine or one of the tetracyclines is preferable and should be accompanied by repeated stripping of the quarter. Broad-spectrum antimicrobial agents are usually given by intramammary infusion but the quarter is almost always rendered functionless.

Affected quarters can also be treated by permanently drying the quarter off. The best method for permanently drying off a quarter is infusion of 120 mL of 5% povidone-iodine solution (0.5% iodine) after complete milk-out and administration of flunixin meglumine (1 mg/kg BW,

intravenously).<sup>19</sup> This causes permanent cessation of lactation in the quarter but does not alter total milk production by the cow.

Clearing of proteinaceous debris from the affected quarter may be aided by the intramammary application of proteolytic enzymes but the outcome as far as the quarter is concerned is unlikely to be much altered and amputation of the teat to facilitate drainage is a common treatment. Even with intensive therapy, at least 80% of quarters are rendered useless and many of those that respond are greatly reduced in productivity.

#### CONTROL

The question of control of this form of mastitis centers largely on 'summer mastitis'. Many prophylactic measures, including infusion of the quarter when the cow is dried off, sealing the teat ends with collodion and vaccination with toxoid, have been tried but with inconclusive results. The most favored technique is intramammary infusion with a dry cow preparation (e.g. cloxacillin 500 mg and ampicillin 250 mg in a long-acting base) at 3-week intervals during the dry period. Less frequent administration offers less protection.<sup>20</sup> An alternative intramammary infusion procedure is to use cephalonium at 4-weekly intervals.

Repeated spraying of the udder, for example automatically at watering points, with a contact insecticide<sup>21</sup> is commonly carried out during the fly season and is believed to be effective. An alternative to spraying is the use of insecticide-impregnated ear tags,<sup>22</sup> or pour-ons, but ear tags are decreasing in popularity. Careful daily examination of dry cows during the summer may enable affected quarters to be identified, the cows to be isolated and the quarters treated at an early stage and thus limit the spread of infection. In particular, cows with purulent material draining from an affected quarter need to be isolated from other cattle. Early treatment of teat lesions to limit bacterial colonization by bacteria, possibly transported by flies, is recommended. The known susceptibility of particular farms, and particular paddocks on those farms, demands proper care in planning the pasturing of dry cows during the danger period.

#### REVIEW LITERATURE

Egan J. *Actinomyces pyogenes* mastitis with particular emphasis on summer mastitis. *Ir Vet J* 1994; 47:180-186.

#### REFERENCES

- Madsen M et al. *Vet Microbiol* 1992; 32:81.
- Chirico J et al. *Med Vet Entomol* 1997; 11:187.
- Steinhorst JW et al. *Vet Rec* 1991; 128:54.
- Madsen M. *Acta Vet Scand* 1989; 30:165.
- Madsen M et al. *Vet Microbiol* 1992; 30:243.
- Jansson P et al. *J Dairy Res* 1991; 58:179.

- Francis PG. *Vet Rec* 1991; 128:166.
- Hillerton JE, Bramley AJ. *Br Vet J* 1989; 145:148.
- Roberts NH. *Vet Rec* 1990; 127:19 (corr).
- Lean IJ et al. *Cornell Vet* 1987; 77:367.
- Sarashira T, Yonemichi H. *J Jpn Vet Med Assoc* 1991; 44:690.
- Hillerton JE et al. *Br Vet J* 1990; 146:147.
- Slee KJ, McOrist S. *Aust Vet J* 1985; 62:63.
- Saini SS et al. *Vet Rec* 1992; 131:152.
- Hirvonen J et al. *J Dairy Res* 1996; 63:351.
- Schukken YH et al. *J Dairy Sci* 1989; 72:1900.
- Jousimies-Somer H et al. *Antimicrobiol Agents Chemother* 1996; 40:157.
- Hirvonen J et al. *Vet Microbiol* 1994; 42:307.
- Middleton JR, Fox LK. *J Dairy Sci* 2001; 84:1976.
- Egan J. *Ir J Agric Res* 1986; 25:173.
- Bertels G, Robijns JM. *Vlaams Diergeneesk Tijdschr* 1983; 52:77.
- Ron I, Bakken G. *Norsk Vet Tidsskr* 1986; 98:445.

## Mastitis of cattle associated with less common pathogens

### *PSEUDOMONAS AERUGINOSA*

Mastitis in cattle and sheep associated with *Pseudomonas aeruginosa* is rare and occurs usually as sporadic cases after intramammary infusion with contaminated material.

#### ETIOLOGY

*P. aeruginosa* is the most common cause, although other *Pseudomonas* spp. can cause disease.

#### EPIDEMIOLOGY

*P. aeruginosa* is common in the environment of cattle. Occasionally a number of animals in the herd are affected, the infection usually originating in contaminated water used for washing udders.<sup>1</sup> The organism has the capacity to colonize inert materials such as loops of hose and the interior surface of water heaters, so that high bacterial concentrations may be in the water left in the hose between milkings. It may be an advantage in these circumstances to flush out the udder washing system before commencing each milking. Once the teats are contaminated, the entry of the organisms to the teats is facilitated by overmilking and by putting the milking cups on while the udder is still wet.<sup>2</sup> Serious outbreaks in cows have also occurred in association with the use of a suspected contaminated mastitis infusion<sup>3</sup> used as a dry period treatment. The cows became affected soon after calving.

Rarely, strains of this organism are highly virulent and cause fatal mastitis with generalized lesions. Less commonly still there is a high level of infection in a herd due to a contaminated water supply but with no clinical cases. Reinfection is common unless the source of infection is removed, even though there is apparent cure by treatment with spectinomycin.<sup>4</sup>



### CLINICAL FINDINGS

The mastitis may be clinically severe and the mortality rate as high as 17% of affected cows, or it may be subacute or chronic. Clinically there is a severe systemic reaction, acute swelling of the gland and the appearance of clotted, discolored milk; the function of the gland is usually completely lost at the first attack, but recurrent crises may occur.

### CLINICAL PATHOLOGY

Culture of the organism in the milk is necessary to confirm the diagnosis.

### NECROPSY FINDINGS

The disease can be fatal and the gross and histological findings are similar to other causes of clinical mastitis in cows.

### DIFFERENTIAL DIAGNOSIS

Bovine mastitis associated with *Pseudomonas aeruginosa* must be differentiated from the many other forms of acute mastitis associated with this species; this can be done only by bacteriological examination of the milk.

### TREATMENT

**Treatment with antimicrobial agents is generally unsuccessful.** Third-generation cephalosporins such as ceftiofur, aminoglycosides such as gentamicin, and fluoroquinolones are most likely to be efficacious in treating affected animals. Daily intramammary infusions of streptomycin (1 g) or neomycin (0.5 g), or both combined with polymyxin B, for 4 days, have been used.

### CONTROL

The standard control program described later in the chapter should control the disease in cows. The oral administration of an organic iodine compound and vaccination with a killed autogenous vaccine are credited with bringing the disease under control in one herd.

### REFERENCES

1. Erskine RJ et al. J Am Vet Med Assoc 1987; 191:811.
2. Ollis G, Schoenewoerd M. Can Vet J 1989; 30:525.
3. Osborne AD et al. Can Vet J 1981; 22:215.
4. Kirk JH, Bartlett PC. J Am Vet Med Assoc 1984; 184:671.

### PASTEURELLA SPECIES

Mastitis associated with *Mannheimia* (formerly *Pasteurella*) *haemolytica* and *Pasteurella multocida* is common in ewes, occurring in a peracute gangrenous form, but is comparatively rare in cattle and goats.

### ETIOLOGY

In cattle *M. haemolytica*<sup>1</sup> and *P. multocida* are the causative organisms; *M. haemolytica* has also been isolated from many cases of **summer mastitis** in the UK.<sup>2</sup>

### EPIDEMIOLOGY

In cattle the disease is encountered rarely, and usually sporadically, but it may be a problem in individual herds, particularly where calves are reared by nurse cows.

### CLINICAL FINDINGS

In cattle the mastitis is severe with fever, profound toxemic shock, weak pulse, tachycardia, and recumbency. The affected quarter is very swollen and the milk is watery, red-tinged and contains flakes. Disseminated intravascular coagulopathy may cause internal bleeding at many sites. All four quarters may be affected. There is complete cessation of milk flow in affected and unaffected quarters and subsequent fibrosis and atrophy. Newborn calves allowed to suck colostrum from affected cows may die of pasteurellosis.

### Clinical pathology

Culture of the organism in the milk is necessary to confirm the diagnosis.

### NECROPSY FINDINGS

The disease is not fatal in cows.

### DIFFERENTIAL DIAGNOSIS

Bovine mastitis associated with *P. multocida* must be differentiated from the many other forms of acute mastitis associated with this species; this can only be done by bacteriological examination of the milk.

### TREATMENT

In cattle, streptomycin administered by intramammary infusion is effective but tetracycline is preferred. Recurrence in quarters that appear to have recovered is not infrequent, and response to treatment is often poor.

### CONTROL

The standard control program described later in the chapter should control the disease in cows.

### REFERENCES

1. Kiper ML, Paulsen DP. J Am Vet Med Assoc 1988; 192:205.
2. Roberts NH. Vet Rec 1990; 127:191 (corr).

### NOCARDIA SPECIES

Nocardial mastitis is an uncommon occurrence in cattle and is manifest as an acute or subacute mastitis accompanied by extensive granulomatous lesions in the udder.

### ETIOLOGY

*Nocardia asteroides* can be cultured from the milk of affected quarters, and the disease can be produced experimentally by this organism. Occasional cases of chronic mastitis associated with *Nocardia*

*brasilensis* and *Nocardia farcinica* have also been recorded.

### EPIDEMIOLOGY

#### Occurrence

With rare exceptions, nocardial mastitis in cattle has been recorded as a sporadic infection affecting only one or two cows in a herd. Accidental introduction of the causative bacteria into udders when infusions are being administered may create a herd problem.<sup>1</sup> *Nocardia* is recorded as being a relatively common chronic mastitis in Cuba. Commencing in 1987, a large number of cases occurred in Canada. Confinement of dairy cattle in muddy pens has been associated with an increased incidence of nocardial mastitis.<sup>2</sup>

#### Source of infection and mode of transmission

The bacteria is a common soil contaminant and probably gains entrance to the udder when udder washing is ineffective or udder infusion is not carried out aseptically. *Nocardia* can survive in ineffective teat dips and may be spread by their use. The disease is most common in freshly calved adult cows, particularly if infusion of the udder with contaminated materials is carried out in the dry period. *N. asteroides* is capable of surviving in mixtures used for intramammary infusion for up to 7 weeks. There is one record of a massive outbreak with many deaths that was probably due to the use of a contaminated homemade udder infusion.<sup>3</sup>

#### Risk factors

A sharp increase in isolations of *N. asteroides* in milk samples at veterinary diagnostic laboratories in Canada<sup>4</sup> was related to the extensive use of a particular dry period treatment. Teat dips containing recommended concentrations of iodine or dodecylbenzene are effective against *N. asteroides* whereas those containing chlorhexidine acetate are not effective.<sup>5</sup> When the dip is contaminated during use it may spread the organism to other quarters and other cows.

#### Economic importance

The disease is a serious one in that there is extensive destruction of tissue, loss of production, and occasionally death of a cow. Also, there is a possibility that human infection may occur, as the organism may not be destroyed by usual pasteurization procedures.

#### PATHOGENESIS

The inflammation of the teat sinus and lower parts of the gland suggests invasion via the teat canal. Infection of mammary tissue results in the formation of discrete granulomatous lesions and the development of extensive fibrosis, the spread of inflammation occurring from lobule to

lobule. Infected animals are not sensitive to tuberculin.

When infection occurs early, in the first 15 days of lactation, the reaction is a systemic one with fever and anorexia. At other times the lesions take the form of circumscribed abscesses and fibrosis. There may also be infected foci in supramammary and mesenteric lymph nodes.<sup>6</sup>

#### CLINICAL FINDINGS

Affected animals may show a systemic reaction with high fever, depression and anorexia, but an acute or subacute inflammation is more usual. Fibrosis of the gland and the appearance of clots in a grayish, viscid secretion that also contains small, white particles is the usual clinical picture. The fibrosis may be diffuse but is usually in the form of discrete masses 2–5 cm in diameter. Badly affected glands become grossly enlarged, and may rupture or develop sinus tracts to the exterior. None of these cases recovers sufficiently to justify retention and all are eventually culled.

Laboratory examinations of herds in which cases occur may also reveal subclinical cases that have intermittent flare-ups.<sup>7</sup>

#### CLINICAL PATHOLOGY

The bacteria can be detected on culture of the milk. Small (1 mm diameter) specks are visible in the milk and, on microscopical examination, these prove to be felted masses of mycelia. Herds containing infected cows have been readily identified by culture of bulk milk samples.<sup>8</sup> A gentamicin–blood culture medium has good selectivity.<sup>9</sup> The normal blood agar plates need to be kept for an extended period of time in order to detect growth. Colonies may not appear until 72 hours.

#### NECROPSY FINDINGS

Grossly, diffuse fibrosis and granulomatous lesions containing pus are present in the mammary tissue. The lining of the milk ducts and the teat sinus is thick and roughened. On histological examination the granulomatous nature of the lesions is evident. Metastatic pulmonary lesions have been found in occasional long-standing cases.

#### Samples for confirmation of diagnosis

- Bacteriology – mammary tissue, regional lymph node
- Histology – formalin-fixed mammary tissue for light microscopy.

#### DIFFERENTIAL DIAGNOSIS

The appearance of the milk is distinctive but cultural examination is necessary for positive identification.

#### TREATMENT

The disease does not respond well to treatment. Erythromycin and intramammary miconazole are most effective but need to be used for 1–2 weeks.<sup>7</sup>

#### CONTROL

Invasion probably occurs via the teat canal from a soil-borne infection; proper hygiene at milking and strict cleanliness during intramammary infusion are therefore necessary on farms where the disease is enzootic. Treatment in late cases is unlikely to be of value because of the nature of the lesions, and in affected herds particular attention should be given to the early diagnosis of the disease.

#### REFERENCES

1. Argente G et al. *Pointe Vet* 1983; 14:7.
2. Da Costa EO. *Vet Res Commun* 1996; 20:237.
3. Hibbs CM et al. *Proc Annu Mtg Am Assoc Vet Lab Diagn* 1980; 23:73.
4. Dohoo IR. *Can Vet J* 1991; 32:116, 227, 613.
5. Larocque L et al. *J Dairy Sci* 1992; 75:1233.
6. Battig U et al. *Schweiz Arch Tierheilkd* 1990; 132:315.
7. Sears PM. *Bovine Pract* 1983; 18:4.
8. Schoonderwoerd M et al. *Can Vet J* 1990; 31:453.
9. Lynch JA. *Can Vet J* 1990; 31:417.

### Miscellaneous causes of bovine mastitis

#### BACILLUS SPECIES

*Bacillus cereus* and *Bacillus subtilis* are saprophytic organisms and only chance mastitis pathogens; they have been known to cause an acute hemorrhagic mastitis in cattle. *B. cereus* cases are often associated with contamination associated with teat injuries or surgery. The mastitis may also occur in cows at the time of calving and is associated with the feeding of brewers' grains in which the spores of *B. cereus* are present.

The infection is thought to occur during the dry period following the use of dry cow therapy preparations that may have been contaminated with the organism.<sup>1</sup> Infection probably occurs at the time of infusion but the acute mastitis does not occur until after parturition. *B. cereus* is a spore-former and may remain dormant in the mammary gland for long periods, unaffected by the presence of the antibiotic. In one outbreak, 62 of 67 cows infused with a dry cow infusion product contaminated with the organism developed acute hemorrhagic mastitis. Six cows died; the remainder survived but were subsequently culled and slaughtered because of recurrent mastitis, inadequate milk production and loss of weight.

Clinically there is peracute to acute mastitis affecting one or more quarters. There is severe swelling and pain and the

secretions are red-tinged and serous in consistency. Initially there is a high fever (40–41°C, 104–106°F) and severe toxemia. Affected cows are weak and quickly become recumbent; death may occur in 24–36 hours. Gangrene may occur and, in cows that survive, portions of affected gland will slough out and a chronic relapsing mastitis will persist. Experimentally produced mastitis due to *B. cereus* causes toxemia, acute swelling of the quarter and clots in the milk. The mastitis persists in a chronic form and the quarter eventually dries up.<sup>2</sup>

The organism can usually be cultured from milk samples from affected quarters. At necropsy there is focal hemorrhagic necrosis of the mammary tissue, acute lymphadenitis and disseminated intravascular coagulation.

Treatment consists of intensive fluid therapy, a broad-spectrum antibiotic intravenously, and vigorous massage and stripping of the affected gland. Intramammary infusion of the most suitable antibiotic determined by culture and sensitivity is indicated but the results are often not good because of the presence of severe hemorrhage and necrosis and plugging of the lactiferous ducts. Prevention depends on the use of sterile techniques during teat surgery and the use of sterile intramammary infusions and instruments. In problem herds, autogenous bacterins have been prepared but not extensively evaluated.<sup>3</sup> If *B. cereus* infection is identified in the mammary glands of dry cows the recommended prevention program is infusion of each quarter with 750 mg neomycin and 375 mg framycetin.<sup>4</sup>

*B. subtilis* is recorded less frequently as a cause of acute mastitis. Infection is characterized by yellow or bloody milk, sometimes with clots, and the cow is febrile.<sup>5</sup>

#### CAMPYLOBACTER JEJUNI

Only one case has been recorded<sup>6</sup> but the incident is of some importance because of its zoonotic impact. Infection of the udder by the organism is easy to establish and the infection is persistent but subclinical for the most part. Other experimental cases have been recorded and campylobacters that have not been further identified<sup>7</sup> have also been observed in naturally occurring cases. These are characterized by fine granular clots in the milk, very high cell counts and a transient episode of fever and swelling of the quarter.

#### CLOSTRIDIUM PERFRINGENS TYPE A

This is a rare form of mastitis<sup>8</sup> characterized by high fever, swelling, and

superficial hyperemia of the affected quarter, followed later by gangrene, enlargement of the supramammary lymph nodes, a thin brown secretion containing gas, and subcutaneous emphysema. Early treatment with a broad-spectrum antibiotic can be successful,<sup>9</sup> but advanced cases are uniformly fatal

### **FUSOBACTERIUM NECROPHORUM**

This is a rare type of mastitis but is likely to have a high incidence in the herd when it occurs. Mixed infections of *Fusobacterium necrophorum* appear to play an important role in summer mastitis due to *A. pyogenes* (see above). Affected quarters have a viscid, clotty, stringy secretion but there is little fibrosis. No systemic reaction occurs but treatment with a variety of antibiotics is unsuccessful.

### **HISTOPHILUS SOMNI**

*Histophilus somni* (formerly *Haemophilus somnus*) has caused mild, chronic mastitis, an acute form with high fever and blood-stained milk, and a gangrenous form.<sup>10,11</sup>

### **LISTERIA MONOCYTOGENES**

*Listeria monocytogenes* is being recorded with increasing frequency as a cause of bovine mastitis because of the zoonotic importance of the organism in dairy products. Most cases are subclinical and abnormal milk is rare.<sup>12</sup> The SCC is usually greater than 10<sup>7</sup> cells/mL milk. An ELISA test can be used to detect antibody in milk.<sup>12</sup> Culture of bulk milk samples is an adequate means of locating herds with infected cows.<sup>13</sup> Over a 23-year period in Denmark, the percentage of cows infected with the organism varied from 0.01–0.1% and that of herds with an infected cow from 0.2–4.2%.<sup>14</sup> Typing of the isolates from bovine mastitis and human clinical isolates revealed that 79% of bovine and 48% of human isolates shared common types. Identifying infected cows may not be easy because the mastitis is mild; the milk is normal in appearance but the quarter does lose productivity<sup>15</sup> and the milk carries a high SCC. The disease is characteristically unresponsive to treatment with penicillin, although the organism may be sensitive to the antibiotic in *in vitro* tests. The persistence of the clinical signs should arouse suspicion of *L. monocytogenes* as a cause.

### **MYCOBACTERIUM SPECIES**

Tuberculous mastitis is described under tuberculosis. Other mycobacteria, especially *Mycobacterium lacticola*, have been isolated from cases of mastitis in cattle that occur after the intramammary infusion of

therapeutic agents in oils.<sup>16</sup> The disease can be reproduced by the intramammary injection of the organism in oil but not when it is in a watery suspension. Subsequent oily infusions exacerbate the condition. Clinically there is tremendous hypertrophy of the quarter with the appearance of clots in discolored milk, but there is no systemic reaction. Affected animals do not show sensitivity to avian or mammalian tuberculin. No treatment is effective. It is suggested that the treatment of injured teats and quarters with oil-based intramammary preparations is inadvisable because of the risk of them already being infected with mycobacteria.

A mild, acute mastitis, self-terminating and unresponsive to treatment, has occurred in outbreak form.<sup>17</sup> It may be unassociated with intramammary infusion but is apparently predisposed to by stress and associated with an unidentified mycobacterium.

*Mycobacterium fortuitum* is encountered rarely as a cause of a severe outbreak of bovine mastitis. Infected quarters are seriously damaged and do not respond to treatment, and affected cows die or are salvaged.<sup>18</sup> The disease can be reproduced experimentally and affected animals show positive reactions to mammalian and avian tuberculosis and some sensitivity to johnin. Similar experiences are recorded with *Mycobacterium smegmatis*<sup>19</sup> and *Mycobacterium chelonae*.<sup>20</sup> The mammary secretion of affected quarters varies from pus to a watery fluid containing flakes and there is a high milk loss and irreparable damage to quarters. *M. smegmatis* causes hypertrophy of the gland of such proportions that all cases need to be culled.

### **SERRATIA SPECIES**

*Serratia marcescens* causes mild chronic mastitis in which swelling of the quarters with clots in the milk appear periodically. *Serratia* mastitis occurs naturally and has been produced experimentally.<sup>21</sup> Neomycin (2 g initially followed by three daily doses of 1 g by intramammary infusion) is a satisfactory treatment. *Serratia liquefaciens* has caused a similar mastitis.<sup>22</sup> Most cases are sporadic but herd outbreaks caused by the use of contaminated sawdust as bedding and inadequate cleaning of the teats before milking may occur.<sup>23</sup>

### **FUNGI AND YEASTS**

*Trichosporon* spp. can cause mastitis in cattle and is manifested clinically by swelling of the gland and clots in the milk. The infection rate is low and the fungi disappear spontaneously. Experimental transmission of the disease has been effected.

*Cryptococcus neoformans*, the yeast that causes human cryptococcosis, has caused acute mastitis in cattle<sup>24</sup> and buffaloes.<sup>25</sup> Contaminated infusion material and spread from other infected quarters are the probable sources of infection. Infection in humans drinking the milk is unlikely to occur because the yeast does not withstand pasteurization, but there may be some hazard to farm families. While there is no systemic reaction, the mastitis may be acute, with marked swelling of the affected quarter and the supramammary lymph node, a severe fall in milk yield and the appearance of a viscid, mucoid, gray-white secretion. Clinical mastitis persists for some weeks and, in many cases, subsides spontaneously, but in others the udder is so severely damaged that the cow has to be slaughtered. Systemic involvement occurs rarely. At necropsy, there is dissolution of the acinar epithelium and in chronic cases a diffuse or granulomatous reaction in the mammary tissue and lymph node. Similar lesions have been found in the lungs.

Many other yeasts, including *Candida* spp., *Saccharomyces* spp., *Pichia* spp., *Torulopsis* spp., and *Aspergillus fumigatus* have also caused mastitis in cattle. A survey of 91 bovine cases of fungal mastitis in the USA showed that 78% belonged to *Candida* spp.<sup>16</sup> The infection is probably introduced by contaminated intramammary infusions or teat cup liners.<sup>26</sup> Establishment of the infection is encouraged by damage to the mammary epithelium and stimulated by antibiotic therapy; for example *Candida* spp. utilize penicillin and tetracyclines as sources of nitrogen.

A fever (41°C, 106°F) is accompanied by a severe inflammation of the quarter, enlargement of the supramammary lymph nodes and a marked fall in milk yield. The secretion consists of large, yellow clots in a watery supernatant fluid. Lesions are limited to the walls of the milk cistern and there is no invasion of the mammary gland itself.<sup>27</sup> Usually the disease is benign and spontaneous recovery follows in about a week. In cases of infection by *A. fumigatus* or *Aspergillus nidulans* there are multiple abscesses in the quarter. These are surrounded by granulation tissue but the milk ducts are generally unaffected.

**None of these infections responds well to antimicrobial therapy** but treatment with iodides, either sodium iodide intravenously, organic iodides by mouth, or iodine in oil as an intramammary infusion, might be of value. A number of drugs, including cycloheximide, nystatin, polymyxin B, neomycin, and isoniazid, have been tested for efficiency against mastitis in cattle produced

experimentally by the infusion of *C. neoformans* but did not alter the clinical course of the disease. Merthiolate (20 mL of a 0.1% solution) as an infusion daily for 2–3 days is reported to have a beneficial effect if administered early in the course of the disease. Actinomycotic agents tested in vitro against fungi, mostly *Candida* spp., from cases of mastitis showed sensitivity to clotrimazole, nystatin, polymyxin, miconazole and amphotericin B, and least sensitivity to 5-fluorocytosine.<sup>28</sup> Miconazole (100 mg/L as an intramammary infusion, possibly supplemented by 400 mg doses given intravenously) is reported to produce good results.<sup>29</sup> Sulfamethoxypyridazine given parenterally (22 mg/kg BW for 2–3 d) has resulted in more than 50% clinical cures in quarters infected with *Candida krusei*.<sup>30</sup> A case of mastitis due to *A. fumigatus* has been successfully treated by concurrent intra-arterial injection and intramammary infusion of 100 mg of miconazole at each site. Clinical signs included fever, anorexia and depression, a hard, swollen, hot gland with clots in the milk, and a negative response to treatment with intramammary antibiotics.<sup>31</sup>

## ALGAE

*Prototheca trispora* and *Prototheca zopfii* are algae that have been identified as causes of chronic bovine mastitis.<sup>32,33</sup> Reduced milk yield, large clots in watery milk and induration of the affected quarter may be the only clinical signs. Cases of this disease are usually sporadic but one severe outbreak is recorded.<sup>34</sup> The organisms are common isolates from animal environments.<sup>35</sup> Treatment is usually unsuccessful and affected cows should be culled; because of a high prevalence rate in many affected herds the loss to the farmer can be considerable.<sup>34</sup> Experimental transmission of the disease causes a progressive pyogranulomatous lesion in the gland and the organism can be isolated from draining lymph nodes.<sup>36</sup>

## TRAUMATIC MASTITIS

Injuries to the teats or udder that penetrate to the teat cistern or milk ducts, or involve the external sphincter, are commonly followed by mastitis. Any of the organisms that cause mastitis may invade the udder after such injury, and in such cases mixed infections are usual. **All injuries to the teat or udder, including surgical interference, should be treated prophylactically with broad-spectrum antibiotics.**

## REFERENCES

- Gedek W. Tierärztl Umschau 1986; 41:526.
- Horvath G et al. Acta Vet Hung 1986; 34:29.
- Lander KP, Gill KPW. J Hyg 1980; 84:421.
- Heer A et al. Prakt Tierärztl 1987; 68:40.
- Fossum K. NordVetMed 1986; 38:233.
- Morgan G et al. Vet Rec 1985; 116:111.
- Logan EF et al. Vet Rec 1982; 110:229.
- Johnston AM. Vet Rec 1986; 118:728.
- Schoonewoerd M et al. Can Vet J 1990; 31:523.
- Hazlett MJ et al. Can Vet J 1983; 24:135.
- Armstrong KR et al. Can Vet J 1986; 27:211.
- Bourry A, Ibutrel B. J Dairy Sci 1996; 79:2189.
- Fenlon DR, Wilson J. J Appl Microbiol 1989; 66:191.
- Jensen NE et al. Int J Food Microbiol 1996; 32:209.
- Fedio WM et al. Can Vet J 1990; 31:773.
- Richards JL et al. Am J Vet Res 1980; 41:1991.
- Schultze WD et al. Am J Vet Res 1985; 46:42.
- Whitney H, Priddle F. Can Vet J 1992; 33:344.
- Thomson JR et al. Vet Rec 1988; 122:271.
- Menard L et al. Can Vet J 1983; 24:305.
- Bowman GL et al. J Am Vet Med Assoc 1986; 189:913.
- Nicholls TJ, Barton MG. Vet Rec 1981; 109:288.
- Holmgren O. NordVetMed 1984; 36:354.
- Pal M, Mehrotra BS. Mykosen 1983; 26:615.
- Rahman H et al. Vet Rec 1983; 112:16.
- Nicholls TJ et al. Vet Rec 1981; 108:93.
- Dion WM, Dukes TW. Sabouraudia 1982; 20:95.
- McDonald JS. Am J Vet Res 1980; 41:1987.
- VanDamme DM. Vet Med 1983; 78:1425.
- Mackie DP et al. Vet Rec 1987; 120:48.
- Katamoto H, Shimada Y. Br Vet J 1990; 146:354.
- Furuoka H et al. Jpn J Vet Sci 1989; 51:196.
- Dion WM. Can Vet J 1982; 23:272.
- Spalton DE. Vet Rec 1985; 116:347.
- Anderson KL, Walker RL. J Am Vet Med Assoc 1988; 193:553.
- McDonald JS et al. Am J Vet Res 1984; 45:592.

## Control of bovine mastitis

Improvement in udder health has been a major initiative of the dairy industry for over 40 years. The thrust of these efforts has been on the implementation and use of management techniques to limit the spread of major mastitis pathogens, thereby reducing the quarter infection rate. Detailed mastitis control strategies have been outlined and promoted by the National Institute for Research in Dairying (NIRD) and the National Mastitis Council (NMC). With proper implementation, these programs result in a dramatic decrease in the prevalence of common contagious mastitis pathogens. Herds that have successfully implemented a comprehensive mastitis control program also need to develop strategies to control infection with environmental organisms, as well as utilizing an effective monitoring system for new infections. Achievement of excellent udder health for the production of high-quality milk is a realistic and important goal for all aspects of the dairy industry.

The adoption of effective mastitis control programs has often been less than desirable, even with extensive research validation of the recommended control practices and with major extension efforts at both national and local levels. The reasons for this slow adoption of proven

mastitis control strategies are not well documented, even though producers look to the veterinary profession for information on mastitis and its control.<sup>1</sup> If significant progress is to be made towards a general improvement in udder health status, veterinarians must become more active in organizing, conducting and monitoring comprehensive mastitis control programs.

Veterinarians usually become involved in mastitis control in one of the following circumstances:

- The herd is experiencing a higher than normal incidence of clinical cases
- The milk processing plant reports a higher than permissible total bacterial count or bulk tank milk SCC
- A farmer who is not carrying out the standard program of postmilking teat dipping and dry period treatment asks for advice – either as a single mastitis control program or, more probably, as part of a herd health management program.

The procedure is the same in all these situations, any variation being in terms of speed and intensity. It consists of an assessment of the herd's mastitis status and the implementation of a recommended mastitis control program.

## Udder health improvement

The benefit of an integrated mastitis program is improved udder health; this improvement is progressive and can usually be observed within a few years after implementation at the herd level. In a closed, monitored herd applying the control measures there can be a reduction in the annual incidence of clinical mastitis from 130 cases/100 cows to a level of 35–40 cases/100 cows.<sup>2</sup> In the UK it is estimated that, since 1970, farms that have followed the recommended control procedures have reduced the average annual incidence of cases of clinical mastitis from 135 to 40 cases/100 cows each year, while the percentage of quarters remaining uninfected for a whole year has increased from 65% to 80% of the total quarters.<sup>3</sup> The control program has been most effective in reducing mastitis due to the contagious pathogens such as *S. aureus*, *S. agalactiae*, and *S. dysgalactiae*. These are now responsible for one-third or less of all clinical cases of mastitis compared to 30 years ago. This represents an annual reduction from about 90 to 12 cases/100 cows. The percentage of infected cows declined from 22% to 12% and the percentage of infected quarters from 7% to 3%. Methods now exist to control contagious pathogens and reduce the bulk

tank milk SCCs to below 400 000 cells/mL. With good management, the incidence of clinical mastitis can be kept low (7–21 cases/100 cows/year with dairy herds averaging 45 cows/herd) by culling any cow with chronic or recurrent mastitis and by paying great attention to housing and management standards.<sup>4–6</sup>

While the rate of contagious mastitis has been decreased with the program, the rate of infections and the incidence of mastitis associated with environmental pathogens such as *S. uberis* and the coliform bacteria has not decreased. **Approximately 65% of clinical cases are now due to environmental pathogens.** Organisms prevalent in the cow's environment currently cause the most costly types of mastitis in the USA.<sup>7</sup>

### **Economic benefits, incentives, and penalties**

Mastitis is one of the most costly diseases in dairy herds. Some surveys indicate that the cost incurred by producers because of clinical mastitis is much higher than the cost of prevention.<sup>7</sup> An integrated mastitis control program has always been an excellent investment for the dairy farmer,<sup>3</sup> with a revenue to cost ratio of approximately 6:1,<sup>3</sup> most of the additional revenue being due to increased milk production.

Differential payments to farmers for milk quality are also an **economic** incentive to adopt a control program.<sup>6</sup> The widespread adoption of bulk tank milk SCCs as a measure of milk quality, and the adoption of payment schemes of increasing severity, has stimulated farmers to reduce their cell count. Many milk marketing cooperatives have established both penalty and incentive programs based on bulk tank milk SCC and total bacterial counts as global measures of milk quality.

### **Requirements**

The requirements for a successful mastitis control program include a willing farmer, a capable diagnostic laboratory, an enthusiastic and knowledgeable veterinarian, a record keeping system, adequate milking machinery and adequate housing facilities.

The farmer must have health and production goals and be willing to achieve them by making a commitment to invest the resources to control mastitis. Wide variations in the costs of controlling and monitoring mastitis in herds are evident because of lack of client compliance with accepted recommendations for mastitis control.<sup>8</sup> There are also variations in the level of mastitis control procedures adopted by producers, which affect the success of a program. A survey of a large number of dairy herds in Ohio revealed that most herd managers teat dipped all

cows after milking and used dry cow therapy.<sup>9</sup> However, other mastitis control practices were not as widely adopted. In addition, those herds classified as negative for contagious pathogens used predipping compared with herds classified positive for contagious pathogens, which did not. Predipping was also associated with a number of management factors, including having a clean and dry environment for the cows, cows with clean udders and teats, and minimal use of water in the milking parlor. A survey of Ontario dairy farms indicated that only one-third of producers used all five of the recommended mastitis control practices.<sup>10</sup> Lack of adoption may result from a lack of awareness of the economic returns from a complete program, adoption of a new practice only in response to a problem, or competition for liquid financial resources from other aspects of the enterprise.

The veterinarian must be knowledgeable about all aspects of mastitis and be willing to invest the time and effort required to provide sound advice based on the health and production information obtained from monitoring the herd. Some surveys of veterinarians indicate wide variations in their clinical approach to cases of mastitis in the field.<sup>11</sup> Many factors of importance for the clinical diagnosis of mastitis were not considered.

A data recording system that records all the udder health and production data, and the milk quality of each cow and the herd on a regular basis is a vital requirement. A diagnostic laboratory or milk recording agency that provides regular SCCs of individual cows is necessary to monitor udder health. The milking machine and the housing facilities must be adequate for the size of the herd. The animal attendants must be aware of the health and production goals of the herd and adhere to the principles of mastitis control.

### **OPTIONS IN THE CONTROL OF MASTITIS**

The broad options for control are either eradication or decreasing the infection rate, and either legislative control or implementing a voluntary program.

#### **Eradication**

Complete eradication of bovine mastitis from a herd or geographical region is not a practicable target in most circumstances. The exception is mastitis due to *Streptococcus agalactiae*, which can be eradicated from individual herds by a blitz technique. The difficulty in attempting to eradicate mastitis is that the contagious causes of mastitis, *S. agalactiae* and *Staphylococcus aureus*, are so contagious, and the sources of infection so widespread, that adequate quarantine would

be very difficult to maintain. In the case of *S. aureus* there is the additional difficulty of eliminating the infection from its intracellular sites in mammary tissue. The environmental infections, especially *Escherichia coli*, pose an even greater problem. They are so ubiquitous that reinfection would be almost immediate in cows housed in economically practicable surroundings.

#### **Decreasing the infection rate**

This is a practicable proposition, the degree of limitation being dependent on the need to maintain cost-effectiveness. One of the virtues deriving from this necessity is the concept that subclinical mastitis causes a continuous low-level leukocytosis in the milk that acts as a protective mechanism against other infections. Present-day knowledge about immunity in the mammary gland suggests that control programs that reduce milk SCCs to unrealistically low concentrations may reduce the gland's resistance to clinical mastitis. Correspondingly, the complete elimination of common udder pathogens such as *S. agalactiae* and *S. aureus* is thought to increase the susceptibility of the udder to environmental pathogens, especially the coliforms. Another relevant example is the commonly encountered minor pathogen *Corynebacterium bovis*, which may be a significant microbial agent in maintaining the resistance of udders. The mastitic effect of this organism is too low to warrant action against it but the infection rate with major pathogens is significantly lower in quarters that harbor it than in those that do not.<sup>12</sup> An intensive program to disinfect udders could well eliminate *C. bovis* and increase susceptibility to other pathogens. There is good field evidence to suggest that this is in fact happening in North America and the UK. *C. bovis* is likely to be more important where cows are housed, or confined in straw yards, and therefore more exposed to teat contamination with coliforms. The criticism relates to the increasing numbers of clinical cases, often associated with Gram-negative organisms, that occur in herds that have achieved very low levels of udder infection, as indicated by very low bulk milk cell counts. The question of whether it is better practice to maintain some level of bacterial infection with innocuous organisms in the udder as a protection against more damaging pathogens, rather than to attempt complete bacterial sterilization, is still unresolved. For the time being it is generally agreed that decreasing the infection rate is the appropriate target.

#### **Legislative control**

Mastitis does not lend itself to eradication (as set out under Eradication above) and

so legislative control of the disease is not attempted.

### A voluntary program

Most of what is done in mastitis control is by voluntary involvement by producers in programs aimed at reducing the incidence of mastitis and maintaining the infection rate at a low level. The justification for control of the disease is purely economic, and a control program must therefore be based on its applicability on each individual farm. Area or national control can only be in the form of providing incentives by educational and laboratory assistance to individual farmers who wish to participate. The value of a mastitis awareness program, and the part played by the two-way flow of information between farmers and the program operators is most apparent when an area campaign is conducted by a government or industrial sponsor.<sup>6</sup> Once a control program is in place it is customary for milk processors, aided in some places by government agencies, to encourage participation by paying incentives for bulk tank milk with low SCCs or bacteria counts, or refusing to accept milk for processing or, in some cases, refusing to transport milk that does not satisfy statutory requirements. This could be the first step in incorporating the program into planned health and production programs that promote mastitis control and maintenance of milk production at financially optimal levels. Mastitis infections in beef cattle herds are currently at too low a level for a mastitis control program to be financially advantageous.

## PRINCIPLES OF CONTROLLING BOVINE MASTITIS

### Dynamics of infection

The principles of a bovine mastitis control program are based on changing the dynamics of infection, which are as follows:<sup>13</sup>

**Prevalence of infection is a function of the rate of new infection minus the rate of elimination**

**Rate of new infection is a function of the level of exposure times the number of susceptible quarters**

**Rate of elimination is a function of the number of infections times the efficacy of treatment plus spontaneous cure.**

Successful control occurs when the level of infection is held low or is decreased, either by preventing new infections or eliminating existing infections.

The dynamics are not, however, so simple in reality. They vary with the susceptibility of the individual animal,

which changes with **age** and **stage of lactation** and is **season-dependent**. The dynamics may vary with the pathogens involved, and the relative importance between herds can be very considerable and also vary with time. The duration of infection may be extremely different for different pathogens. *E. coli* causes mild to severe acute clinical disease but usually self-eliminates quickly; it is rarely found in subclinical infections. *S. agalactiae* and *S. aureus* are very persistent, and *S. aureus* responds poorly to treatment. The rate of elimination and the persistency of these pathogens are highly variable. Similarly, there can be large variations in the rate of new infections, which is very much related to the identifiable risk factors, including rate of teat contamination, mechanisms aiding teat penetration, and effectiveness of establishment and growth of bacteria in the mammary gland.

The success of a control program can be measured by the decrease in level of infection and the speed with which this is achieved. The farmer must be able to appreciate progress within a year in order to remain enthusiastic about application of the methods. The level of infection can be controlled significantly by lowering the rate of new infections, but the speed of change very much depends on the duration of the infection and is thus related more to the rate of elimination. No control procedures are available to prevent all new infections and only culling of chronically infected cows is absolutely successful in eliminating infections. Control schemes therefore require both prevention and elimination to give optimal effect, and that optimum will vary with each pathogen.

The specific components of a mastitis control program must be devised to fulfill three basic principles, which are to eliminate existing infections, prevent new infections and monitor udder health.

### 1. ELIMINATE EXISTING INFECTIONS

The control program must reduce the duration of infection in the cows. Antimicrobial therapy during the dry period is the best method of achieving this objective. Treatment during lactation can be useful to eliminate some existing infections, depending on the causative agent. Culling of chronic cases that are not eliminated with dry period treatment is also used to remove the most persistent existing infections. Further study needs to focus on development of treatment protocols and on cow-side identification of the causative bacterial agent.

### 2. PREVENT NEW INFECTIONS

The control program must reduce the rate at which new infections occur. The dipping of all teats in an effective teat dip after each milking is the best method of

reducing the new infection rate. Insuring that the milking machine is functioning properly and used correctly will result in less spread of infection. The dry period is the time of greatest risk of new infection, and blanket dry cow therapy or application of an internal teat sealant is efficacious in preventing new infections during the dry period. Environmental and nutritional management have also become important for the prevention of new infections. Specific recommendations for methods of reducing new infection rate depend upon the predominant pathogen in the herd.

### 3. MONITOR UDDER HEALTH STATUS

An ongoing program to monitor the udder health status of individual cows as well as the herd is needed to evaluate the effectiveness of the control efforts. Monitoring methods should also assist with specific decision-making, such as optimized treatment protocols or culling. In the five point mastitis control programs recommended by the NIRD and the NMC, monitoring was not emphasized. As udder health status improves, and as milk quality premiums and penalty programs become meaningful, there is a need to continuously monitor udder health.

## MASTITIS CONTROL PROGRAMS

A major step forward in mastitis control occurred in 1970 with the publication of the results of controlled field studies carried out by the NIRD.<sup>13</sup> The **five-point control plan** was based on attacking the key areas in the dynamic processes of mastitis and the individual components of the plan were evaluated as efficacious by field testing in dairy herds. Its success has been well documented. **The five-point plan has been highly successful for the control of contagious mastitis but is not adequate for environmental mastitis.** The plan depends heavily on the motivation, education and financial commitment of the milkers and the herd owner to achieve good and consistent results.

The five-point mastitis control program is as follows:

1. Udder hygiene and proper milking methods
2. Proper installation, function, and maintenance of milking equipment
3. Dry cow management and therapy
4. Appropriate therapy of mastitis cases during lactation
5. Culling of chronically infected cows.

Five additional management practices are recommended to make a **ten-point mastitis control program**, which includes emphasis on an appropriate environment, particularly for the control of

environmental mastitis, and the keeping of records, monitoring udder health and setting goals for udder health status.

6. Maintenance of an appropriate environment
7. Good record keeping
8. Monitoring udder health status
9. Periodic review of the udder health management program
10. Setting goals for udder health status.

The ten-point mastitis control program satisfies the basic needs of the farmers, an essential prerequisite in the implementation of a voluntary program. The program is profitable, within the scope of the producer's technical skill and understanding, capable of being introduced into current management systems, and encourages farmers to continue the program by rapidly reducing the occurrence of clinical mastitis and the rejection of milk by milk processors on the grounds of quality.

The components of the recommended ten-point mastitis control program are the same for all situations. The exact level of severity at which it will be implemented depends on its cost-effectiveness; higher milk and cattle prices will justify higher financial inputs. The program has the virtues of simplicity, profitability and widespread applicability, and most countries with a significant dairy industry have devised their own variant of it to suit their own local needs, especially the targets of freedom from infection and other quality-control criteria. The ten-point program was designed primarily for the control of the common contagious mastitis pathogens and may encounter difficulties unless measures to control the environmental infections receive special attention.

## THE TEN-POINT MASTITIS CONTROL PROGRAM

### 1. UDDER HYGIENE AND PROPER MILKING METHODS

The principles of a proper milking procedure include:

- Premilking udder hygiene
- Stimulation of milk letdown
- Efficient removal of the milk
- Postmilking teat disinfection.

These principles are important for controlling the spread of contagious pathogens and for preventing new intramammary infections associated with environmental organisms. There is much farm-to-farm and region-to-region variation in how these milking procedures are applied. Milking methods are often taught to milkers by observation of the current

methods used on the farm, and milkers are seldom objectively evaluated, especially in family farm operations with only one or two farm employees.

Several important steps are necessary in establishing a milking management routine, including the following.

### Establish and maintain a regular milking schedule in a stress-free environment

A management routine using twice-daily milking should strive for a 12-hour interval. In the same way, an 8-hour interval between milkings is necessary for thrice-daily milking. The milking schedule is obviously less important with robotic milking. Consistency is as important as maintaining these exact intervals. Any influence that may add stress to the milking environment is to be avoided. For example, harsh crowd gates, rough handling, barking dogs and people shouting can be associated with epinephrine release, which will counteract the effect of oxytocin for efficient milk letdown.

### Insure that teats are clean and dry prior to milking

The major objective of premilking udder preparation and teat sanitation is to reduce the microbial population of teat skin, and particularly at the teat end. The aim of these techniques is to minimize the probability of new intramammary infection and have good milking performance. Milking time hygiene is extremely important because of the potential interaction between milking machine function and the microflora of teat skin. The incidence of intramammary infection is highly correlated with the number of mastitis pathogens on the teat end at milking.

#### Premilking cow preparation

Premilking cow preparation is a step in milking management where there is considerable variability between what is recommended and what is actually practiced. **The goal is to milk clean and dry teats.** Current recommended procedures for premilking udder preparation range from waterhose washing and manual drying of teats, to washing teats with a paper towel wetted in warm sanitized solution plus drying with a single service paper towel, to the use of premilking teat dipping in germicide plus paper towel drying. The additional step of premilking teat disinfection (predipping) has been incorporated as part of the milking routine on many dairy farms. It is argued that manual teat washing improves stimulation and the release of oxytocin for milk letdown, in addition to cleaning debris from the teats and teat ends. However, with properly functioning milking

equipment, there is little evidence that the manual massage is necessary for good milk letdown. In milking parlors where hand-held spray washers are used, it is important to avoid wetting the udder. Excessive water use can lead to bacterial contamination of the teat cups, and to an increase in the incidence of mastitis. In addition to individual paper towels, the use of latex gloves is also recommended in order to minimize cow-to-cow contamination.

#### Udder hygiene score

An udder hygiene scoring system has been developed, with the udder being viewed from behind. Score 1 is an udder free of dirt, score 2 has 2–10% of the surface area dirty, score 3 has 10–30% of the surface area covered with dirt, score 4 has more than 30% of the surface area covered with caked on dirt.<sup>14</sup> A hygiene scoring system is repeatable and easy to use, but only hygiene scores for the udder and hind limbs were associated with cow composite milk SCCs.<sup>15</sup>

#### Premilking teat disinfection

Premilking teat disinfection, more commonly referred to as **predipping**, is used by some dairy producers as a component of a mastitis control program. Premilking teat disinfection with chlorhexidine in association with good udder preparation and postmilking teat disinfection can further reduce the occurrence of new intramammary infections during lactation.<sup>16</sup> The use of a 0.25% iodine premilking teat disinfectant is more effective against major pathogens than postmilking disinfection only.<sup>17</sup> The use of predipping is increasing as the predominant cause of mastitis shifts from contagious pathogens to environmental pathogens. Controlled studies on the effectiveness of predipping indicate significant merit in the use of iodine predipping for the reduction of udder infections due to environmental pathogens.<sup>18,19</sup> Some studies found that premilking teat dipping with 0.25% iodophor did not reduce the incidence of clinical mastitis due to environmental pathogens<sup>19</sup> and the use of 0.5% iodophor plus good udder preparation did not affect the prevalence of infection of coagulase-negative *Staphylococcus* spp., but the rate of clinical mastitis in the control group was 1.38 cases per 1000 cow-days compared to 1.06 cases per 1000 cow-days in the predipped group.<sup>20</sup> The benefit–cost ratio of 0.37 indicated that the benefit of reduced incidence of clinical cases of mastitis did not justify the added expense required to predip the herd.

Although premilking teat dipping with iodine-based sanitizers may play a role in reducing new intramammary infections, there are some precautions that should be



taken. The major concern is the potential for increased iodine residues in milk. Predipping with either 0.5% or 1% iodophor does not significantly increase milk iodine residues if a paper towel is used to dry the teats.<sup>19</sup> Without drying, iodine residues are significantly increased. In addition, predipping in combination with post-milking teat disinfection may increase the potential for residues.<sup>21</sup>

Implementation of predipping into the cow preparation methods may require significant management changes, such as the drying of teats. Some of the improvement in udder health associated with the implementation of a predipping program may be attributable simply to the milking of clean, dry teats. Prior to the commencement of predipping, attaching the unit to wet or dirty teats may have been common. Whatever management methods are adopted on a particular farm, premilking hygiene and udder preparation can have a significant effect on milk bacterial counts, and on the incidence of mastitis.<sup>20</sup> The overall objective is to have **clean and dry** teats ready for attachment of the milking unit.

#### Check foremilk and udder for mastitis

Early clinical mastitis can be detected by physical examination of the udder for swelling, heat or pain, and by using a strip cup or black plate to examine foremilk from each quarter of each cow prior to every milking. This step has been a standard NMC management recommendation but the supporting evidence has been inconsistent. The rate of implementation of foremilk stripping is widely variable and depends upon the management system used being used more commonly in milking parlor situations.

Checking foremilk has three major advantages:

- Detection of clinical mastitis (such as clotty, stringy or watery milk), as early as possible. Detection of abnormalities is enhanced if the milk is evaluated against a dark surface such as a black strip plate
- Forestripping theoretically aids in preventing new infections of the mammary gland by flushing pathogens from the teat streak canal prior to milking. Bacterial colonization of the teat canal may not represent a problem until the organisms gain access to the teat sinus beyond the rosette of Furstenburg
- Stimulation of the milk letdown process. This could be helpful in systems where minimal cow preparation is used, such as a premilking program consisting of only a dry wipe.

In tie-stall barns, a strip cup is necessary to avoid contaminating the stall bedding or the cow herself. In milking parlors, it is common to use the concrete floor surface for detection of abnormalities in the milk. In either case it is important to recognize the potential for cow-to-cow transmission of pathogens by milk contact from one teat to another. For this reason, forestripping is often implemented prior to the predipping or udder washing step.

#### Attach the milking unit properly

The milking unit teat cups should be carefully attached to the udder within 90 seconds of starting udder preparation. The milk letdown process that follows the release of oxytocin after udder stimulation is at maximum for 3–5 minutes. Some effects of the oxytocin may last up to 8 minutes. It is important to use this physiological event to its maximum for the most efficient removal of the milk. The proper timing of milking unit attachment has been shown to shorten milk-out time and increase lactation productivity. However, consistency in the time interval from stimulation to attachment of the unit is as important as the exact time.

When attaching the teat cups, it is imperative to minimize the amount of air drawn into the system. Excessive air inlet could result in vacuum fluctuations, which may predispose to milk aerosol impacts of the teat end and machine-induced infections.

The machine position and support should be adjusted as necessary during milking. This will insure that quarters milk out properly. The milking unit should hang on the cow as straight and level as possible. Improperly adjusted support could contribute to uneven milk-out, and to an unbalanced udder on some cows; in addition, there is an increased probability of liner slips and squawking, which in turn will increase the risk of new intramammary infections. The mechanics and importance of liner slips will be discussed with milking machine function later in this chapter.

The use of proper milking machine attachment and adjustment methods affects the number of milker units that can be efficiently handled per person. With a tie-stall barn pipeline milking system it is recommended that a maximum of three units per person be used. It is unlikely that producers who milk with more than three units in a tie-stall barn are using appropriate cow preparation and milking machine attachment methods.

#### Minimize machine stripping and avoid liner slips

The majority of milking-machine-induced intramammary infections occur near the end of milking. Liner slips occur with a

greater frequency near the end of milking. During a liner slip, air sneaks in between the teat and liner (heard as a squawk), increasing the potential for small droplets of contaminated milk to be propelled backwards against the end of the other teats (teat end impacts). Over a sustained period of time, liner slips and milk impacts may result in an intramammary infection.

Machine stripping is the act of putting hand pressure on the milker unit at the end of milking, for the purpose of removing extra milk. Machine stripping is habit forming, and will eventually lead to increased milking time. It also increases the risk of squawking, liner slips and milk impacts.

#### Avoid overmilking or removing the unit under vacuum

As soon as a cow is milked out, the vacuum to the milker unit should be shut off and the teat cups should be removed. The milker unit should gently 'fall off' the teats, causing no irritation. Removing the unit under vacuum will cause milk and air to impact on to the teat ends. Overmilking should be avoided to prevent teat end irritation. The unit should be removed as soon as the first quarter is milked out. The risk of liner slip is also increased during overmilking but there is little evidence that overmilking will result in an increased rate of intramammary infection, unless liner slips and teat end impacts occur. The practice of removing teat cups individually is also discouraged.

#### Use an effective and safe postmilking teat germicide after every milking

Teat dipping or spraying with a germicidal solution immediately after every milking is an effective milking management practice to reduce the rate of new intramammary infections. **Postmilking teat antisepsis is regarded as the single most effective mastitis control practice in lactating dairy cows.**

Teat dipping is a simple, effective and economical means to reduce bacterial populations on teat skin. There is general agreement that the numbers and types of bacteria on teat skin have a direct relationship to the incidence and types of intramammary infections that develop in a herd. An effective teat dip, correctly used, will reduce the incidence of new udder infections by 50–90%.

There are several major classes of postmilking teat sanitizer, and many available products within each class. The classes of product vary widely in their composition, formulation and mode of action. Each product should be evaluated for its safety, efficacy, advantages and disadvantages. The most commonly used

teat dips in the USA and Canada fall into several major classes.

#### Iodophor formulations

Iodophor teat dips have been used extensively and marketed in a variety of formulations, ranging from 0.1–1.0% available iodine. The safety and efficacy of these products are well established.<sup>21</sup>

#### Chlorhexidine

Chlorhexidine teat dips are also widely used and effective for reducing new infections.<sup>22</sup> They are more efficacious in the presence of organic material than other classes of product. Chlorhexidines have a broad spectrum of antimicrobial activity and excellent persistence on teat skin.<sup>18</sup> Commercial preparations are formulated with a dye to make the product visible, and with glycerine to minimize teat skin irritation.

#### Linear dodecyl benzene sulfonic acid products

Linear dodecyl benzene sulfonic acid (LDBSA) teat dips contain an organic acid and are formulated with emollients. They are generally nonstaining, tolerant of organic matter and less irritating than most other products; their efficacy against major mastitis organisms is well established.

#### Quaternary ammonium compounds

A variety of quaternary ammonium chemicals, in combination with lanolin or glycerine, are available as teat dip germicides and are safe and effective. They are readily broken down in the environment and depend heavily upon proper formulation for effectiveness.

#### Sodium hypochlorite

Many dairy farmers prepare their own teat dip by dilution of commercial laundry bleach to a final concentration of 4% sodium hypochlorite. It is effective and extremely low-cost. However, these dips are not government approved, have a strongly disagreeable odor, and can be inactivated by organic material. There is also a risk of mixing errors, resulting in the potential for irritation of teats and milkers' hands.

#### External teat sealants (barrier teat dips)

A goal that has yet to be achieved is development of a barrier teat dip that provides an effective teat sealant for use in lactating cows and withstands environmental contamination but is easily removed with minimal premilking udder preparation. Latex and acrylic latex-based products have been developed to act as a physical barrier to the entrance of mastitis pathogens into the udder. These products were aimed at the prevention of coliform mastitis. However, it has proved to be difficult to remove the residual product from teats. Furthermore, the barrier

product alone is not intended to be effective against other major mastitis organisms.

External teat sealants have been formulated in combination with disinfectants to provide protection as both a barrier and a germicide. A postmilking teat disinfectant containing 0.64% sodium hypochlorite in a gel formulation was an effective and safe teat dip preparation.<sup>23</sup> However, in experimental studies, barrier teat dips were no more efficacious in preventing new intramammary infections due to *S. aureus* and *S. agalactiae* than no teat dip or the use of a nonbarrier product.<sup>24</sup> In contrast to their current use in lactating dairy cows, external and internal teat sealants are being increasingly applied at dry-off (see Dry cow management and therapy, below).

#### Selection and use of teat disinfectants

With the extensive array of commercially available postmilking teat germicidal preparations, producers need some guidelines in order to make an appropriate selection for use on their farms. Manufacturers of teat dips should provide the producer with documentation of the efficacy and safety of each product. In the USA, teat dip products must be listed with the Food and Drug Administration (FDA). The FDA regulates teat dips for compliance with label accuracy and manufacturing quality, but efficacy data is not required for registration. In Canada, teat dips must be approved by the Bureau of Veterinary Drugs. This approval process requires extensive data on human safety, animal safety and the efficacy of each new teat dip submission. Standard protocols have been endorsed for the evaluation of teat dip efficacy under conditions of experimental challenge with mastitis pathogens, as well as under conditions of natural exposure in commercial dairy herds.

In the USA, iodine-based teat dips are the most commonly used product for postmilking disinfection, and an iodine-based teat dip in 10% glycerin is generally regarded as the gold standard teat dip against which all other teat dips are compared. Dairy producers should request information on effectiveness when selecting a teat dip. Veterinarians should assist producers with interpretation of the data. There is no evidence that changing teat dips on a regular basis is necessary to prevent the development of resistant mastitis bacteria. Monitoring several measures of udder health status will signal the need for a change in teat dip product. The teat dip selected must be compatible with other chemical preparations used in the milking management system.

Postmilking teat dips can be applied by dipping or spraying. In North America,

**dipping has been the most popular method.** However, with the increase in herd size and parlor automation, there is an increase in the use of teat spraying. Spray and dip application of the same product result in equal efficacy, when done appropriately; however, it is easier to do a bad job of teat coverage with spraying than dipping. Under field conditions, the effectiveness of either method will depend upon adequate coverage of each teat. A general recommendation is that **as much of each teat should be covered as is possible, and no less than the lower half.**

Teat dips should be stored in a cool dry place and not allowed to freeze. Contamination should be prevented, and expiry dates observed. For economic reasons, producers are tempted to dilute commercially available products; however, their effectiveness and safety may not be maintained. **At the end of milking, unused teat dip solution should NOT be poured back into the original container.** Dipping devices should be cleaned regularly.

In cold weather conditions, precautions should be taken with respect to teat dipping. Dipped teats should be allowed to dry before cows are exposed to cold and windy conditions. This will minimize the occurrence of frostbite of wet teats.

#### Establish milking order and segregation programs

In herds with a significant prevalence of contagious pathogens, such as *S. aureus*, establishing a specific milking order may be helpful to limit the rate of new infections. This is a popular veterinary recommendation that is **difficult to implement** because it usually requires massive disruption of the milking procedure. In general, first-lactation heifers and fresh cows should be milked first. Cows with high SCCs, chronic clinical mastitis and current clinical cases should be milked last. The maintenance and management of both SCCs and clinical mastitis records becomes important to make milking order programs work.

In larger herds, cows are usually grouped according to stage of lactation and production level. For nutritional management reasons, it is often suggested to have high-, medium- and low-production groups. In herds with a high prevalence of *S. aureus* mastitis, it has been suggested that the problem of spread would be stopped by simply isolating infected cows and milking them last. In theory, segregation combined with culling and effective dry cow management should allow the prevalence of *S. aureus* to approach zero. However, the change in prevalence of *S. aureus* infection in unsegregated herds compared with

herds using a segregated program indicates no significant difference.<sup>25</sup> A more significant decrease in prevalence of *S. aureus* mastitis was found in herds that gave priority to a full milking hygiene program, in combination with dry cow therapy and culling. Segregation is not a simple, stand-alone solution to contagious mastitis problems.

### Disinfect teat liners

Disinfection of the milking machine teat cup liners between cows has the potential of limiting the spread of contagious organisms from cow to cow since bacterial populations in liners can be greatly reduced by sanitization. However, there is considerably less documentation that flushing liners will result in major reductions in contagious mastitis problems.<sup>26</sup>

In tie-stall milking barns, **liner disinfection** is a laborious process that involves dipping the claw in a series of solutions. Liners must be put through a rinse, a disinfectant and another rinse to remove the germicide. The solutions should be kept hot and replaced when they become overly contaminated. Only two liners can be dipped at one time if the milk hose remains connected to the pipeline, in order to avoid an air lock in the claw, which will reduce the disinfection process. However, if the milk hose is disconnected from the milk pipeline, then all four liners can be dipped at one time. Even with these limitations, dairy herds with intensive management, utilizing individual cow SCCs and culture information, can effectively use liner sanitization to limit the spread of contagious pathogens. Electric hot pails are commercially available in order to maintain the disinfection solution at a sterilization temperature.

In large milking parlor operations, automatic **backflushing** of milking units between cows is commercially available but expensive to install. In conjunction with automatic take-offs, the claw is flushed with rinse water, followed by disinfectant, and again rinsed, immediately after the unit detaches from a cow. An alternative procedure (**cluster dunking**) involves back flushing the milking units with water until a clear stream is obtained and then dunking the milking units in a bucket containing disinfectant while avoiding trapping of air in the dunking process. Large numbers of pathogens can be removed from teat cups by the backflushing process but documented reductions in the new intramammary infection rate are not available. For instance, backflushing decreased the numbers of staphylococci and Gram-negative bacteria on liners by 98.5% and 99.5%, respectively, caused a small decrease

in the number of new infections by *C. bovis*, but had no effect on the incidence of new infections by staphylococci, streptococci or coliforms.<sup>27</sup> Until backflushing has been demonstrated to decrease the new infection rate, the procedure cannot be a routine recommendation.

## 2. PROPER INSTALLATION, FUNCTION AND MAINTENANCE OF MILKING EQUIPMENT

The milking machine plays an integral role in the efficiency of the operation of a dairy farm, and it has direct contact with teat tissue. It must perform properly and consistently, twice or three times a day (or much more frequently in robotic milkers), day after day, year after year. For these reasons, it is important that the milking system is installed according to approved guidelines. Regularly scheduled maintenance should be carried out, and machine function should be evaluated by periodic analysis of the system. All persons in the milking management process should thoroughly understand the basic components, function and operation of the milking equipment. They should also be aware of the significance of regular equipment maintenance and of the importance of good milking techniques.

### Milking system function and objectives

The milking system performs several basic functions to achieve its objectives. These are:

- Causing milk to flow from the teat by exposing the teat ends to a partial vacuum
- Massaging the teat in an effort to relieve the effects of a continuous milking vacuum
- Protecting the milk from contamination while it is transported to a storage device, which cools and stores the milk until it can be transported to the processing plant.

### Components of a milking system

In order to carry out the basic functions and to achieve the objective of efficient removal of the milk with minimal opportunity for intramammary infection, milking and milk handling equipment requires three basic components. These are:

- A vacuum system
- A milk pipeline system
- A bulk milk tank for milk cooling and storage.

Considerable engineering expertise goes into the proper design, installation and function of milking equipment. For the purposes of understanding the basic principles of machine milking, a brief description of these three components will be provided.

The vacuum system

#### *Vacuum pump*

The function of milking equipment depends upon the creation of a partial vacuum. A **vacuum pump** is used to continuously remove some of the air from the various lines in the milking system. The amount of air removed determines the system vacuum level, which is important for proper function. The vacuum level is monitored using a gauge which is read in either kilopascals (kPa), millimeters of mercury (mmHg) or inches of mercury (in.Hg). If one-half of the air is removed from the system, the vacuum gauge will read 50 kPa (15 in.Hg) vacuum. Vacuum pumps are rated on the basis of the volume of air they can move when the intake vacuum is at 50.7 kPa (15.0 in.Hg). Cubic feet per minute (CFM) is the standard air flow measurement used. The CFM rating of a vacuum pump determines the number of milking units that can be used on the system. For example, in order to operate six units, the minimum vacuum pump capacity is 52 CFM.

#### *Vacuum reserve tank*

Since the vacuum pump continuously removes a constant amount of air from the system, a **vacuum reserve tank** is placed between the pump and the vacuum supply line. The purpose of this tank is to provide a common site for connecting the vacuum header lines and to provide a reserve of vacuum to help buffer the sudden admission of air into the system. For example, when a milking unit falls off a cow, there should be enough reserve vacuum to maintain the system function. The amount of reserve vacuum needed in a system is a function of pump capacity, pump performance, regulator operation and the degree of system leakage. Vacuum reserve tanks are usually constructed of PVC plastic and should not be less than 75 L capacity.

#### *Vacuum regulator*

A **vacuum regulator** or controller is an important component of the vacuum system. The function of the regulator is to keep the vacuum of the milking system at a preset level by responding to changing air admissions into the system. The regulator should be located in proximity to, or directly on, the vacuum reserve tank. The regulator should be sensitive, for a rapid response to changes in vacuum. Servo-diaphragm regulators are the most sensitive style available, and are highly recommended. An increase in vacuum pump capacity cannot compensate for poor regulator function. Likewise, a sensitive regulator cannot compensate for a deficiency in pump capacity. The two components must work well together.

It is recommended that two vacuum gauges be installed in the system, for the purpose of monitoring the system vacuum. One gauge should be located on the milking vacuum supply line, near the regulator. A second gauge is best situated at the far end of the vacuum pulsation line. A portable mercury manometer should be used on a regular basis to calibrate the accuracy of the system vacuum gauges, as well as to make adjustments to the vacuum regulator. The preferred vacuum system installation consists of two header lines from the vacuum reserve tank, continuing to form a completely looped pulsation line. The recommended vacuum lines are 76 mm diameter PVC pipe, adequately supported, slightly sloped in the direction of air flow, and with automatic drain valves. This line allows for attachment of the milking unit pulsators.

#### Pulsation system

A properly functioning pulsation system is critical to teat and udder health. The pulsator causes the chamber between the teat cup shell and the liner to alternate regularly from vacuum to air source. Pulsators are either electromagnetic or pneumatic. In an electromagnetic system, all pulsators function together off an electrical signal. An electronic control circuit turns current on and off to the electromagnet. Pneumatic pulsators run off the vacuum system, and use air to move a plunger or slide valve to cover and uncover the air passage, producing the pulsating action.

An understanding of the dynamics within the teat cup and the characteristics of pulsation is crucial to insuring that the objectives of mechanical milking are achieved. The chamber between the teat cup shell and the liner is regularly subjected to a vacuum source, whereas the inside of the liner is under stable milking vacuum at all times. The pulsation cycle involves a milk phase and a rest or massage phase. When air is admitted between the shell and the liner, the liner collapses around the cow's teat. The collapsed liner has a massaging action on the teat; this is called the **rest** or **massage phase**. Milk does not flow from the teat during this phase. When the pulsator opens, the space between the liner and the shell is exposed to system vacuum. This creates equal pressure on both sides of the liner, causing it to open. The cow's teat end is now exposed to milking vacuum. This vacuum, in combination with the internal pressure of milk letdown within the cow's udder, causes milk to be drawn out through the teat streak canal. This component of pulsation is called the **milk phase**. The process of milking

involves repeatedly opening (milk phase) and closing (rest phase) the teat cup liner.

The **pulsation cycle** is measured by the time, in seconds, for the completion of one milk phase and one rest phase. The **pulsation rate** refers to the number of cycles completed by a pulsator in one minute. Pulsation rates range from 45–60 cycles per minute. The **pulsation ratio** is the length of time in each cycle that the pulsator is in its milk phase compared to its rest phase. A common pulsation ratio is 60:40, indicating that in each pulsation cycle the teat cup chamber will be milking 60% of the time and massaging the teat 40% of the time. Wide pulsation ratios can speed up milking time but can put undue stress on the teats and teat ends from insufficient rest, predisposing to new intramammary infections.

**Pulsation phase** refers to the method of pulsation for the whole milking unit, and is either simultaneous or alternating. In simultaneous pulsation all four teat cups milk at the same time and rest at the same time. With alternating pulsation, two teat cups milk while two teat cups rest, then alternate to complete the pulsation cycle. The alternating action may be from side to side, or from front to rear. Alternating pulsation has several advantages. It allows a more uniform milk flow into and out of the claw, which helps to minimize flooding of the claw, which can result in fluctuations in teat end vacuum. In addition, front/rear alternating pulsation allows for a wider pulsation ratio on the rear quarters, which encourages a more uniform and timely milk-out of all four quarters. For alternating pulsation systems with two different ratios, care must be taken to insure that air hoses are not reversed when attached to the claw.

Electromagnetic pulsators are unaffected by environmental temperature and can function at a constant preset pulsation rate and ratio. Pneumatic pulsators can be greatly affected by changes in temperature and system vacuum. They require more maintenance and constant checking of the settings. Thus, **electromagnetic pulsators using alternating pulsation are most commonly recommended**, particularly for high-producing cows with fast milk letdown.

If a teat cup is not positioned properly on a teat, the liner may slip down the teat and produce a 'squawking' sound. As this is happening, air is entering around the teat into the liner. The entrance of this air changes the system of stable milking vacuum within the claw and the other teat cups. These changes lead to droplets of milk being driven in a reverse direction back at the teat ends of the other teats. These are referred to as '**milk impacts**'.

Repeated teat end milk impacts, particularly with milk contaminated by mastitis pathogens, can result in new intramammary infections.

The milk transport system  
Milking parlors and stanchion barn pipelines have similar systems for transporting milk from the cow to the bulk tank. The components of the transport system will be described in the direction of milk flow. The rubber or silicone insert in each teat cup is referred to as a **liner** or **inflation**. The liner should milk cows safely, with a minimal number of squawks from downward slippage, and without the teat cup crawl action of riding up on the teats to the base of the udder. Liner performance depends upon many interrelated characteristics of the milking system. **Narrow bore liners are recommended**. Liners must be compatible with the teat cup shell. The most important management consideration with respect to teat cup liners is to **insure regular replacement, as recommended by the manufacturer**. As a general guideline, natural rubber liners last 500–700 cow milkings, synthetic rubber liners 1000–1200 cow milkings and silicone liners 5000–10 000 cow milkings. The desired milking inflation replacement interval (in days) can be calculated using the following formula:

$$\text{Number of days between changes} = \frac{((\text{Number of cow milkings/set of liners}) \times (\text{Number of units}))}{((\text{Number of cows milking}) \times (\text{Number of milkings/day}))}$$

Other rubber parts of the unit, such as the short air tubes on the claw, should be constantly checked for cracks or signs of wear. These problems could seriously affect air flow and liner pulsation. Proper storage in dark, cool conditions, as well as the correct use of cleaners and sanitizers, can affect the life of rubber parts.

#### The milk claw

The **milk claw** is an important component of the milking unit. The claw is the collection point for milk from the four teat cups and should have adequate capacity to handle peak milk flow without flooding. Each claw should have a means of shutting off the vacuum to the teat end, so that the unit is not removed under vacuum. Most claws have an air vent in the upper half to allow a predetermined quantity of air into the unit to facilitate milk flow away from the cow and into the pipeline. Claws should routinely be **inspected for cleanliness, plugged air vents and dented liner connectors**.

A long milk hose is used to carry milk from the claw to the pipeline. The hoses can be made of plastic, rubber or silicone. **They should be as short as possible,**

with an appropriate hose hanger. If the milk hose is crimped or allowed to loop, milk flows will be interrupted, which leads to irregular fluctuations in teat-end vacuum. The milk hose should attach to an inlet located in the top third of the milk pipeline, at the eleven or twelve o'clock position. Inlets should be self-draining, self-closing and should not cause milk flow restrictions that would result in irregular teat-end vacuum fluctuations.

The milk pipeline

The **milk pipeline** serves two important functions: transporting milk from the cow to the receiver jar and carrying air flow to provide milking vacuum to the teat end. Either glass or stainless steel can be used for milk pipeline construction. The milk line should form a complete circuit and must be rigidly supported from the floor in order to maintain the appropriate slope. It is generally recommended that **milk lines be installed as low as is practical**. In milking parlors, low pipelines are installed below udder level. In stall barns, high pipelines are used, but they should be no higher than 2 m above the cow platform. Milk moves by gravity through the pipeline to the receiver jar. The milk line must be self-draining and should have a continuous slope from the high point toward the milk receiver jar. The **correct slope** is important for the movement of milk and air during milking, as well as for proper cleaning of the system. In the construction of new tie-stall barns, it is recommended that the foundation, floor and gutter be sloped towards the milk house end. This will help to minimize pipeline height and to insure that line slope will facilitate drainage during milking and washing.

Line diameter is another important feature of milk pipeline design. In addition to line slope and the level of herd production, pipeline diameter will determine the number of milking units that a system can handle. Too many units will lead to milk line flooding and a reduction in air flow rate. Slugs of milk moving through the line is an obvious sign of milk line flooding. This problem will have a negative impact on milking time, herd production and udder health. The recommended minimum pipeline diameter is 51 mm (2.0 in.). At this pipeline size, high-producing herds should not use more than three milking units per pipeline slope. Thus, larger pipeline sizes are often recommended for new installations. Pipeline couplers or welds must prevent air leakage into the system.

Milk should flow into the receiver jar in a continuous, unimpeded fashion. When sufficient milk has accumulated, an

electronic probe triggers the milk pump to transfer milk from the receiver jar to the bulk tank. A milk filter is inserted into the transfer system, as a mechanism to remove coarse impurities that may have entered the line. The receiver jar is connected to the main vacuum supply. A device called a sanitary trap is used to separate the 'air only' portion of the milking system from the 'milk handling' side of the system. The sanitary trap is designed to protect the vacuum supply from potential damage caused by the chemical cleaning and sanitizing solutions used to clean milk pipelines.

A milking system should have the capability of measuring the amount of milk from each cow. In older milking parlor systems, weight jars were often used for this purpose. They allowed for a quick visual means of monitoring individual cow production at each milking, as well as providing vacuum stability to the cow. However, they were expensive and represented a challenge to clean. More recently, milk metering systems have been developed that give an **electronic digital readout of the milk volume produced** at each parlor station. These systems can often be adopted to automatic data recording in an on-farm computer system. In stall barn pipeline installations, several types of mechanical milk meter are in use. It is important that any metering system not be restrictive to the flow of air and milk. These restrictions can cause a drop in teat-end vacuum and the occurrence of irregular teat end vacuum fluctuations. Increased milking time, incomplete milk-out and new intramammary infections can result.

Bulk milk tank

The bulk milk tank is the vessel used to cool and store raw milk until it is picked up by the bulk milk transport truck. All tanks must be of an approved sanitary design and construction. They must be of sufficient capacity to cool and store up to 3 days of milk production. The cooling capabilities of bulk milk tanks are clearly specified. Appropriate cleaning and sanitizing procedures for bulk tanks are critical, in order to prevent bacterial growth and contamination of raw milk.

#### Relationship of milking equipment to udder health

The milking machine can influence new intramammary infection rates in several ways:

- The milking machine may be a carrier of mastitis pathogens from one cow to the next
- The milking machine may serve as a pathway of cross-infection within cows

- Malfunctioning or improperly used equipment may result in failure to relieve congestion in teat tissue. Eventually, teat end damage and intramammary infection can occur
- Abrupt loss of milking vacuum may create changes in air movement of sufficient force to move pathogens past the streak canal defenses. This phenomenon, known as the impact mechanism, was described earlier.

The pathogenesis of new infections related to machine milking probably involves all four of these factors.<sup>26</sup> However, even though the milking system becomes the focus of many herd udder health investigations, there is little evidence that machine factors are of primary importance in most problem herds. It has been difficult to link milking machine factors and prevalence of herd infection. Mastitis has been difficult to produce experimentally by altering machine function.<sup>28</sup>

A great deal of research has been directed towards the identification of machine factors related to mastitis. Although many problems are identified, the only factors consistently associated with udder health problems are pulsation failure and the impact mechanism.

Appropriate insulation is important for sufficient teat end massage. Although continuous vacuum will remove milk from cows' teats, eventually it will result in excessive congestion, edema and teat end damage. An adequate compressive load by the liner on the teat tissue is necessary to relieve the congestion. Mechanical failure of the pulsator, shortness of the liner barrel and a too-short liner rest phase are the most common examples of pulsation problems. The impact mechanism results from an abrupt loss of milking vacuum. Poor liner design has been shown to increase the frequency of liner slips. During a liner slip, a reverse pressure gradient occurs across the streak canal of the other three teats. Liner design has been shown to be very important in reducing the amount of slippage.<sup>29</sup> In combination with liner slips, the vacuum fluctuations that result from pulsation problems can lead to new intramammary infection.

Even with the myriad of potential machine problems, milking equipment is not usually the major risk factor for poor udder health.

#### Maintenance and evaluation of milking equipment

The most important aspect of udder health management related to milking equipment is the establishment of an appropriate evaluation, maintenance and service schedule. Farm personnel should

incorporate an inspection of the equipment into their regular milking process. Many of the problems discussed in conjunction with the description of milking system components can be discovered during this daily inspection. In addition, the producer should have milking equipment serviced on a regular basis. Items such as the vacuum pump, regulator, pulsators and sanitary trap would be included in this check list. Also included in this inspection will be regular changing of the teat cup liners and other rubber parts. It is common for equipment dealers to schedule a regular visit to each farm client for the purpose of conducting this periodic maintenance schedule and for dispensing chemical cleaners and disinfectants used in the udder health management program.

A complete milking system analysis should be conducted on a regularly scheduled basis. This regular analysis is perhaps just as important as the initial design and installation of the system. Many dairy cattle specialists believe that a regular independent analysis will insure proper equipment function. Milking system analysis can be conducted by equipment dealers, government extension staff, veterinarians or independent technicians. All these individuals need the appropriate knowledge and training. It is essential to use some type of systematic milking system analysis worksheet to record various performance measurements and to identify components requiring service or upgrading. A complete system analysis should be conducted at least once a year, and records should be kept for future reference.

### 3. DRY COW MANAGEMENT AND THERAPY

The proper management of dry cows and late-gestation heifers is an important component of a mastitis control program. The dry period offers a valuable opportunity to improve udder health while cows are not lactating. However, the beginning and the end of the dry period represent periods of increased risk of infection.<sup>30</sup> **The objective of udder health management during the dry period is to minimize the number of infected quarters at calving.** Two of the three major principles of udder health management must be met in order to achieve this objective. **Infections present at the time of drying off should be eliminated and the rate of new intramammary infections during the dry period must be minimized.** Thus dry cow therapy has a dual role in eliminating existing infections and preventing new infections during the dry period, and has been widely adopted by dairy farmers. If

these two principles are followed, udders will be free of infection at calving and can be expected to produce a maximum amount of low-cell-count milk in the subsequent lactation. Intramammary administration of long-acting antimicrobial agents to all cows at drying off remains a routine recommendation.

#### Epidemiology of intramammary infection during the dry period

The development of effective udder health management strategies for the dry period requires an understanding of the epidemiology of intramammary infections in dry cows. This in turn requires an understanding of the incidence of new infections during the dry period and the types of pathogen involved. Risk factors that affect the susceptibility of dry cows should also be understood.

##### Incidence of new infections

The rate of new intramammary infections is significantly higher in the dry period than during lactation.<sup>30</sup> The greatest increase in susceptibility is during the first 3 weeks of the dry period. In this period, the new infection rate is many times higher than during the preceding lactation as a whole. A second period of heightened susceptibility occurs just prior to parturition. The reported rates of new intramammary infection in the dry period vary widely. Reasons for these differences include the diagnostic criteria used and the types of organism considered to be major pathogens. There are also important herd-level effects, such as the prevalence of existing infections at drying off and the method of dry-off. The average rate of new infections in untreated dry cows is expected to be between 8% and 12% of quarters.<sup>30</sup>

Types of pathogen causing new infections during the dry period

**Contagious pathogens** are transmitted among cows and quarters in association with the milking process. **Environmental pathogens** are primarily contracted from contamination with organisms in manure and bedding. **Teat skin opportunistic pathogens** are present on the teat, particularly the teat end. Contagious, environmental and teat skin opportunistic pathogens need to be considered in designing mastitis control schemes for the dry period.

Exposure to environmental pathogens is likely to continue throughout the dry period; thus prevention of new dry period infection with environmental agents represents a considerably greater challenge.<sup>30</sup> Herds that have implemented a basic mastitis control program still need to be aware of the importance of preventing environmental infections in the dry

period. There are different rates of infection by the various environmental agents as the dry period progresses. For example, infections with environmental streptococcal species, *Klebsiella* spp. and *Enterobacter* spp. occur more frequently early in the dry period. On the other hand, *E. coli* infections tend to occur immediately before calving. Dry cow management strategies need to account for the risk of infection during the entire period from last milking until the next calving.

Risk factors that affect susceptibility in dry cows

Several factors contribute to the variation in susceptibility during the dry period. These factors include the following.

##### Teat end protection

The cessation of routine milking-time hygienic practices such as teat dipping allows bacterial subpopulations on teat skin to increase in number and diversity. *S. aureus* numbers are high immediately after drying off and environmental pathogens are more prevalent on teat skin late in the dry period and at calving time.<sup>30</sup> Teat end lesions increase the likelihood of intramammary infections during the dry period. A plausible mechanism to explain this association is that teat end lesions increase the surface area available for bacterial colonization while presenting a variety of environmental niches. For instance, quarters with cracked teat ends were 1.7 times more likely to develop a new intramammary infection during the dry period than unaffected quarters.<sup>31</sup>

The streak canal of the teat is more penetrable by bacteria during the early dry period. The keratin plug in the streak canal must form early and completely in the early dry period in order to prevent penetration and growth of bacteria and decrease the incidence of new intramammary infections. However, this natural internal teat sealant does not form in some cows, and delay in formation is common. For instance, in cows in New Zealand, 45% of teats are open on day 7 of the dry period, and 25% are still open on day 35 of the dry period.<sup>32</sup> Similar results were obtained in North American dairy cows.<sup>31</sup> Quarters that remain open during the dry period are 1.8 times more likely to develop a new intramammary infection than quarters that have developed an effective keratin plug.<sup>31</sup> Internal and external teat sealants are discussed further later in this chapter.

Swelling of the mammary gland, an increasing volume of secretion and leaking colostrum contribute to the high risk of new infection during the prepartum period.

### Resistance mechanisms within the mammary gland

Throughout the dry period there are marked changes in the composition of mammary gland secretions and in the concentration of protective factors such as leukocytes, immunoglobulins and lactoferrin. These changes probably influence the variation in susceptibility to both environmental and contagious pathogens.

Substantial evidence exists that innate and acquired defense mechanisms are lowest from 3 weeks precalving to 3 weeks postcalving.<sup>33</sup> This lowered responsiveness includes aspects of systemic and mammary gland immunity that may account, in part, for the increased incidence of peripartum disease. Polymorphonuclear neutrophil function is impaired during the peripartum period and may contribute to the increased incidence of mastitis following calving. Diminished lymphocyte responsiveness around calving has also been observed.<sup>33</sup> The role of the cow in effectively transferring antibodies and cells to the mammary gland prior to parturition to insure high-quality colostrum is also an important function, and this may be affected by prepartum vaccination schedules and the ability of the animal to respond effectively.

### Milk production at dry off

A high level of milk production at dry off increases the incidence of new intramammary infections at calving.<sup>34</sup> It is reasonable to assume that high milk production at dry-off will produce a higher intramammary pressure, thereby increasing the likelihood of an open streak canal early in the dry period. High milk production at dry-off will also decrease the concentration of protective fractions such as phagocytic cells, immunoglobulin and lactoferrin,<sup>35,36</sup> thereby decreasing resistance within the mammary gland. The finding that cows leaking milk following dry-off are four times more likely to develop clinical mastitis in the dry period<sup>37</sup> supports the concept that **increased milk production at dry-off increases the rate of new intramammary infections.**

### Method of drying off

The industry standard method for cessation of lactation (drying off) is abrupt cessation of milking, whereby milking stops on the day scheduled for dry-off (all cows are usually scheduled to 'go dry' on the same day each week) in order to facilitate administration of dry cow intramammary antibiotics, vaccinations and vitamin E/selenium injections. Abrupt cessation is associated with a higher new intramammary infection rate in the dry period compared to intermittent

cessation,<sup>38,39</sup> although the increase in prevalence is most evident in cows that are not dry treated. The best approach to dry off cows may therefore be intermittent milking, although additional studies are required before the industry standard is altered. In particular, the method of drying off is probably less important with blanket dry cow therapy.

### Parity

Older cows are more likely to develop new intramammary infections during the dry period. This increased predilection may be due to increased milk production at dry-off, increased prevalence of abnormal teat placement (increasing exposure of the teat end to pathogens) or increased prevalence of open streak canals because older cows have higher milk production.

Risk factors that affect susceptibility in heifers

An increased risk for intramammary infection in the preparturient period in heifers is associated with the presence of *S. aureus* or *M. bovis* in the herd, calving in summer, high herd bulk tank milk SCCs, poor fly control, mastitic milk fed to calves and contact with adult cows.<sup>40</sup> Other risk factors are increased age at first calving, prepartum milk leakage,<sup>41</sup> blood in milk<sup>42</sup> and udder edema.<sup>43</sup>

### Udder health management strategies for dry cows

Antimicrobial therapy (dry cow therapy) Antimicrobial therapy at the end of lactation (dry cow therapy) has been one of the key steps in mastitis control programs and has become the most effective and widely used control method for dry cows. The efficacy and advantages of antimicrobial therapy are well known. The use of effective dry cow products results in 70–98% elimination of existing infections. However, elimination of *S. aureus* is less successful. **Dry cow therapy also reduces the incidence of new intramammary infections by approximately 80%.**<sup>44</sup>

Long-acting antimicrobial preparations have been formulated to **eliminate existing infections** and to **prevent new infections**. These preparations include benzathine cephapirin, benzathine cloxacillin and sustained-release formulations of erythromycin, novobiocin and penicillin. The withholding period for milk from animals treated with these dry cow formulations ranges from 30–42 days after treatment. It is important that the label directions be followed carefully for the recommended dosage level, required withdrawal period, storage guidelines and expiry dates. A general recommendation is that dry cow treatment should never be administered within 1 month of the

expected calving date. Single-dose syringe preparations of dry cow antibiotic treatment are recommended. The risk of contamination by environmental bacteria and yeast is much higher for multiple-dose bottles than for single-dose syringes. If bulk containers are used, great attention should be paid to maintaining sterility.

The use of long-acting and short-acting antimicrobial intramammary infusions have been compared.<sup>45</sup> In some cases, short-acting antimicrobial agents were more effective than long-acting ones in eliminating infections due to *S. aureus* or treating cows infected with major pathogens diagnosed twice before drying off. Intramammary infusion of cephapirin sodium 15 days prepartum in heifers was effective in reducing intramammary infections during late gestation and reduced the occurrence of residues in milk during early lactation.<sup>46</sup> The milk of heifers that calve less than 15 days after treatment may contain antimicrobial residues.

Intramammary infusion is a widely used and highly recommended procedure for mastitis therapy; however, there is a potential for the introduction of pathogens during the infusion process. Insanitary infusion practices can introduce antibiotic-resistant environmental organisms into the udder. Infection with opportunistic microorganisms, such as yeast or *Nocardia* spp., may cause more extensive udder damage than the original organism for which treatment was being administered. Adequate teat end preparation and careful dry cow treatment procedures can reduce this risk. Dry cow treatment procedures should be carried out as follows:

- Milk out the udder completely
- Immediately following teat cup removal, dip all teats in an effective teat dip
- Allow the teat dip to dry. If necessary, remove excess dip from teat ends with a clean single-service paper towel
- Disinfect each teat end by scrubbing for a few seconds with a separate alcohol-soaked cotton swab. Start with the teats on the far side of the udder and work to the near side
- Infuse each quarter with a single-dose syringe of a recommended dry cow treatment. Start with the teats on the near side of the udder. Use the partial insertion method of administration into the teat streak canal. Preferably, a modified infusion cannula should be provided with the treatment product
- Dip all teats in an effective teat dip immediately following treatment.

The necessity of using appropriate dry cow treatment procedures cannot be



overemphasized. An increased incidence of *Nocardia* spp. mastitis has been associated with blanket dry cow therapy, especially neomycin-containing products. However, *Nocardia* spp. were not found as a contaminant of the suspected products. Teat end preparation by scrubbing with an alcohol-soaked cotton swab was protective against the occurrence of *Nocardia* spp. infection when teats were experimentally contaminated with organisms immediately before drying off.<sup>47</sup> Most commercial dry cow treatment products provide individually wrapped alcohol-soaked cotton swabs for use with each syringe. The use of good teat end preparation prior to intramammary infusion needs to be continually emphasized.

The method of intramammary infusion may be important. Partial insertion of the infusion cannula (up to 4 mm) results in fewer new intramammary infections and improved cure rates. The improvement with a short cannula is attributed to fewer organisms being delivered beyond the streak canal and decreased physical trauma to the streak canal. In addition, antimicrobial agents that are deposited within the streak canal should control local infections. Modified infusion cannulas for the convenient use of a partial insertion method of administration are now available for commercial dry cow products.

Another approach to preventing the problems associated with intramammary infusion would be the development of an effective systemically administered dry cow treatment. Preliminary results have indicated improved efficacy against *S. aureus* infections using a systemically administered quinoline antibiotic (norfloxacin nicotinate).

#### *Blanket versus selective dry cow therapy*

Three strategies for intramammary antimicrobial treatment of dry cows are available,<sup>48</sup> although the current recommendation for all herds is blanket therapy:

- **Blanket therapy** (treat all quarters of all cows)
- **Selective cow therapy** (treat all quarters of any cow infected in one or more quarters)
- **Selective quarter therapy** (treat infected quarters only).

Although blanket dry cow therapy is a cornerstone of any mastitis control program, there is some controversy concerning the need to treat all quarters of all cows (**blanket therapy**) or only those quarters or cows requiring treatment. The controversy has gained momentum as the implementation of udder health management practices has reduced the prevalence of infection. The major reasons for selective therapy are:

- To avoid the elimination of minor pathogens, which may make cows more susceptible to environmental agents
- To reduce the expense of treatment
- To address increasing consumer concern regarding the routine administration of antibiotics to food-producing animals
- To avoid the possible emergence of antibiotic-resistant organisms.<sup>30</sup>

Each of these reasons should be carefully considered in making a decision between blanket and selective dry cow therapy. Selective dry cow therapy is preferable provided that an accurate, practical and inexpensive method for selecting infected cows is available.<sup>48</sup> This is the major problem with selective dry cow therapy – in most herds the sensitivity and specificity of the test used for selection is not adequate.

As general udder health improves and bulk tank milk SCC remains low, producers question the need to continue dry treatment on all cows and are attracted by a potential reduction in costs for the purchase of dry cow treatment. However, selective therapy requires a decision as to which cows or quarters are to be treated. The sensitivity and specificity of currently available screening tests are inadequate as a basis for decisions concerning selective therapy. The history of the number of episodes of clinical mastitis, individual cow composite SCC during lactation and at dry off, CMT results during lactation or at dry-off and even bacteriological culture towards the end of lactation all result in leaving some infected cows untreated, but conversely result in the treatment of many uninfected cows. An important requirement for large-scale implementation of selective dry cow therapy is the development of a cheap, practical, sensitive and specific test to identify infected cows. The failure to prevent new intramammary infections during the dry period with the selective approach must also be considered. New infections in the dry period will become increasingly important as contagious pathogens are eliminated from herds. Finally, blanket dry cow therapy reduces new infection rates for quarters from approximately 14% to 7%. The increase in milk production alone resulting from prevention of these new infections provides enough return to offset the cost of treatment for all cows.

Information presently available indicates that the general recommendation should be for **routine treatment of all quarters of all cows at the time of drying off (blanket dry cow therapy)**. There is a need to identify important management

practices to limit new infections in untreated dry cows and to develop new screening tests to determine which cows should be treated. New environmental management methods and modern information processing capabilities may lead to the development of better selective dry cow treatment programs. These may include the administration of ancillary therapeutic agents. For instance, the intramammary infusion of recombinant bovine interleukin-2 along with cephalosporin sodium at drying off marginally increased the cure rate of intramammary infections associated with *S. aureus*, but not other pathogens, during the dry period compared with the administration of cephalosporin only.<sup>29</sup> Interleukin did not affect the incidence of new intramammary infections for any pathogen group. However, the intramammary infusion of interleukin at drying off was associated with an increased incidence of abortion in dairy cows 3–7 days after the infusion.

#### *Factors affecting the success of antimicrobial treatment of dry cows*

Despite blanket dry cow therapy, some cows calve with infected quarters and some with clinical mastitis. Several risk factors affecting the results of dry cow treatment have been evaluated.<sup>49,50</sup> Some of these factors are:

- **Number of quarters infected.** With *S. aureus* infections, there is a significant decrease in cure rate as the number of quarters infected per cow increases. Quarters from cows with either three or four of their quarters infected have a very poor cure rate
- **Age of the cow.** As the age of the cow increases, the probability of *S. aureus* infections being cured by dry cow therapy decreases
- **Somatic cell count before drying off.** The cure rate of *S. aureus*-infected quarters diminishes as the SCC prior to treatment increases. Controlling for age and number of quarters infected, there was a significantly lower cure rate in quarters with an SCC of more than 1 000 000 cells/mL<sup>49</sup>
- **Herd of origin.** There is a distinct herd effect on the success of dry cow therapy. The cure rate of *S. aureus* has been shown to be higher in herds with good hygiene and with a low prevalence of *S. aureus* infections at drying off.<sup>49</sup>

There is considerable potential in using individual cow and herd-level information to predict the likelihood of a cure with dry cow therapy. For example, an older cow with three quarters infected with *S. aureus* and a persistently high SCC has a low probability of a cure. Continued

development of information management systems to assist with therapy and culling decisions will clarify the expectations of dry cow treatment.

Persistent *S. aureus* infections represent only one of the shortcomings of antibiotic treatment for dry cows. Most dry cow products are formulated for efficacy against Gram-positive cocci. These antibiotics are of limited usefulness against Gram-negative bacteria. In other words, new coliform infections would not be prevented by this therapy. Even though dry cow products are formulated for sustained activity, the provision of adequate protection during the critical prepartum period is questionable. The persistence of effective levels of antimicrobial agents has been evaluated for various dry cow treatments;<sup>51</sup> very few products have persistent activity until the time of calving.

#### Vaccination of the dry cow

Immunization and immunotherapy for the control and prevention of mastitis have been active areas of research.<sup>52</sup> Effective vaccines would have to eliminate chronic intramammary infections, prevent new intramammary infections or decrease the incidence or severity of clinical mastitis. Currently available mastitis vaccines may reduce the incidence and severity of clinical mastitis but have not eliminated chronic intramammary infections or prevented new intramammary infections. The inability of vaccines to prevent infection may be due to the wide variety of pathogens, inadequate specific antibodies or the failure of antibodies to enter the mammary gland prior to infection. Currently available vaccines should be used as adjuncts to other more effective control strategies.

Vaccines have been developed to reduce the incidence and severity of clinical mastitis associated with Gram-negative pathogens.<sup>53</sup> R-mutant bacteria have an exposed inner wall structure (core lipopolysaccharide antigens) that is highly uniform, even among diverse and distantly related Gram-negative bacteria. Vaccines containing killed R-mutant bacteria provide broad-spectrum immunity against a wide variety of unrelated Gram-negative bacteria. The most commonly used coliform mastitis vaccines are the R-mutant *E. coli* O111:B4, known as the J5 vaccine, and the R-mutant *Salmonella typhimurium*; both of which are commercially available in the USA.<sup>52</sup> R-mutant vaccines have been efficacious in the reduction of the incidence and severity of clinical mastitis due to Gram-negative bacteria. More than 50% of large (> 200 cows) dairy herds and more than 25% of all dairy herds in the USA are

using core lipopolysaccharide antigen vaccines.<sup>54</sup> No protection is provided against environmental streptococci and staphylococci, or the contagious pathogens.

No effective vaccines are currently available for the control of mastitis due to *S. aureus*, *S. agalactiae*, environmental streptococci, and *M. bovis*.

The use of recombinant bovine cytokines as adjuvants to enhance specific immunity in the mammary gland of cows after primary immunization against indicate an enhancement of specific immunity in the mammary gland, which may be effective in mastitis immunization protocols.

#### Management of the environment for dry cows

Dry cows should be provided with an environment that is as clean and dry as possible. If this is not feasible in confinement housing, it is probably better to maintain dry cows on pasture. Variations in the load of coliforms and environmental streptococci in the environment are important predictors of new infection rates. Minimizing the exposure to environmental bacteria will reduce the new infection rate. However, some pasture conditions promote the crowding of cows under shade trees. In hot, humid and muddy conditions, heavy contamination of such a small area can result in a significant risk of new environmental infections in the dry period. In good weather, it is ideal to hold parturient cows in a clean, grassy area where they can be observed and assisted if necessary.

In confinement housing systems for dry cows, it is important to provide adequate space, ventilation, bedding and lighting to insure cleanliness and comfort. Maternity (calving) stalls should be bedded with clean straw, sawdust or shavings. Other important procedures for managing the environment for dry cows include adopting an effective fly control program. Clipping the hair on the udders, flanks and inside the hind legs will help reduce contamination. **The words clean, dry, cold and comfortable summarize the ideal environment for dry cows.** The words clean and dry also summarize the goal for the teat before attachment of the inflation during milking.

#### Nutritional management of dry cows

A nutritionally balanced dry cow feeding program is important to insure udder health. A role has been suggested for specific nutritional factors in resistance to mastitis, especially over the dry period. Adequate levels of vitamin E and selenium in dry cow rations appear to be important for udder health at calving and in early lactation.<sup>55</sup> This effect may be mediated through enhanced resistance mechanisms. Other vitamins and minerals may

be important in udder health, but their role is less well substantiated.

Nutritional management of dry cows is also important for reducing the risk of milk fever, which is an important predisposing factor to mastitis in fresh cows. Appropriate body condition can be achieved by good nutritional management in late lactation. The association between body condition, energy metabolism and udder health needs further clarification.

#### Internal teat sealants

As discussed previously in risk factors for infection in the dry period, **the keratin plug is a natural internal teat sealant** that provides an effective barrier to new intramammary infections. High milk production at dry-off increases the likelihood that the streak canal remains open and presumably compromises formation of the keratin plug, thereby increasing the risk of intramammary infection.<sup>34</sup>

A recent promising development in mastitis control has been **exogenous internal teat sealants** that are applied at dry off. The teat sealant product most extensively evaluated contains a heavy inorganic salt (**bismuth subnitrate**) in a paraffin wax base; this product does not have antibacterial properties but acts as a **physical barrier** to ascending intramammary infections. A New Zealand study involving 528 cows indicated that the internal teat sealant was retained for dry period lengths of more than 100 days, while producing a ten-fold decrease in the new intramammary infection rate, which was similar to that produced by dry cow intramammary infusion alone.<sup>56</sup> In contrast, a UK study involving more than 1000 cows indicated that bismuth subnitrate teat sealant alone decreased the number of new intramammary infections to a great extent than intramammary dry cow infusion alone.<sup>57</sup> The UK study had a greater incidence of new intramammary infections due to Gram-negative bacteria than the New Zealand study. A US study involving 437 cows found that an internal teat sealant at dry-off decreased new intramammary infections by 30% in the dry period and treated cows were 33% less likely to have a clinical mastitis episode between dry-off and the first 60 days of the subsequent lactation<sup>58</sup> compared to untreated quarters. The addition of an antimicrobial agent is a logical addition to the bismuth subnitrate internal teat sealant and has been a routine addition to the teat sealant for some years in Ireland.

Bismuth subnitrate internal teat sealants clearly show promise for the prevention of new intramammary infections during the dry period. However, because **bismuth subnitrate teat sealants do not eliminate**

**existing intramammary infections**, and an accurate method for determining the infection status of a quarter is unavailable (the exception being milk culture), the recommended application of internal teat sealants requires combined application with intramammary dry cow therapy. This combined therapy may be uneconomic. Widespread adoption of internal teat sealants will require an accurate test for determining intramammary infection status at dry-off. Finally, administration of internal teat sealants alone obviously requires proper aseptic technique.

#### External teat sealants

A longer-standing approach to providing a physical barrier to ascending infections is the use of external teat sealants, which were originally developed for use in lactating cows. The major problem with external teat sealants is the duration of adherence, which is too long for lactating cow use and too short for dry cows. Teat end lesions and teat length influence the adherence of external teat sealants.<sup>31</sup> Widespread adoption of external teat sealants will require a product that provides prolonged protection but is easily removed at calving.

#### Teat disinfection

Postmilking teat disinfection is a very effective means of reducing new infections in lactating cows. However, the efficacy of teat disinfection in decreasing the incidence of new intramammary infections in the dry period has been discouraging. Daily teat dipping for the first week of the dry period is not effective in reducing *S. uberis* infections. The lack of efficacy of teat disinfection needs to be contrasted to the efficacy of internal teat sealants.

#### Intramammary devices

Intramammary devices have been developed for use in preventing new infections in both lactating and dry cows. However, there is conflicting evidence as to the reduction in infection rate in quarters fitted with these devices, and such devices are no longer being investigated. The incidence of clinical mastitis may be less in cows fitted with these devices compared to control cows but the prevalence of subclinical infection is unaffected.<sup>59</sup> Intramammary devices induce a significant increase in postmilking SCC compared to control cows, and test-day SCCs may be higher than in control cows.

#### 4. APPROPRIATE THERAPY OF MASTITIS DURING LACTATION

The early recognition and treatment of clinical cases remains an important part of a mastitis control program. Improvements in understanding of the epidemiology, pathophysiology, and response to therapy of various mastitis pathogens

have clarified the role of intramammary and parenteral antimicrobial agents for of the treatment of clinical and subclinical mastitis during lactation. This is covered extensively earlier in this chapter.

#### 5. CULLING CHRONICALLY INFECTED COWS

The final step of the five-point mastitis control program is the selective removal of cows with chronic intramammary infection from the herd. Most producers have interpreted this recommendation to mean that cows with recurrent episodes of clinical mastitis should be eliminated. For example, some herds have established that cows having three or more clinical cases of mastitis in a lactation will be culled (**the popular 'three strikes and out' approach**). However, very little research has been conducted to determine the effect of various culling strategies on herd udder health status, and on the incidence of clinical cases.

Nevertheless, culling chronically infected cows meets one of the three guiding principles of mastitis control, namely the elimination of existing intramammary infections. Through the use of available monitoring techniques and the establishment of a defined culling program, a valuable opportunity exists to improve udder health by culling.

In general, a record of chronic mastitis and severe fibrosis detected on deep udder palpation should be the basis of a recommendation to cull. Culling is an effective and documented mastitis control measure for some specific mastitis pathogens. For example, the removal of infected cows is a key element of the recommended mastitis control program for herds with a high prevalence of *S. aureus* infection. Removal of cows found to be infected with *S. aureus* accounted for more than 80% of the costs involved in the control program. Culling is also important in the control of other mastitis pathogens that respond poorly to antimicrobial therapy. Herds with mastitis cases associated with *M. bovis*, *Nocardia* spp., and *P. aeruginosa* should be aware of the benefits of culling infected cows.

A dairy herd culling program should be based upon consideration of the net present value of each cow in the herd as compared to the value of a replacement heifer.<sup>60</sup> The net present value depends on the age of the cow, her potential for milk production, the stage of lactation and her pregnancy status. Factors that determine the likelihood of treatment success, such as pathogen and duration of mastitis, as well as the cost of treatment, also need to be considered in calculating the net present value of the cow with mastitis. After consideration of the relative import-

ance of udder health in the overall herd health management program, additional economic pressure may be applied to cows with a specific udder health status. For example, if a *S. aureus* control program is a major priority in the health management program, additional economic pressure should be applied in removal decisions of cows with known *S. aureus* infections. As health management data collection and analysis improve in sophistication, decision analysis methods and expert computer models will be used to provide this information automatically.

#### Biosecurity for herd replacements

Replacement animals may be purchased to increase herd size or to maintain cow numbers following culling. Biosecurity measures must be used to insure that herd replacements are not infected with contagious mastitis pathogens (specifically *S. aureus*, *S. agalactiae*, *M. bovis*). However, an economic analysis of the different components of a biosecurity program has not been performed, and it is likely that some components of currently used programs are not cost-effective.

An optimal biosecurity program includes knowing the herd of origin, knowing the cows and protecting the home herd.

#### Know the farm of origin

- Request a bulk tank milk culture from the farm of origin
- Request the following data:
  - 6–12 months of bulk tank milk SCC;
  - bulk tank milk bacterial counts;
  - 6–12 months of records for clinical mastitis.

#### Know the cows

When purchasing single or small groups of animals the following prepurchase procedures are recommended:

- SCC and clinical mastitis records for each cow to be purchased
- Results of bacteriological culturing of quarter milk samples from each cow on arrival (if lactating) or at calving (if late-gestation) for *S. aureus*, *S. agalactiae* and *M. bovis*. In general, the sensitivity of a single milk culture to detect the presence of intramammary infections due to *S. agalactiae* is approximately 95%, for *S. aureus* it ranges from 30–86%, and for *M. bovis* it is 24%
- A physical examination of each cow, including udder, milk quality and teat ends.

#### Protect the home herd

Consider all purchased animals as potential health risks to the home herd by doing the following:

- Maintain all newly purchased animals in separate or isolated facilities until

diagnostic tests for udder health have been completed and there is no evidence of infection that may spread to the rest of the herd (usually < 14 d quarantine)

- Evaluate all herd replacements for evidence of antimicrobial residues in milk
- Milk all purchased animals last or with separate milking equipment until it is determined that they are free of infection
- Obtain results of bacteriological culturing of bulk tank milk samples or string samples for *S. aureus*, *S. agalactiae* and *M. bovis*; culturing should be done on more than one occasion because the sensitivity of bulk tank milk culturing is not 100%, and is less than 50% for *M. bovis*.

## 6. MAINTENANCE OF AN APPROPRIATE ENVIRONMENT

The multifactorial nature of mastitis has been emphasized throughout this chapter. Intramammary infection results from a complex interaction between the cow, the mastitis pathogens and the environment. Thus, the control of unfavorable environmental influences is extremely important in dairy herd udder health management programs.

Intramammary infection involves exposure of the teat surface to potentially pathogenic microorganisms, entry of the pathogens into the gland via the teat duct and establishment of the pathogens in the mammary tissue, producing an inflammatory response. Many environmental factors can influence this process of exposure, bacterial entry and establishment of infection. For example, the type of bedding and manure management can have a great impact on the contamination of teat skin with microorganisms. Housing design can have an impact on the prevalence of teat injuries, which will influence intramammary invasion by mastitis pathogens. Extreme climatic conditions, poor nutritional management and cow stocking densities will influence the immune system and the establishment of intramammary infection. A comprehensive udder health management program should involve steps to minimize the detrimental influences of the environment.

### Global environmental influences

Worldwide, there are major differences in dairy herd health and production systems. For example, the type of animal used, economics of production, climatic conditions, housing structures and management methods are widely variable. These differences greatly affect the interaction of cows with their environment, even though the predominant causative organisms are the same under different

systems. Thus, there are major variations in the relative incidences of different pathogens, and in the importance of various approaches to mastitis control.

### Classification of environmental influences

The influences of the total environment can be divided into:

- **The external environment.** All aspects of the environment outside the housing facilities make up the external environment. This includes the regional differences in climate, geography and agricultural tradition. There are also local factors within a region that can have an important influence. These local factors include the topographical features of the land, natural shelters from the climate and the availability of pasture
- **The internal environment.** All environmental conditions inside the cow buildings make up the internal environment. The general internal environment includes the type of housing system, temperature, humidity and air quality. There are also specific internal environmental influences such as stall design, type of bedding, nutritional management and manure disposal. The milking environment has a major influence through the equipment, cow preparation methods and approach to general hygiene.

### External environmental influences on mastitis control

There is minimal evidence that external environmental factors directly influence the incidence of mastitis; however, the external environment determines the way in which cows are housed, fed and milked. Through these associations, the external environment can be an important risk factor in problems with udder health in dairy herds.

### Regional environment

The climate and geographical features of a region have implications for the prevalence of mastitis. The ambient temperatures and amount of rainfall often determine the types of housing and nutritional program used. Extremely hot or cold conditions interact with other predisposing management factors. In areas prone to severe rainstorms, teats may be exposed to wet or muddy conditions. The soil type, cropping policy and presence of other industries can also have an indirect impact on the prevalence of mastitis; for example, regions suitable for growing cereal grains will commonly use straw as a bedding material, which may favor the growth of environmental streptococcal organisms. In contrast, dairying areas

close to the forestry industries may favor sawdust or shavings as bedding. The use of these materials may influence the incidence of coliform mastitis.

The socioeconomic structure and agricultural policy of a particular region can affect management factors known to influence udder health. These factors determine herd size and labor costs. Large herd sizes necessitated by economic conditions will dictate the housing, feeding and milking management practices employed. More recently, regional policy towards regulation of bulk tank milk SCC levels has had a profound impact on udder health status.<sup>61</sup>

### Local environment

The local environmental factors such as the topography of the land, the presence of natural shelters and the type of pasture grown are thought to influence udder health status. However, direct scientific evidence is lacking. One important exception is 'summer mastitis', which affects nonlactating heifers and cows. This udder infection with *A. pyogenes* is greatly affected by the local environment, probably through the propagation of insects important in its transmission. Protected pastures increase insect populations and can result in a high incidence of infection.

### Internal environmental influences on mastitis control

The incidence of new intramammary infections can be greatly affected by the management and facilities used in confinement dairying systems. General aspects of the internal environment exert their influence on all cows in the herd, such as the type of housing and milking system. Tie-stall barns pose different environmental stresses from a free-stall system. The air quality and noise levels can have an impact on animal health. The nutrient content of component feedstuffs can affect disease resistance.

Specific internal environmental factors exert their influence on an individual cow basis. For example, the stall design and tying system affect individual cows differently. Many epidemiological studies have revealed interactions between udder disease and internal environmental conditions. Most of these studies relate to European tie-stall and seasonal grazing systems. However, the results are generally relevant to most housing and management systems. Some of the most important general and specific influences of the internal environment are as follows.

### Housing

Housing factors account for a great deal of the variation in udder health status between herds. In both tie-stall and free-stall barns, short and narrow stalls are

associated with increased incidence of teat tramps and mastitis. An appropriate partition between stalls is beneficial. Stanchions or neckstraps with chains can restrict the movement of the cow and increase the risk of teat injury. This occurs especially as cows are rising. In addition, the use of electrical cowtrainers has been associated with an increase in the rate of subclinical mastitis. The use of adequate amounts of a good bedding material will reduce mastitis incidence in both tie-stall and free-stall housing systems. Even though there are reports of specific bedding materials being associated with certain mastitis problems, the use of adequate amounts of properly maintained bedding is beneficial. Straw, shavings, sawdust, sand, shredded newspaper and other cushion systems have all been used effectively.

The climate and air quality maintained within a building can have a major influence on udder health. Draughty conditions, high relative humidity and marked changes in indoor temperature over a 24-hour period are factors that contribute to higher mastitis rates. Adaptation to adverse internal environmental conditions may cause stress, which can reduce the cow's defense mechanisms. Indoor climate, especially temperature and humidity, can also account for differences in the concentration of pathogenic organisms to which cows are exposed.

#### *Nutritional management*

A complex relationship exists between the quantity and quality of feed and udder health status. Improper nutritional management can result in an increase of new intramammary infections, the exacerbation of pre-existing chronic infections, and an increase in clinical mastitis. Several mechanisms have been suggested for this association. An improper anion to cation balance in the dry cow ration is a predisposing factor for periparturient hypocalcemia, which in turn increases the risk of new intramammary infections. Feeding programs that result in excessively fat or abnormally thin cows may affect resistance to disease. Also, there is some evidence that feeds high in estrogenic substances may be detrimental to udder health status.

The dietary concentration of some vitamins and minerals may have an important relationship to udder health. Studies have shown that intramammary infection is related to plasma concentrations of vitamin E and blood concentrations of selenium.<sup>55</sup> Dietary supplementation of vitamin E and selenium improved the natural resistance of the mammary gland to infection. Associations between udder health and the levels of vitamin A, beta-

carotene, zinc and other nutrients have been proposed but are not well documented.

#### *Management approach*

Cow supervision, decision-making and general animal care by dairy herd managers may be important epidemiological factors in the relationship between environment and udder health. For example, lack of consistency in the performance and timing of various herd activities results in decreased udder health status. Irregular intervals between milkings should be avoided.

#### *General hygiene*

Even outside the milking environment, general hygiene can greatly influence the exposure of the udder and teats to pathogenic bacteria. The degree of hygiene achieved is directly related to the type of housing, the amount of bedding and the efficiency of manure removal. Worldwide trends towards increasing herd sizes and decreasing labor force necessitate more emphasis on the importance of cow hygiene.

#### *Use of recombinant bovine somatotropin*

It has been suggested that the use of bovine somatotropin may increase the incidence of clinical mastitis by an indirect mechanism that acts through increased milk production. Controlled field studies have shown that the use of bovine somatotropin is not associated with an increase in the incidence of clinical mastitis, milk discarded because of therapy for clinical mastitis, or culling for mastitis.<sup>62</sup>

#### **Environmental control in an udder health management program**

There is a strong association between herd udder health status and the number of stress factors operating within the herd. It has been proposed that mastitis occurs when stress factors exceed the cow's ability to adapt. It follows that a major objective of an udder health management program should be to limit the number and severity of environmental stress factors.

Veterinarians responsible for udder health management programs should have a good understanding of the importance of environmental management. The three major objectives of environmental control for improvement of udder health are:

- To prevent contamination of the teat end
- To prevent invasion of mastitis pathogens
- To prevent pathogens from establishing in the mammary gland.

The important steps in achieving these three objectives have been discussed. For

example, an adequate housing system and manure handling are important to limit bacterial contamination of the teats. The prevention of environmentally induced teat injuries will aid in preventing invasion of pathogens into the gland. The producer's approach to cow management, control of the nutritional program and insuring that the internal environment is appropriate, will all greatly improve host defense mechanisms and prevent intramammary pathogens from establishing within the gland.

#### **7. GOOD RECORD KEEPING**

Good record keeping involves the collection of useful data to monitor performance, calculation of appropriate indices and decision-making based on comparison to target levels. For acceptable performance the monitoring process is repeated and the cycle continues. If performance is not acceptable, further evaluation and analysis is carried out and a plan of action is instituted. Once again, the monitoring process carries on and the cycle continues. For many of the health management programs in food animal practice, a limiting factor is the availability of accurate and objective data. With respect to udder health, data have been readily available. Bulk tank milk SCC, individual cow composite SCC and bacteriological culture results are all accessible and useful. These data provide the information necessary to monitor udder health status and to make specific health management decisions. However, problems can still exist. Herds with a low prevalence of infection and very low bulk tank milk SCC can still have a high incidence of environmental infections and clinical mastitis cases. Thus, an important step in an effective udder health management program is the maintenance and use of mastitis records. The increasing adoption of computerized dairy health management record systems provides an opportunity to make effective use of clinical mastitis episode and therapy data. Even without a computerized system, manual records for clinical mastitis are easy to implement and use.

#### **Objectives and uses of clinical mastitis records**

The objective of maintaining computerized or manual records of clinical mastitis episodes is to complete the decision-making capabilities of a mastitis control program. The availability of this information will allow completion of the health management cycle over the entire spectrum of herd udder health situations.

There are several important uses of clinical mastitis records:

- To assess the risk factors associated with clinical mastitis episodes

- To evaluate lactational and dry cow therapy programs
- To provide information useful in the evaluation of net present value of individual cows for the purposes of culling decisions. Without the ready availability of accurate data surrounding mastitis events, decisions associated with therapy, culling and the removal of risk factors are difficult to make.

### Recording clinical mastitis data

There is a limited amount of specific data necessary to make effective use of mastitis records as a health management tool. The cow identification, date of the clinical episode occurrence, type of therapy used and the date that milk withholding will be complete are the essential pieces of information. If a manual record system is used, it will be important to add the lactation number, the date of calving and the most recent test date production. A standard form that calculates the distribution of clinical episodes by lactation number and by stage of lactation is desirable. These are the same distributions often provided with an individual cow SCC report. A record form that allows the recording of treatment used, the number of days treated, milk withholding periods and an estimate of the costs associated with clinical mastitis has been described.<sup>63,64</sup>

### Using clinical mastitis monitoring systems

Since clinical mastitis is a common event in dairy production, it is ironic that these records have not traditionally been kept. The key to overcoming this hurdle is the regular use of this information for health management decisions. Some of these uses and decisions are as follows.

#### *Cow versus herd clinical mastitis problems*

Calculation of the percentage of cows affected in the herd and the average number of clinical episodes per affected cow will aid in determining if the clinical mastitis is more of an individual cow problem or a herd-level issue.<sup>65</sup>

#### *Probability of recurrence of clinical mastitis in the same lactation*

The number of animals with repeat cases of mastitis divided by the total number of clinical cases gives an estimate of the likelihood of recurrence. The same calculation can be made for specific parity groups. This information can be useful to characterize the problem, and for culling decisions.

#### *Stage of lactation and seasonal profile*

If clinical mastitis data is collected consistently over a considerable period of

time, potentially useful problem-solving information can be derived. For example, calculating days in lactation at first occurrence can help to identify specific risk factors for new intramammary infections. There is a higher proportion of clinical occurrences during the first few weeks after calving. However, analysis of clinical mastitis records might yield a different stage-of-lactation profile. In these cases, the evaluation of potential nutritional, environmental or other stress factors would be indicated. There may be different immediate and long-term solutions that should be implemented.

Analysis of clinical mastitis records over several years may identify a significant seasonal pattern, such as the documented seasonal pattern for bulk tank milk SCC data and antibiotic residue violations. Action may be necessary to deal with seasonal environment and housing problems that impact upon new infection rates.

#### *Days of discarded milk*

It is very common for producers to have an aggressive attitude towards the treatment of clinical mastitis. This approach may result in huge economic losses if waste milk is not fed to calves. These losses are largely the result of discarded milk during the clearance of antibiotic residues from treated cows. Calculating the days of discarded milk may suggest that the mastitis therapy program during lactation should be evaluated. Establishment of an appropriate treatment program and careful selection of cows for therapy might significantly decrease the need for discarding milk. In addition, cows that are responsible for a large percentage of the discarded milk should be identified for selective removal. The calculations from mastitis records that can help to clarify these issues include:

- Total days of discarded milk for the herd
- Days of discarded milk per episode
- Days of discarded milk by lactation number
- Accrued days of discarded milk for individual cows.

## 8. MONITORING UDDER HEALTH STATUS

An important step missing from early mastitis control programs was the monitoring of udder health status. Although intuitively it appears necessary to chart the progress of any program, it is only quite recently that monitoring has been included as an integral component of udder health management. **Monitoring is now recognized as the third key principle of mastitis control.** The development of objective, inexpensive and

efficient methods of monitoring udder health has made it much easier to complete the health management cycle for this component of herd programs.

The implementation of SCC measurement on bulk tank milk and on individual cow samples has been widespread throughout the major dairy regions of the world. Since SCC is objective and standardized, it can be used to evaluate the progress of regional control programs. This has allowed rapid improvement in udder health compared to most of the other components of dairy health management programs. Regional authorities have established new regulatory limits and targets for milk quality performance.

Implementing an effective system of monitoring udder health involves:

- Monitoring udder health at the herd level
- Monitoring udder health of individual cows
- Use of cow-side diagnostic tests.

This discussion will emphasize the use of monitoring methods for decision-making and problem-solving in udder health management programs. Monitoring of udder health should be done at the **herd level** and **individual cow level**.

### Monitoring udder health at the herd level

The monitoring of bulk tank milk provides the best method to evaluate the overall udder health status of dairy herds and the effectiveness of mastitis control programs. **Herd-level monitors of udder health include bulk tank milk SCC, bulk tank milk bacteriological culture and herd summaries of individual cow SCC data.** Analysis of clinical mastitis records is also useful for monitoring udder health at the herd level.

#### Bulk tank milk somatic cell counts

Most milk marketing organizations and regional authorities regularly measure SCC on bulk tank milk as a monitor of the milk quality and udder health status of each herd. Many of these agencies use bulk tank milk SCC for penalty deductions or incentive payments. Improvement in bulk tank milk SCC is associated with improvement in other measures of milk quality such as bacterial counts, inhibitor test violations and milk freezing point.<sup>66</sup> Countries and regions set milk quality targets using this SCC data, with milk being rejected from processing plants when the bulk tank milk SCC exceeds 400 000–1 000 000 cells/mL, depending on the country.

Several management practices are associated with low, medium and high SCC in bulk tank milk.<sup>67</sup> Postmilking teat disinfection and dry cow therapy are most

frequently associated with herds with a low bulk tank milk SCC. In herds with a low bulk milk SCC, more attention is given to hygiene than in herds with a medium or high bulk tank milk SCC. Cubicles, drinking buckets and cows are cleaner in herds with a low bulk tank milk SCC. Cleaner calving pens and cubicles for herds with low bulk tank milk SCC coincide with the observations that bedding for lactating cows and in maternity pens is drier for herds with a low bulk tank milk SCC. In herds with a high bulk tank milk SCC, a higher percentage of cows are culled because of a high SCC.

The incidence of clinical mastitis in dairy herds may not be different among those with low, medium and high bulk tank milk SCC.<sup>68</sup> However, clinical mastitis associated with Gram-negative pathogens such as *E. coli*, *Klebsiella* spp., or *Pseudomonas* spp. occurs more commonly in herds with a low bulk tank milk SCC. Clinical mastitis associated with *S. aureus*, *S. dysgalactiae*, and *S. agalactiae* occurs more often in herds with a high bulk tank milk SCC. Systemic signs of illness associated with clinical mastitis occur more often in herds with a low bulk tank milk SCC. In herds with a high bulk tank milk SCC, more cows with a high milk SCC were culled. In herds with a low bulk tank milk SCC, more cows were culled for teat lesions, milkability, udder shape, fertility and character than in herds with a high bulk tank milk SCC. In herds with a low bulk tank milk SCC, cows were culled more for export and production reasons.

Herd average of weighted individual cow somatic cell count

The arithmetic mean of individual cow SCC values, weighted by the cow's milk production, is also a good measure of the general udder health status of the herd. It should be noted that the high degree of variability of SCC measurements makes it inappropriate to compare this mean directly with the bulk tank milk SCC.

Other herd-level somatic cell count monitors

There are several other calculations using individual cow SCC data that are useful for monitoring herd udder health. In general, these indices attempt to use mathematical calculations to reduce the impact of individual cows and to measure the change over time. These summaries are used to assist producers in the use of individual cow SCC information at the herd level. These indices include the following.

*Herd average somatic cell count linear score*

The use of linear score can simplify SCC interpretation and buffer the effects of

individual cows with very high values. Thus, the herd average of SCC linear score is a very useful monitor of herd udder health status. A realistic goal for most dairy herds is an average linear score of less than 3.0, equivalent to fewer than 100 000 cells/mL. It is not correct to estimate herd production loss from the average linear score using the individual cow linear score-production loss relationship developed for bulk tank milk SCC.<sup>69</sup>

*Percentage of herd over somatic cell count threshold*

Interpretation of SCC and linear score requires the choice of a threshold value for classification of cows as positive and negative. The threshold value used ranges from 200 000–400 000 cells/mL. A useful herd goal for subclinical mastitis is to have less than 15% of cows with SCC values greater than 200 000–250 000 cells/mL (prevalence). A second goal is to have fewer than 5% of cows developing new subclinical infections each month (incidence).

*Percentage of herd changing somatic cell count to over threshold*

Most uses of SCC data focus upon the determination of current udder health status. In other words, SCC is used as an estimate of the prevalence of existing infections in the herd; however, an important objective of a mastitis control program is to minimize the number of new intramammary infections. The change in the SCC of individual cows from month to month can be used as an estimate of the rate of new infections, and the use of SCC data in this way has been evaluated.<sup>70</sup> Using SCC changes from month to month as a test for the rate of new infections has low sensitivity and high specificity. More research is needed on the usefulness of SCC to monitor the occurrence of new infections.

A popular way to represent these data graphically is to plot the SCC value (or linear score) for the current month on the *y* axis and the SCC value (or linear score) for the preceding month on the *x* axis. This graphing arrangement is preferred because the current SCC value is dependent, in part, on the previous SCC value. Using this graphical approach, individual SCC values in the upper left quadrant are new infections, values in the upper right quadrant are persistent infections and values in the lower right quadrant are resolved infections.

Bacteriological culture of bulk milk Although SCC is widely used for monitoring udder health status in dairy herds, decision-making often requires information about the prevalence of specific pathogens. With the regular

collection of bulk tank milk samples for the purposes of quality monitoring programs, culturing of bulk tank milk is an attractive alternative to culturing milk from individual cows. Bulk tank milk culture has been formally evaluated as a mastitis screening test.<sup>71</sup> For the major mastitis pathogens, bulk milk culture had a low sensitivity. Even in herds infected with *S. agalactiae*, repeated bulk milk cultures were necessary to detect positive herds. Mastitis pathogens of greatest interest are contagious pathogens, such as *S. agalactiae*, *S. aureus*, *M. bovis*, and *C. bovis*.

The **standard plate count** (plate loop count) provides an estimate of the total numbers of aerobic bacteria in bulk tank milk and is an important measure of milk quality and udder health. It is most commonly used to evaluate the efficiency of cleaning the milking system. **A standard plate count of less than 10 000 cfu/mL can be achieved on most farms and less than 5000 cfu/mL should be the goal.** Standard plate counts higher than 10 000 cfu/mL indicate milking of cows with dirty teats or mastitis, poorly sanitized milking equipment or delayed cooling of milk in the bulk tank. Many herds routinely have bacteria counts of 1000 cfu/mL or less. Total bacterial counts have some value as an early warning system because up to 50% of violations of the standard are associated with mastitis-related bacteria. For example, bacterial counts in the milk of acute clinical cases may be as high as 10 000 000 cfu/mL. Milk from subclinically infected quarters may contain 1000–10 000 cfu/mL, and normal quarters yield less than 1000 cfu/mL. In nonmastitic cows, higher counts, up to six times higher, are seen in housed cows than in pastured cows.

The **preliminary incubation count** is an estimate of the total number of cold-loving bacteria. As such, the preliminary incubation count provides an index of milk production on the farm. A preliminary incubation count below 50 000 cfu/mL can be achieved on most farms, with less than 10 000 cfu/mL being the goal. The preliminary incubation count should be less than 3–6 × the standard plate count.

Herd-level measures of clinical mastitis The **incidence of clinical mastitis, calculated as cases per 100 cows per year**, can provide a rough assessment of new intramammary infections.<sup>72</sup> The **goal is less than two new cases per 100 cows each month** (equivalent to < 24% of cows affected each year). Calculation of the total treatment days can provide a herd-level assessment of the approach to therapy of clinical mastitis, as well as an estimate of the economic losses.



In a random sample of dairy herds in the Netherlands, the following risk factors were associated with a higher incidence of clinical mastitis:<sup>73</sup> one or more cows leaking milk, one or more cows with trampled teats, no disinfection of the maternity area after calving, consistent use of postmilking teat disinfection, Red and White cattle as the predominant breed, and an annual bulk tank milk SCC of less than 150 000 cells/mL. Factors associated with a higher rate of clinical mastitis caused by *E. coli* included cows with trampled teats, no disinfection of the maternity area after calving, consistent use of postmilking teat disinfection, use of a thick layer of bedding in the stall and the stripping of foremilk before cluster attachment. Factors associated with a higher rate of clinical mastitis caused by *S. aureus* included Red and White cattle as the predominant breed, cows with trampled teats, stripping of foremilk before cluster attachment, no regular disinfection of the stall, no regular replacement of stall bedding and an annual bulk tank milk SCC of less than 150 000 cells/mL.<sup>73</sup> Teat disinfection appeared to increase the incidence of clinical mastitis associated with *E. coli*, which may be explained by the higher incidence around calving and during early lactation, when the resistance of cows is low combined with an increase in the numbers of environmental bacteria associated with maternity pens.

#### Monitoring udder health of individual cows

Earlier in this chapter, one direct (culture) and several indirect tests for intramammary infection were described. Currently, four methods are widely used to detect subclinical mastitis: culture of composite or quarter samples, SCC values of composite or quarter samples, and CMT and electrical conductivity of quarter samples. Currently, cow level data (culture or SCC) are the most commonly used of these four monitoring tools, but the usefulness of these tests varies depending upon their cost, sensitivity, specificity, convenience and availability.

#### Bacteriological culture of milk

Culture of aseptically collected milk samples has been a cornerstone of mastitis control programs. Extensive diagnostic laboratory systems have been developed for the culture of milk. For many years, milk bacteriology has been recognized as the gold standard of mastitis diagnostic tests. The sensitivity and specificity of milk bacteriology are now being examined and, as the costs of laboratory procedures have risen, there is an increasing need to justify diagnostic expenses. However, there is still an important need for infor-

mation concerning the predominant types of mastitis organism active in a herd.

Several schemes have been proposed for obtaining a pathogen profile of the mastitis pathogens in a herd. The following suggestions are offered as the most appropriate times to collect samples for milk bacteriology:

- **Pretreatment milk samples from clinical cases.** Samples should be frozen, collected at a herd visit, and submitted for culture
- **Cows that have an increased SCC.** At each scheduled herd visit, each cow that has increased in SCC over a preset threshold is sampled and the sample is submitted for culture
- **A composite milk sample from each lactating cow in the herd.** This whole-herd culture would be conducted annually, or more frequently depending upon the herd situation. This method is most appropriate for herds having problems with contagious pathogens, but the economics of this approach have not been determined
- **Culture of cows at a specific management event,** for example milk culture at drying off and at the first milking after calving, can be useful for assessment of the dry cow management program.

The cost-effectiveness of any one or a combination of these methods of obtaining a bacteriological profile of a herd's milk will depend on the current situation in the herd. For the vast majority of dairy herds, the routine culture of cows for subclinical mastitis diagnosis is not cost-effective. In fact, herds with a low bulk tank milk SCC and a low incidence of clinical mastitis episodes can conduct an efficient udder health management program without culturing milk. It is very wise, however, to collect pretreatment milk samples from clinical mastitis cases. These samples can be frozen without significant alterations of the culture results for most pathogens.<sup>74</sup> The samples are collected at a scheduled herd visit and submitted to the laboratory. In most herds, this approach will give a meaningful bacteriological profile of the herd and assist in assessment of the treatment protocol.

*C. bovis* is not a common cause of clinical mastitis on most farms but is frequently found in random milk samples. Because *C. bovis* is highly infectious and susceptible to teat disinfection, it has been suggested that *C. bovis* prevalence could be used as an indicator of teat-dipping efficiency in a herd, either of the intensity of the dipping or of the efficacy of the dip. The fact that *C. bovis* is limited in its colonization to the streak canal makes it valuable as a monitor of teat disinfection.

#### Somatic cell counts

Several management decisions can be based on individual cow composite SCC. Before any decisions can be made using SCC, criteria must be established to categorize cows based on their SCC results. This involves establishing threshold values or other criteria. The **recommended threshold is 250 000 cells/mL in herds with a low prevalence (<5%) of subclinical mastitis**, providing a sensitivity of 0.55 and specificity of 0.96. In comparison, the **recommended threshold is 200 000 cells/mL in herds with a high prevalence (40%) of subclinical mastitis**, providing an apparent sensitivity of 0.73–0.89 and a specificity of 0.86. A clinically more appropriate approach is to calculate likelihood ratios using test sensitivity and specificity, estimated herd prevalence and a spreadsheet. Cows are identified for further investigation based on their SCC, using three different methods:

- **Change in SCC to over the threshold.** A cow with a marked increase in SCC from one month to the next would be identified as potentially being infected
- **Persistently elevated SCC.** Cows with a persistently elevated SCC month after month would be identified for management intervention. The lactation average linear score and the lifetime linear score are also useful in this respect. This information is especially useful if dry period therapy has already been unsuccessful for the cow in question
- **Percentage contribution to herd average.** An estimate of the percentage of the SCC in bulk tank milk contributed by each problem cow can be calculated using individual cow test-day weights and SCC data. It should be noted that cows with high milk production and intermediate SCC levels can make a significantly higher contribution to SCC than some cows with a very high SCC but low production. It is not uncommon for a few problem cows to be responsible for more than 50% of the cells in the bulk tank, particularly in small herds. In most circumstances, the cows with the highest percentage contribution merit immediate action.

With these methods of identifying individual cows based on SCC results, several udder health management decisions can be made, including:

**Selection of cows for milk bacteriological culture.** The importance of having a good bacteriological profile of the

intramammary infections in the herd has been emphasized. Several lactation events are suggested as useful times to collect milk for bacteriology. One such event is a clinical mastitis episode. Selection of cows for culture can also be based on an elevated SCC

- **Selection of cows for dry cow treatment.** Blanket dry cow therapy is currently recommended for most herds. However, herds that use selective dry cow therapy need a suitable screening test in order to make therapy decisions; such a test is currently unavailable, although individual cow SCC may be of some help in this decision-making process. Cows with a very high SCC have significantly lower cure rates after dry cow treatment than cows that are infected but have a lower SCC. The SCC can be used as a general indicator of the expected success of dry cow treatment<sup>49</sup>

- **Treatment during lactation.** The development of a treatment protocol and the criteria for selecting cows to treat during lactation are presented above. Treatment on the basis of a change in individual cow SCC from month to month is not economically justifiable. Many other factors need to be considered for a cost-effective treatment decision, and SCC could be one of these criteria

- **Evaluation of the response to treatment.** Individual cow SCC data can be used as a preliminary evaluation of the mastitis therapy program. With good records on clinical cases and the treatment administered, individual cow SCC data in the months following treatment can be used as a general indicator of the response to therapy. Spontaneous cures and new infections will confound this evaluation but with data from multiple farms and over a considerable time period a low-cost preliminary evaluation can be achieved

- **Culling decision.** The lifetime average SCC or linear score of an individual cow is useful additional information in making specific culling decisions.<sup>69</sup> In conjunction with milk culture results, the SCC data are useful to help establish a cow's net present value. An elevated SCC month after month serves to emphasize that culling is the only method of elimination of some chronic cases of mastitis. Removal of these cows eliminates a source of infection for the rest of the herd, as

well as assisting in general improvement in the quality of the bulk tank milk

- **Alter the milking order.** It is generally recommended that infected cows be milked last, although this is often impractical for freestall and pasture-based dairy enterprises. Individual cow SCC can be used to establish a milking order in tie-stall barns. Alternatively, some large herds establish a special milking string for infected cows. These milking order and segregation programs can be based upon SCC results, but cows with an elevated SCC but no intramammary infection may be incorrectly classified. In segregation programs these false-positive cows may be at increased risk
- **Management procedures to limit the effect of individual cows.** There is some evidence that machine disinfection after milking infected cows may limit the spread of contagious pathogens. In an intensively managed tie-stall herd, it is possible to manually disinfect the milking unit between cows. In order to maximize the efficiency of this labor-intensive step, individual cow SCC can be used to identify the cows after which machine disinfection would be useful. Another management method involves using the milk from specific cows for feeding calves. In situations where there are significant financial incentives for low SCC bulk milk, removal of the milk from one or two cows can have an impact on the amount of premium received. Individual cow SCC values can be used to identify specific cows that should be eliminated from the bulk tank. Precautions need to be taken to prevent intersucking between calves receiving this high SCC milk
- **Use of individual cow SCC in economic decision analysis.** The relationship between individual cow SCC and milk production losses has been well established. SCC values can be used to estimate the economic losses from subclinical mastitis. This information may be extremely useful in calculating the potential economic benefit of implementing a new udder health management strategy.

Problem-solving using individual cow somatic cell counts

A simple approach to problem-solving involves defining the problem by **answering the questions: who, when, where and what is involved** in the situation. Individual cow SCCs provide an in-

expensive consistent source of information to answer these questions. This process is completed by dividing the herd into subgroups and calculating the percentage of cows with SCCs over a threshold (250 000 cells/mL) in each group.

- **Who is affected?** The herd can be subdivided based upon several defining characteristics. These include production level, genetic factors (sire) and other characteristics such as having a previous clinical mastitis episode. A gradual increase in the proportion of elevated SCC would normally occur as lactation number increases. Thus, a higher percentage of older cows are expected to have elevated SCCs than first- and second-lactation animals. A high proportion of elevated SCC values in heifers would suggest a problem in the replacement program or a breakdown of hygiene in the immediate periparturient period for first-calf heifers. A markedly elevated percentage of high-SCC cows in older animals suggests that infections have become chronic and that the culling strategy should be re-evaluated
- **When does high SCC occur?** It is appropriate to examine SCC distributions according to stage of lactation and season of the year. Normally there is a gradual increase in the prevalence of elevated counts as the lactation progresses. If the prevalence of cows with elevated SCCs is high in early lactation, it suggests a problem with dry cow management or with new infections occurring around the time of calving. If the distribution of cows over threshold shows a dramatic increase during lactation, cow-to-cow transmission of contagious organisms is suspected. Measures of new infection rate are also helpful in solving these problems. The percentage of cows over threshold in the herd can be charted over time. It is expected that this indicator will indicate the same seasonal trends as found in bulk tank milk SCC in the population. For example, the percentage of the herd over threshold should be highest in the fall and lowest in the spring. An increase in this index in the spring would contradict the population trend and should be investigated

- **Where are the affected cows located?** The distribution of cows with elevated SCC according to their location in the tie-stall barn, in milking strings or according to milking order may provide evidence

for some risk factors for new infections. A mastitis problem due to environmental pathogens in a free-stall operation can be difficult to solve. Calculating the percentage of cows with a SCC greater than 250 000 cells/mL for each milking group can help to determine where the problem is most severe. If a specific milking order is followed, as is the case in most tie-stall systems, the distribution of cows with elevated counts according to milking order can demonstrate weaknesses in milking hygiene

- **What is the problem and why has it occurred?** The information obtained by answering the questions **who, when** and **where** in the problem-solving process can go a long way toward defining **what** the problem is. Prevalence distributions can be combined with the incidence of clinical mastitis, information from milk cultures and an estimate of the financial losses, in order to complete the picture. Subsequently, specific solutions will be aimed at **why** this problem might exist.

With the development of computerized dairy health management records systems, the epidemiological analysis of udder health information can be greatly simplified. Ultimately, specific risk factors would be automatically tested for statistical significance. In addition, the relative importance of many potential risk factors would be evaluated.

### 9. PERIODIC REVIEW OF THE UDDER HEALTH MANAGEMENT PROGRAM

Many aspects of mastitis control, such as milking management and therapy of clinical cases, become routine practices. However, changes continue to occur in the udder health status of the herd, environmental conditions and available technology. With these changes, the current udder health management program may no longer be appropriate. New employees may be introduced and it is possible that various steps are not being appropriately implemented. In some dairy herds, management practices are passed on from previous generations without critical examination. Mastitis results from a continually evolving relationship between microorganisms, the cow and the environment. Any program intended to limit problems from these relationships needs to be re-evaluated on a regular basis.

An effective udder health management program should undergo regular periodic review. This process of appraisal should involve the producer and the herd veterinarian, although input may be

sought from various farm management advisors. The review should be objective and thorough, but simple and easy to conduct. The use of a standard investigation form structured on the 10 steps of the mastitis control program is recommended. The same standard form can be used for the investigation of problem herds.

### 10. SETTING GOALS FOR UDDER HEALTH STATUS

The establishment of realistic targets of performance for various udder health parameters is the final component in an udder health management program. These goals are important to determine whether there have been shortfalls in the milk quality and udder health performance. The goals should be realistic and achievable, as well as having economic significance. In addition, the targets must be easily measured and should be accepted by all members of the farm management and labor team.

The setting of appropriate goals for mastitis control efforts is crucial for completion of the health management cycle. In some cases, the target will be the industry reference value, however in most situations it will be a farm-specific level of performance.

#### Relationship of udder health to productivity and profitability

Mastitis is generally considered to be the most costly disease facing the dairy industry. The reduced profitability is due to two major factors:

- Reduced milk production associated with subclinical mastitis accounts for approximately 70% of the economic loss
- The treatment costs, culling and reduced productivity associated with clinical mastitis are responsible for the remaining losses.

Production losses from increased somatic cell count

It is well accepted that milk production decreases as SCC increases, but the relationship between SCC and milk production is curvilinear for individual cattle but approximates a straight line when a logarithmic transformation (such as linear score) is used. Estimates of the milk production losses range from 3–6% with each one unit increase of linear score above 3. The loss in first-lactation heifers is greater than that in older cows. A general rule of thumb would suggest that there is 5% loss for each unit of linear score increase above a linear score of 3.

There is also a relationship between bulk tank milk SCC and milk production in that a linear decrease in herd milk production with an increase in bulk tank

milk SCC. Estimates of the production loss range from 1.5–3.0% for each increase of 100 000 cells/mL over a baseline of 150 000 cells/mL. Using an average of these estimates, daily milk and dollar losses can be calculated from bulk tank milk SCC and herd production levels.

Clinical mastitis and lost productivity  
Economic losses associated with the treatment of clinical mastitis arise from the cost of drugs, veterinary services and milk discarded. In addition, decreased milk production, premature culling and replacement heifer costs are also significant. However, more than 80% of the loss attributed to a clinical episode involves the discarding of nonsaleable milk and decreased milk production.

### ASSESSMENT OF THE COST-EFFECTIVENESS OF MASTITIS CONTROL

Dairy producers look to their veterinarian for information and services related to mastitis and its control. With this motivation, veterinarians should be able to implement comprehensive udder health management programs on the majority of dairy farms. In order to achieve a high rate of implementation of mastitis control strategies, it may be necessary to demonstrate the cost:benefit ratio of the suggested practices before they are adopted. A reassessment of their impact over time may also be useful.

Mastitis control is feasible, practical, and cost-effective. The economics of the efforts of a mastitis control program in a herd can be estimated. There are several steps necessary to complete this assessment.

1. Programs for monitoring udder health and for establishing achievable goals must be in place for an economic assessment
2. The losses resulting from mastitis must be quantified. The amount of reduced milk production resulting from increased SCC is calculated. In addition, costs associated with the discarded milk and treatment of clinical cases must be estimated
3. The udder health management program to be implemented must be described. An accounting system should be established to calculate the costs associated with this program
4. Using an estimate of the potential loss for a hypothetical herd with no mastitis control efforts, the profitability of the herd's current udder health management program is determined
5. By estimating the costs of implementing new udder health

management measures, the remaining potential profits from mastitis control can be calculated.

This economic assessment is done using a computer spreadsheet program. With such a computer program, veterinarians can simply and rapidly input actual values for a particular farm, and assess the economic circumstances. The impact of each element of control can be considered from the point of view of a cost-benefit ratio. The results of economic assessment will vary widely from farm to farm, but usually the following conclusions are made:

- Mastitis will remain a costly disease, even with implementation of properly applied, effective control programs
- Loss of milk production attributable to subclinical infection will remain a major cause of economic loss due to mastitis in most herds
- Proper application of simple, inexpensive mastitis control procedures will have a significant impact on profitability, and will bring higher returns on investment.

## REVIEW LITERATURE

- Dinsmore RP. Biosecurity for mammary diseases in dairy cattle. *Vet Clin North Am Food Anim Pract* 2002; 18:115-131.
- Dingwell RT, Kelton DF, Leslie KE. Management of the dry cow in control of peripartum disease and mastitis. *Vet Clin North Am Food Anim Pract* 2003; 19:235-265.
- Jayarao BM, Wolfgang DR. Bulk tank milk analysis: a useful tool for improving milk quality and herd udder health. *Vet Clin North Am Food Anim Pract* 2003; 19:75-92.
- Pyyrälä S. Indicators of inflammation in the diagnosis of mastitis. *Vet Res* 2003; 34:565-578.
- Ruegg PL. Investigation of mastitis problems on farms. *Vet Clin North Am Food Anim Pract* 2003; 19:47-74.
- Schukken YH et al. Monitoring udder health and milk quality using somatic cell counts. *Vet Res* 2003; 34:579-596.
- Oliver SP, Gillespie BE, Headrick SJ, Lewis MJ, Dowlen HH. Prevalence, risk factors, and strategies for controlling mastitis in heifers during the periparturient period. *Int J Appl Res Vet Med* 2005; 3:150-162.

## REFERENCES

1. Brown WB et al. *Prev Vet Med* 1988; 5:197, 213, 225.
2. Hillerton JE et al. *J Dairy Res* 1995; 62:39.
3. Beck HS et al. *J Dairy Res* 1992; 59:449.
4. Booth JM. In: Proceedings of the XIXth World Buiatrics Congress, Edinburgh, July 8-12 1996, vol 1:292.
5. Berry EA. *Vet Rec* 1994; 135:479.
6. Saran A. *Israel J Vet Med* 1996; 51:93.
7. Miller GY et al. *J Am Vet Med Assoc* 1993; 202:1230.
8. Morin DE et al. *J Am Vet Med Assoc* 1993; 202:540.
9. Sischo WM et al. *J Am Vet Med Assoc* 1993; 202:595.
10. Howard WH et al. *Can J Agric Econ* 1991; 39:299.
11. Ekman T et al. *Acta Vet Scand* 1994; 35:329.
12. Lam TJGM et al. *Am J Vet Res* 1997; 58:17.

13. Hillerton JE. In: Progress in dairy science. Wallingford, Oxfordshire, UK: CAB International, 1996:171.
14. Schreiner DA, Ruegg PL. *J Dairy Sci* 2003; 86:3460.
15. Reneau JK et al. *J Am Vet Med Assoc* 2005; 227:1297.
16. Oliver SP et al. *J Food Prot* 1994; 57:614.
17. Oliver SP et al. *J Food Prot* 1993; 56:852.
18. Dreschler PA et al. *J Dairy Sci* 1993; 76:2783.
19. Hillerton JE et al. *J Dairy Res* 1993; 60:31.
20. Ruegg PL, Dohoo IR. *Can Vet J* 1997; 38:632.
21. Boddie RL, Nickerson SC. *J Dairy Sci* 1997; 80:1846.
22. Boddie RL et al. *J Dairy Sci* 1997; 80:2809.
23. Boddie RL et al. *J Dairy Sci* 1994; 77:3192.
24. Nickerson SC, Boddie RL. *J Dairy Sci* 1995; 78:2496.
25. Fox LK, Hancock DD. *J Dairy Sci* 1989; 72:540.
26. Spencer SB. *J Dairy Sci* 1989; 72:1907.
27. Smith TW et al. *J Dairy Sci* 1985; 68:424.
28. Olney GR, Mitchell RK. *J Dairy Res* 1983; 50:141.
29. Erskine RJ et al. *J Dairy Sci* 1998; 81:107.
30. Eberhart RJ. *J Dairy Sci* 1986; 69:1721.
31. Dingwell RT et al. *Vet Clin North Am Food Anim Pract* 2003; 19:235.
32. Williamson JH et al. *N Z Vet J* 1995; 43:228.
33. Mallard BA et al. *J Dairy Sci* 1998; 81:585.
34. Rajala-Schultz PJ et al. *J Dairy Sci* 2005; 88:577.
35. Bushe T, Oliver SP. *J Dairy Sci* 1987; 70:696.
36. Paape MJ et al. *J Dairy Sci* 1992; 75:1849.
37. Schukken YH et al. *J Dairy Sci* 1993; 76:2925.
38. Oliver SP et al. In: Proceedings of the International Mastitis Symposium, Indianapolis, IN, 1990:92.
39. Oliver J et al. *J Dairy Res* 1956; 23:204.
40. Oliver SP et al. *Int J Appl Res Vet Med* 2005; 3:150.
41. Waage S et al. *J Dairy Sci* 1998; 81:1275.
42. Waage S et al. *J Dairy Sci* 2001; 84:393.
43. Roberson JR et al. *J Dairy Sci* 1998; 81:687.
44. Berry EA, Hillerton JE. *J Dairy Sci* 2002; 85:112.
45. Osteras O et al. *J Vet Med B* 1994; 41:529.
46. Oliver SP et al. *J Vet Med B* 1997; 44:213.
47. Leslie KE et al. In: Proceedings of the 31st National Mastitis Council Meeting, 1992:234.
48. Browning JW et al. *Aust Vet J* 1994; 71:179.
49. Sol J et al. In: Proceedings of the International Mastitis Symposium, Indianapolis, IN, 1990:118.
50. Deluyker HA et al. *J Dairy Sci* 2005; 88:604.
51. Oliver SP et al. *Prev Vet Med* 1990; 9:301.
52. Sordillo LM et al. *J Dairy Sci* 1997; 80:1851.
53. Cassel BG. *J Dairy Sci* 1994; 77:2130.
54. Morin DE et al. *J Am Vet Med Assoc* 1998; 212:1423.
55. Erskine RJ. *Vet Clin North Am Food Anim Pract* 1993; 9:551.
56. Woolford MW et al. *N Z Vet J* 1998; 46:12.
57. Huxley JH et al. *J Dairy Sci* 2002; 85:551.
58. Godden S et al. *J Dairy Sci* 2003; 86:3899.
59. Goodger WJ et al. *J Am Vet Med Assoc* 1993; 202:1966.
60. Stott AW, Kennedy JOS. *Vet Rec* 1993; 133:495.
61. Leslie KE et al. In: Proceedings of the XIXth World Buiatrics Congress, Edinburgh, July 8-12 1996, vol 1:326.
62. Judge LJ et al. *J Dairy Sci* 1997; 80:3212.
63. Reneau JK, Packard VS. *Dairy Food Env Sanit* 1991; 11:4.
64. Allore HG et al. *J Dairy Sci* 1995; 78:1382.
65. Morse D. In: Proceedings of the Annual Meeting of the National Mastitis Council 1991:31.
66. Schukken YH et al. In: Proceedings of the Annual Meeting of the National Mastitis Council 1992:63.
67. Barkema HW et al. *J Dairy Sci* 1998; 1917.
68. Barkema HW et al. *J Dairy Sci* 1998; 81:411.

69. Fetrow J et al. *J Dairy Sci* 1988; 71:257.
70. Dohoo IR, Leslie KE. *Prev Vet Med* 1991; 10:225.
71. Godkin MA, Leslie KE. *Can Vet J* 1993; 34:601.
72. Reneau JK. *Compend Contin Educ Pract Vet* 1993; 15:497.
73. Elbers ARW et al. *J Dairy Sci* 1998; 81:420.
74. Murdough PA et al. *J Dairy Sci* 1996; 79:334.

## Miscellaneous abnormalities of the teats and udder

### LESIONS OF THE TEAT AND UDDER SKIN

Several diseases are characterized clinically by lesions of the skin of the teats and udder. These diseases are most common in dairy cattle and are of economic importance because teat lesions cause pain and discomfort during milking, and udder edema and udder rot are very common in heifers at calving.

The skin of the wall of the teat and the skin surrounding the teat canal orifice must be inspected closely in order to observe lesions and palpated in order to detect lesions covered by scabs. It may be necessary to superficially irrigate and gently wash teat lesions with warm 0.9% NaCl solution in order to see the morphology and spatial arrangement of the lesions. The entire skin of the cranial, lateral and posterior aspects of the udder should be examined by inspection and palpation. Lesions may be restricted to the lateral aspects of the udder and teats, as in photosensitization, or completely surround the teats, as in pseudocowpox.

In North America, the most common viral diseases of the teats of cattle, which result in vesicles or erosion of the teats, include pseudocowpox and bovine herpes mammillitis, with vesicular stomatitis occurring occasionally. The vesicular diseases of the teats are particularly important because they require differentiation from the exotic vesicular diseases such as foot-and-mouth disease. The appearances of the lesions of each of these diseases are similar, which makes clinical diagnosis difficult. However, in most cases, the morphological and epidemiological differences in the lesions in groups of animals aid in the diagnosis.

In pigs, **necrosis of the skin of the teats of newborn piglets** may occur in outbreak form. Abrasion of the nipples of baby pigs raised on rough nonslip concrete may be observed as acute lesions or be apparent only when the piglets mature and are found to have deficient teat numbers, as described under agalactia.

The skin of the mammary gland and teats of lactating ewes may be affected by the lesions of **contagious ecthyma**, which are transmitted from the lips of

suckling lambs. **Ulcerative dermatosis** of the teats in lactating ewes has lesions similar to those of herpes mammillitis in cows. It is a disease of housed ewes and may be initiated by bedding on infected straw. Mastitis and teat deformity are common sequels. The etiology varies from *Staphylococcus aureus* to coagulase-negative staphylococci or *Pasteurella* spp.<sup>1</sup>

### LESIONS OF THE BOVINE TEAT

**Traumatic injuries to teats** are very common and range from superficial lacerations to deep lacerations into the teat cistern with the release of milk through the wound. Accidental trampling of a teat by a cow may cause amputation of the teat.

**Chapping and cracking of the skin of the teats** is common in dairy and beef cattle. The cracks in the skin are often linear and multiple and are painful when palpated or when the milking machine teat cups are applied to the affected teats. Cracks of the skin of the teats initiated by milking machine action can be aggravated by environmental factors to create chapping of the teats. The condition is common when adverse weather conditions follow turn-out in spring. Linear lesions appear on the teat wall near the teat-udder junction and extend transversely around the teat. The addition of **10% glycerin** to the teat dip provides an excellent method of improving teat skin condition.

**Frostbite of teats** occurs in dairy cows housed outdoors during severely cold weather without adequate bedding. The skin of the teats is cold, necrotic and oozes serum. Usually the front teats are more severely affected than the rear teats because the latter are less exposed to adverse ambient temperatures.

**Teat end lesions** are common in dairy cattle.<sup>2</sup> Lesions include teat canal eversion, teat canal prolapse, prolapse of the meatus, eversion of the meatus and teat orifice erosion. Limited information is presently available as to the mechanism of development for these lesions and their clinical significance; one study found no association between the presence or absence of a teat end lesion and intramammary infection.<sup>2</sup>

It is normal to see a 2 mm wide white ring around each teat orifice of machine milked cows. The first stage of a teat orifice abnormality occurs when this ring undergoes hypertrophy, keratinization, and radial cracking. Progression leads to increased hypertrophy, secondary bacterial infection, scab formation, eversion of the distal teat canal and eventually teat orifice erosion. Improper milking machine function can produce teat orifice abnor-

malities. Excessive or fluctuating vacuum levels, faulty teat cup liners, incorrect pulsation ratios and other faults attributed to inadequate maintenance and careless use of milking machines have been shown to cause teat injury. A high milking vacuum combined with a relatively low pulsation chamber vacuum can result in bruising and hemorrhage of the teat end teat wall by the slapping action of the liner.

**Black spot (black pox)** is a sporadic lesion of the teat tip characterized by a deep, crater-shaped ulcer with a **black spot** in the center. Lesions occurring at the ends of the teats commonly involve the teat sphincter. This abnormality is caused in most cases by excessive vacuum pressure or overmilking in teats that are naturally firm and have pointed ends. There is no specific bacteriology, although *Fusobacterium necrophorum* is commonly present and *S. aureus* is frequently isolated from the lesions. The latter occur only on the teats and take the form of deep, crater-shaped ulcers with raised edges and a black spot in the center. The lesions are confined almost entirely to the tip of the teat, usually invade the sphincter and are responsible for a great deal of mastitis. Lesser lesions of teat sphincters are listed under vacuum pressure in bovine mastitis control.

The lesions are painful, leading to kicking by the cows, sometimes repeated kicking off of the teat cups, and to blockage of the sphincter. *Arcanobacterium pyogenes* mastitis is a common sequel.<sup>3</sup> The lesions are poorly responsive to treatment even if the machine error is corrected.

Treatment of black spot is usually by topical application of ointments: Whitfield's, 10% salicylic acid, 5% sulfathiazole and 5% salicylic acid, 5% copper sulfate are all recommended. An iodophor ointment, or iodophor teat dip with 35% added glycerol, is also effective but treatment needs to be thorough and repeated and milking machine errors need to be corrected.

**Thelitis** or inflammation of the tissues of the teat wall leading to gangrene is a common complication of gangrenous mastitis, most commonly associated with peracute *S. aureus* mastitis. The skin of the teats is cold, edematous and oozes serum. The subcutaneous aspects are commonly distended with gas. The skin is commonly dark-red to purple-black. Sloughing of the skin may be evident.

Inflammation of the wall of the teat (thelitis) is a nonspecific lesion usually associated with traumatic injury to the lining of the teat cistern. The wall of the cistern is thickened, hardened, painful and, in chronic lesions, irregular in its

internal lining. The lesion can be felt as a dense, vertical cord in the center of the teat tip. The lesions have historically been intractable to treatment, which usually consists of intramammary antibiotics and refraining from milking. The recent application of teat endoscopy has assisted in identifying cattle that are most likely to respond to medical or surgical treatment.

**Enzootic nodular thelitis** of alpine cows in Switzerland<sup>4</sup> is characterized by nodular lesions in the teat wall. The lesions are multicentric nodules containing atypical mycobacteria. A similar disease in French cattle is characterized by tuberculoid granulomas on the teats and lower udder that contain acid-fast mycobacteria, including *Mycobacterium terrae*.<sup>5</sup>

**Corpora amyloacea** are inert concretions of amyloid that may become calcified and detached from the mammary tissue so that they cause blockage of the teat canal and cessation of milk flow. They are formed as the result of stasis due to blocked mammary tissue ducts and resorption of the milk fluids.

**Papillomatosis of the teats** is caused by bovine papillomavirus and is characterized clinically by small, white, slightly elevated nodules of 0.3 cm diameter or elongated tags 1 cm long that are removable by traction.

**Pseudocowpox** is characterized clinically by painful localized edema and erythema with a thin film of exudate over the edematous area. Vesicle formation is uncommon. Within 48 hours of onset of signs, a small orange papule develops, shortly followed by the formation of an elevated, small, dark-red scab. The edges of the lesion then extend and the center becomes umbilicated; at 1 week the lesion measures approximately 1 cm in diameter. By 10 days the central scab tends to desquamate, leaving a slightly raised circinate scab commonly termed a 'ring' or 'horseshoe' scab. One teat may have several such lesions, which coalesce to form linear scabs. The majority of lesions desquamate by 6 weeks without leaving scars, although occasionally animals develop chronic infection.

**Photosensitization of the teats (photosensitive thelitis)** is a local manifestation of generalized photosensitization but occasionally photosensitive thelitis is the first clinical abnormality detected by the producer. There is a characteristic erythema and hardness of the unpigmented or white parts of the lateral aspects of each teat. The medial aspect is soft and cool. The teats are also painful and in the early stages apparently irritable, because affected cows will also stand in ponds or waterholes in such a way that the teats are immersed, and then

rock backwards and forwards. They will also brush the sides of the udder with the hind feet in a way that could suggest the stamping movements of abdominal pain. In cases where the photosensitization is related to the induction of parturition by the administration of corticosteroids, the skin lesions are usually restricted to the teats. In cases due to other causes there are usually obvious lesions of photosensitive dermatitis on the dorsal aspects of the body but confined to the white parts.

### LESIONS OF THE BOVINE TEAT AND UDDER

**Thermal burns of the skin of the udder and teats** may occur in mature cattle exposed to grass fires. The hairs of the udder and base of the teats are singed black. Thermal injury to the skin varies from marked erythema of the teats to blistering and necrosis and weeping of serum.

**Bovine herpes mammillitis** is characterized by the formation of variable-sized vesicles, severe edema and erythema of the teat with subsequent erosion of the teat epithelium. The vesicles rupture within 24 hours, and copious serous fluid often exudes from the dermis. Fever and depression are common, particularly in young animals. Scabs form over the lesions by the fourth day and the epithelium is re-established under the scab by the third week, although the trauma of milking may delay healing, especially when secondary infection occurs. Scar formation on recovery is uncommon. Lesions may be present on several teats and the base of the udder.

The epidemiology of infection within a herd is consistent with the presence of carrier animals, which may shed virus during times of stress, particularly in the periparturient period. There is a seasonal incidence of clinical disease that has been related to the activity and presence of insect vectors.<sup>6</sup> Experimental studies indicate that transmission requires virus inoculation at or below the level of the stratum germinativum of the teat or udder skin, and therefore trauma associated with milking, teat cracks or biting flies (such as *Stomoxys calcitrans*) is a requirement for infection to be transferred.<sup>7</sup>

Diagnosis is made on the basis of clinical signs in multiple animals. Virus may be isolated from aspirating the fluid from vesicles before they rupture. Serology has been performed in order to identify a three- to fourfold rising titer but is not widely available and many animals seroconvert early in the disease process.<sup>8</sup>

Treatment is general supportive, including the application of topical antiseptics. Cattle that develop a thickened

teat due to secondary bacterial infections are likely to develop clinical mastitis and treatment success of affected quarters is poor. Standard control measures for mastitis should be implemented, including isolation of clinically active cases. There is one report that suggested iodine-based teat dips are virucidal<sup>9</sup> and therefore may be of assistance in decreasing transmission.

### LESIONS OF THE BOVINE UDDER OTHER THAN MASTITIS

**Udder impetigo** associated with *S. aureus* is characterized by small, 2–4 mm diameter pustules at the base of the teats that may spread to involve the entire teat and the skin of the udder. This disease is of importance because of the discomfort it causes, its common association with staphylococcal mastitis, its not uncommon spread to milkers' hands and the frequency with which it is mistaken for cowpox. The lesions are usually small pustules (2–4 mm diameter) but in occasional animals they extend to the subcutaneous tissue and appear as furuncles or boils. The commonest site is the hairless skin at the base of the teats, but the lesions may spread from here on to the teats and over the udder generally. Spread in the herd appears to occur during milking and a large proportion of a herd may become affected over a relatively long period. The institution of suitable sanitation procedures, such as dipping teats after milking, washing of udders before milking and treatment of individual lesions with a suitable antiseptic ointment, as described under the control of mastitis, usually stops further spread. An ancillary measure is to vaccinate all cows in the herd with an autogenous bacterin produced from the *S. aureus* that is always present. Good immunity is produced for about 6 months but the disease recurs unless satisfactory sanitation measures are introduced.

What appears to have been an exaggerated form of this disease has been reported in a recently gathered herd of cows. It is assumed that the cows were very susceptible and that the *S. aureus* present was very virulent. In addition to the signs described above, there was a high prevalence of clinical mastitis and a generalized exudative epidermitis reaching from the escutcheon to the thighs.

Sores of bovine teat skin in Norway, characterized by the presence of *S. aureus* and referred to as 'bovine teat skin summer sore' are thought to be caused by cutaneous invasion by *Stephanofilaria* spp. nematodes. The differential diagnosis of discrete lesions on bovine teat skin is dealt with in the subject of cowpox.

**Udder rot (udder cleft dermatitis, flexural seborrhea)** of cattle occurs most

commonly in dairy heifers that have calved recently. Lesions are present in three locations: on the caudodorsolateral aspect of the udder where it comes into contact with the medial aspect of the thigh, between the halves of the udder (udder cleft dermatitis) or on the ventral midline immediately cranial to the udder. Lesions are usually detected during foot trimming or milking. Udder edema is believed to play an important role in development of lesions on the caudodorsolateral aspect of the udder, because these occur most commonly in periparturient dairy heifers. In contrast, udder cleft dermatitis occurs most commonly in older dairy cattle and the etiology remains uncertain.<sup>10</sup>

In lesions of all three anatomical sites, there is severe inflammation and a profuse outpouring of sebum. Extensive skin necrosis may develop, characterized by a prominent odor of decay. The irritation and pain of the caudodorsolateral lesion may cause the animal to appear lame when walking, and the animal may attempt to lick the affected part. Shedding of the oily, malodorous skin leaves a raw surface beneath, which heals in 3–4 weeks. Some animals with lesions on the caudodorsolateral aspect of the udder benefit from resolution of udder edema and mechanical debridement using a towel drawn repeatedly across the inguinal area. In advanced cases, a soft tissue curette is used to facilitate debridement of necrotic material. The efficacy of topical treatment is unknown. Lesions in the other two sites are usually asymptomatic.

**Blood in the milk** is usually an indication of a rupture of a blood vessel in the gland by direct trauma (such as getting caught on top of a wooden fence or the result of a kick) or more commonly by capillary bleeding in heifers with udder edema. Although in the latter circumstance the bleeding usually ceases in 2–3 days, it may persist beyond this period and render the milk unfit for human consumption. The discoloration varies from a pale pink to a dark chocolate brown and may still be present 7–8 days after parturition. Rarely, the blood loss may be sufficiently severe to require treatment for hemorrhagic shock (see Ch. 2).<sup>11</sup> Treatment is often requested, although the cow is clinically normal in all other respects. Intravenous administration of calcium borogluconate or parenteral coagulants is widely practiced but efficacy studies are lacking and it is difficult to believe that either treatment has therapeutic value. Difficulty may be experienced in milking the clots out of the teats, but they will usually pass easily if they are broken up by compressing them inside the teat. The presence of blood-

stained milk in all four quarters at times other than immediately postpartum should arouse suspicion of leptospirosis or diseases in which extensive capillary damage occurs. Cases of blood in the milk are usually sporadic in occurrence but there are records of herds with over 50% of cows affected. No clotting defects were evident.

## UDDER EDEMA

Edema of the udder at parturition is physiological but it may be sufficiently severe to cause edema of the belly, udder, and teats in cows and mares. In most cases the edema disappears within a day or two of calving, but if it is extensive and persistent it may interfere with sucking and milking. A 10-level scale of severity has been devised and could be applied in assessing the effects of treatment (Table 15.6).<sup>12</sup> Edema is a prominent sign in inherited rectovaginal constriction of Jersey cows, and is described under that heading.

**Udder edema is most severe in periparturient heifers**, and the mechanism for its development is not well understood. Hypoproteinemia is not a precursor of udder edema. It is a common recommendation that the amount of grain fed in the last few weeks of pregnancy be limited, and there is evidence that heavy grain feeding predisposes to the condition, at least in heifers. High sodium or potassium intakes increase the incidence and

severity of udder edema,<sup>13</sup> especially in housed cattle; the disease often disappears when cows are turned out to pasture. The tendency for udder edema may be heritable in some herds and selection against bulls that sire edematous daughters is thought to be worthwhile.<sup>14</sup> Such a tendency could be mediated through a complex interaction between sex steroids, which are thought to play a role in the etiology.<sup>15</sup> There is also a reduction in blood flow through, and an increase in blood pressure in, the superficial epigastric or milk veins of cows with chronic edema, through an unidentified mechanism.<sup>16</sup>

A mild form of udder edema is the presence of a hard localized plaque along the ventral abdomen immediately cranial to the udder after parturition in heifers. This is common and relatively innocuous but may interfere with milking or ventral abdominal surgical repair of a left displaced abomasum. If the mild udder edema occurs repeatedly over a number of lactations it may result in permanent thickening of the skin (scleroderma) of the lateral aspect of the udder.<sup>17</sup> Hot fomentations, massage and the application of liniments are of value in reducing the hardness and swelling. A chronic form of the disease is recorded from New Zealand but no credible etiological agent has been proposed.

If udder edema is severe, one or more of the following empirical treatments is recommended. Milking should be started some days before parturition, but colostrum from heifers should be discarded as it is likely to be of poor quality. After parturition, frequent milking and the use of diuretic agents is recommended. Corticosteroids appear to exert no beneficial effect. Acetazolamide (1–2 g twice daily orally or parenterally for 1–6 d) gives excellent results in a high proportion of cases, the edema often disappearing within 24 hours. Chlorothiazide (2 g twice daily orally or 0.5 g twice daily by intravenous or intramuscular injection, each for 3–4 d) is also effective. Furosemide is the most potent diuretic agent and should be administered parenterally (1 mg/kg BW, intramuscularly or intravenously; 5 mg/kg BW orally) in severe cases of udder edema,<sup>18–20</sup> but prolonged use can result in hypokalemia, hypochloremia and metabolic alkalosis. The use of diuretics before calving may be dangerous if considerable fluid is lost. When there is a herd problem, detection of the cause is often difficult.

An outbreak of udder edema in ewes has been recorded.<sup>21</sup> Affected animals were afebrile, bright and clinically normal except for the udder, which within 24 hours of lambing was white, cool, and firm, with edema. The milk was normal grossly and

laboratory tests detected no abnormalities. Most ewes recovered within 5–10 days of lambing.

Hard udder or indurative mastitis in goats is described under the heading of caprine arthritis–encephalitis, and that in ewes under maedi.

## RUPTURE OF THE SUSPENSORY LIGAMENTS OF THE UDDER

Rupture of the suspensory ligaments occurs most commonly in adult cows and develops gradually over a number of years. The cause is thought to be severe udder edema at calving, with excessive weight on the udder causing breakdown of the udder attachments, particularly the median suspensory ligament. The result is that the teats on affected cows are not vertically aligned but point more laterally. When rupture of the suspensory ligament occurs acutely, just before or after parturition, the udder drops markedly and is swollen and hard, the teats point laterally and serum oozes through the skin. Severe edema occurs at the base of the udder. The condition may be confused with gangrenous mastitis or abdominal rupture due to hydrops allantois on cursory examination. Partial relief may be obtained with a suspensory apparatus but complete recovery does not occur.

## AGALACTIA

The most important cause of agalactia in farm animals is mastitis–metritis–agalactia (MMA) in sows. The general principles that apply there apply also to the less common cases of agalactia that occur in all species. There is partial or complete absence of milk flow, which may affect one or more mammary glands. The condition is of major importance in gilts and sows, although it occurs occasionally in cattle. The importance of the disease in gilts and sows derives from the fact that piglets are very susceptible to hypoglycemia. The condition may be due to failure of letdown or absence of milk secretion.

The causes of **failure of letdown** include painful conditions of the teat, sharp teeth in the piglets, inverted nipples that interfere with sucking, primary failure of milk ejection, especially in gilts, and excessive engorgement and edema of the udder. In many sows the major disturbance seems to be hysteria, which is readily cured by the use of tranquilizing drugs. Treatment of the primary condition and the parenteral administration of oxytocin, repeated if necessary, is usually adequate.

**Ergotism** may be a specific cause of agalactia in sows and has been recorded in animals fed on bullrush millet infested with ergot.

TABLE 15.6 Score used in grading udder edema

Score	Definition
0	No edema apparent
1	Edema in the base of the udder around one or two quarters
2	Edema in the base of the udder around two or three quarters
3	Edema covering the lower half of the udder
4	Edema beginning to show in the midline and umbilicus
5	Extensive fluid accumulation along the midline and umbilicus
6	Edema covering entire udder. Median suspensory ligament crease has disappeared
7	Midline fluid accumulation extended to the brisket
8	Midline fluid accumulation extended dorsally. The subcutaneous abdominal vein is indistinguishable
9	Fluid accumulation extended to the thighs
10	Severe edema. Marked fluid accumulation in the vulva. Edema extensive in all of the areas mentioned above

Source: from Tucker WB et al. *J Dairy Sci* 1992; 75:2382.



Apparent **hormonal defects** do occur, particularly in cattle. Sporadic cases occur in which cows calve normally and have a normal udder full of milk but fail to let it down when stimulated in the normal way. A single injection of oxytocin is often sufficient to start the lactation. In rare cases repeated injections at successive milkings are required. There is one report of a number of cows in a herd being affected.<sup>22</sup> The cows were under severe stress for a number of reasons and had depressed serum cortisol levels. In heifers and gilts there may be complete absence of mammary development and, in such cases, no treatment is likely to be of value. In animals that have lactated normally after previous parturitions, the parenteral administration of chorionic gonadotrophin has been recommended but often produces no apparent improvement.

Mares grazing fescue may fail to lactate after parturition because of inhibition of prolactin release.

#### Milk drop syndrome

This is a herd syndrome in which the milk yield falls precipitately without there being any clinical evidence of disease, especially mastitis, or obvious deprivation of food or water. Heat stress (particularly the combination of heat and humidity), summer fescue toxicosis and leptospirosis due to *Leptospira hardjo* are among the more common causes.

#### 'Free' or 'stray' electricity as a cause of failure of letdown

Free electrical current is common in dairies, especially recently built ones. The problem is most common when a herd moves into a new shed but it also occurs with alterations to electrical equipment and wiring or with ordinary wear and tear to it. The stray current is present in the metallic part of the building construction, much of which is interconnected. Cows are very sensitive to even small amperages and are highly susceptible because they make good, often wet contact with the metal and with wet concrete on the floor. People working in the dairy are not likely to notice the electrical contact because they are usually wearing rubber boots. The voltage present would be too low to be of much interest to the local power authority, and an independent technician may be necessary to carry out the examination, which should be carried out while the milking machine is working. The effects of free electricity in the milking shed may be:

- Fatal electrocution, stunning causing unconsciousness, frantic kicking and bellowing, all manifested when the animal contacts the electrified metal, as set down under the heading of electrocution

**Table 15.7. Diagnosis of free electricity problems**

Normal	0-0.50
Suspicious	0.50-0.75
Mild reactions	0.75-1.50
Strong reactions	1.50-3.50
Critical reactions	3.50-5.0
Life at risk	5.0

- Restlessness, frequent urination, defecation, failure to let milk down, in tie-stalls frequent lapping at the water bowl but refusing to drink. The abnormal behavior may be apparent only when the cow is in a particular position or posture
- Startled, alert appearance with anxiety, baulking, refusal to enter the milking parlor
- Failure of letdown leads to lower milk production and recrudescence of existing subclinical mastitis leading to appearance of clinical signs.

In spite of the many field observations of these abnormalities experimental application of AC current up to 8 mA causes changes in behavior but not in milk yield or letdown.<sup>23</sup>

Recommended guidelines for a diagnosis of free electricity problems are set out in Table 15.7.<sup>24</sup> For simplicity it can be assumed that cows will behave abnormally if the free voltage exceeds 1V AC, although 2 V and a current of 3.6-4.9 mA does not reduce milk production.<sup>25</sup> A safer threshold is 0.35 V AC as a maximum.<sup>26</sup> A proper voltmeter is necessary to make a diagnosis and in most circumstances a qualified electrician is necessary for the exercise.

The development of voltages in the metalwork of the milking shed can arise from many factors. Obvious short circuits from faulty wiring are the least common cause. Most cases are due to accumulation of relatively low voltages because of increased resistance in the earth or ground system, thus neutral to earth voltages. Reasons for the accumulation include a poor earthing or grounding system, grounding rods that are too short to reach the water table, insufficient grounding rods, or dry seasons lowering the water table. The problem may be intermittent and even seasonal, depending on climatic conditions that facilitate the passage of current through the cow as an alternative grounding system.

#### NEOPLASMS OF THE UDDER

Neoplasms of the bovine udder are particularly rare and have moderate malignancy.<sup>27</sup> A fibrosarcoma originating within or close to a mammary gland has been observed to have high malignancy.<sup>28</sup>

Primary teat fibroma and fibrosarcoma in heifers have been satisfactorily treated by surgical excision.<sup>29</sup> Malignant mammary carcinoma occurs occasionally in mares.<sup>30</sup> A mammary adenocarcinoma and ovarian granulosa cell tumor have been recorded in an aged Toggenburg goat.<sup>31</sup> Neoplasms of the skin of the udder may spread to involve mammary tissue.

The commonest neoplasm of cows' teats is viral papillomatosis. It is esthetically unattractive and may play a part in harboring mastitis organisms on the teat skin. It is dealt with in detail under the heading of papillomatosis. Similar papillomata occur on the teat and udder skin of lactating Saanen goats. Rarely, these lesions may develop a squamous-cell carcinoma lesion of low malignancy.<sup>32</sup>

#### TEAT AND UDDER CONGENITAL DEFECTS

The common sporadic defects in cows are supernumerary teats, fused teats with two teat canals opening into one teat sinus, hypomastia, absence of a teat canal and sinus<sup>33</sup> and absence of a connection between the teat sinus and the udder sinus; in sows insufficient and inverted teats are the common errors. Supernumerary teats are common (up to 33%) in Simmental and Brown Swiss heifers and are removed surgically.<sup>34</sup> A high prevalence of defects is recorded in Murrah buffaloes<sup>35</sup> and inheritance of hypomastia, rudimentary teats and angulation of teats is suspected in cows.<sup>36</sup>

Traditionally sows are required to have at least 12 functional teats<sup>37</sup> and sows deficient in this regard are likely to be culled. Reasons for the deficit include inherited shortage (teat number is highly heritable), misplaced teats (usually too far posteriorly to be accessible to the piglets) or unevenly placed, inverted teats, either congenital or acquired as a result of injury, vestigial nipples that do not acquire a lumen, cistern or gland, and normal-sized teats that are occluded. Inverted teats in sows may be so because they lack a teat upturn, the teat duct opening directly into the mammary gland cistern.<sup>38</sup>

#### REVIEW LITERATURE

- Francis P.G. Teat skin lesions and mastitis. *Br Vet J* 1984; 140:430.
- Sieber RL, Farnsworth RJ. Differential diagnosis of bovine teat lesions. *Vet Clin North Am Large Anim Pract* 1984; 6:313-321.
- Al-Ani FK, Vestweber JGE. Udder edema; an updated review. *Vet Bull* 1986; 56:763-769.

#### REFERENCES

1. Gunning RF, Davies CHV. *Vet Rec* 1989; 125:490.
2. Sieber RL, Farnsworth RJ. *J Am Vet Med Assoc* 1981; 178:1263.
3. Ogden NH. *Vet Rec* 1986; 118:674.
4. Rusch P et al. *Schweiz Arch Tierheilkd* 1984; 126:467.

5. Thorel MT et al. *Vet Dermatol* 1990; 1:165.
6. Gibbs EPJ et al. *Res Vet Sci* 1973; 14:139.
7. Gibbs EPJ et al. *Res Vet Sci* 1973; 14:145.
8. O'Connor M et al. *Ir Vet J* 1994; 47:168.
9. Martin WB, James ZH. *Vet Rec* 1969; 78:100.
10. Warnick LD et al. *J Am Vet Med Assoc* 2002; 221:273.
11. Eddy RG, Clark PJ. *Vet Rec* 1982; 110:482.
12. Tucker WB et al. *J Dairy Sci* 1992; 75:2382.
13. Nestor KE et al. *J Dairy Sci* 1988; 71:366.
14. Dentine MR et al. *J Dairy Sci* 1983; 66:2391.
15. Malvern PV et al. *J Dairy Sci* 1983; 66:246.
16. Al-Ani FK et al. *Vet Rec* 1985; 116:156.
17. Nicholls TJ, Rubira RJ. *Aust Vet J* 1981; 57:54.
18. Vestweber JGA. *Am J Vet Res* 1987; 48:673.
19. Vestweber JGA et al. *Am J Vet Res* 1989; 50:1323.
20. Grunder HD, Bruning G. *Berl Munch Tierarztl Wochenschr* 1966; 5:81.
21. Grant DA. *Vet Rec* 1996; 138:168.
22. McCaughan CJ, Malecki JC. *Aust Vet J* 1981; 57:203.
23. Drenkard DVH et al. *J Dairy Sci* 1985; 68:2694.
24. Williams GFH et al. *Proceedings of the 20th Annual Meeting of the National Mastitis Council* 1981:13, 18, 25, 31, 36.
25. Southwick LH et al. *J Am Vet Med Assoc* 1992; 201:441.
26. Appleman RD, Gustafson RJ. *J Dairy Sci* 1985; 68:1554.
27. Beamer PD, Simon J. *Vet Pathol* 1983; 20:509.
28. Orr JP. *Can J Comp Med* 1984; 48:219.
29. Ford TS et al. *J Am Vet Med Assoc* 1989; 195:238.
30. Munson L. *J Am Vet Med Assoc* 1987; 191:71.
31. Cooke MM, Merrill M. *N Z Vet J* 1992; 40:31.
32. Ficken MD, Andrews JJ. *J Am Vet Med Assoc* 1983; 183:467.
33. Duraes MC et al. *J Dairy Sci* 1982; 65:1804.
34. Von Steiger HU, Grunenfelder R. *Simmentaler Fleckvieh* 1988; 5:86.
35. Rao AVN, Murthy TS. *Indian Vet Med J* 1983; 7:217.
36. Crinion RAP. *Ir Vet J* 1984; 38:116.
37. Done JT. *Vet Annu* 1980; 20:246.
38. Gunther C et al. *Zuchungskunde* 1985; 57:256.

## Mastitis-metritis-agalactia syndrome in sows

The mastitis-metritis-agalactia (MMA) syndrome (also called toxic agalactia, farrowing fever, lactation failure, periparturient hypogalactia syndrome (PHS), or postpartum dysgalactia syndrome (PPDS)) occurs in sows between 12 and 48 hours (sometimes 72 h) after farrowing and is characterized clinically by anorexia, lethargy, restlessness, lack of interest in the piglets, fever, swelling of the mammary glands and agalactia. Most affected animals respond to therapy within 12–24 hours. Pathologically, there are varying degrees of mastitis. In some sows the level of oxytocin may be half the level in unaffected sows. The disease is of major economic importance when outbreaks occur because the inadequate milk production leads to high piglet mortality from starvation and secondary infectious diseases. In cases of subclinical MMA there is often a failure to achieve weaning weights (<4 kg at 24 d). The term mastitis-

metritis-agalactia was originally developed to describe sows with agalactia that had swollen udders, assumed to be due to mastitis, and the appearance of a vulval discharge, assumed to be due to metritis. Necropsy of spontaneously occurring cases has frequently confirmed the presence of mastitis but the incidence of metritis has been insignificant.

The prevalence of the condition appears to have reduced recently with the increased attention to hygiene in the farrowing house and the use of more porous and less traumatic floorings. When it does occur it can be quite common, with up to 11–58% of the sows being affected.<sup>1</sup> A recent case definition<sup>2</sup> suggests that the pathognomonic signs are poor piglet growth and sow rectal temperatures greater than 39.5°C.

### ETIOLOGY

The etiology is unclear. Several different cause-and-effect relationships have been proposed, based on clinical and epidemiological observations, but only infectious mastitis has been substantiated. The list of proposed causes includes infectious mastitis, metritis, overfeeding during pregnancy, nutritional deficiencies, constipation and endocrine dysfunction. The composite view of this is that there are potential sources of bacterial infection with subsequent endotoxin absorption that lead to the subsequent systemic signs. There is a very considerable farm effect in the appearance of the condition as sow care and management are so important.

A major problem in the determination of the etiology is the difficulty of being precise in the description of the clinical findings of the abnormal mammary glands of affected sows. The common clinical findings are:

- Swelling of the glands
- Agalactia
- Toxemia
- Fever.

There is considerable overlap in the clinical findings from one affected sow to another but the lesion present in the mammary glands may vary from uncomplicated physiological congestion and edema to severe necrotizing mastitis.

Ringarp<sup>3</sup> published the classic work on this disease based on 1180 cases of postparturient illness in sows in which agalactia was present. At least five causes of agalactia or hypogalactia were recognized which are as follows (the incidence of each group as a percentage of the total cases is given in brackets):

- **Eclampsia** (0.6%), usually of older sows, responding to calcium and magnesium therapy
- **Failure of milk ejection reflex** (3.3%), affecting primarily first-litter

gilts and usually treated satisfactorily with oxytocin

- **Mammary hypoplasia** (1.5%) in gilts, resulting in deficient milk secretion
- **Primary agalactia** (6%), in which reduced milk supply is the only abnormality
- **Toxic agalactia** (88.6%), the most important numerically and economically. It is characterized by anorexia, depression, fever, swelling of the mammary glands and a course of 2–4 days. Mastitis was commonly present but there was no evidence of metritis.

Infectious mastitis is suggested as a major cause in many clinicopathological investigations and there is a greater incidence of intramammary infection in affected sows compared to normal sows. Peracute mastitis in sows is readily recognized as a clinical entity but less severe infections may result in small foci of inflammation within the gland that cannot be detected on clinical examination.

*Escherichia coli* and *Klebsiella pneumoniae* have been recovered from the mammary glands of naturally affected cases and both bacterial species are associated with histopathological changes of mastitis. Experimental intramammary inoculation of sows with field isolates of *E. coli* and *K. pneumoniae* has resulted in cases of lactation failure and mastitis that closely resemble naturally occurring cases. Unfortunately, they cannot always be demonstrated in the plasma of affected sows and neither can endotoxin. *Streptococcus* spp. and *Staphylococcus* spp. have also been isolated, but these are frequently isolated from healthy glands unassociated with pathological changes. It is unlikely that *Mycoplasma* spp. are important.

Coliforms are the most significant pathogens isolated from sows with mastitis. Pathological examination of affected sows that were euthanized within 3 days after parturition revealed the presence of varying degrees of mastitis, and *E. coli* and *Klebsiella* spp. were the most common organisms recovered. A recent study has shown that *E. coli* strains from mastitis in sows are highly variable in serotype, biochemical profile, virulence factors and random amplified polymorphic DNA (RAPD) type. No relationship between serotypes, virulence factors and RAPD types was found.<sup>4</sup> Toxic agalactia can be produced experimentally by the introduction of *E. coli* endotoxin into the mammary gland of sows at parturition. The clinical, hematological, and serum biochemical changes are similar to those that occur in naturally occurring cases of

toxicagalactia. *E. coli* endotoxin acting at the level of the hypothalamus can suppress prolactin release, which results in a pronounced decline in milk production. Experimental *Klebsiella* mastitis in sows is an excellent model for the study of toxicagalactia due to infectious mastitis.

Agalactia may also be the result of a deficiency of prolactin. Prolactin levels may be dramatically reduced by even the smallest amounts of endotoxin. Any factor that interferes with the release of prostaglandin from the uterus may affect the increase in prolactin that must occur to stimulate lactogenesis immediately prior to parturition.<sup>5</sup>

In summary, field observations have suggested many different causes and predisposing factors, including infectious mastitis, nutritional disturbances, metabolic disorders and the stress of farrowing in total confinement in a crate. Based on the examination of spontaneously occurring cases, infectious mastitis appears to be a major cause. Both prolactin and oxytocin release can be stopped by stressors and toxins from bacteria such as *E. coli*.

## EPIDEMIOLOGY

### Occurrence

The disease occurs most commonly in sows at farrowing or within the first 48 hours after parturition. It is most common in sows that farrow in crates indoors and only occasionally occurs in sows farrowing outdoors, which may be a reflection of the greater number of pigs raised in confinement. A peak incidence during the summer months has also been observed. The disease will often occur in one batch and then disappear again for months, which suggests that some unidentified factor may be affecting a whole group.

### Morbidity and case fatality

Morbidity and mortality data are not readily available nor precise because of the difficulty of making a reliable clinical diagnosis. Epidemiological observations indicate that the risk of sows developing toxic mastitis increases with increasing age up to the third or fourth litter. The population incidence of toxicagalactia ranges from 4–10% of all farrowings while the herd incidence may vary from 0–100%. Some surveys report an overall incidence of 6.9% of all farrowings with a range from 1.1% to 37.2%. The incidence rates in Swedish herds ranges from 5.5% in small herds to 10.3% in large herds.<sup>6</sup> In Denmark, an incidence rate of 9.5% from a total of 80 000 farrowings, independent of herd size, has been reported.<sup>6</sup> In a survey of 70 herds in Norway over a period of 2 years, the incidence rate was about 17.5%<sup>7</sup> and there was no consistent

relationship between disease incidence and herd size.<sup>8,9</sup> Sporadic outbreaks of the disease may occur in which almost all sows farrowing over a period of several weeks or a few months may be affected and then suddenly no further cases develop for no apparent reason.

The fatality rate is usually less than 2%, but piglet losses due to starvation and crushing may be as high as 80%. It is not a major cause of sow mortality.<sup>10</sup> The disease does not usually recur in the same animal, which may suggest that immunity develops and possibly that affected sows should not necessarily be culled because of the disease.

### Risk factors

The risk factors that have been proposed based on field observations include overfeeding during pregnancy, a drastic change of feed at farrowing, insufficient time for the sow to adjust to the farrowing crate after being transferred from the gestation unit and constipation of the sow at farrowing.

### Animal risk factors

The initiating factors have not been identified. The incidence of the disease may also be higher in sows with larger litters than sows in the same herd that remain healthy, and in those with a higher number of stillbirths and pigs found dead after birth.<sup>6</sup>

Each section of the mammary gland of the sow is divided into a separate anterior and posterior section, each with its own teat cistern and teat canal. In a sow with 14 teats there are 28 potential portals of entry for environmental infectious agents and perhaps it is little wonder that mastitis should occur commonly immediately after parturition when the teat canals have become patent. Bacteria in the gut and in endometritis have been proposed as a source of endotoxin, particularly as **beta-hemolytic streptococci** and coliforms have been associated with the condition.

Some clinicopathological examinations of affected sows have revealed the presence of a slightly enlarged, flaccid uterus from which coliform and streptococcal organisms can be recovered. However, pathological evidence of metritis in affected sows is uncommon; the organisms that can be recovered are commonly present in the reproductive tract of normal sows after parturition and their recovery from vaginal mucus is difficult to interpret.

Constipation of sows at farrowing time has been suggested as a cause but has not been substantiated. However, clinical and pathological examinations of both spontaneously occurring cases of toxicagalactia and experimental toxicagalactia induced by the

introduction of *E. coli* endotoxin into the mammary gland have been unable to support the observation of constipation. Both sick and normal sows defecate less frequently from 1 day before farrowing until 2 days later. There is no difference in the weight of feces in the terminal colon and rectum between sick and normal sows. Low exercise has also been suggested as a cause and this also contributes to constipation. The role of water intake or lack of it and stress or disturbance during parturition has also not been investigated.

The nursing behavior of the sow and the sucking behavior of the piglets may provide an explanation for the pathogenesis and clinical findings of some cases of toxicagalactia in sows. Successful ejection of milk by the sow is dependent on proper stimulation of the sow's udder by the piglets followed by a complex response by the sow. A period of time ranging from 15–45 minutes must elapse from the last successful milk ejection to the next. Failure of milk ejection may occur in up to 27% of sows that attempt to suckle their piglets within 40 minutes after the previous milk ejection. The failure of milk ejection in sows within the first few crucial adjustment days after farrowing might possibly contribute to the cause of mastitis and engorgement of the mammary glands. The possible causes of failure of milk ejection, even when a suitable interval has elapsed since the previous milk ejection, include:

- Environmental or other animal noises and disturbances
- Uncomfortable farrowing crates
- High environmental temperatures
- Insufficient time to adjust to the farrowing crate.

### Management and dietary factors

The disease occurs under management, environmental and sanitation conditions ranging from very poor to excellent; however, the possible relationship between the level of bacterial contamination in the farrowing barn and on the skin of the sow and the incidence of the disease has apparently not been examined. Dirty conditions greatly increase the bacterial contamination of the udder.

Digestive disturbances and certain feeding practices have been associated with the disease. Sows that have been on high-level feeding during pregnancy appear to be susceptible to the disease, especially if they are subjected to a change of feed immediately prior to parturition. Also, any management practice that results in a marked change in feed intake at or near farrowing may appear to precipitate the disease. A sudden change of feed severe enough to result in gastrointestinal stasis has

been used to reproduce the condition experimentally.

The effects of different feed allowances during late pregnancy may affect the incidence rate of the disease. Feeding sows during the last 15 days of gestation a diet at a level of 3.4 kg daily compared to 1.0 kg daily resulted in an incidence rate of 26.6% and 14.0%, respectively.<sup>6</sup> The explanation for the effects of feeding is unknown. It has been proposed that intense feeding may promote toxin production in the alimentary tract but how this is related to mastitis is unknown. Another hypothesis suggests that increased feeding in late gestation may intensify the initiation of lactation and result in udder engorgement and increased susceptibility to intramammary infection.<sup>6</sup> A further suggestion is that moldy food may play a part, but this has never been proved.

The clinical status of the mammary glands, the bacteriological findings and the total cell count and its percentage of polymorphonuclear leukocytes and pH in colostrum and milk secretion during the first 3 weeks of lactation of sows on high or low feeding regimes during late pregnancy have been examined.<sup>11</sup> *E. coli* infection was present in 80% of the sows affected with toxic agalactia and 30% of the healthy sows. The *E. coli* were eliminated at between 3 and 8 days of lactation and were not isolated from sows examined at the time of weaning.<sup>12</sup> The different feeding regimes did not influence the total cell count, the polymorphonuclear cells or the pH in milk from bacteriologically negative glands or glands with *E. coli* mastitis. The two feeding regimes had no influence on total cell count, the percentage of polymorphonuclear cells or the pH of colostrum and milk of healthy sows.<sup>13</sup>

#### **PATHOGENESIS**

The pathogenesis of infectious mastitis due to *E. coli* or *Klebsiella* spp. is probably similar to that of bovine mastitis in which the infection gains entry through the teat canal and invades the mammary tissue causing mastitis. Endotoxemia occurs accounting for the fever initially, and the depression, anorexia and agalactia, even in glands that are unaffected.<sup>14</sup> The lipopolysaccharide endotoxins acting at the level of the hypothalamus and hypophysis suppress the release of prolactin which results in a marked decline in milk production.<sup>15,16</sup> The endotoxin may also have a direct inhibitory effect on the mammary gland. There is a higher prevalence of bacterial endotoxin in the blood of affected sows compared to control animals. The endotoxin can be detected in the blood of about 33% of sows affected with coliform mastitis.<sup>14</sup> However, the

oral administration of endotoxin daily to prepubertal gilts did not result in any clinical abnormalities.<sup>17</sup> Experimentally, mastitis can be produced in sows by contamination of the skin of the teats with *K. pneumoniae* either shortly before or after parturition. The clinical signs are similar to those described for MMA; mastitis is present in more than 50% of the mammary gland subsections and a marked leukopenia and degenerative left shift occurs. A total of 120 organisms is sufficient to produce the mastitis when the organisms are inoculated into the teats. In recent experimental infections with *E. coli* it was shown that the time of infection of the mammary gland relative to parturition and the number of circulating neutrophils at the time of infection influenced the development of clinical coliform mastitis in the sow.<sup>18</sup> Similarly parturition allows the penetration of vaginal organisms further up the reproductive tract and the absorption of endotoxin reduces F2 $\alpha$  in the uterus and this stimulates prolactin, which may contribute to the hypogalactia and agalactia.

If noninfectious acute painful swelling of the mammary glands accompanied by agalactia occurs in the sow as a result of the possible noninfectious factors that were described earlier, the pathogenesis is unclear. It is difficult to synthesize a pathophysiological mechanism that would explain how stress, overfeeding, changes in diet or constipation could result in acute swelling of the mammary gland in sows.

#### **CLINICAL FINDINGS**

Sometimes there may be a delay in parturition of more than 5 hours. The sow is usually normal, with a normal milk flow, for the first 12–18 hours after farrowing. Normally, the sow will suckle her piglets for about 20 seconds once an hour. One of the first indications of the disease is the failure of the sow to suckle her piglets. She is uninterested in the piglets, generally lies in sternal recumbency and is unresponsive to their squealing and sucking demands. Litters of affected sows are more noisy and are generally scattered around the pen searching for an alternative food supply. Such piglets may drink surface water or urine in the pen and infectious diarrhea may occur. If sucking is permitted, it does not progress from the vigorous nosing phase to the quiet letdown stage, and it is accompanied by much teat-to-teat movement by the piglets. Many piglets may die from starvation and hypoglycemia. A failure to grow at more than 105 g/d is a sure sign of piglet problems. Some sows are initially restless and stand up and lie down

frequently, which contributes to a high mortality from crushing and trampling.<sup>19,20</sup>

Affected sows do not eat, drink very little and are generally lethargic. The body temperature is usually elevated and ranges from 39.5–41°C (103.1–105°F), especially if there is mastitis. Mild elevations in body temperatures of sows in the first 2 days after parturition are difficult to interpret because a slight elevation occurs in normal healthy sows.<sup>21</sup> This is known as uncomplicated farrowing fever. However, temperatures above 40°C (104°F) are usually associated with acute mastitis that requires treatment. One detailed investigation of the disease in Sweden concluded that 78% of sows with a temperature exceeding 39.5°C had clinical evidence of mastitis. It is suggested that a temperature of 39.4°C at 12–18 hours after farrowing is an appropriate threshold at which to give preventive treatment for the disease. The heart and respiratory rates are usually increased.

Initial temperatures greater than 40.5°C (104.9°F) are usually followed by severe illness and toxemia. Normally, the sows get better within 3 days, but not always if the temperature is very high.

The characteristic findings are present in the mammary glands and consist of varying degrees of swelling and inflammation. In most cases, several sections are affected, which results in the appearance of diffuse involvement of the entire udder. Individual sections are enlarged, warm and painful, and may feel 'meaty' and lack the resilience of normal mammary tissue. There may be extensive subcutaneous edema around and between each section, which results in a ridge of edema on the lateral aspects of the udder extending for its entire length. The skin overlying the sections is usually reddened and is easily blanched by finger pressure. The teats are usually empty and may be slightly edematous. A few drops of milk may be expressed out of some teats after gentle massage of the section or the administration of oxytocin but rarely can a normal stream of milk be obtained. In severe cases of mastitis the milk contains flakes and pus or is watery.

The feces are usually scant and drier than normal but whether or not constipation is present in most cases is uncertain. The inappetence and anorexia and failure to drink normally could account for the reduced volume of feces. Constipation with impaction of the rectum with large quantities of feces is uncommon in sows and when it does occur as the only abnormality it has little effect on appetite and milk production.

A vaginal discharge is normal following parturition, and normal sows frequently expel up to 50 mL of a viscid, nonodorous,

clear mucus that contains variable amounts of white material within the first 3 days following farrowing. Tenacious strands of this discharge may also be observed within the vagina. The presence of this discharge has been misleading and has been interpreted as evidence of the presence of metritis. Necropsy examination after euthanasia of affected sows has failed to reveal evidence of significant metritis. The clinical diagnosis of metritis in sows is difficult but generally large quantities of dark-brown, foul-smelling fluid are expelled several times daily, accompanied by severe toxemia. This is uncommon in sows. Diagnosis is usually on clinical signs.

## CLINICAL PATHOLOGY

### Examination of milk

The number of somatic cells in the milk from sows with mastitis will range from  $2\text{--}20 \times 10^9/\text{mL}$  compared to the normal of less than  $2 \times 10^9/\text{mL}$ . Significant numbers of bacteria are present in the milk of more than 80% of sows with toxic agalactia. Milk obtained for laboratory examination and culture should be taken after thorough cleaning and disinfection of the teats to minimize contamination by skin flora. However, because mastitis may be present in only one or a few of the mammary gland subsections in the sow and because it is often impossible to clinically identify affected subsections and distinguish them from unaffected adjacent glands, which may be swollen and agalactic because of continuous swelling, a valid assessment of intramammary infection is not possible unless milk samples are obtained from each subsection. Subclinical mastitis may not be easy to detect with cells not reaching  $2 \times 10^9/\text{mL}$  but 75% may be polymorphs. Normally, milk is around  $1 \times 10^9/\text{mL}$ .

### Hematology and serum biochemistry

Some hematological and biochemical changes are present in affected sows but may not be marked enough to be a routine reliable diagnostic aid. In severe cases of infectious mastitis, a marked leukopenia with a degenerative left shift is common. In moderate cases there is a leukocytosis and a regenerative left shift. The serum biochemical changes that occur in naturally occurring cases and in the experimental disease are recorded. The plasma cortisol levels are commonly elevated, which may be due to a combination of the stress of parturition and infectious mastitis. The plasma protein-to-fibrinogen ratio is lower than normal and the plasma fibrinogen levels are commonly increased in severe cases that occur 8–16 hours after parturition.

## NECROPSY FINDINGS

Neither lesions in the udder nor the reproductive tract are consistent. If they

are found, the most important lesions are in the mammary gland. There may be extensive edema and some slight hemorrhage of the subcutaneous tissue. Grossly, on cross-section of the mammary tissue there is focal to diffuse reddening and often only one subsection of a mammary gland may be affected. Histologically, the mastitis may be focal or diffuse in distribution and the intensity of the lesion varies from a mild catarrhal inflammation to a severe purulent and necrotizing mastitis usually involving more than 50% of all the mammary glands. There are no significant lesions of the uterus when compared with the state of the uterus in normal healthy sows immediately after parturition. The adrenal gland is enlarged and heavier than normal, presumably due to adrenocortical hyperactivity. In a series of spontaneous cases, *E. coli* and *Klebsiella* spp. were most commonly isolated from the mammary tissues. The abscesses of the mammary glands of sows examined at slaughter are not sequelae to coliform mastitis but rather probably due to injuries and secondary infection.

### Samples for confirmation of diagnosis

- Bacteriology – mammary gland, regional lymph node
- Histology – formalin-fixed mammary gland.

## DIFFERENTIAL DIAGNOSIS

The characteristic clinical findings in toxic mastitis and agalactia are a sudden onset of anorexia and lack of interest in the piglets, acute swelling of the mammary gland, hypogalactia or agalactia, a moderate fever and a course of about 2 days. The mammary secretion from mastitic glands may be watery or thickened and contain pus, and the cell count will be increased up to  $20 \times 10^9/\text{mL}$ . The acute swelling and agalactia of infectious mastitis must be differentiated from other non-infectious causes of acute swelling or 'caking' of the mammary glands, which also results in agalactia as follows:

- **Agalactia due to a failure in milk letdown** is most common in first-litter gilts and is characterized by a fullness of the mammary glands but an inability of the gilt to suckle her piglets in spite of her grunting at them. The gilt is usually bright and alert and systemically normal. The response to oxytocin is dramatic and repeat treatment is rarely necessary
- **Farrowing fever** is characterized clinically by loss of appetite, inactivity and a body temperature of  $39.3\text{--}39.9^\circ\text{C}$  ( $102.7\text{--}103.8^\circ\text{F}$ ) with minimal detectable changes of the mammary gland

- **Parturient psychosis of sows** is characterized by aggressive and nervous behavior of the sow after the piglets are born. The sow does not call the piglets and does not allow them to suck. When the piglets approach the sow's head, she will back away, snap and make noisy staccato nasal expirations. Some sows will bite and kill their piglets. The mammary gland is usually full of milk but the sow will not let it down. Ataractic drugs and/or short-term general anesthesia are indicated and the response is usually excellent. Some sows need repeated tranquilization or sedation for the first few days until the maternal–neonatal bond is established
- **Other causes of agalactia** accompanied by enlargement of the mammary gland include **inherited inverted teats** and **blind teats** due to necrosis of the teats occurring when the gilt was a piglet. These are readily obvious on clinical examination. The sharp needle teeth of piglets may cause the sow to refuse to suckle her piglets. The sow attempts to suckle but leaps up suddenly, grunting and snapping at the piglets. The piglets squeal and fight to retain a teat, thus causing more damage to the teats, which is obvious on clinical examination. Other causes of agalactia accompanied by systemic illness include **retained piglets** and infectious disease such as outbreaks of **transmissible gastroenteritis** and **erysipelas**. The common causes of agalactia in pigs where there is lack of mammary development include **ergotism**, **immature gilts** and **inherited lack of mammary development**. These are set out in Figure 15.1.

## TREATMENT

Most affected sows will recover within 24–48 hours if treated with a combination of antimicrobials, oxytocin and anti-inflammatory agents. The treatment should begin when the temperature reaches  $39.4^\circ\text{C}$ .<sup>22</sup>

**Antimicrobials** are indicated in most cases because infectious mastitis and metritis are the two most common causes of the disease. The choice is generally determined by previous experience in the herd or region but broad-spectrum antimicrobials are indicated because *E. coli* and *Klebsiella* spp. are the most common pathogens involved. They should be given daily for at least 3 days.<sup>23</sup> Usually ampicillin, tetracyclines, trimethoprim–sulphonamide, or enrofloxacin is used.

As soon as possible after the disease is recognized every effort must be made to restore normal mammary function through the use of oxytocin and warm water massaging of the affected mammary glands.

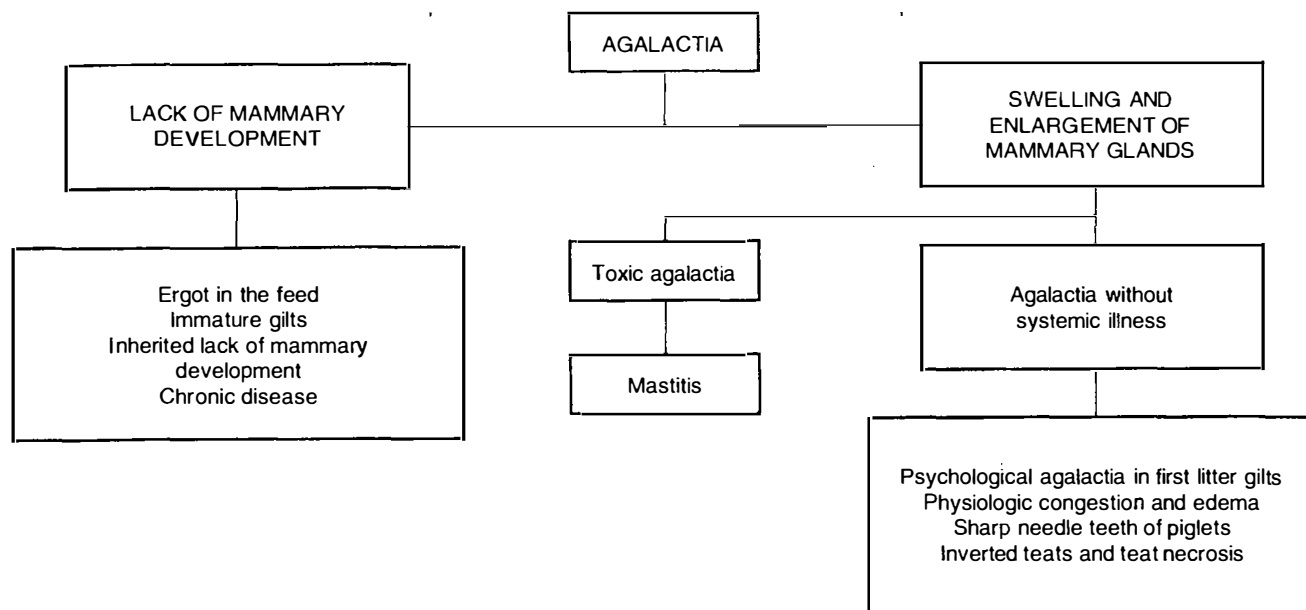

Fig. 15.1 The causes of porcine agalactia.

**Oxytocin** 30–40 U intramuscularly or 20–30 U intravenously, is given, frequently, to promote the letdown of milk. If there is a beneficial response the piglets should be placed on the sow if she is willing to allow them to suck. This will assist in promoting milk flow. Massage of the mammary glands with towels soaked in warm water and hand milking for 10–15 minutes every few hours may assist in reducing the swelling and inflammation and promote the flow of milk. It will also relieve the pain and encourage the sow to suckle her piglets. Intramuscular injections of oxytocin may be repeated every hour, along with massaging of the glands with warm water. Failure of milk letdown or a low response following the use of oxytocin may be due to a reduced sensitivity of the sow to oxytocin during the first week of lactation. In the normal, healthy sow the peak response to oxytocin occurs in the second week of lactation and gradually decreases to a low response at the eighth week.

The use of a long-acting carba oxytocin analog is being explored as a possible substitute for oxytocin. Oxytocin has an effect for about 14 minutes, while the analog has an effect for about 6 hours. Preliminary results of its use in agalactic sows indicate superior results compared to oxytocin.

Anti-inflammatory agents are in common use for their anti-inflammatory effect but are rarely used on their own; flunixin meglumine has been shown to be beneficial and ketoprofen to alleviate pyrexia and endotoxemia. Recently, meloxicam and oxytocin were shown to reduce mortality compared to flunixin only.<sup>24</sup> Plasma cortisol levels are increased

in the experimental disease and for this reason may be contraindicated. However, field reports suggest that their use along with antimicrobials and oxytocin provides a better response than when they are not used. Corticosteroids used alone do not appear to prevent the disease or enhance recovery. To be effective they must be used in combination with antimicrobials and oxytocin. Dexamethasone at the rate of 20 mg intramuscularly daily for 3 days for sows weighing 150–200 kg has been recommended.

#### Supplementation of piglets

The hypoglycemic piglets must be given a supply of milk and/or balanced electrolytes and dextrose until the milk flow of the sow is resumed, which may take 2–4 days, and most important of all must be kept warm until body reserves are re-established. Piglets should receive 300–500 mL of milk per day divided into hourly doses of 40–50 mL given through a 12–14 French plastic tube passed orally into the stomach. A solution of balanced electrolytes containing 5% glucose can also be given for 1–2 days if a supply of cows' milk is not available. Condensed canned milk diluted with water 1:1 is a satisfactory and readily available supply of milk. In severe cases where the return to milk production and flow are unlikely, the piglets should be fostered on to other sows. If these are unavailable, the use of milk substitute fortified with porcine gammaglobulin is recommended to prevent the common enteric diseases. This is discussed under colibacillosis. Many more piglets are treated for diarrhea when the sows are treated for MMA, perhaps up to 19% compared to up to 9% normally.<sup>1</sup>

#### CONTROL

It has been difficult to develop a rational approach to control because the disease has been considered to be a complex syndrome caused by several different factors. However, the control of infectious mastitis would seem to be of major importance. The routine use of antibiotics and oxytocin without indication does not appear to be helpful.<sup>24</sup> Farrowing crates should be vacated, cleaned, disinfected and left vacant for a few days before pregnant sows are transferred from the dry sow barn and placed in the crates. Pregnant sows should be washed with soap and water before being placed in the crate. Farrowing crates must be kept clean and hosed down if necessary, particularly a few days before and after farrowing to minimize the level of intramammary infection. In problem herds, it may be necessary to wash and disinfect the skin over the mammary glands immediately after farrowing. All in/all out in the farrowing area with proper cleaning and disinfection facilitated by batch farrowing will reduce the disease. An opportunity for exercise will help, as under outdoor conditions (sows in paddocks) the condition is rare.

To minimize the stress to the sow of adjusting to the farrowing crate and the farrowing facilities, the sow should be placed in the crate at least 1 week before the expected date of farrowing.

The nature and composition of the diet fed to the sow while in the farrowing crate should not be changed. In order to minimize the risk of toxic agalactia, it is recommended that the daily feed allowance be related to body condition score. It may be necessary to reduce the feed to

1 kg/day (from 100 d gestation) before farrowing.<sup>25</sup> The daily intake (compared to the intake during the dry period) may be increased on the day after the sow has farrowed and in increments thereafter as the stage of lactation proceeds. The inclusion of bran at the rate of one-third to one-half of the total diet for 2 days before and after farrowing has been recommended to prevent constipation. In some herds the use of lucerne meal or other vegetable protein at the rate of 15% of the diet may help control the disease. However, under intensified conditions it may be impractical to prepare and provide these special diets on a regular basis. While field observations suggest that a bulky diet at the time of farrowing will minimize the incidence of toxic agalactia, there is little scientific evidence to support the practice.

Antimicrobial agents used prophylactically have apparently been successful in controlling some outbreaks. A trimethoprim-sulfadiazine and sulfathiazole combination at 15 mg/kg in feed from day 112 of gestation to day 1 after farrowing may reduce the prevalence. Using oxytocin early may also help. In a recent study where *E. coli*, streptococci and staphylococci were the most cultured pathogens, marbofloxacin (10% solution) was found to be superior to amoxicillin. All *E. coli*, were susceptible to the former but 32% were resistant to the latter antibiotic.

The use of prostaglandins for the induction of parturition in sows has not been associated with a marked consistent change in the incidence of the disease. Some field trials have shown a reduction, while others have had no effect.

## REVIEW LITERATURE

- Smith BP. Pathogenesis and therapeutic management of lactation failure in periparturient sows. *Compend Contin Educ Pract Vet* 1985; 9:S523-S532.
- Liptrap RM. Lactational failure. *Vet Annu* 1987; 47:134-138.
- Martineau GP et al. Mastitis, metritis and agalactia. *Vet Clin North Am Food Anim Pract* 1992; 8:661-684.

## REFERENCES

1. Thorup F. Proceedings of the 16th IPVS Congress, Melbourne 2000:97.
2. Klopfenstein C et al. Proceedings of the 15th IPVS Congress, Birmingham 1998; 2:230.
3. Ringarp N. *Acta Agric Scand Suppl* 1960; 7.
4. Ramsoota P et al. *Acta Vet Scand* 2000; 41:249.
5. Peter AT et al. *Res Vet Sci* 1985; 39:222.
6. Persson A et al. *Acta Vet Scand* 1989; 30:9.
7. Lingaas F, Ronningen K. *Acta Vet Scand* 1991; 32:89.
8. Lingaas F. *Acta Vet Scand* 1991; 32:97.
9. Lingaas F. *Acta Vet Scand* 1991; 32:107, 115.
10. Chagnon M et al. *Can J Vet Res* 1991; 55:180.
11. Persson A et al. *Acta Vet Scand* 1996; 37:293.
12. Persson A. *J Vet Med A* 1997; 44:143.
13. Persson A et al. *Acta Vet Scand* 1996; 37:279.
14. Pejsak Z, Tarasiuk K. *Theriogenology* 1989; 32:335.
15. Smith BB, Wagner WC. *Am J Vet Res* 1985; 46:175.
16. Smith BB. *Compend Contin Educ Pract Vet* 1985; 9:S523.
17. Madec F et al. *Rec Med Vet Ec Alfort* 1992; 168:341.
18. Magnusson U et al. *J Vet Med* 2001; B 48:501.
19. Backstrom L et al. *J Am Vet Med Assoc* 1984; 185:70.
20. Delgado J, Jones JET. *Br Vet J* 1981; 137:639-643.
21. King GJ et al. *Can Vet J* 1972; 13:72.
22. Martineau GP et al. *Vet Clin North Am Food Anim Pract* 1992; 8:661.
23. Rose M et al. Proceedings of the 14th IPVS Congress, Bologna 1996:317.
24. Hirsch AC et al. *J Vet Pharmacol Ther* 2003; 26:355.
24. Goransson LJ. *Vet Med A* 1989; 36:506.
25. Thomas E et al. *Prakt Tierarzt* 2000; 81:654.

## Mastitis of sheep

### ETIOLOGY

Most cases (80-90%) of clinical mastitis are due to *Staphylococcus aureus*, the remainder to *Streptococcus agalactiae* and *M. haemolytica*, with rare occurrences of *Escherichia coli* and *Histophilus somni*. (formerly *Histophilus ovis*). Coagulase-negative staphylococci are a major cause of subclinical mastitis in sheep.<sup>1</sup> Sheep at pasture are the only species other than dairy cattle in which outbreaks of mastitis due to *S. aureus* and *M. haemolytica* occur. A small percentage of cases are associated with *Clostridium perfringens* A, *Pseudomonas* spp., or *Corynebacterium pseudotuberculosis*. *Acholeplasma oculi* is pathogenic and can cause mastitis and agalactia.<sup>2</sup> Mycoplasma serogroup II is pathogenic in sheep when inoculated experimentally.<sup>3</sup>

### EPIDEMIOLOGY

#### Occurrence

Clinical mastitis in ewes occurs about equally immediately after weaning or close to parturition. In pastured ewes the prevalence is low and due usually to *M. haemolytica* or *Staphylococcus* spp. In housed ewes many cases are due to teat injury, especially when the sheep are housed on abrasive floors, such as expanded metal.

Up to 10% of ewes used for milk production have subclinical mastitis.<sup>4</sup> Clinical mastitis in pastured ewes averages only about 2% per year, but mastitis causes up to 10% of all ewe deaths.

The forms of loss in milk sheep are the same as those for dairy cattle. In meat and fiber sheep the losses take the form of deaths, due usually to gangrenous mastitis, and to decreased growth in the neonates.<sup>5</sup> Where sucking lambs have access to supplemental feed the effect of subclinical mastitis on lamb performance is negligible.<sup>6</sup>

Although in most European countries sheep are used for mutton and wool production, in Greece nearly all ewes are milked commercially for the production

of Greek feta cheese. Any factor that adversely affects the quantity and quality of ovine milk is of great financial interest. The prevalence of subclinical mastitis in sheep in Greece varies between flocks from 29-43%.<sup>7</sup> Coagulase-negative staphylococci and *S. aureus* were isolated in 44% and 33% of the positive milk samples, respectively.

### Staphylococcal mastitis

The most prevalent mastitis pathogen of the ewe is *S. aureus*.<sup>8</sup> The incidence of clinical mastitis may be as high as 20%; the mortality rate varies between 25% and 50%, and affected quarters in surviving ewes are usually destroyed. Chronic mastitis can result in a 25-30% reduction in milk yield from affected udder halves.<sup>9</sup> The disease can be a very important one in those countries in which ewes' milk is a staple article of diet. The disease is probably spread from infected bedding grounds, the infection gaining entry through teat injuries caused by sucking lambs.

Other staphylococcal mastitides in ewes include *Staphylococcus epidermidis*; many clinically normal quarters show a high rate of infection with coagulase-negative staphylococcus.<sup>10</sup> Experimental infection with *Staphylococcus chromogenes* causes clinical mastitis, *Staphylococcus simulans* causes subclinical mastitis and *Staphylococcus xylosum* causes a transient increase in the SCC.<sup>11</sup>

### Streptococcal mastitis

The disease can be reproduced by the introduction of *S. agalactiae* into the mammary glands and occurs naturally in sheep used as milking animals. The infection originates from an infected udder and is transmitted to the teat skin of other females by milking machine liners, milkers' hands, wash cloths and any other material that can act as an inert carrier. Also listed as occasional causes are *Streptococcus dysgalactiae* and *Streptococcus uberis*.

### Mannheimia mastitis

Peracute, gangrenous mastitis associated with *Mannheimia* spp. is the common mastitis of ewes. *M. haemolytica* can be isolated from affected quarters and the disease can be reproduced experimentally<sup>12,13</sup> by the intramammary infusion of cultures of the organism. *S. aureus*, *Arcanobacterium pyogenes*, and streptococci are often present as secondary invaders.

*Mannheimia* mastitis occurs sporadically in the western USA, Australia, and Europe in ewes kept under systems of husbandry varying from open mountain pasture to enclosed barns. Mastitis is most common in ewes suckling large lambs 2-3 months old. Infection is thought to occur through injuries to teats, perhaps caused by



overvigorous sucking by big lambs. *Mannheimia* mastitis occurrence is not related to hygiene, many outbreaks occurring in sheep at range but, because of the sheep's habit of sleeping at night on often used bedding grounds, it is possible that transmission occurs by contact with infected soil or bedding.

### PATHOGENESIS

The mechanisms of pathogenesis are similar to those for bovine mastitis.

### CLINICAL FINDINGS

In milking ewes clinical mastitis is similar to that in cows, with acute and subacute forms manifested by swelling of the gland and wateriness and clots in the milk. Most clinical cases seen by the veterinarian are in brood ewes, and take the form of gangrenous mastitis, affecting one or both halves.

### Staphylococcal mastitis

In sheep there is a strong similarity between this form of mastitis and that associated with *M. haemolytica*. They are both peracute, gangrenous infections. The ewe is usually recumbent and profoundly toxic, and the affected gland and the surrounding area of belly wall are blue-green in color and cold to the touch. A few drops of clear, bloodstained liquid is all that can be expressed from the udder. A fatal clinical course of 1–2 days is usual.

### *Mannheimia* mastitis

An acute systemic disturbance, with a high fever (40–42°C, 105–107°F), anorexia, dyspnea and profound toxemia, accompanies acute swelling of the gland and severe lameness on the affected side. This lameness is an important early sign and is useful in locating affected animals in a group. The udder is at first hot, swollen and painful and the milk watery, but within 24 hours the quarter is discolored blue-black and cold, with a sharp line of demarcation from normal tissue. The secretion is watery and red and contains clots. The temperature subsides in 2–4 days, the secretion dries up entirely and the animal either dies of toxemia in 3–7 days or survives with sloughing of a gangrenous portion of the udder, followed by the development of abscesses and the continual draining of pus. Usually only one side is affected. Cases of pneumonia due to the same organism may occur in lambs in flocks where ewes are affected.

### Clostridial mastitis

*Clostridium perfringens* A is a rare and highly fatal cause of acute mastitis in ewes. Clinical signs of infection are principally hemolytic and are characterized by hemoglobinuria, jaundice and anemia, plus fever, anorexia and recumbency. The affected quarter is swollen,

painful and hot and contains watery, brown, flocculent secretion.<sup>14</sup>

### Caseous lymphadenitis and mastitis

Suppurative lesions associated with *Corynebacterium pseudotuberculosis* are found commonly in ovine mammary glands, but they usually involve only the supramammary lymph nodes and are not true mastitis, although the function of the mammary gland may be lost when the infection has spread from the lymph node to mammary tissue.

### Pseudomonal mastitis

Naturally occurring pseudomonal mastitis in ewes is likely to be gangrenous and lethal<sup>15</sup> and accompanied by severe lameness in the hindlimb on the affected side. Infected intramammary infusions or milking machine malfunction<sup>16</sup> are the usual means of introducing the infection.

### CLINICAL PATHOLOGY

Determination of the SCC is useful for the prediction of mammary gland infection in sheep.<sup>7</sup> Bacteriologically negative ewe's milk has 2–3% somatic cells, 10–17% lymphocytes, 10–35% neutrophils and 45–85% macrophages.<sup>17</sup> In milking ewes milked by machine, SCCs and CMT scores resemble those in dairy cows.<sup>18</sup> However, a universally accepted value has not yet been set for the ewe. The SCC in normal ewes' milk may range from 500 000–1 000 000 cells/mL. However, more than 95% of milk samples from normal ewes have a total content of less than 500 000 cells/mL. In one survey of milk samples from sheep, mean SCC from mastitis-negative samples was 1500 000 cells/mL.<sup>8</sup> All mastitis-positive samples had somatic cells in excess of 2 000 000 cells/mL and it is suggested that the threshold level for subclinical mastitis in ewes should be close to 1 500 000 cells/mL.<sup>8</sup> The CMT is a reliable indicator of the SCC of ewes' milk and of the level of infection, and it, the SCC and the NAGase all correlate well with the microbiological findings in mastitic quarters. Infection with Maedi-Visna virus does not appear to alter milk SCC in the ewe.

### NECROPSY FINDINGS

The gross appearance of the affected glands varies with the agent involved and the duration of the process.<sup>19</sup> In general, the swollen, hemorrhagic, and/or gangrenous nature of fatal acute ovine mastitis is glaringly obvious. A purulent exudate is sometimes present, especially in the case of chronic *C. pseudotuberculosis* infection.

### Samples for confirmation of diagnosis

Bacteriology – chilled mammary gland for aerobic culture; anaerobic culture if *Clostridium* sp. is suspected.

### DIFFERENTIAL DIAGNOSIS

*Mannheimia* mastitis is peracute and resembles mastitis associated with *S. aureus*. A similar disease in ewes has been ascribed to *Actinobacillus lignieresii*. Suppurative mastitis associated with *C. pseudotuberculosis* is chronic in type and no systemic signs occur. Differentiation from clostridial mastitis is also necessary.

### TREATMENT

Broad-spectrum parenteral and intramammary antimicrobial agents are effective. Although ewes probably require smaller doses of intramammary infusions than cows it is customary to use ordinary cow-type mammary infusion treatments; this may, however, result in a much longer period during which the milk in the quarter has a higher level of antibiotic than is desirable.<sup>20</sup> The treatment of ewes with peracute gangrenous mastitis is as unsatisfactory in terms of results as in cows. Systemic treatment is necessary and requires larger doses than normal to achieve significant levels in the mammary secretion.

### CONTROL

Removal of sources of infection in sheep flocks necessitates culling some ewes with affected udders but even rigid culling usually fails to completely eradicate the disease.

Control programs for milking sheep flocks could easily be arranged by adapting the one described for cows. Dry period treatment with intramammary infusions of cephalixin benzathine is being used;<sup>21</sup> infusion of both halves greatly reduces the subsequent new infection rate.<sup>22</sup> For suckling ewes in flocks with a bad history of mastitis another recommended prophylaxis is the infusion of each half with sodium cloxacillin at weaning.

### Staphylococcal mastitis

It is possible that vaccination could be an effective method of control for staphylococcal mastitis. A bacterin toxoid has proved moderately effective in reducing the incidence of the disease. Two injections of the vaccine are necessary. Vaccination against staphylococcal mastitis in ewes has been on trial for some time. The latest vaccine, consisting of killed *S. aureus* cells, toxoided staphylococcal beta-hemolysin plus dextran sulfate as an adjuvant, appears to provide some protection against experimental infection.<sup>23</sup> Prophylactic infusion of each half of the udder within a few days of weaning, using half of a tube of dry cow treatment of penicillin and streptomycin, has also given good results. The frequent changing

of pasture areas and culling of affected ewes should also help to control the spread of infection.

### Mannheimia mastitis

Polyvalent hyperimmune serum and a formolized vaccine have been shown to be of value in prophylaxis. An autogenous vaccine of killed *M. haemolytica*<sup>24</sup> appears to confer excellent immunity and should be effective in a flock where the disease is occurring.

### REVIEW LITERATURE

Bergonier D, Crémoux R, Rupp R, Lagriffoul G, Berthelot X. Mastitis of dairy small ruminants. *Vet Res* 2003; 34:689–716.

### REFERENCES

- Burriel AR. *Vet Rec* 1997; 140:419.
- Sadhana OP et al. *Aust Vet J* 1993; 70:227.
- Kumar D et al. *Aust Vet J* 1993; 70:70.
- Watkins GH et al. *Br Vet J* 1991; 147:413.
- Fthenakis GC, Jones JET. *Br Vet J* 1990; 146:43.
- Keisler DH et al. *J Anim Sci* 1992; 70:1677.
- Stefanakis A et al. *Anim Sci* 1995; 61:69.
- Mavrogenis AP et al. *Small Rumin Res* 1995; 17:79.
- Deutz A et al. *Wien Tierarztl Monatsschr* 1995; 82:346.
- Watson DL et al. *Aust Vet J* 1990; 67:6.
- Fthenakis GC, Jones JET. *J Comp Pathol* 1990; 102:211.
- El-Masannat ETS et al. *J Comp Pathol* 1991; 105:455.
- Watkins JH, Jones JET. *J Comp Pathol* 1992; 106:9.
- McDonnell AM, Holmes LA. *Br Vet J* 1990; 146:380.
- Bachh AS, Pathak RC. *Indian J Anim Sci* 1986; 56:391.
- Rapoport E, Bar-Moshe B. *Israel J Vet Med* 1986; 42:203.
- Lee CS et al. *J Dairy Res* 1981; 48:225.
- Peris C et al. *J Dairy Sci* 1991; 74:1553.
- Sulaiman MY, Al-Sadhi HI. *Prev Vet Med* 1992; 13:299.
- Buswell JF, Barber DML. *Br Vet J* 1989; 145:552.
- Ahmed G et al. *Sheep Res J* 1992; 8:30.
- Hueston WD et al. *J Am Vet Med Assoc* 1989; 194:1041.
- Watson DL. *Res Vet Sci* 1988; 45:16.
- Kabay MJ et al. *Aust Vet J* 1989; 66:342.

## Mastitis of goats

Goats are much less frequently affected by contagious mastitis than cattle, but mastitis is an important sign in many of the infectious diseases associated with *Mycoplasma agalactiae* and *Mycoplasma mycoides* var. *mycoides*. Details of the other infections encountered are fragmentary and inconsistent; coliform organisms, for example, are listed as not occurring and as being most common. Coagulase-negative staphylococci are a common finding in clinically normal halves<sup>1</sup> and appear to cause persistent infection.<sup>2</sup>

In some surveys, *Staphylococcus aureus* and *Escherichia coli* are the most commonly isolated pathogens from mastitic goats.<sup>3</sup> Other infections are *Pseudomonas*

spp., *Staphylococcus hyicus* (much less pathogenic than *S. aureus*),<sup>4</sup> *Streptococcus dysgalactiae*, *Streptococcus pyogenes*, *Streptococcus intermedius*, *Arcanobacterium pyogenes*, *Bacillus coagulans*, and *Bacillus licheniformis*.<sup>5</sup> *Klebsiella pneumoniae*, *Corynebacterium pseudotuberculosis*, *M. haemolytica*, and *Actinobacillus equuli* have also been isolated from mastitic goats.<sup>3</sup> *Nocardia asteroides* causes a systemic reaction and granulomatous lesions in the udder and lungs.<sup>6</sup>

The prevalence of infection in goats ranges from 10%<sup>3</sup> to 30%.<sup>7</sup> Prevalence of infection in different herds may range from 7–34% of glands and 17–44% of goats.

### Staphylococcal mastitis

This is the most common cause of mastitis in goats. In the experimentally produced disease associated with *S. aureus* in goats the pathogenesis is very similar to that in the cow except that there is a marked tendency for the staphylococci to invade and persist in foci in the interacinar tissue. As in cattle, some staphylococci in goats' milk produce enterotoxins and the toxic shock syndrome toxin and are likely to cause food poisoning in humans. Latex agglutination tests are available for the identification of the enterotoxins.<sup>8</sup>

### Streptococcal mastitis

Goats are uniformly susceptible to *Streptococcus agalactiae*; mastitis associated with it does occur but to a lesser extent than in cattle. In flocks of milking goats the infection is passed from infected quarters to others by means of the milker's hands, the teat cups of milking machines and wash cloths used to disinfect the udder before milking. *Streptococcus zooepidemicus* causes chronic suppurative mastitis in does, and artificially induced infections with *S. dysgalactiae* are indistinguishable from mastitis associated with *S. agalactiae*. The pathogenesis is probably similar in all streptococcal mastitides.

### Pseudomonas mastitis

Experimental pseudomonas mastitis in goats is acute, with extensive necrosis and fatal septicemia.

### Summer mastitis

Summer mastitis associated with *A. pyogenes* has been produced experimentally in goats with udder lesions typical of acute suppurative mastitis. Nonlactating goats developed a severe mastitis, lactating animals only a moderate one.

### Other infections

Mastitis in goats is associated with an organism tentatively identified as *M. haemolytica*. *Yersinia pseudotuberculosis* has caused mastitis in an aborting goat doe that probably experienced a bout of

systemic yersiniosis. The infection would have had zoonotic implications.<sup>9</sup> Granulomatous lesions in the mammary glands and in internal organs have been observed in goats experimentally infected with *Cryptococcus neoformans*.

### CLINICAL FINDINGS

**Clinical mastitis** in goats is similar to that in cattle, subclinical, chronic, acute and peracute gangrenous forms occurring. Particular care is needed in the clinical examination of goat's milk because of its apparent normality when there are severe inflammatory changes in the udder.

**Somatic cell counts in milk of goats** are higher than in cattle or sheep but vary widely.<sup>10</sup> The counts increase with stage of lactation with or without intramammary infection.<sup>11</sup> Lower mature equivalent milk production and increased parity are also associated with an increase. Parity of milking does does not affect SCC, standard plate count and major milk components.<sup>12</sup> The count is highest in lactating goats during October, December and January.<sup>11</sup> Much of the variation was not due to intramammary infection. Non-infected goats may have a SCC of more than 1 000 000 cells/mL. These variations make their value as a guide to diagnosis in this species controversial.<sup>13</sup> A physiological threshold of 500 000 cells/mL has been suggested;<sup>14</sup> however, a count of more than 1 000 000 cells/mL can be regarded as positive for mastitis.<sup>15</sup> Some observations indicate that the most discriminating threshold for diagnosis of infection is 800 000 cells/mL.<sup>2</sup> The Fossomatic instruments and infrared milk analyzers must be calibrated with goat milk standards for more reliable and accurate analysis of milk.<sup>16</sup>

In staphylococcal mastitis infected halves have higher NAGase and CMT tests than normal halves but they and the lactate dehydrogenase and antitrypsin tests give very variable results and are not considered to be reliable. Two of the difficulties encountered are that the efficiency of the tests is not so good in the colostral period, and that halves adjoining affected halves give higher than normal results.<sup>17</sup>

### Treatment and control

Treatment and control of mastitis techniques to be used in goat does can be adapted from those used for cattle, with the details of dry period and lactational treatments supplied by a laboratory culture. If the cow dose rate is used, retention of the antibiotic in the udder will be prolonged and the withholding period will need to be increased. Antibiotic residue tests for screening bovine milk adequately identify goat's milk that is free of antibiotic residues.<sup>18</sup> Vaccination against *S. agalactiae* in goats causes a rise

in serum antibodies that may provide a degree of immunity. Intravenous flunixin meglumine (two doses at 2.2 mg/kg BW 8 hours) was a more effective antipyretic agent in goats with experimentally induced coliform mastitis than intravenous dexamethasone (0.44 mg/kg BW once).<sup>19</sup>

#### REVIEW LITERATURE

Bergonier D, Crémoux R, Rupp R, Lagriffoul G, Berthelot X. Mastitis of dairy small ruminants. *Vet Res* 2003; 34:689–716.

#### REFERENCES

1. Ryan DP, Greenwood PL. *Aust Vet J* 1990; 67:362.
2. Lerondelle C et al. *Small Rumin Res* 1992; 8:129.
3. Ameh JA et al. *Prev Vet Med* 1993; 17:41.
4. Maisi P, Riipinen I. *Br Vet J* 1991; 147:126.
5. Kalogridou-Vassiliadou D. *Small Rumin Res* 1991; 197:203.
6. Megid J et al. *Arch Bras Med Vet Zootec* 1990; 42:545.
7. Contreras A et al. *Small Rumin Res* 1995; 17:71.
8. Kariuki AH. *Israel J Vet Med* 1991; 46:89.
9. Jones TO. *Vet Rec* 1982; 110:231.
10. Zeng SS, Escobar EN. *Small Rumin Res* 1996; 19:169.
11. Wilson DJ et al. *Small Rumin Res* 1995; 16:165.
12. Zeng SS, Escobar EN. *Small Rumin Res* 1995; 17:269.
13. Siddique IH et al. *Vet Med* 1988; 83:87.

14. Contreras A et al. *Small Rumin Res* 1996; 21:259.
15. Kalogridou-Vassiliadou D et al. *J Dairy Res* 1992; 59:21.
16. Zeng SS. *Small Rumin Res* 1996; 21:221.
17. Maisi P. *Small Rumin Res* 1990; 3:493.
18. Contreras A et al. *J Dairy Sci* 1997; 80:1113.
19. Anderson KL et al. *Vet Res Commun* 1991; 15:147.

### Mastitis of mares

Mastitis in mares is rare. *Corynebacterium pseudotuberculosis*, *Pseudomonas aeruginosa*, *Streptococcus zooepidemicus*, *Streptococcus equi*, *Streptococcus pyogenes*, *Staphylococcus aureus*, *Escherichia coli*, *Klebsiella* spp., and *Neisseria* spp. are all recorded.<sup>1,2</sup> Beta-hemolytic streptococci have been found in the milk of many normal, just-foaled mares.<sup>3</sup>

Clinical cases occur at any time during the lactation and many occur in non-lactating mares. Many mares with typical signs of severe swelling and soreness of the udder, but without abnormal milk, are first observed when a sick foal has not sucked for 24 hours. In streptococcal

mastitis there may be severe local pain and moderate systemic signs. In most cases both halves are affected. Gangrenous mastitis similar to that in cows occurs occasionally.

Severe cases, sometimes accompanied by fever, depression, and anorexia, show swelling, pain, and heat in the affected half, ventral edema and clots in the milk; the mare is lame in the leg on the affected side. Gangrene and sloughing of the ventral floor of a gland may occur.

Because of the high frequency of Gram-negative bacteria as causative agents in mares, treatment should include a broad-spectrum antibiotic in an intramammary infusion plus intensive parenteral antibacterial treatment. Trimethoprim-sulfonamide preparations are generally satisfactory. Hot packs and frequent milking are also recommended.

#### REFERENCES

1. Jackson PGG. *Equine Vet J* 1986; 18:88.
2. McCue PM, Wilson WD. *Equine Vet J* 1989; 21:351.
3. Bostedt H et al. *Tierarztl Prax* 1988; 16:367.

# PART 2

## SPECIAL MEDICINE

## Diseases associated with bacteria – I

**INTRODUCTION TO INFECTIOUS DISEASE 765**

Reportable diseases (OIE listings) 765  
Diagnosis of infectious diseases 767

**DISEASES ASSOCIATED WITH STREPTOCOCCUS SPECIES 768**

Septicemia 768  
Enteritis 768  
Pneumonia 768  
Meningoencephalitis 768  
Lymphangitis 768  
Dermatitis 769  
Arthritis in lambs 769  
Genital tract infections 769  
Strangles (equine distemper) 769  
*Streptococcus zooepidemicus* infection 775  
Neonatal streptococcal infection 775  
*Streptococcus suis* infection of young pigs 777  
Streptococcal lymphadenitis of pigs (jowl abscesses, cervical abscesses) 782

**DISEASES ASSOCIATED WITH STAPHYLOCOCCUS SPECIES 783**

Tick pyemia of lambs (enzootic staphylococcosis of lambs) 783  
Exudative epidermitis (greasy pig disease) 784

**DISEASES ASSOCIATED WITH CORYNEBACTERIUM, ACTINOBACULUM, AND ARCANOBACTERIUM SPECIES 787**

Metritis and abortion 788  
Perinatal disease 788  
Arthritis and bursitis 788  
Periodontal disease: cara inchada 788  
Chronic pectoral and ventral midline abscess in horses (pigeon fever) 788  
Contagious bovine pyelonephritis 789  
Cystitis and pyelonephritis of sows 791  
Enzootic posthitis (pizzle rot, sheath rot, balanoposthitis); vulvovaginitis (scabby ulcer) 793  
Caseous lymphadenitis of sheep and goats 795

Bolo disease 798  
Ulcerative lymphangitis of horses and cattle 798  
Contagious acne of horses (Canadian horse pox, contagious pustular dermatitis) 800  
*Rhodococcus equi* pneumonia of foals 800

**DISEASES ASSOCIATED WITH LISTERIA SPECIES 805**

Listeriosis 805

**DISEASES ASSOCIATED WITH ERYSIPELOTHRIX RHUSIOPATHIAE (INSIDIOSA) 810**

Erysipelas of swine 810

**DISEASES ASSOCIATED WITH BACILLUS SPECIES 815**

Anthrax 815

**Introduction to infectious disease**

The infectious diseases are of major importance in agricultural animals. Accordingly the bacterial, viral, fungal, protozoal and parasitic diseases account for a major portion of this book. The infectious diseases are capable of affecting many animals in a short period of time and the case fatality rate in some diseases can be very high and the economic losses may be very large. Certain infectious diseases, especially the viral diseases, are endemic in some countries and pose a threat to other countries considered to be free of them. The veterinary profession has made a major contribution in developing reliable diagnostic techniques and effective control procedures for many of these diseases. Some of the infectious diseases assume major importance because they are directly transmissible to humans.

**REPORTABLE DISEASES (OIE LISTINGS)**

Several infectious diseases of livestock have the potential for serious and rapid spread, implications for international trade and/or risk for significant zoonotic disease. Because of the nature of these diseases and the risk to regional or national animal

health, their control is beyond the capability of the individual practitioner and requires the intervention of state and possibly national veterinary personnel and organizations. In most countries, diseases of this nature are listed as **reportable diseases** or **notifiable diseases** and these must be reported (notified) to the state or national veterinary authority immediately they are diagnosed.

A world organization for animal health, called the Office International des Épizooties (OIE), has been in existence for many years and its major objectives have been the collection, analysis, and dissemination of scientific veterinary information on animal diseases of significant veterinary importance. Member countries have traditionally reported to the OIE, on a regular basis, the occurrence, or absence, of these diseases in their respective countries. The purpose has been to ensure transparency in the global animal disease and zoonotic disease situation, and to provide expertise and encourage international solidarity in the control of animal diseases.

The OIE has established a **Terrestrial Animal Health Code (Terrestrial Code)** where the majority of the reportable diseases are specifically detailed, including their clinical presentations, distribution amongst member countries and methods for diagnosis.<sup>1</sup> The purpose of the Terrestrial Code is to assure the safety of inter-

national trade in terrestrial animals and their products by detailing the health measures to be used by the veterinary authorities of importing and exporting countries. The purpose is to avoid the transfer of agents pathogenic for animals or humans while also avoiding unjustified sanitary barriers. It constitutes a reference within the World Trade Organization (WTO) Agreement on the Application of Sanitary and Phytosanitary Measures (SPS Agreement) as an international standard for animal health and zoonoses.<sup>2,3</sup>

Traditionally, the OIE has classified animal diseases in two lists.

**List A diseases** (Box 16.1). These are transmissible diseases that have the potential for very serious and rapid spread, irrespective of national borders, that are of serious socioeconomic or public health consequence and that are of major importance in the international trade of animals and animal products. The presence of a list A disease in a country may limit or prevent its international trade of animals and animal products. In most countries the control and regulation of list A diseases are under the control of the federal veterinary authorities. Private practitioners have the responsibility to immediately report the occurrence, or

**Box 16.1 List A diseases for cattle, swine, horses, sheep and goats**

Transmissible diseases that have the potential for very serious and rapid spread, irrespective of national borders, that are of serious socioeconomic or public health consequence and that are of major importance in the international trade of animals and animal products

- Foot and mouth disease
- Swine vesicular disease
- Vesicular stomatitis
- Classical swine fever
- African swine fever
- Peste des petits ruminants
- Lumpy skin disease
- Bluetongue
- African horse sickness
- Rinderpest
- Contagious bovine pleuropneumonia
- Rift Valley fever
- Sheep pox and goat pox

suspicion of their occurrence, to state or federal regulatory authorities

• **List B diseases** (Box 16.2). These are transmissible diseases that are considered to be of socioeconomic and/or public health importance within countries and that are significant in the international trade of animals and animal products. The control of these diseases varies between countries and between diseases in this list, but most countries require that they be reported to state or federal authorities if they are diagnosed.

**2005 single list**

In 2005 the OIE reorganized the diseases in the Terrestrial Code to a single list (Box 16.3). In part, this was done in response to concerns that the administration and listings of diseases had led to unfair trade restrictions on certain countries. The new listing is accompanied by the expectation of better international cooperation in the detection and control of animal disease, and support for developing countries in the diagnosis and control of these diseases is proposed. There is also the recognition that many of the recent emerging, or re-emerging, diseases of animal origin have zoonotic potential. The overriding criterion for inclusion of a disease in the OIE single list remains its potential for international spread, but other criteria include a capacity for significant spread within naive populations and zoonotic potential.<sup>1-3</sup> There has been agreement that the occurrence of certain listed diseases in a country does not necessarily preclude trade by that country in animal products. One of the reasons is that the disease may be absent from certain regions of the country that have geographical or ecological

**Box 16.2 List B diseases for cattle, swine, horses, sheep and goats**

Transmissible diseases that are considered to be of socioeconomic and/or public health importance within countries and that are significant in the international trade of animals and animal products

**Affecting more than one animal species**

- Anthrax
- Aujeszky's disease (pseudorabies)
- Echinococcosis/hydatidosis
- Heartwater
- Leptospirosis
- New world screwworm (*Cochliomyia hominivorax*)
- Old world screwworm (*Chrysomya bezziana*)
- Paratuberculosis (Johne's disease)
- Q fever
- Rabies
- Trichinellosis

**Cattle**

- Bovine anaplasmosis
- Bovine babesiosis
- Bovine brucellosis
- Bovine cysticercosis
- Bovine genital campylobacteriosis
- Bovine spongiform encephalopathy
- Bovine tuberculosis
- Dermatophilosis
- Enzootic bovine leukosis
- Hemorrhagic septicemia
- Infectious bovine rhinotracheitis/infectious pustular vulvovaginitis
- Malignant catarrhal fever
- Theileriosis
- Trichomonosis
- Trypanosomosis (tsetse-transmitted)

**Swine**

- Atrophic rhinitis of swine
- Enterovirus encephalomyelitis
- Porcine brucellosis
- Porcine cysticercosis
- Porcine reproductive and respiratory syndrome
- Transmissible gastroenteritis

**Horses**

- Contagious equine metritis
- Dourine
- Epizootic lymphangitis
- Equine encephalomyelitis (Eastern and Western)
- Equine infectious anemia
- Equine influenza
- Equine piroplasmiasis
- Equine rhinopneumonitis
- Equine viral arteritis
- Glanders
- Horse mange
- Horse pox
- Japanese encephalitis
- Surra (*Trypanosoma evansi*)
- Venezuelan equine encephalomyelitis

**Sheep and goats**

- Caprine and ovine brucellosis (excluding *Brucella ovis*)
- Caprine arthritis/encephalitis
- Contagious agalactia
- Contagious caprine pleuropneumonia
- Enzootic abortion of ewes (ovine chlamydiosis)
- Maedi-visna
- Nairobi sheep disease
- Ovine epididymitis (*B. ovis*)
- Ovine pulmonary adenomatosis
- Salmonellosis (*Salmonella abortus-ovis*)
- Scrapie

**Box 16.3 2005 single list of diseases notifiable to the Office International des Épidémiologies****Affecting more than one animal species**

- Anthrax
- Aujeszky's disease
- Echinococcosis/hydatidosis
- Heartwater
- Leptospirosis
- Q fever
- Rabies
- Paratuberculosis
- New world screwworm (*Cochliomyia hominivorax*)
- Old world screwworm (*Chrysomya bezziana*)
- Trichinellosis
- Foot and mouth disease
- Vesicular stomatitis
- Lumpy skin disease
- Rift Valley fever

**Cattle**

- Bovine anaplasmosis
- Bovine babesiosis
- Bovine brucellosis
- Bovine genital campylobacteriosis
- Bovine tuberculosis
- Bovine cysticercosis
- Dermatophilosis
- Enzootic bovine leukosis
- Hemorrhagic septicemia
- Infectious bovine rhinotracheitis/infectious pustular vulvovaginitis
- Theileriosis
- Trichomonosis
- Trypanosomosis (tsetse-transmitted)
- Malignant catarrhal fever
- Bovine spongiform encephalopathy
- Rinderpest
- Contagious bovine pleuropneumonia

**Swine**

- Atrophic rhinitis of swine
- Porcine cysticercosis
- Porcine brucellosis
- Transmissible gastroenteritis
- Enterovirus encephalomyelitis
- Porcine reproductive and respiratory syndrome
- Swine vesicular disease
- African swine fever
- Classical swine fever

**Horses**

- Contagious equine metritis
- Dourine
- Epizootic lymphangitis
- Equine encephalomyelitis (Eastern and Western)
- Equine infectious anemia
- Equine influenza
- Equine piroplasmiasis
- Equine rhinopneumonitis
- Glanders
- Horse pox
- Equine viral arteritis
- Japanese encephalitis
- Horse mange
- Surra (*Trypanosoma evansi*)
- Venezuelan equine encephalomyelitis
- African horse sickness

**Box 16.3 (Cont'd) 2005 single list of diseases notifiable to the Office International des Épizooties**

**Sheep and goats**

- Ovine epididymitis (*Brucella ovis*)
- Caprine and ovine brucellosis (excluding *B. ovis*)
- Caprine arthritis/encephalitis
- Contagious agalactia
- Contagious caprine pleuropneumonia
- Enzootic abortion of ewes (ovine chlamydiosis)
- Ovine pulmonary adenomatosis
- Nairobi sheep disease
- Salmonellosis (*Salmonella abortus-ovis*)
- Scrapie
- Maedi-visna
- Peste des petits ruminants
- Sheep pox and goat pox

characteristics that would not support the disease – an example would be areas of a country that did or did not support the vectors for bluetongue. It is also recognized that management systems may allow freedom from disease and that consequently there could be trade from production systems using these management methods – an example would be the disease and security status in a high health swine unit compared to free-range pigs in the same area.<sup>2,3</sup> There is also the recognition that many of the recent emerging, or re-emerging diseases of animal origin have zoonotic potential.

We have listed the old List A and List B categorizations of diseases as these categories are familiar to practicing veterinarians and we suspect that they will be referred to, as such, in the lifetime of this edition of this book. We further believe that there was some meaning for practicing veterinarians, in terms of disease significance and emergency response, in the old List A and List B categorization that is not evident in the new single listing, which, although it might be politically correct, has less impact for those who practice clinical veterinary medicine at the level of the farm. We have reservations concerning the new single listing and reservations about some of the diseases selected for listing. There are several examples, but three will suffice. We question how a disease such as leptospirosis, generically essentially a universal infection in farm animals, can be equated and placed in a single list with a disease such as foot and mouth disease. We question how African horse sickness, with its huge potential for spread outside Africa, can be compared with the ubiquitous, and usually clinically insignificant, equine rhinopneumonitis. We question the inclusion of a disease such as atrophic rhinitis in the swine list of diseases and the exclusion of a disease such as pleuropneu-

monia, but more importantly, we question why atrophic rhinitis should be equated in economic, or response, importance to African swine fever.

**DIAGNOSIS OF INFECTIOUS DISEASES**

The clinical and laboratory diagnosis of the infectious diseases can be difficult. However, with the appropriate laboratory support and suitable samples, most of them can be diagnosed definitively. For each disease certain samples must be submitted to the laboratory for isolation or demonstration of the specific pathogen.

Clinical and epidemiological findings will usually result in a tentative diagnosis and a rule-out list of possible diagnoses. When herd or area **population epidemics** occur, a detailed examination of the epidemiological characteristics of the disease is often useful in helping to make a diagnosis and in advising on the best treatment and control procedures. Particular attention should be given to the epidemiological aspects of the history, for example:

- The **descriptive epidemiology** including the distribution in age or other groups
- The morbidity and case fatality and population mortality rates
- The seasonal incidence
- Relationship to other species
- Recent changes in management
- Vaccination history
- Nutritional history
- Disease in previous years
- Source of imported animals
- Known risk factors for the diseases under consideration
- The treatments used and the success rate.

The epidemiological behavior of the epidemic includes an examination of the manner of spread of disease between individuals and groups of animals, the age of animals affected, the length of the course of the disease and the estimated incubation period. It may be necessary to establish a prospective survey or surveillance studies on sentinel herds to monitor the spread of the disease. field investigation may include the examination of nearby herds or other species, such as wildlife or humans, that may be sources of the infection.

When an infectious disease is suspected, **laboratory investigations** will aid in diagnosis and differential diagnosis. The veterinary literature contains a large number of reports of the development of antibody-detection or antigen-detection tests for individual animal diseases. Most of these have not been validated in a significant number of animals for sensitivity and specificity in disease detection, and

most are not available commercially or available on line in diagnostic laboratories. Those that are on line vary between countries and between laboratories within countries. The practitioner should consult the appropriate diagnostic laboratories to determine the tests that are available and the laboratories' definition of the sensitivity and specificity of the test to be used. The recommended techniques of investigation and the common differential diagnoses are given for each disease.

- Clinical, hematological, clinical chemistry and immunological examinations, as appropriate, should be done on as many clinically affected animals as possible. Similar examinations should be conducted on normal animals that have been in close contact with the affected animals. The detection of latent carriers among clinically normal animals may require special laboratory tests. Repeated visits and examinations may be necessary to determine the presence and rate of seroconversion in an affected herd as an indication of the rate and direction of spread
- Tissue samples from necropsies and from live animals (biopsies) and discharges, feces and urine should be submitted for isolation or demonstration of the suspected pathogen.

The responsibility of the veterinarian in the case of infectious diseases is to advise the owner of the **risks of spread** to other animals or populations and the need for treatment and/or control. In the case of notifiable diseases, the government regulatory authorities must be notified immediately. Every precaution must be taken to prevent the spread of the disease to nearby herds or other geographical areas. Veterinarians have the responsibility to advise the owner of zoonotic risk of the disease to the farm family and farm workers. Veterinarians also have a responsibility to alert their clients to the possibility that an infectious disease may be approaching geographically and to take the necessary precautions. The **control** of infectious diseases is dependent on a knowledge of the etiology and epidemiological characteristics of the disease. The basic principles of disease control are:

- Reduce the infection pressure
- Eliminate or minimize risk factors that can be influenced
- Increase the nonspecific immunity
- Increase the specific immunity.

Any one or a combination of the following may be effective for the control of a specific infectious disease:



- Insure adequate colostral immunity in the newborn
- Identify affected animals, isolate them from the normal animals and treat or dispose of them as indicated, or return them to the herd if they are considered to be safe
- Prevent the introduction of infected animals into herds previously considered free of the disease. Quarantine all animals imported into a herd for a period of 30–60 days. Serological testing may be done on the imported animals
- Determine the source of the infection and remove it if possible. Sources include infected animals, feed and water supplies, wildlife and contaminated environments
- Control by the use of mass medication of feed and water supplies may be appropriate with some diseases
- Clean and disinfect animal houses and grounds regularly – this is essential. When animals occupy a barn for prolonged periods (weeks or months) without a clean-out and disinfection, the buildup of infectious agents increases almost geometrically and the incidence of disease will increase correspondingly
- Provide an optimal environment for housed animals. This includes adequate ventilation, the prevention of overcrowding and effective removal of manure
- Establish primary breeding stock through the use of specific-pathogen-free animals obtained by hysterectomy or cesarean section and rearing them under controlled conditions; this program may be indicated for the control of diseases such as enzootic pneumonia of swine
- Vaccinate susceptible animals against endemic diseases; this should be part of a regularly scheduled herd health program that includes vaccination of the pregnant dam for the enhancement of colostral immunity in the newborn
- Avoid stress associated with long transportation, inclement weather and undernutrition
- Base effective control of intestinal parasites on measures designed to prevent or limit contact between parasite and host. The strategies are to: a) prevent the build-up of dangerous numbers of larvae on pastures; and b) anticipate the periods during which large numbers of larvae are likely to occur and remove susceptible animals from heavily contaminated pastures before these periods. These aims can be achieved

using three interrelated approaches: grazing management, the use of anthelmintics and dependence on the acquisition of immunity.

#### REFERENCES

1. OIE Terrestrial Code, 14th ed, 2005. Available on line at: [http://www.oie.int/eng/normes/en\\_mcode.htm](http://www.oie.int/eng/normes/en_mcode.htm).
2. Thiermann AB. *PrevVet Med* 2005; 67:101.
3. Zepeda C et al. *PrevVet Med* 2005; 67:125.

### Diseases associated with *Streptococcus* species

Mastitis associated with *Streptococcus agalactiae*, *Streptococcus dysgalactiae*, *Streptococcus uberis*, and *Streptococcus zooepidemicus* is dealt with in Chapter 15. Strangles in horses, neonatal streptococcal infections, disease associated with *S. zooepidemicus* in horses and streptococcal cervical abscesses of pigs are dealt with later in this section.

Other miscellaneous diseases in which streptococci appear to have etiological significance include septicemic infections of swine, sheep and calves, pneumonia in calves, meningoencephalitis and otitis media in feeder pigs, lymphangitis in foals and infectious dermatitis of piglets.

#### SEPTICEMIA

- Acute streptococcal septicemia of adult sows and their litters occurs sporadically. The onset is sudden and death occurs in 12–48 hours. Clinically there is weakness, prostration, fever, dyspnea, dysentery and hematuria. At necropsy, petechial and ecchymotic hemorrhages are present throughout all organs. Animals that survive for several days show extensive edema and consolidation of the lungs. The infection spreads rapidly and the mortality rate may be very high unless the drug sensitivity of the organism, usually *S. zooepidemicus* or *Streptococcus equisimilis*, is determined and appropriate treatment instituted
- Experimental inoculation of *S. zooepidemicus* into horses causes fever, depression, anorexia, abnormal lung sounds, joint inflammation accompanied by mild–severe lameness, emaciation and a leukocytosis<sup>1</sup>
- *Streptococcus pneumoniae* is the apparent cause of septicemia with sudden death in calves
- In ruminants of all ages *Streptococcus suis*, usually a pathogen in pigs, causes a bacteremia with localization in many organs, including lungs, joints, bones, and meninges<sup>2</sup>
- In sheep and goat flocks, septicemia due to *S. zooepidemicus* causes up to

90% mortality in lambs and kids. *S. dysgalactiae* is a common cause of polyarthritis in lambs.

#### ENTERITIS

*Streptococcus (Enterococcus) durans* has been isolated from a foal with enteritis and has caused mild enteritis and diarrhea in foals infected orally. This organism has also been isolated from outbreaks of diarrhea in neonatal pigs<sup>3</sup> and disease has been produced in gnotobiotic piglets.<sup>4</sup> *Streptococcus entericus* sp. nov. has been isolated from the intestine of a cow with enteritis but its causal significance is not known.<sup>5</sup>

#### PNEUMONIA

- A syndrome of pneumonia and fibrinous pleuritis and pericarditis is caused in lambs by *S. zooepidemicus*
- Pneumonia in calves may be associated with *S. pneumoniae*, and unidentified streptococci are common invaders in viral pneumonia of calves. Infections in calves with *S. pneumoniae* may have public health significance; the isolation of identical strains of the organism from the lungs of calves dying of the disease and from the throats of their human attendants suggests that interspecies transmission may occur. Calves may be immunized either by the use of antiserum or through vaccination of their dams with a polyvalent aluminum hydroxide-adsorbed vaccine
- *S. pneumoniae* is also associated with inflammatory disease of the lower respiratory tract of horses,<sup>6</sup> sometimes in association with a virus and sometimes with *S. zooepidemicus*<sup>7</sup>
- Streptococcal pneumonia can be a complication of systemic corticosteroid therapy in horses.<sup>8</sup>

#### MENINGOENCEPHALITIS

Meningoencephalitis is a common complication of streptococcal septicemia of the newborn but *S. suis* is a specific cause in pigs and is dealt with under that heading. Streptococcal meningitis is restricted to the neonate in all species except piglets with *S. suis* and rarely lambs where sporadic meningitis in 3–5-month-old lambs occurs. Streptococcal meningitis and brain abscess may be a rare complication in horses of sinusitis and rhinitis.<sup>9</sup>

#### LYMPHANGITIS

An ulcerative lymphangitis, caused in many instances by *S. zooepidemicus*, has been observed in foals from 6 months to 2 years of age and may be confused with

ulcerative lymphangitis associated with *Corynebacterium pseudotuberculosis*.

## DERMATITIS

Infectious dermatitis (contagious pyoderma) of pigs is characterized by the formation of pustules about the face and neck, and to a lesser extent the trunk. Streptococci and staphylococci are present in the lesions and spread appears to occur through abrasions, especially in young pigs that fight and have not had their needle teeth removed. The disease may be confused with exudative epidermitis.

## ARTHRITIS IN LAMBS

In the UK, *S. dysgalactiae* is a significant cause of outbreaks of arthritis in lambs, especially during the first 3 weeks of life. It occurs more commonly in lambs that are lambed indoors. Affected lambs are lame in one or more legs and are often found recumbent. There is minimal joint swelling in the initial stage of the disease and for this reason differential diagnoses include nutritional myopathy, swayback and spinal abscess. Infection is present in any joint but most common in the tarsal and atlanto-occipital joints. Some die with systemic disease and myocarditis. Survivors may be chronically lame.<sup>10</sup>

## GENITAL TRACT INFECTIONS

Streptococcal infections of the genital tract, including *S. zooepidemicus*, occur commonly, especially in mares, in which the disease is thought to be spread by coitus and is accompanied by a high incidence of abortion, sterility and neonatal infection in foals.<sup>11,12</sup>

Foals from infected mares may be affected each year. Although streptococcal metritis occurs in sows, there appears to be no relationship between uterine infection and neonatal septicemia. Abortions in sows may be associated with infection with beta-hemolytic streptococci.

One of the important features of streptococcal diseases is their lack of susceptibility to control by vaccination. Vaccines against strangles of horses, *S. suis* in piglets and cervical adenitis of pigs are available, but results with them are equivocal. When the vaccines are properly prepared and carefully and intelligently applied the results are good. However, it is apparent that the streptococci are not good antigens and that the vaccines made with them lack the ease of application and safety that one expects with, say, the clostridial vaccines.

## REFERENCES

1. Varma KJ et al. J Vet Pharmacol Ther 1984; 7:213.
2. Hommez J et al. Vet Rec 1988; 123:626.
3. Choen D-S. J Vet Diagn Invest 1996; 8:123.
4. Tzipori S. J Infect Dis 1984; 150:589.

5. Vela AI et al. Int J Syst Evol Microbiol 2004; 52:665.
6. Mackintosh ME et al. In: Proceedings of the 5th International Conference on Infectious Diseases in Horses 1988: 41-44.
7. Burrell MH et al. Equine Vet J 1986; 18:183.
8. Mair TS. Vet Rec 1996; 138:205.
9. Smith JS et al. J Am Vet Med Assoc 2004; 224:739.
10. Watkins G. State Vet J 2000; 10:15.
11. Welsh RD. Equine Pract 1984; 6:6.
12. Smith KC et al. Equine Vet J 2003; 35:496.

## STRANGLES (EQUINE DISTEMPER)

### Synopsis

**Etiology** *Streptococcus equi* subsp. *equi*

**Epidemiology** Highly contagious disease that affects horses of all ages but is most common in young animals. Prolonged carrier state in asymptomatic animals

**Clinical signs** Acute onset of fever, anorexia, depression, submandibular and pharyngeal lymphadenopathy with abscessation and rupture, and copious purulent nasal discharge. Metastatic infection in other organ systems

**Clinical pathology** Culture of *S. equi* from nasal and abscess discharges. Polymerase chain reaction (PCR) of nasal, pharyngeal or guttural pouch swabs. High serum antibody titer to SeM

**Lesions** Caseous lymphadenopathy with rhinitis and pharyngitis, pneumonia and metastatic infection in severe cases

**Diagnostic confirmation** Culture of *S. equi*

**Treatment** Systemic administration of penicillin. Local treatment of abscesses

**Control** Isolation and quarantine of cases and new admissions to barns and stables. Detection of carrier status by PCR and/or culture of guttural pouch washings. Vaccination may reduce the case attack rate and severity of disease

## ETIOLOGY

*Streptococcus equi* subsp. *equi* (*S. equi*) is a Gram-positive coccobacillus that produces a beta-hemolysin, evident as a zone of clear hemolysis surrounding colonies growing on blood agar. There is evidence that *S. equi* is a biovar or genovar of *S. zooepidemicus*.<sup>1</sup> *S. equi*, which is highly host-adapted to Equidae, demonstrates no serological variation, although genetic analysis demonstrates the existence of clones that vary geographically.<sup>2</sup> There is variation in virulence related to the amount of M protein and hyaluronic capsule produced.<sup>3</sup> An atypical milder form of the disease is associated with a capsule-deficient variant of *S. equi*.

## EPIDEMIOLOGY

### Occurrence

Strangles occurs in horses, donkeys, and mules worldwide. Outbreaks are seen relatively frequently on breeding farms and in polo and racing stables, when the infection is introduced by new arrivals that

are often asymptomatic, and in horses taken to fairs and riding schools. An **incidence** of 35% over a 3-year period is reported for horse studs in Australia.<sup>4</sup>

Strangles can affect horses of any age, although the **morbidity rate** is usually greater in younger horses such as foals and weanlings.<sup>5</sup> Age-specific attack rates of strangles of 18% for brood mares, 48% for 1-year-old horses and 38% for foals during an outbreak on a breeding farm are reported, although higher morbidity rates (100%) can occur, especially in young horses.<sup>5,6</sup> The risk of occurrence of an outbreak of strangles increases with the size of the group of horses: farms with 100 or more horses have a 26 times greater risk of experiencing an outbreak than farms with fewer than 15 horses.<sup>4</sup>

The **case-fatality rate** without treatment is about 9%, but with adequate early treatment may be as low as 1-2%. Deaths are usually due to pneumonia.<sup>5,7</sup>

## Source of infection and transmission

*S. equi* is an obligate parasite of horses and all infections are attributable to transmission from infected horses, either directly or by fomites. **Nasal and abscess discharge** from infected animals that contaminates pasture, tack, stalls, feed and water troughs, grooming equipment, and hands and clothes of grooms and veterinarians is often the source of infection for susceptible horses. *S. equi* can survive in the environment for at least 2 months, and fomite transfer is important in transmission of infection.<sup>8</sup> Direct transmission from infected animals to susceptible animals occurs through contact.

Approximately 10-40% of horses that recover from the clinical disease have **persistent infection** of *S. equi* in the pharynx and guttural pouches for many months and are an important source of infection.<sup>9,10</sup> Horses with **clinically inapparent disease**, such as some cases of guttural pouch empyema, may shed the organism for over 3 years.<sup>9</sup> The period of infectivity is important in terms of the length of quarantine that needs to be imposed on horses that have apparently recovered from the disease. Because shedding of *S. equi* may be intermittent, repeated culture of nasopharyngeal swabs or use of PCR examination of guttural pouch washings may be necessary to document the carrier status of individual horses.<sup>10</sup> Endoscopic or radiographic examination of clinically inapparent shedders may demonstrate lesions in the guttural pouches, paranasal sinuses, or pharynx.<sup>11</sup> However, some persistent carriers of *S. equi* do not have detectable abnormalities of the nasopharynx. The clinically inapparent nature of the infection makes detection of carriers problematic, especially

when considering introduction of horses into a previously closed herd in which strangles is not endemic.

### Animal risk factors

Strangles is more common in young or naive horses, although the disease can occur in horses of any age. Animals that have previously had the disease are less likely than naive animals to develop the disease on subsequent exposure.<sup>3,6,12</sup> A proportion (approximately 25%) of horses that recover from the disease do not develop a protective immune response and are susceptible to reinfection and a second bout of strangles.<sup>3,6</sup> Resistance to the disease is associated with the production of **serum and mucosal IgG antibodies** to the streptococcal **M protein**.<sup>6</sup> The presence in the nasopharynx of antibodies to streptococcal M protein is thought to be important in conferring resistance to the disease.<sup>3</sup> Serum IgG antibodies specific for SeM protein, which is important in the antiphagocytic activities of *S. equi*, are produced by most but not all horses during convalescence. Similarly, IgA and IgG antibodies against SeM protein are detectable on nasal and pharyngeal mucosa after *S. equi* infection but not after intramuscular administration of vaccines containing M protein.<sup>13</sup> Serum bactericidal activity alone is not considered to be a good indicator of resistance to the disease, especially if it is induced by administration of a vaccine.<sup>1,3</sup> Antibodies similar to those found in the nasopharynx after infection with *S. equi* are present in colostrum and milk of mares that have recovered from the disease, are passed to foals via the colostrum and are secreted into the foal's nasopharyngeal mucosa.<sup>12</sup> These acquired antibodies are important in mediating the resistance of young foals to the disease.<sup>12</sup>

Although **strong immunity** occurs immediately after an attack, this immunity wanes with time and a horse may suffer further disease if the organism is virulent.

### Importance

Strangles is one of the most important diseases of horses in developed countries, accounting for up to 30% of reported infectious disease episodes.<sup>1</sup> The disease is important not only because of the deaths that it causes but more importantly because of the disruption of the management of commercial horse establishments, the time necessary to treat affected horses and the esthetic unpleasantness of the running noses and draining abscesses.

### PATHOGENESIS

**Virulence** of *S. equi* is attributable to the presence of **M proteins** on the surface of the bacteria, a hyaluronic acid capsule and the production of a leukocidal toxin.<sup>2</sup>

M proteins are associated with *S. equi* adhesion to oral, nasal, and pharyngeal tissues, invasion of pharyngeal tonsils and associated lymphoid structures, and evasion of the innate host immune response.<sup>13</sup> *S. equi* produces two M proteins – SeM and SzPSe. SeM is unique to *S. equi* and plays a dominant role in resistance of the organism to phagocytosis.<sup>14</sup> Variations in structure of M protein are associated with decreased virulence.<sup>15</sup> The M proteins interfere with the deposition of complement component 3b on the surface of the bacteria and bind fibrinogen, both of which reduce the susceptibility of the bacteria to phagocytosis by neutrophils.<sup>16,17</sup> The antiphagocytic activity of *S. equi* reduces the efficacy of neutrophils in engulfing and destroying the bacteria.

The capsule of *S. equi* is associated with resistance to non-immune phagocytosis and pathogenicity. Strains of *S. equi* that do not produce a capsule do not induce disease, although they are able to infect guttural pouches and cause seroconversion in experimental studies.<sup>18</sup>

Following exposure of the oral and nasopharyngeal mucosal surfaces to *S. equi*, bacteria lodge in the **pharyngeal and tonsillar lymphoid tissues** where they multiply rapidly. There is no evidence of colonization of mucosal surfaces and streptococci can be detected in pharyngeal tonsils within hours of exposure.<sup>19</sup> The binding of *S. equi* to pharyngeal cells is caused by fibrinogen binding proteins associated with M protein.<sup>14</sup> The resistance of *S. equi* to non-immune phagocytosis results in accumulation of large numbers of organisms surrounded by degenerating neutrophils. Release of streptolysin S and streptokinase may contribute to tissue damage by directly injuring cell membranes and indirectly through activation of plasminogen.<sup>19</sup> Bacteremia may occur. Migration of neutrophils into the lymph nodes causes swelling and abscessation, with associated disruption of lymph drainage and development of edema in tissues drained by the affected nodes. Swelling of retropharyngeal lymph nodes may interfere with deglutition and respiration. Most abscesses eventually rupture and drain and the infection resolves with the development of an effective immune response. Nasal shedding of *S. equi* usually begins 4–7 days after infection, or 2 days after onset of fever, and persists for 2–3 weeks in most horses but up to years in exceptional horses. Cessation of shedding accompanies development of an effective serum and mucosal immune response.<sup>12</sup>

**Death** is usually due to pneumonia caused by aspiration of infected material, although other causes of death include asphyxiation secondary to upper airway swelling and impairment of organ func-

tion by metastatic infection. Rare deaths also occur as a result of infarctive purpura hemorrhagica in horses infected with *S. equi*.<sup>20</sup>

**Metastatic infection** of the heart valves, brain, eyes, joints, and tendon sheaths or other vital organs may occur and cause a chronic illness and eventual death. Metastatic infection may occur because of bacteremia or extension of infection along chains of lymph nodes. Purpura hemorrhagica may occur as a sequela to *S. equi* infection and is associated with high serum antibody titers to SeM.

### CLINICAL FINDINGS

The disease manifests as an acute disease of varying severity, chronic infection of retropharyngeal lymph nodes and guttural pouches, and as chronic disease associated with metastatic infection of organs distant to the upper respiratory tract. The severity of the acute disease varies with the age and immune status of the animal, and size of the inoculum and duration of exposure to infection. The term strangles derives from the enlarged retropharyngeal lymph nodes and guttural pouches causing respiratory distress in severely affected equids.

### Acute disease

The acute disease is characterized by mucopurulent nasal discharge and abscessation of submandibular and retropharyngeal lymph nodes. After an **incubation period** of 1–3 weeks the disease develops suddenly with complete anorexia, depression, fever (39.5–40.5°C, 103–105°F), a serous nasal discharge, which rapidly becomes copious and purulent, and a severe pharyngitis and laryngitis.<sup>21,22</sup> Rarely there is a mild conjunctivitis.

**Lymphadenopathy** becomes apparent as the submandibular lymph nodes enlarge and palpation elicits a painful response. The pharyngitis may be so severe that the animal is unable to swallow and there is a soft, moist cough. The head may be extended.

The febrile reaction commonly subsides in 2–3 days but returns as the characteristic abscesses develop in the lymph nodes of the throat region. The affected nodes become hot, swollen, and painful. **Swelling of the retropharyngeal lymph nodes** may cause obstruction of the oro- and nasopharynx with subsequent respiratory distress and dysphagia. Death by asphyxiation may occur at this time in severe cases. Obvious swelling of the nodes may take 3–4 days to develop; the glands begin to exude serum through the overlying skin at about 10 days and rupture to discharge thick, cream-yellow pus soon afterwards. Average cases run a course of 3 weeks, severe cases may last as long as 3 months.

Retropharyngeal abscesses may rupture into the guttural pouches, resulting in

guttural pouch empyema and ultimately in prolonged infection and formation of chondroids. Retropharyngeal lymph node abscessation may not be apparent on external evaluation and can often only be detected by radiographic or endoscopic examination of the pharynx. Infection of retropharyngeal lymph nodes and guttural pouches is important in persistent infection and carrier status of some horses.

If the infection is particularly severe, many other lymph nodes, including the pharyngeal, submaxillary, parotid and retrobulbar nodes, may abscess at the same time. Local abscesses may also occur at any point on the body surface, particularly on the face and limbs, and the infection may spread to local lymphatic vessels causing obstructive edema. This occurs most frequently in the lower limbs, where edema may cause severe swelling. Abscess formation in other organs probably occurs at this time.

An atypical form of the disease may occur and is characterized by widespread subclinical infection and a mild disease. Affected horses have a transient fever for 24–48 hours and a profuse nasal discharge, and are anorexic. A moderate enlargement of the mandibular lymph nodes occurs in only about one-half of the affected horses.

**Strangles in burros** is a slowly developing debilitating disease. At postmortem examination the characteristic lesions consist of caseation and calcification of abdominal lymph nodes.

### Complications

Complications occur in about 20% of cases.<sup>5,6</sup> The most common fatal complication is the development of **suppurative necrotic bronchopneumonia**, which probably occurs secondary to the aspiration of pus from ruptured abscesses in the upper airway, or metastatic infection of the lungs.<sup>23</sup>

Extension of the infection into the **guttural pouches**, usually as a result of rupture of retropharyngeal lymph nodes into the medial compartment, causes empyema, which may lead to the formation of accretions of inspissated pus (chondroids). Involvement of the guttural pouches is evident clinically as distension and, after resolution of other signs, unilateral or bilateral nasal discharge. Guttural pouches of affected horses should be examined endoscopically for evidence of retropharyngeal abscessation or guttural pouch empyema or chondroid formation.

Retropharyngeal lymphadenopathy may impair the function of the **recurrent laryngeal nerves**, with subsequent unilateral or bilateral laryngeal paresis and consequent respiratory distress.

**Metastatic infection** ('bastard strangles') results in the formation of abscesses

in any organ or body site but most commonly in the lungs, mesenteric lymph nodes, liver, spleen, kidneys, and brain. Clinical signs depend on the organ affected and the severity of the infection, but intermittent fever, chronic weight loss and sudden death due to rupture of abscesses into a body cavity are common manifestations of metastatic infection. Rectal examination or percutaneous ultrasonographic examination may reveal intra-abdominal abscesses in some horses with metastatic abscesses in the abdomen. Peritoneal fluid from these horses is often abnormal.

Metastatic infections may occur in the **central nervous system**. Extension of infection to the meninges results in suppurative meningitis characterized clinically by excitation, hyperesthesia, rigidity of the neck, and terminal paralysis. Abscesses in the brain cause a variety of clinical signs, depending on location of the abscess, including severe depression, head pressing, abnormal gait, circling, and seizures.<sup>24</sup> Metastatic infections of the ocular and extraocular structures, heart valves and myocardium, joints, bones, tendon sheaths, and veins may occur.

**Purpura hemorrhagica** can occur as a sequela to *S. equi* infection.<sup>20,25</sup>

Two myopathic syndromes occur with *S. equi* infection in horses.<sup>26</sup> **Muscle infarction**, which may be extensive, is assumed to result from immune-mediated vasculitis associated with purpura hemorrhagica.<sup>20</sup> Often the muscle lesions in these horses are associated with other lesions consistent with severe purpura hemorrhagica, including infarctions in the gastrointestinal tract, skin and lungs. **Rhabdomyolysis and subsequent muscle atrophy** results in signs of muscle disease, including stilted gait and elevated serum activity of creatine kinase and other muscle-derived enzymes, and is assumed to be due to cross-reactivity of anti-SeM antibodies with myosin.<sup>26</sup>

Myocarditis and glomerulonephritis have been suggested as sequelae to *S. equi* infection but have not been conclusively demonstrated to occur.

### CLINICAL PATHOLOGY

**Hematological abnormalities** during the acute phase of the disease include leukocytosis with a neutrophilia reaching a peak as the lymph nodes abscess. **Hyperfibrinogenemia** is characteristic of both the acute and chronic disease. Hematological and biochemical abnormalities associated with metastatic infection depend on the site of the infection and its severity. Leukocytosis with a **hyperproteinemia** attributable to a polyclonal gammaglobulinemia is characteristic of metastatic and chronic abscessation. **Hypoalbumi-**

**nemia** may be present. Serum biochemical profile may reveal evidence of specific organ dysfunction. There may or may not be an anemia, which may be due to the hemolytic effect of streptolysin O, immune-mediated hemolysis, or anemia of chronic disease.

A commercial test that measures the **serum IgG antibody titer to SeM** has been developed and has been used to determine response to vaccination, suitability for vaccination and presence of metastatic infection.<sup>19,27</sup> The test is not useful in diagnosis of the acute disease. Serum antibody titers to SeM are very high (> 1:12 800) in horses with metastatic infection or purpura hemorrhagica.

PCR testing is useful to detect shedding of *S. equi* DNA. The test is reported to be more specific than culture for detection of *S. equi* shedding.<sup>10</sup> The PCR does not differentiate between live and dead *S. equi* and false-negative results occur in the presence of large numbers of *S. equi*. PCR testing should be considered an adjunct to routine culture for detection of *S. equi*.

Culture of nasal, pharyngeal, guttural pouch, or abscess discharge will usually yield *S. equi* in horses with active disease or in carriers. Abscesses may rapidly become contaminated with *S. zooepidemicus*, which may impede isolation of *S. equi*.

### NECROPSY FINDINGS

In the rare fatalities that occur, necropsy examination usually reveals suppurative in internal organs, especially the liver, spleen, lungs, pleura, and peritoneum. When the last is involved, it is usually as a result of extension from abscesses in the mesenteric lymph nodes. The microscopic changes of abscessation and suppurative lymphadenitis are uncomplicated. The widespread ecchymotic hemorrhages of purpura hemorrhagica are not specific to this infection, but *S. equi* should always be investigated as a potential cause of such lesions.

### Samples for confirmation of diagnosis

- Bacteriology – swab of abscess wall, enlarged lymph node (CULT).

### DIAGNOSTIC CONFIRMATION

**Confirmation** of strangles depends on the isolation of *S. equi* from nasopharyngeal swabs and discharges from abscesses. Shedding of *S. equi* in nasal discharges begins 1–4 days after the onset of fever, and ruptured abscesses often become contaminated with *Streptococcus zooepidemicus* and *S. equisimilis*.

### TREATMENT

The **specific treatment** of choice for *S. equi* infection of horses is **penicillin**, either as

### DIFFERENTIAL DIAGNOSIS

See Table 16.1 for a list of differential diagnoses of infectious upper respiratory tract disease of horses. Pneumonia should be differentiated from pleuropneumonia associated with transport or other stress. Chronic weight loss due to metastatic infection should be differentiated from equine infectious anemia, parasitism, inadequate nutrition and neoplasia, especially gastric squamous cell carcinoma, alimentary lymphosarcoma and granulomatous enteritis.

procaine penicillin G (22 000 IU/kg intramuscularly every 12 h) or potassium or sodium penicillin G (22 000 IU/kg intravenously every 6 h). Tetracycline (6.6 mg/kg intravenously every 12–24 h) and sulfonamide–trimethoprim combinations

(15–30 mg/kg orally or intravenously every 12 h) may be efficacious but should only be used if penicillin cannot be administered. Aminoglycosides, such as gentamicin or amikacin, and the fluoroquinolones are not effective.

There is considerable debate about the treatment of horses with strangles. Folklore and anecdotal reports suggest that antibiotic treatment of horses with strangles is contraindicated because it promotes the development of metastatic infection. There is no experimental or empirical evidence to support this contention and horses with strangles should be treated with therapeutic doses of an appropriate antibiotic, such as procaine penicillin, for a period of time sufficient to effect a cure, as appropriate.

Treatment for *S. equi* infection depends on the stage of the disease.<sup>28</sup>

Horses with **early clinical signs** including fever, anorexia, depression, and purulent nasal discharge should be isolated and treated with therapeutic doses of penicillin for at least 5 days. The purpose of treatment is to prevent further development of the disease in the affected animal, and to minimize environmental contamination with *S. equi* and transmission to other horses. Treatment should start as soon as clinical signs are observed and the full course of treatment should be completed to minimize the chances of recrudescence of the infection. Treatment at this stage causes rapid resolution of fever, anorexia, nasal discharge, and lymphadenopathy in individual horses and may abort an incipient outbreak of the disease in a

Table 16.1 Differential diagnosis of diseases of the upper respiratory tract of horses

Disease	Epidemiology	Clinical signs		Diagnosis and clinical pathology
		Respiratory tract	Other	
Strangles ( <i>Streptococcus equi</i> infection)	Incubation period 4–8 d. Course 10–21 d. Spreads by inhalation or ingestion. Mostly young horses in recently commingled groups. Long period (many months) of inapparent infection in some horses	Copious, purulent nasal discharge. Cranial lymphadenitis and rupture. Moist cough. Obstruction of pharynx can cause dyspnea	Severe illness with suppuration, fever. Atypical cases show involvement of other organs. Serious sequelae include pneumonia, metastatic spread of infection, mesenteric abscess or purpura hemorrhagica	<i>S. equi</i> in nasal, pharyngeal or guttural pouch swabs, oropharyngeal pus or lymph node abscess pus. PCR of nasal, pharyngeal or guttural pouch swabs. High SeM antibody titer in chronic disease or convalescence. Leukocytosis. Hyperfibrinogenemia. Virus in blood at fever peak. Serology. Leukopenia
Equine viral arteritis (EVA)	Incubation period 1–6 d. Course 3–8 d. Some deaths	Serous/purulent nasal discharge. Slight cranial lymphadenitis, cough. Conjunctivitis, purulent with edema or petechiae. Dyspnea	Severe disease. Anasarca. Ventral edema, prepuce, legs, scrotum. May be diarrhea, jaundice. Up to 50% of mares abort	Virus in nasal discharge or peripheral blood buffy coat. PCR of nasal discharge or blood. Tissue culture and serological tests. Leukopenia. Virus in intranuclear hepatic inclusions of fetus
Equine viral rhinopneumonitis (EHV-1)	Incubation period 2–10 d. Course 2–5 d. Cough may last as long as 3 weeks	Serous/purulent nasal discharge. Slight cranial lymphadenitis, coughing, conjunctivitis. Mild respiratory disease; in young	Abortion in mares. Virus may cause myelopathy	Virus in nasal discharge or peripheral blood buffy coat. PCR of nasal discharge or blood. Tissue culture and serological tests. Leukopenia. Virus in intranuclear hepatic inclusions of fetus
Equine viral rhinopneumonitis (EHV-4)	Incubation period 2–10 d. Course 2–5 d. Cough may last as long as 3 weeks	Serous/purulent discharge. Slight cranial lymphadenitis, coughing, conjunctivitis	Mild respiratory disease; in young horses	Virus in nasal discharge. Tissue culture and serological tests. Leukopenia
Equine influenza (H3N8 rarely H7N1)	Incubation period 2–3 d. Course 7 d. Cough may persist 3–4 weeks. enzootic, worldwide (not Australia). Explosive outbreaks. 80–100% morbidity in young	Nasal discharge slight, serous only. Slight cranial lymphadenitis. Severe cough. No conjunctivitis and no respiratory distress	Minimal extra-respiratory signs. Temperature 39–41°C (102–105°F)	Virus in nasal discharge. Good serological tests available. Rapid ELISA test for viral antigen in nasal secretions. PCR of nasal secretions
Equine rhinitis virus	Incubation period 3–8 d. Rapid spread, high morbidity (70%). Solid immunity after natural infection. Excreted in urine	Pharyngitis, pharyngeal lymphadenitis, nasal discharge serous to mucopurulent. Cough persists 2–3 weeks	Mild disease. Emphasis on coughing. Fever to 39.5°C (103°F)	Equine rhinitis virus on tissue culture. Serological tests available
Equine adenovirus	Many inapparent infections. High proportion of population serologically positive	Mild respiratory signs in adults. Fatal pneumonia in Arabian foals with combined immunodeficiency	Transient softness of feces. In mares can cause abortion without clinical illness	Adenovirus in oropharyngeal swabs. Serological tests available

ELISA, enzyme-linked immunosorbent assay; PCR, polymerase chain reaction.

stable or yard. However, treated horses may not develop a protective immune response and consequently may be at risk of reinfection if exposed to *S. equi* after completion of the course of treatment, leading one authority to recommend that only severely affected animals be treated<sup>28</sup>

- Horses with submandibular **lymph node abscessation** but without other clinical abnormalities probably do not require antibiotic treatment. Such horses should be isolated and efforts made to aid maturation and rupture of affected lymph nodes
- Systemic antibiotic therapy with penicillin is indicated in horses with **advanced signs of strangles**, including prolonged fever, depression, anorexia or dyspnea resulting from retropharyngeal lymphadenopathy. Retropharyngeal abscessation frequently responds to antimicrobial therapy, although surgical drainage may be required in some instances<sup>29</sup>
- Horses with **metastatic infection** require systemic penicillin therapy in combination with specific therapy for the complication. Pulmonary and mesenteric abscesses are problematic because they are usually not amenable to surgical drainage, and prolonged antimicrobial therapy is required to effect a cure
- **Guttural pouch empyema** requires either surgical drainage or repeated flushing of the affected pouch through the pharyngeal openings.<sup>11</sup> Removal of pus and inspissated material in the guttural pouches can be achieved under endoscopic guidance. Alternatively, rigid or flexible indwelling catheters can be inserted for repeated flushing of the pouches with sterile isotonic electrolyte solutions (such as 0.9% NaCl) and topical medications. Substances and solutions that are irritating or injurious to mucus membranes, such as iodine, hydrogen peroxide and similar irritant compounds, should not be infused into the guttural pouches. Combined topical and systemic administration of potassium benzyl penicillin may be beneficial.<sup>30</sup> Chondroids can often be removed using wire snares. Horses with metastatic or guttural pouch infections should be isolated
- Treatment of **purpura hemorrhagica** is dealt with elsewhere
- Management of horses that have been **exposed** to horses with strangles is controversial. Some authorities recommend treatment of such in-contact horses with penicillin until affected horses are isolated and

no longer are a source of infection. However, close examination of exposed animals, including monitoring rectal temperature, and treatment of horses at the first sign of illness is probably a more reasonable approach.

**Ancillary treatment** consists of administration of nonsteroidal anti-inflammatory drugs (NSAIDs) to reduce swelling and provide pain relief, application of hot poultices to encourage rupture of abscesses, provision of intravenous hydration in animals unable to drink, and wound care, including cleaning of ruptured abscesses and application of petroleum ointment to surrounding skin to prevent scalding. Horses with severe upper airway obstruction may require placement of a short-term tracheotomy.

### CONTROL

The principles of control measures include the prevention of transmission of *S. equi* from infected horses (cases or carriers) to susceptible animals and enhancement of resistance to infection and disease.

### Prevention of transmission

Preventing introduction of strangles to herds free of the disease is difficult, especially when there is frequent movement of horses in and out of the herd. Close attention should be paid to the health of horses introduced to herds free of the disease and, although this is an imperfect safeguard, the owner or manager of horses to be introduced to a herd should be questioned about the likelihood of exposure of the horse to strangles. Ideally, horses should be isolated for 3 weeks before introduction to a herd that is free of the disease and should have washings of the guttural pouches performed on three occasions at weekly intervals. The washings should be examined by culture and PCR for the presence of *S. equi*. Clearly, this requirement, while ideal, is demanding of time, space and labor, is expensive and would be difficult to implement as a routine practice.

Methods to control transmission of *S. equi* on affected premises are detailed in Table 16.2.<sup>19</sup>

Table 16.2. Aims and associated measures used to control transmission of *Streptococcus equi* in affected premises and herds

Aim	Measure
Prevention of spread of <i>S. equi</i> infection to horses on other premises and to new arrivals on the affected premises	Stop all movement of horses on and off affected premises immediately and until the outbreak is controlled Horses with strangles and their contacts should be maintained in well demarcated quarantine areas Clustering of cases in groups allow parts of the premises to be allocated as contaminated or clean
Establish whether clinically recovered horses are carriers	At least three nasopharyngeal swabs or washings taken at weekly intervals from all recovered cases and their contacts and examined by culture and PCR Horses that are consistently negative are returned to the clean area
Investigate apparently healthy horses from which <i>S. equi</i> is recovered	Endoscopic examination of the upper airways and guttural pouches
Eliminate <i>S. equi</i> from guttural pouches	Treatment of guttural pouches, as detailed under 'Treatment'
Prevention of infection of uninfected horses by <i>S. equi</i> from infected horses	Personnel should have dedicated protective clothing when dealing with infected horses Personnel should not deal with infected and uninfected horses. If this is not possible, then infected horses should be dealt with after uninfected horses Strict hygiene should be implemented, including provision of disinfection facilities for personnel and diligent and thorough cleaning of stables and barns. If practicable, equipment should be destroyed after use with infected horses Organic material should be removed from stables and then appropriate phenolic disinfectants or steam should be applied. This cleaning should be repeated Feces and waste from infected animals should be composted in an isolated location Uninfected horses should not be introduced to pastures used to house infected horses for 4 weeks Water troughs should be disinfected daily. Horse vans should be thoroughly cleaned and disinfected after each use

PCR, polymerase chain reaction.

Source: modified and used with permission from Sweeney CR et al. *J Vet Intern Med* 2005; 19:123-134.

- Infected animals should be isolated immediately
- All potential sources of fomites – including pails, brooms, grooming brushes and blankets – should be thoroughly cleaned and disinfected and the bedding burned. Disinfection with phenolic compounds is preferred because they retain their activity in the presence of some organic matter, whereas bleach and quaternary ammonium compounds are inactivated by organic material<sup>31</sup>
- Emergency prophylactic treatment, using injections of benzathine penicillin every 48 hours in foals and yearlings that are most susceptible, has been used but most treated animals develop strangles when the treatment is discontinued.<sup>28</sup> This method of prophylaxis is not recommended
- People who care for affected horses should, ideally, avoid contact with susceptible animals. If this is not practical, then strict isolation protocols, including the wearing of protective boots and clothes that are changed between affected and normal horses, should be implemented
- Newly introduced animals should be quarantined for 3 weeks and observed for signs of strangles. Rectal temperature should be monitored twice daily
- Horses with elevated temperatures should have nasopharyngeal or guttural pouch swabs cultured
- Ideally, recovered animals should not be mingled with susceptible animals for a period of several months. The optimum length of a quarantine period has not been determined, but it should be recalled that prolonged shedding (several months to years) occurs in horses with lesions of the guttural pouch. Animals without such lesions can shed *S. equi* for at least 60 days.

#### Enhanced resistance

The majority of horses develop solid immunity to strangles after recovery from the spontaneous disease. This immunity lasts for up to 5 years in approximately three-quarters of recovered horses.<sup>6</sup> Maximum resistance to disease probably requires both systemic and mucosal immunity to a variety of *S. equi* factors including, but not limited to, M protein.<sup>19,32</sup>

The efficacy of **vaccination** of adult horses with *S. equi* bacterins or M protein extracts of *S. equi* administered intramuscularly is controversial. Administration of M protein vaccines elicits an increase in the concentration of serum opsonizing antibodies but does not confer a high degree of resistance to natural exposure.<sup>3</sup>

Anecdotal and case reports suggest that vaccination is not effective. However, in a controlled field trial, vaccination with an M protein commercial vaccine three times at 2-week intervals reduced the clinical attack rate by 50% in a population of young horses in which the disease was endemic.<sup>33</sup> Horses vaccinated only once were not protected against strangles.<sup>33</sup> This result suggests that, in the face of an outbreak, vaccination may reduce the number of horses that develop strangles but will not prevent strangles in all vaccinated horses. A common vaccination protocol involves the administration of an M protein vaccine intramuscularly for an initial course of three injections at 2-week intervals, with further administration of the vaccine every 6 months in animals at increased risk of contracting the disease.<sup>34</sup> On breeding farms, vaccination of mares during the last 4–6 weeks of gestation and of the foals at 2–3 months of age may reduce the incidence of the disease.<sup>35</sup>

The vaccines are administered by the intramuscular route and frequently cause swelling and pain at the injection site.<sup>34</sup>

**Injection site reactions** are usually less severe with the M protein vaccines. Injection into the cervical muscles may cause the horse to be unable to lower its head to eat or drink for several days – injection into the pectoral muscles is preferred for this reason. There are reports of **purpura hemorrhagica**, the onset of which was temporally associated with administration of a *S. equi* vaccine. Owners should be clearly warned of the limited efficacy and potential side-effects of vaccination.

**Foals that receive adequate high-quality colostrum** from exposed or vaccinated mares have serum and nasopharyngeal mucosal immunoglobulins (IgG) that provide them with resistance to *S. equi* infection.<sup>6</sup> This passive immunity wanes at approximately 4 months of age. Vaccination of brood mares 1 month before foaling increases colostrum IgG antibodies to M protein, and presumably serum and mucosal immunoglobulin concentrations in their foals,<sup>3</sup> but the efficacy of this approach in preventing strangles in foals is not reported.

An **intranasal vaccine** of an avirulent live strain of *Streptococcus equi* has recently been developed and appears useful. The vaccine is composed of a live variant (strain 707-27) that does not possess a capsule and is therefore avirulent when administered intranasally. Anecdotal reports suggest that recent manipulation of the genome by deletion of genes HasA and HasB, associated with formation of the capsule, has increased the genetic stability of the vaccine strain.<sup>36</sup> The live attenuated vaccine should only be administered intranasally to healthy

horses. The efficacy of the vaccine in field situations, safety in the face of an outbreak and in pregnant mares, incidence of adverse effects and risk of reversion to virulence have not been reported. It should not be used in potentially exposed horses during an outbreak of the disease. Intramuscular injection of the vaccine results in the formation of abscesses. The vaccine should not be administered to horses concurrently with intramuscular administration of other vaccines because of the risk of contamination of needles and syringes with *S. equi* vaccinal strain and subsequent development of abscesses at injection sites.

Vaccination by **submucosal** injection of a modified live vaccine is reported to provide short-lived (90-day) immunity to disease.<sup>37</sup> The commercial form of the vaccine is administered into the submucosal tissues of the upper lip and is recommended for use in horses at moderate to high risk of developing strangles.<sup>38</sup> At present there is no evidence of reversion of the vaccinal strain to virulence, and horses developing strangles subsequent to vaccination have all been infected with virulent strains of *S. equi*, apparently before development of immunity as a result of vaccination.<sup>38</sup>

#### REVIEW LITERATURE

- Timoney JF. The pathogenic equine streptococci. *Vet Res* 2004; 35:397–409.
- Sweeney CR et al. *Streptococcus equi* infections in horses: Guidelines for treatment, control, and prevention of strangles. *J Vet Intern Med* 2005; 19:123–134.

#### REFERENCES

1. Chanter N. *J Appl Microbiol* 1997; 83:100s.
2. Al-Ghamdi GM. *Am J Vet Res* 2000; 61:699.
3. Timoney JF. *Vet Clin North Am Equine Pract* 1993; 9:365.
4. Jorm LR. *Aust Vet J* 1990; 67:436.
5. Sweeney CR. *J Am Vet Med Assoc* 1989; 194:1281.
6. Hamlen HJ et al. *J Am Vet Med Assoc* 1994; 204:768.
7. Ford J, Lokai MD. *Equine Pract* 1980; 2:41.
8. Jorms LR. In: *Proceedings of the Sixth International Conference on Equine Infectious Diseases* 1991:39.
9. Newton JR et al. *Vet Rec* 1997; 140:84.
10. Newton JR. *Equine Vet J* 2000; 32:515.
11. Newton JR et al. *Equine Vet Educ* 1997; 9:98.
12. Galan JE et al. *Infect Immun* 1986; 54:202.
13. Meehan M. *Microbiology* 2001; 147:3311.
14. Harrington DJ. *Microbes Infect* 2002; 4:501.
15. Chanter N. *Microbiology* 2000; 146:1361.
16. Boschwitz JS, Timoney JF. *Infect Immunol* 1994; 62:3515.
17. Boschwitz JS, Timoney JF. *Microb Pathog* 1994; 17:121.
18. Anzai T. *Vet Microbiol* 1999; 67:277.
19. Sweeney CR et al. *J Vet Intern Med* 2005; 19:123.
20. Kaese HJ et al. *J Am Vet Med Assoc* 2005; 226:1893.
21. Dagleish R. *Vet Rec* 1993; 132:528.
22. Fintl C. *Vet Rec* 2000; 147:480.
23. Sweeney CR et al. *Compend Contin Educ Pract Vet* 1987; 9:845.
24. Spoomakers TJ. *Equine Vet J* 2003; 35:146.



25. Pusterla N. *Vet Rec* 2003; 153:118.
26. Valberg SJ. *Proc Am Assoc Equine Pract* 1996; 42:292.
27. Sheoran AS et al. *Vet Immunol Immunopathol* 1997; 59:239.
28. Sweeney CR. *Equine Vet Educ* 1996; 8:317.
29. Golland LC et al. *Aust Vet J* 1995; 72:161.
30. Verheyen K et al. *Equine Vet J* 2000; 32:527.
31. Dwyer RM. *Equine Dis Q* 1996; 4:4.
32. Flock M et al. *Infect Immun* 2004; 72:3228.
33. Hoffman AM et al. *Am J Vet Res* 1991; 52:589.
34. Smith H. *Vet J* 1994; 71:410.
35. Wilson WD. *J Am Vet Med Assoc* 1995; 207:429.
36. Walker JA, Timoney JF. *Vet Microbiol* 2002; 89:311.
37. Newton R et al. *Vet Rec* 2005; 156:291.
38. Jacobs AA et al. *Vet Rec* 2000; 147:563.

## **STREPTOCOCCUS ZOOEPIDEMICUS INFECTION**

*Streptococcus equi* var. *zooepidemicus* (*S. zooepidemicus*) is one of the bacteria most commonly isolated from the upper respiratory tract of clinically normal horses.<sup>1</sup> Almost all horses harbor a number of antigenic types of *S. zooepidemicus* in their tonsils, and this may be the source of opportunistic infections of other body systems, including the lungs.<sup>1</sup> Pneumonia in an individual horse is usually associated with a single strain of *S. zooepidemicus*, based on variants of the M-protein-like compound SzP.<sup>1</sup> However, there are a large number of SzP phenotypes and it does not appear to be an important determinant of invasiveness or epizootic capability.<sup>1</sup> *S. zooepidemicus* is also frequently isolated from horses with pleuropneumonia, endometritis, neonatal septicemia, abortion, and mastitis, suggesting a role for this organism in the pathogenesis of these diseases.<sup>2,3</sup> *S. zooepidemicus* is likely important in the development of respiratory disease in foals and adult horses.<sup>4-7</sup> *S. zooepidemicus* was isolated from 88% of foals with clinical evidence of lower respiratory tract disease, and isolation of the organism was associated with an increased proportion of neutrophils in bronchoalveolar lavage fluid,<sup>4</sup> suggesting a causal role for this organism. Similarly, the number of *S. zooepidemicus* isolated from tracheal aspirates of adult horses is directly proportional to the number of neutrophils in the aspirate and the probability that they have a cough.<sup>5,8,9</sup> The association of *S. zooepidemicus* and inflammatory airway disease in race horses is independent of previous viral infection, suggesting a role for *S. zooepidemicus* as a primary pathogen.<sup>7</sup> Presence and number of colony forming units (cfu) of *S. zooepidemicus* in tracheal aspirates of horses is significantly associated with the risk of the horse having inflammatory airway disease.<sup>7,10</sup> Adult horses dying of pneumonia associated with transportation often yield *S. zooepidemicus* on culture of lung lesions and the disease can be

reproduced experimentally.<sup>6,11</sup> These results clearly demonstrate a role for *S. zooepidemicus* in the pathogenesis of respiratory disease of horses. However, it is unclear whether *S. zooepidemicus* is a primary cause of disease, a secondary contaminant or an invader of airways compromised by viral infection or other agents.

**Clinical signs** of *S. zooepidemicus* infection of the lower respiratory tract of foals and horses include coughing, mild fever, mucopurulent nasal discharge, and increased respiratory rate. Endoscopic examination of the trachea and bronchi reveals erythema and presence of mucopurulent exudate.<sup>4,5</sup> Tracheal aspirates or bronchoalveolar lavage fluid of affected horses or foals have an increased (>10%) proportion of neutrophils. *S. zooepidemicus* is a frequent isolate from the cornea of horses with ulcerative keratitis.<sup>12</sup>

**Treatment** consists of the administration of antimicrobials including penicillin (procaine penicillin, 20 000 IU/kg every 12 h) or the combination of a sulfonamide and trimethoprim (15–30 mg/kg orally every 12 h). Control consists of isolation to prevent spread of infectious respiratory disease and vaccination to prevent viral respiratory disease.

### **REFERENCES**

1. Anzai T et al. *Am J Vet Res* 2000; 61:162.
2. Welsh RD. *Equine Pract* 1984; 6:6.
3. Chand P et al. *Indian J Anim Sci* 2001; 71:445.
4. Hoffman AM et al. *Am J Vet Res* 1993; 54:1615.
5. Wood JLN et al. *Equine Vet J* 1993; 25:314.
6. Oikawa M et al. *J Comp Pathol* 1994; 111:205.
7. Wood JL et al. *J Clin Microbiol* 2005; 43:120.
8. Christley RM et al. *Equine Vet J* 2001; 33:256.
9. Chapman PS et al. *Vet Rec* 2000; 146:91.
10. Newton JR et al. *Prev Vet Med* 2003; 60:107.
11. Yoshikawa H et al. *J Vet Med Sci* 2003; 65:787.
12. Sauer P et al. *Vet Ophthalmol* 2003; 6:309.

## **NEONATAL STREPTOCOCCAL INFECTION**

**Etiology** Various *Streptococcus* spp.

**Epidemiology** Neonatal foals, calves, lambs, piglets

**Signs** Acute painful swelling of joints, lameness, fever. Signs of meningitis, omphalophlebitis, ophthalmitis. Sudden death

**Clinical pathology** Culture organism from joint fluid

**Necropsy findings** Fibrinopurulent synovitis, purulent meningitis and omphalophlebitis

**Diagnostic confirmation** Recovery of organism from joint fluid

**Differential diagnosis** Other infectious causes of arthritis, meningitis and omphalophlebitis

**Treatment** Antimicrobials, usually penicillin

**Control** See 'Principles of control and prevention of infectious diseases of newborn farm animals' in Chapter 3

## **ETIOLOGY**

Streptococci are an important cause of septicemia, polyarthritis, meningitis, polyserositis, endocarditis, and unexpected death in the neonates of all farm animal species. Meningitis associated with streptococcal infection is restricted to the neonate in all species except piglets, where outbreaks can occur in pigs after weaning, and lambs infected with *S. suis*, where meningitis can occur as a sporadic disease at 3–5 months of age. Historically, there are reports of isolates of most of the Lancefield groups of beta-hemolytic streptococci, of non-beta-hemolytic streptococci and of viridans group streptococci from neonatal disease in farm animals. Commensal skin streptococci can occasionally cause disease in presumably immunocompromised neonates.<sup>1</sup> However, the majority of neonatal disease is associated with a limited number of streptococcal species, although there can be geographical variation in their relative prevalence within animal species.

In **foals**, *S. equi* (*S. equi* subsp. *equi*) and *S. zooepidemicus* (*S. equi* subsp. *zooepidemicus*) are the most common streptococcal species recovered from septicemic disease and polyarthritis and are also a cause of placentitis and abortion in mares.<sup>2-4</sup> *S. equisimilis* (*S. dysgalactiae* subsp. *equisimilis*) is a less common isolate.

*S. suis* and *S. equisimilis* are the most common species incriminated in **piglets**. *S. suis* is especially important and is presented separately in the next section. Other Lancefield groups have been associated with sporadic disease.<sup>5</sup> In **calves**, *S. dysgalactiae* and *S. uberis* are the common streptococcal isolates from synovial fluid of neonatal calves with arthritis.<sup>6,7</sup>

*S. dysgalactiae* is also reported to be the most common cause of outbreaks of arthritis in neonatal lambs in Great Britain.<sup>8,9</sup>

Streptococci can also contribute to purulent infections at local sites, such as navel ill of all species or otitis media in neonatal calves.<sup>10</sup>

## **EPIDEMIOLOGY**

### **Occurrence and prevalence**

The importance and relative prevalence of streptococcal infections in neonatal disease varies among countries and with surveys.

Streptococci are a common cause of postnatal infections of **foals**, representing 50% of such cases in some surveys<sup>10</sup> but with a lower prevalence in others.<sup>4,11</sup> Up to 20% of abortions in mares are due to placentitis from streptococcal infection. Streptococcal septicemia due to beta-hemolytic streptococci may occur in foals under 5 days of age that have been stressed and have failure of transfer of passive immunity.<sup>12</sup>

In **calves**, neonatal infections with streptococci are usually sporadic and less

common than infections with Gram-negative bacteria and may be predisposed by failure of transfer of passive immunity. In lambs, *S. dysgalactiae* is associated with outbreaks with high morbidity and in Great Britain is reported to be the cause of over 70% of cases of polyarthritis in lambs during their first 3 weeks of life. Despite the high attack rate in these outbreaks, it is rare for more than one of twins or triplets to have disease.<sup>8,9</sup> Streptococcal arthritis associated with *S. suis* infection in piglets is a common disease and is covered in a separate section.

#### Source of infection

The source of the infection is usually the environment, which may be contaminated by uterine discharges from infected dams or by discharges from lesions in other animals. *S. dysgalactiae* is reported to survive for up to a year on clean straw, as opposed to wood shavings, which do not support the persistence of the organism.<sup>8</sup>

The portal of infection in most instances appears to be the umbilicus, and continued patency of the urachus is thought to be a contributing factor in that it delays healing of the navel. In piglets there can be high rates of infection associated with infection entering through skin abrasions such as carpal necrosis resulting from abrasive floors or facial lesions following fighting.<sup>13</sup> Contaminated knives at castration and tail docking, or contaminated ear taggers, can result in infection and disease. Other mechanical vectors include the screwworm fly (*Cochliomyia americana*).

The organism can be isolated from the nasopharynx of the sow, and direct infection from the sow to the piglet is suggested by some epidemiological data.

#### Economic importance

Affected foals and other species may die or be worthless as working animals because of permanent injury to joints. There is also loss due to condemnation at slaughter.<sup>14</sup>

#### Zoonotic implications

*S. zooepidemicus* is associated with human infections, particularly nephritis, and many human infections can be traced back to the consumption of contaminated animal food products. Some strains of *S. equisimilis* can also infect humans.<sup>15</sup>

#### PATHOGENESIS

The infection spreads from the portal of entry to produce a bacteremia that is not detectable clinically. The period of bacteremia is variable but it may last several days in piglets. A terminal acute fatal septicemia is the common outcome in animals under 1 week of age but in older animals suppurative localization in various organs is more common. Arthritis is the most common manifestation, with synovitis and invasion of medullary bone

of the epiphysis with microabscessation and ischemic necrosis of bone. Other manifestations of infection include ophthalmitis in foals and calves, meningitis and endocarditis in piglets, meningitis in calves, and endocarditis and sudden death in lambs. Streptococcal endocarditis can be produced by the intravenous inoculation of group L *Streptococcus*. Lesions are well established within 5 days, the left heart is most commonly affected, and myocardial and renal infarction occur.

#### CLINICAL FINDINGS

##### Foals

Foals do not usually show signs until 2–3 weeks of age. The initial sign is usually a painful swelling of the navel and surrounding abdominal wall, often in the form of a flat plaque, which may be 15–20 cm in diameter. A discharge of pus may or may not be present and a patent urachus is a frequent accompaniment. A systemic reaction occurs but this is often mild, with the temperature remaining at about 39.5°C (103°F). Lameness becomes apparent and is accompanied by obvious swelling and tenderness in one or more of the joints. The hock, stifle, and knee joints are most commonly affected but in severe cases the distal joints are involved and there is occasionally extension to tendon sheaths. Lameness may be so severe that the foal lies down most of the time, sucks rarely and becomes extremely emaciated. There may be hypopyon in one or both eyes.

Recovery occurs if treatment is begun in the early stages. When joint involvement is severe, particularly if the abscesses have ruptured, the animal may have to be destroyed because of the resulting ankylosis. Death from septicemia may occur in the early stages of the disease.

##### Piglets

Arthritis and meningitis may occur alone or together and are most common in the 2–6-week age group. More commonly, several piglets within a litter are affected. The arthritis is identical with that described in foals above. With meningitis there is a systemic reaction comprising fever, anorexia and depression. The gait is stiff, the piglets standing on their toes, and there is swaying of the hindquarters. The ears are often retracted against the head. Blindness and gross muscular tremor develop, followed by inability to maintain balance, lateral recumbency, violent paddling and death. In many cases there is little clinical evidence of omphalophlebitis. With endocarditis the young pigs are usually found comatose or dead without premonitory signs having been observed.

##### Lambs

Lameness in one or more limbs of lambs up to 3 weeks of age is the common pre-

senting sign of infection with *S. dysgalactiae* but approximately 25% of lambs can be initially recumbent. With this infection there is not major joint swelling in the early stages and myopathy or delayed swayback may be initial considerations. In contrast with outbreaks that occur following docking the incubation period is short, usually 2–3 days, and there is intense lameness, with swelling of one or more joints appearing in a day or two. Pus accumulates and the joint capsule often ruptures. Recovery usually occurs with little residual enlargement of the joints, although there may be occasional deaths due to toxemia.

##### Calves

These show polyarthritis, meningitis, ophthalmitis, and omphalophlebitis. The ophthalmitis may appear very soon after birth. The arthritis is often chronic and causes little systemic illness. Calves with meningitis show hyperesthesia, rigidity, and fever.

#### CLINICAL PATHOLOGY

Pus from any source may be cultured to determine the organism present and its sensitivity to the drugs available. Bacteriological examination of the uterine discharges of the dam may be of value in determining the source of infection. The success rate with blood cultures is not very high but an attempt is worthwhile. The identification of the causative bacteria is important but the sensitivity of the organism may mean the difference between success and failure in treatment. The specific identity of the streptococcus should be determined.

#### NECROPSY FINDINGS

Suppuration at the navel and severe suppurative arthritis affecting one or more joints are usual. Abscesses may also be present in the liver, kidneys, spleen, and lungs. Friable tan masses of tissue are common on the heart valves of affected piglets and this valvular endocarditis may also be observed in other species. Peracute cases may die without suppurative lesions having had time to develop. Necropsy findings in the meningitic form in pigs include turbidity of the cerebrospinal fluid, congestion of meningeal vessels and the accumulation of white, purulent material in the subarachnoid space. Occasionally this exudate blocks the flow of cerebrospinal fluid in the ventricular system, causing internal hydrocephalus. Histologically there is infiltration of the affected tissue by large numbers of neutrophils, usually accompanied by fibrin deposition.

#### Samples for confirmation of diagnosis

- Bacteriology – culture swabs from joints, meninges, suppurative foci;

tissue pieces of valvular lesions, lung, spleen, synovial membrane (CULT)

- Histology – formalin-fixed samples of a variety of organs, including brain, lung, spleen, liver (LM).

#### DIFFERENTIAL DIAGNOSIS

Omphalophlebitis and suppurative arthritis in foals may be due to infection with *Escherichia coli*, *Actinobacillus equuli* or *Salmonella abortusovae*, but these infections tend to take the form of a fatal septicemia within a few days of birth whereas streptococcal infections are delayed in their onset and usually produce a polyarthritis. In pigs there may be sporadic cases of arthritis due to staphylococci but the streptococcal infection is the common one. Arthritis due to *Mycoplasma hyorhinis* is less suppurative but may require cultural differentiation. Glasser's disease occurs usually in older pigs and is accompanied by pleurisy, pericarditis, and peritonitis. Erysipelas in very young pigs is usually manifested by septicemia. Nervous disease of piglets may resemble arthritis on cursory examination but there is an absence of joint enlargement and lameness. However, the meningitic form of the streptococcal infection can easily be confused with viral encephalitis. Meningitis in young calves may also be associated with *Pasteurella multocida*. Polyarthritis in calves, lambs, and piglets may also be associated with infection with *Arcanobacterium pyogenes* and *Fusobacterium necrophorum*. *S. suis* type 2 can also be the cause of meningitis in older pigs at 10–14 weeks of age.

The response of streptococcal infections to treatment with penicillin may be of value in the differentiation of the arthritides, and the microscopic and histological findings at necropsy enable exact differentiation to be made. In lambs suppurative arthritis occurs soon after birth and after docking. The other common arthritis in the newborn lamb is that associated with *Erysipelothrix rhusiopathiae* but this usually occurs later and is manifested by lameness without pronounced joint enlargement. Calves may also develop erysipelous arthritis.

#### TREATMENT

Penicillin is successful as treatment in all forms of the disease provided irreparable structural damage has not occurred. In newborn animals the dosage rate should be high (20 000 IU/kg body weight (BW)) and should be repeated at least once daily for 3 days. If suppuration is already present, a longer course of antibiotics will be necessary, preferably for 7–10 days. Piglets treated early in the course of the disease will survive but may runt. Because of the common litter incidence in piglets and the occurrence of subclinical bacteremia it is wise to also treat all littermates of

affected piglets. Benzathine or benethamine penicillins can be used in conjunction with shorter-acting penicillins. General aspects of treatment of the newborn are dealt with in Chapter 3.

#### CONTROL

The principles of control of infectious diseases of the newborn are described in Chapter 3. Because the most frequent source of infection in foals is the genital tract of the dam, some attempt should be made to treat the mare and limit the contamination of the environment. Mixed bacterins have been widely used to establish immunity in mares and foals against this infection but no proof has been presented that they are effective. On heavily infected premises the administration of long-acting penicillin at birth may be advisable. A major factor in the control of navel- and joint-ill in lambs is the use of clean fields or pens for lambing, as umbilical infection originating from the environment seems to be more important than infection from the dam in this species. Docking should also be done in clean surroundings and, if necessary, temporary yards should be erected. Instruments should be chemically sterilized between lambs. Regardless of species and where practicable, all parturition stalls and pens should be kept clean and disinfected and the navels of all newborn animals should be disinfected at birth. Where screw-worms are prevalent, the unhealed navels should be treated with a reliable repellent.

#### REFERENCES

1. Wichtel MEG. *Vet Rec* 2003; 153:22.
2. Ozgur NY. *Israel J Vet Med* 2002; 57:9.
3. Puran Chand et al. *Indian J Anim Sci* 2001; 71:445.
4. Smith KC et al. *Equine Vet J* 2003; 35:496.
5. Jones JET. *J Comp Pathol* 1980; 90:11.
6. Grondemange E et al. *Ir Vet J* 2002; 55:237.
7. Feeteau G et al. *Can Vet J* 1997; 38:95.
8. Watkins GH. *State Vet J* 2000; 101:15.
9. Watkins GH, Sharp MW. *Vet J* 1998; 156:235.
10. Platt H. *Br Vet J* 1973; 129:221.
11. Hong GB. *J Vet Diagn Invest* 1993; 5:56.
12. Dubielzig RR. *J Equine Med Surg* 1978; 2:28.
13. Zoric M et al. *J Vet Med B* 2004; 51:278.
14. Green LE et al. *Prev Vet Med* 1995; 22:115.
15. Facklam R. *Clin Microbiol Rev* 2002; 15:613.

### STREPTOCOCCUS SUIS INFECTION OF YOUNG PIGS

#### ETIOLOGY

There are three organisms that infect the neonatal pig quite commonly – *Haemophilus parasuis*, *S. suis*, and *Actinobacillus suis*, which have been dubbed the 'suis-cides'.<sup>1</sup> *S. suis* is therefore one of the early colonizers of the pig and by the end of the nursery period most pigs are infected.<sup>2</sup> These authors suggested that virulence may be an attribute of strains that colonize the young pig poorly but

#### Synopsis

**Etiology** *Streptococcus suis*. At least 34 capsular types (35 if you include 1/2) have been recognized. Type 2 is most common

**Epidemiology** Occurs in piglets under 12 weeks of age

**Signs** Septicemia, arthritis, meningitis, pericarditis, endocarditis, polyserositis, and pneumonia

**Clinical pathology** Culture organism

**Lesions** Fibrinous polyserositis, fibrinous or hemorrhagic pneumonia, purulent meningitis, myocarditis, vegetative endocarditis, fibrinous arthritis

**Diagnostic confirmation** Culture organism from body tissues and blood

**Differential diagnosis** Arthritis due to:

- *Mycoplasma hyorhinis*
- Erysipelas
- Glasser's disease

Meningitis due to:

- *Escherichia coli*
- *Arcanobacterium pyogenes*
- *Pasteurella multocida*

**Treatment** Antimicrobials based on culture and sensitivity

**Control** Provision of optimum environment (temperature and relative humidity). Avoid overcrowding in nursery pens. Age spread of pigs in pens should not exceed 2 weeks. Use all-in, all-out pig flow. Control of other common infectious diseases. Avoid nutritional deficiencies. Consider mass medication of feed with antimicrobials

infect older animals more easily in the absence of maternal antibody.

*S. suis* type 1 and *S. suis* type 2 were the original capsular types of the organism, which appeared to account for most epidemics of the disease. *S. suis* types are subgroups of Lancefield's group D.<sup>3</sup> There are now at least 34 known *S. suis* capsular types.<sup>4</sup> Even now, new species of streptococcus, such as *S. ferus*, are being isolated from pigs.<sup>5</sup>

#### EPIDEMIOLOGY

The epidemiology of *S. suis* is very complex.<sup>6</sup> There is a great genetic heterogeneity of *S. suis*. The isolation of different strains within the same herd and the predominance of particular strains within some herds are evidence that infection by *S. suis* is a dynamic process and reinforces the idea that the epidemiology is complex.

#### Occurrence

Diseases associated with *S. suis* occur worldwide, affecting pigs less than 2 weeks of age and up to 22 weeks of age. Most cases occur within a few weeks after weaning which is associated with stressors such as moving, mixing, overcrowding, and inadequate ventilation. *S. suis* type 2 causes outbreaks of meningitis in young pigs 10–14 days after weaning. The disease occurs most commonly in recently weaned

pigs raised in intensive systems of high population density, such as flat-deck rooms and finishing pens. In the USA, most pigs infected with *S. suis* are under 12 weeks of age;<sup>7</sup> sporadic cases occur in older pigs including adults. In Canada, pigs may be affected from 3–24 weeks of age, with most cases occurring between 6 and 12 weeks of age.

The organism has also been isolated from cattle,<sup>8</sup> sheep, and goats,<sup>4,9</sup> a horse with meningitis,<sup>10</sup> fallow deer,<sup>11</sup> and cats.<sup>12</sup>

### Prevalence of infection

*S. suis* type 2 is the most prevalent serotype. Types 3, 4, 7, 8, and 14 have been isolated from affected pigs in the UK.<sup>13–15</sup> In a survey of pigs at slaughter in Australia, *S. suis* type 2 was detected in 58% of the palatine tonsils, in 66% of the pneumonic lungs and in 28% of the healthy lungs.<sup>16</sup> Overall, the carrier rate in piggeries was 60%. The organism was also present in the blood of 3% of apparently normal pigs at slaughter. It could also be cultured from many other tissues, including those of the reproductive tract of females but not from males. The organism can be cultured from the vagina of sows, and it is possible that piglets are infected during birth. Specific-pathogen-free herds are free of the organism and hysterectomy-derived piglets are born free from infection. The rate of infection of the environment of the pigs can also be very high.<sup>17</sup>

Since 1996, at least 34 serotypes of the organism have been identified.<sup>4</sup> Recently it has been suggested that serotypes 32 and 34 are *Streptococcus orisrattii*.<sup>18</sup> In Canada, all 34 serotypes have been isolated, with type 2 being most prevalent of all isolates.<sup>4</sup> The other capsular types in decreasing order were 3, 7, 1/2, 8, 23, and 4. Over a period of several years, more than 60% of isolates belong to capsular types 2, 1/2, 3, 4, 7, and 8.<sup>19</sup> In a survey of clinically healthy piglets 4–8 weeks of age in Quebec, the organism could be isolated from 94% of piglets and 98% of farms.<sup>20</sup> The typable isolates of the organism are more frequently recovered from pigs between 5 and 10 weeks of age, while untypable isolates are most frequently found in animals more than 24 weeks old. In the USA, serotype 3 was most prevalent (26.1%), followed by serotypes 8 (17.4%), 2, 4, and 7 (all 15.2%) with no significant differences in the epidemiological features, clinical signs or lesions in pigs infected with multiple serotypes compared with a single serotype of *S. suis*.<sup>7,21</sup> Only Scandinavian countries reported a higher incidence of type 7 over type 2.<sup>22</sup> In Denmark, serotypes 2 accounted for 29% of the isolates, serotype 7 for 17% and 3, 4 and 8 for a further 9–10%.<sup>23</sup> Serotype 7 was isolated more frequently than reported

in other countries, causing septicemia, arthritis, and meningitis. In Finland, the most common types isolated from dead pigs were 7, 3, and 2 respectively, and they were most frequently isolated from cases of pneumonia.<sup>24</sup> In the Netherlands, type 2 was most frequently isolated from pigs with meningitis. *S. suis* type 9 and *S. suis* type 2 have been isolated as the cause of septicemia and meningitis in weaned pigs in Australia.<sup>25</sup> The organism has been isolated from a wild sow affected with pneumonia<sup>26</sup> and from a young wild boar.<sup>27</sup>

### Morbidity and case fatality

The incidence of clinical disease ranges from 0–15%. In a 3-year survey of a breeding herd, the combined morbidity and mortality rates due to meningitis from *S. suis* type 2 were 3%, 8%, and 9.1%, respectively, in each of the 3 years.

### Methods of transmission

The organism is carried in the tonsils and occasionally in the nose of healthy pigs, and transmission to uninfected pigs can occur within 5 days of mixing. The introduction of breeding gilts from infected herds results in disease appearing subsequently in weanlings and growing pigs in the recipient herds. The detectable carrier rates in different groups of pigs can vary from 0–80% and are highest in weaned pigs aged 4–10 weeks. Over 80% of the sows in an individual herd may be subclinical carriers. They do not normally carry the organism in the nasal cavity but in the vagina.<sup>28</sup> Based on the results of sampling of sows and piglets at parturition, and being able to culture multiple serotypes of the organism from the sow's vaginal secretions and oropharyngeal samples of piglets, it is highly probable that the newborn piglet is infected during birth by the organism, which is transferred from the sow's vagina to the dorsal surface and oral cavity of the piglet.<sup>29</sup> However, even though most pigs are colonized by weaning age, colonization by the virulent strains of *S. suis* type 2 takes longer and usually does not occur before 15 days of age.<sup>30</sup> This could constitute a risk factor for developing disease later when maternal immunity has waned.

Weaned carrier pigs transmit the infection to previously uninfected pigs after mixing following weaning. The organism can persist in the tonsils of carrier pigs for more than 1 year, and in the presence of circulating opsonic and binding antibodies, and in pigs receiving penicillin-medicated feed. Thus the organism can be endemic in some herds without causing recognizable clinical disease. House flies can carry the organism for at least 5 days and can contaminate feed for at least 4 days.

The carrier rate in some surveys of slaughtered pigs ranges from 32–50% of

pigs 4–6 months of age, which may be associated with the high incidence of *S. suis* type 2 meningitis in humans in the Netherlands. The organism is a potential hazard for abattoir workers, particularly eviscerators who remove the larynx and lungs from carcasses, who have a significantly higher risk of exposure to *S. suis* than other workers.

*S. suis* type 2 has also been isolated from pigs affected with bronchopneumonia, usually secondary to enzootic pneumonia, from cases of pleuropneumonia, arthritis, vaginitis and aborted fetuses, and in neonatal piglets 1–2 days of age affected with fatal septicemia. It appears that the organism is found in the lungs of pigs affected with pneumonia more frequently in North America than in other countries. Although airborne infection of type 2 has been described it is said that indirect transmission is a much better way to infect piglets.<sup>31</sup>

The organism is easily transmitted via fomites. It can survive in feces for 104 days at 0°C and for 10 days at 9°C, and in dust for 54 days at 0°C and 25 days at 9°C. Experimentally, pure cultures of the organism placed on rubber and plastic surfaces, especially when protected by swine manure, are viable at up to 55°C and can survive if kept frozen for up to 10 days. The organism is readily destroyed by disinfectants. It can be spread by contaminated pig nose snares and needles used for blood sampling.<sup>32</sup>

### Risk factors

#### Animal risk factors

The host factors that render pigs susceptible to clinical disease are uncertain. Over 30 different Gram-positive bacterial organisms may occur in the nasal cavities and tonsils of unweaned pigs of between 2 weeks and 6 weeks of age.<sup>33</sup> It is suggested that strains of *S. suis* type 2 vary in pathogenicity, and that the occurrence of disease is dependent on both exposure to a pathogenic strain and undetermined secondary factors. The peak incidence of the disease from 5–10 weeks of age suggests that the stressors of weaning may render pigs susceptible to clinical disease. The presence of other infectious diseases such as porcine reproductive and respiratory syndrome (PRRS) and *Actinobacillus pleuropneumoniae* may be associated with a higher than average prevalence of infection with *S. suis*.<sup>34</sup> PRRS certainly increases susceptibility to *S. suis* infection experimentally.<sup>35,36</sup> In utero infection with PRRS makes pigs more susceptible to subsequent neonatal *S. suis* infections.<sup>36</sup> Infection of specific-pathogen-free pigs with PRRS virus may be a risk factor for infection and disease associated with *S. suis*.<sup>37</sup> Similarly, the pseudorabies virus may

enhance clinical disease associated with *S. suis*.<sup>38</sup>

Environmental and management factors  
The incidence of clinical disease appears to depend on environmental factors such as inadequate ventilation, high population density, and other stressors. Several environmental and managerial risk factors have been associated with a high prevalence of pigs harboring *S. suis* in swine herds.<sup>34</sup> Excessive environmental temperature fluctuation in the nursery pig facilities was the most common factor. Nursery pig environmental temperatures should not fluctuate more than 1.1–1.7°C over a 24-hour period to prevent chilling of pigs. Fluctuations in temperature are caused by drafts, inadequate heaters, or poorly insulated buildings. Excessive relative humidity was also a factor; the recommended range for nursery pigs is 55–70%. The third and fourth most common factors were age spread of more than 2 weeks for pigs in the same room, and crowding. The fifth most common factor was the use of continuous flow facilities, which allows for build-up of dust and manure and increased infection pressure. An unusual case where *S. suis* was isolated from the lumen of the small intestine occurred when a feed was formulated with no salt and 58.5 kg instead of 3.5 kg of vitamin premix. Once the ration was corrected the problem disappeared.<sup>39</sup>

#### Pathogen risk factors

There are now at least 34 serotypes of *S. suis*.<sup>4</sup> The organism is divided into serotypes by the antigenic specificity of its capsular polysaccharide.<sup>40</sup> The capsule, certainly for *S. suis* type 2, plays an important role in pathogenesis.<sup>41</sup> As described under Methods of transmission, colonization of piglets occurs very early in life, most pigs being colonized by weaning age; virulent strains of *S. suis* type 2 may not colonize until later.<sup>30</sup> Early colonization reduces the subsequent clinical signs.<sup>30</sup> Despite the association of bacteria with disease, they may also be recovered from the nasal cavities and tonsils of healthy pigs. High numbers of organisms were isolated from the cerebrospinal fluid of clinically normal pigs.<sup>42</sup> A study also showed that a persistent epidemic strain of *S. suis* was consistently isolated from the brains of pigs over a 2-year period, all with a similar genetic pattern.<sup>43</sup>

There are differences in pathogenicity between serotypes and between strains of the same serotype. In the UK there are differences in pathogenicity between types 1 and 2, type 1 causing less severe disease in piglets while type 2 causes a more severe and acute disease in older and growing pigs. Highly virulent and completely avirulent type 2 strains exist.<sup>44</sup> Different strains

of *S. suis* type 2 vary in their ability to cause meningitis. Streptococci require manganese but not iron as a growth factor, which affects the activity of superoxide dismutase in cell cultures.<sup>45</sup>

The virulence markers of the organism include the structural proteins muramidase-released protein (MRP) and extracellular factor (EF).<sup>46–48</sup> It has also been said that they are not essential for virulence.<sup>48</sup> *S. suis* produces four proteases.<sup>49</sup> Fibrinogen-binding protein played a role in the colonization of specific organisms involved in a *S. suis* infection.<sup>50</sup> A secreted nuclease has also been described.<sup>51</sup> An IgG binding protein in the 60 kDa range has been shown to bind IgG in a nonimmune way.<sup>52</sup> Recently, 36 environmentally regulated genes have been identified.<sup>53</sup> There are virulence differences between strains of the same serotype based on the presence or absence of muramidase-released proteins. Strains of *S. suis* type 2 from Europe are genotypically different from those of North America. Most Canadian field isolates of *S. suis* type 2 do not produce these virulence-related proteins.<sup>54</sup> An extracellular protein with hemolytic properties, called suilysin, has been described.<sup>55</sup> Most type 2 field strains from four different European countries produce this hemolysin.<sup>56</sup> Between 58 and 90% of strains from the Netherlands, Denmark, France, England, and Italy produce the suilysin but only 1% of Canadian strains do.<sup>54</sup> A total of 164 field isolates from diseased pigs in four countries were serotyped and tested for suilysin. *S. suis* type 2 was the most prevalent type isolated from all four countries. After type 2, type 9 was most prevalent in the Netherlands and France and type 7 in Denmark. All the English isolates were type 2. No nonvirulent suilysin-producing *S. suis* type 2 strains have been reported.<sup>57</sup>

The hemolysin gene was found in over 80% of the strains that were associated with meningitis, septicemia, and arthritis but with only 44% of pneumonia isolates.<sup>58</sup>

The organism bears fimbriae and the capsular materials from different serotypes have distinct morphologies.<sup>59</sup> Certain strains possess hemagglutinating properties.<sup>60</sup> The type 2 isolates possess a factor that allows them to adhere to porcine lung.<sup>61</sup> Restriction endonuclease techniques are being used to examine the genomic structure of the organism, which could be useful for epidemiological monitoring of outbreaks of the disease.<sup>62</sup>

A 44 kDa protein has been isolated as a virulence marker of *S. suis* type 2, and the presence of antibodies against this protein appears to be necessary to obtain complete protection against the disease.<sup>63</sup> Australian isolates of *S. suis* are genetically very diverse, which suggests that serotyping

is not a reliable technique for identifying specific strains and not a good predictor of the genetic background of a given isolate.<sup>64</sup>

Some isolates of *S. suis* have developed resistance to penicillin and tetracycline, which may reflect the usage of these antimicrobials in treatment and control programs.<sup>34</sup>

*S. suis* type 2 can survive in feces for 104 days at 0°C (32°F), up to 10 days at 9°C (48°F) and up to 8 days at 22–25°C (71–77°F).<sup>65</sup> It can survive in dust for up to 25 days at 9°C (48°F) but could not be isolated from dust stored at room temperature for 24 hours. The organism is rapidly inactivated by disinfectants commonly used on farms. Liquid soap inactivates *S. suis* type 2 in less than 1 minute at a dilution in water of 1 in 500. The organism can survive in pig carcasses at 40°C (104°F) for 6 weeks, which may be an important source of the organisms for infection in humans.

#### Zoonotic implications

Splenectomized humans are particularly at risk from certain infections, including streptococci.

Infections with *S. suis* type 2 are the most common infections in humans and occur most commonly in people having contact with pigs or raw pork. It is possible that many human cases are misdiagnosed, such as were described in south-east Asia,<sup>66</sup> where five of eight cases of *S. suis* were described as *S. viridans*. A truck driver has recently been described with septic shock.<sup>67</sup> In the UK the highest incidence of meningitis due to *S. suis* type 2 is in butchers and abattoir workers; transmission is thought to be mainly via minor skin abrasions. The clinical manifestations include meningitis and septicemia, which may be accompanied by arthritis, endophthalmitis, and disseminated intravascular coagulation. Endocarditis<sup>68</sup> and acute gastroenteritis have also been reported.<sup>69</sup> In a series of 35 human cases of *S. suis* type 2 meningitis in the UK from 1975–1990, deafness occurred in 50% of patients, vertigo and ataxia in 30% and arthritis in 53%.<sup>62</sup> There was a case fatality rate of 13%. The organism invades the cerebrospinal fluid within monocytes, an example of the 'Trojan horse' mechanism of entry. Deafness may follow in 50–60% of cases and is due to cochlear sepsis following invasion of the organism from the subarachnoid space into the perilymph of the inner ear. Subclinical infection in pigs sent to slaughter represents a potential source of infection for abattoir workers; eviscerators who remove the larynx and lungs have a significantly higher risk of exposure to the organism than other abattoir workers. Within infected herds in New Zealand, up

to 100% of pigs are carriers and *S. suis* type 2 infection may be one of the most infectious potentially zoonotic pathogens present in New Zealand, although very rarely resulting in clinical disease.<sup>70</sup> The annual incidence of subclinical infection and seroconversion in pig farmers in New Zealand is close to 28%.

### **PATHOGENESIS**

Streptococci exist in extremely different phenotypes with regard to adhesion, invasion and cytotoxicity. These features depend on the state of encapsulation and environmental growth conditions.<sup>71</sup>

The tonsils are a site of persistence, multiplication and portal of entry of a variety of pathogens including *S. suis*.<sup>72</sup>

The organism resides in the crypts of the palatine tonsils. Invasive disease occurs in a minority of infected pigs, following entry of organisms into the systemic circulation as a bacteremia and then septicemia, leading to a meningitis.<sup>73</sup> Most bacteria remain extracellular, with fewer than 2% of monocytes containing bacteria. There is a high level of adhesion of bacteria to phagocytic cells. *S. suis* adheres to brain microvascular endothelial cells and suliyisin can damage these.<sup>74</sup> It has been shown that *S. suis* capsular strains stimulate tumor necrosis factor alpha (TNF)- and interleukin (IL)-6 but that the suliyisin and the extracellular protein do not do so on their own.<sup>75</sup> A terminal acute fatal septicemia is the common outcome in young animals, but in older animals localization can occur in synovial cavities, endocardium, eyes, and meninges. A persistent bacteremia is an important phase in the pathogenesis of *S. suis* type 2 meningitis. Virulent isolates of *S. suis* type 2 possess capsules and are relatively resistant to phagocytosis.<sup>76</sup> Isogenic mutants defective in capsule production were not virulent.<sup>77</sup> *S. suis* is able to adhere to but not to invade epithelial cells and the adhesins are partially blocked by the capsule and are part of the cell wall.<sup>78</sup> The highly virulent isolates possessed the suliyisin, muramidase releasing protein and extracellular protein factor phenotype.<sup>79</sup> *S. suis* are able to survive and replicate within macrophages, and the bacteria enter the cerebrospinal fluid space in association with migrating monocytes, which move through choroid plexuses.<sup>80</sup> They therefore enter the cerebrospinal fluid by a 'Trojan horse' mechanism similar to that used by some viral pathogens of the central nervous system.<sup>80</sup> The predominant lesions are suppurative or fibrinopurulent inflammation in brain, heart, lungs, and serosae.<sup>81</sup> *S. suis* type 9 may produce a different distribution of lesions compared to type 2.<sup>82</sup> The disease has been reproduced experimentally in pigs and laboratory animals

by intravenous, intranasal, and subarachnoid routes.<sup>83</sup> Certain strains of *S. suis* can cause vascular lesions, with the development of fibrinohemorrhagic pneumonia and septal necrosis.<sup>84</sup> Of importance in the pathogenesis of *S. suis* infections is the predisposing role of PRRS. This effect of PRRS has still only been experimentally demonstrated with *S. suis*.<sup>85</sup>

### **CLINICAL FINDINGS**

Multiple *Streptococcus* spp. are implicated in lameness and central nervous system signs in piglets and sows.<sup>86</sup> There is significant variation of carrier states and clinical signs with the individual serotypes.<sup>87</sup>

Arthritis and meningitis may occur alone or together and are most common in the 2–6-week age group. More commonly several piglets within a litter are affected. Meningitis is associated with serotypes 1, 2, 1/2, 3, 4, 8, 9, 14, and 16; septicemia with 2; arthritis with 7 and 14; abscesses with 2; bronchopneumonia with 2, 3, 7, 10, 15, and 27; reproductive damage with 2, 13, and 22; 14 can be associated with any clinical condition.<sup>88</sup>

The **arthritis** is characterized by enlarged and distended joint capsules, lameness and pain on palpation of the affected joints. Fever, depression, reluctance to move, and inactivity are common.

**Meningitis** is characterized by a fever, anorexia, and depression. The gait is stiff, the piglets standing on their toes, and there is swaying of the hindquarters. The ears are often retracted against the head. Blindness and gross muscular tremor develop followed by inability to maintain balance, lateral recumbency, violent paddling, and death. In many cases there is little clinical evidence of omphalophlebitis.

In **epidemics of meningitis** due to *S. suis* type 2, sudden death in one or more pigs may be the first sign. Affected pigs found alive are incoordinated and rapidly become recumbent. There is opisthotonos, paddling and convulsions and death in less than 4 hours. A fever of up to 41°C (105°F) is common. In the UK, meningitis of recently weaned pigs is the most striking feature of *S. suis* type 2 infection.

**Otitis interna** is a common sequel to many cases of *S. suis* meningitis.<sup>89</sup>

**Arthritis** is common in younger pigs.

In **endocarditis** and **septicemia** the piglets are usually found comatose or dead without premonitory signs having been observed.

**Valvular endocarditis** due to *S. suis* type 2 has also been reported in a 13-week-old fattening pig in a breeding herd that had a long history of streptococcal meningitis.<sup>69</sup>

### **CLINICAL PATHOLOGY**

#### **Culture or detection of organism**

The organism can be cultured from joint fluid, cerebrospinal fluid, blood, brain, and

lungs of pigs at necropsy. The tonsils of live pigs may be swabbed and cultured for the organism. Improved and selective media are available for the isolation and serotyping of the organism.<sup>90</sup> An indirect fluorescent antibody test can be used to identify the organism on tonsillar swabs of live pigs. Because of multiple antimicrobial resistance among strains of the organism, drug sensitivity testing on a routine basis is recommended.<sup>91</sup> Highly virulent strains of *S. suis* types 2 and 1 were detected in tonsillar specimens using PCR.<sup>92</sup> Rapid serotype-specific PCR assays have been developed.<sup>93</sup>

### **Serology**

The specific serotype of *S. suis* should be determined. A simplified laboratory method is available for the identification of *S. suis* strains associated with different animal hosts or located in different body regions.<sup>94</sup> An enzyme-linked immunosorbent assay (ELISA) using monoclonal antibodies directed against virulence markers of *S. suis* can distinguish between virulent and avirulent strains of the organism.<sup>47</sup> A rapid and specific double-sandwich ELISA is available for the detection and capsular typing of the organism with a specificity of 97.6% and sensitivity of 62.5%.<sup>95</sup> However, many laboratories are not readily equipped to identify the numerous serotypes of the organism. The biochemical characteristics and serotyping techniques have been described.<sup>40</sup>

### **NECROPSY FINDINGS**

In pigs dying from *S. suis* type 2 infection, the gross and microscopic findings include one or more of fibrinopurulent polyserositis, fibrinous polyarthritis, fibrinous or hemorrhagic bronchopneumonia, suppurative meningitis, hemorrhagic necrotizing myocarditis, and vegetative valvular endocarditis.<sup>60</sup> Gross myocardial lesions cannot be distinguished from those of mulberry heart disease. In cases with meningitis, there is turbidity of the cerebrospinal fluid, congestion of meningeal vessels, and variable amounts of white exudate in the subarachnoid space. This suppurative is usually most evident along the ventral aspect of the brain. The typical histological picture is one of acute inflammation – neutrophils and fibrin dominate the response. Other changes that may be observed in *S. suis* infections of the central nervous system include internal hydrocephalus, foci of liquefaction necrosis, subacute (mononuclear cell-rich) meningoencephalitis or meningoencephalomyelitis with bilateral subacute optic perineuritis and Gasserian ganglioneuritis.<sup>60</sup> In the tonsils, *S. suis* organisms can be seen in the subepithelial lymphoid tissue and in the crypt lumen and crypt epithelium.<sup>96</sup> *S. suis* type 9 is more prone to cause

bronchopneumonia than the spectrum of lesions typical of type 2.<sup>82</sup>

### Samples for confirmation of diagnosis

- Bacteriology – lung, spleen; culture swabs from serosal surfaces, joints, meninges. Cerebrospinal fluid is the material for the best diagnosis (CULT). Bacterial culture is difficult if the animals have been treated and this is so even when they receive growth-promoting antibiotics.<sup>97</sup> Immunomagnetic isolation of types 2 and 1/2 from swine tonsils has been described and it is better than the standard procedure<sup>98</sup>
- Histology – formalin-fixed samples of a variety of organs, including lung, brain, heart, liver (LM). Immunohistochemistry and in situ hybridization have been described for use on formalin-fixed tissue and are able to detect single cells.<sup>99</sup>

(Note the zoonotic potential of this organism when handling carcass and submitting specimens.)

### DIFFERENTIAL DIAGNOSIS

In pigs there may be sporadic cases of arthritis due to staphylococci but the streptococcal infection is the common one. Arthritis due to *M. hyorhinis* is less suppurative but may require cultural differentiation. Glasser's disease occurs usually in older pigs and is accompanied by pleurisy, pericarditis, and peritonitis. Erysipelas in very young pigs is usually manifested by septicemia. Nervous disease of piglets may resemble arthritis on cursory examination but there is an absence of joint enlargement and lameness. However, the meningitic form of the streptococcal infection can easily be confused with viral encephalitis. Meningitis in young pigs may also be associated with *P. multocida* and *E. coli*. Polyarthritis in calves, lambs, and piglets may also be associated with infection with *A. pyogenes* and *F. necrophorum*. *S. suis* type 2 can also be the cause of meningitis in older pigs of 10–14 weeks of age.

### TREATMENT Antimicrobials

In Denmark over the last 15 years there has been an increase in resistance of *S. suis* isolates to the two most commonly used antibiotics, tylosin and tetracyclines.<sup>100</sup> The strains show a varying pattern of resistance dependent on which of 21 ribotype profiles they belong to.<sup>101</sup> For example, strains causing meningitis were more resistant to sulfamethoxazole but those causing pneumonia were more resistant to tetracyclines. Tilmicosin has been used successfully to remove clinical signs of streptococcal meningitis from a herd.<sup>102</sup>

Penicillin has been the treatment of choice but penicillin-resistant isolates have emerged. Penicillin sensitivity can no longer be assumed for all strains of *S. suis* and the routine use of penicillin must be re-evaluated.<sup>103</sup> In one study, more than 50% of isolates of *S. suis* were not susceptible to penicillin.<sup>91</sup> Penicillin did not eliminate the organism from the tonsils of carrier pigs treated daily for several days.<sup>104</sup> In some surveys, the antimicrobial sensitivity of *S. suis* indicates a high degree of sensitivity to ampicillin, cephalothin, and trimethoprim–sulfamethoxazole, and resistance to the aminoglycosides gentamicin and streptomycin.<sup>91</sup> It is recommended that trimethoprim–sulfamethoxazole be used for the treatment of affected pigs and be given daily for 3 days. An occasional strain may be resistant to trimethoprim–sulfamethoxazole.

None of the resistant strains produced beta-lactamase. Conjugation of antibiotic resistance in *S. suis* has been reported, which may explain the multiple antimicrobial resistance.<sup>105</sup> The genes responsible for resistance appear to be homologous to genes found in many other species of bacteria.<sup>106</sup> Treatment of pigs affected with meningitis due to *S. suis* type 2 with either trimethoprim–sulfadiazine or penicillin reduced the case fatality rate from 55% to 21%. Cefquinone has been shown to improve cure rates (67%) compared to ampicillin (55%) and to reduce mortality from 35% with ampicillin to 24% with cefquinone.<sup>107</sup>

Passive immunization against *S. suis* type 2 has been described.<sup>108</sup>

### CONTROL

At the present time there are no known specific methods for the prevention of the disease complex associated with *S. suis* type 2. The recommendations are based on empirical field observations.

It has been suggested that ceftiofur administered by injection for three consecutive days following *S. suis* challenge was the most effective regimen for minimizing disease associated with PRRS virus and *S. suis* infection.<sup>109</sup>

### Environment and management

Good management and hygiene techniques should be emphasized. Based on observations of the effects of management practices on *S. suis* carrier rate in nursery pigs, excessive temperature fluctuations, high relative humidity, crowding, and an age spread exceeding 2 weeks of pigs in the same room were associated with a higher-than-average percentage of carrier pigs.

Nursery pig environmental temperature should not fluctuate more than 1.1–1.7°C over a 24-hour period.<sup>34</sup>

Excessive relative humidity must be avoided; the recommended range of

relative humidity for nursery pigs is 55–70%.

The age spread between pigs in the same room should not exceed 2 weeks. Young, potentially naive piglets raised in the same air space as older animals may be exposed to high concentrations of the organism.

Adequate space to avoid crowding is also necessary. Crowding occurs when less than 0.18 m<sup>2</sup> is provided for each 22.7 kg of pig.<sup>34</sup> The use of an all-in, all-out production system is recommended, compared to a continuous flow system, which allows for a buildup of pathogens. The control of the most commonly encountered infectious diseases is also important. A well-fortified nutritional program may also aid in the control of *S. suis* infection and the carrier state in a swine herd.

Segregated early weaning programs have been used in an attempt to control the disease but appear to be unsuccessful in reducing the carrier state.<sup>110</sup> Pigs are weaned at an early age and moved to a separate site in an effort to separate the piglets from the sows, which are the primary source of the organism. Carrier pigs readily transmit the infection to uninfected pigs and the main method of spread between herds is the movement of infected breeding stock or weaner pigs. In herds that are free of the infection, it is necessary to avoid the importation of infected pigs. Eradication of *S. suis* type 2 infection can be attempted by depopulation of suspected carrier sows and replacement with noninfected breeding stock.

### Mass medication of feed

Mass medication of individual pigs or medication of the feed during periods of high risk may control the incidence of clinical disease. Outbreaks in sucking piglets have been controlled by a single injection of benethamine penicillin to all piglets given 5 days before the average age of onset of clinical signs. The feeding of oxytetracycline (400 g/tonne) for 14 days immediately prior to the usual onset may control the occurrence of the disease at a low level in weaned pigs. The use of a medicated feed containing trimethoprim–sulfadiazine (1:5) at a rate of 500 g/tonne for the first 6 weeks after weaning did not significantly reduce the incidence of disease. Oral prophylactic medication with either procaine penicillin G or a mixture of chlortetracycline, sulfadimidine and procaine penicillin G reduced the incidence of meningitis. Phenoxymethyl penicillin administered orally provided higher plasma concentrations of drug. The inclusion of phenoxymethyl penicillin potassium (10%) at a rate of 2 kg/tonne of feed significantly reduced the incidence of streptococcal meningitis when fed to the pigs for a total of 6 weeks from 4–10 weeks of age.<sup>111</sup>



**Tiamulin** in the drinking water at 18 mg/L of water for 5 days significantly reduced the effects of experimentally induced *S. suis* type infections.<sup>112</sup>

### Vaccination

Studies are being conducted on the use of vaccines containing the immunogenic polysaccharide from *S. suis* type 2. Whole-cell vaccines seem to induce significant protection in pigs against a homologous challenge.<sup>113</sup> A commercial vaccine reduced mortality from 17% to 2.6%.<sup>114</sup> However, the protection provided by whole-cell vaccines is probably type-specific, which suggests that such vaccines should contain many serotypes if broad protection is desired. A trial minimizing variation in weaning age to achieve a uniform size with a combination of an autogenous vaccine and ceftiofur sodium has been reported.<sup>115</sup> The protective levels of antibody did not prevent the survival of the organism in either tonsils or joints. An ELISA can be used to evaluate the antibody response in pigs vaccinated with *S. suis* type 2.<sup>116</sup> Different components of the organism are being examined to identify possible fractions for the preparation of a subunit vaccine. A subunit vaccine containing both MRP and EF, formulated with an oil/water adjuvant, protected pigs against challenge with a virulent *S. suis* type 2.<sup>117</sup> Vaccination of sows with 2 mL of bacterin prevented neurological signs but not lameness, bacteriuria, or mortality in their progeny from challenge at 13–21 days of age.<sup>118</sup> Immunization of experimental mice with a live avirulent strain of *S. suis* type 2 provided protection, which may be extrapolated for consideration in pigs.<sup>119</sup> A vaccine containing purified suliyisin protected mice against a lethal homologous challenge and induced protection against clinical signs in pigs after homologous challenge.<sup>120</sup> Pigs vaccinated with a vaccine containing purified suliyisin were protected from challenge with the homologous strain of the organism, whereas pigs vaccinated with a vaccine containing most of the extracellular antigens, and the placebo pigs, developed clinical disease.<sup>117</sup> Suliyisin is produced by most of the field strains tested and could be an important cross-protection factor.<sup>56</sup>

### REVIEW LITERATURE

Gottschalk M, Segura M. The pathogenesis of meningitis caused by *S. suis*; the unresolved questions. *Vet Microbiol* 2000; 76:259–272.

### REFERENCES

- Desrosiers R. *Can J Vet Res* 1999; 63:83.
- Torremorell T, Pijoan C. In: Proceedings of the 15th International Pig Veterinary Society Congress 1998; vol 2:89.
- Devriese LA. *J Appl Bacteriol* 1991; 71:478.
- Higgins R et al. *J Vet Diagn Invest* 1995; 7:405.
- Baele M et al. *Int J Syst Evol Microbiol* 2003; 53:143.
- Vela AI et al. *J Clin Microbiol* 2003; 41:2498.
- Reams RY et al. *J Vet Diagn Invest* 1993; 5:363.
- Higgins R et al. *Can Vet J* 1990; 31:529.
- Hommez J et al. *Vet Rec* 1988; 123:626.
- Devriese LA et al. *Vet Rec* 1990; 127:68.
- Devriese LA. *Vet Rec* 1993; 132:283.
- Devriese LA, Haesebrouck F. *Vet Rec* 1992; 130:380.
- Heath PJ et al. *Vet Rec* 1995; 136:547.
- Heath PJ et al. *Vet Rec* 1996; 139:450.
- MacLennan M et al. *Vet Rec* 1996; 139:423.
- Mwaniki CG et al. *Aust Vet J* 1994; 71:385.
- Robertson ID et al. *Epidemiol Infect* 1991; 107:119.
- Hill JE et al. *Vet Microbiol* 2005; 107:63.
- Higgins R, Gottschalk M. *Can Vet J* 1997; 38:302.
- Brisebois LM et al. *Can J Vet Res* 1990; 54:174.
- Reams RY et al. *J Vet Diagn Invest* 1996; 8:119.
- Boetner AG et al. *Acta Pathol Microbiol Immunol Scand B* 1987; 95:233.
- Aarestrup FM et al. *Vet Microbiol* 1998; 60:59.
- Schvonen L et al. *Acta Vet Scand* 1988; 29:1988.
- Gogolewski RD et al. *Aust Vet J* 1990; 67:202.
- Griffiths IB et al. *Vet Rec* 1991; 128:354.
- Higgins R et al. *Can Vet J* 1997; 38:114.
- Cloutier G et al. *Vet Microbiol* 2003; 97:135.
- Amass SF et al. *Swine Health Prod* 1996; 4:269.
- Torremorell M et al. *Can J Vet Res* 1998; 62:21.
- Berthelot-Herault F et al. *Vet Microbiol* 2001; 82:69.
- Dee SA, Corey MM. *Swine Health Prod* 1993; 1:17.
- Baele M et al. *J Appl Microbiol* 2001; 91:997.
- Dee SA et al. *J Am Vet Med Assoc* 1993; 203:295.
- Thanawongnuwech R et al. *Vet Pathol* 2000; 37:143.
- Feng WH et al. *J Virol* 2001; 75:4889.
- Galina L et al. *Vet Rec* 1994; 134:60.
- Iglesias JG et al. *Am J Vet Res* 1992; 53:364.
- Drum SD, Hoffman J. *Swine Health Prod* 1998; 6:217.
- Higgins R, Gottschalk M. *J Vet Diagn Invest* 1990; 2:249.
- Smith HE. *Infect Immun* 1999; 67:1750.
- Amass SF. *Proc Am Assoc Swine Vet* 2000; 31:315.
- Torremorell M, Pijoan C. *Vet Rec* 1998; 143:395.
- Quessy S et al. *Infect Immun* 1995; 63:1975.
- Niven DF et al. *Can J Microbiol* 1999; 45:1027.
- Gauna L et al. *Am J Vet Res* 1996; 60:72.
- Wecht U et al. *Vet Microbiol* 1993; 34:71.
- Smith HE et al. *Infect Immun* 1996; 64:4409.
- Jobin M-C, Greiner D. *FEMS Microbiol Lett* 2003; 220:113.
- Greiff A et al. *Infect Immun* 2002; 70:1319.
- Fontaine C et al. *Infect Immun* 2004; 72:774.
- Benkirane R et al. *FEMS Immunol Med Microbiol* 1998; 20:121.
- Smith HE. *Microbiology* 2001; 147:271.
- Gottschalk M et al. *Can J Vet Res* 1998; 62:75.
- Gottschalk M et al. *Microbiology* 1995; 141:189.
- Jacobs AAC et al. *Vet Rec* 1995; 137:295.
- Gottschalk M. *Proc Am Assoc Swine Vet* 2002; 33:255.
- King SJ et al. *Infect Immun* 2001; 69:7572.
- Jacques M et al. *J Bacteriol* 1990; 172:2833.
- Gottschalk M et al. *J Clin Microbiol* 1990; 28:2156.
- Gottschalk M et al. *Can J Vet Res* 1991; 55:302.
- Mwanki CG et al. *Epidemiol Infect* 1994; 113:321.
- Gottschalk M et al. *Vet Microbiol* 1992; 30:59.
- Hampson DJ et al. *J Clin Microbiol* 1993; 31:2895.
- Walsh B et al. *Rev Med Microbiol* 1992; 3:65.
- Donkasul K et al. *Southeast Asian J Trop Med Public Health* 2003; 34:154.
- Strangmann E et al. *Int J Hyg Environ Health* 2002; 205:385.
- Trotter S et al. *Rev Infect Dis* 1991; 13:1251.
- Maher D. *Infect Dis* 1991; 22:303.
- Robertson ID, Blackmore DK. *Epidemiol Infect* 1989; 203:157.
- Bengal L et al. *Cell Microbiol* 2004; 6:867.
- Salles M et al. *Vet Immunol Immunopathol* 2002; 87:51.
- Gottschalk M, Segura M. *Vet Microbiol* 2000; 76:259.
- Charland N et al. *Infect Immun* 2000; 68:637.
- Segura M et al. *Infect Immun* 1999; 67:4646.
- Smith HE et al. *Infect Immun* 1999; 67:1750.
- Charland N. *Microbiology* 1998; 144:325.
- Lalonde M et al. *Microbiology* 2000; 146:1913.
- Staats JJ et al. *Vet Microbiol* 1999; 70:201.
- Williams AE, Blackmore WF. *J Infect Dis* 1990; 162:474.
- Reams RY et al. *J Vet Diagn Invest* 1994; 6:326.
- Vasconcelos D et al. *J Vet Diagn Invest* 1994; 6:335.
- Robertson ID, Blackmore DK. *Epidemiol Infect* 1990; 105:469, 479.
- Reams RY et al. *J Vet Diagn Invest* 1995; 7:406.
- Thanawongnuwech R et al. *Vet Pathol* 2000; 37:143.
- Fangman TJ, Fales WH. *Swine Health Prod* 1999; 7:113.
- Wisselink HJ et al. *J Clin Microbiol* 2002; 40:2922.
- Luque I et al. *Vet Rec* 1998; 142:726.
- Madsen LW et al. *Vet Pathol* 2001; 38:190.
- Kataoka Y et al. *Vet Microbiol* 1991; 28:335.
- Turgeon PL et al. *Br Vet J* 1994; 150:263.
- Wisselink HJ et al. *Vet Microbiol* 1999; 67:143.
- Smith HE et al. *J Clin Microbiol* 1999; 37:3146.
- Devriese LA et al. *Vet Microbiol* 1991; 26:141.
- Serhir B et al. *Can J Vet Res* 1993; 57:19.
- Madsen LW et al. *J Comp Pathol* 2002; 126:57.
- Done SH et al. *Pig J* 1998; 41:113.
- Gottschalk M et al. *J Clin Microbiol* 1999; 28:2462.
- Boye M et al. *J Vet Diagn Invest* 2000; 12:224.
- Aarestrup FM et al. *Vet Microbiol* 1998; 63:71.
- Rasmussen SR et al. *J Clin Microbiol* 1999; 37:404.
- Strachan WD et al. *Pig J* 2003; 51:177.
- Gottschalk LM et al. *J Vet Diagn Invest* 1991; 3:170.
- Amass SF et al. *J Vet Diagn Invest* 1996; 8:64.
- Stuart JG et al. *Vet Microbiol* 1992; 30:213.
- Watson Y et al. *Vet Microbiol* 1994; 41:41.
- Thomas E et al. *Pig J* 2004; 50:28.
- Andresen LO, Teetmeier C. *Vet Microbiol* 2001; 81:331.
- Halbur PG et al. *J Clin Microbiol* 2000; 38:1156.
- Amass SF et al. *Swine Health Prod* 1995; 3:189.
- Johnston PI et al. *Vet Rec* 1991; 130:138.
- Chengappa MM et al. *J Am Vet Med Assoc* 1990; 197:1467.
- Holt ME et al. *Res Vet Sci* 1990; 48:23.
- Torremorell M et al. *Swine Health Prod* 1997; 5:139.
- Villani D. *J Swine Health Prod* 2003; 11:27.
- Blouin C et al. *Can J Vet Res* 1994; 58:49.
- Wisselink HJ et al. *Vet Rec* 2001; 148:473.
- Amass SF et al. *Swine Health Prod* 2000; 8:217.
- Quessy S et al. *Can J Vet Res* 1994; 58:299.
- Jacobs AAC et al. *Vet Rec* 1996; 139:225.

### STREPTOCOCCAL LYMPHADENITIS OF PIGS (JOWL ABSCESSSES, CERVICAL ABSCESSSES)

Cervical or 'jowl' abscess of pigs is observed mainly at slaughter. Clinically there is obvious enlargement of the lymph nodes of the throat region, particularly the mandibular nodes. It is of considerable

importance because of the losses due to rejection of infected carcasses at meat inspection.

The condemnation rate of pig heads at slaughter may be as high as 78–94% in some herds. However, based on annual reports from the Federal Meat and Poultry Inspection Service in the USA, the incidence of jowl abscesses in pigs declined steadily to a level in 1981 less than one-third of the peak incidence 20 years earlier.<sup>1</sup> This may be due to changes in management of pig herds and the use of antibiotic feeding.

Most jowl abscesses in swine are associated with beta-hemolytic streptococci of Lancefield's group E type IV,<sup>1,2</sup> although *P. multocida*, *E. coli*, and *A. pyogenes* may also be present. Some additional serotypes have been isolated.<sup>3</sup> The disease occurs primarily in postweaning and fattening swine. Piglets under 28 days of age are relatively resistant and even colostrum-deprived piglets are resistant to clinical disease following experimental infection.<sup>4</sup>

The disease has been produced by feeding or the intranasal or intrapharyngeal instillation of streptococci<sup>5</sup> and they are thought to be the cause, infection occurring through the pharyngeal mucosa from contaminated food and water.<sup>6</sup> In herds where cervical abscess is a problem, streptococci can commonly be isolated from the vaginas of pregnant sows and the pharynges of normal young pigs.<sup>7</sup> The persistence of the infection in herds is thought to depend on the presence of carrier animals.<sup>8</sup> Transmission occurs via feed and drinking water. After infection has occurred a bacteremia develops and abscesses are initiated in the cervical lymph nodes in a high proportion of pigs.<sup>9</sup> Infrequently, abscesses occur in atypical sites other than the head and neck. Pigs that have recovered from the natural disease are immune to experimental challenge.<sup>10</sup> A microtitration agglutination test is available to detect infections associated with type IV streptococci.<sup>11</sup>

Vaccination of pregnant sows with an autogenous or commercial bacterin containing streptococci and staphylococci is thought to be of value in protecting the litters of the vaccinated sows.<sup>12</sup> Vaccination of young pigs with a whole-culture bacterin has provided some protection, but the use of an oral vaccine prepared from an avirulent strain of group E streptococci and sprayed into the oropharynx is highly effective as a preventive measure.<sup>13</sup> A number of prophylactic regimens based on the feeding of antibiotics have been proposed and generally give good results. Chlortetracycline fed to young pigs at the rate of 220 g/tonne for 1 month is an example.<sup>14</sup> Treatment of breeding pigs at the same time is likely to have a beneficial effect in reducing the severity of exposure of the young pigs to infection. A similar

advantage can be gained by keeping the treated groups isolated from untreated groups of older pigs. Because piglets under 28 days of age are relatively resistant to clinical disease, the weaning and isolation from older pigs is a successful control program.

#### REFERENCES

1. Wood RL. Proc US Anim Health Assoc 1982; 86:503.
2. Collier JR, Noel J. Am J Vet Res 1971; 32:1501.
3. Wessman GE et al. Cornell Vet 1983; 73:307.
4. Wood RL et al. Am J Vet Res 1986; 47:1722.
5. Armstrong CH. J Am Vet Med Assoc 1971; 160:655.
6. Collier JR, Noel J. Am J Vet Res 1974; 35:799.
7. Jones JET. Br Vet J 1976; 132:276.
8. Schmitz JA, Olson LD. Am J Vet Res 1973; 34:189.
9. Schmitz JA et al. Am J Vet Res 1972; 33:449.
10. Jenkins EM, Collier JR. Am J Vet Res 1978; 39:325.
11. Armstrong CH et al. Can J Comp Med 1982; 46:201.
12. Conner GH et al. J Am Vet Med Assoc 1965; 147:479.
13. Collier JR et al. J Am Vet Med Assoc 1976; 169:697.
14. Schmitz JA, Olson LD. J Am Vet Med Assoc 1973; 162:55, 58.

### Diseases associated with *Staphylococcus* species

Mastitis associated with *Staphylococcus aureus* is dealt with in Chapter 15, udder impetigo of cattle in the section on miscellaneous abnormalities of the udder, and staphylococcal pyoderma of horses under the heading of dermatitis. Other miscellaneous infections include:

- Tick pyemia of lambs (see below)
- Exudative epidermitis of pigs (see below)
- Staphylococcal septicemia of the newborn, especially lambs. This is a relatively common disease and may have a significant mortality rate, partly due to a high incidence of myocardial lesions. In most cases the navel appears to be the portal of infection but infection may also occur through marking wounds
- **Periorbital eczema.** A severe suppurative ulceration of the skin around the eyes, ears, nasal and maxillary area and the base of the horns occurs in adult sheep.<sup>1,2</sup> Lesions may be unilateral or bilateral and manifest with hair loss and erythematous swelling, initially covered by a serosanguinous exudate and eventually by a red-brown scab. The disease is associated with *S. aureus* and may be predisposed by trauma from aggression where there is inadequate trough feeding space, or by grazing over corn stalks or other abrasive pastures. Lesions persist for 4–5 weeks but a shorter course is seen with local and parenteral antibiotic therapy

- A benign folliculitis of the face of sucking lambs.<sup>3,4</sup> A more severe facial dermatitis is reported in 6-month-old lambs associated with a combined infection with *S. aureus* and contagious pustular dermatitis,<sup>5</sup> which responded well to treatment with procaine penicillin
- Dermatitis of the legs of sheep with most lesions close to the coronet<sup>6</sup>
- An outbreak of skin abscessation associated with *S. aureus* infection following shearing<sup>7</sup>
- *Staphylococcus hyicus*, the causative organism of exudative epidermitis of pigs, is also an occasional cause of a **scabby dermatitis**, accompanied by itching and alopecia, on the skin of the neck and back of donkeys and horses<sup>8</sup>
- Impetigo with a superficial pustular dermatitis at the base of the teats, on the udder, in the intramammary sulcus and in the perineal area occurs in goats associated with either *Staphylococcus intermedius*, *S. aureus*, or *Staphylococcus chromogenes*.<sup>9</sup> Good response to a single dose of tilimicosin (10 mg/kg BW administered subcutaneously) is reported<sup>10</sup>
- A generalized dermatitis in young lambs with clinical similarities to exudative epidermitis in pigs but associated with *Staphylococcus xylosum*.<sup>11</sup>

#### REFERENCES

1. Scott FMM et al. Vet Rec 1980; 107:572.
2. Savey M et al. Rec Med Vet 1983; 159:701.
3. Scott FMM, Scott GR. Vet Rec 1984; 114:23.
4. Parker BNJ et al. Vet Rec 1983; 113:570.
5. Wilson DJ et al. Vet Rec 2002; 150:45.
6. Syngé BA et al. Vet Rec 1985; 116:459.
7. Delafuente R. Small Rumin Res 1997; 26:283.
8. Devriese LA, Thelissen M. Vet Rec 1986; 118:76.
9. Andrews AH, Lampport A. Vet Rec 1997; 140:584.
10. Naccari F et al. Small Rumin Res 2003; 47:1.
11. Gourreau JM et al. Point Vet 1997; 161:87.

### TICK PYEMIA OF LAMBS (ENZOOTIC STAPHYLOCOCCOSIS OF LAMBS)

#### Synopsis

**Etiology** Infection with *Staphylococcus aureus* predisposed by infection with *Anaplasma* (formerly *Ehrlichia*) *phagocytophila*

**Epidemiology** Disease of young lambs that occurs in areas that are habitats for *Ixodes ricinus*

#### Clinical and necropsy findings

Septicemia and subsequent abscessation in internal organs

**Diagnostic confirmation** Isolation of organism

**Treatment** Long-acting antimicrobials

**Control** Tick control

## ETIOLOGY

The disease has a complex causality and results from a septicemia produced by *S. aureus* predisposed by infection with *Ehrlichia* (*Cytoecetes*) *phagocytophila*, which is transmitted by *Ixodes ricinus*.<sup>1</sup>

## EPIDEMIOLOGY

Enzootic disease has been recorded only in the UK and occurs only in the hill areas that are habitats for the tick *I. ricinus*. The disease occurs in the spring and early summer. The annual incidence varies with the year and between farms. On average, 5% of lambs at risk are affected but on some farms the incidence may be as high as 29% in certain years.<sup>2</sup>

In enzootic areas the disease has considerable economic importance and has been stated to affect as many as 300 000 lambs every year, the majority of which die or fail to be profitable.<sup>2</sup>

## PATHOGENESIS

Experimental and epidemiological studies have established a clear relationship between infection with *E. phagocytophila*, the agent of tick-borne fever, and susceptibility to infection with *S. aureus*.<sup>1</sup> The role of the tick is in the transmission of *E. phagocytophila*.<sup>1</sup>

Infection with *E. phagocytophila* produces a significant lymphocytopenia that develops 6 days after infection and affects all subsets of T and B lymphocytes, and also a prolonged neutropenia lasting for 2–3 weeks combined with a thrombocytopenia. Up to 70% of the neutrophils are parasitized from the onset of the parasitemia and have impaired function, and lambs with tick-borne fever have a much higher susceptibility to experimental infection with *S. aureus* than do non-infected lambs.<sup>2</sup> The ticks are not thought to necessarily provide portals of entry for, nor to be the primary carriers of, the infection with *S. aureus*, although they are important in this respect.<sup>3</sup> *S. aureus* can gain entry through a variety of sources and in affected flocks there is a high incidence of lambs carrying the same infection on their nasal mucosa.<sup>4</sup>

## CLINICAL AND NECROPSY FINDINGS

Lambs aged 2–10 weeks are affected. They may die quickly of septicemia or show signs of localization of infection. Clinically this is most evident by infections that localize in joints or the meninges to manifest as arthritis or meningitis but on postmortem examination abscesses can be found in any organ, including the skin, muscles, tendon sheaths, joints, viscera, and brain.

## TREATMENT AND CONTROL

Treatment of the established disease has limited value and efforts should be directed at prevention or mitigation of early infection during the bacteremic phase.

The strategic use of long-acting antibiotics has shown success in this respect. On farms with enzootic disease, benzathine penicillin administered at 3 weeks of life has been shown to result in a marked decrease in the incidence of subsequent clinical disease.<sup>5</sup> The use of long-acting tetracyclines has the additional advantage of protecting against infection with the agent of tick-borne fever as well as *S. aureus* infection; two treatments of lambs, the first between 1 and 3 weeks of age and the second between 5 and 7 weeks, has been shown to result in a significant reduction in morbidity and mortality.<sup>1</sup> In addition, the treatment has been accompanied by increased weight gain.

**Tick control** by dipping lambs in an organophosphatic insecticide every 3 weeks significantly reduces the incidence of clinical disease and increases weight gain of clinically normal lambs. Separation of the lambs for dipping has not been associated with problems of mis-mothering.<sup>1</sup>

Pour-on preparations on the lambs are also successful.<sup>2</sup> A combination of antibiotic and acaricide treatment may be the most effective and in one trial reduced losses from 10.3% to 0.6%.<sup>2</sup> Dipping the whole flock in an acaricide in spring, whereas it will not completely eradicate tick infestation, will reduce the incidence of tick pyemia.

Pyemic infection with *S. aureus* is also recorded in association with tick infestation in camels in Saudi Arabia.<sup>6</sup>

## REFERENCES

1. Brodie TA et al. *Vet Rec* 1986; 118:415.
2. Mitchell GBB et al. *Vet Annu* 1988; 28:69.
3. Webster KA, Mitchell GBB. *Vet Rec* 1986; 119:186.
4. Watson WA. *Vet Rec* 1966; 79:101.
5. Watt JA. *Vet Rec* 1968; 83:507.
6. El-Amrousi S et al. *Assuit Vet Med J* 1986; 15(30):185.

## EXUDATIVE EPIDERMITIS (GREASY PIG DISEASE)

### ETIOLOGY

The condition of exudative dermatitis is similar to staphylococcal scalded skin syndrome in humans associated with *S. aureus*.<sup>1</sup>

*Staphylococcus hyicus* is the cause of exudative epidermitis in suckling and weaned piglets.<sup>2</sup> It also causes several other diseases sporadically in different animal species; bacteriuria in pigs, polyarthritis in pigs,<sup>3</sup> abortion in pigs, flank biting and necrotic ear lesions,<sup>4</sup> and pneumonia.<sup>5</sup>

In other species it has been associated with skin infections in horses, donkeys, and cattle, subclinical mastitis in cows and osteomyelitis in heifers.<sup>2</sup>

A second species, *Staphylococcus chromogenes*, is part of the normal skin flora of pigs,<sup>6,7</sup> cattle, and poultry. It had been considered nonpathogenic until exuda-

### Synopsis

**Etiology** *Staphylococcus hyicus*

**Epidemiology** Affects suckling and weaning piglets under 6 weeks of age; peak incidence under 1 week of age. Morbidity 20–100%; case fatality 50–75%. Organism carried by sow

**Signs** Marked cutaneous erythema and pain, dehydration, extensive greasy exudate; peracute cases die; less severe cases may survive

**Clinical pathology** Bacterial culture of skin

**Necropsy findings** Exudative epidermitis; degenerative changes in kidney

**Diagnostic confirmation** Culture of organism

**Differential diagnosis** See Table 16.3

**Treatment** Penicillin parenterally

**Control** Sanitation and hygiene of pens. In outbreaks, isolate affected piglets and sows

tive epidermitis was associated with it in 2005.<sup>8</sup> These strains also produced exfoliative toxin type B (ExLB), which was identified by PCR.

## EPIDEMIOLOGY

### Occurrence

Most cases of exudative epidermitis occur in suckling and weaned piglets under 6 weeks of age, with a peak incidence in piglets under 1 week. Occasionally groups of pigs up to 3 months of age may be affected. Within litters the incidence is high, often all piglets being affected. The morbidity will vary from 20–100% and the case fatality rate from 50–75%. The organism has been isolated from the joint fluid of lame pigs affected with arthritis.<sup>3</sup> In 28% and 26% of studies of cases of exudative epidermitis<sup>9,10</sup> no cases of toxigenic *S. hyicus* could be detected. In a recent study of 314 cases in Denmark it was shown that 20% had exfoliatum toxin A, 33% had B, 18% had C, and 22% had D in 60% of cases of exudative epidermitis investigated.

### Method of transmission

The source of the organism is unknown but the gilt or sow is probably an inapparent carrier. It can be isolated from the skin of healthy in-contact piglets and healthy sows.<sup>11</sup> It can be frequently isolated from the vagina of prepubertal gilts and the majority of the litters from the same gilts may be colonized by the organism within 24 hours after farrowing.<sup>12</sup> The maternal strains of *S. hyicus* persisted on the skin of the offspring piglets for the first 3 weeks of the piglets' life – the critical period for outbreaks of exudative epidermitis.<sup>12</sup> The organism has also been isolated from the atmosphere of buildings housing affected pigs. Bacteriophage

Table 16.3 Differential diagnosis of diseases of swine with skin lesions

Disease	Epidemiology	Clinical and laboratory findings	Response to treatment
Swine pox	Mainly suckling piglets. High morbidity but low mortality except in very young piglets. Usually associated with swine louse infestation	Papules, vesicles, and circular red-brown scabs on ventral belly wall and over the sides and back. Pox characteristics	None required except for insect and louse control. Spontaneous recovery in 3 weeks
Skin necrosis	Suckling piglets. High morbidity with abrasive flooring	Abrasion and necrosis starting shortly after birth and reaching maximum severity at about 1 week. Anterior aspect of carpus more common site but also fetlock, hock, elbow, and coronet. Bilateral. Necrosis and erosion of anterior two or three pairs of teats	Usually none required. Recovery 3–5 weeks. Protect area with tape if severe, plus topical antiseptics. Teat necrosis will render animal unsuitable for selection and breeding. Correction of flooring
Exudative epidermitis (greasy pig disease)	Entire litters of sucklings pigs, most severe under 1 week of age, occurs up to 10 weeks, high case fatality in younger pigs	Marked cutaneous erythema with seborrhea, severe dehydration, and death in piglets under 10 days. Older piglets covered with greasy exudate and recover. <i>Staph. hyicus</i> on culture	Piglets under 10 days of age die in spite of therapy. Older pigs may survive with penicillin treatment topically and parenterally
Dermatitis vegetans	Inherited and congenital, high morbidity. High case fatality by 8 weeks	Erythema and edema of coronets, uneven brittle hooves, dry brown crusts on belly wall, giant cell pneumonia. Club foot	None indicated. Genetic control
Ptyriasis rosea	One or more piglets in litter after weaning. High morbidity, nil mortality	Lesions begin as small red flat plaques which enlarge from 1 to 2 cm diameter with a prominent ring of erythematous skin covered in center by thin, dry, brown, loose scales. Lesions usually coalesce forming a mosaic pattern, especially on belly. Scraping negative. No growth depression	None required. Emollient to soothe the lesion. Recovery occurs in 4–8 weeks
Parakeratosis (zinc deficiency)	Weaners and feeder pigs on diet low in zinc and high in calcium. Herd problem, high morbidity, no mortality	Erythematous areas on ventral abdomen and symmetrically over back and legs develop into thick crusts and fissures. No pruritus. Skin scrapings negative. Growth rate depression	Add zinc to diet 100 ppm. Adjust calcium. Recovery in 2–6 weeks
Ringworm	Feeder and mature pigs. Usually several pigs within pen or shed. High morbidity with <i>M. nanum</i> in sows	Centrifugally progressing ring of inflammation surrounding an area with scabs, crusts, and brown or black exudate. May reach large size. Bristles usually intact. No pruritus. Positive skin scrapings and hair. No ground depression	Fungicides. In growers spontaneous recovery in 8–10 weeks if well nourished. <i>M. nanum</i> in sows is persistent and responds poorly
Facial dermatitis	Suckling piglets. High incidence in litters associated with fighting. Low mortality	Lesions on cheeks – usually bilateral abrasions which become infected. Scabs hard and brown and difficult to remove. Overlie a raw shallow bleeding ulcer. Occasional extension to other areas	Usually none indicated. Topical antibacterials. Clip teeth at birth
Ulcerative granuloma	Young pigs but all ages. Sporadic infection following abrasion. Poor hygiene	Large swollen tumorous mass with several discharging sinuses. Central slough and ulcer	Fair, depending on site. Surgical removal and/or sulfadimidine and streptomycin
Sarcoptic mange	All ages of pigs. Herd problem. Reservoir of infection in sows. High morbidity. Nil mortality	Intense pruritus. Mites on scraping. Erythematous spots with scale and minor brown exudation. Especially evident in thin skin areas. Secondary trauma to skin and bristles from rubbing. If severe, intense erythema. Chronic infections, thickening and wrinkling of skin. Depression of weight gain	Good response to vigorous therapy with ascaricides. Treat on herd basis
Allergic dermatoses to <i>Tyroglyphus</i> spp. (harvest mites)	Weaner and feeder pigs few weeks after eating dry ground feed from autonomic feeders	Pinpoint erythematous spots and fragile scales. Intense pruritus. Skin scraping positive for mites	Spontaneous recovery common. Insecticide effective
Eysipelas	Feeder and adult pigs, occasionally weaners. Variable morbidity. Low mortality if treated early	Small red spots developing to characteristic rhomboidal lesion raised and red in color. Lesions may become joined and lose their characteristic shape. Progress to necrosis and desquamation. Fever and other signs of septicemia	Penicillin

typing of *S. hyicus* subsp. *hyicus* isolated from pigs with or without exudative epidermitis revealed two or more phage patterns in the isolates from each pig with the disease and a single-phage pattern in isolates from healthy pigs.<sup>13,14</sup>

### Risk factors

#### Animal risk factors

Field evidence suggests that environmental stress of various kinds, including agalactia in the sow and intercurrent infection, predisposes to the disease. Lesions commonly develop first over the head, apparently in association with bite wounds, which occur when the needle teeth have not been cut or have been cut badly. Other factors include fighting following mixing of litters, excessive humidity over 70%, and following sarcoptic mange. The presence of the disease in a swine herd can account for a 35% reduction in the margin of output over feed and veterinary costs over a 2-month period.

#### Pathogen risk factors

Strains of *S. hyicus* can be divided into virulent and avirulent strains with regard to ability to produce exudative epidermitis in experimental piglets; both types of strain can be isolated simultaneously from diseased piglets.<sup>4</sup> It has been shown that different types of *S. hyicus* expressing different types of toxin may be present in the same diseased pig.<sup>10</sup>

*S. hyicus* produces an exfoliative toxin that can be used to reproduce the disease.<sup>15,16</sup> There are several toxins, including ExLA, ExLB, ExLC, ExLD, SHETa, and SHETb.<sup>17</sup> The exfoliative toxins from isolates from different countries have recently been described.<sup>18</sup> Strains of the organism isolated from a large number of Danish pig herds indicated different electrophoretic motility and plasma-mediated antibiotic resistance patterns.<sup>19</sup> The antibiotic and plasmid profiles of strains isolated from pig herds may be a reflection of the use of antibiotics in those herds.<sup>20</sup> Different types of toxin are produced.<sup>21–23</sup>

Recently the genes encoding for the exfoliative toxins SHETb, ExLA, ExLB, ExLC, and ExLD have been identified<sup>24</sup> and sequenced.

The condition has been seen more frequently in cases of PRRS and PCV2 infections.<sup>25,26</sup>

The organism has been found as a frequent inhabitant of the skin of cattle and has been isolated from cattle with skin lesions.<sup>27,28</sup> Naturally occurring lesions of dermatitis of the lower limbs of horses<sup>29</sup> and similar lesions over the neck and back of donkeys<sup>30</sup> have been recorded. Experimentally, the organism can cause lesions in horses similar to those of exudative epidermitis. A concurrent infection

with *Dermatophilus congolensis* has also been reported.<sup>31</sup>

### PATHOGENESIS

*S. hyicus* has cytotoxic activity for porcine keratinocyte cells in culture, which may indicate one of its virulence factors.<sup>31</sup>

The exfoliative toxins are actually epidermolysins<sup>32</sup> that are active against desmoglein-1, which is a desmosomal cadherin-like molecule<sup>33</sup> involved in cell-to-cell adhesion.<sup>34</sup> The ExLs can cause blister formation in the porcine skin by digesting porcine desmoglein-1 in a similar way to exfoliative toxins of *S. aureus*.

The earliest lesion is a subcorneal pustular dermatitis involving the inter-follicular epidermis. Exfoliation follows with sebaceous exudation and formation of a crust. In the well-developed case there is a thick surface crust composed of orthokeratotic and parakeratotic hyperkeratosis and neutrophilic microabscesses with numerous colonies of Gram-positive cocci.<sup>35</sup>

Although the principal lesion is an inflammatory–exudative reaction in the corium and upper layers of the epidermis, the disease is probably a systemic rather than a local one. Experimental infection of gnotobiotic pigs leads to dermatitis of the snout and ears, then the medial aspect of the thighs, the abdominal wall and the coronets. The lesions can be produced experimentally by using crude extracellular products and a partially purified exfoliative toxin.<sup>36</sup>

### CLINICAL FINDINGS

The morbidity varies from 10–100% and the mortality from 5–90%, with an average of 25%.<sup>35</sup>

In the peracute form, which occurs most commonly in piglets only a few days of age, there is a sudden onset of marked cutaneous erythema, with severe pain on palpation, evidenced by squealing. Anorexia, severe dehydration, and weakness are present and death occurs in 24–48 hours. The entire skin coat appears wrinkled and reddened and is covered with a greasy, gray-brown exudate that accumulates in thick clumps around the eyes, behind the ears, and over the abdominal wall. In the less acute form, seen in older pigs 3–10 weeks of age, the greasy exudate becomes thickened and brown and peels off in scabs, leaving a deep-pink-colored to normal skin surface. There is no irritation or pruritus. In the subacute form, the exudate dries into brown scales that are most prominent on the face, around the eyes, and behind the ears. In a small percentage of pigs the chronic form occurs and the course is much longer; there is thickening with wrinkling of the skin and thick scabs that crack along flexion lines, forming deep fissures. Most

peracute cases die, while piglets with the less severe forms will survive if treated. Some pigs are affected with ulcerative glossitis and stomatitis.

Abortion in a sow has been attributed to the organism.<sup>37</sup>

### CLINICAL PATHOLOGY

Bacterial examination of skin swabs may reveal the presence of *S. hyicus*. A phage typing system can be used to determine the presence of virulent strains and to distinguish them from less virulent strains.<sup>14</sup>

### NECROPSY FINDINGS

Necropsy of these dehydrated, unthrifty piglets often reveals a white precipitate in the renal papillae and pelvis. Occasionally this cellular debris causes ureteral blockage. Some piglets also have a mild ulcerative glossitis and stomatitis. Microscopically, there is separation of the cells of the epidermis in the upper stratum spinosum, exfoliation of the skin, erythema, and serous exudation. The crusting dermatitis features a superficial folliculitis and a hyperkeratotic perivascular dermatitis with intracorneal pustules and prominent bacterial colonies. Degenerative changes are visible in the renal tubular epithelium.

### Samples for confirmation of diagnosis

- Bacteriology – samples of acute skin lesions (CULT). The organism forms 3–4 mm white, nonhemolytic colonies on blood agar. It is catalase- and mannitol-negative but hyaluronidase-positive
- Histology – formalin-fixed skin (multiple sites), kidney (LM).

A PCR is available but requires a pure culture and large numbers of organisms to be successful.

### DIFFERENTIAL DIAGNOSIS

Exudative epidermitis may resemble several skin diseases of pigs of all age groups (Table 16.3). However, in exudative epidermitis there is no pruritus or fever. Careful gross examination of the lesions, particularly their distribution, the state of the hair shaft, the character of the exudate and the presence or absence of pruritus must be considered, along with skin scrapings and biopsies.

### TREATMENT

Experimentally infected piglets respond favorably to a topical application of cloxacillin 10 000 IU/g of lanolin base and 1% hydrocortisone combined with parenteral cloxacillin. Treatment must be administered as soon as the lesions are visible. Procaine benzylpenicillin at a dose of 20 000 IU/kg BW intramuscularly daily for 3 days is also recommended. The antimicrobial sensi-

tivities determined in one field investigation revealed that all isolates were sensitive to novobiocin, neomycin, and cloxacillin. Novobiocin may be the antimicrobial of choice since staphylococci are universally sensitive to this antibiotic.<sup>38</sup> However, there is no available information on the efficacy of antimicrobials for naturally occurring cases of exudative epidermitis. A study has suggested that erythromycin, sulfathiazole, and trimethoprim may be the most useful drugs, whereas penicillin and tetracyclines may not be very useful.<sup>39</sup> Naturally occurring cases in piglets under 10 days of age respond poorly, while older pigs recover with a skin wash using a suitable disinfectant soap. The most successful treatment is antibiotics and skin washing for a period of at least 5–7 days. It is also essential to make sure that there is sufficient dietary provision of zinc, biotin, fat, selenium, and vitamin E in the diet.

### CONTROL

The infected accommodation should be cleaned, disinfected and left vacant before another farrowing sow is placed in the pen. Strict isolation of the affected piglets and their dam is necessary to prevent spread throughout the herd. Dead piglets should be removed promptly from the premises and in-contact sows should be washed with a suitable disinfectant soap. Maternal antibodies will protect piglets in the first few weeks of life.

Autogenous **vaccines** have been used with varying degrees of success. It is important to use a strain that produces the exfoliative toxin, so the recent development of PCRs that identify the genes for toxin development will ensure that the right isolate is used for the autogenous vaccine. It will also facilitate the development of a commercial vaccine.

A novel approach to the control is **bacterial interference**. Experimentally, the precolonization of the skin of gnotobiotic piglets with an avirulent strain of *S. hyicus* will prevent the experimental reproduction of the disease with the virulent strain of the organism.

### REFERENCES

- Ladhani S et al. Clin Microbiol Rev 1999; 12:224.
- Wegener HC et al. Can J Vet Res 1993; 57:119.
- Hill BD et al. Aust Vet J 1996; 73:179.
- Miit D. Vet Rec 1999; 144:92.
- Teuscher E, Higgins R. Med Vet Quebec 1990; 20:64.
- Devriese LA et al. Int J Syst Bacteriol 1978; 28:482.
- Saito K et al. J Vet Med Sci 1996; 58:711.
- Andresen LO et al. Vet Microbiol 2005; 105:291.
- Andresen LO et al. FEMS Immunol Med Microbiol 1998; 20:301.
- Andresen LO et al. Vet Microbiol 1999; 68:285.
- Bara MR et al. Aust Vet J 1993; 70:256.
- Wegener HC et al. Epidemiol Infect 1992; 109:433.

- Wegener HC et al. Res Microbiol 1993; 144:237.
- Wegener HC J Vet Med Series B 1993; 40:13.
- Tanabe T et al. Vet Microbiol 1996; 48:9.
- Andresen LO et al. Microb Pathog 1997; 22:113.
- Fudaba Y et al. Microb Pathog 2005; 39:171.
- Andresen LO. Vet Rec 2005; 157:376.
- Wegener HC, Schwarz S. Vet Microbiol 1993; 34:363.
- Noble WC, Allaker RP. Vet Rec 1992; 130:466.
- Tanabe T et al. Infect Immun 1993; 61:2973.
- Sato H et al. J Bacteriol 2000; 182:4096.
- Andresen LO et al. FEMS Immunol Med Microbiol 1999; 23:295.
- Ahrens P, Andresen LO. J Bacteriol 2004; 186:1833.
- Whitaker HK et al. J Vet Diagn Invest 1990; 2:244.
- Wattrang E et al. Vet Microbiol 2002; 86:281.
- Hazirika RA et al. Res Vet Sci 1991; 50:374.
- Hazirika RA et al. Indian Vet J 1991; 68:163.
- Devriese LA et al. Equine Vet J 1983; 15:263.
- Devriese LA, Thelisen M. Vet Rec 1986; 118:1091.
- Allaker RP et al. Vet Microbiol 1991; 26:161.
- Prevost G et al. Curr Opin Infect Dis 2003; 16:71.
- Amagai M et al. Nat Med 2000; 6:1275.
- Hankawa YNM et al. J Clin Invest 2002; 110:53.
- Kim J, Chae C. Vet J 2004; 167:104.
- Andresen LO et al. Microb Pathog 1993; 15:217.
- Onet GE, Pommer JL. J Am Vet Med Assoc 1991; 199:362.
- Wegener HC et al. J Clin Microbiol 1994; 32:793.
- Aarestrup FM, Jensen LB. Vet Microbiol 2002; 89:83.

## Diseases associated with *Corynebacterium*, *Actinobaculum*, and *Arcanobacterium* species

### *Arcanobacterium pyogenes*

*Arcanobacterium* (formerly *Corynebacterium* or *Actinomyces*) *pyogenes* is an ubiquitous organism and is the primary cause of, or a secondary invader in, a wide variety of pyogenic infections in ruminants, pigs and, occasionally, horses.<sup>1</sup> It is present in the environment, in the intestinal tract, and may be carried in the tonsils of healthy cattle.<sup>2</sup>

The organism gains access to the body through contaminated abrasions, wounds, or insect bites and the infection may remain localized in the form of a **subcutaneous abscess** with inflammation of the draining lymph node or it may proceed to a **bacteremia** with internal localization. Internal abscessation is frequently clinically silent but is important in food quality. The organism is a cause of **endocarditis** and commonly present in necrotizing pneumonias. It is a common isolate in septic arthritis and is also a cause of septic arthritis in calves.

*A. pyogenes* is a common isolate from iatrogenic syndromes such as frontal sinusitis following dehorning, injection site abscess, and surgical wound infections. Extensive subcutaneous abscessation and suppurative cellulitis occurs in **buller feedlot cattle** as a result of multiple skin abrasions.

*A. pyogenes* is a common isolate from **intracranial and spinal abscesses**, which may result from hematogenous spread, in association with parasitic migration or from invasion from surrounding structures. Outbreaks of spinal abscessation can occur in conjunction with **tail-biting** in pigs and ear abscessation as a result of ear-biting. A seasonal occurrence of intracranial abscessation occurs in male deer during the period following velvet shedding to the time of antler casting and is associated with wounds and fractures of the antler pedicle.<sup>3</sup> *A. pyogenes* is one of the more common organisms isolated from osteomyelitis in cattle and is also the common isolate from pituitary abscesses.

A syndrome of chronic rhinitis and sinusitis with unilateral or bilateral foul-smelling nasal discharge is reported affecting dairy cattle in three herds in the UK. Contamination of feed by the discharge resulted in food refusal. There was no evidence of predisposing common respiratory viral or other bacterial infection.<sup>4</sup>

The organism is sensitive to penicillin but infections with *A. pyogenes* are **poorly responsive** to antimicrobial therapy despite in vitro sensitivity and usually require surgical drainage in combination with antibiotic therapy. Resistance to tetracyclines and tylosin is more prevalent in isolates from animals in which these antimicrobials are used for growth promotion and disease prophylaxis.<sup>5</sup>

**Vaccines** against the organism are commercially available in most countries but there is little evidence that they induce protective immunity against infection or the pyogenic process.<sup>6</sup>

The role of *A. pyogenes* in the production of **mastitis** in cattle is described in Chapter 15, as a secondary invader in calf and sheep **pneumonia** in the descriptions of the viral pneumonias of calves and sheep, and in **foot abscess** of sheep under that heading.

### *Corynebacterium pseudotuberculosis*

*Corynebacterium pseudotuberculosis* is a soil-borne organism and causes caseous lymphadenitis in sheep and goats, ulcerative lymphangitis in cattle and horses, and also external and internal abscesses in horses. The organism possesses a cytotoxic surface lipid coat that appears to facilitate intracellular survival and abscess formation and produces a phospholipase exotoxin that increases vascular permeability, has an inhibitory effect on phagocytes, and may facilitate spread of infection in the host. There are two biotypes, with the ovine and caprine isolates a different biotype from equine and cattle isolates.

The important specific diseases associated with *Arcanobacterium*, *Corynebacte-*

*rium*, and *Actinobaculum* spp. are described later in this section. Other minor diseases include the following.

### **METRITIS AND ABORTION**

*A. pyogenes* is an important cause of **postpartum metritis** and infertility in cattle and sheep.<sup>7-10</sup>

Cows are infected soon after calving and infection is frequently accompanied by infection with the Gram-negative anaerobes *Fusobacterium necrophorum* and *Prevotella melaninogenica* (formerly *Bacteroides melaninogenicus*), which act synergistically, enhancing the growth and pathogenicity of each other.<sup>11</sup> However, the inoculation of pure cultures of *A. pyogenes* into the nonpregnant uterus is followed by the development of endometritis with a persistent corpus luteum.<sup>12</sup> With natural cases, infections are more common after the retention of fetal membranes. Isolation of *A. pyogenes* from the uterus during the postpartum period is significantly associated with endometritis, pyometritis and purulent discharge, resulting in an increase in time to first service, more services to conception, an increase in days open and an increase in cows culled because of infertility.<sup>7,9,10,13</sup> Oxytetracycline is commonly used in therapy but minimum inhibitory concentrations (MICs) of various antibiotics for isolates from the uterus of cattle suggest that cephalosporins would be more effective.<sup>14</sup>

The organism is also a cause of **abortion**.<sup>9,15</sup> The fetus is autolyzed but the organism can be isolated from all internal organs and the placenta. Abortion can occur at any stage of pregnancy and has been reproduced experimentally in early pregnancy and in mid-gestation.<sup>16</sup> The prevalence of abortion associated with this organism is low and it accounts for fewer than 5% of abortions in cattle.<sup>9,15,16</sup> The examination of a placentome in addition to the aborted fetus improves the accuracy of diagnosis.<sup>17</sup> An unidentified *Corynebacterium*-like organism tentatively identified as *Arcanobaculum pluranimalium* has been isolated from the placenta and stomach contents of lambs in cases of sporadic abortion in sheep.<sup>18,19</sup>

### **PERINATAL DISEASE**

*A. pyogenes* and *Actinobaculum suis* are occasional causes of perinatal septicemia and polyarthritis in calves, lambs, and foals.<sup>20,21</sup>

### **ARTHRITIS AND BURSTITIS**

*Corynebacterium pseudotuberculosis* has been determined to cause a nonsuppurative arthritis and bursitis in lambs. The joints

are only slightly enlarged and many animals show only mild clinical signs. Recovery occurs if the lambs are fed and confined.

### **PERIODONTAL DISEASE: CARA INCHADA**

*A. pyogenes* and *P. melaninogenica* have been isolated from periodontal lesions occurring in young cattle grazing new pastures sown in recently cleared forest areas in Brazil. The cause of the disease is uncertain and multifactorial but enzymes and toxins from these organisms are stated as being capable of causing primary destruction of periodontal tissue.<sup>22</sup> Cattle are affected at an age when premolar and molar teeth erupt. Trace element deficiencies have been suspected of predisposing to the disease but are not proven to do so. One theory is that there is a large increase in *Actinomyces* in soil following the clearance of the forest, that these produce antibiotics, mainly streptomycin, and that the ingestion of subinhibitory concentrations of these predisposes to adherence of bacteria to the gingival epithelium. The disease has markedly decreased in incidence in recent years as forest clearing and the occupation of virgin land for cattle raising has almost ceased.<sup>23</sup> Cara inchada is manifest with a purulent periodontitis, halitosis, progressive loss of premolar teeth, mainly of the upper jaw, and emaciation. In risk areas attack rates and case fatality rates are high. The disease can be suppressed by including spiramycin or virginiamycin in the mineral mix fed to the cattle.

### **CHRONIC PECTORAL AND VENTRAL MIDLINE ABSCESS IN HORSES (PIGEON FEVER)**

In California,<sup>24,25</sup> Texas,<sup>26</sup> and Colorado,<sup>27</sup> *C. pseudotuberculosis* has been associated with a high regional prevalence of chronic abscessation in horses. There is no apparent breed or sex predisposition and cases occur in horses of all ages, but the majority are adult horses and there are few cases under 1 year of age. Usually, only a single horse on a farm is affected. A small proportion of farms have endemic infection, with a prevalence of disease of 5–10% and recurrent infections each year. In some years spread to naive horses results in epidemic disease. Cases can occur in all months of the year but are most common in dry months in autumn, with a peak prevalence in September, October, and November.<sup>17</sup> There is a variation in the prevalence from year to year and, in both Texas and California, years with high prevalence of the disease have been preceded by seasons with higher than normal rainfall and conditions that

promote high insect populations. Insects, such as horn flies (*Habronema irritans*), that produce a ventral midline dermatitis during feeding may predispose to infection, and the organism has been detected by PCR populations of *H. irritans*, *Stomoxys calcitrans*, and *Musca domestica*.<sup>28</sup> Patterns of spatial and temporal clustering indicate that disease is transmitted directly or indirectly from horse to horse with an incubation period of 3–4 weeks.<sup>25</sup> The disease occurs in a region where caseous lymphadenitis is also common in sheep. Stable hygiene, insect control and isolation of infected horses may aid in control.<sup>25</sup>

### **External abscesses**

These occur in a variety of areas on the body but in the majority of cases they are in the pectoral, axillary, inguinal, or ventral midline regions.<sup>24</sup> The abscesses may reach a diameter of 10–20 cm, with a surrounding area of edema, before they rupture 1–4 weeks later. Clinical signs include local swelling, lameness, pain on palpation, ventral edema, reluctance to move, midline dermatitis, fever and depression in the early stage, and eventually rupture of the abscesses.

Treatment of external abscesses is by hot packs to encourage opening and by surgical drainage and lavage. Ultrasound can aid in the detection of deeper abscesses. NSAIDs can be used to control swelling and pain. Recovery rates are excellent and are not improved by antimicrobial therapy.<sup>24</sup>

### **Internal abscesses**

These occur at a variety of sites but predominantly in the liver and can occur in horses with no external abscessation. The diagnosis should be suspected in horses, in the region and the season, with a clinical history of external abscess, fever, anemia and colic, and laboratory evidence of leukocytosis with neutrophilia, anemia, hyperglobulinemia and hyperfibrinogenemia, and elevated activity of hepatic-associated enzymes. Abdominocentesis in most cases shows an elevated protein and nucleated cell count, and the organism can be cultured.<sup>24</sup> Treatment is with antimicrobial therapy but the case fatality rate is high.

The value of a synergistic hemolysis inhibition serological test in diagnosis has been examined.<sup>24</sup> In horses with external abscesses a range of titers was found but high titers were found in horses with internal abscessation.<sup>24</sup>

An autogenous vaccine has given protection against experimental challenge but, in field trials, there has been no difference in the incidence of infection between vaccinated and control horses.<sup>29</sup>

*C. pseudotuberculosis* is also recorded as a cause of pericarditis and pleuritis in a



horse<sup>30</sup> and in association with suppurative facial dermatitis following trauma.<sup>31</sup>

## REFERENCES

1. Lavoie JP et al. *Can Vet J* 1991; 32:292.
2. Duncanson GR, Slater CA. *Vet Rec* 1986; 118:459.
3. Davidson WR et al. *J Wildl Dis* 1990; 26:460.
4. Otter A et al. *Vet Rec* 2000; 146:55.
5. Tinh HT et al. *Vet Microbiol* 2002; 85:353.
6. Hunter P et al. *Onderstepoort J Vet Res* 1990; 57:239.
7. Bonnett BN. *Can J Vet Res* 1991; 55:168.
8. Cohen RO et al. *J Vet Med B* 1996; 43:193.
9. Yamini B et al. *Bovine Pract* 2004; 38:59.
10. Tzora A et al. *Theriogenology* 2002; 57:1809.
11. Smith GR. *Epidemiol Infect* 1991; 100:305.
12. Farin PW et al. *Theriogenology* 1989; 31:979.
13. Takacs T et al. *Theriogenology* 1990; 33:85.
14. Sheldon IM et al. *Vet Rec* 2004; 155:383.
15. Kirkbride CA. *J Vet Diagn Invest* 1993; 5:64.
16. Semambo DKN et al. *Vet Rec* 1991; 129:12.
17. Johnson CT et al. *Vet Rec* 1994; 134:263.
18. Foster G et al. *Vet Rec* 2001; 148:284.
19. Duff JP et al. *Vet Rec* 2001; 148:186.
20. Hariharan H. *Can Vet J* 1992; 33:56.
21. Robinson JA et al. *Equine Vet J* 1993; 25:214.
22. Dobereiner J. *Dtsch Tierarztl Wochenschr* 1990; 97:482.
23. Dobereiner J et al. *Pesque Vet Brazil* 2004; 24:50.
24. Aleman M. *J Am Vet Med Assoc* 1996; 209:804.
25. Doherr MG et al. *Am J Vet Res* 1999; 60:284.
26. Welsh RD. *Equine Pract* 1990; 12:7.
27. Hall K et al. *Equine Vet J* 2001; 21:284.
28. Spier SJ et al. *Am J Vet Res* 2004; 65:829.
29. Davies EW, Spensley MJ. *J Vet Intern Med* 1992; 6:137.
30. Perkins SL et al. *J Am Vet Med Assoc* 2004; 224:1133.
31. Farstvedt EG et al. *J Am Vet Med Assoc* 2004; 224:1139.

## CONTAGIOUS BOVINE PYELONEPHRITIS

### Synopsis

**Etiology** *Corynebacterium renale*

**Epidemiology** Organism is present in the vagina of carrier animals. Infection spread, and disease initiated, by trauma such as breeding or catheterization

**Clinical findings** Periodic episodes of hematuria, pyuria, colic, straining to urinate, fever, loss of condition. Palpable abnormality on rectal examination. Cystitis determined by endoscopic examination, pyelonephritis by renal biopsy and ultrasound examination

**Clinical pathology** Urine pH alkaline. Pyuria on microscopic examination. Elevated blood creatinine and urea concentrations

**Necropsy findings** Cystitis and pyelonephritis

**Diagnostic confirmation** Gross changes in urine, together with palpable abnormalities in the urinary tract and the presence of bacteria including *C. renale* in the urine

**Treatment** Prolonged course of penicillin. Nephrectomy

**Control** Avoidance of urinary catheterization. Artificial insemination

## ETIOLOGY

*Corynebacterium renale*, the specific etiological agent, has three serotypes of which types I and III appear to be the most pathogenic. Piliated forms occur and may be important in attachment to the epithelium in the reproductive and urinary tract.<sup>1,2</sup> *Corynebacterium pilosum* and *Corynebacterium cystitidis* are commonly isolated in conjunction with *C. renale* but are considered part of the normal flora of the vulva.

*Corynebacterium pseudotuberculosis*, *Arcanobacterium pyogenes*, *Actinobacillus equuli*, *Escherichia coli*, and *Staphylococcus aureus* are sometimes found in the urinary tract of cattle and pigs affected with pyelonephritis, either alone or associated with *C. renale*. Of these organisms, *E. coli* in particular is considered a separate cause of pyelonephritis in the cow.<sup>3</sup>

*C. renale* has little apparent resistance to physical or chemical agents and can survive in soil for at least 56 days.<sup>3</sup>

Infection with *C. renale* may stimulate production of antibody that gives cross-reactions with the complement-fixing test for Johne's disease.

## EPIDEMIOLOGY

### Occurrence

The disease is widespread in Europe, North America, Australia, Africa, Japan, and Israel and probably occurs in all countries, although it seldom constitutes an important problem in any herd or area. As a rule, clinical cases are **sporadic**, even in herds found to harbor a significant number of carriers. Differences in disease prevalence probably reflect differences in management. One study in seven herds found an annual incidence that varied from 0.5–1.5% and in one herd was 16%.<sup>4</sup> Subclinical infection may be more frequent than commonly recognized. Chronic cystitis and pyelonephritis (etiology unstated) have been found in 5.3% and 0.2% of cattle at slaughter.<sup>4,5</sup>

Although pyelonephritis is considered to be essentially a bovine disease, sheep are occasionally affected.

### Source of infection and transmission

*C. renale* can be isolated from the urine of affected or **carrier** animals and in Japan has been isolated from the vagina or vaginal vestibule of approximately 6% of **healthy** cows.<sup>6</sup> The incidence of cows excreting *C. renale* in their urine is higher in herds where the disease occurs than in herds where the disease is unknown. *C. renale* is present in the urinary tract of other animals, including rodents, and can be isolated from dust and the environment of infected animals.<sup>7</sup>

In cattle, infection can be **transmitted** by direct contact, by the use of contaminated brushes or by the careless use of **catheters**. A change in the policy of catheterizing cows with suspect ketosis for the collection of urine can be associated with a fall in the incidence of the disease.

There is a strong inference that in some circumstances the disease, or the infection, can be spread **venereally**. This is suggested by the occasional occurrence of a series of cases in a herd, usually related to the use of a particular bull,<sup>8</sup> and the cessation of cases when artificial insemination is used. The organism can often be isolated from the prepuce, urethra, and semen of bulls that have no detectable lesions in the prepuce. *C. renale* can be a cause of balanoposthitis in bulls.

## Risk factors

Cattle are seldom affected before maturity and cows appear to be much more susceptible than bulls. In cows, clinical cases are more common in early lactation. **Mature cows** of all ages are susceptible but in one study there was a significantly higher risk for disease in cows in their second lactation.<sup>4</sup> An increase in clinical cases is usually found in the colder seasons of the year and heavily fed, high-producing dairy herds appear to show an increased susceptibility.

A significant decreased risk for pyelonephritis has been found for cows that have postparturient uterine disease, which may be associated with the treatment of these cows with antibiotics.

Bulls can be predisposed to pyelonephritis by obstructive urinary abnormalities.<sup>9</sup>

In Israel, the ingestion of rock rose (*Cistus salvifolius*) is reported to produce urinary retention and predisposes to pyelonephritis.<sup>10</sup>

## Experimental production

The disease can be reproduced by inoculation of the organism into the urethra.<sup>11,12</sup> It can also be reproduced by intravenous challenge, although the vulva is believed to be the natural portal of entry. Although not intentionally produced, the disease occurred in 10% of a group of cattle used to teach veterinary students the technique of urinary catheterization.

## Economic importance

Unless appropriate treatment is instituted early, the disease is highly fatal and economic loss is due mainly to the deaths of affected animals.

## PATHOGENESIS

Pyelonephritis usually develops as an **ascending infection** involving successively the bladder, ureters, and kidneys. Trauma to the urethra, or urine stasis, may facilitate ascending infection. The destruction of renal tissue and obstruction of urinary outflow ultimately result in uremia and the death of the animal.

Piliated and nonpiliated forms of *C. renale* are present in infected animals but

their relative importance to the pathogenesis of the disease is uncertain. Piliated forms of *C. renale* have a greater ability to attach to urinary tract epithelium, are more resistant to phagocytosis and are probably important to carriage of the organism and to the initial ascending infection.<sup>11</sup> However, in the course of an infection there is a shift from piliated to nonpiliated forms, which may reflect a response to the development of antipilus antibody.<sup>13</sup>

### CLINICAL FINDINGS

Early signs vary considerably from case to case.<sup>14</sup> The first sign observed may be the passage of **bloodstained urine** in an otherwise normal cow. In other cases, the first sign may be an attack of acute **colic**, manifest by swishing of the tail, treading of the feet and kicking at the abdomen, and straining to urinate, the attack passing off in a few hours. Such attacks are caused by obstruction of a ureter or renal calyx by pus or tissue debris and may be confused with acute intestinal obstruction. More often the onset is gradual with a **fluctuating temperature** (about 39.5°C, 103°F), **capricious appetite**, loss of condition and **fall in milk yield** over a period of weeks. Other than this, there is little systemic reaction and the diagnostic signs are associated with the urinary tract.

The most **obvious sign** is the presence of **blood, pus, mucus, and tissue debris in the urine**, particularly in the last portion voided. Urination is frequent, may occur in a dribble rather than a stream, and may be painful. Periods during which the urine is abnormal may be followed by apparent recovery with later remissions.

In the early stages, **rectal examination** may be negative but later there is usually detectable thickening and contraction of the bladder wall and enlargement of one or both ureters. These are not normally palpable but in chronic cases may be felt in their course from the renal pelvis of the left kidney to the bladder. The terminal portion of the ureters may also be palpated through the floor of the vagina over the neck of the bladder. The palpable left kidney may show enlargement, absence of lobulation and pain on palpation, and the right kidney may be palpable if it is significantly enlarged.<sup>14</sup> In many cases there are no distinct clinical signs referable to the urinary tract and the history and clinical signs may be of weight loss and suspected gastrointestinal disease. In these cases examination of the urine is essential to diagnosis.

**Endoscopic examination** of the urethra and bladder can be diagnostic. Ultrasound examination shows a reduction in renal pelvis diameter, a reduction in renal parenchyma and the bladder wall is hyperechoic.

The course is usually several weeks or even months and the terminal signs are those of uremia.

### CLINICAL PATHOLOGY

There is proteinuria and hematuria. Urine pH is greater than 8.5 and the specific gravity has been recorded between 1.008 and 1.021.<sup>14</sup> **Microscopic examination** will show pyuria. The presence of *C. renale* in suspected urine can be confirmed by **culture**, specific immunofluorescence<sup>7</sup> or direct microscopic examination.

There may be hypoalbuminemia and hypergammaglobulinemia. Neutrophilia may be present but is not constant in all cases. There is an elevation of serum creatinine and urea, and concentrations above 1.5 mg/dL and 100 mg/dL, respectively, carry a grave prognosis.<sup>4</sup>

**Renal biopsy**<sup>15</sup> and **ultrasound**<sup>16</sup> can aid in diagnosis. Ultrasound may demonstrate a dilated renal collecting system containing echogenic material and can be an aid in the determination of the severity of the disease.

### NECROPSY FINDINGS

The kidneys are usually enlarged and the lobulation less evident than normal. The renal calyces and grossly enlarged ureters contain blood, pus, and mucus. Light-colored necrotic areas may be observed on the kidney surface. Changes visible on the cut surface include excavation of papillae, abscessation and wedge-shaped areas of necrosis that extend from the distal medulla into the cortex. The bladder and urethra are thick-walled and their mucous membranes are hemorrhagic, edematous and eroded. Histologically, the renal lesions are a confusing mixture of acute suppurative changes and various degrees of fibrosis with mononuclear cell infiltration.

### Samples for confirmation of diagnosis

- ◊ Bacteriology – kidney; culture swab from ureter (CULT)
- ◊ Histology – formalin-fixed kidney, ureter, bladder (LM)
- ◊ Clinical pathology – 1 mL aqueous fluid from eye (BUN).

### TREATMENT

Although several antibiotics appear to inhibit *C. renale*, penicillin remains the antibiotic of choice for treatment of pyelonephritis. Large doses (15 000 IU/kg BW of procaine penicillin G) are recommended daily for at least 3 weeks.<sup>3</sup> In early cases where little structural damage has occurred, permanent recovery can be expected following such a course of treatment.<sup>14</sup> In general, a good prognosis is suggested by an improvement in condition, appetite and milk yield and clearing of the urine. However, in well-established cases, relapse is

### DIFFERENTIAL DIAGNOSIS

Cases characterized by acute colic can be differentiated from acute intestinal obstruction by the absence of a palpable obstruction and the disappearance of abdominal pain within a few hours. Chronic cases may be confused with traumatic reticulitis but may be differentiated by the urine changes present in pyelonephritis.

Sporadic cases of nonspecific cystitis can only be differentiated by culture of the urine.

Polypoid cystitis is a nonspecific result of bladder inflammation and may be a cause of dysuria and obstructive uropathy.<sup>17,18</sup> The differential diagnosis is best made by endoscopic examination, which reveals multiple frond-like fungiform polyps and papillae on the bladder wall.

not uncommon and, where tissue destruction has been extensive, relief through antibiotic therapy is only temporary. In valuable animals, where ultrasound has established the diagnosis, unilateral nephrectomy may be an alternative and the surgical technique has been described.<sup>16</sup>

### CONTROL

No specific control measures are usually practiced but isolation of affected animals and destruction of infected litter and bedding should reduce the population of the organism in the local environment and minimize the opportunity for transmission. Procedures such as urinary catheterization should be avoided and routine vaginal examinations should be conducted with proper hygienic precautions. Where natural breeding is practiced, some reduction in occurrence may be achieved by the introduction of artificial insemination.

### REFERENCES

1. Hayashi A et al. *Vet Microbiol* 1985; 10:287, 381.
2. Hayashi A et al. *Am J Vet Res* 1985; 46:409.
3. Divers T. J. *Proc Am Assoc Bovine Pract* 1983; 15:74.
4. Markusfeld O et al. *Br Vet J* 1989; 145:573.
5. Herenda D et al. *Can Vet J* 1990; 31:515.
6. Hiramune T et al. *Jpn J Vet Sci* 1988; 50:111.
7. Osanai T et al. *Vet Microbiol* 1996; 52:313.
8. Sheldon JM et al. *Vet Rec* 1995; 137:100.
9. Tyler JW et al. *J Am Vet Med Assoc* 1991; 198:871.
10. Yerahum I et al. *Rev Med Vet* 2002; 153:627.
11. Kubota T, Yanagawa R. *Jpn J Vet Sci* 1988; 50:199.
12. Elias S et al. *Br Vet J* 1993; 149:5.
13. Fukuoka T, Yanagawa R. *Jpn J Vet Sci* 1987; 49:1073.
14. Rebhun WC et al. *J Am Vet Med Assoc* 1989; 194:953.
15. Scholz H et al. *Prakt Tierarzt* 1997; 78:326.
16. Hayashi H et al. *J Am Vet Med Assoc* 1994; 205:736.
17. Wallace LLM et al. *J Am Vet Med Assoc* 1990; 197:1181.
18. Lopez A et al. *Can Vet J* 1990; 31:585.

## CYSTITIS AND PYELONEPHRITIS OF SOWS

### Synopsis

**Etiology** *Actinobaculum suis* (*Eubacterium suis*, *Corynebacterium suis*) is the specific cause but a range of other bacteria (principally *Escherichia coli*) may also cause the condition

**Epidemiology** Infection of male pigs causes the disease in sows. Organism is in the prepuce and environment. Transmission is venereal and through dirty farrowing houses. Trauma to the urogenital tract of females predisposes to disease

**Clinical findings** Unexpected death in acute cases. Pain on urination, bloodstained, turbid urine accompanied by vaginal discharge. Cystitis on endoscopic examination

**Clinical pathology** Hematuria, pyuria, proteinuria, bacteremia. Urine pH >8.5. Demonstration of organism by culture or immunofluorescence. Azotemia, increased concentrations of urea and creatinine, hyperkalemia and hyponatremia

**Necropsy findings** Purulent cystitis and pyelonephritis

**Diagnostic confirmation** Urinalysis, endoscopic examination and demonstration of *A. suis*

**Treatment** Unrewarding unless early in the course of the disease – antimicrobials and supportive therapy. Humane destruction of cases

**Control** Antimicrobials by injection, in water or in feed. Insure adequate water supply for lactating sows to aid urination and improve postfarrowing hygiene

### ETIOLOGY

The disease is associated with a variety of agents. A variety of syndromes associated with different bacteria can be distinguished. Urinary tract infections in sows can be associated with *E. coli* and other bacteria (*Pseudomonas aeruginosa*, staphylococci, streptococci, *Proteus* spp., *Klebsiella* spp., enterococci, and *A. pyogenes*) and infections with most of these organisms result in catarrhal/purulent cystitis.

The specific disease is most commonly associated with *Actinobaculum suis*. This was formerly known as *Eubacterium suis* and before that as *Corynebacterium suis*. This organism is a Gram-positive rod that is difficult and slow to grow and requires special culture media.

All these organisms causing this problem are believed to produce the condition as a result of ascending infection. The disease is a particular problem when sows are in stalls or tethered. The condition may not be so serious when associated with all the species other than *A. suis* and in these cases may be seen as frequent urination, the presence of blood or pus in the urine and a progressive loss of condition.

### EPIDEMIOLOGY

The disease occurs in postpubertal sows that have bred.

### Occurrence

The infection may be common but the disease is better viewed as sporadic.

The disease is probably worldwide and has been reported from Great Britain, Europe, North America, Asia, and Australia. It occurs both in outdoor and indoor units. There are no measures of prevalence, although it has been described as the most important cause of sow deaths, with up to 25% associated with urinary tract infection.<sup>1</sup> It probably occurs more frequently than is recognized as there is a considerable subclinical infection rate. In a recent study in the USA, *A. suis* was isolated from 4.7% of the bladders of sows collected at random at a slaughterhouse.<sup>2</sup>

In small herds, the disease tends to occur in small outbreaks when a small number of sows become infected after being mated to a single boar. Often, the clinical outbreak may be 2–3 weeks after the use of the suspected boar. More serious outbreaks can occur in large intensive piggeries. The disease can also occur sporadically and be a normal feature of sow mortality.<sup>3</sup>

In a recent study of 1745 pregnant sows 28.3% were found to have urinary infections and *A. suis* was found in 20.6% of these.<sup>4</sup> *A. suis* was less prevalent (13.7%) in the sows with urinary infections than in those without (23.1%). In an abattoir survey in the Netherlands the prevalence of cystitis in slaughtered sows was 11%, with a variation depending on group from 0–35%.<sup>5</sup> In this study of 114 bladders, *A. suis* was not isolated but *E. coli* was the most commonly isolated together with *S. dysgalactiae*, *A. pyogenes*, *Aerococcus viridans*, and *S. suis*.

### Source of infection and transmission

*A. suis* is a normal inhabitant of the porcine prepuce and can be isolated from the preputial diverticulum of boars of various ages.<sup>3,6,7</sup> The prevalence of the infection in adult males may be as high as 90%<sup>3</sup> and the organism can be isolated from the floor of the pens containing infected boars.

Infection and **colonization** of the preputial diverticulum may occur in pigs as early as 5 weeks of age if they are housed with older pigs. Frequently, this infection may occur from pen floor contamination because of poor hygiene. Piglets can also become infected, at an early age, from sows that have chronic cystitis and pyelonephritis, and the infection can spread rapidly to other male pigs when they are grouped at weaning.<sup>8</sup> Although infection is common in the male pig, cystitis and pyelonephritis is extremely uncommon in

males. *A. suis* is rarely isolated from the urogenital tract of the healthy female pig.

Clinical disease is almost entirely restricted to the female pig that has bred.

**Venereal transmission** is believed to be the primary if not the sole method of infection of the sow.<sup>8,9</sup>

**Trauma** to the vagina may be an important predisposing factor allowing infection to establish and trauma at parturition with infection from the environment may also be important.

There is no doubt that, where the conditions in stall houses are bad with fecal contamination and poor drainage from the rear half of the stall, perineal and vulval contamination is much greater.

### Risk factors

Clinical signs may occur at any age but are common at 3–4 weeks post-service. The disease is more common in sows kept in intensive **confinement** conditions than in those that are kept in open lots, pens, or pasture<sup>10</sup> but it does occur in these systems if the hygiene is poor. Differences in feeding patterns and exercise that occur in the different management systems can influence the **frequency and volume of water intake**. This in turn has an important effect on the frequency of urination and the residual volume of urine in the bladder following micturition, which is one of the factors that may predispose to the establishment of urinary tract infection. Since many lactating sows will only stand when they are fed, usually twice a day, they will also only urinate and drink twice a day. If they cannot take in enough water from either a trough or a tap during this period at the correct flow rate, they may be suffering from an inadequate water intake.<sup>11,12</sup> It has also been shown that crystalluria may well damage the mucosa and aid the formation of cystitis and that the crystals also support infection of the bladder, particularly where there is an insufficient water supply.<sup>13</sup>

### Economic importance

In one of the best studies of sow mortality in the UK it was reported that the principal cause of death in up to 25% of the sows was urinary tract infection.<sup>1</sup> If the sow mortality is below 5% then cystitis/pyelonephritis is unlikely to be an important problem in the herd.

Cystitis and pyelonephritis is of great importance as it is a major cause of death (annual death rate may be in excess of 5%)<sup>11</sup> in sows in both Britain<sup>8</sup> and the USA<sup>10</sup> and even more importantly a cause of serious culling as the recommendation is to cull affected sows as they will always be a source of infection. Considerable prevention, treatment and hygiene costs will also ensue.

## PATHOGENESIS

In healthy sows *A. suis* can be isolated from the vagina, but not from the bladder, for a short period after an infected service.<sup>8</sup> The factors that allow it to establish in the urogenital tract are unknown but trauma to the vagina and urethral opening and service into the bladder are supposed factors.<sup>6,8</sup> It has been suggested that the other organisms mentioned above may also act synergistically to damage the mucosa and facilitate colonization by *A. suis*.<sup>10</sup> This may be true, as *A. suis* possesses pili by which it attaches to damaged bladder epithelium. Cystitis results in damage to the ureterovesicular junction and there is an ascending infection from the bladder to the kidneys.<sup>14,15</sup> In infected sows, tortuosity of the ureters and blockage of the ureters is fairly common.<sup>8</sup> This and the changes in the kidney may lead to chronic renal failure and even acute renal failure if the blockage is complete and bilateral.

## CLINICAL FINDINGS

It is worth remembering that many mildly affected sows may only show transient inappetence, and other animals are recognized because they are uremic. In the more severely affected groups the presentation is either as an acute case, usually post-service, or as a chronic one, which can occur at any time.

Most commonly sows present as **acute renal failure** as they cannot retain sodium and this leads to rises in plasma potassium and sudden death. Sows are suddenly severely ill, unwilling to rise, show profound depression and circulatory collapse and die within 12 hours. In one series of cases, 40% of the affected sows presented as **unexpected deaths** and in the remainder the mean interval between presenting signs and death was 1.6 days with the longest interval 5 days.<sup>8</sup> In a recent study in Ireland<sup>16</sup> the authors reported the condition mainly in fourth parity sows and above.

Where the surveillance is good the sows are observed to be depressed, anorectic, mildly febrile (normal to 39.5°C, 103°F) and sometimes show arching of the back, twitching of the tail and **painful urination**. There is frequent passage of **bloodstained, turbid urine** accompanied by vaginal discharge. Examination with a **vaginal speculum** will confirm the bladder as the source of the bloody discharge.

The case fatality rate is high. Sows that survive the acute disease develop chronic renal failure with weight loss and polydipsia and polyuria.<sup>9</sup> They are usually culled for poor performance.

**Endoscopic examination** of the bladder in acute cases may show little other than mild inflammation but in more serious

cases there are ulcerative and erosive bladder lesions.<sup>17</sup> In sows large enough to allow **rectal examination**, in chronic cases it may be possible to feel the large and thickened bladder and dilated tortuous ureters. Boars are usually unaffected clinically but intermittent, hematuric episodes lasting several days have been recorded.

The condition can be seen as a sequel to any locomotory, particularly central brain or spinal condition in which there is an inability to stand to drink or micturate, e.g. organophosphorus poisoning.<sup>18</sup>

## CLINICAL PATHOLOGY

Sows' urine is frequently turbid (83.1%)<sup>4</sup> and usually this can be associated with the presence of crystals (96.1%).<sup>4</sup>

Urinalysis usually shows hematuria, pyuria, proteinuria, and a pronounced bacteriuria (usually in excess of 10<sup>5</sup> cfu/mL of urine). A Gram stain on a smear of the urine or pus may show the organisms. The urine is **alkaline** with a pH of more than 8.5 and usually approaching 9 as a result of the urease, which cleaves urea to produce ammonia. Midstream urine contains 10<sup>5</sup> cfu/mL or more.<sup>19</sup> A number of species of bacteria may be found as suggested in the introduction but *A. suis* requires special culture media.<sup>3,20</sup> It is now possible to use immunofluorescence for a more rapid and specific diagnosis.<sup>21</sup> Examination of blood shows a pronounced **azotemia**, with increased concentrations of urea and creatinine and also hyperkalemia and hyponatremia. *N*-acetyl-B-D-glucosaminidase concentrations are elevated, indicating proximal renal tubular damage.<sup>8</sup>

## NECROPSY FINDINGS

A very varied pathology may be visible in these cases. In some sows there may be an extensive purulent nephritis and pyelitis with similar changes in the dilated ureters and the bladder. In others there may be severely hemorrhagic kidneys and blood in the pelvises.

In acute cases the bladder wall is swollen, edematous, and hyperemic and may be covered by a gritty, mucinous material.<sup>2</sup> In others the bladder wall may just be thickened, inflamed and covered by an extensive thick mucus. In some of these cases the ureterovesicular valves may have been completely destroyed by necrosis.<sup>14,15</sup> There may be minimal gross changes in the kidneys in acute cases but there may be microscopic changes of a diffuse tubular and interstitial nephritis. In the chronic case there are ulcerative and erosive lesions in the bladder wall and there may be pus in the bladder, thick-walled ureters and an obvious pyelonephritis.

## Samples for the confirmation of diagnosis

- Bacteriology – kidney, bladder, and ureter for aerobic and anaerobic culture and special media for *A. suis*. A special urea-enriched medium<sup>21</sup> in which dry colonies of *A. suis*, about 2–3 mm in diameter, grow after 2 days incubation
- Histology – formalin-fixed bladder, ureter, and kidney
- Clinical pathology – from the eye (BUN).

## DIAGNOSIS

Diagnosis is based on high mortality, clinical findings, history of service, clinical pathology, particularly bacteriology, immunofluorescence for specific bacteria, or isolation by culture.

## DIFFERENTIAL DIAGNOSIS

- Other causes of sudden and unexpected deaths
- Hematuria
- *Stephanurus dentatus* (where it occurs)
- The separation of the condition associated with *A. suis* from those associated with other bacteria can only be achieved by bacterial culture and other laboratory techniques.

## TREATMENT

Early treatment with **antibiotics** is recommended, but if there is acute renal failure then the case fatality rate is high. Penicillin given at 15 000 IU/kg daily for 3–5 days has been successful. The intramuscular injection of streptomycin at 10 mg/kg has also been used successfully.<sup>8</sup> The isolation of other organisms may indicate the need for other broad-spectrum antibiotics. A recent outbreak of cystitis and endometritis<sup>16</sup> associated with a falling conception rate from 88% to 75% and believed to be due to *E. coli* (together with staphylococci and streptococci) was successfully treated with an ammonium chloride urinary acidifier whereas the amoxicillin used previously was without effect. Enrofloxacin at the rate of 10 mg/kg BW in the feed for a period of 10 days has also proved effective, as has 2.5 mg/kg in the food for at least 20 days.

The response can be monitored by the reduction in the urine pH. Treated sows should be loose housed with access to plenty of water. The treatment should be continued for at least 2–3 weeks after the outbreak has appeared to finish clinically. Oral **electrolyte therapy** is also beneficial. In chronic cases the lesions are well advanced and the organisms may be contained in the calculi and then therapy is not successful and relapses may well occur. In many cases **humane destruction**

is the best option especially as it is not possible except in very early cases to eliminate the organism. Preputial washing on a regular basis may prevent the carriage of organisms by boars especially as it has been shown that semen may be frequently contaminated by *A. suis*, and it is said that up to 50% of boars in some studs may be affected.

### CONTROL

Routine **prophylactic administration of antibiotics** has proved of little value in the long-term control of the disease. A **temporary solution** has been the use of sow treatment with oxytetracycline followed by in-feed medication with 400 g/ton for 21 days.<sup>11</sup> It is not possible to eradicate the infection from the prepuce of a boar, although daily infusions may help to reduce the infection.<sup>7</sup> Artificial insemination with the semen treated with antibiotics is a further option.

**Trauma** to the vagina at mating should be reduced by boar management and the supervision of mating. There should be nonslip floors in the service areas. Animals showing distress, pain, or bleeding after mating should be treated.

The service areas should have very good hygiene with regular cleaning and disinfection after every use. The perineal region of each sow should be cleaned before mating. Farrowing accommodation and crates should also be properly **cleaned and disinfected** and allowed to dry before sows are introduced. The major organism (*A. suis*) will persist in bad floors but is susceptible to phenolic, quaternary ammonium and formalin-based products.<sup>9</sup>

Other control procedures involve the provision of an **adequate water intake**. This should preferably be from the mains without impurities or toxins or bacterial contamination. Loose housing and twice-a-day feeding will encourage the consumption of water. The provision of adequate numbers of drinkers for the stage of the breeding cycle, providing the necessary flow rate for each age of pig is essential (at least 1.5 L/min for gestating sows and 2.2 L/min for lactating sows). A simple check on water supply can be to check appetite: if the sows are not consuming 10 kg of food on day 18 of lactation then there is probably something wrong with water provision. Similarly, troughs must contain at least a reasonable supply of water. In the welfare codes all animals have to be provided with a fresh supply of high quality water.

### REVIEW LITERATURE

Done SH, Carr JC. The urinary tract. In: Sims LD, Glastonbury JRW, eds. Pathology of the pig. Victoria, Australia: Agriculture Victoria, 1996, p 359-384.

Wendt M. Urinary system disorders of pigs. Proceedings of the 15th International Pig Veterinary Society Congress, Birmingham, England 1998; vol 1:195-201.

### REFERENCES

1. Jones JET. Br Vet J 1967; 123:327.
2. Walker R, MacLachlan C. J Am Vet Med Assoc 1989; 195:1104.
3. Jones JET, Dagnall GJR. J Hyg 1984; 93:381.
4. Kjelvik et al. In: Proceedings of the 16th International Pig Veterinary Society Congress 2000; 353.
5. Geudeke MJ. Proceedings of the 12th International Pig Veterinary Society Congress 1992; 567.
6. Pijoan C et al. J Am Vet Med Assoc 1983; 183:428.
7. Muirhead M. Vet Rec 1986; 119:233.
8. Carr J et al. Pig Vet J 1991; 27:122.
9. Jones JET. Vet Annu 1984; 24:139.
10. Dee SA. Vet Med 1991; 86:231.
11. Carr J et al. In Pract 1995; 17:71.
12. Wendt M et al. Dtsch Tierarztl Wochenschr 1995; 102:21.
13. Wendt M et al. Dtsch Tierarztl Wochenschr 1996; 103:506.
14. Carr JC et al. J Urol 1992; 148:1924.
15. Carr JC et al. J Urol 1992; 149:146.
16. Dagnall GJR, Jones JET. Res Vet Sci 1982; 32:390.
17. Spillane P. Pig J 1999; 44:162.
18. Wendt M et al. Tierarztl 1990; Prax 18:353.
19. Liebhold M et al. Vet Rec 1995; 137:141.
20. Lingfeldt N et al. Berl Munch Tierarztl Wochenschr 1990; 103:273.
21. Wendt M, Amsberg G. Schweiz Arch Tierheilkd 1995; 137:129.

### ENZOOTIC POSTHITIS (PIZZLE ROT, SHEATH ROT, BALANOPOSTHITIS); VULVOVAGINITIS (SCABBY ULCER)



**Etiology** Multifactorial. Organisms that produce urease, usually *Corynebacterium renale*, produce lesions only in certain circumstances of management and urinary composition

**Epidemiology** Disease of wether sheep and occasional disease of bulls and goats. May occur as enzootic disease in sheep on high-protein diets and following good rains

**Clinical findings** Pustules and scabs at preputial orifice. Extension to involve internal prepuce in severe disease with signs of urinary obstruction. Ulcers and scabs at mucocutaneous junction of vulva in ewes. Urine staining of wool predisposes to fly strike

**Diagnostic confirmation** Clinical

**Treatment** Dietary restriction, topical disinfectants, surgical opening of ventral prepuce

**Control** Reduction of protein intake, testosterone, hemicastrate or cryptorchid castration

### ETIOLOGY

The etiology is **multifactorial**. High urea concentrations in urine, associated with high protein in pasture, result in cytotoxic levels of ammonia when the urea is split

by urease-producing organisms present in the prepuce and vagina. Estrogens in pasture, causing swelling and congestion of the prepuce, may predispose to disease. Most commonly the organism is *C. renale* but an outbreak of posthitis in sheep associated with *Rhodococcus equi* and *Corynebacterium hofmannii*, both of which produce urease, and not associated with *C. renale*, is described.<sup>1</sup>

*Mycoplasma mycoides* LC has also been incriminated as a cause of posthitis and vulvovaginitis in sheep.<sup>2</sup>

### EPIDEMIOLOGY

The disease is reported primarily from Australia, South Africa, and South America but occurs in all countries with large pastoral sheep industries.

### Host occurrence

Sheep

In Australia, enzootic posthitis occurs most commonly in Merino sheep, particularly **wethers** over 3 years of age and young rams, but in a severe outbreak young wethers and old rams may also be affected. An ulcerative **vulvitis** often occurs in ewes in the same flocks in which posthitis occurs in wethers and is thought to be a venereal extension of that disease. The disease also occurs in **goats**.<sup>3</sup>

Cattle

Posthitis is uncommon in bulls but is reported to occur at high rates and to be economically important in South America.<sup>4</sup> There appears to be no counterpart to ovine vulvitis in cows.

### Source of infection and transmission

The causative organism can be recovered from lesions and from the clinically normal prepuce of most sheep. It is also present in the lesions of vulvitis in ewes and posthitis in bulls and Angora goat wethers.

Flies are considered to be probable **mechanical vectors**, and contact with infected soil and herbage is a likely method of spread. Infection at dipping or shearing seems not to be important. Transmission to ewes appears to occur **venereally** from infected rams. Although the natural disease in cattle is usually benign they may act as reservoirs of infection for sheep on the same farm.

### Host and environmental risk factors

**Diet and season** are the major risk factors. Enzootic posthitis occurs most extensively on lush, **improved pasture** with a high **legume** content and reaches its highest incidence in the autumn in summer rainfall areas and in the spring where the major rainfall is in winter. In these circumstances it can occur in epizootic proportions in wethers. The incidence in affected flocks may be as high as 40% and in some areas

the disease is so common that it is not possible to maintain bands of wethers.

Factors of lesser importance are continued wetness of the area around the prepuce due to removal of preputial hairs at shearing, a high-calcium, low-phosphorus diet and the ingestion of large quantities of alkaline water.

The high incidence in castrates and young rams is probably related to the close adherence of the preputial and penile skins, which separate in mature entire animals, and to a lesser understood influence of **testosterone**.

### Experimental reproduction

Implantation of the organism on a scarified prepuce in the presence of urine is capable of causing the external ulceration that is characteristic of the disease.

### Economic importance

Many deaths occur because of uremia and secondary bacterial infections and all affected sheep show a severe setback in growth rate and wool production. Young rams that are affected are incapable of mating.

### PATHOGENESIS

The organism is capable of hydrolyzing urea with the production of ammonia. It is believed the initial lesion in the wether (the external lesion) is caused by the **cytotoxic effect of ammonia**, produced from urea in the urine by the causative bacteria.<sup>5</sup> This lesion may remain in a static condition for a long period but, when there is a high urea content of the urine associated with a high-protein diet, and continued wetting of the wool around the prepuce, the lesion proceeds to invade the interior of the prepuce, producing the 'internal lesion'. A similar pathogenesis is postulated for vulvar lesions.

### CLINICAL FINDINGS

The primary lesion starts as a pustule, which breaks and forms a soft scab. Small scabs are found on the skin dorsal to the preputial orifice (**external lesion**) and around the external orifice on the non-haired part of the prepuce. These may persist for long periods without the appearance of any clinical signs. The scab is adherent and tenacious. When extension to the interior of the prepuce occurs (**internal lesion**) there is extensive ulceration and scabbing of the preputial opening and a hard core can be palpated extending 1–2 inches into the prepuce. With pressure, a semisolid core of purulent material can be extruded from the preputial orifice. Affected sheep may show restlessness, kicking at the belly and dribbling urine as in urethral obstruction. The area is often infested by blowfly maggots. In rams, the development of pus and fibrous tissue adhesions may interfere with urination and

protrusion of the penis, and cause permanent impairment of function.

Some deaths occur due to obstructive uremia, toxemia, and septicemia. During an outbreak many sheep may be affected without showing clinical signs and are detected only when they are subjected to a physical examination. Others recover spontaneously when feed conditions deteriorate.

In ewes the lesions are confined to the lips of the vulva and consist of pustules, ulcers, and scabs. These extend minimally into the vagina. Their presence may distort the vulva and the ewe may urinate onto the wool with a consequent increased susceptibility to fly strike.

In bulls, lesions are similar to the external lesions which occur in wethers but rarely there may be invasion of the interior of the prepuce. The external lesions occur at any point around the urethral orifice and may encircle it. Their severity varies from local excoriation to marked ulceration with exudation and edema. There is a tendency for the lesions to persist for several months without treatment and with highly alkaline urine.

### CLINICAL PATHOLOGY

Isolation of the causative diphtheroid bacterium may be necessary if there is doubt as to the identity of the disease.

### NECROPSY AND DIAGNOSTIC CONFIRMATION

Necropsy is not required and the diagnosis is clinical.

#### DIFFERENTIAL DIAGNOSIS

- Ulcerative dermatosis in sheep
- Herpes balanoposthitis in bulls

Obstructive urolithiasis in wethers may superficially resemble posthitis but there is no preputial lesion.

### TREATMENT

The principal measures are restriction of the diet to reduce the urea content of the urine, removal of the wool around the prepuce or vulva to reduce the risk of fly strike, segregation of affected sheep and disinfection of the preputial area, and surgical treatment of severe cases.

Sheep can be removed on to dry pasture and their feed intake restricted to that required for subsistence only. They should be inspected at regular intervals, the wool should be shorn from around the prepuce, and affected animals should be treated individually. Weekly application of a 10% copper sulfate ointment is recommended for external lesions; when the interior of the prepuce is involved, it should be irrigated twice weekly with a 5% solution of copper sulfate. Cetrinide

(20% in alcohol or water with or without 0.25% acid fuchsin) or alcohol alone (90%) are about as effective as copper sulfate preparations.

Penicillin topically or parenterally may effect a temporary response. Thiabendazole by mouth appears to have a beneficial effect on the lesions but does not eliminate them.

In severe cases the only satisfactory treatment is surgical, and surgical treatment is necessary if the prepuce is obstructed. The recommended procedure is to open the ventral sheath by inserting one blade of a pair of scissors into the external preputial orifice and cutting the prepuce back as far as the end of the urethral process; extension beyond this leads to trauma of the penis. Badly affected rams should be disposed of as they are unlikely to be of value for breeding.

### CONTROL

Subcutaneous implantation with testosterone propionate is highly effective as a preventive but is no longer used for sheep that will be used for human food. A single implantation of 60–90 mg is effective for 3 months; although the treatments can be repeated four times a year, it is more economical to time them to coincide with periods of maximum incidence, which will vary from district to district. Three implantations in fall, winter, and spring provide an effective control program in most areas. The tablets are implanted subcutaneously, preferably at the base of the ear, using preloaded tubes to avoid undue contact to the operator.

Alternative control procedures are under investigation, in part because of public resistance to meat products exposed to synthetic hormones. One alternative is to run male lambs as cryptorchids, so-called **short scrotum** lambs. The testes are pushed into the inguinal canal and a rubber ring is applied to remove the scrotum. Another is to run male lambs as hemicastrates.<sup>6</sup> The prevalence of posthitis is significantly reduced in Merino short scrotum lambs and hemicastrates.<sup>6,7</sup> There is an increase in live weight, with no increase in fleece weight, but there are obvious masculine characteristics such as horn growth.<sup>6–8</sup>

### REVIEW LITERATURE

Dent CHR. Ulcerative vulvitis and posthitis in Australian sheep and cattle. *Vet Bull* 1971; 41:719.

### REFERENCES

1. Doherty ML. *Vet Rec* 1985; 116:372.
2. Trichard CJV et al. *Onderstepoort J Vet Res* 1992; 60:29.
3. Shelton M, Livingston CW. *J Am Vet Med Assoc* 1975; 167:154.
4. Correa FR et al. *Cornell Vet* 1979; 69:33.
5. McMillan KR, Southcott WH. *Aust Vet J* 1973; 49:405.
6. Foster FM et al. *Aust J Exp Agric* 1997; 37:303.

7. Foster FM et al. Wool Technol Sheep Breed 1990; 38:74.
8. Egan JP, Russell DW. Aust J Exp Agric Anim Husbandry 1981; 21:268.

## CASEOUS LYMPHADENITIS OF SHEEP AND GOATS

**Etiology** *Corynebacterium pseudotuberculosis*

**Epidemiology** Disease of sheep and goats. Source of infection is discharge from pulmonary or skin abscesses. Infection is through intact skin or skin wounds.

Transmission in sheep occurs at shearing and dipping in sheep and in goats and sheep by direct contact

**Clinical findings** Abscesses in superficial lymph nodes. Respiratory or wasting disease associated with internal abscesses

**Clinical pathology** ELISA tests can be used to determine flock status but sensitivity and specificity is inadequate to provide reliable identification of infected individuals

**Necropsy findings** Abscesses in lymph nodes and internal organs

**Diagnostic confirmation** The clinical and necropsy features are typical.

Confirmation is by bacterial culture

**Treatment** Surgical for superficial abscesses

**Control** Culling of abscessed sheep or based on serological testing, hygiene at shearing, avoidance of management risk factors, vaccination

## ETIOLOGY

*Corynebacterium pseudotuberculosis* is the specific cause of the disease. There are two proposed biotypes, ovine/caprine and equine/bovine.<sup>1</sup> Both biotypes produce an exotoxin, phospholipidase D, which functions as a sphingomyelinase and is an immunodominant antigen.<sup>2</sup> Variation in toxin production between strains may be related to differences in pathogenicity.<sup>3</sup> The toxic lipid cell wall mediates resistance to killing by phagocytes and is also a virulence factor.

*C. pseudotuberculosis* is also the cause of ulcerative lymphangitis of cattle and horses, and contagious acne of horses, but these have been dealt with as separate diseases because they appear to have a separate pathogenesis and do not occur in association with caseous lymphadenitis.

## EPIDEMIOLOGY

### Geographical occurrence

Caseous lymphadenitis occurs in the major sheep-producing countries in the world including Australia, New Zealand, South Africa, the Middle East, North and South America, the UK, and most of northern and southern Europe. The disease did not occur in the UK and the Netherlands until the importation of infected goats in the

late 1980s<sup>4,5</sup> but subsequently spread to be an important disease in both countries.

### Host occurrence

Caseous lymphadenitis occurs in sheep and goats.

### Sheep

Caseous lymphadenitis increases in prevalence with age<sup>6</sup> and reaches a peak incidence in adults. In one Australian population of unvaccinated sheep the frequency of infection at abattoir inspection was 3.4% for lambs and 54% for adult ewes<sup>7</sup> and similar levels of prevalence are recorded in North<sup>8</sup> and South America.<sup>9</sup> In another large study of mature age slaughter sheep in Australia the overall prevalence of lesions was 26%, with carcass lesions in 20.4% of sheep and offal lesions in 9.5%.<sup>10</sup> The prevalence of lesioned sheep from individual farms can be higher. The prevalence of infection in ewes culled for age in Western Australia has fallen from over 50% in the 1980s to approximately 25% in the early 2000s, which is suggested to be in part the result of the cessation of compulsory dipping for lice during this period.<sup>11</sup> Following the introduction to British flocks in the late 1980s, outbreaks increased to reach a peak in 1998 and have decreased in occurrence since.<sup>12</sup> An examination, by pulse field gel electrophoresis, of isolates through this period suggests that all are related to the initial introduction.<sup>13</sup> A recent serological survey of 745 flocks showed an overall prevalence of seropositive animals of approximately 10%, with 18% of the flocks sampled having one or more positive animals.<sup>12</sup>

### Goats

Prevalence rates in goats may be lower than in sheep. In **domesticated** goats an overall prevalence rate of 8% is recorded in the USA<sup>14</sup> and a similar prevalence is recorded in **feral** goats in Australia.<sup>15</sup> As with sheep the prevalence increases with age – the prevalence at 4 years of age is as high as 22%. The assessment of prevalence in goats based on the presence of abscess is complicated by the fact that a significant proportion of abscesses in goats may be produced by *Arcanobacterium pyogenes*.<sup>16</sup>

### Source of infection

The primary habitat of *C. pseudotuberculosis* is in infected animals. Sources of infection are the **discharges** from ruptured abscessed **superficial lymph nodes** and the **nasal and oral secretions** from animals with **pulmonary abscesses** draining into the bronchial tree.<sup>17</sup>

The organism can survive in pus-infected **soil** for up to 8 months, in infected **shearing sheds** for approximately 4 months, and on straw, hay and other fomites for up to 2 months,<sup>18</sup> but it is not easily isolated from the soil of infected premises.<sup>3</sup> Low

temperatures and moist conditions prolong survival time.<sup>18</sup> Infectivity persists in sheep dips for at least 24 hours.

### Transmission

Infection of an animal is facilitated by the presence of **skin wounds** but the organism can invade through **intact skin**.<sup>2</sup> Transmission is by **direct** contact with infective discharges or **mediated** by contaminated shearing equipment, contaminated shearing shed boards or holding pens, contaminated dipping or shower fluids, or dust from contaminated shearing sheds and yards.

### Risk factors

#### Sheep

Most studies on risk factors have been conducted in Australia and observed risk factors may not always apply to management systems in other countries.

#### Age and sex

There is a higher prevalence in older sheep, which probably reflects greater exposure to risk factors such as shearing. In the UK a disproportionate number of rams are infected and there is a significant prevalence of infection in terminal sire breeds, which are an important vector to otherwise closed flocks.<sup>12</sup> The prevalence in rams may be related to the high stocking rate at which rams are kept for most of the year and fighting behavior with transmission through head wounds.

#### Breed

All breeds are susceptible but, in New Zealand, which has a mix of fine wool and meat sheep breeds, the prevalence of disease is higher in Merino and Merino-cross breeds. This may relate to greater susceptibility to skin damage at shearing because of their finer skin and the presence of neck wrinkles.<sup>19</sup> In the UK, infection is more prevalent in terminal sire breeds.<sup>12,20</sup>

#### Shearing

Shearing is a major risk factor in sheep and, in general, infection rates increase with the number of times sheep have been shorn. The risk for spread varies with shearings. When spread occurs, it occurs mostly within groups of sheep shorn together.<sup>21,22</sup> Sheep may be infected by transfer of pus from abscesses discharging or cut at shearing, via shearing combs, but spread from sheep with discharging pulmonary abscesses to sheep with skin cuts is considered more important.<sup>22</sup>

**Close contact** of recently shorn sheep in any circumstance may facilitate transmission of the disease through the contact of **infected respiratory secretions** with susceptible skin. Sheep are commonly in close contact in collecting pens immediately following shearing and infected nasal and oral secretions can be deposited



directly on to shearing cuts. Keeping sheep under cover for more than an hour after shearing increases the odds for spread.<sup>21</sup>

**Poor hygiene** in the shearing shed, allowing contamination of shearing boards and holding pens, may allow infection of sheep. Movement of infection between flocks can occur through contamination of shearing equipment, of mobile shearing sheds and infection on the clothing of shearers. Contract shearing has been shown to be a risk factor in the UK.<sup>23</sup>

#### Dust

Dust from contaminated yards may transmit infection to recently shorn sheep, although epidemiological studies suggest that environmental contamination is not a major risk factor for disease in Australia.<sup>21</sup>

#### Housing

Close contact associated with high stocking rates at pasture or in-door housing for much of the year may lead to high rates of infection. The difference in lesion distribution between sheep in the UK and Australia is believed to be due to close contact at shared feed troughs under conditions of intensive husbandry in the UK.<sup>23</sup>

#### Dips

The organism can persist in reused (plunge dip) or recycled (shower dip) fluids used for ectoparasite control. As few as 25 organisms/mL in the dip can produce infection.<sup>24</sup> Sheep dipped in infected dipping fluid within a few days of having been shorn are especially susceptible to infection because of the ease of contact between the bacteria and the skin<sup>3</sup> but spread can also occur through dips in sheep shorn 6 months previously.<sup>19,24</sup> An experimental study, where infection-free sheep were shorn and exposed to artificially contaminated dips at 0, 2, 4, 8, and 24 weeks after shearing, showed that a larger percentage of the sheep dipped immediately after shearing seroconverted and had lymph node lesions at slaughter. However, lesions also were present at slaughter in sheep dipped 2 or more weeks after shearing and there was no significant difference in their prevalence in the groups dipped at 2–24 weeks after shearing. This supports the observation that infection can occur through intact skin, possibly in the case of dip-associated infections, influenced by loss of wool grease because of wetting agents in the dip.<sup>24</sup> Shower dipping sheep immediately after shearing also significantly increases the odds of a high incidence of caseous lymphadenitis.<sup>19</sup>

Whereas shearing and dipping are important risk factors, disease can also be transmitted from sheep with pulmonary abscesses to nonshorn sheep by contact.<sup>17</sup>

#### Goats

Shearing is not a risk factor, other than with Angoras. The difference in abscess distribution in goats compared to sheep, with a predominance in the head, neck and sternum in goats, suggests that contact, fomites and trauma are important vector mechanisms. Social contact, head butting, trauma from browse and the use of common neck collars and feed troughs are probable risk factors. Pulmonary abscesses are not as prevalent in goats<sup>15</sup> as in sheep and may be of lesser importance as a source of infection.

With both sheep and goats, **contamination of soil** on bedding grounds, in yards, or in shelters may result in persistence of the organism in the environment for periods significant to the transmission of the disease and can result in infection of wounds created by docking and castration and infection in the region of the sternum.

#### Experimental reproduction

The disease can be readily produced experimentally in sheep and goats by parenteral or intradermal injection, and in both species abscesses form in regional draining lymph nodes and in internal organs.<sup>7,25,26</sup> The disease can also be produced experimentally in sheep by exposure to contaminated dips.<sup>24</sup> The incubation period for the development and rupture of abscesses in regional lymph nodes varies from 3 weeks to 6 months, and shedding of *C. pseudotuberculosis* from open abscesses averages 20 days.<sup>7,26</sup>

#### Economic importance

In the majority of young infected animals there is no overt clinical disease or impairment of health other than visible abscessation but the disease is of considerable economic importance to the sheep and goat industries. In sheep, infection has been associated with a 6.6% reduction in clean **fleece weight** in the first year of infection and a reduction in growth rate.<sup>25,27</sup> Infection is a significant cause of **condemnation of carcass** for human consumption with condemnation rates as high as 3–5% for mutton carcasses and 0.02–0.03% for lamb carcasses.<sup>28</sup> Condemnation rates and economic loss varies depending on country – differences in the number of abscessed lymph nodes dictating condemnation rather than carcass trimming.

In goats the **hide** can represent a significant proportion of the value of the carcass and blemishes produced by infection markedly reduce its value.

Clinical disease occurs in animals with the disseminated visceral form which is a cause of reproductive inefficiency, a major cause of the **thin ewe syndrome**, and of death and culling in older sheep in infected flocks.

#### Zoonotic implications

Human infection is rare, produces a lymphadenitis with a long and recurrent course<sup>29</sup> and is an occupational disease of shearers and abattoir workers with infection occurring through cuts. *C. pseudotuberculosis* may be present in the milk of goats from udders where the mammary lymph node is affected.<sup>30</sup>

#### PATHOGENESIS

Multiple microscopic abscesses develop in the draining lymph node by 1 day after experimental infection in the skin, and between 3 and 10 days of infection these coalesce to form typical pyogranulomas.<sup>31</sup> The sphingomyelin-specific phospholipase D exotoxin produced by the organism is believed to facilitate spread of infection by promoting leakage of plasma from small blood vessels at the site of infection with flooding of lymphatic spaces. Abscesses develop in 60–80% of infected sheep.<sup>25,27</sup> The high lipid content of the bacterial cell wall gives resistance to the digestive enzymes of the phagocyte and the organism persists as a facultative intracellular parasite.<sup>3</sup>

The reduction of **wool growth** in the first year of infection probably results from the catabolic effects of cytokine and toxic metabolites released during the acute inflammatory and immune response to initial infection.<sup>27</sup>

Hematogenous spread of the organism results in abscess formation in many organs and these may occur in the absence of peripheral lesions. Up to 25% of affected sheep at abattoirs are recorded as having lesions only in thoracic viscera.<sup>3</sup> This tendency for a high incidence of lesions in the lung appears to be general, but prevalence varies considerably between geographical areas. The abdominal visceral and somatic tissues are also commonly affected. Less commonly, hematogenous infection occurs in **young lambs** to produce septicemic disease.

#### CLINICAL FINDINGS

There is palpable enlargement of one or more of the superficial lymph nodes. Those most commonly affected are the submaxillary, prescapular, prefemoral, supra-mammary and popliteal nodes. The abscesses commonly rupture and creamy to caseated pus, with no odor, is discharged. Goats have a much greater proportion of lesions in the lymph nodes draining the head, related possibly to superficial injury during browsing.<sup>15</sup> Abscesses may subsequently develop in other lymph nodes. In the UK, clinical signs of infection in sheep are most commonly associated with the superficial lymph nodes of the head and neck.<sup>20</sup> Both sheep and goats may also show abscess in

the skin, particularly of the face, with loss of overlying hair.

In cases in which systemic involvement occurs, chronic pneumonia, pyelonephritis, ataxia, and paraplegia may be present depending on the site of infection. The debilitating disease of adult ewes commonly referred to as 'thin ewe syndrome' is often associated with the occurrence of internal abscesses (81% of ewes), many of which contain *C. pseudotuberculosis* (86%). Other bacteria, especially *Moraxella* spp., are also commonly present. In ewes, local spread from the supramammary lymph node to the mammary tissue is common. The resulting fall in milk yields leads to poor growth and even death of lambs and this may be a serious economic feature in badly affected flocks. Intrascrotal lesions are common in rams but do not involve the testicles or semen.

### CLINICAL PATHOLOGY

There is an increase in blood lymphocytes and neutrophils.<sup>32</sup>

*C. pseudotuberculosis* can be cultured from pus obtained by needle biopsy or by transtracheal wash.

**Serological tests** that have been used in serodiagnosis include indirect hemagglutination, hemolysis inhibition, synergic hemolysis inhibition, immunodiffusion and ELISA tests to detect antibody to cell wall antigens or to the phospholipase exoenzyme. Many of these tests have good specificity but few have high **specificity and sensitivity**. Some have been used to determine flock infection and have been used in eradication schemes.<sup>5</sup> As yet, none is sufficiently reliable to confidently detect infection in individual sheep. The sensitivity of equivalent tests in goats is generally higher and they are used for official control schemes in goats in some countries. An indirect double antibody sandwich ELISA with high specificity and sensitivity at the herd level in goats and sheep is being used in herd eradication of caseous lymphadenitis in the Netherlands.<sup>33</sup>

Recently, an interferon-gamma assay that assesses cell-mediated immunity rather than humoral immunity has been developed and showed high reliability in detecting both infected and noninfected sheep and goats in a limited number of experimental animals.<sup>34,35</sup>

### NECROPSY FINDINGS

Caseous abscesses filled with greenish-yellow pus occur chiefly in lymph nodes and to a lesser extent in internal organs. In the early stages the pus is soft and pasty but in the later stages it is firm and dry and has a characteristic lamellated appearance. Locally extensive bronchopneumonia, with more fluid pus of a similar color, may also be present. Micro-

scopically, nodal architecture is effaced by the abscess. As the lesion expands, the limiting fibrous wall keeps reforming, creating the 'onion-skin' layering noted grossly.

### Samples for confirmation of diagnosis

- Bacteriology – lymph node, lung, culture swab from outer portion of abscess (CULT)
- Histology – formalin-fixed lymph node (LM).

### DIFFERENTIAL DIAGNOSIS

- Melioidosis
- Tularemia
- Other causes of pneumonia in small ruminants
- Lymphosarcoma (rare)

Suppurative lymphadenitis in lambs has also been found to be associated with infection with *Pasteurella multocida*, and a disease characterized by the presence of yellow-green pus in abscesses situated in close proximity to the lymph nodes of sheep is associated with a Gram-positive micrococcus. The latter disease occurs in France and Kenya and is referred to as **Morel's disease**.

### TREATMENT

The organism is susceptible to antibiotics other than the aminoglycoside group but treatment is not usually attempted because the abscess is encapsulated, the organism is intracellular and response is poor. Subcutaneous abscesses can be treated with surgical drainage or extirpation.

### CONTROL

#### Culling

A measure of control can be achieved by culling all animals with enlarged lymph nodes. Although this is a logical procedure it is worth noting that it is not capable of detecting early lesions, nor of detecting those animals with internal abscess but no external abscesses. Ideally, control would be by the identification and culling of infected animals using serological testing. Culling on the basis of serological tests has been used<sup>5,33,36</sup> but the sensitivity and specificity of current tests does not make this a perfect selection method.

#### Control of spread

All docking implements, ear taggers, and shears used for the Mules operation should be dipped in strong disinfectant before each use. Similar attention should be given to the combs and cutters at shearing time. There should be good hygiene and disinfection in the shearing shed, especially of the shearing board and holding pens. Mobile shearing trailers should be cleaned and disinfected between farms. The importance of personal hygiene should be

impressed on shearers and farm-specific overclothing should be provided if possible. Younger age groups should be shorn first, rams second to last and any sheep with palpable lesions last. Pus spilled on the shearing floor should be cleaned up and the area disinfected. All shearing cuts should be disinfected. There can still be a high abscess rate in flocks that practice these control procedures.<sup>16</sup>

Close contact of sheep following shearing should be avoided. All efforts must also be directed to avoid contaminating dipping fluid; one discharging abscess is capable of contaminating an entire tank of fluid. Dipping after shearing may be undesirable in badly affected flocks. The addition of an efficient bactericidal agent to the dipping fluid is worthy of consideration.

Goat housing should be free of wire or other causes of skin trauma, and communal use of equipment such as neck collars should be avoided. External parasites must be controlled. Goat herds that are free of the disease should avoid the purchase of animals from herds with a history of abscessation.

### Vaccination

Vaccines formulated from concentrated, formalin-inactivated *C. pseudotuberculosis* culture supernatants containing phospholipase D have considerable efficacy and are available in many countries. Attenuated mutant vaccines also show promise.<sup>32</sup> Vaccination does not provide complete protection against the development of abscesses but controlled field trials show a significant reduction in the number of sheep that develop abscesses and a reduction in the number of abscesses in infected sheep.<sup>8,22,25,28,37,38</sup> Vaccinated sheep have fewer lung abscesses than unvaccinated sheep, in one study 96% fewer,<sup>22</sup> and are less likely to spread infection from this source. Compliance with the recommended full course of the vaccine has an important influence on the efficacy of vaccination. An Australian study showed that flocks that followed the recommended protocol of two priming doses to lambs with yearly boosters to adult sheep throughout their life had an average slaughter prevalence of infection in sheep of 3%, whereas the average prevalence of lesioned sheep at slaughter from flocks that only partially followed this protocol, by administering a single dose to lambs or not giving yearly boosters to adult sheep, varied from 22–33%.<sup>39</sup>

Immunity to caseous lymphadenitis is believed to be associated with antitoxin activity<sup>10</sup> and primarily cell-mediated,<sup>40</sup> but colostral immunity will protect against experimental challenge at 6 weeks of life. **Colostral immunity** will also affect the development of immunity from

vaccination and lambs in flocks with a high prevalence of caseous lymphadenitis should not be vaccinated at less than 10 weeks of age.<sup>41</sup>

Vaccination appears less successful in goats and, although it protects against experimental challenge and spread of the organism from the site of infection,<sup>42,43</sup> there has been little protection from natural infection in field trials.<sup>38,42</sup>

### PREVENTION

All potential introductions to a flock should be examined clinically for evidence of disease. While this is not a particularly sensitive method of detection of infection, obvious clinical cases will be detected. Determining the infection status of the source flock is a safer procedure and purchase should be direct and not through markets. The ultimate method of prevention will include serological testing of individual animal introductions when adequate tests become available.

### ERADICATION

Eradication is reported in endemically infected flocks by initial culling of all sheep with clinical signs and subsequent serological testing and culling of reactors. Seropositive ewes were allowed to lamb before culling but lambs were removed at birth, isolated from the infected dams and fed cow's colostrum and milk replacer. These procedures were coupled with rigorous disinfection of facilities, removal of bedding and topsoil from barns and pens, isolation of seronegative sheep for 6 months from previously used pastures and tracks, and hygiene at skin-damaging management procedures. Serologically positive sheep were not detected after the second screening.<sup>5</sup>

Total herd or flock eradication and replacement with infection-free animals is also possible.

### REVIEW LITERATURE

- Batey RG. Pathogenesis of caseous lymphadenitis in sheep and goats. *Aust Vet J* 1986; 63:269.
- Brown CC, Olander HJ. Caseous lymphadenitis of goats and sheep: a review. *Vet Bull* 1987; 57:1.
- Williamson LH. Caseous lymphadenitis in small ruminants. *Vet Clin North Am Food Anim Pract* 2001; 17:359–371.

### REFERENCES

1. Songer JG et al. *Am J Vet Res* 1988; 49:223.
2. Muckle CA et al. *Vet Microbiol* 1992; 30:47.
3. Brown CC, Olander HJ. *Vet Bull* 1987; 57:1.
4. Rizvi S et al. *Vet Rec* 1997; 140:586.
5. Schreuder BE et al. *Vet Rec* 1994; 135:174.
6. Paton MW et al. *Acta Vet Scand Suppl* 1988; 84:101.
7. Batey RG. *Am J Vet Res* 1986; 47:482.
8. Ellis JA et al. *J Am Vet Med Assoc* 1990; 196:1609.
9. Unanian MM et al. *Trop Anim Health Prod* 1985; 17:57.
10. Middleton MJ et al. *Aust Vet J* 1991; 68:311.
11. Paton MW et al. *Aust Vet J* 2002; 80:494.
12. Baird G et al. *Vet Rec* 2004; 154:505.
13. Connor KM et al. *Clin Microbiol* 2000; 38:2633.

14. Ashfaq MK, Campbell SG. *Vet Med Small Anim Clin* 1979; 74:1161.
15. Batey RG et al. *Aust Vet J* 1986; 63:33.
16. Gezon HM et al. *J Am Vet Med Assoc* 1991; 198:257.
17. Ellis TM et al. *Aust Vet J* 1987; 64:261.
18. Augustine JL, Renshaw HW. *Am J Vet Res* 1987; 47:713.
19. Bruere AN, West DM. The sheep. Health, disease and production. Palmerston North, New Zealand: NZVA, Massey University, 1993.
20. Baird G. *In Pract* 2003; 25:62.
21. Paton M et al. *Prev Vet Med* 1996; 26:275.
22. Paton MW et al. *Aust Vet J* 1995; 72:266.
23. Binns SH et al. *Vet Rec* 2002; 150:263.
24. Paton MW et al. *Aust Vet J* 2002; 80:494.
25. Paton MW et al. *Aust Vet J* 1988; 65:117.
26. Johnson EH et al. *Small Rumin Res* 1993; 12:349, 357.
27. Paton MW et al. *Aust Vet J* 1994; 71:47.
28. Stanford K et al. *Can J Vet Res* 1998; 62:38.
29. Peel MM. *Clin Infect Dis* 1997; 24:185.
30. Schreuder BEC et al. *Vet Rec* 1990; 127:387.
31. Pepin M et al. *Vet Microbiol* 1991; 29:123.
32. Scott PR et al. *Vet Rec* 1997; 141:548.
33. Derkson DP et al. *Vet Microbiol* 2000; 75:167.
34. Prescott JF et al. *Vet Microbiol* 2002; 88:287.
35. Menzies PI et al. *Vet Microbiol* 2004; 100:129.
36. Sutherland SS et al. *Aust Vet J* 1992; 69:168.
37. Eggleton DG et al. *Aust Vet J* 68:317, 1991; 320, 322.
38. Menzies PI et al. *Can J Vet Res* 1991; 55:362.
39. Paton MW et al. *Aust Vet J* 2003; 81:91.
40. Simmons CP et al. *Infect Immun* 1998; 66:474.
41. Paton MW et al. *Aust Vet J* 1991; 68:143.
42. Holstadt G et al. *Acta Vet Scand* 1989; 30:275, 285.
43. Brown CC et al. *Am J Vet Res* 1986; 47:1116.

### BOLO DISEASE

This disease of the fleece of sheep appears confined to the Eastern Cape province of South Africa and gets its name from the region where it was first described. An unclassified *Corynebacterium* sp. closely resembling *Corynebacterium pseudodiphtheriticum* and *Corynebacterium urealyticum* can be isolated from the skin of affected sheep.<sup>1</sup> This organism is rarely isolated from the skin of sheep with normal fleeces.<sup>2</sup> The disease can be experimentally reproduced by the topical application of the organism on to the intact skin of newly shorn sheep and sheep in 5 months wool, and the organism persists in the produced lesions for at least 169 days.<sup>3</sup>

Bolo disease is a disease of medium- and medium-strong-wool Merino sheep with dense fleeces containing a high yolk content. It occurs in sheep on natural grazing. There is no sex predilection but older sheep and poor-conditioned sheep are more severely affected. It can occur in semi-arid climates and there is no apparent seasonal or climatic influence or influence of external parasites.<sup>3</sup> The attack rate in a flock can be as high as 90% and the disease has considerable economic impact, as the wool is of inferior quality and low economic value.

**Lesions** occur most commonly on the sides of neck and the shoulders, and are more easily seen in unshorn sheep as well

defined, dark gray to black patches and bands that vary in number and in size (20 mm to 30 cm in diameter) and are sunk below the surface of the tips of the surrounding staple. The underlying skin is red-purple in color, tender to the touch and breaks easily. There is a yellow sticky exudate on the surface of the skin and in between the wool fibers, resulting in a spiky staple. On freshly shorn sheep the affected areas are chalky white.

**Histologically** there is acanthosis, superficial and follicular hyperkeratosis and hyperpigmentation, and sebaceous gland hypertrophy.

Treatment regimes are not defined but high-dose parenteral penicillin as used in mycotic dermatitis might be effective.

Bolo disease can be differentiated from fleece rot and mycotic dermatitis by its clinical presentation and the epidemiological circumstances in which it occurs.

### REFERENCES

1. Joubert JPJ et al. *J S Afr Vet Assoc* 1995; 66:222.
2. Van Tonder EM et al. *J S Afr Vet Assoc* 1990; 61:96.
3. Colly PA et al. *J S Afr Vet Assoc* 1990; 61:90.

### ULCERATIVE LYMPHANGITIS OF HORSES AND CATTLE



**Etiology** *Corynebacterium pseudotuberculosis* biotype 2

**Epidemiology** Ulcerative lymphangitis in horses is now an uncommon disease but is associated with poor stable hygiene.

Disease in cattle is common in North Africa and Israel. Infection of cattle with this organism can result in subcutaneous abscesses, occurring most commonly in the summer months, and an ulcerative dermatitis of the heel of the foot, occurring most commonly in the winter months. Flies are vectors of infection

**Clinical findings** Pyogranulomatous abscessation at the site of infection with lymphadenitis and abscessation along drainage lymphatic tracts

**Lesions** Pyogranulomatous abscessation

**Diagnostic confirmation** Culture of *C. pseudotuberculosis*

**Treatment** Drainage of abscesses and local treatment. Antibiotics of limited value

**Control** Housing hygiene. Herd security

### ETIOLOGY

*Corynebacterium pseudotuberculosis* causes the classical disease. It is a soil-borne organism that gains access to tissue through wounds or insect bites. *C. pseudotuberculosis* possesses a cytotoxic surface lipid coat that appears to facilitate intracellular survival and abscess formation. It also produces a phospholipase exotoxin that increases vascular permeability, has an inhibitory effect on phagocytes and may facilitate spread of infection in the host. Biotypes associated with ulcerative lymphangitis in cattle

and horses are different from the biotype associated with caseous lymphadenitis in sheep and goats.

## EPIDEMIOLOGY

### Horses

The disease was of considerable importance and widely distributed during the workhorse era but is now uncommon. The mortality rate was negligible but among the affected horses there was interference with their ability to perform. Infection occurs through abrasions on the lower limbs and is more likely when horses are crowded together in dirty, unhygienic quarters. Contact and inanimate transmission is the means of spread but passive transmission by flies is probable.<sup>1,2</sup> As a rule only sporadic cases occur in a stable.

### Cattle

#### Occurrence

Infection with *C. pseudotuberculosis* is uncommon in most countries but has importance in North Africa and Israel.<sup>1,3-6</sup> It is one of the most commonly diagnosed infectious diseases in cattle in Israel.

The disease may present as ulcerative lymphangitis affecting the limbs, a cutaneous form with pyogranulomatous abscess formation in areas of the body, which may also be accompanied by mastitis or internal abscessation, or a necrotic and ulcerative dermatitis on the heel of the foot accompanied by edematous swelling and lameness.<sup>5,7</sup>

In a study recording the disease in 45 herds over a 13-year period the average morbidity rate was observed to be 6.4%. The disease occurred sporadically in 26 dairy herds, with morbidity rates of up to 5%, and in an epidemic form in 19 herds, in which the morbidity rate ranged from 5–35%. Outbreaks in herds have a course of approximately 5 months. Culling and mortality rates can approach 16%.<sup>4</sup> The disease tends not to recur in a herd following an outbreak suggesting the development of herd immunity.

#### Methods of transmission

Infection may spread within the herd by direct contact between infected and uninfected animals, and by mechanical transmission by houseflies or other diptera.<sup>2</sup> Spread between herds is by introduction of infected animals.

#### Animal risk factors

In Israel ulcerative lymphangitis and skin abscessation is more common in mature animals but necrotic and ulcerative dermatitis on the heel of the foot occurs in heifers.<sup>4</sup>

#### Environmental risk factors

Both outbreaks and sporadic cases of the cutaneous form occur most commonly during the summer months (March to October) in Israel, which may be related

to large populations of houseflies during these months.<sup>4</sup> In contrast the peak incidence of necrotic and ulcerative dermatitis on the heel occurs during the winter months possibly due to conditions underfoot during this season. The organism can survive for prolonged periods in contaminated environments under favorable conditions.<sup>4</sup>

#### Economic importance

In cattle, the economic losses are associated with high culling rates, a decrease in average monthly milk production and an increase in the bulk tank milk somatic cell count.<sup>5</sup>

#### Zoonotic implications

The infection can be zoonotic and human infection can occur as a result of continued close contact with infected animals. Consumption of infected nonpasteurized milk can also be a risk for human infection.

## PATHOGENESIS

Infection of skin wounds is followed by invasion of lymphatic vessels and the development of abscesses along their course. Generalized lymph node involvement is unusual. The organism possesses a cytotoxic surface lipid coat that appears to facilitate intracellular survival and abscess formation and produces a phospholipase exotoxin that increases vascular permeability and has an inhibitory effect on phagocytes.

## CLINICAL FINDINGS

### Horses

Ulcerative lymphangitis: In horses the initial wound infection is followed by swelling and pain of the pastern, often sufficient to cause severe lameness. Nodules develop in the subcutaneous tissue, particularly around the fetlock. This is followed by infection of lymphatic vessels and the development of abscesses along their course. Spread to other subcutaneous sites on all parts of the body can occur.<sup>7</sup> These may enlarge to 5–7 cm in diameter and rupture to discharge a creamy green pus. The resulting ulcer has ragged edges and a necrotic base. Lymphatics draining the area become enlarged and hard and secondary ulcers may develop along them. Lesions heal in 1–2 weeks but fresh crops may occur and cause persistence of the disease for up to 12 months.

### Cattle

Ulcerative lymphangitis: The lesions in cattle are similar to those in horses except that there may be draining lymph node enlargement and the ulcers discharge a gelatinous clear exudate.<sup>3</sup>

**Cutaneous form.** Single or multiple painful abscesses occur in the skin and subcutaneous tissue on the head, flanks, shoulders, neck, and hind legs above the

stifle joint. Abscesses can reach a diameter of 15–20 cm and have a firm, fibrous tissue capsule. Abscesses ulcerate and develop draining tracts. Ruptured abscesses discharge serosanguinous exudates or blood-stained yellowish pus. The regional draining lymph nodes are enlarged but generalized lymphangitis does not occur. Recurrence occurs in a small percentage of animals following initial recovery.

**Necrotic and ulcerative dermatitis on the heel of the foot.** Lameness is apparent and there is edematous swelling on the distal part of the legs associated with a necrotic-ulcerative dermatitis on the heel of the foot.

## CLINICAL PATHOLOGY

The isolation of *C. pseudotuberculosis* from discharging lesions is necessary to confirm the diagnosis. There are no serological tests validated for infection in cattle or horses but serological tests used for serological diagnosis of caseous lymphadenitis in sheep are used for diagnosis of *C. pseudotuberculosis* in horses in some laboratories.

## DIFFERENTIAL DIAGNOSIS

### Horses

- Epizootic lymphangitis
- Glanders
- Sporotrichosis
- *Rhodococcus equi*

Similar lesions can be associated with infection with other pyogenic organisms including streptococci, staphylococci, and *Pseudomonas aeruginosa*.

Differentiation of ulcerative lymphangitis from the other diseases causing similar lesions is important because of the serious nature of such diseases as glanders and epizootic lymphangitis in horses.

Restriction of the lesion to the lower limbs and absence of lymph node involvement are important features although these are shared by sporotrichosis.

### Cattle

- Digital dermatitis
- *Dermatophilus congolensis*

## TREATMENT

*C. pseudotuberculosis* is sensitive to all common antimicrobial drugs with the exception of the aminoglycoside group, but systemic treatment of infected animals does not affect the recovery period.<sup>4</sup> Local treatment of ulcers is the usual and most effective procedure but parenteral injections of penicillin or tetracycline may be necessary in severe cases. In the early stages an autogenous bacterin may have value as treatment.

## CONTROL

Good hygiene in stables and under-foot, careful disinfection of injuries to the lower limbs usually afford adequate protection against ulcerative lymphangitis. With all

manifestations, isolation of the affected animals and local treatment with anti-septics act to prevent the disease from spreading to other animals in the herd. Infected animals should not be introduced to a naive herd and there should be adequate fly control.

## REVIEW LITERATURE

Yeruham I, Elad D, Friedman S, Peri S. *Corynebacterium pseudotuberculosis* infection in Israeli dairy cattle. *Epidemiol Infect* 2003; 131:947–955.

## REFERENCES

1. Addo PB. *Vet Rec* 1983; 113:496.
2. Braverman Y et al. *Rev Sci Tech* 1999; 18:681.
3. Purchase HS. *J Comp Pathol* 1944; 54:238.
4. Yeruham I et al. *Epidemiol Infect* 2003; 131:947.
5. Yeruham I et al. *Aust Vet J* 2000; 78:250.
6. Yeruham I et al. *Vet Rec* 1997; 140:423.
7. Steinman A et al. *Vet Rec* 1999; 145:604.

## CONTAGIOUS ACNE OF HORSES (CANADIAN HORSE POX, CONTAGIOUS PUSTULAR DERMATITIS)

Contagious acne of horses is characterized by the development of pustules, particularly where the skin comes in contact with harness.

### ETIOLOGY

*Corynebacterium pseudotuberculosis* is the specific cause of this disease.

### EPIDEMIOLOGY

The disease is spread from animal to animal by means of contaminated grooming utensils or harness. An existing seborrhea or folliculitis due to blockage of sebaceous gland ducts by pressure from harness probably predisposes to infection. Inefficient grooming may also be a contributing cause.

Contagious acne is of limited occurrence and causes temporary inconvenience when affected horses are unable to work.

### PATHOGENESIS

Infection of the hair follicle leads to local suppuration and the formation of pustules which rupture and contaminate surrounding skin areas. Occasional lesions penetrate deeply and develop into indolent ulcers.

### CLINICAL FINDINGS

The skin lesions usually develop in groups in areas which come into contact with harness. The lesions take the form of papules which develop into pustules varying in diameter from 1–2.5 cm. There is no pruritus but the lesions may be painful to touch. Rupture of the pustules leads to crust formation over an accumulation of greenish-tinged pus. Healing of lesions occurs in about 1 week but the disease may persist for 4 or more weeks if successive crops of lesions develop.

### CLINICAL PATHOLOGY

Swabs of the lesions can be taken to determine the presence of *C. pseudotuberculosis*.

## DIFFERENTIAL DIAGNOSIS

- Ringworm
- Staphylococcal pyoderma
- Nodular necrobiosis

### Diagnostic confirmation

Isolation of *C. pseudotuberculosis* from lesions.

## TREATMENT

Affected animals should be rested until all lesions are healed. Frequent washing with a mild skin disinfectant solution followed by the application of antibacterial ointments to the lesions should facilitate healing and prevent the development of further lesions. Parenteral administration of antibiotics may be advisable in severe cases.

## CONTROL

Infected horses should be rigidly isolated and all grooming equipment, harness and blankets must be disinfected. Grooming tools must be disinfected before each use. Vaccination is not likely to be effective because of the poor antigenicity of the organism.

## RHODOCOCCUS EQUI PNEUMONIA OF FOALS

### Synopsis

**Etiology** Virulent strains of *Rhodococcus equi*

**Epidemiology** Sporadic disease of 1–5-month-old foals that is endemic on some farms. Foals are infected by ingestion or inhalation during first weeks of life

**Clinical signs** Pneumonia, fever, respiratory distress, cough, lack of nasal discharge, failure to thrive, multiple distended joints and uveitis. Occasionally diarrhea or septic osteomyelitis

**Clinical pathology** Leukocytosis, hyperfibrinogenemia, inflammatory cells in tracheal aspirate

**Necropsy lesions** Pulmonary consolidation and abscessation. Nonseptic polyarthritis

**Diagnostic confirmation** Culture of *R. equi* from tracheal aspirate

**Treatment** Erythromycin estolate or microencapsulated base 25 mg/kg every 8 hours orally, in combination with rifampin 5 mg/kg every 12 hours orally. Clarithromycin (7.5 mg/kg every 12 h orally) may be substituted for erythromycin

**Control** Insure adequate transfer of passive immunity. Decrease stocking density. Decrease environmental contamination by virulent strains of *R. equi*

## ETIOLOGY

*Rhodococcus equi* is a Gram-positive, pleomorphic rod. The most important manifestation of *R. equi* infection is pneumonia in foals. It also causes pleuropneumonia, pneumonia, osteomyelitis,

and abortion in immunocompromised and normal adult horses, abscesses that must be differentiated from tuberculosis in pigs and ruminants, and pneumonia in immunosuppressed humans.<sup>1–5</sup> The organism is a natural inhabitant of soil, grows well at temperatures ranging from 10–40°C, and is readily isolated from the feces of herbivores and their environment. However, isolates of *R. equi* vary in virulence, with many isolates obtained from feces or soil not being pathogenic.<sup>6</sup>

There are a large number of virulent strains of *R. equi*, based on pulsed-field gel electrophoresis of chromosomal DNA.<sup>7,8</sup> While there is evidence of clustering of strains on farms and on most farms 1 or 2 strains predominate, there is little evidence of marked regional variations in prevalence of strains of virulent *R. equi*.<sup>7,8</sup> Only rarely will it be possible to link infections to a given site or region on the basis of analysis of chromosomal DNA.<sup>7</sup>

**Virulence** of *R. equi* is dependent upon the ability of the organism to enter, survive in and replicate in macrophages. Virulence is associated with the presence of highly immunogenic **virulence associated proteins** (Vap A, C, D, E, G, H), of which Vap A is apparently the most important, although the role of the other Vap proteins has not been determined.<sup>9,10</sup> Vap A is a surface-expressed, lipid-modified protein that elicits an intense humoral response by foals.<sup>10</sup> Expression of Vap A, C, D, and E is upregulated by incubation at 37°C, consistent with their role as virulence factors. Other genes probably involved in virulence are also upregulated by conditions that mimic those in vivo.<sup>11</sup> The presence of the virulence proteins is associated with enhanced ability of virulent *R. equi* to survive and replicate within macrophages, whereas avirulent strains replicate poorly or not at all.<sup>12</sup> However, the exact virulence mechanisms of *R. equi* are not known.<sup>13</sup>

The genes for Vaps A and C–H are present in a pathogenicity island in an 80–85 kb plasmid that is present in 98% of isolates of *R. equi* from foals with pneumonia.<sup>14</sup> Most isolates from the environment, feces, pigs, cattle, and human patients with *R. equi* infection do not contain either of the two identified virulence plasmids.<sup>4,15,16</sup> Virulence is associated with the presence of the plasmid, and loss of the plasmid by a strain of *R. equi* results in loss of virulence. There is geographical variation both within and between countries in the prevalence of each of the virulence plasmids in isolates from foals with pneumonia.<sup>15,17,18</sup>

## EPIDEMIOLOGY

### Occurrence

*R. equi* pneumonia in foals has a world-wide distribution. Clinical disease is often

sporadic but on farms where the disease is endemic annual **morbidity** can be as high and can vary widely from year to year.<sup>19</sup> The median percentage of foals that developed *R. equi* at farms on which the disease was endemic was 6.6%, with 38% of farms having more than 10% of foals affected.<sup>20</sup> Case fatality rates for foals on farms, as opposed to those treated at veterinary teaching hospitals, is reported as 29–42% (for 113 and 19 affected foals, respectively).<sup>20,21</sup> The median case fatality rate for 32 farms in Texas was 25% and the case fatality rate was more than 50% for 22% of farms. The case fatality rate among foals treated at veterinary teaching hospitals is approximately 28%.<sup>22</sup> The detection of *R. equi* pneumonia in one foal on a farm should prompt an examination of all other foals on that farm.

Current evidence supports the hypothesis that foals are exposed and infected within the first several days of life.<sup>23</sup> The **age at onset** of clinical signs of disease associated with *R. equi* varies between 2 weeks and 6 months but the peak prevalence for pneumonic disease is between 1 and 3 months.<sup>24</sup> The disease is rare in adult horses. Risk factors in foals for development of *R. equi* pneumonia have not been determined although a large number of factors have been examined.<sup>25</sup> The month in which the foal was born, gestational age, dam's parity, antimicrobial administration during the first week of life, exposure to pasture at less than 2 weeks of age, need for treatment to correct inadequate transfer of passive immunity, and size of mare/foal groups were not associated with risk of disease on farms in Texas.<sup>26</sup>

The prevalence of virulent *R. equi* in isolates from the environment does not appear to be greater on farms where the disease is endemic.<sup>18,27</sup> Morbidity varies widely among geographical areas and individual farms, probably because of environmental factors that affect the number of virulent *R. equi* and the ease of infection. Because aerosol infection by virulent *R. equi* in dust is thought to be the most important route of infection of foals, factors that favor the accumulation and persistence of *R. equi* in soil and its ability to become aerosolized most probably increase the risk of infection. Such factors might include:<sup>24</sup>

- Hot and dry weather, favoring formation of dust
- Soil pH and moisture
- Crowding of pastures with young horses
- Poor pasture hygiene, allowing accumulation of feces
- Dusty pastures.

However, empirical demonstration of the importance of these risk factors has not

been reported, with several exceptions.

**Soil** pH, salinity and concentrations of various elements including iron, zinc, and copper are not associated with the risk of foals developing *R. equi* pneumonia on farms in Texas.<sup>28</sup> These soil-associated risk factors were examined because *R. equi* is a normal inhabitant of the soil and of the intestine of ruminants, horses, and pigs. It is not highly resistant but it has been found to survive in moist soil for periods of longer than 12 months. The infection is considered to be soil associated and to be maintained through a soil–horse cycle.<sup>29</sup> The number of organisms in the soil and stable areas on horse farms increases with the time that the farms have housed horses, although there is not a strong correlation between *R. equi* concentration in soil and prevalence of pneumonia in foals.<sup>18,30</sup>

**Farms** of larger size, with more resident mares, greater numbers of foals ( $\geq 15$ ), and greater foal density per acre, and the presence of mares brought on to the farm for breeding, are all associated with greater risk of foals developing *R. equi* pneumonia.<sup>20,31</sup> *R. equi* pneumonia does not appear to be associated with poor farm management or lack of preventative health practices such as vaccination, deworming, or administration of hyperimmune plasma.<sup>25</sup> The practice of testing for failure of transfer of passive immunity is associated with an increased likelihood of the disease on a farm.<sup>32</sup> However, this association probably reflects the facts that the disease is more likely on larger farms, which are more likely to perform this test, and that farms that have had the disease are more likely to institute preventive care procedures.

#### Transmission

Most foals are exposed to infection, as demonstrated by seroconversion, but only a few develop disease. The organism colonizes the intestine of the normal foal during the first 2 months of life and has been detected in the feces as early as 5 days.<sup>33</sup> Inhalation of the organism in dust is probably the most important route of transmission for pneumonic disease.<sup>34,35</sup> Intestinal disease, which may be clinically inapparent, usually occurs with pulmonary disease but the source of the infection is unclear, although it may be ingestion of contaminated material or swallowing of infected respiratory secretions. Foals over 5 weeks of age have generally been resistant to experimental challenge.

#### Zoonotic implications

*R. equi* is an occasional pathogen of humans. Infection is more common in immunocompromised people but is only infrequently associated with strains of *R. equi* that are virulent in foals.<sup>15,34</sup>

#### PATHOGENESIS

Exposure of foals to *R. equi* is common, based on rate of seroconversion, yet the development of respiratory infection and clinical disease is much less common. The reason for this is not fully understood, although development of the disease probably depends on exposure to an infectious dose of organism and the susceptibility of the foal. Recent epidemiology studies suggest that exposure occurs within the first few days of life, before waning of maternally derived passive immunity, and that affected foals have lower CD4<sup>+</sup>:CD8<sup>+</sup> ratios before development of the clinically apparent disease than foals that do not subsequently develop the disease.<sup>36</sup> The differences between groups of foals was largest during the first 2 weeks of life, suggesting that foals that subsequently develop disease associated with *R. equi* may have impaired immune function during early life.<sup>36</sup> In adult horses, in which the disease is rare, protective immunity is associated with both cellular and humoral immune responses characterized by enhanced immunoproliferative responses of CD4<sup>+</sup> and CD8<sup>+</sup> cells and presence of IgG<sub>A</sub> and IgG<sub>B</sub> antibodies to Vap A.<sup>37</sup> Opsonizing antibody to *R. equi* is an important defense mechanism in experimentally infected foals and administration of *R. equi* hyperimmune plasma or plasma rich in anti-Vap A and C antibodies protects experimentally infected foals from developing pneumonia.<sup>38</sup> Overall, these results suggest that foals that develop *R. equi* pneumonia have a T helper cell (Th)2-like response to infection, rather than a Th1-like response. Th1-like responses, which are associated with enhanced CD4<sup>+</sup> and CD8<sup>+</sup> responses, are believed to be important in resistance to the disease.<sup>13</sup> Whether the switch to a Th2-like response to infection is a function of virulent *R. equi* or an attribute of susceptible foals has not been determined.

Experimental and clinical studies indicate that the foal is infected several weeks or months before clinical signs are observed. **Virulent strains** of *R. equi* are facultative intracellular parasites of macrophages, which they ultimately destroy. Neutrophils are bactericidal for *R. equi* but the organism can survive by inclusion in macrophages. Opsonization of *R. equi* by specific antibodies results in enhanced lysosome–phagosome fusion and greater killing of *R. equi* by equine macrophages and monocytes,<sup>13</sup> whereas entry of *R. equi* into macrophages by nonimmune phagocytosis is not associated with enhanced killing. Its survival in the macrophage is associated with absence of phagosome–lysosome fusion.<sup>39</sup> Nonvirulent strains do not proliferate in macrophages and monocytes. The combined action of humoral

and cellular immune systems is important in preventing development of the disease after inhalation of bacteria. Without opsonization, the capacity of the pulmonary macrophage of foals to kill *R. equi* is impaired and the organism has been shown to be able to persist in the pulmonary macrophage of infected foals. The inability of the pulmonary macrophages to destroy *R. equi* leads to persistent infection in the lung and a chronic bronchopneumonia with extensive abscessation and an associated suppurative lymphadenitis.

**Intestinal infection** is common in foals with *R. equi* pneumonia,<sup>40</sup> although clinical manifestations of the intestinal infection, such as diarrhea, are uncommon. Gastrointestinal tract infection is characterized by ulcerative lesions of the mucosa of the large intestine and cecum. In rare cases bacteremia and subsequent **suppurative foci** may develop in many organs, including bones and joints, liver, kidneys, and subcutis.

#### CLINICAL FINDINGS

***R. equi* pneumonia** of foals may present as an acute onset of inappetence, fever, depression and tachypnea or as a more chronic disease characterized by cough and failure to thrive. The former presentation is more common and usually occurs in foals less than 3–4 months of age, with younger foals being more severely affected. It is important to realize that the acute onset of the disease is preceded by a **long incubation period** during which clinical signs are minimal and that the development of clinical signs is associated with severe and extensive lung lesions. The foal is often in respiratory distress and is reluctant to move and to suckle. Cyanosis may be present in severe cases. **Auscultation** of the chest may reveal crackles and wheezes, but abnormal lung sounds are often much less apparent than the severity of the respiratory disease suggests they should be. Foals with *R. equi* **abscesses** may not have abnormal lung sounds. There is usually minimal nasal discharge.

Subcutaneous abscesses, osteomyelitis and septic arthritis may be present or develop.<sup>41</sup> Many foals (20%) have an **aseptic polyarthritis**, evident as nonpainful distension of joints, at the time they develop signs of respiratory disease. Immune-mediated **uveitis** occurs in approximately 10% of severely affected foals.<sup>42</sup>

In older foals the disease assumes a characteristic clinical syndrome marked by development of severe lesions without clinical signs in the foal. A subacute pneumonia develops slowly with coughing, an increase in the depth of respiration with respiratory distress developing in the late stages, and characteristic loud, moist

crackles or 'rattles' on auscultation. The foal continues to suck and the temperature is sometimes normal but the foal becomes emaciated. Severe diarrhea may follow or accompany the respiratory signs. Nasal discharge and lymph node enlargement in the throat regions are absent. Severely affected animals die in 1–2 weeks.

**Thoracic auscultation** may not reveal any abnormalities during the preclinical stage of the disease, although careful auscultation when tidal volume of the foal is increased by exertion or use of a rebreathing bag can reveal localized wheezes and crackles or changes in the intensity of normal breath sounds (indicative of areas of lung consolidation).

**Radiographic examination** is a valuable aid in diagnosis and in monitoring progress in hospitalized foals.<sup>43</sup> Affected animals show evidence of consolidation of lung tissue, lymphadenopathy, and cavitating lesions in the lungs.

**Ultrasonographic examination** of the chest may reveal the presence of pulmonary consolidation before clinical signs are apparent and is useful means of detecting subclinical disease.

When lesions are confined to the intestinal wall the predominant clinical sign will be diarrhea, which may be acute or chronic and intermittent.

**Intra-abdominal abscesses** are associated with ill-thrift, weight loss, variable abdominal distension, fever, depression and in some cases colic. Ultrasonographic examination can reveal the abscess provided that it is within the field of the ultrasound probe.

#### PROGNOSIS

*R. equi* infection in Thoroughbred and Standardbred foals is associated with a reduced chance of racing as an adult compared with the overall population of foals, but affected foals that survive have a similar racing performance as adults to horses that did not have *R. equi* pneumonia.<sup>22,44</sup> The morbidity and case fatality rates are provide above under Epidemiology.

#### CLINICAL PATHOLOGY

**Hematological evaluation** usually reveals leukocytosis with neutrophilia and monocytosis, and elevation in the concentrations of acute phase proteins including plasma fibrinogen and serum amyloid A – changes characteristic, but not diagnostic, of *R. equi* infection.<sup>45</sup> Monitoring of blood white cell concentration and plasma fibrinogen concentration are useful in foals from farms on which the disease is endemic. **White blood cell concentrations** above  $13.0 \times 10^9/L$  ( $13\,000$  cells/ $\mu L$ ) have a sensitivity and specificity of 95% and 61% respectively for *R. equi* pneumonia.<sup>46</sup> The high sensitivity means that few foals with the disease will be missed, while the

moderate specificity means that a number of foals will be incorrectly suspected as having the disease. Because a high white cell count can be caused by a number of diseases other than *R. equi* pneumonia, foals with high white cell counts from farms on which the disease is endemic should be further examined for evidence of disease, including detailed clinical examination possibly including ultrasonographic examination, culture or PCR of tracheal aspirates, or thoracic radiography. Measurement of **plasma fibrinogen concentration** is less useful for detecting foals with *R. equi* pneumonia. Plasma fibrinogen concentrations of 400 mg/dL (0.4 g/L) have sensitivity and specificity of 91% and 51%, respectively, whereas concentrations of 600 mg/dL (0.6 g/L) have sensitivity and specificity of 38% and 96%, respectively.<sup>46</sup> The positive and negative predictive values of the tests depends on the prevalence of the disease among the group of foals examined, being low for farms on which the disease is rare and increasing as the prevalence of the disease increases. Serial measurement of **serum amyloid A** concentrations is not useful for detecting foals with clinically inapparent *R. equi* pneumonia, nor do foals with pneumonia reliably have higher serum amyloid A concentrations than normal foals.<sup>47</sup>

**Transtracheal aspirates** from affected foals reveal a neutrophilic leukocytosis. Intracellular, Gram-positive pleomorphic rods characteristic of *R. equi* may be present in tracheal aspirates but the sensitivity of this observation has not been determined and all tracheal aspirates should be cultured.

Although numerous **serological tests** have been developed, including agar gel immunodiffusion, synergistic hemolysis inhibition, radial immunodiffusion and various ELISAs, none has demonstrated value in the diagnosis of the disease in individual animals. Currently available serological tests, either as single or paired samples, are not reliable in confirming or excluding the presence of *R. equi* pneumonia in foals.<sup>28</sup>

Culture of tracheal aspirates is the gold standard for antemortem diagnosis of the disease, although sensitivity of culture is less than that of PCR examination of tracheal aspirates. Culture of tracheal aspirates has a sensitivity of approximately 86%, based on diagnosis of *R. equi* pneumonia at necropsy.<sup>46</sup> However, *R. equi* can be cultured from 35% of clinical normal foals in populations in which the disease is endemic.<sup>48</sup> A **PCR** test for the rapid detection of *R. equi* in tracheal aspirates has a sensitivity of 100% and a specificity of 91% in foals with a clinical diagnosis of *R. equi* pneumonia.<sup>49</sup> PCR examination of nasal swabs for presence of *R. equi* has a



sensitivity of 15%, which is too low to be clinically useful.<sup>50</sup> More recent quantitative real-time PCR assays permit the rapid detection and quantification of virulent (*VapA*-gene-positive) strains of *R. equi* in tracheobronchial aspirates.<sup>51</sup> This assay detects *R. equi* at concentrations as low as 20 cfu/mL of tracheobronchial fluid, providing a specific and highly sensitive test for the presence of this organism. A **multiplex PCR** test simultaneously detects *R. equi* and the presence of virulence factors, thereby permitting rapid differentiation of pathogenic from non-pathogenic strains of *R. equi* in biological samples.<sup>52</sup>

#### NECROPSY FINDINGS

The predominant lesions are a **pyogranulomatous pneumonia** plus **lymphadenitis** of the bronchial lymph nodes.<sup>12</sup> Grossly, the firm, raised lung nodules may reach several centimeters in diameter and be located anywhere in the lung field, especially in the cranioventral quadrant. If

several nodules coalesce, the lesion may be misinterpreted as a suppurative bronchopneumonia. Histologically, organisms are easily demonstrated within the macrophages and giant cells comprising these lesions. Many cases also have ulcerative enterocolitis, with abscessation of mesenteric or cecocolic lymph nodes. Although necropsy may reveal widespread infection, many cases are subclinical.

#### Samples for postmortem confirmation of diagnosis

- Bacteriology – chilled lung, affected lymph nodes and swabs from atypical sites (CULT)
- Histology – formalin-fixed lung, lymph node, and colonic lesions.

#### DIAGNOSTIC CONFIRMATION

Antemortem diagnosis is by culture of *R. equi* from aspirates of tracheal fluid. Currently available serological tests do not provide confirmation of disease in individual animals.

#### DIFFERENTIAL DIAGNOSIS

The pneumonic form of the disease may be confused with other causes of pneumonia in foals (Table 16.4). Other causes of diarrhea in this age group include parasitism due to cyathostomes, infection by *Salmonella* sp. and antibiotic-induced diarrhea.

The aseptic synovitis and joint effusion that frequently accompanies *R. equi* pneumonia should be differentiated from septic arthritis due to *S. zooepidemicus*, *Salmonella* spp., *R. equi* or other bacteria.

#### TREATMENT

The principles of treatment are cure of *R. equi* infection, relief of respiratory distress and correction of associated immune-mediated diseases.

Elimination of infection requires the administration of antimicrobial agents that are both effective against the organism and able to penetrate infected macrophages to gain access to the organism. In

Table 16.4 Differential diagnosis of respiratory diseases of older (not newborn) foals

Disease	Epidemiology	Clinical findings	Clinical pathology	Necropsy findings	Treatment and response
<i>Rhodococcus equi</i> infection	Enzootic to a farm. Foals up to 6 months. Infection by inhalation. Case fatality rate ≈30%	Pneumonia in 1–6-month-olds. Occasional diarrhea. Aseptic synovitis and uveitis in affected foal. Septic osteomyelitis	Inflammatory cells in tracheal aspirate. Culture or PCR detection of <i>R. equi</i> from tracheal fluid. Serum tests not useful in individual animals	Suppurative bronchopneumonia. May be mesenteric and other lymph node abscess. Rarely septicemia	Erythromycin estolate, or clarithromycin, plus rifampicin. Advanced cases may be refractory
Interstitial pneumonia	Sporadic occurrence in foals to 6 months of age. Cause not identified	Respiratory distress with minimal cough, slight nasal discharge and low grade to non-existent fever. Lungs sounds not remarkable	None diagnostic. Rule out other diseases. Radiography useful	Interstitial pneumonia	Corticosteroids. Broad-spectrum antibiotics (e.g. penicillin and gentamicin). Supportive care
Viral respiratory disease (see Table 16.1)	Foals usually over 2 months. Rhinovirus, herpesvirus and influenza virus infection	Fever, cough, nasal discharge	Viral isolation. Serology	Usually survive although fatal influenza infection reported	Supportive. Antibiotics for secondary bacterial ( <i>Streptococcus zooepidemicus</i> ) infection
Combined immunodeficiency of Arabian foals	Inherited as autosomal recessive trait. Affected animals are homozygous	Poor condition, tire easily, cough, ocular and nasal discharge, diarrhea in some	Severe lymphopenia. Hypogammaglobulinemic as passive immunity declines	Lymphocytes absent from lymphoid tissue. Adenoviral pneumonia	Nil
Respiratory tract infection with <i>S. zooepidemicus</i>	Outbreaks in foals up to weaning. Likely secondary to viral infection	Fever, nasal discharge, cough, inappetence. Minimal lymphadenopathy	<i>S. zooepidemicus</i> in tracheal aspirates	Usually survive	Penicillin. Good recovery rate
Parasitic pneumonia	Migrating stages of <i>Parascaris equorum</i> . Foals > 6 weeks old	Cough, slight nasal discharge. Rarely fever	Eosinophils in tracheal aspirate	Death rare	Anthelmintics, e.g. fenbendazole
<i>Pneumocystis jirovici</i> (formerly <i>carinii</i> ) pneumonia	Immunodeficient foals or foals administered corticosteroids	Cough, mucopurulent nasal discharge, fever, lethargy, tachypnea	Neutrophils and macrophages and <i>P. jirovici</i> cysts in tracheal aspirate or bronchoalveolar average fluid	Pneumonia, diffuse with neutrophilic or lymphocytic/plasmacytic infiltration and alveolar edema. <i>P. jirovici</i> evident in silver-stained lung sections	Sulfonamide/trimethoprim 30 mg/kg q 12 h recommended but often not effective

**vitro antibiotic sensitivity testing** has not been demonstrated to be useful in predicting the clinical efficacy of treatment. *R. equi* isolates from ill foals are frequently sensitive in vitro to a variety of antibiotics, including the aminoglycosides gentamicin and neomycin, tetracycline, sulfonamides and chloramphenicol, while most are resistant to cephalosporins and penicillin.<sup>53-55</sup> However, treatment with antibiotics other than erythromycin and rifampin is associated with a lower recovery rate. Treatment with **penicillin**, with or without **gentamicin**, chloramphenicol or tetracycline, is not effective.<sup>53</sup> **Trimethoprim-sulfadiazine** combinations might be effective in some foals but are not the preferred treatment.<sup>53</sup> Neomycin has been recommended for treatment of *R. equi* pneumonia<sup>56</sup> but the risk of nephrotoxicosis, need for parenteral administration and lack of demonstration of clinical efficacy do not support its use at this time.

The **treatment of *R. equi* pneumonia** in foals is achieved by administration of macrolide antibiotics in combination with rifampin. Conventional treatment is administration of the combination of an acid-stable **erythromycin** (preferably estolate) at a dose of 25 mg/kg orally every 12 hours and **rifampin** at a dose of either 5 mg/kg every 12 hours or 10 mg/kg every 24 hours. Other esters or preparations of erythromycin are less well absorbed or have shorter elimination half-lives than the estolate ester and must be administered more frequently.<sup>32</sup> Erythromycin ethylsuccinate does not provide optimal therapy for *R. equi* pneumonia in foals because of poor absorption after oral administration.<sup>55,57</sup> The macrolide antibiotics **azithromycin** and **clarithromycin** have also been used to treat foals with *R. equi* pneumonia. Treatment of foals with a combination of clarithromycin (7.5 mg/kg orally every 12 h) and rifampin results in improved survival over foals treated with azithromycin (10 mg/kg orally every 24 h) and rifampin or erythromycin and rifampin in a veterinary teaching hospital.<sup>58</sup>

Therapy should be continued until the foal is clinically normal **and** has a normal plasma fibrinogen concentration and white blood cell count, which can require treatment for at least 1 month and often longer. Radiographic or ultrasonographic demonstration of resolution of the pulmonary consolidation and abscessation is useful in the decision to stop therapy. The case fatality rate is approximately 30% (see Epidemiology, above) even with appropriate treatment.

**Side-effects** of erythromycin-rifampin therapy include the development of **diarrhea** in some foals and their dams.<sup>59</sup>

Administration of erythromycin to foals is associated with an eightfold increase in the risk of diarrhea.<sup>50</sup> Antibiotic therapy should be temporarily discontinued in foals that develop diarrhea.

During hot weather, some foals treated with erythromycin become **hyperthermic** (40–41°C, 104–105.5°F) and **tachypneic** and occasional deaths result from this syndrome.<sup>50,60</sup> The basis for this hyperthermic event, which may occur in healthy foals administered erythromycin, is unknown. Affected foals should be treated urgently with antipyretics, cold water bathing and housing in a cooler environment.

The emergence of *R. equi* isolates **resistant to rifampin** during therapy of foals with *R. equi* pneumonia has been reported.<sup>61</sup> However, one case had an atypical clinical course, in that the foal was 10 months of age at presentation and may have been immunosuppressed, and in the other instance the foal was treated with only rifampin. The development of resistance during monotherapy with rifampin is a recognized contraindication to the use of this drug alone.

**Ancillary therapy** with NSAIDs, bronchodilators, and mucolytics might be of value.<sup>53</sup> Foals in severe respiratory distress require intranasal or intratracheal administration of oxygen.

## CONTROL

**Control measures** are designed to maximize the resistance of the foal to infection and to reduce the infection pressure on the foal by decreasing contamination of the foal's environment with virulent *R. equi*. Insuring adequate transfer of **colostral immunoglobulins** in all foals through routine monitoring of serum immunoglobulin concentrations in 1-day-old foals is an essential part of any control program. To **decrease environmental contamination** with virulent *R. equi*, efforts should be made to reduce fecal contamination of pastures and to reduce or eliminate dusty or sandy areas.<sup>24,62</sup> These efforts should include grassing or paving of bare areas, removal and composting of fecal material on a regular basis, reduction of stocking density and reduction in the size of mare/foal bands.<sup>24</sup>

On farms with endemic disease, regular physical examination, including auscultation of foals and once-daily monitoring of rectal temperature, can permit early identification and treatment of affected foals.<sup>63</sup> Measurement of blood white cell count, as detailed above, can be useful in early identification of affected foals. Identification of one foal affected with *R. equi* pneumonia on a farm should prompt an examination of all other foals on the farm.

**Ultrasonographic examination** of the thorax of foals may permit identification of foals with clinically inapparent pulmonary abscesses.

The administration to foals of a hyper-immune serum, obtained from mares vaccinated with an autogenous vaccine, limits the severity of disease produced by experimental challenge but has not been consistently useful in preventing or decreasing the prevalence of naturally occurring disease.<sup>19,34,64,65</sup> There are no vaccines effective in prevention of *R. equi* pneumonia in foals.

## REVIEW LITERATURE

- Giguere S, Prescott JF. Clinical manifestations, diagnosis, treatment, and prevention of *Rhodococcus equi* infections in foals. *Vet Microbiol* 1997; 56:313–334.
- Takai S. Epidemiology of *Rhodococcus equi* infections: a review. *Vet Microbiol* 1997; 56:167–176.
- Cohen ND et al. Control and prevention of *Rhodococcus equi* pneumonia in foals. *Compend Contin Educ Pract Vet* 2000; 22:1062–1069.
- Meijer WG, Prescott JF. *Rhodococcus equi*. *Vet Res* 2004; 35:383–396.

## REFERENCES

- Davis WP et al. *Vet Pathol* 1999; 36:336.
- Verdonck F et al. *Vet Rec* 2004; 154:149.
- Vengust M et al. *Can Vet J* 2002; 43:706.
- Flynn O et al. *Vet Microbiol* 2001; 78:221.
- Cornish N, Washington J A. *Curr Clin Top Infect Dis* 1999; 19:198.
- Bowles PM et al. *Vet Microbiol* 1987; 14:259.
- Cohen ND et al. *Am J Vet Res* 2003; 64:153.
- Morton AC et al. *Appl Environ Microbiol* 2001; 67:2167.
- Takai S et al. *Infect Immunol* 1992; 60:2995.
- Tan C et al. *Can J Vet Res* 1995; 59:51.
- Ren J, Prescott JF. *Vet Microbiol* 2003; 94:167.
- Hondaluk MK et al. *Infect Immun* 1994; 62:4167.
- Meijer WG, Prescott JF. *Vet Res* 2004; 35:383.
- Haites RE et al. *J Clin Microbiol* 1997; 35:1642.
- Nicholson VM et al. *J Clin Microbiol* 1997; 35:738.
- Makrai L et al. *Vet Microbiol* 2002; 88:377.
- Yuyama T et al. *J Vet Med Sci* 2002; 64:715.
- Takai S et al. *J Vet Diagn Invest* 2001; 13:489.
- Hurley JR et al. *Aust Vet J* 1995; 72:418.
- Chaffin MK et al. *J Am Vet Med Assoc* 2003; 222:467.
- Raidal SL. *Aust Vet J* 1996; 73:201.
- Ainsworth DM et al. *J Am Vet Med Assoc* 1998; 213:510.
- Horowitz ML et al. *J Vet Intern Med* 2001; 15:171.
- Prescott JF, Hoffman AM. *Vet Clin North Am Equine Pract* 1993; 9:375.
- Chaffin MK et al. *J Am Vet Med Assoc* 2003; 222:476.
- Chaffin MK et al. *J Am Vet Med Assoc* 2003; 223:1791.
- Martens RJ et al. *J Am Vet Med Assoc* 2000; 217:220.
- Martens RJ et al. *J Am Vet Med Assoc* 2002; 221:825.
- Takai S et al. *Vet Microbiol* 1986; 12:169.
- Prescott JF. *Vet Microbiol* 1987; 14:211.
- Cohen ND et al. *J Am Vet Med Assoc* 2005; 226:404.
- Lakritz J et al. *Compend Contin Educ Pract Vet* 2002; March: 256.
- Takai S. *Vet Microbiol* 1997; 52:63.
- Martens RJ et al. *Proc Am Assoc Equine Pract* 1990; 35:199.

35. Martens RJ et al. *Equine Vet J* 1982; 14:111.
36. Chaffin MK et al. *Vet Immunol Immunopathol* 2004; 100:33.
37. Hines MT et al. *Vet Immunol Immunopathol* 2001; 79:101.
38. Hooper-McGrevy KE et al. *Am J Vet Res* 2001; 62:1307.
39. Brumbaugh GW et al. *Am J Vet Res* 1990; 51:766.
40. Zinc MC et al. *Can Vet J* 1986; 27:213.
41. Giguere S et al. *Equine Vet J* 1994; 26:74.
42. Chaffin MK, Martens RJ. *Proc Am Assoc Equine Pract* 1997; 43:79.
43. Prescott JF et al. *Equine Vet J* 1996; 28:344.
44. Ainsworth DM et al. *Am J Vet Res* 1993; 54:2115.
45. Hulten C, Demmers S. *Equine Vet J* 2002; 34:693.
46. Giguere S et al. *J Am Vet Med Assoc* 2003; 222:775.
47. Cohen ND et al. *Equine Vet J* 2005; 37:212.
48. Ardans AA et al. *Proc Am Assoc Equine Pract* 1986; 32:129.
49. Sellon DC et al. *J Clin Microbiol* 2001; 39:1289.
50. Stratton-Phelps M et al. *J Am Vet Med Assoc* 2000; 217:68.
51. Harrington JR et al. *Am J Vet Res* 2005; 66:755.
52. Halbert ND et al. *Am J Vet Res* 2005; 66:1380.
53. Sweeney CR et al. *Vet Microbiol* 1987; 14:329.
54. Barton MD, Hughes KL. *Vet Bull* 1980; 50:65.
55. Jacks SS et al. *Antimicrob Agents Chemother* 2003; 47:1742.
56. Barton MD. *Aust Vet J* 1986; 63:163.
57. Lakritz J et al. *Vet Ther* 2002; 2:189.
58. Giguere S et al. *J Vet Intern Med* 2004; 18:568.
59. Gustafsson A et al. *Equine Vet J* 1997; 29:314.
60. Traub-Dargatz J et al. *Proc Am Assoc Equine Pract* 1996; 42:243.
61. Fines M et al. *J Clin Microbiol* 2001; 39:2784.
62. Giguere S, Prescott JF. *Proc Am Assoc Equine Pract* 1997; 43:65.
63. Higuchi T et al. *J Am Vet Med Assoc* 1998; 212:976.
64. Perkins GA et al. *Vet Ther* 2001; 2:334.
65. Giguere S et al. *J Am Vet Med Assoc* 2002; 220:59.

## Diseases associated with *Listeria* species

There are currently six species classified within the genus *Listeria*<sup>1</sup> but only *Listeria monocytogenes* and *Listeria ivanovii* (previously classified as *L. monocytogenes* serotype 5) are pathogenic for domestic animals. *L. ivanovii* is only mildly pathogenic and is an occasional cause of abortion in sheep and cattle.<sup>2-4</sup> Aborted fetuses have suppurative bronchopneumonia and lack the multifocal hepatocellular necrosis commonly seen in abortions associated with *L. monocytogenes*.<sup>3</sup> *Listeria innocua* is occasionally associated with encephalitis in ruminants that is clinically and pathologically similar to that associated with *L. monocytogenes*.<sup>5</sup> Most, but not all, reports of both infections record that the animals were being fed silage.

### REFERENCES

1. Low JC, Donachie W. *Vet J* 1997; 153:9.
2. Sergent ESG et al. *Aust Vet J* 1991; 68:39.
3. Gill PA et al. *Aust Vet J* 1997; 75:214.
4. Chand P, Sadana JR. *Vet Rec* 1999; 145:83.
5. Walker JK et al. *Vet Microbiol* 1994; 42:245.

## LISTERIOSIS

### Synopsis

**Etiology** *Listeria monocytogenes*. Ubiquitous in farm environment  
**Epidemiology** Ruminants, particularly sheep. Prime occurrence is seasonal associated with feeding silage with high listerial growth. Also following management-induced stress. Commonly manifest with multiple cases in a group  
**Clinical findings** Most commonly encephalitis with brainstem and cranial nerve dysfunction or abortion in last third of pregnancy. Less commonly septicemia in periparturient and neonatal sheep and goats, enteritis in weaned sheep, spinal myelitis, ophthalmitis and occasionally mastitis  
**Clinical pathology** Culture. Pleocytosis and elevated protein in cerebrospinal fluid with encephalitis  
**Lesions** Microabscesses in brainstem in listerial encephalitis, spinal cord in spinal myelitis, intestine in enteritis. Visceral lesions in septicemia  
**Diagnostic confirmation** Culture and histopathology  
**Treatment** Chlorotetracycline or penicillin. Must be given early in clinical disease  
**Control** Control of listerial growth in feeds. Vaccination

### ETIOLOGY

*L. monocytogenes* is widespread in nature and has characteristics that allow its survival and growth in a wide variety of environments. There is a highly diverse range of strains some of which have the capability of causing disease in animals and humans.

Optimal growth temperatures are between 30°C and 37°C but the organism can grow and reproduce at temperatures between -0.4°C and 45°C. It can grow between pH 4.5 and 9.6 although growth at low pH is minimal at low temperatures.<sup>1</sup> The organism is susceptible to common disinfectants.

*L. monocytogenes* can be divided into 16 serovars on the basis of somatic and flagellar antigens and there is considerable genetic diversity between serovars. Serovars 4b, 1/2a and 1/2b and 3 are most commonly isolated from diseased animals but there are geographical differences.<sup>1-3</sup> Virulent strains can multiply in macrophages and monocytes and produce a hemolysin, listeriolysin O, which is believed to be a major virulence factor.<sup>3</sup>

### EPIDEMIOLOGY

#### Occurrence

Geographical

Although the organism is widespread in nature, clinical disease in animals occurs mainly in the northern and southern latitudes and is much less common in tropical and subtropical than in temperate

climates. The disease is important in North America, Europe, the UK, New Zealand, and Australia.

#### Seasonal

In the northern hemispheres listeriosis has a distinct seasonal occurrence, probably associated with seasonal feeding of silage, with the highest prevalence in the months of December through May<sup>4</sup> but seasonal occurrence is not a feature in Australia.<sup>5</sup>

#### Host

Listeriosis is primarily a disease of ruminants, particularly sheep, and the major diseases associated with *L. monocytogenes* are encephalitis and abortion. In ruminants it also produces syndromes of septicemia, spinal myelitis, uveitis, gastroenteritis, and mastitis. Occasional septicemic disease occurs in horses and pigs.

- **Encephalitis** usually occurs sporadically, affecting a single animal in a herd or flock or a few individuals over several weeks. The mean attack rate in 50 affected flocks in Britain was 2.5% with a range of 0.1–13.3%.<sup>6</sup> More serious outbreaks can occur with attack rates as high as 35% and cases occurring over a 2-month period. The disease occurs in sheep older than 6 weeks but may be more prevalent in lambs between 6 and 12 weeks of age and ewes over 2 years of age. The case fatality is high, especially in sheep, because the short clinical course often precludes treatment
- **Abortion** may also occur sporadically, which is usually true in cattle, but in sheep and goats it more commonly occurs as an outbreak with an attack rate that frequently approaches 10%
- **Spinal myelitis** is an uncommon manifestation but is recorded as occurring in 0.8–2.5% of sheep in affected flocks and in all ages of sheep<sup>4</sup> 4 weeks following spray dipping. Spinal myelitis also occurs sporadically in cattle 12–18 months of age<sup>5</sup>
- **Septicemic disease** is also a less common manifestation of infection with *L. monocytogenes* but can occur as an outbreak with a high case fatality in newborn lambs and kids and also in periparturient ewes and does
- **Ophthalmitis/uveitis** occurs in both sheep and cattle, and can occur as an outbreak. Many, but not all, outbreaks have been associated with round-bale 'self-feed' silage in the winter period<sup>7</sup> and eye infection is directly from the silage as the animals burrow their head into the silage to eat. *L. monocytogenes* is also associated with outbreaks of catarrhal **conjunctivitis** of cattle

- **Gastroenteritis** has been reported primarily by veterinary diagnostic labs in Great Britain and New Zealand as a sporadic disease affecting all ages of sheep after weaning. It occurs during the winter months most commonly in sheep fed baleage or silage. Cases occur 2 days or more after the onset of feeding.<sup>8,9</sup> Less commonly, cases occur in sheep on root crops or on pasture where the quality of the pasture is poor and they are at high stocking densities
- **Mastitis** is uncommon but can occur in cattle, sheep, and goats. It results in contamination of milk with *L. monocytogenes*. The more common source of *L. monocytogenes* in raw milk is fecal contamination. In a Danish study of quarter milk samples from over 1 000 000 cows in 36 199 herds, 0.4% of cows had listerial mastitis and 1.2% of herds had infected cows.<sup>10</sup>

### Source of infection

The organism is common in the environment and infection is not limited to agricultural animals. *L. monocytogenes* has been isolated from 42 species of mammals, 22 species of birds as well as fish, crustaceans, and insects. It is truly **ubiquitous in the environment** and can be commonly isolated from animal feces, human feces, farm slurry, sewerage sludge, soil, farm water troughs, surface water, plants, animal feeds and the walls, floors, drains, etc. of farms and other environments.<sup>1,11,12</sup> The ability to form biofilms may assist in its survival in the environment<sup>13</sup> and may assist in perpetuating its presence in water troughs on infected farms.

Most feed hays, grains and formulated feeds have the potential to contain *L. monocytogenes* but, with most, low levels of available water restrict its multiplication.

In ruminants *L. monocytogenes* can be isolated from the feces and nasal secretions of healthy animals and has been isolated from the feces of cattle in 46% of 249 herds examined<sup>14</sup> and from 82% of samples of feedstuffs.<sup>15</sup> In temperate climates the prevalence of *L. monocytogenes* in the feces of ruminants appears to vary with the season, being higher in the winter period. It is also increased during periods of environmental stress and in association with the stress of lambing and transport.<sup>16-18</sup> The presence in feces and secretions can also be influenced by the numbers of the organism in feeds fed to the animals.<sup>15,18,19</sup> In herds where there is a high proportion of cattle excreting in feces, the organism can be isolated from dried fecal dust on walls and most farm surfaces.

*L. monocytogenes* is not isolated from the feces or environment in all farms and its presence in isolable numbers is largely

a reflection of its presence in feed, or the presence of animals with intestinal carriage. It is apparent that in some healthy herds and flocks there may be a multitude of different strains in the silage and feed, water troughs, feces and environment in a single herd.<sup>19,20</sup>

The presence of *L. monocytogenes* in bulk tank milk or milk filters is used as a measure of farm infection prevalence.<sup>21</sup> Obviously this measure is influenced by the management and environmental conditions on farms that might result in fecal contamination of the teats. Although bulk tank and milk filter infection rates provide information of possible value to measures of environmental contamination and risk for human exposure there is no evidence that this measure has any relation to risk for animal disease on the farm being studied.

### Silage

*L. monocytogenes* is commonly present in silage, but it does not multiply to any significant extent in effectively preserved silage which is characterized by anaerobic storage, high density, a high concentration of organic acids, and a pH below 4.5. *Listeria* can multiply in silage above pH 5.0–5.5, the critical pH depending upon the dry matter content.<sup>10,22,23</sup> *L. monocytogenes* may be present in silage which is **poorly fermented** but it can also occur in pockets of **aerobic deterioration** in otherwise good silage<sup>24</sup> and this is the common occurrence. These areas are often indicated by mold growth and occur at the edges of the clamp and in the top few inches of the surface in plastic-covered clamps where air has circulated under the plastic. Thus the growth of *L. monocytogenes* is a surface problem in silage – except those that are poorly fermented – and occurs in small areas sporadically over the surface of a silage.

The risk for contamination of silage with *Listeria* is higher when it contains soil. **Soil** may be incorporated from mole-hills present in the field and it may also be incorporated in the front of the clamp during final packing. An **ash content** of greater than 70 mg/kg dry matter indicates soil contamination.

**Big bale silage** may have a higher risk for listerial infection than conventional silage because of its lower density, poorer fermentation, the greater surface area relative to clamp silage and the greater risk for mechanical damage to the plastic covering.<sup>10</sup>

**Moist preserved feeds** other than grass silage are at risk for listerial growth; listeriosis is recorded, for example, in association with the feeding of moist brewers' grains, wet spoiled hay bales and silage made from commodity by-products such as orange and artichoke waste. A relatively rapid method for the quanti-

tative assessment of the occurrence and distribution of *Listeria* in suspect silage is available.<sup>24</sup>

Infective material also derives from infected animals in the feces, urine, aborted fetuses and uterine discharge, and in the milk. Although immediate spread among animals in a group has been demonstrated, field observations suggest that mediate contagion by means of inanimate objects also occurs. **Woody browse** may be a risk factor for goats.<sup>25</sup>

### Transmission

With septicemic disease and abortion the organism is transmitted by ingestion of contaminated material. Lambs which develop septicemic disease may acquire infection from contamination on the ewe's teat, from the ingestion of milk containing the organism from ewes or does with subclinical bacteremia, through the navel from the environment, and also as a congenital infection. The encephalitic form of the disease results from infection of the terminals of the trigeminal nerve consequent to abrasions of the buccal mucosa from feed or browse or from infection of tooth cavities. Spinal myelitis is believed to result from growth up spinal nerves subsequent to body area infections.

Outbreaks of encephalitis which occur in sheep after introduction to silage usually commence about 3–4 weeks later, although there is wide variation and one study of a large number of outbreaks found the median time of this period to be 44 days.<sup>6</sup> This delay reflects the time for ascending infection.

Commonly, the serotype that is isolated from the brain of an affected animal is also present in the silage being fed. However, the recent development of methods for genetic analyses of *L. monocytogenes* has demonstrated that serotyping is a relatively crude tool for epidemiological studies and in many instances, although the isolate from brain may be the same serotype as that from silage, there is no relationship on genetic analysis.<sup>20,26</sup> Possibly this reflects differences in strains at different sites in silage and the difference between the time of sampling of the silage and the time when the affected cow ate it.

Septicemic disease in sheep and goats usually occurs within 2 days of introduction to silage and abortions 6–13 days later.<sup>17,27</sup>

### Risk factors

Despite the ubiquity of *L. monocytogenes*, only a small proportion of animals develop clinical disease. A number of predisposing factors have been observed, or proposed, as risk factors for disease. These include factors that cause a lowering of the host animal's resistance and factors that increase

the infection pressure of the organism. In farm animals the latter appear the most important.

Host management risk factors  
Observed risk factors include:

- Poor nutritional state
- Sudden changes of weather to very cold and wet
- The stress of late pregnancy and parturition
- Transport
- Long periods of flooding with resulting poor access to pasture.

Area outbreaks affecting several flocks can occur in sheep on poorly drained and muddy pastures following floods, but outbreaks are also described in droughts.<sup>28</sup> Overcrowding and insanitary conditions with poor access to feed supplies may predispose housed sheep.

Breed difference in susceptibility (Angora goats and Rambouillet sheep) has been observed in some studies<sup>21,29</sup> but not in others.<sup>4</sup>

Pathogen risk factors

Factors that increase the infection pressure largely involve a massive multiplication of *L. monocytogenes* in the feed or environment. The feeding of grass or corn silage as a major risk factor for the occurrence of listeriosis has been recognized for many decades. The increase in use of silage for feed in ruminants may be the reason for the apparent increase in the prevalence of the disease in recent years. Silage may also exert its effect by increasing the susceptibility of the host to listerial infection, although this has been disputed.<sup>30</sup>

Introduction of **virulent strains** to the flock may also occur via a carrier animal, and birds, such as seagulls that scavenge on sewerage areas, may carry a heavy population of the bacteria and can contaminate feed or pastures for silage. The organism persists for as long as 3 months in sheep feces and has been shown to survive for up to 11.5 months in damp soil, up to 16.5 months in cattle feces, up to 207 days on dry straw and for more than 2 years in dry soil and feces. It is resistant to temperatures of  $-20^{\circ}\text{C}$  ( $-6^{\circ}\text{F}$ ) for 2 years and is still viable after repeated freezing and thawing.

### Experimental reproduction

Oral or parenteral challenge of nonpregnant sheep and goats will produce a bacteremia with minor clinical signs of pyrexia and depression in animals with no pre-existing antibody. Clinical disease is more severe in young animals and the infection clears with the development of an immune response.<sup>31-33</sup> The challenge of animals with pre-existing antibody is not associated with clinical disease although there

may be a bacteremia. Lactating animals secrete the organism in milk during the bacteremic period. Prior challenge of goats with *L. ivanovii* or *Listeria innocua* does not protect against subsequent challenge with *L. monocytogenes*.<sup>33</sup>

Several studies have shown that oral, conjunctival, and parenteral challenge of **pregnant animals** results in more severe signs of septicemia and can be followed by **abortion**, although this is not an invariable sequel.<sup>34</sup> Encephalitis has not been reproduced experimentally by intravenous challenge, although meningoen- cephalitis may occur following this route of challenge in young lambs. **Encephalitis** has been reproduced experimentally by the injection of organisms into the buccal mucosa or the tooth pulp cavity, the organism traveling centripetally via the trigeminal nerve to reach the brain stem.<sup>35</sup>

### Zoonotic implications

In humans, listeriosis may occur as a sporadic disease or as a food-borne outbreak to produce septicemic disease, meningoen- cephalitis, abortion and infection in other organs. **Sporadic disease** may involve healthy humans of any age but the disease usually occurs in the very young or unborn, the very old and people who are otherwise immunocompromised. The case fatality is high, and overall approximately 25% of reported cases die. Active surveillance for sporadic cases indicates that approximately 2000 cases and 450 deaths occur each year in the USA to give an annual incidence of 0.8 per 100 000 population.<sup>16</sup> The incidence is increasing, possibly because of an increase in susceptible populations.

The similarity of the disease spectrum in humans and animals and the occurrence of food-borne outbreaks has led to concerns that the disease could be a zoonosis. Whereas there is a potential for zoonotic transmission it would appear that the majority of human exposures to the organism, and the risk for disease, result from contamination of foods during processing and from the particular ability of the organism to grow at refrigerator temperature.

Milk products

**Milk** products have been incriminated in some outbreaks of disease. Numerous studies have shown that *L. monocytogenes* is commonly present in low numbers (usually less than 1/mL) in raw milk from some herds. In the vast majority of herds this is the result of fecal contamination during the milking process or other environmental contamination. Rarely, its presence in raw milk is from an animal with subclinical mastitis and in this case its numbers in bulk tank milk are much higher (2000-5000/mL), even when there is a single cow or goat with *L. monocyto-*

*genes* mastitis.<sup>36,37</sup> In goats and sheep the presence in raw milk may also be the result of a subclinical bacteremia.

There have been concerns that the organism might survive pasteurization, especially if present in phagocytes. D-values for *Listeria* in milk have been determined to be in the range of 0.9 seconds at  $71.1^{\circ}\text{C}$ . The legal limit for high-temperature/short-time pasteurization in the US is  $71.7^{\circ}\text{C}$  for 15 seconds and this temperature is sufficient to inactivate numbers far beyond those present in raw milk.<sup>38</sup> There is no evidence that the organism will survive correct pasteurization procedures.<sup>1</sup>

**Bulk tank infection rates** are higher in winter and spring and cross-sectional and case-control studies have shown that the risk for detecting *L. monocytogenes* in bulk milk is higher in those herds that used a bucket milking system rather than a pipeline system. It is also higher in herds fed component feeds, fed leftover feed, fed from plastic feed bunks and with a low frequency of feed bunk cleaning.<sup>39,40</sup> It is lower in herds that practice pre-milking teat disinfection.<sup>40</sup>

Farmers or others who consume **raw milk** need to be aware of the risk of infection, especially if they fall within at-risk categories. There may be a particular risk with milk from goats and sheep fed silage. People associated with agriculture are also more liable to direct zoonotic transmission of listerial disease. **Dermatitis** with a papular and pustular rash occurs on the arms of **veterinarians** following the handling of infected dystocical cases and aborted fetuses. **Conjunctivitis** is also recorded in agricultural workers handling infected livestock.

Although *L. monocytogenes* rarely causes disease in **pigs** it is present in the tonsils and feces of some pigs at slaughter and this presence is a potential source of contamination of the carcass and the slaughterhouse environment. There is a significantly higher prevalence in the tonsils of fattening pigs than in those of sows.<sup>41</sup> The organism can be isolated from the floors, walls, and feed in pig units. Wet feeding, poor hygiene, and a short spelling period between batches of pigs in the finishing house have been found to be risk factors for infection in pigs. Paradoxically, disinfecting the pipeline used for wet feeding was associated with a higher risk of fecal contamination than no disinfection at all.<sup>42,43</sup>

A further concern for indirect zoonotic risk of *L. monocytogenes* is the presence of the organism in the feces on infected farms and the potential for fecal or wind-borne dust spread to adjacent fields that may contain crops for human consumption.

## PATHOGENESIS

In most animals, ingestion of the organism, with penetration of the mucosa of the intestine, leads to an inapparent infection with prolonged fecal excretion of the organism and to a subclinical bacteremia, which clears with the development of immunity. The bacteremic infection is frequently subclinical and may be accompanied by excretion of the organism in milk. Septicemic listeriosis, with or without meningitis, occurs most commonly in neonatal ruminants and in adult sheep and goats, particularly if they are pregnant and when the infection challenge is large.

The organism is a facultative intracellular pathogen that can infect cells, including intestinal cells, by directed endocytosis. It can survive and grow in macrophages and monocytes.<sup>3</sup> Bacterial superoxide dismutase protects against the bactericidal activity of the respiratory burst of the phagocyte and listeriolysin O disrupts lysosomal membranes, allowing the organism to grow in the cytoplasm.<sup>1,3</sup> The experimental mouse model indicates that cell-mediated immunity is important in protection against listerial infection but studies in goats suggest that the clearance of bacteremic infection and resistance to infection are also strongly associated with humoral antibody.<sup>44</sup>

In **pregnant animals** invasion of the placenta and fetus may occur within 24 hours of the onset of bacteremia. Edema and necrosis of the placenta leads to **abortion**, usually 5–10 days postinfection. Infection late in pregnancy results in **stillbirths** or the delivery of young that rapidly develop a fatal septicemia. Maternal **metritis** is constant and if the fetus is retained a fatal listerial septicemia may follow. Infection of the uterus causing abortion and intrauterine infection occurs in all mammals.

## Encephalitis

Encephalitis in ruminants occurs as an acute inflammation of the brainstem and is usually unilateral. The portal of entry is by ascending infection of the trigeminal or other cranial nerves following loss of the integrity of the buccal mucosa resulting from trauma, the shedding of deciduous or permanent teeth or from periodontitis.<sup>35</sup> Clinical signs are characterized most strongly by an **asymmetric** disorder of cranial nerve function, and in particular the trigeminal, facial, vestibular, and glossopharyngeal nerves, but there is some variation in the involvement of individual cranial nerves depending upon the distribution of lesions in the brainstem. Lesions in the sensory portion of the trigeminal nucleus and the facial nucleus are common and lead to ipsilateral facial hypalgesia and paralysis; involvement of the vesti-

cular nucleus is also common and leads to ataxia with circling and a head tilt to the affected side.<sup>45</sup> The additional signs of dullness, head-pressing, and delirium are referable to the more general effects of inflammation of the brain developing in the agonal stages. Spread of the infection along the optic nerve may result in endophthalmitis in sheep and cattle.

## Spinal myelitis

Spinal myelitis possibly results from ascending infection in the sensory nerves of the skin following dermatitis from prolonged wetting of the fleece.<sup>4</sup>

## Mastitis

*L. monocytogenes* is rarely found to be a cause of **mastitis** in cattle, despite the fact that it can be common in the dairy environment of herds that have milking practices that could be conducive to the introduction of environmental pathogens into the udder. This suggests that it is not a particularly invasive or perpetuating organism for the udder.<sup>36</sup>

## CLINICAL FINDINGS

When disease occurs it is usual to have an outbreak of either encephalitis or abortion. Encephalitis is the most prevalent manifestation in sheep. Septicemia in lambs may occur in conjunction with abortion but it is rare to have all three syndromes on the same farm, at least in the same temporal period. There are always exceptions to such generalities, and the occurrence of septicemia, abortion, and encephalitis in a flock of sheep is possible.<sup>27</sup>

## Listerial encephalitis

### Sheep

In sheep, early signs are separation from the flock, and depression with a hunched stance. Sheep approached during this early stage show a frenetic desire to escape but are uncoordinated as they run and fall easily. The syndrome progresses rapidly with more severe depression to the point of somnolence and the development of signs of cranial nerve dysfunction. Fever – usually 40°C (104°F) but occasionally as high as 42°C (107°F) – is usual in the early stages of the disease but the temperature is usually normal when overt clinical signs are present.

Signs vary between individual sheep but incoordination, head deviation sometimes with head tilt, walking in circles, unilateral facial hypalgesia and facial paralysis are usually present. Facial hypalgesia can be detected with pressure from a hemostat and the facial paralysis is manifest with drooping of the ear, paralysis of the lips and ptosis on the same side of the face as the hypalgesia. This may be accompanied by exposure keratitis, often severe enough to cause corneal ulceration. Strabismus and nystagmus occur in some. Panophthalmitis,

with pus evident in the anterior chamber of one or both eyes, is not uncommon in cattle that have been affected for a number of days. Also there is paresis of the muscles of the jaw, with poor tone or a dropped jaw, in which case prehension and mastication are slow and the animal may stand for long periods drooling saliva and with food hanging from its mouth.

The position of the head varies. In many cases there is deviation of the head to one side with the poll–nose relationship undisturbed (i.e. there is no rotation) but in others there is also head tilt. The head may be retroflexed or ventroflexed depending on the localization of the lesions and in some cases may be in a normal position. The deviation of the head cannot be corrected actively by the animal and if it is corrected passively the head returns to its previous position as soon as it is released. Progression is usually in a circle in the direction of the deviation and the circle is of small diameter. There is ataxia, often with consistent falling to one side, and an affected sheep may lean against the examiner or a fence. The affected animal becomes recumbent and is unable to rise, although often still able to move its legs. Death is due to respiratory failure.

### Cattle

In cattle, the clinical signs are essentially the same but the clinical course is longer.<sup>46</sup> In adult cattle the course of the disease is usually 1–2 weeks but in sheep and calves the disease is more acute, death occurring in 2–4 days.

### Goats

In goats the disease is similar to that in the other species, but in the young goat the onset is very sudden and the course short, with death occurring in 2–3 days.

## Listerial abortion

Outbreaks of abortion are recorded in cattle but occur more commonly in sheep and in goats. Abortion due to this organism is rare in pigs.

### Cattle

In cattle, abortion or stillbirth occurs sporadically and usually in the last third of pregnancy; retention of the afterbirth occurs commonly, in which case there is clinical illness and fever of up to 40.5°C (105°F). Abortion has been observed soon after the commencement of silage feeding but does not always have this association.

### Sheep and goats

In sheep and goats abortions occur from the 12th week of pregnancy onwards, the afterbirth is usually retained, and there is a bloodstained vaginal discharge for several days. There may be some deaths of ewes from septicemia if the fetus is retained. In both species the rates of abortion in a group

are low but may reach as high as 15%. On some farms, abortions recur each year.

#### Abortion due to *Listeria ivanovii*

This occurs as a sporadic disease in cattle and has no distinguishing clinical features from that associated with *L. monocytogenes*.<sup>46,47</sup> Outbreaks in sheep are manifest with abortion and stillbirth but particularly with the birth of live infected lambs, which seldom survive long enough to walk or suck.

#### Septicemic listeriosis

Acute septicemia due to *L. monocytogenes* is not common in adult ruminants but does occur in monogastric animals, and in newborn lambs and calves. There are no signs suggestive of nervous system involvement, the syndrome being a general one comprising depression, weakness, emaciation, pyrexia, and diarrhea in some cases, with hepatic necrosis and gastroenteritis at necropsy. The same syndrome is also seen in ewes and goats after abortion if the fetus is retained. A rather better defined but less common syndrome has been described in calves 3–7 days old. Corneal opacity is accompanied by dyspnea, nystagmus, and mild opisthotonos. Death follows in about 12 hours. At necropsy there is ophthalmitis and serofibrinous meningitis. Septicemic listeriosis is recorded in a foal.<sup>48</sup>

#### Mastitis

Infection in the udder may involve a single quarter or both quarters; it is chronic and poorly responsive to treatment. There is a high somatic cell count in milk from the affected quarter, but the milk appears normal.

#### Spinal myelitis

There is fever, ataxia with initial knuckling of the hindlimbs progressing to hindlimb weakness and paralysis. In some cases, both in sheep and cattle, there is also paresis and paralysis of the front limbs. There is no evidence of cranial nerve involvement and affected animals are initially mentally alert, bright and continue to eat. However, there is rapid deterioration and affected animals are commonly humanely destroyed.

#### Ophthalmitis, iritis

There is swelling of the iris and constriction of the pupil; white focal lesions are evident on the internal surface of the cornea with floccular material in the anterior chamber. Advanced cases have pannus and corneal opacity. One or both eyes are affected.

#### Enteritis in weaner sheep

Initially, sheep are found dead. Others in the group show lethargy, anorexia and pass loose, green-colored feces. Pregnant ewes may abort.

#### CLINICAL PATHOLOGY

The organism can be cultivated from vaginal secretions for up to 2 weeks after abortion and a proportion of aborting animals also have *L. monocytogenes* in the milk and feces.

The cerebrospinal fluid in cases of encephalitis has increased protein and an increased number of leukocytes, most of which are mononuclear cells or lymphocytes.<sup>45,49</sup> *L. monocytogenes* is not detectable by culture or PCR.<sup>50</sup> Electrodiagnostic examinations are reported.<sup>51</sup>

Serological tests (agglutination and complement fixation tests) have been used but lack the predictive value required for diagnostic use. Ruminants commonly have antibody to *Listeria* and high titers are commonly encountered in normal animals in flocks and herds where there have been clinical cases. Nucleic-acid-based techniques can be used to determine the source of a strain of *L. monocytogenes* in an outbreak.<sup>13</sup>

#### NECROPSY FINDINGS

Typically there are no distinctive gross changes associated with listerial **encephalitis**. Histological examination of central nervous system tissue is necessary to demonstrate the microabscesses that are characteristic of the disease. These are present in the brainstem in listerial encephalitis and in the cervical and/or lumbar spinal cord in outbreaks of spinal myelitis. Sampling of the forebrain will typically result in a false-negative diagnosis. Cold enrichment techniques are advisable when attempting to isolate the organism. Gram staining of paraffin-embedded tissue may permit confirmation of the diagnosis in cases for which suitable culture material is unavailable. Alternative test methods such as fluorescent antibody or immunoperoxidase tests are available in some laboratories. In one retrospective study comparing diagnostic methods, immunoperoxidase staining was superior to bacterial culture when correlated with histopathological changes.<sup>52</sup>

Visceral lesions occur as multiple foci of necrosis in the liver, spleen, and myocardium in the **septicemic form** and in **aborted fetuses**. Aborted fetuses are usually edematous and autolyzed, with very large numbers of bacteria visible microscopically in a variety of tissues. In aborting dams, there is placentitis and endometritis in addition to the lesions in the fetus.<sup>30</sup>

Sheep with **enteritis** show ulcerative abomasitis and some also have typhlocolitis at necropsy; histologically there are microabscesses throughout the intestine and a characteristic infiltration of degenerating neutrophils in the mucosa lamina muscularis of the abomasum.<sup>8</sup>

#### Samples for confirmation of diagnosis

- Central nervous system listeriosis
- Bacteriology – half of midsagittally sectioned brain, **including brainstem**, chilled or frozen (CULT, FAT)
  - Histology – formalin-fixed half of midsagittally sectioned brain, **including brainstem**; appropriate segment of spinal cord if spinal myelitis suspected (LM, IHC).

#### Septicemia and abortion

- Bacteriology – chilled liver, spleen, lung, placenta, fetal stomach content (CULT, FAT)
- Histology – formalin-fixed liver, spleen, lung, brain, placenta, fetal intestine (LM, IHC).

#### DIFFERENTIAL DIAGNOSIS

##### Encephalitis

- Pregnancy toxemia in sheep
- Nervous ketosis in cattle
- Rabies
- Gid
- Polioencephalomalacia
- Middle ear disease
- Scrapie

##### Abortion

- Sheep (Table 18.4)
- Cattle (Table 18.5).

##### Gastroenteritis

- Salmonellosis

##### Uveitis

- Contagious ophthalmia

#### TREATMENT

The intravenous injection of chlortetracycline (10 mg/kg BW per day for 5 d) is reasonably effective in meningoencephalitis of cattle but less so in sheep. Penicillin at a dosage of 44 000 IU/kg BW given intramuscularly daily for 7 days, and in many cases for 10–14 days, can also be used. The recovery rate depends largely on the time that treatment is started after the onset of clinical signs. If severe clinical signs are already evident, death usually follows in spite of treatment. Usually the course of events in an outbreak is that the first case dies but subsequent cases are detected sufficiently early for treatment. Dehydration, acid–base imbalances and electrolyte disturbances must also be corrected. Cases of spinal myelitis are poorly responsive to treatment.

Treatment of listerial iritis is with systemic antibiotics in the early stages coupled with subpalpebral corticosteroid and atropine to dilate the pupil.

In vitro resistance to the tetracycline group of antimicrobials is reported.<sup>53</sup>

#### CONTROL

Control is difficult because of the ubiquitous occurrence of the organism, the lack



of a simple method of determining when it is present in high numbers in the environment and a poor understanding of the risk factors other than silage. Where the risk factor is silage there may be some merit in the recommendation that a change of diet to include heavy feeding of silage should be made slowly, particularly if the silage is spoiled or if listeriosis has occurred on the premises previously. Tetracyclines can be fed in the ration of animals at risk in a feedlot. When possible, the obviously spoiled areas of silage should be separated and not fed.

Other recommendations on the feeding of silage include: avoiding making silage from fields where molehills may have contaminated the grass; avoiding soil contamination when filling the clamp; the use of additives to improve fermentation and the avoidance of silage that is obviously decayed, or with a pH of greater than 5 or an ash content of more than 70 mg/kg of dry matter.

Silage removed from the clamp should be fed as soon as possible.

Where uveitis is a problem, feeding systems that avoid eye contact with silage should be used.

A live attenuated **vaccine** has been shown to induce protection against intravenous challenge<sup>54</sup> and a live attenuated vaccine in use in Norway for several years is reported to reduce the annual incidence of the disease in sheep from 4% to 1.5%.<sup>55</sup> An economic model is available for determining whether vaccination should be practiced.<sup>56</sup> Commercial killed vaccines are available for the control of the disease in some countries and some companies will also produce autogenous vaccines on request. The efficacy of vaccination still requires further determination; however, when economics or food availability on the farm dictate that contaminated silage must be fed, consideration might be given to vaccination as a means of providing some protection.

## REVIEW LITERATURE

- Gray ML, Killinger AH. *Listeria monocytogenes* and listeric infections. *Bacteriol Rev* 1966; 30:309.
- Ladds PW, Dennis SM, Njoku CO. Pathology of listeric infections in animals. *Vet Bull* 1974; 44:67.
- Scarratt WK. Ovine listeric encephalitis. *Compend Contin Educ Pract Vet* 1987; 9:F28-F32.
- Gitter M. Veterinary aspects of listeriosis. *PI-ILS Microb Dig* 1989; 6(2):38-42.
- Anon. *Listeria monocytogenes*. Recommendations by the national advisory committee on microbiological criteria for foods. *Int J Food Microbiol* 1991; 14:185-246.
- Farber JM, Peterkin PI. *Listeria monocytogenes*, a food-borne pathogen. *Microbiol Rev* 1991; 55:476-511.
- Low JC, Donachie W. A review of *Listeria monocytogenes* and listeriosis. *Vet J* 1997; 153:9-29.
- Fenlon DR. *Listeria monocytogenes* in the natural environment. In: Ryser ET, Martin EH. *Listeria*, listeriosis and food safety, 2nd edit. New York: Marcel Dekker, 1998.

## REFERENCES

- Farber JM, Peterkin PI. *Microbiol Rev* 1991; 55:476.
- Low JC et al. *Vet Rec* 1993; 133:165.
- Low JC. *Vet J* 1997; 153:9.
- Seaman JT et al. *Aust Vet J* 1990; 67:142.
- Schweizer G et al. *Vet Rec* 2004; 154:54.
- Wilesmith JW, Gitter M. *Vet Rec* 1986; 119:467.
- Walker JK, Morgan JH. *Vet Rec* 1993; 132:636.
- Clarke RG et al. *N Z Vet J* 2004; 52:46.
- Otter A et al. *Vet Rec* 2004; 154:479.
- Jensen NE et al. *Int J Food Microbiol* 1996; 32:209.
- Bosgraud C et al. *Rev Med Vet* 1991; 142:463.
- Garcia E et al. *J Food Protect* 1996; 59:950.
- Borucki MK et al. *J Appl Environ Microbiol* 2003; 69:7336.
- Husu JR. *J Vet Med B* 1990; 37:276.
- Skovgaard N, Morgan CA. *Int J Food Microbiol* 1988; 6:229.
- Anon. *Int J Food Microbiol* 1991; 14:194.
- Loken T et al. *Acta Vet Scand* 1982; 23:380, 392.
- Fenlon DR et al. *J Appl Bacteriol* 1996; 81:641.
- Gudmundsdottir KB et al. *J Appl Microbiol* 2004; 96:913.
- Borucki MK et al. *J Food Protect* 2004; 67:2496.
- Muraoka W et al. *J Food Protect* 2003; 66:1413.
- Perry CM, Donnelly CW. *J Food Microbiol* 1990; 53:642.
- Webster J. *In Pract* 1984; 7:186.
- Fenlon DR. *Vet Rec* 1986; 118:240.
- Johnson GC et al. *J Am Vet Med Assoc* 1996; 208:1695.
- Wesley IV et al. *J Vet Diagn Invest* 2002; 14:314.
- Low JC, Renton CP. *Vet Rec* 1985; 116:147.
- Reiter R et al. *Aust Vet J* 1989; 66:223.
- Nash ML et al. *Prev Vet Med* 1995; 24:147.
- Vasquez-Boland JA et al. *Am J Vet Res* 1992; 53:368.
- Miettinen A et al. *J Clin Microbiol* 1990; 28:340.
- Low JC, Donachie G. *Res Vet Sci* 1991; 51:185.
- Baetz AL et al. *Vet Microbiol* 1996; 51:151.
- Gitter M et al. *Vet Rec* 1986; 118:575.
- Barlow RM, McCorum B. *Vet Rec* 1985; 116:233.
- Fedio WM et al. *Can Vet J* 1990; 31:773.
- Schoder D et al. *J Dairy Res* 2003; 70:395.
- Mackey BM et al. *Lett Appl Microbiol* 1989; 9:89.
- Hassan L et al. *Dairy Food Environ Sanit* 2002; 22:326.
- Hassan L et al. *J Dairy Sci* 2000; 83:241.
- Autio T et al. *J Food Protect* 2004; 67:805.
- Belboeil PA. *Vet Res* 2003; 34:737.
- Belboeil PA. *J Vet Med B* 2003; 50:155.
- Miettinen A et al. *J Clin Microbiol* 1990; 28:340.
- Scarratt WK. *Compend Contin Educ Pract Vet* 1987; 9:F28.
- Gill PA et al. *Aust Vet J* 1997; 75:214.
- Alexander AV et al. *J Am Vet Med Assoc* 1992; 200:711.
- Wallace SS, Hathcock TL. *J Am Vet Med Assoc* 1995; 207:1325.
- Scott PR. *Br Vet J* 1993; 149:165.
- Peters M et al. *J Vet Med B* 1995; 42:84.
- Strain GM et al. *Am J Vet Res* 1990; 51:1513.
- Johnson GC et al. *J Vet Diagn Invest* 1995; 7:223.
- Vela AI et al. *Int J Antimicrob Agents* 2001; 17:215.
- Linde K et al. *Vaccine* 1995; 13:923.
- Gudding R et al. *Vet Rec* 1989; 125:111.
- Vagsholm I et al. *Vet Rec* 1991; 128:183.

## Diseases associated with *Erysipelothrix rhusiopathiae* (*insidiosa*)

### ERYSIPELAS OF SWINE

Erysipelas of pigs is the major disease of animals associated with this bacterium

but there are several other minor conditions that require mention. In pigs the condition is seen as sudden death, possibly with diamond-shaped skin lesions and also arthritis and endocarditis.

### Synopsis

**Etiology** *Erysipelothrix rhusiopathiae* (*Erysipelothrix tonsillarum* is nonpathogenic)

**Epidemiology** Pigs worldwide. Common in unvaccinated pigs raised outdoors. High case fatality rate if not treated. Organism in environment and transmitted by carrier pigs. Important zoonosis

**Clinical signs** Sudden onset of acute disease, fever, anorexia, typical diamond-shaped skin lesions. Arthritis, endocarditis in chronic form

**Clinical pathology** Organism in blood. Hemogram and serology

**Necropsy findings** Skin lesions, widespread ecchymotic hemorrhages (kidney, pleura, peritoneum), venous infarction of stomach. Nonsuppurative proliferative arthritis. Vegetative endocarditis

**Diagnosis** Culture and isolate organism from blood in acute case and then tissues

**Differential diagnosis** Other septicemias of pigs:

- Septicemic salmonellosis
- Hog cholera (African Swine Fever)
- Streptococcal septicemia and arthritis
- Streptococcal endocarditis

Other arthritides of pigs:

- Glasser's disease
- *Mycoplasma* arthritis
- Ricketts and chronic zinc poisoning
- Foot rot of pig
- Leg weakness

**Treatment** Penicillin

**Control** Vaccination, with at most 6 month intervals until new vaccines appear

## ETIOLOGY

*Erysipelothrix rhusiopathiae* (*insidiosa*) is the causative bacterium and the disease can be produced in acute and subacute septicemic and chronic forms by the injection of cultures of the organism. A number of different serotypes<sup>1</sup> have been identified, usually types 1 and 2 in pigs. Many of the serotypes have been regrouped and called *Erysipelothrix tonsillarum*. This is a non-pathogenic type found in the tonsil that is morphologically and biochemically similar to *E. rhusiopathiae* but has a very distinctive genetic profile. In many minimal-disease herds they have tended not to vaccinate and then the epizootics have occurred as a result of an increasing lack of immunity.<sup>2</sup>

## EPIDEMIOLOGY Occurrence

Erysipelas in pigs occurs worldwide and in most countries has reached a level of

incidence sufficient to cause serious economic loss due to deaths of pigs and devaluation of pig carcasses because of arthritis. An epidemic occurred in the USA in 1989/90.<sup>3</sup> However, since total indoor confinement of swine herds and the lack of contact with contaminated soil has increased, the occurrence of the disease has decreased markedly. The exception to this would be outdoor units where no vaccination is practiced. Historically, the disease occurred most commonly in unvaccinated growing pigs over 3 months of age and adults. This is primarily because the maternal antibody is believed to last up to 3 months. The infection, usually with serotypes 1a or 2, has also been demonstrated in wild boars, so these should not be forgotten as a reservoir.<sup>4</sup> Perhaps more importantly, these were resistant to oxytetracycline and/or dihydrostreptomycin.

### Prevalence of infection

The prevalence of infection with *E. rhusiopathiae* in carrier pigs ranges from 3–98%, with most surveys indicating that 20–40% of pigs are carriers.<sup>5</sup> Carriers occur among vaccinated as well as unvaccinated pigs. The organism has been isolated from 10% of apparently healthy slaughter pigs.<sup>5</sup> This explains why the usual source is other pigs.

### Morbidity and case fatality

Morbidity and case fatality rates in pigs vary considerably from area to area, largely because of variations in virulence of the particular strain of the organism involved. On individual farms or in particular areas the disease may occur as a chronic arthritis in finishing pigs, or as extensive outbreaks of the acute septicemia, or both forms may occur together. In unvaccinated pigs, the morbidity in the acute form will vary from 10–30%; the case fatality rate may be as high as 75%.

### Methods of transmission

**Soil contamination** occurs through the feces of affected or carrier pigs.<sup>6</sup> Other sources of infection include infected animals of other species, and birds. The clinically normal carrier pig is the most important source of infection, the tonsils being the predilection site for the organism. Young pigs in contact with carrier sows rapidly acquire the status of carriers and shedders. Since the organism can pass through the stomach without loss of viability, carrier animals may re-infect the soil continuously and this, rather than survival of the organism, appears to be the main cause of environmental contamination. The organism can survive in feces for several months. All effluent contains species of *Erysipelothrix* but there is no need to assume that it is *E. rhusiopathiae*.<sup>7</sup> However, its persistence in soil is variable and may be governed by many factors

including temperature, pH and the presence of other bacteria. It can survive for 60 months in frozen or refrigerated media, 4 months in flesh and 90 days in highly alkaline soil.

The organism can be isolated from the effluent of commercial piggeries and from the soil and pasture of effluent disposal sites for up to 2 weeks after application of the effluent containing the organism. In a survey of the occurrence of potential pathogens in slurry, the organism was found in samples from 49% of 84 cattle herds, 44% of 32 pig herds and 39% of 67 cattle and pig herds.<sup>8</sup> Although the environment is considered to be secondary to animals as a reservoir of infection, the survival of the organism in the environment could create an infection hazard. Flies are known to transmit the disease and a lowered prevalence has been attributed to the use of insecticides.

Under natural conditions, skin abrasions and the alimentary tract mucosa are considered to be the probable portals of entry and transmission is by ingestion of contaminated feed. Occasional outbreaks occur after the use of virulent and incomplete avirulent culture as vaccines. Abortion storms in late pregnant sows with septicemic death in sucklers may be the first indication of the disease in specific-pathogen-free herds.

Spread of the infection can also occur to most other species. The organism has been recovered from sylvatic mammals in north-western Canada.<sup>9</sup> It has been isolated from a horse affected with vegetative endocarditis.<sup>10</sup> It has, at times, been found in fish meal but this is now used much less often in pig diets. It is possible that other species, such as cattle,<sup>11</sup> may harbor strains that are pathogenic for swine.

### Risk factors

There is considerable variation in the ease with which the disease can be reproduced, and in its severity. Many factors such as age, health and intercurrent disease, exposure to erysipelas and heredity govern the ease of both natural and artificial transmission. Although those factors that come under the description of stress may predispose to the condition, virulence of the strain is probably the most important factor. Smooth strains can be used successfully to produce the disease experimentally but rough strains appear to be nonpathogenic. This variation in virulence between strains of the organism has been utilized in the production of living, avirulent vaccines.

### Animal risk factors

Pigs of all ages are susceptible, although adult pigs are most likely to be affected if the local strain is of relatively low virulence. Recently farrowed sows seem to be particularly susceptible. This suggests that

fatigue may be a factor. Sudden diet changes have also predisposed, as have heat and cold stress. When the strain is virulent, pigs of all ages, even sucklers a few weeks old, develop the disease. Almost entire litters under 2 weeks of age may be affected.<sup>12</sup> Piglets from an immune sow may get sufficient antibodies in the colostrum to give them immunity for some weeks. It is likely that the animals are immune to the strains that are normally found in their particular environment. It is possible that it is the arrival of new serotypes through new pig arrivals or the turning over of previously contaminated land together with an increase in stress that are the main factors. It is thought that between 20–50% of pigs may carry the organism in the tonsil by slaughter. It is known that *E. rhusiopathiae* from bovine tonsils is pathogenic for mice and pigs and possibly pathogenic for other animals and humans.<sup>13</sup>

### Pathogen risk factors

At least 32 serotypes are known to exist<sup>5</sup> and many strains,<sup>14</sup> however, 15 probably commonly affect pigs.<sup>15</sup> Serotypes 1 and 2 are the most common types isolated from swine affected with clinical erysipelas and are generally believed to be the only serotypes that cause the acute disease. The other serotypes are relatively uncommon and none of them has yet been a cause of acute epidemics, but some have been isolated from lesions of chronic erysipelas. Serotypes 1a, 3, 5, 6, 8, 11, 21, and type N have been isolated from pigs with chronic erysipelas, mainly arthritis and lymphadenitis.<sup>16</sup> In the USA, 19 of the 22 serotypes have been found and the most frequent are serotypes 1, 2, 5, 6, and 21.<sup>17</sup>

Not all serotypes isolated from pigs are virulent. In a survey in Japan, the organism was found in 10% of the tonsils of healthy slaughter pigs: 54% were serotype 7, 32% serotype 2, 9.5% serotype 6 and 1.6% each of serotypes 11, 12, and 16.<sup>5</sup> All serotype 2 isolates were highly virulent for pigs while the other serotypes were only weakly virulent. Members of the other nonvirulent or weakly virulent group, mainly serotype 7 strains, are considered to be resident in porcine tonsils. Serotypes 1 (subtypes 1a and 1b), 2, 5, 6, and 4 have been found in Puerto Rico.<sup>13</sup> Serotypes 1a or 2 were found most commonly in pigs in Australia, less commonly in sheep and infrequently in other animals.<sup>18</sup> Serotypes 1a and 1b accounted for 79% of the isolates from diseased pigs.<sup>18</sup> A cluster of avirulent strains of serotype 7 from the tonsils of pigs has been identified as *E. tonsillarum*.<sup>19</sup> The genetic diversity of Australian field isolates of *E. rhusiopathiae* and *E. tonsillarum* indicates widespread diversity. Those recovered from sheep or

birds were more diverse than those isolated from pigs, and isolates of serovar 1 were more diverse than those of serovar 2. The diversity indicated that serotyping of *E. rhusiopathiae* is unreliable as an epidemiological tool.<sup>20</sup>

The relatedness of the isolates tested by DNA fingerprinting suggests that *E. tonsillarum* contains the former serotypes 3, 7, 10, 14, 20, 22, and 23, with serotypes 13 and 18 intermediate between this species and *E. rhusiopathiae*. *E. rhusiopathiae* represents serotypes 1, 2, 4, 5, 6, 8, 9, 11, 12, 15, 16, 17, 19, 21, and N. Some serotypes shown to be *E. tonsillarum* on serological grounds have been found to be *E. rhusiopathiae* on enzyme analysis. The serotype antigens of *E. rhusiopathiae* (*insidiosa*) are immunologically distinct, and commercial bacterins prepared from the common serotypes will not provide protection against other pathogenic serotypes. This may be an explanation for the epidemics that may occur in vaccinated pigs. The 64–66 kDa protein appears to be most immunogenic.<sup>21</sup> Also, a variety of serotypes may be recovered from pigs affected with the septicemic and arthritic forms of the disease.

The organism is resistant to most environmental influences, and to heat (15 min at 60°C) and can survive in animal tissues at 40°C and frozen tissues and is not readily destroyed by chemical disinfection, including 0.2% phenol and by drying agents.

### Zoonotic implications

Because of humans' susceptibility, swine erysipelas has some public health significance.<sup>22</sup> Veterinarians in particular are exposed to infection when vaccinating with virulent culture. It commonly contaminates pig products<sup>23</sup> and therefore is quite a common infection in abattoir workers or butchers, or those employed in similar trades. It usually produces a swollen finger and is known as erysipeloid. In this context, there have been recent advances in slide agglutination and latex agglutination tests for rapid diagnosis,<sup>24</sup> which have good correlation with each other and subsequent culture. Now a PCR identifying four species has been described, principally for use in the abattoir.<sup>25</sup> Recently, a case of endocarditis and presumptive osteomyelitis has been described, so care is needed.<sup>26</sup>

### PATHOGENESIS

The invasion of the susceptible pig by *E. rhusiopathiae* can occur under particular circumstances, i.e. if weather conditions are hot and humid or in particular fields or buildings. Experimentally, it is often easier to infect the pig through scarified wounds than through intravenous infusions.

No specific virulence factors have been found but there is the presence in the pathogenic serotypes of an ability to pro-

duce a capsule that resists phagocytosis.<sup>27</sup> Some others may produce a neuraminidase, which may cleave the mucopolysaccharides in cell walls and cause vascular damage leading to hemorrhage and thrombosis. Invasion of the bloodstream occurs in all infected animals in the first instance. Septicemia results within 1–7 days. The subsequent development of either an acute septicemia or a bacteremia with localization in organs and joints is dependent on undetermined factors. Virulence of the particular strain may be important and this may depend upon the number of recent pig passages experienced. Coagulase activity is a possible virulence factor.<sup>28</sup> Concurrent viral infection, especially hog cholera, may increase susceptibility of the host.

Localization in the chronic form is commonly in the skin and joints, and on other heart valves, with probable subsequent bacteremic episodes, and it may start from as early as 4 days after initial infection, although the cartilage lesions may be delayed until about 8 months and they can then continue to progress for at least 2 years. Selective adherence of some strains of *E. rhusiopathiae* (*insidiosa*) to heart valves may be a factor in the pathogenesis of endocarditis.<sup>29</sup> In joints, the initial lesion is an increase in synovial fluid and hyperemia of the synovial membrane, followed in several weeks by the proliferation of synovial villi (really a synovitis), thickening of the joint capsule and enlargement of the local lymph nodes. Diskospondylitis also occurs in association with chronic polyarthritis due to erysipelas.<sup>30</sup> Amyloidosis may occur in pigs with chronic erysipelas polyarthritis.<sup>31</sup> The heart lesions may begin with early inflammatory changes associated with emboli.

There has been some controversy over whether the arthrodial lesions result from primary infection or whether they result from hypersensitivity to the *Erysipelothrix* or other antigen. Current opinion suggests that the former is the case but that the lesions are enhanced by immunological mechanisms to persistent antigen at the site. There are increased levels of immunoglobulins IgG and IgM in the synovial fluids of pigs with polyarthritis due to *E. rhusiopathiae* (*insidiosa*)<sup>32</sup> and the levels are considered only partly due to serum and increased permeability.

Experimentally the disease can be produced by oral dosing, by intradermal, intravenous, and intra-articular injection, and by application to scarified skin, conjunctiva, and nasal mucosa. The arthritic form of the disease can be reproduced by multiple intravenous inoculations of *E. rhusiopathiae*.<sup>1</sup>

The microscopic lesions include vasculitis in capillaries and venules in many

sites, including glomeruli, pulmonary capillaries, and the skin. Sometimes, it is possible to see emboli of bacteria without specific stains to demonstrate bacteria.

### CLINICAL FINDINGS

#### Hyperacute form

Quite often the disease is seen for the first time in pigs approaching market weight.

The animal is found dead or is dull, depressed and with a temperature of 42°C (106–109°F), usually in finishing pigs – it is uncommon in sows.

#### Acute form

After an incubation period of 1–7 days there is a sudden onset of high fever (up to 42°C (108°F)), which is followed some time later by severe prostration, complete anorexia, thirst and occasional vomiting. Initially, affected pigs may be quite active and continue to eat even though their temperatures are high. However, generally in an outbreak one is initially presented with one or two dead or severely affected pigs showing marked red to purple discoloration of the skin of the jawl and ventral surface (may even be whole-body cyanosis), with others in the group showing high fever, reluctance to rise and some incoordination while walking. Dyspnea is a common feature. A conjunctivitis with ocular discharge may be present. Acute nonfatal erysipelas in sows was described recently in the USA.<sup>33</sup> In this outbreak the sows were pyrexial, lethargic, lame, and had multiple erythematous plaques.

Skin lesions are almost pathognomonic but may not always be apparent. These may take the form of the classical diamond-shaped, red, urticarial plaques about 2.5–5 cm square or a more diffuse edematous eruption with the same appearance. In the early stages the lesions are often palpable before they are visible. The lesions are most common on the belly, inside the thighs and on the throat, neck, and ears, and usually appear about 24 hours after the initial signs of illness. Sometimes they can be felt rather than seen. After a course of 2–4 days the pig recovers or dies, with diarrhea, dyspnea, and cyanosis evident terminally. The mortality rate may reach 75% but wide variation occurs. Pregnant animals may abort and it is thought that this is due to the fever but it may be that there is a direct fetal action, as congenital infections and isolations of the organism from the fetus have occurred.

The so-called 'skin' form is usually the acute form with more prominent skin localization but less severe signs of septicemia and with a low mortality. The skin lesions disappear in about 10 days without residual effects. In the more serious cases the plaques spread and coalesce, often over the back, to form a

continuous, deep purple area extending over a greater part of the skin surface. The affected skin becomes black and hard, and the edges curl up and separate from an underlying, raw surface. The dry skin may hang on for a considerable time and rattle while the pig walks, or it may slough off.

### Chronic form

Signs are vague and indistinct except for the joint lesions characteristic of this form of the disease. There may be alopecia, sloughing of the tail and tips of the ears, and a dermatitis in the form of hyperkeratosis of the skin of the back, shoulders, and legs; growth may be retarded. Joint lesions are commonest in the elbow, hip, hock, stifle, and knee joints and cause lameness and stiffness. The joints are obviously enlarged and are usually hot and painful at first but in 2–3 weeks are quite firm and without heat. This is especially the case when the arthritis has been present for some time, allowing healing and ankylosis to develop. Paraplegia may occur when intervertebral joints are involved or when there is gross distortion of limb joints.

A subclinical form of synovitis may occur which affects feed intake and results in a reduced rate of growth.<sup>1</sup>

Endocarditis also occurs as a chronic form of the disease with or without arthritis. Suggestive clinical signs are often absent, the animals dying suddenly without previous illness, especially at times of exertion such as mating, or movement between pens. In others there is progressive emaciation and inability to perform exercise. With forced exercise dyspnea, cyanosis and even sudden death may occur. The cardiac impulse is usually markedly increased, the heart rate is faster, and a loud murmur is audible on auscultation if the valves are badly damaged.

In Switzerland, they suspect<sup>34</sup> chronic swine erysipelas in herds where there is vegetative endocarditis, arthritis and the culture of *E. rhusiopathiae* from vulval discharges. These signs are also accompanied by poor fertility and increased prevalence of abortions, stillbirths and small litter size. The same authors describe the use of vaccine to control an outbreak of purulent periparturient vulval discharge<sup>34</sup> in which *E. rhusiopathiae* was the only organism isolated. In one of their studies anterior vaginal samples from 64 sows all yielded *E. rhusiopathiae*.<sup>35</sup>

### CLINICAL FINDINGS

#### Detection of organism

In the acute form, examination of blood smears may reveal the presence of the bacteria, particularly in the leukocytes, but blood culture is likely to be more successful as a method of diagnosis. Repeated examinations in the chronic forms of the disease may by chance give a positive result during

a bacteremic phase. final identification of the organism necessitates mouse or pigeon inoculation tests, and protection tests in these animals using anti-erysipelas serum.

### Hematology

In the early stages of the acute form there is first a leukocytosis followed by a leukopenia and a monocytosis. The leukopenia is of moderate degree (40% reduction in total leukocyte count at most) compared with that occurring in hog cholera. The monocytosis is quite marked, varying from a fivefold to a tenfold increase (2.5–4.5% normal levels rise to 25%).

### Serology

The efficiency of agglutination tests for *E. rhusiopathiae* (*insidiososa*) is not clear. They appear to be satisfactory for herd diagnosis but not sufficiently accurate for identification of individual affected pigs, particularly clinically normal carrier animals. A more accurate complement fixation test is available but an enzyme immunoassay test is much quicker, easier and more economical to perform.<sup>36</sup> An ELISA test has been used to measure the serological response of experimentally induced erysipelas arthritis in pigs<sup>1</sup> and 65 kDa antigen from the organism is being evaluated as an antigen agent.<sup>37</sup> Complement fixation tests may be more reliable.

### NECROPSY FINDINGS

#### Acute form

In the hyperacute cases all that may be seen is a congested carcass with discoloration of the skin. The degree of skin discoloration may provide a clue to prognosis, in that it is said that if the skin lesions are pink to light purple then resolution will often occur within 4–7 days but the dark angry black/purple lesions have a grave prognosis.

Classic 'diamond skin' lesions may be present. However, the diffuse, purplish discoloration of the belly and cyanosis of the extremities common to other septicemic diseases of pigs is a more reliable finding. Internally, petechial and ecchymotic hemorrhage occurs, mainly on the pleura and peritoneum and beneath the renal capsule but also on the heart, liver, and spleen. Venous infarction of the stomach is accompanied by swollen, hemorrhagic mesenteric lymph nodes and there is congestion of the lungs and liver. Infarcts may be present in the spleen and kidney and the former much enlarged. Histological changes in all tissues are those of toxemia and thrombosis. Large numbers of intravascular organisms are often visible. There are no specific histological changes.

#### Chronic form

A nonsuppurative proliferative arthritis involving limb and intervertebral joints is

characteristic. A synovitis, with a serous or serofibrinous amber-colored intra-articular effusion occurs first and degenerative changes in the subendochondral bone, cartilage and ligaments follow. When the synovial changes predominate, the joint capsule and villi are thickened. There are enlarged, dark red pedunculations or patches of vascular granulation tissue, which spread as a pannus on to the articular surface. When bony changes predominate, the articular cartilage is detached from the underlying bone, causing abnormal mobility of the joint. Ulceration of the articular cartilage may also be present. Local lymph node enlargement is usual. With time, the joint lesions often repair by fibrosis and ankylosis sufficiently to permit use of the limb.

Endocardial lesions, when present, are large, friable vegetations on the valves, often of sufficient size to block the valvular orifice. Occasionally, endocarditis may be the only lesion seen but this is a rare occurrence. Erysipelas is often said to rank below *S. suis* as a cause of endocarditis in growing pigs but *E. rhusiopathiae* (*insidiososa*) was the most frequent isolate from cases of endocarditis seen in slaughtered pigs.<sup>31</sup> Infarcts occur in the kidney and these may also yield pure cultures of the organism. Chronic joint lesions are often sterile but bacteriological culture should nevertheless be attempted. The probability of positive isolation increases with the number of joints sampled, and isolations are more frequent from the smaller, distal joints.

Enrichment techniques and the use of selective media will also increase the frequency of isolation of *E. rhusiopathiae* (*insidiososa*).<sup>1,38</sup>

#### Samples for confirmation of diagnosis

From acute cases includes:

- Bacteriology – culture swabs from joints; synovial membranes in culture media, heart valve masses, spleen, kidney, and bone marrow, particularly from a long bone. Smears of heart blood are particularly useful in the first 1–2 days of the acute diseases. The organism is a slender, facultatively anaerobic, Gram-positive rod that produces a 1 mm gray colony after 24 hours incubation on blood agar. It may be observed singly, in short chains or as a palisade. Different morphological types (rough and smooth colonies) exist and the rough are considered less virulent. Bacteriological examination of subacute cases is less successful and chronic cases not successful. Florescent techniques have been developed to show antigen in joints.

New PCR techniques have also been used<sup>39</sup>

- Histology – formalin-fixed synovial membranes, heart valve masses, spleen, kidney, skin lesions (LM).

Note: the zoonotic potential of this organism when handling carcass and submitting specimens.

### DIAGNOSIS

Clinical signs, isolation of the agent from multiple sites including blood in the acute stages; but diagnosis from joints in chronic stages is more difficult.

### DIFFERENTIAL DIAGNOSIS

Erysipelas in pigs is not ordinarily difficult to diagnose because of the characteristic clinical and necropsy findings. In the occasional situation where anthrax may have occurred in the past it is worth testing a smear of edema fluid taken by a needle from the jowl or ear region for this pathogen. The acute disease may be confused with the other septicemias affecting pigs, but pigs with erysipelas usually show the characteristic skin lesions and are less depressed than pigs with hog cholera or salmonellosis.

#### Other septicemias of pigs

- **Septicemic salmonellosis** is characterized by gross blue-purple discoloration of the skin, especially the ears, some evidence of enteritis, and polypnea and dyspnea
- **Hog cholera** is characterized by large numbers of pigs affected quickly, weakness, fever, muscle tremors, skin discoloration and rapid death; convulsions are also common
- **Streptococcal septicemia** and arthritis are almost entirely confined to suckling pigs in the first few weeks of life as is septicemia associated with *Actinobacillus suis*
- **Streptococcal endocarditis** has a similar age distribution to erysipelas endocarditis and bacteriological examination is necessary to differentiate them.

#### Other arthritides of pigs

The chronic disease characterized by joint disease occurs in pigs of all ages but less commonly in adults and must be differentiated from the following conditions:

- **Glasser's disease** in pigs is accompanied by a severe painful dyspnea. At necropsy there is serositis and meningitis
- **Mycoplasma arthritis** generally affects pigs less than 10 weeks of age and produces a polyserositis as well as polyarthritis. However, *Mycoplasma hyosynoviae* can produce simple polyarthritis in growing pigs. In general the periarticular, synovial, and cartilaginous changes are less severe in these infections when compared to erysipelas; however, cultural differentiation is frequently necessary

- **Ricketts** and **chronic zinc poisoning** produce lameness in pigs but they occur under special circumstances, are not associated with fever, and ricketts is accompanied by abnormalities of posture and gait that are not seen in erysipelas
- **Foot rot of pigs** is easily differentiated by the swelling of the hoof and the development of discharging sinuses at the coronet
- **Leg weakness.** In recent years there has been a marked increase in chronic osteoarthritis and various forms of 'leg weakness' in growing swine, probably related to the increased growth rate resulting from modern feeding and management practices.

### TREATMENT

#### Antimicrobial therapy

Penicillin and anti-erysipelas serum comprise the standard treatment, often administered together by dissolving the penicillin in the serum. Penicillin alone is usually adequate when the strain has only mild virulence. Standard dose rates give a good response in the field but experimental studies suggest that 50 000 IU/kg BW of procaine penicillin intramuscularly for 3 days are required for complete chemotherapeutic effect. Most animals are significantly improved within 2 days. Oxytetracycline is also useful.<sup>40</sup> Chronic cases do not respond well to either treatment because of the structural damage that occurs to the joints and the inaccessibility of the organism in the endocardial lesions. Most strains are resistant to apramycin, neomycin, streptomycin, and spectinomycin and also sulfonamides and polymyxins.

#### CONTROL

Successful control depends on good hygiene, biosecurity (other pigs and other species), reduction of stress, an effective 6-monthly vaccination policy, preferably two doses, for all animals including boars over 3 months of age, as well as rapid diagnosis, quarantine, and treatment.

#### Eradication

Eradication is virtually impossible because of the ubiquitous nature of the organism and its resistance to adverse environmental conditions. Complete removal of all pigs and leaving the pens unstocked is seldom satisfactory. Eradication by slaughter of reactors to the agglutination test is not recommended because of the uncertain status of the test.

General hygienic precautions should be adopted. Clinically affected animals should be disposed of quickly and all introductions should be isolated and examined for signs of arthritis and endocarditis. This procedure will not prevent the introduction of clinically normal carrier animals. All

animals dying of the disease should be properly incinerated to avoid contamination of the environment. Although thorough cleaning of the premises and the use of very strong disinfectant solutions is advisable, these measures are unlikely to be completely effective. The organism is susceptible to all the usual disinfectants, particularly caustic soda and hypochlorites. Whenever practicable, contaminated feedlots or paddocks should be cultivated.

Specific-pathogen-free piggeries established on virgin soil may remain clinically free of erysipelas for several years. However, because of the high risk of introduction of the organism, it is advisable to vaccinate routinely.

### Immunization

Because of the difficulty of eradication, biological prophylactic methods are in common use. Immunizing agents available include hyperimmune serum and vaccines.

#### Anti-erysipelas serum

The parenteral administration of 5–20 mL of serum, the amount depending on age, will protect in-contact pigs for a minimum of 1–2 weeks, possibly up to 6 weeks, during an outbreak. Suckling pigs in herds where the disease is endemic should receive 10 mL during the first week of life and at monthly intervals until they are actively vaccinated, which can be done as early as 6 weeks provided the sows have not been vaccinated. Repeated administration of the serum may cause anaphylaxis because of its equine origin. For this reason, it has been withdrawn from sale in many countries.

#### Vaccination

There is no fully satisfactory vaccine available for erysipelas because of the strain variation<sup>41</sup> and short duration of immunity but the vaccines have reduced the occurrence of clinical disease.<sup>42</sup> Regular administration at 6-monthly intervals overcomes this to some extent but there is always the possibility of a new strain appearing. Vaccines containing serotypes 2 and 10 protect against both *Erysipelothrix* species.<sup>43</sup> Serum-simultaneous vaccination has been largely replaced by the use of bacterins, for which lysate and absorbate preparations are available, or by the use of attenuated or avirulent live-culture vaccines, which are administered orally or by injection. The use of live-culture vaccines is prohibited in many countries because of the risk of variation in virulence of the strains used and the possibility of spreading infection.

None of these vaccines gives lifelong protection from a single vaccination, and the actual duration of protection achieved following vaccination varies considerably. You should not assume that protection lasts longer than 6 months. The recent

identification of the region responsible for protective immunity<sup>44</sup> should improve these vaccines in future. Most of the commercially available vaccines are formalin-treated whole cultures with an adjuvant.

There is considerable difficulty in the experimental evaluation of the efficacy of erysipelas vaccines. Strain differences in immunogenicity and variation in host response to vaccination due to innate and acquired factors influence this evaluation, as does variation in virulence of the challenge strain and the method of challenge. A recent experiment has shown that an antigen of serotype 1a will elicit a protective response to a challenge with serotypes 1a and 2b.<sup>45,46</sup> Similar factors are involved in the variations seen in field response to the use of these vaccines. Cross-protection of mice and pigs given a live-organism vaccine against 10 serovars of *E. rhusiopathiae* (*insidiosus*) has been demonstrated.<sup>47</sup> The use of culture filtrate from a broth culture of an attenuated strain of the organism has been evaluated to produce cross-protective antibody.<sup>48</sup>

Vaccination will reduce the incidence of polyarthritis due to erysipelas, but not mild cases of arthritis. Passively acquired maternal immunity may significantly affect the immune response to vaccination in the young piglet. Also, the immunity engendered by standard vaccines is not uniformly effective against all strains. Under certain conditions, some unusual serotypes have the potential for causing disease in animals vaccinated with vaccines containing the common serotypes. This possibility cannot be ignored and must be considered when vaccination failures occur. Nevertheless, these vaccines are valuable immunizing agents in field situations.

#### Vaccination program

Following a single vaccination at 6–10 weeks of age, significant protection is provided to market age. However, a second 'booster' vaccination given 2–4 weeks later is advisable. In herds where sows are routinely vaccinated prior to farrowing, a persisting maternal passive immunity may require that piglet vaccination be delayed until 10–12 weeks of age for effective active immunity.

Replacement gilts and adults should also be vaccinated. Bacterins are effective, and field evidence suggests that vaccination provides immunity for approximately 6 months. Sows should be vaccinated twice yearly, preferably 3–6 weeks before farrowing, as this will also provide significant protection against the septicemic form in young sucklers. If possible, a closed herd should be maintained. Abortion may occur sporadically following the use of live vaccines.<sup>49</sup>

Vaccination is subcutaneous in the skin behind the ear, or the axilla and the flank. Reactions at the site of injection are not uncommon. Swelling with subsequent nodule formation and occasional abscessation may occur following the injection of bacterins, and modified live vaccines may produce hemorrhage in the skin at the injection site. Granulomatous lesions may occur following the use of oil-based vaccines. There is little evidence that vaccination increases the incidence of arthritis. It has been suggested by a very limited study<sup>50</sup> that maternal antibody does not appear to interfere with the vaccination. These vaccines were also used in pigs with PRRS and found to be safe and effective.<sup>51</sup> In those cases where the vaccine has not worked it may be that the correct serotype was not in the vaccine or the administration and storage instructions were not followed.<sup>52</sup>

#### REVIEW LITERATURE

- Wood RL. Swine erysipelas – a review of prevalence and research. *J Am Vet Med Assoc* 1984; 184:944–949.
- Dial GD, MacLachlan NJ. Urogenital infections of swine. Part 1. Clinical manifestations and pathogenesis. *Compend Contin Educ Pract Vet* 1988; 10:63.

#### REFERENCES

- Eamens GJ, Nicholls PJ. *Aust Vet J* 1989; 66:212.
- Shimoji Y. *Microbes Infect* 2000; 2:965.
- Thomson JU. In: Proceedings of the George A. Young Swine Conference, 1990:83.
- Yamamoto K et al. *Res Vet Sci* 1999; 67:301.
- Takahashi T et al. *J Clin Microbiol* 1987; 25:536.
- Fidalgo SG, Riley TV. *Meth Mol Biol* 2004; 268:199.
- Rafiee M et al. In: Proceedings of the 16th International Pig Veterinary Society Congress, 2000:783.
- Norrung V et al. *Acta Vet Scand* 1987; 28:9.
- Langford EV, Dorward WJ. *Can Vet J* 1977; 18:101.
- McCormick BS et al. *Aust Vet J* 1985; 62:392.
- Sawada T et al. In: Proceedings of the 17th International Pig Veterinary Society Congress, 2002, vol 2:47.
- Bastianello SS, Spencer BT. *J S Afr Vet Assoc* 1984; 55:195.
- Hassanen R et al. *Vet Microbiol* 2003; 91:231.
- Imada Y et al. *J Clin Microbiol* 2004; 42:2121.
- Ahrne S et al. *Int J Syst Bacteriol* 1995; 45:382.
- Takahashi T et al. *Jpn J Vet Sci* 1985; 47:1.
- Wood RL et al. *Am J Vet Res* 1981; 42:1248.
- Eamens GJ et al. *Aust Vet J* 1988; 65:249.
- Takahashi T et al. *Res Vet Sci* 1989; 47:275.
- Chooromoney KN et al. *J Clin Microbiol* 1994; 32:371.
- Timoney JF, Groschup MM. *Vet Microbiol* 1993; 37:381.
- Brooke CJ, Riley TV. *J Med Microbiol* 1999; 48:789.
- Molen G et al. *J Appl Bacteriol* 1989; 67:347.
- Kushima S et al. *Jpn J Vet Med Assoc* 2002; 55:35.
- Takeshi K et al. *J Clin Microbiol* 1999; 37:4093.
- Romney M et al. *Can J Infect Dis* 2001; 12:254.
- Yamazaki Y et al. *Zentralbl Veterinärmed B* 1999; 46:47.
- Tesh MJ, Wood RL. *J Clin Microbiol* 1988; 26:1058.
- Bratberg AM. *Acta Vet Scand* 1981; 22:39.
- Doige CE. *Can J Comp Med* 1980; 44:121.
- Pedersen KB et al. *Acta Pathol Microbiol Immunol Scand* 1984; 92:237.

- Timoney JF, Yarkoni U. *Vet Microbiol* 1976; 1:467.
- Amass SF, Scholz DA. *J Am Vet Med Assoc* 1998; 212:708.
- Gertenbach W, Bilkei G. *Swine Health Prod* 2002; 10:205.
- Hoffmann CW, Bilkei G. *Reprod Domest Anim* 2002; 37:119.
- Kirchoff H et al. *Vet Microbiol* 1985; 10:549.
- Chin JC et al. *Vet Microbiol* 1992; 31:169.
- Blackall PJ, Summers PM. *Queens J Agric Anim Sci* 1978; 35:1.
- Makino SI et al. *J Clin Microbiol* 1994; 32:1526.
- Fitzsimmons M. *Proc Annu Minn Swine Conf* 1990:1990.
- Opiennnig T et al. *J Vet Diagn Invest* 2004; 2004:101.
- Haesebrouck F et al. *Vet Microbiol* 2004; 100:255.
- Enoe C, Norrung V. In: Proceedings of the 12th International Pig Veterinary Society Congress, 1992:345.
- Shimoji Y et al. *Infect Immun* 1999; 67:1646.
- Imada Y et al. *Infect Immun* 1999; 67:4376.
- Yamazaki Y et al. *J Vet Med Series B* 1999; 46:47.
- Sawada T, Takahashi T. *Am J Vet Res* 1987; 48:81.
- Sawada T, Takahashi T. *Am J Vet Res* 1987; 48:239.
- Henry S. *J Am Vet Med Assoc* 1979; 45:453.
- Kitajima T et al. *J Vet Med Sci* 1998; 60:9.
- Sakano T et al. *J Vet Med Sci* 1997; 59:977.
- Riising H-J et al. In: Proceedings of the 13th International Pig Veterinary Society Congress, 1994:228.

## Diseases associated with *Bacillus* species

### ANTHRAX

#### **Etiology** *Bacillus anthracis*

**Epidemiology** Global occurrence and often occurs as outbreaks. Spores survive in soil for many years and disease is enzootic in certain areas. Pastoral outbreaks associated with periods of climatic extremes. Outbreaks also associated with infected feedstuffs

**Clinical findings** Ruminants and horses – peracute disease characterized by fever, septicemia and sudden death. This may be accompanied by subcutaneous edematous swellings in horses. More prolonged disease with cellulitis of the neck and throat occurs in swine

**Clinical pathology** Because of risk, hematology and blood chemistry are not performed. Demonstration of organism in blood or subcutaneous fluid

**Necropsy findings** Carcass not opened if anthrax suspected; the diagnosis is made from the examination of aspirated carcass blood. Exudation of tarry blood from the body orifices of the cadaver, failure of the blood to clot, absence of rigor mortis and the presence of splenomegaly

**Diagnostic confirmation** Identification of organism in blood or tissues by polychrome methylene blue stain of smear or by monoclonal antibody-fluorescent conjugates. Culture, Ascoli test

**Treatment** Antibiotics, antiserum  
**Control** Prevention of further spread.  
Vaccination

## ETIOLOGY

*Bacillus anthracis* is the specific cause of the disease, and pathogenic strains have plasmid-encoded virulent factors: a poly-D-glutamic capsule, which aids in resistance to phagocytosis and is encoded by virulence plasmid pX02, and a tripartite toxin comprised of edema (factor I) lethal (factor II) and protective antigen (factor III) encoded by plasmid pX01.<sup>1,2</sup> Both plasmids are required for full virulence and avirulent strains occur.<sup>3</sup> There is little diversity among isolates of *B. anthracis* but genotyping can be used for epidemiological studies.<sup>4</sup> The organism forms spores that persist in the environment for decades.

## EPIDEMIOLOGY

### Occurrence

The disease probably originated in sub-Saharan Africa<sup>4,5</sup> and has spread to have a worldwide distribution, although the area prevalence varies with the soil, the climate and the efforts put into suppressing its occurrence. It is often restricted to particular areas, the so-called 'anthrax belts', where it is enzootic.

Currently, the characteristic epidemiology of anthrax in developed countries is the occurrence of multicentric foci of infection. Many sudden deaths occur without observed illness, in areas that have recently had appropriate climatic conditions and in which the disease has occurred as long ago as 30 years previously.

In **tropical and subtropical climates** with high annual rainfalls, the infection persists in the soil, so that frequent, serious outbreaks of anthrax are commonly encountered. In some African countries the disease occurs every summer and reaches a devastating occurrence rate in years with a heavy rainfall. Wild fauna – including hippos, cape buffalo, and elephants – die in large numbers. It is probable that predators act as inert carriers of the infection.<sup>5,6</sup>

In **temperate, cool climates** only sporadic outbreaks derive from the soil-borne infection. Accidental ingestion of contaminated bone meal or pasture contaminated by tannery effluent are more common sources. In this circumstance outbreaks are few and the number of animals affected is small. The development of an effective livestock vaccine coupled with the use of penicillin and the implementation of quarantine regulations has caused a marked decline in the occurrence of anthrax in most countries compared to its historical incidence.<sup>5</sup>

### Source of the infection

*B. anthracis* can infect animals directly from the soil or from fodder grown on infected soil, from contaminated bone meal or protein concentrates, or from infected excreta, blood, or other discharges from infected animals. The initial source is

often from old anthrax graves where the soil has been disturbed.<sup>5,7</sup>

Spread of the organism within an area may be accomplished by streams, insects, dogs, feral pigs, and other carnivores, and by fecal contamination from infected animals and birds. Avian scavengers such as gulls, vultures, and ravens can carry spores over considerable distances and the feces of carrion-eating birds can contaminate waterholes. Infected wildlife are also a source for domestic animals on common grazing land.<sup>5</sup>

Introduction of infection into a new area is usually through contaminated animal products such as bone meal, fertilizers, hides, hair and wool, or by contaminated concentrates or forage. In recent times as many as 50% of consignments of bone meal imported into the UK have been shown to be contaminated with the anthrax bacillus. Outbreaks in pigs can usually be traced to the ingestion of infected bone meal or carcasses. Water can be contaminated by the effluent from tanneries, from infected carcasses and by flooding and the deposition of anthrax-infected soil.

An outbreak of anthrax has been recorded following the injection of infected blood for the purpose of immunization against anaplasmosis. There have been a number of reports of the occurrence of anthrax after vaccination, probably as a result of inadequately attenuated spores. Wound infection occurs occasionally.

## Transmission of the infection

Infection gains entrance to the body by ingestion, inhalation, or through the skin. While the exact mode of infection is often in doubt, it is generally considered that most animals are infected by the ingestion of contaminated food or water. It is true that experimental transmission by this means has not always been successful. Injury to the mucous membrane of the digestive tract will facilitate infection but there is little doubt that infection can take place without such injury. The increased incidence of the disease on sparse pasture is probably due both to the ingestion of contaminated soil and to injury to the oral mucosa facilitating invasion by the organism.

Inhalation infection is thought to be of minor importance in animals, although the possibility of infection through contaminated dust must always be considered. 'Woolsorter's disease' in humans is due to the inhalation of anthrax spores by workers in the wool and hair industries, but even in these industries cutaneous anthrax is much more common.

**Biting flies**, mosquitoes, ticks, and other insects have often been found to harbor anthrax organisms and the ability of some to transmit the infection has been

demonstrated experimentally.<sup>5,8,9</sup> However, there is little evidence that they are important in the spread of naturally occurring disease, with the exception of tabanid flies.<sup>5</sup> The transmission is mechanical only<sup>8,9</sup> and a local inflammatory reaction is evident at the site of the bite. The tendency, in infected districts, for the heaviest incidence to occur in the late summer and autumn may be due to the increase in the fly population at that time but an effect of higher temperature on vegetative proliferation of *B. anthracis* in the soil is more likely.

## Risk factors

### Host risk factors

The disease occurs in all vertebrates but is most common in cattle and sheep and less frequent in goats and horses. Humans occupy an intermediate position between this group and the relatively resistant pigs, dogs, and cats. In farm animals, the disease is almost invariably fatal, except in pigs, and even in this species the case fatality rate is high.

Algerian sheep are said to be resistant and, within all species, certain individuals seem to possess sufficient immunity to resist natural exposure. Whether or not this immunity has a genetic basis has not been determined. The most interesting example of natural resistance is the dwarf pig, in which it is impossible to establish the disease. Spores remain in tissues ungerminated and there is complete clearance from all organs by 48 hours. The ability to prevent spore germination appears to be inherited in this species.

### Environment risk factors

Outbreaks originating from a soil-borne infection always occur after a major climate change, for example heavy rain after a prolonged drought, or dry summer months after prolonged rain, and always in warm weather when the environmental temperature is over 15°C (60°F). The hypothesis that these climatic conditions lead to sporulation and vegetative proliferation with the production of **incubator areas** for anthrax in the soil appears improbable, but spores have a high buoyant density and in wet soils could become concentrated and remain suspended in standing water with further concentration on the soil surface as the water evaporates.<sup>10</sup> This relationship to climate has made it possible to predict 'anthrax years'.

Other risk factors in the environment include close grazing of tough, scratchy feed in dry times, which results in abrasions of the oral mucosa, and confined grazing on heavily contaminated areas around water holes. Some genotypes appear to persist better in calcium-rich soils and organic soils and poorly drained soils have risk in endemic areas.<sup>1,5,7,11</sup>



### Pathogen risk factors

When material containing anthrax bacilli is exposed to the air, spores are formed that protract the infectivity of the environment for very long periods. The spores are resistant to most external influences including the salting of hides, normal environmental temperatures and standard disinfectants. Anthrax bacilli have remained viable in soil stored for 60 years in a rubber-stoppered bottle, and field observations indicate a similar duration of viability in exposed soil, particularly in the presence of organic matter, in an undrained alkaline soil and in a warm climate. Acid soils reduce the survival of *B. anthracis*.

### Economic importance

In most developed countries vaccination of susceptible animals in enzootic areas has reduced the prevalence of the disease to negligible proportions on a national basis, but heavy losses may still occur in individual herds. Loss occurs due to mortality but also from withholding of milk in infected dairy herds and for a period following vaccination.

### Zoonotic potential

Anthrax has been an important cause of fatal human illness in most parts of the world, but in developed countries it is no longer a significant cause of human or livestock wastage because of appropriate control measures. However, it still holds an important position because of its potential as a zoonosis and it is still an important zoonosis in developing countries. It is a major concern as an agent of bioterrorism and is listed as a category A agent by the US Centers for Disease Control and Prevention.<sup>12</sup>

An account of an outbreak in a piggery in the UK should be compulsory reading for veterinary students as an example of the responsibilities of veterinarians in a modern public-health-conscious and litigation-minded community.<sup>13,14</sup> In developing countries anthrax can still be a major cause of livestock losses and a serious cause of mortality amongst humans who eat meat from infected animals and develop the alimentary form of this disease, or who handle infected carcasses.<sup>15</sup>

Cutaneous anthrax has occurred in veterinarians following postmortem examination of anthrax carcasses. The areas at particular risk for infection are the forearm above the glove line and the neck. Infection begins as a pruritic papule or vesicle that enlarges and erodes in 1–2 days leaving a necrotic ulcer with subsequent formation of a central black eschar.

### PATHOGENESIS

Upon ingestion of the spores, infection may occur through the intact mucous membrane, through defects in the epithe-

lium around erupting teeth, or through scratches from tough, fibrous food materials. The organisms are resistant to phagocytosis, in part due to the presence of the poly-D-glutamic acid capsule, and proliferate in regional draining lymph nodes, subsequently passing via the lymphatic vessels into the bloodstream; septicemia, with massive invasion of all body tissues, follows. *B. anthracis* produces a lethal toxin that causes edema and tissue damage, death resulting from shock and acute renal failure and terminal anoxia.

In pigs, localization occurs in the lymph nodes of the throat after invasion through the upper part of the digestive tract. Local lesions usually eventually lead to a fatal septicemia.

### CLINICAL FINDINGS

The incubation period after field infection is not easy to determine but is probably 1–2 weeks.

### Cattle and sheep

Only two forms of the disease occur in these species, the peracute and the acute.

The **peracute** form of the disease is most common at the beginning of an outbreak. The animals are usually found dead without premonitory signs, the course being probably only 1–2 hours, but fever, muscle tremor, dyspnea, and congestion of the mucosae may be observed. The animal soon collapses, and dies after terminal convulsions. After death, discharges of blood from the nostrils, mouth, anus, and vulva are common.

The **acute** form runs a course of about 48 hours. Severe depression and listlessness are usually observed first, although they are sometimes preceded by a short period of excitement. The body temperature is high, up to 42°C (107°F), the respiration rapid and deep, the mucosae congested and hemorrhagic, and the heart rate much increased. No food is taken and ruminal stasis is evident. Pregnant cows may abort. In milking cows the yield is very much reduced and the milk may be bloodstained or deep yellow in color. Alimentary tract involvement is usual and is characterized by diarrhea and dysentery. Local edema of the tongue and edematous lesions in the region of the throat, sternum, perineum, and flanks may occur.

### Pigs

In pigs anthrax may be acute or subacute. There is fever, with dullness and anorexia, and a characteristic inflammatory edema of the throat and face. The swellings are hot but not painful and may cause obstruction to swallowing and respiration. Bloodstained froth may be present at the mouth when pharyngeal involvement occurs. Petechial hemorrhages are present in the skin, and when localization occurs

in the intestinal wall there is dysentery, often without edema of the throat. A pulmonary form of the disease has been observed in baby pigs that inhaled infected dust. Lobar pneumonia and exudative pleurisy were characteristic. Death usually occurs after a course of 12–36 hours, although individual cases may linger for several days.

### Horses

Anthrax in the horse is always acute but varies in its manifestations with the mode of infection. When infection is by ingestion there is septicemia with enteritis and colic. When infection is by insect transmission, hot, painful, edematous, subcutaneous swellings appear about the throat, lower neck, floor of the thorax and abdomen, prepuce, and mammary gland. There is high fever and severe depression and there may be dyspnea due to swelling of the throat or colic due to intestinal irritation. The course is usually 48–96 hours.

### CLINICAL PATHOLOGY

Hematology and blood chemistry examinations are not conducted because of the risk for human exposure. In the living animal the organism may be detected in a stained smear of peripheral blood. The **reference standard** for diagnosis is the detection, by microscopic examination, of a clearly defined metachromatic capsule on square-ended bacilli (often in chains) in a blood smear stained with aged polychrome methylene blue. The blood should be carefully collected in a syringe to avoid contamination of the environment. When local edema is evident smears may be made from aspirated edema fluid or from lymph nodes that drain that area. For a more certain diagnosis, especially in the early stages when bacilli may not be present in the bloodstream in great numbers, blood culture or the injection of syringe-collected blood into guinea-pigs is satisfactory.

Fluorescent antibody techniques are available for use on blood smears and tissue sections. Monoclonal antibodies are also used to provide specific identification of anthrax organisms.<sup>16</sup>

As the carcass decomposes and the vegetative forms of *B. anthracis* die, diagnosis by smear is more difficult and an immunochromatographic test for protective antigen has been developed that has high specificity and does not give positive results in recently vaccinated cattle.<sup>17</sup> In cases where antibiotic therapy has been used, the identification from blood smears or culture may be difficult and animal passage may be necessary. Isolation of anthrax bacilli from infected soil is difficult, but a real-time quantitative PCR with reported high sensitivity has been described.<sup>18</sup>

## NECROPSY FINDINGS

There is a striking absence of rigor mortis and the carcass undergoes gaseous decomposition, quickly assuming the characteristic 'sawhorse' posture. All natural orifices usually exude dark, tarry blood that does not clot. **If there is a good reason to suspect the existence of anthrax the carcass should not be opened.** If a necropsy is carried out, the failure of the blood to clot, widespread ecchymoses, bloodstained serous fluid in the body cavities, severe enteritis and splenomegaly are strong indications of the presence of anthrax. The enlarged spleen is soft, with a consistency likened to 'blackberry jam'. Subcutaneous swellings containing gelatinous material, and enlargement of the local lymph nodes are features of the disease in horses and pigs. Lesions are most frequently seen in the **soft tissues of the neck and pharynx** in these species.

To confirm the diagnosis on an **unopened carcass**, peripheral blood or local edema fluid should be collected by needle puncture. Since the blood clots poorly, jugular venipuncture may permit sample collection. Smears prepared from these fluids should be stained with polychrome methylene blue and examined (see Clinical pathology, above). These fluid samples can also be used for bacteriological culture if smear results are equivocal. The smears should be prepared and interpreted by an experienced and qualified microbiologist.

If decomposition of a carcass is advanced, a small quantity of blood may be collected from the fresh surface of an amputated tail or ear. A portion of spleen is the specimen of choice for bacteriological culture if the carcass has been opened. An immunofluorescence test is available but cross-reactivity with other *Bacillus* spp. makes its use impractical. An immunochromatographic test that has high specificity for protective antigen has been developed for use in decomposed carcasses.<sup>17</sup>

The Ascoli test can be used to demonstrate antigen in severely decayed tissue samples and a nested PCR technique has been used to demonstrate antigen in environmental samples;<sup>19</sup> PCR methods can also be used to confirm the identity of bacterial isolates. If other detection methods fail, experimental animal inoculation can be attempted. Immunohistochemical detection of the bacilli in skin biopsies of cutaneous anthrax in humans has been described.<sup>20</sup> This technique may be useful in retrospective analyses of suspect cases if suitable fresh tissue samples were not collected.

Anthrax is a **reportable disease** in many countries, requiring the involvement of government regulatory agencies when the disease is suspected or when the diag-

nosis is confirmed. Representatives of these agencies can often facilitate sample collection and transportation to an appropriate laboratory. **If anthrax is suspected, then shipping diagnostic samples via the mail or courier systems is strongly discouraged.** Instead, samples should be appropriately packed, labeled and transported directly to the laboratory by one of the staff members of the veterinary clinic. In some countries it may be illegal to send material such as anthrax through the mail system.

## Samples for confirmation of diagnosis

- Bacteriology – unopened carcass: blood or edema fluid in sealed, leakproof container; opened carcass: above samples plus spleen (local lymph nodes in horses, pigs) in sealed, leakproof containers (direct smear, CULT, bioassay)
- Histology – formalin-fixed spleen/local lymph nodes if carcass has been opened (LM).

Note the zoonotic potential of this organism when handling carcass and submitting specimens.

## DIFFERENTIAL DIAGNOSIS

There are many causes of sudden death in farm animals and differentiation is often difficult. Diseases where there can be multiple deaths suggestive of anthrax include:

- Lightning strike
- Peracute edema
- Malignant blackleg
- Bacillary hemoglobinuria
- Hypomagnesemic tetany

## TREATMENT

Severely ill animals are unlikely to recover but in the early stages, particularly when fever is detected before other signs are evident, recovery can be anticipated if the correct treatment is provided. Penicillin (20 000 IU/kg BW twice daily) has had considerable vogue, but streptomycin (8–10g/d in two doses intramuscularly for cattle) is much more effective. Oxytetracycline (5 mg/kg BW per day) parenterally has also proved superior to penicillin in the treatment of clinical cases after vaccination in cattle and sheep. Antiserum, if available, should also be administered for at least 5 days in doses of 100–250 mL daily but it is expensive.

In vitro studies show all isolates to be susceptible to ampicillin, streptomycin, erythromycin, tetracycline, methicillin, and netilmicin.<sup>21</sup> It is desirable to prolong treatment to at least 5 days to avoid a recrudescence of the disease.

## CONTROL

The control of meat- and milk-producing animals in infected herds in such a way as to avoid any risk to the human population is a special aspect of the control of anthrax. It is necessary at the same time to avoid unnecessary waste and the imposition of unnecessarily harsh prohibitions on the farmer. When an outbreak occurs, the placing of the farm in quarantine, the destruction of discharges and cadavers, and the vaccination of survivors, are part of the animal disease control program and indirectly reduce human exposure. Prohibition of movement of milk and meat from the farm during the quarantine period should prevent entry of the infection into the human food chain. Vaccination of animals, although the vaccine is a live one, does not present a hazard to humans, although there is a withholding period for meat and milk after its use.

**Disposal of infected material** is most important and hygiene is the biggest single factor in the prevention of spread of the disease. Infected carcasses should not be opened but immediately burned in situ or buried, together with bedding and soil contaminated by discharges. If this can not be done immediately, a liberal application of 5% formaldehyde on the carcass and its immediate surroundings will discourage scavengers. Burning is the preferred method of disposal. Approximately one cord of wood is required to effectively incinerate the carcass of a mature cow. Bags of charcoal briquettes have also been used.<sup>5</sup>

Burial should be at least 2 m deep with an ample supply of quicklime added. All suspected cases and in-contact animals must be segregated until cases cease and for 2 weeks thereafter the affected farm must be kept in quarantine to prevent the movement of livestock. The administration of hyperimmune serum to in-contact animals may prevent further losses during the quarantine period, but prophylactic administration of a single dose of long-acting tetracycline or penicillin is a much commoner tactic.

**Disinfection of premises**, hides, bone meal, fertilizer, wool, and hair requires special care. When disinfection can be carried out immediately, before spore formation can occur, ordinary disinfectants or heat (60°C (140°F) for a few minutes) are sufficient to kill vegetative forms. This is satisfactory when the necropsy room or abattoir floor is contaminated. When spore formation occurs (i.e. within a few hours of exposure to the air), disinfection is almost impossible by ordinary means. Strong disinfectants such as 5% Lysol require to be in contact with spores for at least 2 days. Strong solutions of formalin or sodium hydroxide (5–10%) are probably most effective. Peracetic acid (3% solution) is an

effective sporicide and, if applied to the soil in appropriate amounts (8 L/m<sup>2</sup>), is an effective sterilant. Infected clothing should be sterilized by soaking in 10% formaldehyde. Shoes may present a difficulty and sterilization is most efficiently achieved by placing them in a plastic bag and introducing ethylene oxide. Contaminated materials should be damp and left in contact with the gas for 18 hours. Hides, wool, and mohair are sterilized commercially by gamma-irradiation, usually from a radioactive cobalt source. Special care must be taken to avoid human contact with infected material and, if such contact does occur, the contaminated skin must be thoroughly disinfected. The source of the infection must be traced and steps taken to prevent further spread of the disease. Control of the disease in a feral animal population presents major problems.

### Immunization

Immunization of animals as a control measure is extensively used and many types of vaccine are available. Those vaccines that consist of living attenuated strains of the organism with low virulence but capable of forming spores have been most successful. The sporulation character has the advantage of keeping the living vaccine viable over long periods. These vaccines have the disadvantage that the various animal species show varying susceptibility to the vaccine, and anthrax may result in some cases from vaccination. This has been largely overcome by preparing vaccines of differing degrees of virulence for use in different species and in varying circumstances. Another method of overcoming the virulence is the use of saponin or saturated saline solution in the vehicle to delay absorption. This is the basis of the carbozoo vaccine.<sup>22</sup>

The **Stern avirulent spore vaccine** has overcome the risk of causing anthrax by vaccination and produces a strong immunity that lasts for at least 26 months in sheep and 1 year in cattle. It is the vaccine used in most countries. Although only one dose was originally thought to be necessary, with cases ceasing about 8 days after vaccination, it now appears that two vaccinations are necessary in some situations.<sup>7,23</sup>

A febrile reaction does occur after vaccination; the milk yield of dairy cows will be depressed and pregnant sows will probably abort. The injection of penicillin, and probably other antibiotics, at this time should be avoided as it may interfere with the development of immunity.

When the disease occurs for the first time in a previously clean area, all in-contact animals should either be treated with hyperimmune serum or be vaccinated. The measures used to control outbreaks and the choice of a vaccine depend largely on local legislation and experience. Ring vaccination has been used to contain outbreaks of the disease<sup>7,24</sup> and in enzootic areas annual revaccination of all stock is necessary. Surface contamination of a pasture (as opposed to deep soil contamination) can persist for 3 years and cattle grazing these pastures should be revaccinated annually for this period.<sup>5</sup> In endemic areas cattle are routinely vaccinated yearly.

Milk from vaccinated cows is usually discarded for 72 hours after the injection in case the organisms in the vaccine should be excreted in the milk. Ordinarily the organisms of the Stern vaccine do not appear in the milk nor can they be isolated from the blood for 10 and 7 days respectively after vaccination. Vaccinated animals are usually withheld from slaughter for 45 days.

Deaths due to anthrax have occurred in 3-month-old llamas after vaccination with a Stern vaccine<sup>25</sup> and may occur in goats. Older crias and adults were unaffected. It was assumed that the dose of vaccine was excessive for such young animals. In these species two vaccinations 1 month apart with the first dose one-quarter of the standard dose can be used.<sup>5</sup>

### REVIEW LITERATURE

Dragon DC, Rennie RP. The ecology of anthrax spores: Tough but not invincible. *Can Vet J* 1995; 36:295-301.

Hugh-Jones ME, de Vos V. Anthrax and wildlife. *Rev Sci Tech* 2002; 21:359-383.

### REFERENCES

- Moayeri M, Leppla SH. *Curr Opin Microbiol* 2004; 7:19.
- Bhatnagar R, Batta S. *Crit Rev Microbiol* 2001; 27:167.
- Radnedge L et al. *Appl Environ Microbiol* 2003; 69:2755.
- Smith KL et al. *J Clin Microbiol* 2000; 38:3780.
- Hugh-Jones ME, de Vos V. *Rev Sci Tech* 2002; 21:359.
- Turnbull PCB. *Vet Rec* 1991; 128:399.
- Turner AJ et al. *J Appl Microbiol* 1999; 87:294.
- Turell MJ, Knudson GB. *Infect Immunol* 1987; 55:1859.
- Braak LEO, De Vos V. *Onderstepoort J Vet Res* 1990; 57:141.
- Dragon DC, Rennie RP. *Can Vet J* 1995; 36:295.
- Parkinson R et al. *Can Vet J* 2003; 44:315.
- Davis RG. *J Am Vet Med Assoc* 2004; 224:1084.
- Edginton AB. *Vet Rec* 1990; 127:321.
- Williams DR et al. *Vet Rec* 1992; 131:363.
- Lamarque D et al. *Med Trop* 1989; 49:245.
- Ezzell JW et al. *J Clin Microbiol* 1990; 26:223.
- Muller JD et al. *Aust Vet J* 2004; 82:220.
- Ryu-ChunSun et al. *Microbiol Immunol* 2003; 47:693.
- Beyer W et al. *Microbiol Res* 1995; 150:179.
- Shieh WJ et al. *Am J Pathol* 2003; 163:1901.
- Odendaal MW et al. *Onderstepoort J Vet Res* 1991; 58:17.
- Shlyakhov E et al. *Rev Sci Tech* 1996; 15:853.
- Salmon DD, Ferrier GR. *Vet Rec* 1992; 130:140.
- Murray G. *Bull Off Int Epizoot* 1997; 109:143.
- Cartwright ME. *J Am Vet Med Assoc* 1987; 191:715.

## Diseases associated with bacteria – II

17

**DISEASES ASSOCIATED WITH  
CLOSTRIDIUM SPECIES 821**

- Tetanus 822
- Botulism 824
- Blackleg 828
- Malignant edema, clostridial myonecrosis (gas gangrene) 830
- Braxy (bradsot) 832
- Infectious necrotic hepatitis (black disease) 832

- Bacillary hemoglobinuria 834
- Tyzzler's disease 836
- Enteric disease associated with *Clostridium perfringens* 836
- Enterotoxemia associated with *Clostridium perfringens* type A 836
- Enterotoxemia associated with *Clostridium perfringens* types B, C, and E 838

- Enterotoxemia associated with *Clostridium perfringens* type D (pulpy kidney, overeating disease) 841
- Focal symmetrical encephalomalacia 844
- Enterocolitis associated with *Clostridium difficile* 844

**Diseases associated with  
Clostridium species**

The clostridia are of major importance in farm animals as primary causes of disease. They rarely act as secondary invaders except where gangrene is already present. They are all potent producers of exotoxins, upon which their pathogenicity depends. The **toxins** of the different organisms vary in their effects and in the manner in which they gain entry to the circulation; they may be:

- Ingested preformed in the feed, as in botulism
- Absorbed from the gut after abnormal proliferation of the causative organism in the alimentary tract, as in enterotoxemia
- Elaborated in a more proper infection of the tissues, such as blackleg.

Other clostridial infections develop as local infections with elaboration of toxins in minor lesions, as in tetanus, black disease, braxy and bacillary hemoglobinuria.

Pathogenic clostridia are commonly present in **soils rich in humus** and may multiply in soil in warm weather following heavy rain.<sup>1</sup> They are also found in the intestinal contents of normal animals and cause disease only in special circumstances. The ubiquitous character of these organisms makes eradication of the clostridial diseases virtually impossible and necessitates control by prophylactic measures. Fortunately, diseases of this group are virtually unique among bacterial diseases in that they can be effectively prevented in almost all instances by vaccination with killed culture vaccines.

Because of the common occurrence of a number of clostridial infections in an area, it has become a common practice in recent years to use **multivalent bacterin-toxoids** containing *Clostridium chauvoei*,

*Clostridium septicum*, *Clostridium novyi*, *Clostridium sordellii*, and *Clostridium perfringens* types C and D. The vaccines appear to be highly effective and, in situations where the extra expense can be justified, worthy of recommendation. In high-risk situations such as feedlots they appear to be cost-effective.<sup>2</sup> In the USA more than 60% of producers vaccinate calves before weaning for some form of clostridial disease, as do 91% of the larger feedlots.<sup>3</sup>

**Prepartum vaccination** of the dam, to provide colostral immunity to the young calf or lamb, and subsequent **active immunization** of the growing animal is recommended for most of the clostridial vaccines. However, because of management constraints, particularly in range beef cattle, clostridial vaccines are not always administered at the age and time recommended by the manufacturers. This may result in suboptimal protection. Clostridial vaccines are usually given to nursing beef calves at the time when they are first handled for castration and branding, at 1–4 months of age. With most clostridial vaccines a booster vaccination is recommended 2–6 weeks following the primary vaccination, but this may not be given until weaning in range cattle.

Clostridial vaccines administered intramuscularly can cause **injection site lesions** and severe damage to muscle that can persist for 7–12 months after vaccination;<sup>4</sup> in the USA approximately 10% of top sirloin cuts have lesions at slaughter.<sup>5</sup> These must be trimmed from the carcass at slaughter and, if not detected at that time can result in unfavorable experiences by beef consumers and a loss in confidence in the quality of beef products. Multivalent vaccines cause more damage and there is variation in the degree of damage with different vaccines.<sup>3</sup> The prevention of injection site lesions in muscle is a focus of **beef quality assur-**

**ance programs** in several countries, and subcutaneous administration of vaccines in the neck area is recommended. Subcutaneous administration will result in subcutaneous injection site lesions and the dichotomy is that cattle that develop injection site lesions have a better antibody response to the vaccine than non-lesioned cattle.<sup>6</sup>

There appears to be a difference between **sheep and goats** with respect to their response to clostridial infections. Goats in general suffer more severe forms of these diseases than do sheep, and the protection afforded to goats by multivalent vaccines is less than that afforded to sheep.

As well as the specific disease entities set out below there are some less well-known occurrences of pathogenic clostridia.

**Clostridium sordellii abomasitis**

*C. sordellii* appears to be an emerging pathogen for sheep in Great Britain and possibly Europe in association with a syndrome of **abomasitis and sudden death** in young lambs and adult sheep. Death is reported in 6 hours in sheep previously observed to be normal. Lambs between 3 and 10 weeks of age are particularly at risk and losses vary from sporadic to up to 8%.<sup>7</sup>

Commonly the lambs are from well-managed flocks and from good milking ewes. Many of the affected lambs have had ad libitum access to creep pellets from an early age, and this may be a risk factor.<sup>8</sup> The characteristic finding at necropsy is a severe abomasitis with areas of congestion and erosion on the abomasal folds, gastrorrhagia and **subserosal emphysema** and edema. Sudden death with abomasitis also occurs in weaned and adult sheep but subserosal emphysema and edema are not present. *C. sordellii* is also recorded as a cause of sudden death in periparturient sheep.<sup>9</sup> Carcasses show

rapid decomposition but the salient finding is metritis with a uterine wall that is greatly thickened and emphysematous.

*C. sordellii* has also been associated with fatal hepatitis in newborn lambs, enteritis with hemorrhagic diarrhea in calves and in mature cattle can be an agent in blackleg or malignant edema.

#### Sudden death syndrome

Clostridial infection has been considered a cause of a **sudden death syndrome in feedlot cattle**, which occurs following the acclimatization phase of feeding and presents as death without premonitory signs of illness or agonal struggling and with rapid autolysis of the carcass and no evidence, on postmortem examination, of the common diseases that cause rapid death in feedlot cattle. However, a large controlled trial found no effect on mortality rates from sudden death syndrome from booster vaccination of feedlot cattle with a multivalent bacterin-toxoid (*C. chauvoei*, *C. septicum*, *C. novyi*, *C. sordellii*, and *C. perfringens* types C and D).<sup>10</sup>

#### Enteritis associated with clostridia

The enteric diseases associated with *C. perfringens* and *Clostridium difficile* are described under those headings. *Clostridium tertium* has been isolated from the intestine of cattle with diarrhea and a mild enteritis has been reproduced by experimental challenge with this organism.<sup>11</sup> *C. sordellii* and *Clostridium cadaveris* have been isolated from cases of enterocolitis in horses.

#### REVIEW LITERATURE

Songer JG. Clostridial enteric diseases of domestic animals. Clin Microbiol Rev 1996; 9:216-234.

#### REFERENCES

- Davies RH, Wray C. J Vet Med 1996; 43:119.
- Knott KG et al. Vet Med 1985; 80:95.
- Rogers GM et al. Compend Contin Educ Food Anim Med Manage 1997; 19:S278.
- George MH et al. J Anim Sci 1995; 73:3235.
- George MH et al. J Anim Sci 1996; 74:2095.
- Troxel TR et al. J Anim Sci 2001; 79:2558.
- Lewis CJ, Naylor RD. Vet Rec 1998; 142:417.
- Lewis CJ, Naylor R. Vet Rec 1996; 138:262.
- Clark S. Vet Rec 2003; 153:340.
- DeGroot BD et al. J Am Vet Med Assoc 1997; 211:749.
- Silvera M et al. Vet Rec 2003; 153:60.
- Traub-Dargatz JL, Jones RL. Vet Clin North Am Equine Pract 1993; 9:411.

## TETANUS

### ETIOLOGY

An exotoxin, tetanospasmin, is produced by *Clostridium tetani* growing under anaerobic conditions. The organism forms spores that can persist in soil for many years. The spores are resistant to many standard disinfection procedures, including steam heat at 100°C (212°F) for 20 minutes but can be destroyed by heating at 115°C (239°F) for 20 minutes.

### Synopsis

**Etiology** Muscle spasm from action of the exotoxin tetanospasmin produced by the vegetative stage of *Clostridium tetani*  
**Epidemiology** All species susceptible. Usually a history of a wound or other tissue trauma. Occurs as isolated cases but also as outbreaks in young ruminants following castration and docking  
**Clinical findings** Generalized muscular rigidity and spasms, hyperesthesia, prolapse of third eyelid, trismus, convulsions, respiratory arrest, and death. High case fatality  
**Necropsy findings** None. May demonstrate the organism in necrotic tissue in some cases  
**Diagnostic confirmation** No definitive antemortem test or postmortem lesion. Diagnosis is based on characteristic clinical signs and wound history  
**Treatment** Neutralize residual toxin, control muscle spasms until the toxin is eliminated or destroyed, maintain hydration and nutrition, provide supportive treatment  
**Control** Antitoxin if recent injury but risk of serum hepatitis in horses. Vaccination

### EPIDEMIOLOGY

#### Occurrence

Tetanus occurs in all parts of the world and is most common in closely settled areas under intensive cultivation. It occurs in all farm animals, mainly as individual, sporadic cases, although outbreaks are occasionally observed in young cattle, young pigs, and lambs following wounding management procedures.

#### Case fatality rate

In young ruminants the case fatality rate is over 80%, but the recovery rate is high in adult cattle. In horses it varies widely between areas. In some areas almost all animals die acutely, in others the mortality rate is consistently about 50%.

#### Source of infection

*C. tetani* organisms are commonly present in the feces of animals, especially horses, and in the soil contaminated by these feces. Surveys in different areas of the world show it is present in 30-42% of soil samples.<sup>1</sup> The survival period of the organism in soil varies very widely from soil to soil.

#### Transmission

The **portal of entry** is usually through deep puncture wounds but the spores may lie dormant in the tissues for some time and produce clinical illness only when tissue conditions favor their proliferation. For this reason the portal of entry is often difficult to determine. Puncture wounds of the hooves are common sites of entry in horses. Introduction to the genital tract at the time of parturition is the usual

portal of entry in cattle. A high incidence of tetanus may occur in young pigs following castration and in lambs following castration, shearing, docking, vaccinations, or injections of pharmaceuticals, especially anthelmintics. Docking by the use of elastic band ligatures is reputed to be especially hazardous. **Neonatal tetanus** occurs when there is infection in the umbilical cord associated with insanitary conditions at parturition.

Outbreaks of '**idiopathic tetanus**' occur occasionally in young cattle without a wound being apparent, usually in association with the grazing of rough, fibrous feed, and it is probable that toxin is produced in wounds in the mouth or gastrointestinal tract or is ingested preformed in the feed. Proliferation in the rumen may also result in toxin production.

#### Animal risk factors

The neurotoxin of *C. tetani* is exceedingly potent but there is considerable variation in susceptibility between animal species, horses being the most susceptible and cattle the least. The variation in prevalence of the disease in the different species is partly due to this variation in susceptibility but is also because exposure and wounding management practices are more likely to occur in some species than in others.

#### Importance

Tetanus is important because of its high case fatality and the very long convalescence in the survivors.

### PATHOGENESIS

The tetanus bacilli remain **localized** at their site of introduction and do not invade surrounding tissues. They proliferate and produce tetanolysin and tetanospasmin only if certain environmental conditions are attained, particularly a lowering of the local tissue oxygen tension. Tetanolysin promotes local tissue necrosis. Toxin production may occur immediately after introduction if the accompanying trauma has been sufficiently severe, or if foreign material has also been introduced to the wound, or may be delayed for several months until subsequent trauma to the site causes tissue damage. The original injury may be inapparent by then.

Tetanospasmin diffuses to the systemic circulation, is bound to motor end-plates and travels up peripheral nerve trunks via retrograde intra-axonal transport. The exact mechanisms by which the toxin exerts its effects on nervous tissue are not known<sup>2</sup> but it blocks the spontaneous and nerve-impulse-evoked release of neurotransmitter, resulting in the disinhibition of gamma motor neurones. No structural lesions are produced but there is central potentiation of normal sensory stimuli so

that a state of constant muscular spasticity is produced and normally innocuous stimuli cause exaggerated responses. Death occurs by asphyxiation due to fixation of the muscles of respiration.

### CLINICAL FINDINGS

The **incubation period** varies between 3 days and 4 weeks, with occasional cases occurring as long as several months after the infection is introduced. In sheep and lambs cases appear 3–10 days after shearing or docking.

**Clinical findings** are similar in all animal species. Initially, there is an increase in **muscle stiffness**, accompanied by muscle tremor. There is **trismus** with restriction of jaw movements, **prolapse of the third eyelid**, stiffness of the hind limbs causing an unsteady, straddling gait, and the tail is held out stiffly, especially when backing or turning. Retraction of the eye and prolapse of the third eyelid – a rapid movement of the third eyelid across the cornea followed by a slow retraction – is one of the earliest and consistent signs (with the exception of sheep) and can be exaggerated by sharp lifting of the muzzle or tapping the face below the eye. Additional signs include an anxious and alert expression contributed to by an erect carriage of the ears, retraction of the eyelids and dilation of the nostrils, and hyperesthesia with exaggerated responses to normal stimuli.

The animal may continue to eat and drink in the early stages but mastication is soon prevented by tetany of the masseter muscles, and saliva may drool from the mouth. If food or water are taken, attempts at swallowing are followed by regurgitation from the nose. Constipation is usual and the urine is retained, partly as a result of inability to assume the normal position for urination. The rectal temperature and pulse rate are within the normal range in the early stages but may rise later when muscular tone and activity are further increased. In cattle, particularly young animals, bloat is an early sign but is not usually severe and is accompanied by strong, frequent rumen contractions.

As the disease progresses, muscular tetany increases and the animal adopts a '**sawhorse**' posture. Uneven muscular contractions may cause the development of a curve in the spine and deviation of the tail to one side. There is great difficulty in walking and the animal is inclined to fall, especially when startled. Falling occurs with the limbs still in a state of **tetany** and the animal can cause itself severe injury. Once down it is almost impossible to get a large animal to its feet again. Tetanic convulsions begin in which the tetany is still further exaggerated. Opisthotonos is marked, the hind limbs are stuck out

stiffly behind and the forelegs forward. Sweating may be profuse and the temperature rises, often to 42°C (107°F). The convulsions are at first only stimulated by sound or touch but soon occur spontaneously. In fatal cases there is often a transient period of improvement for several hours before a final, severe tetanic spasm during which respiration is arrested.

The **course of the disease** and the **prognosis** vary both between and within species. The **duration** of a fatal illness in horses and cattle is usually 5–10 days but sheep usually die on about the third or fourth day. A long incubation period is usually associated with a mild syndrome, a long course and a favorable prognosis. **Mild cases** that recover usually do so slowly, the stiffness disappearing gradually over a period of weeks or even months. The prognosis is poor when signs rapidly progress. Animals vaccinated in the past year have a better prognosis, as do horses that have received parenteral penicillin and tetanus antitoxin and in which the wound was aggressively cleaned when fresh.<sup>3</sup>

### CLINICAL PATHOLOGY

There are no specific abnormalities in blood or cerebrospinal fluid<sup>3</sup> and no antemortem test of value in confirming the diagnosis. Blood levels of tetanus toxin are usually too low to be detected.

### NECROPSY FINDINGS

There are no gross or histological findings by which a diagnosis can be confirmed, although a search should be made for the site of infection. Culture of the organism is difficult but should be attempted. If minimal autolysis has occurred by the time of necropsy, the identification of large Gram-positive rods with terminal spores ('tennis-racket morphology') in smears prepared from the wound site or spleen is supportive of a diagnosis of tetanus.

### Samples for confirmation of diagnosis

- Bacteriology – air-dried impression smears from spleen, wound site (cyto – Gram stain), culture swab from wound site in anaerobic transport media; spleen in sterile, leakproof container (anaerobic CULT, bioassay).

### TREATMENT

The main principles in the treatment of tetanus are to:

- Eliminate the causative bacteria
- Neutralize residual toxin
- Control muscle spasms until the toxin is eliminated or destroyed
- Maintain hydration and nutrition
- Provide supportive treatment.

There are no structural changes in the nervous system, and the management of

### DIFFERENTIAL DIAGNOSIS

Fully developed tetanus is so distinctive clinically that it is seldom confused with other diseases. The muscular spasms, the prolapse of the third eyelid and a recent history of accidental injury or surgery are characteristic findings. However, in its early stages, tetanus may be confused with other diseases.

#### All species

- Strychnine poisoning
- Meningitis

#### Horses

- Hypocalcemic tetany (eclampsia)
- Acute laminitis
- Hyperkalemic periodic paralysis
- Myositis, particularly after injection in the cervical region

#### Ruminants

- Hypomagnesemia – cows, sheep and calves
- White muscle disease
- Polioencephalomalacia
- Enterotoxemia

cases of tetanus depends largely on keeping the animal alive through the critical stages.

**Elimination of the organism** is usually attempted by the parenteral administration of penicillin in large doses, preferably by intravenous administration. If the infection site is found, the wound should be aggressively cleaned and debrided but only after antitoxin has been administered, because debridement, irrigation with hydrogen peroxide, and the local application of penicillin may facilitate the absorption of the toxin.

**Tetanus antitoxin** is administered but is of little value once signs have appeared. After the experimental administration of toxin, antitoxin is of limited value at 10 hours and ineffective by 48 hours. The recommended dose is controversial but for optimal results horses should receive 300 000 IU 12-hourly for three injections. Local injection of some of the antitoxin around the wound is advised. There have been a number of attempts to justify the treatment of early cases of equine tetanus by the intrathecal injection of antitoxin but there is limited evidence of therapeutic value and the procedure carries risk.<sup>3,4</sup>

**Relaxation of the muscle tetany** can be attempted with various drugs. Chlorpromazine (0.4–0.8 mg/kg body weight (BW) intravenously, 1.0 mg/kg BW intramuscularly, three or four times daily) and acetyl promazine (0.05 mg/kg BW twice daily) administered until severe signs subside, are widely used.<sup>3,5</sup> A combination of diazepam (0.01–0.4 mg/kg) and xylazine (0.5–1.0 mg/kg, intravenously or intramuscularly) may be effective in horses refractory to phenothiazine tranquilizers.<sup>3</sup>

**Hydration** can be maintained by intravenous or stomach-tube feeding during the critical stages when the animal cannot eat or drink. The use of an indwelling tube should be considered because of the disturbance caused each time the stomach tube is passed. Feed and water containers should be elevated and the feed should be soft and moist.

**Additional supportive treatment** includes slinging of horses during the recovery period when hyperesthesia is diminishing. Affected animals should be kept as quiet as possible and provided with dark, well-bedded quarters with nonslip flooring and plenty of room to avoid injury if convulsions occur. Administration of enemas and catheterization may relieve the animal's discomfort. This level of nursing, plus penicillin, ataractic drug and antitoxin for an average of 14 days, can deliver something like a 50% recovery by an average of 27 days, but the cost is high.

Horses that fall frequently sustain bone fractures and may need to be destroyed.

## CONTROL

Many cases of tetanus could be avoided by proper skin and instrument disinfection at castrating, docking, and shearing time. These operations should be carried out in clean surroundings; in the case of lambs docked in the field, temporary pens are to be preferred to permanent yards for catching and penning.

## Passive immunity

Short-term prophylaxis can be achieved by the injection of 1500 IU of tetanus antitoxin. The immunity is transient, persisting for only 10–14 days.

## Tetanus antitoxin

Tetanus antitoxin should be given to any horse with a penetrating wound or deep laceration, and the wound should also be cleaned aggressively. Tetanus toxoid can be administered at the same time as tetanus antitoxin, provided they are injected at different sites and using different syringes. Animals that suffer injury are usually given an injection of antitoxin and one of toxoid to insure complete protection.

Tetanus antitoxin is often routinely given to **mares** following foaling and to newborn foals. In some areas the risk for tetanus in young foals is high and repeated doses of antitoxin at weekly intervals may be required for protection.

On farms where the incidence of tetanus in **lambs** is high, antitoxin is usually given at the time of docking or castration; 200 IU has been shown to be effective. The risk for tetanus in calves is lower than in lambs and tetanus antitoxin

is not commonly given at the time of castration.

There is a risk for **serum hepatitis** in horses that have been given tetanus antitoxin<sup>6,7</sup> and, while this risk is small,<sup>7</sup> a policy of routine active immunization of the mare to provide the mare with active immunity and the foal with passive colostral immunity is preferred to one that relies on antitoxin. Provided foals get an adequate supply of colostrum they are protected during the first 10 weeks of life by active vaccination of the mare during the last weeks of pregnancy. Prevention of tetanus in newborn lambs is also best effected by vaccination of the ewe in late pregnancy.

## Active immunity

Available vaccines are formalin-inactivated adjuvanted toxoids; they induce long-lasting immunity. Primary vaccination requires two doses 3–6 weeks apart. Protective titers are obtained within 14 days of the second injection and last for at least a year and up to 5 years.

Traditionally **foals** have received primary vaccination at 3–4 months of age, however there is evidence that maternal antibodies acquired by foals born to mares vaccinated shortly before parturition significantly inhibit the antibody response of the foal to primary vaccination until it is 6 months of age and that primary vaccination should be delayed until that age.<sup>8</sup>

Although immunity lasts longer than 1 year, it is common to revaccinate horses yearly with a single booster injection. Pregnant mares should receive a booster injection 4–6 weeks before foaling to provide adequate colostral immunity to the foal.

**Ewes** are immunized with a similar schedule except that the primary doses are usually given at a managerially convenient time when the flock is yarded. A prelambling booster vaccination is given yearly. Commonly, commercial vaccines for sheep also contain antigens for other clostridial diseases for which sheep are at high risk.

Vaccination of **cattle** is usually not considered unless an outbreak of the disease has occurred in the immediate past and further cases may be anticipated.

## REFERENCES

1. Popoff MR. *Curr Top Microbiol Immunol* 1995; 195:1.
2. Schiavo G. *Curr Top Microbiol Immunol* 1995; 195:297.
3. Green SL et al. *J Vet Intern Med* 1994; 8:128.
4. Steinman A et al. *Equine Vet Educ* 2000; 12:237.
5. Pearce O. *In Pract* 1994; 16:322.
6. Guglick MA. *J Am Vet Med Assoc* 1995; 206:1737.
7. Buechner-Maxweel D et al. *J Equine Vet Sci* 2003; 23:220.
8. Wilson WD et al. *Equine Vet J* 2001; 33:644.

## BOTULISM

### Synopsis

**Etiology** Neurotoxin produced by *Clostridium botulinum* during vegetative growth. *C. botulinum* types B, C, and D are associated with disease in animals but the type prevalence varies geographically

**Epidemiology** Ingestion of preformed toxin where feed preparation or storage allows multiplication of the organism in the feed with toxin production.

Contamination of feed with carrion containing toxin. Consumption of carrion on pasture by phosphorus-deficient animals. Risk factors often result in multiple cases. Rare cases occur from toxin production from organisms in the intestine or wounds

**Clinical findings** Early muscle tremor, progressive symmetrical weakness, and motor paralysis leading to recumbency.

Mydriasis, ptosis, weak tongue retraction; sensation and consciousness retained until death

**Necropsy findings** None specific

### Diagnostic confirmation

Demonstration of toxin in serum or feed. Demonstration of organisms in feed, intestinal contents or wounds

**Treatment** Type-specific antiserum and supportive treatment

**Control** Avoidance of exposure by feed management. Vaccination

## ETIOLOGY

The causative organism *Clostridium botulinum*, a spore-forming anaerobe, produces neurotoxins during vegetative growth. Spores can **survive in the environment** for over 30 years. Under favorable conditions of warmth and moisture the spores germinate and vegetative cells multiply rapidly, elaborating a stable and highly lethal toxin which, when ingested, or absorbed from tissues, causes the disease. The toxin is also capable of surviving for long periods, particularly in bones or if protected from leaching. Seven antigenically distinct **toxin types** (A–G), some with subtypes, have been identified. Farm animal disease is produced primarily by types B, C, and D.

The **geographical distribution** of these types varies considerably. In a study in the USA,<sup>1</sup> type A was found in neutral or alkaline soils in the west, while types B and E were in damp or wet soil all over, except that B was not found in the south. Type C was found in acid soils in the Gulf coast, and type D in alkaline soils in the west. Microorganisms capable of inhibiting *C. botulinum* were present, with or without the clostridia, in many soils. Type B is also common in soils in the UK and in Europe. Types C and D are more common in warm climates.<sup>1,2</sup>

The organism is present in the **alimentary tract** of animals that have recently



ingested contaminated material and may be introduced into new areas in this way, or by birds and blowflies.

## EPIDEMIOLOGY

### Occurrence

Botulism has **no geographical limitations**, isolated cases and sporadic outbreaks occurring in most countries. The source of exposure to toxin and the risk for disease differ between regions because of differences in food storage, feeding, and management practices. **Outbreaks** associated with ingestion of toxin in conserved feeds are more common in the northern states of the USA and in Europe whereas outbreaks in animals on pasture are reported primarily from South Africa, Australia, and the Gulf coast area of the USA. The disease usually occurs in a number of animals at one time and has a high case fatality rate.

### Source of infection

Most incidents of botulism are associated with the ingestion of preformed toxin (**forage botulism**). Toxin in feeds may result from the primary growth of *C. botulinum* in the feed or from the contamination of the feed with toxin-containing carrion (**carrion-associated botulism**). Less common sources are growth with toxin production in wounds (**wound botulism**) or growth and toxin production in the alimentary tract (**toxicoinfectious botulism**).

### Forage botulism

Forage botulism occurs when pH, moisture, and anaerobic conditions in the feedstuff allow the vegetative growth of *C. botulinum* and the production of toxin. This can occur in a number of spoiled stored forages. Cereal silages carry a risk in the USA. Silage and hay may spoil to a stage suitable for the growth of *C. botulinum*. This is most likely if the forage is very succulent or is wet by rain when it is made.<sup>3,4</sup>

**Big bale silage** is a particular risk. The type of forage ensiled in big bales often has insufficient water-soluble carbohydrate for adequate lactic acid fermentation to achieve a stable low pH, and the higher dry matter content can also lead to a higher pH.<sup>3</sup> Clostridial multiplication is inhibited below pH 4.5. Most non-carrion-associated botulism is due to type B strains, and horses appear to be especially susceptible.<sup>5</sup>

Proliferation of the organism can occur in **decaying vegetable material**. The disease has also occurred in horses fed on spoiled vegetables and potatoes contaminated by *C. botulinum*, and on alfalfa haylage packed in airtight aluminum foil envelopes. Grass clippings allowed to accumulate and decay in a pile have

poisoned horses, as has round bale hay that spoiled after rain.<sup>6</sup> Decaying grass at the base of old tussocks and in trampled stubble are known to be suitable sites for growth of *C. botulinum*. Cases have occurred with brewer's grains, and high-moisture grain has the potential for toxicity.

### Carrion-associated botulism

This is almost always the cause of botulism in animals on pasture, and carrion is also a common cause of botulism in animals on conserved feeds. Carrion includes domestic and wild animals and birds. In endemic botulism areas, the carcass of dead animals is invaded by *C. botulinum* and high concentrations of toxin are produced such that very small amounts of flesh or bone have lethal concentrations. Most outbreaks of carrion-associated botulism are associated with **type C and D strains**, these strains producing much higher concentrations of toxin in carrion than type A and B strains.<sup>7</sup> Toxin can persist in carrion for at least 1 year. Where the carcasses of rodents, cats, and birds contaminate hay or silage, toxin can leach out and contaminate surrounding hay or other feeds to cause multiple cases of botulism. In one instance a single mouse carcass is believed to have contaminated 200 000 tons of alfalfa cubes.<sup>5</sup> A common source in Australia is hay made at the time of a mouse plague. At such times even good, fresh hay can contain a great deal of carrion. In another recorded incident 427 of 444 dairy cattle died after ingesting feed contaminated with botulinum type C toxin from a cat carcass.<sup>8</sup>

**Poultry manure** and ensiled **poultry litter** have caused outbreaks of botulism when used as cattle feed, as has poultry litter used for bedding cattle. Outbreaks of botulism have occurred in cattle and sheep grazing pastures that have been fertilized with poultry manure or poultry litter. Cattle and sheep may eat poultry litter piled on a pasture prior to disposal. It is probable that the source of toxin in poultry litter is from poultry carcasses. Disease is usually due to *C. botulinum* type C.<sup>9</sup>

**Direct carrion ingestion** can occur where **cattle** subsist on a **phosphorus-deficient diet** and manifest osteophagia, with subsequent ingestion of carrion. The disease is likely to occur in outbreak form. In **sheep**, pica is more usually associated with a dietary **deficiency of protein** or net energy. Occasional outbreaks occur that are due to drinking of **water** contaminated by carcasses of dead animals. A not uncommon occurrence is in livestock drinking lake water contaminated by the carcasses of ducks and other waterfowl that have died of botulism. Wetlands

where outbreaks of avian botulism have occurred are likely to have repeated occurrences because of soil contamination.

### Wound botulism

Wound botulism is rare but is recorded in horses following castration, with omphalophlebitis, umbilical hernias treated with clamps, with an infected wound and in association with an injection abscess.<sup>10</sup>

### Toxicoinfectious botulism

This results when toxin is produced by *C. botulinum* present in the intestine. The disease is also called the '**shaker foal syndrome**'. It is a disease of young foals up to 8 months of age with the highest prevalence in foals 3–8 weeks of age.<sup>11</sup>

The disease occurs sporadically in the USA, Australia, and the UK but may occur repeatedly on some farms. *C. botulinum* type B has been isolated from the feces of naturally occurring cases of the disease and the condition has been produced experimentally by the intravenous injection of *C. botulinum* toxin.

Toxicoinfectious botulism is also postulated<sup>12,13</sup> as the possible cause of equine grass sickness (equine dysautonomia) which is described elsewhere in this text.

### Experimental reproduction

Cows challenged with type C botulinum toxin intravenously showed initial signs of constipation and straining at defecation 48 hours after injection and weakness, decreased tail tone, decreased tongue tone and muscle fasciculation of large-muscle groups between 76 and 92 hours. Weakness progressed to total posterior paresis between 80 and 140 hours in these cattle. On a weight-for-weight basis, cattle were considered to be 13 times more sensitive than mice to type C botulinum toxin.<sup>14</sup>

### Risk factors

#### Animal risk factors

Botulism is most common in birds, particularly the domestic chicken and wild waterfowl. Cattle, sheep, and horses are susceptible but pigs, dogs, and cats appear to be resistant. The horse appears to be particularly susceptible to type B toxin. Cattle and sheep are usually affected by types C and D.

#### Environment risk factors

Botulism in range animals has a seasonal distribution. Outbreaks are most likely to occur during drought periods when feed is sparse, phosphorus intake is low and carrion is plentiful. Silage-associated botulism is also seasonal with the feeding of silage. The variation that occurs in the geographical distribution of the various types, and in carrion versus non-carrion-associated botulism is an important factor when considering prophylactic vaccination programs.

### Importance

Severe outbreaks with high case fatality rates can occur when contaminated feed is fed to large numbers of animals. Under extensive grazing conditions massive outbreaks of carrion-associated botulism also occur unless the animals are vaccinated.

### Zoonotic implications

Botulinum toxin is identified as a possible agent for bioterrorism.

The meat and milk from cattle that have botulism should not be used for human consumption.

### PATHOGENESIS

The toxins of *C. botulinum* are neurotoxins and produce functional paralysis without the development of histological lesions. Botulinum toxins are absorbed from the intestinal tract or the wound and carried via the bloodstream to peripheral cholinergic nerve terminals including neuromuscular junctions, postganglionic parasympathetic nerve endings, and peripheral ganglia. The heavy chain of the toxin is responsible for binding to the receptors and translocation into the cell and the light chain of the toxin for resultant blockade of the release of acetylcholine at the neuromuscular junction.<sup>5,15,16</sup> Flaccid paralysis develops and the animal dies of respiratory paralysis.

### CLINICAL FINDINGS

#### Cattle and horses

Signs usually appear 3–17 days after the animals gain access to the toxic material, but occasionally as soon as 1 day,<sup>5,10,17</sup> the incubation period being shorter as the amount of toxin available is increased. **Peracute cases** die without prior signs of illness, although a few fail to take water or food for a day beforehand. The disease is not accompanied by fever and the characteristic clinical picture is one of progressive symmetric muscular paralysis affecting particularly the limb muscles and the muscles of the jaw, tongue, and throat. Muscle weakness and paralysis commence in the hindquarters and progress to the forequarters, head, and neck. The onset is marked by very obvious muscle tremor and fasciculation, often sufficient to make the whole limb tremble. Colic may be an initial sign in horses.

In most cases the disease is **subacute**. Restlessness, incoordination, stumbling, knuckling, and ataxia are followed by inability to rise or to lift the head. Mydriasis and ptosis occur early in the clinical course; mydriasis can be prominent in type C botulism in the horse.<sup>18</sup> Skin sensation is retained. Affected animals lie in sternal recumbency with the head on the ground or turned into the flank, not unlike the posture of a cow with parturient paresis.

Tongue tone is reduced, as is the strength of tongue retraction. In some cases the tongue becomes paralyzed and hangs from the mouth, the animal is unable to chew or swallow and it drools saliva. In others there is no impairment of swallowing or mastication and the animal continues to eat until the end.<sup>19</sup> This variation in signs is often a characteristic of an outbreak, all the cases having tongue paralysis or all of them not having it. Ruminal movements are depressed. Defecation and urination are usually unaffected, although cattle may be constipated. Paralysis of the chest muscles results in a terminal abdominal-type respiration. Sensation and consciousness are retained until the end, which usually occurs quietly, and with the animal in lateral recumbency, 1–4 days after the commencement of illness.

Occasional field cases and some experimental cases in cattle show **mild signs** and recover after an illness of 3–4 weeks. These chronic cases show restlessness and respiratory distress followed by knuckling, stumbling, and disinclination to rise. Anorexia and adipsia are important early signs but are often not observed in pastured animals. In some there is a pronounced roaring sound with each respiration. The roaring persists for up to 3 months. During the major part of the illness the animals spend most of their time in sternal recumbency. In some animals there is difficulty in prehending hay but concentrate and ensilage may be taken. This disability may persist for 3 weeks.

A syndrome ascribed to toxicosis with type B botulinum toxin and manifest with anorexia, decline in milk production, dysphagia, a fetid diarrhea, vomiting, profuse salivation but without myesthesia, paresis and recumbency is reported in cattle in Holland and Israel.<sup>20</sup> In these cases death occurred as a result of aspiration pneumonia.

With **toxicoinfectious botulism** in foals muscle tremor is often a prominent early sign. If the foal can walk, the gait is stiff and stilted and the toes are dragged. If the foal sucks, milk drools from the mouth; if it attempts to eat hay some of the material is regurgitated through the nostrils. Constipation occurs consistently. There is a rapid progression to severe muscular weakness and prostration, with the foal going down and being unable to rise. If it is held up there is a gross muscle tremor, which is not evident when the foal is lying down. Prostrate foals are bright and alert, have normal mentation and pain perception, and have dilatation of the pupils with a sluggish pupillary light reflex. During the latter period of the illness there is a complete cessation

of peristalsis. The temperature varies from being slightly elevated to slightly depressed. Death occurs about 72 hours after the onset of signs and is due to respiratory failure.

### Sheep

Sheep do not show the typical flaccid paralysis of other species until the final stages of the disease. There is stiffness while walking, and incoordination and some excitability in the early stages. The head may be held on one side or bobbed up and down while walking (**limber neck**). Lateral switching of the tail, salivation, and serous nasal discharge are also common. In the terminal stages there is abdominal respiration, limb paralysis, and rapid death.

### Pigs

Authentic reports in this species are rare. Clinical signs include staggering followed by recumbency, vomiting, and pupillary dilatation. The muscular paralysis is flaccid and affected animals do not eat or drink.

### CLINICAL PATHOLOGY

There are no changes in hematological values or serum biochemistry that are specific to botulism.<sup>11</sup>

Hypophosphatemia may be present where this is a risk factor. Muscle enzyme activities may be moderately elevated.

In foals, arterial blood analysis shows acidemia, hypercapnia, hypoxemia, and desaturation of hemoglobin, and repeated arterial blood gas analyses should be conducted during the first 48 hours of treatment as a significant proportion of foals will require some form of ventilatory support.<sup>11</sup>

Laboratory diagnosis of botulism in the live or dead animal is difficult because of the lack of sensitive confirmatory laboratory tests. Laboratory confirmation<sup>5</sup> is attempted by:

- Detection of preformed toxin in serum, intestinal tract contents, or feed
- Demonstration of spores of *C. botulinum* in the feed or gastrointestinal contents
- Detection of antibody in recovering or clinically normal at-risk animals.

**Detection of toxin** using bioassay in mice coupled with toxin neutralization with polyvalent antitoxin is used but the sensitivity is low in both ruminants and horses as they are substantially more sensitive than mice to botulinum toxin.<sup>14</sup>

In outbreaks of botulism it is not uncommon to have only a proportion of clinically affected animals, or none, test positive. Protection with monovalent antitoxin allows type identification. Toxin detection by an enzyme-linked immunosorbent assay (ELISA) test appears less

sensitive than mouse bioassay.<sup>21</sup> Toxin production or carrion contamination can potentially occur in a number of feeds; however the majority of outbreaks are associated with contamination in hay or silage<sup>5</sup> and suspect feeds should be tested in mice for toxin. To get around the problem of lack of sensitivity with the mouse test, suspect feed has been fed to experimental cattle. Alternatively one can make an infusion of the feed sample and use this as the sole drinking water supply for experimental animals. The problem with all feeding experiments is that the botulinum toxin is likely to be very patchy in its distribution in the feed.

Failure to produce the disease in animals vaccinated against botulism, when deaths are occurring in the unvaccinated controls, has also been used as a diagnostic procedure.

**Demonstration of spores** of *C. botulinum* in the feed being fed or the feces of affected animals supports a diagnosis of botulism as botulism spores are rarely detected in the feces of normal foals and adult horses.<sup>5</sup>

**The detection of antibody** in chronically affected animals and at-risk herd mates by an ELISA test has been used to support a diagnosis in outbreaks of type C and type D botulism.<sup>22,23</sup> It has been used in range cattle where acutely affected clinical cases or fresh animals for postmortem toxin testing were not available. Cattle exposed to sublethal and subclinical amounts of toxin with sufficient immunogenicity develop a specific antibody response.<sup>23</sup> An increased antibody prevalence over time or an increased antibody prevalence in an affected group compared with a similar group nearby suggests exposure to the toxin.

#### NECROPSY FINDINGS

There are no specific changes detectable at necropsy, although the presence of suspicious feedstuffs in the forestomachs or stomach may be suggestive. There may be nonspecific subendocardial and subepicardial hemorrhages and congestion of the intestines. Microscopic changes in the brain are also nonspecific, consisting mainly of perivascular hemorrhages in the corpus striatum, cerebellum, and cerebrum. Nonetheless, unless classic flaccid paralysis was observed clinically, the brain should be examined histologically to eliminate other causes of neurological disease. The presence of *C. botulinum* in the alimentary tract is a further test. The presence of toxin in the gut contents is confirmatory if found but is often misleading, because the toxin may have already been absorbed. The presence of the toxin in the liver at post-mortem examination is taken as evidence that the disease has occurred. In addition

to traditional bioassays such as the mouse protection test, newer methods for toxin detection include ELISA techniques, and a recently described immuno-polymerase chain reaction (PCR) assay.<sup>24</sup>

#### Samples for confirmation of diagnosis

- Bacteriology – suspected contaminated feed material, liver, rumen contents, plus serum from clinically affected herdmates (bioassay, anaerobic CULT, ELISA)
- Histology – formalin-fixed brain.

#### DIFFERENTIAL DIAGNOSIS

A presumptive diagnosis is made on the clinical signs and history, occurrence in unvaccinated animals and the ruling out of other diseases with a similar clinical presentation. The symmetric motor paralysis of botulism with muscle paralysis that progresses to recumbency in 1–4 days is a major differential for botulism from other causes of neurological dysfunction in large animals.

##### Ruminants

Clinically and at necropsy the disease resembles parturient paresis in cattle and hypocalcemia in sheep but the conditions under which the diseases occur are quite different.

- Tick paralysis
- Paralytic rabies
- Poisoning by *Phalaris aquatica*
- Organophosphate/carbamate poisoning
- Louping ill in sheep

##### Horses

- Equine protozoal myelitis
- Equine encephalomyelitis
- Hepatic encephalopathy
- Paralytic rabies
- Ionophore toxicity

#### TREATMENT

Recent studies report a survival rate in foals of 96% which was achieved by the early administration of antitoxin (before complete recumbency) coupled with a high quality of intensive care fluid therapy, enteral or parenteral feeding, nasal insufflation with oxygen and mechanical ventilation if required. Duration of hospitalization approximated 2 weeks.<sup>11</sup> Antitoxin was considered essential to the high success rate in this report and this would limit the success of treatment geographically as antitoxin to the various botulinum toxin types is not available universally. Specific or **polyvalent anti-serum** is available in some countries and, if administered early in the course at a dose of 30 000 IU for a foal and 70 000 IU for adult horses, can improve the likelihood of survival.<sup>5</sup> A single dose is sufficient but it is expensive.<sup>25</sup>

Animals should be confined to a stall with **supportive fluid therapy** and enteral feeding. Muzzling may be required to prevent aspiration pneumonia and frequent turning to prevent muscle necrosis and decubital ulcers. Bladder catheterization may be required in horses that do not urinate and mechanical ventilation may be necessary for recumbent horses. Mineral oil is used to prevent constipation and antimicrobial drugs are used to treat secondary complications such as aspiration pneumonia. Therapy should avoid the use of drugs that deplete the neuromuscular junction of acetylcholine, such as neostigmine, and those, such as procaine penicillin, tetracyclines, and aminoglycosides, that potentiate neuromuscular weakness.

A rapid progression of signs suggests a poor prognosis and, in general, treatment should only be undertaken in subacute cases in which signs develop slowly and which have some chance of recovery. The prognosis in recumbent horses is grave.

Where groups of animals have had the same exposure factor the remainder of the animals in the group should be vaccinated immediately.

#### CONTROL

In range animals, **correction of dietary deficiencies** by supplementation with phosphorus or protein should be implemented if conditions permit. Hygienic **disposal of carcasses** is advisable to prevent further pasture contamination but may not be practicable under range conditions. **Vaccination** with type-specific or combined (bivalent C and D) toxoid is practiced in enzootic areas in Australia and southern Africa. Type B and C vaccines would be more appropriate for prevention of disease in North America and Europe. The immunity engendered by vaccination is type-specific. The number and interval of vaccinations required varies with the vaccine, and the manufacturer's directions should be followed. In horses, the disease is usually sporadic and due to accidental contamination of feed or water; vaccination is seldom practiced in this species. Some local reactions are encountered after vaccination in horses but they are seldom serious. Vaccination of the mare may not prevent the occurrence of botulism in foals.<sup>11</sup>

A common problem that arises when the disease appears to have resulted from feeding contaminated silage, hay, or other feed is what to do with the residue of the feed; there may be a large quantity of it. In these circumstances the stock should be vigorously vaccinated with a toxoid on three occasions at 2-week intervals and then feeding of the same material can be recommenced.

## REVIEW LITERATURE

- Hariharan H, Mitchell WR. Type C botulism: the agent, host spectrum and environment. *Vet Bull* 1977; 47:95–100.
- Smith LDS, Sugiyama H. Botulism, the organisms, its toxins, the disease. Springfield, IL: Charles C Thomas, 1988.
- Jones T. Botulism. In *Pract* 1996; 18:312–313.
- Whitlock RH. Botulism, type C: experimental and field cases in horses. *Equine Pract* 1996; 18(10):11–17.
- Whitlock RH, Buckley C. Botulism. *Vet Clin North Am Equine Pract* 1997; 13:107–128.

## REFERENCES

- Smith LD. *Health Lab Sci* 1978; 15:74.
- Popoff MR. *Curr Top Microbiol Immunol* 1995; 195:1.
- Sargison N. In *Pract* 1995; 15:291.
- Gudmundson SH. *Equine Vet Educ* 1997; 9:156.
- Whitlock RH, Buckley C. *Vet Clin North Am Equine Pract* 1997; 13:1.
- Hunter JM et al. *Compend Contin Educ Pract Vet* 2002; 24:166.
- Ortiz NE, Smith GR. *Epidemiol Infect* 1994; 113:335.
- Galey FD et al. *J Vet Diagn Invest* 2000; 12:204.
- Ortolani EL et al. *Vet Hum Toxicol* 1997; 39:89.
- Mitten LA et al. *Equine Vet J* 1994; 26:420.
- Wilkins PA, Palmer JE. *J Vet Intern Med* 2003; 17:702.
- Newton JR et al. *Equine Vet J* 2004; 36:105.
- McGorum BC et al. *Vet Rec* 2003; 152:334.
- Moeller RB et al. *J Vet Diagn Invest* 2003; 15:523.
- Montecucco C. *Curr Top Microbiol Immunol* 1995; 195:1.
- Humeau Y et al. *Biochimie* 2000; 82:427.
- Van Der Lugt JJ et al. *J S Afr Vet Assoc* 1995; 66:77.
- Whitlock RH. *Equine Pract* 1996; 18(10):11.
- Martin S. *Can Vet J* 2003; 44:493.
- Bruckstein S, Tromp AM. *Israel J Vet Med* 2001; 56:95.
- Thomas RJ. *Aust Vet J* 1991; 68:111.
- Jubb TF et al. *Aust Vet J* 1993; 70:226.
- Gregory AR et al. *Aust Vet J* 1996; 73:55.
- Chao HY et al. *Toxicon* 2004; 43:27.
- Semrad S, Peek S. *Compend Contin Educ Pract Vet* 2002; 24:169.

## BLACKLEG

### ETIOLOGY

**True blackleg**, the clostridial myositis of skeletal muscles, is associated with *Clostridium (feseri) chauvoei*, a Gram-positive, spore-forming, rod-shaped bacterium. The spores are highly resistant to environmental changes and disinfectants and persist in soil for many years.

### EPIDEMIOLOGY

#### Occurrence

When the disease occurs it is usual for a number of animals to be affected within the space of a few days. The disease is enzootic in particular areas, especially when they are subject to flooding; such an area may vary in size from a group of farms to an individual field.

The **case fatality rate** in blackleg approaches 100%.

#### Source of infection

Blackleg is a **soil-borne** infection but the portal by which the organism enters

### Synopsis:

**Etiology** Infectious myositis associated with *Clostridium chauvoei*. True blackleg is common only in cattle but infection with this organism initiated by trauma occurs occasionally in other animals

**Epidemiology** Cattle 6 months to 2 years of age that are rapidly growing and on a high plane of nutrition. Seasonal occurrence in warm wet months. There are often multiple cases in at-risk animals. Sheep of all ages – occurs as outbreaks predisposed by wounds from shearing, docking, castration, dystocia

**Clinical findings** Lameness and pronounced swelling of upper limb in many. Myonecrosis of skeletal or cardiac muscles, severe toxemia and a high case fatality rate. May be found dead

**Clinical pathology** Culture from needle biopsy. No diagnostic change in hematology or serum biochemistry. Fluorescent antibody

**Necropsy findings** Myositis; dark, rancid odor, metallic sheen on the cut surface

**Diagnostic confirmation** Fluorescent antibody identification of *C. chauvoei* in lesion

**Treatment** High doses of penicillin in early stages. Surgical debridement

**Control** Vaccination

the body is still in dispute. It is presumed that the portal of entry is through the alimentary mucosa after ingestion of contaminated feed or associated with erupting teeth. The bacteria may be found in the spleen, liver, and alimentary tract of normal animals, and contamination of the soil and pasture may occur from infected feces or decomposition of carcasses of animals dying of the disease. True blackleg develops when spores that are not lodged in normal tissues are caused to proliferate by mechanisms such as trauma or anoxia.

### Transmission

In cattle the disease usually occurs without a history of trauma but in sheep is almost always a wound infection. Infection of skin wounds at **shearing** and **docking** and of the **navel** at birth may cause the development of local lesions. Infections of the vulva and vagina of the ewe at **lambing** may cause serious outbreaks and the disease has occurred in groups of young ewes and rams up to a year old, usually as a result of infection of skin wounds caused by **fighting**. Occasional outbreaks have occurred in sheep **after vaccination** against enterotoxemia. Presumably the formalinized vaccine causes sufficient tissue damage to permit latent spores of the organism to proliferate.

A special occurrence is in **fetal lambs**. Ewes exposed to infection at shearing

develop typical lesions but ewes treated with penicillin are unaffected except that the pregnant ewes in the latter group show distended abdomens, weakness and recumbency due to edema and gas formation in the fetus, from which *C. chauvoei* can be isolated.

### Risk factors

#### Environment risk factors

Typical blackleg of cattle has a **seasonal incidence**, with most cases occurring in the warm months of the year. The highest incidence may vary from spring to autumn, depending probably on when calves reach the susceptible age group. In some areas there is an increased prevalence in years of high rainfall. Outbreaks of blackleg in cattle have occurred following excavation of soil, which suggests that disturbance of the soil may expose and activate latent spores.

#### Animal risk factors

True blackleg is usually thought of as a disease of cattle and occasionally sheep but outbreaks of the disease have been recorded in deer and it is reported in a horse.<sup>1</sup> In cattle the disease is largely confined to young stock between the ages of 6 months and 2 years, although disease occurs occasionally in younger animals and cattle up to 3 years. In the field, **risk factors** include rapidly growing cattle and a high plane of nutrition. Elevation of the nutritional status of sheep by increased protein feeding increases their susceptibility to blackleg. In sheep there is no restriction to age group.

In pigs, blackleg is not common, although a gas gangrene type of lesion may be associated with *C. chauvoei* or *C. septicum* infection.

### Economic importance

Blackleg is a cause of severe financial loss to cattle raisers in many parts of the world. For the most part major outbreaks are prevented by vaccination, although outbreaks still occur occasionally in vaccinated herds or cattle incompletely vaccinated.

### PATHOGENESIS

In true blackleg the stimulus that results in growth of the latent bacterial spores is unknown. There is usually no history of trauma, although trauma while passing through an alley is reported as the likely inciting factor in one outbreak.<sup>2</sup> Toxin formed by the organism produces a severe necrotizing myositis locally in skeletal muscles, and a systemic toxemia that is usually fatal. In cattle and sheep atypical outbreaks of sudden death occur in which the lethal lesion is a clostridial cardiac myositis.<sup>3,4</sup>

## CLINICAL FINDINGS

### Cattle

If the animal is observed before death there is severe lameness, usually with pronounced swelling of the upper part of the affected leg. On closer examination the animal will be found to be very depressed and have complete anorexia and ruminal stasis, and a high temperature (41°C, 106°F) and pulse rate (100–120/min). Pyrexia is not present in all cases.<sup>2</sup> In the early stages the swelling is hot and painful to the touch but soon becomes cold and painless, and edema and emphysema can be felt. The skin is discolored and soon becomes dry and cracked.

Although the lesions are usually confined to the upper part of one limb, occasional cases are seen where the lesions are present in other locations such as the base of the tongue, the heart muscle, the diaphragm and psoas muscles, the brisket, and the udder. Lesions are sometimes present in more than one of these locations in one animal. The condition develops rapidly and the animal dies quietly 12–36 hours after the appearance of signs. Many animals die without signs having been observed.

### Sheep

When blackleg lesions occur in the limb musculature in sheep, there is a stiff gait and the sheep is disinclined to move because of severe lameness in one limb or, more commonly, in several limbs. The lameness may be severe enough to prevent walking in some animals but be only moderate in others. Subcutaneous edema is not common and gaseous crepitation cannot be felt before death. Discoloration of the skin may be evident but skin necrosis and gangrene do not occur.

In those cases where infection occurs through **wounds** of the skin, vulva, or vagina there is an extensive local lesion. Lesions of the head may be accompanied by severe local swelling due to edema and there may be bleeding from the nose. In all instances there is high fever, anorexia, and depression, and death occurs very quickly. Sheep and cattle with cardiac myositis associated with *C. chauvoei* are usually found dead.<sup>3,4</sup>

### Horses

The clinical syndrome in horses is not well defined. Pectoral edema, stiff gait, and incoordination are recorded.<sup>1</sup>

## CLINICAL PATHOLOGY

The disease is usually so acute that necropsy material is readily available but, failing this, it may be possible to obtain material suitable for cultural examination by needle puncture or swabs from wounds. There are no constant changes in hematological parameters or serum biochemistry.<sup>2</sup>

## NECROPSY FINDINGS

**Cattle** found dead of blackleg are often in a characteristic position; lying on the side with the affected hindlimb stuck out stiffly. Bloating and putrefaction occur quickly and bloodstained froth exudes from the nostrils and anus. Clotting of the blood occurs rapidly. Incision of the affected muscle mass reveals dark red to black, swollen tissue with a rancid odor and thin, sanguineous fluid containing bubbles of gas. Freshly cut surfaces are often dry and may have a metallic sheen. The heart and all skeletal muscles, including those of the tongue, diaphragm, and lumbar region, must be checked, as the lesion may be small and escape cursory examination. The thoracic cavity and the pericardial sac may contain excess blood-stained fluid with variable amounts of fibrin. This serositis is often overlooked, or is misinterpreted as a component of pleuropneumonia. The lungs are usually congested and may be atelectatic as a result of abdominal tympany.

In **sheep** the muscle lesions are more localized and deeper and the **subcutaneous edema is not so marked, except around the head**. Gas is present in the affected muscles but not in such large amounts as in cattle. When the disease has resulted from infection of skin wounds, the lesions are more obvious superficially, with subcutaneous edema and swelling and involvement of the underlying musculature. When invasion of the genital tract occurs, typical lesions are found in the perineal tissues and in the walls of the vagina and occasionally the uterus. In the special case of pregnant ewes, typical lesions may involve the entire fetus and cause abdominal distension in the ewe.

**Histologically**, blackleg cases feature myonecrosis, edema, emphysema, and an unimpressive neutrophilic cellulitis. Organisms may be few in number but can usually be seen in tissue sections. Smears from the affected tissue should be made and material collected for bacteriological examination. The isolation and identification of *C. chauvoei* and *C. novyi* is difficult because of the fastidiousness of these species in culture and rapid postmortem contamination of the tissues by clostridial species from the gastrointestinal tract. Thus it is essential that tissues be examined as soon after death as possible.<sup>5</sup> Most laboratories use fluorescent antibody tests performed on tissue smears to complement (or substitute) anaerobic culture.

**'False blackleg'** may be associated with *C. septicum* and *C. novyi* but this disease is more accurately classified as malignant edema. Mixed infections with *C. chauvoei* and *C. septicum* are not uncommon but the significance of

*C. septicum* as a cause of the disease is debated. However, in a study of 176 cases of clostridial myositis in cattle, *C. chauvoei* either alone or with *C. septicum* was demonstrated in 56%. In 36%, *C. novyi* was found alone or with *C. septicum*.<sup>5</sup> This indicates that maximum protection to cattle can be provided only by a multivalent vaccine that contains the antigens of *C. chauvoei*, *C. novyi*, and *C. septicum*. A multiplex PCR based on the flagellin gene sequence has been used to identify pathogenic clostridia in clinical specimens.<sup>6</sup>

## Samples for confirmation of diagnosis

- Bacteriology – muscle, placed in airtight container; four air-dried impression smears of surface of freshly cut lesion (anaerobic CULT, FAT)
- Histology – fixed samples of suspected muscle lesion

## DIFFERENTIAL DIAGNOSIS

In establishing a diagnosis when a number of animals are found dead in a group not kept under close observation and postmortem decomposition is so advanced that little information can be obtained, one must depend on one's knowledge of local disease incidence, season of the year, age group affected and pasture conditions, and on a close inspection of the environment in which the animals have been maintained. More frequent observation should be established so that sick animals or fresh cadavers will be available for examination.

- **Malignant edema.** In typical cases of blackleg in cattle a definite diagnosis can be made on the clinical signs and the necropsy findings. Definitive identification of *C. chauvoei* is by fluorescent antibody staining. Diagnosis on gross postmortem findings from other causes of clostridial myositides is hazardous and may result in improper recommendations for control
- **Anthrax**
- **Lightning strike**
- **Bacillary hemoglobinuria**
- Other causes of sudden unexpected death.

## TREATMENT

Treatment of affected animals with **penicillin and surgical debridement** of the lesion, including fasciotomy, is indicated if the animal is not moribund. Recovery rates are low because of the extensive nature of the lesions. Large doses (40 000 IU/kg BW) should be administered, commencing with crystalline penicillin intravenously and followed by longer-acting preparations. Blackleg **anti-serum** is unlikely to be of much value in treatment unless very large doses are given.

## CONTROL

### Cattle

On farms where the disease is enzootic, annual vaccination of all cattle between 3 and 6 months with two vaccinations given 4 weeks apart followed by an annual booster vaccination is recommended. This should be done just prior to the anticipated danger period, usually spring and summer. Maternal immunity persists for at least 3 months and will interfere with active immunity in calves vaccinated before this age.

In an **outbreak** all unaffected cattle should be vaccinated immediately and injected with penicillin at a dose of 10 000 IU/kg BW intramuscularly or a combination of penicillin and benzathine penicillin. Movement of the cattle from the affected pasture is advisable. If antibiotics are not given, new cases of blackleg may occur for up to 14 days until immunity develops, and constant surveillance and the early treatment of cases will be necessary.

### Sheep

With sheep in areas where the disease is enzootic, the **maiden ewes** should be vaccinated twice, the last vaccination given about 1 month before lambing and a subsequent yearly booster given at the same time before lambing. This will prevent infection of the ewes at lambing and will also protect lambs against umbilical infection at birth and infection of the tail wound at docking, provided the tail is docked at a young age. If an **outbreak** commences in a flock of ewes at lambing time, prophylactic injections of penicillin and antiserum to ewes requiring assistance are recommended.

A single vaccination of **wethers** can also be carried out 2–3 weeks before **shearing** if infection is anticipated. Because of the common occurrences of the disease in young sheep, vaccination before they go on to pasture and are exposed to infection of skin wounds from fighting is recommended in danger areas. The duration of the immunity in these young vaccinated animals is relatively short and ewes in particular must be revaccinated before they lamb for the first time. Clostridial vaccines have **poorer antigenicity** in sheep and goats than in cattle.

In both sheep and cattle it is advisable to use a **combined vaccine** containing at least *C. chauvoei*, *C. septicum*, and *C. novyi*, where these organisms occur in the area and cause clostridial myositis.

There is limited information on which to base the recommendations above as there is limited information on the **efficacy** of available individual manufacturers' vaccines. There is variability in the immune

response and its duration with different vaccines.<sup>7</sup> **Vaccine failure** has been associated with an inadequate spectrum of the antigens in the vaccine, and in these circumstances a bacterin prepared from a local strain of *C. chauvoei* is preferred.<sup>8</sup> Vaccines combined with anthelmintics or with trace elements are used in some areas to minimize the number of injections required when processing sheep.<sup>9</sup>

It is important that **carcasses** of animals dying of blackleg are destroyed by burning or deep burial to limit soil contamination.

## REVIEW LITERATURE

- Sterne M. Clostridial infections. *Br Vet J* 1981; 137:443–454.
- Hatheway CL. Toxigenic clostridia. *Clin Microbiol Rev* 1990; 3:66–98.
- Songer JG. Clostridial diseases of animals. In: Rood JI, McClane BA, Songer JG, Titball RW, eds. The clostridia: molecular biology and pathogenesis. London: Academic Press, 1997:153–182.
- Lewis C. Aspects of clostridial disease in sheep. In *Pract* 1998; 20:494–500.
- Songer JG. Clostridial diseases of small ruminants. *Vet Res* 1998; 29:219–232
- Useh NM, Nok AJ, Esiebo KAN. Pathogenesis and pathology of blackleg in ruminants; the role of toxins and neuraminidase. A short review. *Vet Q* 2003; 25:155–158.

## REFERENCES

- Hagemoser WA et al. *J Am Vet Med Assoc* 1980; 176:631.
- Jackson CA et al. *Compend Contin Educ Pract Vet* 1995; 17:1299.
- Glastonbury JRW et al. *Aust Vet J* 1988; 65:208.
- Uzal FA et al. *Vet Rec* 2003; 152:134.
- Williams BM. *Vet Rec* 1977; 100:90.
- Sasaki Y et al. *J Vet Med Jpn* 2002; 55:889.
- Troxel TR et al. *J Anim Sci* 1997; 75:19.
- Reed GA, Reynolds I. *Aust Vet J* 1977; 53:393.
- Hogarth-Scott RS et al. *Aust Vet J* 1980; 56:285, 292.

## MALIGNANT EDEMA, CLOSTRIDIAL MYONECROSIS (GAS GANGRENE)

### ETIOLOGY

*Clostridium septicum*, *C. chauvoei*, *C. perfringens*, *C. sordellii*, and *C. novyi* have all been isolated from lesions typical of malignant edema of animals. In some cases there can be mixed infections. The occurrence of malignant edema due to *C. chauvoei* has been discussed in the section on blackleg.

*C. sordellii* has been associated chiefly with malignant edema of cattle but it has been found to be a cause of malignant edema and swelled head in sheep. However, swelled head of rams, in which the lesions of malignant edema are restricted to the head, is most commonly associated with *C. novyi* infection.

In a retrospective study of 37 horses with clostridial myonecrosis, *C. perfringens* was isolated from 68%, *C. septicum* from

## Synopsis

**Etiology** Malignant edema is an acute wound infection associated with organisms of the genus *Clostridium*

**Epidemiology** All ages and species of animals are susceptible. Sporadic disease affecting individual animals following injections but outbreaks following contamination of wounds produced by management procedures

**Clinical findings** Acute onset with fever and toxemia. Inflammation and swelling at site of a wound with heat, edema, pain on palpation, and usually subcutaneous emphysema

**Clinical pathology** No diagnostic change in hematology or serum biochemistry. Fluorescent antibody staining

**Necropsy findings** Gangrene of the skin with edema of the subcutaneous and intermuscular connective tissue around the site of infection

**Diagnostic confirmation** Demonstration of the causal organisms by fluorescent antibody staining

**Treatment** Antibiotics, surgical debridement

**Control** Vaccination. Prophylactic antibiotics

16% and mixed infections with these two species or infection with other clostridia in the remainder.<sup>1</sup>

## EPIDEMIOLOGY

All ages and species of animals are affected. The clostridia that cause malignant edema are **common inhabitants** of the animal environment and intestinal tract and, although some of the causative species have a restricted distribution, the disease is general in most parts of the world. The disease occurs sporadically, affecting individual animals except in circumstances where a management procedure to a group of animals results in an outbreak.

### Source of infection

The infection is usually **soil-borne**, and the resistance of spores of the causative clostridia to environmental influence leads to **persistence** of the infection for long periods in a local area. A dirty environment that permits contamination of wounds with soil is the common predisposing cause.

### Transmission

In most cases a wound is the **portal of entry**. Deep puncture wounds accompanied by severe trauma provide the most favorable conditions for growth of anaerobes, and malignant edema occurs most frequently under such conditions. Infection may occur through surgical or accidental wounds following vaccination, intramuscular injection of drugs, venipuncture, or through the umbilical cord in the

newborn. It is assumed that infection is introduced through the wound but cases of malignant edema can occur following intramuscular injection of drugs despite careful attention to aseptic technique. Dormant spores of *C. perfringens* and other clostridial species can be found in the normal muscle of horses and it is possible in some cases that these may be activated by anaerobic conditions produced by the injected material.<sup>2</sup>

#### Animal and management risk factors

In horses intramuscular injection of drugs, commonly in association with the treatment of colic, is the common precipitating factor. Certain drugs may have a greater propensity to initiate muscle necrosis and disease but these drugs are also commonly used in the treatment of colic. Perivascular leaking of drugs is also a precipitating cause in horses.<sup>1,3,4</sup> In all species there is risk with the intramuscular injection of drugs such as anthelmintics and nutritional supplements, some of which can cause significant tissue damage at the site, particularly if proper asepsis is not practiced.<sup>5-7</sup>

Outbreaks can occur in sheep after management practices such as shearing, and docking, or following lambing. Outbreaks have also been observed in cattle following parturition, sometimes associated with lacerations of the vulva. An unusual method of infection occurs when crows that have eaten infected carrion carry the infection to live, weak sheep and to lambs when they attack their eyes. Castration wounds in pigs and cattle may also become infected. Unless treatment is instituted in the early stages the death rate is extremely high.

The practice of **dipping** sheep immediately they are shorn may cause a high incidence of malignant edema if the dip is heavily contaminated. The disease '**swelled head**', a form of malignant edema, occurs in young rams 6 months to 2 years old when they are run in bands and fight among themselves.

#### Importance

Outbreaks of malignant edema are probably less common as a result of education of farmers and the availability of vaccines. In the wrong circumstances with improper hygiene severe disease can still occur.<sup>8</sup>

#### PATHOGENESIS

Potent necrotoxins are produced in the local lesion and cause death when absorbed into the bloodstream. Locally the exotoxins cause extensive edema and necrosis followed by gangrene.

#### CLINICAL FINDINGS

Clinical signs appear within 6–48 hours of infection. There is always a local lesion at the **site of infection** consisting of a soft,

doughy swelling with marked local erythema accompanied by severe pain on palpation. At a later stage the swelling becomes tense and the skin dark and taut. Emphysema may or may not be present, depending on the type of infection, and may be so marked as to cause extensive frothy exudation from the wound. With *C. novyi* infections there is no emphysema. A high fever (41–42°C, 106–107°F) is always present; affected animals are depressed, weak and show muscle tremor and usually stiffness or lameness. The mucosae are dry and congested and have very poor capillary refill. The illness is of short duration and affected animals die within 24–48 hours of the first appearance of signs. New cases continue to appear for 3–4 days after shearing or other precipitating cause.

When infection occurs at **parturition**, swelling of the vulva accompanied by the discharge of a reddish-brown fluid occurs within 2–3 days. The swelling extends to involve the pelvic tissues and perineal region. The local lesions are accompanied by a profound toxemia and death occurs within 1–2 days.

In '**swelled head**' of rams the edema is restricted initially to the head. It occurs first under the eyes and spreads to the subcutaneous tissues of the head and down the neck.

In **pigs** the lesions are usually restricted to the axilla, limbs, and throat and are edematous, with very little evidence of emphysema. Local skin lesions consisting of raised, dull red plaques distended with clear serous fluid containing *C. septicum* and causing no systemic illness may be encountered in pigs at abattoirs.

In horses, emphysema, detected by palpation or ultrasound, is an early sign.<sup>1,3,4</sup>

#### CLINICAL PATHOLOGY

Antemortem laboratory examination of affected farm animals is not usually undertaken, usually because there are carcasses for postmortem examination.

Examination of a Gram-stained smear of aspirated fluid from edematous swellings or swabs from wounds will give an early diagnosis, allowing therapy early in the course of the disease. A PCR has been developed to allow the rapid identification and differentiation of the clostridia associated with malignant edema in livestock.<sup>9</sup>

Hematological examination in horses may show evidence of an immune-mediated hemolytic anemia.<sup>1,10</sup>

#### NECROPSY FINDINGS

Tissue changes occur rapidly after death, particularly in warm weather, and this must be kept in mind when evaluating postmortem findings. There is usually gangrene of the skin with edema of the subcutaneous and intermuscular con-

nective tissue around the site of infection. There may be some involvement of underlying muscle but this is not marked. The edema fluid varies from thin serum to a gelatinous deposit. It is usually blood-stained and contains bubbles of gas except in *C. novyi* infections when the deposit is gelatinous, clear and contains no gas. A foul, putrid odor is often present in infections with *C. perfringens* and *C. sordellii*.

Subserous hemorrhages and accumulations of serosanguineous fluid in body cavities are usual. In 'swelled head' of rams the edema of the head and neck may extend into the pleural cavity and also involve the lungs.

The **histological** picture of malignant edema consists of abundant edema fluid, emphysema, and neutrophils within the connective tissues. Muscle is not spared but the damage is focused along fascial planes.

#### Samples for confirmation of diagnosis

- Bacteriology – fascial tissue, placed in an airtight container; four air-dried smears of fluid from lesion (anaerobic CULT, FAT)
- Histology – fixed sample of lesion.

#### DIFFERENTIAL DIAGNOSIS

The association of profound toxemia and local inflammation and emphysema at the site of a wound is characteristic.

- **Blackleg.** The disease is differentiated from blackleg by the absence of typical muscle involvement and the presence of wounds
- **Anthrax** in pigs and horses
- **Photosensitivity** in white-faced sheep with swelled head

#### TREATMENT

Affected animals should be treated as emergency cases because of the acute nature of the disease. Specific treatment requires the administration of penicillin (high doses of crystalline penicillin intravenously, repeated at 4–6-hour intervals) or a broad-spectrum antibiotic. Antitoxin aids in controlling the toxemia but is expensive and must be given very early in the course of the disease. A nonsteroidal anti-inflammatory drug (NSAID) and supportive therapy are recommended. Injection of penicillin directly into and around the periphery of the lesions may be of value in some cases. Local treatment consists of surgical incision to provide drainage, and irrigation with hydrogen peroxide. In horses, early and aggressive treatment with myotomy and fasciotomy, repeated if indicated, coupled with intravenous potassium penicillin is reported to



allow recovery rates approaching 70%. The success rate in treating horses with infections with *C. perfringens* was higher than that with *C. septicum*.<sup>1</sup>

### CONTROL

Hygiene at lambing, shearing, castration and docking is essential to the control of the infection in sheep. Vaccination with a specific or multivalent clostridial bacterin-toxoid will prevent the occurrence of the disease in enzootic areas. Penicillin can be given prophylactically to animals at risk for the disease.

### REVIEW LITERATURE

- Hatheway CL. Toxigenic clostridia. *Clin Microbiol Rev* 1990; 3:66–98.
- Songer JG. Clostridial diseases of animals. In: Rood JJ, McCrane BA, Songer JG, Titball RW, eds. *The clostridia: molecular biology and pathogenesis*. London: Academic Press, 1997:153–182.
- Lewis C. Aspects of clostridial disease in sheep. *In Pract* 1998; 20:494–500.
- Songer JG. Clostridial diseases of small ruminants. *Vet Res* 1998; 29:219–232.

### REFERENCES

1. Peek SF et al. *Equine Vet J* 2003; 35:86.
2. Vengust M. *Equine Vet J* 2003; 35:514.
3. Jeanes IV et al. *Compend Contin Educ Pract Vet* 2001; 23:577.
4. Peek SF, Semrad SD. *Equine Vet Educ* 2002; 14:163.
5. Harwood DG. *Vet Rec* 1984; 115:412.
6. Rebhun WC et al. *J Am Vet Med Assoc* 1985; 187:732.
7. Brown CM. *J Am Vet Med Assoc* 1988; 193:668.
8. Assis RA et al. *Vet Rec* 2004; 154:380.
9. Sasaki Y et al. *Res Vet Sci* 2000; 69:289.
10. Weiss DJ, Moritz A. *Vet Clin Pathol* 2003; 32:22.

### BRAXY (BRADSOT)

Braxy is an acute infectious disease of sheep in Britain characterized by inflammation of the abomasal wall, toxemia, and a high mortality rate. The disease was common in the early 20th century but now is extremely rare, as reflected in reports by the British Veterinary Laboratories Agency (Veterinary Investigation Centres).

#### Synopsis

**Etiology** *Clostridium septicum* and ingestion of frosted feedstuffs  
**Epidemiology** Weaners and yearling sheep in winter  
**Clinical findings** Rapid death  
**Clinical pathology** Death too rapid  
**Necropsy findings** Pathognomonic lesion in abomasum  
**Diagnostic confirmation** Typical abomasal lesion and positive fluorescent antibody staining of organism in lesion  
**Treatment** None  
**Control** Annual vaccination preceding the period of risk

### ETIOLOGY

*Clostridium septicum*, the common cause of malignant edema in animals, is generally regarded as the causative bacterium.

### EPIDEMIOLOGY

The disease occurs only in midwinter when there are heavy frosts and snow, and usually only in weaner and yearling sheep. It has occurred in experimental sheep receiving infusions of acetic acid into the abomasum. These were thought to cause abomasitis.<sup>1</sup> Adult animals in an enzootic area appear to have acquired immunity.

*C. septicum* is a soil-borne organism and in many areas can be considered as a normal inhabitant of the ovine intestinal tract.

The disease occurs in the UK and various parts of Europe and has been reported in the southern part of Australia<sup>1</sup> but appears to be rare in North America. It is now not of major importance because of its low incidence, although at one time it was sufficiently common to be an important cause of loss in some countries. In affected sheep the case fatality rate is usually about 50% and in enzootic areas an annual loss of 8% has been reported.

### PATHOGENESIS

Presumably a primary abomasitis, associated with the ingestion of frozen grass or other feed, permits invasion by *C. septicum*, resulting in a fatal toxemia.

### CLINICAL FINDINGS

There is a sudden onset of illness with segregation from the group, complete anorexia, depression, and high fever (42°C (107°F) or more). The abdomen may be distended with gas and there may be signs of abdominal pain. The sheep becomes recumbent, comatose and dies within a few hours of first becoming ill.

### CLINICAL PATHOLOGY

Antemortem laboratory examinations are of little value in establishing a diagnosis.

### NECROPSY FINDINGS

There are localized areas of edema, congestion, necrosis, and ulceration of the abomasal wall. Congestion of the mucosa of the small intestine may also be present and there may be a few subepicardial petechiae. *C. septicum* can be isolated by smear from the cut surface of the abomasal wall or by culture from the heart, blood, and other organs of fresh carcasses. Bacteriological examinations of tissues must be carried out within an hour of death if the diagnosis is to be confirmed.

Mortality in calves with braxy-like lesions in the abomasum is recorded.<sup>2,3</sup>

### Samples for confirmation of diagnosis

- Bacteriology – frozen abomasum, in air-tight container; four air-dried impression smears from freshly cut surface of abomasal mucosa (anaerobic CULT, FAT)
- Histology – fixed abomasum.

### DIFFERENTIAL DIAGNOSIS

Clinically the diagnosis of braxy is most difficult. At necropsy the lesions of abomasitis are characteristic, especially if the disease occurs under conditions of severe cold. Overeating on grain may cause local patches of rumenitis and reticulitis but there are no lesions in the abomasum. Braxy may resemble infectious necrotic hepatitis but there are no liver lesions in braxy. The final diagnosis depends on isolation of *C. septicum* from typical alimentary tract lesions.

### TREATMENT

No treatment has been found to be of value.

### CONTROL

Management of the flock is important. The sheep should be yarded at night, and fed hay before being let out to the frosted pasture each morning. Vaccination with a formalin-killed whole culture of *C. septicum*, preferably 2 injections 2 weeks apart, is also an effective preventive.

### REFERENCES

1. Ellis TM et al. *Aust Vet J* 1983; 60:308.
2. Schamber GJ et al. *Agri Pract* 1987; 8(4):3.
3. Sanford SE. *Can Vet J* 1992; 33:676.

### INFECTIOUS NECROTIC HEPATITIS (BLACK DISEASE)

#### Synopsis

**Etiology** An acute toxemia of sheep, cattle and sometimes pigs and horses caused by the toxin of *Clostridium novyi* elaborated in damaged liver tissue. Outbreaks usually associated with fascioliasis  
**Epidemiology** Adult sheep in good condition. Seasonal prevalence related to the migration of immature liver fluke in the liver  
**Clinical findings** Sheep – rapid clinical course and usually found dead. Short clinical course in cattle and horses with profound depression and toxemia, abdominal pain and peritonitis  
**Clinical pathology** None described  
**Necropsy findings** Rapid autolysis, engorgement of subcutaneous vessels with edema. Liver has small areas of yellow-colored necrosis surrounded by a zone of hyperemia  
**Diagnostic confirmation** Finding of *C. novyi* in the typical liver lesion. Fluorescent antibody staining identifies *C. novyi* but not the type  
**Treatment** Parenteral penicillin but high case fatality  
**Control** Vaccination

### ETIOLOGY

The disease occurs in sheep and cattle and rarely in pigs and in horses<sup>1–4</sup> *Clostridium novyi*, type B, is the cause of

the disease; it is resident in soil and may be present in the liver of normal animals. The intervention of a necrotic process in the liver, which causes the organism to proliferate and produce lethal amounts of toxin, is commonly stated to be the precipitating cause. *C. novyi* types A and C are also resident in soil and may invade a carcass postmortem, but do not cause infectious necrotic hepatitis. Type C is nontoxicogenic.

The disease has been produced experimentally in sheep by the administration of spores of *C. novyi* after prior infection with fluke metacercaria.<sup>5</sup> Although field outbreaks of the disease are usually precipitated by invasion of the liver by immature liver fluke it is possible that other causes of local hepatic injury, e.g. invasion by cysts of *Cysticercus tenuicollis*, and trauma from liver biopsy<sup>6</sup> may precipitate the disease. *Thysanosoma actinoides* is believed to be a predisposing infection in South America.<sup>7</sup>

Cases are reported in which no specific precipitating lesions are detected and have been advanced as an explanation of sudden deaths in feedlot cattle. *C. novyi* types A and B have been incriminated as a cause of sudden death in sows.<sup>8,9</sup>

## EPIDEMIOLOGY

### Occurrence

The disease is **worldwide** in distribution but is of particular importance in Australia and New Zealand and to a lesser extent in the UK, the US, and Europe. In sheep, the incidence rate in a given year is usually about 5% in affected flocks but may be as high as 10–30% and in rare cases up to 50%. The disease is always fatal in both sheep and cattle. Details of the incidence in cattle are scanty but the disease is becoming more common in some areas where fluke is being introduced. The disease is rare in horses.

### Risk factors

#### Animal risk factors

Well-nourished adult sheep in the 2–4-year age group are particularly susceptible, lambs and yearlings rarely being affected.

#### Environmental risk factors

The epidemiological association between **liver fluke** and *C. novyi* has been supported by the observation that both are more prevalent in the soil in areas where black disease occurs than in other areas, and the survival of both the bacteria and the fluke is favored by the same type of soil environment.<sup>10</sup>

In temperate climates, a **seasonal occurrence** is marked because of fluctuation in the liver fluke and host snail population. Outbreaks are most common in the summer or autumn months and

cease within a few weeks after frosts occur because of destruction of encysted metacercaria. Exposure to fluke infestation, as occurs when sheep graze on marshy ground during dry summers and drought, is commonly associated with outbreaks of black disease, although they can occur in winter. Sheep removed from a black disease farm may die of the disease up to 6 weeks later because of the timelag required for migration of the flukes.

Heavy irrigation of pastures creates favorable conditions for the development of flukes and may predispose disease. Outbreaks in cattle commonly occur on irrigated farms.

### Source of infection

Fecal contamination of the pasture by carrier animals is the most important source of infection, although the carcasses of sheep dead of the disease may cause heavy contamination. Many normal animals in flocks in which the disease occurs carry *C. novyi* in their livers, not all strains being pathogenic.<sup>11</sup> The **spread of infection** from farm to farm occurs via these sheep and probably also by infected wild animals and birds and by the carriage of contaminated soil during flooding.

### Other species

There is little information of the epidemiology of the disease in the horse, although prior administration of an anthelmintic may be a risk factor.<sup>2,4</sup> *C. novyi* can be a significant cause of **sudden death of adult pigs**.<sup>8,9,12</sup> In some herds the disease is more common in older sows (average parity 5.6 litters) with the highest prevalence in the spring months.<sup>9,12</sup>

## PATHOGENESIS

Spores of *C. novyi* are ingested and carried to the liver in the lymphatic system; the organism can be isolated from the livers of normal animals.<sup>13</sup> Under local anaerobic conditions, such as occur in the liver when migrating flukes cause severe tissue destruction, the organisms already present in the liver proliferate, liberating alpha toxin, which is necrotic and causes local liver necrosis and more diffuse damage to the vascular system. The nervous signs observed may be due to this general vascular disturbance or to a specific neurotoxin.

## CLINICAL FINDINGS

### Sheep

Affected sheep commonly die during the night and are found dead without having exhibited any previous signs of illness. When observation is possible, clinically affected sheep are seen to segregate from the rest of the flock, lag behind and fall down if driven. There is fever (40–42°C,

105–107°F), which subsides to a pre-mortem (subnormal) level, and some hyperesthesia; respiration is rapid and shallow; the sheep remains in sternal recumbency and often dies within a few minutes while still in this position. The course from first illness to death is never more than a few hours and death usually occurs quietly, without evidence of struggling.

### Cattle

Clinical findings are the same in cattle as in sheep but the course is longer, the illness lasting for 1–2 days. Outstanding clinical findings in cattle include a sudden severe depression, reluctance to move, coldness of the skin, absence of rumen sounds, a low or normal temperature, and weakness and muffling of the heart sounds. There is abdominal pain, especially on deep palpation of the liver, and the feces are semifluid. Periorbital edema may also develop.

### Horses

In the horse<sup>2-4</sup> the syndrome presents as a peritonitis accompanied by severe and progressive toxemia and manifests with depression, reluctance to walk, pain on palpation of the abdomen, frequent straining and recumbency. Fluid from abdominal paracentesis has a profound increase in nucleated cells and protein. Death occurs within 72 hours of onset of the disease.

## CLINICAL PATHOLOGY

Antemortem laboratory examinations are not usually possible because of the peracute nature of the disease, and there is no body of information for this disease.

## NECROPSY FINDINGS

Bloodstained froth may exude from the nostrils. The carcass undergoes rapid putrefaction. There is pronounced engorgement of the subcutaneous vessels and a variable degree of subcutaneous edema. The dark appearance of the inside of the skin, particularly noticeable on drying, has given rise to the name **black disease**. Gelatinous exudate may be present in moderate quantities in the fascial planes of the abdominal musculature. Bloodstained serous fluid is always present in abnormally large amounts in the pericardial, pleural, and peritoneal cavities. Subendocardial and subepicardial hemorrhages are frequent.

The **liver** is swollen, gray-brown and exhibits characteristic **areas of necrosis**. These are yellow areas 1–2 cm in diameter and are surrounded by a **zone of bright red hyperemia**. They occur mostly under the capsule of the diaphragmatic surface of the organ but may be more deeply seated and can easily be missed unless the liver is sliced carefully. In cattle they are often linear in shape and may be

difficult to find. There is usually evidence of recent invasion by liver fluke, with channels of damaged liver tissue evident on the cut surface of the liver. These may be mistaken for subcapsular hemorrhages when viewed from the surface. Mature flukes are not ordinarily observed. **Histologically**, the liver lesion consists of a central tract of eosinophilic inflammation (due to fluke migration) surrounded by a zone of coagulation necrosis and an outer rim of infiltrating neutrophils. Gram-positive bacilli can easily be demonstrated within the lesion.

A diagnosis of black disease requires the culture of *C. novyi* from the typical liver lesion and the demonstration of preformed toxin in the peritoneal fluid and/or the liver lesion from a fresh carcass. Autolysis rapidly clouds the postmortem findings and false-positive diagnoses are likely if toxin assays are performed on carcasses more than 24 hours old.<sup>14</sup> Another problem is the relatively common occurrence of nonpathogenic strains of *C. novyi* B. These strains are detected in livers by the fluorescent antibody technique and this may lead to a false-positive identification of black disease.

Fluorescent antibody techniques are almost as accurate and much less time-consuming than traditional anaerobic culture methods. An ELISA for beta toxin in intestinal contents has been described<sup>8</sup> and PCR techniques for better identification of toxin-producing strains of clostridia are available.

Unusual lesions, such as a large area of inflammation in the wall of the abomasum and congestion of the subcutaneous tissue and muscle in the shoulder and withers, have been observed in some cattle dying of the disease.

#### Samples for confirmation of diagnosis

- Bacteriology – liver in air-tight container; four impression smears from periphery of lesion (anaerobic CULT, FAT)
- Histology – fixed liver.

#### DIFFERENTIAL DIAGNOSIS

- **Acute fascioliasis** in sheep can cause heavy mortality due to massive liver destruction at the same time and under the same conditions as does black disease
- **Other clostridial disease** – blackleg, malignant edema
- **Anthrax**

#### TREATMENT

No effective treatment is available. In cattle and horses the longer course of the disease suggests the possibility of control-

ling the clostridial infection by the parenteral use of penicillin or broad-spectrum antibiotics but reported cases have high case fatality.

#### CONTROL

**Vaccination** with an alum-precipitated toxoid is highly effective and can be carried out during the course of an outbreak. The mortality begins to subside within 2 weeks. On an affected farm the initial vaccination is followed by a second vaccination 4–6 weeks later and subsequently by annual vaccinations. To provide maximum immunity at the time when the disease is most likely to occur, vaccination as a prophylactic measure should be carried out in early summer.

Control of the disease should also be attempted by **control of the liver fluke**. The host snail must be destroyed in streams and marshes by the use of a molluscicide and the flukes eliminated from the sheep by treatment with flukicides. Pasture contamination from cadavers should be minimized by burning the carcasses.

#### REVIEW LITERATURE

- Bagadi HO. Infectious necrotic hepatitis (black disease) of sheep. *Vet Bull* 1974; 44:385–388.
- Sewell MMH. Infectious necrotic hepatitis. *Vet Annu* 1975; 15:79–82.
- Hatheway CL. Toxigenic clostridia. *Clin Microbiol Rev* 1990; 3:66–98.
- Songer JG. Clostridial diseases of animals. In: Rood JI, McClane BA, Songer JG, Titball RW, eds. *The clostridia: molecular biology and pathogenesis*. London: Academic Press, 1997:153–182.
- Lewis C. Aspects of clostridial disease in sheep. *In Pract* 1998; 20:494–500.
- Songer JG. Clostridial diseases of small ruminants. *Vet Res* 1998; 29:219–232.

#### REFERENCES

1. Hollingsworth TC, Greer VJD. *Aust Vet J* 1978; 54:48.
2. Gay CC et al. *Equine Vet J* 1980; 12:26.
3. Sweeney HJ, Grieg GA. *Equine Vet J* 1986; 18:150.
4. Oaks JL et al. *J Vet Diagn Invest* 1997; 9:324.
5. Bagadi HO, Sewell MMH. *Res Vet Sci* 1973; 15:53.
6. Duncan IF. *Aust Vet J* 1984; 61:272.
7. Robles CA. *Arch Med Vet* 2000; 32:93.
8. Itoh H et al. *Jpn Vet Med Assoc* 1987; 40:365.
9. Duran CO, Walton JR. *Pig J* 1997; 39:37.
10. Williams BM. *Br Vet J* 1976; 132:221.
11. Roberts RS et al. *Vet Rec* 1970; 86:628.
12. Marco E. *Pig J* 1995; 35:257.
13. Bagadi HO. *Vet Bull* 1974; 44:358.
14. Bagadi HO, Sewell MMH. *Res Vet Sci* 1974; 17:320.

#### BACILLARY HEMOGLOBINURIA

##### ETIOLOGY

*Clostridium haemolyticum* (*C. novyi* type D) is a **soil-borne** anaerobe. The longevity of the spores in soil is unknown but the organism has been isolated from bones a year after the death of an animal from bacillary hemoglobinuria. In infected areas the organism is often found in the livers of **healthy cattle**. Under anaerobic

#### Synopsis

**Etiology** Necrotoxic and hemolytic beta toxin produced by *Clostridium haemolyticum*, a soil-borne anaerobe, growing in a necrotic infarct in the liver

**Epidemiology** Cattle and sheep. Occurs in summer and autumn in endemic areas, which are usually irrigated or subirrigated fields

**Clinical findings** Toxemia, fever, hemoglobinuria and jaundice; high case fatality

**Clinical pathology** Hemoglobinuria, anemia, blood culture

**Necropsy findings** Single ischemic pale infarct in the liver surrounded by a zone of hyperemia. Hemoglobinuria

**Diagnostic confirmation** Typical liver lesion and positive fluorescent antibody staining of organism in lesion

**Treatment** Antibiotics, antiserum and blood transfusion

**Control** Annual vaccination preceding the period of risk

conditions the organism grows and produces a necrotoxic and hemolytic toxin that is responsible for the clinical disease. Damage to the liver from telangiectasis, necrobacillosis caused by *Fusobacterium necrophorum*, and fascioliasis have been suggested as precipitating causes.<sup>1,2</sup>

The disease has been produced experimentally by infecting calves orally and inducing liver damage by liver biopsy, or by implanting the organism in the liver.<sup>3</sup> Cultures of the organism produce severe muscle necrosis and hemoglobinuria when injected intramuscularly into cattle and experimental animals.

#### EPIDEMIOLOGY

##### Occurrence

Bacillary hemoglobinuria has been reported principally from the western part of the USA, although the disease has also been observed in the southern states, Canada, Mexico, Venezuela, Chile, Turkey, Australia, New Zealand, the UK, and Ireland. The disease is not common but on infected farms death losses, which are usually less than 5%, may reach as high as 25%.

##### Risk factors

###### Animal risk factors

Cattle are the usual species involved although occasional cases occur in sheep and rare cases in pigs. As is the case in many clostridial diseases, animals in good condition are more susceptible.

###### Environmental risk factors

Bacillary hemoglobinuria is a disease of the **summer and autumn** months. A primary association occurs with pastures that also are associated with the occurrence of liver fluke although other, less determined risk factors obtain. The highest

incidence of bacillary hemoglobinuria is on irrigated or poorly drained pasture, especially if the soil is alkaline in reaction.<sup>4</sup> Some outbreaks have occurred in **feed-lots** where hay cut from infected fields was fed.

The disease is rare on dry, open **range country** but does occur in range country where cattle have access to swales with areas naturally irrigated by springs or streams. Heavy mortalities may occur when cattle from an uninfected area are brought on to an infected farm, cases beginning to occur 7–10 days later.

The disease is **spread** from infected to noninfected areas by flooding, natural drainage, contaminated hay from infected areas, or carrier animals. The carriage of bones or meat by dogs or other carnivores could also effect spread of the infection. Contamination of pasture may occur from feces or from decomposing cadavers.

### PATHOGENESIS

Although attempts to produce the disease by feeding the organism have been unsuccessful it is probable that under natural conditions in endemic areas invasion occurs from the alimentary tract after ingestion of contaminated material. Migrating flukes are the primary factor leading to liver necrosis and the establishment of anaerobic conditions in the liver that will lead to the multiplication of the causative organism. Invasion of the liver by *Cysticercus tenuicollis* and other causes of liver damage can also lead to the disease.<sup>5</sup> As in black disease of sheep, the bacteria are carried to the liver and lodge there until damage to the parenchyma of the liver and the resulting hypoxia create conditions suitable for their proliferation. The development of an organized thrombus in a subterminal branch of the portal vein produces the large anemic infarct that is characteristic of the disease. Most of the bacteria are to be found in this infarct and, under the anaerobic conditions, the necrotoxic and hemolytic beta toxin is released systemically to result in toxemia, generalized vascular damage and intravascular hemolysis.

### CLINICAL FINDINGS

Animals brought into contact with the infection in endemic areas seldom develop disease until 7–10 days later. The illness is of short duration and cattle at pasture may be **found dead** without signs having been observed. More often there is a **sudden onset**, with complete cessation of rumination, feeding, lactation, and defecation. Abdominal pain is evidenced by disinclination to move and an arched-back posture. Grunting may be evident on walking. Respiration is shallow and labored and the pulse is weak and rapid. Fever (39.5–41°C, 103–106°F) is evident

in the early stages but the temperature subsides to subnormal before death. **Edema** of the brisket is a common finding. The feces are dark brown; there may be diarrhea with much mucus and some blood. The **urine** is dark red. Jaundice is present but is never very obvious. The duration of the illness varies from 12 hours in dairy cows in advanced pregnancy to 4 days in dry stock. Pregnant cows often abort. Severe dyspnea is evident just before death. The disease in sheep presents with similar signs.<sup>6</sup>

### CLINICAL PATHOLOGY

The red color of the urine is due to the presence of hemoglobin: there are no free red cells. In the later stages there is **anemia**, the erythrocyte count being depressed to between 1 and  $4 \times 10^{12}/L$  and the hemoglobin to 3–8 g/L. Leukocyte counts vary considerably from 6700–34 800  $\times 10^9/L$ . Differential counts vary similarly, with a tendency to neutrophilia in severe cases. Serum calcium and phosphorus levels are normal but blood glucose levels may be elevated (100–120 mg/dL) in some cases.

**Blood cultures** during the acute stages of the disease may be positive. Serum **agglutinins** against *C. haemolyticum* may be detectable at low levels (1:25 or 1:50) during the clinical illness and, if the animal recovers, rise to appreciable levels (1:50 to 1:800) a week later. Titers greater than 1:400 are usual at this time. A positive agglutination test is not conclusive evidence of the presence of the disease.

### NECROPSY FINDINGS

Rigor mortis develops quickly. The perineum is soiled with bloodstained urine and feces. Subcutaneous, gelatinous edema, which tends to become crepitant in a few hours, and extensive petechial or diffuse hemorrhages in subcutaneous tissue are characteristic. There is a variable degree of jaundice. Excessive amounts of fluid, varying from clear to bloodstained and turbid, are present in the pleural, pericardial, and peritoneal cavities. Generalized subserous hemorrhages are also present. Similar hemorrhages appear under the endocardium. Hemorrhagic abomasitis and enteritis are accompanied by the presence of bloodstained ingesta or free blood. The characteristic lesion of bacillary hemoglobinuria is an ischemic infarct in the liver. One or more may be present in any part of the organ and vary from 5–20 cm in diameter. The infarct is pale, surrounded by a zone of hyperemia, and has the general appearance of local necrosis. Red urine is present in the kidneys and bladder and petechiation is evident throughout the kidney.

*C. haemolyticum* can be isolated from the liver infarct and many other organs

from a fresh carcass, but postmortem invaders quickly obscure its presence. A positive fluorescent antibody test on impression smears taken from the hyperemic zone around the liver infarct and stained with FITC-labeled rabbit anti-sheep *C. novyi* antiserum will confirm the presence of *C. novyi*-type organisms but cannot differentiate type B from type D. A PCR test to identify toxin-producing genotypes of *Clostridium* spp. may assist in the identification of isolates.

### Samples for confirmation of diagnosis

- Bacteriology – tissue from edge of liver infarct, placed in an airtight container; four air-dried impression smears from lesion border (anaerobic CULT, FAT)
- Histology – fixed liver lesion, kidney.

### DIFFERENTIAL DIAGNOSIS

The diagnosis of bacillary hemoglobinuria is largely a question of differentiation from other diseases in which hemoglobinuria, myoglobinuria, and hematuria are cardinal signs. In an animal found dead differentiation from other clostridial diseases and anthrax may be required.

- Acute leptospirosis
- Postparturient hemoglobinuria
- Hemolytic anemia caused by cruciferous plants
- Babesiosis and anaplasmosis
- Enzootic hematuria
- Chronic copper poisoning (sheep)

### TREATMENT

**Specific treatment** includes the immediate use of penicillin or tetracyclines at high doses and antitoxic serum if available. Prompt treatment is essential: provided that the serum is administered in the early stages of the disease, hemoglobinuria may disappear within 12 hours.

**Supportive treatment** – including blood transfusion, parenteral fluid, and electrolyte solutions – is of considerable importance. Care is required during treatment and examination, as undue excitement or exercise may cause sudden death. Bulls should not be used for service until at least 3 weeks after recovery because of the danger of liver rupture. Convalescence is often prolonged and animals should be protected from nutritional and climatic stress until they are fully recovered. Hemopoiesis should be facilitated by the provision of mineral supplements containing iron, copper, and cobalt.

### CONTROL

A formalin-killed whole culture adsorbed on aluminum hydroxide gives good

protection for a year in cattle. Vaccination is carried out 4–6 weeks before the expected occurrence of the disease. Annual revaccination of all animals over 6 months of age is necessary in enzootic areas. In some **locations of extreme risk** a second vaccination during the grazing season is recommended. To obviate the local reaction that occurs at the site of injection the inoculum may be administered at several sites and distributed under the skin by massage. The injection must be subcutaneous, as intradermal and intramuscular injections are likely to produce severe reactions. Modern vaccines prepared so as to avoid these local reactions lack immunogenicity and require to be administered twice a year.<sup>7</sup> The carcasses of animals dying of the disease should be disposed of by burning or deep burial.

### REVIEW LITERATURE

- Stogdale L, Booth AJ. Bacillary hemoglobinuria. *Compend Contin Educ Pract Vet* 1984; 6:5284–5290.
- Hatheway CL. Toxicogenic clostridia. *Clin Microbiol Rev* 1990; 3:66–98.
- Songer JG. Clostridial diseases of animals. In: Rood JJ, McClane BA, Songer JG, Titball RW, eds. *The clostridia: molecular biology and pathogenesis*. London: Academic Press, 1997:153–182.

### REFERENCES

- Orr JP et al. *Can Vet J* 1982; 23:177.
- Smith LDS. *Adv Vet Sci* 1957; 3:465.
- Erwin BG. *Am J Vet Res* 1977; 38:1625.
- Van Ness GB, Erickson K. *J Am Vet Med Assoc* 1964; 144:492.
- Stogdale L, Booth AJ. *Compend Contin Educ Pract Vet* 1984; 6:5284.
- Randhawa SS et al. *Trop Anim Health Prod* 1995; 27:31.
- Lozano EA. *Am J Vet Res* 1981; 42:1641.

### TYZZER'S DISEASE

This is a fatal necrotizing hepatitis associated with *Clostridium piliformis* (previously *Bacillus piliformis*).

Monoclonal antibodies for different flagellar antigens of isolates from different animals show that there are distinct antigenic types and that these may have some species specificity. At least two antigenic types infect the horse, one with a rat epitope and one with a horse epitope.<sup>1,2</sup>

Infection is recorded in rodents, lagomorphs, foxes, coyotes, several other wildlife species, cats, foals,<sup>3,4</sup> and calves.<sup>5</sup> In farm animals it is principally a disease of foals 1–5 weeks of age, and in them and in calves it is marked by a sudden onset, high fever (to 40.5°C (113°F)), shock, terminal coma, and a short course of a few hours to 2 days. Foals running with mares are difficult to assess in terms of preclinical disease but it is probable that foals with Tyzzer's disease have clinical signs of fever, tachycardia, and

tachypnea for up to 48 hours before the observable depression appears.<sup>6</sup> Jaundice and severe diarrhea occur in some. Clinicopathological examination shows severe leukopenia with leukocyte counts in the range of 2000–4000/μL, hypoglycemia and severe metabolic acidosis. Serum concentrations of liver-specific enzymes are highly elevated.

At necropsy examination the liver is grossly enlarged and has miliary necrotic foci; there is also jaundice, a necrotizing colitis<sup>7</sup> and in some cases myocarditis. Culture of the causative organism is sufficiently difficult to encourage diagnosis by staining a smear to demonstrate the characteristic bacteria. An ELISA test using a trivalent flagellar antigen is available.<sup>8</sup>

Although clinical disease is rare, the prevalence of antibody in horses suggests that infection is common and the reason for the susceptibility of particular foals remains to be determined.<sup>1</sup> The disease appears to be increasing in prevalence in the USA, although the prevalence is still very low and the occurrence is sporadic, but certain horse farms may have multiple cases. A study in California on a horse farm with a history of Tyzzer's disease found that foals born between March 13 and April 13 were at seven times greater risk of disease than those born at other times in the foaling season and that foals of visiting mares and those of young mares were at greater risk. In examining the management factors that might influence these differences it was thought that they could reflect a difference in exposure to infection coupled with differences in the quality of transferred maternal immunity.<sup>9</sup>

Originally the disease probably came from wildlife, but adult horses become inapparent carriers, excreting the organism in feces, and infect newborn foals, which are normally coprophagous.<sup>10</sup> The disease is likely to be confused with shigellosis, septicemia associated with *Rhodococcus equi*, adenovirus pneumonia of immunodeficient Arabian foals, chronic abscess in the urachus, and idiopathic myopathy. It has been recorded concurrently with combined immune deficiency in Arabian foals.<sup>10</sup> The recovery of a presumptive case of Tyzzer's disease in a foal following penicillin, sulfamethiazole–trimethoprim and intensive supportive therapy is reported.<sup>11</sup>

### REFERENCES

- Chanter N. *Equine Vet J* 1995; 27:1.
- Hook RR et al. *Equine Vet J* 1995; 27:8.
- St-Dennis KA et al. *Can Vet J* 2000; 41:491.
- Humber KA et al. *J Am Vet Med Assoc* 1988; 193:1425.
- Ikegami T et al. *Vet Pathol* 1999; 36:253.
- Trent A, Walsh KM. *Equine Pract* 1983; 5:8.

- Yates WDG, Hayes MA. *Can Vet J* 1980; 21:63.
- Motzel SL, Riley LK. *J Clin Microbiol* 1991; 29:2566.
- Lembcke M et al. *Pferdeheilkunde* 2003; 19:159.
- Peek SF et al. *Equine Vet Educ* 1994; 6:307.

### ENTERIC DISEASE ASSOCIATED WITH *CLOSTRIDIUM PERFRINGENS*

*Clostridium perfringens* resides in the intestinal tract of domestic animals and can produce a number of toxins that result in enteric and histotoxic disease. *C. perfringens* isolates are classified into one of five types, types A–E, depending on their ability to produce the four major lethal toxins: the alpha, beta, epsilon, and iota toxins. The activities of these major lethal toxins are the basis of the pathogenesis of the classical enterotoxemias attributed to this organism and described below. More recently, it has been recognized that *C. perfringens* produces other toxins of probable importance in animal disease. These include an enterotoxin and a cytotoxic beta-2 toxin, the latter encoded by the *cbp2* gene.<sup>1,2</sup>

The amino acid sequence of the beta-2 toxin has little homology with that of the major beta toxin and they are only weakly related immunologically, but the biological activity of the two toxins is similar and both are cytotoxic and cause hemorrhagic necrosis of the intestinal wall.<sup>3</sup> The importance of enterotoxin and the beta-2 toxin to animal disease is still uncertain. Both appear important in the cause and pathogenesis of enteric disease in pigs.<sup>1,2,4,5</sup> The beta-2 toxin may have importance in enterocolitis in foals and adult horses as Cbp2-positive *C. perfringens* type A has been isolated from diarrheic foals and adult horses; however, the significance of these isolations to the disease is still not fully determined.<sup>2,3,6</sup>

### REFERENCES

- Waters M. *J Clin Microbiol* 2003; 41:3584.
- Bueschel DM et al. *Vet Microbiol* 2003; 94:121.
- Schotte U et al. *J Vet Med B* 2004; 51:423.
- Gut P et al. *Schweiz Arch Tierheilkd* 2002; 144:275.
- Garmony HS et al. *Epidemiol Infect* 2000; 124:61.
- Bacciarini LN et al. *Vet Pathol* 2003; 40:376.

### ENTEROTOXEMIA ASSOCIATED WITH *CLOSTRIDIUM PERFRINGENS* TYPE A

The role of *C. perfringens* type A in the pathogenesis of diseases of animals is uncertain because the organism forms part of the bacterial flora of the alimentary tract in many normal animals. However, there are an increasing number of reports that attribute disease and mortality to this organism. The validity of these attributions remains to be fully determined but they are listed below.

### Enterocolitis in horses

Enterocolitis in foals and adult horses is an etiologically poorly defined syndrome. Enterocolitis associated with *C. difficile* is one cause and is covered under that heading elsewhere in this text. In addition, enterocolitis associated with *C. perfringens* type C is covered under that heading. There remains a syndrome of enterocolitis that is manifest with enteritis, diarrhea and colic, and a high case fatality, and one that is diagnosed most often at post-mortem. It appears to occur worldwide and although occurrence is sporadic, there is the perception that there is an increasing prevalence of this disease.<sup>1</sup> A study of risk factors in the western USA found that stock horse breeds were more at risk and that the presence of other livestock on the farm, and housing in a stall or dry lot for the first 3 days of life, was associated with increased risk.<sup>2</sup> Other studies have implicated barn hygiene as a factor that should be considered in preventive procedures.<sup>1</sup>

There have been a number of clostridial species that have historically been associated with the syndrome besides *C. perfringens* type A. In some cases this association has been by identification of type-specific toxin in the intestine of the affected horse but in others it has been made by the presence of large numbers of the incriminated organism in affected animals in comparison to occurrence and numbers in normal horses. This association has risk as the number of clostridia in the intestine can be influenced by diet, clostridia can multiply in the intestine following death, and they can exist in different forms that may be variably isolated with different cultural techniques.

### Equine intestinal clostridiosis

A syndrome historically named equine intestinal clostridiosis has been attributed to intestinal infection with *C. perfringens* type A in adult horses.<sup>3,4</sup> The syndrome was characterized by an acute profuse watery diarrhea with high mortality in adult horses and the demonstration of large numbers of *C. perfringens* type A in the intestine at postmortem. It was described as occurring in horses with hemorrhagic cecitis and colitis similar to colitis X, in horses collapsing and dying following exercise, and in other circumstances. Diarrhea and death were reproduced with massive (biologically implausible) oral challenge with broth cultures of these organisms<sup>4</sup> and colic and hemorrhagic gastroenteritis were produced by intravenous injection of ponies with *C. perfringens* type A enterotoxin.<sup>5</sup> The evidence of an association of *C. perfringens* type A with disease in these early studies was equivocal but *C. perfringens*

type A can be isolated from both foals and adults with enterocolitis.<sup>6-9</sup> However, isolation from this disease and causal association remain to be determined. *C. perfringens* is common in the environment of foals and one study in over 128 healthy foals found that *C. perfringens* type A could be isolated from the feces of the majority of foals at 3 days of age. *C. perfringens* with the gene for beta-2 toxin expression were found in the feces of 28 foals and with the enterotoxin gene in five foals.<sup>1</sup> Consequently the isolation of *C. perfringens* type A expressing the gene for beta-2 toxin does not constitute a causal diagnosis. There is, however, a suggestion that *C. perfringens* type A that expresses the gene for beta-2 toxin may be the particular subset of this isolate that is responsible for this disease.

### Enteritis in piglets

*C. perfringens* type A is associated with diarrhetic food poisoning in humans and a similar **diarrhea in pigs** may be produced by infection with this organism.<sup>10,11</sup> The disease is manifest with a watery yellow diarrhea occurring in piglets under 5 days of age, usually in the first 3 days of age, and a high morbidity but low case fatality.<sup>12</sup> At postmortem there is a mild enterocolitis and villous atrophy. It is controlled with sanitation procedures or with the type of prophylactic procedures used with enterotoxemia associated with *C. perfringens* type C.

### Hemorrhagic enterotoxemia and hemolytic disease in cattle, sheep, and goats

There are reports of a highly fatal **hemolytic disease** in cattle, sheep, and lambs<sup>13,14</sup> (**yellow lamb disease**), of an acute **hemorrhagic enteritis** in calves and adult cattle,<sup>11,15</sup> and of an acute **hemolytic enterotoxemia** in foals<sup>5,16</sup> and goats,<sup>11,17</sup> associated with the presence of large numbers of *C. perfringens* type A in the intestine. These reports have some credibility because of the activity of the primary toxin of *C. perfringens* type A, alpha toxin, which possesses phospholipase C and sphingomyelinase activity and consequently hemolytic action.<sup>11,18</sup> Also the presence of beta-2 toxin in these strains may contribute to the pathogenicity.<sup>19,20</sup>

Some credibility is also engendered by reports, albeit occasional, of similar syndromes in different geographical areas and by different institutes.

In the **hemolytic disease** there is an acute onset of severe depression, collapse, mucosal pallor, jaundice, hemoglobinuria, dyspnea, and the presence of severe abdominal pain. Temperatures range from normal to 41°C (106°F). The disease is highly fatal, most affected animals dying within 12 hours of the onset of illness,

although occasional animals survive for several days. Large numbers of *C. perfringens* and the presence of the specific toxin in feces is used to make a presumptive diagnosis. At **necropsy** the cardinal features are pallor, jaundice, and hemoglobinuria. The kidneys are swollen, dark brown in color, and may contain infarcts; the liver is pale and swollen and there may be hydropericardium and pulmonary edema. There is extensive necrosis of the small intestine. Clostridia dominate the bacterial population of the small intestine, as indicated by smears made from the contents, and alpha toxin is present in large quantities. The toxin is present in large quantities in the intestine, which is indicative of the existence of the disease.

The syndrome is very similar to that associated with chronic copper poisoning and leptospirosis in calves.

In the **hemorrhagic enteritis** of calves, foals, and adult cattle the syndrome observed is indistinguishable from that associated with *C. perfringens* types B and C. The disease in adult cattle occurs most commonly in the period shortly after calving. The experimental disease in lambs<sup>21</sup> and calves<sup>22</sup> produced by the intravenous injection of toxin is characterized by transitory diarrhea and hyperemia of the intestinal mucosa. Type A antiserum has been effective in prevention of the disease in calves and a formalinized vaccine has shown some immunizing capacity in sheep.<sup>23</sup>

### Abomasal ulcer

*C. perfringens* type A has been suspected in the etiology of **abomasal ulcers** in suckling beef calves in western North America and less commonly elsewhere, but there is no compelling evidence for this.<sup>24,25</sup>

### Jejunal hemorrhage syndrome in cattle

*C. perfringens* type A has been proposed as a cause of this disease, largely based on the isolation of this organism from the intestine of affected animals.<sup>26,27</sup>

This organism is present in the intestinal tract of normal animals and, while it is possible that a subset of Cbp2-positive, beta-2 toxin-producing *C. perfringens* type A organisms are responsible for this disease, there is little convincing evidence for an association with current information.

### REFERENCES

1. Tillotson K et al. J Am Vet Med Assoc 2002; 220:342.
2. East LM et al. Prev Vet Med 2000; 46:61.
3. Wierup M, DiPietro JA. Am J Vet Res 1981; 42:2167.
4. Wierup M. Acta Vet Scand Suppl 1977; 62:1.
5. Kanoe M et al. Microbiology 1990; 64:153.
6. Netherwood T et al. Epidemiol Infect 1996; 117:375.

7. East LM et al. J Am Vet Med Assoc 1998; 212:1751.
8. Herholz CR et al. J Clin Microbiol 1999; 37:358.
9. Gamory HS et al. Epidemiol Infect 2000; 124:61.
10. Correa AEE, Taylor DJ. Vet Rec 1989; 124:606.
11. Songer JG. Clin Microbiol Rev 1996; 9:216.
12. Collins JE et al. Swine Health Prod 1994; 2(5):24.
13. Senf W. Monatsh Veterinärmed 1983; 38:528.
14. McGowan B et al. J Am Vet Med Assoc 1958; 133:219.
15. Shirley GN. Vet Rec 1958; 70:478.
16. Dart AJ et al. Aust Vet J 1988; 65:330.
17. Dray T. Can Vet J 2004; 45:251.
18. Rood JI, Cole ST. Microbiol Rev 1991; 55:621.
19. Dray T. Can Vet J 2004; 45:251.
20. Kaeckenbeeck A, Mainil JG. Vet Microbiol 2002; 86:191.
21. Niilo L. Infect Immun 1971; 3:100.
22. Niilo L. J Comp Pathol 1973; 83:265.
23. Niilo L et al. Can J Microbiol 1971; 17:391.
24. Manteca C et al. Rev Med Vet 2001; 152:637.
25. Jelinski MD et al. Can Vet J 1995; 36:379.
26. Kirkpatrick MA et al. Bovine Pract 2001; 35:104.
27. Dennison AC et al. J Am Vet Med Assoc 2002; 221:686.

### ENTEROTOXEMIA ASSOCIATED WITH *CLOSTRIDIUM PERFRINGENS* TYPES B, C, AND E

**Etiology** Beta toxin, a trypsin-sensitive toxin produced by *C. perfringens* types B and C, produces hemorrhagic enteritis and ulceration of the intestinal mucosa resulting in diarrhea and dysentery in young lambs, goats, calves, pigs, and foals. Beta-2 toxin also contributes to these diseases. A number of diseases associated with these clostridia occur in different parts of the world and are given specific names.

**Epidemiology** Young animals, with the exception of struck in sheep, often occurring as outbreaks with a high case fatality rate where there is buildup of infection.

**Clinical findings** Rapid course with hemorrhagic diarrhea, abdominal pain and toxemia.

**Necropsy findings** Focal (type B) or extensive (type C) areas of necrosis in the small intestine.

**Diagnostic confirmation** Clinical signs, gross and microscopic pathology from sacrificed or freshly dead animals, and direct or cultural examination for clostridia.

**Treatment** Antibiotics, specific antitoxin, supportive therapy.

**Control** Vaccination.

#### ETIOLOGY

The general etiology of these diseases is given below but, because of differing circumstances of occurrence, the description of the epidemiology of these diseases is given separately according to animal species.

The causative clostridia occur commonly in soil, the animals' housing environment and the alimentary tract of healthy animals, and management factors precipitate disease. The diseases produced

by these organisms occur in animals in the first few days of life, with the exception of the disease struck in sheep. Their predominance in very young animals may be due to the immaturity of their alimentary tracts, the beta toxin being readily inactivated by **trypsin**, and because of the ready colonization of the gut by *C. perfringens* in the absence of a mature intestinal flora.<sup>1</sup> It is probable that many animals become subclinically challenged but do not show clinical illness, as antitoxin has been detected in clinically normal animals.<sup>2</sup>

The bacteria are capable of forming **spores** that survive for long periods. In general, rapidly growing, well-nourished animals are most susceptible. The **toxins** produced are alpha, beta, and epsilon in type B, and alpha and beta in type C.

**Beta-2 toxin** is also produced by some of these organisms and appears important to their pathogenicity in pigs and horses. There are subtypes of these organisms with differing toxin production abilities. Alpha and iota toxin are produced by type E, which is a rare cause of enterotoxemia in calves and lambs.

The diseases that are produced by these organisms in the different animal species, and the organisms' names, are as follows:

- **Lamb dysentery** associated with *C. perfringens* type B. An enterotoxemia of young lambs is also associated with *C. perfringens* type C
- **Goat enterotoxemia** associated with *C. perfringens* type C and rarely by type B
- **Necrotic enteritis of pigs, pig enterotoxemia** associated with *C. perfringens* types C and less commonly by type B<sup>3</sup>
- **Foal enterotoxemia** associated with *C. perfringens* types C and B
- **Calf enterotoxemia** associated with *C. perfringens* types B and C
- **Struck**, associated with *C. perfringens* type C, affects adult sheep, particularly when feed is abundant.

#### EPIDEMIOLOGY

##### Lamb dysentery and type C enterotoxemia

Occurrence

**Lamb dysentery** associated with **type B** occurs in Great Britain, Europe, and South Africa and is an important disease in these countries. In contrast, this disease is rare or absent in Australia, New Zealand, North America, and Japan, where type C infections are more important. The geographical variation may be due to variation in the occurrence of the types of *C. perfringens*. Lamb dysentery does not occur in New Zealand and *C. perfringens* type B has not been found in sheep or soil samples in that country.<sup>4</sup>

**Type C enterotoxemia** in lambs and goats occurs particularly with shed lambing in North America and where there is close stocking of ewes and lambs at lambing. It is also recorded in Australasia.

Animal and environmental risk factors

In **lamb dysentery**, the incidence of clinical disease in groups of lambs may reach as high as 20–30%. In an outbreak, the disease initially affects 1–4-day-old lambs and the clinical course is very short. A characteristic of the disease is the tendency for an increase in incidence rate as lambing progresses and for the involvement of older lambs, up to 2–3 weeks of age, which survive for longer periods. The case fatality rate approaches 100%.

In Great Britain **lamb dysentery** occurs primarily in the **hill breeds** of sheep, breeds that have a small litter size but good milk production, and the appearance of the disease in a particular year appears to be related to weather conditions that allow sufficient pasture growth to produce profuse lactation in the ewes. The time of onset of the disease in a lambing season is related to the weather conditions that predispose to its occurrence.

**Type C enterotoxemia** in lambs and goats is prevalent in cold weather and on farms where ewes are kept closely confined in small yards or fields for lambing and kidding. Gross contamination of the surroundings with the causative bacteria is likely to occur in these circumstances. The disease can occur as an outbreak with an attack rate of 15–20% and a case fatality that approaches 100%. Type C enterotoxemia is more common in single-born lambs and is largely restricted to lambs 12 hours to 4 days of age. Sporadic disease occurs in orphan or 'bummer' lambs reared on milk replacer, which appear particularly at risk and may develop the disease at up to 2 weeks of age.

##### Necrotic enteritis of pigs

Occurrence

Necrotic enteritis is an important disease of piglets, particularly in intensive pig units. It occurs in most countries but has been reported most commonly from certain areas in the USA, Europe, and the UK.

Animal and environmental risk factors

The **organisms** are recoverable from the skin of sows and the feces of affected piglets, and infection probably occurs during suckling. The number of piglets affected varies between herds and between litters. The **disease** may occur sporadically in a piggery but commonly occurs as an outbreak affecting several litters within a given time period. Pigs up to 7 days of age are most commonly affected and susceptibility to disease and



its severity decreases with age. **Peracute disease** with rapid death occurs in piglets affected at 1–2 days of age, whereas piglets affected at 1–2 weeks show a more protracted clinical course. The case fatality is high and in severe outbreaks 80% of piglets at risk may die.<sup>5</sup> The disease tends to become **endemic** in pig units and to recur on the same premises in succeeding years.<sup>6,7</sup>

Insufficient cleaning and disinfection of farrowing pens, the housing of pigs on concrete, and the routine use of antibiotics to which *C. perfringens* is resistant, such as the aminoglycosides, have been proposed as **risk factors** for buildup of infection in swine units.<sup>8</sup>

#### Enterotoxemia in foals

Enterotoxemia in foals has been associated with both *C. perfringens* type B and type C. Type C predominates in reports from North America.<sup>9–13</sup> Reports are of a single foal on a farm being affected and the disease generally occurs in foals under 7 days of age, although enterotoxemia associated with type B has been recorded in a 4-week-old foal.<sup>14</sup> The factors that predispose to disease in foals are poorly defined.

#### Enterotoxemia in calves

Enterotoxemia due to *C. perfringens* type B or C is uncommon in calves. The disease usually occurs as outbreaks of severe dysentery with some deaths in calves 7–10 days old, although calves up to 10 weeks of age may be affected.

#### Struck in sheep

Struck in adult sheep on good pasture in spring is limited in its occurrence to certain localities in Britain and is rarely reported.

#### PATHOGENESIS

The organism is **ingested** from soil and fecal contamination on the surface of the dam's udder. It proliferates and attaches to the surface of the epithelial cells of the intestinal villus but toxin production and mucosal damage may precede attachment. The factors that allow proliferation and attachment are poorly understood. Toxigenic strains of *C. perfringens* types B and C both produce both alpha and beta toxin.

The **alpha toxin** is a lethal toxin and is produced in varying amounts by isolates of both types. It is a phospholipase, and hydrolysis of membrane phospholipids in erythrocytes, platelets, leukocytes, and endothelial cells results in cell lysis or other forms of cytotoxicity. The **beta toxin** causes increased capillary permeability and may facilitate its uptake from the intestine. Beta toxin is a necrotizing toxin and initially produces damage to the microvilli with degeneration of mito-

chondria, with eventual destruction and desquamation of the intestinal epithelial cells and the production of a hemorrhagic enteritis and ulceration of the intestinal mucosa.<sup>15–17</sup>

The **age incidence** of these diseases may be partially explained by the observation that beta toxin is highly sensitive to inactivation by trypsin, which is a component of normal pancreatic proteases. Colostrum contains a trypsin inhibitor and trypsin is decreased or absent in affected pigs. Experimentally administered soybean flour used as a protease inhibitor converts experimentally induced clostridial enteritis from a nonfatal to a fatal disease.

#### CLINICAL FINDINGS

**Lamb dysentery** can be manifest by sudden death without premonitory signs in peracute cases. In the more common **acute form**, there is loss of sucking drive and severe **abdominal pain** manifest by bleating, stretching, and looking at the abdomen. Lambs pass brown, fluid feces sometimes containing blood, and defecation is often accompanied by painful straining. Death usually occurs after a period of recumbency and coma and within 24 hours of the onset of illness. On farms where the disease has become established, cases may occur in older lambs up to 3 weeks of age and occasional cases may survive for several days. A chronic form of the disease in older lambs called '**pine**', and manifest with chronic abdominal pain and reluctance to suck but no diarrhea, is recognized and responds to treatment with specific antiserum.

**Necrotic enteritis in piglets** is also manifest with rapid death in young animals and more prolonged disease in slightly older piglets. Affected pigs become dull and depressed and exhibit diarrhea, dysentery, and gross reddening of the anus. The feces of piglets affected within 2–3 days of life is watery and initially yellow but in a proportion of pigs will become hemorrhagic and red-brown in color, and contain necrotic debris. The clinical course in piglets affected at this age is usually less than 24 hours; they rapidly become dehydrated, hypoglycemic, hypothermic, and comatose. Piglets affected at an older age have a fluid, yellow-colored diarrhea and blood may not be evident. Frequently the majority of litters born during an outbreak will be affected, although affected litters may include some normal pigs. Occasionally weaned pigs are affected. Acute outbreaks in herds may be followed by the occurrence of chronic necrotizing enteritis.<sup>18</sup>

**Foals** with enterotoxemia associated with *C. perfringens* type B or C show evidence of severe depression, pronounced toxemia, and marked abdominal pain.

Affected foals are a few days old and have an acute attack of collapse with bloody feces, subnormal temperature, fast pulse and respiratory rate, and death within a few hours.<sup>10</sup> Colic may be evident and a major differential diagnosis is an acute intestinal accident. The clinical course is very short and diarrhea does not occur in many cases. There are limited descriptions of the clinical disease in foals because of its sporadic occurrence and rapid course.

In **calves** signs include diarrhea, dysentery, and acute abdominal pain accompanied by violent bellowing and aimless running. There may be additional nervous signs, including tetany and opisthotonos. In very acute cases, death occurs in a few hours, sometimes without diarrhea being evident. In less severe cases, the illness lasts for about 4 days and recovery is slow, usually requiring 10–14 days.

**Struck** in adult sheep is manifested only by sudden death, clinical signs not being observed beforehand. Occasionally death is preceded by abdominal pain and convulsions.

#### CLINICAL PATHOLOGY

The disease in all species is so acute and so highly fatal that the diagnosis is usually made on necropsy material. Antemortem laboratory examinations are not widely used in diagnosis and there is no database but the predominance of clostridia in a fecal smear may suggest a diagnosis of hemorrhagic enterotoxemia. Specific antitoxins are detectable in the sera of recovered animals. A severe hypoglycemia has been observed in baby pigs dying of the disease but this is not specific in this infection.

#### NECROPSY FINDINGS

The major lesion in all species is a hemorrhagic enteritis, with ulceration of the mucosa in some cases. With **type B infections** the lesions occur as localized areas of necrosis, usually most evident in the ileum. The intestinal mucosa is dark red and the ulcers are large (up to 2.5 cm in diameter) and almost transmural. Intestinal contents are bloodstained and may contain fibrin clots.

With **type C infection** the areas of necrosis are more extensive, involving entire segments of small intestine and often inducing a peritonitis. Subendocardial and subepicardial hemorrhages are common in ruminants dying of enterotoxemia. If the necropsy of adult sheep is delayed for several hours, the fascial tissues may develop the appearance of malignant edema. Carcasses of 7–10-day-old pigs may lack the severe hemorrhagic enteritis typical of the disease in newborn pigs. The less acute disease course in this older age group often results in a yellow,

fibrinous deposit on the intestinal mucosa, accompanied by large quantities of watery, lightly bloodstained ingesta in the lumen.

In general, the **histological features** of gut segments affected by these types of enterotoxemia include mucosal hemorrhage, necrosis, fibrin exudation, and a neutrophilic infiltrate. Large numbers of bacterial rods line the luminal surface of these lesions. Unfortunately, postmortem autolysis frequently eliminates the possibility of identifying some of the features.

Smears of intestinal contents can be stained and examined for large numbers of clostridium-like organisms, and filtrates of the contents may be tested for toxin content. Definitive typing of the clostridia has traditionally been via *in vivo* assays but these are undesirable on humanitarian grounds and are being replaced by immunoassays such as ELISA and passive latex agglutination.<sup>15,19</sup> A rapid passive latex agglutination test (RPLA) permits confirmation of the presence of alpha toxin but does not permit distinction between the various types of *C. perfringens* capable of producing the toxin. A multiplex PCR test enables characterization of *C. perfringens* isolates based on their genotypic potential for toxin production. PCR techniques detect the genes encoding the major toxins and are promoted for replacing *in vivo* tests for toxin.<sup>20-24</sup> The PCR test can differentiate toxigenic clostridial isolates recovered from diseased animals and nontoxigenic isolates recovered from normal animals.<sup>20</sup>

#### Samples for confirmation of diagnosis

- Bacteriology – 20–30 mL of intestinal content, **frozen** in a glass or plastic leakproof container (latex agglutination, anaerobic CULT, bioassay, PCR); air-dried smears of mucosal surface from several levels of small intestine (cyto – Gram stain)
- Histology – fixed ileum, jejunum (several segments of each).

#### TREATMENT

In individual cases the disease is often too acute for effective therapy but fluid and supportive therapy are indicated. Hyperimmune serum is the specific therapy and the major therapy of value. Oral and parenteral administration of penicillin may prevent further proliferation of organisms and production of toxins.

#### CONTROL

Vaccination, preferably with type-specific toxoid or bacterin, is the specific preventive measure.

#### Outbreaks

In outbreaks, because of the need for rapid action, it is usually necessary to

#### DIFFERENTIAL DIAGNOSIS

The rapid course and typical necropsy findings suggest the diagnosis but the major differential is with other causes of diarrhea in young animals.

##### All species

- Enteritis associated with *C. perfringens* type A
- Salmonellosis
- Enteric colibacillosis
- Cryptosporidiosis

##### Piglets

- *Isospora suis*
- Transmissible gastroenteritis

##### Foals

Enteritis associated with:

- *Strongyloides westeri*
- *Clostridium difficile*
- *Actinobacillus equuli*.

Struck is strictly regional in distribution and in affected areas can usually be diagnosed on the basis of necropsy lesions.

proceed with vaccination before typing of the organism can be carried out. **Cross-protection** occurs between *C. perfringens* types B and C because the beta toxin is produced by both strains and is central to the disease produced by both strains. Lamb dysentery antiserum will protect against type C infections. Type C toxoid and antiserum are also available.

When an outbreak occurs all pregnant animals should be vaccinated to provide **colostral immunity** to their progeny. However, vaccination of the dam requires a period of at least 2 weeks before there is sufficient protective antibody in colostrum. As a result there will be a period of time between vaccination and protection of the newborn, and animals born during this period need to be provided with protection by the administration of specific antiserum. **Antiserum** will protect susceptible animals and should be administered immediately after birth. An alternate, and sometimes more cost-effective procedure, is to administer benzathine or benethamine penicillin G or depot **amoxicillin** at birth and to repeat as required during the period of susceptibility.

#### Long-term control

Long-term control rests with vaccination of the dams. To initiate the program two injections of vaccine are necessary 1 month apart, the second injection being given 2–3 weeks before parturition. For the prevention of **lamb dysentery** the two vaccinations of ewes may be spaced 2–5 weeks apart and the second injection can be given as early as 2 months before lambing, thus avoiding handling of heavily pregnant ewes. In subsequent

years, ewes require only one booster injection immediately prior to parturition.

For the protection of **piglets** the sow is vaccinated 5 and 3 weeks before farrowing, but vaccination at mating, repeated 2–3 weeks before farrowing, is adequate.

Attention should be given to the unitage of the antigen or antitoxin present in clostridial toxoids and antisera. These vary widely and the manufacturer's instructions should be followed closely. Anaphylaxis may occur with some antisera of equine origin and treated animals should be kept under close observation for 24 hours and treated quickly if signs of dyspnea and muscle shivering occur.

In the face of an outbreak the lambing area should be moved, or with piglets the farrowing rooms vigorously cleaned and disinfected. The feeding of bacitracin (300 mg/kg of feed) or salinomycin (60 mg/kg feed) to the sow for 1–2 weeks before farrowing has been shown to reduce disease incidence, possibly by decreasing the level of excretion of *C. perfringens* by the sow.<sup>24</sup>

#### REVIEW LITERATURE

- Niilo L. *Clostridium perfringens* in animal disease: a review of current knowledge. *Can Vet J* 1980; 21:141–148.
- Niilo L. *Clostridium perfringens* type C enterotoxemia. *Can Vet J* 1988; 29:658–664.
- Songer JG. Clostridial enteric diseases of domestic animals. *Clin Microbiol Rev* 1996; 9:216–314.
- Songer JG. Clostridial diseases of small ruminants. *Vet Res* 1998; 29:219–232.
- Lewis C. Aspects of clostridial disease in sheep. *In Pract* 1998; 20:494–500.

#### REFERENCES

1. Melin J et al. *Vet Microbiol* 1997; 54:287.
2. Ripley PH, Gush AF. *Vet Rec* 1983; 112:201.
3. Itido AE et al. *Israel J Vet Med* 1996; 51:35.
4. Gardiner DE. *Surveillance* 1990; 17(4):19.
5. Niilo L. *Can Vet J* 1988; 29:658.
6. Mackinnon JD. *Pig Vet J* 1989; 28:119.
7. Niilo L. *Can J Vet Res* 1986; 50:32.
8. Kohler B. *Prakt Tierarzt* 1997; 78:1078.
9. Martin PK et al. *Res Vet Sci* 1988; 44:270.
10. Pearson EG et al. *J Am Vet Med Assoc* 1986; 188:1309.
11. Drolet R et al. *Can Vet J* 1990; 31:449.
12. Traub-Dargatz JL, Jones RL. *Vet Clin North Am Equine Pract* 1993; 9:411.
13. Cohen NH, Chaffin MK. *Compend Contin Educ Pract Vet* 1995; 17:568.
14. Stubbings DP. *Vet Rec* 1990; 127:431.
15. Songer JG. *Clin Microbiol Rev* 1996; 9:216.
16. Sukurai J. *Rev Med Microbiol* 1995; 6:175.
17. Rood JL, Cole ST. *Microbiol Rev* 1991; 55:621.
18. Luginbuhl A. *Schweiz Arch Tierheilkd* 2002; 144:263.
19. El Idrissi AH, Ward GE. *Vet Microbiol* 1992; 31:389.
20. Buogo C et al. *J Vet Med B* 1995; 42:51.
21. Yoo HS et al. *J Clin Microbiol* 1997; 35:228.
22. Songer JR, Meer RR. *Anaerobe* 1996; 2:197.
23. Meer RR, Songer JG. *Am J Vet Res* 1997; 58:702.
24. Kyriakis SC et al. *Vet Rec* 1996; 138:281.

## ENTEROTOXEMIA ASSOCIATED WITH *CLOSTRIDIUM PERFRINGENS* TYPE D (PULPY KIDNEY, OVEREATING DISEASE)

### Synopsis

**Etiology** An acute toxemia of ruminants associated with the proliferation of *Clostridium perfringens* type D in the intestines and the liberation of epsilon toxin that produces vascular damage and the damage to the nervous system typical of this disease

**Epidemiology** Lambs 3–10 weeks of age and calves after weaning. Goats of all ages. Affected animals in good condition and on a rising plane of nutrition

**Clinical findings** The disease in lambs and calves and young goats has a rapid course with diarrhea, depression, and convulsions. At this age animals are often found dead. Adult goats show more chronic disease with abdominal pain and bloody diarrhea

**Clinical pathology** Hyperglycemia and glycosuria in sheep

**Necropsy findings** None specific to all cases. Sheep and some goats may have gross or histological areas of malacia in internal capsule, lateral thalamus and cerebellar peduncles

### Diagnostic confirmation

Epidemiology, clinical and necropsy findings, demonstration of epsilon toxin

**Treatment** Anti-epsilon antitoxin

**Control** Feed restriction, antitoxin, vaccination

### ETIOLOGY

Enterotoxemia results from the proliferation of *C. perfringens* type D in the small intestine. This organism produces a number of toxins, of which the **epsilon toxin** is the most important and results in vascular damage and the damage to the nervous system typical of this disease. The presence of *C. perfringens* type D in the intestine does not in itself result in disease unless other factors intercede that promote proliferation and the production of toxin. The natural habitat of the organism is in the intestine and in soil contaminated by feces, although it does not persist in soil for long periods of time.

### EPIDEMIOLOGY

#### Occurrence

Enterotoxemia associated with *C. perfringens* type D is a disease of ruminant animals, primarily of lambs, and is worldwide in its distribution. The common practice of vaccination against this disease has reduced its prevalence but it is still a common disease.

While most common in lambs, it is also an important disease of calves and goats. It occurs rarely in adult cattle, deer, domesticated camels, and possibly horses. In **pastured sheep**, it causes heavy losses,

particularly in flocks managed for the production of lamb and mutton. The prevalence in flocks varies a great deal but seldom exceeds 10%. The case fatality rate approximates 100%. In North America enterotoxemia ranks as one of the main causes of loss among **feedlot lambs**. In a survey in two feedlots the disease had an annual prevalence of 3.14% and 1.49%; it ranked third in importance as a cause of death despite a policy of vaccination, and the costs of prevention programs were the largest expenditure of all disease prevention programs in the feedlots.<sup>1</sup>

### Experimental reproduction

The disease can be produced experimentally in susceptible sheep, goats, and cattle by the injection into the duodenum of whole culture of *C. perfringens* type D and dextrin or starch. Clinical disease occurs as early as 30 minutes and usually within 6–8 hours of the start of duodenal infusion and death 1–9 hours following the onset of clinical signs.<sup>2–4</sup> The disease has also been reproduced by intravenous infusion of epsilon toxin.<sup>5</sup>

### Animal and management risk factors

*C. perfringens* type D normally inhabits the alimentary tract of sheep and other ruminants but only in small numbers. The extent to which it occurs in the alimentary tract varies widely between flocks, although this accounts only in part for the variable prevalence. The organism does not persist for more than 1 year in the soil.

Under certain conditions, the organisms proliferate rapidly in the intestines and produce lethal quantities of epsilon toxin. In most, if not all circumstances, the affected animals are on **highly nutritious diets** and are in very good condition. The husbandry conditions in which the disease occurs include grazing on lush, rapidly growing pasture or young cereal crops, and heavy grain feeding in feedlots. Lambs on well-fed, heavy-milking ewes are particularly susceptible. The occurrence of the disease under these conditions has given rise to the name '**overeating disease**'.

### Sheep

The highest incidence of the disease is in suckling lambs between 3 and 10 weeks of age. The risk for disease in this age group is highest when ewes are grazed on lush pastures that result in profuse lactation. The disease can occur following rain in set stocked flocks, and in flocks newly introduced to lush pastures is often manifest 5–14 days after introduction. Single lambs are more susceptible than twins. Weaned lambs up to 10 months of age are the second most susceptible age group and again the occurrence of disease is associated with highly nutritious diets.

Feeder lambs are most commonly affected soon after they are introduced into feedlots.

### Calves

Enterotoxemia is most common between 1 and 4 months of age and the same risk factors pertain as for lambs. Veal calves are particularly at risk. Feeder cattle may develop disease shortly after introduction to the lot. It is a common belief among cattlemen and veterinarians that many unexplained sudden deaths in **feeder cattle** after the period of acclimatization are due to this type of enterotoxemia. However, there is no laboratory evidence to support such field observations and a controlled trial found no protective effect of vaccination.<sup>6</sup>

### Goats

Enterotoxemia is a common disease in goats under intensive or extensive grazing systems, occurring in many countries,<sup>4</sup> and is particularly important in countries with a large goat population.<sup>4,7,8</sup> The peracute disease in goat kids has the same age occurrence as in lambs but less acute and chronic forms of enterotoxemia occur in adult goats. Sudden changes in diet appear to be the most common predisposing factor. Disease can occur in vaccinated goats, as vaccination is poorly protective against the enteric and chronic form of the disease in this species.<sup>7,9</sup>

Outbreaks in sheep and goats have followed the administration of phenothiazine and other anthelmintics,<sup>4</sup> and a high incidence has been observed in association with heavy tapeworm infestation.

### Horses

Type D enterotoxemia is rare in horses but it has been suspect in a group of mature horses fed concentrates during a drought period.<sup>9</sup> *C. perfringens* type D can be isolated in high numbers from gastric reflux of horses with anterior enteritis.<sup>10</sup>

### PATHOGENESIS

In the normal course of events, ingested *C. perfringens* type D are destroyed in large numbers in the rumen and abomasum, although some survive to reach the duodenum, where multiplication occurs and toxin is produced. Toxemia does not occur because the movement of ingesta keeps the bacterial population and toxin content down to a low level. In certain circumstances, this does not hold and multiplication of the organisms and the production of toxin proceeds to the point where toxemia occurs. One of the circumstances has been shown to be the passage of large quantities of starch granules into the duodenum when sheep overeat on grain diets or are changed suddenly from a ration consisting largely of roughage to one consisting mainly of

grain. Other factors such as heavy milk feeding may have the same effect. A slowing of alimentary tract movement has also been thought to permit excess toxin accumulation and it may be that any factor that causes **intestinal stasis** will predispose to the disease. The importance of diet in the production of ruminal stasis has been discussed in diseases of the forestomachs of ruminants.

The epsilon toxin of *C. perfringens* type D increases the permeability of the intestinal mucosa to this and other toxins, thereby facilitating its own absorption.

A **receptor for epsilon toxin** has been identified on **vascular endothelial cells**, and the clinical signs and pathological findings can be explained by the widespread vascular damage and increase in vascular permeability.<sup>8,11-13</sup>

Acute cases are characterized by the development in the brain of degeneration of vascular endothelium, perivascular and intercellular edema, and microscopic foci of necrosis in the basal ganglia, thalamus, internal capsule, substantia nigra, subcortical white matter, and cerebellum. The damage to the vascular endothelium leads to the accumulation of protein-rich fluid effusions observable in heart, brain, and lung. The postmortem autolysis of kidney tissue that occurs so rapidly and is the characteristic of 'pulpy kidney' has the same basis.

There is a pronounced **hyperglycemia** due to the mobilization of hepatic glycogen, severe hemoconcentration and elevation of blood concentrations of pyruvate, lactate, and alpha-ketoglutarate.

In contrast to sheep, goats with enterotoxemia produced by *C. perfringens* type D also have a **hemorrhagic enterocolitis** that is present in both the natural and the experimental disease.<sup>4,7,14,15</sup> The genesis of this lesion is uncertain but it is responsible for the major clinical signs that present in goats with this disease.

A degree of natural immunity may be attained by nonlethal exposure to the toxin, as a proportion of lambs and calves appear to be exposed to subclinical but antigenic levels of *C. perfringens* toxin so that they become immune without having shown signs of illness or without having been vaccinated.

## CLINICAL FINDINGS

### Lambs

The course of the illness is very short, often less than 2 hours and never more than 12 hours. Many lambs are found dead without previously manifesting signs. In closely observed flocks the first signs may be dullness, depression, yawning, facial movements and loss of interest in feed. **Acute cases** may show little more than severe clonic convulsions with

frothing at the mouth and rapid death. Cases that survive for a few hours show a green, pasty diarrhea, staggering, recumbency, opisthotonos, and severe clonic convulsions. The temperature is usually normal but may be elevated if convulsions are severe. Death occurs during a convulsion or after a short period of coma.

### Adult sheep

These usually survive for longer periods, up to 24 hours. They lag behind the flock and show staggering and knuckling, champing of the jaws, salivation, and rapid, shallow, irregular respiration. There may be bloat in the terminal stages. Irritation signs, including convulsions, muscle tremor, grinding of the teeth, and salivation, may occur but are less common than in lambs.

### Calves

The syndrome is similar to that seen in adult sheep, with nervous signs predominating. Peracute cases are found dead without having shown premonitory signs of illness and with no evidence of struggling. The more common, **acute cases** show a sudden onset of bellowing, mania, and convulsions, the convulsions persisting until death occurs 1-2 hours later. Subacute cases, many of which recover, do not drink, are quiet and docile, and appear to be blind, although the eye's preservation reflex persists. They may continue in this state for 2-3 days and then recover quickly and completely. In an outbreak of the disease in calves all three forms of the disease may be seen.

### Goats

Diarrhea is a prominent sign in affected goats, especially in those that survive for more than a few days.<sup>7,15-17</sup> In the **peracute form**, which occurs most frequently in **young kids**, there are convulsions after an initial attack of fever (40.5°C, 105°F) with severe abdominal pain and dysentery; death occurs in 4-36 hours. In the **acute form**, which is more common in **adults**, there is usually no fever, and abdominal pain and diarrhea are prominent with death or recovery within 2-4 days. In chronic cases, the goats may be ill for several weeks and show anorexia, intermittent severe diarrhea and, in some cases, dysentery and the presence of epithelial shreds in the feces. Chronic wasting, anemia, and eventual emaciation also occur with chronic disease in goats.

## CLINICAL PATHOLOGY

A high blood sugar level of 150-200 mmol/L and marked glycosuria are characteristic of the terminal stages of enterotoxemia in sheep, and are supportive for a diagnosis but are not pathognomonic. Hyperglycemia and glycosuria are variably present in goats with the disease.

## NECROPSY FINDINGS

The body condition of the animal is usually good but there is often fecal staining of the perineum and rapid decomposition of the carcass. In peracute cases there may be no gross lesions. More frequently, there is an excess of clear, straw-colored pericardial and thoracic fluid that clots on exposure to air. Many petechiae are present in the epicardium and endocardium and there is pulmonary edema. Patchy congestion of the abomasal and intestinal mucosae is usual and the small intestine often contains a moderate amount of thin, creamy ingesta. The content of the large intestine may be watery and dark green.

The characteristic finding of soft, **pulpy kidneys** is only useful in animals necropsied within a few hours after death, as it is nonspecific and merely correlates to a more rapid rate of autolysis. Microscopy of experimentally induced ovine type D enterotoxemia cases confirms that the renal changes represent autolysis and not a true nephrosis.<sup>18</sup>

The liver is dark and congested. The rumen and abomasum of feedlot lambs may be overloaded with concentrates. In goats there is acute fibrinonecrotic and hemorrhagic enterocolitis, although microscopic examination may be needed to detect this change.<sup>14,15</sup>

In sheep that have not died acutely there may be symmetrical areas of hemorrhage, edema, and liquefaction in the **brain**, especially in the area of the basal nuclei. Again, microscopic evaluation of the tissue is critical.

**Gram-stained smears** of ingesta from several levels in the small intestine should be examined. In affected animals the short, fat, Gram-positive rods dominate the slide to the almost complete exclusion of other bacteria. Bowel filtrates can be tested for toxicity by **injection into mice**. If the filtrate is toxic, the type of toxin can be determined by protection of the mice with specific antisera, but this does not determine the type of clostridia. The detection of beta toxin indicates the presence of types B or C, and epsilon toxin the presence of B or D.

The time taken for diagnosis by **mouse neutralization tests**, as well as humanitarian considerations, have promoted the development of **alternative tests**. The RPLA test has already been discussed (see *C. perfringens* types B, C, and E). An ELISA test shows good specificity and sensitivity for epsilon toxin<sup>19</sup> and counter-immunoelectrophoresis has an advantage of speed and requires minimal amounts of intestinal content.<sup>20</sup> A recent study showed that a polyclonal capture ELISA could detect lower concentrations of epsilon toxin in intestinal fluid, pericardial

fluid, and aqueous humor than monoclonal capture ELISA, mouse neutralization tests or counterimmunoelectrophoresis but counseled the need to make a diagnosis based on epidemiological, clinical, and pathological data as well as the detection of toxin at postmortem.<sup>21</sup>

At average temperatures one can expect to be able to identify the toxin from the intestine of a sheep dead for up to 12 hours. The addition of one drop of chloroform to each 10 mL of ingesta will **stabilize the toxin** for periods of up to a month.<sup>22</sup> Alternatively, intestinal contents can be absorbed on filter paper and shipped at environmental temperatures with little loss of activity for as long as 74 days as detected by immunoassay.<sup>23</sup> Epsilon toxin is also stable if frozen.<sup>4</sup> Multiplex PCR analysis of *C. perfringens* isolates can confirm the presence of toxigenic strains. Hyperglycemia and **glucosuria** may also be detected in necropsy material.

#### Samples for confirmation of diagnosis

- Bacteriology – 20–30 mL of intestinal content, frozen in a leakproof glass or plastic container (ELISA, latex agglutination, bioassay, anaerobic CULT, PCR); air-dried smears of ingesta from several levels of gut (cyto-Gram stain)
- Clinical pathology – urine (assay – glucose) (best performed at time of necropsy)
- Histology – fixed colon, ileum, jejunum, entire brain.

#### DIFFERENTIAL DIAGNOSIS

##### Lambs

- Acute pasteurellosis
- Septicemia associated with *Histophilus somni* (formerly *Haemophilus agni*)
- *C. sordellii*
- Polioencephalomalacia
- Rumen overload

##### Sheep

- Hypocalcemia
- Hypomagnesemia
- Focal symmetrical encephalomalacia (chronic enterotoxemia)
- Rabies
- Pregnancy toxemia
- Louping ill

##### Calves

- Lead poisoning
- Polioencephalomalacia
- Hepatoencephalopathy
- *Histophilus somni* (formerly *Haemophilus somnus*)

##### Goats

- Salmonellosis
- Coccidiosis

In lambs, but not in goats, a history of vaccination against the disease is a significant consideration in the ranking of a list of differential diagnoses.

#### TREATMENT

In general, the clinical course of the disease is too acute for effective treatment.

**Hyperimmune serum**, an efficient short-term prophylactic, is unlikely to be of much value in sick animals because of the acute nature of the disease. In goats the course is longer, and antitoxin in combination with orally administered sulfadimidine may be effective in treatment.<sup>16</sup>

#### CONTROL

There are three major control measures available: reduction of the food intake, administration of antitoxin, and vaccination. These may be used individually or in combination.

##### Reduction in food intake

Reduction in food intake is the cheapest but least effective in control and is used as a short-term control while waiting for immunity to develop after vaccination. Reduction in food intake will cause a setback in the growth of the lambs and for this reason farmers tend to rely more on vaccination as a control measure.

##### Antitoxin

Antitoxin can be administered to all sheep as soon as an outbreak commences. The administration of epsilon antitoxin 200 IU/kg BW will provide for protective circulating antitoxin levels for 21–29 days.<sup>24</sup> Immediate losses are prevented, and in most instances the disease does not recur. Toxoid is cheaper, but to administer it alone at such times may result in further serious losses before active immunity develops.

##### Vaccination

Immunity in **sheep** is readily produced by suitable vaccination. A blood level of 0.15 Wellcome unit of epsilon antitoxin per milliliter of serum is sufficient to protect sheep. Vaccines available are toxoids, and adjuvants generally improve the antigenicity. Activated alum-precipitated toxoid is the common vaccine in use.

Vaccination of **maiden ewes** twice at an interval of at least 1 month and with the last vaccination approximately 4 weeks before lambing will result in good passive immunity in young lambs, with 97% of lambs having protective antibody levels at 8 weeks of age and a significant proportion at 12–16 weeks of age.<sup>25,26</sup> This is sufficient to protect lambs during their highest risk period. **Older ewes** that have been vaccinated the previous year receive a single booster vaccination 4 weeks before lambing. Sheep vaccinated for 3 consecutive years can be considered to be permanently immune and to require no further vaccination.

When faced with an **outbreak in lambs** the recommended procedure is to administer antiserum and toxoid immedi-

ately and repeat the toxoid in a month's time. The simultaneous administration of hyperimmune serum with this vaccine does not interfere with the stimulation of antibody production, nor does the presence of passively derived colostral immunity.<sup>24</sup>

**Lambs** can be vaccinated with toxoid when 4–10 weeks of age and again a month later.

Any vaccination of sheep is not without **risk** of precipitating blackleg or other clostridial disease, and if these are a severe problem in an area it may be wise to vaccinate a portion of the flock as a pilot test and proceed with vaccination of the remainder only when no complications arise. A **multivalent** bacterin-toxoid containing antigens to all of the clostridial diseases is commonly used in sheep in these circumstances or where all of these diseases are likely to occur. Vaccination should not be done in sheep with wet fleeces.

Vaccination with toxoid is effective in **calves** but is not highly effective in **goats**, having a limited effect in preventing the disease although reducing its incidence and severity.<sup>7,15,16</sup> The anti-epsilon titer in goats following vaccination is variable and has been found equivalent to that obtained by sheep or lower and of shorter duration;<sup>7,15</sup> however, this antibody provides minimal protection against the enterocolitis that occurs with type D infections in goats.<sup>7,15</sup> Vaccination with current commercial vaccines has limited protective value in goats, and owners should be advised of this. The use of serum must be carried out with caution in goats, particularly Saanens, which are very prone to anaphylactic reactions. Despite the limitations of protection against the enteric manifestations of the disease, vaccination is protective against the peracute form of the disease and kids should be vaccinated twice, a month apart, commencing at 4 weeks of age. Subsequent vaccinations are at 6-month intervals.

**Local reactions** to vaccination are common in both sheep and goats<sup>27</sup> and may be visible for at least 6 months. In sheep these are generally hidden by the wool but the vaccination site should be high on the neck and close to the base of the ear in order to minimize carcass blemish. With goats, especially show goats, the owner should be warned of this occurrence. Goats, especially show goats, should be vaccinated under the loose skin of the axilla where local reactions will be hidden by the elbow.

#### REVIEW LITERATURE

- Nilio L. *Clostridium perfringens* in animal disease. Can Vet J 1980; 21:141.
- Nilio L. Enterotoxemic *Clostridium perfringens*. In: Gyles CL, Thoen CO, eds. Pathogenesis of

bacterial infections in animals, 2nd edn. Ames, IA: Iowa State University Press, 1993:114–123.

Songer JG. Clostridial enteric diseases of domestic animals. *Clin Microbiol Rev* 1996; 9:216–234.

## REFERENCES

- Salmon MD et al. *J Am Vet Med Assoc* 1988; 193:1518.
- Uzal FA et al. *J Vet Diagn Invest* 2004; 16:403.
- Uzal FA et al. *J Comp Pathol* 2002; 126:71.
- Uzal FA et al. *Vet Rec* 1994; 135:279.
- Uzal FA, Kelly WR. *J Comp Pathol* 1997; 116:63.
- Glock RD, Degroot BD. *J Anim Sci* 1998; 76:315.
- Uzal FA, Kelly WR. *Vet Res Commun* 1996; 20:481.
- Finnie JW, Hajduk P. *Aust Vet J* 1992; 69:261.
- Carroll CL et al. *Equine Vet J* 1987; 19:344.
- Griffiths NJ. *Anaerobe* 1997; 3:121.
- Songer JG. *Clin Microbiol Rev* 1996; 9:216.
- Sakuri J. *Rev Med Microbiol* 1995; 6:175.
- Finnie JW. *Aust Vet J* 2003; 81:219.
- Blackwell TE et al. *Am J Vet Res* 1991; 52:1147.
- Blackwell TE, Butler DG. *J Am Vet Med Assoc* 1992; 200:214.
- Blackwell TE et al. *Can J Comp Med* 1988; 47:127.
- Efunto MO, Fashanu SO. *Bull Anim Health Prod Afr* 2001; 49:183.
- Uzal FA et al. *J Vet Diagn Invest* 2004; 16:403.
- El Idrissi AH, Ward GE. *Vet Microbiol* 1992; 31:389.
- Hornitzky M et al. *Aust Vet J* 1989; 66:121.
- Uzal FA et al. *J Vet Diagn Invest* 2003; 15:94.
- Cameron CM. *Onderstepoort J Vet Res* 1980; 47:287.
- Rohner E. *Berl Munch Tierarztl Wschr* 1997; 110:46.
- Odendaal MW. *Onderstepoort J Vet Res* 1988; 55:47.
- Wallace GV. *N Z Vet J* 1963; 11:39.
- Delarosa C. *J Anim Sci* 1997; 75:2328.
- Green DS et al. *Vet Rec* 1987; 120:435.

## FOCAL SYMMETRICAL ENCEPHALOMALACIA

### SYNOPSIS

**Etiology** The disease is a chronic neurological manifestation of enterotoxemia associated with *Clostridium perfringens* type D epsilon toxin, with vascular damage and damage to the nervous system

**Epidemiology** Sporadic disease in weaners and mature sheep, usually following a change of pasture or anthelmintic treatment

**Clinical findings** Aimless wandering, an inability to eat and a dummy syndrome are predominant findings

**Clinical pathology** None reported

**Necropsy findings** Gross or histological areas of malacia in internal capsule, lateral thalamus, and cerebellar peduncles

**Diagnostic confirmation** Epidemiology, clinical and necropsy findings

**Treatment** Supportive

**Control** Complete vaccination

## ETIOLOGY

Lesions of focal symmetrical encephalomalacia have been produced in experimental enterotoxemia and by infusion

with epsilon toxin of *Clostridium perfringens* type D.<sup>1,2</sup>

## EPIDEMIOLOGY

The disease occurs in lambs, weaners, and mature sheep,<sup>3–5</sup> and suspected cases have also been reported in calves.<sup>1</sup> In grazing sheep it has the same seasonal occurrence as enterotoxemia but may occur in sheep of poor body condition. In weaners and mature sheep there is often a history of a move to fresh pasture or of anthelmintic administration 5–14 days preceding the occurrence of initial cases. Several outbreaks have been associated with the grazing of young green cereal crops.<sup>4,5</sup> The morbidity is usually low but may approach 15%. The case fatality rate is high.

## CLINICAL FINDINGS

Most commonly, due to infrequent observation of sheep of this age, the finding of dead sheep is the first indication of the disease. Clinically affected sheep are separate from the group or can be detected by slow movement of the flock. They show no fear of humans or dogs and can be examined without restraint. Blindness, aimless wandering, head-pressing, and incoordination are the predominant findings. More severely affected sheep lie quietly in lateral recumbency with moderate dorsiflexion of the head and show infrequent nystagmus with paddling convulsions. The sheep are unable to eat and most cannot drink, although some affected lambs may still retain a suck reflex. The feces of affected sheep are unformed, as are those of a significant number of other apparently normal sheep within the group. The clinical course varies from 1–14 days, with the majority of affected sheep surviving for 5–7 days.

## NECROPSY FINDINGS

Lesions are confined to the brain and formalin-fixed samples of this tissue may be required for confirmation of the diagnosis. In many cases the characteristic lesions can be detected on macroscopic examination and consist of areas of hemorrhage and softening in the internal capsule, lateral thalamus, and cerebellar peduncles. Malacia, edema, and hemorrhage are visible histologically.<sup>6</sup> Glycosuria is not a feature and toxin cannot be demonstrated in gut contents.

## TREATMENT AND CONTROL

There is no treatment. Less severely affected cases may recover if they are maintained with fluids and nutrients given by stomach tube. Outbreaks cease if the sheep are vaccinated with pulpy kidney vaccine.<sup>4,5</sup>

## REFERENCES

- Buxton D et al. *Vet Rec* 1981; 108:459.
- Gardner DE. *J Comp Pathol* 1973; 83:509.
- Uzal FA et al. *Vet Rec* 1997; 141:224.

- Pienaar JG, Thornton DJ. *J S Afr Vet Med Assoc* 1964; 35:351.
- Gill J. *Surveillance* 1992; 19(4):15.
- Ligos C et al. *Vet Rec* 2004; 154:365.

## ENTEROCOLITIS ASSOCIATED WITH *CLOSTRIDIUM DIFFICILE*

### SYNOPSIS

**Etiology** Toxigenic strains of *Clostridium difficile*. Common bacterial etiology in antibiotic-associated diarrhea

**Epidemiology** Horses: most common in young foals but also occurs in adults.

Commonly precipitated by therapy with antimicrobial agents. Pigs: diarrhea and mortality in piglets in first week of life

**Clinical findings** Profuse watery diarrhea, tachypnea, dehydration, metabolic acidosis. High case fatality – especially in very young foals

**Necropsy findings** Fibrinous to necrotic enterocolitis. Edema of mesocolon in pigs

### Diagnostic confirmation

Demonstration of organism and toxins

**Treatment** Fluids and electrolytes.

Horses: metronidazole, if sensitive, or vancomycin

**Control** Isolation and barrier protection, prophylactic metronidazole

## ETIOLOGY

*Clostridium difficile* is a recognized cause of antibiotic-associated diarrhea and pseudomembranous colitis in humans suffering perturbation of the bowel flora from antibiotic therapy or other causes. There is developing evidence that, in foals and adult horses, *C. difficile* can be associated with diarrheal disease that can vary from mild and self-limiting to an acute and fatal enterocolitis. Evidence for this association is the biological plausibility, some evidence that this syndrome can be reproduced experimentally, and the ability to demonstrate the organism or its toxin in the feces of horses with the enterocolitis in comparison with the low prevalence of the organism, and the absence of toxin, in the feces of nondiarrheic horses.<sup>1–7</sup> Commonly this syndrome occurs in horses following antimicrobial therapy and/or hospitalization. It is possible that enterotoxin from intestinal *C. perfringens* may also contribute in horses, and the syndrome has been called equine clostridiosis.<sup>8,9</sup>

*C. difficile* is associated with diarrhea in neonatal pigs and its occurrence, or recognition, appears to be increasing.

## EPIDEMIOLOGY

### Occurrence

Horses

The disease is sporadic and appears to occur worldwide. In young foals within the first 2 weeks of life it may occur without apparent predisposing causes but

in adult horses it commonly follows the use of antimicrobial agents. Case fatality rates are highest in very young foals, where the disease may also be complicated by other existing neonatal disease problems. In foals, disease may be acute, presenting with rapid recumbency and death within 24 hours of onset despite therapy, or it may present as a nonacute syndrome manifest primarily with diarrhea.

#### Pigs

The disease has increasing reportage, or recognition, and occurs predominantly in young piglets<sup>10-12</sup> but also is recorded as a major cause of disease and mortality in sows.<sup>13</sup> The disease in piglets occurs predominantly in the first week of life, when the majority of the litter can be affected and the case fatality can approach 50% but is usually lower. Stunting is a common sequel. Outbreaks occur with or without a history of processing with antibiotics.

#### Experimental reproduction

The disease has not been effectively reproduced with simple challenge of conventional animals, suggesting that *C. difficile* in itself is not a sufficient cause.

Challenge of adult horses with *C. difficile* with and without pretreatment with penicillin did not result in clinical disease in any of the horses, but *C. difficile* was subsequently isolated at greater frequency from the feces of the horses pretreated with penicillin.<sup>14</sup> Challenge of newborn foals with *C. difficile* has resulted in enteric disease and diarrhea, but only in foals not receiving adequate transfer of colostral antibodies.<sup>6</sup> The disease has been reproduced in gnotobiotic but not conventional pigs.<sup>15</sup>

#### Risk factors

##### Animal risk factors

*C. difficile* has been isolated from the feces of 29% of 56 healthy foals less than 2 weeks of age but is not normally present, and its toxins are not commonly demonstrable in the feces of healthy horses over 1 month of age.<sup>6,16</sup> Treatment with antimicrobials increases the likelihood of isolation from feces and occasionally the presence of toxin. In an extensive study in Sweden the feces of horses of varying age and clinical status were tested for the presence of *C. difficile* and positivity to the cytotoxin B test.<sup>16</sup> The feces of 273 adult horses with no signs of enteric disease were negative to both tests; 42% of 43 horses with acute colitis treated with antibiotics were positive to one or both tests; 6% of 72 horses with colitis but no antibiotic treatment were positive to one or both tests; 2% of 47 horses with no enteric disease but treated with antibiotics were positive to both

tests and none of 65 horses with colic were positive.

##### Environmental risk factors

Treatment with antimicrobials is a risk factor for the occurrence of *C. difficile* in the feces of both normal foals and normal adult horses. Antimicrobial therapy is also a risk factor for the occurrence of *C. difficile*-associated enterocolitis.<sup>4</sup> Treatment with penicillin is a major risk factor but the specific incrimination of penicillin may simply reflect its common use as an antimicrobial in horses.<sup>14</sup> There is a risk for mares to develop acute enteritis associated with *C. difficile* when their foals are being treated for *R. equi* pneumonia with erythromycin and rifampicin.<sup>17</sup> It was suspected that the risk occurred as a result of the mares' exposure to these antibiotics from the foal feces or contaminated materials in the environment.

Routine prophylactic antimicrobial treatment of periparturient sows for diseases such as mastitis-metritis-agalactia have resulted in outbreaks of enterocolitis.<sup>18,19</sup>

##### Pathogen risk factors

Pathogenic strains of *C. difficile* produce an enterotoxin (toxin A) and a cytotoxin (toxin B). There are degrees of virulence between strains but nontoxigenic strains are considered nonpathogenic.<sup>20</sup> Other virulence factors, including an actin-specific adenosine diphosphate (ADP)-ribosylating toxin and an outer cell surface coat S-layer, have been proposed as additional virulence factors.<sup>20</sup>

The organism can be isolated from a number of environmental samples, including soil and the environment of veterinary hospitals. Although it appears that the organism is not commonly present in the feces of normal horses, it can be isolated from those of other animal species and has high prevalence in the feces of dogs and cats.<sup>21</sup> The organism can survive in feces for at least 4 years.<sup>16</sup> Spores are resistant to common disinfectants but a 5% bleach solution is stated to be effective for disinfection.<sup>22</sup>

#### Zoonotic implications

*C. difficile* is a cause of diarrhea in humans and most commonly occurs following the administration of antibiotics, although sporadic cases without these risk factors also occur. The disease in humans may be mild and self-limiting or develop to severe pseudomembranous colitis with risk of intestinal perforation. In one study using molecular typing, 25% of isolates from humans were indistinguishable from isolates from animals.<sup>23</sup> The risk for zoonotic infection should be considered but barrier protection and attention to personal hygiene when handling animal

cases should limit the risk for infection. Veterinarians and animal handlers undergoing antimicrobial therapy are particularly at risk.<sup>24</sup>

#### PATHOGENESIS

The disease is associated with severe watery diarrhea and a hemorrhagic necrotizing enterocolitis. The enterotoxin A damages villous tip and brush border membranes and causes necrosis and increased intestinal permeability. The cytotoxin B is lethal to cells once the gut wall has been damaged. Complete erosion of the mucosa may result. Both toxins induce the production of tumor necrosis factor and proinflammatory interleukins, with a resultant inflammatory response and pseudomembrane formation.<sup>25</sup> Lactose intolerance may develop secondary to infection.<sup>26</sup>

#### CLINICAL FINDINGS

##### Horses

Disease occurring with onset in the first 2 weeks of life is initially manifest with a decreased interest in sucking, often with signs of colic with increasingly prolonged and severe episodes of rolling and kicking at the abdomen and the occurrence of profuse watery and occasionally hemorrhagic diarrhea. Rectal temperatures are within the normal range but there is severe dehydration, an elevation of heart rate and respiratory rate, acidemia attributable to metabolic acidosis, and the development of septic shock.<sup>6,9</sup> There is progressive enlargement of the abdomen, and transcutaneous ultrasound shows thickened, fluid-filled loops of intestine and fluid in the ventral abdomen.

In adult horses the disease is manifest with acute and often fatal colitis with profuse diarrhea, toxemia, hypovolemia, and metabolic acidosis, and is reported in individuals and as outbreaks in horses hospitalized and treated for various diseases.<sup>3-5</sup>

##### Pigs

Affected piglets are depressed and have a yellow, mucoid diarrhea with occasional piglets passing feces with specks of blood. As the condition progresses, affected pigs show abdominal distension and tachypnea, and some have scrotal edema. There is progressive dehydration and hypoglycemia.

#### CLINICAL PATHOLOGY

There is a leukopenia, a toxic left shift, a high hematocrit, and hyperfibrinogenemia. Plasma protein may be normal to low and there are a high bilirubin and elevated liver enzyme values. Metabolic acidosis, as evidenced by an increase in anion gap and decrease in total CO<sub>2</sub> concentration, hyponatremia and azotemia are present. Blood IgG concentrations are commonly within the normal range.



Classic methods of diagnosis are by examination of feces by culture of the organism and demonstration of toxins A and B by cytotoxin assays and enzyme immunoassays.<sup>27</sup> Cycloserine–cefoxitin–fructose agar is commonly used to isolate *C. difficile* from feces. The isolation of *C. difficile*, in itself, is generally not considered to be diagnostic and should be accompanied by demonstration of toxin A in the feces by ELISA, or by tissue culture cytotoxin assays, to allow a putative diagnosis.<sup>28</sup> Fecal toxin testing in live animals is an effective method of diagnostic conformation and correlates highly with toxin tests on intestinal contents at postmortem.<sup>15</sup>

The organism, but not the toxins, is labile when kept aerobically at 4°C, with a significant decrease in recovery after 24 hours.<sup>29</sup> Consequently, samples for culture should be taken in anaerobic transport media and shipped on ice.

ELISA tests may lack sensitivity and only detect toxin A whereas some pathogenic strains produce only toxin B. Consequently PCR may provide a more reliable method of detection. Feces, or isolates, can be tested for genes encoding toxins A and B by PCR<sup>28</sup> and PCR can also be used retrospectively following post-mortem for diagnosis in formalin-fixed tissues.<sup>11</sup>

## NECROPSY FINDINGS

### Horses

Gross findings are of enterocolitis with histological findings that vary from a superficial fibrinous colitis with hemorrhage and edema to a severe hemorrhagic multifocal necrosuppurative and ulcerative enterocolitis.

### Pigs

The contents of the small intestine are scant and those of the large intestine yellow to dark yellow in color. Edema of the mesocolon is a common finding, along

with increased fluid in the peritoneal and pleural cavities. Histological findings vary from necrosis and exfoliation of the intestinal mucosa to segmental transmural necrosis in the large intestine.<sup>11,15</sup>

## DIFFERENTIAL DIAGNOSIS

- Horses – See Table 5.13
- Swine – See Table 5.14

## TREATMENT

Horses should be aggressively treated with fluids, plasma, and pressors, to correct the fluid and electrolyte imbalance, correct the metabolic acidosis and control pain. Antimicrobial therapy should be based on sensitivity. Isolates are usually resistant to trimethoprim–sulfamethoxazole and bacitracin, variably resistant to rifampicin and susceptible to vancomycin. Metronidazole, 10 mg/kg intravenously four times daily or 15 mg/kg orally four times daily, has been commonly used for therapy but there is geographical variation in sensitivity.<sup>16,28</sup> Metronidazole and vancomycin are not approved for use in food animal species in most countries.

In vitro studies have shown that di-tri-octahedral (DTO) smectite can bind *C. difficile* toxins A and B and that this can occur without inhibiting the antibacterial action of metronidazole. Clinical trials of efficacy have not been conducted but pharmacological considerations indicate that an initial dose of 1.4 kg of DTO smectite, administered by stomach tube, followed by 454 g every 6–8 hours could be of therapeutic value.<sup>30</sup> Experimental studies in hamsters indicate promise for the use of immune sera and vaccines,<sup>31</sup> but these are not currently available in agricultural animals.

## CONTROL

There is no definitive control procedure. The organism is commonly present in

veterinary environments and equine environments where there are foals. Foaling areas should be clean and disinfected with a sporicidal disinfectant. Metronidazole, 500 mg administered orally twice a day for 2 weeks, may be indicated for at-risk horses. Clinical cases should be isolated and, in a veterinary environment, strict barrier protection established between them and other animals under antimicrobial therapy. Orally administered probiotics and lactic-acid-producing bacteria are in use as an aid to prevention but there are no data on efficacy.

## REFERENCES

1. Traub-Dargatz JL, Jones RL. *Vet Clin North Am Equine Pract* 1993; 9:411.
2. Beier RG et al. *Pferdeheilkunde* 1994; 10:3.
3. Madewell BR et al. *J Vet Diagn Invest* 1995; 7:343.
4. Baverud V et al. *Equine Vet J* 1997; 29:279.
5. Perrin J et al. *J Vet Diagn Invest* 1993; 5:99.
6. Jones RL et al. *J Am Vet Med Assoc* 1988; 193:76.
7. Weese JS et al. *Equine Vet J* 2001; 33:403.
8. Donaldson MT, Palmer JE. *J Am Vet Med Assoc* 1999; 215:358.
9. MacKay RJ. *Compend Contin Educ Pract Vet* 2001; 23:280.
10. Yeager M et al. *J Vet Diagn Invest* 2002; 14:281.
11. Jung K et al. *Vet Rec* 2003; 153:466.
12. Nagy J, Bilkei G. *Vet J* 2003; 166:98.
13. Mauch CP, Bilkei G. *Folia Vet* 2003; 47:210.
14. Gustafsson A et al. *Equine Vet J* 2004; 36:180.
15. Songer JG et al. *Swine Health Prod* 2000; 8:185.
16. Baverud V et al. *Equine Vet J* 2003; 35:465.
17. Baverud V et al. *Equine Vet J* 1998; 30:482.
18. Silvapru BX, Bilkei G. *Indian Vet J* 2005; 82:243.
19. Kiss D, Bilkei G. *Theriogenology* 2005; 63:17.
20. Braun M et al. *FEMS Microbiol Lett* 2000; 184:29.
21. Songer JG. *Clin Microbiol* 1996; 9:216.
22. Weese JS et al. *Can Vet J* 2002; 43:631.
23. Arroyo LG et al. *J Med Microbiol* 2005; 54:163.
24. Weese JS. *Proc Am Assoc Equine Pract* 2002; 48:362.
25. Poxton IR et al. *Clin Microbiol Infect* 2001; 7:421.
26. Weese JS et al. *J Am Vet Med Assoc* 1999; 214:229.
27. Post KW. *J Vet Diagn Invest* 2002; 14:258.
28. Magdesian KG et al. *J Am Vet Med Assoc* 2002; 220:67.
29. Weese JS et al. *J Vet Diagn Invest* 2000; 12:332.
30. Weese JS et al. *Equine Vet J* 2003; 35:638.
31. Giannasca PJ et al. *Infect Immun* 1999; 67:527.

## Diseases associated with bacteria – III

**DISEASES ASSOCIATED WITH  
*ESCHERICHIA COLI* 847**

Acute undifferentiated diarrhea of newborn farm animals (particularly calves and piglets) 847  
Colibacillosis of newborn calves, piglets, lambs, kids, and foals 851  
Enterohemorrhagic *Escherichia coli* in farm animals and zoonotic implications 876

***ESCHERICHIA COLI* INFECTIONS IN  
WEANED PIGS 888**

Edema disease (gut edema, *Escherichia coli* enterotoxemia) 889  
Postweaning diarrhea of pigs (coliform gastroenteritis) 891  
Cerebrospinal angiopathy 895

**DISEASES ASSOCIATED WITH  
*SALMONELLA* SPECIES 896**

Salmonellosis (paratyphoid) 896  
Abortion in mares and septicemia in foals associated with *Salmonella abortusequi* (*abortivoequina*) (equine paratyphoid) 919

Abortion in ewes associated with *Salmonella abortusovis* 920

**DISEASES ASSOCIATED WITH  
*PASTEURELLA* SPECIES 921**

Pasteurellosis 921  
Septicemic pasteurellosis of cattle (hemorrhagic septicemia, barbone) 921  
Bovine respiratory disease: acute undifferentiated bovine respiratory disease 923  
Pneumonic pasteurellosis of cattle (shipping fever pneumonia) 934  
Pasteurellosis of sheep and goats 946  
Pneumonic pasteurellosis of sheep and goats 947  
Septicemic pasteurellosis in weaned sheep 949  
Pasteurellosis of swine 950  
Pneumonic pasteurellosis 950  
Tularemia 952  
Yersiniosis 954  
Progressive atrophic rhinitis (turbinate atrophy of swine) 956

**DISEASES ASSOCIATED WITH  
*BRUCELLA* SPECIES 963**

Introduction 963  
Brucellosis associated with *Brucella abortus* (Bang's disease) 966  
Brucellosis associated with *Brucella ovis* 984  
Brucellosis associated with *Brucella suis* in pigs 988  
Brucellosis associated with *Brucella melitensis* 991

**DISEASES ASSOCIATED WITH  
*MORAXELLA*, *HISTOPHILUS*, AND  
*HAEMOPHILUS* SPECIES 994**

Infectious keratitis of cattle (pinkeye, blight) 994  
Septicemia and thrombotic meningoencephalitis in sheep associated with *Histophilus somni* 997  
*Haemophilus* septicemia of cattle (*Histophilus somni* or *Haemophilus somnus* disease complex) 998  
Infectious polyarthritis (Glasser's disease, porcine polyserositis and arthritis) 1003

**Diseases associated with  
*Escherichia coli***

Colibacillosis, associated with *Escherichia coli*, occurs in all species of newborn farm animals and is a major cause of economic loss in this age group. Gut edema and enteric colibacillosis of recently weaned pigs are also important diseases associated with this organism.

*E. coli* is a major cause of diarrhea in calves, piglets, and lambs, and the term 'colibacillosis' is commonly used; however, diarrhea in newborn calves, for example (and in other species too), can be associated with several different enteropathogens influenced by several risk factors (Table 18.1). Colibacillosis is presented in this chapter. Information on the viral diarrheas of newborn farm animals is presented in Chapter 21. Diarrhea associated with *Cryptosporidium* is presented in Chapter 26. This section first outlines the general aspects of acute undifferentiated diarrhea of newborn farm animals, with emphasis on the disease in calves. Many of the principles can be applied to the other species. This is followed by the diseases associated with *E. coli*.

Table 18.1 Risk factors and their role in acute undifferentiated diarrhea of newborn calves

Risk factor	Role of risk factor
Colostrum immunity of calf	Low levels of serum immunoglobulins render calves highly susceptible to death from diarrhea
Overcrowding	Increased population density increases infection rate and high morbidity and mortality
Parity of dam	Calves born from heifers may not acquire sufficient level of colostrum immunoglobulins
Meteorological	Changes in weather; wet, windy and cold weather commonly precedes outbreaks of diarrhea in beef calves. Higher mortality in dairy calves exposed to hot environmental temperatures. High environmental temperatures precipitate outbreaks
Quality of diet	Heat denatured skim-milk used in milk replacers is less digestible than whole milk and precipitates diarrhea
Calf rearer	The concern and care provided by the calf rearer will have a direct effect on morbidity and mortality associated with diarrhea

**ACUTE UNDIFFERENTIATED  
DIARRHEA OF NEWBORN FARM  
ANIMALS (PARTICULARLY CALVES  
AND PIGLETS)**

Diarrhea in newborn farm animals, particularly calves under 30 days of age and piglets in the first week of life, is one of the most common disease complexes that the large-animal clinician encounters in practice. It is a significant cause of economic loss in cattle and pig herds and

continues to assume major importance as livestock production becomes more intensified. The effective treatment and control of herd epidemics of diarrhea in calves and piglets can be frustrating and unreliable. Considerable progress has been made in the treatment of the effects of diarrhea such as dehydration and acidosis but less so in the control of these disease complexes.

The causes of calf and piglet diarrhea are complex and usually involve an

interaction between enteropathogenic bacteria, viruses, and protozoa, the colostral immunity of the animal and the effects of the environment (Tables 18.1–18.3). Thus the term **acute undifferentiated diarrhea of newborn calves** is used to describe the acute diarrhea that occurs in newborn calves under 30 days of age, characterized clinically by acute profuse watery diarrhea, progressive dehydration and acidosis and death in a few days, or earlier after onset if treatment is not provided. Based on clinical findings alone, it is not usually possible to differentiate between the common known causes of diarrhea in newborn calves, which include enterotoxigenic *E. coli* (ETEC), verocytotoxic *E. coli* (VTEC), necrotogenic *E. coli* (NTEC), rotavirus, coronavirus, bovine torovirus (Breda virus), calicivirus, norovirus (Norwalk-like virus), *Cryptosporidium* spp., *Giardia* spp., and *Salmonella* spp. The common necropsy findings are dehydration, emaciation, and a fluid-filled intestinal tract, with no other obvious gross lesions. The exceptions are enteritis associated with *Salmonella* spp., *Clostridium perfringens* types B and C, *Eimeria* spp., and attaching and effacing *E. coli*, in which there are usually typical gross lesions at necropsy.

Thus the disease is considered to be a complex syndrome because one or any combination of more than one of the specific etiological agents may be the cause of the disease. Risk factors may also precipitate the disease in calves in which the disease might not normally occur, even though they are infected with a specific enteropathogen. The term acute undifferentiated diarrhea of newborn calves is useful to encompass cases of diarrhea in calves in which the etiological diagnosis is not immediately obvious and may not be determined, even after exhaustive diagnostic work.

### RISK FACTORS

A risk factor is any circumstance that can contribute to the occurrence of the disease. Conversely, if that circumstance is not present the disease may not occur. Many interrelated risk factors have been associated with a high incidence of calf diarrhea and have added to the difficulty of understanding the complexity of the disease and controlling it. The identification and modification or removal of these risk factors can be very effective in the clinical management and control of epidemics of the disease.

### Animal risk factors

The host risk factors include immaturity of the neonate at birth, age of the neonate, a lack of vigor of the calf or piglet at birth, the presence of intrapartum hypoxemia and acidosis from a difficult birth, and

failure to acquire sufficient colostral immunity. The nutrition of the pregnant dam can affect the quantity and quality of colostrum, and consequently the vigor of the calf.

### Colostral immunoglobulin status

The role of colostrum in protecting the newborn calf from the effects of enteropathogens is well known. The failure of the newborn calf to ingest an adequate quantity of good-quality colostrum containing a high level of colostral immunoglobulins within a few hours after birth is a major risk factor contributing to acute undifferentiated diarrhea. Complete or partial failure of transfer of passive immunity is highly prevalent in diarrheic veal calves infected with cryptosporidia, coronavirus, and rotavirus.<sup>1</sup> Earlier work centered on the protective effect of colostrum against septicemic and enteric colibacillosis. More recently, the role of colostral and milk antibodies against rotavirus and coronavirus enteritis in newborn calves has been established. Specific protection against these viral diarrheas in the newborn calf depends on the level of antibody in the lumen of the intestine. While it is easy to state that calves should receive liberal quantities of colostrum, the veterinarian in the field who encounters an outbreak of acute diarrhea in beef calves, for example, cannot usually easily determine whether in fact the calves possess protective levels of immunoglobulins.

**Lactose intolerance** as a cause of diarrhea has been reported in a calf but its occurrence is rare.<sup>2</sup>

Cases of diarrhea due to specific **nutritional deficiencies** are reported rarely and not well documented. However, field observations indicate that outbreaks of diarrhea in sucking beef calves may have been associated with specific nutrient deficiencies such as copper or selenium. These are not documented but should be considered in certain situations where these deficiencies are known to be present in the herd. An epidemic of intractable diarrhea in 2-month-old beef calves was associated with deficient tissue and plasma levels of vitamin E in the affected calves, which also had lesions of skeletal and myocardial muscular dystrophy with adequate levels of selenium.<sup>3</sup> A combination of low vitamin E status and low immunoglobulin status may be a contributing factor in neonatal diarrhea of calves,<sup>4</sup> but this is not well documented.

### Environmental and management risk factors

Veterinarians have commonly observed a relationship between adverse climatic conditions and epidemics of diarrhea in calves. During inclement weather, such as

a snowstorm, a common practice in beef herds is to confine the calving cows in a small area where they can be fed and watered, and observed, more easily. The overcrowding may be followed by an outbreak of calf diarrhea. Cold, wet, windy weather during the winter months in temperate climates and hot humid weather during the summer months may be associated with an increased incidence of dairy calf mortality due to diarrhea. Changes in weather and wet, windy and cold weather are commonly associated with subsequent outbreaks of the disease in beef calves raised outdoors. Increases in population density in calf houses, and on calving grounds, resulting in highly contaminated calving grounds, are important risk factors. In beef herds in the USA and Canada, the risk factors that are associated with an increase in calf mortality from diarrhea include:

- The herd of origin. This is because of the genetic composition of the cattle, environmental conditions, degree of exposure to pathogens and management practices unique to the herd
- Increasing the percentage of heifers calving in the herd. The risk of diarrhea in calves born to heifers may be about four times greater than in calves born to cows<sup>5</sup>
- The odds of diarrhea occurring in calves born on or after the median calving date is twice that of calves born before the median calving date.<sup>5</sup> This may be because of increased pathogen exposure as the calving season progresses
- Poor drainage and limited shelter in the nursery yards
- A decrease in the size of the effective calving yards because of poor drainage and wetness
- Wintering and calving cows and heifers on the same grounds<sup>6</sup>

Some studies have shown that the major contributing factor to dairy calf mortality is the care provided by the calf attendant. Not infrequently, however, outbreaks can occur in herds in which the management is excellent and not uncommonly an etiological diagnosis cannot be made.

Certain herd characteristics and herd management practices are associated with an increased incidence of diarrhea in dairy herds.<sup>7</sup> Larger herd size is associated with an increased incidence of diarrhea.<sup>7</sup> The greater disease rate may be associated with a greater possibility of a large epidemic in a larger population, and cows in larger herds may be more densely housed. In dairy herds with 10–49 cows, the number of young stock at the end of the month, the incidence density of

respiratory disease in the calves per herd per calf-month, and the cumulative incidence of vaccinations for calves given to prevent diarrhea may be associated with increased incidence of diarrhea. As the incidence of respiratory disease increases in large dairy herds, the incidence of diarrhea in the calves increases, especially in large herds of over 200 cows.<sup>7</sup> Reduction of the incidence of respiratory disease in calves will result in a decrease in the incidence of diarrheal disease. The use of individual maternity stalls and regular removal of bedding between calvings is associated with a decrease in the incidence of neonatal calf diarrhea. As the number of calves in the herd increases, calf attendants may become too busy to perform duties of calf care thoroughly. Overcrowding may also be a risk factor.

Dairy calves fed milk replacers may develop diarrhea because of the inferior quality of some milk replacers.<sup>8</sup>

Epidemics of diarrhea in piglets are commonly associated with inadequate sanitation and hygiene in the farrowing rooms, which may be under continuous use without sufficient time for cleaning and disinfection between farrowings. Certain management procedures may be associated with differences in the prevalence of enteropathogens.

In dairy calves fed on nipple feeders there may be increased probability of the calves shedding detectable fecal levels of *Salmonella*, *E. coli*, rotavirus, or coronavirus. The use of group pens has been associated with increased odds of encountering *Campylobacter jejuni*, the presence of which is of uncertain significance. Calves with diarrhea on these farms tend to have increased odds of shedding rotavirus and K99<sup>+</sup> *E. coli*.

### Pathogen risk factors

#### Calves

The distribution and occurrence of enteropathogens in the feces of diarrheic and normal healthy calves varies depending on the geographical location, the farm, the age and type of calves being examined, and the extent to which the diagnostic laboratory is capable of isolating or demonstrating the pathogens.<sup>9</sup> Rotavirus, *Cryptosporidium* spp., coronavirus, and enterotoxigenic *E. coli*, collectively, are responsible for 75–95% of infections in neonatal calves worldwide. The relative frequencies of each of the four differ between locations and between seasons and years.<sup>10</sup> Any one of the common pathogens may predominate or be absent in a certain group of animals.<sup>11</sup> Mixed infections are common.<sup>12</sup> Rotavirus will be most common in some groups, especially housed calves.<sup>12</sup> Coronavirus may predominate in beef calves in some

countries and not in others, and *Cryptosporidium* may occur in 30–50% of diarrheic calves on a worldwide basis.<sup>13</sup> A survey of veal calf farms revealed that *Cryptosporidium* infection is an important cause of transient diarrhea and that there was no association between diarrhea and infection with either *Salmonella* spp., enterotoxigenic *E. coli*, rotaviruses, or verocytogenic *E. coli* in the population examined.<sup>14</sup> Cryptosporidia, rotavirus, and coronavirus are the most commonly identified enteropathogens in intensively reared veal calves.<sup>1</sup> In dairy calves, the prevalences of giardiasis and cryptosporidiosis may be high and both parasites may be associated with diarrhea. *Cryptosporidium parvum* is an important pathogen in calves under 1 month of age, but *Giardia duodenalis* may be more important when calves are older. Calves may clear *C. parvum* infections within 2 weeks; however, *G. duodenalis* infections may become chronic in the same calves.<sup>15</sup> The combination of *Cryptosporidium* sp. and rotavirus may predominate in some situations. *Cryptosporidium* spp. were the second most commonly detected pathogens next to rotavirus, and case-control studies indicated a highly significant association with diarrhea. Enteropathogens may not be detectable in up to 30% of diarrheic calves. *Eimeria* spp. can cause coccidiosis in calves any time after about 21 days after birth but the disease is more common in calves several months old.

In some countries, enterotoxigenic K99<sup>+</sup> *E. coli* may occur in 30–40% of diarrheic calves, while in others the incidence may be as low as 3–6%. Attaching and effacing *E. coli* that cause hemorrhagic colitis and blood in the feces of diarrheic calves about 2 weeks of age are being recognized with increasing frequency. They may occur concurrently with other enteropathogens (cryptosporidia, rotavirus, coronavirus, enterotoxigenic *E. coli*, bovine virus diarrhea virus (BVDV), and coccidia). Some isolates of attaching and effacing *E. coli* produce verocytotoxin.

The age occurrence of the common enteropathogens associated with diarrhea in calves is shown in Table 18.2. Case-control studies of diarrheic and healthy calves from the same groups indicate that the enteropathogens commonly found in diarrheic calves can also be found in healthy calves but at a lower frequency, with the exception of rotavirus, which may be excreted by up to 50% of healthy calves. The prevalence of enteropathogens in healthy calves on farms where there is no recent history of diarrhea indicates an absence of *Salmonella* spp., enterotoxigenic *E. coli*, *Cryptosporidium*, and coronavirus, but the presence of rotavirus in some calves. It appears that healthy calves may

Table 18.2 Age occurrence of the common enteropathogens in calves

Enteropathogen	Age (days)
Enterotoxigenic <i>Escherichia coli</i>	<3
Attaching and effacing <i>E. coli</i>	20–30
Rotavirus	5–15
Coronavirus	5–21
Other viruses (Breda virus, parvovirus, bovine virus, diarrhea virus)	14–30 (and older, up to several weeks)
<i>Cryptosporidium</i> spp.	5–35
<i>Salmonella</i> spp.	5–42
<i>Clostridium perfringens</i> types B and C	5–15
<i>Eimeria</i> spp.	> 30
<i>Giardia</i> spp.	10–30

be infected more often with enterotoxigenic *E. coli*, *Cryptosporidium*, coronavirus, and rotavirus in herds in which some calves have or recently have had enteric disease than in herds free from major enteric disease.

*Campylobacter* spp. and *Yersinia* spp. are well adapted to the bovine host and can be found in the feces of diarrheic and healthy calves at a similar prevalence.<sup>16</sup> Their significance as pathogens in newborn calves is questionable. They are probably part of the normal enteric flora of ruminants. However, as they represent a source of gastrointestinal infections in humans, management factors limiting intestinal colonization of these bacteria should be considered in beef cow/calf herds.<sup>16</sup>

Rotavirus and coronavirus occur with almost equal frequency in the intestinal tracts of normal and diarrheic calves of some studies. Intestinal lesions compatible with the viral infections are found in about 70% of diarrheic calves. Thus, these viruses are widespread in the bovine population and only under some circumstances will the infection be severe enough to cause lesions and diarrhea. Other viruses, such as parvovirus, astrovirus, Breda virus, and calici-like virus, have been isolated from the feces of diarrheic calves but their role in the etiology is yet to be defined.

A necrotizing enteritis of suckled beef calves 7–10 weeks of age on pasture in Scotland has been reported.<sup>17</sup> Fever, acute diarrhea and dysentery, and a case fatality rate of 25% are characteristic. No etiological agent has been identified.

#### Lambs and goat kids

The *E. coli* strains isolated from diarrheic lambs and goat kids on Spanish farms are not generally toxigenic and belong to a large number of O serogroups.<sup>18</sup>

#### Piglets

In outbreaks of diarrhea in neonatal piglets during the first 5 days of life, the

enteropathogens that are commonly present in the feces include the transmissible gastroenteritis (TGE) virus, enterotoxigenic *E. coli*, *Isospora* spp., rotavirus, *C. perfringens* type C, and adenovirus. *Clostridium difficile* has emerged as an important pathogen causing enteritis in suckling piglets.<sup>19,20</sup> The TGE virus causes diarrhea in piglets under 15 days of age, enterotoxigenic *E. coli* under 5 days of age, *Isospora* sp. between 5 and 15 days of age, and rotavirus in piglets over 10 days of age. During the second and third weeks of life, *Isospora suis* is the most common pathogen in outbreaks of diarrhea in litters of piglets. While individual piglets may be infected by a single pathogen, it is common for more than one pathogen to be present in the litter. This stresses the importance of submitting to the diagnostic laboratory some piglets that are representative of the problem. A seasonal occurrence of the common enteropathogens has also been observed. The prevalence of the TGE virus may be highest during the fall, winter, and spring months, and the coccidia and *E. coli* are more common during the summer, fall, and early winter, with the lowest prevalence in the spring.

#### Foals

Diarrhea in foals is common but most cases are mild, transient and not associated with infectious agents. Diarrhea is the most commonly reported disease in foals under 7 days of age.<sup>21</sup> The most common occurrence is associated with 'foal heat' in the mare. Group A rotavirus is the most common cause of epidemics of diarrhea in foals.<sup>22</sup> Enterotoxigenic *E. coli* has been isolated from a diarrheic foal. Other pathogens that have been isolated from foals with diarrhea include *C. jejuni*, *C. perfringens*, and *Rhodococcus equi*.

#### CLINICAL MANAGEMENT OF EPIDEMICS

When faced with an outbreak of acute diarrhea in newborn calves in which there is profuse watery diarrhea, progressive dehydration, and death in a few days or earlier, the following steps are recommended:

1. Visit the herd and do an epidemiological investigation to identify the risk factors that may have been responsible for the outbreak. Most outbreaks are multifactorial and an interaction between the environment, management, feeding and the pathogens.<sup>23,24</sup> The investigation of the underlying causes of the outbreak should involve an examination of:
  - Dry cow management
  - Calving management
  - Colostrum management
  - Calf management
  - Calf feeding
  - Feeds used
  - History of the present outbreak
  - The affected calves
  - Results of necropsy and pathology and microbiology
  - The pathogens identified
  - What has changed in the management of the herd
2. Each of the commonly recognized risk factors must be examined for its possible role in the particular outbreak:
  - In beef herds the most common one is overcrowding in the calving yards, which results in increased contamination and a high infection rate
  - Recent changes in climate and recent stress of any kind on the herd are common
  - In dairy herds, the quality of the milk replacer should be investigated
  - Any recent introductions of replacement calves into the herd should be considered as possible sources of pathogens
  - The failure of calves to ingest an adequate quantity of colostrum within hours after birth is also an important risk factor. However, it is usually not possible to determine how much colostrum calves have ingested, and measurement of serum immunoglobulins of calves about 3 days of age may be necessary to determine the level of colostrum immunity in the calf crop. The concentrations of total serum protein and serum gammaglobulin are usually lower in calves with diarrhea, and calves born between May and October have higher levels than calves born in April
3. Affected calves should be examined clinically, dead ones by necropsy, and a case definition should be determined to insure that diarrhea is the major problem
4. All affected calves should be identified, isolated and treated immediately with oral and parenteral fluid therapy as indicated. The use of oral fluid and electrolyte therapy for the treatment of dehydration and acidosis as soon as the calves are seen to be diarrheic must be emphasized
5. Antibacterials may be given orally and parenterally for the treatment of enteric and septicemic colibacillosis. When large numbers of calves are affected at one time it is not usually possible clinically or with the aid of a laboratory to determine which calf is septicemic, and thus all acutely affected calves should be treated.

Treatment, however, should not be continued beyond 3 days

6. Fecal samples (30–50 g) should be collected from diarrheic calves at the first sign of diarrhea, and from normal calves, and submitted to a laboratory for the attempted isolation and characterization of enterotoxigenic *E. coli*, rotaviruses, and *Salmonella* spp. A rapid enzyme-linked immunosorbent assay (ELISA) test is available for the simultaneous detection of *Escherichia coli* K99 antigen, bovine coronavirus, and rotavirus in the feces of diarrheic calves during the acute phase of the infection. The Enterasure Kit is a monoclonal antibody ELISA for the detection of bovine coronavirus, rotavirus serogroup A, and K99<sup>+</sup> *E. coli* antigen. The Cryptosure Kit is a substantial improvement over the stain method for detecting cryptosporidia in the feces. Blood samples from affected and normal calves and colostrum samples, if available, are useful for immunoglobulin and antibody studies. All moribund calves should be submitted for necropsy before they die naturally
7. Pregnant cows that are due to calve shortly should be moved to a new calving area. In a dairy herd this means a different, clean calving stall, preferably in another barn not previously occupied by cattle; in beef herds it may mean moving a large number of cows to a new, uncontaminated calving pasture
8. The control of the disease in future calf crops will depend on application of the principles of control, which are described under colibacillosis and viral diarrhea of calves. If a significant number of cows are due to calve in more than 3–6 weeks, vaccination with the calf diarrhea vaccines can be considered
9. A report should be submitted to the owner that records the observations made at the farm visit and outlines specific recommendations for clinical management of affected calves and for control of the disease in the future.

#### CONTROL

The principles of control are presented in detail in the sections on colibacillosis of newborn calves, piglets, lambs, kids, and foals, and viral diarrhea in calves, lambs, kids, piglets, and foals, using the following principles:

- Reduction of the degree of exposure of the newborn to the infectious agents

- Provision of maximum nonspecific resistance with adequate colostrum and optimum animal management
- Increasing the specific resistance of the newborn by vaccination of the dam or the newborn.

## REVIEW LITERATURE

Andrews AH. Calf enteritis – diarrhea in the preweaned calf – strategic investigation of outbreaks. *Cattle Pract* 2004; 12:109–114.

Fayer R. *Cryptosporidium*: a water-borne zoonotic parasite. *Vet Parasitol* 2004; 126:37–56.

## REFERENCES

1. McDonough S et al. *Am J Vet Res* 1994; 55:1516.
2. Olchoway TWJ et al. *J Vet Intern Med* 1993; 7:12.
3. Radostits OM et al. *Proc Annu Conv Am Assoc Bovine Pract* 1992; 24:101.
4. Wright A et al. *Can Vet J* 1995; 36:36.
5. Clement JC et al. *J Am Vet Med Assoc* 1995; 207:1334.
6. Driesen SJ et al. *Aust Vet J* 1993; 70:259.
7. Frank NA, Kaneene JB. *J Dairy Sci* 1993; 76:1313.
8. Heinrichs AJ. *Compend Contin Educ Pract Vet* 1994; 16:1605.
9. Brenner J et al. *Israel J Vet Med* 2000; 55:5.
10. Kodituwakku SN, Harbour DA. *Vet Rec* 1990; 126:547.
11. Adesiyun AA, Kaminjolo JS. *Prev Vet Med* 1994; 19:151.
12. Fagan JG et al. *Ir Vet J* 1995; 48:17.
13. Fayer R. *Vet Parasitol* 2004; 126:37.
14. Wilson JB et al. *Can J Vet Res* 1992; 56:184.
15. O'Handley RMO et al. *J Am Vet Med Assoc* 1999; 214:391.
16. Busato A et al. *Vet Microbiol* 1999; 69:251.
17. Caldwell GL, Munro R. *Vet Rec* 1995; 137:307.
18. Blanco J et al. *Vet Microbiol* 1996; 49:209.
19. Nagy J, Bilkei G. *Vet J* 2003; 166:98.
20. Yaeger M et al. *J Vet Diagn Invest* 2002; 14:281.
21. Cohen ND. *J Am Vet Med Assoc* 1994; 204:1644.
22. Dwyer RM et al. *Proc Annu Conv Am Assoc Equine Pract* 1991; 36:337.
23. Andrews AH. *Cattle Pract* 2004; 12; 109.
24. Svensson C et al. *Prev Vet Med* 2003; 58:179.

## COLIBACILLOSIS OF NEWBORN CALVES, PIGLETS, LAMBS, KIDS, AND FOALS

### Synopsis

**Etiology** Pathogenic serotypes of *Escherichia coli*: septicemic, enterotoxigenic, enteropathogenic (EPEC), enterohemorrhagic (EHEC), also referred to as verocytotoxigenic (VTEC) or Shiga-toxin-producing (STEC), and necrotoxicogenic *E. coli* (NTEC)

**Epidemiology** Newborn calves, piglets, lambs, goat kids, foals. Risk factors include colostrum deprivation, overcrowding, adverse climatic conditions, inferior milk replacers. Prevalence of enteropathogenic *E. coli* varies between herds.

Enterohemorrhagic *E. coli* (O157:H7) in cattle is of major zoonotic concern

**Signs** Weakness and collapse (septicemia). Diarrhea. Dehydration. Complications such as meningitis

**Clinical pathology** Isolate organism from feces. Hematology and serum biochemistry to evaluate inflammation and acid–base and electrolyte imbalance

**Lesions** Septicemic lesions. Dehydration, enteritis

**Diagnostic confirmation** Culture of organism and serotyping

**Differential diagnosis** See Table 18.3. *E. coli* infections causing septicemia and diarrhea in newborn farm animals must be differentiated from the following:

- Septicemia in calves
  - *Salmonella* spp.
  - *Listeria monocytogenes*
  - *Mannheimia haemolytica*
  - *Streptococcus* spp.
  - *Pneumococcus*
- Septicemia in piglets
  - *Streptococcus* spp.
  - *Listeria monocytogenes*
- Septicemia in lambs and kids
  - *Salmonella* spp.
  - *Listeria monocytogenes*
  - *Erysipelothrix insidiosa*
- Septicemia in foals
  - *Actinobacillus equuli*
  - *Salmonella abortusequi*
  - *Salmonella typhimurium*
  - *Streptococcus pyogenes*
  - *Listeria monocytogenes*
- Acute neonatal diarrhea in calves
  - Rotavirus and coronavirus
  - *Cryptosporidium* spp.
  - *Salmonella* spp.
  - *Eimeria* spp.
  - *Clostridium perfringens* type C
- Acute neonatal diarrhea in piglets
  - Rotavirus
  - Transmissible gastroenteritis virus
  - *Clostridium perfringens* type C
  - *Isospora* spp.
- Acute neonatal diarrhea in lambs and kids
  - Coronavirus
  - *Cryptosporidium* spp.
  - *Clostridium perfringens* type C
  - Rotavirus
- Acute neonatal diarrhea of foals
  - *Salmonella* spp.
  - *Eimeria* spp.
  - Foal heat diarrhea

**Treatment** Antimicrobials. Fluid and electrolyte therapy

**Control** Reduce infection pressure on neonate. Insure adequate intake of colostrum. Vaccinate pregnant dam to induce specific colostrum antibody. Minimize stressors and their effect on neonates

## ETIOLOGY

Colibacillosis is associated with pathogenic serotypes of *Escherichia coli*.<sup>1,2</sup> The prevalence of the different pathogenic serotypes of *E. coli* in farm animals has remained relatively unchanged for many years. Certain serotypes cause diarrhea and others cause septicemia.

- **Enterotoxigenic *E. coli*** is the most common enteropathogen that causes diarrhea in newborn farm animals. The bacteria cause diarrhea by adhering to, colonizing and producing enterotoxins in the small intestine; they are not invasive<sup>3</sup>

- **Enteropathogenic *E. coli*** are the 'attaching and effacing' strains that colonize the small intestine, where they attach tightly to the epithelial cells of the villus and cause typical attaching and effacing lesions. They do not produce toxins and seldom invade the intestinal mucosa
- **Enterohemorrhagic *E. coli*** strains elaborate very potent Shiga toxins. The enterohemorrhagic *E. coli* are considered to be a subset of Shiga-toxin-producing or verotoxin-producing strains of *E. coli*. They are not an important cause of diarrhea in farm animals but some Shiga-toxin-producing *E. coli* have been responsible for diarrhea in calves. Cattle are an important reservoir of *E. coli* O157:H7, one of the important enterohemorrhagic *E. coli* strains, causing a broad range of clinical disease in humans including diarrhea and hemorrhagic colitis, and the highly fatal hemolytic–uremic syndrome in children.<sup>4,5</sup> See 'Enterohemorrhagic *Escherichia coli* in farm animals and zoonotic implications', below
- **Necrotoxicogenic *E. coli* (NTEC)** strains produce cytotoxic necrotizing factor (CNF)1 or 2. NTEC2 isolates are restricted to calves and lambs with diarrhea and septicemia<sup>2</sup>
- **Septicemic *E. coli*** strains of serogroup O78 are invasive and cause septicemia in calves, piglets, and lambs.<sup>1</sup> Their powerful endotoxins cause endotoxic shock with a high case fatality rate.

## EPIDEMIOLOGY

### Occurrence and prevalence of infection

The prevalence of colibacillosis has increased in recent years. There are several possible reasons for this, including size of herds, shortage of qualified labor, automated livestock rearing systems, and increased population density.

Colibacillosis occurs most commonly in newborn farm animals and is a significant cause of economic loss in raising livestock. It is a complex disease in which several different risk factors interact with certain pathogens, resulting in the disease. There are at least two different types of the disease: **enteric colibacillosis** is characterized by varying degrees of diarrhea, dehydration, acidosis, and death in a few days if not treated; **coliform septicemia** is characterized by severe illness and rapid death in several hours.

### Calves

The prevalence of enterotoxigenic *E. coli* in diarrheic calves varies widely geographically, between herds and depending on

Table 18.3 Possible causes of bacteremia/septicemia and acute neonatal diarrhea in farm animals

Calves	Piglets	Lambs and kids	Foals
<b>Bacteremia/septicemia</b>			
<i>Escherichia coli</i>	<i>Escherichia coli</i>	<i>Escherichia coli</i>	<i>Escherichia coli</i>
<i>Salmonella</i> spp.	<i>Streptococcus</i>	<i>Salmonella</i> spp.	<i>Actinobacillus equuli</i>
<i>Listeria monocytogenes</i>	<i>Listeria monocytogenes</i>	<i>Listeria monocytogenes</i>	<i>Salmonella abortusovae</i>
<i>Pasteurella</i> spp.		<i>Erysipelothrix rhusiopathiae</i>	<i>Salmonella typhimurium</i>
<i>Streptococcus</i> spp.			<i>Streptococcus pyogenes</i>
<i>Pneumococcus</i> spp.			<i>Listeria monocytogenes</i>
<b>Acute neonatal diarrhea</b>			
Enteropathogenic and enterotoxigenic <i>E. coli</i>	Enteropathogenic <i>E. coli</i>	<i>Clostridium perfringens</i> type C	Foal-heat diarrhea
Rotavirus	<i>Salmonella</i> spp.	<i>C. perfringens</i> type B	Rotavirus
Coronavirus	Transmissible	(lamb dysentery)	<i>Clostridium perfringens</i> type B
Bovine torovirus (Breda virus)	gastroenteritis virus	Rotavirus	
Bovine calicivirus	<i>Clostridium perfringens</i> type C	Caprine herpesvirus	
Bovine norovirus	(rarely A)		
<i>Cryptosporidium</i> spp.	<i>Clostridium difficile</i>		
<i>Giardia</i> spp.	Rotavirus		
<i>Salmonella</i> spp.	PRRSV		
<i>Eimeria</i> spp. (calves at least 3 weeks old)	<i>Isospora</i> spp.		
<i>Clostridium perfringens</i> type C			
PRRSV, porcine reproductive and respiratory syndrome virus			

the age of the animals. The prevalence can be as high as 50–60% in diarrheic calves under 3 days of age and only 5–10% in diarrheic calves 8 days of age. In some countries the prevalence is only 5–8% in diarrheic calves under 3 days of age. Thus enterotoxigenic colibacillosis is a major cause of diarrhea in calves less than 3 days of age and is not associated with outbreaks of diarrhea in calves older than 3 days. Enterotoxigenic *E. coli* infection in calves older than 2–3 days will in most cases be associated with a virus infection. The prevalence of the organism is also very low or not present in clinically normal calves in herds that have not had a problem with diarrhea. In some beef herds affected with diarrhea in young calves there may be little evidence of infection with enterotoxigenic *E. coli*, and other factors need to be examined.

#### Piglets

The prevalence of enterotoxigenic *E. coli* in diarrheic piglets also varies geographically and with herds. In some areas the K99<sup>+</sup> pilus was found more frequently than the K88<sup>+</sup> or 987P, whereas in other regions the K88<sup>+</sup> is more common.

#### Morbidity and mortality rates

##### Calves

In dairy calves raised under intensive and poorly managed conditions the morbidity rate may reach 75% but is usually about 30%. Case fatality rates vary from 10–50% depending on the level of clinical management.

In beef calves the morbidity rates vary from 10–50% and the case fatality rates from 5–25% or even higher in some years. The population mortality rate in both beef and dairy calves can vary from a low of

3% in well-managed herds to a high of 60% in problem herds in certain years.

#### Piglets

In piglets the morbidity rate of preweaning diarrhea varies widely between herds but averages about 6% of litters, mostly in the first week of life. The morbidity rates increase with increased litter size and decrease with increasing parity of the sow. Losses due to stillbirths, traumatic injuries, starvation, and undersize at birth account for a much greater combined total preweaning loss but colibacillosis accounts for approximately 50% of the gastroenteropathies encountered during the preweaning period.

#### Foals and lambs

Incidence rates are not readily available for foals and lambs, but *E. coli* is the most commonly isolated organism from the tissues and blood of septic foals.

#### Risk factors

Several risk factors influence the occurrence of the disease, each one of which must be considered, evaluated and modified or removed if necessary when investigating the cause of an outbreak so that effective clinical management and control of the disease may be achieved.

#### Animal risk factors

##### Age and birth weight

Colibacillosis is most common in animals under 3 days of age but it may occur as early as 12–18 hours after birth and occasionally occurs in calves up to several days of age when there is a mixed infection with viral enteropathogens. Diarrhea associated with enterotoxigenic *E. coli* occurs in calves mainly during the first few days of life, rarely in older calves and

never in adults. Epidemiological studies of both beef and dairy calves indicate that more than 80% of clinical cases associated with K99<sup>+</sup> enterotoxigenic *E. coli* occur in calves younger than 4 days of age. The mechanism of this age-related resistance is not well understood but may be related to development of resistance to colonization of the small intestine as the calf becomes older. This could be associated with the replacement of villous epithelial cells that occurs in the first few days after birth.

Mortality due to colibacillosis is significantly higher in **goat kids** that are underweight at birth because of multiple births, which may result in the ingestion of inadequate amounts of colostrum.<sup>6</sup>

The disease is more common in **piglets** born from gilts than from sows, which suggests that immunity develops with developing age in the sow and is transferred to the piglets. In a survey of approximately 4400 litters of piglets over a period of 4 years in a large piggery, 64% of the litters were treated for diarrhea before weaning, and piglets born to sows under parity 2 were 1.7 times more likely to develop diarrhea before weaning than litters born to sows over parity 3. The susceptibility or resistance to *E. coli* diarrhea in piglets has an inherited basis.<sup>7</sup> The cell surface receptor for the K88<sup>+</sup> antigen is inherited in a simple mendelian way with adherence (S) dominant over non-adherence (s). Homozygous dominants (SS) and heterozygotes (Ss) possess the receptor and are susceptible, whereas in the homozygous recessive (ss) the receptor is absent and the pigs are resistant. The highest incidence of diarrhea occurs in susceptible progeny born from resistant



dams and sired by susceptible sires. Most if not all pigs have intestinal receptors for K99<sup>+</sup> pili and an inheritance pattern similar to K88<sup>+</sup> receptors does not exist for K99<sup>+</sup> receptors.

#### *Immunity and colostrum*

Newborn farm animals are agammaglobulinemic and must ingest colostrum and absorb colostral immunoglobulins within hours of birth to obtain protection against septicemic and enteric colibacillosis. The transfer of immunoglobulins from the dam to the neonate is termed transfer of passive immunity. **Failure of transfer of passive immunity** predisposes the neonate to development of infectious diseases.<sup>8</sup>

**Calves** Transfer of maternal immunoglobulins to calves depends on three successive processes:

- **Formation of colostrum with a high concentration of immunoglobulin by the dam**
- **Ingestion of an adequate volume of colostrum by the calf**
- **Efficient absorption of colostral immunoglobulins by the calf.**

Colostral immunoglobulins are absorbed for up to 24 hours after birth in calves and up to 48 hours in piglets. However, in calves maximum efficiency of absorption occurs during the first 6–12 hours after birth and decreases rapidly from 12–24 hours after birth. Following absorption, transfer to the intestinal lumen is a major means of IgG<sub>1</sub> clearance in calves, and this transfer results in antigen-binding antibody in the intestinal lumen. Both blood-derived antibody and lactogenic antibody are significant sources of passive antibody in the intestinal lumen of the neonatal calf. Maintenance of high concentrations of milk-derived antibodies in the small intestinal lumen may require more than twice-a-day feedings, since antibodies derived from a milk diet are predominantly cleared from the intestinal lumen by 12 hours after feeding.

Passively acquired antibody from the circulation entering the small intestinal lumen is, therefore, a reasonable hypothesis to explain the strong association between high serum passive immunoglobulin concentrations and reduced morbidity in neonatal calves.

**Newborn dairy calves should ingest 80–100 g of colostral immunoglobulin G<sub>1</sub>, and ideally up to 150 g,** within a few hours after birth in order to achieve serum immunoglobulins of 10 mg/mL.<sup>8</sup> Calves fed colostrum containing less than 100 g immunoglobulin are at increased risk for failure of transfer of passive immunity. The highest levels of serum immunoglobulins are achieved by the

ingestion of colostrum containing high concentrations of immunoglobulins within a few hours after birth. The concentrations of immunoglobulins in first-milking colostrum from dairy cows can vary from 20–150 g/L, with mean levels varying from 40–50 mg/mL.<sup>8</sup> In one study of 919 first-milking colostrums from Holstein cows during a 4-year period on a commercial dairy farm, the colostral immunoglobulin G<sub>1</sub> concentrations varied greatly, with a mean of 48.2 mg/mL and a standard deviation of 21.9 mg/mL. Immunoglobulin (Ig) concentration in colostrum is lower in first- and second-calf heifers than in third or subsequent lactations. It is also lower in colostrum from high-producing dairy cows. Natural sucking by the calf may enhance the efficiency of absorption of colostral immunoglobulins, but the volume of colostrum ingested by sucking calves is frequently inadequate. In dairy herds that allowed calves to suck naturally, the prevalence of failure of transfer of passive immunity was greater than 50% even among calves nursed by cows with above-average colostral immunoglobulin concentration.<sup>8</sup> In order to ingest 100–150 g of immunoglobulins, newborn dairy calves should be artificially fed 3–4 L of fresh or refrigerated first-milking colostrum from cows that have had nonlactating intervals of normal duration.<sup>8</sup> In beef cattle, the concentration of immunoglobulin in colostrum is generally higher than in dairy cattle but there can be deficiencies of volume production, especially in first-calf heifers.

The maximum level of serum immunoglobulins is reached in the calf at 24 hours after birth and the factors that reduce those levels below an adequate level include the effects of maternal behavior and conformation, the vigor of the calf and environmental influences. Before the newborn calf manages to suck for the first time, a chain of specific events occurs. The calf first recovers from the birth process, attempts and is successful in standing up and then begins to search for a teat. The calf must find its dam and then locate the udder and teats. There are wide variations in the length of each interval and many factors can affect the variation in the intervals, and consequently the calf's first suck and acquisition of passive immunity. The risk of diarrhea in calves born to heifers may be about four times greater than calves born to cows, which may reflect maternal behavior and colostral immunity.<sup>9</sup> Some first-calf heifers do not lick and stimulate their calves to get up and suck immediately after birth as does the mature cow with an ostentatious maternal instinct. Others ignore their calves completely. The conformation of the udder and the shape of the teats may

be undesirable in that the calf cannot find the teat so easily on badly shaped udders or the teat may be misshapen, which makes it difficult for the calf to suck. first-calf heifers do not have as much colostrum or as wide a spectrum of specific antibodies as do mature cows.

Calves that receive their first colostrum by bucket do not acquire the same high levels of serum colostral immunoglobulins as calves which receive their first colostrum by natural sucking of the teat. In both cases the presence of the dam improves the absorption. Calves that are weak or have an edematous tongue from a prolonged, difficult parturition may not be able to suck for several hours, by which time the ability to absorb colostral immunoglobulins has decreased markedly. Postnatal respiratory acidosis in calves can adversely affect colostral immunoglobulin absorption, despite adequate colostral intake early in the absorptive period.<sup>8</sup> Risk factors predictive of postnatal acidosis are duration of second-stage parturition greater than 1 hour, dystocia requiring traction, and weakness of the calf at birth. Beef calves born outdoors may be subjected to several influences that affect colostral intake. They may be born during a snowstorm and suffer severe cold exposure; when born they may be dropped in a snow-bank and be unable to get up, even with the assistance of the dam. In crowded calving grounds, mismothering due to mistaken identity may occur, resulting in the calf receiving no or very little colostrum.

Certain parameters measurable in dairy calves at, or shortly after birth may have important prognostic value in evaluating the risk of calf diarrhea.<sup>10</sup> High levels of serum immunoglobulins decrease the length of an episode of diarrhea.<sup>10</sup> The age at onset of diarrhea may be lower in lighter and in heavier newborn calves: lighter calves may be premature and unable to suck adequately, and heavier calves may have experienced dystocia.

**Dairy calves.** The mortality rate from enteric disease is much higher in calves with low levels of serum immunoglobulins than in calves with adequate levels. From the evidence of surveys, up to 40% of newborn dairy calves do not acquire adequate levels of serum colostral immunoglobulins because they do not ingest a sufficient amount of high-quality colostrum soon enough after birth; this makes them very susceptible to neonatal disease, especially enteric disease. In New Zealand, about 50% of dairy calves may not receive colostrum from their dams even when they are left together for up to 24 hours after the birth of the calf.<sup>11</sup> The failure of transfer of passive immunity

was due primarily to calves not sucking soon enough after birth. Of the calves that did suck, the time between birth and first sucking ranged between 0.9 and 19.1 hours.

**Beef calves.** The prevalence of failure of transfer of passive immunity in beef calves in North America ranges from 11–31%. In beef cow/calf herds averaging 56 cows in Quebec, Canada, failure of transfer of passive immunity occurred in 19% of the calves. The risk factors for failure of transfer of passive immunity (serum concentrations < 10 g/L) in the newborn included being born in a stanchion-stall (odds ratio (OR) 10.2). Calves bottle-fed colostrum were less at risk of failure of transfer of passive immunity (OR = 0.06). Calf gender, month of birth, dam parity and dam body condition were not associated with failure of transfer of passive immunity.<sup>12</sup>

**Lambs** Lambs with low serum colostral immunoglobulin levels are also highly susceptible to enteric colibacillosis. The factors related to the risk of neonatal mortality, birth weight and serum immunoglobulin concentrations in lambs in the UK indicate that low birth weight and low serum immunoglobulin concentration were associated with increased odds of mortality.<sup>13</sup> Fifty-six percent of the variation in immunoglobulin concentration was at the lamb level, 36% at the ewe level and only 7% at the farm level. Factors associated with reduced serum immunoglobulin concentration included early or late birth in the lambing season, being born later than 14 days after the first lamb born on the farm, multiple-birth litters and maternal mastitis.

**Piglets** Newborn piglets that do not obtain a liberal quantity of colostrum within a few hours after birth are very susceptible to colibacillosis. Prolonged parturition, weak piglets, slippery floors, cold drafty farrowing crates and the condition of the sow and her colostrum supply all influence the amount of colostrum ingested by the newborn piglet. Enteric colibacillosis is the major disease in piglets that are weaned from the sow immediately after birth and reared on milk replacers. A crude preparation of porcine immunoglobulin added to the milk replacer of colostrum-deprived pigs provided good protection against enteric colibacillosis when fed for the experimental period of 21 days.

Environmental and management risk factors

#### *Meteorological influences*

While few epidemiological data are available to support the claim, many veterinarians have observed a relationship between adverse climatic conditions and

colibacillosis in both calves and piglets. During inclement weather, such as a snowstorm, a common practice in beef herds is to confine the calving cows in a small area, where they can be fed and watered more easily. The overcrowding is commonly followed by an outbreak of acute diarrhea in the calves. There is evidence that cold, wet, windy weather during the winter months and hot, dry weather during the summer months has a significant effect on the incidence of dairy calf mortality.

The risk factors for mortality from diarrhea in beef calves in Alberta, Canada, have been examined.<sup>14</sup> The odds of increased mortality were increased when the cows and heifers were wintered on the same grounds, when the herd was wintered and calved on the same grounds, and if the cows and heifers calved on the same grounds. The morbidity and mortality rates from diarrhea during the first 30 days of life increased with an increasing percentage of heifers calving in the herd. Heifers are commonly more closely confined during the calving season for more effective observation and assistance at parturition. This may lead to increased contamination of the environment and the abdominal wall and udder of the heifers. Additional factors in heifers include a higher incidence of dystocia and maternal misbehavior, and lower volume and quality of colostrum, all of which can result in weak calves that may not acquire sufficient colostral immunity.

#### *Nutrition and feeding methods*

Dairy calves fed milk substitutes may be more susceptible to acute undifferentiated diarrhea, some of which may be due to enteric colibacillosis, compared to those fed cows' whole milk. Extreme heat treatment of the liquid skim-milk in the processing of dried skim-milk for use as milk substitutes for calves results in denaturation of the whey protein, which interferes with digestibility of the nutrients and destruction of any lactoglobulins that are present and may have a protective effect in the young calf.

Irregular feeding practices resulting in dietetic diarrhea may contribute to a higher incidence of enteric colibacillosis in calves. The person feeding and caring for the calves has been an important factor influencing calf mortality due to diarrhea. While it is generally believed that general or specific nutritional deficiencies such as a lack of energy, protein or vitamin A in the maternal diet predispose to colibacillosis, particularly in calves and piglets, there is no direct evidence that specific nutritional deficiencies are risk factors. They probably are, at least in indirect ways, for example by having an effect on the amount of

colostrum available at the first milking after parturition in first-calf heifers underfed during pregnancy.

#### *Standard of housing and hygiene*

Housing and hygienic practices are probably the most important risk factors influencing the incidence of colibacillosis in calves and piglets but have received the least amount of research effort compared to other aspects, for example control of the disease through vaccination. As the size of herds has increased, and as livestock production has become more intensified, the quality of hygiene and sanitation, particularly in housed animals, assumes major importance. Where calves are run at pasture or are individually tethered, or penned, on grass the disease is much less common.

#### *Source of the organism and its ecology and transmission*

Ingestion is the most likely portal of infection in calves, piglets, and lambs, although infection via the umbilical vessels and nasopharyngeal mucosa can occur. It has been suggested that certain serotypes of *E. coli* may enter by the latter route and lead to the development of meningitis.

In most species, it is assumed that the primary source of the infection is the feces of infected animals, including the healthy dams and neonates, and diarrheic newborn animals, which act as multipliers of the organisms. In some cases the organism may be cultured from the vagina or uterus of sows whose litters become affected. In pig herds the total number of organisms on each sow is highest in the farrowing barn, decreases when the sow is returned to the breeding barn, and is lowest when the sow is in the gestation barn.

**Calves** Calves acquire the infection from contaminated bedding and calf pails, dirty calf pens, nearby diarrheic calves, overcrowded calving grounds, and from the skin of the perineum and udder of the cow. The organism is spread within a herd through the feces of infected animals and all the inanimate objects that can be contaminated by feces, including bedding, pails, boots, tools, clothing, and feed and water supplies. The organism is one of the first encountered by newborn farm animals within minutes after birth. In cattle, the tonsil can be a reservoir for Shiga-like positive *E. coli* in healthy animals.<sup>15</sup> It is possible that virulent *E. coli* can be present and may be transferred to calves when they are licked by their dams at birth. The high population density of animals that occurs in overcrowded calving grounds in beef herds, heavily used calving pens in dairy herds and the continuous successive use of farrowing crates without

a break for clean-up contributes to a large dynamic population of *E. coli*. The population of bacteria in an animal barn will continue to increase with the length of time the barn is occupied by animals without depopulation, clean-out, disinfection and a period of vacancy. In some countries, where lambing must be done in buildings to avoid exposure to cold weather, the lambing sheds may become heavily contaminated within a few weeks, resulting in outbreaks of septicemic and enteric colibacillosis.

Infected animals are the main reservoir for enterotoxigenic *E. coli* and their feces are the major source of environmental contamination with the bacteria. Passage of the *E. coli* through animals causes a 'multiplier effect', as each infected animal excretes many more bacteria than it originally ingested. Diarrheic calves are the most extreme multipliers, because they often pass 1 L or more of liquid feces containing  $10^{10}$ /g enterotoxigenic *E. coli* within 12 hours, and recovered calves can continue to shed bacteria for several months.

Normal calves and adult cows can serve as reservoirs of infection, and the bacteria can persist in a herd by circulating through animals of all ages. Carrier animals introduced to an uninfected herd are thought to be one of the main causes of natural outbreaks. The duration and amount of shedding probably depends on the degree of confinement, resulting population density, herd immunity, environmental conditions and perhaps the serotype of the organism.

#### Pathogen risk factors

##### *Virulence attributes of E. coli*

The virulence attributes of **enterotoxigenic *E. coli*** include the adhesins in their pili or fimbriae that allow them to adhere to intestinal villous epithelial cells and prevent peristaltic elimination by the gut, and the production of heat-stable (ST) and heat-labile (LT) enterotoxins. The **septicemic strains** are invasive and commonly cause rapid death due to the effects of a septicemia involving multiple body systems. In animals that do not die of septicemia, localization of the bacteria may also occur in joints and other organs and tissues. Certain strains such as the O115:KXXVX 165 can cause either diarrhea or septicemia in piglets and calves.<sup>16</sup>

The virulence attributes are relevant to vaccine efficacy. The species-specific adhesin antigens must be identified and incorporated into vaccines, which are given to pregnant females in an attempt to stimulate the production of specific antibody in the colostrum, which will provide protection against enterotoxigenic colibacillosis. An essential element of

vaccine development is the detection of common fimbrial antigens occurring among most pathogenic isolates and able to induce antibodies that block bacterial adhesion. The great diversity of potential pathogenic serotypes encountered in colisepticemia and the failure of serotype-specific antibody to cross-protect against a heterologous challenge in experimental infection have made it difficult to develop vaccines against septicemic colibacillosis.

**Calves** The major virulence attributes of the **enterotoxigenic strains of *E. coli*** in calves are the K99<sup>+</sup> adhesin antigen and the heat-stable enterotoxin.<sup>1</sup> The colonization in the small intestine of calves by K99<sup>+</sup> enterotoxigenic *E. coli* appears to be site-specific, having a predilection for the ileum. Some serogroups also elaborate the F41 adhesin to the K99. Other surface-adhesive antigens such as Att 25 and F17 have been identified on bovine enteropathogenic and septicemic *E. coli*.<sup>1</sup> The F17a-positive enterotoxigenic *E. coli* strains are no longer isolated from diarrheic calves in some countries. It is postulated that the use of a vaccine including O101, K32, and H9 antigens in addition to K99 (F5) explains the strongly reduced incidence of the O101:K32:H9, K99(F5) *E. coli* clone.<sup>17</sup> A K88-related fimbrial antigen occurs on some enterotoxigenic and septicemic strains.

The heat-stable enterotoxin from bovine enterotoxigenic *E. coli* has been purified and characterized. There is evidence of a form of heat-stable enterotoxin that is common to bovine, porcine, and human strains of enterotoxigenic *E. coli*.

Most strains of septicemic *E. coli* belong to certain serogroups with virulence properties that enable them to resist the defense mechanisms that would normally eliminate other *E. coli*. Septicemic strains produce endotoxin, which results in shock and rapid death, usually in calves that are less than 5 days of age and are agammaglobulinemic because of failure of transfer of colostral immunity. Isolates of *E. coli* from the blood of critically ill bacteremic calves on a calf-rearing farm in California constituted a heterogeneous group and were aerobactin positive and often resistant to the bactericidal effects of serum.<sup>18</sup> The P fimbriae F11 and F165 have been identified in septicemic *E. coli* strains isolated from calves.<sup>19</sup>

**Enterohemorrhagic *E. coli* and verocytotoxin-producing *E. coli*** are being recognized in humans and animals with increased frequency<sup>20</sup> and constitute a major zoonotic concern. These organisms are members of O111, O103, O5, and O26 serogroups, and none produces heat-stable or heat-labile enterotoxin, nor do they possess the K99 pili.<sup>3</sup> They

produce potent verotoxins, also known as the Shiga-like toxins, SLT1 and SLT2; and some strains, the **attaching and effacing *E. coli* (AEEC)**, attach to and efface the microvilli of the enterocytes, causing diarrhea and dysentery due to a hemorrhagic colitis in calves 2–5 weeks of age. The effacing (*eae*) gene and the gene coding for the Shiga-like toxin 1 (*SLT1*) are associated with most isolates of AEEC in cattle.<sup>21</sup> They have been isolated from both diarrheic and healthy sheep and goats.<sup>22</sup>

A study of the onset and subsequent pattern of shedding of verotoxin-producing *E. coli* O26, O103, O111, O145, and O157 in a cohort of beef calves on a mixed cattle and sheep farm in Scotland found that O26 was shed by 94% of the calves and that 90% of the O26 isolates carried the *vtx1*, *eae*, and *ehf* genes.<sup>23</sup> *E. coli* O103 was the second most commonly shed serogroup of the tested calves and the pattern of shedding was sporadic and random. There was an absence of shedding of *E. coli* O111 and the prevalence of shedding of O145 was low. While some shedding of O157 occurred, shedding in calves was sporadic and infrequent. For O26, O103, and O157, there was no association between shedding by calves and shedding by dams within 1 week of birth. For O26 and O103, there was no association between shedding and diarrhea, and no significant change in shedding following housing. In a sample of Australian dairy farms, calves as young as 48–72 hours had evidence of fecal excretion of Shiga-toxin-producing *E. coli*, indicating that dairy cattle are exposed to Shiga-toxin-producing *E. coli* from birth.<sup>24</sup> Calves at weaning are most likely to be shedding Shiga-toxin-producing *E. coli* O26 or *E. coli* O157, similar to the prevalence surveys in the northern hemispheres.

Naturally occurring cases of attaching and effacing lesions of the intestines in calves with diarrhea and dysentery and infected with *E. coli* O126:H11, the predominant verotoxin-producing *E. coli* in humans, have been described in the UK.<sup>25</sup> Verotoxin-producing *E. coli* and *eae*-positive non-verotoxin-producing *E. coli* have been isolated from diarrheic dairy calves 1–30 days of age.<sup>26</sup>

*E. coli* O157 has been isolated from neonatal calves and has been implicated as a cause of diarrhea in calves.<sup>27</sup> The isolates carried various virulence genes such as *Ehly*, *eae*, *stx1*, and *stx2*. The *Ehly* gene may be a virulence marker for bovine enterohemorrhagic *E. coli* O157 strains. Similar findings have been reported in dairy cattle herds in Brazil.<sup>28</sup> Strains of *E. coli*, possessing a subtype beta intimin, normally found in human enteropathogenic *E. coli*, have been found in diarrheic calves in Brazil.<sup>29</sup>

Non-O157 Shiga-toxin-producing *E. coli* have been isolated from diarrheic calves in Argentina and the serotypes carried virulence traits associated with increased pathogenicity in humans and cattle.<sup>30</sup> Severe clinical syndromes associated with non-O157 Shiga-toxin-producing *E. coli* are common in children under 4 years of age and may be associated with diarrheic calves, which shed highly virulent Shiga-toxin-producing *E. coli* strains and could act as a reservoir and contamination source in these areas.

*E. coli* O116, a serogroup previously associated with cases of hemolytic-uremic syndrome in humans, has been associated with an outbreak of diarrhea and dysentery in 1–16-week-old calves in India.<sup>31</sup> *E. coli* O103:H2, a Shiga toxin strain causing disease in humans, has been isolated from calves with dysentery, and from a sheep in Australia.<sup>32</sup>

**Necrotoxicogenic *E. coli***, which produce **cytotoxic necrotizing factor**, have been isolated from cattle in Northern Ireland<sup>33</sup> and Spain, and from diarrheic piglets in England.<sup>34</sup> NTEC1 strains from cattle, pigs, and humans can belong to the same sero/biogrups, carry genes coding for adhesions belonging to the same families, and possess other identical virulence-associated properties, and therefore do not exclude the possibility of cross-infection between humans and farm animals in some cases.<sup>35</sup> Necrotoxicogenic *E. coli* were detected by tissue culture and polymerase chain reaction (PCR) in 15.8% of diarrheic dairy calves in Spain from 1–90 days of age; the majority were necrotoxicogenic *E. coli* producing CNF2 and the risk increased with age. There was also a strong association between CNF2 and F17 fimbriae.<sup>36</sup> The necrotoxicogenic *E. coli* with their associated adhesins and toxins were present in diarrheic and septicemic calves as early as 1958, and their prevalence seems to be increasing.<sup>37</sup> Their role in causing disease needs further examination.

**Piglets** Most enteropathogenic *E. coli* from neonatal pigs belong to the so-called 'classical serogroups' O8:K87, O45, O138:K81, O141:K85, O147:K89, O149:K91, and O157:KXXV17.<sup>1</sup> Strains of these serogroups usually express and produce K88<sup>+</sup>, 987P<sup>+</sup>, or K99<sup>+</sup> pilus antigens, which adhere to ileal villi, colonize intensively and cause profuse diarrhea when given to newborn pigs. The K88, K99, and 987P pili are also designated F4, F5, and F6, respectively. However, there are also some enterotoxigenic strains that produce none of the three antigens.<sup>38</sup> K88<sup>+</sup> produces heat-labile enterotoxin (LT), the 987P<sup>+</sup> and the K99<sup>+</sup> do not produce LT, and all three types produce heat-stable entero-

toxin STa in infant mice. Some isolates produce neither LT or STa but produce enterotoxin in ligated intestinal loops of pigs (STb). The K99<sup>+</sup> piliated strains are a major cause of enteric disease in piglets under 2 weeks of age.<sup>1</sup> Strains of enterotoxigenic *E. coli* that produce 987P pili colonize the small intestines and cause diarrhea in neonatal pigs under 6 days of age but not older pigs. Other 'nonclassical' strains colonize the small intestine to a certain extent, do not strongly adhere to the intestinal epithelium, and produce enterotoxin and diarrhea in neonatal piglets. Vaccination of a sow population for several years with vaccines containing O149 and K88 antigens may change the pattern of virulent *E. coli* inducing neonatal diarrhea during the first week of life so that other serogroups may dominate.

The **porcine enterotoxigenic *E. coli*** strains which induce fluid secretion in the intestine of piglets less than 2 weeks of age but not in older pigs are designated class 2, whereas those strains which induce fluid secretion in the intestines of older pigs are class 1 enterotoxigenic *E. coli*. The bovine strains of enterotoxigenic *E. coli* have several features in common with the porcine class 2 organisms which include the possession of the O antigens 8, 9, 20, or 101, characterization as mucoid colonies, possession of K99<sup>+</sup> pili and production of heat-stable enterotoxin. Most strains of enterotoxigenic *E. coli* of pigs belong to a restricted number of serogroups.

**Lambs** Enterotoxigenic strains of *E. coli* can be isolated from the feces of approximately 35% of diarrheic lambs. Enterotoxigenic strains of *E. coli* have also been isolated from the blood of a small percentage of diarrheic lambs. K99 piliated *E. coli* are associated with outbreaks of diarrhea in lambs under a few days of age. F17 fimbriae *E. coli* have been isolated from diarrheic lambs and kids but none of the isolates produced any of the toxins normally associated with enteropathogenic strains. Attaching and effacing *E. coli* negative for verocytotoxin but positive for *eae* have been isolated from goat kids affected with severe diarrhea with a high case fatality rate.

**Foals** An enterotoxigenic strain of *E. coli* with some evidence of K99 and F41 pilus antigens, K87 capsular antigens and serotype 101 somatic antigen has been isolated from newborn foals affected with diarrhea. However, they are not considered to be major pathogens in foals. The strains of *E. coli* isolated from the feces of diarrheic and healthy foals are very diverse and enterotoxigenic strains of the organism are not implicated in sporadic foal diarrhea. The isolates of *E. coli*

obtained from the blood and tissues of septic foals are different from those obtained from the feces of healthy foals.<sup>39</sup> Isolates from septic foals were resistant to equine serum. Some isolates of *E. coli* from septic foals contained conjugal plasmids that encoded resistance to multiple antimicrobial agents linked to equine serum resistance and to the production of aerobactin, which permits the growth of the organisms in an iron-limited environment, a trait considered a virulence determinant.

#### Zoonotic implications of *E. coli*

Cattle are a major source of *E. coli* O157:H7, which infects and causes food-borne disease in humans.<sup>4,5</sup> Several strains of enterohemorrhagic *E. coli* associated with enteric disease in humans produce a verotoxin also known as a Shiga-like toxin. The literature on the epidemiology and virulence mechanisms of *E. coli* O157:H7 has been reviewed.<sup>4,5</sup> (See 'Enterohemorrhagic *Escherichia coli* in farm animals and zoonotic implications', below.)

#### PATHOGENESIS

The factors important in understanding the pathogenesis of colibacillosis are the immune status of the animal and the virulence attributes of the strain of *E. coli*, particularly its capacity to invade tissues and produce a septicemia, or to produce an enterotoxin that causes varying degrees of severity of diarrhea. Septicemia, bacteremia, diarrhea, dehydration, and metabolic acidosis are the major pathogenetic events in the various forms of colibacillosis.

#### Septicemic colibacillosis (coliform septicemia)

This occurs in all species as a result of invasive strains of *E. coli* invading the tissues and systemic circulation via the intestinal lumen, nasopharyngeal mucosa and tonsillar crypts, or umbilical vessels. The intestinal permeability to macromolecules in the newborn piglet may predispose to the invasion of septicemia-inducing *E. coli*. These strains are able to invade extraintestinal tissues, to resist the bactericidal effect of complement, to survive and multiply in body fluids, to escape phagocytosis and intracellular killing by phagocytes, and to induce tissue damage by the release of cytotoxins. Calves and piglets that are deficient in colostral immunoglobulins are highly susceptible to septicemia. Colostrum provides protection against colisepticemia but may not prevent diarrhea associated with *E. coli*. Also, colostrum-fed calves are much more resistant to endotoxin than colostrum-deprived calves. Calves, piglets, and lambs that have normal levels of serum

immunoglobulins are generally protected from septicemia. The clinical findings and lesions in septicemic colibacillosis are attributable to the effects of endotoxin, which causes shock. The general effects of endotoxin in cattle include hypothermia, decreased systemic blood pressure, tachycardia and decreased cardiac output, changes in blood counts, alterations in blood coagulation, hyperglycemia followed by hypoglycemia, and depletion of liver glycogen. Animals that recover from septicemia or bacteremia may develop lesions due to localization in other organs at varying periods of time later. Arthritis is a common sequel in calves, foals, and lambs. Meningitis is common in calves and piglets. Polyserositis due to *E. coli* has been recorded in pigs.

### Enteric colibacillosis

#### Enterotoxigenic colibacillosis

Enterotoxigenic strains of *E. coli* colonize and proliferate in the upper small intestine and produce enterotoxins, which cause an increase in net secretion of fluid and electrolytes from the systemic circulation. The adhesion of *E. coli* to the intestinal epithelial cells is mediated by bacterial pili. The enterotoxigenic form of colibacillosis occurs most commonly in calves and piglets and less commonly in foals and lambs.

The factors that allow or control the colonization and proliferation of these strains and their production of enterotoxin are not well understood. The bacterial fimbriae attach to specific receptor sites on villous epithelial cells, following which the bacteria multiply and form microcolonies that cover the surface of the villi. The capsular polysaccharide of *E. coli* may also be involved in adhesion and colonization. The fimbriae of *E. coli* are strongly immunogenic, a factor that is utilized in the production of vaccines. Experimentally, the intestinal fluid from the most proximal small intestine of calves is more suppressive of K99<sup>+</sup> pilus expression than fluid from more distal segments of the small intestine. Thus any factor that results in an increase of the pH in the lumen may allow the proliferation of the organism and, conversely, lowering the pH may reduce the severity of colibacillosis.

Diarrhea, dehydration, metabolic acidosis and electrolyte imbalance

The production of the enterotoxin results in net secretion of fluid and electrolytes from the systemic circulation into the lumen of the intestine, resulting in varying degrees of diarrhea, dehydration, electrolyte imbalances, acidosis, hyperkalemia when the acidosis is severe, circulatory failure, shock and death. The

hyperkalemia in calves with neonatal diarrhea and acidosis has been associated with cardiac rate and rhythm abnormalities, including bradycardia and atrial standstill.<sup>40</sup> The response to the enterotoxin in calves and piglets is similar to cholera enterotoxin in humans and takes place through an intact mucosa. Enterotoxin stimulates mucosal adenylcyclase activity, leading to an increase in cyclic adenosine monophosphate (AMP), which increases intestinal fluid secretion. The secretion originates primarily in the intestinal crypts but the villous epithelium also has a secretory function. The fluids secreted are alkaline and, in comparison to serum, isotonic, low in protein and high in sodium and bicarbonate ions. Distension of the right abdomen of diarrheic calves may occur, which may be associated with fluid distension of the abomasum and the intestines.<sup>41</sup>

When the disease is confined to the intestine, it responds reasonably well to treatment in the early stages. If death occurs, it is due to acidosis, electrolyte imbalance, and dehydration. The acid-base and electrolyte changes in piglets 1-3 days of age infected naturally and experimentally with enterotoxigenic *E. coli* reveal a severe dehydration and metabolic acidosis.

Severe metabolic changes can occur in calves with diarrhea. If the disease is progressive, the acidosis becomes more severe, lactic acidosis develops because of a reduced ability to utilize lactic acid, and severe hypoglycemia may occur because of a reduced rate of conversion of lactic acid to glucose. If extensive fluids are lost, hypovolemia and shock occur. The blood oxygen-binding capacity may be impaired in calves with diarrhea and severe dehydration.<sup>39</sup>

The most commonly accepted explanations of the **metabolic acidosis** in diarrheic calves are fecal bicarbonate loss and L-lactic acidosis. L-lactic acidosis is thought to occur from inadequate perfusion because of dehydration or endotoxemia, with subsequent anaerobic glycolysis and decreased clearance of L-lactate. However, neonatal diarrheic calves have high serum concentrations of D-lactate, with relatively low serum L-lactate concentrations.<sup>42-44</sup> D-lactic acidosis is a contributory factor in calves with high anion gap acidosis. The anion gap significantly correlates with D- and total DL-lactate concentrations in serum but not with serum L-lactate concentrations.<sup>44</sup> The elevated serum and urine concentrations of serum D-lactate are probably gastrointestinal in origin and the rumen and colon in diarrheic calves are considered as sites for the sources of D-lactate.<sup>43</sup>

The anion gap is defined as the sum of the major cations minus the sum of

the major anions and is a measure of 'unmeasured anions':

$$\text{Anion gap} = [\text{Na}^+] + [\text{K}^+] - [\text{Cl}^-] - [\text{HCO}_3^-]$$

The anion gap may be changed in numerous disturbances, including those of acid-base imbalance, and is useful in the interpretation of acid-base findings, but is of no value in assessing the intrinsic severity of acid-base disturbances.

Diarrheic calves are generally hyperkalemic with a high serum anion gap, a depressed serum bicarbonate and a low blood pH.

The severity and nature of the acidosis in diarrheic calves varies with the age of the calf. Diarrheic calves under 1 week of age often have a lactic acidosis, while those over 1 week of age have a nonlactic acidosis. Younger calves tend to dehydrate more rapidly and severely than older calves, which may be related to the greater incidence of enterotoxigenic colibacillosis in the young age group. The severity of dehydration, hypothermia, and metabolic acidosis is associated with the level of mental depression.<sup>45</sup> The clinical signs and age of the calf can be used to predict the severity of acidosis; the more severe the acidosis, the greater the depression.

Metabolic acidosis without clinical evidence of dehydration occurs in some calves that have had a history of diarrhea in the previous several days.<sup>46</sup> A similar syndrome has been described in goat kids. The pathogenesis is unclear but is thought to be associated with diarrhea in the preceding several days. One possibility is an inadequate amount of bicarbonate in the fluids and electrolytes used for the treatment of the dehydration.

Hyperkalemia in the diarrheic calf  
Hyperkalemia is most common in dehydrated diarrheic calves that are severely acidotic. The potassium moves out of the intracellular space into the extracellular space, resulting in hyperkalemia. The predominant clinical finding is bradycardia (heart rate < 90 bpm) in a dehydrated diarrheic calf. However, hypoglycemia and hypothermia may be associated with bradycardia in a similar calf.

Hypernatremia in the diarrheic calf  
Acute hypernatremia may occur in diarrheic calves.<sup>46,47</sup> Clinical findings are non-specific and include depression, weakness, dehydration, and diarrhea. Laboratory determination of serum electrolytes is necessary to make the diagnosis. The serum sodium concentration is above 160 mEq/L. It is presumed that mixing errors in the preparation of oral electrolyte solutions for diarrhea is the cause. The experimental oral administration of 1 L of electrolyte concentrate containing

2750 mEq sodium found that calves would willingly consume the solution mixed with milk and developed signs of hypernatremia within 6 hours of administration.

Hypernatremia (serum sodium > 153 mEq/L) in neonatal elk calves has been described.<sup>48</sup> The most common clinical findings were diarrhea, dehydration, depression, and anorexia.

**Effect of colostrum immunoglobulin status**  
An adequate level of serum immunoglobulins protects calves from death due to the effects of diarrhea, but not necessarily from diarrhea. The best protection is provided if both the immunoglobulin levels in the serum and the levels in the colostrum and milk during the first week after birth are high. The immunoglobulin subclasses in the plasma of calves that have received sufficient colostrum are IgG, IgM (and IgM is probably the more important of the two for the prevention of septicemia) and IgA. The serum IgG concentrations of calves under 3 weeks of age dying from infectious disease were much lower than in normal calves. Of the dead calves 50% had serum IgG levels that were more than 2 standard deviations below the normal mean, and an additional 35% had concentrations greater than 1 standard deviation below the normal mean. In the intestine, no single subclass of immunoglobulin is known to be responsible for protection against the fatal effects of diarrhea. Individually, each immunoglobulin subclass can prevent death from diarrhea even though calves may be affected with varying degrees of diarrhea. In contrast to the situation in the pig, IgA appears to be least effective.

In pigs, IgA becomes the dominant immunoglobulin in sow colostrum after the first few days of lactation, and this is the immunoglobulin that is not absorbed but is retained in, and reaches a high level in, the gut and plays a major role in providing local protection against enteric colibacillosis in piglets. Porcine colostrum IgA is more resistant to gastrointestinal proteolytic enzymes than IgG<sub>2</sub> and IgM. On the other hand, IgG is at a peak concentration in colostrum in the first day after parturition, is readily absorbed by the newborn piglet and is vital in providing protection against septicemia. Lysozyme in sows' milk may assist in the control of the bacterial population in the gut of the unweaned piglet.

#### Intestinal mucosa

In general, the enterotoxigenic *E. coli* exert their effects by the enterotoxin causing hypersecretion through an intact intestinal epithelium. However, the intraluminal exposure of the jejunum of 3-week-old pigs to sterile crude culture filtrates from strains of *E. coli* known to produce two

types of heat-stable enterotoxin will induce microscopic alterations of the villous epithelium. Focal emigration of neutrophils, especially through the epithelium above aggregated lymphatic follicles, stunting of jejunal and ileal villi, and adherence of bacteria to jejunal and ileal mucosae are the most consistent findings. These changes are useful in making the diagnosis of enterotoxigenic colibacillosis in calves. While enterotoxigenic strains are considered to be noninvasive this does not preclude the possibility that invasion into the systemic circulation may occur, resulting in septicemia, or that septicemic strains may not also be present.

Enzyme histochemistry studies of the small intestinal mucosa in experimental infections of calves with rotavirus and enterotoxigenic *E. coli* indicate a marked decrease in enzyme activity in dual infections and a lesser decrease in mono-infections. Increased enzyme activity occurred in parts of the intestinal mucosa that were not affected or only slightly affected by the enteropathogens, which may be an adaptation of the mucosa to maintain absorptive function. Lactose digestion is slightly impaired in calves with mild diarrhea. Calves with acute diarrhea are in a catabolic state and respond with a larger increase of plasma glucose concentration to a given amount of absorbed glucose than do healthy calves.<sup>49</sup> Fat and carbohydrate malabsorption frequently occurs in diarrheic calves over 5 days of age and may contribute to the death of these animals in cold weather.

**Attaching and effacing colibacillosis**  
Attaching and effacing enteropathogenic *E. coli* can cause naturally occurring diarrhea and dysentery in calves at 18–21 days.<sup>1</sup> They do not produce enterotoxin but adhere to the surface of the enterocytes of the large intestine. Affected calves pass bright red blood in the diarrheic feces. The lesions in experimentally infected calves are indistinguishable from those produced by some *E. coli* that are enteropathogenic for humans, rabbits, and pigs. They do not produce enterotoxin. The bovine O118:H16 enterohemorrhagic *E. coli* strain is able to colonize the intestine of newborn calves and to induce diarrhea 24 hours after challenge and to produce attaching and effacing lesions in the small and large intestines.<sup>50</sup>

**Synergism between enteropathogens**  
Enterotoxigenic colibacillosis occurs naturally and can be reproduced experimentally using enterotoxigenic *E. coli* in calves under 2 days of age but not in calves 1 week of age. Diarrheic calves older than 3 days of age may be infected with enterotoxigenic K99<sup>+</sup> *E. coli* and

rotavirus. There is evidence that prior or simultaneous infection of the intestine with rotavirus will enable the *E. coli* to colonize in older calves.<sup>1</sup> Thus, there may be synergism between rotavirus and enterotoxigenic *E. coli* in calves older than 2 days; this may explain the fatal diarrhea that can occur in calves at 1 week of age, which normally would not be fatal with a single infection. The rotavirus may enhance colonization of the *E. coli*. In the Kashmir valley of India, diarrheic lambs from birth to 3 months of age are commonly infected with group A rotavirus and pathogenic serogroups of *E. coli* O26, O113, O157, all of which are pathogenic to humans.<sup>51</sup>

The simultaneous experimental infection of neonatal gnotobiotic calves at 24 hours of age with rotavirus and enterotoxigenic *E. coli* results in a severe diarrheal disease. The same situation occurs in piglets. However, in both species the effect was considered to be additive rather than synergistic.

#### Summary of pathogenesis

Septicemic colibacillosis occurs in newborn animals that are agammaglobulinemic because they have not ingested sufficient colostrum early enough, or have absorbed insufficient colostrum immunoglobulins, thus rendering them highly susceptible. Enteric colibacillosis occurs in colostrum-fed animals and is associated with the colonization and proliferation of enteropathogenic *E. coli*, which produce enterotoxin and cause varying degrees of diarrhea and acidosis and dehydration. While single infections occur commonly, as in piglet diarrhea, and what was previously described as enteric-toxic colibacillosis in calves, multiple infections with enteropathogenic *E. coli* and viruses and other agents are more common.

#### CLINICAL FINDINGS

##### Calves

##### Coliform septicemia

This is most common in calves during the first 4 days of life. Most affected calves have low levels of serum colostrum immunoglobulins because of inadequate transfer of colostrum immunoglobulins.<sup>16</sup> The illness is peracute, the course varying from 24–96 hours with a survival rate of less than 12%.<sup>16</sup> There are no diagnostic clinical signs. Affected animals are depressed and weak, commonly recumbent, and dehydrated; tachycardia is present and, although the temperature may be high initially, it falls rapidly to subnormal levels when the calf becomes weak and moribund. The suck reflex is weak or absent, the oral mucous membranes are dry and cool, and the capillary refill time may be prolonged. Cold extremities, weak peripheral pulse and prolonged

capillary refill time are common. Scleral injection is common. Diarrhea and dysentery may occur but are uncommon.

Multiple body system and organ involvement is characteristic of neonatal septicemia and careful clinical examination is required to detect abnormalities. If a calf survives the septicemic state, clinical evidence of postsepticemic localization may appear in about 1 week. This includes arthritis, meningitis, panophthalmitis and, less commonly, pneumonia. In a series of 32 cases of meningitis in neonatal calves, the most frequent clinical findings were lethargy, anorexia, recumbency, loss of the suck reflex, stupor, and coma.<sup>52</sup> Opisthotonos, convulsions, tremors, and hyperesthesia were seen less frequently. The case fatality rate was 100% in spite of intensive therapy, and lesions of septicemia were present at necropsy.

#### Predictors of septicemia

The early clinical findings of septicemia in neonatal foals and calves are vague and nonspecific and are often indistinguishable from the findings of noninfectious diseases or those of focal infections such as diarrhea. Positive blood cultures are required for a definitive diagnosis of septicemia, but results are not usually available for 48–72 hours, and false negatives are common. A clinical sepsis scoring system for predicting bacteremia in neonatal dairy calves has been described but has not been adequately evaluated in the field.<sup>53,54</sup>

No single laboratory test has emerged as being completely reliable for the early diagnosis of septicemia in farm animal neonates and therefore scoring systems and predictive models using obtainable historical, clinical and clinicopathological data have been developed. The goal of these mathematical models is to identify septicemic neonates early in the course of disease when appropriate therapy would be most likely to result in a favorable outcome.<sup>55</sup> In a study of diarrheic calves under 28 days of age submitted to a referral clinic for treatment, 31% of the calves were septicemic, based on blood culture.<sup>55</sup> Two models to predict septicemia were used. Clinicopathological variables associated with an increased risk of septicemia were moderate (1.99–5.55 mg/dL) and marked (> 5.66 mg/dL) increases in serum creatinine (OR 8.63), moderate to marked toxic changes in neutrophils (OR 2.88), and failure of transfer of passive immunity (IgG concentrations  $\beta$  800 mg/dL, globulin  $\beta$  2 g/dL (OR 2.72), and total serum protein  $\beta$  5 g/dL). The clinical variables associated with an increased risk of septicemia were age under 5 days (OR 2.58), focal infection (OR 2.45), recumbency (OR 2.98), and weak suck reflex (OR 4.10).<sup>55</sup>

#### Enteric colibacillosis

This is the most common form of colibacillosis in newborn calves, primarily 3–5 days of age. It may occur in calves as early as 1 day of age and only rarely up to 3 weeks. The clinical severity will vary depending upon the number and kind of organisms causing the disease. The presence of a single enterotoxigenic strain of *E. coli* may cause a state of collapse usually designated as **enteric toxemia**. In this form of the disease the outstanding clinical signs include severe weakness, coma, subnormal temperature, a cold clammy skin, pale mucosae, wetness around the mouth, collapse of superficial veins, slowness and irregularity of the heart, mild convulsive movements, and periodic apnea. Diarrhea is usually not evident, although the abdomen may be slightly distended and succussion and auscultation may reveal fluid-splashing sounds suggesting a fluid-filled intestine.<sup>41</sup> The prognosis for these calves is poor and they commonly die 2–6 hours after the onset of signs.

In the more common form of the disease in calves, there is diarrhea in which the feces are profuse and watery to pasty, usually pale yellow to white in color, and occasionally streaked with blood flecks and very foul-smelling. The dry matter content of the feces is commonly below 10%. Defecation is frequent and effortless, and the tail and perineum are soiled with feces. The temperature is usually normal in the initial stages but becomes subnormal as the disease worsens. Affected calves may or may not suck or drink depending on the degrees of acidosis, dehydration, and weakness. Calves under 8 days of age may be weak, primarily from the effects of rapid and severe dehydration; in calves older than 8 days the acidosis may be more severe and makes a greater contribution to depression and weakness. In the early stages of the disease, the abdomen may be slightly distended as a result of distension of fluid-filled intestines, which can be detected by succussion and auscultation of the abdomen. In some of these calves the diarrhea is not obvious but is

delayed for several hours, when it can be quite profuse. Mildly to moderately affected calves may be diarrheic for a few days and recover spontaneously with or without treatment. However, 15–20% of calves with enteric colibacillosis become progressively worse over a period of 3–5 days, gradually become more weak, lose the desire to suck and progressively appear more obviously clinically dehydrated.

Throughout the course of the diarrhea the degree of dehydration will vary from just barely detectable clinically (4–6% body weight (BW)) to up to 10–16% of body weight. It is best assessed by 'tenting' the skin of the lateral portion of the cervical region and measuring the time required for the skin fold to return to normal.<sup>56</sup> In calves with 8% of dehydration, 5–10 seconds will be required for the skin fold to return to normal; in 10–12% dehydration up to 30 seconds. Recession of the eyeball (enophthalmos) is a reliable and obvious indication of the degree of dehydration. Slight sinking of the eyeball without an obvious space between the eyeball and the orbit represents 6–8% dehydration; moderate separation of the eyeball from the orbit represents 9–12% dehydration; and marked separation of the eyeball from the orbit represents over 12% and up to 16% dehydration. A summary of the relationship between degree of dehydration (% BW), depth of enophthalmos (mm), cervical skin tent duration in seconds and the state of the mucous membranes and extremities in calves with experimentally induced diarrhea is set out in Table 18.4.<sup>56</sup>

Death usually occurs in 3–5 days. Affected calves can lose 10–16% of their original body weight during the first 24–48 hours of the diarrhea. The hyperkalemia in calves with neonatal diarrhea and acidosis has been associated with cardiac rate and rhythm abnormalities including bradycardia and atrial standstill. Herd outbreaks of the disease in beef calves may last for several weeks, during which time almost every calf will be affected within several days after birth.

**Veal calf hemorrhagic enteritis** is a fatal syndrome of veal calves charac-

Table 18.4 Degree of dehydration in calves with experimentally induced diarrhea

Degree of dehydration (% BW)	Depth of enophthalmos (mm)	Cervical skin-tent duration (s)	Mucous membranes and extremities
0	None	Less than 2	Moist
2	1	3	Dry
4	2	4	Dry
6	3	5	Dry
8	4	6	Cool extremities
10	6	7	Cool extremities
12	7	> 8	Cool extremities
> 14	> 8	> 10	White mucous membranes



terized by anorexia, fever, diarrhea with mucus-containing feces which become bloody in the later stages, and hemorrhagic diathesis on the conjunctivae and mucous membranes of the mouth and nose. The etiology is unknown; the *E. coli* strains isolated from the feces of affected calves produced enterotoxins and verocytotoxins but their significance is uncertain.

In some calves between 10 and 20 days of age with a history of diarrhea in the previous several days, from which they have recovered, there will be metabolic acidosis without clinical signs of dehydration.<sup>45</sup> Affected calves are depressed, weak, ataxic and sometimes recumbent, and appear comatose. Affected calves respond quickly to treatment with intravenous sodium bicarbonate. A similar syndrome occurs in goat kids.

### Lambs and goat kids

Although some cases manifest enteric signs, and chronic cases may occur, colibacillosis in lambs is commonly septicemic and peracute. Two age groups appear to be susceptible: lambs 1–2 days of age and lambs 3–8 weeks old. Peracute cases are found dead without premonitory signs. Acute cases show collapse and occasionally signs of acute meningitis manifested by a stiff gait in the early stages, followed by recumbency with hyperesthesia and tetanic convulsions. Chronic cases are usually manifested by arthritis. The disease in goat kids is similar to that in lambs.

### Piglets

#### Coliform septicemia

This is uncommon but occurs in piglets within 24–48 hours of birth. Some are found dead without any premonitory signs. Usually more than one, and sometimes the entire litter, are affected. Severely affected piglets seen clinically are weak, almost comatose, appear cyanotic, and feel cold and clammy and have a subnormal temperature. Usually there is no diarrhea. The prognosis for these is poor and most will die in spite of therapy.

#### Enterotoxigenic colibacillosis (newborn piglet diarrhea)

This is the most common form of colibacillosis in piglets and occurs from 12 hours of age up to several days of age, with a peak incidence at 3 days of age. As with the septicemic form, usually more than one pig or the entire litter is affected. The first sign usually noticed is the fecal puddles on the floor. Affected piglets may still nurse in the early stages but gradually lose their appetite as the disease progresses. The feces vary from a pasty to watery consistency and are usually yellow to brown in color. When the diarrhea is profuse and watery there will be no

obvious staining of the perineum and hindquarters with feces but the tails of the piglets will be straight and wet. The temperature is usually normal or subnormal. The disease is progressive; diarrhea and dehydration continues, the piglets become very weak and lie in lateral recumbency and make weak paddling movements. Within several hours they appear very dehydrated and shrunken, and commonly die within 24 hours after the onset of signs. In severe outbreaks the entire litter may be affected and die within a few hours of birth. The prognosis is favorable if treatment is started early before significant dehydration and acidosis occur.

### CLINICAL PATHOLOGY

#### Culture and detection of organism

If septicemia is suspected, blood should be submitted for isolation of the organism and determination of its drug sensitivity. Blood for culture is taken aseptically from the jugular vein and inoculated directly into brain–heart infusion broth.<sup>16</sup> At least one additional blood sample is taken a few hours later in order to enhance recovery rate and confirm septicemia.

The **definitive etiological diagnosis of enteric colibacillosis** depends on the isolation and characterization of the *E. coli* from the intestines and the feces of affected animals. The best opportunity of making a diagnosis is when untreated representative affected animals are submitted for pathological and microbiological examination. The distribution of the organism in the intestine and determination of the presence of K88<sup>+</sup>, K99<sup>+</sup> or 987P antigens, the demonstration of enterotoxin by infant mouse test or ligated intestinal loops, and the histopathological appearance of the mucosa all contribute to the diagnosis.

The routine culture of feces and intestinal contents for *E. coli* without determining their virulence determinants is of limited value. The laboratory tests used to identify enterotoxigenic K99<sup>+</sup> *E. coli* include a direct fluorescent antibody technique with conventional culturing methods and the ELISA, with or without monoclonal antibody, to detect the organism or the enterotoxin in the feces. DNA gene probes specific for genes encoding enterotoxin and adhesins are available and are being used to evaluate *E. coli* isolated from diarrheic animals. Isolates of the organism can also be examined for the presence of toxins using an enzyme immune assay test and latex agglutination test.

Detection of verocytotoxic *E. coli* in feces has relied on cytotoxicity testing and DNA hybridization. Several ELISAs are available, and monoclonal antibodies to the verocytotoxins VT1 and VT2 have been used to examine feces from animals.<sup>57</sup> The

isolation of *E. coli* O157H:7 has relied on its ability to ferment sorbitol. A sandwich ELISA using monoclonal antibodies to *E. coli* verocytotoxins 1 and 2 for capture and detection is available for detection of verocytotoxin-producing *E. coli* in animal feces.<sup>57</sup> A PCR test is also available for detection of verocytotoxin genes in *E. coli* isolated from cattle, sheep, and pigs affected with diarrhea.<sup>58</sup>

The determination of drug sensitivity of the *E. coli* isolated from the feces of diarrheic calves and piglets is commonly done but is of limited value without determining which isolate is enteropathogenic.

### Hematology and serum biochemistry

A total and differential leukocyte count and remarkable changes in the fibrinogen concentration may indicate the presence of a septicemia or severe intestinal infection.<sup>16</sup> However, severely affected calves may not have grossly abnormal hemograms. In enteric disease, the major changes in plasma composition are dehydration, electrolyte imbalance, and acidosis. The total plasma osmolality is decreased.

The changes in the blood biochemical and hematological profile of normal neonatal calves with age have been described.<sup>59</sup> The packed cell volume and the total solids concentration of the blood will indicate the degree of dehydration, and the blood urea nitrogen may be increased in severe cases because of inadequate renal perfusion. The blood bicarbonate values are markedly reduced, blood pH values represent acidosis, and the other serum electrolytes are variable. Calves with a venous blood pH below 7.0 are at high risk and require immediate parenteral therapy for acidosis. There is usually a decrease in serum sodium, chloride, and potassium. In severe cases of acidosis, hyperkalemia may occur; this is cardiotoxic and affected calves may die while being handled in preparation for intravenous therapy.

### Harleco apparatus

The acid–base status of individual calves can be determined in the field using a simple total carbon dioxide apparatus, which provides values close to blood bicarbonate concentrations.<sup>60</sup> Unlike the blood gas machines, the Harleco apparatus offers clinicians in practice an affordable means of diagnosing metabolic acidosis.<sup>61</sup> The Harleco measures 'total carbon dioxide', the carbon dioxide liberated from a blood sample by adding strong acid. Nearly all the carbon dioxide is derived from bicarbonate rather than blood carbon dioxide. The CO<sub>2</sub> liberated is derived from bicarbonate and from dissolved CO<sub>2</sub>, but there is so little dissolved CO<sub>2</sub> in blood that the TCO<sub>2</sub> may

be taken for clinical purposes as a measurement of plasma bicarbonate. The level of acidosis in calves can be classified according to the Harleco readings (total carbon dioxide, mmol/L) as follows:

Normal	21.1–28
Mild	16.6–21
Moderate	12.1–16.5
Severe	8.1–12.0
Very severe	< 8.

The strong ion difference method of evaluating acid–base balance in cattle has been described and justified to identify the mechanism for a change in acid–base balance and thereby to focus treatment on the inciting cause, and to quantify unmeasured strong anion concentration in plasma.<sup>62</sup> A comparison of the measurement of total carbon dioxide and strong ion difference (SID) for the evaluation of metabolic acidosis in calves did not find any advantage to the SID.<sup>61</sup>

#### Portable pH meter

A portable pH meter has been evaluated to measure blood pH in neonatal calves.<sup>63</sup> Compared to a blood gas analyzer, the portable pH meter was more accurate in measuring urine pH and ruminal fluid pH in cows than blood pH in neonatal calves.

#### Serum immunoglobulins

The determination of the level of serum immunoglobulins of diarrheic calves may be valuable in assessing prognosis and to determine the intensity of the therapy required for survival. However, the level of serum immunoglobulins as a measure of susceptibility or prognosis is most accurate at 24 hours after birth. After this period, it is unreliable because the serum immunoglobulins may be increased in response to septicemia, increased spuriously in dehydration and decreased in enteric disease.

Several tests are available to assess transfer of passive immunity status in domestic animals.<sup>8</sup> The radial immunodiffusion test and the ELISA are the only tests that directly measure serum IgG concentration. All other available tests, including serum total solids by refractometry, sodium sulfite turbidity tests, zinc sulfate turbidity tests, serum gamma-glutamyl transferase (GGT) and whole-blood glutaraldehyde coagulation, estimate serum IgG concentration based on concentration of total globulins or other proteins whose transfer is statistically associated with that of IgG.

#### Radial immunodiffusion

The radial immunodiffusion is the gold standard for measurement of serum IgG concentration. However, it is too expensive for most situations and requires considerable time before results are available.

#### Commercial immunoassay

An immunoassay using blood is now available for evaluating transfer of passive immunity in calves.<sup>64</sup> The whole blood immunoassay kit consists of a 4 mm lateral flow membrane strip enclosed in a plastic test device. Test kits are incubated for 20 minutes. If the sample IgG concentration is 10 mg/mL or more, a single red line develops, indicating adequate transfer of passive immunity and a negative test result. If the sample IgG concentration is <10 mg/mL, two lines develop on the membrane strip, indicating failure of transfer of passive immunity and a positive test. The sensitivity and specificity of the blood IgG immunoassay were 0.93 and 0.88 respectively, compared with 1.00 and 0.53 for the sodium sulfite test. For refractometry, sensitivity and specificity were 0.71 and 0.83 respectively, when a serum total solids concentration of 5.2 g/dL was used as the cutoff between positive and negative results.

#### Serum total solid concentration by refractometer

The measurement of serum total protein by refractometer is an estimate of serum immunoglobulin concentration.<sup>65</sup> Recommended test endpoints for serum protein concentrations have varied from 5.0–6.0 g/dL. Three refractometers, including a non-temperature-compensating instrument, provided similar results. Serum protein concentration test endpoints of 5.0 and 5.2 g/dL gave accurate results in the assessment of adequacy of transfer of passive immunity; lower or higher test endpoints misclassified large numbers of calves. The test is excellent for herd monitoring and is easily performed in the field. In clinically ill dehydrated calves, a test endpoint of 5.5 g/dL should be used when assessing adequacy of transfer of passive immunity.<sup>66</sup> In a healthy, adequately hydrated calf a serum total protein of 5.2 g/dL or greater is associated with adequate transfer of passive immunity.<sup>8</sup>

The mortality risk associated with inadequate transfer of passive immunity in dairy calves can be partitioned using the observed population mortality and the relative risk of mortality in each serum protein concentration stratum.<sup>67</sup> For a total of 3479 calves studied, 8.2% died before 16 weeks of age. The population baseline mortality rate was 5.0% and the mortality rate due to inadequate transfer of passive immunity was 3.2%. Thirty-nine percent of the observed mortality was attributed to inadequate transfer of passive immunity. Such partitioning of risk between sources related and unrelated to transfer of passive immunity can be useful in conducting investigations of calf mortality in dairy herds.

#### Sodium sulfite turbidity test

The sodium sulfite turbidity test is a three-step semiquantitative test using 1, 4, 16, and 18% sodium sulfite test solutions. The solutions cause selective precipitation of high-molecular-weight proteins, including immunoglobulins. Optimum diagnostic utility is attained using a 18% test solution. The mean serum IgG concentrations of calves at the 1+, 2+, and 3+ endpoints of test turbidity were 1250, 2116, and 2948 mg/dL, respectively.<sup>8</sup>

#### Serum gamma-glutamyl transferase activity

The serum levels of GGT are also reliable indicators of the level of transfer of passive immunity in newborn calves.<sup>68</sup> Calves classified as having failure of transfer of passive immunity (<800 mg IgG/dL) had a 9.5 times greater risk of becoming sick prior to weaning at 5 months of age compared with calves determined to have partial failure of transfer of passive immunity and clinically normal calves. In 1-day-old calves, serum GGT activity should be more than 200 IU/L; in 4-day-old calves it should be more than 100 IU/L and in 1-week-old calves more than 75 IU/L. Calves with GGT activity below 50 IU/L within the first 2 weeks of life should be considered to have failure of transfer of passive immunity. The sensitivity and specificity of cutoff value of 200 IU of GGT of serum for a diagnosis of failure of transfer of passive immunity are 80% and 97%, respectively. The sensitivity and specificity of a cutoff value of 4.2 g of protein/dL of serum for diagnosing failure of transfer of passive immunity were 80% and 100%, respectively.<sup>68</sup>

Recent studies have shown that GGT activity has no apparent advantage relative to other tests for predicting transfer of passive immunity in beef calves.<sup>8</sup>

The relationships between serum and colostrum/milk GGT activities and IgG concentration can be used to assess the transfer of passive immunity status of lambs.<sup>69</sup> Regression models were used to calculate serum and colostrum/milk GGT activities, and it was moderately accurate in predicting serum IgG concentration. The GGT activity can be used as an alternative to single radial immunodiffusion, which is complex, expensive, and time-consuming for estimation of IgG concentration.

#### NECROPSY FINDINGS

In **coliform septicemia** there may be no gross lesions and the diagnosis may depend upon the isolation of the organism from the filtering organs. In less severe cases there may be subserosal and submucosal hemorrhages. A degree of enteritis and gastritis may be present. Occasionally, fibrinous exudates are found

in the joints and serous cavities, and there may be omphalophlebitis, pneumonia, and meningitis. The histological features of such presentations of colibacillosis are those of septicemia and toxemia.

In **enteric colibacillosis** of piglets and calves the carcass appears dehydrated but the intestine is flaccid and fluid-filled. In calves, the abomasum is usually distended with fluid and may contain a milk clot. This clot is typically absent in calves fed milk replacers containing heat-denatured skim milk powder or noncasein milk products such as whey powder. The abomasal mucosa may contain numerous small hemorrhages. In both calves and pigs, the intestinal mucosae may appear normal or hyperemic and there may be edema of the mesenteric lymph nodes. Mild atrophy or even fusion of jejunal and ileal villi is often seen, but the key microscopic observation is the presence of bacilli adherent to the brush borders of enterocytes. Ultrastructurally, there is increased epithelial cell loss from the villus about 12 hours after experimental inoculation of calves with an enterotoxigenic *E. coli*.

In calves affected with attaching and effacing *E. coli* there is pseudomembranous ileitis as well as mucohemorrhagic colitis and proctitis. Microscopic examination of well-preserved gut segments reveals bacterial adherence, atrophy of ileal villi, and erosion of enterocytes.

In addition to traditional bacteriological culture techniques, the enterotoxigenic *E. coli* may be identified by several tests, including indirect fluorescent antibody tests (IFA) specific for K88<sup>+</sup>, K99<sup>+</sup>, and 987P pilus antigens. The IFA tests can be performed on impression smears or frozen sections of ileal tissue and the results are available within a few hours. Newer techniques such as DNA gene probes,<sup>12</sup> enzyme immune assays and latex agglutination tests are now available to identify those isolates that are enterotoxin producers and have adhesin properties.

During severe disease outbreaks it is often necessary to conduct the necropsy examination on diarrheic animals that have been killed specifically for the purpose of obtaining a definitive etiological diagnosis. The combined use of bacteriological, parasitological, and virological methods, together with histological and immunofluorescent studies of fresh intestinal tissue, will provide the most useful information about the location of the lesions and the presence of enteropathogens. Postmortem autolysis of the intestinal mucosae and invasion of the tissues by intestinal microflora occurs within minutes after death, so gut samples should be collected immediately following euthanasia of the animal.

### Samples for confirmation of diagnosis

#### Coliform septicemia

- Bacteriology – chilled spleen, lung, liver, culture swabs of exudates, umbilicus, meninges (CULT)
- Histology – fixed samples spleen, lung, liver, kidney, brain, and any gross lesions.

#### Enteric colibacillosis

- Bacteriology – chilled segments of ileum and colon (including content) (CULT and/or FAT, latex agglutination, PCR)
- Histology – fixed duodenum, jejunum, ileum, colon, and mesenteric lymph node.

### DIFFERENTIAL DIAGNOSIS

The definitive etiological diagnosis of septicemic colibacillosis is dependent on the laboratory isolation of the causative agent, which is usually a single species or organism. The septicemias of the newborn cannot be distinguished from each other clinically. The definitive etiological diagnosis of enteric colibacillosis in newborn calves and piglets may be difficult and often inconclusive because the significance of other organisms in the intestinal tract and feces of diarrheic animals cannot be easily determined.

Table 18.3 lists the possible causative agents of diarrhea and septicemia in newborn farm animals. Using the combined diagnostic approach of detection of enteropathogens in the feces before death, and in the intestinal mucosa after death, it is possible to identify where enterotoxigenic *E. coli*, rotavirus, coronavirus, *Salmonella* sp., and *Cryptosporidium* sp. appear to be the only or principal causative agents. However, as described earlier under acute undifferentiated diarrhea of newborn farm animals, mixed infections are more common than single infections.

Every effort that is economically possible should be made to obtain an etiological diagnosis. This is especially important when outbreaks of diarrhea occur in a herd or where the disease appears to be endemic. The use of an interdisciplinary approach will increase the success of diagnosis. This includes making a visit to the farm or herd and making a detailed epidemiological investigation of the problem. The diagnosis depends heavily on the epidemiological findings, the microbiological and pathological findings, and sometimes on the results of treatment.

The major difficulty is to determine whether or not the diarrhea is infectious in origin and to differentiate it from dietetic diarrhea, which is most common in hand-fed calves and in all newborn species that are sucking high-producing dams. In dietetic diarrhea the feces are voluminous and pasty to gelatinous in consistency; the animal is bright and alert and is usually still sucking, but some may be inappetent.

### TREATMENT

#### Coliform septicemia

**Intensive critical care** is required for the treatment of neonatal coliform septicemia. Early identification of septicemia and early therapeutic intervention can improve treatment success. While *E. coli* may be cultured from the blood of septicemic calves, a significant percentage of isolates are Gram-positive, which justifies the use of antimicrobials that have a broad spectrum.<sup>16</sup> Antimicrobials are given parenterally and may be given continuously intravenously, more than once daily and daily until recovery is apparent. Isolation of the organisms from blood and determination of drug sensitivity is the ideal protocol. Intravenous fluid and electrolyte therapy are administered continuously until recovery is apparent. Whole blood transfusions are used in calves and foals, especially when immunoglobulin deficiency is suspected from the history or is determined by measurement of serum immunoglobulins of blood (see Chapter 3 for details on measuring immunoglobulins using various tests). In one series on neonatal septicemia in calves, in which *E. coli* accounted for 50% of the bacterial isolates, the survival rate was only 12%.<sup>16</sup>

#### Enteric colibacillosis

The considerations for treatment of enteric colibacillosis include the following:

- Fluid and electrolyte replacement
- Antimicrobial and immunoglobulin therapy
- Antimotility drugs and intestinal protectants
- Alteration of the diet
- Clinical management of outbreaks.

#### Fluid and electrolyte replacement

The dehydration, acidosis and electrolyte imbalance are corrected by the parenteral and oral use of simple or balanced electrolyte solutions. The provision of fluid therapy in diarrheic dehydrated calves under field conditions in veterinary practice has been described.<sup>68</sup> It is important to obtain an adequate history of the case including age of the calf, duration of the diarrhea and all treatments already given by the owner. The physical examination of the calf includes a standard clinical examination with emphasis on evaluating the degree of dehydration and acidosis.

**Dehydration** is evaluated by two clinical observations:

- **Skin elasticity.** The skin of the middle of the neck is better than the eyelid. A portion of the skin is tented and twisted for 1 second, and then the time to return to the initial position is measured – less than 2 seconds in the normal calf, 6 seconds in moderate (8%)

dehydration and more than 8 seconds in severe (12%) dehydration

- **Position of eyeball in the orbit and extent of enophthalmos.** This is determined by measuring the distance between the globe and the orbit. The eyeball is not sunken in healthy calves. Degrees of dehydration of 4%, 8, and 12% are represented by a 2 mm, 4 mm, and 7 mm enophthalmos, respectively.

**Acidosis** can be evaluated using the clinical findings of mental status, muscular tone, ability to stand, intensity of the sucking reflex, temperature of the inside of the oral cavity, and age of the calf that correlate with an estimate of the **base deficit**. The following categories for diarrheic calves are being used under field conditions:

1. Calves with good muscular tone and the ability to stand, strong suck reflex and warm oral cavity have no base deficit if younger than 8 days of age, and up to 5 mEq/L if older than 5 days
2. Calves that can stand, have a slightly cool oral cavity and weak suck reflex have a base deficit of 5 mEq/L if under 8 days of age and 10 mEq/L if older than 8 days
3. Calves in sternal recumbency with a cool oral cavity and no suck reflex have a base deficit of 10 mEq/L if under 8 days of age and 15 mEq/L if older than 8 days
4. Calves in lateral recumbency that lack a suck reflex and have a cold oral cavity have a base deficit of 10 mEq/L if under 8 days of age and 20 mEq/L if older than 8 days.

Categorizing diarrheic calves into treatment groups

Based on the history and clinical findings, affected calves can be divided into categories according to the type of therapy required and which is most economical.

1. **Oral fluid therapy.** Calves with a history of acute diarrhea, less than 7% dehydrated, slightly dry oral mucosa, good suck reflex, good muscle tone, alert, able to stand and warm mouth. These can be treated with oral fluids and electrolytes
2. **Oral fluid therapy and hypertonic saline.** Calves with 7–9% dehydration and slight acidosis, weak suck reflex, good muscular tone, warm mouth. Administer hypertonic saline (7.5% NaCl) intravenously at 3–4 mL/kg BW in 5 minutes. Administer oral fluids and electrolytes by stomach tube at 40–60 mL/kg BW. Re-evaluate in 6–8 hours
3. **Intravenous fluid therapy with alkalinizing agents.** Calves are more

than 9% dehydrated, dry and cool oral mucous membranes, recumbent, no suck reflex, very depressed. Provide intravenous replacement and maintenance fluid and electrolyte therapy for a period of 6–8 hours and up to 24–36 hours if necessary.

The details for parenteral and oral fluid and electrolyte therapy are described here.

**Parenteral fluid and electrolyte therapy**  
In severe dehydration and acidosis, solutions containing the bicarbonate ion are indicated.

#### *Parenteral fluid composition*

An equal mixture of isotonic saline (0.85%), isotonic sodium bicarbonate (1.3%), and isotonic dextrose (5%) is a simple, effective solution for parenteral use. Sodium bicarbonate as an alkalinizing compound in the parenteral fluids is superior to the use of compounds such as sodium acetate or sodium lactate, which must be metabolized by the liver, myocardium, and other tissues in order to have an alkalinizing effect. The simple replacement of fluid losses using saline or fluids without alkalinizing compounds is likewise not as effective as sodium bicarbonate. Many commercial preparations are effective in correcting the dehydration and electrolyte imbalances, but only those containing bicarbonate or its precursors are effective in correcting the metabolic acidosis.<sup>45</sup>

#### *Bicarbonate requirements to treat acidosis*

The bicarbonate requirements (mmol) are calculated using the equation:

$$\text{weight (kg)} \times \text{base deficit (mmol/L)} \times 0.6 \text{ (extracellular fluid space).}$$

The base deficit will range from –5 to –20 mmol/L with an average of about –15 mmol/L. The bicarbonate requirements for a 45 kg calf with a base deficit of 15 mmol/L, are  $45 \times 15 \times 0.6 = 405$  mmol, which requires 33.75 g of sodium bicarbonate (1 g of sodium bicarbonate yields 12 mmol of bicarbonate), which can be delivered in 2.5 L of 1.3% isotonic solution. Diarrheic calves over 8 days of age may be nearly twice as acidotic as younger calves and will require more bicarbonate to correct the acidosis. It is estimated that sternally recumbent calves under 8 days of age require 1 L of isotonic sodium bicarbonate to correct the acidosis, in addition to the necessary amounts of saline to correct the dehydration; for calves over 8 days of age, 2 L of isotonic sodium bicarbonate is necessary. For laterally recumbent diarrheic calves under and over 8 days of age, 1 and 3 L, respectively, is required. Isotonic sodium bicarbonate is a safe solution intravenously;

when the degree of acidosis is uncertain, up to several liters can be used safely for the correction of acidosis and volume depletion.

For severe dehydration (10–12% BW) fluids should be replaced as follows: hydration therapy 100 mL/kg BW intravenously in the first 1–2 hours at the rate of 50–80 mL/kg BW per hour followed by maintenance therapy at 140 mL/kg BW over the next 8–10 hours at the rate of about 20 mL/kg BW per hour. For example, a 45 kg calf that is 10% dehydrated should receive 4.5 L of fluid in the first 1–2 hours as hydration therapy, followed by 6–8 L of fluid over the next 8–10 hours. Initially, both the acidosis and the dehydration can be treated by the use of isotonic sodium bicarbonate followed by the use of a combined mixture of isotonic saline and isotonic sodium bicarbonate or multiple electrolyte solutions for maintenance therapy. For moderate dehydration (6–8% of BW), fluids should be replaced as follows: hydration therapy 50 mL/kg BW intravenously in the first 1–2 hours at the rate of 50–80 mL/kg BW per hour followed by maintenance therapy as described above.

Maintenance therapy may be provided using oral fluids and electrolytes if the calf is well enough to suck from a nipple bottle or drink from a pail. The use of solutions containing potassium chloride is sometimes recommended, on the basis that total potassium stores may be depleted in severely affected calves. However, they should be used with caution because a severe hyperkalemia may be present when there is a severe acidosis. If the acidosis and hypoglycemia are corrected with glucose and bicarbonate, the administration of potassium may be beneficial in restoring total potassium stores. However, solutions containing potassium can be cardiotoxic, especially if renal function is not restored.

#### *Hyperkalemia in the diarrheic calf*

Treatment of the acidosis and expanding plasma volume and increasing the serum sodium concentration will correct hyperkalemia in dehydrated diarrheic calves.

#### *Hypernatremia in the diarrheic calf*

The treatment of hypernatremia is difficult and unreliable.<sup>46</sup> If there is a concurrent acidosis it should be treated with a bicarbonate solution. The objective is to decrease serum sodium concentration more slowly than is possible with traditional isotonic fluids. It is recommended that a sodium-containing fluid containing sodium equal to 95–100% of the animal's serum sodium concentration, or with a fluid containing 170 mEq/L of sodium, be used initially.<sup>47</sup> The animal's serum sodium concentration is monitored so as not to

exceed a change of 0.3–0.5 mEq/h in serum sodium. Cerebral edema may be treated with mannitol.

#### *Acidosis without dehydration*

Some calves 10–20 days of age with a history of diarrhea in the previous several days may be affected with metabolic acidosis without obvious clinical evidence of dehydration.<sup>45</sup> They are ataxic, weak, sometimes recumbent, and may appear comatose. The intravenous administration of 2–3 L of isotonic (1.3%) sodium bicarbonate results in recovery within an hour.

#### *Hypertonic saline*

Because the administration of large quantities of isotonic fluids may be impractical in a farm situation because it requires long-term venous catheterization, appropriate restraint and periodic monitoring, the use of hypertonic saline has been explored as a rapid, inexpensive, effective method of fluid administration in severely dehydrated calves.<sup>68,70</sup> Hypertonic saline (7.2% NaCl) solution and 6% Dextran 70 solution have been used successfully to resuscitate animals with hypovolemic endotoxemic shock. Administration of 7.2% hypertonic saline and 6% Dextran 70 solution rapidly increases plasma volume, cardiac output and mean arterial pressure in hypovolemic and endotoxemic shock.<sup>69</sup> The hypertonic saline and Dextran 70 are given intravenously at a rate of 4–5 mL/kg BW over a period of 4 minutes followed by allowing the calf to suck an isotonic alkalizing oral electrolyte solution at 50 mL/kg BW.<sup>69</sup> Calves that do not suck are given the oral fluids by stomach tube. An additional dose of oral fluids at 50 mL/kg BW is given 12 hours later. This regime provides a rapid, practical, economical and effective method for the treatment of dehydrated diarrheic calves.

#### *Intravenous catheterization of calves*

Catheterization of the **jugular vein** is the most widely used approach for continuous long-term intravenous fluid therapy in calves. The jugular vein may be difficult to catheterize in severely dehydrated calves when the vein is collapsed and not visible even after prolonged occlusion. In addition, the tough and dry skin makes catheterization difficult. To increase distension of the vein, calves may be raised by their pelvic limbs, thus increasing blood flow to the head and neck regions. An incision of the skin (a cut-down) makes placement of a catheter easier. A major advantage of jugular vein catheterization is the more rapid flow rate that is possible because 14-gauge catheters are commonly used.

Catheterization of the **auricular veins** in calves is becoming common, especially in Europe.<sup>71</sup> Even in severely dehydrated

calves, ear vein catheterization is successful. Ear catheters allow the application of sufficient amounts of fluids by continuous drip infusion and there are fewer complications compared to jugular vein catheters. In vitro flow rates for 22-gauge catheters range between 28 and 36 mL/min, providing an in vivo flow rate into the calf's ear catheter of approximately 1.2–2.2 L/h.

#### *Oral fluid and electrolyte therapy*

Oral fluid and electrolyte therapy are indicated for calves in the early stages of diarrhea or after they have been successfully hydrated following parenteral fluid therapy. Severely dehydrated or moribund calves may not respond favorably to oral fluid therapy alone. Owners must be encouraged to provide oral fluid and electrolyte therapy to diarrheic neonatal farm animals as soon as possible after the onset of diarrhea. Almost all the information available on oral fluids has been developed following clinical studies in diarrheic calves, and the recommendations here reflect those studies.<sup>72</sup>

In neonatal calves, the ideal oral electrolyte solution should: (a) supply sufficient sodium to facilitate normalization of extracellular fluid deficits; (b) provide two or more agents (such as glucose, acetate, propionate, or glycine) that facilitate intestinal absorption of sodium and water; (c) provide an alkalizing agent (such as acetate, propionate, citrate, or bicarbonate) to treat the metabolic acidosis often present in dehydrated diarrheic calves; (d) not interfere with milk clotting in the abomasum; (e) provide sufficient energy, as these electrolyte solutions may be administered instead of milk or milk replacer for short periods of time; and (f) facilitate repair of damaged intestinal epithelium.<sup>73</sup>

Acetate and propionate are the preferred alkalizing agents for treating dehydrated calves with mild metabolic acidosis. Acetate and propionate have similar alkalizing ability to bicarbonate on an equimolar basis, with the advantage that acetate and propionate produce energy. Acetate and propionate also stimulate sodium and water absorption in the calf small intestine, but in the jejunum to a greater extent than the ileum. Acetate and propionate are readily metabolized by both fed and fasted calves. Moreover, acetate and propionate are metabolized by peripheral tissues, are not produced endogenously in shock and dehydration (as is lactate) and do not have an unmetabolized isomer (D-lactate). Finally, acetate and propionate do not alkalize the abomasum and intestine, whereas bicarbonate can permit bacteria to proliferate in an alkalized abomasum, while also inhibiting the normal clotting of milk.

The ideal electrolyte concentration, osmolarity and energy source for an oral electrolyte solution to treat neonatal calf diarrhea remain controversial. The optimal solution should have a sodium concentration between 60 and 120 mmol/L, a potassium concentration between 10 and 20 mmol/L, a chloride concentration between 40 and 80 mmol/L, 40–80 mmol/L of metabolizable (nonbicarbonate) base, such as acetate or propionate, and glucose as an energy source. Some investigators have suggested that the optimal oral electrolyte solution required a higher sodium concentration (120–133 mmol/L) to rapidly correct extracellular electrolyte and fluid losses that typically develop in calves with diarrhea and dehydration. Combined administration of sodium and glucose is beneficial because glucose facilitates sodium absorption via the small intestinal sodium/glucose co-transport mechanism.

Oral fluid and electrolyte therapy is effective in enteric colibacillosis of neonatal farm animals because glucose continues to be absorbed by the small intestine by an active transport mechanism accompanied by glucose-coupled sodium absorption and absorption of water. In enterotoxigenic colibacillosis, while there is net hypersecretion caused by the enterotoxin, the intestinal mucosa is sufficiently intact so that water and sodium will be absorbed in the presence of glucose. Most oral electrolytes intended for the treatment of dehydration and acidosis in diarrheic calves contain sodium chloride and sodium bicarbonate with one or some of the following substances: glucose, acetates and citrates, phosphates, potassium salts, glycine and amino acids.

Several commercial oral preparations are available. The ideal solutions should be palatable and provide rapid rehydration and correction of acidosis. Diarrheic calves must receive sufficient fluid therapy to compensate for the fluid and electrolyte losses that occur and for maintenance and contemporary losses during the period of clinical diarrhea and convalescence. However, the calf must be returned to a milk diet within a few days in order to avoid the effects of malnutrition. Oral fluid and electrolyte formulas cannot provide the daily maintenance requirements of energy, protein, and fat. Some formulas contain a large quantity of glucose and are supplemented with glycine, sodium acetate, and citric acid, thus making a calorie-dense, partially nitrogen-balanced hyperosmolar solution. A glutamine-containing oral rehydration solution for the treatment of experimental *E. coli* calf diarrhea was more effective in correcting and sustaining plasma, extracellular fluid, and blood volume compared

with standard World Health Organization solutions without the glutamine.<sup>74</sup>

There are marked variations in the alkalinizing abilities of the oral electrolyte solutions that are available commercially.<sup>72</sup> Those that contain at least 80 mmol/L of bicarbonate are much more effective for the rapid correction of acidosis and depression in diarrheic calves than administration of rehydrating electrolyte solutions alone. The bicarbonate-rich preparations have the best alkalinizing response when given to calves affected with acidosis from experimentally induced diarrhea. Oral electrolyte solutions containing acid phosphate salts are undesirable because they cause net acidification of the blood, with a fall in blood pH. One possible theoretical disadvantage of an alkaline electrolyte solution (containing sodium bicarbonate) is that it may prolong the clotting of milk by rennin in the abomasum, which could cause maldigestion and prolong the diarrhea, especially if the oral fluids and electrolytes are diluted 1:1 with whole milk.

Several commercially available oral electrolyte solutions contain metabolizable bases such as acetate instead of bicarbonate and are formulated to correct and maintain acid-base imbalance and maintain normal milk digestion.<sup>72</sup> Those preparations that contain either bicarbonate or acetate provide good therapeutic results and have been evaluated in experimentally induced diarrheic calves, which were also offered milk at the rate of 5% of their body weight twice daily.<sup>72</sup> Offering milk along with the oral electrolytes is effective in maintaining body weight in experimental calves. No scientific information is available on the effects of milk and oral electrolytes in naturally occurring cases. Those preparations not containing any alkalinizing agent do not correct the acid-base imbalance and result in poor recovery rates in experimental calves.

Ideally, the oral fluids and electrolytes should not be mixed with milk but fed or offered between feedings of milk. The oral fluids should be given by nipple bottle if the animal will suck but the use of a stomach tube or esophageal feeder is satisfactory. Fluids can be administered to the dehydrated calf using an esophageal feeder, even though the reticular groove does not close. At least 2 L of fluid should be given, which results in a transfer of fluids from the rumen to the abomasum. If larger doses are required they should be divided and given at intervals of 2 hours or more to avoid abdominal discomfort from distension.

Fecal consistency is not a highly reliable criterion of success in the evaluation of oral fluid therapy for calf diarrhea. Calves with the greatest improvement in fecal

consistency had no greater increase in plasma volume than calves that did not improve their fecal consistency. Thus improvement of the feces may not offer a reliable guide to the rehydration of the calf.

#### Response to therapy

Calves that respond and recover usually show marked improvement from intravenous and/or oral fluid therapy within 24–36 hours. Calves that respond to the hydration therapy begin to urinate within an hour after fluid administration is begun, and usually maintain hydration thereafter. Calves that do not respond will not hydrate normally; they may not begin to urinate because of irreversible renal failure, their feces remain watery, they remain depressed and not strong enough to suck or drink, and continued fluid therapy beyond 3 days is usually futile. Those calves that respond favorably to the initial fluid therapy and then become depressed 12–18 hours later may have returned to a state of metabolic acidosis. Mental depression, the loss of the suck reflex and muscular weakness are indications of acidosis, and affected calves will require retreatment with sodium bicarbonate.

Overhydration and overinfusion at too rapid an administration rate increases intravascular pressure, resulting in pulmonary edema characterized by hyperpnea, tachypnea, tachycardia, and death.

#### Antimicrobial therapy

Antimicrobials have been used extensively for the specific treatment of colibacillosis in calves and piglets because it was assumed that an infectious enteritis was present that had the potential of developing into a bacteremia or septicemia. Some preparations consist of a single antimicrobial, while others are mixtures with or without absorbents, astringents, and electrolytes. They have been used on an empirical basis, since few randomized controlled trials have been conducted.

It has been difficult to evaluate the efficacy of antimicrobials for the treatment of enteric colibacillosis because of the complex nature of the interactive factors that affect the outcome in naturally occurring cases. These include the presence of mixed infections, the effects of whether or not milk is withheld from the diarrheic calves, the effects of the immune status of individual calves, the variable times after the onset of diarrhea when the drugs are given, the possible presence of antimicrobial resistance, and the effects of supportive treatment such as electrolyte and fluid therapy.

The literature on the use of antimicrobials in the treatment of calf diarrhea has been critically reviewed by Constable<sup>75</sup> and the following discussion strongly

reflects his review and his evidence-based recommendations for the use of antimicrobials to treat calf diarrhea.

#### Change in small intestinal bacterial flora in calves with diarrhea

There has been a paradigm shift in the last 40 years towards categorizing an episode of calf diarrhea as being due to a specific etiologic agent, such as rotavirus, coronavirus, cryptosporidia, *Salmonella* spp., or enterotoxigenic *E. coli*. While the etiologic approach has correctly focused attention on preventive programs, including vaccination and optimizing transfer of colostrum immunity, the approach has diverted attention from the universal finding of all studies, that calves with diarrhea have coliform bacterial overgrowth of the small intestine.<sup>75</sup>

Studies completed more than 70 years ago documented increased numbers of *E. coli* bacteria in the abomasum, duodenum, and jejunum of scouring calves. Moreover, calves severely affected with diarrhea had increased numbers of *E. coli* bacteria in the anterior portion of their intestinal tracts compared to mildly affected animals. More recent studies have consistently documented the fact that calves with naturally acquired diarrhea, regardless of age and the etiologic cause for the diarrhea, have altered small intestinal bacterial flora. Specifically, *E. coli* bacterial numbers are increased 5–10 000-fold in the duodenum, jejunum, and ileum of calves with naturally acquired diarrhea, even when the diarrhea was not due to enterotoxigenic strains of *E. coli*, and where rotavirus and coronavirus were identified in the feces. The largest increase in *E. coli* bacterial numbers occurs in the distal jejunum and ileum, whereas the *E. coli* or coliform bacterial numbers in the colon and feces are similar or higher for calves with diarrhea than calves without diarrhea, with *E. coli* being more numerous in the feces of colostrum-deprived than colostrum-fed calves. Small intestinal overgrowth with coliform bacteria can persist after departure of the initiating enteric pathogen.

In calves with naturally acquired diarrhea, increased small-intestinal colonization with *E. coli* has been associated with impaired glucose, xylose, and fat absorption.

Mixed infections with enteric pathogens are commonly diagnosed in calves with naturally acquired diarrhea, and the clinical signs and pathological damage associated with rotavirus infection are more severe when *E. coli* is present than when it is absent. Primary viral morphologic damage to the small intestine also facilitates systemic invasion by normal intestinal flora, including *E. coli*.

In calves with experimentally induced enterotoxigenic *E. coli* diarrhea, colonization of the small intestine by *E. coli* has been associated with impaired glucose and lactose absorption, decreased serum glucose concentration and possibly increased susceptibility to cryptosporidial infection.

In summary, calves with diarrhea have increased coliform bacterial numbers in the small intestine, regardless of etiology, and this colonization is associated with altered small-intestinal function, morphological damage, and increased susceptibility to bacteremia. It therefore follows that administration of antimicrobials that decrease small intestinal coliform bacterial numbers in calves with diarrhea may prevent the development of bacteremia, decrease mortality, and decrease morphological damage to the small intestine, thereby facilitating digestion and absorption and increasing growth rate.

#### Incidence of bacteremia in calves with diarrhea

Calves with diarrhea are more likely to have failure of transfer of passive immunity or partial failure of transfer of passive immunity, and this group of calves, in turn, is more likely to be bacteremic. This is an additional reason that antimicrobials may be indicated in the treatment of calf diarrhea. Colostrum-deprived calves that subsequently developed diarrhea were frequently bacteremic, whereas bacteremia occurred much less frequently in colostrum-fed calves that developed diarrhea.

Based on field studies of diarrheic calves, it can be assumed that, on average, 30% of severely ill calves with diarrhea are bacteremic, that the risk of bacteremia is higher in calves with failure of transfer of passive immunity than in calves with adequate transfer of passive immunity, and that the risk of bacteremia is higher in calves 5 days of age or older. The frequency of bacteremia is sufficiently high that treatment of calves with diarrhea that are severely ill (as manifest by reduced suck reflex, > 6% dehydration, weakness, inability to stand or clinical depression) should include routine treatment against bacteremia, with emphasis on treating potential *E. coli* bacteremia. Veterinarians should also assume that 8–18% of diarrheic calves with adequate transfer of passive immunity and systemic illness are bacteremic. The prevalence of bacteremia is sufficiently high in systemically ill calves that effective antimicrobial treatment for potential bacteremia should be routinely instituted, regardless of transfer of passive immunity status and treatment cost. Withholding an effective treatment for a life-threatening condition, such as bacteremia in calves with diarrhea, cannot be condoned on animal welfare grounds.

#### Antimicrobial susceptibility of fecal *Escherichia coli* isolates

The most important determinant of antimicrobial efficacy in calf diarrhea is obtaining an effective antimicrobial concentration against bacteria at the sites of infection (small intestine and blood). The results of fecal antimicrobial susceptibility testing have traditionally been used to guide treatment decisions; however, susceptibility testing in calf diarrhea probably has clinical relevance only when applied to fecal isolates of enterotoxigenic strains of *E. coli* or pathogenic *Salmonella* spp., and blood culture isolates from calves with bacteremia. Validation of susceptibility testing as being predictive of treatment outcome for calves with diarrhea is currently lacking.

The ability of fecal bacterial culture and antimicrobial susceptibility testing using the Kirby Bauer technique to guide treatment in calf diarrhea is questionable when applied to fecal *E. coli* isolates that have not been identified as enterotoxigenic.<sup>75</sup> There do not appear to be any data demonstrating that fecal bacterial flora is representative of the bacterial flora of the small intestine, which is the physiologically important site of infection in calf diarrhea. Marked changes in small-intestinal bacterial populations can occur without changes in fecal bacterial populations, and the predominant strain of *E. coli* in the feces of a diarrheic calf can change several times during the diarrhea episode. Furthermore, and most importantly, 45% of calves with diarrhea had different strains of *E. coli* isolated from the upper and lower small intestine, indicating that fecal *E. coli* strains are not always representative of small-intestinal *E. coli* strains.

An additional bias present in most antimicrobial susceptibility studies conducted on fecal *E. coli* isolates is that data are frequently obtained from dead calves, which are likely to be treatment failures. The time since death is also likely to be an important determinant of the value of fecal culture, because such a rapid proliferation of bacteria occurs in the alimentary tract after death that the results of examinations made on dead calves received at the laboratory can have little significance. Calves that die from diarrhea are likely to have received multiple antimicrobial treatments, and preferential growth of antimicrobial-resistant *E. coli* strains starts within 3 hours of antimicrobial administration. A further concern with fecal susceptibility testing is that the Kirby Bauer breakpoints (minimum inhibitory concentration (MIC)) are not based on typical antimicrobial concentrations in the small intestine and blood of calves. What are urgently needed are

studies documenting the antimicrobial susceptibility of *E. coli* isolates from the small intestine of untreated calves, based on achievable drug concentrations and dosage regimens. Until these data are available, it appears that antimicrobial efficacy is best evaluated by the clinical response to treatment, rather than the results of in vitro antimicrobial susceptibility testing performed on fecal *E. coli* isolates.

A comparison of antibiotic resistance for *E. coli* populations isolated from groups of diarrheic and control calves in the UK found a higher incidence of antibiotic-resistant *E. coli* in samples obtained from farms with calf diarrhea than from farms without the disease.<sup>76</sup> Considering all samples, bacterial colonies in 84% were resistant to ampicillin, in 13% to apramycin and in 6% to nalidixic acid. Antibiotic resistance among enterotoxigenic *E. coli* from piglets and calves with diarrhea in a diagnostic laboratory survey of one geographic area in Canada over a 13-year period found that least resistance occurred against ceftiofur for all, followed by apramycin and gentamicin for porcine and florfenicol for bovine isolates.<sup>77</sup>

Passive surveillance for antimicrobial resistance in *E. coli* isolates from diarrheic food animals continues to indicate that resistance to many of the common antimicrobials is increasing. In a UK study over a 5-year period, *E. coli* isolates from calves with diarrhea become more resistant to furazolidone, trimethoprim-potentiated sulfonamide, clavulanic-acid-potentiated amoxicillin, and tetracycline.<sup>78</sup> *E. coli* strains from outbreaks of diarrhea in lambs in Spain became increasingly resistant to nalidixic acid, enoxacin, and enrofloxacin on the basis of the National Committee on Clinical Laboratory Standards (NCCL) breakpoints for human and animal isolates.<sup>79,80</sup> Among the fluoroquinolones used for treatment of domestic animals in Spain, enrofloxacin is approved for use for the treatment of colibacillosis and diarrhea in lambs. However, the bovine and ovine strains of *E. coli* that possess potential virulence factors were more sensitive to quinolones than those that do not express those factors. Some antimicrobial-resistant *E. coli* strains from diarrheic calves in the USA may possess a chromosomal *flo* gene that specifies cross-resistance to both florfenicol and chloramphenicol, and its presence among *E. coli* isolates of diverse genetic backgrounds indicates a distribution much wider than previously thought.<sup>81</sup> In Spain, 5.9% of *E. coli* strains from cattle were resistant to nalidixic acid and 4.9% were resistant to enrofloxacin and ciprofloxacin.<sup>82</sup> In sheep and goats only 0.5% and 1.4%, respectively, of the strains were resistant



to nalidixic acid and none to fluoroquinolones. Most of the quinolone-resistant strains were nonpathogenic strains isolated from cattle.

The CTX-M-14-like enzyme has been detected in *E. coli* recovered from the feces of diarrheic dairy calves in Wales.<sup>74</sup> The enzyme is an extended-spectrum beta-lactamase (ESBL), which confers resistance to a wide range of beta-lactam (penicillin and cephalosporin) compounds. Organisms possessing ESBLs are considered to be resistant to second-, third-, and fourth-generation cephalosporins, and in vitro resistance to amoxicillin/clavulanate among producers is variable, reflecting the amount of beta-lactamase produced. In addition to this enzyme, the isolates produced a TEM-35 (IRT-4) beta-lactamase that conferred resistance to the amoxicillin/clavulanate combination. These two enzymes confer resistance to all the beta-lactamase compounds approved for veterinary use in the UK. Thus their occurrence in animals may be an important development for both animal and public health. ESBLs in human infections have emerged as a significant and developing problem, occurring in patients in the community as well as in those with recent hospital contact. Spread of this form of resistance in bacteria affecting the animal population could have serious implications for animal health, rendering many therapeutic options redundant.

Antibiotic resistance to intestinal bacteria also occurs in dairy calves fed milk from cows treated with antibiotics.<sup>83</sup> The resistance increases with higher concentrations of antibiotics in the milk.

#### Antimicrobial susceptibility of blood *Escherichia coli* isolates

The Kirby Bauer technique for antimicrobial susceptibility testing has more clinical relevance for predicting the clinical response to antimicrobial treatment when applied to blood isolates rather than fecal isolates.<sup>75</sup> This is because the Kirby Bauer breakpoints (MICs) are based on achievable antimicrobial concentrations in human plasma and MIC<sub>90</sub> values for human *E. coli* isolates, which provide a reasonable approximation to achievable MIC values in calf plasma and MIC<sub>90</sub> values for bovine *E. coli* isolates. Unfortunately, susceptibility results are not available for at least 48 hours, and very few studies have documented the antimicrobial susceptibility of blood isolates in calves with diarrhea. In a 1997 study of dairy calves in California, the antimicrobial susceptibility of isolates from the blood of calves with severe diarrhea or illness produced the following results; ceftiofur, 19/25 (76%) sensitive; potentiated

sulfonamides, 14/25 (56%) sensitive; gentamicin, 12/25 (48%) sensitive; ampicillin, 11/25 (44%) sensitive; tetracycline, 3/25 (12%) sensitive, although there was a clinically significant year-to-year difference in the results of susceptibility testing that may have reflected different antimicrobial administration protocols on the farm.<sup>75</sup>

Evidence-based recommendations for antimicrobial treatment of diarrheic calves

The four critical measures of success of antimicrobial therapy in calf diarrhea are (in decreasing order of importance): (1) mortality rate, (2) growth rate in survivors, (3) severity of diarrhea in survivors, and (4) duration of diarrhea in survivors.

Success of antimicrobial therapy can vary with the route of administration and whether the antimicrobial is dissolved in milk, oral electrolyte solutions, or water. Oral antimicrobials administered as a bolus or contained in a gelatin capsule are deposited into the rumen and therefore have a different serum concentration-time profile from antimicrobials dissolved in milk replacer that are suckled by the calf or administered as an oral drench at the back of the pharynx. Antimicrobials that bypass the rumen are not thought to alter rumen microflora, potentially permitting bacterial recolonization of the small intestine from the rumen. Finally, when oral antimicrobials are administered to calves with diarrhea, the antimicrobial concentration in the lumen of the small intestine is lower and the rate of antimicrobial elimination faster than in healthy calves.

Orally administered amoxicillin, chlor-tetracycline, neomycin, oxytetracycline, streptomycin, sulfachloropyridazine, sulfamethazine, and tetracycline are currently labeled in the USA for the treatment of calf diarrhea. No parenteral antimicrobials have a label claim in the USA for treating calf diarrhea.

In his review of the literature on the use of antibiotics for the treatment of calf diarrhea, Constable<sup>75</sup> concluded that recommendations by some veterinarians that oral or parenteral antimicrobials should not be used were not supported by a critical evidence-based review of the literature. The arguments used to support a nonantimicrobial treatment approach have included:

- Orally administered antimicrobials alter intestinal flora and function and thereby induce diarrhea, which has been documented on more than one occasion with chloramphenicol, neomycin, and penicillin
- Antimicrobials harm the 'good' bacteria in the small intestine more than the 'bad' bacteria (an undocumented claim in the calf)

- Antimicrobials are not effective (a statement that is clearly not supported by the results of some published peer-reviewed studies)
- Antimicrobial administration promotes the selection of antimicrobial resistance in enteric bacteria.

Constable<sup>75</sup> concluded that antimicrobial treatment of diarrheic calves should be practiced and focused against *E. coli* in the small intestine and blood, as these constitute the two sites of infection. Fecal bacterial culture and antimicrobial susceptibility testing is not recommended in calves with diarrhea, because fecal bacterial populations do not accurately reflect small-intestinal or blood bacterial populations and the breakpoints for susceptibility test results have not been validated. Antimicrobial efficacy is therefore best evaluated by the clinical response to treatment.

In the USA parenterally administered oxytetracycline and sulfachloropyridazine and orally administered amoxicillin, chlor-tetracycline, neomycin, oxytetracycline, streptomycin, sulfachloropyridazine, sulfamethazine, and tetracycline are currently labeled for the treatment of calf diarrhea. Unfortunately, there is little published data supporting their efficacy in treating calves with diarrhea.<sup>75</sup> Extralabel antimicrobial use (excluding prohibited antimicrobials) is therefore justified in treating calf diarrhea because of the apparent lack of published studies documenting clinical efficacy of antimicrobials with a label claim, and because the health of the animal is threatened and suffering or death may result from failure to treat systemically ill calves.

Because the two sites of infection in calf diarrhea are the small intestine and blood, administered antimicrobials should have both local (small intestinal) and systemic effects. In addition, the antimicrobial must reach therapeutic concentrations at the site of infection for a long enough period and, ideally, have only a narrow Gram-negative spectrum of activity in order to minimize collateral damage to other enteric bacteria. In general, oral and parenteral administration of broad-spectrum beta-lactam and fluoroquinolone antimicrobials have proven efficacy in treating naturally acquired and experimentally induced diarrhea, parenteral administration of trimethoprim-sulfadiazine has proven efficacy in treating experimentally induced *Salmonella enterica* serotype Dublin (although efficacy has only been demonstrated when antimicrobial administration starts before diarrhea is present), and oral administration of the predominantly Gram-negative-spectrum

antimicrobial apramycin has proven efficacy in treating naturally acquired diarrhea. Because use of fluorquinolone antimicrobials in an extralabel manner is illegal in the USA, and apramycin is an aminocyclitol antimicrobial that is poorly absorbed after oral administration (oral bioavailability <15%) and has relatively high MIC values against *Salmonella* spp. and *E. coli* (MIC<sub>90</sub> > 3 µg/mL) in the calf, treatment recommendations will focus on the use of broad-spectrum beta-lactam antimicrobials such as amoxicillin, ampicillin, ceftiofur, and potentiated sulfonamides (trimethoprim– sulfadiazine).

#### *Administration of oral antimicrobials to treat Escherichia coli overgrowth of the small intestine*

Based on published evidence for the oral administration of these antimicrobial agents, only amoxicillin can be recommended for the treatment of diarrhea; dosage recommendations are amoxicillin trihydrate (10 mg/kg every 12 h) or amoxicillin trihydrate–clavulanate potassium (12.5 mg combined drug/kg every 12 h) for at least 3 days; the latter constitutes extralabel drug use. Parenteral administration of broad-spectrum beta-lactam antimicrobials (ceftiofur, 2.2 mg/kg intramuscularly or subcutaneously every 12 h; amoxicillin or ampicillin, 10 mg/kg intramuscularly every 12 h) or potentiated sulfonamides (25 mg/kg intravenously or intramuscularly every 12 h) is recommended for treating calves with diarrhea and systemic illness; both constitute extralabel drug use.

Concurrent feeding of milk and amoxicillin does not change the bioavailability of amoxicillin, although amoxicillin is absorbed faster when dissolved in an oral electrolyte solution than in milk replacer and absorption is slowed during endotoxemia, presumably because of a decrease in abomasal emptying rate. Amoxicillin trihydrate is preferred to ampicillin trihydrate for oral administration in calves because it is labeled for the treatment of calf diarrhea in the USA and is absorbed to a much greater extent. However, a field study comparing oral amoxicillin (400 mg every 12 h) and ampicillin (400 mg every 12 h) treatments for diarrhea reported similar proportions of calves with a good to excellent clinical response (79%, 49/62 for amoxicillin bolus; 80%, 59/74 for amoxicillin powder; 65%, 47/65 for ampicillin bolus;  $p > 0.30$  for all comparisons). The addition of clavulanate potassium to amoxicillin trihydrate is recommended because clavulanate potassium is a potent irreversible inhibitor of beta-lactamase, increasing the antimicrobial spectrum of activity.

Sulbactam/ampicillin was effective for the treatment of experimentally induced diarrhea in calves infected with *E. coli* strain B44 (O9:K30:K99H).<sup>84</sup> The survival rate in treated calves was 100% compared to 22% in control calves treated only with saline. Ceftiofur hydrochloride – a broad-spectrum, beta-lactamase-resistant cephalosporin – at an oral dose of 10 mg/kg BW given once was effective for the treatment of experimentally induced enteric colibacillosis in piglets.

Oral administration of potentiated sulfonamides is not recommended for treating calf diarrhea because of the lack of efficacy studies. Gentamicin (50 mg/calf orally every 12 h) markedly decreased *E. coli* bacterial concentrations in the feces of healthy calves and treatment with gentamicin has improved stool consistency in calves with experimentally induced *E. coli* diarrhea.<sup>75</sup> However, oral administration of gentamicin is not recommended, because antimicrobials administered to calves with diarrhea should have both local and systemic effects, and orally administered gentamicin is poorly absorbed.

Fluoroquinolones clearly have proven efficacy in treating calf diarrhea and a label indication exists in Europe for oral and parenteral enrofloxacin and oral marbofloxacin for the treatment of calf diarrhea. In those countries where their administration is permitted to treat calf diarrhea, oral fluoroquinolones are recommended because of their high oral bioavailability. However, it must be emphasized that extralabel use of the fluoroquinolone class of antimicrobials in food-producing animals in the US is illegal and obviously not recommended.

Also, in other countries it may be illegal to use some of the antimicrobials mentioned here because of the regulations regarding their use in food-producing animals. Some are available to farmers on a prescription-only basis, which makes examination of the animals and a diagnosis necessary before recommendations are made. The indiscriminate use of antibiotics in milk replacers for the treatment of newborn calves and piglets is widespread and must be viewed with concern when the problem of drug resistance transfer from animal to animal and to humans is considered.

In calves with diarrhea and no systemic illness (normal appetite for milk or milk replacer, no fever), it is recommended that the clinician monitors the health of the calf, and does not administer oral antimicrobials.

#### *Administration of parenteral antimicrobials to treat Escherichia coli bacteremia*

In calves with diarrhea and moderate to severe systemic illness, the positive pre-

dictive value (0.65) of clinical tests (sensitivity = 0.39, specificity = 0.91) and the positive predictive value (0.77) of laboratory tests (sensitivity = 0.40, specificity = 0.95) for detecting bacteremia are too low assuming reasonable estimates for the prevalence of bacteremia (30%).<sup>77</sup> Accordingly, it is recommended that clinicians routinely assume 30% of ill calves with diarrhea are bacteremic, and that bacteremia constitutes a threat to the life of the calf.

The most logical parenteral treatment is ceftiofur (2.2 mg/kg intramuscularly/subcutaneously every 12 h) for at least 3 days. Ceftiofur is the most appropriate antimicrobial because it is a broad-spectrum beta-lactam antimicrobial that is resistant to the action of beta-lactamase, the MIC<sub>90</sub> for *E. coli* is less than 0.25 µg/mL, the recommended dosage schedule maintains free plasma beta-lactam antimicrobial concentrations at the desired four times above the MIC<sub>90</sub> value for the duration of treatment in 7-day-old calves, and 30% of the active metabolite of ceftiofur (desfuoylceftiofur) is excreted into the intestinal tract of cattle, providing antimicrobial activity in both blood and small intestine. Moreover, parenteral (2 mg/kg, intramuscularly once) and oral (0.5 mg/kg, once) administration of ceftiofur hydrochloride decreased mortality rate and the severity of diarrhea in pigs with experimentally induced enteric colibacillosis, although these pigs were not suspected to be bacteremic.<sup>75</sup> The beneficial effects of parenteral ceftiofur in these pigs was attributed to decreasing intestinal luminal concentration of pathogenic *E. coli*. Orally administered ceftiofur sodium (<5 mg/kg daily) was also effective in treating mice with experimentally induced enteric colibacillosis.<sup>75</sup> Administration of ceftiofur to treat bacteremia and diarrhea in calves constitutes extralabel drug use, and ceftiofur should not be administered to calves to be processed as veal.

Another recommended treatment is parenteral amoxicillin trihydrate or ampicillin trihydrate (10 mg/kg intramuscularly every 12 h) for at least 3 days. Although parenteral ampicillin has proven efficacy in treating naturally acquired diarrhea whereas ceftiofur has unproven efficacy, the broad-spectrum beta-lactam antimicrobials amoxicillin and ampicillin are theoretically inferior to ceftiofur because parenterally administered ampicillin and amoxicillin reach lower plasma concentrations and require a higher MIC than ceftiofur, and are not beta-lactamase-resistant.<sup>75</sup> Amoxicillin or ampicillin should be injected into the neck musculature because this site provides the greatest absorption and minimizes damage to

more valuable areas of the carcass. Amoxicillin and ampicillin should not be administered subcutaneously, as the rate and extent of absorption is reduced relative to intramuscular injection.

A third recommended treatment is parenteral potentiated sulfonamides (20 mg/kg sulfadiazine with 5 mg/kg trimethoprim, intravenously or intramuscularly depending upon the formulation characteristics, every 24 h for 5 d). The efficacy of potentiated sulfonamides has only been proved when treatment commenced before clinical signs of diarrhea were present.<sup>75</sup> It is therefore unknown whether potentiated sulfonamides are efficacious when administered to calves with diarrhea and depression, although it is likely that potentiated sulfonamides are efficacious in the treatment of salmonellosis.

Oral administration of potentiated sulfonamides and apramycin is not recommended for the treatment of bacteremia, because of poor oral bioavailability. Oxytetracycline or chlortetracycline are also not recommended for the treatment of bacteremia, although tetracyclines may have some efficacy for treating *E. coli* bacterial overgrowth of the small intestine. Tetracycline antimicrobials are bound to calcium, and oral bioavailability when administered with milk is 46% for oxytetracycline and 24% for chlortetracycline.

Parenteral administration of gentamicin and other aminoglycosides (amikacin, kanamycin) cannot currently be recommended as part of the treatment for calf diarrhea because of the lack of published efficacy studies, prolonged slaughter withdrawal times (15–18 months), potential for nephrotoxicity in dehydrated animals, and availability of ceftiofur, amoxicillin, and ampicillin.

A label indication exists in Europe for parenteral enrofloxacin in the treatment of calf diarrhea. In those countries where administration is permitted to treat calves with diarrhea, parenteral fluoroquinolones are recommended because of their broad-spectrum bactericidal activity, particularly against Gram-negative bacteria. However, it must be emphasized that extra-label use of the fluoroquinolone class of antimicrobials in food-producing animals in the USA is illegal and obviously not recommended.

Chloramphenicol had proven efficacy in treating calf diarrhea due to *Salmonella enterica* serotypes Bredeney and Dublin, although its use is now illegal in the USA. The related antimicrobial florfenicol achieves high concentrations in the lumen of the small intestine and is 89% absorbed when orally administered to milk-fed calves; however, florfenicol does not provide the most appropriate anti-

microbial for treating calf diarrhea, as the MIC<sub>90</sub> for *E. coli* is very high at 25 µg/mL and florfenicol (11 mg/kg orally or 20 mg/kg intramuscularly) failed to reach the MIC<sub>90</sub> value in plasma, whereas florfenicol (11–20 mg/kg intravenously) only exceeded the MIC<sub>90</sub> value for less than 60 minutes.<sup>75</sup>

In calves with diarrhea and no systemic illness (normal appetite for milk or milk replacer, no fever), we recommend that the clinician monitors the health of the calf and does not administer parenteral antimicrobials.

### Immunoglobulin therapy

One of the important factors determining whether or not calves survive enteric colibacillosis is the serum immunoglobulin status of the animal before it develops the disease. The prognosis is unfavorable if the level of immunoglobulins is low at the onset of diarrhea, regardless of intensive fluid and antimicrobial therapy. Most of the literature on therapy omits this information and is therefore difficult to assess. There is ample evidence that the mortality rate will be high in diarrheic calves that are deficient in serum immunoglobulins, particularly IgG, in spite of exhaustive antimicrobial and fluid therapy. This has stimulated interest in the possible use of purified solutions of bovine gammaglobulin in diarrheic calves that are hypogammaglobulinemic. However, they must be given by the intravenous route and in large amounts, the cost of which would be prohibitive. In addition, they are unlikely to be of value once the calf is affected with diarrhea; they are protective and probably not curative. Whole blood transfusion to severely affected calves may be used as a source of gammaglobulins but unless given in large quantities would not significantly elevate serum immunoglobulin levels in deficient calves. Limited controlled trials indicate that there is no significant difference in the survival rate of diarrheic calves treated with either a blood transfusion daily for 3 days; fluid therapy given orally, subcutaneously, or intravenously depending on the severity of the dehydration; or fluid therapy with antibiotics. Those calves that survived, regardless of the type of therapy, had high levels of immunoglobulins before they developed diarrhea. This emphasizes the importance of the calf ingesting liberal quantities of colostrum within the first few hours after birth.

### Antimotility drugs and intestinal protectants

There is no good evidence that antimotility drugs are of any therapeutic value for the treatment of enteric colibacillosis. Intestinal protectants such as kaolin and

pectin are in general use for diarrheic animals but likewise their value is uncertain. When they are used the feces become bulky but do not have any known effect on the pathogenesis of the disease.

### Alteration of the diet

Whether or not diarrheic newborn animals should be deprived of milk during the period of diarrhea is controversial.<sup>72</sup> Diarrheic piglets are usually treated with an antimicrobial orally and left to nurse on the sow. Diarrheic beef calves are commonly treated with oral fluids and electrolytes and left with the cow. However, it is a common practice to reduce the milk intake of diarrheic hand-fed dairy calves for up to 24 hours or until there is clinical evidence of improvement. The withholding of milk from diarrheic calves has been based on the observations that lactose digestion is impaired and that 'resting' the intestine for a few days minimizes additional osmotic diarrhea caused by fermentation of undigested lactose in the large intestine. Thus it has seemed logical not to feed the animal with milk, which must be digested, but rather to provide readily absorbable substances such as oral glucose-electrolyte mixtures. In contrast, the argument in favor of continuous feeding of milk is that the intestinal tract requires a constant source of nutrition, which it receives from the ingesta in the lumen of the intestine. It has also been proposed that starving diarrheic calves from milk can result in malnutrition, suboptimal growth rates and prolonged recovery.<sup>72</sup> In one study it was shown that the offering of milk to diarrheic calves when they were willing to drink following hydration therapy in a clinic resulted in a higher but insignificant improvement in survival rate than in calves that were starved from milk for 24 hours. In another study, the continued feeding of cows' whole milk and fluids and electrolytes to experimentally induced diarrheic calves sustained the growth rate of the animals over the trial period of 10 days even though the diarrhea persisted.<sup>72</sup> The use of whole milk and oral rehydration solutions for calves with naturally occurring diarrhea did not prolong the diarrhea or make it worse<sup>72</sup> but the calves were in the early stages of diarrhea and were neither severely dehydrated nor acidotic.

It has been common practice to use oral fluids and electrolytes as milk replacement during the period of diarrhea. Such mixtures are inexpensive, easy to use, readily available and, if used by the farmer when diarrhea is first noticed, will usually successfully treat existing dehydration and prevent further dehydration and acidosis.

Following recovery, calves should be offered reduced quantities of whole milk three times daily (no more than total daily intake equivalent to 8% BW) on the first day and increased to the normal daily allowance in the next few days. Milk should not be diluted with water as this may interfere with the clotting mechanism in the abomasum.

### Clinical management of outbreaks

The following principles should be considered when outbreaks of colibacillosis in neonatal farm animals are encountered:

- The veterinarian should visit the farm and conduct an epidemiological investigation to identify risk factors
- Examine each risk factor and how it can be minimized
- Examine affected animals
- Identify and isolate all affected animals if possible
- Treat all affected animals as necessary
- Take laboratory samples from affected and normal animals
- Make recommendations for the control of diarrhea in animals to be born in the near future
- Prepare and submit a report to the owner describing the clinical and laboratory results and how the disease can be prevented in the future.

### Health and welfare of calves

A survey of calf health and welfare on dairy farms in England examined the degree of compliance with the Welfare of Farmed Animals Regulations.<sup>85</sup> The level of veterinary involvement in calf rearing and management on dairy farms was also assessed by questionnaire sent to large-animal practitioners. Compliance with the regulations was variable. The requirements for isolation of sick calves, provision of bovine colostrum within 6 hours after birth, provision of fresh, clean water and restrictions concerning tethering were not well complied with. However, the requirements for twice-daily feeding and inspection, visual and tactile contact between calves, access to forage and the provision of clean, dry bedding were well complied with. The results also suggested that there was some lack of veterinary input into the health and welfare of calves on dairy farms visited by the practices routinely and nonroutinely. These results suggest that there are considerable opportunities to improve calf health and management practices by veterinarians who visit dairy farms. This can be done through animal health management advice provided during routine visits to the farm and encouraging compliance with current welfare regulations and through the use of herd health plans. The major challenge for the veterinarian is to

be able to communicate with owners and animal attendants about the care being provided to clinically ill neonates to insure that they are being treated according to their needs and made comfortable during their convalescence.

### CONTROL

Because of the complex nature of the disease, it is unrealistic to expect total prevention, and control at an economical level should be the major goal. Effective control of colibacillosis can be accomplished by the application of three principles:

- **Reduction of the degree of exposure of the newborn to the infectious agents**
- **Provision of maximum nonspecific resistance with adequate colostrum and optimum animal management**
- **Increasing the specific resistance of the newborn by vaccination of the dam or the newborn.**

### Reduction of the degree of exposure of the newborn to the infectious agents

The emphasis is on insuring that the newborn are born into a clean environment. Barns, confinement pens, and paddocks used as parturition areas must be clean and should preferably have been left vacant for several days before the pregnant dams are placed in them.

#### Dairy calves

These comments are directed particularly at calves born indoors, where contamination is higher than outdoors.

- Calves should be born in well-bedded box stalls that were previously cleaned out
- The perineum and udder of the dairy cow should be washed shortly before calving
- Immediately after birth the umbilicus of the calf should be swabbed with 2% iodine. Tying the umbilicus at the level of the abdominal wall with cotton thread is also practiced
- Calves affected with diarrhea should be removed from the main calf barn if possible and treated in isolation.

#### Beef calves

These are usually born on pasture or on confined calving grounds.

- Calving grounds should have been free of animals previous to the calving period; the grounds should be well drained, dry and scraped free of snow if possible. Each cow-calf pair should be provided with at least 2000 square feet of space. Calving on pasture with adequate protection from wind is ideal. Covering the calving grounds

with straw or wood shavings provides a comfortable calving environment

- In large beef herds, in a few days following birth when the calf is nursing successfully, the cow-calf pair should be moved to a nursery pasture to avoid overcrowding in the calving grounds.

In beef herds, breeding plans should insure that heifers calve at least 2 weeks before the mature cows. Limiting the breeding and therefore the calving season to 45 days or less for heifers also offers several advantages. A short calving season allows the producer to more effectively and economically concentrate personnel resources to the calving management compared to a longer calving season. Calving heifers earlier allows them additional time required before the next breeding season to be on an increasing plane of nutrition necessary to maintain a high conception rate. The earlier calving of heifers also provides less exposure of their calves to infection pressure from the mature animals in the herd.

The incidence and severity of neonatal disease will typically increase, and the age at disease onset will decrease as the calving season progresses. This phenomenon is common in beef herds because of the effect of the calf as a biological amplifier. The more the calving season is shortened, the more the biological amplification effect is negated.

For beef herds, it is necessary to have a plan for cattle movement throughout the calving season. This requires a minimum of four or five separate pastures. These include a gestation pasture, a calving pasture and a series of nursery pastures. To ensure that beef calves are born in a sanitary environment, the herd should be moved from the gestation pasture to the calving pasture 1–2 weeks before calving. One day after birth, the cow or heifer and her calf should be moved to a nursery pasture. Cow-calf pairs should be added to a single nursery pasture until the appropriate number of pairs has been reached. Thereafter, cow-calf pairs can be added to a second nursery pasture. The difference in age between the oldest and youngest calf in a nursery pasture should never exceed 30 days, and smaller differences are preferable. This negates the biological amplification effect. The longer the calving season, the greater the need for a large number of nursery pastures. Calves that develop diarrhea should be removed immediately to an area away from healthy calves, treated and not returned until all calves in the group are at low risk for developing diarrhea (> 30 days of age).

The nutrition of the pregnant cows, and particularly the first-calf heifers, must

be monitored through gestation to insure an adequate body condition and sufficient resources to provide an adequate supply of good-quality colostrum.

#### Veal calves

These calves are usually obtained from several different sources and 25–30% or higher may be deficient in serum immunoglobulin.

- On arrival, calves should be placed in their individual calf pens, which were previously cleaned, disinfected and left vacant to dry
- Feeding utensils are a frequent source of pathogenic *E. coli* and should be cleaned and air-dried daily
- Calves affected with diarrhea should be removed and isolated immediately.

#### Lambs and kids

The principles described above for calves apply to lambs and kids. Lambing sheds can be a source of heavy contamination and must be managed accordingly to reduce infection pressure on newborn lambs.

#### Piglets

Piglets born in a total-confinement system may be exposed to a high infection rate.

- The all-in/all-out system of batch farrowing, in which groups of sows farrow within a week, is recommended. This system will allow the herdsman to wean the piglets from a group of sows in a day or two and clean, disinfect and leave vacant a battery of farrowing crates for the next group of sows. This system will reduce the total occupation time and the infection rate. The continuous farrowing system without regular breaks is not recommended
- Before being placed in the farrowing crate, sows should be washed with a suitable disinfectant to reduce the bacterial population of the skin.

#### **Provision of maximum nonspecific resistance with adequate colostrum and optimum animal management**

This begins with the provision of optimal nutrition to the pregnant dam, which will result in a vigorous newborn animal and adequate quantities of colostrum. At the time of parturition, surveillance of the dams and the provision of any obstetric assistance required will insure that the newborn are born with as much vigor as possible. Parturition injuries and intrapartum hypoxemia must be minimized as much as possible.

#### Colostrum management

The next most important control measure is to insure that liberal quantities of good-quality colostrum are available and ingested

within minutes and no later than a few hours after birth. While the optimum amount of colostrum that should be ingested by a certain time after birth is well known, the major difficulty with all species under practical conditions is to know how much colostrum a particular neonate has ingested. Because modern livestock production has become so intensive, it is imperative that the animal attendants make every effort to insure that sufficient colostrum is ingested by that particular species. In one study, in large dairy herds, 42% of calves left with their dams for 1 day following birth had failed either to suck sufficient colostrum or to absorb sufficient colostrum immunoglobulins.

**Failure of transfer of passive immunity**, as determined by calf serum immunoglobulin IgG<sub>1</sub> concentration below 10 mg/mL at 48 hours of age, occurred in 61.4% of calves from a dairy in which calves were nursed by their dams, 19.3% of calves from a dairy using nipple-bottle feeding and 10.8% of calves from a dairy using tube feeding.<sup>8</sup> A higher prevalence of failure of transfer of passive immunity in dairy calves can occur because an insufficient volume of colostrum is ingested by the calf. When artificial feeding is used, inadequate immunoglobulin concentration in the colostrum fed is the most important factor resulting in failure of transfer of passive immunity.<sup>8</sup> The prevalence of failure of transfer of passive immunity in dairy herds can be minimized by artificially feeding all newborn calves large volumes (3–4 L) of fresh or refrigerated first-milking colostrum from cows that had nonlactating intervals of normal duration. This volume is considerably greater than the intake that Holstein calves usually achieve by sucking, and also exceeds the voluntary intake of most calves fed colostrum by nipple bottle.

Calves need to ingest at least 100 g IgG<sub>1</sub> in the first colostrum feeding to insure adequate transfer of passive immunity. Thus the routine force-feeding of a sufficient amount of pooled colostrum immediately after birth results in high serum levels of colostrum immunoglobulins in dairy calves and is becoming a common practice in dairy herds.

Encouraging and assisting the calf to suck within 1 hour after birth is also effective. The provision of early assisted sucking of colostrum to satiation within 1 hour after birth will result in high concentrations of absorbed immunoglobulins in the majority of calves. The ingestion of 100 g or more of colostrum immunoglobulins within a few hours after birth is more effective in achieving high levels of colostrum immunoglobulins in calves than either leaving the calf with the cow for the next 12–24 hours

or encouraging the calf to suck again at 12 hours, which will not result in a significant increase in absorbed immunoglobulins.

Despite early assisted sucking, a small proportion of calves will remain hypogammaglobulinemic because of low concentrations of immunoglobulins in their dams' colostrum, usually associated with leakage of colostrum from the udder before calving.

In large herds where economics permit, a laboratory surveillance system may be used on batches of calves to determine the serum levels of immunoglobulin acquired. An accurate analysis may be done by electrophoresis or an estimation using the zinc sulfate turbidity test. Blood should be collected from calves at 24 hours of age. Samples taken a few days later may not be a true reflection of the original serum immunoglobulin levels. The information obtained from determination of serum immunoglobulins in calves at 24 hours of age can be used to improve management practices, particularly the early ingestion of colostrum.

#### Quality of colostrum

##### *Specific gravity*

Differentiating high-immunoglobulin-concentration colostrum from low-immunoglobulin-concentration is problematic.<sup>8</sup> Measurement of the specific gravity of the colostrum of dairy cows with a commercially available hydrometer (Colostrometer) has been explored.<sup>86</sup> Originally it was claimed that measurement of specific gravity provided an inexpensive and practical method for estimating colostrum Ig concentration. However, the specific gravity of colostrum is more correlated with its protein concentration than Ig concentration and varies with colostrum temperature, thus limiting the predictive accuracy of the test. In addition, different relationships between specific gravity and Ig concentration of colostrum have been observed for different populations of Holstein and Jersey cows and between herds. Specific gravity may also vary considerably according to season of the year. Specific gravity was measured in 1085 first-milking colostrum samples from 608 dairy cows of four breeds on a single farm during a 5-year period.<sup>86</sup> The specific gravity more closely reflected protein concentration than IgG<sub>1</sub> concentration and was markedly affected by month of calving. Colostrum specific gravity values were highest for Holstein and Jersey cows, cows in third or later lactation and cows calving in autumn. They were lowest in Brown Swiss and Ayrshire cows, cows in first or second lactation, and cows calving in summer. Thus using the specific gravity of colostrum

as an indicator of IgG<sub>1</sub> concentration has potential limitations.

#### *Frozen and thawed colostrum*

Colostrum can be banked as frozen colostrum for future use.<sup>87</sup> Excess colostrum can be stored frozen and thawed as necessary to provide an IgG source when administration of dam colostrum is impractical or insufficient. Experience has shown that the composition of frozen colostrum remains constant throughout storage. No significant changes in pH, percentage acidity, milk fat, total solids, total nitrogen, or nonprotein resulted from colostrum being stored. Feeding 4 L of frozen thawed colostrum (which had been frozen at -20°C for 24 h) to calves by oesophageal tube at 3 hours after birth did not result in a significant difference in IgG absorption when compared to calves receiving fresh colostrum.<sup>87</sup>

#### *Pasteurization of colostrum*

Several infectious diseases of cattle can be transmitted from the dam to the calf through colostrum contaminated by direct shedding from the mammary gland or postharvest contamination. These diseases include Johne's disease, bovine leukosis, *Mycoplasma* spp., *Salmonella* spp., and *E. coli*. Strategies to control transmission of infectious agents to calves include pasteurizing colostrum. Pasteurization is effective in destroying *Mycoplasma bovis*, *Mycoplasma californicum*, and *Mycoplasma canadense* if an adequate temperature and time are used.

The method of pasteurization of colostrum affects its quality for calves. The potential disadvantage of heat-treating colostrum is that the immunoglobulins may become denatured. Pasteurization at 76°C for 15 minutes results in a marked decrease in calf serum IgG concentrations, a severe failure of transfer of passive immunity, indicating that the colostrum immunoglobulins were either destroyed or altered so that absorption was impaired. Pasteurization at 76°C for 15 minutes destroys or alters colostrum proteins and affects the serum concentration of lactoferrin and neutrophil oxidative metabolism.<sup>88</sup> Pasteurization of colostrum at 63°C for 15 minutes causes only negligible decreases in colostrum IgG concentrations when fed to calves.<sup>89</sup> However, these lower temperatures are less effective in the destruction of *Mycobacterium avium* subsp. *paratuberculosis* and other infectious agents transmitted through colostrum.

The effect of commercial on-farm batch pasteurization on colostrum IgG concentrations, fluid characteristics and serum IgG concentrations in calves fed fresh versus pasteurized colostrum have been compared.<sup>90</sup> Pasteurization of moder-

ately sized batches (57 L) using a commercial batch pasteurizer consistently produces a product of normal or slightly thickened consistency that can be fed to calves. Batch pasteurization of 57 L at 63°C for 30 minutes results in a significant reduction of IgG in colostrum (26%) but much less than when 95 L is pasteurized. The percentage loss of IgG is significantly reduced when starting with high-quality fresh colostrum (> 60 mg/L). Feeding pasteurized colostrum results in significantly lower serum IgG concentrations in calves. However, acceptable serum IgG levels can be achieved if the pasteurized colostrum is fed immediately after birth, if at least 4 L is fed and if the interval between the first and second feedings of colostrum is shortened.

#### *Colostrum supplements and replacers*

Some colostrum-derived oral supplements containing immunoglobulin are available for newborn calves in which colostrum intake is suspected or known to be inadequate. **Colostrum supplement** products have been developed to provide exogenous IgG to calves when the dam's fresh colostrum is of low IgG concentration. Many producers also use these products to replace colostrum when it is unavailable as a result of maternal agalactia, acute mastitis or other causes of inadequate colostrum supply. However, they contain low immunoglobulin concentrations compared to those found in high-quality first-milking colostrum. Most colostrum supplements provide only 25–45 g IgG/dose of 454 g, which is reconstituted in 2 L of water. Feeding one or even two doses of such supplements is insufficient to provide a mass of 100 g of IgG within the first 12 hours after birth. **Colostrum replacers** are intended to provide the sole source of IgG and thus must provide at least 100 g IgG. Newborn colostrum-deprived dairy calves fed spray-dried colostrum containing 126 g of immunoglobulin in 3 L of water as their sole source of Ig achieved normal mean serum immunoglobulin concentrations.<sup>91</sup> Whey protein concentrate as a colostrum substitute, administered to calves as a single feeding, was ineffective in preventing neonatal morbidity and mortality compared with a single feeding of pooled colostrum.<sup>92</sup>

The IgG derived from bovine serum or Ig concentrates from bovine plasma are well absorbed by neonatal calves when given in adequate amounts.<sup>93,94</sup> The serum concentration of IgG in calves at 2 days of age force-fed a colostrum supplement containing spray-dried serum (total of 90 g immunoglobulin protein) within 3 hours after birth was much lower than in calves fed 4 L of fresh colostrum.<sup>95</sup>

The mass of IgG and the method of processing are critical. Products providing less than 100 g of IgG/dose should not be used to replace colostrum.

To be successful, colostrum supplements and replacers must provide enough IgG mass, which results in 24-hour calf serum IgG concentrations of more than 10 g/L.

#### *Purified bovine immunoglobulin*

The administration of purified bovine gammaglobulin to calves that are deficient appears to be a logical approach but the results have been unsuccessful. Large doses (30–50 g) of gammaglobulin given intravenously would be required to increase the level of serum gammaglobulin from 0.5 g/dL to 1.5 g/dL of serum, which is considered an adequate level. The cost would be prohibitive. The administration of gammaglobulins by any parenteral route other than the intravenous route does not result in a significant increase in serum levels of the immunoglobulin.

To be effective, infusion of immunoglobulin derived from blood must increase serum IgG concentrations and reduce morbidity and mortality prior to weaning without affecting later production. Parenteral infusions of immunoglobulins will increase the concentrations of serum IgG in calves but may not necessarily have an effect on morbidity or mortality.<sup>96</sup> High levels of specific circulating Ig can serve as a reservoir of antibody to move into the intestine and prevent enteric infection.<sup>97</sup> Thus immunoglobulin sources other than colostrum may not provide Ig that are specific for antigens present in the environment or might be insufficient when calves are exposed to a heavy infection pressure.

The other factors that influence the ingestion of colostrum and the absorption of immunoglobulin are presented in the section on the epidemiology of colibacillosis, above, and in Chapter 3.

#### *Guidelines to insure transfer of colostrum immunoglobulins*

Some guidelines for insuring that newborn farm animals ingest sufficient quantities of colostrum and absorb adequate amounts of colostrum immunoglobulins are summarized here. Additional details are presented in Chapter 3.

#### *Dairy calves*

The following should be implemented:

- Immediately after birth, unless the calf is a vigorous sucker, colostrum should be removed from the cow and fed by nipple bottle or by stomach tube at the rate of at least 50 mL/kg BW in the first 2 hours. Encouragement and assistance to suck to satiation within the first hour after birth is also highly effective in

achieving high levels of colostral immunoglobulins in the serum of the calf.<sup>98</sup> If pooled colostrum is used, calves should be fed 3–4 L of first-milking colostrum

- The calf can be left with the cow for at least 2 days. This contact will improve the absorption of immunoglobulin. However, there is now a trend, at least in large dairy herds, to remove the calf immediately after birth, place it in a stall and force-feed it colostrum. This practice may also prevent spread of infectious disease from mature cattle to calves
- Following the colostral feeding period, dairy calves are usually placed in individual stalls until weaning. The daily feeding of stored fermented colostrum to newborn calves for up to 3 weeks after birth provides a source of lactoglobulins in the intestinal tract and reduces the incidence of neonatal diarrhea of calves due to a wide variety of pathogens, but this practice may be impractical
- Calves should be fed regularly, and preferably by the same person. One of the most important factors affecting dairy calf mortality is the concern and care provided by the calf rearer. The calf mortality rate is likely to be lower when members of the family care for the calves compared to hired help
- Colostrum stored at room temperature should be handled adequately to minimize bacterial contamination. Up to 36% of colostrum samples from calf nursing bottles in dairy herds may be contaminated with *Staphylococcus* spp., Gram-negative rods, coliforms, and *Streptococcus uberis*.<sup>99</sup> The relative risk of contamination with more than 100 000 bacteria/mL was greater in warm months than in cooler months, and in colostrum fed to male calves. The greater risk to male calves may reflect less attention to hygiene and management procedures compared to female calves
- The housing and ventilation must be adequate to avoid stress.

#### Beef calves

The management strategies to decrease calf death losses in beef herds has been described.<sup>100</sup> The role of management intervention in the prevention of neonatal deaths includes measures to improve host defenses and environmental hygiene to minimize outbreaks of neonatal disease. Specific attention is centered on preventing dystocia, improving transfer of colostral immunoglobulins, and limiting environmental contamination.<sup>100</sup>

The following should be implemented:

- Management of the beef herd must emphasize prevention of dystocia, which involves limiting calf size and ensuring adequate pelvic area of the dams<sup>100</sup>
- Beef calves should be assisted at birth, if necessary, to avoid exhaustion and weakness from a prolonged parturition<sup>100</sup>
- Normally beef calves will make attempts to get up and suck within 20 minutes after birth but this may be delayed for up to 8 hours or longer. Beef calves that do not suck within 2 hours should be fed colostrum by nipple bottle or stomach tube. Whenever possible they should be encouraged and assisted to suck to satiation within 1 hour after birth. The dam can be restrained and the calf assisted to suck. If the calf is unable or unwilling to suck, the dam should be restrained and milked out by hand, and the calf fed the colostrum with a nipple bottle or stomach tube. The mean volume of colostrum and colostral immunoglobulins produced in beef cows and the absorption of colostral immunoglobulins by their calves can vary widely. Beef calves deserted by indifferent dams need special attention. Failure of transfer of passive immunity is common and estimated at 10–40% of beef calves<sup>100</sup>
- Constant surveillance of the calving grounds is necessary to avoid overcrowding, to detect diarrheic calves that should be removed, to avoid mismothering, and to insure that every calf is seen to nurse its dam. Although up to 25% of beef calves may not have sufficient serum levels of immunoglobulins, the provision of excellent management will minimize the incidence of colibacillosis. The recently developed practice of corticosteroid-induced parturition in cattle may result in a major mismothering problem if too many calves are born too quickly in a confined space. Every management effort must be used to establish the cow/calf herd as soon as possible after birth. This will require high-quality management to reduce even further the infection rate and minimize any stressors in the environment.

#### Lambs

Lambs require 180–210 mL of colostrum/kg BW during the first 18 hours after birth to provide sufficient energy for heat production.<sup>101</sup> Such an intake will usually also provide enough colostral immunoglobulins. Early encouragement and assistance of the lambs to suck the ewe is

important. Well-fed ewes usually have sufficient colostrum for singletons or twins. Underfed ewes may not have sufficient colostrum for one or more lambs and supplementation from stored colostrum obtained by milking other high-producing ewes is a useful practice.

#### Piglets

The following should be implemented:

- Every possible economical effort must be made to insure that each newborn piglet obtains a liberal supply of colostrum within minutes of birth. The farrowing floor must be well drained and it must be slip-proof to allow the piglets to move easily to the sow's udder. Some herdsmen provide assistance at farrowing, drying off every piglet as it is born and placing it immediately onto a teat
- The washing of the sow's udder immediately before farrowing with warm water and soap will reduce the bacterial population and may provide relief in cases of congested and edematous udders
- The piglet creep area must be dry, appropriately heated for the first week and free from drafts. During farrowing, colostrum is released in discrete ejections, possibly by discrete release of oxytocin associated with parturition. Therefore, as the piglets are born they must be as close to the udder as possible in order to take advantage of these discrete ejections.

#### Increasing specific resistance of the newborn by vaccinating the pregnant dam or the newborn

The immunization of neonate farm animals against colibacillosis by vaccination of the pregnant dam or by vaccination of the fetus or the neonate has received considerable research attention in recent years and the results appear promising.<sup>102</sup>

Such vaccines are practical and effective because:

- Most fatal enterotoxigenic *E. coli* infections in farm animals occur in the early neonatal period when antibody titers in colostrum and milk are highest
- More than 90% of the enterotoxigenic *E. coli* in farm animals belong to a small family of fimbrial antigens
- Fimbriae consist of good protein antigens on the bacterial surface where they are readily accessible to antibody
- Fimbriae are required for a critical step (adhesion–colonization) early in the pathogenesis of the disease
- Novel or previously low-prevalence fimbrial antigens have not emerged to render the vaccines ineffective.



The pregnant dam is vaccinated 2–4 weeks before parturition to induce specific antibodies to particular strains of enteropathogenic *E. coli*, and the antibodies are then passed on to the newborn through the colostrum. The mechanism of protection is the production of antibodies against the pilus antigens, which are responsible for colonization of the *E. coli* in the intestine.<sup>102</sup>

**Vaccination is an aid to good management and not a replacement for inadequate management.** Vaccines to prevent enterotoxigenic *E. coli* diarrhea in calves and piglets are based on the prevailing fimbrial antigens for colonization by enterotoxigenic *E. coli* in calves (F5) and newborn pigs (F4, F5, and F6). Reliable data on the efficacy of the commercial vaccines based on randomized clinical field trials are not available but most animal health professionals perceive that the vaccines are effective and that disease occurs primarily in unvaccinated herds. There are unpublished anecdotal reports that use of the vaccine in cattle has shifted the peak occurrence of diarrhea in calves from the first week to the third and fourth week after birth. The extensive use of fimbria-based vaccines can select against the prevailing fimbrial antigen types as reflected in the vaccines, and emergence of new or previously low-prevalence fimbrial antigens may occur. fimbriae antigenically distinct from F1, F4, F6, F41 occur among enterotoxigenic *E. coli*. However, these antigen types are less prevalent than those currently used in commercial vaccines. There is no evidence that enterotoxigenic *E. coli* with novel colonization mechanisms or new fimbrial antigens have emerged under the selection pressure of vaccination. Nor is there evidence that previously 'low-prevalence' fimbrial antigen type enterotoxigenic *E. coli*, not represented in the vaccines, have emerged as 'common pathogens' filling an ecological niche left by the fimbrial antigen types targeted by the vaccines.

#### Calves

Vaccination of pregnant cattle with either purified *E. coli* K99<sup>+</sup> pili or a whole-cell preparation containing sufficient K99<sup>+</sup> antigen can significantly reduce the incidence of enterotoxigenic colibacillosis in calves. Good protection is also possible when the dams are vaccinated with a four-strain *E. coli* whole-cell bacterin containing sufficient K99<sup>+</sup> pilus antigen and the polysaccharide capsular K antigen. Colostral antibodies specific for K99<sup>+</sup> pilus antigen and the polysaccharide capsular K antigen on the surface of the challenge exposure strain of enterotoxigenic *E. coli* are protective. There is a highly significant

correlation between the lacteal immunity to the K99<sup>+</sup> antigen and the prevention of severe diarrhea or death in calves challenged with enterotoxigenic *E. coli*. The colostrum levels of K99<sup>+</sup> antibody are highest during the first 2 days after parturition, which is the most susceptible period for enterotoxigenic colibacillosis to occur in the newborn calf. The continuous presence of the K99<sup>+</sup> antibody in the lumen of the intestine prevents adherence of the bacteria to the intestinal epithelium. The K99<sup>+</sup> antibody is also absorbed during the period of immunoglobulin absorption and may be excreted into the intestine during diarrhea. This may be one of the reasons that mortality is inversely proportional to serum immunoglobulin levels. The pregnant dams are vaccinated twice in the first year, 6 and 2 weeks prior to parturition. Each year thereafter they are given a single booster vaccination. An oil emulsion *E. coli* K99<sup>+</sup> bacterin given once or twice to pregnant beef cows 6 weeks before calving elicited high levels of serum antibody that provided protection against experimental infection of newborn calves for up to 87 weeks after vaccination.

Vaccines containing both the K99<sup>+</sup> antigen of enterotoxigenic *E. coli* and rotavirus, and in some cases coronavirus, have been evaluated with variable results. The colostrum antibodies to the K99<sup>+</sup> antigen are higher in vaccinated than unvaccinated dams but the colostrum antibodies to rotavirus and coronavirus may not be significantly different between vaccinated and unvaccinated dams. In these field trials vaccination had no effect on the prevalence of diarrhea, calf mortality or the presence of the three enteropathogens. In other field trials the combined vaccine did provide some protection against outbreaks of calf diarrhea. The use of an inactivated oil-adjuvanted rotavirus *E. coli* vaccine given to beef cows in the last trimester of pregnancy decreases the mortality from diarrhea and has a positive influence on the average weight gains of the calves at weaning. To be effective the rotavirus and coronavirus antibodies must be present in the post-colostral milk for several days after parturition during the period when calves are most susceptible to the viral infection. Vaccination of pregnant cows twice during the dry period at intervals of 4 weeks can increase the colostrum antibody levels to *E. coli* K99<sup>+</sup> by 26 times on day 1 compared to controls. Much lower increases occur at the levels of coronavirus and rotavirus.

A commercially inactivated vaccine containing bovine rotavirus (serotype G6 P5), bovine coronavirus (originally isolated from a calf with diarrhea) and purified

cell-free *E. coli* FS (K99) (adsorbed on to aluminum hydroxide gel), formulated as an emulsion in a light mineral oil has been evaluated in a herd of Ayrshire/Friesian cows vaccinated once 31 days before the first expected calving date.<sup>103</sup> Compared to control cows, a significant increase in the mean specific antibody titer against all three antigens occurred in the serum of vaccinated animals (even in the presence of pre-existing antibody), which was accompanied by increased levels of protective antibody to rotavirus, coronavirus, and *E. coli* F5 (K99) in their colostrum and milk for at least 28 days.

Because naturally acquired antibodies to **the J5 antigen** may have an important role in the control of neonatal disease caused by bacterial infections with associated pathogens that share antigens with *E. coli* (J5 strain), vaccination of calves with an *E. coli* O111:B4(J5) vaccine at 1–3 days of age and 2 weeks later has been evaluated to control morbidity and mortality in dairy calves up to 60 days of age.<sup>29</sup> The use of either a killed *E. coli* O111:B4(J5) bacterin or a modified live, genetically altered (aro-) *Salmonella dublin* vaccine, or both in neonatal calves was effective in reducing mortality due to colibacillosis and salmonellosis.<sup>104</sup> Such a vaccine may be beneficial in controlling mortality in well-managed herds but is contraindicated in poorly managed herds.

Passive immunotherapy of calves under 2 days of age with J5 *E. coli* hyperimmune plasma given subcutaneously at a dose of 5 mL/kg BW has been examined.<sup>105</sup> The plasma was safe and potent. It was not superior to control plasma or to no treatment for calf morbidity and mortality.

The oral administration of a K99<sup>+</sup>-specific monoclonal antibody to calves during the first 12 hours after birth may be an effective method of reducing the incidence of fatal enterotoxigenic colibacillosis, particularly when outbreaks of the disease occur in unvaccinated herds. Clinical trials indicate that the severity of dehydration, depression, weight loss and duration of diarrhea were significantly reduced in calves that had received the K99<sup>+</sup>-specific monoclonal antibody. In experimentally challenged calves the mortality was 29% in the treated calves and 82% in the control calves.

The decision to vaccinate in any particular year will depend on the recognition of risk factors. Such risk factors include:

- A definitive diagnosis of enteropathogenic K99<sup>+</sup> *E. coli* in the previous year
- A population density in the calving grounds that is conducive to the disease

- Calving during the year when the environmental conditions are wet and uncomfortable for the calves
- A large percentage of primiparous dams that do not have protective levels of K99<sup>+</sup> antibody in their colostrum.

#### Piglets

Piglets born from gilts are more susceptible than those from mature sows, which suggests that immunity improves with parity. On a practical basis this suggests that gilts should be mixed with older sows that have been resident on the premises for some time. The length of time required for such natural immunization to occur is uncertain, but 1 month during late gestation seems logical.

Naturally occurring enteric colibacillosis in newborn piglets can be effectively controlled by vaccination of the pregnant dam. Field trials in large-scale farm conditions indicate that the vaccines are efficacious.<sup>106</sup> Partial budget analysis of vaccinating pregnant sows with *E. coli* vaccines revealed an economic return on investment of 124% because of the decrease in morbidity and mortality due to diarrhea in piglets 1–2 weeks of age.<sup>107</sup> Three antigen types of pili, designated K88<sup>+</sup>, K99<sup>+</sup>, and 987P, are now implicated in colonization of the small intestine of newborn piglets by enterotoxigenic *E. coli*. The vaccination of pregnant sows with oral or parenteral vaccines containing these antigens will provide protection against enterotoxigenic colibacillosis associated with *E. coli* bearing pili homologous to those in the vaccines. The parenteral vaccines are cell-free preparations of pili, and the oral vaccines contain live enteropathogenic *E. coli*. The oral vaccine is given 2 weeks before farrowing and is administered in the feed daily for 3 days as 200 mL per day of a broth culture containing 10<sup>11</sup> *E. coli*. A simple and effective method of immunization of pregnant sows is to feed live cultures of enterotoxigenic *E. coli* isolated from piglets affected with neonatal colibacillosis on the same farm. The oral vaccine can be given in the feed, beginning about 8 weeks after breeding and continued to parturition. The oral vaccine results in the stimulation of IgA antibody in the intestinal tract, which is then transferred to the mammary gland and into the colostrum. A combination of oral and parenteral vaccination is superior to either route alone. The parenteral vaccine is given about 2 weeks after breeding and repeated 2–4 weeks before parturition. The parenteral vaccination results in the production of high levels of IgM antibody for protection against both experimental and naturally occurring enterotoxigenic colibacillosis. This vaccination also reduces

the number of *E. coli* excreted in the feces of vaccinated sows, which are major sources of the organism. Immunization of pregnant sows with an *E. coli* bacterin enriched with the K88<sup>+</sup> antigen results in the secretion of milk capable of preventing adhesion of K88<sup>+</sup> *E. coli* to the gut for at least 5 weeks after birth, at which time the piglet becomes naturally resistant to adhesion by the organism.

The possibility of selecting and breeding from pigs that may be resistant genetically to the disease is being explored. The highest incidence of diarrhea occurs in progeny of resistant dams and sired by susceptible sires. The homozygous dominants (SS) and the heterozygotes (Ss) possess the receptor and are susceptible whereas in the homozygous recessives (ss) it is absent and the pigs are resistant. Sows that are genetically resistant may not be able to mount an immune response to the K88<sup>+</sup> antigen because of the inability of the organism to colonize the intestinal tract.

#### Competitive exclusion culture

An alternative method of control is the use of competitive exclusion cultures.<sup>108</sup> The theory of competitive exclusion technology is to colonize the neonatal gastrointestinal tract with beneficial/commensal bacteria considered to be the normal flora of the healthy animals of a particular species. The mechanism of action is not known but hypotheses include: exclusion of enteropathogens by competitive attachment sites and/or for nutrients; stimulation of the local immune mechanisms, which preclude colonization/invasion by enteric pathogens; and the production of various antimicrobial substances that either have direct action on pathogenic bacteria or produce conditions within the intestine that are unfavorable for the growth and colonization by pathogens. Experimentally, the oral administration of a porcine competitive exclusion culture to piglets within 12 hours after birth resulted in significant reductions in mortality, incidence of fecal shedding, and intestinal colonization by *E. coli* when compared to control values. Mortality decreased from 23% in the control group to 2.7% in the treated group.

#### Lambs and kids

Vaccination of pregnant ewes with K99<sup>+</sup> antigen will confer colostrum immunity to lambs challenged with homologous enteropathogenic *E. coli*. The pregnant ewes are vaccinated twice in the first year, at 8–10 weeks and 2–4 weeks before lambing, and in the second year one vaccination 2–4 weeks before lambing is adequate.

Immunization of pregnant goats has been used to stimulate the development

of lacteal immunity against naturally occurring colibacillosis in kids.<sup>109</sup> Vaccination of pregnant does 1 month before parturition with a subunit vaccine containing K88, K9, and 987P fimbrial antigens of *E. coli*, and *C. perfringens* types B, C, and D toxins in an aluminum hydroxide adjuvant, along with improved management conditions, was highly successful in reducing neonatal morbidity and mortality due to diarrhea.<sup>40</sup> Compared to two control groups, one in which no improvement in management was made and the second in which improvements were made without vaccination, in the vaccinated group with improved management conditions, neonatal morbidity and mortality were both reduced by a factor of 3 in Group 1 and by factors of 9.5 and 12.5 in Group 3. Also, the duration of diarrhea was 3.7 and 12 times shorter in the kids of Groups 2 and 3, respectively.

#### REVIEW LITERATURE

- Acres SD. Enterotoxigenic *Escherichia coli* infections in newborn calves: a review. *J Dairy Sci* 1985; 68:229–256.
- Gyles CL, ed. *Escherichia coli* in domestic animals and humans. Wallingford, UK: CAB International, 1994.
- Angelos SM, VanMetre DC. Treatment of sodium balance disorders. *Vet Clin North Am Food Anim Pract* 1999; 15:587–607.
- Berchtold J. Intravenous fluid therapy of calves. *Vet Clin North Am Food Anim Pract* 1999; 15:505–530.
- Constable PD. Hypertonic saline. *Vet Clin North Am Food Anim Pract* 1999; 15:559–585.
- Garcia JP. A practitioners' view on fluid therapy in calves. *Vet Clin North Am Food Anim Pract* 1999; 15:533–543.
- Kasari TR. Metabolic acidosis in calves. *Vet Clin North Am Food Anim Pract* 1999; 15:473–486.
- Naylor JM. Oral electrolyte therapy. *Vet Clin North Am Food Anim Pract* 1999; 15:487–504.
- Weaver DM, Tyler JW, VanMetre DC et al. Passive transfer of colostrum immunoglobulins in calves. *J Vet Intern Med* 2000; 14:569–577.
- Barrington GM, Parish SM. Bovine neonatal immunology. *Vet Clin North Am* 2001; 17:463–476.
- DeRoy C, Maddox CW. Identification of virulence attributes of gastrointestinal *Escherichia coli* isolates of veterinary significance. *Anim Health Res Rev* 2001; 1:129–140.
- George JW. The usefulness and limitations of handheld refractometers in veterinary laboratory medicine: an historical and technical review. *Vet Clin Pathol* 2001; 30:201–210.
- Barrington GM, Gay JM, Evermann JF. Biosecurity for neonatal gastrointestinal diseases. *Vet Clin North Am Food Anim Pract* 2002; 18:7–34.
- Renter DG, Sargeant JM. Enterohemorrhagic *Escherichia coli* O157H7: epidemiology and ecology in bovine production environments. *Anim Health Res Rev* 2002; 3:83–94.
- Constable P. Fluid and electrolyte therapy in ruminants. *Vet Clin North Am Food Anim Pract* 2003; 19:557–597.
- Constable PD. Antimicrobial use in the treatment of calf diarrhea. *J Vet Intern Med* 2004; 18:8–17.
- Gyles CL, Prescott JF, Songer JG, Thoen CO. Pathogenesis of bacterial infections in animals, 3rd ed. Ames, IA: Blackwell, 2004.

Larson RL, Tyler JW, Schultz LG et al. Management strategies to decrease calf death losses in beef herds. *J Am Vet Med Assoc* 2004; 224:42–48.

Moxley RA. *Escherichia coli* O157H7: an update on intestinal colonization and virulence mechanisms. *Anim Health Res Rev* 2004; 5:15–33.

## REFERENCES

- Gyles CL, ed. *Escherichia coli* in domestic animals and humans. Wallingford, UK: CAB International, 1994.
- Gyles CL et al. Pathogenesis of bacterial infections in animals, 3rd ed. Ames, IA: Blackwell, 2004.
- DebRoy C, Maddox CW. *Anim Health Res Rev* 2001; 1:129.
- Moxley RA. *Anim Health Res Rev* 2004; 5:15.
- Renter DG, Sargeant JM. *Anim Health Res Rev* 2002; 3:83.
- Vihan VS et al. *Prev Vet Med* 1992; 13:179.
- Chandler DS et al. *Vet Microbiol* 1994; 38:203.
- Weaver DM et al. *J Vet Intern Med* 2000; 14:569.
- Clement JC et al. *J Am Vet Med Assoc* 1995; 207:1134.
- Pare J et al. *Can J Vet Res* 1993; 57:241.
- Wesselink R et al. *N Z Vet J* 1999; 47:31.
- Filteau V et al. *Can Vet J* 2003; 44:907.
- Christley RM et al. *Prev Vet Med* 2003; 57:209.
- Schumann FJ. *Can J Vet Res* 1990; 54:366.
- Frank GH et al. *J Clin Microbiol* 1994; 32:256.
- Aldridge BM et al. *J Am Vet Med Assoc* 1993; 203:1324.
- Contrepolis M et al. *Vet Microbiol* 1998; 64:75.
- Fecteau G et al. *Vet Microbiol* 2001; 78:241.
- Bell CJ et al. *Vet Microbiol* 2002; 85:251.
- Fischer J et al. *Am J Vet Res* 1994; 55:991.
- Mainil JG et al. *Vet Microbiol* 1993; 54:1064.
- De la Feunte R et al. *Am J Vet Res* 2002; 63:262.
- Pearce MC et al. *Appl Environ Microbiol* 2004; 70:1708.
- Cobbold R, Desmarchelier P. *Vet Microbiol* 2000; 71:125.
- Gunning RF et al. *Vet Rec* 2001; 148:780.
- Orden JA et al. *Vet Microbiol* 1998; 63:239.
- Kang SJ et al. *Vet Microbiol* 2004; 98:323.
- Irino K et al. *Vet Microbiol* 2005; 105:29.
- Aidar L et al. *Can J Vet Res* 2000; 64:15.
- Mercado EC et al. *J Vet Med B* 2004; 51:82.
- Wani SA et al. *Vet Rec* 2004; 154:506.
- Bottelheim KA et al. *Aust Vet J* 2001; 79:289.
- Burns AL et al. *Vet Microbiol* 1996; 49:235.
- Wray C et al. *Res Vet Sci* 1993; 54:290.
- Mainil JG et al. *Vet Microbiol* 1999; 70:123.
- Orden JA et al. *Vet Microbiol* 1999; 66:265.
- Van Bost S et al. *Vet Microbiol* 2001; 82:311.
- Casey TA et al. *Am J Vet Res* 1992; 53:1488.
- Cambier C et al. *Am J Vet Res* 2001; 62:799.
- Kristas SK et al. *Small Rumin Res* 2003; 50:51.
- Grove-White DH, White DG. *Vet Rec* 1999; 144:639.
- Omole O et al. *J Nutr* 2001; 131:2128.
- Ewaschuk JB et al. *J Vet Intern Med* 2004; 18:744.
- Ewaschuk JB et al. *J Vet Intern Med* 2003; 17:940.
- Kasari TR. *Vet Clin North Am Food Anim Pract* 1999; 15:473.
- Angelos SM et al. *J Am Vet Med Assoc* 1999; 214:1364.
- Angelos SM, VanMetre DC. *Vet Clin North Am Food Anim Pract* 1999; 15:587.
- Carmalt JL et al. *J Am Vet Med Assoc* 2000; 216:68.
- Gutzwiller A, Blum JW. *Am J Vet Res* 1996; 57:560.
- Stordeur P et al. *Microbes Infect* 2000; 2:17.
- Wani SA et al. *Small Rumin Res* 2004; 52:145.
- Green SL, Smith LL. *J Am Vet Med Assoc* 1992; 201:125.
- Fecteau G et al. *Can Vet J* 1997; 38:101.
- Fecteau G et al. *Can Vet J* 1997; 38:95.
- Lofstedt J et al. *J Vet Intern Med* 1999; 13:81.
- Constable PB et al. *J Am Vet Med Assoc* 1998; 212:991.
- Randall LP et al. *Vet Rec* 1997; 140:112.
- Woodward MJ et al. *Vet Microbiol* 1992; 31:251.
- Knowles TG et al. *Vet Rec* 2000; 147:593.
- Grove-White DH, White DG. *Vet Rec* 1993; 133:499.
- Grove-White DH, Michell AR. *Vet Rec* 2001; 148:365.
- Constable PD. *Am J Vet Res* 2002; 63:482.
- Nappert G, Naylor JM. *Can Vet J* 2001; 42:364.
- Dawes ME et al. *J Am Vet Med Assoc* 2002; 220:791.
- Calloway CD et al. *J Am Vet Med Assoc* 2002; 221:1606.
- Tyler JW et al. *J Vet Intern Med* 1999; 13:40.
- Tyler JW et al. *J Vet Intern Med* 1999; 13:335.
- Perino LJ et al. *Am J Vet Res* 1993; 54:56.
- Maden M et al. *J Vet Med B* 2003; 50:128.
- Garcia JP. *Vet Clin North Am Food Anim Pract* 1999; 15:533.
- Senturk S. *J Vet Med A* 2003; 50:57.
- Constable PD. *Vet Clin North Am Food Anim Pract* 1999; 15:559.
- Berchtold J. *Vet Clin North Am Food Anim Pract* 1999; 15:505.
- Naylor JM. *Vet Clin North Am Food Anim Pract* 1999; 15:487.
- Constable P. *Vet Clin North Am Food Anim Pract* 2003; 19:557.
- Teale CJ et al. *Vet Rec* 2005; 156:186.
- Constable PD. *J Vet Intern Med* 2004; 18:8.
- Gunn GJ et al. *Vet J* 2003; 165:172.
- Hariharan H et al. *Can Vet J* 2004; 45:605.
- Gunn GJ, Low JC. *Vet Rec* 2003; 152:537.
- Orden JA et al. *Vet Rec* 2000; 147:576.
- Orden JA et al. *J Vet Med B* 2000; 47:329.
- White DG et al. *J Clin Microbiol* 2000; 38:4593.
- Orden JA et al. *J Antimicrob Chemother* 2001; 48:421.
- Langford FM et al. *J Dairy Sci* 2003; 86:3963.
- Lofstedt J et al. *Can J Vet Res* 1996; 60:210.
- Howard P. *Vet Rec* 2004; 153:262.
- Morin DE et al. *J Dairy Sci* 2001; 84:937.
- Holloway NM et al. *J Am Vet Med Assoc* 2001; 219:357.
- Lakritz J et al. *Am J Vet Res* 2000; 61:1021.
- Tyler JW et al. *J Dairy Res* 2000; 67:619.
- Godden SM et al. *J Dairy Sci* 2003; 86:1503.
- Chelak BJ et al. *Can Vet J* 1993; 34:407.
- Mee JF et al. *J Dairy Sci* 1996; 79:886.
- Arthington JD et al. *J Dairy Sci* 2000; 83:1463, 2834.
- Quigley JD et al. *J Dairy Sci* 2001; 84:2059.
- Holloway NM et al. *J Vet Intern Med* 2002; 16:187.
- Quigley JD, Welborn MG. *J Dairy Sci* 1996; 79:2032.
- Besser TE et al. *J Virol* 1988; 62:2234.
- Quigley JD et al. *J Dairy Sci* 1995; 78:893.
- Fecteau G et al. *Can Vet J* 2002; 43:523.
- Larson RL et al. *J Am Vet Med Assoc* 2004; 224:42.
- Mellor DJ, Murray L. *Vet Rec* 1986; 118:351.
- Moon HW, Bunn TO. *Vaccine* 1993; 31:213.
- Crouch CF et al. *Vet Rec* 2001; 149:105.
- Selim SA et al. *Vaccine* 1995; 13:381.
- Selim SA et al. *Vaccine* 1995; 13:1149, 1454.
- Osek J et al. *Compend Immunol Microbiol Infect Dis* 1995; 18:1.
- Wittum TE, Dewey CE. *J Swine Health Prod* 1996; 4:9.
- Genovese KJ et al. *Can J Vet Res* 2000; 64:204.
- Vihan VS. *Small Rumin Res* 1993; 11:179.

## ENTEROHEMORRHAGIC *ESCHERICHIA COLI* IN FARM ANIMALS AND ZONOTIC IMPLICATIONS

Enterohemorrhagic *Escherichia coli*, particularly the O157:H7 serogroup, has become a worldwide public health concern because it is the cause of 'hamburger disease'. This serotype was first recognized as a pathogen in 1982 after two human illness outbreaks in Oregon and Michigan. Since then, *E. coli* O157:H7 has caused major human illness outbreaks worldwide, including one affecting 600 people (two deaths) in the western USA and another 10 000 people (11 deaths) in Japan.

Cattle feces are a major source of *E. coli* O157:H7 that cause human diseases, most of which have been traced to consumption of undercooked beef that had been contaminated with bovine feces. In contrast to humans, cattle infected with *E. coli* O157:H7 remain free of disease and are tolerant of *E. coli* O157:H7 for most of their lives. *E. coli* O157:H7 strains are not pathogenic in calves over 3 weeks of age.

As a consequence, considerable resources have been devoted to defining the epidemiology and ecology of *E. coli* O157:H7 in the cattle environment so that control might begin at the farm level. Sheep also harbor *E. coli* O157:H7 and non-*E. coli* O157:H7 verotoxin-producing *E. coli* at rates similar to or higher than those reported in cattle.

## ETIOLOGY

*E. coli* O157:H7 is the major serotype that was first recognized as a cause of human illness. *E. coli* O157:H7 is one of more than 60 serotypes of verotoxin-producing *E. coli* that cause a variety of human illnesses such as mild diarrhea, hemorrhagic colitis and hemolytic-uremic syndrome. These illnesses result from verotoxins (VT1 and VT2) similar to those produced by *Shigella dysenteriae* and are known for their toxic effects on African-Green Monkey kidney (Vero cells in cultures). These toxins are different proteins, are encoded by different genes and have similar toxic effects.

Several non-O157:H7 verotoxin-producing *E. coli* (O6:H31, O26:H- (nonmotile), O26:H11, O48:H21, O9:H-, O104:H21, O113:H21, and O26:H2) have been associated with human disease outbreaks in the USA and in other countries.<sup>1</sup> Because most of these outbreaks have been traced to consumption of undercooked beef that had been contaminated with bovine feces, cattle have been considered to be reservoirs of verotoxin-producing *E. coli*. Sheep may harbor *E. coli* O157:H7 and non-O157:H7 verotoxin-producing *E. coli* at rates similar to or higher than in cattle.

Naturally occurring cases of **attaching** and **effacing** lesions of the intestines in calves with diarrhea and dysentery and infected with *E. coli* O126:H11, the predominant verotoxin-producing *E. coli* in humans, have been described in the UK.<sup>2</sup> Verotoxin-producing *E. coli* and *eae*-positive non-verotoxin-producing *E. coli* have been isolated from diarrheic dairy calves 1–30 days of age.<sup>3</sup>

#### EPIDEMIOLOGY

The literature of the epidemiological surveys on the prevalence of contamination of healthy cattle with *Escherichia coli* O157:H7 has been reviewed,<sup>4</sup> as has the literature on the epidemiology and ecology of *E. coli* O157:H7 in bovine production environments.<sup>5</sup>

#### Occurrence and prevalence of infection

##### Cattle

Cattle are nonclinical natural reservoirs of *E. coli* O157:H7. Estimates of the prevalence of verotoxin-producing *E. coli* fecal carriage among populations of cattle vary considerably.

The herd prevalence of infection with *E. coli* O157:H7 in North American and European cattle herds ranges from 3–8% and 0.5–1.0% of animals, with a higher prevalence up to 5% in weaned calves and heifers.<sup>4</sup> Some surveys reported the organism in dairy and beef cattle at 0.28% and 0.71%, respectively.<sup>6</sup> Other studies found much higher levels of prevalence, such as 15.7% of cattle over a 1-year period. Monthly prevalences ranged from 4.8–36.8% and were highest in the spring and late summer.

The prevalence of *E. coli* O157:H7 is influenced by numerous variables, including the season, the scope, frequency and timing of sampling, and the conditions of sampling and storage. The organism can be found widely distributed in samples from several types of cattle including beef calves, stocker cattle, feedlot cattle, adult beef cows, dairy calves, water sources and wildlife.<sup>7</sup> The prevalence is commonly higher in feeder-age cattle.

The prevalence of *E. coli* O157:H7 infection in range beef calves at weaning prior to arrival at the feedlot varies from 1.7–20.0% with an average of 7.4%.<sup>8</sup> All herds had high prevalence of anti-O157 antibodies, ranging from 63–100% of individuals within herds. Most calves (83%) and all herds (100%) have been exposed to *E. coli* O157:H7. In a naturally infected cow/calf herd followed over a period of 2 years, postpartum shedding of *E. coli* O157:H7 and cow-calf or calf-calf transmission under confined conditions in the postpartum period appeared to be potentially important factors in initial infection of beef calves.<sup>9</sup> Parturition, calving

pens and weaning appear to be important factors in maintaining *E. coli* O157:H7 infections in some herds.

Different serotypes of verotoxin-producing *E. coli* known to cause human illness have been found in the feces of culled beef cows at the time of shipping to slaughter.<sup>10</sup>

The diversity, frequency, and persistence of *E. coli* O157:H7 strains in cattle, wildlife and water sources within range cattle production environments indicates that the molecular epidemiology of the organism is very complex.<sup>11</sup>

The prevalence of *E. coli* O157:H7 in dairy cattle is similar worldwide and ranges from 1–5% in heifers and less than 1% in adult cattle. The herd-level prevalence varies from 0–100%.<sup>4</sup> The herd-prevalence of *E. coli* O157:H7 in dairy cattle in the subtropical south-eastern USA in the summer months was 38.5%, and the cow-level prevalence was 6.5%.<sup>12</sup> Among positive herds, prevalence ranged from 3–35%. The prevalence was higher during the spring and summer months compared to the winter season. Site-specific prevalences of *E. coli* O157:H7 from the oral cavity, skin, and fecal samples were 0%, 0.7%, and 25.2% respectively. Interestingly, in these same areas, reported cases of *E. coli* O157:H7 infections in humans are relatively uncommon and do not support the hypothesis that *E. coli* O157:H7 infections in humans are rare in southern states because of the low prevalence in cattle.

Viable *E. coli* O157:H7 can be isolated from the oral cavity, multiple hide surfaces and feces of a high percentage of feedlot beef cattle, and bacterial culture of feces alone generally underestimates the prevalence of *E. coli* O157:H7 in feedlot cattle.<sup>13</sup>

A survey of 60 Danish dairy cattle farms found a herd-prevalence of *E. coli* O157:H7 of 17% and an individual animal prevalence of 3.6%.<sup>14</sup> The high-risk age group for *E. coli* O157:H7 was calves between 2 and 6 months of age (8.6% positive), in contrast to calves under 2 months of age (0.7%) and cows (2.4%).<sup>14</sup>

*E. coli* O157:H7 is widespread in cattle in England and Wales. During a survey between June and December, the herd-prevalence on positive farms ranged from 1.1–51.4%, and the overall individual animal prevalence was 4.2%, and 10.3% among animals in positive herds.<sup>15</sup> The prevalence of excretion was least in calves under 2 months of age, peaked in calves between 2 and 6 months of age and declined thereafter. Multiple phage types of *E. coli* O157:H7 were isolated from almost a third of the herds, and the phages types were similar to those responsible for human infections in England and

Wales during the same period. Similar prevalences have been found in dairy cattle in Brazil.<sup>16</sup>

Attaching and effacing *E. coli* (AEEC) of various strains have been associated with naturally occurring and experimental dysentery in calves, and outbreaks of hemorrhagic enteritis with attaching and effacing lesions of the colon associated with *E. coli* O126 infection have occurred in heifers 8–12 months of age.<sup>17</sup> *E. coli* O126 is recognized as an enterohemorrhagic pathogen in humans.

##### Prevalence of infection in cattle, sheep, and pigs at slaughter

Based on fecal sampling, the prevalence rate of infection of cattle with *E. coli* O157:H7 varies considerably. Based on fecal samples from the rectums of cattle at slaughter in the UK, the animal-level prevalence was 7.5% and the group prevalence was 40.4%.<sup>18</sup> Of the infected animals, 9% were high shedders whose feces contained *E. coli* O157:H7 at concentrations of more than 10<sup>4</sup> colony-forming units (cfu)/g. This 9% also represented more than 96% of the total *E. coli* O157:H7 produced by all animals tested. This indicates that the presence of high-shedding animals at the abattoir increases the potential risk of beef contamination during the slaughtering process and stresses the need for correct hazard analysis and critical control points procedures.

There is a correlation between the prevalence of *E. coli* O157:H7 in the feces, hides and carcasses of beef cattle during slaughter.<sup>19</sup> Overall, the prevalence of *E. coli* O157:H7 in feces and on hides was 28% and 11%, respectively. Carcass samples were taken at three points during processing: pre-evisceration, post-evisceration before antimicrobial intervention, and postprocessing after carcasses entered the cooler. The prevalence of *E. coli* O157:H7 in the three post processing samples was 43%, 18%, and 2%, respectively. Antimicrobial intervention included steam pasteurization, hot water washes, organic acid washes, or combinations of these treatments. The reduction in carcass prevalence from pre-evisceration to post-processing suggests that sanitary procedures can be effective within processing plants. Fecal and hide prevalence were significantly correlated with carcass contamination, indicating a role for control of *E. coli* O157:H7 in live cattle.

The prevalence of fecal carriage of *E. coli* O157:H7 in cattle and sheep sampled throughout the year at the abattoir before slaughter was 4.7% for cattle and 1.7% for sheep.<sup>20</sup> The most frequently recovered *E. coli* O157:H7 isolates were phage types 2, 8, and 21/28 in cattle and

4 and 32 in sheep, the five most frequently isolated phage types associated with illness in people in Great Britain during the same survey period. In a commercial beef abattoir in Ireland, carcass contamination with *E. coli* O157:H7 can occur during removal of the hide and tying the bung, and this contamination can remain on the carcass during subsequent processing.<sup>21</sup>

The prevalence of attaching and effacing *E. coli* isolated from cattle, sheep, and pigs at slaughter in England and Wales was 8.1%, with a frequency of 18% in sheep, 6% in cattle, and less than 1% in pigs.<sup>22</sup> Several different *eae*-positive serogroups were isolated; some possessed *stx1* but none had *stx2*.

An overall prevalence of *E. coli* O157:H7 fecal shedding by New York cull dairy cattle of 1.3% was found in specimens just before processing the packing plant.<sup>23</sup>

In a survey of downer cattle submitted to two slaughter facilities in Wisconsin, the prevalence of *E. coli* O157:H7 in the feces and/or tissues of downer dairy cattle was 4.9% compared to 1.5% in healthy cattle.<sup>24</sup>

PCR has been used to detect virulence genes and molecular epidemiology of *E. coli* O157:H7 isolates from abattoirs.<sup>25</sup> Samples included swabs of tools, knives and saws, fecal samples, carcass samples and ears removed after slaughter. From 1432 samples, 143 *E. coli* O157:H7 strains were isolated. These results indicate the increase in contamination frequencies during transportation to the abattoir and the lairage period before slaughter, as a result of cross-infection caused by mixing of animals from different sources.<sup>25</sup> Surveys at the abattoir could be useful in detecting infected cattle herds and allow focusing on potentially infected herds, in concert with on-farm surveys.

#### Sheep and goats

Sheep and goats can be naturally infected with *E. coli* O157:H7 and sheep have been used as a model of ruminant infection.<sup>26</sup> Sheep may harbor *E. coli* O157:H7 and non-O157:H7 verotoxin-producing *E. coli* at rates similar to or higher than in cattle. Prevalence rates of 67% and 45% have been reported in Germany and Australia, respectively.<sup>1</sup> Worldwide, sheep have been shown to shed several non-O157 verotoxin-producing *E. coli* in their feces.<sup>1</sup> Several of these verotoxin-producing *E. coli* serotypes have been associated with sporadic cases or major outbreaks of human illnesses. Thus lamb, mutton and their products share a food safety risk factor similar to that of beef. Non-O157:H7 verotoxin-producing *E. coli* have been found in sheep grazing irrigated

pasture or arid rangeland forage in Nevada.<sup>1</sup> In Norway, sheep have carried Shiga-toxin-producing *E. coli* serogroups O5, O91, and O128, and their virulence factors have been characterized.<sup>27</sup> In Brazil, Shiga-toxin-producing *E. coli* occurred in the feces of 51% of healthy sheep grazing on pasture.<sup>28</sup> The serotypes could cause severe disease in humans.

#### Wildlife

Based on fecal samples of deer submitted by hunters, *E. coli* O157:H7 have been found in the feces of free-ranging white-tailed deer in Nebraska at a rate of 0.25%.<sup>29</sup> The prevalence of infection of *E. coli* O157:H7 in white-tailed deer sharing rangeland with cattle was 2.4%.<sup>29</sup> The low overall prevalence of *E. coli* O157:H7 and the identification of only one site with positive deer suggest that wild deer are not a major reservoir of *E. coli* O157:H7 in the southeastern USA.<sup>30</sup>

#### Pigs

*E. coli* O157:H7 has been found in fecal samples of finished pigs at the time of slaughter but the prevalence was very low at 0.08%. In experimentally infected pigs, *E. coli* O157:H7 can persist for more than 2 months.<sup>31</sup> Pigs may have the potential to be reservoirs hosts for *E. coli* O157:H7 but the magnitude of the risk needs to be determined.

#### Risk factors

##### Animal risk factors

Healthy normal cattle are a major reservoir for enterohemorrhagic *E. coli* O157:H7 strains, which cause disease in humans. Cattle that are infected with *E. coli* O157:H7 remain free of disease and are tolerant of *E. coli* O157:H7 for their entire lives. Neonatal calves under 36 hours of age are susceptible to experimental inoculation with *E. coli* O157:H7 and develop attachment and effacing lesions in both the large and small intestines.<sup>32</sup> Neither experimentally infected calves nor older cattle with *E. coli* O157:H7 develop extraintestinal vascular lesions. The lack of vascular receptors for Stx in cattle renders them resistant to the Stx.<sup>33</sup> Neither viable *E. coli* O157:H7 nor Stx-containing extracts caused fluid accumulation in ligated ileal loops of newborn calves, whereas doses of Stx did cause fluid accumulation experimentally in rabbits.<sup>33</sup>

##### Environmental and management risk factors

The factors associated between management, climate and the prevalence of *E. coli* O157:H7 in feedlot-water tanks and in feedlot-cattle feed have been examined in selected feedlots in the USA.<sup>34</sup> *E. coli* O157:H7 was isolated from 13% of the water tanks and at least one water tank

was positive on 60% of the feedlots. The factors associated with *E. coli* O157:H7 in water were a greater percentage of cattle shedding *E. coli* O157:H7 in the feces within the same pen, higher concentrations of total *E. coli* in the water, lack of clarity of the water, the use of fly traps, the reported frequency of rodent sightings in the pen or alley area, and the weather at the time of sampling. *E. coli* O157:H7 was isolated from 14.9% of the feed samples obtained from the feedbunks. Factors positively associated with *E. coli* O157:H7 in the feed were higher heat index at the time of sampling, the presence of cottonseed meal in the ration, and the feedlot location.

The association between management, climate and *E. coli* O157:H7 in the feces of feedlot cattle in the midwestern USA has been examined.<sup>34</sup> The prevalence of *E. coli* O157:H7 was 10.2% at the sample level, 52.0% at the pen-level and 95.9% at the feedlot level. The factors associated with the presence of *E. coli* O157:H7 in cattle feces were the frequency of observing cats in the pens or alleys, the presence of *E. coli* O157:H7 in the water tanks (positive association), the historical use of injectable mass medication (positive association), the use of antibiotics in the ration or water (negative association), the wetness of the pen, number of cattle in the pen (negative association), wind velocity (positive association), and height of the feed bunk (positive association).

##### Housing and management practices

Environmental dissemination of an inoculated strain of *E. coli* O157:H7 given to dairy calves spreads more quickly when calves are housed in groups compared to calves housed in individual pens from 7–110 days of age.<sup>35</sup> This indicates that control may depend on reduction of horizontal transmission within cattle groups, thus decreasing prevalence. The use of segregated penning systems rather than group housing of weaning calves may reduce the prevalence of these potential pathogens within the calf unit. If this results in a reduction in the general herd or farm Shiga-toxin-producing *E. coli* prevalence, then such changes in calf-rearing practice may offer a control point for preharvest Shiga-toxin-producing *E. coli* risk on dairy farms.

The housing of beef suckler cows in Scotland during the winter months was associated with increased level of shedding of *E. coli* O157:H7.<sup>36</sup>

##### Pathogen risk factors

##### Virulence attributes and mechanisms

The primary feature of Shiga-toxin-producing *E. coli* isolates is their ability to produce potent cytotoxins encoded by

*stx1* and *stx2*. They also have the ability to adhere to the intestinal mucosa in an intimate manner through the attachment and effacement protein intimin, encoded by the *eaeA* gene, and most produce a plasmid-encoded enterohemolysin, encoded by the *elixA* gene. Shiga-toxin-producing *E. coli* isolates that cause disease in humans usually have one or both of these virulence-associated factors and have been referred to as complex Shiga-toxin-producing *E. coli* (cSTEC). The most often reported Shiga-toxin-producing *E. coli* serotype causing diseases in humans worldwide is *E. coli* O157:H7, but non-O157 serotypes such as O111:H- and O113:H21 are commonly found to cause diseases such as hemolytic-uremic crisis. There are over 160 Shiga-toxin-producing *E. coli* serotypes that have been isolated from human patients around the world. A broad range of cSTEC serotypes have been isolated in Australian cattle<sup>37</sup> and in Argentina.<sup>38</sup>

Molecular typing of *E. coli* O157:H7 strains is done using pulse-field gel electrophoresis (PFGE) and is accepted as the standard technique in epidemiological investigations. The technique can be used to demonstrate horizontal transmission of a single strain type among animals within a farm and comparing sporadic isolates between animals and humans. The technique has been used to study *E. coli* O157:H7 isolates from cattle and human cases isolated in France and in northern Italy and from French and Spanish cattle imported to Sicily.<sup>39</sup>

#### Acid resistance

*E. coli* O157:H7 is extremely acid-resistant, which contributes to the low infectious dose for humans, which has been estimated to be fewer than 700 cells and possibly even as low as 10.<sup>26</sup> Certain strains of *E. coli* O157:H7 have been considered to be more acid-tolerant than some commensal *E. coli*. In addition, *E. coli* O157:H7 strains may become acid-habituated by exposure to weak acids in the rumen. Consequently, *E. coli* O157:H7 may survive passage through the acid barrier in the stomach, colonizing and replicating in the ruminant colon. The numbers of *E. coli* O157:H7 are much higher in the colon than the rumen.<sup>40</sup>

The acid-resistance characteristics of *E. coli* O157:H7 led to the hypothesis that feeding grain to cattle created an ideal environment in the gastrointestinal tract to promote the growth and persistence of the organism. The research data on the effects of grain versus forage feeding to cattle and its effects on fecal *E. coli* O157:H7 are limited and conflicting. Some early research indicated that grain feeding increased the dissemination of

acid-resistant *E. coli* by cattle, and that feeding hay for a brief period immediately before slaughter would decrease the shedding of *E. coli* O157:H7. The numbers, persistence and acid resistance of generic coliforms and *E. coli* O157:H7 from various gastrointestinal tract sites of cattle fed grain or hay were compared. Grain-feeding or hay-feeding did not affect survival of *E. coli* O157:H7 in the rumen, nor its passage through the abomasum (pH 2.0) to the duodenum.<sup>41</sup> Generic coliforms from the rumen and rectum of hay-fed animals were more sensitive to an acid shock than coliforms from gut locations in grain-fed animals. Thus *E. coli* O157:H7 in bovine ingesta are acid-resistant regardless of animal diet.<sup>41</sup> Abruptly switching cattle from a high-grain diet to a high-quality hay-based diet has been shown to reduce generic *E. coli* and *E. coli* O157:H7 populations but the magnitude of the reduction has varied among studies.<sup>42,43</sup>

Other work has shown that, in the context of acid tolerance, *E. coli* O157:H7 does not appear to be greatly different from commensal *E. coli*.<sup>44</sup> However, *E. coli* O157:H7 may have the ability to generate a higher 'tail' population and this, together with the low infective dose and changes in our lifestyle, has allowed the organism to become a major pathogen. Recent studies on the effect of forage or grain diets have shown that cattle fed forage diets had ruminal persistence of fecal *E. coli* O157:H7 at quantifiable concentrations for twice as long as cattle fed grain diets.<sup>45</sup> Diets high in grain generate high volatile fatty acid concentrations and low pH, creating a less conducive environment for *E. coli* O157:H7, whereas lower volatile fatty acid concentrations and higher pH in forage-fed cattle may be more conducive to the growth and survival of the organism. Monensin supplementation decreased the duration of shedding with forage diet, and the cecum and colon were culture-positive for *E. coli* O157:H7 more often than the rumen of cattle.

#### Antimicrobial resistance

The prevalence of antimicrobial resistance among isolates of *E. coli* O157:H7 recovered from clinical cases in humans, pigs, cattle, and food over a 15-year period (1985–2000) in the USA has been described.<sup>46</sup> There was a high prevalence of resistance to tetracycline, sulfamethoxazole, cephalothin, and ampicillin. The highest prevalence occurred among isolates from pigs, where more than 50% of all isolates were resistant to sulfamethoxazole, cephalothin, or tetracycline and more than 20% were resistant to ampicillin or gentamicin.

## Methods of transmission

### Sources of organism

#### Ruminants as reservoirs

*E. coli* O157:H7 is a transient inhabitant of the gastrointestinal tract of normal healthy ruminants. Cattle and sheep feces serve as sources for contamination of feed and water sources. Fecal **shedding** is **transient** in cattle, often lasting 1–3 months or less, but the organism can persist on individual farms for up to 2 years.<sup>47</sup> Longitudinal surveys have shown that maintenance of *E. coli* O157:H7 in cattle herds relies on continual reinoculation of individual cattle.<sup>6</sup> Repeated isolations of *E. coli* O157:H7 from healthy beef and dairy cattle demonstrate that cattle are asymptomatic carriers of the organism. Short periods of relatively high prevalence of excretion are separated by longer periods of reduced or undetectable shedding. This has contributed to the variance in prevalence data reported in the literature.

Fecal shedding is more prevalent in the USA and Canada during the summer months and is more prevalent in the UK in the spring and fall. Fecal shedding also varies among different classes of animal. Weaned heifers between 3 months of age and breeding age are more likely to shed *E. coli* O157:H7 in feces than adult cattle or younger calves. Increased shedding is associated with weaning and with the first month of lactation in dairy herds, and culled dairy cattle have a higher prevalence than previously reported. Contaminated water troughs, particularly those that are allowed to develop sediments, provide an environment for survival, proliferation and horizontal spread of *E. coli* O157:H7. The organism can also proliferate to very high levels in moist silage.

In Alberta, Canada, the prevalence of *E. coli* O157:H7 was 12.4% of fecal samples from yearling cattle and 2.0% of the fecal samples from cull cows.<sup>48</sup> The prevalence of *E. coli* O157:H7 in yearling cattle increased from 1.4% in the winter months to 40% in the summer. In feedlots, *E. coli* O157:H7 was isolated in pre-slaughter pens of cattle from the feces (0.8%), feedbunks (1.7%), water troughs (12%) and incoming water supplies (4.5%) but not from fresh total mixed rations. Fresh total mixed rations did not support the growth of *E. coli* O157:H7 from feces following experimental inoculation. Many different subtypes of *E. coli* O157:H7 were isolated from the feces, water and feed in pens of feedlot cattle. This suggests that methods to control *E. coli* O157:H7 in feedlot cattle will have to center not only on reducing fecal shedding of the organism in cattle but on the potential of reinfection from

environmental sources, such as water and feed, both at the feedlot and before the cattle arrive on the premises.

The pattern of fecal carriage of *E. coli* O157:H7 in cattle finished under modern intensive feedlot management conditions has been examined.<sup>49</sup> *E. coli* O157:H7 was isolated from 13% of fecal samples, with highest prevalence values of the organism in pens supplied with chlorinated drinking water compared with nonchlorinated water pens. Over a period of 7 months from April to September, certain specific clonal types of *E. coli* O157:H7 persisted and predominated despite massive cattle population turnover. This suggests that the farm environment, and not necessarily the incoming cattle, is an important potential source of *E. coli* O157:H7 on farms. In a longitudinal study of *E. coli* O157:H7 in a cattle-finishing unit in Finland most farm isolates belonged to one PFGE genotype (79.6%) and the remainder to closely related PFGE genotypes. Thus the finishing unit rather than the introduction of new cattle was the source of *E. coli* O157:H7 at the farm and *E. coli* O157:H7 seemed to persist well on barn surfaces.<sup>50</sup>

One dairy calf infected with and shedding *E. coli* O157:H7 can infect other negative calves in a confined environment within 8 days, and the duration of shedding may range from 17–31 days.<sup>51</sup> Experimentally, some calves may begin prolonged, high-level shedding of *E. coli* O157:H7 after only very low exposure doses, and other calves exposed to calves excreting *E. coli* O157:H7 in their feces are at high risk of infection.<sup>52</sup> Experimentally infected calves may begin shedding within 6 days after oral inoculation and continue shedding for up to 70 days.

#### Other species

*E. coli* O157:H7 subtypes indistinguishable from those detected in cattle have been found in pigeons, geese, horses, dogs, opossums, and flies. *E. coli* O157:H7 also has been isolated from insects in cattle environments but their role in dissemination is uncertain.

#### Wild birds

*E. coli* O157:H7 has been found in the feces of wild birds, which may be important in the spread of the organism within and between farms.<sup>53</sup> The presence of wild geese was a significant risk factor in the shedding of *E. coli* O157:H7 by beef suckler cows in Scotland.<sup>36</sup>

#### Flies

The increased presence of flies around cattle during the summer months represents a potential mechanism for the spread of *E. coli* O157:H7 among farm animals. *E. coli* O157:H7 has been isolated

from the crop of house flies (*Musca domestica*) immediately after feeding on a bacterial preparation.

#### Environmental sources

There are many possible sources of *E. coli* O157:H7 in the farm environment, including manure piles, ponds, dams and wells, barns, calf hutches, straw and other bedding, feed and feed troughs, water and water troughs, farm equipment, ground surface and pasture, and water-courses. Once in the environment, the organism can be transferred to other sites by rainwater, wind, and removal and spreading of manure, including animals and humans.<sup>6</sup>

#### Water supplies for livestock

Drinking water offered to cattle is often of poor microbiological quality and the daily exposure of animals to *E. coli* O157:H7 from this source can be substantial.<sup>54</sup> The degree of *E. coli* exposure is positively associated with proximity of water troughs to the feedbunk, protection of the trough from sunlight, and warmer weather. Cattle water troughs can serve as environmental reservoirs for *E. coli* O157:H7 and as a long-term source infection for cattle.<sup>55</sup>

The experimental inoculation of *E. coli* O157:H7 with 1 L of water into dairy calves in a confined environment resulted in shedding of the organism by the calves within 24 hours after administration.<sup>51</sup> The duration of shedding varied from 18 to more than 43 days and the number of doses necessary to initiate shedding varied among calves.

*E. coli* O157:H7 is present in as many as 10% of water troughs. *E. coli* O157:H7 was present in the water or water-tank sediment in 13.1% of water tanks in a feedlot in the USA and 60% of feedlots had at least one positive tank.<sup>56</sup> Cattle were more likely to be shedding *E. coli* O157:H7 in pens with positive water tanks, and water was more likely to be positive when *E. coli* O157:H7 was detected in the sediment.

Chlorination of input water in feedlots was unable to reduce the prevalence of *E. coli* O157:H7-contaminated water troughs.<sup>49</sup>

Water trough sediments with feces from cattle excreting *E. coli* O157:H7 may serve as a long-term reservoir of the organism on farms and a source of infection for cattle. The accumulation of large amounts of organic matter would be expected to rapidly inactivate the biocidal activity of chlorine and provide an ideal niche for the survival of the organism.<sup>55</sup> *E. coli* O157:H7 can survive in farm water under field and shed conditions at temperatures less than 15°C for up to 24 days.<sup>57</sup> The addition of feces to water outdoors resulted in survival for 24 days.

*E. coli* O157:H7 has been isolated from surface waters collected from a Canadian watershed.<sup>58</sup> Systematic sampling of surface water within the Oldman River basin in southern Alberta reveals that it often contaminated with *E. coli* O157:H7 and *Salmonella* spp. The prevalence of *E. coli* O157:H7 and *Salmonella* spp. in water samples was 0.9% and 6.2%, respectively. The region surveyed is noted for high cattle density as well as for one of the highest incidences of gastroenteritis in Canada, resulting from infection by *Salmonella* spp. and *E. coli* O157:H7. While the data indicated a relationship between high livestock density and high pathogen levels in southern Alberta, analysis of the point source data indicates that the predicted manure output from cattle, pig, and poultry feeding operations was not directly associated with the prevalence of either *Salmonella* spp. or *E. coli* O157:H7. Variations in time, amount and frequency of manure applications on to agricultural lands may have influenced levels of surface-water contamination with these bacterial pathogens.

#### Feed supplies

The prevalence of *E. coli* O157:H7 in cattle feeds in feedlots was 14.9%, higher than previously reported, which may be due to more sensitive detection methods.<sup>59</sup> Feed may be a vehicle for dissemination and colonization; however, the source of the *E. coli* O157:H7 contamination in cattle feed is uncertain. Possible sources include saliva and fecal contamination by cattle or other species, or by wildlife, including birds, rodents, and insects. Another possible source is contaminated feed components mixed into the feed. PFGE profiles of *E. coli* O157:H7 isolated from a component feed sample closely resembled that isolated later from the same farm, suggesting that cattle feed may be an important vector for the transmission of *E. coli* O157:H7.<sup>60</sup>

#### Manure

Survival of *E. coli* O157:H7 in manure and manure slurry has been observed under various experimental and environmental conditions. The use of manure as fertilizer could explain foodborne outbreaks of *E. coli* O157:H7 associated with unpasteurized apple cider, potatoes, and other vegetables. Because *E. coli* O157:H7 can survive for extended periods of time, proper manure management is of major importance in preventing the spread of this organism to the environment. Composting is an effective method for eliminating pathogens such as *E. coli* O157:H7 from manure.

#### Soil

*E. coli* O157:H7 inoculated into loam and clay soils can survive for 25 weeks and in



sandy soil for 8 weeks. The organism was detectable for up to 7 days after inoculation into the uppermost 2.5 cm of the soil, and for up to 7 days on grass plots inoculated with a fecal slurry from dairy cattle at an application rate of *E. coli* O157:H7 of 660 cfu/m<sup>2</sup>.

#### Animal-holding facilities

The organism can be cultured from rope devices in a feedlot pen that cattle rub or chew and there is a correlation with the prevalence of cattle shedding the organism in the feces from within the same pen.<sup>61</sup> This pen-test strategy may be useful to identify pens of cattle posing a higher risk to food safety.

#### Immune mechanisms

The Esp and Tir proteins secreted by *E. coli* O157:H7 play critical roles in the development of the attaching and effacing lesions and are recognized serologically in human patients with the hemolytic crisis syndrome. Antibodies to intimin, Esp and Tir proteins have been detected in HUS patients following infections with *E. coli* O157:H7.<sup>26</sup>

In contrast, little is known about the immune responses of cattle to infection with *E. coli* O157:H7.<sup>26</sup> *E. coli* O157:H7 and other enterohemorrhagic *E. coli* are shed sporadically by cattle, and it appears that natural exposure to *E. coli* O157:H7 does not confer protection on the host. Calves 13–30 days of age developed anti-O157 IgG responses following experimental oral inoculation with *E. coli* O157:H7.<sup>62</sup> Mature cows did not develop a significant increase in their serum anti-O157 IgG levels following oral inoculation. These observations suggest that local immunity to *E. coli* O157:H7 may not develop to any degree in the intestine and that immunization to reduce fecal shedding of *E. coli* O157:H7 may not be effective.

Vaccination of cattle with antigenic bacterial proteins involved in colonization can significantly reduce fecal shedding and prevalence of *E. coli* O157:H7 in cattle. Vaccination of cattle with *E. coli* O157:H7 type III secreted proteins can reduce the numbers of *E. coli* O157:H7 shed in the feces, and the duration of shedding in experimentally challenged cattle, and in feedlot cattle under field conditions.<sup>63</sup> Vaccination of pregnant gilts with intimin from *E. coli* O157:H7 induced high intimin-specific immune responses in the serum and colostrum, and suckling neonatal piglets had reduced bacterial colonization and intestinal lesions following experimental challenge.<sup>64</sup> These results suggest that vaccination may be a useful preharvest strategy for reducing the prevalence of *E. coli* O157:H7 infection in cattle.

#### Zoonotic implications

*However secure and well-regulated civilized life may become, bacteria, protozoa, viruses, and infected fleas, lice, ticks, mosquitoes, and bedbugs will always lurk in the shadows ready to pounce when neglect, poverty, famine, or war lets down the defenses. And even in normal times they prey on the weak, the very young and the very old, living along with us in mysterious obscurity awaiting their opportunities.*

Zinsser, 1934

The above wisdom relates to *E. coli* O157:H7.

Enterohemorrhagic strains of *E. coli*, especially serotype *E. coli* O157:H7, have been linked in humans with hemorrhagic colitis, hemolytic-uremic syndrome and thrombocytopenic purpura from eating contaminated foods, such as beef and dairy products, vegetables, and apple cider, from contaminated drinking water or from contact with infected animals or contaminated environments. As few as 10 *E. coli* O157:H7 bacteria can cause illness in humans.

In 1999, the Centers for Disease Control and Prevention estimated that 73 480 people per year in the USA were infected with *E. coli* O157:H7 and that 61 of these cases were fatal.<sup>26</sup> Most cases of *E. coli* O157:H7 illness are attributable to food-borne infection; however, acquisition of disease by direct contact with animals and manure at petting zoos and dairy farms are of increasing concern. Among *E. coli* O157:H7 foodborne outbreaks in 1999, one-third were due to beef; historically, undercooked ground beef is the most common vehicle. Consumption of pink hamburgers at home or in restaurants is a risk factor for *E. coli* O157:H7 infection. Microbiological testing of ground beef patties from a large outbreak that occurred in the Pacific northwest between November 1992 and February 1993 suggested that the infectious dose for *E. coli* O157:H7 is fewer than 700 organisms. This represents a strong argument for enforcing zero tolerance for this organism in processed food and for markedly decreasing contamination of raw ground beef. A major source of the bacteria in ground beef is bovine feces, which contaminates carcasses before evisceration; the organism is thought to be spread from contaminated hides to the surfaces of carcasses at slaughter. In addition to feces and hides, *E. coli* O157:H7 has been isolated from the oral cavities of cattle.

In May 2000, *E. coli* O157:H7 and *Campylobacter jejuni* contaminated the drinking water supply in Walkerton,

Ontario, Canada.<sup>65,66</sup> As a result, seven people died and over 2000 became ill. The pathogens causing the outbreak were attributed to contamination of the town's water well arising from cattle manure from a nearby cattle farm following a period of heavy spring rainfall. Failure to adequately chlorinate the water supply resulted in the contaminated water being consumed by the people in the town.

Argentina has one of the highest recorded incidence of hemolytic-uremic crisis in the world at 300–400 cases per year.<sup>38</sup> It also has the highest per capita consumption of beef of any country in the world.

Visits to farms for recreational or educational purposes have become an important part of the tourism and leisure industries in some countries.<sup>67</sup> The emergence of *E. coli* O157:H7, with its very low infectious dose and associated risks of serious human illness, has greatly increased the potential for zoonotic disease acquired from livestock, including those on open farms. The livestock of these farms may include sheep, goats, mature cattle and calves, pigs, donkeys, ponies, rabbits, guinea pigs, chipmunks, laying hens, bantams, ducks, geese, and a variety of waterfowl. Outbreaks of *E. coli* O157:H7 infection have occurred in people visiting these farms and the *E. coli* O157:H7 has been isolated primarily from the calves and goats.

In a large outbreak of *E. coli* O157:H7 infections among visitors to a dairy farm, predominantly children, high rates of carriage of *E. coli* O157:H7 among calves and young cattle most probably resulted in contamination of both the hides of the animals and the environment.<sup>68,69</sup> Contact with calves and their environment was associated with an increased risk of infection, whereas hand-washing was protective. Thirteen percent of the cattle were colonized with *E. coli* O157:H7, which had the same distinct pattern on PFGE found in isolates from the patients. The organism was also recovered from surfaces that were accessible to the public.

Phenotyping and genotyping of *E. coli* O157:H7 has been used to verify transmission of the organism from dairy cattle to humans with *E. coli* O157:H7 infections.<sup>70</sup> The isolates from cattle and humans were indistinguishable, which indicates that the infection originated from the farms. However, it may not be possible to determine whether the source was unpasteurized milk or direct or indirect contact with cattle.

Transmission of *E. coli* O157:H7 occurs by three major routes: food items such as undercooked meat or unpasteurized milk, person-to-person spread, and direct or indirect contact with animals. Infections

have been associated with visits to cattle farms and farms open to the public, with consumption of farm products, and with camping on a cattle-grazing site. Infections have also been described in farm family members and other farm dwellers.

Undercooked beef products, unpasteurized milk and dairy products, and contaminated water are all potential vehicles for human infection with *E. coli* O157:H7.

### Economic importance

The economic consequences of beef contaminated with *E. coli* O157:H7 are enormous. Since 1994 in the USA, millions of kilograms of ground beef have been recalled from retail outlets because of contamination with *E. coli* O157:H7. Such beef products must be destroyed and not used for animal or human food. Human illness associated with the most common food-borne pathogens alone cost the US economy more than \$7 billion each year.<sup>71</sup> Some of these human outbreaks have been linked to the consumption of meat-based products or to contact with animals and their wastes.

### PATHOGENESIS

Enterohemorrhagic *E. coli* are characterized by the presence of Shiga toxin (Stx) genes, **locus for enterocyte effacement (LEE)** and a high-molecular-weight plasmid that encodes for a hemolysin.<sup>47</sup> These three virulence factors are present in most *E. coli* associated with bloody diarrhea and hemolytic-uremic crisis in humans.

The LEE is a large cluster of genes that are collectively responsible for the intimate attachment of the bacterium to the apical membrane of the enterocyte and subsequent destruction or effacement of the microvilli. The intimate attachment of the bacterial cell to the epithelium is attributed to the adhesin **intimin** and Tir, a bacterial protein, which is inserted into the host membrane and serves as the response for intimin. Both factors are part of the LEE in enteropathogenic *E. coli* and enterohemorrhagic *E. coli*. Intimin appears to be an essential component in initiating attachment, colonization and the subsequent pathological changes that follow infection with enteropathogenic *E. coli* and enterohemorrhagic *E. coli*.

*E. coli* O157:H7 also possesses a high-molecular-weight plasmid that contains several putative virulence genes, including a pore-forming hemolysin. Virulence plasmids are common features of pathogenic *E. coli*, encoding toxins, adhesins and other factors necessary for colonization, survival, and ability to cause disease in its animal host.

In ruminants, *E. coli* O157:H7 persists and proliferates in the lower gastrointestinal tract and does not remain for long periods in the ruminant stomachs or duodenum.<sup>34</sup> *E. coli* O157:H7 exhibits a novel tropism for the terminal rectum in cattle. In calves experimentally infected with *E. coli* O157:H7, in almost all persistently colonized animals, the majority of tissue-associated bacteria identified are in a region within 3–5 cm proximal to the rectoanal junction.<sup>72</sup> This region contains a high density of lymphoid follicles, and microcolonies of the bacterium are readily detectable on the epithelium of this region by immunofluorescence microscopy. As a consequence of this specific distribution, *E. coli* O157:H7 are present predominantly on the surface of the fecal mass. Sampling the feces and terminal rectum of cattle immediately after slaughter found higher numbers of *E. coli* O157:H7 at the site closer to the rectoanal junction, and low- and high-level carriers were identified.<sup>73</sup> High-level carriage was detected in 3.7% of the animals, and carriage on the mucosal surface of the terminal rectum was associated with high-level fecal excretion. This supports the finding that the mucosal epithelium of the terminal rectum of cattle is an important carriage site for *E. coli* O157:H7, and that high-level fecal shedding of *E. coli* O157:H7 results from colonization of this site.

### Experimental reproduction

Experimentally, *E. coli* O157:H7 causes fatal ileocolitis in newborn calves under 36 hours of age.<sup>27</sup> Affected calves developed diarrhea and enterocolitis with attaching and effacing lesions in both the large and small intestines by 18 hours after inoculation.

Natural and experimental infection of calves from 13–30 days of age and mature cows with *E. coli* O157:H7 does not result in any clinical signs of disease and no lesions were present at necropsy.<sup>62</sup> A serological response occurred in the calves but not in the cows.

Attaching and effacing intestinal lesions can be produced by experimental inoculation of 6-day-old conventionally reared lambs with *E. coli* O157:H7.<sup>74</sup> All animals remain normal clinically but attaching and effacing lesions occur in the cecum at 12 and 36 hours post-inoculation and in the terminal colon and rectum at 84 hours. This indicates that the well-characterized mechanisms for intimate attachment encoded by the locus for enterocyte effacement of *E. coli* O157:H7 may contribute to the initial events of colonization. Similar lesions can be produced in ligated intestine loops of 6-month-old sheep using *E. coli* O157:H7.<sup>75</sup>

### CLINICAL PATHOLOGY

#### Detection in feces

A review is available of the details of the culture techniques for the detection of *E. coli* O157:H7 in the feces of cattle.<sup>76</sup>

A number of culture methods for the screening of fecal specimens for *E. coli* O157:H7 are available but no standard protocol is recommended.<sup>77</sup> Because none of the techniques provides 100% sensitivity, the isolation rates of *E. coli* O157:H7 from bovine feces using only one test will result in an underestimation of the incidence of the organism in bovine feces. Performing more than one test must be considered.

Feces may be directly plated on to selective media and/or differential agars or feces may be selectively enriched in a variety of broth enrichment protocols followed by plating on to selective agars. This enrichment step may be followed by immunomagnetic separation with beads coated with O157-specific antibody before plating on to agar.<sup>76</sup> Because *E. coli* O157:H7 often occurs in small numbers in bovine feces, immunomagnetic separation is now in common use. Enrichment broths are comparable to each other but they are superior to direct plating.<sup>23</sup> In addition, regardless of the culture protocol used, recovery of *E. coli* O157:H7 is more likely from fresh fecal samples than from frozen samples.<sup>23</sup>

PFGE has been used extensively to investigate the epidemiology of *E. coli* O157:H7, although it has not been evaluated as a tool for establishing genetic relationships.<sup>78</sup> PCR has been used to detect virulence genes and molecular epidemiology of *E. coli* O157:H7 isolates from abattoirs.<sup>25</sup>

A real-time PCR kit for the detection of *E. coli* O157:H7 in bovine fecal samples is commercially available.<sup>79</sup> Both the sensitivity and specificity of the assay are 99% for isolates in pure culture and the assay detects 1 cfu/g of *E. coli* O157:H7 in artificially inoculated bovine feces following enrichment.

The culture of swabs of the rectoanal junction mucosa is as sensitive and may be more sensitive than culture of feces for the detection of *E. coli* O157:H7 in cattle.<sup>80</sup> This is because the sample site is the location of *E. coli* O157:H7 colonization, which contains high numbers of the organism. For both experimentally and naturally infected cattle, the rectoanal mucosa predicted the duration of infection. Cattle transiently shedding *E. coli* O157:H7 for less than 1 week were positive by fecal culture only and not by rectoanal mucosa culture, whereas colonized animals were positive early on by rectoanal mucosa junction culture.

### Detection in ground beef

A rapid, specific and quantitative method to detect *E. coli* O157:H7 in ground beef in a combined immunomagnetic separation for cell capture and concentration with real-time PCR has been developed.<sup>81</sup>

### CONTROL

In spite of the large amount of information generated about various aspects of *E. coli* O157:H7 since 1982, reliable management practices to control the infection effectively at all stages of beef production from the farm to the slaughter plant, the retail handling and processing, and finally the consumer, have not been examined scientifically so that recommendations could be made at each stage of production that would result in control of the organism at a very low level.<sup>82</sup> Studying *E. coli* O157:H7 during the entire cattle-production process is problematic because of the complexity of the system and the complexity of the ecology of the organism. The development of economically feasible intervention strategies that are effective in reducing foodborne pathogens is a priority for both the beef and dairy industries.

The effective control of *E. coli* O157:H7 will require the implementation of several different infectious disease control strategies and management procedures extending from the farm environment to the meat processing plant, the retail handling and processing of meat products and the handling and cooking of beef products in the home.

The features of the ecology of *E. coli* O157:H7 that are important to consider in a control program include:<sup>83</sup>

- Lack of a host specificity such that indistinguishable isolates can be found in a variety of species
- Near ubiquitous distribution on cattle farms
- Transient residence in the gastrointestinal tract flora of individual animals that is not associated with disease
- Temporal clustering at the population level such that most fecal shedding is confined to sharp bursts in a high percentage of animals separated by much longer periods of very low prevalence
- A higher prevalence in young animals compared to mature ones
- A higher prevalence in animals with gastrointestinal flora disturbances such as those associated with transit, feed changes, or antimicrobial dosing
- A markedly higher prevalence during warm months
- Molecular subtyping of *E. coli* O157:H7 indicate that certain subtypes can persist on cattle farms

- for years, supporting the conclusion that cattle farms represent a reservoir
- New subtypes are periodically found on particular farms, and indistinguishable subtypes can be found on farms separated by hundreds of kilometers even in the absence of any obvious animal movements between them
- Commercial feeds are sometimes contaminated with *E. coli* O157:H7 and it seems likely that feeds represent an important route of dissemination
- Mixed feeds collected from feeding troughs are commonly positive for *E. coli* O157:H7, as are water troughs, and feed and water probably represent the most common means of infection
- Environmental replication in feeds and in the sediments of water troughs occurs and may account for the higher level of fecal shedding in the summer months
- Since *E. coli* O157:H7 has been found to persist in and remain infective for at least 6 months in water trough sediments, this may be an important environmental niche where the organism survives during periods when it cannot be detected, especially during cold months
- Traditional means of controlling infectious diseases, such as eradication or test and removal of carrier animals, do not appear to be feasible
- Certain farm management practices, especially those related to maintenance and multiplication of *E. coli* O157:H7 in feed and water, may provide practical means to substantially reduce the prevalence of these agents in cattle on farms and in those arriving at slaughter plants
- It is virtually impossible to exclude *E. coli* O157:H7 from beef-processing plants and carcasses<sup>82</sup>
- Cross-contamination of whole carcasses with fecal-derived bacteria occurs as a result of airborne transmission (during removal of the hide). Contaminated equipment and cross-contamination is inevitable during boning-out and grinding (where portions of carcasses from a large number of animals are commingled or make contact with a common piece of equipment)<sup>82</sup>
- The very small numbers of *E. coli* O157:H7 predicted to contaminate carcasses under highly effective control could be spread to a large volume of beef product during processing and multiply if the product experienced temperature abuse.

Because the dose of *E. coli* O157:H7 to cause human illness is very low, this dispersion of the organism throughout a high volume of product may constitute the greatest risk to public health.

The control of *E. coli* O157:H7 will depend on implementation of management procedures which extend from the farm (**preharvest**), slaughtering process (**postharvest**) and retail handling and processing, to ultimately the **consumer**.

### Preharvest beef safety production programs – beef quality assurance programs on the farm

Preharvest beef safety production programs consist of policies, strategies, and procedures that are carried out on food-producing animal farms with the objective of producing safe and wholesome product free of antibiotic or chemical residues and with a minimum of pathogens that could be transferred through meat to humans. Some examples follow here.

The **Canadian on-Farm Food Safety (COFFS) Program** is a producer-led, industry/government partnership that provides national commodity groups with the opportunity to develop the strategies and the necessary tools to educate producers and to implement national on-farm food safety initiatives consistent with the Codex Alimentarius Hazard Analysis Critical Control Points (HACCP) definitions and principles and with the Canadian Food Inspection Agency's Food Safety Enhancement Program.

The COFFS Program established in May 1997 is funded by a grant from Agriculture and Agri-food, Canada's Canadian Adaptation and Rural Development Fund. Technical advice is provided by the Canadian Food Inspection Agency and the program is administered by the Canadian Federation of Agriculture.

The beef cattle industry in Canada has begun excellent programs with Canadian Cattlemen – *Quality Starts Here: Good Production Practices for Cow-Calf Producers and Recommended Operating Procedures for Feedlot Animal Health*.

The Canadian Cattlemen's Association has developed a number of quality assurance schemes for the various segments of its industry. The *Quality Starts Here* program was developed through collaborative discussions with all those along the food chain – cow-calf operators, feedlots, packers, veterinarians, and pharmaceutical companies. The objective was to develop a set of good production practices to deal with sanitation and feeding issues and to minimize problems arising from lesions and bruising at injection sites and from drug residues. It is important to note that this program was developed to improve

the beef supply chain as a whole and to augment the processing industry's in-plant HACCP programs. In part, it attempts to reduce information costs along the supply chain.

Manuals have been produced and distributed to those interested including: *Good Practice Guides* for cow-calf operators and feedlots and *Recommended Operating Procedures for Feedlot Animal Health*. The procedures are based on HACCP concepts. At present, the CCA schemes do not include provisions for independent monitoring of cow-calf operations or feedlots. This may be a weakness of the scheme as it may not be accepted by those further along the supply chain (by retailers or the hotels, restaurants, and institutions) and, in particular, export markets. Without independent accreditation, this quality assurance scheme cannot claim to be HACCP-based. If, over time, producers feel that they receive a premium for animals raised according to the specifications of the quality assurance scheme, pressure may increase to have independent verification. The CCA has also endorsed a national animal identification scheme. Technical details still need to be worked out to insure that maximum use can be made of the information. The need for the information to be transferred from the live animal to the carcass remains a technological challenge. However, there is cooperation to find a solution. It is intended that, in the event of an incident that requires traceback, it will be possible with this system to identify the last herd (feedlot, pasture group, etc.) in which the subject animal was located and, from the ear tag, the herd of origin.

#### **Specific strategies for control of *Escherichia coli* O157:H7 at preharvest level**

The literature on preharvest strategies to reduce the carriage and shedding of *E. coli* O157:H7 in cattle has been reviewed.<sup>71,82</sup> A stochastic simulation model was used to assess the benefit of measures implemented in the preslaughter period that are aimed at reducing the contamination of beef carcasses with Shiga-like-toxin-producing *E. coli* O157:H7.<sup>82</sup> Control measures were based on either reducing the herd prevalence of infection, reducing the opportunity for cross-contamination in the processing plant by reordering of the slaughter procedures, reducing the concentration of *E. coli* O157:H7 in fresh feces or reducing the amount of feces, mud and bedding ('tag') transferred from the hide to the carcass. Simulations suggested that the greatest potential is associated with vaccination and with an agent that reduces shedding of *E. coli* O157:H7 in feces. An industry-wide

reduction in the amount of tag attached to hides and addition of a source of cattle having a prolonged average fasting time were not predicted to have a large impact on mean amount of carcass contamination with *E. coli* O157:H7.

#### *Animal management strategies* *Water systems and runoff*

Interventions at the water trough level offer significant potential to reduce *E. coli* O157:H7 contamination and cross-contamination. Suggested potential strategies to reduce *E. coli* O157:H7 survival in the water supply include chlorination, ozonization, frequent cleaning, and screens that reduce organic solids in water troughs. However, field studies found that chlorination of water troughs did not alter the prevalence of *E. coli* O157:H7 in the troughs, or in the feces of cattle in those pens.<sup>49</sup>

#### *Environmental control of Escherichia coli O157:H7*

The survival of *E. coli* O157:H7 for extended periods of time (weeks to months) in livestock production environments may enable transfer of the organism back to cattle through contaminated feed or water. This creates a cycle of infection allowing *E. coli* O157:H7 to be maintained in cattle herds. Effective control of *E. coli* O157:H7 requires suppression at as many points in the cycle of infection as possible in order to reduce its spread. Minimizing contamination of water troughs and feed bunks together with adequate manure management should contribute to a significant reduction in the spread of *E. coli* O157:H7 in cattle, crops, and water sources.

The fecal prevalence of *E. coli* O157:H7 among mature dairy cattle is associated with the choice of bedding material used on a farm.<sup>84</sup> The use of sawdust for bedding material for lactating dairy cows, as opposed to sand, was associated with a significantly higher fecal prevalence of *E. coli* O157:H7.<sup>84</sup> The overall average herd prevalence was 3.1% and 1.4%, respectively, for cows on sawdust and on sand.<sup>84</sup> The total number of days on which herds were positive for *E. coli* O157:H7 was higher for sawdust-bedded herds than for sand-bedded herds; 22 versus 14, respectively. These results provide evidence that specific farm management practices can influence the prevalence of *E. coli* O157:H7 on the farm.

#### *Diet changes*

The literature on the effects of dietary manipulation of *E. coli* populations in cattle has been reviewed.<sup>43</sup> Feedlot and high-producing dairy cattle are fed rations with a high percentage of grain.

When the starches that escape the ruminal microbial degradation move on to the large intestine, enterohemorrhagic *E. coli* ferment the sugars and the populations of *E. coli* increase. Cattle fed grain rations shed larger numbers of *E. coli*, especially *E. coli* O157:H7 in barley-fed cattle. When cattle are abruptly switched from a high-grain ration to a forage diet, generic *E. coli* populations decline by 1000-fold within 5 days. Cattle naturally infected with *E. coli* O157:H7 shed smaller numbers of the organism when the ration is changed to a forage-based diet compared to cattle fed continuously on a high grain diet.<sup>43</sup> However, the magnitude of reduction is highly variable between studies and thus is not currently recommended. Fasting for 48 hours and type of diet prior to fasting has no effect on fecal shedding of *E. coli* O157:H7 in cattle.<sup>42</sup> Thus feed withdrawal prior to slaughter should not increase the risk of *E. coli* O157:H7 entering the food chain. However, re-feeding 100% forage following a 48-hour fast results in a significant increase in the number of animals shedding *E. coli* O157:H7. This may occur when feeder cattle are moved from one farm to another through a sale barn and may be one of the reasons for the higher incidence of *E. coli* O157:H7 shedding by cattle when they first enter the feedlot.

Proposals aimed at dietary modifications must be balanced with the practical applications of commercial livestock feeding operations.

#### *Direct antipathogen strategies*

Several strategies have been examined that specifically target and directly kill pathogenic bacteria. These include: the use of antibiotics; antimicrobial proteins produced by bacteria; bacteriophages; compounds that specifically target the physiology of pathogenic bacteria; and vaccination.

#### *Antibiotics*

Some preliminary studies have found that feeding neomycin to cattle for 48 hours reduced the populations of generic *E. coli* and *E. coli* O157:H7 in their feces.<sup>71</sup>

#### *Antimicrobial proteins and bacteriophages*

Only limited information is available on their effectiveness.

#### *Vaccination against Escherichia coli O157:H7*

There is evidence that virulence factors secreted by the type III system can be used as effective vaccine components for the reduction of colonization of cattle by *E. coli* O157:H7.<sup>63</sup> Vaccination of cattle with proteins secreted by *E. coli* O157:H7, three times at 3-week intervals,

significantly reduced the numbers of bacteria shed in feces, the numbers of animals that shed and the duration of shedding in an experimental model. Vaccination of cattle also significantly reduced the prevalence of *E. coli* O157:H7 in a clinical trial conducted in a typical feedlot. The pretreatment prevalence of animals shedding *E. coli* O157:H7 averaged 30%. The average proportion of cattle shedding the organism in vaccine-treated pens was 8.8%, and in nonvaccinated pens 21.3%. Since the type III secreted antigens are relatively conserved among non-O157 enterohemorrhagic *E. coli* serotypes, the vaccine formulation might be broadly cross-protective.

Using the pig as an experimental model, pregnant dams were vaccinated with *E. coli* O157:H7 adhesin (intimin<sub>O157</sub>) at 2 and 4 weeks before farrowing.<sup>64</sup> *E. coli* O157:H7 adhesin (intimin<sub>O157</sub>)-specific antibody titers in colostrum and serum of dams were increased after parenteral vaccination. Neonatal piglets were allowed to suck vaccinated dams for up to 8 hours before being inoculated with a Shiga-toxin-negative strain of *E. coli* O157:H7. Piglets that had ingested colostrum containing *E. coli* O157:H7 adhesin (intimin<sub>O157</sub>)-specific antibodies from vaccinated dams, but not those nursing sham-vaccinated dams, were protected from *E. coli* O157:H7 colonization and intestinal lesions. This supports the hypothesis that intimin<sub>O157</sub> is a potential antigen for an *E. coli* O157:H7 antitransmission vaccine.

A vaccination field trial evaluated the efficacy of *E. coli* O157:H7 vaccine in a sample of feedlots in Alberta and Saskatchewan.<sup>85</sup> Pens of cattle were vaccinated once on arrival processing and again at reimplanting. The *E. coli* O157:H7 vaccine included 50 µg of type III secreted proteins. Fecal samples were collected from 30 fresh fecal droppings within each feedlot pen at arrival, at revaccination and within 2 weeks of slaughter. The mean pen prevalence of *E. coli* O157:H7 in feces was 5.0%, ranging in pens from 0–90%. There was no significant association between vaccination and pen prevalence of fecal *E. coli* O157:H7 following initial vaccination at reimplanting or prior to slaughter.

#### Competitive enhancement strategies

The use of native or introduced microflora to reduce pathogenic bacteria in the intestine is termed a 'probiotic' or competitive enhancement strategy. The principle is to promote growth of groups of beneficial bacteria that are competitive with, or antagonistic to, pathogens.

#### Probiotics

Probiotic bacteria are effective in reducing the duration of ruminal carriage of *E. coli*

O157:H7 in cattle.<sup>6</sup> Probiotics are live microbial feed supplements that beneficially affect the host animal by improving its intestinal microbial balance. The principle is that these beneficial organisms will combat the effects of stress and prevent undesirable microorganisms from becoming established in the gastrointestinal tract. Dietary supplementation of cattle with *Lactobacillus*- and *Propionibacterium*-based direct-fed microbials reduced the prevalence of *E. coli* O157:H7 in both fecal and hide samples.<sup>86</sup>

#### Sodium chlorate supplementation

Chlorate supplementation has been investigated as a preharvest strategy to reduce populations of *E. coli* O157:H7 and *Salmonella* spp. in food animals.<sup>87</sup> Certain bacteria can respire anaerobically by reducing nitrate to nitrite via the intracellular enzyme nitrate reductase. This same enzyme also reduces chlorate to chlorite, a cytotoxic end-product. Chlorate significantly reduced *E. coli* O157:H7 populations in ruminal fluid incubations, wild-type *E. coli*, inoculated *E. coli* O157:H7 and total coliforms in cattle, and inoculated *E. coli* O157:H7 in sheep. The administration of sodium chlorate in the feed of cattle preharvest for 24 hours reduced the population of *E. coli* O157:H7 strains approximately by two logs (10<sup>4</sup> to 10<sup>2</sup>) in the rumen and three logs (10<sup>6</sup> to 10<sup>3</sup>) in the feces.<sup>87</sup>

#### Control of *Escherichia coli* O157:H7 during slaughtering and postharvest stage

Meat inspection service and surveillance As a result of public concern about *E. coli* O157:H7, the meat inspection service in many countries has been reorganized to deal with control of the organism in the processing of beef. In the USA, the presence of *E. coli* O157:H7 in ground beef was declared an **adulterant**. Surveillance systems have also been established in many countries to obtain more information about the presence of the organism and to report outbreaks, and considerable research has emerged.

Elaborate *E. coli* O157:H7 detection systems are now in place in abattoirs in many countries as part of the **Hazard Analysis of Critical Points System (HACCP)** to insure that contamination of beef carcasses with *E. coli* O157:H7 is below certain legislated levels.

The surfaces of beef cattle carcasses are contaminated with enteric bacteria immediately after removal of the hide during processing following slaughter. Significant correlations between bovine fecal and hide prevalence with beef carcass contamination indicate a role for controlling *E. coli* O157:H7 in live cattle.<sup>19</sup>

Major progress has been made in the last decade in the processing of beef carcasses following slaughter to reduce the microbial contamination of beef using the HACCP.

#### The seven Hazard Analysis of Critical Points System principles

HACCP is a process control system designed to identify and prevent microbial and other hazards in food production.

It includes steps designed to prevent problems before they occur and to correct deviations as soon as they are detected. Such preventive control systems with documentation and verification are widely recognized by scientific authorities and international organizations as the most effective approach available for producing safe food.

In the USA, as of 1996, the US Department of Agriculture (USDA) adopted the Pathogen Reduction HACCP system, which includes four major elements:

- Every plant must adopt and carry out its own HACCP plan, which systematically addresses all significant hazards associated with its products
- Mandatory *E. coli* testing in slaughter plants. Every plant must regularly test carcasses for *E. coli* to verify the effectiveness of the plant's procedures for preventing and reducing fecal contamination
- Pathogen reduction performance standards for *Salmonella*. All plants and plants producing raw ground products must insure that their *Salmonella* contamination is below the current national baseline prevalence
- Sanitation standard operating procedures. Every plant must adopt and carry out a written plan for meeting its sanitation responsibilities. Effective sanitation in slaughter and processing plants is essential to prevent adulteration of meat and poultry products.

HACCP is endorsed by such scientific and food safety authorities as the National Academy of Sciences and the National Advisory Committee on Microbiological Criteria for Foods (NACMCF), and by such international organizations as the Codex Alimentarius Commission and the International Commission on Microbiological Specifications for Foods.

HACCP systems must be based on the seven principles articulated by the NACMCF. The seven principles are: (1) hazard analysis, (2) critical control point identification, (3) establishment of critical limits, (4) monitoring procedures, (5) corrective actions, (6) record keeping, and (7) verification procedures.

### The Seven HACCP Principles

- **Principle 1: Conduct a hazard analysis.** Plants determine the food safety hazards and identify the preventive measures the plant can apply to control these hazards
- **Principle 2: Identify critical control points.** A critical control point (CCP) is a point, step or procedure in a food process at which control can be applied and, as a result, a food safety hazard can be prevented, eliminated, or reduced to an acceptable level. A food safety hazard is any biological, chemical, or physical property that may cause a food to be unsafe for human consumption
- **Principle 3: Establish critical limits for each critical control point.** A critical limit is the maximum or minimum value to which a physical, biological, or chemical hazard must be controlled at a critical control point to prevent, eliminate, or reduce to an acceptable level.
- **Principle 4: Establish critical control point monitoring requirements.** Monitoring activities are necessary to insure that the process is under control at each critical control point. The Food Safety and Inspection Service (FSIS) requires that each monitoring procedure and its frequency be listed in the HACCP plan
- **Principle 5: Establish corrective actions.** These are actions to be taken when monitoring indicates a deviation from an established critical limit. The final rule requires a plant's HACCP plan to identify the corrective actions to be taken if a critical limit is not met. Corrective actions are intended to insure that no product injurious to health or otherwise adulterated as a result of the deviation enters commerce
- **Principle 6: Establish record keeping procedures.** The HACCP regulation requires that each plant maintains certain documents, including its hazard analysis and written HACCP plan, and records documenting the monitoring of critical control points, critical limits, verification activities, and the handling of processing deviations
- **Principle 7: Establish procedures for verifying the HACCP system is working as intended.** Validation insures that the plans do what they were designed to do, i.e. that they are successful in insuring the production of safe product. Plants will be required to validate their own HACCP plans.

HACCP is a system that identifies potential food safety risks, prevents or corrects

them, records what was done and verifies that the system works. The objective is to improve food safety for meat and poultry. It is assumed that a reduction in carcass contamination leads to a proportionate reduction in illness and death. Pathogens can contaminate meat and poultry at any step from production through consumption including final food preparation and handling.

Postharvest decontamination techniques The literature on the current methods and technologies used to decontaminate food carcasses in the USA has been reviewed.<sup>88</sup> Meat carcasses may become contaminated from fecal material, the stomach contents and the hide. Additional sources of cross-contamination exist in the slaughter process, such as processing tools and equipment, structural components of the facility, human contact, and carcass-to-carcass contact.

Decontamination techniques for carcasses are targeted at reducing or eliminating bacteria that may be human pathogens as well as those that may cause meat spoilage. The pathogenic bacteria of most concern include *E. coli* O157:H7, *Salmonella* spp., *Listeria monocytogenes*, *Campylobacter* spp., *Clostridium botulinum*, *Clostridium perfringens*, *Staphylococcus aureus*, *Aeromonas hydrophilia*, and *Bacillus cereus*.

Meat processors strive to produce raw products that have low levels of bacteria on the surface and no pathogenic bacteria. However, the process is not done in a sterile environment and contamination is unavoidable, and occasionally pathogenic microorganisms may come into contact with the surface of the meat carcass. Routine slaughter practices have evolved over the years to reduce the likelihood of inadvertent microbial contamination. This evolution has led to the adoption of the **hurdle technology** approach to microbial carcass interventions.

The principles of hurdle technology state that, if the initial microbial load is substantially reduced as a result of carcass decontamination procedures, fewer microorganisms are present, which are then more easily inhibited in subsequent processing steps. The effectiveness of hurdle technology has been demonstrated experimentally for beef decontamination technologies under controlled conditions. The concept of hurdle technology for beef carcass decontamination has also been validated to be effective in field studies in beef-processing facilities.

The following are some of the more widely used and researched intervention strategies:

- **Hot water rinse.** There is substantial scientific evidence that hot water

(> 74°C) will produce a sanitizing effect on beef carcasses, and this is widely practiced in the industry

- **Steam pasteurization.** The commercialization of the steam pasteurization system has been successful and it is in use in many large beef slaughter facilities in North America. Hot water/steam vacuum systems are designed to remove visible spots of contamination from small areas on the carcass and are used to augment the traditional knife trimming. Steam pasteurization is a process whereby beef carcasses are placed in a slightly pressurized, closed chamber at room temperature and sprayed with steam that blankets and condenses over the entire carcass. This raises the surface temperature to 195°F or 200°F and kills nearly all pathogens. Carcasses then are sprayed with cold water
- **Steam vacuum.** Steam or hot water is sprayed on a beef carcass followed by vacuuming, which has the combined effect of removing and/or inactivating surface contamination. The hand-held device includes a vacuum wand with a hot water spray nozzle, which delivers water at approximately 82–88°C to the carcass surface, as well as the vacuum unit. Steam vacuuming is approved for use by the USDA-FSIS as a substitute for knife trimming for removing fecal and ingesta contamination when such contamination is less than 2.54 cm at its greatest dimension
- **Chemical rinses.** Organic acids are typically applied as a rinse to the entire surface of the carcass. The USDA-FSIS approved the use of organic acid solutions such as acetic, lactic, and citric acids at concentrations of 1.5–2.5%. Acetic and lactic acids have been most widely accepted as carcass decontamination rinses. The effectiveness of organic acids is best achieved shortly after hide removal, when the carcass is still warm.

### Progress made with decontamination processes

The multiple decontamination processes, as applied in actual plant settings, have resulted in significant improvements in the microbiological quality of beef.<sup>88</sup> There is considerable evidence to support the effectiveness of in-plant application of multiple decontamination technologies (hurdle technology). Reductions were achieved from 43% of lots sampled pre-visceration as positive for *E. coli* O157:H7 to 1.9% remaining positive postprocessing after multiple decontamination methods on the slaughter floor.<sup>19</sup>

In February 2005, the beef industry welcomed news from the USDA-FSIS showing a significant drop in *E. coli* O157:H7 prevalence in 2004, as compared to 2003. The FSIS data showed that the percentage of *E. coli*-O157:H7-positive ground beef samples collected in 2004 fell by 43.3% compared with the previous year. The data showed that, between 2000 and 2004, the percentage of positive samples of *E. coli* O157:H7 had declined by more than 80%. FSIS also reported that there were six recalls related to *E. coli* O157:H7 in 2004 compared to 12 in 2003 and 21 in 2002.

This is very good news for consumers and all sectors of the beef industry and represents the coordinated efforts to reduce this pathogen throughout the beef production chain, from farm to kitchen. The Beef Industry Food Safety Council (BIFSCo), which is funded by beef producers with checkoff dollars, directs a broad effort to solve the *E. coli* O157:H7 problem, focusing on research, consumer education, and public policy. BIFSCo has been working toward compiling best practices from across the beef industry, which includes sharing strategies among competitors. The program is coordinated on behalf of the Cattlemen's Beef Board and state beef councils by the National Cattlemen's Beef Association (NCBA). The NCBA serves as one of the Beef Board's contractors for checkoff-funded programs.

Following the *E. coli* summit in January 2003, BIFSCo worked to compile best practices from across the beef industry. Through this effort, all sectors of the beef industry have worked collectively toward the goal of improving safety – from cow-calf producers and feedlot operators to packers and processors, to retailers and foodservice providers. The best practices were completed and distributed throughout the industry.

In addition, checkoff-funded research continues to show promise for interventions such as thermal pasteurization, feed additives, and animal and carcass washes that eliminate or reduce pathogen presence.

#### Irradiation

Irradiation of beef in the postharvest stage is a process which could be used to inactivate pathogens. At the present time, the percentage of beef being irradiated is very small. Constraints include reluctant consumer acceptance of radiation-treated food, increased price of production, and the irradiation's negative effect on odor and flavor.

#### Consumer education on handling and cooking meat

To prevent infection with *E. coli* O157:H7, consumers must be encouraged to follow

four simple steps: Chill promptly; Clean hand and kitchen surfaces; Separate, don't cross-contaminate; and Cook thoroughly.

#### Visitors to animal farms

Farm animals and the farm environment present a variety of possible sources of infection with *E. coli* O157:H7. Farm visits are popular among city families for holidays and family gatherings, and schools in urban areas frequently promote educational farm visits for their students. The consumption of unpasteurized milk by visiting children and close physical contact with animals have been documented as most likely sources of infection in some outbreaks of *E. coli* O157:H7 infection. Farm animals and the farm environment present a variety of possible sources of infection. Visitors to animal farms, especially groups such as schoolchildren, must avoid petting animals whose hair coats and skin may harbor *E. coli* O157:H7.<sup>69</sup> Verotoxin-producing *E. coli* of bovine origin can infect humans in the farm environment. Many dairy-farm residents regularly consume unpasteurized milk, a potential source of *E. coli* O157:H7.

Using geographical information system mapping and modeling, studies in Canada have clearly identified a relationship between an increased risk of verotoxin-producing *E. coli* infections and disease among rural populations and cattle density.<sup>69</sup>

#### REVIEW LITERATURE

Johnson RP, Wilson JB, Michel P et al. Human infection with verocytotoxigenic *Escherichia coli* associated with exposure to farms and rural environments. In: Stewart CS, Flint HJ, eds. *Escherichia coli* O157 in farm animals. Wallingford, Oxfordshire: CAB International, 1999:147–168.

Stewart CS, Flint HJ. *Escherichia coli* O157 in farm animals. Wallingford, Oxfordshire: CAB International, 1999.

Russell JB, Diez-Gonzalez F, Jarvis GN. Invited review: effects of diet shifts on *Escherichia coli*. *J Dairy Sci* 2000; 83:863–873.

Hancock D, Besser T, LeJeune J et al. The control of VTEC in the animal reservoir. *Int J Food Microbiol* 2001; 66:71–78.

Meyer-Broseta S, Bastian SN, Arne PD et al. Review of epidemiological surveys on the prevalence of contamination of healthy cattle with *Escherichia coli* serogroup O157:H7. *Int J Hyg Environ Health* 2001; 203:347–361.

Bach SJ, McAllister TA, Veira DM et al. Transmission and control of *Escherichia coli* O157H7: a review. *Can J Anim Sci* 2002; 82:475–490.

Huffman RD. Current and future technologies for the decontamination of carcasses and fresh meat. *Meat Sci* 2002; 62:285–294.

Renter DG, Sargeant JM. Enterohemorrhagic *Escherichia coli* O157H7: epidemiology and ecology in bovine production environments. *Anim Health Res Rev* 2002; 3:83–94.

Sanchez S, Lee MD, Harmon BG et al. Animal issues associated with *Escherichia coli* O157H7. *J Am Vet Med Assoc* 2002; 221:1122–1126.

Bettelheim KA. Non-O157 verotoxin-producing *Escherichia coli*: a problem, paradox, and paradigm. *Exp Biol Med* 2003; 228:333–344.

Callaway TR, Elder RO, Keen JE et al. Forage feeding to reduce preharvest *Escherichia coli* populations in cattle: a review. *J Dairy Sci* 2003; 86:852–860.

Moxley RA. Detection and diagnosis of *Escherichia coli* O157:H7 in food-producing animals. In: Torrence ME, Isaacson RE, eds. *Microbial food safety in animal agriculture: current topics*. Ames, IA: Iowa University Press, 2003:143–154.

Callaway TR, Anderson RC, Edrington TS et al. Recent pre-harvest supplementation strategies to reduce carriage and shedding of zoonotic enteric bacterial pathogens in food animals. *Anim Health Res Rev* 2004; 5:35–47.

Moxley RA. *Escherichia coli* O157H7: an update on intestinal colonization and virulence mechanisms. *Anim Health Res Rev* 2004; 5:15–33.

#### REFERENCES

- Hussein SH et al. *Exp Biol Med* 2003; 228:358.
- Gunning RF et al. *Vet Rec* 2001; 148:780.
- Orden JA et al. *Vet Microbiol* 1998; 63:239.
- Meyer-Broseta S et al. *Int J Hyg Environ Health* 2001; 203:347.
- Renter DG, Sargeant JM. *Anim Health Res Rev* 2002; 3:83.
- Bach SJ et al. *Can J Anim Sci* 2002; 82:475.
- Renter DG et al. *Am J Vet Res* 2004; 65:1367.
- Laegreid WW et al. *Epidemiol Infect* 1999; 123:291.
- Gannon VP et al. *Epidemiol Infect* 2002; 129:163.
- Hussein HS et al. *Exp Biol Med* 2003; 228:357.
- Renter DG et al. *Appl Environ Microbiol* 2003; 69:542.
- Dunn JR et al. *J Am Vet Med Assoc* 2004; 224:1151.
- Keen JE, Elder RO. *J Am Vet Med Assoc* 2002; 220:756.
- Nielsen EM et al. *Vet Microbiol* 2002; 88:245.
- Paiba GA et al. *Vet Rec* 2003; 153:347.
- Moreira CN et al. *Vet Microbiol* 2003; 93:179.
- Pearson GR et al. *Vet Rec* 1999; 145:370.
- Omisakin F et al. *Appl Environ Microbiol* 2003; 69:2444.
- Elder RO et al. *Proc Natl Acad Sci U S A* 2000; 97:2999.
- Paiba GA et al. *Vet Rec* 2002; 150:593.
- McEvoy JM et al. *J Appl Microbiol* 2003; 95:256.
- Aktan I et al. *Vet Microbiol* 2004; 102:43.
- McDonough PL et al. *J Clin Microbiol* 2000; 38:318.
- Byrne CM et al. *Appl Environ Microbiol* 2003; 69:4683.
- Andral B et al. *Vet Rec* 2004; 155:365.
- Moxley RA. *Anim Health Res Rev* 2004; 5:15.
- Urdahl AM et al. *J Appl Microbiol* 2002; 93:1026.
- Vettorato MP et al. *Vet Microbiol* 2003; 95:103.
- Renter DG et al. *J Wildl Dis* 2001; 37:755.
- Fischer JR et al. *Appl Environ Microbiol* 2001; 67:1218.
- Boher SL et al. *Vet Microbiol* 2002; 89:69.
- Dean-Nystrom EA et al. *Infect Immun* 1997; 65:1842.
- Pruimboom-Brees IM et al. *Proc Natl Acad Sci U S A* 2000; 97:10325.
- Sargeant JM et al. *Prev Vet Med* 2004; 66:175.
- Cobbold R, Desmarchelier P. *Appl Environ Microbiol* 2002; 68:4148.
- Syngé BA et al. *Epidemiol Infect* 2003; 130:301.
- Hornitzky MA et al. *Appl Environ Microbiol* 2002; 68:6439.
- Padola NL et al. *Vet Microbiol* 2004; 100:3.
- Giammanco GM et al. *J Clin Microbiol* 2002; 40:4619.
- Laven RA et al. *Vet J* 2003; 165:78.
- Grauke LJ et al. *Vet Microbiol* 2003; 211.
- Buchko SJ et al. *Can J Anim Sci* 2000; 80:741.
- Callaway TR et al. *J Dairy Sci* 2003; 86:852.



44. Booth IR et al. In: Stewart CS Flint HJ. *Escherichia coli* O157 in farm animals. Wallingford, Oxfordshire: CAB International, 1999:27–38.
45. Van Baale MJ et al. *Appl Environ Microbiol* 2004; 70:5536.
46. Schroeder CM et al. *Appl Environ Microbiol* 2002; 68:576.
47. Sanchez S et al. *J Am Vet Med Assoc* 2002; 221:1122.
48. Van Donkersgoed J et al. *Can Vet J* 2001; 42:714.
49. LeJeune JT et al. *Appl Environ Microbiol* 2004; 70:377.
50. Lahti E et al. *Appl Environ Microbiol* 2003; 69:554.
51. Shere JA et al. *Appl Environ Microbiol* 2002; 68:1947.
52. Besser TE et al. *Epidemiol Infect* 2001; 127:555.
53. Wallace JS. In: Stewart CS Flint HJ. *Escherichia coli* O157 in farm animals. Wallingford, Oxfordshire: CAB International, 1999:195–223.
54. LeJeune JT et al. *J Dairy Sci* 2001; 84:1856.
55. LeJeune JT et al. *Appl Environ Microbiol* 2001; 67:3053.
56. Sargeant JM et al. *Prev Vet Med* 2003; 61:127.
57. McGee P et al. *J Appl Microbiol* 2002; 93:706.
58. Johnson JYM et al. *Can J Microbiol* 2003; 49:326.
59. Dodd CC et al. *Appl Environ Microbiol* 2003; 69:5243.
60. Davis MA et al. *Vet Microbiol* 2003; 95:199.
61. Smith DR et al. *Epidemiol Infect* 2004; 132:297.
62. Wray C et al. *Vet Rec* 2000; 147:65.
63. Potter AA et al. *Vaccine* 2004; 22:362.
64. Dean-Nystrom EA et al. *Infect Immun* 2002; 70:2414.
65. Holme R. *Water Sci Technol* 2003; 47:1.
66. Hruzey SE et al. *Water Sci Technol* 2003; 47:7.
67. Pritchard GC et al. *Vet Rec* 2000; 147:259.
68. Crump JA et al. *N Engl J Med* 2002; 347:555.
69. Johnson RP, Wilson JB, Michel P et al. In: Stewart CS Flint HJ. *Escherichia coli* O157 in farm animals. Wallingford, Oxfordshire: CAB International, 1999:147–168.
70. Lahti E et al. *Eur J Clin Microbiol Infect Dis* 2002; 21:189.
71. Callaway TR et al. *Anim Health Res Rev* 2004; 5:35.
72. Naylor SW et al. *Infect Immun* 2003; 71:1505.
73. Low JC et al. *Appl Environ Microbiol* 2005; 71:93.
74. Wales AD et al. *J Med Microbiol* 2001; 50: 752.
75. Wales AD et al. *J Med Microbiol* 2002; 51:755.
76. Moxley RA. In: Torrence ME, Isaacson RE, eds. *Microbial food safety in animal agriculture: current topics*. Ames, IA: Iowa University Press 2003:143–154.
77. Tutenev AV et al. *Vet Microbiol* 2003; 94:341.
78. Davis MA et al. *J Clin Microbiol* 2003; 41:1843.
79. Bono JL et al. *Appl Environ Microbiol* 2004; 70:1855.
80. Rice DH et al. *J Clin Microbiol* 2003; 41:4924.
81. Zhu F et al. *Int J Food Microbiol* 2005; 99:47.
82. Jordan D et al. *Prev Vet Med* 1999; 41:55.
83. Hancock D et al. *Int J Food Microbiol* 2001; 66:71.
84. LeJeune JT et al. *Appl Environ Microbiol* 2005; 71:326.
85. Van Donkersgoed J et al. *Can Vet J* 2005; 46:724.
86. Younts-Dahl SM et al. *J Food Prot* 2004; 67:889.
87. Callaway TR et al. *J Anim Sci* 2002; 80:1683.
88. Huffman RD. *Meat Sci* 2002; 62:285.

## Escherichia coli infections in weaned pigs

Diarrhea is most frequent when pigs are exposed to pathogenic *E. coli* strains.<sup>1</sup> The effect of weaning is to produce a marked

decrease in the diversity of coliforms in the individual piglet.<sup>2</sup> Different strains of *E. coli* were predominant in different animals,<sup>2</sup> which may in turn facilitate the spread of pathogenic strains.

### Escherichia coli in pigs

Many strains are nonpathogenic. Pathogenic *E. coli* can be divided into a variety of pathotypes but there are three major types. These are enterotoxigenic *E. coli*, verotoxin-producing *E. coli* and attaching and effacing *E. coli*. There are two major complicating factors in pigs: one of these is that the intestine has different distributions of receptors with changing age.<sup>3</sup> The other is that nearly all isolates (94.8%) that carry the enterotoxin genes also carry genes for one of the fimbrial adhesins.<sup>4</sup> The two most prominent genotypes are K88, LT1, STb and F18, STa, STb, SLT.

### Enterotoxigenic Escherichia coli

These have two major virulence factors: (a) adhesins or fimbriae and (b) enterotoxins. The adhesins promote or control the adherence to small intestinal epithelial cells and include K88, K99, F41, 987P, and F18. Only F18 and K88 are frequently associated with disease in weaned pigs. Only young pigs are susceptible to K99 or 987P. Age-related susceptibility is related to the presence or absence of the appropriate receptors in the small intestine. The enterotoxins belong to two groups; heat-labile enterotoxin (LT) and the heat-stable enterotoxins STa or STb. Only weaned pigs are susceptible to F18 and resistance develops by 8 weeks of age, as the binding appears to be blocked. The receptor for F18 has not yet been identified but it is a glycoconjugate in which the attached carbohydrate acts as a target for the fimbriae. The F18 adhesin occurs in two forms: ab (found in verotoxin-producing *E. coli*) and ac (found in enterotoxigenic *E. coli*).<sup>5</sup> There is also an F4 fimbrial antigen which is on a different chromosome from F18. F4 enterotoxigenic *E. coli* cause problems in the first week after weaning but F18 verotoxin-producing *E. coli* cause problems 1–2 weeks after weaning.<sup>6</sup>

### Verotoxin-producing Escherichia coli

These strains produce Shiga toxin or Shiga-like toxins (verocytotoxins) and cause edema disease. Swine verotoxin-producing *E. coli* colonize the intestine via the F18 pilus, as do some swine enterotoxigenic *E. coli*. It is not uncommon to find F18-positive strains that produce enterotoxins and verotoxins and can cause both diarrhea and edema disease.

### Attaching and effacing Escherichia coli

These bacteria possess the *eae* gene, which encodes for intimin, which is an adhesin factor that facilitates the attachment of

bacteria to intestinal epithelial cells.<sup>7</sup> It is on a plasmid that is distinct from the K88-encoding plasmid<sup>8</sup> in enteropathogenic *E. coli* and enterotoxigenic *E. coli* strains that produce attaching and effacing lesions.

The following strains are found:

- K88 ab, ac, ad
- F18ab (more associated with edema disease); F18ac
- F41, usually associated with K99 fimbriae
- Strains containing LT, STa, STb, Shiga-like toxin 2e (Stx2e), and possibly enteroaggregative *E. coli*.<sup>9</sup>

Twenty years ago most of the pig strains were 987p- or K99-positive. The genes for Stx2e and F18 were rare then but are common now.

### O157 in pigs

In a recent survey in Sweden only two O157:H7-positive and four O157:H7-negative strains were found.<sup>10</sup> The O157:H7-positive strains have been described.<sup>11</sup> Pathogenicity is indicated by genes encoding for one or more of the Shiga toxins but several other factors may also be necessary. Most strains do not possess Shiga toxins but do carry the F4 or F18 fimbrial adhesins. A third of strains produced STa or STb but less than a third produce STx and half the *eae* gene.

### Postweaning diarrhea and edema disease

are two common *E. coli* infections of weaned pigs. In postweaning diarrhea, there is diarrhea, dehydration, and often death. In edema disease or enterotoxemia there is subcutaneous edema of the forehead and eyelids, and neurological clinical signs such as ataxia, convulsions, recumbency, and death. Enterotoxigenic *E. coli* strains isolated from cases of postweaning diarrhea mainly belong to O groups O8, O141, O147, O149, and O157. Strains associated with edema disease predominantly have O groups O138, O139, or O141. Postweaning diarrhea is a significant cause of mortality between weaning and marketing in some herds. Although the clinical signs in these two diseases are different, they occur in similar age groups and the same type of management change may precede their occurrence. Weaning and weaning age are both associated with significant effects on the microbial populations.<sup>12</sup> In postweaning diarrhea the bacteria disappear more quickly, usually by about 7 days post-infection, but in edema disease may still be there 9 days postinfection but with a slower buildup to a peak within 3–5 days postinfection.<sup>13</sup> A typical scenario would be severe diarrhea occurring 4–5 days postweaning followed by clinical edema disease with mortality reaching as high as

50%. Both are associated with the proliferation of predominantly hemolytic serotypes of *E. coli* within the small intestine. However, it is rare to encounter both diseases concurrently on the same farm. In postweaning diarrhea the serotypes are enterotoxigenic and the major manifestation is diarrhea resulting from enterotoxin activity at the time of proliferation. In edema disease non-enterotoxigenic strains produce a verotoxin that, after a period of time, indirectly produces the neurological syndrome characteristic of this disease.

One of the features of virulence in *E. coli* is the presence of mobile genetic elements such as plasmids, bacteriophages, and pathogenicity islands. A pathogenicity island coding for F18-positive fimbriae has been found.<sup>14</sup> Cytolethal distending toxins have also been described.<sup>15</sup> In many countries the prevalence of edema disease has decreased markedly during the past decade, whereas that of coliform gastroenteritis has increased. It is possible that this change reflects the trend towards earlier weaning of pigs, although the emergence and spread of new enterotoxigenic strains may also be a factor. More recently a third disease, cerebrospinal angiopathy, has been attributed to the effects of infection with *E. coli*. Although there are some similarities in the etiology and epidemiology of these diseases they are sufficiently different to warrant a separate description. One of the major features in common is the process of weaning, probably the most serious disturbance a young piglet may face. It alters immune functions and produces stress.<sup>16</sup> It also profoundly alters the intestinal microflora<sup>17,18</sup> particularly the coliform flora.<sup>19</sup> Some strains may increase but others may decrease.

### EDEMA DISEASE (GUT EDEMA, ESCHERICHIA COLI ENTEROTOXEMIA)

Edema disease occurs in weaner and grower pigs and is characterized by subcutaneous and subserosal edema, progressive ataxia, recumbency, and death.

#### Synopsis

**Etiology** *Escherichia coli* strains producing verocytotoxin and Shiga-like toxin

**Epidemiology** In rapidly growing weaner pigs between 4 and 12 weeks of age following change in diet or feeding practices. Outbreaks occur

**Sign** sudden death. Incoordination, falling, edema of eyelids and face; piglets die in 6–36 hours

**Clinical pathology** Culture *E. coli* from feces

**Lesions** Facial edema, full stomach and mesenteric edema

**Diagnostic confirmation** Culture specific organism

#### Differential diagnosis list

- Pseudorabies
- Viral encephalomyelitis of pigs
- Encephalomyocarditis
- Streptococcal meningitis
- Salt poisoning
- Organic arsenic poisoning
- Mulberry heart disease

**Treatment** None

**Control** Avoid drastic changes in diet

### ETIOLOGY

Edema disease is associated with *E. coli* strains producing a verocytotoxin type II variant (VT2e), and Shiga-like toxin (SLT2e), and belonging to one of the three serogroups that cause edema disease: O138, O139, or O141.<sup>20</sup> The biochemical phenotypes were studied in Sweden and each of the O138, O139, and O141 serotypes is dominated by one phenotypic type even though others do occur within the serotype.<sup>21</sup> The entire pathogenicity island known as ETT2 is necessary for the edema disease virulence factors in O138, O139, or O141.<sup>22</sup> Isolates of *E. coli* have been found in which the toxin or F18 fimbrial types were not related to selected electrophoretic types which suggests that toxin and F18 genes in the isolates from pigs with postweaning diarrhea or edema disease occur in a variety of chromosomal backgrounds.<sup>23</sup> The bacteria colonize the small intestine without causing significant changes by means of the adherence factor F18 (F107).<sup>24</sup> The *E. coli* strains with the highest mucin-binding capacity belonged to potential ST toxin producers, whereas strains without genes encoding for toxin production displayed much weaker binding to mucin capacity.<sup>25</sup> In a recent outbreak in Denmark, where edema disease had not previously been observed, most isolates were of serotype O139 but a few isolates could not be typed by O serotyping.<sup>26</sup> All the isolates from the Danish pigs with edema disease grouped together in one cluster, in contrast to isolates from other countries, which did not form any clusters. In Denmark 563 isolates were serotyped<sup>27</sup> and O149 was found in 49.9% of the isolates, O138 in 14.9%, O139 in 6.9%, O141 in 4.1%, and O8 in 3.7%. The virulence genes were examined and they fell into six pathotypes, which contained 65.7% of all isolates.<sup>27</sup> The F107 fimbriae are a major colonization factor in *E. coli* that cause edema disease.<sup>28,29</sup> The serotypes of *E. coli* isolated from piglets with diarrhea, piglets

with edema disease, and healthy piglets have been reported.<sup>30,31</sup>

The inheritance of susceptibility to edema disease has been examined.<sup>32,33</sup> Inheritance of resistance to intestinal colonization with *E. coli* causing edema disease is thought to be under the control of one locus consisting of two alleles with susceptibility (S)-dominating resistance(s).<sup>32</sup> Genetic susceptibility to edema disease is due to the ability of F107-expressing *E. coli* to adhere to and colonize intestinal brush border cells, and not due to toxin susceptibility. There is a high correlation between intestinal F18 receptor genotype and susceptibility to disease<sup>34</sup> but pigs with resistant F18 receptor genotypes were not entirely protected against colonization by *E. coli*.

### EPIDEMIOLOGY

The specific serotypes of *E. coli* that are capable of causing the disease are introduced into a piggery and become part of the normal intestinal flora. They may not cause disease until a particular set of environmental conditions arise, when they proliferate excessively within the intestine to produce toxin. The disease occurs predominantly in pigs between 4 and 12 weeks of age. It may occur sporadically but more commonly occurs as an outbreak affecting up to 50% of the pigs within the group. Characteristically the larger and faster-growing pigs within the group are affected. The disease is not common in runt or poorly thriving pigs. Age at weaning, diet, overcrowding, chilling, transportation and other factors influence the susceptibility of pigs to *E. coli* producing SLTIIe and could determine whether subclinical or clinical edema disease occurs following infection. Piglets fed high-protein diets are more susceptible to experimental clinical edema disease than piglets fed low-protein diets.<sup>35</sup> The disease frequently occurs within 1 week following a change in diet or *ad libitum* feeding but may also follow such factors as weaning, vaccination, pen change, and regrouping. A study even found verotoxin-producing *E. coli* O139 in water storage tanks and drinking water.<sup>36</sup>

One of the observations on F18 fimbriae is that they have increased greatly since 1997 from 10% to 70% and this may be tied into the genetic selection of the stress gene.<sup>37</sup>

The outbreak is sudden in onset but short-lived, averaging 8 days and seldom exceeding 15 days. The epidemiology of the disease in affected herds is not characteristic of a highly contagious disease and it does not usually spread to involve other pens of pigs on the same farm.

The disease follows proliferation of the relevant serotypes within the intestine.

Serotypes of *E. coli* associated with gut edema may be isolated from the feces of healthy pigs. The factors initiating proliferation are unknown but changes in the composition or amount of diet commonly precipitate the onset. Management factors that potentiate oral–fecal cycling of these organisms are likely to be of importance in spread within the group.

### PATHOGENESIS

It is a simple progression. The intestine of a susceptible pig, which is usually fast-growing and without maternal antibody, has receptors for F18 pili. This appears to be the major factor, and then colonization by *E. coli* occurs with toxin production, absorption of toxin, and damage to vascular epithelium. The endothelium appears to have a specific toxin receptor for Stx2e<sup>38</sup> and finally edema develops in target tissues.

Nutritional factors and gastrointestinal stasis result in proliferation of the *E. coli* strains in the small intestine and toxin production. There is generally a delay between the initial period of maximal intestinal proliferation of the organism and the onset of clinical signs. In the experimental disease, clinical signs occur 5–7 days following initial oral challenge with bacteria and up to 36 hours following intravenous inoculation with toxin. The delay appears to be related to the development of vascular lesions, with increased vascular permeability leading to edema formation and encephalomalacia. The experimental oral inoculation of the edema-disease-producing *E. coli* results in colonization of the organisms in the small intestine, and lesions of the vessels of the intestinal mucosa are detectable as early as 2 days after infection. An experimental model for subclinical edema disease in weaned pigs has been described.<sup>39</sup> Microscopic vascular lesions were found in pigs 14 days after oral inoculation with a SLT2-positive strain of *E. coli*. Once postweaning diarrhea occurs then there is an increased intestinal permeability that predisposes to edema disease and once edema disease has developed the influx of SLT toxin into the bloodstream is facilitated further, thus precipitating the disease.<sup>40</sup> Edema disease is associated with metabolic acidosis, which might be explained by endogenous acid production, and small-intestinal acidosis. Intestinal acidosis is known to cause mucosal hyperexcitability.

### CLINICAL FINDINGS

The disease occurs sporadically and unexpectedly in a group, often affecting a number of pigs within a few hours, and shows no tendency to spread from group to group. The thriftiest pigs are most likely to be affected and, once the diagnosis is made, all pigs in the pen should be

examined in an attempt to detect other animals in the early stages of the disease. The incidence in a litter will vary up to 50% or more.

The earliest and most obvious sign is incoordination of the hindlimbs, although this may be preceded by an attack of diarrhea. The pig has difficulty in standing and sways and sags in the hindquarters. There is difficulty in getting up and in getting the legs past each other when walking because of a stiff, stringhalt-like action affecting either the forelegs or hindlegs. In some cases there are obvious signs of nervous irritation manifested by muscle tremor, aimless wandering, and clonic convulsions. Complete flaccid paralysis follows.

On close examination, edema of the eyelids and conjunctiva may be visible. This may also involve the front of the face and ears but cannot usually be seen until necropsy. The voice is often hoarse and may become almost inaudible. Blindness may be apparent. The feces are usually firm and rectal temperatures are almost always below normal. The course of the disease may be very short, with some pigs being found dead without signs having been observed. In most cases, illness is observed for 6–36 hours, with a few cases being more prolonged. Recovery does sometimes occur but some degree of incoordination may persist.

### CLINICAL PATHOLOGY

As an aid to diagnosis, while affected animals are still alive, fecal samples should be cultured to determine the presence of hemolytic *E. coli*. Knowledge of the drug sensitivity of the organism may be important in prescribing control measures. The edema disease principle is cytotoxic to Vero cells and may be useful in an assay system for diagnosis. The toxin Stx2e has been detected in the peripheral blood of pigs with clinical disease, which not only shows that toxin is transported but may eventually lead to a technique for the detection of early cases.<sup>41</sup>

### NECROPSY FINDINGS

The pig is well grown for its age, the stomach is full of feed and the feces are usually normal. Edema of the eyelids, forehead, belly, elbow and hock joints, throat, and ears is accompanied by edema of the stomach wall and mesocolon in classical cases. Excess pleural, peritoneal, and pericardial fluid is also characteristic and the skeletal muscles are pale. The edema may often be slight and quite localized, so examination of suspected areas should be carried out carefully, using multiple incisions, especially along the greater curvature of the stomach near the cardia. Hemolytic *E. coli* can be recovered in almost pure culture from the

intestine, particularly the colon and the rectum, and in some cases from the mesenteric lymph nodes. Polyclonal antisera directed against serotypes of *E. coli* associated with edema disease are used to confirm the diagnosis via an agglutination test. Histologically, the important lesions are mural edema, hyaline degeneration and fibrinoid necrosis in arteries and arterioles. In subacute to chronic cases this angiopathy may result in focal brain hemorrhages and encephalomalacia.

### Samples for confirmation of diagnosis

- Bacteriology – ileum and colon (CULT). The differentiation of pathogenic and nonpathogenic *E. coli* can be achieved through PCR.<sup>42,43</sup> A multiplex PCR has been developed for STa, STb, K99, 987P, and F41.<sup>44</sup> The tests tell you that the gene is present but not whether it is actually encoding for the proteins
- Histology – formalin-fixed colon, ileum, jejunum, gastric fundus, brain, mesenteric lymph node (LM).

### DIFFERENTIAL DIAGNOSIS

Although there are a number of diseases of pigs in the susceptible age group in which nervous signs predominate, gut edema is usually easy to diagnose because of the rapidity with which the disease strikes, the number of pigs affected at one time, the short duration of the outbreak, and the obvious edema of tissues. Affected pigs are usually in prime condition. The ataxia and recumbency must be differentiated from diseases of the nervous system of pigs which cause ataxia and recumbency. These include pseudorabies, viral encephalomyelitis (Teschen's disease), encephalomyocarditis, streptococcal meningitis, salt poisoning, and organic arsenic poisoning. Mulberry heart disease and encephalomyocarditis can produce similar signs, and differentiation on necropsy findings and histopathology is necessary. In poisoning by *Amaranthus* spp. and *Chenopodium album* the signs may be roughly similar but the edema is limited to the perirenal tissues.

### TREATMENT

Treatment is ineffective. Elimination of the toxin-producing bacteria may be attempted by use of antimicrobials in the feed or water supplies. The choice of antimicrobial will vary depending on area variations of the drug sensitivities of *E. coli*. The feed consumption of the unaffected pigs in the group should be reduced immediately and then gradually returned to previous levels over a period of a few days.

### CONTROL

Pigs should be kept on the same creep feed for at least 2 weeks after weaning,

and the change in feed should be made gradually over a 3–5-day period. Feed restriction through the critical period is frequently practiced and may reduce the occurrence of gut edema. Similarly an increase in crude fiber and decrease in nutrient quality of the diet through this period may reduce the incidence. However, it is evident that a severe restriction and marked decrease in nutrient quality is required to fully achieve this effect and this is not compatible with the purpose of growing pigs. It is essential that pigs on restricted intakes be provided with adequate trough space to allow an even intake of food among the group. For similar reasons, litters of pigs that are batched at or after weaning should be divided into groups of approximately equal body weight.

The strategic incorporation of an antimicrobial into the feed during the risk period may be necessary on some farms. A reduction in the potential for oral–fecal cycling of organisms in the group may reduce the incidence of gut edema. A reduction in the age of weaning may also reduce the incidence. Both organic acids and medication with 50 ppm of enrofloxacin are useful in controlling and/or preventing postweaning edema disease.<sup>45</sup>

Treatment with anti-VT2E serum can provide protective immunity against edema disease in pigs.<sup>46</sup>

No vaccine is available. Only vaccines with the preformed fimbriae induce protection and this is limited to the homologous variant<sup>47</sup> but, experimentally, vaccination of piglets with a genetically modified Shiga-like toxin 2e prevents edema disease following challenge with the Shiga-like toxin after weaning.<sup>35</sup> The concentration of protein in the diet also influenced susceptibility to edema disease. Pigs fed a low-protein diet and not vaccinated developed subclinical edema disease. Pigs fed a high-protein diet and not vaccinated developed clinical edema disease. Pigs fed a high-protein diet and vaccinated had a reduction in the incidence of subclinical edema and did not develop clinical edema disease.

## REVIEW LITERATURE

- Mainil J. Shiga/verocytotoxins and Shiga verocytotoxic *E. coli* in animals. *Vet Res* 1999; 30:235–257.
- Moxley RA. Edema disease. *Vet Clin North Am Food Anim Pract* 2000; 16:175–185.
- Moxley RA. Prevalence of serogroups and virulence groups in *E. coli* associated with postweaning diarrhea and edema disease in pigs and a comparison of diagnostic approaches. *Vet Microbiol* 2002; 85:169–185.

## REFERENCES

- Melin L. *J Vet Med B* 2004; 51:12.
- Melin L. *J Vet Med B* 2000; 47:663.
- Fang L et al. *Infect Immun* 2000; 68:564.
- Post K et al. *J Swine Health Prod* 2000; 8:119.
- Fekete PZ et al. *Vet Microbiol* 2002; 85:275.
- Van der Broek W et al. *Infect Immun* 1999; 67:520.
- Oswald E et al. *Infect Immun* 2000; 68:64.
- Yamamoto T, Nakazawa M. *J Clin Microbiol* 1997; 35:223.
- Choi C et al. *Vet Microbiol* 2001; 81:65.
- Eriksson E et al. *Vet Rec* 2002; 152:712.
- Osek J. *Vet Rec* 2002; 150:689.
- Franklin MA et al. *J Anim Sci* 2002; 80:2904.
- Verdonck F et al. *Vaccine* 2002; 20:2995.
- Fekete PZ et al. *Int J Med Microbiol* 2003; 293:287.
- Toth I et al. *J Clin Microbiol* 2003; 41:4285.
- Wairang E et al. *J Vet Med B* 1998; 45:7.
- Katouli M et al. *J Appl Microbiol* 1997; 82:511.
- Katouli M et al. *J Appl Microbiol* 1999; 87:564.
- Melin L et al. *Vet Microbiol* 1997; 54:287.
- Aarestrup FM et al. *Vet Rec* 1996; 139:373.
- Matsson S, Wallgren P. In: *Proceedings of the 16th International Pig Veterinary Society Congress* 2000:51.
- Prager R et al. *Vet Microbiol* 2004; 99:287.
- Nagy B et al. *J Clin Microbiol* 1999; 37:1642.
- Rippinger P et al. *Vet Microbiol* 1995; 45:281.
- Styriak I et al. *Dtsch Tierärztl Wochenschr* 2001; 108:454.
- Moller F et al. *J Clin Microbiol* 1997; 35:20.
- Frydendahl K. *Vet Microbiol* 2002; 85:169.
- Imberechts H et al. *Vet Microbiol* 1994; 40:219.
- Rippinger P et al. *Vet Microbiol* 1995; 45:281.
- Garabal JI et al. *Vet Microbiol* 1995; 47:17.
- Garabal JI et al. *Vet Microbiol* 1996; 48:113.
- Bertschinger HU et al. *Vet Microbiol* 1993; 35:79.
- Bosworth BT et al. *J Swine Health Prod* 1994; 2:19.
- Frydendahl F et al. *Vet Microbiol* 2003; 93:39.
- Bosworth BT et al. *Infect Immun* 1996; 64:55.
- Hada M et al. *Jpn J Vet Med Assoc* 1998; 51:659.
- Holtcamp A. *Proc Am Assoc Swine Vet* 2000:337.
- Ha S-K et al. *J Vet Diagn Invest* 2003; 15:378.
- Kausche FM et al. *Am J Vet Res* 1992; 53:281.
- Narbuurs JA et al. *Res Vet Sci* 2001; 70:247.
- Cornick NA et al. *J Infect Dis* 2000; 181:242.
- Johnson WM et al. *J Clin Microbiol* 1990; 28:2351.
- Pollard DR et al. *J Clin Microbiol* 1990; 28:540.
- Rouillard T et al. *Rev Med Vet* 2002; 153:261.
- Tsiloyiannis VK et al. *Res Vet Sci* 2001; 70:281.
- Johansen M et al. *Can J Vet Res* 2000; 64:9.
- Bertschinger VM et al. *Vet Microbiol* 2000; 71:255.

## POSTWEANING DIARRHEA OF PIGS (COLIFORM GASTROENTERITIS)

Postweaning diarrhea occurs commonly within several days after weaning and is characterized by reduced growth rate associated with alterations in the mucosa of the small intestine and, in some pigs, by acute coliform gastroenteritis characterized by sudden death, or severe diarrhea, dehydration, and toxemia. It is a major cause of economic loss from both mortality and inferior growth rate for several days to 2 weeks following weaning. The etiology, epidemiology, and pathogenesis are multifactorial and complex because of the several weaning-associated factors that may interact. In some instances the postweaning diarrhea may be followed by edema disease.

## Synopsis

**Etiology** Specific serotype of enterotoxigenic *E. coli*

**Epidemiology** 3–10 days post weaning; high morbidity and case-fatality rates. Stressors of weaning are risk factors (change of feed, loss of maternal contact and maternal antibody, mixing litters, environmental changes)

**Sign** Some pigs found dead. Outbreaks of severe diarrhea a few days post weaning. Fever, dehydration, anorexia, loss of weight, death in a few days

**Clinical pathology** Culture organism from feces and intestinal contents

**Lesions** Dehydration, serofibrinous peritonitis, fluid-filled intestines, mesenteric edema

**Diagnostic confirmation** Isolate specific serotypes of *E. coli*

### Differential diagnosis list

- Gut edema
- Swine dysentery
- Salmonellosis
- Erysipelas
- Pasteurellosis

**Treatment** Antimicrobials in water supply

**Control** Minimize stress at weaning, antimicrobials in feed and water post weaning. Intestinal acidification. Zinc oxide in diet post-weaning

## ETIOLOGY

The disease is associated with enterotoxigenic strains of *E. coli* that produce adhesion factors that allow colonization of the intestine and enterotoxins that induce the intact intestinal mucosa to secrete fluid. A summary would be that postweaning diarrhea is associated with fimbrial types F4 and F18 and carrying the genes for the Shiga-like toxin 2(SLT-2E), labile toxin (LT) and/or Shiga toxin A and B (STa or STb). Toxin and F18 fimbrial genes in *E. coli* isolated from pigs with postweaning diarrhea or edema disease occur in a variety of chromosomal backgrounds.<sup>1</sup>

Most commonly, O groups 8, 138, 139, 141, and 149 are associated with the disease.<sup>2,3</sup> Most appear to be O149:STaSTbLT:F4(K88). The strains of O149 isolated in recent years from weaned pigs with diarrhea possess the gene for an additional enterotoxin STa, which older strains lack. Of the new strains, which correspond to O149 H10, 92% code for this gene.<sup>4</sup> This enteroaggregative *E. coli* heat-stable enterotoxin 1 (EAST 1) gene is found in isolates from weaned pigs that have diarrhea or edema disease.<sup>5</sup> The F107 fimbriae can be found in association with postweaning diarrhea isolates<sup>6,7</sup> and other adhesive fimbriae such as Av24 and 2134P have been described.<sup>8</sup> Many enterotoxigenic *E. coli* isolates colonize the small intestine of weaned pigs but lack known colonization factors.<sup>9,10</sup> The

serogroups of *E. coli* isolated from pigs with postweaning diarrhea in piggeries in Spain include strains that produce the enterotoxigenic *E. coli* and verotoxin-producing *E. coli* and cytotoxic necrotizing factor toxins.<sup>11,12</sup> The disease can be reproduced consistently in weaned pigs, provided the pig's epithelial cell brush borders are susceptible to the adhesin of strains of *E. coli* with fimbrial antigen F4 (K88).<sup>13</sup> The DNA sequences coding for the F18 fimbrial antigens and AIDA adhesin are on the same plasmid in *E. coli* isolated from the cecum.<sup>14</sup> Usually they were LTSTb or STb(13%) and 12% were hemolytic and F18-positive. The remainder were nonhemolytic, belonging to the K48 serogroup.

Although there is an etiological similarity between postweaning diarrhea and neonatal enteric colibacillosis in sucking piglets, the relationship is not exact. Strains associated with neonatal enteric colibacillosis may not have the ability to produce postweaning diarrhea and many strains isolated from coliform gastroenteritis lack K88<sup>+</sup> antigen.

Cytotoxic necrotizing factor (CNF) strains of *E. coli* have been isolated from weaner pigs with necrotic enteritis in South Africa.<sup>15</sup>

Some non-enterotoxigenic O45 isolates of *E. coli* associated with postweaning diarrhea produce attaching and effacing lesions,<sup>16</sup> and their proliferation may be associated with diet.<sup>17</sup> Dual infection with attaching and effacing and enterotoxigenic *E. coli* may also be associated with postweaning diarrhea.<sup>18</sup>

Infection with rotavirus may be an etiological factor. The rotavirus may infect and destroy villous epithelial cells of the small intestine, which may allow colonization of the *E. coli*. Experimentally, a high nutrient intake fed three times daily to piglets weaned at 3 weeks of age produced the most prolonged diarrhea, colonization of the intestine by hemolytic enteropathogenic *E. coli* and persistent shedding of rotavirus. However, other observations cast doubt on the importance of rotaviruses as a cause of the diarrhea because rotaviruses may be found in the feces of pigs without diarrhea a few days after weaning. The acute disease can be reproduced using K88 *E. coli* strains without concomitant infection with rotavirus.

#### EPIDEMIOLOGY

Postweaning diarrhea occurs predominantly in pigs 3–10 days after they are weaned. There is considerable variation in the morbidity and mortality between groups, rooms of pigs and buildings. Most outbreaks are in early weaned pigs. Most commonly, pigs are first

observed sick or dead on the fourth or fifth day. The spread within affected groups is rapid and a morbidity rate of 80–90% of the group within 2–3 days is not uncommon. Frequently, other pens of susceptible pigs within the same area will also develop the disease within a short period of the initial outbreak. The problem may persist within a herd, affecting successive groups of weaned pigs over a period of weeks or months. The onset of the problem may be associated with the introduction of a different batch or formulation of the creep feed. The case fatality rate may be as high as 30% and survivors may subsequently show a reduced growth rate. The weaning of piglets at 3 weeks of age is commonly followed in a few days by a postweaning reduction in growth rate, variations in total dietary intake and the development of diarrhea. Piglets weaned at 3–4 weeks of age into an uncomfortable unsanitary environment appear especially susceptible.

The proliferation of *E. coli* in the intestine following weaning appears secondary to some underlying gastrointestinal disturbance. After weaning there is a progressive increase in viscosity of the intestinal contents, which alters the intestinal structure and growth and stimulates the proliferation of enterotoxigenic *E. coli* in newly weaned pigs.<sup>19</sup> In all groups of pigs examined the number of serotypes or diversity of intestinal flora was reduced in the first week after weaning.<sup>20</sup> The disease is associated with an earlier, more prolonged and greater proliferation of enterotoxigenic *E. coli* in the small intestines than occurs in healthy pigs after weaning. Some studies have shown that susceptibility to adhesion with K88<sup>+</sup> enterotoxigenic *E. coli* is a requirement for the production of the disease. Experimentally, pigs that did not have the adhesin receptor did not develop diarrhea when challenged with K88<sup>+</sup> *E. coli* and when in the same environment as the adhesin-positive pigs.

It is believed that several factors commonly associated with weaning predispose pigs to postweaning diarrhea associated with enterotoxigenic *E. coli*. Some of these risk factors include:

- Stress from loss of maternal contact
- Introduction to strange pens and penmates
- Inadequate ventilation in the weaning pens
- Reduction in ambient temperature
- Change in diet
- Cessation of lactation immunoglobulins
- Decreased gastric bactericidal activity attributable to a temporary increase in gastric pH

- Prewaning exposure (creep feeding) to the dietary antigens fed after weaning.<sup>21</sup>

Hand-washing and donning clean outerwear did not prevent the transmission of *E. coli* but showering and donning clean outerwear did prevent transmission.<sup>22</sup>

Experimentally, there is some evidence that the stress of cold ambient temperature (15°C) can result in a greater incidence of diarrhea in weaned pigs than in those housed at 30°C.

The nature and the amount of the diet that the piglet consumes before and after weaning may be a predisposing factor. One hypothesis suggests that a transient hypersensitivity of the intestine may occur if piglets are primed by small amounts of dietary antigen before weaning, by creep feeding, followed by ingestion of greater quantities of the diet after weaning. Pigs that develop diarrhea tend to be those that consume more food after weaning than their contemporaries.

In general, weaning at 3 weeks of age is associated with alterations in the villous epithelium of the small intestine that result in varying degrees of malabsorption and a reduction in daily growth rate that may last for 2 weeks. There are large rapid reductions in intestinal lactase activity, which coincide with reductions in growth rate and a reduced ability to absorb xylose. There is a reduction in villus height and an increase in crypt depth in the small intestine but these alterations are not necessarily associated with the consumption of creep feed before weaning, which does not support the hypothesis that hypersensitivity to a dietary antigen caused by priming prior to weaning is a factor. There is now considerable doubt about the validity of the intestinal hypersensitivity hypothesis. Recent experimental work indicates that creep feeding is not required for the production of the diarrhea and does not induce morphological changes characteristic of an allergic reaction in the small intestine.<sup>23</sup> The presence of nondigested food in the gut lumen favors proliferation of enterotoxigenic *E. coli*. Proteins of animal origin may provide some protection.<sup>24</sup>

Dietary manipulation can modify several changes that normally occur in the small intestine of the piglet after weaning.<sup>25</sup> Feeding a sow milk replacer or a diet based on hydrolyzed casein reduces the increases in crypt depth and the reductions in brush border enzymes. The use of an antibiotic to suppress the microbial activity does not alter the changes in the mucosa after weaning.

The ecology of *E. coli* and rotavirus in the stomach and intestines of healthy unweaned pigs and pigs after weaning has

been examined. Gastric pH is higher in weaned pigs and may not reach a level sufficient to prevent significant numbers gaining access to the small intestine. This factor can be of importance in pigs weaned in pens where oral-faecal cycling of *E. coli* may provide a massive challenge. After weaning, the hemolytic enterotoxigenic *E. coli* serotype O149:K91, K88a,c (Abbotstown strain) commonly colonizes the rostral small intestine from lower down the intestinal tract. This serotype was also never found in the gastric contents of weaned pigs. When this serotype is present it tends to dominate the *E. coli* flora at all levels of the intestine. While rotaviruses are common in the intestinal contents of weaned pigs, the presence of the virus is not necessary for production of the disease.

The loss of lactogenic immunity at weaning may be a risk factor. Milk from sows whose progeny develop postweaning diarrhea contain antibodies capable of neutralizing the enterotoxigenic effect of the homologous *E. coli*. This suggests that the presence of antibody-mediated activity against enteropathogenic *E. coli* may be important in preventing the disease during the nursing period. At weaning this protection is removed and the piglet is unable to produce its own antibodies rapidly enough to prevent the disease. The stress of weaning does not appear to affect the immune mechanisms of the pig.

The weaning of piglets at birth or 1 day old is associated with a high mortality rate due to diarrhea and septicemia. The high mortality rate is associated with a lack of colostrum antibodies and the strict hygienic conditions required for the artificial rearing of pigs weaned at birth.

### PATHOGENESIS

The colonization and proliferation of *E. coli* in the small intestine originates from organisms in the lower part of the intestinal tract. Serotypes of *E. coli* associated with postweaning diarrhea may be found in the feces of healthy pigs. The virulence factors for postweaning diarrhea are associated with the F4 and F18 fimbrial antigens that carry the genes for the production of toxins (STa, STb, LT, SLT2a, SLX2e). The F18ab variant is expressed by *E. coli* O139 strain producing Shiga-like toxin and causing edema disease. The F18ac fimbrial *E. coli* strains often relating to serogroup O141 or O157 and cause diarrhea by expressing enterotoxins (STa or STb) either together or without Shiga-like toxins.<sup>26</sup> Following weaning, their numbers in feces normally increase markedly even in pigs that remain healthy. The *E. coli* proliferate in the small intestine and produce an enterotoxin that causes a net loss of fluid

and electrolytes to the lumen and subsequent diarrhea. After weaning the net absorption of fluid and electrolytes in the small intestine of pigs is temporarily decreased.<sup>25</sup>

The number of hemolytic *E. coli* present in the proximal portion of the jejunum may be  $10^3$ – $10^5$  times higher in affected pigs than in weaned pigs of the same age that do not show signs of disease.<sup>27</sup> The susceptibility of the small intestine to the enterotoxin varies according to the area: the upper small intestine is highly susceptible and susceptibility decreases through the more distal portions. Unlike many other species, the weanling pig depends largely on its large intestine for absorption of fluid and electrolytes with only small changes in net fluid movement occurring along the jejunal and ileal segments. In fatal cases, death results from the combined effects of dehydration and acidosis resulting from fluid and electrolyte losses. In the peracute and acute forms of the disease, there is a shock-like syndrome with marked gastric and enteric congestion, hemorrhagic enteritis, and death.<sup>28</sup>

The experimental model of the disease is characterized by the three syndromes:

- Peracute fatal diarrhea
- Moderate diarrhea of 3–4 days' duration, accompanied by fecal shedding of the inoculated organism and reduced body weight gain
- Fecal shedding of the organism with reduced weight gain but without diarrhea.

The role of the rotavirus in the pathogenesis of postweaning diarrhea is uncertain.<sup>29</sup> The rotavirus can be found in the feces of healthy unweaned and weaned pigs. The virus is capable of infecting and destroying villous epithelial cells which could contribute to the partial villous atrophy, loss of digestive enzyme activity, malabsorption and reduced growth rate. Experimental inoculation of an enteropathogenic *E. coli* and the rotavirus causes a more severe disease than either agent does alone. The effects of experimentally induced villus atrophy in weaned pigs infected with the transmissible gastroenteritis virus and a K88<sup>+</sup> enterotoxigenic *E. coli* have been examined.

Changes in the mucosa of the small intestine of recently weaned pigs have been observed and are the subject of much controversy. There is a reduction in the length of the villi, a marked reduction in intestinal disaccharidase activity and an increase in the depth and activity of the intestinal crypts. These changes are maximal at 3–7 days following weaning, persisting until the second week and coinciding with the reduced growth rate.

### CLINICAL FINDINGS

The postweaning reduction in growth rate may affect 50–100% of the pigs within a few days after weaning and persist for up to 2 weeks. In some situations diarrhea may not develop in any of the pigs in the group. A reduction in feed intake, gaunt abdomens, and lusterless hair coats are characteristic findings of piglets with postweaning 'check'. They may appear unthrifty for 10 days to 2 weeks, by which time they will improve remarkably.

Most commonly one or two pigs, in good nutritional condition, are found dead with little having been seen in the way of premonitory signs. At this time the others within the group may appear normal but closer examination will reveal several pigs showing mild depression and moderate pyrexia. A postmortem examination of dead pigs should be conducted early in the examination. A proportion of the group will develop diarrhea within 6–24 hours and by 3 days after the initial onset the morbidity may approach 100%. Feed consumption falls precipitously at the early stages of the outbreak but affected pigs will still drink. Affected pigs may show a pink discoloration of the skin of the ears, ventral neck, and belly in the terminal stages. Diarrhea is the cardinal sign – the feces are very watery and yellow in color but may be passed without staining of the buttocks and tail. Pyrexia is not a feature in individual pigs once diarrhea is evident. Affected pigs show a dramatic loss of condition and luster and become progressively dehydrated. Voice changes and staggering, incoordinated movements may be observed in the terminal stage in some pigs. The course of an outbreak within a group is generally 7–10 days and the majority of pigs that die do so within the initial 5 days. Surviving pigs show poor growth rate for a further 2–3 weeks and some individuals show permanent retardation in growth. In outbreaks in early weaned pigs diarrhea is usually evident before death occurs. There is some evidence to show that the postweaning diarrhea may be activated by porcine reproductive and respiratory syndrome.<sup>30</sup>

### CLINICAL PATHOLOGY

Culture of the feces and intestinal contents for enterotoxigenic strains of *E. coli* is indicated.

### NECROPSY FINDINGS

Pigs dying early in the course of the outbreak are in good nutritional condition but those dying later show weight loss and dehydration. Mild skin discoloration of the ears and ventral areas of the head, neck, and abdomen is usually present. In acute cases there is a moderate increase in



peritoneal fluid and barely perceptible fibrinous tags between loops of the small intestine may be present. The vessels of the mesentery are congested and occasionally petechial hemorrhages and edema are present. The gastric mucosa is congested and an infarct is usually present along the greater curvature. The small intestines are dilated and contain yellow mucoid liquid or occasionally bloodstained material. The mucosa of the small intestine is congested and sometimes there are hemorrhagic areas. The content of the large intestine is fluid to porridge-like in consistency and the mucosa may be congested. In some cases mild mesocolonic edema is visible. Hemolytic *E. coli* can be isolated in large numbers from the small intestine and mesenteric lymph nodes. Polyclonal antisera directed against known pathogenic serotypes are usually employed to test the isolate but a negative result does not preclude the strain from being an enteropathogenic organism.

Microscopically, there is usually bacterial adherence to intestinal villi. Other changes are those commonly associated with endotoxemia, especially microvascular thrombosis in a variety of organs.

#### Samples for confirmation of diagnosis

- Bacteriology – mesenteric lymph node, segment of ileum, colon (CULT)
- Histology – formalin-fixed stomach, several segments of small intestine, colon, liver, lung, spleen (LM).

#### DIFFERENTIAL DIAGNOSIS

Postweaning diarrhea is the prime consideration in pigs that are scouring or dying within a 3–10-day period of some feed or management change. Swine dysentery and salmonellosis are manifested by diarrhea and death but they are not necessarily related to weaning or feed change, and both are more common in older growing pigs. Salmonellosis poses the greatest difficulty in initial diagnosis from coliform gastroenteritis. In salmonellosis, the feces are generally more fetid with more mucus, mucosal shreds, and occasionally blood, and the skin discoloration is more dramatic. On necropsy examination enlarged hemorrhagic peripheral and abdominal lymph nodes and an enlarged pulpy spleen are more suggestive of salmonellosis; however, cultural differentiation is frequently required. If there is doubt the pigs should be treated to cover both conditions until a final decision is obtained. The onset of swine dysentery is comparatively more insidious than that of postweaning diarrhea; the characteristic feces, clinical and epidemiological pattern and postmortem lesions differentiate these two conditions.

Swine fever should always be a consideration in outbreaks in pigs manifested by diarrhea and death. However, the epidemiological and postmortem features are different. Other common causes of acute death in growing pigs such as erysipelas, pasteurellosis, and *Actinobacillus pleuropneumoniae* infection are easily differentiated on necropsy examination.

Edema disease occurs under similar circumstances to coliform gastroenteritis but the clinical manifestation and postmortem findings are entirely different.

#### TREATMENT

A Swedish study<sup>31</sup> showed that, except for resistance to tetracyclines, sulfamethoxazole, and streptomycin, antibiotic resistance is not unduly spread across *E. coli* isolates. A Spanish study<sup>32</sup> was similar. Tetracyclines should not be the first choice of treatment because of the rapid acquisition of resistance. Nearly all isolates are highly susceptible to enrofloxacin, gentamicin, and neomycin.

It is imperative that treatment of all pigs within the group be instigated at the initial signs of the onset of postweaning diarrhea, even though at that time the majority of pigs may appear clinically normal. Delay will result in high mortality rates. Any pig within the group that shows fever, depression, or diarrhea should be initially treated individually both parenterally and orally and the whole group should then be placed on oral antibacterial medication. Water medication is preferable to medication through the feed as it is easier to institute and affected pigs will generally drink even if they do not eat. Neomycin, tetracyclines, sulfonamides, or trimethoprim-potentiated sulfonamides and ampicillin are the usual drugs of choice. Danofloxacin is safe and highly effective.<sup>33</sup> Experimental infection with K88-positive *E. coli* was controlled by ceftiofur sodium given intramuscularly daily for three consecutive days.<sup>34</sup> When pulse dosing is used there appears to be less resistance.<sup>35</sup> In herds with postweaning problems, prior sensitivity testing will guide the choice of the antibacterial to be used. Antibiotic medication should be continued for a further 2 days after diarrhea is no longer evident and is generally required for a period of 5–7 days.

Consideration should be given to the medication of at-risk equivalent groups of pigs within the same environment. Intra-peritoneal fluid and electrolyte replacement for severely dehydrated pigs and electrolytes in the drinking water should also be considered.

#### CONTROL

Recommendations for effective and economical control of postweaning reduced

growth rate and postweaning diarrhea in pigs weaned at 3 weeks of age are difficult because the etiology and pathogenesis of this complex disease are not well understood. Epidemiologically, the disease is associated with weaning and the effects of the diet consumed before and after weaning. In all cases the piglet should be 4.5 kg (10 lb) and preferably 5.5 kg (12 lb) at weaning.

A whole variety of techniques, including intestinal acidification, antimicrobial medication in water or feed, environmental modifications, competitive exclusion, feeding probiotics, binding agents such as eggs, milk, or bacterial byproducts (most of these studies show they do not work), zinc oxide, or vaccination of sows and piglets with toxoids have been tried. The use of dietary egg yolk antibodies also does not appear to be effective.<sup>36</sup>

Intestinal acidification reduces the binding of the *E. coli* to the epithelial surface and a pH of 3.5–4.0 at the trough or nipple drinker is best. Citric acid, formic acid, propionic acid, or a citric acid/copper sulfate mixture can be used.

Zinc oxide in particular stabilizes the intestinal flora. Piglets given lactose and fiber were least affected and the next least affected were animals that received zinc oxide.<sup>37</sup> Pigs fed dietary antibiotic growth promoters and zinc oxide had lower counts of anaerobic bacteria in their feces than control piglets. The removal of these ingredients from the diet will increase days to slaughter.<sup>38</sup>

It has been traditionally accepted, without reliable evidence, that the sudden transition in diet at weaning is the major predisposing factor. However, as presented under Epidemiology, the experimental observations are conflicting. One set of observations indicates that, if pigs eat a small quantity of creep feed before weaning, they are then 'primed' and develop an intestinal hypersensitivity that, following the ingestion of the same diet after weaning, results in the disease. It has been suggested that piglets should consume at least 600 g of creep feed before weaning in order to develop a mature digestive system. Another set of observations indicates that those pigs that consumed an excessive quantity of feed after weaning developed the disease.

The complete withholding of creep feed followed by abrupt weaning at 3 weeks of age seemed to have a protective effect, possibly associated with a low dietary intake. Farms with lower rates of postweaning diarrhea used their first piglet ration (phase 1 feeding) for much longer and also changed over to the second ration over a much longer period. Competitive exclusion has been shown to be of benefit.<sup>39–41</sup>



The recommendations set out here are based on the hypothesis that the consumption of adequate quantities of creep feed prior to weaning is the most effective and economical practice.

Every effort should be made to minimize the stress associated with weaning. Stressors influence the fecal shedding of enterotoxigenic *E. coli* by young piglets by a mechanism that may not involve modulation of the immune response.<sup>42</sup> In order to avoid a sudden transition in diet at weaning, creep feed should be introduced to the suckling piglets by at least 10 days of age. It is important that the creep feed and feeder area be kept fresh to maintain palatability. The same feed should be fed for at least 2 weeks following weaning and all subsequent feed changes should be made gradually over a 3–5-day period. Feed restriction in the immediate 2-week period following weaning may reduce the incidence but generally is not successful. It is a common field observation that the incidence of diarrhea varies with different sources of feed but experimental studies to confirm this relationship are not available.

Where possible, at weaning the sow should be removed and the pigs should be kept as single litters in the same pen for the immediate postweaning period. If grouping of litters is practiced at this time, or later, the pigs should be grouped in equivalent sizes. Multiple suckling in the preweaning period may reduce stress associated with grouping of part-weaned pigs. With all pigs, but especially those weaned earlier than 6 weeks, the pen construction should be such as to encourage proper eliminative patterns by the pigs and good pen hygiene (see Salmonellosis) so as to minimize oral–fecal cycling of hemolytic *E. coli*. The environment also appears especially important in this group and draft-free pen construction should be such as to encourage proper ventilation. It is preferable to wean pigs on weight rather than age and in many piggeries a weaning weight of less than 6 kg is associated with a high incidence of postweaning enteric disease.

The inclusion of an antimicrobial in the feed or water to cover the critical period of susceptibility (generally for 7–10 days after weaning) can be used as a preventive measure. Apramycin at the rate of 150 g/tonne of feed for 2 weeks after weaning may be associated with improved growth rates and a reduction in mortality. The high incidence of drug resistance in isolates of *E. coli*<sup>43</sup> makes prior sensitivity testing mandatory and the antibiotic may need to be changed if new strains gain access to the herd. The routine use of prophylactic antibiotics for this purpose needs to be considered in relation to the

problem of genetically transmitted drug resistance, however it is currently often necessary for short-term control of a problem.

Vaccination may offer an alternative method of control. However, currently there are no vaccines available for the control of colibacillosis in weaned pigs. Oral inoculation with  $5 \times 10^8$ – $10^9$  of non-toxigenic strains can be followed with K88 at day 1 of move, K88/F18ab at day 7 and F18 at days 13–15. Only the oral vaccines with the preformed fimbriae appear to produce any protection to homologous fimbrial variant.<sup>44</sup> The results vary and some authors think that the prolonged transit time in the stomach after weaning may deactivate the F4 fimbriae when this has been used as a fimbrial vaccine.<sup>45</sup> Microencapsulated enterotoxigenic *E. coli* and detached fimbriae have been used for peroral vaccination in pigs.<sup>46,47</sup> Parenteral vaccination for the control of coliform gastroenteritis has proved of variable value, probably because parenterally administered antigens do not usually stimulate the production of IgA antibodies and intestinal immunity. Oral immunization by the incorporation of *E. coli* antigens into creep feed has been shown to reduce the incidence and severity of postweaning diarrhea. A live avirulent *E. coli* vaccine for K88<sup>+</sup>, LT<sup>+</sup> enterotoxigenic colibacillosis in weaned pigs provided protection experimentally. Rearing early-weaned piglets artificially for the purpose of increasing the efficiency of the sow is an attractive management concept. However, high death losses from diarrhea have slowed progress in this new development. The incorporation of antibodies in the diet of such piglets as a prophylactic measure should be possible and is being explored.

The ultimate control is by removing the receptor gene in the population and although this has been done experimentally these animals are not yet available in large numbers commercially.

## REVIEW LITERATURE

- Mainil J. Shiga/verocytotoxins and Shiga verotoxigenic *E. coli* in animals. *Vet Res* 1999; 30:235–257.
- Moxley RA, Duhamel GE. Comparative pathogenesis of bacterial enteric disease of swine. *Adv Exp Med Biol* 1999; 473:83–101.
- Nagy B, Fekete PZ. Enterotoxigenic *E. coli* (ETEC) in farm animals. *Vet Res* 1999; 30:259–284.
- Wills RW. Diarrhea in growing-finishing swine. *Vet Clin North Am Food Anim Pract* 2000; 16:135–161.
- Francis DH. Enterotoxigenic *E. coli* infection in pigs and its diagnosis. *J Swine Health Prod* 2002; 10:171–175.

## REFERENCES

- Nagy B et al. *J Clin Microbiol* 1999; 37:1642.
- Gyles CL. *Can J Microbiol* 1992; 38:734.
- Imberechts H et al. *Vet Microbiol* 1994; 40:219.
- Naomini BN et al. *Vet Microbiol* 2003; 97:87.

- Choi C et al. *Vet Microbiol* 2001; 81:65.
- Rippering P et al. *Vet Microbiol* 1995; 45:281.
- Hidde B et al. *Vet Microbiol* 1995; 47:235.
- Kennan R et al. *Vet Microbiol* 1995; 43:123.
- Nagy B et al. *Vet Pathol* 1992; 29:239.
- Dean-Nystrom EA et al. *Vet Microbiol* 1993; 37:101.
- Garabal JL et al. *Vet Microbiol* 1995; 47:17.
- Garabal JL et al. *Vet Microbiol* 1996; 48:113.
- Fairbrother JM et al. In: Proceedings of the 16th International Pig Veterinary Society Congress 2000:77.
- Mainil JG. *Vet Microbiol* 2002; 86:303.
- Penrith ML et al. *Vet Rec* 1995; 136:493.
- Zhu C et al. *Infect Immun* 1994; 62:4153.
- Neef NA et al. *Infect Immun* 1994; 62:4325.
- Wada Y et al. *J Comp Pathol* 1996; 114:93.
- McDonald DE et al. *Br J Nutr* 2001; 86:487.
- Melin L et al. Proceedings of the 17th International Pig Veterinary Society Congress 2002:326.
- Sarmiento JI et al. *Am J Vet Res* 1990; 49:2030.
- Amass SF. *J Swine Health Prod* 2003; 11:61.
- Sarmiento JI et al. *Am J Vet Res* 1990; 51:1180.
- Bosi P et al. *Asian-Aust J Anim Sci* 2004; 14:1138.
- Nabuurs MJA et al. *Res Vet Sci* 1994; 56:379.
- Smeds QA et al. *Infect Immun* 2003; 71:2163.
- Katwa LC et al. *Infect Immun* 1991; 59:4318.
- Faubert C, Drolet R. *Can Vet J* 1992; 33:251.
- Nabuurs MJA et al. *Res Vet Sci* 1993; 55:70.
- Nakamine M et al. *J Vet Med Sci* 1998; 60:555.
- Melin L et al. In: Proceedings of the 16th International Pig Veterinary Society Congress 2000:119.
- Mateu E, Martin M. In: Proceedings of the 16th International Pig Veterinary Society Congress 2000:120.
- Sunderland SJ et al. *Tierärztl Umschau* 2001; 56:235.
- Hibbard B et al. *J Swine Health Prod* 2003; 11:7.
- Mathew AG et al. *J Swine Health Prod* 2002; 10:7.
- Chernysheva L et al. *J Swine Health Prod* 2004; 12:119.
- Melin L, Wallgren P. *Acta Vet Scand* 2003; 43:231.
- Broom LJ et al. *Anim Sci* 2003; 77:79.
- Genovess K et al. *Can J Vet Res* 2002; 64:204.
- Anderson RC. *J Swine Health Prod* 1999; 7:155.
- Harvey RB. *Proc Am Assoc Swine Vet* 2003:485.
- Jones PH et al. *Res Vet Sci* 2001; 70:9.
- Amezcuca R et al. *Can J Vet Res* 2002; 66:73.
- Bertschinger HU et al. *Vet Microbiol* 2000; 71:255.
- Snoek V et al. *Vet Microbiol* 2001; 98:45.
- Felder ChB et al. *Vaccine* 2001; 19:706.
- Snoek V et al. *Vet Immunol Immunopathol* 2003; 96:219.

## CEREBROSPINAL ANGIOPATHY

Cerebrospinal angiopathy is a sporadic disease of recently weaned pigs manifested primarily by neurological signs. In some areas the disease is the more common cause of central nervous system disorders in this age group of pigs.<sup>1</sup> The disease affects only one or a few pigs within a litter of a group occurring up to 5 weeks after weaning,<sup>1,2</sup> although a similar condition has been reported in fattening and adult pigs.<sup>3</sup> The disease is characterized by the variety of neurological signs that it presents. Incoordination and a decreased central awareness are common presenting signs but abnormal head position, aimless wandering and persistent circling may also be observed.

There is usually apparent impairment of vision. Fever is not a feature and the clinical course may last for several days. Affected animals may die but more commonly are destroyed because of their emaciated condition.<sup>2,4</sup> Wasting without neurological disorder may also occur.<sup>5</sup> They are also prone to savaging by unaffected penmates.

Histologically the disease is characterized by an angiopathy that is not restricted to the central nervous system. The similarity of the angiopathy to that seen in chronic edema disease<sup>6</sup> has led to postulation<sup>1,2,4</sup> that this disease is a sequel to subclinical edema disease. The disease has been reported occurring in pigs 15–27 days after experimental *E. coli* infection.<sup>5</sup> The characteristic feature is the presence of perivascular eosinophilic droplets.<sup>7</sup>

The main differential diagnosis is that of spinal or brain abscess and the porcine viral encephalomyelitides. Affected pigs should be housed separately as soon as clinical signs are observed. In view of the nature of the lesion, therapy is unlikely to be of value; however, recovery following treatment with oxytetracycline has been reported.<sup>1</sup>

## REFERENCES

- Hartigan PJ, Baker KP. *Ir Vet J* 1974; 28:197.
- Harding JDJ. *Pathol Vet* 1966; 3:83.
- Szecky A, Szabo I. *Acta Vet Hung* 1972; 22:283.
- Freere K, von Sanderslebe J. *Berl Munch Tierarztl Wochenschr* 1968; 81:197.
- Bertschinger HU, Pohlentz J. *Schweiz Arch Tierheilkd* 1974; 116:543.
- Kurtz HJ et al. *Am J Vet Res* 1969; 30:791.
- Nakamura K et al. *Vet Pathol* 1982; 19:140.

## Diseases associated with *Salmonella* species

### SALMONELLOSIS (PARATYPHOID)

#### Synopsis

**Etiology** *Salmonella* spp. Cattle: *Salmonella typhimurium*, *Salmonella dublin*, *Salmonella newport*. Sheep and goats: *S. typhimurium*, *S. dublin*. Horses: *S. typhimurium*. Pigs: *Salmonella choleraesuis*

**Epidemiology** Worldwide. Important zoonosis and foodborne illness. Prevalence of infection in healthy animals varies according to species and country. Incidence of clinical disease lower than prevalence; outbreaks occur precipitated by stressors. Spread by direct or indirect means; infected animal source of organism, which contaminates feed and water supplies. Disease may become endemic on farm. Carrier animals shed organism and may introduce infection into herd. Deprivation of feed and water, transportation, drought, intensive grazing and housing, mixing

animals from different sources contribute to onset of disease. Antimicrobial resistance major public health problem. Subclinical infection in pigs potential zoonosis

**Signs** Septicemia in neonatal ruminants and foals, and in pigs up to 4 months of age with high case fatality rate. Acute diarrhea and dysentery, fibrinous fecal casts, fever, marked dehydration, toxemia; chronic enteritis; abortion; dry gangrene of extremities; arthritis and foci of osteomyelitis. Severe diarrhea and dehydration characteristic in horse

**Clinical pathology** Culture organism from feces; detect organism with special tests; hematology for changes in leukon and clinical chemistry electrolyte changes

**Lesions** Septicemic hemorrhages. Mucoenteritis to marked fibrinohemorrhagic necrotic enteritis; enlarged mesenteric lymph nodes. Kidney petechiation in pigs. Foci of necrosis and thickened intestinal wall in chronic enteritis. Culture organism from blood, spleen, liver, lymph nodes

#### Differential diagnosis list

- Septicemia of neonates
  - Coliform septicemia of calves, foals, piglets, lambs
  - Actinobacillus equuli* infection of foals
- Septicemia of growing pigs
  - Hog cholera
  - Erysipelas
  - Pasteurellosis
  - Swine dysentery
- Acute enteritis of cattle
  - Coccidiosis
  - Winter dysentery
  - Acute intestinal obstruction
- Chronic enteritis of cattle
  - Johne's disease
  - Copper poisoning
  - Intestinal parasitism
- Acute enteritis of horses
  - Idiopathic colitis
  - Potomac horse fever
- Abortion: see Table 18.7

**Treatment** Antimicrobials. Supportive fluid and electrolyte therapy

**Control** Prevent introduction of infection into herd. Limit spread of infection within herd by identification of carrier animals, prophylactic antimicrobials, restricting movement of animals, clean water supply, hygiene and disinfection of buildings. Avoid spread of infection in veterinary clinics, dispose of infective materials. Vaccines for immunization are available but not effective

#### ETIOLOGY

The genus *Salmonella* belongs to the family Enterobacteriaceae. Currently there are 2463 serotypes (serovars) of *Salmonella*.<sup>1</sup> The antigenic formulae of *Salmonella* serotypes are defined and maintained by the World Health Organization (WHO) Collaborating Centre for Reference and Research on *Salmonella* at the Pasteur Institute, Paris, France, and new serotypes

are listed in annual updates of the Kaufmann–White scheme.

In 1986, the Subcommittee of Enterobacteriaceae of the International Committee on Systematic Bacteriology recommended that the type species for *Salmonella* be changed to *Salmonella enterica*. However, *Salmonella typhi* and *Salmonella choleraesuis* were maintained as type species.<sup>1</sup> The literature on *Salmonella* nomenclature has been reviewed.<sup>1</sup>

According to the current system used by the Centers for Disease Control, the genus *Salmonella* contains two species, each of which contains multiple serotypes.<sup>1</sup> The two species are *S. enterica*, the type species, and *Salmonella bongori*. *S. enterica* subsp. *enterica* is divided into six subspecies. *S. enterica* subsp. *enterica* I is divided into serotypes, for example serotypes *enteritidis*, *typhimurium*, *typhi*, and *choleraesuis*. At the first citation of a serotype the genus name is given followed by the word 'serotype' or the abbreviation 'ser.' and then the serotype name (e.g. *Salmonella* serotype or ser. *typhimurium*). Subsequently, the name may be written with the genus followed directly by the serotype name (e.g. *Salmonella typhimurium* or *S. typhimurium*). The majority (59%) of the 2463 *Salmonella* serotypes belong to *S. enterica* subsp. *I* (*S. enterica* subsp. *enterica*).

Serovars of *S. enterica* subsp. *I* are associated mainly with warm-blooded vertebrates and are responsible for most *Salmonella* infections in humans and domesticated animals. *Salmonella* serovars differ in the range of hosts they can infect and in the nature of disease that may result: this difference is referred to as **serovar–host specificity**. Some *Salmonella* serovars, for example *typhimurium* and *enteritidis*, can infect a wide range of hosts and are termed ubiquitous. They are usually associated with a relatively mild enteric disease, although in some hosts, such as mice, the disease can be systemic and severe. Other serovars are very restricted in their host range, causing severe systemic disease in only one host. For example, *S. typhi* is restricted to infection in humans, *Salmonella abortusovis* to infections in sheep, *Salmonella dublin* in cattle, *Salmonella abortusequi* in horses, and *Salmonella choleraesuis* in pigs.

A third group of serovars is associated predominantly with disease in one species but may also infect a limited number of other hosts. For example, *S. dublin* is usually associated with cattle but natural infection by this serovar may also occur in other animals, including humans and sheep. The nature of disease associated with this third group of serovars is variable, depending on the specific combination of serovar and host, although

in the predominant serovar-host combination the disease is usually systemic.

The serotypes (serovars) that most commonly cause salmonellosis in farm animal species are as follows:

- **Cattle:** *S. typhimurium*, *S. dublin*, *Salmonella newport*
- **Sheep and goats:** *S. abortusovis*, *S. typhimurium*, *S. dublin*, *Salmonella anatum*
- **Pigs:** *S. typhimurium*, *S. choleraesuis*
- **Horses:** *S. typhimurium*, *S. abortusequi*, *S. anatum*, *S. newport*, *S. enteritidis*, *Salmonella heidelberg*, *Salmonella arizona*, *Salmonella angona*.

The molecular methods are now available for epidemiological investigation of *S. enterica* subsp. *enterica* infections.<sup>2</sup>

### EPIDEMIOLOGY

The epidemiology of salmonellosis is complex, which often makes control of the disease difficult. The epidemiological patterns of prevalence of infection and incidence of disease differ greatly between geographical areas depending on climate, population density, land use, farming practices, food harvesting and processing technologies, and consumer habits. In addition, the biology of the serovars differs so widely that considerations of salmonellosis, *Salmonella* infections or *Salmonella* contamination are inevitably complex.

### Prevalence of infection

Surveys from various countries indicate a 13–15% infection rate in dairy cows in New Zealand, with similar rates in calves and sheep, and 4% in beef cattle. In the Netherlands, the infection rate is 25% in healthy pigs at abattoirs but similar investigations elsewhere record 10% (New Zealand) and 6% (UK). American figures indicate a 10–13% infection rate. *Salmonellas* were isolated from the mesenteric lymph nodes and cecal contents of 84% of slaughtered sows in a Minnesota abattoir. These data are based on abattoir material and should be viewed with caution because of the very rapid increase in infection rate which occurs when animals are held over in yards for several days.

A national survey of the prevalence of fecal carriage of *Salmonella* in healthy pigs, cattle, and sheep at slaughter, and of pig carcass contamination with *Salmonella* in Great Britain found the carriage rate in prime slaughter cattle and sheep was very low compared with pigs.<sup>3</sup> In pigs, the cecal carriage rate was 23.0%, although carcasses were only moderately contaminated at 5.3%. The meat juice ELISA results indicated that 152% of tissue fluid samples were positive at the 40% cutoff level and 35.7% at the 10% experimental

cutoff level. This indicates that pigs are exposed to a relatively high level of *Salmonella* during the weeks prior to slaughter. The carriage rate in cattle and sheep was very low, ranging from 0.1–1.7%.

In the UK, *S. dublin* and *S. typhimurium* account for nearly 90% of bovine salmonellosis. *S. typhimurium* is endemic in calves, especially those purchased at livestock markets and raised for beef or veal. In the USA, the organism is shed by calves on 16% of farms sampled; in Ontario, calves on 22% of farms surveyed were found to shed *Salmonella* spp. In a survey of 47 dairy farms in Ohio, of 452 calves sampled, 10 calves from seven farms were culture-positive.<sup>4</sup> *Salmonella* serotypes isolated were *S. dublin*, *S. typhimurium*, *S. enteritidis*, *S. agona*, *Salmonella mbandaka*, and *Salmonella montevideo*. Bulk milk tank filters from these dairies were also submitted for culture; *Salmonella* spp. were isolated from one of 50 filters and two calves from this herd were found to be shedding *Salmonella* spp. of the same serotype.

The geographical distribution of the serotypes differs: *S. typhimurium* has a universal distribution; *S. dublin* has a more patchy habitat. In the USA, up until 1948, it was limited to California and as recently as 1971 it had not been reported in cattle east of the Rocky Mountains. In 1980, the first case of *S. dublin* occurred in Indiana. The movement of infected adult cattle and calves is responsible for the introduction of infection to areas where it had not previously been diagnosed. In a California survey of 60 dairy herds, milk samples and serum samples tested with an ELISA for antibodies against *Salmonella* serogroup B, C1, and D1 antigens found that 75% of dairy herds surveyed had cows with serological evidence of recent exposure to salmonellas, especially *S. typhimurium* and *S. dublin*. The prevalence of fecal shedding of *Salmonella* by cull dairy cattle marketed in Washington state is estimated to be 4.6 per 1000 head. Neonatal calves under 28 days of age may be shedding *Salmonella* without any evidence or recent herd history of clinical disease. Australia has had little *S. dublin* but there has been a marked increase in outbreaks of abortions, gastroenteritis and calf deaths due to *S. dublin* infection in Queensland dairy cattle since 1983. South Africa, South America, the UK, and Europe have had *S. dublin* as the principal pathogen for cattle for some time. It has also come to surpass *S. abortusovis* as a cause of abortion in sheep.

In Danish pig herds, *Salmonella* infections are usually subclinical. A survey in 1993–94 found that 22% of 1368 larger herds were infected with *Salmonella*. The most prevalent serotypes were

*S. typhimurium* (62% of infected herds), *Salmonella infantis* (10%), *Salmonella* 4.12:b (8%), and *Salmonella panama* (5%). Phage typing of isolates of *S. typhimurium* from pigs and humans reveals that pigs are probably a major source of the infection in humans in Denmark.

In Sweden the prevalence of salmonellosis in food-producing animals is low because of the *Salmonella* control programs, which started in 1961 with the aim of keeping meat-producing animals free from *Salmonella* in Sweden.<sup>5</sup> When Sweden joined the European Union in 1995, surveillance of *Salmonella* in cattle, pigs, and poultry at slaughter was included in the control programs. Any finding of *Salmonella* from animals or in feeds or feed production, regardless of serotype, is notifiable to the Swedish Board of Agriculture. The occurrence of *Salmonella* in animals and in the feed production in Sweden remained relatively stable from 1993–97.<sup>5</sup>

The incidence of salmonellosis in animals and humans may change within a geographical area over a period of years.<sup>6</sup> In Scotland, the incidence of *S. typhimurium* DT104 in cattle peaked in 1996 and then decreased annually to 2001.<sup>6</sup> Similar declines have been observed in its incidence in sheep and pigs. In humans, the number of reports of *S. enteritidis* PT4 peaked in 1997 and then declined to a low level by 2001.

*S. infantis* and *S. typhimurium* persist among cattle in Finland, with a low prevalence rate of 2% of farms, but these serovars play a major role in human salmonellosis.<sup>7</sup> Molecular epidemiology is now used to determine if strains isolated from cattle are the same as those affecting humans.<sup>2,6</sup> Multiple genetic typing of *S. typhimurium* isolates of different phage types (DT104, U302, DT204B, and DT 49) from animals and humans in England, Wales, and Northern Ireland identified different degrees of polymorphism.<sup>8</sup> A prevalent genomic clone, as well as a variety of less frequent clones, is present for each of the phage types. Molecular epidemiology of *S. typhimurium* isolates from wild-living birds, domestic animals and the environment was investigated in Norway using pulse-field gel electrophoresis.<sup>9</sup> Passerines (perching birds) constitute an important source of infection for humans in Norway, whereas gulls and pigeons represent only a minor source of human *S. typhimurium* infections. Passerines, gulls, and pigeons may constitute a source of infection of domestic animals and feed plants. Some isolates from cattle were confirmed as mr *S. typhimurium* DT104 for the first time.

The serotype and phage type distribution of *Salmonella* strains isolated from humans, cattle, pigs, and chickens in the

Netherlands from 1984–2001 were determined.<sup>10</sup> The most prevalent serotypes were as follows: in humans, serovars *typhimurium* and *enteritidis*; in cattle, serovars *typhimurium* and *dublin*; in pigs, serovar *typhimurium*; and in chickens, serovars *enteritidis*, *infantis*, and *typhimurium*. In general, similar sero- and phage types were found in humans and animals, although distinct types were more common in animals.

Monitoring of the population and herd *Salmonella* seroprevalence in finishing pigs and sows provided a baseline for the success of future intervention and control strategies for *Salmonella* in pork. The seroprevalence of *Salmonella* in sows and finishing pigs in the Netherlands was determined using indirect ELISA on blood samples collected at the abattoirs.<sup>11</sup> The population prevalence for finishing pigs in 1996 and 1999 was 23.7% and 24.5%, respectively, and for sows 40.5% and 60.4%, respectively. The prevalence in free-ranging finishing pigs was higher, at 44.6%, than in intensively housed finishing pigs. In 46 multiplying sow herds, the average herd prevalences were 54, 44, and 19%, respectively. The prevalence of *Salmonella* in Danish pork decreased from 3.5% in 1993 to 0.7% in 2000 following introduction of a national program to reduce the prevalence of salmonellas in pork.<sup>12</sup>

### Occurrence

Salmonellosis occurs universally in all species.

#### Cattle

The disease has assumed major importance because of outbreaks in dairy cattle and the occurrence of infections in humans. Of major concern is the increased incidence of outbreaks of salmonellosis in dairy cattle and humans associated with *S. typhimurium* definitive type (DT)104 in the USA<sup>6</sup> and the UK. This strain is multiple-antibiotic-resistant and is classified as R-type ACSSuT by being resistant to ampicillin, chloramphenicol, streptomycin, sulfonamides, and tetracycline. The strain is now the second most prevalent *Salmonella* serotype in humans in England and Wales and the most common *Salmonella* serotype isolated from cattle. A case-control study identified the following risk factors associated with infection with the multiple-resistant *S. typhimurium* DT104:

- A high population density of feral cats around the farm
- Evidence of wild bird access to feed supplies
- Purchase of animals from dealers.

A high frequency of antibiotic-resistant phage types of *S. typhimurium* has been reported from Australia. The intensifi-

cation of cattle production and management has played a large part, but the emergence of *S. dublin* as a common pathogen has been most important. In recent years there has also been a large increase in notifications of exotic species of *Salmonella* such as *S. agona* and *S. newport*, which have mostly originated from the use of unusual food materials of animal and fish origin.

#### Horses

The incidence of salmonellosis has been increasing in the horse population, particularly where horses are assembled at large clinical centers and breeding farms. Moreover, nosocomial salmonellosis is an important problem for horses in veterinary hospitals. It is also possible that many of the unidentified enteritides of horses may have been associated with *Salmonella* spp.

#### Pigs

In the midwestern USA, salmonellosis associated with the host-adapted facultative intracellular *S. choleraesuis* is an important cause of economic loss in pig herds because of death and reduced productivity. It is the most frequent serotype recovered from pigs and is isolated from more than 95% of porcine salmonellosis outbreaks in Iowa. The incidence has been increasing in some geographical areas. *S. typhimurium* causes enterocolitis in young pigs.

The majority of *Salmonella* infections are subclinical, associated with a large number of serotypes. A national US survey for fecal *Salmonella* shedding by pigs most frequently found *S. enterica* serotypes *derby*, *agona*, *typhimurium*, *brandenburg*, *mbendaka*, and *heidelberg*.<sup>13</sup>

#### Sheep

Salmonellosis is commonly encountered when sheep are assembled at high stocking rates. It was one of the main contributing causes of death in sheep exported by sea from Australia to the Middle East, although inanition is usually the primary cause.

In the 1990s there was an increase in the incidence of salmonellosis in sheep associated with *S. enterica* subsp. *diarizonae* serovar 61:k:1,5<sup>14</sup> in the UK<sup>10,15</sup> and Norway.<sup>16,17</sup>

### Morbidity and case fatality

The morbidity rate in outbreaks of salmonellosis in pigs, sheep, and calves is usually high, often reaching 50% or more. Morbidity and mortality are usually highest in calves under 12 weeks of age. In all species the case fatality rate often reaches 100% if treatment is not provided. In outbreaks in out-wintered suckler cattle herds, the morbidity varied from 14–60% and mortality in adult cattle from 0–14%.

In a review of 40 cases of clinical salmonellosis in horses that were diagnosed in one clinic, the case-fatality rate was 60%. Epidemics of salmonellosis affecting up to 40% of foals under 8 days of age on one Thoroughbred horse farm have been reported.

### Methods of transmission

Salmonellas are spread by direct or indirect means. Infected animals are the source of the organisms; they excrete them and infect other animals, directly or indirectly by contamination of the environment, primarily feed and water supplies. The farm animal may be infected in different ways: by animal-to-animal transmission, especially of host-adapted serovars; by contaminated animal feed; and by a contaminated environment (soil, birds, rodents, insects, water supplies). Liquid wastes from infected animals may contaminate the environment directly, including streams, rivers, and pastures. Bacteria may also be disseminated during the transport of infected animals and during the holding of animals in a lairage prior to slaughter. In both situations, the excretion of salmonellas is exacerbated by the stress imposed.

In the UK, surplus calves from dairy farms are sold at public market and moved to rearing farms. The mixing of young susceptible calves and their subsequent transportation is an efficient mechanism for the rapid dissemination of *Salmonella*. The dealers' premises can serve as reservoirs of infection despite cleaning and disinfection. Many vehicles and markets are contaminated with *Salmonella*, and *S. typhimurium* DT204C, the most common *Salmonella* isolated from calves, is the most frequent isolation.

The introduction of infected carrier animals into a herd is a common cause of outbreaks of clinical salmonellosis in dairy herds that are expanding in size.

The organism can persist for an average of 14 months in the environment where calves are reared. *Salmonella* does not survive for more than 5 days in bovine urine not mixed with feces but will survive in dried bovine feces for up to 6 years. After a clinical outbreak of salmonellosis, for example in a dairy herd raising its own replacements, the premises cannot be declared to be *Salmonella*-free solely on the basis of freedom from clinical cases over the next few years or on the basis of comparatively high herd performance. In large dairy herds with modern free-stalls that recycle water in their manure flush systems, it may be possible to isolate *Salmonella* serovars for several years following an outbreak of clinical salmonellosis. The organisms may be found in recycled water samples, bulk tank milk

filters and the feces of calves and adult cows.

Salmonellas can be isolated from piggery waste water after orthodox pondage treatment, and the recirculation of contaminated water through the piggery serves as a constant source of the organism. Housing of finishing-age pigs in barns with open-flush gutters may contribute to increased shedding of *Salmonella* compared to pigs housed on partially slotted floors. Methanogenic fermentation in waste ponds does not eliminate *Salmonella* from piggery waste; acidogenic fermentation with the production of free acid can destroy salmonellas and other potential pathogens.

During slaughter, fecal contamination of the carcass commonly occurs and can be carried through all slaughter procedures up to the processing of the raw products. Milk can be contaminated directly by cows that excrete the organism in the udder, especially those cattle infected with *S. dublin* and *Salmonella muenster*,<sup>18</sup> both of which have adapted to colonize the bovine mammary gland. Although *S. typhimurium* is not usually excreted in the milk, except during the febrile stage of clinical disease, it has been reported to have been persistently isolated from the milk of a healthy cow. *S. enteritidis* has been isolated from ill humans, milking filters, milk from a bulk tank and milk from one quarter of a 5-year-old dairy cow that persistently shed the organism in the milk for several months. Milk is most likely to become contaminated by feces, either from an animal with clinical salmonellosis or from a healthy carrier animal, during the milking process. Additional sources of contamination during milking are use of polluted water or contaminated equipment. Workers who lack personal hygiene skills and have clinical salmonellosis or are chronic shedders of the organism may also contaminate milk supplies.

Airborne transmission can be a primary mode of infection of *S. typhimurium*. Studies have shown that the organism can survive in air sufficiently long to present a significant hazard of air-borne spread.

#### The carrier state

Because salmonellas are facultative intracellular organisms that survive in the phagolysosome of macrophages, they can evade the bactericidal effects of antibody and complement. Thus, persistence of infection in animals and in the environment is an important epidemiological feature of salmonellosis. When an animal is infected with *S. dublin* it may become a clinical case or an **active carrier**, shedding organisms constantly or inter-

mittently in the feces. It may also become a latent carrier with infection persisting in lymph nodes or tonsils but no salmonellas in the feces, or even a **passive carrier** which is constantly acquiring infection from pasture or the calf-pen floor. But invasion of tissues may not occur and when the animal is removed from the environment the infection disappears. However, these animals probably multiply the salmonellas without becoming permanent carriers. The importance of the latent carriers is that they can become active carriers or even clinical cases under stress, especially at calving time. The cattle themselves then become the means by which the infection is retained in the herd for long periods. A major problem with the control of *S. dublin* infection is that latent carriers of the organism, unlike persistent excretors, cannot be readily identified by fecal culture or serological methods. In a 3-year study of one dairy herd, the organism was isolated occasionally from the feces of adult cattle, from some cattle after parturition, and from some calves within 24 hours after birth. In some dairy herds, the organism may persist for many years with a low incidence rate of clinical disease.

For *S. typhimurium* the donor can be any domestic animal species, including humans, or any wild animal or bird. Although all infected adults become carriers it is rarely for any length of time, and calves rarely become carriers. In sheep and cattle the carrier state may persist for as long as 10 weeks, and in horses up to 14 months.

Experimental infection of pigs at 7–8 weeks of age with a single oral dose of *S. typhimurium* can persist continually at least until market age. Regardless of the route of infection, *S. choleraesuis* can persist in the tonsil and ileocolic lymph nodes, ileocolic junction and colon, and can be excreted in the feces of experimentally infected pigs for at least 12 weeks. The amount of shedding and persistence of infection is dose dependent. Low doses of *S. choleraesuis* can be easily cleared, moderate doses can persist for at least 2 months, and high doses result in long-term carrier states. After intranasal inoculation of *S. typhimurium*, the organism rapidly appears in the intestines, suggesting that the tonsils and lungs may be important sites for invasion and dissemination of *Salmonella* species. Experimental infection with a zoonotic strain of *S. newport* can also be established in pigs at 7 weeks of age to persist until market age. Long-term persistence of infection is limited generally to the palatine tonsils, the intestinal tract caudal to the mid-jejunum and their lymph nodes. The prevalence of the organism in pigs creates

a reservoir of infection for animals and humans. The transmission of salmonellosis in pigs can occur in a few days. Exposure to relatively low levels of *S. choleraesuis* may result in high morbidity and initiate a severe outbreak in naive pigs within several days of being exposed to infected pigs. Only a small fraction of carrier pigs are responsible for the maintenance of the pathogen in a pig population.

#### Risk factors predisposing to clinical disease

The clinical characteristics of salmonellosis in large animals vary depending on the various management systems used, the intensity of stocking, whether or not the animals are housed, and the epidemiological characteristics of the different *Salmonella* species. Thus, salmonellosis in cattle is a very serious and persistent disease in areas where it is caused principally by *S. dublin*. But where it is associated with *S. typhimurium* the disease is sporadic and, even though it is highly fatal to individual animals, it is not a serious disease. Although there are probably similar differences with the other species, they are not particularly well defined. The difference between the diseases associated with *S. dublin* and *S. typhimurium* is the marked tendency for *S. dublin* to persist in adult cattle and create a significant reservoir of carrier animals. *S. typhimurium* does not do so as much, so that the disease is likely to subside after an initial exposure and to recur only when the source of infection, from rodents or feedstuffs, or sewage or slurry, reappears. This does not of course preclude the disease from persisting in a flock or herd for long periods. *S. typhimurium* infection persisted in a large dairy herd for 3.5 years. While the incidence rate of clinical disease declined over the study period, the organism could still be cultured from the bulk tank milk filters, which may have been associated with one cow identified as a milk excretor. Three associated human disease incidents occurred following the consumption of raw milk.

#### Animal risk factors

Except in the newborn, especially foals, infection with a *Salmonella* sp. is usually not a sufficient cause of clinical salmonellosis. The response to infection with a *Salmonella* sp. varies depending on the size of the challenge dose and the immunological status of the animal, itself dependent on colostrum intake in neonates, previous exposure to infection and exposure to stressors, particularly in older animals. It is generally accepted that the intervention of some precipitating factor such as transport, intercurrent disease, anesthesia and surgery, dosing with

antimicrobials or anthelmintics, acute deprivation of food, or parturition is usually necessary to cause the disease salmonellosis, as distinct from infection with *Salmonella* sp.

**The portal of infection in salmonellosis** is almost always the mouth, so that the severity of the disease in an individual, or of an outbreak in a group, depends on the degree of contamination and the environmental conditions of temperature and dryness that determine the survival time of the salmonellas. Just as important is the influence of the host on the outcome of the infection. Many animals become infected naturally and are passive carriers; they shed salmonellas in their feces without clinical disease but only for the duration of their cohabitation with other infected animals. It is also possible to reproduce salmonellosis experimentally in most animals using a sufficiently large dose of a virulent strain of the organism. There still remains the common occurrence of the animal that is a subclinical carrier of the infection but develops clinical salmonellosis when exposed to stressors such as long transportation, hospitalization, severe feed deprivation or parturition.

#### *Genetic resistance to salmonellosis in domestic animals*

There is evidence of a strong genetic association with resistance to salmonellosis in several economically important domestic animal species.<sup>19</sup> However, as yet, selective breeding for resistance traits is not utilized in control of diseases or the carriage of *Salmonella* in any of these species. The value of a particular resistance trait in reduction of disease must be balanced against other factors such as productivity of meat and milk. The control of *Salmonella* colonization of the gastrointestinal tract of food animals, particularly where intensive rearing occurs, as in pig units, would appear to be a particularly useful objective with enormous potential public health benefits. There may be a role for several inherited immunological traits, including polymorphonuclear leukocyte function and lecithin-induced mitogenic proliferation.

The interrelationships between the risk factors of the host, the environment, and the pathogen are described here according to species differences.

#### *Dairy cattle*

In calves, the disease is usually endemic on a particular farm, although outbreaks can occur. In adult cattle at pasture the disease is less common. This is particularly so with *S. typhimurium* infections, but *S. dublin* affects both young and adult cattle. Spread between calves in communal pens is by fecal-oral contamination.

Infection of the newborn calf may be from the dam because many cows that are latent shedders become active shedders at parturition. The calves are not infected at birth but become infected from the environment. In adult cattle, *S. dublin* is the common infection and occurs sporadically, but as outbreaks when stressors occur. Spread is usually by the oral route and in cattle at pasture is greatly enhanced by persistently wet conditions. Wild mice are potential reservoirs of *S. dublin* in dairy herds.

Risk factors identified in dairy and beef cattle herds with clinical salmonellosis in Virginia included herd size, exposure to wild geese, rodent activity in housing and feed areas and spreading manure on bordering property.<sup>20</sup> Previous antimicrobial treatment of cattle with laboratory-confirmed *Salmonella* infections increases the probability of isolating salmonellas.<sup>21</sup>

In cattle, deprivation of feed and water is a common risk factor, usually as a result of transportation, but recent calving, sudden changes in the composition of the diet, vaccination with a living vaccine that produces a systemic reaction, treatment with irritant compounds such as carbon tetrachloride for fluke, and fluke infestation can precipitate clinical disease. However, prior infection of calves can provide resistance to experimental infection. In some herds there are sporadic cases in cows as they calve, usually within 1 week afterwards. In grazing cattle there is a distinct seasonal incidence in late summer, fall, and early winter, probably because of greater exposure to infection at pasture.

The pH of rumen contents has been shown to affect the number of salmonellas surviving passage through the rumen. A high volatile fatty acid content and a low pH, such as prevails when a ruminant is on full feed, is unfavorable to salmonellas passing through the forestomachs.

The epidemiological and biological characteristics of three dairy herds in California have been examined and several risk factors were identified that varied between dairies.<sup>22</sup> The various sources of salmonellas in dairy farms indicate that they are part of a larger ecosystem. The prevalence of fecal shedding indicated the magnitude of environmental contamination possible. Animals were exposed to many *Salmonella* serotypes via feed contaminated through irrigation of crops with effluent or dairy wastes. *Salmonella* contamination of irrigation water by human sewage was identified as a potential source of exposure with *S. agona*, *S. montevideo*, and *Salmonella manila*. Nutritional stress caused by transition diets and heat stress was associated with outbreaks in some herds. Salmonellas

were isolated from aseptically collected composite milk samples, and from bulk-tank milk and inline milk filters. Such contamination can result in contamination of human dairy products. A large number of *Salmonella* serotypes were present in cull dairy cows at slaughter with *S. montevideo* being most common.<sup>23</sup> The overall prevalence of *Salmonella* spp. in cull dairy cows at slaughter across the USA was 23.1%, with a range accounting for location and season between 4.3% and 54.5%.<sup>24</sup> This could burden the Hazard Analysis Critical Points Programs implemented in abattoirs. Procedures to reduce *Salmonella* infection at the farm and during transport to slaughter could reduce the risk of spread during the slaughter process.

The water supplies of dairy calves in California dairy herds may be contaminated with *S. typhimurium*.<sup>25</sup> Water offered to weaned dairy calves in a continuous water-tank-filling method was a risk factor compared to a valve on demand and a water pH of more than 8.

Subclinical fecal shedding of *Salmonella* can persist in dairy herds for up to 18 months with no measurable effects on health or production on individual cows.<sup>26</sup> Large herd size and intensive management may provide an environment conducive to *Salmonella* shedding and chronic dairy herd infection.<sup>27</sup> *Salmonella* spp. can be isolated from the environment of free stalls in dairy herds in Wisconsin without any history of clinical salmonellosis.<sup>28</sup> Birds that commonly inhabit California dairy farms harbor *Salmonella* organisms but the low prevalence of infection in birds and the serotypes isolated are not important reservoirs of infection.<sup>29</sup>

The risk factors for fecal shedding of *Salmonella* in US dairy herds were herd size, region of country, use of flush water systems, and feeding brewers' products to lactating cows.<sup>30</sup> The estimated population attributable risks for all four factors combined was 0.95. These factors can be used to predict the presence of *Salmonella* shedders in a herd. *Salmonella* can be isolated from more than 90% of dairy farms but 25% of farms account for more than 75% of *Salmonella*-positive samples.<sup>31</sup> Concentrating control efforts on farms with a high prevalence may be the most effective means of control of the infection in dairy herds.

The risk factors for becoming a carrier of *S. dublin* in dairy cattle in Denmark include heifers infected between the age of 1 year of age and first calving, and cows infected around the time of calving.<sup>32</sup> The risk was higher in the first two quarters of the year (late winter to spring). Herds with the highest risk of

carrier development were those with clinical disease outbreaks.

#### *Beef cattle herds and feedlots*

While salmonellosis can cause significant economic losses in beef herds and feedlots it is not as important as in dairy cattle. Low numbers of beef cattle are found to shed *Salmonella* at the time of slaughter and beef cattle do not appear to be a major risk of carcass contamination. In Australian cattle, the prevalence of *Salmonella* in the feces of cattle at slaughter was 6.8%.<sup>33</sup> In grass-fed cattle the prevalence was 4.5% and not much different to that found in feedlot cattle. In the US, fewer than 7% of cattle in feedlots shed *Salmonella* in their feces.<sup>34</sup> In European cattle, the prevalence of *Salmonella* in feces has ranged from less than 1% to 42%.<sup>33</sup> *S. montevideo* has been the cause of large economic losses due to abortion and cow mortality in an outwintered beef herd in Scotland.<sup>35</sup> Up to 25% of the cows aborted and the overall herd mortality was 7%. The organism had been the cause of abortion in a neighboring sheep flock.

Case-control studies of risk factors for clinical salmonellosis in cattle herds in Virginia, USA, found that larger herd size, exposure to wild geese, rodent activity in housing and feed areas, and spreading poultry manure on bordering property had positive associations with the occurrence of the disease.<sup>20</sup> Case farms were less likely than control farms to have calves born primarily in a building and had smaller percentage changes in the number of mature cows during the previous year. In contrast, in the UK, farms with housed cattle had increased risk of *S. typhimurium* DT104. Feeding recycled poultry bedding that had been stored and stacked properly for 51 days prior to feeding, to feedlot cattle did not increase the prevalence of detectable *Salmonella* in calves.<sup>36</sup>

Changes in the incidence of shedding *Salmonella* in the feces of cattle being transported from the farm to slaughter plant have been examined.<sup>37</sup> In feedlot cattle, fecal shedding remains fairly constant before and after transport (3–5%); in adult cattle the shedding rate increased from 1% to 21%. Contamination of hides increased for both animal types from 18–20% to 50–56%. Nineteen percent of feedlot cattle carcasses and 54% of adult cattle tested positive for *Salmonella*. Feed withdrawal, transport stress, and the commingling of animals prior to slaughter can affect the number of cattle that are contaminated with bacterial pathogens such as *Salmonella*. However, none of the risk factors evaluated prior to or throughout the transport process had

an impact on fecal shedding, hide contamination or carcass contamination.

Feedlot playas (temporary shallow lakes) are frequently contaminated with many *Salmonella* serotypes.<sup>38</sup> Using playas as a source of water for feedlots can be a source of *Salmonella* and they should not be used to cool cattle in the summer months, or for dust abatement, or for irrigation of crops. Wildlife, birds, and migratory waterfowl have access to these bodies of water and, because of their size and number, there is little which can be done to prevent them from becoming contaminated.

#### *Sheep*

Salmonellosis in sheep may occur with a range of different syndromes of variable severity, depending mainly on the particular serovar involved. Serovars *abortusovis*, *dublin*, and *typhimurium*, which each have different degrees of host restriction, are associated with disease in sheep. Serovar *dublin* can cause both enteritis and abortion in adult sheep, and the disease is often associated with metritis, anorexia, and loss of wool. Newborn lambs may develop diarrhea with a high mortality rate. Serovar *typhimurium* is associated with acute disease, enteritis but not usually abortion.<sup>39</sup>

A new strain of *Salmonella brandenburg* has affected livestock and humans in the South Island of New Zealand.<sup>40</sup> The strain has caused abortions in sheep, abortions in cattle and gastroenteritis in calves and adult cattle. The same strain also caused disease in horses, goats, deer, pigs, and humans. Spread of the disease on farms was strongly associated with aborting ewes, which resulted in considerable environmental contamination. During the abortion season, black-backed gulls appeared to spread the disease to other farms. Other potential sources of infection were carrier sheep, contaminated water sources, and contaminated sheep dust.

*Salmonella* infections of sheep and human food poisoning are rare. However, outbreaks of food poisoning in Iceland associated with *Salmonella* were traced to the consumption of singed sheep heads.<sup>41</sup> The organism could be isolated from 20% of the specimens sampled. The prevalence of infection of the sheep population in Iceland is low, at 1.3%. Infection occurs on mountain pastures, which may be contaminated by wild birds, especially gulls.

In range sheep, the commonest occurrence of the disease is during a drought when sheep are concentrated in small areas of surviving grass heavily contaminated by feces. Sheep held in holding yards or transport vehicles previously

occupied by sheep for long periods are also susceptible to clinical disease. This is most likely to occur when they drink from puddles of water, especially in heavily contaminated yards, or when they are exposed to recycled dip wash. In sheep, the disease is commonly associated with deprivation of feed when animals are assembled for vaccination, anthelmintic administration or shipment over long distances. Lambs in feedlots are susceptible to salmonellosis within a few weeks after arrival in the lot.

The modern development of pen-lambing in which ewes about to lamb are brought into small pens is also a means of potentiating spread from a chronic shedder. In all these situations feed stress by deprivation is likely to contribute to susceptibility. Field outbreaks in range sheep have been recorded. In some instances they have been caused by the use of unsterilized bone meal as a phosphorus supplement. Outbreaks occurring in sheep on a number of farms in the same area at the same time have been ascribed to contamination of drinking water by birds eating carrion. Heavy dosing with zinc oxide as a prophylaxis against facial eczema is also credited with precipitating outbreaks of salmonellosis in young sheep.

#### *Goats*

Outbreaks in goats occur in the same circumstances as in other ruminant species. Transportation and capture are additional stressors in feral goats used for embryo transplantation.

#### *Pigs*

The epidemiology of *S. choleraesuis* infection in pigs is well documented and has changed remarkably since the mid-1960s, when explosive outbreaks occurred that could easily be mistaken for hog cholera. The morbidity and mortality rates were high and the disease spread rapidly through commercial pig-finishing units. These outbreaks are now rare and small in scope, largely because of the restriction of garbage feeding, much less movement and mixing of pigs through public auction marts, and disease-prevention strategies such as the use of specific pathogen-free pigs, an all-in/all-out policy in commercial finishing units, and the vertical integration of pig-producing enterprises. This insures a constant supply of disease-free growing hogs to finishing units and the assumption of a pyramid-type responsibility at all levels of the enterprise. The marked decline in the prevalence of swine salmonellosis coincided with the decline in and eradication of hog cholera. However, modern methods of raising pigs in multiple-site production systems, using all-in/all-out management of finishing pigs, appear to



have no benefit in reducing the prevalence of *Salmonella* compared with conventional farrow–finish systems.

*S. enterica* does not normally cause clinical disease in pigs but subclinical infections constitute an important food safety problem throughout the world.<sup>42</sup> Comprehensive longitudinal studies of two multiple-site pig production systems in the USA revealed considerable temporal variability in *Salmonella* prevalence between cohorts of pigs.<sup>43</sup> Cohorts of sows and individually identified growing pigs from their litters were serially sampled to determine the prevalence and serotypes of *Salmonellas* in each stage of production based on fecal culture, and feed and environmental samples. A total of 15 different serotypes were isolated from the two systems. Pig prevalence estimates ranged from 0–48.1%. Environmental contamination was frequently encountered despite cleaning and disinfection. Feed was only rarely contaminated. The prevalence of infection within and among cohorts of pigs was highly variable, which indicates that point estimates of *Salmonella* prevalence and serotypes are not reliable indicators of the *Salmonella* status on farms, and that uncontrolled studies of interventions to control *Salmonella* on pig farms may yield misleading results.<sup>43</sup>

In the USA, new regulations regarding the safety of meat products have been implemented in response to public concerns about food-borne disease outbreaks. The salient features of the regulations are requirements for approved systems of microbiological monitoring of *S. enterica*, *E. coli* O157:H7, and generic *E. coli* as an indicator of contamination by gastrointestinal contents. From the perspectives of public health, regulatory compliance and international competitiveness, *S. enterica* is the most important foodborne pathogen for the US pig industry. This has resulted in longitudinal epidemiological studies of fecal shedding of *S. enterica* in both breeding and growing pig populations.<sup>43</sup>

A quantitative risk analysis model simulating *Salmonella* prevalence in growing pigs and at slaughter would be of great value for food safety. However, sampling strategies for input information to a model are difficult to establish as the relationship between subclinical infections at the levels of the herd, the individual pig, and at slaughter is complex. The onset and duration of *Salmonella* shedding and the patterns of transmission between individual pigs and between different age groups during the growing period all have influence. Bacteriology and serology can be used to assess this relationship but repeated sampling in different cohorts of animals is required to correctly assess the infection dynamics.<sup>78</sup>

Longitudinal studies of *S. typhimurium* infection in farrow–finish pig herds in Denmark reveal that *Salmonella* occurrence varies between and within age groups within herds, even in herds with an apparent moderate-to-high infection level. *Salmonella* was predominant in weaners, growers, and finishers, and was only occasionally detected in sows and gilts. In Denmark, *Salmonella* is typically detected in the nursery and rarely in the sow unit, suggesting that the infection level among sows is low. This is contrary to the results of studies in the USA, where *Salmonella* was found to be common in sows.<sup>44</sup> In the Danish study, there was a rapid increase in *Salmonella* prevalence in the nursery, which may be associated with the stressors of weaning such as change in feed, commingling of litters and piglets being deprived of the antibodies in sow's milk before activation of their own immune response. The observation that no piglets were shedding *Salmonella* just before weaning but 3–4 weeks later in the nursery between 5% and 50% of the piglets were shedding suggests that horizontal transmission occurred in the nursery.<sup>42</sup> During the finishing period *Salmonella* shedding decreased, but with considerable variation. Some pigs cleared themselves of the infection whereas others continued shedding. Average shedding time was estimated to be 18–26 days. Seroprevalence peaked approximately 60 days after peak prevalence in culture. At slaughter there is a marked increase in the prevalence of *Salmonella* infection. This increase may be due to rapid cross-contamination during transport and lairage.<sup>45</sup> Rapid infection during transport, and particularly during holding, is a major reason for increased *Salmonella* prevalence in pigs.<sup>46</sup> A high degree of carcass contamination occurs at slaughter due to the delivery of *Salmonella*-positive pigs and cross-contamination from the slaughterhouse environment.<sup>47</sup> Contaminated feed trucks may also serve as a potential source of *Salmonella* contamination.<sup>48</sup> The withdrawal of feed from pigs prior to slaughter does not increase the prevalence of *Salmonella* colonization or the risk of carcass contamination.<sup>49</sup>

Risk factors associated with serological *Salmonella* prevalence in finishing pig herds in the Netherlands have been examined.<sup>50</sup> Feeding a complete liquid feed containing fermented byproducts and the omission of disinfection after pressure washing a compartment as part of an all-in/all-out procedure were both associated with a lower *Salmonella* seroprevalence. A small to moderate herd size (< 800 finishing pigs), a previous diagnosis of clinical *Salmonella* infection in the herd, the use of tylosin as an antimicrobial

growth promoter in finishing feed, and herds that have more than 16% of their pigs' livers condemned at slaughter because of white spots were associated with a higher *Salmonella* seroprevalence. There was no effect on experimental *Salmonella* infection of the use of tylosin as an antimicrobial growth promoter.<sup>51</sup>

In those herds where the disease does occur, introduction is usually associated with the importation of infected carrier pigs. However, it is possible for the infection to be spread by flies and the movement of inanimate objects such as cleaning equipment and utensils. Feed-stuffs do not provide a favorable environment for *S. choleraesuis*, so food-borne infection is not common. Survival in soil and water is approximately 6 months and in slurry up to 5 weeks. Persistence in streams fouled by piggery effluent is unlikely. Susceptibility to salmonellosis in pigs is thought to be increased by inter-current disease, especially hog cholera, nutritional deficiency of nicotinic acid, and other nutritional stress such as a sudden change in diet.

#### Horses

Based on the culture of single fecal samples from horses on 972 operations in 28 states, the national prevalence of fecal shedding of *Salmonella* spp. among horses in the US horse population was 0.8%. The overall prevalence of operations positive for fecal shedding of *Salmonella* was 0.8%. Based on feed samples taken from the same operations, the prevalence of *Salmonella* spp. in grain and other concentrates used for horse feed was 0.4%.<sup>52</sup>

In adult horses, most clinical salmonellosis occurs after the stress of transport and mostly in horses that are overfed before shipment, receive little or no food or water for the duration of a protracted journey, and are fed excessively on arrival, cases appearing 1–4 days later. Groups of horses that have been exposed to a contaminated environment, such as saleyards or railroad yards, may experience outbreaks in which up to 50% are affected. As with other species, the presence of an asymptomatic carrier in a group of horses is often credited with initiating an outbreak, but the search for the carrier is always laborious and often fruitless. At least five negative cultural examinations of feces should be made before acquitting a suspected donor. On the other hand, the cultural examination of large numbers of horses often reveals up to 50% of the population to be carriers. Multiple serotypes of *S. enteritidis* have been isolated from the mesenteric lymph nodes of 71% of healthy horses examined at an abattoir, which indicates that extraintestinal infection occurs in the horse as it does in other

species. In the light of the high carrier rate in this species it is surprising that there are not more outbreaks.

The occurrence of salmonellosis in horses hospitalized for another disease has become a major problem for veterinary teaching hospitals and private equine practices that provide surgical veterinary care. In these circumstances there is a constant reintroduction of carriers of the disease, a persisting contamination of the environment, and a large population of horses, all of which are under physiological stress because of anesthesia, surgical invasion, or intercurrent disease and many of which are exposed to oral and parenteral treatment with antibiotics, which appears to greatly increase their chances of acquiring salmonellosis. Horses in which nasogastric tubes were passed were at 2.9 times greater risk of having salmonellas isolated than horses that did not undergo this procedure. Horses treated with antibiotics parenterally were at 6.4 times greater risk, and those treated with antibiotics orally and parenterally were at 40 times greater risk of developing salmonellosis, compared with horses not receiving such treatment. In hospitalized horses, the factors found to be associated with fecal shedding of salmonellas included diarrhea at the time of admission, fever while hospitalized, and a change of diet while hospitalized.

The extent of environmental contamination with *Salmonella enterica* in a veterinary teaching hospital in Colorado was examined.<sup>53</sup> The results indicate that environments in veterinary teaching hospitals can frequently be contaminated with *S. enterica* near where infected animals are managed and fecal specimens containing the bacteria are processed for culture in a laboratory. The bacteriological culture of environmental samples collected with electrostatic wipes is an effective method of detecting contamination in a veterinary teaching hospital and may be beneficial as part of surveillance activity for other veterinary and animal-rearing facilities.

Outbreaks of nosocomial salmonellosis among horses in a veterinary teaching hospital have been described.<sup>54</sup> Case fatality rates may be high, necessitating closure of the hospital for complete disinfection and systematic sampling of the environment to detect the presence of persistent *Salmonella*. Strict isolation of hospitalized horses that have been shedding *Salmonella* is necessary. The organisms can be isolated from the feces of hospitalized horses and many different environmental surfaces in the hospital.<sup>55</sup> *Salmonella* may be detected in 5.5% of hospitalized horses. The planning and implementation of infectious disease

control throughout the hospital is then necessary. Bleach is the most effective disinfectant on the largest number of surfaces.

Several variables have been associated with nosocomial *Salmonella* infections in hospitalized horses:<sup>56</sup> the mean number of horses in the hospital shedding *Salmonella krefeld* during the first 4 days prior to and the day of admission, the mean number of horses shedding *S. typhimurium* during this period, a diagnosis of large colon impaction, withholding feed, the number of days fed bran mash, the duration of treatment with potassium penicillin G, and the mean daily ambient temperature.<sup>56</sup>

The factors potentially associated with *Salmonella* shedding among horses hospitalized for colic at a veterinary teaching hospital were examined.<sup>57</sup> *Salmonella* spp. were detected in the feces 9% of patients at least once during hospitalization. They were more likely to shed *Salmonella* if diarrhea was evident 6 hours or less after hospitalization and duration of hospitalization exceeded 8 days (OR 20.3), laminitis developed during hospitalization (OR 12.0), results of nasogastric intubation were abnormal (OR 4.9), leukopenia was evident 6 hours or less after hospitalization (OR 4.6), or travel time to the teaching hospital exceeded 1 hour (OR 3.5). Horses treated with a probiotic did not differ from control horses in likelihood of fecal shedding of *Salmonella* (OR 1.5) or prevalence of clinical signs.

Occasionally, outbreaks occur in young horses at pasture when they are heavily infested with worms. Salmonellosis is also one of the common neonatal septicemias of foals, and the disease may occur as endemic on particular studs or there may be outbreaks with many foals being affected at the one time. The common management strategy on 'visiting stud-farms' of bringing mares and newborn foals to communal studs and then bringing them daily to a central point for observation and teasing is also likely to facilitate spread of an infection through a group of foals.

#### *Immune mechanisms*

Most information on the mechanisms of immunity to *Salmonella*, including the safety and immunogenicity of most *Salmonella* vaccines, has been done experimentally in mice. In primary infections in mice, early bacterial growth in the reticuloendothelial system is controlled by the contribution of both macrophages and polymorphonuclear cells and is affected by the virulence of the strain.<sup>58</sup> In lethal infections, the early growth of the bacteria in the tissues results in high

bacterial numbers that lead to death of the animal. Following natural infection with *Salmonella* antibody responses to lipopolysaccharides and protein determinants can be detected.<sup>58</sup> Anti-*Salmonella* IgM appear in serum early after infection followed by IgG. T-cells have a critical role in the later stages of primary infection.

Environmental and management risk factors

#### *Farming practice in general*

Intensification of husbandry in all species is recognized as a factor contributing significantly to an increase in the new infection rate. A typical example is the carrier rate of 54% observed in intensive piggeries in New Guinea compared to the 9% in village pigs. Any significant change in management of the herd or a group of animals can precipitate the onset of clinical salmonellosis if the infection pre-exists in those animals.

#### *Intensive pasture utilization*

The means of infection is principally ingestion of feed, especially pasture, contaminated by the feces of an infected animal, so that the new infection rate is dependent on all those factors that govern the bacterial population in the environment.

Temperature and wetness are most important, as salmonellas are susceptible to drying and sunlight. *S. typhimurium* can remain viable on pasture and in soil, still water, and feces for up to 7 months. Survival times of the bacteria in soil are influenced by too many variables to make any overall statement meaningful.

As well as infection of pasture by cattle or other domestic animal species, the use of 'slurry' as a means of disposal of animal manure from cow housing or zero grazing areas has led to a highly efficient means of spreading *Salmonella* infections. The chance of cows becoming infected increases considerably if they are grazed soon after the slurry is applied, and is less likely during dry, sunny periods and when there is sufficient pasture growth to avoid it being eaten right down to the ground surface. The survival time of *Salmonella* spp. in cold liquid manure depends on several factors, including pH of the slurry and the serotype of the organism. It can be as long as 28 weeks.

Pasture contaminated by human sewage, especially septic tank or sewage plant effluent or sludge, is also credited with being a potential source of *Salmonella* infection for cattle, but there are a number of reports that do not support this view. Drinking water can remain infected for long periods, as long as 9 months, and in cattle at extensive pasture infected drinking water in stagnant ponds is a significant source of infection.

### Housed animals

In housed animals the same factors apply to the spread of infection as apply to pastured animals. Thus, infection can be introduced by infected domestic animal carriers. For example, in large-scale calf-rearing units, where the disease is often of diabolical severity, many of the calves are infected when they are picked up from their home farms and, if they are penned in groups, all calves in the group are soon infected. The infection can spread among calves penned individually, which suggests that aerosol spread may occur. *S. typhimurium* type 204C can survive for several months in calf-rearing premises despite depopulation, cleansing, and disinfection. However, because of the failure of most calves to continue as carriers, they are usually free of infection within 6 weeks of arrival.

The premixing of food into a liquid form for pumping to feeding stations in piggeries and calf-rearing units is an effective way of spreading salmonellosis if infection is present in the feedstuffs and the mix is allowed to stand before feeding. The feeding of medicated milk replacer and hay to dairy heifers from 24 hours of age until weaning was associated with a reduced risk of *Salmonella* shedding, as was calving in an individual area within a building.

### Contaminated feedstuffs

Housed animals are generally more susceptible to infection from purchased feeds containing animal byproducts than are pastured animals, which are again more susceptible to animal-product-based fertilizers. Organic feedstuffs, including bonemeal, are being increasingly incriminated in the spread of salmonellosis and although the usual figure, for example in the UK, is 23% of consignments being infected, the figure may be as high as 70%. Most of the contamination of meat and bonemeal occurs after heat sterilization, especially if the material is left in digester tanks. Fishmeal is one of the most frequently and badly contaminated feedstuffs. For example, most of a recent increase in reported isolations of salmonellas in the USA was due to *S. agona* introduced in Peruvian fish meal. These feed meals need to be heated at 82°C (180°F) for an hour to be sterilized. The infection of these materials may derive from antemortem infections in the animals used to make the byproduct, but soiling of the material at the preparation plant or abattoir or during storage may also occur. Stored feed not of animal origin, especially grain, is also commonly contaminated by the droppings of rodents that infest it and this can lead to sharp outbreaks of salmonellosis due to

*S. typhimurium*. Of special importance is colostrum stored without refrigeration. If the colostrum is contaminated initially, multiplication of salmonellas may occur and transmission of the infection is likely. Dried milk products appear to be relatively safe.

A case-control study of an outbreak of salmonellosis due to *Salmonella menhaden* in dairy herds was associated with one particular feed mill and feeding animal fat.

Some *Salmonella* serotypes such as *S. typhimurium* have been isolated from 2.8% of pig feed and feed ingredient samples and from 46% of farm feed samples tested. *S. choleraesuis* was not isolated from pig feed.

### Introduction of the infection to a farm

Contaminated feedstuffs, carrier animals and infected clothing of visitors and casual workers are the most common methods of introducing infection. Less common methods include free-flying birds such as the herring gull, and nematode larvae that are already infected with the salmonellas. Salmonellas have been isolated from a wide variety of wild animals, which could act as reservoirs for infection of domestic animals under certain conditions.

### Pathogen risk factors

**Salmonellas are facultative intracellular organisms** that survive in the phagolysosome of macrophages and can therefore evade the bactericidal effect of antibody. Compared to other organisms of the same family, salmonellas are relatively resistant to various environmental factors. They multiply at temperatures between 8° and 45°C, at water activities above 0.94, and in a pH range of 4–8. They are also able to multiply in an environment with a low level of or no oxygen. The bacterium is sensitive to heat and will not survive temperatures above 70°C. It is sensitive to pasteurization. Salmonellas have been shown to be resistant to drying, even for years, especially in dried feces, dust and other dry materials such as feeds and certain foods. Prolonged survival in water and soil has also been described. They are quite sensitive to beta- and gamma-irradiation. The O-antigen lipopolysaccharide of salmonellas is toxic and an important virulence factor, and immunity directed against the lipopolysaccharide is thought to be of major importance in the host defense against salmonellosis.

Fimbrial antigens of some *Salmonella* species have been described and characterized.<sup>59</sup> The fimbriae mediate a variety of virulence factors important for the maintenance and survival of the organisms in the host and environment, including initiation and stabilization of the organism to epithelial cells, colonization

of the organism to receptor sites, maintenance of persistent infection in the host by mediating selective bacterial trapping by phagocytic cells, and evasion of the host's specific immunological defense mechanisms. The fimbriae are also useful in diagnostic tests.

Naturally occurring strains with varying virulence factors and antimicrobial susceptibility patterns can be identified in herds with endemic infection. Strains of *S. dublin* with distinct antimicrobial susceptibility patterns and/or plasmid profiles have been repeatedly isolated from calves in a calf-rearing facility over a period of years.<sup>60</sup> Some of the strains were isolated from numerous calves during outbreaks of clinical salmonellosis, while other strains were not.

The literature on the molecular basis of *Salmonella*-induced enteritis has been reviewed.<sup>61</sup> Most of the *Salmonella* virulence genes have been identified. The effector proteins of *S. typhimurium*, which act in concert to induce experimental diarrhea in calves, have been characterized.<sup>62</sup> There are several differences between *S. dublin* and *S. typhimurium* in the phenotypes, caused by inactivation of genes encoding effector proteins. The literature on the molecular methods for epidemiological investigations of *S. enterica* infections has been reviewed.<sup>2</sup>

### Antimicrobial resistance of Salmonella

Strains of *Salmonella* spp. with resistance to antimicrobials are now widespread in both developed and developing countries.<sup>63</sup> Since 1990 there have been dramatic increases in the occurrence of multiply-resistant strains of *Salmonella* spp. in many developed countries. Of particular note has been the epidemic spread of *S. typhimurium* DT104, which now has a worldwide distribution. Antimicrobial resistance in zoonotically transmitted salmonellas is an undesirable but almost inevitable consequence of the use of antimicrobials in food animals. In general, such use is legitimate. Recommendations have been made that new antimicrobials with cross-resistance to those used in human medicine should not be used for prophylaxis in food animal production. For example, it is argued that the use of antimicrobials in food animals has been a major factor in the development of decreased susceptibility to antibiotics such as ciprofloxacin in zoonotically transmitted salmonellas.<sup>63</sup>

Antimicrobial resistance of salmonellas has been a major controversial concern in veterinary medicine and human public health.<sup>64</sup> Antimicrobials are used in food-producing animals for the treatment of infectious diseases and for growth-promoting effects. Their continued use

has long been incriminated as a major cause of selective pressure that leads to the appearance and persistence of resistant strains. The resistance is usually to multiple antimicrobials and its existence is considered as a potential risk factor. The significance of antimicrobial resistance is most obvious in its impact on the treatment of human infections. If the frequency of drug resistance increases, the choice of antimicrobials for the treatment of systemic salmonellosis in humans becomes more limited. There is also an association between drug-resistant salmonellas and the routine clinical use of antimicrobials for infections other than salmonellosis. Antimicrobial-resistant *Salmonella* infections can complicate antimicrobial therapy of other infections; prior antimicrobial therapy allows fewer numbers of antimicrobial-resistant salmonellas to cause symptomatic infections, and an increase in the proportion of salmonellas that are antimicrobial-resistant will increase the overall frequency of salmonellosis. *S. anatum* isolates from horses have developed multiple drug resistance; this is a public health concern because the serotype has been isolated from humans, and individuals who have contact with infected horses are at risk of becoming infected.

Infections in humans associated with antimicrobial-resistant salmonellas are increasing and have become a cause for public health concern.<sup>14</sup> Prospective studies in the USA claim to show that human infections with antimicrobial-resistant salmonellas are increasing, and that these resistant strains can be traced to foods of animal origin. There are wide variations from country to country in the percentage of *Salmonella* isolates that are antimicrobial-resistant. In general, antimicrobial resistance among salmonellas is much higher in the USA than in other countries. In the UK, over a period of about 20 years, little change has occurred in the antimicrobial resistance patterns of salmonellas isolated from animals. *S. dublin* remains predominantly sensitive to most antimicrobials. Most of the resistance in *S. typhimurium* is associated with phage type DT204C. Serotypes other than *S. dublin* and *S. typhimurium* show low levels of resistance to most antimicrobials, with the exception of sulfonamides and tetracyclines, to which resistance is increasing. The prevalence of antimicrobial resistance among salmonellas in New Zealand is low relative to many other countries.

The occurrence of the same clone of tetracycline- and streptomycin-resistant *S. typhimurium* in several dairy herds closely related geographically, and within a few months, suggests that spread of a

single clone can occur quickly and may have been introduced into the herds by feed, wild animals, use of the same machinery, or a human vector.

Antimicrobial resistance in salmonellas in the UK has been monitored since 1970 using disk diffusion tests. A total of 76% of all *Salmonella* isolates are still sensitive to all 16 antimicrobials used for testing. Most antimicrobial resistance is encountered in bovine isolations of *S. typhimurium* phage type DT204C. This phage type, which was initially resistant to at least seven antimicrobials, has become more sensitive in recent years. Ninety-eight percent of *S. dublin* strains from cattle are still sensitive to all the antimicrobials used for testing. Treatment of calves with apramycin has selected for apramycin resistance in *E. coli* and *S. typhimurium* in the intestine, and plasmid transfer from the *E. coli* to *S. typhimurium* is suspected because the plasmids were similar.<sup>25</sup>

The incidence of antimicrobial resistance in strains of *Salmonella* isolated from Canadian agricultural products and imported fish has increased over specified study periods and emphasizes the need to reassess the benefits of subtherapeutically medicated feeds in current animal management practices.

Multi-drug-resistant *S. newport* has been spreading on an epidemic scale in both animals and humans throughout the USA.<sup>14</sup> In addition to the resistance to five drugs found in *S. typhimurium* DT104, *S. newport*, called Newport MDR-AmpC, is also resistant to amoxicillin-clavulanic acid, cephalothin, cefoxitin, and ceftiofur and exhibits decreased susceptibility to ceftriaxone. The emergence of Newport MDR-AmpC strains in humans has coincided with the emergence of Newport MDR-AmpC infections in cattle.<sup>65</sup> In Massachusetts, the prevalence of the strain among *S. newport* isolates obtained from humans increased from 0% in 1998 to 53% in 2001. Case-control studies found an association with exposure to a dairy farm. Isolates from both humans and cattle had indistinguishable or closely related antibiograms and pulse-field gel electrophoresis patterns. The data document the widespread emergence of Newport MDR-AmpC strains in the USA and show that the fivefold increase, between 1998 and 2001, in the prevalence of *Salmonella* resistant to expanded-spectrum cephalosporins is primarily due to the emergence of that MDR-AmpC strain. The strain was isolated from humans, cattle, or ground beef in 27 states.

Molecular epidemiology of cephalosporin-resistant *S. newport* from animals in Pennsylvania, some from a single farm that experienced an outbreak of clinical salmonellosis in periparturient

dairy cows, found integrons in about 38% of the isolates.<sup>66</sup> (Integrons are potentially independently mobile DNA elements that encode a *recA*-independent, site-specific integration system responsible for the acquisition of multiple small mobile elements called gene cassettes that, in turn, encode antibiotic resistance genes. Integrons have been shown to be integrated within the chromosome in *S. typhimurium* DT104 and have also been described on plasmid DNA in *S. enteritidis*.) There is also evidence that common plasmids have been transferred between animal-associated *Salmonella* and *E. coli* and identical *CMY-2* genes carried by similar plasmids have been identified in humans, suggesting that the *CMY-2* plasmid has undergone transfer between different bacterial species and may have been transmitted between food animals and humans.<sup>67</sup> The prevalence of *Salmonella* resistant to extended-spectrum cephalosporins from food-producing animals in Canada is very low.<sup>68</sup>

The antimicrobial susceptibilities of *Salmonella* strains isolated from humans, cattle, pigs, and chickens in the Netherlands from 1984–2001 have been monitored.<sup>69</sup> Resistance was most common in *S. typhimurium* and among the strains from humans, pigs, and chickens, the level of resistance to tetracycline, ampicillin, chloramphenicol, and trimethoprim-sulfamethoxazole increased over the 17 years. The increase could be attributed to the emergence of *S. typhimurium* DT104. Among the strains from cattle, resistance levels were high in the 1980s and then declined during the study period to the levels of the other species from 1996–2001. This indicates that the levels and patterns of resistance differ considerably among serovars isolated from one host species. A similar finding occurred in England and Wales from 1988–1999.<sup>70</sup>

Since their introduction into veterinary medicine in Europe in the late 1980s and early 1990s, the susceptibility of several bacterial species to fluoroquinolones has increasingly been reported to be decreasing and their resistance to quinolones has been reported to be increasing.<sup>63</sup> The incidence of quinolone resistance in strains of *Salmonella* isolated from poultry, cattle, and pigs in Germany between 1998 and 2001 has increased.<sup>71</sup>

In Canada, resistance to *S. typhimurium* isolated from animals, animal food products and the environment of animals to each of seven antibiotics – ampicillin, chloramphenicol, kanamycin, neomycin, streptomycin, sulfisoxazole, and tetracycline – increased persistently during each of the years 1994–97<sup>72</sup> but none of the isolates showed decreased sensitivity to ciprofloxacin.

Studies on one dairy calf farm rearing animals for dairy-beef production found that 70% of the fecal samples were positive for *Salmonella*, and also found high rates of resistance to several antimicrobials commonly used for the treatment of calf diarrhea.<sup>73</sup>

The susceptibility patterns of *Salmonella* isolates from feedlot cattle across the USA have been examined. In general, with the exception of tetracycline and sulfamethoxazole, most isolates have been susceptible to all antimicrobials tested.<sup>34</sup> Also, resistance was not related to the use of antimicrobials in the rations being fed. The prevalence of *Salmonella* on beef animal hides and carcasses was 15.4% and 1.4%, respectively, and the percentage of isolates resistant to commonly used antimicrobials was low.<sup>74,75</sup>

The prevalence of *S. typhimurium* and *S. choleraesuis* isolates from pigs and humans that are fluoroquinolone-resistant and multi-drug-resistant has increased in Taiwan and the isolates have become widespread across the country.<sup>76</sup> The *S. choleraesuis* isolates from humans and pigs were closely related genotypically, suggesting the nationwide dissemination of the organism from pigs to humans.

During an 8-year period, 232 *Salmonella* strains from horses with salmonellosis in the Netherlands were studied.<sup>77</sup> *S. typhimurium* was the predominant serovar, accounting for 71%, followed by *S. enteritidis* at 8%. Resistance was common against tetracycline and ampicillin. *S. typhimurium* DT104 was most frequent and was more resistant to antimicrobials than other serovars, and had the pentadrug resistance pattern of ASSuT. The most common *S. typhimurium* phage type in horses corresponded with those found in humans, pigs, and cattle during the same period in the Netherlands.

### Zoonotic implications

Salmonellosis, a common human intestinal disorder primarily associated with *Salmonella*-contaminated meats and poultry, is estimated to cost Americans about US\$1 billion or more annually. The Centers for Disease Control report approximately 40 000 confirmed cases of salmonellosis annually.<sup>1</sup> A Canadian study estimated the total cost of salmonellosis in humans at US\$100 million per year in Canada; this included hospital and medical costs, lost production, lost leisure, investigating costs and loss of life. Contaminated poultry is a common source of human infection.<sup>78</sup> The cumulative losses are due to medical costs, productivity losses and absenteeism, pain and suffering, lost leisure time, and chronic disease costs. The costs of food safety regulatory programs and costs to the food industry

for product recalls and plant closures due to food-borne salmonellosis outbreaks, if included, would also increase the size of the estimates.

The disease has assumed increasing importance in recent years because of the much more frequent occurrence of human salmonellosis, with animal salmonellosis as the principal reservoir.<sup>78</sup> Although transmission to humans does occur via contaminated drinking water, raw milk, and meat, particularly sausage, the important pathway today has become that through pigs and poultry. In Denmark, this was an important source of human salmonellosis until control measures were instituted. In most instances the increase in human infections is with 'exotic' serotypes other than *S. typhimurium* that come by animal feedstuffs to pigs and chicken, and then to humans through pork and chicken products. The most serious risk is that the transmitted bacteria will have acquired resistance to specific antibiotics because the animals from which they originate have been treated with the particular antibiotics repeatedly or over a long period.

An epidemic of salmonellosis associated with *S. typhimurium* DT 160 in wild birds and humans in New Zealand has been described.<sup>79</sup> Sparrows and other birds usually die of an acute septicemia and the organism is considered to be a serious zoonotic risk.

The USDA-FSIS issued the Pathogen Reduction: Hazard Analysis and Critical Control Points Systems regulation to encourage effective pathogen reduction systems in meat and poultry processing facilities. This has been successful and is being followed by measures to reduce the numbers of *Salmonella* entering processing plants through live animals.<sup>1</sup>

### *Salmonella* serovar *typhimurium* DT104

The increasingly common isolation of *S. typhimurium* DT104 (definitive phage type) is of major concern for public health officials.<sup>4</sup> *S. typhimurium* DT104 was first reported in the UK in 1984 and emerged in the 1990s as an increasing cause of *Salmonella* infections in humans and animals in England, Wales, Scotland, other European countries such as Germany, France, Austria, and Denmark, and Canada.<sup>80</sup> A wide range of potential reservoirs is associated with this infectious strain, from humans to the traditional food animals such as poultry, cattle, sheep,<sup>81</sup> and pigs. Over a 1-year period in Scotland it was the predominant *Salmonella* isolated from nine species of animal (cattle, pigs, sheep, chickens, pigeons, horses, cats, dogs, and rabbits). All isolates were resistant to at least one antimicrobial and 98% were resistant to multiple anti-

microbials, with R-type ACTSp being the predominant resistance pattern. In the UK, a clonal strain of multiply resistant (mr)DT104 that is resistant to at least five antimicrobials (ampicillin, chloramphenicol, streptomycin, sulfonamides, and tetracycline) (R-type ACSSu T) was detected in humans in 1984 and cattle in 1988.<sup>4</sup>

The organism has emerged as an important cause of diarrhea in horses in Ontario<sup>82</sup> and is a public health concern because of its multiple drug resistance and the close relationship of the horse with humans.

The organism has been found in a variety of human foods, including salami, sausages, chicken, burgers, oysters, and vegetables. Human infections may result from contact with farm animals (cattle and sheep transmit infections to humans) and from consumption of contaminated foods such as chicken, pork, sausages, meat pastes, and beef. The organism is widespread in the USA. It has been isolated from elementary school children in a Nebraska farming community after they experienced an episode of diarrhea. Farm families are particularly at risk of acquiring infection by contact with infected animals or drinking unpasteurized milk.<sup>80</sup> The organism's ecology, its precise reservoirs, and its distribution in the human food chain are unclear. Clinical signs in humans infected with DT104 include diarrhea, fever, headache, nausea, and vomiting. Septicemia may develop in a small percentage of cases with potential complications of meningitis and foci of infection in bones and joints.

The antimicrobial resistance factor of DT104 is a major concern. Resistance to ampicillin, chloramphenicol, streptomycin, tetracyclines, and sulfisoxazole is characteristic of the organism. There is now evidence that DT104 is developing resistance to trimethoprim and fluoroquinolones such as ciprofloxacin, the drug of choice for treating human adult *Salmonella* infections. A large outbreak of salmonellosis due to mrDT104 occurred in people in England who had consumed milk from a dairy that received raw milk supplied by two farms. DT104 was isolated from the milk filter and failure of on-farm pasteurization was thought to be the cause. Strains of the organism from humans, the dairy cattle, and the milk filter showed decreased susceptibility to ciprofloxacin.<sup>83</sup>

Control and prevention of infection with DT104 will depend on increasing surveillance activities, investigating outbreaks, and identifying vehicles and risks of infections.

Contamination of milk usually occurs after the milk leaves the cow, even though the organism can be excreted into the milk

during the acute phase of the disease, and occasionally by carrier animals. In a Canadian study of families from dairy farms with and without *Salmonella*-positive bulk tank filters, 41 of 43 of participating families regularly consumed nonpasteurized milk. Of 22 farms with *Salmonella*-positive milk filters, five had at least one farm family member shedding *Salmonella* sp. In all cases, the organism shed was of the same serotype, biotype, antimicrobial susceptibility pattern, and plasmid profile as the organism isolated from the filters. Of the individuals in these five families, 63% were shedding *Salmonella* sp. There is also the chance that contact between animals and humans in agriculture, and in a companion animal relationship, especially with horses, can cause interspecies spread. An unusual but predictable transmission from lambs to humans occurs when sick lambs are foster-fed, especially by children.

Various clinical forms of salmonellosis can occur in veterinarians working with *Salmonella*-infected animals. Gastroenteritis, bacteremia and other systemic abnormalities can occur. Cutaneous salmonellosis has been reported in veterinarians attending to infected cattle at the time of parturition. The disease was characterized by pustular dermatitis from which *Salmonella virchow* and *S. dublin* were isolated. Veterinarians may develop skin lesions after obstetric deliveries, even after hygienic precautions and the use of abundant amounts of disinfectant creams and careful washing of the arms and hands.

#### Economic importance

Salmonellosis is a significant cause of economic loss in farm animals because of the costs of clinical disease, which include deaths, diagnosis and treatment of clinical cases, diagnostic laboratory costs, the costs of cleaning and disinfection, and the costs of control and prevention. In addition, when the disease is diagnosed in a herd it can create considerable apprehension in the producer because of the difficulty in identifying infected animals. The veterinarian is also often in a difficult position because the diagnosis, treatment, and control of the disease are less than reliable and it is difficult to provide advice with confidence. An estimation of the economic impact of an outbreak of *S. dublin* infection in a calf-rearing unit indicated that the cost of disease represented a substantial proportion of the gross margin of rearing calves. The losses incurred by livestock producers include reduced feed efficiency, and reduced weight gains or deaths because of salmonellosis.

#### PATHOGENESIS

The pathogenesis of salmonellosis is a complex and multifactorial phenomenon.

The nature of the disease that occurs following infection is dependent on the specific combination of serovar and host known as serovar–host specificity. A range of infections is included in the term ‘salmonellosis’. The most common type of infection is known as ‘the carrier state’, in which carriage of the organism is not accompanied by clinical abnormalities or clinical disease. In production animals, these carriers are of importance because they may serve as reservoirs for further spread of infection through shedding and may be present as contaminated food products.

The evolution of host-specific *Salmonella* serovars is considered to be associated with an increase in pathogenicity for the specific host.<sup>84</sup> The hypothesis is based on the fact that broad-range serovars (*typhimurium* and *enteritidis*) are generally associated with severe disease only in young animals, whereas host-restricted serovars cause high mortality in both young and adult hosts.

The pathogenesis of different *Salmonella* serovars possessing different degrees of host restriction have been studied in young lambs to evaluate the basis of the serovar–host specificity in sheep.<sup>39</sup> Infection with *S. abortusovis* resulted in clinical signs of salmonellosis, including a fever and bacterial dissemination to systemic tissues. This confirms the virulence of the strain with sheep. *Salmonella gallinarum* caused relatively mild disease but is virulent in chickens. *S. dublin* was virulent in sheep, confirming its association with ovine salmonellosis. The apparent specificity of a serovar for a particular host or range of hosts as defined by epidemiological data is influenced not only by bacterial virulence but also by the ability of the serovar to circulate within the population of the host.

#### Infection

*Salmonella* infects animals and humans by the oral route. Following ingestion, a proportion of the organisms resist the low pH of the stomach, reach the distal ileum and the cecum, invade the mucosa, and replicate in the submucosa and Peyer's patches.

In young animals, and in adults whose resistance has been lowered, spread beyond the mesenteric lymph nodes occurs and the infection is established in the reticuloendothelial cells of the liver; from there it invades the bloodstream. These steps in the infection process can occur very rapidly. For example, in newborn calves, *S. dublin* when taken by mouth can be found in the bloodstream 15 minutes later. In older calves bacteria can be isolated from the intestinal lymph nodes 18 hours after their oral adminis-

tration. Provided a sufficient number of a sufficiently pathogenic serotype is used, the disease is reproducible with pure cultures, for example of *S. typhimurium* in lambs, *S. choleraesuis* in pigs, *S. dublin*, *S. typhimurium*, and *S. enteritidis* in calves, and *S. typhimurium* in horses. Once systemic infection has been established, salmonellosis as a disease can develop. Its principal manifestations are as septicemia, enteritis, abortion, and a group of localizations in various tissues as a result of bacteremia.

#### Septicemia, bacteremia and the carrier state

After invasion of the bloodstream occurs a febrile reaction follows in 24–48 hours, and the acute phase of the disease, similar to that seen in natural cases, is present 3–9 days later. The early septicemia may be rapidly fatal. If the systemic invasion is sufficient to cause only a bacteremia, acute enteritis may develop, and abortion is a common final sequel in sheep and cattle. Many animals survive this stage of the disease but localization of the salmonellas occurs in mesenteric lymph nodes, liver, spleen, and particularly the gallbladder. In experimental *S. typhimurium* infection in pigs, the organism can persist from 6–8 weeks of age until market age with long-term persistence in the palatine tonsils, gastrointestinal tract, and adjacent lymph nodes. In healthy adults there may be no clinical illness when infection first occurs but there may be localization in abdominal viscera. In either instance the animals become chronic carriers and discharge salmonellas intermittently from the gallbladder and foci of infection in the intestinal wall into the feces and occasionally into the milk. For this reason they are important sources of infection for other animals and for humans. Carrier animals may also develop an acute septicemia or enteritis if their resistance is lowered by environmental stresses or intercurrent infection. Salmonellas can reside intracellularly where they are able to escape antibody-mediated killing, and the numbers of organisms are controlled by cellular defense mechanisms involving the macrophages in which they reside.

Septicemia in pigs associated with *S. choleraesuis* can cause pneumonia in pigs similar to the pneumonia in pasteurellosis and infection with *Actinobacillus pleuropneumoniae*, hepatitis, enterocolitis, and encephalitis.

*S. arizonae* may colonize the upper respiratory tract of sheep and induce a mild proliferative response in lambs.

#### Enteritis

Enteritis may develop at the time of first infection or at some other time in carrier animals. The best information available

on the pathogenesis of enteritis is derived from the experimentally produced disease. In most instances the disease is produced by the administration of massive doses of bacteria, and this may result in the production of a different syndrome from that which occurs naturally. The pathogenesis of enteric salmonellosis is much more complex than cholera, involving an increase in mucosal cell cyclic AMP content and prostaglandin concentration, as well as an inflammatory response to the invading bacteria. Intestinal invasion is a characteristic feature of *Salmonella* pathogenesis. Within minutes of injecting ileal loops in calves, *Salmonella* can be seen to invade both M cells and enterocytes that overlie domed villi associated with lymphoid follicles and absorptive villi.<sup>61</sup> The organism must invade the intestinal mucosal epithelium to cause disease.

*S. typhimurium* requires a functional type III secretion system encoded by *Salmonella* pathogenicity island I (SPII) to cause diarrhea.<sup>61,62</sup> The SP II secretion system mediates the translocation of secreted effector proteins into target epithelial cells. These effector proteins are key virulence factors required for *Salmonella* intestinal invasion and the induction of fluid secretion and inflammatory responses.

After oral infection with *S. dublin*, invasion occurs through the intestinal wall in the terminal ileum and cecum and progresses as far only as the mesenteric lymph nodes. Progress beyond this point, and the development of the disease, salmonellosis, is determined by factors such as immune status and age of the animal, whether or not it is exposed to stress, and the virulence of the strains. A number of characteristics of the bacteria influence their virulence, including the presence of adhesin-pili and flagellae, cytotoxin, enterotoxin, lipopolysaccharide and the inflammatory response that they initiate in the intestinal wall. The effects of some of these factors are not limited to the intestinal tract and also contribute to the systemic complications of salmonellosis. The *S. dublin* virulence plasmid mediates systemic infection in cattle by causing macrophage dysfunction.

*S. dublin* infections in calves have been used to create the disease experimentally. In calves 6–7 weeks of age, an oral dose of the organisms is fatal within 24 hours, with the animals dying of septicemia and an acute necrotizing panenteritis. Calves 12–14 weeks of age developed a progressive fatal diarrhea within 1 week following infection. Experimental infection of ligated ileal loops from calves with *S. typhimurium* results in an acute neutrophilic inflammatory response associated with invasion of Peyer's patches.<sup>85</sup>

In calves, infection is initiated by bacterial invasion of the mucosal epithelium of the distal ileum or proximal colon causing extensive local tissue damage that leads to shortening of the villi and degeneration of the enterocyte layer. *Salmonella* invasion induces potent inflammatory response characterized by a massive infiltrate of polymorphonuclear cells into the lamina propria and submucosa, and secretion of fluid into the intestinal lumen.<sup>86</sup> Damage to the enterocyte layer and the secretion of fluid into the intestinal lumen results in diarrhea, and the fever is due to circulating inflammatory cytokines. The molecular basis of *Salmonella*-induced enteritis has been described.<sup>61</sup>

Experimentally induced *Salmonella* infection in calves results in an increase in serum haptoglobin levels within 3 days of challenge.<sup>87</sup> By day 3 after experimental infection the serum haptoglobin levels increased to a median level of 212 µg/mL while placebo controls had median levels of 0 µg/mL. The increased levels closely reflected the clinical findings of infection and are considered useful markers of infection severity in salmonellosis in calves.

In **sheep**, the experimental disease produced by oral dosing with *S. typhimurium* includes an early acute enteritis of the small intestine at 24 hours. At 5–8 days there is hemorrhagic and necrotic typhlitis and the infection is established in mesenteric lymph nodes and the liver. Experimental *S. dublin* infection of the mammary gland of dairy cattle results in a persistent infection associated with a chronic active mastitis similar to carriers with naturally acquired *S. dublin* infection.

In ponies with experimental infection with *S. typhimurium* orally, there is much variation in the time after infection that the various signs appear. Pyrexia, neutropenia, and high fecal *Salmonella* counts coincided on the second and fourth days, but diarrhea occurred in only some ponies and then on the third to 11th days after inoculation. Positive agglutination tests were recorded from day 1 but were mostly during the period 6–12 days post-inoculation. The neutropenia of the early stages of the disease is transient, and neutrophilia occurs when diarrhea commences.

The characteristic **fever and leukopenia** of **equine salmonellosis** have been attributed to the release of endotoxin from the bacteria during invasion of, and replication within, the intestinal epithelium. The equine colonic mucosa can respond to cholera toxin, which causes an increased secretion of chloride, sodium, and water into the intestinal lumen. The enterotoxin activity of *S. typhimurium* of

equine origin has been compared to cholera enterotoxin.

Although there is sufficient obvious enteritis to account for the diarrhea that characterizes the disease, there appear to be other factors involved. For example, it has been shown experimentally that in *Salmonella* enteritis there is stimulation of active chloride secretion combined with inhibition of sodium absorption, but invasion of the mucosa is not essential for these changes to occur. These observations are of interest in the light of the known hyponatremia that characterizes the disease. Studies of calves with salmonellosis have shown that the fluid loss associated with the diarrhea of this disease is much greater than in other calf diarrheas. This, together with a large solid matter output, contributes to the significant weight loss occurring in salmonellosis. In pigs and to a lesser extent in cattle, ulcerative lesions may develop in the intestinal mucosa and may be of sufficient size to cause chronic intermittent diarrhea. In pigs it has also been observed that villous atrophy is a sequel to infection with *S. choleraesuis*.

In pigs, most clinical cases of salmonellosis are associated with *S. choleraesuis* or *typhimurium*. *S. choleraesuis* is host-adapted to pigs, causing a systemic, typhoid-like disease. *S. typhimurium* is not host-adapted to pigs, and infection results in a localized enterocolitis.

In the **pig** the development of enteritis associated with *S. choleraesuis* begins 36 hours after infection with the appearance of erosions and edema of the cecal mucosa. At 64 hours the wall is thickened and there is diffuse caseation overlying the erosions. The necrotic membrane sloughs at 96 hours and at 128 hours all function is lost and the entire intestinal wall is involved in the inflammatory process, the muscular coat being obliterated by 176 hours. The colon is usually the major organ affected in *S. typhimurium* infections in pigs, causing either focal or diffuse necrotizing colitis. The organisms proliferate in the intestine, invade the intestinal epithelium, stimulate fluid secretion and disseminate from the intestine to mesenteric lymph nodes and other organs. *S. choleraesuis* invades enterocytes by penetration of the brush border, resulting in focal loss of microvilli, and the bacteria are endocytosed into membrane-bound vacuoles. Experimental infection of ileal-gut loops of pigs with *S. enterica* results in preferential bacterial adherence to microfold cells (M cells) within 5 minutes, and by 10 minutes bacterial invasion of the apical membrane occurs in M cells, goblet cells, and enterocytes.<sup>88</sup> Experimental perfusion of porcine livers with polysaccharide or live



*S. choleraesuis* results in the release of mediators that mediate biological activities that have an important role in reducing the severity of bacterial infections. The comparison between early invasion of ileal loops by *S. enterica* and *S. choleraesuis* in the pig has been described.<sup>89</sup>

#### Abomasitis

*S. typhimurium* DT104 has been associated with some independent outbreaks of abomasitis in veal calves.<sup>90</sup> Abomasitis was reproduced experimentally by oral infection of calves.

#### Abortion

**Abortion is a common manifestation of salmonellosis in cattle** between days 124 and 270 of gestation. When infection is associated with *S. dublin*, the organism multiplies in the placenta, having been seeded there from a primary lesion in other maternal tissues. Fetal death has already occurred in many cases, because of its invasion by bacteria, but live calves also occur, suggesting that the placental lesion is the critical one. *S. montevideo* has been associated with a significant number of outbreaks of abortion in ewes.

#### Terminal dry gangrene, osteitis, and polyarthritis

Terminal dry gangrene due to endarteritis of the extremities of the limbs, ears, and tail may occur in calves with *S. dublin* infection. Epiphyseal osteomyelitis affecting the metaphyses, and polysynovitis and arthritis are also possible sequelae.

#### CLINICAL FINDINGS

The disease is most satisfactorily described as three syndromes, classified arbitrarily according to severity as **septicemia, acute enteritis, and chronic enteritis**. These are described first but the differences between the animal species are sufficiently significant to justify describing the disease separately in each of them. There are no significant differences between infections associated with the different *Salmonella* species.

#### Septicemia

This is the characteristic form of the disease in newborn foals and calves, and in young pigs up to 4 months old. Commonly, there is profound depression, dullness, prostration, high fever (40.5–42°C, 105–107°F) and death within 24–48 hours.

#### Acute enteritis

This is the common form in adult animals of all species. There is a high fever (40–41°C, 104–106°F) with severe, fluid diarrhea, sometimes dysentery, and occasionally tenesmus. The fever often subsides precipitously with the onset of diarrhea. The feces have a putrid smell and contain mucus, sometimes blood, fibrinous casts, which may appear as

complete tubular casts of intestine, and intestinal mucosa in sheets or casts. There is complete anorexia but in some cases increased thirst. The heart rate is rapid, the respirations are rapid and shallow and the mucosae are congested. Pregnant animals commonly abort. The case fatality rate without early treatment may reach 75%. In all species, severe dehydration and toxemia occur and the animal loses weight, becomes weak and recumbent, and dies in 2–5 days. Newborn animals that survive the septicemic state usually develop severe enteritis, with diarrhea becoming evident at 12–24 hours after the illness commences. If they survive this stage of the illness, residual polyarthritis or pneumonia may complicate the recovery phase.

#### Chronic enteritis

This is a common form in pigs following a severe outbreak, and occurs occasionally in cattle and adult horses. In calves there is intermittent or persistent diarrhea, with the occasional passage of spots of blood, mucus and firm fibrinous casts, intermittent moderate fever (39°C, 102°F), and loss of weight leading to emaciation. Although chronic enteritis may occur initially it usually succeeds an acute episode.

#### Bovine salmonellosis

The disease associated with *S. dublin* is usually endemic on a particular farm, with sporadic cases occurring when individual animals are exposed to stress. Severe outbreaks are rare but do occur when there is severe stress, usually acute nutritional deprivation, applied to the entire herd.

When *S. typhimurium* is the cause, it is usual to have a single animal or a small number of animals affected at one time. When the disease is in the calf population it is usual for it to be much more severe, with many affected, either as a point outbreak or, when there is a succession of calves, a continuing occurrence of the disease. The emphasis, therefore, is generally on the occurrence of individual, sporadic cases in newborn calves and recently calved cows. *S. muenster* in a dairy herd has been associated with abortions, diarrhea in adults and calves, and shedding of the organism in the milk of about 8% of the cows.<sup>18</sup>

**Septicemia** is the common form of the disease in newborn calves under a few weeks of age. There is depression, toxemia, fever, dyspnea, and weakness; nervous signs, including incoordination and nystagmus, may occur. Diarrhea and dysentery may occur but are not common.

Calves older than a week, and adults, are usually affected by **acute enteritis**, followed in survivors by abortion in pregnant cows and polyarthritis in calves.

In severe cases of enteritis, there is often dysentery, with whole blood passed in large clots, and complete agalactia in lactating cows. Abdominal pain, with kicking at the abdomen, rolling, crouching, groaning, and looking at the flanks, may occur in adult cattle. Rectal examination at this stage usually causes severe distress.

**Chronic enteritis** with inappetence, reduced weight gain, and unthriftiness may follow an attack of acute enteritis or be the only manifestation of the disease. Abortion is a common sequel in pregnant cows that survive an attack of acute enteritis. However, infection with *S. dublin* is also a significant cause of abortion in cattle without there having been any clinical signs other than retained placenta. A sequel to some cases of apparent enteric salmonellosis is the development of terminal dry gangrene due to endarteritis of the extremities, including eartips, tailtip, and the limbs from the fetlock down.

**Terminal dry gangrene of the extremities** of calves is characterized by lameness, swelling of the hindlimbs below the fetlocks, and separation of the skin above the fetlock. The distal portion of the limb is cool, not painful, and the skin is dry or moist. There is a clear line of demarcation of the skin at the level of the fetlock joints between the normal proximal skin and the distal necrotic tissue. The phalanges may be separated from the metatarsus. The tips of the ears may be indurated and deviated medially and the distal aspect of the tail may be dry and shriveled.

**Abortion** due to *S. dublin* may occur spontaneously without any previous clinical evidence of salmonellosis in the herd. Abortion has occurred from days 124 to 270 of gestation. Cows that abort may be ill with a fever, anorexia and hypogalactia and some will retain fetal membranes. In some cases, calves may be born shortly before term and die in the perinatal period. *S. muenster* has also been implicated in abortions in a dairy herd.<sup>18</sup>

The experimental disease produced by infecting adult cattle with *S. dublin* by mouth varies from no clinical illness to fatal dysentery. Abortion occurs in some pregnant females. Many suffer pyrexia, anorexia, and mild diarrhea. Experimental infection of calves with *S. typhimurium* has the same general effect, with more severe syndromes occurring in younger calves. Chronic cases may develop bone lesions, including osteoperiostitis and osteomyelitis, sometimes with epiphyseal separation. Experimental infection with *S. enteritidis* causes profuse yellow diarrhea, fever, dehydration, frequent cough, and a mucopurulent nasal discharge.

### Ovine and caprine salmonellosis

The only recognized form of the disease in sheep is acute enteritis on a flock scale. However, in the early stages of the outbreak there may be some cases of the septicemic form. After experimental infection of sheep with *S. dublin*, fever and diarrhea are followed in pregnant ewes by abortion. Abortion is also common in the naturally occurring disease and has come to exceed *S. abortusovis* as a cause of abortion in sheep in the UK. Some ewes die after abortion and many of the lambs born alive die subsequently. Fever and diarrhea, followed by abortion, have also been produced experimentally in sheep by the administration of *S. dublin*.

In goats, naturally occurring cases are not often reported. *S. dublin* is the usual pathogen in those countries where it is a resident, but *S. typhimurium* is also recorded as a cause. Peracute septicemia, in newborn animals, and acute enteritis occur with signs and lesions similar to those in cattle.

### Porcine salmonellosis

In pigs, the disease varies widely and, although all forms occur in this species, there is often a tendency for one form to be more common in any particular outbreak. In the septicemic form in pigs affected by *S. choleraesuis* a dark red to purple discoloration of the skin is evident, especially on the abdomen and ears, and subcutaneous petechial hemorrhages may also be visible. Nervous signs, including tremor, weakness, paralysis, and convulsions, may be prominent and occur in a large proportion of affected pigs. The case-fatality rate in this form is usually 100%.

A semispecific entity occurring in pigs up to 4 weeks old is manifested by meningitis and clinical signs of prostration and clonic convulsions.

In the acute form there is also a tendency for pulmonary involvement to occur, but the main feature of the disease is enteritis, with pneumonia and occasionally encephalitis present as only secondary signs. In some situations pigs dying of septicemia more commonly yield *S. choleraesuis*, while those with acute enteritis are usually infected with *S. typhimurium*. Acute pneumonia is a common accompaniment of this form of the disease in pigs, and nervous signs and cutaneous discoloration as described in the septicemic form may also be present. Meningitis due to *S. typhimurium* DT104 in 1-week-old piglets has been reported.<sup>91</sup> Incoordination, paralysis, opisthotonos, paddling, and polyarthritis resulting in runts and deaths were common. Bronchopneumonia resembling pasteurellosis, and pleuropneumonia resembling

*A. pleuropneumoniae* infection can be associated with *S. choleraesuis* in pigs.

A syndrome of rectal stricture occurs in feeder pigs as a sequel to enteric salmonellosis associated with *S. typhimurium* and is described under that heading.

### Equine salmonellosis

The disease in horses usually occurs in a single animal and sporadically. However, outbreaks do occur in newborn foals, in groups of horses recently transported, and in horses hospitalized in veterinary clinics. Analysis of spatial and temporal clustering of horses with salmonellosis in an intensive care unit of a veterinary teaching hospital suggested that affected horses were grouped in time. Experimental infection of horses by oral administration of *S. typhimurium* produces a disease similar to the natural disease. The incubation period may be as short as 24 hours. Four syndromes occur:

- **Asymptomatic shedding** of *S. typhimurium* in feces intermittently or continuously for short periods of 4–6 days
- **A subacute enteric form in adult horses** on farms where the disease is endemic, with fever, depression, anorexia but without severe diarrhea, although the feces may have the consistency of soft bovine feces. There is no other obvious intestinal abnormality. There may be a neutropenia with a left shift
- **Severe, acute fulminating enteritis** with diarrhea, fever, dehydration, and neutropenia. There is abdominal pain, which may be sufficiently severe to stimulate violent actions. This is the common form of the disease, occurring commonly in adults that are exposed to stress in one form or another. Newborn and young foals up to 8 days of age also often have this form of the disease,<sup>36</sup> characterized by depression, anorexia, and diarrhea
- **In foals up to about 2 days of age there is a highly fatal septicemia.** Localization in survivors includes lesions in the brain, causing meningo-encephalitis, polyarthritis, and many other sites. Fatal meningo-encephalomyelitis due to *S. agona* has been described in a 7-day-old foal.<sup>92</sup> Clinical findings included head tilt, seizures, and diarrhea.

### CLINICAL PATHOLOGY

A definitive etiological diagnosis of salmonellosis depends on culture of the organism from feces, blood, milk, and other body fluids or tissues. Feed and water samples may also be cultured to determine the source of the organism. Numerous

serological tests are available but lack sensitivity and specificity.

The three aspects of cases of salmonellosis that profit by clinicopathological support are:

- Diagnosis in the individual animal, when its treatment and prognosis depend on a definitive diagnosis
- Diagnosis of a herd problem to insure that expensive herd-wide control measures are not implemented unnecessarily
- Monitoring the biochemical status of a sick animal in order to determine most accurately its requirements for supportive therapy, especially fluid and electrolytes.

The diagnostic techniques available are as follows.

### Bacterial culture and detection

This is the only way of making a definitive etiological diagnosis of salmonellosis and of exactly determining the serotype. However, culturing the organism is unreliable for various factors including the method used to collect samples, the amount of sample submitted, variation in the shedding of the organism, and the bacteriological method used. A major complicating factor is the occurrence of apparently healthy carriers, which shed the organism intermittently in the feces, and silent carriers, which do not shed but harbor the organism in mesenteric lymph nodes or in the mucosa of the cecum and colon. The difficulty varies according to genotype. In cattle with *S. dublin* infections, the bacteria are present in the blood and milk for a very brief period during the bacteremic phase and before diarrhea commences.

The organism can be cultured from fecal samples, bulk tank milk, milk filters, water and feed sources, and environmental sites.<sup>93</sup> When sampling dairy farms weekly for 7–8 weeks, the prevalence of fecal shedding from different groups of cattle may vary widely among herds, indicating that herds with infected cattle may be classified incorrectly if only one group is tested. Cows near calving are most likely to be shedding *Salmonella* in the feces. Testing environmental sample sources is more efficient for identifying infected premises than using individual cattle fecal samples.

### Fecal culture

The culturing of salmonellas from feces is done commonly but can be unreliable. This difficulty is noticeable with *S. dublin* infection in cattle, *S. choleraesuis* infections in pigs and *S. typhimurium* infection in horses. The discrepancy in *S. dublin* infections in calves may be as great as 55% accuracy only and in horses only 50%. The difficulties relate to dilution by

diarrhea and the heavily contaminated nature of the sample; a sample of fluid feces collected in a container is superior to a fecal swab. Clinical laboratories generally require at least 48 hours for presumptive diagnosis of *Salmonella* spp. in feces. Biochemical and serological confirmation of the genotype and the antibiogram may require an additional 24–48 hours. The use of extended enrichment of fecal samples with tetrathionate broth is superior to primary enrichment for detection of salmonellas from cattle.

A special feature of *S. dublin* is the tendency to produce persistent infections without clinical manifestations in some infected cattle – also called carriers. The organism is harbored in lymph nodes and other internal organs, and is only periodically shed in milk and/or feces. The rate of fecal culture of *S. dublin* from known carrier cows and calves is low even when sampled over a period of 12 months – 3.35–17.26%.<sup>94</sup> Carriers frequently have continuously high immunoglobulin levels in serum and milk and ELISAs are used as an alternative.<sup>94</sup>

Because culture of a large number of individual fecal samples is expensive and time-consuming, pooled fecal samples from individual animals provides excellent agreement for detection of *S. infantis* when the number of samples per pool is 20 or less.<sup>95</sup> With the kappa test, the agreement ranged in two groups of pooled fecal samples from 0.81–0.98.

### Multiple fecal cultures

Multiple cultures at 24-hour intervals are superior to single fecal cultures for the diagnosis of clinical salmonellosis in horses.<sup>10</sup> Fecal samples should be cultured directly on Brilliant Green Agar and an additional sample inoculated in Selenite broth and incubated for 24–48 hours followed by culture on Brilliant Green Agar.<sup>54</sup> Simultaneous culture of a pinch biopsy of rectal mucosa may increase the number of isolations of salmonellas in cattle and horses.

### Antigen-capture enzyme-linked immunosorbent assay

An antigen-capture ELISA with enrichment culture for detection of salmonellas from fecal samples is more rapid than routine culture techniques, with a test sensitivity of 69% and specificity of 97%.

### Polymerase chain reaction

A PCR assay is a highly specific and sensitive test for the detection of salmonellas in fecal samples from horses.<sup>96</sup> The test is genotype specific, is much more sensitive than microbiological culture for detecting the organism from fecal swab specimens, requires fewer samples, and can provide results 24 hours after receipt of fecal samples. Direct detection is done by

amplification of part of omp C after extraction of DNA from feces.<sup>96</sup> *Salmonella* DNA was detected in 40% of fecal samples, while *Salmonella* was cultured from only 2% of the samples. The PCR assay has been used to detect *Salmonella* DNA persisting in the environment of a veterinary teaching hospital.<sup>54</sup> Pulse-field gel electrophoresis can be used to characterize the types of *S. enterica* isolate.<sup>54</sup>

A real-time PCR assay uses enrichment of fecal specimens, followed by genomic DNA extraction to detect *Salmonella* ssp.-specific DNA segment.<sup>97</sup> Relative sensitivity was 100% and specificity 98.2% compared with bacterial culture.

### Bulk tank milk filters

The bulk tank milk filter is collected immediately after milking and submitted for culture. Samples of bulk tank milk are also submitted.

### DNA probes

The use of the DNA probe encoding a well-conserved virulence gene of the *Salmonella* virulence plasmid is a sensitive method for screening large numbers of samples to detect potentially virulent *Salmonella* spp.

### Serial blood culture

In the early stages of the disease when the animal is likely to be bacteremic this is not a practicable technique because of the need to collect serial samples and the cost of blood cultures.

### Serology

Serum enzyme-linked immunosorbent assay

Serological testing using ELISA tests on serum or milk can be used in herds to identify *S. dublin* carriers, which can then be culled.<sup>94</sup> The test is based on immunoglobulins to the O antigens of the lipopolysaccharide of the organism. The superior sensitivity and negative predictive value of the serum ELISA is preferable to fecal culture as an initial screening test and for herds not infected with *S. dublin*.<sup>94</sup> It may be able to differentiate between uninfected, recently infected recovered, and milk-shedding (mammary-gland-infected) carrier cows; it can also be used for assessing infection rates and vaccine responses. ELISA testing of individual milk samples can be used for surveillance of herds infected with *S. typhimurium* or *S. dublin*.

An ELISA test using lipopolysaccharide antigen is highly O-antigen-specific and predictable. A serum with a positive result on the screening antigen can then be tested on the other antigens to determine the specific serotype that has infected the animal. The ELISA is suitable for screening for the presence of infection with *S. typhimurium* or *S. infantis* on a herd basis.

Using a variety of ELISA tests, muscle fluid samples from cattle taken at slaughter can be used as an alternative to serum to detect antibodies to *Salmonella* polysaccharide. Bulk tank milk can be tested for antibodies to *S. dublin* and used as a national screening diagnostic aid.<sup>98</sup> The *S. dublin* ELISA had a high sensitivity (97%) and specificity (97%) for muscle fluid samples, compared with serum samples; the relationship for *S. typhimurium* was also good.

### Meat juice enzyme-linked immunosorbent assay: Danish mix-ELISA

The Danish mix-ELISA (DME) is a combination of lipopolysaccharide extractions of *S. choleraesuis* (O antigens 6 and 7) and *typhimurium* (O antigens 1, 4, 5, and 12), used to assay serum samples collected from live animals on the farm or from meat juice (collected when a meat sample from the carcass is frozen and thawed).<sup>12</sup> The DME was designed for surveillance and is recommended for monitoring herds and detecting high levels of *Salmonella* infection.<sup>99</sup> The test has been the basis for national *Salmonella* control programs in Denmark (SALINPORK), Germany, and the UK and is being considered in the Netherlands and Belgium. In a series of studies using pigs experimentally infected with either *S. typhimurium* or *S. infantis*, the sensitivity of the DME was more than 95% and the specificity 100% when compared to culture used to determine the positive or negative status of the pigs.<sup>12</sup> There is a strong association between herd serology and the prevalence of *Salmonella* measured at three sampling sites: cecal content, pharynx, and carcass surface.<sup>100</sup>

### Indirect tests

These include a total and differential white cell count. A leukopenia, neutropenia and severe degenerative left shift are highly suggestive. There is also a marked hyponatremia and a mild hypokalemia. These tests are well established in horses, and the leukopenia has been observed in acute salmonellosis in cattle. The fecal leukocyte count is also a worthwhile supportive test in the search for salmonellosis. A high count is strongly suggestive, but many horses with acute or severe diarrhea have high fecal leukocyte counts in the absence of salmonellas in the feces.

### Laboratory diagnosis in a suspected sick animal

A positive diagnosis depends on culture of the organism, usually from feces but possibly from blood in the septicemic stage. If serological diagnosis is available a serum sample should also be submitted.

Indirect tests are very valuable and, if laboratory availability is good, a total white cell count and estimation of serum sodium levels should be undertaken urgently. A presumptive diagnosis is often all that can be stated, and this may be supported by a herd diagnosis – a diagnosis that the disease or infection is present in the herd and that it is presumed that the subject case is one of the group.

#### Herd diagnosis

A serological examination of a sample of animals is a first step. A completely negative serological test would indicate that the infection is not present. Positive results indicate a need for further examination, and periodic fecal cultures at 15-day intervals using enriching media should be undertaken. When *S. typhimurium* is the causative bacteria, the feces of other species of animals on the farm should be examined, because ducks, dogs, horses, pigs, sheep, and cattle may be sources of infection for each other. It is always advisable to examine the drinking water and feed for evidence of infection.

#### Detection of clinically normal carrier animals

The most difficult diagnostic problem in salmonellosis is the detection of the clinically normal carrier animal. The recommended procedure is to do fecal cultures on all cows at 14-day intervals for 3 examinations, and repeat the examination on the day of calving. At that time, swabs are taken from feces and the vagina of the cow, and the feces of the calf. The sampling should preferably be done when the cows are tied in stanchions and not grazing pasture, because of the large number of passive carriers of the infection in the latter circumstance.

The reliability of diagnosis based solely on culture of fecal swabs is not high and represents the major difficulty in detecting carriers. A combination of fecal culture and serological tests offers some improvement in accuracy, but even with the agglutination or complement fixation tests accuracy is insufficient.

#### Determination of prevalence of infection in population of animals

In food-producing animals it is particularly important to determine the prevalence of *Salmonella* infection in a population of cattle or pigs. Pork and pork products are important sources of nontyphoidal *Salmonella* for humans consuming these products if they are not handled with care. Pigs entering the abattoir that are carriers of *Salmonella* are the most important source of carcass and product contamination. In order to be able to estimate the number of infected

animals entering the abattoir and estimate the size of the *Salmonella* problem in pig herds, the population and herd level prevalence of *Salmonella* have to be investigated. An estimation of the prevalence of *S. enterica* infection in finishing pigs in Iowa was done using on-farm fecal cultures, culture of on-farm necropsy and abattoir-collected samples, and serum ELISA using serum exudate (meat juice).<sup>101</sup> Fecal samples collected on the farm detected only 13.3% of all positive pigs necropsied on the farm. Abattoir and on-farm results combined, the fecal sample detected 57.4% of positive pigs. Abattoir-collected samples provided prevalence estimates much higher than on-farm collected samples (39.9 vs 5.3%). Thus fecal samples have a low sensitivity for detecting infected pigs and abattoir-collected samples overestimate the on-farm *S. enterica* prevalence. Pigs can become infected during routine testing or holding periods during marketing when exposed to relatively low numbers of *Salmonella* in the preslaughter environment. Intervention this step on the production process may have a major impact on the safety of pork products.

The probability of detecting *Salmonella* in seropositive pig herds and thereby correlation between serological and fecal culture results were examined in pig herds as part of an international research program sponsored by the European Commission, *Salmonella* on Pork.<sup>102</sup> Samples were examined from herds in Denmark, the Netherlands, Greece, and Germany. The serological herd status was determined by blood-sampling 50 finishing pigs. There was an increased probability of recovering *Salmonella* with increasing within-herd seroprevalence but the correlation was only moderate.

#### NECROPSY FINDINGS

##### Septicemia

There may be no gross lesions in animals that have died peracutely but extensive submucosal and subserosal petechial hemorrhages are usually evident. In pigs, the petechiae are very prominent and may give the kidney the 'turkey-egg' appearance usually associated with hog cholera. A rhomboidal area of gastric mucosal infarction is usually present in pigs. Congestion and hepatization of lung tissue may also be present in this species. Skin discoloration is marked in pigs and, depending on the severity of the case, this varies from extreme erythema with hemorrhage, to plaques and circumscribed scabby lesions similar to those of swine pox. In some cases the necropsy findings may include splenomegaly and pinpoint white foci in the liver (paratyphoid nodules). The histological lesions are non-

specific, with the exception of the somewhat granulomatous character of the older paratyphoid nodules. The placentas of cattle and sheep aborting due to *Salmonella* spp. often contain very large numbers of intravascular bacteria.

##### Acute enteritis

Some of the changes associated with the septicemic form are often present but the most consistent damage is found in the large and small intestines. The character of the inflammation here varies from a mucoenteritis with submucosal petechiation to diffuse hemorrhagic enteritis. Similar lesions may be present in the abomasum, and in *S. dublin* infections in calves multiple mucosal erosions and petechiation of the abomasal wall are common. In porcine enteric salmonellosis, congestion and infarction of the gastric mucosa is often seen. Infections with *S. typhimurium* are characterized by severe necrotic enteritis in the ileum and large intestine. The intestinal contents are watery, have a putrid odor and may contain mucus or whole blood. In cases that have survived for longer periods, superficial necrosis and fibrin exudation may proceed to the development of an extensive diphtheritic pseudomembrane and fibrin casts. The mesenteric lymph nodes are enlarged, edematous, and hemorrhagic. The wall of the gallbladder may be thickened and inflamed. In pigs, survivors of the septicemic and acute enteric forms of salmonellosis may develop rectal strictures.

##### Chronic enteritis

In cattle, the chronic form is usually manifested by discrete areas of necrosis of the wall of the cecum and colon. The wall is thickened and covered with a yellow-gray necrotic material overlying a red, granular mucosal surface. In pigs the lesion is similar but usually more diffuse. Less commonly the lesions are discrete in the form of button ulcers, occurring most frequently in the cecum around the ileocecal valve. The mesenteric lymph nodes and the spleen are swollen. In all species, chronic pneumonia and a variety of other localized inflammatory processes such as polyarthritis and osteomyelitis may be found.

*Salmonellas* are present in the heart, blood, spleen, liver, bile, mesenteric lymph nodes, and intestinal contents in both septicemic and acute enteric forms. In the chronic form, the bacteria may be isolated from the intestinal lesions and less commonly from other viscera. Culture is more successful if enrichment media such as tetrathionate broth are employed. In pigs experimentally infected with *S. typhimurium* and *S. choleraesuis* var. *kunzendorf* the organisms can be detected with peroxidase-antiperoxidase

immunoenzymetric labeling and immunogold techniques.<sup>51</sup> Surveys that set out to determine the percentage of carriers in animal populations by examining abattoir material show that by far the largest number of isolations are made from the lymph nodes draining the cecum and lower small intestine.

#### Samples for confirmation of diagnosis

- Bacteriology – ileocecal lymph node, ileum, colon, spleen, lung, liver, culture swab from gall bladder (CULT)
- Histology – formalin-fixed samples from these tissues plus kidney, stomach, brain (LM).

Note the zoonotic potential of these organisms when handling carcasses and submitting specimens.

#### DIFFERENTIAL DIAGNOSIS

The clinical diagnosis of salmonellosis is difficult because of the number of other diseases that resemble each form of the disease. Salmonellosis is characterized by septicemia in young animals and acute and chronic enteritis in adults, although acute enteritis can occur in neonates. Thus the septicemic form of the disease must be differentiated from all other causes of septicemia, and the enteric forms from all other causes of diarrhea in both young and adult animals. At necropsy the isolation of salmonellas from tissues and intestinal contents, although suggestive of the presence of salmonellosis, does not of itself confirm the diagnosis, and care must be taken to ascertain whether other disease is present.

#### Cattle Septicemia

The septicemic form of salmonellosis in calves resembles coliform septicemia and differentiation is possible only by bacteriological examination of blood, feces, and tissues. Salmonellosis occurs most commonly during the second and third weeks of life in contrast to coliform septicemia which occurs most commonly in the first few days of life. Both are characterized by weakness, depression, polypnea, tachycardia, fever or hypothermia, scleral injection and hemorrhages, diarrhea, and rapid death.

#### Acute enteritis

Acute enteric salmonellosis in adult cattle or calves is characterized by fever, anorexia, toxemia, abdominal pain, diarrhea and dysentery, excessive mucus and fibrinous casts and strands in the feces, and dehydration.

- **Coccidiosis** occurs most commonly in young cattle 2–8 months of age and is characterized by diarrhea with frank blood in the feces, tenesmus, only occasionally systemic signs of dehydration and anemia, and spontaneous recovery in a few days; rarely there are nervous signs and death

- **Acute intestinal obstruction** is characterized by abdominal pain, scant or absent feces, blood-stained feces, tenesmus, anorexia, and palpable abnormalities on rectal examination
- **Winter dysentery** occurs in explosive outbreaks in housed adult cattle; the feces are gray with flecks of blood, there is no toxemia, no dehydration, and the disease is self-limiting in 24–48 hours
- **Mucosal disease** is characterized by typical oral erosions, anorexia, fever, persistent diarrhea, dehydration, lesions in the interdental clefts and a high case-fatality rate
- **Bracken fern poisoning** is characterized by dysentery, scleral hemorrhages and a history of access to the bracken plant
- **Other poisonings**, especially arsenic and to a lesser extent lead and a number of miscellaneous weeds, may cause a similar acute enteritis.

#### Chronic enteritis

Chronic enteric salmonellosis may resemble **Johne's disease** or **chronic molybdenum poisoning**, but dysentery and epithelial casts do not occur in these diseases. Massive **stomach fluke infestations** may also cause diarrhea and dysentery.

#### Abortion

Abortion due to salmonellosis requires laboratory examination of the fetus, fetal fluids, vaginal mucus, feces, and milk of the aborting animals.

#### Sheep

Diarrhea associated with infections with coccidia or *Campylobacter* spp. or by parasitic infestation may resemble enteric salmonellosis in sheep but the latter is usually more acute and more highly fatal.

#### Horses

##### Septicemia

Septicemic salmonellosis in foals may resemble the septicemias associated with *E. coli* and *Actinobacillus equuli*.

##### Acute enteritis

Acute enteric salmonellosis in adult horses causes profuse diarrhea, dehydration, severe depression, and weakness. A history of recent transportation often helps in suggesting the diagnosis of salmonellosis in adult horses, in which colitis X is the important differential diagnosis.

**Idiopathic equine colitis X** is a severe enterocolitis of adult horses characterized by profuse diarrhea, marked dehydration and a high case-fatality rate in spite of intensive fluid therapy. Many cases are considered to be enteric salmonellosis but the definitive etiological diagnosis is often not obtained.

Other diagnoses that must be considered include:

- **Clostridiosis** due to *Clostridium perfringens* type A, *Clostridium difficile*, may result in peracute hemorrhagic diarrhea, marked dehydration and rapid death.

#### Chronic enteritis

Chronic diarrhea due to salmonellosis may resemble **parasitism**, **granulomatous enteritis**, or **lymphosarcom**.

#### Pigs

Septicemic salmonellosis occurs in pigs 1–4 months of age and is characterized by fever, depression, skin color changes, diarrhea, and rapid death.

- **Hog cholera**, **ASF coliform gastroenteritis of recently weaned pigs**, and **pasteurellosis** may resemble septicemic salmonellosis very closely and laboratory examination is usually necessary for identification
- **Acute erysipelas** is characterized by typical skin lesions, fever, swollen joints, and typical lesions at necropsy
- **Swine dysentery** is characterized by mucoïd feces with dysentery and typical lesions of the large intestine.

#### TREATMENT

##### Primary treatment – antimicrobial therapy

The use of antimicrobials for the treatment of clinical salmonellosis is controversial and different approaches to the problem exist among veterinarians. The controversy centers on two parts of the response to treatment, and which view is taken depends to a large extent on the experience one has with respect to them.

The first issue is that of the success of treatment in saving the lives of clinically affected animals. It is our experience that early treatment with broad-spectrum antimicrobials is highly effective in reducing mortality and returning animals to normal function. It is generally agreed that treatment must be early, because delay means loss of the integrity of intestinal mucosa. A common pattern of response to treatment in a herd is that the first one or two cases are regarded lightly by the owner and they are treated 24–48 hours after diarrhea begins. When these cases die, a more prompt regimen is instituted in which the farmer has the approved drug on-hand and begins treatment as soon as diarrhea with fever is observed. The cure rate is then likely to be of the order of 100%, except in the case of foals and calves, in which a fulminating septicemia is apt to defeat even the best treatment program.

The second issue in the controversy about antimicrobial therapy for salmonellosis is the risk of inducing 'carrier' animals. In humans and in animals there is some evidence that antimicrobials can prolong the duration of the period after clinical recovery during which the causative bacteria can be isolated from

the intestine. It is accepted that this can occur and that the use of antimicrobials can theoretically contribute to the spread of disease. However, because of the way in which animals are kept, and because they constantly ingest contaminated pasture or other feed, there is an almost universal carrier segment in animal populations, and to regard another survivor from salmonellosis as a significant contributor to the carrier frequency seems an exaggeration. In many situations this appears to be the correct view, but in other situations an animal can become infected, for example, in a veterinary hospital or at an exhibition or show, recover clinically with treatment and, after returning to its parent herd, initiate an outbreak of fatal and debilitating salmonellosis. Both epidemiological patterns occur, and they seem to occur in different places, so that the most appropriate attitude to take seems to be the one that fits local circumstances. In an area where only sporadic cases of the disease occur in herds, it would be professionally negligent not to treat infected animals with appropriate antimicrobials. In endemic areas, recovered animals should not be sent into herds until they are known not to be carriers.

Other related issues are the creation of drug-resistant strains of the bacteria and the effect on the normal intestinal flora that results from oral medication. The problem with resistant strains would not have become a significant one if only individual animals had been treated, but mass medication of in-contact animals and prophylactic treatments have generally resulted in a large population of resistant strains.

Oral treatment in cattle and pigs is recognized as a satisfactory treatment but it is not recommended in horses in which an immediate worsening of the diarrhea, or its prolongation as a persisting chronic diarrhea, may be encountered. It is thought that both sequelae result from an alteration of the normal population of intestinal microflora resulting from the 8–10 times greater concentration of drug that occurs in the intestine after oral treatment, compared to the concentration resulting from parenteral injection.

In summary, antimicrobials are recommended for all clinically affected animals as set out below. The choice of antimicrobials depends on a test of drug sensitivity in each case or outbreak but failing this the following generalizations can be applied.

#### Ruminants

Currently there are no antimicrobials labeled for treatment of bovine salmonellosis in the USA. As a result, treatment of salmonellosis in cattle is largely empirical

and extralabel use of certain antimicrobials is common in veterinary practice.<sup>103</sup> Ceftiofur at 5 mg/kg BW intramuscularly/24 hours is effective for the treatment of experimental salmonellosis in neonatal calves.<sup>103</sup> It promotes animal welfare, reduces fecal shedding of *Salmonella*, and may prolong clearance of *Salmonella* infections when plasma ceftiofur concentrations are maintained above MICs.

In calves with *S. dublin* infections trimethoprim-sulfadoxine is recommended, given parenterally daily until clinical recovery occurs. Ampicillin and amoxicillin are also effective. Oral dosing is satisfactory in preruminant calves but it is much less effective when given to grazing ruminants. Trimethoprim and sulfadiazine are very effective for the treatment of experimental salmonellosis in calves with *S. dublin*. There is marked synergism of the two drugs and both parenteral and oral therapy are effective. Sulfadimidine and framycetin are also widely used and recommended. Chloramphenicol was once a commonly used antimicrobial for salmonellosis but is now banned for use in food-producing animals in many countries. Nitrofurazone given orally to calves and adult cattle affected with salmonellosis also was used commonly but is now similarly banned.

#### Horses

Antimicrobial therapy in equine salmonellosis should be based on drug sensitivity of the organisms isolated. Based on some studies of isolates from horses, gentamicin at 3 mg/kg BW combined with ampicillin at 20 mg/kg BW given intravenously at 8–12-hour intervals is recommended. An alternative is trimethoprim-sulfonamide given twice daily intravenously at a combined dose of 30 mg/kg BW. Sulfadiazine, sulfadoxine, and sulfamethoxazole are the best sulfonamides to combine with trimethoprim for salmonellosis in the horse. In a double-blind prospective study, 220 horses undergoing surgery were given a probiotic orally once daily for 7 days postoperatively and fecal cultures for *Salmonella* were done daily for 10 days. The commercial probiotics had no effect on *Salmonella* shedding, prevalence of diarrhea, length of antimicrobial therapy, or length of hospitalization.<sup>104</sup>

#### Foals

Foals with septicemic salmonellosis are usually treated both systemically and orally with antimicrobials, sometimes a different one by each route. Treatment must be given at least at 6-hourly intervals and accompanied by a supportive fluid therapy. Antimicrobials recommended include gentamicin (250 mg intravenously, twice daily), ampicillin (1 g, 6-hourly), and chloramphenicol (20 mg/kg BW intra-

venously, 6-hourly). Care needs to be exercised when treating adult horses for salmonellosis because of the tendency for antimicrobials, especially tetracyclines, to precipitate attacks of diarrhea. Parenteral treatment with ampicillin or sulfonamide combinations is recommended.

#### Pigs

For pigs with septicemic salmonellosis, trimethoprim-sulfadoxine is recommended, along with a combination of mass medication of the water supply with chlortetracycline and sulfamethazine (75 mg of each per liter of water). Where large numbers of pigs are affected, mass medication via the feed or drinking water is usually practiced. Because sick pigs do not eat, water treatment is necessary and if drugs are unpalatable individual treatment is the last recourse. Drugs that dissolve readily and are palatable are therefore in demand. Experimental disease of pigs with *Salmonella typhisuis* can be controlled by the inclusion of low concentrations of chlortetracycline, penicillin, and sulfamethazine in the feed.

#### Supportive therapy

##### Horses

##### Fluid and electrolyte therapy

In adult horses affected with acute salmonellosis, the dehydration, acidosis and loss of electrolytes are severe. The loss of sodium is most serious, followed by potassium and chloride in that order. A solution of 5% sodium bicarbonate at the rate of 5–8 L/400 kg BW given intravenously over a period of 2 hours as the initial electrolyte replacement therapy will usually help to convert the hyponatremia and acidosis. The hypertonic solution is considered necessary to correct the severe loss of sodium. Following this initial therapy, equal mixtures of isotonic saline (0.9%) and isotonic sodium bicarbonate (1.3%) may be given as maintenance fluid and electrolyte therapy in amounts as indicated. The hypokalemia may be severe in some horses and is recognized clinically by muscular weakness and trembling. It may be corrected by adding potassium chloride to the saline and bicarbonate solution at the rate of 1–2 g/L for a total of 4–6 g of potassium chloride given over 2–4 hours. Concentrated solutions of potassium must be given slowly and the heart monitored for evidence of arrhythmia. However, provided that renal function has been restored, the hyperkalemia that may result from electrolyte therapy or that which could occur following correction of the acidosis should not be hazardous, since the kidney will excrete excess potassium. A safer method would be the oral administration of 30 g of potassium chloride in 8 L of water given twice daily.

Under practical conditions, without the aid of a laboratory for serial evaluation of serum electrolytes, the field veterinarian is faced with using hypertonic solutions as described above or balanced electrolyte solutions and careful clinical monitoring for evidence of overhydration or electrolyte imbalances.

The administration of electrolyte solutions by the oral route is gaining popularity because of the ease of administration and relative safety. Large quantities of fluids (10–30 L) can be administered orally, either all at once, for example in a mature cow, or in smaller quantities (5–10 L) three to four times daily in mature horses. This has been discussed in more detail under fluid therapy in Chapter 2.

## CONTROL

### Prevention of introduction of infection (biosecurity)

Avoidance of infection is the major objective but is not easily achieved. The principal sources of infection are carrier animals and contaminated feeds containing foodstuffs of animal origin. There is a critical need to develop methods to control the spread of *Salmonella* infections on dairy farms by instituting biosecurity and biocontainment practices in addition to enhanced farm management. This would result in a reduction in the use of excessive antibiotic treatment of individual animals or herds.

A closed herd minimizes the risk of infection but is not a practicable procedure for the types of animal producer for which salmonellosis is a major problem – the calf-rearer and the commercial pig fattener. For such producers the following rules apply:

- Introduce the animals directly from the farm of origin. Avoid auction marts, saleyards and public transport, all of which are likely to be sources of infection. Insure that the farm of origin is free of salmonellosis
- If possible, purchase animals when they are older, such as 6 weeks of age for calves, to provide an opportunity for specific and nonspecific immunity to develop. Animals from vaccinated herds are desirable
- The premises of dealers, saleyards and transport vehicles must be under close surveillance and the need for frequent vigorous disinfection must be stressed. The infection rate in calves delivered to calf-dealers' yards in the UK was less than 1% but the infection rate increased to 36% if the calves were kept on the premises over the weekend
- Introduce only those animals likely not to be carriers. Unfortunately the

detection of carriers is inaccurate and expensive. To have any confidence in the results, fecal samples for culture must be submitted on at least three occasions. Even then, occasional carriers with lesions in the gallbladder or tonsils will escape the net and be capable of reviving the disease on the farm or transferring it to another one.

For the control of multiple drug-resistant *S. typhimurium* DT104 in cattle herds, the risk factors over which the farmer can exert a level of control and that are effective in reducing the incidence of disease include purchasing replacement stock from direct sources rather than dealers, quarantine of purchased cattle for a 4-week period, housing sick animals in dedicated isolation areas and preventing wild bird access to cattle feed supplies.

Management practices to reduce the risk of *S. brandenburg* on a sheep farm include reducing stocking density; avoiding strip grazing; maintaining adequate nutrition; minimizing yarding of ewes and the time spent in yards; dampening down yards prior to yarding; providing stock with a fresh clean source of drinking water; avoiding the purchase and/or grazing of stock from known affected farms, as they may contain carrier animals; preventing dogs from scavenging; and preventing scavenging by black-backed gulls by removing and burying aborted fetuses frequently during the lambing season.<sup>40</sup>

### Limitation of spread within a herd

When an outbreak occurs, procedures for limiting spread, as set out below, need to be strictly enforced, and medication of affected groups, and of susceptible groups at high risk, must be carried out. The drugs to be used are those listed under treatment, the choice of the individual drug depending on its efficiency and cost.

- **Identify carrier animals and either cull them or isolate and treat them vigorously.** Treated animals should be resampled subsequently to determine whether a 'clean' status has been achieved
- **The prophylactic use of antimicrobials** such as oxytetracycline in the feed at the rate of 10 g/tonne, or chlortetracycline in the drinking water at the rate of 55 mg/L, is used but not recommended because results are poor and there is a risk of developing resistant strains. Probiotics intended for the prevention of shedding of *Salmonella* in the postoperative period in horses with colic have been evaluated and found to be ineffective.<sup>104</sup>

- **Restrict the movement of animals around the farm** and limit the infection to the smallest group. Pasture and permanent buildings are both important, although the major source of infection in most cases is the drinking water
- **The water supply should be provided in troughs that are not susceptible to fecal contamination.** Static drinking water or pasture may remain infected for as long as 7 months
- **Rigorous disinfection of buildings is important.** An all-in/all-out policy should be adopted and steam cleaning and chemical sterilization performed after each batch of animals. Piglets can be reared free of *Salmonella* infections up to 6 weeks of age by removing the piglets from infected herds to isolation facilities when they are weaned at 10–21 days of age. The movement of pigs either at weaning, from the nursery, or from the grower unit to newly built or rigorously cleaned and disinfected finishing units with known history of *Salmonella* infection is highly successful.<sup>102</sup> If economics permit, individual pens for calves are beneficial. Where calves are reared indoors they are common and economical. Pig houses need especially careful treatment. Dirt yards present a problem, especially those used for sheep and calves, but, provided they can be kept dry and empty, two sprayings, 1 month apart, with 5% formalin is recommended
- **The control of salmonellosis in veterinary clinics and veterinary teaching hospitals** requires special attention to the possible sources of infection and containing and preventing the spread of infection. Following the diagnosis of the disease in a clinic, an environmental survey should be carried out using bacteriological culturing of stalls, wall padding, stomach pumps, nasogastric tubes, alleyways, water drains, and other equipment used routinely.<sup>105</sup> This is followed by a thorough cleaning and disinfection of the entire animal-holding premises. A power water sprayer is used, followed by application of 10% solution of hypochlorite for at least 15 minutes. The surfaces are then recultured to determine the presence of residual contamination. Medical and surgical equipment are cleaned and gas-sterilized. Traffic flow patterns in the clinic are reviewed and modified accordingly. Use of disposable gloves



and thorough washing of hands after handling suspect animals are recommended. Stalls in which horses with salmonellosis were housed should only be used to accommodate newly hospitalized horses after sample (collected after two cycles of cleaning and disinfection) from stall drains, cracks and corners yield negative results on bacteriological culture.<sup>105</sup> Using PCR assay for *Salmonella* DNA, samples from floor drains and drainpipes yield the greatest proportion of positive results. The PCR results should be confirmed by bacteriological culture because a positive PCR in itself is not considered to pose a risk of salmonellosis to hospitalized horses. When a hospitalized horse leaves its stall permanently, it should be cleaned of organic matter using a cold water hose and scrubbed with a steel wool mop. This is followed by an application of generic bleach solution. This is then followed 24 hours later by another cleaning and disinfection with a peroxygen solution (Virkon) and allowed to dry. Virkon is a balanced stabilized blend of peroxygen compounds, surfactants, organic acids, and inorganic buffer system. Active ingredients are potassium peroxymonosulfate, sodium chloride, and other ingredients. It is effective against a wide range of bacteria, virus, and fungi, including: *Streptococcus pyogenes*, *Campylobacter pyloridis*, *Klebsiella pneumoniae*, *E. coli*, and *S. typhimurium*.

◦ **Suitable construction of housing is important.** Impervious walls to stop spread from pen to pen, pen design to permit feeding without entering the pen, avoidance of any communal activity and slatted floors to provide escape routes for manure all assist in limiting the spread of enteric diseases. Deep litter systems are satisfactory provided they are kept dry and plenty of bedding is available. With pigs the opportunity for oral–fecal cycling of the organism and buildup and spread of infection within and between groups must be kept to a minimum. Pen design and the environment should be such as to encourage proper eliminative behavior and good pen hygiene. Drinkers should be sited at one end of the pen, preferably on a narrow end with oblong pens, to encourage defecation in this area. Wet or damp areas of the floor in other parts of the pen will encourage defecation and urination there and should be eliminated. Drinkers of the

nipple type rather than bowls are preferable for hygienic reasons. Communal dunging alleys increase the possibility of spread, especially during the cleaning procedure, and the trend is towards slatted or meshed areas over a channel. A totally slatted or mesh floor for pigs from weaning until 10–12 weeks of age will markedly reduce the opportunity of oral–fecal cycling of organisms in this age group, which is especially susceptible to enteric disease. Feeders should allow the ingress of the pig's head and should be constructed to avoid fecal and other contamination of feed. Pigs need to be grouped according to size, and overcrowding, which may result in improper pen hygiene, must be avoided. Space requirements vary according to pen and housing design but generally fall in the region of 0.3 m<sup>2</sup> for recently weaned piglets to 0.6–1 m<sup>2</sup> for market-size pigs. In conventionally floored or partially slatted floored pens, approximately two-sevenths of the area should be available for the dunging area. The construction of the pen should allow for easy and efficient cleaning. In problem herds an especial vigilance for the occurrence of enteric disease is needed following the breakdown of pen hygiene on very hot days.

- **Heat treatment of feed** is an effective procedure for pigs. Heating during pelleting greatly reduces the bacterial content of feed and special treatment is worthwhile because of the very high proportion of animal-derived feeds that are infected. The availability of such feeds guaranteed to be *Salmonella*-free would be an advantage.
- **Disposal of infective material should be done with care.** Carcasses should be burned or, better still, sent to an institution for diagnosis, rather than to a rendering plant to be converted into still more contaminated bone meal. Slurry and manure for disposal should be placed on crops rather than on pasture. Slurry does not constitute a danger via hay, and salmonellas do not survive silage making. When slurry is used on pasture it should be stored for at least a month beforehand and even longer if silo effluent is included. Slurried pasture should not be grazed for 1 month, and for young animals a 6-month delay is recommended. Pig slurry is most dangerous and should always be avoided.
- **All persons working on infected premises should be warned of the hazards to their own health.** Other

peripatetic species, especially dogs, should be kept under close restraint.

### Principles of infectious disease control for prevention of nosocomial gastrointestinal and respiratory diseases in large-animal hospitals

The principles of an infectious disease control (IDC) program for the prevention of gastrointestinal and respiratory diseases in a large-animal hospital have been described and are applicable to the control of salmonellosis.<sup>106</sup> The three basic strategies are reducing exposure to pathogens, avoiding increasing susceptibility to pathogens, and monitoring effectiveness of the IDC program. The major procedures are summarized here.

Reducing exposure to pathogens

- Promoting appropriate personal hygiene
- Using effective methods for cleaning and disinfection
- Controlling the flow of human and animal traffic
- Implementing protocols for prompt identification of patients with signs of contagious disease
- Controlling birds, rodents, and flies.

Avoiding increasing susceptibility to pathogens

- Controlling ambient temperature
- Using antimicrobials appropriately
- Aiding in establishing normal intestinal or rumen flora
- Controlling endotoxemia.

Monitoring effectiveness of the infectious disease control program

- Bacterial culture of fecal samples of animals admitted to the hospital
- Regular culture of environmental samples.

### Recommended steps in developing an effective infectious disease control program (IDC) for a large-animal hospital

An effective IDC program is necessary for all large-animal veterinary teaching hospitals and private veterinary clinics. The recommended steps are outlined here.<sup>106</sup>

- Have all clinicians work together to develop and approve the IDC program, as grassroots buy-in is vital.
- Develop a specific, written IDC program and disseminate it widely among staff members.
- Identify a veterinarian who is active in the large-animal hospital to serve as the IDC officer; this individual will oversee the IDC program and should report to the hospital director and practice partners.
- Provide the resources, both human and monetary, needed for the IDC officer to effectively carry out the

approved IDC program; prevention costs less than the alternatives

- Make students, residents, and staff aware of the key points of the IDC program and the importance that clinicians place on compliance
- Teach the barn crew, particularly those actually responsible for cleaning, disinfecting and feeding, about the goals of the IDC program and the methods to be used
- Monitor the effectiveness of cleaning and sanitation by means of bacterial culture of environmental samples and give regular feedback to the barn crew, staff, students, and clinicians
- Hold a seminar at least yearly to distribute written information about the IDC program and results of monitoring.

### Animals being transported

These are a special case. They should be unloaded or exercised at least once every 24 hours and given water and feed, the feed being provided first and at least 2 hours before watering. Hay or chopped hay is preferred to succulent feeds. All railroad cars and feeding and watering troughs should be properly cleaned and disinfected between shipments. Horses that are to be transported should be yarded and hand-fed on hard feed for 4–5 days beforehand. If the disease is likely to occur, prophylactic feeding with sulfonamides or antimicrobials has been shown to decrease the incidence in all species. Apart from the risk that this practice will produce resistant bacteria, there has been a suggestion that it may so change the normal bacterial flora of the gut as to encourage the proliferation of salmonellas and lead to the development of the clinical disease.

### Immunization

#### *Salmonella* vaccinology

The literature on *Salmonella* vaccines has been reviewed.<sup>58</sup> Host resistance to *Salmonella* relies initially on the production of inflammatory cytokines leading to the infiltration of activated inflammatory cells in the tissues. Thereafter, T- and B-cell-dependent specific immunity develops, allowing the clearance of *Salmonella* from the tissues and the establishment of long-lasting acquired immunity to reinfection. The increased resistance that develops after primary infection or vaccination requires T cells, cytokines such as interferon gamma, tumor necrosis factor and interleukin 2, in addition to opsonizing antibody. Seropositivity and/or the presence of detectable T-cell memory do not always correlate with the development of acquired resistance to infection.

Immunization with live salmonellas induces early resistance rechallenged with

virulent organisms that appears 1 day after infection or vaccination with live but not killed organisms. Early protection is nonspecific and effective against different *Salmonella* serotypes. Long-term immunity using live attenuated vaccines is serotype-specific and involves the recall of immunological immunity. Killed vaccines induce strong antibody responses but trigger insufficient T helper 1 (Th1)-cell responses.

Vaccination can decrease the number of bacteria shed in feces and the number of blood-culture-positive calves, thus decreasing the number of carriers and reducing environmental contamination. Many types of vaccine have been developed and tested in cattle and pigs. If vaccination is combined with the hygienic precautions described, the vaccines are an aid to management. Killed bacterins and live attenuated vaccines are available. Either can be used as a prenatal vaccine to provide passive immunization of the newborn. It is now generally accepted that live *Salmonella* vaccines are more effective immunogens in calves than are killed vaccines.

#### Cattle

In cattle, *S. dublin* is the infection likely to be endemic in a herd and a commercial vaccine, to be effective, must have a strong *S. dublin* component. Live organisms are better able to stimulate antilipopoly-saccharide antibodies and to stimulate cell-mediated immunity. Calves vaccinated at 1–3 weeks of age with a modified-live aromatic-dependent *S. dublin* bacterin have detectable antilipopoly-saccharide immunoglobulins after immunization. Safe live oral vaccines against *S. typhimurium* and *S. dublin* have been constructed and shown to confer protection against experimental infection with virulent wild-type strains of the organism. Vaccination of calves orally with a genetically altered stable nonreverting aro-*S. dublin* as a modified-live vaccine provided a measurable systemic immune response but the vaccine volume makes it unlikely to be practical for field use. Vaccinated calves responded with increases in humoral-mediated immunity and cell-mediated immunity, as measured by ELISA and skin testing. It is claimed that the combination of humoral immunity and cell-mediated immunity stimulated by live-organism vaccines provides superior protection. Other genetically altered vaccines consisting of hybrid strains derived from *S. dublin* and *S. typhimurium* are being evaluated. An avirulent live *S. choleraesuis* vaccine is efficacious experimentally against salmonellosis due to *S. dublin* infection in calves.

The vaccine strain 51, produced in the UK from a rough variant strain of this

organism, has been found to be efficient and safe, and provides good protection against *S. typhimurium* as well as *S. dublin*. It has the disadvantages of a living vaccine but calves can be vaccinated successfully at 2–4 weeks of age. In limited experiments other living, attenuated and killed, adjuvanted vaccines have given calves protection, and a comprehensive program of vaccination, hygiene, and adoption of a closed herd policy has been successful in controlling the disease. Reports on killed *S. typhimurium* vaccines used in calves indicated good results provided the antigenic mass in the vaccine is kept high, but commercial killed vaccines are of doubtful value.

Attenuated *S. typhimurium* (strain SL1479) given orally or intramuscularly has shown good efficiency, and attenuated *S. dublin* (strain SL1438) has been similarly effective. The *S. typhimurium* vaccine also gives some protection against *S. dublin*.

The autogenous bacterin, which must be precipitated on aluminum hydroxide to have any significant effect, is given as two injections 2 weeks apart. Good immunity is produced but calves and pigs less than 6 weeks of age are refractory, and anaphylactic reactions may cause the loss of a significant number of animals. To protect young calves the best program is to vaccinate the cows during late pregnancy. This will give passive protection to the calves for 6 weeks, provided they take sufficient colostrum, and the calves can be vaccinated at that time if danger still exists. Vaccination of pregnant cattle with a formalin-killed *S. typhimurium* vaccine approximately 7 and 2 weeks before parturition protected their calves against experimental infection. Reports of results have not been enthusiastic but if proper attention is given to the detail of the program it has been sufficient, in our hands, to provide almost complete protection. A similar observation has been made with respect to vaccination of calves against *S. typhimurium*.

#### Pigs

A commercial vaccine containing living, attenuated *S. choleraesuis* has also been shown to protect neonatal pigs after vaccination of sows and weaned pigs. Because of the early age at which pigs need to be immune, it is recommended that sows be vaccinated three times at 7–14-day intervals. The young pigs are vaccinated at 3 weeks of age. A live avirulent *S. choleraesuis* vaccine has been developed and evaluated for protection against experimental challenge. Vaccinated pigs were able to maintain normal body weight gains during a 4-week observation period following challenge inoculation with a high dose of a virulent strain. It has

consistently been safe and efficacious in pigs as young as 3 weeks and provides protection for at least 20 weeks.

Most cases of salmonellosis in pigs are subclinical and due to *S. typhimurium*. The ideal vaccine against *S. typhimurium* would prevent colonization, shedding of the organism in the environment, development of carriers and clinical salmonellosis, and promote elimination of the organism from infected animals.<sup>107</sup> Live vaccine strains are considered to provide superior protection compared to inactivated vaccines.

#### Horses

In horses, a similar regimen with a booster dose for all mares in late pregnancy appears to be effective. In foals, an autogenous *S. typhimurium* bacterin has been used in several bad field situations and has been credited with preventing further clinical cases and with reducing environmental contamination, in spite of continued poor hygiene and management practices.

#### Sheep

Results in sheep have been unconvincing. Some live *S. typhimurium* vaccines are being evaluated for their efficacy against salmonellosis in sheep.

#### Nationwide surveillance and control programs

In 1993, the Ministry of Food, Agriculture and Fisheries of Denmark and the Danish Bacon and Meat Council initiated an ambitious program to eliminate pork as an important source of human salmonellosis. In the early 1990s pork had become recognized as an increasingly important source of human salmonellosis in Denmark. In Denmark, the proportion of human salmonellosis attributable to pork was estimated to be 10–15% in 1997 and 1998.<sup>108</sup> In the Netherlands, it was estimated that approximately 15% of human cases of salmonellosis were associated with the consumption of contaminated pork.

The Danish Salmonella Surveillance and Control Program for pigs operates at all stages of the production chain and has been applied nationally since 1995.<sup>108</sup> As a result of the program the level of *Salmonella* in Danish pork declined from 3.5% in 1993 to 0.7% in 2000. Simultaneously, the number of human cases of salmonellosis due to pork declined from approximately 1444 in 1993 to 166 in 2000.<sup>109</sup>

The control program is integrated from 'feed to food'. It is based on routine testing and classification of slaughter pig herds and subsequent slaughter of pigs according to the inherent risk, as measured by the continual test program.<sup>109</sup>

Basically, the level of *Salmonella* is controlled at various stages.

#### Feedstuffs

Compounded feeds are heat treated at 81°C to eliminate *Salmonella*. The national program requires mandatory *Salmonella* testing in all plants producing animal feeds. In 2000, the level of *Salmonella* spp. in final products was only 0.3%.

#### Breeder and multiplier herds

Each month all herds are blood sampled and examined for *Salmonella* antibodies.<sup>110</sup> Based on the level of antibodies, a *Salmonella* index is calculated. If the index exceeds 5, pen fecal samples must be taken and examined for the presence of *Salmonella* spp. When the index exceeds 15, a sales ban on breeding pigs is imposed until the index has declined below 15 again.

#### Weaner producers

If a sow herd sells weaners to a *Salmonella* level 2 or 3 finishing herd, pen fecal samples must be taken and examined for *Salmonella*.

#### Slaughter pigs

Slaughter herd pigs are monitored continuously by serological testing of 'meat juice'. Meat samples are frozen, and meat juice (harvested after thawing) is examined for specific antibodies against *S. enterica* using an ELISA.<sup>111</sup> The ELISA combines several *S. enterica* O antigens and allows detection of antibody response after a variety of serovar infections. The meat samples for testing are collected at the slaughter line, and the number of samples and frequency of sampling are determined by the size of the herd. Herds sending fewer than 200 pigs to slaughter per year are not examined, which amounts to 1.6% of slaughter pigs not examined. The herds are categorized in four levels based on the proportion of seropositive meat juice samples during the previous 3 months. Based on the optical density per cent (OD%) of the ELISA test, the herds are classified into:

Level 0: Herds having only seronegative over 3 months or more

Level 1: Herds with acceptable low *Salmonella* prevalence

Level 2: Herds with moderate *Salmonella* prevalence

Level 3: Herds with unacceptable high *Salmonella* prevalence.

A herd categorized as level 2 or 3 must receive an advisory visit by a practicing veterinarian and a local extension specialist, and certain management precautions must be adopted. In a herd with level 3, the finishing pigs must be slaughtered under special hygiene conditions.

The proportion of serologically positive meat-juice samples collected during 1995 ranged from a mean of 2.9% in small herds to 6.1% in large herds.

Danish National Surveillance Program for *Salmonella dublin*

A national surveillance program for *S. dublin* in dairy cattle was begun in 2002 by initiative of both the Danish Veterinary and Food Administration and the Danish Cattle Federation. The short-term goal was to screen both dairy and beef cattle herds for *S. dublin* infection, and to classify the herds according to the estimated level of infection in order to provide a control scheme. The long-term goal was to reduce the prevalence of *S. dublin* in Danish cattle and reduce the risk of human infection associated with the consumption of meat and milk from Danish cattle.<sup>112</sup> All Danish cattle herds are screened by the use of ELISA assay of bulk tank milk collected from dairy herds every 3 months and of three yearly blood samples from other herds.

#### REVIEW LITERATURE

- Akkina JE, Hogue AT, Angulo FJ et al. Epidemiologic aspects, control, and importance of multiple-drug resistant *Salmonella typhimurium* DT 104 in the United States. *J Am Vet Med Assoc* 1999; 214:790–798.
- Brenner FW, Villar RG, Angulo FJ et al. *Salmonella* nomenclature. *J Clin Microbiol* 2000; 38: 2465–2467.
- Mastroeni P, Chabalgoity JA, Dunstan SJ et al. *Salmonella*: immune responses and vaccines. *Vet J* 2000; 161:132–164.
- Wallis TS, Galyov EE. Molecular basis of *Salmonella*-induced enteritis. *Mol Microbiol* 2000; 36: 997–1005.
- Wray C, Wray A, eds. *Salmonella* in domestic animals. New York: CABI Publishing, 2000.
- Van der Wolf PJ, Hensel A. The Fourth International Symposium on Epidemiology and Control of *Salmonella* and other Foodborne Pathogens in Pork, September 2–5, 2001, Leipzig, Germany. *Berl Munch Tierärztl Wochenschr* 2001; 114: 321–408.
- Liebana E. Molecular tools for epidemiological investigations of *S. enterica* subspecies *enterica* infections. *Res Vet Sci* 2002; 72:169–175.
- Lo Fo Wong DMA, Hald T, van der Wolf PJ, Swanenberg M. Epidemiology and control measures for *Salmonella* in pigs and pork. *Livestock Prod Sci* 2002; 76:215–222.
- Sanchez S, Hofacre CL, Lee MD et al. Animal sources of salmonellosis in humans. *J Am Vet Med Assoc* 2002; 221:492–497.
- Threlfall EJ. Antimicrobial drug resistance in *Salmonella*: problems and perspectives in food- and water-borne infections. *FEMS Microbiol Rev* 2002; 26:141–148.
- Wegener HC. Antibiotics in animal feed and their role in resistance development. *Curr Opin Microbiol* 2003; 6:439–445.
- Wegener HC, Hald T, Lo Fo Wong D et al. *Salmonella* control programs in Denmark. *Emerg Infect Dis* 2003; 9:774–780.
- Smith BP, House JK, Magdesian KG et al. Principles of an infectious disease control program for preventing nosocomial gastrointestinal and respiratory tract diseases in large animal veterinary hospitals. *J Am Vet Med Assoc* 2004; 225:1186–1195.
- Wigley P. Genetic resistance to *Salmonella* infection in domestic animals. *Res Vet Sci* 2004; 76:165–169.

## REFERENCES

1. Brenner FW et al. *J Clin Microbiol* 2000; 38:2465.
2. Liebana E. *Res Vet Sci* 2002; 72:169.
3. Beloeiel PA et al. *Prev Vet Med* 2003; 60:207.
4. Akkina JE et al. *J Am Vet Med Assoc* 1999; 214:790.
5. Boqvist S et al. *Acta Vet Scand* 2003; 44:181.
6. Smith-Palmer A et al. *Vet Rec* 2003; 153:517.
7. Linquist N et al. *J Clin Microbiol* 2003; 40:3648.
8. Liebana E. *J Clin Microbiol* 2002; 40:4450.
9. Refsum T et al. *Appl Environ Microbiol* 2002; 68:5600.
10. Van Duijkeren E et al. *J Clin Microbiol* 2002; 40:3980.
11. Van der Wolf PJ et al. *Vet Microbiol* 2001; 80:171.
12. Harris IT. *J Swine Health Prod* 2003; 11:247, 300.
13. Rabsch W et al. In: Torrence ME, Isaacson RE, eds. *Microbial food safety in animal agriculture: current topics*. Oxford: Blackwell, 2003:97-106.
14. Zhao S et al. *J Clin Microbiol* 2003; 41:5366.
15. Davies RH et al. *Vet Rec* 2001; 149:555.
16. Alvsøe O, Skjerve E. *Prev Vet Med* 2002; 52:277.
17. Sandberg M et al. *Prev Vet Med* 2002; 52:267.
18. Radke BR et al. *Can Vet J* 2002; 43:443.
19. Wigley P. *Res Vet Sci* 2004; 76:165.
20. Wörnack LD et al. *Prev Vet Med* 2001; 49:259.
21. Wörnack LD et al. *Prev Vet Med* 2003; 56:285.
22. Anderson RJ et al. *J Am Vet Med Assoc* 2001; 219:310.
23. Galland JC et al. *J Am Vet Med Assoc* 2001; 219:1216.
24. Troutt HF et al. *J Am Vet Med Assoc* 2001; 219:1212.
25. Kirk J et al. *Prev Vet Med* 2002; 54:169.
26. Huston CL et al. *J Am Vet Med Assoc* 2002; 220:650.
27. Huston CL et al. *J Am Vet Med Assoc* 2002; 220:645.
28. Peek SF et al. *J Am Vet Med Assoc* 2004; 225:574.
29. Kirk JH et al. *J Am Vet Med Assoc* 2002; 220:359.
30. Kabagambe EK et al. *Prev Vet Med* 2000; 43:177.
31. Fossler CP et al. *J Am Vet Med Assoc* 2004; 225:567.
32. Nielsen LR et al. *Prev Vet Med* 2004; 65:47.
33. Fegan N et al. *J Appl Microbiol* 2004; 97:892.
34. Dargatz DA et al. *J Appl Microbiol* 2003; 95:753.
35. Taylor DW et al. *Cattle Pract* 2001; 9:217.
36. Capucille DJ et al. *Bovine Pract* 2002; 36:15.
37. Beach JC et al. *J Food Prot* 2002; 65:1687.
38. Purdy CW et al. *Am J Vet Res* 2004; 65:40.
39. Uzzau S et al. *Infect Immun* 2001; 69:3092.
40. Clark RG et al. *N Z Vet J* 2004; 52:26.
41. Hjartardottir S et al. *Acta Vet Scand* 2002; 43:43.
42. Kranker S et al. *J Clin Microbiol* 2003; 41:2282.
43. Funk JA et al. *Vet Microbiol* 2001; 83:45.
44. Davies PR et al. *J Am Vet Med Assoc* 1998; 212:1925.
45. Hurd HS et al. *Appl Environ Microbiol* 2002; 68:2376.
46. Stark KDC et al. *Prev Vet Med* 2002; 53:7.
47. Bottledorn N et al. *J Appl Microbiol* 2003; 95:891.
48. Fedorka-Gray PJ et al. *J Swine Health Prod* 1997; 5:189.
49. Morrow WEM et al. *J Am Vet Med Assoc* 2002; 220:497.
50. Van der Wolf PJ et al. *Vet Microbiol* 2001; 78:205.
51. Baggensen DL et al. *Am J Vet Res* 1999; 60:120.
52. Traub-Dargatz JL et al. *J Am Vet Med Assoc* 2000; 217; 226.
53. Burgess BA et al. *J Am Vet Med Assoc* 2004; 225:1344.
54. Schott II HC et al. *J Am Vet Med Assoc* 2001; 218:1152.
55. Ewart SL et al. *J Am Vet Med Assoc* 2001; 218:1145.
56. House JK et al. *J Am Vet Med Assoc* 1999; 214:1511.
57. Kim LM et al. *J Am Vet Med Assoc* 2001; 218:740.
58. Mastroeni P et al. *Vet J* 2000; 161:132.
59. Thorns CJ. *Br Vet J* 1995; 151:643.
60. Rice DH et al. *Vet Microbiol* 1997; 56:111.
61. Wallis TS, Galyov EE. *Mol Microbiol* 2000; 36:997.
62. Zhang S et al. *Infect Immun* 2002; 70:3843.
63. Threlfall EJ. *FEMS Microbiol Rev* 2002; 26:141.
64. Wegener HC. *Curr Opin Microbiol* 2003; 6:439.
65. Gupta A et al. *J Infect Dis* 2003; 188:1707.
66. Rankin SC et al. *J Clin Microbiol* 2002; 40:4679.
67. Winokur PL et al. *Antimicrob Agents Chemother* 2001; 45:2716.
68. Allen KJ, Poppe C. *Can J Vet Res* 2002; 66:137.
69. van Duijkeren E et al. *J Clin Microbiol* 2003; 41:3574.
70. Jones YE et al. *Vet Rec* 2002; 150:649.
71. Malorny B et al. *Vet Rec* 2003; 153:643.
72. Poppe C et al. *Microb Resist* 2001; 7:197.
73. Bischoff KM et al. *Lett Appl Microbiol* 2004; 38:140.
74. Bacon RT et al. *J Food Prot* 2002; 65:284.
75. Beach JC et al. *J Food Prot* 2002; 65:1694.
76. Hsueh PR et al. *Emerg Infect Dis* 2004; 10:60.
77. Van Duijkeren E et al. *Vet Microbiol* 2002; 86:203.
78. Sanchez S et al. *J Am Vet Med Assoc* 2002; 221:492.
79. Alley MR et al. *N Z Vet J* 2002; 50:170.
80. Poppe C et al. *Can Vet J* 1998; 39:559.
81. Gough J, McEwen B. *Can Vet J* 2000; 41:413.
82. Weese SJ et al. *Can Vet J* 2001; 42:788.
83. Walker RA et al. *Vet Rec* 2000; 147:395.
84. Baumler AJ et al. *Infect Immun* 1998; 66:4567.
85. Santos RL et al. *Vet Pathol* 2002; 39:200.
86. Wallis TS et al. *Infect Immun* 1995; 63:2755.
87. Deignan T et al. *Res Vet Sci* 2000; 69:153.
88. Meyerholz DK et al. *Vet Pathol* 2002; 39:712.
89. Meyerholz DK, Stabel TJ. *Vet Pathol* 2003; 40:371.
90. Carlson SA et al. *Vet Microbiol* 2002; 85:233.
91. Van der Wolf PJ et al. *Vet Q* 2001; 23:199.
92. Patterson-Kane JC et al. *N Z Vet J* 2001; 49:159.
93. Wörnack LD et al. *Prev Vet Med* 2003; 60:195.
94. House JK et al. *Am J Vet Res* 1993; 54:1391.
95. Kivula SL et al. *Bovine Pract* 33:74.
96. Amavisit P et al. *Vet Microbiol* 2001; 79:63.
97. Kurowski PB et al. *Am J Vet Res* 2002; 63:1255.
98. Wedderkopp A et al. *Can J Vet Res* 2001; 65:15.
99. Alban L et al. *Prev Vet Med* 2002; 53:133.
100. Sorensen LL et al. *Vet Microbiol* 2004; 101:131.
101. Hurd HS et al. *Epidemiol Infect* 2003; 132:127.
102. Lo Fo Wong DM et al. *Vet Microbiol* 2003; 97:201.
103. Fecteau M-E et al. *Am J Vet Res* 2003; 64:918.
104. Parraga ME et al. *J Vet Intern Med* 1997; 11:36.
105. Alinovi CA et al. *J Am Vet Med Assoc* 2003; 223:1640.
106. Smith BP et al. *J Am Vet Med Assoc* 2004; 225:1186.
107. Haesebrouck F et al. *Vet Microbiol* 2004; 100:255.
108. Lo Fo Wong DMA et al. *Livestock Prod Sci* 2002; 76:215.
109. Nielsen B et al. *Berl Munch Tierärztl Wochenschr* 2001; 114:323.
110. Wegener HC et al. *Emerg Infect Dis* 2003; 9:774.
111. Nielsen LR et al. *J Appl Microbiol* 2004; 96:311.
112. Nielsen LR. *Salmonella* Dublin in dairy cattle. Use of diagnostic tests for investigation of risk factors and infection dynamics. PhD Thesis, Department of Animal Science and Animal Health, Royal Veterinary and Agricultural University, Frederiksberg, Denmark, 2003.

**ABORTION IN MARES AND SEPTICEMIA IN FOALS ASSOCIATED WITH SALMONELLA ABORTUSEQUI (ABORTIVOEQUINA) (EQUINE PARATYPHOID)**

This is a specific disease of Equidae characterized by abortion in females, testicular

lesions in males and septicemia in the newborn.

**ETIOLOGY**

*Salmonella abortusequi* (*abortivoequina*) (also known as *Salmonella enterica* serovar *abortusequi*) is a host-adapted serovar causing abortion in mares and donkeys.<sup>1,2</sup> *S. abortusequi* strains vary in virulence, with more virulent strains having greater in vitro cytotoxicity.<sup>3</sup> It is possible to determine the origin and progression of outbreaks of the disease by determining pulsed-field gel electrophoretic patterns of *S. abortusequi*.<sup>2</sup>

**EPIDEMIOLOGY**

The infection appears to be limited to horses and donkeys.<sup>2,4</sup> Although widely reported in the early 1900s, this disease is rarely encountered nowadays and is one of the less common causes of either abortion or septicemia in horses.<sup>5,6</sup> Recent reports of the disease are from Austria, Brazil, Croatia, Japan, and India, although the disease occurs in other countries. However, in the early 1990s, an outbreak of abortion occurred in a herd of 38 horses, in which 21 mares aborted between 5 and 10 months of gestation.<sup>1</sup>

Natural infection may be due to the ingestion of foodstuffs contaminated by uterine discharges from carriers or mares that have recently aborted. Transmission from the stallion at the time of service is also thought to occur. The infection may persist in the uterus and cause repeated abortion or infection of subsequent foals. Transmission from a female donkey to mares is reported with abortion a result in both species.<sup>2</sup>

**PATHOGENESIS**

When infection occurs by ingestion, a transient bacteremia without marked systemic signs is followed by localization in the placenta, resulting in placentitis and abortion. Foals that are carried to term probably become infected in utero or soon after birth by ingestion from the contaminated teat surface or through the umbilicus.

**CLINICAL FINDINGS**

Abortion usually occurs at about the seventh or eighth month of pregnancy. The mare can show signs of impending abortion followed by difficult parturition but other evidence of illness is usually lacking. Retention of the placenta and metritis are common sequels and may cause serious illness, but subsequent sterility is unusual. A foal that is carried to term by an infected mare may develop an acute septicemia during the first few days of life or survive to develop polyarthritis 7-14 days later. Polyarthritis has also been observed in foals from vaccinated mares that showed no signs of the disease.<sup>7</sup>

Infection in the stallion has also been reported, clinical signs including fever, edematous swelling of the prepuce and scrotum, and arthritis. Hydrocele, epididymitis, and inflammation of the tunica vaginalis are followed by orchitis and testicular atrophy.

### CLINICAL PATHOLOGY

The organism can be isolated from the placenta, the uterine discharge, the aborted foal, and the joints of foals with polyarthritis. A high titer of *Salmonella* agglutinins in the mare develops about 2 weeks after abortion. Vaccinated mares will give a positive reaction for up to a year.

### NECROPSY FINDINGS

The placenta of the aborted foal is edematous and hemorrhagic and may have areas of necrosis. The nonspecific changes of acute septicemia will be manifested in foals dying soon after birth; polyarthritis is found in those dying at a later stage.

### Samples for confirmation of diagnosis

- Bacteriology – placenta, fetal stomach content, lung, culture swabs of joints (CULT)
- Histology – formalin-fixed placenta, various fetal tissues including lung, liver (LM).

### TREATMENT

The antimicrobials recommended in the treatment of salmonellosis should also be effective in this disease.

### CONTROL

Careful hygiene, including isolation of infected mares and disposal of aborted material, should be practiced to avoid spread of the infection. Infected stallions should not be used for breeding. In the past, when this disease was much more common than it is now, great reliance was placed on vaccination as a control measure. An autogenous or commercial bacterin, composed of killed *S. abortusovis* organisms, was injected on three occasions at weekly intervals to all mares on farms where the disease was enzootic, commencing 2–3 months after the close of the breeding season. A smaller dose (5 mL) of vaccine of higher concentration is as effective as a larger dose (20 mL) of vaccine of lower concentration.<sup>5</sup> A formal-killed, alum-precipitated vaccine is considered to be superior to a heat-killed, phenolized vaccine.<sup>9</sup> In China a virulent strain vaccine is credited with effective protection after two injections 6 months apart.<sup>5</sup> The widespread use of vaccines and hyperimmune sera is credited with the almost complete

eradication of the disease in developed countries.

### REFERENCES

1. Madic J et al. *Equine Vet J* 1997; 29:230.
2. Hofer E et al. *Wien Tierärztl Monatsschr* 2004; 91:292.
3. Vassava KA et al. *Indian J Vet Res* 2004; 13:31.
4. Singh IP et al. *Br Vet J* 1971; 127:378.
5. Winkinwerder W. *Zentralbl Bakteriol* 1967; 203:69.
6. Morse EV. *Mod Vet Pract* 1976; 57:47.
7. Garbers GV, Monteverde JJ. *Rev Med Vet (B Aires)* 1964; 45:305.
8. Yadav MS, Panday KD. *Indian J Comp Microbiol Immunol Infect Dis* 2002; 23:165.
9. Dhanda MR et al. *Indian J Vet Sci* 1955; 25:245.

### ABORTION IN EWES ASSOCIATED WITH *SALMONELLA ABORTUSOVIS*

*Salmonella abortusovis* (*S. enterica* serovar *abortusovis*) is a relatively uncommon cause of abortion in ewes but appears to be enzootic in particular areas. Spread of the disease may occur after the introduction of carrier animals. The reservoir of infection is infected animals that do not abort. The organisms persist in internal organs of the carriers for up to 6 months, and are excreted in the feces and vaginal mucus for periods up to 4 months.<sup>1</sup> Ingestion is thought to be the main mode of infection. The experimental disease induced by the conjunctival route has been examined.<sup>2</sup> Venereal spread has been postulated, and rams certainly become infected, but all the evidence is against spread at coitus. Experimental induction of the disease in ewes is more successful after the third month of pregnancy.<sup>3</sup> Intrauterine inoculation results in infection of rams and the passage of infected semen for up to 15 days. Abortion 'storms', with up to 10% of ewes aborting, occur about 6 weeks before lambing, and septic metritis and peritonitis subsequently cause a few deaths among the ewes. Mortality in lambs is common due either to death of weak lambs or to the development of acute pneumonia in previously healthy lambs up to 2 weeks old.

Identification of the disease depends upon isolation of the organism, which is present in large numbers in the fetus, placenta and uterine discharges, and the presence of a strong positive agglutination test in the ewe for 8–10 weeks after abortion. An ELISA test detects antibody to *S. abortusovis* in a greater proportion of sheep than does a microagglutination test.<sup>4</sup> The disease can be diagnosed in fetuses by use of a coagulation test on fetal stomach contents. The test had a sensitivity and specificity of 100% and 90% in a small number of samples.<sup>5</sup> Use of PCR to identify *S. abortusovis* is feasible because the organism has an IS200

element in a distinct chromosomal location. The resulting PCR assay has high specificity for *S. abortusovis*, effectively discriminating it from other *S. enterica* serovars.<sup>6</sup>

The clinical and serological findings in *S. dublin* infections in ewes are very similar,<sup>7</sup> and infection has become more important as a cause of abortion in ewes in the UK than *S. abortusovis*. A strong immunity develops after an attack and an autogenous vaccine has given good results in the control of the disease. The results of vaccination need to be very carefully appraised because flock immunity develops readily and the disease tends to subside naturally in the second year.

*Salmonella ruru* has also been recorded as a cause of abortion in ewes, and ewes with salmonellosis associated with *S. typhimurium* may also lose their lambs. *S. brandenburg* is a cause of illness and abortion in sheep, horses, calves, goats, and humans in New Zealand.<sup>8</sup> Spread of the disease is strongly associated with presence of aborting ewes and subsequent heavy environmental contamination.<sup>8</sup>

The administration of broad-spectrum antibiotics might aid in controlling an outbreak but available reports are not generally encouraging. Chloramphenicol, and trimethoprim and sulfadiazine combination are considered effective for treatment but use of chloramphenicol in animals intended for us as human food is not permitted in many countries. A live *S. typhimurium* vaccine with optimal level of attenuation for sheep constructed by means of 'metabolic drift' mutations was highly effective in preventing *S. abortusovis*-induced abortions under field trial conditions.<sup>9</sup> Subcutaneous and conjunctival vaccination with a live attenuated strain of *S. abortusovis* confers immunity for at least three lambing periods. More recent vaccines, including those containing plasmid-cured strains of *S. abortusovis*, are effective in preventing pregnancy loss in response to experimental challenge with wild-type *S. abortusovis*.<sup>10</sup>

### REVIEW LITERATURE

Jack EJ. *Salmonella* abortion in sheep. *Vet Annu* 1971; 12:57.

### REFERENCES

1. Tradjebakhche H et al. *Rev Med Vet* 1974; 387:711.
2. Sanchis R et al. *Vet Res* 1995; 26:73.
3. Sanchis R, Pardon PG. *Ann Rech Vet* 1984; 15:97.
4. Swing R et al. *J Vet Med B* 1997; 44:87.
5. Erganis O et al. *Small Rumin Res* 2002; 45:123.
6. Beuzon CR et al. *Appl Environ Microbiol* 1997; 63:2082.
7. Sanchis R et al. *Vet Res* 1995; 26:110.
8. Clark RG et al. *N Z Vet J* 2004; 52:26.
9. Linde K et al. *Vaccine* 1992; 10:337.
10. Uzzau S et al. *Infect Immun* 2005; 73:4302.

## Diseases associated with *Pasteurella* species

*Pasteurellas* occur in many animal diseases and, although in some instances they act as primary causes, the number of conditions in which they appear to play only a secondary role is gradually increasing. However, their importance is not insignificant. A primary viral pneumonia may be an insignificant disease until the intervention of a secondary pasteurellosis converts it into an outbreak of pneumonia of major economic importance. The common diseases in which *Pasteurella* spp. play an important etiological role are described in this section with due regard to their possible secondary nature. Mastitis associated with *Pasteurella* spp. is dealt with in the section on mastitis. There is now general agreement that atrophic rhinitis in pigs is associated with toxigenic strains of *Pasteurella multocida*.

The bovine strains of *P. multocida* have been characterized and compared with isolates of avian, ovine, and porcine origin.<sup>1</sup> *P. multocida* is a heterogeneous species of Gram-negative bacteria and is a commensal of the upper respiratory tract of many animal species. Under certain predisposing conditions the organism is the etiological agent of a wide range of economically important infections in domesticated animals. The pathogen consists of five capsular subgroups, A, B, D, E, and F, and there is a relationship between the capsular subgroup and disease predilection. *P. multocida* is responsible for two major disease conditions of cattle: hemorrhagic septicemia and pneumonic pasteurellosis. **Hemorrhagic septicemia** occurs almost exclusively in cattle and water buffalo in Asia and Africa and is associated with *P. multocida* strains of capsular serogroups B and E. In contrast, **pneumonic pasteurellosis** is an important infectious disease of cattle in Europe and North America and, in addition to *Mannheimia haemolytica*, is associated mainly with *P. multocida* strains of capsular serogroup A. *P. multocida* is also occasionally the cause of mastitis, abortion and localized infections in cattle such as otitis externa.

There is a limited degree of strain diversity among bovine disease isolates of *P. multocida*.<sup>1</sup> Comparison of the outer membrane profiles of bovine isolates with those of avian, ovine, and porcine strains indicate that a high proportion of the respiratory tract infections in each of these species are associated with different strains. However, the presence of small numbers of closely related strains in more than one host species suggests that transmission of bacteria between different host

species is also a factor in the population biology of *P. multocida*.

Other isolated instances of disease associated with *P. multocida* are meningo-encephalitis of calves<sup>2</sup> and yearling cattle,<sup>3</sup> manifested by muscle tremor, opisthotonos, rotation of the eyeballs, collapse, coma and death within a few hours; and lymphadenitis in lambs, which show enlargement of the submandibular, cranial, cervical, and prescapular lymph nodes.<sup>4</sup> An epidemic of meningoencephalitis in horses, donkeys, and mules has been reported from Mexico. The causative agent was *Mannheimia haemolytica*. Clinical findings included incoordination, paralysis of the tongue, tremor, and blindness. Death occurred 1–7 days after the commencement of the illness.<sup>5</sup> There is also a report of a fatal septicemia in horses and donkeys in India in which *P. multocida* appeared to be implicated as a causative agent.<sup>6</sup> *M. haemolytica* is one of several bacterial pathogens causing otitis externa in cattle.<sup>7</sup>

*Pasteurella (Yersinia) pseudotuberculosis* is a common cause of epizootic disease in birds and rodents and occasionally causes disease in domestic animals. It is described under a separate heading in this chapter. The literature of the molecular biology of *P. multocida* has been reviewed.<sup>8</sup>

### REFERENCES

1. Davies RL et al. *Vet Microbiol* 2004; 99:145.
2. Shand A, Markson LM. *Br Vet J* 1953; 109:491.
3. Rose WK, Rac R. *Aust Vet J* 1957; 33:124.
4. Madeyski S et al. *Med Vet Varsovie* 1957; 13:75, cited in *Vet Bull* 1957; 27:394.
5. Valdes Ornelas O. *Bull Off Int Epizoot* 1963; 60:1059.
6. Pavri KM, Apte VH. *Vet Rec* 1967; 80:437.
7. Duarte ER et al. *J Vet Med B* 2004; 51:1.
8. Hunt ML et al. *Vet Microbiol* 2000; 72:3.

### PASTEURELLOSIS

The nomenclature of the diseases associated with infections with *Pasteurella* spp. in farm animals has been indefinite and confusing. A suggested nomenclature is set out below, which is based on the clinical findings and on the bacteria that are commonly associated with each entity.

- **Septicemic pasteurellosis of cattle** (hemorrhagic septicemia or barbone), commonly associated with infection by *P. multocida* type 1 or B, is the classical disease of southern Asia characterized by a peracute septicemia and a high mortality rate
- **Pneumonic pasteurellosis of cattle**, commonly associated with infection by *Mannheimia* (formerly *Pasteurella*) *haemolytica* biotype A serotype 1, and *P. multocida* biotype A, is a common disease in Europe and the western hemisphere. *M. haemolytica* tends to cause a fulminating fibrinous lobar

pneumonia, and *P. multocida* causes a fibrinopurulent bronchopneumonia. Coagulation necrosis sharply demarcated by leukocytes is considered to be the pathognomonic lesion associated with *M. haemolytica*. There is a lack of multifocal coagulation necrosis in pneumonia associated with *P. multocida*

- **Pasteurellosis of pigs, sheep, and goats.** In pigs this is usually associated with infection by *P. multocida* and is mainly pneumonic in form. Pasteurellosis of sheep and goats is usually associated with infection by *M. haemolytica* and, although it is often pneumonic in form, a septicemic form of the disease is not unusual, especially in lambs.

There are a number of immunologically distinct types of the common causative organism, *P. multocida*. These have been classified as types 1 (or B), 2 (or A), 3 (or C), and 4 (or D) and there is a loose relationship between the serotype and the host species. There is also some relationship between the serotype and the disease produced. Septicemic pasteurellosis is caused only by type 1 and, as this type does not occur in the UK and is uncommon in North America, it is not surprising to find that this form of the disease does not occur there.

The position with *M. haemolytica* is more obscure but preliminary work suggests that a number of serotypes occur and that there may be biological differences in virulence between them.

### REVIEW LITERATURE

Donachie W, Lainson FA, Hodgson JC, eds. *Haemophilus, Actinobacillus, and Pasteurella*. New York: Plenum Press, 1995.

### SEPTICEMIC PASTEURELLOSIS OF CATTLE (HEMORRHAGIC SEPTICEMIA, BARBONE)

#### ETIOLOGY

Hemorrhagic septicemia is associated with two specific serotypes of *P. multocida*. The Asian serotype is designated B:2, 5 and the African serotype is E:2 by the Carter–Heddlestone system, corresponding to 6:B and 6:E by the Namioka–Carter system. The electrophoretic profiles of *P. multocida* isolates from animals with hemorrhagic septicemia can be placed in two distinct groups on the basis of their country of origin. Antibodies against *P. multocida* capsular types B and E were demonstrated in a high percentage of serum samples from a group of domestic feeder calves in the USA. Since capsular E organisms have been isolated only in Africa and there is only one report of capsular B isolation from cattle in the USA, these organisms were not considered

likely sources of the antigenic stimulation that provoked production of these antibodies.

### EPIDEMIOLOGY

Hemorrhagic septicemia occurs in cattle, yaks, camels, and water buffalo and, to a much smaller extent, pigs and horses. It is considered economically important in southern Europe, Russia, Africa, the Near East, Middle East, South Africa, India, and southern and south-east Asia, including Indonesia, Malaysia, Thailand, and the Philippines, where it causes heavy death losses, particularly in low-lying areas and when the animals are exposed to wet, chilly weather or exhausted by heavy work.<sup>1</sup> It is also recorded in bison and cattle in the USA and the causative bacterium and its endotoxin have been used to produce the disease experimentally. Animals of all ages are susceptible but the most susceptible age group is 6 months to 2 years of age. There is no difference in susceptibility between breeds. The incidence of disease is reduced significantly in areas where the vaccine is used. Both morbidity and case-fatality rates vary between 50% and 100%, and animals that recover require a long convalescence. Morbidity will depend on the immune status of the herd, either acquired naturally or induced by vaccination. The greater the percentage of immune to nonimmune animals, the lower will be the morbidity. In endemic areas, adult animals develop a naturally acquired immunity and large outbreaks no longer occur in these areas. The overall mean case fatality rate for buffaloes is nearly three times as high as in cattle.

Outbreaks of the disease are often associated with wet humid weather during the rainy season. During intervening periods the causative organism persists on the tonsillar and nasopharyngeal mucosae of carrier animals. Approximately 45% of healthy cattle in herds associated with the disease harbor the organism, in comparison to 3–5% in cattle from herds unassociated with the disease. Spread occurs by the ingestion of contaminated foodstuffs, the infection originating from clinically normal carriers or clinical cases, or possibly from ticks and biting insects. The saliva of affected animals contains large numbers of *Pasteurella* during the early stages of the disease. Although infection occurs by ingestion, the organism does not survive on pasture for more than 24 hours. The epidemiology of hemorrhagic septicemia in India has been described.

### PATHOGENESIS

The portal of entry of infection is thought to be the tonsils. A fulminating septicemia occurs, which is associated with the capsular material of the organism. The effects of the septicemia are most severe

in the respiratory tract, heart, and gastrointestinal tract. In cattle and buffalo there is rapid translocation of bacteria from the respiratory tract to the blood, liver, and spleen, suggesting that the bacteria are able to invade via the mucosal epithelial layers.<sup>2</sup> Colostral immunity of calves from cows vaccinated against hemorrhagic septicemia peaks at 8–16 weeks of age and then declines.<sup>3</sup>

### CLINICAL FINDINGS

The disease is an acute septicemia and is clinically characterized by a sudden onset of fever (41–42°C, 106–107°F), profuse salivation, submucosal petechiation, severe depression and death in about 24 hours. On range lands, animals may be found dead without any clinical signs having been observed. Localization may occur in subcutaneous tissue, resulting in the development of warm, painful swellings about the throat, dewlap, brisket or perineum, and severe dyspnea may occur if the respiration is obstructed. In the later stages of an outbreak, some affected animals develop signs of pulmonary or alimentary involvement. *Pasteurella* may be isolated from the saliva and the bloodstream. The disease in pigs is identical with that in cattle.

### CLINICAL PATHOLOGY

#### Culture and detection of bacteria

Laboratory diagnosis is by isolation and identification of the causative agent. The organism can be cultured from blood or a nasal swab from an animal within a few hours of death. Blood or a nasal swab during the clinical phase of the disease is not reliable because the septicemia is a terminal event. From older carcasses, a long bone is used for culture from the bone marrow. Samples of blood are injected into mice, which will die in 24–36 hours. Smears made from the mouse blood or cultures of mouse blood will reveal the organisms.

#### Serology

A rapid ELISA is now available for the identification of the specific serotypes of *P. multocida* responsible for hemorrhagic septicemia.

### NECROPSY FINDINGS

At necropsy, the gross findings are usually limited to generalized petechial hemorrhages, particularly under the serosae, and edema of the lungs and lymph nodes. Subcutaneous infiltrations of gelatinous fluid may be present and in a few animals there are lesions of early pneumonia and a hemorrhagic gastroenteritis. Varying degrees of lung involvement range from generalized congestion to patchy or extensive consolidation. Thickening of the interlobular septa may be prominent. Lymph nodes in the thoracic region are enlarged and hemorrhagic. Isolation of

the causative bacteria is best attempted from heart, blood, and spleen.

### TREATMENT

The disease occurs chiefly in areas where veterinary assistance is not readily available, and no detailed reports of the efficiency of various forms of treatment have been published. Oxytetracycline has been shown to be highly effective in pigs and sulfadimidine in cattle and the other treatments listed under pneumonic pasteurellosis of cattle should also be effective in this disease.

### CONTROL

The literature on hemorrhagic septicemic vaccines has been reviewed.<sup>4</sup> Vaccines have been used for many years to protect cattle during the dangerous periods but the method was only moderately effective until the recent introduction of a stable vaccine composed of killed organisms in an adjuvant base containing paraffin and lanolin. This vaccine has been highly effective, especially when used prophylactically, although vaccination in the face of an outbreak may also reduce losses.<sup>1</sup> Immunity after vaccination appears to be solid for at least 12 months and the only apparent disadvantage is the development of persistent subcutaneous swellings when the vaccine is improperly administered. Anaphylactic shock may occur in up to 1% of animals after the injection of some batches of vaccine. A potential refinement in the vaccine used is suggested by the finding that endotoxin-free capsular antigen of *P. multocida* types B and E is capable of immunizing cattle against challenge.

Plain broth bacterins, or alum-precipitated and aluminum hydroxide gel vaccines are administered twice a year since these vaccines offer immunity of 4–6 months.<sup>4</sup> Many countries use oil adjuvant vaccine (OAV), which gives both a higher degree and a longer duration of immunity, up to 1 year. A double emulsion and a multiple emulsion vaccine of a thin viscosity have also been experimentally developed that provide immunity parallel to the OAV.

A live streptomycin-dependent mutant *P. multocida* vaccine provides good protection. A live vaccine containing *P. multocida* serotype B:3,4 isolated from a fallow deer in England has been developed and in preliminary field trials provided good protection.<sup>4,5</sup> It protects cattle and buffaloes against B:2,5 challenge.<sup>5</sup> Although the subcutaneous inoculation of the vaccine in buffalo calves under 5 months of age caused severe reactions and mortality, intranasal aerosol application is safe and has been used in immunizing cattle and buffaloes over 6 months of age.<sup>5</sup> It has the advantages of



apparent absence of anaphylactoid shock, protection for up to 1 year, easy preparation and a relatively small dose, and when lyophilized has prolonged viability. Freeze drying would be necessary for large-scale production of the live vaccine.<sup>5</sup>

The Food and Agriculture Organization has reviewed development and use of the vaccine in Myanmar, has commended the intranasal use of live B:3,4 vaccine as safe and potent, and has suggested that the technology be transferred to other countries.

The *aroA* derivatives of the *P. multocida* B:2 strains are being examined as possible antigens for a live attenuated vaccine.<sup>2</sup> The safety and efficacy of these strains have been demonstrated in a mouse model of infection.<sup>6</sup>

The safety, efficacy, and duration of immunity of an improved oil-adjuvant vaccine containing inactivated cells of *P. multocida* serotype B:2,5 have been tested in young buffalo calves.<sup>7</sup> Protection was satisfactory. To test for cross-protection against the heterologous serotypes E:2,5 and B:3,4, groups of mice were vaccinated once or left unvaccinated. Four weeks later, the vaccinated and control groups were challenged with a dilution series of the different challenge cultures. The vaccine appeared to induce protection against challenge with different strains of serotypes B:2,5 and E:2,5 but not against strains of serotype B:3,4.

The safety, efficacy and cross-protectivity of a live attenuated aerosol hemorrhagic septicemia vaccine containing *P. multocida* serotype B:3,4 has been tested in young cattle and buffaloes in Myanmar, where more than 1.5 million animals were inoculated with the vaccine between 1989 and 1999.<sup>8</sup> A recommended dose of  $2 \times 10^7$  viable organisms was used for the efficacy test. The administration of 100 times the recommended dose to 50 cattle and 39 buffalo calves was innocuous. Three of three buffaloes were protected 7 months after they were vaccinated, and 12 months after they were vaccinated, three of four buffaloes were protected against a subcutaneous challenge with serotype B:2, which killed three of three unvaccinated buffaloes, while 12 months after they were vaccinated, eight of eight cattle survived a serotype B:2 challenge that killed four of four unvaccinated controls. The vaccinated cattle had developed serum antibodies detectable by the passive mouse protection test. Indirect hemagglutination tests on sera taken from cattle 10 days and 5 weeks after they were vaccinated showed high titers on antibodies. The serum of vaccinated cattle cross-protected passively immunized mice against infection with *P. multocida* serotypes E:2, F:3,4, and A:3,4.

The intranasal aerosol vaccination is safe, even at very high dose levels, and does not induce anaphylactic shock even after repeated vaccinations. The freeze-dried live vaccine is stable for at least 3 years at room temperatures of 30–36°C, and thus a 'cold chain', which is impracticable for many hemorrhagic-septicemia-endemic areas, is not necessary for the storage and transport of the vaccine.

#### REVIEW LITERATURE

Verma R, Jaiswal TN. Hemorrhagic septicemia vaccines. *Vaccine* 1998; 16:1184–1192.

#### REFERENCES

1. De Alwis MCL. In: Donachie W, Lainson FA, Hodgson JC, eds. *Haemophilus, Actinobacillus and Pasteurella*. New York: Plenum Press, 1995:9–24.
2. De Alwis MCL. *Br Vet J* 1992; 148:99.
3. El-Eragi AM et al. *Trop Anim Health Prod* 2001; 33:275.
4. Verma R, Jaiswal TN. *Vaccine* 1998; 16:1184.
5. Jones TG et al. *Vet Rec* 2002; 152:120.
6. Tabatabaei M et al. *Infect Immun* 2002; 70:3355.
7. Shah NH et al. *Vet Rec* 2001; 149:583.
8. Myint A et al. *Vet Rec* 2005; 156:41.

### BOVINE RESPIRATORY DISEASE: ACUTE UNDIFFERENTIATED BOVINE RESPIRATORY DISEASE

#### DEFINITION OF THE PROBLEM

A major problem which large animal clinicians commonly encounter is a group of cattle that are affected with an acute respiratory disease of uncertain diagnosis.

Acute undifferentiated bovine respiratory disease (UBRD) is characterized clinically by dyspnea, coughing, nasal discharge, varying degrees of depression, inappetence to anorexia, a fever ranging from 40–41°C, evidence of pneumonia on auscultation of the lungs, and a variable response to treatment. Some unexpected deaths may have occurred as the initial indication of the problem.

In most cases, pneumonia is the cause of the disease but determining the etiology is the formidable diagnostic problem. If lesions typical of any of the common diseases of the respiratory tract of cattle can be recognized clinically, like those of infectious bovine rhinotracheitis, then on a clinical basis a specific diagnosis can be made.

The affected group may be recently weaned beef calves in a farm feedlot; weaned beef calves or yearlings that have recently arrived in a feedlot; cattle that have been in the feedlot for varying periods of time; young growing cattle on summer pasture or mature cows that have recently been placed on a lush pasture; yearling or mature lactating dairy cattle; or a group of veal calves.

The morbidity rate can range from 10–50% depending on the age of animals affected, the immune status of the animals, the nature of the stressors involved and

the nature of the disease. In a study of mortality ratios among US feedlots over a 5-year period (1994–1999), the relative risk of death attributable to respiratory tract diseases increased during most years of the study.<sup>1</sup> Cattle entering the feedlots during 1999 had a significantly increased risk (relative risk, 1.46) of dying of respiratory tract diseases, compared with cattle entering in 1994. Respiratory tract diseases accounted for 57.1% of all deaths. Dairy cattle had a significantly increased risk of death of any cause, compared with beef steers, and beef heifers had a significantly increased risk of dying of respiratory tract diseases compared with steers.

In general, bovine respiratory disease accounts for 65–79% of the morbidity and 44–72% of mortality in feedlot cattle. In addition to direct costs associated with death loss and medical treatment, losses attributable to decreased growth performance associated with the incidence of bovine respiratory disease may also occur. Cattle with detectable lung lesions at slaughter had a reduced (0.08 kg/d) growth rate compared with cattle without lesions. Also, 68% of cattle with lung lesions at slaughter were never treated for bovine respiratory disease, suggesting that current methods of diagnosing bovine respiratory disease based on visual appraisal by feedlot pen riders may not always effectively identify sick animals. In general, medical treatment is more effective the earlier in the process it can be initiated. The limitations of identifying clinically affected animals that need therapy was a major factor in the development of metaphylactic use of antimicrobials.<sup>2</sup>

The primary goal of the clinician is to make the most accurate clinical diagnosis as rapidly as possible, based on the clinical and epidemiological findings that are identifiable on the farm, preferably when examining the animals on the first visit. Giving a prognosis and the formulation of rational and economic treatment that will minimize morbidity and mortality are the next goals. The outbreak may involve a herd of lactating dairy cows, and the selection of antimicrobials used can have a major impact on the length of time the milk from treated cows must be discarded. In any group situation, mass medication of each in-contact animal is a major consideration that will increase costs and must be balanced against the economic losses that might occur if all animals are not treated prophylactically. The clinical management of the outbreak, which includes treatment of the obvious cases and the prevention of new cases if possible, is dependent in part on the diagnosis. However, differentiation between the diseases based on clinical findings can be unreliable and it is usually

necessary to begin antimicrobial therapy that will be effective against the bacterial pathogens most likely to be present. The specific cause may or may not be determined by laboratory examination or further clinical and epidemiological examination. Even after intensive clinical and laboratory investigation, the specific etiology will often not be determined and the clinician is left with a diagnosis of 'acute undifferentiated respiratory disease of cattle' or bovine respiratory disease.

The salient clinical and epidemiological findings of the diseases included in the complex of bovine respiratory disease are summarized in Table 18.5. The common diseases of the respiratory tract of cattle can be broadly divided into those affecting the lower respiratory tract and those affecting the upper respiratory tract. Diseases of the lungs associated with either viruses or bacteria alone or in combination are difficult to distinguish from each other on the basis of clinical findings alone. Thus in a group of cattle with pulmonary disease it

may be difficult to distinguish between pneumonic pasteurellosis, *Haemophilus* pleuropneumonia and the viral interstitial pneumonias with or without secondary bacterial infection. The presence of toxemia, which causes depression and anorexia in bacterial pneumonias, is a useful guide in categorizing the common diseases when making a differential diagnosis list. Cattle affected with uncomplicated viral diseases of the respiratory tract are usually not depressed and anorexic because bacterial toxemia is absent.

Table 18.5 Differential diagnosis of bovine respiratory disease

Disease	Epidemiology	Clinical and laboratory findings	Response to treatment
Pneumonic pasteurellosis (shipping fever)	Common disease in North America. Young cattle recently stressed by weaning or transportation, mixing from many different sources, many animals affected, some found dead, common in feedlots. Epidemics occur 7–10 days after arrival in the lot but cattle may be sick on arrival or within a few days after arrival	Acute toxemic bronchopneumonia, moderate dyspnea, fever, increased breath sounds over ventral aspects of lungs, moist crackles, cough, pleuritis. Leukopenia and neutropenia in severe cases	Good response to treatment in early stages. Failure to respond due to advanced lesions, pleuritis, abscesses, inadequate dosage, and incorrect diagnosis
Viral interstitial pneumonia (parinfluenza-3 virus, bovine respiratory syncytial virus (BRSV))	Yearling and adult cattle indoors or outdoors, young cows in closed dairy herd, may occur following addition to herd, high morbidity, low mortality	Sudden onset of acute pneumonia, moderate dyspnea and toxemia, loud breath sounds and wheezes due to bronchiolitis, no moist crackles unless secondary pneumonia. Leukopenia and lymphopenia	Gradual recovery occurs in 3–5 days. Treat secondary complication with antimicrobials
Enzootic pneumonia of calves	Common disease in housed dairy calves, occasionally in pastured beef calves 2–6 months of age	Acute, subacute, and chronic pneumonia, moderate fever, loud breath sounds ventrally, crackles and wheezes	Respond favorably to treatment for uncomplicated secondary bacterial bronchopneumonia
Bovine respiratory syncytial virus infection	Young cattle 6–8 months of age, adult dairy cattle, herd outbreaks are characteristic; case fatality rate varies from 1–30%. Maternal antibody in calves is not protective	Inappetence, fever, coughing, dyspnea, and abnormal lung sounds suggestive of interstitial pneumonia. Death common in those with severe respiratory distress. Fourfold or greater seroconversion to BRSV. Immunofluorescence of nasopharyngeal smears and virus isolation. Acute bronchiolitis and alveolitis	Treat secondary complications with antimicrobials for 3–5 days
<i>Histophilus somni</i> (formerly <i>Haemophilus somnus</i> ) pneumonia, pleuritis, and myocardial abscesses	Common in feedlot calves, 6–8 months of age; mean fatal disease onset for pneumonia is 12 days after animal in the lot, and day 22 for myocarditis and pleuritis	Toxemic suppurative pleuropneumonia, dyspnea, mouth breathing. Persistent fever for several days. Concurrent myocarditis may cause sudden death	Inadequate response to treatment
Infectious bovine rhinotracheitis	Common disease. All age groups but mostly young feedlot cattle, outbreaks common, occurrence unpredictable. Most common in unvaccinated herds	Acute rhinotracheitis with discrete nasal lesions, inspiratory dyspnea, explosive loud coughing, ocular and nasal discharge, high fever 3–5 days. 1% die of secondary bacterial pneumonia. Virus isolation from nasal swabs. Acute and convalescent serology	Gradual recovery occurs in 3–5 days in spite of treatment. Treat secondary pneumonia
<i>Mycoplasma bovis</i> pneumonia	Feedlot cattle with history of respiratory disease. Dairy calves with enzootic pneumonia. Mastitis in lactating dairy cows	Acute to chronic bronchopneumonia, anorexia, fever, polyarthritis, otitis. Exudative bronchopneumonia, extensive foci of coagulative necrosis. Nasal swabs, joint fluid, lung tissue	No response to antibiotic therapy
Epidemic acute interstitial pneumonia (acute pulmonary emphysema and edema, fog fever)	Occurs 4–10 days after adult cattle turned into lush autumn pasture. Outbreaks usual, sudden onset, high case fatality. Common in beef cattle in North America	Sudden and rapid death, severe loud dyspnea with grunting expiration, loud breath sounds over ventral aspects, crackles, subcutaneous emphysema, severe cases die, laboratory data not helpful, confirm at necropsy	Most severe cases die, moderate to mild cases recover, treatment difficult to evaluate. Can be prevented with monensin in the feed for a few days before and after change of pasture

Table 13.5 (Cont'd) Differential diagnosis of bovine respiratory disease

Disease	Epidemiology	Clinical and laboratory findings	Response to treatment
Acute or chronic interstitial pneumonia (bovine farmer's lung)	Extrinsic allergic alveolitis. Not common. Mature cattle housed during winter months and exposed to moldy or dusty feeds. Several animals over period of time	Chronic coughing, dyspnea, weight loss, reduced milk yield, loud breath sounds, crackles, dull but not toxemic, abnormal nasal discharge	No response to treatment
Chronic interstitial pneumonia (diffuse fibrosing alveolitis)	Single animals only. May be chronic form of epidemic acute interstitial pneumonia	Chronic onset of coughing, dyspnea, weight loss, reduced milk yield, decreased breath sounds, no toxemia, cor pulmonale	No response to treatment
Verminous pneumonia ( <i>Dictyocaulus viviparus</i> )	All ages susceptible, usually young cattle 6–12 months on pasture, wet warm seasons, outbreaks common, enzootic area	Moderate to severe dyspnea, coughing, fever, loud breath sounds, crackles over <b>dorsal half of lung</b> , eosinophilia may occur, larvae in feces 3 weeks after infection	No response to antimicrobials. Responds to anthelmintics
<i>Ascaris suis</i> pneumonia	Not common. All ages. On pasture previously occupied by pigs	Sudden onset, severe dyspnea, rapid deaths, loud breath sounds, crackles over entire lung. Will recover gradually if not too severe	No specific treatment response
Allergic rhinitis (summer sniffles)	Mostly late summer, autumn when pasture in flower. Sporadic cases. Mostly Channel Island breeds. Cows may have disease each year	Sudden onset, dyspnea, inspiratory wheezing, mucopurulent then caseous yellow to orange nasal discharge. Sneeze, rub muzzle in bushes, twigs up nose, bleed	Into housing, antihistamines, excellent response if early. In cases of long duration, wheezing persists until nasal mucosa sloughs
Pulmonary abscess	Single animal. History of pneumonia with no response to treatment. Occasionally, several cases in feedlot	Chronic coughing with epistaxis and hemoptysis, chronic toxemia, mild fever, crackles and wheezes distributed randomly. Neutrophilia	Nil
Calf diphtheria	Young calves, dirty conditions or on rough dry pasture. Usually only few affected	Acute toxemia, fever, inspiratory stridor and stertor, necrotic lesions visible in larynx and oral cavity	Responds to antimicrobials and topical treatment
Embolic pneumonia due to ruptured vena caval abscess	1–8 years of age. History of respiratory disease with hemoptysis and epistaxis and poor response to treatment	Dullness, polypnea, hyperpnea, thoracic pain, frequent coughing with hemoptysis, epistaxis, temperature variable, anemia. Common, widespread foci of crackles and wheezes with increased breath sounds. May die rapidly from massive hemorrhage. Hepatomegaly and congestive heart failure. Neutrophilia and hypergammaglobulinemia	No response to treatment. Slaughter for salvage
Aspiration pneumonia	History is important. Following faulty drenching techniques or regurgitation and aspiration in weak cows (i.e. milk fever)	Acute bronchopneumonia with toxemia. 24–48 hours following aspiration. Loud breath sounds ventral half, moist crackles. Marked leukopenia and neutropenia	May respond to treatment if treated early
Dusty feed rhinotracheitis	Few days following introduction of finely chopped dry feed. Feed contains high concentrations of 'fines'	Outbreak of coughing, rhinitis with copious serous nasal discharge, conjunctivitis and ocular discharge. Bright and alert	Recover in few days following removal of dusty feed
Enzootic nasal granuloma	In enzootic area up to 30% morbidity in a herd, up to 75% of herd. Coastal regions, autumn is worst, Channel Island breeds most affected. Loss is due to continuous loss of production. A chronic debilitating disease. All ages, mostly adults	May be acute 'summer sniffles' early. Then chronic dyspnea with stertor, eat indifferently, lose condition, have to be culled. Chronic nasal discharge. Smear nodules on nasal cavity mucosa palpable through nostril	Nil
Contagious bovine pleuropneumonia	Outbreak in susceptible cattle – morbidity up to 100%, mortality up to 50% if cattle stressed, traveling. Aerogenous spread, no mediate contagion. Outbreaks due to introduction of cattle often inapparent 'carriers' that are detectable by CF test. Incubation period 3–6 weeks	Acute fibrinous pneumonia and pleurisy. Dyspnea, fever 40.5°C (104.5°F), deep cough, shallow, fast, elbows out, grunting respiration. Pain on chest percussion. Pleuritic friction rub early, moist crackles. Course 3 days to 3 weeks	Not to be treated. Eradication is urgent. Is treated in enzootic areas where control is not attempted

## ETIOLOGY

The major etiological agents which cause or may be associated with acute UBRD include the following:

- Viruses
  - Bovine herpesvirus-1
  - Bovine respiratory syncytial virus
  - Parainfluenza-3 virus
  - Bovine virus diarrhea virus
  - Bovine coronavirus
- Bacteria
  - *Mannheimia haemolytica*
  - *Pasteurella multocida*
  - *Histophilus somni* (formerly *Haemophilus somnus*)
- *Mycoplasma* spp.
  - *Mycoplasma bovis*
  - Contagious bovine pleuropneumonia
- Uncertain or unknown etiology
  - Acute interstitial pneumonia
- Verminous
  - *Dictyocaulus viviparus*.

## Role of etiological agents

The role of the etiological agents in the cause of acute undifferentiated respiratory disease in cattle has been controversial and often uncertain because the major pathogens of bovine respiratory disease are ubiquitous in clinically normal animals. The disease is considered to be the result of the effects of stressors causing immunosuppression, which allows colonization of the respiratory tract by opportunistic pathogens. The spectrum of the immune status of the animals is also a major factor. Animals vaccinated well before natural infection will usually be immune to specific pathogens. Animals that have had the natural infection and have adequate humoral immunity, or cell-mediated immunity in the case of some infections, will be immune to clinical disease.

Many epidemiological studies of bovine respiratory disease have attempted to correlate the level of serum antibodies in feedlot calves on arrival at the feedlot and over the first 30–50 days of the feeding period with morbidity and mortality due to bovine respiratory disease. A low level of antibody to a specific pathogen on arrival followed by significant seroconversion in animals that develop bovine respiratory disease in the first few weeks of the feeding period suggest that the pathogen was an important pathogen in the cause of cases of the disease. Conversely, those animals with a high level of antibody on arrival that do not develop bovine respiratory disease are considered immune. However, some animals with low levels of antibody may remain normal and seroconvert during the early part of the feeding period.

Feedlot cattle commonly seroconvert to the viruses of infectious bovine rhinotracheitis (IBRV), parainfluenza-3 virus (PI-3V), bovine virus diarrhea virus (BVDV), and bovine respiratory syncytial virus (BRSV),<sup>3</sup> and to *Mycoplasma bovis* and *Mycoplasma dispar*, within the first month after arrival.<sup>4</sup> Seroconversion to these pathogens occurs both in animals that develop respiratory disease and those that remain normal within the same group, but the relative importance of each agent and their causative nature is controversial. Seroconversion to *M. haemolytica* cytotoxin, BRSV and BVDV were predictive of approximately 70% of all respiratory disease cases in Ontario feedlots.<sup>3</sup> Calves arriving in Ontario feedlots with high serum antibody levels to *Histophilus somni* (formerly *Haemophilus somnus*) had less bovine respiratory disease than calves with lower levels.<sup>5</sup>

Many respiratory pathogens that could cause disease are present in both individuals and groups of feedlot cattle after they are mixed and during outbreaks of bovine respiratory disease.<sup>3</sup> Which ones are most important and causing disease is a major question. It has been suggested that undifferentiated bovine respiratory disease in weaned beef calves entering a feedlot is not a contagious disease and that, while respiratory pathogens may be necessary causes of the disease, they are not sufficient causes.<sup>3</sup> This suggests that groups of animals experiencing a high incidence of bovine respiratory disease have been highly stressed and that it may be more important to identify and prevent the environmental and managerial risk factors.

The relationships between bacterial and viral antibody titers and undifferentiated fever and mortality in recently weaned beef calves in western Canada were examined.<sup>6</sup> Feedlot calves are commonly exposed to *M. haemolytica*, *H. somni*, bovine herpesvirus (BHV)-1 G-IV glycoprotein, BVDV, *M. bovis*, and *Mycoplasma alkalescens* in the early feeding period.<sup>6</sup> Seroconversion to *M. haemolytica* antileukotoxin was associated with a decreased risk of undifferentiated fever. Higher arrival BVDV antibody titer was associated with a decreased risk of undifferentiated fever. Higher arrival *H. somni* antibody titer and increases in *H. somni* antibody titer after arrival were both associated with a decreased risk of undifferentiated fever. The odds of overall mortality (OR 5.09) and hemophilosis mortality (OR 11.31) in clinical cases were higher than in the controls. In summary, protective immunity to *M. haemolytica* antileukotoxin *H. somni*, BHV-1 G-IV glycoprotein, BVDV, and *Mycoplasma* spp. may be necessary to reduce the occurrence of undifferentiated fever.

The association between exposure to *H. somni* and *M. haemolytica* and the risk of acute UBRD was examined using serological evidence of exposure and a vaccine field trial.<sup>7</sup> Vaccination with *H. somni* in combination with *M. haemolytica* and with *M. haemolytica* alone reduced the risk of UBRD. There was no association between serological evidence of concurrent exposure to *M. haemolytica* and UBRD occurrence. Treated animals tend to have lower titers to *H. somni* compared to untreated animals.

Chronic, antibiotic-resistant pneumonia, sometimes with polyarthritis, occurs in feedlot cattle in western Canada.<sup>8,9</sup> *M. bovis*, BVDV, and *H. somni* are commonly found in the tissues at necropsy. This coinfection suggests the possibility of synergism between the BVDV and *M. bovis* in the pneumonia with the arthritis syndrome.

BVDV has been identified as a contributor to respiratory disease in feedlot calves. On arrival in feedlots, 39% of animals were seropositive for BVDV, and those animals treated for UBRD had larger titer increases to the virus than nontreated animals.<sup>10</sup> The virus has been demonstrated by experimental infections of the respiratory tract, isolation of the virus and/or identification of BVDV antigen in tissues and demonstration of active infection through seroconversion in groups of cattle with bovine respiratory disease. BVDV-1b strains have been associated with acute pneumonia in commingled calves that were not vaccinated with BVDV vaccines, and in which *M. haemolytica* and *P. multocida* were also present in the pneumonic lesions.<sup>11</sup> Experimental infection of seronegative and immunocompetent calves with BVDV type resulted in primary respiratory disease.<sup>12</sup>

Bovine coronavirus (BCV) has been implicated as a cause of UBRD based largely on the isolation of the virus from the nasal cavities of cattle with respiratory disease. However, based on seroepidemiology of BCV titers in feedlot cattle, although higher antibody titers to the virus were associated with a decreased subsequent risk of treatment for UBRD, there was no association between evidence of recent infection (titer increase) and the occurrence of UBRD.<sup>13</sup> Other studies have shown that BCV infections are not associated with an increased risk of treatment for UBRD.<sup>10</sup>

BCV is widespread in the cattle population and can be isolated from nasal swabs from cattle with bovine respiratory disease. The virus can be found in the feces and nasal swabs of recently arrived feedlot cattle and calves with and without clinical signs of bovine respiratory disease.<sup>14</sup> Exposure to BCV prior to arrival in the feedlot is common, with 90% of animals

being seropositive on arrival.<sup>10</sup> BCV can be isolated from feedlot cattle in many different locations and most cattle seroconvert to the virus during the first 28 days after arrival in the feedlot.<sup>15</sup> Cattle shedding the virus from the nasal cavity and developing an antibody response to the virus were 1.6 times more likely to require treatment for respiratory disease than cattle that did not shed the virus or develop an immune response. Cattle that shed the virus from the nasal cavity were 2.2 times more likely to have pulmonary lesions at slaughter than cattle that did not shed the virus.<sup>16</sup> In natural outbreaks of shipping fever, more than 80% of affected cattle shed BCV at the beginning of the epidemic when the *M. haemolytica* infection rate was low.<sup>17</sup>

Intranasal vaccination of backgrounded feedlot cattle with a BCV vaccine reduced the risk of bovine respiratory disease.<sup>18</sup> Vaccination had the greatest effect on calves with intranasal BCV, and on those with antibody titers less than 20, on entry.

The role of BCV in epidemics of shipping fever pneumonia in cattle was examined by the collection of nasal swabs and serum samples prior to the onset of the epidemic, during the course of the illness and after death when necropsies were done and samples of lung tissues were examined.<sup>19</sup> Respiratory BCV (RBCV) was isolated from the nasal secretions before and after transport, from lung tissues of those cattle that died early in the epidemic but not later. *Pasteurella* spp. were isolated from all cattle that had severe pneumonia. All cattle were immunologically naive to both infectious agents at the onset of the epidemic but those that died after day 7 had rising antibody titers to RBCV and *M. haemolytica*. In contrast, the 18 clinically normal and RBCV isolation-negative cattle had high HAI antibody titers to RBCV from the beginning, while their antibody responses to *M. haemolytica* were delayed. Application of Evan's criteria for causation were applied to the findings identified RBCV as the primary inciting cause in the epidemics. Because of the multifactorial nature of bovine respiratory disease, the criteria used are as follows.

Evan's criteria for causation

1. The virus infects the mucosa of respiratory tract passages and lungs of affected cattle
2. The virus can be isolated in cell cultures at high rates from respiratory secretions and lung samples during the pathogenesis of bovine respiratory disease
3. Virus-specific immune responses are observed in cattle that recover from bovine respiratory disease. Rising

titers of HAI antibodies against RBCV were detected in all surviving calves that had RBCV infections on days 0, 5 and later. They developed typical primary antibody responses to RBCV infections characterized by rises in IgG1 and IgG2. In contrast, the RBCV isolation-positive cattle with fatal outcomes had no or low titers of HAI antibodies against RBCV in the early stages of the epidemics. These cattle developed only initial IgM responses to RBCV infections before they died

4. Viruses isolated from cattle with bovine respiratory disease are not isolated from clinically normal cattle but they may be detected in the pathogenesis of other respiratory tract diseases
5. Cattle with significant antibody titers against the virus do not develop bovine respiratory disease, which occurs in cattle without such immune protection
6. Elimination of the virus factor prevents or decreases the severity of bovine respiratory disease
7. The whole thing should make biological and epidemiological sense.

## CLINICAL CASE DEFINITION AND EPIDEMIOLOGY

### Clinical case definition

The most important part of the clinical and epidemiological examination is to determine the case definition, which includes the following questions.

**What** is the clinical disease that is present in the affected animals?

- Which body system is affected and where in that body system is the lesion?
- Do the animals have pneumonia, rhinitis, laryngitis, tracheitis, bronchitis or combinations of these abnormalities?

The clinician should attempt to make a clinical diagnosis by closely examining several typically affected animals and determine if the lesions are in the lower or upper respiratory tract. The presence of toxemia, depression, fever, anorexia, and agalactia in lactating dairy cattle indicates a primary or secondary bacterial infection. The presence of loud breath sounds (consolidation) and abnormal lung sounds (crackles and wheezes) indicates the presence of pneumonia. Diseases of the upper respiratory tract are characterized by inspiratory dyspnea, stridor, loud coughing, sneezing, wheezing, and lesions of the nasal mucosa. When a single animal is involved, such as a dairy cow, or a group of dairy cows, a close physical examination, including auscultation of the lungs and inspection of the nasal mucosae and the larynx, is usually done.

In commercial feedlots, where large numbers of clinically affected animals are processed daily, and time is an economically important factor, the clinical examination of affected animals may be cursory and limited to taking the rectal temperature of animals that have been identified as sick based on recognition of depression and the absence of clinical findings suggestive of disease of some body system other than the respiratory tract. In such instances, if depressed animals have a rectal temperature above a predetermined level of, for example, 40°C, they are considered to have bovine respiratory disease if no other clinical findings are detectable that are referable to organ systems other than the respiratory system. In such cases, a diagnosis of **acute undifferentiated fever of feedlot cattle** has been suggested.<sup>20</sup> In most cases, the thorax of these animals is not auscultated for evidence of pneumonia. As a result it is probable that the number of animals with respiratory disease is overestimated. Undoubtedly, some sick feedlot animals have a fever of undetermined origin unassociated with respiratory disease or any other inflammatory lesion. In a pen of recently arrived cattle in a feedlot, many animals that appear normal will have rectal temperatures above the critical temperature without any clinical evidence of bacterial infection that requires treatment. The elevated temperatures of these animals will return to within normal ranges within a few days.

The subjective clinical findings of distant examination that have been used by animal attendants in commercial feedlots to identify sick animals that need to be closely examined include: degree of ruminal fill (1, normal; 2, slightly gaunt; 3, moderately gaunt; 4, excessively gaunt), attitude (1, normal; 2, slight lethargy; 3, severe lethargy; 4, nonambulatory), ocular discharge (1, none; 2, slight; 3, moderate; 4, abundant), nasal discharge (1, none; 2, slight; 3, moderate; 4, abundant).

The sounds heard on auscultation of the lungs at three sites along a line extending from the cranioventral to caudodorsal lung fields (1, normal; 2, slightly harsh; 3, moderately harsh; 4, severely harsh).

The feeding and watering behavior of healthy and sick animals in a commercial feedlot has been examined using radio-frequency technology to record individual animal behaviors.<sup>21</sup> Eating and drinking behaviors are associated with clinical signs of bovine respiratory disease but there is no obvious predictive association between signs of bovine respiratory disease in recently arrived weaned beef calves and eating and drinking behavior.<sup>22</sup>

Calves that were sick had greater frequency and duration of drinking 4–5 days after arrival than calves that were not sick. Sick calves had significantly lower frequency and duration of eating and drinking 11–27 days after arrival but had greater frequency of eating 28–57 days after arrival than calves that were not sick. Calves at slaughter that had a higher percentage of lung tissue with lesions had lower frequency and duration of eating 11–27 days after arrival but had greater frequency and duration of eating 28–57 days after arrival. Agreement of calves being sick and having pulmonary lesions at slaughter was adequate. Agreement for calves being removed and having pulmonary lesions at slaughter was low. Experimentally, the electronic acquisition of feeding behavior data for feedlot cattle, when analyzed using cumulative sums (CUSUM) procedures, offers the potential for predicting morbidity before conventional visual methods of appraisal. The feeding behavior during the first 30 days cattle are in a receiving pen may be used to detect animal morbidity approximately 4.1 days earlier than conventional methods typically employed in commercial feedlots.<sup>23</sup> Overall accuracy, positive predictive value and sensitivity of the CUSUM prediction method were 87, 91, and 90%, respectively.<sup>23</sup>

There is a need to improve our clinical diagnostic techniques and to develop new ones that can be applied to making a rapid and accurate diagnosis beside the animal in the field situation. To base a diagnosis of acute respiratory disease on the presence of depression, which has a component of observer subjectivity, and a fever results in the unnecessary treatment of many animals, which is uneconomic and potentially promotes undesirable antimicrobial resistance and residues in milk and meat.

#### Who is affected?

This includes age of animals affected, a single animal or group of animals, and vaccination history. Recently arrived feedlot cattle mixed from many different origins are susceptible to fibrinous pneumonia associated with *M. haemolytica*.

#### Where are the affected animals?

Are they in the feedlot, on pasture, or housed in a barn with what quality of ventilation?

#### When were the animals affected?

- How soon after arrival in the feedlot did the animals become affected?
- What stressors may have recently preceded the outbreak?
- What risk factors could have predisposed to this outbreak?

- Have the animals been recently shipped and mixed with animals from another source?

Consideration of the clinical and epidemiological findings can then be correlated, and hypotheses formulated and tested to determine **why** the disease occurred.

#### Occurrence

Bovine respiratory disease occurs under many different situations, including all age groups, feedlot animals kept outdoors, housed dairy calves, nursing and recently weaned beef calves, dairy and beef cattle heifers, and adult lactating dairy cows. Epidemics of acute respiratory disease have been described in dairy calves from birth to 6 months of age.<sup>24,25</sup> Outbreaks of BRSV can occur in dairy cattle heifers and adult dairy cattle.<sup>26</sup>

Pneumonic pasteurellosis is most common in recently arrived feedlot calves. In calves 3–5 weeks after arrival in the feedlot, *H. somni* pleuropneumonia may be more likely. Acute interstitial pneumonia (pasture-induced) is the most likely diagnosis when confronted with an outbreak of acute respiratory disease in mature beef cattle that have been moved from a summer pasture to a lush autumn pasture within the last 4–10 days. Acute pulmonary disease in a few head of feedlot animals several weeks or months after arrival in the lot is probably an acute interstitial pneumonia, which may be associated with 3-methylindole (3MI) metabolites.<sup>27</sup>

#### Risk factors

The risk factors that have been identified in outbreaks of respiratory disease in feedlot cattle include the purchase of cattle from auction markets, whereby cattle arrive at the feedlot over an extended period of time, and mixing of cattle from many different sources.<sup>3</sup> An epidemiological study of fatal fibrinous pneumonia in auction-market-derived feedlot calves in western Canada revealed that peak mortality occurred approximately 16 days after arrival at the feedlot.<sup>28</sup> The risk of fatal fibrinous pneumonia was consistently greater for calves entering the feedlot in November, shortly after the auction sales had peaked, when the feedlot was reaching capacity.<sup>29</sup> Mixing of calves from different farms was considerable, with a median of two calves per farm on truckloads arriving at the feedlot. Increased mixing at the auction markets was associated with increased fatal disease risk. The distance calves were transported by truck from the auction markets to the feedlot was not associated with fatal disease risk.<sup>3</sup> When the incidence of fatal fibrinous pneumonia was high, the disease

clustered within truckloads or pens. Risk factors positively associated with disease clustering included increased mixing of calves from different farms at the auction markets, month of purchase, number of calves passing through the auction markets, and weather conditions at arrival.<sup>28–31</sup>

Transportation of feedlot calves increases serum concentration of oxidative stress biomarkers, which are related to episodes of bovine respiratory disease.<sup>32</sup> Transportation stress significantly decreases serum total antioxidant capacity and increases malondialdehyde concentrations in steer calves.<sup>33</sup> It is proposed that stressors such as marketing (through an auction barn) and transportation to the feedlot precipitate oxidative stress, which reduces the antioxidant defense capacity and increases total body lipid peroxidation, resulting in increased susceptibility to bovine respiratory disease. These biomarkers may be useful to measure the oxidative stress of transported cattle. There is some experimental evidence that acidogenic diets and ketoacidosis may affect lymphocyte function, which may affect vaccine efficacy.<sup>34</sup>

The literature on how the adequacy of diets of recently arrived feedlot cattle may affect their health and immunity has been reviewed.<sup>35</sup> Diets for newly arrived stressed beef cattle must be formulated to compensate for decreased feed intake and known nutrient deficiencies.

The literature on the risk factors for bovine respiratory disease in dairy heifers and the effect of the disease on productivity has been reviewed with relevance to commercial dairy farming in the Netherlands.<sup>26</sup> Bovine respiratory disease in dairy heifers increases the risk of mortality directly after the disease episode by up to six times, reduces growth during the first 6 months of life by up to 10 kg, and increases the likelihood of dystocia after first calving. Both herd size and other diseases in dairy heifers are clearly associated with the risk of bovine respiratory disease. Season and colostrum feeding are important. The most important risk factors for mild and severe pneumonia in dairy calves aged birth to 3 months were inadequate air circulation and the purchase of cattle.<sup>24</sup>

An epidemic of acute respiratory disease associated with BRSV occurred during the winter and spring of 1995 in Norway.<sup>36</sup> Data from 431 cattle herds were collected. The risk of acute respiratory disease occurring in cattle was related to herd size and type of production and an expressed interaction between these two variables. The risk of a herd outbreak in a mixed herd of 20 animals was estimated to be 1.7 times greater than in a dairy herd, and 3.3 times greater than in a beef herd of

comparable size. On increasing herd size to 50 animals, the risk increased 1.3-fold for a mixed herd, 3.3-fold for a dairy herd and 2.1-fold for a beef herd, compared to a risk for a corresponding type of herd of 20 animals. The disease spread initially from one location to another during the first 6–9 weeks; the rate of transmission between neighboring farms seemed to be higher than for the other districts included in the study. It was hypothesized that one common source of infection was involved in the outbreak and the case herds were clustered in time as well as spatially.<sup>37</sup> The average daily milk loss was estimated to be 0.70 kg per cow for 7 days after a herd outbreak compared with the period one week before.<sup>38</sup>

### DIAGNOSIS AND DIFFERENTIAL DIAGNOSIS

The clinician is limited in most situations to correlating clinical, epidemiological and necropsy findings in making a diagnosis. Diagnostic laboratories may not be readily available and their resources for microbiological and serological investigations may be much less than is needed for an accurate determination of causes. In the past, investigations of outbreaks of bovine respiratory disease have been incomplete and the interpretation of the findings almost impossible because one or more pieces of information were missing.

A number of important factors contribute to the difficulty of unraveling the etiologies in field outbreaks of respiratory disease. A review of the literature on the morbidity and mortality rates and disease occurrence in North American feedlots found differences in the definition of the terms used that makes the reports difficult to compare.<sup>39</sup> In addition, the case definition or the clinical diagnosis is invariably inadequately defined. In feedlots, the morbidity rate will range from 15–45% of cattle within 3 weeks after arrival and the population mortality rate varies from 1–5%. Respiratory diseases account for about 75% of the diseases. Three important items are to be considered:

- Case definitions should be clearly stated
- The population at risk should be precisely measured
- The period of observation must be stated.

A systematic method of data collection from the customized records of large feedlots has been developed and validated for use in the National Animal Health Monitoring System. The current collection of data from large feedlots provides an acceptable level of sensitivity and specificity for the program but it is important that

the veterinarian makes regular clinical observations to validate the data.

The course of the disease, especially when animals have been treated, alters the gross and microscopic appearance of tissues and the microbiological (bacteriological, virological) and serological findings so that the animal's status is impossible to determine.

### CLINICAL PATHOLOGY

#### Bacterial culture and antimicrobial sensitivity

Nasal swabs taken from clinical cases before treatment often yield a pure culture of pasteurellas but *M. haemolytica* biotype A serotype 1 is the most common isolate obtained from cattle with acute pneumonic pasteurellosis. The same serotype can usually be isolated from in-contact and apparently healthy calves. The antimicrobial sensitivity of the pasteurellas isolated can be done, but interpretation of the results is often difficult because it is not known whether the isolates from nasal swabs represent the organisms causing the lesions. Significant differences may exist between the antimicrobial sensitivities of isolates from nasopharyngeal swabs and those from the lung tissues. Thus it is not yet possible to recommend routine culturing and antimicrobial sensitivity determination of pasteurellas from nasal cavity or nasopharyngeal mucus from cattle with acute bovine respiratory disease. At the individual animal level, nasopharyngeal swabs and bronchoalveolar lavage reveal only moderate agreement; at the group level the isolation rates of various organisms are similar. In healthy calves monitored from the farm to the feedlot there was no relationship between the nasal flora and pulmonary lesions. The results of antimicrobial susceptibilities of bacterial pathogens isolated from the lung tissues of cattle with pneumonia over a period of years may provide some indication of trends in antimicrobial sensitivities but the results are not useful in making decisions about the selection of antimicrobial-affected animals.<sup>40</sup>

The literature on the principles of antimicrobial susceptibility testing of bacterial pathogens associated with bovine respiratory disease has been reviewed.<sup>41</sup> Two different methods are used. The Kirby-Bauer method is the traditional *in vitro* test of bacterial susceptibility or resistance to antimicrobials, which uses a disk containing a standardized concentration of an antimicrobial. Bacteria grow or fail to grow surrounding the disk, and results are interpreted as resistance or susceptibility of the bacteria to certain antimicrobials. The serial-dilution testing uses a broth or agar medium with selected

dilutions of antimicrobials in 1:2 dilution steps. Results are expressed as susceptible, intermediate susceptibility or resistant and also as minimum inhibitory concentrations (MICs), which are considered more reliable. The MIC is defined as 'the lowest concentration of an antimicrobial that prevents visible growth of a microorganism in agar or broth dilution susceptibility test'.

It is important to adhere to standards set by the National Committee on Clinical Laboratory Standards/Veterinary Antimicrobial Susceptibility Testing Subcommittee (NCCLS/VASTS). Veterinary-specific breakpoints are determined by the NCCLS/VASTS through a consensus process based on reviewing pharmacokinetic, MIC, zone-diameter scattergram and clinical trial data relating to an antimicrobial application. The subcommittee selects MIC breakpoints and zone-interpretative criteria that best fit the definitions of susceptible, intermediate susceptibility and resistant.<sup>41</sup>

The most veterinary-specific breakpoints for pathogens in bovine respiratory disease have been determined for five antibiotics: ceftiofur, enrofloxacin, florfenicol, spectinomycin, and tilmicosin.<sup>41</sup> The breakpoints for oxytetracycline and chlortetracycline are adapted from human breakpoints developed for tetracycline.<sup>41</sup>

#### Virus isolation or detection

Nasal swabs may be submitted for isolation or detection of viruses such as BVH-1, BRSV, bovine coronavirus.

#### Serology

Serum samples may be submitted for determination of the levels of specific antibody to suspected viral causes of the bovine respiratory disease. Paired acute and convalescent serum samples from both affected and normal animals in the herd are desirable. In a group of animals in a feedlot, or dairy or beef cattle herd, serology for a specific etiological agent may be followed over a period of time to determine seroconversion and its relationship to occurrence or absence of clinical disease.

#### Hematology

Plasma fibrinogen concentrations are elevated, paralleling the increase in body temperature, and are a more reliable indication of the presence of the lesion than clinical assessment. Young cattle with clinical signs of acute respiratory disease, a fibrinogen concentration greater than 0.7 g/dL, and a temperature greater than 40°C (104°F) are likely to have pneumonic pasteurellosis. Leukocyte counts are of little value, as a leukocytosis and neutrophilia occur in some animals but in others there may be a neutropenia



or no significant change. Acute phase proteins are increased within 24 hours following experimental intratracheal inoculation of *M. haemolytica* into calves. The availability of a rapid test for acute-phase proteins could assist in the field diagnosis of the disease and its possible differentiation from similar diseases.

### NECROPSY FINDINGS

Necropsies should be done on all animals that die with the disease. In feedlots this is a means of obtaining daily information on the occurrence of specific diseases and on the efficacy of the animal health management program. The most common pathological finding is fibrinous pneumonia and coagulation necrosis, with varying degrees of the common complications such as pleuritis and pulmonary abscesses. One of the major problems in the diagnosis of feedlot pneumonia has been to assess the age of the lesions. Determining the age of a bacterial pneumonia with some accuracy would help the health management to assess whether or not the pneumonia was already present in the animal on arrival or whether a treatment failure resulted from late detection or from inadequate drug therapy. An attempt to age the lesions of bacterial pneumonia of feedlot cattle indicated that the degree and extent of necrosis and fibrosis offers the best opportunity to age the pneumonia. In acute interstitial pneumonia, the lungs are diffusely red-tan, enlarged, and do not collapse. All lobes are rubbery, wet, and heavy. Emphysema is present mainly in the diaphragmatic lobes and there is white froth in the trachea. In fibrinous pleuritis there are thick sheets of fibrin over the visceral and parietal pleura. The thorax contains fibrin and straw-colored fluid. In caudal vena caval thrombosis, the lungs contain pulmonary arterial aneurysms and abscesses. Blood clots are present in the airways and the liver has an abscess near the vena cava that contains a thrombus.

Tissue samples are submitted for histopathology and bacteriological and virological examination depending on the specific disease suspected. However, the length of time usually required to do the diagnostic work and interpret the results means that the procedure is expensive and to an extent inconclusive because the results are available only when the outbreak is over.

A method has been described of recording pulmonary lesions of beef calves at slaughter and the association of lesions with average daily gain.<sup>42</sup> Computer imaging technology can be employed to facilitate the capture of feedlot necropsy data.<sup>25</sup> A digital camera is used to capture necropsy findings and the images are electronically transferred to a central

reference laboratory for veterinary interpretation and diagnosis.

### Interpretation of results of clinical pathology and necropsy findings

A large body of information has been generated on the microbiology, and more recently molecular microbiology, of specific pathogens associated with bovine respiratory disease but only a small amount is applicable clinically. Insufficient effort has been directed towards integrating the information and applying it to the effective control of respiratory disease on the farm. Ideally, investigations of outbreaks of bovine respiratory disease should consist of in-depth examinations of a representative sample of the affected group and normal in-contact animals using a multidisciplinary approach involving clinical, epidemiological, and laboratory investigation. These procedures, especially those requiring detailed virological and serological examinations, are expensive and in the light of the economic status of cattle industries not likely to be lightly borne. But it will only be when such a multidisciplinary approach is brought to bear on bovine respiratory disease that we will improve our position with respect to knowing what actually occurs in outbreaks of the disease. Of paramount importance is the identification of risk factors, which, if valid, gives the clinician a powerful clinical tool for the clinical management and control of respiratory disease in cattle. Of even greater importance is the necessity for the clinician to visit the farm and conduct those clinical and epidemiological investigations that are necessary to solve the problem and to monitor the problem and the herd until recovery occurs.

### TREATMENT

The principles of the clinical management of outbreaks of acute undifferentiated bovine respiratory diseases are:

The clinician must visit the farm and do the clinical and epidemiological investigations necessary to solve the problem, to assist the owner or the animal attendants with the clinical management of the disease, and to monitor the problem and the herd until recovery occurs. Simply dispensing antimicrobials to the owner without clinical examination of the animals is inadequate and contradicts the intention of the veterinarian-client relationship. The veterinarian is professionally obliged to provide explicit instructions about medication of affected animals and the drug withdrawal requirements, and to keep adequate records of affected animals, treatments given

and the results of laboratory examinations. A final report should be prepared by the veterinarian and sent to the owner

- Unless otherwise determined, when toxemia and fever are present it is assumed that a primary bacterial pneumonia is present or, if a viral interstitial pneumonia is suspected, then a secondary bacterial pneumonia may occur. Therefore, antimicrobial therapy is of prime importance
- New cases must be identified as soon as possible. This will require increased surveillance of the group to detect affected animals as soon as clinical abnormalities such as depression, nasal discharge, and dyspnea are noticeable
- New cases must be treated as soon as they are detected. Each treated animal should be suitably identified and a record kept of the initial body temperature and the treatment administered. If the outbreak is due to pneumonic pasteurellosis, failure to respond favorably to antimicrobial therapy or relapse that occurs a few days after an initial apparent recovery is usually due to late treatment. Delaying treatment until 48 hours after an experimental aerosol infection of *M. haemolytica* can prolong the course of the disease and increase mortality
- Any of the common antimicrobials must be administered parenterally daily for at least 3 days. Oxytetracycline at 10 mg/kg BW intramuscularly, procaine penicillin G at 30 000–45 000 IU/kg BW intramuscularly, or trimethoprim-sulfadoxine at 3 mL/45 kg BW intramuscularly are effective when given early in the course of the disease. Tilmicosin at a dose of 10 mg/kg BW subcutaneously is also effective. Florfenicol at 20 mg/kg BW intramuscularly and repeated 48 h later is also highly effective.<sup>20</sup> Florfenicol and tilmicosin are comparable for treatment of undifferentiated bovine respiratory disease in western Canada.<sup>43</sup> Florfenicol is superior to tilmicosin for the treatment of undifferentiated fever in feedlot calves that have previously received metaphylactic tilmicosin upon arrival in the feedlot in western Canada.<sup>44</sup> Enrofloxacin at 2.5–5.0 mg/kg BW intramuscularly daily for 3–5 days or a single dose of 7.5–12.5 mg/kg BW is effective for the treatment of bovine respiratory disease.<sup>45</sup>

In lactating dairy cows, antimicrobials with the shortest milk withdrawal times commensurate with effectiveness should

be used. Ceftiofur with no withdrawal period is now available for use in lactating dairy cattle. Milk from treated cows must be kept from the bulk milk supply until the stated withdrawal time has elapsed. Other antimicrobials that have been evaluated for the treatment of acute undifferentiated bovine respiratory disease include sulbactam-ampicillin and the fluoroquinolones.

A beneficial response to therapy should be apparent within 12–24 hours. The body temperature should decline significantly and the appearance of the animal and its appetite should be improved.

The response to treatment, or lack of it, is valuable information in making a final decision on cause. Animals that do not respond to treatment and die should be submitted to intensive necropsy examination and culture of affected lungs. One of the emerging problems inherent in such broad policies in treatment is public health concern with the amount of antibiotic residue in meat. Pressure is now being applied to use antimicrobials only when necessary, which necessitates a more accurate diagnosis. A good example of this problem is when cattle are treated with antibiotics for bovine respiratory disease but the diagnosis is then refined in a day or two to interstitial pneumonia and emergency slaughter is then the appropriate course of action. The cattle cannot be slaughtered until the withdrawal period for the specific antibody used has expired, by which time many of the cattle will have died anyway. The regular use of a particular antimicrobial in feedlots may increase the level of resistance to *M. haemolytica*.

When confronted with an outbreak, one of the major decisions to be made is whether or not to recommend mass medication of the water or feed supplies for several days or to administer an antimicrobial to all in-contact animals in an attempt to treat cases in the preclinical stage. Veterinarians commonly recommend the use of medicated water supplies as an aid in the treatment of outbreaks of acute respiratory disease, and field observations claim beneficial results. However, there is no validated information available to support a recommendation for a medicated water supply for treatment or prophylaxis in the face of an outbreak. Depending on the water supply system it can be difficult to deliver and maintain a constant concentration of a drug in the water supply; palatability of certain drugs can also be a problem. The medication of the water or feed supplies can also create a false sense of security in the animal attendants, who may not be as efficient in the selection of affected animals in the early stages of the disease.

There are no validated reports of the use of medicated feed as an aid to treatment for outbreaks of acute respiratory disease in cattle.

In an outbreak of acute respiratory disease in feedlot cattle when the daily morbidity rate reaches 6–10% the parenteral administration of long-acting oxytetracycline to all in-contact cattle at a dose of 20 mg/kg BW intramuscularly is recommended. Tilmicosin at 10 mg/kg BW subcutaneously is also effective in reducing the morbidity rate when given to beef calves on arrival in the feedlot or 72 hours later.<sup>3</sup> The intramuscular injection of two different formulations of oxytetracycline to high-risk feedlot calves on arrival can reduce the morbidity rate due to respiratory disease during the first 2 weeks on feed and for the entire feeding period by 15–19% and the mortality rate from fatal fibrinous pneumonia by 67–84%. Meta-analysis of field trials of antimicrobial mass medication for prophylaxis of bovine respiratory disease in feedlot cattle indicated that prophylactic parenteral mass medication of calves with long-acting oxytetracycline or tilmicosin on arrival at the feedlot would reduce morbidity rates.

#### CONTROL

The control of outbreaks of acute bovine respiratory disease will depend on mass medication or metaphylaxis, minimizing the effects of the risk factors and enhancing immunity by the judicious use of vaccines.

#### Mass medication or metaphylaxis

The parenteral administration of antimicrobials to each animal as a form of mass medication may assist in the reduction of morbidity and mortality rates due to respiratory disease. The use of long-acting oxytetracycline at a dose of 20 mg/kg BW intramuscularly to feedlot cattle on arrival significantly reduced morbidity and mortality rates. The combined use of long-acting oxytetracycline at a dose of 20 mg/kg BW intramuscularly on arrival followed by the oral administration of 25 g of sustained-release sulfadimethoxine on day 3 resulted in a 90% reduction in treatment days per calf purchased. Tilmicosin, given at a dose of 10 mg/kg body weight subcutaneously to calves on arrival in the feedlot or 72 hours later, can significantly reduce the morbidity rate due to respiratory disease and improve the rate of gain.<sup>46</sup>

A formulation of long-acting oxytetracycline (300 mg/mL) at a dose of 30 mg/kg BW intramuscularly is superior to the standard formulation of long-acting oxytetracycline (200 mg/mL) given at 20 mg/kg BW.<sup>47</sup> The 300 mg/mL preparation of oxytetracycline is also more cost-effective than tilmicosin.<sup>48</sup>

Mass medication of cattle on entry into feedlots in Australia with tilmicosin at 10 mg/kg BW grew 0.08 kg/d faster than cattle medicated with oxytetracycline at 20 mg/kg BW and nonmedicated cattle.<sup>49</sup> There was no significant difference in growth rate between oxytetracycline-medicated cattle and those not medicated on entry into the feedlot. Cattle medicated with tilmicosin had fewer treatments for all illnesses compared with cattle not given an antibiotic on entry to the feedlot and compared with cattle mass-medicated with oxytetracycline. Tilmicosin induces apoptosis in pulmonary neutrophils, leading to a reduction in leukotriene B<sub>4</sub> synthesis, thereby reducing further amplification of the inflammatory injury of bovine respiratory disease. Preshipment medication with tilmicosin are not more effective than mass medication on arrival.<sup>50</sup>

The mass medication of feed supplies of newly arrived feedlot cattle has been investigated as a method of reducing the morbidity and mortality due to respiratory disease. The provision of chlortetracycline in the feed at a rate of 1, 2, or 4 g per head daily during the 2-week period after arrival reduced the number of calves that required treatment for respiratory disease.

#### Management of risk factors

As a general outline for the control of bovine respiratory disease the following factors are considered as contributing to disease and their effects must be minimized with suitable management and disease prevention techniques.

- Young growing cattle are more susceptible than mature cattle because of a lack of sufficient immunity. The mixing of young cattle of different origins requires increased surveillance to detect evidence of disease. Vaccination of calves at strategic times may be necessary
- Cattle purchased from various sources and mingled in a feedlot are more likely to develop bovine respiratory disease than cattle that have originated from one source. Some cattle will be highly susceptible and others relatively resistant because of differences in nasal flora and immunological, genetic, and nutritional backgrounds. A high level of management and constant surveillance are necessary to recognize, isolate, and treat clinical cases early in order to minimize morbidity and case mortality
- Rapid fluctuations in environmental temperatures and relative humidity, not only during the fall and winter months but also during warm seasons, will commonly precede outbreaks of respiratory diseases.

Every practical and economical management technique must be used to provide as much comfort as possible and to avoid overcrowding

- Inadequate ventilation is a major predisposing cause of respiratory disease of cattle raised indoors. This is of major importance in dairy herds during the winter months in temperate climates

- The weaning of beef calves during inclement weather may exacerbate the stress of weaning and commonly results in an outbreak of respiratory disease
- The stress associated with the marketing of cattle is a major factor. The movement of cattle through saleyards – where they may be overcrowded, mixed with cattle of many different origins, temporarily deprived of adequate feed and water, handled roughly while being sorted, weighed, tagged, blood sampled, vaccinated or injected with antibiotics and/or vitamins and then loaded on to uncomfortable vehicles and transported long distances without adequate rest stops – is stressful. The practice of preconditioning cattle before they enter the feedlot must continue to be examined to determine which aspects are most profitable.

Presale vaccination programs are designed to establish an effective immune response to common respiratory tract pathogens well in advance of any natural exposure that may occur while calves travel through the auction market or after they arrive in the feedlot. These programs usually require calves to be castrated, dehorned, and vaccinated against IBRV, PI-3V, BRSV, and BVDV. Some programs also require vaccination against *H. somni* and *M. haemolytica*. Presale conditioning programs involve these procedures but also include weaning and nutritional components. Most such conditioning programs require calves to be weaned and adjusted to a roughage and concentrate diet for at least 30 days prior to sale.

Presale vaccination and conditioning programs have increased and decreased in popularity since their introduction in the 1970s. Producers tend to be reluctant to adopt these practices, because there is no assurance they will be rewarded, in terms of price premiums, for their efforts. However, the establishment of special auctions in Ontario that feature large numbers of vaccinated or conditioned calves resulted in an increased interest in these management practices. Producers selling lots of vaccinated or conditioned feeder calves through special auctions received a premium sale price compared

with lots of feeder calves sold through conventional auctions.<sup>51</sup> Vaccinated and conditioned calves were less likely to receive treatment for bovine respiratory disease during the first 28 days in the feedlot; but there was no difference in mortality.<sup>52</sup> Calves that received antimicrobials on arrival at the feedlot had a reduced risk of treatment for bovine respiratory disease compared with calves that did not.

### Vaccines

While vaccines are available for the control of acute respiratory disease associated with IBRV, PI-3V, and *Pasteurella* spp., there are almost no reports available of their efficacy determined under scientifically designed field trials. Based on current immunological technology, efficacious vaccines are considered to be feasible. The vaccines have been evaluated by experimental challenge of vaccinated animals with specific pathogens in a laboratory environment. However, there is little scientific evidence available that the vaccines are protective against acute UBRD as it occurs in the 'real world' situation. Preshipment vaccination of beef calves 3 weeks prior to weaning with vaccines containing IBRV, PI-3V, *Pasteurella* spp., and *H. somni* did not reduce the incidence of UBRD compared to those unvaccinated.

***Pasteurella* bacterins and respiratory viral vaccines** have been used extensively in an attempt to control bovine respiratory disease. Many veterinarians and feedlot owners maintain that vaccination against respiratory disease is an essential component in their disease prevention programs, both to prevent specific disease of the respiratory tract such as clinical infectious bovine rhinotracheitis and to reduce losses due to respiratory disease in the first few weeks after arrival. However, a review of the literature on the efficacy of the vaccines available for the control of bovine respiratory disease concluded that there are few documented data to support the use of vaccines against respiratory disease under feedlot conditions. Efficacy refers to the ability of the vaccine to reduce overall treatment rate and/or increase weight gains economically.

In North America a large number of bacterial and viral vaccines are available for the control of bovine respiratory disease. There are single antigen or multiple antigen vaccines, modified live virus or inactivated virus vaccines containing one or more of the following antigens: *M. haemolytica*, *H. somni*, IBRV, PI-3V, BRSV, and BVDV. There are many multiple antigen vaccines containing combinations of the respiratory viruses, BVDV, *H. somni*,

and *M. haemolytica*. In western Canada, it is more cost-effective to vaccinate auction-market-derived, fall-placed feedlot calves with a multivalent viral vaccine containing IBR, PI-3, BVD, and BRS viruses than a single univalent viral vaccine containing IBRV only.<sup>53</sup>

### Selection of vaccines

The selection of which vaccine to recommend for the control of UBRD in feedlot cattle is currently not possible based on the efficacy information which is available to the veterinarian. The vaccines are used widely and many anecdotal claims for their effectiveness are made but there is little scientific evidence based on properly designed field trials that the vaccines are effective and economical in reducing the incidence or the consequences of respiratory disease such as suboptimal weight gain. The major problem has been that vaccine manufacturers have not conducted a sufficient number of well-designed field trials to evaluate the efficacy of the vaccine against naturally occurring disease in the field with vaccinated animals and unvaccinated animals as concurrent controls. In most cases the vaccines were approved for sale on the basis of tests for safety in animals, and the potency measured by a serological response to the vaccine or experimental challenge in animals under laboratory conditions.

The information available about the commercial vaccines currently used in Canada for protection against bovine respiratory disease has been reviewed.<sup>54</sup> The available vaccines offer protection against only IBRV, BVDV, BRSV, PI-3V, *M. haemolytica*, and *H. somni*. Various combination vaccines containing modified live virus, killed virus, bacterins, and/or bacterial culture supernatants/surface extracts are available.

### Efficacy of vaccines

Meaningful field trials to evaluate vaccines for the control of bovine respiratory disease are difficult to achieve. The case definition of what is a 'case of respiratory disease' has been very general, such as the presence of anorexia, depression, and a fever. Therefore, when testing a vaccine for the control of pneumonic pasteurellosis, the conclusions reached may be questionable if the cause of the sick animals in either the vaccinated or control group is not known – thus the importance of case definition. In contrast to field trials, the measures used by the manufacturer in the laboratory challenge of the vaccine have been specific. In a field trial, the control group and the vaccinated groups must be comparable. Where more than one vaccine is used to control

respiratory disease in vaccinates and controls it is difficult to evaluate one of the vaccines or the components of a multiple antigen vaccine unless large numbers of animals are used. Another problem is the difficulty of having the controls and the vaccinates experience approximately the same risk of being affected with respiratory disease.

Field trials for bovine respiratory disease vaccines are often unsatisfactory because of inadequate planning, unsatisfactory experimental design and lack of monitoring. A check list of key elements to consider when assessing the clinical research published for a particular vaccine has been suggested. The following items should be considered:

- Has the vaccine been laboratory and field tested in randomized controlled field trials? If so, how many trials, and, in each case:
  - Were the control groups concurrent or historical?
  - How were the trial animals challenged?
  - Was the measure of outcome meaningful?
  - Were the biology and epidemiology of the disease considered?
  - Was the vaccine assigned randomly?
  - Were blinding techniques used to reduce bias?
  - What other potentially important biases are evident?
  - How likely is it that the result was a chance finding?
  - What are the differences between the trial animals and animals in your practice? Are these differences important with respect to the vaccine?

A field trial was conducted to compare the serological responses in weaned beef calves 6–8 months of age vaccinated against IBRV, PI-3V, BRSV, and BVDV. There were significant differences in serological responses among the various commercial vaccines. Antibody titers to IBRV were higher in calves vaccinated with modified-live virus IBRV vaccines than when the inactivated vaccine was used. Following double vaccination with modified-live virus IBRV and PI-3V vaccines, seroconversion rates and antibody titers were higher in calves vaccinated intramuscularly than in those vaccinated by the intranasal route. It is not known if these differences reflect differences in vaccine efficacy under field conditions. The effect of using multiple antigens in the same vaccine on the serological responses is not clear. In some cases, vaccines containing the BRSV antigen

resulted in lower titers to BVDV and PI-3V than vaccines that did not contain the BRSV.

The following comments on the use of vaccines as an aid in the control of acute undifferentiated respiratory disease in feedlot cattle are based on the current information available.

#### *Pasteurella* vaccines

Because fibrinous pneumonia associated with *M. haemolytica* is the most common lesion associated with bovine respiratory disease in feedlot cattle, much of the emphasis has been on the development of effective vaccines for bovine pneumonic pasteurellosis. Based on the immunological and microbiological observations of both naturally occurring and experimentally induced pneumonic pasteurellosis it appears that effective artificial immunization of cattle is possible. High levels of naturally acquired antibody to *M. haemolytica* have been associated with protection against the disease.

Calves that recover from experimentally induced pneumonic pasteurellosis possess increased resistance to subsequent experimental challenge. Calves that were naturally exposed to *M. haemolytica* or exposed by vaccination subcutaneously or intradermally to the live organisms developed some resistance to experimental challenge and developed antibodies to all surface antigens and cytotoxin. Resistance to experimental challenge with the organism correlated directly with serum cytotoxin neutralizing titers. This supports the hypothesis that protection against experimental challenge with *M. haemolytica* may require an immune response to cytotoxin. This is supported by the observation that cattle that died from fibrinous pneumonia due to *M. haemolytica* had lower cytotoxin neutralizing activity in their sera than cattle from the same group that died from other causes.

Antibodies to leukotoxin and certain bacterial surface components appear to be important for resistance to disease. The basis of a recently introduced pasteurella vaccine is that vaccination of calves with a leukotoxic culture supernatant from pathogenic *M. haemolytica* provided some protection against experimental challenge with the organism. The vaccine has been evaluated in field trials in feedlots in Canada with variable results. In one trial, the vaccine was used on arrival in fall-placed calves and reduced the pull rate by 4%, the first relapse rate by 11.9% and the second relapse rate by 18.7%. There was an 8.2% decrease in the mean number of treatment days. Overall mortality was decreased by 49% and mortality rate due to fibrinous pneumonia was reduced by

50%. It appeared that vaccinated animals also responded more favorably than non-vaccinated animals. Vaccination of recently shipped nonpreconditioned calves with the vaccine in Ontario resulted in a slight decrease in morbidity, slight improvement in response rates and perhaps an important reduction in relapse rates. When the vaccine was combined with an intramuscular modified-live IBR/PI-3 virus vaccine, the morbidity rate was increased, the response rate was decreased and the mortality rate was increased in some groups. It appears that the use of modified-live virus vaccines in recently arrived calves is contraindicated; this is consistent with earlier observations in the Bruce County Project, where fall-placed calves were vaccinated on arrival with a modified-live virus vaccine.

The *Pasteurella* vaccine has also been evaluated in a field trial that compared its efficacy in calves vaccinated at the ranch 3 weeks prior to shipping to the feedlot, vaccination of ranch calves on arrival in the feedlot, and auction mart calves assigned to either receive or not receive the vaccine on arrival at the feedlot. The vaccine did not effect a change in morbidity rates or weight gain. Total mortality rates were increased significantly, and mortality rates from respiratory disease tended to be increased in ranch calves that were vaccinated at the ranch. In auction-mart-derived calves, the relapse rates were significantly lower in vaccinated calves. The source of calves was a major factor affecting the incidence and/or effects of bovine respiratory disease. Calves moved directly from the ranches to feedlots, regardless of vaccination status, had lower morbidity and mortality, and better weight gains, than calves purchased from auction marts.

#### *Histophilus somni* (formerly *Haemophilus somnus*) vaccine

A *H. somni* bacterin evaluated in a large number of feedlot cattle had no effect on the overall crude mortality rate; however, vaccination appeared to reduce the incidence rate of fatal disease and the mortality rate during the first 2 months in the feedlot, when risk of fatal disease onset was highest. The incidence of fatal disease onset was highest during the first week after arrival, which suggests that inclusion of a *H. somni* bacterin in a cow-calf preimmunization program might reduce the proportion of disease that occurs during the first week in the feedlot. Crude mortality and incidence of fatal disease onset during the second week were reduced significantly in the vaccinated steers. It was concluded that about 17% of fatal respiratory disease in the unvaccinated

steers could have been prevented by vaccination with the *H. somni* bacterin. Fibrinous pneumonia was the most common pathological diagnosis. Vaccinating calves twice with a killed whole-cell *H. somni* bacterin reduced the clinical and pathological effects of experimentally induced *H. somni* pneumonia.

#### Viral vaccines

Because prior infection of the respiratory tract with either IBRV or PI-3V may predispose to pneumonic pasteurellosis, the vaccination of beef calves 2–3 weeks before weaning and feedlot cattle 2 weeks before shipment to a feedlot has been recommended as part of a preconditioning program. The results are variable, but vaccination of calves at 3–6 months of age with an intranasal modified-live IBR and PI-3 virus vaccine has provided protection against experimental pneumonic pasteurellosis induced by aerosol challenge with IBRV followed 4 days later by an aerosol of *M. haemolytica*. It is important to vaccinate the calves at least 2 weeks before they are weaned, stressed, or transported to a feedlot.

A modified-live virus BRSV vaccine given to beef calves prior to weaning, at weaning or immediately after arrival in the feedlot was associated with a significant reduction in the treatment rate in one of three groups immunized prior to weaning and in calves immunized after arrival in the feedlot.<sup>25</sup> There was no significant effect of the vaccine on treatment rate in calves immunized at weaning, in calves immunized after arrival in a bull test station, or in yearlings immunized after arrival in the feedlot. It would appear that the vaccine did provide some protection but the small reduction may not justify the cost of the vaccination program.

Some feedlot veterinarians recommend that feedlot cattle be vaccinated on arrival with an *M. haemolytica* vaccine, the IBRV and PI-3V vaccine, an *H. somni* vaccine, and the BRSV vaccine. In some cases the BVDV vaccine is also used because some veterinarians feel that the virus is part of the respiratory disease complex. It is expected that control will be achieved if the animals are vaccinated against all the common pathogens that contribute to lesions of bovine respiratory disease. However, there is little, if any, published evidence based on controlled field trials that such blanket recommendations are justifiable.

#### REVIEW LITERATURE

Barrett DC. Cost-effective antimicrobial drug selection for the management and control of respiratory disease in European cattle. *Vet Rec* 2000; 146:545–550.

Bowland SL, Shewen PE. Bovine respiratory disease: commercial vaccines currently available in Canada. *Can Vet J* 2000; 41:33–48.

Coomer BL, Nyarko KA, Noyes TM, Gentry PA. Neutrophil-platelet interactions and their relevance to bovine respiratory disease. *Vet J* 2001; 161:41–62.

Cusack PMV, McMeniman N, Lean IJ. The medicine and epidemiology of bovine respiratory disease in feedlots. *Aust Vet J* 2003; 81:480–487.

#### REFERENCES

1. Lonergan GH et al. *J Am Vet Med Assoc* 2001; 219:1122.
2. Wittum TE et al. *J Am Vet Med Assoc* 1999; 209:814.
3. Cusack PMV et al. *Aust Vet J* 2003; 81:480.
4. Martin SW et al. *Can Vet J* 1999; 40:560.
5. Martin SW et al. *Can J Vet Res* 1998; 62:262.
6. Booker CW et al. *Can Vet J* 1999; 40:40.
7. O'Connor A et al. *Can J Vet Res* 2001; 65:143.
8. Haines DM et al. *Can Vet J* 2001; 42:857.
9. Shahriar FM et al. *Can Vet J* 2002; 43:863.
10. O'Connor A et al. *Can J Vet Res* 2001; 65:137.
11. Fulton RW et al. *Can J Vet Res* 2002; 66:181.
12. Baule C et al. *J Clin Microbiol* 2001; 39:146.
13. Martin SW et al. *Can J Vet Res* 1998; 62:257.
14. Hasoksuz M et al. *J Vet Diagn Invest* 2002; 14:308.
15. Lathrop SL et al. *Am J Vet Res* 2000; 61:1057.
16. Lathrop SL et al. *Am J Vet Res* 2000; 61:1062.
17. Storz J et al. *J Am Vet Med Assoc* 2000; 216:1599.
18. Plummer PJ et al. *J Am Vet Med Assoc* 2004; 225:726.
19. Storz J et al. *J Clin Microbiol* 2000; 38:3291.
20. Booker CW et al. *Can Vet J* 1997; 38:555.
21. Sowell BF et al. *J Anim Sci* 1999; 77:1105.
22. Buhman MJ et al. *Am J Vet Res* 2000; 61:1163.
23. Quimby WF et al. *Can J Anim Sci* 2001; 81:315.
24. Van der Fels-Klerx HJ et al. *Livestock Prod Sci* 2000; 66:35.
25. Wildman BK et al. *Can Vet J* 2000; 41:124.
26. Van der Fels-Klerx HJ et al. *Netherlands J Agric Sci* 2002; 50:27.
27. Ayroud M et al. *Can Vet J* 2000; 41:847.
28. Ribble CS et al. *J Am Vet Med Assoc* 1995; 207:616.
29. Ribble CS et al. *Can J Vet Res* 1995; 59:167.
30. Ribble CS et al. *J Am Vet Med Assoc* 1995; 207:612.
31. Ribble CS et al. *Prev Vet Med* 1994; 21:251.
32. Van Donkersgoed J. *Can Vet J* 1992; 33:786.
33. Chirase NK et al. *Am J Vet Res* 2004; 65:860.
34. Donovan DC et al. *J Anim Sci* 2003; 81:3088.
35. Galyean ML et al. *J Anim Sci* 1999; 77:1120.
36. Norstrom M et al. *Prev Vet Med* 2000; 44:87.
37. Norstrom M et al. *Prev Vet Med* 2000; 47:107.
38. Norstrom M et al. *Prev Vet Med* 2001; 51:259.
39. Kelly AP, Jansen ED. *Can Vet J* 1986; 27:496.
40. Welsh RD et al. *J Vet Diagn Invest* 2004; 16:426.
41. Apley MD. *Vet Clin North Am Food Anim Pract* 2003; 19:625.
42. Bryant LK et al. *Bovine Pract* 1999; 33:163.
43. Hoar BR et al. *Can Vet J* 1998; 39:161.
44. Jim GK et al. *Can Vet J* 1999; 40:179.
45. Hamm M et al. *Bovine Pract* 1999; 33:56.
46. Vogel GJ et al. *J Am Vet Med Assoc* 1998; 212:1919.
47. Schunicht OC et al. *Can Vet J* 2002; 43:940.
48. Schunicht OC et al. *Can Vet J* 2002; 43:355.
49. Cusack PMV et al. *Aust Vet J* 2004; 82:154.
50. Duff GC et al. *J Anim Sci* 2000; 78:267.
51. Macartney JE et al. *J Am Vet Med Assoc* 2003; 223:670.
52. Macartney JE et al. *J Am Vet Med Assoc* 2003; 223:677.
53. Schunicht OC et al. *Can Vet J* 2003; 44:43.
54. Bowland SL, Shewen PE. *Can Vet J* 2000; 41:33.

## PNEUMONIC PASTEURELLOSIS OF CATTLE (SHIPPING FEVER PNEUMONIA)

### Symptoms

**Etiology** *Mannheimia (Pasteurella)*

*haemolytica* biotype A serotype 1.

*Pasteurella multocida* biotype A:3

**Epidemiology** Young growing cattle, especially recently weaned beef calves placed in feedlot. Can occur in nursing calves and mature cows. Stressors include transportation, mixing animals from many different sources, ineffective ventilation of housed animals

**Signs** Sudden deaths, acute bacterial bronchopneumonia, fever, toxemia, anorexia, abnormal lung sounds; respond to treatment with antimicrobials

**Lesions** Acute fibrinohemorrhagic pneumonia with pleuritis

**Clinical pathology** Culture organism from nasal swabs. Hemogram indicates severe infection and increase in fibrinogen

**Diagnostic confirmation** Culture organism from lung and histopathology of lung

**Treatment** Antimicrobials

**Control** Preconditioning programs. Management strategies to reduce stressors. Mass medication with antimicrobials of individual animals on arrival in the feedlot. Vaccines containing antigens of *M. haemolytica*

### Differential diagnosis list

- Acute interstitial pneumonia due to BRSV
- Epidemic acute interstitial pneumonia (fog fever)
- Contagious bovine pleuropneumonia
- Enzootic pneumonia of calves
- *Haemophilus* pleuropneumonia of feedlot cattle
- Infectious bovine rhinotracheitis
- Verminous pneumonia (*Dictyocaulus viviparus*)
- Aspiration pneumonia

### ETIOLOGY

*Mannheimia (Pasteurella) haemolytica* biotype A serotype 1 is the most common cause of the pneumonia.<sup>1</sup> Eleven serotypes have been demonstrated within *M. haemolytica*.<sup>2</sup> *M. haemolytica* serotypes 6, 2, 9, and 11 and untypable serotypes have been found in lesions of pneumonic pasteurellosis.<sup>3</sup> *M. haemolytica*-like bacteria have been isolated from cases of bovine pneumonia, and a careful characterization of such isolates is necessary for a proper identification.<sup>4</sup>

Biotype T strains have been isolated from cases of pneumonic pasteurellosis and *P. multocida* is isolated occasionally. *P. multocida* serotypes A3 and D can cause severe bronchopneumonia in calves.<sup>5</sup> The *Pasteurella* spp. are the final cause of the pneumonia but the mechanisms by which the bacteria enter and colonize the lung

and produce the lesions are complex and unclear. Viruses or mycoplasmas may act synergistically to allow the bacteria to be pathogenic. There is often a history of stressors such as:

- Transportation
- Mixing of groups of cattle from different sources
- Confinement of cattle
- Ineffective housing and ventilation.

## EPIDEMIOLOGY

### Occurrence

Pneumonic pasteurellosis is a common disease of young growing cattle in Europe, the UK, and North America. In Canada and the USA the disease occurs most commonly in recently weaned beef calves 6–8 months of age shortly after being placed into feedlots in the fall of the year. Nursing beef calves, yearlings, and mature dairy and beef cows may also be affected, but less frequently. Pneumonic pasteurellosis, also known as **shipping fever**, is an entity within the bovine respiratory disease complex, characterized clinically by acute bronchopneumonia with toxemia and pathologically by lobar, anteroventrally distributed, exudative pneumonia in which fibrin is usually a prominent part of the exudate and fibrinous pleuritis is common.

### Morbidity and mortality

The morbidity may reach 35%, the case-fatality rate may range from 5–10%, and the population mortality rate may vary from 0.75–1%. However, these morbidity and mortality data may not be reliable because of wide variations in the methods used to calculate disease incidence and prevalence. A review of the literature of morbidity and mortality rates and disease occurrence in feedlot cattle in North America found deficiencies in the epidemiological data available from feedlots.<sup>6</sup> Case definitions of clinical cases are often poorly defined. A summary of 14 comparable studies containing disease incidence rates in calves in the first few weeks following arrival in feedlots found wide variations in how the disease definitions and statistics were used. The incidence of morbidity ranged from 0–69% with most reports between 15% and 45%. The population mortality rate ranged from 0–15% with most reports between 1% and 5%. The peak incidence of disease occurs within the first 3 weeks after arrival of the calves in the feedlot. The most common clinical and pathological diagnosis was respiratory disease, often described as shipping fever.

In order to make valid assessments of morbidity and mortality rates, it is imperative that case definitions are stated clearly, the population at risk is precisely

measured and the period of observation is stated or incorporated into the rate.<sup>7</sup> The morbidity rates quoted for bovine respiratory disease are actually treatment rates based on treatment of animals that appear depressed, have a fever and have no signs to suggest disease of a body system other than the respiratory tract. Systematic methods of data collection from the customized records of large feedlots are now available<sup>8</sup> and have been validated by the National Animal Health Monitoring System.<sup>9</sup>

An observational study of the epidemiology of fatal fibrinous pneumonia in feedlot calves purchased from auction marts in western Canada and placed in a commercial feedlot between September 1 and December 31 over a 4-year period identified some valid information.<sup>1</sup> Peak fibrinous pneumonia occurred approximately 16 days after arrival at the feedlot; the median number of days between arrival and the first treatment of fatal fibrinous pneumonia cases varied from 3–8 days. The fatal fibrinous pneumonia mortality varied 11-fold (0.25–2.73%) between years. The fatal fibrinous pneumonia proportionate mortality varied from 10–57%. Fully 75% of the calves that died of fibrinous pneumonia already were sick within 2 weeks after arrival.<sup>1</sup> When the incidence of fatal fibrinous pneumonia was high (greater than 2%), the disease clustered, either within certain truckload groups of calves or within certain pens, or within both.<sup>10</sup> Clustering could have been due to contagious factors, noncontagious factors, or both.

### Economic importance

Pneumonic pasteurellosis is a major cause of economic loss in the feedlot industry. It is responsible for the largest cause of mortality in feedlots in North America. In addition to the death losses, the costs of treatment (which include the personnel involved in the detection and actual treatment, the drugs used and the vaccines) are considerable. While it has been assumed that there is a loss of production following the illness, this has not been documented. In fact, because of compensatory regrowth in animals that have recovered there may be no correlation between average daily gain, feed conversion and treatment.

### Risk factors

#### Animal risk factors

The disease occurs most commonly in young growing cattle from 6 months to 2 years of age but all age groups are susceptible. Calves that are nonimmune to *M. haemolytica* are considered to be more susceptible to the disease than calves that have serum neutralizing anti-

bodies to the organism and its cytotoxin. Calves that have recovered from the experimental disease are resistant to naturally occurring disease. In western Canada, auction market calves that originate from many different farms and are mixed at the market are at high risk. The calves may develop the disease before weaning if subjected to the stress of an early snowstorm in the late fall in Canada. Similar observations in single-suckled calves have been made in the UK.

The disease occurs commonly in outbreaks 7–10 days after cattle have arrived in the feedlot following stressful transportation. This forms a major part of the 'shipping fever' complex, which is a major hazard in the practice of rearing beef cattle on range country and then transporting them long distances to other centers for growing and finishing. However, in a western Canadian study, the distance that calves were transported by truck from the auction markets to the feedlot was not associated with an increased risk of fatal fibrinous pneumonia.<sup>11</sup> The risk of fatal fibrinous pneumonia was just as high for calves arriving from nearby markets as for calves transported much greater distances.

Although the disease occurs most commonly in young beef cattle soon after their introduction to feedlots it is not uncommon in dairy herds, especially when recent introductions have been made or cattle are returned to their home farms after summer grazing on community pastures or exhibition at fairs. Herd outbreaks of peracute pleuropneumonia due to *M. haemolytica* have been reported in adult dairy cattle.<sup>12</sup> Only adults were affected, many animals were affected, a high proportion of affected cows were in the immediate postcalving period, and all farms had purchased cows and/or heifers within the last 12 months. There was no history of transportation or movement of affected animals. Mature beef cows are also susceptible to pneumonic pasteurellosis if they are subjected to stressors during the summer months or in the fall of the year, usually associated with moving large groups to or from pasture during inclement weather.

#### Environmental and management risk factors

The mixing of cattle from different sources is an important risk factor. Mixing of recently weaned beef calves from different sources at auction markets was associated with an increased risk of fatal fibrinous pneumonia in calves moved to feedlots in western Canada, especially in November, shortly after auction sales had

peaked and when the feedlot was reaching capacity.<sup>13,14</sup>

The role of stress as a risk factor in shipping fever pneumonia has been examined experimentally. Experimental transportation and handling to mimic stress, followed by an aerosol of *M. haemolytica*, did not result in significant lesions of pneumonia but did make the animals susceptible to BHV-1. The effects of transportation and assembling of yearling beef calves can result in an increase in the levels of plasma fibrinogen, which is an indication of some stress. Deprivation of feed and water followed by confinement in unfamiliar surroundings also results in an increase in fibrinogen. The response of the animals was also dependent upon the previous environment and management applied to them before assembly and transportation.

Confinement in drafty or humid and poorly ventilated barns, exposure to inclement weather, transport, fatigue and deprivation from feed and water are commonly followed by outbreaks of the disease in cattle. An increase in virulence of the bacteria is often evident after animal passage; at the commencement of an outbreak only those animals that have been subjected to devitalizing influences are affected but the disease may subsequently spread to other animals in the group. There is little tendency for the disease to become an area problem, sporadic outbreaks occurring with the appearance of conditions favorable to the development of the disease.

#### Pathogen risk factors

The frequency of isolation of *Pasteurella* spp. from the nasal passages of normal healthy unstressed calves is low but increases as the animals are moved to an auction mart and then to a feedlot.<sup>15</sup> Normally, it is difficult to establish long-term colonization of the nasal cavities of healthy, nonstressed calves with *M. haemolytica*. When calves are inoculated intranasally with IBRV or PI-3V, the nasal passages become much more susceptible to colonization with *M. haemolytica* even in the presence of antibodies to the organism in the serum and nasal secretion. The prevalence of *M. haemolytica* biotype A serotype 1 in the nasal cavity and trachea can be low in beef calves from a closed herd that is maintained on range pastures, and serum antibody levels are also low. Over time there may be an increase in the frequency of isolation of the bacteria from healthy calves that were moved to pens, held in low population densities and maintained under low stress conditions. In some cases, serotype 2 predominates while the calves are on the farm, and serotype 1 predominates

when the calves are in the feedlot and affected with pneumonia.

There also are relationships between the numbers of bacteria in the nasopharynx and the ambient temperature and humidity. In calves kept at a constant temperature of 16°C (60°F), the bacterial populations in the nasopharynx were at a minimum between 65% and 75% relative humidity and tended to rise at humidities outside that range.

The possibility that infection with several different viruses and mycoplasma may predispose to pneumonic pasteurellosis has been a subject of intense research activity and is presented in more detail under Pathogenesis. Seroepidemiological surveys of cattle in feedlots reveal that IBRV, PI-3C, BVDV, and BRSV were present, active, and associated with respiratory disease.<sup>16</sup> The presence of antibody indicates current or recent exposure to the virus but does not indicate resistance. Cattle with low titers to IBRV and/or BRSV were at increased risk of subsequent treatment for bovine respiratory disease. Treated cattle also had greater increases to PI-3V and/or BVDV than control calves. While there is evidence that BVDV can experimentally affect certain immune mechanisms, there is little direct evidence that the virus is a major predisposing factor in the causation of naturally occurring pneumonic pasteurellosis. Seroepidemiological surveys indicate that seroconversion to BVDV is related to increased risk of respiratory disease at both individual and group levels. Serologically there is also evidence of a high prevalence of *M. bovis* and *M. dispar* in feedlot calves.<sup>17</sup> But the relative importance of these pathogens as a cause and effect relationship is controversial.

Bovine coronavirus has been associated with some natural outbreaks of shipping fever in feedlot cattle. Up to 80% of affected animals shed bovine coronavirus from their nasal cavities when the infection rate with *Pasteurella* spp. was low.<sup>18</sup>

The virulence factors of *M. haemolytica* include fimbriae, polysaccharide capsule, outer membrane proteins, endotoxin (lipopolysaccharide), and leukotoxin, which are described later under pathogenesis. The genes that code for the various virulence factors of *M. haemolytica* have been cloned for detailed characterization.<sup>19</sup> Fibrinogen-binding proteins may be present in the culture supernatants of *M. haemolytica* serotype 1 and *Pasteurella trehalosi* serotype 10.<sup>20</sup> These bacteria may contribute directly to fibrin formation and the development of fibrinous pneumonia.

*M. haemolytica* serotypes A1 and A2 can survive for long periods of time in relatively low-nutrient *in vivo* fluids. Both strains survived for at least 244 days in

ovine and 156 days in bovine tracheo-bronchial washings, respectively.<sup>21</sup> This may provide an explanation for the long survival of the organism in the nasopharynx of ruminants.

Tetracycline resistance (*tet*) genes have been found in isolates of *P. multocida*, *M. haemolytica*, *Mannheimia glucosida*, and *Mannheimia varigena* from cases of respiratory diseases in cattle and pigs in Germany.<sup>22</sup> Tetracycline resistance in *P. multocida* and *M. haemolytica* is mediated by at least three different *tet* genes, most of which are located on the chromosomes. A new *tet* (H)-carrying plasmid has been identified, and *tet* (B) has been detected in *P. multocida*, and *tet* (G) in *M. haemolytica*.

#### Immune mechanisms

Calves that have recovered from the experimental disease are resistant to naturally occurring disease. Numerous *M. haemolytica* antigens may stimulate the immune response and resistance to disease. These antigens include capsular polysaccharide, leukotoxin, and surface antigens, including iron-regulated proteins,<sup>23</sup> a serotype-specific outer membrane protein, and several other antigens that are less well defined. High antibody responses to *M. haemolytica* surface extract proteins are correlated with resistance to experimental pneumonic pasteurellosis. Resistance to experimental challenge with the organism correlates directly with serum cytotoxin neutralizing titers. Cattle dying from pneumonic pasteurellosis may have lower levels of cytotoxin neutralizing antibody than animals from the same group dying from other causes. Aerosol exposure of calves with *M. haemolytica* results in the development of toxin neutralizing antibodies in pulmonary lavage samples and an accompanying increase in serum neutralizing titer. Since aerosol exposure of calves to viable *M. haemolytica* elicits a protective immune response characterized by enhanced clearance of the organism from the lung and by protection against fibrinous pneumonia, it is possible that the presence of pre-existing antibodies to the leukotoxin in the lungs may provide immunity by protecting phagocytic leukocytes from the leukotoxin and by promoting phagocytosis and intracellular killing of the organism.

Passive immunization with antibodies to whole *M. haemolytica* or leukotoxin-containing supernatants provides protection against experimentally induced pneumonic pasteurellosis similar to the protection provided by active immunization with these antigens.<sup>24</sup> In contrast, antibodies to lipopolysaccharide provided little protection against challenge.



Cattle exposed to live organisms produce antibodies to both cell surface antigens and cytotoxin, whereas exposure to the killed vaccine results in the production of antibodies primarily to cell surface antigens.

The experimental lung challenge of calves with formalin-killed *P. multocida* does not provide subsequent protection to challenge with live *P. multocida*.<sup>25</sup>

#### Method of transmission

Transmission of pasteurillas probably occurs by the inhalation of infected droplets coughed up or exhaled by infected animals, which may be clinical cases or recovered carriers in which the infection persists in the upper respiratory tract. *M. haemolytica* and *P. multocida* are highly susceptible to environmental influences and it is unlikely that mediate contagion is an important factor in the spread of the disease. When conditions are optimal, particularly when cattle are closely confined in inadequately ventilated barns, or when overcrowded in trucks and trains, or held for long periods in holding pens in feedlots, the disease may spread very quickly and affect a high proportion of the herd within 48 hours. In animals at pasture, the rate of spread may be much slower.

#### PATHOGENESIS

The literature on pathogenesis, including the extensive experimental work done on the role of the virulence factors, has been reviewed.<sup>23,26</sup>

#### Colonization of upper and lower respiratory tracts

Considerable research has centered on determining how the pasteurillas, which are part of the normal flora of the upper respiratory tract, colonize first the upper respiratory tract then the lower respiratory tract. Under normal conditions the bovine lung is relatively free of pasteurillas because of an effective lung clearance mechanism. The current hypothesis is that a combination of a viral infection of the respiratory tract and/or devitalizing influences from transportation, temporary starvation, weaning, rapid fluctuations in ambient temperature, the mixing of cattle from different origins and the excessive handling of cattle after arrival in a feedlot can all collectively promote an increase in the total numbers and virulence of pasteurillas in the nasopharynx, which then enter the lung. In clinically normal cattle, *M. haemolytica* are present in low numbers in the tonsil and nasal passages and those that are isolated are predominantly biotype A serotype 2 which is rarely associated with shipping fever. Exposure of healthy cattle to stressors such as viral infection, change in manage-

ment practices and environmental changes leads to an explosive growth and selective colonization by *M. haemolytica* A 1 in the upper respiratory tract.

The experimental intranasal exposure of calves to a leukotoxin-deficient *M. haemolytica* elicits an increase in the serum antibody titers against the organism and decreased colonization of the nasopharynx by wild-type *M. haemolytica*.<sup>27</sup> This could allow an immune response to develop before transportation and offer protection from nasopharyngeal colonization and pneumonia by wild-type *M. haemolytica*.

Under normal conditions, alveolar macrophages will effectively clear pasteurillas from the alveoli by phagocytic mechanisms. When the large numbers of organisms enter and colonize the lung they interact with alveolar macrophages. Neutrophils enter the lung within the first few hours after bacterial inoculation.

Bovine alveolar macrophages release superoxide anion when exposed to *M. haemolytica* and the response is dependent on the presence of opsonizing antibody and the quantity of organisms presented to the phagocyte.<sup>28</sup> This may have a major role in the pathogenesis of the acute lung injury associated with pneumonic pasteurellosis. It is an important mechanism by which this phagocyte can initiate microbicidal activity and may provide clues to further study of the defense mechanisms of the lung.

#### Virulence factors and cellular and humoral reactions

The lung injury caused by the organisms after entry into the lung is dependent on important virulence factors.

Four virulence factors have been associated with *M. haemolytica*:

- **Fimbriae**
- **A polysaccharide capsule**
- **Endotoxin (lipopolysaccharide)**
- **Leukotoxin.**

The interactions of these virulence factors contribute to the pathogenesis of the disease.<sup>23,26</sup> **Fimbriae** enhance the colonization of the upper respiratory tract. The **polysaccharide capsule** of the organism inhibits complement-mediated serum killing as well as phagocytosis and intracellular killing of the organism. The capsule also enhances neutrophil-directed migration and adhesion of the organism to alveolar epithelium. The **lipopolysaccharide** or **endotoxin** can alter bovine leukocyte functions and is directly toxic to bovine endothelium. It also modifies cardiopulmonary hemodynamics and elevates circulatory prostanoids, serotonin, cAMP, and cGMP. The organism induces morphological alterations in bovine

pulmonary endothelial cells, the effects of which can be partially inhibited by indomethacin.<sup>29</sup> Tissue factor is involved in intra-alveolar fibrin deposition and coagulopathy associated with pneumonic pasteurellosis in cattle.<sup>30</sup>

The migration and activation of neutrophils in inflamed tissue are regulated by a complex network of interactions among cytokines, leukocytes, vascular endothelium, cellular adhesion molecules, and soluble chemotactic factors.<sup>26</sup> The inflammatory cytokines tumor necrosis factor alpha, interleukin (IL)-1 beta, and IL-8 play a central role in the initiation and orchestration of these interactions.<sup>23,26</sup> IL-8 is the dominant cytokine expressed within the lungs during the acute phase of pneumonic pasteurellosis.<sup>31</sup>

Neutrophil-mediated inflammation in cattle with pneumonic pasteurellosis contributes to the development of severe disease rather than effective clearing of invading *M. haemolytica*. Leukotoxin is one of the major virulence factors of *M. haemolytica* responsible for impaired functions of neutrophils.

The **lipopolysaccharide** or **endotoxin** of *M. haemolytica* is capable of causing direct injury to bovine pulmonary arterial endothelial cells, which may be a contributing pathogenetic mechanism. Endotoxin interacts with numerous cell types and humoral mediator systems, resulting in widespread injury to the lung. Endotoxin can readily cross the alveolar wall either from the air or blood and interact with cells and humoral mediators. The endotoxin can be found in the neutrophils in the alveolus, interstitial tissue, and capillary lumen; in intravascular, interstitial, and alveolar macrophages; in endothelial cells; and on alveolar epithelial cell surfaces.<sup>23</sup> The interaction of endotoxin with cells leads to cell activation and death.

**Leukotoxin** is produced by all known serotypes and is a heat-labile protein exotoxin, a pore-forming cytotoxin that affects ruminant leukocytes and platelets. The bacterium produces the leukotoxin, with maximum production occurring during the log phase of growth, peaking after 6 hours of incubation. Following the inhalation of *M. haemolytica* into the lung there is an accumulation of neutrophils that, when destroyed by leukotoxin, result in the release of proteolytic enzymes, oxidant products, and basic proteins, which degrade cellular membranes, increasing capillary permeability, which results in fluid accumulation in the interstitium of the alveolar wall, alveolar wall necrosis, and pulmonary edema. Leukotoxin also induces histamine release from bovine mast cells.<sup>32</sup> The importance of the neutrophil is supported

by experimental evidence that depletion of blood neutrophils in calves made the animals much less susceptible to pulmonary injury following intratracheal inoculation of *M. haemolytica*.

Exposure to low concentrations of *M. haemolytica* leukotoxin in vitro induces apoptosis in bovine leukocytes.<sup>33</sup> Apoptosis is a process of cell death distinguished from necrosis by various morphological and biochemical criteria. These include chromatin collapse with subsequent chromatin margination in crescent-shaped masses around the periphery of the nucleus, blebbing of the cytoplasmic membrane, and internucleosomal cleavage of DNA into nucleosome-sized fragments. This may represent an important mechanism by which *M. haemolytica* overwhelms host defenses.

Tilmicosin, a very effective antibiotic for the treatment of pneumonic pasteurellosis, induces apoptosis in neutrophils, which results in reduced levels of the potent proinflammatory mediator leukotriene B<sub>4</sub> in lung fields of infected calves treated with tilmicosin. The tilmicosin-induced apoptosis in neutrophils directly enhances phagocytic removal of these cells by macrophages.<sup>33,34</sup>

Supernatants of the organism can also cause rapid cytolysis of platelets. The genes that code for the synthesis and secretion of the leukotoxin have been cloned. It is a highly immunogenic protein that is produced by all 15 serotypes of *M. haemolytica*. Antiserum raised to the 105 kDa protein neutralizes its leukotoxic activity. Cattle with high leukotoxin antibody titers have higher survival rates in natural and experimental cases of pneumonic pasteurellosis than animals with low antibody titers. The development of efficacious vaccines will probably depend on using leukotoxin antigens and bacterial surface components to elicit maximum resistance against pneumonic pasteurellosis. Assay tests for determination of cytotoxin neutralizing antibody titers in cattle sera are described. There is positive correlation between ELISA titers to cytotoxin and protection to experimental pneumonic pasteurellosis.

### Experimental pneumonic pasteurellosis

In an attempt to understand the pathogenesis of shipping fever pneumonia the experimental disease has been reproduced using several different methods: the most commonly used is the sequential aerosol infection of calves with either the PI-3 virus or the IBR virus followed by an aerosol of *M. haemolytica* 3 days or more later.<sup>35,36</sup> Exposure of calves to aerosols of PI-3V followed by *M. haemolytica* at intervals of 3–13 days later results in a

purulent bronchopneumonia. The virus interferes with the lung clearance of *M. haemolytica* when an aerosol of the bacteria is given 7 days following the viral infection. There is little interference after only 3 days and a moderate degree at 11 days.

Pneumonic pasteurellosis similar to the naturally occurring disease can be reproduced experimentally by exposing calves sequentially to aerosols of BHV-1 and *M. haemolytica* 4 days apart.<sup>35,36</sup> The virus infection partly destroys the clearance mechanism of the respiratory tract epithelium and exacerbates the subsequent *M. haemolytica* infection.<sup>35</sup> Both antigens can be detected by immunohistochemical methods in the bronchoalveolar fluid cells.

The viral–bacterial synergism is associated with the release of cytokines, which attract more leukocytes and increase leukocyte expression of CD11a/CD18. In this experimental model, vaccination of the animal against the virus before challenge with the viral–bacterial aerosol sequence is protective. The interaction between the IBR virus and *M. haemolytica* can persist for up to 30 days after infection with the virus. A sequential aerosol infection of IBRV and *P. multocida*, or *P. multocida* alone, can also result in pneumonia. Experimental in vitro studies indicate that IBRV infection does not have a direct effect on the ability of neutrophils to phagocytose *M. haemolytica* but rather that there is an indirect effect, perhaps through the release of mediators that have an effect on phagocyte function. Large amounts of interferon are produced throughout the course of IBRV infection, which reduces chemotaxis and elevates oxidase activity by bovine neutrophils.

Pneumonic pasteurellosis can also be reproduced by transthoracic intrapulmonic infection of unstressed, conventional calves with only *M. haemolytica* or *P. multocida*, endobronchial inoculation intratracheal challenge, or intranasal inoculation of calves with the organism without a preceding viral infection. The intratracheal injection of *P. multocida* biotype A:3 into 8-week-old calves results in clinical and pathophysiological findings characteristic of bovine pneumonic pasteurellosis and gross pathological and microscopic changes similar to field cases.<sup>5</sup> Concentrations of the acute phase proteins haptoglobin, serum amyloid-A and alpha-1 acid glycoprotein increased, suggesting a role for these proteins as markers of the onset of and progress of the disease.

The intratracheal instillation of live *M. haemolytica* into conscious calves results in acute cardiovascular changes consisting of two systemic hypodynamic

and pulmonary vasoconstrictive phases.<sup>37</sup> Injection of metrenperone (a 5HT<sub>2</sub> receptor antagonist) 2 hours after inoculation abolishes the late increases in pulmonary arterial pressure and pulmonary vascular resistance.<sup>28</sup>

### Synergism between pathogens

Experimentally, synergism may occur between *M. haemolytica* and *M. bovis* in producing pneumonia in gnotobiotic calves and not in conventional calves.

The role of BVDV in outbreaks of pneumonic pasteurellosis is uncertain. In one study the virus did not impair the pulmonary clearance of *M. haemolytica*. In a different study the endobronchial inoculation of calves with the virus and *M. haemolytica* sequentially 5 days apart resulted in a severe fibrinopurulent bronchopneumonia and pleuritis involving up to 75% of the total lung volume. Endobronchial inoculation of the organism only caused a localized noninvasive lesion in the lungs.

**In summary, pneumonic pasteurellosis can be reproduced experimentally without a preceding virus infection, and it is likely that the naturally occurring disease can also occur without a preceding viral infection.**

The terminal lesion is an acute fibrinous pleuropneumonia. The ventral aspects of the apical and cardiac lobes of the lungs are most commonly affected; in advanced cases a greater portion of the lung becomes affected and other lobes of the lung become involved. Consolidation of affected lobes results in loud breath sounds, and the exudative nature of the lesion causes crackles. The pleuritis causes thoracic pain and pleuritic function rubs. Death is due to hypoxemia and toxemia. Complications include pulmonary abscessation, chronic pleuritis with or without pleural effusion, bronchiectasis, pericarditis and, rarely, congestive heart failure due to cor pulmonale.

### CLINICAL FINDINGS

The spectrum of clinical findings depends in part on whether the disease is occurring in groups of young cattle in a large commercial feedlot, in a small farm feedlot or in individual animals such as lactating dairy cows, in which illness is more easily recognized based on milk production and feed intake. In the feedlot situation, affected animals must be identified primarily by visual observation followed by closer physical examination.

### Feedlot

In the feedlot, the disease usually occurs within 10–14 days after the animals have been stressed or have arrived in the feedlot. It may occur within 1 day after arrival if the animals have been incubating

the disease prior to arrival. Animals found dead without any previous warning signs may be the first indication of an outbreak in which many weaned beef calves are obviously affected and some are in the incubation stages of the disease.

When viewed from a distance, affected cattle are depressed and their respirations are rapid and shallow. There may be a weak protective cough, which becomes more pronounced and frequent if they are urged to walk. Those that have been ill for a few days will appear gaunt because of anorexia. A mucopurulent nasal discharge, a crusty nose, and an ocular discharge are common. Although affected cattle are anorexic, they may continue to drink maintenance amounts of water, which may be useful in mass medication of the water supplies.

When the disease has been diagnosed in a group or pen of animals, and new cases are occurring daily, those that are in the earliest stages of the disease are not obviously ill when examined from a distance. If the entire group of animals is put through a chute and examined closely, up to 20%, or even more, of apparently normal animals may have a fever ranging from 40–41°C (104–106°F) and no other obvious clinical abnormalities. Auscultation of the thorax of some of these subclinical cases will reveal rapid shallow respirations and an increase in the loudness of the breath sounds. These animals respond remarkably well to treatment. If not treated at this stage, they may progress to clinical cases within a few days or they may recover uneventfully.

Not all animals that appear depressed have significant lung disease that requires treatment. When the presence of a fever of 40°C, or higher, in animals which are depressed, is used to decide whether or not the animal has pneumonia and requires treatment, some animals are treated unnecessarily. This is a problem in large feedlots that process many 'sick' animals daily based on the clinical findings of depression and fever. Using depression and a fever, the sensitivity of detection of sick animals is high but the specificity is low and therefore more animals are treated than is necessary. Improvement of the accuracy of both the diagnosis and the selection of those animals that require treatment will require improvement in the accuracy of the identification of affected animals by visual observation, and the use of rapid and reliable clinical examination techniques of individual animals that can identify animals with evidence of pulmonary disease. Close physical examination techniques, such as auscultation of the lungs, have not been routinely used in feedlots because of the time required to examine individual

animals and the perceived inaccuracy of the examination in making a clinical diagnosis.

Outbreaks of the disease in feedlots may last for 2–3 weeks or longer after the first **index case**, depending on the health status of the cattle when first affected. Outbreaks can be prolonged in feedlots that add groups of newly arrived cattle to an existing pen of cattle every few days in order to fill the pen to optimum capacity. The disease then occurs in each new group of cattle and may spread to previously resident cattle, perpetuating the disease for several weeks.

The origin of the cattle also influences the severity and length of outbreaks. In well-nourished cattle originating from one ranch and maintained as a single group the morbidity may be less than 5% and the mortality nil. The outbreak will last only a few days and the cattle return to normal quickly. In cattle that have originated from a variety of sources and moved through saleyards and then commingled in the feedlot, the disease may persist for several weeks. In these situations, many animals are sick with the disease when they arrive at the feedlot. Some cattle will develop complications, never fully recover and are culled later.

#### Close physical examination

The relationships between clinical and pathological findings of disease in calves experimentally infected with *M. haemolytica* type A1 indicated that the respiratory rate, rectal temperature and clinical scores are significantly correlated with the extent of consolidation of the lungs.<sup>38</sup> The respiratory rate increased from 30 per minute up to 70 per minute as the percentage of lung consolidation increased from 10% to 50%.

The typical case of pneumonic pasteurellosis reveals a fever of 40–41°C (104–106°F), bilateral mucopurulent nasal discharge, gaunt abdomen with rumen atony, coughing, varying degrees of polypnea and dyspnea, and evidence of bronchopneumonia. In the early stages there are loud breath sounds audible over the anterior and ventral parts of the lungs. As the disease progresses these breath sounds become louder and extend over a greater area; crackles become audible, followed by wheezes in a few days, especially in chronic cases. Pleuritic friction rubs may be audible, although their absence does not preclude the presence of extensive adherent pleuritis. In severe cases or those of several days' duration the dyspnea is marked, commonly with an expiratory grunt, although the respiratory rate may not be elevated.

The course of the disease is only 2–4 days. If treated early, affected cattle

recover in 24–48 hours but severe cases and those that have been ill for a few days before being treated may die or become chronically affected in spite of prolonged therapy. Some cattle recover spontaneously without treatment.

A mild diarrhea may be present in some cases but is usually of no consequence. On an affected farm, calves may be affected with pneumonia and young calves may die of septicemia without having shown previous signs of illness.

### CLINICAL PATHOLOGY

#### Bacterial culture

Nasal swabs taken from clinical cases before treatment often yield a pure culture of pasteurellas, but *M. haemolytica* biotype A serotype 1 is the most common isolate obtained from cattle with acute pneumonic pasteurellosis. The same serotype can usually be isolated from in-contact and apparently healthy calves. The antimicrobial sensitivity of the pasteurellas isolated can be determined, but interpretation of the results is often difficult because it is not known whether the isolates from nasal swabs represent those causing the lesions. Significant differences may exist between the antimicrobial sensitivities of isolates from nasopharyngeal swabs and those from the lung tissues. Thus it is not yet possible to recommend routine culturing and antimicrobial sensitivity determination of pasteurellas from nasal cavity or nasopharyngeal mucus from cattle with acute shipping fever pneumonia. At the individual animal level, nasopharyngeal swabs and bronchoalveolar lavage reveal only moderate agreement; at the group level the isolation rates of various organisms are similar. In healthy calves monitored from the farm to the feedlot there was no relationship between the nasal flora and pulmonary lesions. There is some evidence that antimicrobial resistance is emerging among field isolates of *M. haemolytica*, and plasmid-mediated antimicrobial resistance is now known to occur.

#### Hematology

Plasma fibrinogen concentrations are elevated, paralleling the increase in body temperature, and are a more reliable indication of the presence of the lesion than clinical assessment. Young cattle with clinical signs of acute respiratory disease, a fibrinogen concentration greater than 0.7 g/dL and a temperature greater than 40°C (104°F) are likely to have pneumonic pasteurellosis. Leukocyte counts are of little value, as a leukocytosis and neutrophilia occur in some animals but in others there may be a neutropenia or no significant change. Acute phase proteins are increased within 24 hours following experimental intratracheal inoculation of *M. haemolytica* into calves. The availability

of a rapid test for acute phase proteins could assist in the field diagnosis of the disease and its possible differentiation from similar diseases.

### NECROPSY FINDINGS

There is marked pulmonary consolidation, usually involving at least the anteroventral third of the lungs. The stage of pneumonia varies within the affected tissue, commencing with congestion and edema and passing through various stages of airway consolidation with sero-fibrinous exudation in the interlobular spaces. A catarrhal bronchitis and bronchiolitis, and a fibrinous pleuritis are usually present and may be accompanied by a fibrinous pericarditis. The lung is firm and the cut surface usually reveals an irregular, variegated pattern of red, white, and gray tissue due to hemorrhage, necrosis, and consolidation. Coagulation necrosis of pneumonic lungs is the most characteristic lesion in pneumonic pasteurellosis. In chronic cases there are residual lesions of bronchopneumonia with overlying pleural adhesions. Occasionally, sequestra of necrotic lung tissue are found. *P. multocida* causes a fibrinopurulent bronchopneumonia without the multifocal coagulation necrosis that is characteristic of the fibrinous lobar pneumonia associated with *M. haemolytica*.

The sequential gross and microscopic lesions of experimental bovine pneumonic pasteurellosis have been described and may provide guidelines for aging the lesions in naturally occurring cases.<sup>39</sup> On days 2–3 after infection the lesion is characterized by soft gray-purple consolidation; on day 6 the affected areas are firm and nodular; on days 9–10 the nodular lesions are more prominent and fibrous tissue encapsulates the lesions and becomes obvious. The initial microscopic changes consist of flooding of the alveoli with edema, fibrin, and hemorrhage. Large numbers of neutrophils and macrophages move into the alveoli by day 2. The classical lesion is visible by day 4 and consists of necrotic tissue surrounded by a dark zone of inflammatory cells. The elongate, 'oat-cell' profile of some of these leukocytes is a useful marker in culture-negative cases. In nonfatal cases a walling-off reaction by fibrous tissue isolates the necrotic tissue. Determination of the age of the lesions by gross and/or microscopic examination may assist in correlating the occurrence of the disease with specific health management procedures in the herd.<sup>39</sup> In feedlot cattle, determining the age of bacterial pneumonia can help to assess whether or not the pneumonia was present in the animal on arrival or if treatment failure resulted from late detection or from inadequate

drug therapy. The degree of necrosis and fibrosis are the main lesions used to age pneumonia.<sup>39</sup>

In general, *M. haemolytica* causes a fibrinous pleuropneumonia with extensive thrombosis of interstitial lymph vessels and limited evidence of bronchitis and bronchiolitis. In contrast, bronchopneumonia due to *P. multocida* is associated with a suppurative bronchitis, minor thrombosis of interstitial lymph vessels and considerably less exudation of fibrin.

The organism is easily cultured from acute, untreated cases but other species of bacteria, including anaerobes, are often found in more chronic cases. More sophisticated tests such as PCR and immunoperoxidase techniques are available for the detection of *M. haemolytica* but are seldom required in diagnostic cases.

### Samples for confirmation of diagnosis

- Bacteriology – lung, bronchial lymph node (CULT)
- Histology – formalin-fixed lung (LM).

### DIFFERENTIAL DIAGNOSIS

The differential clinical diagnosis of pneumonic pasteurellosis is summarized in Table 18.5.

As a general guideline the common pneumonias of cattle may be divided into bronchial, interstitial, and hematogenous.

- The **bronchial pneumonias** include pneumonic pasteurellosis and other less common bacterial pneumonias characterized by toxemia and shallow respiration and a good response to early treatment
- The **interstitial pneumonias** include the viral and parasitic pneumonias, and acute interstitial pneumonias characterized by **marked** respiratory distress and a slow response or no response to treatment. In viral pneumonias the animals may die acutely in a few days or recover over a period of several days
- The **hematogenous pneumonias** are associated with vena caval thrombosis and pulmonary aneurysm and are characterized by acute respiratory distress and hemoptysis and no response to treatment.

**Pneumonic pasteurellosis of cattle** is an acute, toxemic bronchopneumonia with a high fever and a good response to treatment in the early stages. Depression and anorexia are common. The disease is most common in young beef calves that have been recently stressed following weaning or mixed in auction markets and shipped to feedlots. The disease can also occur in mature cattle as a primary or secondary pneumonia.

In **viral interstitial pneumonia** of calves, young and adult cattle there is characteristic dyspnea, a moderate fever, only a mild toxemia, loud breath sounds

over the ventral aspects of the lungs followed by crackles and wheezes in a few days, and recovery may take several days. Pneumonia due to BRSV may be mild with uneventful recovery or severe with dyspnea and subcutaneous emphysema and a high case-fatality rate.

**Lungworm pneumonia** occurs most commonly in young pastured cattle and is characterized by dyspnea, coughing, only mild toxemia and a moderate or normal temperature; the course may last several days. Usually many cattle are affected. Crackles and wheezes are usually audible over the dorsal aspects of the lungs and the response to treatment is usually favorable if treatment is initiated early when signs are first noticed.

**Less common causes of acute pneumonia in calves and young cattle** include infection with *Klebsiella pneumoniae*, *Streptococcus* spp., and *Fusobacterium necrophorum*, all of which are characterized by a bronchopneumonia indistinguishable clinically from pneumonic pasteurellosis.

**Epidemic acute interstitial pneumonia (fog fever)** usually occurs in outbreaks in pastured cattle that have been moved from dry to lush pasture (or just a different species of pasture or on to a recently harvested cereal grain field); the onset is sudden, some cattle may be found dead, while others are in severe respiratory distress with an expiratory grunt.

**Infectious bovine rhinotracheitis** is characterized by rhinitis, usually with discrete lesions in the nares, tracheitis, loud coughing, high fever and no toxemia unless secondary bacterial pneumonia is present. Recovery usually occurs gradually over 4–7 days.

**Contagious bovine pleuropneumonia** resembles pneumonic pasteurellosis but occurs in plague form; there is severe, painful, toxemic pleuropneumonia and the case fatality rate is high.

### TREATMENT

#### Antimicrobial therapy

The recommendations for the treatment of bovine pneumonic pasteurellosis are based on clinical experience and the results of clinical field trials.

About 85–90% of affected cattle recover within 24 hours if treated with antimicrobials such as oxytetracycline, tilmicosin, trimethoprim–sulfadoxine, the sulfonamides, and penicillin. Broad-spectrum antimicrobials are used most commonly. One treatment is usually adequate and most economical for most cases but severely affected cattle or those that relapse require treatment daily, or even two to three times daily, depending upon the drug used, for up to 3–5 days.

Choice of antimicrobial  
This will depend on the cost, availability, expected efficacy based on previous experience with the antimicrobial in a

particular area, ease of administration, frequency of administration required, concentrations of the antimicrobial that can be achieved in the lung tissues of affected animals, and length of the withdrawal period required before slaughter or withholding of milk in lactating dairy cattle. The choice of antimicrobial also depends on the concentrations that can be achieved in the lung tissues of affected animals. The concentrations of oxytetracyclines are higher in pneumonic lung than in normal lung. Pharmacokinetic studies of oxytetracycline in experimental pneumonic pasteurellosis indicates the need for observance of 12-hour dose intervals.<sup>40</sup>

The antimicrobials and their dosage schedule in Table 18.6 are recommended as a guideline.

The efficacies of **oxytetracycline, penicillin, and trimethoprim-sulfadoxine** are not significantly different for the treatment of undifferentiated bovine respiratory disease in cattle within the first 28 days after arrival in the feedlot.<sup>41</sup> The response, relapse, and case fatality rates overall were 85.7%, 14.8%, and 1.4%, respectively. In some studies, the use of trimethoprim-sulfadoxine resulted in fewer days of treatment compared to penicillin and oxytetracycline.

**Tilmicosin**, a semisynthetic macrolide antimicrobial, is highly effective as a single subcutaneous injection at 10 mg/kg BW.<sup>42</sup> Tilmicosin is effective in treating experimentally induced pneumonic pasteurellosis as measured by alleviation of clinical signs, reduction in extent of lesions at necropsy and the presence of viable bacteria from the lung.<sup>43</sup> Concentrations substantially above MIC for *M. haemolytica*

were present in the lung tissue even at 72 hours following a single subcutaneous injection of 10 mg/kg BW.<sup>43</sup> Tilmicosin rapidly accumulates in lung tissue and significantly higher concentrations are found in infected pulmonary tissue than in normal lung. Uniquely, tilmicosin effectively controls *M. haemolytica* infection, induces neutrophil apoptosis, reduces pulmonary inflammation and does not affect neutrophil infiltration or function.<sup>42</sup> Tilmicosin-induced peripheral neutrophil apoptosis occurs regardless of the presence or absence of live *M. haemolytica*, exhibits at least some degree of drug specificity and promotes phagocytic clearance of dying inflammatory cells.<sup>34</sup>

Tilmicosin is also effective in reducing the population of *M. haemolytica* colonizing the nasal cavities of calves with respiratory disease.<sup>44</sup> By reducing colonization, prophylactic use of tilmicosin before transportation or at the time of arrival at a feedlot is likely to reduce the incidence of acute respiratory disease in animals during the first several days after arrival.<sup>45</sup> Tilmicosin and danofloxacin did not differ in their effect on mean body temperature of beef calves with experimental pneumonic pasteurellosis.<sup>46</sup> Some studies have shown that tilmicosin has no effect on neutrophil function or apoptosis.<sup>47</sup>

Tilmicosin was highly effective as a single-dose treatment of bacterial pneumonia secondary to severe BRSV pneumonia in weaned beef calves.<sup>48</sup>

**Florfenicol**, an analog of **thiamphenicol**, is highly effective for the treatment of acute undifferentiated respiratory disease of feedlot cattle and its use will become widespread.<sup>49</sup> Florfenicol and tilmicosin are comparable in the treat-

ment of undifferentiated bovine respiratory disease in western Canada.<sup>50</sup>

**Enrofloxacin** at a dose of 2.5–5.0 mg/kg BW subcutaneously daily for 3–5 days or 7.5–12.5 mg/kg BW subcutaneously is effective.<sup>51</sup> Difloxacin and enrofloxacin are equally effective for treatment of the experimental disease.<sup>52</sup> Danofloxacin is rapidly distributed to the lungs and high tissue concentrations are achieved in the pneumonic lung, including areas of consolidation.<sup>53</sup> In calves with experimental pneumonic pasteurellosis, a single dose intravenously is more effective than the same dose administered by continuous infusion.

**Ceftiofur** preparations are being evaluated. Ceftiofur crystalline-free acid sterile suspension (CCFA-SS), a long-acting ceftiofur at 4.4–6.6 mg ceftiofur equivalents/kg administered subcutaneously in the middle third of the posterior aspect of the ear is effective, safe and practical for the treatment of experimental pneumonic pasteurellosis and the control and treatment of bovine respiratory disease in feedlot cattle.<sup>54</sup>

A rapidly disintegrating bolus formulation of **baquilloprim** (an antifolate compound) and **sulfadimidine** was effective for the treatment of experimental pneumonic pasteurellosis.<sup>55</sup> The baquilloprim is absorbed effectively and is synergistic with sulfonamides.

Antimicrobial sensitivity

The antimicrobial sensitivity of *M. haemolytica* varies, depending on the geographical origin of the animals and the previous use of the drug in the herd or the feedlot. Most isolates of *M. haemolytica* have some degree of multiple antimicrobial resistance, associated with continued use.

A 4-year survey of antimicrobial sensitivity trends for pathogens isolated from cattle with respiratory disease in North America based on MIC determinations using a broth microdilution method, indicated that, overall, resistance to ampicillin, tetracycline, erythromycin, and sulfamethazine was frequently encountered among isolates of *M. haemolytica* and *P. multocida*.<sup>56</sup> There was widespread resistance to erythromycin, which, because of cross-resistance, may account for the wide variation in sensitivity to tilmicosin. Ceftiofur was very active against the pathogens.

Ampicillin- and tetracycline-resistant *Pasteurella* isolates from dairy cattle (dairy herds and calf ranches) with pneumonia were spatially clustered within certain geographical areas in California.<sup>57</sup> The percentage of *M. haemolytica* isolates resistant to ampicillin was 21.3%; to *P. multocida*, 12.3%. The percentage of *M. haemolytica* isolates resistant to

Table 18.6. Antimicrobials for respiratory and pasteurellosis of young ruminants (continued)

Antimicrobial	Dosage and route of administration
<b>Individual treatment</b>	
Oxytetracycline	10 mg/kg BW, IV or IM daily for 3 d; can also use long-acting at 20 mg/kg
Florfenicol (analog of thiamphenicol)	20 mg/kg BW, IM; repeat in 48 h
Trimethoprim-sulfadoxine (40 mg trimethoprim/200 mg sulfadoxine/mL)	20 mg/kg BW, IM; repeat in 48 h
Penicillin	3–5 mL/45 kg BW, IV or IM daily for 3 d
Sulfamethazine (sustained-release bolus)	20 000–30 000 IU/kg BW IM or SC daily for 3 d
Tilmicosin	250 mg/kg BW/72 h; severely affected cattle need to be treated parenterally initially with a rapidly acting sulfonamide because of rumen stasis due to toxemia
Enrofloxacin	10 mg/kg BW SC and repeat 72 h later if necessary
	2.5 mg/kg BW IM daily 3–5 d; or single dose of 7.5–12.5 mg/kg
<b>Mass medication (feed and water)</b>	
Sulfamethazine	100 mg/kg BW in drinking water daily for 5–7 d
Oxytetracycline	3–5 mg/kg BW in feed for 7 d
<b>Mass medication (individual)</b>	
Long-acting oxytetracycline	20 mg/kg BW, IM to all in-contact animals
Tilmicosin	10 mg/kg BW SC on arrival and/or 72 h after arrival

BW, body weight; IM, intramuscularly; IV, intravenously; SC, subcutaneously.

tetracycline was 37%; to *P. multocida*, 52.5%. This reinforces the need to establish regional estimates of percentages of bacterial isolates which are susceptible to commonly used antimicrobials.

Early identification of affected animals in feedlots

Where large numbers of cattle are involved, early identification is crucial to successful therapy. Affected animals should be removed from their pen, examined, treated, identified with a suitable tag for reference purposes and placed in a hospital pen until recovered. This avoids confusion in deciding which animal requires treatment the next day. The duration of treatment will depend on the severity of the individual case, the response achieved in the first few days, the economic worth of the animal, the extent of complications that may be present, such as pleurisy, pulmonary abscesses, and bronchiectasis, and the results that the veterinarian may expect from prolonged therapy in difficult cases.

Animal identification

Identification of every animal in the feedlot with a unique eartag when it arrives in the lot, and the use of a chute-side computerized records system allows the collection and collation of animal health reports on individual animals, and on pens or groups of animals. Large commercial feedlots now have computerized records systems, which have replaced the manual card system. The case abstract of each animal will include the number of times it has been examined and treated, its body temperature and diagnosis. The abstract is useful when doing a necropsy on animals that have been treated and died. The epidemic curve can be calculated from the number of animals identified each day from each pen. From the cumulative treatment data, the computer can provide information on the diagnostic capability of identifying sick animals based on their body temperature when they were examined the first time, the treatment response, relapses and when they occurred, and mortality rates.

Medication of feed and water supplies

There is much interest in mass medication of the drinking water or feed supply or both. The rationale is that the medication of the feed or water would successfully abort an outbreak by treating those animals incubating the disease, provide convalescent therapy to those that have already been treated individually, and deal with mild cases before they become acutely ill and need individual treatment. However, there are problems. The amount of water that cattle drink is directly proportional to feed

consumption. If they are inappetent or anorexic, water consumption will decline to only maintenance requirements and therapeutic levels of drug will not be achieved if the concentration in the water is provided at a level for normal consumption. The other major problem is the provision of a uniform concentration of drug in the water supply, either through automatic water proportioners in the waterline or placing the drug directly into water tanks. Both can be unreliable. There is a need for the development of reliable methods of mass medication of the feed and water supplies of cattle.

Mass medication of individual animals

The individual treatment of all in-contact animals in an affected group may be useful in controlling an outbreak of the disease. If the rate of new cases each day ranges from 5–10% of the group, each animal in the remainder of the group may be treated with a long-acting preparation of oxytetracycline at the rate of 20 mg/kg BW intramuscularly. Tilmicosin at 10 mg/kg BW subcutaneously is also effective for mass medication of individual animals. This form of group medication will treat cases during the subclinical stages and may prevent new infections. Long-acting oxytetracycline at the same dose rate is also effective for the treatment of clinical cases and reduces the labor and the stress of handling associated with daily treatment, which may be required in severe cases.

#### Anti-inflammatory agents

Corticosteroids and nonsteroidal anti-inflammatory drugs (NSAIDs) are used by some veterinarians as an ancillary treatment for severe cases. The rationale is their anti-inflammatory effect but no data are available to support the field experience of some veterinarians that they are efficacious and economical.

#### Failure to respond

The causes of failure to respond to therapy include:

- **Advanced pneumonia before treatment is initiated**
- **Presence of viral or interstitial pneumonia or some other pneumonia that is not responsive to antimicrobials**
- **Inadequate dose of antimicrobials**
- **Antimicrobial resistance of the bacteria**
- **Complications such as pulmonary abscess, bronchiectasis, and pleuritis.**

#### CONTROL

Satisfactory economical control of the disease depends on the successful integration of management and perhaps the use of vaccines and antimicrobials

prophylactically. It is unrealistic to depend on a vaccine, an antimicrobial or a single management technique to control the disease. Successful control begins with the adoption of effective management techniques when beef calves are still on the range, the judicious use of efficacious vaccines, and care in handling and transportation of cattle.

#### Management strategies

Preconditioning programs

Because of the common occurrence of the disease at the time of shipment from the range to the feedlot, much attention has been given to reducing the incidence of disease at this time. This led to the development in North America of the concept of preconditioning. The objective of preconditioning was to prepare the weaned calf for the feedlot environment by vaccinating it for all the commonly anticipated diseases before weaning and distributing all stressful procedures such as castration, dehorning, branding, and deworming over a period of time rather than concentrating these at weaning time. Weaning at least 2 weeks before shipment was also considered a desirable practice. This was to result in a weaned calf that could be moved into a feedlot in which the feed bunks and water bowls would not be strange but familiar and the calf would adjust quickly. The most common vaccinations were for IBRV, PI-3V, BVDV, and clostridial disease. In some situations, calves were also vaccinated for *H. somni* and BRSV, and against pneumonic pasteurellosis.

Preconditioning has not been widely accepted because its economic value has not been proven. Nevertheless, the procedures involved promote health and can be recommended even though their economic value remains to be determined. Some reports claim that preconditioning can benefit both cow-calf producers and the buyers of preconditioned calves. Heavier calves at sale, low cost of average daily gain, and the price differential have the greatest impact on increased net return. Preconditioning programs have motivated cow-calf producers to examine preconditioning as a method to improve the marketability of their calves and to develop a reputation for a high-quality product. Calves perform better in the feedlot if the stresses from dehorning, castration, and vaccination occur at the same time, but before the stress of weaning occurs.

Weaning procedures

Beef calves should be weaned well in advance of anticipated inclement weather. This is especially true in North America, where the fall months can be cold and windy, and snowstorms can occur. A

common successful practice is to begin feeding hay and providing water to calves at least 2 weeks before weaning in the same corral or paddock into which they will subsequently be weaned. Following such a weaning program the calves require only a minimum of adjustment: the only adjustment necessary should be the loss of their dams. Recently weaned calves should be observed at least twice daily for evidence of respiratory disease and treated promptly if necessary. They should not be transported long distances until they appear to be healthy and are eating liberal quantities of hay and drinking water normally. During transportation liberal quantities of bedding are necessary and cattle should not be without feed and water for more than 24–30 hours. For long trips, calves should be rested for 8–12 hours and fed water and hay at intervals of 24 hours. This will minimize the considerable loss of body weight due to shrinkage and the effects of temporary starvation.

#### Creep feeding

The use of creep feed for calves for several weeks prior to weaning has been successful but may not always be economical. A high-energy ration containing cereal grains, a protein supplement and the necessary vitamins and minerals is provided for the calves in a creep arrangement to which the dams do not have access. At weaning time the dams are removed from the calves and the stress on the calves is minimal. This program has been very successful for purebred herds, where it may be economic, but in commercial herds it is only economic when the market value of the calves warrants it.

#### Conditioning programs

In the absence of preconditioning programs, conditioning programs have become the usual procedure for preparing beef calves or yearlings for the feedlot. This begins with movement of the animals from their farm source to the feedlot. The ideal situation would be to avoid public saleyards and move the cattle directly from the ranch to the feedlot. This avoids the stress of handling, overcrowding, temporary starvation, exposure to aerosol infection from other cattle, and the unnecessary delays associated with buying and selling cattle. However, large intensified feedlots are unable to buy cattle directly from the herd of origin according to their needs at a particular time and thus inevitably purchase large groups of cattle of different backgrounds. This has necessitated the development of **conditioning procedures** or processing procedures in which, after arrival, the cattle are individually identified, injected with a mixture of

vitamins A, D, and E, treated with a residual insecticide, perhaps given an anthelmintic, injected with a long-acting antimicrobial and vaccinated for clostridial and respiratory diseases. The issue of whether the cattle should be processed immediately after arrival or after a rest period of 2–3 weeks remains unresolved because there are few data to support one time over the other. However, the feedlot industry feels that processing immediately after arrival is most economical.

#### Feeding newly arrived cattle

The feeding and nutritional status of newly arrived cattle is important but there are few scientific data to formulate a sound economic feeding program that will promote rapid recovery from shipping stress. Good results can be achieved when stressed calves are fed a receiving ration consisting of 50–75% concentrate with good-quality hay in a total mixed ration for the 2–3 weeks until the cattle have become adapted to their new environment.

### Vaccines

#### General comments

*Pasteurella* vaccines and respiratory viral vaccines have been used extensively in an attempt to control pneumonic pasteurellosis in cattle. A review of the literature in 1997 on the efficacy of the vaccines available for the control of bovine respiratory disease concluded that there were few documented data to support the use of vaccines against respiratory disease under feedlot conditions.<sup>58</sup> Since that time progress has been made in understanding immunity to pneumonic pasteurellosis, and some vaccines with varying degrees of efficacy have been developed. The development of experimental models to reproduce the disease with *M. haemolytica* has provided a challenge method for evaluating the efficacy of the vaccines.

Various commercial vaccines induce differences in the rapidity and intensity of serum antibody responses to *M. haemolytica* whole cells and leukotoxin.<sup>59</sup> However, well-controlled field trials are necessary to compare efficacy under naturally occurring conditions.

#### *Pasteurella* vaccines

Based on the immunological and microbiological observations of both the naturally occurring and experimental disease it appears that immunization of cattle is possible. Calves that recover from experimentally induced pneumonic pasteurellosis possess increased resistance to subsequent experimental challenge. Cattle that have recovered from the natural disease are resistant to the disease. High levels of naturally acquired antibody to

*M. haemolytica* leukotoxin have been associated with protection against the disease.<sup>59</sup>

### The challenge in the development of an efficacious vaccine against pneumonic pasteurellosis has been to determine the most effective protective antigens of the organism.

Several different *Pasteurella* vaccines have been developed based on the virulence factors, including exotoxin leukotoxin, lipopolysaccharide with endotoxic activity, capsular polysaccharide, and iron-regulated outer membrane proteins. Each of the vaccines produced may provide some protection against experimental and naturally occurring disease but none provides a high degree of protection.

Several outer membrane proteins of *P. multocida* type A:3, which occasionally causes a severe bronchopneumonia in cattle, may be important for immunity to the organism.<sup>60</sup> A vaccine made of the outer membrane protein fraction of *M. haemolytica* induces a protective response in calves against intrathoracic challenge exposure with the homologous serovar.<sup>61</sup> A tissue-culture-derived *M. haemolytica* serotype 1 vaccine elicits a serotype-specific inhibition of nasal and tonsillar colonization by the homologous serotype under field conditions.<sup>15</sup>

Calves naturally exposed to *M. haemolytica* or vaccinated subcutaneously or intradermally with the whole cell live organisms are resistant to experimental challenge and develop antibodies to all surface antigens and leukotoxin antibody titer. This supports the hypothesis that protection against experimental challenge with *M. haemolytica* may require an immune response to leukotoxin. Cattle that have died from pneumonic pasteurellosis have lower leukotoxin neutralizing activity in their sera than cattle from the same group that died from other causes. This important observation was followed by vaccination of calves with a leukotoxic culture supernatant from pathogenic *M. haemolytica*, which provided some protection against experimental challenge with *M. haemolytica* A1.<sup>59</sup> One vaccination of cattle with a *M. haemolytica* leukotoxin extract vaccine was as effective in enhancing protection against experimental challenge as two vaccinations.<sup>62</sup>

The use of modified-live *M. haemolytica* and *P. multocida* vaccine in dairy calves between 14 and 20 days of age was effective in increasing titers of antibodies against *M. haemolytica* but did not improve calf health or performance.<sup>63</sup> Vaccination of colostrum-deprived calves at 2 and 4 weeks of age with a *M. haemolytica* A1 culture supernatant vaccine resulted in high titers of IgM antibodies to capsular polysaccharide



within 1 week of vaccination.<sup>64</sup> All vaccinated calves seroconverted with leukotoxin-neutralizing antibodies but peak antibody levels were low. Following experimental challenge, vaccinated calves had considerable lung injury but survival rate, clinical scores, and amount of lung involvement were better than those of control calves.

#### Leukotoxin extract vaccine

Resistance to pneumonic pasteurellosis correlates well with high serum antibody levels to various antigens of *M. haemolytica*, such as leukotoxin and various capsular antigens, and has led to the use of these components in the development of vaccines.<sup>59</sup> High leukotoxin neutralizing antibody titers induced by natural infections have been associated with reduced susceptibility to pneumonic pasteurellosis. Vaccination of calves with a leukotoxic culture supernatant from pathogenic *M. haemolytica* provides some protection against experimental challenge with the organism.

The efficacy of the leukotoxin extract vaccine has been evaluated in clinical field trials against naturally occurring bovine respiratory disease in weaned beef calves 6–8 months of age entering feedlots in Ontario and Alberta.<sup>58</sup> In an initial field trial in Alberta, auction-market-derived calves were given two doses of the vaccine within 1–5 days of arrival. Mortality from all causes was significantly lower in vaccinated calves (4.2% vs 2.1%) and mortality due to fibrinous pneumonia was lower (2.2% vs 1.1%).<sup>58</sup> In a trial in Ontario feedlots, recently shipped non-preconditioned calves were vaccinated within 24 hours after arrival.<sup>58</sup> The vaccine resulted in a slight decrease in morbidity, slight improvement in treatment response rates and a reduction in relapse rates. When the vaccine was combined with a modified live virus vaccine containing the IBR and PI-3 viruses, the mortality rate increased. However, the number of calves in each group was insufficient to adequately evaluate the differences. In another trial in Alberta, calves were assigned to one of four groups:

- Vaccinated on the ranch of origin 3 weeks prior to shipment to the feedlot
- Vaccinated only on arrival at the feedlot
- Vaccinated at both locations
- Not vaccinated at either location.<sup>58</sup>

The vaccine did not result in a change in morbidity or weight gain. Total mortality rates were increased significantly, and mortality rates from respiratory disease tended to be increased in ranch calves vaccinated at the ranch. However, calves

moved directly from ranches to feedlots, regardless of vaccination status, had lower morbidity and mortality, and better weight gains, than calves purchased from auction markets. In summary, there were no major benefits from vaccination. One of the problems may be the timing of the vaccination. Ideally, calves should be vaccinated at least 2 weeks prior to arrival at the feedlot; this is consistent with the temporal design of the laboratory studies, in which the first vaccination was given 42–51 days before challenge.

A single vaccination of a *M. haemolytica* bacterin-toxoid given to calves on arrival in the feedlot reduced overall crude mortality but there were no differences between vaccinates and nonvaccinates in bovine respiratory disease-specific mortality, morbidity, and/or average daily gain.<sup>65</sup> Vaccination of seronegative persistently infected BVDV calves with a *M. haemolytica* bacterin-toxoid does not result in increased *M. haemolytica* antibodies compared to BVDV negative calves receiving the same vaccine.<sup>66</sup>

Vaccination of feedlot cattle prior to transport to the feedlot with a *M. haemolytica* bacterin-toxoid elicited an antibody response but did not have any effect on *M. haemolytica* colonization of the nasopharynx.<sup>67</sup> Florfenicol given on arrival reduced the incidence of respiratory disease, delayed the interval before onset of disease and reduced the incidence of colonization of the nasopharynx by *M. haemolytica*.

Vaccination of calves after arrival in the feedlot with a genetically attenuated leukotoxin of *M. haemolytica* combined with bacterial extracts of *M. haemolytica* and *H. sommi* reduced morbidity due to bovine respiratory disease.<sup>68</sup> The same vaccine, along with a modified-live BRSV vaccine, has been used to aid in the control of enzootic pneumonia in beef calves vaccinated at 3–5 weeks of age.<sup>69</sup> Vaccination of feedlot calves after arrival with the genetically attenuated leukotoxin of *M. haemolytica* combined with bacterial extracts of *M. haemolytica* alone reduced the risk of UBRD.<sup>70</sup>

#### Whole cell vaccine

Experimental vaccination of calves with live *M. haemolytica* or *P. multocida* by aerosol or subcutaneous route effectively reduces the severity of subsequent experimental disease.<sup>71</sup> Vaccinated calves develop high serum antibody titers to the somatic antigens of the homologous organism.

#### Passive immunity to *Mannheimia haemolytica*

Vaccination of pregnant dairy cows at 6 and 3 weeks before parturition with a leukotoxin extract vaccine induced

leukotoxin-neutralizing serum antibody titers in the cows, increased titers in colostrum and increased passive leukotoxin colostrum antibody titers in the calves.<sup>72,73</sup> Vaccination was also associated with increased indirect agglutinating serum antibody titers in the cows. The protective effect of the antibodies against naturally occurring disease in the calves was not determined.

Vaccination of beef cows with a combined genetically attenuated leukotoxin *M. haemolytica* vaccine and a *H. sommi* vaccine once at 4 weeks prepartum increases passive antibody titers to both organisms in their calves.<sup>74</sup> Double vaccination of the calves with pre-existing maternal antibodies at 1 and 2 months of age will increase antibody titers to both organisms until 6 months of age. Vaccination of beef calves with low levels of pre-existing antibody at 3 and 4 months of age will increase antibody titers to *H. sommi* until 6 months of age and to *M. haemolytica* until 5 months of age.<sup>74</sup> Thus prepartum vaccination may be an effective measure for the control of pneumonia in calves under 2 months of age, and vaccination of the calves at 3 and 4 months of age may provide additional protection until the calves are 6 months of age.

#### Evaluation of efficacy of *Mannheimia haemolytica* vaccines

**Meta-analysis of the published literature** on the efficacy of the various vaccines against pneumonic pasteurellosis of cattle indicates that culture supernatants and/or potassium-thiocyanate-extracted outer membrane protein vaccines perform as well as live vaccines.<sup>75</sup> Live vaccines are considered to be the best in terms of protective immunity induced against pneumonic pasteurellosis because they replicate at the site of injection and produce the important immunogens that stimulate a protective immune response. However, live vaccines are associated with side-effects such as fever, local abscessation, and lameness.

**Commercial vaccines have been evaluated by measuring antibodies** in 4–6-week-old calves vaccinated against leukotoxin, capsular polysaccharide, whole cell antigens, and iron-regulated outer membrane proteins.<sup>76</sup> A bacterin-toxoid, a leukotoxin culture supernatant, a modified-live *M. haemolytica* and *P. multocida* vaccine, and an outer membrane extract of the organism were evaluated. All vaccines induced antibodies to the antigens but there were wide variations between the vaccines: some vaccines demonstrated little if any antibody to leukotoxin or outer membrane proteins. The highest leukotoxin antibody

titer did not reach its peak until 14 days after the booster dose of vaccine, which suggests that a second dose of vaccine is necessary for protection.

The efficacy of three commercial vaccines was evaluated against experimental pneumonic pasteurellosis.<sup>77</sup> Protective immunity was evaluated by assessment of clinical scores and lung lesions after endobronchial challenge with virulent *M. haemolytica*. There was significant correlation between lung and serum antibody levels against leukotoxin, capsular polysaccharide and outer membrane proteins. The vaccines did not provide optimal protection but the bacterin-toxoid vaccine was superior to the others. The culture supernatant containing leukotoxin, lipopolysaccharide, and capsular polysaccharide provided the best protection against experimental disease compared to a sodium salicylate extract containing outer membrane proteins, lipopolysaccharide, and capsular polysaccharide, and a combination of the above two. Leukotoxin is an important virulence factor in the disease and its use in vaccines provides significant protection. Muramyl dipeptide analogs may increase the humoral and protective response of calves to capsular polysaccharide.<sup>78</sup>

#### Adverse vaccine reactions

Some adverse reactions are associated with live vaccines. Systemic infection due to *M. haemolytica* occurred 2–18 days following vaccination with an avirulent live culture of *M. haemolytica*.<sup>75</sup> Lesions included injection site inflammation, purulent meningitis, and polyarthritis. Abscess formation at injection sites after vaccination with modified live *M. haemolytica* vaccines is also possible.<sup>75</sup> The purified capsular polysaccharide of *M. haemolytica* used in combination with other antigens did not provide protection but rather caused a high incidence of anaphylaxis.

#### Viral vaccines

Because prior infection of the respiratory tract with either IBRV or PI-3V may predispose to pneumonic pasteurellosis, the vaccination of beef calves 2–3 weeks before weaning and feedlot cattle 2 weeks before shipment to a feedlot has been recommended as part of a preconditioning program. Vaccination of calves at 3–6 months of age with an intranasal modified live IBRV and PI-3V vaccine provides protection against experimental pneumonic pasteurellosis induced by aerosol challenge with IBRV followed 4 days later by an aerosol of *M. haemolytica*. Using this principle of control it would be necessary to vaccinate the calves at least 2 weeks before they are weaned, stressed, or transported to a feed-

lot. Vaccination on arrival with modified-live virus vaccines, while commonly done, may be associated with increased mortality. The development of viral vaccines that contain viral glycoproteins and inactivated whole-virion IBRV, which are immunogenic but do not cause disease, may show some promise.

#### Vaccination programs

##### Feedlot cattle

Under ideal conditions, feedlot cattle should be vaccinated twice at a 14-day interval with the *M. haemolytica* bacterial extract and genetically attenuated leukotoxin vaccine, with the second dose at least 14 days before arrival in the feedlot. However, in commercial feedlots, cattle are usually vaccinated only once after arrival. The second dose is not given because most cases of shipping fever occur within 2 weeks after arrival. Experimentally, one vaccination is as effective as two vaccinations.<sup>62</sup> The presence of the organism as a natural commensal in the upper respiratory tract can effectively prime the animal and allow it to respond in an anamnestic mode to only one vaccination.

##### Beef breeding herds

The breeding herd is vaccinated annually with the *M. haemolytica* bacterial extract and genetically attenuated leukotoxin vaccine at 4 and 7 weeks prepartum to boost specific colostral antibody levels.

##### Nursing beef calves

Calves are vaccinated at 3–4 months of age, twice, at a 14-day interval with the *M. haemolytica* bacterial extract and genetically attenuated leukotoxin vaccine.

##### Dairy cattle herds

Pregnant dairy cattle are vaccinated with the *M. haemolytica* bacterial extract and genetically attenuated leukotoxin vaccine at 4 and 7 weeks prepartum to boost specific colostral antibody levels. Dairy calves are vaccinated beginning at 4–6 months of age as part of a calfhood vaccination program.

#### Chemoprophylaxis

Antimicrobials are used for the control of pneumonic pasteurellosis, particularly in cattle that have just been introduced into a feedlot.

##### Mass medication of individual animals

The early onset of pneumonic pasteurellosis in cattle within a few days after arrival in the feedlot requires consideration of mass medication of all animals in a group as part of a health management program. Field trials indicate that administration of antimicrobials to calves at varying times on arrival in the feedlot can reduce subsequent morbidity and mortality from respiratory disease. The administration

of antimicrobials to high-risk calves immediately after arrival is particularly effective under commercial feedlot conditions. Meta-analysis of the literature on mass medication for bovine respiratory disease indicates that prophylactic parenteral mass medication of calves with long-acting oxytetracycline or tilmicosin on arrival at the feedlot will reduce bovine respiratory disease morbidity rates.<sup>79</sup>

The injection of trimethoprim-sulfadoxine or oxytetracyclines on arrival reduced morbidity and mortality from respiratory disease in high-risk calves. The administration of a long-acting preparation of oxytetracycline at a dose rate of 20 mg/kg BW intramuscularly to feedlot cattle on arrival can reduce the morbidity and mortality from respiratory disease. Both the intramuscular and subcutaneous administration of oxytetracycline formulation are comparable to the intramuscular administration of currently available oxytetracycline formulations after arrival in the feedlot. Tilmicosin, at 10 mg/kg BW subcutaneously, given to calves immediately after arrival significantly reduced the treatment rate for bovine respiratory disease during the first 5 days as well as during the first month of the feeding period. The relapse rate and the treatment rate for all diseases during the first month were also reduced. The administration of tilmicosin to calves either upon arrival at the feedlot, or 3 days later, reduced the treatment rate for respiratory disease in the first 30 days. The average daily gain was also improved in the treated group compared to the controls, and the feed conversion efficiency over the first 60 days of the feeding period was superior in the medicated group compared to the nonmedicated animals.

##### Mass medication of feed and water supplies

Medication of the feed and water supplies has given variable results because of the difficulties in obtaining adequate levels of antimicrobials in those cattle that most need them. In normal weaned beef calves 6–8 months of age blood levels of sulfamethazine of 5 mg/dL or greater can be achieved in 15–24 hours by providing medicated water at a dose rate of approximately 150 mg/kg BW; at 75 mg/kg BW the same blood levels are achieved by 72–84 hours. A standard recommendation is to provide 150 mg/kg BW for the first 24 hours and reduce the level to 75 mg/kg BW for the duration of the medication period, which may last 5–10 days. A feed additive containing 700 mg/d per head of chlortetracycline and sulfamethazine from the day of arrival at the feedlot to day 56 of the feeding period improved average daily gain and feed conversion

and reduced the incidence of bovine respiratory disease for days 0–28 and 0–56, the rate of relapses and mortality for days 0–56 and the incidence of chronic respiratory disease for days 0–28 and 0–56.<sup>80</sup> Performance and health improvements attributed to the feed additive were cost-effective.

**Medication of the feed and water supplies can result in a false sense of security and the number of advanced cases of disease can actually increase.**

## REVIEW LITERATURE

Perino LJ, Hunsaker BD. A review of bovine respiratory disease vaccine field efficacy. *Bovine Pract* 1997; 31:59–66.

Ackermann MR, Brogden KA. Response of the ruminant respiratory tract to *Mannheimia (Pasteurella) haemolytica*. *Microb Infect* 2000; 2:1079–1088.

Bowland SL, Shewen PE. Bovine respiratory disease: commercial vaccines currently available in Canada. *Can Vet J* 2000; 41:33–48.

Coomber BL, Nyarko KA, Noyes TM, Gentry PA. Neutrophil–platelet interactions and their relevance to bovine respiratory disease. *Vet J* 2001; 161:41–62.

Roth JA, Henderson LM. New technology for improved vaccine safety and efficacy. *Vet Clin North Am Food Anim Pract* 2001; 17:585–597.

Jeyaseelan S, Sreevatsan S, Maheswaran SK. Role of *M. haemolytica* leukotoxin in the pathogenesis of bovine pneumonic pasteurellosis. *Anim Health Rev* 2002; 3:69–82.

## REFERENCES

- Ribble CS et al. *Can Vet J* 1995; 36:753.
- Angen O et al. *Vet Microbiol* 1999; 65:283.
- Angen O et al. *Vet Microbiol* 2002; 84:103.
- Al-Ghamdi GM et al. *J Vet Diagn Invest* 2000; 12:576.
- Dowling A et al. *Res Vet Sci* 2002; 73:37.
- Kelly AP, Janzen ED. *Can Vet J* 1986; 27:496.
- Kelly AP, Janzen ED. *Can Vet J* 1989; 30:170.
- Frank GR et al. *J Am Vet Med Assoc* 1988; 192:1063.
- Salman MD et al. *J Am Vet Med Assoc* 1988; 192:1069.
- Ribble CS et al. *Prev Vet Med* 1994; 21:251.
- Ribble CS et al. *J Am Vet Med Assoc* 1995; 207:612.
- Harwood DG et al. *Vet Rec* 1995; 136:252.
- Ribble CS et al. *Can J Vet Res* 1995; 59:167.
- Ribble CS et al. *J Am Vet Med Assoc* 1995; 207:616.
- Frank GH et al. *Am J Vet Res* 1996; 57:1317.
- Cusack PMV et al. *Aust Vet J* 2003; 81:480.
- Nicholas RAJ, Ayling RD. *Res Vet Sci* 2003; 74:105.
- Storz J et al. *J Am Vet Med Assoc* 2000; 216:1599.
- Lo RYC. *Vet Microbiol* 2000; 83:23
- McNeil HJ et al. *Vet Immunol Immunopathol* 2002; 90:107.
- Rowe HA et al. *Vet Microbiol* 2001; 81:305.
- Kehrenberg C et al. *J Antimicrob Chemother* 2001; 48:631.
- Jeyaseelan S et al. *Anim Health Res Rev* 2002; 3:69.
- Mosier DA et al. *Am J Vet Res* 1995; 56:1317.
- Dowling A et al. *Vet Immunol Immunopathol* 2004; 100:197.
- Ackermann MR et al. *Microb Infect* 2000; 2:1079.
- Frank GH et al. *Am J Vet Res* 2003; 64:580.
- Desmecht D et al. *Can J Physiol Pharmacol* 1996; 74:572.
- Paulsen DB et al. *Vet Pathol* 1995; 32:173.
- Rashid J et al. *Am J Vet Res* 1997; 58:28.

- Malazdrewich C et al. *Vet Pathol* 2001; 38:297.
- Adusu TE et al. *Can J Vet Res* 1994; 58:1.
- Stevens PK et al. *Infect Immun* 1996; 64:2687.
- Chin AC et al. *Antimicrob Agents Chemother* 2000; 44:2465.
- Narita M et al. *J Comp Pathol* 2000; 123:126.
- Leite F et al. *Vet Immunol Immunopathol* 2002; 84:97.
- Watson GL et al. *Am J Vet Res* 1995; 56:1045.
- Reeve-Johnson L. *Vet Rec* 2001; 149:549.
- Daoust PY. *Can Vet J* 1989; 30:155.
- Burrows GE et al. *J Vet Pharmacol Ther* 1986; 9:213.
- Bateman K et al. *Can Vet J* 1990; 31:689.
- Chin AC et al. *Am J Vet Res* 1998; 59:765.
- Morck DW et al. *Can J Vet Res* 1997; 61:187.
- Frank GH et al. *Am J Vet Res* 2000; 61:525.
- Frank GH et al. *Am J Vet Res* 2000; 61:1479.
- Fajt VR et al. *Am J Vet Res* 2004; 65:610.
- Fajt VR et al. *J Vet Pharmacol Ther* 2003; 26:173.
- Scott PR et al. *Aust Vet J* 1996; 73:62.
- Booker CW et al. *Can Vet J* 1997; 38:555.
- Hoar BR et al. *Can Vet J* 1998; 39:161.
- Hamm M et al. *Bovine Pract* 1999; 33:56.
- Olchowy TWJ et al. *Am J Vet Res* 2000; 61:710.
- Sarasola P et al. *Antimicrob Agents Chemother* 2002; 46:3013.
- Hibbard B et al. *Vet Ther* 2002; 3:22.
- Dassanayake L, White G. *Vet Microbiol* 1994; 38:255.
- Watts JL et al. *J Clin Microbiol* 1994; 32:725.
- Singer RS et al. *J Am Vet Med Assoc* 1998; 212:1001.
- Perino LJ, Hunsaker BD. *Bovine Pract* 1997; 31:59.
- Confer AW et al. *Bovine Pract* 2001; 35:141.
- Confer AW et al. *Am J Vet Res* 1996; 57:1453.
- Morton RJ et al. *Am J Vet Res* 1995; 56:875.
- Conlon JAR et al. *Can J Vet Res* 1995; 59:179.
- Aubry P et al. *J Am Vet Med Assoc* 2001; 218:1739.
- Hodgins DC, Shewen PE. *Can J Vet Res* 2000; 64:3.
- MacGregor S et al. *Bovine Pract* 2003; 37:79.
- Fulton RW et al. *Vaccine* 2003; 21:2980.
- Frank GH et al. *Am J Vet Res* 2002; 63:251.
- VanDonkersgoed J et al. *Can Vet J* 1993; 34:731.
- VanDonkersgoed J et al. *Can Vet J* 1994; 35:239.
- O'Connor A et al. *Can J Vet Res* 2001; 65:143.
- Panciera RJ et al. *Am J Vet Res* 1984; 45:2538.
- Hodgins DC, Shewen PE. *Vet Immunol Immunopathol* 1996; 50:67.
- Hodgins DC, Shewen PE. *Can J Vet Res* 1994; 58:31.
- VanDonkersgoed J et al. *Can Vet J* 1995; 36:424.
- Srinand S et al. *Prev Vet Med* 1996; 25:7.
- Srinand S et al. *Vet Microbiol* 1996; 49:181.
- Srinand S et al. *Vet Microbiol* 1996; 52:81.
- Brogden KA et al. *Vaccine* 1995; 13:1677.
- VanDonkersgoed J. *Can Vet J* 1992; 33:786.
- Gallo GF, Berg JL. *Can Vet J* 1995; 36:223.

## PASTEURELLOSIS OF SHEEP AND GOATS

*Mannheimia (Pasteurella) haemolytica* is the cause of pasteurellosis in sheep and goats. In the old classification system of *M. haemolytica* there were two biotypes, A and T, which were further subdivided into serotypes based on antigenic differences in capsular polysaccharide.

- The serotypes within biotype A are now classified as *Mannheimia haemolytica* with the exception of serotype A11, which is recognized as a separate species, *Mannheimia*

*glucosida. M. haemolytica* is associated with enzootic pneumonia in sheep and goats and with septicemic disease in young suckling lambs

- *M. glucosida* comprises a heterogeneous group of organisms that have low virulence and are mainly opportunistic pathogens of sheep
- Biotype T, containing four serotypes, is now classified as *Pasteurella trehalosi*. *P. trehalosi* is primarily associated with septicemic disease in weaned sheep
- Population genetics show that bovine and ovine strains of *M. haemolytica* represent genetically distinct subpopulations that are specifically adapted to, and elicit disease in, either cattle or sheep
- The most common manifestation in sheep is pneumonic pasteurellosis, which occurs in all ages
- *M. haemolytica* is a secondary invader, and a cause of death, in chronic enzootic pneumonia in sheep associated with *Mycoplasma ovipneumoniae*
- Other manifestations of *M. haemolytica* infections in sheep include septicemic pasteurellosis in very young lambs, which often occurs in association with pneumonic pasteurellosis in the same flocks, and mastitis in ewes
- *P. multocida* is an uncommon respiratory pathogen in sheep in temperate areas but may be of greater importance in tropical areas.

## Septicemic pasteurellosis of suckling lambs

This is a disease of young lambs associated with *M. haemolytica* biotype A. It occurs in lambs from 2 days to 2 months of age but presents most commonly at 2–3 weeks of age. The young lamb is highly susceptible to biotype A infections, which progress rapidly to a fatal septicemia. The organism is also a primary pathogen in goat kids. Septicemic pasteurellosis in suckling lambs may occur as an isolated disease but more commonly occurs in conjunction with pneumonic pasteurellosis, younger lambs succumbing to the former and ewes and older lambs to the latter. This disease probably does not warrant a separate classification but is kept separate because some outbreaks are manifest only with this septicemia in lambs.

There is a significant difference in the incidence of death from septicemic pasteurellosis in lambs between flocks that are infested with *Ixodes ricinus* and flocks that are *Ixodes*-free. It is believed that tick-borne fever can predispose to septicemic pasteurellosis<sup>1</sup> and lambs that die are usually 4–8 weeks of age.

A single intramuscular injection of 10 mg/kg tilmicosin or 20 mg/kg oxytetracycline is effective in preventing disease.<sup>2</sup>

*P. multocida* is a rare cause of septicemic disease in neonatal lambs but can occur with a high morbidity and high case fatality rate.<sup>3</sup> Clinically, it presents with a syndrome resembling watery mouth with marked salivation, abdominal distension and a short clinical course. On post-mortem examination there is excess peritoneal and pleural pericardial fluid. Prophylactic long-acting tetracycline at a dose of 100 mg per lamb has prevented further cases.

### Mastitis

*M. haemolytica* is recorded as a major cause of mastitis in ewes in Britain. It has been isolated from the udder of 20% of ewes with subclinical mastitis and from 40% of cases of acute mastitis.<sup>4</sup> A variety of typed and untyped strains within biotype A are isolated and serotype A2 is commonly isolated from acute mastitis. The epidemiology of the disease is unclear. Infection may occur from the organism on bedding<sup>5</sup> but the source of infection is more probably from the nose and mouth of the suckling lamb, which is supported by the observation that the prevalence of mastitis associated with this organism is less in dairy sheep than in conventional flocks.<sup>6</sup> Experimental challenge studies show that strains vary in their pathogenicity for the udder.<sup>6</sup>

### Pneumonic pasteurellosis affecting wildlife

*Pasteurella* and *Mannheimia* spp. have been isolated from a number of different species of wildlife but there has been particular concern with outbreaks of acute fatal pneumonic pasteurellosis that have occurred in Rocky Mountain and desert bighorn sheep (*Ovis canadensis*) following commingling with domestic sheep or feral goats.<sup>7</sup> *M. haemolytica*, *P. trehalosi*, and *P. multocida* have been isolated. *P. trehalosi* serotypes are carried in the tonsils of healthy bighorn sheep<sup>8</sup> but bighorn sheep are believed to be particularly susceptible to pathogenic biotype A strains acquired as a result of commingling with domestic sheep on range coupled with the stress of high densities and food shortage.<sup>9,10</sup> This association has raised environmentalist concerns for practices of communal grazing of domestic sheep with wildlife species. As with sheep, disease associated with these bacterial species in wildlife has not been prevented by vaccination with current vaccines.<sup>11</sup>

### REFERENCES

- Overas J et al. Vet Rec 1993; 133:398.
- Sargison ND, Scott PR. Agri Pract 1995; 16:25.
- Watson PJ, Davis RL. Vet Rec 2002; 151:420.
- Jones JET. Proc Sheep Vet Soc 1985; 10:48.
- Burriel AR. Curr Microbiol 1997; 35:316.
- Watkins GH, Jones JET. J Comp Pathol 1992; 106:9.
- Rudolph KM et al. J Wildl Dis 2003; 39:897.
- McNeil HJ et al. Vet Microbiol 2003; 93:145.
- Monello RJ et al. Can J Zool 2001; 79:1423.
- Foryst WT, Silflow RM. J Wildl Dis 1996; 32:315.
- Cassirer EF et al. J Wildl Dis 2001; 37:49.

## PNEUMONIC PASTEURELLOSIS OF SHEEP AND GOATS

**Etiology** *Mannheimia haemolytica* (*Pasteurella haemolytica* biotype A)

**Epidemiology** Organism carried in oropharynx and tonsils of healthy sheep and goats. Carrier prevalence rate increases in late spring/early summer and again in early autumn, which coincides with an increased prevalence of disease. Disease occurs in ewes and young lambs in late spring and early summer and feeder lambs late summer. Commonly there is a history of stress. In pastured sheep outbreaks often associated with changes in climate or management. Outbreaks in housed sheep associated with poor ventilation

**Clinical findings** Rapid onset and short course. Outbreaks often heralded by sudden death. Fever, cough, respiratory distress, dyspnea. Sheep that recover have persisting ill health

**Necropsy findings** Fibrinous pleuritis, pericarditis, and bronchopneumonia

**Diagnostic confirmation** Lesions found on necropsy. Culture, biotyping, and serotyping

**Treatment** Antibiotics

**Control** Antibiotics. Long-acting tetracyclines in the face of an outbreak. Avoidance of stress. Vaccination may be of value

### ETIOLOGY

Pneumonic pasteurellosis in sheep and goats is associated with biotype A of *Mannheimia* (*Pasteurella*) *haemolytica*. Serotype A2 is the most prevalent serotype isolated from pneumonic lungs in both sheep and goats. Less common but important serotypes in sheep are A1, A6 to A9, A11, and A12, and in goats A1 and A6, although there is some regional variation.<sup>1-6</sup> Some experimental challenge studies suggest that there is a difference in virulence between serotypes, with serotypes A1, A2, A7, and A9 having greater virulence.<sup>6</sup> Untypable serotypes can account for approximately 10% of isolates from pneumonic lungs.

Infection with PI-3V or *Bordetella parapertussis* may predispose to pneumonic pasteurellosis.<sup>7</sup>

*M. haemolytica* is a normal inhabitant of the upper respiratory tract of sheep. Colonization of the nasopharynx and the tonsil occurs very shortly following birth, mainly from the ewe but also from

the environment, and carriage persists through adult life. *M. haemolytica* has been isolated from 95% of the tonsils and 64–75% of nasopharyngeal swabs from normal adult sheep.<sup>1,8</sup> In healthy flocks there is considerable sheep-to-sheep variation in the biotype and serotype present in the nasopharynx and there are cyclical changes in carrier rate with time and changes in the predominant serotypes that are present. When compared to healthy flocks the prevalence of carriers is higher in flocks that are experiencing disease and there is more decisive prominence of a particular serotype. The carrier prevalence rate also increases in late spring and early summer and again in early fall, which coincides with an increased prevalence of disease.

*M. haemolytica* is also present on grass and in water in grazing areas and in the bedding of sheep pens; survival in these environments is prolonged in cooler, wet conditions.<sup>9</sup>

### EPIDEMIOLOGY

#### Occurrence

The disease occurs in sheep of all ages and causes losses in sheep in most parts of the world, through both death and depression of weight gain. The seasonal prevalence varies regionally. In the northern hemisphere, outbreaks, as opposed to sporadic disease, are more prevalent in the late spring and early summer. In contrast, in New Zealand and Australia the disease is more prevalent in the late summer and fall, occurring in lambs associated with mustering or transport in hot weather.<sup>10</sup>

Lambs are most susceptible during the first few months of life and ewes are most susceptible at lambing.<sup>4</sup> Outbreaks in lambs can have attack rates up to 40% and a population mortality up to 5%. Both ewes and lambs can be affected in the same outbreak. Outbreaks often start with sudden death in lambs from septicemic pasteurellosis and progress to pneumonic pasteurellosis in the ewes and also in the lambs as they get older. The loss of 400 of 1200 ewes from this disease over a 3-year period is recorded<sup>11</sup> and a mean flock population mortality of 2.49% has been calculated from 450 outbreaks in Britain.<sup>4</sup>

In **housed lambs** the majority of deaths occur over a 2-week period, 3–6 weeks after entry;<sup>12</sup> death losses in feeder and housed lambs are usually of the order of 5%<sup>10</sup> but may be as high as 20%.

High mortality has occurred in **goats** kept in confined quarters after collection from a number of centers.

### Experimental reproduction

Pneumonic pasteurellosis can be experimentally reproduced by challenge of specific-pathogen-free lambs with aerosols of *M. haemolytica*, either given alone or

preceded by PI-3V or *B. parapertussis* challenge<sup>5</sup> and by intratracheal inoculation.<sup>6</sup>

### Environmental and pathogen risk factors

In **sheep at pasture**, the disease tends to spread slowly and the population mortality rate is lower than in feeder lambs maintained in small areas. Outbreaks in flocks at pasture are frequently associated with changes in climate or management and deleterious changes in environment. In range sheep, confinement for shearing, mating or supplementary feeding may precipitate an outbreak, and severe parasitism or rain and windchill, exposure to bad weather or sudden change in weather may also increase susceptibility,<sup>6,13</sup> with deaths starting within 2 weeks of the stress factor.

In **housed sheep**, risk factors for disease include commingling of animals from different sources, taking sheep to show fairs, drafty or poorly ventilated barns, transport and malnutrition.<sup>3,14</sup>

Feedlot dust contains significant endotoxin and it has been postulated that inhalation of dust may be a predisposing factor in feedlot sheep. However, an experimental challenge study found no effect.<sup>15</sup>

PI-3V appears to be an important predisposing factor to pneumonic pasteurellosis in some outbreaks, based on serological evidence of concurrent infection with PI-3V during outbreaks of pasteurellosis in sheep.<sup>8,16</sup> Adenovirus may also predispose to naturally occurring and experimentally produced pneumonic pasteurellosis.<sup>17,18</sup>

### PATHOGENESIS

The development of pneumonic pasteurellosis in sheep and goats is in general the same as in pneumonic pasteurellosis of cattle. *M. haemolytica* is a **primary pathogen** in very young lambs but older lambs are more resistant and predisposing factors are required for the production of disease. Infection with **PI-3V** impairs the bactericidal activity of ovine neutrophils and the clearance of *M. haemolytica* by the ovine lung,<sup>19</sup> and PI-3V has been incriminated in some outbreaks.<sup>16</sup> Experimental infection of specific-pathogen-free lambs with this virus, followed 4 or 7 days later by challenge with *M. haemolytica*, results in pneumonic pasteurellosis that resembles the naturally occurring disease.

Organisms such as *Mycoplasma ovipneumoniae* and *B. parapertussis* colonize the lower respiratory tract in large numbers and attach to cilia, reducing pulmonary clearance of other organisms, which may explain the predisposition of chronic progressive pneumonia to secondary infection with *M. haemolytica* under stress situations.<sup>4,7</sup>

*M. haemolytica* itself has cell-wall-associated components that may help it to

become established during an infection and that are putative virulence determinants. It produces a **leukotoxin** (cytotoxin) that is considered to be an important virulence factor in the pathogenesis of ovine pneumonic pasteurellosis and promotes bacterial proliferation by killing or incapacitating ruminant neutrophils and pulmonary macrophages.<sup>20,21</sup> It is a member of the RTX family of Gram-negative bacterial pore-forming cytotoxins. It is specific for ruminant lymphoid cells. Leukotoxin binding occurs via a high-affinity species-specific mechanism and beta-2 integrins are the putative leukotoxin receptor on leukocytes.

Two other components, **capsular polysaccharide** and **lipopolysaccharide**, attach to alveolar and bronchial epithelium. Capsular polysaccharide precipitates pulmonary surfactant and *M. haemolytica* may attach to this surfactant layer in the alveolus by the lectin reaction of its capsular polysaccharide, thus promoting its establishment and colonization in the lung.<sup>22</sup>

**Intraspecific variation** in virulence determinants may be responsible for observed differences in host specificity.<sup>21</sup> As in cattle, the endotoxic activities of the bacterial lipopolysaccharide are believed to be critical to the development of the pulmonary lesions, and lipopolysaccharide deposited directly into the lung produces lesions similar to those seen in the lung of natural cases.<sup>22</sup>

In New Zealand, slaughterhouse data consistently show a higher prevalence of lesions of pleurisy and pneumonia in sheep from the warmer areas of the country and this, coupled with the late summer occurrence of clinical disease, suggests heat stress as a predisposing factor, possibly acting through the bypassing of nasal defense mechanisms by open-mouthed breathing.<sup>10</sup>

### CLINICAL FINDINGS

Outbreaks often commence with **sudden deaths** in the absence of premonitory clinical signs. In groups of lambs this occurrence of sudden death without prior illness may continue throughout the outbreak but some older sheep will show signs of **respiratory distress**, which can be accentuated by driving. As the outbreak progresses, respiratory involvement becomes more evident, signs including dyspnea, slight frothing at the mouth, cough, and nasal discharge. Affected sheep have fever from 40.4–42.0°C (105–107°F) and are depressed and anorectic. In more chronic cases an increase in intensity of air-flow sounds with an increase in pitch is heard over the area of the bronchial hilus, often with fluid sounds. Death may occur as soon as 12 hours after the first signs of illness but the course in most cases is about 3 days. Sheep that recover have evidence of chronic pneumonia and

are often culled because of **persisting ill-health and poor thrift**. In cases produced experimentally, arthritis, pericarditis, and meningitis occur in lambs that survive the acute stages of the disease, but these are not often observed in natural cases.

### CLINICAL PATHOLOGY

Most outbreaks are heralded by dead sheep and the diagnosis is established by postmortem examination. There is little information concerning the clinical pathology or the cellular findings in tracheobronchial aspirates in natural case. The organism can survive considerable periods in tracheobronchial washings.<sup>23</sup> Nasal swabs for culture are of little value because of the high carriage rate by healthy sheep of the organism in the nasopharynx.

### NECROPSY FINDINGS

With pneumonic pasteurellosis, petechial and ecchymotic hemorrhages are present throughout the body but the salient findings are in the thoracic cavity. In sheep that have died from peracute pneumonic pasteurellosis there is a greenish gelatinous exudate over the pericardium and large quantities of straw-colored **pleural exudate**. The lungs are enlarged, edematous, and hemorrhagic. With less acute cases there is **consolidation** of the lung, usually the apical and cardiac lobes but occasionally in the diaphragmatic lobe. The affected lung is solid and clearly demarcated. Histologically, there is diffuse alveolar necrosis, edema of interlobular septa, and sloughing of bronchial mucosa, and in sheep that survive the peracute phase of the disease there are so-called 'oat cells' in zones surrounding the necrotic alveoli. The organism can be cultured in large numbers in lung lesions and exudates.

### Samples for confirmation of diagnosis

- Bacteriology – lung, bronchial node, retropharyngeal node, spleen (CULT)
- Histology – formalin-fixed lung, liver, kidney (LM).

### DIFFERENTIAL DIAGNOSIS

When deaths occur in lambs without prior clinical illness the primary differentials are:

- Septicemia associated with *Histophilus somni* (formerly *Haemophilus somnus*)
- Enterotoxemia associated with *Clostridium perfringens* type D
- Other causes of sudden death.

Parasitic pneumonia, jaagsiekte, chronic nonprogressive pneumonia, and chronic progressive pneumonia (maedi) are the common chronic clinical pneumonias of sheep, but these should not be confused with pasteurellosis because of their longer course and distinctive features.

## TREATMENT

Where possible, treatment should be based on sensitivity testing of the isolate associated with the outbreak. Penicillin has commonly been used. Not all strains of biotype A are sensitive to penicillin, but almost all strains are sensitive to oxytetracycline, which may be the drug of choice with the availability of long-acting preparations requiring less handling of the sheep. A commercially available combination of amoxicillin and clavulanic acid has shown good efficacy against the experimental disease.<sup>24</sup> Alternate therapies include florfenicol or ceftiofur. Medication of the water supplies with oxytetracycline for 7–10 days may be beneficial.

## CONTROL

Environmental and managerial factors that may precipitate outbreaks of the disease should be controlled where possible.

## Antibiotics

The use of long-acting tetracycline in the face of an outbreak is a common approach to control. At-risk animals are given the drug intramuscularly at a dose rate of 20 mg/kg BW. The treatment may be repeated at 4-day intervals. A controlled field trial of this procedure has shown it to be efficacious.<sup>25</sup> The feeding of broad-spectrum antibiotics, especially tetracyclines, to lambs in feedlots is a common method of preventing pneumonia in recently weaned lambs. However, there is no documented evidence of its efficiency.

## Vaccination

There has been considerable activity in the development of vaccines for the control of pasteurellosis in sheep and goats; however, the development of an effective vaccine has proved elusive. Early studies showed that sheep that had recovered from infection were resistant to subsequent homologous challenge. Also, immune serum will protect against experimental challenge in specific-pathogen-free lambs.<sup>26</sup> Because *M. haemolytica* A2 is the most common isolate from pneumonic lungs of sheep and goats throughout the world, most research on vaccines for sheep and goats has focused on incorporating either a suitable isolate of *M. haemolytica* A2 or suitable antigens extracted from the serotype. Different antigen preparations have been used and, whereas most studies have shown that vaccination can give protection against homologous challenge, there is variable protection against challenge with other serotypes of *M. haemolytica*.<sup>27</sup> The approach has thus been to incorporate other serotypes in the vaccine, usually the ones that are common in the region of vaccine manufacture. However, despite the fact that vaccines

against experimental challenge with *H. haemolytica* in sheep and goats, they are not always effective in natural outbreaks and several studies show limited or no protection against natural disease in the field.<sup>16,27–30</sup> This may be because the relevant serotype is not in the vaccine formulation. There have been few controlled field studies of vaccination.<sup>30</sup> Vaccines containing concentrated components of organisms such as outer membrane proteins show potential for cross-serotype protection with experimental infections but remain to be proved in the field.<sup>31</sup>

Vaccines containing various serotypes of *M. haemolytica* stimulate antibody production in pregnant ewes and the lambs receive colostral antibody, which does interfere with the production of antibody by the lambs if they are vaccinated at an early age.

Another approach to control is the vaccination of lambs with PI-3V vaccines in addition to *Pasteurella* vaccination in an attempt to immunize lambs against challenge exposure with both this virus and *H. haemolytica*. The experimental vaccination of specific-pathogen-free lambs with an inactivated PI-3V vaccine provides protection against the combined effect of an experimental challenge with PI-3V and *H. haemolytica*, and field reports suggest that this vaccination is of value.<sup>32,33</sup>

## REVIEW LITERATURE

- Gilmour NJL. Pasteurellosis in sheep. *Vet Rec* 1978; 102:100–102.
- Gilmour NJL. Pasteurellosis in sheep. *Vet Annu* 1980; 20:234–240.
- Gilmour NJL, Gilmour JS. Pasteurellosis of sheep. In: Adlam C, Rutter JM, eds. *Pasteurella* and pasteurellosis. London: Academic Press, 1989, 223–262.
- Alley MR. Pneumonia in sheep. *Vet Annu* 1991; 31:52–56.
- Martin WB. Respiratory infections in sheep. *Compend Immunol Microbiol Infect Dis* 1996; 19:171–179.
- Watt NJ. Non-parasitic respiratory disease in sheep. *Vet Annu* 1996; 36:391–398.

## REFERENCES

- Sisay T, Zerihun A. *Vet Res Commun* 2003; 27:3.
- Prince CV et al. *N Z Vet J* 1985; 33:76.
- Harwood DG. *Goat Vet Soc J* 1996; 16:12.
- Alley MR. *Vet Annu* 1991; 31:51.
- Oduibo MO et al. *Small Rumin Res* 2003; 48:239.
- Oduibo MO et al. *Vet Res* 2004; 35:661.
- Porter JF et al. *J Comp Pathol* 1995; 112:381.
- Davies DH et al. *Vet Microbiol* 1981; 6:173.
- Burriel AR. *Curr Microbiol* 1997; 35:316.
- Alley MR. *N Z Vet J* 2002; 50:599.
- Watkins GH, Jones JET. *J Comp Pathol* 1992; 106:9.
- Malone F. *Vet Annu* 1990; 30:64.
- Mclroy SG. *Vet Rec* 1989; 125:79.
- Dercksen DP et al. *Vet Q* 1996; 18:100.
- Purdy CW et al. *Curr Microbiol* 2003; 46:174.
- Roger JL. *Vet Rec* 1989; 125:453.
- Leamaster BR et al. *J Am Vet Med Assoc* 1987; 190:1545.
- Lehmkuhl HD et al. *Am J Vet Res* 1989; 50:671.
- Davies DH et al. *Vet Microbiol* 1986; 11:125.
- Davies DH et al. *Vet Microbiol* 2002; 92:923.

- Davies RL et al. *Infect Immun* 1997; 65:3585.
- Brogden KA et al. *Am J Vet Res* 1989; 50:555.
- Rowe HA. *Vet Microbiol* 2001; 81:305.
- Gilmour NJL et al. *Vet Rec* 1990; 126:311.
- Appleyard WT, Gilmour NJL. *Vet Rec* 1990; 126:231.
- Jones GF et al. *Vet Microbiol* 1989; 20:57.
- Cameron CM, Bester FJ. *Onderstepoort J Vet Res* 1986; 53:1.
- Gilmour NJL et al. *Vaccine* 1991; 9:137.
- Purdy CW et al. *Am J Vet Res* 1996; 57:1168.
- Black H, Duganzich D. *N Z Vet J* 1995; 43:60.
- Sabri MY et al. *Vet Microbiol* 2000; 73:13.
- Wells PW et al. *Vet Rec* 1984; 114:266.
- Davies DH et al. *N Z Vet J* 1983; 31:87.

## SEPTICEMIC PASTEURILLOSIS IN WEANED SHEEP

**Etiology** *Pasteurella trehalosi* (*Pasteurella haemolytica* biotype T)

**Epidemiology** *P. trehalosi* is carried in oropharynx and tonsils of healthy sheep and goats. Carrier prevalence rate increases in late spring/early summer and again in early autumn, which coincides with an increased prevalence of disease. Septicemic pasteurellosis in weaned lambs commonly follows stress such as transport, marketing, shearing, coupled with a change to better feed

**Clinical findings** Clinical disease seldom seen, as clinical course is very short. Affected sheep are dull, rapidly become prostrate and toxemic, with frothy bloody nasal discharge in the terminal stages

**Necropsy findings** Pulmonary congestion and edema. Necrotic ulcers of abomasum. Multifocal hepatitis

**Diagnostic confirmation** Necropsy lesions. Culture, biotyping, and serotyping

**Treatment** Antibiotics

**Control** Antibiotics. Long-acting tetracyclines in the face of an outbreak. Avoidance of stress. Vaccination may be of value

## ETIOLOGY

The disease is associated with septicemic infection with *Pasteurella trehalosi*, which occurs most commonly following stress. *P. trehalosi* is a common inhabitant in the upper respiratory tract and tonsils of healthy sheep.<sup>1</sup> The organism was previously known as *P. haemolytica* biotype T and all four serotypes within this biotype have been incriminated in the disease.<sup>2,3</sup>

## EPIDEMIOLOGY

### Occurrence

This is an important disease in regions of Britain; it occurs in Europe and the USA. While recorded as occurring in Australia or New Zealand it is not a significant disease in these countries.<sup>4</sup> The disease occurs predominantly in weaned lambs 5–12 months of age. It occurs following some form of stress such as transport, marketing or shearing; or coupled with a

**movement to better feed**, which is often to turnips, rape, or alfalfa and crop after-math grazing. In Britain it is a disease of sheep moved from hill and upland farms to lowland farms for fattening.

In North America it is a disease of feedlot lambs and occurs following a change from roughage to concentrate feeding.

In affected groups a population mortality up to 9% is recorded<sup>4</sup> and in some areas septicemic pasteurellosis is the most common cause of death in lambs of this age group.<sup>3</sup>

### Experimental reproduction

The disease has been reproduced by oral inoculation coupled either with rapid change in feed from 100% roughage to 90% concentrate or with drugs eliciting immunosuppression.<sup>5</sup>

### PATHOGENESIS

*P. trehalosi* colonizes the tonsil and in affected sheep necrotic lesions are consistently found in the tonsils and the pharyngeal mucosa and sometimes in the abomasal mucosa.<sup>3</sup> It is postulated that bacteria invade from these lesions and enter the bloodstream via venous and lymphatic routes to produce embolic pneumonia with hematogenous spread of the organism to other internal organs.<sup>3</sup> The organism proliferates in these areas to produce a fatal bacterial **endotoxemia**.

### CLINICAL FINDINGS

#### Septicemic pasteurellosis

Clinical disease is seldom seen as the clinical course is often less than 6 hours and affected sheep are **found dead**. Affected sheep are dull, rapidly become prostrate, are toxemic, and may have a frothy bloody nasal discharge in the terminal stages.

### CLINICAL PATHOLOGY

Most outbreaks are heralded by dead sheep and the diagnosis is established by the typical lesions at postmortem examination. There is little information concerning the clinical pathology. Nasal swabs for culture are of little value because of the high carriage rate in healthy sheep of the organism in the nasopharynx.

### NECROPSY FINDINGS

The principal lesions are in the upper alimentary tract, thorax, and liver. Subcutaneous hemorrhages over the neck and thorax are common. The trachea and bronchi contain blood-stained froth, the lungs are congested and edematous, there are subpleural ecchymoses, but there is **no pneumonia** on gross examination, although an embolic pneumonia is evident histologically. The tonsils and pharyngeal lymph nodes are enlarged and there is ulceration and necrosis of the

pharynx and esophagus. There is also hemorrhage, and small **necrotic ulcers** are present on the tips of the folds of the abomasal mucosa.

Histologically there is acute inflammation and emboli in small arterioles and capillaries. The organism can be isolated in large numbers from the tonsils, lungs, liver, and mucosal lesions of the pharynx and esophagus.

### Samples for confirmation of diagnosis

- Bacteriology – lung, spleen (CULT)
- Histology – formalin-fixed lung, upper alimentary tract ulcers, liver, kidney (LM).

### DIFFERENTIAL DIAGNOSIS

When deaths occur in lambs without prior clinical illness the primary differentials are:

- Septicemia associated with *Histophilus somni* (formerly *Haemophilus somnus*)
- Enterotoxemia associated with *Clostridium perfringens* type D
- White muscle disease
- Toxicities.

### TREATMENT

Where possible, treatment should be based on sensitivity testing of the isolate associated with the outbreak. Isolates of *P. trehalosi* are often resistant to penicillin and oxytetracyclines. Florfenicol or ceftiofur should be considered if the sensitivity is unknown. The whole group should be treated prophylactically by injection or, if there is an appropriate antimicrobial, in the feed or water.

### CONTROL

Environmental and managerial factors that may precipitate outbreaks of the disease should be controlled where possible.

### Vaccination

Immune serum will protect against experimental challenge in specific-pathogen-free lambs.<sup>6</sup> However, despite the fact that vaccines have been developed that engender protection against experimental challenge, they are not always effective in natural outbreaks and several studies show limited or no protection against natural disease in the field.<sup>6-8</sup>

### REVIEW LITERATURE

- Gilmour NJL. Pasteurellosis in sheep. *Vet Rec* 1978; 102:100–102.
- Gilmour NJL. Pasteurellosis in sheep. *Vet Annu* 1980; 20:234–240.
- Gilmour NJL, Gilmour JS. Pasteurellosis of sheep. In: Adlam C, Rutter JM, eds. *Pasteurella* and pasteurellosis. London: Academic Press, 1989, 223–262.

### REFERENCES

1. Sisay T, Zerihun A. *Vet Res Commun* 2003; 27:3.
2. Prince CV et al. *N Z Vet J* 1985; 33:76.
3. Harwood DG. *Goat Vet Soc J* 1996; 16:12.
4. Mackie JT et al. *Aust Vet J* 1995; 72:474.
5. Suarez-Guemes F et al. *Am J Vet Res* 1985; 46:193.
6. Jones GE et al. *Vet Microbiol* 1989; 20:57.
7. Cameron CM, Bester FJ. *Onderstepoort J Vet Res* 1986; 53:1.
8. Wells PW et al. *Vet Rec* 1984; 114:266.

### PASTEURELLOSIS OF SWINE

*Pasteurella multocida* is an important pathogen of pigs. Toxigenic strains, in conjunction with *Bordetella bronchiseptica*, are recognized as the etiological agents of atrophic rhinitis described under that heading. Pneumonic pasteurellosis and septicemic pasteurellosis are also manifestations of infection with *P. multocida* in pigs. It has recently been shown that *P. multocida* capsular type A can cause not only pneumonia in growing pigs but also septicemia and arthritis<sup>1</sup> as well as being associated with the presence of skin lesions in sporadic cases of porcine dermatitis and nephropathy syndrome.<sup>2,3</sup>

### PNEUMONIC PASTEURELLOSIS

#### ETIOLOGY

*P. multocida* is commonly isolated from the lungs of pigs with chronic pneumonia, purulent bronchopneumonia, and pleuritis.<sup>4,5</sup> Isolates are predominantly capsular serotype A strains with some serotype D strains.<sup>6,7</sup> It is possible to serotype *P. multocida*<sup>8</sup> and of the 16 serotypes, serotypes 3 and 5 are the predominant isolates. In most herds there is a single isolate and this is usually A3.<sup>9</sup> In a recent study 88% of the lung strains were type A (OMP strains 1:1, 2:1, 3:1, 5:1, and type 6:1).<sup>10</sup> These authors suggest that the agent may be a primary pathogen with a relatively high degree of virulence and furthermore there has been a considerable transfer of capsular biosynthesis and *toxA* genes between the strains representing subpopulations of both type A and type D strains. It has recently been suggested that most *P. multocida* strains have the *toxA* gene.<sup>11</sup> This is further evidence of a trend reported earlier,<sup>12</sup> when it was suggested that there was widespread genetic diversity in the capsular type A strains and that a single clone might be more predominant in a particular pig population. For many years it was thought that toxigenic strains were not found in the lung but in three surveys 25–90% of the pneumonic strains were toxigenic.<sup>13–15</sup> The largest and most recent study<sup>15</sup> looked at 230 isolates from 250 pigs and found that 200 (88%) were A, 4% were D and 9% could not be identified. The *toxA* gene was found in 13%, of which 11%



belonged to A, 1% to D and 1% could not be typed. Serotype D strains were specifically associated with abscesses in the lung.

*P. multocida* is a common secondary infection in the lungs of pigs with enzootic pneumonia associated with *Mycoplasma hyopneumoniae*. The pneumonic lesions from which both organisms are recovered are more severe than those associated with *M. hyopneumoniae* alone.<sup>16</sup> The organism is also a common secondary infection in pneumonia associated with *Actinobacillus pleuropneumoniae*.

## EPIDEMIOLOGY

Although found in other species it is generally assumed that there is little interspecies transfer.

It is generally considered that *P. multocida* is not a primary pathogen of the lower respiratory tract and that its involvement in pneumonia is secondary to infection with other respiratory pathogens. A large-scale survey in Germany<sup>17</sup> of 6560 postmortem examinations found that pneumonia was present in 24.4% of cases. In 49.3% of these *P. multocida* was found and with increasing age there was an increasing rate of recovery of *P. multocida*. Most of the lung cultures (54.2%) showed multiple infections. Pneumonic pasteurellosis cannot be reproduced by the intranasal or intratracheal challenge of healthy pigs with *P. multocida* but can be reproduced by challenge to pigs whose pulmonary clearance mechanisms have been compromised by infections with *Mycoplasma hyopneumoniae*,<sup>18</sup> pseudorabies virus,<sup>19</sup> or by anaesthesia<sup>20</sup> and also lungworms. Although atmospheric ammonia may predispose to nasal attachment of *P. multocida* type D it seems unlikely that this applies to pulmonary infection.<sup>21</sup> It has been reproduced when nontoxigenic strains are given repeatedly by intrabronchial injection following *A. pleuropneumoniae* or *M. hyopneumoniae* infections.<sup>22</sup> Strains vary in their ability to produce secondary pneumonia and pleuritis in these experimental models, suggesting the existence of specific pneumotropic and pleurotropic strains,<sup>19</sup> which is supported by epidemiological studies that have found that a single strain predominates in problem herds.<sup>23</sup> The organism is carried in the nasal cavity and tonsils of pigs, and carriage rates are higher in herds with a history of chronic respiratory disease.<sup>23</sup>

Transmission is by aerosol and more probably by direct nose-to-nose contact and thence by inhalation or ingestion. The bacterium has a short-term survival in aerosols, particularly of low humidity (less than 1 h), but survives for longer at high

humidity and lower temperature. Heating to 60°C will kill it, but it can survive for up to 14 days in water, 6 days in slurry and up to 7 weeks in nasal washings at room temperature. There is always the feeling that the condition is most common under conditions of poor husbandry, notably overcrowding, and poor hygiene and where environmental stress is high. As a result it is often seen after transport, mixing or moving groups of pigs. The virulence mechanisms are not known but it is known that some may adhere to mucus and some have pili or fimbriae for attachment.<sup>24</sup> Serotype A strains are resistant to phagocytosis, which has been attributed to the presence of capsular hyaluronic acid and might allow their colonization of lung lesions.<sup>9</sup> Isolates from lung lesions are not invariably toxigenic. A recent study has shown that there is a change in the functional capabilities of the blood cells with oxygen radicle formation and phagocytosing neutrophils elevated after infection.<sup>25</sup>

## CLINICAL FINDINGS

There is a possibility of a hyperacute condition in which the only sign is sudden death.

Pneumonic pasteurellosis is a common cause of sporadic cases of acute bronchopneumonia in grower-finisher pigs. Affected pigs have fever of up to 41°C (106°F), are anorectic and disinclined to move (lethargic), and show significant respiratory distress with labored respiration and increased lung sounds, often breathing through the mouth. Cyanosis may occur. Without treatment, death is common after a clinical course of 4–7 days. There is a marked tendency for the disease to become chronic, resulting in reduced weight gain and frequent relapses, and real recovery seldom occurs. Although pneumonic pasteurellosis is secondary to other underlying respiratory disease it can occur as an outbreak, spreading to affect several pigs within a group. The first indication of disease within a group and of an impending outbreak may be the finding of a pig dead with a peracute infection. In an intermediate stage there may be fever, coughing and poor growth rate for about 3–5 weeks before recovery. The disease may also exist in chronic form within pigs in a herd as part of the swine pneumonia complex with little evidence of overt clinical disease but with an effect on growth rate and food conversion efficiency.

## NECROPSY FINDINGS

At necropsy the lesions are considered to be typical of what is normally called enzootic pneumonia – a chronic bronchopneumonia with abscessation. Pleuritis is common and there may also be peri-

carditis. In some instances there may be carcass congestion and the trachea may be full of frothy fluid. Experimental infections have caused between 15.5% and 39.4% of lung tissue to be affected with pneumonia.<sup>25</sup> Histologically, the airways are filled with degenerate leukocytes but the overall lung pathology is often complicated by other pathogens. Peracute fatalities show an acute necrotizing and fibrinous bronchopneumonia reminiscent of bovine pneumonic pasteurellosis. There is edema, congestion, and hemorrhage with bronchiolar exudation containing bacteria, neutrophils, and macrophages, which are also present in the alveoli. Small bronchi and bronchioles may be completely occluded by the exudates.

## DIAGNOSIS

Diagnosis is through the clinical signs (fever, dyspnea, cyanosis, sudden death), lesions at gross post-mortem, histopathology, and isolation of *P. multocida*.

## DIFFERENTIAL DIAGNOSIS

The disease must be differentiated from other causes of respiratory disease in pigs.

**Enzootic pneumonia** of pigs, unless accompanied by pasteurellosis, is not manifested by a marked systemic or pulmonary involvement.

Dyspnea is a prominent sign in **Glasser's disease** but there is obvious arthritis and at necropsy the disease is characterized by arthritis, a general serositis and meningitis.

**Pleuropneumonia associated with *A. pleuropneumoniae*** causes a severe pneumonia with rapid death, and differentiation from pasteurellosis is necessary at necropsy.

The septicemic and acute enteric forms of salmonellosis in pigs are often accompanied by pulmonary involvement but these are usually overshadowed by signs of septicemia or enteritis. Chronic pasteurellosis has to be differentiated from lungworm infestations and ascariasis.

## TREATMENT

The animals are usually severely ill so therefore treatment is firstly by parenteral injection and then by water medication and once they start to eat medication should continue with in-feed antibiotics.

Treatment is with antibiotics, commonly with tetracyclines.<sup>26,27</sup> There is also a case for using ceftiofur, penicillin, streptomycin, trimethoprim/sulfonamides, ampicillin, spiramycin, and spectinomycin for 3–5 days. Tilmicosin and telithromycin would also be suitable antibiotics. There is significant variation in the antibiotic sensitivity of isolates<sup>28</sup> and the choice of antibiotic should be based on a sensitivity established for the organism for that farm. In a recent survey in the UK, 15% of

*P. multocida* isolates were resistant to tetracyclines and it was also reported that resistance to trimethoprim/sulfonamides, apramycin, and neomycin was found in some isolates.<sup>29</sup> A German survey showed that 55% were resistant to sulfonamides.<sup>17</sup>

### CONTROL

Vaccination is ineffective, although auto-genous vaccines have been produced that are effective (need to be certain that you have the strain causing the problem). Control depends on management of the risk factors, which are described under enzootic pneumonia of swine, since pasteurellosis is often secondary to that condition. In particular all-in/all-out management with vaccination for enzootic pneumonia is essential. Tiamulin at 40 ppm in the feed has also been used strategically at the time of stress, for example over mixing and moving.

### SEPTICEMIC PASTEURELLOSIS

Septicemic disease with death occurring within 12 hours and without signs of pneumonia is occasionally observed in neonatal pigs. Septicemic disease is also recorded in India in association with infection with capsular serotype B.<sup>30,31</sup> The disease occurs in all ages of pigs including adults and is manifest with fever, dyspnea, and edema of the throat and lower jaw. A population mortality of 40% in a group of pigs is recorded.<sup>30</sup> Acute septicemic disease in grower pigs aged 14–22 weeks and associated with serotype D has been recorded in Australia.<sup>18</sup> Recently,<sup>32</sup> an outbreak of hemorrhagic septicemia was reported from Australia associated with *P. multocida* subsp. *gallicida* in a large pig herd. Affected pigs were found dead with swelling of the pharyngeal region and blue discoloration of the ventral abdomen and ears.

On gross postmortem there was hemorrhage and congestion on serosal surfaces. Histological examination of the viscera showed widespread vascular damage with thrombus formation and intravascular colonies of bacteria.

### Samples for confirmation of diagnosis

- Bacteriology – lung, bronchial node (plus liver, spleen, kidney for septicemic form). Culture produces large mucoid colonies 3–5 mm in diameter on blood agar. In the past the recovered organisms were rarely toxigenic. Some isolates did have fimbriae. On a smear Gram-negative coccobacilli may be seen. In early cases aerobic cultures of heart blood and lung lesions will give a pure culture. Anaerobic cultures often yield *Bacteroides* spp. as well and if

*Haemophilus* cultures are used as well these will also often prove positive. Further identification using electrophoretic typing may be necessary, as in the case of secondary infection in sporadic cases of porcine dermatitis and nephropathy syndrome.<sup>2,3</sup> Here a high proportion had a single electrophoretic type (01) isolated from a range of tissues. In the septicemic form<sup>1</sup> the organism was readily cultured from the liver, spleen, and lymph nodes

- Histology – formalin-fixed lung (variety of organs for septicemic form) (LM).

### REFERENCES

1. Ono M et al. J Comp Pathol 2003; 129:251.
2. Thomson JR et al. Vet Rec 2001; 149:412.
3. Lainsone FA et al. J Clin Microbiol 2002; 40:588.
4. Jacques M et al. Infect Immun 1993; 61:4785.
5. Buttenschon J. J Vet Med A 1991; 38:287.
6. Hoie S et al. Acta Vet Scand 1991; 32:395.
7. Fussing V et al. Vet Microbiol 1999; 65:61.
8. Pijoan C et al. J Clin Microbiol 1983; 17:1074.
9. Iwamatsu S, Sawada T. Jpn J Vet Sci 1988; 50:1200.
10. Davies RL et al. J Med Microbiol 2003; 52:59.
11. Shin N et al. Korean J Vet Res 1999; 39:1091.
12. McGollon JD. In: Proceedings of the 15th International Pig Veterinary Society Congress 1998:294.
13. Jaques M et al. Microbiology 1994; 2:263.
14. Negrote-Abascal E et al. Curr Microbiol 1999; 38:64.
15. Choi C et al. Vet Rec 2001; 149:210.
16. Morrison RB et al. Can J Vet Med 1985; 49:129.
17. Altrock AV et al. Berl Munch Tierärztl Wochenschr 1998; 111:164.
18. Mackie JT et al. Aust Vet J 1992; 69:227.
19. Pijoan C, Fuentes M. J Am Vet Med Assoc 1987; 191:823.
20. Hall WF. Can J Vet Res 1990; 54:238.
21. Andreasen M et al. Acta Vet Scand 1999; 40:197.
22. Chung WB et al. Can J Vet Res 1994; 58:25.
23. Zhao G et al. Infect Immun 1992; 60:1401.
24. Isaacson RE, Trigo E. FEMS Microbiol Lett 1995; 132:247.
25. Muller G et al. Res Vet Sci 2003; 74:23.
26. Andrews JJ et al. Agri Pract 1988; 9:33.
27. Bousquet E et al. Vet Rec 1998; 143:26.
28. Cote S et al. Am J Vet Res 1991; 52:1653.
29. Teale C. Pig J 2002; 49:52.
30. Verma ND. Vet Rec 1988; 123:63.
31. Pillai AGR et al. Indian Vet J 1985; 63:527.
32. Cameron RDA. Aust Vet J 1996; 73:27.

### TULAREMIA

Tularemia is a highly contagious disease occurring principally in wild animals but it may transmit to farm animals, causing septicemia and high mortality.

#### Synopsis

**Etiology** *Francisella tularensis* biovar *tularensis* in North America is tick-transmitted. *Francisella tularensis* biovar *holarctica* in Asia, Europe, and North America is transmitted by ticks and mosquitoes  
**Epidemiology** Livestock disease mainly reported from North America; seasonal, associated with heavy tick infestation. Majority of reports in livestock are historical. Zoonosis

**Clinical findings** Tick infestation. Fever, stiffness of gait, diarrhea, weight loss, recumbency. Wool break

**Clinical pathology** Culture.

Agglutination and intradermal test but not specific

**Necropsy findings** Subcutaneous swellings at site of tick attachment, lymphadenitis, and septicemia in sheep. Pigs have pleuritis, pneumonia, and abscessation of submaxillary and parotid lymph nodes

**Diagnostic confirmation** Culture or indirect fluorescent antibody staining

### ETIOLOGY

*Francisella tularensis* is the causative organism. It is Gram-negative, does not form spores and gives partial cross-agglutination with *Brucella* spp. Isolates are antigenically similar but they can be divided into **two types** on biochemical and epidemiological features and virulence tests. **Type A**, *Francisella tularensis* biovar *tularensis*, is prevalent in North America. **Type B**, *Francisella tularensis* biovar *holarctica* (*palaeartica*), is found in Asia, Europe and North America. Type A is associated with tick-borne tularemia in rabbits and type B is associated with mosquitoes and with water-borne disease in aquatic rodents. Type A is the more pathogenic of the two types and the more virulent for humans.<sup>1–3</sup> Type B rarely causes disease in higher mammals.

### EPIDEMIOLOGY

#### Occurrence

Tularemia is primarily restricted in its occurrence to countries in the **northern hemisphere** and occurs in most of them. In North America the disease is most prevalent in farm animals in the north-western states of the USA and the adjoining areas of Canada, although in these areas it is rare and the majority of reports in livestock are historical.

#### Risk factors

Animal risk factors

*F. tularensis* has a wide host range and is recorded in over 100 species of bird and wild and domestic animal. Disease is recorded among farm animals, most commonly in **sheep and pigs** and to a lesser extent in calves, which appear more resistant but can be infected in association with heavy tick infestation.<sup>4</sup> Sheep and pigs of all ages are susceptible but most losses occur in lambs, and in pigs clinical illness occurs only in piglets. There is a sharp seasonal incidence, the bulk of cases occurring during the spring months. The morbidity rate in affected flocks of sheep is usually about 20% but may be as high as 40%, and the mortality rate may reach 50%, especially in young animals.

### Transmission

The **major reservoirs** and transmitters of the infection are rabbits, hares, wild rodents, **ticks**, and flies and the principal mammalian target host in North America is the cottontail rabbit (*Sylvilagus* spp.). With sheep, transmission occurs chiefly by the bites of the wood tick, *Dermacentor andersoni*, and from *Haemaphysalis otophila*, the ticks becoming infected in the early part of their life cycle when they feed on rodents.<sup>5</sup> In Europe *Ixodes ricinus* and *Dermacentor reticulatus* are vectors.<sup>6</sup>

**Trans-stadial and transovarial transmission** occurs in the tick. The adult ticks infest sheep, and pastures bearing low shrubs and brush are particularly favorable to infestation. The ticks are found in greatest numbers on the sheep around the base of the ears, the top of the neck, the throat, axillae, and udder. It is assumed that sheep are relatively resistant to tularemia but become clinically affected when the infection is massive and continuous. Transmission to pigs and horses is thought to occur chiefly by tick bites but **mechanical transmission** to laboratory animals does occur with tabanid and blackflies.<sup>7</sup>

### Pathogen risk factors

There is little information concerning virulence mechanisms of *F. tularensis*. The capsule appears to be a necessary component for expression of full virulence and protects against serum-mediated lysis. The lipopolysaccharide has unusual biological and structural properties and low toxicity in vitro and in vivo.<sup>3</sup> The organism can persist in dry straw for 6 months, persists for at least 16 months in **mud and water** and may proliferate in these media.<sup>8,9</sup> It does not appear to survive in carcasses for long periods unless they are frozen, when it may persist for 60–120 days.

### Zoonotic implications

*F. tularensis* biovar *tularensis* has remarkable invasive powers and infection in humans can occur through the **unbroken skin**. Most exposures appear to result from the handling of infected rabbits and other wildlife but infections can arise from **bites** of ticks and the deer fly (*Chrysops discalis*), from the **ingestion** of contaminated meat and water, and from the bite or scratch of infected cats.<sup>10–12</sup> The disease is an occupational hazard to workers in the sheep industry in areas where the disease occurs. Spread of the disease to humans may also occur in abattoir workers who handle infected sheep carcasses. **Shearers** are susceptible because outbreaks often occur at shearing time. The inhalation or intradermal injection of as few as 10 organisms can establish infection in humans,<sup>1,3</sup> and appropriate precautions should be taken in the clinical and postmortem examination of suspect

cases. The organism is identified as a potential agent of bioterrorism.<sup>13</sup>

### PATHOGENESIS

Tularemia is an acute septicemia but localization occurs, mainly in the parenchymatous organs, with the production of granulomatous lesions.

### CLINICAL FINDINGS

#### Sheep

The incubation period has not been determined. A heavy tick infestation is usually evident.

The **onset** of the disease is slow with a gradually increasing stiffness of gait, dorsiflexion of the head and a hunching of the hindquarters; affected animals lag behind the group. The pulse and respiratory rates are increased, the temperature is elevated up to 42°C (107°F), and a cough may develop. There is diarrhea, the feces being dark and fetid, and urination occurs frequently with the passage of small amounts of urine. Body weight is lost rapidly, and progressive weakness and recumbency develop after several days, but there is no evidence of paralysis, the animal continuing to struggle while down. Death occurs usually within a few days but a fatal course may be as long as 2 weeks. Animals that recover commonly shed part or all of the fleece but are solidly immune for long periods.

#### Pigs

The disease is latent in adult pigs but young piglets show fever up to 42°C (107°F), accompanied by depression, profuse sweating, and dyspnea. The course of the disease is about 7–10 days.

#### Horses

In horses, fever (up to 42°C, 107°F) and stiffness and edema of the limbs occur. Foals are more seriously affected and may show dyspnea and incoordination in addition to the above signs.

### CLINICAL PATHOLOGY

An agglutination test is available for the diagnosis of tularemia, a titer of 1:50 being regarded as a positive test in pigs. Serum from pigs affected with brucellosis does not agglutinate tularemia antigen, but serum from pigs affected with tularemia agglutinates brucellosis antigen. Cross-agglutination between *F. tularensis* and *Brucella abortus* is less common in sheep and an accurate diagnosis can be made on serological grounds because of the much greater agglutination that occurs with the homologous organism. Titers of agglutinins in affected sheep range from 1:640 to 1:5000 and may persist at levels of 1:320 for up to 7 months. A titer of 1:200 is classed as positive in sheep. In horses the titers revert to normal levels in 14–21 days.

An intradermal sensitivity test using 'tularin' has been suggested as being more reliable as a diagnostic aid in pigs than the agglutination test, but is unreliable in sheep.<sup>5</sup>

### NECROPSY FINDINGS

In sheep, large numbers of ticks may be present on the hides of fresh carcasses. In animals that have been dead for some time, dark red subcutaneous areas of congestion up to 3 cm in diameter are found and may be accompanied by local swelling or necrosis of tissues. These lesions mark the attachment sites of ticks. Enlargement and congestion of the lymph nodes draining the sites of heaviest tick infestation are often noted. Pulmonary edema, congestion, or consolidation are inconstant findings.

In pigs the characteristic lesions are pleuritis, pneumonia, and abscessation of submaxillary and parotid lymph nodes. The organisms can be isolated from the lymph nodes and spleen, and from infected ticks. Isolation can also be effected by experimental transmission to guinea pigs. Techniques such as immunoperoxidase staining of fixed specimens and PCR of fresh tissues can circumvent the need for culture of this zoonotic agent.

### Samples for confirmation of diagnosis

- Bacteriology – lung, lymph node, spleen (CULT – requires cystine-enriched media, PCR)
- Histology – above tissues plus liver, fixed in formalin (LM, IHC).

Note the zoonotic potential of this organism when handling carcasses and submitting specimens.

### DIFFERENTIAL DIAGNOSIS

The occurrence of a highly fatal septicemia in sheep during spring months when the sheep are heavily infested with *Dermacentor andersoni* should suggest the possibility of tularemia, especially if the outbreak occurs in an enzootic area.

- **Tick paralysis.** This occurs in the same area and at the same time of the year as tularemia but is not accompanied by fever and there is marked flaccid paralysis. Recovery from tick paralysis occurs commonly if the ticks are removed
- **Other septicemias** include *P. trehalosi* in sheep and *Haemophilus* spp. in sheep and cattle. These are unusual in the age group in which tularemia occurs and are not associated with tick infestation. In pigs, local lesions can resemble tuberculosis
- **Anthrax.**

## TREATMENT

Streptomycin, gentamicin, the tetracyclines, and chloramphenicol are effective treatments in humans and companion animals.<sup>10</sup> Oxytetracycline (6–10 mg/kg BW) has been highly effective in the treatment of lambs and much more effective than penicillin and streptomycin.<sup>5</sup>

## CONTROL

An outbreak of tularemia in sheep can be rapidly halted by spraying or dipping with an insecticide to kill the vector ticks. In areas where ticks are enzootic, sheep should be kept away from shrubby, infested pasture or sprayed regularly during the months when the tick population is greatest. An experimental live attenuated vaccine has been developed but there is no routine vaccination of livestock.

## REVIEW LITERATURE

- Hopla CE. The ecology of tularaemia. *Adv Vet Sci* 1974; 18:25–53.
- Feldman KA. Tularemia. *J Am Vet Med Assoc* 2003; 222:725–730.
- Tarnvik A, Priebe HS, Grunow R. Tularaemia in Europe: an epidemiological overview. *Scand J Infect Dis* 2004; 36:350–355.
- Petersen JM, Schriefer ME. Tularemia: emergence/re-emergence. *Vet Res* 2005; 36:455–467.

## REFERENCES

- Rohrbach BW. *J Am Vet Med Assoc* 1988; 193:428.
- Morner T et al. *J Vet Med B* 1993; 40:613.
- Sjostedt A. *Curr Opin Microbiol* 2003; 6:66.
- Philip CB, Williams SC. *Bull Soc Vector Ecol* 1985; 10:45.
- Gordon JR. *Can J Comp Med* 1983; 47:408.
- Hubalek Z, Halouzka J. *J Med Entomol* 1997; 34:660.
- Philip CB, Jellison WL. *Bull Soc Vector Ecol* 1986; 11:197.
- Bell JF et al. *Can J Comp Med* 1978; 42:310.
- Feldman KA. *J Am Vet Med Assoc* 2003; 222:725.
- Woods JP et al. *J Am Vet Med Assoc* 1998; 212:81.
- Klock LE et al. *J Am Vet Med Assoc* 1973; 226:149.
- Taylor JP et al. *Am J Epidemiol* 1991; 133:1032.
- Davis R. *J Am Vet Med Assoc* 2004; 224:1084.

## YERSINIOSIS

### Synopsis

**Etiology** *Yersinia pseudotuberculosis* and *Yersinia enterocolitica* cause occasional disease in farm animals under special circumstances. These organisms also are increasingly recognized as a cause of disease in humans and this is their main importance.

**Epidemiology** Subclinical and clinical disease in ruminants associated with either organism in animals that are debilitated from other influences. Enterocolitis is an emerging form of infection. Pigs carry *Y. enterocolitica* in the tonsils, pharynx, and intestine but the epidemiology of infection is poorly established.

**Clinical findings** Ruminants: chronic ill-thrift and in a wasted condition with or without diarrhea.

**Diagnostic confirmation** Culture. PCR

## ETIOLOGY

There are pathogenic and nonpathogenic strains of *Yersinia pseudotuberculosis* and *Yersinia enterocolitica*. The **pathogenic strains** of both organisms possess chromosomal and plasmid-mediated virulence determinants.<sup>1</sup>

*Y. pseudotuberculosis* can be divided into 15 major serogroups, based on O-antigens, some of which can be further divided into subgroups on the basis of type-specific somatic and flagellar antigens. There is variation in animal and human pathogenicity between the serogroups.

*Y. enterocolitica* is divided into five biovars. It is serologically heterogeneous and 27 serotypes have been identified on the basis of somatic and flagellar antigens with further subdivisions. Bioserotypes may be host-specific. Serotypes O:2, O:3, O:5, O:8, and O:9 have been associated with infection in farm animals and humans, whereas other serotypes appear to be nonpathogenic. Serotype O:9 is antigenically very similar to *Brucella* spp., and infection with this serotype is a cause of false-positive reactions to *Brucella* agglutination and complement fixation tests.

## EPIDEMIOLOGY

### Occurrence

Yersiniosis has **worldwide** occurrence, although there appear to be regional differences in the species of animal infected, the **prevalence** of disease and the organism involved. *Y. pseudotuberculosis* has historically been associated with **sporadic pyemic disease** in sheep manifest with extensive abscessation of internal organs such as liver and spleen. More recently it, and *Y. enterocolitica*, have been associated with **enterocolitis** occurring in cattle,<sup>2–4</sup> sheep, pigs and goats,<sup>3,5</sup> buffalo,<sup>6</sup> and farmed and feral deer.<sup>7–9</sup> Enteric disease in ruminants has been particularly reported in recent years from Australia and New Zealand.

### *Yersinia pseudotuberculosis*

*Y. pseudotuberculosis* is a common inhabitant of the **intestine** in a wide variety of domestic and wild mammals. Wild birds and rodents are also **reservoirs** of the organism, and fecal–oral spread on pastures and in water is a major method of transmission. Spring migratory birds can spread pathogenic types over long distances.<sup>10</sup>

There may be differences in the **host specificity** of different serotypes and strains. Rodents and birds may be the major reservoirs for serotypes I and II, which infect deer and goats,<sup>9</sup> whereas sheep and cattle may be a maintenance host for serotype III.

In an Australian study *Y. pseudotuberculosis* serotype III was isolated from

the feces of healthy **sheep** in 5% of flocks examined and the prevalence was probably much higher as only a small number of sheep were sampled in each flock. Infection was more common in young sheep, occurred during the winter and spring months, and excretion of the organism persisted for 1–14 weeks.<sup>2</sup>

In **cattle** the organism has been found without disease in 26% of normal cattle and on 84% of farms tested.<sup>11</sup> The fecal excretion that occurs in clinically normal sheep and cattle possibly results from a subclinical infection of the intestine, as experimental challenge of ruminants can result in the establishment of organism in the intestine with the presence of microscopic abscessation in the lamina propria and serological conversion in the absence of clinical disease.<sup>2,5</sup>

**Enteric disease** associated with this organism in both cattle and sheep appears to occur as the result of a heavy **infection pressure** in animals that are **debilitated** from other influences. These include cold wet weather, inanition and starvation, trace element deficiency, change of diet, management procedures such as marking and, in farmed deer, procedures such as capture, yarding, and recent transport.<sup>2–5,12</sup>

In sheep, attack rates in the flock for clinical disease have ranged from 1–90% with a mean of 18% and a population mortality varying from 0–6.7%.<sup>13</sup> *Y. pseudotuberculosis* may also cause **sporadic abortion** in cattle and sheep.<sup>11,14</sup> In sheep, abortion rates of 1–9% of pregnant sheep are recorded, abortion occurring in the latter part of pregnancy and without clinical illness in the ewes.<sup>11</sup> The organism is the cause of occasional cases of bovine caprine mastitis,<sup>15,16</sup> epididymitis, and orchitis in rams, and it may be found in sporadic cases of abscessation and lymphangitis in ruminants.

### *Yersinia enterocolitica*

*Y. enterocolitica* is not commonly associated with clinical disease in farm animals. Diarrhea associated with this organism can occur in sheep, and the organism can be isolated from affected lambs. However pathogenic strains of *Y. enterocolitica* are less pathogenic to sheep and goats than pathogenic strains of *Y. pseudotuberculosis*.

**Enterocolitis** is recorded in **sheep and goats**.<sup>3,13,17,18</sup> Biotype 5, serotype O:2,3 has been isolated from some of these.<sup>18</sup> In an Australian survey this organism was detected in 17% of flocks and was isolated from young sheep at all seasons of the year.<sup>2</sup> Clinical disease appears to be predisposed by the same **stress factors** as apply with disease associated with *Y. pseudotuberculosis*. Disease is recorded in sheep under 1 year

of age with an attack rate that varied from 2–55% and a population mortality that ranged from 0.3–16.7%.<sup>13,17</sup> *Y. enterocolitica* is also an occasional cause of abortion in sheep and this has been reproduced experimentally.<sup>19</sup>

Whereas *Y. enterocolitica* is commonly isolated from pigs, and pigs are a major reservoir for human disease, it is a rare cause of clinical disease in conventional pigs,<sup>20</sup> although clinical enteric disease can be produced by experimental challenge of colostrum-deprived pigs.<sup>21</sup> Conventional pigs challenged with serotype O:3 excreted the organism in feces but were fecal-culture-negative 10 weeks after challenge and at slaughter, even though the organism could be isolated from the tonsils at slaughter. Pigs seroconverted at day 19 postchallenge and remained seropositive until slaughter 70 days later.<sup>20</sup>

#### Zoonotic implications

##### *Yersinia pseudotuberculosis*

Human infection with *Y. pseudotuberculosis* is primarily manifest with septicemia, and renal failure is a sequel. In addition to food-borne infection the consumption of water contaminated by animal feces appears to be a major risk factor. Raw milk consumption is also a risk.<sup>22</sup>

##### *Yersinia enterocolitica*

Gastrointestinal disease associated with *Y. enterocolitica* appears to have **increasing prevalence** in humans and can be associated with a reactive arthritis as a sequel. Septicemia does occur but is largely limited to those with other underlying disease. Serotypes O:3, O:5, O:8, and O:9 are incriminated. **Pigs are a major reservoir** for *Y. enterocolitica*, and pork and pork products are sources for human infection. Serotype O:3, in particular, is commonly isolated from the tonsils and pharynx of pigs at slaughter and less commonly from feces. The rate of isolation varies geographically and with farm source and it has been suggested that pathogen-free breeding is a method for control.<sup>23</sup>

In contrast to Australia and New Zealand, it is believed that in Europe the pig is the only domestic animal consumed by humans that regularly harbors pathogenic *Yersinia*.<sup>24</sup> There is an apparent increasing prevalence of O:3 infections in humans in the northern hemisphere and pigs and pork products are considered to be important sources.<sup>23,25</sup> A survey in Great Britain comparing isolates of *Y. enterocolitica* from cattle, sheep, and pigs with those from humans over a 2-year period did not find a strong correlation between pathogenic serotypes isolated from the two groups, with the exception of isolates from pigs.<sup>26</sup> The importation of meat products has been incriminated as

the vehicle of introduction of pathogenic serotypes into Japan.<sup>27</sup> There would appear to be an increased risk for infection in humans handling pigs at slaughter and in veterinarians in pig practice.

#### PATHOGENESIS

Invasion of the intestinal epithelium is followed by inflammation in the mucosa and the formation of microabscesses in the lamina propria and mesenteric lymph nodes. Ulcers and disruption of the intestinal mucosa lead to loss of fluid and function. The intestinal lesions are accompanied by villous atrophy and lead to malabsorption and ill-thrift, diarrhea and a combination of the two.<sup>13</sup>

#### CLINICAL FINDINGS

Affected animals may present with a syndrome of chronic ill-thrift and in a wasted condition with or without diarrhea. Where diarrhea is present the feces are watery, foul-smelling, and black in color, but occasionally they also contain mucus and blood. Diarrhea persists for 2–3 weeks in an individual animal and may require yarding and dagging as control procedures to avoid fly strike.

#### CLINICAL PATHOLOGY

There is a neutrophilia with a left shift. Affected animals are often hypoproteinemic and anemic, although this may be a reflection of the underlying malnutrition. In experimental infections antibody develops by 9–19 days postinfection and may be an aid to diagnosis.<sup>5,20</sup> The organism can be isolated from the feces. A multiplex PCR is capable of detecting 10 pathogenic serotypes of *Y. enterocolitica*<sup>28</sup> and PCR has been developed to discriminate pathogenic *Y. enterocolitica* from other members of this genus.<sup>29</sup>

#### NECROPSY FINDINGS

There are liquid intestinal contents but usually no gross findings. Some sheep may have thickening of the mucosa of the small intestine and the cecum and colon, and the mesenteric lymph nodes may be enlarged and edematous.

The characteristic findings on histopathology consist of a segmental suppurative erosive enterocolitis.<sup>13</sup> Microabscesses, consisting of aggregations of neutrophils with prominent colonies of Gram-negative coccobacilli, are present in the mucosa. Lesions are most prevalent in the jejunum and ileum and are accompanied by atrophy of villi and hyperplasia of cryptal epithelium. Microabscesses may coalesce to produce extensive erosions and there may be microabscesses in the liver.

The placenta from sheep that have aborted in association with *Y. pseudotuberculosis* is thickened and edematous with necrotic debris in the inter-

cotyledonary zone and must be differentiated from enzootic abortion.<sup>14</sup>

#### Samples for confirmation of diagnosis

- Bacteriology – jejunum, ileum, colon, mesenteric lymph node (CULT – sometimes requires cold enrichment)
- Histology – formalin-fixed jejunum, ileum (several sections), colon, mesenteric node (LM).

Note the zoonotic potential of this organism when handling carcasses and submitting specimens.

#### DIFFERENTIAL DIAGNOSIS

The major differential is the syndrome of weaner ill-thrift.

#### TREATMENT AND CONTROL

Isolates vary in their sensitivity to antibiotics and a sensitivity test is advisable. Most isolates show in vitro sensitivity to the aminoglycosides, to tetracyclines and to sulfonamides or a combination of sulfonamides and trimethoprim.<sup>13,23,30</sup> Sulfonamides and trimethoprim are reported not to be effective in the treatment of yersiniosis in cattle; long-acting tetracyclines are recommended for the treatment of both infections, in combination with supportive therapy.<sup>31</sup>

There is no specific control but the maintenance of good nutrition is believed to be an important factor in avoiding clinical disease.

#### REVIEW LITERATURE

Brubaker RR. Factors promoting acute and chronic disease caused by yersiniae. *Clin Microbiol Rev* 1991; 4:309–324.

Bottone EJ. *Yersinia enterocolitica*: the charisma continues. *Clin Microbiol Rev* 1997; 10:257–276.

#### REFERENCES

1. Nagano T et al. *J Vet Med Sci* 1997; 59:153.
2. Slee KJ, Skilbeck NW. *J Clin Microbiol* 1992; 30:712.
3. Gill J. *Surveillance* 1996; 23:24.
4. Slee KJ et al. *Aust Vet J* 1988; 65:271.
5. Slee KL, Button C. *Aust Vet J* 1990; 67:320.
6. Hum S et al. *Aust Vet J* 1997; 75:95.
7. Sanford SE. *J Vet Diagn Invest* 1995; 7:78.
8. Wilson PR. *Surveillance* 2002; 29:13.
9. Jerrett IV et al. *Aust Vet J* 1990; 67:212.
10. Niskanen T et al. *Appl Environ Microbiol* 2003; 69:4670.
11. Hodges RT, Carman MG. *N Z Vet J* 1985; 33:175.
12. McLennan MW, Kerr DR. *Aust Vet J* 2000; 78:28.
13. Philbey AW et al. *Aust Vet J* 1991; 68:108.
14. Otter A. *Vet Rec* 1996; 138:143.
15. Jones TO et al. *Vet Rec* 1982; 112:231.
16. Bleul U et al. *Vet Rec* 2002; 151:767.
17. McSparran KD et al. *N Z Vet J* 1984; 32:38.
18. Slee KL, Button C. *Aust Vet J* 1990; 67:396.
19. Corbel MJ et al. *Br Vet J* 1992; 148:339.
20. Nielsen B et al. *Vet Microbiol* 1996; 48:293.
21. Shu D et al. *N Z Vet J* 1995; 43:50.
22. Bahout AA, Moustafa AH. *Assuit Vet Med J* 2004; 50:57.

23. Hariharan H et al. *Can J Vet Res* 1995; 59:161.
24. Nesbakken T et al. *Contrib Microbiol Immunol* 1991; 12:32.
25. Thibodeau V et al. *Vet Microbiol* 2001; 82:249.
26. McNally A et al. *Lett Appl Microbiol* 2004; 39:103.
27. Fukushima H et al. *J Food Microbiol* 1998; 35:205.
28. Harnett N et al. *Epidemiol Infect* 1996; 117:59.
29. Arnold T et al. *Syst Appl Microbiol* 2001; 24:285.
30. Funk JA et al. *J Food Protect* 2000; 63:395.
31. Slee KJ, Button C. *Aust Vet J* 1990; 67:471.

### PROGRESSIVE ATROPHIC RHINITIS (TURBINATE ATROPHY OF SWINE)

Atrophic rhinitis is a disease affecting primarily young pigs but causing anatomical lesions which may persist for life. The term nonprogressive atrophic rhinitis is used for the slight to severe rhinitis and usually transient turbinate atrophy in which no toxigenic *P. multocida* are found, when there are no clinical signs and no obvious growth retardation. This mild form is probably as a result of infection with *Bordetella bronchiseptica* and/or nontoxigenic *P. multocida*. The term progressive atrophic rhinitis is proposed for the infection with toxigenic *P. multocida* (capsular serotype D and A strains) characterized by shortening or distortion of the snout, sneezing, nasal discharge, and epistaxis. Progressive atrophic rhinitis is often accompanied by reduced growth rates in severe cases.

#### Synopsis

**Etiology** Toxigenic strains of *Bordetella bronchiseptica* and *Past. multocida*

**Epidemiology** Young growing pigs. High percentage of pigs reared under intensive conditions may have some degree of atrophic rhinitis. Infection widespread and transmitted by carrier sow to piglet. Housing and ventilation risk factors. Immunity develops in herd. Major economic importance because may affect growth rate and predispose to pneumonia

**Signs** Initially sneezing when piglets 3–9 weeks of age. Nasal discharge. Deformity of face with nasal bones (twisted snout). Growth rate may be decreased

**Clinical pathology** Culture organism from nasal swabs. PCR

**Lesions** Varying degrees of severity of atrophic rhinitis

**Diagnostic confirmation** Necropsy examinations of snouts

#### Differential diagnosis list

- Inclusion body rhinitis
- Necrotic rhinitis
- Inherited prognathia

**Treatment** Antimicrobials in early stages; nothing later

**Control** Eliminating toxigenic strains of *Past. multocida*. Depopulation and repopulation. Reduction of infection. Mass medication. Medicated early weaning. Vaccination

### ETIOLOGY

Infection of the nasal cavities with *B. bronchiseptica* followed by toxigenic strains of *P. multocida* – primarily capsular type D<sup>1-4</sup> and occasionally type A – results in progressive turbinate atrophy.<sup>5</sup> *P. multocida* type A strains were formerly thought to be associated entirely with lung infections but there is increasing evidence that some strains of *P. multocida* type A are increasingly toxin producers and may be involved in atrophic rhinitis.<sup>6,7</sup> Toxin production appears to be independent of serotype. The strains of *P. multocida* isolated from the lungs are usually nontoxigenic and of capsular type A<sup>8</sup> but a small proportion are toxigenic and/or possess capsular type D.<sup>8,9</sup> A complex study of the porcine strains from progressive atrophic rhinitis and pneumonia has been completed.<sup>10</sup> Eighteen groups of strains were identified on the basis of specific combinations of capsular type, *toxA* status and outer membrane protein (OMP) type. The majority (88%) of cases of pneumonia were associated exclusively with nontoxigenic capsular type A strains of OMP types 1.1, 2.1, 3.1, and 5.1 and capsular type D isolates of OMP6.1. They are primary pathogens with a relatively high degree of virulence.<sup>10</sup> In contrast the majority (76%) of cases of progressive atrophic rhinitis were associated with *toxA*-containing capsular type D strains of OMP4.1 and capsular type A and D strains of OMP6.1. They further found that toxigenic capsular type A strains associated with progressive atrophic rhinitis and nontoxigenic strains of capsular type A associated with pneumonia represented separate populations of *P. multocida* recognizable by their OMP types.<sup>10</sup> The results of this analysis led the authors<sup>10</sup> to conclude that horizontal transfer of capsular biosynthesis and *toxA* genes has occurred between certain strains of *P. multocida*.

### EPIDEMIOLOGY

#### Occurrence

Atrophic rhinitis occurs worldwide where pigs are reared under intensive conditions. It has, however, become much less important with the onset of vaccination, improvement in resistance by pig breeding companies and general attention to the environment in the farrowing house. It is one of the most common diseases in pigs in the midwestern USA. Some surveys have shown that 50% of finished pigs and sows at slaughter have lesions of atrophic rhinitis. The incidence of clinical disease varies from 5–30%, which in part depends on the method of detection of the gross lesions. Abattoir surveys of the snouts of slaughtered pigs indicate that the incidence of gross lesions ranges from

14–50%. However, the incidence of gross lesions in abattoir surveys is biased by the source of the pigs; the incidence may be low in pigs from herds that have attempted to control the disease and high in some commercial herds with no control program. In pigs slaughtered from pig testing stations the incidence of lesions may be uniform over a long period.<sup>3</sup> The published data on the incidence of gross lesions are also variable because of the lack of a uniform method of evaluating and quantifying the lesions. However, major improvements in the development of uniform and repeatable methods of evaluating lesions have occurred in recent years.

The incidence and severity of the lesions may vary with the season and the type of facility in which pigs are reared. In a slaughter survey of the snouts and lungs of pigs from 21 pig herds over one winter and one summer the lesions of atrophic rhinitis were more severe among pigs slaughtered in the summer, whereas lesions of pneumonia were more severe among pigs slaughtered in the winter.<sup>11</sup> Lesions of atrophic rhinitis were also more severe in pigs farrowed in central, enclosed farrowing houses and finished in enclosed, mechanically ventilated buildings than in pigs farrowed individually in sow huts and finished on dirt lots. It is possible that the incidence and severity of the lesions at slaughter may be a reflection of the condition of the housing facilities when the animals were piglets several months previously, but many other factors could have been involved.

#### Prevalence of infection

*B. bronchiseptica* readily colonizes the ciliated mucosa of the respiratory tract of pigs and infection of the nasal cavities of pigs is present in almost every pig herd, with the prevalence of infection in pigs in commercial herds varying from 25–50%. Serological surveys of individual herds have found that up to 90% of the pigs are positive, which indicates that there is no reliable correlation between the frequency of isolation of the organism and the percentage of animals with antibody. The prevalence of infection is just as high in specific-pathogen-free herds as in non-specific-pathogen-free herds.

The prevalence of infection of toxigenic *P. multocida* type D is higher in herds with clinical disease. The organism can be present in 50–80% of weaned pigs in a herd with clinical disease in the finishing pigs. Toxigenic type D *P. multocida* was first detected in New South Wales, Australia, in 1986; in all herds examined, the introduction of pigs from an infected herd in South Australia was associated

with an increased risk of infection.<sup>12</sup> Toxigenic *P. multocida* type D has been isolated rarely from herds free of atrophic rhinitis.<sup>13</sup>

Whereas *B. bronchiseptica* is eliminated from the respiratory tract of most infected pigs, leaving only a few infected at slaughter, *P. multocida* often persists.

#### Method of transmission

Direct contact and droplet infection are presumed to be the most likely methods of transmission. The reservoir of infection is the infected sow, and litters of piglets become infected at an early age. Colonization of the tonsil by *P. multocida* in conventionally reared pigs is common.<sup>14</sup> In the Netherlands it has been recognized that infection is usually by one of four possibilities.<sup>15</sup> These are artificial insemination centers, laborers, neighborhood infection by direct aerosol or indirect local contact, and the presence of carrier animals and birds.

The infection is usually introduced into a herd by the purchase of infected pigs. Spread between piglets is probably enhanced after weaning when mixing of litters occurs and 70–80% of a large weaned group become infected. Infection persists for up to several weeks and months, followed by a gradual reduction in the intensity and rate of infection. In herds where *B. bronchiseptica* is the initiating agent, up to 90% of pigs 4–10 weeks of age will have nasal infection, but this infection rate falls to approximately 15% by 12 months of age and the proportion of carrier pigs within the breeding herd decreases with increasing age of sow. The prevalence of infection is also much higher during the period from October to March than at other times of the year, and the prevalence of serologically positive animals is highest from July to December. This is most probably a result of the winter housing conditions, with few air changes per hour, fluctuating temperatures, and high humidity.

The epidemiology of toxigenic strains of *P. multocida* as a causative agent of atrophic rhinitis is not as well understood. The organism colonizes the tonsils of clinically normal pigs. In contrast to *B. bronchiseptica*, which is ubiquitous in pig herds the toxigenic isolates of *P. multocida* appear to be restricted to herds affected with progressive atrophic rhinitis.<sup>5</sup> The organism is invariably present in herds with progressive atrophic rhinitis but may also be present in about 5% of the pigs in a herd with no clinical history of atrophic rhinitis. The main source of toxigenic isolates of *P. multocida* for young pigs appears to be the pharyngeal tissues of the breeding stock. About 10–15% of sows in farrowing

houses may be infected with toxigenic isolates and piglets become infected within a week after birth. In contrast to *B. bronchiseptica*, infection of piglets at 12–16 weeks of age with toxigenic *P. multocida* will still result in varying degrees of severity of lesions.

It is possible for growing pigs to develop lesions of atrophic rhinitis well beyond the age of 3 weeks if they are exposed to pigs affected with disease and infected with *P. multocida* and *B. bronchiseptica*.

#### Risk factors

##### Animal risk factors

The age at which piglets first become infected with *B. bronchiseptica* has an important effect on the development of lesions. The most severe lesions occur in nonimmune animals infected during the first week of life. Animals infected at 4 weeks of age develop less severe lesions, while those infected at 10 weeks do not develop significant lesions.

##### Immune mechanisms

The level of immunity in the young pigs will influence the level of infection and the incidence of clinical disease. Colostral immunity from sows serologically positive to *B. bronchiseptica* is transferred to piglets and provides protection for 2–5 weeks. Clinical disease does not occur in piglets with high levels of passive antibody. Older pigs from 10–12 weeks of age may become infected but are less likely to develop severe turbinate atrophy and may develop inapparent infection and become carriers.

Vaccination of the sow before parturition to increase colostral immunity or vaccination of the young pig will increase the rate of clearance of the organism from the nasal cavity and reduce the incidence of clinical disease. In chronically affected herds a level of immunity develops with increasing age of the breeding herd.

##### Pathogen factors

The virulence characteristics of *B. bronchiseptica* and the toxigenic isolates of *P. multocida* are important risk factors. Both organisms are required to produce lesions similar to the naturally occurring progressive disease. The virulence of *B. bronchiseptica* is dependent on the ability to produce heavy, persistent colonization in the nasal cavity and the production of a heat-labile toxin. Bordetellas produce several virulence factors and toxins, which are regulated by a two-component sensory transduction system encoded by the *bvg* locus.<sup>16,17</sup> These virulence factors include adhesins such as filamentous agglutinin, pertactin, and fimbriae, and the adenylate cyclase-hemolysin toxin and the dermonecrotic toxin. In cell

cultures the dermonecrotic toxin stimulates DNA and protein synthesis and assembly of actin stress fibers while inhibiting cell division, resulting in polynucleation of cells.<sup>18,19</sup> It mediates these through the modification and activation of the small guanosine 5'-triphosphate (GTP)-binding protein Rho.<sup>20,21</sup>

There are both toxigenic and non-toxigenic strains of *B. bronchiseptica*.<sup>22</sup> Colonization of the nose was greater with the dermonecrotic-toxin-positive strains than with the dermonecrotic-toxin-negative mutant strains.<sup>23</sup> This was maintained for the first, second, and third weeks postinoculation but by the fourth week the position had changed to the opposite. All dermonecrotic-toxin-positive pigs had pneumonia but the dermonecrotic-toxin-negative animals were able to colonize the lung more freely. There is an outer membrane protein P68 perlectin (*B. bronchiseptica* perlectin gene (*prm*)) that is an adhesin, which may play a part in the protective immunity<sup>24</sup> and may be extremely variable.<sup>25</sup> The most important experiment is one that shows that *P. multocida* mutant strains without the capacity to produce *P. multocida* type D toxin did not produce turbinate atrophy.<sup>26</sup> Only certain porcine phase 1 cultures possess both properties. However, even the most virulent of 10 isolates of *B. bronchiseptica* did not cause progressive turbinate atrophy or significant snout deformation in experimental infections. The severe lesions of atrophic rhinitis cannot be attributed to this organism alone. Experimental inoculation of specific-pathogen-free or gnotobiotic pigs with the organism results in a nonprogressive moderately severe turbinate atrophy 2–4 weeks after infection, followed frequently by regeneration of the turbinates. These virulence characteristics of *B. bronchiseptica* are consistent with the observations that in herds where the organism is common it can provoke sneezing and coughing but no evidence of clinical turbinate atrophy. Examination of the turbinates within 2 weeks after the sneezing will reveal some mild lesions but no lesions will be evident when the pigs are examined at slaughter. It may be that the adhesins left over in the nasal cavity from an infection of *B. bronchiseptica* are subsequently available for the attachment of other bacteria.<sup>27</sup>

Toxigenic isolates of *P. multocida* colonize the nasal cavities, elaborate several toxins, and produce progressive lesions of the turbinate bones and snout. Toxigenic *P. multocida* can colonize the upper respiratory tract of pigs<sup>28</sup> and the presence of the capsule is a virulence factor.<sup>29</sup> The presence of *B. bronchiseptica* can enhance the colonization of



*P. multocida*, particularly the toxigenic type D strains isolated from pigs. The cytotoxin of *B. bronchiseptica* is required for optimum growth by toxigenic *P. multocida*; other products of phase 1 *B. bronchiseptica* growth assist colonization by *P. multocida*, and the degree of atrophy of the turbinates in these mixed infections is related to the numbers of toxigenic *P. multocida* in the nasal cavity.<sup>30</sup> Severe turbinate damage and shortening of the snout can be reproduced in specific-pathogen-free and gnotobiotic pigs by combined infection with *B. bronchiseptica* and certain strains of *P. multocida*. Following experimental infection both organisms may persist in the nasal cavities for up to 64 days. The cell envelope proteins and lipopolysaccharides of *P. multocida* strains associated with atrophic rhinitis have been characterized and compared. At least three protein patterns and six lipopolysaccharide patterns can be distinguished, which can be used to predict the pathogenic character of some of the strains. This will obviate the need to use the guinea-pig skin test to distinguish those strains that are associated with atrophic rhinitis and those that are not.

The gene for the osteolytic toxin of *P. multocida* has been cloned and expressed in *E. coli*; the protein expressed has been shown to have the same properties as the native toxin. The toxin is the main colonization factor produced by toxigenic strains of the organism and antitoxin made from the toxin is protective experimentally and cross-protective between toxins from different capsule types.<sup>31</sup> The toxin can produce turbinate atrophy when injected intranasally and also when given intramuscularly, intraperitoneally, intravenously, or intradermally.<sup>32</sup> Fingerprinting techniques have been used to show that outbreaks of atrophic rhinitis since 1985 in Australia have been associated primarily with a single strain of toxigenic type D *P. multocida*.<sup>12</sup>

#### Environmental factors

The effects of housing, population density and adequacy of ventilation on the prevalence of infection of *B. bronchiseptica* and toxigenic isolates of *P. multocida*, and on the incidence and severity of atrophic rhinitis, have not been examined in detail. Atmospheric ammonia, dust, and microbial concentrations in the farrowing house and dust in weaner barns have a significant role in the severity of atrophic rhinitis.<sup>33,34</sup> The mean daily gain of gilts with atrophic rhinitis exposed to ammonia may be smaller than that of those not affected.<sup>35</sup> Undocumented field observations suggest that the disease is more common and severe when pigs are confined, overcrowded and housed in poorly

ventilated unsanitary barns, all of which promote the spread of infection.

There is no effect of high levels of ammonia on the severity of turbinate atrophy. It has been shown that high levels of ammonia have no effect on the disease progression of atrophic rhinitis and pneumonia but do enhance the colonization of the nasal turbinates by toxigenic *P. multocida*.<sup>36</sup> A recent experiment has shown<sup>34</sup> that higher numbers of *P. multocida* bacteria were isolated from the tonsil than the nasal membranes per gram of tissue. Aerial pollutants contribute to the severity of lesions associated with atrophic rhinitis by facilitating colonization of the upper respiratory tract by *P. multocida*.

Management factors such as confinement farrowing and the use of continual throughput farrowing houses and weaner houses are also considered to be important risk factors. Adverse climatic conditions (below thermoneutrality with drafty periods) can result in a lower amount of energy available for production because of increased maintenance requirements,<sup>37</sup> which results in growth retardation associated with lowered feed intake.

#### Economic importance

Historically, it was accepted as dogma that atrophic rhinitis was an important cause of economic loss in pig herds because of decreased growth rate, less than optimal feed efficiency and the fact that it was a major risk factor in enzootic swine pneumonia. A number of field studies have found an association between atrophic rhinitis and reduced growth rate in some herds, whereas other observations were unable to show an association between the presence of the disease and growth rate. The lack of a standard system for evaluation of conchal lesions may be a factor in the variable results between observations.<sup>38</sup>

Some field studies have failed to show that the disease has an effect on growth rate in finishing pigs or that there is a cause and effect relationship between atrophic rhinitis and pneumonia. The presence of pneumonia in pigs from a test station reduced mean daily weight gains by 33% for each 10% of affected lung, but atrophic rhinitis did not affect daily gain and there was no association between the development of atrophic rhinitis and the development of pneumonia. Pigs vaccinated against *B. bronchiseptica* had turbinate atrophy scores or mean daily gains no different from those of unvaccinated pigs. In another study there was a low positive correlation between the herd mean turbinate atrophy score and the herd mean percentage pneumonia score. A recent report from Illinois indicates that

the prevalence of clinical atrophic rhinitis in farrow-to-finish herds ranged from 0–20% and in pigs from those herds examined at the abattoir the incidence of turbinate lesions ranged from 5–92%. In some of the herds the mean daily weight gain was 15–18% higher than in herds where pigs had severe turbinate lesions. In an Australian report there was no correlation between the severity of atrophic rhinitis and growth rate or back fat thickness.

In one study of three commercial pig herds, the snouts and lungs of individual pigs were examined and scored at slaughter and the results were correlated with growth indicators for each pig (average daily gain during the growing and finishing phases, and days to reach market). Scores for lung lesions were also correlated to scores for snout lesions. Contrary to findings in many other studies, pigs that reached market weight at the youngest age did not have the lowest score for lung lesions, nor the lowest grade for snout lesions, nor the least extensive or severe lesions.<sup>39</sup> It was concluded that lung lesions and grades for snout lesions in pigs at slaughter are not valid indicators for determining the economic effect of either pneumonia or atrophic rhinitis on growth performance of pigs.

#### PATHOGENESIS

Following infection of the nasal cavity, *B. bronchiseptica* becomes closely associated with the ciliated epithelium of the respiratory tract. The organism produces a heat-labile toxin that results in a non-progressive, moderately severe turbinate atrophy that is apparent within 2–4 weeks after infection, followed frequently by regeneration of the conchae. There is, initially, ciliary loss and ciliary stasis, followed by reduction in mucociliary clearance followed by hyperplasia and metaplasia of the nasal epithelium, fibrosis in the lamina propria, and resorption and replacement fibrosis of the osseous core. Experimental infection with *B. bronchiseptica* alone does not result in severe persistent conchal atrophy or twisting or shortening of the snout. The strains of *B. bronchiseptica* that produce cytotoxin may predispose to the colonization of *P. multocida* in the nasal cavities.

Infection and colonization of the nasal cavities with the toxigenic strains of *P. multocida* results in the elaboration of a toxin that causes progressive conchal atrophy. The toxin is thermolabile and dermonecrotic and is called the dermonecrotic toxin of *P. multocida*. The inoculation of a toxin from a toxigenic strain of type D *P. multocida* into the nasal cavities of gnotobiotic pigs results in

severe bilateral atrophy of the conchae. Atrophy of the ventral conchae can be produced experimentally with pathogenic *B. bronchiseptica* in piglets at 6 weeks of age and with toxigenic *P. multocida* strains in piglets as old as 16 weeks of age.

The toxin enhances osteoclastic resorption and impairs osteoblastic synthesis of the conchal osseous core; irreversible changes can occur within a few days.<sup>40</sup> The toxin is able to subvert cell cycle progression and cell-cell signaling systems in osteoblasts and osteoclasts.<sup>41,42</sup> The toxin is the sole agent responsible for the conchal atrophy and the effect appears to be related to the total exposure to the toxin, i.e. dose-dependent.<sup>43</sup> More importantly, this also appears to have an immunomodulatory effect. There is an inverse relationship between the number of *P. multocida* and the total concentration of immunoglobulin.<sup>44</sup> This may in part be one of the reasons that local changes in the nose produce such adverse growth effects, and they may be due to the fact that the *P. multocida* type D toxin has in fact changed the immune functions and that the *P. multocida* may have pre-disposed to many other agents.<sup>43</sup> These authors' conclusion is that *P. multocida* significantly suppresses the antigen-specific IgG immune responses of pigs to parenteral antigen challenge.<sup>43</sup> The epithelium and the submucosa undergo secondary atrophy and the conchae may disappear almost completely within 10–14 days. These lesions can persist until the animal is 90 kg in body weight. The conchal atrophy is not accompanied by an inflammatory reaction. The effect of the *P. multocida* toxin is restricted to the nasal cavity; this is supported by the intriguing observation that the parenteral injection of the toxin into gnotobiotic piglets results in turbinate lesions and shortening and twisting of the snout. The parenteral injection of the dermonecrotxin of *P. multocida* capsular type D into specific-pathogen-free adult pigs will result in moderate conchal atrophy.<sup>45</sup> In piglets 7 days of age, the intramuscular injection of the purified dermonecrotxin will result in severe atrophy of the conchae.<sup>45</sup> The culture filtrate of a non-atrophic-rhinitis pathogenic *P. multocida* will not cause lesions after intramuscular injection. The disappearance of the conchae and the involvement of the bones of the face lead to deformity of the facial bones with the appearance of dishing and bulging of the face and, if the lesion is unilateral, to lateral deviation of the snout.

The effect on growth rate, if any, may be due to the chronic irritation and interference with prehension. Experimentally, atrophic rhinitis suppressed the health of

pigs, reducing their activity and feed intake.<sup>46</sup> Experimentally, parenteral injections of the toxin decrease physeal area and reduce chondrocyte proliferation in long bones, in addition to conchal atrophy.<sup>47</sup>

Reliable experimental models of atrophic rhinitis in gnotobiotic pigs are now available and are useful for studying the pathogenesis of the disease and testing vaccine strategies. A sterile sonicate of a toxigenic strain of *B. bronchiseptica* is instilled into the nasal cavities of piglets at 5 days of age followed by intranasal inoculation of toxigenic strains of *P. multocida* at 7 days of age.<sup>48</sup>

### CLINICAL FINDINGS

The clinical findings of atrophic rhinitis depend on the stage of the lesions. In acute cases in piglets 3–9 weeks of age, irritation of the nasal mucosa causes sneezing, some coughing, small amounts of serous or mucopurulent nasal discharge, and transient unilateral or bilateral epistaxis. The frequency of sneezing may be a measure of the incidence and severity of the disease. In piglets born from sows vaccinated with *B. bronchiseptica* and *P. multocida* vaccine before farrowing, followed by two vaccinations within 3 weeks of age, the frequency of sneezing at 3–9 weeks of age was much less than in piglets given only *B. bronchiseptica* vaccine. There may be rubbing of the nose against objects or on the ground. A watery ocular discharge usually accompanies this and may result in the appearance of dried streaks of dirt below the medial canthus of the eyes. There may be a decrease in growth rate. In infection with *B. bronchiseptica* these clinical signs will disappear spontaneously in a few weeks, when the pigs will appear normal. In severe cases, respiratory obstruction may increase to the point of dyspnea and cyanosis, and sucking pigs may have great difficulty in nursing. The nasal secretions become thicker and nasal bleeding may also occur.

In the more chronic stages, inspissated material may be expelled during paroxysms of sneezing. During this chronic stage, there is often pronounced deformity of the face due to arrested development of the bones, especially the conchae, and the accumulation of necrotic material in the nasal cavities. The nasal bones and premaxillae turn upwards and interfere with approximation of the incisor and, to a lesser extent, the molar teeth. There are varying degrees of brachygnathia superior and protrusion of the lower incisor teeth. Prehension and mastication become difficult, with a resulting loss of body condition. Facial distortion in the final stages takes the form of severe 'dishing' of the face with wrinkling of the overlying skin.

If the condition is unilateral, the upper jaw may be twisted to one side. These visible facial deformities develop most commonly in pigs 8–10 weeks old within 3–4 weeks after infection, but they may occur in younger pigs.

The most serious effects of the advanced disease are depression of growth rate and unthriftiness. The appetite may be unaffected but much feed is lost by spillage and feed efficiency may be reduced in some instances.

### CLINICAL PATHOLOGY

#### Culture and detection of bacteria

It is important to be able to detect infected animals in a herd, especially the carrier animal. Nasal swabs are used to detect the bacteria and to determine their drug sensitivity. The collection of the nasal swabs must be done carefully and requires a special transport medium to insure a high recovery rate. A sampling technique and a special culture medium to facilitate the isolation and recognition of *B. bronchiseptica* are described.<sup>49</sup> The external nares are cleaned with alcohol and a cotton-tipped flexible wire is pushed into the nasal cavity (of each side in turn) until it reaches a point midway between the nostril and the level of the medial canthus of the eye. On removal, the cotton tip is cut off into 0.5 mL of an ice-cold sterile transport medium comprising phosphate-buffered saline (PBS, pH 7.3) with fetal calf serum (5% v/v). The samples are then placed on special media, preferably within 4 hours. Normally the organism grows well on conventional culture media, especially when younger pigs are sampled. However, in the carrier pig the organism may be sparse and the selective medium is recommended.

The nasal culturing procedure has been used as an aid in the control of atrophic rhinitis associated with *B. bronchiseptica*. A series of three nasal swabs from each animal is considered to be about 77% efficient in detecting infected animals for possible culling and elimination from the herd. However, in some studies there may be no marked difference in the prevalence of *B. bronchiseptica* or *P. multocida* in pig herds with or without clinical atrophic rhinitis.<sup>49</sup>

Toxigenic *P. multocida* grow readily in the laboratory but are difficult to isolate from nasal swabs because they are frequently overgrown by commensal flora. Selective laboratory media containing antimicrobial agents have been developed to promote the isolation of *P. multocida* from nasal swabs. Inoculation of cotton swabs to selective medium on the same day as the sampling provides the best isolation of toxigenic *P. multocida*.

Immersion of pigs at slaughter in the scalding tank can result in a marked reduction in the isolation of toxigenic *P. multocida*.

A cell culture assay using embryonic bovine lung cell cultures is available and is a sensitive *in vitro* test for the differentiation of toxigenic from nontoxigenic isolates of *P. multocida*. This test can replace the lethal tests in mice or the dermonecrotic tests in guinea-pigs.

### Serology

Agglutination tests and an ELISA test are available for the detection of pigs infected with *B. bronchiseptica*, especially carrier animals. Serology is of value in the assessment of the response of pigs vaccinated with the *B. bronchiseptica* vaccines. There are currently no reliable serological tests for *Pasteurella*.

### Antigen detection

A PCR method originally described in 1996<sup>50</sup> for the enhanced detection of toxigenic *P. multocida* directly from nasal swabs has been described and upgraded.<sup>51</sup> This was shown to be 10 times more sensitive than *P. multocida* type D toxin (PMT) ELISA and five times more sensitive than clinical bacteriology with subsequent use of PMT ELISA. A nested PCR has also been described.<sup>52</sup> Similarly, a PCR method for the detection of *B. bronchiseptica* has been described<sup>53</sup> that produces 78% more positives than culture, particularly with swabs with a high mixed bacterial load. Recently a nested-PCR has been described that was reported to be more specific and sensitive than the other PCR methods previously described.<sup>54</sup> It does not require culture, it is less laborious and the results can be provided within 24 hours. The authors concluded that this test was suitable for breeding company evaluations and for eradication schemes.

### Radiography

Some aids to the clinical diagnosis have been examined but are not highly accurate. Radiography of the nose is not reliable in detecting the severity of conchal atrophy.

### NECROPSY FINDINGS

The typical lesions of atrophic rhinitis are restricted to the nasal cavities, although concurrent diseases, especially virus pneumonia of pigs, may produce lesions elsewhere. In the early stages there is acute inflammation, sometimes with the accumulation of pus, but in the later stages, there is evidence only of atrophy of the mucosa, and decalcification and atrophy of the conchae and ethmoid bones, which may have completely disappeared in severe cases. The inflammatory and atrophic processes may

extend to involve the facial sinuses. There is no evidence of interference with the vascular supply to the affected bones. The changes in the nasal cavities are most readily seen if the head is split in the sagittal plane but for accurate diagnosis the degree of conchal symmetry, volume and atrophy and medial septum deviation should be assessed by inspection of a vertical cross-section of the skull made at the level of the second premolar tooth.

The clinical diagnosis is confirmed and the severity of the lesions is assessed by the postmortem examination of a cross-section of the snout. The snout must be sectioned at the level of the second premolar tooth because the size of the conchal bone reduces anteriorly and may give a false-positive result if the section is taken too far forward. Quantification of the severity of the lesions has been of value for monitoring the incidence and severity of the disease in a herd. Several systems have been used for grading the severity of lesions of the snout. Most of them have used a subjective visual scoring system in which snouts are grade 0 (complete normality) to 5 (complete conchal atrophy). Reasonable agreement among observers recording morphological changes of nasal conchae is achievable with some training.<sup>49</sup>

The standards for each grade are as follows:<sup>55</sup>

- Grade 0:** No deviation from absolute normality, with nasal septum straight and conchae symmetrical and filling nasal cavities
- Grade 1:** Slight irregularity, asymmetry or distortion of the nasal structures without atrophy
- Grade 2:** Marked distortion of nasal structure but without marked atrophy
- Grade 3:** Definite atrophy of the conchae with or without distortion
- Grade 4:** More severe atrophy with severe atrophy of one or more conchae
- Grade 5:** Very severe atrophy in which all conchae have virtually disappeared.

Such a discontinuous grading system does not provide a direct quantitative relationship. Regular examination of the snouts from heads of pigs sent to slaughter can be used to assess the level of conchal atrophy in the herd. Morphometric methods, using either point counting or semi-automated planimetry applied to photographic or impression prints of sections of the snout to measure the extent of conchal atrophy on a continuous scale as a morphometric index, are now available. Cross-sections of the snout are photographed or used to make impression prints, which are then measured.<sup>56</sup> A morphometric index is determined, which is the ratio of free

space to total cross-sectional area of the nasal cavity. The system correlates well with the visual grading system of 0–5 but is labor-intensive and relatively expensive. The conchal perimeter ratio may be a more reliable morphometric measure of atrophic rhinitis and also provides parametric data suitable for quantitative analysis.<sup>57</sup> A morphometric analysis using conchal area ratio is the best method for quantifying gross morphological turbinate changes.<sup>58</sup> Descriptions of the methods for making snout impressions are available.<sup>59,60</sup> Computed tomography has been described.<sup>61</sup>

A major limitation of the grading system is that conchal atrophy occurs as a continuous spectrum and it is difficult to decide, for example, if a pig with a grade 3 lesion represents the more severe manifestation of *B. bronchiseptica* infection, which may not progress further, or an early manifestation of infection with toxigenic *P. multocida*, which could develop into a severe herd problem.

### Samples for confirmation of diagnosis

- Bacteriology – nasal swabs
- Histology – formalin-fixed cross-section of snout at level of second premolar
- Antigen detection – nasal swabs.

### DIFFERENTIAL DIAGNOSIS

The occurrence of sneezing in the early stages and of facial deformity in the later stages are characteristic of this disease.

Inclusion body rhinitis due to a cytomegalovirus is a common infection in young piglets in which there is sneezing and conjunctivitis. However, by itself it does not progress to produce turbinate atrophy and facial distortion. Under good hygienic conditions the course of the disease is about 2 weeks and the economic effects are minimal. In the early acute stages, atrophic rhinitis may be mistaken for swine influenza which, however, usually occurs as an outbreak affecting older pigs and accompanied by a severe systemic reaction without subsequent involvement of facial bones.

Necrotic rhinitis is manifested by external lesions affecting the face, and virus pneumonia of pigs is characterized by coughing rather than sneezing.

The inherited prognathic jaw of some breeds of pigs has been mistaken for the chronic stage of atrophic rhinitis; protrusion of the lower jaw is quite common in adult intensively housed pigs and has been attributed to behavioral problems of pushing the snout against fixed equipment such as bars and nipple drinkers.

### TREATMENT

Treatment early in the course of the disease will reduce the severity of its effects, but it

is of little value in chronically affected pigs, and these pigs are best culled at an early age because of their persistent poor growth rate and high food conversion.

Tylosin at 20 mg/kg BW, oxytetracycline at 20 mg/kg BW, or trimethoprim-sulfadoxine (40 mg/200 mg/mL) at 0.1 mL/kg BW may be given parenterally or the creep feed may be medicated with sulfamethazine and/or tylosin at 200 and 100 mg/kg of feed respectively. Parenteral injections need to be repeated every 3–7 days for at least three injections and feed medication should be given for 3–5 weeks. The problem with early creep medication is in obtaining adequate intakes of the antibacterial. This is seldom achieved before 2 weeks of age and parenteral antibiotics may be required if significant infection occurs before this stage.

The parenteral administration of antimicrobial agents to individual piglets at 3–7-day intervals beginning at 3 days of age for a total of three to five injections per piglet has been recommended for the treatment and control of atrophic rhinitis. However, in a large herd such a treatment regimen would be a major task and, until a cost-benefit analysis indicates a beneficial effect over other methods, we cannot recommend such a practice.

The treatment of experimental *B. bronchiseptica* infection in young pigs has been successful with the use of trimethoprim-sulfadiazine in the drinking water at levels of 13.3 and 77.6 µg/mL respectively, for 3 weeks. This method would remove the necessity to inject pigs repeatedly.

Tilmicosin has proved useful;<sup>62,63</sup> fed continuously over 6 weeks at concentrations of 200 g per ton of feed it controlled transmission of atrophic rhinitis, weight gains were positively affected, and fewer nasal swabs were positive for *P. multocida* at the end of the study period.<sup>64</sup>

## CONTROL

Effective control depends on developing methods of eliminating or controlling the prevalence of toxigenic isolates of *P. multocida*, which cause progressive atrophic rhinitis if they become established in the nasal cavity. Previous infection of the nasal cavity with *B. bronchiseptica* can enhance the establishment of toxigenic *P. multocida* and result in progressive atrophic rhinitis.

While there is considerable information available on the ecology of *B. bronchiseptica* and the methods by which it might be eliminated or controlled in a herd, there is little documented information available on methods that can be used for control of the toxigenic isolates of *P. multocida* associated with atrophic rhinitis.

Control of atrophic rhinitis can be attempted in at least four ways:

- Total eradication
- Reduction of infection pressure
- Mass medication with antimicrobials to reduce the severity and adverse effects of infection
- Vaccination.

Regardless of the method employed, any effective control program must have a system for monitoring the incidence of clinical disease in the herd and the incidence and severity of conchal lesions of the pigs sent to slaughter. Accurate and reliable methods for monitoring clinical disease are not available but the incidence of acute rhinitis and facial deformities could be recorded regularly. At slaughter, snouts can be examined for lesions of conchal atrophy and for assessing a mean snout score for each group of pigs slaughtered.

## Eradication

Total eradication can only be achieved with confidence by complete depopulation for a 4-week period and repopulation with primary or purchased specific-pathogen-free stock. This approach has the added advantage of also eliminating enzootic pneumonia, which may be a significant contributing factor to the economic importance of this disease. However, this method of control is extremely costly and the economic importance of the disease would need to be carefully evaluated in relation to this cost before this method was instituted. Other techniques of obtaining pigs free of atrophic rhinitis, such as the isolated farrowing of older and presumed non-carrier sows with subsequent clinical and postmortem examinations of a proportion of the litters, have had a significant failure rate in the field and are not recommended. Eradication by repopulation with cesarean-derived stock may be essential in breeding nucleus herds where a high generation turnover results in a low herd sow age and a low herd level of immunity. The breakdown rate of herds established by this method can be significant, presumably because the initiating organisms are not solely confined to pigs.

A pilot control scheme was initiated in Britain in which a herd had to meet the following conditions:

- It must be inspected by a veterinarian every 6 months over a period of 2 years, over which time there must be no clinical evidence of atrophic rhinitis
- The herd owner must certify that atrophic rhinitis has not been suspected over the same time period

- Cross-sections of snouts taken from at least 30% of marketed pigs must be examined regularly by a veterinarian, and over a 2-year probationary period the average 6-monthly snout score must not exceed 0.5
- There must be no vaccination or treatment for atrophic rhinitis
- New breeding stock can be introduced only from other qualified herds or herds derived by hysterectomy, artificial insemination, or embryo transfer techniques.

Over a 5-year period 45 herds qualified at some stage, and 34 were still qualified at the end of 5 years. As of 1988, some herds had exceeded the snout score limit of 0.5, with their average scores increasing to 2.24.<sup>65</sup> In these herds, there was no clinical, epidemiological, or bacteriological evidence that they were at risk of developing severe atrophic rhinitis. It is suggested that the higher scores were associated with a group of recurrent husbandry factors, especially overstocking and unsatisfactory conditions in the weaner barns. These increased scores suggested the possibility that the upper limit for the snout scores in qualifying herds could be raised and allow bacteriological testing to be confined to more doubtful herds.

Eradication in the Netherlands was based on the fact that they thought that there were four main possibilities for the spread of toxigenic *P. multocida*: artificial insemination centers, laborers, neighborhood infection either by aerosol or by local spread, and carrier animals or birds. They assumed that most herds were closed or buying certified stock and that the major source of infection was therefore the boar.<sup>26</sup> In this study they tested boars; in herds with less than 50 boars they tested all and in those with more than 50 they tested 50 as the minimum. They took nasal and tonsil samples,<sup>66,67</sup> which were placed in cold transport medium<sup>68</sup> and sent to the laboratory within 24 hours under cooled conditions for overnight culture followed by PCR.<sup>69</sup>

## Reduction of infection

Reduction of infection pressure can be attempted. Infection of piglets occurs primarily either from carrier sows or from other infected piglets in the immediate environment and severe atrophic rhinitis generally results from infection of piglets under 3 weeks of age. If these factors can be minimized the incidence and severity of the disease can be reduced.<sup>70</sup> An all-in/all-out pig flow is one of the most effective methods of control of atrophic rhinitis. Changing to an all-in/all-out pig flow from continuous flow management can improve snout scores by 50%, lung

scores by 55%, average daily gain by 0.14 lb and days to market by 13 days.<sup>71</sup>

Since severe lesions depend upon infection of the piglet under 3 weeks of age, every attempt should be made to minimize the severity of the challenge to young piglets. It is a common observation that the effects of atrophic rhinitis are minimal under good systems of management and adequate ventilation, nondusty conditions and good hygiene. The use of continual-throughput farrowing houses and weaner houses allows a buildup of infection with the presence of actively infected pigs that can provide a high infection pressure on piglets born into or introduced into these areas. The use of all-in/all-out systems of management in these areas is recommended and young piglets should be kept in a separate area from older pigs.

### Mass medication

The prophylactic use of antimicrobials is frequently employed to reduce the incidence of the disease within the herd. Antimicrobials are used both within the breeding herd to reduce the prevalence of carriers and in young suckling and weaner pigs to reduce the severity of the infection. The medication is begun about 2 weeks before farrowing, continued throughout lactation and incorporated in the creep feed for the sucking pigs and the starter feeds for the weaned pigs. In this way there is continuous medication of the sow and the piglets during the most susceptible period. For the breeding herd, sulfamethazine at levels of 450–1000 mg/kg feed, with the higher levels being given to dry sows on restricted feeding, has been recommended. Sulfonamide resistance has proved a problem in some countries but beneficial results may still be achieved with these levels. It is recommended that medication be continued for a 4–6-week period. Carbadox at a level of 55 ppm in combination with sulfamethazine at 110 ppm is reported to be effective in clearing experimentally induced *B. bronchiseptica* infection, and when used alone improved growth rate and feed efficiency in pigs with naturally occurring atrophic rhinitis. In the starter period, carbadox fed alone or in combination with sulfamethazine improved average daily gain in piglets from herds with naturally occurring atrophic rhinitis.<sup>72</sup> Use of the medication, however, did not result in a reduction of mean nasal lesion scores due to atrophic rhinitis. Sulfamethazine at 110 mg/kg of feed is more effective than sulfathiazole at the same concentration for the control of experimentally induced atrophic rhinitis due to *B. bronchiseptica*. Sulfamethazine may also be incorporated in creep rations

and the use of tetracyclines (200 mg/kg), tylosin (50–100 mg/kg), and penicillin (200 mg/kg) have also been suggested.

Medicated early weaning is recommended to obtain pigs free from pathogens, including *B. bronchiseptica*, that are endemic in the herd of origin. The sows are fed medicated feed from 5 days before to 5 days after weaning and the piglets are dosed from birth to 10 days of age.

### Vaccination

There has been considerable interest in the development of vaccines for the control and prevention of atrophic rhinitis due to *B. bronchiseptica*. Inactivated vaccines have been used to vaccinate the pregnant sow 4–6 weeks before farrowing, and in some cases, followed by vaccination of the piglets at 7 and 28 days of age. In general, the use of the vaccine in pregnant sows in herds where the disease has been endemic has reduced the incidence of clinical atrophic rhinitis. However, the results from one study to another have been highly variable. Vaccination of the pregnant sow results in an increase in colostrum antibody titer, which does improve the clearance rate of *B. bronchiseptica* in the piglets. However, it has been difficult to evaluate the efficacy of the *B. bronchiseptica* used alone because the turbinate atrophy associated with infection of piglets with *B. bronchiseptica* experimentally or naturally heals and regenerates completely when they are reared to about 70–90 kg BW in good housing conditions.

Vaccination with both components (*B. bronchiseptica* and *P. multocida*) in a vaccine reduces lesions considerably when compared with a placebo and a group with only *P. multocida* type D toxin in the vaccine<sup>73</sup> but neither vaccine eliminated toxigenic *P. multocida* from the upper respiratory tract.

Experimentally, piglets born from sows vaccinated with *P. multocida* are protected from a challenge with atrophic rhinitis toxin. This indicates that artificial immunization for atrophic rhinitis should be possible. Vaccination of sows at least three times before farrowing for the first time and during each subsequent pregnancy with a vaccine containing *B. bronchiseptica* and *P. multocida* was highly successful in reducing the incidence of atrophic rhinitis in the pigs. The incidence in affected herds was reduced from 7.5% to about 2%. Experimentally, the vaccine provides good protection against challenge in piglets from vaccinated sows.<sup>72</sup>

A recombinant *P. multocida* toxin derivative vaccine given to gilts 4–5 weeks before farrowing and again 2–3 weeks later provided excellent protection in their piglets against experimental challenge

with *B. bronchiseptica* and toxigenic *P. multocida*.<sup>74</sup> This indicates the excellent immunoprotective properties of the nontoxic derivative of the *P. multocida* toxin. In five field trials a single component vaccine containing a nontoxic but highly immunogenic protein, the d0-protein, as the antigen, provided much better protection than the control vaccine containing killed *P. multocida* and killed *B. bronchiseptica*.<sup>75</sup>

Experimental infection and vaccination of pregnant minimum-disease sows with *B. bronchiseptica* resulted in much higher agglutinins in serum and colostrum than in sows only vaccinated or control animals, and the piglets were provided with protection against experimental disease. Vaccination of pregnant gilts with purified inactivated *P. multocida* toxin resulted in a high degree of protection of their progeny against progressive atrophic rhinitis.<sup>76</sup>

A new vaccine has been described<sup>77</sup> using a truncated *P. multocida* type D toxin that is immunogenic and nontoxic, a toxoid for *B. bronchiseptica* and an adjuvant. Sows were vaccinated at 8–6 weeks and 4–2 weeks before farrowing. The vaccinated animals had fewer organisms.

### REVIEW LITERATURE

- Chanter N, Jones PW, Barnard S, Pennings A. Atrophic rhinitis of swine. In: Manual of standards for diagnostic tests and vaccines, list A and B: diseases of mammals, birds and bees. Paris: Office International des Epizooties, 2000:615–622.
- Magyar T, Lax AJ. Atrophic rhinitis. In: Brogden KA, Gunthmiller JM, eds. Polymicrobial diseases. Washington, DC: ASM Press, 2002:169–197.

### REFERENCES

- Eamens CJ et al. Aust Vet J 1988; 65:120.
- Foged NT et al. J Clin Microbiol 1988; 26:1419.
- Gardner IA et al. J Vet Diagn Invest 1994; 6:442.
- Lariviere S et al. J Clin Microbiol 1992; 30:1398.
- Chanter N. Pig News Info 1990; 11:503.
- Fussing V et al. Vet Microbiol 1999; 65:61.
- Sakano T et al. J Vet Med Sci 1992; 54:403.
- Rubies X et al. Vet Microbiol 2002; 84:69.
- Choi c et al. Vet Rec 2001; 149:210.
- Davies RL et al. J Med Microbiol 2003; 52:59.
- Cowart RP et al. J Am Vet Med Assoc 1991; 200:190.
- Gardner IA et al. Aust Vet J 1991; 68:364.
- Kavanaugh NT et al. Vet Rec 1994; 134:218.
- Ackermann MR et al. J Vet Diagn Invest 1994; 6:375.
- De Jong M et al. In: Proceedings of the 17th International Pig Veterinary Society Congress 2002:329.
- Arico B et al. Mol Microbiol 1991; 5:2481.
- Monack DM et al. Mol Microbiol 1989; 3:1719.
- Horoguchi Y et al. Infect Immun 1993; 61:3611.
- Horoguchi Y et al. FEMS Microbiol Lett 1994; 106:19.
- Horoguchi Y et al. FEMS Immunol Med Microbiol 1995; 12:29.
- Horoguchi Y et al. Proc Natl Acad Sci U S A 1997; 94:11623.
- Magyar T et al. Vet Microbiol 1988; 18:135.
- Brockmeier SL et al. Vet Microbiol 2000; 73:1.
- Novotny P et al. Infect Immun 2000; 50:190.

25. Register KB. In: Proceedings of the 16th International Pig Veterinary Society Congress 2000:483.
26. Brockmeier SL et al. *Infect Immun* 2002; 70:481.
27. Tuomanen E. *Infect Immun* 1986; 54:905.
28. Pijoan C, Trigo F. *Can J Vet Res* 1990; 54:516.
29. Jacques M et al. *Infect Immun* 1993; 61:4785.
30. Chanter N et al. *Res Vet Sci* 1989; 47:48.
31. Lax AJ, Chanter N. *J Gen Microbiol* 1990; 136:81.
32. Williams PP et al. *Can J Vet Res* 1990; 54:157.
33. Robertson JF et al. *Anim Prod* 1990; 50:173.
34. Hamilton TDC et al. *Clin Diagn Lab Immunol* 1999; 6:199.
35. Diekman MA et al. *Am J Vet Res* 1993; 54:2128.
36. Andreasen M et al. *J Vet Med* 2000; 47:161.
37. Van Diemen PM et al. *Livestock Prod Sci* 1995; 43:275.
38. Cowart RP et al. *J Am Vet Med Assoc* 1990; 196:1062.
39. Scheidt AB et al. *J Am Vet Med Assoc* 1990; 196:881.
40. Ghoshal NG, Niyoy A. *J Vet Res* 1994; 54:738.
41. Rozengurt E et al. *Proc Natl Acad Sci U S A* 1990; 87:123.
42. Mullan PB, Lax AJ. *Infect Immun* 1996; 64:959.
43. Jordan RW et al. *FEMS Immunol Med Microbiol* 2003; 39:51.
44. Elias B et al. *J Vet Med Sci* 1996; 55:617.
45. Martineau-Doize B et al. *Can J Vet Res* 1991; 55:224.
46. Van Diemen PM et al. *J Anim Sci* 1995; 73:1658.
47. Ackermann MR et al. *Am J Vet Res* 1996; 57:848.
48. Ackermann MR et al. *Infect Immun* 1991; 59:3626.
49. Lariviere S et al. *J Clin Microbiol* 1993; 31:364.
50. Kamp EM et al. *J Vet Diagn Invest* 1996; 8:304.
51. Ohlinger VF et al. In: Proceedings of the 16th International Pig Veterinary Society Congress 2000:478.
52. Choi CS, Chae CH. *Vet J* 2001; 162:255.
53. Reizenstein E et al. *Diagn Microbiol Infect Dis* 1993; 17:185.
54. Sulko C et al. In: Proceedings of the 17th International Pig Veterinary Society Congress 2002:90.
55. Jackson GH et al. *Br Vet J* 1982; 138:480.
56. Done JT et al. *Vet Rec* 1984; 114:33.
57. Collins MI et al. *Am J Vet Res* 1989; 50:42.
58. Gatlin CL et al. *Can J Vet Res* 1996; 60:121.
59. Done JT et al. *Br Vet J* 1984; 140:418.
60. Lund LJ, Beckett P. *Vet Rec* 1983; 113:473.
61. Magyar T et al. *Acta Vet Hung* 2003; 51:485.
62. Clark LK et al. *J Swine Health Prod* 1998; 6:257.
63. Olson LB, Backstrom LR. *J Swine Health Prod* 2000; 8:263.
64. Backstrom L et al. *J Swine Health Prod* 1994; 2:11.
65. Goodwin RFW. *Vet Rec* 1988; 123:566.
66. De Jong MF et al. In: Proceedings of the 13th International Pig Veterinary Society Congress 1994:238.
67. De Jong MF et al. In: Proceedings of the 14th International Pig Veterinary Society Congress 1996:249.
68. De Jong MF et al. In: Proceedings of the 16th International Pig Veterinary Society Congress 2000:477.
69. Baekbo P et al. In: Proceedings of the 13th International Pig Veterinary Society Congress 1988:51.
70. Pejsak Z et al. *Compend Immunol Microbiol Infect Dis* 1994; 17:125.
71. McCaw MB. *Compend Contin Educ Pract Vet* 1994; 16:1615.
72. Kobisch M, Pennings A. *Vet Rec* 1989; 124:57.
73. Magyar T et al. In: Proceedings of the 16th International Pig Veterinary Society Congress 2000:479.

74. Nielsen JP et al. *Can J Vet Res* 1991; 55:128.
75. Bording A et al. *Acta Vet Scand* 1994; 35:155.
76. Foged NT et al. *Vet Rec* 1989; 125:7.
77. Riising H et al. *Vet Rec* 2002; 150:569.

## Diseases associated with *Brucella* species

### INTRODUCTION

The species of *Brucella* and their principal farm animal hosts are *Brucella abortus* (cattle), *Brucella melitensis* (goats), *Brucella suis* (pigs), and *Brucella ovis* (sheep). In general, the principal manifestations of brucellosis are reproductive failure, such as abortion or birth of unthrifty newborn in the female, and orchitis and epididymitis with frequent sterility in the male. Persistent (lifelong) infection is a characteristic of this facultative intracellular organism, with shedding in reproductive and mammary secretions. Brucellosis is also an important zoonosis causing debilitating disease in humans. Because of the major economic impact on animal health and the risk of human disease, most countries have attempted to provide the resources to eradicate the disease from the domestic animal population.

Control programs have employed two principal methods: vaccination of young or mature animals and the slaughter of infected and exposed animals, usually on the basis of a reaction to a serological test.

Brucellosis has been eradicated from cattle in several regions of the world and is nearly eradicated in others. However, it is still widespread and is an economically important agricultural disease in many countries. There are still many cases of human brucellosis reported each year in regions where the disease has not been eliminated in farm livestock.

In 2002, an entire issue of the journal *Veterinary Microbiology*, vol 90, pp 1-603, was devoted to brucellosis. Several review articles on various aspects of brucellosis from that special issue are listed below under Review literature.

The history of brucellosis is fascinating.<sup>1</sup> In 1884, Captain David Bruce and several others working on Mediterranean fever isolated an agent they called *Micrococcus melitensis* from human spleens. Hospital patients were fed raw goat's milk for many illnesses and this was an early example of a nosocomial infection. The ship *SS Joshua Nicholson*, when anchored in Malta in 1905, took on board 65 goats bound for Washington. The Bureau of Animal Industry of the USDA had decided to import Maltese goats to encourage goat husbandry among peasant immigrants from Southern Europe. Nearly all the ship's crew drank the raw milk and,

within weeks, were ill. The goats were never shipped to the USA, on the recommendation of Bruce. Goat's milk was banned from the military garrison in 1906, essentially ending the problem among naval forces, but the controversy about goats persisted for many years: The goat had a special niche in Maltese culture and was taken door to door providing fresh milk. A pasteurization commission was formed in 1938 and but not enforced until 1959. Even as late as 1955, over 200 human cases of brucellosis were associated with ingestion of a special cheese. Human brucellosis exists worldwide and is spread mainly by ingestion of unpasteurized dairy products. An overview of the literature on human brucellosis is available.<sup>2</sup>

In 1985, Professor L.F. Benhard Bang, Danish veterinary pathologist and bacteriologist, described a different causative organism isolated from cattle, called *Bacillus abortus*. The first recognized human case of brucellosis in the USA was in 1898 in an army officer who contracted the disease in Puerto Rico. In the early 20th century contagious abortion of cattle and tuberculosis were recognized as major causes of economic loss. By 1922, several states had passed laws and regulations in an attempt to prevent introduction of the disease in cattle purchased from other states. In 1930, concerns were raised about the relationship between the disease in animals and humans. The American Veterinary Medical Association recommended a field trial of a vaccine, which was developed from a strain of lower virulence named *Brucella abortus* strain 19. This vaccine has been used several decades as the most common immunizing agent for control of bovine brucellosis.

In 1934, a cooperative State Federal Brucellosis Eradication program was launched on a nationwide scale in the USA. A uniform plan provided for blood tests, slaughter of seropositive cattle and federal indemnities. In 1941, strain 19 was introduced and used in most states. All vaccinated cattle had to be properly identified. In 1934/35, the reactor rate in cattle tested was 11.5%. In 1954, the US Congress appropriated funds for a comprehensive national effort to eradicate brucellosis. The brucellosis eradication program was designed as a cooperative effort between the federal government, the states, and livestock producers. In 1957, shortly after the inception of the program, there were almost 124 000 infected herds identified. As of December 2004, there were no brucellosis-affected cattle herds in the USA; truly a success story in veterinary medicine.<sup>3</sup> When brucellosis can be identified, contained



and eliminated before spread occurs, eradication can be achieved.

The evolution of the *Brucella* spp. and its taxonomy have been described in detail.<sup>4</sup> In 2002, the genomes for *B. melitensis* were published, and *B. suis* and *B. abortus* are in their final stages.<sup>5</sup> The proteomes of selected *Brucella* spp. have been extensively analyzed, all of which will provide opportunities to understand the complete biology of different *Brucella* species.<sup>6</sup> The major outer membrane proteins of *Brucella* spp. have also been determined.<sup>7</sup> The lipopolysaccharide of *Brucella* is unique and considered as a virulence factor that helps bacterial survival by circumventing the immune response.<sup>8</sup> The pathology of brucellosis reflects the outcome of a battle between the host genome and the *Brucella* genome.<sup>9</sup>

In addition to brucellosis occurring in terrestrial wildlife, *Brucella* spp. have been isolated from some marine mammals of North America<sup>10</sup> and there is serological evidence of *Brucella* spp. infection from several species of marine mammal from both hemispheres.<sup>11</sup> Serological evidence of *Brucella* spp. has been found in odontocetes (suborder of toothed whales, including sperm whales, porpoises, grampuses, dolphins, beaked whales, bottle-nosed whales, and narwhals) from the south Pacific and the Mediterranean.<sup>11</sup>

### Status of brucellosis in regions of the world and countries

The status of brucellosis in regions of the world and countries varies considerably. The following is a summary of the status of brucellosis in various regions of the world as of 2002.

#### Romania

Romania, like many other developed countries, eradicated *B. abortus* from cattle in 1969.<sup>12</sup> The incidence of brucellosis in sheep and pigs is rare and *B. melitensis* has never been reported. Vaccination against brucellosis is prohibited.

#### Countries in central and south-east Europe

In Macedonia and Greece, brucellosis occurs in sheep, goats, and humans, **associated with** *B. melitensis*.<sup>13</sup> In Greece, cows are infected with *B. abortus* or *B. melitensis*. In Croatia, *B. suis* biovar 2 is found in pigs. In Yugoslavia, brucellosis is endemic in some regions. A financially well-supported control and eradication program such as that sponsored by the European Union is needed.

#### Kosovo

The overall serological prevalence of infection is 6.26% in sheep, 7.24% in goats and 0.58% in cattle.<sup>14</sup> *B. melitensis* predominates as the cause of brucellosis in ruminants in Kosovo.

#### Sub-Saharan Africa

Brucellosis is an important disease among livestock and humans in sub-Saharan Africa.<sup>15</sup> The disease in cattle is prevalent and widespread and is caused primarily by *B. abortus*; *B. melitensis* and *B. suis* have been suspected. In sheep and goats, *B. melitensis* is common and the prevalence of infection is high. Brucellosis has occurred in pigs in these countries but information is limited. Brucellosis due to *B. abortus* is one of the most important diseases of camels in the arid and semi-arid pastoralist areas of central, east, and west Africa.

#### Eritrea

Seroepidemiological surveys for brucellosis in Eritrea found a prevalence of 8.2% in dairy cattle, with a herd prevalence of 35.9%.<sup>16,17</sup> The prevalence in sheep and goats was variable depending on the geographical area. In camels, the seroprevalence was 3.1%.

#### Near East

In the near East region, animal brucellosis affects almost all domestic animals, particularly cattle, sheep, and goats.<sup>18</sup> Brucellosis occurs in camels in Saudi Arabia, Kuwait, Oman, Iraq, Iran, Sudan, Egypt, Libya, and Somalia. In Egypt, brucellosis occurs in cattle, buffaloes, horses, and pigs. *B. melitensis* biovar 3 is the most commonly isolated species from animals in Egypt, Jordan, Israel, Tunisia, and Turkey. The highest incidence of human brucellosis occurs in Saudi Arabia, Iran, Palestinian Authority, Syria, Jordan, and Oman. Bahrain has none. Most human cases are **associated with** *B. melitensis*, biovar 3 but *B. abortus* is increasingly being reported in humans. The control of brucellosis in these countries is very controversial, with varying emphases on different aspects of control. The most commonly used vaccines are *B. abortus* strain 19, *B. melitensis* Rev. 1, and *B. abortus* RB 51.

#### Sri Lanka

*B. abortus* is a major cause of abortion among cattle and buffaloes.<sup>19</sup> The incidence of the disease is low and the small size of the country would facilitate an effective disease control program.

#### India

Brucellosis was first recognized in India in 1942 and is endemic throughout the country.<sup>20</sup> The disease occurs in cattle, buffalo, sheep, goats, pigs, dogs, and humans. *B. abortus* biotype 1 in cattle and buffaloes and *B. melitensis* biotype 1 in sheep, goats, and humans are the predominant infective biotypes. Economic losses are considerable in an agrarian country such as India. There is no organized and effective brucellosis control program. Plans for a large-scale control program,

including calfhood vaccination, are underway.

A major constraint of a control program is that all slaughter of cows is banned and that segregation of seropositive cows until their death will therefore be necessary, but very costly.

#### China

Before the 1980s, human and animal brucellosis was severe. *B. melitensis* is most common in outbreaks.<sup>21</sup> Sheep, cattle, and pigs are the main sources of infection for humans. Beginning in 1950, control programs have been in place and progress is being made towards control and eradication.

#### Brazil

Bovine brucellosis due to *B. abortus* is the most prevalent *Brucella* infection in Brazil, followed by *B. suis* in pigs. *B. melitensis* and *Brucella neotomae* have not been isolated. The prevalence of bovine brucellosis ranged from 4–5% in the period of 1989–1998. The disease is considered endemic, with a higher incidence in regions with a higher cattle density.<sup>22</sup> In 2001, a New National Program was launched, including compulsory vaccination of heifers aged 3–8 months, voluntary accreditation of free herds, voluntary monitoring of beef herds based on periodic sampling, regulatory tests for breeding stock prior to interstate movement and entrance into livestock fairs and exhibitions, compulsory slaughter of cattle testing positive, and standardization of testing procedures through short courses for accredited veterinarians.

#### Paraguay

Brucellosis has existed in the country for many years. Most reports are on *B. abortus* in cattle, but *B. melitensis* and *B. suis* have been identified. In 2000, it was estimated that the prevalence of *B. abortus* in the cattle population was 3.15%.<sup>23</sup> A national campaign for the control and eradication of brucellosis was begun in 1978. The program is based on vaccination of calves at 3–8 months of age, testing and culling of seropositive animals, declaration of *Brucella*-free areas, and promotion of *Brucella*-free Herd Certification Programs in dairy herds. For beef herds there is mandatory vaccination, control of movement of animals intended for breeding, including testing for those imported, destined to fairs and auctions.

#### Venezuela

Brucellosis continues to be a serious disease for animal and human health in Venezuela.<sup>24</sup> *B. abortus* is the most common biovar, causing high rates of abortion in cattle and buffalo. Based on the rapid agglutination plate test, the positive reactor rate ranges from 0.8–1.2%; using



the ELISA the prevalence is 10.5%. A control program, in effect since 1968, consists of vaccination of calves with strain 19 vaccine, and test and slaughter of positive reactors. Improved testing methods and vaccination of all female calves between 3 and 8 months of age, and revaccination at 10–15 months of age and adult cattle in high prevalence areas.

Central America (Guatemala, Belize, Honduras, El Salvador, Nicaragua, Costa Rica, and Panama)

*B. abortus* and *B. suis* infections occur in all Central American countries, and sheep and goat brucellosis associated with *B. melitensis* occurs in Guatemala.<sup>25</sup> The estimated prevalence of bovine brucellosis ranges from 4–8% with a herd prevalence (dairy herds) of 10–25%.<sup>25</sup>

A national control program based on vaccination of calves and test and slaughter of reactors has been unsuccessful. Possible reasons include inadequate economical support for vaccination and test and slaughter programs, and the high density of *Brucella* infections.

Argentina  
Brucellosis has been recognized in Argentina since the 19th century.<sup>26</sup> In 2000, the individual cow prevalence was 5% and the herd prevalence 10–15%.<sup>26</sup> In dairy cattle, the prevalence is estimated at 2–2.5%. The annual economic losses due to the disease in cattle have been estimated at US\$60 000 000. A control program began in 1932 and successive changes have been issued since then. The current program mandates vaccination of all females with *B. abortus* strain 19 between 3 and 8 months of age, and test and slaughter of positive animals. However, the compensation paid for reactors is inadequate and producers commonly retain the reactors in the herd. The program has been most successful in dairy herds, which receive incentive payments if the prevalence of infection is low. The disease has been found in pigs, goats, sheep, and dogs. Human brucellosis is an important disease in Argentina. Federal financial support is needed to assist the livestock industry to eradicate the disease.

Mexico

Brucellosis is an important disease in Mexico.<sup>27</sup> Five of the seven known *Brucella* species have been isolated, including *B. melitensis* biovars 1–3; *B. abortus* biovars 1, 2, 4–6; *B. suis* biovar 1; *Brucella canis* and *B. ovis*. Brucellosis is endemic in the cattle, sheep, and goat populations. The disease is a trade barrier. Each year Mexico exports 1.2 million steers and heifers to the USA. The heifers must be spayed to minimize the risk of brucellosis trans-

mission. A control program has been in effect since 1942 but vaccination was voluntary and the disposition of reactors inconsistent. Brucellosis is a significant public health problem in Mexico because 35% of the milk and cheeses consumed are unpasteurized. As of 2002, about 3500 cases of human brucellosis are reported annually and it is estimated this figure represents only one-third of the actual cases. About 98% of cases are due to ingestion of contaminated dairy products (mainly goat cheeses). About 93% of human cases are infected with *B. melitensis* of goat origin. In 1993, a control program was reinforced with the creation of the National Commission for Bovine Tuberculosis and Brucellosis Eradication. In high-risk areas, massive vaccination programs of goats with *B. melitensis* Rev. 1 strain in adults and young females are being implemented, along with a Sanitary Package to improve goat and sheep health. In 1997, the use of *B. abortus* RB 51 vaccine was officially approved. Mexico is one of the few countries authorized to produce this live attenuated vaccine. To reduce abortions, a reduced dose is commercially produced for adult females. As of 2000, almost 1 million beef and dairy cattle, and 1 million goats are vaccinated annually; almost 97% of the dairy cattle population is vaccinated.

Canada and the USA

The status of bovine brucellosis in Canada and the USA is presented below under Bovine brucellosis associated with *Brucella abortus*.

European Union  
*Bovine brucellosis*

Austria, Denmark, Finland, Germany, the Province Bolanzo (Italy), Luxembourg, Norway, Sweden, the Netherlands, and Great Britain have gained the status of being officially brucellosis free.<sup>28</sup> Countries not officially brucellosis-free are France, Greece, Ireland, Italy, Portugal, and Spain. The prevalence of infection in countries not free of brucellosis is extremely diverse. The highest numbers of infected herds occurred in southern Europe: Greece, Spain, Italy, and Portugal. The prevalence of infection has increased in both the Republic of Ireland and Northern Ireland.

Both *B. abortus* and *B. melitensis* have been isolated from cattle; *B. melitensis* may be isolated from cattle in contact with sheep and goats. *B. melitensis* may cause isolated cases of abortion in cattle rather than outbreaks of abortion.

Great Britain has been free from brucellosis since 1993 and is required by the European Union regulations to test 20% or more of both beef and dairy cattle below 24 months of age routinely.

*Ovine and caprine brucellosis*

Belgium, Denmark, Finland, Germany, the Netherlands, Ireland, Austria, Luxembourg, Norway, Sweden, the UK, Spain, and France are officially free of ovine and caprine brucellosis. Greece, Italy, and Portugal are not officially free. Ovine and caprine brucellosis is a significant problem for both public health and animal production in Greece, and a control program consists of vaccination of lambs and kids, and test and slaughter policy. European co-financed eradication programs for sheep and goat brucellosis are in place in France, Greece, Italy, Portugal, and Spain.<sup>28</sup>

*Brucellosis in pigs*

Brucellosis in pigs, especially outdoor-raised pigs, has re-emerged as a result of infection from the wild boar brucellosis (*B. suis* biovar 2) reservoir. In all EU countries and Norway, boars are subject to pre-entry testing and regular testing every 18 months at artificial insemination stations.

## REVIEW LITERATURE

- Adams LG. The pathology of brucellosis reflects the outcome of the battle between the host genome and the *Brucella* genome. *Vet Microbiol* 2002; 90:553–561.
- Cloekaert A, Vizcaino N, Paquet J-Y et al. Major outer membrane proteins of *Brucella* spp.: past, present and future. *Vet Microbiol* 2002; 90:229–247.
- DelVecchio VG, Wagner MA, Eshenbrenner M et al. *Brucella* proteomes: a review. *Vet Microbiol* 2002; 90:593–603.
- Letesson J-J, Lestrade P, Delrue R-M et al. Fun stories about *Brucella*: the 'furtive nasty bug'. *Vet Microbiol* 2002; 90:317–328.
- Michaux-Charachon S, Jumas-Bilak E, Allardet-Servent A et al. The *Brucella* genome at the beginning of the post-genomic era. *Vet Microbiol* 2002; 90:581–585.
- Moreno E, Cloekaert A, Moriyon I. *Brucella* evolution and taxonomy. *Vet Microbiol* 2002; 90:209–227.
- Nicoletti P. A short history of brucellosis. *Vet Microbiol* 2002; 90:5–9.
- Ragan VE. The Animal and Plant Health Inspection Service (APHIS) brucellosis eradication program in the United States. *Vet Microbiol* 2002; 90:11–18.
- Doganay M, Aygen B. Human brucellosis: an overview. *Int J Infect Dis* 2003; 7:173–182.
- Lapaque N, Moriyon I, Moreno E, Gorvel J-P. *Brucella* lipopolysaccharide acts as a virulence factor. *Curr Opin Microbiol* 2005; 8:60–66.

## REFERENCES

- Nicoletti P. *Vet Microbiol* 2002; 90:5.
- Doganay M, Aygen B. *Int J Infect Dis* 2003; 7:173.
- Ragan VE. *Vet Microbiol* 2002; 90:11.
- Moreno E et al. *Vet Microbiol* 2002; 90:209.
- Michaux-Charachon S et al. *Vet Microbiol* 2002; 90:581.
- DelVecchio VG et al. *Vet Microbiol* 2002; 90:593.
- Cloekaert A et al. *Vet Microbiol* 2002; 90:229.
- Lapaque N, Moriyon I, Moreno E, Gorvel J-P. *Curr Opin Microbiol* 2005; 8:60–66.
- Adams LG. *Vet Microbiol* 2002; 90:553.
- Nielsen O et al. *J Wildl Dis* 2001; 37:89.
- Van Bresseme M-F et al. *Vet Rec* 2001; 148:657.
- Dobrea V et al. *Vet Microbiol* 2002; 90:157.
- Taleski V et al. *Vet Microbiol* 2002; 90:147.

14. Jackson R et al. *Vet Rec* 2004; 154:747.
15. McDermott JJ, Arimi SM. *Vet Microbiol* 2002; 90:111.
16. Omer MK et al. *Vet Microbiol* 2002; 90:257.
17. Omer MK et al. *Epidemiol Infect* 2000; 125:447.
18. Refai M. *Vet Microbiol* 2002; 90:81.
19. Bandara AB, Mahipala MB. *Vet Microbiol* 2002; 90:197.
20. Renukaradhya GJ et al. *Vet Microbiol* 2002; 90:183.
21. Dequi S et al. *Vet Microbiol* 2002; 90:165.
22. Poester FP et al. *Vet Microbiol* 2002; 90:55.
23. Baumgarten D. *Vet Microbiol* 2002; 90:63.
24. Francisco J, Vargas O. *Vet Microbiol* 2002; 90:39.
25. Moreno E. *Vet Microbiol* 2002; 90:31.
26. Samartino LE. *Vet Microbiol* 2002; 90:71.
27. Luna-Martinez JE, Mejia-Teran C. *Vet Microbiol* 2002; 90:19.
28. Godfroid J, Kasbhrer A. *Vet Microbiol* 2002; 90:135.

## BRUCELLOSIS ASSOCIATED WITH *BRUCELLA ABORTUS* (BANG'S DISEASE)

### Synopsis

#### **Etiology** *Brucella abortus*

**Epidemiology** Major cause of abortion in cattle in countries without a national control program. Undulant fever in humans an important zoonosis. Sexually mature animals susceptible; outbreaks occur in first-calf heifers, older cows infected but do not abort. Transmitted directly from infected animal to susceptible animal by uterine discharges. Congenital infection occurs. Infection in wildlife species but significance to domestic animals unknown. Infection introduced into herd by unknown infected carrier animal. Natural infection and vaccination result in immunity to abortion but not infection, and infected animals remain serologically positive for a long time

**Signs** Abortion epidemics in first-calf unvaccinated heifers after fifth month of pregnancy. Subsequent pregnancies carried to term. Orchitis and epididymitis in bulls. Synovitis (hygromas) occurs. Fistulous withers in horses

**Clinical pathology** Serology. Serum agglutination test is standard test. Rose Bengal test (rapid screening test). Complement fixation test. ELISA test. Milk ring test. False-positive reactors are major problem

**Lesions** Necrotizing placentitis, inflammatory changes in fetus

**Diagnostic confirmation** Culture organism from fetus. Positive serological test in unvaccinated animal

**Differential diagnosis list** Other causes of abortion (see Table 18.7)

**Treatment** No treatment

**Control** Test and reduce reservoir of infection. Quarantine. Depopulation. Vaccination to reduce incidence of abortion and percentage of infected animals. Eradication on herd and area basis by test and slaughter

### ETIOLOGY

*Brucella abortus* is the causative organism and at least nine biotypes have been

recognized including a number of strain variants. Approximately 5% of infections are from biotype 1. Biotype 2 was isolated in an outbreak of brucellosis in cattle in Canada in 1986. In the USA biotypes 1–4 are found.

### EPIDEMIOLOGY

#### Occurrence and prevalence of infection

Brucellosis is an important disease of cattle and an important zoonosis worldwide. It is of major economic importance in developing countries that have not had a national brucellosis eradication program (see Introduction, above). The prevalence of infection varies considerably among herds, areas, and countries. Many countries have made considerable progress with their eradication programs and some have eradicated the disease. However, in other countries brucellosis is still a serious disease problem facing the veterinary and medical professions. In Argentina, for example, the prevalence of infection in cattle is more than 10% and it is estimated that 20 000 new cases of human brucellosis occur annually.

#### Cattle

Infection occurs in cattle of all ages but is most common in sexually mature animals, particularly dairy cattle. **Abortions occur most commonly in outbreaks in unvaccinated heifers after the fifth month of pregnancy.** Bulls are affected with orchitis, epididymitis, and seminal vesiculitis. The infection has been confirmed in cattle and water buffaloes in Trinidad.<sup>1</sup>

#### Wildlife species

The infection has occurred in bison (*Bison bison*),<sup>2,3</sup> elk (*Cervus elaphus canadensis*),<sup>4</sup> deer, coyotes, wild opossums and raccoons, moose, and other wild and domesticated ruminants, but there is no evidence that these species are a source of infection for cattle. Infection of moose with *B. abortus* biovar 1 is highly fatal and it is likely that the moose is a dead-end host for brucellosis. Experimental inoculation of the organism into badgers results in the development of antibodies and elimination of the organism, which indicates that the badger is relatively resistant to infection and unlikely to be a reservoir of the organism.

Bison and elk are potential reservoirs of brucellosis and, because they are the species of choice for game farming, which is a recent development in North America and elsewhere, they could serve as a source of infection for cattle. Brucellosis associated with *B. abortus* was first detected in bison (*Bison bison*) in Yellowstone National Park in 1917 and has been present ever since.<sup>5</sup> Bison can

remain latently infected with virulent *B. abortus* until attainment of reproductive age despite extensive use of vaccination and serological testing.<sup>6</sup>

A strain of biotype 1 isolated from bison in Canada is infectious and contagious for cattle. While bovine brucellosis is being effectively eradicated in North America, infected populations of bison, elk, and moose in Canada and the USA are of sufficient size and geographical distribution to create a real and serious threat to the livestock producers in certain areas of both countries.<sup>5</sup> *B. suis* biovar 4 is the cause of rangiferine brucellosis, a disease of reindeer and caribou (*Rangifer tarandus*).<sup>7</sup> Under natural conditions, rangiferine brucellosis is limited to the circumpolar Arctic but translocations to reindeer for game ranching may place traditional livestock species, game-farmed species and non-Arctic wildlife at risk. Naturally infected reindeer can transmit *B. suis* biovar 4 to brucellosis-free cattle.<sup>7</sup> Exposed cattle had a serological response; the organism remained in tissues 60 days after exposure. *B. suis* biovar 4 does not cause clinically important disease in cattle and is not shed in sufficient numbers to maintain infection in cattle populations. Conventional serological tests can be used to detect *B. suis* biovar 4 infection in cattle, but their ability to detect exposed animals varies widely and they cannot discriminate between *B. suis* biovar 4 and *B. abortus* of cattle. Cattle to cattle transmission of *B. suis* biovar 4 is unlikely.<sup>7</sup>

In Canada, the wood bison herd in Wood Buffalo National Park has been infected with *Mycobacterium bovis* and *B. abortus* since 1925.<sup>8</sup> The infected herd poses a potential threat to the nearby MacKenzie Bison Sanctuary, in which these infections are not present.

#### Horses

In horses the organism is often found in chronic bursal enlargements as a secondary invader rather than a primary pathogen. It is commonly present with *Actinomyces bovis* in fistulous withers and poll evil. It has also been identified as a cause of abortion in mares. A serological survey of horses over a period of 8 years revealed that 8–16% of serum samples were positive. However, experimentally infected horses do not excrete the organism in sufficient numbers to infect susceptible in-contact cattle.

#### Pigs and sheep

The organism can be recovered from naturally infected pigs and, although not normally pathogenic in this species, may occasionally cause abortion. The disease occurs naturally in sheep exposed to infected cattle, which has significant implications for brucellosis eradication.

## Dogs

Naturally acquired *B. abortus* infection can occur in dogs associated with infected cattle.<sup>9</sup> While farm dogs are not generally considered to be a major reservoir of *B. abortus*, the organism has been isolated from dogs on a farm where several cattle were serologically positive for brucellosis and dogs should be included in any investigation and eradication of the disease.

## Methods of transmission

### Parturition

The **risk posed to susceptible animals** following parturition of infected cattle depends on three factors:

- **The number of organisms excreted**
- **The survival of these organisms under the existing environmental conditions**
- **The probability of susceptible animals being exposed to enough organisms to establish infection.**

The organism achieves its greatest numbers in the contents of the pregnant uterus, the fetus and the fetal membranes, all of which must be considered as major sources of infection. The numbers of organisms in the tissues of two naturally infected cows and their fetuses were as follows: umbilicus  $2.4 \times 10^8$  –  $4.3 \times 10^9$ /g –  $1.4 \times 10^{13}$ /g. This illustrates the potentially large numbers of organisms that can be shed and to which other animals and humans are potentially exposed. However, the numbers of organisms decrease when uterine discharges are cultured at sequential parturitions, and a substantial number of uterine samples from infected cows are culture-negative at the second and third parturition following challenge.

### Transmission

The disease is transmitted by ingestion, penetration of the intact skin and conjunctiva, and contamination of the udder during milking. The organism does not multiply in the environment but merely persists, and the viability of the organism outside the host is influenced by the existing environmental conditions. Grazing on infected pasture, or consuming other feedstuffs and water supplies contaminated by discharges and fetal membranes from infected cows, and contact with aborted fetuses and infected newborn calves are the most common methods of spread.

Intra-herd spread occurs by both vertical and horizontal transmission. **Horizontal transmission is usually by direct contamination** and, although the possibility of introduction of infection by flies, dogs, rats, ticks, infected boots, fodder, and other inanimate objects exists, it is not significant relative to control measures. The organism is ingested by the face fly

but is rapidly eliminated and there is no evidence for a role in natural transmission. Evidence exists for horizontal, dog-to-dog, cattle-to-dog, dog-to-cattle and dog-to-human transfer of infection.<sup>9</sup> The most likely and effective means of cattle-to-dog transfer is exposure to aborted fetuses or infected placental membranes, because dogs commonly ingest the products of parturition.

### Spread between herds

Movement of an infected animal from an infected herd to a susceptible noninfected herd is a common method of transmission. The rate of spread will depend on the level of surveillance testing.<sup>10</sup> In Great Britain, which is officially brucellosis free, 20% or more of both beef and dairy cattle more than 24 months old are tested routinely. A simulation model indicates that reducing the level of testing would have a major effect on the rate of spread of infection, should it be imported.

### Spread between countries (breach of biosecurity)

A quantitative risk assessment model to determine the annual risk of importing brucellosis-infected breeding cattle into Great Britain from Northern Ireland and the Republic of Ireland, which are not brucellosis free, was developed.<sup>11</sup> Predictions estimated that brucellosis could be imported from Northern Ireland every 2.63 years and from the Republic of Ireland every 3.23 years. Following this assessment, the Department of Environment, Food and Rural Affairs introduced post-calving testing for all imported breeding cattle. Under this system, all imported animals are issued a passport that records their age and pregnancy status. This information enables identification of animals that require testing and provides an additional safeguard in maintaining official brucellosis status.

### Congenital infection

Congenital infection may occur in calves born from infected dams but its frequency is low. The infection occurs in utero and may remain latent in the calf during its early life; the animal may remain serologically negative until its first parturition, when it then begins to shed the organism. Calves born from reactor dams are serologically positive for up to 4–6 months because of colostral antibodies and later become serologically negative even though a latent infection may exist in a small proportion of these calves. The **frequency of latent infections** is unknown, but may range from 2.5–9%. Latent infections in serologically negative animals are of some concern because they remain unnoticed and can potentially serve as a source of infection later. How-

ever, latent infections in calves born from infected cows are infrequent. The organism could not be isolated from any of 150 calves born to infected cows, 135 of which were experiencing their first pregnancy after infection. In one report a heifer from a herd affected with wide-spread infection with *B. abortus* biotype 2 was moved to a brucellosis-free herd and remained apparently free from brucellosis until 9 years later, when the same animal produced a strongly positive serological reaction and the same biotype was isolated from its milk. Such observations have resulted in the recommendation that calves from seropositive dams should not be used for breeding. Even vaccinated heifers from seropositive dams can harbor a latent infection. There is a risk that 2.5% of heifer calves born from serologically positive dams will react in early adulthood and constitute a threat to a re-established herd.

### Survival of organism

The organism can survive on grass for variable periods depending on environmental conditions. In temperate climates, infectivity may persist for 100 days in winter and 30 days in summer. The organism is susceptible to heat, sunlight, and standard disinfectants but freezing permits almost indefinite survival. The activity of several disinfectants against *B. abortus* has been examined, and representatives of the phenolic, halogen, quaternary ammonium, and aldehyde groups of disinfectants at 0.5% or 1.0% concentrations in the absence of serum generally inhibited a high concentration of the organism.

### Uterine discharges and milk

A cow's tail heavily contaminated with infected uterine discharges may be a source of infection if it comes in contact with the conjunctiva or the intact skin of other animals. In the same way that the more common forms of mastitis can be spread during milking, *B. abortus* infection can be spread from a cow whose milk contains the organism to an uninfected cow. This may have little significance in terms of causing abortion but it is of particular importance in its effects on agglutination tests on milk and the presence of the organism in milk used for human consumption.

### Bulls and semen

Bulls do not usually transmit infection from infected to noninfected cows mechanically. Infected bulls may discharge semen containing organisms but are unlikely to transmit the infection. The risk of spread from the bull is much higher, however, if the semen is used for artificial insemination. Some infected bulls are

negative on serum agglutination tests and their carrier status can only be detected by the isolation of organisms from the semen or agglutination tests on seminal plasma.

#### Carrier cows

Few infected cows ever recover from infection completely and should be considered as permanent carriers whether or not abortion occurs. Excretion of the organism in the milk is usually intermittent, is more common during late lactation and can persist for several years. In cattle vaccinated before infection the degree of excretion of *B. abortus* in the milk is less than in nonvaccinated animals. Embryo transfer from infected donors may be achieved without transfer of infection and superovulation is unlikely to reactivate the release of *Brucella* into the uterus during the period when embryos are normally collected. Thus embryo transfer is a safe procedure for salvaging genetic material from infected animals.

The herd characteristics and the results of the first herd test may be used as predictors of the potential presence or absence of *B. abortus* in herds with reactors to the tube agglutination test. The presence of only single suspicious reactors on the first test is a reliable predictor of lack of infection. The presence of one or more positive reactors on the first herd test is a reliable predictor of the presence of infection.

#### Risk factors

The risk factors that influence the initiation, spread, maintenance, and/or control of bovine brucellosis are related to the animal population, management, and the biology of disease.<sup>12</sup> The variables that contribute significantly to seropositive animals are:

- **Size of farm premises**
- **Percentage of animals on a premises that are inseminated artificially**
- **Size of investment in livestock**
- **Number of cows which aborted in the previous year, whether or not dairying is the major agricultural activity of the premises**
- **Policy of the owner with regard to disposal of reactor animals.**

The longer infected animals are in contact with the remainder of the herd, the greater will be the ultimate number of seropositive animals. In a defined geographical area in northern Mexico where a brucellosis control program did not exist, the greatest percentage of seropositive animals was related to larger farms, poor artificial insemination technique, and small financial investment in the farm.

From a practical viewpoint, the factors influencing the transmission of brucellosis in any given geographical region can be classified into two fundamental categories: those associated with the transmission of disease between herds and those influencing the maintenance and spread of infection within herds. Factors influencing interherd transmission include the purchase of infected replacement animals and are in turn influenced by frequency of purchase, source of purchase, and brucellosis test history of purchased animals. The proximity of infected herds to clean herds is an important risk factor. Cattle contacts at fence lines, sharing of pastures and strays of infected animals into clean herds are common methods by which transmission occurs to adjacent herds.

The risk factors associated with spread of the disease within a herd include unvaccinated animals in infected herds, herd size, population density, method of housing, and use of maternity pens. Large herd sizes are often maintained by the purchase of replacement cattle, which may be infected. It is also more difficult to manage large herds, which may lead to managerial mistakes that allow the disease to spread. There is a positive association between population density (number of cattle to land area) and disease prevalence, which is attributed to increased contact between susceptible and infected animals. The use of maternity pens at calving is associated with a decrease in the prevalence of infection, presumably due to decreasing the exposure of infected and susceptible animals.

#### Animal risk factors

Susceptibility of cattle to *B. abortus* infection is influenced by the age, sex, and reproductive status of the individual animal. **Sexually mature, pregnant cattle are more susceptible to infection with the organism than sexually immature cattle of either sex.** Natural exposure to field strains occurs primarily at the time of parturition of infected cows. The greater the number of infected cows that abort or calve, the greater the exposure risk to the other cattle in the herd. An important application of this observation is that infected cows need to be removed from the herd prior to parturition. Thus the stage of gestation and parturition are more important factors in herd plans than early removal of postparturient infected cows following whole-herd strain-19 vaccination. Young cattle are less susceptible to *B. abortus* than older, sexually mature cattle. Susceptibility appears to be more commonly associated with sexual maturity than age. Young, sexually immature cattle generally do not become infected

following exposure, or recover quickly. Susceptibility increases with pregnancy and as the stage of gestation increases.

The probability of isolation of the organism at parturition increased from 0.22 to 0.90 as fetal age at exposure of nonvaccinated heifers increased from 60 to 150 gestation days. The stage of pregnancy at experimental challenge exposure of strain-19 vaccinated heifers is positively associated with the proportion of animals that become infected. Nonvaccinated young cattle are also at high risk of brucellosis if exposed to pathogenic strains of the organism. In cattle vaccinated as yearling heifers, the risk of brucellosis is also related to the number of organisms in the vaccine. The risk of brucellosis in heifers vaccinated with  $10^8$ ,  $10^9$ , or  $10^{10}$  of strain 19 was, respectively, one-third, one-seventh, or one-17th that of diluent controls or nonvaccinated heifers.

#### Management risk factors

The spread of the disease from one herd to another and from one area to another is almost always due to the movement of an infected animal from an infected herd into a noninfected susceptible herd. The unregulated movement of cattle from infected herds or areas to brucellosis-free herds or areas is the major cause of breakdowns in brucellosis eradication programs. A case-control study of brucellosis in Canada indicated that herds located close to other infected herds and those herds whose owners made frequent purchases of cattle had an increased risk of acquiring brucellosis. Once infected, the time required to become free of brucellosis was increased by large herd size, by active abortion and by loose housing.

#### Pathogen risk factors

*B. abortus* is a facultative intracellular parasite capable of multiplication and survival within host phagocytes.<sup>13</sup> The organisms are phagocytosed by polymorphonuclear leukocytes in which some survive and multiply. These are then transported to lymphoid tissues and fetal placenta. The inability of the leukocytes to effectively kill virulent *B. abortus* at the primary site of infection is a key factor in the dissemination to regional lymph nodes, other sites such as the reticulo-endothelial system, and organs such as the uterus and udder. The organism is able to survive within macrophages because it has the ability to survive phagolysosome. The bacterium possesses an unconventional non-endotoxic lipopolysaccharide, which confers resistance to antimicrobial attacks and modulates the host immune response.<sup>14</sup> These properties make lipopolysaccharide an important virulence factor for *Brucella* survival and replication in the host.

Brucellas are able to survive within host leukocytes and may utilize both neutrophils and macrophages for protection from humoral and cellular bactericidal mechanisms during the periods of hematogenous spread. The placenta is a favored site for replication of the organism. Large numbers of the organism can be found in chorionic trophoblasts, which contain metabolically active cells capable of producing a variety of hormones and secretory proteins that may stimulate the growth of brucellas. The ability to survive in the host may explain both the transitory titers occurring in some animals following isolated episodes of bacteremia and the disappearance of titers in animals with latent infection.

Three major groups of outer membrane proteins have been identified in *Brucella* spp.<sup>15</sup> Certain mutants of *B. abortus* lack a major 25 kDa outer membrane protein (Omp25), which renders them unable to replicate efficiently in bovine phagocytes and chorionic trophoblasts.

#### Immune mechanisms

Immunity against brucellosis is principally mediated by cellular immune responses since it is an intracellular pathogen. *B. abortus* is an efficient inducer of type 1 cellular immune responses and interferon-gamma is crucial for control of brucellosis.<sup>16</sup> Infections are chronic and often lifelong. The bovine T lymphocyte in brucellosis is a critical component of host defense based on mononuclear phagocyte activation by interferon-gamma. The killing of *Brucella*-infected mononuclear phagocytes and interferon-gamma-mediated activation of mononuclear phagocytes are the major mechanisms of host defenses against brucellosis in cattle.<sup>17</sup>

The antibody response to *B. abortus* in cattle consists of an early IgM isotype response, the timing of which depends on the route of exposure, the dose of the bacteria and the health status of the animal. The IgM response is followed almost immediately by production of IgG1 antibody and later by small amounts of IgG2 and IgA. Most cross-reacting antibody from exposure to other bacteria other than *Brucella* spp. or environmental antigens consists mainly of IgM. Serological tests that measure IgM are therefore not desirable, as false-positive results occur. Since IgG2 and IgA antibodies accumulate later after exposure and are usually present in small and inconsistent amounts, the main isotype for serological testing is IgG1.<sup>18</sup>

Naturally infected animals and those vaccinated as adults with strain 19 remain positive to the serum, and other aggluti-

nation tests, for long periods. The serum of infected cattle contains high levels of IgM, IgG<sub>1</sub>, IgG<sub>2</sub>, and IgA isotypes of antibody. Most animals vaccinated between 4 and 8 months of age return to a negative status to the test within a year. All are considered to have a relative immunity to infection. Calves from cows that are positive reactors to the test are passively immunized via the colostrum. The half-life of colostrum antibodies to *B. abortus* in calves that have received colostrum from either vaccinated noninfected or infected dams is about 22 days. It is possible that some calves remain immune sufficiently long to interfere with vaccination. After vaccination of cattle with strain 19 of the organism, IgM antibodies appear after about 5 days, reaching peak values after 13 days. IgG<sub>1</sub> antibodies appear a little later or simultaneously with IgM, and peak values are reached at 28–42 days, after which they decline. The same general pattern follows experimental infection with virulent strains and also in chronic field cases, except that IgM antibody declines to low levels and residual activity resides in IgG<sub>1</sub> and IgG<sub>2</sub> as well as in IgA, which remain at higher levels.

#### Economic importance

Losses in animal production due to this disease can be of major importance, primarily because of decreased milk production in aborting cows. The common sequel of infertility increases the period between lactations, and in an infected herd the average intercalving period may be prolonged by several months. In addition to the loss of milk production, there is the loss of calves and interference with the breeding program. This is of greatest importance in beef herds, where the calves represent the sole source of income. A high incidence of temporary and permanent infertility results in heavy culling of valuable cows, and some deaths occur as a result of acute metritis following retention of the placenta.

#### Zoonotic implications

Brucellosis is an important zoonosis causing **undulant fever in humans**.<sup>19</sup> According to the Food and Agriculture Organization, the World Health Organization and the Office International des Epizooties, brucellosis is still one of the most important and widespread zoonoses in the world. The disease spreads mainly by the ingestion of unpasteurized dairy products.<sup>19</sup> Officially approved methods of commercial pasteurization render naturally *Brucella*-contaminated raw milk safe for consumption. However, most cases in humans are occupational and occur in farmers, veterinarians, and butchers. The organism can be isolated from many organs other than the udder and uterus, and the

handling of a carcass of an infected animal may represent severe exposure.

The importance of the disease in humans is an important justification for its eradication. Between the years 1965 and 1974 the incidence of brucellosis in humans in the USA increased. Most cases occur in people employed in the meat processing industry, while other sources include the domestic pig, cattle, and unpasteurized dairy products. A majority of human brucellosis cases in Texas could be prevented by prohibiting the importation of unpasteurized goat's milk cheese. Laboratory-acquired brucellosis in humans constituted 1.7% of the cases of brucellosis reported in the USA between 1964 and 1974.

The cost-effectiveness to human health and the potential net economic benefits of a nationwide mass vaccination program for livestock over a period of 10 years has been evaluated using Mongolia as the model.<sup>20</sup> If the costs of vaccination of livestock against brucellosis were allocated to all sectors in proportion to the benefits, the intervention would be cost-effective and would result in net economic benefits.

#### PATHOGENESIS

*B. abortus* has a predilection for the pregnant uterus, udder, testicle and accessory male sex glands, lymph nodes, joint capsules, and bursae. After the initial invasion of the body, localization occurs initially in the lymph nodes draining the area and spreads to other lymphoid tissues, including the spleen and the mammary and iliac lymph nodes.

*B. abortus* is phagocytized by macrophages and neutrophils in an effort by the host to eliminate the organism. However, once inside the phagocyte, *B. abortus* is able to survive and replicate. The phagocyte migrates via the lymphatic system to the draining lymph node, where *Brucella* infection causes cell lysis and eventual lymph node hemorrhage 2–3 weeks following exposure. Because of vascular injury, some of the bacteria enter the bloodstream and subsequent bacteremia occurs, which disseminates the pathogen throughout the body. If the infected animal is pregnant, *B. abortus* will colonize and replicate to high numbers in the chorionic trophoblasts of the developing fetus. The resulting tissue necrosis of the fetal membranes allows transmission of the bacteria to the fetus. The net effect of chorionic and fetal colonization is abortion during the last trimester of pregnancy.

Sexually immature and other non-pregnant cattle can become infected but lose their humoral antibody to the organism much more quickly than cattle infected while pregnant.

In the adult, nonpregnant cow, localization occurs in the udder, and the uterus, if it becomes gravid, is infected from periodic bacteremic phases originating in the udder. Infected udders are clinically normal but they are important as a source of reinfection of the uterus, as a source of infection for calves or humans drinking the milk, and because they are the basis for the agglutination tests on milk and whey.

Erythritol, a substance produced by the fetus and capable of stimulating the growth of *B. abortus*, occurs naturally in greatest concentration in the placental and fetal fluids and is responsible for localization of the infection in these tissues. Invasion of the gravid uterus results in a severe ulcerative endometritis of the intercotyledonary spaces. The allantochorion, fetal fluids, and placental cotyledons are invaded and the villi are destroyed. The organism has a marked predilection for the ruminant placenta. In acute infections of pregnant cows, up to 85% of the bacteria are in cotyledons, placental membranes, and allantoic fluid.

The successful coexistence of *Brucella* spp. with its preferred host is the outcome of coevolutionary relationships and selection pressures, which result in a stalemate where the pathogen has evolved to survive within the biological system of the host, and the host has evolved innate and acquired immune systems that allow controlled survival of infection by the pathogen, ultimately supporting the survival of the host-pathogen system.<sup>21</sup> In contrast to other pathogens, genes controlling virulence, survival and persistence of *Brucella* spp. have been documented as the dominant feature of its genome.

The host responses at the organ and tissue levels have been described and are summarized here.<sup>21</sup> Lymph nodes draining the sites of the early stages of infection have marked germinal center hyperplasia and hypertrophy, accompanied by acute neutrophilic and eosinophilic lymphadenitis. In the later stages of the infection, lymph nodes draining mammary gland, head, and reproductive tract develop chronic granulomatous lymphadenitis, which is usually associated with cortical and paracortical T-cell-dependent lymphoid depletion, germinal center expansion, and deep histiocytic expansion. The spleen may develop lymphoid hyperplasia and histiocytic and plasmacytic expansion in the germinal centers, and the mammary gland usually has a pronounced interstitial lymphoplasmacytic mastitis. In the uterus, there is usually an endometritis, fibrosing mural lymphocytic metritis, and caruncular necrotizing vasculitis, while the placenta is colonized

with *B. abortus* and has extensive desquamation of fetal chorioallantoic trophoblasts with subsequent hematogenous spread to villous trophoblastic epithelium, and necrotizing fibrinopurulent cotyledonary placentitis of the placental arcades accompanied by granulation and intercotyledonary inflammation exudation. The fetal lesions consist of marked fibrinopurulent necrotizing bronchopneumonia, monocytic and neutrophilic alveolitis, thromboembolic necrotizing arteritis and lymphangitis, fibrinopurulent pleuritis, and granulomata of the liver, spleen, kidney, and lymph nodes.

Variable disease expression may occur in the male reproductive tract and musculoskeletal system of either sex. The affected joints usually develop a fibrinous and granulomatous synovitis with proliferative villous projection formation, proliferative tendovaginitis with lymphoplasmacytic nodule formation, and arthritis with articular erosions, which may be associated with suppurative, granulomatous bursitis. In the testes there are uni- or bilateral visceral to parietal tunica adhesions, interstitial lymphocyte orchitis with seminiferous tubular degeneration, necrotizing intratubular orchitis, and acute fibrinopurulent periorchitis with infarction. The ampulla may have a uni- or bilateral granulomatous epididymitis with focally necrotic purulent, calcified sperm granulomata and the seminal vesicles have uni- or bilateral necrotizing fibrinopurulent seminal vesiculitis and interstitial lymphocytic, plasmacytic seminal vesiculitis with necrosis.

In fetuses naturally and experimentally infected with *B. abortus* the tissue changes include lymphoid hyperplasia in multiple lymph nodes, lymphoid depletion in the thymic cortex, adrenal cortical hyperplasia and disseminated inflammatory foci composed mainly of large mononuclear leukocytes. The fetal pneumonia is due to localization of perivascular foci in the interlobular septa of the lung, indicative of hematogenous spread in the fetus rather than aspiration of contaminated fetal fluids. Fetuses inoculated with sufficient numbers of *B. abortus* will abort 7–19 days post-inoculation. With experimental conjunctival exposure of pregnant heifers with the organism, the numbers of infected animals and the number of tissue samples positive for the organism are increased as fetal age at exposure increases from gestation days less than 127 to more than 157.

**Abortion occurs principally in the last 3 months of pregnancy**, the incubation period being inversely proportional to the stage of development of the fetus at the time of infection.

Congenital infection can occur in newborn calves as a result of in utero infection and the infection may persist in a small proportion of calves, which may also be serologically negative until after their first parturition or abortion.

## CLINICAL FINDINGS

### Abortion

The clinical findings are dependent upon the immune status of the herd. In highly susceptible nonvaccinated pregnant cattle, abortion after the 5th month of pregnancy is the typical feature of the disease in cattle. In subsequent pregnancies the fetus is usually carried to full term although second or even third abortions may occur in the same cow. Retention of the placenta and metritis are common sequelae to abortion. Mixed infections are usually the cause of the metritis which may be acute, with septicemia and death following, or chronic, leading to sterility.

The history of the disease in a susceptible herd can usually be traced to the introduction of an infected cow. Less common sources are infected bulls, or horses with fistulous withers. In a susceptible herd it is common for the infection to spread rapidly and for an abortion 'storm' to occur. The 'storm' might last for a year or more, at the end of which time most of the susceptible cows are infected and have aborted and then carry their calves to full term. Retained placentae and metritis could be expected to be common at this time. As the abortion rate subsides, the abortions are largely restricted to first-calf heifers and new additions because other animals of the herd acquire partial resistance.

In recent years, particularly in areas where vaccination is extensively practiced, an insidious form of the disease may develop, which spreads much more slowly and in which abortion is much less common.

### Orchitis and epididymitis

In the bull, orchitis and epididymitis occur occasionally. One or both scrotal sacs may be affected, with acute, painful swelling to twice normal size, although the testes may not be grossly enlarged. The swelling persists for a considerable time and the testis undergoes liquefaction necrosis and is eventually destroyed. The seminal vesicles may be affected and their enlargement can be detected on rectal palpation. Affected bulls are usually sterile when the orchitis is acute but may regain normal fertility if one testicle is undamaged. Such bulls are potential spreaders of the disease if they are used for artificial insemination.

### Synovitis

*B. abortus* can often be isolated from the tissues of nonsuppurative synovitis in

cattle. Hygromatous swellings, especially of the knees, should be considered with suspicion. Progressive and erosive non-suppurative arthritis of the stifle joints has occurred in young cattle from brucellosis-free herds that had been vaccinated with strain 19 vaccine. The calves may or may not be serologically positive, but synovial fluid and joint tissue samples contain immunological evidence of strain 19 *B. abortus* antigenic material. The synovitis has been reproduced by intra-articular injection of the vaccine.

#### Fitulous withers

In horses, the common association of *B. abortus* is with chronic bursal enlargements of the neck and withers, or with the navicular bursa, causing intermittent lameness, and the organism has been isolated from mares that have aborted.<sup>22</sup> When horses are mixed with infected cattle, a relatively high proportion can become infected and develop a positive reaction to the serum agglutination test without showing clinical illness. Some horses appear to suffer a generalized infection with clinical signs including general stiffness, fluctuating temperature, and lethargy.

#### CLINICAL PATHOLOGY

The major objective in the laboratory diagnosis of brucellosis is to identify animals which are infected and potentially shedding the organism and spreading the disease. Most infected animals are identifiable using the standard serological tests but latent infection occurs in some animals which are serologically negative. Furthermore, vaccinated animals may be serologically positive and uninfected, and transitory titers occur sporadically in a small percentage of animals, for which there is no clear explanation. These diagnostic problems make control and eradication programs difficult to administer and difficult to explain to animal owners.

The collection and submission of samples to the laboratory must be done with care, and careful attention must be given to recording the identity of the animal and the corresponding sample which should be uniquely identified. For blood samples, it is recommended that silicone-coated evacuated glass tubes without additives be used to collect the blood sample, as they insure effective clotting and clot retraction, to provide an easy source of serum without the need for centrifugation. Clotting is also aided by maintaining the sample at 25–37°C for 1–2 hours.

Laboratory tests used in the diagnosis of brucellosis include isolation of the organism and serological tests for the presence of antibodies in blood, milk, whey, vaginal mucus, and seminal plasma.

The organism may be present in the cervical mucus, uterine flushings, and udder secretions of experimentally infected cows for up to 36 days after abortion. An ELISA test is available for the detection of the organism in vaginal secretions.

#### Culture and detection of *Brucella abortus*

##### Culture

The 'gold standard' diagnostic test continues to be based on isolation and characterization of the organism from the organs and lymph nodes of the fetus, the placenta, milk, vaginal mucus, or uterine exudate. Bacteriological methods have the advantage of detecting the organism directly and thus limit the possibility of false-positive results. Isolation of the organism from the udder secretion of a cow is conclusive evidence of infection. Culture methods are reliable and usually definitive. However, disadvantages are the long time required for definitive identification, usually 2 weeks; the tests are complex and must be done by highly skilled laboratory personnel; and the zoonotic nature of the organism is a potential hazard for laboratory personnel.<sup>23</sup>

##### Detection by polymerase chain reaction

The PCR-based assays for *Brucella* have been developed and are simple.<sup>23</sup> The PCR has been applied to tissues such as aborted fetuses and associated maternal tissues, blood nasal secretions, semen, and food products such as milk and soft cheeses.<sup>23</sup> The detection of *Brucella* DNA from aborted bovine fetuses by PCR has been compared with microbiological techniques and the estimated concordance calculated by Kappa index was 0.73 which is considered satisfactory.<sup>24</sup>

*Brucella* spp. can be detected in the milk of naturally infected cattle, sheep, goats, and camels using a PCR assay which is more sensitive than the culture method.<sup>25</sup> The literature on the use of the PCR-assay as a diagnostic method for brucellosis has been reviewed.<sup>23</sup>

#### Serological tests

In the absence of a positive culture of *B. abortus* a presumptive diagnosis is usually made based on the presence of antibodies in serum, milk, whey, vaginal mucus, or seminal plasma.

The antibody response following infection depends on whether or not the animal is pregnant and on the stage of gestation. On average, the agglutinins and complement fixation antibodies become positive 4 weeks following experimental infection during the fourth to sixth months of gestation and not until about 10 weeks if experimental infection occurs 2 months before or after insemination.

The serological diagnosis is considered to be unreliable when applied during the period of 2–3 weeks before and after abortion or calving.

Any of the currently available serological tests or combination of tests measures the response of a single animal at one point in time and does not describe the status of the herd. When the tests are used in the recommended sequence and in combination, along with a consideration of accurate epidemiological data, the limitations of each test can be minimized. None of the tests is absolutely accurate and there are varying degrees of sensitivity. The result has been the development of a very extensive range of tests, each of which has its own special applicability. The details are available.<sup>18</sup> The salient features are as follows.

#### Agglutination tests

##### Standard tube agglutination test

This is one of the traditional standard tests which is widely used, but its limitations include the following:

- The test detects nonspecific antibodies as well as specific antibodies from *B. abortus* infection and vaccination
- During the incubation stage of the disease the test is often the last to reach diagnostically significant levels
- After abortion due to *B. abortus* it is often the last test to reach diagnostically significant levels
- In the chronic stage of the disease, the serum agglutinins tend to wane, often becoming negative when the results of some other tests may be positive.

##### Rose Bengal test (buffered plate antigen or card test)

This is a simple, rapid test that detects early infection and can be used as an initial screening test. 'Overkill' using the test is estimated to vary from 1–3%, depending on the level of infection and vaccination history in the herd. False-positive reactions are due to residual antibody activity from vaccination, colostral antibody in calves, cross-reaction with certain bacteria, and laboratory error. False-negative reactions are observed during early incubation of disease and immediately after abortion. However, the rose Bengal test is an excellent test for the large-scale screening of sera. The application of the rose Bengal test as a screening test, followed by a confirmatory complement fixation test along with the indirect hemolysis test, can markedly increase the proportion of infected cattle which are tested positive. This combination can be useful during the latter stages of an eradication program.



For **beef cattle**, screening of herds can be achieved by collecting blood at abattoirs and submitting it to the **rose Bengal test** or **tube agglutination test**. Reactors are traced back to the herd of origin and the herd is tested. In heavily infected herds it is best to remove all cows positive to the rose Bengal test even though it is highly sensitive and a small percentage of false-positive cows will result. In herds where the prevalence of infection is low and where vaccination has been used, this procedure will eliminate too many false-positive cows. In this situation the sera positive to the rose Bengal test are submitted to a more definite confirmatory test such as the complement fixation test and only those animals reacting to the test are discarded.

#### Complement fixation test

The complement fixation test (CFT) rarely exhibits nonspecific reactions and is useful in differentiating titers of calthood vaccination from those due to infection. The reactions to the CFT recede sooner than those to the serum agglutination test after calthood vaccination with the strain 19 vaccine. The CFT titers do not wane as the disease becomes chronic and often the CFT reaches diagnostic levels sooner than the serum tube agglutination test following natural infection. In addition, recent technical laboratory advances have allowed much greater speed and accuracy in doing the CFT and it is now considered to be the nearest approach to a definitive test for infection.

#### Primary binding assays

##### Enzyme-linked immunosorbent assays

Two main types of immunosorbent assay have been used: the indirect and competitive formats.<sup>18</sup> The **indirect ELISA (IELISA)** has been a useful test during an eradication program, after vaccination has ceased, for screening or as a supplementary test to the complement fixation test. Preliminary evaluations of the IELISA test alone, or in combination with the complement fixation test and monoclonal antibodies, indicate some comparative advantages over other serological tests. The IELISA has gained wide acceptance for serological diagnosis of bovine brucellosis because of its ability to detect antibody of all isotopes, unlike the conventional tests.<sup>18</sup> The ELISA can be useful in conjunction with the complement fixation test during the latter stages of an eradication program when it is important to reduce the number of false-negative serological reactions which contribute to the persistence of problem herds. The sensitivity and specificity of indirect ELISA has been excellent but it could not distinguish between the antibody response induced by vaccination with *B. abortus*

strain 19 and natural infection with the organism. The **competitive ELISA (CELISA)** can differentiate between the induced antibody responses. An improved competitive enzyme immunoassay (C-ELISA) has a sensitivity of 100% and specificity of 99.7% and is considered a reasonable alternative as a single assay for serological diagnosis of brucellosis.

In a comparison of the IELISA with two screening tests, the rose Bengal and the buffered plate antigen, and with two confirmatory tests, the 2-mercaptoethanol agglutination and the complement fixation tests, the overall diagnostic specificity and sensitivity of the ELISA is comparable, if not superior, to the tests used to confirm buffered plate antigen-positive reactor status.<sup>26</sup> The indirect ELISA kits produced by the Joint Food and Agriculture Organization and the International Atomic Energy Authority (FAO/IAEA) were able to detect residual anti-*B. abortus* strain 19 antibodies in adult cows vaccinated with strain 19 vaccine between 3 and 8 months of age but which were negative to the rose Bengal and Rivanol tests.<sup>27</sup> A 'dipstick' enzyme immunoassay is also available and being evaluated.

#### Fluorescence polarization assay

This test can be done outside the diagnostic laboratory, allowing for rapid and accurate diagnosis.<sup>18</sup> The fluorescence polarization assay (FPA) can be done almost anywhere using a portable analyzer, which receives power from a laptop computer, using serum, milk, or EDTA anticoagulated blood.<sup>28</sup> The FPA technology has been developed and validated for the serological diagnosis of brucellosis in cattle, pigs, sheep, goats, bison, and cervids. Sufficient cross-reactivity of the common epitopes of *B. abortus*, *B. melitensis*, and *B. suis* O-polysaccharide has allowed for the use of a single antigen for all species of smooth *Brucella* and animals. The FPA was initially developed for testing serum; however, the technology has been extended to testing whole blood and milk from individual animals or bulk tank samples pooled from 2000 or fewer animals. The accuracy results of the FPA equals or exceeds those obtained using other serological tests such as the buffered antigen plate agglutination test, the milk ring test, the CFT, the IELISA, and the CELISA. Validation of studies of the FPA and the CELISA for the detection of antibodies to *B. abortus* in cattle sera and comparison to the standard agglutination test, the complement fixation test and the indirect ELISA, found that the FPA is highly superior.<sup>29</sup> The FPA offers clear advantage due to its ease of use. Full implementation and acceptance of FPA

methods for the diagnosis of brucellosis will necessitate the use of an International Standard Serum panel containing at least a low titer positive sample and a negative.<sup>29</sup>

#### Sensitivity and specificity of serological tests

Serological tests must have high sensitivity to insure that all true serological reactors are detected. However, with a high sensitivity, a high rate of false-positive reactions may be expected and hence the need for the use of a confirmatory test to identify false-positive reactors. Confirmatory tests must therefore demonstrate a high level of diagnostic specificity and yet maintain an effective diagnostic sensitivity.

The sensitivity and specificity of several serological tests for the diagnosis of brucellosis in Canada have been compared.<sup>18</sup> It is recommended that either the buffered plate antigen test or indirect enzyme immunoassay test be used as a screening test. Either the complement fixation test or the indirect enzyme immunoassay is appropriate for use as a confirmatory test in situations requiring a high specificity. In brucellosis-free herds, the specificity of tests was 98.9% for buffered plate antigen test (BPAT), 99.2% and 99.3% for the standard tube and plate agglutination tests (STAT and SPAT), respectively, and 99.8% for the 2-mercaptoethanol test (2-MET). The rose Bengal plate test (RBPT), the card test (CARD), and the CFT correctly classified all sera as negative. On a sample of culture-positive cattle, the sensitivities of the tests were complement fixation 79.0%, buffered plate antigen test 75.4%, rose Bengal plate test 74.9%, card test 74.3%, standard plate agglutination test 73.1%, standard tube agglutination test 68.9%, and 2-mercaptoethanol 59.9%. All tests combined detected only 82% of infected cattle. Analysis of the relative sensitivity of the six agglutination tests gave the following ranking from highest to lowest: BPAT, RBPT, CARD, SPAT, STAT. The 2-MET ranked between BPAT and RBPT or between the RBPT and CARD depending on the analysis used. The BPAT is recommended as a screening test, followed by the CFT.

The relationships between the quantitative serology and infection status of brucellosis in bison in Yellowstone National Park have been evaluated and found to be similar to those in chronically infected cattle.<sup>2</sup>

#### Antibodies in milk

The **milk ring test** is a satisfactory inexpensive test for the surveillance of dairy herds for brucellosis. A small sample of pooled fresh milk or cream, from no more than 25 cows, is tested and the herd

is classified only as suspicious or negative. Final determination of the status of a suspicious herd and each animal in it is accomplished by blood testing. The more frequently a herd is tested with the milk ring test, the more effective the test becomes as a method to detect early infections and thereby prevent serious outbreaks in susceptible herds. At least three tests done annually are now required by some regulatory agencies. The major limitation of the test is the dilution factor which occurs in large dairy herds where large quantities of milk are stored in bulk tanks.

The Bruc ELISA test is a sensitive, specific, and inexpensive method for screening large numbers of individual or bulk milk samples for antibody to *B. abortus*. An ELISA using potassium chloride extract of the organism used on bulk tank milk samples of dairy herds was highly specific and is considered as a highly reliable test for monitoring brucellosis control programs which are being initiated.<sup>30</sup> An indirect ELISA using polysaccharide as the antigen has a sensitivity of 95% and specificity of 99.95% when compared in milk samples from brucellosis-free and brucellosis-infected herds.<sup>31</sup> The combined use of an ELISA and PCR on milk samples gives a sensitivity of 100%.<sup>32</sup>

#### False-positive reactors

A major problem in brucellosis eradication programs has been the false positive animals or singleton reactor which may remain persistently suspicious or positive in a herd that is otherwise considered to be free of brucellosis. It is of some concern because of the unnecessary slaughter of uninfected animals.

Cross-reacting antibodies usually result from exposure to antigen(s) that share antigenic determinants with *Brucella* spp. which are found in a large number of bacteria. The most prominent cross reaction is with *Yersinia enterocolitica* O:9, which shares the major O-polysaccharide almost completely with *B. abortus*. Serological cross-reactions have also been demonstrated between smooth *Brucella* spp. and *E. coli* O116:H21 and *E. coli* O157:H7, *Francisella tularensis*, *Salmonella* serotypes of Kauffman-White group N, *Pseudomonas maltophilia*, *Vibrio cholerae*, and *Yersinia enterocolitica* serotype O:9. Only rarely will naturally occurring *E. coli* O157H:7 infections cause false-positive reactions with standard serological tests for bovine brucellosis. The standard serological tests are unreliable in differentiating between *Y. enterocolitica* and *Brucella*-infected cows but both the lymphocyte transformation and brucellin skin tests could be used to differentiate them.

Other causes of false positives include a *B. abortus*-infected animal, strain 19

residual vaccination titer and naturally occurring nonspecific agglutinins, which may occur in some cattle populations. These agglutinins are EDTA-labile and can be differentiated from agglutinating antibodies by the addition of EDTA to the diluent used in the standard serum agglutination test. The serological cross-reactions are of major significance when the prevalence of infection has decreased to a very low level. At this stage it becomes much more important to correctly identify the status of animals reacting to the serological tests for brucellosis.

The incorrect attribution of such reactions to factors other than *Brucella* infection is likely to result in herd breakdowns and failure to control the disease. On the other hand, the misinterpretation of cross-reactions as evidence of brucellosis results in the imposition of unnecessary restrictions and waste of resources. The problem of serological cross-reactions has resulted in considerable research and an investigation to find laboratory tests, which will accurately distinguish positive, infected animals from positive, noninfected animals. Differentiation of cross-reacting antibodies can be difficult to achieve, especially in the case of *Y. enterocolitica* O:9 antigen, but immunodiffusion, immunoelectrophoresis and primary binding tests and cross-absorption procedures are useful. The DNA homology of *B. abortus* strains 19 and 2308 has been examined using restriction enzyme analysis. Strain 19 is the official USDA-attenuated *Brucella* vaccinal strain for cattle, and strain 2038 is a virulent laboratory-adapted strain that is pathogenic to cattle. The DNA differences between the two strains are small and will require analysis at the DNA sequence level.

The serological assay of choice for screening samples for antibody to *B. abortus* is the FPA.<sup>33</sup> It is robust, very rapid and field-adaptable, without subjective results. The CELISA is a useful confirmatory assay. The sera from cattle naturally infected with *B. abortus*, vaccinated with *B. abortus* S19, or immunized with *Y. enterocolitica* O:9 or *E. coli* O157H:7 were compared for antibody content to the same bacteria by IELISA, FPA, and CELISA.<sup>33</sup> The serological assay of choice for screening samples for antibody to *B. abortus* is the FPA. Between the two tests, nearly all reactivity to *E. coli* O157H:7 and more than one-half of the sera with antibody to *Y. enterocolitica* O:9 could be eliminated as *Brucella* reactors. These assays, perhaps in combination with a brucellergen skin test, may be capable of distinguishing virtually all reactions due to *Y. enterocolitica* O:9.<sup>33</sup> A brucellosis skin test was more specific

than other tests and may be useful as a herd test for brucellosis in the Office International des Epizooties *Manual of Standards for Diagnostic Tests and Vaccines* and as an official test in the European Union when monitoring is made difficult by a specific brucellosis serological testing.<sup>34</sup>

#### NECROPSY FINDINGS

Necrotizing placentitis and disseminated inflammatory reactions in aborted fetal tissues are the characteristic changes. Adult animals are seldom necropsied. Findings in bovine fetuses infected with *B. abortus* usually include serohemorrhagic fluid in the body cavities and subcutis, and a pneumonia. Often granulomatous lesions and focal necrosis are noted in several fetal organs and a granulomatous leptomeningitis may also occur. Pneumonia is not a consistent finding and its character may vary. The placenta is usually edematous. There may be leathery plaques on the external surface of the chorion and there is necrosis of the cotyledons. The key microscopic feature of this inflamed chorioallantois is the presence of **intra-cytoplasmic coccobacilli within chori-ionic trophoblasts**. The use of modified Ziehl-Neelsen stains on impression smears from fresh placentas can provide a rapid presumptive diagnosis. The histopathological findings in experimental infections in pregnant goats are similar to those described in infected cows and fetuses.

The distribution of *B. abortus* in experimentally and naturally infected cattle has been examined. In experimentally infected pregnant cows, the most frequently infected specimen was the mammary lymph node; the organism could also be found in other lymph nodes, uterine caruncles, cotyledons, or fetal tissues. In naturally infected heifers the most frequently infected specimen was the mandibular lymph node. In bulls, the most frequently infected tissues were the mandibular, caudal superficial cervical, subiliac, and scrotal lymph nodes.

The lesions in *Brucella*-positive aborted fetuses and placentas in bison are similar to those in experimental infections of *B. abortus* in bison and cattle.<sup>3</sup> Both *B. abortus* biovar 1 and *B. abortus* biovar 2 were isolated from specimens collected from aborted bison fetuses or stillborn calves and their placentas. The infection can also be associated with death in calves at least 2 weeks of age.<sup>3</sup>

The development of PCR tests for *Brucella* spp. antigens may permit more timely confirmation of infection and immunohistochemical tests on formalin-fixed tissues can also improve the detection of this slow-growing organism.

### Samples for confirmation of diagnosis

- Bacteriology – maternal caruncle; placenta, stomach content, lung (CULT – has special growth requirements; CYTO – Stamp's or Koster's stain on placental smears)
- Histology – fixed placenta, lung, spleen, brain, liver, kidney; maternal caruncle (LM, IHC).

Note the zoonotic potential of this organism when handling carcasses and submitting specimens.

### DIFFERENTIAL DIAGNOSIS

The diagnosis of the cause of abortion in a single animal or in a group of cattle is difficult because of the multiplicity of causes that may be involved. When an abortion problem is under investigation, a systemic approach should be used. This includes a complete laboratory evaluation and follow-up inquiries into each herd. The following procedure is recommended:

- Ascertain the age of the fetus by inspection and from the breeding records
- Take blood samples for serological tests for brucellosis and leptospirosis
- Examine uterine fluids and the contents of the fetal abomasum at the earliest opportunity for trichomonads, and subsequently by cultural methods for *B. abortus*, *Campylobacter fetus*, trichomonads, *Listeria* spp., and fungi
- Supplement these tests by examination of urine for leptospirae, and of the placenta or uterine fluid for bacteria and fungi, especially if the fetus is not available
- Examine placenta fixed in formalin for evidence of placentitis.

It is most important that all examinations be done in all cases because coincident infections with more than one agent are not uncommon.

In the early stages of the investigation, the herd history may be of value in suggesting the possible etiological agent. For example, in brucellosis, abortion at 6 months or later is the major complaint, whereas in trichomoniasis and vibriosis, failure to conceive and prolongation of the diestral period is the usual history.

A summary of the differential diagnosis of contagious abortion in cattle is provided in Table 18.7. Of special interest is epizootic bovine abortion, a major disease of rangeland cattle in the western USA. A spirochete has been isolated from the soft tick *Ornithodoros coriaceus* and from the blood of fetuses with lesions of epizootic bovine abortion.<sup>35</sup> The disease occurs at a very high level of incidence but only in cattle introduced to a certain area; resident cattle are usually unaffected. Cattle returned to the area each winter are unaffected after the first abortion. The cows are unaffected systemically. Aborted fetuses show characteristic multiple petechiae in the skin, conjunctiva and mucosae, enlargement of lymph nodes, anasarca, and nodular involvement of the liver.

In most countries where brucellosis is well under control and artificial insemination limits the spread of vibriosis and trichomoniasis, leptospirosis may be the commonest cause of abortion in cattle.

However, surveys in such countries reveal that in about two-thirds of the abortions that occur no causative agent is detectable with routine laboratory techniques. In only 35% of cases was the cause determined and brucellosis accounted for less than 1% of the total. In an Australian experience the cause of abortion was determined in only 37% of cases in spite of the submission of the fetus, placenta, and maternal serum. The general procedures for submission of specimens to the laboratory and laboratory methods are available.<sup>36</sup>

#### Bulls

Infected bulls may be serologically positive or negative, their semen may be culturally positive or negative, but the organism may be isolated at slaughter. Clinical examination may reveal the presence of epididymitis, orchitis, seminal vesiculitis, and ampullitis. All bulls from known infected herds should therefore be considered as suspicious, regardless of their serological status, and not be used for artificial insemination.

### TREATMENT

Treatment is unsuccessful because of the intracellular sequestration of the organisms in lymph nodes, the mammary gland, and reproductive organs. *Brucella* spp. are facultative intracellular bacteria that can survive and multiply within the cells of the macrophage system. Treatment failures are considered to be due not to the development of antimicrobial resistance but rather to the inability of the drug to penetrate the cell membrane barrier.

### CONTROL AND ERADICATION

Most countries with brucellosis have programs designed to control and ultimately eradicate the infection in cattle to reduce economic losses and protect the public from the disease. These programs usually have several components, and to insure effectiveness each component needs to be scientifically sound and accepted by all concerned.<sup>37</sup> The major components of a control and eradication program are as follows.

#### Test and reduction of reservoir of infection

All breeding cattle in the herd are tested and those that are positive are culled and sent for slaughter. This removes infected cows from the herd and reduces exposure and transmission within the herd. Of particular importance is the detection and removal of infected cows prior to parturition.

### Quarantine

This is a period of time during which cattle movement is restricted and the cattle are tested. This will prevent interherd transmission by infected cattle, especially those that are test-negative and incubating the disease. The quarantine period should be sufficiently long that all cattle have had sufficient time to develop brucellosis and insure that the remaining cattle will not be a source for interherd transmission. The time will usually range from 120 days to 1 year, or until all breeding animals have completed a gestation without test evidence of infection.

### Depopulation

Depopulation is slaughter of all cattle in a herd when all animals have been exposed and are capable of becoming infected and acting as a source of new infection.

### Vaccination

The strain 19 vaccine of *B. abortus* provides increased resistance against field strain infection following natural exposure. Properly vaccinated cattle are less likely to be infected and, therefore, are not a source of field strains of the organism. As the number of infected cattle in the herd is reduced, the exposure potential should be reduced and, if exposure is reduced, then new cases should be reduced.

### Education

All participants in a program must understand and adopt the scientific basis for the program. This includes livestock producers, veterinarians, and regulatory officials.

### Guidelines

To be successful, any program needs guidelines and policies, which must be followed and modified to meet the needs of certain areas or herds. In the USA, the Uniform Methods and Rules for brucellosis eradication were developed by Veterinary Services of the US Department of Agriculture in cooperation with the US Animal Health Association. The Uniform Methods and Rules are continually updated as new scientific information is made available, and the document is used as a guide for state programs.

Bovine brucellosis can be controlled with an effective vaccination program or eradicated using a test and slaughter program. Vaccination using strain 19 will markedly reduce the incidence of abortion but the level of infection will not be reduced at a corresponding rate. Even with a widespread vaccination program there will be foci of infection, which are perpetuated indefinitely. Complete eradication is the alternative to control by vaccination; some countries have already achieved this status and others are currently engaged in eradication programs.

Table 16.7 Diagnostic summary of causes of abortion in cattle

Disease	Field examination			Laboratory diagnosis			
	Clinical features	Abortion rate	Time of abortion	Placenta	Fetus	Isolation of agent	Serology
Brucellosis ( <i>Brucella abortus</i> )	Zoonotic disease, chronic infection, abortion, retained placenta and metritis	High, up to 90% in susceptible herds	5 months +	Severe placentitis, thickened placenta with surface exudate	May be pneumonia	Culture of fetal stomach, placenta, uterine fluid, milk, and semen	Serum and blood agglutination test, milk ring test, whole milk plate agglutination test. When plate agglutination, semen plasma, and vaginal mucous agglutination test
Trichomonosis ( <i>Trichomonas foetus</i> )	Venerally transmitted disease resulting in early embryonic loss with occasional abortion and pyometra	Moderate, 5–30%	Primarily first 5 months	Flocculent material and clear, serous fluid in uterine exudate	Usually no gross lesions, histologically fetal giant cell pneumonia may occur	Hanging drop or culture examination of fetal stomach and uterine exudate within 24 hours of abortion. Isolation, best source in female pyometra fluid if pyometra exists, best method is InPouch. In male bulls preputial smegma with InPouch	Cervical mucous agglutination test. Serology rarely performed, mucus agglutination or complement fixation hemolytic assay
Neosporosis ( <i>Neospora caninum</i> )	Worldwide distribution of infection in both dairy and beef cattle, most abortions reported in dairy cattle. In addition to abortion, mummification and birth of full-term infected calves can occur with or without clinical signs. Chronic infection in which congenital transmission commonly occurs during pregnancy, acquired postnatal infection may also occur	Sporadic or outbreaks common (20–40%). Repeat abortions from same cow can occur	3–8 months of gestation (mean 5.5 months)	No characteristic gross lesions in placenta. Parasite may be present	Autolyzed midgestation fetus, widespread histological inflammatory lesions in fetus including nonsuppurative necrotizing encephalitis and myocarditis	Identify parasite in fetal tissues by immunohistochemistry stain or PCR	Antibodies in fetus and cow. IFAT and ELISA antibodies used for serological detection. Positive result supports infection in cow and/or fetus but is not causal proof; negative result in dam strong evidence that neosporosis not involved in abortion; serological comparison of groups of aborting and nonaborting herd mates useful in establishing the role in herd outbreaks of abortion
Vibriosis ( <i>Campylobacter fetus</i> subsp. <i>venerealis</i> )	Venerally transmitted, resulting in infertility, irregular, moderately prolonged diestrus with occasional abortion. (BB) Epidemiology similar to trichomonosis except for a longer vaginal carrier state (up to 4 months after uterus has cleared organism), significance: her fertility returns but she is still a threat to any uninfected bull	Low, up to 5%, may be up to 20%	46 months	Semi-opaque, little thickening. Petechiae, localized avascularity and edema	Flakes of pus on visceral peritoneum. Fibrin may be present in serosal cavities. Usually associated with suppurative pneumonia in fetus	Culture of fetal stomach, placenta, and uterine exudate. Sporadic abortion, not venerally transmitted, can be associated with <i>C. fetus</i> subsp. <i>fetus</i> and <i>Campylobacter jejuni</i> , which need to be differentiated from <i>C. fetus</i> subsp. <i>venerealis</i>	Blood agglutination after abortion (at 3 weeks). Cervical mucous agglutination test at 40 days after infected service

(cont'd)

TABLE 18.10. Clinical features, time of abortion, abortion rate, field examination, laboratory diagnosis, and serology of abortion storms in animals.

Disease	Clinical features			Field examination		Laboratory diagnosis	
	Abortion rate	Time of abortion	Placenta	Fetus	Isolation of agent	Serology	
Leptospirosis ( <i>Leptospira interrogans</i> serovar <i>pomona</i> and <i>Leptospira hardjo</i> ) <i>L. hardjo</i> is now called <i>L. interrogans</i> serovar <i>hardjo</i> type <i>hardjo-prajitno</i> in Europe and elsewhere and <i>Leptospira borgpetersenii</i> serovar <i>hardjo</i> type <i>hardjo-ovis</i> in North America Infectious bovine rhino-tracheitis	25–30%	Abortions may occur throughout gestation. Late, 6 months +	Avascular placenta, atonic yellow-brown cotyledons, brown gelatinous edema between allantois and amnion	Fetus usually autolyzed, occasional icterus. Fetal death common	Fluorescent antibody stain of smears of fetal kidney or PCR. Direct examination of urine of cow by darkfield or fluorescent antibody stain	Positive serum agglutination test 14–21 days after febrile illness. Titers usually at or near maximum at time of abortion. Chronically infected <i>L. hardjo</i> dams may have low or negative titers	
Mycoses ( <i>Aspergillus</i> , <i>Absetzia</i> )	Variable	Most in second half of gestation	No significant gross lesions	Autolyzed fetus, rarely may have pale foci of hepatic necrosis. Histopathology characteristic with disseminated multifocal necrosis Minority of fetuses have skin lesions May be small raised, gray-buff, soft lesions, or diffuse white areas on skin. Resemble ringworm	Virus isolation on placenta or fetal tissues. Immunohistochemistry or fluorescent antibody stain on fetal tissues	Acute and convalescent sera	
Abortion storms in inadequately vaccinated animals	Variable	Most in second half of gestation	No significant gross lesions	Autolyzed fetus, rarely may have pale foci of hepatic necrosis. Histopathology characteristic with disseminated multifocal necrosis Minority of fetuses have skin lesions May be small raised, gray-buff, soft lesions, or diffuse white areas on skin. Resemble ringworm	Virus isolation on placenta or fetal tissues. Immunohistochemistry or fluorescent antibody stain on fetal tissues	Acute and convalescent sera	
Variable incidence, more common in cooler moist climates, retained placenta may occur	Unknown. 6–7% of all abortions encountered	3–7 months	Necrosis of maternal cotyledon, adherence of necrotic material to chorionic cotyledon causes soft, yellow, cushion-like structure. Small yellow, raised, leathery lesions on intercotyledonary areas	Autolysis. Foci of necrosis in liver and other organs	Direct examination of cotyledon and fetal stomach for hyphae, suitable cultural examination. Histopathology on placenta	Agglutination titers higher than 1:400 in contact animals classed as positive	
May be an associated septicemia. (Cows that abort may die of septicemia near term.) Retained placentas and metritis may also occur	Low, rare abortion storms related with poorly fermented silage	About 7 months	–	Autolysis. Foci of necrosis in liver and other organs	Organisms in fetal stomach, liver and throughout fetus placenta and uterine fluid	Agglutination titers higher than 1:400 in contact animals classed as positive	
Listeriosis ( <i>Listeria monocytogenes</i> )	Low, rare abortion storms related with poorly fermented silage	About 7 months	–	Autolysis. Foci of necrosis in liver and other organs	Organisms in fetal stomach, liver and throughout fetus placenta and uterine fluid	Agglutination titers higher than 1:400 in contact animals classed as positive	

(cont'd)

Table 10.7. *Brucella abortus* and *Brucella melitensis*

Epidemiology	Field examination			Laboratory diagnosis			
	Disease	Clinical features	Abortion rate	Time of abortion	Placenta	Fetus	Isolation of agent
Epizootic bovine abortion	Tick-transmitted bacterial infection, occurs in dry foothill pastures in western USA in which tick vector resides. No clinical signs in aborting cattle. Herd immunity develops. Incubation period ≈ 3 months after exposure to agent	Abortion storms may occur, usually in heifers and newly introduced cattle. High, 30–40%	Third trimester abortion or birth of premature weak calves	Negative	Fresh fetus with petechiae in mucosa, enlarged lymph nodes and spleen, subcutis edema, ascites, nodular swollen liver	Diagnosis based on typical histological lesions, etiological bacterial agent has been identified by DNA analysis but is not culturable on artificial media. Bacterial rod can be detected with special stains (Steiner silver stain and immunohistochemistry)	No serology test, elevated fetal IgG levels
Bovine virus diarrhoea	Variable outcome of fetal infection depending on timing of infection and other factors. Persistent BVDV infection in full-term live calves a significant problem for exposure of other animals	Less than 10%	Any time during gestation; most common in first trimester	No obvious gross lesions	Mummification, variable fetal lesions possible including deformities (cerebellar, pulmonary or renal hypoplasia), myocardial lesions with congestive heart failure, thymic depletion or no lesions	Immunohistochemical or fluorescent antibody examination of tissues to detect virus. Virus isolation or PCR also available. Animals affected early with congenital lesions may no longer be positive for virus at time of abortion	Fetal antibody, evidence of seroconversion in dam and/or herd

**Nutritional:** Ingestion of excessive amounts of performed estrogens in the diet may cause abortion. There are usually accompanying signs due to increased vascularity of the udder and vulva. Possible dietary factor in so-called 'lowlands' abortion.

**Isommunization:** Has not been observed to occur naturally in cattle. It has been produced experimentally by repeated intravenous injections of blood from the one bull of pregnancy. Intravascular hemolysis occurs in the calves.

**Unknown:** 30–75% of most abortions examined are undiagnosed. The ingestion of large quantities of pine needles is suspected as a cause of abortion in range cattle in the USA. Infection with *Ureaplasma* and *Mycoplasma* spp. are other causes of undetermined relative importance.

BVDV, bovine virus diarrhoea virus; EUSA, enzyme-linked immunosorbent assay; IFAT, indirect fluorescent antibody test; PCR, polymerase chain reaction.

Apart from the question of human exposure to infection, the cost and economic benefits of an eradication program must be assessed against the costs and benefits from a vaccination control program.

Certain basic considerations apply to all programs aimed at the eradication of brucellosis.

- The control programs indigenous to any given area must receive primary recognition, and any plan or plans must be adapted to that area
- Cooperation at all levels of government from the local to the national is essential for the success of a program. This is attained only after an intensive program of education has been carried out. The individual owner of an infected herd must recognize the problem of brucellosis and express a willingness to cooperate. Experience has shown that the owner must be impressed with the hazards of the disease for human health and with the economic losses in the herd
- A reliable and uniform diagnostic procedure must be generally available
- If disease is detected in a herd, established procedures should be available for handling the disease. If immunization is to be used, a standardized and effective vaccine must be readily available. The disposal of infected animals may create a serious economic threat for the owner and the possibilities of financial compensation must be explored
- Finally, and of major importance, the movement of animals from one area to another must be controlled at a high level, since a rigid eradication program in one area may be nullified by neglect in a neighboring area.

Sufficient information exists about bovine brucellosis that it can be eradicated. The disease was considered to have been eradicated from Great Britain in 1981; in 1985, having met certain European Community criteria for national surveillance and with over 99.8% of the cattle herds free from brucellosis, all herds within the country not under restrictions were designated as being officially brucellosis-free for trade purposes. However, small foci of infection persisted, and following the prohibition of the use of *Brucella* vaccines the national herd was becoming fully susceptible to brucellosis. This was followed by outbreaks of brucellosis in south-west England during 1984–1986. The movement of cattle through premises owned by dealers who specialized in the purchase and sale of newly calved cattle was a significant epidemiological feature of these herd breakdowns.

### Control by vaccination

The literature on *Brucella* vaccines in the past, present, and future has been reviewed.<sup>38</sup> Because of the serious economic and medical consequences of brucellosis, efforts have been made to prevent the infection through the use of vaccines.

#### *Brucella abortus* strain 19 vaccine

*B. abortus* strain 19 vaccine has been most widely used to prevent bovine brucellosis. The vaccine protects uninfected animals living in a contaminated environment, enabling infected animals to be disposed of gradually. This overcomes the main disadvantage of the test and disposal method of eradication, in which infected animals must be discarded immediately to avoid spread of infection. Vaccination cannot eradicate brucellosis but can be used to lay the groundwork for eradication. Eradication requires that the infected animals be identified and eliminated from the herd as a source of infection.

Strain 19 *B. abortus* has a low virulence and is incapable of causing abortion except in a proportion of cows vaccinated in late pregnancy, although it can cause undulant fever in humans. Its two other weaknesses are its failure to completely prevent infection, especially infection of the udder, and the persistence of vaccinal titers in some animals.

The **optimum age for vaccination is between 4 and 8 months** and there is no significant difference between the immunity conferred at 4 and at 8 months of age. In calves vaccinated between these ages the serum agglutination test returns to negative by the time the animals are of breeding age, except in a small percentage (6%) of cases. The lipopolysaccharide with an O-chain on *B. abortus* strain 19 explains the appearance and persistence of antibodies in serum following vaccination. These antibodies are detectable in the serological assays used for the diagnosis of brucellosis and are the major problem with strain 19 vaccination, since they prevent easy differentiation of vaccinated from infected cattle. The appearance and persistence of these antibodies depends on age, dose, and route of vaccination. This situation makes the continued use of the vaccine incompatible with simultaneous application of test and slaughter procedures for the control of brucellosis.

In brucellosis-free herds where heifers are vaccinated between 4 and 9.5 months of age, positive titers may persist for up to 18 months if they are tested with screening tests such as the rose Bengal test. This supports the official policy in some countries not to test vaccinated heifers

before 18 months of age and to retest positive cases with the complement fixation test.

Calves vaccinated with strain 19 at 2 months of age have resistance comparable to those vaccinated at 4–8 months of age. However, in general, calves under 75 days of age are immunologically immature in response to strain 19 vaccine. Vaccination of calves with a single dose at 3–5 weeks of age does not provide protection compared to vaccination at 5 months of age.

In most control programs, vaccination is usually permitted up to 12 months of age, but the proportion of persistent postvaccinal serum and whey reactions increases with increasing age of the vaccinates. Such persistent reactors may have to be culled in an eradication program unless the reaction can be proved to be the result of vaccination and not due to virulent infection.

Vaccination of adult cattle is usually not permitted if an eradication program is contemplated but it may be of value in reducing the effects of an abortion 'storm'.

Vaccination of bulls is of no value in protecting them against infection and has resulted in the development of orchitis and the presence of *B. abortus* strain 19 in the semen. For these reasons the vaccination of bulls is discouraged.

Strain 19 has been isolated from vaccinated cattle; it is estimated that the organism can be recovered from fewer than 1:100 000, excluding hypersensitivity cases.

#### *Efficiency of Brucella abortus strain 19 vaccine*

#### **Calfhood vaccination**

This can be assessed by its effect on both the incidence of abortion and the prevalence of infection as determined by testing. Field tests show a marked reduction in the number of abortions that occur, although the increased resistance to infection, as indicated by the presence of *B. abortus* in milk, may be less marked. Vaccinated animals have a high degree of protection against abortion and 65–75% are resistant to most kinds of exposure. The remaining 25–35% of vaccinated animals may become infected but usually do not abort. Experimentally, 25% of cattle vaccinated with strain 19 will become infected following challenge. Vaccinated animals continually exposed to virulent infection may eventually become infected and act as carriers without showing clinical evidence of the disease.

The breed of cattle does not affect the serologic response to vaccination with strain 19. Vaccination of adult Bali cattle (*Bos javanicus*) with the low dose, and of calves 6–12 months of age, induced protection and the vaccine is an important



aspect in the control of brucellosis in Timor, Indonesia.<sup>39</sup>

In summary, vaccination with a single 5 mL dose of *B. abortus* strain 19 vaccine given subcutaneously at 2–6 months of age confers adequate immunity against abortion for five or more subsequent lactations under conditions of field exposure. Multiple or late vaccinations have no appreciable advantage and increase the incidence of postvaccinal positive agglutination reactions. When breakdowns occur, they are due to excessive exposure to infection and not to enhanced virulence of the organism. In herds quarantined for brucellosis, calfhood vaccination reduces reactor rates, duration of quarantine and the number of herd tests.

#### Adult vaccination

Vaccination of adult cows with strain 19 vaccine is highly successful in reducing the number of infected cows in large dairy herds in which it is impossible to institute management procedures for the ideal control of brucellosis. The difficulty of eliminating brucellosis from large dairy herds by test and slaughter methods alone is well documented. Large numbers of animals are concentrated in relatively small areas, few or no replacements are raised in the herd, and the number of lactating animals is kept relatively constant by purchase of mature replacements. The infection rate is high and the acutely affected herd experiences abortion and rapidly spreading disease. In the USA this problem resulted in the evaluation and adoption of vaccination of adult cattle with strain 19 *B. abortus* vaccine.

The vaccination of adult cattle with a reduced dose of vaccine is efficacious.<sup>38</sup> The use of about 1/20th of the standard subcutaneous dose of vaccine results in an agglutinin response that declines more rapidly after vaccination than when the full dose is used. The reduced dose also provides protection comparable to the standard dose. The experimental challenge of pregnant adult cattle and sexually mature nonpregnant heifers that had been vaccinated with 1/400 of the standard calf dose of strain 19 revealed that, although immunity was incomplete, the increase in resistance to infection was greater than that achieved by standard calfhood vaccination. The serological response to vaccination was greatly reduced and there was no adverse effect on pregnancy. Vaccination eliminates clinical disease and reduces exposure of infection to susceptible cattle. The reduction of infected adult cattle may vary from 60–80% in 6–9 months following vaccination. The complement fixation test becomes negative sooner than the stan-

dard tube agglutination test following vaccination and can be used to distinguish postvaccine titers from culture-positive cows. The use of reduced doses of strain 19 vaccine in adult cows will also help to eliminate the problem of postvaccine titers.

The **subcutaneous and conjunctival routes of vaccination** of adult cattle with strain 19 *B. abortus* vaccine have been compared.<sup>38</sup> The protection provided is the same regardless of the route of administration. However, the subcutaneous route may result in a persistent serological response, which requires complement fixation testing and milk culture to identify infected animals.

The **principal advantages of adult vaccination** include:

- An effective method of control of abortion
- Reduction in the reactor losses in herds
- Reduction of the number of tests required to eliminate brucellosis from infected herds.

The **major disadvantages of adult vaccination** are:

- Residual vaccine titers
- Persistent positive milk ring test
- Persistent strain 19 infection in a small percentage of adult vaccinates
- The stigma attached to adult vaccinates, which identifies them with infected herds, even though brucellosis has been eliminated and the herd released from quarantine.

*B. abortus* strain 19 has been recovered from the supramammary lymph nodes of cattle at slaughter that were vaccinated with a low dose of the vaccine 9–12 months previously and had persistent titers to the complement fixation test. The stage of gestation affects the immune responses of cattle to strain 19 vaccination. Cattle that are late in the first or early in the second trimester of gestation (84–135 days) at the time of administration of a low dose of strain 19 are at greater risk of being positive by official tests for brucellosis. Vaccination of cattle during the third trimester with a low dose of the vaccine is not as efficacious as when carried out earlier. Although reduced-dose strain 19 vaccination is a possible alternative to the total depopulation of problem herds, its use during pregnancy should be avoided because of the risk of abortion and positive serological titers and positive bulk milk ring tests. It should never be used in uninfected herds.

The results expected following adult vaccination depend on the disease situation. In herds vaccinated in the acute phase of the disease, abortion may continue for 60–90 days but the incidence

begins to decline by 45–60 days. A large number of serological reactors will be present for the first 120 days following vaccination and testing is usually not done for the first 60 days. The rate of reactors declines rapidly after 120 days and with good infected herd management most adult vaccinated herds can be free of brucellosis 18–24 months following vaccination.

The prevalence of strain 19 *B. abortus* infection in adult vaccinated cattle is low and is often not permanent. The prevalence is lower among cattle given the reduced dose of the vaccine subcutaneously. Bacteriological examination of the milk and serological examination of the infected cattle are necessary to identify strain 19 infected cattle, which can be retained for milk production because the infections are temporary.

Adult vaccination, even with a low dose, should not be used in uninfected herds because of persistent titers, which may last for more than 12 months in up to 15% of vaccinated animals, and because of the potential for abortion. The illegal or unintentional use of the standard dose of strain 19 vaccine in adult cattle will result in a sudden steep antibody titer response in the CFT, which declines in 6–11 months. In herds where adult vaccination with a reduced dose of vaccine is used, blood samples should be collected about 4 months after vaccination and subsequently at intervals of 2 months. Those positive to the CFT should be culled. In one study of three large dairy herds in California, the CFT at 2 and 4 months after vaccination was used to identify and cull pregnant reactor cows that were at risk of aborting or calving. The prevention of parturition of infected cows is an effective management technique.

#### Systemic reactions to vaccination with strain 19

These occur rarely in both calves and adults, and may be more severe in Jersey calves than in other breeds. A local swelling occurs, particularly in adult cattle, and there may be a severe systemic reaction manifested by high fever (40.5–42°C, 105–108°F) lasting for 2–3 days, anorexia, listlessness and a temporary drop in milk production. An occasional animal goes completely dry. The swellings are sterile and do not rupture, but a solid, fibrous mass may persist for many months.

Deaths within 48 hours of vaccination have been recorded in calves after the use of lyophilized vaccine.

*B. abortus* strain 19 vaccine has been associated with lameness in young cattle with synovitis following vaccination. Experimentally, the intra-articular injection of the vaccine strain can produce synovitis

similar to that which occurs following vaccination.

Septicemia due to *B. abortus* may cause some deaths but in most cases the reaction is anaphylactic, and vaccinated calves should be kept under close observation. Immediate treatment with epinephrine hydrochloride (1 mL of 1:1000 solution subcutaneously) or antihistamine drugs is recommended and is effective provided it can be administered in time.

Cows in advanced pregnancy may abort if vaccinated, but the abortion rate is only about 1%; although *B. abortus* strain 19 organisms can be recovered from the fetus and placenta, their virulence is unchanged and they do not cause further spread of infection. Vaccination with strain 19 does not have a deleterious effect on the subsequent conception rate.

#### *Brucella abortus* strain RB51 vaccine

*Brucella abortus* strain RB51 (SRB51) is a live, stable, rough mutant of *B. abortus* strain 2308 that lacks much of the lipopolysaccharide O-side chain.<sup>40,41</sup> The O-side chains are responsible for the development of the diagnostic antibody responses of an animal to brucellosis infection.

Heifer calves vaccinated at 3, 5, and 7 months of age with the SRB51 vaccine were protected when challenged against infection and abortion during their first pregnancy.<sup>42</sup> None of the heifers developed antibodies that reacted in the standard agglutination test, but did react in a dot blot assay using RB51 antigen. In pregnant cattle, SRB51 vaccine has a tropism for the bovine placental trophoblast but when given subcutaneously does not cause placentitis or abortion and the induced humoral and cell-mediated immune response does not interfere with the serological diagnosis of field infections.<sup>43,44</sup> Vaccination of mature sexually intact bulls and pregnant heifers with a standard calfhooed dose of SRB51 is not associated with shedding or colonization in tissues, and does not appear to cause any reproductive problems when administered to sexually mature cattle.<sup>45</sup> One study found that *B. abortus* RB51 isolated from the milk of a cow was no different from the RB51 vaccine strain and it is possible that shedding of vaccine strains may be associated with the vaccine.<sup>46</sup> Use of the vaccine in cattle already vaccinated with strain 19 vaccine will not cause positive responses on confirmation tests and does not interfere with brucellosis surveillance.<sup>37,47</sup>

Vaccination with a reduced dosage of SRB51 (reduced dose vaccination) protects adult cattle against abortion or infection caused by exposure to virulent *B. abortus* during the subsequent pregnancy.<sup>48</sup>

Revaccination of cows with a reduced dose of SRB51 in endemic zones does not cause abortion and protects 94% of animals against field infection but may cause an atypical response to conventional serological tests.<sup>49</sup>

The summary of studies with strain RB51 vaccine indicate that it is as efficacious as *B. abortus* strain 19 vaccine but is much less abortigenic in cattle. It does not produce any clinical signs of disease after vaccination, nor does it produce a local vaccination reaction at the injection site. The organism is cleared from the blood stream within 3 days and is not present in nasal secretions, saliva, or urine. Immunosuppression does not cause recrudescence and the organism is not spread from vaccinated to non-vaccinated cattle. The vaccine is safe in all cattle over 3 months of age. In case of human exposure, strain RB51 is sensitive to a range of antibiotics used in the treatment of human brucellosis but is resistant to rifampin and penicillin.

In the USA, strain RB51 vaccine was licensed by USDA's Animal and Plant Health Inspection Service (APHIS) in 1996 for use in cattle and was approved for use in the Cooperative State-Federal Brucellosis Eradication Program. Strain RB51 vaccine must be administered by an accredited veterinarian or by a state or federal animal health official. Calves must be vaccinated with the calf dose (10–34 billion organisms) between 4 and 12 months of age. Only animals in high-risk areas should be vaccinated over 12 months of age.

Vaccinates must be identified with the standard metal vaccination eartag and a vaccination tattoo. The tattoo will be the same as with *B. abortus* strain 19 vaccine except the first digit for the quarter of the year will be replaced with an 'R' to distinguish animals vaccinated with RB51 from those vaccinated with strain 19. Recording and reporting are the same as with strain 19 vaccine. *B. abortus* strain 19 vaccine has not been removed from the market in the USA or from the Brucellosis Eradication Program at this time. However, APHIS has been advised that strain 19 vaccine production has ceased, and some states no longer allow vaccination with strain 19.

*B. abortus* strain RB51 has not yet been approved for general use in bison. Preliminary studies indicate that RB51 is safe and efficacious in bison calves. However, in order for RB51 to be conditionally licensed in bison, additional safety and efficacy trials must be completed.

Bison calves can be vaccinated with strain RB51 as part of a field safety trial evaluation prior to its being licensed. The requirements for participating in the trials are that all abnormal reactions or clinical

problems associated with the vaccination be reported to a USDA, APHIS Veterinary Services veterinarian for investigation. Bison vaccinated as part of the field safety trials will be recognized as official vaccinates provided that the proper vaccination charts and identification are completed as required under the Brucellosis Eradication Program Uniform Methods and Rules.

#### *Brucella* vaccines in wildlife

The literature on the use of *Brucella* vaccines in wildlife has been reviewed.<sup>50</sup> A reservoir of *B. abortus*-infected bison in the Greater Yellowstone Area of the USA is an obstacle in the effort to eradicate brucellosis from the USA and a source of potential reinfection for livestock in the states of Wyoming, Idaho, and Montana. The free-ranging and infected bison in the area migrate from public land on to private lands and may come into contact with cattle. *Brucella*-induced abortions in bison have occurred under experimental and field conditions, and infected bison can transmit brucellosis under range conditions. Wild and free-ranging bison in parts of western Canada have also been shown to be infected with bovine brucellosis. Therefore, a safe and effective vaccine suitable for delivery to free-ranging bison in the greater Yellowstone area and in Canada is considered useful in reducing the risk of transmission and an aid in the prevention and control of the disease.<sup>50</sup>

#### *Brucella abortus* strain 19 in bison

The use of strain 19 vaccine has been evaluated in pregnant bison and 10-month-old calves, and the results have been unsatisfactory.<sup>50</sup>

#### *Brucella abortus* strain RB51 in bison

The literature on the safety and efficacy of the RB51 vaccine in bison has been reviewed.<sup>50</sup> The vaccine is safe for vaccination in herds of naive and previously exposed bison calves, young growing bison, adult males, and adult pregnant and nonpregnant females. Fetal lesions do not appear to be significant with bison cows vaccinated with RB51 in early gestation. Efficacy studies indicate that the amount of protection provided to bison from RB51 has not yet been determined precisely.<sup>50</sup>

Calfhood vaccination of bison with SRB51 is efficacious in protecting against intramammary, intrauterine, and fetal infection following exposure to a virulent strain of *B. abortus* during pregnancy.<sup>51</sup> Calfhood vaccination with SRB51 would be beneficial in a program to reduce the prevalence of *B. abortus* field stains in American bison. To be effective, it would have to be combined with a test and slaughter policy program. As with cattle, SRB51 calfhood vaccination provides a

method to prevent transmission and reduce the numbers of susceptible individuals in a bison herd without interfering with serological identification of *Brucella*-infected animals. The vaccine can also cause placentitis and abortion in pregnant bison.<sup>52</sup> The vaccine can be safely used to booster vaccinate pregnant bison in a *Brucella*-infected herd.<sup>6</sup>

Brucellosis management programs in bison and elk are unlikely to be successful if capture and hand vaccination is necessary. The effect of hand vaccination versus ballistic vaccination for vaccination of bison and elk on the immunological responses to SRB51 has been evaluated.<sup>53</sup> Ballistic delivery may require a greater dose of SRB51 to induce cell-mediated immune responses in bison that are comparable to those induced by hand injection.

#### *Brucella abortus strain RB51 in elk* (*Cervus elaphus canadensis*)

Following vaccination with SRB51, elk remain bacteremic for a prolonged period of time, rapidly develop high antibody titers and are slower to develop detectable proliferative responses in peripheral blood mononuclear cells than cattle or bison.<sup>54</sup> The safety and efficacy of a reduced dose of SRB51 to prevent *Brucella*-induced abortion in elk vaccinated as calves has been evaluated.<sup>55</sup> A single dose does not provide significant protection against *B. abortus*-induced abortion in elk.<sup>55</sup> A higher dose also does not prevent abortion.<sup>55</sup> The vaccine is safe in bull elk.<sup>12</sup>

#### Other wildlife species

A single oral dose of SRB51 is safe in bighorn sheep, pronghorn, mule deer, moose, and coyotes.<sup>22</sup>

#### Vaccination technique

The vaccine is a living agent and must be handled with care if satisfactory results are to be obtained. Lyophilized vaccine is superior to liquid vaccine because of its greater stability and greater longevity but it must be kept under refrigeration at all times, be reconstituted only when required, and unusual material must be discarded. It must be used in an aseptic manner to avoid contamination with other bacteria. The use of a common needle for vaccination on a given day in a herd of dairy cattle is not an effective means of transmission of bovine leukemia virus infection.

#### Control programs on a herd basis

The following recommendations are based on the need for flexibility depending on the level of infection that exists and the susceptibility of the herd and the disease regulations in effect at the time.

During an abortion storm

Test and disposal of reactors may be unsatisfactory during an outbreak because

spread occurs faster than eradication is possible. Vaccination of all nonreactors is recommended in some countries or, if testing is impracticable, vaccination of all cattle. Strain K45/20A vaccine may be used and must be given in two doses at 6-month intervals. It is preferable to retest the herd before the second vaccination and to cull cows with a threefold rise in agglutination titer. However, strain-19 vaccine is a superior vaccine even for use in adult pregnant cattle, although it may cause abortion in a small percentage of animals.

Heavily infected herds in which few abortions are occurring

These do not present an urgent problem because a degree of herd resistance has been reached. All calves should be vaccinated with strain 19 immediately and positive reactors among the remainder should be culled as soon as possible. Periodic milk ring tests (preferably at 2-month, no more than 3-month, intervals) on individual cows are supplemented by complement fixation and culture tests.

Lightly infected herds

These present a special problem. If they are situated in an area where infection is likely to be introduced, the calves should be vaccinated and positive reactors immediately culled. If eradication is the goal in the area, culling of reactors will suffice, but special market demands for vaccinated cattle may require a calfhood vaccination policy. When a herd is declared free of brucellosis on the basis of serum agglutination tests, its status can be maintained by introducing only negative-reacting animals from brucellosis-free herds, and annual blood testing. In areas where dairying predominates, semi-annual testing by the milk tests may be substituted for blood testing.

In all the above programs the careful laboratory examination of all aborted fetuses is an important and necessary corollary to routine testing. There are many difficulties in the way of achieving control and eventual eradication on a herd basis. These relate mainly to the failure of owners to realize the highly infectious nature of the disease and to cooperate fully in the details of the program. Particularly, they may fail to recognize the recently calved cow as the principal source of infection. In a herd control program such cows should be isolated at calving and blood tested at 14 days, since false-negative reactions are not uncommon prior to that time.

Hygienic measures

These include the isolation or disposal of infected animals, disposal of aborted fetuses, placentas, and uterine discharges, and disinfection of contaminated areas. It

is particularly important that infected cows be isolated at parturition. All cattle, horses, and pigs brought on to the farm should be tested, isolated for 30 days, and retested. Introduced cows that are in advanced pregnancy should be kept in isolation until after parturition, since occasional infected cows may not show a positive serum reaction until after calving or abortion. Chlorhexidine gluconate is an effective antiseptic against *B. abortus* and is recommended for washing the arms and hands of animal attendants and veterinarians who come into contact with contaminated tissues and materials.

#### Eradication on an area basis by test and slaughter and cessation of calfhood vaccination

Following a successful calfhood vaccination program, eradication on an area basis can be considered when the level of infection is below about 4% of the cattle population. Brucellosis control areas must be established and testing and disposal of reactors and their calves at foot is carried out. Financial compensation is paid for disposal of reactors. Infected herds are quarantined and retested at intervals until negative; in heavily infected herds complete depopulation is often necessary. Brucellosis-free areas are established when the level of infection is sufficiently low, and the movement of cattle between areas is controlled to avoid the spread of infection.

Farms with a low incidence may find it possible to engage in an eradication program immediately provided the incidence on surrounding farms is low. Breakdowns may occur if there are accidental introductions from nearby farms, and in these circumstances it is hazardous to have a herd that is not completely vaccinated. When the area incidence is low enough (about 5%) that replacements can be found within the area or adjoining free areas, and immediate culling of reactors can be carried out without crippling financial loss, compulsory eradication by testing and disposal of reactors for meat purposes can be instituted. Compensation for culled animals should be provided to encourage full participation in the program.

The work of testing can be reduced by using screening tests to select herds for more intensive epidemiological and laboratory investigation. In dairy herds the milk ring test is useful. In beef herds, the favored procedure is the collection of blood from drafts of cattle at the abattoir and use of the rose Bengal test. The same technique has also been used to screen shipments of beef destined for countries with an aversion to meat infected with *B. abortus*. An additional means of reducing labor costs in an eradication program is

the use of automated laboratory systems such as the one available for the rose Bengal agglutination test and the one based on the agglutination and complement fixation test. An educational program to promote herd owners voluntarily submitting all aborted fetuses to a laboratory for bacteriological examination is also deemed necessary in any eradication scheme. When an area or country is declared free, testing of all or part of the population need be carried out only at intervals of 2–3 years, although regular testing of bulk milk samples and of culled beef cows in abattoirs and examination of fetuses should be maintained as checks on the eradication status. Such a program has achieved virtual eradication of the disease in Switzerland, Sweden, and Northern Ireland.

In all eradication programs some problem herds will be encountered in which testing and disposal do not eliminate the infection. Usually about 5% of such herds are encountered and are best handled by a 'problem herd' program. Fifty percent of these herds have difficulty because of failure to follow directions. The other half usually contain infected animals that do not respond to standard tests. Supplementary bacteriological and serological tests as set out above may occasionally help these spreader animals to be identified and the disease to be eradicated.

#### USA

The **Cooperative State–Federal Brucellosis Eradication Program of the USA** is making progress. Efforts to eradicate brucellosis associated with *B. abortus* in the USA began in 1934 as an economic recovery program to reduce the cattle population because of the great depression. Brucellosis was considered the most significant livestock disease at that time, with a reactor rate of 11.5%.<sup>56</sup> In 1954, a cooperative federal and state program was launched based on calfhood vaccination and test and slaughter with compensation. Two very effective surveillance programs for detecting brucellosis were the market cattle testing and milk ring testing of dairy herds. As of December 2000, there were no brucellosis-infected herds in the USA.<sup>56</sup> Infected animals (reactors) are traced to farms of origin. The number of human cases of brucellosis declined with the decline in number of cases in animals. As of 2002, about 100 human cases per year are reported. Most cases are associated with consumption of unpasteurized milk and milk products of goat origin infected with *B. melitensis*.<sup>56</sup> A critical element in a successful surveillance program is **individual animal identification**. A uniform national identification system is being developed

to insure the ability to trace animals to their herds of origin.

Bison and elk in the greater Yellowstone area are the last known remaining reservoir of *B. abortus* in the USA. Control of brucellosis in these species on public lands requires special consideration in order to preserve the largest wild, free-ranging population of bison in the USA. Vaccination trials are under way.

As of December 2004, the overall status of the Cooperative State–Federal Brucellosis Eradication Program is that 48 states are designated as Class Free for brucellosis and two states, Texas and Wyoming, are designated as Class A. Puerto Rico and the Virgin Islands maintain their Class Free status. The development of the National Animal Identification System and the National Surveillance Unit will assist in the final eradication of brucellosis.

The USA Department of Agriculture, Animal and Plant Health Inspection Service, in October 2003, published *Brucellosis Eradication: Uniform Methods and Rules* (UM&R), which includes the minimum standards of the Cooperative State–Federal Brucellosis Eradication Program.<sup>57</sup> These UM&R contain minimum standards for certifying herds, classifying states and areas, and detecting, controlling and eradicating brucellosis, as well as minimum brucellosis requirements for the intrastate and interstate movement of cattle and bison.

The publication is divided into two chapters that are further subdivided into parts. Chapter 1 deals with general provisions for cattle and/or bison. Part I of Chapter 1 contains definitions. Part II covers procedures used in the Cooperative State–Federal Brucellosis Eradication Program, and part III explains participation in area plans. Chapter 2 deals with all of the classifications of herds and areas for bovine brucellosis: Certified Brucellosis-Free Herds (part I), Class Free Status (part II), Class A Status (part III), and Class B Status (part IV).

The provisions of the UM&R were approved by the USDA-APHIS Veterinary Services. They may be amended in the future by replacing pages or by adding new pages.

The USA Department of Agriculture, Animal and Plant Health Inspection Service, in September 2003, published *Brucellosis in Cervidae: Uniform Methods and Rules* (UM&R), which provides minimum program standards and procedures of the Cooperative State–Federal Cervid Brucellosis Program to eradicate and monitor brucellosis in farm or ranch-raised Cervidae.<sup>58</sup> Content was approved by the USDA-APHIS Veterinary Services, incorporating recommendations from the

state animal health authorities, industry representatives and the USA Animal Health Association. This UM&R may be amended in the future by replacing pages or by adding new pages.

The primary surveillance methods for testing eligible cattle in the US have been the **market cattle testing** program in the beef industry and the **milk ring testing** in the dairy industry. They are constant and can survey virtually all of a specific animal population.

#### Market cattle testing

Surveillance by this method is part of the marketing process. Testing is done at livestock markets, slaughterhouses, livestock buying stations, or dealer premises. This type of testing is very effective, especially if required at the first point of assembly of cattle after leaving the farm of origin. In the USA, 95% of more of cows and bulls 2 years of age or older are required to be tested for brucellosis at slaughter. Essential factors of this method of surveillance are animal identification and records so that infected animals (reactors) can be traced to the farms of origin.

In the Market Cattle Identification (MCI) program, cattle are identified at each point of sale by application of a paper backtag held on with glue. The type of animal eligible for backtagging and testing differs between states. In the slaughterhouses, inspectors collect blood samples from all tagged animals. Samples and tags are sent to the laboratory and reactors are traced back to the herd of origin. Epidemiological studies have shown a distinct herd size bias in the MCI surveillance system. For example, the probability of detection in a nine-cow herd is 24%, compared to 85% for a 645-cow herd 1 year after infection. This herd size bias implies that secondary testing may be efficiently used by concentrating testing in smaller herds when funds for secondary testing are limited.

#### Milk ring testing

Surveillance by this method involves the regular, periodic testing of milk or cream from commercial dairy herds. Milk ring testing is required twice annually in commercial dairy herds in states officially declared free of brucellosis, and four times annually in states not officially free of brucellosis. This test is very sensitive and is done on a small sample of milk from the entire herd. The milk ring test itself is simple and inexpensive. A well-managed testing program is important to public health and can reduce the exposure potential of contaminated dairy products to humans by quickly identifying affected herds.

### Australia

In Australia, under range conditions, considerable progress towards eradication of brucellosis in large beef herds has been possible. Management must be motivated and confident that the disease can be permanently eradicated. All cattle should be permanently identified, security between subherds must be good, vaccination histories must be accurate, and accurate round-up (mustering) of cattle must be possible. Quarantine facilities for infected subherds must be strict and absolutely reliable, and fence lines must be impenetrable. The development of a two-herd system, based on segregation of weaned heifer calves from adult cows and maintenance of testing pressure on the adults, will reduce the chance of infection of heifers. All calves from reactor dams are discarded, which necessitates positive identification. Only bulls or semen from brucellosis-free herds should be used in clean herds. In some situations, a laboratory is established on the ranch and equipped to do the rose Bengal test and CFT. This increases the efficiency of the testing program and creates an excellent team effort between management, laboratory personnel and the field veterinarian.

### New Zealand

In New Zealand, the brucellosis status of accredited herds is monitored by a triennial complement fixation test with a sensitivity of greater than 95%.<sup>58</sup> Slaughterhouse surveillance, as carried out in Australia, has a low probability of identifying infected herds. A skin test for brucellosis is attractive because it could be used at the same time as routine tuberculin testing.<sup>50</sup>

### Chile

In a region in Chile, a brucellosis eradication program was very successful in 5 years.<sup>59</sup> There was a decrease in the incidence and prevalence of brucellosis-infected herds and in the surveillance rates monitored during the interval. The key components were: implementation of an epidemiological surveillance system that detects the occurrence of infection, an orientation of the state effort towards the cleaning of infected herds, the use of an effective vaccine that doesn't interfere with the diagnosis of the infection, and the active participation of farmers, veterinarians, private laboratories, and the cattle industry.

### Canada

In Canada, the bovine brucellosis eradication program is a success story that began in 1950 when the national prevalence of infection was about 9%. With the cooperative Federal-Provincial Calftooth Vaccination Program, the prevalence of

infection was reduced to 4.5% by 1956. In 1957, a test and slaughter program was begun in which brucellosis control areas were established and mandatory testing of all cattle was done using the tube agglutination test. Reactors were identified and ordered to be slaughtered, and compensation was paid. Infected herds were quarantined and retested until negative or in some cases completely depopulated. When the infection rate was reduced to below 1% of the cattle population and 5% of the herds, the area was certified for a period of 3 years. When the infection rate was reduced to below 0.2% of the cattle in the area and 1% of the herds, the area was designated brucellosis-free and certified for a period of 5 years. In the 1960s the milk ring test and the market cattle testing programs were introduced as surveillance procedures. These are done on a continuing basis, are effective in locating infected herds and have reduced the volume of on-farm testing required to recertify areas.

When the national level of infection was reduced to below 0.2%, calftooth vaccination was de-emphasized to overcome the problem of distinguishing between persistent vaccination titers and titers due to natural infection. Thus all seropositive animals could be disposed of and no vaccination privileges allowed. In 1973 an increase in the incidence of brucellosis occurred, which necessitated some modifications in the eradication program. The intensity of milk ring testing was increased, herds adjacent to infected herds were tested, the length of quarantine of infected herds was increased, and calves from reactor dams were ordered to be slaughtered. In heavily infected herds and in those in which it is not possible to maintain effective quarantine, it was preferable to completely depopulate a herd rather than conduct tests and successive retests. In the Canadian experience, brucellosis-free herds usually became infected when the owner unknowingly purchased an infected animal. The uncontrolled movement of infected animals from infected herds to brucellosis-free herds was a major obstacle in the final stages of the eradication.

The rate of progress in an eradication program is determined mainly by the rate at which herds that are accredited free of the infection become reinfected. The severity of reinfection (or **breakdown**) is dependent upon the proportion of the herd that has been vaccinated as calves. The cessation of compulsory calftooth vaccination results in a large proportion of cattle that are fully susceptible to *B. abortus* infection. The prevention of reinfection requires a constant surveillance system.

In Canada, **three concerns** followed eradication of brucellosis in 1985:

- The **first** concern was the need for continuous surveillance to identify hidden foci of infection that might be present but not become apparent until a full generation of cattle had passed, and to detect infection that might be imported with livestock brought into the country. A related concern was the presence of infection in Canadian wildlife, particularly bison and elk, which are the species of choice in game farming
- The **second** concern was the dilemma faced by livestock owners to use the vaccine, when normally they do not use it, to vaccinate cattle intended for export to importing states or countries that require vaccination. The continued use of the vaccine in a brucellosis-free area or country perpetuates the diagnostic problem
- The **third** concern was the importation of cattle from countries or regions that had not eradicated brucellosis.

The importance of unknown infected or latent carriers that may be seronegative is a major concern because it can result in herd epidemics of abortion in unvaccinated cattle. The risk can be minimized by pre-entry and postentry testing combined with certification of the animals on the basis of the regional and herd health status. Limiting the importation of cattle from areas where brucellosis persists and the use of embryo transfer technology can also reduce the risk of introducing infection. Vaccination of adult cattle in Canada was not permitted.

Canada was declared free of bovine brucellosis in 1985. No cases of bovine brucellosis have been identified since an atypical biovar 5 *B. abortus* was isolated in 1989 from a beef cow vaccinated with strain 19 *B. abortus*. A field strain *B. abortus* has been found in one herd of farmed bison in 1988 and has never been reported in farmed Cervidae in Canada.

In 1997, a comprehensive review of Canada's bovine brucellosis surveillance program was undertaken. As a result of the findings of this review, a number of modifications to the surveillance program were introduced in 1999. The routine serological testing of market and slaughter cattle and the routine milk ring testing of all dairy cattle were discontinued in 1999. However, auction market testing of cattle 24 months and older continues in the five markets in northern Alberta and British Columbia in response to the disease risk associated with the infected free-roaming

bison herds in and around Wood Buffalo National Park.

In 1998/99, a bovine serum survey was conducted involving the collection and testing of 17 170 randomly selected sera. Twenty samples were positive to the buffered plate agglutination test and, when the competitive-ELISA was applied to these 20 sera, one weak positive sample was found. This result was considered to be insignificant. From this survey, it was concluded that the prevalence of bovine brucellosis in Canada's cattle population is less than 0.02%.

The next bovine serum survey was postponed from 2001/02 to take advantage of the implementation of the national cattle identification program to assist in the trace-back of any suspicious findings. This survey commenced in 2003 and is nearing completion. All samples are being screened using FPA and any positive samples are subject to confirmatory testing using the competitive ELISA. To date, no evidence of bovine brucellosis has been detected.

In addition, in 2002, 80 253 cattle were tested for brucellosis in conjunction with modified market and slaughter cattle testing (27 814), export and artificial insemination center testing (43 664), investigatory testing (7130), and for other reasons (1645). Thirty-three suspect animals were detected and investigated, with negative results.

In April 2000, the vaccination of calves with reduced dosage strain 19 *B. abortus* vaccine was discontinued. Strain RB51 *B. abortus* vaccine is not licensed for use in Canada.

Bovine brucellosis in wildlife is restricted to free-roaming bison in and around Wood Buffalo National Park in northern Canada. Information on this occurrence is found in Canada's report to the OIE Wildlife Diseases Working Group.

#### Porcine brucellosis (*Brucella suis*)

Canada continues to be free of porcine brucellosis. *B. suis* biovar 1 has never been found in Canadian pigs. Surveillance for porcine brucellosis is based on a national serological survey of slaughter sows that is conducted every 3 years. A survey conducted in 1997/98 concluded that the prevalence of porcine brucellosis in Canada's pig population is less than 0.02%. *B. suis* biovars II and IV occur in *Rangifer* spp. (caribou and reindeer) in the Canadian Arctic. Movement controls within the country prevent these animals from entering the livestock-producing areas of Canada.

#### REVIEW LITERATURE

Tessaro SV. The existing and potential importance of brucellosis and tuberculosis in Canadian wildlife: a review. *Can Vet J* 1986; 27:119–124.

Nielsen K, Duncan JR. Animal brucellosis. Boca Raton, FL: CRC Press, 1990.

Cheville NF, McCullough DR, Paulson LR. Brucellosis in the Greater Yellowstone Area. Washington, DC, National Academy of Sciences, National Research Council, 1998.

Nielsen K, Gall D. Fluorescence polarization assay for the diagnosis of brucellosis: a review. *J Immunoassay Immunochem* 2001; 22:183–201.

Adams LG. The pathology of brucellosis reflects the outcome of the battle between the host genome and the *Brucella* genome. *Vet Microbiol* 2002; 90:553–561.

Cloekaert A, Vizcaino N, Paquet J-Y et al. Major outer membrane proteins of *Brucella* spp.: past, present and future. *Vet Microbiol* 2002; 90:229–247.

DelVecchio VG, Wagner MA, Eshenbrenner M et al. *Brucella* proteomes: a review. *Vet Microbiol* 2002; 90:593–603.

Moreno E, Cloekaert A, Moriyon I. *Brucella* evolution and taxonomy. *Vet Microbiol* 2002; 90:209–227.

Nicoletti P. A short history of brucellosis. *Vet Microbiol* 2002; 90:5–9.

Nielsen K. Diagnosis of brucellosis by serology. *Vet Microbiol* 2002; 90:447–459.

Ragan VE. The Animal and Plant Health Inspection Service (APHIS) brucellosis eradication program in the USA. *Vet Microbiol* 2002; 90:11–18.

Doganay M, Aygen B. Human brucellosis: an overview. *Int J Infect Dis* 2003; 7:173–182.

Lapaque N, Moriyon I, Moreno E, Gorvel J-P. *Brucella* lipopolysaccharide acts as a virulence factor. *Curr Opin Microbiol* 2005; 8:60–66.

#### REFERENCES

- Fosgate GT et al. *Vet Rec* 2002; 151:272.
- Roffe TJ et al. *J Wildl Manage* 1999; 63:1132.
- Rhyan JC et al. *J Wildl Dis* 2001; 37: 101.
- Ferrari MJ, Garrott RA. *J Wildl Manage* 2002; 66:1246.
- Cheville NF, McCullough DR, Paulson LR. Brucellosis in the Greater Yellowstone Area. Washington, DC: National Academy of Sciences, National Research Council, 1998.
- Olsen SC. *J Wildl Dis* 2003; 39:824.
- Forbes LB, Tessaro SV. *J Am Vet Med Assoc* 2003; 222:1252.
- Tessaro SV et al. *Can J Vet Res* 1993; 57:231.
- Palmer MV, Cheville NF. *Am J Vet Res* 1997; 58:851.
- England T et al. *Prev Vet Med* 2004; 63:63.
- Jones RD et al. *Prev Vet Med* 2004; 63:51.
- Cook WE et al. *J Wildl Dis* 2000; 36:484.
- Ficht TA. *Vet Microbiol* 2002; 90:213.
- Lapaque N, Moriyon I, Moreno E, Gorvel J-P. *Curr Opin Microbiol* 2005; 8:60.
- Edmonds MD et al. *Am J Vet Res* 2001; 62:1461.
- Baldwin CL, Parent M. *Vet Microbiol* 2002; 90:367.
- Wyckoff III JH. *Vet Microbiol* 2002; 90:395.
- Nielsen K. *Vet Microbiol* 2002; 90:447.
- Doganay M, Aygen B. *Int J Infect Dis* 2003; 7:173.
- Roth F et al. *Bull World Health Organ* 2003; 81:867.
- Adams LG. *Vet Microbiol* 2002; 90:553–561.
- Kreeger TJ et al. *J Wildl Dis* 2002; 38:552.
- Bricker BJ. *Vet Microbiol* 2002; 90:435.
- Cortez A et al. *Aust Vet J* 2001; 79:500.
- Hamdy MER, Amin AS. *Vet J* 2002; 163:299.
- Saravi MA et al. *Vet Immunol Immunopathol* 1995; 47:93.
- Abalos P et al. *Vet Rec* 1996; 138:140.
- Nielsen K, Gall D. *J Immunoassay Immunochem* 2001; 22:183–201.
- McGivern JA et al. *J Immunol Methods* 2003; 278:171.
- Thoen CO et al. *Vet Microbiol* 1995; 45:185.
- Nielsen K et al. *Vet Microbiol* 1996; 52:165.
- Romero C et al. *J Clin Microbiol* 1995; 33:3198.

- Nielsen K et al. *Vet Microbiol* 2004; 100:25.
- Godfried J et al. *Vet Microbiol* 2002; 90:461.
- King DP et al. *J Clin Microbiol* 2005; 43:604.
- Kirkbride CA, ed. *Laboratory Diagnosis of Livestock Abortion*, 3rd edn. Oxford: Blackwell, 1990.
- Samartino LE et al. *Prev Vet Med* 2000; 45:193.
- Schurig GC et al. *Vet Microbiol* 2002; 90:479.
- Geong M, Robertson ID. *Prev Vet Med* 2000; 47:177.
- Olsen SC. *Vet Ther* 2000; 1:183.
- Halling SM. *Vet Microbiol* 2002; 90:545.
- Cheville NF et al. *Am J Vet Res* 1996; 57:1153.
- Palmer MV et al. *Vet Pathol* 1996; 33:682.
- Palmer MV et al. *Am J Vet Res* 1997; 58:472.
- Edmonds MD et al. *Am J Vet Res* 1999; 60:722.
- Arellano-Reynoso B et al. *Vet Microbiol* 2004; 98:307.
- Olsen SC et al. *J Vet Diagn Invest* 1996; 8:451.
- Olsen SC. *Res Vet Sci* 2000; 69:135.
- Leal-Hernandez M et al. *Compend Immunol Microbiol Infect Dis* 2005; 28:63.
- Davis DS, Elzer PH. *Vet Microbiol* 2002; 90:533.
- Olsen SC. *Res Vet Sci* 2003; 74:17.
- Palmer MV et al. *Am J Vet Res* 1996; 57:1604.
- Olsen SC. *J Wildl Dis* 2002; 38:738.
- Olsen SC et al. *J Wildl Dis* 2002; 38:746.
- Cook WE et al. *J Wildl Dis* 2002; 18:27.
- Ragan VE. *Vet Microbiol* 2002; 90:11.
- United States Department of Agriculture, Animal and Plant Health Inspection Service. Brucellosis Eradication: Uniform Methods and Rules. October 1, 2003. Washington, DC: United States Department of Agriculture, 2003.
- United States Department of Agriculture, Animal and Plant Health Inspection Service. Brucellosis in Cervidae: Uniform Methods and Rules. September 30, 2003. Washington, DC: United States Department of Agriculture, 2003.
- Rivera SA et al. *Vet Microbiol* 2002; 90:45.

#### BRUCELLOSIS ASSOCIATED WITH *BRUCELLA OVIS*

##### Synopsis

##### Etiology *Brucella ovis*

**Epidemiology** Disease of sheep. Organism carried by sexually mature rams with spread by direct contact or passive venereal infection

**Clinical findings** Clinical or subclinical disease. Infertility in rams due to epididymitis. Epididymal abnormality can be detected by palpation in some affected rams. Abortion in ewes and neonatal mortality in lambs are also occasionally caused by the infection

**Clinical pathology** Semen examination. Serology of most value including complement fixation, gel diffusion, and ELISA

**Diagnostic confirmation** Physical palpation of the contents of the scrotum combined with cultural examination of semen (or aborted material), and serological examination

**Treatment** Oxytetracycline in valuable rams

**Control** Total segregation of normal and young rams. Initial culling of rams with palpable scrotal abnormality and subsequent repeated serological testing and culling of seropositive rams. Alternative is vaccination with live *B. melitensis* strain Rev. 1

## ETIOLOGY

*Brucella ovis* has significant DNA homology with other members of the genus *Brucella*<sup>1,2</sup> and also shares many antigenic and other characteristics but it is permanently rough.

## EPIDEMIOLOGY

### Geographical occurrence

Brucellosis of sheep associated with *B. ovis* has been reported in most of the **major sheep-producing regions** of the world and is present in Australia, New Zealand, North and South America, Central Asia, Russia, South Africa, and Europe but is not a major cause of ram wastage in Great Britain. When the disease is first diagnosed in a country, and before control procedures are established, the **flock prevalence** of infection can be as high as 75% and as many as 60% of rams may be infected.<sup>3,4</sup> The prevalence of infection is generally much lower in countries and in flocks that have established control programs.

### Host occurrence

In nature only **sheep** are affected, although the ram is more susceptible than the ewe. Infection can be established experimentally in laboratory animals only with difficulty.<sup>3</sup> White-tailed deer and goats can be infected experimentally, leading to the development of an epididymitis, but there is no evidence of natural infection in goats, even in those that cohabit with infected sheep.

The **Merino breed** and Merino-derived crossbreeds show a much lower incidence of the disease than do British breeds. The disease is most important in large flocks where there is multi-sire breeding.

### Source of infection

The **infected ram** is the source of infection and perpetuates the disease in a flock. The majority of infected rams excrete the organism in semen<sup>5</sup> and in most rams the active excretion in semen probably persists indefinitely.

**Ewes** are more resistant to infection but the organism can be isolated from them in infected flocks.<sup>6</sup> After being bred by an infected ram, the majority will not carry infection for more than one or two heat cycles.<sup>7</sup> Infection may result in early embryonic death and occasionally abortion or the birth of weak and poorly viable lambs.<sup>3</sup> In ewes where the infection does persist to produce abortion, the organism is present in the placenta, vaginal discharges, and milk.

### Transmission

Transmission between rams occurs via passive venereal infection and by direct ram-to-ram transfer.<sup>3,7</sup>

**Passive venereal infection** occurs from ewes that have been bred by an

infected ram in the same heat cycle. Under natural conditions, this may be the major form of transmission from ram to ram that occurs during the breeding season. Infection can also be transmitted between rams in the nonbreeding season that are housed together or **grouped together** on pasture. This occurs as they sniff and lick each other's prepuce and by homosexual activity. Submissive rams may lick the prepuce of dominant rams as a trait in the dominance hierarchy. Spread of infection in a group of virgin rams is recorded.<sup>8</sup> Lambs born from infected ewes and drinking infected milk do not become persistently infected.

The organism can survive on pasture for several months but transmission by fomites appears is believed to have no practical significance. However, transmission from infected rams to infection-free red deer stags grazed on the same pasture can occur and it is not known if this results from direct contact between the animals or indirectly via environmental and pasture contamination.<sup>9</sup>

### Host risk factors

**All postpubertal** rams are susceptible to infection, but disease occurs more commonly in adult rams and **disease prevalence increases with age**, probably because of greater exposure to infection.<sup>4</sup> Differences between flocks in the prevalence of disease suggest that environmental factors and stress may modulate susceptibility<sup>7</sup> but the risk factors are poorly defined. When the number of affected rams in a flock is greater than about 10%, the fertility of the flock is appreciably decreased.

### Experimental reproduction

Experimentally, rams can be infected by the intravenous, subcutaneous, intratesticular, oral, **conjunctival, and preputial** routes but the latter two are the most effective.<sup>3,10,11</sup> The first observable abnormality is the presence of inflammatory cells in the semen, which appear at 2–8 weeks. *B. ovis* appears in the ejaculate at approximately 3 weeks but it is not invariably present in all examinations of an infected ram. Testicular and epididymal lesions can be palpated at about 9 weeks after infection but may occur earlier in some rams. A significant proportion of infected rams have no palpable lesions but still excrete the organism.

Ewes in early pregnancy can also be infected by the oral and intravenous routes but many of these infections are transient and do not result in abortion. Abortion due to **placentitis** has been produced experimentally. Intrauterine infection produced experimentally also causes lesions in, and death of, the fetus

but the significance of this to natural cases is undetermined.

### Economic importance

The economic effects of the disease are subtle but significant. The effect of the disease on **ram fertility** can influence the number of rams that are required in a flock: the required ram to ewe ratio is significantly reduced in *B. ovis*-free flocks. The percentage of lambs born early and within the first 3 weeks of the lambing period is also markedly increased. Lambing percentage may be reduced by 30% in flocks recently infected and by 15–20% in those where the infection is endemic.<sup>7</sup> Additional costs are the loss of rams of high genetic potential and the cost of repeat serological testing. In the USA, an additional return of US\$12 per ewe mated has been calculated as the advantage in a control program.<sup>12</sup>

### Zoonotic implications

*B. ovis* is not a zoonosis but live *Brucella* vaccines used for prevention of this infection in some countries, such as Rev. 1 *B. melitensis* vaccine, are pathogenic to humans and should be handled and used with due caution.

## PATHOGENESIS

There is an initial bacteremia, often with a mild systemic reaction, and the organism can be isolated from the internal organs of animals slaughtered after experimental infection. However, systemic disease is not a feature of the natural disease, and clinical disease results from localization and inflammation in the **epididymides**. Inflammation in this area results in sperm stasis and extravasation with a subsequent immunological reaction that is usually in the tail and unilateral, causing a **spermatocoele** and therefore reduced fertility. Not all infected rams have palpable lesions in the epididymis: infection can also establish in the seminal vesicles and ampullae. In either case the organism is shed in the ejaculate.

In general, the evidence is that *B. ovis* has low pathogenicity for ewes: the primary effect of infection is a **placentitis**, which interferes with fetal nutrition, sometimes to the point of causing fetal death but more commonly producing lambs of low birth weight and poor viability.

### CLINICAL FINDINGS

The first reaction in rams is a marked deterioration in the quality of the semen together with the presence of leukocytes and *Brucella*. Acute edema and inflammation of the scrotum may follow. A systemic reaction, including fever, depression, and increased respiratory rate, accompanies the local reaction.



Regression of the acute syndrome is followed, after a long **latent period**, by the development of **palpable lesions in the epididymis and tunicae** of one or both testicles.

The palpation of both testicles simultaneously from behind is the best method of examination. The epididymis is enlarged and hard, more **commonly at the tail**, the scrotal tunics are thickened and hardened, and the testicles are usually atrophic. The groove between the testis and epididymis may be obliterated.

The abnormalities are often detectable by palpation but many affected rams show no acute inflammatory stage and others may be actively secreting *Brucella* and poor-quality semen in the chronic stage in the **absence of palpable abnormalities**. Palpable abnormality of the scrotal contents may be present in less than 50% of serologically positive rams.<sup>3</sup> Affected rams have normal libido.

There are usually no clinical signs in the ewe but in some flocks infection causes abortion or the birth of weak or stillborn lambs, associated with a macroscopic placentitis.

#### CLINICAL PATHOLOGY

Semen examination, including culture of the ejaculate, and serological tests are used in suspect individuals and in groups of rams. The complement fixation or other serological tests (agar gel immunodiffusion, ELISA) are by far the most important; many infected rams have palpably normal scrotal contents and microbiologically negative semen.

#### Semen examination

A combination of semen examination and palpation of the testicles for abnormality is stated to identify approximately 80% of infected rams.<sup>12</sup> In affected animals the findings are a general reduction in semen quality, a reduced total sperm output, poor motility, and a high proportion of spermatozoa with secondary morphological abnormalities.

#### Culture

*B. ovis* is fastidious in its growth and requires special cultural techniques. The examination of the semen for the presence of leukocytes has been used to determine those sheep that should be cultured for *B. ovis* but this criterion is not highly sensitive.<sup>13,14</sup> PCR for detection of *B. ovis* in semen has equivalent sensitivity to culture.<sup>15</sup>

#### Serology

The complement fixation test is the standard test in many countries, is the prescribed test for international trade and, when used in conjunction with genital palpation and semen culture, has allowed the eradication of *B. ovis* from flocks.

However, a small proportion of infected rams are negative to the complement fixation test, which can compromise eradication programs. A number of tests, including ELISA tests,<sup>16–18</sup> immunoblotting,<sup>19</sup> and gel diffusion tests,<sup>18</sup> are also used.

The sensitivity and specificity of the various serological tests depend mainly on the antigens used and the serological cutpoints,<sup>3,18,20</sup> which may vary between countries and laboratories. One study<sup>20</sup> reported the sensitivity of the ELISA, gel diffusion, and complement fixation tests as 97.6%, 96.4%, and 92.7% respectively, with all tests 100% specific. Studies in other countries support this ranking<sup>3,7,21,22</sup> and the ELISA is becoming more commonly used. Other studies suggest that the ELISA has no advantage in specificity over the classic complement and gel diffusion tests.<sup>18</sup> A combination of serological tests may improve sensitivity to 100%.<sup>20,21,23</sup>

Serological tests will not differentiate vaccinated from infected sheep or sheep infected with *B. melitensis*.

In Australia, there has been an unexpectedly high prevalence of false-positive reactors in some flocks because rams exposed to infection have developed a positive reaction to a serological test but have not developed the disease. These transient infections have not been found to be a problem in other regions.<sup>20,21</sup>

#### NECROPSY FINDINGS

In the acute stage, there is inflammatory edema in the loose scrotal fascia, exudate in the tunica vaginalis and early granulation tissue formation. In the chronic stage, the tunics of the testes become thickened and fibrous and develop adhesions. There are circumscribed indurations in the epididymis and these **granulomata** may also be present in the testicle. In advanced stages they undergo **caseation necrosis**. As the epididymis enlarges the testicle becomes atrophied. *B. ovis* can usually be isolated from the genital organs, especially the tail of the epididymis, and rarely from internal organs and lymph nodes.<sup>24</sup>

The abortus is characterized by thickening and edema, sometimes restricted to only a part of the placenta, with firm, elevated yellow-white plaques in the intercotyledonary areas and varying degrees of cotyledonary necrosis. Microscopically, organisms are visible within the cytoplasm of trophoblasts of the inflamed placenta. A vasculitis is often present. The organism can be isolated from the placenta and the stomach and lungs of the lamb.

#### Samples for confirmation of diagnosis

- Bacteriology – epididymal granuloma, seminal vesicle, inguinal lymph

- node/fetal lung, stomach content, placenta (CULT – has special growth requirements, CYTO – Stamp's or Kosters' stain on placental smear)
- Histology – formalin-fixed epididymis, testicle, inguinal lymph node/placenta, fetal lung, liver, spleen, kidney, heart, brain.

#### DIFFERENTIAL DIAGNOSIS

Many rams with abnormalities of intrascrotal tissues do not have brucellosis.<sup>5</sup> Most are cases of epididymitis and need to be differentiated.

Abortion in ewes may be associated with a number of infectious diseases, summarized in Table 18.8.

#### TREATMENT

Treatment of naturally occurring cases is rarely undertaken.

In experimentally infected rams, the intramuscular administration of long-acting oxytetracycline at 20 mg/kg BW, given every 3 days for 24 days, along with the daily intramuscular administration of 20 mg/kg of dihydrostreptomycin sulfate, has resulted in bacteriological cure in 11 of 12 rams.<sup>25</sup> Oxytetracycline alone is less effective. In another study using a similar treatment, seven of nine rams had bacteriological cure.<sup>13</sup> Treatment is economically practicable only in valuable rams and must be instituted before irreparable damage to the epididymis has occurred. The treatment of rams that are infected but without palpable lesions results in a significant improvement in breeding soundness classification on examinations subsequent to treatment.<sup>13</sup>

#### CONTROL

Control is by the prevention of spread of infection between rams and the detection and culling of infected rams. In small commercial flocks, **culling** of all rams and replacement with *B. ovis*-free rams may be the most economical approach. A measure of control can be achieved using **scrotal palpation** to detect infected rams but this must be coupled with **repeated serological examinations** if eradication is the goal. Vaccination may be the most economical and practical means of controlling the disease in areas with a high incidence of infection and in regions of the world where eradication by test and slaughter is impractical.<sup>14</sup>

#### Eradication

In a herd where the diagnosis has been confirmed all rams are palpated and those with scrotal abnormalities are culled. The remainder are tested serologically and reactors are culled. Serological tests are repeated at monthly intervals, with

Table 13.3. Diagnostic summary of infectious abortion in ewes

Disease	Epidemiology				Laboratory findings	
	Transmission	Time of abortion	Clinical data	Fetus	Serology	Vaccination
Brucellosis ( <i>Brucella ovis</i> )	Passive venereal, ram to ram	Late or stillbirth, weak lambs	Epididymitis in rams. In ewes abortion only	Organisms in fetal stomach and placenta	Complement fixation test (CFT) or ELISA	Simultaneous strain 19 <i>Brucella abortus</i> and killed <i>B. ovis</i> adjuvant vaccine. Rev. 1 vaccine
<i>Campylobacter fetus</i> or <i>jejuni</i>	Ingestion	Last 6 weeks of pregnancy, stillbirths, weak lambs	Metritis in ewes after abortion	<i>Campylobacter</i> in stomach, large necrotic foci in liver	Agglutination test, flock only	Adjuvant vaccine doubtful efficacy
Enzootic abortion of ewes ( <i>Chlamydomphila abortus</i> )	Ingestion	Last 2–3 weeks. Stillbirths, weak lambs	No sickness in ewes, neonatal mortality	<i>Chlamydomphila</i> in fetal cotyledons. Degenerative changes in placenta	ELISA, complement fixation, PCR	Killed vaccine gives moderate immunity. Live attenuated vaccine
Listeriosis ( <i>Listeria monocytogenes</i> )	Probably ingestion	After 3 months	Retained placenta and metritis. Septicemia in some ewes	Organisms in fetal stomach. Autolysis, necrotic foci in liver	Agglutination and complement fixation of doubtful value	Killed vaccine, live attenuated vaccine in some countries
Salmonellosis ( <i>Salmonella abortusovis</i> )	Probably ingestion. Carrier sheep	Last 6 weeks	Metritis after abortion	Organisms in fetal stomach. Not in USA	Agglutination test	Doubtful efficacy
Salmonellosis ( <i>Salmonella dublin</i> , <i>S. montevideo</i> , <i>S. typhimurium</i> )	Ingestion	Last month	Abortion: fetal metritis, neonatal mortality	Organisms in stomach	Agglutination test	–
Toxoplasmosis	Ingestion	Late or stillbirths. Liveborn weak lambs	Abortion, stillbirths and neonatal mortality. No illness in ewe	Multiple small necrotic foci in fetal cotyledons. Toxoplasma in cells of trophoblast epithelium	Modified agglutination test, ELISA of limited value in adult. Test pleural fluid of fetus. PCR	S48 tachyzoite in some countries
Rift Valley fever	Insects	–	Important cause of abortion in all species Central Africa. Heavy mortality in young animals	Acidophilic inclusions hepatic cells	Hemagglutination inhibition and ELISA. Fluorescent antibody for tissues	Available
<i>Coxiella</i> available	Inhalation, ingestion	Later term and weak lambs	No illness in ewe, neonatal mortality	Fetus fresh, Intercotyledonary necrotizing placentitis	Fluorescent antibody and PCR. Serology of limited value	Vaccine not available in most countries
Tick borne fever	Ticks	Late, following systemic disease	Fever and abortion	None specific	Giemsa smear of blood, PCR. Counterimmuno-electrophoresis	None
Border disease	Ingestion	All stages, stillbirth	Infertility in ewes, Hairy shaker lambs	Virus isolation	See text description	None that are specific for sheep strains

culling of reactors, until all rams are serologically negative. A further test, 6 months later, is used for confirmation.<sup>23</sup>

The **rate of spread** of infection is high during the mating season and it is not recommended that eradication should be attempted until after the breeding season. During breeding it may be wise to run two breeding flocks, with virgin rams and rams known to be free of infection separate from older or suspicious rams. Strict separation of the two ram flocks must be maintained at all times of the year, and the clean group must not mate ewe flocks that have been mated to these older rams.

The use of the ELISA test available in the USA has allowed the eradication of the disease in flocks with as few as four tests.<sup>12</sup>

Several countries have voluntary accreditation schemes.

#### Vaccination

A number of vaccines are in use but none is fully effective. In some countries vaccination is not permitted and eradication by test and slaughter is the only method of control.

**Killed *B. ovis* vaccines**, even when adjuvanted, have poor efficacy.<sup>7,15</sup> The use of a killed vaccine may be inadvisable in

flocks where eradication is being attempted, as it may protect against clinical disease but allow a carrier state in some rams in which there is excretion of the organism in animals that become seronegative.<sup>15</sup> An experimental vaccine prepared from enriched outer membrane proteins and rough lipopolysaccharide of *B. ovis* has given equivalent protection in challenge studies to that given by *B. melitensis* Rev. 1 vaccine.<sup>26</sup>

**A combined vaccine** containing killed *B. ovis* in an adjuvant base and *B. abortus* strain 19 gives a high-level, durable immunity but the vaccine has several disadvantages. Vaccinated animals become

seropositive, which hinders subsequent use of serological tests for eradication. Strain 19 itself can cause epididymitis and vaccinated rams may excrete strain 19 in their semen.<sup>3</sup> Severe outbreaks of osteomyelitis and epiphysitis have been recorded in rams following vaccination.<sup>27</sup>

**Live *B. melitensis* strain Rev. 1** has been found to be **most effective** and is generally recommended.<sup>3,28,29</sup> Strain Rev. 1 is avirulent for rams, and subcutaneous or conjunctival vaccination provides protection against experimental and field challenge. Vaccinated animals become positive to the complement fixation test and ELISA test, but the titers produced are low and can be minimized by using the conjunctival route for vaccination.<sup>29,30</sup>

***B. suis* strain 2 (S2)** has been used in China for vaccination of all target species against brucellosis. It is given orally in the drinking water and colonizes the cranial lymph nodes. In a comparative study of S2 vaccine and Rev. 1 vaccine, S2-vaccinated rams had less protection than Rev. 1-vaccinated rams when challenged with *B. ovis* and an equivalent degree of protection to the nonvaccinated controls.<sup>31</sup>

***B. abortus* RB51 vaccine** does not protect rams against experimental challenge with *B. ovis*.<sup>32</sup>

**Outer membrane protein (Omp) antigens** are currently being examined as vaccine candidates. A detergent-extracted Omp31 from *B. melitensis* produced in *E. coli* has been shown to be a protective immunogen against *B. ovis* in a mouse model and to induce antibody and a cellular immune response in sheep.<sup>33</sup> Its efficacy in protecting sheep against experimental or natural infection is not reported.

In all vaccination programs there should be a concurrent program of culling of clinically abnormal rams. All ram replacements should be yearlings vaccinated at 4–5 months.

## REVIEW LITERATURE

- Afzal M, Kimberling CV. How to control *Brucella ovis*-induced epididymitis in rams. *Vet Med* 1986; 81:364–370.
- Rahaley RS. Ovine brucellosis; recent advances. *Aust Adv Vet Sci* 1986;90–92.
- Blasco JM. *Brucella ovis*. In: Nielsen K, Duncan JR, eds. *Animal brucellosis*. Boca Raton, FL: CRC Press, 1990.
- Bulgin MS. Epididymitis in rams and lambs. *Vet Clin North Am Food Anim Pract* 1990; 6:683–690.
- Genetzky RM. Epididymitis in rams. *Compend Contin Educ Pract Vet* 1995; 17:447–454.
- Elberg S. Rev 1 *Brucella melitensis* vaccine. Part III 1981–1995. *Vet Bull* 1996; 66:1193–1200.
- Ridler AL. An overview of *Brucella ovis* infection in New Zealand. *N Z Vet J* 2002; 50:S96–S98.

## REFERENCES

1. Verger JM et al. *Int J Syst Bacteriol* 1985; 35:292.
2. Michaux-Charachon S. *J Bacteriol* 1997; 179:3244.
3. Blasco JM. In: Nielsen K, Duncan JR, eds. *Animal brucellosis*. Boca Raton, FL: CRC Press, 1990:351.
4. Walker RL et al. *J Am Vet Med Assoc* 1986; 188:393.

5. Genetzky RM. *Compend Contin Educ Pract Vet* 1995; 17:447.
6. Marco J et al. *Vet Rec* 1994; 135:254.
7. Bulgin MS. *Vet Clin North Am Food Anim Pract* 1990; 6:683.
8. Bulgin MS. *J Am Vet Med Assoc* 1990; 196:1120.
9. Ridler AL et al. *N Z Vet J* 2000; 48:57.
10. Worthington RW. *N Z Vet J* 1983; 32:58.
11. Rahaley RS, Dennis SM. *Aust Vet J* 1984; 61:353.
12. Kimberling CV, Schweitzer D. *Agri-Practice* 1989; 10:36.
13. Dargatz DA et al. *J Am Vet Med Assoc* 1990; 196:605.
14. Marin CM et al. *Res Vet Sci* 1990; 48:209.
15. Manterola L et al. *Vet Microbiol* 2003; 92:65.
16. Kittleberger R et al. *Vet Microbiol* 1998; 59:213.
17. Vigliocco AM et al. *Vet Microbiol* 1997; 54:357.
18. ficipal A et al. *Vet Rec* 1995; 137:145.
19. Kittleberger R et al. *N Z Vet J* 1997; 45:75.
20. Marin CM et al. *Vet Rec* 1989; 125:504.
21. West DM, Bruce RA. *N Z Vet J* 1991; 39:29.
22. Gall D et al. *Small Rumin Res* 2003; 48:173.
23. West DM et al. *N Z Vet J* 1993; 41:82.
24. Searson JE. *Aust Vet J* 1986; 63:30.
25. Marin CM et al. *Am J Vet Res* 1989; 50:560.
26. Blasco JM et al. *Vet Immunol Immunopathol* 1993; 37:257.
27. West DM et al. *N Z Vet J* 1978; 26:133.
28. Erasmus JA, Bergh EC. *J S Afr Vet Assoc* 1985; 56:205.
29. Blasco JM. *Prev Vet Med* 1997; 31:275.
30. Marin CM et al. *Res Vet Sci* 1990; 48:209.
31. Blasco JM. *Vaccine* 1993; 11:1291.
32. De-Baques MJP et al. *Vaccine* 1995; 13:301.
33. Estein SM et al. *Vet Microbiol* 2004; 102:203.

## BRUCELLOSIS ASSOCIATED WITH *BRUCELLA SUIIS* IN PIG

**Etiology** Disease in pigs is caused by *Brucella suis* biovars 1, 2, and 3. Biovars 1–4 cause rare disease in cattle

**Epidemiology** Disease in pigs is transmitted by contact, ingestion, and venereally

**Clinical findings** Sows: infertility, irregular estrus, small litters, and abortion. Boars: orchitis, lameness, incoordination, and posterior paralysis. Piglets: mortality

**Clinical pathology** Isolation of organism. Several serological tests available but none with good sensitivity

**Necropsy** Metritis, orchitis, osteomyelitis. Granulomatous inflammation and foci of caseous necrosis

**Diagnostic confirmation** Isolation of *Br. suis* and herd serology tests

**Treatment** None satisfactory

**Control** Serological testing and disposal of reactors. No effective vaccine. Humans, and occasionally cattle. Transmission congenital or by ingestion or contact with infected placenta, vaginal discharge, or milk

**Clinical findings** Abortion storms, abortions often in last 2 months of pregnancy. Weak-born lambs

**Clinical pathology** Culture of organism. Serological tests and skin hypersensitivity testing for herd diagnosis

**Necropsy findings** Placentitis

**Diagnostic confirmation** Only by isolation of the organism

**Control** Slaughter eradication. Vaccination with Rev. 1 vaccine. Rev. 1 vaccine will produce abortion in pregnant animals

## ETIOLOGY

The disease is associated with *Brucella suis*. There are **five biovars**, of which biovars 1, 2, and 3 are important in pigs. Biovar 4 is a cause of rangiferine brucellosis and biovar 5 of murine brucellosis. Biovar 4 can transmit to cattle but does not appear to be a disease of pigs.

Biovar 3 has close similarity to *B. melitensis* biovar 2 and requires phage typing, oxidative metabolic testing or PCR for differentiation.<sup>1</sup>

## EPIDEMIOLOGY

### Geographic occurrence

Biovars 1 and 3

Disease associated with biovars 1 and 3 occurs in many countries and continents, including Europe, South America, particularly Venezuela,<sup>2</sup> Africa, the Indian subcontinent, Central Asia, south-east Asia, Australia, and the Pacific islands. The infection has not been recorded in Britain, Canada is free of biovars 1 and 3, and prevalence in the USA is very low.<sup>3</sup>

Biovar 2

Domestic livestock disease associated with biovar 2 is confined to Europe and is of particular interest in the wild boar and domestic livestock in Croatia.<sup>4</sup> It is also seen in the Czech Republic.<sup>5</sup>

Biovar 4

This occurs in mainland caribou (*Rangifer tarandus*) in Canada and has been isolated from a herd of commercial reindeer (*Rangifer tarandus tarandus*) in Canada.<sup>6</sup>

### Host occurrence

Biotypes 1 and 3

Domestic, wild, or feral **pigs** are the host for biotypes 1 and 3 and widespread infection in **feral pigs** is recorded in Queensland, Australia<sup>7,8</sup> and the southern states of the USA.<sup>3,9</sup> Bison may remain reservoirs.

**Cattle and horses** may be infected, especially if they share a range with feral pigs<sup>10</sup> and this association adversely affects the status of cattle herds undergoing brucellosis eradication programs.<sup>8</sup> Cattle are **noncontagious hosts**, but an outbreak in Switzerland where the disease had not appeared since 1946 has been attributed to a spread of infection from horses.

Biovar 1 has been isolated from the semen of a ram.<sup>11</sup>

Infection in dogs, usually symptomless but occasionally producing orchitis or epididymitis, can result from eating raw pig meat.

Biovar 2

In addition to the pig, the European hare (*Lepus capensis*) is also a major host for biovar 2 and this biovar is common in central Europe.<sup>12</sup>

#### Biovar 4

This can transmit to cattle in contact with infected reindeer.<sup>6</sup> Wild canids can also be naturally infected with biovar 4, presumably by ingestion.<sup>12</sup>

#### Source of infection

The introduction of **infected pigs** or the communal use of an infected boar is the common means of introduction into a pig unit. Artificial insemination using non-certified or untreated semen can also spread the disease.

The feeding of kitchen waste containing **raw pig meat** also presents a risk. Domestic herds are also at risk when they are kept under extensive husbandry methods in areas where there is a high prevalence of infection in feral pigs. Cattle infected with biovar 1 are noncontagious to other livestock and can have normal pregnancies and give birth to uninfected calves.<sup>10</sup>

Wild animals, including hares and rats, may provide a source of infection with biovar 2 and ticks are also suspected of transmitting the disease.

#### Transmission

Within a piggery the disease is spread by **ingestion** and by **coitus**. The ingestion of food contaminated by infected semen and urine and discharges from infected sows are also important methods of spread. Dried secretions, if frozen, may remain infective. Most disinfectants and sunshine kill the virus.

#### Host and pathogen risk factors

The fact that it survives so well in raw meat, e.g. 128 days in sausage meat, means that prepared pork products are always a source of infection.

*B. suis* is more resistant to adverse environmental conditions than *B. abortus*, although its longevity outside the body has not been fully examined. It is known to survive in feces, urine, and water for 4–6 weeks.

Amongst pigs, susceptibility may vary with age. The prevalence of infection is much higher in adults than in young pigs, although this may represent an **exposure risk** rather than an age-related risk.<sup>12</sup> Susceptibility is much greater in the postweaning periods and is the same for both sexes, but there may also be genetically determined differences in susceptibility. Some piglets acquire infection from the sow, either from the ingestion of infected milk or by congenital infection.

Lateral spread through a herd is rapid because of the conditions under which pigs are kept. **No durable herd immunity** develops and, although a stage of herd resistance is apparent after an acute outbreak, the herd is again susceptible within a short time and a further outbreak may occur if infection is reintroduced.

In an enzootic area, the proportion of herds infected is usually high (30–60%). The prevalence of seropositivity in an infected herd varies but can be as high as 66%.<sup>13</sup> Seroprevalence in feral pigs is also high, is higher in adult pigs than pigs under 6 months of age, and varies between populations of feral pigs.<sup>9</sup>

#### Economic importance

The disease owes its economic importance to the infertility and reduction in numbers of pigs weaned per litter. Mortality in liveborn piglets, which occurs during the first month of life, may be as high as 80%. The mortality rate is negligible in mature animals but sows and boars may have to be culled because of sterility, and occasional pigs because of posterior paralysis. In addition, eradication involves much financial loss if complete disposal of a registered herd is undertaken.

#### Zoonotic implications

Biovar 2 is not a zoonosis but biovars 1 and 3 have considerable significance for public health and are very pathogenic to humans. In countries where pigs are a significant part of animal farming and the **human diet**, *B. suis* is the major cause of **human brucellosis**. A recent report describes the death of a retired pig farmer at least 20 years after her last exposure to livestock.<sup>14</sup>

*B. suis* presents an **occupational hazard**, particularly to abattoir workers, and to a lesser extent to farmers and veterinarians. *B. abortus* and *B. melitensis* may also be found in pig carcasses and present similar hazards. *B. suis* can be widespread in the carcass of infected pigs, and undercooked meat can be a source of human infection.<sup>12</sup> This is particularly true for wild boar and feral pigmeat. A recent experiment described infection with biovar type 1 and its transmission to negative pigs after 4–6 weeks. Antibody was detected in blood samples from farmers and abattoir workers.<sup>15</sup>

In infected cattle *B. suis* localizes in the mammary gland without causing clinical abnormality and, where cattle and pigs are run together, the hazard to humans drinking **unpasteurized milk** may be significant.<sup>10</sup> Biovar 4 causes human disease associated with consumption of caribou.<sup>16</sup>

#### PATHOGENESIS

As in brucellosis associated with *B. abortus*, there is initial systemic invasion, the organism appearing in the bloodstream, usually within 1–7 weeks and persisting for up to 34 weeks. However, infection with *B. suis* differs from that associated with *B. abortus* in that **localization** occurs in several organs in addition to the uterus and udder, the

organism being found in all body tissues and producing a disease similar to undulant fever in humans. The organisms persist in lymph nodes, joints, bone marrow, and the genital tract. The more common manifestations of localization are abortion and infertility due to localization in the uterus; lymphadenitis, especially of the cervical lymph nodes; arthritis and lameness due to bone and joint localization; and posterior paralysis due to osteomyelitis. In boars, involvement of the testicles often leads to clinical orchitis.<sup>12</sup> Widespread infection makes handling of the freshly killed carcass hazardous and creates a risk for brucellosis in humans eating improperly cooked pork.

#### CLINICAL FINDINGS

Do not forget that clinical signs in pigs may also be produced by *B. abortus* and *B. melitensis*.

The clinical findings in swine brucellosis vary widely, depending upon the site of localization. The signs are not diagnostic and in many herds a high incidence of reactors is observed with little clinical evidence of disease. Reproductive inefficiency is the common manifestation.

#### Sows

Infertility, irregular estrus, small litters, and abortion occur. Mummification and stillbirths do occur. The incidence of abortion varies widely between herds but is usually low and is usually early on. Infection of the fetus may lead to abortion. As a rule, sows abort only once in a lifetime and this is most common during the third month of pregnancy. Affected sows usually breed normally thereafter. Sows may remain carriers and may shed organisms in milk and uterine discharges. These discharges may be extremely bloody. They may be accompanied by an endometritis and retained placenta.

#### Boars

Orchitis with swelling and necrosis of one or both testicles is followed by sterility. Lameness, incoordination, and posterior paralysis occur reasonably commonly. The onset is gradual, and signs may be caused by arthritis or, more commonly, osteomyelitis of lumbar and sacral vertebral bodies. Testicular atrophy may result. Boars have a low rate of recovery (less than 50%). After infection, enough animals remain infected to perpetuate the disease.

#### Piglets

A heavy mortality in piglets during the first month of life is sometimes encountered but most piglet loss results from stillbirths and the death of weak piglets within a few hours of birth. Up to 10% may contract infection when they are young and retain the infection until adulthood.

## CLINICAL PATHOLOGY

### Culture

Laboratory identification of the disease is difficult. Isolation of the organism should be attempted if suitable material is available. Such material for culture includes aborted fetuses, testicular lesions, abscesses, lymph nodes, and blood. The organism is a small, slender, aerobic, Gram-negative organism that produces 1–2 mm colonies on blood agar after 2–4 days.

### Serology

There is **no satisfactory** serological test. Some animals remain seronegative to all tests. Recently two ELISAs have been developed.<sup>17,18</sup> An ELISA compared with complement fixation was found to be just as sensitive and as specific a test for both pigs and hares for *B. suis* infections.<sup>19</sup> A meat juice ELISA has also been shown to be a valuable method for testing both hares and wild boars.<sup>20</sup> There is considerable individual variation in the antibody response of pigs following infection – some may be culture-positive but have negative or indefinite titers to the common tests.<sup>12</sup> Pigs under 3 months of age have a poor antibody response to infection.<sup>12</sup>

Serological tests in common use include the rose Bengal plate agglutination test, Rivanol test, rose Bengal card test, complement fixation, agar gel immunodiffusion, and tube agglutination. The preferred test varies between countries but most use the rose Bengal plate or card test. *B. abortus* antigens are used for diagnosis as *B. suis* has the same surface lipopolysaccharide antigens. Estimates of the sensitivities of the complement fixation and tube agglutination tests range from 40–51%, and from 62–79% for the rose Bengal plate test.<sup>12,21</sup> The immunodiffusion test has poorer sensitivity than the standard serological tests.<sup>2</sup> The sensitivity and specificity of all the tests have been shown to vary with the stage of infection in the experimental disease and it has been recommended that more than one test should be used for diagnosis.<sup>21,22</sup> A recent study<sup>23</sup> showed a range of sensitivity from 84–100% with the CFT low at 84% and the serum agglutination test high at 100%. The sensitivities ranged from 79.7–100%, with the serum agglutination test low at 79.7% and indirect ELISA and competitive ELISA high at 100%. A recent validation of the polarization assay as a serological test for the presumptive diagnosis of porcine brucellosis has shown promise.<sup>24,25</sup>

### NECROPSY FINDINGS

Many organs may be involved in chronic cases. Chronic **metritis** manifested by nodular, white, inflammatory thickening, 2–5 mm in diameter, and abscessation of

the uterine wall is characteristic. Arthritis may be purulent and necrosis of vertebral bodies in the lumbar region may be found in lame and paralyzed pigs. The clinical **orchitis** of boars is revealed as testicular necrosis, often accompanied by lesions in the epididymis and seminal vesicles. Splenic enlargement and pronounced lymphadenopathy, due to hyperplasia of mononuclear phagocytes, occur in some cases. Typical histological changes consist of granulomatous inflammation and foci of caseous necrosis in liver, kidney, spleen, and reproductive tract.

### Samples for confirmation of diagnosis

- Bacteriology – *adults*: culture swab from joint, lymph nodes, spleen, uterus, epididymis, or other site of localization; *fetus*: lung, stomach content, placenta (has special growth requirements)
- Histology – formalin-fixed samples of above tissues (LM).

Note the zoonotic potential of this organism when handling carcasses or submitting specimens.

### DIFFERENTIAL DIAGNOSIS

The protean character of this disease makes it difficult to differentiate. Syndromes that need differentiation include:

- Abortion and infertility in sows (Table 20.2)
- Posterior paresis diseases of spinal cord
- Mortality in young pigs is also caused by many agents and the important entities are listed under disease of the newborn (Chapter 3).

### TREATMENT

Treatment with a combination of streptomycin parenterally and sulfadiazine orally, or with tetracycline, is ineffective. It is unlikely that treatment will ever be attempted on a commercial scale.

### CONTROL

#### Vaccination

No suitable vaccine is available. Strain 19 *B. abortus*, *B. abortus* 'M' vaccine, living attenuated *B. suis* vaccines and phenol and other extracts of *B. suis* are all **ineffective**.<sup>12</sup>

#### Test and disposal

In herds where the incidence of reactors is high, complete **disposal** of all stock as they reach marketing age is by far the best procedure because of the difficulty in detecting individual infected animals. This is most practicable in commercial pork-producing herds. **Restocking** the farm should be delayed for 6 months. The

existing serological tests can be used for certifying herds free of infection that can then provide replacement stock. Repopulation programs can also use specific-pathogen-free pigs.

The alternative is to commence a **two-herd segregation program**, and this is recommended for purebred herds that supply pigs for breeding purposes. Total disposal is not usually economical in these herds. Once a herd diagnosis has been established, all the breeding animals must be considered to be infected; all piglets at weaning are submitted to the serum agglutination, Rivanol or other test and, if negative, go into new quarters to start the nucleus of a free herd. It is probably safer to wean the pigs as young as possible and test again before mating. If complete protection is desired, these gilts should be allowed to farrow only in isolation, should then be retested, and their piglets used to start the clean herd. A modified scheme based on the above method of weaning and isolating the young pigs as soon as possible but without submitting them to the serum agglutination test has been proposed, but its weakness is that infections may occur and persist in young pigs.

After eradication is completed, **break-downs** are most likely to occur when infected animals are introduced. All **introductions** should be from accredited free herds, should be clinically healthy and be negative to the serum agglutination test twice at intervals of 3 weeks before introduction.

Eradication of swine brucellosis from an area can only be achieved by developing a nucleus of accredited free herds and using these as a source of replacements for herds that eradicate by total disposal. Sale of pigs for breeding purposes from infected herds must be prevented.

### REVIEW LITERATURE

- Macmillan AP, Stack J, Angus RD. Brucellosis. In: Manual of standards for diagnostic tests and viruses. List A and B diseases of mammals, birds and bees. Paris: Office International des Epizooties, 2000:623–629.
- Godfroid J, Kasbohrer A. Brucellosis in the European Union and Norway at the turn of the 21st century. *Vet Microbiol* 2002; 90:135.
- Moreno E. Brucellosis in Central America. *Vet Microbiol* 2002; 90:31.
- Gresham A. Infectious reproductive disease in pigs. In *Pract* 2003; 25:466–473.

### REFERENCES

1. Bricker BJ, Halling SM. *J Clin Microbiol* 1994; 32:2660.
2. LordVR et al. *J Clin Microbiol* 1997; 35:295.
3. Frye GH, Lenard DM. *Proc US Anim Health Assoc* 1991; 95:81.
4. Cvetnic Z et al. *Acta Vet Hung* 2003; 51:465.
5. Hubalek Z et al. *Vet Med (Prague)* 2002; 47:60.
6. Forbes LB et al. *J Am Vet Med Assoc* 1993; 203:289.
7. Cook DR, Kingston GC. *Aust Vet J* 1988; 65:162.

8. Rogers RJ et al. Aust Vet J 1989; 66:77.
9. Van der Leek ML et al. J Wildl Dis 1993; 29:410.
10. Ewalt DR et al. J Vet Diagn Invest 1997; 9:417.
11. Paolicchi FA et al. Vet Rec 1993; 132:67.
12. Alton GG. In: Nielsen K, Duncan JR, eds. Animal brucellosis. Boca Raton, FL: CRC Press, 1990:379.
13. Cornell WD et al. J Vet Diagn Invest 1989; 1:20.
14. Paton NI. Clin Infect Dis 2001; 32:1248.
15. Sudibyo A. J Ilmu Dan Vet (Indonesia) 1998; 3:257.
16. Forbes LB. Can Vet J 1991; 32:686.
17. Teson M et al. Vet Argent 1998; 15:32.
18. Sarga M, Neculescu M. Stud Res Vet Med 1996; 4:29.
19. Szulowski K. Pol J Vet Sci 1999; 2:65.
20. Szulowski K. Bull Vet Inst Pulawy 2000; 44:45.
21. Payeur JB et al. Proc US Anim Health Assoc 1990; 94:147.
22. Ferris RA et al. J Am Vet Med Assoc 1995; 207:1332.
23. Jauregui LH. In: Proceedings of the 15th International Pig Veterinary Society Congress 1998:171.
24. Nielsen K. Vet Microbiol 1999; 68:245.
25. Nielsen K, Gall D. J Immunoassay Immunochem 2001; 22:183.

## BRUCELLOSIS ASSOCIATED WITH *BRUCELLA MELITENSIS*

### **Etiology** *Brucella melitensis*

**Epidemiology** Disease of goats, sheep, humans, and occasionally cattle. Transmission congenital or by ingestion or contact with infected placenta, vaginal discharge, or milk

**Clinical findings** Abortion storms, abortions often in last 2 months of pregnancy. Weak-born lambs. Important zoonotic disease in humans

**Clinical pathology** Culture of organism. Serological tests and skin hypersensitivity testing for herd diagnosis

**Necropsy findings** Placentitis

**Diagnostic confirmation** Only by isolation of the organism

**Control** Slaughter eradication. Vaccination with Rev. 1 vaccine. Rev. 1 vaccine will produce abortion in pregnant animals

### ETIOLOGY

*Brucella melitensis* causes brucellosis in goats and sheep and is capable of infecting most species of domestic animal. There are three biovars of the organism that have differing geographical distribution but no difference in pathogenicity or animal species affected. There is a close relationship to other members of the genus.<sup>1</sup>

### EPIDEMIOLOGY

#### Geographical occurrence

The distribution of *B. melitensis* is more restricted than that of *B. abortus* and its primary area of occurrence is in the **Mediterranean** region, including southern Europe. Infection is also present in west and central Asia, Mexico and countries in

Central and South America, and in Africa. Northern Europe is free of infection, except for periodic incursions from the south, as are Canada, the USA, south-east Asia, Australia, and New Zealand.

#### Host occurrence

Goats and sheep are highly susceptible. Susceptibility in sheep varies with the breed, with Maltese sheep showing considerable resistance. The organism is capable of causing disease in cattle and has been isolated from pigs. The prevalence of infection varies between countries and regions but in many countries prevalence has declined in the past decade in association with mandatory vaccination policies.<sup>2</sup>

#### Source of infection

The source of infection is the **infected carrier animal**. Introduction to a naive herd or flock occurs with the introduction of an infected animal and persistence results from sheep or goats that are prolonged excretors. Excretion is from the reproductive tract and in milk.

#### Reproductive tract

Infected does and ewes, whether they abort or birth normally, discharge large numbers of brucellas in their uterine exudates and **placenta**. The organism can be present in uterine discharge for at least 2 months following parturition in infected goats.<sup>3</sup> The vaginal exudate of infected virgin or open animals may also contain the bacteria but transmission between animals is most likely from the massive exposure that only an infected placenta can provide.

#### Milk

The majority of goats infected during pregnancy will excrete the organism in milk in the subsequent lactation and many will excrete it in all future lactations.<sup>3</sup> In sheep the period of excretion of the organism from the uterus and in milk is usually less than in goats but the organism can be present in milk throughout lactation.<sup>4</sup> The duration of excretion in cattle is not known.

#### Transmission

Routes of infection for both adults and young are via ingestion, by nasal or conjunctival infection, and through skin abrasions, with infected placenta and uterine discharge as a major source.

#### In utero infection

Infection of the fetus during pregnancy does not necessarily result in abortion: infected kids and lambs may be born alive but weak or they may be quite viable. In some cases the infection persists in a **latent** form until sexual maturity, when pregnant animals may abort the first pregnancy.<sup>4</sup> However, others, if weaned

early from their dams and from the infected environment, become free from the infection as adults.<sup>3</sup>

#### Colostrum and milk

Latent infection can also be acquired from the ingestion of infected colostrum and milk; this is a major route of transmission and perpetuation of infection in a herd or flock.<sup>4</sup>

#### Host and pathogen risk factors

The organism is reasonably **resistant** to environmental influences and under suitable conditions can survive for over 1 year in the environment. *B. melitensis* is susceptible to disinfectants in common use at recommended concentrations.

In goats and sheep the infection of a naive herd or flock will produce an abortion storm, following which most animals are infected but immune; further abortions are usually limited to introduced or young animals. Because of the limited periods of excretion in sheep the disease tends to be **self-limiting** in **small flocks** that have few new introductions. It can be a **continuing problem in large flocks** because of massive environmental contamination of areas used for pregnant and lambing ewes.<sup>3</sup> In some areas the prevalence of brucellosis associated with *B. melitensis* is linked to the practice of animal movement to summer and mountain pastures where there is commingling of sheep and goats from a variety of sources on the same pasture.<sup>5</sup>

Spread in beef cattle is slow, presumably because they do not abort. Spread in dairy herds can be more extensive,<sup>6</sup> possibly via milking procedures.

#### Economic importance

Brucellosis has major veterinary and human importance in affected countries. Costs include production loss associated with infection in animals, the considerable cost of preventive programs, and human disease.<sup>2</sup> There is further loss from restriction in international trade in animals and their products.

The occurrence of *B. melitensis* in the sheep and goat population of countries that have eradicated *B. abortus* poses a threat for the continuing problem of brucellosis in cattle herds.

#### Zoonotic implications

*B. melitensis* is the **most invasive and pathogenic** for humans of the three classical species of the genus, and is the cause of 'Malta' or 'Mediterranean' fever in humans, an extremely debilitating disease. It is an important zoonosis in areas of the world where *B. melitensis* is enzootic in goats and sheep. The disease in humans is **severe** and **long-lasting** and often occurs in communities with limited access to antimicrobial therapy.

Control and eradication of the infection in animal populations has high priority in all countries.

Large numbers of organisms are excreted at and following parturition, providing a source of infection for humans managing the herd or flock and also for people in the immediate vicinity from **aerosol infection** with contaminated dust. The risk of infection is high in cultures that cohabit with their animals or when weak, infected newborn animals are brought into the house for warmth and intensive care. Milking of sheep and goats is usually manual, often with poor sanitation and milking-time hygiene.

**Raw milk and cheese products** from infected goats, sheep, or cattle also provide a risk and were the mechanism for the occurrence of Malta fever that initiated the definition of the disease.

Abattoir workers, shearers, and people preparing goat and sheep skins are also at risk. The risk for **veterinarians** is primarily with dystocia problems in infected animals and herds but is also present in the examination of any animal that is subclinically infected. There is also the risk of accidental self-inoculation during vaccination against the disease.

Vaccination of small ruminants with *B. melitensis* Rev. 1 vaccine is a primary method in controlling the human disease. In Greece a 15-year period of vaccination was associated with a drop in the incidence of human brucellosis but when this program was stopped the prevalence of abortions in animals and the incidence of brucellosis in humans increased dramatically, only to be controlled by the reinstatement of vaccination of animals as an emergency mass vaccination program.<sup>7</sup> However, while the Rev. 1 vaccine is attenuated when compared with field strains, it retains some virulence and incorrect selection from the seed stock can result in vaccines with considerable virulence for both vaccinated animals and in-contact humans.

In view of its pathogenicity to humans and animals, *B. melitensis* requires major consideration as an **agent of bioterrorism** and agroterrorism. It is believed that fewer than 10 cfu are capable of infecting humans and infection can occur from aerosol infection. This would require mass therapy of human populations and destruction of animal populations, with associated problems.<sup>8</sup>

### **PATHOGENESIS**

The organism is a facultative intracellular parasite. As in other forms of brucellosis, the pathogenesis depends upon localization in lymph nodes, udder, and uterus after an initial bacteremia. In goats, this bacteremia may be sufficiently severe to produce a

systemic reaction, and blood culture may remain positive for a month. Localization in the placenta leads to the development of placentitis, with subsequent abortion. After abortion, **uterine infection** persists for up to 5 months and the **mammary gland** and associated lymph nodes may remain infected for years.<sup>3,4</sup> Spontaneous recovery may occur, particularly in goats that become infected while not pregnant. In sheep the development of the disease is very similar to that in goats. In cattle, *B. melitensis* has a similar pathogenesis and produces a persistent infection in the mammary gland and the supramammary lymph node, with obvious significance for public health.<sup>6</sup>

### **CLINICAL FINDINGS**

**Abortion** during late pregnancy is the most obvious sign in **goats and sheep**, but as in other species there may be a 'storm' of abortions when the disease is introduced, followed by a period of flock resistance during which abortions do not occur. Abortion is most common in the last 2 months of pregnancy. The excretion of the organism in milk is not accompanied by obvious signs of mastitis. Infection in males may be followed by orchitis, which is frequently unilateral.

In experimental infections, a systemic reaction occurs, with fever, depression, loss of weight, and sometimes diarrhea. These signs may also occur in acute, natural outbreaks in goats and may be accompanied by mastitis, lameness, and hygroma; however, they are uncommon in the natural disease and their occurrence in the experimental disease reflects a massive challenge dose.<sup>3</sup> Osteoarthritis, synovitis, and nervous signs may occur in sheep.

In pigs the disease is indistinguishable clinically from brucellosis associated with *B. suis*.

In many instances, *B. melitensis* infection reaches a high incidence in a group of animals without signs of obvious illness and its presence may be first indicated by the occurrence of disease in humans infected from the herd or flock. This is so in **cattle** where the infection is subclinical and does not produce abortion, but the organism is shed in milk.

### **CLINICAL PATHOLOGY**

#### **Culture**

Positive blood culture soon after the infection occurs, or isolation of the organism from the aborted fetus, vaginal mucus, or milk, are the common laboratory procedures used in diagnosis. The organism is moderately acid-fast and staining smears from the placenta and fetus with a modified Ziehl-Neelsen method may give a tentative diagnosis; however this does not distinguish this infection from

*B. ovis* or the agent of enzootic abortion, and culture is required.

The organism can be detected by PCR in the abomasal fluid of aborted fetuses and, compared with culture, PCR has a sensitivity and specificity of 97.4% and 100%, respectively.<sup>9</sup> PCR can also be used to detect the organism in semen.<sup>10</sup>

### **Serology**

The **conventional serological tests** for the diagnosis of *B. melitensis* – agglutination, CFT, and the rose Bengal or card test – use the same antigens as are used for the diagnosis of *B. abortus* infections.

The rose Bengal test and CFT are the prescribed tests for international trade. In most laboratories these tests, in **unvaccinated** animals, are 100% specific and have high sensitivity. However the sensitivity is not sufficiently high to allow completely accurate detection of infection in an individual animal.<sup>11,12</sup> They can be used for the detection of infected herds for slaughter eradication of the disease but have significant limitations when used for selective culling of positive animals within an infected herd.

Conventional serological tests will **not differentiate** infection with different species of *Brucella* nor will they differentiate infection associated with *Y. enterocolitica* type O:9. **Other tests** that have been developed include ELISA tests, radial immunodiffusion, and counterimmunoelectrophoresis; the sensitivity and specificity of these appears to vary between laboratories.<sup>12-15</sup> An ELISA test using purified antigen is described as being able to differentiate the seropositivity of *B. melitensis* from that of *B. ovis*.<sup>16</sup>

The rose Bengal test has excellent specificity and high sensitivity,<sup>11,15</sup> is easy to perform, and is suitable for **herd and flock testing**.<sup>3</sup>

For the testing of infection status of **individual animals**, the rose Bengal test and the CFT have the highest sensitivity in most studies. A combination of tests and tests carried out on several occasions may increase the accuracy of detection of infected animals.<sup>17</sup> If only one test is possible, the CFT is recommended but it suffers from the requirement for a sophisticated laboratory, which is not always available in affected areas.<sup>3</sup>

*Brucella*-free animals are serologically positive for long periods following **vaccination**, with a difference in persistence with different serological tests. The period of seropositivity is shorter in animals vaccinated conjunctively.<sup>12,13,15</sup>

#### **Milk tests**

Tests are also conducted on milk. They include the milk ring test, the whey CFTs, whey Coombs or antiglobulin test, whey agglutination tests, and an ELISA.<sup>3,18</sup> They



have no apparent advantage over serological tests and in many cases are less sensitive and are unsuitable as screening tests using flock or herd pooled milk samples. An ELISA test using crude polysaccharide from *B. melitensis* biovar 1 as antigen has a better sensitivity and may be of greater value as a screening test, although there are limited field data.<sup>19</sup>

#### Allergic tests

An intradermal allergic test using 50 mg of brucellin INRA can be used for diagnosis. The injection sites in goats are the neck or caudal fold and in sheep the lower eyelid. Reactions are read in 48 hours. The test has high specificity in flocks that are free of infection and are not vaccinated. However, it has little advantage over conventional serological tests in infected herds and Rev.-1-vaccinated animals can react for years.<sup>3,15,20</sup> It has particular value in identifying animals that are false-positive reactors due to antibody to cross-reacting bacterial antigens. It can differentiate infections with *Y. enterocolitica*, but cannot differentiate *B. ovis* infections in sheep. **Anergy** occurs between 6 and 24 days after injection.<sup>15</sup> Vaccinated sheep retain an allergic state for at least 2 years.<sup>3</sup>

#### NECROPSY FINDINGS

There are no lesions that are characteristic of this form of brucellosis. The causative organism can often be isolated from all tissues but the spleen, lymph nodes, and udder are the most common sites for attempted isolation in chronic infection.

#### Samples for confirmation of diagnosis

- Bacteriology – **adults**: spleen, lymph node, udder, testicle, epididymis; **fetus**: lung, spleen, placenta (CULT – has special growth requirements, CYTO – Stamp's or Koster's stain on placental smear); **fetus**: PCR detection in fetal abomasal fluid
- Histology – formalin-fixed samples of above tissues.

Note the zoonotic potential of this organism when handling carcasses or submitting specimens.

#### DIFFERENTIAL DIAGNOSIS

The primary differential is from other forms of brucellosis (this chapter) and other causes of abortion in small ruminants

#### TREATMENT

Treatment is unlikely to be undertaken in animals and is also unlikely to be economically or therapeutically effective. A

cure rate of 65% and 100%, respectively, is reported following the daily intraperitoneal administration of 500 mg and 1000 mg of tetracycline to naturally infected goats for a period of 6 weeks.<sup>21</sup> A dose of 1000 mg of long-acting tetracycline given every 3 days for a period of 6 weeks achieved a cure rate of 75%.

#### CONTROL

##### Hygiene

Control measures must include hygiene at kidding or lambing and the disposal of infected or reactor animals. Separate pens for kidding does that can be cleaned and disinfected, early weaning of kids from their does and their environment, and vaccination are recommended. In endemic areas all placentas and dead fetuses should be buried as a routine practice.

##### Eradication

Where a group is infected for the first time it may be most economic to dispose of the entire herd or flock. **Test and slaughter** procedures are prolonged because of the inaccuracy of the tests.

Many countries that have this disease have statutory control measures. The disease can be eradicated and Cyprus has recently achieved this.<sup>22</sup> *B. melitensis* also can be eradicated, with difficulty, from dairy cattle.<sup>5</sup> However, vaccination may be the only practical method of control in areas where there is a high prevalence of the disease, extensive management systems, communal grazing and a low socioeconomic level.<sup>23,24</sup>

##### Rev. 1 vaccination

The universally recommended vaccine is Elberg's Rev. 1, which is effective in both sheep and goats.<sup>2,24,25</sup> Rev. 1 vaccine is a live, attenuated *B. melitensis* strain derived from a virulent *B. melitensis* isolate. It stimulates protection against infection with *B. melitensis* in sheep and goats and also protects rams against infection with *B. ovis*. However, this is at the expense of a persistent serological response. Further, although this vaccine is attenuated when compared with field strains it retains some virulence and incorrect selection from the seed stock can result in vaccines with considerable virulence for both vaccinated animals and in-contact humans.<sup>26,27</sup>

Vaccination with Rev. 1 produces a bacteremia that is cleared by 14 weeks in goats and a shorter time in sheep. Vaccination of animals 3–8 months of age confers a high degree of immunity that lasts for more than 4 years in goats.<sup>4,28</sup> and 2.5 years in sheep.<sup>25</sup> The initial recommendations for use were vaccination of replacement animals with the expectation that herd/flock immunity would develop over the years; however,

this has proved ineffective in some regions and whole-flock/herd vaccination is now recommended in certain countries.<sup>23</sup>

Vaccination of pregnant goats and sheep, especially in the second and third month of pregnancy, will result in **abortion** and the excretion of the living *B. melitensis* vaccine organism in the vaginal discharge and the milk. The vaccine should not be used in pregnant animals or for 1 month prior to breeding. Vaccination of lactating animals may be followed by a temporary period of excretion of the organism in the milk.<sup>3,18</sup> Neither **reduced dose vaccination** nor **conjunctival vaccination** significantly reduces the risk of vaccine-induced abortions in pregnant animals,<sup>23</sup> although reduced-dose Rev. 1 vaccination has been shown to provide protection for at least 5 years in endemically infected areas.<sup>29</sup>

Conjunctival vaccination does decrease the period of seropositivity following vaccination.<sup>17,19</sup> Vaccine efficacy and safety can vary with the manufacturer.<sup>17,19</sup> National policies promoting widespread vaccination of sheep and goats with Rev. 1 vaccine have resulted in a significant reduction in the prevalence of small ruminant brucellosis and in the incidence rates of human brucellosis.<sup>7,25,30</sup> However, Rev. 1 vaccine is also pathogenic to humans and its excretion and persistence in milk following vaccination can result in human infection.<sup>27</sup>

The general approach in endemically infected countries is to institute a whole-flock vaccination scheme followed by a young-stock vaccination scheme until the prevalence of the disease is reduced, at which time test and slaughter can be implemented to eradicate the disease. This ignores the risk of adverse disease in the vaccinated animals and the risk for human infection from the vaccine strain. There is an urgent need for a non-virulent vaccine that induces seropositivity that can be differentiated from the seropositivity resulting from natural infection.<sup>27</sup>

##### Other vaccines

To circumvent the problem of persistent serological response, attempts are being made to develop defined rough mutant vaccine strains that would be more effective against *B. melitensis*. Various studies have examined cell-free native and recombinant proteins as candidate protective antigens, with or without adjuvants. Limited success has been obtained with these, or with DNA vaccines encoding known protective antigens, in experimental models.<sup>26,27</sup>

A formalin-killed adjuvant vaccine, called **53H38 vaccine**, has been used but it confers less immunity than Rev. 1 and

causes local reactions and a prolonged allergic and serological response.<sup>23</sup> The rough mutant vaccine, **RB51**, is not of value in sheep or goats.<sup>31</sup>

**B. abortus strain 19** has been used for vaccination and appears to give protection that is as good as that achieved with the attenuated *B. melitensis* vaccine.

A **B. suis strain 2** vaccine has been used in China for some years. It can be administered in the drinking water and is used in areas where the terrain does not allow the regular handling of animals. In a comparative study of S2 vaccine and Rev. 1 vaccine, S2-vaccinated pregnant ewes had less protection than Rev.-1-vaccinated ewes when challenged with *B. melitensis*, and an equivalent degree of protection to the nonvaccinated controls.<sup>20</sup>

Initial studies on the pathogenicity and immunogenicity of **gene-deleted mutant B. melitensis Rev. 1** live vaccines in mice suggest that they might be an effective alternate to the standard vaccines used in small ruminants. Serological testing would allow the differentiation of infection. The use of these vaccines would allow the serological differentiation of seropositive vaccinated sheep from infected sheep; however, these vaccines have not yet been tested in small ruminants.<sup>32</sup>

## REVIEW LITERATURE

- Verger JM, Plommet M. *Brucella melitensis*. Current Topics in Veterinary Medicine and Animal Science. Dordrecht: Martinus Nijhoff, 1985:270.
- Young EJ, Corbel MJ. Brucellosis: clinical and laboratory aspects. Boca Raton, FL: CRC Press, 1989:184.
- Alton GG. *Brucella melitensis*. In: Nielsen K, Duncan JR, eds. Animal brucellosis. Boca Raton, FL: CRC Press, 1990.
- Elberg S. Rev 1 *Brucella melitensis* vaccine. Part III 1981–1995. Vet Bull 1996; 66:1193–1200.
- Blasco JM. A review of the use of *B. melitensis* Rev 1 vaccine in adult sheep and goats. Prev Vet Med 1997; 31:275–283.
- Nielsen K. Diagnosis of brucellosis by serology. Vet Microbiol 2002; 90:447–459.
- Schurig GG, Sriranganathan N, Corbel MJ. Brucellosis vaccines: past, present and future. Vet Microbiol 2002; 90:479–496.
- Blasco JM. Caprine and ovine brucellosis. In: Manual of diagnostic tests and vaccines for terrestrial animals. Paris: Office International des Epizooties, 2004, Ch 2.4.2.

## REFERENCES

- Moreno E et al. Vet Microbiol 2002; 90:209.
- Elberg S. Vet Bull 1996; 66:1193.
- Alton GG. In: Nielsen K, Duncan JR, eds. Animal brucellosis. Boca Raton, FL: CRC Press, 1990:379.
- Grillo MJ et al. Vet Rec 1997; 140:602.
- Verger JM et al. Ann R chV t 1989; 20:93.
- Dafni I et al. Israel J Vet Med 1991; 46:13.
- Minas A et al. Prev Vet Med 2004; 64:41.
- Rubenstein E, Levi I. Curr Infect Dis Rep 2004; 4:28.
- Leyla G et al. Vet Microbiol 2003; 93:53.
- Amin AS et al. Vet Microbiol 2001; 92:65.
- MacMillan AP. World Anim Rev 1997; 89:57.
- Jimenez de Baques MP et al. Vet Microbiol 1992; 30:233.

- Dias Aparicio E et al. J Clin Microbiol 1994; 32:1159.
- Delgado S et al. J Vet Diagn Invest 1995; 7:206.
- Blasco JM et al. J Clin Microbiol 1994; 32:1835.
- Plackett P et al. Vet Microbiol 1989; 20:339.
- Mahajan NK, Kulshreshtha RC. Trop Anim Health Prod 1991; 23:11.
- Bianciferi F et al. Compend Immunol Microbiol Infect Dis 1996; 19:17.
- Chand P et al. Vet Rec 2004; 155:639.
- Ebadi A, Zowghi E. Br Vet J 1983; 139:456.
- Radwan I et al. Trop Anim Health Prod 1989; 21:211.
- Polydorou I et al. Israel J Vet Sci 1990; 45:215.
- Blasco JM. Prev Vet Med 1997; 31:275.
- Kolar J. Prev Vet Med 1984; 2:215.
- Elberg SS. Vet Bull 1981; 51:67.
- Schurig GG et al. Vet Microbiol 2002; 90:479.
- Bardenstein S et al. J Clin Microbiol 2002; 40:1475.
- Verger JM et al. Vaccine 1995; 13:191.
- Diaz-Aparicio E et al. Trop Anim Health Prod 2004; 36:117.
- Al Khalaf SAS. Trop Anim Health Prod 1992; 24:45.
- Moriyon I et al. Vet Res 2004; 35:1.
- Cloekaert A et al. Vaccine 2004; 22:2827.

## Diseases associated with *Moraxella*, *Histophilus*, and *Haemophilus* species

### INFECTIOUS KERATITIS OF CATTLE (PINKEYE, BLIGHT)



**Etiology** *Moraxella bovis* is the primary infectious agent. Pili and hemolysin are the main virulence factors. Solar radiation, flies, and dust are contributing factors

**Epidemiology** Cattle of all ages are susceptible. Source is carrier cattle, with transmission by mediate contagion and by flies. More common in summer months. Usually multiple cases in a herd

**Clinical findings** Conjunctivitis, lacrimation, blepharospasm, photophobia, central corneal opacity

**Diagnostic confirmation** Culture  
**Treatment** Self-limiting disease. Topical antibiotics, subconjunctival penicillin, parenteral oxytetracyclines. Protection of eye from sunlight

**Control** Current vaccines have limited efficacy. Fly control

## ETIOLOGY

Hemolytic *Moraxella bovis* is the primary infectious agent concerned, although other organisms can exacerbate the severity of the disease.<sup>1</sup> Experimental infections in calves and studies on corneal tissue culture show a great variation in virulence between strains.<sup>2</sup> Beta-hemolysin, pili, leukotoxin, and proteases are **virulence factors**.<sup>3</sup> *M. bovis* has serologically distinct shared and variable pilus epitopes, and strains can be distinguished by their pilus antigens into seven distinct **serogroups**.<sup>4,5</sup> There are two distinct types of **pilus**,

I and Q (formerly  $\alpha$  and  $\beta$ ). **Q pili mediate bacterial adhesion** to the cornea and the establishment of infection<sup>6</sup> by preventing removal of the organism by the continual flushing effect of ocular secretions and the mechanical action of blinking. Beta-hemolysin is **cytotoxic** and produces corneal damage.<sup>7</sup> In some outbreaks of pinkeye more than one serotype can be isolated from affected eyes.<sup>5</sup>

Whereas *M. bovis* initiates the disease, **other agents** can be responsible for some of the severe keratitis that occurs. *Rickettsia*, *Chlamydia*, *Neisseria*, *Mycoplasma*, and *Acholeplasma* spp. and viruses have been identified as common participants.<sup>1</sup> Infectious bovine rhinotracheitis virus causes ocular disease in its own right but it may also be involved with *M. bovis* in causing the more severe disease. Clinical disease in experimentally induced infectious bovine keratoconjunctivitis has been shown to be more severe when the calves are concurrently given a modified live infectious bovine rhinotracheitis virus vaccine.<sup>8</sup>

Conjunctival infection with *Mycoplasma bovoculi* has been found to enhance the colonization of *M. bovis*<sup>9</sup> and it is possible that other organisms can act in a similar way. *Branhamella ovis* causes a severe conjunctivitis in sheep and goats and is also recorded from outbreaks of keratoconjunctivitis in cattle in Israel;<sup>10,11</sup> it may be a cause of vaccine breakdown in other countries.

Because the naturally occurring disease is usually much more severe than that produced experimentally, factors other than infectious agents have been examined. **Solar radiation, flies, and dust** have been shown to have an enhancing effect.<sup>1</sup> Cultural characteristics of the organisms isolated from the conjunctiva can change with the level of solar ultraviolet radiation.<sup>12</sup>

## EPIDEMIOLOGY

### Occurrence

The disease occurs in most countries of the world and, although it can occur in all seasons, is most common in **summer and autumn**. The prevalence and severity of the disease vary greatly from year to year, and it may reach epizootic proportions in feedlots and in cattle running at pasture. Only cattle are affected, the young being most susceptible, but in a susceptible population, cattle of all ages are likely to be affected. There is no mortality, and cases in which there is permanent blindness or loss of an eye are rare. However, the morbidity rate can be as high as 80%, with the peak infection rate at weeks 3–4 of the outbreak. Severe outbreaks can be experienced in **winter**, especially if the cattle are confined in close quarters such as barns or intensive feedlots.

### Source of infection

Cattle are the reservoir and the organism is carried on the conjunctiva and also in the nares and vagina of cattle. Persistence of the disease from year to year is by means of **infected animals**, which can act as carriers for periods exceeding 1 year.<sup>13</sup> Receptors for **I-pili** may be found on tissues other than the cornea and facilitate colonization of noncorneal tissue and inapparent infection,<sup>6</sup> and the organism can switch from expression of one pilus type to the other.<sup>5</sup>

### Transmission

The disease is most common in summer and autumn and reaches epizootic proportions when **flies and dust** are abundant and **grass** is long; transmission is thought to be by means of these agents contaminated by the ocular and nasal discharges of infected cattle. Under experimental conditions, transmission is unusual in the absence of flies<sup>14</sup> and occurs generally in their presence.<sup>15</sup> The face fly (*Musca autumnalis*) and Asian face fly (*Musca bezzii*), because of feeding preference for the area around the eyes, are important vectors. *Musca autumnalis* is known to remain infected for periods of up to 3 days. *M. bovis* can be isolated from the crops of *Musca autumnalis* that have fed on the eyes of infected cattle.<sup>16</sup>

### Animal risk factors

It is commonly observed that there is a much higher prevalence of the disease in *Bos taurus* cattle as distinct from *Bos indicus* cattle,<sup>17</sup> and the severity and proportion of bilateral infections is much greater in *B. taurus* cattle than in cross-breeds. Charolais and Chianina cows may be less susceptible than Hereford cattle.<sup>18</sup> In British-bred cattle there is also a relationship between rate and severity of infection and the degree of **eyelid pigmentation**, eyes with complete pigmentation being less affected. This effect of pigmentation on susceptibility may be the basis of an apparent inherited resistance of some families of Hereford cattle.<sup>19</sup> The exposure of the eye to **ultraviolet light** may increase susceptibility to the disease and the severity of signs resulting from it.

### Immune mechanisms

Previous infection appears to confer a significant immunity that lasts through to the next season, when further reinfection, usually with minimal clinical disease, confers further immunity. Lacrimal secretions contain antibody, and antibody directed against the **pilus antigens** of *M. bovis* will prevent adherence of the organism to the cornea. In experimental infections, significant protection against challenge can be achieved by prior vacci-

nation with pilus antigens of the homologous strain.<sup>20-22</sup>

However, there is antigenic diversity in pili from different strains of *M. bovis* and vaccines composed of pili from one strain only confer protection to challenge with organisms of the same serogroup.<sup>20</sup> Further, *M. bovis* in the eye can **switch** their pilus antigenicity in response to antibody presence and render monovalent vaccines ineffective.<sup>22</sup> A polyvalent vaccine might provide protection but polyvalent vaccines are less immunogenic than monovalent vaccines because of antigenic competition.<sup>22</sup>

### Experimental production

Experimental reproduction is usually preceded by irradiation of the eye with ultraviolet light prior to inoculation. Under these conditions, inoculation with Q-piliated *M. bovis* produces a relatively high frequency of infection and keratoconjunctivitis, I-piliated organisms produce a lower frequency, and nonpiliated organisms do not produce infection.<sup>6</sup>

### Economic importance

Infectious keratoconjunctivitis is a prominent disease in surveys of the predominant diseases in cattle.<sup>23</sup> Loss of milk production or body condition may be caused by the discomfort, failure to feed, and temporary blindness. The conditions under which calves are reared can affect the importance of the disease. In veal calves, the disease may have no measurable effect on growth<sup>24</sup> but in calves running at pasture it can result in a significant reduction of weaning weight. Occasionally, animals become completely blind and those at pasture may die of starvation.

There is also a welfare concern.

### PATHOGENESIS

Attachment of *M. bovis* to the corneal epithelium is mediated by the presence of pilus antigens, and **Q-piliated** organisms are **more infectious** than I-piliated strains.<sup>5,6</sup>

Microscopic corneal erosions are present within 12 hours of infection and occur at this time in the absence of a significant inflammatory response, indicating that the initial production of the corneal ulceration is due to the direct cytotoxic activity of the organism.<sup>3</sup> This is followed by focal loss of corneal epithelium, degeneration of keratocytes, and invasion of the corneal stroma with fibrillar destruction. An inflammatory reaction occurs several days postinfection and results in enlargement of the corneal ulcers with deeper stromal involvement, corneal edema, and corneal neovascularization. The lesions are localized in the eye and there is no systemic infection.

### CLINICAL FINDINGS

An incubation period of 2-3 days is usual, although longer intervals, up to 3 weeks, have been observed after experimental introduction of the bacteria. Injection of the corneal vessels and edema of the conjunctiva are the **early signs** and are accompanied by a copious watery lacrimation, blepharospasm, photophobia and, in some cases, a slight to moderate fever with fall in milk yield and depression of appetite.

In 1-2 days, a small **opacity** appears in the center of the cornea and this may become elevated and ulcerated during the next 2 days, although spontaneous recovery at this stage is quite common. With progressive disease the opacity becomes quite extensive and at the peak of the inflammation, about 6 days after signs first appear, it may cover the entire cornea. The color of the opacity varies from white to deep yellow. As the acute inflammation subsides, the ocular discharge becomes purulent and the opacity begins to shrink, complete recovery occurring after a total course of 3-5 weeks.

One or both eyes may be affected. The degree of ulceration in the early stages can be readily determined by the infusion of a 2% fluorescein solution into the conjunctival sac, the ulcerated area retaining the stain.

About 2% of eyes have complete **residual opacity** but most heal completely with a small, white scar persisting in some. In severe cases the cornea becomes conical in shape, there is marked vascularization of the cornea, and ulceration at the tip of the swelling leads to under-running of the cornea with bright yellow pus surrounded by a zone of erythema. These eyes may rupture and result in complete blindness.

A proportion of cases develop minimal clinical lesions and heal spontaneously, and the severity of clinical disease can also vary between outbreaks.

### CLINICAL PATHOLOGY

The organism can be identified by culture or fluorescent antibody. The hemolytic form of the bacterium is noticeably more pathogenic than the nonhemolytic form. Serum agglutinins (1:80 to 1:640) are present 2-3 weeks after clinical signs commence, and a modified gel diffusion precipitin test is capable of detecting *M. bovis* antibodies. An ELISA test is also used for antibody detection in experimental studies; however, neither agglutinating antibody nor antibody detected by ELISA correlates well with individual animal resistance to infection.<sup>20</sup> There is little indication for serological examinations in clinical practice. Necropsy examinations are not usually necessary.

## DIFFERENTIAL DIAGNOSIS

- **Traumatic conjunctivitis** is usually easily differentiated because of the presence of foreign matter in the eye or evidence of a physical injury
- ***Pasteurella multocida* (capsular type A)** has been isolated from the eyes of housed heifers that experienced outbreaks of severe keratitis with severe loss of corneal stroma within 72 hours of onset
- ***Mycoplasma bovis*** has been isolated from the eyes of steers with an outbreak of severe conjunctivitis with corneal opacity and ulceration, disease being followed by serological conversion in affected animals.<sup>25</sup> Involvement of the eyelids with marked swelling was prominent. Conjunctivitis is prominent in other mycoplasmal infections that produce keratoconjunctivitis<sup>26</sup>
- ***Listeria monocytogenes* iritis**
- **Infectious bovine rhinotracheitis**
- **Bovine malignant catarrh**
- **Thelaziasis**
- **Chlamydial keratoconjunctivitis** presents with identical clinical findings but has a protracted course despite treatment and a higher morbidity.<sup>27</sup> *Chlamydiophila* DNA can be detected by PCR in conjunctival swabs. This disease is a possible zoonosis

## TREATMENT

Bovine infectious keratoconjunctivitis is frequently a **self-limiting disease**. Recovery commonly occurs without treatment, although early treatment will reduce the incidence of scarring of the eyes. Antibacterial treatment is commonly used and mass treatment of the herd as opposed to just affected individuals may halt the occurrence of further cases.<sup>28</sup> The route of administration is often determined by ease of repeated access to the animals, and cost.

### Topical therapy

Early, acute cases respond to treatment with ophthalmic ointments and solutions containing antibiotics but they need to be instilled in the conjunctival sacs at frequent intervals, which may be impractical under field conditions. The organism is **sensitive** to most antibiotics and sulfonamides but is resistant to erythromycin, lincomycin, and tylosin. The administration of an oil-based formulation containing 375 mg of benzathine cloxacillin has been found to be effective in therapy in controlled trials.<sup>28-30</sup> Two doses, 72 hours apart, are recommended.

### Subconjunctival therapy

Subconjunctival therapy with antibiotic is effective, and when corneal vascularization is extensive the injection of a mixture of corticosteroid and antibiotic under the bulbar conjunctiva is recom-

ommended to promote healing. Often one injection is sufficient, but it may be necessary to repeat it daily for a few days in advanced cases. Recovery may require 3-4 weeks and daily examination of the eye should be made to detect any complication that may occur. Another technique for prolonging the maintenance of high levels of antibiotic in the conjunctival sac is the use of collagen inserts impregnated with an antibiotic.

Subconjunctival procaine penicillin ( $3-6 \times 10^5$  IU) given through the skin of the upper eyelid or under the bulbar conjunctiva gives prolonged therapeutic concentrations in conjunctival secretions<sup>31</sup> and is commonly used in therapy, alone or in combination with subconjunctival dexamethasone. Injection of the penicillin through the skin of the upper eyelid rather than through the conjunctiva confers a significantly longer presence of penicillin in the conjunctival fluids.<sup>32</sup> Therapy must be administered under the bulbar conjunctiva and is ineffective if given in the superior palpebral conjunctiva.<sup>33,34</sup> A controlled trial found that subconjunctival penicillin was effective in treatment but recurrence was higher than with treatment with parenteral oxytetracycline<sup>34</sup> and mass treatment of calves with subconjunctival penicillin does not eliminate infection.<sup>35</sup>

### Parenteral therapy

Parenteral therapy with sulfadimidine at the normal dose rate of 100 mg/kg BW is an effective parenteral treatment, and a single treatment with long-acting oxytetracycline (20 mg/kg intramuscularly) has shown efficacy in controlled field trials.<sup>36</sup> Parenteral treatment with two doses of long-acting oxytetracycline (20 mg/kg) 72 hours apart, coupled with oral administration of oxytetracycline at 2 g/250 kg BW for 10 days, is credited with markedly reducing the herd incidence of the disease.<sup>28,34</sup> Recent studies comparing other antimicrobials with oxytetracycline suggest that recovery rates are faster following therapy with florfenicol or tilmicosin.<sup>37,38</sup>

### Ancillary therapy

Severe cases should be placed in a dark shelter out of direct sunlight. If housing is not possible, eye flap **patches** are available and effective. They are glued on above the eye and can be flipped up for medication of the eye.

When corneal ulceration has occurred recovery is always protracted. The use of topical ophthalmic anesthetics combined with atropine administration may be indicated to minimize ciliary spasm and pain. Severe cases may require that the third eyelid be temporarily sutured across the globe of the eye for several days to promote healing.

## CONTROL

Eradication or prevention of the disease does not seem possible under extensive range conditions because of the method of spread, but if **fly control** can be fitted into the farm's management program this should significantly reduce the infection rate. Insecticide impregnated ear tags may help in the control of the disease but do not prevent it. In many herds the best that can be done is to keep animals under close surveillance and isolate and treat any cattle that show excessive lacrimation and blepharospasm. Cattle that have had the disease should not be mixed with those that have not until after the fly season.

## Vaccination

There has been considerable effort to develop methods of immunoprophylaxis; however the commercial bacterins, although available for over 30 years, have given inconsistent results, providing at best limited protection from subsequent infection and clinical disease. Killed, whole-cell vaccines require repeat injections, may be associated with anaphylactic reactions and have not proven effective in the field. To avoid the need for repeated injections an adjuvant vaccine has been tested, but without apparent benefit.

Vaccines containing pilus antigens, with or without cornea-degrading enzyme antigens, protect against challenge with homologous strains of *M. bovis*<sup>20,39,40</sup> and some field trials report efficacy in naturally occurring outbreaks.<sup>40,41</sup> However, others do not<sup>42,43</sup> and the results of field studies that have shown a beneficial effect from vaccination have been criticized on the basis of bias in the selection of controls.<sup>43</sup> It is probable that currently available vaccines do not contain the diversity of antigens required to protect against the variety of strains that occur in natural outbreaks. Autogenous vaccines are a consideration in individual herds but a recent controlled trial of an autogenous vaccine administered by subcutaneous or subconjunctival injection found no significant effect of either route or the vaccine on the incidence of disease.<sup>44</sup>

Weekly treatment of both eyes of calves, but not the cows, with a furazolidone eye spray has been shown to be a more effective prophylaxis than vaccination with a commercial bacterin in some areas.<sup>45</sup>

Total eyelid pigmentation may reduce the incidence of this disease but the recorded differences<sup>19</sup> are unlikely to arouse enthusiasm for a genetic approach to the problem.

## REVIEW LITERATURE

- Cox PJ. Infectious bovine keratoconjunctivitis. *Rec Prog Vet Annu* 1984;75-79.
- George LW. Clinical infectious bovine keratoconjunctivitis. *Compend Contin Educ Pract Vet* 1984; 6:S712

- George LW. Antibiotic treatment of *Moraxella bovis* infection of cattle. J Am Vet Med Assoc 1984; 185:1206.
- Punch PJ, Slatter DH. A review of infectious bovine keratoconjunctivitis. Vet Bull 1984; 54:193-207.
- Brown MH, Brightman AH, Fenwick BW, Rider MA. Infectious bovine keratoconjunctivitis: a review. J Vet Intern Med 1998; 12:259-266.

## REFERENCES

- Punch PJ, Slatter DH. Vet Bull 1984; 54:193.
- Chandler RL et al. J Comp Pathol 1985; 95:415.
- Kagonyera GM et al. Am J Vet Res 1988; 49:386.
- Moore LJ, Lepper AWD. Vet Microbiol 1991; 29:75.
- Conceicao FR et al. Can J Vet Res 2003; 67:315.
- Ruehle WW et al. Am J Vet Res 1993; 54:249.
- Beard MKMcG, Moore LJ. Vet Microbiol 1994; 42:15.
- George LW et al. Am J Vet Res 1988; 49:1800.
- Rosenbusch RF. Am J Vet Res 1983; 44:1621.
- Elad D et al. J Vet Med B 1988; 35:431.
- Yerahum I et al. Israel J Vet Sci 1991; 46:142.
- Lepper AVD, Barton IJ. Aust Vet J 1987; 64:33.
- Iwasa M et al. J Vet Med Sci 1994; 56:429.
- Kopecky KE et al. Am J Vet Res 1986; 47:622.
- Arends JJ et al. J Econ Entomol 1984; 77:394, 399.
- Glass HW, Gerhardt RR. J Econ Entomol 1983; 76:532.
- Makinde AA et al. Br Vet J 1985; 141:643.
- Stelman CD et al. J Agric Entomol 1993; 10:97.
- Pugh GW et al. Am J Vet Res 1986; 47:885.
- Lepper AWD et al. Vet Microbiol 1992; 32:177.
- Lepper AWD et al. Vet Microbiol 1993; 36:175.
- Lepper AWD et al. Vet Microbiol 1995; 45:129.
- Salman MD et al. J Am Vet Med Assoc 1991; 198:962.
- Donovan GA et al. Prev Vet Med 1998; 33:1.
- Kirby FD, Nicholas RAJ. Vet Rec 1996; 22:552.
- Naglic T et al. Acta Vet Hung 1996; 44:21.
- Otter A et al. Vet Rec 2003; 152:787.
- George LW. Cornell Vet 1990; 80:229.
- George LW et al. Am J Vet Res 1989; 50:1170.
- Daigneault J et al. Am J Vet Res 1990; 51:376, 381.
- Abeynayake P, Cooper BS. J Vet Pharmacol Ther 1989; 12:25, 31.
- Abeynayake P, Cooper BS. N Z Vet J 1985; 33:6.
- Allen LJ et al. J Am Vet Med Assoc 1995; 206:1200.
- Eastman TG et al. J Am Vet Med Assoc 1998; 212:560.
- Sargison ND et al. N Z Vet J 1996; 4:142.
- Edmondson AJ et al. Am J Vet Res 1989; 50:838.
- Gokce HI et al. Ir Vet J 2002; 55:573.
- Zielinski GC et al. Vet Ther 2002; 3:196.
- Lepper AWD. Aust Vet J 1988; 65:310.
- Gerber JD et al. Vet Immunol Immunopathol 1988; 18:41.
- Lekr C et al. Vet Med 1985; 80:96.
- Bateman KG et al. Can Vet J 1986; 27:23.
- Smith PC et al. Am J Vet Res 1990; 51:1147.
- Davidson HJ, Stokka GI. Can Vet J 2003; 44:577.
- Kopecky KE et al. Am J Vet Res 1986; 47:622.

## SEPTICEMIA AND THROMBOTIC MENINGOENCEPHALITIS IN SHEEP ASSOCIATED WITH *HISTOPHILUS SOMNI*

### Synopsis

**Etiology** *Histophilus somni* (formerly *Haemophilus agni*, *Histophilus ovis*)

**Epidemiology** Worldwide occurrence but not a common disease. In affected flocks cases occur over several weeks to result in a significant population mortality

**Clinical findings** Acute disease and affected sheep commonly found dead. Septicemia, polyarthritis, and occasionally meningitis primarily in lambs 4-7 months of age

**Necropsy findings** Multiple hemorrhages throughout the carcass. Focal hepatic necrosis. Polyarthritis, meningoencephalitis

**Diagnostic confirmation** Isolation of the organism

**Treatment and control** Oxytetracycline

## ETIOLOGY

*Histophilus somni* falls within the family Pasteurellaceae. This organism, previously known as *Haemophilus agni* and *Histophilus ovis*, has been isolated from sheep with a number of different pyogenic conditions including septicemia, polyarthritis, thrombotic meningoencephalitis, general pyemia, metritis, mastitis, abortion, neonatal mortality, and epididymitis.<sup>1-5</sup>

## EPIDEMIOLOGY

Disease associated with *H. somni* in sheep has worldwide occurrence but is not common.

The most common presentation is lameness and septicemia in lambs aged 4-7 months<sup>6-9</sup> but infection with this organism can also result in polyarthritis in lambs 1-4 weeks of age. The morbidity rate varies between outbreaks but the case fatality rate is likely to be 100% unless treatment is undertaken, and the population mortality rate can approach 10%.<sup>8</sup> Outbreaks may last several weeks and, within a flock, cases of the disease occur sporadically but over a long period.

In some outbreaks, both in lambs and adult sheep, meningoencephalitis is the primary presentation and the clinical and pathological findings are similar to thromboembolic meningoencephalitis in cattle.<sup>3,10,11</sup> The method of transmission is unknown but the disease does not appear to spread by pen contact nor can it be produced by oral, nasal, or conjunctival exposure to the organism. Environmental or other stress may be a predisposing factor.<sup>9</sup>

## PATHOGENESIS

The organism colonizes the respiratory and reproductive tract mucosa and invades to produce septicemia and disseminated bacterial thrombosis, leading to a severe focal vasculitis.

## CLINICAL FINDINGS

Affected sheep are often found dead. Depression, high fever (42°C, 107°F), disinclination to move and collapse with movement are the obvious clinical signs and affected lambs may die within 12 hours of becoming ill. Lambs that survive more than 24 hours develop a severe

fluid and heat in the joints. They are usually recumbent and those with meningoencephalitis show hypersalivation, convulsions and opisthotonos. The clinical course is short.

## CLINICAL PATHOLOGY

Hematology and blood chemistry are not commonly conducted because of the acute nature of the disease and the availability of carcasses for postmortem. Initially there is leukopenia and neutropenia with a neutrophilia and left shift in more prolonged cases. Total cell count is elevated in cerebrospinal fluid and joint fluid and these also can be cultured for the organism. Antibody detected by complement fixation persists for about 3 months in animals that survive.

## NECROPSY FINDINGS

At necropsy the most striking feature is the presence of multiple hemorrhages throughout the carcass. Focal hepatic necrosis surrounded by a zone of hemorrhage is also a constant finding. Lambs that die in the early stages of the disease show minimal joint changes but those that survive for more than 24 hours develop a fibrinopurulent arthritis. Histologically, the disease is a disseminated bacterial thrombosis leading to a severe focal vasculitis. This change is most apparent in the liver and skeletal muscles. A basilar meningitis will be present in more protracted cases.

## Samples for confirmation of diagnosis

- Bacteriology - culture swabs from joint fluid, liver, meningeal fluid (CULT)
- Histology - formalin-fixed liver and brain.

## DIFFERENTIAL DIAGNOSIS

Because of the acute nature of the clinical disease, the disease is likely to be confused with acute septicemia associated with *E. coli* or *P. trehalosi*, and with enterotoxemia. The characteristic hepatic lesions and histology serve to identify the disease, and final diagnosis depends on isolation of the organism.

## TREATMENT AND CONTROL

Antimicrobials, such as tetracyclines, need to be given very early in the course of the disease if they are to be effective. Because of the acute nature of the disease, vaccination is likely to be the only satisfactory method of control.<sup>8</sup> Although there is no label, vaccine immunity after a field attack seems to be solid. Mass treatment of the group of sheep at risk with long-acting tetracyclines is a possible strategy to reduce the occurrence of further cases.

## REFERENCES

1. Humphrey JD, Stephens LR. *Vet Bull* 1983; 53:987.
2. McDowell SWJ et al. *Vet Rec* 1994; 134:504.
3. Philbey AW et al. *Aust Vet J* 1991; 68:387.
4. Low JC, Graham MM. *Vet Rec* 1985; 117:64.
5. Webb RF. *Res Vet Sci* 1983; 35:30.
6. Kennedy PC et al. *Am J Vet Res* 1958; 19:645.
7. Lundberg MS. *Can Vet J* 1986; 27:501.
8. Gill J. *Surveillance* 1992; 19:13.
9. Kearney KP, Orr MB. *N Z Vet J* 1993; 41:149.
10. Orr J et al. *Can Vet J* 1992; 3:4.
11. Cassidy JP et al. *Vet Rec* 1997; 140:193.

## HAEMOPHILUS SEPTICEMIA OF CATTLE (*HISTOPHILUS SOMNI* OR *HAEMOPHILUS SOMNUS* DISEASE COMPLEX)

### Synopsis

**Etiology** *Histophilus somni* (formerly *Haemophilus somnus*)

**Epidemiology** High prevalence of infection in cattle population; low incidence of disease. Occurs in North American feedlot cattle, also in the UK and some European countries. Young growing cattle and those 6–12 months of age are most commonly affected, nursing beef calves less commonly. Originally, meningoencephalitis was most common lesion but pleuropneumonia and myocarditis now common. Several virulence attributes of organism may account for different forms of disease. Organism resides in respiratory and reproductive tracts of both females and males

**Signs** Meningoencephalitis with fever, ataxia, joint swellings, fundic lesions, weakness, recumbency, and death in 12–24 hours. Pleuropneumonia and myocarditis with rapid death

**Clinical pathology** Marked changes in leukon. Demonstrate and culture organism from cerebrospinal fluid, joint fluid, pleural cavity, and myocardium

**Lesions** Meningoencephalitis, hemorrhagic infarcts in brain, retinal hemorrhages, pleuropneumonia, myocarditis with abscessation

### Differential diagnosis

- **Pneumonia and pleuritis:** Pneumonic pasteurellosis and pleuritis
- **Myocarditis:** Other causes of sudden death and congestive heart failure
- **Meningoencephalitis:** *Listeria* meningoencephalitis, poliоencephalomalacia, hypovitaminosis A

**Diagnostic confirmation** Culture organism

**Treatment** Antimicrobials

**Control** Unreliable. Mass medication of individual animals on arrival in feedlot. Vaccination with bacterin

### ETIOLOGY

*Histophilus somni* is the cause.<sup>1,2</sup> Earlier investigations have shown that *H. somni*, *Haemophilus agni*, and *Histophilus ovis* represent the same species and recent analysis of genes of strains supports the allocation of this species to a novel genus

within the family Pasteurellaceae as *Histophilus somni*.<sup>3</sup> *H. somni* causes a variety of diseases in cattle, including septicemia, thrombomeningoencephalitis, pleuropneumonia, myocarditis, reproductive failure, and in sheep mastitis, septicemia, and epididymitis.

### EPIDEMIOLOGY

#### Prevalence of infection

The prevalence of infection of *H. somni* in the cattle population is much higher than the incidence of clinical disease. More than 50% of normal bulls, 8–10% of normal cows, and 10% of normal rams have *H. somni* in their reproductive tract.<sup>4</sup> Among those that have had the disease and survived, the serological reactor rate varies from 50–100%. Some surveys found more positive reactors in beef cattle and dairy cattle from infected herds than in dairy cattle from clinically normal herds. The percentage of cattle that seroconvert may be higher in dairy herds of more than 100 cows than in smaller herds.

#### Occurrence of disease

Infection of cattle with *H. somni* may cause septicemia, thrombotic meningoencephalitis, polysynovitis, pleuritis, suppurative bronchopneumonia, myocarditis, otitis media, mastitis, and reproductive tract diseases. When infection of cattle with the organism was first described in 1956, the primary form of the disease was thrombotic meningoencephalitis. Since that time, many different clinical forms of the infection have been described. Suppurative bronchopneumonia, fibrinous pleuritis, and myocarditis are now being recognized with increased frequency in feedlot cattle and are being attributed to *H. somni* infection.<sup>5,6</sup> Based on necropsy examinations over a 20-year period in a Saskatchewan diagnostic laboratory, there has been an increasing percentage of cattle with pneumonia and myocarditis associated with the organism and a decreasing percentage with meningoencephalitis.<sup>5</sup> However, because of the practical difficulties in making a specific clinical, pathological, and microbiological diagnosis in situations where the disease complex occurs, there is some uncertainty about the relative importance of the organism in causing certain diseases such as pneumonia of feedlot cattle. For example, because of the variability of the nature and extent of the lesions in bovine respiratory disease in feedlot cattle, the several factors that can influence the laboratory isolation of some bacteria from affected tissues, and the common occurrence of mixed infections, it is difficult to determine whether *H. somni* or *M. haemolytica* is the primary pathogen.

The disease occurs most commonly in **feedlot cattle** in North America after they have been commingled from different sources. The disease has also been recognized in the UK, Germany, Switzerland, and recently in Israel.<sup>7</sup> The disease also occurs in nursing beef calves and young cows on pasture and in young dairy cattle, but to a much lesser extent. The organism has been found in the tonsillar tissues of American bison (*Bison bison*)<sup>8</sup> and has been the cause of bronchopneumonia in bison.<sup>9</sup>

The incidence rate of the nervous form of the disease in a susceptible group of calves is low, averaging about 2%, but may be up to 10% in some outbreaks. The case fatality rate, however, is 90% if affected animals are not identified and treated early in the course of the disease.

The **nervous form** of the disease occurred historically most commonly in feedlot cattle from 6–12 months of age during the fall and winter months, which may be a reflection of stress associated with crowding and cold and changing weather. In Canada the nervous form occurred most commonly in cattle about 4 weeks after arrival in the feedlot, with a range of 1 week to 7 months. The nervous form has also occurred in feedlot cattle in Argentina.<sup>10</sup>

The disease complex that is encountered more commonly now is characterized by **pleuritis, myocarditis, and pneumonia**, and can be the most significant cause of mortality in fall-placed weaned beef calves in large commercial feedlots in western Canada.<sup>11</sup> Death from pneumonia due to the infection occurred mainly during the first 5 weeks in the feedlot; death from myocarditis, pleuritis, thrombotic meningoencephalitis, septicemia, and euthanasia because of polysynovitis occurred mainly after the third week.<sup>11</sup> Furthermore, this disease complex is occurring despite routine vaccination of calves on arrival in the feedlot.<sup>11</sup> A history of respiratory tract disease preceding the outbreak is common and in some cases meningoencephalitis had occurred in the same herd in the previous year. Myocarditis due to *H. somni* in a 6-month-old bull calf has been described in the UK.<sup>12</sup>

*H. somni* also causes various forms of reproductive failure in cattle. A review of the literature on this subject is available.<sup>3</sup> The importation of infected young rams into a flock can have a deleterious effect on the percentage of ewes that lamb.<sup>13</sup> Purchasing replacement animals and having cattle on the same farm were risk factors for infection in the flock. The possibility of interspecies transmission between cattle and sheep requires further study.

## Risk factors

### Animal risk factors

The meningoencephalitis, pleuropneumonia, and myocarditis forms of the disease occur most commonly in feedlot calves 6–12 months of age. The disease may occur in unvaccinated cattle or cattle not vaccinated soon enough before entry into the feedlot. Most weaned beef calves placed into commercial feedlots in Canada are not vaccinated for *H. somni* before entry into the feedlot but rather on arrival.

In Canadian feedlots, feedlot calves that have significant *H. somni* serum antibody levels on arrival or that are able to increase their levels after arrival tend to have a reduced risk of bovine respiratory disease.<sup>14–16</sup>

### Environmental and management risk factors

No information is available.

### Pathogen risk factors

The literature on the virulence factors of the organism has been reviewed.<sup>4</sup> Several virulence factors have been identified, including lipo-oligosaccharide phase variation, induction of apoptosis, intraphagocytic survival, and immunoglobulin Fc binding proteins.<sup>4</sup> *H. somni* is able to synthesize and secrete histamine, which may contribute to the pathogenesis of respiratory disease.<sup>17</sup> The organism is able to survive and multiply in bovine alveolar macrophages and blood monocytes, which may be related to its ability to escape macrophage killing and disseminate in the body.<sup>18</sup>

The organism is an obligate inhabitant of mucosal surfaces and an opportunistic pathogen. It colonizes the surface of mucous membranes; in the asymptomatic carrier state the organism remains at the mucosal surface without invading cells.<sup>2</sup> The organism is able to persist in the lungs of calves for 6–10 weeks in the presence of specific antibody and in the absence of clinical abnormalities other than sporadic coughing. Attachment may be all that is necessary to produce infertility due to endometritis or degeneration of embryos. The organism attaches in large numbers to bovine vaginal epithelial cells.<sup>2</sup> It has the ability to invade the circulatory system, resulting in septicemia. Various strains of *H. somni* adhere to bovine aortic endothelial cells and the adherence is enhanced by the tumor necrosis factor.<sup>4</sup>

Some isolates of the organism are able to multiply in vivo because they are resistant to complement, and bovine leukocytes are incapable of destroying the organism in the absence of specific antibody. Certain suppressive components in *H. somni* have been identified that inhibit the function of polymorphonuclear

leukocytes. *H. somni* antigen has been found in heart and lung tissues in association with chronic pneumonia due to *Mycoplasma bovis* and BVDV.<sup>19</sup>

The organism also has cytotoxic properties that may be related to the production of endotoxin.<sup>2</sup> Some strains are serum resistant and others serum sensitive, which may explain the ability of certain strains to invade beyond mucous membrane surfaces. Another virulence determinant is a nonimmune binding mechanism that is present on the surface of the organism.<sup>4</sup> This determinant may be related to the organism's resistance to complement-mediated killing, its persistence at mucosal surfaces, its capacity to evade host effector functions in vivo and its ability to cause a range of bovine infections. Differences between pathogenic and preputial isolates have been identified.<sup>4</sup> Similarly, there are pathogenic strains of the organism in the genital tract of apparently normal cows as well as those with inflammatory disease.<sup>4</sup>

Virulence differences also exist between *H. somni* strains following intratracheal challenge of bovine lungs.<sup>20</sup> Those strains isolated from encephalitic lesions, or from the prepuce, will not produce the same degree of experimental pneumonia as those strains isolated from lung lesions. Preputial and septicemic isolates of ovine *H. somni* are similar to bovine *H. somni* in pathogenicity and in surface antigens. Ovine isolates given by intracisternal inoculation to 2–3-month-old lambs caused fatal meningoencephalitis and myelitis.

In summary, many virulence factors are involved in several steps of pathogenesis. Adherence is likely to be important in colonization, complement resistance in survival in the circulation or inflammatory sites, and cytotoxicity in evading killing by phagocytes and in initiation of vasculitis, as well as invasion through the endothelium. The host damage that occurs as a result may be further exacerbated by inflammatory mediators released by the host in response to *H. somni*.

## Methods of transmission

The method of transmission and portal of entry are unclear. A feature of infections with this organism is its persistence at mucosal sites in both subclinical and diseased animals. The organism can be isolated from the respiratory and reproductive tracts of normal animals.<sup>3</sup>

In bulls, the organism has been isolated from semen and the preputial orifice, preputial cavity, urinary bladder, accessory sex glands, ampulla of the ductus deferens and the preputial washings of steers. Most bulls harbor the organism in the prepuce. Thus, the potential exists for

venereal transmission of *H. somni*, for lateral spread from the genital tract and for environmental contamination by the organism.

The organism has also been isolated from the vagina, vestibular gland, cervix, uterus, and bladder of cows. The prevalence of infection in normal cows varies depending on the herd and geographical location but 10–27% can harbor the organism.<sup>3</sup> The organism can colonize the vagina of cows without causing disease and it is thought to have a primary etiological role in vaginitis and cervicitis in cows.

The role of *H. somni* in diseases of the bovine reproductive tract has been reviewed.<sup>3</sup> The organism has been isolated from the udder secretions of cattle with naturally occurring mastitis.

Urine is also a source of the organism. The young beef calf in a cow-calf herd can become infected as early as 1 month of age and become a nasal carrier of the organism without showing any signs of clinical disease. The mature cow is considered to be a major source of the organism for the calf. The method of transmission is presumed to be by contact with infective respiratory and reproductive secretions or by aerosol transmission, especially in close-contact feedlots.

The organism can survive more than 70 days when it is mixed with cerebrospinal fluid, whole blood, blood plasma, vaginal mucus, or milk and frozen at  $-70^{\circ}\text{C}$  ( $-94^{\circ}\text{F}$ ). At  $23.5^{\circ}\text{C}$  ( $73.5^{\circ}\text{F}$ ) it can survive beyond 70 days when mixed with whole blood and nasal mucus. The viability of the organism in urine at all temperatures is less than 24 hours and less than 15 minutes at  $20^{\circ}\text{C}$  ( $68^{\circ}\text{F}$ ) and  $37^{\circ}\text{C}$  ( $98^{\circ}\text{F}$ ). It survives for less than 1 day in milk at room temperature or when incubated at  $37^{\circ}\text{C}$ , and should be considered as a possible cause of mastitis in cases that are negative on routine bacteriological culture.

## Immune mechanisms

Serum antibody tests measured by several serological tests do not correlate with susceptibility to clinical disease. Naturally acquired humoral immunity does not influence the outcome of experimental intravenous inoculation of the organism. Also, the role of naturally acquired antibodies in protecting cattle from disease is uncertain. The levels of naturally occurring serum bactericidal activity to *H. somni* are low or absent in calves at 4–6 months of age, when they are most susceptible to the nervous form of the disease. The levels increase with age and are high in mature cows; yearlings have intermediate levels.

Experimentally, convalescent sera from calves with experimental *H. somni*



pneumonia protects calves against acute *H. somni* pneumonia.<sup>21</sup> Marked serum exudation characterizes the early stages of experimental pneumonia, and antibody should be involved in protection. The specificity of this protection is directed primarily against surface-accessible antigens of the bacterial outer membrane. These antigens may also be useful in serological diagnosis because convalescent calves have high IgG<sub>1</sub> and IgG<sub>2</sub> titers to *H. somni* for several weeks. The measurement of serum IgG<sub>1</sub> is a more reliable test to detect a current or recently active infection. Later, there is a sustained increase in IgG<sub>2</sub>. The role of IgG<sub>2α</sub> antibodies in providing protection against *H. somni* pneumonia has been examined.<sup>22</sup> The development of a systemic IgG<sub>2</sub> antibody response is the basis for local immunological protection in the bovine reproductive tract.

The immune response in cattle to the major outer membrane protein during infection is weak and directed to antigenically variable determinants in a strain specific manner that may have important implications in protective immunity.<sup>23</sup> Vaccination of 1–2-month-old calves with commercial aluminum-hydroxide-adjuvanted *H. somni* bacterins elicits an ELISA-detectable IgE response 14 days after injection, which may be associated with severe clinical disease associated with type I hypersensitivity.<sup>24</sup>

### **PATHOGENESIS**

*H. somni* first establishes itself in the host by colonizing the surface of the mucous membranes. Some strains of the organism are able to invade the circulatory system and cause septicemia, with localization in many tissues and organs, causing a vasculitis. The ability of *H. somni* to survive in both mononuclear phagocytes and neutrophils may be important in the establishment of the chronic multi-systemic infection characteristic of bovine haemophilosis.<sup>18</sup> In the thrombotic meningoencephalitic form of the disease, the sequence of events in the genesis of the lesions may be adhesion of the organism to vascular endothelial cells. The organism lipo-oligosaccharide induces endothelial cell apoptosis, which may play a role in producing vasculitis.<sup>25</sup> Contraction and desquamation of cells, with exposure of subendothelial collagen, thrombosis and vasculitis, is followed by ischemic necrosis of adjacent parenchyma. The common site of localization is the brain, causing a thrombomeningoencephalitis. Multifocal areas of hemorrhagic necrosis occur throughout the brain, resulting in the major clinical findings of depression, paresis, and recumbency. Localization in synovia results in poly-

synovitis. Fibrin thrombi occur in the small vessels and capillaries of the liver, spleen, kidney, lung, heart, and brain, which suggests that disseminated intravascular coagulation may be a feature of the pathogenesis of *Haemophilus* septicemia. Myocarditis has been recognized with increased frequency<sup>6,26</sup> and is characterized by acute or chronic heart failure.

The pathogenesis of the pneumonia is not clear. Although *H. somni* has been isolated from cattle with bronchopneumonia and fibrinous pneumonia in pure culture and in combination with *Pasteurella* spp., the lungs of cattle dying with thrombomeningoencephalitis are not usually affected with a fibrinous pneumonia. The pneumonia that is attributed to the organism is characteristically subacute or chronic and it is probable that the portal of entry is via the upper respiratory tract. However, it is difficult to reproduce the disease by aerosol challenge with *H. somni*.<sup>20</sup> The organism produces and secretes histamine, which may be enhanced by carbon dioxide concentrations that approximate those in the bronchial tree.<sup>17</sup> This may explain some of the postvaccination reactions.

The microscopic lesions in the lungs of cattle with pneumonia from which *H. somni* is isolated consist of suppurative to necrotizing bronchiolitis, particularly in calves with subacute to chronic pneumonia. The experimental pneumonia is characterized by purulent to fibrinopurulent bronchiolitis accompanied by alveolar filling with fibrin, neutrophils, and macrophages. Laryngitis and polypoid tracheitis have also been attributed to *H. somni*, but the evidence for a cause and effect relationship is limited.

Hemorrhagic necrotic lesions also occur in the spinal cord, which contributes to the muscular weakness, recumbency, and paralysis encountered in some cases with or without brain lesions. Lesions in the esophagus, forestomachs, and intestines may account for the bloat and alimentary tract stasis that occurs in the experimental disease.

The septicemia usually causes a marked leukopenia, neutropenia, and degenerative left shift.

Cattle dying of experimentally induced and naturally occurring disease have high levels of agglutinating anti-*H. somni* antibody, but not of complement-fixing antibody. Because septicemia can occur even with high levels of serum antibody, it is hypothesized that the formation of antigen-antibody complexes may contribute to the development of the vasculitis. It is possible that previous exposure to *H. somni* infection is necessary for typical thrombomeningoencephalitis to occur. Inoculation of colostrum-deprived calves

with *H. somni* causes septicemia but does not produce lesions typical of thrombomeningoencephalitis. This suggests that the disease may be an example of a type III hypersensitivity reaction or serum sickness.

The organism can cause inflammatory disease in the genital tract of cows or may merely colonize the healthy genital mucosa.<sup>3</sup> Vaginitis, cervicitis, and endometritis have been associated with infection by *H. somni*. Experimentally, the organism can be embryocidal, which indicates a possible role in early embryonic mortality. Sporadic abortions have been reported following septicemia.<sup>3</sup>

### **CLINICAL FINDINGS**

The range of clinical findings associated with *H. somni* infection in cattle has changed remarkably in the last two decades. Historically, thrombotic meningoencephalitis was the major form of the disease. However, fewer cases of the nervous form are being diagnosed now while many more cases of other forms of the disease are becoming prevalent.<sup>6</sup>

#### **Meningoencephalitis**

In the typical **nervous form** of the disease, it is common for several animals to be affected within a few days or at one time, but single cases do occur. Some affected animals may be found dead without any premonitory signs and often this may be the first sign of disease in the group.

In the more common acute form, in which there is usually neurological involvement, cattle may be found in lateral or sternal recumbency and may not be able to stand. The temperature is usually increased up to 41–42°C (105.8–107.6°F) but in some cases it may be normal. Depression is common, the eyes are usually partially or fully closed and, while blindness may be present in both eyes, it is usually confined to one eye, or the eyes may be normal. Originally the disease was called the '**sleepers syndrome**' because the eyes were partially closed. Recumbent cattle that attempt to stand may have considerable difficulty and exhibit obvious ataxia and weakness. Others that are able to stand, when attempting to walk, knuckle over on the hind fetlocks, are grossly ataxic, and usually fall after walking a short distance. In the recumbent position, opisthotonos, nystagmus, muscular tremors, hyperesthesia, and occasionally convulsions will occur, but the emphasis is on muscular weakness and paralysis rather than signs of irritation. Otitis media with concurrent meningitis may also occur.

The **nervous form** of the disease is rapidly fatal in 8–12 hours if not treated

when signs are first noticed. Affected cattle that are treated before they become recumbent commonly recover in 6–12 hours, which is an important clinical characteristic of the disease. Once recumbent, particularly with obvious neurological involvement, they will either die in spite of treatment or remain recumbent and fail to improve or get worse over several days. Secondary complications, such as pneumonia and decubitus ulcers, usually result. The organism has been isolated from a 5-month-old ram that died suddenly with pathological evidence of septicemia.

The **ocular lesions** consist of foci of retinal hemorrhages and accumulations of exudate that appear like 'cotton tufts'. While these fundic lesions are not present in all cattle affected with *H. somni*, they are a valuable aid to the diagnosis. The organism has been isolated from the conjunctival sacs of feedlot cattle affected with conjunctivitis.

**Otitis in feedlot cattle** has also been attributed to the organism. The ears are commonly drooping and affected animals appear depressed. A combination of otitis and meningitis young cattle associated with the organism has been described.<sup>27</sup>

The **synovitis** is characterized by distension of the joint capsules, usually the major movable joints such as the hock and stifle joints but any joint may be involved. Pain and lameness are only mild and, when treated early, the synovitis usually resolves in a few days. In a few cases there is marked lameness and a preference for recumbency associated with hemorrhages in muscle. The organism has been isolated from a calf with a urachal abscess.<sup>28</sup>

### Respiratory disease

The clinical findings of the **respiratory form** of the disease, which has been diagnosed with increased frequency in the last decade, have not been clearly described. There are no published descriptions available of the clinical findings of pneumonia or pleuritis associated with the organism. It is unlikely that there are any distinctive clinical features. Most feedlot calves with pleuritis due to *H. somni* die in the pen without ever having been treated.

Epidemiological surveys of weaned beef calf mortality due to pneumonia and pleuritis associated with *H. somni* suggest that death from pneumonia occurred during the first 5 weeks after arrival in the feedlot.<sup>11</sup> The **median fatal disease onset** for pneumonia was day 12, and for myocarditis and pleuritis, day 22. It is suggested that pneumonia and pleuritis should be suspected in feedlot cattle that have been treated unsuccessfully for bovine respiratory disease in the previous

several days. Laryngitis, tracheitis, pleuritis, and pneumonia can occur alone or in combination with the acute neurological form of the disease. The laryngitis is characterized clinically by severe dyspnea, mouth-breathing, and stertor. Conjunctivitis similar to that seen in infectious bovine rhinotracheitis may occur and isolation of the organism from ocular swabs is necessary to make the definitive diagnosis. Chronic suppurative orchepididymitis in a calf from which *H. somni* was isolated has been described.

### Myocarditis

In the **myocardial form** of the disease, affected animals may be found dead without any previous illness having been recorded or they may have been treated for respiratory disease within the previous few weeks with a variable response. If seen early in the course of the myocarditis, the most common clinical findings are a fever and depression.<sup>14</sup> With advanced stages of myocarditis, exercise intolerance, mouth-breathing, and protrusion of the tongue occur. Affected animals may collapse and die while being moved from their home pen to the hospital pen in the feedlot. Most animals with myocarditis have a previous history of being treated for an undifferentiated fever and depression within the previous 10–14 days. When returned to their home pens, they may be found dead or in severe respiratory distress.

**Chronic free-gas bloat** is a not uncommon finding in naturally occurring cases and occurs frequently in the experimental disease.

### CLINICAL PATHOLOGY

#### Hematology

In most cases there are changes in the total and differential leukocyte count. Leukopenia and neutropenia may be present in severe cases while in less severe cases a neutrophilia with a left shift is more common. In the cerebrospinal fluid, the total cell count is markedly increased and neutrophils predominate. The Pandy globulin test on cerebrospinal fluid is usually strongly positive. In the synovial fluid the total cell count is also increased and neutrophils predominate.

#### Culture of organism

The organism can be cultured from blood, cerebrospinal fluid, synovial fluid, urine, brain, kidney, and liver, less commonly from pleuritic fluid and tracheal washings. The laboratory isolation of *H. somni* from swabs, tissues, and body fluids requires special transport media and selective culture media to insure reliable recovery. It is difficult to determine whether a positive culture of the organism from a mucosal surface indicates an

etiological role or merely a carrier role. The PCR technique is a more sensitive method for detection of the organism on swabs from either the cut surface or from a bronchus than bacterial culture and immunochemistry.<sup>29</sup>

### Serology

Cattle with experimental or naturally occurring disease have high levels of agglutinating anti-*H. somni* antibody. Recovered animals are positive to the CFT within 10 days following infection and titers begin to decline to low levels 30 days after infection. Acute and convalescent sera are required for accurate interpretation of results.

A microagglutination test is available but most cattle are positive. Naturally or experimentally infected animals have elevated IgG<sub>2</sub> antibody titers compared to controls. However, there is no significant difference in serum IgG<sub>2</sub> titers between culturally negative and culturally positive but asymptomatic animals. An immunoblot test can detect an immune response after experimental abortion, experimental pneumonia or vaccination with a killed vaccine. It is also able to distinguish between animals with an immune response due to disease or vaccination with the organism and those animals that are asymptomatic carriers, culture negative or infected with closely related bacteria.

### NECROPSY FINDINGS

The characteristic lesions of the nervous form are hemorrhagic infarcts in any part of the brain and spinal cord. These are usually multiple and vary in color from bright red to brown and in diameter from 0.5–3 cm. Cerebral meningitis may be focal or diffuse and the cerebrospinal fluid is usually cloudy and slightly yellow-tinged. Hemorrhages may also be present in the myocardium, skeletal muscles, kidneys, and the serosal surfaces of the gastrointestinal tract.

There may be petechiation and edema of the synovial membranes of joints. There is an excessive quantity of synovial fluid, which is usually cloudy and may contain fibrinous flecks. The articular cartilage is usually not affected.

Pulmonary involvement is characterized by a fibrinopurulent bronchopneumonia, although the posterior aspects of the lung may be edematous and have a rubbery consistency. Histologically there is fibrinopurulent bronchiolitis accompanied by filling of the alveoli with fibrin, neutrophils, and macrophages. Peribronchiolar fibrosis and bronchiolitis obliterans, interlobular fibrosis and thrombosis of interlobular and pleural lymphatics develop in chronic cases. Fibrinous or serofibrinous inflammation of the peritoneum, pericardium, or pleura is found in more than 50% of cases. There

may be focal ulceration and fibrino-necrotizing inflammation extending from the pharynx down into the trachea. Poly-poid tracheitis has also been reported.

Histologically, vasculitis and thrombosis with or without infarctions and a cellular component composed almost entirely of neutrophils may be seen in all tissues where localization occurs, especially the heart. Myocardial abscesses may develop and are most common in the left ventricular free wall, particularly in the papillary muscles.

*H. somni* is easily cultured from the tissues of untreated animals but immunohistochemical techniques can be attempted to demonstrate the organisms if culture is unsuccessful.<sup>30,31</sup>

#### Samples for confirmation of diagnosis

- Bacteriology – culture swabs from brain/meningeal and joint lesions; lung, spleen, heart (CULT)
- Histology – formalin-fixed brain, lung, heart, kidney, synovial membrane (LM, IHC).

#### DIFFERENTIAL DIAGNOSIS

**Meningoencephalitis** due to *H. somni* is characterized by sudden onset of weakness, ataxia, depression, fever, enlarged joints and rapid death within 12–24 hours. There are marked changes in the cell count of the cerebrospinal fluid and the leukogram. There is a rapid response to treatment in the early stages.

- In **polioencephalomalacia**, blindness, normal temperature, nystagmus, opisthotonos, and convulsions are common
- In **Listeria meningoencephalitis** there is unilateral facial paralysis with deviation of the head and neck and a normal or slightly increased temperature. The cerebrospinal fluid in listeriosis usually contains an increased number of mononuclear cells
- **Hypovitaminosis A** in young cattle 6–12 months of age is characterized by sudden onset of short-term convulsions and syncope lasting 10–30 seconds, during which they may die but from which they more commonly recover to appear normal. Exercise such as walking from pasture to the farmstead will commonly precipitate the seizures. Eyesight may be slightly impaired but the menace reflex is usually present. The differential diagnosis of diseases of the brain of cattle is summarized in Table 31.3

**Pneumonia and pleuritis** associated with *H. somni* cannot be distinguished clinically from the other common causes of pneumonia in cattle and the diagnosis is usually made at necropsy.

**Myocarditis** due to *H. somni* may cause sudden death or congestive heart failure, which will require a necropsy examination for a diagnosis.

#### TREATMENT

Cattle with the nervous form of the disease must be treated with antimicrobials as soon as clinical signs are obvious. Florfenicol, an analog of thiamphenicol, at a dose of 20 mg/kg BW intramuscularly and repeated 48 hours later, is effective for the treatment of acute undifferentiated fever in feedlot calves<sup>32</sup> and may be the antimicrobial of choice if *H. somni* infection is a major cause of mortality in feedlot calves. Oxytetracycline at 20 mg/kg BW intravenously daily for 3 days is effective when treatment is begun within a few hours after the onset of clinical signs. The prognosis in recumbent cattle is unfavorable but treatment for 2–4 days may be attempted. A failure to respond after 3 days of treatment usually indicates the presence of irreversible lesions. The MICs of 33 antimicrobial agents for *H. somni* indicated high susceptibility to penicillin G, ampicillin, colistin, and novobiocin. Oxytetracycline also revealed high activity. Once the disease has been recognized in a group, all in-contact animals should be observed closely every 6 hours for the next 7–10 days to detect new cases in the initial stages so that early treatment can be given. Mass medication of the feed and water supplies may be indicated but efficacy and benefit–cost data are not available.

The treatment of pneumonia and pleuritis due to *H. somni* is the same as for acute undifferentiated bovine respiratory disease.

#### CONTROL

Satisfactory control procedures are not available because the pathogenesis and epidemiology of the disease are not well understood. When an outbreak of the nervous form of the disease is encountered, the provision of constant surveillance and early treatment is probably the most economical and effective means of control.

#### Mass medication

Postarrival mass medication with long-acting oxytetracycline has been evaluated to reduce the risk of hemophilosis mortality in feedlots.<sup>33</sup> Mass medication did not reduce the risk of hemophilosis mortality but it reduced the risks of bovine respiratory disease morbidity and mortality by 14% and 71%, respectively.<sup>33</sup> Hemophilosis accounted for 40% of the mortality in the feedlot calves for each year over 3 years.

#### Vaccination

Vaccines have been available for use in North America but their efficacy is uncertain. One bacterin is immunogenic and will protect vaccinated cattle against

the **nervous form** of the infection produced by intravenous and intracasternal inoculation of the organism.<sup>6</sup> Two injections of the bacterin given subcutaneously 2–3 weeks apart are recommended. Controlled field trials indicate that the bacterin reduces the morbidity and mortality rates of nervous system disease in vaccinated cattle compared to non-vaccinated animals. However, the efficacy of the bacterin has been difficult to evaluate because the incidence of naturally occurring disease in nonvaccinated control animals is usually low and may not be significantly greater than in vaccinated animals.

The efficacy of a *H. somni* bacterin to reduce mortality was evaluated in auction-market-derived beef calves vaccinated immediately upon arrival at the feedlot.<sup>34</sup> The vaccine had no significant effect on overall crude mortality but appeared to reduce the incidence rate of fatal disease during the first 2 months in the feedlot when the risk of fatal disease onset was highest. When mortalities unlikely to be associated with *H. somni* were removed from the analysis, the mortality rate in male calves was reduced by about 17% in the vaccinated group. The incidence rate of fatal disease was higher in female calves during the first week. A second vaccination 2 weeks after arrival did not reduce the mortality risk.

Vaccination of feedlot calves on arrival with a genetically attenuated leukotoxin of *M. haemolytica* combined with bacterial extracts of *H. somni* increased serum antibody titers to both organisms and reduced acute undifferentiated bovine respiratory disease.<sup>35</sup> However, it is not known what proportion of the respiratory disease was due to *H. somni*.

Vaccinating calves twice with a killed whole-cell bacterin reduced the clinical and pathological effects of experimentally induced *H. somni* pneumonia. Calves vaccinated once were incompletely protected.

There is no published evidence to indicate that vaccination of feedlot calves before or after entry into the feedlot with any of the available *H. somni* vaccines will provide protection against the various forms of clinical disease, particularly the respiratory and myocardial types described earlier. The disease complex is occurring in feedlot calves in spite of vaccination.<sup>11</sup> A rational vaccination program would consist of vaccinating calves at least twice, 2–4 weeks apart, with the second vaccination occurring at least 2 weeks before entry into the feedlot.

#### REVIEW LITERATURE

Humphrey JD, Stephens LR. *Haemophilus somnus*: a review. Vet Bull 1983; 53:987–1004.

- Miller RB, Lein DH, McEntee KE et al. *Haemophilus somnus* infection of the reproductive tract: a review. *J Am Vet Med Assoc* 1983; 182:1390-1392.
- Little PB. *Haemophilus somnus* complex: pathogenesis of the septicemic thrombotic meningoencephalitis. *Can Vet J* 1986; 27:94-96.
- Harris FW, Janzen ED. The *Haemophilus somnus* disease complex (hemophilosis): a review. *Can Vet J* 1989; 30:816-822.
- Kwiecien JM, Little PB. *Haemophilus somnus* and reproductive disease in the cow: a review. *Can Vet J* 1991; 32:595-601.
- Siddaramappa S, Inzana TJ. *Haemophilus somnus* virulence factors and resistance to host immunity. *Anim Health Res Rev* 2004; 5:79-93.

## REFERENCES

- Angen O et al. *Int J Syst Evol Microbiol* 2003; 53:1449.
- Corbeil LB et al. In: Donachie W et al, eds. *Haemophilus, Actinobacillus, and Pasteurella*. New York: Plenum Press, 1995:93.
- Kwiecien JM, Little PB. *Can Vet J* 1991; 32:595.
- Siddaramappa S, Inzana TJ. *Anim Health Res Rev* 2004; 5:79-93.
- Orr JP. *Can Vet J* 1992; 33:719.
- Harris FW, Janzen ED. *Can Vet J* 1989; 30:816.
- Grinberg A et al. *Israel J Vet Med* 1993; 48:61.
- Ward ACS et al. *Can J Vet Res* 1999; 63:166.
- Dyer NW. *J Vet Diagn Invest* 2001; 13:419.
- Descarga CO et al. *Vet Rec* 2002; 150:817.
- VanDonkersgoed J et al. *Can Vet J* 1990; 31:821.
- Wessels J et al. *Vet Rec* 2004; 154:608.
- Lees VW et al. *Can J Vet Res* 1990; 54:331.
- Martin SW et al. *Can J Vet Res* 1998; 62:262.
- Booker CW et al. *Can Vet J* 1999; 40:40.
- O'Connor A et al. *Can J Vet Res* 2001; 65:143.
- Ruby KW et al. *Compend Immunol Microbiol Infect Dis* 2002; 25:13.
- Gomis SM et al. *Microb Pathog* 1998; 25:227.
- Shahriar FM et al. *Can Vet J* 2002; 43:863.
- Tegtmeier C et al. *Vet Microbiol* 2000; 72:229.
- Gogolewski RP et al. *Infect Immun* 1987; 55:1403.
- Corbeil LB et al. *Can J Vet Res* 1997; 61:207.
- Tagawa Y et al. *Vet Microbiol* 2000; 71:245.
- Ruby KW et al. *Vet Microbiol* 2000; 76: 373.
- Sylte MJ et al. *Infect Immun* 2001; 69:1650.
- Guichon PT et al. *Can Vet J* 1988; 29:1012.
- Duarte ER, Hamdan JS. *J Vet Med B* 2004; 51:1.
- Starost MF et al. *Vet Pathol* 2001; 38:547.
- Tegtmeier C et al. *Vet Microbiol* 2000; 76:385.
- Haines DM et al. *Can Vet J* 2004; 45:231.
- Haines DM et al. *Can Vet J* 2001; 42:857.
- Booker CW et al. *Can Vet J* 1997; 38:555.
- VanDonkersgoed J et al. *Can Vet J* 1994; 35:573.
- Ribble CS et al. *Can J Vet Res* 1988; 53:491.
- VanDonkersgoed J et al. *Can Vet J* 1993; 34:731.

## INFECTIOUS POLYARTHRI- TIS (GLASSER'S DISEASE, PORCINE POLYSEROSITIS AND ARTHRITIS)



### **Etiology** *Haemophilus parasuis*

**Epidemiology** Common in pigs several weeks after weaning and up to 4 months of age. Sporadic outbreaks. Environmental stressors are risk factors

**Signs** Sudden onset of anorexia, dyspnea, lameness, swollen joints, fever, nervous signs, and death

**Clinical pathology** Culture organisms from serous membranes

**Lesions** Peritonitis, pleuritis, synovitis, meningitis

**Diagnostic confirmation** Culture organism and a variety of new techniques

**Differential diagnosis** Erysipelas, mycoplasmal and streptococcal arthritis, other serositis, also *Actinobacillus pleuropneumoniae* infection, vitamin E deficiency

**Treatment** Antimicrobials

**Control** Minimize stressors at weaning and in nursery barns

## ETIOLOGY

Initially, the agent was thought to be *Haemophilus influenzae suis*, now known to be *Haemophilus parasuis*.<sup>1,2</sup> Now recognized as one species, it is, however, extremely pleomorphic. There were many serovars, reported first in 1952<sup>3</sup> and many of these were incorporated into a modified classification<sup>4</sup> of 15 major serotypes. *H. parasuis*, together with other *Haemophilus* spp. has an affinity for the mucosa<sup>5</sup> of the oropharyngeal and upper respiratory tract.<sup>5-7</sup> *H. parasuis* can be isolated from the nasal cavity,<sup>8</sup> tonsillar area,<sup>9</sup> and trachea.<sup>10</sup> It may be a true commensal in the upper respiratory tract.<sup>7</sup> Responsible for a severe polyserositis in young pigs, it may also occasionally cause an arthritis in older pigs and the individual sow. The organism, like the others with a similar name, *Actinobacillus suis* and *Streptococcus suis*, has been called one of the 'suis-cides' of pigs, which are responsible for considerable economic loss in high-health herds and herds that practice very early weaning.<sup>11</sup> *H. parasuis* is also commonly isolated from lungs with lesions of enzootic pneumonia.<sup>12-16</sup>

## EPIDEMIOLOGY

Although the disease occurs worldwide, reports used to be rare and mainly from Europe. However, since the onset of separate site production, and the occurrence of porcine reproductive and respiratory syndrome, virulent forms of swine influenza and PCV2-associated diseases the disease (*H. parasuis*) has become one of the most common of the so-called secondary infections. It is a significant contributor to the porcine respiratory disease complex. In naive or specific-pathogen-free herds when it first occurs it may be a common cause of sudden death and cases may be numerous. It also under these circumstances affects younger animals. When the disease becomes endemic it may affect older animals with less sudden death but more chronic polyserositis. The disease has also been observed in Australia, the USA,<sup>17,18</sup> Canada,<sup>19</sup> and the UK. The disease accounted for less than 1% of total mortalities of pigs submitted to veterinary diagnostic laboratories over an 11-year period in Ontario.<sup>19</sup> However, the disease

was the second most common cause of mortality in test station boars. In a survey of 19 excellent specific-pathogen-free pig herds, 16 were positive and the average number of culture-positive pigs per herd was 6/10 for positive herds.<sup>19</sup>

It is probably spread by aerosol and certainly by nose-to-nose contact.

The disease occurs as sporadic outbreaks - usually in weaning to 4-month-old pigs that have been recently chilled, transported, weaned or moved to different pens. The onset is sudden, with several pigs in the group affected, and occurs within 2-7 days of the initiating stress. Occasionally, it causes arthritis in older animals, or even sow herds. The case-fatality rate is high in untreated pigs. Acute myositis in primary specific-pathogen-free sows has been associated with *H. parasuis*.<sup>20</sup>

Little is known of the method of transmission of the disease. The causative organisms are facultative pathogens and can be frequently isolated from pig lungs diseased from other causes, even though they are generally not present in normal lungs. It is probable that a respiratory carrier state does exist and that invasion with subsequent septicemia and polyserositis is initiated by stress situations in young pigs that have lost maternal immunity but have not yet gained active immunity. Piglets probably acquire the infection soon after birth but maternal antibody protects them from clinical disease until they are 2-4 weeks of age. Animals that are weaned early are likely to have this infection so the supposition is that most pigs acquire the infection at or immediately after birth. *H. parasuis* has been found in the tonsil using IHC and EM.<sup>8</sup>

There are several pathogenic serovars of *H. parasuis*.<sup>2,8</sup> Serotypes 3, 6, 7, 8, 9, and 11 are considered to be avirulent, 15 more pathogenic and 1, 4, 5, 10, 12, 13, and 14 virulent.<sup>21</sup> However this pattern cannot be considered permanent as genes can be shared and in any case up to 50% of isolations are considered nontypeable. In the USA and Canada 15.2% were classified as untypeable,<sup>2</sup> 26.2% in Germany,<sup>22</sup> 29.3% in Spain,<sup>23</sup> and 41.9% in Australia.<sup>24</sup> In a particular pig herd, many strains can be isolated but, in most cases, one or two strains predominate.<sup>25</sup> In many herds the untypeable outnumber the typeable. Of seven reference strains examined, only serotypes 1 and 5 were pathogenic<sup>26</sup> and the seven strains have common antigenic determinants. Within specific-pathogen-free herds, many herds have common strains; no strains are common to both conventional and specific-pathogen-free herds, which is a reflection of little or no movement of pigs

between these types of herd. Specific-pathogen-free pigs are often free of this organism and are highly susceptible to the infection even at several months of age if they are mixed with conventionally raised pigs that may be infected. Outbreaks with rapid spread and high mortality have been reported in specific-pathogen-free pigs.<sup>27</sup> It has been suggested that the causative bacteria are common in most herds and that the disease arises only when pigs from uninfected herds are introduced to a contaminated environment, especially if they have been exposed to environmental stress during transport. When infection is introduced into a previously noninfected herd the disease may act as a contagious disease until herd immunity is developed or the infection eliminated. Recently, it has been suggested that the nasal cavity strains may be nonpathogenic and form a completely different population to the pathogenic strains.<sup>25</sup> Serotypes from nasal and tracheal cultures were shown to be similar in one study.<sup>28</sup> They found that there was a lower level of colonization in the litters of the young sows. The genetic diversity of the strains is not well understood.<sup>29</sup> Several serotypes may be isolated from the same herd or even from the same pig.

### **PATHOGENESIS**

One of the key factors may be that maternal antibody does not last a long time and may be gone by 2–4 weeks of age but will last until 6–8 weeks if sow antibody titers are high. It is the animals that become infected after their maternal protection has waned that have resulting clinical disease. Serovar 5 is highly virulent when inoculated into specific-pathogen-free piglets 6–8 weeks of age.<sup>30</sup> *Bordetella bronchiseptica* increases *H. parasuis* colonization of the nasal cavity.<sup>31</sup> However, it is also said that previous infection with PRRSV has no effect on the occurrence.<sup>32</sup> The severity of the disease increases with the increase in the dose of the organisms.<sup>33</sup>

The precise relationship between protein patterns, serovars, and virulence potential remains to be defined.<sup>34</sup> A new technique called differential display reverse transcription PCR (RT-PCR) has been used to search for virulence factors.<sup>35</sup> The pathogenic *H. parasuis* may have an outer membrane protein, fimbriae and lipopolysaccharides and a cytotoxin has yet to be described but may be a membrane neuraminidase.<sup>36</sup> The outer membrane protein may be iron-regulated and appear to have similar outer-membrane protein profiles.<sup>37</sup> A fibrinous meningitis, polyserositis and polyarthritis are typical. A fatal septicemia can occur spontaneously

or following the intraperitoneal inoculation of pigs with *H. parasuis*. The intranasal inoculation of *H. parasuis* into cesarean-derived colostrum-deprived pigs results in a suppurative rhinitis, which may represent an initial event in the pathogenesis of the systemic infection in pigs.<sup>5</sup> After infection with *H. parasuis* there is a highly significant rise in radical formation and monocyte proliferation was reduced. Neutrophils reacted inconsistently.<sup>38</sup> In this experimental study the CD25<sup>+</sup> marker cells were markedly reduced. Experimental infections<sup>39</sup> showed that not all field isolates are pathogenic and it may be that route of infection and dosage are most important in determining the outcome of infections. In a new study, polyacrylamide gel electrophoresis (PAGE) typing of *H. parasuis* and virulence potential based on site were looked at together.<sup>40</sup> PAGE group I had 83.4% of the isolates from the upper respiratory tract (these were mostly of serotype 3 or untypable) but of the PAGE group II isolates 90.7% of all the isolates were from the systemic sites (these are mostly serotypes 1, 2, 4, 5, 12, or 14). It may be that there is also a tropism for some of the sites in that some strains are only found in the brain and others in the pericardium.<sup>41</sup> This means that the systemic sites are the best sites for the identification of pathogenic *H. parasuis*.

Most practitioners have the opinion that the problem is more apparent when there is predisposing viral infection, particularly PRRS, swine influenza, or PCV2. Although most practitioners would say that the prevalence of PRRS-associated *H. parasuis* infections have increased the natural occurrence of *H. parasuis*, experimental confirmation is lacking.<sup>32,42</sup> Only PRRS consistently increased the isolation of *H. parasuis* from the lung.<sup>43</sup>

On the other hand, both PRRS and *B. bronchiseptica* increase the colonization of the upper respiratory tract by *H. parasuis*. There is no additive effect here. There is no doubt that the occurrence of the vasculitis plays a part in the pathogenesis.

### **CLINICAL FINDINGS**

In the naive herd and where specific-pathogen-free animals have entered commercial herds, sudden death may be the only feature. Some people are of the opinion that there may be polyserositic, arthritic, and meningitic forms.

The onset is sudden, with a fever, an unusual rapid, shallow dyspnea with noisy lung fields, an anxious expression, extension of the head, and mouth-breathing. There may be a serous nasal discharge and coughing may occur. Depression and anorexia are observed.

The animals are very lame, stand on their toes, and move with a short, shuffling gait. All the joints are swollen and painful on palpation and fluid swelling of the tendon sheaths may also be clinically evident. In many animals there may be just a single joint affected and that is often the hock. A red to blue discoloration of the skin appears near death. Most cases die 2–5 days after the onset of illness. Animals that survive the acute stage of the disease may develop chronic arthritis, and some cases of intestinal obstruction caused by peritoneal adhesions occur. Meningitis occurs in some pigs, particularly when these are naive or where there is an acute onset, and is manifested by muscle tremor, paralysis and convulsions. Although Glasser's disease can occur in pigs of any age, weanling pigs are most commonly and most seriously affected. In chronic cases, pigs may lose part of an ear as a result of ischemic necrosis. There may be also wasting piglets who fade and die.

Another type of syndrome of necrosis of the masseter muscles was described<sup>44</sup> in which sows had swollen, cyanotic heads with *H. parasuis* isolated from the affected muscles. Purulent rhinitis has also been described.<sup>45,46</sup>

### **CLINICAL PATHOLOGY**

The disease is essentially a polyserositis and arthritis and as a result the organism is recoverable from joint fluid and pleural exudate. Material aspirated from joints may be serous, fibrinous, or purulent. It may just be a few fibrin tags that have organized from an initial fibrinous exudate. The disease can be diagnosed serologically on the presence of precipitins in the serum of recovered pigs, and complement-fixing antibody can be detected following infection. But these are not reliable methods. In an experiment where 183 specific-pathogen-free pigs were given infections, the hemoglobin concentrations and hematocrit fell.<sup>47</sup> Leukopenia developed 1–2 days after infection, with leukocytosis later. Any changes in the cerebrospinal fluid were not related to the clinical signs. One of the common findings in *H. parasuis* infections is vitamin E deficiency, and this is most likely to be as a result of the toxic oxygen radical damage.

### **NECROPSY FINDINGS**

In the main, Glasser's disease is associated with three main lesions: fibrinous polyserositis and arthritis, signs of septicemia, toxemia and in some cases no gross lesions at all.

In some cases all that is seen is a small amount of peritoneal fluid or a very thin fibrin strand (tag).

A serofibrinous or fibrinous pleuritis, pericarditis and peritonitis are usually present but the exudate is scanty in some cases. Pneumonia may also be apparent. There is inflammation and edema of the periarticular tissues and the joint cavities contain turbid fluid and flattened, discoid deposits of yellowish green fibrin. A suppurative rhinitis is also possible. A fibrinopurulent meningitis is common. In specific-pathogen-free pigs, the lesions may be minimal and only successful isolation of the organism permits the differentiation of Glasser's disease from other causes of sudden death. The distinction may be a difficult one because of the fastidious culture requirements of *H. parasuis*. Eventually, all surfaces are covered with a thick mat of fibrin where the individual organs may be difficult to recognize. This eventually becomes fibrotic. The spleen and liver may be enlarged.

Histologically, acutely affected serosal surfaces are thickened by neutrophils entrapped in a matrix of fibrin. As these lesions age, fibrous adhesions may develop and lead to chronic pleuritis, arthritis and pericarditis. Such cases are often culture-negative, even when selective media are used. Most isolates are made from the lungs.

### Samples for confirmation of diagnosis

#### Bacteriology

The collection of samples from animals that have been dead for several hours is not worth considering even at the best of times and certainly not when *H. parasuis* is suspected. An acutely affected live pig, freshly autopsied, will give much better results, especially if there is no overheating of the carcass postmortem or subsequent cooling, as the organism is temperature-sensitive. Transport media to the laboratory will also be beneficial in recovery rates. It is said that culture of the nasal swabs will be as rewarding as collecting tracheal swabs but it is likely that the larynx and below is normally sterile. What you isolate from the nasal cavity may then be a commensal population of largely nontypable species, whereas the trachea harbors the pathogenic forms. Other authors say that they are the same serotypes.<sup>28</sup> These authors have also found that a lower level of colonization was found in the litters of young sows, and a low level of colonization at weaning probably predisposed pigs to clinical disease in the nursery, assuming the presence of a virulent serotype.

Culture swabs from serosal surfaces, including joints and meninges. It is essential to collect samples from areas that are not enclosed in fibrin. Nasal swabs are

more easily collected than tracheal but may indicate a different population of *H. parasuis*.<sup>28</sup> It is usually said that it is difficult to isolate from fluids<sup>48</sup> but is easier from the lesions. It is necessary to have a fresh pig with no antibiotic therapy. It may also be necessary to use Amies transport medium to preserve *H. parasuis* on the way to the laboratory.<sup>49</sup>

*H. parasuis* is a Gram-negative rod existing as a coccobacillus to long filamentous chains. There is usually a capsule but the expression of this is influenced by culture.<sup>2</sup> NAD or V factor is required for growth (chocolate agar or staph streak and then there is satellite growth). The availability of NAD may determine growth capabilities.<sup>50,51</sup> After 24–48 hours the colonies are small, translucent and nonhemolytic on chocolate agar.

#### Histology

Formalin-fixed brain, synovial membranes, liver, lung (LM). Immunohistochemistry can be used to show the organisms in the cytoplasm of neutrophils and macrophages in the lungs and in the mononuclear cells in the subscapular and medullary sinuses of the lymph nodes.<sup>52</sup> Immunofluorescence was observed on the bronchiolar epithelium in the alveoli and in the lung parenchyma.<sup>53</sup>

#### Serology

Recently an indirect hemagglutination test has been described for the serotyping of field isolates.<sup>49</sup> A new indirect hemagglutination technique has just been described<sup>21</sup> and it is rapid and effective. It is also much more sensitive than the immunodiffusion test.

#### DIAGNOSIS

The first improvement in the diagnosis of *H. parasuis* occurred with the development of an oligonucleotide-specific plate hybridization assay<sup>54,55</sup> that could be used on the nasal swabs. The assay detects fewer than 100 cfu/mL in a pure culture and gives a positive result when *H. parasuis* is present in the ratio of 1:10<sup>3</sup>–10<sup>4</sup> in a mixed culture. The assay is more sensitive than culture for detection of *H. parasuis* in nasal swabs.

In-situ hybridization<sup>56</sup> will demonstrate a patchy to multifocal distribution of *H. parasuis* in the lung.

A repetitive-element-based polymerase chain reaction (rep-PCR) has been developed,<sup>19,57</sup> which is a technique that compares very favorably with traditional microbiology. The rep-PCR uses repetitive sequences within the bacterial genome to produce strain-specific fingerprints, allowing comparison and differentiation between *H. parasuis* strains. This enables comparison of these strains and allows the source of virulent strains to be identified.

Another new technique is ERIC-PCR,<sup>24</sup> and this is very successful compared with conventional microbiological techniques. Identification and differentiation of *H. parasuis* using a species-specific PCR with subsequent DNA fingerprinting using the digestion of PCR products using Hind III endonuclease has been described.<sup>58</sup> This PCR-RFLP (restriction fragment length polymorphism) enabled eight patterns to be determined for the untypable strains.

Recently, a technique for the computer-based analysis of *H. parasuis* protein fingerprints has been described that is a considerable improvement on serotyping.<sup>40</sup> It was shown<sup>59</sup> that there is a high genetic diversity within the serovars. The authors described at least 12 different strains within the type 4 serovar and genetic diversity in the other serotypes as well. Nontypable isolates were divided into 18 genotypes. The major advantage of this technique is that there is no need for isolation, culture, and biochemical identification of the isolates. In addition, all strains can be identified, not just those of certain serotypes.<sup>59</sup> At the moment there is no direct demonstration of a linkage between PCR-RFLP, OMP patterns and serotyping and rep-PCR. In a recent study,<sup>60</sup> 32 strains were grouped into six serovars and 11 genotypes. This led to the hypothesis that *H. parasuis* strains with a similar distribution of repetitive sequences can express different antigens.

#### DIFFERENTIAL DIAGNOSIS

The unusual combination of arthritis, fibrinous serositis, and meningitis is sufficient to make a diagnosis of Glasser's disease, but differentiation from the many similar disease entities apparently caused by other agents can only be confirmed by bacteriological examination.

The disease may be confused with erysipelas, mycoplasma arthritis, and streptococcal arthritis on clinical examination. Mycoplasmosis is a much milder disease and is manifested principally by the presence of a few unthrifty or lame pigs in the litter just before weaning, rather than an acute outbreak with a high mortality. Differentiation between cases of Glasser's disease with meningitis and the other diseases of the nervous system in young pigs, especially streptococcal meningitis and Teschen disease, may not be possible without necropsy examination.

#### TREATMENT

Pigs are usually ill with this disease, so parenteral treatment is required first, followed by water medication, as they do not drink as they would usually, before in-feed medication is given when they are beginning to recover.

Treatment with penicillin, trimethoprim-sulfadoxine, or oxytetracycline is effective in the early stages of the disease.<sup>61</sup>

Resistance has been reported for penicillin<sup>62</sup> and numbers of strains are resistant to tetracyclines, erythromycin, and other aminoglycosides. Tilmosin can be used for effective treatment<sup>63,64</sup> as it is concentrated in the macrophages and neutrophils.<sup>65</sup> These can migrate to the site of infection and therefore there may be higher levels of antibody in the tissue.<sup>66</sup>

Medication of the water supply for several days may also be effective.

## CONTROL

Control is only possible if there is (1) diagnosis of infection, (2) identification of prevalent strains, (3) use of autogenous vaccines, and (4) management of new strains.<sup>67</sup>

Avoidance of undue exposure to adverse environmental conditions at weaning is recommended. Prophylactic dosing at the time of shipping or medication of feed or drinking water on arrival with the above-mentioned drugs may be of value in preventing outbreaks. Feeding a mixture of 3% sulfamonomethoxine and 1% trimethoprim at 160 and 240 ppm for 5 days and challenging with *H. parasuis* at 3 days prevented clinical disease and bacteria were not recovered.<sup>68</sup>

Maternal antibody does not interfere with vaccination of pigs at 1–3 weeks of age.<sup>69</sup>

A formalin-killed bacterin administered before weaning with two injections at 5 and 7 weeks of age has proved highly effective in preventing the disease.<sup>70</sup> A formalin-killed whole-cell culture bacterin developed in Ontario is effective in protecting 4-week-old pigs against experimental challenge with the organism.<sup>71-73</sup> A recent trial<sup>74,75</sup> showed that vaccinating sows at 80 and 95 days of pregnancy with a commercial bacterin containing *H. parasuis* 2, 3, and 5 was useful in reducing pneumonic lesions and arthritic joint changes in subsequently challenged piglets. Vaccination of piglets seem to have no effect. The vaccination of the sows seemed to have no effect on the colonization of the nasal mucosa by the *H. parasuis*, nor on the timing.<sup>28</sup>

Autogenous vaccines against homologous strains have been shown to work<sup>69,72,73</sup> but vaccination failures do occur.<sup>1</sup> There may be little cross-protection between strains.<sup>2,72,76</sup>

A new serotype 5 vaccination was described<sup>70</sup> and the subsequent challenge with serotypes 1, 12, 13, and 14 produced different responses in control pigs.

Vaccination has three important components.<sup>77</sup> First, there is the decision of commercial or autogenous vaccination and this depends on the strains in the field and whether they are in the commercial vaccine. Second, the timing of vaccination should take into account the length of persistence of maternal antibody and the peak of piglet mortality. If this peak is at 2–3 weeks then the sows should be vaccinated. The piglets should then be vaccinated at weaning and 2 weeks later. Third, since sow and piglet vaccination together is not recommended, as the sow's vaccination can produce maternal antibody that interferes with the piglet's active immunity, you should make a choice of one or the other.

Recently, the technique of introducing known populations of live *H. parasuis* to the young piglet shortly after birth, thus allowing a slow rate of acquisition of organisms, has been advocated.<sup>33,59,78</sup>

All-in/all-out by age is absolutely essential to prevent carry-over of infection and it is likely that nose-to-nose transmission is important, so solid partitions between different litters may help.

## REVIEW LITERATURE

Olivera JA, Pijoan C. *Hemophilus parasuis*; new trends on diagnosis, epidemiology and control. *Vet Microbiol* 2004; 99:1–12.  
Blackall PJ. *Pig News Info* 2004; 22:71N–77N.

## REFERENCES

- Smart NL et al. *Can Vet J* 1993; 34:487.
- Rapp-Gabrielson VJ, Gabrielson DA. *Am J Vet Res* 1992; 53:659.
- Bakos K et al. *Nord Vet Med* 1952; 4:241.
- Kilstein P, Rapp-Gabrielson VJ. *J Clin Microbiol* 1992; 30:862.
- Vahle JL et al. *Can J Vet Res* 1997; 61:200.
- Rapp-Gabrielson VJ et al. *J Clin Microbiol* 1985; 22:945.
- Moller K, Killian M. *J Clin Microbiol* 1991; 28:2711.
- Amano H et al. *J Vet Med Sci* 1994; 56:639.
- Olivera S et al. *J Vet Diagn Invest* 2001; 13:495.
- Segales J et al. *J Vet Diagn Invest* 1997; 9:237.
- Macinnes JL, Desrosiers R. *Can J Vet Res* 1999; 63:89.
- L'Ecuycer C et al. *Am J Vet Res* 1961; 22:1020.
- Osborne AD et al. *Can Vet J* 1981; 22:82.
- Morrison RB et al. *Can J Comp Med* 1985; 49:129.
- Falk K et al. *Acta Vet Scand* 1991; 32:62.
- Little T. *Vet Rec* 1970; 87:399.
- Rapp-Gabrielson VJ et al. In: *Proceedings of the 14th International Pig Veterinary Society Congress* 1996:300.
- Rapp-Gabrielson VJ et al. *Vet Med* 1997; 92:83.
- Smart NL et al. *Can J Vet Res* 1989; 30:339.
- Hoefling DC. *J Vet Diagn Invest* 1991; 3:354.
- Tadjine M et al. *J Clin Microbiol* 2004; 42:839.
- Kielstein P et al. *J Clin Microbiol* 1992; 30:862.
- Rubies X et al. *Vet Microbiol* 1999; 62:245.
- Rafiee M. *Aust Vet J* 2000; 78:846.
- Blackall PJ et al. *Aust Vet J* 1996; 73:93.
- Nielsen R. *Acta Vet Scand* 1993; 34:193.
- Amano H et al. *J Jpn Vet Med Assoc* 1993; 46:99.

- Kirkwood RN et al. *J Swine Health Prod* 2001; 9:77.
- Olivera S et al. *Can J Vet Res* 2003; 65:161.
- Kielstein P et al. *Monatsh Veterinärmed* 1994; 49:71.
- Brockmeier SL. *Vet Microbiol* 2004; 99:75.
- Segales J. *Vet Microbiol* 1999; 64:287.
- Olivera S et al. *Can J Vet Res* 2003; 67:146.
- Rapp-Gabrielson VJ et al. *Am J Vet Res* 1992; 53:987.
- Hill CE et al. *Vet Microbiol* 2004; 96:189.
- Lichtensteiger CA, Vimr ER. *Vet Microbiol* 2003; 93:79.
- Ruiz A et al. *J Clin Microbiol* 2001; 39:1757.
- Muller G et al. *Res Vet Sci* 2003; 74:23.
- De Blesser B et al. *Pig J* 2002; 49:84.
- Olivera S, Pijoan C. *Can J Vet Res* 2004; 68:71.
- Pijoan C, Olivera S. *Proc Am Assoc Swine Vet* 2003:401.
- Kim J et al. *J Vet Med Sci* 2002; 64:57.
- Brockmeier SL et al. *Proc Am Assoc Swine Vet* 2002:106.
- Hoefling DC et al. *J Vet Diagn Invest* 1991; 3:354.
- Gois M et al. *Am J Vet Res* 1983; 44:372.
- Vahle JL et al. *J Vet Diagn Invest* 1995; 7:746.
- Wiegand M et al. *Tierärztl Prax* 1997; 25:226.
- Menendez-Trigo AV, Trigo E. In: *Proceedings of the 14th International Pig Veterinary Society Congress* 1996:314.
- Rio M et al. *Am J Vet Res* 2003; 64:1176.
- Kielstein P et al. *Vet Microbiol* 2001; 81:243.
- O'Reilly T, Niven DF. *Can J Vet Res* 2003; 67:229.
- Sohn HJ et al. *J Vet Sci* 1998; 40:69.
- Lopez R et al. In: *Proceedings of the 18th International Pig Veterinary Society Congress* 2004:210.
- Calsamiglia M, Pijoan C. *J Vet Diagn Invest* 1998; 10:480.
- Calsamiglia M, Pijoan C. *J Vet Diagn Invest* 1999; 11:140.
- Jung K, Chae C. *J Comp Pathol* 2004; 130:294.
- Olivera S, Pijoan C. *Proc Am Assoc Swine Vet* 2001:479.
- Lin BC. *Proc Am Assoc Swine Vet* 2003:2003.
- Olivera S, Pijoan C. *J Swine Health Prod* 2002; 10:221.
- Olivera S et al. In: *Proceedings of the 16th International Pig Veterinary Society Congress* 2002:224.
- Aarestrup FM et al. *Vet Microbiol* 2004; 101:143.
- Kielstein P, Leirer R. *Monatsh Veterinärmed* 1990; 45:577.
- Paradis MA et al. *Proc Am Assoc Swine Pract* 2002:129.
- De Rosa DC. *J Vet Diagn Invest* 2000; 12:54.
- Scoreaux B, Shyrock TR. *J Vet Pharmacol Ther* 1998; 21:157.
- Diara MS et al. *Int J Antimicrob Agents* 1999; 12:229.
- Olivera S, Pijoan C. *J Swine Health Prod* 2002; 10:221.
- Amano H et al. *J Jpn Vet Med Assoc* 1996; 49:796.
- Solano-Aguilar GI et al. *Am J Vet Res* 1999; 60:81.
- Bak H, Riising H-J. *Vet Rec* 2002; 151:502.
- Miniats OP et al. *Can J Vet Res* 1991; 55:33.
- Smart NL, Miniats OP. *Can J Vet Res* 1989; 53:390.
- Miniats OP et al. *Can J Vet Res* 1991; 55:33.
- Baumann G, Bilkei G. *Vet Rec* 2002; 151:18.
- Hoffmann CR, Bilkei G. *Dtsch Tierärztl Wochenschr* 2002; 109:271.
- Takahashi K et al. *J Vet Med Sci* 2001; 63:487.
- Pijoan C et al. *Proc Allen D Lemman Swine Conf* 2003:105.
- Olivera S et al. *J Swine Health Prod* 2004; 12:123.



## Diseases associated with bacteria – IV

**DISEASES ASSOCIATED WITH MYCOBACTERIUM SPP. 1007**

Tuberculosis associated with *Mycobacterium bovis* 1007  
 Mycobacteriosis associated with *Mycobacterium avium-intracellulare* complex and with atypical mycobacteria 1014  
 Tuberculosis associated with *Mycobacterium tuberculosis* 1016  
 Skin tuberculosis 1016

**Diseases associated with Mycobacterium spp.****TUBERCULOSIS ASSOCIATED WITH MYCOBACTERIUM BOVIS****Synopsis**

**Etiology** *Mycobacterium bovis*

**Epidemiology** All age groups and species are susceptible but infection is predominantly in cattle and pigs. Infected cattle are the main source of infection but wildlife reservoirs are important in some regions and preclude the eradication of bovine tuberculosis in some countries. Inhalation is the major method of transmission

**Clinical findings** Progressive emaciation, capricious appetite, and fluctuating temperature with signs referable to localization such as respiratory disease, pharyngeal obstruction, reproductive disorder, mastitis. In pigs the disease is subclinical but tuberculous lesions in cervical lymph nodes

**Clinical pathology** Tuberculin testing. Single intradermal test is the official test in most countries with the comparative test for cattle suspected as false-positive reactors. Interferon-gamma testing

**Necropsy findings** Tuberculous granulomas may be found in any of the lymph nodes, or there may be generalized tuberculosis

**Diagnostic confirmation** Culture of organism or identification by polymerase chain reaction (PCR) or other molecular techniques

**Control** Test and slaughter. Most countries have official eradication programs

**ETIOLOGY**

*Mycobacterium bovis* is the specific cause of tuberculosis in cattle. Identification of the organism has been, until very recently, dependent on laborious determinations of cultural characteristics and susceptibility to therapeutic agents. Exact definition of mycobacteria is now possible by nucleic acid probes and molecular techniques.<sup>1</sup>

Bovine farcy 1016  
 Paratuberculosis (Johne's disease) 1017

**DISEASES ASSOCIATED WITH ACTINOMYCES SPP., ACTINOBACILLUS SPP., NOCARDIA SPP., AND DERMATOPHILUS SPP. 1044**

Actinomycosis (lumpy jaw) 1045  
 Actinobacillosis (wooden tongue) 1046  
 Dermatophilosis (mycotic dermatitis, cutaneous streptotrichosis, Senkobo

In addition, a new species, *Mycobacterium bovis* subsp. *caprae* previously classified as *Mycobacterium tuberculosis* subsp. *caprae* has been identified as a cause of infection in goats and humans in Spain and goats, cattle, deer, and swine in Europe.<sup>2</sup>

**EPIDEMIOLOGY****Occurrence**

All species, including humans, and age groups are susceptible to *M. bovis*, with cattle, goats, and pigs most susceptible and sheep and horses showing a high natural resistance. In developed countries that have had rigorous TB control programs in place for many years, tuberculosis in animals is now a rarity, with occasional severe outbreaks occurring in a small group of herds. The presence of the disease is usually signaled by detection in carcasses at abattoirs.

**Source of infection****Cattle**

Infected cattle are the main source of infection for other cattle. Organisms are excreted in the exhaled air, in sputum, feces (from both intestinal lesions and swallowed sputum from pulmonary lesions), milk, urine, vaginal and uterine discharges, and discharges from open peripheral lymph nodes. Animals with gross lesions that communicate with airways, skin, or intestinal lumen are obvious disseminators of infection. Cattle in the early stages of the disease, before any lesions are visible, may also excrete viable mycobacteria in nasal and tracheal mucus.<sup>3</sup> In experimentally infected cattle excretion of the organism commences about 90 days after infection.<sup>4</sup>

**Wildlife reservoirs**

A large number of wildlife and feral species are naturally infected with *M. bovis*.<sup>5,6</sup> While most wildlife and feral animals are unimportant as sources for infection to cattle, in some areas of the world certain wildlife species appear to be a significant maintenance host and

disease of cattle, lumpy wool of sheep) 1048

Strawberry foot rot (proliferative dermatitis) 1051

**DISEASES ASSOCIATED WITH ACTINOBACILLUS SUIIS 1052****PLEUROPNEUMONIA OF PIGS ASSOCIATED WITH ACTINOBACILLUS PLEUROPNEUMONIAE 1053**

reservoir for infection in cattle. This reservoir escapes traditional test and slaughter control programs and results in regions where the disease remains endemic in cattle herds.

In areas of south-west England and the Republic of Ireland infected badgers (*Meles meles*) are significant in the epidemiology of the disease in cattle and infection of cattle is believed to be from badger urine contamination of pastures.<sup>7,8</sup> Badgers have also been found to make nocturnal visits to farm buildings and cattle troughs to feed during which they defecate and urinate directly onto the cattle feed<sup>9</sup>

In New Zealand infection occurs in the brush-tail possum (*Trichosurus vulpecula*) and produces lesions in peripheral lymph nodes with discharging sinuses. Much of New Zealand's residual problem with bovine tuberculosis is in cattle running on the pasture-bush margin where there is ample opportunity for cattle-possum contact. Infection to cattle is believed to occur when curious cattle sniff moribund possums.<sup>10,11</sup> Mule deer (*Odocoileus hemionus*), white tailed deer (*O. virginianus*), elk (*Cervus elaphus canadensis*) and bison (*Bison bison*) in North America,<sup>12,13</sup> and red deer in Great Britain and Ireland can all act as maintenance hosts and in some regions spread infection to cattle through comingling or sharing of winter feed resulting in foci of herd infections<sup>14,15</sup>

Buffaloes (*Syncerus caffer*) in South Africa<sup>16</sup> and water buffaloes (*Bulbalis bulbalis*) in Australia can also act as maintenance hosts in these countries.

**Methods of transmission**

Commonly, entry is effected by inhalation or ingestion. Inhalation is the almost invariable portal of entry in housed cattle, and even in those at pasture it is

considered to be the principal mode of transmission.

#### Ingestion

Infection by ingestion is possible at **pasture** when feces contaminate the feed and communal **drinking water** and **feed troughs** but a large infective dose is required. Under natural conditions, stagnant drinking water may cause infection up to 18 days after its last use by a tuberculous animal, whereas a running stream does not represent an important source of infection to cattle in downstream fields.

The **survival** of the organism in the environment is influenced by temperature, moisture, exposure to the desiccating effect of sunlight, and ultraviolet light. The organism can survive for long periods in feces and soil but most studies show that survival on pasture is measured in weeks rather than months<sup>10</sup> and that environmental contamination of pasture is **not of major importance** in the epidemiology of the disease in cattle.<sup>17</sup>

#### Other routes

The drinking of **infected milk** by young animals is a common method of transmission where the disease is endemic, but mammary infection occurs late in the course of the disease and is less common in countries with advanced control programs. Other uncommon routes of infection include **intrauterine infection** at coitus, by the use of infected semen or of infected insemination or uterine pipettes, and **intramammary** infection by the use of contaminated teat siphons or by way of infected cups of milking machines. The feeding of **tuberculous cattle carcasses** to pigs has also caused a severe outbreak of the disease. Unusual sources of infection are infected cats, goats, or even humans. Stockmen with genito-urinary infections have transmitted infection to cattle through urinating in the cattle environment.<sup>18</sup>

#### Experimental reproduction

Pulmonary disease with typical tuberculous lesions in the pulmonary parenchyma and tracheobronchial and mediastinal lymph nodes can be produced by aerosol delivery of *M. bovis* to cattle.<sup>19</sup>

#### Risk factors

##### Environment risk factors

Housing predisposes to the disease, as does high stocking intensity and a large number of animals on a farm<sup>20</sup> so that the disease is more common and serious where these forms of husbandry are practiced. The closer the animals are in **contact** the greater is the chance that the disease will be transmitted. In spite of the low overall incidence in countries where cattle are at pasture all the year round, individual herds with 60–70% morbidity may be encountered.

Amongst beef cattle the degree of infection is usually much lower because of the open range conditions under which they are kept. However, individual beef herds may suffer a high morbidity if infected animals are introduced and large numbers of animals have to drink from stagnant water holes, especially during dry seasons.

##### Host risk factors

Zebu (*Bos indicus*) type cattle are thought to be much more resistant to tuberculosis than European cattle, and the effects on these cattle are much less severe but under intensive feedlot conditions a morbidity rate of 60% and a depression of weight gain can be experienced in tuberculous Zebu cattle.

In **pigs**, disease levels reflect those in the local cattle population from which the infection derives either by the ingestion of dairy products or by grazing over the same pasture as cattle. The lower relative prevalence in pigs is due to a number of factors, particularly the tendency of the disease to remain localized in this species and the early age of slaughter. Prevalence is higher in older pigs. When the disease is common among dairy cattle in an area, 10–20% of the local pigs are likely to be infected. A high prevalence has been observed in pigs bedded on shavings infected with *M. bovis*.

**Feral pigs** can be infected but the prevalence also reflects the prevalence in local cattle populations and they appear to be end-hosts.<sup>21</sup>

**Goats** are quite susceptible and if they are maintained in association with infected herds of cattle the incidence may be as high as 70%. **Sheep** have always been considered to be resistant, but experience in New Zealand has shown that the disease can be quite prevalent in this species with up to 5% of flocks being infected,<sup>22</sup> probably due to a high prevalence in local cattle and possums. Tuberculosis can be a problem in **farmed deer**.<sup>6</sup>

In **horses** the disease occurs rarely, largely due to limited exposure to infection, but natural resistance also appears to play a part.

Tuberculosis may also be encountered in elk, wild deer of various species, water buffalo, camels, bison, wild carnivores, monkeys and other wild fauna, and birds. Most are dead end-hosts but some may act as important reservoirs of infection for cattle as mentioned earlier.

##### Pathogen risk factors

The causative organism is moderately resistant to heat, desiccation, and many disinfectants. It is readily destroyed by direct sunlight unless it is in a moist environment. In warm, moist, protected positions, it may remain viable for weeks.

#### Economic importance

Tuberculosis occurs in every country of the world and is of major importance in dairy cattle. It is under strict control in most developed countries but is still a major cause of loss in many less well-endowed countries. Apart from actual deaths, infected animals lose 10–25% of their productive efficiency. Because the disease is relatively benign in pigs, major financial loss from clinical disease does not occur but at slaughter organs with tuberculous lesions are discarded and the entire carcass may be condemned or require heat treatment before being released for human consumption.

#### Zoonotic importance

The current increasing incidence of tuberculosis in humans, particularly in immunocompromised humans, has given a renewed interest in the zoonotic importance of *M. bovis*, especially in developing countries<sup>23</sup> and the ease and frequency of the spread of tuberculosis from animals to humans in an uncontrolled environment makes this an **important zoonosis**. *M. bovis* can be responsible for 5 to 10% of human tuberculosis with higher rates in children in some areas.<sup>24</sup> Infection in humans occurs largely through consumption of infected raw milk and raw milk products by children but spread can also occur by inhalation. Transmission to humans can be significantly reduced by pasteurization of milk but only complete eradication of the disease can protect the farmer and his family.

Transmission from cattle to humans in developed countries is an unlikely event nowadays but still occurs and resurgence of the disease in association with wildlife reservoirs has resulted in a spillover into human populations.<sup>25,26</sup>

The widespread occurrence of tuberculosis in exotic animals maintained in captivity adds to the public health importance of these infections.

#### PATHOGENESIS

Tuberculosis spreads in the body by two stages, the primary complex and post-primary dissemination. The **primary complex** consists of the lesion at the point of entry and in the local lymph node. A lesion at the point of entry is common when infection is by inhalation. When infection occurs via the alimentary tract, a lesion at the site of entry is unusual, although tonsillar and intestinal ulcers may occur. More commonly the only observable lesion is in the pharyngeal or mesenteric lymph nodes.

A visible primary focus develops within 8 days of entry being effected by the bacteria. **Calcification** of the lesions commences about 2 weeks later. The developing necrotic focus is soon

surrounded by granulation tissue, monocytes, and plasma cells and the pathognomonic 'tubercle' is established. Bacteria pass from this primary focus, which is in the respiratory tract in 90–95% of cases in cattle, to a regional lymph node and cause the development of a similar lesion there. The lesions in the lungs in cattle occur in the caudal lobes in 90% of cases.<sup>27</sup> In calves fed tuberculous milk the primary focus is likely to be in the pharyngeal or mesenteric lymph nodes, with hepatic lesions as the major manifestation of post-primary spread.

**Post-primary dissemination** from the primary complex may take the form of acute miliary tuberculosis, discrete nodular lesions in various organs, or chronic organ tuberculosis caused by endogenous or exogenous reinfection of tissues rendered allergic to tuberculo-protein. In the latter case there may be no involvement of the local lymph node. Depending upon the sites of localization of infection, clinical signs vary but, because the disease is always progressive, there is the constant underlying toxemia which causes weakness, debility, and the eventual death of the animal.

In **cattle, horses, sheep, and goats**, the disease is progressive and, although generalized tuberculosis is not uncommon in **pigs**, localization as non-progressive abscesses in the lymph nodes of the head and neck is the most common finding.

## CLINICAL FINDINGS

### Cattle

Although signs referable to localization in a particular organ usually attract attention to the possible occurrence of tuberculosis, some general signs are also evident. Some cows with extensive miliary tubercular lesions are clinically normal but in most cases **progressive emaciation** unassociated with other signs occurs, and should arouse suspicion of tuberculosis. A **capricious appetite** and **fluctuating temperature** are also commonly associated with the disease. The hair coat may be rough or sleek. Affected animals tend to become more docile and sluggish but the eyes remain bright and alert. These general signs often become more pronounced after calving.

### Lungs

Pulmonary involvement is characterized by a chronic cough due to bronchopneumonia. The **cough** is never loud or paroxysmal, occurring only once or twice at a time and is low, suppressed, and moist. It is easily stimulated by squeezing the pharynx or by exercise and is most common in the morning or in cold weather. In the **advanced stages** when much lung has been destroyed, **dyspnea** with increased rate and depth of respira-

tion becomes apparent. At this stage, abnormalities may be detected by auscultation and percussion of the chest. Areas with no breath sounds and dullness on percussion are accompanied by areas in which squeaky crackles are audible, often most audible over the caudal lobes. Tuberculous **pleurisy** may occur but is usually symptomless because there is no effusion. Involvement of the bronchial lymph nodes may cause dyspnea because of constriction of air passages, and enlargement of the mediastinal lymph node is commonly associated with recurrent and then persistent ruminal tympany.

### Intestine

Rarely tuberculous ulcers of the small intestine cause diarrhea. Retropharyngeal lymph node enlargement causes **dysphagia** and **noisy breathing** due to **pharyngeal obstruction**. Pharyngeal palpation, or endoscopy, reveals a large, firm, rounded swelling in the dorsum of the pharynx. Chronic, painless swelling of the submaxillary, prescapular, precrural, and supramammary lymph nodes is relatively rare.

### Uterus

**Reproductive disorders** include uterine tuberculosis which is uncommon with bovine strains except in advanced cases. Spread by contiguity from the uterus causes peritonitis, bursitis, and salpingitis, the lesions in the salpinx taking the form of small enlargements containing a few drops of yellow fluid. In tuberculous metritis, there may be **infertility**, or conception may be followed by recurrent **abortion** late in pregnancy, or a live calf is produced which in most cases dies quickly of generalized tuberculosis. Lesions similar to those of brucellosis occur on the placenta.

In cows that fail to conceive, there may be a chronic purulent discharge heavily infected with the organism and the condition is very resistant to treatment. A number of cows will have an associated tuberculous vaginitis affecting chiefly the ducts of Gartner. Rare cases of tuberculous orchitis are characterized by the development of large, indurated, painless testicles.

### Mastitis

Tuberculous **mastitis** is of major importance because of the danger to public health, and of spread of the disease to calves, and the difficulty of differentiating it from other forms of mastitis. Its characteristic feature is a marked **induration** and hypertrophy which usually develops first in the upper part of the udder, particularly in the rear quarters. **Palpation** of the supramammary lymph nodes is essential in all cases of suspected tuberculous

mastitis. Enlargement of the nodes with fibrosis of the quarter does not necessarily indicate tuberculosis but enlargement without udder induration suggests either tuberculosis or lymphomatosis. In the early stages, the **milk** is not macroscopically abnormal but very fine floccules appear later and settle after the milk stands, leaving a clear, amber fluid. Later still the secretion may be an amber fluid only.

### Pigs

Tuberculous lesions in cervical lymph nodes usually cause **no clinical abnormality** unless they rupture to the exterior. Generalized cases present a syndrome similar to that seen in cattle although tuberculous involvement of the meninges and joints is more common.

### Horses

The commonest syndrome in horses is caused by involvement of the cervical vertebrae in which a painful osteomyelitis causes stiffness of the neck and inability to eat off the ground. Less common signs include polyuria, coughing due to pulmonary lesions, lymph node enlargement, nasal discharge, and a fluctuating temperature.

### Sheep and goats

Bronchopneumonia is the commonest form of the disease in these species and is manifested by cough and terminal dyspnea. In some goats intestinal ulceration, with diarrhea, and enlargement of the lymph nodes of the alimentary tract occur. In both species the disease is only slowly progressive, and in affected flocks many more reactors and necropsy-positive cases are often found than would be expected from the clinical cases which are evident. In kids the disease may be more rapidly progressive and cause early death.

## CLINICAL PATHOLOGY

Because of the universal dependence on the tuberculin test for diagnosis, and the policy of slaughtering all positive reactors whether they are open cases or not, few clinicopathological tests are carried out. Sputum or discharges may be examined by inoculation into guinea-pigs but improved cultural techniques, and the use of nucleic acid probes<sup>28</sup> make this unnecessary.

The basis of all tuberculosis eradication schemes to date is the **tuberculin test** and a knowledge of the various tests used, their deficiencies and advantages, is essential. It should be remembered, however, that clinical examination is still of value, particularly in seeking out the occasional advanced cases which do not give a positive reaction to a tuberculin test.

### Single intradermal (SID) test

This test is applied by the intradermal injection of bovine tuberculin PPD into a skin fold and the subsequent detection of swelling as a result of delayed hypersensitivity. The tuberculin is prepared from cultures of *M. tuberculosis* or *M. bovis* grown on synthetic media. **Bovine tuberculin** is more potent and specific.<sup>29</sup> The reaction is read between 48 and 96 hours after injection with a preference for 48–72 hours for maximum sensitivity and at 96 hours for maximum specificity, and a positive reaction constitutes a diffuse swelling at the injection site.

#### Site of injection

In some countries the injection is made into an anal or caudal fold at the base of the tail. In others it is made into a cervical fold, a fold of skin picked up in the center of the lateral aspect of the neck. The cervical fold test is thought to provide greater sensitivity, the caudal fold providing the greater specificity. An additional injection is sometimes made into the lip of the vulva at the mucocutaneous junction. In **England and Europe** the injection is made into the skin of the neck and the injection site is measured with calipers. The subjective method of palpation is more accurate. It also permits a decision to be shaded by the nature of the lesion. Neck skin is more sensitive than that of the tail area but it is necessary to restrain each animal and measure all reactions carefully. In the **United States, Canada, Australia, and New Zealand** the site is the caudal fold of the tail.

#### Dose

The exact dose for the particular tuberculin should be strictly adhered to when the cervical skin test is used. In the United States, 0.1 mL is recommended for herds of unknown status and 0.2 mL in known infected herds when cases with low sensitivity are to be carefully sought. The method of injection of tuberculin also has some importance when the cervical site is used. A careful intradermal injection produces the largest swelling and a quick thrust the least. Variations in technique appear to have little effect on the size of reaction when the caudal fold is used.

#### Disadvantages of SID

The main disadvantage of the SID test is its lack of specificity and the number of **no-visible-lesion reactors** (NVLs) which occur. Mammalian tuberculin is not sufficiently specific to differentiate between reactions due to infection with *M. bovis* and infection with *M. avium*, *M. tuberculosis*, *M. paratuberculosis* (including vaccination), or *Nocardia farcinicus*. The maximum permissible rate of NVL reactors is 10%

and when this rate is exceeded, tests other than the SID test should be used.

Other disadvantages of the SID test include failure to detect cases of minimal sensitivity such as may occur in the early or late stages of the disease, in **old cows** and in cows which have **recently calved**. This failure to detect tuberculous animals can be of considerable importance and must receive close attention when reactors are detected at an initial test. Serological tests to detect these cases of minimal sensitivity are described below. Other field tests devised to overcome these deficiencies of the SID test are the short thermal, Stormont, and comparative tests. Of these, the comparative test is most commonly used.

#### Short thermal test

Intradermal tuberculin (4 mL) is injected subcutaneously into the neck of cattle which have a rectal temperature of not more than 39°C (102°F) at the time of injection and for 2 hours later. If the temperature at 4, 6, and 8 hours after injection rises above 40°C (104°F), the animal is classed as a positive reactor. The temperature peak is usually at 6–8 hours and is generally over 41°C (105.8°F). Occasional deaths due to anaphylaxis occur at the peak of the reaction.

#### Stormont test

The test is performed similarly to the single intradermal test in the neck with a further injection at the same site 7 days later. An increase in skin thickness of 5 mm or more, 24 hours after this second injection, is a positive result. The increased sensitivity begins at the 5th day, is at its peak at the 7th and ends on the 12th day after the injection. Cattle infected with *M. avium* do not give a positive reaction but 'skin tuberculosis' cases do. It is more accurate than the single intradermal test but a practical difficulty is the necessity for three visits to the farm. Special purified protein derivative (PPD) tuberculin of a specified potency must be used to fulfill the requirements of the test.

#### Comparative test

Where the presence of **Johne's disease** or **avian tuberculosis** is suspected or '**skin tuberculosis**' is apparent, non-specific sensitization must be considered, and a comparative test used. Transitory sensitization may occur in cattle due to the presence of human tuberculosis in their attendants but the comparative test will not differentiate the sensitivity from that due to bovine strain infection.

The comparative test depends on the greater sensitivity to homologous tuberculin. **Avian and bovine tuberculin** are injected simultaneously into two separate sites on the same side of the

neck, 12 cm apart and one above the other, and the test is read 72 hours later. Care must be taken in placing the injections as sensitivity varies from place to place in the skin. The greater of the two reactions indicates the organism responsible for the sensitization. The test is not generally intended for primary use in detecting reactors but only to follow up known reactors to determine the infecting organism. Its use as a primary test is recommended when a high incidence of avian tuberculosis or Johne's disease is anticipated, or when vaccination against Johne's disease has been carried out. The comparative test is adequate to differentiate between vaccination against Johne's disease and tuberculosis and the distinction is easier the longer the time between vaccination and testing.

#### Special aspects of sensitivity to tuberculin

##### Site of injection

Sensitivity to tuberculin injected intradermally varies considerably from site to site on the body. In cattle the relative sensitivities of different areas to tuberculin and to johnin have been determined as follows: back 1, upper side 1.75, lower side 2.5, neck 2.75–3. The cervical area is also much more sensitive than the anal fold, and has the advantages that reactions are more pronounced, animals can be retested immediately, and the area is more sanitary. Its disadvantages are that restraint of each animal is necessary and the proportion of NVL reactors increases.

##### Potency of tuberculins

For maximum specificity tuberculin prepared from *M. bovis* is recommended, and for preference it should be a **purified protein derivative** (PPD). One of the important problems in tuberculin testing is deciding the optimum amount of tuberculin to be used to get maximum specificity. A dose rate between 5000 and 10 000 tuberculin units (0.1 mL tuberculin containing 0.1 or 0.2 mg of bovine PPD) is considered to be most suitable. The 0.2-mg dose is preferred as detecting more infected animals. For farmed deer a special tuberculin is used which contains 2 mg tuberculin/mL.

##### Desensitization during tuberculin testing

When a suspicious reactor is encountered, the question of when to retest is complicated by the phenomenon of desensitization caused by the absorption of tuberculin and other foreign proteins. Desensitization is more marked and of longer duration after a subcutaneous than after an intradermal injection. After a SID test the period of **desensitization** is short but, as a practical procedure, it is recommended that animals giving a suspicious result to

a SID test be not retested before 60 days. However, after a Stormont test desensitization may persist for as long as 6 months.

The desensitization phenomenon can be used to obscure a positive reaction. If tuberculin is injected so that the test is made in the desensitized period, no reaction will occur in infected animals.

#### Postparturient desensitization

Tuberculous cattle go through a period of desensitization immediately before and after calving and as many as 30% give false-negative reactions returning to a positive status 4–6 weeks later. The loss of sensitivity is probably due to the general immunological hyporeactivity that occurs associated with parturition. Calves drinking colostrum from infected dams give positive reactions for up to 3 weeks after birth even though they may not be infected.

#### Anergy

Anergic animals are those with visible lesions of tuberculosis but which do not react to a cutaneous, delayed hypersensitivity test. The number of these can be reduced by being careful to inject sufficient tuberculin (0.2 mg) at the right site, and to read the test at 48–72 hours. There is still a residuum of cases which do not respond, especially those with extensive pulmonary involvement.

Summary of testing procedures in cattle  
In summary, it is usual to use the single intradermal test as a routine procedure.

Annual testing of all cattle, quarantine of test-positive herds, and a movement ban into TB-free areas has historically been effective in TB control schemes.<sup>30</sup> The sensitivity and specificity of the skin test is moderately high but false-positive and false-negative reactions occur.<sup>31</sup>

**False-positive reactions** (no gross lesion reactors) may be given by:

- Animals sensitized to other mycobacterial allergens, including those of human or avian tuberculosis or Johne's disease, relatively non-pathogenic mycobacteria, e.g. skin tuberculosis, and, by ingestion, non-pathogenic mycobacteria in permanent waters inhabited by birds, or poultry litter fed to cattle when the birds are infected with *M. avium*
- Animals sensitized to other allergens, e.g. *Nocardia farcinicus*
- Animals injected with irritants at the injection site prior to reading of the tuberculin test, when compensation rates for reactors exceed true cattle prices.

The proportion of false-positive reactions is likely to increase as control programs progress towards eradication and can

undermine farmers' confidence in the control program. Reactors which are thought to be non-specific should be retested by the comparative test in the cervical region 7 days after the response to the caudal fold test. Alternatively cattle can be re-tested using the whole blood interferon-gamma assay 8–28 days after the skin test.

**False-negative reactions** may be given by:

- Advanced cases of tuberculosis
- Early cases until 6 weeks after infection
- Cows which have calved within the preceding 6 weeks
- Animals desensitized by tuberculin administration during the preceding 8–60 days
- Old cattle
- Low-potency tuberculin or bacterial contamination of the tuberculin
- Variable dose with multidose syringes.

#### Tuberculin testing in pigs

The most generally used method is the **SID test**, injecting 0.1 mL of standard potency mammalian tuberculin into a fold of skin at the **base of the ear**, but the test is relatively inaccurate in this species. The test is read 24–48 hours later and an increase in skin thickness of 5 mm or more constitutes a positive reaction. In positive animals the skin thickening often exceeds 10 mm and shows superficial necrosis and sloughing.

If the animal is infected with *M. avium*, the maximum skin thickening may not occur until 48 hours after injection. When no attempt is being made to determine the type of infection, mixed avian and mammalian tuberculins may be used and the test read at 24–48 hours. If avian tuberculin alone is used, the test should be read at 48–72 hours and an increase in skin thickness of 4 mm is classed as positive.

Many suspicious reactions occur in pigs because of the tendency of lesions to regress and the sensitivity to tuberculin to diminish, maximum sensitivity occurring 3–9 weeks after infection. A **retest** in 6–8 weeks should determine whether or not the disease is progressing. Although positive reactors may in time revert to a negative status, there may be macroscopic lesions in these animals at necropsy. However, viable organisms are not usually recoverable from the lesion, the infection apparently having been overcome.

The Stormont test is unlikely to have any application in pigs because there is no local increase in skin sensitivity after one injection. Some decrease in skin sensitivity after parturition occurs in sows infected with *M. bovis* but may not occur when the infection is associated with *M. avium*.

Comparative tests work efficiently in this species with little or no reaction to heterologous tuberculin.

#### Tuberculin testing in other species

##### Horse

The results obtained with subcutaneous and intradermal tuberculin tests are very erratic and must be assessed with caution especially when the test is positive because many **false-positives** occur. The horse appears to be much more sensitive than cattle to tuberculin and much smaller doses of standardized tuberculin are required. As little as 0.1 mL of PPD tuberculin is sufficient to elicit a positive reaction and testing may provoke an **anaphylactic reaction**. No safe recommendations can be made on tests in this species because of lack of detailed information, but the occurrence of a systemic reaction with a positive cutaneous test can be accepted as indicating the presence of infection.

##### Sheep and goats

The single intradermal test is relatively inaccurate, some tuberculous animals giving negative reactions, although on the basis of results achieved in experimentally infected goats<sup>32</sup> it is adequate. The test injection is usually given in the **caudal fold** as in cattle but injection into the skin of the inside of the **thigh** of sheep is also satisfactory. An increase in thickness of 5 mm in the fold constitutes a positive reaction.

#### Serological tests for diagnosis of tuberculosis

In the final stages of a tuberculosis eradication program the percentage of reactors, which are not in fact tuberculous, increases to the point where a more discerning test than the one based on cutaneous hypersensitivity is required. Most of the tests tried so far have been serological ones. Their aim is to identify anergic animals and cases sensitized by some other bacteria.

Serological tests including complement fixation, fluorescent antibody, direct bacterial agglutination, precipitin, and hemagglutination tests have been developed but have little potential value for the routine diagnosis of tuberculosis.

Early enzyme-linked immunosorbent assay (ELISA) tests to crude mycobacterial antigens had limited value but an ELISA which examines antibody to defined antigens of *M. bovis* before and afterskin testing appears useful in detecting non-specific reactors.<sup>33</sup>

An *in vitro* assay of cell-mediated reactivity by detection and quantitation of  $\gamma$ -interferon known as the **interferon- $\gamma$  assay** (IFN- $\gamma$ ) is licensed and commercially available in some countries. It is based on

the detection of IFN- $\gamma$  liberated from white blood cells in whole blood cultures incubated with PPD tuberculin and has the advantage that tested cattle need only be handled once. It can detect infected cattle earlier in infection than can the skin test. It also has value in retesting skin-test-positive cattle that may be false-positive reactors but for this purpose should be used between 8 and 28 days after skin testing because assay reactions are diminished if conducted on samples taken at the 3 day reading re-visit after skin testing.<sup>34,35</sup>

Ideally the test should be set up in the laboratory on the same day as sampling or, at the most, after overnight storage of the blood.<sup>31</sup> Current testing is with *M. bovis* PPD which can contain cross-reacting antigens to other mycobacterial species and more specific and sensitive tests using antigens specific to *M. bovis* are being evaluated.<sup>31,36</sup>

## NECROPSY FINDINGS

### Cattle, sheep, and goats

These show similar lesions with a standard distribution. Tuberculous granulomas may be found in any of the lymph nodes, but particularly in bronchial, retropharyngeal, and mediastinal nodes.<sup>37,38</sup> In the lung, miliary abscesses may extend to cause a suppurative bronchopneumonia. The pus has a characteristic cream to orange color and varies in consistency from thick cream to crumbly cheese. Tuberculous nodules may appear on the pleura and peritoneum.

All localized lesions of tuberculosis tend to stimulate an enveloping fibrous capsule but the degree of encapsulation varies with the rate of development of the lesion. Generalized cases are denoted by the presence of **miliary tuberculosis** with small, transparent, shot-like lesions in many organs, or by pulmonary lesions which are not well-encapsulated and caseated. The presence of bronchopneumonia or hyperemia around pulmonary lesions is highly suggestive of active disease. Cases with tuberculous mastitis or discharging tuberculous metritis must also be considered as likely to be potent spreaders of the infection.

**Chronic lesions** are characteristically discrete and nodular, and contain thick, yellow to orange, caseous material, often calcified and surrounded by a thick, fibrous capsule. Although such lesions are less likely to cause heavy contamination of the environment than open lesions, affected animals are important as sources of infection. It should be noted that suspect cattle slaughtered as part of bovine tuberculosis eradication programs may be culture-positive and yet have no typical gross or microscopic lesions.<sup>38</sup>

## Pigs

Generalized tuberculosis, with miliary tubercles in most organs, is seen in pigs but the common finding is localization in the tonsils, and the submaxillary, cervical, hepatic, bronchial mediastinal, and mesenteric lymph nodes. The nodes are markedly enlarged and consist of masses of white, caseous, sometimes calcified, material, surrounded by a strong, fibrous capsule and interlaced by strands of fibrous tissue. Because of the regressive nature of the disease in pigs, these lesions are often negative on culture.

## Horses

The characteristic distribution of tubercles in horses includes the intestinal wall, mesenteric lymph nodes, and spleen. The cut surface of these firm nodules has a fleshy appearance similar to that of neoplastic tissue. There is also a tendency for lesions to develop in the skeleton, particularly the cervical vertebrae.

Histologically, there is some variation between the domestic species with regard to features such as mineralization and the degree of tissue necrosis. In some cases acid-fast bacilli may be difficult to demonstrate using conventional stains. A comparison of the infection in cattle and cervid species suggests that tuberculosis should be considered in cervids even when the lesions have a suppurative and necrotizing character, with a minimal granulomatous component.<sup>39</sup> Culture of *M. bovis* is difficult, time-consuming and poses a considerable public health risk. Methods such as immunoperoxidase staining and PCR can permit detection of the organisms while minimizing public health risks.

Samples for confirmation of diagnosis

- Bacteriology – affected lymph nodes, lung, granulomas from viscera (CULT (has special growth requirements), PCR)
- Histology – formalin-fixed samples of these tissues (LM, IHC, PCR).

Note the zoonotic potential of this organism when handling carcasses and submitting specimens.

## DIFFERENTIAL DIAGNOSIS

Because of the chronic nature of the disease and the multiplicity of signs caused by the variable localization of the infection, tuberculosis is difficult to diagnose on clinical examination. If the disease occurs in a particular area, it must be considered in the differential diagnosis of many diseases of cattle. In pigs the disease is usually so benign that cases do not present themselves as clinical problems and are found only at necropsy. The rarity of the disease in horses, sheep, and goats makes

it an unlikely diagnostic risk except in groups which have had abnormally high exposure to infected cattle. Mycobacteriosis is associated with the *M. avium-intracellulare* complex and atypical mycobacteria and *M. tuberculosis*

- Lung abscess due to aspiration pneumonia
- Pleurisy and pericarditis following traumatic reticulitis
- Chronic contagious bovine pleuropneumonia
- Upper respiratory disease
- Actinobacillosis
- Bovine leukosis
- Lymphadenopathy
- Other causes of mastitis.

## TREATMENT

Because of the progress being made in the treatment of human tuberculosis with such drugs as isoniazid, combinations of streptomycin and *para*-aminosalicylic, and other acids, the treatment of animals with tuberculosis has undergone some examination and claims have been made for the efficiency of long-term oral medication with isoniazid both as treatment and as prophylaxis. It is not a favored option in eradication-conscious countries.

## CONTROL

Eradication of bovine tuberculosis has been virtually achieved in many countries. The methods used have depended on a number of factors but ultimately the **test and slaughter policy** has been the only one by which effective eradication had been achieved.

### Control on a herd basis

Control in a herd rests on removal of the infected animals, prevention of spread of infection, and avoidance of further introduction of the disease.

### Tuberculin testing

Detection of infected animals depends largely upon the use of the tuberculin test. All animals over 3 months of age should be tested and positive reactors disposed of according to local legislation. Suspicious reactors are retested at intervals appropriate to the test used. At the **initial test**, a careful clinical examination should be conducted on all animals to insure that there are no advanced clinical cases which will give negative reactions to the test. Doubtful cases and animals likely to have reduced sensitivity, particularly old cows and those that have calved within the previous 6 weeks, may be tested by one of the special sensitivity or serological tests described above or re-tested subsequently. The comparative test should be used where infection with *M. paratuberculosis* or *M. avium* is anticipated or where a high

incidence of reactors occurs in a herd not showing clinical evidence of the disease.

#### Retesting

Until recently, if the incidence of reactors was high at the first test or if 'open' lesions were found at necropsy in culled animals, emphasis was placed on repeat testing at short intervals to avoid the situation in which the spread of the disease might overtake the culling rate. It is now thought that all animals with tuberculosis should be regarded as equally potent disseminators of the infection.<sup>7</sup> Retests of the herd should be carried out at 3-monthly intervals until a negative test is obtained. A further test is conducted 6 months later and if the herd is again negative, it may be classed as free of the disease. Subsequent check tests should be carried out annually.

#### Prevention of spread

Hygienic measures to prevent the spread of infection should be instituted as soon as the first group of reactors is removed. Feed troughs should be cleaned and thoroughly disinfected with hot, 5% phenol or equivalent cresol disinfectant. Water troughs and drinking cups should be emptied and similarly disinfected. Suspicious reactors being held for retesting should be isolated from the remainder of the herd. Separation of infected and susceptible animals by a double fence provides practical protection against spread of the disease.

It is important that calves being reared as **herd replacements** be fed on tuberculosis-free milk, either from known free animals or pasteurized. Rearing calves on skim milk from a communal source is a dangerous practice unless the skim milk is sterilized. All other classes of livestock on the farm should be examined for evidence of tuberculosis. **Farm attendants** should be checked as they may provide a source of infection.

If a number of reactors are culled, attention must be given to the possibility of **infection being reintroduced** with replacements, which should come from accredited herds. Failing this, the animals should be tested immediately, isolated and retested in 60 days. Infection from other herds should be addressed by preventing communal use of watering facilities or pasture, and by maintaining adequate boundary fences.

It is inadvisable to attempt a control program until it can be guaranteed that all animals can be gathered, identified, tested and segregated, a difficult proposition in cattle run on extensive range country with little manpower and few fences.

#### Control on an area basis

The method used to eradicate bovine tuberculosis from large areas will depend

on the incidence of the disease, methods of husbandry, attitude of the farming community, and the economic capacity of the country to stand losses from a test and slaughter program.

#### Education

An essential first step is the prior education of the farming community. Livestock owners must be apprized of the economic and public health significance of the disease, its manifestations, and the necessity for the various steps in the eradication program. Eradication must also be compulsory since voluntary schemes always leave foci of infection. Adequate compensation must be paid to encourage full cooperation by way of payment for animals destroyed, or bonuses for disease-free herds or their milk or beef.

#### Staging

It is essential at the beginning of a program to determine the incidence and distribution of the disease by tuberculin testing of samples of the cattle population and a meat inspection service. **Eradication** can commence in herds and areas which have a low incidence of the disease. These will provide a nucleus of tuberculosis-free cattle to supply replacements for further areas as they are brought into the eradication scheme.

#### Vaccination

Vaccination may offer a major alternative to test and slaughter in the control of bovine tuberculosis but currently suffers from both lack of efficacy and the problem of vaccinated cattle reacting to current tests for TB. Vaccination may be used as a temporary measure when the incidence of tuberculosis is high and a routine test and slaughter program may be economically impossible until it is lowered, or when an eradication program cannot be instituted for some time but it is desired to reduce the incidence of the disease in preparation for eradication.<sup>40</sup>

BCG vaccination is the only method available for field use. Vaccination must be repeated annually and the vaccinated animal remains positive to the tuberculin test. Calves must be vaccinated as soon after birth as possible and do not achieve immunity for 6 weeks. The immunity is not strong and vaccinated animals must not be submitted to severe exposure. In field circumstances where the disease is prevalent, only modest results, if any, can be expected.<sup>40-42</sup>

There are a number of newer, prospective vaccines including subunit and synthetic peptide vaccines, antigenically improved BCG, attenuated mutants of *M. bovis* and protective antigens expressed in attenuated live vaccine vectors.<sup>42</sup> Detection of vaccinated cattle from naturally infected

cattle could be possible with vaccine-specific antigens in the interferon-gamma assay.

#### Test and slaughter

When the overall incidence of tuberculosis is 5% or less, compulsory testing and the slaughter of reactors is the only satisfactory method of eradication. A combination of lines of attack is usually employed.

**Accredited areas** are set up by legislation, and all cattle within these areas are tested and reactors removed. **Voluntary accreditation** of individual herds is encouraged outside these areas. In some countries, focal points of extensive infection outside accredited areas have been attacked under special legislation.

When an area or country has been freed from the disease, quarantine barriers must be set up to avoid its reintroduction. Within the area, the recurrent cost of testing can be lessened by gradually increasing the inter-test period to 2 and then to 3 or even 6 years as the amount of residual infection diminishes. Meat inspection services provide a good observation point should any increase in incidence of the disease occur. Amongst range beef cattle it is usual to check samples of animals at intervals rather than the entire cattle population.

#### Problems in tuberculosis eradication

Complete eradication of tuberculosis has not really been achieved in any country. In many, a state of virtual eradication has been in existence for years but minor recrudescences occur. In the final stages of an eradication program a number of problems achieve much greater importance than in the early stages of the campaign. The major problems which arise are as follows.

##### No visible lesion reactors

The percentage of reactors with no gross lesions or no visible lesions (NVL) at slaughter rises steeply as the disease prevalence decreases. In part this occurs because gross examination has poor sensitivity for detection of infection, but it is also inevitable given the falling prevalence of disease and the specificity of the tuberculin test.<sup>10,37</sup> NVL reactors create administrative and public relations difficulties. Resolution of this problem awaits the validation of the interferon-gamma assay, or other accepted serological test.

##### 'Breakdowns'

Individual herds which have been accredited after a number of free tests may be found to have the disease again, often with a very high incidence. These may be because an anergic carrier has been left in the herd, and tests have been too far apart, or because of a break in the security of the herd with infection from



purchased cattle or transmission between cattle in neighboring herds.<sup>43</sup>

#### 'Traceback'

A principal source of information on the location of infected herds in the final stages of a program could be a traceback originating from infected animals at packing plants. It is often impossible, and a major advance would be a suitable method of **identifying individual animals** which could be utilized up to the killing floor. The two most popular methods are fabric labels stuck on the rump with skin contact glue, and wraparound plastic or metal tail-tags bearing an identification number for the farm of origin. They have two problems. They can be removed at the abattoir and reused; they fall off if the tail is docked, a popular practice in some areas. Electronic identification might solve this problem but meets political and other resistance in many countries. Recent experience with bovine spongiform encephalopathy and other concerns for food safety will likely remove this resistance and most countries have or are developing effective traceback programs.

#### Large herds

Another kind of difficulty in eradication is where cattle are run under very extensive conditions on **large ranches** or stations as in North America, South America, and Australia. There can be difficulty in insuring a complete muster and there is a great need for a test that does not require that cattle be held in a mustering site for 3 days before the test is read. Problems with continuing infection also occur in **large intensive dairies** where the policy is test and cull, and the whole dairy can not be depopulated at one time.

#### Wildlife reservoirs

Spread to cattle from wild fauna is a major problem in the UK where badgers and deer are important sources of infection, in New Zealand, where the brush-tailed possum plays the same role, and a risk from deer exists in several countries. In New Zealand, the possum is considered a pest, does considerable damage to the ecosystem, and possum control programs are accepted. However, the badger in Britain, and deer in most countries, are protected species and suitable control programs, acceptable to animal protectionists, are difficult to negotiate in this sensitive area of public relations.<sup>42,44</sup> DNA fingerprinting can establish sources of infection and the importance of wildlife reservoirs to cattle.<sup>1,45</sup>

#### Control of tuberculosis in pigs

*M. bovis* infection in pigs usually results from the feeding of infected milk, skim milk or whey to pigs, or allowing cattle and pigs to graze the same pasture. The

first step in the control of tuberculosis in a pig herd is to remove the source of infection, and then to test and remove the reacting animals, not an efficient procedure because of the relative inaccuracy of the tuberculin test in this species. The non-progressive nature of the disease means that transmission between pigs is unlikely to occur to a significant extent except perhaps in breeding animals.

#### REVIEW LITERATURE

- Pritchard DG. A century of bovine tuberculosis 1888–1988: conquest and controversy. *J Comp Pathol* 1988; 99:357–399.
- Clifton-Hadley RS, Wilesmith JW. Tuberculosis in deer, a review. *Vet Rec* 1991; 129:5–12.
- Wood PR, Monahan ML (eds). Bovine tuberculosis. *Vet Microbiol* 1994; 40:1–205.
- Second International Symposium on *Mycobacterium bovis*. *NZ Vet J* 1995; 249–364.
- de Lisle GW, Mackintosh CG, Bengis RG. *Mycobacterium bovis* in free-living and captive wildlife, including farmed deer. *Rev Sci Tech Off Int Epiz* 2001; 20:86–111.
- Cousins DV. *Mycobacterium bovis* infection and control in domestic livestock. *Rev Sci Tech Off Int Epiz* 2001; 20:71–85.
- Delay RJ, Leeuw ANS, Barlow AM, Clifton-Hadley RS, Cheeseman CL. The status of *Mycobacterium bovis* infection in UK wild mammals: a review. *Vet J* 2002; 164:90–105.

#### REFERENCES

- Haddad N et al. *Res Vet Sci* 2003; 76:1.
- Aranaz A et al. *Int J System Evolut Microbiol* 2003; 53:1785.
- McIlroy SG et al. *Vet Rec* 1986; 118:718.
- Neill SD et al. *Vet Microbiol* 1991; 28:103.
- Delay RJ et al. *Vet J* 2002; 164:90.
- de Lisle GW et al. *Rev Sci Tech Off Int Epiz* 2001; 20:86.
- Cheeseman CL et al. *Epidemiol Infect* 1989; 103:113.
- Mairtin DO et al. *Prev Vet Med* 1998; 34:47.
- Roper TJ et al. *Cattle Pract* 2003; 11:9.
- Morris RS et al. *Vet Microbiol* 1994; 40:153.
- Morris RS, Pfeiffer DU. *NZ Vet J* 1995; 43:256.
- Chaddock HM. *Proc US Anim Hlth Assoc* 1996; 100:142.
- Whipple DL et al. *J Vet Diag Invest* 1997; 9:381.
- Lees VW. *Can Vet J* 2004; 45:28.
- Norby B et al. *J Vet Diag Invest* 2004; 16:126.
- Keet DF et al. *Onderstepoort J Vet Res* 1996; 63:239.
- Jackson R et al. *NZ Vet J* 1995; 43:346.
- Grange JM, Yates MD. *Vet Microbiol* 1994; 40:137.
- Palmer MV et al. *Tuberculosis* 2002; 82:275.
- White PCL et al. *Prev Vet Med* 2004; 63:1.
- McInerney J et al. *Aust Vet J* 1995; 72:448.
- Davidson RM et al. *NZ Vet J* 1981; 29:1.
- Moda G et al. *Tuberc Lung Dis* 1996; 77:103.
- Wedlock DN et al. *Microbes Infect* 2002; 4:471.
- Yates MD, Grange JM. *Epidemiol Infect* 1988; 101:225.
- Smith RMM et al. *Emerg Infect Dis* 2004; 10:539.
- Neil SD et al. *Vet Microbiol* 1994; 40:41.
- Monaghan ML et al. *Vet Microbiol* 1994; 40:111.
- Thoen CO et al. *Proc US Anim Hlth Assoc* 1983; 87:582.
- Hancox M. *J Agric Sci* 2002; 139:223.
- Norby B et al. *J Vet Diag Invest* 2004; 16:126.
- Duffied BJ et al. *Aust Vet J* 1985; 62:424.
- Lightbody KA et al. *Vet Rec* 1998; 142:295.
- Ryan TJ et al. *Res Vet Sci* 2000; 69:57.
- Whelan AO et al. *Vet Rec* 2004; 155:204.

- Buddle BM et al. *Vet Rec* 2003; 153:615.
- Conner LA. *Vet Microbiol* 1994; 40:137.
- Whipple DL et al. *J Vet Diag Invest* 1996; 8:351.
- Rhyan JC, Saari DA. *Vet Pathol* 1995; 32:215.
- Milian-Suazo F et al. *Prev Vet Med* 2003; 58:1.
- Daborn CJ, Grange GM. *Br Vet J* 1993; 149:405.
- Newell DG, Hewinson RG. *Vet Rec* 1995; 136:459.
- Griffin JM, Dolan LA. *Irish Vet J* 1995; 48:228.
- Krebs JR et al. *Science* 1998; 297:817.
- De Lisle GW et al. *NZ Vet J* 1995; 43:266.

### MYCOBACTERIOSIS ASSOCIATED WITH *MYCOBACTERIUM AVIUM-INTRACELLULARE* COMPLEX AND WITH ATYPICAL MYCOBACTERIA

#### Etiology *Mycobacterium*

*avium-intracellulare* complex and other mycobacteria

#### Epidemiology

Ubiquitous in nature. Infection by ingestion. High concentration can build up in animal bedding of various types. Domestic or wild birds are a source of classic avian tuberculosis serovars

**Clinical findings** Most infections are of the draining lymph nodes of the alimentary tract, are subclinical, but can result in carcass condemnation. Generalized cases manifest with chronic weight loss and diarrhea

**Clinical pathology** Tuberculin testing in cattle and swine. Culture, PCR

**Necropsy findings** Microgranulomas, with or without caseation, in lymph nodes

**Control** Reduction of environmental contamination

#### ETIOLOGY

The *M. avium* complex is comprised of *M. intracellulare* and the subspecies of *M. avium*, which are *M. avium* subsp. *avium*, *M. avium* subsp. *paratuberculosis*, and *M. avium* subsp. *sylvaticus*. *M. avium* subsp. *paratuberculosis* is the cause of Johne's disease and is discussed elsewhere.

Mycobacteriosis is associated with members of the *Mycobacterium avium-intracellulare* complex (*M. avium* subsp. *avium* and *M. intracellulare*), and occasionally by other less well-defined mycobacterial species such as *M. kansasii*, *M. chelonae*, *M. fortuitum*, *M. aquae*, *M. cookii*, and *M. scrofulaceum*. Accuracy in the identification of these organisms has been enhanced by the use of modern molecular techniques, but the epidemiology of infection with most is poorly understood.

The *M. avium-intracellulare* complex consists of 28 serovars and two species. Currently, serotypes 1–6, 8–11 and 21 are *M. avium* and serotypes 7, 12–20, and 25 are *M. intracellulare*. The remaining serotypes do not fit with either species.<sup>1,2</sup> The classical *M. avium* serovars 1–3 are the cause of tuberculosis in domestic and wild birds. Serovars 1, 2, 4–6, 8–10, and 21 appear to be the most common in infections of domestic livestock. Individual

pigs may be infected with more than one serovar.<sup>3</sup> Recently it is proposed to restrict the designation of *M. avium* subsp. *avium* to the 'bird-type' isolates serotypes 1-3 and to use the designation *M. avium* subsp. *hominissuis* for serotypes 4-6, 8-11, and 21.<sup>4</sup>

The *M. avium-intracellulare* complex comprises ubiquitous opportunist pathogens of a large range of species, and in livestock have most importance in swine. Tuberculosis associated with these organisms in livestock is usually not manifest clinically and is not a major disease problem, but infected animals react to the mammalian **tuberculin test**, creating difficulty in *M. bovis* tuberculosis eradication programs. Outbreaks in pig herds can cause significant losses because of **carcass condemnation**. In pigs, a significant proportion of reactors to tuberculin are due to infection with organisms of this complex and infected cattle and pigs are potential sources of infection for the increasing number of *M. avium* complex infections in humans.

## EPIDEMIOLOGY

### Occurrence

Lymphadenitis in pigs associated with these organisms is reported from all continents.<sup>3</sup>

### Source and transmission

Organisms of the *M. avium-intracellulare* complex are **ubiquitous** in nature and can be isolated from soil, plants, water, and animal feed and animal bedding. Infected birds nesting in animal or feed buildings are the most common source of *M. avium* subsp. *avium* of serotypes 1-3, and contaminate feed and water supplies. In contrast, isolates of *M. avium* subsp. *hominissuis* (serotypes 4-6, 8-11, and 21) are commonly isolated from the environment and can be isolated from various species of flies and beetles that inhabit the ground, bedding and feed in farm environments.<sup>5-7</sup> The organisms are resistant to acidic environments which allows them to survive in the acidic, humid environments of peat bogs and decomposed feces and the lipopolysaccharide bacterial wall promotes survival in environments inside and outside barns for extended periods of time.<sup>7</sup>

**Ingestion** appears the normal route of infection and pigs infected with some serovars excrete the organism in **feces**. In pigs the use of dirt **floors** or deep litter, rather than bare concrete or slats, increases the risk of infection and the development of macroscopic lymphadenitis in large numbers of pigs. The length of time that pigs are kept on the litter is also important and severe outbreaks can occur in pigs kept on litter for the entire period from weaning to slaughter. Sawdust, straw, peat, and wood shavings have all

been found to be highly infected. Serovars 4 and 8, in particular, have been associated with infection from bedding.<sup>8,9</sup> Sphagnum moss infected with *M. cookii*, and environmental exposure to other mycobacteria, may result in sensitization of cattle to *M. bovis* tuberculin.<sup>10,11</sup>

The classic *M. avium* serovars 1-3 are the cause of tuberculosis in domestic and wildbirds which are infected by ingestion of contaminated feed or soil and excrete large numbers of organisms in feces. Although infection in domestic livestock is commonly contracted from domestic poultry, from soil-borne infection, or from pen floors or feeds contaminated by wild birds, pig to pig transmission can also occur.<sup>12</sup>

### Economic importance

Clinical disease is not important, but at slaughter organs with tuberculous lesions are discarded and the entire carcass may be condemned or require heat treatment before being released for human consumption.

### Zoonotic importance

Infections with atypical mycobacteria are not uncommon in humans and have higher prevalence in immunodeficient humans. Members of the *Mycobacterium avium-intracellulare* complex cause both pulmonary infections in immunocompetent individuals and disseminated diseases in acquired immunodeficiency syndrome.

Animals, or animal products, may be a source for human infection but direct associations are difficult to prove. Although not clinically ill, human workers have been found to be infected on farms when the disease occurred in pigs. It is likely that infections in humans and animals on the one farm come from the one source, but it is also possible that spread from animals to humans occurs.

## CLINICAL AND NECROPSY FINDINGS

### Pigs

Infection is **usually sporadic** in pigs in herds but in some herds can be enzootic.<sup>13</sup> The naturally occurring disease is non-progressive and usually restricted to the lymph nodes of the head and neck and the mesenteric lymph nodes. Occasional generalized cases occur and an outbreak of pulmonary tuberculosis associated with *M. avium* has been recorded in pigs. The lesions may be free of suppuration and resemble neoplastic tissue but granulomatous and occasionally caseous lesions in lymph nodes also occur. Similar lesions are associated with *Rhodococcus equi*. Granulomatous lesions which develop in the tonsils and intestinal wall result in the passage of organisms in the feces for at least 55 days<sup>14</sup> and **transmission to in-contact** pigs occurs readily.

Tuberculosis produced experimentally in pigs by the oral administration of *M. avium* is generalized, provided the inoculation dose is sufficiently large. Transmission from these pigs to contact pigs occurs. Vaccination of pigs with BCG vaccine provides partial protection against experimental infection with *M. avium*.

*M. bovis* also can infect pigs and *M. fortuitum* is recorded as a cause of chronic arthritis in pigs.<sup>15</sup>

### Cattle

With classic avian tuberculosis, sensitivity to tuberculin may disappear soon after cattle are removed from contact with infected birds. Infection with this group of organisms produces **microgranulomas in lymph nodes**. Local lesions may persist in the mesenteric lymph nodes, the meninges, and in the uterus and udder, and occasional cases of open pulmonary tuberculosis have been observed. In uterine infections recurrent abortion may occur, and mammary localization causes induration and involvement of lymph nodes, similar to the lesions associated with *M. bovis*. Generalized tuberculosis can occur in up to 50% of cases.

### Horses

Horses are **resistant** to infection with *M. avium* complex, although rare, generalized cases of tuberculosis have been recorded in this species with serovars 1, 2, 4, 5, and 8.<sup>16-18</sup> It is possible that disease occurs only in horses that are immunosuppressed by other factors. A common history is chronic diarrhea and weight loss. Less common manifestations include dermatitis, alopecia, and skin ulceration. **Granulomatous enteritis** is commonly present at necropsy. Two cases have been recorded in which the lesions in the cervical lymph nodes were accompanied by lesions in cervical vertebrae. The lesions were similar to those seen in cervical vertebral osteomyelitis associated with *M. bovis*.

### Goats and sheep

Goats and sheep appear to have a strong natural resistance to infection with *M. avium* complex. A high incidence of avian tuberculosis has been observed in a flock of goats and, although the disease progresses slowly, this species may act as reservoirs for other species. Animals with progressive disease show anorexia and chronic diarrhea and wasting.<sup>19</sup>

### Deer

Infection in wild and farmed deer<sup>20</sup> occurs and may serve as a source of infection for carrion-eating birds.

## CLINICAL PATHOLOGY

The lesions at postmortem or slaughter inspection are characteristic but culture and identification of the organism is

required for confirmation. Growth is slow and PCR technologies offer faster diagnosis with some ability to distinguish between individual species and serovars.<sup>21</sup> Smears of lesions associated with some of these agents **do not stain positive** with acid-fast stains.<sup>9,18</sup>

### Tuberculin testing

With infections in **cattle**, sensitivity to tuberculin occurs to both avian and bovine tuberculin but is greater to avian tuberculin. With atypical mycobacteria the response is also short-lived, significant changes in sensitivity occurring between successive tests.<sup>22</sup> The comparative tuberculin test is becoming more widely used because of the growing importance of these infections. It is not uncommon for there to be more than one species of mycobacteria causing disease in a herd at the one time.

The use of a comparative tuberculin test in **swine** to differentiate between infections with *M. avium-intracellulare* complex and *M. bovis* is discussed in the previous section.

Tuberculin skin testing in **horses** is not conducted as 70% of clinically normal horses show positive reactions.

### TREATMENT AND CONTROL

Treatment is not usual, except possibly in horses. Antimicrobial treatment in humans for this complex of organisms includes amikacin, ciprofloxacin, rifampin, and the macrolide azithromycin.

In swine herds with enzootic infection culling on the basis of skin sensitivity is usually not practical because of the high prevalence of infection and high environmental contamination. Control procedures concentrate on the reduction of **environmental contamination** by a change from bedding to solid or slatted floors, frequent washing and disinfection of pen floors, separate weaner and grower facilities, and exclusion of wild birds from buildings and feed areas.<sup>23</sup>

### REVIEW LITERATURE

Thorel MF, Huchzermeyer HF, Michel AL. *Mycobacterium avium* and *Mycobacterium intracellulare* infection in mammals. Rev Sci Tech Off Int Epiz 2001; 20:204–218.

### REFERENCES

- Inderlied CB et al. Clin Microbiol Rev 1993; 6:266.
- Nishimori K et al. J Clin Microbiol 1995; 33:2102.
- Thorel MF et al. Rev Sci Tech Off Int Epiz 2001; 20:204.
- Mijs W et al. Internat J Syst Evol Microbiol 2002; 52:1505.
- Matlova L et al. Vet Microbiol 2004; 102:227.
- Fischer OA et al. Med Vet Entomol 2001; 15:208.
- Fischer OA et al. Vet Microbiol 2004; 102:247.
- Windsor RS et al. Vet Rec 1984; 114:497.
- Margolis MJ. J Am Vet Med Assoc 1994; 204:1571.
- Monaghan ML et al. Vet Rec 1991; 129:383.
- Kazda J, Cook BR. NZ Vet J 1988; 36:184.
- Gardner IA, Hird DW. Can J Vet Res 1989; 53:33.
- Morita Y et al. J Vet Med Sci 1994; 56:475.
- Ellsworth S et al. Am J Vet Res 1980; 41:1526.

- Chengappa MM et al. Vet Med 1983; 78:1273.
- Mair JS et al. Equine Vet J 1986; 18:226.
- Flores JM et al. Vet Rec 1991; 128:407.
- Gunnes G et al. Vet Rec 1995; 136:565.
- Thorel MF. Vet Res 1997; 28:439.
- Mackintosh CG et al. NZ Vet J 2004; 52:163.
- Fiezabadi MM et al. J Clin Microbiol 1996; 34:1136.
- Corner LA. Aust Vet J 1987; 57:216.
- Alfredsen S, Skjerve E. Prev Vet Med 1993; 15:253.

## TUBERCULOSIS ASSOCIATED WITH MYCOBACTERIUM TUBERCULOSIS

*Mycobacterium tuberculosis* is occasionally isolated from cattle or pig livestock with tuberculous lesions but this is rare.<sup>1–3</sup> Outbreaks of tuberculosis in animals associated with *M. tuberculosis* of human origin are transitory, and removal of tuberculous humans from the environment usually results in the disappearance of positive reactors in cattle. In cattle herds the reactors and necropsy lesions are most common in the young stock. Many reactors have no visible lesions: those which do occur are small and confined to the lymph nodes of the digestive and respiratory systems. Pigs may develop minor lesions in lymph nodes, but sheep, goats, and horses appear to be resistant. *M. tuberculosis* infections in pigs are usually the result of feeding offal from a tubercular household or contact with a tuberculous attendant.

### REFERENCES

- Rishendra V, Srivastava SK. Indian J Anim Sci 2001; 71:129.
- Pavlik I et al. Vet Medicina 2003; 48:83.
- Pavlik I et al. Vet Medicina 2003; 48:113.

### SKIN TUBERCULOSIS

Chronic indurative lesions of the skin in cattle, occurring usually on the lower limbs, are called 'skin tuberculosis' because they frequently sensitize affected animals to tuberculin.

### ETIOLOGY

Acid-fast organisms can often be found in the lesions in small numbers. They have not been identified and are probably not true pathogens. Iatrogenic lesions may be caused by aluminum adsorbed vaccines which produce subcutaneous granulomas, colonized by acid-fast bacteria.

### EPIDEMIOLOGY

The disease occurs in most countries of the world, particularly where animals are housed and incur minor abrasions and pressure sores. The frequent occurrence of lesions on the lower extremities suggests **cutaneous abrasions** as the probable portal of entry of the causative organism.

The lesions cause little inconvenience but they are unsightly and affected animals may give a suspicious or positive

reaction to the tuberculin test when they are in fact free of tuberculosis. This becomes important when herds and areas are undergoing eradication and attention is focused on any condition which complicates the tuberculin test.

### PATHOGENESIS

Tubercloid granulomas occur at the site of infection with spread along local lymphatics but without involvement of lymph nodes.

### CLINICAL FINDINGS

Small, 1–2 cm diameter lumps appear under the skin. The **lower limbs** are the most common site, particularly the forelimbs, and spread to the thighs and forearms, and even to the shoulder and abdomen, may occur. The lesions may be single or multiple and often occur in **chains** connected by thin cords of tissue. The nodules are attached to the skin, may rupture and discharge thick cream-to-yellow pus. Ulcers do not persist. Individual lesions may disappear but complete recovery to the point of disappearance of all lesions is unlikely if the lesions are large and multiple.

### CLINICAL PATHOLOGY

Affected animals may react to the tuberculin test. Bacteriological examination of smears of pus may reveal the presence of acid-fast bacteria.

### NECROPSY FINDINGS

The lesions comprise much fibrous tissue, usually containing foci of pasty or inspissated pus, and are sometimes calcified.

### DIFFERENTIAL DIAGNOSIS

In herds with tuberculosis, reactors which have lesions of skin tuberculosis are disposed of in the usual way. In herds free of tuberculosis a positive reaction to the tuberculin test in animals with skin tuberculosis is usually taken to be non-specific and the affected animal is retained provided it is negative on retest.

- Bovine farcy
- Ulcerative lymphangitis.

### TREATMENT AND CONTROL

Treatment and control measures are not usually instituted although surgical removal may be undertaken for cosmetic reasons.

### BOVINE FARCY

Bovine farcy is a chronic infectious disease of Zebu cattle which is endemic to regions of East and central Africa and a cause of considerable economic loss. In some areas 25 to 30% of cattle are affected.<sup>1,2</sup> The disease is slowly progressive and affects primarily adult cattle. Lesions

occur in superficial lymph nodes, mostly in the prescapular and precrucial lymph nodes. Affected lymph nodes suppurate and there is induration of the lymphatic vessels. There can be infection in the mesenteric lymph nodes with some cases having lesions in the udder or the lung. Lesions are common in areas of the body where *A. variegatum* attaches.<sup>2</sup> Histological examination shows a severe granulomatous reaction with lymphocyte macrophage and giant cell infiltration.<sup>3</sup>

*Mycobacterium farcinogenes* and *M. senegalense* have been considered the principal, if not sole, causal agents<sup>1</sup> but there is some debate on the etiology.<sup>4</sup>

## REFERENCES

1. Hamid ME et al. J Clin Microbiol 2002; 40:707.
2. Marchot P et al. Rev Elev Med Vet Pays Trop 1989; 42:173.
3. Hamid ME et al. J Comp Pathol 1991; 105:287.
4. Bercovier H, Vincent V. Rev Sci Tech Off Int Epiz 2001; 20:265.

## PARATUBERCULOSIS (JOHNE'S DISEASE)

### Synopsis

**Etiology** *Mycobacterium avium* subspecies *paratuberculosis* (*Map*)

**Epidemiology** Occurs in cattle, sheep, and goats. High prevalence of infection in cattle population and among herds.

Incidence of clinical disease in herds about 1% annually. Transmitted by fecal-oral route. Prenatal infection occurs. Infection occurs soon after birth. Long incubation period

### Clinical signs

**Cattle** Chronic progressive intractable diarrhea and emaciation in adult cattle extending over several weeks and months

**Sheep** Chronic wasting disease of adult sheep; diarrhea not a distinct clinical finding. Common cause of emaciation in ewes

### Clinical pathology

Culture feces. Serological tests (ELISA, AGID, CF). Low serum protein and marked hypoalbuminemia in affected sheep

**Lesions** Chronic granulomatous enteritis

**Diagnostic confirmation** Presence of intestinal lesion and culture of organism. Positive serological test

**Treatment** No specific treatment of significant value

**Control** Identify and eliminate clinical cases and subclinically infected animals. Test herd serologically. Identify and cull positive animals. Improve management and hygiene to minimize spread of infection in herd with emphasis on avoiding infection of newborn calves. Vaccination prevents clinical disease but not infection

### Differential diagnosis list

#### Diarrhea in adult cattle

- Intestinal parasitism (ostertagiasis)
- Salmonellosis
- Secondary copper deficiency

### Emaciation in adult cattle

- Chronic traumatic reticuloperitonitis
- Malnutrition
- Pyelonephritis
- Lymphosarcoma
- Amyloidosis

### Diarrhea and weight loss in sheep and goats

- Gastrointestinal parasitism

### Chronic weight loss in sheep and goats

- Internal abscesses
- Caseous lymphadenitis
- Caprine arthritis-encephalitis
- Ovine progressive pneumonia
- Dental disease

## ETIOLOGY

There are at least two main strain types of *Map*, designated C (cattle) and S (sheep), which can be distinguished by restriction fragment length polymorphism patterns.<sup>1,2</sup> *Map* isolates analyzed by pulse-field electrophoresis appear to segregate into distinct clusters: Type I comprises the pigmented ovine isolates, and Type II comprises isolates from a wider host range.<sup>3</sup> Four Type I (sheep) isolates of *Map* have been differentiated from nine Type II (bovine) isolates.<sup>3</sup> It is hypothesized that *Mycobacterium avium* subsp. *paratuberculosis* Type I strains are an evolutionary intermediate between *M. avium* subsp. *avium* and *M. avium* subsp. *paratuberculosis* I Type II isolates or share a subset of *M. avium* subsp. *avium* type-specific loci through horizontal transfer. There is also evidence of a goat-specific strain in Norway which does not appear to be pathogenic for calves. A unique bison (*Bison bison*) strain has been found in Montana.<sup>4,5</sup>

Molecular epidemiology studies of *Map* have identified a high degree of genetic similarity within the bovine isolates, regardless of geographic origin, indicating that only a few closely related clones of *Map* may be responsible for widespread infection in cattle, other ruminants, and possibly wildlife.<sup>6</sup> There is a higher degree of genetic heterogeneity among *Map* isolates recovered from human and ovine sources.<sup>6</sup> Extensive analyses of the IS900-RFLP patterns have identified that Johne's disease in cattle and other species such as goats and rabbits is associated with indistinguishable strains. Johne's disease in sheep appears to be associated with a different strain which also infects goats and deer. The occurrence of a 'sheep strain' in cattle with Johne's disease has been reported, indicating that interspecies transmission is possible.<sup>2</sup> Bovine strains infect cattle, goats, and deer, and rarely sheep.

## EPIDEMIOLOGY

### Occurrence

Cattle, sheep, and goats

The disease occurs worldwide most commonly in cattle and to a lesser extent in sheep and goats.<sup>7</sup> The disease is widespread in cattle in Europe and has been spread to many countries by the export of infected clinically normal purebred stock. It is of major importance in cattle and sheep in temperate climates and some humid, tropical areas. The incidence is greatest in animals kept intensively under climatic and husbandry conditions which are conducive to the spread of infection.

The Icelandic story of paratuberculosis is an example of the risk of importing animals into a country without accurate tests or testing. In 1933, 20 stud rams of the Karakul breed were imported from Germany into Iceland to improve the quality of the skin of Icelandic sheep. The imported sheep appeared healthy and had certificates of good health control. After 2 months of quarantine they were distributed to 14 farms in the main sheep farming areas. The first clinical case of paratuberculosis in sheep was diagnosed in 1938 or 5 years after the arrival of the sheep. Gradually, infection spread from these five original farms during the next few years, and over the next 18 years, 20-30% of the farms in the sheep breeding areas were infected.<sup>8</sup> Within 16 years paratuberculosis together with other diseases (maedi-visna and jaagsiekte) almost ruined the sheep industry, the main agricultural industry in Iceland. The first clinical case of Johne's disease in Iceland occurred on these sheep farms in 1944. The annual morbidity of sheep during the epidemic averaged 8-9% in affected areas and was up to 40% on individual farms.

Johne's disease was first confirmed in Australia in 1980, and by 1999 had spread to some other states.<sup>9</sup> It is presumed that infection originated from sheep imported from New Zealand in the 1970s.

Johne's disease is not known to exist in Western Australia.<sup>10</sup> A requirement that imports be derived from flocks which had negative surveillance tests to Johne's disease provides the necessary protection for the sheep industry in Western Australia.

In South Africa, ovine paratuberculosis was unknown until an infected Merino ram was imported in 1967.<sup>11</sup> During the 1990s the disease spread among sheep farms in the Western Cape and Eastern Cape provinces. Links between infected farms indicated a positive correlation between acid soils and occurrence of infection.

Sheep are easily infected experimentally and excrete large numbers of the organism but many recover spontaneously. However,

the disease can also cause significant financial losses to the sheep farmer. For example, the disease has become established in sheep flocks in Cyprus where sheep are farmed semi-intensively for milk production for cheese, and losses can be as high as 4% per year.

The disease is being recognized with increased frequency in goats and when established in goat flocks can cause large losses. In Australia, Johne's disease occurs in dairy goat breeds with some endemic foci in south-eastern Australian states. Western Australia is free of Johne's disease in goats, sheep, and cattle.<sup>12</sup>

The occurrence of Johne's disease in cattle in Ireland is very low.<sup>13</sup> In the 51-year period from 1932 to 1982 there were only 92 cases diagnosed. The disease has been compulsorily notifiable in the Republic of Ireland since 1955 and all confirmed or suspected *Map* animals are slaughtered. The disease has been associated most frequently with imported pedigree stock. In the early 1990s, sporadic cases of the disease have been diagnosed annually. There is concern that the incidence could increase with the continuing intensification of dairy herds and following the importation of high-merit breeding heifers into many dairy herds from continental Europe where the incidence is high. Serological and fecal culturing screening of animals imported into the Republic of Ireland revealed that some animals were carriers of *Map*.<sup>14</sup> Culture-positive animals had been imported from the Netherlands, France, and Denmark. None of the culture-positive animals gave a positive serological reaction.

#### Morbidity and case fatality

The incidence of clinical disease in an infected herd is very low at any one time and rarely exceeds 5% of mature animals. The population mortality rate is less than 1% per year. In exceptional circumstances it can be as high as 5–10%. Although death losses are not high, when they are added to the losses caused by long periods of ill-health and reduced productivity the economic losses can be significant. For every clinical case of Johne's disease in a herd, it is estimated that there are 15–25 additional infected animals in various stages of clinical disease, 4–8 cases of subclinical disease and carrier adults, and 10–14 with silent infection in calves, young cattle, and adults.<sup>15</sup>

#### Wildlife and exotic species

*M. avium* subsp. *paratuberculosis* has a very broad host range. Infection may also occur in many different wildlife and exotic species. Water buffalo, captive and free-living wild ruminants including deer, bighorn sheep, Rocky Mountain goats, aoudads, mouflon sheep, camels, moun-

tains goats, reindeer, antelopes, llamas, and yaks are all susceptible. The disease has been diagnosed in alpacas in Australia. Outbreaks of the disease have occurred in farmed red deer and the incidence is increasing in some regions. The organism has been isolated from the intestinal tissues of Eastern white-tailed deer killed on a farm with a history of Johne's disease.

There is evidence that wildlife in Scotland are naturally infected with *Map* and that the host range is much wider than previously thought. The organism has been found in fecal cultures from foxes, stoats, crows, weasels, jackdaws, hares, badgers, rooks, rats, and wood mice.<sup>17</sup> Such environmental contamination with the organism can thereby pose a risk to grazing livestock and farms adjoining paratuberculosis-infected properties. Paratuberculosis has been found in wild rabbits (*Oryctolagus cuniculus*) in Scotland.<sup>17–19</sup> Analysis indicates a significant relationship between a past or current problem of paratuberculosis in cattle and in the wild rabbit population on infected farms.<sup>17</sup> The organism can be found in rabbit fecal pellets and urine.<sup>19</sup> On infected farms rabbits potentially input millions of viable *Map* organisms per ha per day onto pasture grazed by livestock through fecal contamination. Also, grazing cattle do not avoid rabbit fecal contaminated pasture which is the only recorded example of a herbivore species not avoiding their own feces or the feces from sympatric wildlife species.<sup>18</sup> The greatest overlap between habitat use by rabbits and livestock grazing occurred in rough grazing and gorse scrub habitats particularly in autumn and where adjacent habitats were favored by rabbits. Therefore, a reduction in potential transmission risk could be achieved by reducing contact between livestock and rabbits in these habitats, especially reducing access to these habitats by young livestock as they are more susceptible to infection.

In the Czech Republic, paratuberculosis has been diagnosed in all four of the most common wild ruminant species including red deer, roe-deer, fallow deer, and mouflon.<sup>20</sup> The highest incidence of clinical disease in wild ruminants was in farmed deer. Using restriction fragment length polymorphism (RFLP) (molecular epidemiology), transmission between domestic and wild ruminants and between ruminant and non-ruminant species was examined. Transmission from domestic infected ruminants to wild animals occurred but the transmission from wild animals to domestic ruminants is uncertain. Non-vertebrates, wild ruminants, or non-ruminant wildlife can be vectors and potentially become a risk factor in the spread of *Map*.

Johne's disease was recognized in farmed deer in New Zealand in the 1980s and by 2000, the disease has been diagnosed in 619 animals from 299 herds, representing approximately 6% of deer herds in New Zealand.<sup>21</sup> In 60% of the herds only one infected animal was identified. The majority (90%) of the 619 cases were identified from lesions in mesenteric lymph nodes, including the ileocecal lymph nodes, identified at meat inspection. Only 5.8% cases came from clinically affected animals identified on farms by veterinarians. These survey data suggest that without rapid control intervention, the disease will become endemic in farmed deer. The disease has occurred in farmed red deer in Belgium.<sup>22</sup>

The epidemiological implications of cattle and wildlife co-mingling on the same pasture are unknown. The rate of infection can be the same in both species and it seems that both share a common source, which might well be a common herd of deer and cattle. Pigs mixed with infected cattle may develop enlargement of the mesenteric lymph nodes suggestive of tuberculosis and from which the causative organism can be isolated. Pigs and horses infected experimentally develop granulomatous enteritis and lymphadenitis. Mice and hamsters are also susceptible and are used in experimental work.

#### Prevalence of infection

The prevalence of infection in a region is difficult to estimate because of the uncertainty of the diagnosis and the failure to report cases unless a specific survey or eradication program is undertaken. It appears that the prevalence of infection has been increasing in the last 10 years and there are large variations in the estimates of prevalence.<sup>15</sup>

Because of the insidious nature of Johne's disease, it is considered to be potentially a hidden threat to the livestock industry.

#### Cattle

Most surveys of prevalence have been based on the results of culture of fecal or tissue samples collected from cull cows at slaughter. Some examples of prevalence rates are as follows. Depending on the region studied, 2.6–18% of cows were found infected. The prevalence of the organism in the ileocecal lymph nodes of cattle culled in the United States was 1.6% overall, with 2.9% in dairy culls and 0.8% in beef culls. Abattoir surveys in Wisconsin found a prevalence of 10.8% and in Connecticut 18%. In Ontario, the organism was isolated from the distal ileum and/or ileocecal lymph node of 5.5% of 400 cull cows, and based on a lipoarabinomannan antigen ELISA on

sera, the predicted true prevalence among 304 dairy herds was 6.1%. Based on a systematic random sampling of culled dairy cattle in Atlantic Canada and Maine, the prevalence of infection was 16.1%. Mesenteric lymph nodes and ileum from 984 dairy cows were examined by histologic and bacteriologic methods.<sup>23</sup>

In Louisiana beef herds the individual animal prevalence is estimated at 4.4% and prevalence among herds is 30%. A serological survey in Florida reported a seroprevalence of 8.6% in beef cattle and 17.1% in dairy cattle. Using an absorbed ELISA, in a survey of herd prevalence and geographic distribution of infection in 158 Wisconsin dairy herds and 4990 cattle the calculated true prevalence of infection from the apparent infection indicated that 4.79% of cattle and 34% of the herds had serologic evidence of infection. Among the herds classified as positive on the basis of true prevalence estimation, the mean number of test-positive cattle was 20.3%. The geographic distribution was not uniform but certain districts had a larger number of infected herds than others. In a Missouri survey, the apparent seroprevalence in dairy cattle and beef cattle was 8% and 5%, respectively; and 74% of dairy herds and 40% of beef herds were positive, respectively.

There is considerable variation in the prevalence of infected herds in different countries and within specific geographic areas.<sup>15</sup> Surveys done in the US have found seroprevalences up to 7.29% of cows and 50% of herds, and fecal-culture prevalences of 3.05%.<sup>24</sup> Based on seroprevalence studies the true prevalence of *Map* infection in the Belgian cattle population is 6% and the true herd prevalence is 10%.<sup>25</sup> In dairy herds in Alberta, Canada, the true-herd prevalence determined by ELISA was 26.8%.<sup>26</sup> The true herd-prevalence as determined by fecal culture ranged from 27 to 57%. In beef herds on community pastures in Saskatchewan, Canada, using a test sensitivity of 25% and specificity of 98%, the true sample prevalence was 0.0% and the average herd apparent prevalence was 3% or very low.<sup>6</sup> In beef cow-calf herds in the United States, using the ELISA, 7.9% of herds had one or more positive animals and only 0.4% of animals were positive.<sup>28</sup> In dairy herds in Colorado, 4.12% of cows were positive; within-herd prevalence of seropositive cows ranged from 0% to 7.82%.<sup>29</sup> Cows in herds that had imported more than 8% of their current herd size annually during the preceding 5 years were 3.28 times as likely to be seropositive as were cows in herds that imported less than 8% of cows. Cows in herds with  $\geq 600$  lactating cows were 3.12 times as likely to be seropositive as

were cows in herds with  $< 600$  lactating cows. Cows in herds with a history of clinical disease were 2.27 times as likely to be seropositive as were cows in herds without clinical Johne's disease. In dairy herds in the United States, the overall seroprevalence ranged from 5 to 17%. Dairies in western United States have been expanding since 1980 but few producers have tested for *Map* infection prior to purchase. In California the true prevalence in dairy cattle overall was 9.4% with variations from 7.5 to 14.15% depending on different regions of the state.<sup>24</sup> In a survey of 1155 cows in 22 Danish dairy herds the prevalence of cows was 8.8%; and 19 of 22 herds had  $\geq 1$  test-positive cow.<sup>30</sup> The highest probability of a negative test result was found in a large-breed cow, in first parity, in a small herd, having calved more than one month previously; the highest probability of a positive test result was found by testing a cow in parity  $\geq 5$ , in a large herd, in the first month after calving.

The prevalence of *Map* infection in dairy herds in the Netherlands is high with a herd-prevalence of 55% and cow-prevalence of 2%.<sup>31</sup> In vaccinated herds, the cow-prevalence was 23% and in non-vaccinated herds, 2.5%. A possible role for sheep in the epidemiology of *Map* in cattle herds in the Netherlands has been identified.<sup>32</sup>

#### Sheep

Johne's disease in sheep in Australia was first diagnosed in 1980 in central New South Wales.<sup>33</sup> The disease has a highly clustered geographic distribution in Australia. Based on surveys as of the year 2000, the 95% probability limits for flock-prevalence were 0.04–1.5%, 8–15%, and 29–39% for low, moderate, and high prevalence regions in New South Wales, respectively. The other states had an upper 97.5% probability limit of about 1% or less. Based on these estimates about 6–10% of flocks in New South Wales and 2.4–4.4% of flocks Australia-wide are likely to be infected. More than 80% of affected flocks are in a relatively small geographic area of NSW. Some states such as Queensland and Western Australia have a prevalence equal or close to 0%.

#### Methods of transmission

Exposure to the organism can occur by a variety of routes. The most common is through nursing from an infected dam (via contaminated teats or direct shedding of the organism into the colostrum/milk) or ingestion of fecally contaminated solid feed and water.

Infected cows and other species excrete *Map* directly into the milk during at least the late disseminated stage of the infection.<sup>15</sup> Up to 45% of clinically affected cows may excrete the organism in milk.<sup>34</sup>

The organism can be found in the colostrum of subclinical cases; the organism was found in 36% of colostrum samples from heavy shedders and 9% of samples from light shedders, nearly three times as often as it is found in milk.<sup>35</sup> Thus colostrum of infected cows, if fed to calves, could serve as a potential source of infection. Some herds have attempted to avoid this route of infection by pasteurizing colostrum and raw milk.<sup>36</sup>

There is firm evidence of the presence of *Map* in commercially pasteurized cow's milk manufactured for retail sale.<sup>37</sup> The potential public health aspect is an issue given that an association with Crohn's disease in humans is possible but uncertain. However, the presence of the organism in pasteurized milk is undesirable. The organism has been found in raw goat's milk in Norway.<sup>38</sup> Conditions in cheese production have been shown to have little effect on the viability of *Map* and viable bacteria have been found in hard and semi-hard cheese 12 days after production. Therefore consumption of cheese manufactured from raw goat milk in Norway might lead to transmission of *Map* to humans.

Because of the normally long incubation period, infected animals may excrete organisms in the feces for 15–18 months before clinical signs appear. Also, animals reared in a contaminated environment may become permanent or temporary excretors of the organism without becoming clinically affected. The organism has been isolated from the genitalia and the semen of infected bulls, survives antimicrobial addition and freezing, and as a result intrauterine infection may occur. However, small numbers of the organism experimentally inoculated into the uterus of cattle at the time of insemination are destroyed and do not result in systemic infection of the dam or persistent hypersensitivity. It is possible to isolate the organisms from the uterine flush fluids of clinically infected cows and experimentally the organism may adhere to the ova in spite of a 10-step wash procedure to insure the removal of potential pathogens from embryos. Isolation of *Map* from the semen of bulls and rams is unusual and represented by single case reports.

Serologically positive animals, which are moderate shedders of *Map* might be used as donors of embryos without transmitting the organism.<sup>39</sup> The data indicate that transmission of the organism from moderate shedders via the trophoblast is unlikely before the stage of development of cotyledons. However, this does not exclude the possibility of transmission of the organism at a later stage in pregnancy (over 60 days). It is hypothesized that the

epithelio-chorial placenta is impermeable to the organism from 42 to 49 days post-insemination but that this could change after 60 days.

All of these modes of transmission are most significant in animals in relatively advanced stages of the disease and provide the passage of the organism from one generation of hosts to the next, and are the reason for recommending artificial rearing of calves and culling of progeny from infected cows during control and eradication programs.<sup>40</sup>

Spread of the organism from farm to farm is usually due to trading of livestock which are unknown infected carriers and shedders of the organism but lateral spread of feces across boundary fences also occurs.

Tracer sheep have been used to detect the sheep strains of *Map* on pasture.<sup>41</sup> Lambs, weaners, and adult ewes are introduced to pasture with varying amounts of *Map* contamination and monitored using skin tests, gamma interferon assay, fecal culture, and serial necropsy of small groups for up to 15 months after first exposure. Culture from tissues was the most sensitive method for detecting early infection in sheep and serologic tests had low sensitivity during the early stages of naturally acquired infection. Experimental infection of weaner sheep at 12–16 weeks of age with the S strain of *Map* and detection of infection was accomplished within the first few months post-exposure.<sup>41</sup>

Field studies have shown that the nymphs of the Oriental cockroach (*Blattia orientalis*) may serve as a passive vector of *Map*.<sup>42</sup> Also, earthworms and adult Diptera may be vectors of the organism on cattle farms with paratuberculosis. Ovine trichostrongylid larvae (*Haemonchus contortus*, *Ostertagia circumcincta*, *Trichostrongylus colubriformis*) may become contaminated with *Map* and may play a role in the transmission of the organism.<sup>43</sup>

The survival of *Map* in amitraz-based dip fluid for at least 2 weeks suggests that dips could play some role in the transmission of Johne's disease in cattle.<sup>44</sup> The main risk is to calves suckled by cows that have just been dipped and whose udders are covered in dip fluid.

#### Fetal infection

Fetal infection can occur in cattle with and without clinical signs of disease. The prevalence of fetal infection was as high as 37% of cows with clinical signs of the disease, compared with 8.6% of fetuses from cows without signs of disease.<sup>45</sup> Fetal infection is more likely to be associated with more advanced stages of infection when the pregnant female is a heavy shedder of the organism. In a study of fetal infection in sheep a total of 83% of

fetuses from clinical cases in ewes were infected. From subclinically infected ewes, only 1.6% of fetuses were infected, and no fetuses were infected from a sample of uninfected ewes.<sup>46</sup>

#### Risk factors

Animal risk factors

##### *Age of animal*

A distinguishing characteristic of Johne's disease is that infection occurs in animals at an early age, usually under 30 days of age, and clinical disease does not occur until 3–5 years of age. This age limit should not be used as a reliable diagnostic criterion; in extreme circumstances, for example calves reared on infected nurse cows, clinical disease can occur at 12–18 months of age. Exact details of the effect of exposure to infection in adults are not available, but it is probable that some animals exposed for the first time as adults develop clinical disease while others develop only a sensitivity to johnin for short periods although they may become carriers of the organism without manifesting clinical signs.

##### *Breed incidence and genetic susceptibility*

The information on breed incidence is controversial. Field observations indicate a much higher incidence in the Channel Island and Shorthorn breeds of cattle, but this may be related to increased exposure rather than to increased breed susceptibility. The frequency of disease in any particular breed is proportional to the abundance of that breed, and paratuberculosis will occur with highest frequency in the most predominant breed. In comparison to dairy breeds, beef cattle generally range over greater areas and have less exposure to other cattle and their feces. Thus, the prevalence of infection is usually lower in beef than in the dairy breeds. Since Holstein cattle are the predominant dairy breed in the United States, the disease occurs with a greater frequency in that breed than in any other breed.

In Australia, fine wool Merino sheep are more likely to die from ovine Johne's disease than other sheep breeds.<sup>47</sup>

The estimated heritability of cattle to *Map* was low at 0.06 for a sample population of 3020 cows which is comparable to the heritabilities of many other disease traits.<sup>48</sup>

##### *Other diseases and stressors*

The possible cross-protection between tuberculosis and paratuberculosis suggests that eradication of tuberculosis may make the cattle population generally more susceptible to Johne's disease, but this has not been borne out by field experience in North America.

Other factors which affect susceptibility to infection include size of infective dose, level of dietary iron intake, age, stress, and immunosuppressive agents such as bovine virus diarrhea (BVD) virus. These factors may affect the probability of development of clinical disease but they have not been well-documented. Field observations indicate that stress, including parturition, transportation and nutritional deficiencies or excesses may influence the development of clinical disease. Housed animals are subjected to a high risk of infection because of the heavy contamination by feces and the long survival of the bacteria in protected sites.

##### *Herd characteristics*

A computer simulation model of paratuberculosis in dairy cattle has been used to examine the course of the disease in a herd. Seven variables were specified at the initial stage of the model:

- herd size
  - annual herd birth rate
  - annual herd replacement rate
  - number of infected cows at time zero
  - number of herd replacements purchased each year
  - risk of purchasing an infected heifer
  - number of effective cow-calf contacts per year.

All variables affect the course of paratuberculosis spread in herds, but the model is most sensitive to the effective contact rate. This is consistent with the findings of other infectious disease models and with recommendations on Johne's disease control, namely **minimize cow-calf contact** to prevent transmission of infection.

The prevalence of infection in **purchased cattle** directly affects the risk of buying infected cattle and the rate at which herds become infected in the model. Purchase of a large percentage of replacement heifers from populations with modest infection rates annually will quickly result in infection of a herd. Age-specific culling rates are also important in the development of the model. Accurate prediction of the rate at which infected cattle leave a herd was a major determinant of the course of the epidemic because each year an infectious cow remained in the herd, the cow contributed in an exponential manner to the generation of infected calves and thus the number of infected herd replacements. Over the range of realistic values for all variables in the model, the prevalence of the disease in infected herds continued to increase until a plateau was reached. True prevalence rates in the model generally plateaued at 40–60% of the herd. These data results suggest infection is spreading



quickly in dairy cattle as well as in sheep and goats. Paratuberculosis could become epidemic in dairy cattle and may become a greater problem for the dairy industry than was tuberculosis or brucellosis. In dairy herds in the Canadian Maritimes, the seroprevalence for Johne's disease was higher in herds which purchased replacements.<sup>49</sup>

#### Environmental and management risk factors

The relationship between on-farm management practices and the prevalence of infection in Wisconsin dairy herds has been examined. The management factors which are important in influencing the prevalence of infection include:

- newborn calf care
- bred heifer management
- environmental conditions
- handling of manure
- care and management of growing calves.

These are not cause and effect relationships but hypotheses based on observations in dairy herds.

#### Care of the newborn calf

Care of the newborn calf is correlated with apparent prevalence and is reflected in the level of hygiene used to collect colostrum from the calf's dam. Failure to be concerned about a dirty udder during collection of colostrum may increase the risk of contaminating the colostrum with the organism. Removal of the calf within 1 hour after birth, rather than leaving it with the dam for 8–12 hours, may minimize exposure to the fecal-laden calving environment.

Care and feeding of the growing calf, not the milk-fed calf or the weaner/starter calf, is correlated with prevalence. It is suggested that contact of postweaned calves with adult cattle manure should be avoided in order to limit new infections of young calves. In high-prevalence dairy herds in Wisconsin, calves were separated after weaning into calf barns and hutches rather than into pens in the cow barn more often than in herds with lower prevalence. Calves in this age group may be able to transmit the infection to other calves with which they are housed. The factors identified as having low association with apparent prevalence may be de-emphasized in control programs and allow the operators and managers to emphasize control or modification of those risk factors which are considered to be more important in affecting apparent prevalence.

The herd management practices associated with paratuberculosis seroprevalence in Dutch dairy herds have been examined compared to seronegative

herds.<sup>50</sup> Important management measures for the prevention of paratuberculosis, such as calving in a cleaned calving area, removing the calf immediately after birth, and feeding non-contaminated roughage to calves were used only rarely. Four factors were statistically different between seronegative and seropositive herds: herd size, cows with clinical signs of paratuberculosis, prompt selling of clinically affected cattle, and feeding milk replacer.

In a study of more than 1000 dairy herds in the United States, from 20 states, the herd-level risk factors for infection with *Map* and association between familiarity of the herd manager with the disease or prior diagnosis of the disease in that herd and use of preventive measures were examined.<sup>51</sup> Serologic testing revealed that 3.4% of cows and 21.6% of dairy herds were infected with *Map*. Factors which increased the herd status for the disease included increasing herd size, percentage of cows born on other dairy herds, use of group housing for periparturient cows during the previous year, and use of group housing for calves prior to weaning during the previous year. Only 68% of dairies washed the teats and udder before collecting colostrum or the calf sucking the cow. It was also evident that neither familiarity of the herd manager with Johne's disease nor prior diagnosis of the disease in the herd had any significant influence on the use or implementation of measures to control or prevent the disease. In the US, 44% of dairy herds introduce new cattle each year and it is critical that prepurchase testing for *Map* be instituted to avoid even greater dissemination of infection among dairy herds. Less than 1% of US dairy herds participate in a Johne's disease certification program. These findings emphasize the need for renewed and vigorous educational efforts to effect control of Johne's disease on a national basis.

In Michigan dairy herds, use of an exercise lot for lactating cows was associated with a three-fold increase in odds of a herd being positive for *Map*.<sup>52</sup> Cleaning of maternity pens after each use was associated with a three-fold reduction in odds of a herd being positive for *Map*. Application of lime to pasture areas resulted in a ten-fold decrease in odds of a herd being positive for *Map*. Cleaning of calf hutches and pens was associated with an almost three-fold reduction in odds of being positive for *Map*.

A survey of farms in Scotland found that the factors which increased the likelihood of a farm having Johne's disease included large numbers of rabbits, access of wildlife to feed supplies, the application of manure to grazing pasture, the type of water supplies, and the number of crows.<sup>53</sup>

#### Soil characteristics and manure handling

An association between high prevalence of *Map* infection in ruminants and soil type has been recognized. The literature on the possible links between the clinical expression of paratuberculosis and deficiency of macro- and micronutrients has been reviewed.<sup>54</sup> The evidence strongly implicates regional soil acidification, excesses of iron and molybdenum, and marginal deficiencies in copper and selenium in the progressive expression of Johne's disease. Spatial distribution of cattle herds in Indiana, USA, with greater than the median seroprevalence of paratuberculosis was associated with soil characteristics.<sup>55</sup> Survival of the organism may be enhanced by silt or sand content in loamy soils. In Australia, mortality from Johne's in sheep was higher on farms with light sandy soils and those with a high percentage of improved pastures containing subterranean clover.<sup>47</sup> Winter shearing was also associated with clinical expression of Johne's disease in sheep.

Environmental conditions and manure handling are correlated with prevalence and are reflected in overall cleanliness of the farm, and the amount of contamination resulting from faulty design, maintenance, location of housing facilities, and frequency of cleaning by the farm operator.

The distribution of *Map* in the environment surrounding dairy farms and its relationship to fecal pool prevalence in herds known to be infected and uninfected was described and compared.<sup>56</sup> Eighty percent of the infected herds had at least one positive pool. Environmental samples were culture positive in 78% of infected herds. Seven percent of the uninfected herds had one positive pool, and one herd had one positive environmental pool. Environmental samples were cultured positive in cow alleyways (77% of herds), manure storage (68%), calving areas (21%), sick cow pen (18%), water run-off (6%), and postweaned calves areas (3%). There was an association between maximum level of colonies per tube from cow alleyways and manure storage and fecal pool prevalence. Herds with both areas cultured negative were estimated to have 0.3–4% fecal pool prevalence. Herds with both areas having a heavy load of bacteria were estimated to have 53–73% fecal pool prevalence. This indicates that targeted sampling of cow alleyways and manure storage areas appears to be an alternative strategy for herd screening and *Map* infection status assessment and for estimating herd fecal prevalence.

#### Pathogen risk factors

*M. avium* subsp. *paratuberculosis* is an obligate pathogen and parasite of animals,

and in theory can be eradicated by removal of all infected animals.<sup>57</sup> However, the organism can survive for long periods outside the host, enabling it to persist and spread in the grassland environment and to withstand a periodic lack of suitable hosts.

#### *Survival and dormancy of organism in the environment*

Bovine strains of *Map* can be extremely persistent in nature, with survival for more than one year. Studies of the survival of the organism on Australian farms where Johne's disease is prevalent indicate that when the organism in feces becomes mixed with soil, there is a reduction of 90–99% in the apparent viable count of the organism.<sup>57</sup> This is thought to be caused by binding of bacteria to soil particles, which are excluded from culture by sedimentation during sample preparation. Survival of the organism in fecal material applied to soil was greatest (55 weeks) in a fully shaded environment and was least where fecal material and soil were fully exposed to the weather and where vegetation was also removed. The organism survived for up to 24 weeks on grass that germinated through infected fecal material applied to the soil surface in completely shaded boxes and for up to 9 weeks on grass in 70% shade. Dormancy of the organism appears to be a feature in the Australian environment and the dormancy characteristics are related to genetic elements present in the genome of the organism.<sup>57</sup> However, survival was finite. Significant degrees of pasture decontamination can be achieved in a relatively short period which will have benefit for disease reduction in a herd or flock because of the beneficial effects lower doses of the organism would have on incubation period and disease outcome. Pasture management, such as selective grazing with no susceptible hosts or mechanical slashing, may be used to maintain a relatively low level of shade at the soil surface to hasten decontamination.

The organism persists without multiplication in pasture for long periods and such pastures are infective for up to 1 year. The organism is relatively susceptible to sunlight and drying, to a high calcium content and high pH of the soil and continuous contact with urine and feces reduces the longevity of the bacteria. However, in slurry stored in tanks the organism can survive for 98–287 days depending on the composition and alkalinity of the slurry. The alkalinity of the soil may also influence the severity of the clinical signs. Herds raised on alkaline soils, particularly in limestone areas, may have a high incidence of infection but

little clinical disease. A high prevalence of infection is recorded in the USA on acid soils in contrast to alkaline soils. Adult cattle moved from herds where the soil is alkaline to areas where the soil is acid often develop severe fatal clinical disease. This observation may have some practical value in the control of the disease, but it is probable that factors other than the dietary intake of calcium or the pH of the soil will also influence susceptibility to infection.<sup>15</sup>

#### *Thermal resistance of organism*

The survival of the organism was seen in colostrum subjected to pasteurization temperatures of 63°C for 30 minutes. Pasteurization lessened but did not eliminate the growth of the organism from experimentally inoculated colostrum. Pasteurization of colostrum resulted in a significant decrease in colostrum IgG concentrations but not to a level which would preclude its use for passive transfer. Pasteurization of milk experimentally inoculated with the organism at 63°C for 30 minutes killed 90% of four different isolates of the organism; the effect of commercial pasteurization of naturally infected milk is unknown.

#### *Pathogenicity*

Studies of the molecular cause for pathogenicity of *Map* have identified three novel *Map* operons present within a 38-kb locus.<sup>58</sup>

#### **Economic importance**

The economic losses associated with Johne's disease in dairy cattle can be substantial and occur across all herd sizes and regions. Lost milk production and higher net cow-replacement costs contribute to decreased value of production per cow inventory in affected herds.<sup>59</sup> In a 1996 study of the National Animal Health Monitoring System, affected herds experienced an economic loss of about \$US100 per cow compared to Johne's-free herds. In herds with at least 10% of their culls cows with clinical signs of the disease, economic losses were over \$US200. These high prevalence herds experienced reduced milk production of over 700 kg per cow, culled more cows but had lower cull-cow revenues, and had greater cow mortality than negative herds. In dairy herds in the Canadian Maritimes, total annual costs for an average Johne's disease-infected, 50-cow herd were \$US2472.<sup>49</sup>

#### Losses at herd level

The economic losses due to subclinical Johne's disease include:

- reduced feed efficiency
- decreased milk production
- decreased milk fat and protein
- reduced slaughter weight at culling

- decreased fertility
- premature culling
- increased incidence of mastitis.<sup>15</sup>

The salvage value of clinically affected animals is negligible because of severe emaciation. The basis for the effects of infection are negative energy balance and impaired cellular immunity.<sup>15</sup> The slow spread and chronic disease results in a recurrent, rather than an acute, economic loss. Most economic studies have investigated associations between production and clinical and subclinical paratuberculosis as defined by bacteriology or histopathology at culling. The economic losses which have been examined have been associated with levels of mastitis, calving intervals, milk production per lactation, and premature culling. In Michigan dairy herds, ELISA-positive cows on average had a 28-day increase in days open compared to negative cows.<sup>60</sup>

Earlier observations indicated that infected cattle also have significantly higher mastitis and infertility rates than non-infected cattle but the results are inconsistent. The associations between subclinical disease and its effect on production and economics do not necessarily support a cause and effect relationship of the disease on production. In dairy herds subclinical disease, as determined by an ELISA, and milk production were associated with a 4% reduction in milk yield but no differences were found in lactation average, percentage of fat and protein, or somatic cell count linear score. In dairy cattle with clinical illness there can be a decrease in milk production of 19.5% in the current lactation compared with the lactation 2 years before culling. The period in which there is reduced production coincides with the period of shedding of the organisms. Using the LAM-ELISA test as the test for subclinical disease, a positive serological status was associated with higher milk somatic cell counts at both the herd average and individual cow levels. There was no relationship between LAM-ELISA results and calving intervals. The relation between LAM-ELISA results and milk production was inconsistent but there was a trend to a positive association with the amount of milk produced per cow per year. This suggests that cattle with a high production potential may be at a greater risk of later being culled for paratuberculosis.

The effect of subclinical *Map* infection on mature equivalent milk, protein, and fat production in a sample of Michigan dairy herds with a history of cows positive for *Map* diagnosed by fecal culture was examined.<sup>61</sup> Subclinical *Map* test-positive cows had no significant effect on mature equivalent milk, fat, or protein production.

The magnitude and direction of the association between subclinical *Map* infection and milk production depends upon the parity of the animal, stage of disease, and stage in lactation being monitored. In herds with an average parity of 2 or less, subclinical infection may have little impact on milk production. In herds maintaining an average herd parity of 2, many subclinical infected animals would be culled before experiencing any decline in milk production in which case the direct economic losses attributable to reduced milk production would be negligible. The average dairy cow was 44 months of age (3.67 years) which means the cows would have a parity of approximately 2. If significant reductions in milk production occur primarily at later lactations, herds with an average parity of 2 may not demonstrate losses in milk production due to subclinical *Map* infection.

In a sample of Danish dairy cows, there was a significant relationship between milk antibody response to *Map* and milk production. There was poor persistency and considerable milk loss, especially for second-parity cows. In third and later parities, milk yield is depressed through the entire lactation but only at very high milk antibody levels.<sup>62</sup>

**Losses at national dairy industry level**  
In 1996, averaged across all dairy herds in the US, Johne's disease cost the dairy cattle industry, in reduced productivity, \$US22–\$27 per cow or \$200–\$250 million annually.<sup>59</sup> The economic impact of the disease in Australia and New Zealand and regions of the United States have been estimated but their validity is questionable because of the accuracy of the diagnostic tests and the survey methodology. Some observers have indicated that Johne's disease has emerged as one of the most prevalent and costly diseases of dairy cattle but this is not well-documented. There is insufficient information available on the economic importance of Johne's disease in the beef cattle industry.

### Zoonotic implications

Potentially, *Map* is of great public health significance because it is speculated to be involved in Crohn's disease in humans.<sup>63</sup> The literature on the possible relationship between *Map* and Crohn's disease has been reviewed.<sup>15,63</sup>

In 1913 the similarities between segmental human intestinal disease and granulomatous intestinal disease in cattle were identified. It is rational to consider that an infectious etiology for Crohn's disease might be acquired through ingestion of food-stuffs. Also, the epidemiology of the disease, which includes rising incidence

rates in Western societies concurrent with low rates in developing countries over the second half of the 20th century and high rates among immigrants to Western societies, is consistent with the possibility that a critical infection may be acquired from cattle or other farm animals via milk or meat ingestion, staples of Western diets, and cause Crohn's disease in subjects with appropriate genetic predisposition.<sup>64</sup>

The isolation of *M. paratuberculosis* from some human patients with Crohn's disease has prompted investigations into a possible link between the organism and the disease in humans.<sup>15</sup> The finding of *Map* in breast milk supports the possibility that it can be a systemic infection in humans. Some studies claim the rate of detection of *Map* in individuals with Crohn's disease is highly significant.<sup>65</sup> The organism has been cultured from the peripheral blood of a higher percentage of individuals with Crohn's disease than in controls which does not prove that *Map* is a cause of the disease but suggests that a larger-scale investigation is needed to ascertain the role of the organism in the illness.<sup>66</sup>

In Manitoba, Canada, the reported incidence of Crohn's disease at 15 patients/100 000 people per year is among the highest in the world.<sup>64</sup> Population-based case-control studies of seroprevalence of *Map* in patients with Crohn's disease and ulcerative colitis have concluded that a high seroprevalence in Manitoba raises the possibility that the high rates of Crohn's disease in Manitoba could be related to high exposure rates for *Map*.<sup>64</sup> However, *Map* is not serologically specifically associated with Crohn's disease in a community with a relatively high prevalence of Crohn's disease.<sup>64</sup>

Crohn's disease, also called Crohn's colitis, Crohn's ileitis, or regional ileitis, is a chronic granulomatous ileocolitis of humans of unknown etiology. Pathogenetically, it is an immunologic hyper-responsive lesion to an exogenous and/or endogenous antigen. It is characterized clinically by chronic weight loss, abdominal pain, diarrhea or constipation, vomiting, and generalized malaise. Surgical resection of the affected intestine is often necessary because of complications. Original studies published in 1984 reported isolation of three strains of the organism from 26 patients with Crohn's disease but none from control patients. However, using acid-fast light microscopy and immunohistochemistry the organism has not been found within diseased intestinal tissues of patients with Crohn's disease. But mycobacterial DNA has been found in tissues of patients with Crohn's disease and in some controls, which suggests that environmental mycobacteria may

colonize the disrupted mucosa of both Crohn's disease patients and controls. A species-specific insertion sequence of *M. paratuberculosis* of a cell wall-deficient isolate of the organism (IS900-PCR) has been detected in about one-third of the intestinal cultures from Crohn's disease. In summary, no consistent or reproducible immunologic response to *M. paratuberculosis* or any other *Mycobacterium* spp. has been demonstrated in patients with Crohn's disease. There is no epidemiological evidence at present to indicate that the incidence of Crohn's disease is associated with possible exposure to organisms such as might be expected in farmers, animal health care workers, or other individuals having direct contact with infected animals.

If *Map* does have a role in Crohn's disease, then milk from infected animals may be a potential vehicle of transmission of the organism from animal to man.<sup>67</sup> *Map* has been cultured from milk from cows with subclinical and clinical Johne's disease. Published reports indicate it may not be completely inactivated by the pasteurization of milk at 72°C for 15 seconds.<sup>67</sup> This resulted in the UK dairy industry in 1998 increasing holding time for commercial milk pasteurization to 25 seconds in an effort to increase the effectiveness of the pasteurization process. However, a survey of commercially pasteurized milk samples in the UK found that *Map* in naturally infected milk may even survive 72°C for 25 seconds.<sup>67</sup> The tendency of *Map* to exist as clumps may aid in its survival during heating.

The organism can also survive in cheese made from raw milk. *Map* are resilient and are able to withstand the acidic conditions in cheese. During the laboratory manufacture of soft cheese using raw milk spiked with *Map*, the majority of *Map* cells are concentrated into the cheese curd rather than lost with the whey. When the resulting soft cheese was stored at 4°C, *Map* could still be cultured after 35 days.

The United Kingdom Food Standards Agency found confirmed *Map* isolates in 1.6% and 1.8% of raw and pasteurized cow's milk, respectively.<sup>37</sup> All indications were that pasteurization had been done effectively at all of the culture-positive dairies. Thus viable *Map* is occasionally present at low levels in commercially pasteurized cow's milk in the United Kingdom. The literature relating to the characteristics of *Map*, its potential significance for public health, its survival in pasteurized milk and other dairy products, current detection methods for the organism in milk, and possible strategies for preventing contamination of milk with *Map* at the farm level has been reviewed.<sup>67</sup>

## PATHOGENESIS

Following oral ingestion, the organism localizes in the mucosa of the small intestine, its associated lymph nodes and, to a lesser extent, in the tonsils and supra-pharyngeal lymph nodes. The primary site of bacterial multiplication is the terminal part of the small intestine and the large intestine. At least three different groups of animals can occur depending on the host–bacteria relationship that becomes established. In the first group, animals develop resistance quickly, control the infection and do not become shedders (**infected-resistant**). In the second group, the infection is not completely controlled; some animals will partially control the infection and will shed the organism intermittently, others will become **intermediate** cases which are incubating the disease and will be heavy shedders of the organism.

In the third group, the organism persists in the intestinal mucosa and from among these animals the **clinical** cases develop. The different possibilities are summarized in Table 19.1.

The organism is phagocytosed by macrophages which in turn proliferate in large numbers and infiltrate the intestinal submucosa which results in decreased absorption, chronic diarrhea, and resulting malabsorption. There is a reduction in protein absorption and leakage of protein into the lumen of the jejunum. In cattle, the loss of protein results in muscle wasting, hypoproteinemia, and edema. In sheep, a compensatory increase in protein production in the liver masks the protein loss and clinical signs appear only when this compensatory mechanism fails. Within the macrophages, the bacteria remain viable and protected from humoral factors. In vitro studies indicate that blood-derived macrophages from clinically normal cows or cows infected with *M. paratuberculosis* were incapable of destroying the organism.

### Immune response and spectrum

The patterns of immune response to infection with *Map* in cattle have been reviewed.<sup>68,69</sup> There are three main stages of infection: **early infection; subclinical infection; and clinical disease.**

Cattle and other ruminants are usually exposed to *Map* within the first months of life, either via the fecal–oral route or by ingestion of infected colostrum. The outcome of infection is largely dependent upon a variety of genetic elements. Cattle older than 10 months appear to be resistant to the onset of disease, although susceptibility to infection may not change. Acquired resistance to disease may involve maturation of the immune system, including the balance between various T-cell subsets and the specific tissue distribution of immune cells.

The first line of defense against invading *Map* in the ruminant intestine involves M cells (special epithelial cells associated with ileal Peyer's patches and lymphoid follicles that actively take up particulate matter from the intestinal contents; they are the portal of entry for bacteria and viruses), and phagocytic macrophages.<sup>69</sup> In early stages of infection the organism is found in phagocytic macrophages in the intestine. Once inside the phagosome of an infected macrophage, the organism interferes with the normal course of phagosome maturation into phagolysosomes, thereby escaping the process of destruction. The infection of inactivated macrophages within the intestine is the first step in establishing persistent infection and in the subsequent development of disease. The host immune system begins a series of attacks against *Map*-infected macrophages, including the rapid development of activated T cells, CD4<sup>+</sup> T cells, and cytolytic CD8<sup>+</sup> cells. These cells interact with the persistently infected macrophage and with each other through a complex network of cytokines and receptors. Despite these aggressive efforts to clear the infection, *Map* persists and the constant struggle of the immune system leads to pronounced injury to the intestinal epithelial cells.

During the early subclinical stages of infection, the organism elicits a cell-mediated response by the host that can be characterized by strong delayed-type IV hypersensitivity reactions, lymphocyte proliferation responses to mitogens, and production of cytokines by stimulated T lymphocytes.<sup>69</sup> As the disease progresses

from subclinical to clinical stages, the cell-mediated immune response wanes, and a strong humoral response becomes dominant. However, this depends highly on the antigens and isotypes used to study the disease. The classical patterns occur only with purified protein derivative (PPDP) antigens and the IgG1 isotype.<sup>70</sup> For other antigens and isotypes and the total IgG levels, the response pattern is different and indicates that there is no uniform association with increased antibody responses during the progression from the subclinical stage to the clinical stage of bovine paratuberculosis. When comparing total IgG1 and IgG2 concentrations, it appears that there is no general increase in humoral responses in clinically diseased animals. Progression of cattle from subclinical to clinical Johne's disease is associated with a decreased ability of mononuclear cells to produce IFN-gamma, both specifically and non-specifically at the site of infection and in the blood.<sup>71</sup> The loss of putatively protective CD4<sup>+</sup> T cells leads to a lack of control of mycobacterial replications and, subsequently, to the progressive granulomatous enteritis typical of bovine paratuberculosis.<sup>72</sup>

Using a lipoarabinomanann-based ELISA, specific serum immunoglobulin can be detected as early as 134 days after experimental infection of calves with *Map* into the tonsillar crypts.<sup>71</sup> This indicates that mycobacteria-specific antibody is detectable early in the course of experimental Johne's disease, even preceding the development of specific cell-mediated responses. Both humoral and cellular immune responses were detected. Specific CD4<sup>+</sup> cell proliferative and IFN-gamma responses occurred concurrently with humoral responses to a LAM-enriched antigen preparation. A commercially available ELISA kit (IDEXX Laboratories) did not detect serum antibody responses in the experimental calves at any time point during the study.

Antibody to *Map* does not protect the host against disease; rather, TH-1-mediated immunity appears to be essential to keep the infection under control. During the final stages of disease, lack of antigen-specific cell-mediated immune response or complete anergy may result, allowing for rapid dissemination of the infection throughout the host.

The host response varies between species. Bison calves are more susceptible to tissue colonization than beef calves after challenge with the cattle isolate and, conversely beef calves were more susceptible to the bison strain of *Map*.<sup>73</sup> Interferon-gamma (IFN-gamma) responses were noted in some calves by one month post-inoculation and were sustained

Table 19.1 The relationship between the stages in the pathogenesis of Johne's disease, the presence of clinical disease and the results of diagnostic tests

	Resistant animals	Intermediate (incubation period)	Advanced clinical disease
Clinical signs present	–	+	+++
Fecal shedding	+ (–)	++	+++
Antibody response	–	++	+++
Skin test	+ (–)	+ (–)	+ (–)
Lymphocyte transformation	+++	+++	+ (–)

longer in beef calves after challenge with the bison isolate. Antibody was not detected in either beef or bison calves during the 6-month infection period.

There appears to be an immune spectrum and no serological or cellular immunity test will identify all animals in the spectrum. There are infected-resistant animals which control their infection but are unable to completely eliminate the organism. These animals do not react in antibody assays, only rarely or never shed organisms and respond to the lymphocyte transformation test because their circulating lymphocytes are sensitized. In the intermediate stage, the animal fails to control the infection, antibodies appear in the serum and organisms are shed in the feces. In the stage of clinical disease, the organisms are shed in the feces and the antibody responses and skin tests are variable.

The immunological response following infection is variable and depends on the stage of the infection and whether or not clinical disease develops. In general, infected animals initially develop a cell-mediated response, followed by a humoral response initiated by the release of bacteria by dying macrophages as the disease progresses. In the late stages of clinical disease, anergy may occur and neither cell-mediated nor humoral immunity may be detectable. These immunological features occur independently of the stages of clinical disease and may appear at any time during the clinical course. Additional details of the cellular components of the immune mechanisms are available.<sup>69,72</sup>

In sheep with paratuberculosis with or without clinical signs, a range of intestinal lesions according to histological appearance are characteristic. Two distinct histological types of granulomatous enteritis occur with a significant relationship between the infiltrating cell type and the degree of intestinal mycobacterial infection.<sup>74</sup> At the two ends of the spectrum of lesions are two widely differing forms:

- **tuberculoid extreme**, with a strong cell-mediated immune response and lesions consisting of small granulomata composed of epithelioid cells surrounded by many lymphocytes and with few or no bacilli in the lesions
- **lepromatous extreme**, with a strong humoral immune response and lesions composed of accumulations of macrophages containing large numbers of mycobacteria.

Between these two extremes are the so-called 'borderline forms', which tend to be associated with the most severe clinical disease. Most sheep with Johne's

disease have the multibacillary lesion (lepromatous) with extensive diffuse macrophage infiltrate within the intestinal mucosa and submucosa. In the paucibacillary lesion (tuberculoid) there is a marked lymphocytic and giant cell infiltration of the intestine. There is also a correlation between high numbers of acid-fast bacteria and a positive serum antibody test result.<sup>74</sup> In sheep, the local release of macrophage and other lymphocyte-derived cytokines may exert an influence on the type of inflammatory and immune response which develops during infection. It is proposed that the elevated production of cytokines along with a failure to clear a heavy burden of bacteria may be one factor encouraging the chronic inflammatory lesion in paratuberculosis. Experimental infection of vaccinated lambs accelerates the progress of the infection, and results in more rapid healing. It seems that infection with *M. paratuberculosis* is closely associated with organized lymphoid tissue of the intestine such as Peyer's patches. This may explain the location of the lesion in the ileum of clinical cases and the lower susceptibility of adult animals in which the intestinal lymphoid tissue is markedly reduced.

The bacteria are carried by macrophages to other sites, particularly the uterus, the fetus, and the mammary gland, and the testes and semen of bulls. The post primary dissemination of the lesions is more widespread in adult animals than in calves and the early lesions are more severe in the former but the organisms do not persist. Disseminated lesions consisting of microgranulomas in other lymph nodes and organs have been described in mature cattle. In calves, the organism proliferates slowly, particularly in the small intestinal site, which results in a massive cellular infiltration of the intestinal submucosa. In adult cows, infection may penetrate to the fetus and cause prenatal infection.<sup>40</sup> Uterine infection occurs more frequently than is commonly thought, and often in animals which are clinically normal. There is evidence that intra-uterine infection occurs in sheep. From experimental observations in sheep and calves it appears that vaccination against Johne's disease does not prevent infection but restricts the cellular response to the intestinal wall and thus prevents the onset of clinical disease.

Important features of the natural history of the disease are the long incubation period of 2 years or more and the development of sensitization to johnin and to mammalian and avian tuberculin. This sensitivity develops in the preclinical stage but has disappeared in most cases by the time clinical signs are evident. On

the other hand, complement-fixing antibodies appear late in the disease and in general increase with increasing severity of the lesions. This suggests that two independent antibodies are involved in the two reactions.

## CLINICAL FINDINGS

### Cattle

Stages of disease

Four stages of paratuberculosis in cattle have been described.<sup>15</sup>

#### Stage one

**Silent infection.** Calves, heifers, and young cattle up to 2 years of age. There are no clinical signs and no effects on body weight gain or body condition but these animals may shed the organism. Clinicopathologic tests cannot detect the infection but culture of the feces or demonstration of the organism in tissues may be possible.

#### Stage two

**Subclinical disease.** Carrier adults: no clinical signs but may be affected by other abnormalities such as mastitis or infertility. Most of these animals will be negative on fecal culture but 15–25% may be positive on fecal culture. These are also negative to most serological tests and if not culled will move onto stage 3.

#### Stage three

**Clinical disease.** Clinical disease is the tip of the iceberg in terms of the total number of infected animals in the herd. The 'Iceberg concept' states that for every animal with clinical signs born in the herd, another 15–20 animals are infected but less than half of whom will be detected by a sensitive fecal culture.<sup>75</sup> Clinical signs do not appear before 2 years of age and are commonest in the 2 to 6-year age group. Cases occur only sporadically because of the slow rate of spread of the disease. Gradual loss of body weight despite a normal appetite. During a period of several weeks, concurrent with the weight loss, diarrhea develops. Milk production declines and the temperature, heart rate, and respirations are within normal limits. The fall in milk yield is often apparent in the lactation before diarrhea commences. The animal eats well throughout but thirst is excessive. The feces are soft and thin, like thick pea soup, homogeneous, and without offensive odor. There is marked absence of blood, epithelial debris, and mucus. Diarrhea may be continuous or intermittent with a marked tendency to improve in late pregnancy only to reappear in a severe form soon after parturition. A temporary improvement may also occur when animals are taken off pasture and placed on dry feed.

### Stage four

**Advanced clinical disease.** As the disease worsens, emaciation is the most obvious abnormality and is usually accompanied by intermandibular edema which has a tendency to disappear as diarrhea develops. The diarrhea is characterized by a fluid 'waterhose' or 'pipe-stream' passage of feces. The course of the disease varies from weeks to months but always terminates in severe dehydration, emaciation, and weakness necessitating destruction.

### Sheep and goats

In sheep and goats the disease is manifested principally by emaciation, and shedding of wool may occur in sheep. Diarrhea is not severe but the feces may be soft enough to lose their usual pelleted form in both species. Affected sheep may lose weight for up to 4 months, be partially anorexic and their feces may appear normal until the terminal stages when the feces may become soft and pasty. Depression and dyspnea are evident in goats but are less obvious in sheep.

### CLINICAL PATHOLOGY

In an infected herd, animals may be divided into four categories:

- Animals with clinical disease and shedding the organism
- Subclinical infection and shedding the organism (intermediate and incubating)
- Infected, but neither ill nor shedding enough bacteria to be culturally detectable (infected-resistant)
- Uninfected cattle.

For successful eradication and control of the disease the diagnostic tests must be able to identify the intermediate group. The primary hindrance to making a diagnosis in the live animal is the paradoxical immune response during various stages of the disease. Subclinical infection is characterized by a strong cell-mediated immune response which can be detected by such assays as lymphocyte proliferation to a T-cell-independent mitogen and delayed-type hypersensitivity reactions or skin tests. A negligible humoral response during subclinical infection reduces the usefulness of serological diagnostic tests. In contrast, clinical disease is characterized by a strong humoral immune response and a weak cell-mediated response. During clinical disease, high numbers of *M. paratuberculosis* are shed in the feces and one of the definitive tests is culture of the organism from feces.

The clinicopathological tests used to help in the diagnosis of Johne's disease are described below for each of the animal species involved. They have always been difficult to interpret, and control of the

disease has been correspondingly delayed. What follows is a summary of the position at the present time and it is apparent that many questions still remain to be answered.

### Predictive value of a test

This is a function of disease **prevalence** and the **sensitivity** and **specificity** of a given diagnostic test. **Sensitivity** is the percentage of diseased animals with a positive test among all the diseased animals tested. **Specificity** is the percentage of non-diseased animals with a negative test result among all the non-diseased animals. Both sensitivity and specificity are intrinsic properties of a given diagnostic test and remain constant regardless of the number of animals tested. **Prevalence** is the most important factor affecting the usefulness of a diagnostic test result. The **predictive value of a positive test** decreases as the specificity of the test declines. The **predictive value of a negative test**, however, is not seriously affected by test sensitivity. Thus a diagnostic test for Johne's disease to identify infected animals for culling from herds must have a high specificity while some compromise in test sensitivity can be tolerated. The predictive value model illustrates that a single diagnostic test for Johne's disease applied to populations of cattle with a low to moderate prevalence of disease, such as 5%, must have a specificity of ~99.8% and a sensitivity of ~40% to yield results that indicate the correct disease status with 90% probability.

**False-positive** results are due to cross-reactivity and resistant animals which have recovered. Cross-reactivity can occur as a consequence of infection with other *Mycobacterium* spp., *Actinomyces* spp., *Dermatophilus* spp., *Nocardia* spp., *Streptomyces* spp., and *Corynebacterium* spp. *M. avium*, and *M. paratuberculosis* cannot be distinguished by immunological methods.

**False-negative** results occur as a result of tolerance and anergy which occurs most often during the terminal stages of clinical disease, but it may occur at any stage of chronic infection.

### Cattle

Because of the very long incubation period during which infected animals shed very large numbers of *M. paratuberculosis* to contaminate the environment, the control of Johne's disease cannot be contemplated without a test to detect the clinically normal carrier. This need has dominated recent research into the disease and although finality has not been achieved a reasonable attempt can now be made. However, no single test will suffice. It is necessary to use at least two tests in a

diagnostic profile. These need to match the stages of pathogenesis of the disease as set down in Table 19.1. The serological tests are, in general, too inaccurate although the complement fixation test is still required by many statutory agencies.

### Diagnostic tests in cattle

#### Culture or detection of organism

**Bacteriological examination.** Examination of the feces is a valuable diagnostic aid for detecting infection in clinically diseased animals and to some extent in apparently healthy cattle in known infected herds. **Fecal culture** is presently recognized as the most reliable index of infection in live cattle. The sensitivity and specificity are both 100% on a herd basis, assuming herds of about 50 or more animals and an infection rate of 20% or more within the herds. A major advantage of fecal culture is that it can identify cattle 1–3 years prior to the appearance of clinical signs. But current procedures are laborious and fail to detect animals shedding low numbers of organisms, and require approximately 8–16 weeks of incubation for the development of colonies. Because of the relatively low sensitivity of conventional fecal culture in subclinically infected animals, and because *Map* grows very slowly on artificial media, much has been done to improve performance of the procedures including hybrid test procedures.

Several procedures are used to improve the sensitivity of detecting *Map* by culture including decontamination of specimens, and concentration of the organism from specimens. Conventional *Map* culture consists of decontaminating the specimen, concentrating the organisms, and inoculating a growth medium. The literature on the medium constituents and techniques for culture of *Map* has been reviewed.<sup>75</sup> A molecular-based confirmatory test, such as PCR to detect the *Map* marker sequence IS900, can be used to confirm positive specimens on the fecal culture slant after 6 weeks incubation.<sup>76</sup> The sensitivity and specificity of a CS-PCR test on fecal culture were estimated at 72.1% and 98.9%, respectively.

The main criteria for differentiating *M. paratuberculosis* from other mycobacteria are the extreme slow growth and dependence on mycobactin for growth.<sup>15</sup> *M. paratuberculosis* is a slow-growing mycobactin-dependent mycobacterial species.

Fecal culture by radiometric technique is also available and is considered the most sensitive and least expensive compared to conventional fecal culture and DNA probes.<sup>15</sup> The radiometric system in most common use is the BACTEC system which is highly automated, faster, and has

slightly higher sensitivity than conventional culture systems but is more expensive and requires the use of radioisotopes.<sup>15</sup> A confirmatory test such as IS900 PCR is required on positive specimens.

#### **Pooled fecal samples and culture.**

The culture of pooled fecal samples from several animals in a herd or flock has been evaluated as a means of determining a herd's infection status. Pooling samples reduces the number of fecal cultures necessary to determine infection, thereby reducing the cost of a large-scale Johne's disease control or eradication program. Strategically pooled culture specimens (five animals of the same age per pool) compared with individual fecal specimens can yield a sensitivity and specificity of 86% and 96%, respectively.<sup>77</sup> This would reduce the cost considerably when a herd is not suspected of being infected. If a herd is infected, individual cultures or other organism-based tests would be necessary to identify infected individuals. A comparison culture of individual and pooled fecal samples in dairy cattle herds found that pooled fecal samples detected at least 88% of samples that contained feces from at least one animal shedding moderate to high concentrations of *Map*.<sup>78</sup> Culture of 10 pooled fecal samples (50 animals/herd) was satisfactory for detection of most infected herds, with an estimated 79 and 99% of infected herds with <10 or ≥10% prevalence of infection detected, respectively.<sup>78</sup> The use of pooled fecal samples from 10 cows is a cost-effective method for herd screening and can provide a reliable estimate of the percentage of *Map*-infected cows in large dairy herds with a low prevalence of infection.<sup>79</sup> Estimated sensitivity for pooled fecal samples among all dairy herds was 0.69. Sensitivity increased as the number of culture-positive samples in a pool increased. Herd-level sensitivity estimates ranged from 90 to 100% and was dependent on prevalence in the population and the sensitivity for culture of pooled fecal samples.

Targeted sampling of cow alleyways and manure storage areas appears to be an alternative strategy for herd screening and *Map* infection status assessment and for estimating herd prevalence.<sup>56</sup> See earlier under *Environmental and management risk factors*.

Pooled fecal culture is a highly sensitive and specific flock-test for detection of ovine Johne's disease and is substantially more sensitive than serology using AGID.<sup>80</sup> The estimated minimum flock-specificity of pooled culture when used for surveillance and assurance testing is 99.1%. Surveillance and assurance programs in Australia are designed to

provide a flock sensitivity of 95% for an assumed prevalence of 2%. The costs are much lower at 30% of those for serologic testing. Pooling of samples is possible because of the large numbers of *Map* present in the feces of sheep with multi-bacillary disease. The average rate of excretion of *Map* in such sheep is  $1.09 \times 10^8$  organisms per g of feces. As the analytical sensitivity of similar culture methods has been estimated to 100 CFU per g of feces, the pooling rate could be large.

**Microscopic examination of Ziehl-Neelsen stained smears of feces** for the presence of typical clumps of acid-fast bacteria has been an attractive alternative to fecal culture since the results are available within an hour. However, the sensitivity and specificity of the microscopical examination have always been in doubt. It may be difficult to distinguish the Johne's bacillus from other acid-fast organisms which are frequent in feces. Also it may be necessary to examine smears on several occasions to obtain a positive result. Of the infected animals some are non-shedders, some are light shedders (less than 100 organisms/g of feces) and some are heavy shedders and, of these, the heavy shedders develop clinical disease. Clumps of acid-fast bacteria in epithelial cells are diagnostic and are more likely to be observed during a diarrheic phase, when epithelial cells are more likely to be shed, than in a period when feces are normal. In general, the microscopical examination of fecal smears for the presence of acid-fast clumps is an unreliable method of detecting *M. paratuberculosis* in bovine feces, and culture is superior. A pinch biopsy collected with the fingernails, or scrapings of rectal mucosa, are of no great advantage compared to fecal smears, as it is probably only in the late clinical stages that the rectal mucosa is invaded. If rectal scrapings or rectal pinch biopsy are used a positive finding is clumps of acid-fast bacilli in epithelial cells or macrophages.

**Genetic probe.** Molecular genetics provides a new way to identify organisms through the use of DNA probes. A genetic element unique to *Map* is an insertion element designated as IS900.<sup>15</sup> Strains of the organism infecting goats are genetically similar to cattle strains.<sup>81</sup> Genetic probes for detection of IS900 in clinical samples such as feces are available as commercial kits and employ the polymerase chain reaction. The sensitivity of the test is superior to the commercial PCR test. The advantage is speed; the assay requires only 3 days and thus identification of fecal shedders can be rapid compared to fecal culture requiring up to 12 weeks. The disadvantages are its low sensitivity and high cost, and the assay

requires skilled and experienced technicians and special equipment. False-positives are common due to contamination of samples by gene products from the laboratory.

Because of the demand for fast and reliable methods to distinguish *Map* from closely related mycobacteria and for strain-specific typing of clinical isolates for epidemiological studies, the IS900/ERIC-PCR has been used to distinguish *Map* from closely related mycobacteria.<sup>82</sup>

A fast and sensitive alternative to bacterial cultures of feces is an extraction method based on buoyant density centrifugation in Percoll along with a sequence capture PCR combined with a dot blot assay. Its sensitivity allows detection of low numbers of *Map* likely to be found in subclinically infected animals.<sup>82</sup> The test achieved a sensitivity of  $10^3$  CFU/g feces.

Detection of nucleic acids specific to *Map* in fecal samples is a technique that circumvents the culture method. A rapid, simple, and effective method to extract DNA from fecal samples with a modification of a PCR assay for optimal sensitivity of detection has been described.<sup>84</sup> An evaluation of 1000 well-characterized fecal samples indicated that sensitivity was highly dependent on the load of bacteria in the fecal samples with an 81% detection of samples containing >70 colony-forming units/g of feces and a 45% detection rate for samples containing less than 1 cfu/g. The reproducibility of the technique between two laboratories was much higher (75%) for the fecal samples containing high numbers of *Map* and only 25% for samples with less than 1 cfu/g. An overall specificity of 83% was obtained for negative samples. The method is rapid, simple, and inexpensive compared with other techniques and can detect animals which are shedding less than 1 cfu/g.

**Culture of milk and blood.** The organism can be cultured in the milk of subclinically infected cows<sup>15</sup> and the prevalence of infection of milk is highest in samples from cows with heavy fecal shedding and lowest with light shedding. A nested PCR test has been used to detect *Map* in the blood and milk of cattle with clinical and subclinical infection.<sup>85</sup> Between 8 and 22% of subclinically infected and about 35% of clinically affected cows harbor *Map* in their udders.

**Biopsy.** Surgical biopsy of the terminal ileum and mesenteric lymph node of sheep for detection of *Map* has been described.<sup>86</sup> Histological examination and bacteriological culture are highly specific and sensitive. Early detection of animals is a major advantage but the time and costs involved are major disadvantages and its use may be restricted to special



circumstances and valuable pedigree sheep.

#### Serological tests

Serological tests are potentially cheaper and much more rapid than fecal culture, and several are available. Problems with sensitivity and specificity are common.

Four serological tests, the complement fixation test (CFT), an agar gel immunodiffusion (AGID) test, and two commercial ELISAs, for bovine paratuberculosis have been evaluated and compared in dairy cattle with subclinical infection.<sup>15</sup> The diagnostic specificities were high and ranged from 95 to 99%. The sensitivities were low and ranged from 14 to 47% for non-shedders and from 40 to 65% for shedders, with the ELISAs providing the best performance. The sensitivity of the tests increases as the prevalence of infection increases in the herd. Conversely, as the prevalence of infection decreases the sensitivity decreases. Thus as the sensitivity of the tests decreases it is necessary to use additional tests such as detection of the organism in the feces.

**CFT** Up until recently the most widely used serological test for the diagnosis of bovine paratuberculosis was the complement fixation test (CFT). Many foreign countries require that cattle have a negative CFT prior to importation. Because of the limitations of the CFT, these countries usually require negative results of intradermal johnin testing or fecal cultures. The limitations of the CFT include false-negative and false-positive test results. Diagnostic sensitivities of approximately 90%, and specificities of approximately 70%, for the CFT in clinical disease have been reported.<sup>15</sup> This reflects severity of lesions rather than severity of the clinical abnormality, but early cases and non-clinical carriers fail to give positive reactions and a number of non-specific, transient, positive reactions do occur. The diagnostic accuracy of the CFT is reduced when applied to subclinical infections.

The test sensitivity in subclinically infected cattle shedding low numbers of organisms is about 54%. The CFT does not have sufficient sensitivity to be used as a single test for definitive identification of cattle with subclinical infection. However, the specificity is high enough so that any positive test result can be regarded as a presumptive diagnosis of infection and fecal culture can be done to confirm. In cattle with subclinical infection detected by fecal culture, the sensitivity estimates of the CFT and the AGID test were 11% and 19%, respectively. In cattle classified as disease-free, the specificity estimates of the CFT and the AGID test were 97.4% and 99.4%, respectively. Negative tests obtained with the use of either test in

apparently normal cattle should be interpreted with caution because both tests suffer from low sensitivities in subclinically infected animals.

False-positive results with the CFT in infected herds are due to cross-reactions with other bacteria, early antibody response to infection before detectable fecal shedding, and simple exposure to the organism rather than infection.

**AGID** The sensitivity of the agar gel immunodiffusion (AGID) test for the diagnosis of clinical paratuberculosis is 96% with a specificity of 94%. The AGID test is considered to be the most appropriate available for the diagnosis of clinical disease. The test has one-third the diagnostic sensitivity of fecal culture in the diagnosis of subclinical infection. The test is rapid, inexpensive, and accurate and the results are available within 48 hours. Because positive reactions are given by tuberculous animals, the test is limited to use in tuberculosis-free herds.

A fluorescent antibody test is available but is unable to distinguish between the antigens of *M. avium* and *M. paratuberculosis*. It does distinguish between *M. paratuberculosis* and *Corynebacterium renale* which are easily confused by the complement fixation test. Combined with the CFT the fluorescent antibody test is used to detect early, subclinical cases, but the results are far from accurate. A refinement of the conventional fluorescent antibody test which gives greater accuracy in identifying specific mycobacterial antigens is the observation of the uptake by macrophages of fluorescein-coated insoluble spheres. The trouble with all of these serological tests is the failure to detect early cases.

**ELISA** Several different enzyme-linked immunosorbent assays (ELISA) tests are available.<sup>15</sup> The original ELISA test was considered to be sensitive but had low specificity. A modified ELISA had a sensitivity of 57% and a specificity of 98.9% in cattle positive on fecal culture. A new commercial kit known as the **Johne's Absorbed ELISA** (Herd Chek *Mycobacterium paratuberculosis* test kit, IDEXX Laboratories) has been evaluated.<sup>87</sup> Using samples from uninfected cattle, subclinically infected cattle shedding low numbers in the feces, subclinical heavy shedders, clinical cases, and randomly selected cattle in an abattoir the test had an overall sensitivity of 45% with a specificity of 99%. The sensitivity was 87% for clinical cases of Johne's disease and lowest for subclinical, light shedding cattle at 15%. Changing the cut-off point did not improve performance of the test. The test detected 60% of animals that shed the organism in their feces, as

defined by conventional fecal culture, at the time of serum collection.

Other evaluations of the IDEXX test on individual cattle yielded a sensitivity varying from 15.4% to 88.1%, depending on the clinical stage and bacterial shedding of the animals.<sup>88</sup> Variability also occurs between samples collected at variable intervals. Repeated sampling of individual dairy cattle at intervals ranging from 77 to 600 days found that cows with an initial high S/P value ( $\geq 0.70$ ) (a ratio for the value of the sample to the value of positive-control serum (S/P)) as determined by measurement of optical density (OD) were more likely to maintain positive status than cows classified as positive on the basis of cutoff values of  $\geq 0.25$  or  $\geq 0.40$ .<sup>89</sup>

The herd sensitivity of the Herd Chek test has been evaluated in the Voluntary Johne's Disease Herd Status Program for identifying herds free from paratuberculosis in the United States.<sup>90</sup> Sensitivity at the herd level of the testing strategy used in Level 1 of the program (use of the ELISA to test samples from 30 cows followed by confirmatory fecal culture of positive cows) ranged from 33 to 84% for infected herds, depending on the percentage of cows in the herd with positive fecal culture. If followed-up fecal culture was not used to confirm positive ELISA results, sensitivity ranged from 70 to 93% but probability of identifying uninfected herds as infected was 89%. The test will fail to identify as infected most dairy herds with a low prevalence of paratuberculosis.

In dairy cattle herds participating in the Victorian Bovine Johne's Disease Test and Control Program (Australia), the ELISA sensitivities at the first test round in herds achieving 5, 6, and 7 annual herd tests were 16.1, 14.9, and 13%, respectively.<sup>91</sup> The ELISA sensitivity in 2, 3, and 4-year-old animals at the first test round in herds testing seven times was 1.2, 8.9, and 11.6%, respectively. The estimated adjusted sensitivity of the absorbed ELISA for detection of *Map* in an unselected cattle population on the study ranged from 13.5 to 16.7% which is considerably lower than the estimates of 43–65% at which testing confidence in the program was planned to operate.

The proportion of ELISA-positive reactors in dairy cattle in Victoria, Australia, subsequently found to be infected on the basis of histological examination or culture increased from 70.1% to 89.4% over a 5-year period as more reactors were confirmed by culture of tissues at slaughter each year.<sup>92</sup> In Northern Australian cattle the estimates of specificity for the absorbed ELISA in mature cattle were 98.0% in beef cattle, 98.3% in dairy cattle.<sup>93</sup>

The ELISA response to *Map* may also vary according to the characteristics of the cow and stage of lactation.<sup>94</sup> The probability of being ELISA positive may be 2 to 3 times lower for cows in parity 1 compared to cows in later parities. In early lactation the probability of being positive was highest in the milk ELISA. In the serum ELISA the odds of being positive was highest at the end of lactation.

In Australia, in a population of sheep with a high prevalence of subclinical infection the sensitivity of the AGID test was 38–56% and the sensitivity of the absorbed ELISA was 34–54%.<sup>95</sup> The AGID was much better at detecting infected sheep in low body condition than the ELISA. But the ELISA was superior in detecting infected sheep with lesions localized or contained small numbers of acid-fast bacilli. In goats in Australia, the specificity of the AGID tests was 100% and the absorbed ELISA were 99.7 to 99.8%<sup>96</sup> but the ELISA is more sensitive for detection of infected goats and is recommended in preference to the AGID.

These results demonstrate the effect of stage of infection on serodiagnosis. The subclinical, light-shedding cattle are usually seronegative, whereas heavily infected animals are usually seropositive. In most cows in the early stages of infection when fecal shedding is low, the humoral antibody response is below the limit of detection, and currently available serologic tests are inadequate to detect those animals. As the infection progresses, the humoral response increases, and heavy fecal shedders and clinically affected animals are more readily detected.

Using milk samples from dairy cows to detect antibodies to the organism would facilitate the testing of large numbers of animals and potentially could be incorporated into routine milk testing programs. However, the milk ELISA for the detection of exposure to the organism in dairy cows lacked correlation with serum ELISA.<sup>97</sup>

In a single herd, 84 cows with signs of Johne's disease were tested before being sent to slaughter.<sup>13</sup> The disease was confirmed in 56 animals by culture and histopathology. *Map* was isolated from 70% of 56 fecal samples cultured from confirmed cases and acid-fast organisms were observed in smears from 23.6% of samples examined. The absorbed ELISA was positive in 76.8% of the animals. Serum samples from 58.9% had CF titers of 1/5 or greater and 41.4% had titers greater than 1/10. Overall the ELISA was the most sensitive and rapid method for identifying infected animals.

**Immunity tests** The in vivo tests of cell-mediated immunity included the skin and

intravenous johnin tests which were the original tests used. They are no longer used because of inadequate sensitivity and specificity. The interferon gamma assay (IFN- $\gamma$ ) has been compared with serological tests for the diagnosis of *Map* in experimentally infected sheep<sup>98</sup> and for the natural disease in pygmy goats.<sup>99</sup> A modified interferon gamma assay has been evaluated for detection of paratuberculosis in dairy herds.<sup>100</sup> The combined use of the IFN- $\gamma$  test and the absorbed ELISA antibody test accurately predicted infection status of 73% of cows from dairy herd with a high level of *Map* infection and 90% from a well-characterized group of dairy cows. The antigen-specific IFN- $\gamma$  assay is a very sensitive diagnostic aid for detection of subclinical infection in cattle and may be valuable on an individual animal basis to remove infected animals from the herd.

Skin testing as a means of measuring cell-mediated immunity has been replaced by assays for cytokines. A cytokine assay is available but insufficient data are available to recommend its use.<sup>15</sup>

**Summary of diagnostic testing** Only repeated testing of cattle, especially young animals, from infected herds will provide the data to determine the true infection rates within infected herds.<sup>75</sup> Based on monitoring 10 dairy herds tested repeatedly over 4 years the estimated sensitivity of fecal culture was 33%. The specificity of fecal culture has been accepted as 100%. The reported overall sensitivity of ELISA test ranges from 40 to 55% but most often in relationship to an insensitive fecal culture method. The sensitivity of the ELISA test is highest in those animals in the later stages of the disease, usually when the animals develop clinical disease. The estimated ELISA sensitivity for Stage 1 animals infected, but not detectable by fecal culture is unknown. However, the absorbed ELISA sensitivity for Stage 1 animals will be low at about 10%. Overall the absorbed ELISA detects approximately 35% of the animals found positive by concurrent fecal culture.

#### *Tests for different situations*

The above diagnostic tests are used under different situations which are outlined here.

- **Diagnosis confirmation.** The most rapid and accurate, and least expensive, test to confirm a clinical case of Johne's disease in cattle is the ELISA (USDA-licensed).<sup>15</sup> More than 85% of clinical cases with diarrhea and weight loss will be seropositive
- **Seropositive confirmation.** Confirmation of a seropositive animal

may be desirable as in the case of valuable animals in a Johne's disease-free herd which are found unexpectedly positive or a bull of proven merit in an artificial insemination unit which is found positive. A positive fecal culture or surgical biopsy of ileocecal junction including one or two lymph nodes for histopathological examination

- **Estimation of prevalence.** The most rapid and easiest method to estimate prevalence of infection is to test all animals over 2 years of age with the ELISA.<sup>15</sup> The results are most reliable in herds confirmed to be infected by isolation of the organism. The true prevalence of infection in the herd is twice the apparent prevalence of infection as determined by the results of the ELISA (a test sensitivity of 50%). The diagnostic tests are most useful for estimation of prevalence in herds which have not been routinely tested, and for culling seropositive animals. The prevalence of infection will be underestimated in herds which have been culling clinical cases
- **Disease control.** The first herd diagnostic step in a control program is to test all animals over 2 years of age and consider culling all seropositive animals. After the ELISA-positive animals are culled from the herd, a second ELISA can be done on the entire herd again. An alternative is fecal culture which is more expensive but will detect animals missed by the ELISA. It is suggested that every third or fourth test should be a fecal culture.<sup>15</sup> The frequency of testing and the types of tests used will depend on factors such as: the type of farm enterprise and the use of the animals, the estimated prevalence of infection, the owner's perception of the importance of the disease and how it has affected productivity, the willingness of the owner to invest in the costs of the tests, how quickly the owner wishes to begin a control program, and the eagerness of the owner to control the disease
- **Herd certification.** A model herd certification program for Johne's disease was adopted by the US Animal Health Association in 1993.<sup>15</sup> The goal of the program is to establish uniform herd certification standards among the states. Identification of herds free of infection is vital to preventing spread of infection nationally and internationally. Certification of laboratories in performing the diagnostic tests such as being able to

culture the organism is an important part of the program. The model herd certification program consists of using the ELISA and an organism detection test, such as fecal culture, on an alternating basis annually on all animals in the herd more than 20 months of age. Herds are given levels of certification based on the number of herd negative tests up to level 5. After attaining a level 5 Johne's-free certification, herds can maintain certification by retesting annually with either a serum antibody test or organism detection-based test

- **Herd screening.** Testing herd replacements raised on the farm before they are nominated for breeding (15 months of age) would be a desirable strategy but the available tests are unlikely to detect subclinically infected animals at that age
- **Prepurchase testing.** Herds become infected by the introduction of unknown subclinically infected animals. The estimated risk of purchasing an infected animal from an auction mart or cattle dealer is 10% based on the overall prevalence of infection in the cattle population. Ideally, purchased herd replacements should be obtained from certified paratuberculosis-free herds. If these are not available the next best option is to purchase from herds which have had no recent history of clinical disease. Then a prepurchase plan should be arranged with the seller to test the animals, and the costs should be determined. If the seller is unwilling to cooperate with a prepurchase testing as a condition of sale, the buyer may wish to purchase the animal, and quarantine it until testing on the farm is completed. The ELISA is recommended for purchased animals but replacement heifers 12–15 months of age are unlikely to be seropositive and fecal culture would improve the accuracy of testing
- **Export testing.** The testing requirements for export of animals to other countries are set by the importing country. The complement fixation test has been commonly used but has insufficient sensitivity in young animals under 2 years of age. The ELISA may soon be accepted as an alternative but because of 50% sensitivity in young animals may also be inadequate. There is no available test which can detect subclinically infected breeding animals, which are commonly purchased under 24 months of age.

### Sheep and goats

The tests used in cattle are applicable in sheep and goats but the diagnosis, particularly in sheep, and in an individual animal, is much more difficult than in cattle. Procedures for detecting the organism in feces, by microscopic examination, polymerase chain reaction assay, or culture are of limited value either because of low sensitivity or because of technical demands. The ELISA used in cattle is being used for the diagnosis in sheep and goats. The sensitivity and specificity are similar to those in cattle but cross-reactions occur due to *Corynebacterium pseudotuberculosis* and sera absorbed with those heat-treated organisms improve the results. The AGID and ELISA have been evaluated and compared in adult sheep culled from flocks with a history of severe chronic weight loss. The sheep were examined at necropsy, and sensitivity and specificity evaluated using histopathologic findings as a reference. The sensitivity and specificity of the AGID was 37% and 100%, respectively. The sensitivity of the ELISA was 48% but the specificity was only 89%. Other studies in diseased sheep report that the ELISA and AGID test had sensitivities of 62% and 78%, respectively. In sheep, a histopathologic spectrum is defined by the existence of two widely differing forms of the disease: a tuberculoid form with strong cell-mediated immune response and lesions characterized by small granulomata composed of a few epithelioid cells surrounded by a large number of lymphocytes and with no or few bacilli in the lesions; and a lepromatous form, with a strong humoral immune response accompanied by lesions consisting of macrophages full of large numbers of mycobacteria. The sensitivities of the ELISA and AGID test were 86% and 100%, respectively, in sheep with lepromatous lesions but the sensitivities in sheep with tuberculoid lesions were only 10–50% and 30%, respectively. Thus there is a close correlation between serologic response to AGID and the presence of acid-fast bacilli in the intestinal tissues, and the diagnosis of tuberculoid cases remains difficult. However, the AGID is rapid, inexpensive, easily available, technically easy to perform, and has practical efficacy compared to bacteriological culture of feces. The AGID is useful for flock-screening programs to identify infected sheep with chronic weight loss due to paratuberculosis, to confirm infection in sheep with clinical disease, and to identify sheep shedding the greatest number of organisms.

#### Serum biochemistry

A simple serum biochemistry profile of serum proteins and mineral status may

provide a useful preliminary diagnosis of Johne's disease in emaciated and unthrifty sheep. Sheep with clinical Johne's disease have decreased serum concentrations of calcium, total serum proteins, and serum albumin compared with controls.<sup>101</sup> Serum protein concentrations in animals with Johne's disease ranged from 49 to 5 g/L with controls at 68 g/L. Serum albumin concentrations in affected sheep ranged from 14 to 19 g/L with controls at 29 g/L.<sup>101</sup> Sheep with the lepromatous lesions are more severely affected for calcium and protein depletion than the tuberculoid cases.

### Deer

Deer and other wild species present a special problem because their capture and restraint are so hazardous. A single capture technique is required and this eliminates any delayed hypersensitivity skin tests. Fecal culture, complement fixation, and lymphocyte immunostimulation tests are satisfactory, with a preference for the latter as being most accurate.

### NECROPSY FINDINGS

#### Cattle

Lesions are confined to the posterior part of the alimentary tract and its associated lymph nodes. The terminal part of the small intestine, the cecum, and the first part of the colon are usually affected. In advanced cases the lesions may extend from the rectum to the duodenum. Typically, the intestinal wall is three or four times normal thickness, with a corrugated mucosa and prominent thickened serosal lymphatics. The ileocecal valve is always involved, the lesion varying from reddening of the lips of the valve in the early stages to edema with gross thickening and corrugation later. A high incidence of arteriosclerosis has been observed in advanced cases of Johne's disease, with a distinct correlation between the vascular lesions and macroscopic changes in the intestine. The mesenteric and ileocecal lymph nodes are enlarged and edematous, but unlike tuberculosis, foci of necrosis and mineralization are rarely visible. The characteristic microscopic findings include large numbers of epithelioid macrophages and multinucleate giant cells within the lamina propria and submucosa of affected gut segments and within the paracortical areas of draining lymph nodes. A granulomatous lymphangitis is often visible.

#### Rabbits

In natural paratuberculosis in rabbits there are no macroscopical lesions suggestive of Johne's disease.<sup>102</sup> Histopathologically, the lesions are either severe or mild. Severe lesions consist of extensive

macrophage granulomata and numerous giant cells, with many intracellular acid-fast bacteria in the small intestine.

### Sheep and goats

Gross necropsy lesions are often minimal despite severe clinical signs during life. Emaciation and subcutaneous edema are usually present. In sheep there may be a deep yellow pigmentation of the intestinal wall and of the cortex of the draining lymph nodes. The intestinal wall may be thickened, although corrugation of the mucosa is not a common finding. Serosal lymphatics are often very prominent. Caseation and mineralization of the lymph nodes or enteric tubercles may occur. The pattern of lesions seen in cases of ovine paratuberculosis may be classified into two major types and detailed descriptions of these histopathologic changes are available.<sup>74</sup>

Bacteremia occurs with *M. paratuberculosis* infection, so granulomatous lesions are sometimes identified in filtering organs such as the liver, lung, and spleen. No lesions occur in an infected fetus but the organism can be isolated from its viscera and from the placenta and uterus. Traditionally, the most accurate post-mortem tests to detect *M. paratuberculosis* have been a combination of histopathologic examination and bacteriological culture. The development of PCR techniques may eventually provide a higher level of sensitivity. For most clinical cases of paratuberculosis, the demonstration of acidfast bacilli within typical lesions is sufficient for confirmation of the diagnosis at necropsy. *M. paratuberculosis* can be detected in ruminant tissue sections from formalin-fixed, paraffin-embedded blocks with a PCR technique that utilizes primers specific for the IS900 sequence of the organism.<sup>103</sup> The technique is more sensitive than acid-fast Ziehl-Neelsen and immunohistochemical staining.

In adult goats with clinical and sub-clinical paratuberculosis, the lesions were divided into four categories.<sup>104</sup> Focal lesions consisted of small granulomata in the ileocecal Peyer's patches or related lamina propria. Diffuse multibacillary lesions consisted of a granulomatous enteritis, affecting different intestinal sites. Numerous macrophages containing many mycobacteria are usually present, resulting in macroscopical changes in the normal gut morphology. In diffuse lymphocytic lesions, the lymphocyte was the main inflammatory cell, with some macrophages. In diffuse mixed lesions the infiltrate consisted of numerous lymphocytes and macrophages, with small numbers of mycobacteria. The three types of diffuse lesions are often associated with necrosis in the lymph vessels of the

mucosa, mesentery, and lymph nodes, and with greater thickening of the jejunum than of the ileum.

Experimental subclinical infection of goat kids with *Map* at several weeks of age and killed 2 years later, results in lesions predominantly associated with intestinal segments containing persistent organized lymphoid tissue, the distal jejunum, and proximal ileum being without lesions.<sup>105</sup>

### Bison

The lesions of paratuberculosis in the American bison (*Bison bison*) are similar to those in cattle.<sup>5</sup> Gross intestinal lesions are most common in the distal segments of the small intestine and the mesenteric lymph nodes are grossly enlarged. In a study of 70 bison suspected of having Johne's disease the AGID test identified only 3% of the morphologically positive animals, the ELISA identified 69%, and of a sample of 25/70, only 40% were positive on fecal culture. The fecal PCR identified 73% and the tissue PCR identified 100% of the morphologically positive animals.<sup>5</sup>

Samples for confirmation of diagnosis

- Bacteriology – distal ileum, colon, ileocecal lymph node (CULT (has special growth requirements), DIRECT SMEAR (acid-fast stains), PCR)
- Histology – formalin-fixed samples of these tissues (LM, PCR).

### DIFFERENTIAL DIAGNOSIS

The characteristic features of clinical Johne's disease include chronic diarrhea which does not respond to therapy, progressive weight loss, and emaciation in a single animal. The definitive etiological diagnosis can be obtained by using a combination of serological tests, fecal culture, and biopsy of intestine.

#### Cattle

In cattle the clinical disease must be differentiated from diseases which cause chronic diarrhea in adult cattle. The chronic nature of Johne's disease is usually sufficient to differentiate it from the other common enteritis of cattle. **Salmonellosis, coccidiosis, and gastrointestinal helminthiasis** are usually acute and the latter two occur principally in younger animals and are distinguishable on fecal examination for oocysts and helminth eggs. **Secondary copper deficiency (chronic molybdenum poisoning)** is likely to be confused with Johne's disease in cattle, but is usually an area problem affecting large numbers of animals and responds well to the administration of copper. Other debilitating diseases in which diarrhea is not an important clinical finding are **malnutrition, chronic reticuloperitonitis, hepatic abscess, pyelonephritis, lymphosarcoma, and amyloidosis.**

Idiopathic eosinophilic enteritis in cattle is characterized clinically by chronic diarrhea and weight loss, and recovery may occur following treatment with dexamethasone.<sup>106</sup>

### Sheep and goats

The characteristic features of clinical Johne's disease in sheep and goats are emaciation, weakness, and normal feces with intermittent bouts of mild diarrhea. The other causes of unexplained weight loss in sheep and goats include **caseous lymphadenitis, internal abscesses, gastrointestinal parasitism, caprine arthritis-encephalitis, ovine progressive pneumonia, dietary deficiencies, and dental disease.** A guide to the differential diagnosis, therapy, and management of unexplained weight loss in sheep and goats is available.

The major difficulty encountered in the diagnosis of paratuberculosis is the accurate identification of subclinically infected animals which are negative to the serological tests but are in the intermediate stage of the diseases and excreting the organism in their feces. This is a major diagnostic problem in the individual animal. On a herd basis the serological tests will usually indicate if the infection is present or absent in the herd and this can then be followed up by fecal culture to identify animals which are shedders. A combination of a highly sensitive and specific serological test, with fecal culture should improve the accuracy of diagnosis.

### TREATMENT

Currently, no antimicrobials are approved for the treatment of Johne's disease. *M. paratuberculosis* is more resistant to chemotherapeutic agents in vitro than *M. tuberculosis* so that prospects for suitable treatment are poor. Because of this lack of efficacy and the failure of any of the antimicrobials to provide a bacteriological cure, treatment is not recommended. The antimicrobials which have been used are summarized here:

- **Streptomycin** has most activity against the organism but treatment of affected cattle with daily doses of 50 mg/kg BW IM causes only a transient improvement in clinical signs
- **Isoniazid** given to cattle at 20 mg/kg BW orally daily for up to 100 days has a minor degree of activity against the organism but failed to cure clinical cases of Johne's disease<sup>107</sup>
- **Clofazimine**, a phenazine dye, shows some activity against early infections in sheep, and causes transitory but obvious clinical improvement in cattle when given to cattle at a dose of 600 mg daily for 10 months<sup>107</sup>
- **Monensin and tilcomisin** have been evaluated as therapeutic agents in an experimental murine model. Neither

time of incubation nor concentration of medication had any effect on the infectivity of the organisms.<sup>108</sup> Monensin significantly reduced the number of hepatic granulomas in genetically susceptible mice while tilmicosin phosphate did not. Monensin fed to adult cows with clinical Johne's disease at a rate of 147.5 mg/kg in the feed, each cow receiving 450 mg of monensin daily for 120 days, resulted in a beneficial effect on the lesions in the ileum, liver, and rectal mucosa compared to the controls in which the course of the disease worsened.<sup>109</sup>

## CONTROL

The control of Johne's disease in ruminants is challenging because of the ubiquitous nature of the organism, the long incubation period, most cases are subclinical, and the laboratory tests available lack sufficient sensitivity to identify infected animals which allows the infection to spread within and between herds.

Although there are large gaps in the understanding of various aspects of the epidemiology of *Map* and the diagnostic tests are not reliable in the early stages of infection, enough is known about the essentials of control programs for dairy herds which were proposed 50 years ago.<sup>15</sup> There is little difference from currently recommended control strategies. The implementation of herd or flock level control programs, establishment of test-negative or low-risk herds or flocks, and reduction of environment and feed contamination with *Map* are attainable goals.

Because of the inaccuracy of the diagnostic tests available, it is impossible to eradicate the disease, other than by complete depopulation of the herd and restocking with non-infected animals. Eradication strategies are usually not practical for economic reasons and the impossibility of acquiring non-infected animals. The next best option is control of the disease at a very low level of prevalence. Veterinarians usually are uncertain how to begin a control program in a herd once clinical disease has been encountered. Generic control recommendations often fail because they do not account for uncertainties inherent in control recommendations or for the unique circumstances of an individual herd. A systematic and practical farm-specific approach to control is recommended and the details are available.<sup>110</sup> The literature on the control of *Map* infection in agricultural species on a worldwide basis has been reviewed.<sup>111</sup>

A complete comprehensive control program consists of understanding three

major aspects which should be explained to the producer before planning a control program:

- Issues that impede efforts to control Johne's disease
- Characteristics of tests and alternative testing strategies that influence control programs
- Developing farm-specific control programs.

### Issues that impede efforts to control Johne's disease

The subclinical nature and long incubation of the disease makes it difficult to identify infected animals early enough before they shed organisms in the environment and infect other animals.<sup>112</sup> Because of its subclinical nature, producers tend not to recognize the importance of the disease and do not practice control measures. Successful control requires a commitment by the herd owner over many years.

The low level of clinical cases, a 5% population mortality rate per year, also impedes control efforts because the producer is not aware that the infection rate may be as high as 50% at any one time.

Incomplete understanding of some of the risk factors involved in control of the disease and the economic importance of the disease has slowed progress towards effective control procedures.

The lack of integrated national control programs in countries where the disease is endemic allows the disease to spread continuously from herd to herd and region to region. In the past many attempts have been made to decrease the prevalence of *Map* using a test-and-cull and vaccination strategies. However, none of these strategies has been effective in controlling *Map*, and the worldwide prevalence of infection continues to increase.<sup>113</sup> The **Voluntary Johne's Disease Herd Status Program** was developed in the United States in an effort to certify herds free of paratuberculosis. The program was intended as a model for control programs within each state, and the guidelines were considered to be minimal requirements to control the disease in dairy herds. In 2002, USDA-APHIS published the Uniform Program Standards for the Voluntary Bovine Johne's Disease Control Program.<sup>15</sup> The purpose of the document was to provide minimum national standards for the control of Johne's disease. The program outlines a testing strategy in addition to establishing education and management requirements for herds which choose to participate. At the state level, administrative requirements for personnel, Johne's-certified veterinarians and an advisory committee are established. Finally, performance standards for diagnostic laboratories as part of the program are identified.

Results consistently demonstrate that participation in a testing program for Johne's disease is associated with the adoption of management practices recommended for disease control.<sup>114</sup> Producers who believed their herds were not infected with Johne's disease might have felt it was unnecessary to adopt the management practices recommended for Johne's disease control.

A simulation model reveals that the mean prevalence of paratuberculosis as well as the economic loss attributable to the disease will slowly increase in a typical midsize dairy herd in the US if a control program is not implemented.<sup>113</sup> However, analysis of results indicate that the test-and-cull strategies alone do not reduce the prevalence of *Map* in cattle and are costly for producers.<sup>113</sup> Vaccination did not reduce the prevalence of infection but was economically attractive. Calf health management strategies were found to be critically important in every control program and most were economically attractive to midsize dairy herds in the US.<sup>113</sup>

The failure of herd owners to acknowledge that their herds are infected is another obstacle to control.

Failure of cattle producers to comply with the recommendations for control of Johne's disease is a major factor in failure of control programs.<sup>111</sup> In a survey of responses by dairy farmers in Victoria, Australia, 91% failed to comply with more than two of six important recommendations regarding calf health management.

To be effective, the control plans must be integrated with the unique resources and management skills of individual farms. The management capability of the producer, the facilities available, the nature of the herd, the disease control procedures already in place, the financial resources available, and the long-term production goals of the producer are crucial to a successful control program. Producers must be informed and understand that an effective control program may require up to 3–5 years before results are obvious.

### Characteristics of diagnostic tests and alternative testing strategies that influence control programs

The diagnostic tests have been described under Clinical pathology. The veterinarian must be fully informed about the sensitivity and specificity of the tests available and select appropriate tests. The ELISA and fecal culture are most commonly used with an overall sensitivity of about 40–50% and specificity of about 98–100%. A single test with the ELISA fails to detect about 50% of infected animals. A combination of the ELISA and fecal culture is

most effective in detecting animals in the later stages of infection. The sensitivity of both tests will be higher in herds with a high prevalence of infection.

Cost of the tests is a factor. Herd testing is expensive and producers are commonly reluctant to invest in the costs necessary.

Interpretation of the results and the making of decisions about the results based on ELISA or fecal culture testing requires leadership from the veterinarian to explain the options and their consequences. Testing provides an estimate of the prevalence of infection in the herd and can be used to monitor progress over time. Testing and culling infected animals promptly reduces the prevalence of infection immediately. Animals with clinical disease shed large numbers of organisms and should be culled immediately; delaying culling merely allows spreading of infection to continue. In some cases, culling certain infected animals may not be appropriate for economic reasons, and segregating them from the rest of the herd as a separate group can be considered if facilities are available. These animals can be culled over a period of time as part of the culling program of the herd. Culling of the progeny of subclinically infected animals and those with clinical disease should also be given high priority.

How often testing should be done, which animals should be tested, and which combination of tests to be used each time are major considerations. Repeated testing following the initial test until the prevalence of infection is low is recommended.<sup>75</sup> Only repeated testing of cattle, including youngstock, from infected herds will provide the data to determine the true infection rates within infected herds.

Choosing which groups of animals in the herd are to be tested is a major consideration. The entire herd or subgroups can be tested initially. Testing animals under 18–20 months is usually not informative because of the low sensitivity of the test. Examples of subgroups which can be tested include those with evidence of clinical disease and their age cohorts, animals related to or exposed to infected animals, animals from the same infected source, or animals which are probably not infected. Animals being brought into the herd should be tested with the ELISA and fecal culture.

### Developing farm-specific control programs

Understanding the issues that impede control and the characteristics of the tests used indicate that the development of effective on-farm control plans and

strategies should be directed towards the individual farm using the principles of control.<sup>110</sup> Each farm and herd is different, the management capability varies considerably, and the disease status of affected herds varies widely. Therefore, the control program should be planned and implemented to meet the needs of the herd in question.

### Control on a herd basis

Principles of control

The control of Johne's disease is based on two major principles:

- The identification and elimination of infected animals
- The prevention of new infections.

Dairy and beef cattle herds

#### *Identification and elimination of infected animals*

Identification of infected animals is done using the diagnostic tests available, and prevention of new infections depends on improvement of environmental management and avoiding the introduction of infected animals into the herd. Vaccination is also a control strategy to prevent clinical disease but it does not prevent infection.

Livestock owners are often unaware of the essential features of Johne's disease and must be educated by the veterinarian. A successful control program depends heavily on how well the owner understands some fundamental premises about the control of Johne's disease which are:<sup>15,111</sup>

- Infection occurs most commonly in calves during the first 6 months of life and the incubation period of clinical disease varies from 2 to 5 years
- The disease decreases milk production in subclinically infected cows and shortens the productive herd-life of cows
- Spread of infection occurs by the fecal-oral route, by congenital transmission, and through colostrum and milk of infected cows
- Calves born to infected cows have a higher likelihood of becoming infected than calves born to non-infected cows
- It must be managed as a herd disease, not an individual animal disease. The disease must be controlled to improve the productivity and profitability of the herd
- The rate of infection in the herd will increase with time unless control procedures are implemented
- The disease can be controlled. Diagnostic tests are available and there is sufficient information available about methods of transmission so that infected animals

can be identified and new infections prevented

- Control in a herd takes time and requires changes in management to prevent new infections, and the identification and elimination by culling of both clinical affected and subclinically infected animals. Reducing the prevalence of infection to a low level requires 3–7 years; to eliminate infection and reduce prevalence to 0% 7–15 years; to reduce and eliminate clinical disease 2–5 years.

Each of these goals depends on how the owner adopts and implements the control procedures and monitors progress by continued testing.

Before undertaking a control program, the owner of the herd should address three questions:

1. What are the objectives for the herd? Milk production, meat production, or rearing of breeding stock? Commercial milk producers may not be concerned about the disease and may merely cull clinical cases as they occur. If the prevalence of infection is below 5% the effects may be minimal. Breeders and owners of pedigreed breeding stock for sale to other herds will be interested in eradication of the infection from the herd.
2. What are the long-term goals of the producer? Because of the slow spread of the disease, it takes several years for clinical disease to become evident and several years for control to be effective. Unless the owner intends to maintain the herd for several years, there may be little justification for a comprehensive program.
3. How aggressively does the owner want to adopt and implement the control program? Owners must consider their available financial and managerial resources, housing facilities, and their understanding of the concepts and requirements of control. Many Johne's disease control programs fail because of lack of client compliance and loss of interest within a short time after beginning the program.

#### *Determination of prevalence of infection in the herd*

The first step in a control program is to estimate the prevalence of infection using a diagnostic test such as the ELISA. All animals over 2 years of age are tested, and with a test sensitivity of 50% the true prevalence of infection will be approximately twice the results of the test. The first test will provide an indication of the magnitude of infection in the herd and

decisions about culling and further testing in the future can be made.

**Culling clinical cases and subclinically infected animals (identification and elimination of infected animals).** The simplest program is to cull clinical cases as they occur and not test the herd but this will not eliminate subclinically infected animals and the infection will continue to spread in the herd.

The first test to estimate the prevalence of infection will identify seropositive animals which along with their offspring can be culled and sold only for slaughter. Calves from infected animals can be kept separate and grown and fed under feedlot conditions until ready for market. The farm is quarantined and residual animals are retested at 6- to 12-month intervals until two consecutive negative herd tests are achieved. A combination of the ELISA and fecal culture of all animals over 2 years of age every 6 months is recommended.<sup>15</sup> Not all fecal-positive animals will be seropositive and fecal culture-positive cows and their offspring should be culled and slaughtered even if seronegative. The disease can be markedly reduced by this method but results depend largely on the degree of contamination of the environment. The method has the virtue that many heavy fecal shedders are detected early, and the contamination of pastures is reduced. The culture and cull method is much more accurate, but is expensive and still has the deficiency that resistant, intermittent shedders may escape detection. Another alternative is to maintain infected and non-infected herds separately. The progeny of the infected cows are raised separately from their dams and should not be returned to the uninfected herd unless tested and found to be negative.

A simulation model of the control of the disease in a dairy herd indicated that test-and-cull control procedures decrease the prevalence of infection in the herd and that test sensitivity was the sole determinant of this control strategy. A combination of test-and-cull and improved calf-management techniques provides the most rapid means of controlling the disease in a dairy herd.

An economic decision analysis model of paratuberculosis in a dairy herd indicates that a test-and-cull program should be profitable when the pretest prevalence of infection is greater than 5%. The model predicted that the best diagnostic test would be the one with the highest specificity and lowest cost, with test sensitivity of secondary importance. Given the costs of various types of diagnostic technology, it appears that the absorbed ELISA is the most efficient for testing and culling programs.

#### *Prevention of new infections*

**Biosecurity.** For herds free of Johne's disease, all measures must be employed to avoid the introduction of infected animals into the herd by maintaining a completely closed herd or by carefully screening purchased animals. The purchase of cattle is the most common way *Map* is introduced into a herd.<sup>45</sup> Purchasing cattle only from herds documented to be free of Johne's disease is preferable to testing specific cattle prior to introduction because of the low sensitivity of available tests for individual cattle.<sup>115</sup> Currently this is difficult because less than 1% of US dairy herds participate in a Johne's disease certification program.<sup>51</sup> Dairy herds using typical management practices experience preventable risks of Johne's infection and disease. A dairy herd with 400 cows in milk that introduces 40 cows per year from the general population of dairy cows has an estimated 64% probability of introducing *Map* to the herd. This risk could be reduced to 4% through the purchase of cows from herds at level 2 of the US Voluntary Johne's Disease Herd Status Program.<sup>116</sup> A simulation model to assess the risk of introduction of *Map* infection into a dairy herd through purchase of female replacement cattle has been used to estimate the probabilities of a producer purchasing an infected lot during a given period of time.<sup>115</sup> The probability of introducing infection is directly proportional to the prevalence of infection in the herds of origin.

**In a control program for Johne's disease, certified *Mycobacterium* subsp. *paratuberculosis*-free cattle herds are essential as sources of non-infected cattle.**

All herd replacements should be tested and found negative before being purchased and introduced into the herd. Only test-negative animals from herds with no or few positive animals should be purchased. Owners should be provided with an information sheet explaining how to limit the risk of buying subclinically infected cattle.<sup>15</sup>

#### *Environment and management (preventing new infections)*

Veterinarians should promote management recommendations which adapt recognized control principles to specific situations.<sup>15</sup> Most control measures are in one of three generally accepted categories of Johne's disease control.

#### **Dairy Herds**

##### **1. Minimize contact between young and older animals and from fecal contaminated feed and water:**

- Clean and disinfect maternity and calf pens after each use

- Calve cows in clean, dry, dedicated maternity pens
- Remove calves immediately after birth to clean, dry calf pens, stalls, or hutches
- Feed colostrum only from test-negative cows
- After colostrum feeding, use pasteurized milk, or use milk replacer
- Raise calves separate from the adult herd for at least the first year of life
- Do not allow shared feed or water between adults and young animals; do not offer feed refusals from adult cattle to young animals
- Avoid vehicular and human traffic from adult animal areas to young animal areas.

##### **2. Prevent manure contamination of feed and water sources:**

- Use separate equipment for handling feed and manure
- Design and maintain feedbunks and waterers to minimize risk of contamination with manure
- Do not spread manure on grazing land.

##### **3. Reduce total farm exposure to the organism:**

- Immediately cull all animals with clinical evidence of Johne's disease
- Cull culture-positive animals as soon as possible; for cows with low or moderate fecal culture colony counts, removal at the end of lactation may be acceptable
- Test adult cattle at least annually by serum or fecal tests; positive serum test results should be confirmed by fecal culture
- Purchase replacement animals from test-negative herds; if this is not possible, assess the status of the herd of origin through owner or veterinarian's statements, by negative serum ELISA tests of at least 30 adult animals, or both.

**Hygiene.** Controlling the disease at a low level of prevalence in the herd requires hygienic precautions to limit the spread of infection. Environmental conditions and manure handling procedures correlate with prevalence of infection.<sup>117</sup> Overall cleanliness of the farm, especially the amount of fecal contamination resulting from the design, maintenance, location of the housing facilities, and frequency of cleaning are important items for discussion with the producer. Opportunities for exposure of young cattle to adult cattle feces, either because of direct access to water contaminated from adult cow feces or because of the common practice of using the same loader for feeding and



manure handling of young stock and adult groups of cattle are risk factors to be removed or modified. Avoidance of fecal pollution of drinking water and feed by providing troughs in high positions, fencing of marshes and ponds, and closing contaminated pastures for up to 3 years are worthwhile measures.

Strip grazing should be avoided as fecal contamination of pasture is likely to be intense. The provision of piped water supplies to cattle on pasture rather than the use of ponds and ditches has been associated with a decline in the incidence of Johne's disease. Frequent harrowing of pasture fields to disseminate dung pats facilitates destruction of the bacteria by exposing them to sun and drying. Yard and barn manure should be spread only on cultivated fields.

In infected herds, any animal with any signs suggestive of the disease should be isolated until its status has been determined. Adoption of these hygienic precautions has been shown to greatly reduce the prevalence of the disease.

#### Dairy calf health management.

Attention to calf health management practices is a vital component of a control program.<sup>15,17</sup> A simulation model of the control of the disease in a dairy herd indicates that calf-management techniques that reduce the number of effective cow-calf contacts decreases the prevalence of infection in the herd. Although congenital infection may occur, it is still advisable to rear calves away from infected cows, and if possible in individual pens to prevent spread among the calves. Newborn dairy calves should be removed from the dam immediately after birth and fed colostrum by stomach tube and reared in individual calf pens. Colostrum must be collected with care to avoid contamination with feces. Dirty and fecal-stained udders of recently calved cows should be cleaned before collecting colostrum.

High-temperature, short-time (HTST – 72°C for 15 s), on-farm pasteurization of raw milk is effective for the destruction of *Map* and effectively destroys *Map* in colostrum.<sup>36</sup> On-farm pasteurization of moderately sized (57 L) batches of colostrum using a commercial batch pasteurizer at 63°C for 30 min produces colostrum of normal or only mildly thickened consistency which can be fed to calves.<sup>118</sup> Batch pasteurization does result in a significant reduction in IgG in colostrum but the concentrations are higher after pasteurization when the fresh colostrum IgG is >60 mg/mL. Feeding at least 4 L of fresh or pasteurized colostrum results in similar concentrations of serum IgG concentrations.

This provides dairy producers with an alternative to purchasing commercial

replacement products, resulting in reduced costs. Pasteurized waste milk also significantly reduces the incidence of infectious diseases of calves. On-farm batch pasteurization at 65.5°C for 30 min is adequate to destroy *Map* in waste milk.<sup>119</sup>

Group housing for periparturient dairy cows has been considered a practice with increased risk of Johne's disease transmission because access by multiple cows to calving areas can predispose newborn calves to increased risk of exposure to *Map*.<sup>51</sup>

The variable use of an exercise lot for lactating dairy cows was associated with a three-fold increase in odds of a herd being positive for *Map*.

Dairy cows due to calve should be kept separately from the milking herd and calved in calving box stalls. Calves from cows which are clinically affected should not be reared as herd replacements but grown and fed for beef production. Sucking of dams and nurse cows should not be permitted. Milk for bucket feedings should be collected hygienically and rearing on milk substitutes should be encouraged. Calves from birth to breeding age should not have any contact with yearling animals or mature cows which may shed the organism. Postweaning calves should not have contact with the adult herd in order to avoid infections.<sup>15</sup> In dairy herds with a high prevalence of infection, calves should be moved to calf barns and hutches rather than to pens in the cow barn.

**New York State Cattle Health Assurance Program (NYSCHAP).** This program is designed to encourage dairy producers to adopt best management practices to minimize the transmission of infection.<sup>120</sup> Farms enrolled in the program were given a herd-specific plan with intervention strategies ranked to limit the risk of spread on each farm. Effective communication and understanding of the issue between farmers, veterinarians, employees, herd veterinarians, and state veterinarians, is required for success.

**Beef Herds** Control programs for beef cow-calf herds apply the same principles as for those in dairy herds but must adapt the procedures to meet calf health management needs. Some specific control measures for beef herds include:

- Avoid manure build-up in pastures and corrals where late-gestation cows are kept
- Provide a clean calving area, with low cow density
- Move cow-calf pairs to clean pasture as soon as bonding occurs
- Move feedbunks, waterers, and creep-feed areas frequently to avoid exposing calves to manure build-up

- Do not place weaned calves on pasture used by cows
- Blood or fecal test the entire breeding herd annually; avoid calving-out and raising offspring from test-positive animals
- If possible, calve first-calf heifers in an area separate from older cows.

Sheep and goats

#### Sheep

The control or eradication of Johne's disease in sheep flocks has been more widely accepted and implemented in Australia than in many other sheep-raising countries.<sup>9,15,101</sup> The Australian program is based on negative serologic testing (ELISA or AGID) of a sample of the adult flock (2 years or older) and culling positive animals. The flock-sampling program, which is designed to detect a 2% or greater prevalence of infection with 95% confidence, requires testing 400–500 sheep from each flock. Management procedures include boundary fencing and introducing flock additions only from flocks of similar *Map* status. Fecal culture of pooled fecal pellets from up to 50 animals per pool and use of Middlebrook agar or modified BACTEC radiometric medium have greatly improved the sensitivity of detection of positive animals.

**Vaccination** is a common method of control of ovine paratuberculosis. Because of the higher ratio of diagnostic test cost per individual animal value, fecal culture is not a practical test in sheep flocks. In addition, the ovine strains are more difficult to culture from feces than in cattle. An economic and epidemiological simulation of different control strategies for ovine paratuberculosis evaluated no intervention, testing and culling, vaccination, and testing and culling together with vaccination. The size of the flock was 200 and annual replacement rate by causes other than Johne's was 15%. Vaccination was considered to be 90% effective. Eradication could be reached with any of the three methods in 10 years and, in a situation of low prevalence, the costs for culling methods are higher than those of no intervention. At high prevalence rates, these methods become more profitable but do not cover the high costs of replacing the culled animals. The best strategy is to vaccinate the replacement ewes, a practice which reaches a positive benefit-cost ratio at both levels of prevalence and does not demand heavy initial investment. Use of the Weybridge vaccine given to lambs before they were 1-month-old, subcutaneously in the brisket, successfully controlled the disease after 3 years of vaccination.<sup>121</sup>

The use of a live-attenuated vaccine against paratuberculosis in sheep may

have therapeutic value. Vaccination of lambs with a live-attenuated vaccine two weeks after experimental infection with *Map* stimulated a host response against the organism and resulted in a reduced mycobacterial burden. Both the antibody response and the gamma interferon response were detected earlier and were more substantial in the vaccinated group.<sup>122</sup>

Vaccination with the Sigurdsson vaccine of heat-killed *M. paratuberculosis* in mineral oil has given excellent results, reducing the disease to negligible proportions. The use of vaccination in sheep is not impeded by interference with tuberculin testing. However, vaccination of sheep will result in positive CFT titers which can interfere with serological testing for export and diagnostic purposes.<sup>15</sup>

#### Goats

The disease can be eradicated from a goat herd by identifying positive animals by fecal culture semiannually, using AGID testing quarterly, and weighing all goats monthly. The essential elements of the control program evolved over a period of 5 years. Treatment trials were ineffective. The environmental and management changes included:

- Minimization of contamination of feed and water supplies by introduction of keyhole feeders, metal grain troughs, and automatic waterers
- Movement of goats between pens was discontinued unless essential for health reasons
- Pen cleaning was changed from once a week to three times weekly
- Pasturing of goats was discontinued
- Accumulated goat manure was spread on fields and plowed under before hay fields were reseeded
- Young and newly acquired goats were kept isolated from the general herd until their test status had been determined
- Personnel dipped their footwear in disinfecting solution before entering or exiting barns or isolation areas.

A high incidence of clinical Johne's disease in goats has been controlled by the vaccination of adult goats using a commercial inactivated vaccine.<sup>123</sup> The incidence of clinical cases was markedly reduced in the vaccinates compared to the non-vaccinated animals.

#### Vaccination of cattle

If local legislation permits it, vaccination provides protection against clinical disease and reduces the rate of spread of infection but it will not eliminate infection. Because of the potential risk of spreading *Map* from cattle vaccinated with the live vaccine, and the possible association between *Map* and Crohn's

disease, only killed vaccines have been allowed for use in the Netherlands.<sup>124</sup> Vaccination of calves with a killed vaccine does not prevent transmission of natural infection, and therefore, management practices remain essential for control of Johne's disease.

The efficacy of vaccination has been questioned and reported results of vaccine trials are varied ranging from no reduction in infection rate, to 50–90% reduction. The current consensus is that vaccination may reduce the incidence of clinical disease, and to a lesser extent the prevalence of infection, but vaccinates are not fully protected from infection.

In a cross-section study of 25 vaccinated and 29 non-vaccinated herds the rate of shedding of *Map* was not significantly different between the vaccinated (4.4%) and non-vaccinated herds (6.7%). Two years of culturing feces of each herd at 6-month intervals, was effective in decreasing the prevalence of infection in vaccinated and non-vaccinated herds. The culling of fecal culture cows, combined with prevention of infection through proper calf health management practices were more important than vaccination.<sup>124</sup> Farm management practices which limited the opportunities for transmission of *Map* were as important in decreasing the rate of shedding of *Map* in the feces as did vaccination.

Vaccination is done only in calves less than 1 month of age.<sup>15,111</sup> Calves are not revaccinated because the degree of protection appears to diminish and because of the unsightly nodules which sometimes develop. The vaccine is of no benefit to infected animals, but it is incapable of causing the disease or of producing carriers.

A major complication is that vaccinated animals are positive to the johnin test and to the tuberculin test, using both avian and mammalian tuberculin, but much less to the mammalian tuberculin. The positive test to tuberculin is maximum at 5 weeks after vaccination and has completely disappeared at 18 months. In general terms, vaccination can be recommended in heavily infected, tuberculosis-free herds, but only in areas where tuberculosis eradication is neither underway nor projected. The comparative tuberculin test can be used to detect tuberculosis in Johne's vaccinated herds. Vaccination of calves from 5 to 40 days of age with an inactivated paratuberculosis vaccine resulted in positive ELISA titers for at least the first 15 months, which could interfere with the serodiagnosis of the disease in control programs that are based on serological tests.

Vaccination of dairy calves in the Netherlands reduced the number of

clinically affected animals by almost 90%.<sup>111</sup> It also reduced the number of subclinically infected animals and those with a histological and/or bacteriological test result. Vaccination did not prevent loss of milk production but it reduced infection pressure and the clinical disease. Partial budgeting revealed that vaccination was highly profitable per cow. Similar vaccination trials in dairy herds indicates a reduction in clinical disease, reduction in culling due to Johne's disease, but prevalence of infection may not be reduced. In a control trial over 5 years, the vaccination of calves in a large dairy herd in which the management was not changed resulted in a marked reduction in fecal shedding.<sup>111</sup>

Vaccination for paratuberculosis in The Netherlands has been restricted to herds with severe clinical disease. A heat-killed vaccine was given to calves in the first few months of age.<sup>125</sup> The effect of the vaccine on the long-term immune response was evaluated in two Dutch dairy herds over a period of 12–14 years. The B-cell response was evaluated using both the CFT and an ELISA, and the cell-mediated immunity was evaluated using the gamma interferon assay.<sup>125</sup> The vaccine had a marked and prolonged effect on both the cellular and humoral immune responses, in particular to the paratuberculosis antigen and to the bovine tuberculin.

Vaccination is available on a limited basis in the United States. The vaccine currently approved for use is an oil suspension of killed Strain 18 organisms, originally considered to be a laboratory-adapted strain of *Map* but now known to be a closely related strain of *M. avium* and not subsp. *paratuberculosis*. The immune response in calves following vaccination before or after oral challenge to *Map* and using both a commercial *M. avium* Strain 18 and a field-isolate of *Map* vaccine preparations has been examined.<sup>126</sup> The effect of prior exposure to *Map* and the adjuvant effect of (human recombinant interleukin) rIL-12 on vaccine efficacy was also tested. A significant reduction in mycobacterial colonization was observed when calves were vaccinated with the field isolate prior to challenge but not following vaccination with Strain 18 vaccine. Vaccination with (interleukin) rIL-12 prevented infection in some calves but its overall effect on gamma interferon response and total mycobacterial load was not significant. The efficacy of paratuberculosis vaccines may be enhanced if calves are vaccinated prior to *Map* exposure with field-isolate vaccine instead of Strain 18 vaccine currently in use.

#### Control on a country-wide basis

Johne's disease in cattle is being recognized with increased frequency in North

America and elsewhere. The overall prevalence of infection in dairy cattle is about 10% and no reliable data are available for beef herds. Despite reports that the disease is spreading in the cattle population and the reported economic losses associated with the disease, there is no concerted national effort to control the disease.<sup>15</sup> The recent concern that Crohn's disease in man may be associated with *M. paratuberculosis* has increased the level of awareness of the disease and livestock producers and the veterinary profession have become interested in control programs. Livestock producers who have developed non-infected herds are also interested in maintaining their infection-free status. It has been suggested that the time has come for the livestock industry and the veterinary profession to take Johne's disease seriously. The continued spread of infection in cattle herds, the economic consequences of loss in productivity, and the biological possibility that the organism may be a food-borne disease deserves consideration by the appropriate authorities and research agencies.

Historically, national efforts to control Johne's disease have not been successful because the livestock industry was not convinced of its economic importance and because the diagnostic tests did not have a good reputation. As a result no concerted national or regional effort was made to control the disease, which allowed the continued spread of infection between herds and between regions because of the movement of breeding animals. Currently, there are wide variations in how Johne's disease is controlled by national, state, or provincial agencies. In some jurisdictions, the disease is reportable and in others it is not. The state of Wisconsin has a law concerning the sale of cattle which states that every animal sold in the state has an implied warranty that it is free of infection with *M. paratuberculosis*. However, the seller can negate this liability by providing a written statement to the buyer prior to the sale stating that the animal is not warranted as being uninfected.

In addition, veterinarians' complete health certificates for interstate or intrastate movement of cattle, and most certificates require a statement that the animals are free of certain diseases. If the animal originates from an infected herd, the veterinarian is liable if the animals are found to be infected.

Voluntary national guidelines are now available to certify herds as low-risk for paratuberculosis.<sup>15</sup> Voluntary national and regional Johne's disease control programs for dairy and beef cattle herds, and sheep flocks have been introduced in the United

States,<sup>15</sup> Australia,<sup>9,111</sup> and New Zealand,<sup>21</sup> and in the Netherlands.<sup>111,127</sup> The disease is notifiable in Greece, Republic of Ireland, Luxembourg, Norway, Switzerland, Spain, and Sweden.<sup>111</sup> Most countries of Western Europe do not have strategically planned control programs. Denmark and France have implemented non-government industry-supported programs in cattle herds. The emphasis in the early stages is to control clinical disease.

A significant development in recent years has been accreditation programs for negative herds such as the United States Voluntary Johne's Disease Herd Status Program for Cattle in the US, and Johne's Disease Market Assurance Program in Australia.<sup>15,111</sup>

A National Paratuberculosis Certification Program has been outlined for the USA.<sup>15</sup>

The Johne's disease control programs for cattle and sheep in Australia are excellent models of attempts to control an infectious disease of ruminants on a national basis with cooperation between the livestock industries and the state and national governments.

In Australia, the National Johne's Disease Market Assurance Program for cattle was launched in 1996<sup>111</sup> and became the CattleMap. The program is a voluntary, audited, quality assurance program. It is based on negative testing of the adult herd, or a large sample of it, combined with movement controls, to assure owners and clients that participating herds have a very low risk of being infected or becoming infected. CattleMap testing in large herds is designed to achieve a probability of at least 95% of detecting infection if it is present in 2% or more of adult animals in the herd. Continued assurance is based on negative herd testing at 2-year intervals, combined with management procedures to reduce the risk of introducing infection. Herds with a high-level status may be classified as free of infection in the future depending on experience with the program.

The guidelines are intended to be used by states to establish Johne's disease-free herd certification programs. The goal is to develop a list of test-negative herds from which producers can purchase low-risk animals. Hopefully, the concept of herd certification will spread and be adopted by more producers and the national animal health agencies will promote control programs.

A herd in the CattleMap must comply with the published rules and guidelines and with a written agreement between the herd owner and his or her approved veterinarian. The state veterinary authorities train and approve private veterinary practitioners who evaluate the farm and its management, develop written farm

management plans with each producer, take the blood samples and follow-up reactors, interpret results, assign herd status and issue official status certificates. Herd owners must maintain the schedule of testing, comply with management requirements of the program and ensure that the animals are only introduced from herds of the same or higher status. If a herd does not comply with its testing schedule or other requirements, the status will revert to the next lowest level, or possibly even to suspect status. Herds and veterinarians are audited annually.

In Victoria, Australia, the Victorian Johne's disease test and control program in beef and dairy cattle is based on testing cattle with the ELISA, culling positive animals, management procedures to prevent new infections, and repeated annual testing of the herds.<sup>128,129</sup> The program resulted in a marked decline in the number of clinical cases, and a marked reduction in prevalence of reactors only when most herd animals were born after the program began. In beef herds, the modal age of reactors and clinical cases was 5 and 6 years, respectively. In dairy herds, the average age of reactors and clinical cases was 5.7 and 5.9 years, respectively. The sensitivity of the ELISA was only about 26% in the first testing compared to those which subsequently became positive or developed clinical disease.

In Australia, the Australian Sheep Johne's Disease Market Assurance Program (SheepMap) was launched in 1999.<sup>111</sup> It is a voluntary, audited, quality assurance program. It is based on negative serological testing (ELISA or AGID) of a sample of the adult flock (animals 2 years and older), combined with prudent flock management (attention to boundary fencing, introduced sheep are from flocks with similar flock status), to assure owners and clients that participating flocks have a very low risk of being or becoming infected.

In 1999, in Australia, a national Ovine Johne's Disease Control and Evaluation Program was established.<sup>9</sup> The program is jointly funded by the sheep industries and Commonwealth and state governments, and is managed by Animal Health Australia. The plan consisted of two stages. The first stage was a control and surveillance program for 1 year, to limit further spread of the disease and to determine its distribution. Known infected and suspect flocks were subject to movement restrictions to limit further spread, and movements of sheep onto and off known infected farms were traced and investigated. This stage also included proposals for development of a market assurance program and zoning within a state, as well as advisory and research

programs. The second stage of the plan, eradication of the disease, proceeded only if this was found to be feasible after completion of stage 1.

By 2000 Johne's disease of sheep had been confirmed in every Australian state or territory except Queensland and the Northern Territory. A national program is now in place to support the control of the disease in sheep and research to determine the feasibility and cost-effectiveness of eradication.

National Johne's Disease Program Standard Definitions and Rules for sheep were endorsed early in the program. These rules provided guidelines and minimum standards for the management of Johne's disease in sheep in Australia, and provide the basis for individual state or territory control programs. Zoning and movement restrictions within Australia and classification of flocks according to their level of risk of being infected were effected. Flocks were classified into the following categories:

- Infected, where Johne's disease has been confirmed on the farm
- Suspect, where there is epidemiological evidence to suggest that the flock may have been exposed to infection but it has not yet been confirmed
- Under surveillance, where there is evidence to suspect the disease, but after investigation the risk is determined to be low
- Nil assurance where a flock has no history of Johne's disease and has not been assigned any other classification.

In 1999, zoning for Johne's disease in sheep was implemented across Australia according to the following categories:

- Residual Zones are endemic but some level of control is in place
- Control Zones may be present at a manageable level and are actively controlled
- Protected Zones occur only sporadically and eradication measures are enforced
- Free Zones. There are no known or suspected infected flocks, and the absence of Johne's has been demonstrated to the satisfaction of the veterinary committee.

Surveillance in the program has relied primarily on the testing of 'at-risk' flocks identified by tracing the movement of sheep onto and off infected farms, or as neighbors of infected farms. Abattoir surveillance in all states has substantially increased the amount of surveillance in Control and Free Zones providing much greater assurance of their status. Abattoir surveillance also provides an effective

method of detecting flocks with established infection in those areas that are independent of tracing from known infected flocks. Abattoir surveillance is based on visual inspection of the intestinal tract of sheep with histopathological examination of tissue samples from any gross lesions. As a screening method replacing serology, the culture of pooled fecal samples in lots of up to 50 sheep is now being done with the BACTEC system with a *Map* confirmation by PCR testing using IS900 sequence by subculture.<sup>9</sup> The higher sensitivity of pooled fecal culture makes it a very useful and economic tool for market assurance testing.

#### Johne's Disease control in the Netherlands

In the Netherlands, cattle herds can obtain *Map*-free status following five annual herd examinations for which all results are negative.<sup>127</sup> The first herd examination consists of serial testing of all cattle  $\geq 3$  years of age by serology (ELISA) and individual fecal culture of seropositive animals. The second to fifth herd examinations each consist of serial testing of all cattle  $\geq 2$  years of age with pooled fecal culture and individual-animal fecal culture of positive pools. The status of these certified '*Map*-free' herds is then monitored by annual herd fecal examinations, the same as for the second and fifth herd examinations. For the pooled fecal culture, all animals  $\geq 2$  years of age are stratified by age. A pooled fecal sample is then obtained from each group of five animals and cultured as a single sample. If a pooled sample is culture positive, the five animals are re-examined by individual fecal culture. If all individual fecal samples of a previously positive pool are negative, then this pool is regarded as culture negative. To reduce the risk of introduction of *Map* infection in *Map*-free herds, cattle may be added to these herds only if the cattle originate from another *Map*-free certified herd or if they originate from a herd with an equal or higher number of negative annual herd examinations.

In 2000, the first Dutch dairy herd obtained *Map*-free status, and by the end of 2002, there were 233 *Map*-free herds certified in the Netherlands. However, it was considered to be too expensive and alternatives were examined. Using a stochastic simulation model ('JohneSim') it was concluded that the current Dutch certification-and-monitoring scheme for *Map*-free herds could be optimized by: (i) certification of *Map*-free herds after four herd examinations at 2-year intervals consisting of pooled fecal culture of all cattle  $\geq 2$  years of age; (ii) monitoring of *Map*-free herds by pooled fecal culture of all cattle  $\geq 1$  year of age at 2-year intervals;

and (iii) vigorous implementation of preventive management practices against the transmission of *Map* infections. In addition, the designation '*Map*-free' should be changed to 'low-risk *Map*'.

Vaccination has been used for control of Johne's in the Netherlands.<sup>125</sup> See under *Vaccination of cattle*.

#### Johne's disease control in the United States

In the United States several attempts have been made since 1993, to establish nationwide management programs to eliminate Johne's disease from animal herds. In 1993, a task force of the Johne's disease committee of the United States Animal Health Association drafted a model herd certification program to provide states with an example from which to develop or standardize programs.<sup>15</sup> Some states modified their programs to conform, but relatively few herd owners elected to pursue herd certification. The primary deterrents were the amount of testing required and the associated costs.

In 1998, a revised program was adopted as the US Voluntary Johne's Disease Herd Status Program for Cattle. The standards have been adopted in whole or in part by at least 20 states. In 1999, additional guidelines were developed for Johne's disease-affected herds: the Minimum Recommendations for Administering and Instituting State Voluntary Johne's Disease Programs for Cattle.

Control programs have in general relied on management techniques to identify infected herds and then clear those herds of the disease, because effective treatment and vaccination strategies do not exist. In addition, because of the long subclinical phase and the limited sensitivity of diagnostics, eradication programs require a long-term commitment.

The US Voluntary Johne's Disease Herd Status Program for Cattle (1998) is designed as a model for improving the equivalency of state control programs, as a framework for the establishment of new state programs, and to assist state veterinarians and state Johne's disease advisory committees as they considered implementation of herd certification.<sup>15</sup> The model is a voluntary herd status program, which identifies minimum requirements for operation of a scientifically sound approach to identification of low-risk herds. It provides for confidentiality of testing results at the discretion of the producer (within state limits), but it also encourages producers who have entered the program to reveal test results as a way to promote the value added by Johne's disease-free herd certification.

The program consists of an initial risk evaluation, to inform producers of existing

on-farm factors associated with the spread of the disease and to introduce to them the Best Management Practices which have been identified to prevent the introduction and spread of Johne's disease. Important practices which must be adopted before entry into the program are the prevention of commingling, the prevention of exposure to the manure or raw milk of susceptible animals over a period of 12 months, and the permanent identification of individual cattle.

The program was designed to identify uninfected or low-risk Johne's disease herds. The testing protocol involves testing a subset of adult cows in a herd using a serum ELISA to detect antibodies against *Map* and follow-up testing of ELISA-positive cattle by fecal culture to confirm the presence of *Map*. The first level test (Level 1 of 4) of the program includes 30 serologic samples per herd. Because the ELISA sensitivity is low (15%) in subclinically infected low fecal shedding cows, the Level 1 test strategy detects only an estimated 33% of herds with <5% prevalence and 68% of herds with 5–9% prevalence of Johne's disease. After 2 years of testing, herds which tested negative in two consecutive ELISAs can progress to Level 3. For Level 3, the test includes fecal cultures on a statistical subset of animals  $\geq 3$  years of age.<sup>90</sup>

There are two paths through the program: the standard and the fast track. If the producer can certify that the herd has been free of Johne's disease for 5 years, that the farm has been free of the disease for one year, and that no cattle have been introduced from Johne's-infected herds for 5 years, then the herd can be entered into the certification program through the fast track. This allows entry directly into Level 2, by-passing the first of four levels of certification. The fast track permits producers to proceed more quickly than the standard track does, but it requires a greater financial investment at the program entry. The fast track will allow herds to reach Level 4 in 2 years with three tests to reach Level 4. However, the standard track allows entry to the program with a minimal investment of funds and gradually increases the producer's investment in the program.

The four levels differ primarily by the number of herd animals tested and the types of diagnostic tests performed (Tables 19.2 and 19.3). Previously infected herds and JD-vaccinated herds can enter the program after infected animals are removed or vaccination is discontinued and the number of non-vaccinated animals meets the testing criteria. There is also a provision for an appeal process, for example, if results from an ELISA or fecal-culture test are disputed.

**Table 19.2** Standard-Track Certification from the US Voluntary Johne's Disease Herd Status Program for Cattle

Level	Criteria
1.	Program entry requirements have been met, and negative ELISA tests have been performed on 30 second- or higher-lactation animals. A sample size of 30 was selected to optimize herd sensitivity and herd specificity and to maintain a fixed cost for all herds entering the program.
2.	The herd has met the requirements for Level 1, and negative ELISA on a statistical subset of second- or higher-lactation animals has been performed. The Level 2 testing must be completed between 10 and 14 months after any Level 1 testing.
3.	The herd has met requirements for Level 2 and has negative fecal-culture-test results on a statistical subset of second- and higher-lactation animals. Bulls 2 years of age and older must be included in this testing. The fecal culture must be collected between 10 and 14 months after any Level 2 testing.
4.	The herd has met the requirements for Level 3 and has a negative ELISA on a statistical subset of second- or higher-lactation animals. Level 4 testing must be completed between 10 and 14 months after any Level 3 testing. Level 4 status is maintained by achieving negative ELISA results on 30 second- or higher-lactation animals every 10–14 months.

**Table 19.3** Fast-Track Certification from the US Voluntary Johne's Disease Herd Status Program for Cattle

Level	Criteria
2.	Fast-track program entry requirements have been met, and negative ELISA results have been obtained on a statistical subset test of second- or higher-lactation animals.
3.	The herd has met requirements for Level 2 fast-track and has negative fecal-culture test results on 30 second- or higher-lactation animals. (A history of JD freedom for 5 years before program entry adds sufficient confidence to allow fast-track herds to test 30 animals rather than the statistical subset used in the standard track to obtain Level 3 status.) Level 3 testing must be completed 10–14 months after any Level 2 testing.
4.	The herd has met the requirements for fast-track Level 3 and has negative ELISA results on a statistical subset test of second- or higher-lactation animals. Level 4 testing must be completed 10–14 months after any Level 3 testing. Level 4 status is maintained by achieving negative ELISA results on 30 second- or higher-lactation animals every 10–14 months.

On-farm biosecurity measures are required to prevent the spread of JD from animals of unknown status. Exposure to pooled milk (for calves) or to manure from untested cattle should be eliminated, and cattle should not be grazed or have other contact with other JD-susceptible species. Cattle being transported should be hauled in cleaned and disinfected trailers, and commingling should be avoided.

#### DIAGNOSIS AND CONTROL OF JOHNE'S DISEASE. NATIONAL RESEARCH COUNCIL OF THE NATIONAL ACADEMIES, WASHINGTON DC, 2003

In 2003, the NRC of the National Academies of the United States published a document on the Diagnosis and Control of Johne's Disease. Part of the Executive Summary is reproduced here as a summary of the important issues on Johne's disease which confront livestock producers, veterinary practitioners, veterinary diagnosticians, regulatory veterinarians, consumers, and others.

In July 2000, the US Department of Agriculture (USDA) requested that the Board on Agriculture and Natural

A key feature of the program is the status of herd additions. Young cattle are required to come from program herds of similar status. Older animals have more stringent testing and biosecurity requirements, if purchased from non-program herds.

Replacement cattle must come from herds of equivalent status. Semen and embryos may be used from any herd.

Resources of the National Academies convene a committee on the diagnosis and control of JD. Specifically, the committee was instructed to conduct a thorough review, evaluation, and compilation of all scientific research related to JD in domesticated and wild ruminants. The committee's task was to: (1) review and synthesize current information regarding diagnostic techniques, mode of transmission, clinical expression, global prevalence, and potential animal and human health implications associated with JD in domesticated and wild ruminants; (2) evaluate current programs for controlling and preventing JD in

ruminants; (3) provide policy recommendations for identification, monitoring, and management strategies applicable to US livestock herds; (4) conduct an objective, critical assessment and summary of the state of knowledge regarding the relationship of JD in ruminants and Crohn's disease in humans; and (5) provide recommendations on future research priorities and potential mechanisms to facilitate prevention and control of the disease.

The committee reviewed the literature on diagnosis, modes of transmission, clinical expression, global prevalence, and potential animal and human health implications of JD with the following goals in mind:

- Determine whether JD presents a problem sufficient to warrant control efforts
- Objectively review the data that provide the basis for control plans
- Identify significant gaps in knowledge that affect diagnosis and control
- Differentiate well-established facts from dogma or prevailing opinion
- Determine whether available diagnostic tests are adequate for control programs
- Make recommendations on the research needed to fill in knowledge gaps.

The committee also evaluated existing state, national, and international control programs with the goal of identifying sound control principles to guide program development and to make recommendations for a national control program.

Finally, the committee evaluated the evidence for and against a role for *Map* in some cases of Crohn's disease in humans. Considerable controversy has surrounded this issue and there are diverse viewpoints about how some of the evidence should be weighed against other evidence. This problem is not unique to Crohn's disease. Determining the cause of chronic human diseases is a difficult and often controversial process. One outcome of the debate has been the proposal by Hill and Evans for a set of objective criteria, which, if met, could be considered sufficient evidence to determine that a causal relationship exists between an agent and a chronic disease. To approach this important task most objectively, the committee used the Hill–Evans criteria to develop a list of the research results that would be necessary to establish with reasonable certainty that infection by *Map* causes some cases of Crohn's disease. The list of necessary research results was developed before the literature review and it was used to evaluate the strength of the evidence.

## Conclusions

Based on its review and synthesis of the literature, the evaluation of existing control and herd status programs, and information presented at the public workshop, the committee reached the following conclusions:

- **Conclusion 1.** Johne's Disease (JD) is a significant animal health problem that warrants implementation of control programs tailored to specific animal species and specific segments of the agriculture industry. Furthermore, JD control deserves high priority from USDA, individual states, and industry. The significance of the disease derives primarily from its consequences for animal and herd health, for the agriculture industry, and for national and international trade. The current concern about JD in industry and government agencies and the potential link with Crohn's disease in humans provide additional support for making JD control a high priority
- **Conclusion 2.** There remains insufficient evidence to prove or disprove that *Mycobacterium avium* subsp. *paratuberculosis* is a cause of some or all cases of Crohn's disease in humans; a new approach is needed to resolve the issue – one that is based on a research agenda that will provide answers to specific criteria set forward in Hill–Evans postulates. A causal link between *Map* and Crohn's disease remains a plausible hypothesis that warrants a new research approach and steps by industry and government agencies to identify and mitigate avenues of exposure
- **Conclusion 3.** Available diagnostic tests and information about the biology of JD and methods to control it are adequate for immediate implementation of control programs
- **Conclusion 4.** There are significant gaps in knowledge about some areas relevant to control that are discussed in the recommendations section. The committee emphasizes that closing knowledge gaps will improve control programs, although the need for more information should not delay implementation
- **Conclusion 5.** Control will require a long-term commitment and iterative program implementation to maximize the chance of success. This commitment must come from all constituencies, including USDA, state agencies, and industry
- **Conclusion 6.** Because control of JD is of greatest concern to the dairy industry, much of the emphasis in

control recommendations is directed there. Other industries, however, should consider this an opportune time to deal aggressively with the disease, before infection prevalence increases and the disease becomes more widespread

- **Conclusion 7.** The USDA National Animal Health Monitoring System (NAHMS) prevalence surveys have been a critical element in laying the groundwork for control programs
- **Conclusion 8.** The Voluntary Bovine Johne's Disease Control Program proposed by the NJWG has most of the elements necessary for a successful control program, but prospects for success are and will be limited by a lack of uniform implementation among individual states
- **Conclusion 9.** The committee endorses the NJWG's efforts in educating producers and veterinarians, and advocates the expansion of these efforts.

## Disease control

The occurrence of a particular infectious agent in a herd is a consequence of one or more environmental or management risk factors being out of control. If the focus is placed on controlling the risk factor(s), which may be common to a number of infectious agents, rather than on the agent itself, a producer will be more likely to adopt a control practice because the incidental control of other agents will result in a greater return on the investment. While the committee strongly endorses a Best Management Practices approach to control, it felt that control programs should initially focus on JD to take advantage of growing support for control of the disease. In addition, it is anticipated that funding for various aspects of control will be more readily available through government–industry partnerships if control has an easily identifiable target, such as JD, rather than a broader concept of Best Management Practices. As control efforts progress, an incremental transition to a Best Management Practices approach should be more feasible.

- **RECOMMENDATION 1.** An integrated, bottom-up approach to on-farm disease control is required that meets the needs of the livestock producer and motivates behavioral change, with support at broader industry, state, and federal levels. Components of such a control program are as follows:

### At the farm level:

1. On-farm risk assessment and development of a farm plan

2. Manure management that minimizes potential for transmission of pathogens by the fecal-oral route
3. Protection of young stock
4. Acquisition of replacement animals free from infection by *Map* and other significant pathogens that are shed in the feces
5. Removal of infected animals from the farm
6. Reduction of environmental contamination by *Map*.

#### At the state-federal program level:

1. Minimum national standards for program implementation
2. Performance-based criteria for diagnostic testing and laboratory accreditation
3. Rapid identification and protection of JD-free herds that can be used to provide *Map*-free replacement animals
4. Incremental implementation, progressing from a voluntary herd status program to a system of strong (preferably market-based) incentives for participation and disincentives for nonparticipation, culminating in a mandated herd control program, if JD eradication is the ultimate goal
5. A gradual transition from an exclusive focus on *Map* to a broader health and market assurance program that emphasizes Best Management Practices to prevent the spread of all pathogens by the fecal-oral route
6. A mechanism for periodic program review and self-correction
7. A program to prevent the reemergence of disease after low prevalence or eradication is achieved.

#### Recommendations for a stepwise expansion of the federal role in JD prevention and control:

1. The government should promulgate uniform methods and rules (UM&R) for voluntary JD status and control programs. The federal standards would provide consistent definitions and program guidelines for a baseline across all states. Individual states could mandate additional requirements
2. The federal government should provide control infrastructure, including support and incentives to upgrade diagnostic laboratories across the United States, to promote large-scale testing
3. All states should be required to implement a control program that is voluntary for producers in accordance with the UM&R
4. Producers should be encouraged to test all herds and register them either

- in status programs or in control programs, based on test results. Federal subsidies may be needed to cover the cost of initial testing, in order to encourage participation
5. Federal restrictions should continue on interstate and international transport of cattle from *Map*-positive herds
  6. A federal plan should be established to monitor the success of the control program. The plan should provide for periodic program review and self-correction.

General control program outlines for a given category of management and husbandry situation will be the same, but must be sufficiently flexible to be easily adaptable to the specific circumstances of each farm. Finally, the information must be packaged and delivered in a manner that is in harmony with the style with which the producer manages information and can motivate them to change their behavior.

This motivation may require feedback signals in the form of market price differentials established through testing of the farm product by the downstream purchaser.

While control programs for dairy herds may be of highest priority, control programs for beef cattle, sheep, goats, and captive cervids should be developed and implemented. Control programs for zoo animals and wildlife should also be monitored to insure that a non-domesticated animal reservoir does not compromise control efforts for any species.

#### Education and training

The National Johne's Working Group has made education of producers and veterinarians a high priority. The committee endorses this effort and offers the following additional recommendations for action by federal and state authorities:

- **RECOMMENDATION 2.** Commodity-oriented (dairy, beef, sheep, goat, llama) materials should be developed that are standardized nationally, and a rationale and guidelines for development of control and certification plans should be provided. These should not be considered the same as national program standards, but they should serve as the information base for participation in national programs.
- **RECOMMENDATION 3.** Informational resources should be developed for practicing veterinarians that includes guidance on diagnostic test selection, sample size and selection of animals for testing, interpretation of test results,

development of risk assessment methods, writing of herd plans, and monitoring of compliance and progress.

- **RECOMMENDATION 4.** Educational resources that emphasize control of risk factors (Best-Management Practices) should be developed instead of materials that emphasize control of a single etiologic agent.
- **RECOMMENDATION 5.** Training programs are needed for state Johne's coordinators, USDA personnel, practicing veterinarians, and laboratory personnel to insure a uniform base of knowledge and practice.

#### Research

The committee identified significant gaps in the current state of knowledge of the pathophysiology, immunology, diagnosis, and control of JD in domesticated livestock and in wildlife. Choosing the research projects needed to fill those gaps will be important to the success of any JD herd status or control program. The issues also are complex enough to warrant the convening of a USDA expert panel to formulate consensus methods to address the research questions. The committee considered ongoing research to be important for the success of any control program and therefore felt that a research element should be integral to future program development. The committee developed recommendations in several areas.

#### Epidemiology of map infection and JD

The committee found significant gaps in the understanding of the epidemiology of JD that could affect the success of proposed control programs. In particular, the committee recommends five additional areas of research.

- **RECOMMENDATION 6.** Age-dependent dose-response curves are needed to clarify the magnitude and significance of age-related susceptibility or resistance to infection and the degree to which horizontal transmission occurs in different age groups. Use of epidemiologic modeling would help to determine the best measure of infectivity.

With the increase in concentrated calf-rearing operations, there is an urgent need to investigate the possibility of horizontal transmission in young animals. Current control strategies assume that horizontal transmission among adult cattle is insignificant, but this should be confirmed because the success of control strategies could be at stake.



- **RECOMMENDATION 7.** The effects of chronic, low-level exposure on infectivity and on the outcome of infection should be studied.

Much of the data on infectivity and age susceptibility have been derived from decades-old studies in which one or a few large infective doses typically were administered. Although this provides valuable information, because it does not mimic natural exposure, the conclusions that can be drawn are limited. It would be helpful to have a better understanding of the outcome of chronic, low-level, or intermittent exposure to *Map* in the environment.

- **RECOMMENDATION 8.** Experimental studies and field investigations of natural infection in non-ruminant and ruminant wildlife in the United States should focus initially on native lagomorphs and other small mammals prevalent on or around livestock operations with endemic JD.

Recent investigations on the role of wildlife in the epidemiology of JD in livestock in Scotland, Australia, and the Czech Republic have yielded interesting results. The identification of endemic *Map* infections in European rabbits in Scotland has important ramifications for control programs there. Little work has been done in the United States on the susceptibility of non-ruminant wildlife to *Map* infection.

Determining the prevalence of *Map* infection in wildlife on or around livestock operations will be important to understanding the success or failure of any livestock JD control programs.

- **RECOMMENDATION 9.** Results of diagnostic testing, control practices, and other epidemiologic data should be evaluated and used to answer remaining research questions and to refine and optimize control programs.
- **RECOMMENDATION 10.** The USDA NAHMS prevalence surveys should continue, with attention paid to maximizing the data obtained from the samples collected through 'add-on' projects and investigations.

As control programs are implemented, they present opportunities to take advantage of resulting 'natural experiments'. The committee recommends that these opportunities not be lost. Results of the two investigations proposed above will help regulators to establish a scientific basis for several control measures, including how long to wait before restocking contaminated land, whether environmental decontamination can expedite restocking, and whether removal of calves from dams

at birth is the best means of breaking the transmission cycle.

#### Diagnostics and immunology

Although the committee acknowledges that available diagnostic tools are sufficient to implement control programs, significant deficiencies still exist. To address these important gaps, the committee recommends the following:

- **RECOMMENDATION 11.** Epidemiologically sound sampling and sample-pooling protocols should be developed and validated to facilitate screening and monitoring of large cattle herds and sheep flocks.

Recent research in Australia suggests that pooling of sheep fecal samples could enable more cost-effective flock screening for control programs. This work should be repeated in the United States and expanded to include cattle. Another important need is for a rapid, sensitive test to detect the presence of *Map* in bulk-milk samples. This would promote more efficient and cost-effective collection of herd prevalence data, which will be important for control. Some promising studies have been conducted, but additional research is needed in this area.

- **RECOMMENDATION 12.** Sensitive and specific serologic and fecal culture methods should be developed and validated for use in sheep and goats.

The development of diagnostic tests for JD in sheep, goats, and other species has trailed that for cattle. Although much of the current control emphasis is on dairy cattle, development of more sensitive and specific tests is needed for these other species. Recent reports suggest that the difficulty in isolating sheep strains of *Map* by fecal culture has largely been overcome, but methods are still slow and not ideal for use in control programs.

- **RECOMMENDATION 13.** Methods for detecting an early, specific immune response to *Map* should be developed.

There are no reliable tests to identify animals in the early stages of infection, before fecal shedding. Early identification of infected animals would be helpful for control programs, especially for pre-purchase testing of replacement animals. Exposure to other mycobacteria, such as *M. avium* subsp. *avium*, is likely to be common in cattle, so it is essential that any test to identify animals in the early stages of infection be highly specific for *Map*. This might require identification of unique antigenic epitopes in *Map*, against which an early immune response is generated.

#### Map genome studies

As the committee evaluated knowledge gaps and research needs, the importance of complete sequencing of the *Map* genome became evident. Sequencing would yield many benefits, including identification of unique *Map* antigens for development of diagnostic tests and vaccines, improvement of diagnostic methods based on PCR, and identification of potential virulence factors. The *Map* genome sequencing project at USDA's National Animal Disease Center is nearing completion, and the committee strongly recommends the following:

- **RECOMMENDATION 14.** USDA and other agencies should seize the opportunity presented by the completion of the *Map* genome project to accelerate progress in JD research, diagnostic test improvement, and vaccine development.

Information about the completion of this project needs to be disseminated to the international research communities for JD and Crohn's disease, and the sequence data should be made available as soon as possible. Research funds should be directed to research and development that use the results of the *Map* genome project. The paucity of funds available for JD research has limited progress in several important areas. The completion of the *Map* genome project provides a unique opportunity to correct this oversight, and it should not be neglected.

#### Vaccine development

Current vaccines for *Map* are highly problematic. There are conflicting data on their ability to reduce shedding of *Map*, and the fact that they generate cross-reactions to intradermal tests for *M. bovis* makes them unsuitable for widespread use in control programs. Because vaccines can expedite the reduction of disease prevalence, the committee recommends the following:

- **RECOMMENDATION 15.** Research should be done on the nature and evolution of the immune response to *Map*, and ways to modulate the immune response to elicit protection should be studied.
- **RECOMMENDATION 16.** Research is needed on the feasibility of using recombinant-vaccine technology to create a vaccine that generates a specific, protective immune response in domesticated livestock without interfering with diagnostic tests for JD, bovine tuberculosis, or other diseases.

Development of an efficacious vaccine will require identification of unique *Map* antigens that will elicit a protective immune response without generating cross-reactions to other mycobacteria. The *Map* genome project has the greatest potential for providing the basis for these advances.

#### Human and animal health issues

After evaluating all of the available evidence for and against a causal role for *Map* in Crohn's disease, the committee was of the unanimous opinion that the confidence was insufficient either to establish or to refute a causal connection. The committee considered the following research to be important to the resolution of this question:

- **RECOMMENDATION 17.** A blinded study should be done for the detection of *Map* and *Map* RNA-DNA in identical coded intestinal tissue samples sent to various laboratories using standardized methods for *Map* culture and detection. This will help clarify the degree to which conflicting research results have been the result of variations in methods versus operators.
- **RECOMMENDATION 18.** A large-scale, double-blind, multicenter study should be done to detect the presence of *Map* and *Map* RNA-DNA in tissue specimens from patients with Crohn's disease, using the same standardized methods as above. The specimens should be stratified by type of disease, duration of disease, presence or absence of known Crohn's susceptibility genes, and treatment. Control subjects without Crohn's disease should be included in the study.
- **RECOMMENDATION 19.** A large-scale, multicenter, double-blind study of the treatment of Crohn's disease patients with anti-*Map* combination antimicrobial therapy should be undertaken. The patients should be stratified by type of disease, duration of disease, presence or absence of known susceptibility genes, treatment, and presence or absence of *Map* by culture or PCR methods. There also should be an appropriate control group of patients with Crohn's disease who do not receive anti-*Map* therapy.
- **RECOMMENDATION 20.** A multicenter, double-blind study is needed on the presence of *Map*, *Map* antigens, and *Map* RNA-DNA in breast milk of lactating women with Crohn's disease, compared to controls. Finding such in lactating

women with Crohn's disease would provide strong support for the proposed connection between *Map* and Crohn's disease.

If a subset of CD patients responds to anti-*Map* therapy, or *Map* is otherwise implicated as a cause of CD in a subset of patients, research on methods to better identify this subset will be needed. Other research considered important by the committee included on-going studies of Crohn's susceptibility genes and familial tendencies, gene microarray studies to determine which genes are up- and down-regulated in Crohn's disease, and animal models, especially in genetically altered animals.

- **RECOMMENDATION 21.** The National Institutes of Health or a similar body should convene a panel with experts in gastroenterology, Crohn's disease, infectious disease, mycobacteriology, biostatistics, epidemiology, etc., to define the precise study designs and to rank order the various studies to be done.

Although the committee did not find sufficient evidence to implicate *Map* as a cause of Crohn's disease, there was consensus that efforts to identify and mitigate avenues of exposure to *Map* would be prudent while awaiting definitive resolution of this important question.

Identifying environmental sources of *Map* also is an important element of JD control in livestock, so there is additional justification for such investigations. The committee therefore recommends researching the following projects:

- **RECOMMENDATION 22.** Research should be conducted to determine the prevalence of viable *Map* in potable-water supplies, streams, ponds, and other bodies of water with potential for *Map* contamination. This may require development of better methods for identifying and quantifying *Map* in environmental samples.
- **RECOMMENDATION 23.** Additional studies are needed to determine whether *Map* is present in retail milk or other dairy products, as well as in pasteurized colostrum or commercial colostrum replacers that are fed to calves.
- **RECOMMENDATION 24.** Research should be done to determine the prevalence of viable *Map* in peripheral lymph nodes, muscle, and other tissues that are processed for human consumption.
- **RECOMMENDATION 25.** Research should be done to determine the prevalence and concentration of *Map*

in other environmental materials likely to be contaminated with ruminant manure and associated with exposure to humans or susceptible animals. Those materials could include composted manure, fruits and vegetables, pastures, and crops fed to livestock.

If a causal relationship is established between human *Map* infection and even a subset of Crohn's disease cases, the above research recommendations will be essential for implementation of new control programs aimed at protecting public health by minimizing exposure to *Map*. Additional research would then be needed to develop methods for routine screening of dairy products, meat, and meat products for *Map*.

#### REVIEW LITERATURE

- Hermon-Taylor J, Bull TJ, Sheridan JM et al. Causation of Crohn's disease by *Mycobacterium avium* subspecies *paratuberculosis*. *Can J Gastroenterol* 2000; 14:521-539.
- Grant IR, Rowe MT, Dundee L, Hitchings E. *Mycobacterium avium* subspecies *paratuberculosis*: its incidence, heat resistance and detection in milk and dairy products. *Int J Dairy Technol* 2001; 54:2-13.
- Harris NB, Barletta RG. *Mycobacterium avium* subsp. *Paratuberculosis* in veterinary medicine. *Clin Microbiol Rev* 2001; 14:489-512.
- Kennedy DJ, Benedictus G. Control of *Mycobacterium avium* subsp. *Paratuberculosis* infection in agricultural species. *Rev Sci Tech Off Int Epiz* 2001; 20:151-179.
- Manning EJB, Collins MT. *Mycobacterium avium* subsp. *Paratuberculosis*: pathogen, pathogenesis and diagnosis. *Rev Sci Tech Off Int Epiz* 2001; 20:133-150.
- Sergeant ESG. Ovine Johne's disease in Australia - the first 20 years. *Aust Vet J* 2001; 79:484-491.
- Whittington RJ, Sergeant E. Progress towards understanding the spread, detection and control of *Mycobacterium avium* subsp. *paratuberculosis* in animal populations. *Aust Vet J* 2001; 79:267-278.
- de Lisle GW. Johne's disease in New Zealand: the past, present and a glimpse into the future. *NZ Vet J* 2002; 50 (Supplement): 53-56.
- National Research Council of the National Academies. Diagnosis and control of Johne's Disease. Committee on Diagnosis and Control of Johne's Disease. Board on Agriculture and Natural Resources. Division on Earth and Life Studies. The National Academies Press, Washington DC, 2003; 1-229.

#### REFERENCES

1. Collins DM et al. *J Clin Microbiol* 2002; 40:4760.
2. Whittington RJ et al. *Vet Microbiol* 2001; 79:311.
3. Dohmann K et al. *J Clin Microbiol* 2002; 41:5215.
4. Whittington RJ et al. *Mol Cell Probes* 2001; 15:139.
5. Buergetl CD et al. *Vet Pathol* 2000; 37:428.
6. Motiwala AS et al. *J Clin Microbiol* 2003; 41:2015.
7. Harris NB, Barletta RG. *Clin Microbiol Rev* 2001; 14:489.
8. Fridriksdottir V et al. *Vet Microbiol* 2000; 77:263.
9. Sergeant ESG. *Aust Vet J* 2001; 79:484.
10. Higgs ARB, Hawkins CD. *Aust Vet J* 1998; 76:546.

11. Michel AL, Bastianello SS. *Vet Microbiol* 2000; 77:299.
12. Ellis TM et al. *Aust Vet J* 1998; 76:630.
13. Egan J et al. *Irish Vet J* 1999; 52:86.
14. O'Doherty A et al. *Vet Rec* 2002; 150:634.
15. National Research Council of the National Academies. *Diagnosis and Control of Johne's Disease*. Committee on Diagnosis and Control of Johne's Disease. Board on Agriculture and Natural Resources Division on Earth and Life Studies. The National Academies Press, Washington, DC, 2003; 1–229.
16. Beard PM et al. *J Clin Microbiol* 2001; 39:1517.
17. Greig A et al. *J Clin Microbiol* 1999; 37:1747.
18. Daniels MJ et al. *Vet J* 2003; 165:248.
19. Daniels MJ et al. *Epidemiol Infect* 2003; 130:553.
20. Machackova M et al. *Vet Microbiol* 2004; 101:225.
21. de Lisle GW et al. *NZ Vet J* 2003; 51:58.
22. Godfroid J et al. *Vet Microbiol* 2000; 77:283.
23. McKenna SLB et al. *J Dairy Sci* 2004; 87:3770.
24. Aaska JM et al. *Prev Vet Med* 2003; 60:255.
25. Boelaert F et al. *Vet Microbiol* 2000; 77:269.
26. Sorensen O et al. *Can Vet J* 2003; 44:221.
27. Waldner CL et al. *Can Vet J* 2002; 43:542.
28. Dargatz DA et al. *J Am Vet Med Assoc* 2001; 219:497.
29. Hirst HL et al. *J Am Vet Med Assoc* 2004; 225:97.
30. Jakobsen MB et al. *Prev Vet Med* 2000; 46:15.
31. Muskens J et al. *Vet Microbiol* 2000; 77:253.
32. Muskens J et al. *Vet Microbiol* 2001; 78:101.
33. Sergeant ESG, Baldock FC. *Aust Vet J* 2002; 80:762.
34. Giese SB, Ahrens P. *Vet Microbiol* 2000; 77:291.
35. Streeter RN et al. *Am J Vet Res* 56: 1995; 1322.
36. Stabel JR et al. *J Dairy Sci* 2004; 87:2177.
37. Grant IR et al. *Appl Environ Microbiol* 2002; 68:2428.
38. Djonje B et al. *Vet Microbiol* 2003; 92:135.
39. Kruij TAM et al. *Theriogenol* 2003; 59:1651.
40. Whittington RJ, Sergeant E. *Aust Vet J* 2001; 79:267.
41. Reddaclipp LA et al. *Aust Vet J* 2004; 82:426.
42. Fischer OA et al. *Med Vet Entomol* 2003; 17:145.
43. Lloyd JB et al. *Vet Rec* 2001; 148:261.
44. Eamens GJ et al. *Aust Vet J* 2001; 79:703.
45. Sweeney RW. *Vet Clin North Am Food Anim Pract* 1996; 12:305.
46. Lambeth C et al. *Aust Vet J* 2004; 82:504.
47. Lugton IW. *Aust Vet J* 2004; 82:355.
48. Koets AP et al. *J Dairy Sci* 2000; 83:2702.
49. Chi J et al. *Prev Vet Med* 2002; 55:57 & 137.
50. Muskens J et al. *J Vet Med B* 2003; 50:372.
51. Wells S, Wagner BA. *J Am Vet Med Assoc* 2000; 216:1450.
52. Johnson-Ifearrulunde YJ, Kaneene JB. *Prev Vet Med* 1998; 37:41.
53. Daniels MJ et al. *Vet Rec* 2002; 150:135.
54. Lugton IW. *Aust Vet J* 2004; 82:490.
55. Ward MP et al. *Am J Vet Res* 2004; 65:10.
56. Raizman EA et al. *J Dairy Sci* 2004; 87:2959.
57. Whittington RJ et al. *Appl Environ Microbiol* 2004; 70:2989.
58. Stratmann J et al. *Infect Immun* 2004; 72:1265.
59. Ott SL et al. *Prev Vet Med* 1999; 40:179.
60. Johnson-Ifearrulunde YJ et al. *Prev Vet Med* 2000; 46:171.
61. Johnson YJ et al. *J Dairy Sci* 2001; 84:2188.
62. Kidahl A et al. *Prev Vet Med* 2004; 62:119.
63. Hermon-Taylor J et al. *Can J Gastroenterol* 2000; 14:521.
64. Bernstein CN et al. *J Clin Microbiol* 2004; 42:1129.
65. Bull TJ et al. *J Clin Microbiol* 2003; 41:2915.
66. Naser SA et al. *Lancet* 2004; 364:1039.
67. Grant IR et al. *Int J Dairy Technol* 2001; 54:2.
68. Chiodini RJ. *Vet Clin North Am Food Animal Pract* 1996; 12:313.
69. Stabel JR. *Vet Microbiol* 2000; 77:465.
70. Koets A et al. *Infect Immun* 2001; 69:1492.
71. Waters WR et al. *Infect Immun* 2003; 71:5130.
72. Koets A et al. *Infect Immun* 2002; 70:3856.
73. Stabel JR et al. *J Wildlife Dis* 2003; 39:545.
74. Clarke CJ, Little D. *J Comp Pathol* 1996; 114:419.
75. Whitlock RH et al. *Vet Microbiol* 2000; 77:387.
76. Checkley SL et al. *J Appl Res Vet Med* 2003; 1:1.
77. Kalis CHJ et al. *J Vet Diagn Invest* 2000; 12:547.
78. Wells SJ et al. *J Am Vet Med Assoc* 2003; 223:1022.
79. Tavornpanich S et al. *Am J Vet Res* 2004; 65:1061.
80. Sergeant ESG et al. *Prev Vet Med* 2002; 52:199.
81. Thoresen OF, Olsaker I. *Vet Microbiol* 1994; 40:293.
82. Englund S. *Vet Microbiol* 2003; 96:277.
83. Halldorsdottir S et al. *Vet Microbiol* 2002; 87:327.
84. Stabel JR et al. *J Vet Diagn Invest* 2004; 16:22.
85. Burgelt CD, Williams JE. *Aust Vet J* 2004; 82:497.
86. McConnel CS et al. *Aust Vet J* 2004; 82:149.
87. Sweeney RW et al. *J Vet Diagn Invest* 1995; 7:488.
88. Dargatz DA et al. 2001; *J Am Vet Med Assoc* 218:1163.
89. Hirst HL et al. *J Am Vet Med Assoc* 2002; 220:1685.
90. Wells SJ et al. *J Am Vet Med Assoc* 2002; 220:1053.
91. Jubb TF et al. *Aust Vet* 2004; 82:569.
92. Holmes IRL et al. *Aust Vet J* 2004; 82:233.
93. Pitt DJ et al. *Aust Vet J* 2002; 80:57.
94. Nielsen SS et al. *Prev Vet Med* 2002; 54:1.
95. Hope AF et al. *Aust Vet J* 2000; 78:850.
96. Whittington RJ et al. *Aust Vet J* 2003; 81:71.
97. Klausen J et al. *Prev Vet Med* 2003; 58:171.
98. Gwozdz JM et al. *Aust Vet J* 2000; 78:778.
99. Manning EJB et al. *Can J Vet Res* 2003; 67:2003.
100. Stabel JR, Whitlock RH. *Vet Immunol Immunopathol* 2001; 79:69.
101. Jones DG, Kay JM. *Vet Rec* 1996; 139:498.
102. Beard PM et al. *J Comp Path* 2001; 124:290.
103. Whittington RJ et al. *Aust Vet J* 1999; 77:392.
104. Corpa JM et al. *J Comp Path* 2000; 122:255.
105. Valheim M et al. *J Comp Path* 2002; 127:194.
106. Cebra ML et al. *J Am Vet Med Assoc* 1998; 212:258.
107. St Jean G. *Vet Clin North Am Food Anim Pract* 1996; 12:417.
108. Brumbaugh GW et al. *Can J Vet Res* 2004; 68:175.
109. Brumbaugh GW et al. *J Comp Path* 2000; 123:22.
110. Rossiter CA, Burhans WS. *Vet Clin North Am Food Anim Pract* 1996; 12:373.
111. Kennedy DJ, Benedictus G. *Rev Sci Tech Off Int Epiz* 2001; 20:151–179.
112. Manning EJB, Collins MT. *Rev Sci Tech Off Int Epiz* 2001; 20:133.
113. Groenendal H, Galligan DT. *J Am Vet Med Assoc* 2003; 223:1767.
114. Naugle AL et al. *Prev Vet Med* 2004; 65:77.
115. Carpenter TE et al. *J Vet Diagn Invest* 2004; 16:31.
116. Wells SJ. *J Dairy Sci* 2000; 83:2380.
117. Goodger WJ et al. *J Amer Vet Med Assoc* 1996; 208:1877.
118. Godden SM et al. *J Dairy Sci* 2003; 86:1503.
119. Stabel JR. *J Dairy Sci* 2001; 84:524.
120. Wapenaar W et al. *Bovine Pract* 2003; 37:23.
121. Cranwell MP. *Vet Rec*, 1993; 133:219.
122. Gwozdz JM et al. *Aust Vet J* 2000; 78:560.
123. Corpa JM et al. *Vet Rec* 2000; 146:195.
124. Kalis CH et al. *Am J Vet Res* 2001; 62:270.
125. Muskens J et al. *Vet Microbiol* 2002; 86:269.
126. Uzonna JE et al. *Vaccine* 2003; 21:3101.
127. Weber MF et al. *Prev Vet Med* 2004; 62:1.
128. Jubb TF, Galvin JW. *Aust Vet J* 2004; 82:228.
129. Jubb TF, Galvin JW. *Aust Vet J* 2004; 82:164.

## Diseases associated with *Actinomyces* spp., *Actinobacillus* spp., *Nocardia* spp., and *Dermatophilus* spp.

This group of infectious diseases includes actinomycosis, actinobacillosis, mycotic dermatitis, strawberry footrot of sheep, actinobacillosis in piglets, and shigellosis of foals.

Painless, granulomatous lesions of the skin (mycetoma) occur naturally, especially in horses, and have been produced experimentally by infection with *Nocardia brasiliensis* and with *Actinomadura* spp.<sup>1</sup> Nocardial mastitis in cattle has been dealt with in Chapter 15 on mastitis. Other infections by *Nocardia* spp. include infections in the uterus of repeat breeder cattle and mares and in granulomas in the nasal cavity or lungs of cattle but these are rare.<sup>1-3</sup>

Less common occurrences of infection with this group of organisms include *Actinomyces actinoides* as a secondary bacterial invader in enzootic pneumonia of calves and seminal vesiculitis in bulls, *Actinomyces bovis* in a large proportion of unopened lesions of fistulous withers and poll evil, and *Actinomyces* spp. in abscessation of the mandibular lymph node in horses.

### *Actinobacillus* spp.

*Actinobacillus* spp. isolated from disease in large animals include *Actinobacillus equuli*, *Actinobacillus lignieresii*, *Actinobacillus pleuropneumoniae*, *Actinobacillus suis*, *Actinobacillus hominis*, *Actinobacillus (Pasteurella) ureae*, *Actinobacillus capsulatus*, and equine *Actinobacillus suis*-like organisms. These organisms share significant biochemical characteristics and electrophoretic patterns<sup>4-6</sup> and historical reports associating a given organism with a specific disease may have errors in classification. The reported taxa of the genus *Actinobacillus* includes 22 species and unnamed taxa of which 19 have been associated with animals.<sup>7</sup> Only four, *A. pleuropneumoniae*, *A. suis*, *A. lignieresii*, and *A. equuli* are frequently associated with disease in animals and many of the others are probably misclassified in this genus.<sup>7,8</sup>

Specific species causal associations, if they exist, remain to be determined for many of the diseases associated with *Actinobacillus* spp. For this reason we have chosen to describe these diseases under a broad traditional clinical classification. Future more defined etiological classification may allow a better epidemiological subdivision of these syndromes and a more refined epidemiological approach to prevention and control.

*Actinobacillus suis* infection in pigs is described under that heading. Organisms reported as *Actinobacillus suis* have also been isolated from horses with acute hemorrhagic pulmonary infarction and **necrotizing pneumonia**,<sup>9</sup> and as an occasional cause of **septicemia** in neonatal foals<sup>10</sup> and calves.<sup>11</sup> *Actinobacillus* spp. are also associated with **endocarditis** in horses.<sup>12</sup> They are also associated with **peritonitis** in horses which may be acute or manifest with chronic weight loss, ventral edema, pleurisy, and pallor of the mucosae. Abdominocentesis yields ample amber fluid with a high white cell count, up to 270 000/ $\mu$ L, and a marked neutrophilia. Treatment with ampicillin or penicillin/streptomycin gives excellent responses. Verminous arteritis may predispose this disease.

*Actinobacillus seminis* is a cause of **epididymitis** in rams and is recorded in Australia, Spain, Brazil, South Africa, New Zealand, the USA, Europe, and the UK.<sup>13-16</sup> Infections commonly occur in virgin rams and the infection is detected between 4 and 18 months of age<sup>17</sup> but also occurs in adults.<sup>18</sup> Fertility is reduced but the main economic impact is from the loss of purebred sales and the need to differentiate the disease from brucellosis. A very similar syndrome occurs in epididymitis produced by infection with *Haemophilus*-like organisms,<sup>15</sup> and the control of this complex of epididymitis has been approached by the use of a multivalent, adjuvanted vaccine to both groups of organisms and the long-term feeding of low doses of antibiotics.<sup>18</sup> *Actinobacillus seminis* is also recorded as a rare cause of abortion in sheep<sup>19</sup> and has also been isolated from the joints of lambs affected by **septicemia**, **synovitis**, and purulent **polyarthritis**.

#### REVIEW LITERATURE

Rycroft AW, Garside LH *Actinobacillus* species and their role in animal disease. *Vet J* 2000; 159:18-36.

#### REFERENCES

- Gumaa SA, Abu-saura MTJ. *Comp Pathol* 1981; 91:341.
- Shibahara T et al. *Aust Vet J* 2001; 79:363.
- Harvey D et al. *Can Vet J* 1993; 558.
- Samitz EM, Biberstein EL. *Am J Vet Res* 1991; 52:1245.
- Fodor L et al. *Acta Vet Hung* 1990; 38:225.
- Bada R et al. *Vet Microbiol* 1996; 51:393.
- Chritensen H, Bisgaard M. *Vet Microbiol* 2004; 99:13.
- Rycroft AN, Garside LH. *Vet J* 2000; 159:18.
- Carr EA et al. *J Am Vet Med Assoc* 1997; 210:1774.
- Nelson KM et al. *Vet Rec* 1996; 138:39.
- Debey BM et al. *J Vet Diag Invest* 1996; 8:248.
- Maxson AD, Reef VB. *Equine Vet J* 1997; 29:394.
- Bulgin MS. *Vet Clin North Am Food Anim Pract* 1990; 6:683.
- Low JC et al. *Vet Rec* 1995; 136:268.
- Genetzky RM. *Comp Cont Educ Pract Vet* 1995; 17:447.

- Puente Redondo VA de la et al. *J Comp Pathol* 2000; 122:217.
- Bulgin M, Anderson BC. *J Am Vet Med Assoc* 1983; 182:372.
- Bulgin M et al. *J Am Vet Med Assoc* 1990; 196:1110.
- Foster G. et al. *Vet Rec* 1999; 144:479.

### ACTINOMYCOSIS (LUMPY JAW)

Synopsis
<p><b>Etiology</b> <i>Actinomyces bovis</i></p> <p><b>Epidemiology</b> Inhabitant of the bovine mouth. Common but sporadic disease from infection through wounds to the buccal mucosa by feed or through dental alveoli</p> <p><b>Clinical findings</b> Initially painless, hard, immovable bony swelling on mandible or maxilla. Eventually discharge small amounts of pus through one or more openings in skin</p> <p><b>Clinical pathology</b> Presence of 'club' colonies containing Gram-positive filaments</p> <p><b>Diagnostic confirmation</b> Demonstration of organism</p> <p><b>Treatment and control</b> Surgical debridement. Iodides and/or sulfonamides orally or parenterally</p>

#### ETIOLOGY

*Actinomyces bovis* is the primary cause but other bacteria may be present in extensive lesions including non-*bovis* *Actinomyces* spp.<sup>1</sup>

#### EPIDEMIOLOGY

The disease is sporadic but common in cattle. Occasional cases occur in pigs and horses and rarely in goats.<sup>2</sup> Although actinomycosis occurs only sporadically, it is of importance because of its widespread occurrence and poor response to treatment. It is recorded from most countries of the world.

*Actinomyces bovis* is a common inhabitant of the bovine mouth and infection is presumed to occur through wounds to the **buccal mucosa** caused by sharp pieces of feed or foreign material. Infection may also occur through **dental alveoli**, and may account for the more common occurrence of the disease in young cattle when the teeth are erupting. Infection of the **alimentary tract** wall is probably related to laceration by sharp foreign bodies.

#### PATHOGENESIS

In the jawbones a rarefying **osteomyelitis** is produced. The lesion is characteristically granulomatous both in this site and where visceral involvement occurs. The effects on the animal are purely physical. Involvement of the jaw causes interference with prehension and mastication, and when the alimentary tract is involved there is physical interference with ruminal

movement and digestion, both resulting in partial starvation. Rarely, localization occurs in other organs, caused apparently by hematogenous spread from these primary lesions.

#### CLINICAL FINDINGS

##### Cattle

Actinomycosis of the **jaw** commences as a painless, **bony swelling** which appears on the mandible or maxilla, usually at the level of the **central molar teeth**. The enlargement may be diffuse or discrete and in the case of the mandible may appear only as a thickening of the lower edge of the bone with most of the enlargement in the intermandibular space. Such lesions are often not detected until they are too extensive for treatment to be effective.

The more common, discrete lesions on the lateral surfaces of the bones are more readily observed. Some lesions enlarge rapidly within a few weeks, others slowly over a period of months. The swellings are very **hard, immovable** and, in the later stages, painful to the touch. They usually break through the skin and discharge through one or more openings.

The discharge of pus is small in amount and consists of sticky, honey-like fluid containing minute, hard, yellow-white granules. There is a tendency for the sinuses to heal and for fresh ones to develop periodically. Teeth embedded in the affected bone become malaligned and painful and cause difficult mastication with consequent loss of condition. In severe cases, spread to contiguous soft tissues may be extensive and involve the muscles and fascia of the throat. Excessive swelling of the **maxilla** may cause dyspnea. Involvement of the local lymph nodes does not occur. Eventually the animal becomes so emaciated that destruction is necessary although the time required to reach this stage varies from several months to a year or more.

The most common form of actinomycosis of soft tissues is involvement of the **esophageal groove** region, with spread to the lower esophagus and the anterior wall of the reticulum. The syndrome is one of **impaired digestion**. There is periodic diarrhea with the passage of undigested food material, chronic bloat, and allotriophagia. Less common lesions of soft tissue include **orchitis** in bulls, the **trachea** causing partial obstruction, and abscess in the brain or lungs.<sup>3</sup>

##### Pigs

Rare cases of wasting occur due to visceral actinomycosis but extensive granulomatous lesions on the skin, particularly over the **udder**, are more common.

### CLINICAL PATHOLOGY

Smears of the discharging pus stained with Gram's stain provide an effective simple method of confirming the diagnosis. Gram-positive filaments of the organism are most readily found in the centers of the crushed granules.

### NECROPSY FINDINGS

Rarefaction of the bone and the presence of loculi and sinuses containing thin, whey-like pus with small, gritty granules is usual. An extensive fibrous tissue reaction around the lesion is constant, and there may be contiguous spread to surrounding soft tissues. The presence of 'club' colonies containing the typical, thread-like bacteria is characteristic of the disease. These formations may be seen on microscopic examination of smears made from crushed granules in pus or on histological examination of section.

**Granulomatous lesions** containing pockets of pus may be found in the esophageal groove, the lower esophagus and the anterior wall of the reticulum. Spread from these lesions may cause a chronic, local peritonitis. There may be evidence of deranged digestion with the rumen contents sloppier than usual, an empty abomasum and a mild abomasitis and enteritis. Involvement of local lymph nodes does not occur, irrespective of the site of the primary lesion.

### DIFFERENTIAL DIAGNOSIS

Abscesses of the cheek muscles and throat region are quite common when spiny grass-awns occur in the diet. They are characterized by their movability and localization in soft tissues compared to the immovability of an actinomycotic lesion. Pus may be thin, fetid, or caseous depending on the duration of the abscess. Prompt recovery follows opening and drainage.

Foreign bodies or accumulations of dry feed jammed between the teeth and cheek commonly cause a clinical picture which resembles that associated with actinomycosis and the inside of the mouth should be inspected if the enlargement has occurred suddenly.

The syndrome of indigestion caused by visceral actinomycotic lesions resembles that caused by chronic peritonitis.

Cutaneous and mammary lesions in sows closely resemble necrotic ulcers associated with *Borrelia suilla*.

### TREATMENT AND CONTROL

Treatment is with surgical debridement and antibacterial therapy, particularly iodides as detailed under actinobacillosis. Additional treatment recorded as being effective includes isoniazid given orally at the rate of 10–20 mg/kg body weight daily for about 30 days. Cessation of the growth

of the lesion should occur but response in advanced cases is poor.<sup>4</sup> Repeat cryotherapy with liquid nitrogen is reported to be effective.<sup>5</sup> For control, isolation or disposal of animals with discharging lesions is important, although the disease does not spread readily unless predisposing environmental factors cause a high incidence of oral lacerations.

### REFERENCES

- Hall V et al. Int J Systematic Environ Microbiol 2004; 53:603.
- Seifi HA et al. J Vet Med A 2003; 50:219.
- Bertone AL, Rebhun WC. J Am Vet Med Assoc 1984; 185:221.
- Maiti SK, Parai TP. Indian Vet J 1959; 11:1186.
- Bose VCS et al. Indian Vet J 2004; 81:76.

### ACTINOBACILLOSIS (WOODEN TONGUE)

#### Synopsis

**Etiology** *Actinobacillus lignieresii*

**Epidemiology** Organism is inhabitant of alimentary tract. Infection through abrasion. Site difference in sheep and cattle reflects differences in risk associated with prehension of food. Sporadic disease but outbreaks where herd/flock predisposing factors are present

**Clinical findings** Difficulty in prehension of food. Inflammation and abscessation of tongue and draining lymph nodes in cattle and of lips in sheep

**Clinical pathology and diagnostic confirmation** Demonstration of organism

**Treatment and control** Iodides, antibiotics, hygiene. Avoidance of abrasive pastures

### ETIOLOGY

*Actinobacillus lignieresii* may be recovered in pure culture from the lesions but other pyogenic organisms may also be present. Recent investigations have shown that bacteria with phenotypic similarity to *A. lignieresii* isolated from horses are genotypically distinct from those isolated from ruminants and they have been designated as *Actinobacillus* genomospecies 1.<sup>1</sup>

### EPIDEMIOLOGY

#### Occurrence

The disease in **cattle** is worldwide in distribution and usually of sporadic occurrence on individual farms. In **sheep**, the disease is common in Scotland but is recorded in most sheep-raising countries. In most instances, only occasional cases occur but in some flocks a morbidity rate of up to 25% may be encountered. Actinobacillosis also occurs, but is rare, in **horses**.

#### Source of infection and transmission

*Actinobacillus lignieresii* is a normal inhabitant of the oral cavity and rumen of ruminants. The organism is susceptible to

ordinary environmental influences and does not survive for more than 5 days on hay or straw. Infection in soft tissue results from damage to the oral mucosa.

In **cattle**, infection most commonly occurs through ulcerating or penetrating lesions to the sulcus of the tongue, penetrating lesions in the apex, and lacerations to the side of the body of the tongue caused by the teeth. Abattoir surveys suggest that subclinical infections are common and have found small actinobacillary granulomas in the draining lymph nodes of the head and approximately 3% of tongues in slaughter cattle.<sup>2-3</sup> In **sheep**, the different nature of prehension of food leads to lesions predominantly in the lips and cheeks with occasional extension to the mucous membranes of the turbinates and the soft tissue of the head and neck.

### Risk factors

The disease is usually sporadic but multiple cases in a herd and apparent outbreaks of the disease can occur when animals graze **abrasive pasture** species or pastures with **spiny awns** and transmission may be enhanced by infected discharges contaminating these pastures or feeds. A high prevalence is recorded in cattle grazing 'burnt-over' peat pastures in New Zealand. These pastures contain much gravel and ash likely to cause oral injury. A similar high incidence has been observed in sheep fed prickly pear (*Opuntia* spp.). A severe outbreak has also been reported in heifers fed on very dry, stemmy, tough haylage and in cattle fed wheat straw from a specific thresher that produced straw with sharp edges.<sup>4</sup> There is a higher prevalence of this disease in cattle in areas of copper deficiency.

Actinobacillosis granulomas may also occur at **atypical sites** in cattle such as the external nares or the jugular furrow following infection of **traumatic lesions** caused by nose grips or jugular venepuncture.<sup>5</sup> Iatrogenic infection of surgical incision wounds is also recorded.<sup>6</sup> Infection of the cheeks resulting in bilateral facial enlargement is also recorded.<sup>7,8</sup>

### Zoonotic implications

*Actinobacillus lignieresii* is rarely associated with human disease but has been isolated from bite wounds inflicted by horses and ruminants.<sup>9</sup>

### PATHOGENESIS

Local infection by the organism causes an acute inflammatory reaction and the subsequent development of granulomatous lesions in which necrosis and suppuration occur, often with the discharge of pus to the exterior. Spread to regional lymph nodes is usual. Lingual

involvement in cattle causes interference with prehension and mastication due to acute inflammation in the early stages and distortion of the tongue at a later stage. Visceral involvement is recorded and is identical with that described under actinomycosis.

## CLINICAL FINDINGS

### Cattle

The onset of glossal actinobacillosis is usually acute, the affected animal being unable to eat for a period of about 48 hours. There is excessive **salivation** and **gentle chewing** of the tongue as though a foreign body were present in the mouth. On **palpation** the tongue is swollen and hard, particularly at the base, the tip often appearing to be normal. Manipulation of the tongue causes pain and resentment. Nodules and ulcers are present on the side of the tongue and there may be an ulcer at the anterior edge of the dorsum. In the later stages when the acute inflammation is replaced by fibrous tissue, the tongue becomes shrunken and immobile and there is considerable interference with prehension.

**Lymphadenitis** is common and is often independent of lesions in the tongue. There may be visible and palpable enlargement of the submaxillary and parotid nodes. Local, firm swellings develop and often rupture with the discharge of thin, non-odorous pus. Healing is slow and relapse is common. Enlargement of the retropharyngeal nodes causes interference with **swallowing**, and loud **snoring** respiration.

**Cutaneous actinobacillosis** is also recorded<sup>8,10</sup> with actinobacillosis granulomas occurring on atypical but visible areas such as the external nares, cheeks, skin or eyelid, and hind limbs. External trauma from abrasive materials in the environment is the usual initiating cause. Lesions are several centimeters in diameter and are pliable or firm and painful on palpation, red, and can bleed easily. Caseated small foci may be evident in the mass when it is debulked.

### Sheep

In sheep the tongue is not usually affected. Lesions up to 8 cm in diameter occur on the **lower jaw, face, and nose**, or in the skin folds from the lower jaw to the sternum. They may be superficial or deep and usually extend to the cranial or cervical lymph nodes. Viscid, yellow-green pus containing granules is discharged through a number of small openings. Extensive lesions cause the formation of much fibrous tissue which may physically impede prehension or respiration. Thickening and scabbiness of the lips may also be observed. Involvement of the nasal cavities may cause

persistent bilateral nasal discharge. Affected sheep have difficulty in eating and many die of starvation. *Actinobacillus lignieresii* is also an occasional cause of **mastitis** in ewes.

Actinobacillosis has been suspected as the cause of a problem of **cud-dropping** in a group of sheep. Affected sheep showed green staining around the lips and had a lower body condition score in association with the presence of palpable, hard, raised nodules in the tongue. The problem responded to treatment with streptomycin.<sup>11</sup>

A similar involvement of the lips with abscessation in the area of the mandibular lymph nodes is recorded in camels.<sup>12</sup> In **horses** the disease is uncommon but intermandibular phlegmon, or infection of the tongue or of the muzzle can occur and also infection at other body sites.<sup>13</sup>

## CLINICAL PATHOLOGY

Purulent discharges commonly contain 'sulfur' bodies which are granular in nature and, on microscopic examination, consist of **club-like rosettes** with a central mass of bacteria. These are not pathognomonic for *Actinobacillus lignieresii* but can also be found in purulent exudate from granulomas associated with *Actinomyces bovis*, *Pseudomonas aeruginosa*, and *Staphylococcus aureus*. Examination of smears or culture of pus for the presence of *Actinobacillus lignieresii* is advisable.

Full-thickness incision biopsies can be of value in diagnosis and show multiple abscessation in the deep dermis with distinct club rosettes.<sup>8,11</sup>

## NECROPSY FINDINGS

Necropsy examination is not usually carried out in cattle affected by the disease. In sheep, lymphangitis and abscesses containing thick, tenacious, yellow-green pus occur around the local lesion. Typical club colonies are visible on staining sections of affected tissue. Culture of material from lesions usually detects the presence of *Actinobacillus lignieresii*.

## DIFFERENTIAL DIAGNOSIS

- Foreign bodies in the mouth
- Rabies
- Esophageal obstruction
- Tuberculosis
- Cutaneous lymphosarcoma

## TREATMENT

Iodides are still a standard treatment for both actinomycosis and actinobacillosis. In the former, the results are relatively inefficient, but in actinobacillosis, response is usually dramatic and permanent. Laboratory studies suggest that iodides have little bactericidal effect against *Actinobacillus lignieresii* and that the

sulfonamides are of greater value.<sup>9</sup> It is probable that iodides exert their effect by reducing the severity of the fibrous tissue reaction.

Oral or intravenous dosing of iodides may be used. Potassium iodide, 6–10 g/day for 7–10 days, given orally as a drench to cattle, is a time-consuming treatment but effective. Treatment may be continued until iodism develops. Lacrimation, anorexia, coughing, and the appearance of dandruff indicate that maximum systemic levels of iodine have been reached. Sodium iodide (1 g/12 kg body weight) can be given intravenously as a 10% solution in one dose to both cattle and sheep. One course of potassium iodide or one injection of sodium iodide is usually sufficient for soft-tissue lesions, the acute signs in actinobacillosis disappearing in 24–48 hours after treatment. At least one or preferably two further treatments at 10- to 14-day intervals are required for bony lesions.

Occasional animals show distress, including restlessness, dyspnea, tachycardia, and staggering during injections of sodium iodide. Abortion occasionally occurs following the treatment of heavily pregnant cows with sodium iodide. This has not been reproduced in an experimental study;<sup>12</sup> however, although uncommon, it is wise to advise the owner of this risk. Subcutaneous injections of sodium iodide causes severe irritation and local swelling immediately. The irritation disappears within an hour or two but the swelling persists for some days. Subcutaneous injection is the standard route of administration for sheep, the dose rate of sodium iodide being 20 mL of a 10% solution weekly for 4–5 weeks.

The sulfonamides, penicillin, streptomycin, and the broad-spectrum antibiotics are also used. Streptomycin, given by intramuscular injection (5 g/day for 3 days) and repeated if necessary, has given good results in actinomycosis in cattle when combined with iodides and local surgical treatment.<sup>14</sup> Isoniazid has been used as a treatment for actinomycotic infections in humans and it has been reported on favorably as an adjunct to antibiotic or iodide therapy in cattle. The daily dose rate recommended is 10 mg/kg body weight orally or intramuscularly, continued for 3–4 weeks.

Cutaneous actinobacillosis may require an extended course of treatment with streptomycin and/or dihydrostreptomycin for 2–4 weeks to achieve resolution.<sup>8</sup>

## CONTROL

Restriction of the spread of disease is best implemented by quick treatment of affected animals and the prevention of contamination of pasture and feed troughs. Isolation or disposal of animals with discharging lesions is essential, although the

disease does not spread readily unless predisposing environmental factors cause a high incidence of oral or skin lacerations.

## REFERENCES

1. Chritensen H, Bisgaard M. *Vet Microbiol* 2004; 99:13.
2. Herenda D, Duker TW. *Can Vet J* 1988; 29:730.
3. Bradley JA, Jericho KWF. *J Food Protect* 1997; 60:157.
4. Dhand NK et al. *Vet Rec* 2003; 153:280.
5. Rebhun WC et al. *Cornell Vet* 1988; 78:125.
6. Kruijff A et al. *Vet Rec* 1992; 131:18.
7. Anderson KL. *J Am Vet Med Assoc* 1990; 197:1359.
8. Milne MH et al. *Vet Rec* 2001; 148:273.
9. Benaoudia F et al. *Eur J Clin Microbiol Infect Dis* 1994; 13:439.
10. Holzhauer M, Roumen TPHM. *Vet Rec* 2002; 151:276.
11. Sproat JB. *Vet Rec* 1988; 123:582.
12. Momotani E et al. *J Comp Pathol* 1989; 100:129.
13. Carmalt JI et al. *J Am Vet Med Assoc* 1998; 215:826.
14. Peel MM et al. *J Clin Microbiol* 1991; 29:2535.

## DERMATOPHILOSIS (MYCOTIC DERMATITIS, CUTANEOUS STREPTOTRICHOSIS, SENKOB DISEASE OF CATTLE, LUMPY WOOL OF SHEEP)

The disease in sheep is commonly called mycotic dermatitis, in cattle cutaneous streptotrichosis, although other local names exist including Senkobo skin disease in Central Africa, Kirchi in Nigeria, and Saria in Malawi. Dermatophilosis is a name common to the disease in all species.

### **Etiology** *Dermatophilus congolensis*

**Epidemiology** Organism present in minor carriage lesions on face and feet. Serious disease occurs when body skin is broken by shearing or insect bites, or macerated by prolonged wetting, coupled with management practices that promote transmission. The disease has significant importance in cattle in tropical areas and occurs mainly in sheep and horses in high rainfall areas in temperate climates. In tropical areas ticks promote severe infection in cattle by suppression of immune function

**Clinical findings** *Sheep*: hard crusts distributed over backline palpable in fleece. *Cattle and horses*: non-pruritic crusting dermatitis, initially with paintbrush tufts of hair. In cattle in tropical areas extensive skin lesions

**Clinical pathology** Branching filaments containing cocci in pairs

**Diagnostic confirmation** Clinical.

Organisms in scrapings or biopsy sections, culture

**Treatment** Antibiotics. Topical antibacterial in horses

**Control** Avoidance of skin trauma and of management practices that promote transmission. Use of topical bactericides to prevent infection of shear cuts, and of skin in risk periods. Acaricides in cattle

## ETIOLOGY

*Dermatophilus congolensis* is the infective agent but requires damage to the skin from other causes to establish infection. The organism is dimorphic and grows as **branched filamentous mycelia** containing dormant zoospores which are transformed by **moisture** to the **infective stage** of motile isolated cocci. There is considerable genetic diversity between isolates. Isolates from the same geographic region are not necessarily closely genetically related<sup>1</sup> although a recent study found that genotypic variation between isolates did correlate with host species.<sup>2</sup>

## EPIDEMIOLOGY

### Occurrence

Geographic occurrence

The disease occurs in all areas of the world but can be epizootic in **tropical** and subtropical areas of the world where it can result in considerable economic loss.<sup>3</sup> Surveys of large numbers of cattle in Africa report prevalence rates approaching 15% with a 100% infection rate in some herds at the time of peak seasonal prevalence.<sup>4</sup> In **temperate** climates the disease is usually sporadic but can still be of considerable economic importance where predisposing factors pertain. An incidence varying from 10 to 66% is recorded in nine dairy herds where shower cooling was the predisposing factor to disease.<sup>5</sup>

High prevalence in sheep flocks occurs in the high and medium rainfall areas of Australia. Significant clinical disease has been reported as far north as Canada, the northern United States and Scotland, and as far south as New Zealand.

### Host occurrence

Disease occurs in cattle, sheep, goats, horses, donkeys, and occasionally in deer, pigs, camels, and wildlife species.<sup>4</sup> Animals of all ages are susceptible, including sucklings a few weeks old.

### Source of infection

The major source of infection for outbreaks of clinical disease exists with minor active lesions on the face and feet in otherwise **healthy carrier animals**, and with infection in **scabs** still carried in the hair and wool from healed lesions.<sup>6</sup>

*D. congolensis* is not highly invasive and does not normally breach the barriers of healthy skin. These barriers include the stratum corneum, the superficial wax layer produced by the sebaceous glands and, on the body of sheep, the physical barrier of the wool. On the feet and face these barriers are easily and commonly broken by abrasive terrain or thorny and spiny forage and feedstuffs.

*Dermatophilus* may infect these lesions and may be transmitted mechanically by

feeding flies to result in minor infection on the face and feet. This '**subclinical carriage form**' of the disease is common in most herds and flocks and the minor lesions are most evident at the junction of the haired and non-haired areas of the nares and of the claws and dewclaws. Minor lesions may also be present in the haired areas of the face and feet and on the scrotum and, in lambs, on the skin along the dorsal midline of the back.<sup>7</sup> They are of no clinical significance to the animal except that they provide a source of more serious infection when other areas of the skin surface are predisposed to infection.

### Transmission

Transmission occurs from the carriage lesions by contact from the face of one animal to the fleece or skin of another, and from the feet to the skin during mounting. Infection can be transmitted mechanically by flies and ticks and mediate infection by contaminated dips.

### Environmental and management risk factors

Sheep

**Prolonged wetting of the fleece** is the major risk factor and leads to emulsification of the wax barrier and maceration of the skin surface with disruption of the stratum corneum. A prolonged and **heavy rain** is sufficient to do this especially if followed by warm and humid weather that retards drying of the fleece. Increased environmental humidity and temperature, as distinct from wetting of the skin, does not appear to promote the development of lesions.<sup>8</sup> Moisture releases infective zoospores from carriage lesions and these may be carried mechanically by flies which are attracted to the wet wool. The motile zoospores are aided in their movement to the skin surface by the moisture of the fleece and their positive chemotactic response to carbon dioxide at the skin surface.

A protracted wetting period of the fleece can also occur following **dipping**, jetting, or spraying of sheep for external parasites when these procedures are conducted at periods greater than 1–2 months after shearing; the incidence of mycotic dermatitis in sheep has been shown to increase with the time period between shearing and dipping. The infection onto the fleece comes primarily from the lesions on the face and feet and is promoted by tightly yarding sheep following these procedures.

**Shearing cuts** also destroy the barriers of the skin and cuts may become infected mechanically by flies, physically by **tight yarding** after shearing, and by mediate infection in **dips** when sheep are dipped immediately following shearing. The



resultant lesions do not spread over the body but provide a significant source of infection for other sheep in the flock when management or climatic circumstances lead to a high degree of flock skin susceptibility. Skin infection can also occur following infection with contagious ecthyma.<sup>9</sup>

### Cattle

#### Temperate zones

Outbreaks in herds and severe disease in individuals are uncommon but can occur associated with high rainfall with attack rates of 50%.<sup>10</sup> There is a particular tendency for lesions to occur on the rump and back in females and males probably due to the introduction of infection through minor skin **abrasions caused by mounting**. Lesions down the flanks of cattle may also result from abrasions and direct infection from the dewclaws during mounting. Other penetrating lesions caused by ear tags or biting flies can also result in minor lesions.

The use of periodic showers or continual **misting** to cool cattle during hot periods is a risk factor for infection in dairy herds.<sup>5,11,12</sup> **Intercurrent disease** and stress are also risk factors and in infected dairy herds a higher incidence has been observed during the first weeks of parturition in first-calf heifers that also had endometritis or mastitis.<sup>5,11</sup>

#### Tropical zones

Climate is the most important risk factor and in tropical and subtropical regions, the disease has its highest incidence and severity during the humid, high rainfall season. Animals in which the disease regresses are usually reinfected repeatedly in successive wet seasons. As in sheep, the disease in cattle requires disruption of natural skin barriers. However, prolonged wetting of the skin of cattle does not appear to be a major predisposing factor by itself and the seasonal occurrence is associated with a concomitant increase in tick and insect infestation.<sup>4</sup> For example, a recent study in Ethiopia found that although prevalence was higher in cattle in the wet season, in both seasons infestation with *A. variegatum* significantly affected the occurrence of disease with infested cattle seven times at higher risk.<sup>13</sup>

**Tick infestation**, particularly with *Amblyomma variegatum*, *Hyalomma asticum*, and *Boophilus microplus*, is strongly associated with the occurrence of extensive lesions of dermatophilosis, which can be minimized by the use of acaricides.<sup>14</sup>

The lesions of dermatophilosis on the body do not occur at the predilection sites for ticks and it is thought that the importance of tick infestation relates to a tick-produced **immune suppression** in the host rather than mechanical or biological transmission.<sup>15,16</sup>

Lesions do occur at predilection sites for **biting insects**, mainly *Stomoxys* spp. and *Lyperosia* spp., *Glossinia* spp., *Calliphoria* spp., and mosquitoes.<sup>4,17</sup> In Africa the disease is often combined with demodicosis to produce '**Senkobo disease**', a more severe and often fatal combination.

**Trauma** to the skin produced by thorny bushes and the Ox-pecker bird (*Buphagus africanus africanus*) can also initiate lesions.

### Horses

Biting flies (*Stomoxys calcitrans*) are thought to act as mechanical vectors of the infection and the house fly (*Musca domestica*) can carry infection. Skin damage from trauma or from ectoparasites can predispose disease as does wetting from rainfall or from **frequent washing**.<sup>18</sup>

### HOST RISK FACTORS

There are **breed differences** in susceptibility in cattle and sheep. In Africa, the N'dama and Muturu cattle breeds and native sheep are resistant, while Zebu, White Fulani, and European breeds are susceptible.<sup>4</sup> **Within-breed differences** in susceptibility are also apparent and genetic markers have been identified in Zebu cattle<sup>19</sup> and Merino sheep.<sup>20</sup> Susceptibility in cattle can be influenced by genetic selection and selection against susceptibility to dermatophilosis based on a BOLA-DR/DQ haplotype has resulted in a reduction over a 5-year period in the prevalence of disease in Brahman cattle in Martinique.<sup>21</sup>

In the Merino, sheep of the strong or medium wool strains are more susceptible. Open-fleeced sheep, and sheep with a low-wax and high-suint content in their fleece are more prone to infection.

### PATHOGEN RISK FACTORS

*D. congolensis* does not live well off the body and in the normal environment, and is susceptible to the external influences of pH and moisture fluctuations. In the laboratory it can survive for 4 years in otherwise sterile broth culture and for at least 13 years in dry scab material kept at room temperature.<sup>22</sup>

### EXPERIMENTAL REPRODUCTION

Local lesions, but not with spread to extensive disease, can be readily reproduced in sheep and cattle by removal of the skin wax followed by local challenge.<sup>23,24</sup> Genetic differences modulate the severity of the lesion that occurs.<sup>23</sup>

### ECONOMIC IMPORTANCE

#### Sheep

Damage to the fleece causes severe losses, up to 30% loss of value of wool and 40% loss of skin value,<sup>25</sup> and may be so extensive in lambs that spring lambing has to be abandoned. Other losses in

sheep are caused by interference with shearing<sup>26,27</sup> and a very great increase in susceptibility to blowfly infestation.<sup>28</sup>

### Cattle

In Africa the disease in cattle causes great losses and many deaths, and the disease ranks as one of the four major bacteriological diseases with equivalent importance to contagious bovine pleuropneumonia and brucellosis.<sup>4</sup> Goats in the same area also suffer a high incidence.<sup>4,29</sup> Losses are from direct animal loss, decreased work ability of affected oxen, reproductive failure from vulval infection or infection on the limbs of males preventing mounting, death from starvation of calves of dams with udder infection, loss of animal meat and milk production, and downgrading of hides.<sup>4</sup> In **temperate climates** deaths are uncommon but cows that fail to respond to treatment and have to be culled are not infrequent. In a study in nine herds in Israel death or culling rates from this disease ranged from 2 to 17% and there was an average 23% fall in milk production in affected cattle.<sup>5</sup> Reproductive inefficiency is a common accompaniment in severe cases.<sup>30</sup>

### Zoonotic implications

Human infection is reported, such as on the hand of a veterinarian working with infected sheep,<sup>31</sup> but contagion from livestock is rare in spite of ample opportunity.

### PATHOGENESIS

The natural skin and wool waxes act as effective barriers to infection. **Minor trauma**, or maceration by prolonged wetting, allows establishment of infection and multiplication of the organism in the epidermis. The formation of the typical **pyramidal-shaped crusts** is caused by repeated cycles of invasion into the epidermis by hyphae, bacterial multiplication in the epidermis, rapid infiltration of neutrophils, and regeneration of the epidermis. The organism in the scab is the source for the repeated and expanding invasion which occurs until immunity develops and the lesion heals.<sup>24,32</sup> The scab then separates from the healed lesion but is still held loosely in place by hair or wool fibers. In **sheep**, the extensive **maceration** of skin that can occur with prolonged fleece wetting can result in extensive skin lesions under the fleece. In **cattle**, tick infestation suppresses **immune function** and promotes the spread of the lesion.<sup>24,32</sup> Secondary bacterial invasion may occur and gives rise to extensive suppuration and severe toxemia.

### CLINICAL FINDINGS

#### Sheep

Lesions are commonly not visible in sheep because they are obscured by the

fleece but the crusts can be palpated as hard masses at the surface of the skin (**lumpy wool disease**) and typically are distributed irregularly over the dorsal midline with 'ribs' spreading laterally and ventrally. The crusts are roughly circular, thick, up to 3 cm, often distinctly **pyramidal** with a concave base, often pigmented, and the underlying skin is moist and reddened. The muzzle, face and ears, and the scrotum of rams, may also be involved. The health of the animal is unaffected unless the lesions are widespread.

Heavy mortalities can occur in very young **lambs** where there can be extensive lesions over the body. Many develop cutaneous blowfly myiasis and in occasional cases a secondary pneumonia due to the organism may cause the death of the animal.

### Cattle

The early lesion is a pustule and the hair over the infected site is erect and matted in tufts (**paintbrush lesions**) with greasy exudate forming crumbly crusts which are hard to remove. These develop to scabs which are greasy and fissure at flexion points, and finally to scabs that are hard, horny, and confluent. The scabs vary in color from cream to brown, are 2–5 cm in diameter and are often in such close apposition that they give the appearance of a mosaic. In the early stages the crusts are very tenacious and attempts to lift them cause pain. Beneath the crusts there is granulation tissue and some pus. In the later stages, the dermatitis heals and the crusts separate from the skin, are held in place by penetrating hairs, but are easily removed.

Lesions occur on the neck, body, the back of the udder and may extend over the sides and down the legs and the ventral surface of the body. Commonly they commence along the back from the withers to the rump and extend halfway down the rib cages. In some animals the only site affected is the flexor aspect of the limb joints or the inguinal area or between the forelimbs.

In young **calves**, infection commences on the muzzle, probably from contact with the infected udder or because of scalding by milk in bucket-fed calves, and may spread over the head and neck.

### Horses

Lesions in horses are similar to those in cattle. The hairs are matted together over the lesion and an exudative dermatitis produces a firm mat of hairs and debris just above the skin surface. If this hair is plucked the entire structure may lift off, leaving a characteristic ovoid, slightly bleeding skin area. **No pruritus** or irritation is apparent although the sores are tender to the touch.

Infection can appear on the head, beginning at the muzzle and spreading up the face to the eyes, and if sufficiently extensive may be accompanied by lacrimation and a profuse, mucopurulent nasal discharge. In some horses the lesions are confined to the lower limbs, with a few on the belly. In very bad environmental conditions the lesions may be widespread and cover virtually the whole of the back and sides. The lesions on lower limbs are most common behind the pastern, around the coronet and on the anterior aspect of the hind cannon bones. If the underlying skin cracks, the horse can become very lame. This variable distribution of lesions may depend upon the inciting skin trauma.

### Goats

Lesions appear first on the lips and muzzle and then spread, possibly by biting, to the feet and scrotum. They may extend to all parts of the body, especially the dorsal midline and inside the thighs.<sup>29</sup> In some cases lesions commence on the external ear.<sup>33</sup> Heavy crust formations may block the ear canal and the external nares.

### CLINICAL PATHOLOGY

The causative organism may be isolated from scrapings or a biopsy section and is much easier to isolate from an acute case than a chronic one. Polymyxin B sulfate can be used to suppress contaminants. Typical **branching** organisms with **double rows** of zoospores can be seen in a stained impression smear made directly from the ventral surface of a thick scab pressed firmly onto a slide. The organism can also be demonstrated by fluorescent antibody.<sup>34</sup> ELISA and counterimmunoelectrophoresis have also been used to detect serological evidence of infection with *D. congolensis*.<sup>35</sup>

### NECROPSY FINDINGS

In animals that die, there is extensive dermatitis, sometimes a secondary pneumonia, and often evidence of intercurrent disease.

### Samples for confirmation of diagnosis

- **Bacteriology** – affected skin and draining lymph node (CYTO FUNGAL CULT)
- **Histology** – formalin-fixed samples of these tissues (LM).

### DIFFERENTIAL DIAGNOSIS

- Ringworm
- Staphylococcal dermatitis/folliculitis
- Scabies
- Pediculosis
- Fleece rot – sheep.

Other causes of dermatitis are listed in Table 22.4.

### TREATMENT

#### Sheep

**Bactericidal dips** are used, but have limited efficacy as topical treatments do not penetrate the scab to the active lesion, and are more appropriate for control.

**Antibiotic treatment** at high dose for a single treatment is effective in reducing the proportion of active lesions in an affected flock. Antibiotics that are effective include procaine penicillin combined with streptomycin at a dose of 70 000 units/kg and 70 mg/kg, respectively,<sup>26</sup> erythromycin at 10 mg/kg,<sup>26</sup> long acting tetracycline at 20 mg/kg<sup>27</sup> and combination of lincomycin and spectinomycin at a dose of 5 mg/kg and 10 mg/kg, respectively<sup>21</sup>; all treatment being given intramuscularly. Treatments appear effective in wet weather.<sup>27</sup> The usual strategy is to treat 8 weeks prior to shearing so that there is time for the lesions to heal and shearing to occur without interference from active lesions. Sheep may be dipped in a bactericidal dip after shearing as detailed below under control. An alternate approach is to cull affected sheep.

#### Cattle

With the disease that occurs in **temperate areas** tetracycline (5 mg/kg BW) repeated weekly as required is recommended, and long-acting tetracycline (20 mg/kg BW) in one injection is reported to give excellent results in cattle.<sup>10,32</sup> Parenteral procaine penicillin (22 000 iu/kg) daily for three days is also reported as efficacious.<sup>5</sup>

With the disease that occurs in **tropical areas** and associated with tick infestation, there is no completely satisfactory treatment in herds with extensive involvement, or those being constantly reinfected or exposed to predisposing causes. In general terms, better results are obtained during dry weather and in dry climates. In tropical Africa treatments which are reasonably effective elsewhere are of little or no value.

Parenteral treatment with antibiotics, as above, can be used and should be used in conjunction with **acaricides** when ticks are present.

#### Horses

Topical therapy is most commonly used in horses coupled with removal from whatever is causing prolonged wetness of the skin. Although horses generally respond well, in bad weather even they can be recalcitrant to treatment. Scabs can be removed by grooming under sedation and the lesions treated topically daily with povidone-iodine or chlorhexidine until the lesions heal.<sup>36</sup> Benzoyl peroxide has keratolytic, antibacterial, and follicular flushing properties and is reported to be effective in therapy when applied topically at a concentration of 2.5%.<sup>37</sup>

Severe cases can be treated daily for 3 days with penicillin at 20 000 units/kg intramuscularly alone or in combination with streptomycin at 10 mg/kg.

### CONTROL

The principal approach, where possible, is the avoidance of predisposing factors. The disease usually disappears in dry weather. Isolation of infected animals and avoidance of contact by clean animals with infected materials such as grooming tools is desirable. Affected sheep should be shorn and/or dipped last.

**Close yarding** of sheep, or factors that promote face to skin contact immediately after shearing or after dipping, should be avoided. Insecticidal dips should contain a bactericide. Where dipping immediately after shearing is a risk factor the severity of infection can be reduced by delaying dipping, for example, from the 1st to the 10th day after shearing, or by dipping in zinc sulfate immediately following shearing with later dipping in an insecticide. Alternatively, pour-on insecticides can be substituted.

**Bactericidal dips** will give some protection to sheep. Spraying or dipping of sheep in a 0.5–1.0% solution of zinc sulfate immediately after shearing is used to prevent infection of shear cuts. Spraying or dipping sheep in a 1% solution of alum (potassium aluminum sulfate) provides protection against infection for up to 70 days, alum rendering the organism non-motile, and can be used to provide protection during the rainy season in woolled sheep. Alum strips from the dip and the dip requires frequent replenishment, the amount depending on wool length. An alternate treatment is to dust alum along the back of the sheep.

With cattle in tropical areas, **tick control** (Chapter 28) is most important in control of dermatophilosis. Attempts at prophylaxis by vaccination in both sheep and cattle have been unsuccessful,<sup>32</sup> immunity appears to be isolate-specific.<sup>24</sup>

### REVIEW LITERATURE

- Bida SA, Dennis SM. Dermatophilosis in Northern Nigeria. *Vet Bull* 1976; 46:471,478.
- Lloyd DH, Sellers KC. *Dermatophilus* Infections in Man and Animals. Proceedings of a Conference held at the University of Ibadan, Nigeria, 1976. New York: Academic Press.
- Scanlan CM, Garrett PD, Geiger DB. *Dermatophilus congolensis* infections of cattle and sheep. *Comp Cont Educ* 1984; 6:S4–S9.
- Oduye OO. Dermatophilosis. 7th Conf. Reg. Commission for Africa, Cairo, 1987, 268 pp. Paris: OIE, pp. 3–14.
- Zaria LY. *Dermatophilus congolensis* infection (Dermatophilosis) in animals and man. An update. *Comp Immun Microbiol Infect Dis* 1993; 16:179–222.

### REFERENCES

- Trott DJ et al. *Zbl Bakt* 1995; 282:24.
- Larrasa J et al. *J Vet Med B* 2002; 49:135.

- Samui KL, Hugh-Jones ME. *Vet Res Comm* 1990; 14:357.
- Zaria LT. *Comp Immun Microbiol Infect Dis* 1993; 3:179.
- Yerahum I et al. *Vet Rec* 2000; 146:695.
- Bida SA, Dennis SM. *Res Vet Sci* 1977; 22:18.
- Pfezzer A et al. *NZ Vet J* 1996; 44:121.
- Lloyd DH. *Prev Vet Med* 1984; 2:93.
- Yerahum I et al. *Israel J Vet Med* 1994; 49:161.
- Loeffler A et al. *Vet Rec* 2004; 154:635.
- Yerahum I et al. *Rev Elev Med Vet Pays Trop* 1995; 48:25.
- Barrington GM, Pond DT. *Bovine Practit* 2004; 38:79.
- Kassaye E et al. *Dtsch Tierart Wschr* 2003; 110:422.
- Hadrill DJ, Walker AR. *Trop Anim Hlth Prod* 1994; 26:28.
- Koney EBM et al. *Trop Anim Hlth Prod* 1996; 28:185.
- Walker AR et al. *Trop Anim Hlth Prod* 1996; 28:65.
- Davis D. *J Comp Pathol* 1984; 94:25.
- Yerahum I et al. *J Vet Med A* 1996; 43:393.
- Maillard JC et al. *Ann NY Acad Sci USA* 1996; 791:185.
- Masters AM et al. *Vet Microbiol* 1997; 57:337.
- Maillard JC et al. *Genet Select Evol* 2003; 35:S193.
- Makinde AA et al. *Vet Rec* 2001; 149:154.
- Sasiak AB et al. *Aust J Exp Agric* 1993; 33:729.
- Ambrose NC. *Trop Anim Hlth Prod* 1996; 28:295.
- Edwards JR. *Aust Vet J* 1985; 62:173.
- Scrivener CJ, Vizard AL. *Aust Vet J* 1995; 72:475.
- Jordan D, Venning CM. *Aust Vet J* 1995; 12:234.
- Gherardi SG et al. *Aust Vet J* 1983; 60:27.
- Scott DW et al. *Compend Cont Educ Pract Vet* 1984; 6:S190.
- Huffman EM, Cowen P. *Theriogenology* 1984; 21:941.
- Harman M et al. *Br J Dermatol* 2001; 145:170.
- Sutherland SS et al. *Vet Microbiol* 1991; 27:91.
- Larsen JWA. *Aust Vet J* 1987; 64:160.
- Scott DW et al. *Cornell Vet* 1984; 74:305.
- Martinez D et al. *Vet Microbiol* 1993; 34:47.
- Evans AG. *Compend Cont Educ Pract Vet* 1992; 14:161.
- Paterson S. In *Practice* 2003; 25:146.

### STRAWBERRY FOOT ROT (PROLIFERATIVE DERMATITIS)

This is a proliferative dermatitis of the lower limbs of sheep.

#### ETIOLOGY

The causative agent is believed to be *Dermatophilus congolensis* (*D. pedis*).<sup>1</sup>

#### EPIDEMIOLOGY

The disease is recorded from the UK and occurs extensively in some parts of Scotland and in Australia. It is not fatal but severely affected animals do not make normal weight gains. Up to 100% of animals in affected flocks may show the clinical disease.

All ages and breeds appear susceptible but under natural conditions lambs are more commonly affected. Most outbreaks occur during the **summer months** and lesions tend to disappear in cold weather. Although the disease is recorded naturally only in sheep, it can be transmitted experimentally to man, goats, guinea-pigs, and rabbits. Complete immunity does not develop after an attack, although sheep

recently recovered from contagious ecthyma may show a transient resistance.

The natural method of transmission is unknown but the frequency of occurrence of lesions at the knee and coronet suggests infection from the ground through cutaneous injuries. Dried crusts containing the causative agent are infective for long periods and ground contamination by infected animals, or infection from carrier animals, is the probable source of infection.

### PATHOGENESIS

Histologically, the lesions are those of a superficial epidermitis similar to that of contagious ecthyma.

### CLINICAL FINDINGS

Most cases appear 2–4 weeks after sheep have been moved onto affected pasture but incubation periods of 3–4 months have been observed. Small heaped-up **scabs** appear on the leg from the coronet to the knee or hock. These enlarge to 3–5 cm in diameter and become thick and wart-like. The hair is lost and the lesions may coalesce. Removal of the scabs reveals a **bleeding, fleshy mass** resembling a fresh **strawberry**, surrounded by a shallow ulcer. In later stages the **ulcer** is deep and pus is present. There is no pruritus or lameness unless lesions occur in the interdigital space. Most lesions heal in 5–6 weeks but chronic cases may persist for 6 months.

### CLINICAL PATHOLOGY

Swabs and scrapings should be examined for the causative organism.

### DIFFERENTIAL DIAGNOSIS

Lesions of strawberry foot rot closely resemble those of contagious ecthyma but are restricted in their distribution to the lower limbs, whereas lesions of contagious ecthyma occur mostly on the face and rarely on the legs. The absence of a systemic reaction and the proliferative character of the lesions differentiate it from sheep pox.

### TREATMENT

There is little information on treatment. Antibiotics as used in dermatophilosis should be effective.

### CONTROL

In the light of present knowledge, isolation of infected sheep and the resting of infected fields are the only measures which can be recommended.

### REFERENCE

- Austwick PKC. *Vet Rev Annot* 1958; 4:33.

## Diseases associated with *Actinobacillus suis*

### Synopsis

**Etiology** *Actinobacillus suis*

**Epidemiology** Opportunist pathogen in conventional herds producing diseases in pre-weaned pigs. Pathogen of all ages of swine in high-health herds

**Clinical findings** Septicemia and polyarthritis in young pigs, sudden death and respiratory disease in growing pigs, abortion in sows

**Lesions** Septicemia and polyserositis in young pigs, hematogenous pneumonia in grower pigs

**Diagnostic confirmation** Culture

**Treatment** Antimicrobial

**Control** None specific

### ETIOLOGY

*Actinobacillus suis* is an emerging swine pathogen. Historical literature has ascribed this bacterial species to a number of diseases in different animal species. Recent studies suggest that strains of *A. suis* isolated from swine appear **swine-specific** and different from *A. suis*-like organisms from other species, suggesting that this organism has a specific role in swine disease and that other animal species are not reservoirs for the disease in pigs.<sup>1</sup>

### EPIDEMIOLOGY

*A. suis* is generally a pathogen of preweaned pigs and only a pathogen of older pigs in minimal disease herds. Historically *A. suis* has been regarded as an opportunistic pathogen of conventionally reared swine that can cause sporadic disease following stress or an opportunistic pathogen causing disease in association with infections such as swine fever. However, in the past 10–15 years it has become apparent that *A. suis* can be a significant pathogen in high-health herds when it is introduced to such a herd or when high-health-status animals are mixed with conventionally reared swine.<sup>2</sup>

### Occurrence

The infection has probable world-wide occurrence and is reported in most countries where swine are a significant agricultural industry; however, disease has particular importance in the USA and Canada.

### Prevalence of infection

*A. suis* has been associated with disease in young piglets and, less commonly, with disease in growing and adult pigs, and with abortion. The incidence of disease varies with the health status of the herd. It is usually a cause of sporadic septicemia

and polyserositis in sucking pigs but in some high-health swine units a large proportion of litters can be affected with up to 30% of piglets in a litter affected and a preweaning mortality of 25% during an outbreak,<sup>3</sup> and in post-weaned growing pigs can be associated with short outbreaks of disease with high case fatality.<sup>4</sup> Abortion occurs with the highest incidence in gilts and first-parity sows with abortion rates approaching 10% in the abortion storm period.<sup>5</sup>

### Methods of transmission

The organism colonizes the oropharynx, upper respiratory tract, and vagina of normal pigs and infection is believed to be by aerosol infection with invasion through the upper respiratory tract.<sup>6</sup>

### Pathogen risk factors

The pathogenicity of *A. suis* in disease is still not well understood. The organism shares a number of virulence determinants with other Gram-negative organisms such as capsule, lipopolysaccharide (LPS), and pore-forming toxins. The hemolytic/cytolytic toxins produced by *A. suis* are very closely related to ApxI and ApxII toxins of *Actinobacillus pleuropneumoniae*. There are two different major LPS (O) antigen types, O1 and O2, and O2 strains are more likely to be associated with severe disease.<sup>7,8</sup> Geographic clustering of strains occurs.<sup>8</sup>

### Economic importance

The disease has emerged to be an important cause of disease in high-health swine herds in North America.<sup>9</sup>

### Zoonotic implications

The infection in pigs is not a major zoonosis but local infection in man is reported following a bite by a pig.<sup>10</sup>

### CLINICAL FINDINGS

The disease manifests with septicemic disease with fever and sudden death in suckling or weaned pigs and less commonly older pigs. Most commonly the disease involves pigs under 2 months of age, with the major occurrence in suckling piglets and occurring in one or more litters. The presenting syndrome is usually one of sudden death of piglets associated with **septicemic** disease followed by the development of more chronic disease in the remaining piglets in the litter. Affected pigs are listless, pyreptic and show respiratory distress, neurological disturbances, and arthritis and have petechial hemorrhages or cyanotic areas in the skin most noticeable on the abdomen and ears. **Polyarthritis** manifests with reluctance to stand, lameness, and palpable swelling in the joints develops in piglets which live longer than 24 hours after clinical onset.

Manifestations of the disease in mature animals can include pyrexia and

the occurrence of erysipelas-like skin lesions, abortion, metritis, and meningitis. In growers and adults in high-health herds *A. suis* can cause septicemia, respiratory distress, and brief cyanosis before death with clinical and pathological findings that superficially resemble *Actinobacillus pleuropneumoniae*.<sup>2,11</sup> In adult pigs a major manifestation can be signs resembling erysipelas with pyrexia and the early occurrence of round, oval, or rhomboid raised erythematous **skin lesions**.<sup>3,12</sup>

*Actinobacillus* spp. have been isolated from **aborted fetuses** in swine.<sup>5,13,14</sup> The abortions are usually in gilts and lower-parity sows and are late term and sporadic.

### NECROPSY FINDINGS

Postmortem examination may reveal gross evidence of septicemia, such as petechial hemorrhages in the lungs and abdominal viscera, serofibrinous exudates in the pericardial, peritoneal, and pleural cavities, polyarthritis with pale yellow fibrinous joint fluid and edematous thickening of the joint capsule, and splenomegaly. Grossly, the cardiac hemorrhages and pericardial effusion can resemble mulberry heart disease.<sup>15</sup> Dead suckling piglets often have cyanosis of the extremities and the peritonitis may be restricted to fibrin tags over the surface of the intestines.<sup>3,13,16</sup> In some instances, raised, oval to rhomboidal, cutaneous plaques reminiscent of erysipelas lesions are seen in older pigs. Growers and feeders may have a lobular bronchopneumonia with a hemorrhagic and fibrinonecrotic character that is grossly somewhat similar to that produced by *A. pleuropneumoniae*.<sup>4</sup> Microscopic changes in all ages are typical of bacterial septicemia and can include intravascular colonies of coccobacilli in a variety of tissues. Acute myocardial and hepatic necrosis is often observed microscopically. Diagnosis is by postmortem findings and culture of the organism.

### DIFFERENTIAL DIAGNOSIS

- *Streptococcus suis*
- Glasser's disease
- Erysipelas
- Pleuropneumonia
- Mulberry heart disease

### TREATMENT

The organism is susceptible to most antibiotics with the exception of erythromycin, clindamycin, neomycin, and tetracyclines,<sup>17</sup> but the sudden onset precludes effective treatment in most pigs. Although the disease is sporadic and outbreaks are unusual, prophylactic treatment of in-contact and at-risk piglets is advisable for a short period.

## CONTROL

Currently there is no effective method of control, other than strategic medication of pigs during the risk period for that herd. Nor is there a practical method of insuring that infection will not be introduced to a herd. Routine biosecurity measures should be followed. Colonization by *A. suis* is believed to occur in the first 3 weeks of age but varies between animals<sup>17</sup> and the value of early segregated and medicated weaning is not established for this disease. There is no commercial vaccine.

## REVIEW LITERATURE

MacInnes JJ, Desrosiers R. Agents of the 'suis-ide diseases' of swine: *Actinobacillus suis*, *Haemophilus parasuis*, and *Streptococcus suis*. Can J Vet Res 1999; 63:83–89.

## REFERENCES

- Christensen H, Bisgaard M. Vet Microbiol 2004; 99:13.
- MacInnes JJ, Desrosiers R. Can J Vet Res 1999; 63:83.
- Wilson RJ, McOrist S. Aust Vet J 2000; 78:317.
- Yeager MJ. J. Vet Diag Invest 1996; 8:381.
- Mauch C, Bilkei G. Vet J 2004; 168:186.
- Roycroft AN, Garside LH. Vet J 2000; 159:18.
- Slavic D et al. Can J Vet Res 2000; 64:81.
- Slavic D et al. J Clin Microbiol 2000; 38:3759.
- MacInnes JJ, Desrosiers R. Can J Vet Res 1999; 63:83.
- Escande A et al. Lancet 1996; 348:888.
- Jeannotte ME et al. Vet Microbiol 2002; 85:83.
- Miniats OP et al. Can Vet J 1989; 30:943.
- Fodor L et al. Acta Vet Hung 1990; 38:225.
- Orr J et al. Can Vet J 1990; 31:42.
- Sanford SE. Can J Vet Res 1987; 51:481.
- Sanford SE et al. Can Vet J 1990; 31:443.
- Lapointe L et al. Vet Res 2001; 32:175.

## PLEUROPNEUMONIA OF PIGS ASSOCIATED WITH *ACTINOBACILLUS PLEUROPNEUMONIAE*

### ETIOLOGY

*Actinobacillus pleuropneumoniae* (APP), formerly known as *Haemophilus pleuropneumoniae*, is the causative organism and requires factor V for growth.<sup>1</sup> Recently, a completely non-pathogenic species, *A. porcitosillarum*, capable of producing some Apx toxins but not Apx IVa has been identified.<sup>2</sup>

### EPIDEMIOLOGY

#### Occurrence

The only natural host is the pig but it has been isolated from cattle, deer, and lambs and some rodents can be infected experimentally.<sup>3</sup> The diversity of strains isolated from healthy pigs could be higher than that of strains recovered from diseased pigs.<sup>4</sup>

The disease occurs worldwide in growing pigs from 2 to 6 months of age with rapid spread both within the initially affected group and subsequently to other older or younger pigs in a herd. Abattoir surveys have found that the lungs of pigs

from about 50% of herds monitored for several months may have lesions attributable to APP. Seroepidemiological surveys have found that pigs in 70% of herds may have antibodies to one or more of several recognized serotypes of the organism. The prevalence of infection continues to increase – presumably due to confinement rearing, crowding, inadequate ventilation, close contact, and commingling of pigs of various age groups. The incidence of clinical disease is much less than the prevalence of infection. In most countries the more dense the pig population the more prevalent the APP is likely to be and this has been documented in Belgium.<sup>5</sup>

#### Morbidity and case fatality

The morbidity rate can exceed 50% and the mortality may vary from 1 to 10%.<sup>1</sup>

#### Methods of transmission

Transmission is usually by pig to pig contact. Only a few organisms need to be carried in the tonsil and nasopharynx for a pig to become infectious during travel. The subclinically infected carrier pig is the most common source of infection.<sup>6</sup> It has been suggested that shedding only takes place at the time of active infection not when the organism is just carried.

Transmission is by the respiratory route, principally via nose to nose contact. Overcrowding and inadequate ventilation may facilitate spread. The organism can be spread in the air for a distance of 1 m.<sup>7</sup> Aerosol transmission of serovar 9 was possible over 2.5 m.<sup>8</sup> An experiment with transferring air from a group of pigs with serotype 2 showed that if 10% of the air was transferred, then there was no transmission, but if 70% was transferred, then the APP did spread.<sup>9</sup> Peak transmission may occur at around 11 weeks.<sup>10</sup> Experimental aerosol exposure of pigs to serotype 9 results in infection and induces protection to subsequent challenge from the homologous strain.<sup>11</sup> Experimental intranasal challenge has been followed by death in a period as short as 24 h. The mixing of infected pigs (seeder pigs) with normal susceptible pigs for 48 h can mimic field infection with the development of clinical disease, febrile responses, lung lesions, and mortality.<sup>12</sup>

The subclinically infected carrier pig is the most common means by which the infection is transmitted between herds. Severe outbreaks may occur unexpectedly in susceptible breeding herds with no previous history of the disease or in intensive feeder pig operations in which pigs are introduced on a regular basis from a variety of sources. Herds which continuously introduce replacement stock are highly susceptible to an outbreak. Following the initial outbreak general herd immunity develops, but the infection

persists and sporadic cases may continue to occur. The organism is not readily isolated from normal respiratory tissues, but persists in chronic lesions within the lungs of recovered and apparently clinically healthy pigs. These pigs provide a source of infection, especially in a finishing herd buying from diverse sources. The indirect transmission of infection has been proposed but may be rare. An on-farm study described five cases of being transmitted by aerosol or boots or clothes, but the other three cases could have been any combination of these three or even other indirect sources.<sup>13</sup>

### Risk factors

#### Pathogen factors

##### Serotypes

There are two biotypes. Biotype 1 requires NAD (13 serotypes) and biotype 2 does not (2 serotypes). The isolation of biotype 2 may be increasing. In 1997, two new serotypes were proposed: serotype 14<sup>14</sup> and serotype 15.<sup>15</sup> Serotypes 1–12 form biotype 1 together with 15. Biotype 2 is serotypes 13 and 14.<sup>16</sup>

Serotype 5 is subdivided into subtypes A and B. Serotype 1 has also been divided into antigenic subtypes 1A and 1B.<sup>17</sup> The prevalence of serotypes of APP varies considerably according to geographical location. Serovars 1, 5, and 7 are common in North America, serovars 2 and 9 are common in continental Europe, while serovar 3 is common in England. Serovars 1, 7, and 12 are the most common and are present in Australian pigs,<sup>18</sup> with serovar 1 being the most common.<sup>19</sup> In Denmark they routinely find 9 strains.<sup>20</sup> It is usually 2 followed by 6, 5, and 12. Serotypes 1, 7, 8, and 14 are infrequent and serotypes 3, 4, 9, 11, 13, and 15 have not yet been found.<sup>20</sup> In North America the most common serotypes, in order of their frequency, are serotypes 1, 5, and 7.<sup>1</sup> Serotype 1 is most common in eastern Canada, accounting for 66–83% of the isolates, and is the second most prevalent isolate in western Canada and the USA. Serotype 2 is of low frequency in Canada, but is the dominant isolate in Sweden, Switzerland, and Denmark. However, serotype 2 has now been reported as causing disease in growing and finishing pigs in the USA.<sup>21</sup> Serotype 3 has a low incidence in Canada and the USA and has been reported in Ireland. Serotype 5 isolations are common in Canada and the USA. Serotype 6 has not been reported in North America but occurs in Denmark. Serotype 7 is found in Canada and the USA, and a serotype 8 has recently been identified in outbreaks of pleuropneumonia in pigs in Ireland and Denmark. APP 10 is common in France and Brazil.<sup>22</sup> The most common serotypes isolated in Quebec were 1, 5, 2, and 7 in that order. In the British Isles,

serotypes 2 and 8 were most common with 3, 6, and 7 also occurring frequently. Serotypes 5, 9, 10, and 12 occurred only rarely. Serotypes 1 and 4 were not isolated. Among isolates from the Irish Republic, serotype 2 was predominant and serotype 6 was absent.<sup>23</sup>

The serotyping of isolated strains is important in the epidemiological and immunological study of APP infection. It is also important when comparing or analyzing the effectiveness of different treatments to know the virulence of the strains and sensitivity to antimicrobials. An effective immunization program also depends on consideration of the multiplicity of immunogenic types which occur in a particular area or country. Some of the serotypes are heterogeneous (they share antigenic determinants with other serotypes). Heterogeneity has been reported for serotypes 3, 6, and 8, serotypes 4 and 7, and serotypes 1, 9, and 11.<sup>24,25</sup> Restriction endonuclease fingerprinting analysis can be used for comparison of serotypes.<sup>26</sup>

#### Virulence factors

APP attaches to tonsillar epithelium.<sup>27</sup> It also adheres to tracheal rings in vitro and alveolar epithelial cells.<sup>28</sup> Genes that are involved in energy metabolism, nutrient uptake, and stress response are essential for the survival of APP in the pig host.<sup>29</sup> These would include enzymes that are produced in vivo to ensure that there is oxygen.<sup>30,31</sup> A metalloprotease has been found that can degrade porcine IgA and IgG.<sup>32</sup>

Several other virulence attributes and their biological effects have been described.<sup>33,34</sup> Multiple virulence factors are involved in the development of the disease, and lesions are likely caused by toxic factors associated with the organism. The capsular components are anti-phagocytic and inhibit bactericidal activity of the serum but do not cause any lesions themselves. Discovery of mutants without capsules that were no less able to adhere to respiratory tract tissues suggests that the outer membrane proteins were then unmasked (without the capsule) and these were able to adhere to epithelial cells.<sup>35</sup> It is therefore an LPS independent adherence.<sup>36</sup> The outer membrane proteins (OMP) (60 kDa) adhere to fibers of type III collagen in the lung. The outer membrane proteins appear to be common to all serotypes.

The lipopolysaccharides (LPS) of APP are serotype specific but will cross react with one another.<sup>37</sup> LPS of APP is an important adhesin.<sup>38-40</sup> It also induces inflammation by stimulating TNF  $\alpha$ , IL-1, IL-6, and IL-8.<sup>41,42</sup> However, the construction of antibodies to LPS blocked

adherence to tracheal cells<sup>43</sup> so our understanding is not yet complete. The LPS causes an endotoxemia and reproduces certain typical lesions of the natural disease but not the hemolytic or necrotizing effects. Some LPS also help APP to stick to mucus, tracheal rings, and lung, but they do not seem to be involved in adherence to cultured porcine alveolar epithelial cells.

Porcine hemoglobin also binds to LPS with APP<sup>44</sup> and this is a property of the APP OMP.<sup>45</sup>

Under iron-deficiency growth conditions, APP expresses 2 transferrin binding proteins.<sup>46-50</sup> Recently, a ferrichrome receptor in APP<sup>51</sup> has been described.

There are adhesions (fimbriae) involved.<sup>52,53</sup> They are particularly associated with serotype 1 but also 3 and 5 and are usually a feature of subculture 1 (56% of strains), but only 8% on subculture 2 and none on 3.<sup>54</sup>

Several exotoxins are produced including hemolysins.<sup>55</sup> The hemolytic activity of this organism is characteristic of this species of bacteria. This range of exotoxins is part of the pore-forming RTX group known as the Apx toxins. The latest is Iva.<sup>56-58</sup> The Apx IVa gene is found in all APP serotypes and is absent in the other related species in the Pasteurellaceae and, therefore, is considered species specific for APP<sup>59</sup> and is, therefore, being used in a PCR to identify APP strains.<sup>60</sup>

The Apx toxins are described below: I-III can be produced in vitro, but Apx IVa is only produced in vivo<sup>56</sup> and is specific only to APP.<sup>61</sup> All 90 strains investigated in one study had Apx IVa genes.<sup>59</sup> Mutants without the capacity to produce Apx toxins do not cause disease.<sup>62</sup> There are basically four different patterns. Both ApxI and II are essential for the production of lesions:<sup>63</sup>

- ApxI is strongly hemolytic and weakly cytotoxic
- ApxII is weakly hemolytic and moderately cytotoxic
- ApxIII is not hemolytic but strongly cytotoxic
- Serotypes 1, 5a, 5b, 9, and 11 produce I and II
- Serotypes 2, 3, 4, 6, and 8 produce II and III
- Serotypes 7 and 12 produce II
- Serotype 10 only produces Apx I.

These are toxic to alveolar macrophages, neutrophils, and endothelial cells. In small doses they are stimulatory but in large doses lethal. The gene expression is controlled over the growth curve by a novel regulating pathway.<sup>64</sup> Several genes have recently been identified which have helped in survival including the knowledge that it can produce toxins under

anaerobic conditions.<sup>65</sup> The LPS of APP can also stimulate the release of nitric oxide from macrophages by virtue of the enzyme nitric oxide synthase which damages tissues and may disrupt vascular tone, neuronal signaling, and host defense mechanisms.<sup>66-69</sup> Nitric oxide synthase 2 and cyclooxygenase 2 have been found in swine experimentally infected with APP.<sup>70</sup> Urease activity may also be required for APP to establish infection in the respiratory tract.<sup>71</sup>

The increase in antimicrobial drug resistance which has occurred is an indirect virulence factor and an important disease-promoting mechanism.<sup>33</sup> The ability of the organism to resist complement killing in vitro may reflect a virulence mechanism in vivo which assists bacteria in avoiding the pulmonary defenses of swine and promotes bacterial invasion of the lung.<sup>72</sup>

Differences in pathogenicity exist between serovar 1 and serovars 7, 3, and 2.<sup>73</sup> The differences between serotypes 1, 2, and 7 are low. Serotype 3 seems less virulent than 1. The differences in capsular structure and biochemical composition between virulent and avirulent isolates may contribute to virulence. A smooth-type lipopolysaccharide and a rough-type lipopolysaccharide have been isolated and characterized from serotype 5. The intrabronchial infusion of the preparations into pigs induces lesions typical of those in pigs which die from acute pleuropneumonia.

APP may interact with *P. multocida* to produce a severe pneumonia, whereas *P. multocida* alone is relatively non-pathogenic. Experimentally, a combination of *P. multocida* and the crude toxin of APP resulted in moderate-to-severe pneumonic pasteurellosis.<sup>74</sup>

#### Animal risk factors

The major animal risk factors are related to the immune mechanisms and the immune status of pigs of varying ages. A major animal risk factor is that clinically recovered pigs commonly serve as carriers of the organism and never fully recover from the infection. Normally, the APP is detected in mixed bacterial samples from the tonsils and/or nasal samples by PCR from the age of 4 weeks onwards but it has been detected as early as 11 days in tonsil samples, so it is possible for the sow to infect the piglet.<sup>75</sup> Isolations become more common from 4 to 12 weeks as maternal antibody wanes. The median length of tonsillar carriage may be 7-8 weeks. Colonization of the lungs can develop from around 12-16 weeks in some herds to as late as 23 weeks in others.

#### Immune mechanisms

In most herds you can still detect high antibody levels in 4-week-old piglets and

this maternal antibody (AB) continues to decrease until about 12 weeks and then the AB starts to rise with the acquisition of a pathogenic burden. The presence and decay of acquired colostral antibodies between 2 weeks and 2 months<sup>76</sup> determines the age at which APP infection is most likely to occur.<sup>75,77</sup> The maternal antibody titers halve every 3 weeks and therefore may remain for 12–56 days.<sup>78</sup>

Nasal colonization can occur as early as 4 weeks and APP can be found in the lungs from 12 weeks; it is usually 12–23 weeks before there is any seroconversion to Apx toxins.<sup>77</sup> In other words nasal colonization does not always produce antibodies.

Active immunity to disease usually follows experimentally induced and naturally occurring infections, and infection with one serotype of APP confers a strong immunity to the same serotype and a partial protection against heterologous strains. Most recovered pigs have a strong humoral immunity but it does not necessarily stop them from becoming carriers and thence possible shedders of APP.<sup>79</sup> Vaccination with killed bacteria produces partial protection against the homologous strain and none against heterologous strains. Second-generation vaccines with Apx toxins produce good protection against clinical disease caused by any serotype but do not prevent animals from becoming carriers through subclinical infections.<sup>80</sup> **However, vaccine immunity is serotype specific.**

The antibody response to APP infections or vaccination is demonstrated by the complement fixation test or other serological tests. There is a good correlation between a CF titer and resistance to infection, and the organism usually cannot be isolated from seropositive animals. Susceptibility to APP can be predicted by the absence of neutralizing antibodies to the organism, whereas protection can be predicted by the presence of these antibodies.<sup>81</sup> An aerosol exposure of pigs to viable or inactivated serotype 9 induced antibodies in pulmonary fluids and serum, and protected against homologous challenge.<sup>11</sup> However, the organism may persist in necrotic foci in the lungs or tonsils of pigs considered immune to the infection. Within 2–3 weeks of an acute disease outbreak, the morbidity decreases owing to the development of immunity. Clinical disease is unlikely in adult immune animals, and immune sows confer passive immunity to their piglets which provides protection for the first weeks of life. However, acute disease may occur in piglets 3–8 weeks of age if colostral immunity is initially low and wanes to below protective levels. Also, severe cases can occur in non-immune

gilts and boars introduced into infected herds.

Pigs infected with hemolytic *Actinobacillus* spp. may become false-positive reactors for APP. Such pigs may also be less susceptible to pleuropneumonia caused by APP.

Environmental and management factors. Outbreaks of the disease appear to occur in pigs which lack immunity, are overcrowded or have been subjected to recent stressors, such as marked changes in ambient temperature or a failure in the ventilation system. Outbreaks may occur in breeding herds following transportation to and from livestock shows and sales. Presumably, the infection was contracted by commingling with clinically healthy but infected pigs. The hypothalamic-pituitary-adrenal axis is stimulated in response to a wide variety of stressors<sup>82</sup> and this may lead to activation of the organism from the tonsils. The highest risk is associated with the introduction of pigs from sales barns and the lowest risk from stock whose health status is known to the purchaser.

#### Economic importance

The economic losses associated with the disease are considered to be due to peracute deaths, the costs of treatment of individually affected pigs and mass medication of the feed and water, and chronic disease that delays the marketing of finishing pigs. Field observations indicate that 5.64 additional days are required for pigs with subclinical infection to reach market weight of 113.6 kg, compared with uninfected herd mates.<sup>83</sup> However, other observations and investigations indicate that average daily gain is not significantly affected by infection with APP. Undoubtedly, there are major economic losses associated with the endemic nature of the disease which is characterized by peracute deaths which recur sporadically, sometimes punctuated by outbreaks.

#### PATHOGENESIS

The natural route of infection is aerogenous. In growing pigs the disease appears to be a respiratory infection without septicemia, producing a fibrinous necrotizing hemorrhagic pleuropneumonia with pleuritis. Early after intranasal inoculation the bacteria were mainly associated with the stratified squamous epithelium and detached epithelial cells in the tonsil.<sup>27</sup> If only a few organisms are inhaled, probably they are trapped in the tonsil and remain there until they are activated. If large numbers are inhaled or if spread from the tonsil reservoir occurs, then a bacteremia probably results. Vacuolation and desquamation of the tonsillar epithelium was observed and there were

many migrating neutrophils. Discharge of vesicles containing proteases and Apx toxins from the organisms themselves of serotype 1 has been described.<sup>84</sup> Later the bacteria are associated with the crypt walls and detached cells in the crypts.<sup>85</sup> Experimental aerosol exposure of pigs to APP results in a severe fibrinous hemorrhagic necrotizing pleuropneumonia which simulates the natural disease. Within a few hours following endobronchial inoculation of various doses of the organism into 12-week-old pigs, clinical evidence of dyspnea and fever are obvious. An aerosol infection with the organism results in pulmonary edema with multifocal petechial hemorrhages and a diffuse neutrophilic bronchiolitis and alveolitis within hours of infection. In the lung, the recruitment of neutrophils is directed towards the viable APP organisms and possibly 30% of the lung neutrophils respond. This is further enhanced by IL-8 activity.<sup>86</sup>

The lesion is particularly marked in the dorsocaudal regions of the lung. The ability of APP hemolysin to debilitate pulmonary macrophages may enhance the multiplication of the organism but experimentally the hemolysin of serovar 2 is not an essential factor for the production of the lesions.<sup>87</sup> In the acute stages there are marked vascular changes in the lungs. The lesions resemble infarcts because of the vasculitis, thrombosis, and hemorrhage. There are many necrotic foci which serve as reservoirs of the organism in pigs which recover. In the experimental disease, the leukogram is typical of acute inflammation; however, hypoxemia and alveolar hypoventilation are not features of the disease. The hematological and physiological findings indicate that the peracute disease resembles septic shock.<sup>88</sup> Immediately after infection the levels of IL-1, IL-6, and TNF- $\alpha$  begin to rise. Moderate levels help in defense, but high levels make things worse.<sup>89</sup> At the same time the IL-10 suppresses TNF- $\alpha$  and IL-1 production in macrophages and monocytes, which up-regulates the other inflammatory cytokines. Pretreatment of the pig with IL-10 reduces the severity of the pleuropneumonia.<sup>90</sup> The prolonged survival of APP during the infections may be due to the effect the organism has in down-grading the protective responses of the host.<sup>91</sup>

#### CLINICAL FINDINGS

The clinical signs vary with the immune status and environmental stress, and customarily may be seen between 6 and 20 weeks of age. In all cases there is a reduced growth rate and reduced feed intake, and, therefore, reduced weight gain.<sup>92</sup> There is no relationship between



average daily gain and serologic response to APP.<sup>93</sup> The illness may be peracute, acute, subacute, or chronic. The onset is sudden. Several pigs that were not seen ill may be found dead and others show severe respiratory distress. Affected pigs are disinclined to move and are anorexic. A fever of up to 41°C (105.8 °F) is common and labored respirations with an exaggerated abdominal component ('thumps'), cyanosis, and frequently a blood-stained frothy discharge from the nose and mouth are characteristic. In peracute cases the clinical course may be as short as a few hours, but in the majority of pigs it is 1–2 days. Chronic cases are febrile and anorexic initially, but respiratory distress is less severe and a persistent cough may develop. If affected pigs are not treated there will be a high case-fatality rate. Otitis media in a weaned pig caused by infection of the middle ear with the organism has been described.<sup>94</sup> There may also be lesions in the joints with fluctuating swellings of the hocks<sup>95</sup> and the synovial membranes replaced by granulation tissue.

The course of the disease in a herd may last for several weeks, during which time new acute cases develop and chronic cases become obvious by an unthrifty appearance and chronic coughing.

Abortions may occur and the disease may cause sudden deaths in adult pigs, particularly those that are kept outdoors during the summer months and exposed to very warm weather.

### CLINICAL PATHOLOGY

Plasma cortisol rises 24 h post challenge.<sup>96</sup>

Haptoglobin is increased.<sup>89,97</sup> Within 48 h IL-1 $\alpha$ , IL-1 $\beta$ , and IL-8 were increased<sup>97</sup> and there was a 50% reduction in iron and zinc. Plasma IGF-1 concentrations were reduced in response to the APP challenge<sup>98</sup> as they were with endotoxin challenge.<sup>99</sup> The LPS of APP produces rises in inflammatory cytokines (TNF- $\alpha$ , IL-6, and IL-10).<sup>100</sup>

Band neutrophils are significantly increased in early infections from 18 to 48 h.<sup>97</sup>

### Culture of organism

In an outbreak, the diagnosis is preferably made by culture at necropsy. Carrier pigs can be identified by culturing the organism from the upper respiratory tract using nasal swabs from live pigs on the farm, and samples from tonsils at slaughter.<sup>101</sup> A selective medium for the culture of the organism from the airways of slaughtered pigs may increase the isolation rate because of the high degree of contamination.<sup>1</sup> The culture of APP has recently been complicated by the identification of the non-pathogenic *A. porcitonisillarum*.<sup>102, 103</sup>

### Serotype of organism

Tests to determine the serotype include slide agglutination, immunodiffusion, ring precipitation, indirect hemagglutination, immunofluorescence, coagglutination, and counter-immunoelectrophoresis. The latter is quicker, more sensitive, and more easily performed than direct immunofluorescence and immunodiffusion procedures. The coagglutination test is simple and rapid, the immunodiffusion test is considered to be the most serotype-specific, and there is a good correlation between the rapid slide agglutination test and the indirect fluorescent antibody tests. The rapid slide agglutination test is the method of choice of some workers but the coagglutination test is serotype-specific, sensitive, simple, rapid, reproducible, and easier to read and interpret than the rapid slide or tube agglutination tests. The International Pig Veterinary Society has recommended that the coagglutination test is currently the method of choice for routine serotyping of field strains. This technique does not allow separation of the heterogeneous serovar 8 from serovars 3 and 6, the heterogeneous serovar 9 from serovar 1, or the heterogeneous serovar 7 from 4. The results are reported as group 9–1, group 8–3–6, and group 7–4 respectively. The final identification of heterogeneous serovars can only be achieved by the agar gel diffusion test and by indirect hemagglutination. Reference strains and the corresponding antisera are available in order to bring some uniformity into serotyping.

### Detection of antigen

The polymerase chain reaction (PCR) is a highly sensitive test for the detection of the organism from tissue samples.<sup>104–107</sup> A PCR for type 4 has been developed.<sup>108</sup> Some detect OMP<sup>105</sup> others Apx genes.<sup>109,110</sup> Immunomagnetic separation of APP1 and 2 has been described with greater sensitivity than possible with isolation or even PCR.<sup>111,112</sup> A PCR-based RFLP analysis of the OM1A gene may also be of value in differentiating APP serotypes.<sup>113</sup> A multiplex PCR has been developed.<sup>114,115</sup>

### Serology

For the serological diagnosis of infection in live animals the complement fixation test is reliable but an enzyme-linked immunosorbent assay (ELISA) test is highly specific and more sensitive than the complement fixation test.

The **complement fixation test** has been used routinely in some countries and has a high degree of sensitivity and specificity. It is, however, a cumbersome test and many laboratories find it difficult to perform.

The **ELISA** is a rapid and sensitive test and can be adapted to automation. The

ELISA for serotypes 1, 2, 5, and 7 distinguishes exposed from unexposed pigs or herds.<sup>116</sup> Due to cross-reactivity with other serotypes and *Actinobacillus suis*, the serodiagnosis of serotype infections cannot be made with certainty.<sup>117</sup> A blocking ELISA is available for detection of antibodies against serotype 2<sup>118</sup> and also 2, 6, 8, and 12,<sup>119,120</sup> which is the dominating serotype in Danish swine herds, causing approximately 70% of diagnosed outbreaks of pleuropneumonia. A similar test is available for serotype 8.<sup>121</sup> A mixed-antigen ELISA for serodiagnosis of serotypes 1, 5, and 7 has a sensitivity of 96% and specificity of 99.5% and can be used for herd health monitoring programs.<sup>122</sup> The long-chain lipopolysaccharide of serotypes 4, 5, and 7 is a superior antigen to the crude extracts used as antigens in the ELISA for the serodiagnosis of pleuropneumonia.<sup>123</sup>

There are now ELISAs for the detection of antibodies to the Apx toxins<sup>124</sup> and the one for type II Apx was described as sensitive, inexpensive, and highly discriminatory.<sup>125</sup> A multiplex PCR for all toxins in one test is a reliable typing system.<sup>126,127</sup>

A new ELISA for the Apx IV produced by all 15 serotypes<sup>128</sup> means that you can detect all APP with one test. It has a specificity of 100% and a higher sensitivity than culture (93.8%). This is important because you can find Apx I–III in pigs associated with *A. suis* and *A. rossii* but Apx IV is only produced by APP in vivo. It will detect the toxin from 2 to 3 weeks post infection.

An inhibition enzyme immunoassay for the serodiagnosis of serotypes 2 and 5 had a sensitivity and specificity of 100% and 98.9%, respectively.<sup>129</sup>

The detection of antibodies to APP is an essential feature in the epidemiological study and control of pleuropneumonia in pigs. Serological testing can be used to monitor the level of infection in a breeding herd over a period of time and as the piglets become older. A minimum of 30 serum samples from adult pigs is necessary to provide a reliable assessment of the herd's infection status. None of these serological tests is completely reliable and in certain situations a combination of two tests is needed for interpretation of low titers in some pigs. In most instances serological diagnosis is type-specific and protection obtained by vaccination is type-specific and will protect only against the serotype contained in the vaccine. Thus, it is important to determine the serotype(s) which are causing disease in the herd.

An important strategy of control of this disease is to detect infected pigs in a herd or to exclude infected pigs from being

imported into a herd. Because there is no reliable method for the detection of every infected pig, the effectiveness of this barrier is reduced whenever pigs, such as breeding stock or weanlings, are allowed into a herd. There is a need for a highly sensitive and specific test for the identification of infected pigs. While bacteriological culture is specific it is not sensitive. The ELISA test may be a useful test for the antemortem diagnosis of infected herds.

### NECROPSY FINDINGS

Characteristic lesions are confined to the thoracic cavity and consist of hemorrhagic and fibrinous pleuropneumonia with a tendency to sequestration in the chronic form. In peracute cases the lungs are swollen, firm, and dark red. Fluid and blood ooze from the cut surface and there may be marked edema of the interlobular septa, reflecting widespread thrombosis and alterations in capillary permeability.<sup>118</sup> In pigs which die less acutely, focal black or red raised areas of pneumonia are present. Lesions may occur throughout the lung, including the diaphragmatic lobes. The quantitative morphology of peracute pulmonary lesions induced by the organism has been described.<sup>118</sup> A fibrinous pleuritis overlies the affected lung tissue and a fibrinous pericarditis may also be present. The organism can be isolated from affected lung tissue, but generally not from other internal organs. Occasionally, otitis, endocarditis, pericarditis, and serous arthritis may follow, particularly when infection involves serotype 3.<sup>130</sup> An osteomyelitis and arthritis caused by APP has been demonstrated using fluorescent in-situ hybridization.<sup>131</sup>

Histologically, vasculitis and widespread thrombosis is usually evident, in addition to an abundance of fibrin and neutrophils within alveoli. A fibrinous thrombosis with IHC demonstration of APP has been described.<sup>132</sup> In situ hybridization can be used to detect IL-1, IL-6, and TNF- $\alpha$  in streaming degenerate alveolar leucocytes (oat cells) and the boundary zone of oxidative necrosis. A less intense signal was seen in the dense zone of degenerate cells in granulation tissue surrounding the necrotic areas. IL-1 was also seen in the scattered endothelial cells bordering zones of coagulative necrosis.<sup>67</sup> IL-6 is the cytokine that is most elevated and serum amyloid and haptoglobin are also elevated.<sup>133</sup>

In a chronically infected herd, fibrous pleural adhesions may be present in a large proportion of the pigs at market as a result of infection several months earlier. Subacute to chronic lung lesions are encapsulated by fibrous tissue, and sequestra may be present.

Samples for confirmation of diagnosis

- Bacteriology – lung (CULT). They can also be isolated from pure and mixed bacterial cultures by immunomagnetic separation.<sup>134</sup>
- Histology – formalin-fixed lung (LM). App can be further identified by IHC<sup>135</sup> and ISH.<sup>127,131</sup>

### DIFFERENTIAL DIAGNOSIS

The rapidity of onset and spread with fever, anorexia, severe dyspnea, and high mortality differentiates APP from the majority of respiratory diseases in pigs.

**Enzootic pneumonia** is more insidious in its occurrence and has distinctively different epidemiological, clinical, and pathological features.

**Pasteurellosis** is characterized by a necrotizing bronchopneumonia.

**Swine influenza** is characterized by an explosive outbreak of respiratory disease. However, this is not restricted to growing pigs and the mortality is low. There is a distinct difference in the respiratory lesion on necropsy examination.

**Glasser's disease** is characterized by serositis, arthritis, and meningitis, and occurs in younger pigs.

**Mulberry heart disease** may present with similar clinical findings but there is no pneumonia on necropsy examination.

### TREATMENT

#### Antimicrobial therapy

The results of treatment are often disappointing because of the severity of acute disease and persistence of infection in recovered pigs. Although antimicrobials may reduce mortality and improve average daily gain, treated animals often continue to harbor the organism and are a source of infection to other animals. Affected and in-contact pigs should be treated parenterally with antimicrobials. Tetracycline, spectinomycin, and penicillin have been effective and are recommended unless drug resistance has occurred. Fluoroquinolones are distributed to bronchial secretions, bronchial mucosa, and alveolar macrophages. The pharmacokinetics of danofloxacin are favorable for APP treatment.<sup>136</sup> In fact, elevated C-reactive protein, IL-6, and haptoglobin (all elevated rapidly after infection) all return to normal, as do the reduced plasma zinc, ascorbic acid, and alpha tocopherol rapidly after treatment.<sup>137</sup> Ceftiofur and fluoroquinolones were the most active agents against APP.<sup>138</sup> APP is only eliminated from the respiratory tract in animals medicated with enrofloxacin.<sup>139</sup> Tilmicosin is useful for treating outbreaks.<sup>140</sup>

In finishing units where outbreaks of the disease have been confirmed, the twice-daily intramuscular injection of pigs early in the course of the disease with

antimicrobials, based on drug sensitivity tests, daily until clinical recovery occurred, was superior to the mass medication of feed and water. A considerable amount of labor is required but it is considered to be the most cost-effective method.

#### Antimicrobial sensitivities

The antimicrobial sensitivities of isolates of APP have been monitored and there is some variation based on geographical location. The large expansion in the size of swine herds, and the introduction of breeding stock from many different sources, has led to an increase in the incidence of porcine pleuropneumonia and extensive use of parenteral antimicrobials. To insure an optimal response to therapy it is necessary to monitor antimicrobial sensitivity on a herd basis.

The antimicrobial sensitivity of the organism was determined in isolates from Europe, Japan, South Africa, and North America between 1989 and 1991.<sup>141</sup> They were highly susceptible to danofloxacin, moderately susceptible to amoxicillin, ceftiofur, and trimethoprim-sulfamethoxazole. There was widespread resistance to other currently available antimicrobials. In another study, thiamphenicol and metronidazole had good activity, and the cephalosporins and fluoroquinolones were most active.<sup>117,142</sup> A comparison of the minimum inhibitory concentrations (MICs) of several antimicrobials against several bacterial pathogens of swine, including APP, from the USA, Canada, and Denmark found that ceftiofur and enrofloxacin were the most active antimicrobials.<sup>143</sup>

Plasmid-mediated antimicrobial resistance has been found in isolates of the organism which are resistant to certain antimicrobials.<sup>144</sup>

#### Antimicrobials in experimental disease

The therapeutic efficiency of some commonly used antimicrobials has been evaluated for the treatment of experimentally induced pleuropneumonia using serotype 1 APP. Florfenicol in the feed at 50 ppm prevented pneumonia when pigs were experimentally inoculated with serotype 1, 2, 5 strains and thiamphenicol-resistant strains of the organism.<sup>145</sup> The combination of trimethoprim and sulfamethoxazole is superior to a combination of trimethoprim and sulfadimethoxine.<sup>146</sup> Oxytetracycline in the water at 222 mg/L for 7 days beginning 24 h before experimental challenge reduced the case-fatality rate, lung lesions and the isolation of the organism compared to the unmedicated group. Treatment of chronically affected pigs did not improve rate or gain, nor did it eliminate the infection. Enrofloxacin at 150 ppm in the feed provided effective control of the experimental disease.<sup>147</sup>

### Mass medication of feed

In-feed medication with sulfadimethoxine and trimethoprim in combination with sulfamethoxazole in combination with trimethoprim has been described.<sup>148</sup>

Oxytetracycline in the feed at 1600 mg/kg of feed for 6 days before experimental challenge, and for 9 days after challenge, provided 100% protection from clinical disease, but 400, 800, or 1200 mg/kg of feed did not prevent subsequent shedding and transmission to seronegative animals.<sup>149</sup> Tetracycline should be administered through the feed of all in-contact pigs during the outbreak, but the persistence of the organism in chronically affected pigs may result in clinical disease when the medication is withdrawn.

Doxycycline in feed at 250 ppm for 8 consecutive days is useful for the control of APP.<sup>150</sup>

Tilmicosin fed to pigs at 200–400 µg/g is effective in controlling and preventing APP-induced pneumonia, using seeder pigs, when administered in the feed for 21 days.<sup>151,152</sup> In commercial herds, 400 µg/g of feed for 21 days is no more effective than 200 µg/g of feed for the control of naturally acquired pneumonia caused by APP and *P. multocida*.<sup>153</sup> Sulfathiazole at the rate of 28 g/3.8 L of drinking water for 12 days has also been successful. Tiamulin in the drinking water at a concentration to deliver 23 mg/kg BW for 5 days after an initial individual treatment of affected pigs has also been recommended.

### CONTROL

It is impossible to guarantee freedom because the detection of carriers is almost totally impossible.<sup>154</sup> There are no techniques as yet for identifying the animal that may have only a few organisms in the tonsil. You can guarantee freedom from clinical disease at the time of inspection but little else. In a recent study of 980 pigs there was no evidence of an APP clinical or pathological case until the occurrence of PMWS resulted in the isolation of an APP7 from the series of pigs in a unit which had until that time been considered free.<sup>155</sup>

There are two options for the control and prevention of porcine pleuropneumonia:

1. Control at an economical level using good management combined with the possible use of vaccines
2. Eradication of the infection from the herd.

Determining which option to select requires careful consideration of the advantages and disadvantages of each option. With an understanding of the factors that result in clinical disease, it is possible to maintain an infected breeding herd and produce pigs with a small risk of clinical disease.

### Control by management

Management and housing improvements can prevent clinical episodes. One of the most important things to do is to make sure that there is vaccination for enzootic pneumonia.

Control is difficult and unreliable, because pigs that recover from clinical disease provide a source of future infection for finishing operations which purchase all of their introductions. The all-in/all-out system of purchasing, feeding, and marketing pigs, with a thorough cleaning between groups of animals in a finishing operation should be adopted. The disease is highly contagious and control measures must be directed towards identifying infected pigs and eliminating their introduction into uninfected herds. When moving pigs between herds, it is critically important that the herds be matched according to their infection status. Source herds for feeder animals are serotested, and then pigs of like immune status are commingled to produce a population that is compatible immunologically. By commingling only animals from seronegative herds, the risk of disease is greatly decreased and growth performance improved. The mixing of animals from herds known to be infected with homologous serotypes is also effective.

Every economical effort must be made to identify and isolate infected pigs and to exclude the importation of clinically normal, but infected pigs into herds in which the infection is not present. This is a major challenge which is dependent on the availability of a highly sensitive and specific laboratory test. The acquisition of new breeding stock for herds free of the infection should include a period of quarantine and two serological tests 3 weeks apart. Only seronegative animals should be introduced into the herds. A seropositive animal should be considered a potential carrier. Field trials have shown that it is not possible to rear seronegative animals within a breeding and rearing herd heavily infected with serotype 2 of the organism.<sup>156</sup> Neither medication of the sows and piglets with trimethoprim-sulfonamides, nor a strictly applied all-in/all-out system reduced the percentage of seropositive animals.<sup>156</sup>

Management practices must emphasize the rearing of weaned pigs in pens separate from older stock which are carriers of the organism. Large breeding herds and finishing units should subdivide the total herd into separate units, which minimizes the spread of infection. Early weaning and segregation of gilts from infected stock have been used to develop a seronegative herd.

Herds can be classified into one of three categories depending on their infection status:

**CATEGORY 1.** Serologically positive for APP without a history of clinical disease. A majority of herds are serologically positive but do not have clinically apparent disease. Good management and environmental quality control can minimize the incidence of clinical disease. Good ventilation, the use of all-in/all-out management practices, and appropriate stocking densities are important.

**CATEGORY 2.** Serologically negative and clinically free of APP. These herds can be maintained free of infection with good biosecurity practices. New breeding stock must be obtained from herds free of infection. Artificial insemination can be used to limit the introduction of live pigs. Pigs sold from these herds to herds with endemic infection are highly susceptible to infection.

**CATEGORY 3.** History of clinical disease caused by APP, which has been pathologically and microbiologically confirmed. In these herds, acute disease outbreaks occur most commonly in pigs 9–20 weeks of age. Pigs are usually protected by colostral immunity for the first 8 weeks of life. The severity of outbreaks can be reduced by mass medication of the feed, treatment of individual pigs, and good management practices to insure adequate ventilation.

### Eradication

The Danish SPF system was the first to try to eradicate APP.<sup>157</sup> Each month 20 serum samples were tested for APP 2 and 6 and were collected at the monthly clinical inspection. This happened every 3 months also for APP12 and annually for APP 1, 5, 7, and 10. Recurring outbreaks of pleuropneumonia is the most common reason for an eradication strategy. Eradication is done by depopulating the entire herd, followed by repopulation with animals from herds that are clinically and serologically negative. Eradication can be successful but the risk of introducing infections into the herd is high unless biosecurity measures are adopted and strictly implemented.

An alternative to depopulation is medicated early weaning, in which pigs are weaned at 10–15 days of age, treated with antimicrobials, and reared in isolation.<sup>1</sup> Transmission of infection between the sow and piglets does not occur before 11 days of age, about half of the piglets are infected at 16 days of age, and if

weaned at 21 days of age most of the piglets are infected.

The early weaning program can be expanded to the three-site system of rearing. Adults and nursing piglets are housed in one site. At weaning, piglets are moved to the nursery barn for growth to 25 kg, and then moved to a third site for the final growing period. The adults may be serologically positive for infection, but the nursery pigs, growing pigs, and finishing pigs are negative.

Age segregation, distance which prevents aerosol transmission, and adherence to strict biosecurity practices can reduce the prevalence of infection and the incidence of disease.

### Vaccination

Natural or experimental infection with a serotype of APP induces a strong immunity to both homologous and heterologous serotypes. Vaccination has been attempted to prevent pleuropneumonia in pigs. However, the protection obtained by parenteral vaccination is serotype-specific and vaccines must, therefore, contain the serotype existing in the swine population. The mortality rate is lower in vaccinated animals, but they are still carriers of the organism.

Serotype 8 is closely related to serotypes 3 and 6, and parenteral revaccination using a capsular extract or killed APP serotype 8 provides a high degree of protection against challenge with serotypes 3 or 6. A tetravalent vaccine containing serotypes 1, 2, 5, and 7 stimulated titers to all four serotypes and an anamnestic response was induced by a second vaccination. This suggests that the serological and cross-protective properties of APP serotypes should be identified before they are used as antigen in the complement fixation test and in vaccines.

The protein associated with the capsule of APP is responsible for serotype-specific protection against mortality in mice. Further purification and characterization of this protein antigen is needed to determine if it is the specific antigen responsible for protection against mortality in swine or if it is a necessary carrier for a serotype-specific capsular disaccharide antigen.

The vaccines that have been evaluated are killed vaccines with an adjuvant. In one experimental trial, two and three vaccinations using a bacterin containing serotypes 1 and 5 prevented mortality following an aerosol challenge with the same serotypes as present in the vaccine. However, all vaccinated pigs had severe signs of respiratory disease and the vaccine did not prevent the development of lung lesions. The use of a formalin-inactivated alum-precipitated vaccine

containing serotype 1 was effective in decreasing the morbidity and mortality rates from naturally occurring pleuropneumonia. The adjuvanted vaccines have caused considerable tissue reaction, resulting in abscesses and granulomas.<sup>158</sup> The mineral oil adjuvants are highly irritant and cause granulomas, which are present 8 weeks after vaccination but result in high titers. The aluminum hydroxide adjuvants are less irritant, but result in lower titers.<sup>158</sup> Vaccines containing a lecithin-base oil at 5% are non-irritating and stimulate high complement fixation titers.

Subunit vaccines containing purified or partially purified antigens provide better protection than whole cell vaccines. Capsular antigens, outer membrane proteins, lipopolysaccharide, and soluble toxic factors are immunogenic in pigs. An acellular vaccine containing multiple virulence factors provided complete protection from mortality and significantly reduced morbidity to homologous challenge.<sup>159</sup> Pigs vaccinated with the cell extract had fewer clinical signs of pleuropneumonia than pigs vaccinated with three other commercial vaccines and challenged with serotype 1.<sup>160</sup> A vaccine containing the LiCi cell extracts and a crude hemolysin isolated from serotype 1 provided protection against both mortality and morbidity in vaccinated pigs challenged by intratracheal inoculation.<sup>161</sup> An experimental vaccine using bacterial 'ghosts' which are empty cells produced by bacteriophage lysis appears to be successful.<sup>162</sup> A better cellular response was observed to inactivated bacteria than to ghost vaccines.<sup>163</sup> Bacteria grown in conditions resulting in high in vitro adhesin levels induced better protection than those grown in NAD rich medium.<sup>164</sup> An APP type 2 vaccine has been described with deletions in the Apx IIA gene which can then function as a negative marker vaccine, which appears to be capable of protecting pigs without shedding.<sup>165</sup>

Antigenic variation within a capsular serotype, for example in subtypes 1A and 1B, due to antigenic variation within the lipopolysaccharide, can result in the failure of whole cell bacterins to provide protection against the same capsular serotype.<sup>166</sup> This lack of cross-protection within a capsular serotype provides a partial explanation for vaccination failures observed under field conditions.

A polyvalent bacterin containing serotypes 1, 3, 5, and 9 provided satisfactory protection against homologous challenge 14 days after the second vaccination.<sup>167</sup> Mortality was reduced, and lung lesions, pleural adhesions, and isolations of the organism from the tonsils and lungs were reduced.

### REVIEW LITERATURE

- Dubreuil JD, Jaques M, Mittal KR, Gottschalk M. APP surface polysaccharides; their role in diagnosis and immunogenicity. *Animal Health Research Reviews* 2000; 1:73-93.
- Bosse JT, Janson II, Sheehan BJ, Beddek AJ, Rycroft AN, Kroll JS, Langford PR. *Actinobacillus pleuropneumoniae*; pathology and pathogenesis of infection. *Microbes and Infection* 2002; 4:225-235.
- Jaques M. Surface polysaccharides and iron-uptake system of *Actinobacillus pleuropneumoniae*. *Canadian Journal of Veterinary Research* 2004; 68:81-85.
- Horter D, Yoon K-J, Zimmermann JJ. A Review of Porcine Tonsils in Immunity and Disease. *Animal Health Research Reviews* 2003; 4:143-155.

### REFERENCES

- Fenwick B, Henry SJ. *Am Vet Med Ass* 1994; 204:1334.
- Gottschalk M et al. *J Vet Diag Invest* 2000; 12:444.
- Rycroft AN, Garside LH. *Vet J* 2000; 159:18.
- Chatellier S et al. *Canad J Vet Res* 1999; 63:170.
- Maes D et al. *Vet Rec* 2002; 151:208.
- Chiers K et al. *Vet Med* 2001; 83:147.
- Torremorell M et al. *Am J Vet Res* 1997; 58:828.
- Jobert J et al. *Canad J Vet Res* 2000; 64:21.
- Kristensen CS et al. *Vet Microbiol* 2004; 98:243.
- Wongnarkpet S et al. *Prev Vet Med* 1999; 39:1.
- Hensel A et al. *Vet Microbiol* 1995; 47:27.
- Lechtenberg KF et al. *Am J Vet Res* 1994; 55:1703.
- Desrosiers R et al. *J Swine Hlth Prod* 1998; 6:263.
- Nielsen R et al. *Vet Microbiol* 1997; 71:81.
- Blackall PJ et al. *Vet Microbiol* 2002; 84:47.
- Gottschalk M et al. *J Microbiol* 1999; 37:2877.
- Jolie RAV et al. *Vet Microbiol* 1994; 38:329.
- Blackall PJ et al. *Aust Vet J* 1999; 77:39.
- Stephens CP et al. *Aust Vet J* 1990; 67:462.
- Sorensen V et al. *Pig J* 2002; 47:74.
- Frank RK et al. *J Vet Diagn Invest* 1992; 4:270.
- Andreasen LE et al. *Vet Med* 2002; 89:61.
- McDowell SWJ, Ball HJ. *Vet Rec* 1994; 134:522.
- Mittal KR et al. *Res Vet Sci* 1993; 55:179.
- Nielsen R et al. *Acta Vet Scand* 1996; 37:327.
- MacInnes JJ et al. *Can J Vet Res* 1990; 54:244.
- Chiers K et al. *Vet Microbiol* 1999; 68:30.
- Van Overbeke I et al. *Proc 16th Int Pig Vet Soc Cong* 2000; p 504.
- Sheehan BJ et al. *Infect Immun*, 2003; 71, 3690.
- Shea RJ, Mulks MH. *Infect Immun* 2002; 70:794.
- Baltes N et al. *Infect Immun* 2003; 71:6784.
- Gonzalez OG et al. *FEMS Microbiol Lett* 2004; 234:81.
- Bertram TA. *Can J Vet Res* 1990; 54:S53.
- Haesebrouck F et al. *Vet Microbiol* 1997; 58:239.
- Ward CK et al. *Infect Immun* 1998; 66:3326.
- Bouke KHL et al. *Vet Microbiol* 2003; 93:138.
- Gottschalk M et al. *Vet Microbiol* 2003; 92:87.
- Jaques M, Paradis S-E. *FEMS Microbiol Rev* 1998; 22:45.
- Rioux S et al. *Canad J Microbiol* 1999; 45:1017.
- Dubreuil JD et al. *Anim Hlth Res* 2000; 1:73.
- Baarsch M et al. *Am J Vet Res* 2000; 61:684.
- Baarsch M et al. *Infect Immun* 2000; 68:4752.
- Paradis S-E et al. *Current Microbiol* 1998; 39:313.
- Archambault M et al. *Canad J Vet Res* 2003; 67:271.
- Archambault M et al. *J Endotoxin Res* 1999; 4:53.
- Baltes N et al. *FEMS Lett* 2002; 209:283.
- Gerlach G-F et al. *Infect Immun* 1992; 60:982.
- Gonzalez GC et al. *Microbiol* 1995; 41:2405.
- Wilke M et al. *J Vet Med B* 1997; 44:73.
- Jaques M et al. *Canad J Vet Res* 2004; 68:81.
- BogYS et al. *Vet Microbiol* 2001; 81:51.

52. Zhang Y et al. *FEMS Microbiol Lett* 2000; 189:15.
53. Stevenson A et al. *Vet Microbiol* 2003; 92:121.
54. Garibay J et al. *Ind J Comp Microbiol. Immunol Infect Dis* 2000; 21:122.
55. Frey J, Nicolet JJ *Clin Microbiol* 1990; 28:232.
56. Schaller A et al. *Microbiol* 1999; 145:2105.
57. Schaller A et al. *Vet Microbiol* 2000; 74:365.
58. Schaller A et al. *Vet Microbiol* 2000; 79:47.
59. Cho C, Chae C *J Vet Diag Invest* 2001; 13:175.
60. Costa MM et al. *Current Microbiol* 2004; 31:1155.
61. Frey J, Kuhnert P. *Int J Med Microbiol* 2002; 292:149.
62. Jansen R et al. *Infect Immun* 1995; 63:27.
63. Boukema BKL et al. *Vet Microbiol* 2004; 100:17.
64. Jarma E, Regassa LB. *Microbial Pathogen* 2004; 36:197.
65. Jarma E et al. *Microbial Pathogen* 2004; 37:29.
66. Cho C, Chae CJ. *Comp Path* 2002; 126:109.
67. Choi C et al. *J Comp Path* 1999; 121:349.
68. Cho C, Chae C. *Vet Path* 2002; 39:27.
69. Cho W-S, Chae C. *Vet Path* 2003; 40:276.
70. Cho W-S, Chae C. *Vet Path* 2004; 41:666.
71. Bosse JT, MacInnes JI. *Canad J Vet Res* 2000; 64:145.
72. Rycroft AN, Cullen JM. *Am J Vet Res* 1990; 51:1449.
73. Rogers RJ et al. *Aust Vet J* 1990; 67:9.
74. Chung WB. et al. *Can J Vet Res* 1994; 58:25.
75. Vigre H et al. *Vet Microbiol* 2002; 89:151.
76. Vigre H et al. *J Vet Med B* 2003; 50:430.
77. Chiers K et al. *Vet Microbiol* 2002; 85:343.
78. Clark LK et al. *Swine Hlth Prod* 1998; 6:257.
79. Crujnsen TLM et al. *Infect Immun* 1999; 63:2341.
80. Van Overbeke IK et al. *J Vet Med B* 2001; 48:15.
81. Crujnsen T et al. *Vet Microbiol* 1995; 47:219.
82. Besedovsky HO, Del Rey A. *Zeitschrift Rheumatologie* 2000; 59:26.
83. Rohrbach BW et al. *J Am Vet Med Assoc* 1993; 202:1095.
84. Negrote-Abascal E et al. *FEMS Microbiol Lett* 2000; 191:109.
85. Chiers K et al. *Vet Microbiol* 1999; 68:301.
86. Wang F-I et al. *Exp Anim* 2001; 50:139.
87. Rycroft AN et al. *Vet Rec* 1991; 29:441.
88. Kiorpes AL et al. *Can Vet J* 1990; 54:164.
89. Huang H-S et al. *Canad J Vet Res* 1999; 63:69.
90. Morrison DF et al. *Infect Immun* 2000; 30:4752.
91. Hennig I et al. *Microbial Pathog* 1999; 26:53.
92. Wallgren P et al. *J Vet Med B* 1999; 46:249.
93. Andreasen M et al. *Prev Vet Med* 2001; 49:19.
94. Duff J. et al. *Vet Rec* 1996; 139:561.
95. Jensen TK et al. *Vet Pathol* 1999; 36:258.
96. Balaji R et al. *J Anim Sci* 2002; 80:202.
97. Baarsch et al. *Am J Vet Res* 2000; 61:684.
98. Kerr CA et al. *Aust J Agric Res* 2003; 54:1057.
99. Spurlock ME et al. *J Interf Cytok Res* 1998; 18:1051.
100. Myers MJ et al. *Domest Anim Endocrinol* 1999; 17:345.
101. Sidibe M et al. *Can J Vet Res* 1993; 57.
102. Schaller A et al. *Vet Microbiol* 2000; 74:365.
103. Gottschalk M et al. *Vet Med* 2003; 92:87.
104. Gram T et al. *Vet Microbiol* 1996; 51:95.
105. Savoye CH. et al. *Vet Microbiol* 2000; 73:337.
106. Chiers K et al. *J Vet Med B* 2001; 48:127.
107. Schaller A et al. *Vet Microbiol* 2001; 79:47.
108. Hussy D et al. *Vet Microbiol* 2004; 99:307.
109. Gram T et al. *Vet Microbiol* 2000; 75:43.
110. Gram T, Ahrens PJ. *Clin Microbiol* 1998; 36:443.
111. Gagne A et al. *J Clin Microbiol* 1998; 36:251.
112. Angen O et al. *Vet Microbiol* 2001; 79:19.
113. Cho W-S, Chae CJ. *Vet Med B* 2003; 50:90.
114. Rigout S, Chevalier BJ. *Rech Porc France* 1999; 31:365.
115. Chiers K et al. *Vet Microbiol* 2001; 83:147.
116. Klausen J et al. *Vet Microbiol* 2002; 88:223.
117. Gutierrez CB et al. *Am J Vet Res* 1993; 54:546.
118. Nielsen R. *Vet Microbiol* 1995; 43:277.
119. Andreasen LO et al. *Vet Microbiol* 2002; 89:61.
120. Klausen J et al. *Vet Microbiol* 2001; 79:11.
121. Nielsen R et al. *Vet Microbiol* 1993; 34:131.
122. Bosse JT et al. *J Vet Diagn Invest* 1993; 5:359.
123. Gottschalk M et al. *Can J Vet Res* 1997; 61:62.
124. Nielsen R et al. *Vet Microbiol* 2000; 71:81.
125. Leiner G et al. *Clin Diag Immunol* 1999; 6:630.
126. Fussing V et al. *Syst Appld Microbiol* 1998; 21:408.
127. Fussing V et al. *Vet Microbiol* 1998; 62:145.
128. Dreyfus A et al. *Vet Microbiol* 2004; 99:227.
129. Stenbaek EI et al. *Can J Vet. Res* 1997; 61:1.
130. Duff JP et al. *Vet Rec* 1996; 139:561.
131. Jensen TK et al. *Vet Path* 1999; 36:258.
132. Narita M et al. *J Comp Path* 1997; 117:25.
133. Hulten C et al. *Vet Microbiol* 2003; 95:75.
134. Angen O et al. *Vet Microbiol* 2001; 79:19.
135. Takashima H et al. *J Vet Med Sci* 1999; 61:713.
136. Lauritzen B et al. *Res Vet Sci* 2003; 74:271.
137. Lauritzen B et al. *Res Vet Sci* 2003; 74:261.
138. Yoshimura H et al. *Vet Res Commun* 2002; 26:11.
139. Herradora LM, Martinez-Gamba RJ. *Vet Med A* 2003; 50:259.
140. Hoflack G et al. *J Vet Med B* 2001; 48:655.
141. Raemdonck DL et al. *Vet Rec* 1994; 134:5.
142. Gutierrez CB et al. *Vet Rec* 1995; 137:62.
143. Salmon SA et al. *J Clin Microbiol* 1995; 33:2435.
144. Ischii H et al. *Am J Vet Res* 1991; 52:1991.
145. Ueda Y et al. *J Vet Med Sci* 1995; 57:261.
146. Mengelers MJB et al. *J Vet Pharmacol Ther.* 1995; 18:243.
147. Smith IM et al. *Vet Rec* 1991; 129:25.
148. Mengelers M et al. *Vet Quart* 2000; 22:157.
149. Hunneman WA et al. *Vet Rec* 1994; 134:215.
150. Luque I et al. *J Vet Med B* 2000; 47:445.
151. Moore GM et al. *Am J Vet Res* 1996; 57:220.
152. Paradis M-A et al. *Canad J Vet Res* 2004; 68:7.
153. Moore GM et al. *Am J Vet Res* 1996; 57:224.
154. Chiers K et al. *Vet Microbiol* 2002; 88:385.
155. Done SH et al. *Vet Rec* 2005; 157:71.
156. Hunneman WA, Quing L. *Vet Q* 1991; 13:172.
157. Sorensen V et al. *Pig Journal* 2001; 47:74.
158. Straw BE et al. *J Am Vet Med Assoc* 1990; 196:600.
159. Fedorka-Cray PJ et al. *Vet Microbiol* 1993; 37:85.
160. Stine DL et al. *Am J Vet Res* 1994; 55:1238.
161. Beaudet R et al. *Vet Microbiol* 1994; 39:71.
162. Hensel A et al. *Vaccine* 2000; 18:2945.
163. Katinger A et al. *J Bacteriol* 1999; 73:251.
164. Overbeke van I et al. *J Vet Med* 2003; 50:289.
165. Tonpitak W et al. *Infect Immun* 2002; 68:81.
166. Jolie RAV et al. *Vet Microbiol* 1995; 45:383.
167. Tarasiuk K et al. *Can Vet J* 1994; 35:233.

## Diseases associated with bacteria – V

**DISEASES ASSOCIATED WITH  
*FUSOBACTERIUM* AND  
*BACTEROIDES* SPP. 1061**

Necrobacillosis of the liver (liver abscess) 1062  
 Bovine interdigital necrobacillosis (foul in the foot, foot rot, interdigital phlegmon) 1064  
 Bovine digital dermatitis, papillomatosis, digital dermatitis of cattle (Mortellaro's disease) (foot warts, hairy foot warts, 'heel warts') 1066  
 Infectious foot rot in sheep 1070  
 Foot abscess in sheep 1077  
 Foot rot in pigs (Bush foot) 1078  
 Oral and laryngeal necrobacillosis 1079  
 Necrotic rhinitis (Bullnose; paranasal abscessation) 1080

**DISEASES ASSOCIATED WITH  
*PSEUDOMONAS* AND  
*BURKHOLDERIA* SPP. 1081**

Fleece rot in sheep 1081  
 Melioidosis 1082  
 Glanders 1083

**DISEASES ASSOCIATED WITH  
*CAMPYLOBACTER* AND  
*LAWSONIA* SPP. 1085**

Ileitis (regional ileitis, porcine proliferative enteritis complex, porcine intestinal adenomatosis, porcine proliferative enteropathy, necrotic enteritis, regional enteritis, proliferative hemorrhagic enteropathy of pigs) 1087  
 Proliferative enteropathy in horses 1093

**DISEASES ASSOCIATED WITH  
*LEPTOSPIRA* SPP. 1094**

Leptospirosis 1094  
 Borreliosis (Lyme Barreliosis, Lyme disease) 1110  
 Swine dysentery 1113  
 Porcine intestinal spirochetosis (spirochetal colitis; porcine colonic spirochetosis) and non-specific colitis 1120  
 Ulcerative granuloma (necrotic ulcer; spirochetal granuloma; ulcerative spirochetosis; ulcerative dermatitis; granulomatous dermatitis) of pigs 1123

**DISEASES ASSOCIATED WITH  
*MYCOPLASMA* SPP. 1123**

Diseases of the genital tract 1125  
 Mycoplasma mastitis in dairy herds 1125

Diseases of the respiratory tract 1126  
 Diseases of the eyes 1126  
 Diseases of the blood 1126  
 Diseases of the joints 1126  
 Diseases in horses 1127  
 Diseases in sheep and goats 1127  
 Mycoplasma bovis pneumonia, polyarthritis, mastitis, and related diseases of cattle 1127  
 Contagious bovine pleuropneumonia 1131  
 Contagious agalactia in goats and sheep 1138  
 Contagious caprine pleuropneumonia 1140  
 Mycoplasma arthritis in cattle 1141  
 Ovine and caprine contagious ophthalmia (ovine and caprine infectious keratoconjunctivitis, contagious conjunctivokeratitis, pinkeye in sheep and goats) 1142  
 Mycoplasma pneumoniae of pigs (formerly enzootic pneumonia, now also a component of the porcine respiratory disease complex) 1144  
 Mycoplasma polyserositis in pigs 1152  
 Eperythrozoonosis 1154

**Diseases associated with  
*Fusobacterium* and  
*Bacteroides* spp.**

Infection with *Fusobacterium* spp. especially *F. necrophorum* is common in all species of farm livestock. *F. necrophorum* is a non-spore-forming obligate anaerobe of the family Bacteroidaceae and a normal inhabitant of the alimentary tract (particularly the rumen), the respiratory tract, and the genital tract. There are four biovars, three of which – biovars A, AB, and B – are important in livestock disease. The fourth, biovar C, is not a pathogen. Two of these have been given subspecies status: *F. necrophorum* subsp. *necrophorum* (biovar/ biotype A) and *F. necrophorum* subsp. *funduliforme* (biovar/ biotype B). The subspecies vary in their production of leukotoxin, in the quantity and composition of endotoxin and probably in virulence, but the full significance of this to individual diseases in livestock is not yet fully determined as both are isolated from the diseases associated with this infection.<sup>1,2</sup> The leukotoxin carries epitopes that can induce protective immunity to experimental infections.<sup>3</sup>

The specific diseases dealt with here as being associated with primary infection

with *F. necrophorum* are foot rot of cattle, oral necrobacillosis, foot rot of pigs, and foot abscess of sheep. In foot rot of sheep the causative organism (*Dichelobacter nodosus*) occurs in association with *F. necrophorum*. In foot rot of pigs a species of *Fusobacterium* and spirochetal organisms are commonly found together.

In many infections the organism is present as a secondary invader rather than as a primary cause of disease. Some of the common conditions in which *F. necrophorum* is found as a secondary invader are navel ill and hepatic necrobacillosis in sheep and cattle, pneumonia of calves and in the secondary infections of covering epithelium. These include necrotic enteritis associated with *Salmonella* spp. in pigs, necrotic rhinitis and atrophic rhinitis of pigs, most diseases in which vesicular eruption and erosive lesions of the buccal mucosa and coronary skin of cattle and sheep occur, and in vulvitis, vaginitis, and metritis.

*Fusobacterium* spp. have been associated with stomatitis, enteritis, and granulocytopenia in calves, summer mastitis in cattle, hematogenous metaphyseal osteomyelitis in a 6-month-old calf, and endocarditis of swine examined at slaughter.<sup>4</sup>

The factors which contribute to the pathogenicity of *F. necrophorum* include a potent endotoxin, a polysaccharide capsule, an exotoxin (a leukocidin), and a hemolysin. The biochemical and functional properties of a leukocidin produced by different strains of *F. necrophorum* have been described.<sup>1,5,6</sup>

Extensive studies have been directed towards the immunity of the organism and the possibility of vaccination against the several diseases associated with *F. necrophorum*. However, the main virulence factors of *F. necrophorum* are only weakly immunogenic and the experiments give only limited encouragement for an effective necrobacillosis vaccine,<sup>1,7</sup> although trials with a vaccine against liver abscess in cattle show positive results.<sup>8</sup>

Other organisms are commonly present in infections with *F. necrophorum* and it is thought that this is a pathogenic synergy where facultative pathogens utilize oxygen and lower the redox potential to create an anaerobic environment for growth of *F. necrophorum*. In turn the leukotoxin of *F. necrophorum* protects other organisms from phagocytosis.<sup>1</sup>

An enzyme-linked immunosorbent assay (ELISA) for the detection of *F. necrophorum* antibodies in the serum of cattle

and sheep has been developed<sup>9</sup> as has a PCR that can differentiate *F. necrophorum* subsp. *necrophorum* from *F. necrophorum* subsp. *funduliforme*.<sup>10</sup>

## REVIEW LITERATURE

- Langworth BF. *Fusobacterium necrophorum*. Its characteristics and role as an animal pathogen. *Bacteriol Rev* 1977; 41:373.
- Tan ZL, Nagaraja TG, Chegappa MM. *Fusobacterium necrophorum* infections: Virulence factors, pathogenic mechanisms and control measures. *Vet Res Commun* 1996; 20:113–140.
- Narayanan SK, Nagaraja TJ, Chengappa MM, Stewart GC. Leukotoxins of Gram-negative bacteria. *Vet Microbiol* 2002; 84:337–356.

## REFERENCES

1. Tan ZL et al. *Vet Res Commun* 1996; 20:113.
2. Brown R et al. *J Med Microbiol* 1997; 46:873.
3. Narayan SK et al. *Vet Microbiol* 2003; 93:335.
4. Narushima T et al. *J Jap Vet Med Assoc* 1986; 56:221.
5. Smith GR et al. *J Hyg Camb* 1985; 95:59.
6. Narayanan SK et al. *Vet Microbiol* 2002; 84:337.
7. Emery DL, Vaughan JA. *Vet Microbiol* 1986; 12:255.
8. Jones G et al. *Bov Practit* 2004; 38:36.
9. Evans JW, Berg JN. *Am J Vet Res* 1985; 46:132.
10. Narongwanichgam W et al. *Vet Microbiol* 2003; 91:183.

## NECROBACILLOSIS OF THE LIVER (LIVER ABSCESS)

### Synopsis

**Etiology** *Fusobacterium necrophorum* subsp. *necrophorum* (biovar/biotype A) is the most common isolate and is usually present in pure culture. *F. necrophorum* subsp. *funduliforme* (biovar/biotype B) is less common and usually isolated as a mixed infection with *Arcanobacterium pyogenes*

**Epidemiology** Greatest importance in grain-fed cattle where it occurs secondary to rumenitis

**Clinical findings** May be associated with abdominal pain but most infections are subclinical. Importance is in slaughter condemnation of affected organs

**Clinical pathology** Inflammatory response

**Diagnostic confirmation** Ultrasound. Slaughter examination

**Treatment** Not commonly conducted. Control. Feed management to avoid ruminal acidosis, prophylactic antibiotics, vaccination

## ETIOLOGY

*Fusobacterium (Sphaerophorus) necrophorum* is commonly found in pure culture in hepatic abscesses in ruminants. *F. necrophorum* subsp. *necrophorum* (biovar/biotype A) is the more common type isolated and is usually present in pure culture. *F. necrophorum* subsp. *funduliforme* (biovar/biotype B) is less common and usually isolated with other bacterial species, commonly *Arcanobacterium (Actinomyces, Corynebacterium) pyogenes* *Bacteroides* spp., *Streptococcus* spp. and *Staphylococcus* spp.

*A. pyogenes* is the most common species isolated; it acts synergistically to promote growth of *F. necrophorum* by utilizing oxygen to create an anaerobic environment and provide iron for growth through its hemolytic activity. The leukotoxin of *F. necrophorum* is believed to protect *A. pyogenes* against phagocytosis.<sup>1,2</sup>

## EPIDEMIOLOGY

### Occurrence

The disease occurs in all ages and types of cattle and sheep but achieves the greatest economic significance in **grain-fed cattle** where it occurs secondary to **rumenitis**. In feedlots in the United States the prevalence varies widely between feedlots but ranges from 12–32% in most;<sup>3</sup> equivalent rates occur in 'barley beef' cattle in the United Kingdom. Sporadic cases or occasionally outbreaks of liver abscess occur in the **neonate** from **umbilical** infection.

### Pathogen risk factors

*F. necrophorum* is a common **inhabitant of the intestine and rumen** in normal cattle and a common inhabitant of the **environment** of farm animals. It uses lactate as the major sugar substrate and its numbers in the rumen increase with a **change from roughage** to high grain diets.<sup>4</sup> *F. necrophorum* is not capable of prolonged survival outside the animal body; 1 month is the probable maximum period under favorable conditions. Infection to the liver requires a **pre-disposing injury** at a primary site of infection. The disease can be reproduced experimentally by intraportal inoculation of *F. necrophorum*.<sup>5</sup>

### Risk factors in grain-fed cattle

Rumenitis, resulting from **rumenal acidosis**, is the primary site of infection in grain-fed cattle. The risk for liver abscess is increased by factors that predispose rumenitis such as low roughage and **high-energy diets** and the incidence increases as roughage in the diet decreases.

### Management

Introducing hungry cattle to high-energy diets, rapidly increasing dietary energy and poor feedbunk management with irregular periods and amounts of feeding is associated with higher rates of liver abscess.

### Diet

The type of grain and the use of processed, including gelatinized, grain can influence risk of abscess as can the physical nature of the diet if it allows feed sorting by the animal during feeding. Cattle hair in the rumen may exacerbate the ruminal lesion and promote the invasion of *F. necrophorum* and may account for a higher incidence of liver abscess in the spring, when cattle are grooming coats that are shedding.<sup>1</sup>

### Breed

Holsteins are at greater risk than beef breeds because they are fed longer and have higher feed intakes and the prevalence in steers is marginally higher than in heifers, probably also related to higher feed intake.<sup>2</sup>

### Risk factors in other farm animals

In lambs, infection usually occurs through the **navel** at birth or through **ruminal ulcers**; the infection originates from infected bedding grounds or barn bedding. Liver abscess can be a sequella to other disease such as traumatic reticulitis and peritonitis.

### Economic importance

In feedlot cattle there is considerable financial loss due to **condemnation of use of livers** in abattoirs. Cattle that are more severely abscessed (with very large abscesses or multiple small abscesses) have a significant depression of weight gain and decrease in feeding efficiency.<sup>3</sup>

## PATHOGENESIS

Vascular drainage from the primary lesion, omphalitis or rumenitis, leads to localization in the liver. The pathogenesis of rumen acidosis in grain-fed cattle is described under that heading.

It is postulated<sup>6</sup> that the ruminal wall in rumenitis is colonized by the bacteria in the rumen including both biotype A and biotype B *F. necrophorum*. Most of the ruminal wall lesions heal without penetration, especially if they contain only the less virulent biotype B. The more virulent biotype A strains persist longer and possibly penetrate the portal system with the help of leukotoxin. The lower virulence biotype B requires helper organisms to penetrate the defense mechanisms and leads to a mixed infection. There are differences in the biological activities of *F. necrophorum* isolated from liver abscesses and those of the general population in the rumen, and many of the ruminal inhabitants are probably not capable of invasion to cause disease.<sup>7</sup>

The experimental inoculation of viable cultures of *F. necrophorum* into the hepatic portal veins of cattle results in the development of diffusely distributed micro-abscesses within 30 min up to 2 h.<sup>6</sup> Gross abscesses develop in 3–36 h. Neutrophils are the predominant phagocyte in lesions of 8 h or less, and macrophages are the predominant phagocyte in lesions of 12 h duration or more. The **leukotoxin** is postulated to be responsible for allowing the bacteria to withstand the phagocyte cell response and enable the infection to persist. If there is sufficient hepatic involvement, a toxemia develops from the bacterial infection, and causes a chronic or acute illness



In most infections, the lesions are too small to produce clinical signs. **Hematogenous spread** from hepatic lesions, including rupture into the caudal vena cava, may result in multiple lesions in many organs, severe pulmonary disease with hemoptysis, and rapidly fatal termination.

#### CLINICAL FINDINGS

In the majority of cases of hepatic abscessation in feeder cattle there are **no clinical signs** of illness. Abscesses that are very large may result in an acute or chronic illness.

In **acute cases** in dairy cattle there is fever, anorexia, depression, fall in milk production, and weakness. Abdominal pain is evidenced on percussion over the posterior ribs on the right side and affected cattle show arching of the back, and reluctance to move or lie down. The liver may be so enlarged that it is readily palpable behind the costal arch. The abdominal pain may be sufficiently severe to cause grunting with each breath. In **chronic cases**, there are no localizing signs but anorexia, emaciation and intermittent diarrhea and constipation occur.

Animals infected through the navel show signs at about 7 d of age and omphalophlebitis is usually present.

#### CLINICAL PATHOLOGY

A high leukocytosis with a marked neutrophilia may be present with large or multiple abscesses. Clinical chemistry and liver function tests have been found to be **poor indicators** and of little diagnostic value in predicting the presence of liver abscesses<sup>8</sup> but hepatic dysfunction can be detected by these means in the acute stage of hepatic injury. **Ultrasound** and centesis may aid in diagnosis.<sup>8,9</sup>

#### NECROPSY FINDINGS

Usually, multiple hepatic abscesses are present. The hepatic lesions may be deep in the parenchyma or under the capsule, especially on the diaphragmatic surface. Extension to the diaphragm or perirenal tissues is not unusual.

In bovine rumenitis cases, the anterior, ventral sac is most commonly affected. There are local or diffuse mucosal lesions with thickening of the wall, superficial necrosis and the subsequent development of ulcers. In lambs there may be lesions at the cardiac end of the esophagus. The histologic appearance of acute to subacute necrobacillosis lesions consists of a zone of necrosis bordered on one edge by mats of filamentous rods and on the other by a band of karyorrhectic leukocytes.

#### Samples for confirmation of diagnosis

- **Bacteriology** – swab of abscess or tissue sample from deep edge of lesion (ANAEROBIC CULT)

#### DIFFERENTIAL DIAGNOSIS

Acute cases in cattle resemble cases of traumatic reticuloperitonitis and differentiation can only be made on localization of the pain, ultrasonography, and by exploratory rumenotomy. The latter is essential if traumatic hepatitis is a possible diagnosis.

- Other causes of liver abscess
- Caseous lymphadenitis in sheep

#### TREATMENT

*F. necrophorum* is sensitive to B-lactam antibiotics, tetracyclines, the macrolide and lincosamide antimicrobials but is resistant to aminoglycosides and ionophores with no difference in sensitivity between the two subspecies except for clindamycin and lincomycin.<sup>10</sup>

Liver abscess in feedlot cattle is not clinical and not routinely treated as a clinical disease. In clinical disease associated with liver abscess, prolonged treatment with high doses of antimicrobial or sulfonamides is required if therapeutic concentrations are to be achieved at the site of infection.

**Relapse** is common because of incomplete control of the localized infection.

#### CONTROL

Control procedures in feedlot cattle include prevention of rumenitis by feed management and the use of prophylactic antimicrobials.

#### Feed management

Feed management aims to prevent the occurrence of rumen acidosis and rumenitis and requires controlled dietary energy step up, attention to the grain type and content of the diet and correct feedbunk management.<sup>11</sup> The control of rumen acidosis is discussed elsewhere under that title.

#### Prophylactic antibiotics

The addition of antimicrobials to the feed can significantly reduce the incidence of liver abscesses and is a routine practice in most feedlots. The site of action may be in rumen or the liver or possibly in both, but is probably the rumen as tylosin and virginiamycin, which are both effective in prevention, are not absorbed into the circulation.<sup>8</sup> Tylosin has been shown to inhibit the increase in ruminal *F. necrophorum* numbers that occur in association with feeding high-grain diets.<sup>2</sup>

In the United States, bacitracin, chlortetracycline, oxytetracycline, tylosin, and virginiamycin are approved for feed inclusion for the control of liver abscess in feedlot cattle. Tylosin appears highly effective<sup>2</sup> and a summary of trials feeding tylosin at 11 g/t of feed or 90 mg/animal/d showed a 73% reduction in the occur-

rence of liver abscesses.<sup>2</sup> Antimicrobial feed additives also increase average daily gain and feed conversion efficiency, but the inclusion level for these effects and prevention of liver abscess is not necessarily the same.<sup>12</sup>

#### Vaccination

Vaccination with leukotoxoid vaccines has shown some protection against intra-portal challenge<sup>13</sup> and has reduced the abscess rates in a study of naturally occurring disease in a feedlot.<sup>14</sup> A trial of the efficacy of a high antigenic-mass-combined *Arcanobacterium pyogenes-Fusobacterium necrophorum* bacterin-toxoid in preventing naturally occurring liver abscess in feedlot cattle showed a significant effect of vaccination with a reduction of the prevalence and severity of abscesses that was equivalent to that achieved by the incorporation of tylosin in the feed.<sup>15</sup> The reduction in prevalence in two trials comparing vaccinated and non-vaccinated cattle was 48.4% (31% of controls and 16% of vaccinates with liver abscess) and 37.5% (48% of controls and 30% of vaccinates with liver abscess).<sup>15</sup>

#### Control in young lambs

In **young lambs**, the disease can be controlled by disinfecting the navel at birth and providing clean bedding or bedding grounds.

#### REVIEW LITERATURE

- Scanlan CM, Hathcock TL. Bovine rumenitis–liver abscess complex: A bacteriological review. *Cornell Vet* 1983; 73:288–297.
- Nagaraja TG, Laudert SB, Parrott JC. Liver abscesses in feedlot cattle. Part 1. Causes, pathogenesis, pathology and diagnosis. *Comp Cont Educ Pract Vet Suppl* 1996; 18:S230–S256.
- Nagaraja TG, Laudert SB, Parrott JC. Liver abscesses in feedlot cattle. Part 11. Incidence, economic importance and prevention. *Comp Cont Educ Pract Vet Suppl* 1996; 18:S264–S273.
- Nagaraja TG, Chengappa MM. Liver abscesses in feedlot cattle: A review. *J Anim Sci* 1998; 76:287–298.

#### REFERENCES

1. Nagaraja TG et al. *Comp Con Educ Pract Vet Suppl* 1996; 18:S230.
2. Nagaraja TG, Chengappa MM. *J Anim Sci* 1998; 76:287.
3. Brink DR et al. *J Anim Sci* 1990; 68:1201.
4. Tan ZL et al. *Appl Environ Microbiol* 1994; 60:1387.
5. Saginala S et al. *Vet Res Commun* 1996; 29:493.
6. Nakajima YH et al. *Jpn J Vet Sci* 1986; 48:509.
7. Okwumabua O et al. *Appl Environ Microbiol* 1996; 62:469.
8. Liberg P, Jonsson G. *Acta Vet Scand* 1993; 34:21.
9. Braun U et al. *Vet Rec* 1995; 137:209.
10. Lechtenberg KF et al. *Am J Vet Res* 1998; 59:44.
11. Popp JD et al. *Vet Clin Nutr* 1997; 4:63.
12. Rogers JA et al. *J Anim Sci* 1995; 73:9.
13. Saginala S et al. *J Anim Sci* 1997; 75:1160.
14. Terhaar BL et al. *Agri Pract* 1996; 17:15.
15. Jones G et al. *Bov Pract* 2004; 38:36.

## BOVINE INTERDIGITAL NECROBACILLOSIS (FOUL IN THE FOOT, FOOT ROT, INTERDIGITAL PHEGGMON)

### Synopsis

#### Etiology

Biotypes A and B of *F. necrophorum*. Other organisms can facilitate infection

#### Epidemiology

All ages susceptible. Infected feet are source of infection. Transmission highest where conditions are wet underfoot and in wet humid seasons

**Clinical findings** Sudden onset of fever, lameness, drop in milk production with typical fissuring, necrotic, lesion in the skin at the top of the interdigital cleft

**Clinical pathology** Not routinely done

**Diagnostic confirmation** Clinical findings. Culture may be done

**Treatment** Antimicrobials

**Control** Avoidance of abrasive under-foot conditions. Footbaths, antimicrobials, vaccination

### ETIOLOGY

Foot rot is usually described as being associated with *F. necrophorum*. Other bacteria such as *Prevotella melaninogenica* (formerly *Bacteroides melaninogenicus*) are also present and may be important in cause. Experimentally, the subcutaneous inoculation of only *F. necrophorum* into the interdigital skin of cattle will result in typical lesions of interdigital necrobacillosis.<sup>1</sup> The majority of isolates of *F. necrophorum* obtained from the feet of cattle and sheep belong to biotypes A and AB; they produce a soluble exotoxin, a leukocidin, and are pathogenic experimentally in cattle and mice.<sup>2</sup> The isolates obtained from lesions which are not classified as interdigital necrobacillosis and from clinically normal feet are predominantly biotype B (*F. necrophorum* subsp. *funduliforme*), and cause few experimental lesions and produce little or no leukocidin.

Strains of *Bacteroides nodosus*, that are associated with the non-progressive form of ovine foot rot, can also be isolated from the feet of cattle and cause mild interdigital dermatitis. It is possible they may predispose to the much more severe dermatitis that characterizes bovine interdigital necrobacillosis.

### EPIDEMIOLOGY

#### Occurrence

The disease is common in most countries and accounts for 5–15% of cases of lameness in dairy cattle.<sup>3,4</sup>

Usually the disease is sporadic but under favorable conditions, as many as 25% of a group may be affected at one time. An epidemiological study of foot rot in pastured cattle in Denmark over a 12-year period revealed that incidence rates

annually ranged from 0.1–4.8% but in most years it was below 1%.<sup>5</sup> The incidence rates were higher in some breeds than others, higher in some geographical areas than others (usually where the fields were smaller and soil higher in pH), and 4–8 weeks after periods of high rainfall.

#### Transmission

Discharges from the feet of **infected animals** are the probable source of infection. Duration of the infectivity of pasture or bedding is unknown. Infection gains entrance through **abrasions** or damage to the skin in the interdigital cleft. Introduction of the infection to a farm by transient cattle is often observed but again the disease may not develop on some farms in spite of the introduction of the infection. Contaminated footbaths can be a source of infection.

#### Environmental risk factors

In many<sup>6</sup> but not all<sup>3</sup> regions, the incidence is much higher during **wet, humid weather** or when conditions are **wet underfoot**. Stony ground, lanes filled with sharp gravel and pasturing on coarse stubble also predispose to the condition. A high incidence can occur with beef cattle at high stocking densities on irrigated pastures. The observation that the disease is common on some farms and does not occur at all on others suggests that there may be factors which limit the persistence of infectivity in certain soils or environments.

Abrasions to the skin of the feet are more likely to occur when the skin is swollen and soft due to continual wetting. The increased incidence in wet summer and autumn months may be so explained in part, although wet conditions may also favor persistence of the infection in pasture. In housed cattle the incidence is higher in **loose-housed** cattle than tied cattle.<sup>6</sup> Unhygienic cubicle passageways and poorly maintained straw beds may predispose to infection.

#### Host risk factors

Cattle of all ages, including young calves, may be affected but the disease is much more common in adults. The highest incidence occurs in cows in the **first month of lactation**.<sup>6</sup> A field observation is that *Bos indicus* cattle are much more resistant to infectious foot rot than *Bos taurus* breeds and variations in prevalence have been observed among dairy breeds.<sup>6</sup> The occurrence of the foot disease digital dermatitis on a farm or infection with bovine virus diarrhea has been suspected as predisposing to more severe foot lesions.<sup>7</sup>

#### Economic importance

Foot rot is of greatest economic importance in dairy cattle, in which it reaches

the highest level of incidence, because of the intensive conditions under which they are kept. In beef cattle at range the incidence is usually low but many cases may occur in purebred herds and in feedlot cattle. Lame cows will lie down for longer and eat less, have difficulty rising and are at greater risk for teat trampling and mastitis. Loss of production occurs and an occasional animal may suffer a serious involvement of the joint and other deep structures of the foot necessitating amputation of a digit. The disease is not fatal but some cases may have to be slaughtered because of joint involvement.

#### PATHOGENESIS

The pathogenesis is not completely understood, but with the experimental SC inoculation of the virulent biotype of *F. necrophorum* into the interdigital skin of cattle the typical lesion of foot rot develops in approximately 5 d.<sup>1</sup> This suggests that any injury or constant wetting of the skin of the cleft which interferes with its integrity will allow the organism to invade the tissues. There is acute swelling and necrosis of the skin and SC tissues which may spread to adjacent tendon sheaths, joint capsules and bone if treatment is delayed or ineffective.

#### CLINICAL FINDINGS

Severe foot **lameness** appears suddenly, usually in one limb only and may be accompanied by a moderate systemic reaction with a **fever** of 39–40°C (103–104°F). There is temporary depression of milk yield in cows and affected bulls may show temporary infertility. The animal puts little weight on the leg although the limb is carried only when severe joint involvement occurs. Swelling of the coronet and **spreading of the claws** are obvious.

The typical lesion occurs in the skin at the top of the **interdigital cleft** and takes the form of a **fissure** with swollen, protruding edges which may extend along the length of the cleft or be confined to the anterior part or that part between the heel bulbs. Pus is never present in large amounts but the edges of the fissure are covered with **necrotic material** and the lesion has a **characteristic odor**. Occasionally in early cases no external lesion may be visible but there is lameness and swelling of the coronet. Such cases are usually designated 'blind fouls' and respond well to parenteral treatment.

A more severe form of the disease which is peracute in onset and refractory to conventional therapy has been termed 'super foul' or '**super foot rot**'.<sup>8</sup> With this type there is sudden onset of acute lameness, severe interdigital swelling and rapid progression to necrosis and

deep erosion of the interdigital space with swelling of soft tissue above the coronary band. The hindfeet or all four feet may be affected.<sup>7</sup> It may be predisposed by the foot disease digital dermatitis. Septic arthritis is a common sequella if this type is not treated early in its course.

Spontaneous recovery is not uncommon but if the disease is left untreated, the lameness usually persists for several weeks with adverse effects on milk production and condition. The incidence of **complications** is also higher if treatment is delayed and some animals may have to be destroyed because of local **involvement of joints and tendon sheaths**. In such cases the lameness is severe, the leg is usually carried and the animal strongly resents handling of the foot. Swelling is usually more obvious and extends up the back of the leg. There is poor response to medical treatment and surgical measures are necessary to permit drainage. **Radiological examination** may be of value in determining the exact degree of involvement of bony tissue.

Long continued irritation may result in the development of a wart-like mass of fibrous tissue, the **interdigital fibroma**, in the anterior part of the cleft and chronic mild lameness. Interdigital fibroma occurs commonly without the intervention of foot rot, the important cause being inherited defects in foot conformation in heavy animals.

#### CLINICAL PATHOLOGY

Bacteriological examination is not usually necessary for diagnosis but direct smears of the lesion will usually reveal large numbers of a mixture of *Fusobacterium* and *Bacteroides* spp. Routine differentiation between virulent and non-virulent bovine isolates of *F. necrophorum* can be done by assessment of the cultural characteristics of the colonies grown on blood agar.<sup>2</sup>

#### DIFFERENTIAL DIAGNOSIS

The characteristic site, nature, and smell of the lesion, the pattern of the disease in the group and the season and climate are usually sufficient to indicate the presence of true foot rot.

#### NECROPSY FINDINGS

Necropsy examinations are rarely carried out in cases of foot rot. Dermatitis is followed by necrosis of the skin and SC tissues. In complicated cases there may be supuration in joints and tendon sheaths.

#### Interdigital dermatitis/stable foot rot

This infection occurs commonly in cattle which are housed for long periods. Although the condition occurs most com-

monly when the cattle are kept under unsanitary conditions, it is also seen in well-managed herds. The causative agent has not been established but *Bacteroides nodosus* can be isolated.

The initial lesion is an outpouring of sebaceous exudate at the skin-horn junction, particularly at the bulbs of the heel. There is a penetrating foul odor and the lesion is painful to touch, but there is little swelling and no systemic reaction. More than one foot is commonly affected. In longstanding cases there is separation of the horn at the heel bulb and this is followed by secondary bacterial infection of the sensitive structures of the foot. Often there is a purulent dermatitis of the interdigital space. Stable foot rot does not respond satisfactorily to the standard parenteral treatments used in foot rot but local treatments as set out as follows are effective.

#### Verrucose dermatitis

Verrucose dermatitis is a proliferative inflammatory lesion of the **skin of the plantar surface** of the foot extending from the bulb of the heels to the fetlock joint. The condition is seen particularly in feedlot cattle that are overcrowded in wet muddy conditions and may occur in outbreaks. **All four feet** may be affected, there is considerable pain and lameness and, on smear of the lesion, *F. necrophorum* is present in large numbers. The treatment of verrucose dermatitis consists of washing the affected skin with a disinfectant soap, followed by daily applications of 5% copper sulfate solution. When many animals are affected, a daily walk through and soaking in a foot bath containing the copper sulfate solution is very effective.

#### Traumatic injury

Traumatic injury to bones and joints, puncture by foreign bodies, bruising of the heels and gross overgrowth of the hoof can usually be distinguished by careful examination of the foot. **Laminitis** is the major cause of lameness in most herds but with this condition there are no skin lesions present.

#### TREATMENT

Parenteral administration of antibiotics or sulfonamides and local treatment of the foot lesion are necessary for best results. **Immediate treatment** as soon as possible after the onset of swelling and lameness will give excellent recovery in 2-4 d. In the experimental disease, when treatment was delayed for a few days after the onset of signs, severe lesions developed and recovery was extended. Under field conditions, the disease may be present in cattle at pasture for several days before being recognized, making it

necessary to confine them for daily treatment until recovery is apparent.

#### Antimicrobials

Ceftiofur, 1-2 mg/kg (BW) IM, or procaine penicillin G, 22 000 iu/kg BW IM twice daily, or once daily for three consecutive days are effective.<sup>9</sup> Oxytetracycline, 10 mg/kg BW IV, or long-acting tetracycline IM may also be used but injection site tolerance and withdrawal period is less favorable than ceftiofur. When a high incidence of foot rot is experienced in a herd, treatment of all animals simultaneously has been carried out.<sup>10</sup>

Sodium sulfadimidine (150-200 mg/kg BW) solution given by IV injection is highly effective. Sulfabromomethazine at the rate of 30 g/kg grain was given for two consecutive days to calves weighing 150 kg and results were excellent. Sulfonamides are not approved for use in lactating dairy cattle in many countries. **'Super foot rot'** has been effectively treated by parenteral tylosin or a single dose of long-acting tetracycline.<sup>8</sup>

#### Local treatment

**Local treatment** necessitates restraint of the affected leg and this procedure is greatly facilitated by a restraint table or the administration of a very small dose of xylazine. The foot is scrubbed, all necrotic tissue curetted away and a local dressing applied under a pad or bandage. Any **antibacterial**, and preferably **astringent**, dressing appears to be satisfactory. A wet pack of 5% copper sulfate solution is cheap and effective. Any suitable antibacterial ointment preparation may be applied and secured with a bandage, which may be left on for several days. The main advantage of local treatment is that the foot is cleaned and kept clean. If conditions underfoot are wet, the animal should be kept stabled in a dry stall.

In cattle running at pasture, or in the case of large numbers of feedlot cattle, examination of the foot and local treatment are often omitted because of the time and inconvenience involved. However, identification of the animal with a marker is considered necessary in outbreaks to avoid unnecessary confusion in the days following, and examination of the foot is deemed necessary to insure that foreign bodies are not involved. Local treatment may not be necessary in the early stages of the disease if the animal can be prevented from gaining access to wet, muddy areas.

#### Surgical drainage

Surgical drainage may be necessary in refractory cases or when complications with spread to deeper tissues have occurred. **Amputation** of the digit may be necessary.

## CONTROL

Prevention of foot injuries by filling in muddy and stony patches in barnyards and lanes will reduce the incidence of the disease. Lanes and bedding should be kept clean and dry. The incorporation of biotin in the diet, while reducing the incidence of lameness caused by white line lesions, has no effect on the incidence of interdigital necrobacillosis.<sup>11</sup>

## Footbaths

Provision of a footbath containing a 5–10% solution of formaldehyde or copper sulfate, in a doorway so that cattle have to walk through it twice daily, will practically eliminate the disease on dairy farms. A mixture of 10% copper sulfate in slaked lime is often used in the same manner. Similar measures can be adopted for small groups of beef animals.

## Antibacterials

Feeding chlortetracycline to feedlot cattle 500 mg/head/d for 28 d, followed by 75 mg/d throughout the finishing period has been recommended but controlled comparative trials have not been carried out. The feeding of organic iodides (200–400 mg) of ethylene diamine dihydroiodide (EDDI) in the feed daily has been used for many years as a preventive against the disease in feedlot cattle. Feeding EDDI in an ad libitum salt mixture at a level of 0.156% EDDI (0.125% iodine) is also effective in reducing the incidence of foot rot. Dosing cattle daily with zinc sulfate by including it in the feed has no prophylactic effect.

## Vaccination

Commercial vaccines against bovine interdigital necrobacillosis are available but their efficacy has not been established in controlled comparative trials.<sup>12</sup> A mineral-oil adjuvant vaccine containing whole cells or fractions of *F. necrophorum* provided about 60% protection from experimentally induced interdigital necrobacillosis. A similar vaccine containing *Bacteroides nodosus* appeared to reduce the severity of lesions but not the incidence rate compared to non-vaccinates.

## REVIEW LITERATURE

Egerton JR et al. Footrot and foot abscess in ruminants. Boca Raton: Florida, CRC Press, 1989.  
Tan ZL, Nagaraga TG, Chegappa MM. *Fusobacterium necrophorum* infections: Virulence factors, pathogenic mechanisms and control measures. Vet Res Commun 1996; 20:113–140.

## REFERENCES

1. Clark BL et al. Aust Vet J 1985; 62:47.
2. Emery DL et al. Aust Vet J 1985; 62:43.
3. Murray RD et al. Vet Rec 1996; 138:586.
4. Jubb TF, Malmo J. Aust Vet J 1991; 68:21.
5. Monrad I et al. Acta Vet Scand 1983; 24:403.

8. Cook NB, Cutler KL. Vet Rec 1995; 136:19.
9. Rebhun WC, Pearson EG. J Am Vet Med Assoc 1982; 181:572.
10. Clark BL et al. Aust Vet J 1986; 63:107.
11. Kausche FM, Robb, EJ. Vet Therapeut 2003; 4:83.
12. Hedges J et al. J Dairy Sci 2001; 84:1969.

## BOVINE DIGITAL DERMATITIS, PAPPILLOMATOSIS DIGITAL DERMATITIS OF CATTLE (MORTELLARO'S DISEASE) (FOOT WARTS, HAIRY FOOT WARTS, 'HEEL WARTS')

Papillomatous digital dermatitis (PDD) is a painful, erosive, papillomatous-like lesion of the skin of the feet of cattle. The region proximal and adjacent to the interdigital skin midway between the heel bulbs of the plantar surface of the foot is most frequently affected. Early lesions are circumscribed, with a red, granular appearance and variable degrees of proliferation of filiform papillae. Mature lesions tend to be more proliferative and may have long papillary fronds. Lameness is severe, and economic losses are due to decreased milk production and reproductive performance.<sup>1</sup>

## ETIOLOGY

The etiology is uncertain. A mixed population of Gram-negative bacteria including anaerobes, microaerophilic organisms, and spirochetes have been demonstrated in or isolated from PDD lesions. Histologically, invasive spirochetes have been isolated from the tissues of cattle with typical lesions, but their significance is uncertain.<sup>2</sup> The humoral response to spirochetes in cattle with the disease is different from that in cattle without detectable lesions.<sup>1</sup> At least five different spirochetal phylotypes within the genus *Treponema* have been identified in lesions and *Treponema denticola*-like spirochetes were most common.<sup>3</sup> DNA analysis of the spirochetes recovered from typical lesions revealed that the organisms were closely related to *Treponema denticola*.<sup>4</sup> A combination of spirochetes and *Campylobacter faecalis* has also been found in typical lesions.<sup>5</sup>

A spirochete isolated from cases of severe virulent ovine foot rot (SVOFR) in Australia<sup>6</sup> and the UK<sup>7</sup> and Ireland<sup>8</sup> is closely related to a treponeme isolated from human periodontitis and bovine digital dermatitis. This suggests the possibility of cross-species transmission, and that a number of spirochetes could be involved in the pathogenesis of either PDD or SVOFR.

## EPIDEMIOLOGY

### Occurrence and prevalence of infection

primarily in dairy cattle and has been reported as a cause of lameness in cattle worldwide.<sup>9</sup> Beef cattle are also affected. Surveys of dairy farms in California in the United States found that 25–75% of farms have had the disease and about 10% of cows have been affected with a range from 1–99% of cows in affected herds.<sup>10</sup>

The disease has occurred in a herd of dairy bulls in New Zealand.<sup>11</sup> Lesions similar to PDD have been recognized in cattle in Australia, occurring during periods of high rainfall and being responsive to topical and parenteral therapy, but not associated with the presence of spirochetes in the lesions.<sup>12</sup>

The National Animal Health Monitoring System (NAHMS) Dairy 1996 assessed the incidence of digital dermatitis in US dairy herds.<sup>13</sup> The study design was a population-based cross-sectional survey of US dairy herds with at least 30 cows in 20 states, representing 79% of US dairy cows. PDD was reported in the previous 12 months from 43.5% of dairy herds. Within affected herds, 18.9% of cows were affected and 81.9% of affected cows and 85.9% of affected heifers were lame. Regions of the US with the highest percent of herds affected included the Southwest, Northwest, and Northeast. Factors associated with high incidence (>5%) included region, herd size, type of land lactating cows accessed on a daily basis, flooring type where lactating cows walked, percent of cows born off the farm, use of a primary hoof trimmer who trimmed cows' hooves on other farms, and lack of washing of hoof-trimming equipment between cows.

People providing a hoof-trimming service report that 97% of dairy farms in California have the disease but, mysteriously, some farms have none. Regional differences in the prevalence occurred but reasons for the incidence were not examined. Seasonal differences occur and may be due to a combination of weather, housing, and management. The incidence may be higher during the winter months, when the weather is cold and wet, and cows are kept in confined housing than during the summer months when cows are on pasture.

Based on examination of the feet of cattle at an abattoir, 29% of culled dairy cattle and 4% of beef cattle had gross lesions of PDD, and spirochetes were present in 61% of the lesions.<sup>14</sup>

In a commercial dairy farm in Mexicali, Mexico, 33% of cows were affected during lactation and 1% during the dry period; 68% of cows that had lesions in the previous lactation had lesions in the current lactation.<sup>15</sup> The highest risk occurred

The disease was first described in 1974 as Mortellaro's disease. It occurs yearly, estimates cumulative incidence

risk was 35% and the incidence density rate was 44.6 cases per 1000 cow-months. More animals were affected in summer and fall than in winter and spring. Purchased animals were 3.4 times more likely to be affected than animals born on the farm. Healthy cows conceived 93 days after calving (median), but affected cows conceived 113 days after calving.

In 214 dairy herds in two main dairy areas in Chile, 91% of herds were affected and a median of 6% of cows had PDD.<sup>16</sup>

### Risk factors

#### Host risk factors

A cross-sectional study of prevalence and risk factors of digital dermatitis in female dairy calves between 2.5 and 12 months of age in the Netherlands revealed a mean prevalence of 67%.<sup>17</sup> The prevalence increased with age and by 1 year of age almost all animals had lesions in at least one claw. The clinical disease is much more common in first calf heifers and young cows. First-parity cows have the highest odds of PDD, and the odds decrease, in a dose-effect manner, as parity increases.<sup>18</sup> The odds of PDD increase with increasing days in lactation.

The plantar and palmar regions of the foot may be more conducive to the development of PDD because these anatomical sites are exposed to more moisture. Epidemiologic observations indicate that the risk of PDD is associated with environmental conditions that cause moist feet in commercial dairy herds. The greater incidence of the lesions in the hindfeet is considered to be associated with more exposure to deeper slurry during feeding times than the forelimbs. The plantar and palmar regions of the interdigital cleft are, therefore, more susceptible to being continually moist, compared with the more open dorsal locations. The anatomic location of PDD lesions also has an effect on the efficacy of topical treatment with antibiotics.<sup>19</sup>

#### Immune mechanisms

*Treponema phagedenis*-like spirochetes isolated from active PDD lesions in dairy cattle are associated with serum IgG<sub>2</sub> antibodies and most react with lipopolysaccharide.<sup>20,21</sup> Both the antibody and blastogenic responses were reduced in convalescent dairy cattle, suggesting the immune response to the spirochetes has short duration. The presence of IgG<sub>2</sub> spirochete antibodies detected by ELISA does not necessarily describe an active immune protective response by affected cows but reflects prior infection and repeated exposures to treponemes.<sup>22</sup>

Cattle and sheep with PDD and severe virulent ovine foot rot, respectively, and which may be infected by the same group of treponemes, have increased

seropositivity rates to both treponeme isolates, with different patterns of reactivity between farms.<sup>7</sup>

### Environmental and management risk factors

Case-control studies in dairy farms indicate that the odds of having a higher proportion (>5%) of affected cows were about 20 times more likely in dairy farms with muddier corrals than in farms with drier ground surfaces in corrals.<sup>10</sup> The disease appears to be more common in freestall confined herds where feet are constantly exposed to moisture and manure conditions. The feet often become coated with a layer of dried feces which may provide the anaerobic conditions necessary for bacterial growth.

Buying replacement heifers was associated with a 4.7-fold increase in the odds of a higher occurrence of disease than in herds which did not purchase heifers. In dairy herds in Chile, cows on farms that bought heifers in the previous 10 years had a 3-fold increase in the odds of PDD compared to those on farms that never bought heifers. Cows in dairy herds that used a footbath were less likely to have PDD than those herds not using one. There also may be a positive relationship between risk and the number of heifers purchased. Animals housed in a straw yard were 3.2 times less likely to be affected compared to cattle on slatted floors. Herd size was positively associated with the presence of the disease. Feeding with a larger variety of dietary components (hay, milk, concentrates plus silage) was a protective measure.

#### Pathogen risk factors

Several spirochete strains have been isolated from PDD lesions in dairy cattle in Iowa and compared with strains previously isolated from dairy cattle in California.<sup>20</sup> All strains are *Treponema phagedenis*-like and exhibit genetic and antigenic diversity.

Molecular typing of PDD-associated *Treponema* isolates have found some genetic relatedness to those of the related human-associated *Treponema* spp. associated with human periodontal disease.<sup>23,24</sup> These *Treponema* strains have adhesion properties and produce high levels of chymotrypsin-like protease and high levels of proline iminopeptidase which are major virulence factors.

#### Economic importance

The economic losses associated with the lameness associated with PDD in lactating cows include loss in milk production,<sup>25</sup> the effects on reproductive performance, and the costs of treatment including the time required to recognize the lesions and the costs of individual medication of

affected cows if necessary, and the costs of construction and maintenance of a foot bath. Lameness has an important effect on milk yield. In a data set including 8000 test-day milk yields from 900 cows on five farms in the UK collected over 18 months, the total mean estimated reduction in milk yield per 305-d lactation was 360 kg.<sup>25</sup>

In a 600-cow dairy herd in Mexico, cows with PDD produced a mean of 268 lb less milk than healthy cows.<sup>26</sup> Using Dairy Herd Improvement Association Records in the dairy herds in Florida, interdigital phlegmon was associated with a 10% decrease in milk production. Cows with PDD produced less milk than healthy cows but the difference was not significant.

Lameness has an important effect on reproductive performance.<sup>27</sup> Dairy cows with claw lesions have a higher calving to conception interval, and a greater number of services per conception.

### PATHOGENESIS

PDD is an acute or chronic ulcerative lesion of the skin of the bulbs of the heel or interdigital cleft. In the early stages of the lesion there is loss of superficial keratin, with a concurrent thickening of the epithelium by both hyperplasia and hypertrophy of epithelial cells. Superficial layers are eosinophilic and undergo necrotic change with the appearance of small holes. Large numbers of spirochetes are present around the holes. Loss of superficial layers of keratin stimulates epidermal proliferation and hyperplasia. In advanced cases, large numbers of spirochetes infiltrate the eroded dermis and may destroy the epidermis.<sup>28</sup> PDD is characterized by erosion of the superficial layers of the epidermis, epithelial hyperplasia and hypertrophy, pain, swelling, and a foul odor. Lesions usually occur on the hind feet and are prone to bleeding. Early lesions are circumscribed with a red, granular (strawberry-like) appearance and variable degrees of proliferation of filiform papillae. Mature lesions are more proliferative and may have long wart-like projections, thus the term 'hairy-wart' disease.

### CLINICAL FINDINGS

PDD typically occurs in dairy cattle as lameness episodes of variable severity. Affected cattle are lame and reluctant to move. The affected limb is often held trembling in partial flexion as if the animal is in pain. Less severely affected limbs are rested on the toes and animals may walk on their toes, which become markedly worn and may even expose the sensitive laminae. Affected cattle lose weight and may not eat normally if they have to walk some distance to obtain feed. Milk production may decline if the lesions are severe enough.

Lesions are confined to the digits and do not occur above the dewclaws. The feet of the hind limbs are most commonly affected. The plantar surface of the feet are most commonly affected but the palmar aspects may also be involved.

The majority of lesions are medium to large, measure 2–6 cm across at their largest dimension and are **located on the skin at its junction with the soft perioplic horn of the heel and midway between the two claws**. Most lesions are situated proximal and adjacent to the plantar/palmar interdigital space and rarely involve the interdigital skin. The surface of the lesions is moist, prone to bleeding and intensely painful to the touch. The lesions are circular to oval in shape, raised and variable in color and in degree of papillary proliferation. The washed surfaces are typically red and granular or a composite of white-yellow, gray, brown, or black papillary areas mixed with red granular areas (strawberry-like) with a very strong pungent odor. Filiform papillae commonly protrude from the surface of the lesions. Most lesions are circumscribed or delineated by a discrete line of raised hyperkeratotic skin with long wart-like projections. The lesions are restricted to the skin and do not extend into the deeper soft tissues. If untreated, PDD can persist for months associated with persistent lameness, reduced milk production, and impaired reproductive performance, and premature culling. More advanced lesions may lead to progressive separation of horn from the sensitive laminae, resulting in a typical underrun sole which may extend forward from the heel to reach half-way to the toe. Outbreaks of the disease may occur in dairy herds in which up to 75% of all cows may be affected over a period of several months.<sup>29</sup>

A screening method for the detection of lesions of dairy cattle has been described.<sup>16</sup> At the milking parlor and once the cows are in place for milking, a water hose is used to wash the cows' feet. Then using a powerful flashlight, the digits are carefully inspected for PDD lesions. A PDD case is defined as a cow with a circular-to-oval, well-demarcated, alopecic, moist, erosive foot lesion, surrounded by a white hyperkeratotic ridge or hypertrophic hairs. Lesions bleed easily and are very painful. When impacted by a concentrated jet of water from a hose, the animal frequently reacts by pulling the foot away and sometimes shaking it. Lesions can be classified into one of three stages based on their morphology: early, classical, and papillomatous. The screening method has a sensitivity of 0.72 and a specificity of 0.99.

## CLINICAL PATHOLOGY

### Detection of organism

Smears of the exudate and scrapings of the surface of the lesions are submitted for culture and for staining for spirochetes. Dark-field microscopy of the scrapings may reveal profuse motile spirochetes with vigorous rotational and flexing movements. Biopsy specimens of the lesions can be submitted for histological examination and special silver staining to identify the spirochetes.

### Serology

Using an ELISA, in cattle with PDD, there is a significant humoral response to certain strains of spirochetes isolated from lesions.<sup>1,21</sup> Animals without PDD lesions show little or no response.

## PATHOLOGY

The majority of lesions are 2–6 cm across their largest dimension, circular to oval, raised, and variable in color.<sup>30</sup> Washed surfaces are typically either extensively red and granular or a composite of white-yellow, gray, brown, and/or black papillary areas interspersed with red granular areas. The surface of the lesions is covered by filiform papillae, 0.5–1 mm in caliber and 1–3 mm in length. Most lesions are characteristically circumscribed or delineated by a discrete line of raised hyperkeratotic skin often bearing erect hairs 2 to 3 times longer than normal. The surfaces are also partially to completely alopecic, moist, prone to bleed and intensely painful to touch. Histologically, active lesions are characterized by zones of acute degeneration, necrosis, and inflammatory cell infiltration within the stratum corneum, usually associated with focal thinning.<sup>14</sup> Using immunocytochemical staining and PCR of lesion biopsies, *Borrelia burgdorferi*, *Treponema denticola*, and *Treponema vincentii* have been identified.<sup>31</sup>

## DIFFERENTIAL DIAGNOSIS

Digital dermatitis must be differentiated from:

- Interdigital dermatitis: moist, gray thickening of the skin, with focal areas of shallow ulceration and hyperkeratosis. It is less painful and rarely has a granular, tufted or papillomatous surface
- Heel erosion (slurry heel) – occurs commonly in dairy cows standing for long periods in slurry.<sup>32</sup> The intact smooth horn of the heel develops deep, black fissures which may become totally eroded. There is no liquefaction necrosis of keratin characteristic of digital dermatitis<sup>32</sup>
- Interdigital necrobacillosis (foot rot) – a necrotizing infection of the interdigital skin. There is marked painful deep

swelling of the tissues of the interdigital cleft; cracking of the skin may occur with release of a foul-smelling discharge. Response to treatment with antimicrobials is good unless the lesion is advanced

- Verrucose dermatitis – occurs in cattle kept in deep muddy yards and is characterized by marked painful proliferative dermatitis of the plantar surface of pastern from the bulbs of the heels to the fetlocks. *Fusobacterium necrophorum* is usually present in the lesions. Affected cattle are lame and respond to topical treatment and use of a footbath with a suitable antimicrobial
- Interdigital fibroma (corn) – develops from the fold of skin adjacent to the axial wall of the hoof in the interdigital space. The lesion consists of firm fibrous tissue and may extend the entire length of the interdigital cleft. Lameness is caused by the presence of the corn in the interdigital cleft; advanced corns must be removed surgically.

## TREATMENT

### Antimicrobials parenterally and topically

Antimicrobial therapy is indicated and effective and various methods of administration have been used including parenteral and topical application in individual animals, and foot baths for medication of large numbers of animals.

### Parenteral antimicrobials

Procaine penicillin, at 18 000 U/kg BW IM twice daily for 3 days, or ceftiofur sodium at 2 mg/kg daily for 3 days was highly successful for the treatment of PDD in dairy cattle in California.<sup>30</sup> However, the use of parenteral antimicrobials on an individual basis is labor intensive, costly, and not feasible when large numbers of animals are involved. In addition, drug residues in the milk are more likely when animals are treated parenterally. Recurrence after treatment may also occur. In one report, the lesions recurred in 18% of cows treated with antibiotics parenterally.<sup>30</sup>

### Cleaning the surface of the lesion

It is very important to wash and clean the surface of the lesion with a disinfectant soap before the topical administration of any medication. Treatment failures are commonly associated with failure to adequately wash and clean the surface of the lesion.

### Topical antimicrobials

Topical antimicrobial sprays or ointments are used on individual animals after the lesions have been cleaned. Direct spraying of the lesions with oxytetracycline at 25 mg/mL in 20% glycerine in deionized water once daily for 5 d using a garden-

type spray applicator was effective.<sup>33</sup> Only affected cows and individual lesions should be treated.<sup>34</sup>

The anatomic location of PDD lesions has an effect on the efficacy of topical treatments. The use of oxytetracycline solution (25 mg/mL in distilled water) as a topical spray on cows with PDD lesions was most effective on lesions located on the heels or dewclaws compared to those in the interdigital cleft.<sup>19</sup> Application of oxytetracycline and bandaging the affected part has been effective but not practical when large numbers of animals are affected.

Oxytetracycline solution (100 mg/mL), acidified ionized copper solution, acidified sodium chlorite, or placebo given as a topical spray three times daily, after washing the lesions, for 3 weeks was effective in decreasing the lameness associated with the disease.<sup>33</sup> In a Swedish dairy herd, topical oxytetracycline was more effective for the treatment of PDD in cattle with heel-horn erosion than hoof trimming alone and than glutaraldehyde.<sup>35</sup>

The use of an oxytetracycline solution topically at doses of 15 mL of a solution containing 100 mg oxytetracycline/mL sprayed twice daily for 7 days, or a one-time application of a bandage of cotton soaked with 20 mL of a solution containing 100 mg oxytetracycline/mL had a low risk of causing violative antibiotic residues in milk.<sup>36</sup>

Lincomycin at a dose of 25 mL of a solution containing 0.6 mg lincomycin/mL or valnemulin at a dose of 25 mL of a solution containing 100 mg/mL valnemulin, given as an individual topical spray for two treatments 48 hours apart resulted in significant improvement within 14 days after the first treatment.<sup>37</sup>

#### Nonantibiotic formulations

The efficacy of oxytetracycline has been compared with nonantibiotic solutions, a commercial preparation of soluble copper, peroxide compound and a cationic agent, 5% copper sulfate, acidified ionized copper solution, hydrogen peroxide-peroxyacetic acid solution, and, tap water, for the treatment of PDD.<sup>38</sup> The commercial formulation of soluble copper, peroxide compound, and a cationic agent appeared to be as effective as oxytetracycline. A non-antimicrobial cream containing soluble copper with peroxide and a cationic agent was compared with topical lincomycin.<sup>39</sup> The efficacy of the treatments was not different for decreasing pain or lesion activity but lincomycin was more effective in decreasing lesion size and preventing recurrence. Cows with  $\geq 3$  lactations were more likely to have a healed lesion at 29 days, compared with first and second lactation cows.

A nonantibiotic formulation based on a reduced soluble copper solution, peroxide compound, and a cationic agent (Victory), was most effective for the treatment of PDD, once daily for 5 days, compared to other similar formulations and oxytetracycline.<sup>40</sup>

A nonantibiotic paste, Protexin Hoof-Care, containing formic acid (6.8%), acetic acid (3.74%), copper (3.29%), and zinc sulfate (0.40%), essential oils (peppermint /eucalyptus, 0.16% and a pH of 3.5 has been compared under controlled conditions with topical oxytetracycline and is considered an effective alternative to the antibiotic for the treatment of PDD.<sup>41</sup> Only one topical application is required after cleaning the lesion. Advantages include no prescription is required, no withdrawal time is required, and it does not result in any concerns about antibiotic residue in meat or milk.

#### Bandaging the lesion

Whether or not the lesion should be bandaged after cleaning and medicating is controversial. Bandaging requires additional restraint to handle the leg and foot, it is labor intensive, and is an additional cost. However, field observations indicate topical treatment under a bandage is particularly effective with most cows showing remarkable improvement in 24–48 hours. Furthermore, when properly applied the bandage and the topical medication have the potential of reaching lesions in the interdigital cleft.

#### Footbaths

Footbaths containing antimicrobials and germicides have been used for treatment of groups of animals and for control of the disease. The most important benefit of using footbaths is that all animals are treated for PDD at the same time. Types of footbaths include walk-through and stand-in (stationary). The walk-through footbath, commonly located in milking-parlor exit lanes, is most popular in loose housing systems. Portable walk-through footbaths constructed of rubber, fiberglass, or hard plastic are also available and can be relocated as needed.<sup>42</sup> The portable footbath is also the most convenient type for individual treatment situations that may involve bathing two, or possibly all four feet, for prolonged periods.

Most walk-through footbaths are at least 1 m wide, 2 to 3 m long, and 12 to 15 cm deep. Proper construction includes systems for efficient drainage, cleaning and refilling. The capacity of a rectangular footbath varies according to its dimensions, which can be calculated using the formula: width  $\times$  length  $\times$  depth 7.46 = capacity in gallons. (Multiplying the number of gallons by 3.8 will provide capacity in liters – US.) The size of the

footbath needed will depend on the number of feet which will be treated with the system. Footbaths must be carefully monitored for excessive contamination with dirt and feces and solutions should be changed after every cow passes.<sup>34</sup>

The maximum number of cows which can be treated with a footbath varies according to the cleanliness of the cows, size of the bath, type and concentration of the medication used, housing system, weather conditions, and cow flow patterns. One recommendation suggests one footbath is sufficient for 150 to 200 cows and that PDD may be controlled with a single monthly passage through a footbath containing 5 to 10 g/L of oxytetracycline or 1 to 3 g/L of lincomycin in 200 L of water or erythromycin at a rate of 50 g/150 L of water.<sup>42</sup> A common recommendation is that a foot bath can treat 150 to 200 cows per change of solution, used three times per week in outbreaks, once every week or two for maintenance.

Other observations however, suggest that as few as 30 to 50 cows through a footbath may cause major shifts in pH and solids loading, and the largest increment of change in pH occurred with the passage of the first 32 cows through the bath.

In summary, footbaths make biological sense for the treatment and control of PDD. However, most of the recommendations regarding their use, frequency of use, optimum number of cows, are based on uncontrolled field observations.

#### Antibiotics in footbaths

Antibiotics are commonly used in footbaths for the treatment and control of PDD.<sup>42</sup> Antibiotics in footbaths are rapidly neutralized in the presence of excessive contamination from mud and manure. This is a significant limitation in large herds or in housing situations in which muddy conditions are present.

Tetracycline in 6–8 g/L of water has been used in a footbath for treatment of PDD. Tetracycline powder (324 g/lb) at 20 to 40 g per gallon (US) to deliver 0.5 to 1%. Lincomycin mix at 0.5 to 4 g/gallon US is also used. A mixture of lincomycin and spectinomycin in 150 g/200 L of water for treatment and 125 g/200 L of water for control was also effective. Walking cows through a footbath containing erythromycin, at a concentration of 35 mg erythromycin/L, after two consecutive milkings is effective.<sup>43</sup> Four days after treatment, four of the measured signs (exudation, reddening, creaminess, and pain) were all significantly improved.

Most of the antibiotics used require a veterinary prescription and must be used according to specific recommendations and compliance with withdrawal periods as necessary.



Non-antibiotics in footbaths

Copper sulfate has been used widely in footbaths to control PDD but is considered ineffective.<sup>42</sup> Copper sulfate and zinc sulfate combine with organic matter and become neutralized.

Formalin (37%) diluted to a 3–5% concentration has also been used extensively worldwide in footbaths for the control of lameness in cattle. However, it is not recommended for use in footbaths for the treatment of PDD.

A 7-day footbath of 6% formalin, 2% copper sulfate or 1% peracetic acid can be as effective in controlling PDD as erythromycin at 210 g/L for two days.<sup>44</sup>

In a dairy herd with heel-horn erosion, a foot bath containing acidic ionized copper through which the cows walked twice daily after milking for a total of 47 days was effective in controlling PDD.<sup>35</sup>

### Treatment failure

The possible causes of treatment failure include inconsistent application of treatments and/or failure to periodically retreat all feet of all cows in the herd every 2 to 3 months with a topical spray, improper formulation of the medication, the neutralization of the antibiotics by manure, and the inaccessibility of the medication when the lesion is in the interdigital cleft.<sup>45</sup> In addition, ideally lesions should be washed and cleaned thoroughly before applying the medication.

### Protocol for evaluation of treatment

A uniform protocol to evaluate the results of treatment and control of PDD has been described.<sup>46</sup> The protocol includes herd information including history and facilities, animal identification and production and clinical information about the lesions, the trial design which includes the duration of the trial, the positive and negative controls, how the lesions will be described and scored, the lameness score, the evaluation of pain, and the different treatments being evaluated.

### CONTROL

Because the risk factors which predispose to the lesions are uncertain, specific environmental control strategies have not been examined using controlled field trials. Recurrence rates of PDD vary from 40 to 52% after 7 to 12 months.<sup>45</sup> Thus it makes biological sense to have an infectious disease control system in place in the herd to provide optimum control.

◦ **Housing, environment, and management.** The high incidence of the disease in dairy cattle in drylot and freestall housing suggests that a high infection rate may be associated with high population density and contamination of bedding and the environment. Providing environmental

conditions which promote clean and dry ground surfaces and bedding appears to be a logical strategy. Improving cow comfort by providing clean stalls, corrals, and alleys, dry and comfortable bedding, reducing the stocking rate, and improving ventilation to allow drying of stalls and alleys may decrease the incidence and severity of clinical cases. Hoof trimming, mobile tilt tables, and livestock trailers should be thoroughly cleaned and disinfected to prevent potential transmission of the agent of PDD.

- **Biosecurity.** For herds which are free of PDD, the most important control consideration is the purchase of herd replacements. According to the NAHMS survey of 1996 in the US, the odds of PDD infection were 8 times greater in herds which purchased replacements from outside sources compared with those that did not.<sup>45</sup> Herd replacements should be purchased from herds known to be free of PDD. Quarantine procedures may be applicable but often impractical.
- **Footbath.** Successful control is possible by single passage of cattle through a footbath containing 5–6 g/L oxytetracycline or 150 g lincospectin 100 in 200 L water.<sup>47</sup> For optimum results the heels of affected cows should be spray washed prior to entering the footbath. Repeating the footbath treatment in 4–6 weeks is recommended. Regular footbaths with 5% copper sulfate solution and formalin 3–5% solution once weekly, according to the incidence of the disease may be necessary in certain circumstances. Regular inspection of the feet of cattle is recommended to monitor the occurrence of the lesions.
- **Vaccination.** There is no evidence that a vaccine is effective for the control of PDD.<sup>45</sup>

### REVIEW LITERATURE

- Symposium on Digital Dermatitis. 8th International Symposium on Disorders of Ruminant Digits. Conference on Bovine Lameness, Banff, Canada. Cont Vet Education Program. Saskatchewan, Canada: University of Saskatchewan, Saskatoon, 1994, pp. 137–185.
- Shearer JK, Elliott JB. Papillomatous digital dermatitis: treatment and control strategies: Part I. *Compend Contin Educ Pract Vet* 1998; 20: S158–S168.
- Shearer JK, Hernandez J, Elliott JB. Papillomatous digital dermatitis: treatment and control strategies: Part II. *Compend Contin Educ Pract Vet* 1998; 20: S213–S223.
- Berry SL, Read DH, Walker RL, Hird DW. Etiology, treatment and prospects for vaccination against papillomatous digital dermatitis. In: 12th International Symposium on Lameness in Ruminants. Editor: JK Shearer. Orlando, Florida, January 9–13 2002, pp. 5–11.

### REFERENCES

1. Walker RL et al. *Am J Vet Res* 1997; 58:744.
2. Walker RL et al. *Vet Microbiol* 1995; 47:343.
3. Choi BK et al. *Int J System Bacteriol* 1997; 47:175.
4. Rijpkema SGT et al. *Vet Rec* 1997; 140:257.
5. Dopfer D et al. *Vet Rec* 1997; 140:620.
6. Collighan RJ et al. *Vet Microbiol* 2000; 74:249.
7. Dhawi A et al. *Vet J* 2005; 169:232.
8. Demirkan I et al. *J Med Microbiol* 2001; 50:1061.
9. Rodriguez LA et al. *J Am Vet Med Assoc* 1996; 209:1464.
10. Rodriguez LA et al. *Prev Vet Med* 1996; 28:117.
11. Vermunt JJ, Hill FI. *NZ Vet J* 2004; 52:99.
12. Milinovich GJ et al. *Aust Vet J* 2004; 82:223.
13. Wells SJ et al. *Prev Vet Med* 1999; 38:11.
14. Brown CC et al. *Am J Vet Res* 2000; 61:928.
15. Argaez-Rodriguez F et al. *Prev Vet Med* 1997; 32:275.
16. Rodriguez-Lainz A et al. *Prev Vet Med* 1998; 37:197.
17. Frankema K et al. *Prev Vet Med* 1993; 17:137.
18. Rodriguez-Lainz A et al. *Prev Vet Med* 1999; 42:87.
19. Hernandez J et al. *J Am Vet Med Assoc* 2000; 216:1288.
20. Trott DJ et al. *J Clin Microbiol* 2003; 41:2522.
21. Demirkan I et al. *Vet J* 1999; 157:69.
22. Murray RD et al. *Res Vet Sci* 2002; 73:223.
23. Stamm LV et al. *J Clin Microbiol* 2002; 40:3463.
24. Edwards AM et al. *Microbiology* 2003; 149:1083.
25. Green LE et al. *J Dairy Sci* 2002; 85:2250.
26. Hernandez J et al. *J Am Vet Med Assoc* 2002; 220:640.
27. Hernandez J et al. *J Am Vet Med Assoc* 2001; 218:1611.
28. Blowey RW et al. *Vet Rec* 1994; 135:117.
29. van Amstel SR. *J South Afr Assoc* 1995; 66:177.
30. Read DH, Walker RL. *J Vet Diagn Invest* 1998; 10:67.
31. Demirkan I et al. *Vet Microbiol* 1998; 60:285.
32. Blowey RW, Done SH. *Vet Rec* 1995; 137:379.
33. Shearer JK, Elliott JB. In: *Proc Int Symp Disorders Ruminant Digit*, Banff, Canada, 1994, p. 182.
34. Britt JS et al. *J Am Vet Med Assoc* 1996; 209:1134.
35. Manske T et al. *Prev Vet Med* 2002; 53:215.
36. Britt JS et al. *J Am Vet Med Assoc* 1999; 215:833.
37. Laven RA, Hunt H. *Vet Rec* 2001; 149:302.
38. Hernandez J et al. *J Am Vet Med Assoc* 1999; 214:688.
39. Moore DA et al. *J Am Vet Med Assoc* 2001; 219:1435.
40. Shearer JK, Hernandez JJ. *Dairy Sci* 2000; 83:741.
41. Kofler J et al. *J Vet Med A* 2004; 51:447.
42. Shearer JK, Elliott JB. *Compend Contin Educ Pract Vet* 1998; 20:S158.
43. Laven RA, Proven MJ. *Vet Rec* 2000; 147:503.
44. Laven RA, Hunt H. *Vet Rec* 2002; 151:144.
45. Shearer JK et al. *Compend Contin Educ Pract Vet* 1998; 20:S213.
46. Britt JS et al. *Bov Pract* 1999; 33:149.
47. Blowey RW. In: *Proc Int Symp Disorders Ruminant Digit*, Banff, Canada, 1994, p. 168.

### INFECTIOUS FOOT ROT IN SHEEP

#### Synopsis

**Etiology** *Dichelobacter nodosus*. Strains vary in virulence to produce benign and virulent foot rot

**Epidemiology** Source of infection is lesion discharge from other infected sheep. The survival of *D. nodosus* in the environment is short. Highly contagious

disease with high attack rate in warm wet conditions. Lesions are present on both claws of the foot and commonly in more than one foot. Significant effect on productivity

**Clinical findings** Inflammation of the skin at the skin-horn junction in the interdigital area with underrunning of the soft horn in benign (non-progressive) foot rot. Progresses to underrunning of the hard horn and inflammation of the sensitive laminae in virulent (progressive) foot rot and severe lameness

**Clinical pathology** Protease test for strain virulence

**Diagnostic confirmation** Clinical

**Treatment and control** Topical treatment with bactericides in footbaths at time of transmission to minimize new infections, parenteral antibiotics for treating virulent footrot, vaccination, culling

## ETIOLOGY

*Dichelobacter (Bacteroides) nodosus* is the essential causal pathogen. It is a highly specialized organism in the small taxonomic group, the Cardiobacteriaceae. *F. necrophorum* aids *D. nodosus* in the invasion of the foot and contributes in the inflammatory reaction. Two other bacteria, a treponeme originally known as *Spirochaeta (Treponema) penortha*, and a motile fusiform bacillus, are commonly present in affected feet but are believed to have no primary etiological importance.

The type IV fimbriae of *D. nodosus* are recognized as a major virulence factor, are highly immunogenic, and provide the basis for the classification of *D. nodosus* strains into two major classes based on the genetic organization of the fimbrial gene region, with class I containing strains of serogroups A, B, C, E, F, G, I, and M and class II consisting of serogroups D and H. The serological diversity observed in the fimbriae is due to sequence variation in the fimbrial subunit protein and the fimbriae are the major immunoprotective antigens, although protection is serogroup-specific.<sup>1-4</sup>

Within this typing scheme there are strains that have major and minor prevalence in the disease. A strain-specific typing system based on genetic analysis of the *fimA* locus and combined with DNA sequencing is suggested for the characterization of *D. nodosus* strains.<sup>5</sup>

## EPIDEMIOLOGY

### Geographical occurrence

Foot rot of sheep is common in all countries where there are large numbers of sheep, except that it does not occur in arid and semi-arid areas unless the sheep have access to wet areas such as sub-irrigated swales.

## Host occurrence

Sheep are the species principally affected but goats are also susceptible. Infection has been identified in farmed red deer,<sup>6</sup> in cattle and is considered the cause of overgrown and deformed claws in wild mouflon in Europe.<sup>7</sup> With environmental conditions of moisture and warmth, the disease in sheep has a high attack rate and a large proportion of a group of sheep can be affected within 1 to 2 weeks. Both claws of a foot and more than one foot (usually all) on the sheep will be affected. The disease is common and in high-risk areas the prevalence of infected flocks is high.

## Source of infection

The source of infection of *D. nodosus* is discharge from the active or chronic infection in the feet of affected animals. The major **reservoir** of infection for virulent strains of sheep is other sheep as the isolates from cattle and deer generally produce the benign form of foot rot in sheep. The organism does not survive in the **environment** for more than a few days, 2 weeks at the most, but it can survive virtually indefinitely in lesions on chronically infected feet. Two classifications of foot rot have been made based on the site of survival and perpetuation of the organism in a flock and the importance of this to control strategies:

1. **Virulent foot rot (progressive foot rot) and intermediate foot rot** – strains survive between foot rot transmission periods in pockets in previously underrun ovine hoof
2. **Benign foot rot (non-progressive foot rot)** – strains survive in the interdigital skin and the organism can be demonstrated in interdigital skin of a high proportion of asymptomatic sheep.<sup>8,9</sup>

## Methods of transmission

Infection is usually introduced into a flock by the introduction of **carrier sheep**. Infection into a flock can also occur from the **environment** when foot rot-free sheep use yards, roads, or trucks that have been used by foot rot-infected sheep in the immediate past. Transmission has occurred to sheep held for 1 hour in a yard that 4 hours previously had contained a flock of sheep in which less than 1% had foot rot.<sup>10</sup> Spread within a flock is facilitated by the flocking nature of sheep and heavy environmental contamination around communal drinking and feeding areas.

## Host risk factors

### Age

Foot rot occurs in sheep of all ages. In a flock outbreak, the age-specific incidence and severity of lesions in ewes increases with age.<sup>11</sup> Older lambs have more severe lesions; young lambs and lambs from

maiden ewes have less severe lesions than lambs from higher parity ewes. Prior natural infection does not engender immunity to a subsequent challenge that have had the disease. However, sheep do vary in their resistance or susceptibility to footrot infection. This appears to be, in part, immunologically mediated with the ability of some sheep to mount a strong T-cell response and to produce agglutinating antibodies to *D. nodosus* fimbriae an important factor in conferring resistance to severe infection.<sup>5</sup>

## Breed

Sheep of the Merino type are the most susceptible to foot rot. British breeds, particularly Romney Marsh, are less susceptible and suffer from a milder form of the disease; they respond better to vaccination by suffering fewer subsequent attacks of foot rot but have worse reactions to the vaccination than Merinos.<sup>12</sup> In the natural disease some animals never become infected, a few become infected but recover and most become infected and persist as chronic cases. There is developing evidence that this variation is **genetically determined** and selection for resistance, based on exposure to the disease and rigorous culling of affected individuals, has been demonstrated in the Targhee, Romney, Merino, Corriedale, and Perendale breeds.<sup>13,14</sup> Genetic markers can be identified and the SY1b histoglobulin may be associated with this resistance.<sup>13</sup>

## Environmental risk factors

### Climate

Moistness of the pasture and environmental temperature are major determinants for the transmission of foot rot. Conditions of **wetness** and **warmth** favor persistence of the bacteria in pasture and increase susceptibility of the feet to injury and dermatitis, thus facilitating spread of the disease from carrier sheep. The wetness has to be of considerable duration; short, heavy rainfalls are not significant – persistent rain over several weeks is, as there must be continued moistness on the ground for transmission to occur. Warmth is also required and moisture in winter in colder climates exerts no effect on foot rot – the daily mean temperature must be above 10°C (50°F) for transmission to occur. There is a linear relationship between the prevalence of farms with foot rot and yearly rainfall.<sup>15</sup>

### Season

The requirement for both moisture and a warm environmental temperature determines that most serious outbreaks in sheep at pasture occur in the spring or in autumn and the transmission period is usually 4–6 weeks of each of these

seasons. Transmission and outbreaks occur in winter in housed sheep when conditions underfoot are wet and in summer with sheep on irrigated pastures.

#### Management

Any practice that concentrates sheep in small areas will favor spread of the disease when environmental conditions favor transmission. Routine foot trimming may increase risk of infection and clinical disease.<sup>16</sup>

Failure to isolate introduced sheep until their foot rot status has been determined is a risk factor.

#### Pasture type

Foot rot is commonly associated with lush or improved pastures, irrigated pastures, and clover-dominant pastures. Long mature grass may result in interdigital abrasions as it is dragged through the interdigital space and facilitates infection, as may penetration of interdigital skin by barley grass seeds (*Hordeum murinum*).<sup>10,11</sup> Skin penetration by larvae of the nematode *Strongyloides* spp. may also predispose to infection.

#### Pathogen factors

The major *D. nodosus*-encoded virulence factors that have been implicated in the disease are type IV fimbriae and extracellular proteases and the fimbrial subunit gene, *fimA*, is essential for virulence.

There is considerable variation in the virulence of strains of *D. nodosus*. Some produce benign foot rot whereas others produce deep lesions that facilitate their survival and confound eradication programs.<sup>17-19</sup> As a result they have traditionally been subdivided into **benign, intermediate, and virulent** strains to conform with the types of clinical foot rot they are associated with in the field.<sup>20</sup> The virulence of each strain depends on its **keratinolytic capacity**; virulent strains produce more extracellular protease, and an earlier production of elastase, than benign strains.<sup>20,21</sup> The separation of the hard horn of the claw from the germinal layer, which is a characteristic of virulent foot rot, has been associated with infection with strains that produce a **heat-stable protease** with a single isoenzyme pattern, whereas benign strains have thermolabile protease.<sup>18,22</sup> Infection associated with more than one strain is reported and up to five serogroups including up to eight strains have been reported from a single foot.<sup>5,19</sup>

#### Economic importance

Benign foot rot is generally considered to cause little if any economic effect and its occurrence is confined to the wet season. However, even benign foot rot infections are reported to depress body weight, wool growth, and wool quality in some countries.<sup>7</sup>

In contrast, virulent foot rot certainly results in severe loss of bodily condition and this, combined with a moderate mortality rate, a reduction in wool production, the disruption of the general routine of the farm, and the expense of labor and materials to treat the disease adequately, makes foot rot one of the most costly of sheep diseases. In addition there are welfare concerns, societal pressures encountered by owners of foot rot-infected flocks and, in control areas, the community costs of statutory foot rot control programs.

In controlled studies severe under-running foot rot has resulted in an 11% depression in body weight and an 8% reduction in clean fleece weight of affected sheep.<sup>3</sup> The magnitude of the loss can be related to the virulence of the infecting organism and the severity of the disease.

The effects on body weight are most severe during the active transmission period of the disease and there may be compensatory growth during the recovery period. Both greasy and clean fleece weight are significantly depressed by foot rot with a linear association between the extent of the depression and the severity of the disease. Wool fiber diameter is also decreased, which could partially compensate for fleece weight decrease in the final price for wool. Some sheep with severe disease may develop a break in the wool.

Feet of sheep affected with foot rot are attractive to blowfly strike. Necrotic exudate with accompanying maggots from affected feet can be deposited on the fleece to result in a focus of body strike.

#### PATHOGENESIS

**Maceration** of the interdigital skin from prolonged wet conditions underfoot allows infection with *F. necrophorum*. This **initial local dermatitis** associated with infection with *F. necrophorum* at the skin and the skin-horn junction may progress no further, but the hyperkeratosis induced by this infection facilitates infection by *D. nodosus* if it is present. The preliminary dermatitis has been named '**ovine interdigital dermatitis**' and is also called '**foot scald**'.

#### Ovine interdigital dermatitis, foot scald

This disease is commonly seasonal and occurs when moist conditions under-foot, or trauma from pastures or frost, produces maceration of the interdigital skin and allows invasion by *Fusobacterium necrophorum*, a ubiquitous organism in feces and soil.

Lesions are in the interdigital space where there is hyperemia, or swelling and blanching, and wetness of the interdigital skin. There is no, or only minimal, separation at the skin-horn junction. Lambs are more commonly affected,

particularly in spring, but the disease can involve all ages of sheep. Most or all feet on a sheep are affected and it is present in a large proportion of the age cohort of the flock.

In Australia and New Zealand the disease is not usually associated with lameness and is often found incidentally when examining sheep for other reasons.

In Britain it is reported as a common cause of lameness<sup>23</sup> but this might reflect a lack of cultural differentiation from the less virulent forms of infectious foot rot that can present with identical clinical findings.<sup>24,25</sup>

Control is by avoiding grazing lambs on long grass and where there are muddy conditions. The disease will regress spontaneously when the pasture dries up but can be treated with topically applied oxytetracycline or by walking through a foot bath containing 3% formalin or standing (10 minutes) in one containing 10% zinc sulfate.

Ovine interdigital dermatitis can predispose to infectious foot rot, or to foot abscess.

#### Benign and virulent foot rot

It is assumed that the pili of *D. nodosus* facilitate attachment of the organism to the epithelium of the foot. When the feet of sheep with interdigital dermatitis are colonized with a strain of *D. nodosus* that has little keratinolytic ability, there is under-running of the soft horn but no further progression and this infection has been given the name of **benign foot rot** or **non-progressive foot rot**. Benign foot rot cannot be easily distinguished on clinical examination from ovine interdigital dermatitis. Colonization with keratinolytic and virulent strains leads to the clinical disease of **virulent foot rot**. The under-running lesion is the result of keratolytic activity and the associated inflammation is a consequence of a combined activity of *D. nodosus* and *F. necrophorum*. A designation of intermediate foot rot has been used by some to provide a mid-classification of severity between benign and virulent foot rot and the classification of infected sheep into these categories is based on a foot lesion scoring system (see below). There is much difficulty in specifying exactly the characteristics of these clinical forms in natural outbreaks, in part because commonly more than one strain is involved, the more so because the severity of the lesions is also modulated by geographic and climatic conditions.<sup>8-11,26</sup>

#### CLINICAL FINDINGS

##### Sheep

##### Virulent foot rot

In a flock, a sudden onset of **lameness** of several sheep is the usual presenting sign

of foot rot as the disease is not detected before this occurs. The pain associated with infection is severe and affected sheep will limp or carry the affected leg. Usually more than one foot is affected and affected sheep may graze on their knees.

On close examination the earliest sign of virulent foot rot is swelling and moistness of the skin of the interdigital cleft and a parboiled and pitted appearance at the skin-horn junction in the cleft. This inflammation is accompanied by slight lameness which increases as necrosis underruns the horn in the cleft. The **underrunning** starts as a separation of the skin-horn junction at the axial surface just anterior to the bulb of the heel and proceeds down the axial surface and forwards and backwards. There is destruction of the epidermal matrix beneath the hard horn, which is subsequently separated from the underlying tissues. In severe cases both the axial and the abaxial wall and the sole are underrun and deep necrosis of tissue may lead to the shedding of the horn case. The separation may not be obvious on superficial visual examination but can be detected with a knife blade or by paring of the feet. There is a distinctive, **foul-smelling** exudate, which is always small in amount. Abscessation does not occur.

Both claws of the one foot will be involved and commonly more than one foot is involved. When extensive underrunning has occurred lameness is severe. A systemic reaction, manifest by anorexia and fever, may occur in severe cases. Recumbent animals become emaciated and may die of starvation. Secondary bacterial invasion and/or fly strike may result in the spread of inflammation up the legs.

#### Benign foot rot

Benign foot rot is manifest with interdigital lesions, a break at the skin-horn junction and separation of the soft horn, but the disease does not progress beyond this stage to severe underrunning of the hard horn of the foot. The interdigital skin becomes inflamed and covered by a thin film of moist necrotic material; the horn is pitted and blanched.

It is difficult to distinguish between an established infection with benign foot rot and the early stages of virulent foot rot. With virulent foot rot it is common to find all stages and severity of the disease in the same flock. A large number of sheep should be examined in order to differentiate benign from virulent foot rot and it may be necessary to re-examine the flock after a period of time to determine if the disease has progressed to the virulent type.

#### Scoring systems

Several scoring systems, based on severity and persistence, have been devised to aid in epidemiological and control programs and can be used to categorize the severity of disease, and the virulence of associated strains of *D. nodosus*, within a flock.<sup>27</sup> In the Australian system, a score of 0 to 4 is allocated to each foot but the score is used to classify the flock or a cohort, as to the severity of disease. Feet scored 0 have no evidence of necrosis or inflammation or cleavage of horn. Scores of 1 and 2 are confined to sheep with interdigital lesions whereas a gradation of scores from 3 to 4 reflect progressive underrunning and separation of horn from the underlying lamina with 3 representing underrunning of the soft horn. In this score system benign foot rot cases score 0 with some allowance for scores of 3. Intermediate foot rot in a cohort is defined when 1 to 10% of the cohort have a score of 4. Virulent foot rot is defined by greater than 10% of the cohort with a score of 4.<sup>28</sup> It has been suggested that the score system is not valid as the severity of disease can be influenced by climate but one study suggests that score systems are strain specific rather than climate specific. It found that a cohort of sheep with scores defining intermediate foot rot maintained that clinical classification when moved to a climate that would promote the development of more severe disease.<sup>28</sup>

#### Symptomless carriers

These carriers may be affected for periods of up to 3 years. Most such animals have a misshapen foot and a pocket of infection beneath underrun horn can be found if the foot is pared. A less common form of the chronic disease is an area of moist skin between the claws without obvious involvement of the claw.

#### Goats

Foot rot is associated with *D. nodosus* and is manifested by severe interdigital dermatitis; there may be some separation of the skin-horn junction at the axial surface but rarely is there an underrunning of the horn of the sole or the abaxial surface of the foot as in sheep.<sup>29</sup>

#### Cattle

Infection with *D. nodosus* is also associated primarily with a severe interdigital dermatitis and there may be lameness. There is fissuring and hyperkeratosis of the interdigital skin with pitting and erosion at the skin-horn junction in the cleft. There is also fissuring, pitting, and erosion on the horny bulbs of the heel. There may be underrunning at the heel but it is usually minimal.

#### Contagious ovine digital dermatitis (CODD)

CODD is an apparent new disease recently described in the UK.<sup>30,31</sup>

It is manifest with severe, rapidly spreading, lameness and is more common in adults than lambs. Commonly there is a history of poor response to conventional methods of footrot control. The initial lesion is a proliferative or ulcerative lesion at the coronet, with subsequent extensive under-running of the hoof horn and, in some cases, complete separation. Interdigital lesions are absent. It may affect only one claw on one foot. A spirochete, morphologically different from *Spirochaeta penartha* but with similarities to the spirochete associated with digital dermatitis (hairy foot wart) in cattle has been isolated.<sup>31,32</sup>

*F. necrophorum* and *D. nodosus* may also be present in some flocks but their contribution, at present, is unclear.

Response to formalin and zinc sulfate footbaths is poor but the disease is reported to respond to topical lincomycin and spectinomycin solutions.<sup>30</sup>

#### CLINICAL PATHOLOGY AND NECROPSY FINDINGS

In countries that do not have a large sheep industry identification of *D. nodosus* in most laboratories, is made by examining a smear made of exudate taken from underneath some underrun horn at the advancing edge, and stained with Gram's stain. This is potentially inaccurate and to increase the validity of a decision, a fluorescein-stained antibody can be used. A highly sensitive polymerase chain reaction (PCR) can be used.<sup>20,33</sup> PCR tests can be used to detect gene sequences and identify particular strains and are used in eradication schemes in Australia.<sup>17,19</sup>

Examinations of protease type, gene probe category and nucleotide sequence to differentiate virulent from benign strains are used in regions with eradication programs for virulent foot rot and in epidemiological studies.<sup>20,21</sup> Of the protease tests, the gelatin gel protease thermostability test allows clear-cut and rapid differentiation between virulent and benign strains.<sup>34</sup>

Serum antibody following natural infection develops as early as 2 weeks after infection and the level obtained is proportional to the severity of the early clinical disease. The antibody response is not long lasting and falls to pre-infection levels within a few months after resolution of the foot lesions.<sup>35,36</sup> An ELISA for serological detection of infected sheep has some value for diagnosis of flock infection but lacks specificity and is inaccurate in older sheep.<sup>35</sup>

**Necropsy** of sheep for diagnosis of foot rot is not needed.

#### DIFFERENTIAL DIAGNOSIS

Diagnosis of virulent foot rot is clinical, is based on a whole flock approach, and postmortem examination is not necessary.

Because of the rigorous control measures required sometimes by law to control or eradicate infectious foot rot of sheep, it is imperative that the diagnosis be made with great care. The greatest problem is in the identification of carrier sheep in the non-transmitting periods. A number of conditions may be confused with foot rot, especially when they occur under the same environmental conditions (Table 20.1).

**Foot abscess** – a major differential and can be present in several sheep in a flock at the same time. It usually affects only one foot, is not contagious and is characterized by extensive suppuration. The abscess occurs in a single claw on the foot and there is obvious local heat and pain on palpation.

#### Contagious ovine digital dermatitis.

**Shelly toe** – the name given to a condition where there is separation of the wall of the foot in Merino sheep and occasionally in other breeds on improved pasture. The abaxial wall of the hoof separates from the sole near the toe and the crevice formed becomes packed with mud and manure. The hoof in the region is dry and crumbly. The cause is not known but it is probably a form of laminitis.

**Suppurative cellulitis** – associated with *F. necrophorum*, commences as an ulcerative dermatitis of the pastern above the bulb of the heel, and extends up the leg to the knee or the hock and more deeply into SC tissues.

Other diseases with foot lameness include:

- Contagious echyma
- Bluetongue
- Foot and mouth disease
- Ulcerative dermatosis
- Strawberry foot rot
- Laminitis
- Lameness associated with *Erysipelothrix insidiosus*, and occurring after dipping

#### TREATMENT AND CONTROL

The time-honored method of treatment of foot rot has been the application of topical bactericidal agents to the foot. These are most effective early in the transmission period, prior to any extensive underrunning of the horn. When there is underrunning of the horn, the underrun horn must be removed so as to expose the infection to the topical agent. This approach has been used successfully for treatment, control, and eradication purposes. However, it requires extensive paring of affected feet, which is labor intensive, time consuming and distressing

both to the operator and to the sheep. Recent years have seen the advent of treatment methods that minimize the need for extensive paring of the feet. These include the use of topical zinc sulfate, the use of parenteral antibiotics and the recognition of vaccination as an adjunct to treatment as well as a strategy for control.

#### Topical treatment

Most topical treatments require that all underrun horn be carefully removed so that the antibacterial agent to be applied can come into contact with infective material. This necessitates painstaking and careful examination, and paring of all feet. Incomplete paring will leave pockets of infection. With severely underrun feet, it is impossible to expose all of the underrun areas without causing hemorrhage as it may be necessary to remove all of the sole and the wall of the claw. Very sharp instruments including a knife and hoof secateurs are necessary to do the job properly and they should be disinfected after each use. The parings should be collected and burned. Sheep restraint cradles lessen the labor of paring of the feet.

With small numbers of sheep topical treatment may be applied by brush, by spray, or aerosol. Topical treatments are likely to be washed off the feet and their efficacy under wet conditions is a determinant in selecting the agent to be used. Local applications include chloramphenicol (10% tincture in methylated spirits or propylene glycol), oxytetracycline (5% tincture in methylated spirits), cetyltrimethyl ammonium bromide or cetrimide (20% alcoholic tincture), zinc sulfate (10% solution), copper sulfate (10% solution) and dichlorophen as a 10% solution in either diacetone alcohol or ethyl alcohol.

Chloramphenicol is expensive but efficient under both wet and dry conditions. Its use with food animals is prohibited in many countries. Oxytetracycline must be used as a 5% tincture for optimum results and is not as efficient as chloramphenicol under wet conditions, but gives excellent results when the weather is dry. Cetrimide is a relatively cheap product and appears to be as effective as chloramphenicol under all conditions. It is possible that in different countries with different climates and environmental conditions, the efficiency of particular treatments will vary. When only a few sheep are affected, bandaging may help maintain local concentrations of the topical preparation. In general, parenteral treatment with antibiotics, without paring of the feet, has replaced topical antimicrobial treatment of individual or small numbers of sheep.

#### Footbathing for treatment and control

Footbathing is a more practical approach to topical treatment, and for control during transmission periods, when dealing with large numbers of sheep. All sheep are passed through the footbath but it is usual to divide the flock into affected and unaffected groups by examination prior to the initial footbathing, and to pasture them separately following footbathing to minimize subsequent infection of uninfected sheep. After several footbaths and inspections the majority of the flock should be free of infection and the residual infected sheep are culled.

Preparations suitable for footbaths include 5% copper sulfate, 5% formalin and 10% zinc sulfate with or without a surfactant to aid wetting of tissues. Regardless of the agent used, it is recommended that the sheep be kept standing on concrete, on wooden slats, or on dry ground for a few hours after treatment.

The relative merits and disadvantages of the various preparations used are as follows.

#### Copper sulfate solution (5%)

Copper sulfate solution colors the wool, deteriorates with pollution, corrodes metal, and may cause excessive contamination of the environment with copper. The feet of the sheep must be pared and all infected areas exposed before treatment. Copper sulfate footbathing appears to harden the horn, which can be an advantage but also a disadvantage if further paring is required at a later date. A patented copper salt preparation (not copper sulfate) has efficacy in treatment without the disadvantages of copper sulfate.<sup>37</sup>

#### Formalin solution (5%)

Formalin solution does not deteriorate with pollution but causes extreme discomfort to sheep that have heavily pared feet and its use for sheep with severe lesions is discouraged on humane grounds. The feet of the sheep must be pared and all infected areas exposed before treatment. Formalin is unpleasant to work with in enclosed areas, has toxicity for humans and its use may be banned in some countries for this reason. Sheep should be passed through the footbath weekly for 4 weeks or weekly during periods of high risk for transmission.

The use of solutions containing more than 5% formalin or dipping at intervals of less than 1 week may cause irritation of the skin. Farmers can be neglectful in maintaining proper concentrations of formalin in footbaths, and frequent use of the bath combined with hot weather can result in a concentration of 30% formalin. Such concentrations cause extensive cellulitis around the coronets, and a

Table 20.1. Differential diagnosis of lameness accompanied by foot lesions in sheep

Disease	Epidemiology	Foot lesions	Other lesions	Other clinical signs	Response to treatment	Diagnostic microbiology
Infectious foot rot	Serious outbreaks in wet, warm weather. High morbidity. Few chronic lame sheep in dry seasons	Interdigital dermatitis, underrunning of horn medial aspect of claw. Strong smell of necrotic horn	–	Very severe lameness. Walk on knees	To penicillin and streptomycin, erythromycin excellent	<i>Dichelobacter nodosus</i> on smear, or fluorescent antibody test
Benign foot rot (scald)	High morbidity in wet warm weather. Disappears with dry weather	Interdigital dermatitis, no smell, almost no underrunning of horn	–	Mild lameness	Not treated	<i>D. nodosus</i> avirulent strains not distinguishable microbiologically
Infectious bulbar necrosis	Adult sheep, usually less than 10% affected. Serious in wet seasons	Toe abscess usually in front feet. Heel abscess in hind feet. Swelling, pain, discharge of pus	–	Very severe lameness	Good to sulfonamides or penicillin-streptomycin	<i>F. necrophorum</i> and <i>Actinomyces (Corynebacterium pyogenes)</i>
Contagious ecthyma	Lambs mostly or non-immune adults. Dry summer	Raised proliferative lesions with tenacious scabs on coronet skin	Lesions around mouth almost always	Rarely lambs have septicemia. Lameness mild only	–	–
Ulcerative dermatitis	Spread by physical contact at mating. Morbidity usually 20%	Raw granulating ulcers in interdigital space and on coronet. No pus	Around mouth and genitalia usually	Moderate lameness	–	–
Bluetongue	Insect-borne disease. Variable morbidity	Coronitis, separation of horn. Are late in syndrome	Severe erosions around mouth and nasal cavities	High fever, salivation. Severe lameness and recumbency	–	Virus isolation
Strawberry foot rot	In summer, high morbidity, carrier sheep infect	Proliferative dermatitis, piled up scabs. Heal in 5–6 weeks. Coronet to knee or hock	–	No itching or lameness	–	<i>Dermatophilus congolensis</i>
Foot-and-mouth disease	May present like outbreak of contagious foot rot	Vesicles at coronary band and skin of interdigital cleft	Vesicles in mouth	All ages	–	Virus demonstration
Infestation with <i>Strongyloides</i> or trombiculid mites	Wet summer conditions. Local distribution only	Non-specific dermatitis of skin of lower legs	–	–	Organophosphates for trombiculids	Parasites in scrapings

high proportion of animals may be so badly affected that they need to be destroyed. The safest precaution is to empty the vat and prepare a new mixture.

#### Zinc sulfate solution (10–20%)

Zinc sulfate solution is as effective as formalin, more pleasant to use and is generally the preferred topical chemical for the treatment of foot rot.<sup>38</sup> It has a superior ability to **penetrate** the hoof horn which is enhanced by the addition of the **surfactant** sodium lauryl sulfate to the footbath solution.<sup>39</sup> Significant cure rates can be achieved without prior paring of the feet which removes a significant labor cost from the treatment and control of the disease.<sup>38–40</sup>

Cure rates, without paring, are higher in sheep that have moderate rather than severe lesions in their feet. Some paring of chronically affected, overgrown feet may be required to allow the treatment access to pockets of infection in the anterior aspects of the sole, and also of

feet that have underrunning that has progressed to the abaxial area of the digit. Sheep are stood for 1 h in a footbath containing a 10 to 20% zinc sulfate solution with 2% sodium lauryl sulfate with sufficient depth to cover the coronet. The treatment is repeated in 5 d and after a further 21 d the sheep are individually examined to determine their status and are retreated or culled depending upon the strategy of treatment and control in the flock. Zinc sulfate footbathing can provide protection to the foot against reinfection for periods of at least 2 weeks<sup>41</sup> and can be used effectively during periods of active spread of the disease.<sup>42</sup> Repeated daily footbathing (10 min each day for 5 days) in a zinc sulfate solution with surfactant has eradicated (as opposed to controlled) virulent foot rot in sheep associated with some strains but was ineffective against a strain that produced severe underrunning.<sup>17</sup>

Thirsty sheep that drink from the footbath may die of acute zinc poisoning.

#### Antibiotic treatment

Foot rot can be treated with antibiotics without the necessity of paring of the feet. Treatment is considerably more effective if done during dry periods, and when the sheep are kept on dry floors for 24 h after treatment, as in wet conditions the concentration of antibiotic at the tissue level is much reduced.

*D. nodosus* is susceptible *in vitro* to penicillin, cefamandole, clindamycin, tetracycline, chloramphenicol, erythromycin, sodium cefoxitin, tylosin tartrate, nitrofurazone, tinidazole and has the least susceptibility to sulfonamides and the aminoglycosides. However, *in vitro* tests may have little relevance to field application due to differences in the penetrance of antibiotics to the affected part of the foot.

Antibiotics and their dosage shown effective against virulent foot rot are:

• **Penicillin/streptomycin.** Single IM dose of 70 000 U/kg procaine

penicillin and 70 mg/kg dihydrostreptomycin<sup>43</sup>

- **Erythromycin.** Single IM dose of 10 mg/kg<sup>44,45</sup>
- **Long-acting oxytetracycline.** Single IM dose of 20 mg/kg<sup>44,46,47</sup>
- **Lincomycin/spectinomycin.** Single SC dose of 5 mg/kg lincomycin and 10 mg/kg spectinomycin.<sup>48</sup>

Cure rates in sheep kept in a dry environment, preferably a shed, for 24 h following treatment are approximately 90% with all except penicillin/streptomycin, which may be slightly less efficacious.<sup>49</sup> Cure can occur even in severely affected sheep and extensive paring prior to treatment does not improve cure rates.<sup>46,49</sup> Cure rates fall to 60% if sheep are in a wet environment following treatment and in wet conditions cure rates improve slightly if sheep are footbathed at the time of antibiotic administration.<sup>47,49</sup>

Following treatment and holding, sheep are moved to a 'clean' dry pasture and inspected for cures 3–4 weeks later when clinically affected animals are culled. Reinfection will occur in foot rot spread periods and, in general, the use of antibiotics for control of foot rot should be confined to the summer period when there is no spread.<sup>26</sup>

All treatments are 'off label' and some are not approved for use on sheep in some countries. Choice may be determined by the withholding period required before culled sheep can be sent to market. Lincomycin/spectinomycin in sheep may precipitate severe outbreaks of salmonellosis in some flocks.<sup>49</sup> Antibiotics are particularly valuable for the treatment of late-pregnant sheep that develop foot rot, where more drastic treatment could lead to problems such as pregnancy toxemia.

Antibiotics have no role in the prevention of foot rot.

### Vaccination

Vaccination against foot rot can significantly increase short-term resistance to infection and is an important component of **control** strategies, especially in circumstances where climate and management practices make other control strategies difficult to apply. Vaccination also shortens the clinical course in infected sheep and can be used as a **treatment** strategy. In neither case is vaccination 100% effective.

Pilus antigens are the major host-protective immunogens and confer protection against challenge with homologous strains. Immunity is associated with circulating antibody but high levels of **pilus-specific** circulating antibody are required for adequate diffusion into the epidermis and protection against the disease. In groups of sheep, resistance is associated with the acquisition of flock

mean agglutination titers of greater than 5000; there is a positive correlation between antibody titer and foot rot resistance in the first few months following vaccination. Immunity can be passively transferred with gammaglobulins from immunized sheep to naive recipients and from vaccinated ewes to their lambs via colostrum to provide protection for the first 8 weeks of life.<sup>24,25</sup>

Vaccines must contain adjuvants for an adequate antibody response and vaccination with oil-adjuvant vaccines is accompanied by significant **local reaction**, including local swelling at the injection site and abscessation in a proportion of animals.<sup>50</sup> This reaction is more severe in British breeds of sheep than in Merinos. In milk goats and sheep, vaccination can result in a significant drop in milk production. The potential gains from vaccination need to be weighed against this effect in a decision to use vaccination as a method of control rather than other control procedures.

Commercial vaccines have contained up to 10 strains of *D. nodosus* representative of the most common serogroups associated with foot rot. The extent to which these vaccines will give protection or will promote earlier cure depends upon the relationship of the vaccine pilus types to those associated with the foot rot problem. Vaccine failure is generally attributable to the occurrence of foot rot associated with strains of the organism not present in the vaccine or to which there is no cross-protection, and to individual animal variation in response.<sup>1,25,51,52</sup> However, more recently it is recognized that there is a limitation to the number of strains that can be incorporated in current vaccines due to antigenic competition.<sup>51,53</sup> Mixing different *D. nodosus* fimbriae in vaccines may lead to inadequate host responses to individual antigens and an alternative approach is to identify *D. nodosus* strains present in a given geographical region enabling the development of optimized and localized strain(s)-specific vaccines.<sup>5,54</sup>

Field trials have shown a wide variation in the therapeutic effect of vaccination with a reduction in foot rot incidence varying from 27–54% in sheep where there was no routine foot care to 69–91% in flocks in which vaccination was coupled with routine foot care such as trimming and footbathing.<sup>12,25,53,55</sup> The effect is to reduce both the incidence, severity, and duration of the infection. The improvement seems to be due to accelerated healing of the lesions with some protection against reinfection. For an optimum effect, two vaccinations are required and the duration of this effect depends upon the adjuvant and the breed of sheep. Even so the duration of the

protection is limited to 4–12 weeks in most studies. It can be very effective in control when coupled with a culling policy of sheep that remain clinically infected.<sup>54</sup>

Whereas vaccination is of value for control of an existing flock infection, it may not be economic to use vaccination as a strategy to prevent infection of a foot rot-free flock.<sup>25,55</sup> The use of foot rot vaccines may be prohibited in areas where there are foot rot eradication programs.

### Summary of control procedures in infected flocks

The objective of foot rot control in an infected flock is to maintain the prevalence of disease at a low level by reducing the incidence of new infections, to prevent the development of the debilitating and painful underrunning lesions of advanced foot rot, and to achieve this with strategies that are based on whole-flock control with minimal need for individual handling of individual animals. This approach is most likely to be adopted by sheep owners.<sup>56</sup> Routine footbathing, especially during transmission periods, coupled with vaccination can achieve this and sheep that are affected with severe underrunning are treated with parenterally administered antibiotics or culled.

### Genetic selection

Whereas there are breed effects on susceptibility and an apparent high heritability coefficient for resistance,<sup>13,14</sup> genetic selection for resistance has not advanced sufficiently to be used practically in control programs. Resistance can be determined by direct challenge of a candidate ram.<sup>14</sup> Antibody response to vaccination cannot be used as a surrogate.

### ERADICATION

Eradication of **virulent** foot rot is a desirable but not always feasible objective but it can be accomplished in climates where the transmission periods are short. Where rainfall is heavy and the ground moist most of the year, much greater difficulty may be encountered. Area eradication of virulent foot rot is a much more daunting task but is proceeding satisfactorily in several regions in Australia. Eradication of **benign** foot rot is not justified economically, nor is it possible with current knowledge as benign foot rot strains can be carried in the interdigital skin of asymptomatic sheep.<sup>8,9</sup>

Eradication programs are based on the following facts:

1. *D. nodosus* persists in the flock in infected feet
2. Infection in the foot can be detected and the infected sheep cured or culled
3. The organism does not persist in pasture for long periods and does not transmit in dry periods.



Fields kept free of sheep for 14 d can be considered free of infection. If all infected animals are culled or cured and infection removed from the pasture, eradication is achieved. Eradication of the disease should be undertaken during a dry summer season, but active measures must be taken to reduce the incidence of infection and spread during the transmission period in the preceding spring. Vaccination and footbathing may be part of this strategy.

In the eradication phase in the non-transmission period, all feet of sheep are examined and affected or suspicious sheep are segregated. When examinations are carried out during dry weather, the feet are likely to be hard and the disease at a quiescent stage. In such circumstances minor lesions may be missed, necessitating an extremely careful trimming and examination of all feet. Clean sheep are run through a foot bath (5% formalin or 10% zinc sulfate) and put into fresh fields, while the affected are isolated and treated with antibiotics and/or footbathing with one of the preparations described earlier. Footbathing treatments must be repeated weekly. Sheep that do not respond may be treated intensively, for example two 1-hour soaks in 10% zinc sulfate,<sup>30</sup> but preferably should be culled. In areas where flocks are small and there are insufficient fields to carry out this program completely, it has been found to be sufficient to treat all affected sheep weekly but to put all affected sheep back in the flock and the flock back onto the infective pasture, providing conditions are dry. Eradication of virulent foot rot from sheep and goats in an area of Nepal by a combination of treatment with parenteral antibiotics and a type-specific vaccine, routine vaccination with the type-specific vaccine and culling of non-responders is reported.<sup>54</sup>

**Culling** is an important strategy in foot rot eradication and if the number of infected sheep is small, immediate culling may be the most economic strategy. Culling can be an important strategy in the eradication of disease associated with moderately virulent strains if it is conducted in the climate periods of low transmission.<sup>58</sup>

### Introduced sheep

Most breakdowns in eradication occur because of inefficient examination and treatment or the introduction of affected sheep without first insuring that they are free from the disease. Introduced sheep should be run as a separate group from the main flock until they have been proven to be foot rot-free in a climatic transmission period. Similar isolation of introduced sheep should also be practiced in flocks free of the disease. It should also be

a management practice in flocks that have disease to minimize the risk of introduction of different strains of the organism.

### REVIEW LITERATURE

- Beveridge WIB. Footrot in sheep: a transmissible disease due to infection with *Fusiformis nodosus*. Bull Counc Sci Indust Res Aust 1941; 140:1-56.
- Egerton JR et al. Footrot and Foot Abscess of Ruminants. Boca Raton, FL: CRC Press, 1989.
- Kimberling CV, Ellis RP. Vet Clin North Am. Food Anim Pract 1990; 6:671.
- Stewart DJ, Claxton PD. Ovine footrot: Clinical diagnosis and bacteriology. Australian Standard Diagnostic Techniques for Animal Diseases 1993; 1-27.
- Winter A. Lameness in sheep. 1 Diagnosis. In Practice 2004; 26:58-63.
- Winter A. Lameness in sheep. 1 Treatment and control. In Practice 2004; 26:130-139.
- Abbot KA, Lewis J. Current approaches to the management of ovine footrot. Vet J 2005; 169:28-41.

### REFERENCES

- Stewart DJ et al. Aust Vet 1991; J 68:50.
- Katz, ME et al. J Gen Microbiol 1991; 137:2117.
- Olson, ME et al. Can J Vet Res 1998; 62:33.
- Kennan RM et al. Vet Microbiol 2003; 92:169.
- Zhou H, Pickford JGH. Vet Microbiol 2000; 71:113.
- Skerman TM. NZ Vet J 1983; 31:102.
- Nattermann H et al. Monatschft Vet Med 1991; 46:471.
- Glynn T. Aust Vet J 1993; 70:7.
- Depiazzi LJ et al. Aust Vet J 1998; 76:32.
- Whittington RJ. Aust Vet J 1995; 72:132.
- Woolaston RR. Aust Vet J 1993; 70:365.
- Stewart DJ et al. Aust Vet J 1985; 62:116.
- Raadsma HW et al. Wool Technol Sheep Breed 1990; 38:7.
- Raadsma HW et al. J Anim Breed Genet 1995; 112:349.
- Locke RH, Coombes NE. Aust Vet J 1994; 71:348.
- Wassink GJ et al. Vet Rec 2003; 152:351.
- Depiazzi LJ et al. Aust Vet J 2003; 81:58.
- Depiazzi LJ et al. Vet Microbiol 1991; 26:151.
- Jelinek PD et al. Aust Vet J 2000; 78:273.
- Lui D, Wong WK. Vet J 1997; 153:99.
- Moore LJ et al. Vet Microbiol 2005; 108:57.
- Palmer MA. Vet Microbiol 1993; 36:113.
- Wassink GJ et al. Vet Rec 2004; 154:551.
- Emery DL. Footrot and Foot Abscess of Ruminants. Boca Raton, FL: CRC Press, 1989; p. 141.
- Stewart DJ. Footrot and Foot Abscess. Boca Raton, FL: CRC Press, 1989; p. 167.
- Allworth B. Proceedings of the 2nd Pan Pacific Veterinary Conference, 1996; 159.
- Links JJ, Morris S. Vet Microbiol 1996; 51:305.
- Abbott KA, Egerton JR. Aust Vet J 2003; 81:756.
- Whittington RJ, Nichols PS. Res Vet Sci 1995; 58:26.
- Wassink GL et al. Vet Rec 2003; 152:504.
- Demirkan I et al. Med Microbiol J 2001; 50:1061.
- Collinhan RJ et al. Vet Microbiol 2000; 74:249.
- Claxton PO, O'Grady KC. In: Proceedings of a CSIRO Workshop. Footrot of Ruminants, Melbourne, 1985.
- La Fontaine S et al. Vet Microbiol 1993; 35:101.
- Whittington DJ, Nichols PJ. Res Vet Sci 1995; 59:128.
- Whittington RJ et al. Vet Microbiol 1997; 54:255.
- Reed GA, Alley DU. Aust Vet J 1996; 74:375.
- Kimberling CV, Ellis RP. Vet Clin North Am 1990; 237:671.
- Stewart DJ. Footrot of Sheep. Boca Raton, FL: CRC Press, 1989; p. 5.
- Malecki JC, Coffey L. Aust Vet J 1987; 64:301.

- Bulgin MS et al. J Am Vet Med Assoc 1986; 189:194.
- Marshall DJ et al. Aust Vet J 1991; 68:186.
- Hinton DJ. Aust Vet J 1991; 68:118.
- Webb-Ware JK et al. Aust Vet J 1994; 71:88.
- Rendell DK, Callinan APL. Aust Vet J 1997; 75:354.
- Jordan D et al. Aust Vet J 1996; 73:211.
- Grogonothomas R et al. 1994; Br Vet J 150:561.
- Venning CM et al. Aust Vet J 1990; 67:258.
- Vizzard AL. Proceedings of the 2nd Pan Pacific Veterinary Conference, 1996; 163.
- Walduck AK, Opdebeeck JP. Aust Vet J 1996; 74:451.
- Hunt JD et al. Vaccine 1994; 12:457.
- Gradin JL et al. Am J Vet Res 1993; 54:1069.
- Stewart DJ et al. Vet Microbiol 1991; 27:283.
- Egerton JR et al. Vet Rec 2002; 151:290.
- Lewis RD et al. J Anim Sci 1989; 67:1160.
- Abbott K et al. Vet Rec 2003; 152:510.
- Davies IH et al. Vet Rec 1999; 145:646.
- Abbot KA, Egerton JR. Aust Vet J 2003; 81:688.

### FOOT ABSCESS IN SHEEP

Foot abscess includes two diseases: heel abscess and toe abscess, which will be discussed in turn.<sup>1</sup>

#### HEEL ABSCESS/INFECTIOUS BULBAR NECROSIS

Heel abscess is a sequel to damage to the interdigital skin. This damage may result from physical damage from sharp stones or stubble, or friction in the area produced by overgrown feet, but most commonly results as an extension from **ovine interdigital dermatitis** into the soft tissues of the heel and is associated with *Fusiformis necrophorum* and *Arcanobacterium (Actinomyces; Corynebacterium) pyogenes*.<sup>2</sup> In interdigital dermatitis, the organisms can invade deep into the interdigital skin. The joint capsule of the distal interphalangeal joint is extremely vulnerable to invasion on the axial interdigital area and this leads to abscessation.

Most flocks experience cases of heel abscess but the yearly incidence is usually less than 1%. Heel abscess occurs mainly during very wet seasons as does foot rot but the former is limited largely to adult sheep, especially ewes heavy in lamb, and rams. Interdigital dermatitis and heel abscess are frequently present in the flock at the same time. An increased prevalence in a flock of young rams may be due to close flocking and to increased muddying of pasture due to this high concentration of livestock.<sup>1</sup> Usually only one foot and one claw is involved, although in severe outbreaks all four feet may become affected. Most commonly, the **medial claw** of the **hindfoot** is affected.

In the initial stages the affected digit is hot and painful. There is an acute lameness – the affected sheep holds the foot off the ground while walking. There is swelling and inflammation of the interdigital skin and pain on pressure across the heel. Pressure in this area may result in the

discharge of pus from sinuses in the interdigital space. When the phalangeal joints are involved there is severe swelling at the back of the claw and the infection may extend to break out at one or more points above the coronet with a profuse discharge of pus.

#### Treatment of heel abscess

The treatment of foot abscess is by surgical drainage, parenteral treatment with sulfonamides or a combination of penicillin and streptomycin and the application of a local bandage. Therapy should be continued for several days. Recovery is not rapid. Because of the frequent involvement of the distal interphalangeal joints<sup>3</sup> with heel abscess, treatment with antibiotics without surgical intervention is unlikely to be successful but some cases heal spontaneously in 6–8 weeks.

#### TOE ABSCESS

Toe abscess is a lamellar suppuration with purulent underrunning of the horn at the toe. It results from damage to the sole, white line, or wall of the foot and is a common sequel to overgrown feet. Most commonly, it involves a digit on the **front** feet. The affected digit is hot and there is pain on pressure across the sole and toe. There is severe lameness, swelling of the coronet with pain and heat apparent, and usually rupture and purulent discharge at the coronet between the toes. Penetration to deeper structures may also occur.

#### Treatment of toe abscess

The only treatment of toe abscess is by surgical drainage and the response is rapid. **Toe granuloma** can be a sequel but more commonly toe granuloma is a response to overzealous foot paring.<sup>4</sup>

#### REFERENCES

1. West DM. NZ Vet J 1983; 31:71
2. Roberts DS. Infect Dis 1969; 120:720.
3. West DM. NZ Vet J 1983; 31:152.
4. Winter A. In Pract 1997; 19:214.

#### FOOT ROT IN PIGS (BUSH FOOT)

Foot rot in pigs is similar clinically to foot rot in other species and is included here for this reason, although the cause of the disease appears different and in most instances the disease is more analogous to foot abscess.

#### ETIOLOGY

The majority of cases appear to result from secondary infection of lesions that are traumatic in origin. The most common traumatic lesions are erosions of the sole and wall of the claw that occur in pigs reared on rough, abrasive flooring. By themselves these lesions do not usually produce lameness, unless they are extensive, but when pigs are also reared in dirty

conditions, infection and subsequent lameness may occur.

Foot lesions are common in pigs of all ages<sup>1,2</sup> and bruising of the sole–heel junction, one of the earliest lesions observed can be seen in piglets less than 24 hours old. If the bruising is severe and further trauma is not prevented necrosis will follow quickly in the feet.<sup>3,4</sup> These studies have suggested that the cause may be a combination of factors including trauma, contact dermatitis, and subsequent infection. Wet conditions underfoot may cause maceration of the horn and exacerbate the abrasive effect of the flooring. Foot abscess in neonatal pigs is associated with being reared on woven-wire floors.<sup>5,6</sup> Dietary deficiency, especially biotin deficiency, may also result in foot lesions that predispose to secondary infection.

*Fusiformis necrophorum*, *Arcanobacterium* (*Corynebacterium*) *pyogenes*, staphylococci and an unidentified spirochete have been isolated from affected feet. In an outbreak of the disease on a semi-extensive pig farm, *Dichelobacter nodosus* and other anaerobic bacteria including *Prevotella*, *Peptostreptococcus*, *Fusobacterium*, *Porphyromonas*, *Bacteroides*, and *Eubacterium* have also been isolated from affected feet.<sup>7</sup>

#### EPIDEMIOLOGY

The disease has been reported from several countries and is probably universal in occurrence. A study of the prevalence and distribution of foot lesions in finishing pigs in England found that 94% of pigs had at least one foot lesion.<sup>8</sup> The prevalence of the different lesions was: toe erosion (33%); sole erosion (62%); heel erosion (13%); heel flaps (14%); white-line lesions (55%); false sand cracks (24%); and wall separation (11%). The hind feet are more commonly affected than the front feet, and on each foot the lateral digits were significantly more frequently affected than the medial digits. Sole erosions, heel flaps, wall separation, and false sand cracks were observed more frequently on the lateral than the medial digit.

Erosive lesions on the foot are common and have been reported at an incidence as high as 65%. They have been reproduced experimentally and the nature of the flooring has a marked influence on claw wear in pigs. Recently poured alkaline concrete and poorly laid concrete with constituents leading to a rough abrasive surface lead to a high incidence. A slope inadequate to allow proper drainage may also be an important predisposing factor. All ages of pigs are susceptible, but clinical lameness is uncommon. In individual herds where the unfavorable predisposing factors prevail, a high incidence of infection and clinical lameness can

occur. The disease may cause reproductive inefficiency due to reluctance to stand or mount for mating.

#### PATHOGENESIS

Perforation of the horn leads to infection of the sensitive laminae. The infection may track up the sensitive laminae to the coronary band and discharge to the exterior. Elastolytic activity is a virulence factor involved in the pathogenesis of foot rot in pigs associated with *Dichelobacter nodosus* and *Prevotella melaninogenica*.<sup>7</sup>

#### CLINICAL FINDINGS

Where the disease is due to abrasion of the horn by rough concrete surfaces, a number of characteristic lesions occur, including:

1. Erosion of the sole at either the toe or the heel
2. Bruising of the sole with hemorrhagic streaks in the horn
3. Separation of the hard horny wall from the heel or sole to produce a fissure at the white line, or
4. A false sand crack in the posterior third of the lateral wall of the claw.

In the majority of cases these do not produce lameness nor do they have any apparent effect on productivity. However, when they are extensive or where infection has occurred severe lameness is apparent. In most cases only the lateral digit of one foot is affected. Heat and obvious pain with only moderate pressure being applied to the affected claw are constant findings. Necrosis extends up between the sole and sensitive laminae and may discharge at the coronet, causing the development of a granulomatous lesion, or it may extend to deeper structures of the foot with multiple sinuses discharging to the exterior. A minimal amount of purulent material is present. Productivity is affected with this type of lesion. With deeply infected feet the recovery rate is only fair with treatment. A permanently deformed foot may result and destruction of the pig may be necessary in severe cases. Secondary abscessation in other parts of the body is an occasional sequel and may result in partial carcass condemnation.

Foot abscesses in neonatal pigs are characterized by necrotic pododermatitis, severe osteomyelitis, arthritis, and tenosynovitis.<sup>6</sup> The primary sites of injury are located at either<sup>5</sup> the point of the toe at the white line,<sup>6</sup> the bulb of the heel<sup>7</sup>, or the haired skin around the coronet, including the interdigital area. The least severe lesions are superficial abrasions or ulcerations of the hoof wall, heel bulb, or interphalangeal skin, with only minimal inflammatory changes in deeper tissues. The most severely affected digits have focal superficial abscesses, or deep, diffuse,

purulent inflammation and fibrosis around tendons, joints, and bones.<sup>6</sup> The hind limbs are more commonly affected than the forelimbs, and in the hind limbs the medial claws are most likely to have lesions, whereas in the forelimbs the lateral claws are more likely to be affected. Approximately 6% of piglets develop foot abscess prior to weaning. About one-third of litters may be affected and most litters have only one or two affected pigs. Discharge of pus from the coronary band is common and the horny claw may slough, leaving sensitive laminae of one or more claws or accessory digits exposed. Skin necrosis may be present over the carpi, the fetlocks, hocks, coronary bands, and elbows in about 75% of pigs during the first week of life.

#### CLINICAL PATHOLOGY

Bacteriological examination of discharges from the lesions may aid in deciding the treatment to be used. In foot abscesses of neonatal pigs, bacteria isolated include:

- *Arcanobacterium pyogenes*
- *Staphylococcus* spp.
- Beta-hemolytic *Streptococcus* spp.
- *Actinobacillus* spp.
- *Escherichia coli*.

#### NECROPSY FINDINGS

Necrosis of the laminar tissue with indications of progression from an infected sole are the usual findings.

#### DIFFERENTIAL DIAGNOSIS

Most other causes of lameness in pigs are not manifested by foot lesions. In adult pigs housed indoors, an overgrowth of the hoof may occur and be followed by underrunning of the sole, necrosis and the protrusion of granulation tissue causing severe lameness and often persistent recumbency. The general appearance of these feet is not unlike that of canker in horses. Swelling of the hoof is caused by an extensive fibrous tissue reaction. Vesicular exanthema and foot-and-mouth disease are characterized by the presence of vesicular lesions on the coronets and snout.

#### TREATMENT

There are few published reports of treatment of foot rot in pigs. Broad-spectrum antimicrobials or penicillin given parenterally seems rational and the use of Nuflor was said to be a successful treatment.<sup>9</sup>

#### CONTROL

Prevention of excessive wear of the feet by the use of adequate bedding and less abrasive flooring in pig pens is suggested as a reasonable control measure. Any existing dietary deficiency should be corrected. Of particular interest is the response to biotin supplementation of the diet of pigs in the prevention of foot lesions of various kinds.

#### REFERENCES

1. Penny RHC et al. *Vet Rec* 1963; 75:1225.
2. Penny RHC et al. *Vet Rec* 1965; 77:1101.
3. Penny RHC Fellowship Thesis, Royal College of Veterinary Surgeons, London, 1968.
4. Penny RHC et al. *Aust Vet J* 1971; 47:529.
5. Gardner IA, Hird DW. *J Am Vet Med Assoc* 1994; 204:1062.
6. Gardner IA et al. *J Am Vet Med Assoc* 1990; 196:1791.
7. Piriz S et al. *Vet Rec* 1996; 139:17.
8. Mouttoto N et al. *Vet Rec* 1997; 141:115.
9. Mota RA et al. *A Hora Veterinaria* 2002; 21:67.

#### ORAL AND LARYNGEAL NECROBACILLOSIS

##### Synopsis

**Etiology** *Fusobacterium necrophorum*

**Epidemiology** Oral infection principally in calves less than 3 months old. Laryngeal involvement in older animals up to 18 months of age

##### Clinical findings

**Necrotic stomatitis:** Fetid breath and necrotic ulceration of mucosa of cheek

**Calf diphtheria:** Fetid breath. Inspiratory dyspnea, necrotic lesions on arytenoid cartilages

**Lesions:** Necrosis at site of lesion

**Treatment** Antimicrobials. Tracheostomy may be required to allow breathing with necrotic laryngitis

**Control** None specific

The term 'oral necrobacillosis' is applied to infections of the mouth and larynx with *Fusobacterium necrophorum*. It includes **calf diphtheria**, in which the lesions are largely confined to the larynx and pharynx, and **necrotic stomatitis**, in which the lesions are restricted to the oral cavity. They are considered together because the essential lesion and infection are the same in both instances.

#### ETIOLOGY

*F. necrophorum* is present in large numbers in the lesions and is considered to be the causative agent, probably aided by prior injury to the mucosa. In the case of the laryngeal disease, the point of entry is thought to be contact ulcers in the mucosa caused by repeated closure of the larynx.<sup>1</sup> Both *F. necrophorum* subsp. *necrophorum* (biovar/biotype A) and *F. necrophorum* subsp. *funduliforme* (biovar/biotype B) are associated with the disease.

#### EPIDEMIOLOGY

##### Occurrence

The disease has no geographical limitations but is more common in countries where animals are housed in winter or maintained in feedlots. In the United States, infections involving the pharynx and larynx appear to be more prevalent in the western states than in other sections of the country. It is a common disease in

feedlots in yearling cattle, often in company with papillomatosis of the larynx.<sup>1</sup>

There is also a difference in age incidence, necrotic stomatitis occurring mainly in calves 2 weeks to 3 months of age, while laryngeal infections commonly affect older calves and yearlings. Although the disease is more common in housed or penned animals, it can occur in animals running at pasture.<sup>2-4</sup>

The disease is seen commonly only in cattle but has been observed in sheep and goats.<sup>5,6</sup> Laryngeal chondritis has been described in Texel sheep, which may be predisposed to the disease because of anatomical factors, namely the short head of the breed.<sup>7</sup> This may affect the shape of the larynx or its relationship to adjacent tissues.

#### Transmission

The causative bacterium is a common inhabitant of the environment of cattle and under unsanitary conditions the infection may be spread on dirty milk pails and feeding troughs. Entry through the mucosa is probably effected through abrasions caused by rough feed and erupting teeth. The difficulty of reproducing the disease and the irregularity of its occurrence, even when *F. necrophorum* is known to be present, suggests the possibility of etiological factors presently unknown.

#### Risk factors

Animals suffering from intercurrent disease or nutritional deficiency are most susceptible and the incidence is highest in groups kept in confined quarters under unsanitary conditions.

#### PATHOGENESIS

*F. necrophorum* is a normal inhabitant of the oral cavity and causes inflammation and necrosis following injury of the mucosa of the oral cavity, pharynx, and larynx. Edema and inflammation of the mucosa of the larynx results in varying degrees of closure of the rima glottidis and inspiratory dyspnea and stridor. The presence of the lesion causes discomfort, painful swallowing and toxemia. Extension of the lesion to the arytenoid cartilages will result in laryngeal chondritis.<sup>7</sup> Involvement of the cartilage will usually result in delayed healing or failure to recover completely.

#### CLINICAL FINDINGS

In describing the clinical findings, a distinction must be made between calf diphtheria characterized by involvement of the larynx and the more common necrotic stomatitis. In the former, a moist painful cough accompanied by severe inspiratory dyspnea, salivation, painful swallowing movements, complete anorexia, and severe depression are the characteristic signs. The temperature is high

(41°C; 106°F), the pharyngeal region may be swollen and painful on external palpation, and there is salivation and nasal discharge. The breath has a most foul rancid smell.

Examination of the pharynx and larynx by visual inspection through the oral cavity with the aid of a speculum positioned over the base of the tongue will often reveal the lesions. Visual inspection of the larynx is relatively easy and simple with the aid of a cylindrical plastic speculum placed over the base of the tongue in calves and adult cattle. The larynx can be viewed directly and illuminated with a strong source of light. A flexible fiberoptic scope is also useful when available and is necessary for examination of the equine larynx. The mucosa of the larynx and glottis are usually edematous, inflamed and a necrotic lesion is usually present and visible on one or both arytenoid cartilages. The opening of the larynx is commonly reduced due to the edema and inflammation. Careful visual inspection of the larynx during inspiration may reveal that the lesion extends into one or both vocal cords. The examination usually causes considerable discomfort, anxiety and the production of purulent or blood-stained saliva.

Death is likely to occur from toxemia or obstruction to the respiratory passages on days 2–7. Most affected calves die without treatment but only a small proportion of calves in a group are usually affected. Spread to the lungs may cause a severe, suppurative bronchopneumonia.

In calves affected with necrotic stomatitis, there is usually a moderate increase in temperature (39.5–40°C; 103–104°F), depression, and anorexia. The breath is foul and saliva, often mixed with straw, hangs from the mouth. A characteristic swelling of the cheeks may be observed posterior to the lip commissures. On opening the mouth this is found to be due to a deep ulcer in the mucosa of the cheek. The ulcer is usually filled with a mixture of necrotic material and food particles. An ulcer may also be present on the adjacent side of the tongue and cause severe swelling and protrusion of the tongue. In severe cases the lesions may spread to the tissues of the face and throat and into the orbital cavity. Similar lesions may be present on the vulva and around the coronets, and a spread to the lungs may cause fatal pneumonia. In other cases death appears to be due to toxemia.

#### CLINICAL PATHOLOGY

Bacteriological examination of swabs from lesions may assist in confirming the diagnosis.

#### Necropsy findings

Severe swelling, due to edema and inflammation of the tissues surrounding

the ulcer, is accompanied by the presence of large masses of caseous material. Occasionally, lesions similar to those in the mouth, pharynx, and larynx may be found in the lungs and in the abomasum. Microscopically, areas of coagulation necrosis are bordered by large numbers of neutrophils and filamentous bacteria.

#### Samples for confirmation of diagnosis

- **Bacteriology** – anaerobic culture swab from deep within lesion (ANAEROBIC CULT)
- **Histology** – formalin-fixed sample of interface between ulcer site and normal tissue (LM).

#### DIFFERENTIAL DIAGNOSIS

Necrotic laryngitis is characterized by inspiratory dyspnea and stridor, toxemia, fever, edema, (inflammation) and necrotic lesions of the laryngeal mucosa.

- **Neoplasms of the larynx** – occur only rarely, usually in mature cattle, and cause chronic inspiratory dyspnea
- **Traumatic pharyngitis** – may resemble laryngitis but the lesions are obvious on visual inspection of the pharynx. In chronic cases of traumatic pharyngitis there may be peri-esophageal cavities containing rumen contents
- **Foreign bodies** – i.e. pieces of wire and small wooden sticks may become lodged in the mucosa of the arytenoid cartilages and cause clinical signs similar to necrotic laryngitis.

#### TREATMENT

The lesions of necrotic stomatitis will usually heal in a few days following debridement of the ulcers, application of a solution of tincture of iodine, and oral administration of sulfamethazine at a dose of 150 mg/kg BW daily for 3–5 d where this is labeled for use in food animals, or parenteral penicillin or broad-spectrum antimicrobials. Therapy should be at least for 5 days and therapy for up to 3 weeks may be necessary.

Successful treatment of necrotic laryngitis is dependent on early recognition and prompt therapy with antimicrobials daily for several days. Corticosteroids may be a beneficial adjunctive therapy, especially to reduce the edema. Tracheostomy may be necessary in some cases to relieve dyspnea. Failure to respond is usually associated with chronic suppurative chondritis, which requires subtotal arytenoidectomy.

#### CONTROL

Proper hygienic precautions in calf pens or feeding and drinking places together with avoidance of rough feed should prevent the spread of the disease. When the incidence is high prophylactic

antibiotic feeding may keep the disease in check.

#### REFERENCES

1. Jensen R et al. 1981; Vet Pathol 18:143.
2. Kingman HE, Stansbury WM. North Am Vet 1944; 25:671.
3. Lovell R. Vet Rec 1945; 57:179.
4. Sutherland AK. Aust Vet J 1950; 26:238.
5. Diplock PT. Vet Insp NSW 1958; 51:53.
6. Yeraham I, Elad D. JVet Med B 2004; 51:46.
7. Lane JG et al. Vet Rec 1987; 121:81.

#### NECROTIC RHINITIS (BULLNOSE; PARANASAL ABSCESSATION)

Necrotic rhinitis is often confused with atrophic rhinitis. It occurs in young growing pigs and may occur in herds where atrophic rhinitis is present and even in the same pig, but there appears to be no relationship between the two diseases. There are a variety of other conditions of the face of the young pig that can be confused.<sup>1</sup> The common occurrence of *Fusobacterium necrophorum* in the lesions suggests that any injury to the face or nasal or oral cavities may lead to bacterial invasion, especially if the environment is dirty and heavily contaminated.<sup>2</sup> The incidence of the disease has diminished in recent years, due probably to a general improvement in hygiene in piggeries but possibly also to the declining occurrence of progressive atrophic rhinitis following vaccination and eradication of *P. multocida* toxigenic type D.

The lesions develop as a necrotic cellulitis of the soft tissues of the nose and face but may spread to involve bone and produce osteomyelitis. Local swelling is obvious and extensive lesions may interfere with respiration and mastication. Depression of food intake and toxemia result in poor growth and some deaths. Treatment by the local application of antibacterial drugs and the oral administration of sulfonamides is satisfactory in early cases. Oral dosing with sulfadimidine has been effective in young pigs.<sup>3</sup> Improvement of sanitation, elimination of injuries and disinfection of pens usually result in a reduction of incidence.

The disease differs from atrophic rhinitis by the presence of oral and facial lesions. Necrotic ulcer in pigs may involve the mouth and face but the lesions are erosive rather than necrotic.

#### REVIEW LITERATURE

Done JT. Facial deformities of the pig. Vet Ann 1977; 17:96.

#### REFERENCES

1. Done JT. Vet Ann 1977; 17:96.
2. Bennett PC. Necrotic rhinitis (bullnose). In: HW Dunne (ed) Diseases of swine, 2nd edn. Iowa State University Press, 1964; p. 695.
3. Eieland E, Faanes T. Nord Vet Med 1950; 2:204.

## Diseases associated with *Pseudomonas* and *Burkholderia* spp.

*Pseudomonas aeruginosa* is an occasional cause of infection in large animals. In cattle, there are occasional cases of generalized infection with *Pseudomonas aeruginosa*, usually following an attack of mastitis associated with this organism. Systemic invasion in cattle is manifested by fibrinous **pericarditis** and pleurisy and chronic **pyelonephritis**. *Pseudomonas* spp. are an occasional cause of **septicemia in foals**, **septic arthritis**, **vegetative endocarditis** in horses<sup>1</sup> and **placentitis** in mares,<sup>2</sup> and is isolated from cases of **pneumonia** in all large animal species. Infection in the urogenital tract is accompanied by infertility.

Outbreaks of **otitis media** in suckling calves and in sheep following dipping have been associated with pseudomonas infections.<sup>3,4</sup> The association of *Pseudomonas* spp. with **fleece rot** in sheep is covered elsewhere.

*Pseudomonas* spp. are commonly isolated from bacterial **corneal ulcers and keratitis** that develop after trauma to the corneal epithelium in horses<sup>5,6</sup> and the organism promotes rapid liquifaction of corneal stromal proteoglycans. Early cases respond to aggressive topical therapy with tobramycin or gentamicin<sup>5</sup> although there has been a significant increase in the resistance of isolates from ulcerative keratitis in recent years.<sup>7</sup>

Infections with *Pseudomonas* spp. are notoriously difficult to treat. Clinical isolates from animals are usually sensitive to tobramycin, polymyxin B, carbenicillin, and gentamicin.<sup>8</sup>

### REFERENCES

1. Travers CW et al. J South Afr Assoc 1995; 66:172.
2. Hong CB et al. J Vet Diag Invest 1993; 5:56.
3. Henderson JJ, McCullough WP. Vet Rec 1993; 132:24.
4. Davies IH, Done SH. Vet Rec 1993; 132:460.
5. Sweeney CR, Irby NL. J Am Vet Med Assoc 1996; 209:954.
6. Moore CP et al. J Am Vet Med Assoc 1995; 207:928.
7. Sauer P et al. Vet Ophthal 2003; 6:309.
8. Hariharan HJ et al. Can. Vet J 1995; 36:166.

### FLEECE ROT IN SHEEP

#### Synopsis

**Etiology** Dermatitis associated with growth of chromogenic *Pseudomonas aeruginosa* following prolonged wetting of the skin of sheep

**Epidemiology** Occurs with high incidence in sheep with susceptible fleece characters in wet seasons. Major risk factor for body fly strike

**Clinical findings** Dermatitis with fleece coloration over the backline

**Diagnostic confirmation** Clinical

**Control** Selection of sheep with resistant fleece characters

### ETIOLOGY

Fleece rot develops as an **exudative dermatitis** following wetting of the fleece by rain. The growth of toxigenic strains of *Pseudomonas aeruginosa* is believed to be the major cause of the dermatitis, and the **fleece coloration** that usually accompanies it, but other *Pseudomonas* spp. including *Ps. maltophilia*, have been incriminated in the genesis of the condition.<sup>1,2</sup> The enzyme phospholipase C in *Ps. aeruginosa* is a virulence determinant for this disease.<sup>3</sup>

### EPIDEMIOLOGY

#### Occurrence

The disease is common in most parts of Australia, occurs in South Africa and also in areas of New Zealand. Its occurrence is associated with **wet years** and in these circumstances the incidence in affected flocks varies from 40–100%.<sup>2,4</sup>

#### Environmental and host risk factors

Fleece rot occurs in sheep only in wet seasons and when the fleece is predisposed to wetting by its physical characters.

**Prolonged rainfall**, sufficient to wet sheep to the skin for a week, is required for this condition to occur. Young sheep are more susceptible than old, and **heritable differences in fleece characters** affect the susceptibility of individual sheep. These characters are probably related to the ease with which the skin can be wetted.

#### Fleece characteristics

The degree of 'grip' and body skin wrinkling are unimportant as factors affecting susceptibility but fleece weight, fiber diameter and variability, staple density and neck wrinkling are positively correlated with susceptibility.<sup>5,6</sup> These characteristics produce visible differences between fleeces. Resistant sheep have closely packed elliptical wool staples with blocky tips and even crimp. **Susceptible fleeces** have thin staples of unevenly crimped wool and with a fringe-tipped appearance due to the protrusion of thicker wool fibers above the top of the staple. This fringed appearance is visible along the back and sides. **Susceptible flocks** are characterized by fleeces with longer, heavier, thicker staples with lower crimp frequency and higher fiber diameter and variability.<sup>6</sup>

Fleeces with a **high wax content** are less susceptible probably because of the waterproofing effect of the wax. This view is supported by the observation that disruption of the sebaceous layer on the skin increases its susceptibility to wetting.<sup>7</sup>

Greasy fleece color has been found a good predictor of susceptibility to fleece rot in some studies<sup>4</sup> but not others.<sup>5</sup> Wool with a high suint content is highly susceptible.<sup>8</sup>

### Experimental production

The disease can be reproduced experimentally by inoculating *Ps. aeruginosa* epicutaneously and wetting the fleece.<sup>9</sup>

### Economic importance

Fleece rot causes considerable financial loss because of the depreciation in the value of the damaged fleeces. It also is the **major risk factor for body fly strike**.

### PATHOGENESIS

With prolonged wetting, the conditions of high humidity in the fleece micro-environment, and the availability of rich nutrients from serous exudates and indigenous suint, allow the proliferation of opportunistic skin and fleece bacteria including *Ps. aeruginosa*, and result in dermatitis. The predominant bacterium is usually *Ps. aeruginosa*,<sup>10</sup> which inhibits the growth of other bacteria and its **pyocyanin** produces a green color. Its rapid growth is accompanied by the production of the **dermonecrotic toxin** phospholipase C, which exacerbates the dermatitis and initiates the inflammatory cascade that draws neutrophils and lymphocytes into the skin.<sup>11</sup>

In the experimental disease there is outpouring of serous exudate and infiltration of leukocytes into dermis but *Ps. aeruginosa* is localized as aggregates at the leading front of the seropurulent exudate and never penetrates the dermis.<sup>12</sup>

Other discolorations may occur depending upon the predominance of a particular **chromogenic bacterium**; many which belong to *Pseudomonas* spp. *Ps. maltophilia* can result in yellow coloration, and *Ps. indigofera*, blue coloration.

The **odor** produced by the bacteria and the serum protein on the skin surface is very attractive to blowflies, and most body strikes are due to pre-existing fleece rot lesions. To add a further complication, *Ps. aeruginosa* also proliferates in the presence of organophosphorus insecticides and facilitates its biodegradation.<sup>13</sup>

### CLINICAL FINDINGS

Lesions occur most commonly over the **withers and along the back**. In active cases, the wool over the affected part is always saturated and the tip is more open than over unaffected areas. The wool is leached and dingy and in severe cases can be plucked easily. The skin is **inflamed** and serous exudate produces bands of matted and colored fibers across the staple. The **coloration** of the fibers is commonly green, but may be yellow, yellow-brown, or red-brown<sup>1</sup> and occurs

in fibers at skin level or extending the full length of the staple.

The **general health** of the sheep is unaffected in typical fleece rot but severe ulcerative dermatitis with mortality associated with *Ps. aeruginosa* can occur.

A chronic ulcerative and necrotic dermatitis associated with *Ps. aeruginosa*, occurring on the tail, udder, and legs of sheep and accompanied by green coloration of the surrounding fleece is recorded following excessive rain in the Mediterranean climate zone of Israel.<sup>14</sup>

#### CLINICAL PATHOLOGY AND NECROPSY FINDINGS

Autopsy examinations are not carried out and laboratory examination of the living animal is not usually necessary.

There are differences in the inflammatory response and in peripheral blood lymphocyte subsets between fleece rot-resistant and susceptible sheep.<sup>15,16</sup>

#### DIAGNOSIS

Fleece rot resembles mycotic dermatitis in body distribution and predisposing factors but the typical scab is not present in fleece rot.

#### CONTROL

Treatment is unlikely to be of value but some degree of control may be effected by selection of **fleece rot-resistant sheep** for use in susceptible localities. In these same localities, shearing before the wet season should facilitate drying of the fleece and lessen susceptibility. The **heritability** of resistance to fleece rot has been estimated to be between 0.35 and 0.4 and selective breeding programs have been advocated<sup>11</sup> and genetically selected lines show increased resistance in high-risk environments.<sup>17</sup>

Chemical means of drying the living fleece have been shown to reduce wetness, fleece rot and blowfly strike. A mixture of zinc and aluminum oxides with sterols and fatty acids (the mixture identified as B26), applied at the rate of 100–200 mL per sheep as a mist-like simulated rain, caused significant reduction in fleece moisture for 10–12 weeks and this could be extended by further applications. Fleece rot was reduced by 60% and blowfly strike by 75%.

A vaccine containing killed *Ps. aeruginosa* has protected against the severe exudative form of fleece rot<sup>1</sup> and there is hope that a vaccine prepared against highly conserved outer membrane antigens of the organism may give more universal protection.<sup>12</sup>

#### REFERENCES

- Burrell DH. *Adv Vet Dermatol* 1990; 1:347.
- Kingsford NM, Raadsma HW. *Vet Microbiol* 1997; 54:275.
- Chin JC, Watts JE. *J Gen Microbiol* 1988; 134:2567.

- Keown AM, Reid TC. *Proc NZ Soc Anim Prod* 1997; 57:83.
- Cottle DJ. *Aust J Agric Res* 1996; 47:1213.
- Raadsma HW. *Aust J Agric Res* 1993; 44:915.
- Pascoe L. *Aust J Agric Res* 1982; 33:141.
- Lipson M et al. *Aust J Exp Agric* 1982; 22:168.
- Gogolewski RP. *Aust J Agric Res* 1996; 47:917.
- Chin JC, Watts JE. *Vet Microbiol* 1992; 32:63.
- Chin JC, Gogolewski RP. *Wool Technol Sheep Breed* 1991; 39:112.
- Chin JC et al. *Vet Microbiol* 1995; 43:21.
- Merritt GC et al. *Aust Vet J* 1981; 57:531.
- Yerahum I et al. *J Vet Med A* 1995; 42:35.
- Chin JC, Gogolewski RP. *Wool Technol Sheep Breed* 1992; 39:112.
- McCull KA et al. *Aust Vet J* 1997; 75:421.
- Chin JC, Watts JE. *Aust Vet J* 1991; 68:23.

#### MELIOIDOSIS

##### Synopsis

**Etiology** *Burkholderia pseudomallei*.

**Epidemiology** Ubiquitous soil saprophyte endemic to Southeast Asia, northern Australia and the South Pacific. Occurs primarily 20° north and south of the equator. Transmission is by inhalation of contaminated dust and cutaneous abrasion. Primarily a disease of sheep and goats and humans, occasional disease in horses and subclinical infection in pigs

**Clinical findings** Septicemia, weakness recumbency and death in sheep. Septicemia, pneumonia, and lymphangitis in horses

**Clinical pathology** Culture, serology, allergic skin test

**Necropsy findings** Abscessation of internal organs

**Treatment and control** General hygienic procedures. Little specific information available

#### ETIOLOGY

*Burkholderia pseudomallei* (*Pseudomonas pseudomallei*, *Malleomyces pseudomallei*) is the sole cause. There is considerable genetic variability and strains vary in pathogenicity.<sup>1</sup>

#### EPIDEMIOLOGY

##### Occurrence

The disease occurs almost exclusively in tropical countries 20° north and south of the equator and is endemic in South East Asia, Asia, and northern and sub-northern areas of Australia. Disease occurs in rodents, rabbits, pigeons, humans, animals in zoological gardens, dogs, cats, horses, pigs, sheep, goats, alpacas, and camels but rarely in cattle.<sup>2,3</sup> In domestic animals the disease has occurred in outbreak form in pigs, goats, and sheep in Australia,<sup>3,4</sup> in the Caribbean area and in Cambodia, in horses in Malaysia and Iran, in pigs and cattle in Papua New Guinea and Australia, in horses in France in 1976–1978<sup>5</sup> and in cattle in Argentina.<sup>6</sup>

#### Source and methods of transmission

In endemic areas the organism is a ubiquitous soil saprophyte and is present in moist soil and waterholes which are the primary reservoirs from which most infections are acquired. A variety of free-living amoebae including *Acanthamoeba* and *Hartmannella* spp. are potential hosts to *B. pseudomallei*.<sup>7,8</sup> The majority of cases in livestock are associated with the 'wet season' and exposure to surface water and mud. Infection occurs through inhalation, ingestion, in association with skin wounds via contaminated dust particles or water or by insect bites. Infected animals pass the organism in their feces and the disease in rodents runs a protracted course, making these animals important reservoirs of infection.

#### Pathogen risk factors

*B. pseudomallei* can survive in water at room temperature for up to 8 weeks, in muddy water for up to 7 months, and in soil in the laboratory for up to 30 months.<sup>9</sup> The organism can survive in contaminated injectable drugs and has ability to survive for some time in cetrimide 3% and chlorhexidine 0.3% solution.<sup>3</sup> Varying degrees of virulence are observed in different strains of the organism but starvation or other conditions of stress appear to increase the susceptibility of experimental animals to infection.

#### Experimental production

The disease can be produced experimentally in goats, sheep, rats, mice, hamsters, and pigs.<sup>10</sup>

#### Zoonotic implications

Humans are at risk for infection within endemic areas and while this can be zoonotic it can also occur without direct animal contact through inhalation. The disease of humans presents with various clinical pictures ranging from asymptomatic state, localized infection such as pneumonia, to acute fatal septicemia.<sup>11</sup>

Veterinarians and animal owners are at risk from localized or generalized infection from infected animals. Pregnant women handling goats aborting with this infection have risk for infection and abortion.<sup>3</sup> Infected areas are often rural in nature and pasteurization of commercially sold milk should be ensured as should condemnation of infected carcasses at abattoirs.

#### Pathogenesis

There is initial bacteremia or septicemia and subsequent localization in various organs. Experimentally induced melioidosis in goats is characterized by septicemia with undulating fever, wasting, anorexia, hindlimb paresis, mastitis, and abortion. Necropsy lesions include widely scattered microabscesses after intraperitoneal

injection, and a chronic disease with abscesses in the lungs and spleen when the infection is administered subcutaneously.<sup>12</sup> In pigs experimental infection results in a generalized chronic infection.<sup>10</sup>

## CLINICAL FINDINGS

### Sheep

Signs consist mainly of weakness, respiratory disease and recumbency with death occurring in 1–7 d. In experimentally infected sheep, a severe febrile reaction occurs and is accompanied by anorexia, lameness and a thick, yellow exudate from the nose and eyes. Some animals show evidence of central nervous system involvement including abnormal gait, deviation of the head and walking in circles, nystagmus, blindness, hyperesthesia, and mild tetanic convulsions. The disease is usually fatal. Skin involvement is not recorded.

### Goats

The syndrome may resemble the acute form as seen in sheep, but more commonly runs a chronic course with abscessation.<sup>13</sup> Mastitis is common in infected goats; one study finding mammary infection in 35% of infected goats.<sup>3</sup>

### Pigs

Disease is usually chronic and manifested by cervical lymphadenitis, but in some outbreaks there are signs similar to those in other species. In such outbreaks slight posterior paresis, mild fever, coughing, nasal and ocular discharge, anorexia, abortion, and some deaths may occur.

### Horses

The syndrome is one of an acute metastatic pneumonia with high fever and a short course. Cough and nasal discharge are minimal and there is a lack of response to treatment with most drugs. Other signs in horses include colic, diarrhea, and lymphangitis of the legs. Subacute cases become debilitated, emaciated, and develop edema.<sup>5</sup> Affected horses may survive for several months. A case of acute meningoencephalitis is described in a horse. The onset was sudden and manifest with violent convulsions.<sup>14</sup>

## CLINICAL PATHOLOGY

The organism is easily cultured and may be isolated from nasal discharges. Injection into guinea pigs and rabbits produces the typical disease. An allergic skin test using melioidin as an antigen,<sup>5</sup> a complement fixation test (CFT), and an indirect hemagglutination (IHA) test are available. The IHA test is recommended for screening and the CFT for confirmation in cases of active melioidosis in goats<sup>15</sup> and pigs.<sup>16</sup> Affected horses may give a positive reaction to the mallein test.<sup>17</sup>

## NECROPSY

Multiple abscesses in most organs, particularly in the lungs, spleen, and liver, but also in the subcutis and the associated lymph nodes, are characteristic of the disease in all species. In sheep respiratory infection is common and these abscesses in the lung contain thick or caseous, green-tinged pus similar to that found in *Corynebacterium pseudotuberculosis* lesions. Lesions in the nasal mucosa proceed to rupture with the development of ragged ulcers. An acute polyarthritis, with distension of the joint capsules by fluid containing large masses of greenish pus and acute meningoencephalitis have been observed in experimental cases.

A high incidence of lesions in the aorta of goats is reported in Australia. Nine out of 43 (21%) goats had aortic lesions at autopsy. Seven of these goats died as a result of a ruptured aortic aneurysm.<sup>3</sup>

## DIAGNOSTIC CONFIRMATION

Culture of organism.

## DIFFERENTIAL DIAGNOSIS

### Sheep

- Caseous lymphadenitis
- Actinobacillosis.

### Horses

- Glanders
- Strangles.

### Pigs

- Tuberculosis.

## TREATMENT

Treatment is unlikely to be undertaken in farm animals because of the nature of the disease and the risk of exposure to humans. Little information is available on satisfactory treatments of melioidosis in farm animals but recommendations for man are available.<sup>18</sup> Penicillin, streptomycin, chlortetracycline, and polymyxin are ineffective but *in vitro* tests suggest that oxytetracycline, novobiocin, chloramphenicol, and sulfadiazine are most likely to be valuable, with oxytetracycline the preferred drug. In horses chloromycetin has been shown to be an effective treatment.<sup>5</sup>

## CONTROL

Prevention involves removing animals from the contaminating source. Water supplies can be chlorinated. This and the elimination of infected animals and the disinfection of premises should be the basis of control procedures. Housed animals can be removed from soil by raising them from the ground on wooden slats, concrete or paved floors.

## REVIEW LITERATURE

Choy JL, Mayo M, Janmaat A, Currie BJ. Animal melioidosis in Australia. *Acta Tropica* 2000; 74:153–158.

## REFERENCES

1. Fushan A et al. *Res Microbiol* 2005; 156:278.
2. Bergin JJ, Torenbeeck LR. *Aust Vet J* 1991; 68:309.
3. Choy JL et al. *Acta Tropica* 2000; 74:153–158.
4. Thomas AD. *Aust Vet J* 1981; 57:146.
5. Loganathan P, Tan S. *Kajian Vet Malaysia* 1983; 15:74.
6. Conigliaro S et al. *Vet Argentina* 1999; 16:285.
7. Inglis TJJ et al. *Epidemiol Infect* 2004; 132:813.
8. Chua KL et al. *Infect Immun* 2003; 71:1622.
9. Thomas AD et al. *Aust Vet J* 1981; 57:535.
10. Najdenski H et al. *J Vet Med B* 2004; 51:225.
11. Leelarasamee A. *Acta Tropica* 2000; 74:129.
12. Thomas AD et al. *Aust Vet J* 1988; 65:43.
13. Van der Lugt JJ, Henton MM. *J S Afr Vet Assoc* 1995; 66:71.
14. Ladds PW et al. *Aust Vet J* 1981; 57:36.
15. Thomas AD et al. *Aust Vet J* 1988; 65:261.
16. Thomas AD et al. *J Clin Microbiol* 1990; 28:1874.
17. Zhang WD, Lu ZB. *Chin J Vet Med* 1983; 9:8.
18. Chaowagul W. *Acta Tropica* 2000; 74:133.

## GLANDERS

### Synopsis

**Etiology** *Burkholderia mallei*

**Epidemiology** Contagious disease of solipeds

**Clinical findings** Acute or chronic form, and characterized by pneumonia and nodules or ulcers in the respiratory tract and on the skin. The disease is highly fatal

**Clinical pathology** Complement fixation test, mallein test, isolation of organism

**Necropsy findings** Extensive bronchopneumonia in acute cases. Miliary nodules in internal organs and ulcerated nodules in skin and respiratory tract

**Treatment and control** No effective treatment. Control is by slaughter of clinically affected and carrier animals detected by serological or mallein tests

## ETIOLOGY

*Burkholderia (Pseudomonas) mallei* is the causative organism. It has close genetic and antigenic relatedness to *Burkholderia pseudomallei*.<sup>1,2</sup> Isolates of *B. mallei*, recovered from three continents over a period of 30 years have identical allelic profiles.<sup>1</sup>

## EPIDEMIOLOGY

### Geographical occurrence

Glanders is restricted geographically to Eastern Europe, Asia Minor, Asia, and North Africa. It was more widespread but has been **eradicated** from most countries.<sup>3</sup> Glanders was an important disease when there were large concentrations of horses in cities and armies, but now has sporadic occurrence, even in infected areas.

### Host occurrence

Horses, mules, and donkeys are the species usually affected. Humans are susceptible and the infection is usually fatal. Carnivores, including lions may be infected by eating infected meat and infections have been observed in sheep and goats.



### Source of infection and transmission

*B. mallei* is an obligate parasite and is readily destroyed by light, heat, and the usual disinfectants and is unlikely to survive in a contaminated environment for more than 6 weeks.

Infected animals or **carriers** that have made an **apparent recovery** from the disease are the important sources of infection. **Chronic nodular lung lesions**, which have ruptured into the bronchi, infect upper airway passages and nasal or oral secretions. Spread to other animals occurs mostly by **ingestion**, the infection spreading on fodder and utensils, particularly **communal watering troughs**, contaminated by nasal discharge or sputum. Rarely the cutaneous form appears to arise through contamination of skin abrasions by direct contact or from harness or grooming tools. Spread by inhalation can also occur but this mode of infection is probably rare under natural conditions.

### Experimental reproduction

An experimental model for disease has been reproduced by intratracheal inoculation of horses with cultures of *B. mallei*.<sup>4</sup> Horses showed fever within 24 to 48 hours of challenge followed by the progressive development of signs of respiratory distress with epistaxis and purulent nasal and ocular discharge. On post-mortem there was lymphadenopathy, ulcerative lesions in the nasal septa and pneumonia.

### Host and pathogen risk factors

**Horses** tend to develop the chronic form, **mules and donkeys** the acute form, but all types of equid and all ages are susceptible. The disease is more likely when animals are in a **stressed state** from heavy work and animals that are poorly fed and kept in a poor environment are more susceptible.

The stress associated with movement of a large number of horses can precipitate an outbreak with high mortality rates. In the few animals that recover, there is a long convalescence with the frequent development of the **'carrier'** state. Animals rarely make a complete recovery.

### Economic importance

The disease has little current economic importance, although the threat of horse movement reintroducing glanders into countries that have eradicated it is a concern.<sup>5</sup>

### Zoonotic implications

While humans are not highly susceptible, the infection may gain access through skin abrasions to produce granulomatous disease and pyemia. Infection can also occur from inhalation of infectious material. The case fatality is high. Horse handlers in general are at risk and veterinarians

conducting postmortem examinations without proper precautions are at particular risk. The organism is identified as a possible agent of bioterrorism.

### PATHOGENESIS

Invasion occurs mostly through the intestinal wall and a septicemia (acute form) or bacteremia (chronic form) is set up. Localization always occurs in the lungs but the skin and nasal mucosa are also common sites. Other viscera may become the site of the typical nodules. Terminal signs are in the main those of bronchopneumonia, and deaths in typical cases are caused by anoxic anoxia.

### CLINICAL FINDINGS

#### Acute disease

There is a high fever, cough, and nasal discharge with rapidly spreading ulcers appearing on the nasal mucosa, and nodules on the skin of the lower limbs or abdomen. Death due to septicemia occurs in a few days.

#### Chronic disease

Three major manifestations are described:

1. Pulmonary
2. Skin
3. Nasal, although the chronic nasal and skin forms commonly occur together.

#### Pulmonary form of disease

The **pulmonary** form manifests as a chronic pneumonia with cough, frequent epistaxis, and labored respiration.

#### Nasal form of disease

In the **nasal form**, lesions appear on the lower parts of the **turbinates** and the cartilaginous **nasal septum**. They commence as nodules (1 cm in diameter), which ulcerate and may become confluent. In the early stages there is a serous nasal discharge which may be unilateral and which later becomes purulent and blood stained. Enlargement of the submaxillary lymph nodes is a common accompaniment. On healing, the ulcers are replaced by a characteristic **stellate scar**.

#### Skin form of disease

The **skin** form is characterized by the appearance of subcutaneous nodules (1–2 cm in diameter), which soon **ulcerate** and discharge pus of the color and consistency of dark honey. In some cases the lesions are more deeply situated and discharge through fistulous tracts. Thickened **fibrous lymph vessels** radiate from the lesions and connect one to the other. Lymph nodes draining the area become involved and may discharge to the exterior. The predilection site for cutaneous lesions is the medial aspect of the hock, but they can occur on any part of the body.

Animals affected with the chronic form are usually ill for **several months**, fre-

quently showing improvement but eventually either dying or making an apparent recovery to persist as occult cases.

### CLINICAL PATHOLOGY

Disease is accompanied by a low hemoglobin content of the blood, a low erythrocyte count and packed cell volume, and a moderate leukocytosis and neutrophilia. The principal tests used in the diagnosis of glanders are the mallein test, the complement fixation test on serum, and demonstration of the organism.

#### Mallein test

The intradermopalpebral test has largely displaced the ophthalmic and SC tests. Mallein (0.1 mL) is injected intradermally into the **lower eyelid** with a tuberculin syringe. The test is read at 48 h, a positive reaction comprising marked edema of the lid with blepharospasm and a severe, purulent conjunctivitis.<sup>5</sup> Some infected animals exhibit a general hypersensitivity reaction after inoculation.

#### Serological tests

The CFT is the most accurate of the serological tests available, and the usual official test, but some strains of *B. mallei* give cross-reactions with *B. pseudomallei*. Other tests used are an indirect hemagglutination test using mallein as the antigen<sup>6</sup> and the conglutinin complement absorption test.<sup>7</sup> The accuracy of the complement fixation test may be improved by the simultaneous testing with the indirect hemagglutination test. CFT may be unsuitable in mules and asses because of anticomplement activity. A dot enzyme-linked immunosorbent assay (ELISA) test has been developed that is suitable for use in all soliped species.<sup>8</sup> It is reported to have high sensitivity and can be used as a field test without specialized equipment. All serological tests may be inaccurate for periods up to 6 weeks following the mallein test.

#### Demonstration of organism

If pus is available, from either open ulcers or necropsy material, the organism can be **cultured** or the pus injected intraperitoneally into male guinea pigs to attempt to elicit the **Strauss reaction**. This is a severe orchitis and inflammation of the scrotal sac but it is not highly specific for *B. mallei*.

Gene sequencing can be used for rapid identification and differentiation from *B. pseudomallei*.<sup>9</sup>

### NECROPSY FINDINGS

In the **acute** form there are multiple petechial hemorrhages throughout the body and a severe catarrhal bronchopneumonia with enlargement of the bronchial lymph nodes.

In the more common **chronic** form, the lesions in the lungs take the form of **skin nodules**, similar to those of miliary tuberculosis, scattered throughout the lung tissue. **Ulcers** are present on the mucosa of the **upper respiratory tract**, especially the nasal mucosa and to a lesser extent that of the larynx, trachea, and bronchi.<sup>10</sup> Nodules and ulcers may be present in the **skin and subcutis** of the limbs, which may be greatly enlarged. Local lymph nodes receiving drainage from affected parts usually contain foci of pus and the lymphatic vessels have similar lesions. Necrotic foci may also be present in other internal organs. *B. mallei*, and sometimes *Arcanobacterium pyogenes*, are isolated from infected tissues, and this is main means of confirmation of diagnosis at necropsy.

#### DIAGNOSTIC CONFIRMATION

In live animals that could be carriers, the complement fixation test is used as the official test in most countries. The mallein test is used in those horses whose sera is anticomplementary.

#### DIFFERENTIAL DIAGNOSIS

- Epizootic lymphangitis
- Ulcerative lymphangitis
- Sporotrichosis
- Melioidosis
- Other causes of pneumonia.

#### TREATMENT

There is little information on treatment. However, it is unlikely that treatment would be an option in most countries. Penicillin and streptomycin have no detectable effect on the progress of the disease but sodium sulfadiazine has been highly effective in the treatment of experimental glanders and melioidosis in hamsters. Treatment for a period of 20 d was necessary to effect 100% recovery. Combinations of a formalized preparation of *B. mallei* and sulfadiazine, or mallein and sulfadimidine, are reported to be effective in the treatment of affected horses.

#### CONTROL

Although clinical and serological recovery from glanders occurs occasionally, recovered animals are not solidly immune and attempts to produce artificial immunity have been uniformly unsuccessful.

Complete quarantine of affected premises is necessary. Clinical cases should be destroyed and the remainder subjected to the mallein test at intervals of 3 weeks until all reactors have been removed. A vigorous disinfection program for food and water troughs and premises generally should be instituted to prevent spread while eradication is being carried out. Restriction of the movement of horses should be instituted and the mallein test

carried out in horses which may have had contact with the infected group.<sup>11</sup>

#### REVIEW LITERATURE

Pritchard DG. Glanders. Equine Vet Educ 1995; 7:29.  
Sharrer GY. The great glanders epizootic USA, 1861–1866: A Civil War legacy. Agric History 1995; 69:79–97.

#### REFERENCES

1. Gody D et al. J Clin Microbiol 2003; 41:2068.
2. Anuntagool N, Sirisinha, S. Microbiol Immunol 2002; 46:143.
3. Derbyshire JB. Can Vet J 2002; 43:722.
4. Lopez J et al. Microbes Infect 2003; 5:1125.
5. Hagebock JM et al. J Vet Diag Invest 1993; 5:97.
6. Gangulee PC et al. Ind Vet J 1966; 43:386.
7. Sen GP et al. Ind Vet J 1968; 45:286.
8. Verma RD et al. Vet Microbiol 1990; 25:77.
9. Gee JE et al. J Clin Microbiol 2003; 41:4647.
10. Bazargani TT et al. J Equine Vet Sci 1996; 16:232.
11. Hickman J. Equine Vet J 1970; 2:153.

## Diseases associated with *Campylobacter* and *Lawsonia* spp.

#### ETIOLOGY

Several species of the genus *Campylobacter* are known to cause disease in farm animals; some are potentially zoonotic and the role of some is uncertain. *Campylobacter fetus* var. *venerealis* is the cause of infertility and abortion in cattle and the reader is referred to a textbook in theriogenology for more details. *C. fetus* subsp. *fetus* causes sporadic abortion in cattle and enzootic abortion in sheep and has been associated with bacteremia in man.<sup>1</sup> The organism has also been isolated from the intestines of healthy sheep and cattle and from enteric lesions in cattle with enteritis, but its significance as the causative agent is uncertain.

#### EPIDEMIOLOGY

##### Prevalence of infection

*Campylobacter jejuni* and *Campylobacter coli* can be isolated from the intestines of healthy farm animals, poultry, pets, zoo animals, and wild birds.<sup>2</sup> *C. jejuni* and *C. hyointestinalis* can be found in the rumens and intestines of normal adult cattle and calves. *C. jejuni* and *C. coli* were isolated from rectal swabs of dairy cows in New Zealand where the prevalence was 24%, 31%, and 12% in the summer, autumn, and winter, respectively. *C. jejuni* and *C. coli* were present in the feces of slaughter-age cattle and sheep in Australia with median prevalences and ranges for dairy cattle, 6% (0–24%), feedlot beef cattle, 58% (12–92%), pasture beef cattle, 2% (0–52%) mutton sheep, 0% (0–4%), and prime lambs 8%.<sup>3</sup> The cattle production system being used may be an important risk factor. The organism may be present in about 15% of cattle at the time of slaughter. *C. jejuni* is widely

distributed among northwestern US dairy farms, while *C. coli* is more narrowly distributed, more particularly in calf rearing farms.<sup>4</sup>

Approximately 60% of the specimens of healthy slaughter pigs may yield *C. jejuni*.<sup>2</sup> *C. coli* has been isolated from the intestinal contents of 99% of pigs at slaughter. A high prevalence of *C. coli* in the stomach of pigs at slaughter in France is recorded, and a high proportion of the strains were resistant to tetracyclines and erythromycin.<sup>5</sup> *C. jejuni*, *C. coli*, *C. lari* can be isolated from pigs on commercial swine herds.<sup>6</sup> Piglets probably become colonized with *Campylobacter* within a few hours of birth.

The prevalence of *Campylobacter* infections in both diarrheic and non-diarrheic calves, piglets, lambs, and goat kids may average around 50% but there is no correlation between the occurrence of the organism in the feces and the presence of diarrhea. However, the presence of these organisms constitutes a potential zoonosis among animal handlers. The details of surveys of the incidence of campylobacters from the tissues of cattle at slaughter and from fresh and frozen meat and poultry collected at slaughter are available.<sup>3</sup> An adaptation of the ELISA test is available for the detection of antibodies to *Campylobacter* sp. for use in seroepidemiological studies in herds of cattle and sheep. Wild birds probably constitute the main natural reservoir of infection.

Individual single-visit farm prevalence of intestinal *Campylobacter*, predominantly *C. jejuni*, in lactating dairy cows from various regions of the US ranges from 0 to 10%, and there was no difference geographically.<sup>7</sup> This low prevalence compares favorably with the rates of 5% for beef cattle on pasture,<sup>8</sup> with 7% of dairy cows in the UK,<sup>9</sup> and with 6–7% of adult cattle in the US.<sup>8</sup> Using a PCR assay of the feces for *C. jejuni*, 80% of dairy herds were positive, and 38% of individual cows were positive.<sup>10</sup> Possible risk factors for *C. jejuni* were application of manure with broadcast spreaders, feeding of whole cottonseed or hulls, and accessibility of feed to birds.

In feedlot beef cattle, 100% of the animals may shed campylobacters over a period of several months.<sup>11</sup> In surveys of feedlot cattle in Ireland over a period of several months, 54% of the animals shed *Campylobacter* and *Campylobacter coli*, 69 and 30%, respectively.<sup>12</sup> Of environmental pen samples, 29% were positive, and *C. jejuni* and *C. coli* accounted for 35 and 59%, respectively. *Campylobacter* was not isolated from any of the dressed carcasses.

Abortions in beef cattle herds have been attributed to *C. jejuni*.<sup>13</sup> The abortion rates were 19% and 10% in two herds on

neighboring ranches in Saskatchewan. Abortions occurred in late gestation and were accompanied by retention of fetal membranes and weight loss. Necrotizing and suppurative placentitis and fetal bronchopneumonia along with culture of large numbers of *C. jejuni* from the placental and fetal tissues were present. The organism was also isolated from the feces of aborting and healthy cows, and diarrheic and healthy calves. It is suggested that the source and mode of transmission of the organism was fecal contamination of water supplies and feeding grounds by carrier cows or wildlife. *C. coli* alone and *C. jejuni* and *C. fetus* subsp. *fetus* together have been isolated in epidemics of abortion in sheep. The IV inoculation of *C. jejuni* into pregnant sheep results in abortion 7–12 days later. A purulent endometritis and vasculitis were present.

*C. jejuni* has been isolated from an aborted fetus from a goat and the fetus of a heifer which aborted.

### Risk factors

#### Pathogen risk factors

*Campylobacter jejuni* is adapted to the intestinal tract of warm-blooded animals and does not normally replicate outside this environmental niche.<sup>14</sup> The single polar flagellum and corkscrew shape facilitates motility in the viscous intestinal mucus. The bacterium gradually dies outside the host's intestinal tract. *C. jejuni* strains could not be isolated from water after 3 weeks but may survive for up to 60 days in unstirred water. The distribution and diversity of campylobacters in a large-scale farming environment in the UK was determined by systematic sampling of feces, soil, and water.<sup>15</sup> The organism was widespread, there were low levels of antibiotic resistance, high genetic diversity, and a strain of *C. coli* which may have become adapted to survival or persistence in water.

The organism is not normally pathogenic in farm animals. In humans, the infectious dose is considered to be <1000 *Campylobacter* organisms.<sup>14</sup>

**Antimicrobial resistance.** Increasing antimicrobial resistance in *Campylobacter* is being recognized worldwide, and resistance to the quinolones is most common in isolates of both *C. jejuni* and *C. coli* from food-producing animals, especially poultry.<sup>16,17</sup> Resistance of *C. jejuni* from poultry increased to 30% within several years after its approval for use as mass water medication in poultry.<sup>18</sup> The antimicrobial susceptibilities of *Campylobacter* spp. isolated from organic and conventional dairy herds in Wisconsin, US, were not different.<sup>19</sup> Thus the restricted use of antimicrobials on organic dairy farms had no effect on antimicrobial resistance

to ciprofloxacin, gentamicin, erythromycin, and tetracycline in *Campylobacter* spp. From dairy farms in Washington State, *C. coli* isolates were more frequently resistant than *C. jejuni* to ciprofloxacin, nalidixic acid, erythromycin, and doxycycline.<sup>4</sup> Of *C. coli* isolates from dairy calf rearing farms, 89.3% and 72.2% from feedlots were resistant to quinolone antimicrobials, respectively. Multidrug resistance was more common among *C. coli* than *C. jejuni*.

#### Zoonotic implications

*Campylobacter* is the leading bacterial cause of diarrhea in humans in many industrialized countries. In the United States, disease caused by *C. jejuni* or *C. coli* has been estimated to affect 7 million people annually, causing 110–511 deaths.<sup>20</sup> Data from population-based studies indicate that the most important cause of indigenous foodborne disease is contaminated chicken.<sup>21</sup> Red meat (beef, lamb, and pork) also contribute to illness despite the lower risk.

*C. jejuni* is ubiquitous in areas contaminated with cattle feces but the intensity of infection varies considerably. Humans can be exposed to *Campylobacter* spp. in a range of sources via both food and environmental pathways. In dairy farm areas in which there are also outdoor recreational activities, *Campylobacter* spp. have been isolated from a range of environmental samples by use of a systematic sampling grid.<sup>22</sup> *C. jejuni* was the most prevalent species in all animal species, ranging from 11% in samples from nonavian wildlife to 36% in cattle feces, and from 15% of water samples. *C. coli* was most commonly found in water (17%) and sheep (21%). *C. lari* was commonly found in water and in birds. Many of the *C. jejuni* genotypes isolated from cattle, wildlife, and water were indistinguishable from those recovered from human clinical cases.<sup>22</sup>

The annual increase in *Campylobacter* infections in England and Wales begins in early May and reaches a peak in early June. This seasonal incidence may be associated with transmission of the organism by flies.<sup>23</sup>

An estimated 20% of cases of illness associated with *C. jejuni* are due to vehicles of infection other than food, including water. *Campylobacter* spp. have been found to cause waterborne outbreaks worldwide, especially where people drink untreated water from streams and other sources.<sup>20</sup> Untreated surface water has been implicated in *Campylobacter* outbreaks in New Zealand, Finland, England, Wales, Australia, the United States, and Canada. The Walkerton, Ontario, waterborne outbreak of 2000 resulted from entry of

*Escherichia coli* 0157:H7 and *Campylobacter* spp. from neighboring cattle farms into the town water supply.<sup>20</sup> The bacteriologic, epidemiologic, and hydrogeologic data indicated that the bacteria from cattle manure were able to enter groundwater after heavy rains and contaminate a well serving the town of Walkerton, subsequently infecting those consuming the water. Some investigations consider that beef cattle represent a limited threat to water supplies and subsequent transmission of *Campylobacter* to humans.<sup>24</sup>

Raw milk contaminated by infected cows is a major cause of food-borne human campylobacteriosis in the United States and United Kingdom.<sup>14</sup> *C. jejuni*, along with other food-borne pathogens such as shiga-toxin producing *E. coli*, *Listeria monocytogenes*, *Salmonella* spp., and *Yersinia enterocolitica* can be found in the bulk tank milk supply of dairy herds in Canada and the United States.<sup>25</sup> Drinking raw cows' milk is commonly related to illness due to *C. jejuni*.<sup>2</sup> Raw goats' milk may transmit *C. jejuni* infection from animals to humans.<sup>2</sup> There is a strong association of *Campylobacter* infection in humans with residence on a farm<sup>14</sup> and contact with diarrheic animals is a major risk for *Campylobacter* enteritis in humans. Fecal contamination, rather than udder infection, is considered to be the means by which campylobacters enter milk and thereby infect humans. *C. jejuni* has been isolated from the bulk milk supply of goats whose milk was associated with *Campylobacter* infection in a human.

Along with other food-borne bacteria, such as *E. coli*, *Salmonella* spp., *Campylobacter* spp. can be found in retail raw meats (chicken, turkey, pork, and beef) sampled in supermarket chain stores.<sup>26</sup>

There is good evidence that isolates of *C. jejuni* from human disease and farm animals are very similar. The use of multilocus sequence typing is being used to compare the genotypes of *C. jejuni* from farm animals and the environment with those from retail food and human disease.<sup>15,27</sup>

### PATHOGENESIS

The role of *C. jejuni* as primary pathogens in farm animals is uncertain. The organism was originally thought to be the causative agent of winter dysentery in cattle but reliable evidence for this relationship has not been found. Experimentally, the organism will cause a mucoid diarrhea, often with dysentery and a fever in calves.

*C. jejuni* or *C. coli* can cause a mild self-limiting enteritis and bacteremia when inoculated orally into newborn calves. The organism has been isolated from the feces of diarrheic calves and lambs, which suggests that it may be a causative agent

in some outbreaks of diarrhea but this has not yet been substantiated. The oral inoculation of pure cultures of *C. fetus* subsp. *intestinalis* into young calves will also result in an enteritis similar to that associated with *C. jejuni*. The oral inoculation of *C. jejuni* into gnotobiotic pigs results in diffuse edema and neutrophil infiltration of the mucosa of the cecum and colon. An episode of diarrhea in calves 5–12 weeks of age has been attributed to *C. hyointestinalis*. A *Campylobacter*-like organism has been isolated from young sheep about 1–2 months after weaning, when they were about 6 months of age, affected with weaner colitis. The morbidity rates in flocks ranged from 20–75% and the case–fatality rate was about 3%. *Campylobacter* spp. can be found in a high proportion of foals on horse farms where persistent non-responsive diarrhea has been a problem. Outbreaks of severe gastroenteritis in fattening lambs have been attributed to *C. jejuni*, these outbreaks were treated successfully with daily injections of erythromycin followed by a single injection of long-acting oxytetracycline.

*Campylobacter fetus* subsp. *fecalis* has been isolated from intestinal lesions of cattle and experimentally will cause a diarrhea and dysentery in calves.

*Campylobacter coli* (formerly *Vibrio coli*) has been isolated from the small intestines of diarrheic piglets and experimentally can cause colitis in young piglets. The organism may be the cause of naturally occurring diarrhea in nursing piglets and weaned pigs in certain circumstances.

#### CLINICAL FINDINGS

The disease may be so mild as to be unapparent, without fever, and may be manifested only by mild depression and soft feces with occasional strands of mucus.

#### CLINICAL PATHOLOGY

The information on the various methods used for the detection and identification of *Campylobacter* in laboratory samples has been reviewed.<sup>28</sup> Because of the unique growth characteristics of *Campylobacter*, isolation of these organisms from field samples requires the use of special media and culture conditions, and is generally laborious and time-consuming. However, isolation of *Campylobacter* from feces is possible with high success rates. Recovery of *Campylobacter* from environmental samples can be difficult because the organism does not propagate in the environment.<sup>28</sup> The use of molecular detection methods has greatly facilitated the specific and rapid detection and identification of campylobacters, but has not replaced the gold standard of traditional culture methods. Detection and

quantification of *C. jejuni* in the feces of naturally infected cattle is possible using real-time quantitative PCR.<sup>29</sup>

The laboratory methods used to distinguish epidemic-associated *Campylobacter* strains isolated from animals and humans have been examined.<sup>7</sup>

#### NECROPSY FINDINGS

At necropsy, there may be a diffuse catarrhal to severe hemorrhagic enteritis of the jejunum and ileum.

#### CONTROL

Control depends on sanitation and hygiene in livestock barns to reduce the bacterial populations in the environment of the animals. The numbers of organisms can be reduced and controlled in meat processing plants by using Hazard Analysis of Critical Control Points including the washing, handling and freezing of carcasses. Improvement of food-handling skills in restaurants and in the home kitchen will reduce transmission of the organism and adequate cooking of raw meat such as poultry to an internal temperature of 82°C will eliminate the organism.<sup>14</sup>

#### REVIEW LITERATURE

Altekruse SF, Tollefson LK. Human campylobacteriosis: a challenge for the veterinary profession. J Am Vet Med Assoc 2003; 223:445–452.

#### REFERENCES

1. DeLong WJ et al. Am J Vet Res 1996; 57:163.
2. Altekruse SF et al. J Am Vet Med Assoc 1994; 204:57.
3. Bailey GD et al. Commun Dis Intell 2003; 27:249.
4. Bae W et al. Appl Environ Microbiol 2005; 71:169.
5. Payot S et al. Vet Microbiol 2004; 101:91.
6. Young CR et al. Res Vet Sci 2000; 68:75.
7. Harvey RB et al. J Food Prot 2004; 67:1476.
8. Beach JC et al. J Food Prot 2002; 65:1687.
9. Ataby HI et al. J Appl Microbiol 1998; 84:733.
10. Wesley IV et al. Appl Environ Microbiol 2000; 66:1994.
11. Inglis GD et al. J Appl Microbiol 2004; 97:410.
12. Minhan D et al. J Vet Med B 2004; 51:28.
13. Van Donkersgoed J et al. Can Vet J 1990; 31:373.
14. Altekruse SF et al. J Am Vet Med Assoc 2003; 223:445.
15. Leatherbarrow AJH et al. Appl Environ Microbiol 2004; 70:822.
16. Pezzoti G et al. Int J Food Microbiol 2003; 82:281.
17. Ishihara K et al. Int J Antimicrobiol Agents 2004; 24:63.
18. Lucey B et al. Vet Rec 2002; 151:317.
19. Sato K et al. Appl Environ Microbiol 70: 1442.
20. Clark CG et al. Emerg Infect Dis 2004; 9:1232.
21. Adak GK et al. Emerg Infect Dis 2005; 11:365.
22. Brown PE et al. Appl Environ Microbiol 2004; 70:6501.
23. Nichols GL. Emerg Infect Dis 2005; 11:361.
24. Hoar BR et al. Epidemiol Infect 2001; 127:147.
25. Jayarao BM, Henning DR. J Dairy Sci 2001; 84:2157.
26. Ohya T et al. Vet Rec 1999; 145:316.
27. Colles FM et al. Appl Environ Microbiol 2003; 69:7409.
28. Sahin O et al. In: Microbial food safety in animal agriculture. ME Torrence, RE Isaacson. Iowa State University Press, 2003; p. 183.
29. Inglis GD, Kalischuk LD. Appl Environ Microbiol 2004; 70:2296.

## ILEITIS (REGIONAL ILEITIS, PORCINE PROLIFERATIVE ENTERITIS COMPLEX, PORCINE INTESTINAL ADENOMATOSIS, PORCINE PROLIFERATIVE ENTEROPATHY, NECROTIC ENTERITIS, REGIONAL ENTERITIS, PROLIFERATIVE HEMORRHAGIC ENTEROPATHY OF PIGS)

### Synopsis

**Etiology** *Lawsonia intracellularis* (ileal symbiont intracellularis)

**Epidemiology** Four to 8 weeks after weaning, feeder pigs, and young gilts, sows and boars. Risk factors not known

**Signs** Diarrhea, weight loss, inappetence, and may recover. Outbreaks of bloody diarrhea and rapid death may occur in feeder pigs, young gilts, and boars

**Clinical pathology** Demonstrate organism

**Lesions** Proliferative ileitis. Proliferative hemorrhagic enteropathy, fibrinous casts, blood clots

**Diagnostic confirmation** Demonstrate organism in tissues

#### Differential diagnosis list

- Esophagogastric ulceration
- Intestinal hemorrhage syndrome
- *Clostridium perfringens* type C hemorrhagic enteritis

**Treatment** Antimicrobials in feed

**Control** No reliable strategies. Medication of feed

#### ETIOLOGY

The causative agent is *Lawsonia intracellularis* (LI), which was isolated in 1993.<sup>1</sup> It was described about 60 years earlier and first reported in 1974.<sup>2</sup> Koch's postulates for the disease were fulfilled in 1993.<sup>3</sup> It is an obligate intracellular bacterium<sup>4</sup> or in other words host cell dependent. It was also known as *ileal symbiont intracellularis*. Recent classification of DNA from infected enterocytes indicates a close relationship to *Desulfovibrio* species.<sup>4</sup> It has also been shown to be closely related to *Bilophila wadsworthii* which is a known inhabitant of the human colon and may be associated with appendicitis and is widely found in pigs in Australia.<sup>5</sup> Molecular typing of the organism has recently been described.<sup>6</sup> The isolates of *Lawsonia intracellularis* from the United States are similar to the European isolates.<sup>7</sup>

Formerly, the intracellular organisms, *Campylobacter sputorum* subsp. *mucosalis* and *Campylobacter hyointestinalis* were considered to be the causative agents because they could be isolated from the intestines of pigs with proliferative ileitis. Both pure cultures and mucosal homogenates of LI will produce clinical signs, lesions, and shedding.

The disease complex, often just called ileitis, occurs in two forms; a chronic form usually referred to as porcine intestinal adenomatosis (PIA) or necrotic enteritis occurs from 6–20 weeks and an acute form called porcine hemorrhagic enteropathy or regional ileitis occurs earlier from 4–12 weeks.

## EPIDEMIOLOGY

### Occurrence

The worldwide occurrence has been described<sup>8</sup>

The porcine proliferative enteropathy complex affects pigs from weaning age to feeder pigs and also young gilts, sows, and boars. It is characterized clinically by diarrhea, loss of body weight and inappetence in recently weaned pigs, and sudden death in feeder pigs, young gilts, and boars. The essential lesions are proliferative and there seems to be an etiological and pathological relationship between **porcine intestinal adenomatosis, necrotic enteritis, regional enteritis, and hemorrhagic enteropathy**. A study in Belgium suggested that 24% of slaughtered pigs had a thickened ileum with a range in farm batches from 10–49%.<sup>9</sup> In Denmark 94% of herds were infected with a mean within herd prevalence of 30%.<sup>10</sup> In Canada, there is a widespread distribution between 50–100% of herds in the provinces with 5–89% of pigs affected.<sup>11</sup> In the USA it was found using the IPMA test to study antibodies that 75% of growing herds had antibodies and within the herd the prevalence was 11–91%. Of the breeding herds 78% had antibodies with two peaks at the time of infection and 9–18 weeks later<sup>12</sup> and with an overall prevalence of 5–61%.

In Canada, studying 96 cases of porcine proliferative enteropathy,<sup>13</sup> it was found that 15% were in weaners (8–10 weeks), 36% in growers from 10–18 weeks and 14% amongst finishers of 18–26 weeks. A further 16% were in mature pigs of >26 weeks.

Estimation of the incidence of disease is complicated by the difficulties in making an accurate clinical and pathologic diagnosis. Surveys of pig farms in Australia indicate that 56% had either observed the disease or the veterinarian had made the diagnosis.<sup>14</sup> Non-hemorrhagic proliferative enteritis occurred most commonly in pigs 6–24 weeks of age. Proliferative hemorrhagic enteropathy usually affects pigs over 16 weeks of age but occurs in pigs as young as 6 weeks and as old as 4 years of age.<sup>14</sup>

Proliferative hemorrhagic enteropathy is one form of the proliferative enteropathy complex and has been reported from the United Kingdom, Europe, Australia, Asia, and the United States, and appears to occur in most countries. It probably has a

worldwide distribution<sup>8</sup> with 30–60% of herds affected depending on the country. In Germany 82.7% of finishing herds had seroconversion.<sup>15</sup> It is especially common in hysterectomy-derived or specific pathogen-free (SPF) herds and has a higher prevalence in the hot summer period. In some countries its prevalence is increasing and it is emerging as a major syndrome in SPF herds.

The disease in all ages is frequently associated with the concurrent occurrence of porcine intestinal adenomatosis, but it is unknown whether the hemorrhagic syndrome results from some insult to the intestine which also predisposes to a proliferative enteropathy or whether it is simply an acute manifestation of this disease. The related syndromes of necrotic enteritis and regional ileitis can be found in apparently healthy pigs examined at slaughter. Because the disease is common in pigs, suboptimal growth of pigs in nutritional studies may be due to the disease complex.<sup>16</sup> It has been suggested that it can live extracellularly within the environment for two weeks<sup>17</sup> at 5–15°C. It appears highly resistant to a lot of cleaning agents such as povidone-iodine, or K permangosulfate but may be susceptible to 3% cetrimide. In one study transmission occurred despite cleaning, use of footbaths, and dedicated boots, etc.<sup>18</sup>

It has been suggested that it normally lives in organic matter in weaner units awaiting the arrival of batches of susceptible pigs with the resultant sudden increase in shedding 4–12 weeks after weaning.<sup>19</sup> The recent finding of LI in the tonsil may be a coincidental finding in that they have just been trapped in the crypts after licking of infected material<sup>20</sup> as they were only found in this site in 2/32 pigs. Mixed infections are found in 10% of growers and there is a strong association between diarrhea and prevalence of *B. hyodysenteriae* and *B. pilosicoli*.<sup>21</sup>

### Economic effect

The potential economic effect can be quite severe with estimates of \$1.48–3.42 for mild infections and \$11.50–22.19 for severe infections.<sup>22</sup>

### Prevalence of infection

Surveys of fecal samples from swine herds in Taiwan revealed an overall prevalence of infection of *Lawsonia intracellularis* in 30% of herds and 5.5% of pigs.<sup>23</sup> They have looked for it in wild pigs in Sweden but not found it.<sup>24</sup>

### Morbidity and case fatality

The disease can occur in all ages of post-weaned pigs, but it has a high incidence in young replacement gilts and boars at 6–9 months of age and in pigs approxi-

mately 4–8 weeks after weaning. The high incidence in replacement gilts may be due to suppression of the disease by low-level feeding of antibacterial agents during the growing period, but frequently the syndrome appears first in gilts and some time later in the growing pigs. In gilts, outbreaks may be explosive, but generally are short-lived with morbidity rates of up to 50% of the group occurring within a 2- to 3-week period. The case-fatality rate does not usually exceed 10%. In large herds with continual addition to the replacement gilt herd and in herds where the disease occurs in grower pigs, outbreaks may be more prolonged. The disease in growers generally has equivalent morbidity and case-fatality rates, but is more severe in that runting of surviving and contemporary pigs may occur necessitating further economic loss through culling.

When given experimentally at a high level of 10<sup>9</sup>–10<sup>10</sup> LI per pig mortality in the untreated groups varied from 10–50% which is considered much higher than in the natural outbreak.<sup>25,26</sup>

### Risk factors

There may be two patterns of infection. One is an early infection and the second is a delayed infection which is seen in farms which have separation of pigs at weaning and all in/all out methods of production.<sup>8</sup>

Very little is known about the risk factors. A gene has been discovered which encodes for a surface antigen (LsaA) which is believed to be associated with attachment to and entry into cells and which is synthesized during infections.<sup>27</sup> A study of recorded outbreaks of proliferative hemorrhagic enteropathy indicated the disease often occurred within 12 months after repopulation of the herd, and following withdrawal of antimicrobials from the feed.<sup>28</sup> It has been proposed that the introduction of breeding stock from herds where the disease is endemic may be a risk factor but this is not documented. In a study in the UK<sup>29</sup> there seemed to be a higher risk where there were over 500 sows. An older parity structure in the sow population seemed to reduce infection. There seemed to be a higher risk if buying in boars. Fully slatted or fully meshed floors also carried a higher risk of infection compared with solid floors or straw. A higher risk was seen in those herds where large numbers of pigs entered the finishing units simultaneously. Pigs on concrete slats may also be predisposed. Intensive systems were more severely affected than outdoor systems. There was a reduced risk if there was thorough cleaning and disinfection (all in/all out) before the next group of pigs arrived.<sup>30</sup> Seroconversion usually occurred as the

pigs entered the finishing site suggesting that the exposure takes place in the nursery.<sup>31</sup> A recent study in the USA<sup>32</sup> identified five major types of risk factor. These were co-mingling, temperature fluctuations (overheating/ chilling), transportation, depopulation and new buildings. Sows may have low levels of antibody and are capable of passing on colostral protection to the piglets. Maternal antibodies have usually declined by 3–5 weeks of age but may be extended to 42 days by repeated sow vaccination<sup>33</sup> by which time exposure may have occurred and therefore there may be both active and passive antibodies.<sup>31</sup>

#### Methods of transmission

The organism is found in hamsters, ferrets, foxes, hares, deer, emus, ostriches, and primates. The significance of these alternative hosts has not yet been ascertained. Most significant host is the pig. The organism can be spread by both growing pigs and adults. Gilts can be shedders and carriers. It can probably survive in the extra-cellular world for 1–2 weeks at 5–15°C.<sup>17</sup>

The method of transmission between pigs is assumed to be the fecal–oral route but no information is available to support this.

#### PATHOGENESIS

The infection process appears to go ileum to colon, to cecum and finally rectum. The histological lesions may have cleared from the ileum by day 29 following inoculation.<sup>34</sup>

Proliferative enteropathy is characterized by the hyperplasia of the epithelial cells of the intestinal crypts, particularly in the ileum and colon. The presence of non-membrane bound, curved bacteria free in the cytoplasm of the affected enterocytes is a consistent feature of the disease.<sup>35</sup> These bacteria have been cultured in a rat enterocyte cell line<sup>36</sup> and the disease has been reproduced in hamsters by inoculation of a pure culture of the organism derived from pigs.<sup>37</sup> The disease has been reproduced experimentally by inoculation of conventional pigs with the organisms.<sup>38,39</sup> The organisms infect the immature cells of the mucosal glands and stop them from maturing. This causes them to multiply without leaving the gland and they then degenerate and the glands continue to proliferate. Gross and microscopic lesions typical of acute proliferative enteritis can be reproduced by inoculation of cell-cultured *Lawsonia intracellularis* into pigs 3 or 7 weeks of age.<sup>39</sup> The incubation period is about 7–14 days with the early lesions appearing in the terminal ileum. Fecal shedding usually occurs about 7 days post-challenge and the animals seroconvert about 14 days post-challenge. The disease

peak is about 21 days post-infection. The clinical signs decrease and the lesions begin to resolve after 28 days. The disease process results in a 2 week delay in marketing. Inoculation of gnotobiotic pigs does not cause the disease. It now seems certain that *Lawsonia intracellularis* is the causative agent of the disease complex.<sup>40</sup> Infection of intestinal epithelial cells is causally linked to marked hyperplastic proliferation of affected tissue.<sup>41</sup>

*Lawsonia intracellularis* is an obligate intracellular bacterium which causes hyperplasia of intestinal tissues; this eventually reverts to normal. The organism internalizes and multiplies within the cells and it is proposed that the organism is capable of affecting, directly or indirectly, the cell cycle within the intestinal epithelium. This may or may not be concerned with the role of cyclin kinase p27 which regulates differentiation of immature crypt cells into the differentiated form.<sup>42</sup> The changes in the experimental disease are similar to those in the natural disease. Following experimental infection there is almost complete replacement of normal ileal mucosa by adenomatous mucosa. Affected crypts are enlarged and branched, with loss of goblet cells and marked proliferation of crypt epithelial cells. Hyperplastic lesions may develop 2–3 weeks after challenge and persist for several weeks. In older animals, the lesions may be complicated by acute mucosal hemorrhage or necrosis. In the progressive stage of the disease, 3 weeks after infection, numerous organisms are consistently present within affected intestinal epithelial cells but not elsewhere.<sup>41</sup> In the developed and recovering stage of the disease, 7–9 weeks after infection, ultrastructural features in affected intestinal tissues consist of pale, swollen, protruding epithelial cells and shrunken epithelial cells. This is followed by the appearance of apoptotic bodies in both epithelial cells and macrophages, the reappearance of normal goblet cells and reduced numbers of organisms within the lesions. Bacteria are released from cells via cytoplasmic and cellular protrusions into the intestinal lumen and can be found in fecal samples.

In the experimental disease in pigs, seroconversion to the organism does not occur, confirming the weak response characteristic of the natural disease.<sup>43</sup>

The proliferative lesion may result in suboptimal performance in otherwise normal pigs or unthriftiness, or be manifested as acute intestinal hemorrhage during the recovery stages of intestinal adenomatosis. The hemorrhagic lesions are more difficult to explain but there may be direct or indirect toxic damage to the endothelium of the blood vessels.

It has been suggested that there is a close association between the presence of LI and reduced T- and B-cell numbers. This provides evidence of an immunosuppressive effect operating in this disease. It seems also that macrophages have an important function with activated macrophages accumulating in the infected hyperplastic glands.<sup>44</sup> At day 14 post-infection there were a few pinpoint lesions and the percentage of infected crypts was minimal but at the same time the number of CD3<sup>+</sup> cells was reduced and the number of intra-epithelial CD3<sup>+</sup> cells was also reduced whilst the CD8 and CD4 cells showed no changes. Apparently there is an induction of an immunosuppressive phenotype with down regulation of an adaptive immune response through the reduction in the CD8<sup>+</sup> T- and B-cells.

#### CLINICAL FINDINGS

This disease is one of the common causes of failure to grow, weight variation in batches of pigs and delay to market. Pigs may appear gaunt and may pass watery stools.

Regional ileitis is the most common differential diagnosis of the granulomatous enteritis that is seen in PCV2-associated enteric disease. In many cases both PCV2 and LI have been seen in the same case<sup>45</sup> as both target the ileum.<sup>46</sup>

Porcine proliferative enteropathy (PPE) or ileitis occurs in pigs 6–16 weeks of age. In the chronic form, a reduction in growth rate and failure to thrive are common. Affected pigs are afebrile and diarrhea occurs, but is unremarkable. Most cases recover spontaneously within 6 weeks of the onset of signs. When inflammation and necrosis have resulted in necrotic enteritis and regional ileitis, diarrhea and severe weight loss occur followed by death, often by ileal perforation in the case of regional ileitis.

**Proliferative hemorrhagic enteropathy (PHE)** occurs in older pigs such as young gilts and boars and is manifested primarily by bloody diarrhea and sudden death. Others within the group may show skin pallor and hemorrhagic feces with fibrin casts but otherwise appear clinically normal. In some pigs there is continual blood loss and death occurs within 48 h of the onset of hemorrhage, but in the majority the hemorrhage is transient. In outbreaks, up to 70% of pigs affected with dysentery may die within 24 h after the onset of signs.<sup>28</sup> Fever is not a feature and the majority of pigs suffer only a minor setback for a 2-week period. A small percentage develop chronic illthrift.

In grower pigs the disease is economically more severe. As in gilts, acute death with marked skin pallor and without premonitory signs can occur but survivors

show illthrift and as the outbreak progresses contemporary pigs may show a chronic syndrome of illthrift with the periodic passage of bloody feces.

The most staggering advance in clinical diagnosis may be by use of ultrasonics,<sup>47</sup> where it is said that it is possible to diagnose the condition by measuring the thickness of the ileal mucosa. It was said to increase from 0.27–0.36 cm in normal animals to 0.30–0.70 in affected animals.

### CLINICAL PATHOLOGY

**Detection of organism.** The organism can be detected in the feces of healthy 10- to 25-week-old growing/finishing pigs, which is probably the age group of pigs serving as the main source of infection for younger nursery pigs.

A polymerase chain reaction assay is highly reliable for the detection of the organism in feces and intestinal tissues.<sup>48,49</sup> It may detect as few as  $2 \times 10^2$  bacterial cells per gram of feces<sup>50</sup> but more likely is that the PCR detects shedding of  $10^3$  or greater per gram of feces.<sup>51,52</sup>

Positive results with the PCR are only present in animals with active lesions of proliferative enteropathy.<sup>53</sup> Shedding as detected by PCR may start as early as 6–8 weeks and continue to 28 weeks. From seroconversion to first shedding was 2–8 weeks.

A fluorescent in situ hybridization technique targeting 16S ribosomal RNA using an oligonucleotide probe successfully identified LI.<sup>54</sup>

Seroconversion may commence between 12–27 weeks. The range for positivity from first detection was 7–23 weeks.

### NECROPSY FINDINGS

The immediate impact is of a thickened ileum and cecum and less frequently a spiral colon. Not all cases have lesions. Some may be so mild as to be overlooked. Obvious gross lesions occur in severe cases but in the less severe, histology is needed. The pathology is related to the dose.<sup>55</sup> As long as you remember these facts you can monitor LI in the abattoir.<sup>56</sup>

A complex gross, histological and immunohistochemical study of LI has been made<sup>57</sup> in which the pigs showed complete recovery and were IHC –ve by 35 days post-infection. The antigen was detected in the intestine, lymph node (macrophages) and in the tonsils (free living in the crypts). They were found in the rectum and in several portions of the large intestine. The first site of colonization was the jejunum and ileum and then the lower intestinal segments. On day 29 there was nothing in the small intestine but the LI were still observed in the cecum, proximal colon, and rectum. Mucosal IgA was first detected on day 15 and was still detectable on day 29

but in all cases the titers varied from only 1:4–1:16.

The macroscopic lesions of proliferative enteropathy were first detected at 11 days post-infection which is the same time as histological identification with enterocyte hyperplasia and reduced goblet cells. Immunohistochemical identification can be seen at 5 days post-infection and continues until day 29.

In porcine intestinal adenomatosis, the prominent lesions are in the terminal ileum and proximal portion of the large intestine. There is gross thickening of the mucosa and submucosa of the terminal ileum and the colonic mucosa may also appear congested and slightly thickened.

In both forms of the disease the mucosal surface may be eroded and may look granular with abundant adherent material in the form of fibrinonecrotic debris. There may also be a fibrinonecrotic core filling the lumen. In PHE the only difference may be that the surface of the mucosa may be covered by large undigested blood clots.

Histologically, the mucosal change consists of marked proliferation of immature epithelial cells and a suppurative cryptitis.

In regional ileitis (called hosepipe gut) the distal ileum is rigid due to thickening of the intestinal wall caused by muscular hypertrophy and granulation tissue formation. The initiating mucosal damage is often somewhat masked due to colonization of the ulcerated mucosa by secondary bacterial invaders.

In proliferative hemorrhagic enteropathy, the carcass is usually very pale and massive amounts of blood are often present within the intestinal tract. The mucosa and submucosa of the ileum are thickened and may be coated in fibrin. Fibrin casts are also sometimes present. Although the intestinal wall is dark red and hemorrhagic, there may be no obvious points of hemorrhage. Histologically, there is evidence of vascular congestion, fibrin thrombi, increased permeability of blood vessels and necrosis of the intestinal mucosa. The character of the vascular lesion resembles an acute bacterial infection and type I hypersensitivity reaction. Again, the key microscopic feature is the presence of proliferating immature epithelial cells with basophilic nuclei, which line the greatly elongated crypts. There are no goblet cells in this site. In an analysis of histological lesions crypt abscesses were seen in 20% of pigs, decreased goblet cells in 90%, hypertrophy and hyperplasia in 3%, hypertrophy of both muscle coats in 78%, increased eosinophils in 34% and lymphoid hyperplasia in 90%.

In chronic cases the lesions described above are nearly all replaced by fibrous connective tissue and the diagnosis may rely on seeing just isolated pieces of mucosa.

Lawsonia are also a common cause of colitis. In 70% of cases of colitis LI are also found in the colonic mucosa. In three cases, LI were found only in the colon and in these infected large bowels there was an excess of mucus on the surface.<sup>58</sup>

Staining of smears of ileal mucosa with modified acid-fast stains may reveal typical curved bacterial rods in the apical cytoplasm of the infected proliferating enterocytes, permitting a presumptive diagnosis. It is not always specific for Lawsonia. They are not always present in necrotic debris or autolysed tissue. Immunohistochemistry or silver stains (Warthin/Stary)<sup>59</sup> of formalin-fixed gut are usually sufficient to detect the intracellular organisms in all forms of proliferative enteritis. *Lawsonia intracellularis* can also be identified using a PCR assay.<sup>49,53</sup> It is possible to find bacterial antigen in the lamina propria and draining lymph nodes of the ileum and this is a result of the natural process of infection clearance.<sup>57</sup>

### Samples for confirmation of diagnosis

- **Bacteriology** – distal ileum, proximal colon (DIRECT SMEAR, PCR). The organism needs to grow on tissue cell lines at oxygen and CO<sub>2</sub> concentrations that mimic the small intestine. It is not really an option because these techniques are difficult and the organism is an obligate intracellular organism.

There has been a considerable development of PCR techniques for feces as an antemortem technique.<sup>60,61</sup> This is a variable sensitivity which is affected by sample quality and the presence of inhibitory factors in feces, but the specificity is around 97%. It appears to be very useful in the clinically ill but not so reliable in the subclinically affected. The PCR is more specific when applied to the ileal mucosa rather than to feces. It has been reported that fecal samples are more likely to be PCR positive in herds with PHE rather than in PIA herds. It is more sensitive than either WS staining or IFAT.<sup>62</sup> Shedding commences around 7 weeks and is observed most between 13–16 weeks.<sup>63,64</sup> A one tube nested-PCR has been developed which is very sensitive and less prone to false positives compared to a standard nested-PCR.<sup>65</sup> A 5' nuclease assay has been developed with a detection limit of 1 LI cell per PCR tube.<sup>66</sup> A real-time PCR has been designed<sup>67</sup> as a high-throughput test for use on feces. It is as specific as a conventional PCR but is more sensitive. It can be quantified and can be carried out with pure cultures, tissue homogenate or bacteria shed in feces.



A multiplex PCR has also been described for *B. hyodysenteriae*, *pilosicoli*, and *L. intracellularis*. It has a 100% specificity for the three species and does not generate false positives.<sup>68</sup>

There is also an indirect fluorescent technique but this requires expertise and a reliable *Lawsonia* specific antibody and again is not 100% for subclinically affected animals.<sup>69,70</sup> The percentage of agreement between IFAT and IPMA was 98.6%.<sup>71</sup> It has been suggested that IFAT is more sensitive than PCR in antemortem testing.<sup>50</sup>

- **Histology** – distal ileum, proximal colon (LM, IHC). Immunohistochemistry was described<sup>72–75</sup>
- **Serology** – current methods utilize LI grown in enterocytes or LI prepared on slides as the antigen. These assays are specific because cell cultures or slides are examined microscopically and specifically stained bacteria can be distinguished from any background. Staining of bacteria is either by a fluorescent (IFA) or peroxidase-labeled IPMA. The IPMA test is highly specific (100%) and fairly sensitive (90%) in experimentally infected animals.<sup>71,76</sup> It is an appropriate diagnostic test for herd screening but not for diagnosing PPE on an individual animal basis. The IgG antibodies may be only short lived and found only between 18–24 weeks. These have proved useful for routine PPE diagnosis, although the humoral response is often weak and short lived. Titers of 1:30 to LI appear about 2 weeks after infection and 90% become positive by about 3 weeks after challenge with 5% having titers of 1:480 or above. They are however already decaying by about 4 weeks after challenge. Antibody was not detected until 16 weeks of age and often not until 19–22 weeks.<sup>71</sup>
- **A cell-mediated response** can be detected in the research laboratory using an (enzyme linked immunospot assay) Elispot-T-cell assay that measures the LI specific secretion of IFN- $\gamma$  by lymphocytes. It appears to follow the same pattern as the humoral response and it also starts to decay from about 3 weeks although more slowly.

Both humoral and cell-mediated responses can still be detected 13 weeks after challenge or vaccination.<sup>71,76</sup>

#### DIFFERENTIAL DIAGNOSIS

##### **Porcine intestinal adenomatosis.**

Characteristic clinical findings are inappetence, loss of weight and mild diarrhea in recently weaned pigs. Must be differentiated from postweaning coliform

gastroenteritis – clinically much more severe and death rapidly occurs. The postweaning drop in average daily gain (postweaning check) occurs within several days after weaning and recovery occurs within several days following consumption of a normal daily intake of feed.

##### **Proliferative hemorrhagic enteropathy.**

Occurs in feeder pigs, young gilts, and boars and is characterized by sudden death and extreme pallor of the skin. Must be differentiated from fatal hemorrhagic esophagogastric ulceration, acute swine dysentery, and intestinal hemorrhage syndrome.

##### **Esophagogastric ulceration.**

Occurs in all ages of pigs but especially in growers. The necropsy finding of ulceration in the non-glandular portion of the stomach at the esophageal entrance along with hemorrhage into the stomach with passage into the intestines provides easy differentiation. Acute death with intestinal hemorrhage occurs occasionally in swine dysentery. More common in adults affected with the disease and at the onset of an outbreak, skin pallor is not as marked and hemorrhage is restricted to the large intestine, and is associated with the characteristic lesions of swine dysentery in this area. Contemporary pigs show clinical and necropsy findings typical for this disease and the diagnosis can be confirmed with laboratory studies.

##### **Intestinal hemorrhage syndrome.**

More difficult to differentiate from the proliferative hemorrhagic enteropathy. Occurs most commonly in 3–6-month-old pigs that are well-nourished and many but not all outbreaks have been associated with whey feeding. Typically associated with abdominal distension and evidence of abdominal pain preceding death and the presence of marked intestinal tympany on postmortem examination. In many cases, hemorrhage in the intestine appears to result from torsion which occludes the mesenteric veins. It occurs in all areas of the intestine except the proximal duodenum and stomach, which have separate drainage. Owing to intestinal distension the torsion may be easily missed but it is best determined by the abnormal cranial direction of the blind end of the cecum and palpation of the mesentery. This distribution of hemorrhage may occur without the occurrence of torsion and the etiology in these cases is unknown.

##### **Other diseases**

##### **Infectious necrotic enteritis associated with *Clostridium perfringens* type C.**

May cause hemorrhage into the intestine but they are easily differentiated on clinical, epidemiological and laboratory findings.

#### TREATMENT AND CONTROL

Biosecurity to prevent the entry of infection is the key to control. Beware of carrier pigs, isolate for 30–60 days, use preventive antibiotics as outlined below, use laboratory diagnostics and vaccinate using the new water vaccine.

Eradication using early weaning is not a possibility, but using medication and vaccination is a possibility.

It has been said<sup>77</sup> that pigs between 30–50 kg shed fewer LI in the feces when they are fed non-pelleted and non-heated (home-mixed) feed.

An eradication scheme for LI used in Denmark following the use of antimicrobials (tiamulin, lincomycin, and tylosin) failed.<sup>78</sup>

A control program was tried in the UK using PCR to identify affected animals and medication with chlortetracycline and tiamulin for control.<sup>79</sup> The number of PCR-positive animals declined from 50–70% to 0%. In pigs over 14 weeks there were some PCR positives derived from treated groups. Another farm used tylosin phosphate and these remained clean.

#### Antimicrobials

In acute disease, water medication and particularly individual medications are more effective than treatment through in-feed medication.<sup>80</sup>

Continuous medication for LI can prevent infection but is frowned upon because it can prevent the development of immunity and extend susceptibility to infection. In fact the timing of any medication can affect the immune response, subsequent fecal shedding and the development of lesions.

There is no published information available on the treatment of individually affected pigs. The disease is usually treated on a herd basis by medication of the feed.

There appears to have been no changes in the in vitro MICs since the 1980s/1990s. There are probably four reasons why medication does not work: (i) underdosing; (ii) concurrent infections; (iii) some other disease or nutrition problem, i.e. misdiagnosis; (iv) antibiotics given too late to be effective.

If you are going to use antimicrobials it is a good idea to start at least 3 weeks before the anticipated acquisition of the infection.

The antimicrobial susceptibility of the organism isolated from pigs with proliferative enteropathy was determined in a tissue culture system. Penicillin, erythromycin, difloxacin, virginiamycin, and chlortetracycline were the most active compounds tested.<sup>81</sup> Tiamulin and tilmicosin were the next most active, and the aminoglycosides had the highest minimum inhibitory concentrations. Both lincomycin and tylosin were relatively inactive against the strains of the organism tested.

In the field bacitracin, virginiamycin and salinomycin are useless as are penicillins and fluoroquinolones.

Chlortetracycline, one of the oldest drugs is still used; at 300 or 600 mg/kg it can prevent challenged pigs from developing clinical disease. Chlortetracycline at 300 ppm and tylosin at 600 ppm have prevented the clinical signs of PE.<sup>82,83</sup>

Tylosin is ideal for treatment by injection, in-feed or through the water and was successfully used for treating PPE at 100 ppm.<sup>80</sup> For effectiveness, the antimicrobial would have to accumulate in the cytoplasm of the intestinal cell and block bacterial protein synthesis. The macrolides, tetracyclines, and virginiamycin act by selectively blocking protein synthesis in ribosomes. The oral administration of tylosin phosphate at a dose of 100 or 40 ppm in the feed to pigs for 4 days before experimental challenge and continued for 16 days when the dose was reduced to 40 and 20 ppm was effective in preventing the clinical signs and lesions of proliferative enteropathy.<sup>81</sup> It does not appear to block the pattern of seroconversion to LI. Tylosin at 110 ppm significantly reduced fecal shedding of LI and histologic lesions consistent with PPE.<sup>84</sup> Injection of tylosin produced an improved diarrhea score, and clinical impression score and thereby weight gain.<sup>85</sup> Tylosin tartrate in drinking water for the treatment of ileitis was effective in reducing clinical signs, lesions and reduction in growth rate.<sup>86</sup>

Lincomycin is ideal for injection, water treatment, and in-feed treatment. Lincospectin at 80 ppm used consecutively was shown to be useful for treatment of PPE.<sup>87,88</sup> Lincomycin at 44 and 110 ppm for 21 consecutive days<sup>89</sup> was effective in controlling the clinical signs of PPE and at 110 ppm also reduced the mortality associated with PPE. Lincomycin water soluble powder at 250 mL/gal is also effective.<sup>90</sup>

Aivlosin was found to be useful at concentrations 25% less than those used for tylosin.<sup>91</sup>

Valnemulin was also shown to be effective at 75 ppm in the feed.<sup>92,93</sup>

Tiamulin is useful for in-feed medication and water administration. Tiamulin given 50 ppm, 2 days before experimental challenge and kept for 3 weeks prevented the clinical disease.<sup>94</sup> In addition, pigs given 150 ppm tiamulin 7 days after challenge remained clinically normal and had no specific lesions of proliferative enteropathy at necropsy. Tiamulin in water is very useful<sup>95</sup> but a study showed that in water it interfered with seroconversion whereas administration in feed did not.<sup>96</sup>

The use of zinc-bacitracin in the feed of growing/finishing pigs at 300 or 200 ppm from weaning up to 100 d of age; or 200 or 100 ppm from 100–125 days of age; and 100 or 50 ppm from 125–156 days of age was effective in controlling the effects of

proliferative enteropathy in pigs on a farm with a previous history of the disease.<sup>97</sup>

Carbadox might have some effect against LI as might zinc oxide.<sup>98</sup> It has been shown to be useful if fed in the final 2 weeks in the nursery. It reduces fecal shedding, clinical signs and no IHC+ve or PCR+ve animals were found in one study.<sup>99</sup>

Hyperimmune chicken eggs for controlling LI infection in growing swine has been described.<sup>100</sup>

### Vaccines

The main difference between respiratory and alimentary diseases in the last few years has been the development of vaccines for the former but not the latter. The recent development of an ileitis vaccine is the first of these for the enteric diseases.

It is a safe, labor-saving, efficient, and easy method of vaccinating pigs through the administration of drinking water using the water proportioner. In the presence of feed medication, vaccinated pigs performed better than the non-vaccinated pigs when exposed to LI challenge. The percentage morbidity was reduced, the feed conversion better and the average daily gain increased by about 6%. There was also a 23% reduction in culls. It is best given in a 7-day antibiotic-free period. The present vaccine is given in water to 70–90 lb gilts. It can be dispensed with antimicrobials and produce protective immunity.<sup>101</sup> There is a reduction in gross and microscopic lesions in the complete absence of antimicrobials when the gilts are vaccinated as finishers and the animals receive a booster vaccination every 6 months.<sup>102</sup>

### REVIEW LITERATURE

Lawson GHK, Gebhart CJ. Proliferative enteropathy. *J Comp Pathol* 2000; 122:77–100.

McOrist S, Barcellos DE, Wilson RJ. Global patterns of porcine proliferative enteropathy. *Pig J* 2003; 51:26–35.

### REFERENCES

- Lawson GHK et al. *J Clin Microbiol* 1993; 31:1136.
- Rowland AC, Lawson GHK. *Res Vet Sci* 1974; 17:323.
- McOrist S et al. *Inf Immun* 1995; 61:4286.
- Gebhart CJ et al. *Int J Syst Bacteriol* 1993; 43:533.
- McOrist S et al. *J Clin Microbiol* 2001; 39:1577.
- Beckler DC et al. *Proc 18th Int Pig Vet Soc Cong* 2004; p. 249.
- Knittel JP et al. *Swine Health Prod* 1996; 4:119.
- McOrist S et al. *Pig J* 2003; 51:26.
- Maes D et al. *Vlaams Diergeneesk Tijdschr* 1999; 68:231.
- Stege H et al. *Prev Vet Med* 2000; 46:279.
- Paradis MA et al. *Proc 18th Int Pig Vet Soc Cong* 2004; p. 302.
- Marsteller TA et al. *Proc Am Ass Swine Vet* 2002; 33:85.
- Wilson JB et al. *Can Vet J* 2002; 43:604.
- Holyoake PK et al. *Aust Vet J* 1994; 71:418.
- Wendt M. *Proc 18th Int Pig Vet Soc Cong* 2004; p. 252.

- Gogolewski RP et al. *Aust Vet J* 1991; 68:406.
- Collins A et al. *Swine Hlth Prod* 2000; 8:211.
- Moller K et al. *Vet Micro* 1998; 62:59.
- Vestergaard K. *Proc 18th Int Pig Vet Soc Cong* 2004; p. 831.
- Jenson TK et al. *Res Vet Sci* 2000; 68:23.
- Lofstedt M et al. *Proc 18th Int Pig Vet Soc Cong* 2004; p. 289.
- Veenhuizen MF et al. *Proc 15th Int Pig Vet Soc Cong* 1998; p. 264.
- Chang WL et al. *Vet Rec* 1997; 141:103.
- Fellstrom C et al. *Proc 16th Int Pig Vet Soc Cong* 2002; p. 192.
- Guedes RMC. *Vet Microbiol* 2003; 91:135.
- Guedes RMC. *Vet Microbiol* 2003; 93:159.
- McCluskey T et al. *Infect Immun* 2002; 70:2899.
- Holyoake PK, Cutler RS. *Aust Vet J* 1995; 72:253.
- Smith D et al. *Vet Rec* 1998; 142:690.
- Bronsvort M et al. *J Swine Hlth Prod* 2001; 9:285.
- Just SD et al. *Swine Hlth Prod* 2001; 9:57.
- Bane, D. *Proc 15th Int Pig Vet Soc* 1998, p. 107.
- Kroll J et al. *Proc 18th Int Pig Vet Soc Cong* 2004; p. 149.
- Guedes RMC et al. *Proc Am Ass Swine Vet* 2004; p. 439.
- McOrist S et al. *Res Vet Sci* 1995; 59:255.
- Lawson GHK et al. *Vet Microbiol* 1995; 45:339.
- Jasni S et al. *Vet Microbiol* 1994; 41:1.
- McOrist S et al. *Vet Rec* 1994; 134:331.
- Joens L. A et al. *Am J Vet Res* 1997; 58:1125.
- McOrist S et al. *Int J Syst Bacteriol* 1995; 45:820.
- McOrist S et al. *J Comp Pathol* 1996; 115:35.
- Quironi A et al. *Am J Physiol Cell Physiol* 2000; 279:C1045.
- McOrist S et al. *Infect Immun* 1993; 61:4286.
- MacIntyre N et al. *Vet Path* 2003; 40:421.
- Segales J et al. *Proc 16th Int Pig Vet Soc Cong* 2000; p. 60.
- Jensen TK et al. *Proc 18th Int Pig Vet Soc Cong* 2004; p. 326.
- Bermudez V et al. *Proc 16th Int Pig Vet Soc Cong* 2000; p. 34.
- Holyoake PK et al. *J Vet Diag Invest* 1996; 8:181.
- Gebhart CJ et al. *Vet Pathol* 1994; 31:462.
- Moller K et al. *Vet Microbiol* 1998; 62:59.
- Knittel JP et al. *Am J Vet Res* 1998; 59:722.
- Jones GF. *Am J Vet Res* 1993; 54:1585.
- McOrist S et al. *Vet Microbiol* 1994; 41:205.
- Boye M et al. *Vet Path* 1998; 35:153.
- Guedes RMC et al. *Vet Rec* 2003; 153:432.
- Jensen TK et al. *Vet Rec* 1999; 145:613.
- Guedes RMC et al. *Proc 18th Int Pig Vet Soc Cong* 2004; p. 250.
- Jensen TK et al. *Proc 17th Int Pig Vet Soc Cong* 2002; p. 217.
- Driemeier D et al. *Acta Histochem* 2002; 104:285.
- Jones GF et al. *J Clin Microbiol* 1993; 31:2611.
- Sun DK et al. *J Vet Sci* 2000; 1:33.
- Jordan DM et al. *J Vet Diag Invest* 1999; 11:49.
- Guedes RMC et al. *J Vet Diag Invest* 2002; 14:528.
- Guedes RMC et al. *Proc 17th Int Pig Vet Soc* 2002; p. 220.
- Pejsak Z et al. *Med Wet* 2001; 57:723.
- Lindercrona RH et al. *J Clin Microbiol* 2002; 40:984.
- Beckler DC et al. *Proc Am Ass Swine Vet* 2003; p. 81.
- La T et al. *Proc 18th Int Pig Vet Soc Cong* 2004; p. 283.
- Knittel JP et al. *Am J Vet Res* 1998; 59:722.
- Guedes RMC et al. *Can J Vet Res* 2002; 66:99.
- Guedes RMC et al. *J Vet Diag Inv* 2002; 14:400.
- Boye M et al. *Vet Path* 1998; 3:153.
- Jensen TK et al. *Eur J Vet Path* 1997; 3:115.
- McOrist S et al. *Vet Path* 1989; 26:260.

75. Huerta B et al. *J Comp Path* 2003; 129:179.
76. Guedes RMC et al. *Proc Am Ass Vet Lab Diag* 2001; p. 117.
77. Stege H et al. *Prev Vet Med* 2001; 50:153.
78. Johansen M et al. *Proc 17th Int Pig Vet Soc Cong* 2002; p. 222.
79. McOrist S et al. *Vet Rec* 1999; 144:202.
80. Veenhuizen MF et al. *Swine Hlth Prod* 1998; 6:67.
81. McOrist S et al. *Am J Vet Res* 1997; 58:136.
82. McOrist S, Morgan J *Proc 15th Int Pig Vet Soc Cong* 1998; 3:111.
83. Winkelman NL. *Proc 15th Int Pig Vet Soc Cong* 1998; 3:112.
84. Paradis MA et al. *Proc 18th Int Pig Vet Soc Cong* 2004; p. 835.
85. Marsteller T et al. *Vet Ther* 2001; 2:51.
86. Paradis MA et al. *Swine Hlth Prod* 2004; 12:176.
87. Winne de R, Neiryck W. *Proc 16th Int Pig Vet Soc Cong* 2002; p. 207.
88. McOrist S et al. *Vet Rec* 2000; 146:61.
89. Winkelman NL et al. *J Swine Hlth Prod* 2002; 10:107.
90. Winkelman NL et al. *Proc Am Ass Swine Vet* 2002; 33:139.
91. Tasker JB et al. *Proc 18th Int Pig Vet Soc Cong* 2004; p. 256.
92. Ripley P. *Proc 15th Int Pig Vet Soc Cong* 1998; p. 115.
93. McOrist S et al. *Proc 15th Int Pig Vet Soc Cong* 1998; p. 114.
94. McOrist S et al. *Vet Rec* 1996; 139:615.
95. Winkelman NL et al. *Proc 16th Int Pig Vet Soc Cong* 2000; p.197.
96. Waters D et al. *J Swine Hlth Prod* 2001; 9:109.
97. Kyriakis SC et al. *Vet Rec* 1996; 138:489.
98. Sumano LH et al. *Pig J* 1998; 42:24.
99. Winkelman NL et al. *Proc Am Ass Swine Vet* 2003; p. 136.
100. Kinsley K et al. *Proc Am Ass Swine Vet* 2000; p. 275.
101. Knittel JP, Roof MB. *Proc Am Ass Swine Vet* 2001; p. 149.
102. Waddell J et al. *Proc Am Ass Swine Vet* 2003; p. 245.

## PROLIFERATIVE ENTEROPATHY IN HORSES

### ETIOLOGY

The disease is associated with *Lawsonia intracellularis*, an obligate intracellular Gram-negative bacterium associated with proliferative enteropathy in pigs, horses, hamsters, dogs, deer, rabbits, rats, and ratites.<sup>1</sup> There is close similarity in DNA among isolates from a variety of species.<sup>2</sup> Isolates derived from pigs are infective in hamsters but there is no information regarding infectivity of porcine strains for horses, or vice versa.<sup>1</sup> The organism from pigs is viable and able to produce disease in pigs when stored in feces at room temperature for up to 2 weeks.<sup>14</sup>

### EPIDEMIOLOGY

The disease was initially reported from North America and has recently been diagnosed in Australia and Europe.<sup>4,5,15</sup> Nine of 164 randomly selected weanlings in the Hunter Valley of Australia had serum antibodies to *L. intracellularis*.<sup>5</sup>

The disease in foals occurs as isolated cases and as outbreaks on breeding farms<sup>4</sup>

There is evidence that outbreaks begin after introduction of foals or weanlings to farms with no history of the disease, although whether this is coincidence or represents the mechanism of introduction of infection to the farm is unknown.<sup>4</sup> Morbidity among foals and weanlings on affected farms is 20–25%, although this is based on disease outbreaks on only two farms.<sup>4</sup> Case fatality rate is 15–20%.<sup>4</sup>

Affected foals are usually 3–13 months of age and disease in adults is rare. There is insufficient information to determine if there is a breed predisposition to the disease. The disease is presumably transmitted by the fecal-oral route, as in pigs, but there are no reports of experimental induction of the disease in foals.

### PATHOGENESIS

The pathogenesis of the disease in foals has not been determined, but it is probably similar to that of the disease in pigs.<sup>6</sup> Infection results in development of an enteropathy characterized by proliferation of intestinal crypt epithelial cells and infiltration of the lamina propria with mononuclear inflammatory cells.<sup>4,7-9</sup> Subsequent malabsorption of small intestinal contents and protein loss from diseased intestine cause weight loss and hypoproteinemia characteristic of the disease in foals. However, there was no evidence of decreased absorption of glucose in three foals in which this was examined.<sup>4</sup> Colic and diarrhea result from intestinal dysfunction and malabsorption. Hypoproteinemia and the subsequent decrease in plasma oncotic pressure result in edema and signs of hypovolemia. Death is associated with severe hypoproteinemia, inanition, and colic.

### CLINICAL SIGNS

The disease may present as one with a short course characterized by rapid weight loss, colic and death within 2–3 days of onset of clinical signs or as a more chronic disease characterized by gradual development of weight loss and depression.<sup>4,7,8,10</sup> Weight loss and poor body condition are consistent findings among foals affected by the chronic disease. Most affected foals have diarrhea that ranges in severity from acute profuse watery diarrhea to, more commonly, excessively soft feces. Foals are often depressed although they continue to nurse. Edema of the ventral abdomen and intermandibular space is common. Fever is not a consistent feature of the disease.

**Ultrasonographic** examination of the abdomen reveals multiple loops of mildly distended small intestine with thickened walls. Loops of intestine can have walls of 5–8 mm thick (normal < 3 mm).

Many affected foals, and especially those that die of the disease, have concurrent diseases including parasitism and pneumonia.

The incubation period in pigs is 2–3 weeks but that in horses is unknown. Foals that recover from the disease may take several weeks to regain normal body weight. There do not appear to be long-term consequences of the disease in recovered foals.

### CLINICAL PATHOLOGY

**Hypoproteinemia** with moderate to severe hypoalbuminemia is present in most affected foals. Serum albumin concentrations can be as low as 0.6 g/dL (6 g/L).<sup>8</sup> Hyperfibrinogenemia and mild anemia are common but not consistent findings.<sup>4</sup> White cell count is elevated (>14 × 10<sup>9</sup> cells/L) in most foals. Serum sodium and chloride concentrations are lower than normal and serum creatinine concentrations higher than normal in about 50% of affected foals. PCR examination of feces for *L. intracellularis* is specific for detection of organism in affected foals. An indirect immunofluorescent assay detects serum IgG antibody to *L. intracellularis* in foals, although the specificity of this finding for detection of the disease in foals is unknown.<sup>4,5</sup> Foals with proliferative enteropathy have titers of 1:30 or greater.<sup>5</sup> Antemortem diagnosis in pigs is based on positive serology and detection of *L. intracellularis* DNA in feces by PCR.<sup>11</sup>

### NECROPSY

Gross lesions are mainly thickening and irregular corrugation of the small intestine.<sup>4,7,8</sup> There is proliferation of intestinal crypt epithelium with projection of crypt cells into the intestinal lumen. The lamina propria is infiltrated by mononuclear inflammatory cells. Silver staining of intestinal sections reveals numerous short, curved bacteria in apical cytoplasm of crypt epithelial cells.<sup>4</sup>

### Samples for confirmation of diagnosis<sup>12</sup>

- **Histopathology** of small intestine
- **Silver staining** of small intestine to demonstrate intracellular bacteria associated with hyperplastic cryptic cell
- **Bacteriology** – culture (which can be difficult as it requires cell cultures) and PCR examination of small intestinal tissue.

### DIFFERENTIAL DIAGNOSIS

Antemortem diagnosis of proliferative enteropathy in foals should be based on the presence of characteristic clinical, hematological and biochemical signs, positive serology and detection of *L. intracellularis* DNA in feces by PCR.

The primary differential diagnosis is **parasitism** by *Parascaris equorum*, Cyathostomes, and large strongyles (in older foals). Examination of feces for

helminth ova is diagnostic in cases with patent infections, but parasite infestations are often not patent in young foals. A history of an adequate parasite control program makes parasitism less likely, but does not rule it out. **Malnutrition** due to inappropriate or inadequate feeding practices or agalactia should be ruled out as a cause of failure to thrive.

Protein-losing enteropathy secondary to **enteritis and colitis** may be associated with *Salmonella* sp., *Rhodococcus equi*, or *Cryptosporidium* sp. Other intestinal diseases that cause enteritis but less commonly cause protein loss include the intestinal clostridiosis, equine granulocytic ehrlichiosis, and *Bacteroides* sp. infection. Intra-abdominal abscesses associated with *R. equi* or *Streptococcus* sp. can cause chronic weight loss and hematological signs similar to proliferative enteropathy.

Hypoproteinemia can occur secondary to gastrointestinal ulceration. Neoplasia is rare in foals of this age but intestinal lymphosarcoma can cause hypoproteinemia and weight loss. Intoxication by **non-steroidal anti-inflammatory drugs** can cause a protein-losing enteropathy.

Diarrhea and ill thrift caused by colitis and typhlitis associated with *Brachyspira* sp. (a spirochete) is reported from Japan.<sup>13</sup>

## TREATMENT AND CONTROL

Principles of treatment are eradication of infection and correction of hypoproteinemia. Administration of **antibiotics** is curative in many foals.<sup>4,16</sup> Isolates of the organism from pigs are sensitive in vitro to a wide range of antimicrobials including penicillin, erythromycin, difloxacin, virginiamycin, and chlortetracycline.<sup>14</sup> Antibiotics used to treat *L. intracellularis* infection in foals include oxytetracycline (6.6 mg/kg q 12 h IV),<sup>16</sup> doxycycline (10 mg/kg q 12 h, orally),<sup>16</sup> chloramphenicol (50 mg/kg, q 6 h, orally), or erythromycin estolate or similar product (15–25 mg/kg q 6–8 h orally), sometimes in combination with rifampin (5–10 mg/kg q 12 h orally). Erythromycin or oxytetracycline/doxycycline appear to be effective in treatment of affected foals.<sup>4,16</sup> Chloramphenicol is used in place of erythromycin in foals that develop intractable or severe diarrhea when treated with erythromycin, but its use is illegal in some countries and is not recommended because of the risk of aplastic anemia in people exposed to the drug. Enrofloxacin might be effective, based on MIC values, but should be reserved as a drug of last resort because of the arthropathy associated with its use in foals.

Mildly or moderately affected foals require only administration of antimicrobials and nursing care. More severely affected foals may need intensive supportive care including intravenous administration of plasma and/or hetastarch to

restore plasma oncotic pressure and minimize edema formation, fluid and electrolyte supplementation because of hypovolemia and abnormalities in serum electrolyte concentration, calorie enhanced diets or parenteral nutrition, and antiulcer medications if signs of gastric ulceration are present.

Specific **control measures** to prevent spread of the disease among horses have not been developed. Given the putative fecal-oral cycle of infection and association of outbreaks of the disease in pigs after introduction of new stock or mingling of groups, hygiene measures that minimize fecal contamination of the environment by potentially infected foals is sensible. The organism from pigs can survive in feces for up to 2 weeks. Foals with the disease should be isolated from healthy foals, although the duration of this isolation is not known, and should not be transported to other farms until clinical and hematological signs of the disease have resolved. The role for wildlife hosts, if any, in the disease of foals is unknown. There is currently no vaccine for the disease in foals.

## REFERENCES

1. Lawson GHK, Gebhart CJ. J Comp Path 2000; 122:77–100.
2. Cooper DM et al. Vet Microbiol 1997; 54:47–62.
3. Collins AM et al. Swine Health Prod 2000; 8:211–215.
4. Lavoie JP et al. Equine Vet J 2000; 32:418–425.
5. McClintock SA, Collins AM. Aust Vet J 2004; 82:750–752.
6. Smith DGE, Lawson GHK. Vet Micro 2001; 82:331–345.
7. Frank N et al. Equine Vet J 1998; 30:549–552.
8. Brees DJ et al. JAVMA 1999; 215:511–514.
9. Williams NM et al. J Vet Diagn Invest 8:254–256.
10. Schumacher J et al. J Vet Int Med 2000; 14:630–632.
11. Knittel JP et al. Am J Vet Res 1998; 59:722–726.
12. Smith DGE. Equine Vet J 1998; 30:452–453.
13. Shibahara T et al. J Vet Med Sci 2002; 64:633–636.
14. McOrist S et al. J Clin Micro 1995; 33:1314–1317.
15. Wuersh K et al (2006) J Vet Med A 53:17–21.
16. Samperi F et al (2006) Equine Vet J 38:89–92.

## Diseases associated with *Leptospira* spp.

### LEPTOSPIROSIS

#### Synopsis

**Etiology** *Leptospira interrogans* (many distinct serovars). *Leptospira borgpetersenii* (many distinct serovars)

**Epidemiology** Worldwide distribution, most commonly in warm, wet climates. Occurs in cattle, sheep and goats, pigs, and horses. Host-adapted (maintenance or reservoir) and non-host-adapted (accidental or incidental) leptospirosis dependent on response of each species to particular serovars. Prevalence of infection greater than incidence of clinical disease. Transmission by urine of infected animals; some wildlife species may transmit to

cattle. Ground surface moisture most important factor for persistence of organism. Major zoonosis

**Signs** Acute, subacute, and chronic forms. Fever, acute hemolytic anemia, changes in milk, stillbirths, abortion in all species (especially pigs), weak neonates, infertility, milk drop syndrome, periodic ophthalmia (recurrent uveitis in horse)

**Clinical pathology** Demonstration and/or culture of organism in blood, urine, cervico-vaginal mucus, body fluids, and tissues; serological tests, primarily macroscopic agglutination test. ELISA and DNA probes

**Lesions** Anemia, jaundice, hemoglobinuria, serous hemorrhages, autolysis of aborted fetuses, fetal hepatitis, and nephritis.

**Diagnostic confirmation** Culture or demonstrate organism in body fluids or tissues; high serum titers

#### Differential diagnosis list:

##### Cattle

- Acute leptospirosis: anaplasmosis; rape and kale poisoning; postparturient hemoglobinuria; bacillary hemoglobinuria
- Chronic leptospirosis: all other causes of abortion in cattle (Table 18.6). Milk drop syndrome

##### Pigs

All other causes of abortion, mummification and stillbirths in swine (Table 20.2)

##### Sheep and goats

Chronic copper and rape poisoning; anaplasmosis

##### Horses

Abortion, stillbirths, perinatal deaths of foals due to: *Streptococcus zooepidemicus*; *Salmonella abortus equina*; *Escherichia coli*; *Actinobacillus equuli* (*Shigella equuli*).

Equine herpes virus; equine viral arteritis.

Weak neonatal foals due to

isoimmunization hemolytic anemia.

Periodic ophthalmia from other causes of

iritidocyclitis of horses, and conjunctivitis,

keratitis and hypopyon

**Treatment** Antimicrobials to treat acute infection and eliminate leptospiruria

**Control** Antimicrobials to eliminate

carriers. Vaccination with vaccines containing serovars which are causing the disease in that geographical area

## ETIOLOGY

The pathogenic leptospires are classified into one species of *Leptospira interrogans* containing over 212 serovars arranged into 23 serogroups,<sup>1</sup> for example, *L. interrogans* serovar pomona. Differentiation between serovars, formerly serotypes, belonging to a particular serogroup is by cross-agglutination tests. Two strains are considered different if, after cross-absorption with adequate amounts of heterologous antigen, 10% or more of the heterologous titer regularly remains in either of the two antisera.<sup>1</sup> Because this system is subjective, the restriction endonuclease analysis (REA) of leptospiral DNA is used as a genotyping taxonomic tool<sup>2</sup> which is less

Table 20.2. Diagnostic summary of common causes of abortion, mummification, and stillbirths in swine

Disease	Epidemiology	Clinical features	Laboratory diagnosis	
			Isolation of agent	Serology
Leptospirosis ( <i>L. interrogans</i> serovar pomona) possibly also <i>muenchen</i> and <i>bratislava</i>	Abortion last 2–3 weeks of gestation. Follows introduction of infected boar or sow or contamination of water supply or rodent infestation	Abortion, vulval discharges, sow systemically normal. Weak piglets sometimes.	Fetal tissues and urine of sow.	Positive or rising titers in aborting sows. Antibody in thoracic fluids in stillborn fetuses is diagnostic
Brucellosis ( <i>B. suis</i> )	Abortion may occur any time during gestation. Spread by coitus (early abortion)	Embryonic death infertility, abortion. Orchitis in boars	Culture from lymph nodes	Positive titers in herd (cross-react with <i>Yersinia</i> ). Many animals seronegative
Porcine parvovirus infection	Herd outbreak when introduced for first time. Subsequently herd immunity develops and problem sporadic, affecting primarily gilts. May be continual low-grade problem in piggeries where sows are stalled. Due to incomplete spread	Abortion outbreaks possible. Mainly mummification, stillbirth and infertility. Sow clinically normal. Failure to farrow. Small litters. Returns to estrus	Virus detectable by hemagglutinating antibody or fluorescent antibody in fetuses less than 16 cm crown–rump (C–R) length. PCR for antigen in fetuses. ELISAs for fetal antibody	Antibody present in fetuses greater than 16 cm C–R length. Antibody in high titer in sow. Variety of tests including ELISA
SMED1 virus	Poorly defined. Similar to parvovirus. Sporadic, affecting gilts primarily	Small litter size, uneven pigs and poor piglet viability, stillbirth and mummification. Infertility	Virus difficult to isolate from affected fetuses. Lung from fetuses or stillborn best site	Antibody in fetus, greater than 16 cm C–R length and paired samples from sow with 1:32 increase in titer
Porcine reproductive respiratory syndrome (PRRS) (Lelystad virus)	Epidemics of reproductive failure. Possibly even death (Sams syndrome)	Abortion, mummified stillbirths, fetuses, weak piglets, increased preweaning mortality	Virus isolation from lung, tonsil, serum or lymph node. RT-PCR and nPCR, ISH, IHC, etc. can be used	Serology (wide variety of techniques; ELISAs, indirect ELISAs, IFA, SNT) (pre-colostrum, colostrum, active Abs)
Aujeszky's disease (pseudorabies)	Abortion usually 10–20 days after clinical illness. At any time but especially first 2 months of pregnancy. Concurrent or preceding clinical disease in young pigs in herd	Sows may show mild clinical disease at time of infection, anorexia, depression, transient pyrexia. Abortion or stillbirth or mummified fetuses at term	Difficult. Histology, with inclusions, IHC of CNS and lungs of fetus best. Also FAB, for virus in tonsil or CNS and vaginal swab sow, brain, spleen or lung for culture	Positive titers in herdmates. Variety of tests now ELISAs
Hog cholera (classical swine fever) and African swine fever	Usually signs of clinical disease within piggery. Low virulence strains may produce reproductive/teratogenic effects only. New herd entrants? Waste food feeding? Contact wild boar?	Abortion of sows during or following acute clinical disease. Also embryonic death, small litter size, stillbirth and mummification. 'Trembling pigs' at birth may be only manifestation.	Fetal pigs and affected pigs within herd. Variety of antigen techniques— isolation, PCR, RT-PCR, IHC, ISH, FAB for antigen, antigen capture ELISA. Transmission studies	Positive titers in herds. Wide variety of tests (SN, CF, ELISAs, blocking ELISAs)

Other agents such as *Erysipelothrix*, *Japanese encephalitis virus*, *Japanese hemagglutinating virus*, fungi, nutritional deficiency may produce abortion or reproductive inefficiency. Any infectious agent may produce abortion because of pyrexia in the sow. Many outbreaks of abortion in sows remain undiagnosed and there must be important agents as yet unrecognized producing this syndrome. An example of agents in this category include *Chlamydia* and *Arcobacter*.

time and labor consuming than cross-agglutination absorption and gives highly reproducible results. This method allows observations between strains of the same serovar which can be correlated with differences in the epidemiology of the strains and, possibly, the pathogenicity of the strains. It has also found instances in which strains have been incorrectly identified by conventional typing methods.

Serological typing has revealed many groups, some of which share antigenic configuration. The serovar is the serologically least divisible recognized type. It is accepted as the basis of taxonomy as the subspecific level. The serovar name is spelled with a lower case initial letter, e.g.

serovar pomona. The name of the serovar was previously italicized but this is no longer recommended.

Serovars which share antigens can be identified after controlled absorption and agglutination. They are grouped into serogroups, which have no taxonomic status, but are convenient for application such as diagnosis and epidemiology. The name of the serogroup is spelled with an initial capital letter, e.g. serogroup Pomona. Within some serovars further subgroups can be identified by genomic analysis. These groups are types of the serovar, and are not serologically distinguishable from one another (e.g. serovar hardjo, types hardjoprajitno and hardjobovis).

### Nomenclature of leptospire

For efficiency, in this text, the specific leptospire serovars will be abbreviated, for example, *L. pomona* for *Leptospira interrogans* serovar pomona, or the serovar only will be used, e.g., pomona.

### EPIDEMIOLOGY

#### Animal risk factors

#### Serovars and species susceptibility.

The epidemiology of leptospirosis is most easily understood by classifying the disease into two broad categories: **host-adapted** and **non-host-adapted** leptospirosis. An animal infected with a host-adapted serovar of the organism, is a 'maintenance' or 'reservoir' host. Exposure of susceptible animals to non-

host-adapted serovars results in **accidental** or **incidental disease**. Each serovar is adapted to a particular **maintenance host**, although they may cause disease in any mammalian species.

A serovar behaves differently within its maintenance host species than it does in other, incidental or accidental hosts. A **maintenance host** is characterized by:

1. A high susceptibility to infection
2. Endemic transmission within the host species
3. Relatively low pathogenicity for its host
4. A tendency to cause chronic rather than acute disease, producing insidious economic loss through reproductive losses
5. Persistence of the serovar in the kidney and sometimes the genital tract
6. A low antibody response to infection, with difficulties in diagnosis
7. Low efficacy of vaccination in prevention of infection.

Examples of this relationship are serovar bratislava in swine, and serovar hardjo type hardjo-bovis in cattle. In contrast, an **incidental host** is characterized by:

1. Relatively low susceptibility to infection but high pathogenicity for the host
2. A tendency to cause acute, severe rather than chronic disease
3. Sporadic transmission within the host species and acquisition of infection from other species, sometimes in epidemic form
4. A short kidney phase
5. A marked antibody response to infection, making for ease of diagnosis
6. More efficacious vaccines for preventing infection.

An example of this relationship is serovar pomona (*kennewicki*) infection in cattle.

**Some common leptospiral serovars and their maintenance hosts are as follows:**

Serovar	Maintenance hosts
hardjo-bovis (North America):	cattle
hardjo-prajitno (Europe):	cattle, pig, horse
bratislava:	horse
pomona (kennewicki):	pig, skunk, racoon, opossum
grippotyphosa:	racoon, opossum, squirrel
icterohaemorrhagiae:	brown rat

**Some common leptospiral serovars and their accidental hosts are as follows:**

Serovar	Accidental hosts
hardjo:	sheep, man
pomona:	sheep, cattle
grippotyphosa:	sheep, cattle
icterohaemorrhagiae:	cattle, pig

Calves and lambs are highly susceptible to infection and septicemia is likely to occur.

### Occurrence and prevalence of infection

Most leptospiral infections are subclinical<sup>3</sup> and infection is more common than clinical disease. *L. pomona* is the commonest infection in all farm animals but its international distribution is unpredictable; it had not been present in the United Kingdom until recent years and then only sporadically. The number of serovars of concern in domestic animals has been increasing and serovars and their antibodies have been detected which were thought previously to be exotic.

*L. canicola* infection has been recorded in cattle and in pigs and specific antibodies have been detected in horses. *L. icterohaemorrhagiae* is a rare isolation in large animals but has been reported in cattle and pigs, and serological evidence of infection has been found in the horse. *L. hyos (L. mitis)* has been isolated from cattle and pigs, *L. grippotyphosa* from cattle and goats, and positive serological tests have been obtained in horses. *L. sejroe*, *L. hebdomadis* and *L. australis* infection have been observed in cattle. *L. szwajzak* is thought to be the predominant serovar in Israel.

Serological surveys of cattle in the African continent reveal evidence of antibodies against numerous leptospiral serovars<sup>4</sup> and some previously not described strains of serovars. In West Africa, serosurveys of dairy herds revealed 45% of cattle were positive to one or more serovars, which probably represented natural infection because vaccination had not been practiced.<sup>4</sup>

Leptospirosis is common in farm animals in Portugal.<sup>5</sup> Outbreaks of clinical disease have been recorded in cattle and pigs, and also in sheep and goats, and in horses to a lesser extent. In Italy, serological surveys indicate that sheep, horses, pigs, and dogs have the highest number of positive responses.<sup>6</sup>

### CHARACTERISTICS OF LEPTOSPIROSIS IN SPECIES OF ANIMAL

Leptospirosis affects all farm animal species and the epidemiological characteristics of the infection, some of which are unique with a species and important in the diagnosis, treatment and control strategies, are outlined here.

#### Cattle

*Leptospira interrogans* is divided into seven genospecies of leptospire, two of which are *L. interrogans* and *L. borgpetersenii*.<sup>7</sup> *L. borgpetersenii* serovar genotype hardjo-bovis formerly *L. interrogans* serovar hardjo-bovis occurs worldwide<sup>3</sup> and in many areas outranks *L. pomona* in cattle.

It is now the commonest serovar in cattle in some parts of Australia, New Zealand, the United States, and Canada. *L. interrogans* serovar genotype hardjo-prajitno so far has been recovered only in the United Kingdom, Nigeria, India, Malaysia, Brazil, Mexico, and the United States. *L. hardjo* is a common cause of abortion in dairy cattle in Brazil.<sup>8</sup> New serovars occur occasionally, as for example, serovar *ngawi*, in the serogroup Tarassovi isolated from oxen in Zimbabwe.<sup>9</sup>

*L. interrogans* serovar hardjo (type hardjoprajitno) and *L. borgpetersenii* (type hardjo-bovis) are serologically indistinguishable but genetically distinct.<sup>10</sup> The former has been isolated primarily from cattle in the UK, while the latter is common in cattle populations throughout the world.

*L. hardjo-prajitno* has not yet been identified as a pathogen of North American cattle.<sup>11</sup> Because this genotype, instead of hardjo-bovis is used in vaccines it may explain the lack of complete protection of animals against hardjo-bovis and the difficulties in laboratory diagnosis. In addition, there are at least two variations of the hardjo-prajitno genotype. These differences may be associated with differences in pathogenicity of hardjo strains, and although the cross-agglutination absorption test cannot distinguish these strains as separate serotypes, the degree of cross-protection conferred by these heterologous genotypes in vaccines is not known.

**Cattle are the maintenance host** for *L. hardjo* and are the only reservoir. *L. hardjo* is an important cause of bovine abortion<sup>3</sup> and is the commonest leptospiral infection in man. It is a common infection in Australian sheep and may affect up to 40% of the population.

Seroprevalence surveys found 34–65% of sera obtained from cows at slaughter in parts of the United States had antibodies to leptospira serovars.<sup>3</sup> Approximately 30% of all sera were positive when tested for *L. hardjo*, the host-adapted serovar of cattle. This seroprevalence is similar to reports from Europe, Australasia, and South America, in which 25–65% of all cows tested for *L. hardjo* were positive. The morbidity rate for clinical disease may vary from 10–30%, depending on the clinical manifestation of infection, and the case-fatality rate is usually low at about 5%. The case-fatality rate in calves is much higher than in adult cattle. A high rate of abortions (up to 30%) and loss of milk production are the major causes of loss but deaths in calves may also be significant.

Serovar hardjo-bovis is the most common serovar of cattle in the UK,<sup>3</sup> Australia, New Zealand, and North America. Abattoir surveys of sera and

kidneys of beef cattle in Quebec found a high prevalence of infection and nephritis associated with hardjo-*bovis* in contrast to pomona, which occurs more frequently in dairy cattle in that area. It is also possible that hardjo-*bovis* infection may be more common in feedlot cattle because they originated from Alberta, where the prevalence of infection with that serovar is prominent.

In serological survey of dairy cows in herds with suboptimal reproductive efficiency in a region in Spain. *L. bratislava* and *L. grippotyphosa* were the most prevalent serovars.<sup>12</sup> The risk of seroconversion against *L. grippotyphosa* was higher during the spring season while *L. bratislava* did not differ among seasons. The prevalence of *L. hardjo* was low which indicates that the reproductive inefficiency was unassociated with hardjo. In surveys of dairy and beef cattle in Spain, *L. bratislava* is the most frequently detected serovar while hardjo is at a relatively low seroprevalence compared with similar studies in western European countries.<sup>13</sup> In Spain, serovars grippotyphosa, tarassovi and copenhageni are more frequent in dairy herds, probably related to management practices and geographical location of these herds which facilitate the contact with maintenance hosts for these serovars.

A serological sampling of adult dairy cows in Brazil, not vaccinated for leptospirosis, and from herds with lowered fertility, 47% were positive for *L. hardjo*.<sup>14</sup> The major risk factor associated with seropositivity was co-grazing with other species, mainly pigs.

*L. pomona* and *L. hardjo-bovis* are responsible for most bovine leptospirosis in Australia.<sup>11</sup> Serovar pomona is a pig pathogen for which cattle are an accidental host and is a cause of bovine abortion, and fatal hemolytic disease in calves. Serovar hardjo-*bovis* is adapted to cattle as a maintenance host, is maintained in the bovine population but has a relatively low pathogenicity.<sup>11</sup> It is responsible for epidemics of agalactia, **the milk drop syndrome**, and a major cause of infertility. However, diagnostic surveys in Australia suggest that hardjo-*bovis* is not responsible for any substantial proportion of bovine abortion in contrast to the situation in Northern Ireland, where the genotype hardjo-prajitno is present. In beef cattle in Queensland, Australia, the major serovars in order of decreasing crude seroprevalence were hardjo (15.8%), tarassovi (13.9%), pomona (4.0%), and szwajizak (2%).<sup>15</sup> Vaccinates were not included in the hardjo and pomona seroprevalence; and the seroprevalence for hardjo and pomona tended to increase with age of the animals. The data indicate that serovars other than

hardjo, pomona, and tarassovi, are unlikely to have a significant role in bovine infertility, and cattle are unlikely to be a source of human infection in central Queensland.

Seroprevalence surveys in Ontario, found hardjo-*bovis* was most commonly found in beef cattle, whereas pomona was most commonly found in dairy cattle. In Prince Edward Island, 14% of dairy cows were serologically positive for serovar hardjo. Serological surveys of cattle farms in Alberta found infection with hardjo-*bovis* was widespread across the province and the prevalence has increased. In contrast, pomona reactors were found usually on single premises within a locality as compared to the clustering of hardjo reactor herds. This is an expression of the difference between host-parasite relationships in which cattle are well-adapted reservoir hosts for hardjo, generally inducing a weak agglutinin response to natural infection and remaining capable of transmitting infection for months or years.

With pomona infection, cattle tend to develop high agglutinin titers with or without clinical disease, and not remain long-term carriers. Thus, pomona infections can remain limited to a single herd unless cattle are dispersed to other herds at the height of infection. In addition, reservoir hosts such as skunks may become infected and contaminate other premises, or a water supply common to a number of premises becomes contaminated when the water is near neutral pH (about 15–25°C) and of appropriate volume to deliver infectious numbers of organisms to cattle downstream.

As a measure of the loss associated with *L. hardjo-bovis* in beef cattle, the percentage of cows which are serologically positive has been related to the proportion of the herd affected with lactation failure, and there is a greater wastage in reactor cows.

Seroprevalence surveys of mature cattle in the United States found antibodies of hardjo-*bovis* were most common, followed by pomona and copenhageni.<sup>16</sup> This confirmed earlier observations that the nationwide seroprevalence of hardjo-*bovis* was greater than pomona. The isolation rates were also higher in beef cattle than in dairy cattle and higher in bulls than in cows. Combined culture and immunofluorescence results found that 2% of mature cattle were renal carriers of leptospire.<sup>16</sup>

In Greece, the seroprevalence in pigs, goats, sheep, cattle, and dogs is 17.8%, 16.2%, 5.7%, 12.6%, and 11.4%, respectively.<sup>17</sup> The overall prevalence is high, and against multiple serovars, indicating a considerable level of infection in each animal species, and that the zoonotic risk

is considerable. In Turkey, *L. hardjo* is the dominant serovar identified in serological surveys of cattle, but *L. grippotyphosa* is the dominant serovar causing clinical disease in cattle while the disease in sheep is uncommon.<sup>18</sup>

The distribution of isolates and prevalence of serovars varies according to regions of the country.<sup>16</sup> Both isolation rate and seroprevalence are higher in the south eastern, south central, and Pacific coast regions than for other regions of the United States.<sup>16</sup> The isolation rate is related more to regional temperature than to amount of precipitation. This suggests that high levels of precipitation are not required for transmission of leptospirosis; oases in arid lands and deserts may become well-defined endemic zones by introduction of carrier animals.

### Farmed deer

Leptospirosis is a well-established clinical disease in farmed deer in New Zealand.<sup>19</sup> Slaughterhouse surveys of farmed deer in New Zealand found serological evidence of serovar hardjo in 73.6%, pomona in 41.5%, copenhageni in 11.3%, and tarassovi in 15.1% of farms. Antibodies to serovars australis, ballum, and balonica were present in three, one, and four of six herds studied, respectively. The titer prevalence to hardjo was higher than that of pomona and other serovars within farms. Renal lesions were characteristic of subclinical leptospirosis, and spirochetes were present in renal tubules. Cultures were positive in 10 stags from six lines with similar prevalence across age groups. On-farm surveys found a 10 to 30% within-herd prevalence of pomona and hardjo titers in 56% of 3-month-old deer herds; by 11 months of age, 100% of herds were titer-positive with high prevalences to one or both serovars.

### Sheep and goats

The disease in sheep has been reported in many countries and in goats in Israel. Leptospirosis in sheep can cause lamb losses due to congenital infections, starvation of lambs because of the acute agalactia of hardjo infection of the ewes, and fatal infection of feedlot lambs infected with grippotyphosa. Deaths of animals and loss of condition in mildly affected animals are the main causes of loss.

Although few outbreaks are recorded, an infection rate of 75% is not uncommon in sheep and case-fatality rates usually average about 20% in this species and up to 45% in goats. *L. pomona* is the common infection and the cause of most clinical leptospirosis in sheep. Infection with *L. hardjo* occurs but is unlikely to be a source of infection for cattle herds. Sheep are not natural maintenance hosts for pomona or hardjo and are likely to have infections of relatively short duration,



producing severe pathological effects. However, persistent leptospiruria due to hardjo in sheep where no contact with cattle has occurred suggests that sheep may be a maintenance host for this serovar.<sup>20</sup> This could complicate control of hardjo infection in cattle which are free of this serovar, and infected sheep are a potential zoonotic risk to abattoir workers, sheep farmers, and shearers which previously had not been considered. Infection with serovar hardjo is widespread in Merino stud rams in South Australia.<sup>21</sup>

### Pigs

In infected herds the prevalence of positive serological reactors is high, and in large infected pig populations is about 20%. Economic losses are about equally divided between abortions and deaths of weak and unthrifty newborn pigs. In Iowa, 38% of sera from National Animal Health Monitoring System herds were positive to one or more of 12 serovars. Infection of pigs at slaughter is associated with multifocal interstitial nephritis, which results in condemnation of kidneys.<sup>2</sup> *L. pomona* (genotype *kennewicki*) has been the predominant infection in pigs but with the widespread use of bacterins against it, other infections are assuming importance. *L. tarassovi*, *copenhageni*, *ballum*, *bratislava*, *muenchen*, and *hardjo* are now isolated more frequently.

Swine are affected by several leptospiral serovars and the clinical signs often associated with these infections include poor reproductive performance.<sup>22-24</sup> Seropositive sows have a greater risk of weak newborn pigs and having more weak newborn piglets per litter.<sup>23</sup> In some areas suboptimal reproductive performance was associated with certain serovars such as *grippotyphosa* and not others such as *autumnalis*, *bratislava*, *pomona*, and *icterohemorrhagiae*.<sup>24</sup>

The most common serovar antibodies found in pigs in Prince Edward Island swine herds were *L. icterohemorrhagiac*, *L. bratislava*, *L. autumnalis*, and *L. pomona*.<sup>25</sup> Only herds with a higher prevalence of *L. bratislava* had more infertility as measured by non-productive sow days per parity.

Pigs in intensive housing present a different problem from those in more conventional housing or at pasture. In large pig units the possibility for cross-infection is high because of high population density. The movement of pigs from pen to pen, and access to effluent from other pens are the critical means of spread in these circumstances. The spread of infection within piggeries is encouraged by mixing infected with uninfected pigs, which results in epidemics within the

pens. Transmission from infected to susceptible grower pigs occurs continuously in grower houses, with a constant proportion of pigs becoming infected each week. Introduction onto a farm may be via an imported boar who frequently is found to harbor leptospirae in the genital tract. *Lepospira* were found commonly in the kidneys of slaughter fattening pigs in Vietnam but are not considered to be the cause of the white spotted kidneys of pigs.<sup>26</sup>

The Australis serogroup of leptospirae is now important because of an increasing awareness that antibodies to *bratislava* are widespread in the pig populations of many countries, the recovery of *lora*, *muenchen*, and *bratislava* from pigs, and the involvement of *bratislava* and *muenchen* in reproductive problems of swine herds. All of the pig isolates of the Australis serogroup have been identified as either *bratislava* or *muenchen*, and there are also differences at the subserovar level which may be important in understanding the epidemiology of the Australis serogroup, the development of efficacious vaccines, and the pathogenesis of disease. Certain genotypes are associated with abortion and stillbirths in pigs, while another genotype may be responsible for meningitis in piglets.

House mice on swine farms may be serologically positive to *L. bratislava*, which suggests a possible source of the organism.

### Horses

◦ **Recurrent uveitis.** Leptospirosis is relatively mild in the horse, except for blindness due to recurrent uveitis or periodic ophthalmia. When groups of horses are infected, up to 30% of the adult horses may be serologically positive with a higher prevalence in tropical areas. The dominant serovar varies widely between localities. A high seroprevalence of *bratislava* occurs in healthy horses in Ireland and in horses in Ohio. The high seroprevalence to *bratislava* suggests that the horse may be a maintenance host for this serovar.

◦ **Nonulcerative keratouveitis.** A case of nonulcerative uveitis associated with leptospira infection in a 2-year-old horse in Japan has been described.<sup>27</sup> The horse was seropositive to three serovars of *L. interrogans* (*pyrogenes*, *canicola*, and *icterohemorrhagiae*)

◦ **Neonatal foal disease.** A severe rapidly fatal illness in foals characterized by massive pulmonary hemorrhage and kidney disease has been associated with serological evidence of *bratislava* and serogroup Australis serovar *lora*

### ◦ Abortion and stillbirths.

Leptospirosis is an important cause of abortions and stillbirths in the horse population of central Kentucky in the United States. *L. kennewicki*, *grippotyphosa*, *pomona*, and *bratislava* were isolated from aborted fetuses.<sup>28</sup> Leptospirosis has also been diagnosed as a cause of abortions, stillbirths, neonatal illness, and neonatal death on a horse farm involved in a flooding incident.<sup>29</sup> Serological surveys of thoroughbred and standardbred horses in Ontario revealed a higher prevalence of *bratislava*, which increased with age. In a survey of horses in Alberta, titers to *L. icterohemorrhagiae*, *bratislava*, *copenhagi*, and *autumnalis* were common (94.6%, 56.6%, 46.5%, and 43.5%, respectively). The prevalence to other serovars ranged from 0.8–27.2%.<sup>30</sup> The probability of being seropositive increased by approximately 10% with each year of life. Horses managed as individuals (e.g. racetrack horses) were about half as likely to be seropositive as those managed in groups (e.g. rodeo horses). A giant cell hepatitis in four aborted foals has been associated with the presence of *pomona* (*kennewicki*).

The risk factors associated with the likelihood of seropositivity to *L. pomona*, *L. autumnalis*, and *L. bratislava* in horses in New York State have been quantified.<sup>31</sup>

Rodent exposure was associated with risk of exposure to all serovars. Management was associated positively with the risk of exposure to serovars *pomona* and *bratislava*, but not with risk of exposure to *autumnalis*. Soil and water had a positive association with risk of exposure to *pomona* and *autumnalis* but not to *bratislava*. The wildlife index value and the population density of horses turned out together were associated with risk of exposure to *autumnalis*.

A bacteriological survey of kidneys from abattoir horses in Portugal found serogroups *L. australis* and *L. pomona*, which were identified as *L. bratislava*, and *L. kirschneri* serovar *Tsaratsovo*, respectively.<sup>32</sup> Leptospiral antibodies were more than 1:10 in 37% of the horses.

### Methods of transmission

The source of infection is an infected animal which contaminates pasture, drinking water, and feed by infective urine, aborted fetuses, and uterine discharges. All of the leptospiral types are transmitted within and between species in this way. A viable infected neonate can harbor the infection for several weeks after birth. The semen of an infected bull may contain leptospirae and transmission by natural

breeding or artificial insemination can occur but is uncommon. In rams, the semen is likely to be infective for only a few days during the period of leptospiremia; in boars there is no evidence of coital transmission. *L. interrogans* serovar hardjo is excreted from the genital tract of aborting cows for as long as 8 days after abortion or calving and is detectable in the oviducts and uterus for up to 90 d after experimental infection and in naturally infected cows. It may also be present in the genital tract of bulls and venereal spread of the infection is possible. Young pigs may act as carriers for 1 year and adult sows for 2 months. Because of the high intensity and long duration of the infection in pigs, they play an important role in the epidemiology of leptospirosis.

#### Leptospiuria

**Urine is the chief source of contamination** because animals, even after clinical recovery, may shed leptospirae in the urine for long periods. All animals which have recovered from infection may intermittently shed organisms in the urine and act as 'carriers'. In cattle, leptospiuria may persist for a mean period of 36 d (10–118 d) with the highest excretion rate in the first half of this period. Sheep and horses are not common sources of infection because of low grade and intermittent leptospiuria. In any species, the leptospirae may persist in the kidney for much longer periods than they can be recovered from the urine by routine laboratory methods. Urine drinking by calves is not an uncommon form of pica in some dairy herds and is a means of transmission.

#### Wildlife as source of infection

Although surveys of the incidence of leptospirosis in wildlife have been conducted and the pathogenic effects of *L. pomona* on some species, particularly deer and skunks have been determined, the significance of wildlife as a source of infection for domestic animals is uncertain. Variable rates of seroprevalence to leptospirae have been documented in white-tailed deer, mule deer, pronghorns, moose, red deer, and elk.<sup>33</sup> There is a high prevalence of infection in feral pigs, and in wild brown rats trapped on farms in the United Kingdom the prevalence of *L. icterohaemorrhagiae* and bratislava was about 14%.<sup>34</sup> *L. canicola* is known to spread from domestic dogs and jackals to cattle and, when hygiene is poor, even from humans to cattle. The serovar bratislava has been associated with severe interstitial nephritis in raccoons in a recreational area in Quebec which were also serologically positive to pomona, hardjo, and grippotyphosa.<sup>35</sup>

#### Portal of entry of organism

Entrance of the organism into the body occurs most probably through cutaneous or mucosal abrasions. Transplacental transmission is uncommon but neonatal infection in utero has occurred. Oral dosing is an unsatisfactory method for experimental transmission as compared to injection and installation into the nasal cavities, conjunctival sac, and vagina.

#### Environmental and management risk factors

**Survival of the organism in the environment** depends largely upon variations in soil and water conditions in the contaminated area. The organism is susceptible to drying, and a pH lower than 6 or greater than 8 is inhibitory. Low urinary pH in cattle fed with brewer's grains may inactivate leptospirae in animals with leptospiuria.<sup>36</sup> Ambient temperatures lower than 7–10°C (44.6–50°F) or higher than 34–36°C (93–96°F) are detrimental to its survival.

#### Ground surface moisture and water

is the most important factor governing the persistence of the organism in bedding or soil; it can persist for as long as 183 days in water-saturated soil but survives for only 30 min when the soil is air-dried. In soil under average conditions, survival is likely to be at least 42 d for *L. pomona*. It survives in free, surface water for long periods; the survival period is longer in stagnant than in flowing water although persistence in the latter for as long as 15 d has been recorded. Contamination of the environment and capacity of the organism to survive for long periods under favorable conditions of dampness may result in a high incidence of the disease on heavily irrigated pastures, in areas with high rainfall and temperate climate, in fields with drinking water supplies in the form of easily contaminated surface ponds, and in marshy fields and muddy paddocks or feedlots. Because of the importance of water as a means of spreading infection, new cases are most likely to occur in wet seasons and low lying areas, especially when contamination and susceptibility are high. A differential distribution has been observed in the prevalence of seropositives in cattle in Australia. *L. hardjo* antibodies have a high prevalence through all rainfall areas, but *L. pomona* is much more common in low rainfall areas.

**Certain management factors** have been identified which pose risks of *L. hardjo* infection being introduced into dairy herds:<sup>37</sup>

- Purchase of infected cattle
- Co-grazing or common grazing with infected cattle or sheep
- Purchase or loan of an infected bull

- Access of cattle to contaminated water supplies such as streams, rivers, flood or drainage water.

#### Economic importance

Leptospirosis is a major cause of economic loss in farm animals. The majority of leptospiral infections are subclinical and associated with fetal infections causing abortions, stillbirths, and the birth of weak neonates with a high death rate in cattle, sheep, horses, and pigs. In cattle, epidemics of abortions, infertility, and increased culling rate cause major economic losses. Epidemics of agalactia in dairy herds, the **milk drop syndrome**, are associated with infection with *L. hardjo*.

#### Zoonotic implications

In the past decade, leptospirosis has emerged as a globally important infectious disease in human medicine.<sup>38,39</sup> It is uncommon in developed countries but the incidence is increasing in travelers returning from endemic countries. The epidemiology has undergone major changes, with a shift away from the traditional occupational disease in developed countries, to a disease associated with recreational exposures.<sup>39</sup> It is now recognized as an emerging, potentially epidemic disease associated with excess rainfall in tropical settings, representing a significant public health hazard. Mortality in humans with leptospirosis remains significant because of delays in diagnosis due to lack of diagnostic infrastructure and adequate clinical suspicion when patients are presented for medical diagnosis and care. The differential diagnosis of febrile illness in returning travelers should include leptospirosis. Pulmonary hemorrhage is increasingly being recognized as a major, often lethal, manifestation of leptospirosis in humans, the pathogenesis of which is unclear. Treatment consists of tetracyclines and beta-lactam/cephalosporins. No vaccine is available for the prevention of leptospirosis in humans.

Leptospirosis is an important zoonosis and is an occupational hazard to butchers, farmers, and veterinarians.<sup>40</sup> The high prevalence of leptospiral infection (serovars pomona and hardjo) in Texas cattle represents potential threats to human health and agricultural economics.<sup>41</sup> The incidence of positive agglutination tests in humans in contact with infected cattle is surprisingly low and clinical cases in humans in which the infection is acquired from animals are not common. Human infection is most likely to occur by contamination with infected urine or uterine contents. Veterinarians may become infected by handling the tissues and urine of sows which have aborted from pomona infection. Although leptospirae may be

present in cow's milk for a few days at the peak of fever in acute cases, the bacteria do not survive for long in the milk and are destroyed by pasteurization. However, farm workers who milk cows are highly susceptible to *L. interrogans* serovar hardjo infection and one New Zealand survey found 34% of milkers were seropositive, mostly to *L. interrogans* serovar hardjo, but a high proportion also to *L. interrogans* serovar pomona. This has aroused alarm and leptospirosis became known as 'New Zealand's No. 1 dairy occupational disease'. A campaign of vaccination of dairy cattle across the country resulted in a marked decrease in the incidence of the disease in humans. In most situations, dogs, cats, and horses are unlikely to contribute to human infection.<sup>40</sup>

Leptospirosis is New Zealand's most common occupationally acquired infectious disease, and the incidence of the disease is high compared with other temperate developed countries.<sup>42</sup> The epidemiology of leptospirosis in New Zealand has been changing. The annual incidence of human leptospirosis in New Zealand from 1990–98 was 4.4 per 100 000. Incidence was highest among meat processing workers (163/100 000), live-stock farm workers (91/100 000) and forestry-related workers (24/100 000). The most commonly detected serovars were *L. borgpetersenii* sv. ballum (11.9%). The annual incidence of leptospirosis declined from 5.7/100 000 in 1990–92 to 2.9/100 000 in 1995–98. The incidence of *L. borgpetersenii* sv. hardjo and *L. interrogans* sv. pomona infection declined, while the incidence of *L. borgpetersenii* sv. ballum infection increased. The increasing incidence of *L. borgpetersenii* sv. ballum suggests changing transmission patterns via direct or indirect exposure to contaminated water. The risk of transmission of leptospirosis from dairy cattle infected with *L. hardjo* to dairy workers in Israel was low.<sup>43</sup>

Leptospirosis is a risk factor for swine producers and slaughterhouse workers. An epidemiological investigation of people exposed to infected pigs from a university-owned swine herd found 8% of the workers were confirmed to have leptospirosis.<sup>44</sup> Risk factors included smoking and drinking beverages while working with infected pigs. Washing hands after work was protective. Leptospirosis is infrequently diagnosed by human physicians in the United States and veterinarians have often informed physicians of the potential of leptospirosis in humans. The disease can be prevented through appropriate hygiene, sanitation, and animal husbandry.<sup>44</sup> It is essential to educate people working with animals or animal tissues about measures for reducing the risk of exposure to such zoonotic pathogens as leptospira.

Veterinary students may be exposed to leptospirosis by taking courses in food inspection and technology, on-farm clinical work experiences, contact with pets especially carnivores, and contact with animal traders.<sup>45</sup> In a one-year period, the seroprevalence of leptospirosis in veterinary students in a veterinary school in Spain increased from 8.1% to 11.4%. The incidence of the disease during the study was 0.0394.

#### PATHOGENESIS

Leptospirosis manifests itself as a disease in several different ways. Leptospire invade the host across mucosal surfaces or softened skin. They have the ability to bind to epithelial cells and attach to the constituents of the extracellular matrix through an active process involving surface proteins. Pathogenic leptospire are found extracellularly between cells of the liver and kidney. Release of lymphokines such as tumor necrosis factor (TNF-alpha) from monocytes through the endotoxic activity of the leptospiral LOS may be an important virulence mechanism. Induction of TNF-alpha release may help explain the damage to endothelial cells with resultant hemorrhage seen in severe leptospirosis.

Leptospirosis can occur as an acute and severe disease due to septicemia with evidence of endotoxemia such as hemorrhages, hepatitis, nephritis, meningitis; as a subacute moderately severe disease with nephritis, hepatitis,agalactia, and meningitis, or as a chronic disease characterized by abortion, stillbirth, and infertility. In the occult form there is no clinical illness. The form of the disease that occurs depends largely on the species of the host as set out in Table 20.3. Variations between serotypes of *L. interrogans* in their pathogenicity also affect the nature of the signs which appear. For example, in *L. pomona* infections, intravascular hemolysis and interstitial nephritis are important parts of the disease. However, *L. hardjo* does not produce hemolysin and does not cause interstitial nephritis. But it does cause clinical infection in **sexually mature, lactating or pregnant females**. Thus infection occurs in the

pregnant uterus and lactating mammary gland resulting in septicemia, abortion, and mastitis. The pathogenesis of the disease associated with *L. pomona* is set out as follows.

#### Acute form

After penetration of the skin or mucosa, the organisms multiply in the liver and migrate to, and can be isolated from, the peripheral blood for several days until the accompanying fever subsides. At this time serum antibodies begin to appear and organisms can be found in the urine.

#### Septicemia, capillary damage, hemolysis, and interstitial nephritis

During the early period of septicemia, sufficient hemolysin may be produced to cause overt hemoglobinuria as a result of extensive intravascular hemolysis. This is an unlikely event in adult cattle, but is common in young calves. If the animal survives this phase of the disease, localization of the infection may occur in the kidney. Hemolysis depends on the presence of a serovar which produces hemolysin. Capillary damage is common to all serovars and during the septicemic phase, petechial hemorrhages in mucosae are common. Vascular injury also occurs in the kidney and if the hemolysis is severe, anemic anoxia and hemoglobinuric nephrosis may occur. There is some evidence that leptospire produce a lipopolysaccharide endotoxin which may exacerbate the vascular lesions. The infection localizes in the renal parenchyma, causing an interstitial nephritis and persistence of the leptospirae in these lesions results in prolonged leptospiruria. The renal lesion develops because the infection persists there long after it has been cleared from other tissue sites. In the acute phase of the disease, the animal may die from septicemia or hemolytic anemia or both. Subsequently, the animal may die of uremia caused by interstitial nephritis.

Focal chronic interstitial nephritis, also called 'white spotted kidney' is a common finding in clinically healthy cattle at slaughter and has frequently been assumed to be related to current of prior infection with *Leptospira* spp. However, studies of

Table 20.3: Forms of leptospirosis in the animal species

	Acute form	Subacute form	Chronic form
Cattle	+	+	+
	(Calves only)		(Abortion)
Sheep and goat	+	-	-
	(Includes abortion)		
Pig	+	-	+
	(Rarely and only in piglets)		(Abortion)
Horse	-	+	+
			(Abortion and periodic ophthalmia)

'white spotted kidney' in cattle at the abattoir indicate that neither *Leptospira* spp. nor active infection by other bacteria are associated with the lesions.<sup>46</sup>

### Abortion

Following systemic invasion, abortion may occur due to fetal death, with or without placental degeneration. Abortion usually occurs several weeks after septicemia because of the time required to produce the changes in the fetus, which is usually autolyzed at birth. Abortion occurs most commonly in the second half of pregnancy, due probably to the greater ease of invasion of the placenta at this stage, but may occur at any time from 4 months on. Although abortion occurs commonly in both cattle and horses after either the acute or the subacute form of the disease, abortion without prior clinical illness is also common. This is particularly the case in sows and occurs to a less extent in cows and mares; this may be due to degenerative changes in the placental epithelium. *Leptospirae* are rarely present in the aborted fetuses, however if the aborted fetus has survived the infection long enough to produce antibodies, these may be detectable.

Experimental infection of serologically negative pregnant cattle with a north-Queensland strain of *L. borgpetersenii* serovar hardjo resulted in seroconversion and shedding of the organism in the urine.<sup>47</sup> Elective cesarean sections were done 6 weeks after challenge. No evidence of *L. hardjo* infection of the fetuses occurred. Some of the fetuses had histopathological lesions consistent with *Neospora* sp. infection.

### Encephalitis

Localization of leptospirae in nervous tissue is common in sheep and goats and may result in the appearance of signs of encephalitis.

### Subacute and occult forms

In the subacute form, the pathogenesis is similar to that of the acute septicemic form, except that the reaction is less severe. It occurs in all species, but is the common form in adult cattle and horses. Occult cases, with no clinical illness but with rising antibody titers, are common in all animals. These are difficult to explain but may be associated with strains of varying pathogenicity. But with leptospirosis, characteristically, differences between groups may be associated with prior immune status, environmental conditions, or number of carriers in relation to severity of exposure.

### Periodic ophthalmia (recurrent uveitis) in the horse

There is some evidence of a causal relationship between leptospiral infection and

periodic ophthalmia in the horse.<sup>48</sup> The incidence of serologically positive reactors is higher in groups of horses affected with periodic ophthalmia than in normal animals. Agglutinins are present in the aqueous humor in greater concentration than in the serum. Serological surveys indicate that leptospira infection is not a major factor in the etiology of equine anterior uveitis in the United Kingdom, but serological evidence of pomona is associated with uveitis in horses in the United States. The opacity in both cornea and lens is a consequence of the antigenic relationship between leptospirae and components of the ocular tissues and does not require the presence of living bacteria. A 52-kDa protein appears to be involved in the antigenic relationship between the leptospirae and equine ocular tissues and is located inside the bacterium. The uveitis alters the composition of the aqueous humor and impedes the nutrition of the ocular structures, leaving sequelae such as iris atrophy, synechiae, and corneal opacity.

Retinal immunopathology in horses with uveitis has been described and may be a primary immunological event in equine uveitis, providing evidence that leptospira-associated uveitis may be a distinct subset of equine uveitides.<sup>48</sup>

### Immune mechanisms

Following infection, specific antibodies are induced which opsonize leptospirae, facilitating their elimination from most parts of the body. However, leptospirae which reach the proximal renal tubules, genital tract and mammary gland appear to be protected from circulating antibodies. They persist and multiply in these sites, and may be excreted and transmitted to susceptible, in-contact animals, primarily by urine. Furthermore, and of major importance, the level of serum antibody commonly declines to undetectable levels in animals which are persistently infected.

The first serological response with *L. hardjo* infection is the production of immunoglobulin M (IgM) antibodies. These rise rapidly but commonly decline to undetectable concentrations by 4 weeks after infection. Within 1-2 weeks of infection, IgG1 antibodies appear, and at 3 months they represent 80% of antibodies detected in the microscopic agglutination test (MAT). The MAT titer peaks 11-21 d after infection but may vary from 3200 to an undetectable concentration. The MAT titer declines gradually over 11 months but the persistence is variable. Vaccination induces antibodies that are mainly of the IgG class with levels peaking at 2 weeks after a two-dose vaccination but decreasing rapidly to levels lower than those after

natural infection. **Approximately 95% of vaccinated heifers do not have MAT antibodies 20 weeks after the second of two vaccinations given 4 weeks apart and the absence of titers is not necessarily an indication that protection has waned.** Vaccinated animals 'are protected from natural challenge for many months after their MAT titers become undetectable. The serological response of calves vaccinated at 3 months of age is lower than those vaccinated at 6 months of age because of the presence of maternal antibody. Transfer of passive immunity antibodies to newborn calves occurs via the colostrum and the antibodies persist in the calves for 2-6 months.

While antibodies against leptospiral lipopolysaccharides (LPS) give passive protection in some animal models, cattle vaccinated against serovar hardjo with pentavalent vaccines are vulnerable to infection with serovar hardjo despite the presence of high titers of anti-LPS antibody. It is now known that peripheral blood mononuclear cells (PBMC) from cattle vaccinated with an *L. interrogans* serovar hardjo vaccine which protects against serovar hardjo proliferated in vitro in response to hardjo antigens. Thus a cell-mediated immune response to serovar hardjo may be necessary for protection.<sup>10</sup> A protective killed vaccine against serovar hardjo induces a strong antigen-specific proliferative response by PBMC from vaccinated cattle 2 months after the first dose of vaccine. This response was absent from unvaccinated cattle. The mean response peaked by 2 months after completion of the two-dose vaccination regimen, and substantial proliferation was measurable in vitro cultures throughout 7 months of the study period. Up to one-third of the PBMC from vaccinated animals produced gamma interferon (IFN- $\gamma$ ) after 7 days in culture with antigen. One-third of the interferon gamma producing cells were (gamma delta lymphocytes, with the remainder cells being CD4<sup>+</sup> T-cells.<sup>10</sup> Thus a very potent Th1-type immune response was induced and sustained following vaccination with a killed bacterial vaccine adjuvanted with aluminum hydroxide and the involvement of gamma delta T-cells in the response. The induction of this Th1-type **cellular immune response** is associated with the protection afforded by the bovine leptospiral vaccine against *L. borgpetersenii* serovar hardjo.<sup>10</sup>

The immune response of naive and vaccinated cattle following challenge with a virulent strain of *L. borgpetersenii* serovar hardjo has been examined.<sup>49</sup> Beginning at 2 weeks after challenge, gamma interferon was measured in antigen-stimulated PBMC cultures from nonvaccinated animals, although the

amount produced was always less than that in cultures of PBMC from vaccinated animals. IFN- $\gamma^+$  cells were also evident in antigen-stimulated cultures of PBMC from vaccinated but not from non-vaccinated animals throughout the post-challenge period. Naïve and vaccinated animals had similar levels of antigen-specific immunoglobulin G1 (IgG1) following challenge; vaccinated animals had two-fold more IgG2. It is evident that while infection may induce a type 1 response, it is too weak to prevent establishment of chronic infection.

### CLINICAL FINDINGS

The clinical findings in leptospirosis are similar in each animal species and do not vary greatly with the species of *Leptospira* except that infection with *icterohaemorrhagiae* usually causes a severe septicemia. For convenience the various forms of the disease are described as they occur in cattle, and comparisons are made with the disease in other species. In all animals the incubation period is 3–7 d.

#### Cattle

Leptospirosis in cattle may be **acute**, **subacute** or **chronic** and is usually associated with **pomona** or **hardjo**.

Acute leptospirosis associated with pomona

Calves up to 1 month old are most susceptible to the acute leptospirosis. The disease is manifested by septicemia, with high fever (40.5–41.5°C; 105–107°F), anorexia, petechiation of mucosae, depression, and acute hemolytic anemia with hemoglobinuria, jaundice and pallor of the mucosae. Because of the anemia, tachycardia, loud heart sounds and a more readily palpable apex beat are present: dyspnea is also prominent. The case–fatality rate is high and if recovery occurs, convalescence is prolonged. In adult cattle, abortion due to the systemic reaction may occur at the acute stage of the disease. Milk production is markedly decreased and the secretion is red-colored or contains blood clots, and the udder is limp and soft. Mastitis as part of leptospirosis has often been described in cattle and a high somatic cell count in grossly abnormal milk suggests mastitis, but these changes are due to a general vascular lesion rather than local injury to mammary tissue. Severe lameness due to synovitis is recorded in some animals and a necrotic dermatitis, probably due to photosensitization, in others.

Subacute leptospirosis associated with *L. pomona*

The subacute form of leptospirosis differs from the acute form only in degree. Similar clinical findings are observed in a number of affected animals but not all

of the findings are present in the same animal. The fever is milder (39–40.5°C; 102–105°F), and depression, anorexia, dyspnea and hemoglobinuria are common but jaundice may or may not be present. Abortion usually occurs 3–4 weeks later. One of the characteristic findings is the marked drop in milk production and the appearance of blood-stained or yellow-orange, thick milk in all four quarters without apparent physical change in the udder.

Chronic leptospirosis associated with *L. pomona*

The clinical findings in the chronic form of leptospirosis are mild and may be restricted to abortion. Severe 'storms' of abortions occur most commonly in groups of cattle which are at the same stage of pregnancy when they are exposed to infection. The abortions usually occur during the last trimester of pregnancy. Apart from the abortion, there is no depression of reproductive efficiency in cattle affected by leptospirosis. Many animals in the group develop positive agglutination titers without clinical illness.

There are occasional reports of leptospiral meningitis in cattle. In coordination, excessive salivation, conjunctivitis and muscular rigidity are the common signs.

Leptospirosis associated with *L. hardjo*

**Infertility and milk drop syndrome** occurs only in pregnant or lactating cows because the organism is restricted to proliferation in the pregnant uterus and the lactating mammary gland. There is a sudden onset of fever, anorexia, immobility andagalactia. The milk is yellow to orange and may contain clots. The udder is flabby, there is no heat or pain, and all four quarters are equally affected. The **sudden drop in milk production** may affect up to 50% of cows at one time and cause a precipitate fall in the herd's milk yield. The decline may last for up to 8 weeks but in individual cows milk production will return to normal within 10–14 days. The milk may have a high leukocyte count which subsides over a period of about 14 days as milk production returns. In some cases, there is no evidence of mastitis, no change in the consistency of the milk and no changes in the udders of affected cows, but leptospiruria may be present in up to 30% of affected cows. In endemically infected dairy herds, there may be no relationship between seropositive and seronegative cows in different lactations, nor at different stages of lactation and total lactation milk yield.<sup>50</sup>

The **herd fertility status** incorporating the **first service conception rate, the number of services per conception for cows conceiving, the calving-**

**to-conception interval, and the culling rate** usually reveals a low reproductive performance, especially during the year of the diagnosis.<sup>51</sup> The effect is also temporary and not easily detected. Exposure of nonvaccinated dairy cows to *L. hardjo* can be associated with a subsequent reduction in fertility, as indicated by a greater time from calving to conception and a higher number of breedings per conception.<sup>52</sup>

**Abortion** may occur several weeks after the initial infection and may also occur as the only evidence of the disease; in some areas or circumstances it is the principal clinical manifestation of leptospirosis due to hardjo, and the principal cause of abortion in cattle. In others it is thought to be an uncommon cause of abortion. This may be related to different strains of the serotype, or to the degree to which the disease has become enzootic. Thus outbreaks of milk yield drop and systemic illness appears to be the characteristic clinical picture when the disease first appears in an area. However, as natural immunity develops in adult cows, only heifers become newly infected, and the only sign is abortion. Furthermore, many cows have subclinical infections with hardjo in which only a fall in milk yield may be detectable.

Leptospirosis associated with *szwajizak*, produced experimentally, is characterized by a short bout of fever, listlessness and anorexia, and diarrhea in some. The illness lasts for 24 h.

#### Pigs

Pomona is the common infection, *tarassovi* is the other common infection, and chronic leptospirosis is the commonest form of the disease in pigs. It is characterized by abortion and a high incidence of stillbirths. Failure to conceive is not usually observed in leptospirosis but has been reported in infections with canicola. In an infected herd the rearing rate may fall as low as 10–30%. An abortion 'storm' may occur when the disease first appears in a herd but abortions diminish as herd immunity develops. Most abortions occur 2–4 weeks before term. Piglets produced at term may be dead or weak and die soon after birth. Hardjo may be a sporadic cause of reproductive disease and muenchen and bratislava are occasional isolations during investigations of porcine abortion and stillbirths. In a survey of swine farms in Canada, those herds with a high serological prevalence of serovars bratislava and pomona had more infertility as measured by non-productive sow days per parity.<sup>25</sup> There was no association between infertility and antibodies to serovars autumnalis and icterohemorrhagiae.<sup>25</sup>

Rarely the acute form as it occurs in calves also occurs in piglets in both natural field outbreaks and in experimentally produced cases. *Icterohaemorrhagiae* infection causes septicemic leptospirosis with a high mortality rate.

### Sheep and goats

The disease is rare in these species so that good descriptions of the naturally occurring disease in them are lacking; most affected animals are found dead, apparently from septicemia. Affected animals are febrile, dyspneic, snuffle, and hang their heads down. Some have hemoglobinuria, pallor of mucosae and jaundice, and die within 12 h. Lambs, especially those in poor condition, are most susceptible. The chronic form may occur and is manifested by loss of bodily condition, but abortion seems to be almost entirely a manifestation of the acute form when the infection is pomona. With hardjo, abortion has been recorded as the only clinical sign, and oligolactia and agalactia, similar to the bovine milk drop syndrome, have been observed in lactating ewes.

### Horses

#### Abortion

*Leptospira interrogans* serovar pomona type *kennewicki* is a major cause of abortions and stillbirths in the equine population in Kentucky in the United States;<sup>53,54</sup> other serovars also occur. The gestational ages range from 140 d to full-term mean (250 d).<sup>55</sup> Horses in central Kentucky are exposed to multiple *Leptospira* serovars including *bratislava*, *icterohaemorrhagiae*, *grippotyphosa*, *pomona* genotype *kennewicki*, *hardjo* and *canicola*.<sup>56</sup> In some years in Kentucky, leptospiral infection is a leading cause of abortion in which fetoplacental infections account for one-third of the abortions, stillbirths and perinatal deaths and in which 75% are due to bacterial infection.<sup>57</sup>

#### Periodic ophthalmia

Recurrent uveitis in horses (**periodic ophthalmia, moon blindness, recurrent iridocyclitis**) is a late complication of systemic leptospirosis in horses with signs beginning months to years after naturally acquired or experimentally induced infection. It is often associated with infection with *L. interrogans* serovar pomona. Clinically there are recurrent episodes of ocular disease including photophobia, lacrimation, conjunctivitis, keratitis, a pericorneal corona of blood vessels, hypopyon and iridocyclitis. Recurrent attacks usually terminate in blindness in both eyes. There is a strong relationship between uveitis and leptospiral seroactivity in horses. Seropositive horses with uveitis are at increased risk of losing vision, compared with seronegative

horses with uveitis, and Appaloosas are at an increased risk of developing uveitis and associated blindness, compared with that in non-Appaloosas. The disease has been produced experimentally by producing infection with pomona. Infection with pomona in foals has been observed in association with *Rhodococcus equi* to cause a very heavy mortality. The foals died of a combination of interstitial nephritis and uremia, and pulmonary abscessation and chronic enteritis. Leptospirosis has been suspected as a cause of renal dysfunction in a horse<sup>58</sup> and hematuria and leptospiruria described in a foal.<sup>59</sup>

Nonulcerative keratouveitis associated with leptospiral infection has been described in horses.<sup>27</sup> Photophobia, epiphora, and blepharospasm are common. Hyperemia of the bulbar conjunctiva, edema of the paralimbal cornea, pupillary block and iris bombe are also present. As the disease progresses, there may be hyphema, hypopyon, and organized fibrin in the anterior chamber, myosis, dyscoria due to posterior synechiae and the cornea may become opaque and vascularized.<sup>27</sup> The cornea retains no fluorescein dye.

### CLINICAL PATHOLOGY

#### General considerations

Laboratory procedures used in the diagnosis include culture or detection of leptospire in blood or body fluids, and detection and measurement of antibody in blood and body fluids such as urine, cerebrospinal fluid and cervico-vaginal mucus.<sup>60</sup> Culture of leptospire is laborious and can take up to 2 months. Serological and microbiological detection of chronically infected animals is difficult, as is the confirmation of leptospirosis as a direct cause of reproductive losses in a herd. A positive diagnosis of leptospirosis in individual animals is often difficult because of the variation in the nature of the disease, the rapidity with which the organism dies in specimens once they are collected and their transient appearance in various tissues. During the septicemic stage, leptospire are present only in the blood and there may be laboratory evidence of acute hemolytic anemia and increased erythrocyte fragility and often hemoglobinuria. A leukopenia has been observed in cattle while in other species there is a mild leukocytosis. However, the only positive diagnostic measure at this stage of the disease is culture of the blood. If abortion occurs, the kidney, lung and pleural fluid of the aborted fetuses should be examined for the presence of the organism. Serological testing at the time of abortion is often unreliable because the acute titers have already peaked and are declining. In the stage

immediately after the subsidence of the fever, antibodies begin to develop and the leptospire disappear from the blood and appear in the urine. The leptospiruria is accompanied by albuminuria of varying degrees and persists for varying lengths of time in the different species.

The diagnosis of leptospirosis is much easier on a herd basis than in a single animal because in an infected herd, some animals are certain to have high titers and the chances of demonstrating or isolating the organism in urine or milk are increased with samples being taken from many animals. On the other hand, in a single animal, depending on when the infection occurred, the titer may have declined to a low level and be difficult to interpret. This becomes particularly important for the clinician confronted with a diagnosis of abortion due to leptospirosis in which the infection may have occurred several weeks previously and the serum may be negative or the titers too low for an accurate interpretation. Examination of the urine may be useful in these cases.

### Serological and related tests

**Acute and convalescent sera** taken 7–10 d apart should be submitted from each clinically affected animal, or from those with a history of abortion, and sera should also be taken from 15–25% of apparently normal animals. Ten blood samples should be taken from each of the yearlings, the first-calf dams, the second-calf dams, and the mature age group in order to determine the infection status across the herd. If possible, wildlife or rodents which are known to inhabit the farm and use nearby water supplies should be captured and laboratory examinations of their tissues and blood carried out and the results compared with those obtained in the farm animals.

**The Microscopic Agglutination Test (MAT)** is the most commonly used serological test for the diagnosis of leptospirosis. In animals which survive infection, acute leptospirosis can readily be diagnosed on the basis of demonstrating a rising antibody titer in acute and convalescent sera.<sup>60</sup> Although paired sera are normally considered necessary so that a rise in titer can be detected, in cases of bovine abortion or stillbirth, infection may have occurred 1–4 weeks before the abortion by which time the MAT titers may be declining. Following infection, the IgM class of antibodies are first to appear followed by IgG antibodies, which persist for longer than IgM antibodies. The MAT detects both IgM and IgG antibodies. The MAT is particularly useful in diagnosis of disease associated with incidental, non-host-adapted serovars or acute disease associated with host-adapted serovars. It

is less useful in diagnosis of chronic disease in maintenance hosts since antibody response to infection may be negligible in chronic infections or may persist from subclinical infections. In pigs, MAT has an adequate sensitivity for some serovars, such as pomona, but is insensitive to infection associated with bratislava. The herd serological response to infection is often more helpful than the individual's response in chronic infections in maintenance hosts. Because agglutinating antibodies wane, the sensitivity of the MAT in detecting animals infected for more than 2 years is low, probably less than 50%. A major concern is the failure of the MAT to differentiate between titers after vaccination and those after natural infection since the titers may be of similar magnitude; however, titers after infection are in general, higher and persist longer than vaccination titers. Vaccinated cattle which subsequently become infected, may not mount an agglutinating antibody response.

**A MAT titer of  $\geq 100$  is considered positive** but there are several considerations in evaluating the MAT response. The MAT is a serogroup-specific test and serovars representative of all suspected serogroups should be tested. The test is a more sensitive detector of IgM antibody than IgG. It has a low sensitivity in chronic leptospirosis for detecting maintenance hosts. The test is inadequate for the detection of the carrier state in maintenance hosts, because titers  $\geq 100$  against host-adapted serovars have a low sensitivity but high specificity. The MAT is not a measure of immunity to infection because vaccination results primarily in an IgG response, with low (100–400) and transient (1–4 months) titers but immunity commonly persists in vaccinated animals long after MAT titers are negative. In cattle, titers of  $\geq 100$  are considered significant and a four-fold rise in titer on a paired sample taken 2 weeks apart is diagnostic. In abortion associated with incidental serovars, MAT titers against pomona and other incidental serovars are high, often  $\geq 3000$ .

Paired sera are of limited value in chronic infections because abortion occurs after infection and titers are static or declining. In chronic hardjo infections, a recently aborting cow with a titer of  $\geq 300$  has about a 60%, of  $\geq 1000$  an 80%, and  $\geq 3000$  a 90% chance of fetal infection. If several aborting cows have high titers ( $\geq 300$ ), this is evidence for the diagnosis of leptospirosis in unvaccinated herds. A semiautomated complement fixation test is available and is comparable in efficiency with the MAT.

The **ELISA test** is much more accurate than the others and has many advantages from the point of view of laboratory

practice. It can be specific for IgM antibodies or IgG antibodies. A positive IgM-specific ELISA result can therefore indicate that infection occurred within the previous month. It has excellent diagnostic specificity and sensitivity, convenient technical features including automation, and can be used efficiently as a screening test for large numbers of serum samples. Some difficulty is encountered in interpreting the significance of titers of antibody in serum. For a diagnosis of leptospiral abortion in cattle, a reciprocal titer of 3000 is proposed as the threshold for pomona but no similar critical figure is available for hardjo. For a herd diagnosis of leptospirosis due to hardjo 10 animals from each of the yearling, first-calf heifer, second-calf heifer and adult cow groups should be tested.

An **indirect ELISA** has been developed for the detection of bovine antibodies to multiple *Leptospira* serovars including canicola, copenhageni, grippityphosa, hardjobovis pomona, and sejroe.<sup>61</sup>

An **antibody capture ELISA** is available to detect antibodies to a protective lipopolysaccharide fraction of *Leptospira borgpetersenii* serovar hardjo in cattle.<sup>62</sup>

A commercially available **ELISA** and the **Immunocomb Leptospirosis Kit** which detect *L. hardjo* antibodies have been compared with the **MAT**.<sup>63</sup> The Immunocomb and ELISA tests both exceeded the positive results obtained with the **MAT**.<sup>63</sup> The Immunocomb is very simple, and quick, requiring no sophisticated equipment.

**Aqueous humor antibody.** Measurement of aqueous humor antibody titers against leptospire in horses offers a more accurate means of establishing a diagnosis of leptospiral-associated uveitis than serology alone.

**Serology in pigs.** A comparison of diagnostic procedures for the diagnosis of porcine leptospirosis reveals that the apparent (maximum) sensitivities of diagnostic procedures for detecting infection were as follows: MAT (at a titer of 64 or 1024) 95%; IgM enzyme immunoassay 82%; culture of kidneys 61%; presence of white spots 55%; immunogold staining 52%; presence of large white spots 30%; and, Warthin–Starry silver staining 20%. An axial filament ELISA is a sensitive and specific test for the detection of antibodies against *L. interrogans* on a species rather than serovar level and has advantages over the MAT.

#### **Demonstration or culture of organism or antibody**

A number of tests are available to detect leptospire or leptospiral DNA in tissues or body fluids.<sup>64</sup>

**Culture of urine.** Of all the laboratory diagnostic tests for leptospirosis, the

examination of urine samples for the organism probably offers the best opportunity to demonstrate the presence of infection. Following natural infection with *L. hardjo*, cattle may shed leptospire in the urine for between 28 and 40 weeks;<sup>65</sup> following experimental infection, shedding occurs for about 26–32 weeks. After the initial infection, large numbers of leptospire are shed in the urine for several weeks and thereafter there is a progressive decline in the numbers shed, which may be associated with a sharp increase in urinary anti-leptospiral IgG and IgA antibody levels.<sup>66</sup> Urine samples should be obtained from a cross-section of affected and non-affected (in-contact) animals. Furosemide can be given IV at 0.5–0.8 mg/kg BW and the second voiding of urine collected for culture. For maximum efficiency, one-half of each urine sample should be submitted with added formalin (1 drop to 20–30 mL of urine) and the other half submitted in the fresh state. The formalin prevents bacterial overgrowth and the fresh urine sample may be used for culture. Examination of urine using dark-field microscopy or fluorescent antibody test are useful tests. The fluorescent antibody test is more sensitive than dark field microscopy, detects degenerated as well as intact leptospire and may be serovar specific. Standard techniques for culture of leptospire have been described.<sup>65</sup>

Detection of organism in urine

**Fluorescent staining of antibody in urine.** A fast and accurate diagnostic method for detecting the presence of leptospire and for identifying serotypes. Antibodies also appear in urine and milk and their measurement may have some significance in special circumstances.

**Antibody in cervico-vaginal mucus.** An ELISA has been used to detect specific antibody to *L. hardjo* in the cervico-vaginal mucus as early as 2 weeks after natural or experimental infection and may reach high levels after 8 weeks.<sup>67</sup> This may show some promise in diagnosis but has not yet been evaluated.

A comparison of a PCR assay with bacteriologic culture, immunofluorescence, and nucleic acid hybridization for detection of *L. borgpetersenii* serovar hardjo in urine of cattle found all were sensitive but a single technique was not the most sensitive for each animal tested.<sup>68</sup> Two techniques in combination are recommended for maximal sensitivity.

Detection of organism in tissues

**DNA probes and PCR.** Leptospire can be detected in tissues using a DNA genomic probe and DNA-based techniques will probably provide rapid and sensitive diagnostic techniques that are



serovar- and genotype-specific. Nucleic acid hybridization is a sensitive and rapid test for the detection of leptospires in the urine of cattle which become infected subsequent to vaccination, and is superior to bacteriological culture and fluorescent antibody testing. The polymerase chain reaction is also a promising test for the rapid detection of small numbers of leptospires in the urine of cattle infected with *L. hardjo-bovis*. A multiplex PCR is highly sensitive for detection of the organism in aborted bovine fetuses.<sup>69</sup>

Using a leptospira PCR assay, *L. kirschneri* has been identified as a potential cause of abortion in a fetal foal born on a farm with a history of repeated abortions.<sup>70</sup> Further confirmation of *L. kirschneri* was done by DNA sequence analyses of the PCR amplified DNA fragment.

Detection of organism in semen  
In some countries, bulls destined for artificial insemination centers must be free of antibody to hardjo, grippotyphosa, canicola, pomona, sejroe, and icterohaemorrhagiae at a final serum dilution of 1:100 in the MAT. However, since animals with leptospirosis may not have a serum titer, it is possible that the semen of serologically negative but infected bulls may contain leptospires. Culture of leptospires is difficult, costly and time consuming. A polymerase chain reaction assay has been developed to detect pathogenic leptospires in the semen and urine of infected bulls.<sup>71,72</sup> PCR is a method of great potential for the detection of *Leptospira* spp. at bovine artificial insemination units.<sup>54</sup>

Detection in aqueous humor of horses with uveitis

Using PCR to detect the presence of *Leptospira* DNA, 70% of horses with uveitis were positive for *Leptospira* DNA, and 28% were culture positive for leptospires from the aqueous humor;<sup>73</sup> only 6% of horses free of uveitis used as controls were positive. The serologic results did not correlate well with the presence of *Leptospira* DNA or organisms in the aqueous humor.

## NECROPSY FINDINGS

**Acute bovine leptospirosis** is characterized by anemia, jaundice, hemoglobinuria and subserosal hemorrhages. There may be ulcers and hemorrhages in the abomasal mucosa. Pulmonary edema and emphysema are also common in this species. Histologically, there is focal or diffuse **interstitial nephritis**, **centrilobular hepatic necrosis** and in some cases, vascular lesions in the meninges and brain in subacute to chronic infections. Leptospirae may be

visible in silver-stained sections, especially in the proximal convoluted tubules of the kidney. In acute infections there may be minimal inflammation, with only **hemoglobin-filled renal tubules** and centrilobular hepatic necrosis evident microscopically.

In the later stages, the characteristic finding is a progressive interstitial nephritis manifested by small, white, cortical foci which are initially raised but become slightly depressed as the lesion ages. Many clinically normal cattle presented to abattoirs have these lesions, which may represent sequela to episodes of bacteremia from a variety of pathogens and should not be considered pathognomonic for leptospirosis.<sup>74,75</sup>

**Aborted bovine fetuses** are usually autolyzed to the point where no lesions or bacteria can be demonstrated. Even in a fresh fetus the positive identification of leptospirae in lesions is not an easy task. Culture of these organisms is difficult – *L. interrogans* serovar *hardjo* is particularly fastidious in its cultural requirements. The use of a fluorescent antibody technique assists in the demonstration of organisms but false-positives are common unless the test is interpreted by an experienced diagnostician. Dark-field microscopy may be attempted but is not well-suited to tissues collected at necropsy. PCR techniques show considerable promise, although sample processing requirements are stringent and the use of multiple primer sequences may be required in some cases.<sup>46,76</sup> Immunoperoxidase techniques are highly useful in the demonstration of leptospirae in formalin-fixed tissues, although this test is not serovar specific. Traditional silver-based staining of fixed material is also successful in a few cases. Antibodies to leptospirae are detectable in the serum of some aborted fetuses.<sup>3</sup>

Gross placental lesions in cases of **equine abortion and stillbirth** associated with leptospirosis include nodular cystic allantoic masses, diffuse edema, and areas of necrosis with a mucoid exudate on the chorionic surface. The liver is enlarged, mottled and pale-red to yellow. The kidneys are swollen and edematous with pale, radiating streaks in both cortex and medulla. Microscopic changes may include a suppurative and non-suppurative nephritis, dissociation of hepatocytes, a mixed leucocytic infiltration of portal triads, a giant cell hepatopathy, pneumonia and myocarditis. Thrombosis, vasculitis and a mixed population of inflammatory cells are evident in the placenta.<sup>55</sup> A variety of tests, as described for cattle, are available to try to confirm the diagnosis.

**Aborted piglets** are usually severely autolytic, with blood-stained fluid in the subcutis and filling the body cavities.

Multiple necrotic foci, 1–4 mm in diameter and irregular in outline, are found in the liver of approximately 40% of aborted fetuses. Microscopic inflammatory changes may also be found in the kidneys. The fetal membranes are thick and edematous. Leptospirae can be demonstrated utilizing the battery of tests already mentioned for cattle.

## Samples for confirmation of diagnosis

- **Bacteriology** – chilled kidney, liver, placenta (CULT (has special growth requirements), FAT, PCR)
- **Histology** – formalin-fixed kidney, liver, brain, heart, lung, placenta (LM, IHC)
- **Serology** – heart-blood serum or pericardial fluid from fetus (MAT).

**The zoonotic potential of this organism should be noted when handling carcasses and submitting specimens.**

## DIFFERENTIAL DIAGNOSIS

The differential clinical diagnosis of the common forms of leptospirosis in each species is as follows:

### Cattle

- Acute leptospirosis – must be differentiated from those diseases causing hemolytic anemia with or without hemoglobinuria (Table 20.4). They include: Babesiosis; anaplasmosis; rape and kale poisoning postparturient hemoglobinuria; bacillary hemoglobinuria
- Chronic leptospirosis causing abortion – must be differentiated from all other causes of abortion in cattle (Table 18.7). Most diagnostic surveys reveal that a specific cause is identifiable in only about 30% of fetuses submitted to a diagnostic laboratory. The vaccination history of the aborting cattle is a crucial part of the history since, for example, outbreaks of abortions due to infectious bovine rhinotracheitis occur primarily in unvaccinated cows. The specific causes of abortion in cattle vary depending on geographical location. Other common causes of abortion in cattle include: infectious bovine rhinotracheitis; protozoal abortion (*Sarcocystis* sp., *Toxoplasma gondii* and *Neospora caninum*). Less common causes are: brucellosis; bovine virus diarrhoea; pine needle abortion; mycotic placentitis; campylobacter; *Actinomyces pyogenes*, ureaplasma
- Milk drop syndrome – characterized by a sudden drop in milk yield in up to 30–50% of the cows within several days. Must be differentiated from other causes of a decline in milk production of the herd including: (i) change of feed; (ii) change of management; and (iii) epidemic of infectious disease such as bovine respiratory disease.

**Pigs**

- Abortion in the last trimester – the common manifestation of leptospirosis in pigs and must be differentiated from all other causes of abortion, mummification and stillbirths in swine (Table 20.2). Other common causes of abortion in swine are: parvovirus; porcine reproductive respiratory syndrome. Less common causes are: brucellosis; pseudorabies; Stillbirth, Mummification, Embryonic death, Infertility (SMEDI) virus.

**Sheep and goats**

Chronic copper poisoning and poisoning caused by rape in sheep may present a clinical picture similar to that in leptospirosis but there will be no febrile reaction. Anaplasmosis associated with *Anaplasma ovis* may be accompanied by fever and hemoglobinuria but is more commonly a chronic, emaciating disease.

**Horses**

- Abortion, stillbirths, perinatal deaths of foals – *Streptococcus zooepidemicus*; *Salmonella abortus equina*; *Escherichia coli*; *Actinobacillus equuli*. Other bacterial infections: Equine herpes virus; Equine viral arthritis; fungal infections. Diagnosis depends on laboratory examination of fetal tissues and fluids including bacterial culture, direct fluorescent antibody test for equine herpes virus and leptospire, serologic examination of fetal fluids for leptospiral antibodies using the MAT and special stains to demonstrate leptospire in fetal tissues
- Isoimmune hemolytic anemia – within 36 hours after birth, there is weakness, hemoglobinuria, pallor, failure to suck, tachycardia, high case-fatality rate and cross-matching blood tests
- Infectious equine anemia – chronic relapsing fever, anemia, weakness, jaundice, edema, oral mucous membrane hemorrhages, Coggins serological test
- Exertional rhabdomyolysis – acute onset of stiff gait, weakness, sweating, distress, myoglobinuria, creatine kinase test
- Periodic ophthalmia differentiate from other causes of iridocyclitis of horses, and conjunctivitis, keratitis and hypopyon which may occur in equine viral arthritis.

**TREATMENT**

**Antimicrobial therapy.** The primary aim of treatment is to control the infection before irreparable damage to the liver and kidneys occurs. Treatment with dihydrostreptomycin preferably, or one of the tetracyclines, as soon as possible after signs appear is recommended. The results of treatment are often disappointing because in most instances animals are

**Table 20.4** Differential diagnosis of diseases of cattle characterized by acute hemolytic anemia with or without hemoglobinuria

Disease	Epidemiology	Clinical findings	Laboratory findings
Leptospirosis	All ages, cattle on pasture	Acute fever, red-colored milk. Hemoglobinuria abortion. May die in 24–48 hours	Leptospira titers
Postparturient hemoglobinuria	High-producing lactating cows 4–6 weeks postpartum	Acute. No changes in milk. No fever. Die in 12–48 hours. Marked hemoglobinuria	Hypophosphatemia
Bacillary hemoglobinuria	Usually mature cattle on summer pasture in enzootic area	Acute fever, abdominal pain. May die in 2–4 days. Hemoglobinuria	Leukopenia or leukocytosis
Babesiosis	Enzootic areas, tick-borne, young animals	Acute fever, jaundice, abortion, course of 2–3 weeks. Marked hemoglobinuria	Blood smear, complement fixation test, transmission tests
Anaplasmosis	Yearling and mature cattle, common in summer, insect-borne, common in feedlots	No hemoglobinuria, jaundice common, fever	Anaplasms on blood smear, complement fixation test
Chronic copper poisoning	Follows long-term oral administration of medicines or feeds containing copper	Severe jaundice. No fever. Hemoglobinuria	Toxic levels of copper in blood, liver and feces
Cold-water haemolytic anemia of calves	Following consumption of large quantities of cold water after period of limited intake	Sudden onset within 1 hour after ingestion. No fever. May die in few hours. Hemoglobinuria	Acute hemolytic anemia
Rape and kale poisoning	All ages of cattle on rape crop grown for fodder in fall	Peracute hemolytic anemia, may die in few hours after onset. No fever. Hemoglobinuria	Acute hemolytic anemia
Drug-induced	Some drug preparations when given intravenously	Mild hemoglobinuria. No hemolytic anemia	Nil
Blood transfusion reaction	Using blood from same donor more than 1 week after initial transfusion	Sudden onset, dyspnea, hiccoughs, trembling, responds to adrenalin	Nil

*The common causes of hematuria in cattle are pyelonephritis and cystitis due to Corynebacterium renale, non-specific cystitis and enzootic hematuria. Myoglobinuria occurs occasionally in young cattle affected with enzootic-nutritional muscular dystrophy and may be confused with hemoglobinuria.*

presented for treatment only when the septicemia has subsided. The secondary aim of treatment is to control the leptospiruria of 'carrier' animals and render them safe to remain in the group.

**Parenteral antimicrobials.** For infections due to pomona, dihydrostreptomycin (12 mg/kg BW IM twice daily for 3 d) is effective in the treatment of the systemic infection. For the elimination of leptospiruria in cattle and pigs, a single dose of dihydrostreptomycin (25 mg/kg BW IM) is recommended.<sup>77,78</sup> In an outbreaks in cattle the simultaneous treatment of all animals with dihydrostreptomycin at 25 mg/kg BW IM and vaccination has been successful in preventing new cases and abortion when pregnant cattle are involved. When the participation rate of dairy farmers in an area in the Netherlands was high, the combination of antimicrobial and vaccination was economical. A similar approach is recommended for outbreaks in swine. **Annual revaccination and regular serological testing**

for new infections, combined with controlling the source of new infections, will usually successfully control further outbreaks. A surveillance system in the area is necessary, however, to detect the introduction of new serotypes. Streptomycin is no longer available for use in the United States and long-acting oxytetracycline at 20 mg/kg BW is an alternative.<sup>64</sup> Oxytetracycline, tilmicosin, and ceftiofur are also effective for resolving leptospirosis in cattle.<sup>79</sup> For the treatment of *L. hardjo*, amoxicillin is also an alternative to streptomycin.<sup>80</sup>

Dihydrostreptomycin G (25 mg/kg BW IM for 1, 3, or 5 d), or oxytetracycline (40 mg/kg BW IM daily for 3 or 5 d), tylosin (44 mg/kg BW IM daily for 5 d), or erythromycin (25 mg/kg BW IM daily for 5 d) are all effective for treatment of persistent leptospirosis due to pomona in swine.<sup>81</sup>

In vitro studies indicate that leptospire are highly susceptible to ampicillin, amoxicillin, penicillin G, cefotaxime, erythro-

mycin, fluoroquinolone ciprofloxacin and have a good susceptibility to streptomycin, tylosin and tetracyclines. Doxycycline and penicillin G are effective in treating acute leptospirosis.

For outbreaks of **leptospiral abortion in horses**, treatment of pregnant mares with dihydrostreptomycin (50 mg/kg BW) IM daily for 3–5 d can minimize further abortions<sup>10</sup>; this treatment regimen however has not been extensively evaluated.

For **equine periodic ophthalmia**, most recommended treatments have little effect on the course of the disease. A course of a suitable antibiotic systemically, and the administration of a corticosteroid, either parenterally in an acute episode, or subconjunctivally in a chronic case, is most likely to be satisfactory. Nonulcerative keratouveitis require long-term and intensive medication, and recur with tapering of treatment.<sup>27</sup> Topical and subconjunctival corticosteroids are recommended in controlling nonulcerative keratouveitis. Intravitreal implantation of cyclosporine is effective.<sup>53</sup> Atropine eye ointment is also usually applied three times daily to maintain dilatation of the pupil.

**Antimicrobials in feed.** In groups of pigs, the feeding of oxytetracycline (800 g/t of feed for 8–11 d) is claimed to eliminate carriers. Antimicrobial feeding should begin 1 month before farrowing to avoid the occurrence of abortion. Other experimental trials using long-acting tetracycline by injection or tetracycline in the feed have been inconclusive and the use of mass feeding techniques as control programs should not be recommended lightly. Antimicrobial feeding has also been suggested as a preventive measure in calves. The feeding of small amounts of tetracyclines (3 mg/kg/d BW) for 7 d before and 14 d after exposure, prevents the appearance of clinical signs but not infection as measured by the agglutination-lysis reaction.

**Blood transfusions.** Blood transfusions (5–10 L/450 kg BW) are indicated as treatment for the hemolytic anemia in acute leptospirosis in cattle. The clinical indications for a blood transfusion include obvious pallor of the mucous membranes, weakness and tachycardia.

## CONTROL

### Biosecurity and biocontainment

On an individual farm, leptospirosis can be eradicated or controlled by vaccination. With the diagnostic tests available, the success of antimicrobial therapy in eliminating the carrier state, and the vaccines, it is now reasonable to attempt eradication of the disease from individual herds, and possibly from areas. The major risk is the introduction of carrier animals of any species, or by reintroduction of the infection

by rodents or other wildlife. It is because of this risk that most programs aim at containment rather than eradication. In these circumstances where only sporadic cases occur, it might be more profitable to attempt to dispose of reactors or treat them to insure that they no longer act as carriers.

The first step in control is to identify the source of the original source of infection and to interrupt transmission.<sup>2</sup> Sources of infection include clinically affected animals, aborted fetuses, placentas, carrier animals, wildlife, dogs and cats, and environmental sources such as water supplies. Education about leptospirosis is an effective method for reducing its incidence and its effects. Intensive well directed education and publicity campaigns in New Zealand, used in conjunction with a campaign for immunization of cattle, reduced the incidence of leptospirosis.<sup>2</sup> Groups to which educational efforts should be directed include professionals in human and veterinary medicine and public health, primary human and animal health care practitioners, wildlife and conservation scientists, water and sewage engineers and planners, health administrators and educators, and not least, the public at risk.

Risk-assessment and computer simulation models of the possible costs of infections due to *L. hardjo* have been developed to explore the risks and likely consequences to producers of the disease in dairy herds in the United Kingdom. Three main considerations are important when assessing the risks and likely financial implications of the disease to dairy producers:

1. Likelihood of a herd being infected
2. Likely effects of the disease on the dairy enterprise, both physically and financially, following the initial infection compared to a leptospirosis-free herd
3. Likely longer-term effects of the disease.<sup>37</sup>

The probability of infection of cattle by *L. hardjo* is increased by four factors:

1. Purchase of infected cattle
2. Co-grazing or common grazing with infected cattle or sheep
3. Use of natural service with an infected bull
4. Access of cattle to contaminated water such as streams, rivers, flood or drainage water.

Assessment of the risks facing different types of herds suffering losses from *L. hardjo* can then be used to help support decisions concerning control of the disease.

The major consequences of *L. hardjo* infection are milk loss and abortion in the dairy herd, and the risk of illness in man.

The financial losses associated with disease in a herd according to the presence of different risk factors can be estimated using a static risk model.<sup>37</sup> The cost of various control strategies can then be considered in the light of these expected costs which result from doing nothing to control the disease. A dynamic simulation model can be used to consider how the disease might develop in a dairy herd following initial infection and over the next few years.

Producers with one or more of the main risk factors should consider strategies which (i) directly remove or diminish those risk factors or (ii) indirectly diminish their importance for the herd, for example, by vaccination. Strategies which successfully diminish one or more of the risk factors, but leave one other will yield little benefit due to the importance of each of the identified risk factors.

Vaccination is one strategy which can diminish all of the risk factors and provide some degree of assurance against potentially high and costly disease losses. Producers with high-risk herds are likely to choose vaccination. The dynamic simulation model estimates that the cost of endemic disease can be relatively high and that some form of vaccination strategy would be cost-effective. If a herd continues to have any of the risk factors, then whole-herd vaccination is likely to be the preferred option, since the disease could otherwise easily be reintroduced. Decision tree analysis of leptospirosis vaccination in beef cattle in Australia indicates that the beneficial economic effects of vaccination depend on the value of the calf and the probability of calf loss due to leptospirosis.

**Artificial insemination centers.** Bulls destined for artificial insemination centers must be free of antibody to *hardjo*, *grippotyphosa*, *canicola*, *pomona*, *sejroe*, and *icterohaemorrhagiae* at a final serum dilution of 1:100 in the MAT. However, since animals with leptospirosis may not have a serum titer, it is possible that the semen of serologically negative but infected bulls may contain leptospires. Culture of leptospires is difficult, costly and time consuming. A PCR assay has been developed to detect pathogenic leptospires in the semen and urine of infected bulls<sup>71</sup> (see Clinical pathology).

## Eradication

### Detection and elimination of carrier animals presents some difficulties.

Positive reactors to the MAT do not necessarily void infective urine and to determine their status as carriers necessitates repeated examination of the urine for the organism. For practical purposes, serologically suspicious and positive reactors should be considered carriers and culled or treated as described above.

In groups of pigs, it should be assumed that infection is herd-wide and all pigs should be treated as though they were carriers. In these circumstances, the feeding of antimicrobials provides some protection, although it is not guaranteed to eliminate the carrier state. Leptospirosis has been eradicated from commercial pig herds by treating all pigs with dihydrostreptomycin at 25 mg/kg BW IM at one time. However, if the pigs have been exposed to heavy infection, not all of them are completely cleared of leptospirosis, and further treatment will be necessary.

In cattle herds, if the bulls are infected they should not be used naturally or for artificial insemination even though the antimicrobials in the semen diluent is sufficient to insure that no spread occurs. Elimination of infection can be difficult, especially in large commercial herds in an endemic area in which replacement cows and bulls are introduced from sales yards and cattle mingle with other herds on range. Eradication of **hardjo** is a possibility in purebred herds in which intensive measures are economically feasible and owners should be urged to undertake a program to eliminate leptospirosis from the herd and to prevent its entry. The following measures can be taken to eliminate hardjo infection:

1. Judicious combination of group serological testing
2. Segregation of age classes
3. Selective vaccination
4. Possibly artificial insemination
5. Determination of the cause of reproductive failures
6. Isolation of the herd from outside sources of infection.

Bulls suspected of spreading infection should be treated to reduce the level of urinary shedding regardless of subsequent vaccination. Exposure of cattle to herds, heavily infected with leptospirosis, for example, on communal grazing pastures should be avoided. The herd should be monitored periodically, coincident with other serological testing. In endemic areas, all cattle over 6–9 months of age should be vaccinated, and vaccination should be continued for up to 5 years to minimize the number of susceptible cattle until no long-term shedders remain in the herd.

Simple management procedures to limit the infection in beef cows until their second calves are born, and the culling of older carriers can greatly decrease and possibly eradicate the infection from a herd. Virgin yearling bulls are used on virgin yearling heifers, and young cows are segregated from older cows until 38–39 months of age, when they go to pasture after being bred, with their second calf. This delays direct exposure of heifers to infected cattle until

their third breeding. These practices must be combined by monitoring infection by serological and other laboratory methods.

If eradication is attempted and completed, introduced animals should be required to pass a serological test on two occasions at least 2 weeks apart before allowing them to enter the herd. Urine examination for leptospirae should be carried out if practicable.

### Occupational hygiene

Occupational hygiene is important for prevention of leptospirosis wherever the disease is known to occur predominantly in certain occupational groups. Exposure to risk is unavoidable in people whose livelihoods depend on rice planting or farming, sugar cane cutting, work in tropical forests, keeping peridomestic pigs, building or maintaining drains or sewers, milking cows, and slaughtering or herding pigs or cattle. Occupational hygiene is concerned with means of minimizing the risks, by employing measures to reduce direct or indirect contact with animals which might be infected.

Control of the source of the organism is achieved by appropriate hygienic strategies. If the environmental sources of infection are identifiable, in the form of yards, marshes and damp calf pens, every attempt must be made to avoid animal contact with these infective surroundings. In dairy farming areas where human leptospirosis comes from cattle, milkers and transporters should be protected. The main measures available are immunization of cattle and pigs, education, and modification of work practices, including protective clothing. It is important to avoid urine splash. Cows should be handled calmly to minimize urination in the milking sheds. Sheds and yards should be hosed out so as to avoid aerosol and splash from urine on the floors. Herdspeople and milkers must be made aware of the risks of infection from mud contaminated with urine. Wet areas should be drained or fenced and pens disinfected after use by infected animals. The possibility that rats and other wild animals may act as a source of infection suggests that contact between them and farm animals should be controlled.

Meat industry workers are at high risk during the examination and dressing of carcasses. The dangerous parts of carcasses are the bladder, urine and kidneys. Handling bovine or porcine kidneys with bare hands is especially risky and rubber gloves should be worn. Wearing protective clothing in abattoirs is not well accepted because speed is paramount and gloves are an impediment. Nevertheless it offers protection.

### Control of clinical disease by immunization

A control program to limit the occurrence of clinical disease is achieved by vaccination to maintain a high level of immunity in herd.

#### Vaccination

Vaccination against leptospirosis in cattle and swine is in general use and an effective method for control of the disease. In New Zealand, a publicity campaign to promote the widespread vaccination of cattle resulted in a marked reduction in the incidence of human leptospirosis. Most of the vaccines are formalin-inactivated bacterins containing one or more serotypes. Vaccines containing Freund's complete adjuvant induce higher serological responses but not necessarily superior protection. The immune response is serotype-specific and protection is dependent on the use of bacterins containing serotypes prevalent in the area. The bacterins induce a low titer to the MAT which appears early and declines after several weeks; however, protective immunity against the disease and renal infection persists for at least 12 months in cattle. Regular serological testing in herds vaccinated annually can be used to monitor new infections since these will induce a titer to the MAT. However, neither the CFT nor the MAT can reliably differentiate serological responses in cattle following leptospiral vaccination from those following natural infections.

#### Cattle

The difficulty of keeping purebred herds free of hardjo infection increases as the reservoir of infection increases. Several control measures can be applied especially in large herds which are at high risk. In endemic areas, transmission in commercial herds can be suppressed by annual vaccination of bulls, replacement heifers, and 2- and 3-year-old females a few weeks before release of the bulls. A cow which fails to carry a calf to term, or that produces a dead or weak calf, should be culled. Potential replacement heifer calves should be handled and raised in segregation from the adult herd after weaning and vaccinated a month before exposure to older cattle. Herd sires should be purchased from uninfected herds or at least purchased subject to a negative serological test.

Vaccination as part of a herd health program should start with the calves at 4–6 months of age, followed by revaccination annually. Such programs should provide significant rises in calving rates, but have little or no effect on perinatal or postnatal losses.

Bovine leptospiral vaccines and their efficacy

Many vaccines are available but there is conflicting evidence about their efficacy. A pentavalent leptospiral vaccine containing hardjo-bovis did not protect cows from experimental infection with hardjo-bovis. Vaccination of cattle with a pentavalent leptospiral vaccine containing either hardjo-bovis or hardjo-prajitno failed to protect cattle from experimental infection with hardjo-bovis 6 months after vaccination.<sup>10</sup> The hardjo-bovis vaccine is more antigenic than the hardjo-prajitno as measured by higher antibody titers in vaccinated animals. Calves as young as 4 weeks of age, vaccinated in the presence of maternally derived antibody can be fully protected against homologous virulent challenge.

**Vaccine antigens.** Most bovine leptospiral bacterins contain the reference strain hardjo-prajitno. However, North American cattle are predominantly infected with hardjo-bovis. DNA probe techniques can be used to identify animals infected with hardjo-bovis which enables diagnosticians to correctly diagnose infection in animals which have been previously vaccinated. Serovar hardjo-prajitno is used to prepare the hardjo component of pentavalent, whole-cell, leptospiral vaccines. The hardjo component of whole cell leptospiral vaccines is a weak immunogen, as evidenced by low-serum agglutinating antibody titers in vaccinated cattle and short duration immunity. Restriction endonuclease analysis of Australian and New Zealand isolates of *L. pomona* reveal that most closely resemble the serovar kennewicki reference strain, and all differed from the reference strain of serovar pomona. This suggests that vaccine manufacturers should consider using the genotypes which are most prevalent in cattle and pigs. In New Zealand, a trivalent vaccine containing inactivated *L. borgpetersenii* serovar hardjo Hardjobovis, *L. pomona* and copenhageni has been developed and tested for efficacy and potency in cattle.

Leptospiral vaccines used in cattle in the United States are inactivated whole-cell vaccines containing *L. interrogans* serovar hardjo (type hardjoprajitno), canicola, pomona, and icterohemorrhagiae and *L. kirschneri* serovar grippotyphosa. These pentavalent vaccines provide adequate protection against disease associated with each of the serovars in the vaccine except serovar hardjo. They have failed to prevent abortion, stillbirth, and vertical transmission of infection when vaccinated cows were challenged with *L. borgpetersenii* serovar hardjo during pregnancy, and the infection rates for control and vaccinated cattle did not

differ. Attempts to improve the protection against *L. borgpetersenii* serovar hardjo by including *L. borgpetersenii* serovar hardjo in a pentavalent vaccine or by increasing the quantity of serovar hardjo antigen in a monovalent serovar hardjo vaccine failed. However, monovalent vaccines with a field isolate of *L. borgpetersenii* serovar hardjo and another with *L. interrogans* serovar hardjo found these vaccines prevented infection and colonization following challenge with *L. borgpetersenii* serovar hardjo strains from the United States and Europe.<sup>10</sup>

A protective killed vaccine against serovar hardjo induced a strong, sustained Th1 or cell-mediated response.<sup>10</sup> The vaccine is composed of a whole-cell bovine isolate of *L. borgpetersenii* serovar hardjo and aluminum hydroxide and is given as two doses subcutaneously 4 weeks apart.<sup>49</sup> Following vaccination, a type 1 (Th1) cell-mediated response occurred characterized by the production of gamma interferon cells including CD4<sup>+</sup> and WC1 gamma delta T-cells. Vaccinated animals had twofold-more IgG2.

A monovalent *L. borgpetersenii* serovar hardjo (type hardjo-bovis) vaccine commercially available in Australia, New Zealand, Ireland, and the UK, given as two doses, 4 weeks apart, protected heifers against renal colonization and urinary shedding when challenged with *L. borgpetersenii* serovar hardjo strain 203 four months after vaccination.<sup>82</sup> None of the animals shed leptospires in their urine, or kidneys at necropsy. In contrast, all nonvaccinated control heifers became infected with serovar hardjo and shed organisms in their urine. A monovalent US reference hardjo vaccine failed to prevent infection, renal colonization, and urinary shedding in cattle challenged with *L. borgpetersenii* serovar hardjo.<sup>82</sup> The reference vaccine was prepared with *L. borgpetersenii* serovar hardjo (type hardjo-bovis) rather than *L. interrogans* serovar hardjo (type hardjoprajitno), which is used in many cattle leptospiral vaccines available in the US, because *L. borgpetersenii* serovar hardjo is the organism which infects cattle in the US.<sup>82</sup>

Two monovalent Hardjo vaccines provided protection from infection against *L. borgpetersenii* serovar hardjo while a pentavalent vaccine containing the Hardjo organisms did not.<sup>76</sup> The protective monovalent vaccines produced strong cell-mediated immune responses in vaccinated cattle as demonstrated by proliferation of lymphocytes and production of IFN-gamma by their peripheral blood mononuclear cells in response to culture with serovar Hardjo antigens. This response is generally much lower or absent in antigen-stimulated cultures of PBMC from cattle vaccinated with the

pentavalent vaccine and nonvaccinated cattle.

In conclusion, protective immunity to serovar Hardjo correlates with induction of a substantial immune response that is characterized by antigen-specific IFN-gamma-producing T-cells, IgG1 and IgG2 antibodies which react with antigens common between serovars as well as antibodies that are largely serovar-specific and agglutinate leptospires through reactivity with surface lipopolysaccharide. These results contrast with those induced by pentavalent vaccines that have a superior ability to induce antibodies that agglutinate all the serovars of leptospires included in their formulation with the exception of serovar hardjo.

There is no cross-immunity between *L. pomona* and hardjo, and in areas where both diseases occur, a bivalent vaccine is used routinely. If separate vaccines are used the *L. pomona* vaccine should be administered at least once annually, but the *L. hardjo* vaccine provides some protection against *L. szwajizak*.

**Vaccination of calves less than 3 months of age** is unlikely to be effective and is not recommended, but vaccination of cows in late pregnancy gives effective immunity to their calves.

**Swine.** Vaccination of sows and gilts before breeding with a bivalent vaccine, containing pomona and tarassovi, protects them against infection and the development of leptospiuria and is widely practiced, especially in large intensive piggeries. In the United-States, vaccination of gilts and sows with two doses of a bacterin containing five or six leptospiral serovars, one of which contained bratislava, before the first breeding and thereafter before each breeding improves reproductive performance. *L. bratislava* is an important cause of abortions in sows in North America and Europe and vaccination is effective. Vaccination of pregnant gilts and sows can provide protection to the piglets for the first several weeks after birth.

**Vaccination and antimicrobial strategies.** Whether or not to vaccinate depends upon the cost of the procedure relative to the losses which can be anticipated. If the disease is spreading rapidly, as evidenced by the frequent appearance of clinical cases, a high range of titers or rising titers in a number of animals, (i) all clinical cases and positive reactors should be treated; (ii) the negative animals vaccinated; and (iii) the herd moved on the first day of treatment to a clean field. Retesting a group to determine the rate of spread would be an informative procedure but active measures must usually be commenced before this information is available. Another variation

of this program, and a highly practical one, is the vaccination of all cattle in the herd, and the treatment with one dose of dihydrostreptomycin (25 mg/kg BW IM) of all pregnant cows to eliminate renal infection and leptospiuria. However, antimicrobial therapy is not highly efficacious, especially in cattle infected with hardjo.

A successful control strategy has been described for hardjo infection in a large, closed beef herd. All animals were treated with dihydrostreptomycin at 25 mg/kg BW IM once followed by removal to a clean pasture to prevent new cases, and annual vaccination of the whole herd for 5 years. All cattle introduced into the herd were treated with the antimicrobial and quarantined; at the end of the trial the entire herd was treated prophylactically with the antimicrobial to minimize the risk of residual infection. By the end of the trial all young stock entering the breeding program were seronegative. There was serological evidence of a high level of control and bacteriological monitoring at the end of the trial indicated that hardjo had been eliminated from the herd.

Vaccination is also recommended to protect animals continuously exposed to infection from wildlife, other domestic species, and rodents. The serological status of these groups can also be determined as necessary before a decision is made to vaccinate.

If only sporadic cases occur, it may be more profitable to attempt to dispose of reactors or treat them to insure that they no longer act as carriers. A degree of immunity is likely to occur in pigs after natural infection and when the disease is endemic, 'herd immunity' may significantly decrease incidence of clinical disease.

One of the theoretical disadvantages of vaccination is the possible development of renal carrier animals which are sufficiently immune to resist systemic invasion but not colonization of the kidney, which leads to the development of a carrier animal with transient leptospiuria. This may occur but not sufficiently frequently to invalidate vaccination.

## REVIEW LITERATURE

- Ellis WA. Leptospirosis as a cause of reproductive failure. In: *Diagnosis of abortion*. Vet Clin North Am Food Anim Pract 1994; 10:463–478.
- Smith CR, Ketterer PJ, McGowan MR, Corney BGA. Review of laboratory techniques and their use in the diagnosis of *Leptospira interrogans* serovar hardjo infection in cattle. *Aust Vet J* 1994; 71:290–294.
- Faine SB, Adler CA, Bolin CA, Ferlat P. *Leptospira and leptospirosis*, 2nd edn. Melbourne: MedSci Press, 1999.
- Marshall RB, Manktelow BW. Fifty years of leptospirosis research in New Zealand: A perspective. *NZ Vet J* 2002; 50: 61–63.
- O'Keefe JS. A brief review on the laboratory diagnosis of leptospirosis. *NZ Vet J* 2002; 50: 9–13.
- Bharti, AR, Nally JE, Ricaldi JN et al. Leptospirosis: a

zoonotic disease of global importance. *Lancet Infect Dis* 2003; 3:757–771.

- Adler B, Pena-Moctezuma de la A. *Leptospira*. In: Gyles CL, Prescott JF, Songer JG, Thoen CO (eds). *Pathogenesis of bacterial infections in animals*, 3rd edn. Oxford: Blackwell Publications 2004, pp. 385–396.
- Levett PN. Leptospirosis: A forgotten zoonosis? *Clin Appl Immunol Rev* 2004; 4:435–448.

## REFERENCES

- Kmety E, Dikken H. Classification of the species *Leptospira interrogans* and history of its serovars. Groningen, The Netherlands: University Press, 1993.
- Faine SB et al. 1999; *Leptospira and leptospirosis*, 2nd edn. Melbourne: MedSci Press.
- Ellis WA. *Vet Clin North Am Food Anim Pract* 1994; 10:463.
- Niang M et al. *Prev Vet Med* 1994; 18:259.
- Rocha T. *Rev Sci Tech* 1998; 17:699.
- Cerri D et al. *Microbiologica* 2003; 26:383.
- Adler B, Pena-Moctezuma de la A. *Leptospira*. In: Gyles CL, Prescott JF, Songer JG, Thoen CO (eds). *Pathogenesis of bacterial infections in animals*, 3rd edn. Oxford: Blackwell Publications, 2004, pp. 385–396.
- Langoni H et al. *Prev Vet Med* 1999; 40:271.
- Feresu SB et al. *Int J Syst Bact* 1998; 48:207.
- Naiman BM et al. *Infect Immun* 2001; 69:7550.
- Corney B. G et al. *Aust Vet J* 1996; 73:75.
- Guitian FJ et al. *Vet Microbiol* 2001; 80:275.
- Alonso-Andicoberly C et al. *Prev Vet Med* 2001; 52:109.
- Lilenbaum W, Souza GN. *Res Vet Sci* 2003; 75:249.
- Black PF et al. *Aust Vet J* 2001; 79:344.
- Miller DA et al. *Am J Vet Res* 1991; 52:1761,1766.
- Burriel AR et al. *Vet Rec* 2003; 153:146.
- Ozdemir V, Erol E. *Vet Rec* 2002; 150:248.
- Wilson PR et al. *NZ Vet J* 1998; 46:131.
- Gerritsen MJ et al. *Am J Vet Res* 1994; 55:1232.
- Ellis GR et al. *Aust Vet J* 1994; 71:203.
- Choi C et al. *Vet Rec* 2001; 148:416.
- Neto JSF et al. *Prev Vet Med* 1997; 31:87.
- Boqvist S et al. *Theriogenology* 2002; 58:1327.
- Van Til LD, Dohoo IR. *Can J Vet Res* 1991; 55:352.
- Boqvist S et al. *Vet Microbiol* 2003; 93:361.
- Wada S et al. *Vet Ophthalmol* 2003; 6:191.
- Donahue JM, Williams NM. *Vet Clin North Am Equine Pract* 2000; 16:443.
- Kinde H et al. *Equine Vet J* 1996; 28:327.
- Lees VW, Gale SP. *Can Vet J* 1994; 35:635.
- Barwick RS et al. *Prev Vet Med* 1998; 36:153.
- Rocha T et al. *Res Vet Sci* 2004; 76:199.
- Bender, LC, Hall PB. 1996; *J Wildlife Dis* 32:121.
- Webster JP et al. *Epidemiol Infect* 1995; 114:195.
- Mikaelian I et al. *Can Vet J* 1997; 38:440.
- Leonard F et al. *Vet Rec* 1992; 131:53.
- Bennett RM. *Vet Rec* 1993; 132:59.
- Bharti AR et al. *Lancet Infect Dis* 2003; 3:757.
- Levett PN. *Clin Appl Immunol Rev* 2004; 4:435.
- Marshall RB, Manktelow BW. *NZ Vet J* 2002; 50:61.
- Talapada MD et al. *Vector Borne Zoonotic Dis* 2003; 3:141.
- Thornley CN et al. *Epidemiol Infect* 2002; 128:29.
- Belmaker I et al. *Isr Med Assoc J* 2004; 6:24.
- Campagnolo ER et al. *J Am Vet Med Assoc* 2000; 216:676.
- Simon MC et al. *Vet Rec* 1999; 144:287.
- Uzal FA et al. *Vet Microbiol* 2002; 86:369.
- Smith CR et al. *Aust Vet J* 1997; 75:822.
- Kalsow CM et al. *Ocul Immunol Inflamm* 1998; 6:239.
- Naiman BM et al. *Infect Immun* 2002; 70:6147.
- Dhaliwal GS et al. *Vet Rec* 1996; 139:110,139.
- Dhaliwal GS et al. *Vet Rec* 1996; 138:272.

- Guitian J et al. *J Am Vet Med Assoc* 1999; 215:515.
- Donahue JM et al. *J Vet Diag Invest* 1995; 7:87.
- Heinemann MB et al. *Vet Microbiol* 2000; 73:261.
- Poonacha KB et al. *Vet Pathol* 1993; 30:362,369.
- Williams DM et al. *Equine Vet J* 1994; 26:105.
- Giles RC et al. *J Am Vet Med Assoc* 1993; 203:1170.
- Divers TJ et al. *J Am Vet Med Assoc* 1992; 201:1391.
- Bernard WV et al. *J Am Vet Med Assoc* 1993; 203:276.
- O'Keefe JS. *NZ Vet J* 2002; 50:9–13.
- Surujballi O, Mallory M. *Can J Vet Res* 2004; 68:1.
- Yan KT et al. *Vet Microbiol* 1999; 69:173.
- Woodward MJ et al. *Vet Rec* 1997; 141:603.
- Bolin CA, Alte DP. *Bov Pract* 1999; 33:50.
- Leonard FC et al. *Vet Rec* 1995; 131:435.
- Leonard FC et al. *Res Vet Sci* 1993; 55:195.
- Dhaliwal GS et al. *Res Vet Sci* 1996; 60:157,163.
- Wagenaar J et al. *Am J Vet Res* 2000; 61:316.
- Richtzenheim LS et al. *Vet Microbiol* 2002; 87:139.
- Vesulapalli R et al. *J Vet Diag Invest* 2005; 17:67.
- Mamari SA et al. *Can J Vet Res* 1999; 61:15.
- Heinemann MB et al. *Aust Vet J* 1999; 77:32.
- Faber NA et al. *J Clin Microbiol* 2000; 38:2731.
- Yener Z, Keles H. *J Vet Med A Physiol Pathol Clin Med* 2001; 48:441.
- Uzal A et al. *Vet Microbiol* 2002; 24:369.
- Brown RA et al. *Vaccine* 2001; 21:4448.
- Parma AE et al. *Vet J* 1997; 153:75.
- Gerritsen MJ et al. *Am J Vet Res* 1994; 55:339.
- Alt DP et al. *J Am Vet Med Assoc* 2001; 219:636.
- Smith CR et al. *Aust Vet J* 1997; 75:818.
- Alt DP, Bolin CA. *Am J Vet Res* 1996; 57:59.
- Bolin CA, Alt DP. *Am J Vet Res* 2001; 62:995.
- Gilger BC et al. (2001) *Am J Vet Res* 62:1892.

## BORRELIOSIS (LYME BORRELIOSIS, LYME DISEASE)

### Synopsis

**Etiology** Spirochete, *Borrelia burgdorferi*  
**Epidemiology** Occurs in United States, Europe, Asia, Australia, in cattle, sheep, horses, dogs and humans. Transmitted from small wild animals which are reservoirs of organisms by *Ixodes* spp. ticks. Principal hosts are the white-footed mouse; the cottontail rabbit and jack rabbit are also known carriers. The adult tick feeds on deer, horses, cattle and dogs

**Signs** In horses: chronic weight loss, sporadic lameness, persistent fever, swollen joints, muscle stiffness, depression, anterior uveitis, neurological signs, abortion and weak foals. In cattle and sheep: polyarthritis, chronic weight loss, fever  
**Clinical pathology** Serological tests (indirect immunofluorescent antibody test (enzyme-linked immunosorbent assay) (ELISA))

**Lesions** Polysynovitis, lymphadenopathy, emaciation, interstitial myocarditis, nephritis, meningoencephalitis

**Differential diagnosis list** Other diseases causing muscle stiffness, lameness, polyarthritis, lymphadenopathy.

**Treatment** Tetracyclines and penicillin  
**Control** No available methods

## ETIOLOGY

*B. burgdorferi*, a spirochete, is the causative agent.<sup>1</sup>

## EPIDEMIOLOGY

### Occurrence and prevalence of infection

The disease has been described in cattle,<sup>2</sup> horses,<sup>3</sup> sheep,<sup>4</sup> dogs,<sup>5</sup> and is now considered one of the most common vector-borne infections in humans in the United States.<sup>1</sup> Lyme disease has been recognized in Canada,<sup>6</sup> Europe,<sup>7</sup> Asia, Australia, and in the countries of the former USSR.<sup>1</sup> In the United States, the infection is primarily found in three regions: the northeast (from Massachusetts to Maryland); the midwest (in Wisconsin and Minnesota); and the northwest (in California and Oregon). The disease occurs most commonly in areas with an appropriate density of the insect vector, intermediate hosts, and the environmental conditions favoring transmission. Much of the available information on borreliosis is based on serological studies which must be interpreted carefully because clinical disease is not common.

#### Cattle

Seroprevalence studies of cattle in the United Kingdom indicate that the seropositivity rate increased from 44% to 67% after the cattle were turned out to pasture<sup>8</sup> and the seropositivity rate was higher in cattle with digital dermatitis (71%) than in cattle without the lesions (7.3%). The proportion of seropositive cows increases with age and also following grazing. None of the housed cattle were seropositive. In Japan, the seroprevalence of infection varies from 8–15% and is higher during the summer months; cows with arthritis have higher titers to the organism than healthy cows.<sup>9</sup> Similar observations have been made in dairy cows in Minnesota<sup>10</sup> and Wisconsin in areas with endemic *B. burgdorferi* infections.<sup>11</sup> In Wisconsin, the peak seasonal incidence of clinical disease in horses and cattle occurs in May and June, and October which correlates with emergence of *I. dammini* in the spring, usually March and April, and again in September.<sup>3</sup>

#### Sheep

Seroprevalence studies in sheep infested with *Ixodes ricinus* in Scotland indicate an infection rate in lambs of 2.7%, 24–40% in young sheep and 0–6% in ewes.<sup>12</sup> There is also evidence for transmission of Lyme disease to sheep in Cumbria in the United Kingdom, grassland and heath communities where wild fauna are uncommon and sheep are believed to be the main host for all feeding stages of the tick.<sup>13</sup> However, there was no evidence of clinical disease associated with the infection. Serological surveys of infection in sheep in Norway indicate that 10% of animals tested are seropositive by the

ELISA with a range of 0–20% between counties.<sup>4</sup> The distribution of seropositive animals correlated with the known distribution of *I. ricinus* with the highest proportion of seropositive animals being in southern coastal areas of Norway. The majority of animals appear to become infected during the first 2 years of life; the animals were all healthy at the time of sampling.

#### Horses

A large percentage of adult horses in the more eastern parts of the northeastern and mid-Atlantic United States are or may have been infected with *B. burgdorferi*.<sup>3</sup> In tick-infested areas of Connecticut in the United States, horses may have serum antibodies to both *B. burgdorferi* and *Ehrlichia equi*.<sup>14</sup> Serological surveys of horse populations in the United States revealed that in the New Jersey–Pennsylvania area, approximately 10% of horses have significant serum antibody titers to the organism.<sup>15</sup> Appearance of the organism appears to be uncommon in horses in Texas, where infection does not occur.<sup>16</sup> In Cape Cod horses, the seroprevalence was 35%, which is age-specific and considered to be a reflection of exposure because of the relative absence of disease.<sup>17</sup> It was found that 7–13% of horses admitted to a veterinary teaching hospital were seropositive to the organism and the frequency of antibody response varied according to the geographical origin of the horses.<sup>18</sup> Lyme disease in the horse is rare but it is clinically important in the United Kingdom.<sup>19</sup> In areas where the disease occurs in humans, the seroprevalence of infection in horses was 49% compared to 3–4% in horses from other areas.<sup>20</sup> Horses with unexplained lameness associated with fever and tick infestation had high levels of antibody to the organism. Within endemic areas, up to 60% of mares and yearlings on one farm were serologically positive. On such farms, there may be a clustering of clinical cases in foals after weaning. However, there is no evidence that abortion in mares is associated with infection.<sup>21</sup>

#### Wildlife

In Ontario, epidemiological studies indicate a widespread but low level or scattered distribution of infection in wildlife reservoirs in southern Ontario, with occasional spillover into human and canine populations.<sup>6</sup> Serologically, the organism was found to be circulating in populations of white-footed mice, field mice, and white-tailed deer.

#### Zoonotic implications

Lyme borreliosis was first recognized when a cluster of suspected juvenile rheumatoid arthritis cases occurred

among residents of Lyme, Connecticut.<sup>22</sup> An arthropod-transmitted disease was suspected as the etiologic agent because in addition to recurrent, short-lived joint pain, patients had an expanding, red, annular rash resembling erythema chronicum migrans similar to a lesion identified in Europe in the early 20th century associated with tick bites and was responsive to penicillin. An infectious cause was confirmed when spirochetal bacteria isolated from *Ixodes* ticks and blood, CSF, and other tissues of patients were shown to be identical. Subsequently, *B. burgdorferi* was identified in ticks in numerous regions of the United States, and infection was associated with clinical disease in other animals including dogs and horses.

The disease has been recognized in man in most areas of the United States and in at least 20 countries spanning every continent.<sup>23</sup> The literature on Lyme borreliosis in humans has been reviewed.<sup>24,25</sup> In the United States, the northeastern states of Connecticut, Massachusetts and New York; the mid-western states of Wisconsin, Minnesota, Michigan, Illinois, and Indiana; and the western states of California and Nevada are considered as the most endemic areas, especially in wooded and grassy parts of these regions.

Lyme borreliosis is the most common tick-transmitted disease of humans in the northern hemisphere.<sup>24,25</sup> In 2000, in the United States, 17 730 cases of Lyme borreliosis were reported nationwide.<sup>22</sup> The geographical prevalence of borreliosis in man and animals is related to the distribution of the various *Ixodes* spp. of hard ticks and the location of herds of deer, which are preferred hosts for the ticks. Geographical areas with dense vegetation and high humidity promote the development of the tick. Risk of infection is correlated with the opportunity of being bitten by an infected tick and dependent on the density of vector ticks in an endemic area, the proportion of ticks infected, and the duration and extent of the susceptible host's activities in that area.

#### Methods of transmission

The principal hosts for *B. burgdorferi* are rodents such as the white-footed mouse, *Peromyscus leucopus*. The cottontail rabbit in the eastern United States and the jack rabbit in California can also serve as hosts. It is suggested that migrating birds acting as carriers may account for the widespread nature of the infection in a country.

The spirochete is transmitted by *Ixodes* ticks including *Ixodes scapularis*, the deer tick, in the northeastern and midwestern United States, *Ixodes pacificus*, the western



black-legged tick, in the western United States,<sup>22</sup> *Ixodes ricinus* the sheep tick in Europe, and *Ixodes persulcatus* in Asia.<sup>1,6</sup> The lifecycle of the deer tick is 2 years and includes the stages of egg, larvae, nymph and adult. The white-footed mouse is the primary rodent which infects the tick. During the larval stage, the tick will feed on an infected mouse. Both immature stages of the tick feed on the white-footed mouse which makes the life cycle of the organism dependent on horizontal transmission from infected nymphs to mice in the early summer and from infected mice to the larvae in late summer. The white-footed mice are susceptible to oral infection and transmit the infection to each other by direct contact.<sup>26</sup> The white-footed mouse is thus linked to the transmission and maintenance of the organism. Infection with the spirochete does not cause clinical or pathological changes or alter the biological features of the mouse.<sup>25</sup> These combined factors indicate a longstanding relationship between the mouse and the spirochete. Furthermore, the mouse is an excellent reservoir host but an unsatisfactory laboratory model for the study of Lyme disease. When the tick becomes infected it is ready to feed on animals and humans. A nymphal tick will feed on small animals such as rodents, squirrels, birds, dogs and cattle. The adult tick feeds primarily on larger animals such as deer, horses, cattle, and dogs. All three stages of the tick will feed on humans.

The white-tailed deer is the preferred host for the adult stage of the tick and often harbors large numbers of adult ticks. Adult ticks are likely to be responsible for transmission of infection to horses and cattle.

The ticks, *Dermacentor variabilis* and *Aniblyomma americanum*, tabanid flies and mosquitoes have also been shown to carry the organism.<sup>2</sup>

The organism can be found in the urine of infected animals and it is possible that transmission may occur through close contact without the bite of a tick. Infected cattle purchased from an endemic area could shed the organisms in the urine and transmit them to animals in a different herd. The resistance of the organism to heat is generally less at 50°C, and greater at 70°C than that of other non-spore-forming pathogens.<sup>27</sup> Heat treatments similar to that of high temperature, short time pasteurization of milk are expected to decrease the population of the organism but not eliminate it. When present in meats in large numbers, it is likely that the organism can survive heat treatments sometimes used to process these products.

Transplacental transmission of the organism from infected dams to their fetuses also occurs through in utero

infection and can be a cause of mortality in foals<sup>28</sup> and calves.<sup>3</sup>

### **PATHOGENESIS**

*Borrelia* are highly motile and invasive, and localize in selected tissues. They spread through tissues and can directly transcytose endothelial layers. Following infection there is multisystemic inflammation resulting in polyarthritis,<sup>2</sup> generalized lymphadenitis, pleuritis, peritonitis, interstitial pneumonia, encephalitis, and in utero infection resulting in fetal infection. In humans, the progression of Lyme borreliosis is divided into early localized, early disseminated, and late stages.<sup>29</sup> In humans, skin is the most frequently affected tissue. Erythema migrans, borrelial lymphocytoma, and acrodermatitis chronica atrophicans, neuroborreliosis, myocarditis, arthritis, and ocular disease are possible outcomes of infection.

Borreliosis has been reproduced in ponies by exposure to *Ixodes* ticks infected with *B. burgdorferi*.<sup>30</sup> Infection with *B. burgdorferi* was detected in skin biopsies and various tissues at necropsy by culture and PCR. The model can be used to evaluate chemotherapy and vaccines. Clinical signs were limited to skin lesions, all ponies seroconverted, and there were no significant other lesions.

### **Immune mechanisms**

*B. burgdorferi* is able to persist in the mammalian host because of active immune suppression, induction of immune tolerance, phase and antigenic variation, intracellular seclusion, and incursion into immune privileged sites all as survival strategies.<sup>29</sup> Vaccination with outer surface protein A (OspA) from the organism could prevent *B. burgdorferi* infection in animal and human studies. Vaccination of 1-year-old ponies with recombinant OspA (*ospA* gene derived from *B. burgdorferi* B31) with adjuvant (aluminum hydroxide), followed by challenge with *B. burgdorferi*-infected adult ticks (*Ixodes scapularis*), provided protection against skin infection compared to unvaccinated controls.<sup>31</sup>

### **CLINICAL FINDINGS**

Because Lyme disease has been recognized only recently, the characteristic clinical findings in farm animals are not yet well described. The variety of clinical manifestations of the disease has made it difficult to obtain a definitive diagnosis in cases where the disease has been suspected. Based on serological surveys, subclinical infections are much higher than the incidence of clinical disease.

### **Horses**

In horses, chronic weight loss, sporadic lameness, laminitis, persistent mild fever,

swollen joints, muscle stiffness, anterior uveitis and neurological signs such as depression, behavioral changes, dysphagia, head tilting and encephalitis have been reported.<sup>1,3</sup> Polyarthritis and swelling of tendon sheaths in horses of all ages are commonly reported.<sup>3,32</sup> A confirmed case in a 20-year-old horse had a history of exposure to ticks, was depressed, had a temperature of 38.2°C, urticarial plaques, tendon sheath swelling and hindlimb lameness. This was followed by periodic episodes of fever, lameness with hindlimb stiffness, effusion of joints and tendon sheaths, and conjunctivitis. Acute bilateral blepharospasm, photophobia and excessive lacrimation are reported<sup>3</sup> followed by neurological signs of depression, compulsive walking, stupor, holding the head against a wall and quadripedal ataxia and eventual recumbency.<sup>3</sup> Infection of pregnant mares can result in abortion, and the birth of weak foals which die soon after birth.<sup>28</sup> An unexplained increase in early embryonic loss or failure of conception in mares has been associated with Lyme disease antibodies but not confirmed.<sup>33</sup>

### **Cattle**

In cattle, polyarthritis, lameness, chronic weight loss, and a persistent mild fever have been reported.<sup>2,34</sup> In acute Lyme disease, fever, stiffness, swollen joints and decreased milk production are common.<sup>1</sup> Erythema of the udder or the skin between the digits has also been described.<sup>1,22</sup> Edematous lesions on the hairless skin of the udder, poor bodily condition, inappetence, and decreased milk production, stiff gait, and swollen joints have been described in cows with *B. burgdorferi* infection.<sup>35</sup>

### **Sheep**

In sheep, lameness, swollen joints, unthriftiness, and a persistent fever occur.<sup>29</sup>

### **CLINICAL PATHOLOGY**

#### **Detection of organism**

The organism is difficult to isolate because *B. burgdorferi* is found in low numbers in blood or tissues. Aseptically collected blood, cerebrospinal fluid, urine and colostrum can be examined under dark-field microscopy or in a culture. Cultures are difficult to maintain and require several weeks to grow.

#### **Serology**

Serological testing is the most practical method of making a diagnosis of *B. burgdorferi* infection.<sup>1</sup> Serum and synovial fluid samples may contain antibodies to the organism in horses.<sup>20</sup> The indirect immunofluorescent antibody (IFA) test has been used with reliable results in horses and cattle.<sup>1</sup> The ELISA is ideal for high-volume testing, the results are quantitative, and can detect total immunoglobulins or

class-specific IgM and IgG antibodies to the organism.<sup>36</sup> An ELISA and immunoblots using certain antigens of the spirochete are more specific for the diagnosis of Lyme borreliosis in horses.<sup>37</sup> An ELISA using a purified protein of the organism detects antibody in cattle and is useful as a screening method for borreliosis in cattle.<sup>38</sup> Western blotting techniques and the ELISA have been used for serological surveys and for examination of synovial fluids of horses in the United Kingdom where the incidence of infection is common in some areas.<sup>39</sup> The positive results in horses are not due to cross-reactions with *Leptospira* which has been suggested.

In cattle, the infection has been diagnosed by detection of *B. burgdorferi sensu strictu* DNA in samples of synovial fluid and milk of affected cows.<sup>40</sup>

A polyvalent ELISA, incorporating highly specific recombinant antigens of *B. burgdorferi* has been used to determine seropositivity to *B. burgdorferi* and *Anaplasma phagocytophilum* infection.<sup>41</sup>

Subclinical infections are common in domestic animals and the interpretation of serological results must be done in conjunction with the clinical findings. Positive antibody results are an aid to diagnosis but are not conclusive evidence of current infection or clinical disease. False-positive results may be due to infection with other *Borrelia* species.

#### NECROPSY FINDINGS

Polysynovitis, lymphadenopathy, and emaciation are present.<sup>34</sup> Multifocal interstitial myocarditis, glomerulonephritis, interstitial pneumonitis, and polysynovitis have been described in cattle.<sup>34</sup> In the horse, polysynovitis and meningoencephalitis have been reported.<sup>3</sup> Using PCR amplification of DNA, necropsy tissues may be positive for *B. burgdorferi* DNA.<sup>3</sup>

#### Samples for confirmation of diagnosis

- **Bacteriology** – kidney, joint synovium, lung, choroid plexus (PCR)
- **Histology** – formalin-fixed kidney, joint synovium, heart, brain, lung, lymph node (LM).

#### DIFFERENTIAL DIAGNOSIS

Diagnosis is dependent on recognition of clinical signs, a history of possible exposure to infection by the bites of ticks and identification of the spirochete in the affected animal. Because clinically normal animals have antibody to the organism, a positive antibody result is not conclusive of current infection or clinical disease. Other diseases causing muscle stiffness, lameness, polyarthritis, lymphadenopathy, and fever must be considered in the differential diagnosis.

#### TREATMENT

Tetracyclines or penicillin has been recommended.<sup>1</sup> Procaine penicillin at 30 000–45 000 iu/kg BW IM daily for 10 d followed by benzathine penicillin every other day has been recommended for horses.<sup>1</sup> Doxycycline, 5–10 mg/kg BW orally/12 h for one month has been recommended but not based on any clinical trials.<sup>3</sup> Phenylbutazone has been used for the treatment of laminitis. Oxytetracycline at 6–12 mg/kg BW IV once daily for 3 weeks has also been used.<sup>1</sup> Oxytetracycline is reported to be successful for treatment of suspected borreliosis in an old horse.<sup>20</sup> Penicillin or oxytetracyclines daily for 3 weeks have also been recommended for use in cattle.

#### CONTROL

Prevention of Lyme borreliosis in domestic animals and humans is dependent on reduction of the risk of tick bites at the environmental or individual animal level.<sup>22</sup> A knowledge of the ecologic requirements for the tick-borne diseases which are present in an area is necessary for selection and implementation of the most effective integrated prevention strategies. Protective measures may include the avoidance of tick-infested areas, the use of protective clothing, repellents, and acaricides, tick checks, and modifications of landscapes in or near residential areas. After a tick bite has occurred in humans, the body of the tick should be grasped with medium-tipped tweezers as close to the skin as possible and removed by gently pulling the tick straight out, without twisting motions.<sup>24</sup>

A commercial adjuvanted vaccine is now available for use in dogs.<sup>1,42</sup> An experimental vaccine, composed of recombinant OspA protected ponies against *B. burgdorferi* infection and further studies are necessary to determine duration of protection after vaccination, safety and cross protection against the possible heterogeneous OspA structures which may be present among new *B. burgdorferi* strains isolated in the U.S.<sup>31</sup>

Two vaccines for Lyme borreliosis in humans, consisting of OspA in adjuvant, have been developed.<sup>24</sup> The Advisory Committee on Immunization Practice of the Center for Disease Control advises that vaccination for Lyme borreliosis should be considered for people older than 15–17 years who live in or visit high-risk areas and have frequent or prolonged exposure to *I. scapularis* ticks.<sup>24</sup>

#### REVIEW LITERATURE

- Levine JF. J Am Vet Med Assoc 1995; 207:768–775.  
 Parker JL, White KK. Lyme borreliosis in cattle and horses: a review of the literature. Cornell Vet 1992; 82:253–274.  
 Divers TJ, Chang YF, Jacobson RH, McDonough SP.

- Lyme disease in horses. Comp Cont Educ Pract Vet 2001; 23:375–381.  
 Fritz CL, Kjemtrup AM. Lyme borreliosis. J Am Vet Med Assoc 2003; 223:1261–1270.  
 Hengge UR, Tannapel A, Tyring SK et al. Lyme borreliosis. Lancet Infect Dis 2003; 3:489–500.  
 Stanek G, Strle F. Lyme borreliosis. Lancet 2003; 362:1639–1647.  
 Embers ME, Ramamoorthy R, Phillip MT. Survival strategies of *Borrelia burgdorferi*, the etiologic agent of Lyme disease. Microbes Infect 2004; 6:312–318.

#### REFERENCES

1. Parker JL, White KK. Cornell Vet 1992; 82:253.
2. Rothwell JT et al. Aust Vet J 1989; 66:296.
3. Divers TJ et al. Comp Cont Educ Pract Vet 2001; 23:375.
4. Fridriksdottir V et al. J Clin Microbiol 1992; 30:1271.
5. Madigan JE, Teitler J. J Am Vet Med Assoc 1988; 192:892.
6. Levine JF. J Am Vet Med Assoc 1995; 207:768.
7. Uilenberg G et al. Vet Q 1988; 10:63.
8. Blowey RW et al. Vet Rec 1994; 135:577.
9. Isogal H et al. Microbiol Immunol 1992; 36:1029.
10. Wells SJ et al. Am J Vet Res 1993; 54:398.
11. Ji B, Collins MT. Am J Vet Res 1994; 55:1228.
12. Mitchell GBB, Smith IW. Vet Rec 1993; 133:66.
13. Ogden NH et al. Vet Rec 1994; 135:383.
14. Magnarelli LA et al. J Am Vet Med Assoc 2000; 217:1045.
15. Cohen D et al. Ann NY Acad Sci 1988; 539:244.
16. Cohen ND et al. J Am Vet Med Assoc 1992; 201:1030.
17. Maloney EM, Lindenmayer JL. Equine Pract 1992; 14:15.
18. Bernard WV et al. J Am Vet Med Assoc 1990; 196:1255.
19. Rees DHE, Axford JS. Equine Vet J 1994; 26:175.
20. Browning A et al. Vet Rec 1993; 132:610.
21. Eisner RJ et al. J Equine Vet Sci 1994; 14:102.
22. Fritz CL, Kjemtrup AM. J Am Vet Med Assoc 2003; 223:261.
23. Reotutar R. J Am Vet Med Assoc 1989; 194:1391.
24. Hengge UR et al. Lancet Infect Dis 2003; 3:489.
25. Stanek G, Strle F. Lancet 2003; 362:1639.
26. Wright SD, Nielsen SW. Am J Vet Res 1990; 51:1980.
27. Lee SK et al. J Food Protect 1990; 53:296.
28. Burgess EC et al. In: Powell DG (ed.) Equine Infectious Diseases V. Proceedings of the 5th International Conference 1988; p. 217.
29. Embers ME et al. Microbes Infect 2004; 6:312.
30. Chang YF et al. Vet Pathol 2000; 37:68.
31. Chang YF et al. Vaccine 2000; 18:540.
32. Yates WDG. Can Vet J 1988; 29:393.
33. Sorensen K et al. J Equine Vet Sci 1990; 10:166.
34. Burgess EC et al. Vet Microbiol 1993; 35:61.
35. Post JE, et al. Ann NY Acad Sci 1988; 539:488.
36. Magnarelli LA, Anderson JF. J Am Vet Med Assoc 1989; 195:1365.
37. Fikrig E et al. J Clin Microbiol 1993; 31:2451.
38. Ji B et al. Am J Vet Res 1994; 55:1213.
39. Carter SD et al. Equine Vet J 1994; 26:187.
40. Lischer CJ et al. Vet Rec 2000; 146:497.
41. Magnarelli LA et al. Can Vet J 2004; 45:667.
42. Straubinger RK et al. Vaccine 2002; 20:181.

#### SWINE DYSENTERY

##### Synopsis

**Etiology** *Brachyspira hyodysenteriae*  
**Epidemiology** Major economic importance in growing pigs 8–16 weeks of

age. Transmitted by fecal–oral route. Crowding and high stocking density are risk factors. High morbidity and moderate mortality if not treated

**Signs** Mucohemorrhagic diarrhea, weight loss, commonly persistent if not treated

**Lesions** Colitis, typhlitis

**Diagnostic confirmation** Detection of organism in intestine. Serological diagnosis in herd

**Treatment** Tiamulin to individual pigs. Organic arsenicals in feed and water supplies. Carbadox, monensin in feed and water

**Control** Eliminate infection with treatment in the feed and water supplies. Prevent reinfection and avoidance of introduction of carrier animals into herd. Eradicate by depopulation and repopulation and biosecurity measures

Swine dysentery is a highly fatal disease characterized by mucohemorrhagic diarrhea and death if untreated for a few days.

## ETIOLOGY

*Brachyspira* (formerly *Serpulina* and before that *Treponema*) *hyodysenteriae* (BH) a large strongly beta-hemolytic spirochete, is the principal causative agent.<sup>1</sup> It is supposedly indole positive but in a study in Belgium half were indole negative.<sup>2</sup> It will cause typhlocolitis in captive rheas<sup>3</sup> and rats and mice may act as reservoirs.

Two other spirochetes *B. innocens* and *B. pilosicoli*, which are weakly beta-hemolytic, cause porcine colonic spirochetosis, a mild disease of pigs.<sup>4,5</sup> Human intestinal spirochetes are distinct.

They are all anaerobic organisms but they are oxygen tolerant and will grow in the presence of 1% oxygen.

## EPIDEMIOLOGY

### Occurrence

Swine dysentery occurs in most major pig-producing countries and was an important disease of pigs in North America (11% in USA), Australia, and the United Kingdom.<sup>6</sup>

A postal survey suggested that 10.5% of herds were infected.<sup>7</sup> In Denmark 14% had BH.<sup>8</sup> However, in recent years with the increase in minimal disease herds, the incidence of the disease has decreased. It is most common in the 7- to 16-week-old age group but may affect older pigs to 6 months. Adult pigs are seldom affected, and rarely suckling piglets. The overall occurrence is probably around 10% with a considerable control through drugs, particularly growth-promoting antibiotics, in countries where these are allowed. A Swedish study,<sup>9</sup> showed that *Brachyspira* species were isolated from 58.5% of all samples. Of these 25.4% were *B. hyodysenteriae*, 16.4% were *B. pilosicoli*,

and 58.2% were *intermedia*, *innocens* or *murdochii*.

### Morbidity and case–fatality rate

Morbidity within a group of pigs can range from 10–75% and if untreated the case–fatality rate can be as high as 50%.

### Risk factors

Animal risk factors

Pigs from 8–16 weeks of age are most susceptible to swine dysentery. Most outbreaks occur in herds which have purchased infected animals from herds known to have the disease. Infection is spread within and between swine herds by carrier pigs.

Experimentally, a highly digestible diet can protect pigs from swine dysentery.<sup>10</sup>

**Immune mechanisms.** Clinical disease is associated with development of specific IgG, IgA, and IgM antibodies in serum and local production of IgA in gut mucosal tissues. Treated and untreated convalescent pigs develop elevated titers which are maintained as long as 150 days after infection. The relationship between the magnitude of the agglutinin titers and protective immunity is not clear. Carrier pigs shed *B. hyodysenteriae* while elevated agglutination titers against the organism are present.

Untreated pigs which recover from swine dysentery are resistant to experimental challenge for up to 16–17 weeks. In herds affected with swine dysentery, the disease may reappear at 3–4 week intervals following treatment and the more efficacious drugs may inhibit the development of immunity.

### Pathogen factors

There are many latent infections without clinical signs. There is some evidence that the organism destabilizes the microbial community in the large intestine.<sup>11</sup>

The disease has been reproduced with pure cultures of *B. hyodysenteriae* in conventional and specific pathogen-free (SPF) pigs. Challenge of gnotobiotic pigs with pure cultures results in colonization of the organism but disease does not occur until other intestinal organisms are given, which suggests that the disease is the result of a mixed synergistic infection of the spirochete and other intestinal anaerobic organisms. Experimentally, the oral inoculation of gnotobiotic pigs with a combination of *B. hyodysenteriae* and *Bacteroides vulgatus* or *Fusobacterium necrophorum* will result in the development of the characteristic clinical signs and lesions of swine dysentery. These results and others are consistent with the concept that *B. hyodysenteriae* is the primary causative agent of swine dysentery and that the presence of one or more other anaerobes is a prerequisite for expression

of pathogenicity of *B. hyodysenteriae*. This prerequisite can be met by a variety of anaerobes.

Although closely related, the intestinal spirochetes isolated from pigs have been categorized into four groups based on phylogenetic studies.<sup>12,13</sup> Groups I and II are isolated only from pigs with dysentery or diarrhea. Group II was differentiated from Group I only by weak beta-hemolysis. In Sweden, members of Group II are often isolated from young weaned pigs up to 25 kg BW, in herds where a non-specific diarrhea, which is clinically distinct from swine dysentery, occurs frequently. These strains seem to be absent or rare in herds without such diarrheic pigs. Group III included the type strain for *Brachyspira innocens*. Group IV included the pathogenic, weakly beta-hemolytic strain P43 shown to cause spirochetal diarrhea in pigs.

There is much antigenic heterogeneity among isolates of *B. hyodysenteriae*. At least nine serotypes and nine groups have been recognized.<sup>14</sup> They can be differentiated by pulsed field electrophoresis and multilocus electrophoresis and the former is particularly good at differentiating strains which are genetically 53–100% similar.<sup>15,16</sup> Strains of *B. hyodysenteriae* possess several antigens, some of which are shared by both species. Organisms have been described which are phenotypically characteristic of *B. hyodysenteriae* but their 23s RNA genetic signature and sequence are consistent with *B. innocens*.<sup>17</sup> Within the genus of *B. hyodysenteriae* there are some strains that are apparently non-virulent or of reduced virulence potential.<sup>18</sup>

Although *B. hyodysenteriae* is the primary etiological agent of swine dysentery, *B. innocens* has been isolated from healthy swine and those with postweaning diarrhea. Besides *B. innocens*, there are other groups of weakly beta-hemolytic spirochetes.<sup>19</sup> *B. pilosicoli* is the cause of porcine colonic spirochetosis originally known as spirochetal diarrhea.<sup>4,19</sup>

There is considerable variation in virulence among strains of different serotypes of *B. hyodysenteriae* when given orally to specific pathogen-free piglets or mice.<sup>20</sup> A virulent *B. hyodysenteriae* has been isolated from a herd free of clinical swine dysentery<sup>21</sup> which indicates that the organism can still be present in herds considered to be free of the disease.

Serotyping of isolates of the organism is important in terms of diagnosis and epidemiological evaluation.<sup>22</sup> The range of serologically distinct strains of the organism which exists is much wider than was previously realized. *B. hyodysenteriae* has heterogeneous antigens in the lipopolysaccharide portion of the outer membrane and several serotypes of

*B. hyodysenteriae* have been described on the basis of agar gel double immunodiffusion precipitation.<sup>23</sup> Some serotypes predominate in certain geographical areas.<sup>23,24</sup> Restriction endonuclease analysis is being used to type strains.<sup>25,26</sup>

The major polypeptides of *B. hyodysenteriae* are strong immunogens and present in the various serotypes but there is considerable diversity in the antigenicity of lipopolysaccharides between those same serotypes. A PCR-based DNA fingerprinting technique can analyze genetic profiles of isolates of the organism from cases of swine dysentery in different herds, which could be important epidemiologically.<sup>22</sup>

A hemolysin with cytotoxic activity extracted from a virulent strain of the organism causes severe epithelial damage when injected into ligated loops of the ileum and colon of germ-free pigs<sup>27</sup> and is a virulence factor in swine dysentery.<sup>28</sup> The organism can adhere to a culture of intestinal cells in vitro which may be one of its virulence factors. The organism is also highly motile, which provides it with the ability to move through mucus and facilitates penetration into the mucosa. This may be a very important virulence<sup>29</sup> factor. A wide variety of other virulence factors may be important. The organism probably does not attach to the epithelial surface of cells but instead colonizes the overlying mucus layer. Chemotactic attraction of the organism to sites containing mucus is also a potentially important factor.

Potentially pathogenic weakly beta-hemolytic intestinal spirochetes may be present in swine herds with a high incidence of diarrhea and can be distinguished from non-pathogenic strains by the hippurate hydrolysis test.<sup>30</sup> The prevalence of these strains is reduced in herds medicated with olaquinox.

#### Environmental and management risk factors

The usual source of infection is through the import of pigs. It is however difficult to control these because of asymptomatic carriers.

Investigation has shown that it may be the dirty truck that is important. In other words biosecurity has failed.

Overcrowding and the build-up of fecal wastes in pens contribute to an increased incidence of swine dysentery. The failure to clean solid floor pens on a regular basis results in an accumulation of fecal wastes, which increases the infection pressure. The contamination of pens with fecal effluent from adjacent pens or by open flush gutter systems allow pigs access to the flush water and can provide sources of infection and reinfection. The

continuous introduction of young pigs into pens which have not been previously cleaned out and washed provide sources of infection. The mixing of weaner pigs from different sources is often a source of infection for susceptible pigs.

Several factors affect the survival of the organism from the feces of infected pigs.<sup>31</sup> The organism can survive for up to 48 days in dysenteric feces at 0–10°C (32–50°F); survival is reduced to 7 days at 25°C (77°F) and to less than 24 hours at 37°C (98.6°F). Dilution of dysenteric feces with tap water (1:10) enhances survival to 61 days at 5°C (41°F). Recently, it was found in feces after 112 days.<sup>32</sup> Drying and disinfection rapidly eliminates the organism from the environment. Phenolic and sodium hypochlorite disinfectants are most effective. The organism can survive in lagoons for up to 60 days; however, how long it will persist in an anaerobic lagoon is unknown. In swine herd facilities with an open gutter-flush system which has housed dysentery-infected swine, the lagoon water is used to expel feces from the building thus allowing the pigs to drink the effluent as it flows through the gutter. Under these conditions the organism may survive for 5–6 days after the removal of infected shedders.<sup>31</sup> The organism has been isolated from the lagoon of a waste-handling system of a swine farm which could be partially responsible for maintenance of swine dysentery within a herd.

Recently, the study of the effects of dietary constituents on the commensal bacterial flora of the large intestine has become fashionable but the conclusions are not definite. This was based on the suggestion that non-starch polysaccharide was drawn into the distal parts of the colon and was then available for fermentation.<sup>33,34</sup> It was first suggested<sup>35</sup> that inclusion of wheat and soybean and/or addition of exogenous enzymes to pig diets influenced the large intestine microflora but did not prevent SD. The colonization of the gut by spirochetes<sup>36</sup> was highly related to soluble non-starch polysaccharide and the development of SD was influenced by the resistant starch content of the diet. Feed containing large amounts of soyabean meal and group housing of pigs were considered to be the major contributing factors in the experimental production of swine dysentery.<sup>37</sup> Feed containing high levels of soluble non-starch polysaccharides results in an increase in viscosity of gut contents, an increased amount of gut fluid, a low pH, and an increased number of coliforms in the intestines.<sup>38</sup> A recent experiment with feeding and SD showed no effect of feeding rice in the diet.<sup>39</sup> The feeding of rice was not able to prevent SD and neither was the increase of non-

starch polysaccharide or resistant starch able to reduce the incidence or prevalence of SD<sup>40,41</sup> and in fact the clinical signs were worse.

#### Methods of transmission

The organism is present in the feces of affected pigs. Infection is by ingestion and transmission is enhanced by conditions leading to fecal-oral cycling. Spread of infection within a group is slow, taking up to 7–14 days, and may spread to other pens of pigs over a 2–3-week period. Pigs which have recovered from clinical disease with or without treatment may become carriers and still have the ability to shed the organism and infect in-contact animals for 50–90 days. Clinical disease may initially be precipitated by stress but infection subsequently spreads by direct contact. The frequency of shedding varies with time and only a small proportion of a convalescent population may be expected to be carriers.

The organism has been isolated from a dog on a swine farm where swine dysentery was present. Experimentally, mice are susceptible to the infection and may be a potential source of infection in a piggery. Direct evidence of transmission has been shown from mice<sup>42</sup> when eight farm mice were trapped and three were found which had BH which was of the same PFGE pattern as that of the pigs. This suggests that farm mice are a confirmed reservoir of infection. They are capable of carrying the organism for up to 180 days after inoculation.

#### Economic importance

The disease can cause heavy mortality in growing pigs but it is equally important for its effect on the efficiency of production. The economic losses from decreased feed efficiency are estimated at four times the cost of medication. The infection tends to be persistent within a herd and may have a cyclic occurrence, which is a problem in intensive pig-rearing enterprises and frequently control can be achieved only by costly continuous prophylactic medication.

#### PATHOGENESIS

*B. hyodysenteriae* is strongly beta-hemolytic and invades the intestinal crypts and disrupts the colonic epithelium causing a mucohemorrhagic colitis. The organism colonizes the intestinal mucosa by association with intestinal mucus in both the mucus gel covering the epithelium and the mucus-filled crypts. (On the other hand the weakly beta-hemolytic *B. pilosicoli* attaches by one cell end to the luminal surface of the colonic epithelium to form a dense carpet of adherent spirochetes.)

It is still not known if invasion is a necessary feature of infection for SD. Where it lives normally is unknown but in

the intestine it can obviously breed more quickly than it is evacuated. The pattern of colonization appears to be random.<sup>43</sup> The hemolysin lyses the intestinal mucosal cells which then supply the *Brachyspirae* with the vital sterols from the membranes. Several genes may be involved in virulence including *thyA* and *Llya*.<sup>44</sup> For infection to establish it seems that a gene for the production of NADH oxydase is required<sup>45</sup> as it protects against the effects of oxygen toxicity. Similarly there may be a *Brachyspira* iron transport system<sup>46</sup> and the presence of this may correlate with the pathogenicity of *B. hyodysenteriae*. Another gene of interest is the *mgIB* gene which may eventually be shown to be of great importance.<sup>47</sup> Lipo-oligosaccharide production may also be a virulence factor.

Chemotactic- or motility-regulated mucus association appears to be the predominant mechanisms of mucosal association.<sup>48</sup> There is progressive erosion of superficial epithelium, excess mucus production, edema and hemorrhage of the lamina propria and pseudomembrane production. The erosive colitis is the cause of the diarrhea, dysentery and excessive quantities of mucus in the feces. Experimentally, the cytotoxic hemolysin of the organism affects intestinal epithelial cells.<sup>49</sup> The hemolysin produces some of the same changes as the whole bacteria.<sup>50</sup> Some CD8<sup>+</sup> cells may be associated with susceptibility to experimentally induced SD whereas monocytes and CD4<sup>+</sup>CD8<sup>+</sup> T-cells appear to be the major responding leukocytes during the disease.<sup>51</sup> Death results from chronic dehydration and bacterial toxemia. In some animals, an acute shock syndrome results in rapid and sudden death. Early in the disease it activates IL-1 and IL-6 and stimulates macrophages. In the later stages T-cells play an important part in defence.<sup>52</sup>

#### CLINICAL FINDINGS

**Swine dysentery.** Most commonly, initially, only a few pigs are affected within a group but spread occurs over a period of a few days to 2 weeks to involve the majority. Affected pigs are slightly depressed, have a reduced appetite, and a moderate fever. The feces are only partially formed, usually of a porridge-like consistency and are passed without apparent conscious effort and splatter on contact with the pen floor. Affected pigs commonly defecate almost anywhere and on anything in the pen. The feces are light gray to black and on close inspection much mucus is present and flecks of blood and epithelial casts may be seen. In some pigs, the presence of larger amounts of blood will discolor the feces accordingly. The occurrence of blood in the feces generally occurs 2–3 days after the initial

onset of diarrhea. Affected pigs become progressively dehydrated and their abdomens appear gaunt and sunken. Death usually occurs some days to weeks after the initial onset of signs and results primarily from dehydration and toxemia. Pigs with a severe hemorrhagic diarrhea die more quickly. Skin discoloration is not a feature except in the terminal stages.

In untreated pigs the disease may persist for 3–4 weeks before clinical recovery. Less commonly an outbreak may start with the sudden death of one or two pigs with no evidence of premonitory signs or a terminal hemorrhagic diarrhea. This occurs more commonly in market-age pigs and adults in herds where swine dysentery has been introduced for the first time. It also is a rare cause of sporadic death of gilts and sows in conventional herds.

The disease responds well to treatment but following withdrawal of treatment the disease may recur within the same group of pigs. A chronic form of the disease with persistent diarrhea and failure to grow occurs in some pigs with irreversible lesions of the colonic mucosa.

#### CLINICAL PATHOLOGY

##### Detection and culture of organism

The organism may be detected in the feces of affected pigs by dark-field microscopy as highly motile organisms with a characteristic serpentine motility or in dried smears with Giemsa or Victoria blue 4R staining. The best diagnosis is achieved by taking samples from the upper colon. Fecal samples submitted for laboratory examination should be diluted (1:10) in phosphate-buffered saline or rectal swabs placed in Amies medium to avoid death of the organisms which will occur when the samples are stored at room temperature or sent in the mail. Microagglutination tests (MATs), slide agglutination tests, and indirect and direct fluorescent antibody tests are also used to detect the organisms.<sup>5</sup>

The organism can be cultured on Trypticase Soy agar containing 5% defibrinated bovine blood under specific atmospheric conditions.<sup>6</sup>

**Fluorescent antibody staining** aids considerably in its demonstration, but may not distinguish non-pathogenic strains and false-positive and false-negative results are common.<sup>53</sup> The presumptive diagnosis from the fluorescent antibody test (FAT) can be supplemented with a variety of laboratory tests which serve to identify the spirochetes as pathogenic. The **slide agglutination test** is a useful and specific means of identifying an organism but requires an appreciable amount of growth of spirochetes on the surface of the agar to carry out the test.<sup>54</sup> The **microscopic agglutination test** is a

rapid test for the definitive laboratory identification of *B. hyodysenteriae* but it cannot distinguish the avirulent strains of the organism.<sup>54</sup>

A major diagnostic problem has been the identification of carrier pigs which are infected with the organism and are a potential source of infection to other pigs. Indirect and direct FATs used to examine feces and colonic material from pigs for *B. hyodysenteriae* have not been sensitive or specific enough to identify individual infected pigs.

Any diagnostic test must be able to distinguish between the different *Brachyspira* spp.<sup>55</sup> Some are harmless commensals, while others are potentially pathogenic. *Brachyspira innocens*, a non-pathogenic inhabitant of the porcine large intestine, is very similar to *B. hyodysenteriae* in both morphology and growth characteristics and shares many of the same surface antigens. Numerous serological tests with sera from pigs that have recovered from *B. hyodysenteriae* infection have demonstrated the presence of cross-reactive antibodies between *B. hyodysenteriae* and *B. innocens*, which makes differentiation difficult.

**Antigen detection methods.** Detection methods based on the use of DNA probes or polymerase chain reaction PCR have recently been developed and show considerable promise.<sup>33</sup>

A PCR was developed that could detect 10<sup>3</sup>–10<sup>4</sup> organisms and this was more rapid and detected more positive samples than did fecal culture and isolation.<sup>56,57</sup> The duplex PCR developed<sup>58</sup> was also more sensitive than the culture and biochemical tests which were shown to detect 10<sup>2</sup> bacteria per gram of.<sup>59</sup> A multiplex PCR has been developed that will differentiate *B. hyodysenteriae*, *B. pilosicoli* and *L. intracellularis*.<sup>60</sup>

In situ hybridization was also shown to work for BH.<sup>61</sup>

The most definitive method for differentiating *B. hyodysenteriae*, *B. innocens* and *B. pilosicoli* is the DNA–DNA relative reassociation method.<sup>4</sup>

**Serological tests.** Monoclonal antibodies against the serotype-specific lipopolysaccharide antigens of *B. hyodysenteriae*<sup>62</sup> can be used in ELISA, indirect immunofluorescence and immunoblot assays to differentiate between *B. hyodysenteriae* and *B. innocens*.<sup>63,64</sup>

A variety of serological tests have been used<sup>65</sup> and typically these tests have used whole-cultures or lipopolysaccharides as the antigen. The former tends to increase false positives and the latter increases false negatives but gives fewer false positives. In general these techniques are useful for detecting infected herds but are unable to detect individual infected pigs

that may be acting as carrier animals. Recently a 30 kDa outer membrane lipoprotein (BmpB) which is specific to BH and is recognized in both experimentally and naturally infected pigs was identified and the gene cloned and sequenced and specific epitopes on BMPB are being identified.

Serological tests can assist in the identification of carrier pigs.<sup>66</sup> An evaluation of several serological tests for detection of antibodies against *B. hyodysenteriae* concluded that only the MAT detected antibodies to the organism.<sup>64</sup> The ELISA has been used to detect antibodies in individual pigs but cross-reactions between *B. hyodysenteriae* and *B. innocens* are common.<sup>65</sup> An ELISA using serotype 2 *B. hyodysenteriae* as antigen could not differentiate between stages of infection but could indicate if the pig had been infected.<sup>66</sup>

### NECROPSY FINDINGS

Lesions are restricted to the cecum and colon. They vary from catarrhal to fibronecrotic to hemorrhagic typhlocolitis.

The carcasses of pigs that have died from swine dysentery usually show weight loss, dehydration and a microscopically visible typhlitis and colitis. The colitis is initially present in the apex of the spiral colon but subsequently spreads to involve the whole colon and the cecum. In the early stages, there is inflammation and necrosis with varying degrees of hemorrhage into the lumen. The submucosal glands are enlarged and frequently visible through the serosa of the colon as opaque spots. In advanced cases a fibrinonecrotic exudate is adherent to a reddened and granular mucosal surface. Intestinal contents may also adhere to the mucosa. The crypts are often thickened with edema. The draining lymph nodes are enlarged and congested. The small intestine is spared except for involvement of the terminal ileum in advanced cases. Spirochetes may be demonstrated in large numbers using Warthin/Stary stains in smears from the mucosal surface of these lesions, especially in early cases, but there is no systemic invasion.

Electron microscopic examination of the colon of pigs with swine dysentery reveals changes indicative of stasis in the microcirculatory vessels of the lamina propria. The earliest colonic lesion consists of superficial vascular congestion and dilatation, edema of the lamina propria and intercellular separation of the epithelial cells at the crypt shoulders. This lesion progresses to epithelial cell necrosis and extrusion with extravasation of red blood cells into the lumen. Degeneration, necrosis and extrusion of superficial colonic enterocytes follows progressively. Large spirochetes are present in the

crypts, in the cytoplasm of damaged epithelial cells and in cavities around vessels of the lamina propria. The characteristic lesion of swine dysentery is necrosis of the superficial colonic epithelium. This feature may be difficult to appreciate in partially autolysed tissues, or if the animals sampled are recovering from the infection or being treated with antibiotics. In sub-acute lesions the crypt hyperplasia and goblet cell hyperplasia is more pronounced and the extensive mucus production distends all the crypts.

*B. hyodysenteriae* is difficult to culture, requiring anaerobic conditions and selective media. This has promoted the development of alternative diagnostic techniques such as the polymerase chain reaction (PCR) and immunohistochemical stains. Wet mount preparations from the colonic mucosa are often utilized to make a presumptive diagnosis and a fluorescent antibody test is also available.

### Samples for confirmation of diagnosis

- **Bacteriology** – colon (CULT (has special culture requirements), DIRECT SMEAR (modified acid-fast stains), FAT, PCR)
- **Histology** – formalin-fixed colon, several sites (LM, IHC).

### DIFFERENTIAL DIAGNOSIS

Swine dysentery must be differentiated from other diseases in which there is diarrhea in growing pigs.

**Porcine colonic spirochetosis** – associated with a mild diarrhea in weanlings and growing pigs.

**Coliform gastroenteritis, salmonellosis and hog cholera** – characterized by more rapid onset and spread within a group than with swine dysentery and death occurs earlier. In coliform gastroenteritis and salmonellosis, the initial sign may be sudden death or severely depressed and weak pigs with fever, skin discoloration, anorexia and a profuse watery diarrhea. Coliform gastroenteritis occurs within a few days after weaning whereas hog cholera occurs in all ages of pig. Swine dysentery is more insidious in onset, the appetite is rarely completely lost and the feces are soft and mucohemorrhagic. At necropsy the lesions of swine dysentery are confined to the large intestine whereas in coliform gastroenteritis, salmonellosis and hog cholera lesions are also present in the small intestine.

Other diseases may result in the passage of bloody feces.

**Intestinal hemorrhage syndrome** – generally persists as a severe hemorrhagic diarrhea with rapid death rather than as a chronic syndrome but pathological differentiation may be necessary. Chronic hemorrhage due to an **esophagogastric ulcer** results in melena, the epidemiological findings are different, and the necropsy findings are characteristic. Intestine and other organs.

### TREATMENT

#### Antimicrobial therapy

Antimicrobials are usually administered by mass medication to all pigs within the affected group. Treatment by water medication rather than feed medication is preferable because it is generally easier and quicker to put into place and affected pigs usually continue to drink (but perhaps not in the same quantities as when unaffected) while they are anorexic. Pigs with severe hemorrhagic diarrhea and toxemia may not drink sufficient medicated water and must be treated initially by parenteral injection.

Medication of feed is most suitable for subsequent prophylaxis. When outbreaks occur, all severely affected pigs should be treated individually, and the drinking water medicated for several days at therapeutic levels, followed by possible medication of the feed for up to 3 weeks or longer at prophylactic levels.

**Choice of antimicrobials.** The susceptibility of different Brachyspirae to antimicrobials has been discussed.<sup>67</sup>

Several antimicrobials are suitable for the treatment and control of swine dysentery and the choice is largely dependent on availability, cost, efficacy and the regional withdrawal regulations. The antimicrobials and their dosages given here are used in treatment and control.

Currently, tiamulin, lincomycin and the nitroimidazoles (dimetridazole, ronidazole, and ipronidazole) are the most effective antimicrobials for treatment by water medication. In some countries, certain antimicrobials may not be approved for use in pigs. The most efficacious antimicrobials for use in the feed are carbadox, the nitroimidazoles, tiamulin and lincomycin.

A macrobroth dilution in vitro technique determined the antimicrobial sensitivity of a group of isolates of *B. hyodysenteriae* from Australia, the United States and Canada.<sup>68</sup> Dimetridazole and tiamulin were effective against most of the isolates. Lincomycin inhibited the growth of some isolates, and tylosin failed to inhibit most of the isolates tested.<sup>69</sup> A group of isolates of *B. hyodysenteriae* from the United Kingdom were all sensitive to tiamulin and there was no evidence that the organism was developing resistance to the drug.<sup>70</sup> A large number of strains of *B. hyodysenteriae* isolated in Hungary between 1978 and 1992 were tested against seven chemotherapeutic agents commonly used for the treatment of swine dysentery, and the changes in patterns of resistance were also monitored.<sup>71</sup> All strains remained sensitive to carbadox. The sensitivity to dimetridazole gradually decreased with about 50% of strains still sensitive. Most strains were resistant to tylosin. Resistance to lincomycin gradually



increased but about 50% remained sensitive. Tiamulin was most effective but some resistant strains have emerged.<sup>70,72,73</sup> Monensin was effective for prevention but resistance may evolve quickly. Sedecamycin, a macrolide antimicrobial was effective but the minimum inhibitory concentrations (MICs) were much higher than expected.<sup>71</sup> Isolates of *B. hyodysenteriae* in Denmark were sensitive in vitro to virginiamycin but medication of the feed at 20 ppm was ineffective for control.<sup>74</sup> A combination of tiamulin and salinomycin, and salinomycin alone in the feed for 105 days in diminishing doses is effective in controlling naturally occurring disease<sup>75</sup> and in the first 30 days (60 ppm salinomycin and 30 ppm tiamulin), in the next 60 days (30 ppm each) and the next, 15 days (30 ppm salinomycin). For salinomycin alone: the first 30 days (60 ppm), the next 60 days (30 ppm), and the next 15 days (30 ppm).

**Tiamulin** given once at a dose of 10–15 mg/kg BW IM is effective for the treatment of acute cases; recovery often occurs within 24 hours. Tiamulin in the drinking water of clinically affected pigs at a dose of 45 or 60 mg/L of water for 5 days is efficacious. Tiamulin at 20 ppm in the feed for 4–6 weeks is also effective for control and prevention.

**Valnemulin**, a more recent pleuromutilin was shown to be effective. At 50 ppm 62.5% of the pigs still had BH but only 12.5% of the 75 ppm group and none of the 100 ppm or 150 ppm groups.

**Carbadox** alone at 50 mg/kg of feed for 30 days or carbadox combined with sulfamethazine at 100 mg/kg of feed for 30 days is effective in preventing swine dysentery during the infection plus medication period and during the post-medication period.

**Lincomycin** at 11 mg/kg BW IM or tylosin at 8.8 mg/kg BW IM daily for 3 days for both drugs and up to 7 days for lincomycin are effective. A 1:1 mixture of lincomycin/spectinomycin given orally at a dose of 66 ppm in the feed for 8 days followed by a level of 44 ppm for 20 days was successful for the treatment of the disease in adult swine.

**Monensin**. The continuous administration of monensin in the feed of weaned piglets at a dose rate of 100 ppm for 56 days, followed by 50 ppm from 56–84 days, and 25 ppm until 112 days was effective in controlling swine dysentery.<sup>76</sup> Improvements occurred in mortality rates, diarrhea score/day, average daily gain, and feed conversion ratios.

**Valnemulin**. At 3 mg/kg the drug is highly effective for the treatment of SD<sup>77</sup> and also at 75 ppm in the USA.<sup>78,79</sup>

**Organic arsenicals** are the least expensive and are recommended as the

first drug of choice when available. When given in either the feed or water, there is a risk of toxicity. The general recommendation is to administer the medication for a 7-day period and then withdraw it for a 7-day period before reintroduction. However, this is frequently impractical and continuous medication at 250 ppm in the feed is often used as follow-up therapy. Toxicity does not usually occur below levels of 500 ppm but it has occurred at levels as low as 200 ppm where continuous medication is practiced, and constant surveillance for signs of toxicity is necessary. While resistance to organic arsenicals has been suspected, it has not been documented. There has been a marked decline in the use of arsenicals for the clinical management of swine dysentery.

#### Failure to respond to therapy

The major problems with the treatment of swine dysentery are the failure of some outbreaks of the disease to respond favorably to treatment, and relapses or new cases which may occur following withdrawal of medication of the feed or water. Several drug-related problems have been postulated to explain these problems.

**Drug-delayed** swine dysentery occurs several days after withdrawal of medicated feed. It may be due to either an ineffective drug or inadequate dosage of an effective drug and failure to eliminate the causative organism from the colon. However, reinfection from other swine must also be considered. The nitroimidazoles at high levels will apparently prevent the delay or recurrence of dysentery.

In experimentally induced swine dysentery using colon from affected pigs as the oral inoculum, tiamulin in the drinking water at 45 or 60 mg/L for 5 days was also effective in treating clinical disease. However, diarrhea commonly recurred 2–10 days after withdrawal of the drug and repeated medication of the water with tiamulin was necessary to reduce the severity of diarrhea and prevent deaths. After one to three retreatments, the pigs were immune to experimental exposure and there was a significant increase in their serum anti-*B. hyodysenteriae* antibodies. This supports the observation that when certain antimicrobial agents such as dimetridazole, which are highly effective in preventing the development of diarrhea, are withdrawn, the affected pigs do not become immune.

**Drug-diminished** swine dysentery occurs when suboptimal levels of the drug are used. The severity of the diarrhea is reduced; deaths do not occur, but the disease is not eliminated. However, severe disease may follow withdrawal of medication.

The feeding of ronidazole at 60 ppm for 10 weeks, or carbadox at 55 ppm or lincomycin at 110 ppm for 6 weeks eliminated an experimental infection, and swine dysentery did not recur during a 9-week period after withdrawal of the medication. The feeding of sodium arsenilate at a level of 220 ppm for 3 weeks to pigs which had been fed ronidazole for only 6 weeks did cause the development of swine dysentery.

In both drug-delayed and drug-diminished swine dysentery, there are chronic lesions in the colon. In drug-resistant swine dysentery, medication of the feed is not effective and diarrhea and deaths occur. Certain outbreaks of the disease may be resistant to both tylosin and sodium arsenilate. Selection of an effective drug is necessary. The sensitivity of *B. hyodysenteriae* to dimetridazole has not decreased significantly following use of the drug over several years.

**Drug-augmented** swine dysentery is a more severe form of the drug-resistant disease in which affected pigs are more severely affected than non-medicated controls. The cause is unknown. The disease occurs in a severe form several days or weeks following withdrawal of successful medication for a previous outbreak of the disease. This form appears to occur most commonly in pigs which did not have clinical disease during an earlier outbreak, but received medication. The concentration of the drug administered was sufficient to prevent diarrhea, but not sufficient to eliminate the spirochetes from the colon. During the delay of the initial diarrhea by the drug, there may have been intraglandular recolonization of spirochetes throughout the colon. After withdrawal of medication, rapid intraglandular multiplication of the large spirochetes may occur and result in clinical disease. Drug-delayed augmented dysentery usually occurs only in those pigs that have been infected but did not develop clinical disease, which usually results in immunity. The occurrence of diarrhea is necessary for its development which occurs 4–13 weeks after infection. Treatment of swine dysentery with the more efficacious drugs has been shown to inhibit the development of this immunity and serum antibody to *B. hyodysenteriae*. However, the clinical significance of this is undermined and at present it is suggested that outbreaks of swine dysentery be treated vigorously.

It should be possible to minimize these drug-related problems of swine dysentery by the use of therapeutic levels of effective drugs in the drinking water for short periods followed by prophylactic levels in the feed for 3 weeks or more. This must be combined with proper management techniques and waste disposal systems which minimize or prevent re-exposure.



Regardless of the drug used, many pigs are reinfected following withdrawal of medication because of the continual presence of the organism in the environment. The sources of the organism include in-contact carrier pigs which are shedding the organism and survival of the organism in waste materials, which was presented under the heading epidemiology.

### Cleaning and disinfection

After the institution of treatment, thorough cleansing of the contaminated pens is necessary to prevent reinfection or the transmission of infection to new groups of pigs. This is usually done after 3–6 days when all diarrhea has ceased. The decision to continue with prophylactic medication depends upon the hygiene and a knowledge of past patterns of the disease on the farm. It is generally recommended to continue prophylaxis for at least 2 weeks. Swine housing units with open gutter-flush systems in which swine dysentery-infected pigs have been maintained should remain idle for a longer period than 5 or 6 days to eliminate *B. hyodysenteriae*.<sup>80</sup>

### CONTROL

Effective control of swine dysentery is dependent on the control of infection in the herd and the limitation of reinfection, eradication by depopulation and repopulation or mass medication without depopulation.

### Control of infection/limitation of reinfection

Control of the clinical disease can be achieved by early treatment with adequate levels of antimicrobials for a sufficient length of time. This must be combined with adequate removal of fecal wastes to prevent reinfection. Pigs destined for market should be moved out as a group and their pens cleaned, disinfected and allowed to dry for a few days before pigs are restocked. Where possible the purchase of feeder pigs should be restricted to private sales from herds with no history of the disease. Communal trucks should not be used for transport. Where this is not possible pigs should be placed in isolation pens for 3 weeks and provided with medicated feed or water to eliminate the carrier state in infected pigs. Every effort should be made to avoid potential fecal-oral cycles and contamination by feces between pens. Preventing the build-up of fecal wastes is also of paramount importance. Pigs from different source farms should not be grouped in the same pen. It is also necessary to reduce the stress of transportation and overcrowding on the pigs.

In farrowing-to-market enterprises where the disease is always a threat, routine prophylactic medication may also

be necessary. This is commonly carried out following weaning and during the early growing phase. In countries where withdrawal periods are in force, the use of certain microbials is precluded for this purpose.

The feeding of tiamulin at a dose of 20 mg/kg BW to pregnant sows beginning 10 days before farrowing and continuing until 5 days after farrowing when the piglets are weaned and transferred to an isolation unit has been successful in the prevention of infection of newborn piglets. This is known as the 'barrier method' which can be an efficient method of eradicating endemic infections. To reduce the risk of postnatal infection of the progeny, the piglets should stay with the latently infected sows for the shortest time possible. Furthermore, early weaning is necessary and strict isolation is an important condition to success. *B. hyodysenteriae* is spread primarily by carrier pigs, and contact between infected and uninfected pigs must be avoided.

The administration of tiamulin at 10 mg/kg BW IM daily for 5 days to all animals in a large herd, combined with cleaning, disinfection and rodent control was effective in controlling the disease and no further clinical signs occurred in the subsequent 2.5 years.

**Mass medication and sanitation program without depopulation.** With the strategic use of antimicrobials, effective sanitation, serial depopulation of possible carrier animals and the introduction of non-infected animals, it is possible to virtually eradicate the infection from a herd.

Elimination of infection from closed swine herds is possible using antimicrobials described under the treatment section. There are various options.

**Dietary modification.** Experimentally, modification of the diet can assist in the control of swine dysentery.<sup>10</sup> Feeding a highly digestible diet reduces fermentation in the large intestine and is associated with a failure of colonization by *B. hyodysenteriae* when challenged orally.<sup>10</sup> Pigs fed on a diet based on steam-flaked maize and steam-flaked sorghum had a decreased incidence of disease. Pigs fed on a diet based on cooked white rice were fully protected from experimental infection with *B. hyodysenteriae*.<sup>81</sup>

### Eradication of infection

**Depopulation and repopulation.** The infection can be eradicated by depopulation of the entire herd and repopulation with breeding stock free of infection. However, this can be uneconomical unless it is part of the long-term plans for the herd and the producer.

The disease can be eradicated through the use of minimal disease or high-health-

status herds which are free of several infectious diseases and maintain disease-free status. In such herds, diseases such as swine dysentery occur only rarely and almost never over a period of several years. Details are available in the current authors' book on health management.<sup>82</sup>

A control scheme for swine dysentery has been supervised by the Pig Health Control Association in Britain. To qualify, there must be no clinical signs of swine dysentery or, if any suspicious signs are noticed, laboratory tests for *B. hyodysenteriae* must be negative. In addition, a list of pharmaceutical compounds which might mask the disease or its laboratory diagnosis may not be used routinely after weaning, either for treatment or for control. Qualifying herds can import pigs only from other qualifying herds or by hysterectomy/hysterotomy or embryo-transfer methods; artificial insemination is also permitted. Over a period of 6 years the scheme has been highly successful.

**Biosecurity.** Strict biosecurity measures are necessary to prevent introduction of infected carrier pigs. This requires knowledge of the infection status of the herd of origin. It also requires a highly reliable test to detect the infected pig.

### Vaccines

Pigs which have recovered from clinical swine dysentery may be protected against subsequent challenge, but attempts to immunize pigs with *B. hyodysenteriae* have been proven to provide incomplete protection and involve complex procedures which may have limited practical value. The development of effective vaccines will require attention to serospecificity of the organisms used to formulate the vaccines.

Effective vaccines are not widely available as yet. A commercial vaccine using a protein digested bacterin has shown efficacy in the reduction of disease due to *B. hyodysenteriae*.<sup>83,84</sup> It produced both a systemic and mucosal immunity. Both IFN gamma and lymphocyte blastogenesis responses were stimulated. A recombinant outer membrane lipoprotein has also been shown to be a hopeful vaccine.<sup>85</sup>

An inactivated, adjuvanted, whole-cell vaccine against *B. hyodysenteriae* has been tested experimentally.<sup>86</sup> The vaccine provided significant protection in two small trials but some of the vaccinated and unvaccinated pigs developed late-onset swine dysentery, which is unexplainable. Field trials to test the vaccine are required. An experimentally inactivated *B. hyodysenteriae* vaccine adjuvanted with mineral oil resulted in exacerbation of the clinical disease following challenge; a majority of the vaccinated pigs developed the disease earlier and to a more severe degree than the unvaccinated pigs.<sup>80</sup>

## REVIEW LITERATURE

Hampson DJ. The Serpulina Story. Proceedings of the 16th International Pig Veterinary Society Congress, Melbourne, Australia; 2000; pp. 1–5.

## REFERENCES

- Stanton TD. Int J Syst Bacteriol 1992; 42:189.
- Hommez J et al. Vet Microbiol 1998; 62:163.
- Jensen HS et al. Vet Microbiol 1996; 52:251.
- Trott DJ et al. Int J Syst Bacteriol 1996; 46:206.
- Girard C et al. Can Vet J 1995; 36:291.
- Hampson DJ, Stanton TB. Intestinal spirochetes in domestic animals and humans. Cambridge: CAB International, Wallingford: University Press, 1997; pp. 175–209.
- Pearce GP. Vet Rec 1999; 144:338.
- Moller K et al. Vet Microbiol 1998; 62:59.
- Rasback T et al. Proc 18th Int Pig Vet Soc 2004; p. 286.
- Siba PM et al. Epidemiol Infect 1996; 116:207.
- Leser, T.D et al. Appl Env Microbiol 2000; 66:3290.
- Fellstrom C, Gunnarsson A. Res Vet Sci 1995; 59:1.
- Fellstrom C et al. Res Vet Sci 1995; 59:5.
- Lee JJ et al. Vet Microbiol 1993; 34:273.
- Atyeo RF, Hampson DJ. Proc 15th Int Pig Vet Soc 1998; 3:130.
- Atyeo RF et al. Epid Inf 1999; 123:133.
- Thomson JR et al. Anim Hlth Res Rev 2001; 2:31.
- Walker CA et al. Pig J 2003; 51:184.
- Taylor DJ, Trott DJ. In: Hampson DJ, Stanton TB (eds). Intestinal spirochaetes in domestic animals and humans. Cambridge: CAB International, Wallingford: University Press, 1997; pp. 211–241.
- Achacha M et al. Can J Vet Res 1996; 60:45.
- Hampson DJ et al. Vet Rec 1992; 131:318.
- Dugourd D et al. Vet Microbiol 1996; 48:305.
- Li Z et al. J Clin Microbiol 1991; 29:2794.
- Hampson DJ et al. Aust Vet J 1994; 71:347.
- Harel J et al. Can J Vet Res 1994; 58:302.
- Combs BG et al. Vet Microbiol 1992; 31:273.
- Lysons RJ et al. J Med Microbiol 1991; 34:97.
- Hyatt DR et al. Infect Immun 1994; 62:2244.
- Rosey EL et al. Infect Immun 1996; 64:4154.
- Fellstrom C et al. Am J Vet Res 1996; 57:80.
- Olson LD. J Am Vet Med Assoc 1995; 207:1470.
- Boye M. et al. Vet Microbiol 2001; 81:33.
- Pluske JR et al. J Nutrit 1998; 126:2920.
- Govers MJ et al. Gut 1999; 45:840.
- Durmic Z et al. J Appl Microbiol 2000; 89:67.
- Durmic Z et al. Br J Nutrit 2002; 88:159.
- Jacobson M et al. J Med Microbiol 2004; 53:273.
- McDonald DE et al. Proc 16th Int Pig Vet Soc Cong 2000; p. 39.
- Kirkwood R et al. Swine Hlth Prod 2000; 8:73.
- Lindercrona RH et al. Proc 16th Int Pig Vet Soc Cong 2000; p. 7.
- Lindercrona RH et al. Anim Sci 2003; 76:81.
- Fellstrom C et al. Proc. 18th Int Pig Vet Soc Cong Hamburg 2004; p. 280.
- Jensen TK et al. Acta Path Micro Scand 1998; 106:1061.
- Hsu T et al. Infect Immun 2001; 69:706–711.
- Stanton TB et al. Appl Env Microbiol 1999; 65:5028.
- Dugourd D et al. J Bacteriol 1999; 181:6984.
- Zhang P et al. Infect Immun 2000; 68:4559.
- Kennedy MJ, Yancey RJ. Vet Microbiol 1996; 49:21.
- Bland AP et al. Vet Pathol 1995; 32:24.
- Hutto DL, Wannemuehler MJ. Vet Path 1999; 36:412.
- Jonasson R et al. J Med Microbiol 2004; 53:267.
- Waters WR et al. Proc Am Ass Swine Vet 2000; 31:215.
- Jensen NS. In: Hampson DJ, Stanton TB (eds) Intestinal spirochaetes in domestic animals and humans. Cambridge: CAB International, Wallingford: University Press 1997; pp. 323–341.
- Lysons RJ. Vet Rec 1991; 129:314.
- Hampson D. Vet Rec 1997; 140:51.
- Leser TD et al. Mol Cell Probes 1997; 11:363.
- Atyeo RF et al. Lett Appl Microbiol 1988; 26:126.
- Rasback T et al. Proc 18th Int Pig Vet Soc Cong Hamburg 2004; p. 247.
- Fellstrom C et al. Anim Hlth Res Rev 2001; 2:37.
- La T et al. Proc 18th Int Pig Vet Soc Cong Hamburg 2004; p. 283.
- Jensen TK et al. Acta Path Micro Scand 1998; 106:81.
- Westerman RB et al. J Clin Microbiol 1995; 33:2145.
- Achacha M, Mittal KR. Vet Microbiol 1996; 48:73.
- Achacha M, Mittal KR. Vet Rec 1996; 139:539.
- La T, Hampson D. Anim Hlth Res Rev 2001; 2:45.
- Diarra AT et al. Comp Immunol Microbiol Infect Dis 1995; 18:215.
- Kramomtong I et al. Vet Rec 1996; 138:332.
- Hommez J et al. Diergeneesk Tijdschr 1998; 67:32.
- Buller NB, Hampson DJ. Aust Vet J 1994; 71:211.
- Karlson M et al. Vet Microbiol 1999; 172:255.
- Dalziel RW. Vet Rec 1996; 138:288.
- Molnar L. Vet Rec 1996; 138:158.
- Oxberry SJ, Hampson DJ. Proc 15th Int Pig Vet Soc Cong Birmingham, 1998; 3:132.
- Karlson M. J Med Microbiol 2004; 53:281.
- Ronne H, Jensen JCE. Vet Rec 1992; 131:239.
- Kyriakis S et al. Vet Med 1995; 90:701.
- Kyriakis SC. Br Vet J 1989; 145:373.
- Ritzmann M et al. Proc 16th Int Pig Vet Soc Cong 2000; p. 8.
- Holck JT et al. Proc 16th Int Pig Vet Soc Cong 2000; p. 13.
- Olson LD et al. Am J Vet Res 1994; 55:67.
- Pluske JR et al. J Nutr 1996; 126:2920.
- Radostits OM et al. Herd health: food animal production medicine, 2nd edn. Philadelphia: WB Saunders, 1994.
- Waters WR et al. Vet Immunol Immunopathol 1999; 69:75.
- Waters WR et al. Vaccine 2000; 18:711.
- La T et al. Proc 18th Int Pig Vet Soc Cong 2004; p. 248.
- Hampson DJ et al. Aust Vet J 1993; 70:18.

### PORCINE INTESTINAL SPIROCHETOSIS (SPIROCHETAL COLITIS; PORCINE COLONIC SPIROCHETOSIS) AND NON-SPECIFIC COLITIS

#### INTRODUCTION

Porcine intestinal spirochaetosis is a non-fatal, colonic disease of recently weaned, grower and finisher pigs. The causative organism *B. pilosicoli* was first recognized in 1980.<sup>1</sup> It is a Gram-negative, anaerobic, but oxygen-tolerant spirochete found in the colon.

It is found in a wide variety of hosts including humans,<sup>2</sup> primates, dogs, opossums, commercial chicken production and various species of birds.<sup>3,4</sup>

Porcine colonic spirochetosis (PCS) and non-specific colitis may be two different syndromes.

PCS is certainly associated with *Brachyspira pilosicoli* formerly known as *Serpulina pilosicoli*. *B. hyodysenteriae* was described in 1971,<sup>5</sup> *B. pilosicoli* in 1997<sup>6,7</sup> and these are the only two confirmed pathogens in the Brachyspirae group. *B. innocens* described in 1992<sup>8</sup> and the other two *B. intermedii* and *murdochii* in 1997<sup>9</sup> are considered non-pathogenic.

Non-specific colitis (NSC) may be associated with any of the brachyspirae or any other of the common enteric bacteria but is also more likely to be associated with dietary disturbances of the large intestine. A large postal survey of enteric disease in grower-finisher pigs in England showed that colitis in some form occurred in 345 of farms.<sup>10</sup> Large, anaerobic weakly beta-hemolytic non-*B. hyodysenteriae* spirochetes have been associated with porcine colitis<sup>11</sup> and are capable of inducing disease in gnotobiotic pigs but their role as primary or opportunistic pathogens in colitis in conventional pigs is uncertain.<sup>12</sup> *B. innocens* has been considered as one member of a diverse group of non-pathogenic species which may be involved in a mild disease of the large intestine.<sup>13</sup>

#### ETIOLOGY

A specific colitis can be part of *Brachyspira*, *Salmonella*, *Lawsoniana*, *Trichuris* or *Balantidium* infections.

#### PCS

*B. pilosicoli*, a new species, has now been identified as the cause of porcine colonic spirochetosis (PCS).<sup>14</sup> Other species of weakly beta-hemolytic intestinal spirochetes are encountered less frequently and these may contribute to the non-specific colitis.<sup>15</sup> Three strains were investigated in the UK. The genetic relationships between brachyspirae were determined by pulsed field gel electrophoresis (PFGE).<sup>16</sup>

Swedish workers grouped the intestinal spirochetes isolated from pigs into four groups based on phylogenetic studies<sup>17,18</sup> although closely related. Groups I and II were isolated only from pigs with dysentery or diarrhea. Group II was differentiated from Group I only by weak beta-hemolysis. In Sweden, members of Group II are often isolated from young weaned pigs of up to 25 kg, in herds where a non-specific diarrhea which is clinically distinct from swine dysentery occurs frequently. These strains seem to be absent or rare in herds without such diarrheic pigs. Group III included the type strain for *B. innocens*. Group IV included the pathogenic, weakly beta-hemolytic strain P43 shown to cause spirochetal diarrhea in pigs. A PCR system is used for the detection and identification of Group IV spirochetes (*B. pilosicoli*).<sup>19</sup> Most farms have distinct *B. pilosicoli* genotypes and common genotypes between and among herds are rare.<sup>20</sup>

A complex investigation involving 85 pig units in Scotland over the period from 1992–1996 has provided much needed information on the occurrence of mixed infections.<sup>21</sup> All the pigs were within 20–40 kg (occasionally 50 kg), 8–16 weeks of age, and all had diarrhea

and grew slowly over the period of 2–3 weeks. *B. pilosicoli* was found on 25% of the units. Atypical brachyspirae on 7%; *B. hyodysenteriae* on 6%; with *S. typhimurium* on 4%; *Yersinia pseudotuberculosis* on 4% and *Lawsoniana intracellularis* on a mere 3%. Mixed infections of *B. pilosicoli* with yersinia, salmonella, other combinations and *B. hyodysenteriae* were found on 27%. On six of the 85 units nothing pathogenic was detected.

### NSC

Non-specific colitis was first seen in the UK in intensive management systems. Pigs showed a sporadic diarrhea with soft, wet feces, in 18–35 kg pigs and with a morbidity of 20–30%. Most pigs continued to thrive but some grew poorly. Pigs had enlarged colons with frothy contents and most had a reddened mucosa. Microscopically they have a mild erosive colitis. Most of these cases were probably *B. pilosicoli* cases but there is now some evidence that would be better called dietary colitis. They could be diet related or diet induced and most often pelleted feed was implicated as a complicating factor. It has now been shown that some diets induce a colonic acidosis and enhance colonization by spirochetes. Many of these cases have no involvement of any of the brachyspirae and the possibility exists that there may be a syndrome of colonic dysfunction without direct spirochetal involvement. It is possible that any event that leads to disturbance of colonic microflora may lead to colonic lactic acidosis and damage to the colonic mucosa. You may then get a reduction in colonic fluid absorption and as a result of this diarrhea. At the moment the role of the various possible players is not clear. It might involve feed ingredients, feeding practices, pre-disposing viral enteritis, poor management, poor hygiene, or even sudden changes in husbandry.

### Occurrence

The condition of PCS probably has a worldwide occurrence and has certainly been reported in Korea,<sup>22</sup> Italy,<sup>23</sup> Finland,<sup>24</sup> Sweden,<sup>19,25</sup> the UK,<sup>21</sup> Australia,<sup>26</sup> New Zealand,<sup>27</sup> Brazil,<sup>28</sup> Canada<sup>29</sup> and all the major pig producing states of the USA.<sup>30–32</sup> Recently, 428 pens were examined in Finland; none had *B. hyodysenteriae*, five had *B. intermedia*, *B. pilosicoli* were found in 14 and group III brachyspirae were found in 37. Herds using Carbadox had a lower prevalence of brachyspira species than the ones using olaquinox.

### Risk factors

#### Transmission

It is likely that the common route of transmission is fecal/oral but there may be a role for mice and birds.

Managemental and environmental factors

There may be a close association between this agent and other non-specific factors in the gut. Changes in colonic micro-environment may pre-dispose to colonization and damage being associated with *B. pilosicoli*. There is a lower incidence if antibiotics are fed compared with no antibiotics.

#### Feed

Consumption of a rice-based diet but not vaccination delayed and significantly reduced the onset of excretion of *B. pilosicoli* after experimental challenge. In a recent set of experiments five diets were used in conjunction with *B. pilosicoli*.<sup>33</sup> They included pelleted feed, non-pelleted standard food, standard diet plus lactic acid, formulated liquid diet, and a diet based on cooked rice. The group that were fed rice did indeed excrete *B. pilosicoli* for less time in their feces and in fewer numbers than the other groups. The pigs on the pelleted diet were worse.

#### NSC

It may be associated with variations in a wide variety of factors including feed ingredients, feed formulations, feed availability, absence of fiber, or high salts in water.

### PATHOGENESIS

The initial colonization of the colon appears to be mediated by the motility-regulated mucin association<sup>34</sup> in which there is a positive chemotaxis towards mucin.<sup>35</sup> Galactosamine and glucosamine are important constituents of intestinal mucin and *B. pilosicoli* uses both of these substrates when it is grown in vitro.<sup>6,14</sup> This is followed by the multiplication of the spirochetes in close proximity to the mucosal surface and inside the lumen of the crypts.<sup>31,36</sup> Intimate attachment of the of *B. pilosicoli* to the apical membrane of the colonic enterocytes, causes destruction of the enterocyte microvilli.<sup>31</sup> These lesions are only seen in the first 3 weeks postinoculation in the experiments that have been performed. There may be a specific spirochete ligand and host cell membrane receptor interaction.<sup>32,37,38</sup> *B. pilosicoli* can invade between the enterocytes and reach the lamina propria where it may remain extracellularly or be seen in macrophages.<sup>37</sup> *B. pilosicoli* can virtually eat its way through from the lumen to the lamina propria.<sup>39–41</sup> They spread extra-cellularly in the underlying lamina propria and are phagocytosed by the macrophages and also enter the capillary blood vessels.<sup>30</sup> They are taken up by a novel mechanism that has been called coiling phagocytosis in which the *pilosicoli* are localized and replicate

in the endoplasmic reticulum of the infected cells which suggests intracellular trafficking.<sup>42</sup>

Penetration of the epithelium may involve disassociation of the intercellular junctional areas by the action of a subtilisin-like serine protease present in the outer membrane of the spirochete.<sup>43</sup>

### CLINICAL FINDINGS

Porcine colonic spirochetosis is characterized by mild persistent diarrhea in pigs. Growth retardation and partial anorexia occur commonly. Morbidity and mortality data are not available.

The clinical signs of porcine intestinal spirochetosis (PIS) and NSC are difficult to distinguish from one another, and are similar to those seen in other forms of colitis, as well as those in the early stages of swine dysentery. Prevalence was found to be 5–15% in affected batches and the mortality 1%.<sup>21</sup>

It occurs in pigs from 4–20 weeks of age and is characterized by diarrhea and reduced growth rates in weanlings and growing pigs.<sup>2,3,6,36</sup> There is reduced feed conversion and more days to slaughter.

Typically, it occurs 7–14 d after weaning<sup>6</sup> or after they have been mixed. Morbidity is in the region of 5–30% and the signs last for 2–6 weeks. It is distinct clinically and pathologically from swine dysentery. Clinical findings include a mucoid non-bloody diarrhea, often soft and wet to start forming puddles like 'wet cement' and then becoming watery. During recovery and in chronic cases there may be large amounts of mucus. There is also reduced feed conversion, and reduced growth rate.<sup>29</sup> Affected pigs are usually alert and active but may become depressed, gaunt and found with stary, rough coats. Affected pigs rarely die and eventually recover. Chronic infection and relapses are sometimes recorded. Mixed infections took longer to recover and had a more profound effect on growth rates and often persisted unless there was medication.<sup>21</sup>

#### Non-specific colitis

The clinical signs of non-specific colitis are mild and are characterized by mild persistent diarrhea in pigs 5 to 14 weeks of age.<sup>29</sup> Growth retardation and partial anorexia occur commonly. Morbidity and mortality data are not available.

### PATHOLOGY

Gross lesions are usually subtle or not recognized. They are restricted to the large intestine in all species. The spiral colon is flaccid, and full of watery contents with a variable amount of mucus. Mucosal lesions are most obvious in the mid region of the spiral colon followed by the proximal spiral colon. The cecal mucosa is usually not involved or only mildly. The mucosa is

reddened or thickened by edema, and it may even form ridges. There are a variable number of erosions. If there are few there appears to be nothing visible but if they are many then the surface appears granular and it may be necessary to gently wash the mucosa with water to see these erosions. Fibrin may be mixed with mucus or blood and there may be variable amounts of either loose in the lumen of the colon. In mixed infections with *B. pilosicoli* then the lesions were more extensive and sometimes affected the cecum as well as the colon.

Microscopically, with time the surface epithelium becomes eroded and attenuated<sup>21</sup> but these changes are not specific to *pilosicoli*. There is a mild to moderately severe erosive colitis which can be multifocal or diffuse. The extent and severity of this is probably a function of the colonic microflora.<sup>44,45</sup> There is often adherent fibrino-necrotic exudates and feed particles. Goblet cell hyperplasia with distended mucus filled crypts, mucosal edema and lymphoplasmacytic infiltrates are also found.

The characteristic histological feature is a dense mat or false brush border of spirochete cells which are closely packed parallel to one another and are attached by one end to the colonic epithelium resembling a 'brush border'. This may be a feature only in the first 2–3 weeks of infection. With time the spirochetes persist in the lumen of the colonic glands which are dilated and filled with mucus.<sup>21,36</sup> The lesions of NSC resemble a mild form of swine dysentery.

#### IMMUNOLOGY

Recovered pigs may have serum immunoglobulins to several *B. pilosicoli* antigens<sup>46</sup> but in experimental infections there seems to be a lack of a systemic response.<sup>47</sup>

#### LABORATORY DIAGNOSIS

The laboratory diagnosis of PCS is similar to those used in swine dysentery. The identification of spirochetes in fresh wet smears of feces viewed by phase contrast microscopy may provide evidence of spirochetal infection but this method alone is not reliable and cannot differentiate between the various groups of pathogenic and non-pathogenic spirochetes. It can be combined with fluorescent labeled antibodies.<sup>48,49</sup>

Primary isolation is the technique of choice for confirmation of the disease and it is then necessary to show *B. pilosicoli* in the mucosa or feces by culture or PCR.<sup>50</sup> You can then demonstrate the weakly beta-hemolytic *B. pilosicoli* organisms and provisional identification is by hippurate hydrolysis<sup>19</sup> although there are organisms that are hippurate negative, but have been confirmed as *pilosicoli* by 16S ribosomal DNA analysis. Most have the hippurate

cleaving capacity.<sup>51</sup> It is safer to remember that biochemical analysis is not definite as they can be both hippurate negative or positive.<sup>52</sup> For this reason it is worth checking on their reaction with beta-glucuronidase as they should be negative if they are *B. pilosicoli*.

Microscopic lesions are not diagnostic as they may be confused with salmonellosis or swine dysentery but you can see the organisms in HE sections and they may be confirmed in WS silver stained sections. Specific identification requires IHC staining with *B. pilosicoli* specific mouse monoclonal antibodies.<sup>53</sup> Fluorescent ribosomal RNA can also be detected in ISH.<sup>54</sup> Scanning electron microscopy shows degenerating epithelial cells and spirochetal colonization of the epithelium with *B. pilosicoli* but nothing with *B. intermedia*.<sup>54</sup> The presence of *B. intermedia* can then be detected by PCR using 23SrDNA genes.<sup>55</sup>

#### POTENTIAL ZONOTIC RISK

The human strains can cause colitis in pigs<sup>14</sup> and the wide species occurrence may cause concern for their being a zoonotic risk but this has not yet been confirmed. A cause of special concern is that in some parts of the world the level of infection in humans is quite high and this may be an indicator that spread is possible from some of the other species to humans.

#### TREATMENT

Treatment and control of PIS and PSC are achieved using the same principles as those used for swine dysentery. All USA isolates are susceptible to tiamulin and carbadox. Over 50% were resistant to gentamycin. With lincomycin 42% were susceptible, 15.8% resistant and 42% had an intermediate susceptibility.<sup>56</sup>

In experimental infections when given after challenge valnemulin significantly reduced diarrhea and colonization by spirochetes. More recently in-feed valnemulin has also been shown to be useful at 25 ppm for 14–27 days giving lower lesion scores and less widespread colitis.<sup>57</sup>

#### CONTROL

An effective rodent control policy and prevention of bird entry is probably essential for the control of PSC.

Treatment and control of PIS and PSC are achieved using the same principles as those used for swine dysentery. Control can produce significant savings where there is all in/all out management and multiple site production. Improving hygiene and reducing contact with feces are the essential ingredients for successful control. If there is a lot of contamination then it is always better to allow exposure for about a week before giving antibiotics as this allows at least some immunity to be pro-

duced. Since other species may be a source of infection it is necessary to control mice and birds. Rational use of antibiotics may be useful. Rotation of antibiotic usage may make the occurrence of resistance less likely. The three most likely successful treatments are vanemulin, carbadox and tiamulin, although carbadox cannot be used in many countries.

- Rations shown to contain 33 and 110 ppm of lincomycin provided an effective control
- In Finland the use of tiamulin at 200 ppm for 18–30 days combined with thorough cleaning removed PCS from a 60 farrow to finish operation
- Vanemulin at 25 ppm (1.25 mg/kg) was shown to be effective in controlling spontaneous PCS.

#### Vaccination

Vaccination seems to induce a primary and secondary serological response to *B. pilosicoli* but an experimental whole-cell bacterin was not protective when administered parenterally.<sup>58</sup>

#### REVIEW LITERATURE

- Taylor DJ, Trott DJ. Porcine intestinal spirochaetosis and spirochaetal colitis. In: Hampson DJ, Stanton TB (eds). Intestinal spirochaetes in domestic animals and humans. Cambridge: CAB International, Wallingford: University Press, 1997; pp. 211–241.
- Pluske JR, Pethick DW, Hopwood DE, Hampson DJ. Nutritional influences on some major enteric bacterial diseases of pigs. *Nutrit Res Rev* 2002; 15:333–371.
- Hampson DJ, Pluske J. Role of diet in managing enteric disease in pigs. In *Practice* 2004; 26:438–443.

#### REFERENCES

1. Taylor DJ et al. *Vet Rec* 1980; 106:326.
2. Trott DJ et al. *Epid Infect* 1997; 119:369.
3. Oxberry SL et al. *Epid Infect* 1998; 121:219.
4. Webb DM et al. *Avian Dis* 1997; 41:997.
5. Taylor DJ, Alexander TJL. *Br Vet J* 1971; 127:58.
6. Trott DJ et al. *Inf Immun* 1996; 63:3705.
7. Ochiai S et al. *Microbiol Immunol* 1997; 41:445.
8. Stanton TB. *Int J Syst Bact* 1992; 42:189.
9. Stanton TB et al. *Int J Syst Bact* 1997; 47:1007.
10. Pearce GP. *Vet Rec* 1999; 144:338.
11. Lee JI et al. *Vet Microbiol* 1993; 34:273.
12. Neef NA et al. *Infect Immun* 1994; 62:2395.
13. Ramanathan M et al. *Vet Microbiol* 1993; 37:53.
14. Trott DJ et al. *Int J Syst Bacteriol* 1996; 46:206.
15. Taylor DJ, Trott DJ. In: Hampson DJ, Stanton TB (eds). Intestinal spirochaetes in domestic animals and humans. Cambridge: CAB International, Wallingford: University Press, 1997; pp. 211–241.
16. Atyeo RF et al. *FEMS Microbiol Lett* 1996; 141:77.
17. Fellstrom C, Gunnarsson A. *Res Vet Sci* 1995; 59:1.
18. Fellstrom C et al. *Res Vet Sci* 1995; 59:5.
19. Fellstrom C et al. *J Clin Microbiol* 1997; 35:462.
20. Fossi M et al. *Inf Immun* 2003; 131:967.
21. Thomson JR et al. *Vet Rec* 1998; 142:235.
22. Choi C et al. *Vet Rec* 2002; 150:217.
23. Bonilauri P et al. *Obiettivi Docum Vet* 2002; 23:15.
24. Heinonen M et al. *Proc 15th Int Pig Vet Soc Cong* 1998; 2:57.
25. Fellstrom C et al. *Am J Vet Res* 1996; 57:801.
26. Trott DJ et al. *Inf Immun* 1996; 64:4648.
27. Christensen NH. *Proc 15th Int Pig Vet Soc Cong* 1998; 3:418.

28. Barcellos DE et al. *Vet Rec* 2000; 146:398.
29. Girard C et al. *Can. Vet J* 1995; 36:291.
30. Duhamel GE et al. *Pig J* 1995; 35:101.
31. Duhamel GE et al. *J Vet Diag Invest* 1998; 10:350.
32. Muniappa N et al. *J Vet Diag Invest* 1997; 9:165.
33. Lindcraon RH et al. *Vet Rec* 2004; 154, 264.
34. Witters NA, Duhamel GE. *Proc Conf ResWrkrk Anim Dis Abs* 1998; 55.
35. Witters NA, Duhamel GE. *Adv Exp Biol Med* 1999; 473:199.
36. Thomson JR et al. *Infect Immun* 1997; 65:3693.
37. Muniappa N et al. *Vet Path* 1996; 33:542.
38. Moxley RA, Duhamel GE. *Adv Exp Med Biol* 1999; 473:83.
39. Muniappa N et al. *J Spir Tick Borne Dis* 1998; 5:44.
40. Trivett-Moore NL. *J Clin Microbiol* 1998; 36:261.
41. Trott DJ et al. *Inf Immun* 1995; 63:3705.
42. Cheng X et al. *Ann Meet Conf Res Work Anim Dis* 1999; p. 105.
43. Muniappa N, Duhamel GE. *FEMS Microbiol Lett* 1997; 154:159.
44. Johnston T et al. *Comp Fd Anim Med Manage* 1999; 21:S198-207.
45. Johnston T et al. *Comp Fd Anim Med Manage* 1999; 21:S230-231.
46. Zhang P et al. *Adv Exp Med Biol* 1999; 473:207.
47. Hampson DJ et al. *Vet Microbiol* 2000; 73:75.
48. Lee BJ et al. *FEMS Microbiol Lett* 1995; 131:179.
49. Tenaya IWM et al. *J Med Microbiol* 1998; 47:317.
50. Atyeo RF et al. *Lett Appl Microbiol* 1998; 26:126.
51. Fossi M et al. *J Clin Microbiol* 2004; 42:3153.
52. Thomson JR et al. *Anim Hlth Res Rev* 2001; 2:31.
53. Duhamel GE. *Large Anim Pract* 1998; 19:14.
54. Jensen TK et al. *Vet Path* 2000; 37:22.
55. Suriyaarachchi DS et al. *Vet Microbiol* 2000; 71:139.
56. Duhamel GE et al. *J Vet Diag Invest* 1998; 10:350.
57. Duhamel GE. *Proc 17th Int Pig Vet Soc Cong* 2002; p. 327.
58. Hampson DJ et al. *Proc 15th Int Pig Vet Soc Cong* 1998; 2:56.

### ULCERATIVE GRANULOMA (NECROTIC ULCER; SPIROCHETAL GRANULOMA; ULCERATIVE SPIROCHETOSIS, ULCERATIVE DERMATITIS, GRANULOMATOUS DERMATITIS) OF PIGS

Ulcerative granuloma is an infectious disease of pigs associated with the spirochete, *Borrelia suilla*<sup>1</sup> (formerly *B. suis*), which is characterized by the development of chronic ulcers of the skin and subcutaneous tissues. It can be confused with necrotic ear syndrome<sup>2</sup> and more importantly with swine vesicular disease when there are granulating lesions at the coronary groove.

It occurs most commonly under conditions of poor hygiene in Australia and New Zealand<sup>3</sup> and is recorded in the United Kingdom.<sup>4-6</sup>

Lesions occur on the central abdomen of sows and on the mammary glands. The other important site is the face of sucking pigs, suggesting infection of cutaneous or mucosal abrasions as the portal of entry. In some instances these outbreaks have followed episodes of severe fighting.

Initially the lesions are small, hard, fibrous swellings which ulcerate in

2-3 weeks to form a persistent ulcer with raised edges and a center of excessive granulation tissue covered with sticky, gray pus. All you may see is a grayish, crusty, weeping lesion which may spread. It may follow infection with *Staphylococcus hyicus* or beta-hemolytic streptococci and the lesions may be contaminated by *Arcanobacterium pyogenes*.<sup>7</sup> The lesions expand, often to 20-30 cm in diameter, on the belly of the sow. They are usually single or in small numbers. In young pigs, usually within 2-3 weeks of weaning and whole litters may be affected. The lesions commence about the lips and erode the cheeks, sometimes the jawbone, and often cause shedding of the teeth. The disease has also been described in weaned pigs to affect the lower margin of both ears close to the junction with the neck, with extensive tissue destruction and sloughing. The lesions may continue to enlarge particularly those found on the central abdomen of sows and on the tail of suckling pigs. The major diagnostic problem is that the initial spirochetal lesions may be secondarily infected with environmental organisms such as *Fusobacterium* spp. or *A. pyogenes* and the underlying spirochetes may be missed unless smears are viewed. The pathology usually involves edema, erythema, necrosis, ulceration and purulent lesions.

In adult animals there is considerable inconvenience if the lesions are permitted to develop. In young pigs there may be heavy losses due to severe damage to the face.

In growing pigs, the lesions need to be differentiated from necrotic lesions resulting from the vices of snout rubbing in colored pigs and ear-biting, and those resulting from excessive self-trauma with mange infestation. Necrotic ulcers on the udders of sows may continue to develop and extend deeper into areas with fistulae, and sloughing may result.

Differential diagnosis may include abscesses, foreign bodies, granulomas, and pressure necrosis. It may be mistaken for lesions of actinomycosis and swabs should be taken from the ulcers for bacteriological examination. A fresh smear of the exudates usually shows the spirochetes and if necessary they can be stained by silver stains or viewed in histological sections. A course of potassium iodide given orally (1 g/35 kg up to 3 g), or a 5-day period of injections of penicillin are the methods of treatment. Topical tetracycline spray has been used effectively with early lesions<sup>5</sup> followed by tetracycline injection in the deeper seated and more chronic cases. Dusting with sulfanilamide, arsenic trioxide or tartar emetic has also been recommended. Removal of large granulomas surgically has also been tried. Fly repellants should be used to prevent flystrike.

The injection of 0.2 mL of a 5% solution of sodium arsenite into the substance of the lesion is reported to give good results. Improvement in hygiene particularly at the times of routine treatments and disinfection of skin wounds should reduce the incidence in affected piggeries.

### REFERENCES

1. Mullowney PC, Baldwin EW. *Vet Clin North Am* 1984; 6:113.
2. Richardson JA. *Vet Path* 1984; 21:152.
3. Hindmarsh WL. New South Wales Department of Agriculture, Veterinary Research Report, 1937; 7:64.
4. Blandford TB et al. *Vet Rec* 1972; 90:15.
5. Harcourt RA. *Vet Rec* 1973; 92:647.
6. Beaton D et al. *Vet Rec* 1974; 94:611.
7. Cameron RDA. University of Sydney Post-graduate Seminar on the Skin Diseases of the Pig. *Vet Rev* 1984; 23:9.

### Diseases associated with *Mycoplasma* spp.

The genera *Mycoplasma*, *Acholeplasma* and *Ureaplasma* form the family Mycoplasmataceae within the class Mollicutes. (Mollicutes: A class of Gram-negative bacteria consisting of cells bounded by plasma membrane. Its organisms differ from other bacteria in that they are deficient in cell walls. It contains a single order, Mycoplasmatales. Mollicutes: mollis = soft, cutis = skin.) More than 200 mollicutes, including 102 *Mycoplasma* species, have been named, although many more as yet unnamed species have been isolated.<sup>1</sup> A summary of the major Mollicutes of farm animals and the diseases associated with them is shown in Table 20.5.<sup>2</sup>

The *Mycoplasma* species that affect ruminants cause some of the most economically important diseases worldwide. Contagious bovine pleuropneumonia (CBPP) an Office International des Epizooties (OIE) List A disease is associated with *Mycoplasma mycoides* subspecies *mycoides* small colony type, and contagious caprine pleuropneumonia (CCPP), and OIE List B disease is associated with *Mycoplasma capricolum* subspecies *capricolum*. The disease complex contagious agalactia, an OIE List B disease, is associated with a number of mycoplasma species, including *Mycoplasma agalactia*, *M. capricolum* subspecies *capricolum*, *M. mycoides* subspecies *mycoides* large colony and *Mycoplasma putrefaciens*.

Between 1990 and 2000, more than 1600 mycoplasmas and the related acholeplasmas were identified from ruminant animals by the Mycoplasma Group at the Weybridge Laboratories Agency, Weybridge.<sup>1</sup> Over the period, *Mycoplasma bovis* was the most commonly identified pathogen, with an overall mean

Table 20.5 Major pathogenic Mycoplasmas of ruminants, swine, and horses

Animal host/Mycoplasma species	Disease
<b>Bovine</b>	
<i>M. mycoides</i> subsp. <i>mycoides</i> SC	Contagious bovine pleuropneumonia, CBPP
<i>Mycoplasma</i> sp. bovine group 7	Pneumonia and arthritis
<i>M. bovis</i>	Mastitis, pneumonia (calf), polyarthritis (calf) metritis, abortion, sterility
<i>M. dispar</i>	Pneumonia (calf)
<i>M. californicum</i>	Mastitis
<i>M. canadense</i>	Mastitis
<i>M. bovoculi</i>	Conjunctivitis
<i>Ureaplasma diversens</i>	Metritis, sterility, abortion
<i>Mycoplasma</i> (Eperythrozoon) <i>wenyonii</i>	Anemia
<b>Sheep and goat</b>	
<i>M. capricolum</i> subsp. <i>capripneumonia</i>	Contagious caprine pleuropneumonia
<i>M. capricolum</i> subsp. <i>capricolum</i>	Mastitis, arthritis
<i>M. mycoides</i> subsp. <i>capri</i>	Pneumonia, arthritis septicemia (goat)
<i>M. mycoides</i> subsp. <i>mycoides</i> LC	Pneumonia, mastitis, arthritis, septicemia (goat)
<i>M. agalactiae</i>	Infectious agalactia
<i>M. ovipneumoniae</i>	Pneumonia (lamb)
<i>M. conjunctivae</i>	Infectious keratoconjunctivitis (IKC) (sheep)
<b>Pig</b>	
<i>M. hyopneumoniae</i>	Enzootic pneumonia
<i>M. hyorhinis</i>	Pneumonia, arthritis
<i>M. hyosynoviae</i>	Arthritis
<i>Mycoplasma</i> (Eperythrozoon) <i>suis</i>	Anemia
<b>Horse</b>	
<i>M. felis</i>	Pleuritis
<i>M. equirhinis</i>	
<i>M. equipharyngis</i>	

of 52% of the isolates, mostly from pneumonic calves but also from cattle with mastitis and arthritis. *Mycoplasma canis* was first isolated in Britain in 1995 from pneumonic calves and the number of isolates increased 18% of the total mycoplasmas isolated from cattle in 1999. Other species isolated include *Mycoplasma dispar* from lungs of cattle with respiratory disease, and *Mycoplasma bovigenitalium* from the reproductive tract of cows with vulvovaginitis and infertility. *Mycoplasma bovirhinis* and *Acholeplasma* species were found commonly but are considered as opportunists. In sheep and goats, the majority of *Mycoplasma* species isolated were *Mycoplasma ovipneumoniae* from pneumonic sheep. *Mycoplasma conjunctivae* from sheep with keratoconjunctivitis, and the ubiquitous *Mycoplasma arginini*.<sup>1</sup>

Molecular techniques such as denaturing gradient electrophoresis (DGGE) of a 16S ribosomal DNA PCR product have been used to differentiate almost all mycoplasmas within a host animal group.<sup>3</sup> The method can enable the rapid identification of many mycoplasma species for which there is no specific PCR available and which are currently being identified by culture and serological tests. This has demonstrated that *Mycoplasma* species are not necessarily host specific. Molecular epidemiological analysis of 53 *Mycoplasma bovis* isolates from pneumonic cattle collected in UK between 1996 and

2002, revealed two genetically distinct clusters (A and B).<sup>4</sup> There was no clear relationship between the geographic origin or year of isolation of the isolates and the profiles produced. Group B isolates were relatively more heterogeneous than isolates of the A group.

*Mycoplasma bovis* is a major pathogen causing respiratory disease, arthritis, mastitis, and other diseases such as otitis in cattle.<sup>5</sup> *M. bovis* is found worldwide and has spread into new areas, including Ireland and parts of South America, in the last decade. There is considerable antigenic variation in *M. bovis* associated with its variable surface proteins (Vsp) which differ from other mycoplasmas.<sup>6</sup> *M. bovis* is highly invasive and is not confined to the initial area of colonization, the respiratory tract. Consequently, organisms rapidly gain access to multiple organ systems.

*Mycoplasma* sp. bovine group 7 can cause substantial economic losses due to mastitis, polyarthritis and abortion in dairy cattle.<sup>7,8</sup> The disease may be spread from mammary gland infections, and neonatal calves were most likely infected by the consumption of milk contaminated with the mycoplasmas. Abortions probably occurred due to a systemic infection of mycoplasma.

Mycoplasmas are the smallest prokaryotes with autonomous replication. They are extracellular parasites with an

affinity for mucous membranes, where they exist as commensals or pathogens. Pathogenic mycoplasma have a predilection for the respiratory system, urogenital tract, mammary gland and serous membranes. Most mycoplasmas are adapted to a main host in which they are commonly pathogenic. They may colonize other hosts without being pathogenic. As parasites of mucous membranes, they adhere firmly to epithelial cells and adhesion is a prerequisite for colonization and infection. Their mechanism of virulence is not well-understood and activation of the immune system of the host probably plays a major role in the pathogenesis of mycoplasmoses. In general, mycoplasmas are not highly virulent but rather induce chronic diseases. Most animal mycoplasmoses are herd problems with high morbidity and relatively low mortality and healthy carriers are an important part of the epidemiology of mycoplasmoses.

The most important pathogens are found in the *mycoides* cluster with six species, among them the pathogens of contagious bovine pleuropneumonia, contagious caprine pleuropneumonia, and the pathogens of pneumonia, arthritis and mastitis in goats and sheep. Another group of related mycoplasmas are *M. agalactiae* (contagious agalactia of goats and sheep) and *M. bovis* (mastitis, pneumonia and arthritis in cattle). *M. hyopneumoniae* is the agent of enzootic pneumonia of swine. Many other mycoplasma species, which occur commonly as commensals on mucous membranes, are sporadically associated with disease. They are often found along with bacteria or viruses.

Mycoplasmas lack a cell wall and are therefore resistant to  $\beta$ -lactam antimicrobials but sensitive to numerous other antimicrobials. The most active are macrolides (erythromycin, spiramycin, and tylosin), the tetracyclines, quinolones and chloramphenicol. The in vitro activity of danofloxacin, tylosin and oxytetracycline against field isolates of seven *Mycoplasma* species from cattle and pigs from five European countries were determined.<sup>9</sup> Danofloxacin, a fluorquinolone, has excellent in vitro activity against *M. hyopneumoniae*, *M. dispar* and *M. bovigenitalium* and similar activity to that of tylosin against *M. bovis*.<sup>9</sup> However, response to therapy is often unsatisfactory. In general, the antimicrobial sensitivity of mycoplasmas and ureaplasmas is greatest to tiamulin, then tylosin and least to oxytetracycline, but individual sensitivities vary sufficiently for it to be necessary to carry out laboratory tests of sensitivity on each isolate.

Those diseases in which mycoplasmas have been positively identified as the



causative agent are described separately: contagious bovine pleuropneumonia, bovine arthritis, bovine mastitis, caprine pleuropneumonia and enzootic pneumonia of pigs. Other diseases in which mycoplasmas play a contributory part are set out with a summary in Table 20.6. The comparative characteristics of the two most important mycoplasmas of cattle are summarized in Table 20.7.

### DISEASES OF THE GENITAL TRACT

Vulvovaginitis in cattle, sheep and goats may be associated with *M. agalactiae* var. *bovis*. The same infection when introduced with semen into the uterus can cause endometritis and salpingitis, resulting in a temporary infertility and failure to conceive.

Persistent infection in the genital tract of bulls has also been produced experimen-

tally. Ureaplasmas have been isolated from the vulva of ewes with granular vulvitis and the disease was transmitted experimentally. However, the same organisms are present in the vulva of normal ewes and cows but *Ureaplasma* spp. are usually limited in their distribution to the vestibule and vulva of normal cows. In some areas, *Ureaplasma diversum* is commonly present in the lower reproductive tract of beef and dairy cattle, both cows and bulls, and is associated with granular vulvitis, which has been associated with infertility, sporadic abortions and neonatal mortality.<sup>10</sup> This infection adversely affects reproduction when it is either acute or chronic; it is capable of producing granular vaginitis and some strains can, if introduced to the upper reproductive tract, cause transitory endometritis and salpingitis.

Ureaplasmas, *M. bovis* and *M. bovis genitalium* have been found the reproductive tract of bulls and their semen.<sup>11</sup> Using the PCR for the detection of mycoplasma in semen, *M. mycoides* subsp. *mycoides* SC has been found in semen of yearling bulls with seminal vesiculitis while negative to the complement-fixation test for CBPP.<sup>11</sup>

A combination of lincomycin-spectinomycin-tylosin has been shown to be most effective in the treatment of *Ureaplasma* spp. in bull semen. Chlortetracycline at 350 mg/h/d for 30 d in the prebreeding feed of virginal heifers, most of which had vulvovaginitis and from which 44% cultured positive for *U. diversum*, improved pregnancy rates and decreased the vaginal colonization of the organism.<sup>12</sup>

Parenteral vaccination of heifers with killed *U. diversum* induced antibodies to the mycoplasma but did not prevent subsequent infection or clear the ureaplasmas.<sup>13</sup> The use of the vaginal submucosal route for vaccination resulted in characteristic granular vulvitis in both vaccinated and control animals.<sup>14</sup>

Attempts to produce abortion in cows by the injection of mycoplasmas isolated from aborted fetuses and from weak calves has had varying success. *Acholeplasma* spp. have been isolated from aborted equine fetuses. *M. bovis genitalium* has been a frequent isolate from bovine genital tracts for many years, but its role in genital disease is still uncertain. It has been isolated from frozen bull semen and poses a threat to cows inseminated with infected semen. Mycoplasmas in semen can be transmitted through in vitro fertilization and infect embryos, and supplementation of culture media with standard antibiotics and washing embryos as recommended by the International Embryo Transfer Society are not effective in making IVF embryos free from *M. bovis* and *M. bovis genitalium*.<sup>9</sup>

*Mycoplasma bovis* in frozen semen can survive the antibiotic combination of gentamicin, tylosin, and lincomycin and spectinomycin.<sup>15</sup>

### MYCOPLASMA MASTITIS IN DAIRY HERDS

*Mycoplasma bovis*, *Mycoplasma californicum*, and *Mycoplasma canadense* are causes of outbreaks of mastitis in cattle, and occasionally pneumonia, otitis media, or arthritis in calves of those dairy herds. The literature on mycoplasma mastitis in dairy herds has been reviewed.<sup>16</sup> The infection is highly contagious and is commonly introduced into a previously *Mycoplasma*-free herd by the purchase of infected heifers or cows. At least 11 other species of *Mycoplasma* have been isolated from

Table 20.6 Summary of systemic mycoplasmoses of sheep and goats

Bacterial species	Animals affected	Diseases caused	Pathogenicity
<i>M. agalactiae</i>	Sheep/goats	Contagious agalactia, arthritis, pneumonia, granular vaginitis, pinkeye	High
<i>M. arginini</i>	Sheep/goats	Pneumonia, arthritis, vaginitis, pinkeye, mastitis	Low
<i>M. capricolum</i>	Sheep/goats	Arthritis, mastitis, pneumonia	High
<i>M. mycoides</i> subsp. <i>capri</i>	Goats	Contagious caprine pleuropneumonia, pneumonia, arthritis	Moderate
<i>M. mycoides</i> subsp. <i>mycoides</i> (large colony type)	Sheep/goats	Contagious caprine pleuropneumonia, mastitis, arthritis, high mortality in young kids	Moderate
<i>M. ovipneumoniae</i>	Sheep/goats	Pneumonia	Commonly precursor to pneumonic pasteurellosis
<i>M. putrefaciens</i>	Goats	Mastitis and arthritis	High
<i>Ureaplasma</i> sp.	Goats	Vaginitis	Low
<i>Mycoplasma</i> strain F38	Sheep/goats	Contagious caprine pleuropneumonia	High pathogenicity

Table 20.7 Comparative properties of the two most important cattle mycoplasmas

Properties	<i>M. mycoides</i> subsp. <i>Mycoides</i> SC	<i>M. bovis</i>
Diseases	Contagious bovine pleuropneumonia in cattle, occasionally in arthritis in calves	Calf pneumonia, mastitis, arthritis, abortion, keratoconjunctivitis
Distribution	Subsaharan Africa, probably in parts of Middle East, Central Asia	Worldwide
Hosts	Cattle, goats, (sheep)	Cattle
Histopathological	Fibrinous pleuropneumonima with necrosis	Interstitial pneumonia, lymphohistiocytic bronchitis, catarrhal bronchopneumonia
Clinical signs	Few signs, respiratory distress evident after exercise	Respiratory distress, mastitis, arthritis
Diagnosis	Isolation, serology, PCR, abattoir surveillance	Serology, isolation, PCR
Treatment	Chemotherapy not recommended because it encourages carrier status	Chemotherapy
Control	Vaccination, movement control, slaughter	Management, improved ventilation, reduced stocking density



milk of cows with mastitis and the disease produced by each is similar. Cows of all ages and at any stage of lactation are susceptible. Typically, acute mastitis occurs which is resistant to treatment. Usually all four quarters are affected, there is a marked drop in milk production, and abnormal udder secretions vary from being like watery milk with a few clots to colostrum-like material. The affected cow is usually systemically normal. Chronically affected animals have a tan-colored milk secretion with sandy or flaky sediments which may become purulent-like over several weeks. However, the majority of milk samples which are positive for mycoplasma appear normal. In affected cows, milk production commonly declines, with normal appearance of milk but a high somatic cell count.

Mycoplasma mastitis in cattle is highly contagious and infections are transmitted at milking by means of fomites. Diagnosis is dependent on culture of milk samples from the bulk tank milk or individual cow milk samples. To identify cows with *M. bovis* mastitis, an indirect ELISA is available to detect antibodies to *M. bovis* in milk samples from cows with recently acquired *M. bovis* mastitis.<sup>17</sup> For mycoplasma mastitis, individual cows milk sampling for culture and identification of *M. bovis* is time consuming and expensive. Some herds sample cows monthly with the dairy herd improvement (DHI) program but a preservative is added to the milk that kills *M. bovis*. A nested PCR procedure allows for rapid testing of preservative treated milk and is as sensitive as traditional culture.<sup>18</sup>

In herds where the diagnosis has been made, weekly monitoring of bulk tank milk is necessary to monitor the success of control procedures. Quality Milk Production Services, Cornell University, recommends the use of 1% iodine products to reduce the number of *Mycoplasma* on teat skin during mastitis outbreaks. There is no treatment for mycoplasma mastitis and vaccination has been ineffective. In affected herds, milk of all lactating animals should be sampled, positive animals identified and culled or segregated from the mycoplasma-free animals. Waste milk from infected cows should not be fed to calves without pasteurization.<sup>19</sup>

Experimental vaccines against mycoplasma vaccines have been unsuccessful and may even exacerbate the mastitis.<sup>5</sup> It is best to segregate or cull carrier cows and to implement rigid sanitation procedures to prevent transmission from infected to non-infected cows.

Excellent vigilance and rapid culling of infected cattle are critical control factors affecting the spread of mycoplasma mastitis. Herds commonly become negative

within the first year of the first case of mycoplasma mastitis.<sup>20</sup>

(Additional details on *Mycoplasma mastitis* in cattle are available in Chapter 15.)

## DISEASES OF THE RESPIRATORY TRACT

Several different mycoplasmas have been isolated from pneumonic and non-pneumonic lungs of cattle, sheep and goats, but attempts to reproduce respiratory tract disease with them has resulted in inconclusive findings.

### Sheep

In general, mycoplasmas cause a sub-clinical, mild pneumonia in gnotobiotic animals, but in combination with unidentified agents in lung homogenates administered intranasally, 'enzootic' or chronic progressive pneumonia is produced in sheep. For example, *M. dispar* has a cytopathogenic effect and stops ciliary motility, and destroys ciliated epithelial cells in organ cultures. *M. ovipneumoniae* also has the capacity to colonize the sheep lung and produce mild pneumonic lesions, but in combination with pasteurellae in sheep, causes a proliferative exudative pneumonia. A similar disease in Icelandic sheep (kregda) has been identified as being associated with *M. ovipneumoniae*. Similar diseases are associated with *M. ovipneumoniae* and *M. arginini*.

### Goats

Although contagious caprine pleuropneumonia has not been observed in Australia, a non-fatal respiratory disease of goats, characterized by coughing, fever and extensive pleurisy and pneumonia, has. A variety of mycoplasmas, including *M. agalactiae* and *M. mycoides* and *M. mycoides* var. *capri* have also been found in goats. The caprine *M. mycoides* var. *mycoides* (large colony type) is not pathogenic for cattle and has been associated with a variety of syndromes in goats including fibrinous peritonitis, pneumonia, arthritis, mastitis and abortion. It has been cultured from a goat with a subauricular abscess and mastitis.<sup>21</sup> The most common syndrome in goats associated with mycoplasma is a chronic interstitial pneumonia with cough, unthriftiness proceeding to extreme emaciation, chronic non-painful bony enlargement of joints and chronic indurative mastitis. The pneumonia in some cases progresses to the point where the cor pulmonale develops with a subsequent appearance of the signs of congestive heart failure. *M. ovipneumoniae* has also been credited with causing pneumonia in goats. *M. adleri* has been isolated from a goat with a joint abscess.<sup>22</sup>

### Cattle

*Mycoplasma bovis* is a major cause of calf pneumonia. *Mycoplasma dispar*, *Ureaplasma diversum*, *Mycoplasma bovirhinis*, and *Mycoplasma canis* have also been isolated from the lungs of pneumonic cattle but it is uncertain if they are primary causes of disease.<sup>5</sup> *M. dispar* is capable of producing a pneumonia without clinical signs in gnotobiotic calves, and in conjunction with *Ureaplasma* spp. it has been found commonly in 'cuffing' pneumonia of calves. It could, therefore, be a precursor to other infections causing enzootic pneumonia in calves or with pasteurellae producing fibrinous pneumonia of calves.

### Horses

*M. felis* has been associated with outbreaks of lower respiratory tract disease of race-horses in training.<sup>23,29,30</sup>

## DISEASES OF THE EYES

*Mycoplasma bovoculi* (*Acholeplasma oculi*) has been associated with, without necessarily being the cause in the field of, outbreaks of infectious keratoconjunctivitis of cattle, sheep and goats. The mycoplasmas are capable of producing keratitis experimentally and *M. bovis* has been isolated from the ocular discharge of young cattle affected with conjunctivitis.<sup>24</sup> The naturally occurring disease in goats is manifested by rapid spread and development with intense lacrimation, conjunctival hyperemia, corneal opacity and vascularization. A concurrent respiratory illness occurs in some goats. Response to treatment with oxytetracycline and polymyxin B is good. The disease is reproducible experimentally.

## DISEASES OF THE BLOOD

*Mycoplasma (Eperythrozoon) suis* infection occurs worldwide in pigs causing fever and anemia in young animals and, occasionally, latent anemia in older animals. *E. suis*, originally classified as a *Rickettsia*, has now been shown to belong to the mycoplasmas based on phylogenetic analysis of its *rrs* (16S rRNA) genes and is now proposed to be known as *Candidatus Mycoplasma haemosuis*.

## DISEASES OF THE JOINTS

*Mycoplasma (M. hyorhinis, M. hyosynoviae)* are associated with arthritis and polyarthritis in pigs and the disease is reproducible experimentally. Both organisms are carried in the respiratory tract. *M. hyorhinis* most commonly affects suckling and young pigs, especially after weaning or some stress, and may produce a polyserositis in addition to arthritis. The case-fatality rate is generally low, but residual fibrinous pericardial and pleural



cattle found *M. bovis* positive samples in 18%.

The chronic pneumonia–polyarthritis of cattle has been reported in Canada and the United States.<sup>12,13</sup> It occurs commonly in young feedlot cattle usually affecting many animals a few weeks after arrival and mingling in the lot. The morbidity ranges from 20–85% and the case–mortality rate from 3–50%. In Canada, the disease has been seen commonly in young cattle (6–8 months of age) following shipment from western rangelands to eastern feedlots, which suggests that long transportation and mixing of cattle of different origins may be important epidemiological characteristics. Calves affected with arthritis commonly have necropsy evidence of mycoplasma pneumonia and it is proposed that the pneumonia precedes the development of the arthritis. Calves sucking cows with experimental mastitis due to this organism may develop mycoplasma arthritis, and a high incidence is recorded in calves in dairy herds where mycoplasma mastitis was occurring.

In a group of feedlot cattle, from Alberta, Canada, with chronic unresponsive pneumonia and polyarthritis, *M. bovis* was the most common pathogen demonstrated, having been detected in 82% of cases, including 71% in lungs and 45% in joints.<sup>14</sup> All cases had been treated with antibiotics including tilmicosin, trimethoprim-sulfadoxine, ceftiofur sodium, and sulbactam and ampicillin.

In a series of cases of chronic, antibiotic-resistant pneumonia, sometimes with concurrent polyarthritis, in feedlot cattle in western Canada, *M. bovis* was present in the lung tissues of more than 90% of cases, and the BVDV was present in 60% of the cases suggesting a possible synergism between *M. bovis* and the BVDV.<sup>12</sup> Outbreaks of pneumonia and arthritis in beef calves associated with infection due to *Mycoplasma bovis* and *Mycoplasma californicum* have been described in a mixed dairy cattle and beef cattle herd kept under extremely poor housing and hygienic conditions.<sup>15</sup> During a 3-year period in Belgium, in calves with respiratory disease, the prevalence of *M. bovis* was 31.5%, *M. dispar* 45.5%, *M. canis* 10.7% and *Ureaplasma diversum* 14.8%, and in half the cases they occurred in association with *Pasteurella* and/or *Mannheimia* species.<sup>16</sup>

Because the clinical and pathologic findings of *M. bovis* pneumonia closely resemble those of contagious bovine pleuropneumonia (CBPP), it is very important to ensure the microbiological diagnosis when confronted with lesions resembling either infection. A serological and diagnostic microbiological and pathological survey of pneumonic cattle

sampled on the farm followed by examination of their lungs at slaughter in Hungary confirmed the presence of *M. bovis* as a causative agent of the pneumonia rather than due to *Mycoplasma mycoides* subspecies *mycoides* the cause of contagious bovine pleuropneumonia.<sup>17</sup>

**Otitis media/interna** in dairy and beef calves has been associated with *M. bovis* infection. It has been described in preweaned Holstein dairy calves in dairy herds which have expanded in size.<sup>18,19</sup> Affected calves were 2 to 5 weeks of age, morbidity was 3 to 10% and case fatality rates estimated at 50%. In a retrospective study of *Mycoplasma otitis* in calves submitted for necropsy in California, affected calves were 2 weeks to 4 months of age, 92% were from dairy herds, most cases occurred during late winter and spring.<sup>20</sup> *M. bovis*, *M. bovirhinis*, and *M. alkalescens* were isolated from the ears of affected calves. Outbreaks of suppurative otitis media and pneumonia associated with *M. bovis* have been described in calves on beef cattle farms in Japan.<sup>21</sup> Morbidity and mortality were estimated at 8 to 40% and 30 to 100%, respectively.

#### Pathogen risk factors

The virulence factors of *M. bovis* and mechanisms of pathogenicity are not well-known, but the organism's ability to vary the expression of a family of membrane surface proteins (Vsps) with high frequency is currently being investigated. The organism has 13 *vsp* genes involved in antigenic variation which alter the antigenic character of its surface components, and may act to enhance colonization and/or adherence or evade the host's immune defense systems.<sup>1</sup>

*M. bovis* isolates from pneumonic cattle in the UK separated into two distinct groups based on molecular epidemiological analysis.<sup>22</sup> The organism produces an immunosuppressive peptide which is able in vitro to inhibit mitogen-induced proliferation of bovine lymphocytes.<sup>23</sup> The peptide is a product of variable surface proteins which may have an immunosuppressive effect during infection of the lung.<sup>24</sup> The organism is also able to penetrate through lung epithelial junctions and cause systemic infections.<sup>23</sup> There is some evidence of variability of *M. bovis* strains to cause arthritis.<sup>13</sup>

Genetic fingerprinting of *M. bovis* strains isolated in Denmark over a 17-year period demonstrated remarkable genomic homogeneity which were likely epidemiologically related and have remained stable for many years.<sup>25</sup> The technique used allows the creation of databases for inter-laboratory use and comparison, and continued surveillance

to monitor the spread of the organism as a prerequisite for effective control.

#### Methods of transmission

Clinically normal cattle harbor *M. bovis* in the upper respiratory tract with no apparent adverse effect and may shed the organism through the nasal discharge for months to years.<sup>26</sup> The methods of transmission of *M. bovis* as the causative agent of the pneumonia–polyarthritis syndromes, and related diseases, are unknown. It is assumed that direct contact between infected and susceptible animals is the primary mode of transmission but there is no supporting published evidence. *M. bovis* can be isolated from respiratory secretions such as nasal exudate which indicates at least one route of transmission. Serological surveys of feedlot cattle on arrival and 28 days later in Ontario, Canada, found an increase in titers to *M. bovis* and *M. dispar* which indicates that mixing of animals results in transmission of the organism.<sup>27</sup>

Calves fed discarded milk from cows with mycoplasma mastitis may develop pneumonia and otitis media.<sup>18</sup> Pasteurization of discard milk can eliminate transmission of the mycoplasmas to the calves.

#### PATHOGENESIS

The intra-articular injection of *M. bovis* into calves causes severe fibrino-suppurative synovitis and tenosynovitis, erosion of cartilage and its replacement by polypoid granulation tissue. Erosion of the cartilage is accompanied by chronic osteomyelitis and formation of pannus tissue. Histologically, there is extensive ulceration of synovial membranes of leukocytic infiltration of the subsynovium, congestion, hyperemia and thrombosis of the subsynovial vessels. Intratracheal inoculation of the organism results in pneumonia and severe lameness, which suggests that *M. bovis* is involved in pneumonia–arthritis syndrome.

As with many mycoplasmas, *M. bovis* is both immune reactive and immunosuppressive. Upon incubation with *M. bovis*, alveolar macrophages are activated and produce TNF-alpha and nitric oxide, two powerful initiators of immune activity.<sup>24</sup> *M. bovis* is also immunosuppressive by inhibiting neutrophil degranulation and oxidative bursts and proliferation of lymphocytes by mitogens. *M. bovis* also induces bovine lymphocyte death by apoptosis through the production of a protein which is different from other mycoplasmas both pathogenic and non-pathogenic.<sup>28</sup> The protein is an immuno-inhibitory peptide which can suppress Concanavalin A (ConA)-induced proliferation of bovine lymphocytes.<sup>29</sup> This represents a unique immunosuppressive peptide produced by the *M. bovis*.

Despite its deleterious effects on lymphocytes, infected cattle are able to generate measurable humoral and cellular immune responses against *M. bovis*. Serological analysis indicates that *M. bovis* stimulates increased production of antigen-specific IgG1 while very little IgG2 is produced.<sup>27</sup> Thus experimental lung infection of cattle with *M. bovis* results in a Th2-skewed immune response.

There is a systemic phase of *M. bovis* infection, including a potential interaction of the pathogen with endothelial cells. It is one of the most invasive bovine mycoplasmas capable of invading through lung epithelial junctions and causing systemic infections such as arthritis and mastitis following pneumonia. Localized lung vasculitis and the presence of thrombi within subsynovial vessels has been observed, both suggestive of interaction of *M. bovis* with epithelial cells.<sup>23</sup>

In otitis media/interna of calves there is facial nerve paralysis because of proximity of CN VII to the tympanic cavity.<sup>19</sup> Varying degrees of peripheral vestibulocochlear dysfunction occur because of the involvement of the vestibulocochlear receptors and nerve. The spontaneous regurgitation and dysphagia may be associated with lesions involving the glossopharyngeal nerve (CN IX) with or without the vagus nerve (CN X). These nerves may be affected by the inflammation associated with meningitis because both CN IX and CN X travel through the jugular foramen.<sup>19</sup>

## CLINICAL FINDINGS

### Chronic pneumonia-polyarthritis syndrome

The disease is most common in feedlot calves within a few weeks after arrival in the feedlot.<sup>13</sup> The morbidity rate may be up to 25%. Affected calves commonly have had a history of respiratory disease but have not responded to repeated antibiotic therapy. Auscultation of the lungs reveals areas of loud bronchial tones, crackles and wheezes and areas of muffled lung sounds indicating consolidation and occlusion of the bronchi with exudate. Depression, inactivity, inappetence, coughing, nasal discharge, fever, and progressive weight loss are common.

Concurrently affected calves commonly develop lameness. There is stiffness of gait, and lameness. Swelling of the large movable limb joints and distension of tendon sheaths, associated with fibrinous synovitis and synovial fluid effusions, are characteristic. Affected calves are reluctant to move and commonly are recumbent for long periods, continue to lose weight, and develop decubitus ulcers. Mildly affected cases recover spontaneously in 10–14 d, while severe cases become progressively worse and must be culled.

Pneumonia and polyarthritis associated with *M. bovis* may occur alone or together in cattle of all ages, including dairy and beef calves in their original herds, in growing dairy and beef cattle heifers, and in mature dairy and beef cows.

### Otitis externa, otitis media/interna

Otitis externa is inflammation of the externa ear canal. Otitis media/interna is inflammation of the inner ear involving primarily the tympanic bullae which may extend to the meninges and the brain stem.<sup>19,30</sup> Clinical findings depend on the extent of the inflammation involving only the external ear or middle ear causing otitis media. Varying degrees of depression, coughing, nasal discharge and inappetence are common in affected groups of calves. Otitis externa is characterized by a drooping ear and purulent exudate in the external ear which can be detected by digital palpation of the pinnae which creates a fluid squishing sound. Deep palpation of the base of the ear may be painful.

A unilateral head tilt and paralysis of the lip, eyelid, and ear muscles on the same side are common. When the eye on the affected side is threatened, the eyeball may retract but there is no palpebral fissure closure.<sup>19</sup> An intermittent loss of balance on the affected side may be apparent when the animal attempts to walk.

Bilateral peripheral CN VII and VIII deficits (bilateral ear, lip, and eyelid paresis; bilaterally absent menace and palpebral reflexes; normal gait; balance loss to either side) are suggestive of bilateral otitis media/interna.<sup>19,30</sup> Dysphagia, spontaneous regurgitation of milk and difficulty in sucking from a bottle or prehending feed may occur.<sup>19</sup> Partially chewed feed may accumulate in the oral cavity along with difficult prehension and mastication. Bilateral vestibular disease (balance loss to either side) may occur. Endoscopy of the pharynx may reveal collapse of the nasopharynx, dorsal displacement of the soft palate, and a widely dilated, hypomotile esophagus.

In otitis media there may be no exudate in the external ear. Opisthotonus and nystagmus are common and ataxia, recumbency and death in several days may occur.

The mortality rate is about 50%.<sup>19</sup>

### CLINICAL PATHOLOGY

Clinical and pathological signs are not characteristic for *M. bovis* so laboratory diagnosis is necessary for identification.<sup>1</sup> The organism can be detected by culture, DNA probe and PCR tests.

### Detection of organism

Culture methods for the detection of *M. bovis* are restricted to culture and serology but both methods are time con-

suming, laborious, difficult and expensive. Bronchoalveolar lavage samples and nasal swabs can be used for the culture of *M. bovis* from cattle with respiratory disease; the lavage samples being more representative of the infection status of the lower respiratory tract disease.<sup>31</sup>

### DNA probe and PCR

A DNA probe and semi-nested PCR test are now available to detect the antigen of the organism in milk samples and may be applicable to mucosal samples from conjunctivae, nasal and vaginal mucosae.<sup>32</sup> An arbitrarily primed PCR typing method provides genotypic epidemiological information to successfully characterize *M. bovis* from sequential sampling of outbreaks and different husbandry conditions.<sup>33</sup>

### Immunohistochemistry

Immunohistochemical techniques can be used to detect the antigen of *M. bovis* in the tissues of cattle.<sup>14</sup> Histology and immunohistochemistry can be used to analyze the lesions and distribution of the *M. bovis* antigen in the lungs of cattle with pneumonia.<sup>34</sup>

### ELISA

An ELISA can be used to detect the organism in lung tissue of animals with pneumonia.<sup>35</sup> To identify cows with *M. bovis* mastitis, an indirect ELISA is available to detect antibodies to *M. bovis* in milk samples from cows with recently acquired *M. bovis* mastitis.<sup>36</sup>

### CLINICAL DIAGNOSTIC TESTS

Computer tomographic imaging for otitis media/interna in calves can provide detailed information of the bony structures of the middle and inner ear. Abnormalities of the tympanic bullae and petrous temporal bone may be visible with CT imaging which are not visible with conventional radiography.<sup>19</sup> CSF from affected calves may indicate the presence of a meningitis.

### NECROPSY FINDINGS

At necropsy, the **fibrinous synovitis** is remarkable. There is severe thickening and edema of the synovial membranes and large quantities of fibrinopurulent synovial fluid. The tendon sheaths are similarly affected. Microscopically, large numbers of lymphocytes and plasma cells are found within the hypertrophic synovial villi. *M. bovis* can often be recovered from pneumonic lungs and causes **pulmonary foci of coagulative to caseous necrosis**.<sup>14,37–39</sup> *M. bovis* causes two patterns of pulmonary necrosis in cattle.<sup>34</sup> The first pattern is characterized by large irregular areas of coagulative necrosis surrounded by a dense zone of degenerated neutrophils. *M. bovis* antigen

is present in the center and periphery of the necrotic foci. The second pattern consists of rounded foci of caseous necrosis composed of granular eosinophilic material surrounded by a rim of granulation tissue. Large amounts of *M. bovis* antigen are present in the center and periphery of these necrotic foci.<sup>34</sup> Immunohistochemical techniques are used to detect the antigens of *M. bovis* in the tissues of feedlot cattle with chronic unresponsive respiratory disease and/or arthritis.<sup>14</sup> Immunohistochemical studies suggest that this organism may also briefly localize in the kidney and liver.<sup>37</sup> *Mycoplasma* spp. have been identified as an important cause **suppurative otitis** in dairy calves, often with concurrent mycoplasmal pneumonia.<sup>20</sup> *M. bovis* has also been associated with pleuritis and pericarditis and has been isolated from decubital ulcers of calves.<sup>40</sup>

#### Samples for confirmation of diagnosis

- **Histology** – lung, synovial membrane (LM, IHC)
- **Mycoplasmology** – lung, culture swab from joint cavity (MCULT).

#### DIFFERENTIAL DIAGNOSIS

The disease must be differentiated from other causes of joint swelling and lameness in feedlot cattle.<sup>13</sup> There are usually several animals affected in a short period of time, which serves to distinguish it from other sporadic causes of arthritis in feedlot cattle. A diagnosis of infection by *M. bovis* should be considered when pneumonia and arthritis and synovitis occur at about the same time.

Other diseases causing lameness in feedlot cattle include:

- Interdigital necrobacillosis
- Laminitis (pododermatitis aseptic diffusa)
- Injuries in feedlot cattle
- Buller injuries
- Musculoskeletal injuries
- Lacerations

For a definitive diagnosis, joint fluid must be placed immediately into laboratory media specially prepared for *Mycoplasma* spp. The failure to isolate the mycoplasma from the fluid of joints which have been affected for more than 14 d does not preclude a diagnosis of mycoplasma arthritis because the organism may have been eliminated from the joint.

#### TREATMENT

Treatment is usually ineffective. Several antimicrobials, including tylosin, oxytetracycline, lincomycin and oleandomycin, have been used in naturally-occurring and experimental cases and while the isolates of mycoplasmas may be sensitive to these antibiotics in vitro, the response in affected animals has been unsatisfactory.

The published results of in vitro antimicrobial testing of isolates of *M. bovis* recovered from various locations are highly variable. The antimicrobial susceptibility of *M. bovis* strains, cultured from cases of pneumonia, arthritis, and mastitis of cattle, measured in vitro indicate that enrofloxacin was the only one which exhibited any measurable activity.<sup>41</sup> Spectinomycin has been evaluated for the treatment of experimental *M. bovis* pneumonia in 3-week-old calves and only decreased the level of *M. bovis* and *Pasteurella multocida* infection in the lung but did not alter the course of the illness.<sup>42</sup> The in vitro susceptibilities of Belgian field isolates of *M. bovis* to 10 antimicrobials found that tiamulin was the most active against the organism. The fluoroquinolones, danofloxacin, enrofloxacin, and marbofloxacin were effective against strains of *M. bovis*. Gentamicin was ineffective. Many strains were resistant to tylosin, spectinomycin, lincomycin, tetracycline and oxytetracycline.<sup>43</sup> In a series of British isolates of *M. bovis*, most isolates were susceptible to danofloxacin, less susceptible to florfenicol. Oxytetracycline and spectinomycin had only a limited effect against the majority of isolates. Approximately 20% were highly resistant to spectinomycin, and tilmicosin was ineffective. There was no evidence of resistance to danofloxacin.<sup>44</sup>

In calves with a high incidence of respiratory disease associated with *M. bovis* and *Pasteurella* spp. the use of valnemulin in the milk of the calves for four days resulted in improved weight gains and fewer cases of *Mycoplasma* infection, required fewer treatments with antibiotics than those in the placebo treated group.<sup>45</sup>

#### CONTROL

Effective control of the disease is not yet possible. Some vaccines have been developed but have not been sufficiently efficacious or have yielded poor results. A quadrivalent inactivated vaccine containing BRSV, PI-3 virus, and *M. dispar* and *M. bovis* provided some protection against naturally-occurring outbreaks of bovine respiratory disease.<sup>1</sup> A vaccine containing formalin-inactivated strains of *M. bovis* and *Mannheimia haemolytica* from affected herds reduced losses from pneumonia and the cost of treatment in newly arrived feedlot calves.<sup>1</sup>

A single dose of vaccine for *M. bovis* pneumonia, inactivated with saponin, provided protection against experimental challenge of calves 3 to 4 weeks of age with a virulent isolate of *M. bovis*.<sup>46</sup> The vaccine also reduced the spread of *M. bovis* to internal organs. Attempts to vaccinate against *M. bovis* arthritis have

been unsuccessful.<sup>1</sup> Experimental vaccines against mycoplasma vaccines have been unsuccessful and may even exacerbate the mastitis.

In dairy herds, pasteurization of mycoplasma mastitis milk at 65°C for 1 hour can kill mycoplasmas and reduce the incidence of respiratory disease in calves.<sup>47</sup> A temperature of 65°C killed *M. bovis* and *M. californicum* after 2 min of exposure, while *M. canadense* remained viable for up to 10 min. Exposure to 70°C inactivated *M. bovis* and *M. californicum* after 1 min, but *M. canadense* samples were positive for up to 3 min.

**Biosecurity and biocontainment** procedures should be implemented to prevent the introduction of infection into the herd and to minimize the spread of infection in the herd.

#### REVIEW LITERATURE

- Rosenbusch RF. Bovine mycoplasmosis. Proc Am Assoc Bov Pract 2001; 34:49–52.
- Step DL, Kirkpatrick JG. Mycoplasma infection in cattle. I. Pneumonia arthritis syndrome. Bov Pract 2001; 35:149–155.
- Step DL, Kirkpatrick JG. Mycoplasma infection in cattle. II. Mastitis and other diseases. Bov Pract 2001; 35:171–176.
- Stokka GL, Lechtenberg K, Edwards T et al. Lameness in feedlot cattle. Vet Clin North Am Food Anim Pract 2001; 17:189–207.
- Frey J. Mycoplasmas of animals. In: Razin S, Herrman S (eds) Molecular biology and pathogenicity of mycoplasmas. New York: Kluwer Academic/Plenum, 2002; pp. 73–90.
- Nicholas RAJ, Ayling RD. *Mycoplasma bovis*: disease, diagnosis, and control. Res Vet Sci 2003; 74:105–112.

#### REFERENCES

1. Nicholas RAJ, Ayling RD. Res Vet Sci 2003; 74:105.
2. Djordjevic SP et al. Electrophoresis 2001; 22:3551.
3. Hum S et al. Aust Vet J 2000; 78:744.
4. Frey J. Mycoplasmas of animals. In: Razin S, Herrman S (eds). Molecular biology and pathogenicity of mycoplasmas. New York: Kluwer Academic/Plenum, 2002; pp. 73–90.
5. Henderson JF, Ball HJ. Vet Rec 1999; 145:374.
6. Brice N et al. Vet Rec 2000; 146:643.
7. Bryne WJ et al. Vet Rec 2001; 148:331.
8. Byrne WJ et al. Vet Rec 1999; 144:211.
9. Le Grand D et al. Vet Rec 2002; 150:268.
10. Kusiluka LJ et al. Acta Vet Scand 2000; 41:139.
11. Ayling RD et al. Vet Rec 2004; 153:413.
12. Shahriar FM et al. Can Vet J 2002; 43:863.
13. Stokka GL et al. Vet Clin North Am Food Anim Pract 2001; 17:189.
14. Haines DM et al. Can Vet J 2001; 42:857.
15. Hewicker-Trautwein M et al. Vet Rec 2002; 151:699.
16. Thomas A et al. Vet Rec 2002; 151:472.
17. Bashiruddin JB et al. Vet Rec 2001; 148:743.
18. Walz PH et al. J Vet Diag Invest 1997; 9:250.
19. Van Biervliet J et al. J Vet Int Med 2004; 18:907.
20. Lamm CG et al. J Vet Diag Invest 2004; 16:397.
21. Maeda T et al. J Comp Path 2003; 129:100.
22. McAuliffe L et al. J Clin Microbiol 2004; 42:4556.
23. Lu X, Rosenbusch RF. Microb Pathogen 2004; 37:253.
24. Vanden Bush TJ, Rosenbusch RF. Vet. Immunol Immunopathol 2003; 94:23.
25. Kusiluka LJM et al. FEMS Microbiol Lett 2000; 192:113.

26. Pfrutzner H, Sachse K. Rev Sci Tech Off Int Epiz 1996; 15:1477.
27. Step DL, Kirkpatrick JG. Bov Pract 2001; 35:149,171.
28. Vanden Bush TJ, Rosenbusch RF. FEMS Immunol Med Microbiol 2002; 32:97.
29. Vanden Bush TJ, Rosenbusch RF. Biochem Biophys Res Commun 2004; 315:336.
30. Vestweber JG. Comp Cont Educ Pract Vet 1999; 21:S34-S38.
31. Thomas A et al. Vet Res Commun 2002; 26:333.
32. Hayman B et al. Vet Microbiol 2003; 91:91.
33. Butler JA et al. Vet Microbiol 2001; 78:175.
34. Khodakaram-Tafti A, Lopez A. J Vet Med A 2004; 51:10.
35. Ball HJ et al. Vet Rec 1994; 135:531.
36. Byrne WJ et al. Vet Rec 2000; 146:368.
37. Adegboye DS et al. J Vet Diag Invest 1995; 7:333.
38. Rodriguez F et al. J Comp Path 1996; 115:151.
39. Khodakaram-Tafti A, Lopez A. J Vet Med A Physiol Pathol Clin Med 2004; 51:10.
40. Kinde H et al. J Vet Diag Invest 1993; 5:194.
41. Ball HJ et al. Irish Vet J 1995; 48:316.
42. Poumarat F et al. Vet Microbiol 2001; 80:23.
43. Thomas A et al. Vet Rec 2003; 153:428.
44. Ayling RD et al. Vet Rec 2000; 146:745.
45. Stipkovits L et al. Vet Rec 2001; 148:399.
46. Nicholas RAJ et al. Vaccine 2002; 20:3569.
47. Butler JA et al. J Dairy Sci 2000; 83:2285.

## CONTAGIOUS BOVINE PLEUROPNEUMONIA

### Synopsis

**Etiology** *Mycoplasma mycoides* subsp. *mycoides* (Small colony) (MmmSC)

**Epidemiology** A major plague of cattle, endemic in eastern Europe, Asia, Africa, and has spread to Spain, France and Italy. Major concern in European Community because of relaxation of import controls and increase in international trade. Insidious nature of disease allows it to spread undetected for months

**Signs** Fever, agalactia, anorexia, depression, coughing, thoracic pain, back arched, dyspnea, expiratory grunting, pleuritic friction rubs, dull areas of lung, edema of throat and dewlap

**Clinical pathology** Complement fixation test. Detection of organism with polymerase chain reaction (PCR)

**Lesions** Remarkable pleuritis, marked consolidation and marbling of lung, pleural adhesions

**Diagnostic confirmation** Presence of organism in pleural fluid

### Differential diagnosis list

- Pneumonic pasteurellosis
- Tuberculosis
- Other pneumonias (see Table 18.4)

**Treatment** Not usually done

**Control** Identification and slaughter of sick animals. Vaccination followed by test and slaughter. Establish disease-free areas. Control movement of cattle in control areas

## ETIOLOGY

*Mycoplasma mycoides* subsp. *mycoides* Small Colony (SC) (MmmSC) is the cause of the disease in cattle.<sup>1</sup> The organism belongs to the 'mycoides' cluster, which

**Table 20.8** Members of the *Mycoplasma mycoides* cluster

Name	Main disease	Main (and other) hosts
<i>M. mycoides</i> subsp. <i>mycoides</i> SC variant	Contagious bovine pleuropneumonia	Cattle (goats, sheep, buffalo)
<i>M. mycoides</i> subsp. <i>mycoides</i> LC variant	Caprine pneumonia, contagious agalactiae	Goats (sheep, cattle)
<i>Mycopoides</i> subsp. <i>capri</i>	Caprine pneumonia	Goats (sheep) but rare
<i>M. capricolum</i> subsp. <i>capricolum</i>	Caprine pneumonia, contagious agalactiae	Goats (sheep, cattle)
<i>M. capricolum</i> subsp. <i>capripneumoniae</i>	Contagious caprine pleuropneumonia	Goats (sheep)
<i>M. bovine</i> group 7 (Bg7)	Arthritis, also mastitis, calf pneumonia	Cattle

consists of six closely related mycoplasma. Members of the 'mycoides' cluster are pathogens of cattle, sheep and goats but the agent of contagious bovine pleuropneumonia (CBPP) is not communicable to other species. It is very similar culturally and antigenically to the causative organisms of caprine contagious pleuropneumonia but the two can be differentiated culturally and biochemically. Large colony types are pathogenic for sheep and goats, but not for cattle. Small colony types have been isolated from the milk of sheep with mastitis and goats with pneumonia.<sup>2</sup>

The organisms are pleomorphic and some forms are filterable. They can be maintained readily in special culture media and in embryonated hens' eggs. MmmSC is a member of the *M. mycoides* cluster which includes those listed in Table 20.8. The '*Mycoplasma mycoides* cluster' contains six important mycoplasma of ruminants. Only two of them cause disease in cattle, MmmSC which is the cause of CBPP<sup>2</sup> and *Mycoplasma bovine* group 7 (Bg7) which may cause arthritis and bovine mastitis. The four others, two subspecies within *Mycoplasma mycoides* species and two subspecies within *Mycoplasma capricolum* species are responsible for goat respiratory and other diseases.

## EPIDEMIOLOGY

### Occurrence and prevalence of infection

Under natural conditions, CBPP occurs in cattle of the species *Bos* and allied animals including buffalo, yak, bison and even reindeer.<sup>3</sup> While buffaloes can be infected by artificial means, and pulmonary lesions and the organism have been found in seropositive buffaloes which have been in contact with CBPP-infected cattle in Italy, it is uncertain if they can spread the disease to cattle.

CBPP is widespread in Africa and occurs in some countries of Asia and Europe. In 1995, the Office des International Epizooties (OIE) reported that CBPP in Africa was causing greater losses in cattle than any other disease including

rinderpest. In 2001, 17 countries in Africa declared the presence of the disease and a potential threat for the world.<sup>4</sup> In Africa, it is found in an area south of the Sahara, from the Tropic of Cancer to the Tropic of Capricorn and from the Atlantic to the Indian Ocean.<sup>1</sup> Endemic infection extends throughout the pastoral herds of much of western, central and eastern Africa, with Angola and northern Namibia in southern Africa. Newly infected areas in the 1990s include Uganda, parts of Kenya, the Ituri Region of the Democratic Republic of the Congo, and most of the United Republic of Tanzania, where recently the disease has spread alarmingly. Rwanda in 1994, Botswana in 1995<sup>2</sup> but now free, Burundi in 1997, and Zambia in 1997 were recently re-invaded, but Lesotho, Malawi, Mozambique, South Africa, Swaziland, and Zimbabwe are currently free as of 2002.<sup>1</sup> An abattoir survey of the disease in Nigeria indicates CBPP is endemic and the campaign to control or eradicate the disease has been inadequate.<sup>5</sup> Reasons include inadequate and irregular vaccination programs because of the high cost of mass vaccinations, and the steady illegal introduction of infected cattle into areas across control barriers, and the presence of carrier animals which may not be detected clinically or serologically. Movement of cattle between Niger and Nigeria in the north and between Cameroon and Nigeria in the northeast have also been associated with spread.

The disease was present in most sub-Saharan countries and had reinfected countries such as Uganda and Kenya, where it had been eradicated in the 1970s.<sup>6</sup> Of more concern, countries which had been CBPP-free for many years were also reinfected. Epidemics occurred in Tanzania in 1990 and Botswana and Rwanda in 1995.<sup>7</sup> In addition, Angola, Benin, Cameroon, Chad, Eritrea, Ivory Coast, Ghana, Nigeria, Sudan, Togo and Zaire are infected.<sup>6</sup>

CBPP was first introduced into Tanzania in 1916 and was eradicated in 1964.<sup>8</sup> The disease re-emerged in the country in 1990 and since then it has

spread widely, threatening the entire national cattle herd. Because of lack of a clear disease-control policy, uncontrolled cattle movements, lack of public awareness and commitment, ineffective legislation, attempts to control and eradicate the disease between 1990 and 2000 failed.

The reasons for increase in incidence of CBPP in Africa are related specifically to reduced funding for vaccination, possibly linked to the success of the rinderpest campaign, changes in vaccines and vaccine usage, cost recovery for CBPP vaccination, and reduced disease surveillance.<sup>9</sup>

In Asia, CBPP has been reported recently in Assam in India, Bangladesh, and Myanmar. Sporadic outbreaks have been recognized in the Middle East, probably derived from importation of cattle from Africa.

The status of CBPP in Europe is sharp contrast with that in Africa, because as of 1999, for the first time for over 20 years, no outbreaks were reported.<sup>9</sup> As of 2004, Europe is free from CBPP and the European Union rules prevent the importation of live animals from affected areas. CBPP is usually transmitted through movements of live animals; trade in animal products is not thought to be a significant risk. The disease was diagnosed in France and Spain in the 1960s, Portugal in 1983 and Italy in 1990. An abattoir based survey of CBPP in Turkey indicated the presence of the infection based on ELISA of blood samples and lung tissues of cattle examined in abattoirs but the organism was not identified.<sup>10</sup>

The disease was eradicated from the United States in 1892, South Africa in 1916, and Australia in 1973 after being introduced in 1858.<sup>11,12</sup> The disease was introduced into Australia in 1858 by dairy cattle imported into the colony of Victoria from England. It spread rapidly throughout Australia by cattle being driven to take up new pastoral lands everywhere, aided by the bullock teams, which provided the only form of transportation of goods and supplies in those days. One hundred years later, in 1958, a national eradication campaign was commenced and it took only 15 years before Australia was declared free from the disease, in Darwin in 1973.<sup>11,12</sup> An entire book, 'Clearing a Continent: The eradication of bovine pleuropneumonia from Australia'<sup>11</sup> documents a wonderful success story which resulted in the formation of several existing animal health agencies in Australia.<sup>12</sup>

In France, the recent epidemic was successfully eradicated. The disease is endemic in north western parts of Portugal but outbreaks have decreased significantly in recent years.<sup>6</sup>

Because of the method of spread, outbreaks tend to be more extensive in housed

animals and in those in transit by train or on foot. In groups of susceptible cattle the morbidity approaches 90%, the case mortality may be as high as 50% and 25% of the infected cattle remain as recovered carriers with or without clinical signs.

#### Source of infection

The focus of infection is often provided by recovered 'carrier' animals in which a pulmonary sequestrum preserves a potential source of organisms for periods as long as 3 years. For many years, it was thought that conditions of stress due to starvation, exhaustion or intercurrent disease can cause the sequestrum to break down and convert the animal into an active case. Experimental evidence throws some doubt on this explanation, but droplet infection is usually associated with a donor lesion in the lungs. Renal lesions are not uncommon and large numbers of viable *M. mycoides* are passed in the urine of infected animals, and inhalation of urine droplets may be a route of infection. The organism has been isolated from the semen and preputial washings of two young bulls<sup>13</sup> which were the result of frozen embryos implanted into Portuguese cows and were being considered for entry into a breeding center.

#### Methods of transmission

Transmission occurs from direct and repeated contacts between sick and healthy animals. The principal route of infection is by the inhalation of infective droplets from active or carrier cases of the disease. Mediate infection by contamination of inanimate objects is unlikely under natural conditions, but it has been effected experimentally, the infected hay remaining infective for up to 144 h. A separation of 6 m between animals is usually considered to be sufficient, but transmission over 45 m has been suspected to occur. Spread of the disease may also occur by discharges from local tail lesions resulting from vaccination with virulent culture. Cattle may be exposed to infection for periods of up to 8 months before the disease becomes established and this necessitates a long period of quarantine before a herd can be declared to be free of the disease. Other inanimate objects such as placenta and urine can also remain infective for long periods.

A mathematical model of the effects of chronic carriers on the within-herd spread of CBPP in an African mixed crop-livestock system indicates that chronic carriers are less infectious than clinical cases.<sup>14</sup> Within-herd spread of CBPP occurs regardless of the measures such as isolation or the use of antibiotics.<sup>15</sup>

In 1990, a confirmed outbreak of CBPP was occurred in a dairy herd in Lombardy, Italy.<sup>16</sup> Italy had been free of the disease

since 1899. Within 3 years of the index herd, an additional 94 outbreaks occurred within an area of 59 km<sup>2</sup>. The disease was eradicated in 1993. Epidemiological investigations, especially tracebacks, during the outbreaks over a period of 3 years examined spatial segregation of infected and non-infected farms. In the high-risk area, infected and non-infected herds were spatially segregated. The high density of the cattle population within the study area and the possible intensive interactions between specialized cattle breeding farms, likely contributed to direct and indirect transmission of the infection. Both aerosol and indirect transmission of the infection could have occurred, as previously documented in Africa. It has been suggested that urine may be a mode of transmission especially in European countries with temperate climates where cattle are reared intensively in restricted geographical areas and many herds share the same watercourse.<sup>17</sup>

#### Risk factors

##### Animal risk factors

CBPP occurs only in cattle; rare natural cases have been observed in buffalo, yak, bison, reindeer and antelopes, and the disease has been produced experimentally in captive African buffalo and white-tailed deer. It has not been detected in other wildlife. In sheep and goats the injection of culture causes a local cellulitis without pulmonary involvement. There is no difference in the susceptibility of *Bos taurus* and *Bos indicus* cattle and both races respond equally to vaccination.

**Immune mechanisms.** A strong immunity develops after an attack of the natural disease in cattle and vaccination plays an important part in control. The exact nature of the immunity conferred by vaccination or by naturally occurring disease is not understood, although it can be transferred by the administration of serum from an immune animal. The lack of a cell wall and endotoxins may enable mycoplasmas to colonize the animal without inducing an immune response and the predilection for the mucosal membranes may also limit the humoral response. For these reasons it is suggested that the organism is a poor immunogen, which may account for the frequent lack of good circulating antibody responses in experimentally infected cattle. There is a poor relationship between complement fixation test (CFT) antibody titer and the severity of lesions; animals with high antibody titers may have no visible lesions and those with severe lesions may have low or undetectable titers.<sup>7</sup>

##### Management risk factors

The occurrence and incidence of CBPP is heavily influenced by management



systems, disease control policies and regulations of a country, knowledge of the disease by farmers and veterinarians, and livestock field officers. The diagnostic capability of veterinary laboratories, disease-surveillance and monitoring systems, adequacy of vaccination programs, government budgets allocated to control programs, the effectiveness of education programs, and the desire of cattle owners and traders to control the disease are critically important management factors which influence the effectiveness of control of the disease in a country. A serious commitment from all stakeholders in the cattle industry is necessary and the government has to provide sufficient resources.

#### Pathogen risk factors

*M. mycoides* subsp. *mycoides* is sensitive to all environmental influences, including disinfectants, heat and drying, and do not ordinarily survive outside the animal body for more than a few hours. A low incidence can be anticipated in arid regions because of the rapid destruction of the organism in exhaled droplets. Restriction enzyme analysis of strains of the organism found that European strains have different patterns than African strains.<sup>6</sup> This suggests that recent European outbreaks occurred from an established reservoir within Europe rather than as a result of importation from Africa. It also suggests that the African and Australian strains arose from strains no longer widespread in Europe.

The organism can be grouped into two major, epidemiologically distinct, clusters. One cluster contains strains isolated from different European countries since 1980 and a second cluster contains African and Australian strains collected over the last 50 years.<sup>18</sup>

The current European strains lack a substantial segment of genetic information which may have occurred by a deletion event.<sup>18</sup> The strains found in re-emerging outbreaks of CBPP, which occurred after the eradication of the epidemic in Europe in the middle of the 20th century, represent a phylogenetically newer cluster that has been derived from a strain of the older cluster of MmmSC which is still endemic on the African continent.<sup>18</sup> The genome of MmmSC type strain PG1<sup>7</sup> has been sequenced to map all genes and to facilitate further studies regarding the cell function of the organism.<sup>19</sup> A variety of potential virulence factors have been identified, including genes encoding putative variable surface proteins and enzymes and transport proteins responsible for the production of hydrogen peroxide and the capsule which is thought to have toxic effects on the animal. The phylogeny of the *Mycoplasma*

*mycoides* cluster according to sequencing of putative membrane protein genes has been examined.<sup>20</sup> Molecular epidemiology of CBPP by multilocus sequence analysis of Mmm biotype SC strains found a clear distinction between European, south-western African and sub-Saharan strains.<sup>21</sup> This indicates that the CBPP outbreaks which occurred in Europe were not due to introduction from Africa, and confirms true re-emergence. Strains of MmmSC isolated from recent outbreaks of CBPP in Africa have been compared to vaccine strains and older isolates.<sup>22</sup> A Botswanan field isolate differed from all other strains of MmmSC tested by a variety of criteria. The new isolate may possess a set of protective antigens different from those of other strains of MmmSC including vaccine strains. Such findings have implications for the control of CBPP in Africa.

The last strains isolated from an epidemic are usually of lower virulence than the first strains.<sup>7</sup> Strains are most virulent when first isolated and lose their virulence after subculture. Galactan is associated with pathogenicity of the organism but its mode of action is uncertain. Galactan can cause necrosis and a connective tissue response in cattle similar to the sequestra in chronically infected animals.

#### Economic importance

CBPP is the most economically important disease of cattle in Africa.<sup>5</sup> The direct losses are from mortality, reduced milk yield, vaccination costs, disease surveillance and research programs. The indirect costs are due to the chronic nature of the disease including:

- Loss of weight and working ability
- Delayed marketing
- Reduced fertility
- Losses due to quarantine
- Loss of cattle trade. In the affected countries, enormous losses are experienced each year from the deaths of animals and the loss of production during convalescence. The highly fatal nature of the disease, the ease of spread and the difficulty in detecting carriers also mean that close restriction must be placed on the movement of animals from enzootic areas. For example, in Australia many feeder cattle are reared on range country where the disease was endemic and, before the disease was eradicated, moving them into closely settled areas for fattening caused periodic outbreaks in these free areas. Losses were heavy and the costs of maintaining quarantine and eradication programs were also heavy.

#### PATHOGENESIS

Even after more than 100 years since CBPP was discovered the pathogenesis is not well understood.<sup>9</sup> The possible role of the carbohydrate cell capsule and hydrogen peroxide production in MmmSC has been reviewed.<sup>6</sup> The disease is an acute lobar pneumonia and pleurisy. The organism invades the lungs of cattle and causes a mycoplasmaemia; this results in localization in numerous other sites including the kidneys and brain, resulting in high morbidity and mortality. An essential part of the pathogenesis of the disease is thrombosis in the pulmonary vessels, probably prior to the development of pneumonic lesions. The mechanism of development of the thrombosis is not understood, but there is no general increase in blood coagulability, and no generalized tendency to spontaneous thrombosis.

The isolation of MmmSC from the semen of yearling bulls with seminal vesiculitis has been reported.<sup>23</sup>

The production of hydrogen peroxide and other active oxygen species is widely believed to play an important role in mycoplasma pathogenicity, and has been demonstrated to result in lysis of erythrocytes, the peroxidation of lipids in *M. mycoides* infected fibroblasts and inhibition of ciliary movement in tracheal organ cultures infected with *M. mycoides* and *M. ovipneumoniae*.<sup>9,24</sup> European MmmSC strains appear to be distinguished from other *M. mycoides* strains by their lack of glycerol phosphate oxidase activity and ability to oxidize glycerol.<sup>24</sup>

Death results from anoxia and presumably from toxemia. Under natural conditions a proportion of animals in a group do not become infected, either because of natural immunity or because they are not exposed to a sufficiently large infective dose. These animals may show a transient positive reaction to the complement fixation test. Approximately 50% of the animals that do become infected go through a mild form of the disease and are often recognized as clinical cases.

#### CLINICAL FINDINGS

There is considerable variation in the severity of clinical disease from hyperacute to acute to chronic and subacute forms.

#### Acute form

After an incubation period of 3–6 weeks (in occasional instances up to 6 months) there is a sudden onset of high fever (40°C; 105°F), a fall in milk yield, anorexia and cessation of rumination. There is severe depression and the animals stand apart or lag behind a traveling group. Coughing, at first only on exercise, and thoracic pain are evident; affected animals are disinclined to move, standing with the

elbows out, the back arched and head extended. Respirations are shallow, rapid and accompanied by expiratory grunting. Pain is evidenced on percussion of the chest. Auscultation reveals pleuritic friction sounds in the early stages of acute inflammation, and dullness, fluid sounds and moist gurgling crackles in the later stages of effusion. Dullness of areas of the lung may be detectable on percussion. Edematous swellings of the throat and dewlap may occur and swelling of the large movable joints may be present. In calves, valvular endocarditis and myocarditis may occur. In fatal cases death occurs after a variable course of from several days to 3 weeks. In the **hyperacute form**, affected cattle may die within 1 week after the onset of respiratory distress.

#### Chronic and subacute forms

Recovered animals may be clinically normal but in some an inactive sequestrum forms in the lung, with a necrotic center of sufficient size to produce a toxemia causing unthriftiness, a chronic cough, and mild respiratory distress on exercise. These sequestra commonly break down when the animal is exposed to environmental stress and cause an acute attack of the disease. In Europe, the disease is characterized by low morbidity and the mortality and the majority of infected cattle have chronic lesions. In Italy during the 1990s, less than 5% of cattle in an infected herd had evidence of clinical disease, which may be due to the use of antimicrobials and anti-inflammatory agents which may mask the clinical findings and allow the formation of chronic lesions. In Africa, up to one-third of acute cases that recover become potential carriers, which may be even higher in Europe where there is a more widespread use of antimicrobials.<sup>2</sup>

#### CLINICAL PATHOLOGY

##### Isolation or detection of organism

Isolation of the organism is essential for the diagnosis. The organism is nutritionally very fastidious and special laboratory media is required for growth and identification.<sup>6</sup> Final identification of mycoplasmas is usually made by growth inhibition or immunofluorescence tests on agar.<sup>6</sup> The **polymerase chain reaction (PCR)** has been used to identify the specific organism and differentiate it from other members of the cluster. The test can be used to detect small numbers of organisms in nasal mucous, pleural fluid and pulmonary tissue. The PCR can identify the organism in bacterial isolates or clinical material within 2 d of extraction and is highly specific.<sup>25</sup> The organism can also be identified using the PCR on nasal filter strips placed into the nasal cavities of cattle to be tested.<sup>26</sup>

**Latex agglutination test.** A latex agglutination test (LAT) for the diagnosis of CBPP uses latex microspheres coated with anti-MmmSC IgG and based upon the detection of MmmSC capsular polysaccharide antigen in the serum of infected animals is useful for the detection of acutely infected animals compared to the CFT which is not highly sensitive in the early stages of the disease or for animals with chronic lesions.<sup>27</sup> In comparison to the CFT, the MmmSC IgG-coated LAT exhibited 62 and 61% correlation in diagnosis at 2 to 3 min of incubation, respectively.<sup>27</sup> The LAT combines low cost and high specificity with ease of application in the field, without the need for any specialist training or equipment, and allows rapid and primary herd screening prior to confirmatory laboratory diagnosis (PCR or ELISA).

#### Serological tests

The complement fixation test (CFT) on serum is still the most useful method of detecting infection. It is rapid, simple to perform and easy to interpret the results. It is more specific than the ELISA tests, it lacks sensitivity for serum samples having a very low antibody level.<sup>28</sup> ELISA tests detect late and persistent infections while CFT detects early infections. In a small proportion of animals the results may be deceptive. Early cases may give a negative reaction and some positive reactors show no lesions on necropsy. High levels of circulating capsular polysaccharide antigen can lead to false-negative diagnoses due to antibody 'making', and in up to 36% of CBPP positive animals may be undetectable by the CFT. The test is particularly effective in detecting carriers. Animals recovering from the disease gradually become negative and vaccinated animals give a positive reaction for about 6 weeks, although this period may be much longer if severe vaccination reactions occur. A slide flocculation test and a rapid slide agglutination test have been used but their sensitivity is lower than that of the complement fixation test and they are recommended for herd diagnosis rather than for use in individual animals. A modified complement fixation test, the 'plate CFT' is more accurate than the standard CFT and is much more economical of time and equipment. It has been very accurate and efficient in Australia and made eradication possible. With all of these tests there is a progressive loss of reliability if testing is delayed for very long after the clinical disease has passed.

A comparison of Western and dot blotting techniques with the CFT, indirect enzyme-linked immunosorbent assay (ELISA), mycoplasma culture and gross lung pathology to detect the organism found that the blotting techniques were more sensitive than the CF or ELISA.<sup>29</sup>

An indirect ELISA based on a recombinant protein, LppQ-NX, known as the complete ELISA kit 'CHEKIT-CBPP' has been developed and provides good sensitivity and specificity for the diagnosis of CBPP and is robust under harsh climatic conditions.<sup>30</sup>

The CFT, immunoblotting, indirect ELISA, and competitive ELISA for detection of antibodies to MmmSC were compared in naturally infected cattle in the 1995 outbreak in Botswana.<sup>28</sup> The percentage of seropositive sample in the iELISA (50%), and in the c-ELISA (43%) were similar but lower than those obtained by the IBT (57%) and the CFT (61%). The percentages of positive sera in the IBT and CFT were also similar and overall the efficacy of these tests were better than that of the two ELISA tests. There was 95% agreement between the IBT and the CFT, 85% agreement between the IBT and c-ELISA, 91% agreement between the IBT and i-ELISA, 88% agreement between the i-ELISA and CFT, 80% agreement between the c-ELISA and CFT and 90% agreement between the two ELISA tests.<sup>28</sup>

No single serological test is capable of detecting all CBPP affected animals in the field, and which are useful for diagnosis at the herd level only. In the absence of a 'gold standard' test for the serological diagnosis of CBPP, some uncertainties remain unresolved.<sup>28</sup> Suspicious CBPP cases identified by positive serology must be confirmed by further investigations which demonstrate the presence of antigen in the respiratory tissues of animals. In CBPP free countries like Botswana, CFT should be used in conjunction with other serological tests where possible, so that every stage of disease could be followed serologically should the disease enter the country.

#### NECROPSY FINDINGS

Lesions are confined to the thoracic cavity and lungs and the lesions are usually unilateral.<sup>6</sup> The pleural cavity may contain large quantities of clear, yellow-brown fluid containing pieces of fibrin. This fluid is ideal for culture of the organism. Caseous fibrinous deposits are present on the parietal and visceral surfaces of the lungs. The interlobular septae are prominently distended with amber-colored fluid surrounding distended lymphatics. This fluid distinctly outlines the lobules which vary in color with red, gray, or yellow hepatization. Consolidation of the lungs with a typically marbled appearance is characteristic. In chronic or advanced cases, a sequestrum of necrotic lung varying size from 1–10 cm in diameter is surrounded by a fibrous capsule. If these sequestrae rupture and are drained by a bronchus

they can be a source of aerosol infection to cattle. Such a mechanism accounts for epidemics in closed herds. In affected calves, exudative peritonitis, arthritis, bursitis and fibrinous arthritis of carpal and tarsal joints may be present.

Histologically, in the early stages the typical lesion consists of bronchiolar necrosis and edema, progressing to exudative serofibrinous bronchiolitis with extension to the alveoli, and adjacent lymphatics.<sup>6</sup> This process extends to the tracheobronchial lymph nodes and pleural lymphatics. The mediastinal, sternal, aortic and intercostal lymph nodes are enlarged, edematous and hemorrhagic. Lymphatics become thrombosed and fibrosed. The pulmonary lobules become consolidated with alveolar edema, fibrin and inflammatory cells. Coagulation necrosis is common and the organism can be demonstrated in these lobules by immunohistochemistry.

Perivascular organization foci or 'organizing centers' in the interlobular septa, are considered typical of CBPP. They consist of a center occupied by a blood vessel with proliferation of connective and inflammatory cells surrounded by a peripheral zone of necrotic cells. Type I foci contain more proliferative cells in the central zone, which is larger than the peripheral zone. In Type II foci, the proliferative cells are scarce and the peripheral zone is relatively larger. Immunoreactive antigen is visible in the central zone inside blood vessels. Immunocytochemical tests can be used to detect the organism in tissue sections and provide valuable confirmatory diagnosis after slaughter. Stained antigen is visible in the smaller bronchioles and alveoli and within the interlobular septa of the lung. Immunofluorescent staining of impression smears of lungs may be more sensitive and rapid than culture.<sup>6</sup>

Renal lesions are frequently detectable in CBPP in field and experimental cases.<sup>17</sup> In the acute phase of the disease, multiple renal infarcts are common. In subacute and chronic cases, the infarcts progress to form large areas of fibrosis accompanied by tubular dystrophic calcification, tubular atrophy, and lymphocyte interstitial infiltrates. Immunohistochemically, the MmmSC antigen is present in several renal structures.

A PCR test has also been developed.<sup>25</sup> Abattoir surveillance of lung samples and tracheobronchial lymph node tissues for culture and identification of MmmSC, immunohistochemistry with peroxidase anti-peroxidase system, and molecular detection by the PCR amplification of specific DNA from MmmSC, and supported by serological tests is one of the best methods for the diagnosis of CBPP.<sup>31</sup>

### Samples for confirmation of diagnosis

- **Histology** – formalin-fixed lung (LM, IHC)
- **Mycoplasmology** – effusion fluid in serum tube, lung, bronchial lymph node (MCULT, FAT, PCR).

### DIFFERENTIAL DIAGNOSIS

A diagnosis based on a history of contact with infected animals, clinical findings, a complement fixation test, necropsy findings and cultural examination is necessary.

Diseases which must be differentiated from CBPP include:

**Rinderpest** Erosive stomatitis, dysentery, and erosions throughout the alimentary tract

**Foot and mouth disease** Salivation, lameness, fever, and vesicular stomatitis  
**Hemorrhagic septicemia** Acute disease with death in 6 to 72 hours. Edema of the neck and brisket, lung lesions similar to CBPP. Culture of *Pasteurella* spp.

**Theileriosis (East Coast fever)**

Coughing, nasal and ocular discharge, diarrhea, enlargement of peripheral lymph nodes, ulceration of abomasum. No lung lesions

**Ephemeral fever** Ocular discharge, drooling saliva, lameness, enlarged joints, self-limiting disease of short duration; most affected cattle recover quickly; fluctuating fever; secondary pneumonia may occur.

**Pulmonary abscesses** Large abscesses containing foul-smelling purulent material; may have total destruction of lung

**Tuberculosis** Tubercular nodules may resemble CBPP sequestra but they are degenerative cheese-like lesions, often calcified

**Farcy** Abscesses of lungs containing foul-smelling material and enlarged local lymph nodes

**Actinobacillosis** Generalized lesions of lung and other adjacent tissues

**Echinococcal (hydatid cysts)** Pulmonary cysts with a double wall and containing clear fluid, often calcified when old

### TREATMENT

No therapeutic treatment is effective. Antibiotics can have no role in the eradication of CBPP either at the farm level, or more importantly, nationally and internationally. Antibiotics can alleviate the clinical course of the disease enabling some improvement in condition. For the individual farmer, particularly the nomad, this prevents the loss of, often, his only form of income and livelihood. However, a treatment strategy must be balanced against the difficulty created by subclinical carrier cattle spreading the disease across international boundaries which often results in explosive outbreaks amongst susceptible populations. In reality, antibiotics are used and thus advice is necessary about which ones are most effective.

An in vitro trial of five commonly used antibiotics on recent isolates of MmmSC found that tilmicosin and danafloxacin were effective both in terms of mycoplasmastatic, and mycoplasmacidal activity.<sup>32</sup> Florofenicol and tetracycline were intermediate, and spectinomycin was ineffective against some strains.

### CONTROL

The major obstacles to the control and eradication of the disease are:

- Difficulty in controlling the movements of cattle, especially in sub-Saharan Africa
- Complications of applying quarantine and slaughter policies
- Lack of rapid pen-side diagnostic tests
- Ineffective vaccines
- Insufficient funds to implement control policies
- Civil strife and drought, which have an effect on the spread of the disease in Africa.

Social and civil disturbances interfere with effective disease control. Cattle may be stolen and sold far from their point of origin. Hungry soldiers disregard movement laws. Refugees fleeing war zones sell their cattle before moving, which changes the usual pattern of livestock movement. Farmers fleeing civil unrest may move their cattle to endemic areas and then return with them when the threat is over. This explains the spread of disease into Rwanda from Uganda and Tanzania in 1994. The indiscriminate movement of cattle by cattle traders accelerates the spread of disease. The movement of cattle from sparsely populated areas to densely populated areas is a major risk factor and trade depots and feedlots which receive cattle from other parts of the country regularly experience epidemics. When outbreaks occur, village traders commonly dispose of their animals to traders. It has been suggested that nomadism and pastoralism are major means of transmission of the disease from one area to another.

Control and eradication are applied to the individual herd and to the area with the goal of eradication in the country. The possible strategies used for control in affected countries or regions are:

- **Slaughter of all sick and in-contact cattle.** This requires full cooperation of cattle owners and an adequate and timely compensation system. This strategy is impractical in developing countries with a pastoral economy
- **Slaughter of all sick cattle and vaccination of in-contact cattle.** This strategy is used frequently and usually perpetuates the disease

- **Vaccination of healthy cattle with slaughter of sick cattle in an epidemic and revaccination of cattle at risk.** This method depends on the ability of the authorities to detect epidemics rapidly, most effectively, by abattoir surveillance and to maintain vaccination for at least 3 years. Vaccination in endemic areas must be done annually while newly infected areas require repeat vaccinations aimed at eradication of the disease after 3, 9, 21, and 36 months. Specific therapy is prohibited.

#### On a herd basis

When the disease becomes established in a herd the following measures may be adopted to prevent its spread.

##### Removal of sources of infection

Infected animals should be removed from the herd as soon as possible. The CFT is adequate to identify the infected animals and should be carried out in conjunction with clinical examination. Because animals in the incubation and early stages of the disease may test negative, it is necessary to have two negative tests 2 months apart before the herd can be classified as clean. After vaccination a positive reaction occurs; this usually disappears within 2 months but may persist for 5 months. All positive and suspicious reactors and clinical cases should be destroyed or transported under close control to abattoirs. Where this cannot be done without a chance of spread to animals along the route, destruction on the farm is necessary. Animals which eventually go to abattoirs should be kept under quarantine until slaughter, irrespective of their status.

In circumstances where a minimum of handling is desired, the herd may be blood tested and examined for clinical signs, and vaccinated all in the one visit. Animals which react to the test are then destroyed even though they have been vaccinated. The only difficulty that arises with this method is that cattle in the incubative stages of the disease may give a negative reaction to the test and, because of the serological reaction resulting from vaccination, retesting cannot be performed until 2 months later.

##### Hygiene

Any procedure which brings the animals together should be avoided. Passage through the milking shed, collecting for inspection, bleeding and vaccination all facilitate spread, especially in humid conditions, when droplet inhalation is more likely to occur. Strict quarantine of the infected and in-contact herds must be maintained until all residual infection has been eliminated – usually 12 weeks

after the removal of the last reactor and/or clinical case is sufficient time. Animals in quarantine should be kept under constant surveillance so that clinical cases may be observed.

##### Vaccination

All effective CBPP vaccines have been based upon live versions of the disease-causing mycoplasma, either attenuated or not.<sup>33</sup> Current vaccine strains (T<sub>1</sub> 44 and T<sub>1</sub> SR) for CBPP are made from freeze dried broth cultures of live attenuated *Mycoplasma mycoides* subsp. *mycoides* SC and are generally considered to exhibit poor efficacy and stability. Protection is low (only 30 to 60% of animals are protected), and short-lived (6–12 months), and repeated vaccination is necessary.<sup>34</sup> However, the poor efficacy of vaccines appears to be recent phenomenon because the vaccines used as early as 1852 and up until 1926 were efficacious although the procedure involved the implantation in the tail tip of serous fluid from diseased animals.<sup>34</sup> Recent experiences with the T<sub>1</sub> 44 vaccine in Namibia showed that it was highly effective in bringing CBPP under control. The current vaccine is highly effective when administered as part of a well conducted vaccination campaign, in which high levels of coverage are achieved (in excess of 80%) and in which the vaccine is rapidly used following reconstitution (before a significant loss in titer occurred). If these conditions could be achieved over the entire continent, CBPP would probably be a disease of the past. The T<sub>1</sub> 44 vaccine which is given subcutaneously has been successfully used to control CBPP in different regions of Africa and has advantages and disadvantages. A number of postvaccinal reactions may occur. Within two to four weeks following injection, an invading edema develops known as the 'Willems' reaction.<sup>35,36</sup> The incidence of these reactions varies from area to another.

The reversion to virulence of the T<sub>1</sub> 44 vaccine has also been observed when it was serially passaged by endobronchial intubation resulting in the development of lesions of CBPP in animals which were infectious to in-contact animals. This suggests animals given the currently used vaccines (T<sub>1</sub> 44 and T<sub>1</sub> SR) subcutaneously could be reservoirs for MmmSC and infect other animals in areas previously free of CBPP. Similarly, vaccination with the V<sub>3</sub> vaccine was abandoned in Australia when the prevalence of CBPP was sufficiently low, because the vaccine was responsible for erratic foci. In some situations, the T<sub>1</sub> 44 vaccine induces a good immunity, especially when herds are revaccinated annually in which case the level of protection exceeds 85% which compares favorably with a number of

other bacterial vaccines. The T<sub>1</sub> SR strain is completely devoid of residual virulence and the level of protection afforded seems to be similar to that provided by the T<sub>1</sub> 44 vaccine after 3 months.

Recommendations to improve the efficacy of CBPP vaccines have been reviewed and include methods of preparing the vaccines, and reconstitution procedures and solutions.<sup>34</sup> The literature on the history of the vaccines has been reviewed.<sup>37</sup>

Inactivated CBPP vaccines have been field tested but results have been inconclusive.<sup>38</sup> Immunostimulating complex (ISCOM) protein subunit vaccines have been developed and early results are encouraging. The capsular polysaccharide (CPS) of MmmSC is an important surface antigen and pathogenicity factor previously known as a galactan. The immune response in mice of capsular polysaccharide conjugate vaccines against CBPP indicates that protection against MmmSC mycoplasmaemia in mice is cell-mediated rather than humoral immunity.<sup>38</sup>

CBPP was successfully eradicated from Australia using the V5 broth vaccine, with no problems regarding efficacy or thermostability under field conditions.<sup>11</sup>

Vaccination is an effective procedure for control but its application is usually controlled by local legislation. All the vaccines in use are living preparations and their use is always subject to the suspicion that they may spread the disease. When tail vaccination with organisms of reduced virulence is practised, the possibility of spreading the disease is remote but because the possibility exists, vaccination is usually only permitted in herds or areas where the disease is known to be present. The value of calfhood vaccination is limited because arthritis, myocarditis and valvular endocarditis occur 3–4 weeks after vaccination of calves less than 2 months old. Vaccination of calves after this age is recommended because it avoids the occasional deaths which occur after vaccination of adults.

The vaccines available include pleural exudate from natural cases (natural lymph), cultured organisms of reduced virulence, and an avianized vaccine of low virulence. Vaccination is usually carried out by injection into the tough connective tissue at the tip of the tail with a high-pressure syringe. 'Natural lymph' is unsatisfactory because of the possibility of spreading this and other diseases and because of the severe lesions which commonly result. Severe reactions with this type of vaccine may cause sloughing of the tail and extensive cellulitis of the hindquarters, necessitating destruction or causing death of the animal. An intranasal vaccine avoids these sequels and appears to give satisfactory results. If animals which develop

a severe local lesion after vaccination are treated with a mycoplasmocidal drug, such as tylosin, the treatment will interfere with the development of immunity and animals treated in this way should be revaccinated.

In general, vaccines made from *M. mycoides* grown in broth culture cause less severe reactions but a correspondingly briefer immunity of about 6–10 months and require annual revaccination. The T1 strain broth culture vaccine is the one in most general use in the nomadic cattle herds of Africa. It has the virtue of long-term immunity, of at least 2 years' duration. Avianized vaccines have been developed which overcame the brevity of the immunity, increasing its duration to 3–4 years. These vaccines are the major types in use now and are capable of great variation in their virulence. In spite of increasing the attenuation, the use of these vaccines has been followed on occasions by severe local reactions and pulmonary lesions. This led to an investigation of the KH3J strain, which is less virulent than the standard V5 strain. A vaccine attenuated by egg culture but grown in its last passage in broth eventuated and eliminated the egg proteins from the vaccine which were thought to produce some of the local reactions. However, the more virulent vaccines are still in use and, provided tylosin is available to control undesirably severe reactions, are generally preferred. All vaccines against CBPP are susceptible to light and should be kept in a dark place.

#### On an area basis

The prevention of entry of infected animals into a free area is a difficult task. Only the following classes of cattle should be permitted to enter:

1. Cattle which have not been in an infected area nor in contact with infected animals for at least 6 months. This may be relaxed to permit entry of cattle going to immediate slaughter after a clinical examination and a period of 1 month in a free area
2. Cattle which have given negative reactions to the CFT on two occasions within the preceding 2 months and have not been in contact with infected animals during this period. These animals may or may not have been vaccinated. Less rigid measures than these will permit introduction of the disease.

When the disease is already present in an area, two methods of control are possible: vaccination and eradication by test and slaughter of reactors. The method chosen will depend largely on the economy of the cattle industry in the affected area.

A vaccination program may be the first step to reduce the incidence of the disease to the point where eradication becomes possible.

In areas where farms are large, fencing is poor and the collection of every animal cannot be guaranteed, eradication of the disease by test and slaughter is impractical. Vaccination with culture vaccine can be practiced whenever the cattle are brought together. Animals moving out of or into infected areas, and groups of cattle which contain active cases, must be vaccinated. Moving cattle which develop the disease should be halted, clinical cases slaughtered and the remainder vaccinated. Results are usually good provided the vaccination is carried out carefully but some further cases due to prevaccination infection are to be expected. Extensive vaccination in Australia reduced the incidence of the disease to an extremely low level and complete eradication of the disease was achieved shortly afterwards. The residual problems were largely geographical and an annoying but low proportion of false-positive reactors to the CFT. Eradication was greatly facilitated by the use of the plate agglutination test in a mobile laboratory and autopsy of reactors 24 h later. Of great help also was the appointment of special meat inspectors to local abattoirs during the eradication program.

In countries where the cattle population is nomadic, control and eradication seems impossible by the conventional means described above. Annual vaccination of as many cattle as can be found has the capacity to reduce the occurrence of the disease to negligible proportions.

When outbreaks occur in small areas where herds can be adequately controlled, complete eradication should be attempted by periodic testing and the destruction of reactors, and in-contact animals should be vaccinated. To avoid unnecessary contact between cattle, retesting is delayed until 5–6 months after the first test when vaccination reactions have usually subsided. Under most circumstances all non-reactors should be vaccinated. This practice is particularly applicable in feeder cattle which will be slaughtered subsequently and when extensive outbreaks occur in closely settled areas where the chances of spread are great. Simple test and slaughter in these latter circumstances will be too slow to control the rate of spread. In either case the herd should not be released from quarantine until two tests at an interval of more than 2 months are completely negative.

In Portugal where CBPP is endemic in certain regions, for control purposes the country is divided into three regions: infected, buffer and disease-free. In the infected areas, cattle over 6 months of age

are tested twice yearly. In the buffer region, serological testing is compulsory for at least 50% of all cattle. In the disease-free regions serological testing is reduced to 10% of all cattle. Seropositive cattle in the endemic zone are slaughtered; if these cattle have lesions, the rest of the herd is slaughtered and cattle movement is prohibited within a 2 km diameter of the farm. Restrictions are lifted on neighboring farms only following three consecutive negative CFTs done at 2-month intervals on all cattle. In the disease-free zones seropositive cattle are retested. The trend from 1990 to 1995 has been a reduction in the number of outbreaks.<sup>6</sup>

In Italy, control is based on abattoir surveillance and serological testing before movement of cattle. The policy of slaughter of both affected and contact cattle appears to have been effective.

#### Office des International Epizooties Plan for Eradication

Guidelines are available for eradication of the disease initially from endemic areas and then worldwide in three stages.<sup>6</sup> The first stage is a **declaration of provisional freedom from disease**, which could be made by a veterinary officer based on clinical evidence. This is accompanied by increased surveillance including meat inspection and vaccination would cease. Two years later, a country could declare the second stage, **freedom from disease**, which would include no clinical disease, no vaccination, an adequate surveillance and disease-reporting system, and effective measures to prevent reintroduction of disease. Following another 2 years, a country could declare **freedom from infection**, which would be conferred by an expert panel based on continuation of criteria in the second stage. When **freedom from infection** has been established, the country would make a commitment to continue monitoring. All cases of disease would be reported and vaccination would not be allowed. Countries with no recent history of disease and which do not vaccinate would be able to declare '**freedom from infection**'.

In Europe, legislation exists to prevent the spread of CBPP. Any outbreak in a previously CBPP-free country must be reported to the Commission within 24 h of confirmation of the disease; the Commission will then inform other member states.<sup>6</sup> Unaffected regions may export only to other member states if cattle come from herds in which all animals over 12 months of age have been serologically negative in the previous 12 months. All animals for export must have been serologically tested negative 30 d before being loaded. No disease-free regions have been recognized in countries

in which the disease is endemic. Cattle from restricted areas must not be exported to other member states until all herds in the area have passed three clear herd tests on all animals over 12 months of age at intervals greater than 3 weeks apart.<sup>6</sup>

The return of the disease to southern Europe in the 1960s, its endemic nature in the Iberian Peninsula, and unconfirmed reports of its existence in eastern European countries considered to be free of the disease requires an increased awareness of its spread. The illegal transit of cattle between infected and non-infected regions combined with the political and economic considerations, such as delays in implementing both slaughter and payment of compensation to farmers are factors which delay the eradication of the disease from infected countries. Rules regulating intra-community trade are designed to prevent the movement of infected cattle in Europe but the insidious nature of the disease and the limitations of the tests mean that infected cattle are undetected. Effective control will require increased surveillance at abattoirs and the judicious use of diagnostic tests.

In Africa, there is a need to improve the control of livestock movements through regional and international cooperation.

## REVIEW LITERATURE

- Nicholas RAJ, Bashiruddin JB. *Mycoplasma mycoides* ssp. *mycoides* small colony variant: the agent of contagious bovine pleuropneumonia and a member of the '*Mycoplasma mycoides* cluster'. J Comp Pathol 1995; 113:1–27.
- Egwu GO, Nicholas RAJ, Ameh JA, Bashiruddin JB. Contagious bovine pleuropneumonia: an update. Vet Bull 1996; 66:875–888.
- Newton LG, Norris R. Clearing a Continent. The eradication of bovine pleuropneumonia from Australia. Primary Industries Report Series 74. CSIRO Publishing/PISC SCARM, 2000, 295 pp.
- Nicholas RAJ, Bashiruddin J, Ayling R, Miles R. Contagious bovine pleuropneumonia: a review of recent developments. Vet Bull 2000; 70: 827–838.
- Food and Agricultural Organization of the United Nations. Animal Production and Health Division. Recognizing Contagious Bovine Pleuropneumonia. FAO Animal Health Manual. No. 13, Rev. 1. Rome: FAO, 2002; 24 pp.
- Kusiluka LJM, Sudi FF. Review of successes and failures of contagious bovine pleuropneumonia control strategies in Tanzania. Prev Vet Med 2003; 59:113–123.
- Thiaucourt F et al. Contagious bovine pleuropneumonia vaccines, historic highlights, present situation and hopes. Dev Biol Basel 2003; 114:147–160.

## REFERENCES

1. Food and Agricultural Organization of the United Nations. Animal Production and Health Division. Recognizing Contagious Bovine Pleuropneumonia. FAO Animal Health Manual. No. 13, Rev. 1, Rome: FAO, 2002, 24 pp.
2. Brandao E. Vet Rec 1995; 136:98.
3. European Commission. Diagnostic tests for Contagious Bovine Pleuropneumonia (CBPP). Scientific Committee on Animal Health and Animal Welfare. 2001, pp. 1–33.

4. OIE. 2003; Handistatus. II <http://www.oie.int/hs2/>.
5. Aliyu MM et al. Prev Vet Med 2000; 47:263.
6. Egwu GO et al. Vet Bull 1996; 66:875.
7. Nicholas RAJ, Bashiruddin JB. J Comp Pathol 1995; 113:1.
8. Kusiluka LJM, Sudi FF. Prev Vet Med 2003; 59:113.
9. Nicholas RAJ et al. Vet Bull 2000; 70:827.
10. Cetinkaya B et al. Vet Rec 2003; 152:254.
11. Newton LG, Norris R. Clearing a continent. The eradication of bovine pleuropneumonia from Australia. Primary Industries Report Series 74. CSIRO Publishing/PISC SCARM. 2000, 295 pp.
12. Whittam JH Aust Vet J 2001; 79:365.
13. Gonclaves MR. Vet Rec 1994; 135:308.
14. Lesnof M et al. Prev Vet Med 2004; 62:101.
15. Lesnof M et al. Prev Vet Med 2004; 64:27.
16. Giovanni A et al. Rev Sci Tech Off Int Epiz 2000; 19:764.
17. Grieco V et al. J Comp Pathol 2001; 124:95.
18. Vilei EM et al. Microbiology 2000; 146:477.
19. Westberg J et al. Genome Res 2004; 14:221.
20. Thiaucourt F et al. Vet Microbiol 2000; 72:251.
21. Lorenzon S et al. Vet Microbiol 2003; 93:319.
22. March JB et al. J Clin Microbiol 2000; 38:1419.
23. Stradaoli G et al. Vet Res 1999; 30:457.
24. Rice P et al. Vet Microbiol 2001; 78:343.
25. Bashiruddin JB et al. Vet Rec 1994; 134:240.
26. Kaura HT, Hubschule OJB. Vet Rec 1996; 138:444.
27. March JB et al. Clin Diag Lab Immunol 2003; 10:233.
28. Marobela-Raborokgwe C et al. Onderstepoort J Vet Res 2003; 70:21.
29. Nicholas RAJ et al. Vet Rec 1996; 139:89.
30. Bruderer U et al. Vet Microbiol 2002; 84:195.
31. Bashiruddin JB et al. Vet Rec 1999; 145:271.
32. Ayling RD et al. Vet Rec 2000; 146:243.
33. March JB. Vaccine 2004; 22:4358.
34. Thiaucourt F et al. Ann New York Acad Sci 2000; 916: 71–80.
35. Mbulu R-S et al. Vet Microbiol 2004; 98:229.
36. Thiaucourt F. Vet Rec 2002; 151:156.
37. Thiaucourt F et al. Dev Biol Basel 2003; 114:147–160.
38. Waite ER, March JB. J Comp Path 2002; 126:171.

## CONTAGIOUS AGALACTIA IN GOATS AND SHEEP

**Etiology** *M. agalactiae* in sheep. *M. agalactiae*, *M. mycoides* subsp. *mycoides* large colony type and *M. capricolum* subsp. *capricolum* in goats

**Epidemiology** Occurs on very continent but outbreaks and severe disease occur in the Mediterranean area and Africa. Introduction of infected animals. Direct spread by infected milk and ocular discharge to sucking young and to adults by contamination of bedding, feed, and milking machine equipment

**Clinical findings** Triad of mastitis, arthritis and ocular disease. Sometimes accompanied with respiratory disease, abortion and diarrhea

**Lesions** Indurative mastitis with abscessation, polyarthritis

**Diagnostic confirmation** Culture, PCR, serology

**Treatment** Antimicrobials may mitigate disease severity but not achieve a bacteriological cure

**Control** Flock/herd biosecurity, milking-time hygiene. Test and slaughter eradication. Vaccines have poor efficacy

## ETIOLOGY

Contagious agalactia is a disease of sheep and goats, particularly those used for milk production. *M. agalactiae* is the main causal agent in sheep and goats but *M. agalactiae*, *M. mycoides* subsp. *mycoides* large colony type and *M. capricolum* subsp. *capricolum* produce a similar if not identical clinical presentation. There is apparent variation in virulence between isolates from different countries and frequently, more than one of these agents can be isolated from the same outbreak.<sup>1–4</sup>

*M. putrefaciens*, first isolated from the joints of arthritic goats in California, has been isolated and implicated in some outbreaks of contagious agalactia but experimental challenge with this organism does not produce classical contagious agalactia.<sup>1</sup>

*M. putrefaciens* can cause septicemia, pneumonia and mastitis in small ruminants that are predisposed by other diseases but it should be considered an opportunist when isolated from cases of contagious agalactia.<sup>5</sup>

## Epidemiology

### Occurrence

Contagious agalactia is endemic in most European countries and Africa, and occurs in most other areas of the world including Asia and the Indian subcontinent, Australasia, the Middle-East and North America but with little documented occurrence in Britain or South America.<sup>1,5</sup> The disease is endemic in most Mediterranean countries and is particularly widespread in Spain.<sup>3</sup> An example of how it can become endemic is that it was recently reported for the first time in goats in the Canary Islands<sup>4</sup> but is now recognized as being endemic on all islands.<sup>6</sup>

### Prevalence

In endemic areas the disease is cyclic in occurrence with periods of outbreaks of severe disease interspersed with periods of chronic or mild disease.<sup>5</sup>

Peak rates of clinical disease occur after parturition in both the dams and their young with another peak occurring in association with the onset of machine milking after the young are removed from sucking. The mortality rate can be high (10–30%) and many adult females are culled because the udder is permanently damaged.

### Transmission

The organisms are present in the milk and ocular secretions of infected animals and in respiratory secretions where the pulmonary form of the disease is present. Transmission is by direct contact, aerosol transmission, ingestion and by contact with infected fomites. The young are infected through the ingestion of infection present in colostrums and milk. Infected

milk can also contaminate bedding, feed<sup>7</sup> and dairy equipment and spread occurs with machine milking.

The organisms are also resident in the ear canal of sheep and goats and transmission by ear mites is thought to occur.<sup>8-10</sup> The common practice of transhumance and communal grazing in endemic areas also promotes transmission between herds and flocks either from direct contact or grazing over infected pastures. Illegal importation of animals from an endemically infected area to countries free of disease has also resulted in introduction of disease.<sup>11</sup>

#### Experimental reproduction

The disease can be reproduced experimentally and reflects the natural disease with acute and chronic multifocal necrotizing mastitis, acute arthritis, conjunctivitis, and subacute enteritis. Shedding of the organism precedes the onset of clinical disease by 1 to 10 days.<sup>1,5,8,12</sup> The experimentally produced disease is much more severe in pregnant animals.<sup>13</sup>

#### Host risk factors

The relative severity of clinical disease in sheep versus goats depends on the infecting mycoplasma and varies with region<sup>1,5</sup> and there are breed differences in susceptibility. Septicemia and acute disease more common in young lambs and kids and lactating females with less severe disease in adult males and non-lactating non-pregnant females

#### Pathogen risk factors

There is regional variation in the virulence of isolates, or in some regional environmental factor. *M. agalactiae*, *M. mycoides* subsp. *mycoides* large colony type, *M. capricolum* subsp. *capricolum* and *M. putrefaciens* have all been isolated from goats in Australia and the USA over several decades but clinical disease in these countries associated with these organisms is extremely rare.

#### CLINICAL FINDINGS

The classical signs of contagious agalactia include septicemia, arthritis, mastitis, conjunctivitis and localization in abscesses but these are not all consistently present in outbreaks.

In acute cases the onset is sudden with pyrexia, abrupt and complete agalactia, and unilateral or bilateral swelling of the udder with enlargement of the mammary lymph nodes and the development of multiple abscesses in the mammary gland. Induration of the udder may result in culling. In animals that survive mycoplasma are excreted in the milk for several months<sup>8,13</sup> and will persist in the udder to subsequent lactations.

Arthritis may be manifest by lameness or recumbency and its presence detected

in the carpal and tarsal joints by the occurrence of heat and palpable joint fluid, and confirmed by aspiration and examination of joint fluid. Conjunctivitis progresses to keratitis with corneal revascularization in one or both eyes. Some cases have diarrhea.

In less acute cases, there is a long period of illness of from one to several months. Abortion may also occur and genital disease with vulvovaginitis and metritis occurs in some outbreaks.<sup>14</sup>

#### CLINICAL PATHOLOGY

Herd diagnosis is possible by the isolation of the organism *M. agalactiae* from the bloodstream, joint fluid and mammary tissue. PCR can be used for identification.<sup>15,16</sup>

Herd diagnosis can also be made serologically by CFT which becomes positive soon after a clinical attack. There are also commercial ELISA tests available that have limitations in sensitivity and specificity but that can be used for serological diagnosis.<sup>17</sup>

#### NECROPSY FINDINGS

Lesions are of indurated mastitis with abscessation, lymphadenopathy, arthritis and ocular disease.

#### Samples for confirmation of diagnosis

- **Bacteriology** – milk, ocular fluid, joint fluid aspirate (AEROBIC CULT PCR)
- **Serology** – CFT, ELISA.

#### TREATMENT

Antimicrobial therapy is restricted to the reduction of the severity of the disease and mortality. The cost and practicality of therapy in many endemic areas is a consideration as is the concern that a bacteriological cure is unlikely with antimicrobials such as tetracycline. In vitro sensitivity testing of field isolates of *M. agalactia* found enrofloxacin most effective followed by tylosin, tetracycline, lincomycin, and spectinomycin.<sup>18</sup>

High cure rates are reported with the use of lincomycin, spectinomycin, and tylosin.<sup>19</sup>

#### CONTROL

The majority of infections in healthy flocks come from introduction of carriers or contact with infected animals. Isolation from infected flocks and herds and a closed herd policy is important in the control of disease.

Where disease is restricted to a small number of flocks in a geographically isolated area slaughter of serologically or culturally positive flocks can be an effective method of control,<sup>11</sup> but in most affected areas the disease is endemic, slaughter eradication is not an option, and control rests with immunoprophylaxis.<sup>6</sup>

However, the efficacy and duration of immunity is poor. Vaccination of sheep and goats with either an attenuated live vaccine or a killed adjuvant vaccine of *M. agalactiae* gives mixed results; in late pregnant ewes the former is rather too virulent, and the latter insufficiently 'so unless it is used in ewes before mating, when efficiency is good. Early vaccination is recommended because of the susceptibility of young animals but should not be carried out before 10 weeks of age. Extensive use of both vaccines over a period of 13 years has resulted in almost complete disappearance of the disease from Romania but live attenuated vaccines are banned in many countries.

Comparison between commercial vaccines shows that a saponized vaccine gives better results than a live, egg-cultured vaccine and saponin and phenol inactivated vaccines show better efficacy against experimental disease than do vaccines killed by heat or formalin.<sup>20</sup> An *M. agalactiae* bacterin combined with a mineral oil adjuvant has given good results when three doses are given before, and one dose after each parturition, and the herd is kept isolated.<sup>3</sup> Intramammary vaccination provides the highest level of antibody.<sup>21</sup>

Autogenous vaccines prepared from milk brain and mammary gland homogenates from infected sheep have been used for many years in parts of Europe but have been linked to outbreaks of scrapie.<sup>22</sup>

In infected herds, milking-time hygiene is important in limiting the spread of disease.

#### REVIEW LITERATURE

- Stalheim OHV. Mycoplasmal respiratory disease of ruminants: a review and update. *J Am Vet Med Assoc* 1983; 182:403-406.
- Bergonier D, Berthelot X, Poumarat F. Contagious agalactia of small ruminants: current knowledge concerning epidemiology, diagnosis and control. *Rev Sci Tech Off Int Epiz* 1997; 16:848-873.
- Egwu GO, Ball HJ, Roderiquez F, Fernandez A. *Mycoplasma capricolum* subspecies *capricolum*, *Mycoplasma mycoides* subspecies *mycoides* LC and *Mycoplasma mycoides* subspecies *capri* in 'agalactia syndrome' of sheep and goats. *Vet Bull* 2000; 70:391-402.

#### REFERENCES

1. Egwu GO et al. *Vet Bull* 2000; 70:391.
2. Swanepoel R et al. *Vet Rec* 1977; 101:446.
3. Vizcaino LL et al. *Vet Rec* 1995; 137:266.
4. Real F et al. *Vet Rec* 1994; 135:15.
5. Bergonier D et al. *Rev Sci Tech Off Int Epizoot* 1997; 16:848.
6. Assuncao P et al. *Vet Rec* 2004; 54:684.
7. Kinde H et al. *J Vet Diag Invest* 1984; 6:423.
8. DeMassa AJ, Brooks DC. *Small Rumin Res* 1991; 4:85.
9. DeMassa AJ et al. *J Vet Diag Invest* 1992; 4:101.
10. Gil MC et al. *Vet J* 158:152.
11. Cokrevski S. et al. *Vet Rec* 2001; 148:667.
12. Hasso SA et al. *Small Rumin Res* 1994; 13:79.
13. Hasso SA et al. *Small Rumin Res* 1993; 10:263.
14. Gil MC et al. *J Vet Med B* 2003; 50:484.



15. Tola S et al. *Vet Microbiol* 1997; 54:17.
16. Nicholas RAJ. *Small Rumin Res* 2002; 45:145.
17. Pepin M et al. *J Vet Diag Invest* 2003; 15:281.
18. Loria GR et al. *Res Vet Sci* 2003; 75:3.
19. Kwantes LJ, Harby HM. *Small Rumin Res* 1995; 16:287.
20. Tola S et al. *Vaccine* 1999; 17:2764.
21. Hasso SA, Al-Omran AH. *Small Ruminant Res* 1994; 14:79.
22. Agrimi U et al. *Lancet* 1999; 353:560.

## CONTAGIOUS CAPRINE PLEUROPNEUMONIA

### Synopsis

**Etiology** *Mycoplasma capricolum* subsp. *capripneumoniae*

**Epidemiology** Disease of goats. Highly contagious to susceptible goats

**Clinical findings** Pleuropneumonia.

**Lesions** Pleuropneumonia

**Diagnostic confirmation** Culture, PCR on pleural fluid. Latex agglutination tests.

**Treatment** Antimicrobials

**Control** Herd biosecurity, vaccination strong immunity but short duration

### ETIOLOGY

Contagious caprine pleuropneumonia (CCPP) is a classical disease of goats, associated with *Mycoplasma capricolum* subsp. *capripneumoniae* and commonly confused with other serious pneumonias of goats and sheep. It presents primarily as a pleuropneumonia. The causative agent is previously known as mycoplasma strain F38.<sup>1</sup> This organism is difficult to grow which has led to poor differentiation of the disease from that induced by *M. mycoides* subsp. *mycoides* LC and *M. mycoides* subsp. *capri*.<sup>2</sup> There are different strains and one study established four different lineages of *M. capricolum* subsp. *capripneumoniae* based on nucleotide sequence.<sup>3</sup> These correlated relatively well to the geographic origin of the strains.

### EPIDEMIOLOGY

#### Occurrence

CCPP is one of the most serious fatal diseases of goats.<sup>4</sup> The exact distribution of the disease is unknown but clinical disease has been reported from 38 countries, mostly from Africa and Asia. However, the causative organism has only been isolated from some of these due to the difficulty in growing it and the lack of mycoplasmal laboratories in many countries.<sup>3,5,6</sup> The disease is called Abu Nini in the Sudan.<sup>7</sup> CCPP has many similarities clinically and at necropsy to contagious bovine pleuropneumonia, but it is not transmissible to cattle. The incubation period is 6–10 d, infectivity is high with a morbidity of 100%, and the illness is acute and severe with a case-

mortality rate of 60–100%. Morbidity and mortality rates in a recent outbreak in a herd in Eritria were 90 and 65% respectively.<sup>8</sup>

This represents the response to the introduction of infection into a susceptible flock. What the epidemiological picture would be in a naturally immunized flock receiving constant invasions of infected animals is not clear.

### Transmission

The disease is readily transmitted by inhalation, but the organism does not survive for long outside the animal body and the infection is brought into the flock by a carrier or infected animal.

### Experimental reproduction

The disease has been reproduced experimentally and in most reports mortality is high.<sup>9,10</sup> Spread to in-contact goats seen with experimental infections parallels this occurrence in natural cases in the field.<sup>7</sup>

### CLINICAL FINDINGS

The following description does not fit most current descriptions of the disease. It is customary in them to include other serious pneumonias of goats associated with *M. mycoides* var. *capri* and *M. mycoides* which may manifest with disease in additional organ systems.

The clinical findings in contagious caprine pleuropneumonia are restricted to the respiratory system and include cough, dyspnea, lagging, lying down a lot (but the animal can stand and walk), fever (40.5–41.5°C; 104.5–106°F) and in the terminal stages, mouth-breathing, tongue protrusion and frothy salivation with death in two or more days. Under adverse climatic conditions the disease may occur in a septicemic form with little clinical or postmortem evidence of pneumonia.

### CLINICAL PATHOLOGY

Antigen can be detected in lung tissue and pleural fluid by PCR.<sup>2</sup> Serological tests used to identify carrier animals include complement fixation, ELISA and a latex agglutination test. The latter is robust, available commercially and suitable for field use.<sup>2</sup> The F38 monoclonal antibody is used in serological tests to identify caprine F38-type isolates by the disc growth inhibition method, which will include *M. agalactiae*, *M. capricolum* subsp. *capricolum* and the other members of the *Mycoplasma mycoides* cluster associated with goats.<sup>11</sup> A blocking ELISA using monoclonal antibodies is highly specific for CCPP.<sup>12</sup>

### NECROPSY FINDINGS

The more usual necropsy findings are similar to those of contagious bovine pleuropneumonia except that sequestra

are not formed in the lungs. Lesions are restricted to the lungs and pleura with hepatization of parts of the lung and an increase in pleural fluid with a fibrinous pleuritis. Histologically, contagious caprine pleuropneumonia is characterized by an interstitial intralobular edema rather than a thickening of the interlobular septa seen with other mycoplasmal infections.<sup>2</sup> The lesions may be confined to one lung.

### Samples for confirmation of diagnosis

- **Bacteriology.** These mycoplasmas are fragile and should be freeze dried if there is to be a significant transport time. More effective detection is by PCR performed on samples of pleural fluid dried on filter paper
- **Serology.** CFT or Latex agglutination.

### DIFFERENTIAL DIAGNOSIS

The other pulmonary mycoplasmoses from which this disease needs to be differentiated are those associated with *Mycoplasma mycoides* subsp. *capri*, *M. mycoides* subsp. *mycoides* (large colony type) and *M. capricolum*.<sup>8</sup>

### TREATMENT

Treatment of cases of CCPP with tylosin tartrate 10 mg/kg BW or oxytetracycline (15 mg/kg/d) is highly successful in limiting the severity of disease. The severity of the disease is reduced but treated animals are still sources of infection.

### CONTROL

Herd biosecurity to prevent contact with infected animals is important. Vaccination with an inactivated mycoplasma F38 vaccine induces an immune response which is effective in reducing morbidity and mortality rates, and a booster dose 1 month after the first vaccination provides additional protection.<sup>13,14</sup> Immunity is generally short-lived. Maternal antibody may interfere with the development of immunity and kids born to does that have been vaccinated while pregnant should themselves not be vaccinated prior to 12 weeks of age.

### REVIEW LITERATURE

- Stalheim OHV. Mycoplasmal respiratory disease of ruminants: a review and update. *J Am Vet Med Assoc* 1983; 182:403–406.
- Nicholas RAJ. Improvements in the diagnosis and control of diseases of small ruminants caused by mycoplasmas. *Small Rumin Res* 2002; 45:145–149.

### REFERENCES

1. Leach RH et al. *Int J System Bacteriol* 1993; 43:603.
2. Nicholas RAJ. *Small Rumin Res* 2002; 45:145.
3. Lorenzon S et al. *Vet Microbiol* 2002; 85:111.
4. Msami HM et al. *Vet Rec* 2001; 148:22.
5. Thiaucourt F, Bolske G. *Rev Sci Tech Off Int Epiz* 1996; 15:1397.

6. Houshaymi B et al. *Small Rumin Res* 2002; 45:139.
7. Harbi MSMA. *Vet Res Commun* 1983; 6:139.
8. Houshaymi B et al. *Trop Anim Hlth Prod* 2002; 34:383.
9. Harbi MS et al. *Trop Anim Hlth Prod* 1983; 15:51.
10. March JB et al. *Vet Microbiol* 2002; 84:29.
11. Belton D et al. *Vet Rec* 1994; 134:643.
12. Thiaucourt F et al. *Vet Microbiol* 1994; 41:191.
13. King GJ et al. *Vet Rec* 1992; 131:461.
14. Rurangirwa FR et al. *ResVetSci* 1991; 50:240.

## MYCOPLASMAL ARTHRITIS IN CATTLE

### Synopsis

**Etiology** *Mycoplasma bovis*

**Epidemiology** Occurs in association with pneumonia or lotitis in calves, mastitis in cows, but occasionally with no apparent inciting disease. Attack rates can be high and recovery slow

**Clinical findings** Moderate fever, lameness, pronounced swelling of the joints and tendon sheaths

**Lesions** Fibrinous synovitis

**Diagnostic confirmation culture**

Detection by PCR

**Treatment** Refractory to treatment. Early treatment with tylosin may be effective

**Control** Herd biosecurity. Control of pneumonia. Pasteurization of milk fed to calves

### ETIOLOGY

The cause is *Mycoplasma bovis*.<sup>1</sup> *Mycoplasma alkalescens* has also been isolated from 3-week-old calves affected with polyarthritis and a group 7 mycoplasma has been recovered from a calf with polyarthritis. *M. bovis* may be found in calves with polyarthritis and enzootic pneumonia, which may suggest a pneumonia-arthritis syndrome. *M. californicum*, usually isolated only from mammary disease, has also been isolated from the joints of cattle with arthritis in Germany.<sup>2</sup>

### EPIDEMIOLOGY

*Mycoplasma* arthritis of cattle has been reported in a number of countries including Canada, the United States, Europe and the United Kingdom. The causal organism and its associated diseases appears to be spreading in association with animal movement and occurring in areas where it has not previously been recorded.<sup>3-5</sup> Commonly arthritis occurs in association with respiratory disease or otitis media in calves, or mastitis in adult cattle, and isolations from arthritis are much less common than isolations from these other diseases.<sup>4,6</sup>

Coincident with the geographic spread the age and type of animal affected is also changing, or expanding. Earlier reports suggested that it occurred most commonly in young feedlot cattle usually affecting

many animals a few weeks after arrival and mingling in the lot. The morbidity ranged from 20–85% and the case-mortality rate from 3–50%. In Canada, the disease has been seen commonly in young cattle (6–8 months of age) following shipment from western rangelands to eastern feedlots, which suggests that long transportation and mixing of cattle of different origins may be important epidemiological characteristics. Calves affected with arthritis commonly have necropsy evidence of mycoplasma pneumonia and it is proposed that the pneumonia precedes the development of the arthritis. Calves sucking cows with experimental mastitis due to this organism may develop mycoplasmal arthritis, and a high incidence is recorded in calves in dairy herds where mycoplasmal mastitis was occurring.

In Ireland, infection has occurred in housed adult dairy cattle, without any evidence of pneumonia, producing severe polyarthritis with a clinical incidence in 12 farms that varied from 2 to 66%.<sup>5</sup>

In calves, the feeding of unpasteurized discard milk from cows with mycoplasmal mastitis is a risk factor.<sup>7</sup>

### PATHOGENESIS

*M. bovis* arthritis is normally regarded as a sequel to pneumonia or mastitis and infection in the respiratory tract or in the mammary gland is believed to lead to bacteremia and localization in joints.<sup>2,3</sup> However, arthritis can suddenly occur in regions or countries where mycoplasmal pneumonia has been recognized for many years suggesting that a new strain with different virulence or tropism has been introduced. Also, clinical disease in individual herds commonly follows the introduction of new animals to the herd.

Adherence to host cells of isolates from different pathologies has been examined as a possible explanation for this but does not appear a determinant for differences in disease presentation.<sup>8</sup>

The intra-articular injection of *M. bovis* into calves causes severe fibrinosuppurative synovitis and tenosynovitis, erosion of cartilage and its replacement by polypoid granulation tissue. Erosion of the cartilage is accompanied by chronic osteomyelitis and formation of pannus tissue. Histologically, there is extensive ulceration of synovial membranes of leukocytic infiltration of the subsynovium, congestion, hyperemia and thrombosis of the subsynovial vessels. Intratracheal inoculation of the organism results in pneumonia and severe lameness, which suggests that *M. bovis* is involved in pneumonia-arthritis syndrome.

A combined infection of *M. bovis* and bovine virus diarrhoea (BVD) has been

found in the joints of feedlot cattle that had chronic unresponsive arthritis.<sup>9</sup>

### CLINICAL FINDINGS

There is stiffness of gait, lameness, inappetence, moderate fever and progressive loss of weight. Swelling of the large movable limb joints and distension of tendon sheaths, associated with fibrinous synovitis and synovial fluid effusions, are characteristic.

Both forelimbs and hind limbs can be affected and commonly involvement of the carpal joints, the fetlocks and the proximal and distal interphalangeal joints can be clinically detected. In calves, pneumonia is a common finding in the affected group.

Some affected cattle spend considerable time in recumbency, lose weight and develop decubitus ulcers, and must be destroyed. Mildly affected cases recover spontaneously over a period of several weeks but severe cases become progressively worse, may develop discharging sinuses over affected joints, and must be culled.

### CLINICAL PATHOLOGY

Culture methods for the detection of *M. bovis* are restricted to culture and serology but both methods are time consuming, laborious, difficult and expensive.

A DNA probe and PCR test are now available to detect the organism in milk samples<sup>10</sup> and may be applicable to samples from joint fluid and an ELISA can be used to detect the organism in lung tissue of animals with pneumonia.<sup>11</sup>

### NECROPSY FINDINGS

At necropsy, the fibrinous synovitis is remarkable. There is severe thickening and edema of the synovial membranes and large quantities of fibrinopurulent synovial fluid. The tendon sheaths are similarly affected. Microscopically, large numbers of lymphocytes and plasma cells are found within the hypertrophic synovial villi. There can be multiple foci of coagulative necrosis within the joint capsule. *M. bovis* can often be recovered from pneumonic lungs and has been linked to pulmonary foci of coagulation necrosis.<sup>2,12,13</sup>

Immunohistochemical studies suggest that this organism may also briefly localize in the kidney and liver.<sup>12</sup> *M. bovis* has been associated with pleuritis and pericarditis and has been isolated from decubital ulcers of calves.<sup>14</sup>

### Samples for confirmation of diagnosis

- **Histology** – formalin-fixed lung, synovial membrane (LM, IHC)
- **Mycoplasmology** – lung, culture swab from joint cavity (MCULT).

## DIFFERENTIAL DIAGNOSIS

The disease must be differentiated from other causes of joint swelling and lameness in feedlot cattle. There are usually several animals affected in a short period of time, which serves to distinguish it from other sporadic causes of arthritis in feedlot cattle. A diagnosis of infection by *M. bovis* should be considered when pneumonia and arthritis and synovitis occur at about the same time. For a definitive diagnosis, joint fluid must be placed immediately into laboratory media specially prepared for *Mycoplasma* spp. The failure to isolate the mycoplasma from the fluid of joints which have been affected for more than 14 d does not preclude a diagnosis of mycoplasma arthritis because the organism may have been eliminated from the joint.

## TREATMENT

Treatment is usually ineffective. Several antimicrobials, including tylosin, oxytetracycline, lincomycin and oleandomycin, have been used in natural, and experimental cases and while the organism is sensitive to these antibiotics in vitro, the response in affected animals has been unsatisfactory. The antimicrobial susceptibility of *M. bovis* strains, cultured from cases of pneumonia, arthritis, and mastitis of cattle, measured in vitro indicate that enrofloxacin was the only one which exhibited any measurable activity.<sup>15</sup> Administration of tylosin at the onset of clinical signs has been reported to arrest the progression of the disease.<sup>5</sup>

## CONTROL

Effective control of the disease is not yet possible. A formalized *M. bovis* vaccine provided protection against experimentally induced mycoplasmal arthritis but was unsuccessful under naturally occurring conditions. The disease usually disappears from an affected group, which suggests that herd immunity may develop.

## REVIEW LITERATURE

Nicholas RAJ, Ayling RD. *Mycoplasma bovis*: disease, diagnosis and control. Res Vet Sci 2003; 72:105–112.

## REFERENCES

1. Adegboye DS et al. J Am Vet Med Assoc 1996; 209:647.
2. Hewicker-Trautwein M et al. Vet Rec 2002; 151:699.
3. Nicholas RAJ, Ayling RD. Res Vet Sci 2003; 74:105.
4. Byrne WJ et al. Vet Rec 2001; 148:331.
5. Henderson JP, Bali HJ. Vet Rec 1999; 145:374.
6. Ayling RD et al. Vet Rec 2004; 155:413.
7. Butler JA et al. J Dairy Sci 2000; 83:2285.
8. Thomas A et al. Vet Microbiol 2003; 91:101.
9. Haines DM et al. Can Vet J 2001; 42:857.
10. Ghaderoshi A et al. Vet Microbiol 1995; 56:87.
11. Ball HJ et al. Vet Rec 1994; 135:531.
12. Adegboye DS et al. J Vet Diag Invest 1995; 7:333.
13. Rodriguez F et al. J Comp Path 1996; 115:151.
14. Kinde H et al. J Vet Diag Invest 1993; 5:194.
15. Ball HJ et al. Irish Vet J 1995; 48:316.

## OVINE AND CAPRINE CONTAGIOUS OPHTHALMIA (OVINE AND CAPRINE INFECTIOUS KERATOCONJUNCTIVITIS, CONTAGIOUS CONJUNCTIVO-KERATITIS, PINKEYE IN SHEEP AND GOATS)

**Etiology** *Mycoplasma conjunctivae* is a significant cause but many agents can produce clinically identical disease

**Epidemiology** Spread by contact or mediate infection from carrier animal. Usually occurs as outbreak in summer months and when conditions are dry and dusty. Disease in lambs is less severe than in adults, and most severe in weaned

**Clinical findings** Lacrimation, conjunctival hyperemia, pannus, neovascularization, iritis, keratitis in one or both eyes

**Diagnostic confirmation** Clinical examination of the flock, exfoliative cytology, culture

**Treatment** Topical or preferably parenteral tetracycline

**Control** Avoid confinement and movement in dusty conditions. Fly control

## ETIOLOGY

A variety of organisms have been isolated from the eyes of animals affected with this disease. Some are primary pathogens and others secondary invaders. It is difficult to attribute a primary etiological cause to a single agent as all the putative causal organisms have also been isolated from the eyes of normal sheep. Many of the agents are demonstrable in the eyes of sheep in a single outbreak. The management circumstances that lead to flock outbreaks of disease with each of these agents, and the clinical syndromes that result, are not sufficiently distinct to allow the differentiation of the various etiologies on clinical or epidemiological grounds. There have been limited studies on the relative prevalence of flock outbreaks of disease associated with the various putative causes but there is a developing literature to incriminate *Mycoplasma* spp. as the major cause. For this edition the disease is described under this chapter heading.

### *Mycoplasma conjunctivae*

*Mycoplasma conjunctivae* is a common isolate in outbreaks of the disease but it is not present in all affected sheep and it can also be isolated, with lesser frequency, from the eyes of clinically normal sheep.<sup>1–4</sup> Nevertheless the disease can be reproduced experimentally by the installation of pure cultures of this organism into the eye of sheep and the disease will spread to other sheep by contact transmission.<sup>4–8</sup> Consequently, it is believed

to be a principal cause of pinkeye in sheep and goats. It has been further suggested that the inclusion bodies believed typical for rickettsial infection in ovine keratoconjunctivitis are in fact extracellular mycoplasmas.<sup>5</sup>

Other mycoplasma

Other *Mycoplasma* spp. are frequently identified in the eyes of sheep and goats with pinkeye.<sup>1–3,5,9</sup> *M. agalactiae* is considered a primary cause of an outbreak in Spain.<sup>10</sup> *M. arginini* and *Acholeplasma oculi* have been isolated from clinical cases of contagious ophthalmia but have not been implicated as causal agents.<sup>2,11,12</sup> Diseases reproduced by other mycoplasmas such as *M. capricolum*, *M. mycoides* subsp. *mycoides* can be accompanied by conjunctivitis but other manifestations predominate.

### *Chlamydophila pecorum*

*Chlamydophila pecorum* (*Coleiotea conjunctivae*) was initially incriminated as a cause of contagious ophthalmia in sheep and goats in South Africa and Australia and has also been isolated from outbreaks of keratoconjunctivitis in sheep in the United States and the United Kingdom and the disease has been reproduced experimentally.<sup>7</sup> Involved strains are related to those associated with polyarthritis in sheep and not to those associated with abortion.<sup>5</sup> A rickettsial agent, *Rupricapra rupricapae*, has been isolated from keratoconjunctivitis in chamois (*R. tragis*) and ibex (*Capra ibex*) in the French Alps.<sup>13</sup>

A number of bacteria including *Branhamella* (*Neisseria*) *ovis*, *Staphylococcus aureus* and *Escherichia coli* can be isolated from the eyes of animals with contagious ophthalmia and the rates of isolation from affected eyes are higher than that from normal sheep. They have not been shown capable of producing disease by experimental challenge and are considered to be secondary infections and not to have a causal role.<sup>1,5,7,9</sup> However, they may have a significant secondary role in the disease after resistance has been reduced by the primary inciting agent.<sup>14</sup> *B. ovis* is considered a cause of follicular conjunctivitis.<sup>15</sup> Similarly *Moraxella bovis* which is associated with contagious keratoconjunctivitis in cattle, has no apparent causal association with the disease in sheep or goats.<sup>1,5</sup> *Listeria monocytogenes* may be a primary cause of keratoconjunctivitis and iritis in sheep.

## EPIDEMIOLOGY

### Occurrence

The disease in sheep is widespread in most countries. All breeds of sheep are equally affected but the disease in lambs is less severe than in adults, and recently weaned animals are most severely affected.

### Source of infection and transmission

Source of infection is infected or carrier animals. The disease is spread indirectly by flies, long grass and dust contaminated by the tears of infected sheep, or directly by means of exhaled droplets or immediate contact.<sup>16</sup> *M. conjunctivae* also infects wild small ruminant species and can transmit between domestic and wild animals.<sup>16</sup>

### Risk factors

The prevalence is highest during the warm, summer months and when conditions are dry and dusty, and the fly population is heavy. The morbidity rate varies widely depending on seasonal conditions. It is usually about 10–15% but may be as high as 80%. Resistance to infection is reduced by concurrent disease, poor nutrition and adverse weather conditions. The disease occurs as **widespread outbreaks** in some years and in such circumstances may cause appreciable losses in weight gains for unexplained reasons. Outbreaks during the mating season can reduce the incidence of twinning.

In many flocks at pasture, the disease causes only minor inconvenience and weight loss by interfering with grazing for a few days, however, in some it becomes endemic. Clinical experience suggests that the incidence and the severity of the disease in an affected flock is increased by the stress, dust and close contact associated with gathering and yarding of the flock. Thus a decision to treat an outbreak can be associated with an apparent exacerbation of clinical disease.

### PATHOGENESIS

Rapid onset of acute inflammation of the conjunctiva is followed by hyperemia of the sclera, pannus, and opacity of the cornea.

### CLINICAL FINDINGS

Clinical findings are **similar with all agents** associated with the disease. There is conjunctivitis with lacrimation and blepharospasm followed by keratitis with cloudiness of the cornea and some increase in vascularity. There is profuse lacrimation and initial signs in the flock may be a brown discoloration below the eye associated with dust accumulation on lacrimal discharges.

Corneal opacity is initially most pronounced at the dorsal corneal-scleral junction and is followed by vascularization to produce a **horizontal zone of opacity** associated with an area of vertical-oriented vascularization in the upper area of the eye. In severe cases, the whole cornea is affected and there may be

corneal ulceration. In some outbreaks there is severe corneal edema in affected sheep.

In most sheep in flocks experiencing an outbreak, the disease is mild providing there are no complicating circumstances; the initial watery discharge from the eye becomes purulent but **recovery** commences in 3–4 d and is complete at about 20 d. In some animals the cloudiness of the cornea may persist for several weeks or even permanently. Local ulceration of the cornea may cause collapse of the eyeball. One or both eyes may be affected but many sheep have both eyes affected in outbreaks and spread through the flock is rapid.

Conjunctivitis is followed by the development of granular lesions of **follicular conjunctivitis** on the palpebral conjunctiva and third eyelid, which are thought by some to be specific for infections involving *B. ovis*.

In **goats**, the disease is milder with little apparent ophthalmia or keratitis. A more severe keratoconjunctivitis than that associated with *M. conjunctivae*, and manifest with corneal edema, occurs in some outbreaks in goats but its cause has not been established.<sup>11</sup> All age groups are affected and although the morbidity is usually 12–20%, it may reach 50%. Direct contact between animals appears to be necessary for spread of the infection, but the disease has not been transmitted experimentally. Conjunctivitis, opacity, vascularization and sometimes ulceration of the cornea are accompanied by an ocular discharge and blepharospasm. In some goats there is severe corneal edema with intracorneal edema accumulating to a degree to produce corneal vesicles. In mildly affected goats, recovery begins in 4–7 d but in severe cases, healing may not be complete for 2–4 weeks or longer.

### CLINICAL PATHOLOGY

Scrapings can be taken for **exfoliative cytology** from the palpebral conjunctiva following topical anesthesia. Samples should be collected from early clinical cases. *Mycoplasma*, *Branhamella* and *Chlamydia* have characteristic morphology and can be demonstrated in Giemsa-stained smears or by immunofluorescent staining.<sup>12</sup> Samples can also be submitted for cultural identification and paired serum samples can be submitted for examination for antibodies to *Chlamydia*. The determination of the etiological agent currently has limited significance to the subsequent approach to the control of the disease and is largely academic. However PCR can be used to detect *M. conjunctivae*<sup>3,17</sup> and PCR can be a better method of detection of infection than

culture.<sup>17</sup> Indirect ELISA has been used to detect infected sheep flocks.<sup>18</sup>

### TREATMENT

A decision for treatment needs to be taken with consideration of the adverse effects on the disease of the associated movement and close yarding of the flock. Repeated treatments of sheep pastured under extensive grazing are impractical and spontaneous recovery will occur within 3 weeks. Consequently, in extensive grazing conditions a decision for no treatment is often made.

A single intramuscular injection of long-acting tetracycline at 20 mg/kg halts further development of clinical conjunctivitis when given as clinical signs develop and results in rapid clinical cure in animals affected with keratoconjunctivitis produced by *M. conjunctivae*. However, neither parenteral or topical antibiotic treatment eliminates infection and relapse in individual animals and recurrence of outbreaks in flocks is common.<sup>19–21</sup> Where the etiology is not known and treatment is deemed desirable, tetracyclines administered either topically or parenterally or topical treatment with cloxacillin ophthalmic ointment have been shown to be of benefit.<sup>19,22</sup>

### CONTROL

Complete eradication of the disease is not attempted but isolation of affected sheep, and removal to grassier, less dusty pasture may reduce the rate of spread. Confinement of affected sheep should also be avoided.

### REVIEW LITERATURE

- Hosie BO. Infectious keratoconjunctivitis in sheep and goats. *Vet Ann* 1989; 29:93–97.  
Egwu GA. Ovine infectious keratoconjunctivitis. *Vet Bull* 1991; 61:547–559.

### REFERENCES

- ter Laak EA et al. *Vet Q* 1988; 10:217.
- Akerstedt J, Hofshagen M. *Acta Vet Scand* 2004; 45:19.
- Motha MXJ et al. *NZ Vet J* 2003; 51:186.
- van Halderen A et al. *Onderstepoort J Vet Res* 1994; 61:231.
- Egwu GO. *Vet Bull* 1991; 61:547.
- Surman PG. *Aust J Biol Sci* 1968; 21:447.
- Wilemore AJ et al. *Vet Rec* 1990; 127:229.
- Dagnall GJR. *Br Vet J* 1993; 149:429.
- Bankemper KW et al. *J Vet Diag Invest* 1990; 2:76.
- Rodriguez JL et al. *Small Ruminant Res* 1996; 22:93.
- Busch TJ, Belton DR. *NZ Vet J* 1989; 36:153.
- Dagnall GJR. *Vet Rec* 1994; 135:127.
- Bijlenda G et al. *Sci Vet Med Comp* 1983; 85:267.
- Egwu GO, Faull WB. *Small Ruminant Res* 1993; 12:171.
- Dagnall GJR. *Br Vet J* 1994; 150:65.
- Belloy L et al. *Appl Environ Microbiol* 2003; 69:1923.
- Baker SE et al. *Vet Rec* 2001; 148:240.
- Belloy L et al. *Vet Res* 2001; 32:155.
- Hosie BO. *Vet Ann* 1990; 93.
- Hosie BD, Greig A. *Br Vet J* 1995; 151:83.
- Egwu GO et al. *Bull Anim Hlth Prod Afr* 1995; 43:73.
- Webber JJ et al. *Aust Vet J* 1988; 65:95.

## MYCOPLASMAL PNEUMONIA OF PIGS (FORMERLY ENZOOTIC PNEUMONIA, NOW ALSO A COMPONENT OF THE PORCINE RESPIRATORY DISEASE COMPLEX)

### ETIOLOGY

*Mycoplasma hyopneumoniae* (once also called *Mycoplasma suis pneumoniae*) is the primary causative agent and *Pasteurella multocida* is commonly a secondary invader.<sup>1</sup> *M. hyopneumoniae* (*M. hyo*) inhabits the respiratory tract of pigs, appears to be host specific and survives in the environment for only a very short period of time. The disease has been reproduced with pure cultures and the organism can be demonstrated directly or indirectly in pigs with enzootic pneumonia worldwide. The isolation of *M. hyo* is complicated by the presence of other mycoplasmas in the upper respiratory tract of pigs including *M. hyopharyngis*,<sup>2</sup> *M. hyorhinis*, *M. suis*, and *Acholeplasma* species. The agent is also a significant contributor to the Porcine Respiratory Disease Complex (PRDC) together with PRRS, PCV2, SIV, and secondary bacterial agents.<sup>3</sup> This complex is characterized by slow growth, decreased food conversion efficiency, anorexia, fever, cough and dyspnea in grow/finish pigs typically around 16–22 weeks of age.

### EPIDEMIOLOGY

#### Occurrence and prevalence of infection

Enzootic pneumonia occurs in pigs worldwide and the incidence is high in intensive pig rearing enterprises. Lesions may be present in 40–80% of the lungs of pigs at abattoirs. The peak incidence of pneumonia occurs at 16–20 weeks of age, which is likely related to increased stocking density. In northern climates, the incidence of clinical disease and prevalence of lesions at slaughter are higher in the summer months.<sup>4</sup> The prevalence of lung lesions is often highest in pigs slaughtered in the winter months compared to autumn-slaughtered pigs.<sup>5</sup> In a survey of the gross lung lesions of 855 slaughter weight pigs from nine selected herds in Norway, pneumonic or pleuritic lesions were found in 84% of the lungs, ranging from 37% in the least affected herd to 97% in the one most affected.<sup>6</sup> Bronchopneumonia suggestive of a primary *M. hyo* infection was present in 70% of the lungs, ranging from 9–82% in the individual herds. The amount of bronchopneumonic lesions in individual lungs ranged from 0–69%, with an average of 7.8%. A 2002 survey in the USA showed that 82.3% of finishing sites had at least one animal positive on antibody testing and 94.4% of breeding sites.<sup>7</sup> Seroprevalences were higher in

the clinically affected herds and most of the pigs were infected with *M. hyo* at a younger age.<sup>8</sup>

#### Morbidity and case fatality

In infected herds, the morbidity rate is high during the growing period but the case-fatality rate is low. There is however an increase in the number of treatments of sick pigs in comparison with herds free of the disease and secondary bacterial pneumonia can be a significant cause of mortality in the weaning-to-market period. The morbidity rate falls markedly with increasing age and there is a much lower incidence of pneumonic lesions in sows, even though they may still harbor the organism. However, when enzootic pneumonia gains entry into a herd which has been previously free of the disease, all ages of pigs are affected and mortality, even in adults, can occur.

#### Methods of transmission

The organism is an inhabitant of the respiratory tract of pigs and transmission occurs by direct pig-to-pig contact. This is the main source of transmission. Airborne transmission<sup>9</sup> and fomites are less important sources of transmission. *Mycoplasma* can be transmitted over 1, 75, and 150 meters.<sup>10</sup> Airborne transmission was suggested on 80% of farms where acute respiratory disease was present. No airborne organisms were found on farms without acute respiratory disease. There is no other known host for the organism although infection and breakdown of closed pneumonia-free herds has occurred without any pig introductions. The number of organisms required for infection is very small and the possibility of wind-borne infection has been suggested. Transmission is by the respiratory route and in infected herds occurs primarily from the sow to the suckling piglets. In a study of shedding of *M. hyo* in different parities: gilts were 73% positive, parity 2–4 sows were 42% positive, parity 6–7 sows 50% positive and parity 8–11 sows were 6% positive.<sup>11</sup> Generally, the nursery is considered the area where transmission occurs<sup>12</sup> and infection spreads slowly.<sup>13</sup> Within pen transmission measured by PCR is very slow.<sup>14</sup> Animals can be PCR positive and not infectious for long periods of time and then can become very infectious. There is therefore a nonlinear excretion of *M. hyo*.<sup>14</sup> It is thought that one infected nursery pig will infect on average one littermate.<sup>15</sup> Boars can also infect sows when they are kept together in service areas but in these areas the disease spreads slowly.<sup>16</sup> The disease is also transmitted and exacerbated during the grouping and stress of pigs that occurs at weaning. The highest clinical and pathological incidence occurs in the

postweaning and growing period and in most herds this is maintained through the growing period to market age. The start of finishing is the critical point.<sup>17</sup> Direct exposure (nose-to-nose contact) of pigs at 9–11 weeks of age to seropositive gilts results in seroconversion to the organism by 21 d and is most frequent by about 11 weeks after exposure.<sup>18</sup> The presence of gross lesions of pneumonia correlated with the seroconversion.

Frequent coughing by infected, intensively reared pigs suggests that repeated aerosol exposure occurs and is an important natural mode of transmission of respiratory pathogens. There is general agreement that management and environmental conditions considerably influence the severity of the disease.

The reinfection of enzootic pneumonia-free herds, recurrences or so-called breakdowns, occurs at a rate of about 3% of herds every 6 months. In a study of swine herds which had participated in the Pig Health Control Association Scheme in the United Kingdom, the close proximity of the uninfected herds to infected herds appeared to be the most important risk factor which could explain the introduction of the infection. The size of the herd, the density of the pig population in the area, the distance to the next road regularly used for transportation of pigs and differences in topography were risk factors associated with reinfection.<sup>19</sup> There was little evidence to indicate that unexplained breakdowns occurred in association with long-term latent infection in other herds from which animals had been imported. Clinical signs of enzootic pneumonia in these herds commonly did not occur for several months after the introduction of infected pigs.

*M. hyopneumoniae* was not transmitted during a 20-week period when personnel weekly contacted susceptible pigs in a naïve herd after they had been in contact with pigs in an infected herd.<sup>20</sup>

#### Risk factors

The prevalence, incidence and severity of pneumonia in swine herds are determined by interactions among infectious agents, the host, the environment and management practices. This being said a large survey of the seroprevalence of *M. hyo* in 50 finishing herds showed<sup>21</sup> that there were no risk indicators. Each farm is an individual one with the farm itself exerting a great effect.<sup>22</sup>

#### Animal risk factors

Several factors such as breed, age, presence of diarrhea, the prevalence of atrophic rhinitis, birth weight, weaning weight, have been examined as animal risk factors. In some herds, the risk of coughing and pneumonic lesions increased

with increasing age of pigs within a herd. In a survey of two different groups of pigs slaughtered at different ages, the age-specific prevalence of pneumonic lesions was 2.7% in pigs less than 16 weeks of age at slaughter, but increased rapidly when pigs were between 16 and 22 weeks of age at slaughter.<sup>23</sup> Infection at an early age has a greater effect than infection later in life. Pigs coughing by 14 weeks of age were, on average, 6.2–6.9 kg lighter than those with onset of disease near market age.<sup>24</sup> The highest seroconversion rate occurs between 3–4 months of age.<sup>25</sup> In a recent experimental infection 77.7% of the infected animals were still positive 185 days later<sup>26</sup> and 100% of the naturally infected animals were still infected at the same time. There may be selective differences in the colonization rates between litters.<sup>27</sup> There may also be a sex effect on colonization as well.<sup>27</sup>

Atrophic rhinitis may also be present along with enzootic pneumonia and the two diseases in combination may have a greater economic effect than either disease alone. When outbreaks of respiratory disease in pigs occur, they are frequently the result of complex interactions between many agents. The importance of *M. hyo* is not only its effect as a primary pathogen but also its ability to act synergistically with other infecting agents to produce significant respiratory disease. *M. hyopneumoniae* causes a mild pneumonia, whereas *P. multocida* is not pathogenic alone but aggravates the pneumonia initiated by the former pathogen. The epidemiological associations between *M. hyo* and *Actinobacillus pleuropneumoniae* antibody titers and lung lesions in pigs at slaughter have been examined.<sup>28</sup> Only titers to the mycoplasma pneumonia were associated with lesions.<sup>28</sup>

#### Immune mechanisms

Pigs which recover from experimentally induced enzootic pneumonia are resistant to subsequent challenge. The nature of the immunity, whether serum or local antibody-mediated, T-cell mediated, or a combination of these factors, is not clear. Based on lymphocyte transformation tests of experimentally infected pigs, it is possible that cell-mediated immunity correlates with protective immunity. The median half-life of passively acquired antibodies to *M. hyo* is 16 d, the persistence of antibodies is related to the initial antibody concentration, and antibodies waned by 30–63 d after birth depending on initial concentration.<sup>29</sup> It has been detected as late as 155 days of age.<sup>30</sup> The titer of maternal antibodies is a major concern when pigs are vaccinated. The age of the piglet vaccinated is not the key factor.<sup>31</sup> The level of the sow's antibodies

approximately 4 weeks prepartum are at their highest and similar to the levels in colostrums.<sup>32</sup> Immunity is not conferred through colostrum immunoglobulins and thus piglets born from immune dams are susceptible to infection and clinical disease. No significant correlations have been found between the colostrum antibody levels and the colonization status of the sows.<sup>33</sup> The level of immunoglobulins to *M. hyo* can be used to monitor infection in the herd.<sup>34–36</sup> Pigs usually seroconvert to APP and then *M. hyo*.<sup>37</sup>

Pigs raised under unfavorable conditions develop pneumonic lesions more frequently than pigs raised under better conditions, regardless of their immune status.<sup>25</sup> Pigs vaccinated with inactivated *M. hyo* organisms develop both a cell-mediated and humoral immune response, but they are not protected from challenge exposure by natural infection. Local immunity, particularly secretory IgA, is considered to be important in protection against mycoplasma infection. *M. hyopneumoniae* may suppress alveolar macrophage function, which may predispose the lung to secondary infection. The organism is very clever in evading the immune response probably by changing the nature of the immune response to one that is less effective. To do this it causes the production of cytokines IL-1 alpha and beta, IL-6, and TNF alpha by macrophages and monocytes and induces local inflammation.<sup>38</sup> This is essentially moving the immune response from a TH1 type response to a T-helper type 2 response.<sup>39</sup>

#### Pathogen risk factors

*M. hyopneumoniae* adheres to the tracheal and bronchial mucosae and causes an extensive loss of cilia.<sup>40</sup> An evaluation of the virulence factors of *M. hyo* field isolates has been made.<sup>41</sup> The extent of the lesions produced may be influenced by other contributing factors to account for the variations in severity of lesions. Concurrent infection with lungworm, migrating ascarids and an adenovirus has resulted in lesions of greater severity and secondary invasion of pneumonic lesions by pasteurellae, streptococci, mycoplasmas and *Bordetella bronchiseptica*; *Klebsiella pneumoniae* is very common and largely influences the outcome of the disease in individual pigs. In some abattoir surveys of lungs, *P. multocida* can be cultured from 16% of normal lungs and from 55% of lungs with lesions resembling those of enzootic pneumonia. *P. multocida* and *Haemophilus* spp. may also be found in conjunction with *M. hyo* in the lungs of slaughter weight swine affected with pneumonia and examined at the abattoir. Those lungs with both *M. hyo* and

*P. multocida* had the most macroscopic pneumonia and those lungs with either of the agents alone had much less pneumonia. *M. hyopneumoniae* renders the lungs susceptible to *P. multocida* colonization and infection.<sup>1</sup>

Along with *M. hyo*, other mycoplasma species such as *M. hyorhinis*, *Acholeplasma granularum* and *Acholeplasma laidlawii* have been isolated from the lungs of pigs at slaughter, but their significance is unclear. *M. hyopneumoniae* and *Mycoplasma hyorhinis* have been isolated from 30% and 50% of pneumonic lungs, respectively, from pigs examined at slaughter. *M. hyopneumoniae* was also isolated from 12% of lungs with no gross lesions of pneumonia. In a survey in Norway, *M. hyo*, *P. multocida* and *M. hyorhinis* were detected in 83%, 43%, and 37% of the pneumonic lungs respectively.<sup>42</sup> Most of the macroscopic pneumonia – up to 25% – occurred in lungs with all three pathogens. *M. flocculare* was the most frequently isolated organism in the non-pneumonic lungs.

*Mycoplasma hyopneumoniae* potentiates the severity of PCV2 associated lung and lymphoid lesions, increases the amount and perhaps the presence of PCV2 antigen. It also increases the incidence of PMWS in pigs.<sup>43</sup>

#### Environmental and management risk factors

Several environmental and management factors are associated with a high prevalence of pneumonic lesions at slaughter. They include continuous vs all-in/all-out production, open herds, large temperature fluctuations, semisolid pen partitions, and large numbers of pigs in a common air space. These factors may operate individually or in combination synergistically. Housing pigs in a clean, isolated, disease free and low stress environment positively influences the health of pigs.<sup>44</sup>

The primary and secondary pathogens of the disease produce their most detrimental economic effects and the highest level of morbidity and mortality during the finishing period when the economics of production necessitate indoor housing and intensification.<sup>45</sup>

Four main groups of environmental factors which contribute to high levels of clinical disease and lesions at slaughter include:

1. Meteorological
2. Population and social
3. Management
4. Air-borne pollution.

**Meteorological factors** include wide fluctuations in the temperature indoors, wide variations in relative humidity, irregular ventilation rates and winter

housing. However, experimentally, elevated concentrations of ammonia and fluctuating ambient temperature did not influence the severity of the pneumonia nor its effect growth rate.<sup>46</sup>

**Population factors** which contribute to an increased prevalence of pneumonia are increasing herd size, increased population density and decreased air space and floor space per pig. All management practices influence the microclimate, and the quality of housing and management influence the incidence of pneumonic lesions at slaughter. Larger-than-average swine farms milling their own feed and with characteristics of modern buildings (mechanized inlets, slatted floors) and in close proximity to other farms tend to have a higher risk of enzootic pneumonia.<sup>47</sup> Extensively housed pigs with above-average pen space and air volume have a reduced prevalence of enzootic pneumonia lesions.<sup>48</sup>

**Management factors** associated with enzootic pneumonia include family farms which feed pigs on the floor<sup>47,48</sup> and feeder barns which obtain pigs from multiple sources compared to those with good facilities and where the pigs originate directly from breeding units.<sup>45</sup> The disease is a particular problem in continuous-flow herds. In pigs reared in all-in all-out groups in the farrowing house, nursery, and growing-finishing unit, any mycoplasmas transmitted from sows to pigs or between pigs do not necessarily result in clinical signs or lesions of pneumonia. Pigs reared in all-in all-out systems do not have lesions or minimal lesions at slaughter and gained at a faster rate than littermate pigs reared in a continuous system.<sup>46</sup>

In small herds, the factors commonly associated with a high prevalence of enzootic pneumonia were larger numbers of pigs per pen section, larger group sizes and drafty farrowing and weaner accommodation.

**Airborne pollution in pig houses** is thought to contribute to an increased incidence of clinical disease and prevalence of lesions at slaughter but this has not been well documented. Toxic levels of ammonia, high concentrations of aerial dust, and high colony counts of aerial bacteria may contribute to an increased incidence and prevalence of pneumonia but these factors have not been quantified and are commonly based on subjective evaluations by the observer. A large study of 960 pigs has shown that there are no influences of ammonia or dust on the respiratory health of pigs.<sup>49</sup> Environmental air contaminants such as dust, ammonia, carbon dioxide and microbes in swine barns measured over a period of 12 months

were associated with lesions of pneumonia and pleuritis at slaughter.

In large herds, factors associated with a high prevalence were higher pen stocking rate and air space stocking rate, and a trend toward higher atmospheric ammonia levels in the summer months. The trend to increased herd size has not been accompanied by the satisfactory control of pneumonia.

Combination and interaction of environmental risk factors

A computer-based guide can indicate how the prevalence of the disease can be influenced by the combined effect of risk factors.<sup>50</sup> The expected prevalence is estimated by consideration of 11 risk factors which include the following:

1. Number of pigs in the same room
- 2/3. All-in/all-out vs continuous flow of pigs
4. Type of partitions separating adjacent pens
- 5/6. Presence or absence of diarrhea as a clinical problem
- 7/8. Liquid vs solid manure disposal
9. Ascarid control efficiency
- 10/11. Presence or absence of active Aujeszky's disease.

The temperature and humidity influence the penetration into the lungs of both primary and secondary pathogens by influencing the size of infected aerosol particles and the protective mechanism in the respiratory tract. Temperature and humidity also influence the sedimentation of infected particles in the air, and the ventilation and stocking density. Pigs kept at high stocking densities and subjected to environmental temperature fluctuations, cold drafty conditions and poor nutrition are more likely to suffer greater adverse effects from this disease.

#### Economic losses and importance

In annual surveys completed by the American Association of Swine Practitioners, pneumonia consistently ranks as the most economically important disease in finishing pigs.<sup>51</sup> The prime importance of enzootic pneumonia is in its economic effects on pig rearing. The disease adversely affects feed conversion efficiency and daily rate of gain under certain circumstances. However, the magnitude of these effects depends on the conditions in which the pigs are reared and has been a subject of much controversy. The complexity of pneumonia and its interactions with the environment make measuring the effect of pneumonia on performance very difficult.<sup>51</sup>

An accurate assessment of the biological and economic effects of enzootic pneumonia has been difficult because of

the difficulty of conducting a controlled experiment in which pigs of equivalent genetic merit, both free of the disease and infected, are raised in an identical manner. In addition, studies on the association between performance parameters and the severity of lesions of the lungs have yielded widely variable results dependent on the management and environmental conditions and the different research design and techniques used. In general, there is a proportional relationship between severity of pneumonia and depression of performance<sup>51</sup> but in other observations, this relationship was not found.<sup>52</sup> Where pigs are raised under good management, infection of herds previously free of the disease has resulted in no adverse economic effect other than during the initial period of acute infection in the herd. However, in other situations adverse economic effects are associated with the disease. One study estimated a reduction of feed conversion efficiency as high as 22% and although the effect of the disease is probably not this severe in most piggeries, a significant economic reduction can occur even under good management conditions.<sup>53</sup>

Because there is no universally accepted method of measuring the extent or prevalence of pneumonia in pigs at slaughter, the results of studies of correlations between the lesions and performance have been difficult to compare. In general, the economic loss associated with respiratory disease ranges from a 2–25% reduction in average daily gains. Some methods have been compared and the most informative procedure is to assess the percentage of lung involved and calculate a mean value for the herd sample. The relationship between the weight of pneumonic lesions from pigs at slaughter and their performance indicated that within a range between 3.32 and 74.5% for the weight of a pneumonic lung, a 10% increase in the weight of pneumonic lung was associated with a decrease in mean daily gain of 31.4 g and a 13.2 d increase to slaughter at 104 kg liveweight.<sup>54</sup> There is a high correlation between rapid gross lung scores and detailed examination, which indicates that lungs can be visually scored accurately as they pass on a slaughter line.<sup>55</sup> On average, mean daily gain decreases from 23–37 g for every 10% of the lung affected by pneumonia.<sup>56</sup> However, the rapid subjective scoring of the lungs, adjusted for lung proportions, is considered adequate for estimating naturally occurring pneumonia and just as informative as detailed dissection of the lungs.<sup>57</sup>

Because the prevalence of pneumonia peaks at about 60–65 kg BW and then declines steadily to a very low level in pigs



that are 125 kg or more, the age and weight at slaughter must be considered when evaluating the effects of the lesions on performance and when comparing results between different observations. Weight losses are more substantial in pigs affected early in life.<sup>18</sup> In some studies, lung lesion scores detected at slaughter did not significantly correlate to growth indicators during any season.<sup>52</sup> The gross lesions of mycoplasmal pneumonia heal over a 2-month period, which may explain why significant correlations are not found between growth indicators and lung lesion scores.<sup>52</sup> The effects of the lesions on mean daily gains over an entire growth period may vary from one study to another because of the different times during growth when the lesions exerted their effects and in part to compensatory regrowth following recovery from the lesions.<sup>58,59</sup> Radiographic examination of the lungs of pigs from 21–150 d of age, and gross examination of the lungs at slaughter revealed that lesions progress and regress dynamically throughout the life of the animals and examination at slaughter is an inadequate indicator of lifetime pneumonia.<sup>60</sup>

#### **PATHOGENESIS**

Little is as yet known about the virulence factors of *M.hyo*. A wide variety of proteins are produced. Mycoplasmas have the smallest genomes of organisms capable of separate existence. This genome encodes for several immunogenic proteins including a cytosolic protein p36 (which may have lactic dehydrogenase activity), membrane proteins p46, p65, and p74 (can produce neutralizing antibodies) and an adhesin p97.<sup>61</sup> The p97 adhesin mediates adherence of *M.hyo* to swine cilia.<sup>62</sup> An adhesin-like protein (p110) composed of a p54 and 2p28 units has also been found.<sup>63</sup> Attachment is a complex process involving many gene products. A recent study of the total protein profile, glycoprotein profile and size differences in the amplified PCR product of p97 adhesin genes suggests that there is an intraspecies variation in the *M.hyo* population in the USA.<sup>64</sup>

The mycoplasma penetrate the mucus layer and attach to cilia. They appear only to attach to the cilia.<sup>65,66</sup> They release calcium<sup>++</sup> ions from the endoplasmic reticulum of the ciliated cells. As a result there is a clumping and a loss of cilia and excess production of mucus by goblet cells. As a result there is a dysfunction of mucociliary clearance. The secondary bacteria attach to the damaged epithelium.

In experimental infections of tracheal explants with *M.hyo* it was shown that IL-10 was produced, and this was a possible mechanism for the enhancement of the duration and severity of pneumonia

with PRRSV and a mechanism to modulate the immune response.<sup>67</sup>

The experimental inoculation of the J strain of *M.hyo* into piglets causes gross pneumonic lesions which are detectable 7–10 d later. Moderately extensive pneumonia is present 6 weeks after inoculation, progressive recovery can be observed after 10 weeks and residual lung lesions are detectable in a few pigs up to 37 weeks after inoculation.

*M.hypopneumoniae* causes peribronchiolar lymphoreticular hyperplasia and mononuclear accumulation in the lamina propria, which causes obliteration of the bronchial lumina. There is also perivascular lymphoid hyperplasia. The bronchial mucous glands undergo hypertrophy; there are increased numbers of polymorphonuclear cells in the bronchial lumina and macrophages in the alveoli. Lymphocytes, together with plasma cells and macrophages are responsible for the increase in the thickness of the interlobular septa as the disease progresses. The hyperplastic BALT (bronchial and bronchiolar associated lymphoid tissue) in enzootic pneumonia cases consisted of macrophages, dendritic cells, T and B lymphocytes, and IgG<sup>+</sup> and IgA<sup>+</sup> cells. In these aggregates CD4<sup>+</sup> predominated over CD8<sup>+</sup> cells.<sup>68</sup> The cells in the BALT released IL-2, IL-4 TNF alpha and to a lesser extent IL-1 alpha and beta. IL-1 alpha and TNF alpha were also released in bronchoalveolar lavage fluids and IL-6 and IL-8 were found in the mononuclear cells of the alveolar septa.<sup>68,69</sup>

Hyperplasia of Type II alveolar epithelial cells is progressive as the disease becomes worse. Affected pigs cough persistently, show labored respiration and reduced exercise tolerance. The lesions are similar to those of chronic bronchitis. After infection, *M.hyo* multiplies in tracheal and bronchial mucosae, adheres to the ciliated cells and causes a cytopathic effect and exfoliation of epithelial cells.<sup>70</sup> There is a significant increase in the gland/wall ratio and a decrease in the ratio of respiratory to expiratory resistance.<sup>45</sup>

The effects of this chronic pulmonary lesion have been the subject of considerable investigation. It is thought that the presence of mycoplasmal lesions uncomplicated by secondary bacterial infections has minimal effect on the production of the pig if the environmental conditions are suitable. The lesions will heal and any loss in production from the initial infection will be regained by compensatory regrowth. Severe lesions or those accompanied by secondary bacterial bronchopneumonia and pleuritis will usually cause a significant decrease in average daily gain and feed efficiency. Secondary infection with *Pasteurella* spp.

results in acute episodes of toxemic bronchopneumonia and pleuritis. Dual infections are usually more severe than single infections. For example SIV and *M.hyo* together are more severe.<sup>71</sup>

The pulmonary and hematological changes in experimental *M.hyo* pneumonia cause no significant changes in heart rate, respiratory rate and rectal temperature, even though at necropsy well-demarcated pulmonary lesions were present. There were several measurable changes in respiratory functions due to the atelectasis: partial occlusion of the bronchioles with exudate, localized pulmonary edema and a reduction in oxygen perfusion to the alveoli leading to a decrease in the partial pressure of oxygen in the arterial blood. There are no remarkable changes in the hematology. The body weight gains are decreased compared to the control animals.

The distribution of lesions is characteristic. They occur in the right middle lobe, the right cranial and left middle lobes, the left cranial and diaphragmatic lobes, in that order of frequency. It has been suggested that their distribution is in part due to the more commonly affected lobes.

#### **CLINICAL FINDINGS**

A natural incubation period of 10–16 d is shortened to 5–12 d by experimental transmission. Two forms of the disease are described. In the relatively rare acute form, a severe outbreak may occur in a susceptible herd when the infection is first introduced. In such herds pigs of all ages are susceptible and a morbidity of 100% may be experienced. Suckling piglets as young as 10 d of age have been infected. Acute respiratory distress with or without fever is characteristic and mortality may occur. The usual course of this form of the disease within a herd is usually about 3 months after which it subsides to the more common chronic form.

The chronic form of the disease is much more common and is the pattern seen in endemically infected herds. Young piglets are usually infected when they are 3–10 weeks of age and clinical signs may be seen in suckling piglets. More commonly, the disease shows greatest clinical manifestation after weaning and in the growing period. The onset of clinical abnormality is insidious and coughing is the major manifestation. Initially only a few pigs within the group may show clinical abnormality, but then the incidence generally increases until coughing may be elicited from most pigs. It may disappear in 2–3 weeks or persist throughout the growing period. In affected herds, individual pigs may be heard to cough at any time, but coughing is most obvious at initial activity in the morning and at

feeding time. Coughing may also be elicited by exercising the pigs around the pen and it occurs with greater frequency in the period immediately following the exercise. A dry or crackling, hacking cough, which is usually repetitive, is characteristic. Respiratory embarrassment is rare and there is no fever or obvious inappetence. Subsequently there is retardation of growth which varies in severity between individuals so that uneven group size is common. Some pigs affected with the chronic form of the disease may later develop acute pneumonia due to secondary invasion with *pasteurellae* or other organisms.

Clinical disease becomes less obvious with increasing age and is rarely detected in the sow herd, though gilts and young sows frequently harbor *M.hyo*.

Simultaneous occurrence of Aujeszky's disease does increase the severity of acute mycoplasmal pneumonia.<sup>72</sup>

A series of investigations has shown that PRRSV does not predispose to *M.hyo* infection although lesions are more severe in those pigs that both infections. *M.hyo* does potentiate PRRSV induced disease and lesions.<sup>73,74</sup> There may be an association between the seroconversion to PRRS virus and the transmission of *M.hyo*.<sup>75</sup>

## CLINICAL PATHOLOGY

### Serological tests

Serological tests have included the CFT (low sensitivity), indirect hemagglutination test (good for early detection as it detects IgM) and the latex agglutination test. The unsatisfactory sensitivities and specificities of these tests led to the development of ELISA systems, DNA probe technology and polymerase chain reaction to accurately diagnose enzootic pneumonia. The ELISAs detect all classes of IgG, are very sensitive, but detect the onset of seroconversion not infection.

An ELISA using a commercially available antigen (Auspharm) is highly sensitive (95.6%) and specific (98.8%) for antibodies against *M.hyo* when pig sera from commercial herds of known infection status were evaluated.<sup>76</sup> An improved ELISA is also available and the two ELISAs are able to distinguish populations of gross pathology-negative pigs in endemic herds from pigs in true specific pathogen-free (SPF) herds.<sup>77</sup> Pigs from the former group have significantly higher ELISA activity with both tests and would represent recovered or exposed non-diseased pigs, or pigs with only histological lesions in endemic herds. The ELISA is ideal for diagnostic laboratories and should obviate much of the need for culture and immunofluorescent histopathology, reducing the cost of diagnosis. The ELISA can also detect antibodies in

the colostrum of sows with a high specificity.<sup>78,79</sup> A recent study comparing three ELISAs has shown that the sensitivities of the tests were lower than previously reported especially for vaccinated animals. Animals within 21 days post-infection were also not easily detected.<sup>80</sup> The blocking ELISA was the most sensitive. All three were highly specific. There is also a blocking ELISA against a p40 protein.<sup>81</sup>

### Detection of organism

The organism can be detected in lung tissues by culture, immunofluorescence, polymerase chain reaction and antigen-ELISA, and all have high sensitivity in the acute stages of pneumonia.<sup>82</sup> A polymerase chain reaction (PCR)-based assay can also differentiate *M. hyopneumoniae*, *M. flocculare*, and *M. hyorhinis* and also detect low numbers of organisms.<sup>83-86</sup> It can also be used on the bronchoalveolar lavage.<sup>87</sup> The identification of the p36 and p46 protein genes has enabled them to be used in a PCR for *M.hyo* with a sensitivity of 86.6% and a specificity of 96.7%.<sup>88</sup> Nested PCR is much better.<sup>89</sup> There is a good correlation between the results of nested-PCR and histology.<sup>90</sup> In situ hybridization shows *M.hyo* on the surface of the epithelial cells not in the cytoplasm with an occasional signal in the cytoplasm of the alveolar and interstitial macrophages.<sup>91</sup>

### Herd certification

The determination of the presence or absence of enzootic pneumonia within a herd for certification purposes can be difficult and should be approached with caution. It should not be based on a single examination procedure. It requires a surveillance system which combines regular farm visits and serological, cultural and tissue examination of selected pigs and of those sent to slaughter. The herd should be examined clinically for evidence of the disease and the lungs from several shipments of pigs should be examined at the abattoir and subsequently histologically. There can be seasonal variation in the severity of lung lesions and at certain times market-age pigs may not have visible gross lesions, even though infection may be present in the herd. If doubt exists, the lungs of younger pigs, preferably clinically suspect pigs, or recently weaned pigs, should be examined after elective slaughter. The herd should also be examined for the presence of antibody to *M.hyo*.

### NECROPSY FINDINGS

Except in severe cases, the damage is confined to the cranial and middle lobes, which are clearly demarcated from the normal lung tissue. The lesions are commonly more severe in the right than

in the left lung. Plum-colored or grayish areas of lobular consolidation are evident. Enlarged, edematous bronchial lymph nodes are characteristic. In acute cases, there is intense edema and congestion of the lung and frothy exudate in the bronchi. When secondary invasion occurs, pleuritis and pericarditis are common and there may be severe hepatization and congestion with a suppurative bronchopneumonia.

Evaluation of the pneumonic lesions at slaughter has been used extensively for herd health monitoring. Scoring of the lesions is typically done on both lungs (the entire pluck). To overcome the logistical problems associated with examining entire plucks during the slaughtering procedure, an alternate system based on scoring the right lung only has been investigated.<sup>92</sup> The overall right lung relative sensitivities for the detection of catarrhal pneumonia or chronic pleuritis were 81% and 72%, respectively. It is suggested that an evaluation of the right lung pathology is a useful alternative when the purpose of the survey is to demonstrate the presence or absence of lesions, or when scoring the severity of the lesion is the objective.

The microscopic changes of enzootic pneumonia include lymphohistiocytic peribronchiolar cuffing with increased numbers of mononuclear leukocytes in the bronchial lamina propria. There is hyperplasia of the bronchiolar epithelium and filling of alveoli with macrophages, protein-rich fluid and small numbers of lymphocytes and plasma cells. Hyperplasia of Type II alveolar epithelial cells occurs as the disease progresses.

In one study, a definitive diagnosis of mycoplasmal pneumonia of swine was based on the demonstration of *M.hyo* in lung sections using specific antisera or successful culture of the organism. Utilizing these techniques, it was found that up to 19% of grossly normal lungs may be infected with *M.hyo*. Conversely, the organism could not be demonstrated in about 33% of the lungs of pigs from herds thought to be affected with mycoplasmal pneumonia, even though typical gross lesions were present. The sensitivity of these techniques may be surpassed by newer PCR methods. The organism can also be detected in formalin-fixed paraffin-embedded porcine lung by the indirect immunoperoxidase test. The results of immunofluorescence tests performed on piglets with experimentally induced pneumonia revealed that *M.hyo* organisms are located primarily on bronchial and bronchiolar epithelial surfaces of lungs with gross lesions of pneumonia. Fluorescence was most intense 4–6 weeks after infection and began to decrease at 8–12 weeks. This suggests a decrease in the number of *M.hyo* in the more advanced stages of

the disease. When assessing plucks at slaughter to determine the severity of pneumonia in a group, it must be remembered that in most instances the lesions observed represent a chronic, partially resolved disease process. Therefore the clinical effects of the infection may have caused a greater degree of respiratory compromise than is apparent at slaughter.

### Samples for confirmation of diagnosis

- **Touch preparations** using Giemsa stained slides have been used
- **Histology** – formalin-fixed lung (LM, IHC). Simple histopathology may not always indicate mycoplasma infection. For example Aujeszky's disease together with *P. multocida* may be difficult to differentiate from *M. hyo*. Lesions may be characteristic but not pathognomonic.<sup>93</sup> Indirect immunofluorescence (IF) and indirect immunoperoxidase (IHC) for *M. hyo* in tissues are extremely useful.<sup>94</sup> However IF has a lack of sensitivity and IHC is time consuming and expensive
- **Mycoplasmaology** – lung (MCULT, FAT, PCR). Isolation of *M. hyo* is complicated by the overgrowth that occurs from *M. hyorhinis* and *M. flocculare*. The organism is fastidious. Many animals that are culture positive do not have gross or microscopic lesions. The PCR can be used as a one step test but is not good for nasal swabs. The nested PCR can be used for these but it does tend to produce some false positives. Correct samples give a better diagnosis. Samples from lavage and tracheobronchial sites were the best for nested PCR and lung tissue and nasal swabs are not the most reliable.<sup>95</sup>

### TREATMENT

There is no effective treatment to eliminate infection with *M. hyo*, although the severity of the clinical disease may be reduced.

Isolates of the organism from the United States were susceptible to lincomycin-spectinomycin, tylosin and oxytetracycline.<sup>96</sup> Isolates from the United Kingdom were susceptible to doxycycline and oxytetracycline.<sup>97</sup> Doxycycline, a semi-synthetic tetracycline has a greater antimicrobial activity, is better absorbed orally and is more widely distributed in tissues than the first generation tetracyclines (oxytetracycline, tetracycline and chlortetracycline).

In some early studies, a mixture of tylosin tartrate at a dose of 50 mg/kg BW and tiamulin at 10 mg/kg BW orally daily for 10 d significantly reduced the pulmonary lesions associated with the experimental disease. However, the use of

60 mg, 120 mg or 180 mg of tiamulin per liter of drinking water for 10 d was not effective in suppressing the lesions of experimentally induced *M. hyo* pneumonia or infection in disease-free pigs.

The newer fluoroquinolones have good *in vitro* activity against *M. hyo* and exhibit superior activity to tylosin, tiamulin, oxytetracycline and gentamicin. Ciprofloxacin is particularly active against *M. hyo*.

Tilmicosin is particularly effective since it appears to prevent the attachment of *M. hyo* to the surface of the epithelial cells.<sup>98</sup>

Tetracyclines will either prevent transmission or suppress lesion formation in experimental pigs but the levels required are high and in an infected herd continuous administration would be necessary, which would be uneconomic. Treatment is generally restricted to individual pigs showing acute respiratory distress as a result of a severe infection or secondary invaders. Broad-spectrum antimicrobials are used, usually tetracyclines, but the response is only moderately good. The occurrence of severe signs within a group of pigs may necessitate treatment. Tetracyclines, tylosin or spiramycin fed at 200 mg/kg feed for 5–10 d are recommended. A combination of 300 g of oxytetracycline and 30 g of tiamulin per tonne of finished feed fed for 2–3 d/week over a 16-month period has been used to reduce the incidence of enzootic pneumonia in a large herd.<sup>99</sup> Lung lesions were reduced, average daily gain increased, and efficiency of feed conversion increased with an overall increase in profitability. Valnemulin may prove to be effective in the treatment of enzootic pneumonia.<sup>100</sup> There is a higher susceptibility to valnemulin and tiamulin when used in conjunction with doxycycline as a treatment.<sup>101</sup>

Tulathromycin administered as a single injection at a standard dosage of 2.5 mg/kg is effective in the treatment of swine pneumonia associated with mycoplasmosis.<sup>102</sup>

There is no evidence for resistance to lincomycin/spectinomycin, oxytetracycline, doxycycline, gentamicin, flufenicol, and tiamulin. There is evidence for some resistance to tylosin, tilmicosin, fluquinolone and enrofloxacin.<sup>103</sup>

### CONTROL

*M. hyopneumoniae* infects only pigs and transmission requires close pig-to-pig contact. If transmission can be prevented it is possible to limit or even eradicate the disease from a herd. There are thus two levels at which control can be practised:

1. Complete eradication of the disease or
2. Controlling the disease and its effects at a low level.

The principles of control of enzootic pneumonia include the following strategies:

- Regular inspection of the herd for clinical evidence of disease and slaughter checks of lungs
- Rigorous biosecurity of animals being introduced into the herd and control of visitors
- Provision of adequate environmental conditions including air quality, ventilation, temperature control and stocking density
- The use of the all-in all-out system of production in which groups of pigs by age or stage of production are moved through the herd from the gestation barn, farrowing barn, nursery rooms and finishing units as groups and the pens previously occupied are cleaned, disinfected and left vacant for several days before animals are reintroduced. Since most infection is believed to occur between 4–12 weeks nursery depopulation has become an effective way of controlling the infection in nursery pigs.<sup>12</sup>

### Control by eradication

This method of control is the most satisfactory and is probably mandatory for large breeding companies, and herds supplying replacement stock to other herds and for large intensive farrow-to-finish enterprises. It is based on the principle that the source of infection for the young pig is the gilt or the sow and this chain of infection must be interrupted to prevent infection. In the past the 10-month cutoff point has been used in eradication programs but in view of the colonization studies<sup>26</sup> this may be too soon. This is especially so in off-site production systems where the time of infection is delayed.

There are three different principles.<sup>104</sup> First, there is total depopulation followed by re-stocking with non infected stock (Danish SPF system). Second, test and removal of all positives and inconclusives. Third, eradication without total depopulation and restocking.

Eradication without restocking has been described<sup>105</sup> and here the secret was to wait until farrowing finished, then vaccinate all sows and treat with tiamulin at 6 mg/kg daily for 3 weeks and then monitor with blood tests.

### Specific pathogen-free or minimal disease pigs

Several methods of eradication have been attempted but the most satisfactory is repopulation with specific pathogen-free (SPF) pigs. The principle underlying this method is that the piglet in utero is free of infection with *M. hyo*. If it is taken from the uterus at term by suitable sterile hysterectomy or hysterotomy techniques

and reared artificially in an environment free of pigs, it will remain free of this infection. In practice this has been carried out in special units and the piglets have been subsequently used to repopulate existing farms where all pigs have been removed 30 d prior to the introduction of the SPF pigs and a thorough cleaning program completed. This method was initially developed for the control of enzootic pneumonia and atrophic rhinitis. Moreover, if suitable precautions are taken and if the piglets are used to populate new units that have had no previous exposure to pigs, then freedom from other important diseases such as internal and external parasitism, leptospirosis, brucellosis, swine dysentery and others can be achieved. The progeny of these primary SPF herds can subsequently be used to repopulate other or secondary SPF herds known as minimal disease pigs. The details of these procedures are available in the textbook *Herd Health*.<sup>106</sup>

Because of the cost and technical difficulty of this method, other methods of eradicating enzootic pneumonia have been attempted but they are generally less satisfactory and have a higher failure rate. These include 'snatching' of pigs at birth and isolated farrowing. In the former the piglets are caught and removed from the sow immediately at birth and reared as previously described or foster-suckled on SPF sows in another environment. Although enzootic pneumonia may be eliminated by this method, fecal contamination during parturition of the vulva and vagina and consequently of the piglet is common and this method is less satisfactory for disease control than removal by hysterectomy.

#### Isolated farrowing

Isolated farrowing techniques have proved successful in small herds but have a high failure rate when practiced on a large scale. Older sows believed to be free of infection are farrowed in isolation in individual pens erected outside on pasture and each sow and litter is kept as a separate unit. The litter is inspected clinically at regular intervals and subsequently a proportion of the litter, usually excess males and gilts undesirable for breeding, are examined at slaughter for evidence of pneumonia. Any litters with clinical, pathological or laboratory evidence of pneumonia are eliminated from the program. Litters that pass inspection are kept for repopulation of the herd. Because of the difficulties in detecting carrier pigs without lesions, eradication by methods using these principles frequently fails.

#### Minimal disease herds

Minimal disease herds have been established in most countries with significant

pig populations either by breeding companies or private purebred breeders. As a result there is, in most countries, a nucleus of enzootic pneumonia-free stock which is a major swine-producing enterprise worldwide. The establishment of primary SPF herds is technically difficult, very costly and should not be undertaken lightly. There is also a considerable delay in cash flow between the time of initial population and build-up of herd numbers to the time when significant numbers of pigs are available for sale. Because of this, if eradication by repopulation is intended, it is preferable to purchase pregnant gilts from established primary SPF herds unless the maintenance of existing genetic lines dictates otherwise. Before recommending eradication by this method it is essential that the pig owner understands the principles of this method of control and the restrictions that will need to apply if it is to be successful. Farrow-to-finish enterprises established by this method should be run as closed herds and if further genetic material is required it should be introduced by hysterectomy techniques or by purchase from the initial source herd. The use of artificial insemination is an alternate method; however, isolation of *M. hyo* from semen is recorded.

The problem of certifying and maintaining herds free of enzootic pneumonia is a major task.

#### Reinfection of herds

Reinfection of enzootic pneumonia-free pig herds occurs despite high standards of isolation and strict precautions whereby complete protective clothing and showering routines are required for all visitors entering the unit. All visitors are debarred entry if they have been to a possible source of infection during the previous 48 h and even up to 7 d. Also, the majority of breakdowns occur in herds which have not imported infected stock recently. In reinfected herds which imported stock there was no concurrent evidence of breakdown in the parent herds, which supported the contention that the importation of infected pigs was an unlikely source of the infection. An epidemiological investigation of these reinfections suggests that close proximity of uninfected herds to infected herds may be an important factor. The organism does not survive for more than a few days under dry conditions; however, it can survive in diluted tapwater and rainwater for 2–3 weeks and it has been suggested that the organism may be transported in moist air and that airborne infection between piggeries is a possible method of transmission. In Switzerland 107 farms were reinfected of 3983 that eradicated during the period 1996–1999

(2.6%).<sup>107</sup> The significance of known risk factors such as farm size, high density of pigs, and farm type was confirmed in this analysis.

Some preliminary estimates of risk indices based on the proximity of other pig units has indicated that the most important factor was the reciprocal of the square of distance to the nearest other unit. The crucial distance for maximum survival was about 3.2 km. A breakdown was described recently in which a whole variety of measures were included in an attempt to control the disease.<sup>108</sup>

#### Antimicrobial prophylaxis

Eradication has also been attempted by antimicrobial treatment of newborn piglets with oxytetracycline on days 1, 7 and 14, weaned on day 14 and moved to offsite nursery.<sup>109</sup> This is known as a low-cost modified medicated-early-weaning program. This can be followed by serological testing of the breeding herd and culling of positive reactors. Control by vaccination on the one hand and by the use of tilmicosin on the other produced similar results when measured by serological results and the prevalence of macroscopic lung lesions.<sup>110</sup> Lincocin with or without vaccination considerably improves the growth and performance.<sup>111</sup> Doxycycline in the feed at 11 mg/kg bodyweight is effective in controlling pneumonia due to *P. multocida* and *M. hyo* in feeder pigs.<sup>112</sup>

#### Low-level disease

The alternative to eradication is to limit the effects of the disease in those herds where eradication is either not desirable or feasible. The effects of the disease are generally less severe in non-intensive rearing situations, in small herds where individual litters are reared separately and where litters from older sows can be reared separately from other pigs. Where litters are grouped at weaning, a low stocking density with less than 25 pigs in initial pen groups and 100 pigs in a common air space may also reduce the severity of the disease.

Temperature, humidity and ventilation also have an important influence on the disease. It is possible to determine an optimal air temperature zone for growing-finishing pigs based on the measurement of behavioral and health-related problems. They are interrelated with stocking density and housing. The subject is too broad for treatment here and the requirements for pigs at different ages and under different housing situations may be found in standard texts on pig housing and production. The environmental risk factors associated with the incidence of enzootic pneumonia should be assessed in each circumstance. Some

important environmental variables which should be assessed and modified include.<sup>45</sup>

- Number of pigs per shed
- Number of pigs per pen
- Air space per pig
- Floor space per pig
- Cleaning and disinfection techniques used
- Number of air changes per hour
- Waste disposal system
- Number of temperature fluctuations in a 24-hour period
- Direction of the flow of air in the building
- Concentrations of ammonia and hydrogen sulfide in the building
- Dust levels
- Feeding and watering systems
- Whether or not the all-in/all-out system is being used effectively.

#### Medication of breeding stock

The original medicated early weaning program was based on medication of the sows with tiamulin at the time of farrowing and the early weaning of the piglets to an off site location. A variation of this method is to prevent the spread of infection by.<sup>113</sup>

- Isolation of the breeding stock
- Strategic antimicrobial medication of the breeding stock
- Reintroduction of the breeding stock to the original but empty and disinfected gestation barn
- Separate rearing of the piglets before and after initiating the program
- Regulation of flow of animals through the herd. Farrowing barns are emptied out when possible and cleaned, disinfected and left empty. After weaning their piglets, sows are transferred to the dry sow barns. Sows about to farrow are treated with tiamulin and moved to the farrowing barn.

#### Source of feeder pigs

Where possible the purchase of weaners or pigs for finishing units should be from herds free of the disease or from a single source. Purchase through saleyards or the purchase of coughing or uneven litters is not advisable. When pigs from infected herds are purchased it may be necessary to medicate the feed prophylactically with one of the tetracycline group of antibiotics or tylosin or spiramycin at 100–200 mg/kg of feed for a 2-week period after introduction. Medication of the feed of finishing pigs with tiamulin at 20 and 30 mg/kg of feed over an 8-week period on farms with histories of severe complicated enzootic pneumonia resulted in improved weight gains and feed efficiency, but the extent and severity of the lung lesions did

not change.<sup>114</sup> The level of 30 mg/kg in the feed was superior to the level of 20 mg/kg. Tiamulin at 100 mg/kg combined with chlortetracycline at 300 mg/kg of feed for 7 d was effective in herds with a history of enzootic pneumonia complicated by the presence of *P. multocida* and *Actinobacillus pleuropneumoniae*.<sup>115</sup>

Introduced pigs should be isolated from the rest of the herd and preferably they should be reared as a batch through a house on the all-in/all-out system.<sup>116</sup> A high stocking density should be avoided and internal parasites should be controlled.

#### Vaccination

*Mycoplasma hyopneumoniae* vaccines are generally bacterins consisting of outer membrane proteins or whole organisms. The vaccines give little protection against initial infection and often incomplete protection against clinical pneumonia. The vaccines produce a TH1 response and also IgA and IgG in the lavage fluids. Natural maternal antibodies do not seem to inhibit vaccination but vaccination of sows may inhibit subsequent immunity.

Vaccination with killed *M.hyo* induces protection in pigs against experimental challenge exposure with the organism. A cost benefit analysis shows that the vaccination is economically beneficial.<sup>21</sup> The relationships between maternally derived antibodies, age and other factors in vaccine response have been discussed.<sup>117–120</sup>

A killed *M.hyo* vaccine evaluated in a single herd reduced the prevalence of pneumonic lesions in slaughter pigs from 69% to 36% and the prevalence of pleuritis from 20% to 13%.<sup>121</sup> There was a small decrease in the number of days to market. It usually results in a 2–8% increase in daily gain. The mortality rate is usually only better numerically. Feed conversion efficiency increases by about 2–3%.<sup>122</sup> Other limited studies indicate that vaccination can reduce the severity and prevalence of lung lesions detected at slaughter<sup>123</sup> (4–6% compared to 12% in controls). It improves feed efficiency and increases average daily gain during the finishing period.<sup>124</sup> In other studies the average daily gain was not improved.<sup>125</sup> Vaccination of sows against *M.hyo* reduced the prevalence of positive piglets at weaning and could be used to control *M.hyo* infections<sup>126</sup> as judged by a nested PCR. PRRS vaccination does not interfere with *M.hyo* vaccination.<sup>127</sup> Needle less intradermal vaccination has also been described.<sup>128</sup>

Both dual and single injection vaccines are available but the protection obtained is similar.<sup>129,130</sup> The single dose vaccine<sup>131</sup> gives protection for up to 23 weeks.<sup>132</sup> The level of protection will probably last

4 months.<sup>133</sup> Vaccination is economically attractive.<sup>134</sup>

DNA vaccination using a p42 heat stable protein gene has also been used and this induces rises in IL-2, IL-4, and IFN gamma which indicates that it induces both a TH1 and a TH2 response.<sup>135</sup> Vaccination for mycoplasma generally induces local mucosal immunity, humoral and cellular immunity.<sup>136</sup>

#### REVIEW LITERATURE

Stark K. Epidemiological investigations of the influence of environmental risk factors on respiratory diseases in swine; a selective review. *Vet J* 2000; 159:39.

Desrosiers R. A review of some aspects of the epidemiology, diagnosis and control of *M. hyopneumoniae* infections. *J Swine Health Prod* 2001; 9:233–237.

#### REFERENCES

1. Amass SF et al. *J Am Vet Med Assoc* 1994; 204:102.
2. Friis NF et al. *Acta Vet Scand* 2003; 44:103.
3. Thacker EL et al. *Pig J* 2001; 48:66.
4. Cowart RP et al. *J Am Vet Med Assoc* 1992; 200:190.
5. Scheidt AB et al. *J Am Vet Med Assoc* 1992; 200:1492.
6. Liium BM, Falk K. *Acta Vet Scand* 1991; 32:55.
7. Erlandson KR et al. *Proc Am Assoc Swine Vet* 2002; p. 31.
8. Vicca T et al. *J Vet Med B* 2002; 49:349.
9. Stark KD et al. *Appl Environ Microbiol* 1998; 64:543.
10. Cardona AC et al. *Vet Rec* 2005; 156:91.
11. Calsamiglia M, Pijoan C. *Proc 15th Int Pig Vet Soc Cong* 1998; p.146.
12. Sur D-K et al. *Swine Hlth Prod* 1998; 6:151.
13. Meyns T et al. *Proc 18th Int Pig Vet Soc Cong* 2004; p. 168.
14. Torremorell M et al. *Proc 16th Int Pig Vet Soc Cong* 2000; p. 47.
15. Meyns T et al. *Prev Vet Med* 2004; 66:265.
16. Wallgren P et al. *Vet Microbiol* 1998; 60:193.
17. Leon E et al. *Vet Microbiol* 2001; 78:331.
18. Morris CR et al. *Prev Vet Med* 1995; 21:323.
19. Stark KDC et al. *Vet Rec* 1992; 131:532.
20. Batista L et al. *J Swine Hlth Prod* 2004; 12:75.
21. Maes D et al. *J Vet Med B* 1999; 46:341.
22. Sibila M et al. *Can J Vet Res* 2004; 68:12.
23. Gardner IA, Hird DW. *Am J Vet Res* 1990; 51:1306.
24. Morris CR et al. *Can J Vet Res* 1995; 59:197.
25. Yagihashi T et al. *Vet Rec* 1993; 34:155.
26. Fano E et al. *Proc 18th Int Pig Vet Soc Cong* 2004; p. 167.
27. Utrera V et al. *Proc 17th Int Pig Vet Soc Cong* 2002; p. 284.
28. Van Til LD et al. *Can J Vet Res* 1991; 55:347.
29. Morris CR et al. *Prev Vet Med* 1994; 21:29.
30. Cornaglia E et al. *Proc Am Assoc Swine Vet* 2002; p. 83.
31. Hodgins DC et al. *J Swine Hlth Prod* 2004; 12:10.
32. Wallgren P et al. *Vet Microbiol* 1998; 60:193.
33. Calsamiglia M, Pijoan C. *Vet Rec* 2000; 146:530.
34. Levonen K. *Res Vet Sci* 1994; 56:111.
35. Rautianinen L et al. *Proc 14th Int Pig Vet Soc Cong* 1996; p. 303.
36. Levonen K et al. *J Vet Diag Invest* 1999; 11:547.
37. Andreassen M et al. *Prev Vet Med* 2000; 45:221.
38. Thacker EL. *Am J Vet Res* 2000; 61:1384.
39. Thacker EL et al. *Proc Am Assoc Swine Vet* 2001; p. 467.
40. Zielinski GC, Ross RF. *Am J Vet Res* 1993; 54:1262.

41. Vicca J et al. *Vet Microbiol* 2003; 97:177.
42. Falk K et al. *Acta Vet Scand* 1991; 32:67.
43. Opriessnig T et al. *Vet Pathol* 2004; 41:624.
44. Jolie R et al. *Swine Hlth Prod* 1999; 7:269.
45. Done SH. *Vet Rec* 1991; 128:582.
46. Clark LK et al. *Swine Health Prod* 1993; 1:10.
47. Hurnik D et al. *Prev Vet Med* 1994; 20:147.
48. Hurnik D et al. *Prev Vet Med* 1994; 20:135.
49. Done SH et al. *Vet Rec* 2005; 157:71.
50. Morrison RB, Morris RS. *Vet Rec* 1985; 117:268.
51. Straw BE et al. *Prev Vet Med* 1990; 9:287.
52. Scheidt AB et al. *J Am Vet Med Assoc* 1990; 196:881.
53. Caruso JP, Ross LF. *Am J Vet Res* 1990; 51:227.
54. Hill MA et al. *Res Vet Sci* 1994; 56:240.
55. Hurnik D et al. *Can J Vet Res* 1993; 57:37.
56. Straw BF et al. *J Am Vet Med Assoc* 1989; 195:1702.
57. Davies PR et al. *Am J Vet Res* 1995; 56:709.
58. Paisley LG et al. *Acta Vet Scand* 1993; 34:319.
59. Paisley LG et al. *Acta Vet Scand* 1993; 34:331.
60. Noyes EP et al. *J Am Vet Med Assoc* 1990; 197:1025.
61. Hsu T, Minion FC. *Gene* 1998; 214:13.
62. Minion FC et al. *Infect Immun* 2000; 68:3056.
63. Chen JR et al. *Vet Microbiol* 1998; 62:97.
64. Lin BC. *Proc Am Assoc Swine Vet* 2001; p. 225.
65. Park S-C et al. *J Vet Clin* 2001; 18:93.
66. Park S-C et al. *Infect Immun* 2002; 70:2502.
67. Thanawongnuwech R et al. *Clin Diag Immunol* 2004; 11:901.
68. Sarradell J et al. *Vet Pathol* 2003; 40:395.
69. Rodriguez F et al. *J Comp Path* 2004; 130:306.
70. Blanchard B et al. *Vet Microbiol* 1992; 30:329.
71. Yazawa S et al. *Vet Microbiol* 2004; 98:221.
72. Shibata I et al. *J Vet Med Sci* 1998; 60:295.
73. Thacker EL et al. *J Clin Microbiol* 1999; 37:620.
74. Thacker EL et al. *Vaccine*, 2000; 18:1244.
75. Bosch J. *Proc Am Assoc Swine Pract* 2000; p. 175.
76. Sheldrake RF, Romalis LF. *Aust Vet J* 1992; 69:255.
77. Djordjevic SP et al. *Vet Microbiol* 1994; 39:261.
78. Levonen K. *Res Vet Sci* 1994; 56:111.
79. Rautiainen L et al. *Acta Vet Scand* 1998; 39:325.
80. Erlandson KR et al. *J Swine Hlth Prod* 2005; 13:198.
81. Levonen K et al. *J Vet Diag Invest* 1999; 11:547.
82. Sorensen V et al. *Vet Microbiol* 1997; 54:23.
83. Stemke GW et al. *Am J Vet Res* 1994; 55:81.
84. Calsamiglia M et al. *J Vet Diag Invest* 1999; 11:246.
85. Verdin E et al. *Mol Cell Probes* 2000; 14:365.
86. Verdin E et al. *Vet Microbiol* 2000; 76:31.
87. Baumeister AK et al. *J Clin Microbiol* 1998; 36:1984.
88. Caron J et al. *J Clin Microbiol* 2000; 38:1390.
89. Stemke GW. *Lett Appl Microbiol* 1997; 25:327.
90. Calsamiglia M et al. *Vet Microbiol* 2000; 76:299.
91. Kwon D, Chae C. *Vet Pathol* 1999; 36:308.
92. Mousing J, Christensen G. *Acta Vet Scand* 1993; 34:151.
93. Sorensen VP et al. *Vet Med* 1997; 54:23.
94. Bouh KCS. *Clin Diag Lab Immunol* 2003; 10:549.
95. Kurth T. et al. *J Vet Diag Invest* 2002; 14:463.
96. Tanner AC et al. *Vet Microbiol* 1993; 36:306.
97. Bousquet E et al. *Vet Rec* 1997; 141:37.
98. Thacker EL et al. *Vet Ther* 2001; 2:293.
99. Kavanaugh NT. *Irish Vet J* 1994; 47:58.
100. Hannan PCT et al. *Res Vet Sci* 1997; 63:157.
101. Stipkovits L et al. *Proc 18th Int PigVet Soc Cong* 2004; p. 518.
102. McKelvie J et al. *Proc 18th Int PigVet Soc Cong* 2004; p. 528.
103. Vicca J et al. *Proc 18th Int PigVet Soc Cong* 2004; p. 535.
104. Baekbo P et al. *Proc Am Assoc Swine Pract* 1999; p. 479.
105. Lorenzen JB et al. *Danske Vet* 83:6.
106. Radostits OM, Leslie KE, Fretrow J. *Herd health. Food animal production medicine*, 2nd edn. Philadelphia: WB Saunders.
107. Zellweger K et al. *Proc 18th Int PigVet Soc Cong* 2004; p. 166.
108. Wargen LE. *CanVet J* 2004; 45:543.
109. Dee SA. *Swine Health Prod* 1994; 2:6.
110. Mateusen B et al. *J Vet Med B* 2001; 48:733.
111. Van Burgh J et al. *Proc Am Assoc Swine Vet* 2001; p. 119.
112. Bousquet E et al. *Vet Rec* 1998; 143:269.
113. Wallgren P et al. *J Vet Med Series B* 1993; 40:157.
114. Burch DGS et al. *Vet Rec* 1984; 114:209.
115. Burch DGS et al. *Vet Rec* 1986; 119:108.
116. Clark LK et al. *Vet Med* 1991; 86:946.
117. Burch DGS et al. *Pig J* 2003; 51:242.
118. Pallares FJ et al. *Vet Res* 2000; 31:573.
119. Pallares F et al. *Vet Rec* 2001; 148:104.
120. Maes D et al. *J Vet Med B* 1998; 45:49.
121. Dohoo IR, Montgomery ME. *Can Vet J* 1996; 57:299.
122. Maes D et al. *Proc Am Assoc Swine Pract* 2000; p. 327.
123. Maes D et al. *Vaccine* 1999; 17:1024.
124. Scheidt AB et al. *Swine Health Prod* 1994; 2:7.
125. Morrow WEM et al. *Swine Health Prod* 1994; 2:13.
126. Ruiz AR et al. *J Swine Hlth Prod* 2003; 11:131.
127. Boettcher TB et al. *J Swine Hlth Prod* 2002; 10:259.
128. Jones GF. *J Swine Hlth Prod* 2005; 13:19.
129. Morris J et al. *Proc Am Assoc Swine Pract* 2001; p. 157.
130. Dawson A. *Vet Rec* 2002; 151:535.
131. Moreau IA. et al. *Vaccine*, 2004; 22:2328.
132. Dawson A. *Pig J* 2001; 50:83.
133. Rapp-Gabrielson VJ et al. *Proc Am Assoc Swine Pract* 2002; p. 105.
134. Maes D et al. *Livestock Prod* 2003; 83:85.
135. Chen Y-L et al. *Infect Immun* 2003; 71:1155.
136. Thacker EL et al. *Am J Vet Res* 2000; 61:1384.

### MYCOPLASMAL POLYSEROSITIS IN PIGS

Mycoplasmal arthritis occurs in suckling and growing pigs and is characterized clinically by dyspnea and lameness.

#### ETIOLOGY

*M. hyorhinis* causes arthritis and polyserositis in young pigs, and *M. hyosynoviae* causes arthritis in growing pigs. *M. hyorhinis* has also been isolated from pigs with otitis media.<sup>1,2</sup> *M. hyoarthrinosa* has been associated with a syndrome similar to that produced by *M. hyosynoviae* but they may be the same species. Other mycoplasmas including *M. flocculare* and *Acholeplasma* spp. have been isolated from pigs but appear to have no propensity to produce arthritis.

#### EPIDEMIOLOGY

*M. hyorhinis* is an inhabitant of the respiratory tract and conjunctivae<sup>3,4</sup> of pigs and is a common secondary infection in pre-existing respiratory disease.<sup>5</sup> It probably spreads pig to pig through nasal contact or by aerosol. It colonizes the mucosa of suckling piglets within the first few weeks of life and may spread with subsequent polyserositis and arthritis but

more commonly does so following stress. Disease is essentially restricted to pigs between 3 and 10 weeks of age and occurs in older suckling pigs and following weaning, but may occur occasionally in older pigs. Disease occurs sporadically in most herds and is a significant cause of sporadic runting and general poor bodily condition in young pigs. There is some evidence to show that pigs with high and low immune responses differ in their cytokine response to *M. hyorhinis* but there is no characteristic cytokine response in association with the relative susceptibility to infection in high immune expression pigs.<sup>6</sup> In some cases there may be no external signs except bursitis and septic fluctuating joints. Affected pigs limp, shift weight, and are unable to rise. Outbreaks can occur with multiple cases within and between litters. Morbidity may reach 20–35% but mortality is rarely high. The case fatality rate seldom exceeds 10% but chronically affected pigs fail to grow and become runts. *M. hyorhinis* is also associated with otitis media in pigs.<sup>1,2,7</sup>

*M. hyosynoviae* is a causative organism with a very wide heterogeneity<sup>8</sup> and is resident on the pharyngeal mucosa and tonsil. Shedding is less frequent than with *M. hyorhinis* and the organism cannot usually be isolated from the pharynx of piglets prior to 7 weeks of age and is regarded as rare before 12 weeks by some authors.<sup>9</sup> This is true even when most of the sows in a herd are tonsillar carriers.<sup>9,10</sup> There is a very varied pattern of carriage. It appears that this transference is fairly rare but when it does occur can be the source of infection for the other littermates.<sup>9</sup> There is some variation in virulence between strains. With virulent strains, bacteremia with subsequent arthritis follows within a few days of minor stress such as vaccination, movement, regrouping or a change in weather. The overall prevalence of clinical disease appears to be low but it achieves significance in certain herds which experience a persistent problem. The reasons for this are still unclear.<sup>11</sup> These authors have shown that infection profiles between herds vary considerably.<sup>9</sup> In some herds in the UK the incidence may be higher with 21% of sows culled because of lameness primarily associated with *M. hyosynoviae*. In these herds the sows are nearly always culled for lameness before the 4th parity which constitutes a huge economic loss. Failure to treat leads to chronic lameness.<sup>12,13</sup> When gilts and sows are treated they do not appear to have a reduced overall survival time indicating that treatment is cost effective. Clinical disease occurs primarily in pigs over 3 months of age and in replacement stock brought into these problem herds. It appears that

there is a latent period between the tonsillar infection and the development of generalized infection and arthritis<sup>9</sup> which may be accounted for by the long persistence of maternal antibodies of 8–16 weeks. The active serological response possibly indicating immunity only seems to occur when there is the onset of arthritis<sup>9</sup> but others disagree<sup>14,15</sup> and not even when there is hematogenous spread. In only a few pigs was a rising OD ratio observed before the onset of generalized infection. It is more prevalent in heavily muscled pigs with straight-legged conformation and there is variation in breed susceptibility. Morbidity in problem herds is generally 5–15% but may reach 50%. Mortality is rare but 2–15% may become chronically affected.

Abattoir studies have suggested that 5–10% of pigs may be affected.<sup>16</sup> Transmission of infection is by direct contact or possibly by aerosol infection.

*M. hyosynoviae* can survive drying for up to 4 weeks and may be capable of survival in the environment for longer periods than most mycoplasmas. A further consideration of the importance of these diseases must be given to their possible contribution to the occurrence of carcass condemnation from arthritis.

#### **PATHOGENESIS**

The most important thing is that pigs can carry the infection in their tonsils and their synovial fluid without clinical signs of lameness and may therefore not be diagnosed as carriers and can act as a potential source of infection to others.<sup>17,18</sup>

Systemic infection by mycoplasma may occur following stress. Clinical disease is manifest if localization occurs but this is probably the exception rather than the rule. In the experimental disease the incubation period varies from 4–10 days. After experimental intranasal infection with *M. hyosynoviae* septicemia usually takes about 2–4 days. The reason for the variation in age susceptibility between the two diseases is unknown. *M. hyorhinis* produces a polyserositis in which fibrinous pericarditis, pleuritis and occasionally pneumonia, or polyarthritis, may be the predominant features. Acute eustachitis associated with *M. hyorhinis* occurs as early as 1 week of life and precedes inflammation of other sites of the ear. *M. hyosynoviae* produces synovitis with some arthritis, especially in the larger joints of the hindlimbs.

#### **CLINICAL FINDINGS**

Diagnosis of both infections is often difficult to make clinically and it is essential that a good clinical diagnostic test or tests are produced in the near future.

Pigs affected with *M. hyorhinis* are usually 3–10 weeks and show initial

transient fever, depression and inappetence. Normally, however fever is absent. The first presenting sign may be just stiff legs. Dyspnea with abdominal breathing and a pleural friction rub may be present. There is polyarthritis with lameness, reluctance to rise and moderate swelling and heat in affected joints. Pigs may recover spontaneously in 1–2 weeks but more commonly become unthrifty. Acute outbreaks may occur in suckling pigs 3–8 weeks of age but more commonly the disease is more sporadic and insidious, producing moderate ill-thrift in a proportion of the sucklers which then show severe runting following weaning. With *M. hyosynoviae* infection there is a sudden onset of acute lameness in one or more limbs, usually without fever. Lameness may be referable to one or more joints and the stifle, hock and elbow joints are most commonly affected. In many cases the pigs may lie in sternal recumbency. The lameness is severe although clinical swelling of the affected joint may be minimal. In the majority of affected pigs clinical recovery occurs after 3–10 days but some may become permanently recumbent. Otitis media is characterized by anorexia, circling and tilting of the head and neck, leaning against the wall,<sup>19</sup> and eventually recumbency with the affected side down.

In the UK, the condition is often associated with delivery of high herd health gilts to more conventional farms, with the condition occurring 2–4 weeks after the delivery or with a change of housing. Other outbreaks have followed the introduction of pigs to straw yards whereas contemporary animals kept in fully slatted accommodation have been unaffected.<sup>20</sup> Both mycoplasma infections may require humane slaughter.

#### **CLINICAL PATHOLOGY**

Blood cell counts remain within the normal range but there is an increase in leukocytes and protein in synovial fluid. The organisms may be detected by immunofluorescent techniques, and complement fixing antibody develops following infection.

#### **NECROPSY FINDINGS**

A serofibrinous pleuritis, pericarditis and peritonitis are present with *M. hyorhinis* infections. Chronic cases show fibrous pleural and pleural-pericardial adhesions. Synovial hypertrophy with an increased amount of serosanguinous synovial fluid occurs in affected joints with both mycoplasma species. Sometimes the amount of fluid is considerable. Chronic cases show thickening of the joint capsule with a varying degree of articular erosion and pannus formation.<sup>12</sup> Joint lesions are most likely to be found in the carpus, shoulder, stifle and tarsus. Quite often

with *M. hyosynoviae* infections one joint usually the hock is affected.

Microscopically, there is usually edema, hyperemia, hyperplasia of synovial cells, and an increased density of subsynovial cells. Lymphocytes and plasma cells are present in the affected serosal and synovial membranes of subacute to chronic cases. There is often a significant villus hypertrophy of the synovial membrane. In the chronic phase there may be some fibrosis.<sup>21</sup> A full description of the phases of infection has recently been described.<sup>22</sup> With both infections, the organism is more easily demonstrated during the acute stage of the disease. A synergistic link between *M. hyorhinis* and PRRS virus has been suggested to contribute to some cases of pneumonia.<sup>23</sup> This species of mycoplasma may also play a role in porcine otitis media, possibly via ascension of the eustachian tubes.<sup>23,24</sup>

#### **Samples for confirmation of diagnosis**

- **Histology** – synovial membrane, liver, lung, heart. Sometimes the mycoplasmas can be seen between the synoviocytes on the tips of the villi of the synovial membrane
- **Mycoplasmology** – culture swabs from serosal surfaces, joints. Friis's medium suppresses the growth of *M. hyorhinis* in mixed cultures. It can be recovered from blood for 7–11 days from 1–4 days post-exposure. It can be recovered from the joints for 5–21 days and from the tonsils from 6–61 days.<sup>25,26</sup>
- ***M. hyosynoviae* is best grown in anaerobic conditions** where it outgrows *M. hyorhinis*
- **Synovial fluid** has been taken from the hock joint under general anaesthesia and cultured. It was shown<sup>27</sup> that isolation from the joints of lame pigs was twice as high as from littermates that were not lame. About 8–9% of synovial fluid samples from non-patent arthritis samples from Danish slaughterhouse pigs were positive.<sup>28</sup> The same authors also showed that blood culture was also effective
- **Antigen detection.** An in situ hybridization technique for the differentiation of *M. hyosynoviae*, *M. hyorhinis* and *M. hyopneumoniae* has been described for use with formalin fixed tissues<sup>29</sup>
- **PCR** can be used to amplify a p36 or p46 gene to differentiate *M. hyorhinis* and *M. hyosynoviae* infections<sup>30</sup>
- **Serology.** It has been shown that herds with *M. hyosynoviae* arthritis had higher serological responses and more carriers amongst growers of



16 week old pigs than did the unaffected herds, but by the end of the finishing period the serological response and carrier prevalence were as high in herds with arthritis as without

- **An indirect ELISA** has been developed using membrane lipoprotein antigens.<sup>31,32</sup>

The differential diagnosis of mycoplasma infections must include *S. suis*, and *H. parasuis*.

### TREATMENT

Treatment with tylosin at 1–2 mg up to 15 mg/kg BW IM or lincomycin at 2.5 mg/kg BW IM for three consecutive days has been recommended.<sup>14,15</sup> The lincomycin was effective in one outbreak but as soon as it was removed the outbreak flared up again.<sup>20</sup> Oxytetracycline also can be used.<sup>33</sup> Early treatment of *M. hyosynoviae* arthritis with 8 mg of betamethasone IM has been found to reduce the occurrence of chronic lameness. Tiamulin at both 10 and 15 mg/kg BW IM daily for 3 days is effective for treatment of pigs affected with arthritis associated with *M. hyosynoviae* and is as effective as lincomycin. Recently, enrofloxacin has been used at 2.1 mg/kg for 3 days. It is essential to treat the incontacts<sup>34</sup> and to isolate the treated animals until the clinical signs have disappeared. Valnemulin was highly active against *M. hyosynoviae*,<sup>35</sup> whereas tiamulin and enrofloxacin were much less active.

### CONTROL

The control of both diseases rests largely in the avoidance of stress situations. The administration of tylosin or tetracyclines in the drinking water or feed during unavoidable stress such as weaning can reduce the incidence.<sup>36</sup> The use of tiamulin as a single im injection prior to moving pigs from one house to another was sufficient to prevent 50% of the cases of the disease.<sup>15</sup> Early weaning at 3–5 weeks of age has been recommended as a method of preventing infection of pigs with *M. hyosynoviae* and thus of reducing the occurrence of the disease in growing pigs. However, in a recent study<sup>37</sup> it was shown that *M. hyosynoviae* was not eliminated in herds where the piglets were commingled after 4 weeks and reared in herds using all in/all out management. In fact the herd had widespread infection when the herd was 4 months old. The authors concluded that elimination of *M. hyosynoviae* requires that the pigs are moved immediately from weaning at an age of no more than 4 weeks.

### REVIEW LITERATURE

Hagedorn-Olsen T. *Mycoplasma hyosynoviae* arthritis in pigs. PhD thesis, Royal Veterinary and Agricultural University, Copenhagen, Denmark, 1997.

### REFERENCES

1. Kazama S et al. Res Vet Sci 1994; 56:108.
2. Morita T et al. Vet Pathol 1995; 32:107.
3. Friis NF. Acta Vet Scand 1976; 17:343.
4. Rogers DG et al. J Am Vet Med Ass 1991; 198:450.
5. Friis NF, Feenstra AA. Acta Vet Scand 1994; 35:93.
6. Reddy NRJ et al. Inf Imm 2000; 68:1150.
7. Friis NF et al. Acta Vet Scand 2002; 43:191.
8. Kokotovic B et al. 2002; 85:221.
9. Hagedorn-Olsen T et al. J Vet Med A 1999; 46:555.
10. Ross RF, Spear ML. Am J Vet Res 1973; 34:373.
11. Hagedorn-Olsen T et al. Proceedings of the 15th Int Pig Vet Soc Cong 1998; p. 203.
12. Ross RF et al. Am J Vet Res 1971; 32:1743.
13. Roberts DH et al. Vet Rec 1972; 90:307.
14. Burch DGC, Goodwin RFW. Vet Rec 1984; 115:594.
15. Blowey RW, Pott JM. Proc 12th Int Pig Vet Soc Cong 1992; p. 286.
16. Hariharan H et al. J Vet Diag Invest 1992; 4:28.
17. Nielsen EO et al. Proc 16th Int Pig Vet Soc Cong 2002; p. 252.
18. Nielsen EO et al. Danske Vetmed 2002; 85:6.
19. Blowey RW. Pig Vet J 1993; 30:72.
20. Smith WJ. Vet Rec 1999; 145:440.
21. Hagedorn-Olsen T et al. J Vet Med A 1999; 46:317.
22. Hagedorn-Olsen T et al. Acta Path Micro Scand 1999; 107:201.
23. Kawashima K et al. J Comp Path 1996; 114:315.
24. Morita T et al. Vet Path 1999; 36:174.
25. Friis NF et al. Acta Vet Scand 1991; 32:425.
26. Nielsen E et al. Proc 14th Int Pig Vet Soc Cong 1996; p. 224.
27. Nielsen EO et al. Proc 14th Int Pig Vet Soc Cong 1998; p. 205.
28. Buttenshon J et al. J Vet Med A 1995; 42:633.
29. Boye M et al. APMS, Acta Path Micro Scand 2001; 109:656.
30. Caron J et al. J Clin Microbiol 2000; 38:1390.
31. Jungersen G et al. Proc 17th Int Pig Vet Soc Cong 2002; p. 264.
32. Goethe R et al. Vaccine 2000; 19:966.
33. Aarestrup FM et al. Acta Vet Scand 1998; 39:145.
34. Madeiros CA. Vet Rec 1984; 115:446.
35. Hannan PCT et al. Res Vet Sci 1997; 63:157.
36. Nielsen HC et al. Proc 14th Int Pig Vet Soc Cong 1996; p. 236.
37. Nielsen EO, Busch ME. Proc 15th Int Pig Vet Soc Birm 1998; 2:204.

### EPERYTHROZONOSIS

Synopsis
<p><b>Etiology</b> Hemotrophic mycoplasmas (previously <i>Eperythrozoon</i> species)</p> <p><b>Epidemiology</b> Subclinical infection common and clinical disease precipitated by stress. Horizontal transmission by blood. Vertical transmission important in swine</p> <p><b>Clinical findings</b> Acute icterohaemia or chronic ill-thrift in sheep and swine. Reproductive inefficiency and neonatal anaemia in swine. Syndromes in cattle less defined</p> <p><b>Clinical pathology</b> Anemia and bilirubinemia. Blood smear for parasite in early disease. Serology useful as flock/herd test. PCR</p> <p><b>Treatment</b> Tetracyclines, organic arsenicals</p> <p><b>Control</b> Non-specific. Prophylactic administration of tetracyclines</p>

### ETIOLOGY

The disease is associated with hemotrophic mycoplasmas that were, until recently, thought to be rickettsial parasites and were classified as *Eperythrozoon*. Species in farm livestock that have been associated with disease are *Mycoplasma (Eperythrozoon) ovis* in sheep, *M. haemosuis* in swine and *M. wenyonii* in cattle.<sup>1,2</sup> They cannot be grown in culture.

### EPIDEMIOLOGY

#### Occurrence

Eperythrozoonosis occurs in sheep, swine, cattle, and llamas but has greater clinical occurrence in swine and sheep. Latent eperythrozoonosis also occurs in mule deer, elk and goats. The organisms appear species specific although *M. ovis* has been transmitted from sheep to goats. The distribution is as follows:

- **Sheep.** Eperythrozoonosis of lambs associated with *M. ovis* is recorded in Africa, Iran, the United States, Canada, Great Britain, France, Norway, Germany, Poland, Australia, and New Zealand
- **Pigs.** Disease is recorded mainly in the United States, Canada, Great Britain, and continental Europe
- **Cattle.** Eperythrozoonosis in cattle is apparently widely distributed with reports from North and South America, Africa, Australasia, the British Isles, western Europe, and the Middle East<sup>1</sup>
- **Llamas.** Infection with *Eperythrozoon* spp. is reported in llamas in the United States and apparently has widespread occurrence.<sup>3</sup> Infection has been detected in animals that also had other disease problems or as the result of specific survey studies, and it is likely that the organism acts primarily as a secondary opportunistic pathogen in llamas

#### Source and transmission

The reservoir of infection is the **persistently infected** animal and the disease can be transmitted by any mechanism that transfers infected blood. It is proposed that in sheep the minimal infective dose is one parasitized erythrocyte.<sup>4</sup> **Horizontal and vertical** transmission is possible.

#### Sheep

The method of natural spread of the infection in sheep is probably via biting insects. Serological studies in Australian sheep show that the prevalence of farms with infection is high and that spatial differences are probably due to differences in vector occurrence.<sup>5</sup> In an infected flock or herd the disease can also be spread by management practices that transfer infected blood. In sheep these include vaccination, ear-tagging, shearing and

mulesing, although these risk factors have not been associated with infection in flock epidemiologic studies.<sup>5</sup>

#### Pigs

Skin parasites and blood-contaminated needles and instruments have been shown to transmit disease in swine.<sup>6</sup> **Transplacental transmission** is also an important route in swine.

#### Host and pathogen risk factors

**Seasonal** differences in disease prevalence occur – it is more common in the summer and autumn. **Regional** differences in the clinical severity of the disease has led to postulations of differences in virulence between strains of the organism. There may also be **genetic** difference in host susceptibility and field observations are that the Merino is more susceptible to infection and disease.

Several studies suggest that subclinical infection is common and that the development of clinical disease requires the presence of some other debilitating factor or **stress** for manifestation. **Viral infections** with porcine reproductive and respiratory syndrome (PRRS) and swine influenza appear to predispose its occurrence in swine.<sup>7</sup>

#### PATHOGENESIS

Following experimental infection there is a variable prepatent period, usually 1–3 weeks, which is followed by a period of intense parasitemia. Ring form, coccoid and rod-shaped organisms are evident in stained blood smears. The organism is epicellular, infecting the surface and periphery of erythrocytes and is also found free in the plasma in blood examinations. There is a profound hypoglycemia during the parasitemic phase which is believed to be due to direct consumption of glucose by the parasite.<sup>2,8,9</sup> The period of intense parasitemia lasts for a period of 5–10 days following which visible organisms in the blood become much less frequent and anemia develops. Parasitized erythrocytes are removed from the circulation by the spleen. It is believed the parasite alters the erythrocyte membrane, exposing new antigenic determinants and stimulating the development of antierythrocyte antibodies. The severity and duration of the anemia varies between individuals but commonly lasts from 1–2 months. Upon recovery there may be further cycles of parasitemia and anemia which are less severe. Sheep that develop a high antibody titer tend to rapidly clear the parasitemia whereas sheep that have a poorer antibody response tend to show persistent parasitemia and recurrent episodes of anemia. Once an animal is infected it is probably infected for life.

#### CLINICAL FINDINGS

##### Sheep

Sudden death and deaths associated with exercise, accompanied by hemoglobinuria and icterus, may be a feature in some sheep and some outbreaks but, more commonly, the disease is manifest with fever and depression followed by the development of **anemia**, exercise intolerance and ill-thrift. In some areas it may be the principal cause of **ill-thrift** in lambs.<sup>10</sup> There is reduced **wool yield** and in the experimental disease in lambs at pasture a retardation of growth of up to 2 kg has been recorded 5 weeks after infection.<sup>11</sup> Lambs suckled by infected ewes are passively immunized via the colostrum until weaning.

##### Pigs

**Acute icterooanemia** is the classical syndrome and occurs in feeder pigs. It is characterized by weakness of the hind legs, mild fever (40°C, 104°F), increased pulse rate, pallor of the mucosae and emaciation. Jaundice is a frequent but inconstant feature of the disease. Case fatality is high and death occurs 1–5 days after the onset of clinical signs. Although once quite common, the prevalence of this form has decreased, possibly due to the use of feed additives containing arsenicals and to effective ectoparasite control.<sup>12</sup>

**Anemia and weakness** in neonatal pigs accompanied by low piglet viability and affecting several litters is another manifestation.<sup>12,13</sup> Affected pigs are pale and lethargic and there is marked variation in birthweight within affected litters. Low birthweight piglets die shortly after birth. The anemia increases in severity between birth and weaning age, the pigs have skin palor, exercise intolerance, and there is considerable variability in weaning weights. The syndrome may or may not be accompanied by reproductive inefficiency characterized by delayed estrus cycles and embryonic death. Anemia, jaundice and poor growth rate can also present primarily in weaner pigs.<sup>14</sup>

**Subclinical infections** associated with subclinical anemia are reported to result in reproductive failure, anestrus and delayed estrus, reduced sow body condition, increased susceptibility to enteric and respiratory disease, and failure of feeder pigs to gain weight at the expected rate.<sup>12–14</sup>

##### Cattle

Clinical disease has been considered uncommon and has largely been a problem in cattle that have been splenectomized for experimental use, disease occurring 1–4 weeks after the **splenectomy**. However, clinical disease is recorded in adult commercial dairy cattle<sup>15</sup> manifest with lassitude, stiffness, pyrexia, diarrhea, and a fall in milk production.

Eperythrozoonosis has also been associated with a syndrome occurring in heifers in early to mid-lactation during the late summer and early autumn in which there was fever, swelling of the teats and the hindlimbs, lymph node enlargement and a fall in milk production. Signs of infection resolved in 7–10 days regardless of treatment.<sup>1</sup> A similar transient disease occurring in the spring and summer months, and manifest with scrotal and hindlimb edema and infertility, has been recorded associated with eperythrozoonosis in young bulls.<sup>16</sup>

#### CLINICAL PATHOLOGY

##### Blood smears and hematology

The presence of the organism can be established by examination of a blood smear taken during a clinical episode and when the animal has fever. In countries where there is no serological test available this may be the only method of diagnosis.

**Parasitemia** is most intense prior to the development of clinical anemia and appears as 0.5–1.0 mm, coccoid, rod- or ring-shaped basophilic particles on red cells or free in plasma. Parasitemia is difficult to detect once clinical signs of disease are evident and very difficult in chronic disease. It is recommended that blood samples from a number of animals in the group be examined if eperythrozoonosis is suspected.

Lowered values for hemoglobin and packed cell volume (PCV) are evident on hematological examination of clinically affected animals and there is marked red cell anisocytosis and polychromasia with basophilic stippling and the presence of many Howell-Jolly bodies in sheep. A profound hypoglycemia may be demonstrated and there are elevated concentrations of unconjugated and total bilirubin.

##### PCR

The recent development of PCR-based assays has allowed a more precise and efficient method of detection and diagnosis and is much more sensitive than blood smear.<sup>2,17,18</sup>

##### Serology

###### Sheep

Complement fixation test and an indirect fluorescent antibody test (IFA) have been used. With the complement fixation test sera from affected animals give positive reactions on the 3rd day of clinical illness, remain positive for 2–3 weeks, and then gradually revert to negative. Chronic carriers of the disease are usually negative reactors. The IFA test or an ELISA test are more suitable for serological studies as infected animals remain seropositive for significantly longer periods.<sup>5</sup>

### Pigs

The indirect hemagglutination test and ELISA test can be used in swine and are of value in herd diagnosis but may not detect infection in an individual pig, especially those under 3 months of age.<sup>12,19</sup> Experimental challenge of splenectomized piglets may be used to determine the presence of infection. PCR may resolve laboratory detection diagnostic problems.<sup>20</sup>

### TREATMENT

A single intramuscular injection of tetracycline or oxytetracycline (3 mg/kg BW or more) is an effective treatment in sheep, with clinical improvement occurring in 24 hours in the early stages of the disease. Chronic infections are less responsive. Treatment of affected lambs with nearsphenamine (30 mg/kg BW) or Antimosan (6 mg/kg BW antimony) is effective in relieving clinical illness, but does not completely eliminate the parasite. Imidocarb dipropionate also is effective in

treatment but recrudescence at 2–4 weeks is common.

### CONTROL

Control of disease in sows and neonates has been reported with the inclusion of chlortetracycline in the sow feed at 300 g/tonne, or by intramuscular administration of oxytetracycline to sows at 14 and 7 days before the expected farrowing date.<sup>12</sup> Tetracyclines can also be used in feed or by in-line water medication in feeder pigs. With large flocks of sheep in enzootic areas, reinfection or recrudescence occurs so quickly that control by treatment may be an unwarranted expenditure.

In confined swine operations, the detection carrier pigs by PCR, and their subsequent removal has been proposed as a possible control procedure.<sup>17</sup>

### REVIEW LITERATURE

Gwaltney SM. *Eperythrozoon suis* infections in pigs: clinical syndromes and diagnosis. Swine Hlth Prod 1996; 3:25–27.

### REFERENCES

1. Neimark H et al. Int J Syst Evol Microbiol 2004; 54:365.
2. Messick JB. Vet. Clin Pathol 2004; 33:2.
3. McLaughlin BC et al. J Am Vet Med Assoc 1990; 197:1170.
4. Mason RW, Statham P. Aust Vet J 1991; 68:116.
5. Kabay MJ et al. Aust Vet J 1991; 68:170.
6. Heinritzi K. Tierarztl Umsch 1992; 47:588.
7. Gresham AC. J. Pig J 1996; 37:20.
8. Smith JE et al. J Vet Med B 1990; 37:587.
9. Burkhard MJ, Garry F. Vet Clin Pathol 2004; 33:244.
10. Burroughs GW. S Afr Vet J 1988; 59:195.
11. Sutton RH, Jolly RD. NZ Vet J 1973; 21:160.
12. Gwaltney SM. Swine Hlth Prod 1995; 3:25.
13. Henderson JP et al. Vet Rec 1997; 140:144.
14. Gresham A et al. Vet Rec 134:71.
15. Goff WL et al. Exp Parasitol 1986; 61:103.
16. Wells EG et al. Theriogenology 1995; 43:427.
17. Hoelzle LE et al. Vet Microbiol 2003; 93:185.
18. Vandervoort JM et al. J Am Vet Med Assoc 2001; 219:1432.
19. Schuller W et al. Berl Munch Tierarztl Wochenschr 1990; 103:9.
20. Gwaltney SM et al. J Vet Diag Invest 1993; 5:40.

## Diseases associated with viruses and *Chlamydia* – I

### VIRAL DISEASES WITH MANIFESTATIONS ATTRIBUTABLE TO INVOLVEMENT OF THE BODY AS A WHOLE 1157

Hog cholera (classic swine fever) 1157  
 African swine fever (African pig disease, wart hot disease) 1167  
 Equine infectious anemia (swamp fever) 1173  
 Bovine ephemeral fever 1177  
 African horse sickness 1179  
 Encephalomyocarditis virus disease in pigs 1183  
 Postweaning multisystemic wasting syndrome (PMWS) and porcine dermatitis and nephropathy syndrome (PDNS) and porcine circovirus-associated diseases 1185  
 Porcine reproductive and respiratory syndrome (PRRS); blue-eared pig disease; mystery swine disease; swine

infertility and respiratory syndrome (SIRS) 1194  
 Rift valley fever 1205  
 Congenital arthrogryposis and hydranencephaly; Akabane disease; Cache Valley virus disease 1207

### ENZOOTIC BOVINE LEUKOSIS (BOVINE LYMPHO SARCOMA) 1209

### BOVINE IMMUNODEFICIENCY-LIKE VIRUS 1221

### VIRAL DISEASES CHARACTERIZED BY ALIMENTARY TRACT SIGNS 1223

Foot-and-mouth disease (FMD, aphthous fever) 1223  
 Swine vesicular disease 1230  
 Vesicular stomatitis 1232  
 Vesicular exanthema in swine 1236  
 Rinderpest (cattle plague) 1237

Peste des petits ruminants (PPR, goat plague or kata) 1242  
 Jembrana Disease 1244  
 Nairobi sheep disease 1244  
 Malignant catarrhal fever (bovine malignant catarrh, malignant head catarrh) 1245  
 Bovine virus diarrhea, mucosal disease, bovine pestivirus disease complex 1248  
 Bovine papular stomatitis 1277  
 Transmissible gastroenteritis in pigs 1277  
 Vomiting and wasting disease in pigs (hemagglutinating encephalomyelitis virus disease in pigs) 1285  
 Viral diarrhea in calves, lambs, kids, piglets, and foals 1286  
 Winter dysentery in cattle 1297  
 Bluetongue 1299  
 Epizootic hemorrhagic disease 1305

The comments made earlier about diseases associated with bacteria and their importance as infectious diseases to animal agriculture apply also to diseases associated with viral infections, which are presented in this chapter and Chapter 22. However, there are several factors that make viral diseases even more important.

Viruses have a much greater capability for surviving independently of their host. Spore-forming bacteria survive for long periods in the environment, but, in general terms, viruses are more viable at large than are bacteria. Because of their structure, viruses are much less susceptible to destruction by cleaning and disinfectant agents than are bacteria.

Viruses also have a greater capacity for living in relative harmony with the host, without destroying it. Some, such as the Lentivirus group, produce persistent infections with antigenic drift and the emergence of novel antigenic strains, with consequent relapsing disease. Many of the viruses are insect-borne and have reservoir hosts in other species, especially wildlife. These properties pose unique problems for the diagnosis, control and eradication of these viral infections, and in the development of suitable vaccines. In terms of exotic disease threats, viral diseases can represent a much more significant challenge than bacterial diseases. They have the capacity for escaping beyond standard prophylactic barriers and proceeding on a path of global dis-

ease. In recent times African swine fever, bluetongue and African horse sickness have made territorial gains in this way, while the vesicular diseases and the insect-borne encephalitides are constantly on the move into new territory. Perhaps the biggest threat, because of its zoonotic potential, is Rift Valley fever. The viral diseases with potential for severe economic effect and risk for spread to uninfected areas are listed in the table of List A diseases (Table 16.1).

The role of the field veterinarian is made very much more onerous by the presence of these diseases. Because of the speed with which they spread, for example when foot-and-mouth disease virus is airborne, or when ephemeral fever is carried by *Culicoides* sp., they can appear for the first time in an outbreak some distance from their point of entry and in places where an imported exotic disease would not be expected to appear for the first time. Field veterinarians must be on the alert at all times for the appearance of new diseases in their practice areas, and be aware of the implications of their presence, and the kinds of emergency action necessary when they are recognized.

There is no way to prepare oneself for an encounter with an exotic viral disease other than by becoming familiar with their clinical and clinico-pathological findings and their epidemiological behavior. This chapter and Chapter 22 attempt to fill that need.

### Viral diseases with manifestations attributable to involvement of the body as a whole

#### HOG CHOLERA (CLASSIC SWINE FEVER)

Hog cholera, also known as classical swine fever (CSF), is a highly infectious pestivirus infection of pigs which causes acute, chronic or inapparent disease. At one time it was characterized clinically by an acute highly fatal disease and pathologically by lesions of a severe viremia. It is now known that chronic or inapparent disease also occurs, including persistent congenital infection in newborn pigs infected during fetal life. In many countries, where it is endemic, clinical ability will diagnose it more often than laboratory skills, as long as you remember that is a real diagnostic possibility.

#### Synopsis

**Etiology** Hog cholera virus, a pestivirus belonging to the genus *Flaviviridae* and related to the bovine virus diarrhea virus  
**Epidemiology** Affects domestic pig of all ages; causes major economic losses interfering with trade when outbreaks occur in pig-raising countries. Occurs in Europe, South America and the Far East. Highly virulent virus causes high morbidity

high mortality; less virulent strains cause milder form. Transmitted by direct contact, feeding of uncooked pork products.

Neutralizing antibodies provide protection  
**Signs** Sudden onset of peracute deaths first indication in herd. Many pigs affected within days. Severe depression, fever, anorexia, purplish discoloration of skin, ocular discharge, nervous signs, and death in few days. Nervous form may predominate. Reproductive failure in pregnant sows (abortions, mummification, stillbirths, birth of persistently infected pigs)

**Clinical pathology** Leucopenia.

Detection of virus in tissues and serological testing

**Lesions** Diffuse hemorrhages subcapsular of kidney, lymph nodes, bladder, larynx, swollen lymph nodes, splenic infarcts, congestion of liver and bone marrow, button ulcers in colon, non-suppurative encephalitis. Hydropic degeneration and proliferation of vascular endothelium

**Diagnostic confirmation** Detection of virus in tissues and serological tests

**Differential diagnosis list**

- African swine fever
- Erysipelas
- Salmonellosis

**Treatment** None

**Control** Eradication in hog cholera-free countries by slaughter of all in-contact and affected pigs. Use of vaccines in endemic areas. Eradication in countries where endemic by use of vaccination followed by test and slaughter, quarantine farms

## ETIOLOGY

Hog cholera is associated with a virus of the family Flaviviridae, genus Pestiviridae. There is only one antigenic type but a number of strains of variable virulence and antigenicity.<sup>1,2</sup> Genetic typing has been described in detail<sup>3,4</sup> and is absolutely essential for following the world wide pattern of infection.<sup>5</sup> For example, there are at least 8 antigenic groups in Thailand. It is generally stable *in vitro* and *in vivo*.<sup>6</sup> The viruses have been grouped. In Europe they used to be mainly group 1 viruses but these have been replaced by group 2 viruses. Group 1 still survives in Russia and also Cuba. Group 3 appear to be found in Asia only.

The virus has an antigenic relationship to the bovine virus diarrhoea virus (BVDV).<sup>7</sup> In Denmark, BVDV antibodies were found in 6.4% of the sera of pigs while all area were found to be free from antibodies to the hog cholera virus.

## EPIDEMIOLOGY

### Occurrence

The pig is the only domestic animal species naturally infected by the virus. All breeds and ages are susceptible and adults are more likely to survive an acute infection. The disease originated in the United States but is now almost world-

wide in distribution. Canada, Australia, New Zealand and South Africa have not experienced the disease for many years. A mild form of the disease occurred in Australia in 1960–1961.<sup>8</sup> The disease was eradicated from the United Kingdom during the period 1963–1967 and the United States was declared free of the disease in 1978. Outbreaks of acute hog cholera have occurred occasionally in other countries but were quickly controlled by a rigorous policy of slaughter and quarantine. The disease occurred in the United Kingdom in 1986 in which three primary outbreaks were identified; all outbreaks were attributed to the feeding of unprocessed waste feed containing imported pig meat products. A similar origin was suspected for the outbreak in the UK in 2000.<sup>9</sup> In this outbreak an interesting feature was the transport of infected pig carcasses from a site where bodies were dumped for quite long distances by scavenging foxes, infecting new outside pig arks across fields as they went. Between 1982 and 1984 epidemics occurred in Germany, the Netherlands,<sup>10</sup> Belgium, France, Italy, Greece, and the Iberian peninsula. As of 1985, six countries in Europe were free of classic swine fever: Denmark, Ireland (including Northern Ireland), Norway, Sweden, Finland, and Switzerland.

The disease is currently endemic in most countries of South America and the Far East except Japan and Korea. In Asia the problem is the back-yard pig that is not vaccinated and is always a reservoir. Here extension services, appropriate vaccination schemes and regulatory control is difficult to implement but it may be time to try for world wide eradication. The costs are astronomical (the Belgian outbreak of 1997 cost an estimated 11 million euros,<sup>11</sup> and the Netherlands outbreak even more).<sup>12</sup> This 1997–1998 outbreak in the Netherlands was very serious.<sup>13</sup> The disease has also concentrated in certain parts of Europe where the pig populations are intense and live in close proximity to wild boar and feral pig populations. For instance outbreaks occurred regularly between 1997–2001 in Croatia, one source was imported pig meat and the other strains reaching domestic pigs from wild boar.<sup>14</sup> These areas include parts of Germany and Poland and probably most of Eastern Europe. The disease together with ASF is endemic in the central highlands of Sardinia. Many outbreaks of classical swine fever occurred in Germany between 1993 and 1995 and major outbreaks occurred in 1996–1997 in Germany and the Netherlands.<sup>15</sup> The risk factors for Germany have been described.<sup>16</sup> In these countries, over the past 25 years, the disease occurred as a series of epidemics in which many swine herds in a

geographical area were affected within a few months. As pig production continues to become intensified the disease has been more difficult to control. In some areas of Western Europe, the pig population has more than doubled in the last 10 years. The hazards of introduction of the disease have increased considerably, due to the introduction of free movement of animals and the non-vaccination policy currently practiced in the European Union. Improvements in the Identification and Recording system which is supposed to identify all relevant animals in a particular population and record their movements and changes in inventory, are necessary to support the control of contagious diseases such as classical swine fever.<sup>17</sup> Most of the outbreaks of swine fever in Belgium in 1990 had to be classified (afterwards) as being due to 'area' and 'unknown' transmission.

In the Philippines, the disease is endemic on many large-scale swine farms.<sup>18</sup> In spite of vaccination of the sows and boars every 6 months and piglets at 6–8 weeks of age, the disease causes sub-optimal performance in 10–30% of pigs between 7–16 weeks of age.

Infection with the classical swine fever virus has also occurred in the wild boar population in Tuscany in Italy, Germany, France, Austria, and Czechoslovakia<sup>19</sup> and Croatia. Serological surveys of wild boar in Sardinia found an overall prevalence of 11%<sup>20</sup> and seropositive boars were found not only in areas where they share their habitat with free ranging domestic pigs but also in areas of the island where contacts between wild and domestic pigs are unlikely to occur. Thus there may be transmission and persistence of the virus within the wild boar population. This has occurred with the low virulence strain in Germany.<sup>21</sup> The persistence of infection in a wild boar population in the Brandenburg region of Germany provided optimum conditions for the establishment of a CSF epidemic in Germany.<sup>22</sup>

### Morbidity and case fatality

The disease usually occurs in epidemics, often with a morbidity of 100% and a case-fatality rate approaching 100%, when a virulent strain of the virus infects a susceptible population. However, in recent years outbreaks of a relatively slowly spreading, mild form of the disease have caused great concern in many countries. The disease associated with strains of low virulence may be unnoticed in growing and adult pigs but the infection can be associated with perinatal mortality, abortions and mummified fetuses. In a recent outbreak a mild form given experimentally to sows only produced a mild viremia with widespread antigen distribution, but without clinical signs, except lesions of

hemorrhagic dermatitis. It did however produce an antibody response and transplacental infection.<sup>23</sup>

### Methods of transmission

The source of virus is always an infected pig or its products and the infection is usually acquired by ingestion but inhalation is also a possible portal of entry. Direct animal to animal contact is the most important method of spread. Infected pigs shed a large amount of the virus in all normal secretions<sup>24</sup> – nasal, salivary, urinary, fecal and is important in transmission when there are clinical signs of the disease. It is excreted in the urine for some days before clinical illness appears and for 2–3 weeks after clinical recovery. Virus spread via excretions is more important in early stages of an outbreak.<sup>25</sup> Highly contagious by direct contact, it is likely to be transmitted by aerosol only when all the pigs in the same airspace are viremic<sup>26</sup> and even then only for a distance of 1 meter.<sup>27</sup> It has been spread experimentally by aerosol which followed the pattern of air currents.<sup>28</sup>

Sick pigs excrete virus until they die, and obviously even longer if they recover. The resistance and high infectivity of the virus make spread of the disease by inert materials, especially uncooked meat, a major problem. The UK virus in the 2000 outbreak probably came from an infected pork product, imported illegally and fed to an outdoor pig.<sup>29</sup> Outside pens, in warm weather and exposed to sunlight, lose their infectivity within 1–2 days. The ability of the virus to survive in the environment in more favorable situations is uncertain. However, it is probable that it can survive for considerable periods as the virus is quite resistant to chemical and physical influences. Transmission from neighboring units is very easy.<sup>5</sup> One of the major features of the recent Dutch outbreak was the proof that transmission from boar studs (AI) was possible as infected boars excreted virus in semen<sup>30–32</sup> and the virus probably infects spermatogonia.<sup>33</sup> It was shown that following insemination with semen containing CSF antibodies could occur as early as 7 days and all pigs were positive by 14 days.<sup>34</sup> The transmission rates in the Dutch outbreak have been calculated.<sup>35</sup>

**In areas free of the disease, introduction is usually by the importation of infected pigs or the feeding of garbage containing uncooked pork scraps.** Hopefully, in Europe the ban on swill feeding will prevent further cases of infected meat causing the problems.<sup>5</sup> Movement of pigs which are incubating the disease or are persistently infected is the most common method of spread. The infection usually originates directly from infected breeding farms. Birds and humans may also act as physical carriers of the

virus. In endemic areas, transmission to new farms can occur in feeder pigs purchased for finishing, or indirectly by flies and mosquitoes, or on bedding, feed, boots, automobile tires or transport vehicles. Farmers, veterinarians and vaccination teams can transmit the virus by contaminated instruments and drugs<sup>10</sup> but recent evidence suggests that mechanical transmission may have been overestimated.<sup>25</sup> Farmers can spread the virus within a herd by treating sick animals or employing routine health management procedures such as iron injections of newborn pigs. The common practice of not changing syringes and needles between farm visits constitutes a major risk when viremic animals are present. The most common cause of dissemination occurs through the movement and sale of infected or carrier pigs through communal sale yards when there is ample opportunity for infection of primary and secondary contacts.

When the disease is introduced into a susceptible population, an epidemic usually develops rapidly because of the resistance of the virus and the short incubation period. In recent years outbreaks have been observed in which the rate of spread is much reduced and this has delayed field diagnosis. It is not spread by dogs, cats or rats<sup>36</sup> and bird transmission is unlikely.<sup>37</sup>

### Risk factors

Following the 1997–1998 severe outbreak in the Netherlands analysis showed that there were five major increased risk factors identified.<sup>38</sup> These were: (i) presence of commercial poultry on the farm; (ii) visitors to the units not being provided with protective clothing; (iii) drivers of lorries using their own clothes not the premises they were visiting; (iv) larger size; and (v) aerosols produced by high pressure hosing. Reduced risk was associated with (i) over 30 years experience of farming; and (ii) additional lorry cleaning before being allowed on to the farm.

### Animal risk factors

Historically, infection with the hog cholera virus rapidly resulted in severe clinical disease. It is now recognized that with less virulent strains, a carrier state can occur, at least for a period of time. Following exposure to these strains, pigs may become infected without showing overt signs of the disease and although they may eventually develop clinical disease, this latent period is of importance in dissemination of infection when such pigs are sold and come in contact with others. In recent outbreaks in high pig density areas in Belgium, the interval between the first occurrence of clinical signs and the report of a suspect herd was shorter when the disease was first diagnosed in finish-

ing pigs rather than in sows, boars or nursing piglets.<sup>39</sup> The proportion of clinically affected animals was positively correlated with the proportion of serologically positive animals.

Susceptible pregnant sows, if exposed to less virulent strains of the virus, may remain clinically healthy but infection of the fetuses in utero is common and virus may be introduced into susceptible herds by way of these infected offspring. The sow with 'carrier sow syndrome' can give birth to normal healthy appearing piglets which are persistently infected and immunotolerant; these pigs along with those with chronic infections are responsible for the perpetuation of the virus in the pig population.<sup>10</sup> A fully virulent virus may also be transmitted in this manner if the sows are treated with inadequate amounts of antiserum at the time of exposure or if they are exposed following inadequate vaccination. Piglets infected in utero, if they survive, may support a viremia for long periods after birth.

During outbreaks of classical swine fever in Germany between 1993 and 1995, differing clinical courses were observed ranging from mild clinical signs to severe typical disease. The genotype of pigs may influence the outcome of hog cholera virus infection. In certain pig breeds the chronic form of the disease is more likely to occur and these pigs may excrete the virus over prolonged periods.<sup>40</sup> Experimental inoculation of purebred pigs resulted in acute fatal infections, while cross-bred pigs experienced acute, chronic and transient infections.<sup>40</sup>

### Pathogen risk factors

#### *Virulence characteristics*

The most virulent strains produce clinical disease in pigs of all ages. But there are differences in the clinical and pathological features between strains of the virus<sup>8</sup> and in their virological characteristics.<sup>41</sup> The less virulent strains cause only mild clinical disease or disease restricted primarily to fetal and newborn piglets. It is probable that this variance has always occurred in field strains of the virus but the use of inadequately attenuated live virus vaccines is also a contributory factor. The occurrence of variation in virulence and antigenicity has been recognized as a cause of failure of vaccination and 'vaccine breakdowns'. It is equally important in causing problems with the diagnosis of hog cholera in eradication programs when infection is manifest in patterns not traditionally associated with this disease.

Genetic analysis of isolates of the virus for a series of epidemics of swine fever in Italy affecting both domestic pigs and wild boar has provided useful

epidemiological information.<sup>42</sup> The isolates were divided into three subgroups and it is suggested that there have been at least two separate introductions of classical swine fever over a 7-year period and that the virus has been transmitted between domestic pigs and wild boar. Molecular analysis can aid in tracing the transmission of the virus from domestic pigs to wild pigs and back to domestic pigs.

In the outbreaks of hog cholera in England in 1986, affected pigs in the first outbreak exhibited clinical signs and necropsy lesions indicative of a virulent strain of the virus. However, in subsequent outbreaks, clinical disease was much milder and case-fatality rates low. Experimental infection of pigs with a field isolate of the virus resulted in variations in clinical response, from acute illness to inapparent infection, including minimal changes visible at necropsy, all of which indicates that genotype may influence the pathogenesis of the disease. High titers of virus were found in several tissues of one experimental pig which was recovering, even in the presence of serum neutralizing antibodies. It is clear that some infected pigs may pass through an abattoir without detection because of the absence of lesions.

**Resistance of virus.** The virus is destroyed by boiling 5% cresol, or 3% sodium hydroxide and by sunlight, but it persists in meat which is preserved by salting, smoking and particularly by freezing. The virus can be inactivated in at least 80% of pork hams after exposure to a flash temperature of 71°C (159°F). It can survive in infected uncooked ham pork for at least 84 days and 140 days in diced ham or sausage<sup>43</sup>; bacon for 27 days after traditional curing processes and for at least 102 days in hams cured in salt concentrations of up to 17.4%, which is much higher than that normally used in curing bacon. The use of lower salt concentrations in curing solutions, and the decreased time between slaughter and consumption as a result of modern abattoir practices, increases the risk of disease transmission. It survives pH ranges from 3 to 11. Persistence in frozen meat has been observed after 4.5 years. The virus persists for 3–4 days in decomposing organs and for 15 days in decomposing blood and bone marrow.

#### Immune mechanisms

Maternal antibodies may interfere with the production of viral specific cell mediated immunity.<sup>44</sup> Neutralizing antibodies occur as early as 9 days after infection in recovering pigs and after 15 days in fatally infected pigs.<sup>45</sup> Neutralizing antibodies are the most important antibodies in terms of protection. The maximum anti-

body response occurs 3–4 weeks after infection and levels may persist indefinitely but last at least 6 months. In chronic hog cholera, neutralizing antibodies may be transiently detectable during the phase of partial recovery between 3 and 6 weeks after infection. Low virulent strains of hog cholera may cause inapparent infections and are described as poorly immunogenic but in some instances may induce considerable titers of neutralizing antibodies in immunocompetent pigs. Cellular immunity mechanisms are probably very important in that it has been shown that there is CSFv specific IFN-gamma formed early after antigen exposure.<sup>46</sup> These mechanisms produce a higher response after I/N or oral vaccination than after I/M vaccination and therefore vaccines should be looked at for their potential to induce higher T-cell responses.<sup>47</sup> Intra-uterine infection of piglets with the virus may induce a state of specific immunological unresponsiveness. The piglets are persistently viremic and may continue to live for several weeks or months but the majority die within the first 3 weeks of life. Piglets with PRRSv infections have been shown to produce a poorer response.<sup>48</sup>

#### Economic importance

Hog cholera has been responsible for large economic losses in the swine industry worldwide. It is considered to be the most important disease of pigs in the European Union and a common program of eradication in the member states is in effect. The magnitude of the economic importance of the disease is directly proportional to the size of the pig population and the standards of the swine industry. In countries with intensified systems of pig production, such as the Netherlands, it is estimated that the direct costs of transport and destruction of infected herds, disinfection of premises, indemnities to farmers, vaccination, and identification and registration of pigs on behalf of the control of the disease amounted to a large percentage of the gross slaughter value. The additional, indirect, damage as a result of loss of production on infected farms, standstill of pig movements in affected areas or regions and restrictions on export is difficult to evaluate. Losses due to the death of pigs are aggravated by the high cost of vaccination programs in enzootic areas and by the problem that vaccination may not be completely effective in controlling epidemics. Recovered or partially recovered pigs are very susceptible to secondary infections, and exacerbation of existing chronic infections such as enzootic pneumonia are likely to occur during the convalescent period. Between 1990 and 1994, outbreaks occurred in Belgium which resulted in the destruction of about

2 million pigs and the total cost of control by 1995 was \$120 million.<sup>49</sup>

#### PATHOGENESIS

The tonsil is the primary site of virus invasion following oral exposure. Primary multiplication of the virus occurs in the tonsils, beginning within several hours after infection. The virus is first found in plasma before the mononuclear cell populations.<sup>50</sup> The primary cell in the peripheral blood to be infected is the mixed granulocyte.<sup>51</sup> The virus then moves through lymphatic vessels and enters blood capillaries, resulting in an initial viremia at approximately 24 hours. At this time the virus is present in the spleen and other sites such as peripheral and visceral lymph nodes, bone marrow and Peyer's patches. The virus exerts its pathogenetic effect on endothelial cells, lymphoreticular cells and macrophages, and epithelial cells.<sup>52</sup> A B-lymphocyte deficiency associated with viral destruction of germinal centers in lymphoid tissues is the most significant pathoimmunological consequence of acute hog cholera infection.<sup>53</sup> This lymphocyte apoptosis which is activation induced programmed cell death is one of the key features of CSF infections.<sup>54</sup>

Most of the lesions are produced by hydropic degeneration and proliferation of vascular endothelium, which results in the occlusion of blood vessels. This effect on the vascular system results in the characteristic lesions of congestion, hemorrhage and infarction from changes in arterioles, venules and capillaries. Thrombosis of small and medium-sized arteries is another feature. Vascular changes are most severe in the lymph nodes, spleen, kidneys and gastrointestinal tract. Lesions related to the effects on the endothelial cells also occur in the adrenals, central nervous system and eyes. Atrophy of the thymus, depletion of lymphocytes and germinal follicles in peripheral lymphoid tissues, renal glomerular changes and splenitis are characteristic. A leukopenia is common in the early stages, followed by a leukocytosis in some animals, and anemia and thrombocytopenia occur.<sup>52</sup> The thrombocytopenia may be caused by massive platelet activation and subsequent phagocytosis of platelets secondarily to the release of platelet activating factors by activated macrophages.<sup>55</sup> Disseminated intravascular coagulation is common with microthrombi in small vessels, particularly of the kidney, liver, spleen, lymph nodes, lung, intestine, and intestinal lymph nodes. The end stage of a lethal infection in the natural host is associated with a marked depletion preferentially of B-lymphocytes in the circulatory system as well as in the lymphoid tissues.<sup>14</sup> Macrophage activation and



subsequent release of pro-inflammatory cytokines, plays an important role in the development of the classical signs of CSF. This is particularly true for the pulmonary intravascular macrophages.<sup>56</sup>

It has been shown that there is a significant expression of TNF $\alpha$  in virus infected lymph nodes.<sup>57</sup> It may be that commitment to apoptosis may depend on the IFN production.<sup>58</sup> In these lymph nodes lymphocyte death occurred by apoptosis and some of the cells were positive on IHC for both TNF $\alpha$  and apoptosis. It may be that the release of the TNF $\alpha$  may induce the apoptosis in the uninfected bystander cells. Early immunosuppression is an important feature of the development of CSF<sup>59</sup> with the depression of CD1<sup>+</sup>, CD4<sup>+</sup> and CD8<sup>+</sup> common thymocytes. It has recently been shown that CSF can replicate in the dendritic cells and control IFN type 1 responses without interfering with immune reactivity.<sup>60</sup> It is still not clear, even though it is known that there is clear targeting of macrophages and monocytes, how these cells produce this immunosuppression and account for the death of the T-lymphocytes.<sup>61</sup> It is known that the dendritic cells are the sentinels of the immune system<sup>62</sup> and respond to easy viral contact.<sup>63</sup> They then develop the effective immune responses by migrating into the lymphoid tissue to present the processed viral antigens to the T-lymphocytes.<sup>64</sup> However, in both CSF and BVD infections there is no activation of the dendritic cells<sup>65</sup> and this may be a feature of pestivirus infections and enable them to evade the immune response. At the same time there is no interference with the maturation of the dendritic cells. The virus induces pro-inflammatory cytokine production (IL-1, IL-6, and IL-8) by 3 hours and even further at 24 hours post-infection and also increases the coagulation factors, tissue factor and vascular endothelium cell growth factor.<sup>66</sup> Endothelial cells that were chronically infected were unable to produce IFN type 1 and these cells were also protected from apoptosis. This establishes a long-term infection of endothelial cells with virus replication and increasing levels of IL-1, IL-6, and IL-8. It shows that there has been long term interference with cellular antiviral defences<sup>67</sup> possibly by targeting interferon regulating factor 3 like BVDv does<sup>68,69</sup> or by increased binding of NF- $\kappa$ B (kappa/beta) which modulates an apoptotic pathway controlling several anti-apoptotic genes.<sup>70</sup>

In many cases, secondary bacterial infection occurs and plays an important part in the development of lesions and clinical signs.

The experimental disease is characterized by a biphasic temperature elevation at

the 2nd and 6th day after inoculation, a profound leukopenia and an appreciable anemia 24 hours after inoculation, diarrhea at the 7th day, and anorexia and death on the 4th to 15th day in slaughter pigs.<sup>71</sup> The anemia can be explained by the infection of 2–9% of the megakaryocytes 2–9 days after infection.<sup>72</sup>

The inoculation of pregnant sows with a low-virulent field strain of hog cholera virus at various stages of pregnancy results in prenatal mortality in litters from sows infected at pregnancy day 40 and postnatal death at 65 days. The later that infection occurs in pregnancy the greater the number of uninfected piglets born in infected litters. Transplacental infection of the porcine fetus with both field and vaccine strains of the virus may induce a spectrum of abnormalities including hypoplasia of the lungs, malformation of the pulmonary artery, micrognathia, arthrogryposis, fissures in the renal cortex, multiple septa in the gallbladder and malformations of the brain. Infection of the fetus at a critical stage of gestation (30 days) induces retardation in growth and maturation of the brain, resulting in microencephaly. The teratogenicity of the virus clearly depends on the stage of gestation. In general, the earlier the infection occurs the more severe the abnormalities are likely to be. The virus can be found in the ovaries because the blood vessels deliver peripheral macrophages to the ovaries through atretic follicles.<sup>73</sup>

One of the sequelae of transplacental hog cholera virus infection of the fetus is congenital persistent virus infection with the evolution of a runt-like syndrome during the first few months of life.<sup>52</sup> At birth, affected piglets appear normal, although they are viremic and the viremia persists throughout life of the animals. The first evidence of clinical disease may occur at about 10 weeks of age but it may be delayed until 4 months of age. Growth retardation, anorexia and depression, conjunctivitis, dermatitis, intermittent diarrhea, and locomotor disturbance with posterior paresis occur. At necropsy, the most remarkable lesion is atrophy of the thymus gland and lesions of classical hog cholera are not present. In experimental congenital persistent hog cholera infection, the earlier the infection occurs in pregnancy the greater the number of persistent infections in piglets born alive with immunological tolerance.<sup>52</sup> The immunological tolerance is specific to the virus because affected piglets respond to other selected antigens.

The experimental infection of pregnant goats with the hog cholera virus on days 64–84 of gestation can result in transplacental infection with the virus replicating and persisting in the fetuses for at least

40–61 days. The virus is highly pathogenic for goat fetuses and serum antibodies may be present in the pre-colostral sera of the kids.

## CLINICAL FINDINGS

### Diagnosis

Nearly always the detection is too late because it has been missed.<sup>74,75</sup> The clinical signs are often non-specific but the score system suggested by the Dutch may help to suggest it.<sup>76</sup> The differences in the four most recent German outbreaks in terms of clinical and pathological signs were minimal.<sup>77</sup> In former times most of the European outbreaks were associated with the virulent genotype 1 of the virus but now they are types 2:1, 2:2 or 2:3,<sup>78,79</sup> which are much less virulent and therefore produce a milder clinical course that is much more difficult to recognize over the first 14 days post-infection. In a recent set of experiments (with a strain of virus SF0277) all the pigs died but in other experiments<sup>80</sup> some of the pigs survived.

A recent report has suggested that the occurrence of PRRS does not appear to potentiate the clinical outcome of CSF in young pigs,<sup>81</sup> but this has been disputed.<sup>48</sup>

Simultaneous infection with *Trypanosoma evansi* does seem to produce a poor response to CSF vaccination.<sup>82</sup>

As a result of the recent outbreak in the Netherlands a quantitative retrospective analysis was made of the clinical signs<sup>83</sup> which suggested that the clinical inspection was the most important part of detection but was not very specific. Moderate virulence and low virulence strains cause a mild disease that may be so mild that clinical disease is not suspected.<sup>84</sup>

Differential diagnosis should include PRRS, PDNS,<sup>85</sup> ASF, salmonellosis, and coumarin poisoning.

### Peracute and acute disease

Clinical signs usually appear 5–10 days after infection but incubation periods up to 35 days or more are recorded. At the beginning of an outbreak, young pigs may die peracutely without evidence of clinical signs having occurred. Acute cases are the most common. Affected pigs are depressed, do not eat, and stand in a drooped position with their tails hanging. They are disinclined to move and, when forced, do so with a swaying movement of the hind-quarters. They tend to lie down and burrow into the bedding, often piled one on top of the other. Prior to the appearance of other signs, a high temperature (40.5–41.5°C; 105–107°F) is usual. In recent European outbreaks respiratory signs have not been common. Constipation followed by diarrhea and vomiting also occur. Later a diffuse purplish discoloration of the abdominal skin occurs. Small areas of necrosis are sometimes seen on the edges

of the ears, on the tail and lips of the vulva. A degree of conjunctivitis is usual and in some pigs the eyelids are stuck together by dried, purulent exudate. Nervous signs often occur in the early stages of illness and include circling, incoordination, muscle tremor and convulsions. Death can be expected 5–7 days after the commencement of illness. Infection with *Salmonella choleraesuis* may also be potentiated by hog cholera infection and the two diseases in combination can result in high mortality.

### Nervous manifestations

A form of the disease in which nervous signs predominate is attributed to a variant strain of the virus. The incubation period is often shorter and the course of the disease more acute than usual. Pigs in lateral recumbency show a tetanic convulsion for 10–15 seconds followed by a clonic convulsion of 30–40 seconds. The convulsion may be accompanied by loud squealing and may occur constantly or at intervals of several hours, often being followed by a period of terminal coma. In some cases convulsions do not occur but nervous involvement is manifested by coarse tremor of the body and limb muscles. Apparent blindness, stumbling and allotriphagia have also been observed.

### Chronic disease

Low virulence strains of virus result in less severe disease syndromes.<sup>86</sup> A chronic form occurs in field outbreaks and occasionally after serum–virus simultaneous vaccination. The incubation period is longer than normal and there is depression, anorexia, persistent mild fever, unthriftiness, the appearance of characteristic skin lesions including alopecia, dermatitis, blotching of the ears and a terminal, deep purple coloration of the abdominal skin. Pigs may apparently recover following a short period of illness but subsequently relapse and die if stressed.

Pigs infected with the low virulence strains of the virus appear more susceptible to intercurrent bacterial disease. The changeable nature of this combination is such that hog cholera should be suspected in a herd or area where there is an increase in mortality from any apparent infectious cause that either does not respond, or responds only temporarily, to therapeutic ploys that are usually effective.

### Reproductive failure

Reproductive failure can be a significant feature and may occur without other clinical evidence of disease within the herd. It may occur when inadequately protected pregnant sows are exposed to virulent virus, or when susceptible pregnant sows are vaccinated with live attenuated vaccines or exposed to low-virulent field strains. Infection of the sow

may result in no clinical signs other than a mild pyrexia, but it may be followed by a high incidence of abortion, low litter size, mummification, stillbirth and anomalies of piglets.<sup>52</sup> Liveborn pigs, although carriers, may be weak or clinically normal. Persistent congenital infection is characterized by persistent viremia, continuous virus excretion and late onset of disease, with death occurring 2–11 months after birth. No antibodies to the virus are present in spite of the persistent infection; affected pigs have a normal immune response to other antigens, but do not respond to the hog cholera virus.<sup>52</sup> Cell-mediated immunity appears to be normal. A high incidence of myoclonia congenita (congenital trembles) associated with cerebellar hypoplasia has been observed in some outbreaks where prenatal infection with hog cholera virus has occurred and this syndrome has been reproduced experimentally.<sup>52</sup> The prevalence of any one of these manifestations appears to vary with the strain of the virus and the stage of gestation at the time of infection.<sup>52</sup>

## CLINICAL PATHOLOGY

### Hematology

A valuable antemortem diagnostic test is the total and differential leukocyte count. In the early stages of the disease there is a marked leukopenia, the total count falling from a normal range of 14 000–24 000  $\mu\text{l}$  to 4000–9000  $\mu\text{l}$ .<sup>35</sup> This is specifically a granulocytopenia caused by a bone marrow atrophy.<sup>54</sup> It is a result of apoptosis or necrosis, from 1–3 days post-infection probably as a result of cytokine interaction. Depletion of the lymphocyte sub-populations occurs 1–4 days before the virus can be detected by RT-PCR on serum. If a virulent form depletion is evident by 2 days.

B-lymphocytes, T-helper cells and cytotoxic T-cells are the most affected by the virus. The loss of the circulating B-lymphocytes was consistent with the failure to generate a circulating neutralizing antibody.<sup>87</sup> Virulent strains produce a more reduction in B-lymphocytes than do mild forms.<sup>88</sup> This can be of value in differentiation from bacterial septicemias but it should not be used as the sole method of differentiation. In the late stages of hog cholera, a leukocytosis due to secondary bacterial invasion may develop. Piglets less than 5 weeks of age normally have low leukocyte counts.

### Diagnostic tests

A comparison of diagnostic tests shows that the best results are detected by RT-PCR (98.9%) which is earlier than VI on blood which gives only a result of 94.5%. RT-PCR is expensive and labor intensive. The antigen-ELISA gives a later detection and the worst results.<sup>89</sup> The leukocyte count gives the earliest pointer to CSF infection but of course does not confirm the disease.

The advent of eradication programs has resulted in the development of diagnostic tests for hog cholera. These tests must be accurate and rapid so that control measures can be rapidly instituted or lifted as required. Diagnosis by virus isolation is slow, cytopathic effect may be minimal and some strains have low infectivity and limited growth in tissue culture. This method is seldom used as a primary diagnostic method. Animal inoculation tests still provide an excellent method for the diagnosis of hog cholera and involve the challenge of susceptible and immune pigs with suspect material followed by subsequent challenge at a later date with fully virulent hog cholera virus. However, this test is time-consuming and costly and, although it is used for the final confirmatory test for the presence of hog cholera infection in various situations, it is not satisfactory for a rapid diagnostic test.

### Detection of virus

The more rapid tests rely on the detection of antigen in infected pig tissues or the detection of antibody following infection.

#### Fluorescent antibody techniques

This technique allows the rapid detection of antigen in frozen sections of tissue or impression smears and in infected tissue cultures and these methods have been adopted as a primary test in the eradication program in the United States. Antigen can be detected up to 2 days after death and this method has been considered more reliable than the agar gel precipitation test. The method is capable of detecting virus carriers among vaccinated pigs.

#### Antigen-capture ELISA

The antigen-capture enzyme-linked immunosorbent assay (ELISA) can detect the virus antigens in blood and tissues from experimentally infected pigs at 4–6 days after infection with a moderate-high virulent strain (Weybridge virus) and 7–9 days after infection with a low-virulent strain (New South Wales virus).<sup>90</sup> The technique does not require tissue culture and takes less than 36 hours for a definitive result.

#### Agar gel precipitation test

This test detects antigen in tissue by means of a precipitin formed with immune sera. Usually pancreas from suspect pigs is tested. This test was used widely in the United Kingdom eradication program and is the standard primary test in many countries.

### Differentiation of swine fever virus from other pestiviruses

#### PCR tests

A polymerase chain reaction (PCR) assay can be used to differentiate classical swine fever virus from ruminant

pestiviruses.<sup>91</sup> An international reference panel of monoclonal antibodies for the differentiation of hog cholera virus from other pestiviruses has been developed.<sup>92</sup> Restriction endonuclease cleavage of PCR amplicons can distinguish between vaccine strains and European field viruses.<sup>93</sup> The RT-PCR can also detect CSF in boar semen.<sup>94</sup> A RT-PCR was then described.<sup>95</sup> Rapid detection of CSF using a portable real time reverse transcriptase PCR (RT-PCR; TaqMan) has been described.<sup>96</sup> Further modifications have been described<sup>97</sup> so that the test can be performed in a single tube with all the ingredients. It can then be used as a pen-side test and detects virus in nasal and tonsil scrapings 2–4 days before the onset of clinical signs. A further modification of RT-PCR and ISH has been that they can be used on formalin fixed sections.<sup>98</sup> A multiplex PCR is available to separate BVD from CSF.<sup>99</sup>

#### Serological tests

Antibody can be detected by the fluorescent antibody neutralization test, tissue culture serum neutralization test or an indirect ELISA. Serological tests are less satisfactory for detection of hog cholera in the acute phase and are of limited value in vaccinated animals. They are of value in the detection in sows of the subclinical infection of hog cholera associated with reproductive failure and for survey studies to determine the prevalence of hog cholera infection. BVDV may infect pigs, especially those in close contact with cattle, and may give false-positive serological reactions. The incidence of these false-positive reactions may be high and they pose a problem for hog cholera identification in eradication programs. The neutralizing peroxidase-linked antibody assay is a highly sensitive and specific test for hog cholera and will distinguish between pigs infected with different strains of the hog cholera virus and BVDV. The complex, trapping, blocking ELISA is sensitive, specific and reliable for screening purposes for early identification of infected herds and their elimination in an eradication program.<sup>100</sup> A peroxidase-labeled antibody assay can be used to detect swine IgG antibodies to hog cholera and BVDVs.<sup>101</sup> Monoclonal antibodies to pestiviruses are also available to discriminate between both viruses.<sup>102,151</sup> A competitive ELISA using a truncated E2 recombinant protein has been described which can be used when a large number of samples are to be tested.<sup>103</sup>

#### Samples for laboratory

When hog cholera is suspected, tissues submitted for examination should include the brain and sections of intestine and other internal organs in formalin, and pancreas, lymph node and tonsil unprepared in sealed containers. Local regu-

lations and requirements should be followed. The viral antigens are densely distributed in the skin and tongue of infected pigs, and biopsies of ear may be useful for diagnosis on a herd basis.<sup>104</sup>

#### NECROPSY FINDINGS

In many cases the single most important diagnostic aid is the post-mortem examination although in the Dutch outbreaks it was thought that the contribution to the detection of CSF was limited.<sup>105,106</sup> The reason for this is that there is tremendous individual variation. In the outbreak in the UK in 2000 there were few lesions in fetuses or in neonates and in the sows lesions were often restricted to conjunctivitis and lesions in the hepatic and splenic lymph nodes even though 15 animals in each group were examined. The only group showing more consistent lesions were the growers and in these the lesions were similar to those that are reported in the classical outbreaks.

In peracute cases there may be no gross changes at necropsy. In the more common acute form, there are many submucosal and subserosal hemorrhages but these are inconstant and to find them it may be necessary to examine several carcasses from an outbreak. The hemorrhage results from erythrodiapedesis and increased vascular permeability, probably aided by mast cell degranulation.<sup>107</sup> The hemorrhages are most noticeable under the capsule of the kidney, about the ileocecal valve, in the cortical sinuses of the lymph nodes and in the bladder and larynx. The hemorrhages are usually petechial and rarely echymotic. The lymph nodes are enlarged and the spleen may contain marginal infarcts. Infarction in the mucosa of the gallbladder is a common but not constant finding and appears to be an almost pathognomonic lesion. There is congestion of the liver and bone marrow and often of the lungs. Circular, raised button ulcers in the colonic mucosa are usual but cannot be distinguished from those of salmonellosis. Although these gross necropsy findings are fairly typical in cases of hog cholera, they cannot be considered as diagnostic unless accompanied by the clinical and epizootological evidence of the disease. They can occur in other diseases, particularly salmonellosis. In a recent study<sup>77</sup> found that the lymph nodes had the highest score for lesions and that the least lesions were found in the spleen and tonsil because infection of these organs was also rare. The most common lesions were also in the lymph nodes, around the ileo-caeco-colic junction and around the blood vessels of the brain. Atypical bronchiolar cilia have been reported.<sup>108</sup>

There are characteristic microscopic lesions of a non-suppurative encephalitis

in most cases and a presumptive diagnosis of hog cholera can be made if they are present. It is thought that the most common lesion in chronic CSF is the mononuclear cell cuff in the CNS. Here ISH is capable of detecting viral nucleic acid even when viral antigen is not detected.<sup>94</sup> Histologically, the main site of tissue injury is the reticuloendothelial system. There is always a progressive lymphoid depletion and mucosal necrosis. The depletion is probably caused by apoptosis but not by direct apoptosis. Atrophy of the thymic cortex and loss of thymocytes is also a feature and may be related to synthesis of the cytokines, TNF $\alpha$  and IL-1 $\alpha$  in particular<sup>109</sup> which may increase the apoptosis of the thymocytes.

Fibrinoid necrosis of the tunica media combined with hydropic degeneration and proliferation of the vascular endothelium causes occlusion of blood vessels. The more virulent 'neurotropic' strains produce lesions of a similar nature but greater severity.

In the intestinal tract mucosa there are large, usually infected macrophages.<sup>110</sup> The GALT areas are lymphocyte depleted usually because of massive lymphocyte apoptosis particularly in the B-cell areas. These changes are possibly due to the large amounts of TNF $\alpha$  and IL-1 $\alpha$  released from the infected macrophages.<sup>111</sup> They also showed that the macrophages in the splenic marginal zone were amongst the first cells to be infected. The infection, mobilization, and apoptosis of splenic macrophages plays a very important role in the course of the infection through cytokine release. An unusual manifestation of CSF infection is the onset of metaphyseal bone formation caused by the partly thrombosed vessels in the bone with strong CSF viral specific fluorescence.<sup>112</sup>

Histology, showed swelling and vacuolation of megakaryocytes in the bone marrow 2 days after infection and they were necrotic 4 days after infection.<sup>113</sup> Severe swelling and necrosis of endothelial cells in the vascular endothelium were observed 3 days after infection. It was concluded that the thrombocytopenia due to direct viral damage to MKC and endothelial damage can cause hemorrhagic diathesis whereas coagulation disorders are not involved in early stages of the disease.<sup>114</sup>

In the chronic form of the disease, ulceration of the mucosa of the large intestine is usual. Secondary pneumonia and enteritis commonly accompany the primary lesions of hog cholera.

Infection of the fetus produces a persistent immunologically tolerant non-cytolytic infection, often with little evidence of cell necrosis or inflammatory reaction to suggest the presence of a virus. Aborted fetuses show non-diagnostic

changes of petechial hemorrhage and ascites. Malformations such as microcephaly, cerebellar hypoplasia, pulmonary hypogenesis and joint deformity appear due to inhibition of cell division and function in these areas. Antibody is not detected in fetal blood when infection occurs early in fetal life. In pigs showing signs of myoclonia congenita, cerebellar hypoplasia is highly suggestive of hog cholera infection.

An immune complex glomerulonephritis has been described<sup>115</sup> in which there is macrophage infiltration of the mesangium with immune complex deposits of IgM, IgG, and Clq in mesangial, subepithelial and subendothelial areas from 10 days post-infection and by 14 days neutrophils had also congregated.<sup>116</sup>

This is a disease of major economic importance and confirmation of the diagnosis is usually performed in specialized governmental laboratories. Virus isolation and fluorescent antibody tests<sup>104</sup> are most commonly used but other techniques, including immunoperoxidase staining of cryostat sections.<sup>92</sup> The demonstration of viral antigen in the crypts of the tonsils, tubular epithelial cells of the kidney, bronchiolar mucosal gland cells and the pancreatic epithelial cells has been shown to be possible even after 18 years in formalin.<sup>117</sup>

#### Samples for confirmation of diagnosis

Fresh tonsil can be used for polyclonal direct fluorescent antibody which also detects BVD and BDV and can then use additional tests. The sensitivity of this test was shown to be only 78% so to give a 99% chance of infection being detected you had to postmortem five animals.<sup>118</sup>

- **Histology** – formalin-fixed brain, spleen, lymph nodes, colon, cecum, ileum, kidney, tonsil, skin, tongue (LM). Tissue sections can also be used for ISH and IHC<sup>115</sup>
- **Virology** – lymph nodes, tonsil, spleen, distal ileum, skin, tongue, brain (FAT, ISO, IHC, PCR). Heparinized blood.

#### TREATMENT

##### DIFFERENTIAL DIAGNOSIS

A positive diagnosis of hog cholera is difficult to make without laboratory confirmation. This is particularly true of the chronic, less dramatic forms of the disease. A highly infectious, fatal disease of pigs with a course of 5–7 d in a group of unvaccinated animals should arouse suspicion of hog cholera, especially if there are no signs indicative of localization in particular organs. Nervous signs are

probably the one exception. The gross necropsy findings are also non-specific and reliance must be placed on the leukopenia in the early stages and the non-suppurative encephalitis visible on histological examination. Both of these bacterial infection, particularly salmonellosis, is present.

The major diseases which resemble hog cholera include:

- **Salmonellosis** usually accompanied by enteritis and dyspnea
- **Erysipelas** in which there are characteristic diamond skin lesions, and the subserous hemorrhages are likely to be ecchymotic rather than petechial;
- **Pasteurellosis** in which respiratory signs predominate and lesions of pleuropneumonia at necropsy are characteristic.

Epidemiological considerations and hematological and bacteriological examination will usually differentiate these conditions.

**Other encephalitides**, particularly **viral encephalomyelitis** and **salmonellosis** cause similar nervous signs.

**African swine fever** apart from its greater severity, is almost impossible to differentiate from hog cholera without laboratory testing.

Hyperimmune serum is the only available treatment and may be of value in the very early stages of the illness if given in doses of 50–150 mL. It has more general use in the protection of in-contact animals. A concentrated serum permitting the use of much smaller doses is now available.

#### CONTROL

The methods used in the control include **eradication** and control by **vaccination**. Both modeling and real time prediction have been described.<sup>119</sup> In areas where effective barriers to reintroduction of the disease can be established, eradication of the disease by slaughter methods is feasible and usually desirable. In contrast, in areas where the structure and economics of the pig industry require considerable within-country and across-border movement of pigs, it may not be practical or economically feasible to institute a slaughter eradication program. The establishment of a highly susceptible population in a high-risk area is unwise. If repeated breakdowns occur, the restriction of movement of pigs within the quarantine areas creates considerable managemental problems for pig owners and they may, as a result, eventually become non-cooperative in the program. In these areas, control and possibly even eradication by vaccination is the approach of choice and this method is used in some countries like the Phillipines.<sup>18</sup> The Commission for the European Communities has declared its policy, supported by appropriate com-

munity legislation, to eliminate hog cholera without vaccination.<sup>17</sup> A full discussion of the possibility of using vaccination in the future has been outlined.<sup>120</sup> A computerized framework for the risk assessment for CSF has been produced.<sup>150</sup> In Germany there are big risks with regard to the import of pigs, wild boars and the import of pig meat.<sup>121</sup> A retrospective spatial and statistic simulation to compare two vaccination techniques with the non-vaccination scenario in the Dutch 1997/1998 CSF outbreak showed that both emergency vaccination techniques would hardly have been more efficient.<sup>122</sup> General procedures are described first followed by a description of the immunizing products available.

#### Control of outbreaks in hog cholera-free areas

Modelling for the control of CSF in such areas has been described B.<sup>123</sup>

In areas where the disease does not normally occur, eradication by slaughter of all in-contact and infected pigs is possible and recommended. The pigs are slaughtered and disposed of, preferably by burning. All herds in the area should be quarantined and no movement of pigs permitted unless for immediate slaughter. In areas with high pig densities, control strategies depend on highly effective identification and recording systems which provide information on herd inventories and animal movements so that herd epidemics can be traced back to their origin.<sup>17</sup> Recent experiences with epidemics of swine fever in Belgium and the Netherlands found that, with the current ear tag with manual recording and use of documents system, most epidemics could not be traced back to their origin.<sup>17</sup> The tracing and removal of carrier herds prevents these herds from becoming infectious and prevents the spread of disease at an early stage.

All vehicles used for the transport of pigs, all pens and premises and utensils must be disinfected with strong chemical disinfectant such as 5% cresylic acid. Contaminated clothing should be boiled. Entry to and departure from infected premises must be carefully controlled to avoid spread of the disease on footwear, clothes and automobile tires. Legislation prohibiting the feeding of garbage or commanding the boiling of all garbage before feeding must be enforced. This eradication procedure has controlled outbreaks which have occurred in Canada and Australia and has served to maintain these countries as free from the disease.

#### Control where hog cholera is endemic

One of the major problems in Europe is the wild life reservoir in the wild boar population. In areas where there is little

risk there are few positive animals but where there is a high risk then many animals may be positive. In Switzerland 179 of 528 boars in a risk area were positive.<sup>124</sup> The oral vaccination of wild boars was described in Germany<sup>125,126</sup> has no risk for the establishment of a persistent wild boar CSF infection.<sup>127</sup> However it was shown that more than 50% of the wild boar did not feed on the vaccination baits and therefore did not become immune.<sup>125</sup> There is evidence from wild boar studies in Italy that the level of infection in the free population gradually reduces in any case.<sup>129</sup> Where you have wild pigs with maternal antibodies when they contract live CSF virus they have transient clinical signs but the disease is not lethal. Infected wild boars could therefore play a very big part in the transmission of a natural outbreak.<sup>130</sup> The vaccination studies in wild boar were reported recently and showed that after the 5th vaccination there was no viremia, no virus excretion, and no post mortem virus recovery.<sup>131</sup> Oral vaccination of wild boar usually reduces the presence of CSF but only a low rate of wild boar (30–35%) become seropositive.<sup>132</sup>

In endemic areas, control is mostly a problem of selecting the best vaccine and using it judiciously. In Asia almost all the control is vested in the use of vaccines and their proper use. Most problems are caused by policy failures, or changes in demographics whereas most of a vaccination policy should be determined by the epidemiology of the disease. Much can also be done to keep the incidence of the disease low by the education of farmers whose cooperation can be best assured by a demonstration that eradication is both desirable and practicable. Once farmers are motivated to act, the greatest stumbling block to control, **failure to notify outbreaks**, is eliminated. Education of the farmer should emphasize the highly contagious nature of the disease and the ease with which it can be spread by the feeding of uncooked garbage and the purchase and sale of infected or in-contact pigs. The common practice of sending pigs to market as soon as illness appears in a group is one of the major methods by which hog cholera is spread.

There are two sorts of vaccine:<sup>133</sup>

1. The first group is the classical live group containing attenuated virus and these are to be preferred. Live, virulent virus vaccines produce a solid immunity within just a few days and give lifelong protection but are capable of introducing the infection and of actually causing the disease when vaccination 'breaks' occur. The reaction to live virus vaccine may be

severe and the susceptibility of pigs to other diseases may be increased.

Eradication of the disease is impossible while the use of this type of vaccine is permitted.

2. There is a recently developed second group of live vaccines aimed as marker vaccines<sup>134</sup> based on the E2 protein<sup>135</sup> but these are still undergoing development. There appears to be no complete protection against congenital infection, they do reduce transmission of virus<sup>136</sup> and they seem to only last about 1 year.<sup>137</sup> They do have the potential to allow tests to be used to differentiate between naturally infected and vaccinated animals.<sup>138</sup> They may also fail in the face of natural infection.<sup>139–141</sup> Recent further developments of these marker vaccines<sup>77</sup> possibly include a chimeric vaccine where one of the genes has been replaced by a BVD gene and a second vaccine where a DNA vaccine expresses the E2 protein after entering the host cell and others with E2 peptides.<sup>142–145</sup>

When an outbreak occurs in a herd, the immediate need is to prevent infection from spreading further. This can be best achieved by removing the source of infection and increasing the resistance of in-contact animals by the administration of hyperimmune serum or one of the available vaccines. Removal of the source of infection necessitates:

- Isolation of infected animals. This was highlighted in the recent Dutch outbreak<sup>146</sup>
- Suitable hygienic precautions to prevent the spread of infections on boots, clothing and utensils
- Disposal of carcasses by burning
- Disinfection of pens. The pens should be scraped, hosed and sprayed with 5% cresylic acid solution or another suitable disinfectant. The choice of serum or vaccine may depend on local legislation and will depend upon circumstances. Pigs in the affected pen should receive serum (20–75 mL depending on size) and pigs in unaffected pens should be vaccinated. Pigs receiving serum only will require active vaccination at a later date if a strong immunity is to be achieved. Routine vaccination of all pigs is desirable.

### Hog cholera eradication

The elimination of hog cholera from a country where it is well established presents a formidable problem. Before the final stage of eradication can be attempted, the incidence of the disease must be

reduced to a low level by widespread use of vaccination and enforcement of garbage-cooking regulations.

One of the most important problems encountered in eradication programs is the clinically normal 'carrier' animal and steps need to be taken to avoid the sale of all pigs from infected premises. A procedure which has been particularly effective in the control of this and other diseases of pigs is the complete prohibition of all community sales of feeder pigs. There are obvious political difficulties in such a prohibition, but despite their usefulness as marketing agencies, community sales continue to be a major source of swine infections. When the occurrence of virulent hog cholera has been eliminated, further necessary steps include the prohibition of use of any vaccine and serological studies to detect low virulence carrier states.

The eradication of swine fever in the United Kingdom in 1986 was an important achievement. Control was radical in that all herds in which the disease was diagnosed were slaughtered and all carcasses burned or buried to avoid missing atypical cases and recurrence through the swill cycle. The two focal points which became apparent were the need to avoid vaccination and the need to diagnose accurately. Vaccination was not permitted because it was not completely effective, produced 'carriers', and encouraged the development of mild and chronic forms of the disease. The need to diagnose accurately led to changes in diagnostic procedure as the campaign progressed. As the proportion of classical epidemics declined, there was increasing dependence on serological and antigen-detection tests. The program in the United States, which currently appears complete, is an equivalent achievement.

### IMMUNIZATION METHODS

Very few pigs possess natural immunity to hog cholera and, until the introduction of the serum-virus method of vaccination, an outbreak of the disease in a herd meant virtually that the herd would be eliminated. The situation changed rapidly thereafter and it can be safely claimed that the development of the swine industry in the United States would have been impossible without the protection which the serum and virus provided. On the other hand, the dangers inherent in the use of fully virulent or partially avirulent virus do not recommend their use and have led to a continuing search for safe methods of immunization. The ideal vaccine should retain strong immunogenicity but should be completely avirulent, even for pregnant sows, the fetus and young or stressed pigs. It should be stable in the degree of

attenuation and should not persist in the vaccinee nor transmit from the vaccinee to in-contact pigs. Killed vaccines are safe and do not directly spread virus, but in general, they engender only a limited immunity. Live vaccines provide a longer lasting immunity but frequently have not met the criteria listed above.

#### Serum-virus vaccination

The serum-virus vaccination produces an immediate, solid and lasting immunity when properly administered to healthy swine. The virus, produced by collecting blood 6–7 days after artificial infection, is injected SC in 2 mL doses followed immediately by serum in doses graduated to the size of the pigs and varying from 20 mL for suckling pigs to 75 mL for adults. Overdosing with serum will not prevent the development of immunity. Vaccination is performed at any age after 4 weeks. Because of the availability of safer vaccines this method is not recommended.

#### Attenuated vaccines

Attenuated vaccines include tissue culture vaccines attenuated by repeated passage through tissue culture of porcine or other origin, lapinized vaccines produced by repeated rabbit passage, and vaccines from mutant strains. Many of the early vaccines of this type were not stable and could cause disease when not used in conjunction with serum. Furthermore, transmission to in-contact pigs, especially with porcine origin vaccines, and fetal disease following vaccination of pregnant sows have been problems. Attenuated vaccines are in wide use in Europe and Asia and include the Chinese or LPC and GPE strains. Recently, a safe and efficacious CSF marker vaccine based on the E2 protein (major immunogen) of the virus has been developed. This protein has neutralizing antibodies and it is also conserved. It can be used where there is an endemic problem and also after the outbreak.<sup>147</sup> It also prevents or reduces drastically the problem of trans-placental infection.<sup>148</sup> Experimental, non-transmissible marker vaccines have also been developed.<sup>149</sup> Highly passaged preparations are antigenically stable and show no evidence of reversion. They produce a very limited viremia, or none, and no leukopenia or clinical illness. Protection is evident within 5–10 days of vaccination. Piglets from non-immune sows can be vaccinated within the first 2 weeks of life. Because the presence of maternal immunity can interfere with effective immunization, the vaccination of piglets from immune sows should be delayed until at least the second month. The French Thiverval strain is a cold mutant strain which has lost its virulence but retained good immunogenicity. Vaccination of piglets even with ten times the regular dose produced no clinical illness and virtually no viremia. A single IM vaccination will produce resistance to challenge by 5–10 days and immunity persists for 3 years. Colostral immunity will protect piglets for periods up to 2 months after birth. When given to pregnant sows, even the highly attenuated strains have the ability to cross the placenta and produce fetal infection even though no clinical evidence of this may be manifest. Consequently it is recommended that replacement gilts be vaccinated at least 2 weeks prior to mating and that recently vaccinated animals be kept separate from susceptible pregnant sows.

In the Netherlands, the control of swine fever has relied on a slaughter policy on affected farms plus an emergency vaccination program in which all pigs over 2 weeks of age in areas of risk are vaccinated. The mass vaccination program is followed by supplementary vaccination of pigs at 7–9 weeks of age and revaccination of breeding gilts when they reach when 6–7 months of age. The serological response of piglets born from vaccinated sows is best at 9–10 weeks of age rather than at 5–6 weeks of age. A vaccine-induced neutralizing antibody titer of <32 is adequate to provide protection against clinical disease and to prevent virus transmission.

In the Netherlands, the control of swine fever has relied on a slaughter policy on affected farms plus an emergency vaccination program in which all pigs over 2 weeks of age in areas of risk are vaccinated. The mass vaccination program is followed by supplementary vaccination of pigs at 7–9 weeks of age and revaccination of breeding gilts when they reach when 6–7 months of age. The serological response of piglets born from vaccinated sows is best at 9–10 weeks of age rather than at 5–6 weeks of age. A vaccine-induced neutralizing antibody titer of <32 is adequate to provide protection against clinical disease and to prevent virus transmission.

#### Inactivated vaccines

These are usually prepared from the blood or tissues of infected pigs. Crystal violet vaccine has been the one most widely used of this type and was used in the United Kingdom prior to eradication but never gained full acceptance in the United States. It is completely safe but its immunogenicity is poor. Immunity does not develop until 12 days after vaccination. Its duration is short and booster injections are required for maintenance. Vaccinated sows may still develop fetal infection when exposed to virulent virus and there is a danger that the use of this vaccine in enzootic areas may in this way induce virus carriers. The production of immune antibodies to the blood components of the vaccine may result in the occurrence of isoimmune hemolytic anemia in some breeds. For these reasons inactivated vaccines are not in common use.

#### REVIEW LITERATURE

Duikhuizen AA (ed.) The 1997–1998 outbreak of CSF in the Netherlands. *Prevent Vet Med Spec Iss* 1999; 39:348 pp.  
 Paton D, Edwards S. Classical swine fever. *Vet Microbiol Spec Iss* 2000; 73:91–252.  
 Smit AJ de. Laboratory diagnosis, epizootiology and efficiency of marker vaccines in CSF; a review. *Vet Q* 2000; 22:182–188.  
 Stegeman A et al. The 1997–1998 epidemic of CSF in the Netherlands. *Vet Microbiol* 2000; 73:183–196.

Kleiboeker SB. Swine fever: classical swine fever and African swine. *Vet Clin N Am Food Anim Pract* 2002; 18:431–451.

Moennig V, Floegel-Niesmann G, Greiser-Wilke I. Clinical signs and epidemiology of classical swine fever; a review of new knowledge. *Vet J* 2003; 165:11–20.

Paton DJ, Greiser-Wilke I. Classical swine fever: an update. *Res Vet Sci* 2003; 75:169–178.

#### REFERENCES

- Liess B. *Dev Vet Virol* 1988; 27:1–298.
- Vilicek S et al. *Virus Res* 1996; 43:137.
- Paton DJ et al. *Vet Microbiol* 2000; 73:137.
- Parachariyanon S et al. *Dtsch Tierarztl Wschr* 2000; 107:236.
- Fritzemeier JJ et al. *Vet Microbiol* 2000; 83:121.
- Vanderhallen H et al. *Arch Virol* 1999 144:1669.
- Becher P et al. *Virol* 1999; 262:64.
- Kamoliriprichaiporn S et al. *Aust Vet J* 1992; 69:240.
- Sharpe K et al. *Vet Rec* 2001; 148:91.
- Terpstra C. *Vet Quart* 1987; 9 Suppl:505–605.
- Mintiens K et al. *J Vet Med B* 2001; 48:143.
- Crauwels APP et al. *Prev Vet Med* 2003; 61:263.
- Stegeman A et al. *Vet Microbiol* 2000; 73:183.
- Jemers L et al. *Vet Microbiol* 2003; 96:25.
- Cawthorne RJG. *Vet Rec* 1997; 140:187.
- Nissen B, Krieger J. *Arch Tierz Dummer* 2003; 46:535.
- Saatkamp HW et al. *Prev Vet Med* 1996; 26:119.
- Geerts P et al. *J Vet Med Sci* 1995; 57:917.
- Laddomada A et al. *Vet Rec* 1994; 134:183.
- Lowings P et al. *Epid Inf* 1999; 122:553.
- Kaden V et al. *Berl Munch Tierarztl Wschr* 2000; 113:412.
- Kern B et al. *J Vet Med B* 1999; 46:63.
- Pin Y-H et al. *Proc 16th Int Pig Vet Soc Cong* 2000; p. 618.
- Ribbens S et al. *Proc 18th Int Pig Vet Soc Cong* 2004; 1:340.
- Dewulf J et al. *Proc 17th Int Pig Vet Soc Cong* 2002; 1:323.
- Laevens H et al. *Proc 15th Int pig Vet Soc Cong* 1998; 3:189.
- Gonzalez C et al. *J Vet Med Sci* 2001; 63:991.
- Dewulf J et al. *Vet Rec* 2000; 147:735.
- Gibbens JC et al. *Vet Rec* 2000; 147:310.
- Floegel T et al. *Vet Microbiol* 2000; 77:109.
- Smit A et al. *Vet Microbiol* 1999; 67:239.
- Henneken M et al. *Vet Q* 2001; 22:228.
- Choi CS, Chae CH. *J Gen Virol* 2000; 83:2717.
- Choi C, Chae C. *J Vet Diag Invest* 2003; 15:35.
- Stegeman T et al. *Epid Inf* 2002; 128:285.
- Dewulf J. *Vet Rec* 2001; 149:212.
- Dewulf J et al. *Vet Rec* 2001; 149:212.
- Kaden V et al. *J Vet Med B* 2003; 50:357.
- Koenen F et al. *Vet Rec* 1996; 139:367.
- Depner KR et al. *Vet Rec* 1997; 140:506.
- Kamoliriprichaiporn S et al. *Aust Vet J* 1992; 69:245.
- Lovings JP et al. *J Gen Virol* 1994; 75:3461.
- Mebus CA et al. *Fd Chem* 1997; 59:555.
- Suradhat S et al. *Proc 16th Int Pig Vet Soc Cong* 2000; p. 619.
- Laevens H et al. *Vet Q* 1998; 20:246.
- Suradhat S et al. *Vet Immunol* 2001; 83:177.
- Piriou L et al. *Vet Res* 2003; 34:389.
- Li H, Yang HC. *Vet Microbiol* 2003; 95:295.
- Vanthsche P. *Pig J* 1996; 37:43.
- Gisler ACF et al. *J Vet Med B* 1998; 46:585.
- Pontrakulpipat S et al. *J Vet Med B* 2001; 48:593.
- Trautwein G. *Dev Vet Virol* 1988; 27:54.
- Susa M et al. *J Virol* 1992; 66:1171.
- Summerfield A et al. *Virology* 2000; 272:50.
- Bautista MJ et al. *Vet Path* 2002; 39:84.
- Carrasco L et al. *J Comp Path* 2001; 125:1.

57. Choi C et al. *Vet Microbiol* 2004; 95:295.  
 58. Tanaka N et al. *Genes Cells* 1998; 3:29.  
 59. Pauly T et al. *J Gen Virol* 1998; 79:31.  
 60. Carrasco L et al. *J Gen Virol* 2004; 85:1633.  
 61. Knoetig SM et al. *Immunol* 1997; 97:359.  
 62. Banchereau J et al. *J Ann Rev Immunol* 2000; 18:767.  
 63. MacPherson GG, Liu LM. *Curr Top Microbiol Immunol* 1999; 236:33.  
 64. Pulendran B et al. *Science* 2001; 293:253.  
 65. Glew EJ et al. *J Gen Virol* 2003; 84:1771.  
 66. Bensaude E et al. *J Gen Virol* 2004; 85:1029.  
 67. Ruggli N et al. *J Virol* 2003; 77:7645.  
 68. Baigent SL et al. *J Virol* 2002; 76:8979.  
 69. Charleston B et al. *J Gen Virol* 2001; 82:1893.  
 70. Karin M, Lin L et al. *Nat Immunol* 2002; 3:221.  
 71. Laevens H et al. *Vet Rec* 1999; 145:243.  
 72. Gomez-Villamandos JC et al. *J Comp Path* 1998; 119:111.  
 73. Choi C, Chae C. *J Comp Path* 2003; 128:60.  
 74. Terpstra C, de Smit AJ. *Vet Microbiol* 2000; 77:3.  
 75. Sandvik T et al. *Vet Rec* 2000; 147:251.  
 76. Mittelholzer CC et al. *Vet Microbiol* 2000; 74:293.  
 77. Floegel-Niesmann G et al. *J Vet Med B* 2003; 50:214.  
 78. Greiser-Wilke I et al. *Vet Microbiol* 1998; 73:181.  
 79. Wonnemann H et al. *Dtsch Tierarztl Wschr* 2001; 108:252.  
 80. Uttenthal AM et al. *Vet Microbiol* 2001; 83:85.  
 81. Depner KR et al. *J Vet Med Sci B* 1999; 46:485.  
 82. Holland WG et al. *Vet Paras* 2003; 111:115.  
 83. Elbers ARW et al. *Vet Microbiol* 2002; 85:323.  
 84. Elbers ARW et al. *Prev Vet Med* 1999; 42:157.  
 85. Done SH et al. *In Pract* 2002; 23:14.  
 86. Depner KR et al. *Euro J Vet Path* 1996; 2:61.  
 87. Markowska-Daniel I et al. *Res Vet Sci* 1999; 67:53.  
 88. Narita M et al. *Vet Path* 2000; 37:402.  
 89. Dewulf J et al. *J Virol Meth* 2004; 119:137.  
 90. Shannon AD et al. *Vet Microbiol* 1993; 34:233.  
 91. Canal CW et al. *Vet Microbiol* 1996; 48:373.  
 92. Edwards S et al. *Vet Microbiol* 1991; 29:101.  
 93. Vilcek S, Belak S. *Acta Vet Scand* 1998; 39:395.  
 94. Choi C, Chae C. *Vet Path* 2003; 40:107.  
 95. Vydelingum S et al. *Rev Sci Tech OIE* 1998; 17:674.  
 96. McGoldrick A et al. *J Virol Meth* 1998; 72:125.  
 97. Risatti GR et al. *J Clin Microbiol* 2003; 41:500.  
 98. Ha S et al. *Res Vet Sci* 2004; 77:163.  
 99. Zhou XB, Chin J. *Vet Sci* 2002; 22:557.  
 100. Koenen F et al. *Vet Rec* 1992; 131:396.  
 101. Afshar A et al. *J Virol Meth* 1989; 23:253.  
 102. Hess RG et al. *Vet Microbiol* 1988; 16:315.  
 103. Clavijo A et al. *J Vet Diag Invest* 2001; 13:357.  
 104. Pan IC et al. *Arch Virol* 1993; 131:475.  
 105. Elbers ARW et al. *Vet Microbiol* 2003; 94:345.  
 106. Elbers ARW et al. *Prev Vet Med* 2004; 66:239.  
 107. Gomez-Villamandos JC et al. *J Comp Path* 2000; 123:47.  
 108. Carrasco L et al. *J Comp Path* 2001; 124:29.  
 109. Sanchez-Cordon PJ. *J Comp Path* 2002; 127:239.  
 110. Sanchez-Cordon PJ. *Vet Path* 2003; 40:254.  
 111. Gomez-Villamandos JC et al. *J Comp Path* 2001; 125:98.  
 112. Teifke JP et al. *Vet Rec* 2002; 151:122.  
 113. Gomez-Villamandos JC et al. *Vet Path* 2003; 40:157.  
 114. Calderon NL et al. *Acta Vet Hung* 1997; 66:171.  
 115. Choi C, Chae C. *Vet Rec* 2003; 153:20.  
 116. Ruiz-Villamos E et al. *Vet Immunol Immunopathol* 2001; 124:246.  
 117. Narita M et al. *J Comp Path* 1999; 121:283.  
 118. Bouma A et al. *J Vet Diag Invest* 2001; 13:383.  
 119. Meester R. *Biometrics* 2002; 58:178.  
 120. Oirschot JT van. *Develop Biol* 2003; 114:259.  
 121. Nissen B, Krieter J. *Archiv Tierzucht* 2003; 46:535.  
 122. Mangen JJ. *Prev Vet Med* et al. 2001; 48:177.  
 123. Klinkenberg D et al. *Math Biosci* 2003; 186:145.  
 124. Schnyder M et al. *Vet Res* 2002; 150:102.  
 125. Kaden V et al. *Berl Munch Tierarztl Wschr* 2002; 115:179.  
 126. Kaden V et al. *Berl Munch Tierarztl Wschr* 2003; 116:362.  
 127. Kaden V et al. *Acta Virol* 2001; 45:23.  
 128. Kaden V et al. *Vet Microbiol* 2000; 73:239.  
 129. Zanardi G et al. *Vet Rec* 2003; 152:46.  
 130. Depner KR et al. *Dtsch Tierarztl Wschr* 2000; 107:66.  
 131. Kaden V et al. *Dtsch Tierarztl Wschr* 2004; 111:63.  
 132. Kern B, Lahrmann KH. *Dtsch Tierarztl Wschr* 2000; 107:490.  
 133. Oirschot JT van. *Vet Microbiol* 2003; 96:367.  
 134. Moormann RJM et al. *Dtsch Tierarztl Wschr* 2000; 73:209.  
 135. Bouma A et al. *Vaccine* 2000; 18:1374.  
 136. Smit AJ et al. *Vet Quart* 2000; 22:150.  
 137. Smit A et al. *Vet Microbiol* 2001; 78:307.  
 138. Llangedijk JP. *J Clin Microbiol* 2001; 39:906.  
 139. Dewulf J et al. *Vaccine* 2000; 19:475.  
 140. Dewulf J et al. *Vaccine* 2001; 20:86.  
 141. Dewulf J et al. *Proc 17 Int Pig Vet Soc Cong* 2002; p. 325.  
 142. Hammond JM et al. *Vet Microbiol* 2001; 80:101.  
 143. Yu X et al. *Vaccine* 2001; 19:1520.  
 144. Dong XN et al. *Vaccine* 2002; 21:167.  
 145. Van Rijn PA et al. *Vaccine* 1999; 17:433.  
 146. Crauwels APP et al. *Prev Vet Med* 2003; 61:263.  
 147. Kretzdorn D, Trigo A. *Proc Am Ass Swine Vet* 2000; p. 107.  
 148. Bouma A et al. *Vet Microbiol* 1999; 66:101.  
 149. Gennip HGP van. *Vaccine* 2002; 20:1544.  
 150. De Vos CJ et al. *Rev Sci Tech Off Int Epid* 2003; 22:795.  
 151. Moening V et al. *Dtsch Tierarztl Wochenschr* 1990; 97:91.

### AFRICAN SWINE FEVER (AFRICAN PIG DISEASE, WART HOG DISEASE)

This is an OIE List A disease. It is indistinguishable in the field from classical swine fever as both are hemorrhagic diatheses and it is just as contagious. However, it is associated with a totally different virus.

#### Synopsis

**Etiology** Large icosahedral cytoplasmic DNA virus

**Epidemiology** Disease of major threat to pig-producing countries. Occurs in Africa, western European countries, Caribbean countries. High morbidity, high case-fatality rate in classic form; low virulence form less fatal. In Africa, transmitted by argasid tick from wild pigs to domestic pigs. In Europe transmitted by direct contact with infected pigs

Antibodies in colostrum of recovered sows provide passive protection to piglets

**Signs** High fever, purplish skin, depression, anorexia, huddling, disinclination to move, weakness, incoordination, nasal and ocular discharges, diarrhea, vomiting, abortions, death in a few days. Historically, highly virulent forms; recent decades subacute and chronic forms common with fever,

depression, lethargic, recover in few weeks but remain persistently infected; chronic cases are intermittently pyrexial and become emaciated with soft edematous swelling over joints and mandible

**Clinical pathology** Severe leukopenia and lymphopenia. Detect antigen or serological tests

**Lesions** Marked petechiation of all serous surfaces, lymph nodes, epicardium and endocardium, renal cortex, bladder, edema and congestion of colon and lungs. Renal hemorrhages are considered pathognomonic

**Diagnostic confirmation** Identify virus in tissues

#### Differential diagnosis list

- Hog cholera
- Erysipelas.
- Salmonellosis.

**Treatment** None

**Control** Identification of affected pigs, slaughter and quarantine premises. Establish disease-free areas

#### ETIOLOGY

It is associated with a DNA virus which is the sole member of the Asfarviridae and as such is the only known DNA arbovirus.<sup>1</sup>

It is a large icosahedral virus that contains a linear, double-stranded DNA genome (170–190 kbp). The viral genome may encode for 165 genes<sup>2</sup> and encodes for approximately 113 viral proteins, most with an as yet unknown function.<sup>3</sup> Morphologically, it is similar to the iridoviruses but resembles the pox viruses in genome construction and gene expression. There are different forms from highly lethal to sub-clinical with different field strains and tissue culture adapted strains.<sup>4</sup> These are recognized by restriction fragment length polymorphism (RFLP) and protein p72 recognizes all viral groups. Partial p72 gene characterization allows genotyping of field strains.<sup>5</sup>

#### EPIDEMIOLOGY Occurrence

African swine fever is indigenous to the African continent where it affects wild pigs. These include wart hogs, bush pigs and escaped (feral) forest hogs which act as reservoirs of the virus which cycles between the pigs and the ticks. Wild pigs in some areas are free of infection and consequently the disease is not endemic in all areas. It was always considered to be a disease of Sub-Saharan Africa but over the years has reached new areas. The occurrence has recently been reviewed.<sup>6</sup> These include Mozambique in 1994, Kenya in 1994, Ivory Coast in 1996,<sup>7</sup> Benin in 1997 and also Togo and Nigeria in 2001.<sup>8</sup> The Kenyan outbreak seemed to be maintained in the domestic pigs without sylvatic hosts.<sup>9</sup> The Nigerian strain was 92–97% homologous to the strains from



Uganda, Dominican Republic, and Spain. The serious worry was the appearance of the virus in Madagascar in 1998.<sup>10</sup> Although studies showed only a seropositivity of 5.3%<sup>11</sup> Infection of wild pigs produces no clinical disease but with virulent strains, infection in the domestic pig is almost always fatal. Since its recognition, occurrence of the disease in South Africa has been cyclical with periods of 10–12 years of clinical disease and then an absence of disease. Until 1957, African Swine Fever (ASF) had not occurred outside the African continent. To the rest of the world it represented the most formidable of the exotic diseases of swine, a disease which had to be kept within its existing boundaries at all costs. However, ASF spread from Africa, appearing in the domestic pig population in Portugal in 1957 and Spain in 1960; and resulted in the death or slaughter of thousands of pigs. Subsequently the disease appeared in France and then Italy and in 1971 occurred in Cuba. It was successfully eradicated from these latter three countries by extensive slaughter and quarantine programs.

The exception in Europe is Sardinia where the disease is endemic in the Central Highlands although it has decreased from Oct 1994 to March 1996. In a survey in 1998, 45 of 82 municipalities in the province of Nuoro in Sardinia were found to have ASF. The principal reasons being the extensive pig farming and the occurrence of wild boar.<sup>12</sup> The partial confinement farms have less seropositivity than the free-range farms<sup>13</sup> and those in total confinement have only 20% of the level of the free-range farms. In 1978, outbreaks occurred in Malta,<sup>14</sup> Brazil, Dominican Republic and Haiti. In Malta, the disease resulted in the death or slaughter of the entire population of 80 000 pigs within 12 months of the diagnosis.<sup>14</sup> This is one of the few examples where a country had to slaughter an entire species of a domestic animal in order to eliminate a disease. An outbreak occurred in Belgium in March 1985. The source of infection was thought to be pork imported from Spain, which was fed to only one boar. Once the official diagnosis was made, all animals on affected farms were slaughtered. Animals which had direct commercial contact with infected herds were also slaughtered and the disease was declared eradicated in September 1985. In Spain, the disease had been present since 1960 but the implementation of regulations for eradication adopted in 1985 made it possible to divide the country into an African swine fever-free region and an infected region.<sup>15</sup> Since 1995 Spain and Portugal have been declared free from the disease although there was an isolated outbreak in Portugal in 1995. This has result-

ed in a marked change in the distribution and incidence of the disease.

Only pigs are affected; domestic pigs of all ages and breeds are highly susceptible, but the virus can be passed in tissue cultures of rabbits, goats and embryonated hen eggs.

Until recently, the occurrence of the disease in Africa was limited to explosive outbreaks in European pigs which came in contact with indigenous African pigs. These outbreaks tended to be self-limiting because all pigs in affected herds died or were destroyed, but after a number of years the disease became enzootic in domestic herds. Surveys of the disease in countries like Malawi illustrate the changing behavior of the disease over a period of years. The virus which was introduced to Europe in 1957, was capable of persisting in European pigs and after a period of several years in which the disease was epizootic, a change to an enzootic character occurred. The outbreak in Cuba was of a comparatively virulent form.

When the disease occurred in the Caribbean region, it posed a major threat to the large swine industry of the United States principally because of the possible spread of the virus to the feral swine population in Florida.<sup>16</sup> The feral swine population in Florida is the largest in the United States and is of major recreational and economic importance to hunters, trappers, taxidermists and dealers who sell feral swine to hunting clubs. The feral swine in Florida are descendants of domestic swine which were allowed to run wild. Experimental inoculation of these pigs with virulent isolates of the virus will cause fatal disease.

#### Morbidity and case fatality

Early in the history of African swine fever, the morbidity rate could be as high as 100% and the case-fatality rate was also often over 90%. However, a decrease in the virulence of the virus occurs with time in enzootic areas, and the case-fatality rate may now be as low as 2–3%.<sup>17</sup>

#### Methods of transmission

In **Africa**, the method of transmission of the disease from the reservoir in wild pigs to the domestic pig has been the subject of considerable interest. Infection is primarily transmitted to domestic pigs via the argasid tick *Ornithodoros moubata*. The viremic wart hog is a source of infection for the ticks. The virus can be maintained in wart hog-associated argasid ticks by a transstadial, transovarial and sexual (male to female, but usually not vice versa) transmission mechanism. It needs to replicate in the mid-gut epithelium of the tick for successful ASF infection of the tick.<sup>18</sup> The tick is relatively restricted in its habitat and if contact between domestic pigs and

wild pigs and their burrows is prevented, transmission can be prevented.<sup>14</sup> The virus can be maintained in these ticks for long periods in the absence of fresh sources of infection, with a low level of viremia lasting a long time. The young wart hogs in the burrows are infected early on, so that they act as a reservoir as well as vectors of infection. Sporadic outbreaks may thus occur in endemic areas when the virus spreads from infected ticks or wart hogs to domestic pigs. In some areas where infected wart hogs are common but where *O. moubata* is apparently absent, *O. savignyi* may be a natural field vector of the virus. It is also found in *O. porcinus porcinus*.<sup>19,20</sup> The ASF virus replicates to a high titer in the developing cells of the egg of the tick.<sup>21</sup> Ticks infected with ASF virus also have a higher mortality than uninfected ticks.<sup>22</sup>

The long-held belief that the source of the virus in primary epidemics of African swine fever in southern and eastern Africa is the carrier, wild pig, is not tenable. It is postulated that infected ticks are transported to the vicinity of domestic pigs either by wart hogs or on the carcasses of wart hogs.

In Africa, the virus is maintained primarily by a cycle of infection between wart hogs and soft ticks (*Ornithodoros moubata*).<sup>14</sup> The virus does not have an apparent effect on either wart hogs or ticks and it is only when infection of domestic pigs occurs that the virus produces disease. Indeed most wart hogs are aviremic but seropositive. The tick has a wide distribution in Africa south of the Sahara, and its main habitat is in burrows which are inhabited by the wart hog. There is a good correlation between antibodies in wart hogs and the presence of ticks. Newborn wart hogs can become infected soon after birth if bitten by infected ticks and the consequent viremia would be high enough to infect previously uninfected ticks feeding on them. It is also found in the bush pig (*Potamochoerus porcus*)<sup>23,24</sup> which following infection may be viremic for 35–91 days, and these also transmit the infection to ticks.

In **Spain and Portugal**, the methods of spread are contact between neighboring farms and the introduction of infected pigs either during the incubation period or as persistently infected virus carriers. During the last 20 years, an increasing number of outbreaks occurred in which clinical disease was not readily recognized. The mortality rates decreased and a wide range of clinical disease occurred, ranging from acute to chronic and including apparent recovery to normal health. The major consequence of the emergence of these less virulent forms of the virus was the development of persistently viremic

carriers and a large population of pigs with inapparent infection. The African swine fever virus may persist in the pig population by persistent infection in recovered pigs for several months, during which time the virus must be reactivated before transmission can occur. The virus can also persist by reinfection of recovered pigs in which virus replicates without producing clinical disease and transmission occurs by excretion and by infected blood and tissues. Wild boars in Spain carry the virus without clinical signs.<sup>25</sup>

The **European vector** of the virus is the soft tick *O. erraticus*.<sup>14</sup> It can maintain and transmit the virus for at least 300 days. In various areas of Spain, *O. erraticus* was found in 42–64% of the pens occupied by pigs.<sup>26</sup> Following the outbreak of the disease in Spain, abandonment of these pig pens has resulted in the elimination of most soft ticks infected with the virus.<sup>26</sup> The adults and large nymphs can survive for about 5 years or longer in the soil of pig pens when animals occasionally enter them. There is a relationship between the persistence of the disease and the distribution of the tick in Spain.<sup>27</sup> Hungry tick populations may transmit the virus when feeding in the winter but populations that have continuous access to pigs do not feed until the pig pens reach a temperature of 13–15°C. The development from larva to adults takes 2–3 years. In a recent study on the ticks (*O. erraticus*) from farms in Southern Portugal two types of ASF were isolated.<sup>28</sup> One produced the acute, 100% fatal disease, and the other just a low viremia in pigs.

In **Sardinia**, the major factors involved in the spread of the disease are related to the:

- Mountainous terrain in which pigs may range freely in previously infected areas
- Movement of pigs which may survive infection and mingle with other herds
- Introduction of infected pigs from unknown sources into healthy herds because of the uncontrolled movement of pigs
- Feeding of waste food containing meat from infected pigs.<sup>14</sup>

The virus has been experimentally transmitted to healthy swine by *O. coriaceus*, an argasid tick indigenous to the United States. The potential arthropod vectors of the virus in **North America and the Caribbean Basin** has been examined. Most *Ornithodoros* spp. of ticks that will feed on pigs may be capable of acting as vectors of the virus, and the possible existence of potential vectors among the other blood-sucking arthropods should not be ignored. The soft tick *O. (Alectorobius) puertoricensis* found on the Caribbean Island of

Hispaniola (Haiti and Dominican Republic) where African swine fever was endemic from 1978 to 1984, was experimentally able to transmit the virus from infected to susceptible pigs.<sup>29</sup> The *O. coriaceus* tick is able to harbor and transmit the virus for more than 440 days, passing it transstadially from the first nymphal stage to the adult, sustaining it through at least four molts. *O. puertoricensis* has all of the prerequisites for becoming a true biological vector and reservoir of the virus.

Once established in domestic pigs the disease can spread rapidly. Virus is present in high titer in nasopharyngeal excretions at the onset of clinical signs and is present in all organs and excretions in acutely sick pigs. In experimentally inoculated domestic pigs, the virus is present in substantial amounts in secretions and excretions of acutely infected pigs for only 7–10 days after the onset of fever and is present in the greatest amount in the feces. The virus can persist in the blood of some recovered pigs for 8 weeks and in the lymphoid tissues for 12 weeks. Feces are the environmental contaminant most likely to spread the infection, but blood is also highly infective and transmission could occur by contamination of wounds created by fighting. Infection occurs via oral and nasal routes and with the short incubation period once the disease is established in a herd, it spreads rapidly by direct contact. Infection amongst domestic pigs can also reputedly be spread by:

- Indirect contact by infected pens
- Ingestion of contaminated feed and water
- Feeding uncooked garbage containing infected pig material. Transmission via the hog louse *Haematopinus suis* is also probable. An important source of infection is the recovered pig which may remain persistently infected and a carrier indefinitely. Pigs which have recovered from the western hemisphere isolates (Brazilian and Dominican Republic) may be persistently infected and are resistant to experimental challenge.

### Risk factors

#### Pathogen factors

The African swine fever virus is a multi-clonal population of viruses in which all combinations of at least four markers (hemagglutination, virulence, plaque size, and antigenicity) are found. This may explain the epidemiological observation that when the disease was confined to Africa and the Iberian peninsula in the early 1960s, the viruses isolated were highly virulent to swine, but in subsequent years mortality decreased and subacute and chronic infection became more common. Experimentally, moderately virulent

African swine fever virus obtained from the Dominican Republic, when inoculated into pigs, results in an acute febrile illness along with viremia and a transient neutrophilia from which the pigs recover. The Malta 78 isolate of the virus experimentally produces a clinical syndrome similar to the African isolates of the virus.

A huge amount of research is continuing apace into the genes and the proteins produced from the expression of these genes but these are really beyond the scope of this text.<sup>30</sup> However, recent studies of ASF have suggested that the virulence may depend on their ability to regulate the expression of macrophage derived cytokines which in turn regulate Th1 and Th2 responses and control the host protective responses.<sup>31</sup> The less virulent cultures of ASF with macrophages produce more TNF $\alpha$ , IL-6, IL-12, and IL-15, i.e. virulent strains inhibit their production. It also affects chemotactic responses and phagocytic capacity<sup>32,33</sup> at the same time as a reduction in the release of toxic oxygen radicals.

The virus is highly resistant to putrefaction, heat (it will survive 2 h at 56°C and dryness and survives in chilled carcasses for up to 6 months<sup>17</sup> and at 4°C for 2 years. Probably 0.5–0.66 of all the genes of ASF are not connected with virus replication but are important for viral transmission and survival in the host.<sup>34</sup>

#### Immune mechanisms

Antibodies against the African swine fever virus occur in the colostrum of sows previously infected with the virus and are transferred passively to nursing pigs. Experimentally, passively transferred virus-specific immunoglobulins alone will protect swine against lethal infection with a highly virulent homologous strain of the virus.<sup>35</sup> The antibody-mediated protective effect is also an early event which effectively delays disease onset. The construction of blocking antibodies by some of the viral proteins probably prevents the complete neutralization of the virus by antibodies.<sup>36</sup>

Pigs infected with virulent or attenuated virus may recover and resist challenge exposure with virulent homologous and, under certain conditions, heterologous viruses. Although pigs develop antibodies which are detectable by different tests, virus-neutralizing antibodies have only recently been demonstrated against viral protein p72.<sup>37</sup> However it has recently been suggested that p30, p54, p72, and p22 proteins are not associated with neutralizing antibodies.<sup>38</sup> The sera from pigs which have been infected and are resistant will inhibit virus replication but the nature of the inhibition is not understood. Neutralization of virulent virus

isolates in both Vero cell cultures and swine macrophages using swine immune sera has been demonstrated.<sup>39</sup> Experimental exposure of pigs to a low-virulent field isolate of the virus results in a range of virus-induced specific cellular responses.

The virus induces strong *in vitro* blastogenesis of primed blood mononuclear cells, when less virulent, but live virus isolates are used. Pigs recovering from an acute infection with the virus have significant levels of virus-specific cytotoxic T-lymphocytes after *in vitro* stimulation. Viral protein p36 induces a helper T-cell response in mice.<sup>40</sup> Resistance to infection appears to be related to the level of antibody dependent cell mediated cytotoxicity. Virus-specific blastogenic and cytotoxic T-cells are prime candidates for the cells inducing and conferring protective immunity against challenge with the virus suggesting that cellular based mechanisms are highly important.<sup>41,42</sup>

### PATHOGENESIS

The virus invades through the tonsils and respiratory tract and replicates in the lymphoid tissues of the nasopharynx prior to the occurrence of a generalized viremia, which can occur within 48–72 hours of infection.

Infectivity and contact transmission develops at this time and continues for at least 7 d. Pigs inoculated with field isolates of the virus from the western hemisphere develop thrombocytopenia with a characteristic pattern. Infected pigs become thrombocytopenic over a 48-hour period after 3–4 days of illness. After several days of thrombocytopenia, the platelet count returns to baseline level even with a continuing viremia. Experimentally, the virus causes hematopoiesis in bone marrow which coincides with macrophage activation and bone marrow function is not impaired.<sup>43</sup> Membrane proteins on the surface of permissive cells act as receptors for ASF and specific interactions take place at this site.<sup>44</sup>

The effects of ASF are primarily hemorrhages and apoptosis.<sup>45,46</sup> A new protein (p54) encoded by the virus has just been shown to be the first that directly induces apoptosis.<sup>47</sup> The disease is characterized by apoptosis with abundant lymphocyte particularly B-cell death.<sup>24</sup> Both T and B-cells, particularly in the spleen, are affected as early as 3 days after infection. The apoptosis being induced by cytokines or apoptotic mediators released from ASF infected macrophages. In all probability there is an intra-cellular pathway triggered at the same time as the process of virus encoding.<sup>48</sup> It is probable that the inducers of apoptosis are balanced by the inhibitors of apoptosis.<sup>49</sup>

Tissue necrosis and generalized endothelial cell infection are not features of the disease caused by isolates of moderate virulence.

The virus causes hemorrhages through its effect on hemostatic mechanisms<sup>50</sup> by affecting vascular endothelium.<sup>46</sup> After about 4–5 days the vascular damage extends to the basement membranes and death ensues usually because of the serious edema and hemorrhage. The mechanisms related to hemorrhage consist of the:

1. Activation and extensive destruction of monocytes and macrophages. Serum TNF $\alpha$ <sup>51</sup> and IL-1 $\beta$  increase in the serum.<sup>52</sup> The lymphocytes also appear to have decreased activity.<sup>53</sup> Apoptosis of thymocytes has been reported<sup>54</sup>
2. Disseminated intravascular coagulation
3. Infection and necrosis of megakaryocytes. Many apoptotic and also pyknotic and karyorrhetic megakaryocytes<sup>55</sup> can be seen which are induced either by cytokine damage or peripheral destruction of platelets.<sup>56</sup> Between 0.2–9.5% of cells may be affected. Early in the infection there is prolongation of coagulation times due to inhibition of fibrin formation and later thrombocytopenia develops. The thrombocytopenia and coagulation defects lead to the development of:
  - Hemorrhages
  - Serous exudates
  - Infarction
  - Local edema
  - Engorgement of tissues.

All clinical forms of the disease are characterized by extensive hemorrhages at necropsy and it is this feature which often establishes a presumptive diagnosis in the field. A highly virulent virus produces renal hemorrhages as a result of intense endothelial injury, facilitated by phagocytic activity.<sup>57</sup> With strains of moderate virulence, hemorrhage is a consequence of an increase in vascular permeability with diapedesis of erythrocytes.<sup>57</sup> Activation of platelets by the virus may also contribute to increased permeability.

The virus mainly infects cells of the mononuclear phagocyte system and also impairs lymphocyte function. Pulmonary intravascular macrophages demonstrate intense TNF $\alpha$  and IL-1 $\alpha$  activity which coincides with the pulmonary edema, neutrophil sequestration and fibrin microthrombi.<sup>58</sup> The lymphopenia which is so characteristic of the disease is due to a significant increase in lymphocyte death by apoptosis (programmed cell death).<sup>59</sup>

In the experimental disease, there is marked apoptosis of lymph-node lymphocytes and this occurs in both compartments of cortical tissue, but is more intense in diffuse lymphoid tissue (T area). The peripheral lymphopenia is associated with T-lymphocyte depletion. There is no evidence of virus replication in lymphocytes in the lymph nodes but there is a high rate of viral replication in macrophages in diffuse lymphoid tissue compared to the low rate in lymphoid follicles.<sup>60</sup> In summary, there is lymphoid tissue impairment and programmed cell death of a high percentage of lymphoid and monocyte/macrophage cell populations. This accounts for the lymphopenia and the state of immunodeficiency. There are also a variety of proteins encoded by the virus that are apoptosis inhibiting proteins.<sup>61</sup> Experimentally, the virus also causes activation and degranulation of platelets from day 3 after inoculation onwards, coinciding with activation of the mononuclear phagocyte system and virus replication in monocyte/macrophages.<sup>62</sup> Virions of the virus also appear in the platelets, which suggests that platelets assist in disseminating the virus within the body, especially in subacute infections. Probably 95% of the infectivity of blood is in the form of virus adsorbed to the red blood cells.

The virus can cross the placenta, replicate in fetal tissues and cause abortion. However, the pregnancy failure is probably the result of the effects of the virus infection on the dam more than from direct viral damage to the placenta or fetus.<sup>63</sup>

### CLINICAL FINDINGS

In the acute form of the disease the animals die in an acute state of shock characterized by a disseminated intravascular coagulation with multiple hemorrhages in all tissues.<sup>64</sup> The incubation period after contact exposure varies from 5–15 days. A high fever (40.5°C; 105°F); appears abruptly and persists, without other apparent signs, for about 4 days. The fever then subsides and the pigs show marked cyanotic blotching of the skin, depression, anorexia, huddling together, disinclination to move, weakness and incoordination. Extreme of the hindquarters with difficulty in walking is an early and characteristic signs. Coordination remains in the front legs and affected pigs may walk on them, dragging the hind legs. Tachycardia, and serous to mucopurulent nasal and ocular discharges occur and dyspnea and cough (sometimes up to 30%) are present in some pigs. Diarrhea, sometimes dysentery, and vomiting occur in some outbreaks and pregnant sows usually abort. Purple discoloration of the skin may be present on the limbs, snout, abdomen and ears.

Abortion may occur in all stages of gestation about 5–8 days after the infection commences or after 1–2 days of fever. Death usually occurs within a day or two after the appearance of obvious signs of illness, and is often preceded by convulsions.

Historically, African swine fever was an acute to peracute disease with a case–fatality rate of almost 100%. However later, subacute and chronic diseases were observed. More recently, an even less virulent form of the disease has evolved. High fever and varying degrees of depression and lethargy are observed during the acute phase but some pigs continue to eat, case–fatality rate is usually less than 5%, the fever subsides in 2–3 weeks and the pigs return to full feed and grow at a normal rate. Recovered pigs have no lesions suggestive of the disease but may be viremic for several weeks. These persistently infected pigs would pass routine antemortem inspection at slaughter and potentially infectious offal and carcass trimming could be fed unknowingly to other pigs. Chronic cases are intermittently febrile, become emaciated and develop soft edematous swellings over limb joints and under the mandible.

Diagnosis depends on clinical signs (which are not distinguishable in the field from acute PDNS or CSF), post-mortem examination (it is said that button ulcers and turkey egg kidney are more rare in ASF but this cannot and must not be relied upon) but most importantly on diagnostic tests to rule out CSF and confirm ASF.

## CLINICAL PATHOLOGY

### Hematology

As in hog cholera, there is a fall in the total leukocyte count to about 40–50% of normal by the fourth day of fever. There is a pronounced lymphopenia and an increase in immature neutrophils. In chronic cases there is hypergammaglobulinemia. Clotting times are increased from about 5 days post-infection. Thrombocytopenia is detectable from day 6.

### Detection of virus

Antigen can be detected by the fluorescent antibody technique in tonsil and mandibular lymph node within 24–48 hours of infection and elsewhere once generalization has occurred. The indirect fluorescence antibody and direct fluorescence tests are commonly carried out on pooled visceral fluid samples.<sup>15</sup>

### Serological tests

Antibody to the virus may be detected within 7 days of infection. The ELISA is highly sensitive and specific and can be automated for screening large numbers of sera. It has been developed for a variety of ASF proteins such as p73 or p30. More than 90% of infected pigs can be detected

by the demonstration of specific antibodies against the virus. An immunoblotting assay is a highly specific and sensitive test which is easy to interpret, and provides an alternative to immunofluorescence and can be carried out in less than 90 min under field conditions.<sup>65</sup> Complement testing is also a possibility. The inadequate storage or transport of sera may lead to samples being kept at high temperatures for long periods and up to 20% of these may be false-negatives by ELISA. All blood samples should be held at 4°C before testing and if incorrectly stored or handled should be tested by immunoblotting.<sup>66</sup> A monoclonal antibody immunoperoxidase test is also useful for screening purposes.

## NECROPSY FINDINGS

Gross changes at necropsy resemble closely those found in hog cholera except that in the acute ASF, the lesions are more severe. In many organs there is a hyperemia or edema, with fibrinous microthrombi.<sup>67</sup> The most common gross findings are swollen and hemorrhagic gastrohepatic and renal lymph nodes, often so badly affected that they may resemble the spleen, subcapsular petechiation of the kidneys, ecchymoses of the cardiac surfaces and various serosae, and pulmonary edema with hydrothorax.<sup>50</sup> There may be hemopericardium. The renal hemorrhages are considered almost pathognomonic and are a consistent lesion following inoculation of pigs with the virulent or moderately virulent virus.<sup>57</sup> Splenomegaly is usual but in contrast to hog cholera, splenic infarcts are rarely seen. The gallbladder is edematous and hemorrhagic but this is not as sometimes thought a pathognomonic lesion. In chronic cases the lesions are essentially the same but also include pericarditis, interstitial pneumonia and lymphadenitis. There is severe submucosal congestion in the colon, although button ulcers in the large intestine are less common than in hog cholera. Histologically the lesions are more diagnostic. The virus causes destruction of the mononuclear phagocyte system and then infects megakaryocytes, tonsillar crypt cells, renal cells, hepatocytes and endothelial cells. Postcapillary venules undergo hyalinization and endothelial swelling. Destruction of monocytes/macrophages is visible in the lymph nodes, the spleen and the bone marrow. In the liver, there is extensive destruction of hepatocytes. Marked karyorrhexis of lymphocytes is visible in both normal lymphoid tissues and in the infiltrating population of cells within parenchymatous organs. An encephalitis may be present with lymphoid infiltration of the leptomeninges, but is generally less severe than that of hog cholera. In recovered animals the presence of virus

and antibody simultaneously (persistent infection) can cause the formation of immune glomerulonephritis.

As for hog cholera, the diagnostic testing to confirm ASF tends to be restricted to specialized laboratories.

## Samples for confirmation of diagnosis

- **Histology** – formalin-fixed spleen, lung, lymph nodes, kidney, liver, colon, cecum, brain (LM). The virus can be detected by IHC or ISH<sup>24</sup>
- **Virology** – spleen, kidney, submandibular and abdominal lymph nodes, tonsil (ISO (the virus grows well in bone marrow), FAT, PCR). A highly sensitive PCR has been developed.<sup>68</sup> A Taqman PCR has been developed for ASF.<sup>69</sup> A PCR has also been developed that can be used on a blood sample on filter paper<sup>70</sup> and also a plaque assay.<sup>71</sup> The PCR developed using the p72 protein will enable detection of ASF within 5 hours of clinical sample submission and full characterization of the virus within 48 hours.<sup>5</sup>

## DIFFERENTIAL DIAGNOSIS

The disease is easily confused with hog cholera and very careful examination is required to differentiate the two. Clinically, the illness is much shorter (2 d as against 7 d) than in hog cholera. Gross necropsy changes are similar to but more severe than those of hog cholera. The marked karyorrhexis of lymphocytes characteristic of ASF is not observed in hog cholera. Differential diagnosis must rely on laboratory testing. In the past, differentiation has been achieved by the challenge of hog cholera-susceptible and immune pigs with suspect material. More recently, reliance has been placed on the demonstration of hemadsorbing activity with virus from suspected outbreaks grown on pig leukocyte tissue cultures. But hemadsorbing activity may be weak, delayed or even absent and there is sometimes difficulty in isolating virus from subacute or chronic cases in enzootic areas. Demonstration of antigen by fluorescent antibody staining will allow diagnosis of acute cases. For chronic cases, serological testing has been recommended and with the use of more than one test a high degree of accuracy can be achieved. Several sensitive laboratory tests for detection of the virus in tissues and serum antibody are now available. ELISA tests are highly sensitive. Radioimmunoassay tests are also sensitive and isolates of the virus may be titrated in swine monocyte cultures using a microtechnique. In the lymphocyte response test to virus infection, there is a cytolytic effect on the lymphocytes; the effect is greater on the B-lymphocytes than on the T-lymphocytes. Pigs with demonstrable antibody should be considered as chronic carriers of the virus as it is doubtful that true recovery ever occurs.

## TREATMENT

There is no treatment for ASF.

## CONTROL

Slaughter affected pigs and their ticks as quickly as possible.

The control and eradication of ASF is difficult because of the:

- Lack of an effective vaccine
- Transmission of the virus in fresh meat and cured pork products
- Recognition of persistent infection in some pigs, particularly wild feral pigs, possibly warthogs and bush pigs
- Clinical similarity of hog cholera and African swine fever
- Recognition that in some parts of the world soft ticks of the genus *Ornithodoros* (*erraticus*, *moubata*, *porcinus*, *porcinus*) are involved in the biological transmission of the disease and can remain carriers for long periods (possibly 5 years).

Prevention of introduction of the disease to free countries is based on the prohibition of importation of live pigs or pig products from countries where African swine fever occurs. Strict application of the prohibition has prevented the spread of the disease from enzootic areas within South Africa. If a breakdown does occur, control must consist of prevention of spread by quarantine, slaughter of infected and in-contact animals and suitable hygienic precautions. The need for close contact between pigs for the disease to spread and the ease with which this can be prevented by the erection of pig-proof fences facilitates control. Conversely, the disease is virtually uncontrollable when pigs from a number of farms have access to communal grazing.<sup>14</sup> The virus is highly resistant to external influences including chemical agents and the most practical disinfectant to use against the virus is a strong solution of caustic soda. Contaminated sties can remain infective for periods exceeding 3 months. These factors and the persistence of the virus in recovered pigs probably contributed to the difficulties encountered in the eradication program in Portugal, where the disease was stamped out but reappeared in 1960. However, the most important factor appears to have been the indiscriminate use of attenuated vaccines, which fostered the development of carrier pigs. In this outbreak so very little was seen in the form of clinical signs.

In Spain in 1985, a comprehensive nationally coordinated program for the eradication of the disease was begun and substantial progress had been made.<sup>72,73</sup> Prior to 1985, the only method of control of the disease in Spain was depopulation of herds with clinical disease. The current

eradication program consists of the following:

- Depopulation of herds with clinical disease
- Serological surveillance of all sows and boars in every herd
- Improvement of sanitary conditions of housing
- Improved hygiene (safe disposal of manure, vehicle disinfection, insect and rodent extermination)
- Veterinary control of all swine livestock transfers (with individual identification of every animal moved for finishing or breeding purposes)
- Health certification of every animal used for herd replacement
- Destruction of every seropositive animal
- Formation of mobile veterinary field teams exclusively dedicated to support the program.

Following introduction of this program, it has been possible to divide Spain into a disease-free region (the criteria is a minimum of 2 years without the disease) and an infected region. Eradication of the disease in Spain occurred by 2001.<sup>73</sup> In 1991, the Spanish government claimed that 96% of the Spanish territory was free of ASF.<sup>73</sup> The calculated benefit–cost ratio is estimated to vary from 1.23 to 1.47, depending on the intensity of the program. A reduction in the funding for control would result in a benefit–cost ratio of 0.97, making the program unprofitable.

## Vaccines

Several different vaccines have been used, including an ineffective inactivated virus vaccine and modified live virus vaccines. The modified live virus vaccines provide some protection but the results following their use have been neither satisfactory nor safe and they have the two disadvantages of confounding laboratory tests and producing ‘carrier’ pigs.

## REVIEW LITERATURE

- O'Brien V. Virus and apoptosis. *J Gen Virol* 1998; 79:1833–1845.
- Gomez-Villamandos JC et al. The pathogenesis of ASF; the role of monokines. *Res Develop Virol* 1999; 1:7–17.
- Geering WA et al. Manual on procedures for disease eradication by stamping out. *FAO Animal Health Manual* 2001; No 12, 130 pp.
- Geering WA et al. Manual on procedures for disease eradication; contingency plans. *FAO Animal Health Manual* 2001; No 11, 74 pp.
- Arias M, Sanchez-Vizcaino JM. African swine fever. In: Morilla A, Yoon K-J, Zimmermann J (eds). *Trends in emerging viral diseases of swine*. Ames: Iowa State Press. 2002; pp. 119–124.
- Arias M, Sanchez-Vizcaino JM. African swine fever eradication; the Spanish model. In: Morilla A, Yoon K-J, Zimmermann J (eds). *Trends in emerging viral diseases of swine*. Ames: Iowa State Press. 2002; pp. 133–139.

- Gomez-Villamandos JC et al. African swine fever and classical swine fever; a review of the pathogenesis. *Deutsch Tierarztl Wschr* 2003; 110:165–169.
- Salas J, Salas M, Vinuela E. African swine fever virus: a missing link between poxviruses and iridoviruses. In: Domingo E, Webster RG, Holland JJ. *Origin and evolution of viruses*. London: Academic Press, 2003.
- Hernaez B, Escribano JM, Alonso C. Switching on and off the cell death cascade; African swine fever virus apoptosis regulation. *Prog Mol Subcell Biol* 2004; 36:57.

## REFERENCES

1. Andres G et al. *J Biol Chem* 2001; 276:280.
2. Yanez RJ et al. *Virol* 1995; 208:249.
3. Tulmon ER, Rock DL. *Curr Opin Microbiol* 2001; 4:456.
4. Ekue NF, Wilkinson PJ. *Rev d'Elevage Meddes pays Trop* 2000; 53:229.
5. Bastos AD et al. *Arch Virol* 2003; 148:693.
6. Cornelius ST. *CVA News* 2003; 19:44.
7. El Nicheri O et al. *Rev Sci Tech Bull OIE* 1998; 17:660.
8. Babalobi OO et al. *Israel J Vet Med* 2003; 58:86.
9. Penrith M-L. *Proc 15th Int Pig Vet Soc Cong* 1998; 2:195.
10. Rousset D et al. *Adv Inst Past Madag* 2001; 67:31.
11. Gouzague M. *Epid Inf* 2001; 126:453.
12. Mannelli A et al. *Prev Vet Med* 1998; 35:297.
13. Mannelli A et al. *Prev Vet Med* 1997; 32:235.
14. Wilkinson PJ. *Prev Vet Med* 1984; 2:71.
15. Bech-Nielsen S et al. *Br Vet J* 1995; 151:203.
16. Gibbs EPJ, Butler JF. *J Am Vet Med Assoc* 1984; 184:644.
17. Mebus CA. *Adv Virus Res* 1988; 35:251.
18. Kleiboeker SB et al. *Virol* 1999; 73:8557.
19. Kleiboeker SB et al. *Virol J* 1998; 72:1711.
20. Burrage TG et al. *J Virol* 2004; 78:2445.
21. Rennie L et al. *Med Vet Entomol* 2001; 15:140.
22. Rennie L et al. *Med Vet Entomol* 2000; 14:355.
23. Anderson EC et al. *Vet Microbiol* 1998; 62:1.
24. Oura CA et al. *J Gen Virol* 1998; 79:1439.
25. Perez J et al. *Vet Rec* 1998; 143:136.
26. Oleaga-Perez A et al. *Vet Rec* 1990; 126:32.
27. Perez-Sanchez R et al. *Vet Rec* 1994; 135:207.
28. Boinas FS et al. *J Gen Virol* 2004; 85:2177.
29. Endris RG et al. *J Med Entomol* 1991; 28:854.
30. Zsak L et al. *J Virol* 2001; 75:3066.
31. Gils S et al. *Arch Virol* 2003; 148:2077.
32. Powell PP et al. *J Virol* 1996; 70:8527.
33. Revilla AY et al. *J Biol Chem* 1998; 273:5405.
34. Dixon LK et al. *Vet Immunol Immunopathol* 2004; 100:117.
35. Onisk DV et al. *Virology* 1994; 198:350.
36. Gomez-Puertas P, Escribano JM. *Vir Res* 1997; 49:115.
37. Gomez-Puertas P et al. *J Virol* 1996; 70:5689.
38. Neilan JG et al. *Virol* 2004; 319:337–342.
39. Zsak L et al. *Virology* 1993; 196:596.
40. Vilanova M et al. *Immunol* 1999; 96:389.
41. Jensen JS et al. *J Immunol Meth* 2000; 242:33.
42. Lestao A et al. *J Gen Virol* 2001; 82:513.
43. Gomez-Villamandos J C et al. *Vet Pathol* 1997; 34:97.
44. Galindo I et al. *Virus Res* 1997; 49:193.
45. Ramiro-Ibanez GJ. *Gen Virol* 1996; 77:2209.
46. Takamatsu H et al. *J Gen Virol* 1999; 80:1453.
47. Hernandez B et al. *FEBS Lett* 2004; 569:224.
48. Carrascosa A et al. *Virol* 2002; 294:372.
49. Granja AG et al. *J Virol* 2004; 78:7165.
50. Rodriguez F et al. *Vet Rec* 1996; 139:249.
51. Gomez del Moral M et al. *J Virol* 1999; 73:2173.
52. Salguero F et al. *Vet Immunol Immunopathol* 2002; 90:11.
53. Childerstone A et al. *Vet Immunol Immunopathol* 1998; 62:281.
54. Salguero FJ et al. *Histol Histopathol* 2004; 19:77.

55. Perez J et al. *Vet Rec* 1997; 141:386.
56. Gomez-Villamandos JC et al. *J Comp Pathol* 1998; 118:1.
57. Gomez-Villamandos J C et al. *J Comp Pathol* 1995; 112:283.
58. Carrasco L et al. *J Comp Pathol* 2002; 126:194.
59. Carrasco L et al. *J Comp Pathol* 1996; 115:415.
60. Carrasco L et al. *Vet Res* 1996; 27:305.
61. Hay S, Kannourakis G. *J Gen Virol* 2002; 83:1547.
62. Gomez-Villamandos JC et al. *J Comp Pathol* 1996; 115:327.
63. Schlafer DH, Mebus CA. *Am J Vet Res* 1987; 48:246.
64. Vallee L et al. *J Virol* 2001; 75:10372.
65. Pastor MJ et al. *J Vet Diagn Invest* 1992; 4:254.
66. Arias M et al. *Vet Rec* 1993; 133:189.
67. Mozos E et al. *Dtsch Tierarztl Wschr* 2003; 110:150.
68. Agüero M et al. *J Clin Microbiol* 2003; 41:4431.
69. King DP et al. *J Virol Meth* 2003; 107:53.
70. Guy-Gonzague M et al. *J Appl Res Vet Med* 2003; 1:143.
71. Bustos MJ et al. *Arch Virol* 2002; 147:1453.
72. Bech-Nielsen S et al. *Prev Vet Med* 1993; 17:225.
73. Bech-Nielsen S et al. *Prev Vet Med* 1993; 17:235.

## EQUINE INFECTIOUS ANEMIA (SWAMP FEVER)

**Etiology** Equine infectious anemia virus, a retrovirus (lentivirus)

**Epidemiology** Worldwide distribution. Affects all species of Equidae. Transmission of disease by contaminated blood of clinically affected or inapparently infected horses during interrupted feeding of blood-feeding insects. Horses are infected for life

**Clinical signs** Fever, depression, edema, petechial hemorrhages, abortion, chronic weight loss, splenomegaly

**Clinical pathology** Anemia, thrombocytopenia, hypergammaglobulinemia, positive agar gel immunodiffusion (AGID) or competitive enzyme-linked immunoassay (CELISA) test

**Diagnostic confirmation** AGID or CELISA test

**Differential diagnosis list:**

- Acute disease
- Chronic disease

**Treatment** There is no specific treatment

**Control** Compulsory identification and testing with eradication of infected horses

### ETIOLOGY

The virus causing equine infectious anemia (EIAV) is a retrovirus, a member of the subfamily *Lentivirinae* of the family *Retroviridae*. The virus is an RNA virus that uses a reverse transcriptase enzyme to generate proviral DNA which is spliced into the host's genome. The virus infects only Equidae and there is not evidence that it infects or causes disease in humans. EIAV shares antigenic cross-reactivity with human and feline immunodeficiency viruses but not with the viruses causing caprine arthritis-encephalitis or maedi-visna of sheep. The

virus has **one major group-specific antigen**, p26, that is conserved and is the basis of the agar gel immunodiffusion (AGID) and competitive ELISA diagnostic tests. There is considerable **antigenic drift** in the surface glycoproteins (gp45, gp90) and the emergence of novel antigenic strains within an individual horse is associated with the relapsing febrile reactions characteristic of the disease. Examination of variations in the viral regulatory protein, Rev, and the transmembrane protein, gp90, demonstrates the existence of viral quasispecies such that genetically distinct viral subpopulations of differing phenotype exist within a chronically infected, often asymptomatic, animal.<sup>1,2</sup> Mutations in gp45 and gp90 are random and related to the lack of a proof reading capacity of the viral reverse transcriptase enzyme.<sup>3</sup>

### EPIDEMIOLOGY

#### Occurrence

EIA has been diagnosed on all continents except Antarctica. In Europe it is most prevalent in the northern and central regions. It has appeared in most states of the United States and the provinces of Canada but the principal enzootic areas are the Gulf Coast region and the northern wooded sections of Canada.<sup>4</sup>

Extensive **serological surveys** using the AGID (Coggin's) test have shown rates of infection of 1.5–2.5% in the United States, 6% in Canada, a low level in France, 1.6% in West Germany and 15–25% in Argentina. Within a geographic area, the **prevalence of infection** (positive AGID) varies depending on the density of the population, the proportion of carrier animals and the density of the population of insect vectors. Under ideal conditions the incidence of infection can approach 100% over a period of weeks, but this rapid spread is unusual.<sup>5</sup>

The **morbidity** varies considerably and depends on the strain of the virus and the inoculum delivered by the biting insect. Some horses become acutely ill and die after infection, while in others the infection is clinically inapparent. Outbreaks of disease associated with EIAV in horses of developed countries are rare.

#### Animal risk factors

Horses and ponies are susceptible to infection by EIAV and characteristically develop signs of the disease within days to weeks of infection. **Mules** also become infected and develop clinical signs similar to that of horses and ponies when infected with strains of the virus pathogenic to horses, but **donkeys** do not subsequently develop signs of the disease despite persistent infection with the horse-derived virus.<sup>6,7</sup> The resistance of donkeys to horse-derived strains of EIAV is not

definitive evidence that donkeys do not develop equine infectious anemia and there is suspicion that strains of the virus pathogenic to donkeys exist.<sup>7</sup>

#### Methods of transmission

The source of all new infections of EIAV is an infected horse, donkey or mule. Horses are persistently infected and clinically normal infected horses are a source of the virus.<sup>8</sup> The virus can also be spread from clinically affected animals which, because of the high concentration of virus in their blood, are a potent source of infection and important in the rapid spread of infection. Transmission of EIAV occurs almost exclusively through the transfer of contaminated blood or blood products. In field conditions this occurs through the mechanical transmission of contaminated blood from an infected horse to an uninfected horse by biting insects.

#### Insect vectors

The insect vectors responsible for the transmission of EIAV between horses are all large biting flies including *Stomoxys calcitrans* (stable fly), *Chrysops* sp. (deer fly), and *Tabanus* sp. (horse flies). Mosquitoes are not recognized as an important vector. **Transmission is mechanical** because the virus does not replicate in insects and is related to the large (10 nL) quantity of blood that the biting insects are capable of holding in their mouth.<sup>9</sup> Infection occurs only if the feeding of the insect is interrupted. If this occurs the insect may attempt to feed again on the initial host or may seek another host that is close by. If the initial host is infected, the insect can carry blood from this animal to the second host and spread the infection. Tabanid flies can travel over a distance of 6 km, but when feeding is interrupted, the flies usually attempt to complete the meal on the initial host or a nearby animal and rarely travel more than 200 m to complete the meal.<sup>10</sup>

**Insect factors** that influence the likelihood of spread include<sup>11</sup>:

- Climate and season (tabanids prefer hot and humid conditions for feeding and breeding and their activity is much reduced or absent in winter months)
- Attractiveness of the host (foals are less likely to be bitten)
- Proximity of hosts to woodlands (tabanids preferred treed or sheltered habitat)
- Host housing (tabanids do not enter closed shelters)
- Distance between horses (as noted earlier, tabanids prefer to complete an interrupted meal on the initial host or a nearby host).

Other means of transmission

**Intrauterine infection** can occur and result in abortion or the birth of infected foals that often die within 2 months.<sup>11</sup> Mares can be infected by insemination with semen containing the virus. Infection can be readily achieved by the use of **contaminated surgical instruments** or needles or by the injection of minute quantities of virus, and the use of a common needle when injecting groups of horses can cause an outbreak of the disease. In enzootic areas outbreaks have been caused by the use of untreated **biological preparations** of equine origin.

The virus is also capable of invasion through intact oral and nasal mucosae, wounds and even unbroken skin, but these portals are probably of minor importance in field outbreaks. Transmission of infection from horse to horse seems possible via swabbing instruments used to collect saliva for doping tests.

### Economic importance

The difficulty of diagnosis and the persistence of the 'carrier' state for periods of many years have resulted in embargoes on the introduction of horses into countries with a low prevalence of the disease, causing economic embarrassment and interference with sporting events.

### PATHOGENESIS

#### Viral multiplication

After infection, EIAV multiplies in tissues that have abundant macrophages with the spleen being the principal site of viral infection and propagation and accounting for over 90% of cellular viral burden.<sup>12</sup> Viral replication occurs only in **mature tissue macrophages** and circulating monocytes account for only 1% of the cellular viral burden.<sup>12</sup> The concentration of cell free virus in blood, which can be as high as  $10^6$  TCID<sub>50%</sub> per mL, parallels the clinical course. Fever and other clinical signs develop within **2–7 d of infection** as the concentration of virus in the blood increases, and resolves as the viremia abates. There is a persistent but low level viremia that persists for the life of the horse. The level of viremia in horses without clinical signs of the disease is very low and undetectable using conventional virus culture techniques but evident using PCR.<sup>13</sup> The virus is detectable in low concentrations in most tissues of asymptomatic horses.<sup>12</sup> During periods of **relapse** of the clinical disease the degree of viremia increases. On these occasions, the virus isolated from the blood has antigenic characteristics different than that which originally infected the horse. **Antigenic drift** of the gp45 and gp90 antigens, which occurs constantly even in asymptomatic horses with low levels of viremia, allows mutations of the virus that then

avoid immune surveillance, multiply and cause clinical disease.<sup>2</sup> The frequency of relapses of the clinical disease declines markedly after the first year of infection and horses that survive become asymptomatic carriers.

#### Immune reaction

The immune response to EIAV is responsible for controlling replication of the virus and also plays an important role in the pathogenesis of the disease. The major clinical signs and lesions of equine infection anemia are attributable to the host response to the virus and not direct viral damage to tissue.<sup>3</sup> Replication of EIAV stimulates a strong immune response that is detectable in horses and ponies within 7–10 d of infection. The initial infection is likely controlled by **cytotoxic T-lymphocytes** before the appearance of **neutralizing antibodies**.<sup>13</sup> Antibodies to the p26 core protein are detectable by AGID test in almost all horses 45 d after infection and by 60 d after infection antibodies to gp45 and gp90 are present. The neutralizing antibodies are specific to the phenotype of virus causing the viremia – this phenotype can change over time as discussed above. Hypergammaglobulinemia develops. The immune response includes the production of virus neutralizing antibodies, complement-fixing antibodies, and cytotoxic T-lymphocytes.<sup>13</sup> The immune responses are responsible for the termination of viremia although this effect is not mediated by antibody-dependent cellular cytotoxicity against EIAV-infected macrophages,<sup>14</sup> but rather by development of neutralizing antibody and cytotoxic T-lymphocytes.<sup>13</sup> The importance of neutralizing antibodies in control of the disease within an animal is indicated by the observation that viremia is never associated with a virus with a neutralizing phenotype already recognized by the horse.<sup>13</sup>

Most virus in viremic horses is a complex of virus and antibody. The **virus-antibody complex** is readily phagocytosed by cells of the reticuloendothelial system, including tissue macrophages, and is involved in the development of the fever, depression, thrombocytopenia, anemia and glomerulonephritis characteristic of the disease.<sup>15</sup>

Neurologic disease in horses with EIAV infection is attributable to viral infection of neural tissue but not necessarily neurons.<sup>15</sup>

#### Anemia and thrombocytopenia

The **anemia** characteristic of horses experiencing several febrile episodes of EIA is attributable to shortened life of red blood cells and decreased red cell production. Infection with EIAV shortens the lifespan of circulating red blood cells to about 38 d, compared with the normal

value of 130 d.<sup>16</sup> The reduction in red blood cell lifespan is likely due to the presence of virus-antibody complexes on the surface of red blood cells with subsequent clearance of such cells by the reticuloendothelial system as evidenced by the presence of sideroleukocytes in peripheral blood of infected horses. EIAV also has a suppressive effect on erythroid series cells in bone marrow.<sup>17</sup> Anemia occurs in Arabian foals with severe combined immunodeficiency infected with EIAV, indicating that the anemia is not wholly due to the adaptive immune response of the host.<sup>18</sup> Anemia of chronic disease, which is due in part to limited availability of iron stores, likely contributes to the lack of bone marrow response.

**Thrombocytopenia** is a consistent feature of the acute, febrile episodes of EIA and has been attributed to the deposition of virus-antibody complexes on platelets with subsequent removal of affected platelets by tissue macrophages.<sup>19</sup> However, others have identified a primary production deficit due to an indirect, non-cytotoxic suppressive effect of EIAV on megakaryocytes.<sup>20</sup> EIAV does not infect megakaryocytes and the suppressive effect of infection is due at least in part to tumor necrosis factors alpha and beta.<sup>20,21</sup> Another explanation for the thrombocytopenia is increased removal of platelets because of increased in vivo activation and formation of platelet aggregates, a form of non-immune mediated platelet destruction.<sup>22</sup> This was associated with increased thrombopoiesis and an increase in the proportion of young platelets in blood.<sup>22</sup> The precise mechanisms underlying the thrombocytopenia associated with acute EIAV infection of horses is unclear.

Platelets of EIAV infected horses with clinical signs of disease have diminished function in vitro.<sup>22</sup> Platelets from infected horses had greater amounts of fibrinogen bound to their surface, ultrastructural abnormalities consistent with activation, and diminished in vitro aggregation responses.<sup>22</sup>

#### Persistence of infection

The **cell reservoir of virus** in persistently infected horses is unknown, as are the mechanisms underlying latency. However, the ability of retroviruses to **splice a DNA copy of their genome** into the genome of the host is probably important in the persistence of viral infection. Viral genome is detectable in clinically normal but persistently infected horses.<sup>6</sup> Presence of viral DNA in host tissue is indicative of infection whereas the presence of viral RNA in blood is suggestive of viral replication.<sup>6</sup> This viral strategy allows the virus to escape immune surveillance of the host. Factors triggering a relapse of



virus production from the latent genome are unknown, but relapse is associated with antigenic drift.

### Summary of pathogenesis

A likely scheme of pathogenetic events includes:

- Primary entry and infection of tissue macrophages, especially in the spleen
- Destruction of macrophages and release of virus and components
- Production of antibodies to antigenic components
- Formation of antigen-antibody complexes, which induce fever, glomerulitis, anemia, thrombocytopenia and complement depletion
- Hemolysis or phagocytosis caused by specific complexes activating the reticuloendothelial system
- Temporary iron-deficient erythropoiesis caused by delayed release of iron from macrophages
- Subsidence of pathological processes as virus-neutralizing antibody restrains viral multiplication in macrophages. The virus is incorporated into the host genome and becomes latent
- Appearance of a new antigenic variant of the virus and commencement of a new cycle of viral replication in macrophages and a new clinical episode. The antigenic variation is due to changes in the surface glycoprotein of the EIA virus
- Less frequent recurrence of these episodes and the horse becomes permanently asymptomatic. The animal can be said to have achieved an appropriate level of immune response sufficient to protect it against antigenic epitopes that are common to all EIA virus strains.

### CLINICAL FINDINGS

An **incubation period** of 2–4 weeks is usual in natural outbreaks of equine infectious anemia. Outbreaks usually follow a pattern of slow spread to susceptible horses after the introduction of an infected animal. On first exposure to infection, horses manifest signs of varying degree, classified as acute or subacute. Occasionally the initial attack is mild to inapparent and may be followed by rapid clinical recovery. As a rule there is initial **anorexia, depression, profound weakness** and loss of condition. Ataxia, behavioral changes, hyperesthesia and blindness occur and in some horses is recorded as the only clinical abnormality.<sup>18,23</sup> There is intermittent fever (up to 41°C; 105°F) which may rise and fall rapidly, sometimes varying as much as 1°C within 1 h. Jaundice, edema of the ventral abdomen,

the prepuce and legs, and petechial hemorrhages in the mucosae, especially under the tongue and in the conjunctivae, may be observed. Pallor of the mucosae does not occur in this early stage and they tend to be congested and edematous. There is a characteristic increase in rate and intensity of the heart sounds, which are greatly exacerbated by moderate exercise. Respiratory signs are not marked and there is no dyspnea until the terminal stages, but there may be a thin serosanguineous nasal discharge. There is considerable enlargement of the spleen which may be detectable per rectum. Pregnant mares may abort. Many animals recover from this acute stage after a course of 3 d to 3 weeks. Others become progressively weak, recumbent and die after a course of 10–14 d of illness.

Animals recovering from the acute disease may appear normal for 2–3 weeks and then **relapse** with similar but usually less severe signs. Death may occur during such a relapse. Relapses continue to occur at intervals of as little as 2 weeks but usually cease after about a year. If they recur, they are usually associated with periods of stress and characterized by fever, increasing emaciation, weakness, ventral edema, and the development of pallor of the mucosae, a late sign of this disease. In this chronic stage, the appetite is usually good, although allotriophagia may be observed. Some affected animals appear to make a complete recovery but they remain infected and may suffer relapses in later years. Prolonged therapy with corticosteroids can cause such a relapse. Even in the absence of clinical illness infected animals often perform less efficiently than the uninfected. Most deaths occur within a year of infection. Survivors persist as asymptomatic carriers.

### CLINICAL PATHOLOGY

Hematological examination of horses with the acute disease reveals a moderate to marked **thrombocytopenia** and an **anemia** that may be severe. Thrombocytopenia occurs during relapses of the disease, is most severe during the febrile episodes, and may be sufficiently low that it allows petechial hemorrhages to develop. The anemia may become more severe with relapse (14–20%, 0.14–0.20 L/L) and is normocytic and normochromic. The presence of **sideroleukocytes** (leukocytes containing hemosiderin) are considered highly suggestive of EIA.<sup>24</sup> There are no characteristic changes in the white blood cell count.

Hypergammaglobulinemia may be present. Serum biochemical examination may reveal an increase in bilirubin concentration and a decrease in serum iron concentration.

### DIAGNOSTIC CONFIRMATION

**Diagnostic confirmation** is achieved through detection of antibodies to the p26 core antigen of EIAV. Two tests are in general use: the AGID test (Coggin's test) and a number of ELISAs including a competitive ELISA (CELISA) test.<sup>25,26</sup> Results of AGID testing are available in 24 hours while those of ELISA testing can be available in as little as one hour. Two commercially available ELISA tests detect antibody to the p26 antigen whereas the other detects antibody to the gp45 transmembrane protein. The ELISA tests inherently have greater sensitivity (detect lower concentrations of antibody) than does the AGID but often the characteristics of the commercial ELISA assays are modified to decrease the sensitivity (increase the lowest concentration of antibody detected by the kit) so that results obtained with these kits are concordant with those obtained by AGID.<sup>25</sup> The ELISA for detection of antibodies to gp45 has a slightly lower sensitivity than do those that detect antibody to p26.<sup>27</sup> For practical purposes the tests may be considered to have equal sensitivity and specificity, and are very accurate in the diagnosis of EIA.<sup>26</sup> However, the CELISA test can detect lower concentrations of antibody than the AGID can, therefore suspected false-negative or equivocal tests based on the AGID can be repeated using the CELISA.<sup>26</sup> Conversely, the CELISA has a slightly higher false-positive rate than the does the AGID, and positive reactions on the CELISA should be verified by AGID. A positive AGID test is accepted as synonymous with being infected and infective.

An advantage of an ELISA that detects antibodies to gp45 antigen is that, when combined with testing for antibodies to p26, the ability to detect infected horses with equivocal test results on a single test is increased.<sup>25</sup> This is similar to the technique of using a **Western blot test** to demonstrate the presence of antibodies to more than one antigen, especially those against the gp45 and gp90 antigens, when equivocal AGID or ELISA results are obtained.

**False-negative reactions** for either test may occur because the horse lacks antibodies to the p26 antigen. The AGID and CELISA tests might not detect a **recently infected** horse that has yet to develop antibodies. Some horses do not develop anti-p26 antibodies for 45 d after infection. **False-positive reactions** may occur in foals born to infected mares. Colostral transfer of anti-p26 antibodies to the foal will be detectable up to 6 months after birth.

Positive reactions to ELISA testing (to the p26 antigen) in samples that are negative by AGID testing can be the result of

**Table 21.1** Algorithm for testing horses for infection by equine infectious anemia virus when the prevalence rate is less than 1 in 1000<sup>a</sup>

Collect sample and separate serum from red cells as soon as possible.

Test sample using a p26-based ELISA.

If negative, report the results. (False-negatives with p26-based ELISA occur with lower frequency than with AGID).

If repeatedly positive, confirm with another p26-based ELISA, then a gp45-based ELISA.

If positive for both p26 and gp45-based ELISA then infection is confirmed and a report issued.

If negative on the second p26-based ELISA and/or the gp45-based ELISA, then perform an AGID.

If negative on all but the initial test, report as negative.

If positive on any two tests, then perform an immunoblot test to confirm reactions to both p26 and gp45. If only p26 is recognized then the horse is not considered infected with EIAV (interspecies determinants – see text). If gp90 and/or p26 and gp45 are recognized, then the horse is infected and a positive report issued.

<sup>a</sup> If the prevalence is high (approximately 1 in 10 horses) then samples with equivocal results on ELISA testing should be examined by immunoblot. This additional testing is indicated because of the high risk of false-negative reactions when large numbers of horses from a population with a high prevalence of the disease are tested.

If equivocal test results are obtained, repeat testing on samples obtained from the horse approximately 2 weeks after the initial sample was collected.

interspecies determinants.<sup>26</sup> It is suspected that horses exposed to related lentivirus produce antibodies to structural proteins that cross react with the EIAV p26 antigen in ELISA, but not AGID, testing.

An algorithm for testing of equine samples for EIAV is provided in Table 21.1.

Tests to detect proviral DNA or viral RNA in blood and tissue have been developed and are useful in detecting the presence of virus when viral concentrations in blood and/or tissue are low.<sup>28,29</sup> The identification of proviral DNA in blood of infected horses is as specific and apparently more sensitive than the AGID in detecting infected horses.<sup>29</sup>

**Experimental transmission** of the disease to susceptible horses by the SC injection of 20 mL whole blood or Seitz-filtered plasma is also used as a diagnostic test and is a valuable, although expensive and archaic supplement to other tests. The donor blood should be collected during a febrile episode when the viremia is most pronounced, and the recipient animals are checked for increases in body temperature twice daily.

### NECROPSY FINDINGS

In the acute stages, there may be subcutaneous edema, jaundice and petechial or ecchymotic subserosal hemorrhages. There is considerable enlargement of the liver and spleen, and local lymph nodes. The bone marrow is reddened due to increased amounts of hematopoietic tissue and may contain focal infarcts. In the chronic stages, emaciation and pallor of tissues are often the only gross findings. Histological examination is helpful in the diagnosis, even in asymptomatic chronic carriers. Characteristic lesions include hemosiderosis, perivascular infiltrates of round cells in many organs, and an extensive proliferation of the mononuclear phagocytic cells throughout the body. A glomerulitis, probably caused by the deposition of virus-antibody complexes on the glomeru-

lar epithelium, may be present. Lesions in the brain are a lymphohistiocytic periventricular leukoencephalitis.<sup>15</sup> Culture of this virus is time-consuming and the diagnosis is usually confirmed on the basis of a positive serologic test and typical microscopic lesions.

### Samples for confirmation of diagnosis

- **Histology** – formalin-fixed spleen, liver, bone marrow, kidney, lung, heart
- **Serology** – heart blood or pericardial fluid (AGID, ELISA)
- **Virology (if desired)** – chilled spleen, liver, bone marrow and perihepatic lymph node (ISO).

### DIFFERENTIAL DIAGNOSIS

#### Acute disease

- Purpura hemorrhagica
- Babesiosis
- Equine granulocytic ehrlichiosis
- Equine viral arteritis
- Autoimmune hemolytic anemia
- Leptospirosis
- Parasitism
- Idiopathic thrombocytopenia.

#### Chronic disease

- Internal abscessation (metastatic *Streptococcus equi* infection
- Chronic inflammatory disease, neoplasia and chronic hepatitis.

### TREATMENT

No specific treatment is available. Supportive treatment including blood transfusions and hematinic drugs may facilitate clinical recovery but it is important to remember that recovered horses are persistently infected and infectious for life.

### CONTROL

Control of EIA is based on **identification and eradication or life-long quarantine of infected animals**, quarantine and testing of new stock, compulsory testing of imported horses, and efforts to prevent

spread of the virus by controlling insect access to horses and use of strict hygiene when vaccinating or collecting blood samples from horses.

The control of equine infectious anemia is still universally based on the eradication of the disease by identifying the infected, clinically normal animals with a serological test and then destroying them. Identification is by means of the AGID or CELISA tests. The ability of a program of test and eradication to eliminate the disease is evidenced by the eradication of EIA from Hong Kong. An effective control program is described for Kentucky in the United States that permits the maintenance of infected horses with indelible identification and prescribed restrictions on housing.<sup>30</sup>

Control programs based on this test-and-slaughter policy are under fire because of the view of horse owners that many asymptomatic horses, with very low infectivity, are being destroyed unnecessarily. A decision on the matter depends on whether the objective is eradication or containment, and if the latter, at what level. Until now the policy has been eradication and it is obvious that another attitude is possible. Some flexibility in official attitude is desirable because of the fallibility of the recommended control procedures and the devastating losses that can occur when the optimum environment for the spread of the disease is encountered.

Foals from infected mares can be raised free of infection.<sup>31</sup> Such foals have detectable antibodies to EIAV for up to 330 days on immunoblot and 260 days on ELISA testing because of transfer of maternal immunoglobulins in colostrum during the neonatal period. However, foals that are ultimately free of infection do not have detectable viral RNA in blood and have declining concentration of antibodies to EIAV.<sup>31</sup> Foals should be isolated from infected horses as soon as feasible after diagnosis of EIAV infection in the dam.

**Restriction of introduction of infected horses** into clean herds or areas is important to prevent introduction of the disease. Horses should be tested before introduction to the herd, and perhaps again in 1 to 2 months. If suspect horses are to be introduced, they should be kept under close surveillance for at least 6 months before being admitted. Horses known or suspected to be infected should be separated from all other uninfected horses, donkeys and mules by a distance of at least 200 m. This recommendation is based on observations of the feeding behavior of tabanids, which are very unlikely to fly more than 100 m after an interrupted feeding. **Suspect positive horses** should be retested after at least 1 month and probably at regular intervals thereafter. Operators of open stud farms, and rest farms can also insist on proof of a negative test before admitting each horse. One deficiency of this policy is the long period of 'incubation' of up to 45 d between infection and seroconversion to a positive test.

In countries where the incidence is high, it is usual to control horse movement by a system of permits and certificates of freedom from the disease, and to insist on skin branding or lip tattooing of all horses. AGID or ELISA test-positive horses should be allowed to move only under specified conditions.<sup>26</sup>

Draining of marshy areas and the **control of biting insects** may aid in limiting spread of the disease. A degree of protection may be obtained by the use of **insect repellents** and by stabling in screened stables. Great care must be taken to avoid transmission of the disease on **surgical instruments** and hypodermic needles, which can only be sterilized by boiling for 15 min or by autoclaving at 6.6 kg pressure for a similar period. Chemical disinfection of instruments and tattoo equipment requires their immersion for 10 min in one of the less corrosive phenolic disinfectants. All materials to be disinfected need to be cleaned of organic matter first. For personal disinfection sodium hypochlorite, ethanol or iodine compounds are safe, and for materials where organic matter is not removable, agents such as chlorhexidine or phenolic compounds combined with a detergent are satisfactory.

There are considerable problems associated with development of vaccines against EIA because only neutralizing antibodies are capable of causing sterile immunity and preventing infection.<sup>13</sup> Neutralizing antibodies are specific for the homologous virus, but the large variation in phenotypes of the wild virus means that it will be difficult to stimulate neutralizing antibodies protective against all of the possible infecting phenotypes.

**Vaccines** are available in parts of the world but are not in general use. Killed, whole virus vaccines are safe but subunit vaccines may actually enhance the occurrence of the disease.<sup>32</sup> An experimental live attenuated ELAV DNA proviral vaccine affords complete protection in experimentally infected horses but is not commercially available at the time of writing.<sup>33</sup>

#### REVIEW LITERATURE

McGuire TC et al. Cytotoxic T-lymphocytes and neutralizing antibody in control of equine infectious anemia virus. *Viral Immunol* 2002; 15:521.

#### REFERENCES

- Baccam P et al. *J Virol* 2003; 77:12122.
- Leroux C et al. *J Virol* 2001; 75:4570.
- Sellon DC. *Vet Clin North Am Equine Pract* 1993; 9:321.
- Paquette B. *Can Vet J* 1985; 26:373.
- Hall RF et al. *J Am Vet Med Assoc* 1988; 193:1082.
- Spyrou V et al. *Vet Microbiol* 2003; 95:49.
- Cook SJ et al. *Vet Microbiol* 2001; 79:93.
- Coggins LJ. *Am Vet Med Assoc* 1984; 184:279.
- Foil LD et al. *J Med Entomol* 1987; 24:613.
- Foil LD. *J Med Entomol* 1983; 20:301.
- Issel CJ et al. *Equine Infect Dis* 1992; 6:249.
- Harrold SM et al. *J Virol* 2000; 74:3112.
- McGuire TC et al. *Viral Immunol* 2002; 15:521.
- Tschetter JR et al. *Virology* 1997; 230:275.
- Oaks JL et al. *Vet Pathol* 2004; 41:527.
- McGuire TC et al. *Am J Vet Res* 1969; 30:2091.
- Swardson CJ et al. *Am J Vet Res* 1992; 53:1176.
- Petryman LE et al. *J Virol* 1988; 62:3073.
- Clabough DL et al. *J Virol* 1991; 65:6242.
- Crawford TB et al. *J Virol* 1996; 70:7842.
- Tornquist SJ, Crawford TB. *Blood* 1997; 90:2357.
- Russell KE et al. *Virology* 1999; 259:7.
- McClure JJ et al. *J Am Vet Med Assoc* 1982; 180:279.
- Granzien CK, Newton LG. *Aust Vet J* 1963; 44:406.
- Issel CJ et al. *J Equine Vet Sci* 1999; 19:728.
- Issel CJ, Cook RF. *J Vet Diagn Invest* 1993; 5:137.
- Pare J, Simard C. *Can J Vet Res* 2004; 68:254.
- Cook RF et al. *J Virol Methods* 2002; 105:171.
- Nagarajan MM, Simard C. *J Virol Methods* 2001; 94:97.
- www.ukg.edu/Ag/Animalsciences/extension/pubpdfs/vct10.pdf accessed July 11, 2006.
- McConnico RS et al. *J Equine Vet Science* 2000; 20:387.
- Issel CJ et al. *J Virol* 1992; 66:3398.
- Li F et al. *J Virol* 2003; 77:7244.

#### BOVINE EPHEMERAL FEVER

**Etiology** Arthropod-borne rhabdovirus of the genus *Ephemerovirus*  
**Epidemiology** Enzootic in tropical areas. Transmitted by insect vectors. Episodic epizootics in summer in incursive areas probably initiated by wind-borne transmission of insect vector. High morbidity but low case fatality  
**Clinical findings** Disease of cattle with fever, respiratory distress, muscular shivering, stiffness, lameness and enlargement of the peripheral lymph nodes  
 Generally spontaneous recovery in three days and low case-fatality rate  
**Clinical pathology** Leukocytosis, hyperfibrinogenemia, hypocalcemia,

elevated creatine kinase. Blocking ELISA for serology

**Necropsy findings** Serofibrinous polyserositis

#### Diagnostic confirmation

Demonstration of specific bovine ephemeral fever (BEF) viral antigen by immunofluorescence or by isolation in mice

**Treatment** Non-steroidal anti-inflammatory drugs cause remission of clinical signs

**Control** Vaccination and supportive treatment

#### ETIOLOGY

Ephemeral fever is associated with an arthropod-borne rhabdovirus which is the type species of the genus *Ephemerovirus*. There are a number of strains that vary antigenically.<sup>1,2</sup> Other antigenically related but non-pathogenic species of *Ephemerovirus* occur in the same environment in Australia. The BEF virus is closely associated with the leukocyte-platelet fraction of the blood, and can be maintained deep frozen or on tissue culture and chick embryos.

#### EPIDEMIOLOGY

##### Occurrence

A disease of cattle, ephemeral fever is enzootic in the tropical areas of Africa, in most of Asia, the Middle East, the East Indies, and in much of Australia with extensions into the subtropics and some temperate regions. In these areas the disease presents as episodic epidemics. Area outbreaks can last several months, with the spread of infection following prevailing winds, and during this period most herds within a region will be infected. The proportion of herds affected in outbreaks in the Jordan Valley in Israel in 1990 and 1999 were 78.5% and 97.7% respectively.<sup>3</sup>

The morbidity rate in outbreaks is usually between 25% and 45%, but if the population is highly susceptible or the infecting strain virulent, the morbidity rate may reach 100%. In enzootic areas, only 5–10% will be affected. A case-fatality and loss from involuntary culling rate of 1% is usual with low virulence strains but can approach 10%.<sup>4,5</sup>

##### Source of infection

The source of infection is the animal affected with the clinical disease and biological vectors.

##### Method of transmission

A great deal of work in recent years has not clearly defined the **vector** list which probably includes the mosquitoes *Aedes* spp., *Culex annulirostris*, *Anopheles bancroftii* and *A. annulipes*, and the biting midge *Culicoides brevitarsis*.<sup>6,7</sup> *Culex annulirostris* has been identified as a biological vector in Australia.<sup>8,9</sup> This mosquito can transmit

infection within a week of feeding on an infected animal and the epidemiology of the disease in Australia supports transmission by mosquitoes rather than *Culicoides* spp.<sup>10</sup>

The **reservoir** host, other than cattle, has not been identified. This is of particular importance when the epidemiological pattern of occurrence of the disease changes as it has done in Australia. The disease now occurs annually in areas where it used to occur only once each decade, probably because of establishment of the virus in indigenous vectors.<sup>11</sup>

Spread by **wind-borne carriage** of vectors is suspected.<sup>12, 13</sup> Epidemiological studies suggest that outbreaks in Japan originate from Korea.<sup>13</sup> Spread is largely **independent of cattle movement**, and transmission does not occur through contact with infected animals or their saliva or ocular discharge. The disease is not spread through semen, nor is intrauterine administration of the virus a suitable route of transmission.

#### Experimental reproduction

The disease can be transmitted by the injection of whole blood or the leukocyte fraction of it. Experimental reproduction in cattle requires intravenous administration and viremia lasts 3 days with a maximum of 2 weeks. There is no carrier state.

#### Environment risk factors

The disease occurs in the **summer** months, outbreaks are **clustered** and relatively **short lived**,<sup>13</sup> and spread depends largely on the insect vector population and the force and direction of prevailing winds.<sup>3</sup> The disease tends to disappear for long periods to return in epizootic form when the resistance of the population is diminished.

Recurrence depends primarily on suitable environmental conditions for increase and dissemination of the insect vector.<sup>6</sup> During periods of quiescence the disease is still present but the morbidity is reputed to be very low. However, in many enzootic areas the degree of surveillance is less than intense and clinical cases may occur without being observed. Temporary protection against infection is provided by subclinical infections by other unrelated arboviruses, e.g. Akabane, Aino, and others.<sup>11</sup>

#### Animal risk factors

Among domestic animals, only **cattle** are known to be naturally affected but antibodies can be found in African ruminant wildlife. All **age groups** of cattle are susceptible but calves less than 3 to 6 months old are not affected by the natural disease. With experimental infections calves as young as 3 months old are as susceptible as adults to experimental infection but do not show clinical disease.

In dairy cattle, higher producing cows are at greater risk and clinical disease may

be minimal in cows under 2 years of age. A recent Israeli study in 10 beef herds found an average morbidity and mortality rate of 46.2% and 4.8% respectively with higher rates in bulls than cows and a higher morbidity in cows 2 to 5 years of age than in heifers less than 2 years of age.<sup>14</sup> In natural outbreaks there is no breed susceptibility.<sup>12</sup>

In Africa, based on serological results, the virus is thought to be cycling in populations of wild ruminants between epidemics in domestic cattle. Buffalo (*Bubalus bubalis*) are susceptible to experimental infection, but it is unlikely that they play any part as a reservoir host.<sup>15</sup> After experimental infection of cattle there is solid immunity against homologous strains for up to 2 years. Immunity against heterologous strains is much less durable which probably accounts for the apparent variations in immunity following field exposure.

#### Economic importance

Although the case-fatality rate is very low, considerable loss occurs in **dairy herds** due to the depression of milk flow – up to 80% in cows in late lactation. In an Israeli study of eight infected dairy herds, the decline in milk yield from preinfection levels varied between cows and ranged from 30% to 70% with the highest yielding cows having the greatest drop. Following recovery from disease, milk production was still less than that of preinfection levels.<sup>4</sup>

There is also a lowered resistance to mastitis. Reproductive inefficiency is associated with a significant delay in the occurrence of estrus, abortion in cows and temporary sterility in bulls. Occasional animals die of intercurrent infection, usually pneumonia, or prolonged recumbency. BEF can have a serious effect on the agricultural economy in countries where cattle are used as **draught animals**. For cattle-exporting countries such as Australia, BEF causes interference with movement of cattle when receiving countries insist on evidence of freedom from the disease.

#### PATHOGENESIS

Experimental production of the disease requires the IV route of transmission. Virus multiplication probably occurs primarily within the **vascular system**.<sup>8</sup> After an incubation period of 2–10 days, there is a biphasic fever with peaks 12–24 h apart.<sup>16</sup> The fever lasts 2 d and increased respiratory rate, dyspnea, muscle trembling, limb stiffness and pain are characteristic at this time.<sup>17</sup>

There is **generalized inflammation** with vasculitis and thrombosis, serofibrinous inflammation in serous and synovial cavities, and increased endothelial permeability at the same sites.<sup>18</sup> The

virus can be detected in circulating neutrophils and plasma, the serosal and synovial fluids, the mesothelial cells of synovial membrane and epicardium, and in neutrophils in the fluids.<sup>8</sup> Clinical signs are believed caused by the expression of mediators of inflammation coupled with a secondary hypocalcemia.<sup>14</sup>

#### CLINICAL FINDINGS

Calves are least affected, those less than 3 to 6 months of age showing no clinical signs. Overweight cows, high producing cows, and bulls are affected the most.

In most cases the disease is acute. After an incubation period of 2–4 d, sometimes as long as 10 d, there is a sudden onset of **fever** (40.5–41°C; 105–106°F), which may be biphasic or have morning remissions. **Anorexia** and a sharp **fall in milk yield** occur. There is severe constipation in some animals and diarrhea in others. Respiratory and cardiac rates are increased, and stringy nasal and watery ocular discharges are evident. The animals shake their heads constantly and muscle shivering and weakness are observed. There may be swellings about the shoulders, neck and back.

Muscular signs become more evident on the second day with severe **stiffness**, clonic muscle movements and weakness in one or more limbs. A **posture** similar to that of acute laminitis, with all four feet bunched under the body, is often adopted. On about the third day, the animal begins eating and ruminating, and the febrile reaction disappears, but lameness and weakness may persist for 2–3 more days.

Some animals remain standing during the acute stages, but the majority go down and assume a position reminiscent of parturient paresis, associated with **hypocalcemia**, with the hindlegs sticking out and the head turned into the flank. Occasionally, animals adopt a posture of lateral recumbency. Some develop clinically detectable pulmonary and SC emphysema, possibly related to a nutritional deficiency of selenium.<sup>19</sup> In most cases recovery is rapid and complete after an illness of 3–5 d unless there is exposure to severe weather, or unless aspiration of a misdirected drench or ruminal contents occurs. Some cases have a second episode of clinical disease 2 to 3 weeks after recovery.

Occasional cases show persistent recumbency and have to be destroyed and abortion occurs in a small proportion of cases. Affected bulls are temporarily sterile. Milder cases, with clinical signs restricted to pyrexia and lack of appetite, may occur at the end of an epizootic.

#### CLINICAL PATHOLOGY

Blood taken from cattle in the febrile stage clots poorly.<sup>20</sup> A marked **leukocytosis** with a relative increase in neutrophils occurs

during the acute stage of the disease. There is a shift to the left and a lymphopenia. Plasma fibrinogen levels are elevated for about 7 d<sup>17</sup> and there is a marked increase in **creatinase kinase**. In natural cases, but not experimentally produced ones, a significant **hypocalcemia** occurs.<sup>17,21,22</sup> Available serological tests include a complement fixation test, serum neutralization, fluorescent antibody test, agar gel immunodiffusion (AGID) test,<sup>19</sup> and a **blocking ELISA**, which is reported to be simple and the preferred test.<sup>23</sup>

#### NECROPSY FINDINGS

Postmortem lesions are not dramatic. The most consistent lesions are a **serofibrinous polyserositis**, involving synovial, pericardial, pleural and peritoneal cavities, with a characteristic accumulation of neutrophils in these fluids and surrounding tissues. Hemorrhage may also be observed in the periarticular tissues, and there may be foci of necrosis in the musculature of the limbs and back. All lymph nodes are usually enlarged and edematous. **Pulmonary emphysema** and fibrinous bronchiolitis are standard findings and subcutaneous emphysema along the dorsum may be observed. Characteristic microscopic findings consist of a mild vasculitis of small vessels, with perivascular neutrophils and edema fluid plus intravascular fibrin thrombi.

Necropsy examinations of animals that develop persistent recumbency have shown severe degenerative changes in the spinal cord similar to those produced by physical compression but the pathogenesis of these lesions remains uncertain. Although nucleic acid sequences of the agent are known, PCR tests are not yet widely utilized.

Antigen in reticuloendothelial cells can be detected by immunoperoxidase and immunofluorescent techniques<sup>24</sup>

#### Samples for confirmation of diagnosis

- **Virology** – chilled lung, spleen, synovial membrane, pericardium (ISO)
- **Serology** – pericardial fluid (ELISA)
- **Histology** – formalin-fixed samples of above tissues.

#### DIFFERENTIAL DIAGNOSIS

The diagnosis of ephemeral fever in a cattle population is not difficult on the basis of its epidemiology and clinical presentation. It can produce difficulties in individual animals where differentials include:

- Botulism
- Parturient paresis
- Pneumonia
- Traumatic reticulitis.

#### TREATMENT

Palliative intramuscular treatment with the **non-steroidal anti-inflammatory** drugs phenylbutazone (8 mg/kg at 8-hour intervals) or flunixin meglumine (2.2 mg/kg/d) or with ketoprofen (3 mg/kg/d) result in **remission** of signs without in any way influencing the development of the disease.<sup>21,22,25,26</sup> There is little effect on the respiratory manifestations of the disease but a major effect on stiffness, lameness and anorexia. All treatments are continued for 3 days. Phenylbutazone may be most effective but the injection frequency is less practical. Parenteral treatment with **calcium borogluconate** should be given to cows that show signs of hypocalcemia and field observations are that parenteral treatment with calcium solutions often helps to get a recumbent cow to her feet. Proper nursing of the recumbent animal is required.

#### CONTROL

Restriction of movement from infected areas is practiced but **vaccination** is the only effective method of control. Vaccines prepared from **attenuated** tissue culture virus or in mouse brain and adjuvanted in Freund's incomplete or Quil A adjuvants are commercially available in Australia, Japan, Taiwan and South Africa. Two vaccinations are required and are effective in preventing disease in natural outbreaks for periods up to 12 months.<sup>27</sup> The use of vaccination in Japan is credited with preventing further major outbreaks.<sup>13</sup> Attenuated vaccines are expensive to produce, have a short shelf-life, and breakdowns are recorded after their use. Formalin **killed** vaccines are used, with and without adjuvants, and give protection for approximately 6 months, requiring frequent boosting for effect.<sup>2,5</sup> Vaccines prepared from the envelope glycoprotein (G protein) protect against experimental challenge.<sup>21</sup> Immunity is positively correlated with the level of specific antibody measured with a blocking ELISA or as virus neutralizing antibody.

#### REVIEW LITERATURE

- Uren MF. Bovine ephemeral fever. *Aust Vet J* 1989; 66:233–236.
- Nandi S, Negi BS. Bovine ephemeral fever; a review. *Comp Immunol Microbiol Infect Dis* 1999; 22:81–91.

#### REFERENCES

1. Wang-Funln et al. *J Vet Diag Invest* 2001; 13:462.
2. Nandi S, Negi BS. *Comp Immunol Microbiol Infect Dis* 1999; 22:81.
3. Yeruham I et al. *Vet Rec* 2002; 151:117.
4. Yeruham I et al. *Vet Rec* 2003; 153:180.
5. Wang-F-I et al. *J Vet Diag Invest* 2001; 13:462.
6. Davies EG et al. *Bull WHO* 1985; 63:941.
7. Standfast HA, Miller MJ. In: Della-Porta AJ (ed) *Veterinary viral diseases*. New York: Academic Press, 1985; p. 394.
8. St George TD. In: *Proc 1st Int Symp ACIAR Beijing* 1993; 44:13.
9. Kirkland PD. In: *Proc 1st Int Symp ACIAR Beijing* 1993; 44:33.

10. Murray MD. *Aust Vet J* 1997; 75:20.
11. St George TD. *Vet Microbiol* 1985; 10:493.
12. Abu Elzein EME et al. *Vet Rec* 1997; 140:630.
13. Shirakawa H et al. *Aust Vet J* 1994; 71:50.
14. Yeruham I et al. *Vet Rec* 2003; 152:86.
15. Wenbin B et al. *Aust Vet J* 1989; 66:373.
16. Young PL, Spradbrow PB. *Vet Rec* 1990; 126:86.
17. Uren MF, Murphy GM. *Vet Microbiol* 1985; 10:505.
18. Young PL, Spradbrow PB. *J Comp Pathol* 1990; 102:105.
19. Gard GP, Melville LF. *Aust Adv Vet Sci* 1985; 152.
20. St George TD. *Aust Vet J* 2000; 78:857.
21. Uren MF et al. *Vaccine* 1994; 12:845.
22. Fenwick DC, Daniel RCW. *Aust Vet J* 1996; 74:37.
23. Zakrzewski H et al. *J Immunol Methods* 1992; 151:289.
24. Shehab GG et al. *Vet Med J Giza* 2004; 52:135.
25. Uren MF et al. *Vet Microbiol* 1989; 19:99.
26. St George TD. *Aust Vet J* 1997; 75:221.
27. Vanselow BA et al. *Vet Microbiol* 1995; 46:117.

#### AFRICAN HORSE SICKNESS

##### Synopsis

**Etiology** African horse sickness virus  
**Epidemiology** Infectious, non-contagious, arthropod-borne disease of horses, donkeys and mules endemic to sub-Saharan Africa. Epizootics occur in the Iberian peninsula, Mediterranean coasts, Middle East and Indian subcontinent  
**Clinical signs** *Pulmonary form*: fever, respiratory distress, frothy nasal discharge, death. *Cardiac form*: fever, edema of the head and ventral chest, hydropericardium. *Mixed form* has characteristics of both pulmonary and cardiac forms. *Horse fever*: mild fever, often inapparent infection  
**Clinical pathology** Leukopenia, disseminated intravascular coagulation. Serology often negative in horses that die acutely  
**Lesions** Pulmonary edema, hydropericardium, ascites, edema of the gastrointestinal tract  
**Diagnostic confirmation** Histopathology. Detection of virus by cultivation or reverse transcriptase-polymerase chain reaction (RT-PCR) in blood or tissues  
**Differential diagnosis list**:  
 • Pulmonary form  
 • Cardiac form  
**Treatment** None Supportive care  
**Control specific** *Enzootic area*: vaccination, reduce exposure to biting insects. Quarantine and eradication in non-enzootic areas

African horse sickness is an important disease of horses and mules in southern and central Africa and, during epizootics, in northern Africa and the Arabian and Iberian peninsulas. The disease in southern Africa occurs as frequent, intermittent small outbreaks and as periodic epidemics that kill large numbers of horses. An epidemic during 1854–55 killed over 17 000 horses, 40% of the horse population, in the Western Cape region. During pre-mechanized exploration and development of southern and central Africa and

during the Boer war the disease had a major economic and military impact. For example, during a single campaign in the Boer War, of 1732 British horses involved 323 died of African Horse Sickness within a 17 day period in late April, 1901.<sup>1</sup>

### ETIOLOGY

African horse sickness (AHS) is associated with a viscerotropic orbivirus (family Reoviridae) of which nine antigenic strains (serotypes) are recognized. The serotypic differences are due to variations in the capsid proteins, predominantly VP2 and to a lesser extent VP5. VP2 contains the predominant neutralizing epitopes although antibodies to VP5 are one of the earliest serologic markers of infection and have neutralizing activity.<sup>2</sup> Lineages are also evident within serotypes and the resultant clades are grouped geographically, at least for the serotypes studied.<sup>3</sup> Identification of clades facilitates epidemiologic studies.<sup>3</sup> There are also variants of each serotype with attenuated virulence.<sup>4</sup> No new serotypes have been identified since 1960 and all virtually all epidemics outside of southern Africa, with the exception of that in the Iberian peninsula in 1987-90 (serotype 4), were caused by serotype 9.<sup>5</sup> The virus is similar to other animal orbiviruses including bluetongue virus, enzootic hemorrhagic disease virus, and equine encephalosis virus. The host range includes equids (horses, donkeys, mules, zebra), elephants, camels, sheep, goats, and predatory or scavenging carnivores.<sup>4</sup> Infection produces disease in horses and mules, and less commonly African donkeys, but rarely in the other herbivorous hosts.

The virus is inactivated by heating at 50°C for 3 hours or 60°C for 15 minutes, is stable at 4°C, and survives for 37 days at 37°C. It remains viable at pH of 6-12, but is inactivated by acid and in 48 hours by 0.1% formalin or phenol, sodium hypochlorite, and iodophores.<sup>6,7</sup>

Disease associated with African horse sickness virus is on List A of the Office International des Epizooties.<sup>6</sup>

### EPIDEMIOLOGY

African horse sickness is an **infectious but not contagious** disease of Equidae. It is spread by the bite of blood-feeding insects.

### Occurrence

The disease is **enzootic in sub-Saharan Africa**, causing clinical disease in horses, donkeys, mules and dogs, and infecting zebras, elephants and perhaps other wildlife.<sup>8</sup> The disease occurs from Senegal through sub-Saharan Africa to Somalia.<sup>5</sup> The disease makes occasional incursions into Iran, Pakistan, India, Turkey and the eastern Mediterranean and Cyprus. The virus occurs in the Middle East, including

Saudi Arabia and the Yemen. It does not appear to be enzootic to Saudi Arabia<sup>9</sup> although the long-term status of this region is uncertain. In 1987 the disease recurred in Spain through introduction of infected zebras into a game park. By 1990 the disease had spread throughout Spain and Portugal but was eliminated by 1991.

### South Africa

The disease has been recognized in South Africa since shortly after introduction of domesticated horses in the 1600s. The disease occurred throughout what is now South Africa in the 19th and early 20th centuries, but as an enzootic disease became restricted to the north east of the country in the middle and later part of the 20th century. The geographic contraction of disease was associated with elimination of large herds of wild zebra from all except the game parks of the north east of the country. Elimination of zebra, the reservoir of infection, reduced the occurrence of the disease dramatically.<sup>10</sup> Outbreaks of disease outside of the endemic areas in the north east of South Africa are associated with introductions of virus from endemic areas at times of high abundance of *Culicoides* spp., the vector. The disease does not overwinter in the essentially zebra-free non-endemic areas. Serotype 9 causes enzootic disease in central Africa in the absence of zebra - the wildlife host has not been identified.

African horse sickness occurred in 1999 in the surveillance zone of the Cape Province of South Africa surrounding the disease-free area of Cape Town. The virus (serotype 7) was of a clade identical to that found in Kwazulu Natal Province<sup>13</sup> and its introduction was by the movement of infected horses from that region into the Cape Province.

### Transmission of infection

African horse sickness virus (AHSV) is transmitted by the **bite of hematophagous insects** including midges (*Culicoides* spp.), ticks (*Hyalomma dromadarii* and the brown dog tick, *Rhipicephalus sanguineus*), and mosquitoes (various species in laboratory studies).<sup>11</sup> **Midges** are by far the most important vector in the spread of the spontaneous disease. The source of virus for midges is blood of infected horses, donkeys, mules and zebra. Horses and mules have clinical signs of disease while viremic, but donkeys are often and, most importantly, zebra are always, inapparently infected. Zebras may remain viremic for 6 weeks, donkeys for 12 d, and horses for 18-21 d.<sup>10,12,13</sup> Dogs are infected by eating infected animals, although transmission to and from dogs by ticks can occur.

Transmission of the virus to areas where it does not usually exist occurs

both by movement of infected animals, such as zebras and horses, and by transportation of midges by wind. Mechanical transmission of the virus on contaminated surgical instruments and needles should be considered a possibility.

### Zebra

In areas in which the disease is enzootic, the virus persists by cycling between the mammalian host, the zebra, and vectors year round.<sup>10,12</sup> Zebra in enzootic areas can seroconvert during any month of the year, indicating that persistence of the virus is associated with sequential infection of zebra within a herd or region. Persistence of the virus in a region is attributable to the long period of viremia in zebra and the presence of a herd of sufficient size to support cycling of infection among animals. The minimum size of a zebra population to maintain an enzootic infection is unknown.<sup>10</sup> However, in areas in which the disease is not enzootic, the virus does not persist over the cooler winter months when viremic animals recover and the vectors die. Concern exists that reintroduction of zebra to areas of the country currently free of enzootic AHS might permit reestablishment of the virus and disease in horses.<sup>5,10</sup>

### Midges

Midges are infected with AHSV, that is they are not mechanical vectors but rather the virus infects and replicates in the midge, although transovarial transmission of infection between generations of midges does not occur. *C. imicola* is the vector responsible for the transmission of AHSV within its enzootic area, and during epizootics. *C. bolitinos* is also a vector of AHSV in southern Africa<sup>14</sup> while a number of other *Culicoides* spp. are unlikely to be vectors as they are unable to maintain infection with virus 10 days after ingesting a meal of infected blood.<sup>15</sup> However, *C. varipennis*, *C. pulicaris*, and *C. obsoletus* are competent and likely important vectors because of their ability to maintain infection over winter, as demonstrated in Portugal.<sup>16</sup>

The abundance of midges can be predicted from measures of soil moisture content and land surface temperature.<sup>4</sup> Midges breed in damp soils that are rich in organic material, such as irrigated pastures, that provide soil moisture adequate for completion of the life cycle (at least 7 to 10 days).<sup>5</sup> Higher temperatures increase the rates of infection of midges, virogenesis within midges, and transmission rate but decrease midge longevity.<sup>5</sup> Replication of AHSV in midges does not occur at temperatures <15°C although midges continue to be active at 12°C. Midges can be transported by winds for up to 700 km.<sup>17</sup>



## Risk factors

### Environment factors

The incidence of the disease is often **seasonal** because of the seasonal variations in the number of *Culicoides* spp. present and possibly other weather related factors such as host (zebra) behavior. Vector activity is favored by temperatures between 12.5 and 29°C and it is likely that several cool or cold episodes, rather than one 'killing frost', are necessary to kill all or most vectors.<sup>12</sup> Local factors, including topography, influence the distribution of midges within their overall range and therefore the disease has a geographical distribution: the areas most severely affected are low lying and swampy.

Epizootics of AHS occur in southern Africa in association with variations in the El Nino/southern oscillation.<sup>18</sup> Epizootics of the disease occur in years in which the oscillation produces drought followed by heavy rains. The reason for this association, which was first anecdotally reported in the 1800s, is unknown but could be related to congregation of zebra around water holes during the drought. Congregation of large numbers of zebra might increase the infection rate among midges which then disseminate the infection when rains produce widespread conditions favorable to their reproduction.<sup>18</sup>

### Animal factors

Natural infection occurs in Equidae, the most severe disease occurring in horses, with mules, donkeys and zebras showing lesser degrees of susceptibility in that order. The virus causes severe disease in dogs.<sup>19</sup> Elephants seroconvert when exposed to infection, but are probably not an important reservoir.<sup>20</sup> The case fatality rate varies depending on the severity of disease (see under 'Clinical signs') but can be as high as 90% in susceptible horses, but is lower in mules and donkeys.

After natural infection or vaccination immunity to that strain, but not to heterologous strains, is solid. The development of immunity is slow and may require 3 weeks to be appreciable: titers may continue to rise for 6 months after infection. Foals from immune dams derive passive immunity from the colostrum and are immune until 5–6 months of age.

## Economic importance

The disease was of tremendous economic concern in southern Africa when horses were important for transportation and as draft animals. The disease is currently an economic concern because of the costs associated with preventive measures in enzootic areas, monitoring for introduction of disease in neighboring unaffected areas, and restrictions on importation of horses from countries in which the disease is enzootic. The high case fatality rate and

morbidity of the disease in outbreaks is another source of loss. The cost of disease epizootics can be large, as demonstrated by the outbreak in the Iberian Peninsula where control of the disease in Portugal in 1990–1991 was achieved at a cost of US\$2 000 000.<sup>21</sup>

## Zoonotic disease

African horse sickness caused encephalitis and chorioretinitis in eight workers in an AHS vaccine factory. Infection was likely be inhalation of freeze-dried virus.<sup>22</sup>

## PATHOGENESIS

AHSV affects vascular endothelium and monocytes/macrophages.<sup>23,24</sup> The tissue tropism of the infecting serotype determines which organs are most severely affected, with virus serotypes affecting endothelium in different organs, resulting in a variety of 'forms' or clinical presentations of the disease. After infection, the virus multiplies in local lymph nodes and a primary viremia ensues with dissemination of infection to endothelial cells and intravascular macrophages of lung, spleen and lymphoid tissues. Viral multiplication then results in a secondary cell-associated (red cell and white cell) viremia in horses of up to 9 days duration.<sup>5</sup> Fever and viremia occur at the same time and resolution of the viremia is associated with defervescence. Localization of antigen depends on the form of the disease – horses with horse sickness have most of the antigen in the spleen whereas horses with the more severe cardiopulmonary form have abundant antigen in cardiovascular and lymphatic systems.<sup>5</sup>

Infection of endothelial cells results in degenerative changes, increases in vascular permeability, impaired intercellular junctions, loss of endothelium, subendothelial deposition of cell debris and fibrin, and evidence of vascular repair.<sup>23</sup> Edema, hemorrhage, and microthrombi are associated with the vascular lesions. Abnormalities in the lungs include development of alveolar and interstitial edema, sequestration of neutrophils and platelet aggregates and formation of fibrinous microthrombi.<sup>24</sup> Combined these changes likely result in a coagulopathy, systemic inflammatory response syndrome, edema, impaired cardiovascular and pulmonary function and hypovolemia.

## CLINICAL FINDINGS

The **incubation period** in natural infections is about 5–7 d. Three or four clinical forms of the disease occur, an acute or pulmonary form, a cardiac or subacute form, a mixed form, and a mild form known as 'horse sickness fever'. An intermittent fever of 40–41°C (105–106°F) is characteristic of all forms.

## Acute (pulmonary) horse sickness (dunkop)

This is the most common form in epizootics and has a case fatality rate of 95%. Fever is followed by labored breathing, severe paroxysms of coughing and a **profuse nasal discharge** of yellowish serous fluid and froth. Profuse sweating, profound weakness and a staggy gait progress to recumbency. Death usually occurs after a total course of 4–5 d although it can be so acute as to be without observed premonitory signs in some horses. Severe respiratory distress persists for many weeks in surviving animals. This is the form of the disease that occurs naturally in dogs.

## Subacute (cardiac) horse sickness (dikkop)

Subacute (cardiac) horse sickness is most common in horses in enzootic areas and has a case fatality rate of 50%. The incubation period may be up to 3 weeks, and the disease has a more protracted course than does the acute, pulmonary form. There is **edema** in the head, particularly in the temporal fossa, the eyelids and the lips, and the chest which may not develop until the horse has been febrile for a week. The oral mucosa is bluish in color and petechiae may develop under the tongue. Examination of the heart and lungs reveals evidence of **hydropericardium**, endocarditis and pulmonary edema. Restlessness and mild abdominal pain and paralysis of the esophagus, with inability to swallow and regurgitation of food and water through the nose, is not uncommon. Recovery is prolonged. A fatal course may last as long as 2 weeks.

A **mixed form** of the disease, with both pulmonary and cardiac signs, is evident as an initial subacute cardiac form that suddenly develops acute pulmonary signs. Also, a primary pulmonary syndrome may subside but cardiac involvement causes death. This mixed form is not common in field outbreaks.

## Horse sickness fever

A mild form of horse sickness fever that may be easily overlooked, and is common in enzootic areas. The disease occurs in horses with some immunity or infection by serotypes of low virulence. This is the only form of the disease that occurs in zebras. The temperature rises to 40.5°C (105°F) over a period of 1–3 d but returns to normal about 3 d later. The appetite is poor, there is slight conjunctivitis and moderate respiratory distress.

## CLINICAL PATHOLOGY

**Leukopenia**, with lymphopenia, neutropenia and a left shift, mild thrombocytopenia and hemoconcentration are characteristic of the acute forms of AHS.<sup>25</sup> **Serum biochemical abnormalities** include increases



in creatine kinase, lactate dehydrogenase, and alkaline phosphatase activities and creatinine and bilirubin concentrations.<sup>25</sup> There is evidence of activation of coagulation cascade and fibrinolysis although disseminated intravascular coagulation is unusual.<sup>25</sup>

**Serological diagnosis** of the acute disease may be difficult because many horses die before they mount a detectable antibody response.<sup>26</sup> In horses that survive for at least 10 d, agar gel immunodiffusion (AGID), indirect fluorescent antibody (IFA), complement fixation (CF), virus neutralization (VN) and ELISA tests are all effective in detecting antibody to the virus.<sup>27,28</sup> An indirect ELISA (I-ELISA) is more sensitive in detecting early immunological responses to vaccination or infection and the declining immunity in foals.<sup>29</sup> However, in outbreaks of disease early and accurate diagnosis of disease and identification of the serotype involved is important to guide selection of vaccine and thereby control spread of the disease. Diagnosis early in the course of the disease can be achieved by demonstration of **viral antigen or nucleic acid** in blood or tissue samples by any of a number of ELISA tests. A recent RT-PCR test enables rapid identification and differentiation of viral serotype from both live and formalin inactivated virus.<sup>30</sup> This test has utility in the early diagnosis of outbreaks of AHS. Viral isolation can be achieved in suckling mice or cell culture. Suitable samples are blood collected into heparin during the febrile stage of the disease or lung, spleen or lymphoid tissue collected at necropsy.

Tests approved for testing horses for international trade include a complement fixation test and an indirect sandwich ELISA.<sup>31</sup>

#### DIFFERENTIAL DIAGNOSIS

The fulminant disease in groups of horses is characteristic, although acute intoxication by monensin, salinomycin, or similar compounds can produce similar signs. Individual horses affected with purpura hemorrhagica and groups of horses affected with equine viral arteritis can have signs similar to horses with AHS. Piroplasmiasis (*B. caballi* or *T. equi*) and trypanosomiasis cause fever and depression. Anthrax can cause acute deaths in solitary horses or groups of horses.

#### NECROPSY FINDINGS

Gross findings in acute cases include **severe hydrothorax and pulmonary edema** and moderate ascites. The liver is acutely congested and there is edema of the bowel wall. The pharynx, trachea and bronchi are filled with yellow serous fluid

and froth. In cases of cardiac horse sickness there is marked hydropericardium, endocardial hemorrhage and myocardial degeneration. Edema of the head and neck is common, especially of the supra-orbital fossa and nuchal ligament. Microscopic lesions are minimal in the acute form; pulmonary edema but no obvious vascular injury. Myocardial damage, including foci of necrosis, hemorrhage, and mild leukocytic infiltrates, may be seen during histologic examination of many cardiac (subacute) cases.

#### Samples for confirmation of diagnosis

- **Virology** – chilled spleen, lung, lymph node (PCR, VI)
- **Histology** – fixed lung, heart.

#### TREATMENT

There is no specific treatment for AHS. Supportive care and treatment of complication of the disease should be provided.

#### CONTROL

The **principles of control** in enzootic areas are **vaccination** and **reduction of exposure** of horses to biting insects, whereas in **non-enzootic** areas the aim is to **prevent introduction** of the disease, and **eradication** if it is introduced. The objectives of a control program for African horse sickness are:<sup>5</sup>

- Prevention of introduction of infection by clinically ill or inapparently infected animals
- Slaughter of viremic animals where animal welfare and economic considerations permit this course of action
- Management changes to reduce exposure to midges
- Vector control
- Induction of active immunity in animals at risk of disease.

#### Prevention of introduction

Infection can be introduced into an area free of AHSV by infected animals or midges. Control of midges is discussed below. Infected animals can be horses incubating the disease, clinically ill animals, or animals, including donkeys and zebras, that have no clinical signs of illness but are infected and viremic, as was the case of the Portuguese epizootic. Appropriate control measures to prevent movement of animals at risk of being infected should be instituted and include<sup>32</sup>: completion of a vaccination protocol effective against all important serotypes at least 42–60 days before introduction of the horse, positive identification of all horses by microchipping and passport documenting vaccination status, and a veterinary certificate confirming health and issued no more than 48 hours before introduction. Equids

imported from areas in which the disease is enzootic, or from neighboring regions, should be housed in isolation in insect proof enclosures for 60 days. Recommendations that call for vaccination of all equids within 10 miles (16 km) of imported horses are not appropriate for most countries to which the disease is exotic.

#### Slaughter of sick or viremic animals

This extreme measure is appropriate in controlling infection recently introduced into areas previously free of the disease. It is an effective adjunct in control of spread of infection, as demonstrated in Portugal.<sup>21</sup> There are obvious economic, animal welfare and public relations aspects to this practice, especially in areas where horses have high intrinsic worth or are companion animals.

#### Reduce exposure to biting midges

Horses should be housed in insect proof buildings or, at a minimum, buildings that limit exposure of horses to midges by closure of doors and covering of windows with gauze.<sup>33</sup> Impregnation of gauze with an insecticide further reduces biting rates.<sup>5</sup> Stables should be situated in areas such as on hill tops or well-drained sites, that have minimal midge populations. Midge numbers on individual farms should be reduced by habitat alteration, so that areas of damp, organically enriched soils are eliminated. Widespread use of insecticides is unlikely to be environmentally acceptable.<sup>5</sup>

The feeding pattern of midges is such that housing of horses during the crepuscular periods and at night will significantly reduce biting rates and likelihood of infection.<sup>5</sup> Horses kept at pasture should have insect repellents applied regularly and especially to provide protection during periods of high insect biting activity. DEET (N,N-diethyl-metaltoluamide) is the only commercially available repellent with documented activity against *Culicoides* spp.<sup>34</sup>

#### Vaccination

Vaccination is used in two circumstances – in areas in which the disease is endemic and in regions with an epizootic of the disease. Vaccination can be used in enzootic or neighboring regions to provide active immunity of all resident equids because of the continual risk of the disease in these areas. Vaccination in this instance is initiated as soon as foals no longer have passive immunity to the virus, and continues annually throughout the horse's life. Alternatively, vaccination may be used in the face of an epizootic to induce active immunity in horses in contact or in regions surrounding the outbreak. In this instance, vaccination is stopped when the infection is eradicated from the area.

Early attenuated virus vaccines, while effective in preventing AHS, were associated with significant side-effects, such as encephalitis. More recent vaccines of virus attenuated by passage through tissue culture are effective in preventing disease but do not prevent viremia. They were used to control the most recent outbreak in Spain and Portugal. Currently available vaccines are polyvalent or monovalent preparations containing attenuated strains of the virus. Protection against heterologous serotypes is usually weak and most vaccines are polyvalent. The polyvalent vaccines contain serotypes 1, 3, and 4 or serotypes 2, 6, 7, and 8, respectively.<sup>35</sup> AHSV-9 is not included as serotype 6 is cross protective.<sup>5</sup> A monovalent vaccine containing attenuated serotype 9 is used in western Africa where this is the only serotype present.<sup>5</sup> Inactivated vaccines are effective in preventing viremia in most animals and disease without side-effects.<sup>27</sup> Inactivated vaccines are no longer available and vaccination with sub-unit vaccines and DNA vaccination are experimental at the time of writing.

The recommended vaccination program for horses in South Africa is:<sup>36</sup>

- The primary vaccination consists of Horse Sickness Vaccine I (AHS I) and Horse Sickness Vaccine II (AHS II) administered at least 3 weeks apart to foals between 1 February and 31 July
- The primary vaccination should preferably not be administered before foals are 6 months of age to avoid the effect of maternally derived passive immunity on vaccine efficacy
- Revaccination with AHS I and AHS II at least 3 weeks apart to yearlings between 1 August and 31 January
- Subsequent revaccination with AHS I and AHS II either at intervals not exceeding 12 months, or every year between 1 July and 31 December.

**Immunity** after vaccination is protective for at least 1 year but annual revaccination of all horses, mules and donkeys is recommended.

There is concern over the use of attenuated virus vaccines in epizootic situations, that is in regions where AHSV is not enzootic. These reasons include the lack of vaccines approved for use in the European Community, the availability of only two types of polyvalent vaccines and one type of monovalent vaccine, delays in availability of vaccine for emergency vaccination, introduction of virus, even attenuated virus, into regions in which it is not present, attenuated virus viremia in some vaccinated horses, and reversion of vaccine strains to virulence.<sup>5</sup> These concerns have heightened the need for availability of inactivated virus or subunit vaccines.

## REVIEW LITERATURE

Mellor PS, Hamblin C. African horse sickness. *Vet Res* 2004; 35:445.

## REFERENCES

1. Smith F. Veterinary history of the War in South Africa 1899–1902. London: H&W Brown, 1914; p. 166.
2. Martinez-Torrecuadrada JL et al. *Virology* 1999; 257:449.
3. Koekemoer JJO et al. *Virus Res* 2003; 93:159.
4. Calisher CH, Mertens PPC. In: African horse sickness. Wein, Austria: Springer-Verlag, 1998; p. 3.
5. Mellor PS, Hamblin C. *Vet Res* 2004; 35:445.
6. [http://www.oie.int/eng/maladies/fiches/a\\_A110.htm](http://www.oie.int/eng/maladies/fiches/a_A110.htm) Accessed 21 February 2005.
7. Shirai J et al. *J Vet Med Sci* 2000; 62:85.
8. Binopal VS et al. *Vet Microbiol* 1992; 31:19.
9. Al-Afaleq AI et al. *Rev Sci Tech Off Int Epiz* 1998; 17:777.
10. Barnard BJH. In: African horse sickness. Wein, Austria: Springer-Verlag, 1998; p. 14.
11. Mellor PS, Boorman J. *Annals Trop Med Parasitol* 1995; 89:1.
12. Skowronek AJ et al. *Vet Pathol* 1995; 32:112.
13. Hamblin C et al. In: African horse sickness. Wein, Austria: Springer-Verlag, 1998; p. 37.
14. Meiswinkel R, Paweska JT. *Prev Vet Med* 2003; 60:243.
15. Venter GJ et al. *Med Vet Entom* 2000; 14:245.
16. Capela R et al. *Med Vet Entom* 2003; 17:165.
17. Sellers RF. *J Hyg* 1980; 85:65.
18. Baylis M et al. *Nature* 1999; 397:574.
19. van Rensburg IBJ. *J S Afr Vet Assoc* 1981; 52:323.
20. Barnard BJH et al. *Onderst J Vet Res* 1995; 62:271.
21. Portas M et al. *Epidemiol Infect* 1999; 123:337.
22. van der Meyden CH et al. *Sth Afr Med J* 1992; 81:451.
23. Gomez-Villamandos JC et al. *J Comp Path* 1999; 121:101.
24. Carrasco L et al. *J Comp Path* 1999; 121:25.
25. Mellor PS. *Comp Immun Infect Dis* 1994; 17:287.
26. Martinez-Torrecuadrada JL et al. *J Clin Microbiol* 1997; 35:531.
27. House C et al. *Ann NY Acad Sci* 1992; 653:228.
28. Kweon CH et al. *J Virol Meth* 2003; 113:13.
29. Marec S, Paweska JT. *J Virol Meth* 2005; 125:55.
30. Sailleau C et al. *J Gen Virol* 2000; 81:831.
31. [http://www.oie.int/eng/normes/mmanual/A\\_00034.htm](http://www.oie.int/eng/normes/mmanual/A_00034.htm) Accessed 22 February 2005.
32. <http://www.freyja.co.za/ahscontrolpolicy.htm> Accessed 22 February 2005.
33. Meiswinkel R et al. *Bull Entom Res* 2000; 90:509.
34. Braverman Y et al. *Med Vet Entomol* 1997; 11:355.
35. House JA. In: African horse sickness. Wein, Austria: Springer-Verlag, 1998; p. 297.
36. [www.jockeyciubs.co.za](http://www.jockeyciubs.co.za) accessed 22 February 2005.

## ENCEPHALOMYOCARDITIS VIRUS DISEASE IN PIGS

Encephalomyocarditis is a viral infection of rodents, transmissible to domestic animals and man but it is only a significant pathogen in pigs and elephants. It is postulated as a risk in xenotransplantation.<sup>1</sup>

### ETIOLOGY

The cause is a cardiovirus (family Picornaviridae) that is primarily a pathogen of rodents but which has the ability to produce disease in domestic animals, wild and zoo animals (particularly elephants), primates, and artiodactyls and man. It is found worldwide but its seriousness as a

pathogen varies from probably inconsequential in the USA to important in Belgium.<sup>2</sup>

### EPIDEMIOLOGY

It was first described as a cause of neonatal mortality in 1975.<sup>3</sup> When the disease was first described, pigs from 3–6 weeks were affected with myocarditis and encephalitis.<sup>4</sup> It is now known that the virus may cause reproductive failure in gilts and sows characterized by stillbirths and mummified fetuses.<sup>5</sup> The prevalence of inapparent infection in the swine population is high.

Outbreaks of the disease or serological evidence of the virus have been reported from the United States,<sup>6–8</sup> Canada,<sup>9</sup> Australia,<sup>4,10</sup> Italy,<sup>11</sup> Greece,<sup>12</sup> and many other countries including central America and now Venezuela.<sup>13</sup> Most work appears to have been carried out in Belgium<sup>14,15</sup> where there were major outbreaks in 1995–96 due to a new virus.<sup>16</sup> Serological studies of pigs in the United Kingdom, where the disease has not yet been recorded, found approximately 30% possess antibody to the virus. It is extraordinary that there never has been an outbreak that could be described clinically, pathologically or histologically as EMCV considering the close proximity of the UK to Belgium where the disease is widely reported. First reported in 1991 in Belgium, between 1995 and 1996 the disease was diagnosed 154 times in Belgium<sup>16</sup> either as a cause of myocardial failure with sudden death in finishing pigs and suckling piglets or as a cause of reproductive failure in sows. Their experience suggests that each isolate is specific for one age category and that the spread of the virus is limited. This recent finding suggests that rodents do play a part in the transmission of the virus but that pig to pig transmission is equally important as a source of infection.

In Iowa,<sup>17</sup> infection is widespread in swine herds; the true prevalence of infection in breeding stock is estimated at 13.8% and 8.5% in finishing animals.<sup>8</sup> About 90% of the herds surveyed in Iowa had one or more seropositive animals and seroprevalence increased with age. In Italy, most herds and 70% of pigs are seropositive for the virus. Clinical disease has been observed in very young suckling pigs to grower pigs up to 4 months of age but not in adults. It may occur as a sporadic disease or as an outbreak involving several litters of pigs, or pigs within a group. In outbreaks in Greece, in one herd of 100 breeding sows, 200 pigs aged 8–16 weeks of age died from the disease within 2 months.<sup>12</sup> Population mortality in a group of young pigs is variable but it may approach 50% in younger pigs. Transmission is usually believed to be oral

and spread amongst pigs is said to be limited<sup>18</sup> although because of the presence of virus clones there may be the occasional large outbreak as well.

The role of rodents, especially the genus *Rattus*, always supposed to be the main reservoir of the virus for domestic pigs has been suspected but not documented as the source of spread of the infection to pigs.<sup>19</sup> No pig to pig transmission has been shown and the pig is probably not a risk to man. Serological surveys of free-living animal species in Iowa in the United States have failed to find evidence of infection in these species and it is suggested that swine themselves are the main reservoir of infection. In an Australian outbreak, a plague of rats in the piggery may have been the source of the virus.<sup>4</sup> The virus is relatively resistant to heat and chemical influences and a wide variety of pH but is sensitive to desiccation. Outbreaks are frequently associated with rodent plagues in the piggery or area, or with rodent infestation of feed stores. An epidemic in Australia was associated with a plague of mice which were present in all piggeries reporting the disease.<sup>20</sup>

The virus is now considered a major cause of reproductive failure in swine herds.<sup>21</sup> The virus has been recovered from fetuses, antibodies to the virus have been demonstrated in fetal fluids, and histological lesions supporting a diagnosis of the viral infection have been observed.<sup>21</sup>

The economic losses associated with reproductive and neonatal losses associated with the virus have been estimated at US\$100 per inventoried sow.<sup>21</sup> Investigations of outbreaks on two Minnesota (United States) swine farms indicated that the monthly averages for the numbers of piglets born dead per litter reached 4.6 and 3.6, the pre-weaning mortalities 50% and 31%, and the farrowing rates 52% and 63%, respectively.

Isolates of the virus from different countries have different clinical characteristics and differences in pathogenicity, molecular and antigenic properties.<sup>22</sup> A possible pneumotropic strain was identified in Quebec, Canada and this caused interstitial pneumonia.<sup>9</sup> Strain differences between isolates are manifested in differences in virulence. The Belgian isolate is classified as a reproductive strain and the Greek isolate as a myocardial strain. Both strains are able to cause reproductive failure in sows in gestation and to cause myocardial lesions in piglets but a difference in virulence between both isolates is evident.<sup>22</sup>

The effects of different experimental doses and ages in experimental infections of pigs are described in a paper from Greece.<sup>23</sup> The pathogenesis of these Greek viruses has been described<sup>24</sup> and in most cases there is a viremia with the

lymphoid tissues containing the virus and they are probably the main source of the virus replication. Inoculation of a suspension of heart, spleen and lymph node tissues from affected pigs can result in sudden deaths of experimental pigs within 3 days.<sup>12</sup> The highest titers of the virus are found in the areas of damaged heart muscle. The virus can cause fetal death if the pregnant sow is infected in late pregnancy. The experimental inoculation of the virus into pregnant sows at 46–50 d of gestation results in transplacental infection and fetal deaths.<sup>21</sup> On the other hand experimental infections of 4–6 week old conventional pigs with a USA isolate produced no overt clinical disease.<sup>25</sup>

#### CLINICAL FINDINGS

Rarely is there clinical disease as most cases are seen as sudden death without clinical signs. Sub-clinical infection is the normal event and particularly in older or adult animals but even here, occasionally, death may occur.

The clinical course in young and growing pigs is short and manifested by inappetence, depression, trembling, incoordination and dyspnea. It has been described as being associated with respiratory disease in the USA.<sup>26</sup> There may be cyanosis of the extremities. Most frequently, pigs are found dead or die suddenly while feeding or when excited. Death appears to result from cardiac failure and clinical signs referable to encephalitis are rare. The reproductive form of the disease is characterized clinically by inappetence and fever, possibly to 41°C followed by farrowing at 109–111 days of gestation in affected sows.<sup>6</sup> There are numbers of mid to term abortions. The numbers increase for still-born piglets, mummified fetuses and weak piglets, which are more susceptible to crushing and starvation and other common neonatal diseases. The course of the outbreak will usually last several weeks and possibly as long as 2–3 months with continuing reproductive failure with persistence of the virus.<sup>23,27</sup> Animals with cardiac failure should be killed humanely because the heart damage does not resolve.

#### CLINICAL PATHOLOGY

Neutralizing antibodies to the virus are present in sows and healthy in-contact pigs of affected farms.<sup>12</sup> In outbreaks of reproductive failure, specific antibody to the virus can be found in both fetal and neonatal sera collected from abnormal litters.<sup>6</sup> The hemagglutination inhibition and AGID tests are comparable for the detection of antibodies to encephalomyocarditis virus in fetal thoracic fluids.<sup>22</sup> A microtiter serum-neutralization test is a relatively specific and sensitive test for the diagnosis.<sup>28</sup> Antibodies of above eight are suspicious, and titers  $\geq 16$  are positive.

Serum-neutralizing antibodies persist for several months and it is necessary to examine paired samples. A nucleic-acid probe can detect the presence of the virus in infected cell lysates.<sup>29</sup> Enzymes such as serum creatine kinase-MS and lactic dehydrogenase isoenzyme are also elevated.<sup>30</sup>

#### NECROPSY FINDINGS

At necropsy, there is reddening of the skin, excess peritoneal, pleural and pericardial fluid – frequently with fibrinous strands and edema of the omentum and mesentery. Sometimes there is pulmonary edema and liver enlargement. Characteristically, the heart appears pale and soft and there is diffuse or focal myocardial pallor involving the ventricles and associated with myocardial necrosis.<sup>12</sup> These may appear as distinct white foci or streaks<sup>31</sup> from 2–15 mm in diameter and these are most commonly on the right ventricular epicardium. Histologically, there is diffuse or focal myocarditis, with infiltration by histiocytes, lymphocytes, plasma cells and degeneration of cardiac muscle cells.<sup>12</sup> The virus can be identified in the cytoplasm of cardiac muscle cells<sup>32</sup> and virus particles are also seen in the protrusions from the cell surface of the Purkinje fibers and endothelial cells of the capillaries and intranuclearly in the cardiac muscle fibers. In chronic cases these have healed in the only way possible as fibrous plaques. In acute cases virus may be isolated from the heart muscle and also from the brain, spleen and other tissues. Neutralizing antibody becomes detectable 5–7 days after infection.

The predominant histopathological lesion in stillborn fetuses is myocarditis consisting of myocyte degeneration and necrosis with focal or diffuse mononuclear cell infiltration. In nursing piglets with the disease, histologically there are lesions of multifocal interstitial pneumonia, myocarditis, and mild multifocal non-suppurative meningoencephalitis.<sup>14</sup> The immunohistochemistry is usually positive in the nuclei of the cardiac muscle cells, Purkinje cells, the endothelial cells of the capillaries and in the macrophages.<sup>33</sup>

#### Samples for confirmation

- Serological samples for neutralizing antibodies<sup>34</sup> which is widely available and is specific or HI antibodies may be helpful
- The virus can be isolated from stillborn pigs.<sup>35</sup> It can also be demonstrated by PCR, RT-PCR and one step PCR.<sup>36</sup> The RT-PCR can be followed by genetic typing using sequence analysis and this is useful in molecular epidemiology.<sup>37</sup> It has also been demonstrated by in situ hybridization (ISH)<sup>38</sup>

- o. Histopathology on heart muscle also useful with immunohistochemistry to follow to confirm. In the neonate, the brain histology may show a non-suppurative meningo-encephalitis which can be confirmed by immunohistochemistry.

### Diagnosis

The diagnosis is from the history, clinical signs, gross and microscopic pathology and from isolation of the virus or demonstration of the antigen by immunohistochemistry. In some cases it may be necessary to consider vitamin E deficiency (Mulberry heart disease). The reproductive form of the infection may need to be differentiated from porcine parvovirus infection.

### DIFFERENTIAL DIAGNOSIS

The disease must be differentiated from bowel edema and mulberry heart disease in growing pigs and the per-acute bacterial diseases in suckling pigs. The myocardial lesions in suckling pigs have similarities to those produced by foot and mouth disease virus in this age group of pigs – the so-called 'Tiger Heart'.

### TREATMENT AND CONTROL

There is no treatment and the control of the disease currently rests with rodent control and eradication in the piggery. There is now an inactivated vaccine available, which is an oil adjuvanted vaccine developed to protect elephants. It has been shown to work in mice and pigs<sup>39</sup> and is believed to produce high antibody titers in both domestic and wild animals.

### REVIEW LITERATURE

- Acland HM. Encephalomyocarditis virus. In: Pensaert M (ed.) Virus infections of porcines. Edinburgh: Elsevier, 1989.
- Billinis C et al. A comparative study of the pathogenic properties and transmissibility of a Greek and Belgian encephalomyocarditis virus (EMCV) for piglets. *Vet Microbiol* 1999; 70:179.
- Koenen F et al. The genetics of European EMCV. *Arch Virol* 1999; 144:893.

### REFERENCES

1. Brewer L et al. *Xenotransplant* 2001; 8 suppl:135.
2. Koenen F et al. *Arch Virol* 1999; 144:893.
3. Acland HM, Littlejohns IR. *Aust Vet J* 1975; 51:409.
4. Mercy AR et al. *Aust Vet J* 1988; 65:355.
5. Koenen F et al. *Vet Microbiol* 1994; 39:111.
6. Christianson WT et al. *Rec Vet* 1990; 126:54.
7. Coulson A, Carlson J. *Proc 12th Int Pig Vet Soc Cong* 1992; p.103.
8. Zimmerman JJ et al. *J Am Vet Med Ass* 1991; 199:1737.
9. Dea SA et al. *Arch Virol* 1991; 117:121.
10. Littlejohns IR. *Aust Vet J* 1984; 61:93.
11. Gualandi GL et al. *Microbiology* 1989; 12:129.
12. Paschaleri-Papadopoulou I et al. *Vet Rec* 1990; 126:364.
13. Rolo M et al. *Fonaiap Divulga* 1998; 59:23.
14. Koenen F et al. *Zentbl Vetmed B* 1999; 46:217.
15. Castryck F et al. *Proc 14th Int Pig Vet Soc Cong Bologna* 1992; p. 132.

16. Koenen F et al. *J Vet Med Ser B* 1999; 46:217.
17. Sangar DV et al. *Vet Rec* 1977; 100:240.
18. Maurice H et al. *Vet Microbiol* 2002; 88:301.
19. Smith KE et al. *Can Vet J* 1992; 33:645.
20. Seaman JT et al. *Aust Vet J* 1986; 63:292.
21. Christianson WT et al. *Am J Vet Res* 1992; 53:44.
22. Kim HS et al. *J Vet Diag Invest* 1991; 3:283.
23. Billinis C et al. *Vet Microbiol* 2004; 99:187.
24. Papaioannou N et al. *J Comp Path* 2003; 129:161.
25. Zimmerman JJ et al. *J Vet Diag Invest* 1993; 5:317.
26. Dea S et al. *J Vet Diag Invest* 1991; 3:275.
27. Christianson WT et al. *Am J Vet Res* 1992; 53:44.
28. Zimmerman JJ et al. *J Vet Diag Invest* 1990; 2:347.
29. Meng XJ et al. *J Vet Diagn Invest* 1993; 5:254.
30. Billinis C et al. *Vet Rec* 1997; 140:628.
31. Littlejohns IR, Acland HM. *Aust Vet J* 1975; 51:416.
32. Psychas V et al. *Am J Vet Res* 2001; 62:1653.
33. Vlemmas J et al. *J Comp Path* 2000; 122:235.
34. Joo HS et al. *Arch Virol* 1986; 100:131.
35. Littlejohns IR. *Aust Vet J* 1984; 61:93.
36. Kassimi LB et al. *J Virol Methods* 2002; 101:197.
37. Vanderhallen H, Koenen F. *J Clin Microbiol* 1998; 36:3463.
38. Oh SH et al. *Kor J Vet Res* 1999; 39:148.
39. Hunter P et al. *Vaccine* 1998; 16:53.

### POST-WEANING MULTISYSTEMIC WASTING SYNDROME (PMWS) AND PORCINE DERMATITIS AND NEPHROPATHY SYNDROME (PDNS) AND PORCINE CIRCOVIRUS-ASSOCIATED DISEASES

This disease (PMWS) was first described in weaned pigs possessing unique macroscopic and microscopic features<sup>1</sup> It was first recognized in Western Canada<sup>2-5</sup> and then Europe<sup>6</sup> and finally Asia and the United States. PDNS was originally thought to be a separate condition when it occurred as sporadic PDNS but now it is seen as an important component of PMWS.

A good definition of the disease was provided by Steve Sorden.<sup>7</sup> For a diagnosis you must have: (i) wasting, poor growth rate, often dyspnea, and swollen inguinal lymph nodes; (ii) lymphocyte depletion and granulomatous inflammation in lymph nodes; and (iii) detection of PCV2 in the lesions in the lymph nodes. The study of PCV2 and PMWS is still in its infancy.

### ETIOLOGY

Porcine circovirus 2 (PCV2) is not a new agent but it is newly discovered as a pathogen. It has been found in 30 year old serum.<sup>8-10</sup> It does not appear to be found in horses or cattle.<sup>11</sup>

PCV2 is the essential infectious cause of the condition<sup>5,12</sup> but it is not the primary pathogen in the accepted sense of the word. Some authorities and many practitioners would still see the cause as unknown. The reason for thinking this is that there are only three things that could have changed so that an infection which has obviously been present for a

long time could suddenly become infectious. One is that the agent has itself changed but there is no evidence that this is so. The second is that the environment of the pig has changed and this is so in the sense of weaning and nutritional changes. The third thought is that 'the host is different and this may be so because of genetic engineering and breeding developments. Compare the growth rate and feed efficiency of pigs in the 21st century with those of the 1960s. The agent PCV2 is best viewed as a ubiquitous primary pathogen that can cause disease with the help of adequate co-factors and susceptible hosts.<sup>13</sup> The problem is that we do not know all these factors and neither do we know what the determinants of the host susceptibility are.<sup>14</sup>

PCV2 has been found in the tissues from pigs with PDNS.<sup>15</sup> The discussion goes on. The triggering of PMWS in herds could not be linked to coinfection with either PRRSV or PPV or to the use of specific immunostimulants such as vaccines or to particular genomic differences between the PCV2 strains.<sup>16</sup>

The Danish case study and the geographical spread in Denmark suggests that PMWS is an infectious disease. These studies also show that there may be a case for thinking that there is still an agent X out there that has not yet been discovered.<sup>17</sup>

### The agent

The group of viruses known as circoviruses is an odd assortment of viruses. They are an important group of plant viruses and avian viruses including chicken anemia virus, psittacine beak and feather virus and pigeon circovirus. Initially Porcine Circovirus, now known as PCV1, was discovered in tissue culture<sup>18,19</sup> and it is now widely distributed in pigs worldwide. It is non-pathogenic<sup>20</sup> and has no place in the etiology of PMWS. There is only about 70-80% homology between PCV1 and PCV2.

In some cases PPV has been seen in the PMWS cases in the field. In gnotobiotics it may be essential for the full expression of the disease. Where it does occur the lesions of PMWS may be more severe.<sup>21-23</sup> Neither PCV2 or PPV on their own were pathogenic for gnotobiotics and produce a disease which is not the same as that seen in the field.

Porcine circovirus 2 (PCV2) is classified in the Circoviridae, which are single stranded circular genomic DNA viruses. Protein and viral nucleic acid has been found in the tissues of pigs with PMWS. The fulfillment of Koch's postulates with PCV2 in both gnotobiotic and conventional colostrum deprived pigs has been carried out.<sup>6</sup>

The genetic work so far carried out on PCV2 shows that the virus is quite stable

with 94% nucleotide identity. It is a very small virus with little of its own genetic makeup coding for proteins. It has only two open reading frames (ORF1 codes a replicase protein; ORF2 encodes a 30 kDa capsid protein).<sup>24</sup>

#### PCV2-associated diseases

PCV1 is non-pathogenic. The pathogenic porcine circovirus type 2 (PCV2) is implicated in the occurrence of PMWS. No pig with PMWS has been found without evidence of infection with PCV2.

PCV2 is also implicated in the causation of epizootic (acute) PDNS.<sup>15,25</sup>

It has been suggested as a cause of congenital tremor AII,<sup>26</sup> but other authors could find no evidence for this but could neither prove or disprove it.<sup>27</sup> It was shown (using indirect fluorescent assay, ISH and PCR) that there was an association between PCV2 in neonatal pigs and congenital tremor in pigs from 4 farms in the mid west of the USA.<sup>26</sup>

It may be a cause of neonatal cardiomyopathy. Myocarditis and abortion were seen in intra uterine infections of sows.<sup>28</sup>

It may be a cause of reproductive failure. Transplacental infection does occur in the field and stillbirths in pigs may be associated with the PCV2 infections.<sup>29</sup> Multiple abortions were seen in a multi-site system.<sup>30</sup>

It is also a significant contributor to porcine respiratory disease complex (PRDC).<sup>31-33</sup>

In the mid 1980s in the UK it was a contributor to granulomatous enteritis although this was only detected retrospectively.

## EPIDEMIOLOGY

### Distribution

Worldwide distribution now includes the original areas like Canada, the USA and widely in Europe notably France,<sup>34</sup> Spain,<sup>35</sup> the British Isles,<sup>36</sup> and Ireland.<sup>37</sup> It occurred in Taiwan in 1995,<sup>38</sup> Japan in 1995<sup>39</sup> and Korea.<sup>40</sup> Not very significantly in the southern hemisphere until recently when it occurred in New Zealand in 2004.<sup>41</sup> Now been found in the Australian pig herd<sup>42</sup> and also from South Africa<sup>43</sup> and Brazil in 2005.<sup>44</sup>

### Occurrence

Evidence was found of the virus as early as 1973 in Ireland<sup>8</sup> and from 1985 in Canada<sup>45</sup> and Belgium<sup>46</sup> and 1986 in Switzerland when archived tissue was looked at.<sup>47</sup>

In the USA proven occurrences in the field are described as rare.<sup>28,48</sup>

As well as the countries documented above it has also occurred in Korea,<sup>49</sup> Japan,<sup>50</sup> Switzerland since 1986,<sup>51</sup> and Germany since 1999.<sup>52</sup>

Wild boar have been found to have both PCV1 and PCV2 not only in the young pigs but also in the pigs of 1-2 years.<sup>53</sup> Also found in the feral pigs in Germany.<sup>54</sup> PCV2 occurs in wild boar in Spain with 3/656 being positive and one had PMWS.<sup>55</sup>

PRRS occurs before PCV2 in the life of the pig as it is either born with the infection or picks up the infection in the nursery. Only a few pigs have serological evidence of PPV varying from perhaps over 50% in the USA, to 25% in Korea, and 13% in Canada.

One of the first studies on the epidemiology of PCV2 was carried out in Ontario.<sup>56</sup> Data sheets were sent to 21 practitioners covering 922 herds and they said 15 herds had evidence of PMWS. The authors investigated 15 farms of which 13 turned out to be negative for PMWS. Of the other 12 some had PCV2 but were PMWS negative. 5/25 farms had epidemic disease and 7/25 endemic disease. The other 12 had either higher than average mortality or low grade PMWS. You can have a 95-100% prevalence of infection but this is rare. Most typically PMWS affects 4-33% of pigs with 70-80% case mortality.<sup>57,58</sup>

Nobody knows where it replicates although the supposition is rapidly dividing cells but it is able to infect macrophages and express its two viral proteins.<sup>59</sup>

The virus is probably found in all secretions<sup>60</sup> including the nasal, fecal and urinary secretions.<sup>61</sup> It is certainly shed in feces from pigs that have no enteritis and this suggests that fecal/oral/fecal route is the common method of spread.<sup>60</sup>

It is readily transmitted from inoculated to sentinel pigs and can be found in the tissues for at least 125 days and shed in all secretions.<sup>62</sup> It is secreted intermittently in semen<sup>63,64</sup> and it could be that it only occurs there because it is contained within macrophages which are extruded into the semen via the local lymphoid tissues particularly the bulbourethral glands.

### Risk factors

The slow spread of the syndrome PMWS through Sweden appears not to be related to the spread of a new contagious microbe and it has not been spread through the semen.<sup>62</sup>

Herds that vaccinate for *Mycoplasma hyopneumoniae* (M.hyo) had a lower mortality. In Denmark the case study showed that the use of M.hyo vaccines in PMWS positive herds reduced the mortality rate.<sup>17</sup>

It has been found in wild boar in Germany and Spain so they may potentially act as a reservoir.<sup>62</sup>

### Clinical history

Risk factors for PMWS show that infected farms had more nursery pig diseases and lower biosecurity scores than non-infected farms.<sup>65</sup>

### Genetic

In a study of Duroc, Landrace and Large White pigs only the Landrace had PMWS cases which suggests that there may be a predisposition in this breed.<sup>66</sup> In a study in Denmark, albeit only in one herd, Duroc boar progeny had a higher survival rate.<sup>17</sup> This author also made the point that 80% of Danish stock are supplied by the same breeding company and therefore nationwide the genetics are similar but the occurrence of PMWS is still very variable.

There may be a significant litter effect.<sup>67</sup> This litter effect may in part be explained by the sow's humoral immune state at farrowing. Measures to reduce the sow viremia and increase the colostral antibody provision at farrowing would increase the chances of piglet survival. Most farmers in the UK are convinced that there is a considerable repeatable maternal or litter effect on PMWS mortality, however the mechanism underlying this is unknown. One possible explanation is that these pigs may have extremely low levels of vitamin E.<sup>68</sup> It may be that castrated males are more affected.<sup>69</sup>

A recent study of 1063 piglets using PCR tests concluded that there was a significant effect of genetics on the expression of PMWS. It was not possible to say whether this effect was due to breed or particular boar lines.<sup>70</sup>

In an experiment involving the transfer of passive immunity maternal antibodies to PMWS it was shown that none of 36 piglets born to sows with PCV2 serum antibody levels >1/1250 developed PMWS. Piglets from sows with levels of 1/50 and four piglets with 1/250-1/500 also developed the disease.<sup>71</sup>

### The agent

Phylogenetic analysis of the entire genomic sequence of PCV2 isolates has been determined with a >95% nucleotide homogeneity amongst all the tested strains.<sup>72,73</sup> The strains of PCV2 from PMWS subjected to genomic analysis<sup>74</sup> had a 99% nt sequence identity with other isolated PMWS strains had a 95% homology with associated strains from around the world. The strains from congenital tremor cases (2 PCV2 and 1PCV1) had only 72% sequence identity with each other. The PCV1 strain from the neonatal pig in the 1960s did cause congenital tremor when inoculated into the sow as an experimental infection.<sup>74</sup>

Pigs with PMWS have more PCV2 compared to the pigs on the same farm that are not clinically affected.<sup>75,76</sup> We are not as yet able to answer the question as to whether the severity of PCV2 associated disease is related to the virulence of the strain as in a recent study 94-100% shared the same nucleotide sequence and

91–100% shared the same amino acid sequence.<sup>77</sup>

The quantitative TaqMan-based real time PCR<sup>78</sup> allows the determination of viral load. No healthy pig had in excess of 10<sup>6</sup> PCV2 genomes per mL of serum or 500 ng of tissue sample. On the other hand all the clinically sick PMWS pigs had above 10<sup>7</sup> in both the serum and the tissues. Also the estimated viral load in the tissues of the PMWS pigs was related to the IHC findings with the LN, ileum and tonsil giving both a high viral load and high IHC staining. There is increasing evidence that the viral load in the affected pig is the crucial factor in the conversion of a latently infected animal to clinical PMWS.<sup>79</sup> PCV2 may be associated with different tissues of the reproductive tract but it is unlikely that it is associated with the uterine stage embryo.<sup>80</sup> It was found that 13.1% of 350 aborted fetuses<sup>46</sup> were positive for PCV2 by PCR and the virus was detected at all stages of gestation.<sup>81</sup>

The virus that causes PDNS is the same virus that is found in the cases of sow abortion.<sup>82</sup>

The agent can persist in the dendritic cells in the absence of viral replication.<sup>83</sup>

#### Environmental influences

The virus is very stable. It is not affected by heat, dryness, humidity, or common disinfectants.<sup>84</sup>

Clinically healthy pigs from PMWS affected farms developed the disease when transported and commingled with clinically affected pigs.<sup>85</sup>

#### Co-infections

The Danish view is that the higher the standard of health care the lower the losses.<sup>17</sup> It may be that co-infection is necessary to further the replication of PCV2. The more co-infections the more PCV2 material and it may be that it is this increased viral load that is the key to overcoming the host defenses. It would certainly explain why SPF and high health herds appear to be less severely affected by PMWS although they have PCV2. It would also explain that in some cases the extra antigens provided by vaccines may also be a triggering factor as the vaccine antigens or adjuvants may cause more replication of PCV2.

There is no doubt that PCV2 is associated with PMWS. No cases of PMWS have been described without the presence of PCV2.

Infections with porcine parvovirus (PPV) may be an important factor in the pathogenesis of some but not all PMWS cases.<sup>86</sup>

A study in Germany described the pathogens found in PMWS cases other than PCV2. PRRSv was found in 75%, *H. parasuis* in 13.4%, *E. coli* in 7.7%, *S. suis* in

7.2%, coronavirus in 7.2%, swine influenza in 4.4% and brachyspira in 4.2%.

The most common of the coinfections is *M. hyo*, which is a common agent in the respiratory component of PMWS. It increases the severity and duration of PCV2 induced lesions in lung and lymphoid tissues, the PCV2 replication in the tissues and the incidence of PMWS in conventional pigs.<sup>87,88</sup>

It was thought that PRRSv was the necessary sole catalytic agent for the conversion to the clinical case.<sup>89–91</sup> In a series of Spanish cases the PRRSv was found in only 23% of cases.<sup>92</sup> However, it seems that PRRSv infection occurs some time before PCV2 infection.<sup>76</sup>

The epidemiology of PPV suggests that the simultaneous co-infection with PPV and PCV2 is unlikely in the 6–12-week-old period of life when pigs have PMWS.<sup>93</sup> On the other hand<sup>94</sup> in a study of 138 farrow to finish farms in France a strong association was suggested between PRRS and PPV in a herd with PMWS.

Simultaneous coinfection with salmonella has also been described. Here the pigs with salmonella had severe lymphoid depletion.<sup>95</sup> Infection resulted in more severe clinical disease and an increased mortality up to 80%.

- *Pneumocystis carinii* has been described in PCV2 infected pigs<sup>96</sup>
- *Cryptosporidium parvum* has also been found in association<sup>97</sup>
- *Chlamydia* has been found in association with the PMWS<sup>98</sup>
- It has also been associated with pulmonary aspergillosis<sup>99</sup>
- PCV2 and PEDv infections were described in the same animal.<sup>100</sup>

#### Immunology

Experimental studies and field observation confirm that the transfer of passive immunity maternal antibodies to PCV2 does confer protection against the development of PMWS.<sup>71</sup>

Immediately after birth the immune system of the pig is programmed to a sequence of actions that down regulate the responses of the immune system particularly in the gastrointestinal tract. In PMWS there appears to be the opposite up regulation of the immune response. Immunostimulation is not important<sup>101</sup> so it may be a failure of down regulation. Whatever happens, and it is not yet clear, the immune system is impaired.<sup>102</sup>

Maternal antibodies can prevent PMWS but they only limit virus circulation and shedding to some extent<sup>103</sup> and certainly not PCV2 infection.<sup>104</sup> Active antibody production occurs during the early grower period<sup>69</sup> at about 6–10 weeks and earlier if there is a heavy infection.<sup>105–107</sup>

It may be that conventionally raised pigs can establish protective immunity and not develop PMWS if animals at the age of 4–10 weeks are exposed to the viral proteins (virus or vaccine) but not exposed to any major immunostimulants or co-infected with any other viral infections.

Suppression of cell mediated immunity may play a part in the etiology of PMWS.<sup>108</sup>

Cytometric analysis shows that leukocyte subsets change after PCV2 infection with the increase in monocytes, reduction in T-cells (mainly CD4<sup>+</sup>), and B-lymphocytes and the presence of low density immature granulocytes. This suggests an inability to mount an effective immune response.<sup>109</sup> Serum antibodies occur but PCV2 persists.

Serological profiles of affected and non affected herds have been described in France.<sup>94</sup> PCV2 antibodies have a high prevalence in all countries. Convalescent sera from pigs with the clinical disease will also induce antibodies to PCV2. In the UK titers seldom exceed 1:640 but those that received serotherapy responded with serum antibody levels possibly as high as 1:32 000.

#### Vaccinations

There has been a considerable controversy over the effect of vaccination on the conversion of sub clinical infection to clinical disease. The basis of this thinking was that vaccines are essentially no different to any other antigen and if other agents were important in the production of clinical PMWS why not vaccine antigens. In one study approximately 215 of the vaccinated pigs developed clinical signs and histopathological changes typical of PMWS.<sup>110,111</sup> The vaccines particularly suggested as culprits were those for APP and more importantly *M. hyo*. This latter was regarded as particularly important as the use of *M. hyo* occurred much at the same time as the epidemic of PMWS. Vaccines may help the pathogenesis of PCV2 diseases.<sup>23,110,112,113</sup> In an on farm trial in the UK when half the pigs were vaccinated and the other half were not there were no significant differences in overall death rates between the two groups.<sup>114</sup> It is possible that the timing of vaccination may not be important. There are no or minimal PCV2 associated lesions when pigs are vaccinated at 2–4 weeks prior to expected PCV2 exposure.<sup>115</sup> There is also the possibility that the adjuvants may be involved in the up regulation of the immune response. All the adjuvants at an early stage of infection increased the severity of lymphoid depletion associated with PCV2. In the later stages of infection (post 35 days) the oil/water adjuvants increased the length of viremia, the amount of PCV2 in serum

and tissue and the severity of lymphoid depletion.<sup>116</sup> It has been shown that local immunostimulation with a vaccine adjuvant is not sufficient to induce PMWS in conventional pigs and also not to increase the PCV2 load.<sup>117</sup>

### PATHOGENESIS

PRRS may complicate PMWS. PPV is often present in the affected pigs but is not essential for PMWS. However the worst clinical signs and often the most severe lesions are seen in pigs that also have PPV infection and where the serological titers for PPV in these pigs are their highest point of seroconversion.

The role of the PPV is to enhance the PCV2 replication and thereby to exceed the threshold for the development of PMWS. How this is done is not known. There is some evidence that PMWS affected pigs seroconvert to PCV2 earlier than non affected pigs and this may suggest that they are infected earlier.<sup>118</sup> Both are non-enveloped DNA viruses and both probably use the DNA synthesis and protein synthesis of the host cell. Where joint infections occur the number of cells that are positive for PPV is much less than those that are positive for PCV2. It may facilitate high levels of replication of PCV2 during the preclinical phase of co-infection by promoting monocyte proliferation. It is possible that both viruses have similar tissue tropisms.<sup>119</sup> The primary target in vivo is probably not the monocytic series of cells,<sup>120</sup> although other authors suggest that the target cell changes from cardiomyocyte, hepatocyte, and macrophages of the fetal pig to just the macrophage/monocyte series in the neonatal pig<sup>121</sup> and possibly the nephrogenic zone of the kidney.

It is possible that the PPV may induce immunosuppression or macrophage activation. Death in these experimental infections may be due to liver failure.

Destruction of thymic lymphocytes has a central role in the pathogenesis of PMWS infections. Pigs with PMWS have altered cytokine responses to mitogens and other antigens.<sup>122</sup>

PCV2 in PMWS causes a reduction or loss in the T and B-cells, increased numbers of macrophages and partial loss and redistribution of antigen presenting cells throughout all the lymphoid tissues compared with control cases.<sup>123</sup>

The loss of B-cells is the earliest characteristic. There is also a loss of T-cells and in particular the memory T-cells although naive T-helper, cytotoxic T-lymphocytes, natural killer cells and mature granulocytes were also depleted but not the monocytes. There appears to be no direct PCV2 effect on lymphocytes and how this lymphopenia is caused is unknown. It does not cause

apoptosis either.<sup>124,125</sup> Positive PCV2 macrophages can in fact phagocytose apoptotic cells.<sup>126</sup> The PCV2 remains detectable at all stages of the infection. This suggests that it somehow does not trigger the degradation systems of macrophages and dendritic cells and the virus remains silent. Perhaps a novel thought is that the virus does not replicate in cells but can replicate free in the serum. PCV2 does not appear to harm macrophages but persistent PCV2 infection is a problem for dendritic cells. They are the most potent antigen presenting cells and are also mobile and may therefore spread through the body system. They are particularly adept at capturing antigens and migrating to lymph nodes and lymphoid tissues where they act directly with B and T-lymphocytes. The dendritic cells accumulate large quantities of PCV2 antigen by endocytosis not replication and retain this for several days if not longer. All that happens is that there appears to be no transmission of messages to the T-lymphocytes and therefore no further triggering of immune or cellular responses occurs.

The PCV2 may contain a sequence that has a marked inhibitory effect on interferon  $\alpha$  production by porcine leukocytes.<sup>127</sup>

Co-infected pigs always have more severe microscopic lesions than pigs infected with PCV2 alone.

It may be an early or inappropriate immune stimulation which is the most likely event that triggers the PMWS in the PCV2 infected pigs. In situ hybridization shows that PPV can be visualized in the same animals that have PCV2<sup>128</sup> but on the other hand PCV2 can induce PMWS lesions in weaned pigs in the absence of PPV.<sup>129,130</sup>

Fetuses inoculated with PCV2 in the first two-thirds of the gestation are likely to be resorbed or die with severe heart congestion whilst fetuses infected in late gestation are minimally infected.

The PCV2 capsular protein is first detected in the cytoplasm of infected cells in a perinuclear position. After 18 hours the proteins are detected in the nucleus. Later protein is found in both the nucleus and cytoplasm of the infected cells. Sometimes immense amounts of viral protein and viral DNA are produced.<sup>131</sup>

The antigen is widely distributed. The cell most usually infected is the macrophage/histiocyte and also the dendritic cells of lymphoid tissues. Kupffer cells in the liver show considerable positivity. Virus can also be identified in cardiac myofibers, isolated myofibers in the intestinal tract and also hepatocytes. Lymphocytes do not contain virus.

PCV2 increased the levels of IL-10 and IFN- $\gamma$  mRNA levels in the thymus and tonsils and were thought to be indicative

of a T-cell immunosuppression.<sup>132</sup> There were no differences in the IL-6 levels between clinically and subclinically affected animals.<sup>133</sup> However the IFN- $\gamma$  levels were lower in the PMWS animals which suggests a down regulation.<sup>134</sup>

In a similar study IL-1  $\beta$ , IL-2 and IL-6 were expressed to a higher degree in PMWS pigs whereas IL-4 and IFN- $\gamma$  were reduced.<sup>135</sup> In experiments with PCV2 and PPV there were no changes in the cellular response but in a joint experiment CD2<sup>+</sup>CD4<sup>+</sup> cells decreased significantly in 21 and 35 day post-infection samples compare with 10DPI. There was also a strong influx of NK cells into the LN and peripheral blood monocytes.<sup>136</sup> There is a collapse over time in both T and B-cell populations. All T-cells are affected but the memory activated T-helper cells may be the worst affected.<sup>137</sup> The PMWS affected pig is depleted of CD8<sup>+</sup> and CD4<sup>+</sup> cells (both T and B-cells).

In the field, secondary infections are the most common presentation.<sup>90</sup> The chief of these is often Glasser's disease (*H. parasuis* infection).

Secondary infections with opportunistic organisms are common.<sup>122</sup> Co-infection with PPV, PRRSv, or mycoplasma will trigger PMWS.<sup>21</sup> Since these different pathogens have different targets and pathogenicity, a common aggravating factor can indeed be found in the immune stimulation.

A marked granulomatous inflammation takes place in the lymph nodes and this spreads to the parenchymatous organs. This is manifested as LN hyperplasia and macrophage infiltration of the cortex and medulla with syncytia and inclusions.<sup>22</sup> The virus load generated is enormous and the organs are all loaded with virus. There is an extremely dysfunctional immune system.<sup>122</sup>

### Experimental infections

There is no really reliable method to produce PMWS in all experimental pigs with the characteristic clinical signs, gross lesions and microscopic lesions. PCV2 infections can be produced easily but PMWS is much more difficult.

In all experimental models of PMWS, replication of PCV2 is enhanced and concentrations of PCV2 are higher in animals that develop PMWS. It may simply be that these animals have more dividing cells to provide a replication site than those that do not develop PMWS.

### Conventional pigs

One of the most interesting experiments was the clinical disease produced using a virus that had been present in the Swedish population since 1993 without causing problems but when injected into pigs did produce PMWS.<sup>138</sup>



PMWS has been completely reproduced with typical PMWS clinical signs, gross lesions, and microscopic lesions by use of CD/CD pigs with only PCV2.<sup>62,139</sup> They also produced the disease with dual inoculation with both PPV and PCV2.<sup>21-23</sup>

In another study with PCV2 and keyhole limpet hemocyanin (KLH) emulsified in Freund's incomplete adjuvant a total PMWS and enhanced replication of PCV2 was seen only in pigs receiving both PCV2 and the KLH.

Adjuvant and antigen resulted in immunostimulation that enhanced PCV2 replication.<sup>101</sup> The PCV2 is present in lesions in proportion to the severity of the PMWS and it can be said that the PCV2 plays an important part in the occurrence of PMWS. Only in some pigs will coinfection evolve into PMWS between 6-10 weeks of age.<sup>140</sup>

The only piglet infection group which developed clinical evidence of PMWS were those piglets which received combined inocula as either infected lymph node homogenates or dually infected pigs with both PCV2 and PPV propagated in PK-15 cell lines.<sup>141</sup> PCV2 was isolated or antigen recovered (IHC or ISH) from tissues in all the pigs that were given the dual inocula. An unusual dose dependent relationship has been identified. Low titer PPV/PCV2 produced a milder but still active form of the disease. A 100-fold higher titer produced fulminant and fatal disease. The liver is the primary target organ followed by the kidneys, gastrointestinal tract and pulmonary tissues.

PRRS together with PCV2 will also produce PMWS.<sup>142</sup> Again the PRRS seems to increase the replication of PCV2 and thereby exceed the threshold for PMWS.<sup>143,144</sup>

A Swedish virus isolated before PMWS was described in Sweden was given to the workers in N. Ireland and given to pigs. These pigs went on to show PMWS.<sup>145</sup>

Experimental infection of fetuses produced mummified, stillborn or weak piglets in 13 pigs and 24 were normal.<sup>146</sup> This shows that PCV2 can infect late term fetuses.<sup>146</sup> It was shown that PCV2 spreads amongst fetuses in utero. Four of six sows inoculated with PCV2 aborted 7-21 days post-infection. Three of four litters had 85-100% of stillborn piglets.<sup>146</sup>

### Infections in gnotobiotics

If PCV2 is inoculated into gnotobiotics, CD/CD pigs or conventional pigs then you get typical microscopic lesions but few to moderate gross lesions whilst the clinical disease is mild or absent.<sup>21-23,129</sup> A novel study in germfree pigs confirmed PCV2 as the sole essential infectious cause of PMWS, fulfilling Koch's postulates.<sup>147</sup>

Experimental infections in gnotobiotic pigs have been described.<sup>119,140</sup> They repro-

duced PCV2 infections but most animals failed to reproduce any pathological changes and/or clinical signs similar to those observed in PMWS in the field. Most of the animals had the virus or viral antigens in the tissues such as trachea, lung, liver, kidney, pancreas, lymph nodes, spleen, thymus, ileum, colon, cecum, salivary gland heart, brain, and testis. This experiment did not fulfil Koch's postulates. Pigs with clinical signs consistent with PMWS were only seen in pigs with PCV2/PPV co-infected animals, PPV vaccinated and non-vaccinated. Mild to severe lymphoid depletion was seen and lymphoplasmocytic interstitial nephritis and hepatitis.

An infectious molecular clone has been developed and produced PMWS<sup>148</sup> and two chimeric infectious DNA clones also were effective<sup>149</sup> in producing PMWS.

### CLINICAL FINDINGS

It should always be remembered that there are at least 25 other causes of failure to thrive and loss of weight and wasting. These should be examined first. A wasting pig does not always equal PMWS.

Diagnosis of PMWS is made on the basis is made on the basis of three criteria: clinical signs consistent with PMWS; secondly histopathologic changes; and detection of PCV2 in the microscopic lesions.

The initial clinical findings were described in Canada<sup>2,3</sup> and a full account of the clinical side of PMWS in Spain has also been described.<sup>150</sup> It was often found in high health herds in Canada an observation that has also been made throughout Europe. All sizes of herd have been affected.<sup>151</sup> Things usually return to normal in the period of 10-20 months. The cynics would suggest that that is because the susceptible population of pigs has died out over this period.

Sick pigs may exist alongside fit and healthy pigs. The major sign is not thriving.

There is a progressive weight loss. The ribs of the pigs are usually visible often with a severe abdominal distension. There may also be signs of heart failure with pericardial effusions and myocardial dysfunction.

There may be evidence of respiratory disease in the form of cough, dyspnea, and or tachypnea. There may be slight fever, pallor, diarrhea and less commonly there is icterus or jaundice.

The most characteristic clinical feature is the presence of swollen inguinal lymph nodes which in Europe is the first time that this has been described as a clinical sign. This may not be so in North America where some of the strains of PRRSv have been capable of causing this gross lesion.

Unless there is a susceptible coinfection there is no response to antibiotics.

Mortality is variable, but usually low, 5-15%<sup>7,151</sup> although the case mortality rate may reach 80-90%.<sup>151</sup> 65% of the deaths are males and 34% females. The morbidity is 10-30%.

The peak of PMWS mortality typically coincides with seroconversion to PCV2. Sub clinical infection is the most common presentation. It can be very mild and transient.<sup>152</sup> Often the records of production may be the only method of detecting that there is a problem of PMWS or PCV2 infection. Sometimes this is only appreciated by a higher return of condemnations from the slaughterhouse. There is a reduced average daily weight gain, increased time to slaughter, more severe lung lesions, and higher amount of antigen.

There was an association between the levels of infectious PCV2 and/or PCV2 DNA load and the severity of the clinical signs as described for PMWS.<sup>153</sup>

The occurrence of PRDC is a major manifestation and both PCV2 and M.hyo are common in respiratory disease. In growing and finishing pigs PCV2 associated PRDC is characterized by slow growth, prolonged growth, and dyspnea that is refractory to antibiotic therapy. There is also a marked increase in mortality from single and multiple concurrent bacterial infections.<sup>31,154-156</sup>

There are four criteria for a diagnosis of PCV2 associated PRDC: (i) respiratory signs; (ii) microscopic characteristic lung lesions; (iii) IHC or other demonstration of PCV2 in the lesion; and (iv) the absence of characteristic microscopic lesions of PMWS in lymphoid tissues.

PCV2 associated PRDC should be differentiated from PMWS clinically and histopathologically.

The condition of Porcine Necrotizing Pneumonia (PNP) is a result of coinfection with PRRSv and PCV2.<sup>25</sup>

In the past there have been wasting problems in pigs with loss of weight and watery diarrhea in which there is a granulomatous inflammation in the intestines with characteristic lesions with giant cells and possibly inclusions affecting the Peyer's patches.<sup>157</sup>

The common differential diagnosis of PMWS is PIA.<sup>158</sup>

Reproductive problems associated with PCV2 infection are uncommon.<sup>159</sup> In a recent survey in Spain it was shown that PRRSv was an important cause of reproductive failure but that the PCV2 was not a common cause of a problem.<sup>160</sup> Elevated abortion, stillbirths, and fetal mummification are a feature. Midgestation abortion, mummified fetuses, and early embryonic death were also observed in a recent Korean study.<sup>142</sup> *In utero* infection may produce fetal deaths and abortions.<sup>48,161-163</sup> Abortion is typically

sporadic and characterized by increased numbers of mummified fetuses. Multiple PCV2 associated abortion and reproductive failure in a **multisite** production system has been described.<sup>164</sup> Transplacental infection with PCV2 was associated with reproductive failure in a gilt.<sup>165</sup>

Reproductive failure associated with PCV2 is uncommon in the USA<sup>166</sup> and the UK. There are no characteristic lesions in the PCV2 affected fetuses. PCV2 is associated with reproductive failure at all stages of gestation.<sup>167</sup> The replication kinetics of these reproductive strains are different from those from pigs with PMWS or PDNS.<sup>168</sup>

### CLINICAL PATHOLOGY

The early changes in PMWS are anemia. This may be related to the sub acute/chronic nephritis, gastric ulceration or *M. suis* infections.

Monocytic hyperchromic regenerative anemia is the most common type with anisocytosis and polychromasia and later monocytic normochromic non-regenerative anemia. Significant differences (lower levels) were observed in RBC counts and hemoglobin levels, between healthy and naturally and experimentally infected pigs.<sup>169</sup> Most of the pigs seem to have *M. suis* (*Eperythrozoon suis*).

Neutrophilia and lymphopenia were recorded. Animals which will subsequently become PMWS cases show a lymphopenia,<sup>102,126,170,171</sup> very early on in their history,<sup>172</sup> and certainly before they show clinical signs. Many of the pigs showed increased levels of blood urea and creatinine with persistent leucopenia or sporadic leukocytosis both with neutrophilia and lymphopenia.<sup>173</sup> Wasting pigs with high blood urea, low albumin, and hemoglobin with lymphopenia provides further evidence of PMWS infection.

The risk of dying is related to the increasing titers against PCV2 from weaning until 4 weeks after weaning.<sup>174</sup> Pigs suffering from PDNS usually show high blood levels of creatinine and urea.

### NECROPSY FINDINGS

The carcass is wasted. The skin is pale and rarely jaundiced except in the USA and Canada where it may be more common. The relationship between PCV2 and hepatitis E has probably not been examined. The abdomen is distended. The lesions were classically described in Canada.<sup>2,3,175</sup> The most common manifestation of PCV2 infection is often pneumonia. Analysis of the submissions to the diagnostic laboratory at Iowa State University shows that the PCV2 antigen is often associated with the characteristic lung lesions.<sup>177,178</sup> The second most common manifestation of PCV2 infection

(in the records of the Iowa diagnostic laboratory) is PMWS.

The third manifestation is the systemic infection and PCV2 associated enteric infection is relatively uncommon but where it does occur often resembles regional ileitis.

The examination of the carcass generally reveals a lymphadenopathy in the form of enlarged lymph nodes.<sup>179</sup> Lymphoid organs are always affected. These gross lesions occur before other gross and histopathological lesions occur. The subcutaneous lymph nodes and in particular the superficial inguinals are the most severely affected. Other swollen lymph nodes include the tracheobronchial and mesenteric lymph nodes which is a reflection of the antigenic strain that the respiratory and alimentary systems are under all of the time in PCV2 affected pigs. The lymph nodes in cross section appear homogeneous, often pale and in many cases also edematous.

The lungs are swollen, often rubbery and may be edematous and these lungs do not collapse.

The other early change is the presence of fluid in the body cavities (peritonitis, pleurisy, pericarditis). These occasionally have fibrin tags which may or may not be associated with the presence of *H. parasuis* which is the most commonly isolated secondary bacterium from these cases.

Stomach ulcers (*pars esophagea*) are a common feature and in many of these there is also an edema of the gastric wall. There may also be cecal edema.

Sometimes the liver is atrophic or yellow. The spleen may be enlarged.

The kidneys may be very swollen but may have petechiae or even white stripes. Reproductive pathology is uncommon. Occasionally, we can find lymphohistiocytic myocarditis and/or myocardial fibrosis.<sup>160</sup> One of the manifestations is PDNS where there is both PRRSv and PCV2 in the same tissues.<sup>180</sup>

### Microscopy

The overall histological changes in PMWS are granulomatous inflammation with inflammatory cell exudates. The lesions form angiocentric granulomatous formations and often include eosinophils, neutrophils, and lymphocytes. There are often multinucleate giant cells but not always. The granulomas may coalesce and then the LN appears as a solid mass of cells. The follicular architecture is lost and the germinal centers become obscured. Paracortical T-cell areas become less cellular and eventually there is a marked lymphocyte depletion. Often there are massive inclusions which may be distinct intracytoplasmic inclusions or intranuclear basophilic inclusions. These inclusions are

not sites of active viral protein and DNA synthesis but are aggregations of ingested virions.

These occur in the lymph nodes<sup>2</sup> and also in lymphocytic aggregates such as BALT or GALT (Peyer's patches). Lymphoid depletion and histiocytic infiltration are highly specific for the disease.<sup>7</sup> Necrotizing vasculitis is also a feature in some instances.<sup>181</sup>

The PCV2 antigen is associated with characteristic lung lesions, with necrotizing and ulcerative laryngitis, ulcerative bronchiolitis, bronchiolitis obliterans, fibroplasias of the lamina propria, and granulomatous inflammation of the alveolar septae. For this reason the tracheobronchial LN often show the most characteristic lesions of PMWS probably as these are the ones most affected by the continual inhalation of antigens. In many pigs the lung lesions are mild and consist only of an interstitial pneumonia.

Hepatic histiocytic infiltration is a feature and sometimes necrotizing hepatitis.<sup>21</sup>

The kidney has lesions which are very similar to some of the lesions described in mycotoxicosis which are essentially a pyelitis with a multifocal interstitial plasmacytic cellular infiltration extending through the cortex with focal lymphoid aggregates forming at the corticomedullary junction. Myocarditis is a common feature particularly in the younger pig.

Diffuse hepatic necrosis has been described associated with PCV2 infection in a piglet.<sup>182</sup> Immunohistochemistry reveals the presence of antigen in the cytoplasm of macrophages and dendritic cells but no T-lymphocytes.<sup>120</sup> No replicating proteins have been found in the macrophages.<sup>183</sup> This suggests that the virus is being endocytosed by the macrophages and not produced by them. Infectious PCV2 remains associated with these cells for several days, possibly even weeks, without impairing their functions or losing its own infectivity. The IHC characterization of the LN reaction in pigs has been described.<sup>184</sup> In the initial and intermediate stages there is an absence of follicles and depletion of lymphocytes. There is also a reduction of interfollicular dendritic cells and interdigitating cells and a reduction/absence of B-cells and in particular CD4<sup>+</sup> T-cells.

After the evaluation of histopathology and IHC and/or ISH and the conclusion is that the pig has only mild lesions then it is possible to say that the pig may have (a) subclinical PCV2; (b) early PCV2 leading subsequently to PMWS; or (c) are recovering from PCV2 infection. If there are moderate to severe lesions then there is no problem it is either PMWS or PRDC or granulomatous enteritis or any combination thereof.

### Samples for confirmation of diagnosis

- **Blood** – The virus may be present in the serum before or after the virus can replicate in the tissues so therefore blood may be useful and PCR is more sensitive than ISH<sup>185</sup>
- **Tissues – Microscopy and antigen detection.** The best tissues are lymphoid organs particularly tonsil, lymph nodes especially the inguinal, mesenteric and tracheobronchial as these will also give you comment on the general systemic state, lung and alimentary tract. Also ileum (which has Peyer's patches), and spleen. Other tissues may have lesions (kidney, liver, and lung).

### DIAGNOSIS

Techniques such as virus isolation, neutralization tests and indirect immunofluorescence have been used primarily by research workers and are not normally part of the diagnostic methods used. Virus isolation has also been described.<sup>5</sup>

### Serology

PCV1 and PCV2 can be distinguished by PCR and monoclonal antibody techniques. Several serological tests have been developed for PCV2<sup>8,69</sup> and these showed that nearly all pigs become seropositive during the growing phases. Since most pigs are seropositive there is little point in carrying out serology.

### Antigen detection

A PCV2 specific antigen capture ELISA has been described.<sup>186</sup> The double ISH technique has been used for the demonstration of both PCV1 and PCV2 in tissues.<sup>187,188</sup>

The original PCR was developed<sup>189</sup> and superseded by a multiplex PCR that will detect both PCV1 and PCV2.<sup>190,191</sup> One that can be used for boar semen<sup>192</sup> was then developed. A positive PCR result confirms the presence of PCV2 only<sup>193</sup> and does make a diagnosis of PMWS.<sup>194</sup> When the PCR detects PCV2 in lesions in histologically identified lesions then it is positive for PMWS.<sup>195</sup> Quantitative PCR is a molecular technique that can allow you to assess the viral load.<sup>73,142</sup>

Immunohistochemistry was shown to be useful for the detection of PCV2 in tissues.<sup>12,40,196</sup> IHC was shown to be better than ISH.<sup>197</sup>

### TREATMENT

The only treatment is for secondary bacterial diseases. These require an accurate diagnosis and probably bacterial sensitivity testing for effective results. The results of antibiotic therapy are not good.

Serotherapy has received publicity as an effective treatment but the effects are very variable. It will work for some batch-

es but not others and is not without risk of other diseases been transmitted as well as the prospect of dirty conditions causing outbreaks of clostridial disease.<sup>198</sup>

The use of aspirin for the sows may be of use<sup>150</sup> and the administration of corticosteroids may reduce stress and therefore help in the reduction of death losses.

### CONTROL

The first attempt at control was the 20-point plan of Madec<sup>199</sup> who said that you had to get 16/20 points adopted by the farmer to get the plan to work. In most cases certainly in the UK it was difficult to persuade the farmer to do 4–5.<sup>200</sup> The core of the plan was to use all in/all out production, feed pigs with multivitamins, minimize stress, and handle pigs with extra care. In some cases the high mortality rates were still observed even after implementing good management practices.<sup>201</sup> In many ways the plan was no different to those proposed 20 years earlier for the control of respiratory disease or alimentary disease. Many of the UK farmers simply tried to limit pig to pig contact, to remove stress from the system, to introduce better hygiene and improve nutrition. Batch farrowing helped to allow all in/all out production, and others tried partial or total depopulation. One of the major controls is to reduce stress.<sup>67</sup>

A considerable effort was put into the provision of an improved diet. Many increased the amounts of vitamin E and selenium believing that there was an element of antioxidant deficiency in the rations when the pigs were being bombarded with toxic oxygen radicals. Many farmers were also convinced that part of the problem related to a high wheat content in the diet and tried to reduce it and replace it with barley. This may be one of the key differences between the low prevalence of PMWS in the USA (where maize is used) and the high occurrence of PMWS in Europe where diets are used in which wheat and barley figure highly. Reduction of wheat was often associated with a reduction in the level of PMWS.

Many producers said that ad libitum feeding was associated with an increase in the problem. In many ways the methods of control were summarized by a study on a farm in East Anglia in the United Kingdom.<sup>202</sup> He described the control as requiring attention to six main features: (i) keep the population closed; (ii) not mixing pigs of different ages; (iii) reducing the amount of mixing and moving between pigs of the same batch; (iv) reducing the number of moves that the piglets made; (v) clean and disinfect the buildings before the next batch; (vi) visit the pigs in situ, pull out the ill and cull immediately. One group of UK farmers

said that the best way of controlling this disease was to go organic and what that means in practice is that the weaning age has to be raised to a minimum of 8 weeks.

Control of secondary infections is an essential control.<sup>31,142,144,203</sup> The second point is the removal of the factors that may promote immune stimulation.<sup>87,88,115,204,205</sup> The main measures in the control of the disease are as follows.<sup>150</sup>

#### 1. Maintain the balance of health.

These include the reduction of stocking density (the only measure that does reduce environmental and microbiological challenge), all in/all out management of the rooms of buildings with cleaning and disinfection and time to dry out before the next batch. No moving of animals back to clear a room. Reduction of entry of new stock to large batches i.e. 3-monthly not each month for replacement gilts. Depopulation of flat decks. Try and use a 3-site production system.

#### 2. Avoid contagion between animals.

Change weekly production to 3-weekly production. Avoid any form of fostering if possible and under no circumstances have 25% adopted piglets. Avoid piglet handling and therefore stress. Increase the hygiene in the farrowing quarters. Do not use needles on more than one litter.

#### 3. Favor the natural immune response.

Make sure that the piglets have an adequate colostrums intake. Make sure that they are a good weight at weaning. Avoid stress. Avoid vaccinating piglets too early. Generate the right environmental conditions particularly for temperature and humidity and regulate with the stage of growth. Avoid overcrowding. Administer high quality feed. Avoid vaccination coinciding with the movement of pigs. Control parasites particularly if production is outside.

Segregated early weaning has limited success because (i) most pigs are weaned negative and get exposed to the PCV2 during growing;<sup>206</sup> (ii) adult animals with antibodies are not susceptible to PCV2;<sup>207</sup> (iii) PMWS is most common at 4–6 weeks of age or 2–3 weeks post-weaning.<sup>4</sup>

With the escalating prevalence in Denmark it has been found that rapid removal of the clinically affected animals (massive sources of virus) to hospital accommodation followed by plenty of fresh air and highly palatable food has been helpful in recovery.<sup>208</sup>

A recent paper from Denmark has described the control of PMWS simply through the use of depopulation and

repopulation.<sup>209</sup> Only one herd of the group examined was reinfected after 3 months and that was supplied by the original source of pigs to that farm.

The use of other vaccines and their role in the onset of the condition was discussed<sup>210</sup> and recent information from Denmark suggests that in the cases in the epidemic in Denmark vaccination for *M. hyo* has played no part.<sup>211</sup> In the USA there have been similar recommendations for control.<sup>212</sup> These include the diagnosis of the specific infections that are contributing to the disease picture. If it is possible to vaccinate for these then do so (PRRS, SIV, PPV, *M. hyo*, APP, HPS). If there is a vaccine problem, then re-evaluate. Treat the bacterial infections and consider the use of anti-inflammatory drugs. Remove pigs that are not responding to treatment. Strictly adhere to all in/all out policies and the rules of pig flow. Minimize the moving and mixing of pigs. Decrease the density of stocking. Use disinfectants. Change source of pigs. By the use of segregated early weaning it is possible to produce PCV2 virus-free pigs from PCV2-positive sows.<sup>213</sup>

#### Vaccines

A tremendous amount of effort has gone into the search for an effective vaccine for PCV2 associated conditions.

Chimeric PCV1 live virus and a chimeric infectious DNA clone induce strong immune responses against PCV2 in pigs, at least experimentally, and protect pigs against PCV2 challenge.<sup>214</sup>

An inactivated PCV2 vaccine has also been described.<sup>215</sup> Recently the use of PCV2 vaccination in France and Spain has, it is believed, been a great success.

#### PDNS

The case definition is relatively simple.<sup>216-218</sup> These animals are generally older than the animals affected with PMWS but the conditions usually occur in the same herd.<sup>219</sup> There are two main features. Firstly, there is the presence of necrotizing skin lesions particularly over the hind limbs, perineum, and extending forward along the abdomen. Secondly there is a systemic necrotizing vasculitis and necrotizing and fibrinous glomerulonephritis.

The condition in terms of either gross or histological features has not been reproduced experimentally.

The probable first case of the endemic form was reported from Chile in 1976.<sup>220</sup>

It was reported in the UK as a sporadic problem<sup>221,222</sup> and subsequently as part of the PMWS/PDNS outbreaks.<sup>223</sup> This has been reported worldwide including recently from Hungary<sup>224</sup> and Canada<sup>225</sup> and the rest of the world.<sup>226</sup>

The acute form is probably associated with PCV2 infection.<sup>15</sup> The major point is that it is indistinguishable from classical or African swine fever. The disease occurs at the end of the nursery stage and the beginning of the grower stage. It is also found occasionally in finishing pigs and replacement gilts. The skin lesions are multifocal, well-circumscribed, slightly raised, dark red, circular to irregular and 1 mm to 2 cm in diameter. They may coalesce. Other times they may heal. They are particularly severe over the hind legs, pelvis and perineum.

The lymph nodes are usually swollen as in PMWS but may also be dark red and hemorrhagic. The pigs affected are usually still eating but may be febrile and if so are usually anorectic. The lower limbs may be edematous and joints may also have excess or blood stained joint fluid. There are severe renal lesions which often include red focal lesions up to several millimeters in diameter, that correspond to congested or hemorrhagic glomeruli on the cortex of the kidney. These kidneys are often enlarged and the associated renal lymph nodes are very hemorrhagic. Many of these cases are detected in the abattoir as the kidneys are declared unfit for human consumption. The kidney failure is quite severe with a very elevated blood urea nitrogen and creatinine. Many cases also have a pneumonia and a gastric ulceration.

Histologically, the major lesion is a severe, fibrinoid, necrotizing vasculitis in the small vessels affecting the subcutis and dermis of the skin and renal pelvis and medulla. There is also a multifocal severe acute necrotizing glomerulonephritis. The lesions of the acute PDNS often mask the underlying PMWS. The target cells for the PCV2 in PDNS were cells of the macrophage/monocyte series.<sup>15</sup> The sporadic cases which occurred before PMWS in the UK were often associated with the occurrence of *P. multocida* of one electrophoretic type.<sup>227,228</sup> The cases occurring simultaneously with PMWS or after as these animals are slightly older do not show the same pattern of bacterial isolation. The condition is probably caused by an immune complex reaction occurring in the small blood vessels.

The subject has been described in detail.<sup>229</sup>

#### REVIEW LITERATURE

- Allan GM, Ellis JA. Porcine circoviruses: a review. *J Vet Diag Invest* 2000; 12:3-14.
- Done SH et al. PMWS: The current European situation. *Pig J* 2002; 49:215-232.
- Done SH, Cook A, Gresham A. Porcine circoviruses and PMWS: Factoids. *Pig J* 2002; 50:197-220.

Done SH. The porcine respiratory disease complex. *Pig J* 2002; 50:174-196.

Chae C. Postweaning multisystemic wasting syndrome: a review of etiology diagnosis and pathology. *Vet J* 2004; 168:41-49.

#### REFERENCES

- Draft B et al. *Proc 39th Am Ass Vet Lab Diag* 1996; p. 32.
- Clark EG. *Proc Am Ass Swine Pract* 1997; p. 499.
- Harding J. *Proc Am Ass Swine Pract* 1997; p. 503.
- Harding JS, Clark EG. *Swine Hlth Prod* 1997; 5:201.
- Ellis J et al. *Can Vet J* 1998; 39:44.
- Allan GM et al. *J Vet Diag Invest* 1998; 10:3.
- Sorden S. *Swine Hlth Prod* 2000; 8:133.
- Walker IW. *J Vet Diag Invest* 2000; 12:400.
- Albina E. *J Comp Pathol* 2000; 125:292.
- Allan GM et al. *Vet Rec* 2000; 150:255.
- Ellis JA et al. *Can J Vet Res* 2001; 42:461.
- Morozov I et al. *J Clin Microbiol* 1998; 36:2535.
- Grierson SS et al. *Res Vet Sci* 2004; 77:265.
- Stevenson GW et al. *Proc Allen D Leman Conf* 2003; p. 117.
- Rosell C et al. *Vet Rec* 2000; 146:40.
- Larochelle R et al. *Can J Vet Res* 2003; 67:114.
- Dahl J. *Allen D Leman Conf Minn* 2004; p. 92.
- Tischer I et al. *Zentralbl Bakt A* 1974; 226:153.
- Dulac GC, Afshar A. *Can J Vet Res* 1989; 53:431.
- Tischer I et al. *Arch Virol* 1986; 91:271.
- Allan GM et al. *J Comp Path* 1999; 121:1.
- Kennedy YS et al. *J Comp Path* 2000; 122:9.
- Krakowka S et al. *Vet Pathol* 2000; 37:254.
- Choi J et al. *Proc 16th Int Pig Vet Soc Cong* 2000; p. 576.
- Pesch S et al. *Proc 16th Int Pig Vet Soc Cong* 2000; p. 581.
- Stevenson GW et al. *J Vet Diag Invest* 2001; 13:57.
- Kennedy S et al. *J Vet Diag Invest* 2003; 15:151.
- West KH et al. *J Vet Diag Invest* 1999; 11:530.
- Farnham MDE et al. *Can J Vet Res* 2003; 67:108.
- O'Connor B et al. *Can Vet J* 2001; 42:551.
- Harms PA et al. *J Swine Hlth Prod* 2002; 10:27.
- Halbur PG. *Proc 15th Int Pig Vet Soc Cong* 1998; p. 1.
- Thacker EL. *Pig J* 2001; 48:66.
- Rose N. *Pig J* 2002; 50:124.
- Segales J et al. *Vet Rec* 1997; 141:600.
- Kennedy S. *Vet Rec* 1998; 142:495.
- Spillane P et al. *Vet Rec* 1998; 143:511.
- Tsai SS et al. *Taiwan J Vet Med Anim* 1997; 67:27.
- Onuki AJ. *Vet Med Sci* 2000; 61:1119.
- Choi C et al. *J Vet Diag Invest* 2000; 12:151.
- Lawton DEB et al. *Proc 18th Int Pig Vet Soc Cong* 2004; p. 210.
- Raye W et al. *Aust Vet J* 2005; 83:300.
- Drew T et al. *Vet Rec* 2004; 155:149.
- Franca T et al. *Pesq Vet Brasil* 2005; 25:39.
- Magar R. *Can J Vet Res* 2000; 64:184.
- Mesu AP. *Vet Quart* 2000; 22:234.
- Staebler S et al. *Vet J* 2005; 170:132.
- Bogdan J et al. *Can Vet J* 2001; 42:548.
- Choi C, Chae C. *J Comp Path* 1999; 121:265.
- Sato K et al. *J Vet Med Sci* 2000; 62:627.
- Staebler S et al. *Proc 18th Int Pig Vet Soc Cong* 2004; p. 63.
- Hinrichs U et al. *Tierartz Umschau* 1999; 54:255.
- Exel B et al. *Proc 18th Int Pig Vet Soc Cong* 2004; p. 106.
- Knell S et al. *Proc 18th Int Pig Vet Soc Cong* 2004; p. 150.
- Vicente J et al. *Proc 18th Int Pig Vet Soc Cong* 2004; p. 9.
- Cottrell TS et al. *Proc Am Assoc Swine Pract* 1999; p. 389.
- Segales J, Domingo M. *Vet Quart* 2002; 24:109.

58. Pogradichny RM et al. *J Vet Diag Invest* 2002; 14:449.
59. Meerts P, Nauwynck H. *Proc 18th Int Pig Vet Soc Cong* 2004; p. 18.
60. Yang JS et al. *J Vet Diag Invest* 2003; 15:369.
61. Calamiglia M et al. *Proc 18th Int Pig Vet Soc Cong* 2004; p. 11.
62. Bolin SR et al. *J Vet Diag Invest* 2001; 13:185.
63. Laroche R et al. *Proc 16th Int Pig Vet Soc Cong* 2000; p. 580.
64. Laroche R et al. *J Clin Microbiol* 2000; 38:4629.
65. Cottrell TS et al. *Pig J* 1999; 49:10.
66. Opriessnig T et al. *Proc 18th Int Pig Vet Soc Cong* 2004; p. 12.
67. Madec F et al. *Livestock Prod Sci* 2000; 63:223.
68. Baekbo P. *Proc 18th Int Pig Vet Soc Cong* 2004; p. 62.
69. Rodriguez-Arrioja GM et al. *Am J Vet Res* 2000; 63:354.
70. Lopez-Zoria S et al. *Proc Am Assoc Swine Vet* 2005; p. 391.
71. Allan GM et al. *Pig J* 2002; 50:59.
72. Laroche R. *Virus Res* 2002; 90:101.
73. Mankertz A et al. *Virus Res* 2000; 66:65.
74. Choi J et al. *Can J Vet Res* 2002; 66:217.
75. Liu Q et al. *J Clin Microbiol* 2000; 38:3474.
76. Laroche R et al. *Can J Vet Res* 2003; 67:114.
77. Opriessnig T et al. *Proc Am Assoc Swine Vet* 2005; p. 387.
78. Brunborg IM et al. *J Virol Meths* 2004; 122:171.
79. Krakowka S et al. *J Vet Diag Invest* 2005; 17:213.
80. Belanski A et al. *Vet Rec* 2004; 155:597.
81. Kim J et al. *Vet Rec* 2004; 155:489.
82. Meehan BM et al. *Arch Virol* 2001; 146:835.
83. Vincent IE. *J Virol* 2003; 77:13288.
84. Royer RL et al. *J Swine Hlth Prod* 1997; 9:281.
85. Kristensen CS et al. *Proc 18th Int Pig Vet Soc Cong* 2004; p. 77.
86. Ellis JA et al. *J Vet Diag Invest* 2001; 12:21.
87. Opriessnig T et al. *Vet Pathol* 2003; 45:521.
88. Opriessnig T et al. *Proc 18th Int Pig Vet Soc Cong* 2004; p. 95.
89. Allan GM et al. *J Vet Diag Invest* 2000; 12:3.
90. Pallares FJ et al. *J Vet Diag Invest* 2002; 14:515.
91. Pogradichny RM. *J Vet Diag Invest* 2002; 14:449.
92. Segales J et al. *Proc 16th Int Pig Vet Soc Cong* 2000; p. 582.
93. Nash WA. *Pig J* 2002; 50:119.
94. Rose N. *Pig J* 2002; 50:135.
95. Ha Y et al. *Vet Rec* 2005; 156:583.
96. Fukura H et al. *J Jap Vet Med Sci* 2002; 55:584.
97. Nunez A. *J Vet Med B* 2003; 50:255.
98. Carrasco L et al. *Vet Rec* 2000; 146:21.
99. Segales J et al. *Pig J* 2003; 52:41.
100. Hirai T et al. *Vet Rec* 2001; 148:482.
101. Ladekjaer-Mikkelsen AS et al. *Vet Microbiol* 2002; 89:97.
102. Darwich L et al. *Clin Diag Lab Immunol* 2002; 9:236.
103. Charreyre C et al. *Proc 16th Int Pig Vet Soc Cong* 2000; p. 630.
104. Caprioli A et al. *Proc 18th Int Pig Vet Soc Cong* 2004; p. 52.
105. Ladekjaer-Mikkelsen AS et al. *Proc 4th Int Symp Emerg Re-emerg Pig Dis Rome* 2003; p. 184.
106. Laroche R et al. *Proc 4th Int Symp Emerg Re-emerg Pig Dis Rome* 2003; p. 226.
107. Meerts P et al. *Proc 4th Int Symp Emerg Re-emerg Pig Dis Rome* 2003; p. 232.
108. Kawashima K et al. *J Comp Pathol* 2003; 129:294.
109. Segales J et al. *Vet Immunol Immunopathol* 2001; 81:37.
110. Allan GM et al. *Vet Rec* 2000; 147:170.
111. Kyriakis SC et al. *J Comp Pathol* 2002; 126:38.
112. Allan GM et al. *Pig J* 2001; 48:34.
113. Kyriakis SC et al. *J Comp Pathol* 2002; 126:38.
114. Harvey R. *Pig* 2003; J 52:201.
115. Opriessnig T et al. *Vet Microbiol* 2004; 98:209.
116. Hoogland M et al. *Proc 18th Int Pig Vet Soc Cong* 2004; p. 97.
117. Resendes AR et al. *Proc 17th Int Pig Vet Soc Cong* 2002; p. 201.
118. Blanchard M et al. *Vet Microbiol* 2003; 94:183.
119. Krakowka S et al. *Am Assoc Swine Pract* 1999; p. 417.
120. Gilpin DF et al. *Vet Immunol Immunopathol* 2003; 94:149.
121. Sanchez RE. *Vet Microbiol* 2003; 95:15.
122. Darwich L et al. *Proc 4th Int Symp Emerg Re-emerg Pig Dis Rome* 2004; p. 226.
123. Chianini F et al. *Vet Immunol Immunopathol* 2003; 94:63.
124. Vincent L et al. *J Virol* 2003; 77:13288.
125. Vincente J et al. *Vet Res* 2004; 35:243.
126. Shibahara T et al. *J Med Sci* 2000; 62:1125.
127. Hasslung F et al. *Proc 6th Int Cong Vet Virol* 2002; p. 73.
128. Choi C, Chae C. *J Comp Path* 2000; 123:302.
129. Magar R et al. *J Comp Path* 2000; 123:258.
130. Magar R et al. *Can J Vet Res* 2000; 64:184.
131. Krakowka S et al. *Viral Immunol* 2002; 15:567.
132. Darwich L et al. *J Gen Virol* 2003; 84:2117.
133. Darwich L et al. *J Gen Virol* 2003; 84:3453.
134. Stevenson LS et al. *Proc 18th Int Pig Vet Soc Cong* 2004; p. 16.
135. Sipos W et al. *Proc 18th Int Pig Vet Soc Cong* 2004; p. 17.
136. Kim J, Chae C. *Vet J* 2003; 165:325.
137. Nielsen J et al. *Vet Immunol Immunopathol* 2003; 92:97.
138. Hasslung F et al. *Vet Microbiol* 2005; 106:49.
139. Okada Y et al. *J Vet Diag Invest* 2003; 15:107.
140. Ellis J et al. *J Vet Diag Invest* 1999; 11:3.
141. Kim J et al. *J Comp Pathol* 2003; 128:52.
142. Rovira A et al. *J Virol* 2002; 76:3232.
143. Allan GM et al. *Arch Virol* 2000; 145:2421.
144. Harms PA. *Vet Pathol* 2001; 38:528.
145. Allan GM. *J Vet Diag Invest* 2003; 15:553.
146. Johnson CC. *J Vet Diag Invest* 2002; 14:507.
147. Krakowka S et al. *Vet Pathol* 2001; 38:31.
148. Fenaux M et al. *J Virol* 2002; 76:541.
149. Fenaux M et al. *J Virol* 2003; 77:11232.
150. Marco E. *Pig J* 2002; 50:135.
151. Harding J et al. *Swine Hlth Prod* 1998; 6:249.
152. White MEC. *Pig J* 2001; 48:148.
153. Wellenberg GJ et al. *Res Vet Sci* 2004; 77:177.
154. Done SH. *Pig J* 2002; 50:174.
155. Kim J et al. *Vet J* 2003; 166:251.
156. Thacker EL. *Pig J* 2001; 48:66.
157. Higgins R et al. *Proc 43rd Ann Meet Am Assoc Vet Lab Diag* 2000; p. 9.
158. Sjollund M, Wallgren P. *Proc 18th Int Pig Vet Soc Cong* 2004; p. 50.
159. Yoon K-J et al. *Theriogenology* 2004; 61:1025.
160. Maldonado J et al. *Vet J* 2005; 169:454.
161. West KW et al. *J Vet Diag Invest* 1999; 11:530.
162. Sanchez RE et al. *Vet Microbiol* 2001; 83:169.
163. Nelson J et al. *Proc Int Pig Vet Soc Cong* 2004; p. 14.
164. O'Connor B et al. *Can J Vet* 2001; 42:551.
165. Ladekjaer-Mikkelsen AS et al. *Vet Rec* 2001; 148:759.
166. Halbur P, Opriessnig T. *12th Ann Swine Conf Pract Iowa State Univ* 2004; p. 12.
167. Sanchez RE et al. *Vet Microbiol* 2001; 83:169.
168. Meerts P et al. *Arch Virol* 2005; 150:427.
169. Segales J et al. *Vet Rec* 2000; 146:675.
170. Krakowka S et al. *Vet Immunol* 2002; 15:567.
171. Segales J et al. *Vet Immunol Immunopathol* 2002; 81:37.
172. Nielsen J et al. *Vet Immunol Immunopathol* 2002; 92:97.
173. Arauz S et al. *Proc 18th Int Pig Vet Soc Cong* 2004; p. 64.
174. Hassing A-G et al. *Proc 18th Int Pig Vet Soc Cong* 2004; p. 76.
175. Harding JC et al. *Proc Western Can Assoc Swine Pract* 1996; p. 21.
176. Rossell CJ et al. *J Comp Pathol* 1999; 120:59.
177. Halbur PG et al. *Proc 11th Ann Swine Dis Conf Swine Producers Iowa* 2003; p. 152.
178. Harms PP et al. *Vet Pathol* 2001; 38:528.
179. Nash WA. *Pig J* 2002; 49:110.
180. Choi C, Chae C. *Vet Pathol* 2001; 38:436.
181. Kim J, Chae C. *Vet Rec* 2005; 156:177.
182. Okuda K et al. *J Japan Vet Med Assoc* 2001; 54:181.
183. McNeilly F et al. *Arch Virol* 2001; 146:909.
184. Sarli G et al. *Vet Immunol Immunopathol* 2001; 83:53.
185. Calsamiglia M et al. *Proc 16th Int Pig Vet Soc Cong* 2000; p. 579.
186. McNeilly F et al. *J Vet Diag Invest* 2002; 14:106.
187. Kim J, Chae C. *Vet J* 2000; 164:247.
188. Kim J, Chae C. *Res Vet Sci* 2001; 70:265.
189. Arnaud C et al. *Mol Cell Probes* 1998; 12:407.
190. Ouardani M et al. *J Clin Microbiol* 1999; 37:397.
191. Laroche R et al. *J Virol Meths* 2000; 80:69.
192. Kim J-H et al. *J Virol Meths* 2001; 98:25.
193. Caprioli A et al. *Proc 18th Int Pig Vet Soc Cong* 2004; p. 80.
194. Kim J et al. *Vet Rec* 2001; 149:304.
195. Kim J-H, Chae C. *Can J Vet Res* 2003; 67:133.
196. Kiupel M et al. *Vet Pathol* 1998; 35:303.
197. McNeilly FJ. *Vet Meths* 1999; 80:123.
198. Waddilove AGJ et al. *Proc 17th Int Pig Vet Soc Cong* 2002; p. 204.
199. Madec FJ. *Rech Porcs France* 1999; 31:347.
200. Madec F, Waddilove J. *Proc 17th Int Pig Vet Soc Cong* 2002; p. 45.
201. Baird FJ. *Vet Rec* 2000; 146:619.
202. Dennis I. *Pig J* 2002; 49:103.
203. Rose N et al. *Prev Vet Med* 2003; 61:209.
204. Harding J. *Proc Am Assoc Swine Vet* 2002; p. 21.
205. Opriessnig T et al. *Vet Microbiol* 2004; 98:209.
206. Tischer S et al. *Arch Virol* 1995; 40:737.
207. Chadd SA. *Pig J* 2003; 51:13.
208. Rathkjen PH et al. *Proc 18th Int Pig Vet Soc Cong* 2004; p. 46.
209. Hassing A-G. *Proc 18th Int Pig Vet Soc Cong* 2004; p. 13.
210. Mackinnon JD. *Pig J* 2003; 51:36.
211. Fraille LJ, Bolla J. *Proc 18th Int Pig Vet Soc Cong* 2004; p. 57.
212. Halbur PG, Opriessnig T. *Proc Iowa Conf Swine Vet* 2004; p. 12.
213. Opriessnig T et al. *J Swine Hlth Prod* 2004; 12:186.
214. Fenaux M et al. *Proc 18th Int Pig Vet Soc Cong* 2004; p. 20.
215. Pogradichny R et al. *Proc 18th Int Pig Vet Soc Cong* 2004; p. 55.
216. Helie P et al. *Can Vet J* 1995; 36:150.
217. Segales J et al. *Vet Rec* 1998; 142:483.
218. Thibault S et al. *Vet Pathol* 1998; 35:108.
219. Gresham A et al. *Pig J* 2001; 47:155.
220. Morales GA, Guzman VH. *Proc 4th Int Pig Vet Soc Cong* 1976; p. 121.
221. Smith W et al. *Vet Rec* 1993; 132:47.
222. White MEC. *Vet Rec* 1993; 132:199.
223. Gresham A et al. *Vet Rec* 2000; 146:143.
224. Molnar T et al. *Acta Vet Hung* 2002; 50:5.
225. Drolet R et al. *Swine Hlth Prod* 1999; 6:283.
226. Ramos-Vara JA et al. *Vet Rec* 1997; 141:479.
227. Thomson J et al. *Vet Rec* 2001; 148:282.
228. Thomson JR et al. *Vet Rec* 2001; 149:412.
229. Duran CO et al. *Swine Hlth Prod* 1997; 5:241.

## PORCINE REPRODUCTIVE AND RESPIRATORY SYNDROME (PRRS); BLUE-EARED PIG DISEASE; MYSTERY SWINE DISEASE; SWINE INFERTILITY AND RESPIRATORY SYNDROME (SIRS))

### Synopsis

**Etiology** Porcine reproductive and respiratory syndrome virus (PRRSV) belonging to Arteriviridae family

**Epidemiology** Highly contagious disease of swine manifested by reproductive failure, and respiratory disease in young pigs. Worldwide occurrence; spread rapidly in swine-raising areas during last 15 years. Subclinical infection endemic in most swine herds; incidence of clinical disease lower but causes severe economic losses. Pigs become infected in nursery from older infected pigs; persistent infection for several months is common. Different antigenic strains with variable virulence. Natural infection or vaccination results in immunity, but viremia still common. Infection with virus may predispose to secondary infections of respiratory tract. Transmitted by direct contact, feces and discharges, importation of infected pigs into herds, aerosol infection and semen

**Signs** Highly variable clinical syndrome  
**Reproductive failure** Outbreaks of late gestation abortions, stillbirths, mummified fetuses, weak neonates, high rate of return to estrus. Problem may persist and recur for many months

**Respiratory form** Anorexia, fever, dyspnea, polypnea, coughing, unthriftiness, high mortality in young pigs and low in older pigs and breeding stock. Deaths occur in acute phase

**Lesions** Interstitial pneumonia with reduction in alveolar macrophages. Aborted and mummified fetuses, stillbirths, weak neonates with pulmonary lesions

**Diagnostic confirmation** Serological testing for viral antibody titers. Detection of virus in tissues and alveolar macrophages using immunofluorescent microscopy

#### Differential diagnosis list:

**Respiratory disease: Pneumonia due to:**

- *Mycoplasma hyopneumoniae*
- *Actinobacillus pleuropneumoniae*
- *Pasteurella multocida*
- Glasser's disease (*Haemophilus parasuis*)
- *Streptococcus suis*

#### Reproductive failure

- Leptospirosis
- Parvovirus
- Brucellosis
- Aujeszky's disease
- Hog cholera virus

**Treatment** Must clinically manage outbreak to minimize mortality in young pigs

**Control** Segregation and off-site rearing of recently weaned pigs. Nursery depopulation and clean up protocol. Import only virus-free breeding stock into breeding herds. Vaccines available but insufficient information on efficacy

### ETIOLOGY

Porcine reproductive and respiratory syndrome (PRRS) is associated with an RNA virus morphologically, structurally, and genomically similar to members of the genus arterivirus of the family **Arteriviridae** belonging to the Order Nidovirales. The virus was first isolated in Lelystad, The Netherlands in 1991 and called the Lelystad virus<sup>1,2</sup> it is closely related to the equine virus arteritis virus. The Mystery swine disease of the USA was then shown to be a similar virus.<sup>3,4</sup> These two strains are considered to be one virus but the European and North American strains are genetically<sup>5,6</sup> and antigenically different.<sup>7</sup> The US and European strains are only 55–70% identical at the nucleotide level.<sup>8</sup> The current theory of its origin is that Lactic Dehydrogenase Virus of Mice infected wild boar in Central Europe and became adapted. It then went to North Carolina in the USA in wild boars.<sup>9</sup> It is thought that the most likely date for a common isolate of the European strains is before 1981.<sup>10</sup> The two species of PRRSV then developed separately on the two continents.<sup>11</sup> Some evidence of this comes from a study of the number of nucleotides in ORF7 of the virus<sup>12</sup> from the USA (372 nucleotides), EU (Lelystad types) had 387 nucleotides but the Lithuanian strains that were collected had 378 nucleotides. In tissue culture it was suggested that a recombination between US and European isolates was 10 000 times less likely to occur than between diverse European isolates.<sup>13</sup>

### EPIDEMIOLOGY

#### Occurrence

PRRS was first reported as a new disease in swine-raising areas in North America in 1986–1987,<sup>14</sup> and in 1991 was recognized in, and spread rapidly across, western European countries.<sup>15</sup> The disease was first recognized in Germany in 1990 and in The Netherlands in 1991, and occurs in Spain, France, Belgium, Denmark, Taiwan, and other countries. The rapid spread of the disease initially to the southwest of Europe and then to the north, paralleled the direction of the wind. Airborne spread was also suspected because even well-managed and isolated herds became infected.

Based on serological surveys, there is no evidence of infection in swine herds in Switzerland<sup>16</sup> and Australia.<sup>17</sup>

The introduction of legislation in some countries to restrict the movement of pigs from affected farms slowed the spread of the disease, but airborne spread over distances of a few km continued to occur, particularly in areas of high pig population density.<sup>18</sup>

The terms 'mystery pig disease' and 'blue-eared pig disease' were used

because the etiology was unknown and the skin of the ears of affected pigs commonly appeared blue. The disease affects pregnant gilts and sows, unweaned and recently weaned pigs, and growing-finishing pigs. Outbreaks of late-term abortions, high numbers of stillbirths and mummified or weak newborn piglets, and respiratory disease in young unweaned and weaned pigs are common. After ten or more years of acceptance and relief that the European virus was not so pathogenic as the North American virus it is now accepted in Europe that the recent evolution of the virus may now be causing as many problems as the USA virus always has done.

#### Prevalence of infection

In endemic herds 30–70% of pigs may be seropositive to the virus and about 60% of herds have some seropositive pigs.<sup>19</sup> While the seroprevalence may be high in herds in some regions, the incidence of clinical disease is lower and variable.<sup>20</sup> Although the number of herds with the acute form of the disease has been decreasing, the infection is now **endemic** in many herds, characterized by increased mortality and suboptimal performance in nursery pigs, with active spreading of the virus mainly in nurseries. In endemically infected herds, **subpopulations of infected animals** may exist consisting of a low prevalence (<10%) of seropositive animals in the breeding animals and a high prevalence (>50%) of seropositive nursery piglets.<sup>21</sup> The elimination of these susceptible subpopulations by exposing all members of a population to the virus is used as a control strategy in large herds in which there may be subpopulations of highly susceptible breeding females. The virus can persist in non-pregnant sows and be transmitted to naïve in contact sows.<sup>22</sup> A PRRSV strain may persist in a herd for up to 3.5 years displaying as little as 2% variation in ORF5 during this period. In 78% of herds with multiple submissions genetically different strains were identified within 1 year of the original identification.<sup>23</sup> Virulent PRRSV isolates exhibit longer viremias but of no more elevated levels but they induce higher death rates and cause more severe clinical signs in a respiratory disease model. More virulent strains grew to significantly higher levels in pigs than did cell culture adapted isolates. Pathogenic consequences and immunological responses of pigs to PRRSV are closely related to viral load in acute infections as reflected in viral titers in blood.<sup>24</sup>

#### Morbidity and mortality

The morbidity rate in young pigs may be up to 50% and mortality in nursery piglets can reach 25%. Death is usually



associated with secondary bacterial infections such as *Salmonella choleraesuis*, *Streptococcus suis*, *Actinobacillus pleuropneumoniae*, *Haemophilus parasuis*. Major losses occur in reproductive failure but figures for the magnitude of reproductive losses during an outbreak are not readily available. In general, the reproductive performance of positive herds is significantly lower than negative herds.<sup>25</sup>

### Risk factors

The severity and duration of outbreaks following infection are variable. Some herds may be devastated by high production losses, whereas other herds may have almost no losses. Differences in morbidity and mortality may be due to dose of virus at exposure, differences in host susceptibility, differences in strain virulence, environmental or housing differences, or the production practices in the herd.

#### Animal risk factors

Nursing piglets lacking maternal immunity, and young growing and finishing pigs and sows lacking acquired immunity from natural infection or vaccination are highly susceptible to infection and clinical disease. Severe disease appears to be more likely in large herds that have a large turnover of pigs, purchase replacements from other herds, and do not use a quarantine system. Introduction of the virus to previously virus-naïve herds may cause severe economic losses. In the recent outbreaks in Denmark the study of 107 herds showed that a variety of hazards were identified including close neighboring herds, increasing herd size, purchase of semen from infected AI studs.<sup>26</sup>

**Immune mechanisms.** The immune responses that are generated by PRRSV are not understood and the control of the disease by immune mechanisms is not understood. The core effect of the virus is to infect and cause abnormalities in the macrophages. Disturbed macrophages may fail to present antigen successfully. More importantly whatever cytokines are present in the pig or are induced by the PRRS in that particular host may determine the outcome). It was shown that PRRSv is slow to produce both neutralizing antibodies and a cell mediated immunity.<sup>27</sup> It does produce an IFN response in PRRSv infected lymphoid tissue.

Following natural infection, most pigs are resistant to subsequent infection but the mechanisms of protective immunity are not understood. It has been suggested that the immune response to PRRSv has some degree of strain specificity.<sup>28</sup> Indeed it has also been suggested that the ability to cross the placenta is also strain specific and that although maternal immunity may not prevent transplacental infection it may exert additional selection pressure.<sup>29</sup>

Circulating antibodies to the virus are detectable within 14–21 days after infection based on indirect immunofluorescence test or ELISA,<sup>30,31</sup> and 15-kDa protein is the most immunogenic of the viral proteins and may provide the antigenic basis for the development of improved diagnostic tests.<sup>32</sup> However, this response is not of neutralizing antibodies. These may take a long time to develop. At the same time the occurrence of interferon gamma producing cells is initially weak but this becomes much stronger from 3–6 months after infection. This response may be enhanced by the use of IL-12.<sup>33</sup> Several structural, functionally distinct, and specific antibodies to the virus are generated following infection or vaccination. Cell-mediated immune responses specific to the virus also occur.<sup>34</sup> The relative role of humoral and cell-mediated immunity in providing protection against disease is unknown.

A unique feature of infection is that viremia and circulating antibodies may exist together; the antibodies protect pigs from re-infection and reduce or eliminate shedding of the virus in the semen of boars. Sows are immune to further disease associated with the virus following recovery from acute infection. Following an outbreak of reproductive disease the level of performance will return to normal, suggesting that immunity develops following natural exposure.<sup>35</sup> Protection against subsequent reproductive losses is of long duration in individual animals. However, cross-protection to different strains may not occur. Experimentally infected sows are protected against reproductive losses when challenged with homologous virus over 300 days after initial exposure.<sup>36</sup> Extended studies against homologous infection found that the duration of protection was at least 604 days, which is essentially lifelong protection.<sup>37</sup> Protective immunity was based on two criteria: the absence of transplacental transfer of challenge virus, and the apparent lack of virus replication in the dam 21 days following inoculation.<sup>38</sup>

Piglets born from seropositive sows acquire **colostral antibodies** which decline at highly variable rates from 3 to 8 weeks after birth.<sup>39</sup> Passive immunity provides effective immunity for the piglets,<sup>40</sup> but loss of passive immunity at various ages results in susceptible pigs and infection that results in persistence of the virus in pigs 6–9 weeks of age, which are considered as the major reservoir of the virus in farrow-finish herds.<sup>40</sup> In the absence of natural infection, maternal antibodies become undetectable between 6 and 10 weeks of age.<sup>39</sup> Some litters do not have maternal antibodies and may not have detectable antibodies until 4 weeks of age,

and clinical disease may occur at 2 weeks of age.<sup>31</sup> By 8 weeks of age, antibodies are usually detectable in all pigs and they persist for several months. However, there may be a large variation in the levels of antibodies in piglets at 10–12 weeks of age when they are moved to the finishing units.<sup>39</sup> In longitudinal surveys, the seroprevalence of the virus in the 4- to 5-week-old pigs were higher than in the 8- to 9-week-old pigs, and most pigs were negative when they entered the finishing units.<sup>41</sup> In herds where the virus persists, sows did not suffer repeated reproductive losses, indicating that some form of protective immunity develops.

The virus has a predilection for immune cells and disease manifestations can be linked directly to changes in the immune system.<sup>34</sup> The replication of the virus in the cells of the immune lineage, especially macrophages, may lead to immunosuppression and predispose to secondary infections. Thus immunity to the virus may be a double-edged sword; the virus attacks the immune system, which may cause immunosuppression, while at the same time inducing protective antibodies.

Antibody-dependent enhancement of infection may also occur since low levels of antibody enhance the ability of the virus to enter the pulmonary alveolar macrophage cells and replicate and destroy the cells. This may be important in sucking and nursery pigs exposed to the virus during a period of declining maternal antibody.

#### Environmental and management risk factors

Housing of all age groups in one building, introduction of new animals, housing on slatted floors, storage of slurry under floors, exposure to transport vehicles, and lack of disinfection procedures have been suggested as factors that increase the probability of herd infection. Lack of quarantine facilities for recently imported pigs is a major risk factor. There appears to be infrequent spread during warm weather compared to cold weather.<sup>42</sup>

#### Pathogen risk factors

PPRS virus strains have many identical properties but some antigenic differences. Strains of the virus from the United States and Canada are antigenically similar, and different from the European Lelystad virus isolate.<sup>14,43</sup> All the strains appear to be highly infectious.<sup>44</sup> There are serological differences between the European and American strains,<sup>45</sup> and the antigenic and genomic differences between the North American and European isolates suggests the existence of two genotypes.<sup>46</sup> There are different genotypes and at least three minor genotypes within the major US genotype.<sup>47</sup> The simultaneous



coexistence of the strains has been shown but the significance of the observation is not understood.<sup>48</sup> Genetic variations exist not only between European and US strains but among the US isolates, indicating the heterogeneous nature of the virus. Antigenic variation may affect the accuracy of diagnostic tests and the efficacy of vaccines.<sup>49</sup> The North American strains have been called type 2 virus. They are continuously varying. The European type 1 virus was thought to be less virulent and less likely to change but this may not be so, as recent isolations show that it is also continuing to change.

Infection with the virus does not always result in clinical disease and the detection of high levels of serum antibody in many herds without history of clinical disease suggests that the consequences of natural and experimental infection depend on a complex of factors associated with host susceptibility and virus virulence. In 2000–2001 there were severe outbreaks in the USA associated with new isolates.<sup>50</sup> There are now both European and US strains originating from viral vaccines in Poland.<sup>51</sup> The effects of the virus on reproductive performance are strain-dependent.<sup>52</sup> Strains of the virus cross the placenta when given to pregnant sows and most sows will remain clinically normal and farrow normally. However, depending on the strain used, the number of late-term dead fetuses from gilts infected experimentally at 90 days gestation may vary widely, and all gilts become viremic and develop antibody.<sup>52</sup> There are also marked differences in pathogenicity for the respiratory tract between US strains of the virus compared to the Lelystad virus when inoculated experimentally into 4-week-old cesarean-derived colostrum-deprived pigs.<sup>53,54</sup> Some strains cause severe lesions of the lymphoid and respiratory systems, which appear to be the major sites of viral replication.<sup>55</sup> The difference in pathogenicity may explain the variation in severity of clinical disease observed in field outbreaks.

Field observations have suggested that the presence of the virus in a herd may increase the susceptibility of animals to other infections. However, studies with sequential infection of the virus followed by experimental inoculation with *H. parasuis*, *Pasteurella multocida*, or *A. pleuropneumoniae* have failed to demonstrate increased severity of disease.<sup>56</sup> There is however strong evidence to say that PRRSV predisposes to *S. suis*.<sup>57–60</sup> It may also predispose to *Salmonella choleraesuis*,<sup>61</sup> *Bordetella bronchiseptica*,<sup>62</sup> or *M. hyopneumoniae*.<sup>63</sup> This view is not universal in that infection with the virus did not increase the severity of experimental *Mycoplasma hyopneumoniae* infection in

young piglets.<sup>64</sup> However, in the laboratory investigation of PRDC the most potent combination of agents is PRRSV and *M. hyopneumoniae*.<sup>65,66</sup> A model of the dual infection has recently been described in which *M. hyo* was shown to predispose to PRRSV infection.<sup>67</sup> Based on diagnostic submissions, however, concurrent pulmonary bacterial infections may occur in up to 58% of cases in which the virus was also isolated.<sup>68</sup>

There is also the possibility that many strains may be found in the same herd, e.g. three strains were found in one herd.<sup>69</sup> Several viruses have been found in the same pig and one great authority has expressed the view that each virus in each pig may be different from every other virus.<sup>70</sup>

A syndrome was described in neonatal pigs marked by neurovirulence. Replication in the brain was verified by IHC in brain sections. Meningoencephalitis induced by the virus was unusually severe.<sup>71</sup>

#### Methods of transmission

Virus is produced rapidly after infection probably within 12 hours.<sup>72</sup> The virus was shown to evolve continuously in infected pigs, with different genes of the viral genome undergoing various degrees of change.<sup>73</sup>

There are unlikely to be any wildlife reservoirs (except for feral and wild pigs)<sup>61</sup> although infected mallard can still excrete the virus 39 days later.<sup>74</sup> Most pigs clear PRRSV within 3–4 months but some may remain persistently infected for several months.<sup>75,76</sup> The antibody response does not reflect the carrier status. It is possible that cytokines can switch the balance from a sub-clinical infection to disease manifestation.<sup>77</sup> There is no evidence that PRRSV is found in the tonsils as a representative tissue.<sup>78</sup>

The virus spreads rapidly within herds when infected pigs are housed in confinement. Up to 90% of sows may seroconvert within 3 months of the virus being introduced into a closed breeding herd. The mode of spread is presumed to be by direct contact probably nose to nose. The virus generally requires close pig to pig contact to achieve an exposure dose. The virus is present in a variety of biological fluids,<sup>74</sup> nasal discharge (positive 21 days later), oropharyngeal scrapings (158 days later), possibly mammary secretions although this probably uncommon especially as previous vaccination does appear to prevent shedding,<sup>79</sup> urine (28 days) and feces (28 days), and intranasal inoculation has been used to reproduce the disease experimentally. The feces may be an intermittent source, a usual source, or not a source.<sup>80</sup> The virus is present in saliva and, considered in the context of the

**social behavior** of pigs, may play an important role in transmission.<sup>81</sup>

The virus may persist in, and circulate between, different age groups and locations in a herd for several months despite the absence of clinical disease and may be transmitted by contact to replacement animals or to uninfected farms.<sup>82</sup> Infected pigs may remain carriers of the virus for up to 15 weeks.<sup>31</sup> Persistent and contact infection can be maintained in a nursery if uninfected pigs are continuously exposed to infected pigs.<sup>19</sup> Pigs in the nursery become infected through contact with older infected pigs and not by in utero or postpartum exposure to infected sows.<sup>83</sup> Long-term surveys of farrow-finish herds reveal that isolation rates of the virus reach highest level of 70–100% of pigs 6–8 weeks of age, which coincided with the lowest level of maternal immunity.<sup>40</sup> If you rely on infected nursery pigs to transmit infection to incoming gilts in acclimatization studies then nursery pigs may only be viremic for a maximum of 60 days.<sup>84</sup> There is no association between lymphadenopathy and PRRS viremia in nursery pigs 4 and 6 weeks post-weaning. Viremia cannot be predicted solely on the basis of clinical signs.<sup>85</sup> Large finishing enterprises purchasing pigs of variable infection and immune status provide ideal conditions for persistent virus circulation. Breeding herd subpopulations of infected pigs may exist, and perpetuate and enhance the infection in a herd. The inability to control such subpopulations may reduce opportunities for successfully controlling the disease.<sup>21</sup>

Infection may **persist** for an extended period of time because of:

- Incomplete infection of the susceptible population during the acute phase
- Introduction of susceptible breeding stock
- A persistent viral infection in individual pigs with the potential of shedding virus under certain conditions, such as grouping for weaning or farrowing
- A rapid decline in passive immunity in young pigs; and variable periods of active immunity.

Genetic randomness of isolates does not correlate with geographical distance. Movement on to the farm of PRRSV does not generally occur by distance limited processes such as the usual wildlife vectors but more typically occurs because of long distance transport of animals or semen.<sup>86</sup>

Spread between herds is associated with the introduction of infected carrier pigs. Infected boars may shed the virus in their semen for up to 40 days after experimental infection. In boars the virus can be found in semen by PCR for much longer

periods than can be found in the blood by virus isolation or antigen detection and the likelihood is that monocytes enter the bulbourethral glands which then contaminate the semen.<sup>87</sup> Following experimental infection of sexually mature boars the virus was present in the semen 3–5 days after infection, and on days 13, 25, 27, and 43.<sup>88</sup> Using a PCR assay the virus can be detected in semen for up to 92 days after experimental infection.<sup>89</sup> The insemination of gilts with semen from experimentally infected boars resulted in clinical signs of disease and failure to conceive.<sup>90</sup> Following artificial insemination of gilts with semen from experimentally infected boars, the gilts will seroconvert.<sup>91</sup> The use of the modified-live PRRS virus vaccine in boars is controversial because some boars may still shed wild-type virus in semen after challenge exposure 50 days after vaccination.<sup>92</sup> The inoculation of PRRSv negative replacement gilts with serum from nursery pigs presumed to be viremic resulted in seroconversion of all 50 gilts tested.<sup>93</sup>

Exposure of pregnant gilts to either attenuated (vaccine) or virulent (field) strains of the virus can result in **congenital infection**.<sup>94</sup> Congenitally infected pigs can support virus replication for a long period of time during which the viral replication is confined to the tonsils and lymph nodes.<sup>95</sup> After 260 days there were no serum antibodies and between 63–132 days there was no evidence of virus in the lung.<sup>95</sup> Vaccine and field strains can be transmitted postnatally from infected to non-infected littermates. Pigs infected with field strains have an inferior rate of survival and growth than do non-infected pigs. This suggests that use of attenuated virus vaccine during gestation is questionable.

The disease has occurred in PRRS-seropositive herds in Denmark with no previous clinical evidence of PRRS virus. These herds were then vaccinated with a modified live virus vaccine licensed for use in pigs 3–18 weeks of age.<sup>96</sup> Boars entering artificial insemination units were also vaccinated. Following vaccination, a large number of herds experienced an increased number of abortions and still-born piglets, and an increasing mortality in the nursing period. The problems occurred mainly in herds without clinical signs among sows, and with sows with low antibody titers in the period immediately before vaccination. The PRRS virus was isolated from fetuses and identified as the vaccine virus. The evidence suggested that the vaccine virus had spread to non-vaccinated sows followed by transplacental infection of the fetuses. Spread of the vaccine virus was also demonstrated in a non-vaccinated and previously virus-free breeding herd.

Possible routes of transmission include:

- Introduction of vaccinated animals
- Use of semen from vaccinated artificial insemination boars
- **Aerosol transmission.** Although an experiment failed to transmit infection from pigs to pigs in a trailer parked 30 meters away<sup>97</sup> there is a suggestion that it is transmitted for a short distance but this possibly only occurs intermittently.<sup>98</sup>
- **Others.** Fomites and infected personnel were shown to be capable of transmitting the virus following contact with infected material. Infected hands, boots and protective clothing can do it.<sup>99</sup> Needles will transmit the virus.<sup>100</sup> People do not usually act as vectors.<sup>101</sup> Mosquitoes were not seen in one study to be a likely vector for PRRSv.<sup>102,103</sup> Houseflies. The intestinal tract of houseflies will support infectious PRRSv for up to 12 hours following feeding on an infected pig but only for a short period of time on the surface of the fly.<sup>104</sup> Houseflies may transmit PRRSv within a herd of pigs and potentially between pig farms.<sup>105</sup>

**Airborne spread** across regions and between countries is suspected. In Europe, during the winter of 1990/91, the infection appeared to spread by the airborne route from Germany, across The Netherlands and into Belgium. Low temperatures, low sunlight, and high humidity may have facilitated airborne spread. Airborne spread up to 20 km has been suggested but most airborne spread is probably limited to less than 2 km. Usually it is difficult to transmit the agent one meter.<sup>106,107</sup> One author thinks that it may be capable of being transmitted 150 meters.<sup>108</sup>

A study in France of a series of outbreaks showed that 56% of the herds were infected through pigs, 20% through semen, 21% through fomites and the source was unknown in 3% of cases.<sup>109</sup> Epidemiological investigations in Belgium attribute 70% of herd infections to local spread, 9% to purchase of infected pigs, 4% to other contacts, and in 18% of cases the source of infection could not be determined. There is no evidence that rodents are susceptible to infection with the virus and are probably not a reservoir for the virus.<sup>110</sup>

Most spread between herds occurs by the introduction of unknown **infected breeding stock** into herds previously uninfected. Primary infections are common in multiplying herds which supply unknown infected replacement gilts to other farms.

The PRRS virus is fairly labile and does not survive for more than 1 day on solid fomites, but for several days in well and city water.<sup>111</sup> It may survive for several years in deep frozen tissues, but only 1 month at 4°C, 48 hours at 37°C and less than 45 minutes at 56°C. There appears to be a low risk from contaminated lagoon water and the viability of PRRSv in swine effluent is relatively short (1–8 days) although this is very temperature dependent.<sup>112</sup>

Pig meat does not retain detectable amounts of the virus and it is unlikely that the transmission through meat occurs.<sup>113</sup>

It is likely that piglets born with infection from in utero infection probably may remain viremic for ever even in the face of antibody formation. Neonatal infection is probably cleared slowly but infection in the older animal may be cleared much more quickly.

### Economic importance

The export market for pork from a country can be seriously affected when a disease such as PRRS occurs. When the disease was recognized in the United States, countries such as Mexico, Japan, Canada, and South Korea banned the importation of pork from the United States, or required certification that the swine originated from premises where, within the 30 days prior to the issuance of the health certificate, no swine were introduced from a municipality in which a premises infected with the virus is located.

The economic losses may be very high because of stillbirths, abortions, small litter sizes, birth of weak pigs, which increases preweaning mortality, and increased non-productive days. In weaned pigs, losses are associated with respiratory disease. In addition, there are the costs of control which may be high, dependent on the control strategies undertaken. Typically, about 20% loss in annual production can be expected from a severe outbreak.

Negative weaned pigs had an increased margin per pig of \$2.12 over the pigs minimally affected by PRRSv in the nursery but which seroconverted in the finishing herd, and \$7.07 over the pigs with persistently circulating PRRSv in the nursery.<sup>114</sup>

### PATHOGENESIS

Many piglets are probably infected in utero. This infection modulates the leukocyte subpopulations in peripheral blood and bronchoalveolar fluids.<sup>115,116</sup> Following infection the number of CD8<sup>+</sup> cells increased in systemic lymphoid tissue whereas numbers of B-cells increased in mucosal associated lymphoid tissue.<sup>117</sup> Virus infection induces a simultaneous polyclonal activation of B-cells mainly in

the tonsils and an exaggerated and prolonged specific humoral immune response due to persistent viral infection in lymphoid organs.<sup>118</sup> Piglets surviving in utero infections have a high count of CD8<sup>+</sup>, CD2<sup>+</sup>, CD4<sup>+</sup>CD8<sup>+</sup>, SLA-class II cells in the peripheral blood.<sup>119</sup> The cytokine changes have been described.<sup>120-122</sup> Persistent infection occurs in these pigs.<sup>123</sup> Virus appears to persist in the lymphatic organs and particularly the tonsils and the lungs.<sup>124</sup> Lymphoid tissue tropism occurs during persistent infection when the piglets have been exposed in utero.<sup>125</sup> There may be a PRRSV ligand for a cell surface heparin-like receptor on pulmonary alveolar macrophages.<sup>126</sup> It has been shown that PRRSV entry into the alveolar macrophage involves attachment to a specific virus receptor followed by a process of endocytosis, by which virions are taken into the cell within vesicles by a clathrin dependent pathway.<sup>127</sup> The alveolar macrophages when infected round up, show bleb formation and eventually rupture.<sup>128</sup> TNF  $\alpha$  released from damaged macrophages after PRRSV infection may induce apoptosis in uninfected lymphoid cells.<sup>129</sup> In a study of cells in the lungs it was found in both non-infected and infected cells. The majority of the apoptotic cells were non-infected. The peak of apoptosis was at 14 days and was preceded by a peak of IL-1 and IL-10 production at 9 days post-infection.<sup>130</sup> The PRRSV infection directly interferes with type 1 IFN transcriptional activation.<sup>131</sup>

Neonatal or nursery infection is probably through the virus reaching the nasopharyngeal epithelium following inhalation from the nose to nose contact with other pigs. It is then probably removed to the tonsils where they are internalized into cells of the macrophage/monocyte series.

As few as 10 or even fewer virus particles inoculated into the nose or given intramuscularly will infect a pig.<sup>132</sup> The virus may enter the cell through an endocytic pathway<sup>133</sup> or through a virus receptor.<sup>134</sup> A third possibility is that the virus may enter the cell through an antibody-dependent enhancement with virus-antibody complexes entering the cell through Fc receptors on the cell surface.<sup>135</sup>

Initially, a viremia occurs, with subsequent distribution and multiplication of the virus in multiple body systems and organs causing interstitial pneumonia, vasculitis, lymphadenopathy, myocarditis, and encephalitis.<sup>136</sup> Alveolar macrophages are primary targets for virus multiplication but this does not fully explain the pathogenesis.<sup>34</sup> Multiple glycoproteins appear to be involved in infection of pulmonary alveolar macrophages.<sup>137</sup> Possibly up to 40% of alveolar macrophages are destroyed.<sup>138</sup> Whether it is a particular

group that is damaged or not or all the alveolar macrophages is not known but after about 28 days there is a resumption of normal alveolar macrophage function. PRRSV causes the apoptosis of alveolar macrophages and pulmonary intravascular macrophages.<sup>139</sup> The increase in IFN gamma positive cells correlated well with the severity of the lung lesions which may be because of the presence of PRRSV in the lung.<sup>140</sup> IFN gamma markedly inhibits the replication of PRRSV in macrophages.<sup>141</sup> The effects of the virus on the immune system may explain the suspected immunosuppression and secondary infections, which are recognized clinically but have not been reproduced experimentally. The cytokines IL-10 and IL-12 are expressed in inflammatory lesions in the lung and play an important role in the defense against PRRSV.<sup>142</sup> In utero infected pigs showed significantly increased IL-6, IL-10 and IFN gamma mRNA expression (IL-2, IL-4 and IL-12 remained the same) and this was concurrent with a significant decrease in the number of CD4<sup>+</sup>CD8<sup>+</sup> T-cells.<sup>121</sup> The cell mediated and cytokine message profiles returned to normal levels similar to those of control pigs by about 10 weeks of age. The induction of the IL-10 response may be one of the strategies used by PRRSV to modulate the host immune responses.<sup>143</sup> Increases in IL-4, gamma IFN and TNF  $\alpha$  were found in the lymphocytes of infected piglets but IL-8 showed a decrease.<sup>120</sup> Other authors have the opposite views<sup>144</sup> who showed that T-cells showed an increase in CD8<sup>+</sup>CD4<sup>+</sup> and CD4<sup>+</sup>CD8<sup>+</sup> subsets within activated cells, whereas CD4<sup>+</sup>CD8<sup>-</sup> cells decreased with time. T-cells responding to the virus showed a Th1 type cytokine production pattern.<sup>145</sup> These authors also reported a decrease in TNF- $\alpha$  and a decrease of IL-1- $\alpha$  and macrophage inflammatory protein which are contrary results to the above. Perhaps this is the key to PRRSV infections in that all pigs may respond differently. There may be either depressive or stimulatory effects.<sup>146,147</sup> The imbalance of IL-12 and IL-10 produced in PRRSV infected pigs may favor the humoral responses and suppress cell mediated immune responses for the first 2 weeks of life.<sup>148</sup>

There was also a temporary immunosuppression in piglets at about 4 weeks post-infection. Vascular lesions associated with PRRSV virus infection are analogous to those observed in horses with equine arteritis virus, also a member of the Arteriviridae family,<sup>149</sup> and the renal lesions of equine viral arteritis infection correspond to those of PRRSV. Inflammatory infiltrates are seen at the junction of the renal cortex and medulla, with vascular

changes associated with the muscular tunics of small arterioles.

The characteristic lesions can be reproduced in conventional pigs at 1, 4, or 10 weeks of age, and the variation in severity of clinical disease can be attributed to differences in strain virulence.<sup>54,150</sup> The effects of the virus on reproductive performance are also strain-dependent.<sup>52</sup> There is no evidence that virus will grow in the ovarian tissues but may be taken into them by circulating macrophages. PRRSV virus can replicate in the testicular germ cells<sup>151</sup> but there is no evidence that there is any PRRSV in ova indicating that the female gonad is resistant to persistent infection.<sup>152</sup> Some strains are of low pathogenicity, while others are highly pathogenic.<sup>153</sup> The reproductive disease has been reproduced experimentally and the effects on the fetus are dependent on the stage of gestation. Aerosol exposure of non-immune pregnant gilts to the Lelystad virus in late gestations (84 days) results in clinical disease.<sup>154</sup> After an incubation period of 4-7 days, all sows are inappetent and listless for 6-9 days. Some sows develop blue-colored ears accompanied by abdominal respirations. Sows may farrow at days 116 and 117 of gestation, giving birth to dead, mummified, and live piglets. Many of the live-born piglets are pale, listless, and weak, and some are in respiratory distress and exhibit varying degrees of splayleg or muscular tremors. The virus may be isolated from stillborn piglets or those born alive. Antibody is present in pre-colostrum serum samples or ascitic fluids of piglets, which demonstrates transplacental passage of the virus.

The gross and microscopic lesions in the fetuses from sows experimentally infected oronasally with the virus at 90 days of gestation consist of hemorrhage of the umbilicus and necrotizing umbilical arteritis with periarterial hemorrhage.<sup>155</sup> Severe pulmonary lesions are present in fetuses inoculated in utero with the virus between 45 and 49 days of gestation.<sup>156</sup> Even the lowest PRRSV exposure dose<sup>102</sup> caused reproductive failure in naive, unvaccinated animals.<sup>157</sup> When sows are inoculated oronasally with the virus in mid-gestation the virus does not readily cross the placenta, but replicates in fetuses that are inoculated directly in mid-gestation.<sup>158</sup> It is suggested in prenatal piglets that PRRSV replicates primarily in lymphoid tissues, having gained access to the them from the placenta via the bloodstream.<sup>159</sup> Thus the fetuses are more susceptible in late gestation than earlier in mid-gestation,<sup>160</sup> or there is greater likelihood of transplacental infection during late gestation.<sup>161</sup> Experimentally, the intrauterine inoculation of the virus

into gilts on the day after natural breeding may have little or no effect on their reproductive performance.<sup>162</sup> There appears to be no direct or indirect effect on luteal function contributing to PRRSV induced abortion.<sup>163</sup> The virus may cause cell death directly such as the alveolar macrophages, or in lymphoid tissues. PRRSV affects Marc 145 cells which undergo necrosis at a much higher rate than apoptosis, and increases with virus levels used to infect the cells.<sup>164</sup> Apoptosis does occur in PRRSV infected cells but it is a late event during PRRSV replication and rapidly results in a necrotic-like death.<sup>165</sup> Lesions have been seen in the placenta and in the vessels of the umbilical cord but these are rarely reported with European strains although they may be more common with the USA strains.

The original descriptions of porcine necrotizing pneumonia (PNP) were associated with swine influenza but more recent research has shown that PRRSV is consistently and predominantly associated with PNP and should be considered the key etiologic agent for PNP together with PCV2.<sup>166</sup>

#### CLINICAL FINDINGS

The main feature of clinical disease associated with this virus was the extreme variability of the clinical signs. In general signs associated with PRRSV appear to result from a combination of genetic factors and herd management characteristics. The relative influences of these two factors differ depending on the specific clinical signs in question.<sup>167</sup> These may vary from inapparent infection to sudden death and abortion storms (the sow abortion and mortality syndrome). Its synergism with PCV2 is in doubt. It does not seem to be potentiated by the other great pig pathogen PCV2 virus<sup>168</sup> on one hand but on the other hand, others think it increases the severity of PRRSV induced interstitial pneumonia.<sup>169</sup> It may be that PRRS infection enhances PCV2 replication.<sup>170</sup> It is predisposed by *M. hyopneumoniae* and this can be reduced by vaccination for *M. hyopneumoniae*.<sup>171</sup> In turn PRRS predisposes to *Bordetella bronchiseptica*.<sup>172,173</sup> Both may interact to reduce the efficiency of lung defense mechanisms and facilitate infection with *P. multocida*. There is little effect on *H. parasuis* secondary infection with a slight increase in macrophage uptake of HPS during the early infection which is reduced after 7 days.<sup>174</sup> There is evidence that concurrent infection with TGEV and PRRSV is likely to have little or no effect on subsequent shedding or persistence of infection.<sup>70</sup> Infection with PRRS is common in pigs with PMWS but there is no evidence that PRRS is necessary for the

development of PMWS.<sup>175</sup> PRRS has been seen in a swine herd with PCMV.<sup>176</sup> Synergism between PRRSV and *Salmonella choleraesuis* has been described with unthriftiness, rough hair coats, dyspnea, and diarrhea. Pigs that received dexamethasone were the most severely affected and half died but they also shed significantly more organisms in feces and also had significantly higher PRRSV titers.<sup>177</sup> Simultaneous infection between PRRSV and *S. suis* is much more severe than with either agent on its own.<sup>178</sup> PRRSV induced suppression of pulmonary intravascular macrophage function may in part explain PRRSV associated susceptibility to *S. suis* infection.<sup>179</sup>

There is also a clear synergism between PRRSV and LPS in the exhibition of respiratory signs in conventional pigs.<sup>180,181</sup> In these joint infections the rise in TNF- $\alpha$ , IL-1, and IL-6 were 10–100 times higher than in the single infections.<sup>181</sup> Reproductive failure and respiratory disease are the major clinical findings which are also highly variable between herds. All age groups in a herd may be affected within a short period of time.

Pigs infected with both PRRSV and *M. hyopneumoniae* had a greater percentage of pneumonic lung, increased clinical disease and lower viral clearance<sup>182</sup> than pigs with single infections. There were also increased levels of IL- $\beta$ , IL-8, IL-10, and TNF- $\alpha$  in lung lavage fluid and this may be the way that the joint infection increases the pulmonary response.

#### Reproductive failure

If 90-day gestational gilts are given vaccine or field strains of PRRSV then some pigs are born dead, most pigs survive and some pigs were infected in utero. Vaccine strains did not affect postnatal growth but field strains reduced growth.<sup>94</sup> It may be that the virus entered the reproductive tract through the viremia and then the seeded tissues may release the virus back into the serum at low levels.<sup>183</sup>

Anorexia, lethargy, depression, and mild fever in pregnant gilts and sows are common initial clinical findings affecting 5–50% of animals. This is commonly followed by a sudden increase in early farrowings at 108–112 days of gestation, late-term abortions, stillborn and mummified fetuses, partially autolyzed fetuses, weak neonates with high mortality within a few hours or days after birth, late returns to estrus, and repeat breeders. This is generally followed by mid-gestation abortions, and marked increases in the percentage of mummified fetuses, early embryonic death, and infertility. In large herds, successive groups of 10–20% of gilts and sows may become anorexic over

a period of 2–3 weeks. Cyanosis of ears, tails, vulvas, abdomens, and snouts may occur in a small number of sows, and occurs more commonly in European outbreaks and is uncommon in North America. Following the initial outbreak, a 'storm' of reproductive failure may occur consisting of premature farrowings, late-term abortions, an increase in stillbirths, mummified fetuses, and weak neonates. This second phase of reproductive failure may last 8–12 weeks. Stillbirths may reach 35–40%. Weakborn piglets die within 1 week and contribute to a high preweaning mortality.

In subsequent times with the European strains there may be just outbreaks of rolling inappetence or occasional early farrowings. However, there are serious clinical outbreaks in Italy, Poland and outbreaks associated with new variants in the UK.<sup>184</sup>

Reproductive disease may be preceded by, or follow, respiratory disease in the breeding herd, the finishing pigs, or younger pigs. The reproductive aspect of the disease typically lasts from 4–5 months, occupying an entire reproductive cycle within a herd. This is followed by a return to normal performance. Repeated incidents of reproductive failure in individual gilts and sows are unusual but recurrent episodes may occur in herds purchasing replacement gilts that do not have sufficient immunity.<sup>185</sup>

Outbreaks of the disease are characterized by a period of severe reproductive problems in the breeding herd, followed by a return to near normal reproductive performance, punctuated by recurrent episodes of reproductive failure.<sup>186</sup> Most herds eventually return to pre-outbreak levels of reproductive performance but some herds never achieve pre-outbreak performance levels.

Boars may also be affected with anorexia, fever, coughing, lack of libido, and temporary reduction in semen quality.<sup>184</sup>

#### Respiratory disease

The most important problem facing many of the larger pig industries in the world is porcine respiratory disease complex (PRDC). The most important contributor to this syndrome is PRRS virus. The generation of immunity capable of protecting pigs by mediating virus inhibition through virus neutralizing antibodies or interferon takes time.<sup>187</sup>

Disease occurs in pigs of any age, but especially in nursing and weaned pigs, and is characterized by anorexia, fever, dyspnea, polypnea, coughing, and subnormal growth rates. A bluish discoloration of the ears, abdomen, or vulva may also occur – 'blue-eared disease'. Death may occur in the acute phase. In some herds up to 50% of pigs are anorexic, up to 10%

may have a fever, up to 5% are cyanotic, and up to 30% have respiratory distress. In weaning pigs the morbidity may be as high as 30%, with a mortality of 5–10%. Nursery pigs exhibit respiratory distress and growth retardation. Conjunctivitis, sneezing, and diarrhea are common. All of these signs may appear to move through the various age groups in the herd over several days and a few weeks. The course of the disease in a herd may last 6–12 weeks. In gilts and sows of any parity, anorexia and fever, lasting for several days, are noted initially. The acute-phase respiratory disease may last several months but is often followed by a long period of postweaning respiratory disease which may last up to 2 years. This long course is often accompanied by secondary infections in successive batches of weaned pigs. Unthriftiness may persist throughout the finishing period with an ineffective response to antibiotics and vaccines.

Prewaning morbidity and mortality is a major feature of the disease. Litters are often unthrifty, and many deaths occur within the first week of age.

#### CLINICAL PATHOLOGY

PRRSv infection significantly increases the number of alveolar macrophages in bronchoalveolar lavage fluid approximately 10-fold between day 10 and day 21 of infection.<sup>188</sup> Approximately 63% of the cells were cytotoxic T-cells and natural killer cells. Serum haptoglobin levels were increased from 7–21 days.<sup>189</sup>

Piglets also become anemic in PRRSv infections and the most highly pneumovirulent strains induced the more severe anemia. This is probably due to a direct or indirect effect on the erythroid precursor cells of the bone marrow.<sup>190</sup>

A definitive diagnosis requires detection of virus in infected animals, detection of antibodies in fetal fluid, or in precolostral blood of stillborn and weak-born piglets.<sup>191</sup> Detection of antibodies in sera of groups of pigs of different ages is also necessary. The most suitable body fluid and tissue samples and diagnostic tests for the etiologic diagnosis of PRRS are dependent on several variables including:

- Age of pigs from which samples are collected
- Stage of infection (acute or persistent)
- Available complement of diagnostic reagents
- Urgency of obtaining results.<sup>192</sup>

When congenitally or neonatal pigs are affected, both serum and alveolar macrophages are reliable samples. For older pigs, alveolar macrophages are more reliable than serum.

#### Detection or isolation of virus

The virus can be demonstrated by isolation using cell cultures, by direct detection of viral antigen in tissue sections, or by the detection of virus-specific RNA.<sup>191</sup>

Samples used for virus isolation include serum, thoracic fluid, spleen, and lung. Porcine pulmonary alveolar macrophages are used for isolation of virus. Alveolar macrophages using immunofluorescence microscopy can be used for detection of virus during acute infections.<sup>193</sup> The PCR assay is a reliable, sensitive, and rapid test for the detection of virus in boar semen.<sup>194</sup> It can also be used to determine whether suckling piglets are infected with PRRSv before vaccination and for determining the relationship between parity and shedding of virus.<sup>195</sup> It can also be used to obtain PRRSv piglets.<sup>196</sup> PCR followed by RFLP analysis using several restriction enzymes provides a good genetic estimate for isolate differentiation.<sup>197</sup> A reverse transcription and PCR, coupled with a microplate colorimetric assay, is an automated system that is a reliable and easy test for the routine detection of the virus in semen samples from seropositive boars.<sup>198</sup> Multiplex RT nested PCR can be applied to formalin-fixed tissues.<sup>199</sup>

A nested PCR has been described that is 100–1000 times more sensitive than the usual PCR.<sup>200</sup>

An assessment of the viral load can possibly be made by using the quantitative competitive RT-PCR.<sup>201</sup> A quantitative Taqman RT PCR is time saving, easy to handle, less likely to be cross contaminated and highly sensitive and specific.<sup>202</sup> Immunohistochemical techniques are available for the detection of virus in formalin-fixed tissues.<sup>203,204</sup> The virus was detected in 11–23% of animals with interstitial pneumonia. It was found in 21–31% of animals less than 3 months of age but in only 6–17% of those more than 4 months of age.<sup>205</sup> The immunogold silver staining is superior to the immunoperoxidase staining systems for detection of virus in formalin-fixed tissues.<sup>206,207</sup> Reverse transcription-polymerase chain reaction (RT-PCR) is also available and can distinguish between North American and European strains.

A double ISH technique has been developed<sup>208</sup> which can show both PRRSv and PCV2 and a small number of alveolar macrophages stain for both antigens.

#### Serology

Serological tests have good sensitivity and specificity for diagnosis on a herd level and less so on the individual animal. The tests in common usage are described below. One of the problems is that the serological response to a nonvirulent strain is the same as it is to a virulent strain.<sup>204</sup> It is also

important to realize that although a positive result for antibody indicates exposure to virus, a negative test does not necessarily mean that the pig is free from PRRSv or has not been in contact with the virus.<sup>209</sup>

**Immunoperoxidase monolayer assay test**  
The immunoperoxidase monolayer assay (IPMA) is often the first test used. Approximately 75% of sows infected with the virus seroconvert to the Lelystad virus. However, the IPMA does not allow for large scale surveys.

**Indirect enzyme-linked immunosorbent assay**

Indirect ELISA is used for the routine serodiagnosis; it is simple, inexpensive, effective, and a better alternative to the indirect immunofluorescent assay or the immunoperoxidase assay.<sup>210</sup> It is suitable for the screening of large numbers of samples and is best used as a herd test.<sup>211</sup> Because of marked differences between and within North American and European virus isolates, serological tests using only one antigenic type of the virus may potentially yield false-negative results with antisera against diverse antigenic types of the virus. A mixture of ELISA antigens from North American and European strains gives superior results when both types of viruses are known to exist.<sup>212</sup>

A meat juice ELISA has been developed which gives complete agreement with the serum ELISAs.<sup>213,214</sup>

**Indirect fluorescent antibody assay**

Immunofluorescent antibody (IFA) is a highly sensitive test. Antibody titers are detectable in infected pigs 8 days after inoculation. The IgM IFA test is also a rapid and simple test for diagnosing recent infection as early as 5–28 days after infection in 3-week-old piglets, and 7–21 days in sows.<sup>215</sup>

**Modified serum neutralization test**

This test is useful for the detection of later and higher levels of antibody when the conventional methods cannot detect antibody. The test can differentiate between strains.<sup>216</sup> The serum neutralization test is not used for routine diagnosis<sup>191</sup> because neutralizing antibodies do not appear early on in the infection.<sup>217</sup>

**Herd diagnosis**

The serological diagnosis must be used and applied on a herd basis, and acute and convalescent sera submitted for optimal results. A baseline herd sampling is necessary to evaluate the status of a herd and to determine if and in which groups the virus is circulating. In large herds of over 500 sows, samples are taken from 30 animals in each breeding, gestation, and farrowing group, with representation from all parities. In

addition, 10 nursery pigs (5 weeks old), 10 pigs at the end of the nursery period, and 10 pigs in late finishing stage constitute a **herd profile**. Thus, serological monitoring can be used to monitor the circulation of virus within a closed herd and to determine infection status of breeding animals which are to be introduced into seronegative herds.<sup>218</sup> Results from the sow sera indicate if the sow herd is virus-negative, stable, or has an active virus circulation. Comparison of the early and late nursery pigs indicates if the virus is circulating in the nursery. Comparing the nursery results with the end of the finishing period indicates if the virus is circulating in the finishing groups of pigs. IFA titers in pigs range from 1:256 to 1:1024 by 2–3 weeks after infection. Titers decline over 3–4 months unless reinduced by exposure to circulating virus. Uninfected nursing pigs are negative or have maternal antibody. Seropositive 9 to 10-week-old pigs leaving the nursery indicate virus circulation in the nursery. If pigs leaving the nursery are negative, and positive later in the finishing unit, virus circulation is occurring in the finishing unit.

Sera from outbreaks of the disease in the United States, Canada, and Europe have been compared, and although the isolates from both continents are closely related, the strains isolated in the United States and Canada are more closely related serologically than they are to the European strains.

### NECROPSY FINDINGS

A series of postmortem examinations of different aged pigs obviously from different stages of production will tell you what is going on over time. A series of such examinations will probably tell you more than any other investigations.

No characteristic gross lesions are present in sows, aborted fetuses or still-born piglets. Microscopic lesions which may be present in aborted fetuses include vasculitis of the umbilical cord (not recorded in European strain infections) and other large arteries, myocarditis, and encephalitis.<sup>219,220</sup> Unfortunately, none of these changes is present consistently, and the majority of fetuses and placentas are histologically normal. These lesions are all more common in the North American virus infections.

In suckling and grower pigs, infection with the PRRS virus is usually characterized by an interstitial pneumonia. The PRRSV affects both pulmonary intravascular macrophages which may be important as a replication site and alveolar macrophages.<sup>221</sup> Loss of bactericidal function in Pulmonary intravascular macrophages may facilitate hematogenous bacterial

infections. When Danish isolates were injected into piglets, PRRSV was isolated from the lungs and/or tonsillar tissues from both dead and culled piglets under 14 days of age.<sup>222</sup> Tracheobronchial and mediastinal lymph nodes are usually enlarged and firm. The gross pulmonary changes vary from lungs that appear normal but fail to collapse, to lungs that are diffusely red, meaty, and edematous. Porcine proliferative and necrotizing pneumonia has been linked to infection with PRRS virus, although the involvement of an unidentified co-pathogen cannot yet be discounted. Grossly, this form of pneumonia appears as confluent consolidation of the cranial, middle, and accessory lobes, together with the lower half of the caudal lobe. Affected lobes are red-gray, moist, and firm (meaty) in consistency. On cross-section, the affected lobes are bulging and dry, and the pulmonary parenchyma appears similar to thymic tissue.

In general histological lesions in piglets are focal non-suppurative inflammatory conditions particularly in the lung and heart.<sup>222</sup> Most of the cells undergoing apoptosis do not have markers for PRRSV which suggests that there is an indirect mechanism for the induction of apoptosis.<sup>223</sup>

Histologically, in addition to marked proliferation of type II pneumocytes in alveoli, there is severe necrosis of bronchiolar epithelium, with necrotic cellular debris plugging the airway lumina.

In the less severe and more common forms of PRRS pneumonia, the alveoli contain protein-rich fluid and large macrophages, some of which may appear degenerate. There is patchy thickening of the alveolar septa, due to infiltrating mononuclear leukocytes and mild, type II pneumocyte hyperplasia. Lymphoplasmacytic cuffing of arterioles is common and syncytial cells are occasionally seen. In field outbreaks, it is usual for the lung pathology to be complicated by concurrent respiratory pathogens.

Microscopic lesions may be found in many other tissues and include multinucleate cell formation within lymph nodes, infiltrates of lymphocytes and plasma cells in the heart, the brain, and the turbinates, plus a lymphocytic perivascularitis in various sites.<sup>18,224</sup> Thymic lesions include severe cortical depletion of thymocytes.<sup>225</sup> An in situ hybridization technique is a rapid, highly specific, and sensitive detection method for the diagnosis of PRRS virus in routinely fixed and processed tissues.<sup>226</sup> Immunohistochemical techniques can also be used to detect the virus in neurovascular lesions.<sup>227</sup> PRRSV and reovirus 2 have been found in brain, lung and tonsil by inoculation into Marc 145 and CPK cells.<sup>228</sup> Immuno-

histochemistry on one section would give a positive in 48% of cases, but if five sections were studied then there are positives in >90% of PRRSV infected pigs. If the animals are vaccinated then the positives fall to 14%.<sup>229</sup>

### Samples for confirmation of diagnosis

- **Histology** – lung, tonsil thymus, thoracic lymph node, brain, kidney, heart, (umbilicus from fetus) (LM, IHC)
- **Virology** – lung, thoracic lymph node, tonsil (ISO, FAT, PCR).

### DIFFERENTIAL DIAGNOSIS

**Respiratory disease** must be differentiated from:

- Swine influenza
- Porcine respiratory coronavirus
- Enzootic pneumonia (*Mycoplasma hyopneumoniae*)
- *Actinobacillus pleuropneumoniae*
- *Pasteurella multocida*
- Glasser's disease (*Haemophilus parasuis*)
- *Streptococcus suis*.

**Reproductive disease** must be differentiated from other causes of abortion, stillbirths, and weak neonates in pigs:

- Leptospirosis
- Encephalomyocarditis virus
- Hog cholera virus
- Pseudorabies virus
- Parvovirus
- Fumonisin, a recently identified mycotoxin produced by *Fusarium moniliforme*, has been associated with the appearance of PRRS in swine herds in the United States.

A definitive diagnosis requires a detailed epidemiological investigation of the epidemic including a detailed analysis of the breeding and production records for the previous several months, and the submission of tissue and serum samples for laboratory investigation.

### TREATMENT

There is no specific treatment against the virus. In outbreaks of respiratory disease, mortality can be reduced by insuring that the environmental conditions in the barns and pens are adequate, the stocking density is kept low, and the feeds and feeding program are monitored. Routine procedures such as tail docking, iron injections, castrations, teeth clipping, and cross-fostering should be delayed or not done during the acute phase of the disease. Supplemental heat for neonatal pigs should be provided if necessary. Sows that have aborted their litters should not be bred until the normal time of weaning. This will reduce the incidence of infertility common at the first estrus after the abortion or premature farrowing. Culling of



sows should be minimized and weekly breedings increased by 10–15%. Replacement gilts may be introduced into the premises for exposure to infection before breeding. The consequences of boar infertility and low libido may be minimized by use of artificial insemination or by using multiple sires on each sow. Recurrent illness and secondary infections in weaner and growing pigs can be continuing problems for a few months after an acute outbreak. Reducing the stocking density and an all-in all-out strategy have been successful to reduce the chronic problem. If there is the possibility of treating secondary infections then this should be undertaken. Serum inoculation of naïve gilts has been described and this was shown to be capable of stabilizing sow herds and as shown by the production of negative weaned pigs.<sup>230</sup>

### CONTROL

Control of PRRS is difficult, unreliable, and frustrating because of the complexity of the disease; the uncertainty of some aspects such as immunity, persistence, diagnosis, and the lack of published information based on control programs which have been evaluated under naturally-occurring field conditions. Much of the information available on control is anecdotal and not based on well-designed control programs that can be compared and evaluated. A major problem is the difficulty of obtaining a definitive etiological diagnosis when presented with young growing pigs with respiratory disease and the possibility that other pathogens could be involved. The diagnosis of reproductive failure in gilts and sows is also commonly uncertain.

Some characteristics of the disease are important in planning control programs for individual herds:

- Infection is highly contagious and is transmitted by direct contact. Non-immune pregnant gilts and sows, and young pigs, are highly susceptible to infection resulting in large economic losses
- Infection of breeding stock results in immunity. The efficacy of vaccination is not well-established
- Maternal immunity is present in piglets born from seropositive sows
- Infection can persist for many weeks and months in individuals and in subpopulations of animals
- Infections are usually introduced into a herd by the introduction of infected pigs.

There are two main options for control: **eradication of the virus from individual swine herds**; and **controlling the disease**

Table 21.2 Nursery depopulation and clean up protocol for elimination of PRRS

Day	Procedure
1	Empty all nurseries, off-site weaning, pump out slurry pits, clean and wash rooms with hot water (>95°C), and disinfect with formaldehyde-based product. Allow disinfectant water to remain in pits overnight
2	Pump out pits, repeat washing procedure, and disinfect in phenol-based product. Allow disinfectant to remain in pits
3–11	Allow facility to remain vacant
12	Pump out slurry pits, repeat washing procedure, and disinfect with formaldehyde-based product
13	Allow facility to remain vacant
14	Resume conventional flow of pigs into clean nurseries

**in individual herds to create a stable positive system that allows you to live with the disease.** Controlling the disease requires developing strategies to make pigs immune to the infection by controlling infection pressure in the herd and inducing naturally acquired immunity in the herd, or inducing acquired immunity through vaccination. The recommendations for control set out here are guidelines that can be applied and modified to meet different circumstances.

### Eradication of the virus from the herd

Depopulation and repopulation  
Eradication of the virus from the herd by depopulation of the entire herd followed by repopulation with virus-free breeding stock is biologically possible, but in most cases is impractical and too expensive. Obtaining virus-free breeding stock is usually not possible and, if possible, the herd is highly susceptible to accidental reinfection.

### Control in infected herds

#### Nursery depopulation

Control within a breeding herd is based on the observation that pigs commonly seroconvert to the virus during the nursery period. Pigs are seronegative shortly after weaning, but 80–100% are seropositive at 8–10 weeks of age.<sup>83</sup> A control program based on a **nursery depopulation** consists of emptying the nurseries and moving **all of the pigs** to off-site finishing facilities or selling them as feeder pigs.<sup>231</sup> Test and removal has been described.<sup>232</sup> This is combined with batch farrowing and weaning at intervals of at least 3 weeks.<sup>19</sup> The nurseries are completely emptied, cleaned three times with hot water and disinfectant, the slurry pits are pumped out after each cleaning, and the facilities are kept empty for 14 days, during which time all pigs weaned are moved to off-site nurseries, and after which the conventional flow of pigs into the cleaned facilities are resumed. The control program can result in significant improvements in both average daily gain and percentage mortality but it will not

eliminate the virus from the herd.<sup>231</sup> Using a partial budget model to measure the profitability of nursery depopulation, the financial consequences indicate that it is a profitable strategy to improve pig performance in herds affected with the virus.<sup>233</sup> Additional income is generated by the increased number and weight of marketable pigs, as a result of their increased growth rate and decreased mortality. Lower treatment costs reduce overall expenses but there are additional costs due to extra feed necessary to raise the additional pigs and the costs required to house the depopulated pigs. However, it is possible that the economic benefits are due to the control of other pathogens and not merely the PRRS virus.

The details for a nursery depopulation and clean-up protocol for the elimination of the virus are shown in Table 21.2.<sup>234</sup>

### Management of gilt pool

Management of the gilt pool is the single most important strategy for long-term effective control. Controlling the infection in the breeding herd is a prerequisite to controlling infection in the nursery and finishing pig groups. Strategies like partial depopulation and piglet vaccination are ineffective unless the breeding herd is first stabilized, preventing piglets from being infected before weaning. Replacements are a major source of introduction of the virus and activating existing virus in the breeding herd. They also initiate the formation and maintenance of breeding herd replacements.

**Subpopulations** are subsets of naïve or recently infected gilts or sows which co-exist within chronically infected herds. These subpopulations perpetuate viral transmission in the breeding herd and farrowing units, which ultimately produces successions of infected piglets prior to weaning. Modifications in gilt management that may minimize subpopulations include ceasing introduction of replacement animals for a 4-month period, beginning to select replacements from the finishing unit, or introducing a 4-month allotment of gilts at one time.



Exposure to the virus in the breeding herd can be controlled by managing the gilt pool using two strategies.<sup>235</sup> In one strategy, herds may be closed to outside replacements, and replacement males and females are raised on the farm. In the other strategy, replacement gilts are held in an off-site holding facility from 9 to 12 weeks of age until breeding age at 7–7.5 months, or even much earlier. This is combined with nursery depopulation as described above. Prior to entry of the gilts into the herd they are serologically tested for evidence of seronegativity or a declining titer, which is required for entry into the herd. The gilts are isolated and quarantined for acclimatization for 45–60 days. This may be combined with two vaccinations, 30 days apart, after entering quarantine. This method reduces the risk of introducing potentially viremic animals into the existing population. The method selected will depend on the production system, management capabilities, and facilities available on each farm. The introduction of younger gilts, in larger groups, less frequently throughout the year, is being recognized as the most effective method for introducing replacement stock to virus-infected herds and long-term control of the disease.

#### **Controlled infection of breeding herd**

The presence of subpopulations of highly susceptible breeding animals in the herd can be a major risk factor for maintaining viral transmission within problem herds and may explain recurrent outbreaks of reproductive failure. By intentionally exposing all members of a population to the virus it may be possible to eliminate subpopulations and produce consistent herd immunity.<sup>21</sup> In endemic herds, exposure of gilts to the virus prior to breeding is critical for prevention of reproductive failure. Seronegative replacement gilts can be introduced into seropositive herds at 3–4 months of age to allow for viral exposure before breeding. If the status is uncertain, quarantine and exposure to nursery pigs of the importing unit is a suitable policy if replacement gilts are bought in before they are bred. It is possible to convert a PRRS positive unit to a negative herd by managing the gilt pool and regulating the pig flow. It appears that PRRSv infection eventually either disappears or becomes inactive in the donor gilt population.<sup>236</sup> Similarly serum from nursery pigs (thought to be PRRSv viremic) given to negative replacement gilts resulted in seroconversion of all 50 gilts receiving the serum.<sup>237</sup>

#### **Control of secondary infections**

When outbreaks of the disease occur in nursing piglets, and virus circulation is

occurring continuously in the farrowing facility, the following are recommended:

- Cross-foster piglets only during the first 24 hours of life
- Prevent movement of pigs and sows between rooms
- Eliminate the use of nurse sows
- Euthanize piglets with low viability
- Minimize injections of suckling pigs
- Stop all feedback of pig and placental tissues
- Follow strict all-in all-out pig flow in the farrowing and nursery rooms.

These are similar to the system developed in the USA called the McRebel system. This was a method of control which showed that cross fostering of piglets should be minimal within the first 24 hours and banned after this time.<sup>238</sup>

Feedback has been tried although there are a lot of reasons not to do so. Minced whole piglets were fed to sows and the herd then closed for 23 weeks. No clinical signs were observed. One third of the sows present at the time of the outbreak were still seropositive 20 months after the deliberate infection.<sup>239</sup> Disinfection at cold temperatures was described.<sup>240</sup>

#### **Biosecurity**

Standard methods, such as quarantining and serological screening of imported breeding stock and restrictions on visitors are recommended to keep units free of infection. Control of infection between herds depends on restricting the movement of pigs from infected herds to uninfected herds. If pigs have to be bought in, then seropositive animals should be imported into seropositive herds. Only seronegative boars should be allowed entry into artificial-insemination units.

#### **Vaccine and vaccination**

Vaccination is an aid to management in developing effective immunity. The goal is to produce a constant level of immunity across a defined population. This effectively immunizes the entire population and eliminates the non-immune, susceptible subpopulations. Vaccination is most effective when used in replacement gilts combined with adequate isolation and acclimatization, and in sows after farrowing and prebreeding. The routine vaccination of sows is not economically viable in herds affected with PRRS virus.<sup>241</sup> The vaccine is best suited for stabilizing the herd and is a necessity prior to nursery depopulation or commingling segregated early weaning piglets from virus-positive herds. Vaccination is also intended to produce protective immunity in weaned and growing pigs. The PRRS virus exists in many forms and therefore the closer the genetic make up between the immunizing virus and the challenge virus the better.<sup>159</sup>

Both inactivated and modified live virus vaccines are available. Killed vaccines may not produce a measurable antibody response stimulation and activation of lymphocytes does occur and any subsequent exposure with vaccine or field virus increases that response. There is no possibility of producing a viremia and no chance of producing shedding and there are no detrimental effects on the host. However there is no evidence that killed vaccines protect against heterologous challenge.

A killed, oil-adjuvanted vaccine based on a Spanish isolate of the virus is intended for protection against reproductive disease in gilts and sows. Initial vaccination involves two vaccinations, 21 days apart, with the second vaccination at least 3 weeks before breeding and with booster vaccinations recommended during subsequent lactations. Experimental challenge provides 70% protection based on pigs born alive and surviving to 7 days.

Modified live vaccines do give a safe and efficacious protection against a wide variety of heterologous challenge strains.<sup>242</sup> The vaccine virus can be transmitted from vaccinated to naive pigs.<sup>94,96,243</sup> and to naive herds. Vaccination of boars causes the virus to be shed<sup>244</sup> but if they have been previously exposed and then are vaccinated then there is no release of virus.<sup>245</sup>

The live vaccine given to finishing pigs will protect against respiratory infections.<sup>246</sup>

A modified live virus vaccine given once is safe for use in pregnant sows, and vaccine virus is not transmitted to susceptible contact pigs. In growing pigs, vaccinated at 3–18 weeks of age, the vaccine elicits protective immunity within 7 days which lasts 16 weeks. Compared to controls, vaccinated animals have a reduced level of viremia, their growth rates are superior, and they have a reduced number of lung lesions. Field trials suggest that the vaccine provides protection to nursery pigs in units with endemic infection. Live viral vaccines in sows may or may not be a good idea<sup>247</sup> as they demonstrated that reduced numbers of pigs were born alive and there were increased numbers of stillborn piglets to vaccinated sows irrespective of stage of vaccination. Both single strain and multistrain vaccines can be attenuated and be useful immunogens but additional studies are needed to make sure that the multistrain vaccines can be recommended for routine field use.<sup>248</sup>

In Denmark in 1996, the use of a modified live virus vaccine licensed for use in pigs 3–18 weeks of age was used in a large number of PRRS virus-seropositive herds.<sup>96</sup> Following vaccination, a large number of herds experienced an increased incidence of abortions, stillbirths, and

poor performance during the nursery period. The vaccine virus was isolated from fetuses and it was concluded that the virus was transmitted to seronegative non-vaccinated pregnant gilts and sows (see Methods of transmission). The viruses were collected and sequenced<sup>204,249</sup> and shown to have a 60% homology to Lelystad but a 98.5% homology to the USA strain ATC-2332 the USA reference strain. It was therefore thought that the vaccine viruses were reverting to their natural antecedents and their virulence.<sup>250-252</sup> Describing the vaccine virus it was shown that given to piglets it could infect non vaccinated sows. Given to sows it can produce congenital infection, fetal death, and an increased pre-weaning mortality.<sup>252</sup>

The vaccine virus can be maintained in the population where it may undergo considerable genetic change and then lead to the establishment new variants. Vaccination with the US type vaccine produces little effect on viremia with EU PRRSv. Vaccination with EU type vaccines produced complete suppression of EU PRRSv isolates.<sup>253</sup>

A modified live virus vaccine has been evaluated in pigs vaccinated at 3 weeks of age and challenged at 7 weeks of age.<sup>254</sup> Efficacy was evaluated using homologous and heterologous strains of virus known to cause respiratory and reproductive disease. The vaccine controlled respiratory disease but did not prevent infection and viremia. There are no published reports of randomized clinical trials evaluating the vaccines under naturally occurring conditions. In many cases of PRDC vaccination fails simply because it was given too late or because there was no cross protection to heterologous strains.

DNA vaccination is said to produce both humoral and cellular responses and neutralization epitopes on the viral envelope glycoproteins encoded by ORF4.<sup>255</sup> Possibly recombinants can be used as vaccines.<sup>256</sup>

#### Vaccination of boars

The use of an attenuated virus vaccine in boars results in a marked reduction in viremia and shedding of the virus in semen compared to non-vaccinated control animals.<sup>257</sup> Introducing a vaccination program using the live virus vaccine may be considered as a potential method to reduce the risk of transmission of virus by artificial insemination. In contrast, no changes in onset, level, and duration of viremia, and shedding of virus in semen were observed using the inactivated virus vaccine.

#### REVIEW LITERATURE

Meng X-J. Heterogeneity of PRRS virus; implications of current vaccine efficacy and future vaccine development. *Vet Microbiol* 2000; 74:309-329.

Martelli P, Cavirani S, Lavazza A (eds). 4th International Symposium on Emerging and Re-Emerging Pig Diseases: PRRS PMWS Swine Influenza. Palazzo Dei Congressi Rome, University of Parma, Parma, 2003.

Prieto C, Castro JM. PRRS in the boar; a review. *Theriogenology* 2005; 63:1-16.

#### REFERENCES

- Wensvoort G et al. *Vet Quart* 1991; 13:121.
- Terpstra C et al. *Vet Quart* 1991; 13:131.
- Collins JE et al. *J Vet Diag Invest* 1992; 4:117.
- Benfield DA et al. *J Vet Diag Invest* 1992; 4:127.
- Murtaugh MP et al. *Proc 23rd Ann Lemna Conf Minn* 1996; 23:89.
- Murtaugh MP et al. *Proc 24th Ann Lemna Conf Minn* 1997; 24:146.
- Nelson EA et al. *J Clin Microbiol* 1993; 31:3184.
- Forsberg R et al. *Viol* 2002; 299:38.
- Plagemann PGW et al. *Emerg Infect Dis* 2003; 9:903.
- Forsberg R et al. *Viol* 2001; 289:174.
- Nelson CJ et al. *J Virol* 1999; 73:270.
- Stadejek T et al. *J Gen Virol* 2002; 83:1861.
- Vugt JJFA et al. *J Gen Virol* 2001; 82:2615.
- Mardassi H et al. *Can J Vet Res* 1994; 58:55.
- Christianson WT, Joo HS. *Swine Health Prod* 1994; 2.
- Canon N et al. *Vet Rec* 1998; 142:142.
- Garner MG et al. *Aust Vet J* 1997; 75:1997.
- Done SH et al. *Br Vet J* 1996; 152:153.
- Yoon I. *Swine Health Prod* 1993; 1:5.
- Cho SH et al. *J Vet Diagn Invest* 1993; 5:259.
- Dee SA et al. *Swine Health Prod* 1996; 4:181.
- Bierk MD et al. *Can J Vet Res* 2001; 65:261.
- Larochelle R et al. *Virus Res* 2003; 96:3.
- Johnson W et al. *Vet Immunol Immunopathol* 2004; 102:233.
- Baysinger AK et al. *Swine Health Prod* 1997; 5:173.
- Mortensen S et al. *Prev Vet Med* 2002; 53:83.
- Meier WA et al. *Viol* 2003; 309:18.
- Mengeling WL et al. *Vet Microbiol* 2003; 93:13.
- Lager KM et al. *Can J Vet Res* 2003; 67:121.
- Nelson EA et al. *J Vet Diagn Invest* 1994; 6:410.
- Albina E et al. *Vet Rec* 1994; 134:567.
- Yoon K-J et al. *J Vet Diagn Invest* 1995; 7:305.
- Zuckermann FA et al. *Adv Vet Med* 1999; 41:447.
- Molitor TW et al. *Vet Microbiol* 1997; 55:265.
- Shibata I et al. *J Vet Med* 2000; 62:105.
- Zimmerman JJ et al. *Vet Microbiol* 1997; 55:187.
- Lager KM et al. *Vet Microbiol* 1997; 58:127.
- Lager KM et al. *Vet Microbiol* 1997; 58:113.
- Houben S et al. *J Vet Med Series B* 1995; 42:209.
- Chung W-B et al. *Can J Vet Res* 1997; 61:292.
- Nodelijk G et al. *Vet Microbiol* 1997; 56:21.
- Dee SA et al. *Can J Vet Res* 2003; 67:12.
- Magar R et al. *Can J Vet Res* 1995; 61:69.
- Yoon K-J et al. *Vet Res* 1998; 30:629.
- Katz JB et al. *Vet Microbiol* 1995; 44:65.
- Larochelle R, Magar R. *J Virol Meth* 1997; 68:161.
- Meng X-J et al. *J Gen Virol* 1995; 76:3181.
- Dee SA et al. *Can J Vet Res* 2001; 65:254.
- Yoon K-J et al. *J Vet Diagn Invest* 1995; 7:386.
- Key KF et al. *Vet Microbiol* 2001; 83:249.
- Stadejek T et al. *Med Wet* 2005; 61:321.
- Mengeling WL et al. *Am J Vet Res* 1996; 57:834.
- Halibur PG et al. *Vet Pathol* 1995; 32:648.
- Halibur PG et al. *J Vet Diagn Invest* 1996; 8:11.
- Halibur PG et al. *Vet Pathol* 1996; 33:159.
- Yaeger MJ et al. *Swine Health Prod* 1993; 1:7.
- Halibur PG et al. *J Clin Microbiol* 2000; 38:1156.
- Galina L et al. *Vet Rec* 1994; 134:60.
- Thanawongnuwech R et al. *Vet Path* 2000; 37:143.
- Feng WH et al. *J Virol* 2001; 75:4889.
- Wills RW et al. *Vet Microbiol* 2000; 71:177.
- Brockmeier SL et al. *Am J Vet Res* 2000; 61:892.

- Thacker EL et al. *Vaccine* 2000; 18:1244.
- Alstine WG van et al. *Vet Microbiol* 1996; 49:297.
- Dee SA. *Swine Hlth Prod* 1996; 4:147.
- Dee SA. *Proc Am Ass Swine Pract* 1997; p. 465.
- Thacker EL et al. *J Clin Microbiol* 1999; 37:620.
- Zeman DH. *Swine Health Prod* 1996; 4:143.
- Dee S et al. *Proc Am Ass Swine Pract* 2001; 32:191.
- Mengeling WL. *Proc 4th Int Symp Emerg Re-emerg Pig Dis* 2003; p. 3.
- Rossov KD et al. *Vet Rec* 1999; 144:444.
- Rossov KD et al. *Vet Path* 1995; 32:361.
- Chang CG et al. *J Virol* 2000; 76:4750.
- Zimmermann JJ et al. *Swine Hlth Prod* 1997; 5:74.
- Horter DC et al. *Vet Microbiol* 2002; 86:213.
- Wills RW et al. *J Clin Microbiol* 2003; 41:58.
- Van Reeth K et al. *Danske Vet* 2002; 85:6.
- Bierk MD et al. *J Vet Diagn Invest* 2005; 13:165.
- Wagstrom EA et al. *Am J Vet Res* 2001; 62:1876.
- Rossov KD et al. *J Vet Diagn Invest* 1994; 6:3.
- Wills RW et al. *Vet Microbiol* 1997; 57:69.
- Bilodeau R et al. *Can J Vet Res* 1994; 58:291.
- Stevenson GW et al. *J Am Vet Med Assoc* 1994; 204.
- Wills R et al. *J Swine Hlth Prod* 2002; 10:161.
- Cuartero L et al. *J Swine Hlth Prod* 2002; 10:119.
- Goldberg TL et al. *J Gen Virol* 2000; 81:171.
- Christopher-Hennings J et al. *J Vet Diagn Invest* 2001; 13:133.
- Swenson SL et al. *J Am Vet Med Assoc* 1994; 204:1943.
- Christopher-Hennings J et al. *J Vet Diagn Invest* 1995; 7:456.
- Solano GJ et al. *Vet Microbiol* 1997; 55:247.
- Gradil C et al. *Vet Rec* 1996; 138:521.
- Christopher-Hennings J et al. *Am J Vet Res* 1997; 58:40.
- Batista L et al. *J Swine Hlth Prod* 2002; 10:147.
- Mengeling WL et al. *Am J Vet Res* 1998; 59:52.
- Rowland RRR et al. *Vet Microbiol* 2003; 96:219.
- Botner A et al. *Vet Rec* 1997; 141:497.
- Otake SA et al. *Vet Rec* 2002; 150:804.
- Mengeling WL. *J Swine Hlth Prod* 2005; 13:910.
- Otake SA et al. *J Swine Hlth Prod* 2002; 10:59.
- Otake S et al. *Vet Rec* 2002; 150:102.
- Amass SF et al. *Swine Hlth Prod* 2000; 8:161.
- Otake SA et al. *Can J Vet Res* 2003; 67:265.
- Otake SA et al. *Vet Rec* 2003; 152:73.
- Otake S et al. *Can J Vet Res* 2003; 67:198.
- Otake S et al. *Vet Rec* 2004; 154:80.
- Wills RW et al. *Swine Hlth Prod* 1995; 5:213.
- Torremorell M et al. *Am J Vet Res* 1997; 58:828.
- Dee SA et al. *Vet Rec* 2005; 156:56.
- Le Potier MF et al. *Vet Microbiol* 1997; 55:355.
- Hooper CC et al. *J Vet Diagn Invest* 1994; 6:13.
- Pirtle EC, Beran GW. *J Am Vet Med Assoc* 1996; 208:390.
- Dee SA et al. *Vet Rec* 2005; 156:56.
- Larochelle R, Magar R. *Vet Microbiol* 1997; 58:1.
- Main RG. *Proc 11th Ann Iowa Swine Dis Conf* 2003; p. 172.
- Nielsen J et al. *Vet Immunol Immunopathol* 2003; 93:135.
- Riber U et al. *Vet Immunol Immunopathol* 2004; 99:169.
- Kawashima K et al. *Vet Immunol Immunopathol* 1999; 71:257.
- Lamontage L et al. *Vet Immunol Immunopathol* 2001; 82:65.
- Nielsen H-S et al. *J Virol* 2003; 77:3702.
- Aasted B et al. *Clin Diag Lab Immunol* 2002; 9:1229.
- Feng WH et al. *Vet Immunol Immunopathol* 2003; 94:35.
- Johnsen CK et al. *Viral Immunol* 2002; 15:549.
- Wills RW et al. *J Clin Microbiol* 2003; 41:58.

124. Beyer J et al. *J Vet Med Sci B* 2000; 47:9.
125. Rowland RR et al. *Vet Microbiol* 2003; 96:219.
126. Delapuitte PL et al. *Arch Virol* 2002; 76:4312.
127. Nauwynck HJ et al. *J Gen Virol* 1999; 80:297.
128. Chou MT et al. *Vet Microbiol* 2000; 71:9.
129. Choi C, Chae C. *J Comp Path* 2002; 127:106.
130. Labarque G et al. *Vet Res* 2003; 34:249.
131. Miller LC. *Arch Virol* 2004; 149:2453.
132. Yoon K-J et al. *Vet Res* 1999; 30:629.
133. Kreutz LZ, Ackermann MR. *Virus Res* 1996; 42:137.
134. Duan X et al. *J Virol* 1998; 72:4250.
135. Yoon K-J et al. *Vet Immunol* 1996; 9:51.
136. Rossow KD et al. *Vet Pathol* 1995; 32:361.
137. Wissink E et al. *Arch Virol* 2003; 148:177.
138. Oleksiewicz SD, Nielsen T. *Vet Microbiol* 1999; 66:15.
139. Sirinarumit T et al. *J Gen Virol* 1998; 79:2989.
140. Thanawongnuwech R et al. *Vet Immunol Immunopathol* 2003; 91:73.
141. Bautista EM, Molitor TW. *Arch Virol* 1999; 76:4312.
142. Chung HK, Chae C. *J Comp Path* 2003; 129:205.
143. Suradhat S et al. *J Gen Virol* 2003; 84:453.
144. Lopez Fuertes L et al. *Virus Res* 2001; 69:41.
145. Lopez Fuertes L et al. *Virus Res* 1999; 64:33.
146. Albina E et al. *Vet Immunol Immunopathol* 1998; 61:49.
147. Segales J et al. *J Comp Path* 1998; 118:231.
148. Feng WH et al. *Proc 16th Int Pig Vet Soc Cong* 2000; p. 657.
149. Cooper VL et al. *J Vet Diag Invest* 1997; 9:198.
150. Rossow K D et al. *J Vet Diag Invest* 1994; 6:3.
151. Sur J-H et al. *Vet Path* 1997; 35:506.
152. Sur JH et al. *Vet Path* 2001; 38:58.
153. Park BK et al. *Am J Vet Res* 1996; 57:320.
154. Christianson WT et al. *Am J Vet Res* 1992; 53:485.
155. Lager KM, Halibur PG. *J Vet Diag Invest* 1996; 8:275.
156. Lager KM, Ackermann MR. *J Vet Diag Invest* 1994; 6:480.
157. Benson JE et al. *Swine Hlth Prod* 2000; 8:155.
158. Christianson WT et al. *Can J Vet Res* 1993; 57:262.
159. Cheon DS, Chae C. *Arch Virol* 2000; 45:1481.
160. Mengeling WL et al. *Am J Vet Res* 1994; 55:1391.
161. Lager KM, Mengeling WL. *Can J Vet Res* 1995; 59:187.
162. Lager KM et al. *Vet Rec* 1996; 138:227.
163. Benson JE et al. *Theriogen* 2001; 56:777.
164. Miller LC, Fox JM. *Vet Immunol Immunopathol* 2004; 102:131.
165. Kim TS et al. *Virus Res* 2002; 85:133.
166. Droiet R et al. *Vet Path* 2003; 40:143.
167. Goldberg TL et al. *Prev Vet Med* 2000; 43:293.
168. Allan GM et al. *Arch Virol* 2000; 145:2421.
169. Harms PA. *Vet Path* 2001; 38:528.
170. Rovira A et al. *J Virol* 2002; 76:3232.
171. Thacker EL et al. *Vaccine* 2000; 18:1244.
172. Brockmeier S et al. *Am J Vet Res* 2000; 62:521.
173. Brockmeier SL, Lager KM. *Vet Microbiol* 2002; 89:267.
174. Solano GL et al. *Can J Vet Res* 1998; 62:251.
175. Segales J et al. *Vet Microbiol* 2002; 85:23.
176. Yoon K-J et al. *Vet Med* 1996; 91:779.
177. Wills RW et al. *Vet Microbiol* 2000; 71:177.
178. Halbur P et al. *J Clin Microbiol* 2000; 38:1156.
179. Thanawongnuwech R et al. *Vet Path* 2000; 37:143.
180. Labarque G et al. *Vet Microbiol* 2002; 88:1.
181. Gucht S et al. *J Clin Microbiol* 2003; 41:960.
182. Thanawongnuwech R et al. *Clin Diag Virol* 2004; 11:901.
183. Prieto C et al. *Theriogenology* 2003; 60:1505.
184. Done SH et al. *Pig J* 2005; 55:230.
185. Dee SA, Joo HS. *J Am Vet Med Assoc* 1994; 205:1017.
186. Baysinger AK et al. *Swine Health Prod* 1997; 5:179.
187. Meier W et al. *Proc Am Ass Swine Pract* 2000; p. 415.
188. Samsom JN et al. *J Gen Virol* 2000; 81:497.
189. Asai T et al. *Vet Microbiol* 1999; 70:143-148.
190. Halbur PG et al. *Vet Rec* 2002; 151:344.
191. Botner A. *Vet Microbiol* 1997; 55:295.
192. Mengeling WL et al. *J Vet Diag Invest* 1995; 7:3.
193. Mengeling WL et al. *J Vet Diag Invest* 1996; 8:238.
194. Christopher-Hennings J et al. *J Clin Microbiol* 1995; 33:1730.
195. Dee SA, Philip RE. *Swine Hlth Prod* 1999; 7:237.
196. Donadeu M et al. *Swine Hlth Prod* 1999; 7:255.
197. Cheon DS, Chae C. *Arch Virol* 2000; 145:1481.
198. Legeay O et al. *J Virol Meth* 1997; 68:65.
199. Chung H-K et al. *J Vet Diag Invest* 2002; 14:56.
200. Umthun AR, Mengeling WL. *Am J Vet Res* 1999; 60:802.
201. Vincent A, Thacker E. *Proc A Ass Swine Vet* 2001; 31:15.
202. Egli C et al. *J Virol Meth* 2001; 98:63.
203. Botner A et al. *Vet Microbiol* 1999; 68:187.
204. Halibur PG et al. *Vet Pathol* 1995; 32:200.
205. Takashima H, Tominatsu H. *J Jap Vet Med Ass* 1999; 52:772.
206. Laroche R, Magar R. *J Vet Diag Invest* 1995; 7:540.
207. Laroche R et al. *Can Vet J* 1994; 35:513.
208. Sirinarumit T et al. *J Vet Diag Invest* 2001; 13:68.
209. Kleiboeker SB et al. *J Vet Diag Invest* 2005; 17:165.
210. Cho H-J et al. *Can J Vet Res* 1997; 61:161.
211. Sorensen KJ et al. *Vet Microbiol* 1998; 60:169.
212. Cho HJ et al. *Can J Vet Res* 1997; 61:299.
213. Mortensen S et al. *Danske Vet* 1999; 82:626.
214. Mortensen S et al. *Vet Res* 2001; 32:441.
215. Park BK et al. *J Vet Diag Invest* 1995; 7:544.
216. Yoon IJ et al. *J Vet Diag Invest* 1994; 6:289.
217. Christianson WJ, Joo HS. *Swine Hlth Prod* 1994; 2:10.
218. Paton DJ, Drew TW. *Vet Rec* 1995; 136:297.
219. Halbur PG et al. *Vet Path* 1995; 32:648.
220. Halbur PG et al. *Proc Am Ass Swine Pract* 2000; p. 319.
221. Thanawongnuwech R et al. *Vet Immunol Immunopathol* 1997; 59:323.
222. Kranker S et al. *Vet Microbiol* 1998; 61:21.
223. Sur JH et al. *Vet Path* 1998; 35:506.
224. Rossow KD. *Vet Pathol* 1998; 35:1.
225. Feng WH et al. *J Virol* 2001; 75:4889.
226. Laroche R, Magar R. *J Virol Meth* 1997; 63:227.
227. Thanawongnuwech R et al. *J Vet Diag Invest* 1997; 9:334.
228. Uchinuno Y et al. *J Jap Vet Med Ass* 1998; 51:713.
229. Yaeger M et al. *J Vet Diag Invest* 2002; 14:15.
230. Fano E et al. *Can J Vet Res* 2005; 69:71.
231. Dee S et al. *Can J Vet Res* 2001; 65:22.
232. Dee S et al. *Can J Vet Res* 2005; 69:58.
233. Dee SA et al. *Vet Rec* 1997; 140:247.
234. Dee SA, Joo HS. *Vet Rec* 1994; 135:6.
235. Dee S et al. *Swine Health Prod* 1995; 3:64.
236. Torremorell M et al. *J Swine Hlth Prod* 2002; 10:153.
237. Bautista L et al. *J Swine Hlth Prod* 2002; 10:147.
238. McCaw MB et al. *Swine Hlth Prod* 2000; 8:15.
239. Desrosiers R, Boutin M. *J Swine Hlth Prod* 2002; 10:23.
240. Dee SA et al. *Can J Vet Res* 2005; 69:64.
241. Bouwkamp FT. *Tijd Diergeneesk* 1999; 124:530.
242. Mengeling WL et al. *Am J Vet Res* 1999; 60:796.
243. Torrison J et al. *Proc Am Ass Swine Pract* 1996; 27:89.
244. Shin J et al. *Vet Microbiol* 1997; 55:337.
245. Vilaca KJ et al. *Proc Am Ass Swine Vet* 2001; 32:59.
246. Mavromatis I et al. *J Vet Med B* 1999; 46:603.
247. Dewey CE et al. *Prev Vet Med* 1999; 40:233.
248. Mengeling WL et al. *Vet Microbiol* 2003; 93:25.
249. Madsen KG et al. *Arch Virol* 1998; 143:1683.
250. Storgaard T et al. *Arch Virol* 1999; 144:2389.
251. Nielsen J et al. *J Gen Virol* 2001; 82:1263.
252. Nielsen J et al. *Vet Microbiol* 2002; 84:1.
253. Woensel van PAM. *Vet Rec* 1998; 142:510.
254. Hesse RA et al. *Proc Am Assoc Swine Pract* 1997; 137.
255. Kwang J et al. *Res Vet Sci* 1999; 67:199.
256. Heisejoh M et al. *Vaccine* 2003; 21:2556.
257. Nielsen TL et al. *Vet Microbiol* 1997; 54:101.

## RIFT VALLEY FEVER

### Synopsis

**Etiology** Rift Valley fever virus, a member of the family Bunyaviridae

**Epidemiology** Enzootic in sub-Saharan Africa and Egypt and recently the Arabian peninsula. Virus maintained in flood water mosquitoes and transmitted by hematophagous insects. Ruminants are amplifying hosts. Epizootics in high rainfall periods

**Clinical findings** Acute, febrile disease characterized in lambs and calves by hepatitis and high mortality, in adult sheep and in cattle by abortion, and in humans by influenza-like disease or hemorrhagic fever

**Necropsy findings** Hepatic necrosis

### Diagnostic confirmation

Immunohistochemical localization of viral antigens in tissues

**Treatment** None other than supportive

**Control** Vaccination, vector control, quarantine

## ETIOLOGY

Rift Valley fever virus, a member of the family Bunyaviridae, genus *Phlebovirus*. Isolates from outbreaks in different countries are antigenically similar and there is only minor genetic variation between isolates.<sup>1,2</sup>

## EPIDEMIOLOGY

### Occurrence

Rift Valley fever was initially reported in the Rift Valley in Kenya but now exists and occurs as epizootics throughout sub-Saharan Africa with recent extensions into Egypt and Madagascar, Mauritania and most recently expansion to the Arabian peninsula.<sup>3,4</sup> It has great potential for spread to other countries. The pattern of occurrence is cyclical epidemics with periods of quiescence between, with the majority of cattle in enzootic areas remaining seronegative for periods of 5 years. A Rift Valley fever-like disease is reported in sheep in India.

### Source of infection

The virus is believed to be maintained through a cycle involving mosquito vectors, wildlife and domestic livestock and by **transovarial** transmission in certain

floodwater *Aedes* mosquitoes which have drought-resistant eggs that survive several years without hatching. These **interepizootic vectors** belong to the *Aedes* subgenus *Neomelanimonion* in East Africa and the subgenus *Aedimorphus* in West Africa.<sup>5</sup> Epizootics occur in enzootic areas when wet and flood conditions promote the expansion of the vector population in the presence of susceptible livestock. Ruminants are highly susceptible and serve as the main amplifying hosts.<sup>5</sup> A pronounced, but short, viremia occurs in infected animals and facilitates the spread of the disease by biting insects. Virus is also present in milk, feces and aborted fetuses. An unidentified wildlife reservoir host may also exist.

#### Method of transmission

A wide variety of mosquitoes from several genera have been identified as vectors, or possible vectors, including species on continents such as Australia and North America. Sandflies and culicoides have also been identified as vectors but are not maintenance hosts.<sup>2,5,6</sup>

#### Experimental reproduction

The disease can be transmitted by most routes including inoculation and the inhalation of aerosols. Following inoculation of sheep and cattle the incubation period is 1 to 2 days and high virus titers are found in blood. Virus persists in the body for approximately 3 weeks but long-term carriage has not been observed. Pregnant animal abort but infection may be clinically mild in non-pregnant animals. IgM antibody can be detected as early as 4 days after infection and persists for 2 to 6 months.<sup>2,7-9</sup>

#### Environment risk factors

The incidence of the disease varies with the size of the vector population. It is greatest in seasons of **heavy rainfall** which allows the vector population to increase and expand from permanent water sites to breed in surface waters in normally dry areas.<sup>10,11</sup> Expanding irrigation schemes may also enlarge areas at risk.

#### Animal risk factors

Losses are due mainly to deaths in young lambs and calves, although there may be a high incidence of abortions and some deaths in adult sheep and cattle.

Mortality is higher in lambs than in calves. Indigenous breeds may have inapparent infections. Camels, domestic buffalo, monkeys, humans, mice, rats, ferrets, and hamsters are susceptible to infection and goats moderately so, but pigs, rabbits, guinea pigs, and poultry are not. A large number of different African wildlife species also have seropositivity in endemic areas.<sup>12,13</sup> Trade animals are suspect as the source of infection to previously free areas.

#### Zoonotic implications

The disease in humans is usually a transient illness but complications of hemorrhagic fever, retinal disease and encephalitis occur. Traditionally the groups exposed to greatest risk are laboratory workers handling the virus and those working amongst infected animals or their products, including veterinarians. However cases were not limited to these groups in the large outbreaks in Egypt in 1977 and 1978 and the more recent outbreaks in the Arabian peninsular and the occurrence rate in humans was very high in Egypt (more than 20 000 cases in 1977 with 600 deaths). In Saudi Arabia the case fatality was 14% in one cohort of 886 human cases.<sup>14</sup> The agent is identified as one for potential bioterrorism.<sup>15</sup>

#### PATHOGENESIS

Hepatocytes are the primary site of viral replication in lambs and calves and **age** is a determining factor in the progression and outcome of infection.<sup>16,17</sup> In very young animals, hepatic lesions progress from degeneration and necrosis of individual hepatocytes to extensive necrosis throughout the liver resulting in hepatic insufficiency and failure. In young animals, encephalomyelitis may also occur.<sup>16</sup>

#### CLINICAL FINDINGS

The major presentation is a regional outbreak of abortion and neonatal mortality. In lambs and calves, after an incubation period of about 12 h there is a sudden onset of high fever and incoordination followed by collapse and death within 36 h in 95–100% of affected lambs and 70% of young calves.

In adult sheep and cattle, abortion is the outstanding sign but the mortality rate in adult sheep may be as high as 20–30% and 10% in cattle. In less severe cases in cattle there is febrile disease and dysgalactia and some animals develop emaciation with jaundice. In fatal cases, sudden death is preceded by a high fever for 1–2 d. Goats show a febrile reaction but few other clinical signs.

#### CLINICAL PATHOLOGY

Severe leukopenia is a common finding. Antibodies appear in the serum about 1 week after infection and persistence depends on antibody type. Sera are usually screened using hemagglutination-inhibition or ELISA tests and positives confirmed with plaque reduction neutralization tests.<sup>13,18</sup> Transmission tests to white Swiss mice and sheep are also used.

ELISA tests that meet the desire for an accurate and safe test and that use inactivated antigen and that can meet international validation requirements are described.<sup>19,20</sup>

#### NECROPSY FINDINGS

**Extensive hepatic necrosis** is the characteristic lesion in Rift Valley fever. Other

non-specific lesions include congestion and petechiation in the heart, lymph nodes, gallbladder, and alimentary tract. Abomasal and intestinal content may be dark brown to red due to hemorrhage. Microscopically there is focal or diffuse necrosis of the liver and there may be acidophilic intranuclear inclusion bodies in hepatic cells. The lesions are much more extensive in newborn lambs and calves than in older animals.<sup>16,17,21</sup> Immunohistochemical localization of viral antigens in tissues provides a specific diagnosis.<sup>22</sup>

#### Samples for confirmation of diagnosis

- **Virology** – liver, spleen, brain (VI, FAT, PCR)
- **Histology** – liver, spleen, brain (LM, IHC).

**Note the zoonotic potential of this disease when handling these specimens.**

#### DIFFERENTIAL DIAGNOSIS

In regions where this disease has not occurred it should be suspect when there is an area outbreak of abortion and neonatal mortality in sheep and cattle coupled with an area outbreak of flu-like disease in humans

- Wesselsbron disease
- Bluetongue
- Ephemeral fever
- Brodifacoum poisoning has been mistaken for Rift Valley fever.<sup>21</sup>

#### TREATMENT

Little attention has been given to the aspect of treatment of the disease and no known treatment is of any value.

#### CONTROL

Vector control and quarantine may aid in protection of livestock and humans in enzootic areas but vaccination is the single most practical and economic control measure. Killed-virus and living attenuated virus vaccines are available.

**Live attenuated vaccines** and mutagenized live virus vaccines provide good protection which lasts for at least 28 months but are not recommended for pregnant animals because they are abortigenic, causing fetal death and some teratogenic anomalies. The recorded problems include hydrops anmii, arthrogryposis, hydranencephaly, and microencephaly. There is also a concern for reversion to virulence.

**Killed-virus vaccines** require repeat administration for good immunity and annual vaccination of all dairy cattle is recommended as a cost-effective control program in endemic countries. They are also recommended for pregnant and young animals.

A mutagen attenuated vaccine protects against challenge in both sheep and cattle.<sup>23,24</sup> Viremia following vaccination is minimal and thought not to be a risk for infection of susceptible mosquitoes.<sup>24</sup> Mutagenic vaccines were initially thought to have no deleterious effect on the fetus but abortion and teratogenicity has been observed in the lambs of sheep vaccinated early in pregnancy.<sup>25</sup>

Prevention of the introduction of Rift Valley fever into countries free of the disease requires the prohibition of the importation of all susceptible species from Africa. All necessary steps to prevent the introduction of infective insects and infected biological materials should be taken. The possibility of humans carrying the infection from country to country is very real.

#### REVIEW LITERATURE

- Shimshony A, Barzilai R. Rift Valley fever. *Adv Vet Sci Comp Med* 1983; 21:347-425.  
Gerdes GH. *Vet Clin North Am Food Anim Pract* 2002; 18:549-555.

#### REFERENCES

- Rollin PE et al. *Emerg Infect Dis* 2002; 8:1415.
- Worthington RW, Bigalke RD. *Onderstepoort J Vet Res* 2001; 68:291.
- Madani TA et al. *Clin Infect Dis* 2003; 37:1084.
- Paweska JT et al. *Onderstepoort J Vet Res* 2003; 70:49.
- Zeller HG et al. *Am J Trop Med Hyg* 1997; 56:265.
- Mellor PS et al. *Ann Rev Entomol* 2000; 45:307.
- Morrill JC et al. *Am J Vet Res* 1997; 58:1110.
- Morvan J et al. *Trans Roy Soc Trop Med Hyg* 1992; 86:675.
- Peters CJ et al. *Res Virol* 1989; 140:43.
- Bicout DJ, Sabatier P. *Vector Borne Zoonot Dis* 2004; 4:33.
- Davies FG et al. *Epidemiol Infect* 1992; 108:185.
- House C et al. *Ann NY Acad Sci* 1996; 791:345.
- Olaleye OD et al. *Rev Sci Tech Off Int Epiz* 1996; 15:937.
- Madani TA et al. *Clin Infect Dis* 2003; 37:1084.
- Sidwell RW, Smee DF. *Antiviral Res* 2003; 57:101.
- Rippy MK et al. *Vet Pathol* 1992; 29:495.
- Van Der Lugt JJ et al. *Onderstepoort J Vet Res* 1996; 63:341.
- Meegan JM et al. *Am J Vet Res* 1987; 48:1138.
- Paweska JT et al. *Onderstepoort J Vet Res* 2003; 70:49.
- Paweska JT et al. *J Virol Methods* 2003; 113:103.
- Coetzer JAW. *Onderstepoort J Vet Res* 1982; 49:11.
- Rippy MK et al. *Vet Pathol* 1992; 29:495.
- Hubbard KA et al. *Am J Vet Res* 1991; 52:50.
- Morrill JC et al. *Am J Vet Res* 1997; 58:1110.
- Hunter P et al. *Onderstepoort J Vet Res* 2002; 69:95.

### CONGENITAL ARTHROGRYPOSIS AND HYDRANENCEPHALY; AKABANE DISEASE; CACHE VALLEY VIRUS DISEASE

#### Synopsis

**Etiology** Akabane virus in the Simbu serogroup of *Bunyavirus*: Cache Valley virus in the Bunyamwera serogroup of *Bunyavirus*

**Epidemiology** Transmission by hematophagous insects. Outbreaks when cattle or sheep are infected in early pregnancy

**Clinical findings** Abortions, stillbirths and birth of calves with skeletal deformities and neurological disorders

**Necropsy findings** Necrotizing non-suppurative encephalomyelitis and polyomyelitis. Arthrogryposis and hydranencephaly

**Control** Vaccination

#### ETIOLOGY

Akabane virus and Cache valley viruses are both members of the genus *Bunyavirus* in the family Bunyaviridae with Akabane virus a member of the Simbu serogroup of the genus *Bunyavirus* and Cache Valley virus a member of the Bunyamwera serogroup of the genus *Bunyavirus*. There are a large number of members of the *Bunyavirus* genus and several can produce clinically inapparent infections in ruminants but Akabane virus and Cache Valley virus produce fetal disease when they infect the dam in early pregnancy.<sup>1-3</sup> There are subtypes of these viruses.<sup>4</sup>

Other *Bunyavirus* that have been associated with natural or experimentally produced fetal disease in ruminants include:

- Simbu serogroup. Aino and Peaton viruses<sup>2,5,8</sup>
- Bunyamwera serogroup. Main Drain viruses<sup>6,7</sup>
- California serogroup. LaCrosse and San Angelo viruses.<sup>7</sup>

Antibodies to the related, but as far as is known non-pathogenic, viruses Douglas and Tinaroo have been detected in cattle, sheep, goat, buffalo and deer.<sup>1,2</sup>

#### EPIDEMIOLOGY

##### Occurrence

##### Akabane

Serologic studies suggest that infection occurs in cattle, sheep, goats, horses, donkeys, camels, pigs, and buffaloes but disease occurs only in calves, lambs, and goat kids.<sup>9</sup>

The disease is most common in calves and has been recorded as the cause of epizootics of abortion, stillbirths and congenital malformation in calves in Australia, Israel, Iran, Kenya, Japan, Korea, and Taiwan with high attack rates in affected herds. Congenital disease in lambs is less common but is recorded in Israel and Australia.<sup>5</sup> The virus has also been isolated from insect vectors in Africa and is the probable cause of the 'rigid lamb syndrome' in Zimbabwe. Serological surveys suggest widespread distribution of the virus in the Middle East, Asia and southeast Asia, and in parts of Africa.<sup>2,10,11</sup> Whereas infection in adult cattle is common in endemic areas, reports of

clinical disease are rare but neurological disease associated with infection in cattle 2 to 7 years of age has been observed.<sup>12</sup>

##### Cache Valley

There is serologic evidence that infection occurs in sheep, goats, horses, cattle, pigs and in several wildlife species but disease is recorded only in sheep. The disease in sheep is recorded as an occasional epizootic in flocks in North America.<sup>4,7,13</sup> Cache Valley virus is one of the more common *Bunyaviruses* in North America and has been isolated from mosquito pools collected in 22 states and several provinces in Canada and Mexico and also in Central and South America.<sup>4,7</sup>

##### Aino

Aino virus is present and believed a cause of disease in Australia, Japan and Israel.<sup>8,14</sup> Serological studies in Australia show a similar distribution in cattle to Akabane but at a lower prevalence<sup>7,15</sup> and clinical disease is much less common than with Akabane.

##### Source of infection

The viruses are maintained through a cycle involving vectors, in which there is probably transovarial transmission, and a susceptible vertebrate population. Replication occurs in both vertebrate and insect populations.

##### Akabane

Viremia in cattle is short-lived, lasting 1-9d and long-term carriers are not believed to occur. Herbivores appear essential to the vector-virus-host cycle<sup>16</sup> and there is serological evidence of infection in cattle, sheep, goats, camels, horses, and buffaloes.<sup>2,15,17</sup>

In Australia, transmission is by the bites of *Culicoides brevitarsis* and *C. nebeculosus*.<sup>18</sup> Virus has been isolated from *C. brevitarsis* and this is probably the major vector as serological data in Australia shows that most identified infections are within the known habitat of *C. brevitarsis*. Introduction of the virus into the bovine uterus in semen causes no developmental defects.

The vector(s) for Akabane disease in Japan and Korea are *C. brevitarsis*, *Culicoides oxystoma* and *Aedes vexans* and *Culex tritaeniorhynchus*.<sup>3,9</sup>

##### Cache Valley

The virus has been isolated from mosquitoes and *Culicoides* spp.<sup>4,7</sup> Mosquitoes are the believed vector but the species involved and the natural history of the disease are not known.

##### Aino

The virus has been isolated from mosquitoes and midges including *C. brevitarsis*.<sup>2</sup> Serological studies show antibody in cattle, sheep, goats, and buffalo but not camels, dogs or horses.

### Host and environmental risk factors

The seasonal and geographic pattern of epizootics of abortions and premature births are determined by the distribution of vectors and the availability of susceptible ruminant populations in early pregnancy.

#### Akabane

In the north of Australia, *C. brevitarsis* is active throughout the year and cattle are infected with Akabane virus before their first pregnancy and disease does not occur. Epizootics occur in southern Australia when *C. brevitarsis* extends its range of distribution,<sup>19</sup> probably by wind-borne spread from the north, to infect immunologically naive herds. Abortions and premature births commence in the autumn, with clinical cases of arthrogryposis, and hydranencephaly occurring in mid-winter.

Wind-borne introduction of *Culicoides* spp. is also postulated as the means of introduction of infection in Israel.<sup>20</sup> The movement of immunologically naive pregnant cattle into an enzootic area can be the result in severe outbreaks in those herds.<sup>21</sup>

The disease is likely to disappear for intervals of 5–10 years, until there is combination of a susceptible population and a heavy vector population. Occurrences of the disease are also dependent on the presence of susceptible, early pregnant females at the time that the vectors are plentiful. These conditions are provided by a series of years of drought in an enzootic area, so that there are no insect vectors, no infection, and no immunization activity of prepubescent females, followed by a wet season when the vectors are plentiful.

#### Cache Valley

Outbreaks occur after a long period of drought and winter frosts reducing the population of mosquito vectors and resulting in populations of seronegative ewes. Mating in the summer appears a major risk factor allowing sheep to be in the susceptible stage of pregnancy during the vector season.<sup>22</sup> Many outbreaks are in areas that interface between suburban and rural environments.<sup>7</sup>

### Experimental reproduction

Disease has been reproduced by inoculation into early pregnant cattle, sheep and goats.<sup>2,6,8,15,16,23,24</sup>

### Zoonotic implications

*Bunyavirus* infections occur in man from bites from infected insect vectors.

### PATHOGENESIS

#### Akabane

Viremia occurs in the dam for 2–4 d, with an antibody peak 4–5 d after the viremia and a subsequent secondary rise. The dam is unaffected but there is a focal viral

persistence in cotyledons and subsequent viremia in the fetus.

Inflammatory and degenerative lesions occur in the central nervous system but tissue tropism and damage is determined by the age of the fetus and its ability to mount an immune response. Three forms, or principal manifestations, of the disease in an affected herd are described. The first is arthrogryposis occurring in calves infected at an older age than others (fetus infected at 105–174 d of pregnancy). The second is arthrogryposis accompanied by hydranencephaly. The third is hydranencephaly only (infected between days 76 and 104 of pregnancy).

With arthrogryposis, there is almost complete absence of ventral horn cells in the spinal cord and an accompanying neurotropic failure of muscle development. Contracture of the joints results. The hydranencephaly is manifested by a partial or complete failure of development of the cerebral cortex. The brainstem and cerebellum are usually normal.

Several other manifestations have been described. They include pre-arthrogryposis groups of calves with incoordination and a mild to moderate non-suppurative encephalitis, and other calves with flaccid paralysis and active secondary demyelination in motor areas of the spinal cord. Some calves are unable to stand and have thickened dorsal cranial bones and hydranencephaly involving anterior and mid-brainstem, and a diminutive cerebellum. The infection with Akabane virus is also credited with causing abortion, stillbirth and premature birth.

Lesions produced in lambs by experimental inoculation of the ewes during early pregnancy (days 32–36) include skeletal muscle atrophy and degeneration, and inflammatory and degenerative lesions in the cerebrum; the lesions in the central nervous system vary from porencephaly to hydranencephaly. There are also brachygnathism, scoliosis, hypoplasia of the lungs, agenesis or hypoplasia of the spinal cord, and arthrogryposis.<sup>25</sup> Lesions are also present in fetuses of ewes inoculated between 29 and 45 days of gestation.<sup>15</sup>

#### Cache Valley

Ovine fetuses are susceptible to the teratogenic effects between 28 and 48 days of gestation.<sup>13</sup> Destructive lesions occur in the central nervous system but infection of fetal membranes with a reduction in the volume of amniotic fluid and constriction by membranes around the fetus are believed to contribute to the occurrence of arthrogryposis.<sup>7</sup>

### CLINICAL FINDINGS

#### Akabane

Infection in adult cattle is most commonly clinically inapparent, unless there is dys-

tocia, but neurological disease manifest with hypersensitivity, tremor and ataxia is recorded.<sup>12</sup> In calves, the two syndromes, arthrogryposis and hydranencephaly, occur separately; arthrogryposis in the early stages of the outbreak and hydranencephaly at the end. Calves with both defects occur in the middle of the outbreak. In some outbreaks only one of the manifestations of the disease is seen.<sup>26,27</sup>

Calves with arthrogryposis almost always are the subjects of difficult birth requiring physical assistance. They are small and significantly underweight but they are fully mature in terms of teeth eruption and hair coat and hoof development. They are unable to rise, stand or walk. One or more limbs is fixed at the joints: there is a congenital articular rigidity. The limb is usually fixed in flexion but it may be in extension. The joint becomes freely movable if the tendons around it are severed, that is, there is no abnormality of the articular surface. The muscles of affected limbs are severely wasted. Kyphosis or scoliosis are common.

Calves with hydranencephaly have no difficulty rising and walking. The major defects are a lack of intelligence and blindness. They will suck if put onto the teat but if this is not done, they stand and bleat and have no apparent dam-seeking reflex. A few calves have microencephaly and are more severely affected. They are dummies, very uncoordinated in gait, unable to stand properly and move erratically when stimulated. These calves appear at the very end of the outbreak.

As well as the skeletal and neurological diseases, cases of abortion, stillbirth and premature birth are also regarded as being associated with Akabane virus infection in cows. They are usually recorded at the beginning of the outbreak before the neurological defects occur.

#### Cache Valley

Affected flocks have a higher rate of stillbirth and mummified fetuses. Congenital malformations in liveborn lambs include arthrogryposis of one or more limbs, scoliosis, torticollis, and neurological signs are similar to those seen in calves with Akabane disease.

### CLINICAL PATHOLOGY

The presence of specific antibody in fetal sera or the precolostral sera of neonates is diagnostic but its absence does not exclude the diagnosis if infection precedes the development of immunological competence. Precolostral sera from several animals should be tested and most cases are positive at high titer.<sup>2,24</sup> A rising titer with paired samples from the dam, or a high titer in the serum of surviving



neonates is suggestive of recent infection but not confirmatory for disease. Serological tests include microneutralization, hemagglutination inhibition, agar gel immunodiffusion (AGID) and an (ELISA) test.<sup>2,28,29</sup>

### NECROPSY FINDINGS

The primary lesions with both Akabane and Cache Valley infections in the fetus are a **necrotizing non-suppurative encephalomyelitis and polymyositis**.<sup>2</sup>

In calves and lambs with arthrogryposis there is severe muscle atrophy, fixation of joints by tendon contracture and normal articular surfaces. The joints are easily released by cutting the surrounding tendons. Histologically, there may be almost complete absence of ventral horn cells in the spinal cord. This lesion may be localized to one segment of the cord and viral antigen may be demonstrated via immunohistochemistry.<sup>25</sup>

In calves and lambs with hydranencephaly the cerebral hemispheres are completely absent and the vacant space is filled with fluid enclosed by the normal meninges. In a few cases the lesions may be limited to porencephaly. In most, the brainstem and cerebellum lack cavitations but diminution of their size may be recorded.

### Samples for confirmation of diagnosis

- **Virology** – 2 mL fetal thoracic fluid and maternal serum for serology
- **Histology** – brain, spinal cord, muscle (LM, IHC).

### DIFFERENTIAL DIAGNOSIS

Akabane virus disease and Cache Valley virus disease in sheep, as they are manifest epidemiologically, are well-defined and easily recognizable entities. Differentials include:

- Lupine-induced arthrogryposis in calves
- Manganese deficiency in calves
- Heritable forms of arthrogryposis and/or micrencephaly
- Fetal infection with bluetongue virus, rift valley fever virus, or pestivirus

Cattle in Japan may also produce hydranencephalic calves, which are recumbent, opisthotonic and unable to suckle at birth, when infected during pregnancy by the Chuzan virus.<sup>30,31</sup> The virus, a member of the Polyam subgroup of orbiviruses, is transmitted by *Culicoides oxystoma*.

In Africa infection with flaviviruses including West Nile, Banyi and AR5189 also cause abortion, stillbirth and congenital brain malformations.<sup>32</sup>

### TREATMENT AND CONTROL

No treatment would be contemplated because affected calves are not viable nor humanely kept alive.

Vector control is not possible with current knowledge and vaccination is the only effective method of control. Killed vaccines for Akabane virus have proved very effective against natural exposure and are available in Japan and Australia.<sup>2,15</sup> They require two inoculations prior to pregnancy and an annual booster. The economics of their annual use is dictated by the risk of disease in regions subject to periodic outbreaks of disease.

### REVIEW LITERATURE

- Konno S et al. Akabane disease in cattle: congenital abnormalities caused by viral infection. Spontaneous disease. *Vet Pathol* 1982; 19: 246–266.
- Charles JA. Akabane virus. *Vet Clin North Am Food Anim Pract* 1994; 10:525–546.
- Edwards JF. Cache Valley virus. *Vet Clin North Am Food Anim Pract* 1994; 10:5515–5524.
- Concha-Bermejillo A de la et al. Cache Valley virus is a cause of fetal malformation and pregnancy loss in sheep. *Small Rumin Res* 2003; 49:1–9.

### REFERENCES

1. Cybinski DH. *Aust J Biol Sci* 1984; 37:91.
2. Charles JA. *Vet Clin North Am Food Anim Pract* 1994; 10:525.
3. Stram Y et al. *Virus Res* 2004; 104:93.
4. Concha-Bermejillo A de la et al. *Small Rumin Res* 2003; 49:1.
5. Haughey KG et al. *Aust Vet J* 1988; 65:136.
6. Edwards JF et al. *Am J Trop Med Hyg* 1997; 56:171.
7. Edwards JF. *Vet Clin North Am Food Anim Pract* 1994; 10:515.
8. Tsuda T et al. *Vet Res* 2004; 35:531.
9. Chin-Chen H et al. *Vet Microbiol* 2003; 24:1.
10. Taylor WP, Mellor PS. *Epidemiol Infect* 1994; 113:175.
11. Mohamed MEH et al. *Rev MedVet Pays Trop* 1996; 49:285.
12. Lee JK et al. *Vet Pathol* 2002; 39:269.
13. Chung SJ et al. *Am J Vet Res* 1990; 51:1645.
14. Brenner J. *J Israel Vet Med Assoc* 2004; 59:7.
15. Kirkland PD, Barry RD. In: St George TD (ed). *Arbovirus Research in Australia. Proc 4th Symposium, 1986*; p. 229.
16. Parsonson IM et al. *Adv Virus Res* 1985; 30:279.
17. Nakamura K et al. *J Jpn Vet Med Assoc* 1987; 40:513.
18. Jennings M, Mellor PS. *Vet Microbiol* 1989; 21:125.
19. Bishop AL et al. *Aust Vet J* 1996; 73:174.
20. Braverman Y, Chechik F. *Rev Sci Tech Off Int Epizoot* 1996; 15:1037.
21. Jagoe S et al. *Aust Vet J* 1993; 70:56.
22. Shelton M et al. *Sheep Goat Res J* 1994; 10:124.
23. Parsonson IM et al. *Vet Microbiol* 1981; 6:197:209.
24. Kirkland PD et al. *Vet Rec* 1988; 122:582.
25. Narita M, Kawashima K. *Am J Vet Res* 1993; 54:420.
26. Tateyama S et al. *Res Vet Sci* 1990; 49:127.
27. Brenner J et al. *J Vet Med Sci* 2004; 66:441.
28. Ide S et al. *Vet Microbiol* 1989; 20:275.
29. Ungar-Waron H et al. *Trop Anim Hlth Prod* 1989; 21:205.
30. Miura Y et al. *Jpn J Vet Sci* 1990; 52:689.
31. Goto Y et al. *Am J Vet Res* 1988; 49:2026.
32. Barnard BJH, Voges SF. *Onderstepoort J Vet Res* 1986; 53:235.

## Enzootic bovine leukosis (bovine lymphosarcoma)

### Synopsis

**Etiology** Bovine leukemia virus (BLV), the causative agent of enzootic bovine leukosis (EBL), is an exogenous C-type oncovirus in the Retroviridae family

**Epidemiology** Occurs worldwide, prevalence of infection varies between countries. Persistent infection is most common, followed by persistent lymphocytosis (PL) in 30% of infected animals, and less than 5% of infected animals develop lymphosarcoma. Clinical disease most common in mature cattle.

Infected animal is only source of virus which is transmitted horizontally by infected lymphocytes in blood from parturition, contaminated surgical instruments, rectal palpation, blood-sucking insects. Congenital infection in 4–8% of calves born to infected cows.

Genetic makeup of animal determines if becomes infected and develop disease. Economic losses due to loss in milk production traits and premature culling

### Is not a zoonosis

**Signs** No clinical signs during stage of infection and persistent lymphocytosis. Lymphosarcomas characterized by loss of body weight, inappetence, pallor, weakness, and loss of milk production. Enlargement of all lymph nodes. Abomasal ulceration. Congestive heart failure. Paresis and paralysis due to neural involvement. Stertor due to enlargement of retropharyngeal lymph nodes. Eventually weak and recumbent. Sporadic bovine leukosis consists of juvenile lymphosarcoma, thymic lymphosarcoma, and cutaneous forms of tumors which may resemble enzootic bovine leukosis but are BLV-negative serologically

**Clinical pathology** Serology for BLV virus using AGID or ELISA

Detect virus by PCR or sheep bioassay

**Lesions** Multicentric lymphoid tumors affecting all body systems especially heart, digestive tract, nervous system, reproductive tract

**Diagnostic confirmation** Serology and detection of virus by PCR

### Differential diagnosis list

Sporadic bovine leukosis  
Congestive heart failure due to traumatic pericarditis

Lymphadenitis due to tuberculosis and actinobacillosis

Compression of spinal cord

Fat necrosis

**Treatment** None

**Control** Test and slaughter seropositive animals in herds and areas with low prevalence of infection. Use bulk tank milk ELISA as screening test. Establish virus free herds and certify by retesting. Control disease in herds and countries with high prevalence of infection by limitation of spread within herds and prevent introduction of infection



## ETIOLOGY

### Enzootic bovine leukosis and persistent lymphocytosis

The causative agent is bovine leukemia virus (BLV), an exogenous C-type oncovirus in the Retroviridae family. The complete genomic sequence of BLV strain from a cow has been described.<sup>1</sup> Infection occurs by iatrogenic transfer of infected lymphocytes from one individual to another and is followed by a permanent antibody response and, less frequently, development of persistent lymphocytosis or lymphosarcoma.<sup>2</sup> The virus causes a chronic B-cell proliferative disease in cattle and is an important model for human T-cell leukemia virus type 1 infection because of many shared molecular and biological features. However, EBL is not a zoonosis. It has leukemogenic activity, can be grown in tissue culture and produces specific antibodies in calves<sup>2</sup> and sheep.

### Sporadic bovine leukosis

Sporadic bovine leukosis affects animals under 3 years of age including:

- Juvenile form in calves less than 6 months old, characterized by multiple lymph node enlargement
- Thymic form in yearlings less than 2 years old, characterized by a swelling in the neck causing bloat and edema
- Cutaneous form in cattle 1–3 years old, characterized by the development of nodes and plaques in the skin
- Cutaneous T-cell lymphoma in two Friesian cows in Azores has been described.<sup>3</sup>

The bovine leukemia virus cannot be cultured from nor antibodies to the virus be detected in animals affected with sporadic bovine leukosis. There is no evidence that these forms of sporadic bovine leukosis are associated with an infectious agent.<sup>4</sup>

## EPIDEMIOLOGY

### Prevalence of infection and occurrence of clinical disease

Leukosis in cattle was originally described in Germany in 1871.<sup>2</sup> Reports of the disease in cattle became common following World War II and most countries which raise cattle have reported the occurrence of the disease. The infection is now common in cattle in Canada, the United States, and many countries in Europe and South America.<sup>2</sup>

Serological surveys in cattle in the United States indicate prevalence rates within herds ranging from 0–100%. The disease does not spread rapidly and the number of herds containing positive reactors to the agar gel immunodiffusion (AGID) test is usually small. However, in

infected herds the number of seropositive animals may be as high as 80%. Infection with the virus is estimated to be at least 20% in the adult dairy cow population of the United States, 6–11% in Canada, 27% in France, 37% in Venezuela; in the United Kingdom the prevalence of infection is low. In New Zealand, it is estimated that about 6.5% of the dairy herds have infected cattle, with an estimated within herd prevalence of 3.7%.<sup>5</sup> The prevalence of infection in beef cattle in Australia is 0.22%. In a national survey in Canada, 40% of the herds contained BLV-infected cows. In Prince Edward Island in Canada, 49.2% of the herds tested had at least one positive reactor, and 5.5% of all the cows tested were positive. In maritime Canadian dairy cattle, the individual cow prevalence was 21% and the herd prevalence 70%.<sup>6</sup>

The seroprevalence of BLV infection in breeding beef bulls under 2 years of age offered for sale in Kansas was 8.5%.<sup>7</sup> This indicates that young bulls purchased for entry into recipient herds could be infected with the virus.

In Argentina the individual seroprevalence is 33%, while the percentage of infected herds with one or more infected animals is 84%.<sup>8</sup> The infection occurs in water buffalo in Brazil<sup>9</sup> and in draught animals in Cambodia.<sup>10</sup>

An outbreak of enzootic bovine leukosis in Egypt was associated with the importation of Holstein Friesian heifers and bulls from Minnesota in 1989 to form a closed dairy herd in Upper Egypt.<sup>11</sup> In 1996, clinical evidence of enzootic leukosis occurred and ELISA testing revealed a BLV seroprevalence of 37.7% in cattle under 2 years of age and 72.8% in animals over 2 years of age.

The **occurrence of clinical lymphosarcoma** in countries where the infection occurs is about 1 per 1000 per annum and in infection-free countries, 1 per 50 000 per annum. All of these data are subject to serious error because of the selective nature of the surveys, and until much larger random surveys are conducted, it is not possible to give accurate figures. Even in countries or areas where the infection and the disease are common, there are many herds that remain uninfected. Dairy cattle are much more commonly infected than beef cattle, and have a much higher incidence of lymphosarcoma. In severely affected dairy herds, an annual mortality rate of 2% is unremarkable and it may be as high as 5%.

All breeds of cattle are susceptible to BLV infection. It occurs rarely in animals less than 2 years of age and increases in incidence with increasing age.<sup>2</sup> The prevalence of infection is higher in large herds than in smaller herds. The higher prevalence in dairy herds compared to

beef herds is probably due to their closer confinement and the higher average age of the herds.

There are a number of forms taken by the disease:

- Enzootic bovine leukosis infection alone
- Enzootic bovine leukosis with persistent lymphocytosis
- Enzootic bovine leukosis with tumors – the common form in adults.

## Methods of transmission

### Direct contact

Horizontal transmission is the usual method by which the virus is spread under natural conditions. It appears that close physical contact and exchange of contaminated biological materials are required for transmission. The virus is present mostly in lymphocytes and can be found in the blood, milk and tumor masses. Most susceptible cattle become infected by exposure to infected lymphocytes, and not by cell-free virus.<sup>2</sup> Either 10  $\mu$ L (45 240 lymphocytes) or 1  $\mu$ L (4524 lymphocytes) of whole blood from a BLV-seropositive cow when injected into calves resulted in infection and seroconversion. It is likely that a threshold number of approximately 100 BLV-infected cells is required to establish infection in the recipient.<sup>3</sup> Therefore, any means by which BLV-infected lymphocytes can be transmitted from one cow to another is a potential means of transmission. Natural transmission occurs mostly in cattle more than 1.5 years of age, usually during the summer months between in-contact animals and possibly by insect or bat transmission of infected lymphocytes in whole blood. Some observations found an increased risk of infection in dairy cattle during the periparturient period; the crude odds ratio ranged from 4.7–6.0. This suggests that vaginal secretions, exudates and placentas from cows, as well as contaminated calving instruments may serve as sources of infected blood cells. The virus has been found in the nasal secretions of infected cattle for 2–4 years but there is no evidence that transmission to other animals occurred.

### Semen, artificial insemination and embryo technology

Most workers have failed to find the virus in semen, and artificial insemination (AI) is not a method of spread, nor is embryo transplantation using zona pellucida intact embryos. Fertilized embryos from donors infected with BLV virus have been transferred without infection of the fetus. It is possible to produce transferable stage in vitro fertilized embryos which are free of the integrated BLV provirus, from oocytes which had been exposed to BLV

during maturation.<sup>12</sup> However, the virus has been found in semen collected by massage of the donor's urethra and accessory glands per rectum, a procedure which is associated with contamination of semen with blood.<sup>2</sup> While transmission by AI has not been demonstrated, it is possible that semen containing infected lymphocytes transmission could serve as a source of the virus. Thus bulls at AI centers will be required to be negative serologically to BVL virus. Properly collected semen from BLV seropositive bulls will not contribute to dissemination of viral infection.<sup>13</sup>

Transmission experiments suggest that the virus is not present in saliva but it does appear intermittently in urine.<sup>2</sup> It is present in nasal and tracheal washings but only in cells, not as a free virus.

#### Iatrogenic transmission

Transmission can occur via infected blood which contaminates surgical instruments, such as dehorning gouges, ear tattooing pliers and hypodermic needles used on infected and then susceptible animals without disinfection. Transmission can also occur during blood transfusions and vaccines containing blood such as those for babesiosis and anaplasmosis.<sup>2</sup> Amounts of blood as small as 0.1  $\mu$ L are capable of transmitting the infection. Thus the infection can be transmitted via the tuberculin intradermal test. However, while some studies have found that use of common needles for blood sampling infected and non-infected cows at the same time poses a great risk of transmission of the virus to non-infected cows, other studies suggest that the quantities of infective blood passed during injection with common needles is too small to induce infection. The routine practice of brucellosis vaccination, ear-tagging and tattooing in dairy herds did not seem to be associated with the spread of the disease but infection could be reduced from 80% to 4% in heifers between the time of weaning to calving by altering dehorning methods. Transmission via infective milk is possible by the passage of infected lymphocytes through intestinal mucosal epithelium during the first few hours of life. However, infection via this route appears to occur very rarely, if at all, possibly because of the presence of maternal antibodies in the milk.

#### Rectal palpation

The virus can be transmitted by rectal inoculation of infected blood into cattle and sheep. Using blood-contaminated sleeves from palpating seropositive heifers to palpate seronegative cows resulted in transmission of infection as evidenced by antibody formation.<sup>14</sup> This poses the possibility that the virus can be transmitted by rectal examination of cattle,

particularly in dairy herds, when a single rectal palpation sleeve is used repeatedly during reproductive tract examinations as part of a health management program when many animals are palpated. Field studies to examine whether using the same sleeve for more than one animal or an individual sleeve for each animal, indicate that rectal transmission is a potential route of spread of BLV, but that it is related to frequency of palpation and age of cattle. Controlled studies of rectal palpation of cows in a dairy herd over a period of 22 months, using a single sleeve per animal or not changing the sleeve between an infected animal and seronegative animals resulted in a 2.8-fold increase in the risk of BLV infection.<sup>15</sup> Thus rectal examination without a change of sleeve may be a risk factor in some herds.

#### Insects

Blood-sucking insects may be involved in transmission of the virus. Evidence implicating arthropod vectors in BLV transmission is indirect, involving experiments in which virus-carrying arthropods or parts of them were transferred to uninfected cattle. In several experiments, infected tabanids, other biting flies, and ticks were placed by hand on cattle and sheep. Minced mouthparts or hematophagous insects previously fed on BLV-infected cattle also were injected into hosts. In some countries there is empirical evidence that the incidence of seroconversion is higher after the tabanid fly season.<sup>2</sup> A space-time study found a significant positive geographical correlation between the rate of incidence of BLV infection and the density of the horsefly population. Seasonal variations in the incidence rates also occur; the highest rates are generally observed during summer, and the lowest during winter, spring and early summer. There is also a time link between the rate of seroconversion and the variations in activity of the horsefly population. Experimentally, the virus has been transmitted by horse flies, *Tabanus fuscicostatus*, from a seropositive cow to recipient calves and goats. Horse flies take relatively large blood meals, have a painful bite, and are often interrupted in feeding and must finish feeding on other animals. This behavior and the large number of flies, and the low volume of blood and small number of lymphocytes required to transmit BLV, make tabanid flies candidates for mechanical vectors of the virus. The stable fly, *Stomoxys calcitrans*, has an insufficient mouth part volume to carry enough blood lymphocytes to transmit the virus.

#### Congenital infection

Congenital infection occurs in 4–8% of calves born from BLV-seropositive cows

in naturally infected herds. These probably occur as a result of transplacental exposure to the virus during gestation. Calves born from clinically healthy cows naturally infected with BLV are negative for BLV before receiving colostrum, and in utero transmission of BLV may occur but is infrequent.<sup>16</sup> Calves born from seropositive cows acquire colostral antibodies if they ingest colostrum and the antibody levels decline during the first 6–7 months of life. In one study the minimum and maximum duration of colostral antibodies were 14 and 147 d, respectively with a half-life of 36). The decay of colostral antibodies and the age at which a calf can be expected to become seronegative is a function of the quantity of BLV antibodies absorbed by the calf and the infection status of the calf.

Prevention of in utero transmission can be done using embryo transfer.

#### Interspecies transmission

Cattle are the only species infected naturally, although sheep and goats can be infected experimentally. The infection does not spread from cattle to commingled sheep, nor between experimentally infected and non-infected sheep. However, horizontal transmission of a naturally occurring lymphosarcoma in sheep is associated with an antigenically similar virus to the BVL virus. It is assumed that horizontal spread of the BVL virus from cattle to sheep will not occur. The experimental transfer of infection from cattle to sheep is effected so readily that it has become a preferred technique for testing for the presence of a virus.

#### Source of infection

In cattle, infection with the virus is permanent, spontaneous recovery has not been demonstrated and the virus is maintained in the cattle population. The virus is located in lymphocytes in a covert non-productive state, resulting in an inability of antibodies to arrest the infection, and multiplication of the virus is not necessary for survival or transmission. The virus is also capable of periodic antigenic change and circumventing control by immune mechanisms, thus the infected animal remains a source of infection for long periods, probably for life, regardless of the simultaneous presence of specific antibodies. This virus-host system is the same as that of other retroviruses, especially equine infectious anemia (EIA) and visna-maedi of sheep. In most circumstances, infection occurs when animals are in close physical contact and are more than 12 months old. Infection is established readily by SC and ID injection and by intratracheal infusion, but it does not occur after oral administration.<sup>2</sup>

Experimental transmission of the infection using tumor material, infected

blood or tissue culture virus can be achieved in cattle, sheep, goats and with some doubts to chimpanzees, but the tumors are produced only in the three ruminants. A sheep bioassay can be used to determine the presence of the virus in infected cattle.<sup>17</sup>

### Risk factors

#### Animal risk factors

The prevalence of infection based on seroprevalence is positively associated with increasing age in both dairy and beef cattle.<sup>2</sup> The prevalence of infection in dairy cattle under 17–24 months of age is much lower than in adult cattle and increases sharply after 24 months of age when heifers join the milking herd and are in close contact with older cattle.<sup>2</sup> The rate of spread may also be associated with the prevalence of infection; in herds with a prevalence of 13–22% when first tested, the spread was slow; in a herd with a prevalence of 42%, the spread was much more rapid.

#### Genetic resistance and susceptibility.

Infection with the BLV is not synonymous with clinical disease. Most animals which become infected do not develop neoplastic disease. Once infection has occurred, the subsequent development of only an antibody response, or antibody plus persistent lymphocytosis (PL) or antibody plus lymphosarcoma, with or without PL, is determined by the host's genetic makeup. Lymphosarcoma, the terminal stage of BLV infection involving the clonal transformation of infected B-cells, occurs in about 1% of BLV-infected cattle and is under genetic control of the host.<sup>18</sup>

A complex relationship exists among genetic merit, milk production, *BoLA* genotype, and susceptibility to PL. Cows with high genetic potentials for milk and fat yields are more susceptible to PL than cows with lower genetic potentials, but cows with PL do not produce yields of milk or fat according to their predicted genetic values. Early attempts to quantify the economic impact of subclinical infection emphasized differences in milk production between seropositive and seronegative cattle. However, seropositive cattle may be in different stages of the disease complex. Antibodies to BLV may be present in recently infected cows with no other abnormality, in cows over 3 years of age with PL, and in animals older than 6 years of age with tumors.<sup>18</sup> In addition, the genetic potential was not considered. It is now known that genetic merit is correlated with susceptibility to BLV infection and PL and thus inconsistent results are not surprising. When seropositive cows are divided into PL and non-PL categories and the genetic potential for various measures of milk production for

each animal are taken into account, the results are much more clear.<sup>18</sup>

The phenotype frequencies of two *BoLA-A* alleles are associated with resistance and susceptibility to PL.<sup>18</sup> Genetic resistance to PL maps closely to the class II genes of the bovine major histocompatibility complex, (*BoLA*). The frequency of the PL resistance-associated *BoLA-A14* allele in any age group was higher in BLV-infected non-PL cattle than in BLV-infected PL cattle in the same age group and increased from 30% in 3-year-old cows to 52% and 59% in 7- and 8-year-old cows which were retained in the herd. In contrast, the frequency of *BoLA-A14* in cows with PL decreased in frequency from 7% in 3- to 5-year-old cows to 0% in cows older than 6 years. The relationship between *BoLA-A* allele frequencies and BLV infection over time, and between BLV infection and milk yield, imply an association of *BoLA-A* alleles with the full expression of milk and fat production potentials under conditions where BLV infection is prevalent. This suggests that genetic resistance to PL is associated with longevity in the herd, where there is a high prevalence of BLV infection.

**Susceptibility to other diseases.** A highly significant correlation was shown between BLV infection and the persistence of *Trichophyton verrucosum* infection, which suggests that the immune system may be impaired in BLV-infected cows. Observations in Sweden indicate many significant associations between BLV infection status and measures of incidence, reproduction and production, but most were of low magnitude. The risk for other infectious diseases seemed to be greater among BLV-infected herds, while the risk for non-infectious diseases did not differ.

#### Immune mechanisms

Bovine leukemia virus is a type C retrovirus infecting B-cells and causing enzootic bovine leucosis.<sup>19</sup> The disease is divided into three stages: serologically positive, but negative for lymphocytosis; serologically positive and positive for persistent lymphocytosis; and leukemia. Both humoral and cell-mediated immunity are induced in natural BLV infection. The cytokine profiles change as the infection progresses and interleukin-2 contributes to the development of BLV-induced persistent lymphocytosis. Tumor necrosis factor (TNF- $\alpha$ ) are involved in the control of B-cell death, the virus-induced B-cell proliferation and the leukemogenesis of B-1 cells.

Following infection, a persistent antibody response occurs primarily to the envelope glycoprotein gp51 and the major core protein p24 of the BLV virions.

The time from infection to development of antibodies can be as long as 14 weeks. Experimental infection of calves with the virus results in seroconversion which can be demonstrated with the ELISA in 4–5 weeks after infection.<sup>20</sup> Acute lymphocytosis occurs at about the same time after infection.

#### Environmental and management risk factors

##### *Lack of biosecurity*

The introduction of infected animals into a herd has a significant positive effect on the subsequent prevalence of infection and clinical disease.<sup>21</sup> The appearance of new outbreaks of leukosis is almost always the consequence of the introduction of BLV-infected animals in farms or areas previously free of the infection. Some outbreaks have followed restocking after brucellosis eradication. Others have occurred following the enlargement of the size of a dairy herd by purchasing animals from a variety of sources. In dairy herds in the Canadian Maritimes, those herds which had routine vaccination practices for other infectious diseases, the seroprevalence for BLV was lower than in herds which did not.<sup>22</sup> The infection was introduced into an accredited BLV-free dairy herd following the introduction of 75 pregnant heifers 2.5 years before a clinical case of lymphosarcoma occurred in the herd and recognized at slaughter.<sup>23</sup> Some of the heifers originated from a BLV-infected herd including the animal with lymphosarcoma.

##### *Calf management*

The level of calf management in dairy herds is also a major risk factor. Any environmental factor or management practice which allows newborn calves access to infective blood will increase the level of infection in the calves, including:

1. Prolonged close contact between the cow and calf immediately after parturition
2. Feeding of colostrum and milk from infected cows
3. Use of:
  - Gouge dehorners and ear-tagging equipment
  - Tattooing equipment
  - Instruments used for castration or the removal of supernumerary teats
  - Use of single needles for vaccination
  - Instruments for control of excessive fly population in calf barns.

Some observations have found positive associations between BLV status of dairy herds and weaning age, housing pre-weaned calves in hutches or separate calf housing, and contact between young-

stock and older animals during the winter housing period.<sup>24</sup> In Ontario, dairy herds with at least one seropositive cow were more likely to have calves raised in calf hutches in winter, more likely to have calved in separate pens in the winter, and less likely to have cows calved in separate pens during the summer.<sup>25</sup> However, the calves housed in hutches were not the same animals sampled for BLV and the results indicate only that those farms using this management procedure had a higher prevalence of BLV. BLV-seropositive cows had a slight, significant increase in calving interval compared to BLV-negative cows.

#### Pathogen risk factors

The BLV is an exogenous C-type retrovirus closely related to the human T-lymphocyte virus types I and II.<sup>2</sup> It is highly cell associated and persists in a subpopulation of peripheral B-lymphocytes which proliferate as a result of the infection. Free virus is rarely or never found in the blood of infected cattle, and therefore not highly contagious. Once an animal is infected, the infection persists for life in the chromosomes of the infected host. The virus can be experimentally transmitted to a variety of animal species such as sheep, goats, pigs, rabbits, rhesus monkeys, chimpanzees, and buffalo.

#### Economic importance

##### General comments

Enzootic bovine leukosis causes significant economic losses associated with the costs of control and eradication programs. In Europe, the losses have been significant to the extent that an eradication campaign supported by the European Community has been in place for many years. Denmark has had an established national program for the control of the disease since 1959<sup>26</sup> and because of its importance, Sweden introduced a control program in 1990 with the aim of complete eradication of BLV from the Swedish cattle population.<sup>3</sup>

The nature and extent of the economic losses associated with enzootic bovine leukosis (EBL) have been controversial because the evidence has been conflicting. The obvious economic losses include the culling of cattle with lymphosarcoma, shortening of lifespan and loss of production potential, and restrictions on export of cattle and semen to importing countries. In Canada, BLV-seropositive bulls are barred entry into artificial insemination units.

In a spreadsheet analysis of dairy herds in the Maritimes in Canada, total annual costs for an average, infected 50 cow herd were \$806.00 for enzootic bovine leukosis, compared to \$2472.00 for Johne's disease, \$2412.00 for BVD, and \$2304.00 for

neosporosis.<sup>27</sup> The association between EBL infection and annual value of production on dairy herds in the United States, as part of the National Animal Health Monitoring System's 1996 dairy herd study, found that compared to herds with no test-positive cows, herds with test-positive cows produced 218 kg less milk per cow.<sup>28</sup> The average reduction in average value of production was \$59.00 per cow relative to test-negative herds. Most of the economic loss was due to reduced milk production in test-positive herds.

The effects of subclinical BLV infection on milk production, reproductive performance, longevity and culling rate are variable. In some observations, a BLV-seropositive cow had a shorter lifespan than both its seronegative counterpart and the entire milk cow population. Among older dairy cows, BLV-seropositive cows were culled prematurely, compared with uninfected cows.<sup>29</sup> The culling rate was higher and milk production was lower in BLV-infected herds compared to BLV-free herds. The effect on reproduction was minor. In other observations, milk production, somatic cell count, age at disposal and culling were not influenced by seropositivity. A comparison of culling rates among dairy cows grouped on the basis of serologic status for BLV did not find any association between culling rate and serological status.<sup>30</sup>

Economic effects on milk production traits. When the effects of infection were examined according to genetic potential for milk and fat production in dairy cows, the results were surprising. The genetic potential for milk production was significantly greater in seropositive cows with PL and in seropositive hematologically normal cows than in seronegative herdmates. At the individual cow level, infected cows had greater milk production than uninfected cows based on seropositivity to BLV and 305-day mature equivalent fat-corrected milk production.<sup>31</sup> Among seropositive cows, those with PL were culled at a younger age and had reduced production in the last lactation relative to other groups. Cows with PL do not produce butterfat according to their potential.

Using data collected over a 6-year period, milk and fat yields in BLV-infected cows with PL declined significantly relative to their BLV-infected non-persistently-infected herdmates.<sup>18</sup> The estimated annual loss in milk yield is 366 kg for cows which had PL for 2 years, and 1204 kg for cows with PL for 3 years.<sup>18</sup> The economic losses to the dairy industry in the United States have been estimated on the basis of the total number of cows with PL, price of milk, average milk yield, net income per cow, and loss in milk yield

in cows with PL. Assuming 70% of cows are infected and 20% of infected cows develop PL, it is estimated that economic loss is about 0.25% of the gross income of milk production<sup>18</sup> and the percent annual loss in net profit to the dairy industry due to PL is 3%.

The estimated costs of bovine leukemia infection, including costs of clinical disease and subclinical infection, in a dairy herd representative of the mid-Atlantic region in the US are \$412.00 for a case of lymphosarcoma; for a herd with a 50% prevalence of infection, annual incidence of lymphosarcoma was 0.66.<sup>32</sup> The mean annual cost of subclinical infection at 50% prevalence of infection was \$6406.00. Mean annual cost of a test-and-manage control program was \$1765.00. The cost of clinical disease and subclinical infection varied substantially with the prevalence of infection, whereas the cost of control varied with herd size. A basic BLV control program is considered economical in herds in which the prevalence of infection is  $\geq 12.5\%$ .

##### Economic effects of clinical disease

On an industry basis, the economic losses from lymphosarcoma are not large because only 0.1–5% of seropositive cows and 10–50% of cows with persistent lymphocytosis develop lymphosarcoma. However, for individual farms, a high incidence of the disease can be a major cause of economic loss, particularly in high producing elite dairy herds where pedigreed livestock are sold. In these pedigreed herds, individual animals are kept to a much older age than in the average commercial herd and, because of the increased prevalence of lymphosarcoma in cows over 5 years of age, the death losses are likely to be very severe in exactly the group of cows which is critical to the success of herd. In addition, there is the severe downgrading effect on the salability of stock from a herd known to have a disease in which genetic susceptibility is an important causative factor.

Loss may also result from lymphosarcoma by way of reduced production during the developmental stages of the disease. The course of the disease is usually sufficiently brief to make this a relatively unimportant consideration. Similarly, the immunosuppressive effect of infection with the virus appears not to have influence on the prevalence of other diseases.

##### Trade restrictions

A major economic effect of the disease lies in import restrictions placed by some countries on infected cattle and on semen either from infected bulls or from non-infected bulls from a positive herd. It is the practice, particularly in countries that do not have the disease, to require proof

of freedom from infection with the virus from animals about to be imported into the country. This trend has been increased by the introduction of the infection into the United Kingdom in cattle imported from Canada. This is a matter of major importance when the cattle are purebred and are sold at high prices as breeding animals. Some countries are already demanding a negative blood test for all cattle and meat to be imported, and this could represent a loss of export markets for some countries.

### Zoonotic implications

The possibility of transmission of the virus from cattle to humans is a real one; the virus is commonly present in the milk of infected cows and the disease has been transmitted to chimpanzees in this way. However, in spite of exhaustive, but certainly not complete, studies there is no evidence to support the notion that transmission occurs from cattle to humans.<sup>2</sup> A case-control study failed to show any relationships between human acute lymphoid leukemia and exposure to dairy cattle and drinking raw milk nor with residence in the general area where dairy cattle are raised.<sup>2</sup> The measurement of occurrence of disease in persons living on farms is the critical measurement because short-term pasteurization procedures destroy the infective agent in milk; farm dwellers who take their milk from the supply before the pasteurization points are thus exposed. All the evidence suggests that humans are at minimal risk of acquiring BVL infection and the diseases clinically associated with the virus.<sup>2</sup>

Using an immunoblot test, a serological survey of 257 humans in California found at least one antibody isotype reactive with

BLV in 74% of the sera tested.<sup>33</sup> This does not necessarily mean that humans are actually infected with BLV. Only 9% of the subjects indicated any direct contact with cattle or their biological products. The antibodies could be a response to heat-denatured BLV antigens from consumed milk or meat.

### Other species

Lymphosarcoma occurs sporadically in all species, but natural infection with the BVL virus has been demonstrated only in sheep and capybaras.

Although there is no evidence of a relationship between bovine viral leukosis and any disease of pigs, there is a record of enzootic leukosis in that species which is inherited.

### PATHOGENESIS

#### Virus and lesion

The virus establishes a persistent infection in a subpopulation of B-lymphocytes by integrating proviral DNA into the host cellular DNA.

The four possible outcomes after exposure of cattle to BVL virus are outlined in Fig. 21.1, including:

1. Failure of the animal to become infected, probably because of genetic resistance
2. Establishment of a permanent infection and the development of detectable levels of antibodies. (These animals are latent carriers of infection)
3. Establishment of a permanent infection; the animal becomes seropositive and also develops a persistent lymphocytosis, a benign lymphoproliferative process. It is not a preclinical stage of lymphosarcoma

4. Infected, seropositive animals that may or may not have been through a stage of persistent lymphocytosis and which develop neoplastic malignant tumors – lymphosarcoma.

Whether or not the animal becomes infected or develops any of the other forms of the disease depends on the recipient's genetic constitution (see **Animal risk factors** above). The outcome may also be influenced by the animal's immune status and the size of the infective dose of virus. About 80% of animals with the adult form of the disease have a marked depression of IgM globulins. The immunological responsiveness of leukotic cattle to administered antigens is significantly depressed overall, especially to IgM, resulting from a deficiency in its production in the spleen and lymph nodes.

Lymphomatosis is a neoplasm of the lymphoreticular system. It is never benign and the lesions develop at varying rates in different animals so that the course may be quite short or protracted over several months.

The effects of BLV infection on milk production may not be related solely to overall animal health but may also be mediated directly at a cellular level.<sup>34</sup> An *in vitro* system revealed that the casein production and mRNA synthesis by mammary epithelial cells from a BLV-infected cow were reduced compared with control cell lines without BLV.

### Lesions and clinical disease

In adult cattle, almost any organ may be the site of lesions, but the abomasum, heart, and visceral and peripheral lymph nodes are most commonly affected. In calves, the visceral lymph nodes and spleen and liver are the common sites. Depending on the organ which is most involved, several clinical syndromes occur. Involvement of the abomasal wall results in impaired digestion and persistent diarrhea. When the atrial wall is affected, congestive heart failure occurs. In nervous tissue, the primary lesion is in the roots of peripheral nerves and spreads along the nerve to involve meninges and cord. Involvement of the spinal meninges and nerves results in the gradual onset of posterior paralysis. The skin, reproductive tract, and periorbital tissues are commonly affected. In the cutaneous form, intradermal thickenings develop which persist but do not cause discontinuity of the epithelium. They are composed of aggregations of neoplastic lymphocytes. Invasion of periorbital tissues commonly results in exophthalmos. Esophageal obstruction may result from mediastinal lymph node involvement in calves.

The exact nature of the tumor is unclear. The tumors consist of aggregations of

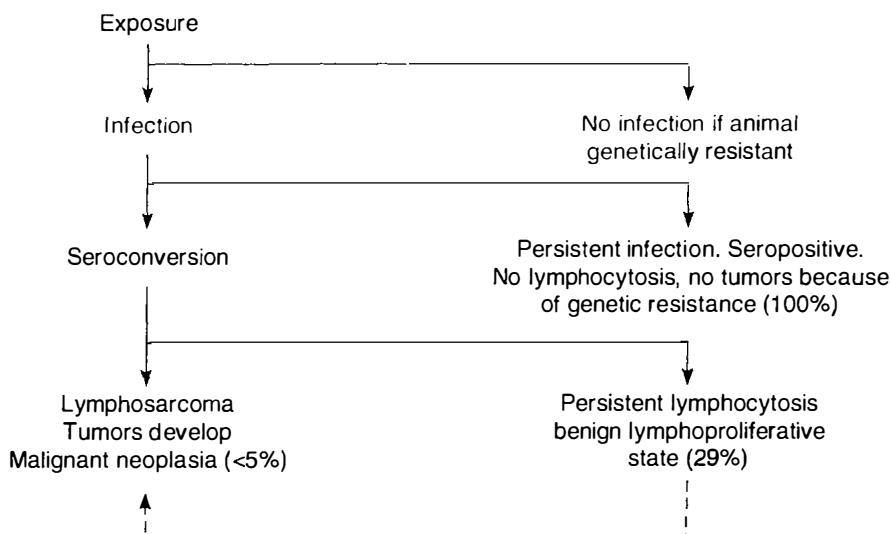

**Fig. 21.1** Possible pathways after exposure to BVL virus (percentage figures indicate proportion of seroconverted animals that develop the particular form referred to<sup>2</sup>).

neoplastic lymphocytes, but in many cases they may be more accurately described as reticulosarcoma. They are highly malignant and metastasize widely. The hemogram is variable and, although there may be an accompanying lymphocytosis, the presence of large numbers of immature lymphocytes in the blood smear is a more reliable indication of the presence of the disease. Some degree of anemia is common.

#### CLINICAL FINDINGS

##### Enzootic (adult) bovine viral leukosis (bovine lymphosarcoma)

This disease is characterized by the occurrence of multiple cases of adult multicentric lymphosarcoma, with tumors developing rapidly in many sites with an accompanying great variation in clinical signs and syndromes. An approximate indication of the frequency with which individual signs appear is set out in Fig. 21.2.<sup>35</sup>

The usual incubation period is 4–5 years with most occurring 4–5 years after the original case was introduced or a blood transfusion from an outside herd was given. This form is rarely seen in animals under 2 years of age and is most common in the 4–8 years age group. Persistent lymphocytosis without clinical signs occurs earlier but rarely before 2 years of age. Many cows remain in the preclinical stage for years, often for their complete productive lifetime without any apparent reduction in performance, but clinical disease appears in a proportion of these cows. The clinical signs and the duration of the illness vary with the number and importance of the sites involved and the speed with which the tumor masses grow.

In 5–10% of clinical cases the course is peracute and the affected animals often die suddenly or unexpectedly without any prior evidence of illness. Involvement of the adrenal glands, rupture of an abomasal ulcer or an affected spleen followed by acute internal hemorrhage are known causes. These animals are often in good bodily condition.

In most cases the course is subacute (up to 7 d) to chronic (several months) and initiated by an unexplainable loss of body condition and appetite, pallor and muscular weakness. The heart rate is not increased unless the myocardium is involved and the temperature is normal unless tumor growth is rapid and extensive, when it rises to 39.5–40°C (103–104°F). Although the following specific forms of the disease are described separately, in any one animal any combination of them may occur. In many cases, clinical illness sufficient to warrant the attention of the veterinarian is not observed until extensive involvement has occurred and the possibility of slaughter of the animal for beef purposes cannot be considered. On the other hand, many cases are examined at a time when diagnostic clinical signs are not yet evident. Once signs of clinical illness and tumor development are detectable the course is rapid and death occurs in 2–3 weeks.

##### Enlargement of the superficial lymph nodes

Enlargement of the superficial lymph nodes occurs in 75–90% of cases and is often an early clinical finding. This is usually accompanied by small (1 cm in diameter) SC lesions, often in the flanks and on the perineum. The skin lesions are

probably enlarged hemolymph nodes and are of no diagnostic significance, often occurring in the absence of other signs of the disease. In many cases with advanced visceral involvement, peripheral lesions may be completely absent. Enlargement of visceral lymph nodes is common, but these are usually subclinical unless they compress other organs such as intestine or nerves. They may be palpable on rectal examination and special attention should be given to the deep inguinal and iliac nodes. In advanced cases, extensive spread to the peritoneum and pelvic viscera occurs and the tumor masses are easily palpable.

Although the enlargement of lymph nodes is often generalized, in many cows only a proportion of their nodes are involved. The enlargements may be confined to the pelvic nodes or to one or more SC nodes. Involvement of the nodes of the head is sometimes observed. The affected nodes are smooth and resilient and in dairy cows are easily seen and their presence may be marked by local edema. Occasionally, the entire body surface is covered with tumor masses 5–11 cm in diameter in the SC tissue.

##### Digestive tract lesions

Digestive tract lesions are common. Involvement of the abomasal wall results in a variable appetite, persistent diarrhea, not unlike that of Johne's disease and occasionally, melena due to bleeding of an abomasal ulcer. Tumors of the mediastinal nodes may cause chronic, moderate bloating.

##### Cardiac lesions

Lesions in the heart usually invade the right atrial wall primarily, causing right-side congestive heart failure. There is hydropericardium with muffling of the heart sounds, hydrothorax with resulting dyspnea, engorgement of the jugular veins and edema of the brisket and sometimes of the intermandibular space. The heart sounds are commonly muffled and other cardiac abnormalities may be obvious. Tachycardia due to insufficiency and arrhythmia due to heart block are common. A systolic murmur is also common along with an abnormal jugular pulse. The liver may be enlarged and palpable caudal to right costal arch, and passive congestion of the liver and visceral edema result in persistent diarrhea.

##### Nervous system involvement

Neural lymphomatosis is usually manifested by the gradual onset over several weeks of posterior paralysis. Knuckling of the fetlocks of the hind legs while walking is common and one leg may be more affected than the other. This is followed by difficulty in rising, and finally clinical recumbency and inability to stand. At this stage, sensation is retained, but movement

#### ENZOOTIC BOVINE LEUKOSIS (BOVINE LYMPHOSARCOMA)

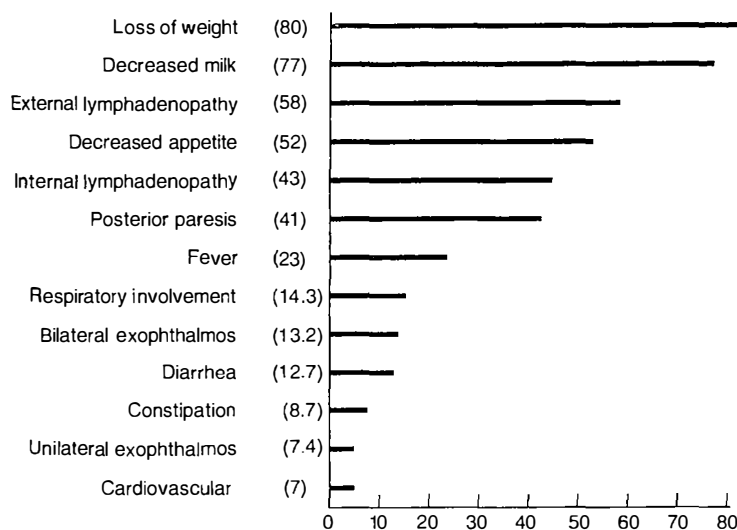

Fig. 21.2 Clinical diagnosis: frequency of predominant signs of bovine leukemia – 1100 field cases. (By courtesy of *Canadian Veterinary Journal*<sup>34</sup>.)

is limited or absent. There may be a zone of hyperesthesia at the site of the lesion, which is usually at the last lumbar or first sacral vertebra. Appetite and other functions, apart from the effects of recumbency, are usually normal. Metastases in the cranial meninges produce signs of space-occupying lesions with localizing signs referable to the site of the lesion.

### Less common lesions

These include enlargement of the retropharyngeal lymph nodes which may cause stertor and dyspnea. Sometimes clinically detectable lesions occur in the periorbital tissues, causing protrusion of the eyeball (exophthalmos), and in limb muscles, ureter and kidney,<sup>36</sup> and genitalia. Involvement of the uterus may be detectable as multiple nodular enlargement on rectal examination.<sup>37</sup> Severe bilateral exophthalmos may occur along with generalized lymphadenopathy.<sup>38</sup> Periureteral lesions may lead to hydronephrosis with diffuse enlargement of the kidneys while tumors in renal tissue cause nodular enlargements. In either case terminal uremia develops.

BLV particles have been detected by electron microscopy around lymphocytes in the mammary tissue of BLV antibody positive cows affected by subclinical mastitis.<sup>39</sup> Whether the virus is a causative agent or an immunosuppressant in bovine mastitis is unknown.

### Sporadic bovine leukosis

The calf, thymic and cutaneous forms are designated sporadic bovine leukosis.

#### Juvenile or calf lymphosarcoma

This occurs in calves at 2 weeks to 6 months of age and is manifested by gradual loss of weight and the sudden enlargement of all lymph nodes, and depression and weakness. Fever, tachycardia and posterior paresis are less constant signs. Death occurs in 2–8 weeks after the onset of signs. Signs of pressure on internal organs, including bloat and congestive heart failure may occur. Diffuse infiltration of major nerves of a limb may also occur.<sup>40</sup> Unusually the disease may be fully developed in utero, so that the newborn calf is affected with tumors, or be delayed until 2 years of age. Lymphosarcoma of the pharyngeal region causing retropharyngeal swelling and dyspnea in a 7-month-old beef steer has been recorded.<sup>41</sup>

**Bone and bone marrow necrosis** associated with the calf form of sporadic bovine leukosis has been recorded in calves 3 weeks to 8 months of age. Clinical findings included unthriftiness and inactivity, posterior ataxia, superficial lymph node enlargement, lameness and respiratory distress. Involvement of the tibio-tarsal

joint, ribs, and spinal canal may also occur resulting in ataxia and paresis.<sup>42</sup> Multiple bone infarcts and bone marrow necrosis were present at necropsy. Lymphosarcoma of the mandible of a 2-year-old heifer has also been recorded.

**Thymic lymphosarcoma** of young cattle. Infiltration of the thymus is a common finding in animals 1–2 years of age and is characterized by massive thymic enlargement and lesions in bone marrow and regional lymph nodes. Jugular vein engorgement and marked brisket edema extending to the submandibular region are common. Moderate bloat due to inability to eructate because of compression of the esophagus may occur.<sup>25</sup> The thymic mass is usually not palpable. This form is more common in beef than in dairy cattle. An atypical lymphosarcoma in a mature cow negative for BLV and similar to the thymic form has been reported.<sup>43</sup> Metastatic thymic lymphosarcoma in a calf has been recorded<sup>36</sup> including a case with metastases causing spinal cord compression. Cases of both the systemic and local forms of sporadic bovine leukosis have been described.<sup>25</sup> A large number of the thymic lymphosarcoma occurred in calves in five regions in France over a period of 5 months. Most of the calves had been sired by the same bull, which suggests that the disease had an inherited basis.

#### Cutaneous lymphoma

This is most common in cattle less than 3 years of age. It is rare and manifested by cutaneous plaques (1–30 cm diameter) appearing on the neck, back, croup and thighs. The plaques become covered with a thick, gray-white scab and the hair is shed; then the center becomes depressed and the nodule commences to shrink. The surface of some plaques may become ulcerated and have a serosanguinous exudate. Some of the lesions have a cauliflower-like appearance, appear black, and are ulcerated and foul-smelling. After a period of weeks or months hair grows again and the nodules disappear as does the enlargement of the peripheral lymph nodes. Spontaneous regression of bovine cutaneous leukosis has been recorded. Relapse may occur in 1–2 years with reappearance of cutaneous lesions and signs of involvement of internal organs as in the enzootic form of the disease. In one series of 10 heifers, all animals had lymphadenopathy.<sup>44</sup> Some had leukocytosis and some had lymphocytosis. The body condition may vary from normal to thin and underdeveloped. Some affected animals may have a fever.

Cutaneous T-cell lymphoma in two Friesian cows in the Azores has been reported.<sup>4</sup> The lesions consisted of raised pink plaques, with no pruritus or signs of

associated pain, which were extensively distributed over both lateral and ventral body regions. Immunocytochemistry found the tumor cells positive for CD3, confirming the T-cell origin of the cells which involved both skin and regional lymph nodes.

#### Other species

**Outbreaks of lymphosarcoma in sheep** have been observed with clinical, epidemiological, hematological and necropsy findings similar to those of enzootic bovine leukosis. B-cell leukemia has been described in sheep.<sup>45</sup>

Infection of other species with BVL virus has not been demonstrated, but epidemic occurrences of lymphosarcoma have been observed in pigs, but only sporadic cases in horses.

**In pigs**, non-specific emaciation, limb weakness and anorexia are most commonly observed. Sporadic cases in this species are unlikely to be recorded, and although outbreaks have occurred, they and the enzootic form are not commonly encountered. In one herd with the enzootic disease all cases encountered were in pigs less than 6 months of age. There was stunting of growth, development of a pot belly, enlargement of peripheral lymph nodes, and a lymphocytosis, including the presence of immature cells.

**In horses**, the disease occurs most commonly in animals over 6 years of age. The common clinical manifestations are:

- Subcutaneous enlargements which may ulcerate
- Enlargement of internal and external lymph nodes
- Jugular vein engorgement
- Cardiac irregularity
- Exophthalmia
- Bilateral swelling of the eyelids
- Anasarca.

The course varies from acute to chronic, but most affected horses die within a month of first showing signs. Diffuse alimentary lymphoma of the small intestine in adult horses is characterized by:

- Malabsorption
- Hypoalbuminemia
- Increased gammaglobulin levels
- Anemia
- Chronic alimentary tract dysfunction but without diarrhea.

Malignant lymphoma with ulcerative pharyngitis in horses has been recorded.

### CLINICAL PATHOLOGY

A definitive antemortem diagnosis depends on the clinicopathological examination of the animal. Several diagnostic techniques are available and it is important to make the appropriate selection for the particular



stage of the disease that is being considered, thus:

- Diagnosis of the viral infection is made by serological or virological techniques
- Persistent lymphocytosis is identified by hematology
- Neoplastic tumors are identified by histological examination of a biopsy specimen.

Because of the increasing economic impact of BLV infection in the cattle industry, the availability of a highly sensitive and specific assay for the identification of BLV-infected animals is of critical importance. Such an assay is needed for the selection of BLV-free cattle for commercial sale, prepurchase testing of breeding animals, and import or export testing, and for control and eradication programs. Ideally, the assay should be practical, inexpensive, and able to be adapted for large-scale use.

#### Diagnosis of the presence of infection with BVL virus

##### Serological tests

Virtually all cattle infected with BLV will continuously have antibodies against the major internal (p24) and envelope (gp51) virion proteins in their serum, and serological tests are commonly used for the diagnosis of BLV infection in cattle over 6 months of age.

**Radioimmunoprecipitation assay (RIP).** The RIP using gp51 or p24 as antigen, is a highly sensitive and specific method for serologic diagnosis of BLV infection.<sup>46</sup> The RIP assay has been used as the criterion-referenced standard to critically evaluate the performance of other diagnostic tests for BLV infection. Detailed comparisons of various BLV assays in a large number of cattle of various origins and ages found that the RIP assay is the most sensitive and specific test. However, its major disadvantage is that it requires a gamma counter and radioisotopes, which are expensive.

**AGID test.** This is a good screening test to determine the presence of infection in an individual animal or herd.<sup>2</sup> The estimated specificity of 99.8% and the sensitivity of 98.5% indicate that the test is a reliable and accurate method to detect BLV infection. False-positive and false-negative results do occur and may be associated with some variability of the immune system or from human error. The AGID test is the official reference test of the Office International des Epizooties and the European Community and is the test recognized by most governments as the official test for purposes of testing imported animals. There is however, a lack of standardization between the BLV-

AGID kits used in North America and Europe.<sup>47</sup>

**Radioimmunoassay (RIA).** This is suitable for individual cow testing because of its accuracy. There are several versions of this and the one using the virion gp antigen is preferred.<sup>2</sup> It is one of the most sensitive tests and is useful for the detection of BLV antibodies in cattle exposed no longer than 2 weeks, in milk samples, and in serum samples from periparturient dams.

**Serum ELISA.** In more recent years, ELISA-based testing has replaced the AGID in eradication programs in several countries. It is more sensitive than other serological tests and can be used on milk.<sup>2</sup> The superior sensitivity of the ELISA for pooled serum samples allows detection of antibodies in herds with a prevalence of less than 1%, whereas the AGID test detected only 50% of the herds detected by the ELISA.<sup>2</sup> Two commercially available ELISAs and the polymerase chain (PCR) were evaluated and compared with the AGID to detect antibodies to BLV or its nucleic acid.<sup>5</sup> The ELISA tests detected about 10% more reactors than the AGID and the electrophoretic immunoblotting results. Some ELISA positive animals were not detected by the PCR.

Four commercially available BLV-ELISA kits from Europe or the United States were compared to the AGID test officially approved by the Canadian Food Inspection Agency. The ELISA tests were more sensitive than the AGID test kits and the gp51 BLV-ELISA is now recognized as an official test method for the serodiagnosis of bovine leukosis in Canada.<sup>48</sup>

A highly sensitive and specific blocking ELISA comparable to the radioimmunoprecipitation assay for the detection of BLV antibodies in serum and milk samples has been developed.<sup>46</sup>

**The chronology of seroconversion** is important in the serological diagnosis. Calves from infected dams have a 20% chance of being infected in utero and seropositive at birth. If they are serologically negative at birth they seroconvert at their first ingestion of colostrum from seropositive cows and this passively acquired immunity persists for 2–7 months. These calves, and calves from uninfected mothers become positive at varying ages depending on when they come into contact with infection, usually when they are placed into the infected adult herd. This can be as early as 9 months of age, but as a general rule positive reactions are uncommon in cattle which are less than 2 years of age. Seroconversion usually takes place 3–4 months after the negative animals are placed in the infective group, although the interval is longer in the winter than in the summer. Infected

animals are seropositive and infected for long periods, usually for life.

Using the ELISA, experimental infection of calves at 3–4 months of age results in seroconversion to the virus at 4–5 weeks after infection.<sup>20</sup>

In a control and eradication program, early detection of infected calves is difficult because colostral antibodies to BLV cannot be differentiated from antibodies resulting from natural infection. By using measures of colostral antibody concentration, calves infected in utero could be identified by 80 d of age. Calves over 6–8 months of age with a positive immunodiffusion test will likely be infected permanently. Calves which have ingested colostrum from seropositive cows usually have maternal antibodies and polymerase chain reaction tests are necessary to detect the virus and distinguish between infected and virus-free calves.<sup>49</sup>

**Milk ELISA.** This is much more sensitive than the AGID and has been adopted for testing milk from individual cows and pooled milk samples.<sup>46,50</sup> A comparison of the ELISA and AGID tests for the detection of BLV antibodies in bovine serum and milk found a high level of agreement.<sup>50</sup> The bulk tank milk ELISA is useful for identification of herds which are negative for BLV infection.<sup>51</sup> The ELISA identified 80% of herds as positive for BLV and had an apparent sensitivity and specificity of 0.97 and 0.62, respectively.<sup>51</sup> But after accounting for the sensitivity and specificity of the AGID test in individual animals, the specificity of the ELISA test for milk was 0.44. With the moderately low specificity, herds identified as positive by the ELISA would require further testing at the individual or herd level to definitively establish their BLV status.

An indirect ELISA to detect antibodies to BLV in bulk-milk samples in Sweden is being used to assist in the eradication of infection from Swedish herds.<sup>52</sup> The antibody level in milk is lower than in serum but the sensitivity of the ELISA is as effective as for sera. Testing of bulk milk is a useful and practical method for large-scale epidemiological studies and initial eradication programs. Heifers, bulls, and dry cows are not included when bulk milk is tested and all animals over 1 year of age need to be sampled individually before a herd is declared free of the virus. The sensitivity and specificity of the milk ELISA is estimated to be adequate until the prevalence of BLV-infected individuals in the country is less than 1%.

##### Detection of virus

**Polymerase chain reaction (PCR).** The PCR is a sensitive and specific assay for direct diagnosis of BLV infection in peripheral blood lymphocytes.<sup>53</sup> The test

is useful for the early detection of BLV infection even before antibodies are present. It is more sensitive than the AGID test or the ELISA in detecting infected cattle where the prevalence of infection is less than 5%.<sup>54</sup> The test can identify proviral DNA of BLV in the lymphocytes of calves at birth which are born to infected cows.<sup>55</sup> All calves found to be infected at birth were born to BLV-positive cows with persistent lymphocytosis. At birth, the presence of a titer can be due to colostral antibodies or perinatal infection and the PCR test can differentiate uninfected newborn calves with colostral antibodies from BLV-infected calves and detect the presence of the virus in the presence of antibodies.<sup>47</sup> The PCR has a practical application in the identification of BLV-infected calves, regardless of colostral antibody, which allows immediate removal of the source from the herd. In a dairy herd with a high prevalence of BLV, a positive PCR assay result provided definitive evidence that a cow was infected with BLV.<sup>56</sup> However, sensitivity and specificity were 0.672 and 1.00, respectively. Predictive value of a positive test was 1.00, and predictive value of a negative test was 0.421. Thus PCR assay alone is unreliable for routine detection of BLV in herds with a high prevalence of BLV infection.

The PCR can also be used to ensure that cattle used in the production of a whole blood vaccine for tick-borne disease are free from BLV infection.<sup>17</sup> The sheep bioassay, currently in use, requires 4 months of serological testing to insure that donor animals are not infected. Replacement of the sheep bioassay with the PCR could result in considerable saving of time and effort. Use of the PCR requires stringent precautions to prevent false-positive results due to contamination of samples with PCR product.<sup>17</sup>

A nested PCR identified 98% of BLV seropositive cows from blood and 65% from milk, whereas real-time PCR detected 94% of BLV seropositive cows from blood and 59% from milk.<sup>57</sup> BLV was also detected in 10% of seronegative cows most likely because of early detection before seroconversion.

**Differentiation between enzootic and sporadic bovine leukosis.** The role of BLV in some cases of sporadic bovine lymphomas needs to be re-examined. The findings of persistently seronegative PCR-positive and seropositive PCR-negative cattle indicates that the BLV cannot be excluded as a causative agent in sporadic bovine leukosis. Enzootic bovine leukosis cannot be distinguished from sporadic bovine leukosis on histopathological examination. The ELISA is recommended as a method of choice to

differentiate between EBL and sporadic bovine leukosis (SBL) because it is a rapid, reliable and sensitive test which is inexpensive and easy to perform. In cases where no blood or other fluids are obtained, the PCR test is the most useful method for the direct detection of BLV.

#### Diagnosis of persistent lymphocytosis (PL)

Approximately 30% of animals infected with the BLV develop PL, which is defined as an increase in the absolute lymphocyte count of three or more standard deviations above the normal mean as determined for that respective breed and age group of animals in leukosis-free herds. The PL is an increase in peripheral B-lymphocytes. It has been suggested that one additional criterion for PL should be that it persists for more than 3 months. When PL was first recognized in herds which experienced clinical lymphosarcoma, it was considered a subclinical expression of the tumor stage of the disease. It became an important diagnostic criterion in control and eradication programs until serological tests became available to more accurately identify infected animals. The majority of cells involved in PL are normal lymphocytes but atypical and abnormal forms have been described and are considered as indicative of preleukemic condition. The total count increases from a normal of 6000 to as high as 15 000/ $\mu$ L. The percentage of lymphocytes in the total white blood cell count increases from the normal of 50–65% is considered a positive result. The presence of 25% or more of the total lymphocyte count as atypical immature cells is also considered a significant aberration. The PL may subside in animals which subsequently develop lymphosarcoma.

The association between the strength of serologic recognition of BLV by the use of ELISA and lymphocyte count in bovine leukosis virus-infected cows has been examined.<sup>52</sup> The sample-to-positive ratio, which is the ratio between the test sample and a positive control sample, was compared among lymphocytotic and nonlymphocytotic cows. The sample-to-positive ratio and lymphocyte count were related but cows with high sample-to-positive ratio were not always lymphocytotic. Culling cows on the basis of sample-to-positive ratio will reduce culling of ELISA-positive cows, however, culling on the basis of lymphocyte count will eliminate a greater proportion of the reservoir of infection.

#### Diagnosis of lymphosarcoma

This can only be done by histopathological examination of a section of tumor material obtained by biopsy or necropsy. A

needle aspirate of an enlarged peripheral lymph node may provide a rapid and inexpensive diagnosis. Enlarged lymph nodes or hemolymph nodes are the usual sources, but when the genital tract is involved an exploratory laparotomy is usually performed so that a sample can be obtained. The lymphocyte count may increase to 20 000–30 000/ $\mu$ L, and in some cases may reach values of 50 000–100 000/ $\mu$ L, and even 400 000–500 000/ $\mu$ L. Conversely, in some cases, the lymphocyte count decreases. Chromosomal changes may be detectable in cells from lymph nodes or in leukocytes from peripheral blood of affected animals. When there is myocardial involvement there may be obvious changes in the electrocardiogram but these are unlikely to be of value in differential diagnosis.

#### NECROPSY FINDINGS

In cattle, firm white tumor masses may be found in any organ although two rather different patterns of distribution are apparent. In newborn and young animals, the common sites are: kidneys, thymus, liver, spleen and peripheral and internal lymph nodes. This may or may not be a characteristic of the 'sporadic' form of the disease. In adults, the heart, abomasum and spinal cord are often involved. In the heart, the tumor masses invade particularly the right atrium, though they may occur generally throughout the myocardium and extend to the pericardium. The frequency of early changes in the subepicardial tissue of the right atrium suggests that this is an area from which tissues should be selected in latent or doubtful cases. The abomasal wall, when involved, shows a gross, uneven thickening with tumor material in the submucosa, particularly in the pyloric region. Similar lesions occur commonly in the intestinal wall. Deep ulcerations in the affected area are not uncommon. Involvement of the nervous system usually includes thickening of the peripheral nerves coming from the last lumbar or first sacral cord segment or more rarely in a cranial cervical site. This may be associated with one or more circumscribed thickenings in the spinal meninges. Affected lymph nodes may be enormously enlarged and be composed of both normal and neoplastic tissue. The latter is firmer and whiter than normal lymphoid tissue and often surrounds foci of bright yellow necrosis. Less common sites include the:

- Kidney
- Ureters (usually near the renal pelvis)
- Uterus (either as nodular masses or diffuse infiltration)
- Mediastinal, sternal, mesenteric and other internal lymph nodes
- Mandibular ramus.

When performing the necropsy, it is important to remember that lymphosarcoma can appear not only as discrete nodular masses but as a diffuse tissue infiltrate. The latter pattern results in an enlarged pale organ which is easily misinterpreted as a degenerative change rather than as a neoplastic process.

Histologically, the tumor masses are composed of densely packed, monomorphic lymphocytic cells. Attempts to better characterize the nature of these cell populations have been published.<sup>58,59</sup> The cleaved variant of the diffuse large cell type with a high mitotic index is characteristic of enzootic lymphoma and this high-grade type of B-cell tumor may be a consequence of the viral etiology of this form of the disease.<sup>31</sup> It is possible to confirm viral infection in some cases by a PCR test but such testing is rarely justified. Immunohistochemical staining of formalin-fixed, paraffin-embedded tissue sections of tumors can be used to confirm that neoplastic lymphocytes are of thymic origin when thoracic masses are examined.<sup>60</sup>

#### Samples for confirmation of diagnosis

- **Histology** – formalin-fixed samples of gross lesions, plus enlarged lymph nodes, bone marrow, liver, spleen, thymus, right atrium, abomasum, uterus (LM, IHC)
- **Virology** – neoplastic tissue (PCR).

#### DIFFERENTIAL DIAGNOSIS

Because of the very wide range of clinical findings, a definitive diagnosis of BVL is often difficult. Enlargement of peripheral lymph nodes without fever or lymphangitis is unusual in other diseases, with the exception of tuberculosis, which can be differentiated by the tuberculin test. In the absence of these enlargements, the digestive form may easily be confused with Johne's disease. The cardiac form closely resembles traumatic pericarditis and endocarditis, but there is absence of fever and toxemia, and the characteristic neutrophilia of these two diseases is usually absent. Involvement of the spinal nerves of meninges may be confused with spinal cord abscess or with the dumb form of rabies. An examination of cerebrospinal fluid may be of value in determining the presence of an abscess and rabies has a much shorter course and other diagnostic signs. Multiple lymph node enlargements in the abdominal cavity, and nodular lesions in the uterine wall may be confused with fat necrosis, but the nature of the lesion can usually be determined by careful rectal palpation. Stertor caused by enlargement of the retropharyngeal lymph nodes is also commonly caused by tuberculosis and actinobacillosis.

Cases of atypical lymphosarcoma<sup>43</sup> and thymic lymphosarcoma<sup>41</sup> which are BLV-negative may resemble lymphosarcoma of enzootic bovine leukosis.<sup>61</sup>

Echocardiography is now being used to detect intracardiac masses which may be compatible with EBL.<sup>62</sup>

#### TREATMENT

There is no treatment.

#### CONTROL

The disease can be eradicated from a herd and even a country, or controlled at a low level. The **option chosen** depends initially on the **prevalence of infection in the herd**, the **value of the animals in the herd**, and whether a **governmental indemnity** offered for seropositive cows which are culled and sent to slaughter.

#### History of Compulsory Eradication Program in Denmark

Control and eradication programs have been in effect on a nationwide basis in several western European countries.<sup>2</sup> Denmark began an eradication program in 1959 based on the occurrence of clinical lymphosarcoma, and the identification of cattle with PL using the Bendixen hematological key for classifying cattle as **normal, suspect or lymphocytic**. Leukosis was declared a reportable disease, and all adult cattle from herds in which cases of leukosis originated were subjected to a hematological examination. Affected herds were quarantined, and indemnity was offered to induce owners to have their entire herd slaughtered. This herd-slaughter policy was continued until 1982. When the AGID test became available, the Bendixen key was discontinued and only the AGID test was used in the official program between 1979 and 1982. Routine testing was discontinued in 1982. Surveillance involved testing random sera collected from every sixth adult cow to be slaughtered. According to the official Danish control program, the incidence of tumors in adult cattle at the start of the eradication program was at least 10 times greater than 10 years later. The hematological test was less sensitive than subsequent serological tests but the specificity was fairly high and only a few herds were erroneously classified as leukosis herds.<sup>61</sup> When the serological tests were introduced, some herds which were classified as leukosis-free based on the hematological key, were found to be infected.

**Voluntary eradication programs** using the AGID test have been effective in other member countries of the European Community in the last two decades and have been successful in reducing the prevalence

of infection and disease.<sup>2</sup> In the Federal Republic of Germany, eradication was achieved in 5 years. These programs have been successful in part because of the low prevalence of infection and the economic losses from culling seropositive cows has not been large.

In **Britain**, EBL is a reportable disease but is uncommon.<sup>41</sup> A national testing program was begun in 1992. All blood samples collected for routine periodic testing for brucellosis have also been tested for BLV and milk samples are collected every 3 months from dairy herds for BLV testing. The prevalence of infection has been low and the source of infection undetermined. Some of the animals had been imported from Canada but in other cases there was no association with importation.

Considering the animal-health aspects and possible consumer reactions against having a widespread retrovirus infection in food-producing animals, and the requirements for exporting cattle and semen, **Sweden** introduced a national program for the eradication of BLV in 1990.<sup>52</sup> An ELISA test was evaluated for detection of antibodies to BLV in individual and bulk milk and serum samples. It is proposed that eradication can be based on using the ELISA on milk samples in combination with other diagnostic tests and the prompt removal of infected animals.

In **Canada and the United States**, it is considered cost prohibitive to cull and slaughter all seropositive cattle because of the high prevalence of infection. Many seropositive cows are valuable pedigreed animals, and there are no indemnity programs available. Thus all control and eradication programs in these countries are herd based and strictly voluntary. Livestock producers are willing to adopt control programs because of the economic losses associated with export restrictions if their cattle are infected, and the losses due to the occasional clustering of cases of lymphosarcoma.

Enzootic bovine leukosis was eradicated from **Finland** in 1996.<sup>63</sup> The disease was first recognized in 1966 and it required 30 years using the key principle of test and slaughter policy to achieve eradication. The infection status was monitored at meat inspection, and hematologically between 1970 and 1977, serologically between 1978 and 1989. Annual surveys including all dairy herds and samples from beef animals were conducted in 1990–2001. Bulk tank samples represented the dairy herds in the surveys; beef animals were sampled individually at slaughter. The maximum positive herd-level percentage in the survey was 0.03%. The herd level prevalence of infection never exceeded 5%.

### Eradication programs

Enzootic bovine leukosis can be eradicated only by:

- Test and slaughter of cattle infected with the virus. Programs based on the culling of seropositive cows are effective
- The maintenance of a closed herd which permits the entry of only those animals free of infection.

The efficiency of such a program depends on the accuracy of the test used to identify the infected animals, and the repetition of the test at an appropriate interval so that animals that were in the incubation stages of the disease at the time of the first test will have had time to seroconvert. The recommended procedure is:

1. Identify infected animals using the AGID test<sup>2</sup>
2. Cull and slaughter seropositive animals immediately
3. Retest the herd 30–60 d later
4. Use the PCR assay to test young calves and as a complementary test for clarifying doubtful test results in herds with a low prevalence of infection.<sup>54</sup>

Testing is repeated until the herd has a negative test. When the herd is negative, testing is repeated every 6 months and the herd declared free when there have been no positive reactors for 2 years. Future introductions into the herd are managed most safely by artificial insemination or fertilized ovum transfer, or importations of animals which have been tested and are seronegative on two tests carried out 30 and 60 days prior to arrival.

In herds where the prevalence is high, a two-herd scheme can be successful. Newborn calves are removed from seropositive cows immediately after birth, fed colostrum from seronegative cows and raised in isolation. All animals over 6 months of age are tested periodically and seropositive animals culled. The parent herd is eventually disposed of as negative replacement animals become available. Only those bulls which are seronegative may be used and they must be tested every 3 months.

Although eradication is biologically feasible, it is unlikely that area eradication programs will be implemented on an extensive scale because losses from the disease are not sufficiently high, and there is a high risk of insect vectors reintroducing it which poses a real threat to maintenance of a BVL-free herd. The cost-effectiveness of an eradication program on a national basis would be a major consideration. For an individual herd, it is feasible provided some steps

were taken to increase genetic resistance of the residual stock and to reduce the chances of in-contact infection occurring.

### Limitation of spread of infection

In herds with a high prevalence of infection, the test and slaughter method of eradication is not economically viable if the animals have a high economic value because of superior genetic potential. Control of infection in these herds is possible using embryo transfer from infected dams to negative recipients and isolation of newborn calves but these are not practical on a country-wide basis. An alternative method is segregation of BLV-infected and non-infected animals based on the AGID test. This is known as the test and segregation method, which is based on the evidence that the spread of infection between animals is relatively slow and that the virus is spread by movement of infected animals from one herd to another and within a herd. Following the initial testing of the herd, the herd is divided into two groups, BLV-positive and BLV-negative, and kept at least 200 m apart. A third separate location is used for quarantine of replacement animals. Replacement animals must be found negative in two consecutive AGID tests, the first within 30 d before purchase and the second after 60 d of isolation, prior to being moved into the negative group. The AGID tests are conducted every 3 months and the reactors removed to the positive group location until the remaining animals in the herd have attained BLV-negative status by the test. Thereafter, the tests are done every 6 months and continued until at least four consecutive negative tests are obtained for each herd. Variations of this method of test and segregation with subsequent removal of seropositive animals in the routine culling program have been successful. The colostrum and milk fed to calves in the BLV-negative group must be from seronegative cows or be pasteurized to inactivate the virus.

In Canada, cattle owners may enrol in the Canada Health Accredited Herd program to declare freedom from EBL. All reactors must be removed from the herd. If a large number of reactors are detected, two herds on two separate farms can be established: one herd comprised of the reactors and the other of cattle which are seronegative. Calves from the reactor herd can be added to the accredited herd in accordance with strict isolation and testing procedures. To qualify for accredited certification, a herd must have two consecutive negative herd tests, at least 4 and less than 12 months apart. The tests must include all cattle in the herd. The first annual renewal test must occur no

more than 12 months following the second qualifying test for certification, and must include all cattle in the herd. Subsequent renewal tests must occur within the same 12-month interval. Only cattle 24 months of age and older must be tested but a herd inventory and audit must be performed on the whole herd. In herds with reactors, the two qualifying tests do not begin until at least 4 months after the removal of the last reactor uncovered during any test. Herd additions can be made during the qualifying test period or after certification has been achieved. Each animal must be accompanied by a health certificate and depending on the enzootic bovine leukosis status of the originating herd, certain testing and isolation procedures could apply. Owners wishing to have their animals attend exhibitions can do so providing they adhere to certain conditions. Properly processed semen and embryos can be introduced without restrictions. Owners are encouraged to follow preventive health management practices to augment the eradication of enzootic bovine leukosis from their herds. These include all areas where blood transfer could occur (needles, dehorning, castrating, extra teat removal, ear tagging, tattooing, hoof trimming, rectal palpations, drenching) and other procedures which transfer leukocytes, and routine insect control.

### Prevention of infection in calves and young stock

Several management techniques can be used to prevent infection in calves from birth until they become herd replacements. The feeding of newborn calves with colostrum and milk from seronegative cows has been widely accepted as effective in preventing infection in calves. Postnatal infection in calves can also be minimized by feeding milk replacer, and/or whole milk from non-infected cows. The use of colostrum and milk from non-infected cows permits early serological detection of infected calves. However, feeding colostrum from seropositive cows to newborn calves can provide significant protection from infection during the first 3 months of life. Field studies indicate that colostrum-derived BLV antibodies may prevent as much as 50% of the infection during the first 3 months compared to calves which did not receive colostrum with BLV antibodies. Further reduction in the risk of infection via colostrum can be achieved by pasteurization of the colostrum – 63°C for 30 min.<sup>64</sup> The colostrum-derived BLV antibodies will however delay early detection of infection in calves. The replacement of whole milk feeding with high-quality milk replacer may also be considered.

Transmission to newborn calves can also be reduced by avoiding exposure to maternal blood at the time of parturition, housing calves in individual hutches with individual feeders and waterers, and management techniques to avoid iatrogenic transmission.<sup>65</sup> When handling a group of calves, the youngest ones should be handled first and the older and sick calves last. Equipment which could act as fomites in transferring blood should be disinfected with chlorhexidine when used between calves. These instruments include:

- Nose tongs
- Scissors
- Forceps
- Dehorning instruments
- Esophageal tubes
- Balling guns
- Tattoo equipment
- Ear taggers.

Dehorning calves using the electrocautery method before 2 months of age can reduce the prevalence of infection compared to gouge dehorning, which allows the transfer of infected blood between calves. Handling facilities which become contaminated with blood should be cleaned between calves. Fly control should be instituted as necessary. Single needles should be used for vaccination and calves should be tested serologically for BLV infection at about 6 months of age.

A marked reduction in the prevalence of infection within the heifer age groups of a dairy herd with a high prevalence can be achieved by:

1. Use of single needles and individual sleeves for rectal examination
2. Disinfection of tattoo equipment before use
3. Dehorning by use of electrocautery.

### Biosecurity

**Prevention of entry of infection into herd** can be achieved by insuring that all imports into the herd have been tested at least 30 d prior to arrival and are seronegative. Control of insect vectors is highly desirable. Blood transfusions and vaccines containing blood, such as those used for babesiosis and anaplasmosis are particularly potent means of spreading the disease and donors must be carefully screened to insure that they are free of the disease. In the future the selection of cattle with inherent resistance to BLV may be a possibility. Embryo transfer from valuable pedigreed seropositive cows may aid in reducing prenatal infection. Insemination is not a method of transmission so that artificial breeding programs are not disrupted.

### Vaccine

The possibility of a vaccine for BLV has been explored.<sup>2</sup> However, the prospects are not good thus far. A BLV vaccine would have to be non-infectious, non-oncogenic, and should not interfere with the serological tests commonly used to detect infection.

### REVIEW LITERATURE

Johnson R, Kaneene JB. Bovine leukaemia virus and enzootic bovine leucosis. *Vet Bull* 1992; 62:287-312.

### REFERENCES

1. Dube S et al. *Virology* 2000; 277:379.
2. Johnson R, Kaneene JB. *Vet Bull* 1992; 62:287.
3. Peleteiro MC et al. *Vet Dermatol* 2000; 11:299.
4. Klintevall K. Bovine leukemia virus: course of infection and means of detection. Dissertation Department of Veterinary Microbiology Faculty of Veterinary Medicine Swedish University of Agricultural Sciences and The National Veterinary Institute Department of Virology Uppsala Sweden, 1995.
5. Reichel MP et al. *New Z Vet J* 1998; 46:140.
6. VanLeeuwen JA et al. *Can Vet J* 2001; 42:193.
7. Gnad DP et al. *Intern J Appl Res Vet Med* 2004; 2:215.
8. Trono KG et al. *Vet Microbiol* 2001; 83:235.
9. Molnar E et al. *Vet Rec* 2000; 146:705.
10. Meas S et al. *J Vet Med Sci* 2000; 62:779.
11. Zaghawa A et al. *J Vet Med B Infect Dis Vet Public Health* 2002; 49:123.
12. Bielanski A et al. *Vet Rec* 2000; 146:255.
13. Choi KY et al. *J Vet Diagn Invest* 2002; 14:403.
14. Wentink GH et al. *Vet Rec* 1993; 132:135.
15. Divers TJ et al. *Prev Vet Med* 1995; 23:133.
16. Meas S et al. *Vet Microbiol* 2000; 84:275.
17. Eaves FW et al. *Vet Microbiol* 1994; 39:313.
18. DaY et al. *Proc Natl Acad Sci* 1993; 90:6538.
19. Kabeya H et al. *J Vet Med Sci* 2001; 63:703.
20. Klintevall K et al. *Comp Immun Microbiol Infect Dis* 1997; 20:119.
21. Casal J et al. *Prev Vet Med* 1990; 10:47.
22. Chi J et al. *Prev Vet Med* 2002; 55:57.
23. Garazi S et al. *Israel J Vet Med* 2001; 56:125.
24. Sargeant JM et al. *Prev Vet Med* 1997; 31:211.
25. Hendrick SH. *Can Vet J* 2002; 43:617.
26. Goetschau A et al. *Am J Epidemiol* 1990; 131:356.
27. Chi J et al. *Prev Vet Med* 2002; 55:137.
28. Ott SL et al. *Prev Vet Med* 2003; 61:249.
29. Pollari FL et al. *Am J Vet Res* 1993; 54:1400.
30. Rhodes JK et al. *J Am Vet Med Assoc* 2003; 223:229.
31. Pollari FL et al. *Can J Vet Res* 1992; 56:289.
32. Rhodes JK. *J Am Vet Med Assoc* 2003; 223:346.
33. Buehring GC et al. *Aids Res Human Retro* 2003; 19:1105.
34. Motton DD, Buehring GC. *J Dairy Sci* 2003; 86:2826.
35. Reed VI. *Can Vet J* 1981; 22:95.
36. Sparling AM. *Can Vet J* 2000; 41:315.
37. Aljarrar AH et al. *J Am Vet Med Assoc* 2004; 224:1591.
38. Malatestinic A. *Can Vet J* 2003; 44:664.
39. Wellenberg GJ et al. *Vet Microbiol* 2002; 88:27.
40. Dubreuil P et al. *Can Vet J* 1998; 39:431.
41. Ivany JM et al. *Can Vet J* 2000; 41:486.
42. Oliver-Espinosa O et al. *Can Vet J* 1994; 35:777.
43. Southwood LL et al. *Vet Rec* 1996; 138:260.
44. Schweizer G et al. *Vet Rec* 2003; 153:525.
45. Valentine BA, McDonough SP. *Vet Pathol* 2003; 40:117.
46. Gutierrez SE et al. *Am J Vet Res* 2001; 62:1571.
47. Simard C et al. *Can J Vet Res* 2000; 64:96.
48. Simard C et al. *Can J Vet Res* 2000; 64:101.

49. Klintevall K et al. *Vet Microbiol* 1994; 42:191.
50. Brenner J et al. *Israel J Vet Med* 1994; 49:165.
51. Sargeant JM et al. *Prev Vet Med* 1997; 31:223.
52. Nagy DW et al. *J Am Vet Med Assoc* 2002; 220:1681.
53. Klintevall K et al. *Vet Microbiol* 1994; 42:191.
54. Fechner H et al. *J Vet Med Series B* 1996; 43:621.
55. Agresti A et al. *Am J Vet Res* 1993; 54:373.
56. Nagy DW et al. *J Am Vet Med Assoc* 2003; 222:963.
57. Kuckleburg CL et al. *J Vet Diagn Invest* 2003; 15:72.
58. Wernau W et al. *Vet Pathol* 1997; 34:222.
59. Wernau W et al. *Vet Pathol* 1992; 29:183.
60. Alexander AN et al. *J Vet Int Med* 1996; 10:275.
61. Gibson LAS. *Vet Rec* 1995; 136:156.
62. Schmitz DG, Seahorn TL. *J Am Vet Med Assoc* 1990; 205:159.
63. Nuotio L et al. *Prev Vet Med* 2003; 59:43.
64. Sprecher DJ et al. *J Am Vet Med Assoc* 1991; 199:584.
65. Thurmond MC. *Cornell Vet* 1991; 81:227.

## Bovine immunodeficiency-like virus

### ETIOLOGY

Bovine immunodeficiency-like virus (BIV), also known as bovine lentivirus-1, is a lentivirus, within the larger family of Retroviridae. The virus shares structural and genomic similarities with other lentiviruses, such as equine infectious anemia virus, caprine arthritis-encephalitis virus, maedi-visna virus, feline, and the simian and human immunodeficiency viruses. The BIV was first described in cattle in the United States in 1972.<sup>1</sup> These viruses replicate primarily in the cells of the host's immune system following their insertion as provirus into the genome of these target cells, thus establishing a chronic, lifelong infection. The lentiviruses above are usually associated with specific diseases. However, a clear involvement of BIV in the development of a clinical syndrome is not well established.

### EPIDEMIOLOGY

#### Prevalence of infection

Seroepidemiological evidence indicates that BIV infection has a worldwide distribution. Seropositive cattle have been identified in the United States, the Netherlands, New Zealand, Australia,<sup>2</sup> Bali,<sup>3</sup> Indonesia, Brazil,<sup>4</sup> and Canada with estimates ranging from 1-5%.<sup>5,6</sup> In Italy, the prevalence is 5.8% in dairy cattle and 2.5% in beef cattle.<sup>7</sup> In individual herds the prevalence of infection may be much higher. In the UK, the seroprevalence was found to be 5.9% in dairy cattle and 5.0% in beef cattle.<sup>8</sup> The dairy and beef herd prevalences were 60% and 59%, respectively. While the BIV infection in the UK is low, it is widespread. Recent studies, using DNA, derived from semen and buffy coat samples, analyzed by nested PCR, found no evidence of BIV infection in western Canadian cattle.<sup>9</sup>

A seroprevalence of greater than 50% was present in a dairy herd at a university in the southeastern United States, which is an area with a high prevalence of infection in the cattle population.<sup>10</sup> There is some evidence that in some cattle herds with a high incidence of unthrifty animals, the prevalence of seropositive animals may be as high as 95%.<sup>11</sup> The prevalence of BIV infection among dairy cattle in Ontario is low and may be associated with an economically important decrease in milk production.<sup>6</sup> Dual infection with BIV and BLV have been reported in Mississippi dairy cattle.<sup>10</sup>

The virus has been found in the seminal leukocytes of 82% of randomly selected semen samples from a bovine stud semen repository<sup>12</sup> suggesting the possibility that artificial insemination of dairy cows may have a major role in the transmission of the virus. The BIV may be involved in the pathogenesis of mastitis in cattle due to its immunosuppressive effects but no clear evidence is available.<sup>13</sup>

Retroviruses are heat labile and readily inactivated at 56°C, and pasteurization of milk for human consumption should provide an adequate safeguard. Feeding milk seeded with the virus and pasteurized before inoculation into calves is effective in inactivating the virus and preventing transmission.<sup>14</sup> There is no evidence that the virus is a potential human pathogen.

#### Methods of transmission

The virus is strongly cell-associated and may be transmitted in infected blood, colostrum, and milk that contains lymphoreticular cells.<sup>15</sup> There is some evidence of transplacental infection of the virus in cattle. In dairy cows naturally infected with BIV and seropositive at parturition, 40% gave birth to calves that were BIV seropositive before receiving colostrum;<sup>16</sup> seronegative cows do not. Calves born with anti-BIV-specific antibody do not demonstrate increased risk of clinical disease during the neonatal period but the calves born to dams which are seropositive at parturition appear to be at increased risk of occurrence of some clinical signs. The prevalence rate of infection among bulls housed in stud farms was 9.6% using serology, and 12.6% using PCR for the presence of BIV provirus in peripheral blood leukocytes.<sup>17</sup>

The BIV has no obvious morphological effects on the embryonic development of cattle and it is possible to obtain embryos at the transferable stage free of the virus from cows infected with the virus.<sup>18</sup> It is unlikely that BIV is associated with the zona pellucida-intact embryos derived by *in vitro* fertilization from oocysts obtained from infected animals or with oocysts fertilized with infected semen when

embryos are washed as recommended by the International Embryo Transfer Society. Embryos from donors infected with the virus are not likely to transmit the virus to recipients and the resulting offspring.<sup>19</sup>

#### PATHOGENESIS

The pathogenetic mechanisms of BIV infection are unclear. Its pathogenicity is controversial. It is uncertain if the virus is a primary pathogen or a primary immunodeficiency virus which predisposes the animal to secondary infections.<sup>15</sup> Despite extensive experimental studies the pathogenic significance of the virus is uncertain.

Infection of cattle with BIV is associated with lymphoproliferation, lymphadenopathy, immunosuppression, neuropathy, and progressive emaciation.<sup>15</sup>

The virus was initially isolated from a cow with persistent lymphocytosis, lymphadenopathy, neuropathy and progressive emaciation. However, overt clinical disease in seropositive cattle is rare and experimentally induced infection in calves has resulted in only mild clinical consequences.<sup>20</sup>

Early studies of inoculation of calves with the virus resulted in lymphoproliferative disease and lymphocytosis and persistence of the virus.<sup>1</sup> Later studies have failed to reproduce significant clinical disease which may in part be due to the long incubation period.<sup>11</sup> It is also possible that the lentiviruses have variable virulence due to genetic variation producing viruses with both antigenic and biological heterogeneity in pathogenesis.<sup>11</sup> Experimental infection of an 11-month-old calf with the virus was followed by the development of a T-cell lymphosarcoma<sup>21</sup> and the bovine leukosis virus was not present.

The virus and its DNA have been detected in the blood and semen of experimentally infected bulls.<sup>22</sup> But the virus has not been detected in the semen, blood leukocytes, or semen leukocytes of samples supplied by artificial insemination centers.<sup>23</sup>

Retroviruses, including the lentiviruses, are characterized by the expression of the unique enzyme, reverse transcriptase, which facilitates the transcription of the RNA of an infectious virus to a complementary DNA copy. The viral DNA has the ability to become incorporated into the host's cell nucleus as a 'provirus'. Proviruses are non-infectious, can remain latent for many years and persist in the presence of antibody. Changing the virus from its latent form into an infectious RNA virus can occur and depends on activation of the latently infected cells. The stimuli for activation can include concurrent infection and stress, or both. While other lentiviruses such as equine

infectious anemia virus can cause severe clinical disease, the cause and effect relationship between BIV infection in cattle and clinical disease has not yet been documented.

#### CLINICAL FINDINGS

Naturally occurring BIV infection in Holstein dairy cattle in Louisiana, US, have been described.<sup>24</sup> Progressive weight loss was common, and concurrent infections included metritis, subcutaneous abscesses, purulent arthritis, laminitis and infectious pododermatitis, fascioliasis, and mastitis. Reduced vitality, dullness and stupor were also common.

The course of the disease varied from 3 to 40 weeks.

#### CLINICAL PATHOLOGY

**Detection of virus.** A PCR test has been used to detect the BIV in the blood and milk of BIV-seropositive cows.<sup>25</sup> The virus can be detected in experimentally infected calves using PCR in peripheral blood mononuclear cells.<sup>26</sup>

**Serological tests.** Using the BIV ELISA, naturally occurring cases in dairy cattle are serologically positive.<sup>24,27</sup> An indirect immunofluorescent antibody test has been used to detect seroconversion in experimentally infected bulls by 17 days after infection.<sup>22</sup> The sensitivity and specificity of the indirect fluorescent-antibody assay (IFA) and the nested-set PCR have been compared using Bayesian techniques.<sup>28</sup> The PCR is the more sensitive assay.

#### NECROPSY FINDINGS

Moderate to marked enlargement of hemal lymph nodes have been described.<sup>24</sup> Lymphoid depletion is common and characterized by an absence of follicular development in nodes draining regions with secondary infections. Encephalitis characterized by meningeal, perivascular and parenchymal infiltration with lymphocytes, plasma cells and macrophages with perivascular edema has been observed.<sup>27</sup> Several secondary infections have been observed in cattle with BIV infection but the role of BIV as a predisposing pathogen is uncertain.

#### REVIEW LITERATURE

Gonda MA. Bovine immunodeficiency virus. *AIDS* 1992; 6:759–776.

#### REFERENCES

- Gonda MA. *AIDS* 1992; 6:759–776.
- Burkala EJ et al. *Vet Microbiol* 1999; 68:171.
- Barboni P et al. *Vet Microbiol* 2001; 80:313.
- Meas S et al. *Jpn J Vet Res* 2002; 50:9.
- Jacobs RM et al. *Can J Vet Res* 1995; 59:271.
- McNab WB et al. *Can J Vet Res* 1994; 58:36.
- Cavirani S et al. *Prev Vet Med* 1998; 37:147.
- Scobie L et al. *Vet Rec* 2001; 149:459.
- Gonzalez GC et al. *Can J Vet Res* 2001; 65:73.
- St Cyr Coats 1995; *Vet Rec* 136:269.
- Brownlie J et al. *Vet Rec* 1994; 134:289.
- Nash JW et al. *Am J Vet Res* 1995; 56:760.

13. Wellenberg GJ et al. *Vet Microbiol* 2002; 88:27.
14. Venables C et al. *Vet Rec* 1997; 140:275.
15. Evermann JF et al. *J Am Vet Med Assoc* 2000; 217:1318.
16. Scholl DT et al. *Prev Vet Med* 2000; 43:239.
17. Jacobs RM et al. *Can J Vet Res* 1998; 62:231.
18. Bielanski A et al. *Vet Res Commun* 2001; 25:663.
19. Bielanski A et al. *Theriogenol* 2001; 55:641.
20. Flaming K et al. *Vet Immunol Immunopathol* 1993; 36:91.
21. Rovid AH et al. *Vet Pathol* 1996; 33:457.
22. Gradil CM et al. *Vet Microbiol* 1999; 70:21.
23. Burger RA et al. *Am J Vet Res* 2000; 61:816.
24. Snider III TG et al. *Comp Immunol Microbiol Infect Dis* 2003; 26:89.
25. Nash JW et al. *Am J Vet Res* 1995; 56:445.
26. Baron T et al. *Arch Virol* 1998; 143:181.
27. Snider III TG et al. *Comp Immunol Microbiol Infect Dis* 1996; 19:117.
28. Orr KA et al. *Prev Vet Med* 2003; 61:79.

## Viral diseases characterized by alimentary tract signs

### FOOT-AND-MOUTH DISEASE (FMD, APHTHOUS FEVER)

#### Synopsis

**Etiology** Foot-and-mouth disease virus, an aphthovirus

**Epidemiology** Affects ruminants and pigs. Highly contagious, usually low mortality but great economic impact worldwide

**Pathogenesis** Inhalation/ingestion → oropharyngeal infection → viremia → epidermal cells → signs and lesions enhanced by mechanical trauma

**Clinical signs** Fever, profuse salivation, vesicles in mouth and feet, sudden death in young animals

**Clinical pathology/diagnostic confirmation** Virus isolation, serology and RT-PCR detection. Typing confirmed in a reference laboratory

**Lesions** Vesicular, erosive/ulcerative stomatitis and esophagitis, vesicular/ulcerative dermatitis (feet and teats) and in neonates, interstitial mononuclear and necrotic myocarditis

#### Differential diagnostic list

Vesicular stomatitis  
Vesicular exanthema  
Swine vesicular disease  
Rinderpest  
Bovine viral diarrhea

**Treatment.** None except symptomatically.

**Control.** Mass vaccination with killed vaccines in endemic areas, eradication by slaughter when feasible, and strict quarantine during outbreaks

#### ETIOLOGY

Foot-and-mouth disease is associated with an aphthovirus (family Picornaviridae) which occurs as seven major serotypes: A, O, C, Southern African Territories (SAT) 1, SAT 2, SAT 3 and Asia 1. However, there are a number of immunologically and serologically distinct subtypes with different degrees of virulence, especially

within the A and O types. As there is no cross-immunity between serotypes, immunity to one type does not confer protection against the others. This presents difficulties to vaccination programs. Furthermore, there can be great changes in antigenicity between developing serotypes; virulence may also change dramatically. There are also biotypical strains which become adapted to particular animal species and then infect other species only with difficulty. There are strains that are much more virulent for pigs (so-called porciphilic strains), some for buffalo, and some even for tropical breeds of cattle, which generally react only mildly to endemic strains. Newer techniques for identifying subtypes involve enzyme-linked immunosorbent assay (ELISA), reverse transcriptase-polymerase chain reaction (RT-PCR) and nucleotide sequence analysis.<sup>1</sup>

#### EPIDEMIOLOGY

##### Occurrence

FMD affects all cloven-footed animals and is endemic in Africa, Asia, South America and parts of Europe. The disease can occur in any country but Japan, New Zealand and Australia are disease free. A devastating epidemic occurred in Taipei, China in 1997 and over 4 million pigs died or were slaughtered within a few months.<sup>2</sup> The virus was believed to have been introduced from a neighboring country through the smuggling of animal products on fishing boats. Western Europe is essentially free of the disease but cattle imported from Eastern Europe gave rise to an epidemic in Italy during 1993. More recently, there was a massive outbreak in Britain in 2001 which spread to Ireland, France and The Netherlands before it was eventually contained. The outbreak was traced to illegal import to the UK of infected meat products. Spread within the country and to other countries was mostly through the movement of livestock not showing obvious clinical signs. As for North America, the last outbreak in the United States was in 1929, Canada in 1951–1952, and Mexico in 1946–1954. During the outbreaks, movement of cattle and cattle products between the United States and either Canada or Mexico was brought to a standstill. The importance of the Darien Gap in maintaining the disease-free status of North America is well known. This tract of impassable territory between Colombia and Panama prevents any chance of direct contact between cattle populations in North and South America.

##### Prevalence

There are no reliable figures for the prevalence of FMD in different countries. The disease generally occurs in the form of an

outbreak that rapidly spreads from herd to herd before it is controlled. Of the seven standard types, O, A and C are prevalent in all continents where the disease occurs, SAT 1 is found in Africa and Asia, and SAT 2 and SAT 3 are limited to Africa, whereas Asia 1 occurs only in Asia. These limitations are due more to the pattern of the meat trade than to any inherent properties of the serotypes. Overall, outbreaks of types O and A occur more frequently than the others.

##### Morbidity and case-fatality rate

The morbidity rate in outbreaks of FMD in susceptible animals can rapidly approach 100% but some strains are limited in their infectivity to particular species. However, the case fatality is generally very low, about 2% in adults and 20% in young stock. Nonetheless, severe outbreaks of a more violent form sometimes occur as in the 1997 Taiwan outbreak in pigs where case fatality was 18% and reaching 100% in piglets,<sup>2</sup> or in calves of exotic dairy animals in Nigeria.<sup>3</sup> During outbreaks in non-endemic countries, most deaths are due to a slaughter policy that usually involves all susceptible animals and herds in contact with, or within a certain radius of, the infected herd.

##### Methods of transmission

FMD is transmitted by a variety of methods between herds, countries and continents but spread from one animal to another is by inhalation or by ingestion. In endemic areas, the most important method of spread is probably by direct contact between animals moving across state and national boundaries as trade or nomadic cattle. In non-endemic areas such as Europe, the first introduction to a new area is often via pigs which contract infection by ingestion of infected meat scraps. Spread from these pigs to cattle is via movement of people, abattoir waste or animals. Further spread between cattle is more likely to be by airborne means. The virus can persist in aerosol form for long periods in temperate or subtropical climates but not in hot and dry climates. The speed and direction of the wind are important factors in determining the rate of airborne spread. Humidity is also important but rain as such appears not to be. In the most favorable circumstances, it is now estimated that sufficient virus to initiate an infection can be windborne as far as 250 km (156 miles). There are peaks of spread at dawn and dusk. Animals in the United Kingdom are believed to be vulnerable to airborne transmission of the virus from the European mainland. It has been shown that pigs are the most potent excretors of airborne virus and cattle the most susceptible to airborne infections. During the 2001 outbreak in England,



there was no indication of airborne spread to the mainland, perhaps because ruminants rather than pigs were mostly affected.

In cattle, the first site of virus infection and subsequent rapid multiplication is the pharynx. Following a few days of viremia, the virus appears in milk and saliva for up to 24 h before vesicles appear in the mouth. All other excretions including urine, feces and semen may be similarly infective before the animal is clinically ill and for a short period after signs have disappeared. However, the period of maximum infectivity is when vesicles are discharging, since vesicular fluid contains the virus in maximum concentration. Although it is generally conceded that affected animals are seldom infective for more than 4 d after the rupture of vesicles, except insofar as the virus may persist on the skin or hair, some animals may remain as **carriers** and are now believed to be important in the epidemiology of the disease in the field.<sup>4</sup> In cattle, carriers may develop during convalescence from the natural disease, or more importantly in vaccinated animals which are exposed to infection. Up to 50% of cattle, sheep and goats may become carriers, but pigs do not.

The nasopharynx is the main site for persistence of the FMD virus and erratic low-level excretion may occur for up to 2 years. The virus may also persist in mammary tissue for 3–7 weeks. Wild fauna may serve as FMD reservoir and in southern, central and eastern Africa, the African buffalo (*Syncerus caffer*) is a significant reservoir. Humans are often a vehicle for transmission of the virus. It has been recovered from the nasal mucosa of persons working with infected cattle for up to 28 h after contact. Nose-blowing did not eliminate it nor did cotton face masks prevent infection. In a more recent study, the virus could not be detected in nasal secretions 12 h after contact, and contaminated personnel could not transmit the disease to susceptible pigs and sheep after they had showered and changed into clean outer wear.<sup>5</sup>

The disease is **spread from herd to herd** either directly by the movement of infected animals, or indirectly by the transportation of virus on inanimate objects, particularly uncooked and unprocessed meat products and other animal products, including milk. The pH and temperature of milk significantly affect survival, which may be as long as 18 h. Flash pasteurization procedures, as distinct from the holding method, do not inactivate the virus in milk – neither does evaporation to milk powder or processing into butter, cheese or casein products.

Introduction of FMD into a herd or country as a result of the use of infected

cattle semen for artificial insemination is possible. The virus can also be detected in the semen of infected boars, but this has not been a means of transmitting it. Similarly, it is not transmitted through the transfer of embryos from viremic donor cows.<sup>6</sup>

Epidemics in free areas occur intermittently and from a number of sources. In England it was estimated that outbreaks arose in the following manner:

- Meat products used as pig food – 40%
- Completely obscure causes – 28%
- Transportation by birds – 16%
- Contact with meat and bones other than swill – 9%
- Unknown causes (probably swill) – 7%.

The greatest danger appears to be from uncooked meat scraps fed to pigs. A common pattern is the importation of the virus in sheep meat, from sheep which showed no illness, an initial infection in pigs, and then spread to cattle. However, more unusual methods of introduction must not be disregarded. With modern methods of transport, farm workers can carry the virus long distances in their clothing.

### Risk factors

#### Host factors

The disease is most important in cattle and pigs but goats, sheep, buffaloes in India and llama in South America are also affected. Some strains of the virus are limited in their infectivity to particular species. Although cattle, sheep and goats can be carriers, they are not regular sources of infection, and early studies in Kenya showed that goats were infrequent carriers, and sheep not at all.<sup>7</sup> Immature animals and those in good condition are relatively more susceptible and hereditary differences in susceptibility have also been observed. Horses are not susceptible to the disease.

A variety of **wildlife species** such as the deer in England, the water buffalo (*Bubalus bubalis*) in Brazil and wild ungulates in Africa become infected periodically but are believed to play little or no role as reservoirs of infection for domestic animals. A notable exception is the **African buffalo (*Syncerus caffer*)**, probably the natural host of the SAT types of the virus and the major source of infection for cattle in southern Africa.<sup>8</sup> The disease in buffalo populations is mild but the infection rate is often high and can be persistent. On the other hand, the domesticated **Asian buffalo** shows typical clinical disease and spread from buffalo to other species. Small rodents and hedgehogs in Europe and capybaras in South America may also act as reservoirs.

### Environmental and pathogen factors

The virus is resistant to external influences including common disinfectants and the usual storage practices of the meat trade. It may persist for over 1 year in infected premises, for 10–12 weeks on clothing and feed, and up to a month on hair. It is particularly susceptible to changes in pH away from neutral. Sunlight destroys the virus quickly but it may persist on pasture for long periods at low temperatures. Boiling effectively destroys the virus if it is free of tissue but autoclaving under pressure is the safest procedure when heat disinfection is used. The virus can survive for more than 60 days in bull semen frozen to  $-79^{\circ}\text{C}$  ( $-110^{\circ}\text{F}$ ). In general, the virus is relatively susceptible to heat and insensitive to cold. Most common disinfectants exert practically no effect, but sodium hydroxide or formalin (1–2%) or sodium carbonate (4%) will destroy the virus within a few minutes.

All uncooked meat tissues, including bone, are likely to remain infective for long periods, especially if quick-frozen, and to a lesser extent meat chilled or frozen by a slow process. The survival of the virus is closely associated with the pH of the medium. The development of acidity in rigor mortis inactivates the virus but quick freezing suspends acid formation and the virus is likely to survive. However, on thawing, the suspended acid formation recommences and the virus may be destroyed. Prolonged survival is more likely in viscera, bone marrow and in blood vessels and lymph nodes, where acid production is not so great. Meat pickled in brine, or salted by dry methods may also remain infective. For example, dry-cured Serrano and Iberian hams from experimentally infected pigs were shown to contain viable virus for up to 6 months.<sup>9</sup> Fomites, including bedding, mangers, clothing, motor tires, harness, feedstuffs and hides, may also remain a source of infection for long periods. There are claims that the virus can pass unchanged through the alimentary tracts of birds which may thus act as carriers and transport infection for long distances and over natural topographical barriers such as mountain ranges and sea.

Some outbreaks in Europe have been associated with vaccine virus either accidentally escaping from the laboratory or that was incompletely inactivated.<sup>10</sup>

### Immune mechanism

In endemic areas, periodic outbreaks occur which sweep through the animal populations and then subside. A 6-year epidemic cycle has been demonstrated in India.<sup>11</sup> This is probably due to the disappearance of immunity which develops during an epidemic and the sudden flaring

up from small foci of infection when the population becomes susceptible again. Immunity after natural infection lasts for 1–4 years in cattle and for a shorter time in pigs. When outbreaks follow each other in quick succession, the presence of more than one strain of virus should be suspected. In countries where general vaccination is practiced every year, outbreaks are usually associated with different strains imported in carrier animals or infected meat.

#### Experimental reproduction

The clinical signs and lesions of FMD can be reproduced by rubbing virus-containing material on the oral mucosa of susceptible cattle or by intradermal inoculation into the dorsum of the tongue. The disease can easily spread from infected to susceptible animals housed in close proximity (cohabitation). With mice and guinea pigs, inoculation of footpads of hind feet is preferred (see Clinical pathology below).

#### Economic importance

With the possible exception of bovine spongiform encephalopathy (mad cow disease), FMD is the most feared animal disease in the developed world, even though the mortality rate is low. This is because it is the most contagious disease of livestock and has a great potential for causing severe economic loss in high producing animals. Losses occur in many ways although loss of production, the expense of eradication and the interference with movement of livestock and meat between countries are the most important economic effects. There are also significant losses in agriculture and tourism due to restriction on human movement. In Canada, it was estimated in the 1980s that if an outbreak were to occur in 10–15 farms and was eradicated in 6 months, it would still result in farm cash receipts declining by CAN\$2 billion in 5 years.<sup>12</sup> The 2001 outbreak in the United Kingdom was eradicated within 7 months but resulted in the death of nearly 10 million livestock costing up to 8 billion pounds sterling (about US\$12 billion).<sup>13</sup> However, in unimproved or low-grade *Bos indicus* cattle reared under extensive or nomadic system of management, or in pigs in some southeast Asian countries, FMD is often less severe and it impacts less on the subsistent producer. Nevertheless, because of its severity in exotic or improved breeds, and because of its impact in international trade, FMD control and eradication in such countries will still result in a strong benefit–cost ratio in places like Thailand.<sup>14</sup>

#### Zoonotic implications

Humans are believed to be slightly susceptible to infection with the virus and

vesicles may develop in the mouth or hands. Very few cases have been reported even among people working with infected carcasses and laboratories. However, humans and particularly their clothing can be vehicles for transmission to animals.

#### Biosecurity concerns

Since FMD is highly contagious, there are biosecurity concerns regarding intentional or accidental introduction of the virus into nonendemic countries. Intentional introduction would be a form of agroterrorism and this would be devastating in any country that is FMD-free, since it would probably take some days before the disease would be recognized and much longer before it could be stamped out. Laboratories working with FMD virus or producing FMD vaccines and reagents must comply with OIE requirements for Containment Group 4 pathogens to ensure that there is no escape of the virus. There are also strict regulations for shipping diagnostic samples to national or international laboratories.

#### PATHOGENESIS

Virus particles first attach to mucosal epithelial cells, penetrate into the cytoplasm and replicate until the cells disintegrate. This releases more viral particles to infect other cells, including macrophages which drain into the efferent lymphatic system and then the blood. Irrespective of the portal of entry, once infection gains access to the bloodstream, the virus is widely disseminated to many epidermal sites, probably in macrophages, but gross lesions develop only in areas subjected to mechanical trauma or unusual physiological conditions<sup>15</sup> such as the epithelium of the mouth and feet, the dorsum of the snout of pigs and the teats. Characteristic lesions develop at these sites after an incubation period of 1–21 d (usually 3–8 d in most species). The initial phase of viremia is often unnoticed and it is only when localization in the mouth and on the feet occurs that the animal is found to be clinically abnormal.

The experimental disease in sheep is characterized by an incubation period of 4–9 d after contact or 1–3 d after virus inoculation. Thereafter, viremia occurs at 17–74 h and hyperthermia from the 17–96 h. Clinical signs are serous nasal discharge, salivation and buccal lesions in 75% and foot lesions in 25% of cases. At the end of viremia, the animal recovers but the virus may persist in the pharyngeal area of convalescent ruminants as previously discussed.

Bacterial complications generally aggravate the lesions, particularly those of the feet and the teats, leading to severe lameness and mastitis, respectively. In young animals, especially neonates, the virus

frequently causes necrotizing myocarditis and this lesion may also be seen in adults infected with some strains of the virus, particularly type O.

#### CLINICAL FINDINGS

In typical field cases in cattle, there is an incubation period of 3–6 d, but it may vary between 1 and 7 d. The onset is heralded by a precipitate fall in milk yield and a high fever (40–41°C; 104–106°F), accompanied by severe dejection and anorexia, followed by the appearance of an acute painful stomatitis. At this stage, the temperature reaction is subsiding. There is abundant salivation, the saliva hanging in long, ropy strings, a characteristic smacking of the lips, and the animal chews carefully. Vesicles and bullae (1–2 cm in diameter) appear on the buccal mucosa, dental pad and tongue. These rupture within 24 h, leaving a raw painful surface which heals in about 1 week. The vesicles are thin walled they rupture easily and contain a thin, straw-colored fluid. Concurrently with oral lesions, vesicles appear on the feet, particularly in the clefts and on the coronet. Rupture of vesicles causes acute discomfort and the animal is grossly lame, often recumbent, with a marked, painful swelling of the coronet.

Secondary bacterial invasion of foot lesions may interfere with healing and lead to severe involvement of the deep structures of the foot. Vesicles may occur on the teats and when the teat orifice is involved, severe mastitis often follows. Pregnant animals may abort or have stillbirths. Very rapid loss of condition and fall in milk yield occur during the acute period and these signs are much more severe than would be anticipated from the extent of the lesions. Eating is resumed in 2–3 d as lesions heal but the period of convalescence may be as long as 6 months. Young animals are more susceptible and may suffer heavy mortality from myocardial damage, even when typical vesicular lesions are absent in mouth and feet.

In most outbreaks, the rate of spread is high and clinical signs are as described earlier but there is a great deal of variation in virulence and this may lead to difficulty in field diagnosis. For example, there is a malignant form of the disease in adults in which acute myocardial failure occurs. There is a typical course initially but a sudden relapse occurs on days 5–6 with dyspnea, a weak and irregular heart action, and death during convulsions. Occasional cases show localization in the alimentary tract with dysentery or diarrhea, indicating the presence of enteritis. Ascending posterior paralysis may also occur. On the other hand, there is a mild form which usually occurs when endemic strains infect only indigenous *Bos indicus* (Zebu)

cattle. This is the form most commonly seen in endemic countries in Africa, Asia and South America.

A sequel to FMD in cattle, due probably to endocrine damage, is a chronic syndrome of dyspnea, anemia, overgrowth of hair and lack of heat tolerance. Affected cattle are described colloquially as 'hairy panthers'. Diabetes mellitus has also been observed as a sequel in cattle.

In sheep, goats and to a lesser extent, pigs, the disease is often mild and go unnoticed, and is important mainly because of the danger of transmission to cattle, but a devastating epidemic involving pigs only occurred in Taiwan in 1997.<sup>2</sup> Large vesicles and bullae occur in the snout and feet and these may rupture to expose large, raw surfaces. Adult sheep may develop a syndrome identical to that of cattle so that it becomes a crippling disease with occasional loss of hooves from bacterial complications. Goats are sometimes spared during an outbreak. The more common syndrome in these species is the appearance of a few, small lesions, but with more severe involvement of all four feet. As in cattle, young stock are more susceptible.

#### CLINICAL PATHOLOGY

Exhaustive laboratory studies are needed for diagnosis, determination of the type of the virus involved and to differentiate the disease from vesicular stomatitis, vesicular exanthema and swine vesicular disease. A handbook of the tests is available on line.<sup>1</sup> Fresh vesicular fluid and surrounding epithelial tissue should be collected in glycerol-saline for laboratory tests. This is the sample of choice. If the vesicles are

already healing, blood should be collected, along with esophageal-pharyngeal (OP) fluid samples from ruminants or throat swabs from pigs. The OP samples should be collected from up to five animals with the use of a probang cup. The major methods for diagnosis are:

#### 1. Identification of the agent in tissue or fluid.

- (a) *Virus isolation* by inoculation into cell cultures or unweaned mice. The FMD virus is cultivable on tissue culture and in hen eggs, and use is made of this in the preparation of live attenuated or inactivated vaccines. In diagnosis, neutralization of the virus by known antisera is highly efficient
- (b) Immunological methods:
  - *Enzyme-linked immunosorbent assay (ELISA)*: This is the preferred test. The indirect ELISA can detect the FMDV antigen in epithelial cells and in South America, this technique with polyvalent antisera against types O, A and C was more effective for the routine diagnosis of epithelial samples from field cases than was the same technique using monovalent antisera.<sup>16</sup> It can simultaneously test for SVD or VS
  - *Complement fixation test (CFT)*: Direct CFT on epithelial suspension is one of the fastest methods of making a positive diagnosis, within a few hours. But negative samples must be checked in tissue cultures because of the number of false-negatives which

occur with the CFT, especially in poorly collected and packaged samples. Type-specific and strain-specific complement-fixing antisera can be prepared and this permits typing of strains in an outbreak. Diagnostic antisera can also be prepared for differentiation from vesicular stomatitis

- *Nucleic acid recognition methods*: These include the reverse transcription polymerase chain reaction (RT-PCR) and the in situ hybridization (ISH). The RT-PCR amplifies fragments of FMD genome in samples and can be used for typing. It is more sensitive than ELISA. A portable real-time RT-PCR that can be performed within 2 h has been described.<sup>17</sup> The ISH detects FMD virus RNA in infected tissues including those obtained during necropsy
- (c) *Virus morphology* by electron microscopy.

#### 2. Serological tests for specific antibody response to FMD structural or nonstructural proteins:

- *Virus neutralization (VN)*, a prescribed test for international trade. It is serotype specific
- *Solid-phase competitive enzyme-linked immunosorbent assay (ELISA)*, another prescribed test
- *Liquid-phase blocking ELISA*
- *Nonstructural protein (NSP) antibody tests* that enable detection of past or current infection, irrespective of vaccination status. They are more useful on a herd basis. The test

Table 21.3 Differentiation of acute vesicular disease

Animal species	Route of inoculation	FMD	Vesicular stomatitis	Vesicular exanthema of swine	Swine vesicular disease	Bluetongue
<b>Natural infection</b>						
Cattle		+	+	-	-	+ (occurs rarely)
Pig*		+	+	+	+	-
Sheep and goat		+	±	-	-	+
Horse		-	+	-	-	-
<b>Experimental Transmission</b>						
Cattle	Intradermal in tongue, gums, lips	+	+	-	-	+
	Intramuscular	+	-	-	-	
Pig*	Intradermal in snout, lips	+	+	+	+	
	Intravenous	+	-	-	+	
	Intramuscular					
Sheep and goat	Various	+	+	-	+	(no lesions) +
Horse	Intradermal in tongue	-	+	+	-	
	Intramuscular			+	-	
Guinea pig	Intradermal in footpad	+	+	-	-	-
Unweaned white mice	Intradermal	+	+	-	+	+
Adult chicken		+	+	-	-	

White skinned pigs fed on parsnips or celery and exposed to sunlight develop vesicles.

measures antibody to virus infection-associated antigen (VIAA) by agar gel immunodiffusion (AGIP), or better, antibody to NSPs produced by recombinant techniques.

- 3. Experimental transmission.** The propagation of the virus in unweaned white mice can be used to detect the presence of virus in suspected material, the presence of antibodies in serum and for investigations into the transmission of immunity and the pathogenesis of the disease. In guinea pigs, intradermal injection of fresh vesicular fluid into the plantar pads causes vesicles to appear on the pads in 1–7 d and secondary vesicles in the mouth 1–2 d later. Large animal inoculation may be used for the differentiation of FMD, vesicular stomatitis and vesicular exanthema based on the different species' susceptibilities to the three viruses (Table 21.3) as well as to test the potency of vaccines. To avoid disseminating the virus, animal inoculation should be done only in specially equipped facilities.

#### NECROPSY FINDINGS

The lesions of FMD consist of vesicles and erosions in the mouth and on the feet and udder. The erosions often become ulcers especially if secondary bacterial infection has occurred. In some cases, vesicles may extend to the pharynx, esophagus, forestomachs, and intestines as well as trachea and bronchi. The teats and mammary gland are often swollen. In the malignant form and in neonatal animals, epicardial hemorrhages with or without pale areas are also present. Grossly, the ventricular walls appear streaked with patches of yellow tissue interspersed with apparently normal myocardium, giving the typical 'tiger heart' appearance. If the animal survives, there is replacement fibrosis and the heart is enlarged and flabby.

Histologically, vesicles start as foci of progressive swelling, necrosis and lysis of infected keratinocytes in the deeper layers of the epidermis and accumulation of fluid in the space. This is followed by necrosis of overlying keratinocytes and rupture of vesicles to form erosions that may extend deep into the dermis to form ulcers, especially on the feet. There is only mild leukocytic infiltration around the erosions and ulcers. Similar changes in mammary gland epithelium lead to acinar necrosis and mild interstitial cellular infiltration. Heart (and occasionally skeletal muscle) lesions in the malignant form are characterized by severe hyaline degeneration, necrosis and occasional calcification of myocardial fibers and marked inter-

stitial infiltration by mononuclear cells. In addition, pancreatic islet and acinar degeneration has been reported in chronically infected cattle.

Tissues to be submitted for histopathology should include oral mucosa and skin containing vesicles or fresh erosions. The heart, mammary gland and pancreas should also be included. Viral antigen can be detected in tissues by immunohistochemistry. Since most animals infected with FMD will not die, and since it is important to make prompt diagnosis from clinical cases, histopathology of necropsy materials is often secondary.

#### DIFFERENTIAL DIAGNOSIS

The need to identify FMD is of paramount importance in all countries. It is of particular importance in those countries in which the disease is not endemic because of the need to introduce strict control measures quickly. The field veterinarian must be able to recognize suspicious cases, take appropriate samples and submit to a laboratory facility able to confirm the diagnosis promptly. Clinical signs in sheep and goats may be difficult to recognize. In countries where the disease is endemic, there are special difficulties in clinical recognition because of the frequent subdued severity of the oral and feet lesions even in cattle. Where the other vesicular diseases do not occur, suspicions will be readily aroused, but in North America, the presence of vesicular stomatitis and vesicular exanthema may result in misdiagnosis. Vesicular stomatitis in horses, cattle and swine, vesicular exanthema of swine and swine vesicular disease resemble FMD closely (Table 21.3). Three other vesiculoviruses – Piry, Chandipura and Isfahan – cross-react with vesicular stomatitis virus<sup>18</sup> but are much less virulent. The observations that white-skinned pigs fed parsnips or celery and exposed to sunlight will develop vesicles on the snout and feet,<sup>19</sup> and that cattle fed on grain treated with caustic soda can develop profuse salivation<sup>20</sup> are further confounding factors in the differentiation of the vesicular diseases.

Bluetongue of sheep may also present a problem in differentiation. Details of these are provided separately but a summary is given in Table 21.3. Rapid laboratory differentiation and diagnosis of these diseases may be achieved as described under Clinical Pathology (see above).

Bovine viral diarrhea/mucosal disease, rinderpest, malignant catarrhal fever and lumpy skin disease are easily differentiated by the lesions which develop in the mucosa and sometimes on the feet. The lesions are never vesicular, commencing as superficial erosions and proceeding to the development of ulcers. Pox infections of the mammary gland and foot rot in sheep should also be differentiated from FMD. Ingestion of any caustic material may cause oral vesiculation and salivation.

#### TREATMENT

Treatment with mild disinfectant and protective dressings to inflamed areas to prevent secondary infection is recommended in endemic countries where a slaughter policy is not in force. A good symptomatic response is reported to the administration of flunixin meglumine.<sup>21</sup>

#### CONTROL

Many factors govern the control procedure in a given area. The procedures commonly used are (a) control by eradication and (b) control by vaccination, or a combination of the two. In countries where the disease is endemic, or where there are wildlife reservoirs, eradication is seldom practicable. In areas with only occasional epidemics, slaughter of all infected and in-contact animals is usually carried out. It must be remembered that vaccination is costly and sometimes ineffective and that eradication would be the ideal objective in all countries. For countries in large continents, international cooperation is required for eradication. The European Union phased out mass vaccination in 1991 in order to increase its international competitiveness in trade in livestock and livestock products. Soon after, outbreaks of FMD in Italy were controlled by surveillance and slaughter of thousands of cattle, sheep/goats and pigs in all infected and contact herds.<sup>22</sup> A similar procedure was adopted in 2001 in England, Ireland and France and with some modification in The Netherlands, and the outbreaks were successfully controlled within months. Similar results were obtained in Taiwan in 1997.

As in the control of all epidemic infectious diseases, the problems posed for administrators are complex and continually changing. For example, the prospect of making a wrong decision about when to switch from an eradication-by-slaughter program to a containment-by-vaccination program, when an outbreak is raging and public sentiments are running high, is a daunting one. A wrong decision may cost a livestock industry many millions of dollars. To avoid making such errors, it is customary nowadays to develop a mathematical or computer model which simulates the progress of an outbreak in terms of numbers of animals infected, affected and dead, and how these numbers will change under pressure from control procedures, management practices and prevailing weather. An essential aspect of such an analysis is the economic effect of various control programs and their outcomes. The cost-benefit aspects of computer simulation models and the meteorological predictions of the likely spread of the disease are used to determine an appropriate strategy for control. Even

then, conclusions from such models may still be controversial as was the case in the 2001 outbreak in England.

### Control by eradication

The success of an eradication program depends on the thoroughness with which it is applied. As soon as the diagnosis is established, all cloven-footed animals in the exposed groups should be immediately slaughtered and burned or buried on site. No reclamation of meat should be permitted and milk must be regarded as infected. Inert materials which may be contaminated must not leave infected premises without proper disinfection. This applies particularly to human clothing, motor vehicles and farm machinery. Bedding, feed, feeding utensils, animal products and other articles which cannot be adequately disinfected must be burned. Barns and small yards must be cleaned and disinfected with 1–2% sodium hydroxide or formalin or 4% sodium carbonate solution. Acids and alkalis are the best inactivators of the virus and their activity is greatly enhanced by the presence of a detergent. The effective pH at a disinfection surface may be grossly altered by the presence of organic matter and needs to be adequately maintained. When all possible sources of infection are destroyed, the farm should be left unstocked for 6 months and restocking permitted only when 'sentinel' test animals are introduced and remain uninfected. There are strict international requirements for demonstrating freedom from infection.

Recommendations for outdoor sites are difficult to make. Observations in Argentina suggest that contaminated pastures and unsheltered yards are clear of infection if left unstocked for 8–10 d. No animal movement can be permitted and human and motor traffic must be reduced to a minimum. Persons working on the farm should wear waterproof clothing which can be easily disinfected by spraying and subsequently removed as the person leaves the farm. Clothing not suitable for chemical disinfection must be boiled. Because of the rapidity with which the disease may spread, immediate quarantine must be imposed on all farms within a radius of 16–24 km (10–15 miles) of the outbreak.

Although the eradication method of control is favored when the incidence is low, it imposes severe losses on the animal industry in affected areas and is economically impracticable in many countries. However, it must be regarded as the final stage in any control program. The standard strategy is the containment of the disease by ringing the outbreak with a zone of vaccinated animals and

setting about reducing the infection rate within the ringed area and eventually eradicating remaining hot-spots by slaughter. Containment of an outbreak is a difficult task with high rewards as shown by various cost-benefit analyses.

The controversy about whether to eradicate or vaccinate is ongoing. For example, the 1967–1968 epidemic in the United Kingdom involving the slaughter of nearly half a million animals at a cost of US\$250 million was so damaging financially that it was arranged for vaccination to be available should there be a recurrence of such an epidemic. Nevertheless, the slaughter policy was still adopted in 2001 and a lot more animals killed. Part of the increased concern about a test-and-slaughter policy derives from:

- increasing size of herds
  - risks involved if infection was introduced
  - environmental concerns regarding carcass disposal if thousands or millions of animals are to be slaughtered within a short time.
- During the 1997 epidemic in Taiwan, it was reported that a disposal capacity of 200 000 pigs per day was reached despite ring vaccination. In England, disposal capacity was overwhelmed in 2001, even with military intervention, and carcasses were sometimes left for days before burial or burning.

### Vaccination

Regular vaccination against FMD is a way of life for most of the world and vaccine production is a major industry. In the endemic countries, eradication does not seem possible within the foreseeable future and countries free of the disease may require regional vaccination during outbreaks. Consequently, it has been estimated that 1.5 billion monovalent doses of the FMD vaccine are administered annually, with South America alone accounting for some 1300 million doses.<sup>23</sup>

Killed trivalent (containing O, A, and C strains) vaccines are in general use, but because of the increasing occurrence of antigenically dissimilar substrains, the production of vaccines from locally isolated virus is becoming a more common practice. The virus is obtained from infected tongue tissue, a cell culture of bovine tongue epithelium or other cell culture. Baby hamster kidney (BHK) is a favored viral cultural medium and BHK vaccine is now in general use. Its principal virtue is its adaptability to deep suspension culture in contrast with its growth on monolayer culture, enabling large-scale production of virus to be carried out within practicable space limits. Inactivation

of the virus to produce a killed vaccine used to be done with formalin but there are disadvantages with its use and more sophisticated agents, especially binary ethylene imine (BEI) are now used. Serviceable immunity after a single vaccination can be relied on for only 6–8 months. Vaccines produced from 'natural' virus give longer immunity than those produced from 'culture' virus. Vaccines produced in oil-adjuvant offer promise of providing longer immunity, and require only annual revaccination in adult cattle and biannual revaccination for young stock or every 4–6 months in pigs.

A general vaccination program for an area must be planned for that area. Thus in continental Europe, the program until 1991 included an annual vaccination of all adults with an additional campaign every 6 months to vaccinate calves as they reached about 4 months of age. In South America, the specific recommendations are that calves from unvaccinated dams should be vaccinated at 4 months and revaccinated at 8 months of age, but calves from vaccinated cows should be vaccinated twice, the first at 6 months and the second at 10 months of age.<sup>24</sup> The important considerations in calves are to avoid vaccination while the calf is still carrying maternal antibodies derived from colostrum and to avoid infection before they can develop active immunity. Calves as young as 1 week old respond as actively to vaccination as adult animals, provided they are free of maternally derived antibody. Immunity is present 7–20 d after vaccination, depending on the antigenicity of the vaccine. It is not usual to include sheep, goats, and pigs in a general vaccination program unless they are also affected during outbreaks. After the outbreak in Taiwan, it was recommended that piglets be vaccinated at 8–12 weeks followed by a boost 4 weeks later, and that sows be vaccinated 3–4 weeks before farrowing or every 4–6 months.<sup>25</sup>

Because of the short duration of the immunity produced by killed vaccines, attention has been focused on the production of an attenuated living-virus vaccine. The major difficulty encountered so far has been the narrow margin between loss of virulence and loss of immunogenicity. Attenuated vaccines have been produced by passage through white mice, embryonated hen eggs, rabbits and tissue culture. Their use has contributed to the eradication of the disease in cattle in South Africa and it has proved effective in Venezuela, where killed-virus vaccines failed to stem a major outbreak. Provided constant surveillance can be maintained over vaccinated animals, their value in such circumstances

cannot be denied. However, their early promise has not been fulfilled, and improved killed vaccines are most generally favored. In spite of the uncertain stability of the lapinized virus, control of the disease in Russia was reported after the use of a rabbit-passaged vaccine. In those countries where vaccination of very large numbers of animals is carried out annually, one of the emerging problems is the quality control of vaccines with respect to innocuity and to immunizing capacity or potency. The techniques to monitor these characteristics are available, but they do add to the costs of the vaccine, and if commercial competition is keen, this aspect of production may be spared. Some outbreaks have been linked to attenuated vaccines.

A great deal has been written about genetically engineered FMD vaccine produced by biotechnological manipulation and their distinct safety advantages over whole-virus vaccines. Initial reports of a polypeptide vaccine (protein VP1) in cattle are encouraging and the peptide can be chemically synthesized and incorporated into the core of hepatitis B virus to produce a vaccine.<sup>26</sup> However, much work still needs to be done and these newly developed vaccines cannot yet replace the classical inactivated vaccines.<sup>27</sup>

General vaccination as a means of control is recommended for countries where the disease is enzootic, or where the threat of introduction is very great, e.g. Israel. If an outbreak occurs, a booster vaccination with the relevant serotype will greatly increase the resistance of the population. However, the strategy of general vaccination has many difficulties. The following disadvantages are suggested:

1. To be effective, the program should consist of vaccination against a number of strains three times yearly. More frequent vaccination may be necessary in the face of outbreaks during optimum conditions for spread. Young animals with maternally derived antibodies do not respond to vaccination.
2. Vaccination of sheep and pigs is also used in control programs. In pigs a bi- or trivalent, inactivated, adjuvant vaccine gives strong immunity for 6 months and some resistance for 12 months. Severe local reactions (abscesses and granulomas) at vaccination sites can be reduced by the inclusion of an oil-adjuvant. However, vaccination of pregnant sows leads to a high rate of abortions and stillbirths. In sheep, monovalent or trivalent vaccines give immunity for 5-6 months but the sheep may act as inapparent carriers.

3. Inapparent infections may occur in animals whose susceptibility has been reduced by vaccination, permitting the existence of 'carrier' foci. It has become generally recognized that the number of carrier animals produced by vaccination is very much greater than was previously thought. Apart from the fact that these animals are a potent method of spreading the disease, they also provide an excellent medium for the mutation of existing virus strains, because the hosts are immune. The carrier state in vaccinated and unvaccinated cattle may persist for as long as 6 months and be capable of causing new outbreaks in all species. But the problem must be kept in perspective. The number of carriers produced in this way is directly related to the rate of occurrence of the disease in the population, and if this is kept to a minimum by an assiduous vaccination program and a strict limitation on the movement of infected animals into the population, the rate of occurrence of carriers can be very small. Nevertheless, in FMD-free countries, vaccinated animals are subsequently slaughtered to comply with OIE regulations so as to resume meat export as soon as possible.
4. Importation of vaccinated animals is often prohibited. An additional disadvantage is the production of sensitivity resulting in anaphylaxis in 0.005% of cattle vaccinated repeatedly, especially when the vaccines contain antibiotics or the vaccine contains foreign protein not associated with the antigen, or the virus has been killed with formalin which has also denatured the protein in the vaccine. Edema, urticaria, dermatitis, abortion and fatal anaphylaxis all occur. Cows in early and late pregnancy or otherwise stressed from other diseases, are most susceptible to adverse effects of vaccination.<sup>28</sup> Satisfactory purification and standardization of the vaccine can eliminate many of the problems because the hypersensitivity is to the culture medium, and to the agent used to kill the virus, rather than the virus itself.
5. Countries that vaccinate during an outbreak have to re-establish their FMD free status to the satisfaction of their trading partners. This is difficult because currently available vaccines stimulate production of antibodies indistinguishable from those following infection, and because vaccinated animals can be infected and become carriers. The detection of antibodies to

nonstructural proteins is helpful in making the distinction at herd level and further research is ongoing to standardize the techniques.<sup>29</sup>

Alternatives to general vaccination are modified programs including 'ring' vaccination to contain outbreaks, 'frontier' vaccination to produce a buffer area between infected and free countries and vaccination of selected herds on a voluntary basis when an outbreak is threatened. Such emergency vaccinations can reduce the risk of spreading infection by reducing the rate of virus excretion. It is generally conceded that vaccination of an entire population may be necessary when eradication is incapable of preventing the spread of the disease. For this reason, many countries have strategic reserves of concentrated vaccines, but no such vaccine banks exist in Africa.

Prevention of entry of the disease into free areas is an ever-increasing problem because of modern developments in communications. The following prohibitions are necessary if the disease is to be excluded:

- There must be a complete embargo on the importation of animals and animal products from countries where FMD is endemic. The embargo should include hay, straw, and vegetables. Where the disease occurs only as occasional outbreaks, importation of animals can be permitted provided they are subjected to a satisfactory period of quarantine
- Particular attention should be given to preventing entry of uncooked meats from ships, airplanes and other forms of transport and in parcels originating in infected areas. In danger areas all swill fed to pigs must be cooked and all food waste satisfactorily disposed of
- Personal clothing and other effects of people arriving from infected areas should be suitably disinfected. Persons arriving from endemic countries or countries experiencing outbreaks should keep away from livestock for several days
- The risk of introducing the disease through importation of semen or fertilized ova is now thought to be minimal. The virus can survive in frozen bull semen and possibly in some fertilized ova, for example, zona pellucida-free bovine embryos but not in others, for example, zona pellucida-intact bovine embryos.<sup>30</sup> However, since even viremic animals do not transmit the disease through their embryos, bovine embryos with intact zona pellucida can be safely imported from enzootic areas regardless of the serological status of the donor.<sup>6</sup>

Consequently, if exotic or special animals have to be imported from enzootic countries, embryo transfer may be a means of controlling the transmission of FMD.<sup>31</sup> Even for llama embryos that lack a zona pellucida, the risk of FMD transmission was calculated to be close to zero if favorable epidemiological or ecological conditions exist in the region of origin of the embryos.<sup>32</sup>

## REVIEW LITERATURE

- Blackwell JH. Internationalism and survival of foot-and-mouth disease virus in cattle and food products. *J Dairy Sci* 1980; 63:1019-1030.
- Rweyemamu MM et al. The control of foot and mouth disease by vaccination. *Vet Ann* 1982; 22:63-80.
- Brown F. Review literature Foot-and-mouth disease - one of the remaining great plagues. *Proc R Soc Lond Biol* 1986; 229:215-226.
- Scott GR. Foot-and-mouth disease. In: Sewell MMH, Brocklesby DW (eds). *Handbook on animal diseases in the tropics*, 4th edn. London: Baillière Tindall, 1990; pp. 309-312.
- Donaldson AI, Doel TR. Foot-and-mouth disease: the risk for Great Britain after 1992. *Vet Rec* 1992; 131:114-120.
- Thomson GR, Bastos ADS. Foot-and-mouth disease. In: Coetzer JAW, Tustin RC (eds) *Infectious diseases of livestock*, vol 2, 2nd edn. Cape Town: Oxford University Press, 2004; pp. 1324-1365.

## REFERENCES

- OIE Manual of diagnostic tests and vaccines for terrestrial animals, 5th edn. Chapter 2.1.1 [http://www.oie.int/eng/normes/mmanual/A\\_00024.htm](http://www.oie.int/eng/normes/mmanual/A_00024.htm).
- Yang PC et al. *Vet Rec* 1999; 145:731.
- Ikede BO, Onyekwuodiri EO. *Nig J Anim Prod* 1977; 4:227.
- Salt JS. *Br Vet J* 1993; 149:207.
- Amass SF et al. *Vet Rec* 2003; 153:137.
- Mebus CA, Singh EL. *Theriogenology* 1991; 35:435.
- House JA, Wilks CR. *Proc 8th Ann Mtg US AHA* 1983; p. 276.
- Dawe PS et al. *Vet Rec* 1992; 134:230.
- Mebus CA et al. *Food Microbiol* 1993; 10:133.
- Barteling SJ, Vreeswijk J. *Vaccine* 1991; 9:75.
- Sharma SK, Singh GR. *Vet Rec* 1993; 133:448.
- Krystynak RHE, Charlebois PA. *Can Vet J* 1987; 28:523.
- Kao RR. *Proc R Soc Lond Series B Biol Sci* 2003; 270:2557.
- Perry BD et al. *Rev Sci Techn (OIE)* 1999; 18:487.
- Brown CC et al. *Vet Pathol* 1991; 28:216.
- Alonso A et al. *J Vet Invest* 1992; 4:249.
- Callahan JD et al. *J Am Vet Med Assoc* 2002; 220:1636.
- Murphy FA et al. *Arch Virol Suppl* 1995; 10:280.
- Montgomery JF et al. *NZ Vet J* 1987; 35:27.
- Kilner CG. *Vet Rec* 1994; 134:222.
- Benitz AM et al. *Proc 13th World Cong Dis Cattle* 1984; p. 71.
- Maragon S et al. *Vet Rec* 1994; 135:53.
- Della-Porta AJ. *Aust Vet J* 1983; 60:129.
- Woodham CB. *Foreign Anim Dis Report* 1992; 20:11.
- Liao PC et al. *Taiwan Vet J* 2003; 39:46.
- Brown F. *World J Microbiol Biotech* 1991; 7:110.
- Kitching RP. *Br Vet J* 1992; 148:375.
- El-Belely MS et al. *Br Vet J* 1994; 150:595.
- Clavijo A et al. *Vet J* 2004; 167:9.
- Singh EL et al. *Theriogenology* 1986; 26:587.
- McVicar JW. *Theriogenology* 1986; 26:595.
- Sutmoller P. *Rev Sci Tech (OIE)* 1999; 18:719.

## SWINE VESICULAR DISEASE

### Synopsis

**Etiology** Enterovirus of family *Picornaviridae*

**Epidemiology** Important because resembles foot-and-mouth disease. Occurs in Europe, Hong Kong, Japan, and Malta. Transmitted by direct contact, movement of pigs, feeding uncooked garbage containing pork products

**Signs** Fever, lameness, vesicles on coronary bands, recovery in 2-3 weeks

**Clinical pathology** Demonstrate antigen in tissues

**Lesions** Vesicles

**Diagnostic confirmation** Demonstrate virus in tissues

**Differential diagnosis**

- Foot rot of pigs
- Differentiate from other vesicular diseases by laboratory examination and virus identification

**Treatment** None needed

**Control** Control of garbage feeding, movement of infected pigs

The importance of this disease is that the clinical signs of this economically unimportant disease are indistinguishable from those of foot-and-mouth disease which is an economic disaster if it occurs in your country.

### ETIOLOGY

The disease is associated with an enterovirus (family *Picornaviridae*) related to human coxsackie B5 virus, which may have arisen from a variant of this virus that has become adapted to swine. It was once regarded as porcine coxsackie virus.<sup>1</sup> Human isolates of coxsackie B5 virus do not cause disease in pigs although swine vesicular disease virus may infect humans and cause an influenza like condition. In animals, the disease is restricted to pigs, although experimental challenge of sheep has produced subclinical infection.

### EPIDEMIOLOGY

#### Occurrence and prevalence of infection

The disease was first recognized as a limited outbreak in Italy in 1966 and was eradicated by slaughter. It then appeared in Hong Kong (1970), England (1972), many countries in Europe, including Poland, Austria, and France (1972-1974), Japan (1973), and Malta (1975). Eradication programs based on a slaughter policy were instituted and in most cases were effective. The disease occurred in 1992 and 1993 in several member states of the European Union, which had never before reported the disease or in which the disease had not occurred since the 1970s.<sup>2</sup> Italy had several outbreaks in 1996 and 1997. Serological surveys in 1993, using the virus neutralization (VN) test found

no serological evidence of infection in the pigs in the United Kingdom, Denmark, Portugal and Greece.<sup>2</sup> Africa, America, and Australasia remain free from infection. There has been some variation in virulence<sup>3,4</sup> which is determined at two amino acids in the capsid<sup>5</sup> and there may be seven antigenic strains although there is no wide genetic variation. The epidemiological pattern of the disease in the various outbreaks is due presumably to different strains of the virus. The molecular evolution of the virus has been described.<sup>6</sup>

### Methods of transmission

Infection generally occurs through minor abrasions on the feet but may occur through other routes. The incubation period is 2-14 days and the virus may be excreted prior to the onset of clinical signs. During and for a short period following the viremic phase, the virus is excreted in oral and nasal secretions. It is excreted in feces for periods up to 3 weeks, and vesicular fluid and shed vesicular epithelium are potent sources of infection. A chronic infection with shedding of virus for periods up to 3 months has been described.

Large amounts of virus are shed in the immediate vicinity of infected pigs. Transmission occurs by direct contact or contact with infected food or water or infected feces, and the disease spreads rapidly between pigs within the same group.<sup>7</sup> Airborne transmission of the virus is not a feature and the spread between groups of pigs is less rapid than that which occurs with FMD. The resistance of the virus and its persistence within the environment allows spread by mechanical methods such as trucks and contaminated boots. Areas which have housed infected pigs may remain infective for a considerable period of time. The potential for contaminated communal livestock trucks and markets to spread infection is considerable due to the occurrence of minor foot abrasions that occur during the movement of pigs. During the period 1972-1981 the major methods of spread were contaminated hauliers, movement of pigs, feeding contaminated waste, contact at markets, movement of equipment or personnel, local spread and recrudescence of previous infection. The biggest group was obscure in origin. In the UK the outbreaks were much fewer in the summer when it was supposed that not much pork was consumed and this resulted in much reduced pig movements.

The disease may be sufficiently mild to escape clinical detection. This plus the occurrence of subclinical infection and the reluctance of farmers to report suspicions of its occurrence facilitates spread by the



movement of infected pigs to other farms or through markets. Vertical transmission has not been demonstrated.

The disease may also be spread by the feeding of uncooked garbage but it is believed that more virus is needed to infect pigs via this route. Pigs killed during the incubation period of the disease or with subclinical infection possess a considerable amount of virus in body tissues. There is little reduction in infectivity with cold storage and the virus can persist in pork and pork products indefinitely. Recycling of the virus through garbage feeding with subsequent spread to other piggeries has been a major source of new outbreaks of swine vesicular disease in England. In addition, spread by direct movement of infected pigs to other piggeries or infection following movement through contaminated markets or livestock trucks accounts for the majority of outbreaks investigated.

### Risk factors

#### Pathogen factors

There are minor antigenic differences and variation in virulence between some isolates of swine vesicular disease virus from different countries and two genetically and antigenically distinct variants exist in Europe.<sup>8</sup> Swine vesicular disease virus can be grown in tissue culture and has characteristics distinguishing it from the viruses associated with FMD, vesicular stomatitis and vesicular exanthema. The virus is extremely resistant to chemical and physical influences, which has made control of the disease very difficult. It is inactivated only at extremes of pH, (it can survive pH 2–12) and temperatures. It may remain infective in the environment and in manure for periods of at least 6 months. It is resistant to the action of many disinfectants and recommendations for disinfectants include 2% sodium hydroxide, 8% formaldehyde and 0.04% sodium hypochlorite if organic material is not present. It is easily transmitted in infected meat. The virus survives the processing of pork and pork products especially salami, except heating at greater than 68°C (154°F) and can persist in these products indefinitely (salami, 40 days).

Infected carcasses can be held in cold storage for months and then released at neutral pH and 40°C and the virus can still be found after 160 days. It is very stable and therefore difficult to decontaminate the environment, particularly where swine are housed on the soil. The virus can be found in earthworms from above the burial pits.

### Economic importance

Although the economic effects of the primary disease are minor, the cost of the

slaughter method for eradication is high. Although the morbidity rate with most strains is high, the disease generally runs its course in 2–3 weeks and produces a negligible mortality and only a minor setback to production. The major importance of the disease is its close clinical similarity to other vesicular diseases and the ban on export animals to other countries. The necessity for immediate differentiation of an outbreak from FMD and the problem of having such a similar clinical entity present in the pig population has made eradication of the disease desirable. In most countries this has proved extremely expensive.

### PATHOGENESIS

The pathogenesis may be mediated by heparin sulfate which mediates virus attachment to the host cell.<sup>9</sup>

There is variation in the susceptibility of different sites of the body to invasion by swine vesicular disease virus and in natural outbreaks initial infection is most likely through damaged skin, particularly damaged feet. It has recently been suggested that 90% of the infection may be through the tonsil. A large amount of virus is in the tissues before the clinical signs develop. Once infection is established in a pig, virus excretion is so massive as to result in infection of others in the group through the tonsil and gastrointestinal tract as well as through skin abrasions. Massive amounts of the virus are excreted in the feces. Experimentally, the disease can be reproduced by IV, IM, SC and ID inoculation of virus. Virus spreads at the site of infection and enters the blood stream through the lymphatics. It is followed by viremia which may last 2–3 days. Recent research has suggested that the virus can persist for a longer length of time for up to 63 days but at 119 days post-infection the virus was again found in feces when two groups of pigs were mixed. This suggests that the virus and RNA can persist for a long time and possibly suggests a carrier state<sup>10</sup> but the same authors also suggest that persistent infection is rare.<sup>11</sup> Most virus is produced during the first week but lesions are infective for a long time. The virus has an especial affinity for epithelium of the coronary band, tongue, lip and snout and for myocardium. Lesions in the brain, especially the brainstem, are seen histologically but nervous signs are not a common clinical finding.

### CLINICAL FINDINGS

The incubation period varies from 2–14 days. The disease is usually mild or even inapparent in its manifestation. It may be seen initially just as lame pigs. The morbidity rate varies from 25–65% and up to 100% of pigs within a pen may be

affected. A transient fever (40–41°C; 104–105°F) and temporary mild inappetence may be seen. Lameness, arching of the back and other signs of foot discomfort are evident but are less severe than with FMD. Very occasionally they walk on the knees or scream. Both the incidence of lameness and of foot lesions are influenced by management and are less severe on bedding or with soft conditions underfoot. Characteristic vesicles occur at predilection sites frequently associated with trauma. They occur most commonly on the coronary band of the claws, especially at the heel, and of the supernumerary digits. They start as areas of blanching and swelling and progress in 1–2 days to thick-walled vesicles which rupture to give the appearance of an ulcer. Sometimes pigs may have a retracted recovery. In severely affected pigs, the lesions will encircle the coronary band and the horn may be shed as in FMD. Lesions also occur on the tongue, lips and snout and the skin of the legs and belly. They are much less frequent in these areas and frequently do not progress to typical vesicles. An examination of the feet of other apparently normal pigs within the group will often reveal the presence of minor lesions, and the extent of involvement of pigs within the group may be underestimated without careful examination. In some outbreaks, the incidence of clinical lesions has been minimal and even a single vesicle on the pig's foot should be treated as suspect. Some pigs show no clinical signs but develop significant titers of neutralizing antibody. The course of the disease within a group is generally 2–3 weeks, mortality is very uncommon and there is only a minor setback to production unless complete separation of the horny foot occurs. Nervous signs with ataxia, circling, head pressing and convulsions and paralysis have been observed rarely. Recovered pigs have immunity that protects against re-infection.

### CLINICAL PATHOLOGY

Tests for the identification of swine vesicular disease include the demonstration of antigen in tissue and the detection of antibody. Vesicular epithelium provides the best material for direct antigen demonstration and it may be present even in the remnants of 10-day-old lesions. With fluorescent antibody or direct complement fixation, a result may be obtained within 8–12 h. The virus can also be grown on tissue culture and identified. Specific antibody is produced within 4–6 days and may be demonstrable before clinical disease is evident. Antibody may be detected by virus neutralization or the ELISA<sup>12</sup> for the diagnosis and surveillance of the disease.

Isotype-specific ELISAs were described.<sup>13</sup> The direct liquid phase blocking ELISA correlates well with the neutralization test which is used by the European Community authorities.<sup>7</sup> An RT-PCR has been developed<sup>14</sup> and PCR and PCR-ELISA have been described.<sup>15-17</sup> Monoclonal antibody trapping ELISA was used in Canada, Italy, and England to test results against other tests and it was found that virus neutralization should be used as a definitive test.<sup>18</sup>

### NECROPSY FINDINGS

There are no gross or histological findings that differentiate swine vesicular disease from foot-and-mouth disease. Lesions in the skin consist of areas of coagulative necrosis with intraepithelial vesicle formation. Additional necrotic foci are present in the tonsils, renal pelvis, bladder, salivary glands, pancreas and myocardium. There is also non-purulent meningoencephalitis. Intranuclear inclusions are present in the ganglion amphotocytes. An ELISA used on vesicular fluid or epithelium can give a result in 4-24 h. It grows well in culture in swine kidney cells and may show effects within 6 h. The intracerebral infection of mice causes paralysis and death.

### DIFFERENTIAL DIAGNOSIS

The occurrence of vesicles differentiates this disease from other non-vesicular diseases of pigs. So-called footrot in pigs is associated with lesions on the sole and horn of the claw rather than the epithelial area of the coronary band. The differentiation of swine vesicular disease from other vesicular diseases relies on laboratory examination and virus identification as detailed above.

### TREATMENT AND CONTROL

No treatment is described and none is warranted. In most countries where outbreaks have occurred, control has been attempted or achieved by slaughter eradication. Depopulation is followed by thorough cleansing and disinfection and limited repopulation effected after a period of 2-3 months. The disposal of infected carcasses can be important as the disposal site may remain infective.

The detection of infected herds can be a problem. The mild nature of the disease means that it can easily escape detection, especially in darkened pig houses or where conditions underfoot obscure observation of the feet. Mild infections may produce little clinical disease and any vesicular lesions should be treated with suspicion. The reluctance of some farmers to report suspicious lesions can also be important and it is essential to institute educational programs that emphasize the

necessity for early detection and diagnosis of outbreaks. Serological surveys to identify present or past infections have proved of value in aiding detection of the disease. Serological single reactors cause a lot of trouble in trade.<sup>19</sup>

The three most important methods of spread are:

1. Feeding of garbage containing infected pig meat
2. Movement of pigs from infected farms either directly from farm to farm or indirectly through markets
3. Movement of pigs in contaminated transport vehicles.

Control of these methods of spread must include:

- Strict enforcement of garbage-cooking regulations
- Closing of markets, except perhaps for holding areas for pigs going directly to slaughter
- Strict control of movement and sale of pigs
- Adequate cleansing and sanitation of infected areas and transport vehicles.

Transmission through feeding of infected meat in garbage appears the most difficult to control and the latent period of this cycle means that outbreaks can recur at a time when eradication was thought to be complete. Disinfection of slurry is also difficult but can be achieved by treatment with sodium hydroxide.<sup>20</sup>

In the United Kingdom, the most crucial item in its control was the introduction of a 21-day movement prevention after the initial movement. Sentinels put in after 8 weeks after the initial disinfection and are observed for about 3 weeks. If they are free after this time they are allowed to restock.

Vaccination has not been used for control in most countries however an inactivated vaccine is reported to provide significant protection in France.

### REVIEW LITERATURE

- Dekker A, Lin F, Kitching RP. Swine vesicular disease studies on pathogenesis diagnosis and epizootiology; a review. *Vet Q* 2000; 22:189-192.
- Escribano-Romero E et al. *Anim Health Res Rev* 2000; 1:119-126.
- Kitching P. Swine vesicular disease. In: Morilla A, Yoon KJ, Zimmermann JJ (eds). *Trends in emerging viral infections of swine*. Ames, Iowa: Iowa State Press, 2002; pp. 205-208.

### REFERENCES

1. Verdaguier N et al. *J Virol* 2003; 77:9780.
2. Mackay DKJ et al. *Vet Rec* 1995; 136:248.
3. Nijjar SK et al. *J Gen Virol* 1995; 80:277.
4. Kanno T et al. *J Gen Virol* 1999; 73:2710.
5. Kanno T et al. *Virus Res* 2001; 80:101.
6. Zhang G et al. *J Virol* 1999; 80:639.
7. Dekker A et al. *Vet Microbiol* 1995; 45:243.
8. Brocchi E et al. *Epidemiol Infect* 1997; 118:51.
9. Escribano-Romero E. *J Gen Virol* 2004; 85:653.

10. Lin F et al. *Epid Inf* 1998; 127:135.
11. Lin F et al. *Epid Inf* 2001; 129:459.
12. Chenard A et al. *J Virol Meth* 1998; 75:105.
13. Dekker A et al. *Epid Inf* 2002; 128:277.
14. Nunez JI et al. *J Virol Meth* 1998; 72:227.
15. Reid SM et al. *J Virol Meth* 2004; 116:169.
16. Lomakina NF et al. *Arch Virol* 2004; 149:1155.
17. Callens M, De Clercq K. *J Virol Meth* 1999; 77:87.
18. Heckert RA. *J Vet Diag Invest* 1998; 10:295.
19. Lenghaus C, Mann JA. *Vet Path* 1976; 13:186.
20. Turner C, Williams SM. *J Appl Microbiol* 1999; 87:148.

### VESICULAR STOMATITIS

#### Synopsis

**Etiology** Vesiculovirus in the family *Rhabdoviridae*

**Epidemiology** Disease of cattle and horses and occasionally pigs in the western hemisphere. Clustered outbreaks occur in summer and autumn. Vector, direct and mediate transmission

**Clinical findings** Vesicular lesions or healing ulcers on oral mucosa, teats and prepuce

**Diagnostic confirmation** Virus isolation or polymerase chain reaction, serology with rising titers

**Treatment** None specifically. Supportive

**Control** Notifiable disease. Quarantine and movement control

### ETIOLOGY

The causative virus is a vesiculovirus (family *Rhabdoviridae*).<sup>1</sup> There are two antigenically distinct serotypes of the virus: vesicular stomatitis New Jersey (VS-NJ) and vesicular stomatitis Indiana (VS-IN). There are three subtypes of the vesicular stomatitis Indiana, Fort Lupton, Alagaos (Brazil) and Cocal (Trinidad). The **New Jersey serotype** is the most virulent and most common. The virus is much less resistant to environmental influences than the virus of FMD and it is more readily destroyed by boiling and use of disinfectants.

The disease is of major importance because it is indistinguishable from foot and mouth disease, and it can cause disease in humans.

### EPIDEMIOLOGY

#### Occurrence

Geographic occurrence

The disease is limited to the **Western Hemisphere** and is **endemic** in Mexico and Panama and south to Venezuela and Peru, with periodic **incursions** into the United States, Brazil and Argentina to produce epizootic disease. It is also enzootic in Ossabaw Island, off the shore of Georgia in the United States.<sup>2</sup> The Island is the only recognized enzootic focus of vesicular stomatitis virus New Jersey (VSV-NJ). The VSV-NJ antibodies have been detected only from feral swine, cattle, horses and donkeys, deer, and

raccoons. However, despite high transmission rates, clinical disease is rarely detected.

The first major occurrence of the disease or 'sore tongue' in horses, cattle, and swine in the United States was in 1801.<sup>1</sup> The disease disabled 4000 horses needed to fight the Civil War in 1862. Major epidemics in US cattle and horses occurred in the Southwestern states from 1889 to 1995. A major outbreak occurred in military horses in the United States during the 1914–1918 war but in recent years, in addition to clinical disease in horses, it has come to assume greater importance in cattle and pig herds.

Vesicular stomatitis is the most important cause of vesicular disease in foot and mouth disease free countries in the Americas causing thousands of outbreaks annually from southern Mexico to northern South America.<sup>3</sup> Vesicular stomatitis is endemic from northern South America (Columbia, Venezuela, Ecuador, Peru) to southern Mexico, in which areas outbreaks occur annually. In endemic areas, outbreaks are seasonal, often associated with the transitions between rainy and dry seasons. The NJ serotype accounts for more than 80% of clinical cases and the IN-1 for the remaining. Sporadic cases of the disease occur in Brazil and Argentina where the viruses are related to VSV-IN and classified as VSV-IN2 and VSV-IN3.<sup>4</sup>

In the United States, there are two different patterns of occurrence; in the southern states (Georgia, Alabama, North Carolina, and South Carolina) a pattern of yearly occurrence of clinical cases in livestock occurred from the 1900s to the 1970s. Since then, viral activity in the region has been focal and limited to isolated wildlife populations. In contrast in the southwestern states (New Mexico, Arizona, Utah, and Colorado) outbreaks have occurred sporadically at approximately 10-year intervals, with last cycle of activity occurring from 1995 to 1998.

The disease occurs seasonally every year in the southwestern United States, southern Mexico, throughout Central America and in northern South America, and emerges from tropical areas to cause sporadic outbreaks in cooler climates during the summer months.<sup>1</sup>

In the **United States, outbreaks** occur periodically in the late summer and autumn; a major outbreak occurred in 14 western states in 1982–1983 and another in 1995 involving six states, with sporadic disease in intervening years. The outbreaks occur in the **western states**, start in the south and progress northerly, and **cluster** in areas of high livestock density in irrigated and green zone areas.<sup>5</sup>

In the 1997 outbreak the disease occurred in Arizona, Colorado, New

Mexico, and Utah.<sup>6</sup> The epidemic curve suggested a propagating epidemic; the number of positive premises peaked during week 39 and then rapidly declined. As in previous outbreaks in the southwestern United States, there was a northerly progression of the disease over time. Nationwide, horses accounted for 88% of examinations done for the disease, and 97% of the premises on which species of infected animal were identified recorded horses positive. Cattle accounted for 10% of examinations carried out, and 3% positive premises on which species were identified had cattle positive.

#### Host occurrence

Cattle, horses, and donkeys are most susceptible but infection can also occur in pigs, camelids and humans and possibly sheep and goats. Outbreaks of the disease are **most common in horses and cattle** and to a lesser extent in pigs. Calves are much more resistant to infection than adult cattle. Many species of wildlife are seropositive.

Humans are susceptible – infection causes an influenza-like disease – and the development of high antibody titers in humans often accompanies outbreaks in cattle.

Serological surveys have found that in addition to domestic livestock, many species of wild animals such as bats, deer, monkeys, and humans living in endemic areas of Mexico, Central and South America are exposed to the infection and develop neutralizing antibodies. In the 1995 outbreak in the United States, the overall seroprevalence in livestock in Colorado was less than seroprevalence in epidemic areas, and seroprevalence rates in epidemic areas were greater for horses than cattle.<sup>7</sup> The seroprevalence results suggest that some animals had subclinical vesicular stomatitis infection during epidemics and that animals may be exposed to the virus between epidemics. Sentinel premises in Colorado visited quarterly during a 3-year period, when there was not clinical disease, found evidence of seroconversion to both serotypes of virus.<sup>8</sup>

The **morbidity rate** varies considerably; 5–10% is usual but in dairy herds it may be as high as 80%. There is usually no mortality in dairy herds but overall case–fatality rates ranging from 0–15% are recorded for beef herds. Morbidity in horse herds is high but there is no mortality. Outbreaks in an area are usually not extensive but the disease closely resembles FMD and has achieved considerable importance for this reason.

#### Source of infection

**Sandflies and blackflies** are capable of transovarial transmission and infection of

susceptible hosts but the low frequency of transovarial transmission in these insects suggests that there are **other natural reservoirs** from which insect vectors obtain the virus. The VSV-NJ initially infects the gut of black flies in the natural situation but subsequent spread to the salivary gland may be blocked in older flies decreasing their ability to transmit the virus.<sup>9</sup>

Antibody to vesicular stomatitis virus has been demonstrated in a large number of **wildlife species** in Central America but their significance as wildlife reservoirs remains to be determined.<sup>1,3</sup> It is possible that outbreaks in the United States originated in Mexico and were transmitted via **windborne infection**. Feral pigs are believed to be the reservoir and amplifying host on Ossabaw Island.

The saliva and vesicular fluid from clinically affected animals are highly infective but infectivity diminishes rapidly and may be lost within 1 week after the vesicles rupture. However, **convalescent cattle** have been suspect as perpetuating disease and spreading it with movement to other herds. Vesicular stomatitis virus has been isolated from convalescent cattle 38 d after the disappearance of clinical signs and disease can recur in convalescent cattle. Viral RNA can be detected in the tongue and draining lymph nodes of cattle 5 months after experimental inoculation but there is no evidence for the long-term persistence of replication-competent virus in cattle.

Domestic animals appear to be dead-end hosts in which the virus does not persist and does not return to its natural cycle.<sup>4</sup>

#### Method of transmission

The reservoir host is unknown. However, biological transmission by blood-feeding insects, which have been demonstrated repeatedly to be abundant on case-positive premises indicates that the insect-vector hypothesis is plausible.<sup>5</sup> The virus can be biologically transmitted by black flies (*Simulium vittatum*) and mechanically by *Culicoides* spp. flies (*Musca domestica*, and *M. autumnalis*) and eye gnats (*Hippelates* spp.). Both genera of biting insects are common in the western United States and can inflict thousands of bites per hour on livestock.<sup>10</sup> Black flies are the likely vector over long distances. Biological transmission of the New Jersey virus by *Simulium vittatum* and *Simulium notatum* can occur.<sup>11</sup> Both wild and colonized black flies readily ingest the Indiana serotype and virus is present in a large percentage of susceptible black flies and it is likely that insects, including black flies, are responsible for transmitting the virus to livestock during epidemics. Experimentally, New Jersey

serotype infected black flies *Simulium vittatum* readily transmitted the virus to domestic swine.<sup>12</sup> Transmission was confirmed by seroconversion or by the presence of clinical vesicular stomatitis. As in other domestic animal species, where viremia has not been detected naturally or experimentally, viremia did not occur in the pigs infected by infected black flies.

In Ossabaw Island, transovarial transmission has been demonstrated in a phlebotomine sandfly (*Lutzomyia shannoni*), which may be a biological vector in that region from feral pigs acting as the amplifying host.<sup>2</sup> Other suspect vectors for vesicular stomatitis include *L. trapidoi* and mosquitoes.

**Mediate or immediate contagion** occurs by contact or ingestion of contaminated materials, especially in large intensive dairies where there is much communal use of water and feed troughs. It also occurs by the ingestion of contaminated pasture. In fed cattle the use of coarse roughage or hard pellets encourages the spread of the infection.

Spread within dairy herds also appears to be aided by milking procedures. The importation of embryos from infected areas is considered a minimal risk for introduction of infection.

### Risk factors

#### Host factors

In Costa Rica, which is an endemic area for vesicular stomatitis in dairy cattle, parity (animals of parity 4 or 5 were 5.3 times more likely to exhibit clinical signs of vesicular stomatitis than animals of parity 3 or lower.<sup>13</sup> Animals of parity 6 and higher had an odds ratio of 4.6 times greater than animals of parity 3 and lower. Animals in premountain moist areas were 7.4 times more likely to exhibit clinical signs than those in lower rain forest. Factors associated with seropositivity at birth were farm and breed (Jersey calves had an odds ratio of 14.7 times greater than Holstein calves.

#### Environmental factors

There is a marked **seasonal incidence** of the disease, cases decreasing sharply with the onset of cold weather. The disease is enzootic in low-lying coastal countries with tropical climates, heavy rainfall and high insect populations. There is also a greater prevalence in geographically protected areas with heavy rainfall, such as valleys in the mountains and foothills. Areas of low incidence are protected by natural barriers to insect migration. These observations promote the importance of biting insects in the spread of the disease both locally and from infected to clean areas. In enzootic areas there is a much higher risk for dairies in forest land, the presence of sandflies, and a higher risk for

clinical disease in older cows and cows in lactation.

The management factors affecting the risk for vesicular stomatitis in horses, cattle and sheep during the 1997 outbreak in Colorado, New Mexico, Utah, and Arizona, were examined.<sup>10</sup> Animals with access to a shelter or barn had a reduced risk of developing the disease with an odds ratio (OR) of 0.6. This was more pronounced for horses at an OR of 0.5. When horses had access to pasture, the risk of developing disease was increased with an OR of 2.01. On all premises, where owners reported insect populations were greater than normal, the OR was 2.5. Premises with animals housed <0.5 miles from running water were more than twice as likely to have clinical signs of vesicular stomatitis (OR 2.6). This suggests that rivers are a pathway or a risk factor for vesicular stomatitis which is consistent with outbreaks of the disease following major waterways northward during the summer.

#### Pathogen risk factors

The two major vesicular stomatitis serotypes are vesicular stomatitis virus-Indiana (VSV-IN) and vesicular stomatitis virus-New Jersey (VSV-NJ). The two serotypes are distinct viruses, with only 50% similarity in the glycoprotein gene sequence. VSV-NJ is more predominant than VSV-IN in North America. Phylogenetic analysis indicates that the 1995 VSV-NJ belongs to a lineage distinct from that of the 1982 to 1985 viruses which caused previous outbreaks in the western United States.<sup>14</sup> It is also distinct from strains of the virus from Central America and from the Georgian Hazelburst strain.

In the last 70 years, each sporadic outbreak in the southwestern US has been associated with viral lineages distant from those causing previous outbreaks in the US but closely related to viruses maintained in endemic areas in Mexico. This pattern of viral occurrence contrasts with that observed in endemic areas in Central and South America where viral genetic lineages are maintained in specific ecological areas over long periods of time. Thus the phylogenetic data and the geographical and temporal distribution of outbreaks indicate that vesicular stomatitis does not have a stable endemic cycle in the western United States.

#### Experimental reproduction

Livestock can be infected with vesicular stomatitis virus by injection or aerosol exposure but not by rubbing virus on intact skin. Intradermal injection causes obvious skin lesions at the inoculation site but intramuscular injection. Experimental inoculation with the virus kills neonatal mice and chick embryos, and

most guinea pigs, hamsters, ferrets, and mice, and chicks.<sup>1</sup>

Experimentally, VS-NJ virus infected black flies when exposed to the abdomen or planum rostrale (snout) of young pigs results in lesions developing post-infection day 1.<sup>12</sup> The entire surface of the snout ventral to the nostrils becomes reddened and swollen, with pin point pale raised areas. This proceeds to vesiculation on day 2, and subsequent rupture, erosion, and crusting by day 3. Erosion persists for several days, and by day 7, the vesiculated area is almost healed. Secondary vesicles develop on the upper lips and the tip of the tongue by day 3. Virus can be recovered from tissues surrounding the snout lesions but cannot be isolated from whole blood or plasma.

Pigs can be experimentally infected with the 1995 equine isolate of VS-NJ (Colorado) and the 1997 equine isolate of vesicular stomatitis Indiana (New Mexico).<sup>15</sup>

Viremia has not been detected in any domestic animal species naturally or experimentally infected with the New Jersey serotype of the virus. Details of the Infection and pathogenesis of vesicular stomatitis virus at the cellular level are available.<sup>1</sup>

#### Economic importance

Most cases of vesicular stomatitis recover in a few days. The losses on large dairy farms due to disruption of continuity of milk supplies may cause severe financial loss.<sup>1,3</sup> There is also much inconvenience and temporary inability to feed.

There are also losses associated with quarantine such as loss of market opportunities and pasture damage from overgrazing of pastures used for quarantine. Other economic effects result from the cancellation of animal events such as fairs and the cost of loss of international markets.<sup>1</sup>

In the 1995 epidemic of VSV-NJ in the Western United States, the direct costs for increased labor and veterinary expenses incurred in caring for horses with the disease were estimated at \$382.00 per case. In a dairy herd, losses were estimated at \$787.00 per animal from increased culling, and in beef ranches the costs were \$15 565.00 per ranch.<sup>5</sup> State regulations restricting the movement of animals within a zone of 10 miles around premises with confirmed cases for 30 days after the last lesion healed, and declaring a quarantine, all added to economic losses.

Vesicular stomatitis is classified by the Office Internationale des Epizooties as a List A disease, along with such economically important diseases as foot and mouth

disease and bovine spongiform encephalopathy. In the United States, all livestock with clinical signs of vesicular disease must be inspected by personnel from the USDA Animal Plant and Health and Inspection Service. Premises confirmed to have vesicular stomatitis positive animals remain quarantined until 30 days after all clinical signs of the disease have disappeared from livestock on the premises. Thus local and national activities involving horses and cattle may be disrupted, and international exports may be prohibited because of meat and livestock embargoes.

#### Zoonotic implications

Occasional human infections give the disease some public health significance, but the disease is mild, resembling influenza.<sup>1</sup>

#### PATHOGENESIS

Local infection of the mucous membrane of the mouth and the skin around the mouth and coronets is followed by the development of vesicles on the lips, muzzle, tongue, and also on the teats and interdigital clefts. The frequent **absence of classical vesicles** on the oral mucosa of affected animals in field outbreaks has led to careful examination of the pathogenesis of the mucosal lesions. Even in experimentally produced cases, only 30% of lesions develop as vesicles; the remainder dehydrate by seepage during development and terminate by eroding as a dry necrotic lesion.

#### Immune mechanisms

Following infection, serum neutralizing antibodies develop within a few days and may persist for 8 to 10 years.<sup>3</sup> Reinfection can occur in the presence of a high antibody titer. In cattle, horses, and swine, high titers of virus are found at the margins of lesions and in vesicular fluids for a short period after infection. However, viremia is undetectable and there is no known carrier state in cattle, horses, or swine.

#### CLINICAL FINDINGS

##### Cattle

In **cattle** after a short incubation period of 3–15 d, there is a sudden appearance of mild fever and the development of vesicles on the dorsum of the tongue, dental pad, lips and the buccal mucosa. The vesicles rupture quickly and the resultant irritation causes profuse, ropy salivation and anorexia. Confusion often arises in field outbreaks of the disease because of failure to find vesicles. In some outbreaks with thousands of cattle affected, vesicles have been almost completely absent. They are most likely to be found on the cheeks and tongue where soft tissues are abraded by the teeth. At other sites there is an

erosive, necrotic lesion. In milking cows there is a marked decrease in milk yield. Lesions on the feet and udder occur only rarely except in milking cows where teat lesions may be extensive and lead to the development of mastitis. Recovery is rapid, affected animals are clinically normal in 3–10 d, and secondary complications are relatively rare.

##### Horses

In **horses**, the signs are broadly similar. There is fever, depression, inappetence, drooling of saliva and affected horses may rub their lips on troughs and jaw champ. Vesicles coalesce and rupture with detachment of the epithelium and the formation of shallow ulcers. The period of fever and vesicles is short lived. Not infrequently the lesions seen are limited to the dorsum of the tongue or the lips and are in the coalescing ulcer stage. Other less common sites include the udder of the mare and the prepuce of males. Lesions may occur at the coronary band and lead to lameness and deformity of the hoof wall.

##### Pigs

In **pigs**, vesicles develop on or behind the snout or on the feet and lameness is more frequent than in other animals.

#### CLINICAL PATHOLOGY

Inoculation of Vero cell cultures with epithelial cell material or vesicular fluid and subsequent staining with anti-vesicular stomatitis virus **fluorescent antibody** conjugate is commonly used for diagnosis. **Animal transmission** experiments as set out in Table 21.1 may be attempted using fluid or epithelium collected from unruptured vesicles. Typical vesicles develop after inoculation.

**Serological tests** include virus neutralization, complement fixation, and ELISA tests; the latter has advantages in speed and expense and has comparable sensitivity and specificity.<sup>6</sup> Titers, especially those to the serum neutralization test, can persist for years. In the 1997 outbreak in the United States, the definition of the index case was detection of clinical signs of vesicular stomatitis, accompanied by virus isolation or a fourfold increase in the titer (**complement fixation** test) or **serum neutralization** test in paired sera collected 7 days apart. A positive result for a **competitive ELISA (cELISA)**, and clinical signs were also used for subsequent case definitions.<sup>6</sup>

#### NECROPSY FINDINGS

Necropsy examinations are not usually undertaken for diagnostic purposes but the pathology of the disease has been adequately described.

#### DIFFERENTIAL DIAGNOSIS

Because of its case-for-case similarity to FMD, prompt and accurate diagnosis of the disease is essential. In most countries the **disease is notifiable**.

##### All species

- FMD and other vesicular diseases.

##### Cattle

- Bovine virus diarrhea
- Bovine malignant catarrh
- Pseudocowpox.

##### Horses

- Blister beetle toxicosis
- Bullous phlegmiod
- Phenylbutazone toxicity
- Grass seed awns.

#### TREATMENT

Treatment is seldom undertaken but non-steroidal anti-inflammatories may contribute to the comfort of the animal and the rapidity of recovery.

#### CONTROL

**Hygienic and quarantine precautions** to contain the infection within a herd are sufficient control and the disease usually dies out of its own accord. Animal movement off the farm should be prohibited until 30 d after all lesions have healed. There are usually restrictions of movement of animals from infected areas to different jurisdictional areas that are free of clinical disease and vesicular stomatitis is an Office of International Epizootics **List-A disease**.

Immunity after an attack appears to be of very short duration, probably not more than 6 months, but serological titers persist much longer. An **autogenous killed vaccine** was approved for use in dairy cattle in infected or at-risk areas during the 1995 outbreak in the United States but vaccine efficacy could not be determined.

A DNA vaccine expressing the glycoprotein gene from VS-NJ virus elicits neutralizing antibody titers in mice, cattle, and horses.<sup>16</sup> The level of protection of antibody required for protection is unknown.

A recombinant vesicular stomatitis (Indiana) virus expressing New Jersey and Indiana glycoproteins has been generated and examined as vaccine candidate. When inoculated into pigs it induced neutralizing antibodies and the pigs were protected against homologous high dose challenge.<sup>17</sup>

#### REVIEW LITERATURE

Letchworth GJ, Rodriguez LL, Barrera JDC. Vesicular stomatitis. *Vet J* 1999; 157:239–260.

Schmitt B. Vesicular stomatitis. *Vet Clin North Am Food Anim Pract* 2002; 18:453–459.

#### REFERENCES

1. Letchworth GJ et al. *Vet J* 1999; 157:239.
2. Stallnecht DE. *Ann NY Acad Sci* 2000; 96:431.

3. Schmitt B. *Vet Clin North Am Food Anim Pract* 2002; 18:453.
4. Rodriguez LL. *Virus Res* 2002; 85:211.
5. Schmidtman ET et al. *J Med Entomol* 1999; 36:1.
6. McCluskey BJ et al. *J Am Vet Med Assoc* 1999; 215:1259.
7. Mumford EL et al. *J Am Vet Med Assoc* 1998; 213:1265.<sup>7</sup>
8. McCluskey BJ et al. *Ann NY Acad Sci* 2002; 969:205.
9. Howerth EW et al. *Ann NY Acad Sci* 2002; 969:340.
10. Hurd HS et al. *J Am Vet Med Assoc* 1999; 215:1263.
11. Mead DG et al. *Ann NY Acad Sci* 2000; 96:437.
12. Mead DG et al. *J Med Entomol* 2004; 41:78.
13. Remmers L et al. *Ann NY Acad Sci* 2000; 96:417.
14. Llewellyn ZN et al. *Am J Vet Res* 2000; 61:1358.
15. Stallnecht DE et al. *Am J Vet Res* 2004; 65:1233.
16. Cantlon JD et al. *Vaccine* 2000; 18:2368.
17. Martinez I et al. *Vaccine* 2004; 22:4035.

## VESICULAR EXANTHEMA IN SWINE

Vesicular exanthema of swine is an acute, febrile, infectious disease of swine associated with a calicivirus. At least 34 types of caliciviruses have been recognized in the ocean<sup>1</sup> and new outbreaks continue to occur.<sup>2</sup> The relationship between these viruses and VES is a continual source of speculation.<sup>3</sup> The virus isolated in 2000 from sea lions was shown to be infectious for swine.<sup>2</sup> It is indistinguishable clinically from foot-and-mouth disease (FMD) in swine, vesicular stomatitis and swine vesicular disease. It has not been a problem for the pig industry for over 40 years.

### ETIOLOGY

The causative virus is a calicivirus and 13 antigenic strains have been isolated with some variation in virulence between strains. Even in one herd the virus isolated may have been antigenically different from others. At least 17 antigenic types have been isolated since 1972. Only pigs are susceptible although experimental transmission to horses can be effected with some strains. All ages and breeds of pigs are susceptible to infection. The initial outbreak in pigs was traced to the feeding of meat from sea mammals.

### EPIDEMIOLOGY

#### Occurrence

It was first diagnosed in Southern California in 1932. In 1952, it was diagnosed outside California and by 1953 had occurred in 42 states. However rigid control eradicated it by 1956 with particular importance being paid to garbage feeding control.

Except for isolated outbreaks in Hawaii and Iceland, the disease has occurred only in the United States. It is important because of its direct effect and because of its resemblance to FMD. Although vesicular exanthema is a mild disease with a low mortality rate (usually less than 5%

although there may be many deaths in unweaned pigs) affected animals may suffer a severe loss of body weight and convalescence may require several weeks. Pregnant sows may abort and lactating sows may go dry with resultant heavy losses in baby pigs. The disease was eradicated from the United States in 1959, 27 years after its initial appearance.<sup>4</sup>

### Methods of transmission

The sources of infection are infected live pigs and infective pork. Infected pigs excrete the virus in saliva and feces but not in the urine for 12 h before vesicles develop and for 1–5 d afterwards. Raw garbage containing infective pork scraps is the most common medium of spread from farm to farm. On infected premises the disease is spread by direct contact and, although the virus is resistant to environmental influences, spread by indirect means does not occur readily. Pigs frequently become infected, as evidenced by the development of immunity, without evidence of clinical disease. Ingestion of infected material is sufficient to produce infection.

The isolation from marine animals of an identical virus, which is capable of producing a disease identical to vesicular exanthema when inoculated into pigs, has led to the hypothesis that the primary reservoir for vesicular exanthema is in marine animals. Epizootics in pigs may have been initiated by the feeding of marine meat or garbage containing marine animal products.

### Risk factors

#### Pathogen risk factors

The virus is resistant to environmental influences and persists in frozen and chilled meats. It is readily destroyed by several different commonly used disinfectants including sodium hypochlorite, sodium hydroxide and phenol. A good immunity develops after an attack and persists for about 20 months. There is no appreciable cross-immunity between the strains of the virus and a series of outbreaks, each associated with a different strain of the virus, may occur in the one herd of pigs.

A similar if not identical virus, San Miguel sea lion virus, has been isolated from sea lions and fur seals off the coast of California in the United States. It is physically, chemically and morphologically identical to the vesicular exanthema virus, although the same antigenic types have not been found. The virus produces an identical disease to vesicular exanthema when inoculated into pigs and appears to have a similar host range. The vesicular exanthema of swine virus is infective for the harp seal but the disease is inapparent and self-limiting. The intradermal ino-

culcation of the vesicular exanthema of swine virus into otterid (fur) seal pups will result in plaque-like lesions. Feeding swine the seal tissues from the inoculation experiments will result in seroconversion in swine which were fed tissues from seals infected with the vesicular exanthema of swine virus but not in those which were fed tissues from seals infected with the San Miguel sea lion virus. Antibody to this virus has also been detected in California gray whales and in feral swine inhabiting coastal areas.

### PATHOGENESIS

As in other vesicular diseases there is a viremia, lasting for 72–84 h and commencing 48 h before vesication, with localization occurring in the buccal mucosa and the skin above the hooves. The intradermal inoculation of the vesicular exanthema of swine virus and the San Miguel sea lion virus into swine results in fluid-filled vesicles at the sites of inoculation in the snout, coronary band, and tongue. Lesions are usually limited to the non-haired portions of the integument and tongue. A mild viral encephalitis occurs in pigs inoculated with the swine virus and the sea lion virus can be recovered from the brain tissue of pigs infected with the virus.

### CLINICAL FINDINGS

The incubation period varies with the virulence of the causative strain of virus but is usually 1–3 d. Morbidity is always high but mortality is low. There is an initial high fever (40.5–41°C; 105–106°F) followed by the development of vesicles in the mouth, on the snout, on the teats and udder and on the coronary skin, the sole, the heel bulbs and between the claws, and accompanied by extreme lassitude and complete anorexia. The initial lesion is a blanched area which soon develops into a vesicle full of clear fluid. The vesicles rupture easily leaving raw, eroded areas. This usually occurs about 24–48 h after they appear and is accompanied by a rapid fall of temperature. Secondary crops of vesicles often follow and may cause local swelling of the face and tongue. Lesions on the feet may predominate in some outbreaks whereas in others they may be of little significance. The affected feet are very sensitive and there is severe lameness. Healing of the oral vesicles occurs rapidly although secondary bacterial infection often exacerbates the lesions on the feet. Recovery in uncomplicated cases is usually complete in 1–2 weeks. It may occasionally cause encephalitis, myocarditis, and diarrhea and failure to thrive. When sows become infected late in pregnancy, abortion frequently occurs and lactating sows may go dry.

## CLINICAL PATHOLOGY

Fluid from the vesicles is used in transmission experiments and for tissue culture. Blood serum is used for the complement fixation, viral neutralization in cell culture and gel diffusion precipitin tests.

## NECROPSY FINDINGS

Postmortem examinations are not of much value in the diagnosis of vesicular exanthema but the pathology of the disease has been defined. The lesions are limited to epithelial lesions where there are vesicles, necrosis, sloughing and rapid healing with mild scarring. Diagnosis involves virus isolation in cell culture, with electron microscopy as a possibility and various serologic tests including fluorescent antibody tests for the antigen. PCR tests have also been developed.

## DIFFERENTIAL DIAGNOSIS

Because of its case-for-case similarity to FMD, prompt and accurate diagnosis of the disease is essential. In most countries the **disease is notifiable**.

### All species

- FMD and other vesicular diseases.

### Cattle

- Bovine virus diarrhea
- Bovine malignant catarrh
- Pseudocowpox.

### Horses

- Blister beetle toxicosis
- Bullous pemphigoid
- Phenylbutazone toxicity
- Grass seed awns.

## TREATMENT

There is no effective treatment. The immunity is solid following infection but heterologous infection is possible.

## CONTROL

Eradication of the disease should be attempted whenever practicable. In most instances it is essential to report to the regulatory authorities. The first step is to quarantine infected premises and restrict movement of pigs in the area. Infected animals should be slaughtered but the carcasses may be salvaged for human consumption provided the meat undergoes special treatment to insure destruction of the virus. Normal freezing and chilling procedures are not sufficient to destroy it. All garbage fed to pigs must be boiled. Infected premises should be thoroughly cleaned and disinfected with a 2% sodium hydroxide solution before restocking. The implementation of these measures was eminently successful in eradicating the disease from the United States.

In view of the reservoir of virus in marine animals and apparent infection in feral swine in the coastal areas of

California, it is possible that the disease could recur in domestic swine in the United States. Possible methods of re-introduction that need to be guarded against have been described.

Active immunization may be practicable if the disease reappears and other control measures fail. A formalin-killed virus preparation produces an immunity lasting for at least 6 months. Multivalent vaccines may be required if more than one strain of the virus is involved.

Recently the pathogenic class of VESV-like caliciviruses (genus vesivirus) endemic in certain ocean species and US livestock has possibly caused vesicular disease on the hands and feet of humans.<sup>5</sup>

## REVIEW LITERATURE

Thiel H-J, König M. Caliciviruses; an overview. *Vet Microbiol* 1999; 69:55-62.

## REFERENCES

1. Smith AWT, Boyt PM. *J Zoo Wild Med* 1990; 21:3.
2. Van Bonn W et al. *J Wild Dis* 2000; 36:500.
3. Smith AW et al. *Emerg Inf Dis* 1998; 4:13.
4. Smith AW, Akers TG. *J Am Vet Med Ass* 1976; 169:700.
5. Smith AW et al. *J Am Vet Med Ass* 2002; 220:455.

## RINDERPEST (CATTLE PLAGUE)

### Synopsis

**Etiology** Rinderpest virus, a morbillivirus  
**Epidemiology** Affects ruminants, rarely swine. Outbreaks in Asia, Middle East and tropical Africa, highly contagious and high mortality

**Pathogenesis** Inhaled/ingested virus → upper respiratory infection → viremia → target cells (lymphocytes and alimentary mucosa) → signs and lesions

**Clinical signs** High fever, oculonasal discharge, salivation, ulcerative stomatitis, diarrhea, dehydration and death

**Clinical pathology** Marked leukopenia  
**Diagnostic confirmation** Virus isolation, serology and immunohistochemistry

**Lesions** Necrotic stomatitis and esophagitis, ulcerative and hemorrhagic enterocolitis, massive necrosis of lymphocytes in Peyer's patches, lymph nodes and spleen

### Differential diagnosis list

- Bovine virus diarrhea
- Foot-and-mouth disease
- Malignant catarrhal fever
- Peste des petits ruminants.

**Treatment** None

**Control** Surveillance and annual vaccination with tissue culture vaccine in endemic areas, eradication by slaughter and rigid quarantine during outbreaks in non-endemic areas

## ETIOLOGY

Rinderpest is associated with a morbillivirus (family Paramyxoviridae) and there are many strains with considerable variation in virulence between them but all are immunologically identical. Conse-

quently, the immunity which develops after infection or vaccination with one strain protects against all other strains or isolates. Three genetically distinct lineages of the virus are now recognized, with lineages 1 and 2 being of African origin and lineage 3 of Asian origin,<sup>1</sup> but the differences between lineages are small and do not affect the immunity induced.<sup>2</sup> Rinderpest virus is quite fragile and is antigenically related to the other members of the morbillivirus group including the viruses causing peste des petits ruminants (PPR) in sheep and goats, canine distemper in dogs, measles in humans, phocine distemper in seals and hedgehog distemper.<sup>2</sup>

## EPIDEMIOLOGY

Historically, rinderpest (cattle plague) was a most devastating disease spread from Asia to Europe, the Middle East and Africa, usually as a sequel to wars. The need to combat the disease was instrumental in the establishment of the first veterinary school in 1762 in Lyon, France. Its complete eradication is the goal of the Global Rinderpest Eradication Program (GREP) of the Food and Agriculture Organization and the geographic distribution of the disease has been shrinking steadily since the beginning of the 20th century. Rinderpest was eradicated from southern Africa, Europe and China by the middle of that century. In the 1960s, the disease was cleared from West Africa and most of East Africa, but there was a dangerous resurgence less than 10 years later and again in the 1990s.

## Occurrence

Most countries today claim to be free of rinderpest. At the end of the last century, the disease was still endemic in parts of Asia and in a small area bordering on Kenya and Somalia. In the 1980s, outbreaks occurred over much of tropical Africa and Asia. The most recent outbreaks occurred in Kenya and Tanzania (1993-97, 2003) and in Pakistan (2000-2002). The disease has never appeared in North America but there have been single outbreaks which were quickly eradicated in Brazil and Australia. All ruminants and pigs are susceptible to infection with rinderpest virus. Natural infection occurs commonly only in domestic cattle, buffalo and yak but in some outbreaks, sheep and goats do become infected and show clinical signs. European pigs are susceptible to infection but only show a mild transient fever and do not spread the disease. Pigs indigenous to Thailand and Malaysia are highly susceptible and natural spread of the clinical disease can occur. Similarly, clinical disease is common in Asian sheep and goats and they contribute to the



persistence of the virus in the region. There is the belief that rinderpest became prevalent in small ruminants in Africa and Asia only after the introduction of goat-adapted rinderpest vaccine from which the virus of PPR probably mutated. One-humped camels become infected, but show no clinical signs.

Wildlife are often affected during outbreaks and the infection usually spreads to them from infected cattle. Nevertheless, it has been suggested that strains of the virus that are of low pathogenicity and low transmissibility could cycle in wildlife in the absence of disease in cattle. In the 1980–1983 outbreaks involving over 2 million cattle in Nigeria, free-living and captive wild animals also died but the disease did not occur in wildlife after it was eradicated from cattle.<sup>3</sup> Similarly, wildlife (especially buffalo and eland) did not appear to act as reservoirs but as fully susceptible hosts during the Kenyan epidemic of 1993–1997 involving the lineage 2 virus in national parks.<sup>4</sup> The wildlife most commonly affected are the buffalo, bushbuck, waterbuck and warthogs, all water and shade-loving. Others include the eland, giraffe, kudu, deer and wildebeest. An outbreak in the former Soviet Union involved yaks near the Mongolian border.<sup>3</sup>

### Prevalence

In the absence of an outbreak, the prevalence of the disease in endemic countries is low. In India, it was less than 10 per 100 000 cattle before 1963, 5–7.5 per 100 000 in 1963–1974 and 2 per 100 000 in 1974–1988<sup>5,6</sup> as a result of great expansion of the numbers of vaccinated cattle. By mid-1990s, India was free of the disease. In general, recent vaccination campaigns in tropical Africa and Asia have greatly reduced the number of susceptible animals in the region, up to the point that one can say that the disease is currently under control worldwide.

### Morbidity and case fatality

When epidemics occur in highly susceptible populations, the morbidity and case-fatality rates approximate 100% and 50% (25–90%) respectively,<sup>7</sup> and large numbers of in-contact animals may have to be destroyed. In endemic areas, most of the cattle population have some degree of immunity and case-fatality rates rarely exceed 30%. The African lineage 2 strain of the virus caused a high mortality in buffaloes but a milder form of the disease in transhumant cattle.<sup>8</sup>

### Methods of transmission

Close contact between infected and non-infected animals is usually necessary for spread of the disease to occur because the virus does not survive for long outside the

host. The virus is excreted by infected animals in urine, feces, nasal discharges, and perspiration. Transmission occurs through contaminated feed or by inhalation of aerosol. Survival of aerosolized virus depends particularly on humidity and it may last for more than 30 min at relatively low humidity. Ingestion of food contaminated by discharges of clinical cases, animals in the incubation stage, or animals with subclinical infections, may also be important modes of infection, especially in pigs. Aborted bovine fetuses may contain live virus.<sup>9,10</sup>

Insects, many of which have been shown to contain the virus, are unlikely to act as vectors. Other species, including European breeds of pigs in particular, and sheep, goats, camels and wild ruminants may serve as a source of the virus for cattle. Although there may be rare exceptions,<sup>11</sup> it is doubtful that recovered animals act as carriers for more than a few days. Because of the failure of the virus to persist outside the body, rinderpest can be controlled by interrupting its transmission.<sup>12</sup>

### Risk factors

#### Host factors

Cattle and buffalo of all ages are susceptible to rinderpest, unless they have been vaccinated or have recovered from a previous infection or, in the case of calves, they have received colostral antibodies. European breeds of cattle are believed to be more susceptible than zebu cattle, but zebu cattle without antibodies from previous exposure or vaccination are fully susceptible. For example, the interruption of routine rinderpest vaccination in Central and West Africa in the 1970s was believed to be a major factor in the epidemics that ravaged zebu cattle populations in that region a few years later.<sup>13</sup> Rinderpest used to occur in explosive outbreaks when it was first introduced to a herd and it would spread easily to other in-contact herds. This was particularly common among nomadic herds that seasonally migrate over long distances in search of pasture and water. Any other legal or illegal movement of animals incubating the disease could be a mode of spread. Cattle raids and communal grazing can be risk factors. Other ruminants and pigs in contact with infected cattle or buffalo may develop the disease.

#### Environmental and pathogen factors

The virus is present in the blood, tissues, secretions and excretions of infected animals, reaching its peak of concentration at about the height of the temperature reaction and subsiding gradually to disappear about a week after the temperature returns to normal in those animals that recover. The risk of transmission is

therefore greatest during the febrile stage. The virus does not persist outside the host for more than a few hours at normal temperatures. It is inactivated in cadavers within 24 h as a result of pH changes and putrefaction, and it is readily destroyed by heat, drying and most disinfectants. Even in untreated premises, it survives for only a few days. However, it is relatively resistant to cold and may survive for as long as 1 month in blood kept under refrigeration. The risk of transmission can therefore be greatly minimized by applying appropriate sanitary and other control measures.

### Immune mechanism

Immunity after a natural infection or by vaccination is long and for all practical purposes, persists for life. The protection is associated with the induction of humoral antibodies, first IgM and later, IgG and IgA, which are detectable by enzyme immunoassay.<sup>14</sup> The disease is also associated with immunosuppression because the virus causes extensive necrosis of lymphocytes throughout the body. Older live vaccines can also cause immunosuppression. However, the newer tissue culture vaccine does not and can be simultaneously administered with other vaccines, for example, FMD and contagious bovine pleuropneumonia vaccines, without any diminished responses to any of the immunogens used.

### Experimental reproduction

Rinderpest can be experimentally reproduced by bringing susceptible animals in close contact with an infected one or by directly inoculating with blood or tissues from an infected animal or tissue culture. Rabbits can be artificially infected and this was made use of in the production of a lapinized virus vaccine.

### Economic importance

Rinderpest has been one of the major diseases of cattle that occur in the form of epidemics. It is a List A disease by OIE classification. Under extensive systems of management as practised in many African and Asian countries, the disease easily spreads across national boundaries and can involve most of the national herds of cattle and buffalo. Losses can be colossal and are due to deaths, loss of productivity and cost of effective prevention and control. During the outbreaks that occurred in Africa in the 1980s, millions of cattle were affected in the central and western regions. Reports from Nigeria indicated a death toll of 0.4 million infected cattle in 1983 and that the toll was higher in poorer countries that could not procure adequate doses of the vaccine. Fortunately, the situation has improved considerably due to the vaccination and surveillance

programs of the Global Rinderpest Eradication Program (GREP) and the Pan African Rinderpest Campaign (PARC).

### Zoonotic implications

The virus of rinderpest is not pathogenic to humans.

### Biosecurity concerns

Although rinderpest is not highly contagious, the mortality rate can be so high that care should be taken in handling diagnostic specimens to avoid accidental spread. Under intensive system of management, any accidental infection can be easily curtailed and eradicated.

### PATHOGENESIS

The virus is inhaled in infected droplets; it penetrates through the epithelium of the upper respiratory track and multiplies in tonsils and regional lymph nodes. From these sites, the virus enters the blood in mononuclear cells and is disseminated throughout the body, intimately associated with leukocytes and only a small proportion free in plasma. The virus has a high degree of affinity for lymphoid tissues and alimentary mucosa and replicates in monocytes, lymphocytes and epithelial cells.<sup>11,15</sup> There is a striking destruction of lymphocytes in tissues resulting in marked leukopenia. Lymphocytes are destroyed by apoptosis as well as necrosis. The focal, necrotic stomatitis and enteritis which are characteristic of the disease are the direct result of viral infection and replication in epithelial cells in the alimentary tract. However, because the virus induces a strong antibody response shortly after infection, there is a rapid decline and elimination of virus from the body as clinical signs and lesions become manifest. Death is usually from severe dehydration, but in less acute cases, death may be from activated latent parasitic or bacterial infections which are exacerbated because the animal is immunosuppressed as a result of the destruction of lymphoid organs by the virus.

### CLINICAL FINDINGS

The following descriptions present the principal clinical signs of classical rinderpest but it must be remembered that an almost unlimited series of variations in syndromes may be encountered depending on the virulence of the strain of virus, the susceptibility of the host, and the presence or absence of concurrent diseases. Most outbreaks reported recently have been usually mild in cattle. In general, clinical signs may be **peracute**, **acute**, **subacute** or **inapparent** (in species other than cattle and buffalo).

The **peracute form** is not common except after experimental administration of the virus. It is characterized by

high fever, congested mucous membranes, respiratory distress and death 1–3 d later.

**Acute cases** may be seen in naive cattle in areas or countries that were previously free of the disease. An incubation period of 6–9 d is usual. The first stage of the disease is several days of high fever (40.5–41.5°C; 105–107°F), without mucosal lesions (phase of prodromal fever). Anorexia, a fall in milk yield, lacrimation and a harsh, staring coat accompany the fever and this corresponds to the period of peak virus production in tissues. This is followed by the mucosal phase characterized by inflammation of buccal, nasal and conjunctival mucosae and, in some cases, hyperemia of vaginal mucosa and swelling of vulva. The lacrimation becomes more profuse and then purulent and is accompanied by blepharospasm. Bubbly salivation of clear blood-stained saliva is followed by purulent saliva and halitosis. A serous nasal discharge similarly becomes purulent. Discrete, grayish, raised necrotic lesions (1–5 mm in diameter) develop, appearing first on the inside of the lower lip and adjacent gum, on the cheek mucosa at the commissures, and on the lower surface of the tongue. Later they become general in the mouth, including the dorsum of the tongue, and may become so extensive that they coalesce. Similar lesions are common on nasal, vulval and vaginal mucosae. The necrotic material sloughs, leaving raw, red areas with sharp edges and these may coalesce to form shallow ulcers. Vesicles are not present.

Severe diarrhea, and sometimes dysentery with tenesmus, appear as lesions develop in abomasum and intestines. Skin lesions affecting the perineum, scrotum, flanks, inner aspects of thighs and the neck are less common. The skin becomes moist and reddened and later covered with scabs.

After a period of illness lasting from 3–5 d, there is a sudden fall in temperature, accompanied by exacerbation of the mucosal lesions. Other signs include dyspnea, cough, diarrhea, severe dehydration and sometimes abdominal pain. Prostration and a further fall in body temperature to subnormal levels occur on days 6–12, after which death usually occurs within 24 h. A few animals may survive and go into a convalescent phase during which the mucosal lesions heal rapidly, the diarrhea eventually stops and recovery of body condition takes several weeks. Pregnant cattle may abort at this stage, discharging infective virus in the fetus and vaginal secretions for up to 24 h.<sup>10</sup>

In enzootic areas, both a **subacute form** and a **skin form** occur with lower morbidity and mortality. In the subacute

form, the temperature reaction is mild and the accompanying anorexia and malaise are not marked. The inflammation of the mucosae is catarrhal only and there is no dysentery. In the skin form, the systemic reaction is absent and small pustules develop on the neck, over the withers, inside the thighs and on the scrotum. Most affected animals recover and convalescence is short. However, because of the severe lymphocytolysis, latent pathogens, particularly *Anaplasma marginale*, are often activated and the resulting disease may overshadow the primary rinderpest.

Signs and lesions similar to those which occur in cattle develop in **sheep** and **goats** and in **Asian pigs**. The disease in European pigs is clinically **inapparent** and wild ungulates exhibit a wide range of clinical signs, from severe to mild. Keratoconjunctivitis has been described in buffaloes and kudus affected with lineage 2 virus.<sup>4</sup>

### CLINICAL PATHOLOGY AND LABORATORY DIAGNOSIS

A marked leucopenia occurs at the height of the infection and after vaccination in cattle and in experimentally infected sheep and pigs. The total count usually falls to below 4000  $\mu$ L and is due to a precipitous drop in lymphocytes. With diarrhea, animals also become severely dehydrated. Later, they may show neutrophilia.

Various methods for diagnosing rinderpest have been described and basically involve identification of the agent and serological tests.<sup>1</sup> A rapid chromatographic strip test (Penside test) that can detect rinderpest antigen in lachrymal fluid<sup>16</sup> is a useful tool for field personnel. In areas where there had been recent outbreaks, a presumptive diagnosis also can be made on the basis of the history, clinical signs and postmortem findings. Since the prevalence of the disease is decreasing, it is recommended that for each outbreak, the virus should be isolated, its lineage identified and its virulence in cattle assessed.<sup>1</sup> Antibody detection in paired serum samples is not recommended during an outbreak because of the length of time required to confirm a diagnosis but it is used for disease surveillance and vaccine evaluation. For antigen detection and virus isolation, the key to diagnostic success is the collection of suitable samples at the optimum time (3–5 d after fever commences) from many animals rather than many samples from one sick or dead animal. The proportion of positive reactors falls sharply after diarrhea commences and in moribund or dead animals.

A technique suitable for laboratory and field use is the agar gel diffusion (AGID) technique in which needle biopsy samples

of lymph node are used as antigen. Other satisfactory methods of detecting rinderpest antigen in feces, buccal scrapings, and ocular and nasal discharges in the early stages of the disease are the complement fixation, counterimmunoelectrophoresis (CIEP),<sup>17</sup> immunofluorescence, immunohistology and passive hemagglutination tests. The virus can be detected immunohistochemically in the tonsil despite marked autolytic changes.<sup>18</sup> Using specific cDNA probes, isolates of rinderpest and PPR viruses can now be differentiated<sup>19</sup> and a test employing the polymerase chain reaction has been developed that can detect viral RNA in tissues otherwise unsuitable for standard techniques.

The isolation of the virus in tissue culture and its identification is best done with washed leukocytes harvested from blood buffy coat or from fresh lymph node. Rapid virus isolation is possible using continuous growing lines of bovine T-lymphocytes.<sup>9</sup>

For antibody detection, a CFT is of limited value on a herd basis. Antibodies in serum reach peak levels about 14 d after the development of clinical disease. In animals which have recovered for longer periods, the antibody level may be so low that the test is unsatisfactory. For this reason, the serum neutralization test is used more widely, even though it is time consuming and involves the use of tissue culture facilities. Neutralizing antibodies remain detectable for years and they correlate very closely with clinical and virological immunity. This test is at present the most suitable assay for surveillance for virus circulating in the field and for monitoring the efficiency of a recent vaccination campaign. Other available serological tests include those based on the detection of fluorescent antibody and immunoperoxidase,<sup>11</sup> an ELISA which is accurate and easy to perform<sup>20</sup> and can differentiate between rinderpest and PPR,<sup>21</sup> and a rapid dot-enzyme immunoassay test suitable for field use.<sup>22</sup>

Confirmation by the experimental transmission of the disease is expensive and dangerous unless isolation facilities with maximum security are available. The recipient group should include one or more animals known to be immune to rinderpest. The intravenous inoculation of 5 mL of blood from an affected animal at the height of the disease into susceptible cattle is followed by the development of signs in 3–10 d. Sheep as recipient animals may only show mild febrile reaction and mucosal erosions.

#### NECROPSY FINDINGS

The important necropsy findings are in the alimentary and upper respiratory tracts and in the external genitalia in females. The carcass is dehydrated, ema-

ciated and soiled with fetid feces. Small, discrete, necrotic areas develop on the oral mucosa and separation of the necrotic material leaves sharply walled, deep erosions with a red floor which may coalesce to form large erosions or ulcers. These lesions extend to the pharynx, upper esophagus and abomasum, particularly the pyloric region. The forestomachs are spared and lesions are mild in the small intestine except at the Peyer's patches which are swollen, hemorrhagic and necrotic. Severe changes occur in the mucosa and lymphoid nodules in the large intestine, particularly at the cecocolic junction. Zones of hemorrhage and erythema running transversely across the colonic mucosa produce a characteristic striped appearance, the so-called 'zebra stripes'. The nasal turbinates and septa are coated with a tenacious mucopurulent exudate beneath which is an eroded and ulcerated surface. Lesions may extend to the upper trachea but not beyond and the lungs are usually not affected. Congestion, swelling and erosion of the vulval and vaginal mucosae may occur.

Histologically, the mucosal changes are characterized by necrosis of stratified squamous epithelium of the upper alimentary tract and necrosis of crypts in the intestine, with resulting erosions and superficial ulcers. Inflammatory cells are minimal but multinucleated syncytia are characteristic. Intranuclear and intracytoplasmic viral inclusion bodies may be present, especially in the tonsils. Lymph nodes and spleen may appear normal grossly but microscopically, they show characteristic massive necrosis of lymphocytes.

Materials sent for laboratory examination should include fixed sections of lymph node, tonsil and alimentary tract lesions, as well as fresh spleen, blood and alimentary tract for antigen detection or virus isolation.

#### DIFFERENTIAL DIAGNOSIS

Rinderpest should be suspected when a number of cattle or buffalo are affected by a febrile, fatal, highly infectious disease with characteristic signs. FMD and hemorrhagic septicemia are other diseases which occur in epidemics but are sufficiently dissimilar to present no difficulty in differentiation. Malignant catarrhal fever (MCF) and bovine virus diarrhea/mucosal disease (BVD/MD) present the major difficulty in diagnosis. MCF rarely affects many animals in one herd and is characterized by specific eye lesions and nervous signs. BVD/MD occurs either in explosive outbreaks like rinderpest but the mortality rate is low, or it occurs sporadically, but is uniformly fatal. The postmortem lesions of rinderpest and

BVD/MD are virtually identical. Jembrana disease in Indonesia is another highly fatal disease of cattle and buffalo but anemia will be a feature and the microscopic lesions are different from those of rinderpest. Infectious bovine rhinotracheitis may produce similar mucosal lesions. In sheep and goats, PPR presents the greatest problem in differentiation but pneumonia is usually a feature of PPR but not rinderpest. If only sheep and goats are affected in an outbreak, it is most likely PPR. Other diseases to be considered are bluetongue, sheep, and goatpox and Nairobi sheep disease.

#### TREATMENT

Treatment is ineffective and should not be undertaken because of the danger of disseminating the disease. Vaccines are of no value in treating already infected animals or those infected up to 48 hours after vaccination.

#### CONTROL

Rinderpest is a simple disease and outbreaks can be effectively controlled by **slaughter and rigid quarantine measures**. In endemic areas, control used to be by **annual vaccination and surveillance**. Preparation of the vaccines is simplified by the common antigenicity of all known strains of the rinderpest virus, thus a vaccine prepared from one strain will protect against all other strains. Rinderpest vaccine protects goats against infection with the virus of PPR, probably for life despite antigenic differences between the two viruses. Although rinderpest virus has no serological similarity to BVD virus, immunity to the latter is believed to provide some protection against infection with the former.

The introduction of rinderpest to a previously uninfected country is most likely to occur through importation of infected animals, particularly to zoological gardens, but the possibility does exist that carcass meat infected with the virus could be a portal of entry. Uncooked, infected garbage has been shown to be capable of infecting pigs which subsequently spread the infection to other pigs and to cattle. Prevention of the introduction of ruminants and pigs from known infected areas is routinely practiced in countries which do not have the disease. Countries with land borders to enzootic areas can usually be adequately protected by satisfactory quarantine at the border and the erection of immune barrier zones.

When epidemic occurs in normally free areas, it is necessary to prevent movement of both living animals and fresh animal products. All susceptible animals in infected and in-contact groups must be slaughtered and disposed of on the respective farms. All ruminants and pigs

must be considered susceptible and special attention should be given to native fauna. Infected premises should be cleaned and disinfected. Solutions of caustic soda and lysol are ideal and the premises can be restocked after 1 week. When outbreaks are threatened or when an outbreak is extensive and likely to get out of control, all ruminants and pigs in the danger area should be vaccinated with an attenuated virus vaccine.

In endemic areas, control depends upon the use of an efficient vaccination procedure and disease surveillance at national, regional or continental level as is being done under the auspices of GREP. For example, African countries successfully initiated the Joint Project 15 in 1962–1976 followed later with a Pan-African Rinderpest Campaign (PARC) to rid the whole continent of the disease. The initial step was to vaccinate all animals in each national herd annually until the immune status exceeded 90%. Thereafter, calves were vaccinated annually and revaccinated the following year until there were no more outbreaks for at least 5 years. Currently, there is periodic surveillance to monitor the immune status of each national herd and to deal quickly with any new outbreaks by control of animal movement and ring vaccination of all surrounding herds. Suitable legal and administrative powers are necessary for the proper use of control by vaccination. The ideal vaccine is one which can be produced with varying degrees of attenuation suitable for safe and effective vaccination of cattle with different levels of susceptibility. It should also be highly thermostable, inexpensive and easy to administer under current systems of animal husbandry in Africa and Asia.

The second most important problem associated with rinderpest vaccination is the activation of existing latent infections in vaccinated animals. In general, the problem is greater after the use of less attenuated vaccines. Although protozoal infections present the greatest risk, bacterial and viral diseases may also be activated.<sup>23</sup> Vaccination of cattle with ears heavily infested with the tick *Rhipicephalus appendiculatus* should be avoided.

Calves present a special problem. If they receive no antibodies in the colostrum, they can be successfully vaccinated at 1 d of age, but if they are from immune cows the vaccination will be ineffective if carried out while they still have high levels of maternally derived antibodies. Colostrum-fed calves from immune cows are believed to be passively immune for periods of 4–8 months, the duration depending upon the immune status of the dam. A recent study recommended vaccinating calves after 3–3.5 months of age when maternal

immunity conferred. A highly attenuated vaccinia virus double recombinant that expressed both the F and H genes of rinderpest virus was found to protect cattle against experimental rinderpest and did not cause pox lesions.<sup>32</sup> The vaccine is heat-stable and calves can be vaccinated at any age, even in the presence of colostrum antibodies.<sup>33</sup> A variant of this vaccine which expressed only the H protein protected experimental cattle for up to 3 years.<sup>34</sup> Cattle can also be protected against rinderpest and lumpy skin disease (LSD) with a recombinant capripoxvirus vaccine expressing the fusion gene of rinderpest virus.<sup>35</sup> In another study, two of four vaccinated animals were solidly protected from virulent rinderpest challenge after 2 years, and all four from challenge with virulent LSD virus.<sup>35</sup> The recombinant vaccine showed no loss of potency when stored lyophilized at 4°C for up to 1 year. Nevertheless, there is still the need to improve the cold chain for many veterinary products and samples in parts of Africa and Asia.

possibility that vaccinated animals can be infected and become active carriers of the virus is unresolved, but this is unlikely to occur with tissue culture vaccines. With the older vaccines, vaccinated calves or calves with colostrum antibody were susceptible to experimental intranasal infection with the rinderpest virus, which was subsequently excreted to susceptible in-contact animals.<sup>25</sup>

In areas where PPR is endemic, antibodies to PPR in cattle, sheep and goats could prevent an immune response to rinderpest vaccine. Since PPR antibodies are both cross-neutralizing and cross-protective against rinderpest virus, further vaccination in the presence of these antibodies would be wasteful.<sup>26</sup>

A dual vaccine against rinderpest and contagious bovine pleuropneumonia has been in use in Africa but its efficiency against contagious bovine pleuropneumonia (CBPP) is less than maximal and it is not generally recommended.<sup>27</sup>

The principal vaccine used to control rinderpest throughout the world is the tissue culture rinderpest vaccine (TCRV) produced in calf kidney cells<sup>14,28</sup> for cattle. Before its development, attenuated vaccines were prepared by passage of the virus in goats, rabbits and chicken eggs to produce caprinized, laprinized and avianized vaccines, respectively. TCRV is easy and cheap to produce and can be freeze dried or lyophilized<sup>29</sup> and therefore has a long shelf-life before it is reconstituted. Furthermore, it is capable of varying degrees of attenuation and is thus safer in all situations. Finally, it produces a life-long immunity and does not spread from vaccinated to in-contact cattle. Its main drawback is that after reconstitution, the vaccine must be used within a few hours unless refrigerated. The establishment of cold chains in the tropics thus adds to the cost of the vaccination program. Another drawback is the difficulty in distinguishing between antibodies due to infection and those due to vaccination since both lead to life-long immunity. Cultures should also be free of infection with BVD virus.<sup>23</sup> The use of Vero cell line obviates this risk and a lyophilized vaccine that can be kept without refrigeration at high ambient temperatures for up to 2 months has been developed from this cell line.<sup>9</sup> TCRV used for cattle is suitable for use in buffaloes and also in sheep and goats which can also be protected against rinderpest by vaccination with attenuated PPR virus.<sup>30</sup>

The measles vaccine protects calves against rinderpest at an age when ordinary rinderpest vaccines are ineffective due to interference from colostrum antibody. It is also an efficient vaccine for use in adult cattle.<sup>31</sup> Recombinant vaccines against rinderpest are being developed

immunity conferred. A highly attenuated vaccinia virus double recombinant that expressed both the F and H genes of rinderpest virus was found to protect cattle against experimental rinderpest and did not cause pox lesions.<sup>32</sup> The vaccine is heat-stable and calves can be vaccinated at any age, even in the presence of colostrum antibodies.<sup>33</sup> A variant of this vaccine which expressed only the H protein protected experimental cattle for up to 3 years.<sup>34</sup> Cattle can also be protected against rinderpest and lumpy skin disease (LSD) with a recombinant capripoxvirus vaccine expressing the fusion gene of rinderpest virus.<sup>35</sup> In another study, two of four vaccinated animals were solidly protected from virulent rinderpest challenge after 2 years, and all four from challenge with virulent LSD virus.<sup>35</sup> The recombinant vaccine showed no loss of potency when stored lyophilized at 4°C for up to 1 year. Nevertheless, there is still the need to improve the cold chain for many veterinary products and samples in parts of Africa and Asia.

## REVIEW LITERATURE

- Plowright W. Rinderpest virus virology monographs. Vienna and New York: Springer Verlag, 1986.
- Rossiter PB, Wamwayi HM. Surveillance and monitoring programmes in the control of rinderpest: a review. *Trop Anim Health Prod* 1989; 21:89–99.
- Scott GR. Cattle plague. In: Sewell MMH, Brocklesby DW. *Handbook on animal diseases in the tropics*, 4th edn. London: Baillière Tindall, 1990; pp. 287–292.
- OIE Manual of diagnostic tests and vaccines for terrestrial animals, 5th edn, 2004; Chapter 2.1.4 [http://www.oie.int/eng/normes/mmanual/A\\_00027.htm](http://www.oie.int/eng/normes/mmanual/A_00027.htm).
- Rossiter PB. Rinderpest. In: Coetzer JAW, Tustin RC (eds). *Infectious diseases of livestock*, 2nd edn, vol 2. Cape Town: Oxford University Press, 2004; pp. 629–659.

## REFERENCES

- OIE Manual of diagnostic tests and vaccines for terrestrial animals, 5th edn, 2004; Chapter 2.1.4 [http://www.oie.int/eng/normes/mmanual/A\\_00027.htm](http://www.oie.int/eng/normes/mmanual/A_00027.htm).
- Rossiter PB. Rinderpest. In: Coetzer JAW, Tustin RC (eds). *Infectious diseases of livestock*, 2nd edn, vol 2. Cape Town: Oxford University Press, 2004; pp. 629–659.
- Barret T et al. *Rev Sci Tech* 1993; 12:865.
- Kock RA et al. *Vet Rec* 1999; 145:275.
- Scott GR, Ramachandran S. *Trans R Soc Trop Med Hyg* 1974; 68:276.
- Dutta J et al. *Indian Vet J* 1991; 68:99.
- Abraham A et al. *Refuah Vet* 1984; 41:112.
- Mariner JC, Roeder PL. *Vet Rec* 2003; 152:641.
- Grocock CM. *Foreign Anim Dis Rep* 1992; 20:14.
- Wafula JS et al. *Vet Rec* 1989; 124:485.
- Joshi RC et al. *Trop Anim Health Prod* 1984; 16:67.
- Taylor WP et al. *Vet Microbiol* 1995; 44:359.
- Ikede BO. *Trop Vet* 1984; 2:1.
- Anderson J et al. *Res Vet Sci* 1982; 32:242.
- Re-Nores JE, McCullough KC. *J Virol* 1996; 70:44:19.
- Bruning A et al. *J Virol Methods* 1989; 81:143.
- Obi TU, Patrick D. *J Hyg Camb* 1994; 93:579.

19. Diallo A et al. *J Virol Methods* 1989; 23:127.
20. Sharma B et al. *Ind J Anim Sci* 1983; 53:292.
21. Diallo A et al. *Vet Microbiol* 1995; 44:307.
22. Afshar A, Myers DJ. *Trop Anim Health Prod* 1986; 18:209.
23. Scott GR. *Prog Vet Microbiol Immunol* 1985; 1:145-174.
24. Ertuk A, Burgu I. *Etlık-Veteriner-Mikrobiyoloji-Dergisi* 2002; 13:1.
25. Provost A. *Rev Elev Med Vet Pays Trop* 1972; 25:155.
26. Anderson J, McKay JA. *Epidemiol Infect* 1994; 112:225.
27. Jeggo MH et al. *Vet Rec* 1987; 120:131.
28. Plowright W. *J Hyg Camb* 1984; 92:285.
29. Mariner JC. *Vet Microbiol* 1990; 22:119.
30. Couacy-Hymann E et al. *Res Vet Sci* 1995; 59:106.
31. Provost A et al. *Rev Elev Med Vet Pays Trop* 1986; 21:145.
32. Giavedoni L et al. *Proc Natl Acad Sci USA* 1991; 88:8011.
33. Yilma TD. *Vaccine* 1989; 7:484.
34. Ohishi K et al. *J Gen Virol* 2002; 81:1439.
35. Romero CH et al. *Vet Rec* 1994; 135:152.

## PESTE DES PETITS RUMINANTS (PPR, GOAT PLAGUE OR KATA)

**Etiology** Peste des petits ruminants virus, a morbillivirus

**Epidemiology** Contagious disease of goats and sheep; endemic in west and central Africa, outbreaks in northeastern Africa, Middle East and Asia, high mortality in goats

**Pathogenesis** Inhaled/ingested virus → upper respiratory infection → viremia → target cells (lymphocytes, alimentary and respiratory mucosae) → signs and lesions

**Signs** Fever, oculonasal purulent discharge, necrotic stomatitis, diarrhea and respiratory distress

**Clinical pathology** Marked leukopenia

**Diagnostic confirmation** Virus neutralization test and immunohistochemistry

### Differential diagnosis list

- Rinderpest
- Contagious ecthyma
- Bacterial pneumonias
- Coccidiosis

**Treatment** Hyperimmune serum and symptomatic treatment for valuable animals

**Control** Segregation of new stock, vaccination with tissue culture or other vaccines

## ETIOLOGY

Peste des petits ruminants (PPR) is associated with PPRV, a morbillivirus (family Paramyxoviridae) closely related to the rinderpest virus as well as the viruses of canine distemper in dogs, phocine distemper in seals, and measles in humans.<sup>1</sup> Four lineages of PPRV have been identified; lineage 1 and 2 viruses in west Africa, lineage 3 in east Africa, Arabia and southern India, and lineage 4 in the Middle East and Asia subcontinent, reaching east as far as Nepal and Bangladesh.<sup>2</sup> The African and Asian line-

ages (strains) of the virus have some biochemical and genetic differences, implying that both strains may have evolved separately.<sup>3</sup> All four lineages have been shown to be genetically distinct from the rinderpest virus, thereby raising some doubt to the notion that PPRV might have evolved in the first half of the 20th century from goat-adapted rinderpest vaccines.

## EPIDEMIOLOGY

### Occurrence

The disease occurs mostly in goats and sheep. Outbreaks were first described in West Africa in 1942 and the disease is now endemic in the region. In addition, outbreaks have been reported from much of sub-Saharan Africa north of the equator. Since the 1990s, outbreaks have been reported from the Arabian Peninsula as far north as Turkey and extending through Pakistan and India to Nepal and Bangladesh. It is possible that some of the earlier reports of rinderpest in sheep and goats in Asia might have been PPR outbreaks since the two diseases in these species are not easily distinguishable on clinical examination only. Cattle and pigs develop serum-neutralizing antibodies but no disease following experimental infection. Natural disease may occur in the wild sheep, gazelle and the deer but there are no known reservoirs in domestic animals and wildlife. Based on clinical signs and detection of antibodies, PPR and rinderpest viruses were suspected to be involved in a highly contagious disease of Ethiopian camels in 1995,<sup>4</sup> but the role of the two viruses in camels requires further studies. PPR is not transmissible to humans.

Outbreaks invariably occur when new stock is introduced into a farm. In West Africa, this usually takes place when Sahelian goats and sheep believed to have high innate resistance to the virus are moved southwards and commingle with the dwarf breeds in the humid and sub-humid tropics. Such mingling occurs during seasonal migrations and religious festivals. Market goats do harbor and can transmit the virus. The first outbreaks in Saudi Arabia were associated with the importation of sheep from Africa or the return of unsold lambs from livestock markets.

### Morbidity and case-fatality rate

Infection rates in enzootic areas are generally high (above 50%) and can be up to 90% of the flock during outbreaks. The percentage of sheep and goats with antibodies rises with age. The disease, however, is more severe in goats than in sheep and is rapidly fatal in young animals. Case-fatality rates are also much higher in goats (55-85%) than in sheep (less than 10%). Goats have also been more severely affected in the more recent outbreaks involving the virus of Asian lineage.<sup>5</sup>

There is no significant seasonal variation in the prevalence of the disease but since maternal antibodies are lost at about 4 months of age, the number of susceptible animals is likely to increase 3-4 months after peak kidding and lambing seasons.

### Methods of transmission

As in rinderpest, close contact with an infected animal or contaminated fomites is required for the disease to spread. Large amounts of the virus are present in all body excretions and secretions, especially in diarrheic feces. Infection is mainly by inhalation but could also occur through the conjunctiva and oral mucosa.

### Risk factors and immune mechanisms

Kids over 4 months and under 1 year of age are most susceptible to the disease. Sahelian breeds of sheep and goats are believed to be more resistant than the dwarf breeds in the humid and sub-humid zones of West Africa. In a particular flock, the risk of an outbreak is greatly increased when a new stock is introduced or when animals are returned unsold from livestock markets. Recovered animals have lifetime immunity.

### Experimental reproduction

The disease can be experimentally transmitted through close contact with an infected animal or through inoculation of infected tissues or blood.

### Economic importance

PPR is regarded as the most important disease of goats and sheep in West Africa and possibly in all countries where the disease occurs. In many of those countries, these animals are a major source of animal protein.

### Zoonotic implication

The virus of PPR does not affect humans.

### Biosecurity concerns

Like rinderpest, PPR requires close contact with an infected animal for transmission to occur. Nevertheless, since live goats and sheep are traded and may be carried over long distances, the disease can be easily introduced to a new herd or even a new country unknowingly from animals incubating PPR or showing only mild lesions.

## PATHOGENESIS

PPR virus penetrates the retropharyngeal mucosa, sets up a viremia and specifically damages the alimentary, respiratory and lymphoid systems. Infected cells undergo necrosis, and in the respiratory system, also proliferation. Death may occur from severe diarrhea and dehydration, before respiratory lesions become severe, or is hastened by concurrent diseases such as

pneumonic pasteurellosis, coccidiosis or coliform enteritis. Lymphoid necrosis is not as marked as in rinderpest and the possibility of immunosuppression has not been investigated. Most sheep and some adult goats recover.

#### CLINICAL FINDINGS

The disease can be acute or subacute. The acute form is seen mainly in goats and is similar to rinderpest in cattle except that severe respiratory distress is a common feature of PPR. Signs generally appear 3–6 d after being in contact with an infected animal. A high fever (above 40°C) is accompanied by dullness, sneezing and serous discharge from the eyes and nostrils. A day or two later, discrete necrotic lesions develop in the mouth and extend over the entire oral mucosa, forming diphtheric plaques. There is profound halitosis and the animal is unable to eat because of a sore mouth and swollen lips. Nasal and ocular discharges become mucopurulent and the exudate dries up, matting the eyelids and partially occluding the external nares. Diarrhea develops 3–4 d after the onset of fever. It is profuse and feces may be mucoid and blood tinged. Dyspnea and coughing occur later and the respiratory signs are aggravated when there is secondary bacterial pneumonia. Erosions have been described in the vulva and prepuce. Abortions have been reported during outbreaks in India.<sup>5</sup> Death usually occurs within 1 week of the onset of illness.

Subacute forms are more common in sheep but they also occur in goats. The signs and lesions are less marked and a few animals may die within 2 weeks, but most recover. Contagious ecthyma (orf) may complicate the labial lesions or develop in surviving animals.

#### CLINICAL PATHOLOGY

A leukopenia occurs but is not as marked as in rinderpest. As diarrhea develops, there is a progressive hemoconcentration and low serum sodium and potassium.<sup>6</sup>

Diagnostic techniques used in the past were virus neutralization test (VNT), agar gel immunodiffusion (AGID), complement fixation, counter immunoelectrophoresis (CIEP), virus isolation in cell cultures, and animal inoculation. Some are still used on a herd basis and VNT is the prescribed test for international trade.<sup>7</sup> More recently, competitive or blocking enzyme-linked immunosorbent assays (c-ELISAs) have been developed based on monoclonal antibodies specific for the nucleocapsid (N) or hemagglutinin (H) proteins of PPR and rinderpest viruses, and which enable differential diagnosis of the two viruses.<sup>6</sup> The efficacy of c-ELISA compares very well with virus neutralization test for detection and titration of antibodies to

PPRV in goats and sheep.<sup>8</sup> Viral antigen can also be detected in buffy coat, body secretions, feces, lymph node and tonsils by immunohistochemical<sup>9–11</sup> and dot-ELISA<sup>12</sup> methods as well as by AGID and CIEP. Furthermore, the reverse transcription-polymerase chain reaction (RT-PCR) has been reported to be more rapid and far more sensitive than conventional titration technique on Vero cells.<sup>13</sup> Unlike rinderpest, PPR viral antigen is still high in tissues of animals dying from the disease.

#### NECROPSY FINDINGS

The carcass is severely dehydrated, the hindquarters are soiled with fluid feces, and crusts of exudate are present around eyes, nose and lips. Discrete or extensive areas of erosion, necrosis, and ulceration are present in the oral mucosa, pharynx, and upper esophagus and may extend to the abomasum and distal small intestine. Hemorrhagic ulceration is marked in the ileocecal region, colon and rectum where they produce typical 'zebra stripes'. Regional lymph nodes are enlarged and wet and the spleen may be enlarged. Severe lesions are often present throughout the respiratory tract. A mucopurulent exudate extends from the nasal opening to the larynx whereas the trachea and bronchi may be hyperemic and contain froth due to pulmonary congestion and edema. An interstitial pneumonia is usually present.<sup>9,10</sup> Grossly, the pneumonia is diffuse or more commonly, antero-ventral or apical. With bacterial complications, there will be purulent or fibrinous bronchopneumonia and pleuritis.

Microscopic lesions in the alimentary tract are similar to those in rinderpest but are often more severe. In the early stages, syncytial cells are present in the oral mucosa and intracytoplasmic eosinophilic inclusion bodies in intestinal crypt epithelium. The respiratory tract shows proliferative rhinotracheitis, bronchitis, bronchiolitis, proliferation of type II pneumocytes, and formation of huge syncytial giant cells. Intracytoplasmic and intranuclear inclusion bodies are common in these cells. In a recent immunohistochemical study of natural PPR pneumonias in goats, viral antigens were found most frequently in the cytoplasm and rarely in the nucleus of lower respiratory epithelial cells, type 11 pneumocytes, syncytial cells and alveolar macrophages.<sup>14</sup> Lymphoid organs are depleted of lymphocytes but not usually as marked as in rinderpest.

For diagnostic purpose, specimens should be collected from several live animals and should include swabs of conjunctival, nasal and buccal mucosae, as well as whole blood in anticoagulant for virus isolation and other tests. At

neuropathy, the following specimens should be collected for virology and histopathology:

- Lungs
- Small and large intestines
- Oral mucosa
- Tonsil
- Mesenteric lymph nodes.

#### DIFFERENTIAL DIAGNOSIS

Other diseases that cause diarrhea or pneumonia in sheep and goats may pose a diagnostic challenge but a history of recent introduction of new stock and the clinical and postmortem findings of stomatitis, enteritis and syncytial giant cell pneumonia are typical for PPR. Laboratory tests are required to rule out rinderpest. Other diseases to be considered are:

- Heartwater
- Pneumonic pasteurellosis
- Contagious caprine pleuropneumonia in goats
- Contagious bovine pleuropneumonias
- Helminthosis
- Coccidiosis
- Contagious ecthyma
- Possibly Nairobi sheep disease.

#### TREATMENT

Valuable sick animals in the early stages of the disease should be isolated and given hyperimmune serum, which may be obtained from cattle hyperimmunized against rinderpest. Supportive treatment includes fluid therapy for dehydration and antibiotics to prevent secondary bacterial infections. Lesions around the eyes, nostrils and mouth should be cleaned, and good nursing provided.

#### CONTROL

The disease can be prevented by not introducing new stock from unknown sources, especially animals bought at livestock markets. In addition, animals returned unsold from markets should be segregated unless the entire herd or flock has been vaccinated. The tissue culture rinderpest vaccine is effective but its use in enzootic areas is not as organized as it is for rinderpest. Kids and lambs should be vaccinated at 3–4 months of age by which time maternal antibodies would have waned. Newly developed recombinant vaccinia<sup>15</sup> or capripox<sup>16</sup> viruses expressing the fusion (F) and hemagglutinin (H) protein genes of the rinderpest virus are also effective against PPR. More recently, a homologous PPRV tissue culture vaccine was produced by serial passages in Vero cells. This vaccine is now widely used in the control of PPR.<sup>17</sup> The homologous vaccine has the advantage that it avoids confusion with rinderpest vaccine when serological surveys are performed.<sup>7</sup>



## REVIEW LITERATURE

Scott GR. Goat plague In: Sewell MMH, Brocklesby DW (eds) Handbook on animal diseases in the tropics, 4th edn. London: Baillière Tindall, 1990; pp. 312-315.

OIE. Manual of diagnostic tests and vaccines for terrestrial animals, 5th edn. 2004; Chapter 2.1.5 [http://www.oie.int/eng/normes/mmanual/A\\_00028.htm](http://www.oie.int/eng/normes/mmanual/A_00028.htm).

Rossiter PB. Peste des petits ruminants In: Coetzer JAW, Tustin RC (eds) Infectious diseases of livestock, 2nd edn, vol 2. Cape Town: Oxford University Press, 2004; pp. 660-672.

## REFERENCES

- Murphy FA et al. Virus taxonomy Arch Virol Suppl 1995; 10:271.
- Pronab D et al. Vet Microbiol 2002; 88:153.
- Abu Elzein EME et al. Vet Rec 1990; 127:309.
- Roger F et al. Rev Med Vet 2001; 152:265.
- Pankaj K et al. Indian J Vet Pathol 2002; 26:15.
- Diallo A et al. Vet Microbiol 1995; 44:307.
- OIE Manual of diagnostic tests and vaccines for terrestrial animals, 5th edn, Chapter 2.1.5, 2004. [http://www.oie.int/eng/normes/mmanual/A\\_00028.htm](http://www.oie.int/eng/normes/mmanual/A_00028.htm).
- Singh RP et al. Vet Microbiol 2004; 98:3.
- Bundza A et al. Can J Vet Res 1988; 52:46.
- Brown CC et al. Vet Pathol 1991; 28:166.
- Diallo A et al. J Virol Methods 1989; 23:127.
- Obi TU, Ojeh CK. J Clin Microbiol 1990; 27:2096.
- Couacy HE et al. J Virol Methods 2002; 100:17.
- Yener Z et al. Small Ruminant Res 2004; 51:273.
- Jones L et al. Vaccine 1993; 11:961.
- Romero CH et al. Vaccine 1995; 13:36.
- Diallo A et al. In: Vaccines for OIE list A and emerging diseases. Proceedings of a symposium, Ames, Iowa, USA, 16-18 September 2002. Basel Switzerland: S Karger AG, 2003; pp. 113-119.

## JEMBRANA DISEASE

Jembrana disease is the name of a highly fatal, infectious, disease that occurs in Bali cattle (*Bos javanicus*) and buffaloes (*Bubalus bubalis*) on the island of Bali in Indonesia. The disease is endemic in areas of Indonesia, but the severe disease of the initial outbreak has modified with time.

### ETIOLOGY

The disease is caused by a lentivirus, genetically related but distinct from bovine immunodeficiency virus.<sup>1</sup> Both viruses are present in Bali cattle but the bovine immunodeficiency virus has been identified in cattle on islands where Jembrana disease has not occurred.<sup>2</sup> Jembrana disease virus has not been propagated in vitro and there is difficulty in differentiating infection with the two viruses by serological methods.<sup>3,4</sup>

### EPIDEMIOLOGY

#### Occurrence

The disease originally occurred in Jembrana district on the Island of Bali, Indonesia in 1964 and rapidly spread to the rest of the island resulting in the deaths of approximately 17% of Bali cattle.<sup>5</sup> Since 1964 the disease has been endemic on Bali island but with lower morbidity and mortality rates. It has subsequently spread to the Indoensian islands of Sumatra, Java

and Kalimantan, producing initial epidemic disease with high mortality followed by endemic disease with lower morbidity and mortality.<sup>5</sup>

### Transmission

Transmission probably occurs by direct contact with infective secretions in the acute phase of the disease and by mechanical transmission by hematophagous insects or mechanically by needles during mass vaccination of animals for the control of diseases, such as hemorrhagic septicemia.<sup>6</sup>

### Experimental reproduction

The disease can be experimentally transmitted by IV or intraperitoneal inoculation of blood or spleen into *B. javanicus*. The virus is present in high titer in the blood during the febrile phase and in the saliva and milk.<sup>6,7</sup> In *B. javanicus* an incubation period of 4-12 days is followed by fever lasting from 5 to 12 days and clinical signs typical of the enzootic form of the disease. Persistent infection occurs for periods of at least 2 years following recovery.

Experimental challenge of *B. indicus*, *B. taurus* and crossbred (*B. javanicus* and *B. indicus*) cattle results in only a transient febrile response, mild clinical disease and a viremia that persist for 3 months, although antibody persists for at least 4 years following infection.<sup>8</sup> Infection, as determined by antibody response, but not clinical disease can be transmitted experimentally to pigs, sheep, goats and buffaloes.<sup>5</sup>

### PATHOGENESIS

Jembrana disease is not typical of other lentivirus infections, which are characterized by chronic progressive disease with long incubation periods. There is a high viremia during the febrile stage. Initial virus proliferation in the spleen is followed by widespread dissemination during a second proliferative phase and infection in lymph nodes, lungs, bone marrow, liver and kidney. The specific cell types infected by Jembrana virus have not yet been identified but appear to be of lymphocyte origin or of the monocyte/macrophage lineage.<sup>9</sup>

### CLINICAL FINDINGS

Natural clinical disease is reported only in *B. javanicus*, other cattle types and buffalo are subclinically infected in natural outbreaks. Clinical signs include fever (40-42°C; 104-107°F), which lasts up to 12 days, anorexia, generalized lymphadenopathy, nasal discharge, increased salivation and anemia. In severely affected cattle there is diarrhea followed by dysentery. Mucosal erosions can occur but are rare. Hemorrhages are present in the vagina, mouth and occasionally the anterior chamber of the eye in the severe disease.

Where the disease is enzootic and less severe in presentation clinical signs include inappetence, fever, lethargy, reluctance to move, enlargement of the superficial lymph nodes, mild erosions of the oral mucosa and diarrhea.

### CLINICAL PATHOLOGY

During the febrile period there is a moderate normocytic normochromic anemia and a leukopenia with lymphopenia, eosinopenia and thrombocytopenia.<sup>7</sup> Bone marrow shows no changes historically. Elevated blood urea concentrations and diminished total plasma protein are seen in *B. javanicus* but not *B. taurus*.<sup>6</sup> An ELISA test and an agar gel immunodiffusion test can be used for serological surveys. Both are specific but the ELISA test has greater sensitivity but limited sensitivity.<sup>4,10</sup>

### NECROPSY FINDINGS

Necropsy lesions in *B. javanicus* include generalized lymphadenopathy, with enlargements up to 20-fold, and generalized hemorrhages. The spleen is enlarged to three to four times its normal size. Histologically, there is vasculitis and perivasculitis and follicular atrophy in the spleen and lymph nodes, and para-follicular proliferation of mononuclear cells in intestinal lymphoid tissue.<sup>5,9</sup>

### TREATMENT AND CONTROL

Treatment is supportive. There is currently no specific control. Vaccination has been attempted using virus-containing plasma and spleen tissue from acutely affected cattle with the virus inactivated with triton X-100 and the vaccine adjuvanted with either mineral oil or Freund's incomplete adjuvant.<sup>11</sup> Protection is only partial and not of real value in control.

### REVIEW LITERATURE

Wilcox GE, Chadwick BJ, Kertayadnya G. Recent advances in the understanding of Jembrana disease, Vet Microbiol 1995; 46:249-255.

Wilcox GE, Jembrana disease. Aust Vet J 1997; 75:492-493.

### REFERENCES

- Chadwick BJ et al. J Gen Virol 1995; 76:1637.
- Barboni P et al. Vet Microbiol 2001; 80:313.
- Desport M et al. J Virol Methods 2005; 124:135.
- Stewart M et al. J Clin Microbiol 2005; 43:5574.
- Wilcox GE, Aust Vet J 1997; 75:492.
- Soeharsono S et al. Epidemiol Infect 1995; 115:367.
- Soeranto M et al. J Comp Pathol 1990; 103:61.
- Soeharsono S et al. J Comp Pathol 1995; 112:391.
- Chadwick BJ et al. J Gen Virol 1998; 79:101.
- Hartaningsih N et al. Vet Microbiol 1994; 39:15.
- Hartaningsih N et al. Vet Immunol Immunopathol 2001; 78:163.

### NAIROBI SHEEP DISEASE

This is a tick-transmitted disease of small ruminants, particularly sheep, associated with the Nairobi sheep disease virus (NSDV), a bunyavirus (genus *Nairovirus*)



and characterized by fever, hemorrhagic gastroenteritis, abortion and high mortality.<sup>1,2</sup> It is endemic in East and Central Africa (Kenya, Uganda, Tanzania, Ruanda, Somalia, and Ethiopia) and antibodies to the virus and other bunyaviruses have been detected in southern and north-eastern Africa and Sri Lanka.<sup>3,4</sup> Genetic and serologic data have shown that the Ganjam virus in Indian goats is an Asian variant of NSDV.<sup>5</sup> Other antigenically related viruses are the Crimean-Congo hemorrhagic fever virus in humans and the Dugbe fever virus in west African cattle. NSD virus does not affect cattle but can cause a mild febrile disease in humans, hence a zoonosis. The most common vector is the brown ear tick *Rhipicephalus appendiculatus*, but other species may be involved, as well as the bont tick, *Amblyomma variegatum*. Transmission by *R. appendiculatus* is both trans-stadial and trans-ovarial. Animals in endemic areas are usually immune and the virus can persist in ticks for long periods, more than two years in unfed adults.

Clinical disease occurs when susceptible animals are moved into endemic areas (e.g. for marketing purposes) or when there is a breakdown in tick control measures. Outbreaks occur outside endemic areas when there has been unusual increase in tick population brought about by excessive or prolonged rains. There are differences in susceptibility among different breeds of sheep and goats, and unlike in most other diseases, some indigenous breeds are more susceptible than exotic breeds. A sudden onset of fever is followed by anorexia, nasal discharge, dyspnea and a severe diarrhea, sometimes with dysentery, abortion and death in 3–9 d. The case–mortality rate is 30–90% but is lower in goats. The necropsy picture is typical of a hemorrhagic diathesis and consists of hemorrhages on serous surfaces of visceral organs and on mucosal surfaces, particularly the abomasum, colon and female genital tract. Lymph nodes are enlarged. Later, a hemorrhagic gastroenteritis becomes more obvious and there may be zebra striping of the colon and rectum.<sup>1</sup> The uterus and fetal skin are hemorrhagic. Ticks are likely to be found in the body, especially in the ears and head. Common histopathologic lesions outside the gastrointestinal tract include myocardial degeneration, nephritis and necrosis of the gall bladder.<sup>1</sup>

Differential diagnoses include peste des petits ruminants (PPR), rinderpest, Rift Valley fever, heartwater, parasitic gastroenteritis and salmonellosis, all to be confirmed by laboratory tests. Specimens for laboratory diagnosis should include uncoagulated blood, mesenteric lymph node and spleen collected safely to avoid aerosol infections. The virus is first

isolated in tissue culture or in infant mice, and the disease can be reproduced in susceptible sheep. The recommended serological test is the indirect fluorescent antibody test, but others are the complement fixation test (CFT) and the indirect hemagglutination test.<sup>1</sup> For viral identification, the recommended tests are immunofluorescence, agar gel immunodiffusion, CFT and ELISA. Apparently, there are no reports of involving the use of reverse transcription-polymerase chain reaction (RT-PCR) test in small ruminants but the test was found to be less sensitive in ticks.<sup>6</sup> There is no treatment for NSD but the disease can be controlled by vaccination and vector control. Animals to be moved to endemic areas should receive a killed tissue culture vaccine or an attenuated live virus vaccine.

## REFERENCES

1. OIE Manual of diagnostic tests and vaccines for terrestrial animals, 5th edn. 2004; Chapter 2.10.2. [http://www.oie.int/eng/normes/mmanual/A\\_00128.htm](http://www.oie.int/eng/normes/mmanual/A_00128.htm).
2. Davies FG, Terpstra C. In: Coetzer JA, WTustin RC (eds) Infectious diseases of livestock, 2nd edn, vol 2. Cape Town: Oxford University Press. 2004; pp. 1071–1076.
3. Perera LP et al. Ann Trop Med Parasitol 1996; 90–91.
4. Scott GR. In: Sewell MMH, Brocklesby DW (eds) Handbook on animal diseases in the tropics, 4th edn. London: Baillière Tindall, 1990; pp. 335–337.
5. Marczinke BJ, Nichol ST. Virology 2002; 303:146.
6. Sparagano OA et al. Exp Appl Acarol 1999; 23 929.

## MALIGNANT CATARRHAL FEVER (BOVINE MALIGNANT CATARRH, MALIGNANT HEAD CATARRH)

### Synopsis

**Etiology** Alcelaphine herpesvirus-1, the wildebeest-associated malignant catarrhal fever (MCF) virus; Ovine herpesvirus-2, the sheep-associated MCF virus

**Epidemiology** Highly fatal disease of cattle and farmed deer and occasionally pigs. Disease associated with contact with sheep, often lambing ewes, and in Africa also with wildebeest calves. Disease may occur sporadically or in outbreaks

**Clinical findings** Erosive stomatitis and gastroenteritis, erosions in the upper respiratory tract, keratoconjunctivitis, encephalitis, cutaneous exanthema and lymph node enlargement. The head and eye form is most common and there is a distinctive lesion in the cornea

**Clinical pathology** Competitive inhibition enzyme-linked immunosorbent assay (ELISA) for serology. Polymerase chain reaction (PCR) detection of viral DNA

**Necropsy findings** Erosions in gastrointestinal tract and lymphadenopathy. Necrotizing vasculitis

**Diagnosic confirmation.** Detection of viral DNA by PCR.

**Treatment** Supportive

**Control** Avoid cattle contact with sheep and wildebeest

## ETIOLOGY

Malignant catarrhal fever (MCF) is really two diseases, clinically and pathologically indistinguishable, but associated with two different infectious agents with different ecologies:

- Alcelaphine herpesvirus-1 (AHV-1) in the genus *Rhadinovirus* of the subfamily Gammaherpesvirinae. This is the wildebeest-associated MCF virus, transmitted to cattle from blue wildebeest (*Connochaetes taurinus*)
- A virus designated ovine herpesvirus-2 (OvHV-2) also a *Rhadinovirus* of the subfamily Gammaherpesvirinae. This is the sheep-associated MCF virus transmitted to cattle from sheep.

Neither agent appears to transmit from cattle to cattle and neither of the viruses cause any disease in their principal host, the wildebeest and the sheep. AHV-1 can be grown in eggs and tissue culture but OvHV-2 has never been propagated in vitro. The molecular genomic structure of these viruses is described.<sup>1</sup> A gamma-herpesvirus closely related to OvHV-2 has been isolated from goats<sup>2</sup> and called caprine herpesvirus-2 (CpHV-2) and another, also closely related, has been isolated from deer<sup>3</sup> and called deer herpesvirus (DVH). The pathogenicity of these newly recognized viruses is not known.

## EPIDEMIOLOGY

### Occurrence and prevalence

Alcelaphine MCF

Wildebeest-associated MCF occurs in most African countries in cattle which commingle with clinically normal wildebeest and hartebeest. It is epizootic and seasonal. It can also occur in zoological gardens in other countries.

Sheep associated MCF

Sheep-associated MCF occurs worldwide. Cases mostly occur when cattle have had contact with lambing ewes and usually start 1–2 months later.<sup>4–6</sup> Goats can also act as a source of OvHV-2 infection for cattle.<sup>7</sup> Cases without apparent or recent exposure to sheep do occur but are uncommon.

The morbidity rate varies. Usually the disease is sporadic and presents as a single or small number of cases over a short period but on occasion up to 50% of a herd may be affected in rare but devastating outbreaks which may be short-lived or last for several months.<sup>8,9</sup> The disease with both agents is **almost invariably fatal**.

Besides cattle, MCF is also an important disease of farmed deer. It is an occasional disease of pigs and is recorded in pigs that had contact with sheep on a farm and in a petting zoo.<sup>10,11</sup>

### Methods of transmission

#### Alcelaphine MCF

Infection with AHV-1 in wildebeest occurs in the perinatal period by horizontal and occasional intrauterine transmission, and infected young wildebeest up to the age of about 4 months have viremia and shed virus in ocular and nasal secretions. The disease is transmitted from wildebeest to cattle by contact or over short distances, probably by inhalation of aerosol or ingestion of pasture contaminated by virus excreted by young wildebeest in nasal and ocular discharges. In contrast, infected cattle do not excrete virus in nasal or ocular secretions.<sup>12</sup> The disease can transmit between wildebeest and cattle over a distance of at least 100 m and it is suggested that cattle need to be kept at least 1 km from wildebeest to avoid disease.<sup>13</sup>

In Kenya the peak incidence of alcelaphine MCF occurs when 3- to 4-month-old wildebeest are in maximum numbers.<sup>14</sup> In South Africa the peak incidence is at a time when young wildebeest are 8–10 months old and not infectious, requiring that there be another, high volume, source of the infection.<sup>15</sup> The proportion of sheep in a wildebeest area which are serologically positive and presumably infected with the wildebeest-associated virus is very high.<sup>16</sup>

#### Sheep associated MCF

Virtually all domestic sheep raised under natural flock conditions are infected with OvHV-2. **High rates of seropositivity** have been found in domestic sheep and goats over 1 year of age in several surveys.<sup>5,17–19</sup> In a study of 14 species of North American wildlife, a high rate of seropositivity was also found in muskox (*Ovibos moschatus*) and bighorn sheep (*Ovis canadensis*), suggesting that they might be sources of infection. There were low seropositivity rates in clinically susceptible species such as deer and bison.<sup>17</sup>

In contrast to AHV-1 infection in wildebeest, the transmission of OvHV-2 between sheep appears minimal in the perinatal period. There is no evidence for transplacental infection and although antigen, detected by PCR, is present in colostrum and milk from infected ewes, the majority of lambs are not infected until after 2–3 months of age.<sup>19,20</sup> The rate of infection in lambs and the age at infection is not influenced by passively acquired maternal immunity and appears to be dose dependant.<sup>21,22</sup> Infected sheep excrete OvHV-2 in nasal secretions but very high levels of excretion occur between 6 and 9 months of age, suggesting the 6 to 9-month period as the time when most virus is shed into the environment. Viral antigen has been detected in the ejaculate of rams<sup>23</sup> but there is little epidemiological evidence for significant venereal transmission.

The means by which OvHV-2 spreads

but is presumably by inhalation or ingestion. The common epidemiological association of diseased cattle having had contact with lambing ewes suggests that perinatal lambs play a role in transmission similar to that played by wildebeest calves, however the age at infection of lambs and the excretion patterns of virus do not fit this assumption. Shedding from ewes does not increase in the lambing period.<sup>21</sup>

Contact with ewes is not a prerequisite, one outbreak having occurred when cattle commingled with rams.<sup>24</sup> Infection can also occur when sheep and cattle are housed in the same building but with no common contact through feeding or watering points.

Occasional cases occur in cattle that have had no apparent contact with sheep and the persistence of the infection in a particular feedlot, or on a particular farm, from year to year when no contact with sheep exists, is unexplained. Persistence of the virus on inanimate fomites has been suggested but the virus is a most fragile one and this seems unlikely. The observation that some recovered cattle show a **persistent viremia** for many months suggests that carrier cattle may be the source of these carryover infections.<sup>12,25,26</sup> In addition, the virus, detected by PCR, has been demonstrated in cattle and farmed deer with no evidence of MCF disease.<sup>27</sup> It is possible that stress could activate a latent infection in animals with no sheep contact.

### Experimental reproduction

Sheep-associated MCF virus does not replicate in tissue culture. It has a close association with lymphoblastoid cells, particularly large granular lymphocytes, which can be grown in tissue culture, and induce MCF when injected. MCF can also be transmitted to cattle by transfusion of large volumes of blood if given within 24 h of collection. Wildebeest-associated MCF virus, can be readily transmitted by several routes. It has been adapted to grow on egg yolk-sac and tissue culture, and transmission to rabbits to yolk-sac to cattle has been achieved.

### Environment risk factors

The disease shows the greatest incidence in late winter, spring and summer months. There have been suggestions that copper deficiency or exposure to bracken fern might be environmental stressors that predispose the expression of the disease in cattle.<sup>8,28</sup>

### Animal risk factors

Clinical disease had been described in over 30 species of ruminants.<sup>29</sup> In Africa assorted **wild ruminants** contract the disease and suffer a severe illness and a high mortality rate. Similar species in zoos are also commonly affected, e.g. Père

Greater kudu (*Strepsiceros kudu*).

Amongst **domestic animals**, all ages, races and breeds of cattle are equally susceptible but banteng (*Banteng sondaicus*), buffalo (*Bubalus bubalis*), bison (*Bison bison*) and deer are more susceptible and suffer a more severe form of the disease than do commercial cattle. Disease is recorded in captive deer or farmed deer including sika deer (*Cervus nippon*), roe deer (*Capreolus capreolus*), white-tailed deer (*Odocoileus virginianus*), rusa deer (*C. timorensis*), and red deer (*C. elaphus*).<sup>30,31</sup>

MCF is considered one of the most important diseases of **farmed deer**. The clinical signs and necropsy findings closely resemble those of MCF in cattle but the morbidity and mortality can be disastrously high, resulting in heavy losses for the deer farmer.

### Economic importance

Losses due to the disease can be catastrophic on rare individual farms. For the most part it is a nuisance because of its resemblance to rinderpest and mucosal disease.

### PATHOGENESIS

MCF is a fatal, multisystemic disease characterized by lymphoid proliferation and infiltration, and widespread **vascular** epithelial and mesothelial lesions, which are morphologically associated with lymphoid cells. CD8<sup>+</sup> T-lymphocytes are the predominant cells associated with the vascular lesions. Involvement of the vascular adventitia<sup>32</sup> accounts for the development of gross lesions, including the epithelial erosions and keratoconjunctivitis. The lymph node enlargement is due to atypical proliferation of sinusoidal cells and the cerebrospinal changes, usually referred to as encephalitis, are in fact a form of vasculitis. There is commonly a synovitis, especially involving tibiotarsal joints and this also is associated with a lymphoid vasculitis. It is believed that the pathogenesis of this disease is the result of direct virus-cell interactions or perhaps immune-mediated responses directed against infected cells.<sup>33</sup>

### CLINICAL FINDINGS

The **incubation period** in natural infection varies from 3–8 weeks, and after artificial infection averages 22 d (14–37 d). MCF is described as occurring in a number of forms:

1. Peracute
2. Alimentary tract form
3. Common 'head and eye' form
4. Mild form, but these are all gradations, cases being classified on the predominant clinical signs. In serial transmissions with one strain of the virus all of these forms may be produced. The most common manifestation is the head and eye

### Head and eye form

There is a sudden onset of the following symptoms:

- Extreme dejection
- Anorexia
- Agalactia
- High fever (41–41.5°C; 106–107°F)
- Rapid pulse rate (100–120/bpm)
- Profuse mucopurulent nasal discharge
- Severe dyspnea with stertor due to obstruction of the nasal cavities with exudate
- Ocular discharge with variable degrees of edema of the eyelids
- Blepharospasm
- Congestion of scleral vessels.

Superficial necrosis is evident in the anterior nasal mucosa and on the buccal mucosa. This begins as a diffuse reddening of the mucosa, and is a consistent finding about day 19 or 20 after infection. Discrete local **areas of necrosis** appear on the hard palate, gums and gingivae. The mouth is painful at this time and the animal moves its jaws carefully, painfully and with a smacking sound. The mucosa as a whole is fragile and splits easily. The mouth and tongue are slippery and the mouth is hard to open. The erosive mucosal lesions may be localized or diffuse. They may occur on the:

- Hard palate
- Dorsum of the tongue
- Gums below the incisors
- Commissures of the mouth
- Inside the lips.

The cheek papillae inside the mouth are hemorrhagic, especially at the tips which are later eroded. At this stage there is excessive salivation with saliva, which is ropy and bubbly, hanging from the lips. The skin of the muzzle is extensively involved, commencing with discrete patches of necrosis at the nostrils which soon coalesce causing the entire muzzle to be covered by tenacious scabs. Similar lesions may occur at the skin–horn junction of the feet, especially at the back of the pastern. The skin of the teats, vulva and scrotum in acute cases may slough off entirely upon touch or become covered with dry, tenacious scabs.

**Nervous signs**, particularly weakness in one leg, incoordination, a demented appearance and muscle tremor may develop very early, and nystagmus, head-pushing, paralysis and convulsions may occur in the final stages. Trismus has been described, but it is probably due to pain in the mouth rather than a neuromuscular spasm.

In natural cases the superficial lymph nodes are often visibly and usually palpably enlarged. **Lymphadenopathy** is also one of the earliest, most consistent, and persistent signs of the experimental disease. The consistency of the feces varies

dysentery. In some cases there is gross hematuria with the red coloration most marked at the end of urination.

**Opacity of the cornea** is always present to some degree, commencing as a narrow, gray ring at the corneoscleral junction and spreading centripetally with conjunctival and episcleral hyperemia. Hypopyon is observed in some cases. In cases of longer duration, **skin changes**, including local papule formation with clumping of the hair into tufts over the loins and withers, may occur. In addition, eczematous weeping may result in crust formation, particularly on the perineum, around the prepuce, in the axillae and inside the thighs. Infection of the cranial sinuses may occur with pain on percussion over the area. The horns and rarely the hooves may be shed. Persistence of the fever is a characteristic of MCF, even cases that persist for several weeks with a fluctuating temperature, usually exceeding 39.5°C (103°F).

During some outbreaks an occasional animal makes an apparent recovery but usually dies 7–10 d later of acute encephalitis. In the more typical cases the illness lasts for 3–7 days and rarely up to 14 d.

### Peracute and alimentary tract forms

In the peracute form the disease runs a short course of 1–3 d and characteristic signs and lesions of the 'head and eye' form do not appear. There is usually a high fever, dyspnea and an acute gastroenteritis. The alimentary tract form resembles the 'head and eye' form, except that there is marked diarrhea and only minor eye changes consisting of conjunctivitis rather than ophthalmia. This form of the disease has been encountered in outbreak form in cattle in large dairy herds in drylots, with only indirect contact with sheep, and in cattle to which transmission was attempted and farmed deer. A feature of this form of the disease is reported to be a brief period of slight illness followed by the final fulminating disease which is common in deer.

### Mild form

The mild form occurs most commonly in experimental animals but is observed in natural outbreaks. There is a transient fever and mild erosions appear on the oral and nasal mucosae. Mild disease may be followed by complete recovery, recovery with recrudescence or chronic MCF. A distinctive clinical feature in chronic MCF is persistent bilateral ocular leukomata.<sup>26</sup>

### Pigs

The disease in pigs is similar to the head and eye form in cattle and manifests with fever and tremor, ataxia, hyperesthesia and convulsions and death.<sup>10,11</sup>

### CLINICAL PATHOLOGY

A leukopenia, commencing at first illness and progressing to a level of 3000–6000/μL

observation. The leukopenia recorded was due mainly to an agranulocytosis. In our experience a moderate leukocytosis is more common.

**Virus isolation** is not practical with either virus because of the instability of cell-associated AHV-1 and the fact that OHV-2 does not replicate in cell culture.

**Transmission** can be used for diagnosis using whole blood, nasal swabs or washings and preferably lymph node collected by biopsy, with histological lesions in the recipient rabbits or calves as the criterion. **Detection of viral nucleic acid** by PCR has largely replaced transmission experiments.

There are a number of **serological tests** that can be used but they have limited value for diagnosis of clinical cases because only a small percentage of animals seroconvert and do so late in the course of the disease. The antibody titer is low and there is cross reaction with other herpes viruses. A **competitive-inhibition ELISA** using a monoclonal antibody to a broadly conserved epitope of the MCF virus can be used for detection of antibody<sup>34</sup> and has largely replaced other serological tests. It is of particular value for epidemiological studies. The development of antibody following infection is delayed in a significant proportion of young animals and serology is unreliable for determining infection status until after one year of age.

Uninfected lambs or kids under 4 months of age may test positive due to the presence of maternal antibody.

**Detection of viral nucleic acid** by PCR techniques is the current accepted diagnostic technique.<sup>5,27,35–37</sup> The buffy coat is probe-positive 2 d after experimental infection with alcelaphine herpesvirus-1.<sup>37</sup> Virus can be present in cattle without clinical MCF and if these have a disease that is not MCF, but test probe positive, a **false diagnosis** is possible.<sup>37</sup>

### NECROPSY FINDINGS

Lesions in the mouth, nasal cavities and pharynx vary from minor degrees of hemorrhage and erythema, through extensive, severe inflammation to discrete ulcers. These lesions may be shallow and almost imperceptible or deeper and covered by cheesy diphtheritic deposits.

**Erosion** of the tips of the cheek papillae, especially at the commissures, is common. Longitudinal, shallow erosions are present in the esophagus. The mucosa of the forestomachs may exhibit erythema, or sparse hemorrhages or erosions. Similar but more extensive lesions occur in the abomasum. Catarrhal enteritis of moderate degree and swelling and ulceration of the Peyer's patches are constant. The feces may be loose and blood stained.

Similar lesions to those in the mouth

and sometimes in the bronchi but the lungs are not usually involved except for occasional emphysema or secondary pneumonia. The liver is swollen and severe hemorrhage may be visible in the urinary bladder. All lymph nodes are swollen, edematous and often hemorrhagic. The gross ocular lesions are as described clinically. Petechial hemorrhages and congestion may be visible in brain and meninges.

**Histologically**, MCF is characterized by perivascular, mononuclear cell cuffing in most organs and by degeneration and erosion of affected epithelium. The pathognomonic lesion is a **necrotizing vasculitis** which features infiltration of the tunica media and adventitia by lymphoblast-like cells and macrophages. Acidophilic, intracytoplasmic inclusion bodies in neurons have been described<sup>7</sup> but their identity as viral inclusions has not been established. Large numbers of inclusion bodies have been observed in the tissue of artificially infected rabbits. The histologic features of the panophthalmitis have been described.<sup>38</sup>

Cattle with chronic MCF have chronic bilateral central stromal keratitis with or without corneal pigmentation. An **obliterative arteriopathy** is characteristic and this vascular lesion is present in all major organs.<sup>26</sup> Results of a competitive inhibition ELISA serologic test suggesting a role for the virus in the development of obliterative arterial lesions in cattle<sup>5</sup> have been supported by in-situ PCR and immunohistochemical studies of the disease in bison<sup>33</sup> which demonstrated OHV-2 within the infiltrating lymphocytes. These lymphoblast-like cells were also shown to be CD8 (+) T-cells.

A PCR technique or immunohistochemical stains can be used to confirm the presence of viral antigen in whole blood or in tissues harvested at necropsy.<sup>35,39</sup> When transmitted to rabbits, both the wildebeest and sheep-associated viruses elicit a rapidly fatal lymphoproliferative disorder. The newer molecular biology-based techniques have made this bioassay method obsolete.

#### Samples for confirmation of diagnosis

- **Histology** – fixed brain, lymph node, alimentary tract mucosa including pharynx, esophagus, rumen and Peyer's patch, liver, adrenal gland, kidney, urinary bladder, salivary gland (IHC, LM); Bouin's-fixed eye (LM)
- **Virology** – lymph node, spleen, lung (PCR).

#### DIFFERENTIAL DIAGNOSIS

- Mucosal disease
- Infectious bovine rhinotracheitis
- Sporadic bovine encephalomyelitis
- Rinderpest
- Jembrana disease.

#### TREATMENT

Treatment of affected animals is unlikely to influence the course of the disease. Non-steroidal anti-inflammatories may ease the discomfort.

#### CONTROL

Isolation of affected cattle is usually recommended but its value is questioned because of the slow rate of spread and the uncertainty regarding the mode of transmission. Because of the field observation that sheep are important in the spread of the disease, **separation** of cattle and sheep herds is recommended. The introduction of sheep from areas where the disease has occurred to farms with cattle should be avoided. A program to produce sheep free of OHV-2 infection by separation and isolation of lambs before they become infected is recommended for sheep used in petting zoos.<sup>40</sup>

Attempts to immunize cattle with live or inactivated culture vaccines with Freund's incomplete adjuvant do not provide protection against experimental challenge or natural challenge by exposure to wildebeest herds. High and persistent levels of virus-neutralizing antibody are demonstrable following vaccination but humoral mechanisms are probably not important in determining resistance to infection with the virulent virus. An inactivated wildebeest-associated MCF virus vaccine has provided protection against challenge with virulent viruses.

#### REVIEW LITERATURE

- Reid HW et al. Malignant catarrhal fever. *Vet Rec* 1984; 114:581–583.
- Selman IE. The epidemiology of malignant catarrhal fever. *Vet Ann* 1987; 27:98–102.
- Metzler AE. The malignant catarrhal fever complex. *Comp Immunol Microbiol Infect Dis* 1991; 142:107–124.

#### REFERENCES

1. Coulter LJ et al. *J Comp Pathol* 2001; 124:2.
2. Li H et al. *J Gen Virol* 2001; 82:227.
3. Kleiboeker SB et al. *J Clin Microbiol* 2002; 40:1311.
4. Taneichi A et al. *Vet Rec* 1986; 118:612.
5. O'Toole D et al. *J Vet Diagn Invest* 1995; 7:108.
6. Collery P, Foley A. *Vet Rec* 1996; 139:16.
7. Hamilton AF. *Vet Rec* 1990; 127:231.
8. Otter A et al. *Vet Rec* 2002; 151:321.
9. Brenner J et al. *J Vet Med B* 2002; 49:304.
10. Loken T et al. *Vet Rec* 1998; 143:464.
11. Albin SJ. *Clin Microbiol* 2003; 41:900.
12. Michel AL, Aspelung IA. *J S Afr Vet Assoc* 1994; 65:26.
13. Worthington RW, Bigalke RD. *Onderstepoort J Vet Res* 2001; 68:291.
14. Barnard BJH, Pypekamp HE van de. *Onderstepoort J Vet Res* 1988; 55:69.
15. Barnard BJH et al. *Onderstepoort J Vet Res* 1989; 56:131–135.
16. Rossiter PB. *J Comp Pathol* 1981; 91:303.
17. Li H et al. *J Wildl Dis* 1996; 32:437.
18. Sentsui H et al. *J Vet Med Sci* 1996; 58:1.
19. Li H et al. *J Clin Microbiol* 1994; 32:1674.
20. Kim O et al. *Virus Res* 2003; 98:117.
21. Li H et al. *J Clin Microbiol* 2004; 42:5558.
22. Li H et al. *Am J Vet Res* 2003; 63:631.

23. Hussey D et al. *J Clin Microbiol* 2002; 40:4700.
24. Vanselow BA. *Vet Rec* 1980; 107:15.
25. Hoffman D et al. *Aust Vet J* 1984; 61:113.
26. O'Toole D et al. *Vet Rec* 1997; 140:519.
27. Tham KM. *Vet Rec* 1997; 141:303.
28. Twomey DF. *Vet Rec* 2002; 151:486.
29. Heuschele WP. *Zoologische Garten* 1988; 58:123.
30. Tomkins NW et al. *Aust Vet J* 1997; 75:722.
31. Horner G. *Surveillance* 1996; 232:16.
32. Reid HW et al. *Res Vet Sci* 1986; 41:76.
33. Simon S et al. *J Gen Virol* 2003; 84:2009.
34. Li H et al. *J Vet Diagn Invest* 2001; 13:361.
35. Li H et al. *J Clin Microbiol* 1995; 33:2048.
36. Ellis TM, Masters AM. *Aust Vet J* 1997; 75:520.
37. Michel AL. *Vet Rec* 1994; 135:264.
38. Whiteley HE et al. *Vet Pathol* 1985; 22:219.
39. Crawford TB et al. *J Vet Diagn Invest* 1999; 11:111.
40. Li H et al. *Vet Microbiol* 1999; 65:167.

### BOVINE VIRUS DIARRHEA, MUCOSAL DISEASE. BOVINE PESTIVIRUS DISEASE COMPLEX

#### Synopsis

**Etiology** Bovine virus diarrhea virus. Type 1 and type 2 genotypes and subtypes. Noncytopathic and cytopathic biotypes. Antigenic diversity and cross-reactivity among strains of virus

**Epidemiology** Occurs worldwide and major economic importance. Prevalence of infection high in cattle population. Persistently-infected (PI) calves are major source of virus. Young and unvaccinated cattle in herd most susceptible

**Pathogenesis** Virus causes subacute infections, peracute infections and thrombocytopenia and hemorrhagic syndrome, immunosuppression, fetal infections which persist in the fetus until and after birth in persistently-infected cattle which are also immunotolerant and may develop mucosal disease

**Signs** Inapparent subclinical bovine virus diarrhea acute mucosal disease, in persistently infected cattle 6–24 months of age with fever, diarrhea, oral erosions and high case–fatality rate, peracute bovine virus diarrhea in cattle of all ages including adults with severe diarrhea, fever, agalactia and rapid death in few days, thrombocytopenia and hemorrhagic disease in veal calves; reproductive failure (decreased conception rate, abortion, stillbirth, weak neonates, congenital defects)

**Clinical pathology** Leukopenia in acute mucosal disease. Virus isolation from persistently infected animals and from cattle with acute viremia, serology for serum neutralizing antibodies

**Lesions** Erosive stomatitis and gastroenteritis, depletion of Peyer's patches. Widespread hemorrhages in peracute form. Abortions. Congenital defects of calves (cerebellar hypoplasia, ocular defects)

**Diagnostic confirmation** Virus isolation from blood and tissues. Antigen detection (antigen capture ELISAs and immunohistochemical tests). Polymerase chain reaction amplification of RNA. Viral neutralization serum antibody and ELISA tests

**Differential diagnosis list** Diseases with oral erosions and diarrhea (rinderpest, bovine malignant catarrh). Diseases with oral lesions and no diarrhea (foot-and-mouth disease, vesicular stomatitis, bluetongue, bovine papular stomatitis, necrotic stomatitis), disease with diarrhea and no oral lesions (salmonellosis, winter dysentery, John's disease, copper deficiency, ostertagiasis, coccidiosis, arsenic poisoning, carbohydrate engorgement)

**Treatment** None

**Control** Detection and elimination of PI animals from the herd. Prevention of introduction of infection into herd. Vaccination of breeding females to prevent fetal infection. Eradication by detection and elimination of persistently-infected animals, no vaccination and strict biosecurity measures to prevent introduction of PI animals into the herd

## ETIOLOGY

The bovine virus diarrhea virus (BVDV) is one of **three pestiviruses**:

1. Bovine virus diarrhea virus (also known as mucosal disease virus or bovine pestivirus),
2. Border disease virus of sheep
3. Hog cholera virus (also called European or classical swine fever virus).

The viruses are classified in the virus family Flaviviridae and are members of the genus *Pestivirus*.<sup>1</sup> Cross-infection between species can be achieved experimentally and has been demonstrated in field infections.<sup>1</sup> The molecular biology of the BVDV has been reviewed.<sup>2</sup>

Pestiviruses are nonsegmented, single, sense stranded (positive polarity (+)) RNA viruses. The genomic structure has been described.<sup>1</sup> Phenotypic diversity, such as antigenic variation, infectivity and replication rates, which can affect viral virulence, can be attributed to genomic reassortments, mutations or recombinations.<sup>1</sup>

Among the ruminant pestiviruses, particularly BVDV, there are two biotypes designated as **non-cytopathic (NCP)** and **cytopathic (CP)** depending on their effect on tissue culture cells. The non-cytopathic type is the most common and most important. Only the non-cytopathic type crosses the placenta, invades the fetus and establishes persistent infection in the fetus, which is crucial for spread of the virus. It is the cause of a wide range of congenital, enteric and reproductive diseases. In contrast, the cytopathic biotype of the virus is usually associated with only mucosal disease in animals already persistently infected with the non-cytopathic biotype. Both biotypes can be isolated from animals dying of mucosal disease and there is evidence that the cytopathic biotype evolves by mutation from the non-

cytopathic biotype within PI animals. There is considerable antigenic diversity and antigenic cross-reactivity among isolates of BVDV which has implications for diagnostic testing and for control by vaccination.<sup>2</sup> Antigenic and genetic differences have divided the BVDV into type I and type II genotypes. Each genotype has been subdivided into subgenotypes. BVDV-1 isolates are grouped by phylogenetic analysis into at least 11 genetic groups.<sup>3</sup>

Two subgenotypes of BVDV-1 are designated 1a and 1b. BVDV 1a strains are considered to be American in origin, whereas BVDV 1b is considered to have originated in Europe. However, genetic typing of bovine pestiviruses from both Northern Ireland and the Republic of Ireland were found to be BVDV 1a.<sup>4</sup> Most strains in England and Wales are BVDV 1b. It is suggested that the widespread importation of Holstein cattle from North America may have contributed to the predominance of BVDV 1a in the British Isles. Import restrictions which limited importation of livestock from continental Europe may explain the prevention of introduction of BVDV 1b strains to Great Britain and Ireland which will change with increased levels of animal movement following the introduction of the Single European Market.

Genomic recombination can occur in noncytopathic viruses from either genotype giving resulting in cytopathic viruses.<sup>5</sup> Only noncytopathic BVDVs cause severe acute bovine virus diarrhea. Genetic drift results in genotype; genomic recombination is associated with changes in phenotype (biotype). Variation in genotype is more significant to detection and control than variation in biotype.<sup>5</sup>

BVDV-2 genotypes are antigenically distinct and some isolates cause severe disease outbreaks.<sup>5</sup> Not all BVDV-2 isolates cause clinically severe disease; avirulent strains do exist. Virulent BVDV-2 strains inoculated into calves produce disease characterized by fever, diarrhea, leucopenia, lymphopenia, neutropenia, thrombocytopenia, and death. Infection with avirulent BVDV-2 strains causes leucopenia and low-grade fever.<sup>6</sup>

## EPIDEMIOLOGY

### Occurrence

Diseases associated with the BVDV have been recorded in most countries where cattle are raised and in some countries may be the single most important virus infection of cattle. The prevalence of infection is high but the incidence of clinical mucosal disease is low.

The BVDV causes several different diseases including:

- Benign bovine virus diarrhea, which is usually subclinical

- Fatal mucosal disease which occurs in persistently viremic animals and those specifically immunotolerant as a result of an infection acquired in early fetal life
- Peracute, highly fatal diarrhea
- Thrombocytopenia and hemorrhagic disease
- Reproductive failure
- Congenital abnormalities in calves as a result of fetal infection in mid-gestation.

The virus may also be immunosuppressive.

Mucosal disease was first recognized in 1946 and for the next 35 years it was assumed that the disease was the result of an infection prior to the onset of illness. It is now clear mucosal disease occurs only in PI animals as a result of a congenital infection with a non-cytopathic strain of the virus acquired in early fetal life. These animals remain specifically immunotolerant to the homologous strain of the BVDV throughout postnatal life, and fatal mucosal disease is precipitated by a superinfection with a cytopathic strain of the virus occurring usually at 6–24 months of age or older.

In the late 1980s and early 1990s, a peracute form of the enteric form of the disease and thrombocytopenia in young and adult immunocompetent animals infected with highly virulent strains of the virus were recognized. **This was the first indication that mucosal disease could occur in immunocompetent animals as a result of postnatal infection.**

### Prevalence of infection

Of cattle over 1 year of age, 60–80% have serum neutralizing antibodies to the virus.<sup>7</sup> Vaccination programs and the existence of persistently viremic animals which excrete the virus are responsible for the serologically positive animals in a herd.<sup>7</sup> In a survey of 256 beef breeding herds in the United States, over 90% of herds and more than 68% of cattle have been exposed to the BVDV either through vaccination or natural exposure.<sup>8</sup> Based on serum neutralization assays of type 1 and type 2 BVDV in a diagnostic laboratory in the Upper Midwest United States over a 7-year period there has been a progressive increase in the number of cases with high SN titers.<sup>9</sup> The increase is due in part to more extensive use of vaccination but probably also related to a rise in field infections. However, the lack of standardization of the serum neutralization testing between laboratories may affect the interpretation of such surveys.

**Young cattle which are persistently infected with a non-cytopathic strain of the virus are the major source of infection in a herd.** Conversely, the absence of PI animals in a herd could result in a

serologically negative herd. Seroepidemiological surveys of feedlot cattle also reveal that animals seroconvert to the BVDV during the first several weeks following the arrival in the feedlot due to presence of PI animals.

The mean prevalence of PI animals in herds is about 1–2%. A survey of all cattle in 19 Danish dairy herds with unknown status of BVDV infection revealed that 1.4% of the animals were PI. The prevalence of seropositive animals in herds with one or more PI animals was 87%; in herds without PI animals the prevalence was 43%. The prevalence is also much higher in animals under 1 year of age compared to the older animals in the herd. The theoretical risk of fetal infections occurring during the first 3 months of pregnancy was estimated to be 3.3%.<sup>10</sup> The age distribution of PI animals may be clustered into two separate groups based on the introduction of infected animals followed by the birth of infected animals.<sup>10</sup> In 66 selected herds in the United States, the mean frequency of persistent infection was 1.9% from six herds and nil from 60 herds.<sup>11</sup> However, in two of the six herds the prevalence of PI animals was 27% and 18%, and in one herd all PI animals died of mucosal disease within 5 months of the initial sampling.<sup>11</sup> Of randomly selected beef herds in the United States, about 3% had calves with persistent BVDV infection, and 19% of herds suspected by the herd veterinarian to be a BVDV infected herd had calves with persistent infection.<sup>12</sup> Most persistently infected calves survived to weaning and could provide a constant source of virus throughout the breeding season and early gestation.

Serological surveys in Norway revealed a prevalence rate of 18.5% in cattle, 4.5% in sheep and 2.2% in pigs.<sup>11</sup> In all three species, the prevalence rate varied considerably according to herd and geographical location.

The prevalence of PI cattle may vary between countries due to vaccination practices, the population densities of cattle and housing compared to pastured animals, the selling of male calves after birth, and housing young animals on different premises.<sup>11</sup>

The prevalence of BVDV infection in a population of feedlot calves in western Canada was 27% according to the ELISA test and it varied from 0–63%; according to the virus neutralization test the seroconversion risk was 40% and it varied from 0–100%.<sup>13</sup> In the same survey, the prevalence of PI calves was <0.1%, which is unusually low suggesting that few PI calves were purchased. The prevalence of acute viremia in the calves treated in the feedlot hospital was low at 4%, thus the

prevalence of persistent infection was low but serological tests suggested a high risk of seroconversion to BVDV.

The prevalence of PI calves born in a beef herd in 1 year ranged from 9.1–12.7%.<sup>14</sup> When isolation of the calves on a commercial feedlot to mimic normal management conditions in western Canada, was compared to BVDV-negative herd mates, persistently infected calves were 'poor doers' and had poor survivability to 1 year of age.

A high rate of BVDV infections in replacement dairy heifers between weaning and 9 months of age has been observed.<sup>15</sup> The risk of BVDV infection increased with age from 150 to 260 days of age and coincided with removal from the relative isolation in hutches, diminished expected protection from colostrum antibodies, and increased exposure to a large number of cattle, some of which possibly shed the virus.

Congenital infection (not persistent infection) with the BVDV in apparently healthy dairy calves, at a rate of about 10% has been reported.<sup>16</sup> Calves with congenital infection had a 2-fold higher risk of a severe illness, compared to calves without congenital infection.

Over a 20-year period in the north-western United States from 1980 to 2000, there was a shift in disease profiles associated with the BVDV infection and in the age of animal at onset of disease.<sup>17</sup> In 1980, data indicated a low fetal infection rate (<5%), followed by steady increases of clinical cases and peaking at 6 months of age (30%). By 2000, the shift of BVDV cases was noticeable and indicated a biphasic occurrence of disease. The first phase was fetal infections, which increased to >25%, followed by a second phase at 6 months (>35%). The changing patterns may have been due to increased susceptibility of pregnant cattle to BVDV infection and the emergence of type 2 BVDV. The second phase at 6 months of age may be associated with increased susceptibility following decline of passive immunity. Over a 2-year period (1998–2000) type 2 BVDV isolates were most common and associated with abortion-open cows. BVDV type 1a was associated least with early infection (<100 days gestation) and most with late infections (>100 days); BVDV 1b was intermediate, followed by BVDV type 2 which was associated more with early infection (45%) and less with late infections (55%) when compared with BVDV 1a and BVDV 1b.

**Other ruminant species.** Pestiviruses also infect a wide range of other domestic animals, **captive and free-living ruminants**.<sup>18</sup> There is serological evidence of BVDV infection in exotic ruminants, but outbreaks of disease are recorded only

occasionally and usually as single fatal cases. The clinical and pathological findings in some animals are similar to those of mucosal disease in cattle. Serological surveys indicate that many species of free-living ruminants in North America, Europe and Africa have varying prevalence rates. BVD antibody has been found in some free-living red deer in various districts in Denmark probably as a result of infection from cattle.<sup>19</sup> The virus has been isolated from a free-ranging mule deer in Wyoming and 60% of mule deer in the same area had antibody to type 1a BVDV suggesting the virus circulates in the mule deer population.<sup>20</sup> Experimental infection of New World Camelids, llamas, results in no clinical signs, fetal infection or persistent infection of crias.<sup>21</sup>

Pestiviruses have also been associated with outbreaks of disease among captive ruminants in zoological collections.<sup>18</sup>

Serological surveys of some populations of sheep and goats revealed that 11% of sheep and 16% of goats were seropositive.<sup>18</sup> A pestivirus which cross-reacts with the BVDV causes border disease in lambs following in utero infection of pregnant ewes.<sup>18</sup> Sheep can be infected naturally and transmission of the virus from cattle to sheep has been demonstrated. In Sweden, cattle infected with the BVDV are considered responsible for the majority of pestivirus infections in Swedish sheep.<sup>22</sup> Experimental pestivirus infections in pregnant goats causes reproductive failure, abortions, stillbirths, and persistent infection in newborn kids with a disease similar to border disease in lambs.<sup>18</sup> Experimental infection of newborn kids may result in minor lesions of the central nervous system but no clinical evidence of disease.<sup>18</sup>

Experimental ruminant pestivirus infection in pigs causes reproductive disease and growth retardation in piglets.<sup>18</sup> Some strains of the BVDV inoculated into pigs cause false-positive reactions to tests for swine fever antibodies and may protect against subsequent challenge with swine fever virus.<sup>18</sup> The importance of these and other species as a source of infection for cattle is unknown.

#### **Morbidity and case-fatality rates**

Mucosal disease in PI immunotolerant seronegative animals occurs in all classes of cattle mostly between 6 and 24 months of age, rarely in calves as young as 4 months of age, or cattle older than 2 years of age. The incidence of mucosal disease in a herd is usually less than 5% of the animals up to 2 years of age. Occasionally, epidemics have been observed in which up to 25% or more of the animals of the most commonly affected age group will develop mucosal disease.

Outbreaks of the recently recognized **peracute BVD** occurs in **immunocompetent non-PI animals** are characterized by a high case rate among all clinically affected animals. Morbidity rates may reach 40% and population mortality rates 20%. Herd outbreaks of acute disease associated with BVDV in veal calves caused population mortality rates ranging between herds from 10–25%.<sup>7</sup>

### Methods of transmission

**The major source of infection is the PI viremic animal.** The virus can be isolated from nasal discharge, saliva, semen, feces, urine, tears and milk, each of which would allow wide dissemination of the virus.

#### Direct contact

The virus is transmitted by direct contact between animals, and by transplacental transmission to the fetus. Discharges from the reproductive tract of an infected cow, either PI or systemically immune, including aborted fetuses, can be potent sources of the virus. Nose-to-nose contact is an effective method of transmitting the virus from PI to susceptible animals.<sup>11,23</sup> Thus PI animals may introduce the infection into a herd, or when infected animals are mixed with susceptible animals at the time of breeding or under conditions requiring emergency movement because of drought, flood or fire. The accidental mixing of a PI bull with susceptible breeding females during the breeding season in a beef herd may result in a major herd outbreak of mucosal disease. A pestivirus has been transmitted by contact from a PI bullock to pregnant sheep, resulting in the birth of PI lambs, one of which was able to transmit the virus by contact to pregnant cattle.<sup>24</sup> Two of these animals gave birth to PI calves, one of which transmitted the virus again by contact with pregnant sheep, leading to another generation of PI lambs.

Transmission of the virus between healthy immunocompetent animals is probably insignificant because they produce antibodies and eliminate the virus. However, the spread of transmission from transiently viremic cattle to seronegative animals in a dairy herd was slow, requiring about 30 months to spread to about 83% of the susceptible group. Primary infected animals are not effective transmitters of the virus.<sup>23</sup> Animals with primary infection even when co-infected with the bovine coronavirus do not transmit the virus to susceptible animals in close contact.<sup>25</sup> Susceptible animals introduced into a herd, typically heifers, become infected by contact with persistently viremic animals and major economic losses can occur if they are at a vulnerable stage of pregnancy. The introduction of an unknown persistently infected cow or

heifer into a susceptible herd can also cause major economic losses.<sup>11</sup>

The fetus can be infected by transplacental transmission of the virus from the infected dam, whether the dam is transiently or persistently infected.<sup>11</sup> Fetal infection has been produced by inoculation of non-immune pregnant dams.<sup>7</sup> Epidemics of abortion and congenital defects of calves have occurred when transplacental virus infection of the fetuses of cows in the first trimester, in previously virus-free herds, has followed the introduction of BVDV-infected animals.<sup>7</sup>

**PI females can remain clinically normal for several years**, during which time they may breed successfully and their progeny may also be apparently normal but are invariably also PI. In this way a maternal viremic family can be established which can persist for several generations and provides one of the major mechanisms for maintenance of the virus as endemic in the herd.<sup>7</sup>

**PI bulls may also introduce the virus into artificial breeding units.** A PI bull can shed the virus in his semen for a long period,<sup>26</sup> and if introduced into a susceptible herd could have immediate undesirable effects on reproductive performance. However, PI bulls may have acceptable semen quality and fertility.<sup>26</sup> Previously unexposed heifers have been shown not to conceive to service by a PI bull until they have seroconverted. The virus may be transmitted in cattle by artificial insemination with semen from a PI bull.<sup>26</sup> The use of semen from a transiently infected bull has the potential to introduce pestivirus infection into a group or herd of susceptible animals but the conception rates are usually within normal ranges.<sup>26</sup> However, once the infection is established in such a herd there is the potential for its amplification through a secondary cycle of transmission from heifers which were infected from the semen. The virus can persist in the semen of acutely infected bulls for several months after experimental exposure of immunocompetent, seronegative postpubertal animals.<sup>27</sup> There is also a record of a post-pubertal bull in an artificial insemination unit which was shedding the virus in semen over a period of 11 months while not demonstrating any evidence of viremia but with a high level of serum antibodies.<sup>28</sup> The virus could not be isolated from numerous blood samples and somatic organ tissues but at necropsy the virus was sequestered in the testes. It hypothesized that infection occurred shortly before the blood-testes barrier became fully functional thus allowing the virus to enter the seminiferous tubules but excluding the ensuing high levels of antibody from the site.

#### Indirect contact

**Airborne transmission.** Indirect airborne transmission of the virus can occur in calves housed near a PI calf for one week at distances of 1.5 and 10 m – without having direct contact with a PI calf.<sup>23</sup> Infection can also occur in calves housed in a pen directly after removal of a PI calf, but without the pen being cleaned and disinfected.

**Flies.** The virus has been experimentally transmitted by allowing blood feeding flies to feed on a PI animal followed by feeding on BVDV-free seronegative recipients. The virus was isolated from some of the flies, and from the recipient animals which also seroconverted.<sup>11</sup>

**Fomites.** The BVDV has been transmitted from a PI animal to susceptible heifers which were examined per rectum using the same glove.<sup>29</sup> Reusing a hypodermic needle on susceptible animals 3 min after the needle had been used on a PI animal or reusing a nose tong within 3 min after it had been used on a PI animal could also transmit the infection. The virus can be spread by hypodermic needles used on vaccine bottles contaminated by the nasal discharge of PI calves.<sup>23</sup>

### Risk factors

#### Animal risk factors

In general, young cattle are most susceptible to BVDV infection but adult cattle may develop severe disease if infected with the highly virulent genotypes of the virus. **Persistent infection can be established only** in approximately the first half of fetal life. Compared to many other pathogens, fetal survival following early intrauterine infection with non-cytopathic BVDV is common and can be as high as 70%. Unvaccinated animals, improperly vaccinated animals, or animals whose immune status has waned are most susceptible to infection and the potential for clinical disease. Vaccinated animals may be susceptible if field isolates of the virus are distinct from those used in the vaccine. PI animals are susceptible to the development of mucosal disease following superinfection with the cytopathic virus. They are also susceptible to other infectious diseases such as pneumonia.

#### Immune mechanisms

The literature on the immune response to the BVDV has been reviewed.<sup>30</sup> The interaction of the virus with both innate and adaptive immunity has been made much clearer.

Transient immunosuppression occurs in acutely infected animals. The virus infects cells pivotal in control of the innate and acquired immune response. The effects on the innate immune system have been examined in granulocytes, monocytes,



and natural killer cells. The virus infects cells of the innate immune system affecting the function of neutrophils, monocytes, macrophages, and dendritic cells. Neutrophils are impaired in microbicidal, chemotactic, and antibody-dependent cell-mediated cytotoxicity.

In vitro or in vivo infection with BVDV, either cytopathic or noncytopathic biotype, depresses various aspects of macrophage function which can adversely affect normal defense mechanisms of the lung which can facilitate bacterial colonization.<sup>30</sup> The effect of the different biotypes of the virus on interferon activity are variable.

In the acquired or adaptive immune response, BVDV infections have their major effect on thymic and follicular T-lymphocytes.<sup>30</sup> The effect on the number of circulating T-lymphocytes is strain dependent and varies from a mild to severe lymphopenia with highly virulent strains. The virus also affects T-helper lymphocyte and cytotoxic T-lymphocyte responses. BVDV infections have their major effect on follicular B-lymphocytes. The effect on the number of circulating B-lymphocytes varies but depletion of B-cells occurs in the lymphoid follicles of the lymph nodes with highly virulent NCP BVDV and in Peyer's patches with both mucosal disease and highly virulent BVDV infections.

The BVDV humoral antigens have been examined.<sup>30</sup> There are four major structural antigenic polypeptides. Glycoprotein E2 is the major glycoprotein and antigenic target for antibodies. E2 is highly antigenic and elicits the production of neutralizing antibodies in the host after infection or vaccination with live or killed vaccines. The ability of BVDV antibodies to protect against BVDV infection and the development of long-term virus infection is dependent on the virus strain and the level and isotype of antibodies produced. BVDV antibodies are indicators of the presence of a particular immune response rather than an indicator of a protective immune response. High levels of neutralizing antibodies prevent disease following homologous challenge. However, animals with neutralizing antibodies may develop viremia. Shedding of the virus in nasal secretions may occur in the presence of serum neutralizing antibodies.

In vitro cross protection studies with serum from cattle vaccinated with either modified live virus or inactivated vaccine demonstrated wide crossneutralization against 12 to 22 different BVDV strains but not field studies do not show this extensive crossneutralization.

The immune response in the calf is influenced by two factors: the development of active immunity and the decay of

maternal or passive immunity. Young calves at 10 to 14 days of age seronegative to BVDV can develop a protective immune response following vaccination with MLV vaccine.<sup>31,32</sup> However, the presence of maternal antibody in calves interfered with the immune response and the animals were not protected from a challenge 4.5 months later. A predictive study estimated that calves must be 142 days of age to become seronegative for BVDV type 1 antibodies and 114 days for type 2 antibodies.<sup>33</sup>

The immunology of BVDV persistence has been examined and reviewed.<sup>30</sup> The interaction of NCP BVDV in pregnant animals demonstrated that heifers carrying PI calves develop BVDV antibody titers 5 to 10 times higher than heifers carrying non-PI calves. The inability of NCP BVDV to induce IFN- $\alpha$  in the fetus is one of the major immune evasion mechanisms that allows BVDV to establish persistence. The major mechanism for persistence is tolerance of the CD4<sup>+</sup> cells. The specificity is very high, as PI animals can respond to homologous virus changes as small as a single amino acid. This explains why some PI animals can develop an antibody response to the homologous virus from the multiple BVDV quasispecies that will arise as the PI animals mature. Experimental infection of PI animals with antigenically related CP BVDV resulted in 50% developing mucosal disease. Those which did not develop mucosal disease had higher levels of circulating gamma-delta T-cells before the challenge with CP BVDV. Vaccination of BVDV type 1b tolerant PI animals with vaccines containing either CP BVDV type 1a or a NCP type 1b and also *Mannheimia haemolytica* resulted in an BVDV antibody response only in those animals receiving vaccines containing the heterologous type 1a. All of the PI animals had lower *M. haemolytica* antibody response.

Following natural infection of seronegative immunocompetent cattle with most of the strains of BVDV which do not cause severe disease, there is a transient viremia; serum neutralizing antibodies develop within 2-3 weeks, peak at 8-10 weeks, and remain detectable for many months. The humoral immune response after natural BVDV infection in cattle is considered to be lifelong, and includes antibodies to a range of virus-encoded proteins, including the immunodominant surface glycoprotein gp53 and the highly immunogenic, non-structural, catalytic serine protease NS2-3.<sup>34</sup> Vaccination of naïve cattle with inactivated BVDV vaccines, results in virus neutralization peak titers at about 5 weeks after the second vaccination with a return to seronegativity within 12 weeks of vacci-

nation.<sup>35</sup> This pattern of response is typical of inactivated vaccines. Experimentally and naturally infected animals may have moderate to high levels of serum neutralizing antibodies to the virus for three years after being infected.<sup>34</sup> The ability to cross the placenta of susceptible pregnant animals and cause a variety of fetal infections is the most important evidence of the success of the BVDV in the evasion of the host immune system.<sup>30</sup>

The high percentage of animals which are seropositive in the cattle population or in herds which have experienced the disease is due to the presence of PI animals in the herd. Vaccination of immunocompetent cattle with the live virus vaccines induces a broad spectrum and durable immunity. It is generally accepted that cattle respond to natural infections or vaccination with modified live-virus vaccines with a long-lasting immunity, and it is likely that the immune response includes cell-mediated immunity. Immunization with an inactivated virus vaccine may result in an only very short-lived immunity with a narrow antigenic spectrum. Existence of neutralizing antibodies is generally considered to be the most significant predictor of an effective immune response.<sup>36</sup> The presence of neutralizing antibodies in breeding females will protect the fetus against BVDV infection during pregnancy. Passively acquired antibodies, usually IgG, protect against nasopharyngeal shedding of the virus, and reduce viremia in challenge-inoculated calves. There is considerable antigenic variation among strains of the virus but there is also considerable cross-protection against heterotypic strains of the virus. Recent outbreaks of severe disease due to type II BVDV infections occurred primarily in herds which were not properly vaccinated. Current vaccines derived from type I strains appear to protect against infections with type II strains.<sup>36</sup>

Colostrum antibody in calves lasts until 4-6 months depending on the initial level achieved after the ingestion of colostrums.<sup>37</sup> The half-life of the antibody is 21 d in normal calves but in persistently-infected calves titers decline more rapidly and by 4-8 weeks no antibodies may be detectable.

The predicted ages of dairy calves when colostrum-derived BVDV antibodies would no longer provide protection against disease or interfere with vaccination has been examined.<sup>33</sup> About 50% of calves become seronegative for BVDV type 2 by 114 days of age. Rate of antibody decay was significantly associated with antibody titer at 1 to 3 days of age and with whether calves were congenitally infected with the virus. Three-month old calves were

predicted to have a mean BVDV type-1 antibody titer of 1:32 and mean BVDV type-2 antibody titer of 1:16. These data can be used to estimate the age by which a group of calves would be expected to lose passive protection.

Passively acquired antibodies can prevent clinical disease in experimentally inoculated calves at 2 to 5 weeks of age and protection continues to exist after the decay of passive antibodies which implies the existence of additional immune mechanisms other than serum antibodies.<sup>38</sup>

PI calves are infected during early fetal life and are born seronegative and immunotolerant to the specific strain of virus in their tissues. Most PI calves remain seronegative to specific virus but will respond immunologically to other pathogens.

The immunosuppressive effects of the BVDV are discussed later under that heading.

#### Environmental and management risk factors

The major management risk factors are the introduction of PI animals into a susceptible herd and the failure of a vaccination program or an inadequate vaccination program. In the recent outbreaks of severe disease in cattle herds in Ontario and Quebec, failure to vaccinate or failure to use the vaccine properly was a common historical finding.<sup>39</sup>

#### Pathogen risk factors

The bovine pestivirus is one of the most widespread and important virus infections in cattle throughout the world. While only one serotype of BVDV is recognized, isolates of these viruses vary genomically, antigenically and biotypically. These pathogen characteristics are important in the pathogenesis of the various diseases associated with the virus, the immune response of animals to different isolates of the virus, and the laboratory diagnosis.

**Antigenic diversity.** Positive-strand RNA viruses, like BVDV, are subject to genomic modifications that involve point mutations or recombination of RNA and thus are highly mutable.<sup>40</sup> The genetic diversity among isolates of the virus is characteristic of RNA viruses which exist in nature as quasispecies (a swarm of viral mutants). The high frequency of mutation, propensity for recombination, and selective pressure from immune responses stimulated by natural infection or vaccination has led to the creation of a large assortment of genetic and antigenic variants of the virus. The consequences of diversity include diversity of clinical disease, diagnostic difficulties, and vaccination failures.<sup>2,40</sup>

Several isolates have been identified that are antigenically related, but there may be antigenic variants that are immuno-

logically distinct. In addition to antigenic diversity among strains, there are major molecular differences between the same strains. Differences in neutralizing antibody titers against specific isolates of BVDV are detectable in polyclonal serum from convalescent cattle. Monoclonal antibodies that have neutralizing activity differentiate BVD viruses into several groups. The antigenic variability of this virus may also explain the wide range of lesions and disease complexes which have been observed. Outbreaks of disease associated with the virus in commercial beef herds in Argentina were characterized by different clinical manifestations such as mucosal disease, enteritis and generalized dermatitis each caused by different genotypes of the virus.<sup>41</sup> This requires further virology and molecular studies which are necessary to improve diagnostic methods and formulate effective vaccines. The practical consequences of antigenic diversity are that neither natural infection nor vaccination can provide complete protection against most of the naturally occurring strains. There is also considerable cross-reactivity between isolates of the virus, which explains why properly vaccinated animals have considerable immunity.

Phylogenetic analysis of the viruses from persistently infected cattle on a number of farms in Sweden found a strict herd-specific clustering of the virus.<sup>42</sup>

**Genotypes.** The BVDV can be segregated into two subgroups termed BVDV I and BVDV II.<sup>1,2</sup> Type 2 isolates are those commonly used in vaccine production, diagnostic tests and research. Type II isolates are predominantly from fetal bovine sera, persistently infected calves born to dams vaccinated against BVDV, and cattle which have died from an acute form of BVDV termed 'hemorrhagic disease'. The epidemic of BVDV-associated disease in cattle in Quebec in 1993, associated with morbidity rates of up to 80% in some herds, and mortality rates up to 30%, was associated with isolates belonging to type 2.<sup>43</sup> Experimentally, type 2 BVDV induces the highest degree of viremia and more pronounced lesions and more extensive distribution of viral antigen compared to Type 1 BVDV which induced the lowest.<sup>44,45</sup>

**Non-cytopathic and cytopathic BVD virus biotypes.** Bovine viral diarrhoea viruses exist as non-cytopathic or cytopathic biotypes.<sup>1,2</sup> Non-cytopathic biotypes produce little if any visible cytopathic change in cell cultures, and infected cells generally appear normal. Cytopathic biotypes, in contrast, cause cellular vacuolation and cell death. The biotypes are classified by their ability or lack of ability to cause overt cytopathic change in cell cultures without reference to their ability to cause disease in the animal. The two

biotypes of BVDV are not distinguishable serologically. However, at the molecular level, cytopathic viruses produce one additional protein known as p80. There is strong evidence that cytopathic viruses are derived from non-cytopathic viruses by mutation. In most cases RNA recombination is responsible for the generation of the cytopathic viruses.<sup>39</sup> A second method is based on the introduction of a set of point mutations within the NS2 gene. The non-cytopathic virus is thus the natural 'wild-type' virus.

The BVDV is maintained in the environment by PI animals which were infected by non-cytopathic virus in utero from 42–125 d of gestation, when their immune system does not recognize the persisting virus as foreign and the animal is said to be immunotolerant. In general, PI animals lack neutralizing and non-neutralizing antibodies to the BVDV. The immune tolerance is highly specific, as these animals can mount an immune response to superinfections from antigenically dissimilar BVDV. PI animals with BVDV antibodies, other than calves with passively acquired colostrum antibody, probably acquire them because they have encountered a BVDV, via natural exposure or vaccination that is dissimilar antigenically. There is no evidence that cytopathic viruses can produce persistent infections.

The non-cytopathic BVDV, the NADL-A strain, infects the bovine fetus following oronasal exposure of the pregnant dam, whereas the closely related cytopathic NADL-A are incapable of fetal infection.<sup>46</sup> The inability of the CP BVDV to establish fetal infections following oronasal exposure explains the preponderance of NCP BVDV in the cattle population. The extraordinary ability of the NCP BVDV to establish fetal infections leading to the birth of PI calves provides a robust viral reservoir. Shedding and horizontal transmission maintains a high degree of viral infections in cattle herds.

In some PI animals, viral antigen may be widespread in many tissues, including the cerebellum and other parts of the brain, spleen, kidney, lungs and parts of the intestine. Yet, the PI calf is often born normal and vigorous, and reaches adulthood due to the non-pathogenicity of the virus. But the virus continues to replicate lifelong in the tissues of these animals and virus is shed continually into the environment.

Mucosal disease is the result of PI animals being superinfected with a cytopathic virus that is antigenically similar to the persisting non-cytopathic virus and both types are isolated from cattle with mucosal disease. Because of the antigenic similarity of the viruses, it is thought that the immune system of the PI animal does

not recognize the cytopathic virus as foreign and thus fails to protect the animal from severe disease. The uncontrolled infection with cytopathic virus causes the severe lesions in mucosal disease.

Until recently, it was thought that post-natal infections of non-pregnant cattle with BVDV were benign, and only sometimes produced clinical disease. Following infection of immunocompetent animals, there was viremia, mild fever and diarrhea and recovery. The animals seroconverted, which accounted for the high percentage of normal animals in the cattle population which were serologically positive. In the late 1980s and early 1990s in the north-eastern United States, Ontario, and Quebec, virulent BVD non-cytopathic viruses emerged which caused severe acute disease in both calves and adult cattle.<sup>43</sup> The majority of viral isolates were non-cytopathic and were typed as BVDV 2.<sup>43</sup> Thrombocytopenia and hemorrhagic disease associated with non-cytopathic BVDV has been recognized in adult dairy cattle and weaned beef calves. The disease occurred in veal calves in the same geographical area. In addition, highly virulent BVDV are causing severe diarrhea and death in adult cattle with clinical findings and lesions similar to those of acute mucosal disease. There are now reports of severe illness resembling acute mucosal disease in adult cattle in Britain, attributed to infections with non-cytopathic BVDV. Type 2 viruses have been isolated in British cattle.<sup>47</sup> Only non-cytopathic BVDV have been isolated from these animals. All of the available evidence suggests that these animals are immunocompetent and not persistently infected but they may be non-immune because of lack of vaccination or acquired antibody. Type 2 BVDV has been isolated in Slovakia which means that this genotype is now in central Europe.<sup>48</sup> Experimentally, differences in virulence between two non-cytopathic bovine viral diarrhoea viruses in calves have been described. Type 2 BVDV strains have been isolated in Brazil affecting young cattle with severe gastrointestinal and respiratory disease.<sup>49</sup>

Antigenic similarity between the biotypes is a consistent finding in animals dying from fatal mucosal disease, which suggests that cytopathic strains may arise by mutation from non-cytopathic strains. The literature on the molecular biology of the virus has been reviewed.<sup>6</sup> Analysis of viral proteins with monoclonal antibodies has yielded detailed information about the antigenic composition of both structural and non-structural proteins.

### Economic importance

In Canada, the BVDV disease complex is considered as one of four infectious dis-

eases known as production limiting diseases in dairy herds.<sup>50</sup> The other three are Johne's disease, enzootic bovine leukosis, and neosporosis. These diseases are present on many Canadian dairy farms and have significant economic loss due to disease and lowered productivity. The direct production losses (milk loss, premature voluntary culling and reduced slaughter value, mortality loss, and abortion and reproductive loss) and treatment costs (veterinary services, medication cost, an extra farm labor cost) due to four infectious diseases in the Maritime provinces of Canada were determined.<sup>51</sup> Total annual costs for an average, infected, 50 cow herd in 1997 were: Johne's disease \$2472; BVDV \$2421; neosporosis \$2304; enzootic bovine leukosis \$806. The largest effect on costs was due to milk yield effects.

Calculation of the losses associated with BVD outbreaks in dairy herds vary widely.<sup>52</sup> In most cases the estimated losses only include those due to abortion and dead animals whereas indirect effects such as increasing the risk to other diseases are not included and therefore are considered as conservative estimates. The economic losses associated with outbreaks of the various forms BVDV infection in herds vary from a few thousand up to \$100 000.<sup>52</sup> Most estimations of losses at the national level range from \$10 and 40 million per million calvings. National eradication schemes as done in Scandinavian countries has been cost-effective.<sup>52</sup>

The economic losses associated with the introduction of the BVDV into a susceptible herd of pregnant cattle are due to abortion, congenital defects, stillbirths, increased neonatal mortality, increased occurrence of other infectious diseases, prenatal and postnatal growth retardation, suboptimal reproductive performance due to infertility, deaths from mucosal disease, and the early disposal of PI animals. Large losses due to fetal infection occur during the first 2–3 years following introduction of infection to a susceptible herd.<sup>10</sup> The economic losses are high when epidemics of fatal mucosal disease occur. While the incidence of mucosal disease is usually below 5%, it can be as high as 22%, which is costly because of veterinary visits, the submission of animals to the diagnostic laboratory, the death of animals, and the anxiety the epidemic creates in the mind of the producer who wonders if the entire herd will become affected.

Economic losses due to BVDV infection vary depending on the immune status of the population and the pathogenicity of the infecting virus strains. Introduction of the infection into a totally

susceptible population invariably causes extensive losses until a state of equilibrium is reached. Infection with highly virulent strains cause severe clinical disease and death.

The magnitude of the losses in an infected herd may be expected to fluctuate. They may be relatively large with the occurrence of disease on an epidemic scale after initial horizontal transmission to non-immune pregnant cows, but considerably lower when endemic infection is maintained in the herd through the presence of viremic families. However, a further phase of high losses may occur should management allow heifers to reach breeding age without being exposed to infection or vaccinated. A linear programming model to estimate the economic impact of bovine viral diarrhoea at the whole-farm level has been described.<sup>53</sup>

Using the output from an epidemiological model of an outbreak of BVD in a Scottish beef suckler herd, the estimated losses associated with an outbreak of BVD were 59 Euros mean loss per cow per annum without taking into account any financial premiums associated with disease-free status of the herd.<sup>54</sup> Two highly significant areas of loss often ignored in the field are immunosuppression and reproductive failure.<sup>54</sup>

### PATHOGENESIS

The pathogenesis depends on multiple interactive factors. Host factors which influence the clinical outcome of BVDV infection include:

- Whether the host is immunocompetent or immunotolerant to the virus
- Age of the animal
- Transplacental infection and gestational age of the fetus
- Induction of immune tolerance in the fetus and the emergence of fetal immune competence at about 180 d of gestation
- Immune status (passively derived or actively derived from previous infection or vaccination)
- Presence of stressors. Genetic diversity among isolates may account for differences in the clinical response to infection. Differences in virulence between non-cytopathic isolates and between genotypes have been described.<sup>7</sup> Apart from those infected with the virus in utero, most cattle are immunocompetent to the virus and will successfully control a natural infection, develop antibodies and eliminate the virus so that latency and shedding does not occur.

The consequences of infection with the BVDV are divided into the following

different categories based on the status of the animal. **There is a spectrum of clinical responses based on the host factors and the virulence of the isolates involved.**

### Immunocompetent non-pregnant cattle

#### Subclinical BVDV

This is a subacute infection in seronegative, immunocompetent cattle usually after colostral immunity has waned and it occurs in both sexes and any class of cattle. It is usually a clinically unrecognizable infection with the development of serum-neutralizing (SN) antibodies and elimination of the virus from normal immunocompetent animals. This accounts for the high percentage of normal animals that are serologically positive to the virus. A mild transient clinical disease characterized by inappetence for a few days, depression, fever, mild diarrhea, transient leukopenia and recovery in a few days may occasionally occur.

In some cases, outbreaks of diarrhea occur in animals ranging from 6 months to 1 year of age, characterized by high morbidity and low or no mortality. The most likely source of infection is PI animals in the herd.

#### Peracute bovine virus diarrhea

A severe and highly fatal form of bovine virus diarrhea associated with non-cytopathic Type II isolates of the BVD virus is recognized.<sup>43</sup> Outbreaks were most common in dairy herds with inadequate vaccination programs and which recently introduced animals into the herd.

#### Thrombocytopenia and hemorrhagic syndrome

Thrombocytopenia and the hemorrhagic syndrome occurs in adult cattle and veal calves affected with the peracute form of BVDV infection.<sup>55</sup> Platelet counts are reduced to below 25 000/ $\mu$ L, and clinically are bloody diarrhea, petechial and ecchymotic hemorrhages of the sclera of the eyes, epistaxis and abnormal bleeding from injection sites. Hyphema may also occur. Thrombocytopenia due to destruction of platelets has been reproduced experimentally in young calves by inoculation of the BVDV. type 2 BVDV isolates are most commonly associated with the hemorrhagic syndrome. Experimentally, altered platelet function occurs in calves with type 2 BVDV isolates but not with type 1 BVDV strains.<sup>56</sup> In calves experimentally infected with ncp type 2 BVDV isolates of different virulence induced clinical signs and cytopenia which appeared to be proportional to infection severity.<sup>57</sup> The important virulence characteristics are duration of neutropenia, severity of thrombocytopenia, delayed increase in proliferating myeloid cells, and

the presence of virus in bone marrow precursor cells. Infection of bone marrow megakaryocytes myeloid cells may also be involved. The North American hypervirulent type 2 BVDV induces severe thrombocytopenia, profuse diarrhea and pneumonia in all experimentally infected calves, while none of the European strains tested, all belonging to genotype 1, induced significant pathological signs even though isolated from cases of hemorrhagic syndrome.<sup>57</sup> It is suggested that induction of sporadic hemorrhagic syndrome by BVDV type 1 requires the presence of other co-factors.

Osteopetrosis, anemia, thrombocytopenia and bone marrow necrosis can occur in beef calves naturally infected with type 2 strains of the virus. Experimental infection of calves with the non-cytopathic virus causes thrombocytopenia whereas cytopathic virus did not.

#### Diarrhea of neonatal calves

The role of the virus causing diarrhea in calves under a few weeks of age is uncertain. Naturally occurring cases of acute neonatal diarrhea due to infection with the virus in immunocompetent calves under 6 weeks of age have been reported only rarely. Calves born with PI status may be unthrifty and be affected with chronic diarrhea and pneumonia as young calves. However, if the virus causes diarrhea in calves the pathogenesis is not clear. Calves born from cows free of the infection are not likely to be exposed to the infection. Immunocompetent dams provide colostral immunity to their calves, which should protect them against viremia due to BVDV for 6 months or longer.<sup>59</sup> Fatal enteritis has been reproduced experimentally by infecting colostrum-fed and colostrum-deprived neonatal calves with the virus.<sup>7</sup> In older colostrum-fed calves, experimental infection resulted in mild disease with rapid recovery. Experimentally, calves from 7–50 d of age with colostral virus neutralizing (VN) antibody titers below 256 or lower, developed a fever and systemic spread of the virus when challenged with the virus.<sup>59</sup> Calves with titers lower than 16 developed severe clinical disease characterized by fever, leukopenia, thrombocytopenia and diarrhea. The severity and duration of clinical signs decreased as titers of passively acquired viral neutralizing antibody increased. Another requirement for effective protection, is that the colostral antibody must be specific for the virulent virus. Experimentally, the intranasal inoculation of healthy BVDV-free calves 6 months of age with either the non-cytopathic or cytopathic BVDV results in a mild form of enterocolitis, and mild follicular lymphocyte depletion.

#### Meningoencephalitis

A type 2 BVDV strain has been isolated from the brain tissue of 15-month-old heifer with neurological clinical findings and pathologic evidence of multifocal meningoencephalitis.<sup>60</sup> This suggests a neurovirulent strain of the virus.

#### Immunosuppression

There is evidence that postnatal BVDV infections of cattle can cause immunosuppression and enhance the development of other infectious diseases.<sup>36</sup> However, the evidence is controversial and must take into account the immune mechanisms of PI animals compared to animals with primary infections. There is circumstantial evidence that BVDV infections may be a major factor in multiple etiological diseases such as pneumonia and enteritis. Cytopathogenic isolates from genetic cluster 1 d of BVDV type 1 experimentally induced a primary respiratory disease in previously seronegative and immunocompetent calves.<sup>61</sup> All infected calves seroconverted and contact calves also developed a respiratory infection following exposure to infected calves.

The lesions of BVDV in cattle suggest immunosuppression because of lymphoid depletion and neutropenia.<sup>36</sup> Similarly, some of the modified live-BVDV vaccines are considered immunosuppressive in calves or may potentiate intercurrent infections.

**In vitro evidence of immunosuppression.** This indicates that the virus interferes with lymphocyte and macrophage function. BVDV infection of peripheral monocytes in vitro causes a significant decrease in their random locomotion and chemotactic response to a lymphokine. These abnormalities could impair the ability of the host to localize monocytes and macrophages in the vicinity of other infections. Neutrophils from BVDV-infected cattle may have their bactericidal, fungicidal and virucidal mechanisms impaired, which could increase susceptibility of BVDV-infected cattle to secondary infections. Alveolar macrophage function is reduced in calves experimentally infected by the respiratory route with a cytopathic biotype of the virus and with the other immunosuppressive attributes of the virus, could favor a predisposing role for the virus in the pathogenesis of respiratory disease in calves.<sup>22</sup>

Experimentally, the virus can:

- Alter neutrophil function<sup>36</sup>
- Impair immunoglobulin secretion by peripheral lymphocytes
- Allow the infectious bovine rhinotracheitis (IBR) virus to be more widely distributed in various tissues and infect tissue culture cells

- Cause the release of substances which can suppress the proliferative response of bovine mononuclear cells to blastogenic substances.

Impairment of neutrophil function in cattle persistently infected with the BVDV differs from impairment of neutrophil function in healthy cattle mounting an immune response to the infection.<sup>36</sup>

**In vivo evidence of immunosuppression.** Primary postnatal infections cause a transient reduction in the absolute number of T- and B-lymphocytes and in the percentage of T-lymphocytes. The evidence incriminating the virus as a predisposing pathogen in naturally occurring cases of bovine respiratory disease is largely circumstantial. The presence of the virus in the respiratory tract tissues of cattle affected with pneumonia is difficult to interpret. Several different viruses have been incriminated in the cause of acute bovine respiratory disease but experimental evidence to support their involvement has centered on the IBR and PI-3 viruses.

In outbreaks of respiratory disease in calves and adult cattle associated with multiple viral infections, the BVDV is often the most frequent viral agent. This could indicate that the virus is an important contributory pathogen in respiratory disease of cattle.

Experimentally the BVDV can facilitate the colonization of *P. haemolytica* in the lungs, resulting in severe pulmonary lesions.<sup>36</sup> Severe fibrinopurulent bronchopneumonia and pleuritis involving 40–75% of lung volume developed in calves experimentally inoculated sequentially with the BVDV and *P. haemolytica*. However, in some experiments the BVDV has no effect. BVDV may be present with other pathogens, such as those viruses or *Pasteurella* sp. and this may indicate that synergism occurs. However, it is also possible that the virus may be coincidentally present in some animals and have no adverse effect. It has been argued that there is no substantive evidence to implicate the BVDV, as it occurs in the benign form of the disease, in the pathogenesis of naturally occurring acute undifferentiated respiratory disease of cattle. Field observations suggest that following the introduction of BVDV infection into a susceptible herd, there may be an increased incidence of viral and bacterial pneumonia in the calves, which may continue for up to 2 years.

BVDV types 1 and 2, along with the PI-3 virus, and the BRSV, have been isolated from lung tissue in recently weaned beef calves with acute respiratory disease soon after arrival in the feedlot.<sup>62</sup> The BVDV1b was the predominant subtype identified in recently weaned

beef calves affected with pneumonia due to *Mannheimia haemolytica* and *Pasteurella multocida*.<sup>63</sup>

#### *Bovine viral diarrhea virus in the feedlot*

There is epidemiological evidence that the BVDV may be one of the most economically important infectious pathogens of feedlot cattle.<sup>64</sup> The Academy of Veterinary Consultants has proposed that the beef and dairy cattle industries adopt measures to control and target eventual eradication of BVDV from North America.<sup>65</sup> The immunosuppressive potential of the virus or its synergistic effects with other pathogens are considered to be associated with bovine respiratory disease in feedlot cattle. Individual, unknown persistently infected animals which are purchased and introduced into the feedlot, serve as reservoirs of the virus for naïve cattle which are subsequently co-mingled in the feedlot. BVDV has been incriminated in bovine respiratory disease in feedlot cattle from which pathogens such *Mannheimia haemolytica*, *Mycoplasma bovis*, *Histophilus somni*, *infectious bovine rhinotracheitis virus*, have been isolated from lung lesions.<sup>64</sup> Chronic, antibiotic-resistant pneumonia, often with concurrent polyarthritis, occurs in feedlot cattle in western Canada. The prevalence of *M. bovis* and the BVDV in the tissues of affected animals suggests there may be synergism between the BVDV and *M. bovis*.<sup>66</sup>

There is considerable seroepidemiological evidence that the BVDV titers of feedlot cattle on arrival are associated with subsequent respiratory disease. Cattle arriving with a titer were at decreased risk of respiratory disease; those cattle which seroconverted after arrival were associated with increased risk of disease. Seroepidemiological studies of undifferentiated fever in recently weaned beef calves arriving in the feedlot indicates that animals arriving with a higher BVDV antibody titer were associated with a decreased risk of undifferentiated fever compared to those with lower levels on arrival.<sup>67</sup> Persistently-infected calves introduced into the feedlot usually are unthrifty at the time of weaning, and most will die during the feeding period.<sup>10</sup> Cross-sectional and cohort studies a large number of cattle arriving in a feedlot determined the prevalence and effect of PI animals on subsequent disease. The prevalence of PI cattle on arrival was 0.3%, 2.6% in chronically ill feedlot cattle, and 2.5% in dead cattle.<sup>68</sup> The risk of initial treatment for respiratory disease was 43% greater in cattle exposed to a PI animal compared with those not exposed to a PI animals. Overall, 15.9% of initial respiratory tract disease events were attributable to exposure to a PI animal.<sup>68</sup>

Primary BVDV infections occur in feedlot cattle which are not persistently-infected and may be the inapparent or subclinical form or the peracute form of the disease. The thrombocytopenic form of BVDV infection has also been described in feedlot cattle.<sup>64</sup>

#### *Ovarian dysfunction*

Ovarian dynamics may be changed in cattle infected with BVDV.<sup>26</sup> Ova exposed to the virus in vitro can have virus particles attached to the zona pellucida but the intact zona pellucida protects the developing embryonic cells from infection. However, following removal of the zona pellucida, cytopathic BVDV may have detrimental effects on survivability of blastocysts. Bovine follicular cells and oocytes are permissive to BVDV at all stages of follicular development<sup>69</sup> and there may be a transient fall in estradiol secretion following acute infection; both may reduce fertility. Infection during the critical period of growth of preovulatory follicles causes varying degrees of necrosis of the granulosa cells which can result in a spectrum of ovarian dysfunction including retarded follicular growth, delayed ovulation and anovulation.<sup>70</sup> Return to ovarian function following BVDV infection may take several months in some cases.

#### *Immunocompetent pregnant cattle and fetal infections*

The BVDV can cause significant early reproductive loss in non-immune pregnant cattle including fertilization failure, embryonic mortality and abortion.<sup>71</sup> In addition, infection of the fetus between 42 and 125 d of gestation may result in persistently-infected fetuses which are carried to term and the calf may be born alive and thrive normally or be unthrifty.

The experimental and clinical observations of the effects of the virus on early parts of the reproductive cycle are conflicting. The virus can be transmitted by natural service or artificial insemination with the possibility of fertilization failure or early embryonic mortality, which in turn, leads to repeat breeding. The principal determinant of the outcome of in utero infection in cattle is the age of the conceptus and fetus when infection occurs. The BVDV can cause reproductive failure in susceptible cattle during the following stages of the reproductive cycle:

#### **1. Infection prior to insemination.**

Exposure of cattle to the virus during the estrus cycle prior to insemination can result in a decrease in conception rate due to failure of ovulation or delayed ovulation. BVDV has been associated with ovaritis in infertile heifers.<sup>26</sup> PI cows may have morphologic changes in their ovaries,

suggesting a reduction in normal ovarian activities. It is not known if similar findings occur in cows acutely infected with the virus.

- 2. Insemination of cattle with semen containing bovine pestivirus.** The insemination of seronegative and virus-free heifers with BVDV-contaminated semen can result in poor conception rates initially, followed by normal conception following seroconversion to the virus, and the birth of normal calves with no evidence of infection with the virus.<sup>26</sup> Experimentally, the intrauterine infusion of the virus into cattle at the time of insemination has prevented conception and has been attributed to prevention of fertilization or simply recognized as an empty uterus at 5 weeks after breeding. It seems that intrauterine infection at the time of breeding may have some effects on the very early stages of reproduction, in addition to those that could be attributed to infection by other contact routes. Infection of susceptible cows either 9 d before or soon after insemination can result in a marked reduction in conception rates and significant embryo-fetal loss.<sup>26</sup>

The BVDV can be present in the semen of bulls either due to a persistent infection or an acute postnatal transient infection of the bull. The semen of an immunotolerant PI bull may be normal and the pregnancy rates of heifers bred by him may be normal thus the spermatozoa from an infected bull do not necessarily carry the virus. In other situations the quality of the semen of PI bulls may be abnormal. Acute infection of immunocompetent BVDV seronegative bulls with the virus can result in transient shedding of the virus in semen and to a marked deterioration of semen quality.<sup>26</sup> The amount of virus in the semen of acutely infected bulls is much less than that found in the semen of PI bulls. Experimental acute infection of bulls with the BVDV can result in shedding of the virus in raw, unprocessed, and diluted and extended semen during and after the end of the period of viremia.<sup>26</sup> The most productive sites of virus replication are in the seminal vesicles and prostate gland.<sup>26</sup>

The economic losses can be considerable if the virus is introduced into herds undertaking an embryo transfer and artificial insemination program.<sup>26</sup> Infection may occur following the use of infected semen

for artificial insemination or through the use of infected bovine serum as a transport medium or diluent for embryo transfer.

- 3. Infection during embryonic period: 0–45 d gestation.** Natural BVDV infection of seronegative heifers 4 days after insemination results in viremia between 8 and 17 d and a decrease in conception rate and pregnancy rate compared to uninfected heifers.<sup>26</sup> Infected heifers which fail to conceive return to estrus approximately 20 d later. Experimentally there is no indication of impairment of in vitro development of bovine embryos when they are exposed to the BVDV.<sup>72</sup> The zona pellucida appears to prevent the virus from gaining access to the embryonic cells.<sup>73</sup>

Fetal infections

- 4. Infection during late embryonic-early fetal period: 45–125 d gestation.** Following the infection of a non-immune pregnant animal the virus is capable of crossing the placental barrier and invading the fetus. In experimental infection of pregnant heifers with a noncytopathic strain of the virus at 85 days of gestation, fetal infection can occur 14 days post-infection without preceding or simultaneous high concentration of the virus in uterus or placenta.<sup>74</sup> This supports the proposition that the passage of virus can occur via the vasculature and not via local cell-to-cell spread and that fetal infection can occur in the absence of significant levels of virus in the placenta.

Fetal infection can result in a wide spectrum of abnormalities from death of the fetus to congenital defects, to a persistent infection of the fetus until term and birth of a calf with lifelong infection without clinical signs. The results are mainly dependent on the stage of fetal development at which infection takes place. In general, the risk for the fetus is highest during early pregnancy. Infection of the fetus from 50–100 d of gestation may result in fetal death and expulsion of the fetus (**abortion**) from days to several months after fetal infection, or **mummification**. However, fetal survival following infection is common and can be as high as 70%.

**Persistent viremia and mucosal disease. One of the most important effects of BVDV infections of the fetus is the development of PI animals.** Following infection of the fetus with a non-cytopathic isolate of

the virus from about 45–125 d of gestation, it will not develop serum virus-neutralizing antibodies and may be carried normally to term and be born with a persistent infection.<sup>75</sup> Mucosal disease occurs in a proportion of these, and only in these, PI animals. From birth to the time of clinical disease, which usually occurs between 6 and 24 months of age, and rarely up to 3 years of age, these animals are persistently viremic and specifically immunotolerant to the homologous strain of the persisting virus.<sup>76</sup> They may appear clinically normal or unthrifty and small for their age. Occasionally, PI cattle may survive and remain healthy for up to 5 years during which time they shed the virus in their mucous secretions and may be seropositive to a range of BVDV strains, including their own persisting strain. Calves with either transient or persistent infections with BVDV have lower than normal serum concentrations of thyroid hormones which may be associated with the retarded growth.<sup>77</sup> The heart girth of PI calves is smaller than controls. PI animals are infected only with the non-cytopathic biotype of the virus and they excrete large quantities of the virus into the environment and serve as the major source of the non-cytopathic virus in a herd.

During the postnatal period, superinfection with a cytopathic isolate of the virus may precipitate fatal clinical mucosal disease in these animals. PI calves have been reproduced experimentally by the inoculation of fetuses with a non-cytopathic isolate of the BVDV from 42–125 d of gestation. Fatal mucosal disease has been reproduced by the inoculation of persistently viremic specifically immunotolerant calves with a **homologous cytopathic isolate of the virus**. It is suggested that the cytopathic virus has a qualitative preference for intestinal lymphoid tissue in older postnatal calves, which may not be sufficiently developed for the cytopathic virus to establish a persistent viremia in the young fetus. Following the experimental production of mucosal disease, the cytopathic biotype of the virus can be found in lesions of the lymphoid tissue of the small and large intestines, in Peyer's patches, in intramural ganglia and in duodenal glands. Severe tissue damage is also related to the presence of the cytopathic virus. Both biotypes of the virus are present in animals which develop fatal mucosal disease.

It is now likely that mutation of the non-cytopathic virus to the cytopathic virus occurs within the animal rather than the introduction of a cytopathic virus from an infected animal introduced into the herd.<sup>75</sup> The non-cytopathic biotype could mutate to a cytopathic biotype by taking up cellular sequences during a recombination event. Once a homologous cytopathic virus has arisen, it can quickly spread to other PI animals within the same group and this may explain the rapid development of an outbreak of fatal mucosal disease. Recombination between a non-cytopathic BVDV-1 virus and a cytopathic BVDV-1 vaccine virus causing mucosal disease 3 months after vaccination has been described but is probably rare.<sup>78</sup>

Typical mucosal disease occurs within 2–3 weeks following development of the antigenically homologous cytopathic virus in the PI animal. The affected cattle do not respond serologically to the homologous cytopathic virus. Superinfection with an antigenically heterologous cytopathic virus does not result in typical, but rather atypical, mucosal disease several months later, or not at all, and infected animal respond serologically to the heterologous cytopathic virus.<sup>75</sup>

The pathogenesis of the lesions of mucosal disease remains obscure.<sup>75</sup> The viral antigen can be detected in many tissues including:

- Lymph nodes
- Peyer's patches
- Ileum and lymphoid tissue in the proximal colon
- Palatine tonsils
- Spleen
- Bronchiolar epithelial cells
- Crypts of the intestinal mucosa
- Salivary glands
- Tongue
- Esophagus
- Skin.

The pathological changes which characterize the disease involve the integument and the epithelia of the respiratory and alimentary tracts as well as lymphoid tissues.

The basic lesion is a small vesicle ulcer which affects only epithelial cells. The erosions occur throughout the:

- Oral cavity
- Esophagus
- Forestomachs
- Abomasum
- Small intestine

- Cecum
- Colon.

Vascular injury leading to vasculitis is a characteristic feature of the disease due to the pestiviruses, which may explain the type and distribution of the lesions which occur in fatal mucosal disease. The vascular injury may be initiated by degenerative changes of the endothelial cells; this may lead to formation of a thrombus, which can detach and circulate as emboli, and resulting in generalized vasculitis.

Death from acute mucosal disease usually occurs within 2 weeks of the onset of clinical signs and both cytopathic and non-cytopathic isolates of the virus can be recovered from the tissues of affected cattle.<sup>75</sup>

Animals that are immunotolerant to the BVDV are immunocompetent to other antigens.<sup>79</sup> They develop neutralizing serotiters to the IBR and PI-3 viruses and agglutinating titers to *P. haemolytica*.<sup>36</sup> They will also produce VN antibody titers, following the administration of commercial live-BVDV vaccine, against the vaccine virus as well as other laboratory strains. Furthermore, in spite of this antibody formation, the original virus will persist.

Spontaneous insulin-dependent diabetes mellitus associated with persistent BVDV infection in young cattle has been described.<sup>80,81</sup> Lesions were present in the pancreatic islet cells.

**5. Infection during fetal period: 125–175 d gestation. Congenital defects.** Transplacental infection of the fetus approximately between 125–175 d of gestation can result in numerous congenital defects. This period of development corresponds to the final stages of organogenesis of the nervous system and the development of the fetal immune system, which can result in the generation of an inflammatory response to the virus.

Cerebellar hypoplasia occurs and ocular abnormalities consist of retinal atrophy, optic neuritis, cataract, and microphthalmia with retinal dysplasia.<sup>26</sup> Calves with cerebellar hypoplasia are unable to stand and walk normally immediately after birth. Defects of the eyes result in varying degrees of blindness; the cataracts are obvious when they occur. Calves may be smaller than normal and have a curly hair coat.<sup>26</sup>

Congenital morphological defects follow infections which occur

somewhat later in gestation than do infections resulting in persistent viremia, and may be due in part to the emerging immunological capability. The presence of either persistent infection or antibody is variable.

#### **6. Infection during fetal period between 180 d gestation and term.**

Infection of the fetus with the BVDV after approximately 150 d gestation results in a fully competent immune response and elimination of the virus. At birth, the fetus has antibody to the virus but is virus free. The effects of late-gestation infections are not well documented but abortions, stillbirths, and weak calves are reported.

#### **Border disease**

Border disease of sheep is associated with an in utero infection with a related pestivirus which cross-reacts with the BVDV.<sup>18</sup> Ewes are clinically normal, but affected newborn lambs have a hairy fleece, clonic rhythmic tremors and are unthrifty. Hypomyelination and abnormal cells occur in the central nervous system. The hairy birthcoats have been attributed to hypertrophy of primary follicles and medullation of wool fibers. Surviving lambs are also PI with the virus. The virus can be isolated in cell culture and detected by immunofluorescent staining of the peripheral leukocytes, cellular debris in urine and cerebrospinal fluid of lambs up to 1 year of age. Affected lambs, like calves, have no detectable serum-neutralizing antibody. Adult sheep, after recovery from infection by the virus, have no detectable virus in the leukocytes and have serum neutralizing antibodies. Pestivirus of sheep and cattle will readily infect the alternative species, both naturally and experimentally, but the role that such cross-reaction plays in causing the respective diseases has not been determined. More details are available under border disease.

Sheep are an excellent animal model for studying the pathogenesis of congenital BVDV-2 infection. Experimental infection of pregnant ewes with a Brazilian non-cytopathic BVDV-2 isolate results in many features of BVDV-1 infection of pregnant sheep and cattle.<sup>82</sup> Transplacental transmission of the virus to the fetuses is very efficient and results in fetal and perinatal deaths and the production of persistently-infected viremic lambs. The bovine pestivirus can spread to the ovine fetus within 4 days following intranasal inoculation of ewes in early pregnancy in the absence of maternal immunity.<sup>83</sup> An enteric disease characterized by diarrhea and unthriftiness in 6- to 12-month-old lambs, and death in 3 to 14 days was similar to mucosal disease in cattle.<sup>84</sup> At necropsy, the changes



resembled mucosal disease in cattle and the Border disease virus was isolated.

## CLINICAL FINDINGS

### Inapparent or subclinical infection (bovine virus diarrhea)

The most frequent form of BVDV infection in cattle is non-clinical or a mild disease of high morbidity and low case fatality characterized by a mild fever, leukopenia, inappetence and mild diarrhea followed by rapid recovery in a few days and the production of virus-neutralizing antibodies. This form occurs in immunocompetent seronegative cattle which are infected in postnatal life, accounting for the high proportion of adult animals which possess SN antibodies.<sup>7</sup> The literature commonly refers to this subclinical infection as bovine virus diarrhea. A similar infection, with no long-term consequences other than the development of antibody, can occur in fetuses over about 150–180 d gestation.

### Acute mucosal disease

The acute mucosal form of the disease is characterized by the sudden onset of clinical disease in animals from 6–24 months of age which were infected during early fetal life. The morbidity is low and the case–fatality rate is high (over 90%). Within herds, 5–25% of animals in this age group may develop the disease over a period of several days or sporadic cases may occur over several weeks or months. Morbidity rates of 44% and case–fatality rates of 100% have been reported in isolated herds. Well-nourished, thrifty and previously clinically normal animals can be affected. In severe outbreaks, deaths from mucosal disease may account for only a proportion of the actual number of PI animals in the herd; some of the PI animals may have been culled, died for other reasons or were slaughtered. Following outbreaks of mucosal disease in a herd, there may be a rapid decline in the number of PI animals born in the subsequent few years because of spread of the infection and development of acquired immunity in the breeding females.

Affected animals are depressed, anorexic and drool saliva, wetting hair around the mouth. Fever 40–41°C (104–105°F), tachycardia and polypnea are common. Ruminal contractions are usually absent and a profuse and watery diarrhea occurs 2–4 d after the onset of clinical illness. The feces are foul smelling and may contain mucus and variable quantities of blood. Occasionally, small tags of fibrinous intestinal casts are present. Straining at defecation is common and the perineum is usually stained and smeared with feces.

Lesions of the oral cavity mucosa consist of discrete, shallow erosions which become confluent, resulting in large areas

of necrotic epithelium becoming separated from the mucosa. These erosions occur:

- Inside the lips
- On the gums and dental pad
- On the posterior part of the hard palate
- At the commissures of the mouth
- On the tongue.

The entire oral cavity may have a 'cooked' appearance with the grayish colored necrotic epithelium covering the deep-pink, raw base. Similar lesions occur on the muzzle and may become confluent and covered with scabs and debris. Although the oral lesions are significant in the identification of the disease, they may be absent or difficult to see in up to 20% of the affected animals. Esophagoscopy has been used for visualization of the typical erosions of the mucosa of the esophagus.<sup>85</sup>

There is usually a mucopurulent nasal discharge associated with some minor erosions on the external nares and similar lesions in the pharynx. Lacrimation and corneal edema are sometimes observed. Lameness occurs in some animals and appears to be due to laminitis, coronitis and erosive lesions of the skin of the interdigital cleft, which commonly affect all four feet.

Dehydration and weakness are progressive and death occurs 5–7 d after the onset of signs. In peracute cases, which die within a few days after the onset of illness, the diarrhea may not be evident even though the intestines are distended with fluid. Presumably, there is paralytic ileus and the intestinal fluid is not moved down the intestinal tract.

### Chronic mucosal disease

Some acute cases of mucosal disease do not die within the expected time of several days and become chronically ill. There may be intermittent bouts of:

- Diarrhea
- Inappetence
- Progressive emaciation
- Rough dry hair coat
- Chronic bloat
- Hoof deformities
- Chronic erosions in the oral cavity and on the skin.

Shallow erosive lesions covered with scabs can be found on the perineum, around the scrotum, preputial orifice and vulva, between the legs and at the skin–horn junction around the dew claws, in the interdigital cleft and at the heels, and there may be extensive scurfiness of the skin. The failure of these skin lesions to heal is an important clinical finding suggesting chronic mucosal disease. Chronic cases will sometimes survive for up to 18 months during which time they

are unthrifty and ultimately die from chronic inanition.

The chronic clinical form of the disease described above must be distinguished from the unthrifty persistently viremic animal described next.

### Unthrifty PI calves

Calves which are born PI may be smaller in body size than their contemporaries and may fail to grow normally. A curly haired coat is characteristic of some PI calves.<sup>13,14</sup> They may survive and appear unthrifty for several months or more until they develop fatal mucosal disease or some other infectious disease such as pneumonia. While these calves are stunted and unthrifty in appearance they do not have detectable clinical evidence of mucosal disease and they are seronegative to the BVDV. The birth of a high percentage of PI calves may result in a high incidence of fatal respiratory disease when the calves are 7–9 months of age.

### Peracute bovine virus diarrhea

This is a severe form of the enteric form of the disease; it is often highly fatal, occurs in immunocompetent seronegative cattle in postnatal life and is associated with highly virulent isolates of the Type II virus.<sup>21,39</sup> Dairy herds, beef breeding herds and beef feedlots have been affected in the outbreaks recorded in Ontario,<sup>43</sup> Quebec and Pennsylvania (in the United States), and in the United Kingdom in the early 1990s. Inadequate biosecurity of animals imported into the herd, and the failure to vaccinate for BVDV or an inadequate BVDV vaccination program were common risk factors in affected herds. In affected herds, all ages of cattle are affected including calves, yearlings and adults. Mortality was highest in the young-age groups.

The most common complaint given by the owners was the presence of respiratory disease in affected animals. The outbreaks were slowly progressive and lasted for several weeks. Severe depression, respiratory distress, anorexia, profuse watery diarrhea, dysentery, conjunctivitis, fever up to 42.0°C, and agalactia in adult lactating dairy cows were common. Oral erosions were inconsistent. Abortion, usually in late gestation, was a common but inconsistent occurrence. Morbidity rates may be up to 40% and crude mortality rates may reach 25%. Many animals may die within a few days after the onset of clinical signs, and persistently infected calves were commonly born several months following the outbreaks.

### Thrombocytopenia and hemorrhagic disease

Thrombocytopenia and hemorrhagic disease have been associated with BVDV

infection but whether or not the affected animals were previously PI is uncertain; only non-cytopathic BVDVs have been isolated.<sup>55,58</sup> Bloody diarrhea, petechial and ecchymotic hemorrhages of the visible mucosae, hyphema, epistaxis and prolonged bleeding from injection sites or insect bites have been observed. Cattle have platelet counts of less than 25 000/µl and clinically there is bloody diarrhea. Fever, diarrhea, rumen stasis and dehydration are also common. The case-fatality rate is approximately 25%; survivors can recover and thrive normally or remain unthrifty. A similar syndrome of thrombocytopenia has been described in weaned beef calves but the virus could not be isolated from affected calves.<sup>64</sup>

### Reproductive failure and neonatal disease

The introduction of BVDV infection into groups of susceptible breeding females around the time of insemination and during the embryonic early- to mid-fetal period can result in **conception failure, increased embryonic mortality, fetal mummification, abortion, premature births, stillbirths, congenital defects, the birth of stunted weak calves, and the birth of PI calves which subsequently may develop mucosal disease.**<sup>26</sup> Following introduction of infection into a beef herd, losses may be insidious and characterized by reduced pregnancy rates, abortions, excessive postnatal calf losses and the premature culling of young cows because of their failure to wean a well-grown calf.<sup>86</sup> These losses including those due to mucosal disease in PI animals may continue for 2–4 years.<sup>10</sup> In dairy herds in Norway, time to first calving was increased by 14 to 16 days in the second year after seroconversion, with the effect restricted to young stock.<sup>55</sup> Studies in dairy herds in Switzerland indicate that infection with the virus during the first 45 days of gestation did not influence the rate of return to estrus.<sup>87</sup> By contrast, there was an increase in the abortion rate in mid-term gestation (days 46 to 210) while no such effect occurred in animals which seroconverted later stages of gestation. At least 7% of fetal deaths were attributable to infection with the virus.

A large scale assessment of the effect associated with BVDV infection on fertility of dairy cows in 6149 herds in France, found that the virus was associated with an increase in the risk of embryonic death and fetal death.<sup>88</sup>

Under field conditions, the effect of subclinical BVDV infection on subsequent dairy heifer fertility may be due to a complex interrelationship among multiple BVDV infections dependent on the type of and timing of infection relative to repro-

ductive performance. A high BVDV type 2 antibody titer (1:4096) in dairy heifers at 10 months of age was associated with 32 more days to conceive, compared with a low titer (1:128).<sup>89</sup> Conversely, infection with BVDV by 5 to 6 months of age and a high BVDV type 2 titers one month before conception or breeding was associated with improved fertility. Heifers with evidence of congenital BVDV infection had lower fertility than non-infected heifers (15–42 days longer time-to-first AI), which depended on BVDV type 2 titers at 10 months of age.<sup>89</sup>

In beef herds, although abortions due to BVDV may occur at any time during gestation, typically several cows in a herd abort during a short period of time before the start of the calving season. At the beginning of the calving season, premature births and stillbirths occur. Some calves are born alive, take a few breaths and die. Weak calves are generally born during the first 2–4 weeks of the calving season. Affected calves are weak and flaccid at birth, and may appear small or normal. Death usually occurs within several hours despite intensive care and the feeding of colostrum. The prevalence of fetal infection with BVDV can be as high as 21%.<sup>90</sup> In a study of health and performance in 213 dairy herds in Sweden, the risks for clinical mastitis, retained placenta, and estrus-stimulating treatments were higher and the calving intervals were longer in those herds with an increasing or maintained high prevalence of BVDV antibody-positive cows.<sup>91</sup> A persistent BVDV infection in a dairy herd severely affects reproductive performance of heifers and cows at risk and can have an adverse effect on calf health over a period of time. In multiparous cows giving birth to PI calves there may be increased gestation lengths and retained placentas.

### Congenital defects in calves

A number of congenital defects in calves are present<sup>26</sup> including: microencephalopathy, hydrocephalus, hydranencephaly, porencephaly, cerebellar hypoplasia, and hypomyelination. Cerebellar hypoplasia was the first recognized teratogenic effects of the virus and has been well documented. At birth, affected calves exhibit varying degrees of severity of ataxia, wide-based stance, stumbling gait, and falling backwards when attempting to walk. Mildly affected calves may survive if hand-fed and managed carefully but severely affected cases usually die or are euthanized. Other congenital defects include cataracts, microphthalmia, optic neuritis, retinal degeneration, thymic hypoplasia, hypotrichosis and alopecia, curly hair coat, hyena disease, deranged osteogenesis,

mandibular brachygnathism, and growth retardation.

### CLINICAL PATHOLOGY

The clinical diagnosis of mucosal disease is usually made on the basis of the presence of characteristic clinical and pathological findings. A severe leukopenia is characteristic of acute mucosal disease. The decrease is commonly to below 50% of normal and total leukocyte counts of 1000–3000/µL are common and may persist for weeks.

The laboratory diagnosis of BVDV infections relies on the isolation or detection of the virus or components and/or the demonstration of a serological response to the virus. The literature on the laboratory diagnosis of bovine virus infections has been reviewed.<sup>92</sup>

The type of samples to be submitted depends on the clinical and herd history, whether acute or persistent infections are suspected, and the vaccination history is needed to interpret serology.

### Virus isolation

Despite recent advances in BVDV diagnostic science, culture and identification of the BVDV from clinical specimens remains the 'gold standard' diagnostic technique.<sup>92</sup> Strains of virus can be characterized in vitro as cytopathic or non-cytopathic biotypes. Cytopathic strains cause characteristic in vitro cell changes that are evident in inoculated cell cultures within 48 h. Most BVDV isolates obtained from field cases are non-cytopathic in cell culture. The isolated virus is recognized by identifying viral antigen in positive cell cultures by immunofluorescence or immunoenzyme staining. Virus isolation can be attempted by inoculation of nasopharyngeal and ocular swabs, semen, intestinal tissues, spleen, or most other tissues, or the buffy coat or serum of blood to cell cultures. In the live animal, the best sample for BVDV isolation is whole blood from which blood (buffy coat) cells are extracted and used as inoculum. Both cytopathic and non-cytopathic viruses have been isolated from the spleen or blood of individual cattle with mucosal disease. Whole blood or serum from PI animals is used for the isolation of the virus. The virus can be isolated successfully from blood which has been stored at room temperatures for up to 5 d before being processed.

For handling of large numbers of samples such as in a whole herd screening for PI animals, a microtiter virus isolation method, the immunoperoxidase monolayer assay (IPMA), using serum as the diagnostic specimen is widely used. The assay requires approximately 5–7 working days which allows for two passages to be completed. The main limitation of IPMA in PI

testing is its nonapplicability on sera from animals under 3 months of age in which maternal antibodies can interfere with growth of the virus in cell cultures. Some adult PI cattle have been IPMA negative on serum but virus can still be isolated from the buffy coat cells.<sup>93</sup> However, the prevalence of such animals is extremely low, and IPMA is widely accepted as a reliable test for detecting PI cattle of 3 months or older.

The **indirect immunoperoxidase staining technique** is recommended for certification of BVDV-free bovine semen for artificial insemination units when the immunofluorescent test is not available.

### Antigen detection

**Immunohistochemistry.** The BVDV antigen can be identified rapidly in tissue samples using immunohistochemical methods such as immunofluorescence or immunoenzyme staining in sections of frozen tissue.<sup>92,94,95</sup> A monoclonal antibody 15C5, which reacts with the E0 protein, has been shown to react broadly with most strains of BVDV and can be used to detect BVDV antigen in formalin-fixed, paraffin-embedded tissues. This has broad diagnostic and research applications. Using these methods, the identification of BVDV antigen in fixed tissues can be used as positive laboratory confirmation of BVDV infection without positive virus isolation and is useful when investigating disease syndromes such as enteric disease, respiratory tract disease and reproductive tract disease.

**Skin biopsy.** Immunohistochemical (IHC) staining for BVDV in formalin-fixed, paraffin embedded skin biopsies is an effective method for the diagnosis of persistently-infected cattle.<sup>95</sup> The technique is easy, accurate, and a less expensive ante-mortem diagnostic test for the detection of PI animals compared to virus isolation. It is suitable for herd screening because samples can be taken from cattle of any age, sample collection is simple, the samples are stable for transport and handling, and the test is both sensitive and specific for BVDV PI cattle. Positive IHC staining is most pronounced in the keratinocytes and in the hair follicle epithelium, hair matrix cells of the hair bulb, and the dermal papilla. IHC on skin samples is an effective method for screening neonatal calves for persistent infection.<sup>97</sup> Skin samples from cattle with acute BVDV infection or transient infection may stain positive with IHC but the distribution of staining is confined to the epidermal keratinocytes and follicular ostia, in contrast to PI animals with antigen-positive staining cells in all layers of the epidermis. Uncertain cases should be retested a few weeks after the first test.

**A monoclonal antigen-capture ELISA test** is capable of rapidly and accurately detecting pestivirus-specific antigens in peripheral blood leukocytes, blood clots, and tissue samples of PI cattle.<sup>12,92,94</sup> It has demonstrated good agreement with conventional virus isolation procedures and is suitable for routine diagnostic and certification testing. Monoclonal antibody techniques have also been used to detect the virus antigen in the central nervous system of PI cattle. Four commercially available ELISAs for the detection of BVDV antigen in the blood of PI cattle have been compared and are highly sensitive and specific and considered valuable in eradication programs when monitoring large numbers of animals.<sup>98</sup>

**Herd Chek BVDV Antigen Serum Test Kit (IDEXX).** This is an enzyme immunoassay for the detection of BVDV antigen in serum, plasma and whole blood. It is based on the detection of the E<sup>ms</sup> (gp44-48) glycoprotein of the BVD virus. The E<sup>ms</sup> protein is known to be secreted in serum, plasma or whole blood samples, which can be tested without laborious sample presentation. It has the following attributes: detects types 1 and 2 isolates; designed for identification of PI animals; can be used on serum, plasma or blood; no sample preparation; rapid testing method-quick (<2 hours) and overnight protocols; ready-to-use reagents; same substrate, wash and stop solution as other IDEXX BVDV family assays; compatible with xChek software.

Polymerase chain reaction (PCR) amplification

PCR amplification of an RNA genome involves the binding of specific DNA oligonucleotides to cDNA target sequences, resulting in amplification of size-specific DNA fragments that are detectable by gel electrophoresis.

The PCR test is able to detect small amounts of viral nucleic-acid from samples of blood and tissues including preserved material.<sup>92,94</sup> Factors such as cost, technical expertise, equipment and automation, and RNA extraction methods are considerations in comparing with the standard methods of virus isolation. The PCR is 10–50 times more sensitive than the dot blot hybridization technique.

The reverse transcriptase-polymerase chain reaction (RT-PCR) amplification has gained widespread use as a routine diagnostic method for BVDV.<sup>99</sup> The high analytical sensitivity of the RT-PCR allows for pooling of specimens to reduce unit cost test. Pooling is especially applicable for persistent infection testing whereby a single positive specimen can still be detected in a pool of several dozen samples.

The RT-PCR test has been used to detect the presence of the BVDV in somatic cells from bulk milk samples.<sup>100</sup> Compared to existing methods, RT-PCR test showed 100% specificity and sensitivity in detecting PI lactating cattle in milking herds.

The reverse transcriptase-nested polymerase chain reaction (RT-nPCR) assay is a rapid and sensitive method to detect BVDV in extended semen samples.<sup>101</sup> While the prevalence of persistent testicular infection with the BVDV is very low, use of the rapid, sensitive RT-nPCR assay on extended semen samples can be used to ensure that the virus is not transmitted in cryopreserved semen.

### Serology

Serological techniques are used to detect and measure antibodies. The **serum neutralization (SN) test** has been the standard test to determine the occurrence of a rising BVDV titer between acute and convalescent sera. The test carried out in microtiter plates, takes 3–5 d to complete and is relatively simple to interpret. A cytopathic virus is used in order to easily detect the neutralization of the virus. Because of the antigenic differences that exist within the BVD viruses, the reported antibody titer for a specific serum sample may vary greatly between laboratories depending on the strain of virus used in the test.

Following acute infection, serum antibody is first detectable at 2–3 weeks and peak antibody levels occur 8–10 weeks later. Following successful vaccination, SN titers will be high for many months.

PI animals are seronegative, except if they have colostral antibody for the first several weeks after birth. Antibodies are usually not detectable in the sera of most cattle with mucosal disease. The specific immune tolerance of the persisting virus is also not broken by the cytopathic virus if it is antigenically similar or identical to the persisting virus and results in fatal mucosal disease. PI cattle exposed to other isolates of cytopathic viruses that do not immediately induce mucosal disease may produce highly specific serum-neutralizing antibodies.<sup>75</sup>

Precolostral serum from calves infected in utero as immunocompetent fetuses may have virus-specific neutralizing antibodies and their demonstration is meaningful for the diagnosis of past infection. A short 3-day incubation serum neutralization test is now available which is an improvement over the 5-day test.

### Antibody ELISA

ELISAs are available to measure serum antibodies to BVDV and are a rapid and economical alternative to the serum neutralization test. However, because of laboratory requirements for extensive

purification of antigen for the BVDV ELISA, it has not gained wide acceptance, even though ELISA titers correlate well with SN titers. The Cedist blocking ELISA for BVDV antibodies is a simple, rapid and reliable test for the detection of specific antibodies in serum, plasma, or bulk tank milk.<sup>102</sup> Test results correlate well with virus neutralization test results and may be useful for large-scale screening and eradication programs.

Using a blocking ELISA test, the level of antibodies in bulk milk is a valuable aid to indicate the infectious status of a dairy herd and for identifying herds suspected of harboring an active infection.<sup>103</sup> A herd with two consecutive bulk milk results four months apart of 60% (percentage inhibition) is more likely to have a very high percentage of infection. Testing of bulk tank milk for antibody using the ELISA can be used to determine the prevalence of dairy herds with antibodies, the relationships between the ELISA values in bulk milk and the location, milk yields and somatic cell counts of the herds, the annual incidence risk of new infections, and combined with the RT-PCR to detect viral RNA, to obtain an estimate of the herd prevalence of lactating persistently-infected animals.<sup>104</sup>

#### Use of laboratory tests in the herd

Because of the complex nature of BVDV infections, it is often difficult to obtain a definitive etiological diagnosis. The type of samples to be submitted to the laboratory and the interpretation of the results depends on clinical and herd history, and the vaccination status of the herd. The testing strategies to be used will depend on the specific disease history of the herd, the age of animals to be tested, the cost of the test, the needs of the owner of the herd, and the reasons for doing the testing.<sup>92</sup>

#### Acute infections

The diagnosis of acute infections must be done as early as 3 d after infection to 8–10 d after infection. A whole-blood sample is the best sample for virus isolation to identify acutely infected animals. In herd outbreaks, blood samples from normal animals should also be submitted. For serology, paired acute and convalescent samples collected 30 d apart are required to identify a four-fold increase in serum antibody titers. In abortions, the dam may have already seroconverted before the abortion and there may be no seroconversion between acute and convalescent sera. However, some aborted fetuses may be serologically positive, which confirms intrauterine infection in the later part of fetal life. If the dam is negative, BVDV can be ruled out as a cause of abortion. Calves born with congenital defects may have

antibody but blood samples must be taken before the ingestion of colostrum.

#### Persistently infected animals

Persistently infected animals in a herd can be identified using any or a combination of the following testing procedures:

1. Collect whole blood from all animals in the herd including calves. An RT-PCR can be done on every sample which is very expensive but highly sensitive.<sup>93</sup> The test can be done pools of whole blood. The number of samples in the pool is a function of the sensitivity of the test a particular laboratory.
2. Collect serum on all animals over 3 months of age. Test younger calves as they age or use an alternative test. With serum testing colostrum antibodies may interfere with the test or eliminating detectable virus from the fluid fraction of blood for some variable period of time. Virus in mononuclear cells is unaffected by colostrum antibodies. Tests that can be done on serum include the microplate virus isolation, antigen-capture ELISA, or RT-PCR.
3. Collect skin biopsies (ear notches) from all animals in the herd including calves. The tests of choice are the IHC on formalin-fixed tissues or antigen-capture ELISA using fresh samples. Use of fresh tissue samples eliminates the need for formalin.
4. For dairy herds, collect composite milk samples from lactating cows and screen remainder of herd using procedure 1 or 3 above. Somatic cells from the milk are screened for the virus by RT-PCR or virus isolation.
5. Test calves as they are born with 1 or 3. If the producer has accurate calving records, the determination that the calf is not PI automatically defines the status of the dam as not being PI. Using this protocol, ongoing surveillance is maintained with a single test defining the status of two animals. For dairy herds, bull calves must be tested as well as the heifer calves to achieve a complete herd screening program.

Before the development of the PCR test, identification of PI animals depended on virus isolation from sequential samples collected 30 d apart. By testing 30 d apart, it is also possible to test for a four-fold increase in antibody titer should the first virus isolation be the result of an acute infection. In most cases, serum is adequate for virus isolation. In young calves under 3 months of age, colostrum antibody may decrease the level of free virus in the serum and may result in a false-negative test. For this reason, the use of whole blood which

allows isolation of the virus from the buffy coat is recommended in calves under 3 months of age.

Most PI animals are seronegative after the colostrum immunity has waned, but they may develop SN antibodies to heterologous strains of the virus.

**Prenatal diagnosis of persistent infection**  
Pregnant dams with PI fetuses (PI carriers) have exceptionally high antibody titers.<sup>105,106</sup> Testing pregnant dams can be used to identify and exclude PI carriers from livestock markets without completely blocking the trade with pregnant seropositive cattle. Testing is most reliable when done in late pregnancy (not before the 7th month of gestation). In dams carrying PI fetuses, the immune response was markedly higher ( $13\ 811 \pm 1273$  U ELISA) than those in dams carrying uninfected fetuses ( $2542 \pm 588$  U ELISA).<sup>106</sup>

The BVDV has also been detected in amniotic and/or allantoic fluid from both cattle and sheep with infected fetuses.<sup>107</sup> A blind puncture technique for collection of fetal fluid in late pregnancy is used to collect fetal fluid. The site of collection is over the right ventral abdominal wall approximately 10 cm cranial of the udder and 10 cm medial of the flank. A nested PCR test is used to amplify the viral RNA.

#### Herd screening

When a diagnosis of BVDV infection has been made in a herd, for example in the case of mucosal disease in a yearling, then further investigation for the detection of infected animals at the herd level is indicated. The most common strategy for herd screening is to submit serum samples from all animals over 3 months of age and whole blood samples from calves under 3 months of age. All animals in the herd should be tested. The samples may be tested for SN antibodies and/or the presence of the virus. Virus isolation using the microtiter immunoperoxidase test is the most common method used for large numbers of samples. Calves born for the next 9 months should also be tested to detect any additional PI animals that are born which may have been infected in utero at the time of the herd infection. The goal is to insure that no additional PI animals appear and that the maternal-fetal transmission cycle is broken. In herds in which cases of mucosal disease have been recognized, most of the normal animals will have high levels of SN titers.

During the 9–12 month period of testing, management strategies should ensure that all young stock and breeding females are not in contact with infected animals. However, in some countries where vaccines are unavailable, breeding females are placed in direct contact with persistently-infected animals prior to the

breeding season as a method of natural vaccination.

The serologic evaluation of unvaccinated heifers 6 to 12 months of age is an accurate method for identifying herds containing PI animals.<sup>108</sup> Both type 1 and type 2 BVDV antibody titers should be determined to prevent misclassification. The sensitivity and specificity of serologic evaluation of five heifers for identifying these herds were 66 and 100%, respectively, in herds which contained PI cattle. Pooled-sample testing using PCR/probe testing, can be used as a herd screening test for detection of BVDV persistently infected cattle.<sup>109</sup> However, random serologic testing of a small sample size of beef calves or cows did not satisfactorily predict the presence of a PI in an extensively managed beef cow-calf herd.<sup>110</sup> Whole-herd screening by use of one of the methods for detecting virus or viral antigens such as IHC of skin (ear notch) specimens is required for detection and elimination of animals persistently infected with BVDV in a herd.<sup>110</sup>

## NECROPSY FINDINGS

### Acute mucosal disease

The gross abnormalities are usually confined to the alimentary tract.<sup>111</sup> Characteristic shallow erosions with very little inflammation around them and with a raw, red base are present on the muzzle, in the mouth, and to a lesser extent in the pharynx, larynx and posterior nares. In the esophagus these erosions are linear in shape and lie in the direction of the folds of the esophageal mucosa. Erosive lesions may be present in the forestomachs, but are usually confined to the pillars of the rumen and the leaves of the omasum. Histologically, the lesions of the squamous mucosa of the alimentary tract begin with necrosis of individual cells and groups of cells. These foci enlarge and result in areas of necrosis with little or no inflammation of the lamina propria. If the necrotic foci are abraded, erosions and ulcers develop. In the abomasum, there is often a marked erythema of the mucosa accompanied by multiple submucosal hemorrhages and gross edema of the wall. Erosions and ulcers are common on the sides of the rugae of the abomasum and may be punctuate or more than 1 cm in diameter. The lesions have raised margins with a distinct pale halo. Histologically, there is epithelial necrosis of the deep parts of the glandular epithelium.

The mucosa of the small intestine often appears normal except for patchy or diffuse congestion and edema in some cases. In cases with a short clinical course it is common to find coagulated blood and fibrin overlying and outlining the mucosal aspect of Peyer's patches, which are also

eroded. This is a very distinctive lesion which is paralleled only by rinderpest and sometimes bovine malignant catarrh. Severely affected Peyer's patches may be obvious through the serosa as red-black oval areas up to 10–12 cm long on the antimesenteric border of the intestine. In the large intestine the mucosa may be congested, often in a 'tiger stripe' pattern following colonic folds. The characteristic microscopic lesion in the intestinal mucosa is destruction of the epithelial lining of the crypts of Lieberkuhn. In Peyer's patches, there is lysis of the follicular lymphoid tissue, collapse of the lamina propria and often consequent downgrowth of cryptal epithelium. A less frequently noted microscopic finding is a vasculitis with fibrinoid necrosis of the media; this change may also be observed in a variety of other organs.

Non-alimentary tract lesions which may be seen on occasion include ulceration of the muzzle, interdigital skin and conjunctival membranes. Growth arrest lines in the long bones may be seen and secondary bacterial bronchopneumonia can also occur.<sup>14</sup>

### Peracute BVD

The lesions of this form of the infection are similar to acute mucosal disease and it is *usually not possible to differentiate between the two forms based on gross and histopathological findings*. There may be an absence of gross enteric lesions, especially in animals which die within 24 h after the onset of clinical signs and in calves less than 6 months of age.<sup>6</sup> In these peracute cases, pneumonia may be the most obvious lesion. Cases in which there is widespread hemorrhage attributable to **thrombocytopenia** may also be a form of peracute infection. Experimental infections with non-cytopathic type 2 strains have resulted in viral infection and necrosis of marrow precursor cells, especially megakaryocytes, as well as peripheral thrombocytopenia and leucopenia.<sup>57</sup>

### Chronic mucosal disease

The necrotic epithelium may not be eroded by alimentary movements but instead remain in situ as slightly elevated, yellow, friable plaques, especially on the tongue and in the rumen. Subacute cases with a very prolonged course may show very few gross lesions in the mouth, some in the esophagus and no lesions in the stomachs and intestines. Peyer's patches may be difficult to locate in these animals and when examined histologically the lymphoid follicles are hypocellular.

In naturally occurring mucosal disease, non-cytopathic and cytopathic viruses can be found in the spleen, intestines and esophagus. Viral antigens are also detectable in mucosal cells of the nares, rumen,

abomasum, gallbladder and salivary glands.<sup>33</sup> In PI animals, viral antigen can be found in myenteric ganglion cells, cells within crypts, mononuclear cells of gut-associated lymphoid tissue, and mononuclear cells of mesenteric lymph nodes. Viral antigen can also be found in adrenocortical cells, cerebral neurons, endocrine cells of the pituitary gland, thyroid follicles, and pancreatic islets.

The virus can be demonstrated in sections from formalin-fixed, paraffin-embedded tissue using various immunohistochemical techniques, including a method utilizing a monoclonal antibody<sup>96</sup> and the detection of viral antigen in formalin-fixed sections of skin collected at post mortem remains strongly indicative persistent infection. Such IHC techniques have also enabled the demonstration of viral antigen in association with specific lesions, such as within the Purkinje fibers and conduction system of the myocardium of a 4-month-old calf,<sup>112</sup> pancreatic islet cells of diabetic cattle<sup>81</sup> and various cells of the central nervous system in a heifer with meningoencephalitis.<sup>60</sup> This virus is also recognized as a cause of myocarditis<sup>113</sup> which may include a mild lymphoplasmacytic myocardial arteritis with or without fibrinoid necrosis. It must be remembered that the demonstration of BVDV antigen, or the isolation of the virus from necropsy material, does not mean that the animal suffered from mucosal disease or the peracute form of infection unless supportive lesions are observed. The virus is often found in animals dying as a consequence of other disease processes, such as pneumonia.<sup>66,114</sup> Confirmation of the presence of the virus is nevertheless significant. In terms of the individual animal, the virus may have caused a degree of immunosuppression. For the herd, the presence of circulating virus has important implications for the animals of breeding age.

### Abortion

The pathological criteria for the diagnosis of BVDV as a cause of abortion have not been established.<sup>85</sup> Finding antibody in a fetus, as in an unsuckled neonate, indicates that intrauterine infection has occurred but its diagnostic significance in regard to the abortion is not clear. The recovery of virus from the fetus, or demonstration of viral antigen within fetal tissues is only suggestive of a diagnosis of pestiviral abortion. Recognized BVDV-associated congenital defects in calves, including cerebellar hypoplasia, cataracts, retinal degeneration and dysplasia, hypoplasia and neuritis of the optic nerves, and musculoskeletal deformities<sup>52</sup> are clear-cut indicators of compromised

fetal health. However, microscopic lesions associated with BVD abortion have been described in fetal eyelid, lung and myocardium yet at the present time their diagnostic value is still controversial.<sup>87</sup> Growth arrest lines are sometimes noted in the long bones of aborted fetuses infected with the BVDV and in utero the infection may also produce **osteopetrosis**. Osteopetrotic lesions, as well as anemia, thrombocytopenia and marrow necrosis have been described in 2-month-old beef calves infected with a non-cytopathic strain of BVDV.<sup>115</sup> Infection of megakaryocytes with non-cytopathic strains of BVDV has been confirmed experimentally.<sup>116</sup> Immunohistochemical analysis of cryostat sections of brain, skin, thyroid gland, abomasum and placenta is a rapid, sensitive method for detecting pestiviruses in bovine and ovine fetuses.<sup>117</sup> However, in most bovine fetuses, immunohistochemical testing of formalin-fixed, paraffin-embedded tissues is recommended, as the detection of BVDV antigen in formalin-fixed fetal tissues appears to be superior to traditional virus isolation techniques and fluorescent antibody techniques.<sup>107</sup>

#### Samples for confirmation of diagnosis

**Histology** – formalin-fixed oral/esophageal lesions, thymus, Peyer's patches, colon, abomasum, rumen, mesenteric lymph node, heart, ear. **Abortions** – eyelid, lung, thymus, spleen, intestine, liver, kidney, heart, brain, eye (LM, IHC)  
**Virology** – thymus, thyroid, Peyer's patch, spleen, lung, mesenteric lymph node (ISO, FAT, PCR).

#### DIFFERENTIAL DIAGNOSIS

The differential diagnosis of diseases associated with BVDV infection must be considered according to the many different subclinical and clinical forms of the disease affecting many body systems. Each manifestation of clinical disease must be differentiated clinically and pathologically from similar diseases. The distinguishing features of each manifestation and the diseases they resemble are summarized here.

**Mucosal disease.** The differentiation of the diseases causing erosive lesions of the oral cavity mucosa can be perplexing both clinically and at necropsy. The similarity between them is the more important because rinderpest and foot-and-mouth disease are major plague diseases. The situation is so dangerous that if there is any doubt as to the identity of the disease under examination, samples should be submitted for laboratory examination.

There are many diseases of the alimentary tract of cattle which can be grouped according to the **presence or absence of oral lesions with or without**

**diarrhea.** These have been summarized in Table 21.4. An erosive stomatitis and gastroenteritis are characteristic of **rinderpest, bovine virus diarrhea and bovine malignant catarrh.** The stomatitis and hyperemia are remarkably severe in bovine malignant catarrh along with a corneal opacity, lymph node enlargement, hematuria and terminal encephalitis. **Rinderpest** is characterized by a high morbidity and mortality and knowledge of the disease in the area.

The **vesicular diseases**, foot and mouth disease and vesicular stomatitis, are characterized by the presence of vesicles on the tongue and buccal mucosa, teats and coronets and should be distinguishable from erosions.

Diseases causing diarrhea with no oral lesions include **winter dysentery, salmonellosis, Johne's disease, molybdenum poisoning (conditioned copper deficiency), parasitism (ostertagiasis), and arsenic poisoning.**

A definitive diagnosis depends on isolation of BVDV from the buffy coat or serum of blood and other tissues. Calves with congenital defects can be provisionally identified as bovine virus diarrhea by detection of specific antibodies in calves which have not sucked; this is not an easy specimen to obtain in beef cattle running at pasture.

Although bovine virus diarrhea is not a disease of the respiratory tract it is not uncommon for respiratory signs to be evident and confusion in diagnosis between it and infectious bovine rhinotracheitis (IBR), and even pneumonic pasteurellosis, does arise. It is necessary to depend on a careful clinical examination of oral and nasal mucosae to ensure that there are no mucosal lesions. It is also necessary to include bovine virus diarrhea in the list of diagnostic possibilities when considering the causes of abortion and stillbirth in cattle. Immunoglobulin determinations in aborted fetuses may be of diagnostic value.

The definitive diagnosis of **chronic mucosal disease** presents problems because often the affected animal has no specific neutralizing antibody because of immunosuppression or the inability to secrete antibody. A presumptive diagnosis can be made on the basis of the clinical characteristics of the acute disease, the absence of other lesions to account for the chronic form of the disease and the presence of pancytopenia. Virus isolation must be attempted along with detailed pathological examination.

- **Inapparent subclinical BVDV infection.** Common diseases include acute undifferentiated fever, acute undifferentiated bovine respiratory disease
- **Peracute bovine virus diarrhea.** Malignant catarrhal fever. Acute salmonellosis
- **Respiratory disease.** All common causes of bovine respiratory disease. See Table 18.5
- **Thrombocytopenia and hemorrhagic disease.** Malignant catarrhal fever. Moldy sweet clover poisoning

- **Unthrifty persistently infected calves.** General malnutrition. Copper deficiency. Chronic pneumonia
- **Reproductive failure.** Common causes of reproductive failure in dairy and beef cattle herds characterized by anestrus, failure to breed, unsatisfactory semen, failure of fertilization, embryonic mortality, fetal resorption, fetal mummification, abortion, stillbirth, and perinatal mortality
- **Neonatal calf diarrhea.** All common causes of acute undifferentiated diarrhea of calves under 30 days of age.
- **Congenital defects of calves.** All inherited defects of the nervous system of calves manifested clinically at birth, and diseases of uncertain etiology characterized by nervous system involvement

#### TREATMENT

There is no specific treatment for any of the diseases associated with the BVDV.

The prognosis for severe cases of mucosal disease with profuse watery diarrhea and marked oral lesions is unfavorable and slaughter for salvage or euthanasia should be considered. Animals with chronic BVD should be culled and destroyed.

#### CONTROL AND PREVENTION

*The continued presence of the BVDV in the bovine population is not due to the lack of quality diagnostic tests. BVDV continues to cause significant economic losses because of failures in implementing a sound immunization program, failures in establishing herd-monitoring programs, and failures in developing effective biosecurity and biocontainment programs.*

**The ultimate goal of BVDV prevention and control measures is to eliminate the potential for the birth of calves persistently infected with the virus.<sup>118</sup> 'Persistence is the key'.**

A combination of biosecurity, vaccination, and biocontainment strategies are necessary to control and prevent BVDV infection and its consequences in a herd and country.<sup>119-121</sup>

**Biosecurity** is the action taken to prevent the introduction of a disease agent into a herd or region. The goal of a BVDV biosecurity program is to prevent the introduction of the virus into the cattle herd and preventing transmission of the virus to susceptible animals. Biocontainment includes the strategies to control an already existing disease in a herd or region. The goal of biocontainment is to minimize the occurrence or severity of disease associated with BVDV infection, or to completely eliminate the virus from the herd. Biocontainment includes actions to increase host immunity, remove PI cattle from the herd, and prevent effective contact between BVDV-infected and BVDV-susceptible animals.

Table 21.4 Differential diagnosis of diseases of cattle in which there are either oral lesions or diarrhea alone or together in the same animal

Etiology	Epidemiology	Clinical findings	Clinical pathology and pathology	Response to treatment
<b>Diseases with oral lesions and diarrhea</b> <i>N.B.:</i> Rinderpest, mucosal disease and bovine malignant catarrh closely resemble each other clinically. The erosive stomatitis and gastroenteritis are common to all three and in outbreaks of mucosal disease or bovine malignant catarrh it may be impossible to distinguish either disease from rinderpest on clinical grounds. This necessitates notification of regulatory authorities and confirmation of the diagnosis by transmission tests or suitable laboratory tests.				
Rinderpest	Occurs most commonly in rinderpest areas, young and mature cattle, outbreaks common, rapid spread, up to 90% of susceptible cattle affected and mortality may reach 90%. Subacute and chronic forms occur in relatively resistant populations	Severe erosive stomatitis, bloodstained saliva, blepharospasm, high fever, severe diarrhea and dysentery, many cattle affected and many die	Marked leukopenia, lymphopenia, karyorrhexis (submit lymph nodes)	Nil
Bovine virus diarrhea (BVD) mucosal disease	Young cattle (8 months to 2 years) which have been persistently infected since fetal life. Low incidence (5%) of acute clinical disease but high case mortality. Sporadic cases of chronic form. Acute clinical disease rare in over 2 years of age	<i>Acute:</i> Diffuse erosive stomatitis, moderate fever for few days, profuse diarrhea and severe dehydration, skin lesions of coronets and interdigital clefts common, die in 7–10 days. <i>Chronic:</i> Inappetence, progressive loss of weight, scant soft feces, normal temperature, small rumen, intermittent bloat, chronic skin lesions which do not heal (especially interdigital space)	Leukopenia, neutropenia and lymphopenia. Seronegative. Blood for virus isolation to identify persistently infected animals. Nasal and fecal swabs. Erosions throughout gastrointestinal tract	Almost all die
Peracute bovine virus diarrhea.	Affects young and adult immunocompetent cattle not vaccinated Type II BVDV. Morbidity up to 30%; case fatality rate up to 40%	Sudden onset of anorexia, respiratory distress, fever, anorexia, agalactia, diarrhea, dysentery, death in few days	Blood for virus isolation. Acute and convalescent sera. Lesions similar to mucosal disease	No treatment. High case fatality rate
Bovine malignant catarrh	Usually sporadic in animals. Affects mature and young animals. In North America outbreaks occur commonly after contact with sheep. In Africa outbreaks after contact with wildebeest. Varying forms: peracute, alimentary tract, head and eye, and mild	Severe diffuse intensely hyperemic, erosive stomatitis; persistent high fever, severe conjunctivitis, corneoscleral opacity, hematuria, enlarged lymph nodes, prominent skin lesions, horn coverings shed, terminal encephalitis, diarrhea and dysentery. Peracute die in 3 days, acute in 7–10 days and chronic form may live few weeks	Leukopenia and neutropenia early. Leukocytosis later. Transmission tests. Vasculitis	Nil
Alimentary tract form of infectious bovine rhinotracheitis	Outbreaks in newborn calves (25–50% morbidity). Recent herd introduction of carrier. Case mortality high (90–100%)	Small pin-point gray pustules on soft palate, rhinotracheitis, conjunctivitis, persistent mild fever, usually die from secondary tracheitis and pneumonia	Virus isolation from feces and nasal swabs. Lesions in turbinates, rumen and abomasum	Unlikely to respond
<b>Diseases with oral lesions and no diarrhea</b>				
Foot-and-mouth disease	High morbidity (100%), low mortality. Spreads quickly. Occurs in enzootic areas	High fever, severe dejection, painful stomatitis, ropey saliva, large vesicles in mouth, vesicles on teats and coronets, recovery in 3–5 days, deaths in myocardial form	Animal transmission tests. Serology rapid and accurate	No specific treatment
Vesicular stomatitis	In certain geographical areas, variable morbidity and mortality, insect-borne	Mild fever, anorexia, vesicles in oral cavity, less commonly on teats and feet. Recover in few days	Animal transmission tests. Serology rapid and accurate	Usually not indicated
Bluetongue	Clinical disease not common in cattle, insect vector, seasonal	Fever, stiffness, laminitis, coronitis, erosive lesions in oral cavity, edema of lips, drool saliva, nasal and ocular discharge, most cattle recover	Animal transmission tests. Serology rapid and accurate	No specific treatment
Bovine papular stomatitis	Worldwide, common in young cattle (2 weeks to 2 years), morbidity may reach 100%, nil mortality, may occur coincidentally with ostertagiasis	Round, dark red, raised papules on muzzle, in oral cavity. Heal in 4–7 days but remnants of lesion persist for several weeks. No significant effect on animal. In same age group as, and often associated with, severe ostertagiasis	Clinical diagnosis obvious	Spontaneous recovery



Table 21.4 (Con'd) Differential diagnosis of diseases of cattle in which there are either oral lesions or diarrhea alone or together in the same animal

Etiology	Epidemiology	Clinical findings	Clinical pathology and pathology	Response to treatment
Necrotic stomatitis	Young calves. In dirty conditions or on dry rough pasture	Painful stomatitis with large deep necrotic foul-smelling ulcers on tongue, cheek and pharyngeal mucosa	Clinical diagnosis. Necrotic esophagitis	Respond in few days to parenteral antimicrobials
<b>Diseases with diarrhea and no oral lesions (does not include diarrhea of calves)</b>				
Salmonellosis	All ages. Outbreaks occur, case mortality may be high. Stress-induced. Contaminated feed supplies. Veal calves. Auction mart problem	<i>Acute:</i> High fever, diarrhea, dysentery, feces foul-smelling, fibrinous cast, abdominal pain, die in 24 to 48 hours. <i>Subacute and chronic:</i> diarrhea occurs too	Leukopenia, neutropenia. Fecal culture. Fibrinohemorrhagic enteritis	Favorable response to antimicrobials in early stage. Later many cases die or become chronically ill
Winter dysentery	Housed dairy cattle, winter, explosive outbreak, 100% morbidity, no mortality	<i>Acute</i> profuse watery diarrhea and dysentery, mild fever, inappetence and drop in milk yield for 24 hours, recover spontaneously Nil	Nil.	Recovery is spontaneous
Johne's disease	Single animal, 2 years and older, low morbidity, long course of several months. Chronic granulomatous-like enteritis	Chronic diarrhea, feces homogeneous, progressive loss of weight, normal temperature, appetite usually normal, hydration almost normal	Serological tests and culture feces	No response to treatment
Secondary copper deficiency (molybdenosis)	Enzootic to farm/area. Young cattle particularly. Marginally copper-deficient areas, especially spring	Chronic diarrhea without smell, mucus or blood. Black coats are gray-flecked; red coats are rusty yellow. Very thin	Plasma copper below 0.5 µg/mL, liver copper below 20 mg/kg DM	Excellent response in body weight and resolution of diarrhea to copper, by injection, drench, pasture dressing
Ostertagiasis.	Mostly young cattle 6 months to 2 years, can be adults. Many in group affected	Persistent diarrhea, without smell, mucus or blood. Decreased appetite, bottle jaw, very thin	May be heavy egg count, not if larvae inhibited but plasma pepsinogen level greater than 5000	Several treatments with fenbendazole. Good results. But lesion may be irreversible
Coccidiosis	Young cattle, when overcrowded, fed on ground, gather at water source	Subacute dysentery, mild fever, 2–3 days, appetite and hydration remain normal. About 20% develop 'nervous signs' and die	Feces for oocysts. Hemorrhagic cecitis and colitis	Self-limiting disease. Amprolium and sulfonamides
Arsenic poisoning	Access to arsenic	Sudden and rapid death. Acute abdominal pain, bellowing, regurgitation, diarrhea, muscular tremors, convulsions, die 4–8 hours after onset of signs	Feces and tissues and feed supplies or analysis. Edema of abomasum. Unfavorable response	Difficult to treat
Carbohydrate engorgement	One to several animals. History of access to grain	Anorexia, depression, ataxia, recumbency, dehydration, profuse, foul-smelling diarrhea, grain-kernels in feces, rumen static with fluid-splashing sounds, no rumen protozoal activity	Rumen pH below 5, lactic acidosis, hemoconcentration	Respond favorably if ruminal and systemic acidosis; may need rumen lavage or rumenotomy
Renal amyloidosis	Single animal, mature cow	Profuse chronic diarrhea, anasarca, inappetence, decreased milk production, enlarged kidney	Proteinuria, hypoalbuminemia, grossly enlarged kidneys	Nil
Ragwort ( <i>Senecio jacobea</i> ) poisoning	Group problem. Access to ragwort on pasture or ensiled as feed	Dull, depressed, dark diarrheic feces, severe straining and prolapse of rectum, staggering and ataxia, head pressing	Liver enzymes	
Squamous cell carcinoma of upper alimentary tract	Scotland and northeast England. Adult beef cows grazing marginal land infested with bracken, <i>Pteridium aquilinum</i>	Weight loss, diarrhea, bloat, feces are fibrous and watery	Tumors in oropharynx, esophagus, and rumen	

The most important subpopulation to protect from exposure is pregnant cattle, especially those in early gestation. The herd must be protected from direct exposure to cattle from other herds that may be BVDV transiently infected or persist-

ently infected. Examples of these exposures include fence-line contact, movement to and from fairs and exhibitions, and new herd additions. Quarantine of new additions for 2 to 3 weeks after arrival prevents exposure of the native herd to

unknown infected animals. Each addition must be tested for BVDV PI while in quarantine or before arrival so that these primary reservoirs of virus can be removed before they are commingled with the native herd. New additions that arrive pregnant

should not calve in the presence of pregnant cattle from the native herd. The calves born to pregnant new additions must be isolated from the native herd until their BVDV status can be determined.

Beef feedlots and heifer rearing operations present a special biosecurity challenge because the opportunity to introduce BVDV PI animals into these systems is increased by the frequent introduction of cattle usually co-mingled from multiple sources. The introduction of PI cattle may affect the health and performance of pen-mates and dairy and beef heifers exposed to BVDV during gestation at a heifer development facility may later give birth to PI calves in destination herds. BVDV exposure could be minimized in these facilities by testing all new arrivals and removing PI cattle during a quarantine period of 2 to 3 weeks and before entering into the primary facilities.

Elimination of BVDV PI cattle early in the production system, such as at the cow-calf herd level, benefit the cattle industry at subsequent points, such as at the feedlot and heifer development enterprises. Ideally,

procurement of animals from biosecure herds and animals previously tested negative for BVDV PI would eliminate the risk for virus exposure from PI animals in these types of operations<sup>65,122</sup> (Figs 21.3–21.5).

In response to significant biologic and economic loss due to the bovine virus diarrhea complex, the Academy of Veterinary Consultants drafted and approved a position statement in 2001. The position states: *'The beef and dairy industries suffer loss due to effects of the bovine viral diarrhea virus infection. The highly mutable nature of the BVDV and the emergence of highly virulent strains of the BVDV contribute to limited success of present control programs. Also, persistently infected cattle are the primary source of infection and effective testing procedures are available to identify those infected carriers.'*<sup>65</sup> Therefore, it is the resolve of the Academy of Veterinary Consultants that the beef and dairy industries adopt measures to control and target eventual eradication of BVDV from North America.' The 'BVD Decision/Management Guidelines for Beef Cattle Veterinarians' are available<sup>65</sup> and were adopted July 2003.

The successful control and prevention of the bovine virus diarrhea-mucosal disease complex depends on:

- Identification and elimination of PI animals from the herd
- Prevention of introduction of infection into the herd (biosecurity)
- Immunization programs and biocontainment
- Eradication of the virus from herds.

#### Identification and elimination of PI animals from the herd

Identification and elimination of PI cattle is an essential component of a control program in an infected herd.<sup>119</sup> Elimination of such animals, also known as '**clearance of infection**' will result in the improved health of the herd. The testing procedures to detect PI animals are described under **Clinical pathology**.

In beef herds, to prevent contact with pregnant cows, PI animals should be identified and removed prior to the start of the breeding season. All calves, all replacement heifers, all bulls, and all non-pregnant dams without calves must be tested for PI status. Any female pregnant at the time the herd is tested should be isolated from the breeding herd and kept isolated until her calf is tested and found to be negative. In most whole herd testing situations, IHC testing of skin samples is the test of choice because it can be accurately performed on animals of any age, and a single sample is all that is usually required.

Herd monitoring for PI animals can be done with pooled whole blood or serum samples for PCR testing. By pooling samples, the expense of screening herds with a low prevalence of PI animals is minimized. The PCR test is ideal for pooled sample testing for PI animals because it is sensitive enough to detect minute amounts of virus. A single PI animal can be detected in pools of 200 to 250 negative samples. If the initial pool is PCR-positive, it must be split and retested to differentiate viremic and non-viremic animals. Once the viremic animals are identified, they must be classified as transiently infected or PI with either a subsequent PCR, virus isolation, or IMPA test in three weeks, or using the IHC testing of a skin sample.<sup>122</sup> Using a two-test strategy to screen feeder calves with a PCR assay of pooled samples and the second of immunohistochemical testing only of those animals represented in pooled samples with positive assay, will reduce the cost of screening incoming feedlot cattle, compared with immunohistochemical testing of all animals.<sup>123</sup>

Following the successful detection and removal of PI animals, '**self-clearance**' or elimination of all evidence of the infection from the herd will occur. Transient infections which occur in non-pregnant animals

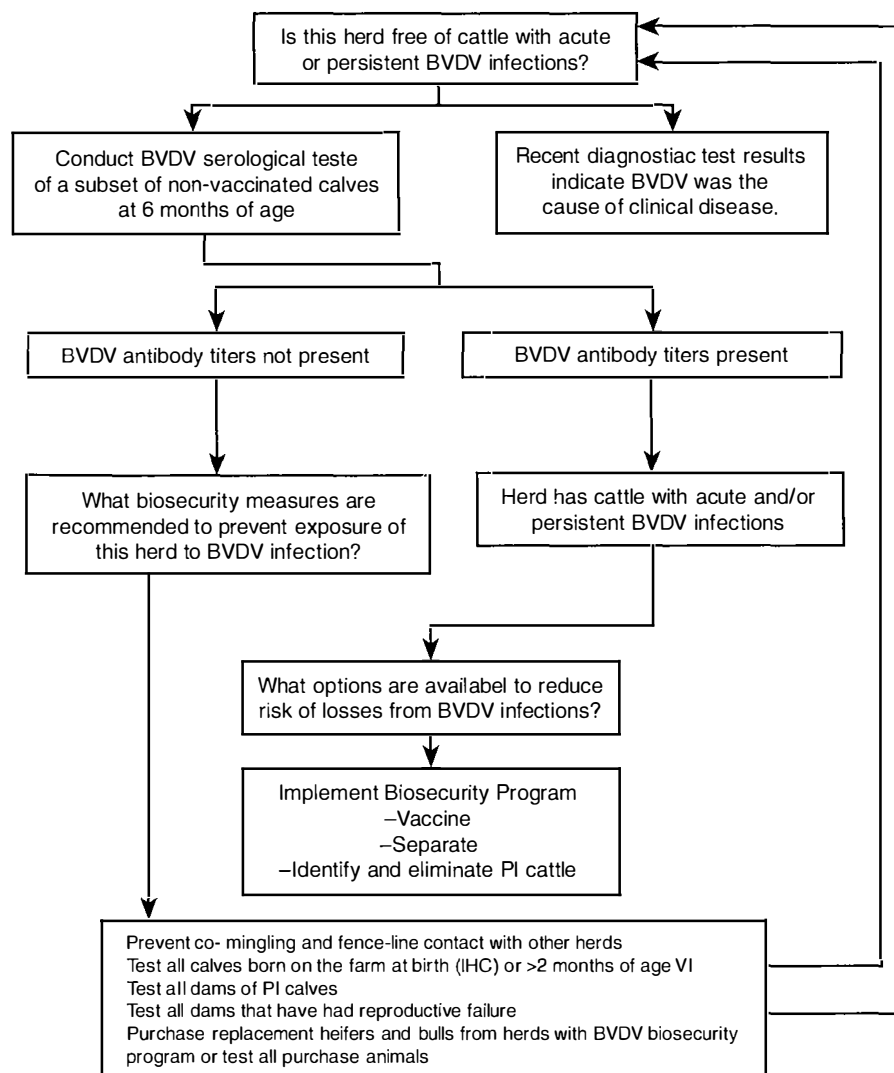
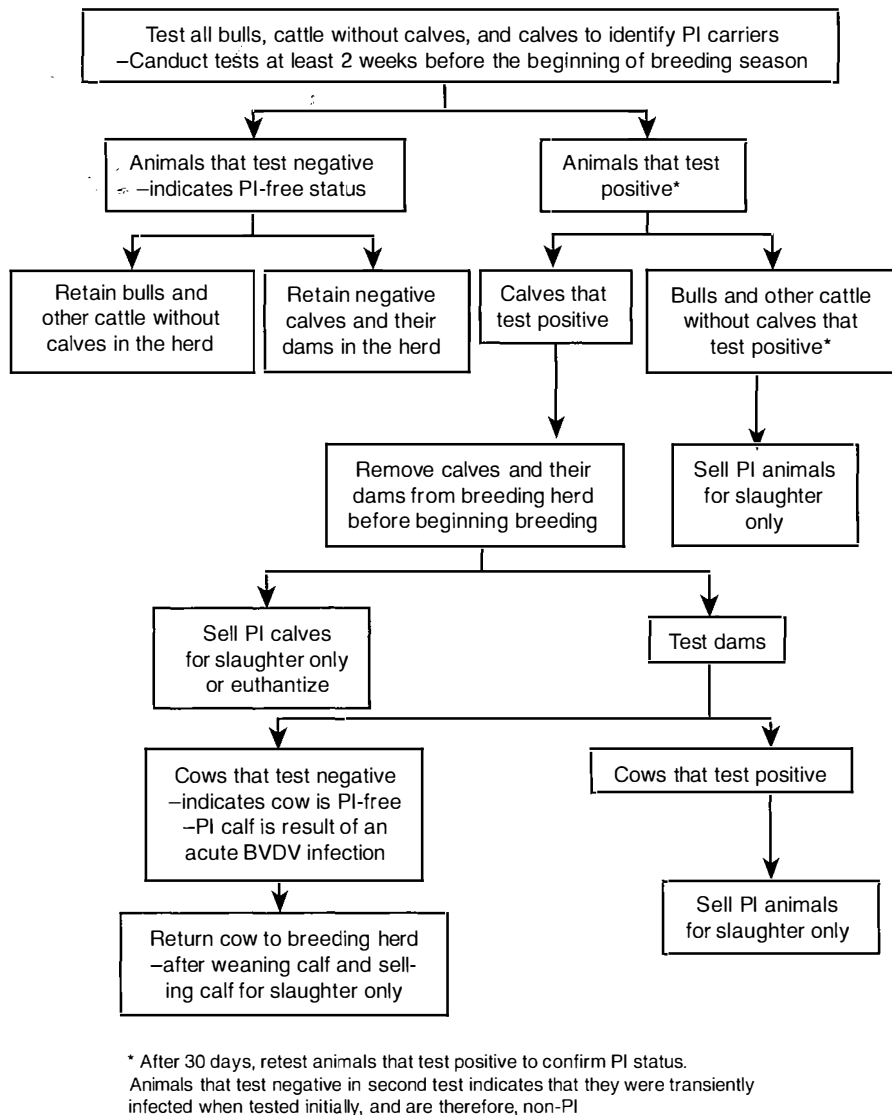

Fig. 21.3 The objectives of herd testing for BVDV.



**Fig. 21.4** Flow chart for testing a beef herd pre-breeding to detect and eliminate BVDV carrier cattle.

are inefficient in transmitting the virus. The main route of transmission within a herd is from PI animals to susceptible animals. The virus is commonly maintained in a herd when seronegative animals in early pregnancy are exposed to PI animals. Self-clearance is also more likely in small herds compared to large herds which commonly have rearing conditions which increase the risk of exposure of PI animals to susceptible seronegative animals in early pregnancy.

#### Prevention of introduction of infection into herd (biosecurity)

After identification and elimination of the PI animals, the new virus-free status of the herd should be maintained by a program of testing of all introduced animals for freedom from infection. In many cases introductions can be guaranteed, as far as is reasonably possible, to be free of infection by selecting animals which have convincing titers of serum antibody or are negative and are derived from a totally

negative herd or stable subherd. According to the period over which the herd of origin has been established and has been free from introductions, its free status may be established by testing an adequate sample of animals. In other cases, antibody-negative introductions should be examined for virus or held for a period of on-property quarantine in close contact with a few serologically negative test animals which are subsequently examined for antibody.

Significant reproductive wastage due to BVDV infection can be prevented by the testing of introductions to the herd or management of the herd to maximize immunity prior to breeding. Cattle producers purchasing pregnant heifers to expand their herds must be aware of the possibility their fetuses may already be PI. At that stage there is no simple test which will identify those heifers which are pregnant with a PI fetus. Calves from these purchased heifers of unknown vaccination history should be considered infected until proven otherwise.

Artificial insemination units are now adopting comprehensive testing programs to identify PI bulls and immunocompetent bulls with the transient acute BVDV infection. PI bulls are detected by virus isolation from blood and not by serological testing. The semen of PI bulls will usually contain the virus but the quality of the semen will not necessarily be abnormal. This emphasizes the need for virological surveillance of breeding herds, and artificial insemination and embryo transfer centers. It is also important to prevent contamination by this virus of the fluids used for recovery, in vitro manipulation and transfer of bovine embryos.

#### Immunization programs and biocontainment

Infectious disease models demonstrate that after BVDV is eliminated, the cattle become increasingly susceptible to new infections and the possibility increases of an outbreak with severe clinical signs following a new BVDV exposure. Thus, in the absence of strict biosecurity, recurring patterns of reinfection with severe clinical signs are expected every few years following actions which eliminate the virus. In North America and other regions where BVDV is endemic and reexposure is likely, it remains prudent to continue vaccination after eliminating the virus from the herd.<sup>119</sup> Considering the high prevalence of BVDV infection that causes high economic losses, vaccination of cattle herds is certainly indicated, provided efficacious and safe vaccines are available. The literature on vaccination of cattle against bovine virus diarrhea<sup>124</sup> and the evolution of the BVDV vaccines have been reviewed.<sup>120</sup>

To be effective, vaccination against BVDV infection should protect against viremia, block infection of target cells of the reproductive and lymphatic systems to avoid occurrence of fetal infection and immunosuppression, respectively.<sup>120</sup> Antibodies present in the systemic circulation effectively neutralized viral infectivity, promote clearance of the virus, and prevent seeding of target organs such as the fetus. The goal of immunization is to stimulate both the B and T-cell arms of the immune systems. The B-cell arm of the immune response has the major responsibility for inactivating free virus. This is achieved primarily by immunoglobulin, which neutralizes the BVDV infectivity and secondarily aggregates BVDV and enhances clearance. Cell-mediated immunity, particularly CD4<sup>+</sup> cells, which is type-2 like is important for the resolution of acute infection with noncytopathic BVDV.

An important strategy for successful control is vaccination of the breeding female at least several weeks before

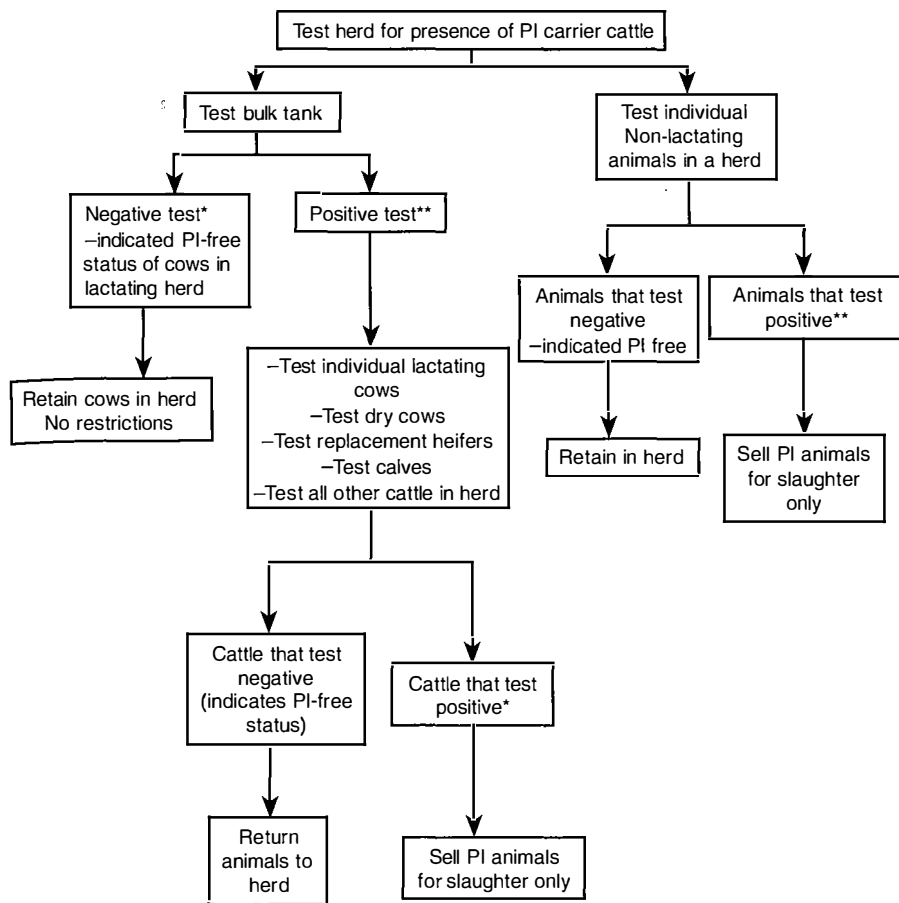

\*A bulk milk sample may yield false positive results if; 1) to shedding in milk, 2) shedding virus in milk below detectable levels, 3) viral RNA destroyed in milk, or 4) there are PCR inhibitors present.

\*\* After 30 days, retest animals that test positive to confirm PI status.

Animals that test negative in second test indicates that they were transiently infected when tested initially, and are therefore, non-PI.

**Fig. 21.5** Flow chart for testing a dairy herd to detect and eliminate BVDV PI carrier cattle.

breeding.<sup>119</sup> **The vaccination program must be vigilant.** Experimental exposure of pubertal heifers to the virus 6 weeks before breeding stimulates the production of SN antibodies which protects against transplacental infection of the fetuses when the pregnant dams are challenged with homologous virus at 100 d of gestation. A high incidence of fetal death and intrauterine growth retardation occurs in the non-immune dams which are challenged with the virus. Thus the presence of maternal immunity protects the fetus from infection. These observations provide justification for the use of BVDV vaccines in females before breeding in an attempt to stimulate maternal immunity to provide protection for the fetus. However, immunization in terms of protecting the fetus may not be effective against strains which are different from that contained in the vaccine and the ultimate precaution is to prevent cows or heifers from making new contacts shortly before or during the first half of pregnancy. It should also be emphasized that control of the infection, and of mucosal disease, depends entirely

on control among the breeding stock. Infection among non-breeders is of no long-term consequence, except insofar as they may be a source of infection to breeders and compromise the continuing freedom from infection of that group.

The emphasis must be on the vaccination of immunocompetent animals which do not have persistent viral infection. This should provide at least partial, if not complete, protection against fetal infection, abortion, stillbirth, intrauterine growth retardation, congenital defects and persistent viral infection of the newborn calf. The aim of a vaccination program is therefore to ensure that all breeding females have antibodies to the virus before they become pregnant. It is important to emphasize that vaccination should be done at least 3 weeks before breeding so that the breeding females become seropositive to the virus before conception. This is necessary regardless of the type of vaccine used. The suppliers of inactivated virus vaccines commonly promote their vaccines on the basis that they can be given safely to pregnant cows. While

it is true that the inactivated virus vaccines are not fetopathogenic, only successful vaccination before conception will protect the fetus from natural infection for the entire gestational period.

### BVDV vaccines

Both **modified live-virus (MLV)** and **inactivated-virus** vaccines are available. Currently there are many BVDV vaccines which are federally licensed in North America alone and all meet or exceed requirements for purity, potency and safety. These requirements ensure that vaccines elicit an immune response, are free from extraneous agents and do not induce disease.

The important variables to consider when selecting a vaccine for use in different production systems include: immune response; cross reactivity; fetal protection; duration of immunity; immunosuppression; reversion to virulence; effect of maternal antibody on immune responses, and purity.

The MLV vaccines usually contain a single strain of attenuated cytopathic BVDV. The strains most commonly are BVDV-NADL, BVDV-Singer and BVDV-C24C. Several inactivated vaccines contain both cytopathic and non-cytopathic strains of the virus.

### MLV-BVDV vaccines

MLV-BVDV vaccines are attenuated so that replication of the virus is restricted, reducing both viral virulence and shedding of the vaccine virus by the vaccinee.<sup>120</sup> The **advantages** of MLV-BVDV vaccines are numerous and significant. Because antigen is amplified by replication in the animal, only small numbers of viral particles are necessary and thus the vaccines are inexpensive and only a single vaccination is necessary for adequate immunization. Within 3 weeks after vaccination, antibody is detectable which will neutralize an antigenically wide range of BVDV strains. It is suggested that the duration of antibody following vaccination is similar to that following natural infection which persists for more than 1 year and for several years in most cattle. However, in some cattle, detectable levels of neutralizing antibody which are distinct from the vaccine virus wane within 2 years. Immunization of calves with MLV vaccine is not inhibited by colostral antibody at titers up to 1:32. Assuming both a half-life of 21 d for colostral antibody and an initial viral neutralizing titer of 1:2000 after ingestion of colostrum, immunization should be successful in most calves that are 4–6 months of age. Revaccination before the first breeding is recommended.

The **disadvantages** of MLV vaccines include failure of immunization if the vaccine is not stored or handled properly. MLV

vaccines may cause disease if the vaccine virus regains virulence. Adventitious agents may also be present, which are capable of causing disease but these are rare. Outbreaks of mucosal disease sometimes occurred about 10–14 d following vaccination. The possible causes postulated for these so-called **vaccination breaks** included the following:

1. The vaccine virus may not have been sufficiently attenuated and actually caused the disease.
2. Calves may have been incubating the disease when vaccinated.
3. Some calves were immunologically tolerant because of infection during fetal life, allowing the vaccine virus to cause the disease. These vaccination breaks gave modified live vaccines a poor reputation and as a result they have not been used on a regular basis. Also, veterinarians began to make regular reports that the vaccine was ineffective against mucosal disease, but the reasons were unknown.
4. MLV vaccines are also potentially fetopathogenic and should not be used in pregnant cows. The possible effects of such vaccination are variable and dependent on the stage of gestation when the vaccination occurs. The vaccination of pregnant cattle, without detectable neutralizing antibodies to the virus, between 51 and 190 d of gestation with a commercial modified BVDV live vaccine can result in transplacental transmission of the vaccine virus and is not recommended. Abortions, congenital abnormalities of the nervous and musculoskeletal systems, perinatal deaths, growth retardation, persistent viral infection and the late onset of mucosal disease are all possible outcomes of vaccinating pregnant cattle with a MLV before 120 d of gestation. Between 120 and 190 d of gestation, the fetus can be expected to become immunocompetent and produce serum-neutralizing antibodies which can be detected in the precolostral serum of the calf at birth. The vaccination of pregnant cattle without neutralizing antibodies to the virus between 190 and 265 d of gestation will also result in transplacental transmission of the virus and the presence of neutralizing antibodies in the precolostral serum of calves at birth. Calves derived from dams vaccinated between 90 and 118 d of gestation may exhibit ataxia, torticollis, opisthotonos and/or growth retardation.

A **temperature-sensitive BVDV vaccine** will cause seroconversion, produces

no clinical signs of disease or leukopenia and, when used experimentally in pregnant cows, does not result in fetal infection as evidenced by lack of virus isolation and absence of precolostral antibodies in the calves which are born healthy.

Immunosuppression and genetic recombination are other potential risks associated with MLV vaccines. Vaccine strains retain some immunosuppressive properties which may predispose animals to the development of other infectious diseases.

#### Inactivated BVDV vaccines

The disadvantages of the MLV vaccines stimulated the development of inactivated-virus vaccines.

The **advantages** of inactivated BVDV vaccines include:

- Lack of infectivity
- Unlikely presence of adventitious agents
- Absence of postvaccinal disease
- Safe use in pregnant animals.

The **disadvantages** of inactivated BVDV vaccines include:

- High cost of the vaccine
- Need for two vaccinations to achieve primary vaccination.

Adverse reactions at the site of vaccination may occur and are associated with the adjuvant in the vaccine. Maternal antibody may interfere with inactivated vaccines and calves may need to be revaccinated periodically from 6 months of age to just before breeding.

#### Combination vaccines

BVDV vaccines are often incorporated in multivalent vaccines to prevent respiratory diseases of cattle. These vaccines include combinations of the live and inactivated antigens of bovine herpes virus-1, parainfluenza-3 virus, bovine respiratory disease virus, and *Mannheimia haemolytica*, and *Histophilus somni* for administration all at the same vaccination time.

#### Immune response to BVDV vaccines

##### Efficacy of BVDV vaccines

It is not possible, on the basis of scientific information available, to recommend the use of one form of the vaccine over another. The lack of comparative efficacy data on different vaccines makes it difficult for veterinarians to recommend which vaccines to use. Ideally, the selection of vaccines should be based on efficacy data from controlled field trials. To be effective, vaccination against BVDV infection should protect against viremia to prevent dissemination of virus throughout the host following infection, to block infection of target cells of the reproductive and lymphatic sys-

tems to avoid fetal infection, and to prevent immunosuppression.

**Fetal protection.** The efficacy of BVDV vaccines for the prevention of fetal infection has been uncertain. Most BVDV vaccines have not been tested for efficacy against protection of infection of the fetus. The criteria used for the evaluation of BVDV vaccines have been assessment of the magnitude of the serological response, safety and purity following vaccination of young calves 4–6 months of age. There are a limited number of studies available which have critically evaluated the efficacy of BVDV vaccines to protect the fetus.

A single dose of a modified live NADL-derived BVDV type 1 vaccine will confer protection to dams and their fetuses against challenge exposure to heterologous BVDV type 1 virus.<sup>124</sup> A single dose of a modified live type 1 isolate of BVDV vaccine protects young calves vaccinated at 10–14 d of age and experimentally challenged intranasally 21 d later with a virulent type 2 isolate of BVDV.<sup>31</sup>

An inactivated vaccine has been evaluated to protect the fetus against experimental challenge.<sup>126</sup> Heifers were vaccinated two or three times before breeding and challenged when between 25 and 80 d of pregnancy. There was no evidence of a viremia in the vaccinated heifers after challenge, or of infection of the fetuses. The challenge strain of the virus was fetopathogenic in control unvaccinated animals. The inactivated vaccine also protected calves against experimental respiratory challenge with the same live strain of the virus as evaluated by an absence of nasal shedding, viremia and leukopenia in vaccinated calves.<sup>127</sup> Because of the high costs of evaluating BVDV vaccines for the protection of the bovine fetus, sheep can be used in initial BVDV vaccination-challenge experiments to evaluate vaccine efficacy, to determine optimal composition of the vaccine, protective dose, method of immunization and duration of protection.<sup>128</sup> A EU licensed inactivated BVDV vaccine provided fetal protection when heifers vaccinated 6 months previously were challenged at about 87 days of gestation by close contact with three persistently infected carrier heifers.<sup>129</sup> However, in another study heifers vaccinated with two inactivated vaccines were challenged at 82 days of gestation with three different Dutch field strains and all calves born from unvaccinated control animals were persistently infected. Calves born from dams vaccinated with two different inactivated BVDV vaccines were persistently infected in 78% and 60%, respectively.<sup>130</sup>

Vaccination of heifers with a non-cytopathic type 1 MLV BVDV vaccine prior to breeding protected fetuses from infection with a heterologous type 1 BVDV

challenge at 55 to 100 days of gestation.<sup>131</sup> A MLV vaccine containing types 1 and 2 BVDV provided fetal protection in 91% of heifers challenged with type 1 virus and 100% heifers challenged with type 2 virus at 60 to 90 days of gestation.<sup>132</sup> A commercial MLV combination vaccine containing type 1 and type 2 BVDV given prebreeding protected 100% of fetuses against type 1 BVDV infection and 95% of fetuses against type 2 BVDV infection.<sup>133</sup> In summary, there is considerable fetal protection provided by vaccines administered prior to breeding but the protection is not 100%.

**Postnatal protection.** Postnatal protection is necessary to provide immunity against the forms of BVDV infection which occur after birth including subclinical infection, acute infections, peracute bovine virus diarrhea, and immunosuppression associated with respiratory disease and other infections predisposed by the BVDV.

The pathogenesis of mucosal disease in PI animals explains why vaccination of calves at about 6 months of age may not provide protection in all cases. If mucosal disease is a late sequel to fetal infection, then some calves will be PI, specifically immunotolerant, and may eventually develop mucosal disease whether they respond to the vaccine virus or not. Thus they could become infected with clinical disease regardless of vaccination. Also, new cases of mucosal disease may occur in 5–10% of calves within a few weeks following vaccination with a live-virus vaccine. It has been postulated that this is likely to be due to the vaccine virus fulfilling the role of a superinfecting virus to precipitate clinical disease. However, it is a relatively infrequent occurrence and it did not occur on one occasion when known persistently viremic cattle were experimentally vaccinated with a cytopathic live-virus vaccine. Clinical disease was subsequently induced following experimental inoculation of persistently infected animals with a different cytopathic strain.

#### Cross-reactivity of vaccines

While there is considerable antigenic similarity between the biotypes of the virus and among isolates of either biotype, there is also antigenic diversity among the isolates and neutralizing antibodies induced by vaccination might not react with certain isolates of the virus. There are significant antigenic differences between certain strains of the virus. Vaccination of yearling cattle with either of two commercially available monovalent modified live BVD vaccines stimulated the production of SN antibodies to each of 10 cytopathic and 10 non-cytopathic isolates of the virus by one or more of the animals by 14 d after vaccination. No animal produced detectable SN antibodies to all 20 viruses.

The use of three different inactivated vaccines in cows stimulated the production of SN antibodies in all animals to each of 10 non-cytopathic and 10 cytopathic isolates of the virus when measured 14 d after the second vaccination. The reciprocals of SN antibody titers varied from 4–256, thus both the attenuated and inactivated vaccines induced antibodies to a broad range of BVD viruses.

The administration of a single dose of a MLV-BVDV vaccine to seronegative cattle, 3–8 years of age, induced an antibody response detectable for 18 months and the antibodies were able to cross-neutralize 12 antigenically diverse stains of the virus.<sup>134</sup> A commercial vaccine containing two inactivated strains of Type 1 BVDV, an inactivated strain of bovine herpesvirus-1, and modified-live strains of bovine respiratory syncytial virus and parainfluenza-3 virus provided virus neutralizing antibodies against 22 BVDV isolates in vaccinated calves.<sup>135</sup>

The sera from a beef herd of 5725 cows which had been vaccinated annually for 7 years with an inactivated vaccine was tested for SN antibodies against several isolates of cytopathic and non-cytopathic viruses.<sup>136</sup> Approximately 96% of the cattle did not have detectable antibody titers to the virus used in the vaccine but did have titers to other isolates of the virus. Non-cytopathic virus was isolated from three of 448 samples of sera which had titers of 64 or less against a particular isolate of the virus. The failure to detect antibody titers against certain isolates of the virus may have been due to antigenic diversity and natural decay of antibodies. Other possibilities include the use of excessive concentrations of virus in the neutralization test, and the failure of the inactivated vaccine to induce antibodies.

**Cross protection of genotypes.** The cross-protective efficacy of BVDV vaccines according to genotypes has been examined with contradictory results. In some cases, prior exposure of cattle to type 1 virus (as either a MLV or inactivated vaccine) does not always provide protection against infection with type 2 virus.<sup>124</sup> A type 1 vaccine provided protection against type 2 challenge.<sup>137</sup> A single vaccination with a type 1 strain was efficacious against a type 2 strain challenge for at least 231 days. Following challenge, most vaccinates were free of febrile response and leukopenia; in contrast challenge virus was isolated from all control calves. A commercial inactivated type 1 BVDV vaccine provided significant but not complete clinical and virological protection against challenge a heterologous type 2 strain of BVDV.<sup>138</sup> A single dose of MLV type 1 vaccine given at 10 to 14 days of age can protect susceptible calves from viru-

lent type 2 BVDV for at least 4 months but high concentrations of BVDV-specific maternally derived antibodies can block the induction of the response.<sup>32</sup> Properly used vaccines containing type 1 virus may reduce the incidence and severity of disease associated with type 2 virus. The recent occurrence of type 2 virus in North America and the UK warrants a review of current laboratory testing to ensure adequate procedures are in place to detect type 2 virus, or antibody to it.<sup>47</sup>

#### Commercially available vaccines

Most of the commercially available vaccines for the BVDV are combined with other antigens such as the IBR, PI-3 and BRS viruses. In one study, the serological responses of beef calves 6–8 months of age were compared following vaccination with eight commercial vaccines containing IBR, PI-3, BRSV, and BVDV.<sup>139</sup> In general, the serological responses to the viruses varied among different commercial vaccines, between and within MLV and killed-virus vaccines, and routes of administration. All vaccinated calves developed higher antibody titers to the antigens than unvaccinated controls. The serological responses to the BVDV were low; only 20% of the calves had a four-fold seroconversion to the virus after two vaccinations. There are wide variations in onset of antibody responses and duration dependent on vaccine type and virus involved.<sup>140</sup> The possibility that multiple antigen vaccines may not contain sufficient antigenic mass of individual antigens to stimulate an adequate level of each specific antibody has not been explored.

Field observations indicate that vaccine potency may vary considerably. Some lots of vaccines have failed to induce seroconversion in calves following carefully controlled vaccination. Unpublished observations by some clinicians found a wide variation in the amount of virus present in vaccines, and manufacturing processes may vary considerably resulting in destruction of live virus. Thus part of the vaccination program may necessarily include evaluation of the vaccine by SN testing before and after vaccination, and submitting a sample of the vaccine to a laboratory for PCR testing or viral isolation.

The use of a multivalent MLV vaccine containing bovine herpes virus-1, BVDV1 and BVDV2 in beef calves in close contact with pregnant control cows did not result in any shedding of the viruses over a period of 103 days following vaccination.<sup>141</sup>

#### Strategies for BVDV vaccination programs

The strategies for effective vaccination against BVDV infections are: prevention of fetal infection, and control and prevention of postnatal infections.

**Prevention of fetal infection in dairy and beef herds.** With the present state of knowledge, a rational vaccination program to prevent fetal infection, for both beef-breeding herds and dairy herds, consists of vaccinating all calves at 4–6 months of age with an MLV vaccine. **The emphasis must be on immunization of the heifers before breeding so that the virus does not reach the fetus before 120 d of gestation.** All heifer replacements and cows are vaccinated 3–6 weeks before breeding with an MLV vaccine. Such vaccination of immunocompetent animals should result in a lifetime of protective immunity. However, to insure a level of herd immunity, all breeding females are revaccinated annually 3–6 weeks before breeding. All bulls are revaccinated annually.

**Colostrum immunity** is present for up to 6 months of age in calves born from immune cows. Calves with even higher titers of colostrum BVDV antibody may have an active response to vaccination but it is questionable whether this is of any useful purpose. If vaccination of the dam before conception is the vital part of the program, the vaccination of calves born from immune cows may be unnecessary until they approach breeding age.

**Postnatal BVDV infections.** There is currently no information available on the efficacy of the available BVDV vaccines for the control of the acute and peracute forms of the disease, including the hemorrhagic form, which have been recognized in the early 1990s and described earlier. A rational vaccination program for the control of the new BVDV infections occurring in immunocompetent animals would be similar to the earlier mentioned program in dairy and beef breeding herds. However, to date there is insufficient information based on clinical field trials or experimental challenge to make recommendations. However, in herds experiencing outbreaks of bovine virus diarrhoea infection due to the highly virulent strains of the virus, it would seem rational to vaccinate all animals in the herd with the precaution that pregnant animals will have to be vaccinated with the inactivated virus vaccine.

### Vaccination schedules

Strategic vaccination schedules for the various situations should emphasize induction of maximal protective responses to correspond with the stage of the production cycle when the risk and consequences of BVDV infections are greatest. This means into well-timed administration of vaccines prebreeding and preweaning to protect against reproductive losses and respiratory tract disease, respectively.<sup>120</sup> Recommendations for vaccination schedules for beef and dairy cattle herds are outlined here.

### Beef cow–calf herd

All beef heifer replacements should be vaccinated with a MLV BVDV vaccine at least three weeks before breeding. Cows should be vaccinated annually, at least three before breeding.

Beef calves should be vaccinated at least three weeks before weaning in order to have maximum protection during subsequent periods of high risk at and after weaning.

### Beef feedlot

There is no indication for vaccination of feedlot cattle for mucosal disease in PI animals. In a population of feedlot cattle originating from several sources, the PI animals will likely develop mucosal disease regardless of any BVDV vaccination. However, if there is a risk of the postnatal forms of BVDV such as the peracute BVD associated with the highly virulent strains of BVDV, the thrombocytopenia, and the immunosuppressive effects of benign BVDV infection, feedlot cattle should be vaccinated on arrival with a MLV vaccine. A review of bovine respiratory disease vaccine efficacy concluded that there were no reliable reports of field trials evaluating the clinical effects of BVDV vaccines in North American feedlot cattle.<sup>64</sup>

The use of multivalent MLV viral vaccines containing IBR, PI-3, BVDV, and BRSV have been evaluated in fall-placed, auction market derived, feedlot calves in western Canada.<sup>142</sup> Those cattle receiving the multivalent vaccine had significantly lower treatment rates than those in the univalent vaccine group. Cattle receiving the multivalent vaccine had higher carcass weights, weight gain, and average daily gain throughout the feeding period. There was a net economic advantage when the multivalent vaccine was used compared to a univalent IBR vaccine. However, it is not possible to determine which of the viral antigens of the vaccine were responsible for the advantage.

### Dairy herd

Dairy heifer calves should be vaccinated at about 4 months of age, and with a booster at 5 to 6 months of age. MLV BVDV vaccines containing both type 1 and type 2 genotypes should be used.

Heifer replacements are vaccinated with a MLV BVDV vaccine about 45 days before being bred for the first time. This will boost serum neutralizing titers as much as possible to prevent fetal infection in the first 140 days of gestation. Dairy bulls are vaccinated at 8 to 12 months of age.

In situations where pneumonia in calves is associated with the BVDV, it is recommended that calves be vaccinated with an inactivated vaccine containing types 1a and 1b and type 2. Vaccination of dairy calves with a killed BVDV type 1

vaccine at 15 days of age, and MLV BVDV type 1 vaccine at 40 to 45 days of age provided an estimated overall protective effect of 48% against type 1 through 4 to 9 months of age.<sup>143</sup> However, the type 1 vaccine did not affect transmission of type 2 virus.

Recently calved cows are vaccinated with MLV BVDV vaccine at about 30 days before breeding. This will ensure high SN titers to prevent fetal infection, reduce transmission of homologous viruses to older fetuses thus preventing some congenital infections, abortions, and stillbirths; and to stimulate high colostrum antibody titers so that calves receive a large mass of BVDV antibody.

Inactivated BVDV vaccines can be used in pregnant cows when BVDV abortions are occurring in the herd. Two vaccinations, 2 to 3 weeks apart beginning at the time of pregnancy diagnosis or one month before the estimated time of abortion. Vaccines containing both type 1 and type 2 genotype are recommended. Inactivated vaccines have also been used at drying off and 3 to 4 weeks later to enhance colostrum antibody titers. The strains of the virus used in inactivated vaccines tend to be different than those used in MLV vaccines, so using inactivated products and alternating manufacturers may provide greater cross protection and cross-react with as many field strains as possible.

Booster vaccination of dairy cows 35 days after calving with a MLV BVDV vaccine greatly increased the antibody response compared with saline controls and cows vaccinated with inactivated vaccines containing BVDV, IBR, BRSV, and PI-3 viral antigens.<sup>144</sup>

Vaccination of pregnant cows and heifers with a multivalent vaccine containing MLV BHV-1, BVDV, PI-3, and BRSV during all three trimesters of pregnancy is safe provided the animals have been previously vaccinated prior to breeding with the same MLV components.<sup>145</sup>

Veal calves should be vaccinated after arrival with a MLV vaccine containing types 1 and 2 genotypes.

### Current vaccination practices

Surveys of livestock producers indicate that about 40% of dairy producers in the United States do not vaccinate dairy heifers against BVDV, and the proportion of improperly vaccinated herds is unknown. In the 1993 outbreaks of peracute/acute forms of BVD in the United States and Canada, initial field reports indicated that affected herds had not been vaccinated or had been vaccinated improperly. When the inactivated vaccine was used, cattle had not been given the second dose of vaccine 2–4 weeks after the primary vaccination as recommended by the manufacturers.



Surveys in Pennsylvania indicate that many producers did not vaccinate all susceptible groups of cattle in the herd.<sup>146</sup> Many producers did not administer the secondary vaccination of the inactivated vaccine. While 82% of dairy producers indicated they routinely vaccinated their herds, only 27% of the herds were found to be adequately vaccinated. A survey of vaccination practices in Saskatchewan dairy herds indicated that only 34% of dairy herds were vaccinated against BVDV.<sup>147</sup> In addition, only 25% of producers who vaccinate follow the label directions for administering inactivated virus vaccines, and more specifically, the requirement to give two doses at the recommended interval. The three most common practices were annual vaccination (50%), vaccination prior to breeding (19.5%) and biannual vaccination (7.3%).

Producers may not vaccinate for a number of reasons:

1. They may not believe in the efficacy and cost-effectiveness of the vaccine
2. They may forget to vaccinate on a regular basis
3. They may have vaccinated only part of the herd when they thought the entire herd was vaccinated.

As dairy herds increase in size by importing animals from dispersed herds, the owners may not consider the necessity to vaccinate and significant numbers of animals in the herd are susceptible. Inadequate vaccination practices can be minimized by the veterinarian who can play an important role in clearly outlining in written form the vaccination program for individual herds. **Constant surveillance of the health management strategies are necessary. Good and reliable records which keep track of vaccinations, when they were given, which animals were vaccinated, and which vaccines were used, are vital.** Veterinarians must work with their clients to develop a specific vaccination and biosecurity protocol for each herd. The specific details of the vaccination program must be very clear (preferably in written form) including:

- Which vaccines are to be used
- How they should be used
- Needles and syringes to be used
- Dose of the vaccine
- Route of administration
- Which groups of animals should be vaccinated
- Often booster doses are required.

Vaccine failures may occur because of improper use and storage of the vaccine. Syringes must be not washed with water or solutions containing chemicals or ingredients which will readily kill any live virus in the vaccine.

Veterinarians providing a health management service should also follow up their recommendations to insure client compliance. Veterinarians can also assist producers in developing methods to handle livestock and purchased replacements by designing protocols for importing animals into the herd.

#### Immunization without vaccines

In Australia, where no BVDV vaccine is available, controlled exposure of non-pregnant heifers to a PI carrier animal for 12 d on pasture resulted in seroconversion by about 20 d.<sup>148</sup> The subcutaneous, intranasal, or conjunctival inoculation of blood from PI animals into yearling heifers also resulted in seroconversion. Neither inoculation nor contact infection produced any clinical illness. The highest dilutions of serum at which seroconversion occurred were conjunctival undiluted; intranasal 101 and subcutaneous 105. With the subcutaneous route all heifers seroconverted at 103.

#### Eradication of BVDV infection without vaccination

The bovine virus diarrhoea disease complex has been known since the late 1940s and early 1950s. Since about 1985, veterinarians have attempted to control the disease by culling PI animals, vaccination and certain levels of biosecurity. The diverse and vague clinical signs of the infection have made diagnosis difficult, costly and often elusive and frustrating. Several diagnostic tests have been developed to aid in diagnosis of BVDV infections, and most importantly for the detection of PI animals. Many vaccines have been developed since about 1960 which have reduced losses but not adequately enough because none of the vaccines will provide complete protection given the antigenic diversity of BVDV isolates. Anything less than absolute fetal protection by vaccines will still allow some PI animals to be present in the herd. Because of these difficulties and the high economic losses associated with BVDV, total eradication of the virus from herds of cattle and from countries has now become a reality.

A control and eradication program against BVDV without vaccination has been initiated in the Scandinavian countries with very promising results.<sup>49</sup> The literature on eradication of BVDV from cattle herds and countries has been reviewed.<sup>121,149,150</sup> The basic strategy, achievements, and status of 'test and cull' control programs implemented in Scandinavian countries and some other European countries are summarized here.

Concepts which are considered universal for developing control and eradication programs for BVDV include: (i) a herd is not infected until one or more persistent

infections have been established; (ii) the high incidence of self-clearance will reduce the prevalence of BVDV infections in cattle populations even without active disease clearance, provided virus is not re-introduced; and (iii) BVDV cannot persist within a herd when contacts between PI animals and susceptible animals in early pregnancy do not occur.<sup>149</sup> Thus, the 'test and cull' strategy is the major principle for effective eradication.

Before considering an eradication program in a region or country, an overall assessment of the economic importance of the BVDV disease complex should be estimated. Cost is an important factor in determining whether any measures against the infection should be initiated. Ideally, the overall cost of organized an eradication program should be administered by dairy and beef cattle associations, and animal health organizations. Diagnostic laboratories must be able to assist with the planning of sampling and providing information on the epidemiology of the infection to cattle producers in general, ensuring that known risk factors are identified and minimized.

Success of any eradication program is dependent on: making farmers aware of the improvements in animal health which can be gained from disease clearance as well as losses anticipated if disease occurs; making them realize that they themselves are responsible for the herd's biosecurity; and, providing them with the information to do so.

The components of an organized eradication program based on test and cull include several factors including the following:<sup>121</sup>

**Population dynamics.** In the region of concern, basic cattle population data such as average size of herd, production type (dairy, beef or others) and population density. Basic knowledge of the dynamics of the cattle industry such as movement patterns, restocking of breeding herds, vaccination programs, livestock markets, community pastures, and cattle exhibitions and sales

**Prevalence monitoring.** A comprehensive knowledge of the prevalence of infection is necessary to identify herds with an ongoing infection with BVDV as well as those susceptible to infection

**Diagnostic tests.** Reliable diagnostic tests for test and cull programs are necessary. The tests must be as sensitive and specific as possible, and they must be easy to use, reproducible, suitable for large-scale testing, and of reasonable cost

- **Education.** All those involved in the actual program must be fully informed with the latest information about the various aspects of the BVDV disease complex, including how the virus is transmitted, diagnostic testing and interpretation of results, and the strategies to be used
- **Biosecurity.** Biosecurity measures to prevent introduction of infection into virus free herds must be given high priority. This includes consideration of the possibilities of direct and indirect contact with infectious animals outside of the herd, and ensuring that all replacement animals imported into herd cleared of BVDV are kept in quarantine facilities until they (and their fetuses) are verified free of the virus. If different herds share common pastures, rules should be set out to ensure only BVDV free animals are allowed onto the pastures. Other means of reinfection are by biological products, including semen, embryos, colostrum, vaccines, and other veterinary drugs, which should be verified free from BVDV before being used
- **Logistics.** The overall plans for sampling and testing should be outlined by an advisory body with access to all available data on epidemiology and laboratory capacity. On a regional basis, organization of testing, actions after initial screening of herds, as well as follow-up testing could be organized advantageously by a district veterinary officer or someone with similar experience in surveillance for notifiable animal diseases
- **Animal identification.** Individual animal identification with easily read ear tags or electronic identification is a strict requirement
- **Legislation.** Organized efforts to control BVD on a national level, requires legislation or some means of regulating free movement of potentially viremic animals. Initially, this may become a requirement of herd managers who have successfully cleared their animals of BVDV or livestock trade or breeding companies who want to promote a specific health status of their animals. At later stages, test certificates documenting freedom from BVDV issued by district veterinary officers engaged in organization of BVD control activities may evolve as mandatory documentation to allow access to livestock auctions, exhibitions, or communal grazing land.

### Scandinavian countries

The Scandinavian countries, and some other regions in Europe, have successfully achieved control of BVDV without the use of vaccines, and are aiming towards complete eradication. The seroprevalences of BVDV in the cattle populations of these countries ranged from very high to low. In the early 1990s, the herd-level seroprevalence of BVDV in Denmark was 100%, 40% in Denmark, 25–40% in Norway, and 1% in Finland. No vaccines against BVDV have been licensed or used in the Scandinavian countries and thus the seroprevalence was due to natural infection.

The basic elements of the control programs in all Scandinavian countries are similar. Three different activity levels can be distinguished. The first level included screening of all cattle herds with the principal aim to identify BVDV-free herds and maintain them free. Bulk milk samples collected for milk quality monitoring or sera from a limited number of animals representing all epidemiologic groups of the herd are tested for antibodies to BVDV. Next they are scored to indicate freedom from BVDV or a more or less likely ongoing infection with BVDV. This population-wide screening is repeated annually to monitor the spread of BVDV or the effect of the control program. The second level of activity aims to identify herds with an active infection among those positive for BVDV, for example, those with one or more PI animals. By limiting the number of herds which require a full herd screening, efforts can be focused where needed and the overall cost minimized. The aim of the third level activity is to identify all PI individuals in herds with active infection. This involves an initial sampling of all cattle on the farm, plus a follow-up phase to test calves born to BVDV antibody positive dams which were pregnant during or shortly after the initial testing. After the herd clearing is completed, surveillance at level 2 serves to verify success and eventually to certify that cleared herds are free from BVDV, despite still strongly positive by level 1 antibody surveillance results.

**Swedish program.** Sweden launched its eradication program in 1993 as a voluntary scheme operated by farmers' organizations with advisory input from veterinary virologists in diagnostic laboratories and animal health authorities. Upon joining the scheme, herd owners agreed to comply with a set of rules restricting free movement of animals of unknown BVDV status, including specific hygienic measures designed to minimize the risk of virus spread. The farmers subscribing to scheme benefited by regular

screening to determine BVDV status and by further guidelines on how to identify PI animals from BVDV-positive herds. When cleared of BVDV, herds were also certified as BVDV free and thus allowed farmers to engage in livestock trade with other affiliated herds. Except for some grants from the Board of Agriculture to assist with testing in high prevalence areas, the farmers covered the expenses of the control program. The program was designed for both dairy and beef herds. In dairy cattle herds, prevalence surveillance could easily be done using antibody testing of bulk milk samples. In beef cattle herds, the 'spot test' strategy was used with either pooled milk from primiparous cows or sera from young animals, using the same antibody ELISA as used for bulk milk. For virus detection, a cell culture-based microplate immunoperoxidase assay was used. By 2002, 99% of the beef herds were affiliated and the percentages of certified BVD-free dairy and beef herds had increased to 93 and 88%, respectively. To address the problem of nonsubscribing herds which acted as potential sources of reinfection, the Board of Agriculture declared in 2002, that subscription to the control program was mandatory for all cattle holdings. In 1998, it was predicted that Sweden would become free of BVDV in 2002 if the rate herd clearing continued as planned. Based on the currently available figures, it might be reasonable to assume that national BVDV free status can be achieved in 2004.

**Norwegian program.** Norway launched a nation wide control program in 1992 with the long term aim of eradication. Most cattle were dairy production herds. Soon after the program was begun, BVD was designated a notifiable disease by the Animal Health Authority. This included legislative power to impose movement restrictions on cattle from infected herds to limit further spread of BVD as much as possible. The diagnostic activities included annual bulk milk antibody testing of dairy herds and spot test serology of beef herds with both sample categories analyzed by ELISA. Herds with high bulk milk antibody levels were selected for further testing of milk from primiparous cows or sera from young animals. Herds with antibody positive second-level samples were considered infected, and movement restrictions were imposed. Samples negative for or with low levels of antibodies to BVDV were tested for BVDV antigen by ELISA. Calves born to antibody-positive dams in recently cleared were not sampled for antigen testing until they reached 3 months of age to avoid analytic interference of maternal antibodies.

The cost of surveillance testing at levels 1 and 2 was covered by the control

scheme, whereas the cost of sampling and testing to clear individual herds for BVDV was paid for by the farmers. Remarkable progress was made and eradication is expected in 2004.

**Danish program.** In Denmark, the high prevalence of infection, the animal density and the structure and management of cattle herds required a specific approach but using the same principles outlined above. A nation-wide control program was begun in 1994. Participation initially was voluntary but since 1996, legislation was introduced to prohibiting transportation of viremic animals. By early 1999, 9% of the dairy and 5% of the beef herds were still registered with PI status. These were attributed to reinfection of previously cleared herds, in part due to non-compliance with biosecurity recommendations on how to avoid infection. There was no legislative requirement of for owners of herds with PI status to get them cleared.

**Finnish program.** In Finland, the herd seroprevalence of BVDV infection has always been much lower at about 1%. In 1999, a voluntary control and eradication program was begun. Bulk milk samples from dairy cattle herds were tested by ELISA, and sera from beef cows tested by microneutralization. Between 1994 and 1997, the prevalence of BVD positive herds declined from 1% to 0.4% of dairy herds, and from 30% to 3.2% in beef herds. The prevalence continued to drop but remained at a low level analogous to the tailing pattern also seen in antibody prevalence in Scandinavian countries. The program was not mandatory and some farmers did not join.

**United Kingdom.** In 1999, in the UK, the cattle industry established Cattle Health Certification Standards (Checs) as a non-trading organization to promote and regulate voluntary schemes for the control of BVDV and other pathogens. The basis is the identification and removal of PI animals from herds, combined with changes in husbandry procedures to prevent infection from being reintroduced. There are three programs, allowing the farmer to work with the veterinarian to formulate a BVDV health strategy to meet the particular needs of that farm. The Accreditation Program demonstrates the herd is free from BVDV, to maintain freedom from the virus, and to allow the sale of animals as accredited free of the virus. In the screening and eradication program the objective is to implement a control program to reduce the detrimental effects on the herd productivity associated with the BVDV and to allow sale of animals of known status. The program applies where there is already evidence of recent BVDV infection in the herd or where

positive results have been found in the course of an accreditation program. In the Vaccination Monitored Free Program the objective is to control BVDV infection through vaccination of the breeding herd and, by regular monitoring of young animals, to demonstrate that the control is effective and exposure of young animals to the virus has not occurred. The goal is to allow the sale of animals that are accredited as being from a vaccinated herd and monitored free of active BVDV infection. This program is considered appropriate for commercial herds selling animals for finishing. The status of these herds is lower than that of BVDV Accredited Herds.

**Shetland Islands.** A scheme to control and eradicate BVDV was initiated in 1994 in the Shetland Islands.<sup>151</sup> Over a three-period every bovine animal on the islands was blood-sampled and laboratory tested using Mab-based ELISAs for BVD virus antibody and antigen detection for evidence of disease. Virus positive cattle were culled from infected herds and compensation was paid as part of the control program. The pilot scheme indicated that it is possible to control and eradicate BVDV in herds in a defined geographical area. If pregnant replacement breeding stock are purchased and imported into a herd, even if they may be antibody positive and virus negative, they may be carriers of persistently-infected fetuses, and their calves when born must be tested before colostrum ingestion for persistent infection and culled if positive.

**Continental Europe.** No countrywide BVDV control schemes involving entire cattle populations have been launched on the European mainland. There is some interest in control of the disease complex using the test and cull procedures in individual herds, in groups of herds supervised by animal health organizations, or even regions within certain countries. Programs have been developed in Lower Saxony in Germany<sup>152</sup> and in Austria.<sup>153</sup>

In Austria, cattle herds are identified as infected or not by using herd-level antibody tests on bulk milk or on groups of young animals. PI animals are detected and eliminated to prevent spread of infection between animals which are commonly grazed on communal pastures.<sup>152</sup> A modified commercially available antigen-capture ELISA, and a RT-PCR tests were used and both were confirmed as 100% when compared to the Ag-ELISA kit (Herd Chek, IDEXX).

In Lower Saxony, because of the high seroprevalence of infection due to vaccination, control and eradication will involve a combination of identification of PI animals, systematic vaccination programs, biosecurity measures to prevent the introduction of infection into BVDV free herds, followed by eventual cessation of the use

of vaccines.

**North America.** In response to significant biologic and economic loss due to the bovine virus diarrhea complex, the Academy of Veterinary Consultants drafted and approved a position statement in 2001. The position states: *'The beef and dairy industries suffer loss due to effects of the bovine viral diarrhea virus infection. The highly mutable nature of the BVDV and the emergence of highly virulent strains of the BVDV contribute to limited success of present control programs. Also, persistently infected cattle are the primary source of infection and effective testing procedures are available to identify those infected carriers.'*<sup>65</sup> Therefore, it is the resolve of the Academy of Veterinary Consultants that the beef and dairy industries adopt measures to control and target eventual eradication of BVDV from North America.' The 'BVD Decision/Management Guidelines for Beef Cattle Veterinarians' are available<sup>65</sup> and were adopted July 2003.

There are no plans to eradicate BVDV from North America as is being done in the Nordic Countries. However, it is very realistic and possible that the virus could be eradicated on a herd by herd basis using detection and elimination of PI animals, the judicious use of effective vaccines, regular diagnostic testing for PI animals, and implementation of biosecurity measures to ensure that re-infection of the herd of does not occur.

## REVIEW LITERATURE

- Donis RO. Molecular biology of bovine viral diarrhea virus and its interactions with the host. In: Epidemiology of bovine virus diarrhea. Bovine viral diarrhea virus. Vet Clin North Am Food Anim Pract 1995; 113:393.
- Houe H. Epidemiological features and economical importance of bovine virus diarrhea virus (BVDV) infections. Vet Microbiol 1999; 64:89-107.
- Lindberg ALE, Alenius S. Principles for eradication of bovine viral diarrhea virus (BVDV) infections in cattle populations. Vet Microbiol 1999; 64:197-222.
- Sandvik T. Laboratory diagnostic investigation for bovine viral diarrhea virus infections in cattle. Vet Microbiol 1999; 64:123-134.
- Hamers C et al. Diversity among bovine pestiviruses. Vet J 2001; 161:112-122.
- Van Oirschot JT. Vaccination of cattle against bovine virus diarrhea. Vet Microbiol 1999; 64:169-183.
- Goens SD. The evolution of bovine viral diarrhea. Can Vet J 2002; 43:946-954.
- Lindberg A. Bovine viral diarrhea virus infections and its control. A review. Vet Quart 2003; 25:1-16.
- Moczysgemba L. A review of the relationship between persistent infection of cattle with bovine viral diarrhea virus and feedlot morbidity and gain. Bovine Pract 2003; 37:155-161.
- Peterhans E, Jungi TW, Schweizer M. BVDV and innate immunity. Biologicals 2003; 31:107-111.
- Slennig BD. Bovine viral diarrhea virus testing options. Proc Am Assoc Bov Pract 2003; 36:45-51.
- Brock KV. The many faces of bovine viral diarrhea virus. Vet Clin North Am Food Anim Pract 2004; 20:1-3.
- Bolin SR, Grooms DL. Origination and consequences of bovine viral diarrhea virus diversity. Vet Clin

- North Am Food Anim Pract 2004; 20:51–68.
- Brock KV. Strategies for the control and prevention of bovine viral diarrhoeal virus. *Vet Clin North Am Food Anim Pract* 2004; 20:171–180.
- Brodersen BW. Immunohistochemistry used as a screening method for persistent bovine viral diarrhoea virus infection. *Vet Clin North Am Food Anim Pract* 2004; 20:85–93.
- Campbell JR. Effect of bovine viral diarrhoea virus in the feedlot. *Vet Clin North Am Food Anim Pract* 2004; 20:39–50.
- Chase CCL, Elmowalid G, Yousif AAA. The immune response to bovine viral diarrhoea virus: a constantly changing picture. *Vet Clin North Am Food Anim Pract* 2004; 20:95–114.
- Grooms DL. Reproductive consequences of infection with bovine viral diarrhoea virus. *Vet Clin North Am Food Anim Pract* 2004; 20:205–19.
- Givens MD, Waldrop JG. Bovine viral diarrhoea virus in embryo and semen production systems. *Vet Clin North Am Food Anim Pract* 2004; 20:21–38.
- Kelling CL. Evolution of bovine viral diarrhoea virus vaccines. *Vet Clin North Am Food Anim Pract* 2004; 20:115–129.
- Larson RL et al. Bovine viral diarrhoea (BVD): Review for beef cattle veterinarians. *Bovine Pract* 2004; 38:93–102.
- Larson RL et al. BVD decision/management guidelines for beef veterinarians. *Bovine Pract* 2004; 38:103–112.
- Lindberg A. The Nordic bovine viral diarrhoea virus eradication programs; their success and future. *Cattle Pract* 2004; 12:3–5.
- Saliki JT, Dubovi EJ. Laboratory diagnosis of bovine viral diarrhoea virus infections. *Vet Clin North Am Food Anim Pract* 2004; 20:69–83.
- Sandvik T. Progress of control and prevention programs for bovine viral diarrhoea virus in Europe. *Vet Clin North Am Food Anim Pract* 2004; 20:151–169.
- Smith DR, Grotelueschen DM. Biosecurity and biocontainment of bovine viral diarrhoea virus. *Vet Clin North Am Food Anim Pract* 2004; 20:131–149.
- ## REFERENCES
- Goens SD. *Can Vet J* 2002; 43:946–954.
  - Hamers C et al. *Vet J* 2001; 161:112.
  - Vilcek S et al. *Arch Virol* 2001; 146:99–115.
  - Graham DA et al. *Res Vet Sci* 2001; 71:127–134.
  - Ridpath JF. *Biologicals* 2003; 31:127–131.
  - Ridpath JF et al. *Vet Microbiol* 2000; 77:145.
  - Baker JC. *Vet Clin North Am Food Anim Pract* 1995; 113:425.
  - Paisley LG et al. *Theriogenol* 1996; 46:1313.
  - Chase CCL et al. *Biologicals* 2003; 31:145.
  - Houe H. *Vet Microbiol* 1999; 64:89–107.
  - Houe H. *Vet Clin North Am Food Anim Pract* 1995; 113:521.
  - Wittum TE et al. *Prev Vet Med* 2001; 49:83.
  - Taylor LF et al. *Can J Vet Res* 1995; 59:87.
  - Taylor LF et al. *Can Vet J* 1997; 38:29.
  - Rush DM et al. *J Am Vet Med Assoc* 2001; 219:1426–1431.
  - Munoz-Zanzi CA et al. *Am J Vet Res* 2003; 64:358–365.
  - Evermann JF, Ridpath JE. *Vet Microbiol* 2002; 129.
  - Loken T. *Vet Clin North Am Food Anim Pract* 1995; 113:597.
  - Nielsen SS et al. *J Wildlife Dis* 36:584.
  - Van Campen H et al. *J Wildlife Dis* 2000; 37:306.
  - Wentz PA et al. *J Am Vet Med Assoc* 2003; 223:223.
  - Welsh MD et al. *Vet Immunol Immunopathol* 1995; 46:195.
  - Niskanen R, Lindberg A. *Vet J* 2003; 165:125–130.
  - Paton D et al. *Arch Virol* 1997; 142:929.
  - Niskanen R et al. *Vet J* 2002; 163:251–259.
  - Grooms DL. *Vet Clin Food Anim* 2004; 20:5.
  - Givens MD et al. *Am J Vet Res* 2003; 64:428.
  - Voges H et al. *Vet Microbiol* 1998; 61:165.
  - Lang-Ree J R et al. *Vet Rec* 1994; 135:412.
  - Chase CCL, Elmowalid G, Yousif AAA. *Vet Clin North Am Food Anim Pract* 2004; 20:95–114.
  - Cortese VS et al. *J Am Vet Med Assoc* 1998; 213:1312.
  - Ellis J et al. *J Am Vet Med Assoc* 2001; 219:351.
  - Munoz-Zanzi CA et al. *J Am Vet Med Assoc* 2002; 221:676–685.
  - Fredriksen B et al. *Vet Rec* 1999; 144:111.
  - Graham DA et al. *Vet Rec* 2003; 152:795.
  - Potgieter LND. *Vet Clin North Am Food Anim Pract* 1995; 113:501.
  - Bolin S. *Vet Clin North Am Food Anim Pract* 1995; 113:615.
  - Ridpath JF et al. *Am J Vet Res* 2003; 64:65.
  - Kummer BM et al. *Vet Microbiol* 2001; 77:117.
  - Bolin SR, Grooms DL. *Vet Clin Food Anim* 2004; 20:51–68.
  - Odeon AC et al. *Vet Microbiol* 2003; 96:133.
  - Vilcek S et al. *Vet J* 1999; 158:33.
  - Carman S et al. *J Vet Diagn Invest* 1998; 10:27.
  - Walz PH et al. *Am J Vet Res* 2001; 62:1095.
  - Kelling CL et al. *Am J Vet Res* 2003; 63:1379.
  - Harding MJ et al. *Am J Vet Res* 2002; 63:1458.
  - Wakeley PR et al. *Vet Microbiol* 2004; 102:19.
  - Vilcek S et al. *Vet Rec* 2002; 151:150.
  - Flores EF et al. *Vet Microbiol* 2000; 77:175.
  - Van Leeuwen JA et al. *Can Vet J* 2001; 42:193.
  - Chi J et al. *Prev Vet Med* 2002; 55:137.
  - Houe H. *Biologicals* 2003; 31:137–143.
  - Stott AW et al. *Prev Vet Med* 2003; 59:51–66.
  - Gunn CJ, Stott AW, Humphrey RW. *Vet J* 2004; 167:143–149.
  - Valle PS et al. *Prev Vet Med* 2001; 51:17.
  - Walz PH et al. *Can J Vet Res* 2001; 65:241.
  - Wood RD et al. *Can J Vet Res* 2004; 68:42.
  - Hamers C et al. *Vet J* 2000; 160:250.
  - Bolin SR, Ridpath JF. *Am J Vet Res* 1995; 56:755.
  - Blas-Machado U et al. *Vet Pathol* 2004; 41:190.
  - Baule C et al. *J Clin Microbiol* 2001; 39:146.
  - Fulton RW et al. *Can J Vet Res* 2000; 64:151.
  - Fulton RW et al. *Can J Vet Res* 2002; 66:181.
  - Campbell JR. *Vet Clin North Am Food Anim Pract* 2004; 20:39–50.
  - Larson RL et al. *Bovine Pract* 2004; 38:103.
  - Shahriar FM et al. *Can Vet J* 2002; 43:863.
  - Booker CW et al. *Can Vet J* 1999; 40.
  - Loneragan GH et al. *J Am Vet Med Assoc* 2005; 226:595.
  - Fray MD et al. *Vet Microbiol* 2000; 77:185.
  - McGowan MR et al. *Theriogenol* 2001; 59:1051.
  - Moening V et al. *Vet Clin North Am Food Anim Pract* 1995; 113:477.
  - Bielanski A, Loewen K. *Anim Reprod Sci* 1994; 35:183.
  - Brock KV et al. *Theriogenol* 1997; 47:837.
  - Frederiksen B et al. *Vet Pathol* 1999; 36:267.
  - Bolin SR. *Vet Clin North Am Food Anim Pract* 1995; 113:489.
  - Peterhans E et al. *Biologicals* 2003; 31:107–111.
  - Larsson B et al. *Res Vet Sci* 1995; 58:186.
  - Ridpath JF, Bolin SR. *Vet Rec* 1995; 212:259.
  - Houe H, Heron I. *Acta Vet Scand* 1993; 34:305.
  - Muronoti A et al. *Vet Rec* 1999; 144:1999.
  - Taniyama H et al. *J Comp Path* 1999; 121:149.
  - Scherer CFC et al. *Vet Microbiol* 2001; 79:285.
  - Swaspidan S et al. *Vet Pathol* 2001; 38:275.
  - Monies RJ et al. *Vet Rec* 2004; 155:765.
  - Franz S, Baumgartner W. *Vet J* 2002; 165:205.
  - Taylor LF, Rodwell BJ. *Aust Vet J* 2001; 79:682.
  - Rufenacht J et al. *Theriogenol* 2001; 56:199.
  - Robert A et al. *Theriogenol* 2004; 61:117.
  - Munoz-Zanzi CA. *Theriogenol* 2004; 61:1085.
  - Munoz DP et al. *Br Vet J* 1996; 152:175.
  - Niskanen R et al. *Prev Vet Med* 1995; 23:229.
  - Saliki JT, Dubovi EJ. *Vet Clin Food Anim* 2004; 20:69.
  - Grooms DL et al. *J Am Vet Med Assoc* 2001; 219:629.
  - Brock KV. *Vet Clin North Am Food Anim Pract* 1995; 113:549.
  - Brodersen BW. *Vet Clin North Am Food Anim Pract* 2004; 20:85–93.
  - Njaa BL et al. *J Vet Diagn Invest* 2000; 12:393.
  - Grooms DL, Keilen ED. *Clin Diagn Lab Immunol* 2002; 9:898.
  - Brinkoff J et al. *Vet Microbiol* 1996; 50:1.
  - Ridpath JF et al. *J Vet Diagn Invest* 2002; 14:303.
  - Drew TW et al. *Vet Microbiol* 1999; 64:145.
  - Givens MD et al. *Vet Microbiol* 2003; 96:145.
  - Kramps JA et al. *Vet Microbiol* 1999; 64:135.
  - Beaudeau F et al. *Vet Rec* 2001; 149:236.
  - Graham DA et al. *Vet Rec* 2001; 149:261.
  - Lindberg A et al. *Prev Vet Med* 2001; 51:199.
  - Brownlie J et al. *Clin Diagn Virol* 1998; 10:141.
  - Lindberg A et al. *Vet J* 2002; 164:151.
  - Pillars RB, Grooms DL. *Am J Vet Res* 2002; 63:499.
  - Munoz-Zanzi CA et al. *J Vet Diagn Invest* 2000; 12:195.
  - Waldner CL, Campbell JR. *Am J Vet Res* 2005; 66:825.
  - Bielefeldt-Ohmann H. *Vet Clin North Am Food Anim Pract* 1995; 113:447.
  - Piero FD et al. *Vet Rec* 1997; 140:407.
  - Haines DM et al. *Can Vet J* 2004; 45:231.
  - Haines DM et al. *Can Vet J* 2001; 42:857.
  - Scruggs DW et al. *J Vet Diagn Invest* 1995; 7:555.
  - Marshal D J et al. *Vet Pathol* 1996; 33:311.
  - Thur B et al. *Am J Vet Res* 1997; 58:1371.
  - Brock KV. *Vet Clin North Am Food Anim Pract* 2004; 20:171.
  - Smith DR, Grotelueschen DM. *Vet Clin North Am Food Anim Pract* 2004; 20:131.
  - Kelling CL. *Vet Clin North Am Food Anim Pract* 2004; 20:115.
  - Sandvik T. *Vet Clin North Am Food Anim Pract* 2004; 20:151.
  - Larson RL et al. *Bovine Pract* 2004; 38:93.
  - Larson RL et al. *J Am Vet Med Assoc* 2005; 226:249.
  - van Oirshot JT et al. *Vet Microbiol* 1999; 64:199.
  - Cortese VS et al. *Am J Vet Res* 1998; 59:1409.
  - Brownlie J et al. *Vet Rec* 1995; 137:58.
  - Howard CJ. *Vet Microbiol* 1994; 42:171.
  - Bruschke CJM et al. *Vet Microbiol* 1996; 50:33.
  - Patel JR et al. *Arch Virol* 2002; 147:2453.
  - Zimmer GM et al. *Vet Microbiol* 2002; 89:255.
  - Dean HJ et al. *Am J Vet Res* 2003; 64:530.
  - Kovacs F et al. *Vet Microbiol* 2003; 96:117.
  - Fairbanks KK et al. *J Am Vet Med Assoc* 2004; 225:1898.
  - Cortese VS et al. *Am J Vet Res* 1998; 59:848.
  - Hamers C et al. *Vet J* 2002; 163:61.
  - Bolin SR et al. *Am J Vet Res* 1991; 52:1033.
  - Dean HJ, Leyh R. *Vaccine* 1999; 17:1117.
  - Hamers C et al. *Vet Rec* 2003; 153:236.
  - Van Donkersgoed J et al. *Can Vet J* 1991; 32:727.
  - Fulton RW et al. *Vaccine* 1995; 13:725.
  - Kleiboeker SB et al. *J Am Vet Med Assoc* 2003; 222:1399.
  - Schunicht OC et al. *Can Vet J* 2003; 44:43.
  - Thurmond MC et al. *J Am Vet Med Assoc* 2001; 219:968.
  - Dubovi EJ et al. *Vet Ther* 2000; 1:49.
  - Ellsworth MA et al. *Vet Ther* 2003; 4:120.
  - Rauffy et al. *J Am Vet Med Assoc* 1996; 209:1618.
  - Carruthers TD, Petrie L. *Can Vet J* 1996; 37:621.
  - Cook IG et al. *Aust Vet J* 1990; 67:393.
  - Lindberg ALE, Alenius S. *Vet Microbiol* 1999; 64:197.

150. Lindberg ALE. *Vet Quarterly* 2003; 25:1.  
 151. Syngde BA et al. *Vet Microbiol* 1999; 64:223.  
 152. Greiser-Wilke I et al. *Biologicals* 2003; 31:113.  
 153. Rossmanith W et al. *Vet Microbiol* 2001; 81:207.

## BOVINE PAPULAR STOMATITIS

Bovine papular stomatitis (BPS) is a mild viral disease of young cattle characterized clinically by papules on the muzzle, inside the nostrils and in the oral cavity. It is important because of the confusion it creates in the differential diagnosis of erosive and vesicular viral diseases of the alimentary tract of cattle. The disease has a worldwide distribution.<sup>1</sup> It is of minor importance, although it may cause mild illness and serve as a portal of entry for secondary bacterial infection.

Papular stomatitis has occurred in Finnish reindeer for many years.<sup>2</sup> Sequence analysis of the viral DNA isolated from an outbreak of disease in reindeer indicates that the virus is most closely related to *Pseudocowpox virus*.

The parapoxviruses (PPV) are members of a genus in the family *poxviridae* which currently includes four species: the prototype parapoxvirus *ovis* or Orf virus (ORFV), parapoxvirus *bovis* 1 (bovine papular stomatitis (BPSV)), and parapoxvirus *bovis* 2 (milker's nodule or pseudocowpox (PCPV)).<sup>3</sup> A new fourth PPV species affects red deer in New Zealand (PVNZ).<sup>3</sup> The literature on the molecular characterization of the parapoxviruses has been reviewed.<sup>3</sup> The genomes of the orf virus and bovine papular stomatitis virus have been sequenced and the genomic differences are consistent with their classification as two PPV species.<sup>1</sup>

Both the bovine papular stomatitis virus and the orf virus have been found circulating in wild ruminants and PPV isolates from wild ruminants have been experimentally transmitted to sheep, goats, and cattle.<sup>1</sup> Both the BPS and orf viruses have caused infections in sheep, cattle and Japanese serows (goat antelope).<sup>4</sup> A North American strain of orf virus isolated from a goat caused an epidemic of atypical, multifocal, persistent, severe, proliferative dermatitis in young goats.<sup>5</sup>

The bovine papular stomatitis virus can cause occupational infections in humans with lesions characterized by large, painful nodules on the hands and, less frequently, the face.<sup>1</sup>

The disease occurs in young animals from 2 weeks up to 2 years of age and in a group the morbidity often approximates to 100%. There may be transient anorexia, weight loss, ptialism, and a slight fever (39.5°C; 103°F) but in most instances the disease goes unnoticed unless a careful examination of the mouth is made. Lesions are confined to the muzzle, just inside the nostrils and on the buccal mucosa. Occa-

sional cases occur in which the only lesions are in the esophageal mucosa.<sup>1</sup> They commence as small (0.5–1 cm) papules which become dark red in color, develop a roughening of the surface and expand peripherally so that the lesions are always round or nearly so. Confluence of several lesions may cause the development of a large irregularly shaped area. As the lesion expands the periphery becomes reddened and the center depressed, gray-brown in color and rough on the surface, and eventually covered with necrotic tissue or on external lesions by a scab. Those lesions on the muzzle may be difficult to see if the area is pigmented. In the mouth the lesions occur on all mucosal surfaces except the dorsum of the tongue, and are most common inside the lips and in close proximity to the teeth. Individual lesions heal quickly, sometimes in as short a time as 4–7 d, but evidence of healed lesions in the form of circular areas of dark pink mucosa usually surrounded by a slightly paler raised zone, may persist for weeks. In the one animal there may be successive crops of lesions so that they can be found continuously or intermittently over a period of months. It is suggested that no immunity occurs and the virus may only cause lesions when intercurrent disease causes lowering of the animal's resistance.

The disease in reindeer associated with a virus closely related to the pseudocowpox virus is characterized clinically by erosions, papules, pustules and ulcers in the oral cavity.<sup>2</sup> Outbreaks have occurred in Finland, particularly during the winter, and case fatality rate can be up to 25%.

Histological examination reveals a characteristic ballooning degeneration and the presence of cytoplasmic inclusions in affected cells. The infection can be transmitted by the inoculation of scrapings from lesions into the oral mucosa of susceptible calves and by submucosal inoculation of undiluted tissue culture virus. Diagnosis of the presence of the virus can be made by electron microscopy of the saliva. It can also be grown in cell culture and a virus neutralization test is available for positive identification. Indirect immunofluorescence can be used on cattle sera to distinguish antigenic differences between bovine papular stomatitis, milker's nodules and contagious ecthyma.

A polymerase chain reaction (PCR) method has been developed for the specific detection of parapoxvirus infections in both domestic and wild animals.<sup>6</sup> The PCR specific primers specific to each virus have not yet been designed.

The disease, known as 'rat-tail syndrome' in young cattle in feedlots, is probably a manifestation of sarcocytosis. However, there is also a high prevalence

of bovine papular stomatitis lesions and virus in these cattle and it is possible that it may contribute to the development of the disease. A concurrent infection of bovine papular stomatitis and bovine virus diarrhoea has been described in a calf.

## REVIEW LITERATURE

Buttner M, Rziha HJ. Parapoxviruses: from the lesion to viral genome. *J Vet Med B* 2002; 49:7–16.

## REFERENCES

1. Delhorn G et al. *J Virol* 2004; 78:168.
2. Tikkanen MK et al. *J Gen Virol* 2004; 85: 1413.
3. Buttner M, Rziha HJ. *J Vet Med B* 2002; 49:7.
4. Inoshima Y et al. *J Gen Virol* 2001; 82:1215.
5. Guo J et al. *Virus Res* 2003; 93:169.
6. Inoshima Y et al. *J Virol Meth* 2000; 84:201.

## TRANSMISSIBLE GASTROENTERITIS IN PIGS

### Synopsis

**Etiology** Transmissible gastroenteritis virus, member of the family *Coronaviridae*  
**Epidemiology** Highly contagious disease of newborn piglets but may affect pigs of all ages in susceptible herd. High morbidity and high case-fatality rate in piglets under 10 d of age. Large economic losses. Epidemics of disease occur in susceptible herd. Transmission by oral and aerosol routes. Recrudescence of infection and endemic disease commonly follows epidemics. Infection of pregnant sows results in protection of piglets by secretory 1gA in milk. Porcine respiratory coronavirus mutant of transmissible gastroenteritis (TGE) virus has reduced incidence of TGE  
**Signs** Epidemic disease: Acute diarrhea, vomiting, dehydration and death in piglets under 10 d of age. Less severe diarrhea in older pigs of all ages

Endemic disease: diarrhea in young pigs 6 d of age and older, including weaned pigs.

**Clinical pathology** Detection of virus in tissues. Serology

**Lesions** Fluid-filled intestines. Villous atrophy

**Diagnostic confirmation** Detection of virus in mucosal scrapings of intestine

### Differential diagnosis list

- Enteric colibacillosis
- Coccidiosis
- *Clostridium perfringens* type C
- Rotavirus enteritis
- Porcine epidemic diarrhea
- Vomiting and wasting disease
- Diarrhea of adult sows, gilts and boars

**Treatment** Supportive therapy. Fluids and electrolytes. No specific treatment

**Control** Isolation of sows due to farrow.

Planned exposure to virus. Biosecurity and acquisition of virus-free replacement stock. All-in all-out management system. Vaccines

## ETIOLOGY

The disease is associated with the transmissible gastroenteritis (TGE) virus, a member of the *Coronaviridae* family<sup>1</sup> belonging to

the Order Nidovirales. The nucleotide sequences from 20 TGE virus isolates obtained from eight countries between 1946 and 1996 have been compared.<sup>2</sup> The virion is enveloped, large-single stranded RNA genome with positive polarity. There are three major structural polypeptides—200 Kda spike protein (S protein), 30 Kda membrane protein (M) and a minor 10 Kda protein (E).<sup>3</sup> These are produced by ORFs 2, 5 and 6. The function of ORF products from 3a and 3b are not known but they have been postulated as an important determinant for virulence.<sup>4</sup>

## EPIDEMIOLOGY

### Occurrence and prevalence of infection

The disease occurs in pig-producing areas of North America, Europe and many parts of Asia, principally in the northern hemisphere. During the past three decades, TGE has changed from a sporadic disease as it historically occurred in the mid-western United States to an endemic disease in most countries of the northern hemisphere. In densely swine-populated areas such as the midwestern United States, the disease is one of the major causes of morbidity and mortality in young pigs.<sup>5</sup> The disease has not been diagnosed in Australia and New Zealand.<sup>6</sup> In 1990, the prevalence of infection in the United Kingdom was low, at 0.6% of sows sampled as being seropositive compared to 3% in 1984.<sup>2</sup> No major epidemics have occurred since 1981. In 1984, a seroconversion to the TGE virus occurred in a closed herd in the absence of any clinical disease. The TGE virus was not isolated and it is possible the seroconversion was due to emergence of the porcine respiratory coronavirus (PRCV) throughout Europe and the United Kingdom beginning in 1986.<sup>2</sup> The PRCV is a deletion mutant of the TGE virus and its high rate of prevalence has markedly reduced the number of TGE outbreaks in European swine herds. The TGE virus probably co-exists in these herds together with the PRCV. In 1999, a single case was diagnosed in East Yorkshire as a one-off.<sup>7</sup> Other isolated outbreaks in herds which were seropositive for PRCV were also reported.<sup>8</sup> An outbreak of TGE occurred in the UK in 1996 in which the virus was a variant with an intact spike gene but with a large deletion in the ORF3a which may not be necessary for enteric virulence.<sup>9</sup>

The prevalence of infection of the TGE virus based on serological surveys of swine herds varies with the size of the herd, the distance between herds and the purchase of breeding stock from non-specific pathogen-free herds.<sup>10</sup> Depending on the geographical location, up to 50%

of herds may be seronegative, and in 45% of herds the prevalence of infection in sows will vary from 10–80%.<sup>10</sup> In the United States in 1990, a national survey of swine herds found that 36% of herds were positive for the TGE virus and 24% of the producers' herds were vaccinated for the virus.<sup>11</sup> By 1997, up to 100% of survey herds and 91% of the sera were positive for both the TGE virus and the PRCV, which indicates a marked increase probably due to subclinical infections.

The disease is highly contagious and affects piglets primarily under 10 days to 2 weeks of age. Pigs over 5 weeks of age often have milder clinical signs. **Epidemic TGE** occurs when the virus is first introduced into a susceptible herd and is usually of short duration and no longer clinically evident after herd immunity develops. Epidemics of the disease occur most commonly during the winter months. **Endemic TGE** occurs when the virus persists in a partially immune herd into which susceptible swine are introduced or if the epidemic form is not well managed. Endemic TGE is a common sequel to a primary epidemic in herds of more than 300 sows in which diarrhea occurs in piglets from 6 days of age to about 2 to 3 weeks after weaning.<sup>11</sup> Recurrence of clinical TGE often occurs in endemically infected herds about 9 months after the first outbreak as the piglets of susceptible sows are exposed to the virus. Recurrence has been associated with:

- Breeding herd sizes of over 100 sows
- Presence of finishing pigs in large herds
- Introduction of purchased gilts.

### Morbidity and case fatality

Typically, an epidemic in a herd is explosive and dramatic. There is rapid spread and high morbidity of pigs of all ages within 2–3 days but major clinical disease is restricted to pigs prior to weaning and to lactating sows. Case-fatality rates may approach 100% in pigs under 10–14 days of age but are much lower with increasing age, and mortality is low in postweaned and adult pigs. The epidemic commonly terminates in 3–5 weeks with the loss of young susceptible pigs and the development of herd immunity and, generally, the disease does not recur again for a 3–6-year period.

### Risk factors

Animal risk factors

**Level of herd immunity.** Epidemics of clinical disease occur following the introduction of the virus into a **susceptible herd with no previous exposure** to the virus. All age groups will become infected and most pigs will be affected clinically to variable degrees. Nursing

piglets under 2–3 weeks of age are most susceptible to clinical disease and experience the highest case-fatality rate. Clinical disease disappears when the herd becomes immune. Endemic TGE develops when the virus and clinical disease persists within partially immune herds, caused by continual or periodic introduction of susceptible pigs. In endemic situations, diarrhea is generally observed in pigs from the age of about 6 days until about 14 days after weaning. Overall pig mortality is lower and generally occurs in recrudescence episodes. After weaning, piglets no longer have the protection provided by TGE-specific secretory IgA antibody in milk and are susceptible to infection and clinical disease if the infection rate in the weanlings is high. Thus weanling pigs serve as a major reservoir of infection.

**Sow parity** may be a risk factor. Parity-1 sows with no previous exposure to the virus may be a risk factor on some farms.<sup>10</sup> On other farms, parity-3 sows were at increased risk for unknown reasons. A single boar may be a high-risk animal on some farms.

**Herd size.** There is a higher likelihood that sows will be seropositive if the herd size exceeds 500 sows and if more than 25 replacement breeding animals are purchased from non-specific pathogen-free herds.<sup>10</sup> A mathematical model of detection and dynamics of disease in Australia indicates that the disease is likely to establish in breeding and finishing swine herds of average size.<sup>6</sup> The threshold number of susceptible pigs for establishment of the infection is 90–160. Swine herds most at risk are those with<sup>1</sup> large numbers of susceptible pigs,<sup>5</sup> continuous breeding of susceptible pigs,<sup>6</sup> high numbers of purchased pigs, and<sup>2</sup> close contact between feral pigs and susceptible domestic pigs.<sup>6</sup> The risk is highest in herds which do not make a rapid diagnosis when there is little or no veterinary involvement in health and disease management. In small farms (containing 15 to 40 sows) outbreaks of TGF are characterized by rapid spread of infection to most animals of all ages but a duration of only 3–5 weeks.<sup>12</sup>

Environmental and management risk factors

Climatic factors appear to be important in the occurrence and establishment of the disease. Climate does not yet have significance in the tropics or southern hemisphere and there is evidence that its spread is limited in hot climates. In areas where the disease is endemic, it has a distinct seasonal occurrence with the majority of outbreaks occurring from midwinter to spring, and cyclic occurrence is recorded.<sup>13</sup>



Virus is labile above 21°C and is very sensitive to sunlight. It is also killed by most disinfectants. The disease tends to occur in area outbreaks in which herds in close proximity are affected within several weeks. Within swine barns, the location of the farrowing crates may be a risk factor if the cold air inlets are directly above the crates.

The use of a continuous flow system of production in a herd is a major risk factor. The constant overlap of farrowing sows in farrowing rooms, overlap of weaned pigs in nursery rooms, and a continuous flow of finishing pigs without adequate cleaning and disinfection between each group of pigs are major risk factors, and perpetuate persistent infection and the endemic form of the disease. An all-in all-out system for each group of pigs reduces the risk of infection between pigs.

**Lack of adequate biosecurity is a major management risk factor.** Infection can be introduced into herds by the importation of infected breeding stock, contaminated trucks and other vehicles, or on workers' clothing and boots.

#### Pathogen risk factors

The virus does not persist in infected premises for more than a few weeks and is readily destroyed by standard solutions of phenol and formalin, by boiling and by drying but not by freezing. The virus is photosensitive, which may account for the more frequent occurrence of the disease during the winter and spring months. The virus survives freezing, and infected pork scraps or offal may provide a source of infection either directly through feeding of uncooked garbage or possibly indirectly via dogs. Purposeful infection by the feeding of frozen infected piglet intestine to sows to induce immunity may also be a significant source of continued infection of a herd or area.

The genome and the genetic basis for the pathogenesis of the virus have been described.<sup>9</sup> Antigenic differences between TGE viruses have been examined and the nucleotide sequences of isolates from various countries have been compared.<sup>14</sup>

The TGE virus is not antigenically related to the two other porcine coronaviruses, hemagglutinating encephalomyelitis virus and porcine epidemic diarrhea virus but it is related to PRCV.

Porcine respiratory coronaviruses (PRCV) The PRCV is a deletion mutant of the TGE virus with altered tissue tropism to the respiratory tract, first recognized in Belgium in 1984. It has a partially deleted receptor binding protein. The virus closely resembles the TGE virus antigenically and pigs infected with the PRCV develop a serological response which cannot be distinguished by virus-neutralization tests

from the response of pigs infected with the TGE virus.<sup>2</sup> In other words it provides cross protection.<sup>15</sup> Despite the antigenic relation of PRCV and the TGE virus, they can be differentiated with monoclonal antibodies.<sup>16</sup> All PRCV strains have around 600–700 nt deletions within the amino-terminal S gene resulting in the loss of hemagglutination activity<sup>17</sup> and two antigenic sites.<sup>18</sup> European PRCVs have an identical deletion of 672 nt at the same position, whereas US strains have 621–681 nt deletion located at different positions which suggests that they arose separately. Natural infection of the sow with the PRCV induces natural antibodies which neutralize classic enteric transmissible gastroenteritis. The virus has spread throughout Europe<sup>19</sup> and has been identified in the United States<sup>20</sup> and Canada.<sup>16</sup> Spread of the virus has been explained in part by airborne transmission and infection shows a seasonal pattern, affecting farms during winter and spring. Seroprevalence studies in Belgium indicate that 95% of sows are PRCV positive.<sup>21</sup> The infection is widespread in swine herds in Spain<sup>22</sup>. The risk factors associated with seropositivity in Danish swine herds include: (a) increasing herd size; (b) certain geographical locations; (c) presence of a slurry system with slatted floors; and (d) purchase of pigs.<sup>19</sup> The serological status of neighboring herds was also risk related and the closeness of a seropositive herd was associated with an increased risk of a herd becoming serologically positive.

The PRCV replicates in the respiratory tract of pigs but to a very limited extent in the intestines. Its pathogenicity is controversial. Some studies indicate that the virus causes only subclinical respiratory infections while others have linked the virus with field outbreaks of respiratory disease. Experimentally, inoculation of the virus intratracheally into 8-week-old piglets results in clinical respiratory disease and bronchointerstitial pneumonia, and the virus can be recovered from the respiratory tract.<sup>23</sup> Some isolates of the virus produce interstitial pneumonia in neonatal piglets with no recognizable clinical respiratory disease.<sup>24</sup>

#### Methods of transmission

The exact mode of transmission of the TGE virus is uncertain. Virus shedding in the feces of infected pigs usually ends at or within a few weeks of recovery, although recovered pigs may harbor the virus in pulmonary or intestinal tissue for periods of more than 100 days. The shedding period is supposed to be 14 days. After weaning, the pig is no longer protected by specific secretory IgA antibody of the sow's milk and is highly susceptible to infection if the rate of infection is high

in the weaning population. The weaning pig is a major reservoir of infection for continuous infection in the herd. Feeder pigs with no clinical signs can be an important reservoir of the virus. The virus has also been isolated from pharyngeal swabs taken from farm-raised sows sent to slaughter.

**Epidemics commonly follow the introduction of pigs into a herd and the carrier pig is a major source of infection.** Frequently the disease first appears in older pigs in the herd and then subsequently spreads to newborn pigs and sows in the farrowing area. **Spread is much more rapid in a continuous-flow system of production compared to an all-in all-out system, whereby groups of pigs of the same age or production stage are handled as groups and their housing facilities are cleaned and disinfected before and after being occupied.**

Visitors, their boots, transport vehicles, equipment, and starlings have also been incriminated in the transfer of infection to new locations. Starlings may act as vectors to spread to adjacent farms. The virus can also multiply in house flies (*Musca domestica* Linnaeus) and they may be a vector. Feral pigs are not a significant reservoir for the TGE virus in the southern United States, but are capable of becoming infected and developing virus-neutralizing antibodies against the virus.<sup>25</sup> Subpopulations of infected pigs may exist within the herd and although shedding is normally for 14 days it is possible for animals to be infected for 100 days.

Once infection has gained access to a herd, transmission occurs by both oral and respiratory routes. The speed of spread without direct contact indicates that the virus can be spread by aerosol. Respiratory transmission appears significant in adults and replication in the respiratory tract is followed by excretion in nasal secretions and milk within 1 day of infection, and also in feces. Excretion in milk results in rapid transmission to suckling piglets which in turn may excrete large quantities of the virus within 2 days of infection.

#### Immune mechanisms

Immunity to clinical disease in newborn piglets is dependent on the level of TGE-specific secretory IgA antibody in the colostrum of the sow known as '**lactogenic immunity**'. When pregnant sows are infected orally with the virulent TGE virus, specific IgA precursor cells are sensitized in the intestine. These sensitized cells migrate to the mammary glands and differentiate into plasma cells that secrete IgA class, TGE virus antibody in colostrum and milk. This immune mechanism to induce protective antibody for suckling pigs is termed the 'gut-mammary



gland link' or the 'gut-associated lymphoid tissue' (GALT) system. Following natural infection with TGE during pregnancy, the recovered sow or gilt is capable of protecting her litter against the disease. After farrowing, the colostrum contains antibodies of the IgG, IgM and IgA isotypes derived from serum. After the third day, milk is produced and the only antibody it contains is the IgA antibody, which is synthesized at the mammary gland. The IgA antibodies of immune sows are the most critical in protection of mucosal surfaces such as the gastrointestinal tract, and this immunoglobulin is the most abundant isotype in porcine milk. These IgA antibodies are not induced after the parenteral administration of viral antigens, which explains the relative ineffectiveness of parenteral vaccines. Serum antibody induced by vaccination of the pregnant sow does not provide protection of piglets through colostrum or milk.

Secretory IgA is the predominant antibody class in milk and is responsible for lactogenic protection of pigs and active protection of the intestine. It is stimulated by oral inoculation with non-attenuated, but not attenuated TGE virus. Although high concentrations of IgA and IgG originating from the serum are present in colostrum, IgG does not persist in the milk, whereas IgA does persist because of local mammary secretion. After the first week of lactation, secretory IgA constitutes 50–60% of the total immunoglobulin concentration in swine milk and IgG makes up 20–30%.

Suckling pigs are protected from infection by continued ingestion of antibody of the IgA class secreted in milk. The level of serum IgA antibody as an indicator of immunity to transmissible gastroenteritis can be measured using the indirect immunoperoxidase antibody test. Young pigs, 6 weeks of age, which are exposed to experimental infection with the virus, develop both a humoral and cellular immunity which reach peaks at 21 and 28 days, respectively.

In recent years, less typical forms of the disease have been observed. With continuous farrowing and the continual introduction of susceptible pigs into an infective environment, outbreaks may be considerably prolonged, and this or recrudescence is more likely than when pregnant sows are kept in relative isolation on pasture or elsewhere. Atypical endemic forms of the disease with a low morbidity and mortality and frequently with the onset of clinical disease delayed until piglets are 2–4 weeks of age have been observed and may go unrecognized because of the atypical clinical findings. They are more likely to occur in large continuous farrowing units and may be associated with partial herd

immunity and low virulence virus. Some sows do not develop a significant immunity following a single infection and in large herds there may be a sufficient number of these to allow the disease to perpetuate in a low-incidence, endemic form.

A recrudescence of the disease may occur after a period of several months and is thought to be due to inadequate exposure and immunity of some pigs, particularly dry stock during the initial outbreak followed by reinfection from a carrier pig. Recrudescence of clinical disease is usually of much shorter duration than the primary outbreak and commonly lasts only 6–10 days. The periods of recrudescence are commonly precipitated by the simultaneous farrowing of several susceptible gilts in the same farrowing room. Of greater long-term concern is that about 50% of some large herds continue to experience clinical recrudescences for almost 2 years or more. The endemic form of the disease appears to be correlated with herds of more than 100 sows and in herds where finishing pigs were kept. In large herds the virus may spread more slowly and replacement gilts entering the herd may take several months to become infected and to seroconvert. In large herds, the rapid turnover of breeding stock and continuous farrowing and early weaning also contribute to perpetuation of an endemic infection, thus endemic transmissible gastroenteritis can maintain itself by the slow and incomplete spread of the virus among adult pigs, particularly herd replacements. Joint infection with PRRS and TGE did not appear to enhance the clinical effects, shedding or persistence of either virus.<sup>26</sup>

#### Economic losses

A herd epidemic of TGE causes economic losses through:

- Death of pigs
- Increased downtime of the swine enterprise
- Increased labor
- Disturbance of the breeding program
- Subsequent reduced growth of young pigs destined for slaughter
- Curtailed performance of older pigs.

The economic losses can be very large. Simulation of the economic losses due to an outbreak of disease in Australia where the disease is exotic estimated a reduction in net revenue of 70% in the 6 months after a moderate outbreak (50% mortality of piglets under 1 week of age), and 100% for a severe outbreak (95% mortality of piglets under 1 week of age).<sup>27</sup> An analysis of the economic losses due to the disease in swine farms in some areas in the United States over a 2-year period estimated the average loss to be between 13%

and 18% of the average return earned above total production costs. It has been assumed that the growth of surviving pigs was depressed by 10% and their feed conversion by 18%, but pigs surviving or born shortly after an epidemic of TGE are profitable to raise.

#### PATHOGENESIS

The S protein of the viral membrane of TGEV has four major antigenic sites and is the major inducer of neutralizing antibodies. The protein mediates the binding of the virus to the cell surface and the subsequent fusion of the viral and cellular membranes.<sup>3</sup> High titers of serum IgG and virus neutralizing antibody to TGEV probably reflect the amount of S spike protein the pig has received.<sup>28</sup> Two different ligands have been shown to interact with the S protein and binding to the porcine aminopeptidase N, the cellular receptor for TGEV is essential for infection of the cells.<sup>29</sup> The TGEV is also able to recognize sialic acid residues and attach to sialylated macromolecules.<sup>30</sup> A second binding site on the N-terminal division of the S protein allows TGEV to interact with terminal sialic acid residues on glycoproteins or glycolipids and to agglutinate RBCs. TGEV also recognizes a porcine intestinal brush border protein called MEP (mucin type glycoprotein and TGEV binds to this mucin produced by goblet cells. A mutant virus that has lost its sialic acid binding capability is not pathogenic as it is unable to attach to goblet cells.<sup>31–34</sup> Sialic acid binding activity is a pathogenicity factor for TGEV and it is important to note that the sialic acid binding sites for TGEV and *E. coli* are different.

The virus infects the upper respiratory tract and the intestines but the major clinical effects are due to intestinal infection.<sup>35</sup> Following oral challenge of susceptible piglets, the incubation period may be as short as 24 h. The virus infects mature differentiated columnar epithelial cells of the intestinal villi but not the undifferentiated cells of the crypts.<sup>36</sup> Replication occurs within 4–5 h with sloughing of the infected cells and release of virus, and after several replication cycles there is a marked reduction in villous size with villous atrophy. The loss of epithelial cells results in increased migration of undifferentiated cells from the crypts to line the shortened villi. With virulent virus, epithelial cells at all levels of the small intestine are infected with major lesions occurring at the proximal jejunum and to a lesser extent the ileum. The lesser virulence of attenuated strains of virus may be associated with their inability to infect and produce lesions in the villi of the more cranial portions of the jejunum. Gnotobiotic pigs inoculated orally with a TGE

vaccine will develop lesions similar to the naturally occurring disease.<sup>37</sup>

Diarrhea results from a combination of malabsorption and osmotic effects subsequent to the loss of intestinal surface area and disaccharidase activity, and impaired lumen-to-extracellular fluid flux of sodium consequent on the occurrence of undifferentiated cells lining the stunted villi. The virus invades the villus, but not the crypt epithelium of the small intestine within hours after experimental administration. The infected villus cells are quickly shed and replaced by relatively undifferentiated enterocytes. As infected cells are shed, the epithelium proliferates and migration of cells from the crypts accelerates. There are marked abnormalities in ion transport function in the jejunum and ileum at the height of the diarrhea. There is failure of the intestine to actively transport sodium and chloride and there is a defect of the glucose-mediated sodium ion transport. Macromolecular hyperpermeability of the small intestine also occurs but its significance is uncertain.<sup>38</sup> Experimentally induced infection of 3-week-old pigs with the virus results in villous atrophy and crypt hyperplasia, and a marked decrease in the secretory response of the villous epithelium to *Escherichia coli* enterotoxins. The disease is more severe in gnotobiotic pigs that are infected with *E. coli* in addition to the TGE virus, suggesting that bacterial factors also influence the severity of the diarrhea.

In the experimental disease in 2-day-old pigs, vomiting and diarrhea occur 12–24 h after oral inoculation of the virus and affected piglets are moribund 1 or 2 days later. Before becoming moribund most piglets become lethargic and comatose. In addition to dehydration and metabolic acidosis, there is a severe hypoglycemia due to a combination of inadequate glucose metabolism inherent to neonatal piglets and the acute maldigestion and malabsorption from the diffuse and severe villous atrophy. The high mortality may be due to a combination of dehydration, acidosis and severe hypoglycemia.

The age-dependent resistance to TGE can be explained in part by a decreased susceptibility of the epithelial cells of older pigs to infection and by an increased proliferative capacity of crypt cells with much more rapid regeneration of atrophic villi in pigs over 2 weeks of age. It may be that the virus has developed strategies to evade apoptosis in intestinal enterocytes by producing huge amounts of the virus.<sup>39,40</sup>

A recent experiment comparing a Korean strain with two US strains showed that the progression of the Korean virus was much slower, i.e. much less virulent, possibly because there was only replication in the ileum and jejunum whereas

the US strains also replicated in the duodenum.<sup>41</sup> The more virulent strains attack a wider area of enterocytes. Most only attack the villous rather than the crypt enterocytes. An outbreak of reduced virulence TGE was associated with the presence on the farm of three strains of PRCV which had variable sequence changes in ORF3/3a/3b.<sup>42</sup>

### CLINICAL FINDINGS

In a primary or epidemic outbreak the clinical findings of typical acute TGE are characteristic. The appearance of the disease is not significantly altered by a concurrent infection with PRRS.<sup>43</sup>

#### Piglets

After an incubation period of 24–48 h there is a sudden onset of vomiting and diarrhea. The diarrhea is profuse and frequent; the feces are watery and usually yellow-green in color. The feces may contain clots of white undigested milk and have an offensive odor. The vomitus is yellow, foamy and slimy. There may be a transitory fever but in most cases the temperature is normal. Depression and dehydration are pronounced, the hair coat is ruffled, and weakness and emaciation progress to death on days 2–5. Some piglets may continue to suck to within a few hours of death; those which survive are severely emaciated and gain weight slowly. The illness may commence as soon as 24 h after birth. It is not uncommon on an individual farm for the disease to become less severe and to spread more slowly with the passage of time. In the outbreak described by Pemberton there was an 80% mortality across two weeks of piglets<sup>7</sup> with 10% of 4 to 6-week-old freshly weaned pigs.

#### Older pigs

In older pigs there may be signs similar to those which occur in piglets but many animals become infected without clinical abnormalities. Diarrhea may occur first in the dry sows.<sup>44</sup> In older pigs, recovery is much more likely to occur, the illness lasting for up to 10 days. Lactating sows may or may not be affected clinically. Fever and inappetence occur, with or without diarrhea, and agalactia is a common complication in sows. In endemically affected herds with continuous farrowing and partial sow immunity, the disease is milder with diarrhea affecting piglets about 6 d of age or older and diarrhea in weaned pigs. Brief periods of clinical disease occur in some parts of the herd, mortality is low, and affected pigs subsequently grow poorly.

### CLINICAL PATHOLOGY

#### Serum biochemistry

A severe dehydration with metabolic acidosis and a marked hypoglycemia are common.

### Detection of virus

The virus can be detected in the mucosal scrapings and feces using an ELISA, immune electron microscopy, fluorescent antibody staining or by the immunoperoxidase test.<sup>5</sup> A capture-enzyme immunoassay has also been developed.<sup>45</sup> A reversed passive hemagglutination test for detection of the virus in feces is also available. A solid-phase immune electron microscopic technique for detection of the virus in feces is also useful for diagnosis in living animals. The PRCV can be isolated by tissue culture.<sup>24</sup>

#### DNA probe

DNA probes can differentiate the porcine respiratory coronavirus from the TGE virus.<sup>46</sup> PCRs were described quite early on for identifying TGE.<sup>47</sup>

In situ hybridization has been described<sup>48</sup> and a nested RT-PCR was developed<sup>49</sup> which was very sensitive. A multiplex RT-PCR for differentiating PED from TGEv in clinical samples has been described.<sup>50</sup> It has also proved possible to use formalin fixed tissue for multiplex PCR, nested-PCR and ISH with 100% conformity.<sup>51</sup>

#### Serology

Several serological tests can detect and measure antibody to the virus in live animals. The serum neutralization test is sensitive and reliable, but is time-consuming and requires facilities for cell culture techniques. Neutralizing antibodies appear in the serum 7–8 days after infection and persist for at least 18 months. An ELISA is more sensitive than the virus neutralization test and a competitive ELISA differentiates between TGE virus and PRCV.<sup>35</sup> A blocking ELISA to differentiate TGE and PRCV has also been described.<sup>52</sup>

### NECROPSY FINDINGS

The lesions are confined to the intestine and stomach although in many field outbreaks and in the experimental disease the changes may be minor. The intestinal wall is thin and translucent and the intestine is distended with fluid ingesta. Despite the presence of milk in the intestine there is little evidence of fat absorption in the draining lymphatics. The important histopathological change is atrophy of villi with failure of epithelial cell differentiation in the small intestine. The atrophy is evident 24 h after infection and regeneration occurs 5–7 days later. The marked reduction in the size of intestinal villi may even be detected at low magnification on a stereomicroscope. In the stomach there may be engorgement of vessels and necrosis of the epithelium deep in mucosal crypts. No inclusion bodies are detectable. When secondary pathogens contribute to the disease there may be inflammatory lesions in

the intestines. In chronic cases a thickening of the intestinal wall identical with that seen in terminal (regional) ileitis has been described.

The disease, as it occurs in Europe, is characterized by more severe mucosal lesions, often including fibrin exudation. There is also degeneration of the heart muscle and, in some cases, of the skeletal muscle.

A simple test for the presence of intestinal lactase in intestinal washings may assist in the laboratory diagnosis. Examination of frozen sections of jejunum from acutely ill piglets by the fluorescent antibody technique is a rapid and effective method for the detection of virus in tissues. The intestine may be segmentally affected so multiple areas must be sampled. Viral antigen is detectable for only 24–36 h utilizing most fluorescent antibody (FA) conjugates. This makes selection of acute cases critical. Electron microscopy is often utilized to identify the presence of coronavirus but this method is not specific for the TGE virus. PCR methods for TGE virus detection are being developed and immunohistochemical techniques are available for use in formalin-fixed tissues.<sup>53,54</sup>

The use of apoptotic markers shows that most of the cells are undergoing apoptosis but are not infected with TGEV they are what is called bystander cells.<sup>55</sup> It has been previously suggested that apoptosis does not occur in the enterocytes of piglets infected with TGEV.<sup>56</sup> An accumulation of interferon alpha producing cells occurs in the GALT of TGEV infected piglets.<sup>57</sup> It has been suggested that these are the mucosal counterparts of the dendritic cells recently shown to produce IFN alpha after in vitro viral induction.<sup>57</sup> The TGEV challenge of pigs produces changes in CD4<sup>+</sup>/CD8<sup>+</sup> cells which rise, natural killer cells and cytotoxic T-cells which also rise together with an increased expression of IL-2 receptors and a decrease in null cell phenotypes.<sup>58</sup>

#### Samples for confirmation of diagnosis

- **Histology** – several segments of jejunum and ileum, stomach (LM, IHC)
- **Virology** – several segments of jejunum and ileum (FAT), feces (EM).

#### DIFFERENTIAL DIAGNOSIS

The epidemiological and clinical characteristics of TGE should make possible a presumptive diagnosis, but confirmation must depend upon the finding of compatible histological lesions, the detection of antigen, transmission experiments and evidence of

seroconversion. It is unusual to encounter outbreaks of diarrhea in piglets which appear to be typical of TGE, and either the virus can be demonstrated in the tissues by fluorescent antibody test (FAT) but serum antibodies cannot be detected in the breeding animals, or serum antibodies can be detected in the adults but the virus cannot be demonstrated in the tissues by either immunofluorescence or tissue culture.

Villous atrophy is not pathognomonic for the disease, since it occurs in 3-week-old piglets affected with diarrhea and steatorrhea, in rotavirus infections of piglets, and in some herds for undetermined causes immediately following weaning.

#### In piglets, TGE must be differentiated from the following:

- **Enteric colibacillosis** A common disease of piglets under 10 d of age with profuse diarrhea, no vomiting, dehydration and a good response to therapy if treated early
- ***Clostridium perfringens* type C** Enterotoxemia occurs in piglets under a few days of age and causes marked depression, diarrhea, dysentery, reddening of the anus and rapid death. Lesions at necropsy are characteristic
- **Coccidiosis** Affects newborn piglets 5–15 d of age, causing profuse diarrhea, depression, dehydration and unthriftiness. Affected piglets may continue to suck. There is a high morbidity, low mortality and oocysts in the feces
- **Rotavirus enteritis** Rotavirus causes diarrhea in suckling and weaned piglets with a high morbidity and low mortality. Most affected piglets recover in a few days and epidemics are commonly associated with continuous farrowing
- **Porcine epidemic diarrhea** A coronavirus-like virus causes diarrhea in pigs similar to TGE, except much less severe with less mortality. **Porcine epidemic diarrhea Type I** causes diarrhea only in pigs up to 4–5 weeks. **Porcine epidemic diarrhea Type II** causes diarrhea in pigs of all ages. The morbidity may reach 100% but mortality is low. The disease may start in the finishing pigs and spread rapidly to pregnant sows and their nursing piglets. The diarrhea may persist in the 6–10-week-old pigs and seronegative gilts introduced into the herd may become infected and develop a profuse diarrhea lasting a few days
- **Vomiting and wasting disease** Vomiting and wasting disease affects piglets under 10 d of age in epidemics similar to TGE. However, vomiting is characteristic, diarrhea is not a feature and laboratory differentiation is necessary.

**In adults (gilts, sows and boars,** TGE must be differentiated from the disease listed below.

Diarrhea in gilts, sows and boars may be due to:

- **Swine dysentery**
- **Salmonellosis**
- **Porcine proliferative enteritis.**

#### TREATMENT

There is no specific treatment. Because dehydration and metabolic acidosis are severe and hypoglycemia occurs, treatment with fluids and electrolytes containing glucose is indicated. Because there is loss of intestinal villi and the enzyme lactase, the ideal treatment would be to reduce the intake of milk for up to 5 days and administer a glucose–glycine–electrolyte solution orally every few hours to maintain hydration. However, removal of affected piglets from the sow is impractical and not recommended. Oral fluid therapy should improve the survival rate, affected piglets recovering in a few days following treatment. In experimentally induced TGE, removal of the milk diet and the use of an oral glucose–glycine–electrolyte solution plus a 5% dextrose solution given intraperitoneally at the rate of 25 mL/kg BW once daily decreased the severity of the diarrhea, dehydration and metabolic acidosis but did not prevent or improve significantly the renal failure and severe hypoglycemia. A newborn piglet weighing 1.25 kg has an energy expenditure of about 170 kcal/d (711 kJ) if maintained at 30°C (86°F); 30 mL of a 5% dextrose solution supplies 1.5 g of glucose for a total of about 5.6 kcal/d (the gross energy of glucose is 3.74 kcal/g). Because the volume of 5% dextrose solution injected daily into piglets should not exceed 8% of their body weight, it is unlikely that the hypoglycemia can be prevented or treated.

The use of natural human interferon given orally to piglets 1–12 days of age affected with the disease increased survival rates compared to placebo-treated piglets.<sup>59</sup>

#### CONTROL

Control of the disease is complex because it is so highly contagious and because of the dynamics of infection between the different age groups of animals within large swine herds. While there is considerable information available about the biology of the virus and the nature of the disease, there is little documented reliable information about the control in a swine-breeding herd. Most of the recommendations for control are empirical and based on clinical experience without any controlled field trials to evaluate different control strategies. What follows are guidelines for the control of TGE based on some principles which are based on the some characteristics of the virus and the disease:

- The disease is highly contagious and spreads rapidly between groups of pigs in a herd. Most epidemics last 6 weeks
- Newborn piglets are highly susceptible to disease if the sow's

milk does not contain specific TGE secretory IgA antibody

- Infection of pregnant sows with the virulent virus results in protective immunity for their piglets. Recovered sows are immune, usually do not harbor or shed the virus, and need not necessarily be culled
- Weaned pigs are a major reservoir of infection in farrow-finish herds
- Vaccination of pregnant sows with any of the available vaccines is not as effective as natural infection in providing protection for piglets
- The disease is controlled either by elimination of the virus from the herd or by controlled natural immunization and use of the all-in all-out system of production.

#### Control during and after an outbreak

The highly contagious nature of the disease makes the immediate control of an outbreak in a herd virtually impossible. Epidemics usually last about 6 weeks, during which time many piglets die and the herd eventually becomes immune. Successful control depends on planning and implementation of certain strategies which must be understood and implemented by the producer, and monitored by the veterinarian. Failure of the producer to fully understand or accept the diagnosis and apply the principles of control will result in failure to control the disease and the persistence of an endemic form of the disease in the herd.<sup>11</sup> Several strategies are used to control the infection pressure and to enhance immunity where possible.

**Isolation of sows due to farrow.** To avoid further new infections of newborn piglets, sows due to farrow within 2–3 weeks should be isolated under strict hygienic conditions. However, this is usually impractical in most intensive swine production enterprises where isolation facilities are usually not available. The disease is so highly contagious that isolation is ineffective. There should be no movement of pigs between the farrowing or nursery rooms. An all-in all-out movement of pigs, especially in the farrowing rooms and nurseries, with complete cleaning and disinfection between groups is established (see all-in all-out practices discussed later).

**Discontinuation of selling and purchasing breeding stock.** Once a diagnosis of TGE has been confirmed in a breeding herd which sells breeding stock, all sales should be discontinued. Likewise, all purchases of breeding stock from other herds should be discontinued for a few months until the epidemic has subsided and future production plans of the herd, including disease control, are reviewed.

**Partial depopulation and culling.** If possible and feasible, all weaned pigs ready for finishing units should be moved off the farm to contract finishing units. This allows a general clean up of facilities, a break in the production cycle and an intensive all-in all-out system. All cull pigs should be destroyed to prevent a reservoir of pigs actively shedding the virus.

**Planned exposure to virulent virus.** To minimize the duration and severity of the outbreak, all pregnant sows due to farrow more than 3–4 weeks ahead should be given an inoculum of virulent TGE virus obtained from virus-infected intestines, ideally from piglets in which the disease began within the last 12–24 h. The piglets should be submitted for necropsy and TGE confirmed by a diagnostic laboratory. It cannot be assumed that all piglets which die in an epidemic of TGE will be infected with the virus. The intestines of the confirmed cases should be homogenized in special media, centrifuged and supernatants poured into capsules and frozen for storage. The contents of the capsules are thawed and poured onto the feed of the sows.<sup>60</sup> The inoculum is given daily for 3 days. Preparation and use of the inoculum insures adequate uniform inoculation of sows, compared to earlier recommendations to feed feces and intestines of piglets which died of the disease to the pigs. More inoculum can be prepared by inoculating weaned piglets in isolation and collecting their small intestines 1–2 h after onset of diarrhea, which is usually 16–21 h after inoculation. The boars are also fed the inoculum. An alternative to the inoculum is to mix the intestines from two affected piglets in 25 L water and feed 50 mL of the solution daily for 3 days.<sup>61</sup>

If there is sufficient time for immunity to develop, the piglets born 3–4 weeks later will be protected through the colostrum and milk which will contain the TGE virus-specific IgA antibodies. Piglets sucking such sows are resistant to infection while sucking, but become fully susceptible if transferred to a non-immune sow. Natural infection by mouth produces a high level of secretory antibody particularly IgA in the colostrum and milk whereas vaccination produces a good IgG response but a much lower IgA response. The newer recombinant vaccines have also been shown to be immunogenic but are still not able to produce lactogenic immunity.

An alternative to the feeding of infectious material to pregnant gilts and sows is vaccination using the available vaccines. The gilts, sows, replacement stock, boars and newborn piglets are vaccinated according to the indications of the vaccines used. However, the efficacy of the vaccines is questionable.

**Biosecurity and acquisition of replacement breeding stock.** Following recovery from an epidemic in a herd, replacement breeding stock should be introduced as a group at one time and exposed to animals in the herd, monitored for clinical disease and tested. Serological testing using paired sera at 30 and 60 days after entry will indicate seroconversion to the virus. The usual precautions to prevent transmission of infection between units of the herd and between herds are necessary, including:

- Washing of boots
- Sanitation of trucks
- Use of separate clothing for each unit of large herds
- Showering of personnel moving between units.

Washing hands and changing into clean outerwear or showering or changing into clean outerwear after being in contact with TGEv infected pigs was sufficient to prevent mechanical transmission of TGEv to susceptible pigs.<sup>62</sup>

**All-in all-out management system.** The all-in all-out management and production system is based on the principle of handling, feeding and housing pigs in small subgroups as they move through the various stages of production. These subgroups either remain free of certain infectious agents, if absent, or all animals in the group become infected and immune to the infectious agents which are present in some pigs and transmitted to others in the subgroup but not to other subgroups. With this system, breeding gilts and sows are handled and bred as subgroups, kept in the gestation units as subgroups, farrowed as subgroups, and nurse their pigs as subgroups. The pigs are weaned as subgroups at the same time, the weaned pigs are placed in the nursery facilities as a subgroup at the same time and all of the pigs are moved out of the nursery to the finishing facilities at the same time. The pigs are handled in finishing units as subgroups and all pigs are marketed as a subgroup. At each stage of production the housing facilities should be cleaned and disinfected following removal of the pigs, and left vacant for a few days before a new subgroup of pigs is introduced into previously cleaned rooms. The system avoids the mixing of pigs back and forth between groups and ages, which is often done to maintain uniformity of size and age of pigs. During an epidemic, the use of a strict all-in all-out system in the farrowing and nursery units will aid in the control of clinical disease. About 2 months after the epidemic and the absence of clinical disease, sentinel seronegative pigs 2–4 months of age can be introduced to each part of the herd and

monitored serologically for evidence of viral activity.

**Complete depopulation and repopulation or establishment of new herd.** In some situations where the disease cannot be controlled, complete depopulation of the herd is the best option. This should be followed by repopulation with breeding stock derived from specific pathogen-free herds or minimal disease-free herds which are known to be free of the virus. Serological testing can be used to test the animals before they are moved into the facilities. The establishment of new swine herds now commonly depends on the acquisition of breeding stock from disease-free herds.

### TGE vaccines and vaccination

In many instances they do not provide a reliable complete protection for suckling pigs against a challenge exposure.<sup>63</sup> However priming piglets with PRCV was very beneficial in providing resistance to TGEV and also gave a much better maternal antibody response.<sup>64</sup>

#### Vaccination of pregnant sows.

Because of the effectiveness of acquired immunity following natural infection, vaccination of the pregnant sow would appear to be the method of choice for control of the disease. However, the available vaccines have not been efficacious enough to be a reliable control strategy. Circulating VN antibodies acquired actively or passively, provide insufficient protection against clinical disease and parenteral vaccines have been relatively ineffective. Protection against the disease requires the presence of secretory IgA antibody, either actively or passively acquired, in the intestine (**see immune mechanisms**).

**TGE vaccines.** Several live-attenuated and inactivated virus vaccines are available for use in pregnant sows and neonatal pigs. Vaccines for oral and intranasal administration were developed on the basis that vaccination by the oral or intranasal route would induce the production of secretory IgA antibody. However, these vaccines have not been efficacious.

The vaccination of pregnant sows with attenuated strains of the TGE virus by either the parenteral or oral routes does not provide sufficient lactogenic immunity to protect their piglets against the virulent TGE virus. Some litters sucking vaccinated sows may achieve partial protection in which the onset of diarrhea is delayed, the diarrhea is less severe, and the case-fatality rate is decreased. Villous atrophy is inhibited to varying degrees in pigs sucking immunized sows, depending in part on the antibody titer in the colostrum and milk.

The severity of the losses in a vaccinated herd after exposure to the virus will vary, depending on:

- Herd management
- Environmental conditions
- History of previous exposure
- Severity of viral exposure.

After natural infection or experimental oral infection of pregnant sows with a virulent strain of the TGE virus, lactogenic immunity is highly protective for piglets and neutralizing antibodies in milk are mainly associated with the IgA fraction. Vaccination of sows orally with a non-attenuated vaccine provides greater levels of lactogenic protection than does orally or parenterally administered attenuated virus vaccine.<sup>65</sup> In vaccinated sows, the levels of colostral antibody correlate with the percentage of survivability of their piglets when challenge exposed at 3–5 days, whereas the serum antibody to TGE does not. There is also a significant relationship between milk antibody and percentage survivability when pigs were challenge exposed at 5, but not at 3 days of age. There is a need to develop an attenuated virus strain which is completely avirulent for pigs, but which also replicates sufficiently in the small intestine of sows after oral administration and induces secretory IgA antibody. It appears that no strains of the virus have been identified which are sufficiently attenuated and safe for pigs while yet able to provide a sufficient immune stimulus in the intestine of the sow. The Nouzilly strain, which is a mutant of the TGE virus resistant to acidity and proteases of the digestive tracts of adult pigs, is being evaluated as a vaccine.<sup>66</sup>

**Vaccine schedule.** If vaccines are used, it is generally recommended that the two vaccinations, 14 days apart, be given during the last trimester of pregnancy. Vaccines are available for vaccination of neonatal piglets, and weaner and finishing pigs but there is insufficient published information available on the efficacy of the vaccines based on randomized clinical trials using controls under field conditions.

**Subunit TGE vaccine.** Experimentally, a recombinant TGE virus S glycoprotein subunit vaccine given subcutaneously or intramammarily to pregnant sows induced colostral and milk IgG, but not IgA antibodies to the virus.<sup>67</sup> Piglets born from vaccinated sows were challenged at 4–5 days of age with the virulent virus and the morbidity was 100% with a mortality ranging from 20–80%.<sup>67</sup> The same vaccine given subcutaneously to 11-day-old piglets induced virus-neutralizing antibodies. This is consistent with the well-known observation that secretory IgA antibody in the milk is necessary for protection in piglets. Compared to VN antibodies, antibodies of the secretory IgA class are more

effective at neutralizing the TGE virus because they are at higher titers in milk, more resistant to proteolytic enzymes, and bind to gastrointestinal enterocytes. Protective immunity to transmissible gastroenteritis correlates with milk whey secretory IgA antibody titer to the TGE virus when pigs are challenge exposed with the virulent virus at 3–5 days of age.

### Immunity to PRCV

There is considerable cross-protection between the TGE virus and the PRCV.<sup>68</sup> There is indirect evidence that a bronchial-associated lymphoid tissue (BALT)–mammary gland link similar to the gut-associated lymphoid tissue (GALT)–mammary gland link described for the TGE virus may exist in pregnant, multiple PRCV-exposed sows. In herds infected with the PRCV, multiple exposures of pregnant sows are associated with higher IgA and IgG antibody titers to TGE virus in milk and these titers contribute to protection against the TGE virus.<sup>68</sup> The immunization of pregnant gilts with the PRCV induces lactogenic immunity and partial protection of piglets from challenge with the TGE virus.<sup>69</sup> An overall survival rate of 70% was found for piglets nursing PRCV-infected gilts, compared to a 16% survival rate for piglets nursing control gilts. The highest degree of protection occurs in sows primed with the PRCV, then given a booster vaccination with the TGE virus 2 weeks later.<sup>70</sup> Infection of pigs with the PRCV primes the systemic and mucosal humoral immune system against the TGE virus, so that subsequent challenge with the TGE virus results in a secondary antibody response and in a decreased duration of excretion of virus.<sup>71</sup> Protective immunity to TGE virus infection can also be induced in piglets exposed to the PRCV at 2–6 days of age.<sup>72</sup>

### REFERENCES

1. Paton D, Lowings P. *Arch Virol* 1997; 142:1703.
2. Brown IH, Paton DJ. *Vet Rec* 1991; 128:500.
3. Schwegmann C et al. *Virus Res* 2001; 75:69.
4. Paul PS et al. *Adv Exp Med Biol* 1997; 412:317.
5. Saif LJ, Heckert RA. In: Saif LJ, Thiel KW. *Viral diarrheas of man and animals*. Boca Raton FL: CRC Press 1990; 190–204.
6. Hone J. *Epidemiol Infect* 1994; 113:187.
7. Pemberton PR. *Pig J* 1999; 44:132.
8. Pritchard GC. *Vet Rec* 1999; 144:616.
9. McCordrick A et al. *Arch Virol* 1999; 144:763.
10. Yanga ST et al. *Prev Vet Med* 1995; 24:213.
11. Carpenter J, Templeton C. *Swine Hlth Prod* 1996; 4:239.
12. Curbeg MJ et al. *Vet Rec* 1993; 132:238.
13. Siegel JD. *J Am Vet Med Assoc* 1991; 199:1579.
14. Jones T et al. *Vet Rec* 1997; 141:427.
15. Pensaert M, Reeth van K. *Proc Am Ass Swine Pract* 1998; 29:433.
16. Jabrane A et al. *Can Vet J* 1992; 33:727.
17. Krempf C et al. *J Virol* 1997; 71:3285.
18. Laude H. *Vet Res* 1993; 24:125.
19. Flori J et al. *Prev Vet Med* 1996; 25:51.

20. Wesley RD et al. *Can J Vet Res* 1997; 61:305.
21. Pensaert MB et al. *Vet Q* 1993; 8:257.
22. Lanza I et al. *Prev Vet Med* 1993; 17:263.
23. Abrane A et al. *Çap Vet J* 1994; 35:86.
24. Walbur PG et al. *J Vet Diag Invest* 1993; 5:184.
25. Woods RD et al. *J Wildl Dis* 1990; 26:420.
26. Mengeling WL et al. *J Swine Hlth Prod* 1998; 10:67.
27. Mullan BP et al. *Aust Vet J* 1994; 71:151.
28. Sestak K et al. *Vet Immunol Immunopathol* 1999; 70:203.
29. Sanchez CM. *J Virol* 1999; 73:7607.
30. Schultze B et al. *J Virol* 1996; 70:5634.
31. Krempl C et al. *J Gen Virol* 2000; 81:489.
32. Scwegmann-Wessels C et al. *J Virol* 2002; 70:5634.
33. Scwegmann-Wessels C et al. *J Virol* 2003; 77:11846.
34. Scwegmann-Wessels C et al. *J Virol* 2002; 76:6037.
35. Simkins RA et al. *Am J Vet Res* 1993; 54:254.
36. Weingarth HM, Derbyshire JB. *Vet Microbiol* 1993; 35:23.
37. Waxler GL. *Am J Vet Res* 1992; 53:116.
38. Egberts HJA et al. *J Vet Med Series A* 1991; 38:157.
39. Kim B, Chae C. *Vet Patn* 2000; 37:62.
40. Kim B, Chae C. *J Comp Path* 2002; 126:30.
41. Kim B et al. *J Comp Path* 2000; 123:64.
42. Kim L et al. *Arch Virol* 2000; 145:1133.
43. Wesley RD et al. *J Vet Diag Invest* 1998; 10:221.
44. Jones TO, Paton DJ. *Vet Rec* 1996; 138:166.
45. Lu W et al. *J Vet Diag Invest* 1991; 3:119.
46. Vaughn EM et al. *J Vet Diag Invest* 1996; 8:161.
47. Woods RD et al. *Can J Vet Res* 1997; 61:167.
48. Kim B, Chae C. *Can J Vet Res* 2001; 65:33.
49. Kim B et al. *J Vet Diag Invest* 2000; 12:385.
50. Kim O et al. *Vet Rec* 2000; 146:637.
51. Jung K-N et al. *J Virol Meth* 2003; 108:41.
52. Carman S et al. *J Vet Diag Invest* 2002; 14:97.
53. Shoup DI et al. *J Vet Diag Invest* 1996; 8:161.
54. Larochele R, Magar R. *J Vet Diag Invest* 1993; 5:16.
55. Sirinarumitir T et al. *Arch Virol* 1998; 143:2471.
56. Kim B et al. *Arch Virol* 2000; 145:1133.
57. Riffault S et al. *Vet Res* 2001; 32:71.
58. Sestak K et al. *J Vet Diag Invest* 1999; 11:205.
59. Cummins JM et al. *Vet Immun Immunopathol* 1995; 45:355.
60. Moxley RA et al. *J Am Vet Med Assoc* 1993; 202:1861.
61. Templeton C, Carpenter J. *Comp Cont Educ Pract Vet* 1991; 13:329.
62. Alvarez RM et al. *Pig J* 2001; 48:22.
63. Park S et al. *Am J Vet Res* 1998; 59:1002.
64. Wesley RD, Lager KM. *Vet Microbiol* 2003; 95:175.
65. Moxley RA, Olsen LD. *Am J Vet Res* 1989; 50:708.
66. Aynaud JM et al. *Vet Microbiol* 1991; 26:227.
67. Shoup DI et al. *Am J Vet Res* 1997; 58:242.
68. Sestak K et al. *Am J Vet Res* 1996; 57:664.
69. Wesley D, Woods RD. *Vet Microbiol* 1993; 35:31.
70. Lanza I et al. *Am J Vet Res* 1995; 56:739.
71. Cox E et al. *Vaccine* 1993; 11:267.
72. Wesley RD, Woods RD. *Am J Vet Res* 1996; 57:157.

## VOMITING AND WASTING DISEASE IN PIGS (HEMAGGLUTINATING ENCEPHALOMYELITIS VIRUS DISEASE IN PIGS)

Vomiting and wasting disease occurs in suckling piglets<sup>1</sup> and is characterized by vomiting and constipation with subsequent ill thrift. An acute encephalomyelitis may also occur following infection with the same virus.<sup>2</sup> A third possibility is inapparent infections in adults.<sup>3</sup>

## ETIOLOGY

A coronavirus with hemagglutinating properties is the cause of both vomiting and wasting disease and an encephalomyelitis of piglets. The physical properties of the virus have been described.<sup>4,5</sup> The same isolate may be capable of causing either syndrome following experimental infection.<sup>6</sup>

## EPIDEMIOLOGY

Vomiting and wasting disease was reported from Canada in 1958<sup>7</sup> and subsequently from the United States,<sup>8</sup> United Kingdom,<sup>9</sup> Europe,<sup>10-12</sup> and Australia.<sup>13</sup> Following its occurrence in Canada, a hemagglutinating virus was isolated from suckling piglets showing encephalomyelitis<sup>14</sup> and it has been subsequently demonstrated that both syndromes are associated with the same agent.<sup>6,9</sup> The encephalitic form has subsequently been reported in the United States.<sup>15</sup> Although clinical disease is comparatively rare, serological surveys suggest that infection is widespread even in countries that have not experienced the disease or where it has been absent for some years.<sup>15-17</sup> The infection is widespread in breeding swine herds.<sup>18</sup> Piglets suckled by immune sows will obtain maternal antibodies which disappear by 15 weeks of age. Active immunity begins between 8 and 16 weeks of age. Disease presumably occurs when the virus gains access to a susceptible herd but the reason for the age limitation is unknown. Transmission is by the oral or respiratory route.<sup>6</sup>

Both syndromes tend to occur in outbreak form affecting several litters within a short period of time. Morbidity approaches 100% and the case-fatality rate is high. The disease occurs in suckling pigs as early as 2 d of age but generally not in pigs older than 3 weeks of age. The encephalitic form tends to involve younger piglets than the gastroenteric form. The clinical course of the encephalitic form is usually 2-3 d whereas pigs with vomiting and wasting may survive several days to several weeks. The course of the outbreak is usually 2-3 weeks and subsequent litters are not affected. Area outbreaks may occur.

## PATHOGENESIS

The pathogenesis is uncertain. Vomiting and wasting disease and encephalomyelitis are probably two clinical extremes of the same disease, and both syndromes may be observed in the same outbreak.<sup>6,15</sup> Differences in pathogenicity of the strain of virus, and age and litter susceptibility may influence the form that the disease takes. Virus may be isolated from the brain of pigs with acute encephalomyelitis but in cases of chronic vomiting and wasting disease, neither virus nor encephalomyelitis

is demonstrable. It is possible that the vomiting and wasting syndrome is centrally mediated but that during the course of chronic illness the virus is eliminated and the inflammatory lesions resolved.<sup>6</sup> Localization of antigen in the stomach wall has been demonstrated in vomiting and wasting syndromes.<sup>19</sup> After experimental oral inoculation, the first site of multiplication is probably the nasal mucosa and then the virus replicates preferentially in the tonsils, lungs and small intestines.<sup>19</sup> This is followed by spread to the central nervous system via the sensory nuclei of the trigeminal and vagus nerves with subsequent spread to the brainstem, cerebrum, and cerebellum. The cause of the vomiting is probably due to the replication of the virus in the *ganglion distale vagi*. The other sign wasting is due to disturbance of the vomiting centre with persistent vomiting resulting in malnutrition.

## CLINICAL FINDINGS

In most cases these infections are not apparent clinically or go unrecognized and continue to cause morbidity.

In many instances the clinical signs are similar to those of poliomyelitis associated with the porcine enteroviruses. Usually pigs under 2 weeks of age are affected. Mortality in young pigs is high but in older pigs they may survive and become stunted.

Vomiting of yellow-green vomitus is the first sign and is accompanied by anorexia and thirst. Ineffective attempts to drink are characteristic. The temperature is usually normal or slightly elevated except for transient febrile reactions (up to 40.5°C; 105°F) for 24 h in the early stages in some pigs, and the feces are usually hard and dry. Diarrhea may occur but is not severe and occurs mostly in the older piglets. Vomiting may continue for some days but, in all affected pigs, there is severe, rapid emaciation and dehydration. They may continue in this state for some weeks and eventually die, apparently of starvation, or are destroyed by the owner.

The encephalitic form is manifest initially by depression. Piglets continue to suck for the first day but rapidly become inappetent and there is rapid loss of condition. Hyperesthesia, incoordination and muscle tremor with occasional vomiting is followed in 48-72 h by an acute encephalitis with paddling convulsions and death. Sows may show inappetence and mild fever for 1-2 d at the onset of the outbreak.

## CLINICAL PATHOLOGY

### Detection of virus

Infection may be demonstrated by the isolation of virus in primary tissue culture and growth detection is made by hemagglutination, fluorescent antibody or electron microscopic techniques.

## Serology

The demonstration of rising antibody titers in surviving piglets is also satisfactory for diagnosis. Virus neutralization and hemagglutination inhibition tests are more sensitive than agar gel immunodiffusion.<sup>20</sup>

## NECROPSY FINDINGS

Gross necropsy findings are generally negative. Non-suppurative encephalomyelitis with perivascular cuffing, gliosis and neuronal death are present in pigs dying with clinical signs of encephalitis but not necessarily in pigs with vomiting and wasting disease.

## Samples for confirmation of diagnosis

- **Histology** – formalin-fixed samples of above tissues, plus stomach and celiac/cranial mesenteric ganglia (LM)
- **Virology** – brain (including medulla and cerebellum), Gasserian and paravertebral ganglia (ISO)
- **Serology techniques** for RT-PCR and nested PCR have been described.<sup>21</sup>

## TREATMENT AND CONTROL

There is no effective treatment. As yet there are no effective vaccines. The control of the disease must depend on prior exposure of sows to infection at least 10 d before farrowing, if necessary by purposeful exposure. The piglets will be protected by colostrum antibody. Sows that have had affected litters will be immune to the disease and should not be discarded from the herd.

## REFERENCES

1. Alexander TJL, Saunders CN. *Vet Rec* 1969; 84:178.
2. Mitchell D. *Res Vet Sci* 1963; 4:306.
3. Appel M et al. *Res Vet Sci* 1965; 6:482.
4. Garwes DJ et al. *Nature Lond* 1975; 275:508.
5. Pensaert MB, Callebaut PE. *Arch Virusforsch* 1974; 44:35.
6. Mengeling WL, Cutlip RC. *J Am Vet Med Assoc* 1976; 168:236.
7. Roe CK, Alexander TJL. *Can J Comp Med* 1958; 22:305.
8. Mengeling WL, Cutlip RC. *J Am Vet Med Ass* 1976; 128:136.
9. Cartwright SF, Lucas M. *Vet Rec* 1970; 86:278.
10. Steinicke O, Nielsen A. *Nord Vet Med* 1959; 11:399.
11. Bugnowski H, Lange S. *Monatshfte fur Veterinarmedizin* 1978; 33:607.
12. Hess RG, Bachmann PA. *Tierarztl Umschau* 1978; 33:571.
13. Forman AJ et al. *Aust Vet J* 1979; 55:503.
14. Grieg AS et al. *Can J Comp Med* 1962; 26:49.
15. Werdin RE et al. *J Am Vet Med Assoc* 1976; 168:240.
16. Hirai K et al. *Jap J Vet Sci* 1974; 36:375.
17. Sorenson KJ. *Nord Vet Med* 1975; 27:208.
18. Pansaert MB et al. *Vet Q* 1980; 2:142.
19. Andries K, Pensaert MB. *Am J Vet Res* 1980; 41:1372.
20. Mengeling WL. *Am J Vet Res* 1974; 35:1429.
21. Sekiguchi Y et al. *J Vet Med Sci* 2004; 66:367.

## VIRAL DIARRHEA IN CALVES, LAMBS, KIDS, PIGLETS, AND FOALS

### Synopsis

**Etiology** Rotaviruses, coronaviruses, toroviruses, parvoviruses

**Epidemiology** Common cause of diarrhea in newborn farm animals, most commonly in calves but also in lambs, kids, piglets and foals. Rotaviruses ubiquitous in environment and 50–100% of adults seropositive. Spread by feces. Protection dependent on specific antibody in colostrum in intestinal lumen. Bovine coronavirus is also pneumotropic and causes respiratory disease

### Signs

#### Calves

Outbreaks of diarrhea at 5–14 d of age and older up to 3–4 weeks. Recover in few days

#### Piglets

Outbreaks of diarrhea at 1–4 weeks of age and following weaning. Porcine epidemic diarrhea Type I at 4–5 weeks of age; Type II at all ages. Recover in few days

#### Foals

Profuse diarrhea, slight fever, dehydration. Recover in few days

**Lesions** Fluid-filled intestine, dehydration. Villous and crypt atrophy

**Diagnostic confirmation.** Many diagnostic tests to identify viruses in fecal samples

### Differential diagnosis list

#### Calves

Enteric colibacillosis, cryptosporidiosis, bovine virus diarrhea, coccidiosis

#### Piglets

Transmissible gastroenteritis, enteric colibacillosis, Porcine epidemic diarrhea Types I and II, coccidiosis, hemorrhagic enterotoxemia

#### Lambs

Enteric colibacillosis

#### Foals

Rotaviral diarrhea, foal heat diarrhea, salmonellosis, *Clostridium perfringens* Type B, and dietary diarrhea from excessive consumption of milk

**Treatment** Oral and parenteral fluid, electrolyte therapy

**Control** Reduce infection pressure, insure adequate colostrum intake, vaccination of dam to provide specific colostrum antibody

## ETIOLOGY

Several families of viruses cause diarrhea in neonatal farm animals, and occasionally in adults. They include: Reoviridae, Coronaviridae, Toroviridae, Parvoviridae.

## Rotaviruses

Rotaviruses of family Reoviridae are primary causes of diarrhea in calves, lambs, kids, piglets and foals. All members of the group of viruses share a common morphology and previously known as the reovirus-like viruses. Rotaviruses of human infants, calves, pigs, and foals are morphologically indistinguishable from

each other and from the virus of infant mice; the lamb rotavirus is similar to both calf and pig viruses.

Atypical rotaviruses known as pararotaviruses have been isolated from pigs, cattle and lambs. They are morphologically similar to rotaviruses but do not possess the common group antigen and are characterized by their failure to be detected in serological tests such as immunofluorescence or ELISAs, which are based on the presence of the common group antigen.

Rotaviruses are assigned to serogroups with group members sharing distinctive common antigens. Currently, seven serogroups – A through G – are recognized.<sup>1</sup> Rotavirus serogroups are further classified into serotypes based on specificity of the outer capsid proteins VP7 (G types) and VP4 (P types). At least 14G and 12P serotypes of Group A rotavirus are recognized.<sup>2</sup> Group A rotaviruses are the most frequently detected viruses as a cause of diarrheal disease in farm animals and humans. Group B rotaviruses have been isolated from adult cows with diarrhea.<sup>3</sup>

## Coronaviruses

Coronaviruses cause acute diarrhea in calves and piglets and perhaps foals.<sup>78</sup> The coronavirus-like virus of pigs is similar to, but distinct from, the virus of TGE and is the cause of porcine epidemic diarrhea type II.

## Toroviruses

The family Toroviridae includes the Berne virus of horses and the Breda virus, which has been isolated from cattle.<sup>4</sup>

## Parvovirus

Parvoviruses have been associated with diarrhea in calves but are not significant pathogens in cattle.<sup>5</sup>

## Other viruses and mixed infections

While the rotavirus and coronavirus are the most common causes of viral diarrhea in newborn farm animals (other than TGE of piglets), the adenovirus and small viruses resembling astroviruses and caliciviruses have been isolated from diarrheic calves but their etiological significance is uncertain.

Multiple mixed viral infections are being recognized more frequently as diagnostic techniques are improved. Both rotavirus and coronavirus may occur in the same diarrheic calf with or without the presence of enteropathogenic *E. coli*.

## EPIDEMIOLOGY

The general aspects of the epidemiology of viral diarrheas of newborn farm animals are described here followed by the specific epidemiological features in calves, lambs and kids, piglets, and foals. The rotavirus is used as a model.



## Occurrence

The rotavirus is ubiquitous in the environment of domestic animals and serological surveys indicate that 50–100% of adult cattle, sheep, horses and pigs have antiviral antibody.

The rotaviruses from one species can infect members of only some other species and experimental infection of pigs, calves, and lambs with human rotavirus is possible. The calf rotavirus can infect pigs. However, the significance of interspecies infection under field conditions has not been evaluated. Cross-infection between species is not a property shared by all rotaviruses.

There are seven serogroups of rotaviruses recognized A–G,<sup>2</sup> and Group A rotaviruses are divided into serotypes defined by surface antigens which elicit neutralizing antibodies.

## Methods of transmission

The intestinal tract is the site of multiplication of the rotavirus and the virus is excreted only in the feces. Infected feces may contain as many as 1010 virus particles/g. Because rotaviruses are stable in feces and relatively resistant to commonly used disinfectants, it is extremely difficult to prevent gross contamination of animal housing once infection has been introduced. The adult animal is the primary source of infection for the neonate. The survival of the bovine rotavirus in air and on surfaces is directly influenced by the level of relative humidity.<sup>6</sup> The rotaviruses in general survive well in an aerosol state and medium-range of relative humidity and air may be one of the vehicles for dissemination of the virus.

## Immune mechanisms

An important epidemiological characteristic of rotavirus and coronavirus infections in newborn farm animals is that protection against disease is dependent on the presence of specific colostral viral antibody in the lumen of the intestine of the newborn. Colostral serum antibody in the newborn does not directly protect neonates against enteritis. The protective effect of colostrum depends on its antibody titer, the amount ingested and the amount available in the lumen of the intestine. The daily oral administration of colostrum containing specific antibody or hyperimmune serum to lambs will protect them against experimental enteritis. The protection is against clinical disease and not necessarily infection. Calves, lambs and piglets may still excrete virus in the feces while they are protected against enteritis by the presence of colostral antibody in the intestinal lumen. The protection lasts only as long as colostral antibody is present within the lumen of the intestine, which explains why rotaviral diarrhea occurs commonly after 5–7 d of

age. Survival from rotavirus diarrhea in calves may be dependent on a high level of serum colostral immunoglobulin.

Protection against bovine rotavirus in calves with a high titer of maternal virus neutralizing antibodies is due to both lactogenic immunity and the intestinal serum-derived antibody.<sup>7</sup>

## Calves

Many of the epidemiological characteristics of neonatal calf diarrhea associated with the rotavirus and coronavirus must be considered in the context of 'acute undifferentiated diarrhea of newborn calves' because mixed infections are more common than single infections.

## Bovine rotavirus

Occurrence and prevalence of infection

In cattle, serogroups A, B and C are most commonly reported.<sup>2</sup> The bovine group A rotavirus was first isolated in the United States in 1969 as the cause of outbreaks of diarrhea in beef calves in Nebraska. Since then the virus has been recovered from calves affected with diarrhea and normal calves worldwide.<sup>2,8</sup> Diarrhea due to Group A rotavirus occurs in calves from 1–2 weeks of age.

The prevalence of infection with Group A rotavirus is high. An overall prevalence of approximately 30% in normal neonatal animals and 40% in diarrheic animals is common.<sup>8</sup> Within 14 d of age, 94% of dairy calves may be positive for Group A rotavirus and 80% may be positive for Group B.<sup>9</sup> Antibody to rotavirus is present in the serum of 90–100% of young adults, and clinically normal calves with high serum antibody may excrete the virus. The explanations include:

- Calves may be protected from disease but excrete the virus during the colostral feeding period
- Calves may be infected at a subclinical level but still excrete the virus although they may have been denied colostral antibody.

Non-Group A rotaviruses, which have Group B characteristics, have been found in normal and diarrheic calves in India.<sup>10</sup>

The prevalence of infection with Groups B and C bovine rotaviruses is less than A. Approximately 70% of adult cattle are seropositive to Group B and 50% of adult cattle are seropositive to Group C.<sup>2</sup> Serotypes G6 and G10 Group A rotaviruses are the most prevalent serotypes in dairy and beef calves with diarrhea in the United States.<sup>11</sup> Unusual Group A rotaviruses have been associated with epidemics of diarrhea in 3-month-old calves, which age is unusual.<sup>11</sup> The predominant G serotypes of bovine rotaviruses from outbreaks of diarrhea in dairy and beef calves in Australia have been determined.<sup>13</sup>

Rotavirus strains belonging to G10P11 constitute the largest proportion of bovine rotaviruses in cattle throughout India.<sup>14</sup> This has major zoonotic implications because this strain is related to those found in newborn children in India.

The prevalence of subclinical infection may be greater than that indicated by isolation of the virus from feces. Rotavirus-immunoglobulin and coronavirus-immunoglobulin complexes may be present in the feces of 44% and 70% of adult cattle, respectively, while the free rotavirus and coronavirus may be absent or present in only 6% of fecal samples, respectively. Clinically normal cows can shed the virus for several weeks in the presence of fecal and serum antibody. Repeated bovine rotavirus infection and re-excretion can occur in calves several months of age, even in the presence of serum antibodies. Clinically normal calves may also shed the virus and there may be histological evidence of lesions of the small intestine due to rotavirus infection.

In a longitudinal survey of calves in a herd over two successive calving periods, the rotavirus was first detected in calves at about 6 d of age. Diarrhea or excretion of abnormal feces was associated with rotavirus infection in 58% of infected calves while in the remaining 42% infection was subclinical. The overall prevalence rate of infection can vary from 16–80% among beef and dairy calves. In a random sample of dairy herds in Ohio in the United States, the prevalence of bovine Group A rotavirus detected in the feces of calves was 16% at an average of 14 d. Of all calves with liquid feces, 28% were shedding rotavirus, in comparison with 25% with semi-liquid feces, 23% of those with pasty feces, and 11% of those with firm feces.

Group C rotavirus, designated the Shintoku strain, has been isolated from adult cattle in Japan with diarrhea. A significant antibody response to the isolate was detected in convalescent-phase sera of cows which excreted the virus and no antibody response to bovine Group A was observed.

**Concurrent infections.** Rotavirus was detected in the feces of 43% of neonatal diarrheic dairy calves in Spain.<sup>15</sup> A concurrent infection was detected in 58% of the rotavirus infected calves, and the most common mixed infection was rotavirus-*Cryptosporidium*. The detection rates of the other enteropathogens with rotavirus infection were 20% for coronavirus, 85% for *Cryptosporidium*, 17% for F5+ *E. coli* and 2% for Salmonella. As age of calf increased, the detection rates of other enteropathogens decreased.

### Risk factors

#### Animal risk factors

The factors which influence rotavirus infection and its clinical severity include:

- Age of the animal
- Immune status of the dam and absorption of colostral antibody
- Ambient temperature
- Degree of viral exposure
- Occurrence of weaning
- Presence of other enteropathogens.

Calves are most susceptible to rotavirus diarrhea between 1–3 weeks of age. This age occurrence is related in part to the rapid decline in specific colostral antibody to the rotavirus.

The mortality is highest in the youngest animals which have received insufficient colostrum and are subjected to severe weather conditions.

The occurrence and distribution of the virus in diarrheic and normal calves have been studied. The rotavirus has been found before, during and after the onset of diarrhea. It has been found along with the coronavirus and adenovirus in diarrheic calves. This serves to emphasize that while the virus can be considered as a primary pathogen in calves, the results of field and laboratory investigations indicate that multiple mixed pathogen infections are probably more common than single pathogen infections. There are also differences in the virulence between isolates. Earlier work suggested that most cases of naturally occurring rotavirus diarrhea in calves were also infected with *E. coli*. However, no attempt was made to determine if the *E. coli* possessed the virulence characteristics described under colibacillosis.

#### Environmental risk factors

While the rotavirus has been most commonly associated with outbreaks of diarrhea in beef calves raised in groups outdoors, it has also been recovered from dairy calves raised together in large groups in large dairy herds. The morbidity rate in beef herds has varied from herd to herd and from one year to another.

The survival of the bovine rotavirus in air and on surfaces is directly influenced by the level of relative humidity.<sup>6</sup> The rotaviruses in general survive well in an aerosol state and medium range of relative humidity and air may be one of the vehicles for dissemination of the virus.

#### Pathogen risk factors

There are differences in virulence among the bovine rotaviruses, which may explain the variability in the severity of disease in natural outbreaks and must be considered when developing vaccines.

Rotaviruses possess two outer capsid proteins: VP4 and VP7. The neutralization

specificity related to VP7 is the G serotype and that associated with VP4 is referred to as P serotype. On the basis of G types, at least 14 serotypes of Group A rotaviruses have been described in animals and humans. The Group A rotavirus has been classified as 14 G serotypes, 11 P serotypes, and 20 P genotypes.

Specific G and P types have been associated with specific animal species. For example, human rotaviruses most commonly belong to G types 6, 8, and 10 and have P types. As more rotaviruses have been characterized from diverse locations worldwide, the host species specificity of P and G types has become less distinct. G types 6, 8, and 10, once thought to be specific to cattle, have been found in humans.

Determination of the serotype specificity is important for development and evaluation of more efficacious vaccines but it is complicated by the dual serotype specificity of the rotavirus. Strains of bovine Group A rotavirus have been isolated from beef herds which had been vaccinating the pregnant cows with the commercial vaccine containing Group A rotavirus.<sup>16</sup> The serological and genotypic characterization of strains responsible for the diarrhea were a bovine rotavirus reassortant with a P gene different from the vaccine virus. In the United States, commercially available rotavirus vaccines for cattle contain only strain NCDV-Lincoln.

G and P genotypes of Group A rotaviruses have been found circulating in calves in Brazil,<sup>17</sup> and in diarrheic calves born to cows vaccinated against the NCDV (P[1], G6) rotavirus strain.<sup>18</sup> The prevalence of the rotavirus G and P types in diarrheic calves in Japan changes in certain areas periodically.<sup>19</sup> A Group A rotavirus with G serotype 8 has been isolated from diarrheic calves in Japan.<sup>20</sup> A bovine Group 3 rotavirus has been identified and characterized which causes age-dependent diarrhea in cattle in the UK.<sup>21</sup>

In Sweden, in beef and dairy herds, several bovine rotavirus G-types (G3, G6, and G8, and G10) were detected.<sup>22</sup> In beef herds, G6 predominated, while G10 predominated or was the only G-type in dairy herds. In Sweden, the same strains of the virus persist for several years which is probably associated with the limited exchange of cattle between dairy and beef suckled herds which are characteristically small.

It is now becoming clear that in contrast to natural recovery from infection, which results in high titers of P-specific neutralizing antibodies, parenteral administration elicits primarily G-specific neutralizing antibodies. Thus, failure in passive protection with a monovalent vaccine for prevention of rotavirus-associated diarrhea in

neonatal calves may be less than optimal due to diversity of P and G types occurring in nature.

Natural subclinical infections are common in calves in the second week of life, which raises doubts about rotavirus pathogenicity. Experimentally, the clinical outcome of infection is dependent on both age and rotavirus isolate. Age-dependent resistance to infection was not found. Bovine rotaviruses differ in virulence for calves in the second week of life and older calves are susceptible to rotavirus infection and disease.<sup>23</sup>

The calf rotavirus can be experimentally transmitted to piglets and has been isolated from natural outbreaks of diarrhea in piglets. The isolation of a rotavirus from neonatal deer affected with diarrhea in a zoo in Australia raises some interesting epidemiological possibilities.

#### Morbidity and case fatality

In some herds the disease starts at a low rate of 5–10% in the first year, increases to 20–50% in the second, and to 50–80% in the third year. In other herds, explosive outbreaks affecting 80% of the calves have occurred in the first year. The case-fatality rate has also been variable – in some herds as low as 5%, while in others as high as 60%. The mortality rate probably depends upon the level of colostral immunity in the calves, the incidence of enteric colibacillosis, and the level of animal husbandry and clinical management provided in the herd.

#### Method of transmission

The virus is excreted by both calves and adult cattle in large numbers (up to 1010/g of feces) and excretion may last for several weeks. Even under open-range conditions, there is a rapid spread of the virus throughout calves which come into frequent contact with each other, particularly during the calving season. Calves are infected after birth from the dam's feces or from other infected diarrheic calves. Pregnant cows excrete the rotavirus intermittently throughout pregnancy, from one calving to the next, and provide a direct source of infection for the newborn calf. Both subclinically infected and diarrheic calves infected by rotavirus can be a source of infection for other in-contact calves.

#### Immune mechanisms

Newborn calves are protected from the rotavirus only during the first few days after birth, when colostrum contains specific rotavirus antibody which is active in the lumen of the intestine. This correlates well with the peak incidence of rotavirus diarrhea which is at 5–7 days of age, and coincides with a marked drop in colostral immunoglobulins by the third day after parturition and an incubation

period of 18–24 h for the disease to occur. The levels of serum and colostral antibody are lower in first-calf heifers, which explains the higher morbidity and mortality in their calves. The serum colostral immunoglobulins of the calf may also be transudated from the serum into the intestine and complement the role of colostral and milk antibodies in the lumen of the intestine.

### Bovine coronavirus (calf diarrhea)

Bovine coronavirus causes diarrhea in both dairy and beef calves worldwide ranging in age from 1 day to 3 months of age but mostly between 1 and 2 weeks of age. Disease is more common during the winter months, which may reflect enhanced survival of the virus in a cool, moist environment. The virus is ubiquitous in cattle populations and the majority of adult cattle are seropositive. The coronavirus may be present in both diarrheic and healthy calves; the incidence rates range from 8–69% and 0–24% for diarrheic calves and healthy calves, respectively.

The virus can be shed by up to 70% of adult cows despite the presence of specific antibodies in their serum and feces. The peaks of shedding are during the winter months and at parturition in North America. Calves born to carrier cows are at a higher risk of diarrhea. Subclinical persistence and recurrent infections are also common in both neonatal and older calves and virus excretion from these animals may maintain a reservoir of infection.

Vaccination of the cows with a modified live rotavirus–coronavirus *E. coli* combination vaccine does not influence seasonal shedding, but in vaccinated cows the incidence of shedding does not increase at parturition as it does in non-vaccinated cows. The bovine coronavirus isolates all belong to a single serotype as polyclonal sera have detected only minor antigenic variations.

The **bovine coronavirus is also a pneumotropic virus** which can replicate in epithelium of the upper respiratory tract. In dairy calves, initial infections occur when the calves are 1–3 weeks of age but there are multiple episodes of shedding of viral antigens or seroconversion when the calves are several weeks of age. Clinical signs of respiratory disease occur between 2 and 16 weeks of age but are mild. A more severe lower respiratory tract infection causing minor lung lesions has been reported but is also not severe enough to warrant treatment. Such infections are probably common in closed herds with recurrent subclinical infections occurring in older calves. Persistence of infection or reinfection of the upper respiratory tract with the virus is also common. The amount and specificity of bovine coronavirus maternal antibodies in calves at the time of infec-

tion with the virus may interfere with the development of an active antibody response in serum and mucosal secretions. The fecal–oral route is the presumed method of transmission but aerosol transmission may also occur.

The bovine coronavirus has been isolated from wild ruminants with diarrhea.<sup>24</sup> Feces from diarrheic sambar deer, one waterbuck and one white-tailed deer in wild animal habitats contained coronavirus particles which were identified as bovine coronavirus. Gnotobiotic and colostrum-deprived calves inoculated with the isolates developed diarrhea and shed coronavirus in their feces and nasal discharge.<sup>24</sup> Thus wild ruminants may harbor coronavirus strains transmissible to cattle.

The bovine coronavirus of winter dysentery in adult cattle is closely related to the coronavirus causing diarrhea in young calves.<sup>25</sup> There is no evidence for serologic or in vivo antigenic differences between these two bovine coronaviruses.

### Parvovirus

The parvovirus has been associated with outbreaks of postweaning diarrhea in beef calves but its pathogenicity is uncertain. Seroprevalence studies found 49–83% of adult cattle seropositive to the virus over a 2-year period.<sup>5</sup>

### Bovine Torovirus (Breda virus)

Breda virus, a member of the genus *Torovirus*, has been isolated from the feces of neonatal calves with diarrhea in Iowa, Ohio, and several areas in Europe, and in Canada.<sup>26</sup> In Ohio, the virus was detected in 9.7% of fecal samples from cattle with diarrhea; it occurred in 26% of the total calf samples.<sup>27</sup> It is a common virus in the feces of calves with diarrhea on farms in Ontario. In veal calf operations in Ohio, 24% of calves shed the virus during the first 35 days after arrival and the shedding of the virus was associated with diarrhea. Calves shedding additional pathogens were more likely to have diarrhea than those shedding less than one pathogen.<sup>28</sup> Calves which were seronegative or had low antibody titer to the Breda virus on arrival were more likely to shed the virus than those calves which were seropositive on arrival.

More than 88% of adult cattle are seropositive to the Breda virus.<sup>4</sup> More than 90% of newborn calves have high maternal antibodies to the virus which wane at a few months of age, followed by active seroconversion between 7 and 24 months of age.

### Bovine Norovirus

Noroviruses, formerly known as Norwalk-like viruses have been recognized as the most common pathogens involved in outbreaks of acute non-bacterial gastroenteritis

in humans. The *Norovirus* genus, is one of four genera in the Caliciviridae family. Norovirus-specific DNA has been detected in the fecal samples of diarrheic calves in Michigan and Wisconsin.<sup>29</sup> The complete genomic sequence of an enteropathogenic bovine calicivirus isolated from Nebraska has been characterized and its enteropathogenicity documented.<sup>30</sup> The seroepidemiological prevalence of the Jena virus, a bovine enteric calicivirus, is 99% in some selected cattle populations in Germany.<sup>31</sup> In The Netherlands, the Norwalk-like virus (NLV) is endemic in veal calf operations and in a selected dairy herd.<sup>32</sup> The highest number of NLV positive veal calf farms were found in the regions with the highest number of veal calf farms. The virus is endemic in cattle populations and genetically distinct from the Norwalk-like virus in humans.

### Lambs and kids

#### Rotavirus

The rotavirus has been isolated from the feces of lambs under 3 weeks of age with diarrhea. The disease is sporadic and no particular epidemiological characteristics have been described. Rotaviruses have been found in the feces of diarrheic lambs born in lambing sheds where about 1300 lambs were born on one sheep ranch and 3000–5000 on another ranch within 30 d. Clinical signs were noticed as early as 12–16 h after birth.<sup>33</sup> Morbidity approached 100% and mortality 10%. The virus was not classified as Group A but probably Group B.

In a series of fecal samples from diarrheic and normal lambs and goat kids from 1–45 d of age, the prevalence of Group A rotavirus infection in diarrheic lambs was very low (2.1%).<sup>34</sup> Group A and B rotaviruses were detected in 8.1% and 13.5% of diarrheic goat kids. Group C rotaviruses were detected in four normal goat kids. An association of diarrhea and infection was demonstrated only for Group B rotaviruses.

Atypical rotaviruses, possibly Group B, have been isolated from the feces of diarrheic goat kids.<sup>35</sup> Affected kids were 2–3 d of age and the disease was severe with marked dehydration, anorexia, and prostration.

The experimental disease in lambs is mild and characterized by mild diarrhea, abdominal discomfort and recovery in a few days. The mortality in lambs is much higher when both the rotavirus and enteropathogenic *E. coli* are used.

#### Piglets

##### Porcine rotavirus

Group A rotaviruses are a common cause of diarrhea in nursing pigs from 1–5 weeks of age with peak occurrence from 1–3 weeks of age, and weaning pigs at 3–5 weeks of age and within 3–5 d of

weaning. Groups A, B and C occur in diagnostic surveys with about 90% belonging to Group A.<sup>36</sup> Group C rotavirus has also been found to be the cause of enzootic neonatal diarrhea in a minimal disease herd. Multiple rotavirus G serotypes and P types have been detected in swine.<sup>37</sup> There is little or no cross-protection between porcine rotaviruses with distinct G and P types, but viruses which share common G and P types induce at least partial cross-protection in experimental studies.<sup>38</sup> Variant serotypes of porcine rotavirus such as G3 may cause severe outbreaks of diarrhea in piglets. Subclinical infections are common, and age resistance to rotavirus infection may not occur.

In an infected herd, piglets become infected between 19 and 35 d of age, and the virus cannot be detected in piglets under 10 d of age, presumably as a result of protection by lactogenic antibody. It is suggested that in an intensive piggery, with a constant shedding of viruses in feces of sows before and after farrowing leading to continuing cycle of rotavirus infection with a build-up of host immunity against a circulating strain in the pig population, a virus such as CRW-8 probably could undergo changes through mutations over a period of time leading to antigenic drift.

In piglets, rotaviral diarrhea is most common in pigs which are weaned under intensive management conditions and the incidence increases rapidly from birth to 3 weeks of age.<sup>36</sup> There is no age-dependent resistance up to 12 weeks of age. The disease resembles milk-scours, or 3-week scours of piglets. Mortality due to rotavirus varies from 7–20% in nursing pigs and 3–50% in weaned pigs depending on the level of sanitation. In the United States, the peak incidence occurs in February and a moderate rise occurs in August–September.<sup>36</sup>

A case-control epidemiological study examined the relationship between Group A rotavirus and management practices in Ontario over a 5-year period.<sup>39</sup> In rotavirus-positive herds, herd size was larger and weaning age was younger compared with rotavirus-negative herds.<sup>39</sup> Pigs raised in all-in all-out nurseries were 3.4 times more likely to have a positive Group A rotavirus diagnosis than in pigs in a continuous flow system. Pigs in the all-in all-out system were weaned at an earlier age.

The sow is the source of infection. Seropositive sows can shed rotavirus from 5 d before to 2 weeks after farrowing, when piglets are most susceptible to infection. There are increased secretory IgA and IgG antibodies to rotavirus in the milk of sows after natural rotavirus infection or follow-

ing parenteral inoculation of pregnant or lactating sows with live attenuated rotaviruses.<sup>38</sup> The early weaning of piglets at a few days of age or at 3 weeks of age results in the removal of the antibody supplied by the sow's milk.

Continuous transmission of the virus from one group to another is an important factor in maintaining the cycle of rotaviral infection in a piggery. The virus can be found in dust and dried feces in farrowing houses which have been cleaned and disinfected. This suggests that the environment is also an important source of infection. The porcine rotavirus can survive in original feces from infected pigs for 32 months at 10°C.<sup>40</sup> Gilts and sows shed virus antigen prior to farrowing and during lactation, which makes it next to impossible to eliminate the infection from a herd. As sows increase in age they develop increasing levels of lactogenic IgA rotavirus antibodies but do not transfer increasing levels of protection to their piglets.

Different electrophoretotypes of Group A rotavirus and different groups of rotaviruses may occur at the same time in a single piggery, which must be considered when developing vaccines. The subgroups of group A porcine rotaviruses have been classified and there are differences in virulence of isolates. Most isolates from outbreaks of diarrhea belong to Group A while a small percentage are atypical rotaviruses. Some porcine rotaviruses are related antigenically to human rotavirus serotypes 1 and 2. Porcine rotaviruses which display the typical bovine P[1], P[5], P[11], G[6], and G8 genotypes have been detected in pigs which indicates the high frequency of rotavirus transmission between cattle and pigs.<sup>41</sup> The various G and P types of the virus have been examined and compared in Poland and the US.<sup>42</sup>

Atypical rotaviruses and other enteroviruses are often present in preweaning and postweaning diarrhea in swine herds and should be considered as potential pathogens.<sup>46</sup> Some atypical rotaviruses are associated with villous epithelial cell syncytia in piglets with enteritis. Single and mixed infections of neonatal piglets with rotaviruses and enteroviruses have been described. Combined rotavirus and K99+ *E. coli* infection causes an additive effect when induced experimentally in gnotobiotic pigs.<sup>32</sup> The inoculation of calici-like viruses into gnotobiotic piglets can result in diarrhea and villous atrophy. Diarrhea in unweaned piglets 1–3 weeks of age has been associated with a combined infection of rotavirus and *Isospora suis*. The combined effect of a dietary change at weaning and rotavirus infection in gnotobiotic piglets is a temporary

villous atrophy and there is no evidence of persistent atrophy of the small intestine.

#### Porcine coronavirus

The **porcine epidemic diarrhea virus** is a coronavirus-like virus which causes diarrhea in pigs, similar to TGE except much less severe and with less mortality. Two clinical forms of the disease have been described: porcine epidemic diarrhea types I and II. **Porcine epidemic diarrhea type I** causes diarrhea only in pigs up to 4–5 weeks of age. **Porcine epidemic diarrhea type II** causes diarrhea in pigs of all ages. The morbidity may reach 100% but mortality is low. The disease may start in the finishing pigs and spread rapidly to pregnant sows and their nursing piglets.<sup>44</sup> The diarrhea may persist in the 6 to 10-week-old pigs and seronegative gilts introduced into the herd may become infected and develop a profuse diarrhea which lasts a few days.

A porcine respiratory coronavirus with close antigenic relationship to the transmissible gastroenteritis virus has been identified as enzootic in the United Kingdom and some European countries.<sup>45</sup> A Canadian isolate of the virus inoculated into 8-week-old piglets caused polypnea and dyspnea and diffuse bronchiolo-alveolar lesions.<sup>46</sup> Seroprevalence studies in Spain reveal that 100% of large herds and 91% of small herds had animals with antibodies.<sup>45</sup> Only mild or inapparent respiratory signs occur and the growth of finishing pigs may be temporarily affected.

#### Foals

##### Equine rotavirus

Although rotavirus infection is a common cause of diarrhea in foals, there are surprisingly few epidemiological and microbiological data. Group A rotaviruses are a major cause of diarrhea in foals up to 3 months of age.<sup>47</sup> Most equine rotaviruses are distinct from those of other species with a distinctive electropherotype and subgroup reaction. Rotavirus serotype G3 and subtypes predominate in horses.<sup>47</sup> In Germany, G3 P[12] is the predominating type of rotavirus in the horse.<sup>48</sup>

The virus can be isolated from the feces of healthy foals and from diarrheic foals in outbreaks of diarrhea. Outbreaks of the disease occur on horse farms with a large number of young foals where the population density is high. A case-control study of foal diarrhea in the United Kingdom over a 3-year period revealed rotavirus was a significant pathogen associated with diarrhea in foals.<sup>49</sup> The other common pathogens were *Clostridium perfringens*, *Strongyloides westeri*, and *Cryptosporidium* spp. A survey of the enteric pathogens in diarrheic thoroughbred foals in the United Kingdom and

Ireland revealed a prevalence of 37% rotaviruses, and 8% in normal foals. In a United States survey of diarrhea in foals on 21 thoroughbred horse farms, rotavirus was detected only in diarrheic foals. A higher percentage of foals born to visiting mares developed diarrhea, compared to foals born to resident mares. Serological surveys indicate the presence of the rotavirus antibody in almost all of the mares whose foals are infected with the virus.<sup>50</sup>

## PATHOGENESIS

### Rotavirus

The rotavirus infects mature brush border villous epithelial cells in the small intestine and to a lesser extent in the large intestine. The infected cells are sloughed, leading to partial villous atrophy and the atrophic villi are rapidly recovered with relatively undifferentiated crypt cells which mature over a few days and result in the healing of the lesion. The activity of the mucosal  $\beta$ -galactosidase (lactase) in the brush border of the villous epithelium is less than that found in normal animals, which results in decreased utilization of lactose. This reduction in enzymes is associated with immature enterocytes on the villi during rotavirus infection. In vitro studies have suggested that lactase may be the receptor and uncoating enzyme for rotavirus, which may explain the high degree of susceptibility of the newborn with high levels of lactase. The net effect of the morphological and functional changes in the intestine is malabsorption resulting in diarrhea, dehydration, loss of electrolytes and acidosis. The diarrhea in milk-fed calves with the experimental disease ceases if the milk is withdrawn and replaced with glucose and water, which is similar to transmissible gastroenteritis. The D-xylose absorption test can be used to measure the degree of malabsorption in calves infected with rotavirus.

The pathogenesis is similar in calves, lambs, pigs and foals. Lesions occur within 24 h after infection, villous epithelial cells of the small intestine are infected and become detached, and regeneration occurs within 4–6 d after the onset of the diarrhea. The intestinal villi usually return to near normal within about 7 d after recovery from the diarrhea. However, calves and pigs may require 10–21 d to fully recover to a normal growth rate following rotavirus infection. Experimental rotaviral infection in 3-week-old piglets results in diarrhea, anorexia and vomiting. Villous atrophy of the small intestine is the most severe lesion which returns to normal in 6 d. Infection and clinical disease developed in the presence of serum-neutralizing antibody obtained from seropositive sows.

While it has been generally accepted that lactose malabsorption is an important factor in the pathogenesis of diarrhea, the experimental infection of gnotobiotic lambs with rotavirus did not result in lactose intolerance as assessed by the measurement of reducing substances in the feces or by the clinical effects and blood glucose levels after a lactose load. Lactose intolerance could be demonstrated by using extremely high doses of lactose, three to four times the normal dietary intake. Thus, lactose-containing feeds such as milk are not necessarily contraindicated in rotavirus diarrhea.

A combined infection with rotavirus and enterotoxigenic *E. coli* may result in a more severe disease than produced by rotavirus infection alone, particularly in calves several days of age when the rotavirus normally produces a mild disease and when calves are resistant to enterotoxigenic colibacillosis. The intestinal lesions of villous atrophy are also more severe and extend into the colon in dual infections. Naturally occurring cases of the dual infection in calves are considered to be more severe than single infections. Under field conditions more than one enteropathogen is likely to be involved in the pathogenesis of the diarrhea.

Experimentally, in gnotobiotic 1-day-old calves, concurrent infection with bovine virus diarrhea virus and bovine rotavirus results in a more severe enteric disease than that associated with either virus alone.<sup>51</sup> The BVDV potentiated the effect of the rotavirus. Severe lymphoid depletion was associated with BVDV infection regardless of the concurrent rotavirus infection. The clinical findings of induced combined BVDV and rotavirus infections in neonatal calves at 8 to 9 days of age are much more severe and the duration of diarrhea much longer than in rotavirus infection alone.<sup>52</sup>

### Coronavirus

The pathogenesis of coronaviral enteritis in calves is similar to the rotavirus infection. The villous epithelial cells of the small and large intestines are commonly affected. The crypt epithelium is also affected, which makes regeneration of villous epithelial cells much longer, which in turn results in persistent diarrhea for several days and death from dehydration and malnutrition. Experimental infection of calves with virulent bovine coronavirus results in depletion of lymphocytes in the mesenteric lymph nodes and Peyer's patches, low levels of immunoglobulins and generalized immune suppression.<sup>53</sup> Experimental infection with the attenuated virus results in lower levels of intestinal immunoglobulin titers than with the virulent virus. Experimentally, newborn calves are capable of mounting an intestinal immune response

to bovine coronavirus and vaccine failures may be the result of overattenuation of the virus.<sup>53</sup> The pathophysiological changes due to coronavirus-induced diarrhea in the calf have been described and are similar to the changes which occur in acute diarrheal disease in the calf associated with other enteropathogens.

### Porcine coronavirus

This virus replicates in the villous epithelial cells of both the small and large intestine and clinically resembles TGE of piglets. There is no evidence that rotavirus infection in piglets is accompanied by increased permeability of the intestine to macromolecules.<sup>54</sup>

### Calicivirus-like (Newbury) agent

This virus causes degeneration of the villous epithelial cells of the proximal part of the small intestine leading to villous atrophy, a reduction in disaccharidase activity and xylose malabsorption. In gnotobiotic calves experimentally infected with the Breda virus, the villous epithelial cells of the ileum and colon are affected, including the dome epithelial cells.

### Parvovirus

Experimental infection of calves with the parvovirus results in lymphopenia and viremia and damage to the small intestinal crypt epithelium and the associated mitotically active lymphoid tissues. Villous atrophy occurs because of failure of replacement of villous epithelial cells. By 5 d after inoculation there was evidence of repair of the intestinal lesions. Following experimental challenge the tonsillar tissues, intestinal mucosa and mesenteric lymph nodes all become infected. Subsequent spread also results in greater involvement in the large intestine and the upper jejunum, Peyer's patches and mesenteric lymph nodes.

## CLINICAL FINDINGS

### Calves

The naturally occurring disease usually occurs in calves over 4 d of age and is characterized by a sudden onset of a profuse liquid diarrhea. The feces are pale yellow, mucoid and may contain flecks of blood. Recovery usually occurs in a few days. Explosive outbreaks occur and up to 50% of calves from 5–14 d of age in the affected population may develop the disease. If enterotoxigenic *E. coli* are present, the disease may be acute; dehydration is severe and deaths may occur. Multiple mixed infection with *E. coli*, coronavirus, and *Cryptosporidium* spp. are common in calves over 4 d of age and thus it may be impossible to describe a typical case of uncomplicated naturally occurring rotavirus or coronavirus-like diarrhea. There is a tendency for viral diarrhea in newborn calves to occur in explosive outbreaks; the

calves are usually not toxemic, but the character of the diarrhea cannot be differentiated clinically from that associated with the other common enteric pathogens of newborn calves.

A coronaviral enteritis affecting calves from 1–7 d of age has been described, but there are no distinguishing clinical characteristics. The diarrhea may be persistent for several days, followed by death in spite of fluid therapy and careful realimentation with milk. The feces are voluminous, mucoid and slimy, and may be dark-green or light-brown in color.

#### Lambs

Experimentally, newborn gnotobiotic lambs develop diarrhea 15–20 h following oral inoculation and show dullness and mild abdominal discomfort. There are only a few documented descriptions of naturally occurring rotaviral diarrhea in newborn lambs. Affected lambs under 3 weeks of age develop a profuse diarrhea and the case-fatality rate is high. It is not clear if outbreaks of uncomplicated rotaviral diarrhea occur in newborn lambs.

#### Piglets

Rotaviral diarrhea may occur in nursing piglets from 1–4 weeks of age and in pigs following weaning.<sup>15</sup> The disease in nursing piglets resembles milk-scours or 3-week scours. Most of the pigs in the litter are affected with a profuse liquid to soft diarrhea with varying degrees of dehydration. Recovery usually occurs in a few days unless complicated by enterotoxigenic *E. coli* or unsatisfactory sanitation, overcrowding and poor management. The disease is often most severe in herds in which there is continuous farrowing with no period of vacancy for cleaning and disinfection in the farrowing barn. The disease may also occur in pigs a few days after weaning and may be a major factor in postweaning diarrhea of piglets weaned at 3 weeks of age or earlier in the case of weaning pigs at 1–2 d of age.

**Porcine epidemic diarrhea type I** affects piglets only up to 4–5 weeks of age and is characterized by profuse watery diarrhea, high morbidity and low mortality.

**Porcine epidemic diarrhea type II** causes a profuse fluid diarrhea in pigs of all ages, including nursing piglets. Explosive outbreaks may occur and the morbidity may reach 100%. Mortality is usually restricted to piglets under 3 weeks of age.

#### Foals

Affected foals appear depressed, fail to suck and become recumbent. The temperature ranges from 39.5–41.0°C (103–106°F) and the respiration may be rapid and shallow. There is a profuse, watery, non-fetid diarrhea which results in severe dehydration

and electrolyte imbalances. Recovery following treatment usually occurs within 2–4 d. Death may occur within 24 h after the onset of diarrhea.

### CLINICAL PATHOLOGY

#### Detection of virus

Fecal samples (20–30 g) should be collected from affected animals as soon possible after the onset of diarrhea and submitted to the laboratory in a chilled state. Samples of intestinal mucosa from several sections of the small and large intestine should be submitted chilled for virus detection and possible isolation.

Because multiple mixed viral and bacterial infections are common, the request for a laboratory diagnosis must include consideration of all of the common pathogens. The viruses are much more difficult to detect than bacterial enteropathogens. In herd outbreaks, fecal samples from several affected animals and some normal animals should be submitted. The rotavirus will usually be present in both normal and diarrheic animals, which presents problems in interpretation and requires evaluation of the clinical and epidemiological findings.

Several laboratory tests are available for detection of rotaviruses and coronaviruses in the feces and intestinal contents and tissues. The particular test used will depend on the facilities and equipment available.

**Electron microscopy.** Demonstration of the virus in feces using electron microscopy has been a standard diagnostic technique. It is easier to see the virus if it has been concentrated by ultracentrifugation or clumped by immune electron microscopy using specific antiserum. With electron microscopy, the virus can be detected for up to 6–10 d after the onset of diarrhea. Protein A-gold immunoelectron microscopy is a valuable test to detect bovine coronavirus in the feces and nasal secretions of infected calves. However, since the equipment and expertise necessary for electron microscopy are not available in many laboratories, alternative diagnostic techniques have been developed.

**Immunofluorescence.** Several tests are based on immunofluorescence. These include immunofluorescent staining of fecal smears and cell culture immunofluorescence of fecal preparations. Immunofluorescent staining of a fecal smear is a more convenient test for diagnostic laboratories because a diagnosis can be made in a few hours and an electron microscope is not necessary. However, the immunofluorescence tests may not be as reliable as some other tests. The fluorescent antibody technique will only detect the virus within epithelial cells which are present in the feces for 4–6 h after the onset of diarrhea. In some

studies the fluorescent antibody technique detects the virus in only 20% of samples while electron microscopy detected the virus in about 60% of the samples.

**Immunodiffusion and electron microscopy.** This test is superior to the fluorescent antibody technique. Treatment of the feces with chymotrypsin improves the detection rate. Monoclonal antibodies to porcine Group C rotavirus can be used in an immunofluorescent test and may have wider applications in the study of Group C rotavirus diarrheas in swine, cattle, and potentially, other species.

**Testing immunofluorescent sections of spiral colon** is the diagnostic method of choice for the detection of coronavirus in calves; fecal samples are unreliable. Isolation of coronavirus in tracheal organ culture is the most sensitive in vitro culture technique. A hemadsorption-elution-hemagglutination assay test for the detection of coronavirus in the feces of calves is a simple and rapid procedure. A counterimmunoelectrophoresis test is available for the detection of coronavirus in calves. An immunohistochemical technique can be used to detect the virus of porcine epidemic diarrhea in the small intestine.<sup>55</sup>

**ELISAs.** These tests are more sensitive and simple than immunoelectrophoresis, complement fixation, immunofluorescence on inoculated cell cultures or electron microscopy for the detection of rotavirus in calf feces. The ELISA is effective in detecting the presence of porcine rotavirus in feces and was confirmed in two-thirds of the samples tested using electron microscopy, immunofluorescence, and polyacrylamide gel electrophoresis (PAGE).<sup>56</sup> A blocking ELISA using monoclonal antibodies can detect the porcine epidemic diarrhea virus in feces and serum antibodies in both naturally and experimentally infected piglets and earlier than an indirect immunofluorescence test.<sup>57</sup>

A competitive blocking **ELISA (CB-ELISA)** is considered most suitable for routine detection of porcine epidemic virus in the feces of pigs.<sup>58</sup>

The **ELISA** or electron microscopy of feces are equally reliable in detecting the rotavirus and coronavirus in the feces of experimentally infected calves. The agreement between the two tests was 95% for coronavirus and 84% for rotavirus. There will always be borderline samples containing antigen in quantities near the detection limit for each test. Some samples will be positive for one test and negative for the other, and vice versa. This problem can be minimized if several individual samples from a disease outbreak are examined. The morphological

identification of rotavirus is usually straightforward but the pleomorphism of bovine coronavirus can present problems. The ELISA may also fail to detect viral antigen in feces which also contain antibody. The test can provide diagnostic results within 24 h after collection of the fecal samples.

**Reverse passive hemagglutination (RPHA), ELISA and polyacrylamide gel electrophoresis (PAGE).** Three techniques for the detection of rotavirus in fecal samples from diarrheic calves have been compared. The RPHA was at least as sensitive as the ELISA, and both were compared with the PAGE. The overall agreement between RPHA and PAGE was 96%; the ELISA was not as sensitive. The commercial ELISA has a slightly higher sensitivity than agglutination, PAGE, and concentrated PAGE, but the specificity of ELISA is lower. The latex agglutination test has a lower sensitivity than ELISA but its specificity is higher.<sup>59</sup> The latex agglutination test is easy to perform, more sensitive than electron microscopy and more specific for detection of rotavirus. A dot hybridization assay can detect and differentiate two serotypes of porcine rotavirus.

**ELISA and RT-PCR.** The fast and inexpensive ELISA combined with the highly specific and sensitive reverse transcriptase-polymerase chain reaction (RT-PCR) is a practical approach epidemiological studies of bovine rotavirus.<sup>60</sup>

**PCR assays** are now available for the detection of bovine rotaviruses in feces.<sup>9</sup>

**Non-radioactive PCR-derived cDNA probe assays** can be used to detect rotavirus serotypes.<sup>61</sup>

**Rapid ELISA.** A rapid ELISA using monoclonal antibodies can be used for the simultaneous detection of bovine coronavirus, rotavirus serogroup A and *E. coli* K99 antigen in the feces of calves.<sup>35</sup> The specificity of all of the components was more than 90% specific and the sensitivity for bovine coronavirus, K99 *E. coli*, and rotavirus, 77%, 93% and 100%, respectively.<sup>35</sup>

**Immunochromatography.** This is a test for the detection of Group A rotavirus in the feces of calves, piglets and foals, has a sensitivity of 89% and specificity of 99% compared to the ELISA, and its reproducibility is 100%.<sup>62</sup> It is a one-step procedure, simple to use, very rapid and can be carried out on the farm.

A field enzyme immunoassay test (Rotazyme test) is highly accurate and reliable for the detection of rotavirus in the feces of horses with and without diarrhea. The test is a simple, rapid and specific procedure which can take the place of a more expensive and slower procedure such as electron microscopy.

**ImmunoCardSTAT Rotavirus [ICS-RV]** is a human group A assay can be used as an on-site diagnostic test for bovine rotavirus with a sensitivity and specificity of 87.0% and 93.6%, respectively.<sup>63</sup> The assay is a 10-min one-step test with all the necessary reagents included in the kit and with no need for any laboratory equipment.

### Serology

Several serological tests are available for the measurement of rotaviral antibody in serum and lacteal secretions. An ELISA is used to detect porcine epidemic diarrhea coronavirus antibodies in swine sera.<sup>40</sup> The radioimmunoassay is the most sensitive test compared to the agar gel immunodiffusion, complement fixation, hemagglutination and hemagglutination inhibition tests.

### NECROPSY FINDINGS

The pathology of experimentally induced rotavirus and coronavirus diarrhea in colostrum-deprived and gnotobiotic calves, lambs, and piglets has been described. Grossly, the changes are unremarkable and consist of dehydration, fluid-filled intestinal tract and distension of the abomasum. The microscopic changes consist of shortening of the length of the villi and replacement of the tall columnar villous epithelial cells by cuboidal and squamous cells. Segments of the small intestine may reveal villous fusion, rounded absorptive cells, villous atrophy and exposure of lamina propria. Crypt hyperplasia occurs in response to the loss of columnar epithelial cells from the villi. Histological lesions due to previous rotavirus infection may be present in the upper small intestine of clinically normal calves. The rate at which enterocytes are affected in older disease-resistant calves is due to the slowing of the virus from entering the cells.<sup>64</sup>

In coronavirus enteritis in calves, there is commonly villous atrophy of both the small and large intestines and destruction of the crypt epithelium; destruction does not occur in rotavirus enteritis. The changes are more severe in field cases of acute diarrhea in calves in which both viruses and enteropathogenic *E. coli* can be isolated. Concurrent infection with BVDV has also been demonstrated to be synergistic in bovine rotaviral diarrhea.<sup>51</sup>

The histological appearance of the intestinal lesions of experimental infection of calves with Breda virus, calicivirus-like agent, and parvovirus have been described. In general, the lesions are similar to those associated with rotavirus and coronavirus infection.

The wide array of diagnostic tests available to confirm the presence of enteric viruses has already been discussed. Owing to the frequency of subclinical infection

with these agents, it is important to histologically confirm concurrent atrophy of villi.

### Samples for confirmation of diagnosis

- **Histology** – duodenum, jejunum, ileum, colon (LM, IHC)
- **Virology** – colonic content (EM, ELISA, LATEX AGGLUTINATION); colon, ileum, jejunum (FAT, ISO).

### DIFFERENTIAL DIAGNOSIS

The cause of acute diarrhea in newborn farm animals cannot be determined clinically. All of the common bacterial and viral enteropathogens can cause an acute profuse fluid diarrhea with progressive dehydration and death in a few days.

When outbreaks of diarrhea are encountered, a detailed examination of the possible risk factors should be made and the appropriate fecal samples and tissues from affected animals should be submitted to the laboratory. The most reliable specimens include fecal samples obtained from animals within a few hours after the onset of diarrhea, and untreated affected animals which are submitted for necropsy and microbiological examination within a few hours after the onset of diarrhea.

The clinical and epidemiological characteristics of the common acute diarrheas of neonatal farm animals are as follows:

#### Calves

**Enteric colibacillosis** occurs primarily in calves under 4 d of age and is characterized clinically by an acute, profuse liquid diarrhea. Recovery following treatment usually occurs in 2 d. Outbreaks occur in beef and dairy calves. Rotavirus and coronavirus diarrhea usually occur in calves over 5–10 d of age and up to 3 weeks of age. Explosive outbreaks occur, characterized by an acute profuse liquid diarrhea with recovery in 2–4 d. Recovery is assisted by oral fluid therapy.

**Cryptosporidiosis** occurs in calves from 5–15 d of age and is characterized by a persistent diarrhea which may last for several days. The cryptosporidia may be detected by Giemsa stain of fecal smears or by fecal flotation.

**BVD.** Whether or not the BVDV causes clinically significant diarrhea with lesions of the small intestine of calves 3–6 weeks of age is unknown. Diagnostic laboratories report the presence of intestinal lesions such as villous atrophy and crypt cell destruction in calves 3–6 weeks of age which have been affected with an intractable diarrhea and from which the BVD virus was isolated from the feces. However, to date there is no evidence of a cause and effect relationship.

#### Piglets

**TGE** occurs most commonly in piglets under 1 week of age and explosive outbreaks are common. There is acute profuse diarrhea and vomiting. Affected piglets may continue to nurse for several hours after the onset of the diarrhea. The case-fatality rate is high in piglets under 7 d of age; older pigs commonly survive.



**Porcine epidemic diarrhea type I** affects piglets under 4–5 weeks of age and is characterized by profuse watery diarrhea, high morbidity and low mortality.

**Porcine epidemic diarrhea type II** causes a profuse fluid diarrhea in pigs of all ages, including nursing piglets. Explosive outbreaks may occur and the morbidity may reach 100%. Mortality is usually restricted to piglets under 3 weeks of age.

**Enteric colibacillosis** usually occurs in piglets under 3 d of age. There is acute diarrhea, dehydration and rapid death. Pigs with coliform septicemia may die without obvious diarrhea and usually appear cyanotic. Entire litters may be affected and the case–fatality rate may be 100%. Early treatment with antibiotics and SC fluids will result in recovery. *Coccidiosis* occurs in piglets from 5–10 d of age and is characterized by an acute diarrhea in which the feces are foul-smelling and vary in consistency from cottage cheese-like to liquid, and gray or yellow and frothy. The diarrhea is persistent for several days and non-responsive to antibiotics. Some pigs recover spontaneously, others die in 2–4 d. *Coccidial oocysts* can be detected in the feces. The morbidity rate varies from 50–75% and the case–fatality rate from 10–20%.

**Hemorrhagic enterotoxemia** due to *Clostridium perfringens* Type C affects entire litters of pigs under 1 week of age, is characterized clinically by severe toxemia, dysentery and rapid death, and at necropsy there is a hemorrhagic enteritis.

#### Lambs

**Enteric colibacillosis** occurs in lambs most commonly under 1 week of age and is characterized by dullness, failure to suck and acute diarrhea which responds to antibiotic and fluid therapy.

**Coliform septicemia** affects lambs under a few days of age and usually causes sudden deaths. Lamb dysentery occurs most commonly in lambs under 10 d of age and there may be sudden death or acute toxemia, tucked-up abdomen and a severe diarrhea and dysentery. At necropsy the characteristic finding is hemorrhagic enteritis.

#### Foals

**Rotaviral diarrhea** occurs in foals from 5–35 d of age, but most commonly in foals under 2 weeks of age. There is acute profuse watery diarrhea, failure to suck, recumbency, dehydration. Recovery is common within 1 week. A mild fever is common.

**Foal heat diarrhea** occurs in foals 6–10 days of age whose dams are in estrus 7–10 d after foaling.

**Salmonellosis, *C. perfringens* Type B and dietary diarrhea from excessive consumption of milk** are less common causes of diarrhea in newborn foals.

## TREATMENT

The treatment of viral diarrheas in newborn farm animals is essentially the same as described for acute undifferentiated diarrhea of newborn calves. There is no

specific therapy for viral diarrhea, but antimicrobial agents may be used both orally and parentally for the possible occurrence of secondary enteric and systemic bacterial infections. In the absence of complications, recovery from viral enteritis usually occurs without specific treatment in 2–5 d, which parallels the replacement of the villous epithelial cells whose complete replacement and maturation requires several days after the cessation of diarrhea.

The **withholding of milk** for 24–48 h is beneficial, but often not possible or practical with nursing beef calves or litters of pigs. Milk can be easily withheld from hand-fed calves and replaced with oral fluids and electrolytes.

**Oral and parenteral fluid therapy** as indicated is essential and details are described in the sections on colibacillosis and fluid and electrolyte therapy). Affected foals may require fluid and electrolyte therapy for up to 72 h. A glucose–glycine electrolyte formulation is an effective fluid therapy for pigs affected with experimental rotaviral diarrhea. The formula is: glucose 67.53%, sodium chloride 14.34%, glycine 10.3%, citric acid 0.8%, potassium citrate 0.2% and potassium dihydrogen phosphate 6.8%. A weight of 64 g of the above is dissolved in 2 L water to produce an isotonic solution.

When possible, affected animals, particularly calves, should be **isolated from calving grounds** and other newborn calves, which are susceptible up to 3 weeks of age. When outbreaks of the disease occur in any species, the principles of good sanitation and hygiene should be emphasized to minimize the spread of infection.

## CONTROL

The principles of control of viral diarrhea are similar to those described for acute undifferentiated diarrhea of newborn calves:

- Reduce infection pressure
- Insure adequate colostrum intake
- Vaccinate the dam to induce specific immunity in the colostrum (passive immunization).

## Management and colostrum intake

The management of pregnant animals at the time of parturition must insure that the degree of exposure of the newborn to infectious agents is minimized. Control of population density to avoid overcrowding, and attention to sanitation and hygiene are important. Because infected neonates excrete large numbers of viral particles for several weeks, effective control is dependent on management of the environment of the newborn species with particular emphasis on hygiene. The ingestion of adequate quantities of good

quality colostrum as soon after birth as possible is also important.

## Vaccination

Two major approaches have been used to provide specific immunity for the control of rotavirus and coronavirus diarrhea in calves:

1. Stimulation of active immunity by vaccinating the newborn calf with an oral vaccine containing the modified live viruses (MLVs)
2. Enhancement of lactogenic immunity by vaccinating the dam during pregnancy (passive immunization).

Oral vaccines to newborn calves

A MLV rotavirus vaccine for oral administration to calves immediately after birth has been available commercially for many years. Initially, good results were claimed but vaccine field trials did not include contemporary controls and the efficacy of the vaccine was uncertain. The incidence of diarrhea in herds not vaccinated in the previous year was compared with the incidence during the year of vaccination, which is inadequate to assess the efficacy of the vaccine.

Field trials using the oral vaccine indicate a failure of protection of calves against rotavirus infection and rotavirus–coronavirus infection. Effective oral vaccination of calves may be hindered by the presence of specific antibodies in the colostrum – the colostrum barrier – and may explain the failure of the vaccine under field conditions. The intestinal antibody response of young calves to an enteric viral infection is associated with the production of IgM and IgA antibodies locally in the intestine. This response is absent or diminished in calves which have ingested colostrum with specific antibodies to the viruses. Most of the efficacy trials with the vaccine were carried out on colostrum-deprived gnotobiotic calves which were vaccinated orally at birth and experimentally challenged a few days after birth. It is probably futile to vaccinate calves orally immediately after birth, particularly in herds where the disease is endemic because the colostrum will contain high levels of specific antibodies.

Fecal shedding of oral vaccine rotavirus seldom occurs after oral inoculation of gnotobiotic calves with a commercial modified live bovine rotavirus–bovine coronavirus vaccine.<sup>65</sup> Because of low shedding of virus in gnotobiotic calves which do not have the interfering effects of colostrum antibodies, it seems unlikely that vaccine rotavirus will be shed in quantities from orally vaccinated conventional calves which have ingested colostrum containing antibody. Thus detection of the

virus by negative stain electron microscopy in feces from orally vaccinated calves is most likely to be virulent field virus rather than vaccine virus.

Vaccination of pregnant dam (passive immunization)

Vaccination of the pregnant dam to enhance specific colostral immunity can provide passive protection against enteric viral infection of newborn farm animals. The success of this method depends on the continuous presence of a sufficient amount of specific antibody to the rotavirus and coronavirus in the intestinal lumen.<sup>35</sup> Normally, the colostral levels of antibody are high in the first few milkings after parturition. However, there is a rapid decline in colostral antibodies to below protective levels within 24–48 h following parturition. Most cases of rotavirus and coronavirus diarrhea occur from 5–14 d after birth when the antibody levels in the post-colostral milk are too low to be protective.

The parenteral vaccination of the pregnant dam before parturition with a rotavirus and coronavirus vaccine will usually increase the level and duration of specific antibody in the colostrums.<sup>38</sup> There is a need for a vaccine which when given to pregnant cattle will initially result in protective levels of specific antibody to the rotavirus and coronavirus in the colostrum, and then in the milk for a sufficient period such as 10 d to 3 weeks, the period in which animals are most susceptible to these viral diarrheas. The use of a modified live rotavirus–coronavirus vaccine stimulated a small but insignificant increase in colostral and milk antibodies. However, by 3 d after parturition, the rotavirus and coronavirus antibody titers in the milk of vaccinated heifers had declined to low or undetectable levels.

Inactivated rotavirus vaccines given to pregnant cows in the last trimester will significantly increase antirotavirus antibody in colostrum and milk from vaccinated dams compared to controls, but the severity of diarrhea may be the same in calves from both groups. The increased milk antibody delays the establishment of infection but does not reduce the severity of clinical disease which was experimentally induced. An inactivated oil-adjuvanted rotavirus vaccine given 1 month before calving to beef cattle significantly reduced the morbidity and mortality in 16 of 17 herds with a total of 4066 cows.<sup>66</sup>

Experimental studies of maternal bovine rotavirus vaccines

The use of an adjuvanted rotavirus vaccine given simultaneously intramuscularly and by the intramammary route significantly enhanced serum, colostrum and milk rotavirus antibody titers, whereas intramuscular

vaccination with a commercial modified live rotavirus–coronavirus vaccine did not.<sup>67</sup> Colostrum supplements, from the cows vaccinated by the intramammary and intramuscular routes, fed to rotavirus-challenged calves at a rate of 1% of the total daily intake of milk, provided protection against both diarrhea and shedding. The 30-day milk antibody titers from these experimental cows were also considered to be protective for calves by which time the calves should have developed a high degree of age-specific resistance to rotavirus infection. The use of an inactivated rotavirus vaccine in an oil adjuvant given to pregnant cows 60–90 d before calving and repeated on the day of calving resulted in a significant increase and prolongation of colostral antibodies up to 28 d after calving. Diarrhea in calves from vaccinated cows was less common and less serious. Similar results were obtained with a combined inactivated adjuvanted rotavirus and *E. coli* vaccine. Similar results have been achieved by vaccination of pregnant ewes. Vaccination of ewes can result in an elevation of specific colostral antibody and prolong the period over which the antibody is present in the lumen of the intestines of the lambs. The vaccination of cows with a monovalent vaccine results in a heterotypic response to all serotypes of rotavirus to which the animals have been previously exposed, which suggests that single serotype vaccination may be sufficient.

The lactogenic antibody responses in pregnant cows vaccinated with recombinant bovine rotavirus-like (VLPS) of two serotypes or inactivated bovine rotavirus vaccines have been evaluated.<sup>68</sup> Bovine rotavirus antibody titers in serum, colostrum and milk were significantly enhanced by the use of triple-layered VLPs and inactivated vaccines but higher antibody responses occurred in VLP vaccinated cows.<sup>68</sup>

Bovine coronavirus vaccine

An oil adjuvanted vaccine containing bovine coronavirus antigen to enhance lactogenic immunity in the calf by vaccinating pregnant cows and heifers between 2 and 12 weeks before calving increased serum antibody in the dams which was reflected in a similar increase in the titer and duration of specific antibody in colostrum and milk for up to 28 days after calving.<sup>69</sup> The overall response was dependent on an adequate antigen payload being incorporated within the single dose vaccine.

Commercial bovine rotavirus–coronavirus and *E. coli* F5 (K99) vaccines

The original rotavirus and coronavirus vaccines for use in pregnant cows to provide passive immunization were not sufficiently efficacious because of the rapid decline in

specific colostral antibodies, which renders the calves susceptible to the viral diarrhea several days after birth. The relative success of the enterotoxigenic K99+ *E. coli* bacterins has resulted in a shift of the epidemic curve for acute diarrhea in calves under 30 d of age from a few days of age to 2–3 weeks of age.

More recently developed vaccines are efficacious. An inactivated combined vaccine against rotavirus, coronavirus and *E. coli* F5 (K99+) administered 31 days before the first expected calving date has been evaluated and compared to controls.<sup>70</sup> There was a significant increase in serum antibody against all three antigens in vaccinated animals, which was accompanied by increased levels of protective antibodies to rotavirus, coronavirus, and *E. coli* in their colostrum and milk for at least 28 days. The levels of specific rotavirus and coronavirus antibodies in the milk of vaccinated cows were greater than a four-fold higher than in the control cows for at least 28 days after calving.

The primary vaccination of pregnant cows with a trivalent commercial vaccine containing live attenuated bovine rotavirus and coronavirus and *E. coli* F5 followed by an annual booster at 6 and 3 weeks before calving, or using the same protocol with an inactivated trivalent vaccine resulted in significant increase in the serum antibody of all vaccinated animals compared to controls.<sup>71</sup> The antibody titers were higher in cows receiving the live vaccine compared to those receiving the inactivated vaccine. The colostral antibodies against all three antigens increased in all live vaccinated groups whereas inactivated vaccinated animals had only significant increases in F5 titers. The colostrum of live vaccinated cows contained much higher specific antibody titers. Thus the modified-live virus vaccine can significantly enhance the specific response to rotavirus and coronavirus and *E. coli* F5 after a primary vaccination followed by a booster annually.

Feeding 2 liters of colostrum within 12 hours after birth, from cows vaccinated 8 weeks before calving with an inactivated vaccine containing rotavirus, coronavirus and *E. coli* K99+/F41 antigens, is efficient in raising the serum antibody titer of calves to a high level, and, thus, protecting them against rotavirus infections which occur in the first few weeks of life.<sup>72</sup>

Stored colostrum

The high levels of viral antibody in the colostrum of the first two milkings of cows can be used to advantage in hand-fed calves. The daily feeding of stored colostrum from the first few milkings of cows from the affected herd will reduce the incidence of clinical disease in the

calves. The colostrum must be fed daily because rotavirus antibody is not retained in the intestinal lumen for more than 2–3 d. In affected herds the specific antiviral antibody in the stored colostrum may be sufficient to prevent the disease if colostrum is fed daily for up to 20–30 d. If a large number of cows are calving over a short period of time, the colostrum from immunized cows can be pooled and fed to the calves daily. Even small amounts of colostrum from immunized cows are efficacious if mixed with cows' whole milk or milk replacer.<sup>38</sup> This supplemental feeding of colostrum may be required for only 3–4 weeks, since older calves generally possess a high degree of age-specific resistance to rotavirus infections.

#### Systemic colostrum antibody

For many years it was uncertain if circulating colostrum antibody in calves was transferred back into the intestinal tract. Evidence shows that passive immunity to calf rotavirus diarrhea can be achieved by adequate calf serum colostrum antibody titers.<sup>73</sup> Calves fed colostrum on the first day of life had significant rotavirus-neutralizing antibody titers in their small intestinal lumina for 5 d and 10 d later. The intestinal antibody titers correlated with the serum antibody titers derived from colostrum and were predominantly of the IgG<sub>1</sub> isotype. Intestinal antibody titers were approximately equivalent in 5- and 10-day-old calves, suggesting that **antibody transfer to the intestinal tract is a continuing process for up to 10 days after birth.** Additional evidence that transfer of passive immunity occurs is that calves can be protected from rotavirus challenge by the administration of colostrum immunoglobulins by parenteral injection. This protection was not due to lactogenic antibody, since the calves received no source of dietary antibody. The transfer of circulating antibody into the intestinal tract may be the mechanism which results in the decreased morbidity and case fatality due to diarrhea in calves with high concentrations of passive serum immunoglobulins.<sup>73</sup>

#### Porcine rotavirus vaccines

Oral porcine rotaviral vaccines have been unsuccessful. Maternal rotavirus vaccines used to induce passive immunity have been examined. In pigs, as in ruminants, IgG antibodies to rotavirus are predominant in colostrum and decline 8–32-fold in the transition to milk. However, secretory IgA is the primary isotype of rotavirus antibody in the milk of pigs. Increased levels of sIgA and IgG antibodies to rotavirus occur in the milk of sows after natural rotavirus infection of nursing piglets or following parenteral inoculation of pregnant or lactating sows with live attenuated rotaviruses.<sup>38</sup> But titers decline

by the end of lactation, suggesting that repeated natural rotavirus infection of sows or parenteral revaccination may be necessary to maintain high sIgA antibody to rotavirus in milk. This observation may account for the higher prevalence of rotavirus infection during the first week of life in pigs born to gilts (38%) than in those born to sows (3%). There are few studies of maternal rotavirus vaccines for use in swine.

#### Equine rotavirus vaccine

An inactivated equine rotavirus vaccine given to mares at 8, 9, and 10 months of gestation was safe and immunogenic, and provided reasonable protection under field conditions.<sup>74</sup> Antibody titers were significantly increased at the time of foaling and 35 d after foaling in vaccinated, compared with control mares and for 90 d after birth in foals born to vaccinated, compared with foals born to control mares. The incidence of rotaviral diarrhea was lower in foals born to vaccinated, compared with foals born to control mares but the difference was not significant. Parenteral vaccination of mares with inactivated rotaviral vaccine stimulates production of high levels of specific IgG, and not IgA, in colostrum and milk.<sup>75</sup>

#### Subunit vaccines

Subunit rotaviral vaccines consisting of virus-like particles given parenterally can enhance bovine rotavirus antibody titers in serum, colostrum and milk.<sup>76</sup> These vaccines offer advantages over conventional modified-live or inactivated vaccines including:

- Exclusion of adventitious agents associated with live vaccines
- Consistent production of outer capsid proteins
- Genetic engineering to allow updating of efficacious vaccines for boosting lactogenic immunity. Field studies to evaluate the vaccine under naturally occurring conditions have not yet been carried out.

#### Chicken egg yolk immunoglobulin

Preliminary studies on the passive protection of anti-rotavirus chicken egg yolk immunoglobulins given orally to calves against experimental rotavirus infections in neonatal calves have been reported.<sup>77</sup> Treated calves had increased body weights and the number of calves shedding high titers of rotavirus in the feces was decreased compared to control calves.

#### REVIEW LITERATURE

Clark MA. Bovine coronavirus. *Br Vet J* 1993; 149: 51–70.

Parwani AV, Tsunemitsu H, Saif LJ. Current research in bovine group A and group C rotaviruses. *Curr Top Vet Res* 1994; 1: 115–132.

Saif LJ, Rosen BI, Parwani AV. Animal rotaviruses. In: Kapikian AZ (ed.) *Viral infections of the*

gastrointestinal tract. New York: Marcel Dekker 1994; pp. 289–314.

Browning GF. Equine rotavirus infections. In: Studdert M (ed.) *Virus infections of equines*. Amsterdam: Elsevier Science, 1996; pp. 127–135.

Saif LJ, Fernandez FM. Group-A rotavirus veterinary vaccines. *J Infect Dis* 1996; 174 Suppl 1: S98–S106.

#### REFERENCES

1. Saif LJ, Rosen BI, Parwani AV. In: Kapikian AZ (ed) *Viral infections of the gastrointestinal tract*. New York: Marcel Dekker 1994; pp. 289–314.
2. Parwani AV et al. *Curr Top Vet Res* 1994; 1:115.
3. Parwani AV et al. *J Clin Microbiol* 1996; 34:1303.
4. Scott FMM et al. *Vet Rec* 1996; 138:284.
5. Sandals WC et al. *Can J Vet Res* 1995; 59:81.
6. Ijaz MK et al. *Comp Immunol Microbiol Infect Dis* 1994; 17:91.
7. Kohara J, Tsunemitsu H. *J Vet Med Sci* 2000; 63:219.
8. Kaminjolo JS, Adesiyun AA. *Br Vet J* 1994; 150:293.
9. Chinsangaram J et al. *Comp Immunol Microbiol Infect Dis* 1995; 18:93.
10. Khurana B, Pandey R. *Vet Rec* 2001; 149:364.
11. Lucchelli A et al. *J Vet Diag Invest* 1994; 6:175.
12. Clark KJ et al. *J Am Vet Med Assoc* 1996; 208:552.
13. Huang JA et al. *J Clin Microbiol* 1992; 30:85.
14. Varshney B et al. *Arch Virol* 2002; 147:143.
15. Garcia A et al. *Comp Immunol Microbiol Infect Dis* 2000; 23:175.
16. Lu W et al. *Vet Microbiol* 1994; 42:159.
17. Alfieri AF et al. *Vet Microbiol* 2004; 99:167.
18. Barreiros MAB et al. *J Vet Med B* 2004; 51:104.
19. Fukai K et al. *Vet Microbiol* 2002; 86:343.
20. Fukani K et al. *Vet Microbiol* 1999; 66:301.
21. El-Attar L et al. *J Clin Microbiol* 2002; 40:937.
22. Klingenberg K De V et al. *Clin Diag Lab Invest* 1999; 6:181.
23. Bridger JC. *Gen Virol* 1994; 75:2807.
24. Tsunemitsu H et al. *J Clin Microbiol* 1995; 33:326.
25. El-Kanawati Z et al. *Am J Vet Res* 1996; 57:48.
26. Duckmanton L et al. *J Clin Microbiol* 1998; 36:1266.
27. Hoet AE et al. *J Vet Diag Invest* 2003; 15:205.
28. Hoet AF et al. *Am J Vet Res* 2003; 64:485.
29. Wise AG et al. *Vet Res* 2004; 100:165.
30. Smiley JR et al. *J Virol* 2002; 76:10089.
31. Deng Y et al. *J Clin Microbiol* 2003; 41:2300.
32. Van der Poel WHM et al. *Vet Microbiol* 2003; 92:297.
33. Thiel KW et al. *J Vet Diag Invest* 1996; 8:245.
34. Munoz M et al. *Epidemiol Infect* 1996; 117:203.
35. Munoz M et al. *Res Vet Sci* 1995; 59:180.
36. Will LA et al. *J Vet Diag Invest* 1994; 6:416.
37. Zaberezhny AD et al. *Prev Vet Med* 1994; 39:97.
38. Saif LJ, Fernandez FM. *J Infect Dis* 1996; 174 Suppl 1:S98.
39. Dewey C et al. *Can Vet J* 2003; 44:649.
40. Ramos APD et al. *Vet Microbiol* 2000; 71:1.
41. Martella V et al. *Clin Diag Lab Immunol* 2001; 8:129.
42. Winiarczyk S et al. *J Vet Med B* 2002; 49:373.
43. Thorns CJ et al. *Am J Vet Res* 1992; 53:36.
44. Carvajal A et al. *Prev Vet Med* 1995; 23:33.
45. Pijpers A et al. *Vet Rec* 1993; 132:129.
46. Martin M et al. *Prev Vet Med* 1994; 21:65.
47. Jabrane A et al. *Can Vet J* 1994; 35:86.
48. Elschner M et al. *Vet Microbiol* 2005; 105:123.
49. Browning GF, Begg AP. *Arch Virol* 1996; 141:1077.
50. Netherwood T et al. *Epidemiol Infect* 1996; 117:375.
51. Kelling CL et al. *Am J Vet Res* 2002; 63:1179.
52. Klingenberg K de V. *Vet Rec* 2000; 147:717.
53. Vellenga L et al. *Am J Vet Res* 1992; 53:1180.
54. Browning GF. In: Studdert M (ed) *Virus infections of equines*. Amsterdam: Elsevier Science, 1996; pp. 127–135.
55. Kunoki M et al. *Arch Virol* 1995; 142:843.

56. Kapil S et al. *Comp Immunol Microbiol Infect Dis* 1994; 17:139.
57. Markowska-Daniel I et al. *Comp Immunol Microbiol Infect Dis* 1996; 19:219.
58. Rodak L et al. *Vet Microbiol* 2005; 105:9.
59. Carvajal A et al. *J Vet Diag Invest* 1995; 7:60.
60. Hoet AE et al. *J Vet Diag Invest* 2003; 15:100.
61. Sueyoshi M et al. *J Comp Pathol* 1995; 113:59.
62. Rosen BI et al. *Vet Microbiol* 1990; 24:327.
63. Maes RK et al. *J Clin Microbiol* 2003; 41:290.
64. Munoz M et al. *J Vet Diag Invest* 1995; 7:546.
65. Varshney KC et al. *Vet Pathol* 1995; 32:619.
66. Thiel KW, McCloskey CM. *J Vet Diag Invest* 1995; 7:427.
67. Saif LJ et al. *Infect Immun* 1983; 41:1118.
68. Kim Y et al. *Vaccine* 2002; 20:1248.
69. Crouch CF et al. *Vaccine* 2001; 19:189.
70. Crouch CF et al. *Vet Rec* 2001; 149:105.
71. Jahnecke von S et al. *Tierarztl Umschau* 2002; 57:32.
72. Le Rousic S et al. *Vet Rec* 2000; 147:160.
73. Besser TE et al. *J Virol* 1988; 62:2234.
74. Bellinzoni RC et al. *Vaccine* 1989; 7:263.
75. Sheoran AS et al. *Vet Rec* 2000; 146:672.
76. Fernandez FM et al. *Vaccine* 1996; 14:1303.
77. Klingenberg K de V, Esfandiari J. *Vet Rec* 1996; 138:393.
78. Guy JS et al. *J Clin Microbiol* 2000; 38:4523.

## WINTER DYSENTERY IN CATTLE

### Synopsis

**Etiology** Bovine coronavirus

**Epidemiology** Northern climates. Adult lactating dairy cows, usually during winter months when housed. Immunity develops and lasts variable periods. High morbidity with outbreaks; no mortality. Transmitted by fecal-oral route

**Signs** Sudden onset of diarrhea affecting almost entire herd within several days. Mild fever, decline in milk production, inappetence. Recover in few days. Some coughing

**Clinical pathology** None routinely

**Lesions** None

**Diagnostic confirmation** Detection of virus in feces. Serology

**Differential diagnosis list.** All common causes of diarrhea in adult cattle (see Table 5.10)

**Treatment** None required

**Control** No specific control measures available. Hygiene. Minimize overcrowding in dairy housing

Winter dysentery is a highly contagious disease of adult cattle characterized by an acute onset of a short course of severe diarrhea and sometimes dysentery. Mild respiratory signs, accompanied by decreased milk production and variable depression and anorexia are also characteristic of the disease. Recovery is spontaneous within a few days

### ETIOLOGY

The disease is associated with a bovine coronavirus (BCV) which is a member of family Coronaviridae, order Nidovirales.<sup>1</sup> The virus can be found in the feces of affected cows along with a serological response to the virus. The disease can be reproduced in bovine coronavirus seronegative lactating cows.<sup>2</sup>

Several studies have found a close serological relationship between the coronavirus causing winter dysentery and the coronavirus causing diarrhea in calves but there are antigenic differences between the different isolates.<sup>1,3</sup> The oral and intranasal inoculation of gnotobiotic and colostrum-deprived calves with the virus of winter dysentery results in diarrhea in the calves indistinguishable from that seen in calves inoculated with the calf diarrhea coronavirus.<sup>4</sup> The BCV has also been isolated from the diarrheic feces of adult wild ruminants (sambar deer, one waterbuck and white-tailed deer) affected with diarrhea in both England and the United States.<sup>5</sup> The BCV has tropism for both the intestinal and respiratory tracts.<sup>6</sup> The virus also causes respiratory tract infections in calves and feedlot cattle.<sup>7,8</sup>

### EPIDEMIOLOGY

#### Occurrence and prevalence of infection

The disease occurs primarily in mature dairy cattle and has been reported in many countries including the United States, Canada, Sweden, Germany, France, Israel, Australia, and New Zealand. It is common in dairy cattle in Sweden.<sup>2,9</sup> A nationwide survey of antibodies to BCV in bulk tank milk in Swedish dairy herds found that 89% of samples were positive and 52% had very high levels of antibodies.<sup>9</sup> There were also higher antibody levels in larger herds.

Winter dysentery is most common in recently calved adult lactating dairy cows. Young cattle may be affected but with only mild clinical signs. The disease is most common in cattle in northern climates when they are housed from November to April. A moderate immunity, which persists for about 6 months, develops after clinical disease, and recurrent clinical disease seldom occurs in less than 2–3 years. In France, the frequency of epidemics in a herd vary from a few months to 10 years. In herds regularly exposed to the infection, epidemics are mild; when the intervals between recurrences are more than 3 years, the epidemics are more severe. Serological examination of paired serum samples from affected herds reveal that almost all cows seroconvert to bovine coronavirus and the BVDV.<sup>2</sup> The titers to the bovine coronavirus are still high 1 year after the outbreak and antibody is transferred to colostrum and to the calves in which it persists for up to 4–6 months of age.<sup>2</sup>

The disease has also occurred in adult beef cattle and in feedlot cattle 6 to 9 months of age.<sup>8</sup>

A coronavirus indistinguishable from BCV has been isolated from wild ruminants with diarrhea similar to winter dysen-

tery in cattle.<sup>10</sup> The virus was isolated from the feces of sambar deer, waterbuck in a wild animal habitat, and from a white-tailed deer on a wildlife farm in Ohio. In a serological survey of coronaviruses among wild deer, 8.7% and 6.6% of sera from mule deer in Wyoming and from white-tailed deer in Ohio, respectively, were seropositive against the wildlife isolates and selected bovine coronaviruses. Thus coronaviruses exist in wild ruminants which may be a source of infection transmissible to cattle.

#### Morbidity and case fatality rates

The morbidity rate may be as high as 30–50% within a few days after the first case is encountered, and up to 100% after 1 week. The case-fatality rate is less than 1%. A typical outbreak may last for 1–2 weeks and in Sweden, 75% occur between November and January.<sup>2</sup> The disease is important in dairy herds because, although few animals die of the disease, it may cause serious loss of body condition and milk flow. In mild epidemics, the maximum decrease in milk production compared to a theoretical lactation curve ranges from 6–11%. The overall decrease in milk production may persist for 8–15 d, after which time milk production levels are regained. In severe epidemics, the maximum decrease in milk production may be as high as 30% and may last for up to 28 d.

Outbreaks of the disease diagnosed by farmers exhibit space-time clustering within a 30-day time and a 5.5 km radius. Large herds with more than 60 cows and a history of an outbreak in the previous year were at increased risk of an outbreak. In Sweden, one-third of the affected herds had experienced an outbreak within the previous 4 years and 18% had a least one further outbreak during the following 2 years.

#### Methods of transmission

Feces from clinical cases or clinically normal carriers are the source of infection, and contamination of feed or drinking water is the method of spread. In France, the disease occurs on small dairy farms where the surface area is smaller than 2.3 m<sup>2</sup>/cow. The disease is highly contagious and is introduced to farms by human visitors, carrier animals and fomites. Infection of the respiratory tract with the bovine coronavirus may enhance the transmission of the infection in addition to the usual fecal-oral route of transmission of enteric pathogens.

#### Experimental reproduction

Both winter dysentery and calf diarrhea can be reproduced using the same strain of BCV.<sup>2</sup> Calf diarrhea and winter dysentery strains of the virus can cause diarrhea

in adult cows in conjunction with host or environmental factors.<sup>3</sup> Winter dysentery can be reproduced in seronegative lactating dairy cows by direct contact with an experimentally infected calf. All experimental cattle shed the virus in the feces at the onset of profuse watery diarrhea with small amounts of blood in the feces of the most severely affected animals including both cows and calves. The cows are commonly more depressed, and their appetites are decreased which is associated with a marked decrease in milk yield. Following infection all cattle will produce early interferon type 1 in serum and in nasal secretions and milk. All cattle develop high IgM antibody responses and long-lasting IgA antibody responses both systemically and locally. Prolonged IgM antibody responses occur in all infected cattle. The IgA antibody response in serum may be detectable for up to 17 months after infection. Bovine-specific IgG can be detected in all cattle during the experimental period of up to 22 months.

#### Risk factors

Host and environmental risk factors

The cow-level risk factors for the development of winter dysentery in dairy cattle have been examined.<sup>11</sup> The likelihood of developing disease increased as the ELISA value for bovine coronavirus (BCV) antigen detectable in feces increased. Pregnant cattle were less likely to develop the disease compared with nonpregnant animals. Cows with high acute antibody titers to BCV which seroresponded had greater odds of developing disease, compared with cows with lower titers.

Some herd-level risk factors have been identified in dairy herds which have been exposed to the BCV and have experienced outbreaks of the disease.<sup>12</sup> The factors which appeared to increase a herd's risk for the disease include: an increase in herd prevalence of adult cows that had a four-fold or more increase in BCV serum IgG antibody titer; increase in herd prevalence of adult cows that had a fourfold or more increase in bovine viral diarrhea titer; housing cattle in tie-stall or stanchion barns rather than free-stall facilities; and use of equipment to handle manure and subsequently handle feed. The adjusted population-attributable risk for these variables was 71, 43, 53, and 31%, respectively, and 99% overall, indicating that these variables had considerable effect on winter dysentery outbreaks.

Pathogen risk factors

Coronaviruses are divided into at least three antigenic groups, and antigenic cross-reactivity exists within an antigenic group.<sup>10</sup> Bovine coronavirus, mouse hepatitis virus, murine enteric coronavirus, rat

coronavirus, human coronavirus, porcine hemagglutinating encephalomyelitis virus belong to the same group. Bovine coronavirus is an important cause of neonatal calf diarrhea, and winter dysentery. BCV also possesses tropism for the respiratory tract of young cattle.

Some BCV strains isolated from the respiratory tract of cattle had different biological, antigenic, and genetic properties compared with enteric strains of the virus. Strains isolated from feedlot cattle and compared to those with the originally described Mebus prototype (from neonatal diarrhetic calves) reveal that the respiratory strains of BCV may differ genetically from the classical calf enteric and adult winter dysentery strains.<sup>13</sup>

Cross-protection studies between respiratory and calf diarrhea and winter dysentery coronavirus strains in calves have been examined using RT-PCR and nested PCR for their detection.<sup>7</sup> Calves inoculated with bovine respiratory coronavirus (BRCV), calf diarrhea coronavirus (CD), winter dysentery (WD) coronavirus strains of BCV and the challenged 3 to 4 weeks later with either BRCV, CD, or WD strains of BCV developed diarrhea, then recovered and were protected from BCV-associated diarrhea after challenge exposure with either homologous or heterologous BCV strains. Nasal and fecal shedding of BCV, which were detectable only by nested PCR, after challenge exposure confirmed field and experimental data documenting reinfection of the respiratory and enteric tracts of cattle, indicating that in closed herds, respiratory or enteric tract infections may constitute a source of BCV transmission to cows or young calves. The biological, serological and genome properties of cytopathogenic RBCV strains isolated in Quebec and Ontario, Canada, have been compared to the original Mebus strain. RBCV strains have also been compared to previously characterized enteric bovine coronavirus strains in order to identify specific strain markers which should be considered for diagnosis and development of vaccines.<sup>1</sup>

#### PATHOGENESIS

The disease is a mild enteritis affecting the small intestine. The virus also has a tropism for the respiratory tract and has been associated with respiratory disease in adult cattle and pneumonia in calves.

#### CLINICAL FINDINGS

##### Cattle

After an incubation period of 3–7 d there is an explosive outbreak of diarrhea which, in the course of the next 4–7 d, affects the majority of adult cattle. The youngest animals of the mature group may have only mild signs. A fever (39.5–40.5°C;

103–105°F) may precede the onset of diarrhea but when clinical signs are evident, the temperature is usually normal. There is a marked fall in milk yield which lasts for up to 1 week, anorexia of short duration, and some loss of body condition. The feces are liquid and homogeneous without much odor, and with no mucous or epithelial shreds; the color is dark green to almost black. Feces are often passed with little warning and considerable velocity. A nasolacrimal discharge and cough may precede or accompany the epidemic. The frequency of coughing may be higher in those herds which have not experienced a more recent outbreak. In most animals the course is short and the feces return to normal consistency in 2–3 d. In occasional cases the syndrome is more severe, dehydration and weakness are apparent, and dysentery – either with feces flecked with blood or the passage of whole blood – occurs. The disease in the herd usually subsides in 1–2 weeks but in some cases production may not return to normal for several weeks or a few months.<sup>2</sup>

In feedlot cattle, 6 to 9 months of age, the disease has been characterized by an acute onset of diarrhea with high morbidity and low mortality, dyspnea, coughing, and nasal discharge, and high body temperature (40 to 41°C in most severe cases.<sup>8</sup> The diarrhea is characterized by fluid dark (brown-black) feces sometimes containing frank blood.

##### Sheep

Diarrhea and unthriftiness in groups of sheep have been associated with the virus but no published information is available.

#### CLINICAL PATHOLOGY

The laboratory diagnosis is dependent on detection of the virus in feces and serology. Fecal and blood samples should be submitted from both affected and normal cows.

##### Detection of virus

Fecal samples can be examined for the presence of bovine coronavirus using the ELISA test and by electron microscopy for viral particles. For routine purposes, direct electron microscopy viral identification and/or ELISA is sufficient. This can be complemented by protein A gold **immune electron microscopy** because of its high sensitivity and specificity in the detection of viral particles. A reverse transcriptase PCR (RT-PCR) can be used to detect the BCV in the feces of experimentally inoculated cattle.<sup>3</sup> The 1-step RT-PCR and nested PCR assays were highly sensitive to detect BCV in nasal and fecal specimens and are useful for the etiological diagnosis of BCV in calves and adult cows.<sup>7</sup>

## Serology

In addition to detection of the virus in feces, an increase in the antibody titer to coronavirus based on acute and convalescent sera collected 8 weeks apart is supportive evidence that the virus is the causative agent.<sup>14</sup> Attempts at diagnosing these infections serologically are often problematic because in adult cattle high BCV-specific IgG levels are often encountered in the acute samples, presumably due to reinfections with the virus, obscuring the detection of a possible increase in titer in paired samples.<sup>14</sup> In addition, adult cattle are usually seropositive and maternal antibodies frequently obliterate the detection of infection in calves. There is a need for serologic tests that do not require the cumbersome and expensive paired samples necessary for an Ig-G based diagnosis.

A capture ELISA test for BCV-specific IgA and IgM in milk and sera has been developed and is useful for discriminating between primary infection and reinfection.<sup>14</sup> In adult cattle, testing of paired serum samples using the antibody-capture ELISA may be a better indicator of recent BCV exposure than testing of serum samples with virus neutralizing assays.<sup>15</sup> Antigen-antibody binding in feces may interfere with results of the antigen-capture ELISA for BCV.

## NECROPSY FINDINGS

In the rare fatalities available for necropsy, there is severe hemorrhage and hyperemia of the colonic and cecal mucosa. Frank blood may be present in the lumen of the large intestine.<sup>8</sup> Microscopically there is widespread necrosis and degeneration of the epithelium of the large bowel. Similar but less severe gross and microscopic changes have been observed in experimentally infected cattle.

## Samples for confirmation of diagnosis

- **Histology** – formalin-fixed cecum, colon (LM, IHC)
- **Virology** – colonic content (EM, ELISA), colon (FAT).

## DIFFERENTIAL DIAGNOSIS

Winter dysentery must be differentiated from:

**BVD/MD** affects cattle 8–24 months of age in small outbreaks. Erosions of the oral cavity are present and the diarrhea and systemic effects are much more severe. The more recently recognized Type II BVD affects cattle of all ages including adult cattle and is a severe, highly fatal disease.

**Coccidiosis** affects cattle from 3–12 months of age and is characterized by frank blood in the feces and tenesmus, and the fecal sample is usually diagnostic.

**Enteric salmonellosis** is a severe toxemic enteritis with diarrhea and

dysentery, fibrinous casts in the feces, a high fever, severe depression and rapid death. Culture of the feces is important.

**Johne's disease.** A chronic intractable diarrhea in mature cattle with loss of body weight and eventual emaciation.

**Group B rotavirus.** Rare cases of diarrhea in mature lactating dairy cows associated with Group B rotavirus have been described.<sup>16</sup> The onset of diarrhea is sudden, milk production decreased, the feces were liquid, and recovery occurred in 3 to 5 days.

**Respiratory tract infections.** The clinical findings of dyspnea, nasal discharge, coughing, and fever associated with the bovine respiratory coronavirus must be differentiated from acute undifferentiated bovine respiratory tract disease.

## TREATMENT

Treatment is of doubtful value because affected cattle usually respond spontaneously in 24–36 h. Occasionally dehydration will become severe and is best treated with fluids and balanced electrolytes as indicated.

## CONTROL

### Management

Because of the explosive nature of the disease and the lack of information on possible precipitating causes, effective control measures cannot be recommended. Every effort must be made to avoid the spread of infection on inanimate objects such as boots, feeding utensils and bedding, but even the greatest care does not appear to prevent the spread of the disease within a herd.

### Vaccination

Some preliminary studies have tested the potency of bovine coronavirus vaccine to induce serum antibodies but randomized controlled trials to test the efficacy of the vaccine have not been done.<sup>17</sup>

## REVIEW LITERATURE

Van Kruiningen HJ et al. Winter dysentery in dairy cattle: recent findings. *Comp Cont Educ Pract Vet* 1985; 7:S591–S599.

Clark MA. Bovine coronavirus. *Br Vet J* 1993; 149:51–70.

## REFERENCES

1. Gelinas A-M et al. *Virus Res* 2001; 76:43.
2. Traven M et al. *Vet Microbiol* 2001; 81:127.
3. Tsunemitsu H et al. *Arch Virol* 1999; 144:167.
4. Tsunemitsu H, Saif LJ. *Arch Virol* 1995; 140:1303.
5. Tsunemitsu H et al. *J Clin Microbiol* 1995; 33:1995.
6. Clark MA. *Br Vet J* 1993; 149:51.
7. Cho K-O et al. *Arch Virol* 2001; 146:2401.
8. Cho KO et al. *J Am Vet Med Assoc* 2003; 217:1191.
9. Traven M et al. *Vet Rec* 1999; 144:527.
10. Tsunemitsu H et al. *J Clin Microbiol* 1995; 33:3264.
11. Smith DR et al. *Am J Vet Res* 1998; 59:986.
12. Smith DR et al. *Am J Vet Res* 1998; 59:994.
13. Hasoksuz M et al. *Virus Res* 2002; 84:101.

14. Naslund K et al. *Vet Microbiol* 2000; 72:183.
15. Smith DR et al. *Am J Vet Res* 1998; 59:956.
16. Hayashi M et al. *Vet Rec* 2001; 149:331.
17. Takamura K et al. *Can J Vet Res* 2002; 66:278.

## BLUETONGUE

### Synopsis

**Etiology** Bluetongue virus, an orbivirus with several serotypes and considerable genetic heterogeneity

**Epidemiology** An infectious, non-contagious disease of sheep and occasionally cattle, transmitted by *Culicoides* spp. Cattle are the reservoir and amplification hosts. Severe disease is restricted to fine wool and mutton breeds of sheep. Infection, but not disease is endemic in tropical and subtropical regions. Disease occurs in epidemic and incursive areas when climatic conditions allow the expansion of vector occurrence

**Clinical findings** Fever, catarrhal stomatitis, rhinitis, enteritis and lameness due to coronitis and myositis

**Clinical pathology** Virus isolation, agar gel immunodiffusion and competitive or blocking enzyme-linked immunosorbent assay (cELISA) serological tests. Detection of nucleic acid

**Necropsy findings** Mucosal lesions, hemorrhage and necrosis of skeletal and cardiac muscles, hemorrhagic lesion at base of pulmonary artery

**Diagnostic confirmation** Detection of viral nucleic acid, virus isolation, rising titer with serology

**Treatment** None specific, supportive  
**Control** Reduction of exposure to vector is attempted but major method of control in epidemic areas is by vaccination

## ETIOLOGY

Bluetongue virus (BTV) is an arthropod-borne *Orbivirus* in the family Reoviridae. Within the BTV serogroup there are at least 24 serotypes of BTV worldwide. There is considerable **genetic variability** within the serogroup. This arises by genetic drift of individual gene segments as well as by reassortment of gene segments when ruminants or the vectors are infected with more than one strain. There is also debate of the biological validity of the classification of BTV into strict types.<sup>1–3</sup> All serotypes do not exist in any one infected area.

## EPIDEMIOLOGY

### Occurrence

Bluetongue virus infects domestic livestock populations in all **tropical and subtropical countries** and occurs on the continents of Africa, Asia, North America, South America, Australia and several islands in the tropics and subtropics, primarily between latitudes 40°N and 35°S.<sup>4</sup> **Incursive disease** has occurred in Portugal, Spain and Greece but until very recently bluetongue was not considered an endemic

infection in Europe. However, in an epidemic beginning in 1998, and persisting to date (2005), five serotypes have spread across and persisted in 12 countries in southern Europe occurring 800 km further north than ever previously recorded.<sup>5</sup> This persistence indicates overwintering of these infections in these new regions and is believed the result of climate change from global warming.

The distribution and intensity of infection in regions of the continents is determined by the climate, geography and altitude, as they affect the occurrence and activity of the *Culicoides* vectors, and by the presence of susceptible mammalian hosts. There is a **gradation** from continuous BTV activity in tropical areas to absence of virus transmission in colder areas. In large countries that span different latitudes, such as the United States and Australia, there are areas that are free of infection.

**In endemic areas**, the infection is always present but clinical disease of the indigenous species is unusual. It can occur with new BTV strains and when non-indigenous susceptible species are introduced to the area.

**Epidemic zones** also exist, where infection and clinical disease occur every few years. Infection in these areas is highly focal and outbreaks occur when climatic conditions allow the vector to spread beyond its usual boundaries and to infect susceptible ruminants.

**Incursive disease** can occur in regions which do not normally experience infection and may occur when the virus is introduced by **windborne movement** of infected *Culicoides* with subsequent insect breeding in the summer before 'die out' in the autumn and winter. This method of spread is believed to have been the genesis of several serious outbreaks of bluetongue in countries normally free of the disease and of the outbreaks in Portugal in 1956, in Cyprus in 1977, in Turkey and Greece in 1979–1980 and in Israel in 1960–1980.<sup>4-6</sup> Polymerase chain reaction-based procedures can be used to determine the serotypic and geographic origin of infection with BTV.<sup>7</sup>

In the **United States**, the prevalence of seropositive cattle varies from high in the southern and western states to low in the northern states, especially the north-eastern states. In the northwest region, there are epidemics of infection in the summer and fall every few years, associated with movement of infected vectors from the south. **Canada** is free of infection except for periodic incursions into the Okanagan Valley in British Columbia from windborne infected *Culicoides* from south of the border.<sup>8</sup> In **Australia**, there has been a sequential introduction of

bluetongue serotypes from Indonesia by windborne *Culicoides* spp. but endemic infection is limited to northern cattle areas with extension down the east coast.<sup>7,9-11</sup>

#### Host occurrence

Infection occurs in a number of animals but significant disease occurs only in sheep. Cattle are the major **reservoir host** for sheep. Under natural conditions infection occurs in sheep and cattle, but it is also recorded in elk, white-tailed deer, pronghorn antelope, camels and other wild ruminants. Natural infection rarely occurs in goats but the infection can be transmitted experimentally.<sup>12</sup>

#### Method of transmission

The disease is not contagious and is **transmitted biologically** by certain species of *Culicoides*. There are over 1400 species of *Culicoides* worldwide but only a limited number have been associated with BTV.<sup>10,13-15</sup> Female *Culicoides* feed on cattle and horses and also sheep, deer, and goats, requiring at least one blood meal for the completion of the ovarian cycle. They feed nocturnally on animals in open pens and fields and the optimal temperatures for activity lie between 13°C and 35°C.

Virus in ingested blood infects cells of the midgut by a **receptor-mediated process**,<sup>16</sup> replicates and subsequently is released to the salivary gland. Once infected, they are infected for life – a period of several weeks.<sup>14</sup> They may feed twice or more and on different hosts, and achieve their greatest transmission potential 6–14 d after feeding on a viremic animal. BTV is maintained in nature by alternating cycles of infection between the midge and ruminant species. In many areas the disease is **seasonal** because *Culicoides* are killed by the first hard frost.

*Culicoides* breed in damp, wet areas including streams, irrigation channels, muddy areas and fecal runoff areas around farms, and habitats for them exist on the majority of farm environments. Species that are **cattle associated**, such as *C. brevitarsis*, breed in cattle dung. The generation time in the summer is about 14 d. Different species have different geographic occurrence and their distribution in a country is determined by climatic factors and the presence of a preferred host.

#### *Culicoides* species

In the **United States**, *C. variipennis* var *sonorensis* is the vector except in the south-east where it is *C. insignis*. This species and *C. pucillus*, *C. insignis*, *C. pusillus* and *C. filarifer* are also important in transmission in the **Caribbean** and Central and **South America**. There are other

subtypes of *C. variipennis* in the United States which have different distributions to *C. variipennis* var. *sonorensis*. In **Africa**, *C. imicola* (*pallidipennis*) is a major vector and in the **Middle East and Asia** *C. fulvis*, *C. imicola*, *C. obsoletus*, *C. nudipalpis* and *C. orientalis*. In **Australia**, *C. wadai*, *C. actoni*, *C. brevitarsis*, *C. peregrinus*, *C. oxystoma*, *C. brevipalpis* and *C. fulvus* are vectors or potential vectors. They have different distribution in the country which oscillates, depending on climate. *C. brevitarsis*, *C. brevipalpis* and *C. wadai* are **obligate parasites** of cattle (dung breeders), but the others can complete their lifecycle in the absence of cattle. *C. brevitarsis* is the most extensively dispersed vector.<sup>10</sup> *C. imicola* has been involved in the recent expansion of bluetongue in **southern Europe**, but *C. obsoletus* and *C. pulicaris* have been implicated as new vectors in these regions.<sup>5,17</sup>

#### Other vectors

Other vectors may transmit the disease mechanically but are unlikely to be of major significance in disease epizootics. The argasid tick *Ornithodoros coriaceus* has been shown experimentally to be capable of transmitting the virus and be a potential vector. The sheep ked (*Melophagus ovinus*) ingests the virus when sucking the blood of infected sheep and can transmit the infection in a mechanical manner. Mosquitoes may play a role in transmission and *Aedes lineatopennis* and *Anopheles vagus* have been suspect.

#### Over-wintering

The life span of an adult *Culicoides* is usually less than 10 days and at the most a few weeks. Cold winters kill virtually all of the adult vectors and there can be **no** transmission during these cold periods. Despite this there is an annual recrudescence of bluetongue in several temperate areas. The reason for the **persistence** of the infection from season to season is not fully understood. There is the possibility of the virus over-wintering in the insect vector but there is little evidence in support of this. *Culicoides* survive winter periods as larvae but there is no evidence of transovarial transmission of BTV in these insects.<sup>5,18</sup>

With infected animals bluetongue viruses can be isolated after initial infection for only a short period of time in infected sheep and only slightly longer in cattle. Infection of *Culicoides sonorensis* that were allowed to feed on infected animals occurred for only 11 days after initial infection in sheep and 49 days following infection of cattle although bluetongue virus nucleic acid can be detected for longer periods.<sup>19</sup> An analysis, in 2001, of published data indicated that the duration of viremia in cattle ceased by 63 days after



infection in adult cattle and a slightly longer period in infected colostrum-deprived calves.<sup>20</sup> Infection, as detected by routine isolation if virus, can also persist in wild ruminants.

However, none of these periods adequately explain the recrudescence and apparent over-wintering of infection in some areas. It has been recently shown that infectious BTV can be recovered from ovine skin biopsies for more than 9 weeks after infection and it is postulated that infection can be covertly present in seropositive and aviremic ruminants as a result of a persistent infection established in  $\gamma\delta$  T-cells. This covert but persistent infection is believed to allow perpetuation of BTV through the winter.<sup>21</sup> It is suggested that the occurrence of new vectors in the following spring with biting activity results in skin inflammation with recruitment of inflammatory cells including  $\gamma\delta$  T-cells and that interaction of these infected cells with skin fibroblasts results in a conversion of a persistent infection of the  $\gamma\delta$  T-cells to a productive lytic infection that allows subsequent infection of biting vectors.<sup>5,21</sup>

#### Venereal transmission

Bluetongue virus has been found in the **semen** of infected bulls during the initial viremic period, and infection has been transmitted through bull semen to susceptible cows,<sup>22</sup> but it is unlikely that this is a significant mechanism of transmission. Transplanted **embryos** from infected services are free of the virus and this is regarded as a minimal risk technique for obtaining offspring from cattle and sheep in infected areas.<sup>23,24</sup>

#### Persistent infection

Persistent infection in immunotolerant animals following in utero infection, once thought to be of importance, is now believed not to occur.<sup>12,25</sup>

#### Pathogen and vector risk factors

The geographical occurrence of bluetongue serotypes varies and is changing with time. There are differences in virulence between serotypes and between strains within serotypes and virulence is also related to virus dose and dependent on vector species, distribution and competence. Different *Culicoides* species **vary in susceptibility** to infection and some known vectors are resistant to infection with some serotypes, which in part explains regional differences in serotype occurrence.<sup>10</sup> Different *Culicoides* species have **different host preferences** and some have a distinct preference for cattle and little host preference for sheep.<sup>10</sup>

#### Climate

Climate is a major risk factor as culicoides require warmth and moisture for breed-

ing and calm, warm, humid weather for feeding. A cold winter or a dry summer can markedly reduce vector numbers and risk for disease. Moisture may be in the form of rivers and streams or irrigation but rainfall is the predominant influence and rainfall in the preceding months is a major determinant of infection.<sup>26-29</sup>

Precipitation affects the size and persistence of breeding sites and the availability of humid microhabitats to allow shelter from desiccation during hot summer and autumn periods. Optimal temperature is also essential and in endemic areas temperatures for survival of the adults and larvae require temperatures sustained above a mean of 12.5°C for the cooler months and temperatures in the range of 18 to 30°C in the summer and autumn for optimum recruitment to adults and for optimal adult activity.<sup>30,31</sup> Temperature also affects the rate of virus production in culicoides.<sup>32</sup> Geographic information systems (GIS) can be used to predict area risk.<sup>28</sup>

#### Serotype occurrence

Genetic studies indicate that BTV tends to exist in discrete, stable ecosystems and that BTV serotypes that circulate in one region of the world are largely different from those in other regions. In the **United States**, five serotypes – 2, 10, 11, 13, and 17 – have been isolated. Serotype 2 is a relatively recent isolate and is restricted to the habitat of *C. insignis*, but the latter four are endemic throughout much of the south and west. Serotype 13 is probably a reassortment virus with a gene segment derived from a vaccine virus parent<sup>33</sup> and other reassortments between live vaccine virus and wild-type virus are a concern for the emergence of virus types that could possess enhanced virulence characteristics or novel antigenic properties.<sup>34</sup> In the **Caribbean Region** and **South and Central America**, serotypes 1-4, 6, 8, 12, 14, and 17 are reported.<sup>4,13,35</sup> In **Australia**, eight serotypes – 1, 3, 9, 15, 16, 20, 21, and 23 – have been isolated. Six of these (3, 9, 15, 16, 20, and 23) have only been found in the north of the Northern Territory, while two serotypes (1 and 21) are widely distributed across the northern and eastern coast of Australia. The introduction appears to have been sequential and five have been introduced since 1981. The virus has been isolated from infected *Culicoides* and sentinel animals and although there is serological evidence of infection in Queensland and New South Wales, there has been no clinical disease. In **Africa**, serotypes 1, 16, 18, 19, and 24 are the major serotypes isolated and in **Asia**, serotypes 1, 4, 7, 9, 10, 12, 16, 17, 20, 21, and 23.<sup>4,36</sup> Serotypes 1, 2, 4, 9, and 16 are associated with disease

in the current expansion in southern Europe.<sup>5</sup>

The bluetongue viruses are stable and resistant to decomposition and to some standard virucidal agents, including sodium carbonate. They are sensitive to acid, inactivated below pH 6.0, and susceptible to 3% sodium hydroxide solution and organic iodides.

#### Host risk factors

##### Cattle

Cattle are the **reservoir and amplifying host** and have a high titer viremia. Cattle appear to be much more attractive to *Culicoides* spp. and this may enhance the importance of cattle as carriers. A **critical density** of cattle in a region may be required to sustain bluetongue in regions where the *Culicoides* vector is strongly cattle associated.<sup>10</sup>

*Bos taurus* breeds are more likely to be seropositive than *Bos indicus* and bulls have a greater risk for infection than females or castrated males. Seroprevalence increases with age, probably a reflection of increased duration of exposure.

##### Sheep

All breeds of sheep are susceptible but to varying degrees. **Merinos and British breeds** are more susceptible than native African sheep. There are also differences in **age** susceptibility to clinical disease which, inexplicably, vary with different outbreaks. With Australian serotypes, disease occurs only in sheep 3 years of age or older.<sup>11</sup> Exposure to **solar radiation** can increase the severity of the disease, as can excessive droving, shearing, poor nutrition and other forms of stress.

#### Morbidity and case fatality

When the disease occurs in a flock for the first time the incidence of clinical disease may reach 50-75% and the mortality 20-50%. Outbreaks in Cyprus and Spain were accompanied by mortality rates of 70% in affected flocks<sup>2</sup> but most outbreaks result in much lower mortality. Mortality rates of 2-30% are reported under field conditions in South Africa and from 0-14% in field outbreaks in the United States. High mortality can occur when a new strain of BTV emerges in an area.

Immunity to BTV tends to be strain specific and in epizootics, more than one strain may be introduced into an area. Infections caused by different serotypes may follow one another in quick succession in a sheep population. The serotypes vary widely in their virulence with a corresponding variation in the severity of the disease produced. However, sequential infection with more than one type of BTV results in the development of heterotypic antibody and may result in protection

against heterologous serotypes not previously encountered.

### Experimental reproduction

Infection is readily produced by experimental infection of sheep and cattle but it is common for the clinical presentation of the experimental disease to be **very mild** despite the fact that the isolate might have been associated with severe disease in the field.<sup>12,37</sup> In many cases experimental infection produces viremia, fever, leukopenia and an antibody response but the localizing, identifying lesions are often minimal, with erythema of the coronary bands as the only visible abnormality in some cases.<sup>38</sup>

### Fetal infection

Congenital defects of the nervous system of lambs occur when pregnant ewes are vaccinated with **attenuated vaccine virus**, and when calves and lambs are inoculated experimentally before midgestation, but **occur rarely with natural** infection. Unadapted virus does not readily cross the placenta.<sup>39</sup> Experimental inoculation of pregnant ewes is more likely to lead to fetal death with a generalized hepatic necrosis and suppressed hepatic hematopoiesis. Infection of the ewe in mid-pregnancy can result in infection of the lamb which is unaffected and born normally, but viremic so that it may remain as a source of infection for a further 2 months.<sup>40</sup> However, such lambs are not expected to have a major role in the spread of the disease.

The location and the nature of the lesions in the lambs of ewes injected with attenuated vaccine virus is related to the level of maturation and migration of nerve cells at the time infection occurs. The degenerative nature of the lesions results from the presence of immature neural cells with enhanced viral susceptibility combined with an inability to mobilize an effective immunological response.<sup>22</sup> In older fetuses, a typical inflammatory response develops and there is also a generalized retardation of growth and lymphoreticular activity.<sup>41</sup>

Experimental inoculation of cows at 60–120 d of pregnancy with virulent viruses can cause **congenital defects**, including excessive gingival tissue, agnathia (tilted mandible), arthrogryposis, ataxia and head pressing. Hydranencephaly or porencephaly may also be a sequel to infection with more virulent strains. The severity of the brain lesions decreases with increasing fetal age and infection at 243 d results in a mild encephalitis and the premature birth of calves which are still viremic but poorly viable.

### Economic importance

Mortality varies with the serotype but can be significant and it is estimated that the

incursion of the disease in Europe since 1998 has caused has death of over 1 million sheep.<sup>5,34</sup> However, production loss is also of great importance. Adults either lose their fleece from a break in the growth of the staple or develop a weakness (tender wool) that causes breaks in processing and markedly reduces the value of the fleece. Pregnant ewes commonly abort. There is a severe loss of condition and convalescence is prolonged, particularly in lambs. The loss from clinical disease and from reduced wool quality and suboptimal production following infection in sheep are significant.

A further major indirect cost of the disease is the restriction in **international trade**. The severe disease that occurred in the outbreaks in Cyprus and the Iberian peninsula in the 1940s and 1950s resulted in bluetongue being placed on **list A** of veterinary diseases by the Office International Des Epizooties (OIE). As a result there are restrictions on the international movement of cattle and sheep and their products from countries that have this infection to those that do not. The validity of these restrictions imposed by countries where bluetongue is unlikely to transmit is questionable. It is estimated that the United States has an annual loss of \$144 million because of the inability to trade with BTV-free countries.<sup>42</sup>

Movement restrictions within an affected country, even though having limited scientific reason for imposition with bluetongue, can have a significant economic effect on a country's tourist-related income. In the year 2005 movement restrictions for cattle in Spain threaten the quality of bullfights and functions such as the running of the bulls in the Pamplona festival.

## PATHOGENESIS

### Sheep

The pathology of bluetongue can be attributed to vascular endothelial damage resulting in changes to capillary permeability and fragility, with subsequent disseminated intravascular coagulation and necrosis of tissues supplied by damaged capillaries. These changes result in edema, congestion, hemorrhage, inflammation and necrosis. Following infection into the skin, there is replication in the local draining lymph node and dissemination in mononuclear cells to secondary sites of replication in lymphoid tissue and lung. Viremia is detectable by day 3 and peak viremia, associated with fever and leukopenia, usually occurs 6–7 d after infection. Circulating virus concentrations subsequently fall with the appearance of circulating interferon and specific neutralizing antibodies.<sup>38,43</sup> With the viremia, there is localization of the virus in **vascular**

**endothelium** which causes endothelial cell degeneration and necrosis with thrombosis and hemorrhage. There is also the development of a hemorrhagic diathesis and coagulation changes consistent with disseminated intravascular coagulation.<sup>44</sup> The distribution of the lesions is believed to be influenced by mechanical stress and the lower temperatures of these areas in relation to the rest of the body.<sup>12</sup>

### Cattle and wild ruminants

With infection in cattle and wild ruminants, infection of endothelial cells is minimal. The viremia in cattle is highly cell associated, particularly with **erythrocytes and platelets**.<sup>38,44,45</sup> Although the virus does not replicate in the erythrocytes, it is protected from circulating neutralizing antibody and infected erythrocytes are likely to circulate for their lifespan. BTV antigen can be detected in erythrocytes of cattle 140 d after infection.<sup>45</sup> The severe clinical disease that occurs in only a few infected cattle is possibly a type 1 hypersensitivity reaction dependent upon virus-specific IgE from repeated exposure.<sup>44</sup>

The presence of the bluetongue virus in the **semen** of bulls is accompanied by structural abnormalities of the spermatozoa and by the presence of virus particles in them.

## CLINICAL FINDINGS

### Sheep

Naturally occurring, florid bluetongue in sheep has the following clinical characteristics. After an incubation period of less than a week, a severe febrile reaction with a maximum temperature of 40.5–41°C (105–106°F) is usual, although afebrile cases may occur. The **fever** continues for 5 or 6 d. About 48 h after the temperature rise, nasal discharge and salivation, with reddening of the buccal and nasal mucosae, are apparent. The **nasal discharge** is mucopurulent and often blood stained and the saliva is frothy. Swelling and edema of the lips, gums, dental pad and tongue occur and there may be involuntary movement of the lips. **Excoriation** of the buccal mucosa follows, the saliva becomes blood stained and the mouth has an offensive odor.

Lenticular, necrotic ulcers develop, particularly on the lateral aspects of the tongue, which may be swollen and purple in color, but more commonly is not. **Hyperemia** and ulceration are also common at the commissures of the lips, on the buccal papillae and around the anus and vulva. Swallowing is often difficult for the animal. Respiration is obstructed and stertorous and is increased in rate up to 100/min. Diarrhea and dysentery may occur.

Foot lesions, including **laminitis** and **coronitis**, and manifested by lameness and recumbency, appear only in some animals, usually when the mouth lesions begin to heal. The appearance of a dark red to purple band in the skin just above the coronet, due to coronitis, is an important diagnostic sign. **Wryneck**, with twisting of the head and neck to one side, occurs in a few cases, appearing suddenly around day 12. This is apparently due to the direct action of the virus on muscle tissue as is the pronounced muscle stiffness and weakness which is severe enough to prevent eating. There is a marked, rapid loss of condition. There is **facial swelling** with extensive swelling and drooping of the ears and hyperemia of the non-wooled skin may be present. Some affected sheep show severe conjunctivitis, accompanied by profuse lacrimation. A break occurs in the staple of the fleece. Vomiting and secondary aspiration pneumonia may also occur. Death in most fatal cases occurs about 6d after the appearance of signs.

In animals that recover, there is a **long convalescence** and a return to normal may take several months. Partial or complete loss of the **fleece** is common and causes great financial loss for the farmer. Other signs during convalescence include separation or cracking of the hooves and wrinkling and cracking of the skin around the lips and muzzle. Although the subsequent birth of lambs with porencephaly and cerebral necrosis is usually recorded after vaccination with attenuated virus, it also occurs rarely after natural infections.

In sheep in **enzootic areas**, the disease is much less severe and often inapparent. Two syndromes occur: (i) an abortive form in which the febrile reaction is not followed by local lesions and (ii) a subacute type in which the local lesions are minimal, but emaciation, weakness and extended convalescence are severe. A similar syndrome occurs in lambs which become infected when colostrum immunity is on the wane.

## Cattle

**Most infections are inapparent**, although a few animals may develop a clinical syndrome not unlike that seen in severely affected sheep. Clinical signs which have been recorded include:

- Fever (40–41°C, 104–106°F)
- Stiffness and laminitis in all four limbs
- Excessive salivation
- Edema of the lips
- Inappetence
- Nasal discharge
- Fetid breath.

Many affected cattle also have ulcerative lesions on the tongue, lips, dental

pad, and muzzle. A severe **coronitis**, sometimes with sloughing of the hoof, may occur. Some cows have **photodermatitis** and lesions on the teats. Serosanguineous exudate may appear in the nostrils and a discharge from the eyes. Contraction of the infection during early pregnancy may cause abortion or **congenital deformities** including hydranencephaly, microcephaly, curvature of the limbs, blindness and deformity of the jaw.

## Goats

Infected goats show very little clinically. There is a mild to moderate fever, and hyperemia of the mucosae and conjunctivae. BTV infections in deer produce an acute disease that is clinically and pathologically identical to epizootic hemorrhagic disease of deer and characterized by multiple hemorrhages throughout the body.

## CLINICAL PATHOLOGY

There is a fall in packed cell volume and an initial leukopenia followed by a leukocytosis. In severe disease there is a marked leukopenia, due largely to lymphopenia. Infected cattle show a similar leukopenia. The skeletal myopathy which occurs in this disease is reflected by a rise in creatine phosphokinase.

Specific diagnosis is either by isolation of the virus, detection of viral antigen or nucleic acid, or detection of specific antibodies in serum. Serological assays can detect prior exposure to BTV but cannot establish if the animal is viremic, which is currently still important for movement decisions concerning cattle.

## Virus isolation

Virus isolation commonly is carried out by tissue culture or culture in developing chick embryos. The virus can be isolated from blood during the febrile period and it, or detection of viral nucleic acid, is the most reliable **confirmation** of BTV infection because there are difficulties with the interpretation of serological test results. However, traditional isolation methods require 2–4 weeks.

Less commonly, diagnosis is by inoculation of blood into susceptible sheep. A positive test depends on the appearance of diagnostic clinical signs and resistance to subsequent challenge with the bluetongue virus, or a significant increase in virus-neutralizing antibodies in the recipient sheep.

## Detection of antigen or nucleic acid

Immunohistochemical tests including immunofluorescence, immunoperoxidase and immunoelectron microscopic techniques using monoclonal antibody can be used for rapid sensitive and specific detection of antigen.<sup>46,47</sup> In situ nucleic acid hybridization and **PCR** can be used for detection of the virus and have the

advantage of speed over tissue culture virus isolation and can also differentiate between wild-type isolates and vaccine strains.<sup>19,46,48,49</sup> Tests that detect viral RNA do not necessarily indicate that an infectious virus is still present.

## Serological tests

A number of serological tests are available based on the detection of group-reactive antibody or serotype-specific antibody. Bluetongue diagnosis by serology is imprecise, unless a rising titer is demonstrated in acute and convalescent serum samples. The commonly available tests include complement fixation, the AGID, a number of different ELISA tests and virus neutralization.<sup>46</sup> In most laboratories the complement fixation test has been replaced by the AGID test. The **AGID test** is easy to perform and inexpensive. Antibody appears 5–15 d after infection and persists for 2 or more years.<sup>50</sup> The test is relatively **insensitive** and detects cross-reacting antibodies to other orbiviruses. Also, in epizootics a significant proportion of antibody-negative animals may be viremic.

There are a number of ELISA tests that have been developed using group-specific monoclonal antibodies and that have been suggested as alternates to the AGID for routine diagnosis and international trade.<sup>42,46,51</sup> The **competitive ELISA** appears more sensitive than most and is highly specific and may replace the AGID test as the preferred test for serodiagnosis of bluetongue.<sup>42,46,52</sup>

## NECROPSY FINDINGS

The mucosal and skin lesions have already been described. Other consistent lesions include generalized edema, hyperemia and hemorrhage and necrosis of skeletal and cardiac muscles. There is a most distinctive hemorrhage at the base of the pulmonary artery. Animals with damage to esophageal or pharyngeal musculature may have lung consolidation due to aspiration pneumonia. Hyperemia and edema of the abomasal mucosa are sometimes accompanied by ecchymoses and ulceration. Microscopically there is thrombosis and widespread microvascular damage leading to myodegeneration and necrosis. Aborted bovine fetuses should be examined for evidence of hydranencephaly or porencephaly. As previously discussed, there are numerous tests available to confirm the presence of BTV in blood and tissue samples.

## SAMPLES FOR CONFIRMATION OF DIAGNOSIS

- **Histology** – fixed oral and mucocutaneous lesions, abomasum, pulmonary artery, skeletal muscle from a variety of sites, left ventricular

papillary muscle. Brain from aborted fetus. (LM, IHC)

- **Virology** – chilled lung, spleen. CNS tissues, thoracic fluid from aborted fetus (ISO, PCR, in situ HYBRID, ELISA, etc.)

#### DIFFERENTIAL DIAGNOSIS

- Foot-and-mouth disease
- Epizootic hemorrhagic disease
- Contagious ecthyma
- Sheep pox.

#### TREATMENT

Local irrigations with mild disinfectant solutions may afford some relief. Affected sheep should be housed and protected from weather, particularly hot sun, and fluid and electrolyte therapy and treatment to control secondary infection may be desirable.

#### CONTROL

##### Reduction of infection through vector abatement

Attempts to control bluetongue through a reduction of infection consist of reducing the risk of exposure to infected *Culicoides* and reduction in *Culicoides* numbers. Neither are particularly effective.

Reducing the risk of exposure is attempted by spraying cattle and sheep with repellents and insecticides and housing sheep at night. Biweekly application of permethrin was found not to be effective in preventing infection.<sup>53</sup>

During transmission periods avoidance of low, marshy areas or moving sheep to higher altitudes may reduce risk. Because of the preference of some *Culicoides* for cattle as a host, cattle have been run in close proximity to sheep to act as vector decoys.<sup>54</sup> Widespread spraying for *Culicoides* control is not usually practical and has only a short-term effect.

There is a high mortality in *Culicoides* that fed on cattle that have been treated with a standard anthelmintic dose of ivermectin and also a larvicidal effect in manure passed for the next 28 d for *Culicoides* that breed in dung.<sup>55</sup>

##### Vaccination

Vaccination is the only satisfactory control procedure once the disease has been introduced into an area. Vaccination will not prevent or eliminate infection but it is successful in keeping losses to a very low level provided immunity to all local strains of the virus is attained.<sup>56,57</sup> Current vaccines are usually **polyvalent attenuated** virus vaccines and are in use in South Africa and Israel and available in other countries. These vaccines have been used in South Africa for more than 50 years and they are known to induce effective

and long lasting immunity. Currently they are produced in cell culture and freeze-dried. The present Onderstepoort Bluetongue Vaccine comprises three bottles (Vaccines A, B, and C) and includes the following serotypes of BTV:

- Bottle A: BTV serotypes 1, 4, 6, 12, and 14
- Bottle B: BTV serotypes 3, 8, 9, 10, and 11
- Bottle C: BTV serotypes 2, 5, 7, 13, and 19.

The three bluetongue vaccines are administered separately at 3-week intervals.

Reactions to vaccination are slight but ewes should not be vaccinated within 3 weeks of mating as anestrus often results.

**Annual revaccination** 1 month before the expected occurrence of the disease is recommended. Immunity is present 10 d after vaccination so that early vaccination during an outbreak may substantially reduce losses. Lambs from immune mothers may be able to neutralize the attenuated virus and fail to be immunized, whereas field strains may overcome their passive immunity. In enzootic areas, it may therefore be necessary to postpone lambing until major danger from the disease is passed and lambs should not be vaccinated until 2 weeks after weaning. Rams should be vaccinated before mating time.

Live attenuated vaccines should not be used in **pregnant ewes** because of the risk of deformity in the lambs or embryonic death.<sup>54</sup> The danger period is between the 4th and 8th weeks of pregnancy with the greatest incidence of deformities occurring when vaccination is carried out in ewes pregnant for 5–6 weeks. The incidence of deformities may be as high as 13%, with an average of 5%. Abortions do not occur although some lambs are stillborn.

The preparation and use of **attenuated vaccines** against BTV is **problematic**. The neutralizing epitopes are highly conserved on some serotypes but they are highly plastic on others<sup>1</sup>. It is therefore necessary to continually monitor the identity and prevalence of the serotypes that need to be in the vaccine.

There are also concerns for the use of live vaccines to control insect-borne diseases because of the risk of the vaccine strain being transmitted, of being exalted in virulence by passage, and of recombinants resulting in the development of new virus strains with unwanted characteristics. There is evidence for the emergence of a **reassortment strain** from a vaccine virus in the United States<sup>33</sup> and suspicion of occurrence elsewhere.<sup>5</sup> However, living vaccines are used for practical reasons, including the fact that inacti-

vated vaccines do not provide protection against infection.<sup>58</sup> The difficulty in obtaining safe vaccines may be overcome by the use of recombinant DNA technologies. There is also good reason to suggest that cattle should be a major target of vaccination for bluetongue control.

##### International movement of livestock

Countries that are free of BTV infection have traditionally erected barriers to avoid its introduction by **prohibiting** the importation of any ruminant animals from countries where the disease occurs. Others have less severe restrictions and several procedures aimed at permitting limited movement are in force; their stringency varies with the importing country. Some countries only require a negative serological test or series of tests prior to movement. Others require a negative test in conjunction with a period of quarantine. The introduction of bovine **semen** from low-risk areas after suitable tests of donors and a prolonged storage period is accepted by most countries. Most countries allow the importation of **embryos**.

A more enlightened understanding of the epidemiology of bluetongue will probably result in a re-evaluation of these requirements in the future including regionalization within a country to allow exports from areas where there is no prevalence or transmission.<sup>42</sup>

#### REVIEW LITERATURE

- Gibbs EPJ. Bluetongue: an analysis of current problems with particular reference to importation of ruminants to the USA. *J Am Vet Med Assoc* 1983; 182:1190–1194.
- Osburn BI et al. A review of bovine bluetongue. *Proc Am Assoc Bovine Pract* 1983; 15:23–28.
- Roberts DH. Bluetongue: a review. *State Vet J* 1990; 44:66–80.
- Roy P, Gorman BM. Bluetongue viruses. *Curr Top Microbiol Immunol* 1990; 162:1–200.
- Walton TE, Osburn BI. Bluetongue African horse sickness and related orbiviruses. Boca Raton FL: CRC Press 1992; p. 1042.
- Osburn BI. Bluetongue virus. *Vet Clin North Am Food Anim Pract* 1994; 103:547–560.
- Ward NP. The epidemiology of bluetongue virus in Australia. *Aust Vet J* 1994; 71:3–7.
- Barratt-Boyes SM, MacLachlan NJ. Pathogenesis of bluetongue virus infection of cattle. *J Am Vet Med Assoc* 1995; 206:1322–1329.
- Mellor PS, Boorman J, Baylis M. *Culicoides* biting midges: their role as arbovirus vectors. *Ann Rev Entomol* 2000; 45:307–340.
- Purse BV et al. Climate change and the recent emergence of bluetongue in Europe. *Nature Rev Microbiol* 2005; 3:171–181.

#### REFERENCES

1. MacLachlan NJ et al. *Vet Microbiol* 1992; 31:303.
2. Gorman BM. *Curr Top Microbiol Immunol* 1990; 162:1.
3. Heidner HW et al. *Virus Res* 1991; 21:91.
4. Gibbs EPJ, Greiner EC. *Comp Immunol Microbiol Infect Dis* 1994; 17:207.
5. Purse BV et al. *Nature Rev Microbiol* 2005; 3:171.
6. Braverman Y, Chechnik F. *Rev Sci Tech Off Internl Epiz* 1996; 15:1037.

7. McColl KA et al. *Aust Vet J* 1994; 71:102.
8. Sellers RF, Maarouf AR. *Can J Vet Res* 1991; 55:367.
9. St George TD. *Aust Vet J* 1989; 66:393.
10. Ward MP. *Aust Vet J* 1994; 71:3.
11. Bishop AL et al. *Aust Vet J* 1996; 73:174.
12. Parsonson IM. *Curr Top Microbiol Immunol* 1990; 162:119.
13. Tanya VN et al. *Vet Microbiol* 1992; 32:1.
14. Mellor PS. *Curr Top Microbiol Immunol* 1990; 162:143.
15. Osburn BI. *Vet Clin North Am Food Anim Pract* 1994; 103:547.
16. Xu G et al. *J Gen Virol* 1997; 78:1671.
17. Torina A et al. *Med Vet Entomol* 2004; 18:81.
18. Mellor PS et al. *Ann Rev Entomol* 2000; 45:307.
19. Bonneau KR et al. *Vet Microbiol* 2002; 88:115.
20. Singer RS et al. *J Vet Diag Invest* 2001; 13:43.
21. Takamatsu H et al. *J Gen Virol* 2003; 84:227.
22. Osburn BI. *Comp Immun Microbiol Infect Dis* 1994; 17:189.
23. Suttmoller P, Wrathall AE. *Prev Vet Med* 1997; 32:111.
24. Singh E L et al. *Theriogenology* 1997; 47:1205.
25. Parsonson IM. *Proc US Anim Hlth Ass* 1993; 97:120.
26. Ward MP, Thurmond MC. *Prev Vet Med* 1995; 24:129.
27. Ward MP. *Vet Rec* 1994; 134:407.
28. Tatem AJ et al. *Vet Microbiol* 2003; 97:13.
29. Purse BV et al. *Med Vet Entomol* 2004; 18:90.
30. Wittmann EJ et al. *Vet J* 2000; 160:107.
31. Wittmann EJ et al. *Med Vet Entomol* 2002; 16:147.
32. Paweska JT et al. *Med Vet Entomol* 2002; 16:10.
33. Osburn BI et al. *Comp Immunol Microbiol Infect Dis* 1996; 19:181.
34. Mellor PS, Wittmann E. *Vet J* 2002; 164:20.
35. Clavijo A et al. *Vet Rec* 2002; 151:301.
36. Pritchard LI et al. *Virus Res* 2004; 101:193.
37. Davies FG et al. *Vet Microbiol* 1992; 31:52.
38. Stott JL, Osburn BI. *Curr Top Microbiol Immunol* 1990; 162:163.
39. Parsonson IM et al. *Am J Vet Res* 1994; 55:666.
40. MacLachlan NJ et al. *Am J Vet Res* 1984; 45:1469.
41. Richardson C et al. *Am J Vet Res* 1985; 46:1912.
42. Hoar BR et al. *Am J Vet Res* 2003; 64:520.
43. Foster NM et al. *Am J Vet Res* 1991; 52:192.
44. MacLachlan NJ. *Comp Immunol Microbiol Infect Dis* 1994; 17:197.
45. Barratt-Boyes SM, MacLachlan NJ. *J Am Vet Med Assoc* 1995; 206:1322.
46. Afshar A. *Comp Immun Microbiol Infect Dis* 1994; 17:221.
47. Blacksell SD, Lunt RA. *Aust Vet J* 1996; 73:33.
48. Breard E et al. *Vet Res* 2003; 34:777.
49. Shad G et al. *J Vet Diagn Invest* 1997; 9:118.
50. Pearson JE et al. In: Walton TE, Osburn BI (eds) *Bluetongue African horse sickness and related orbiviruses*. Boca Raton: CRC Press, 1992; p. 533.
51. Afshar A et al. *J Vet Diagn Invest* 1991; 3:255.
52. Gustafson GA et al. In: Walton TE, Osburn BI (eds) *Bluetongue African horse sickness and related orbiviruses*. Boca Raton: CRC Press, 1992; p. 570.
53. Mullens BA et al. *J Med Entomol* 2001; 38:760.
54. Shimshony A et al. *Rev Sci Tech Off Int Epizoot* 1988; 7:311.
55. Webster WR et al. In: Walton TE, Osburn BI (eds) *Bluetongue African horse sickness and related orbiviruses*. Boca Raton: CRC Press, 1992; p. 843.
56. Breard E et al. *Res Vet Sci* 2004; 77:1.
57. Hammoumi S et al. *J Vet Med B* 2003; 50:316.

58. Mahrt CR, Osborne BI. *Am J Vet Res* 1986; 47:1191.

## EPIZOOTIC HEMORRHAGIC DISEASE

Epizootic hemorrhagic disease virus (EHDV) is a serogroup of *Orbivirus* closely related to bluetongue virus. There are at least 10 serotypes and some have antigenic relations with serotypes of bluetongue virus.<sup>1</sup> The serotypes infect deer and cattle naturally; sheep can be infected experimentally but not goats or pigs. In deer, the serotypes produce clinical disease. The pathogenesis of epizootic hemorrhagic disease is similar to that of bluetongue and infection of ruminants with either virus is characterized by extensive vascular injury, disseminated intravascular necrosis and tissue necrosis.<sup>2</sup>

The **geographic occurrence** of epizootic hemorrhagic disease viruses is similar to that of bluetongue virus. The virus, or serological evidence of infection, occurs on the North American, Australian, Asian and African continents.<sup>3</sup> In North America, there are two serotypes (EHDV-1, EHDV-2) and infection occurs in all areas of the United States, except the northeast and the arid southwest, and in southern Canada. In Australia, five serotypes are identified and the virus has been predominantly isolated from sentinel cattle in the north.<sup>4</sup> **Transmission** is by species of *Culicoides* and some species of gnats and mosquitoes.<sup>3</sup> There are also geographic differences in the severity of disease following EHDV infection with clinical disease in cattle being of rare occurrence in the United States but capable of causing outbreak of disease in cattle in Asia.

### Infection in deer

In North America, epizootic hemorrhagic disease is considered one of the most important diseases of deer, particularly of white-tailed deer (*Odocoileus virginianus*) but also mule deer (*O. hemionus*, and pronghorn antelope (*Antilocarpa americana*).<sup>5</sup> There are areas of enzootic stability, where seroprevalance in deer is high but clinical disease rare, and areas with low seroprevalance where clinical disease is severe.<sup>6,7</sup> All ages are susceptible, morbidity can be as high as 90% and **mortality** as high as 60% in some deer herds. The virus infects endothelial cells and the pathogenesis, clinical signs and postmortem lesions are similar to those of acute bluetongue in sheep with fever, hemorrhage and death.

### Infection in cattle

Seroprevalance studies suggest that infection of cattle is common but **clinical disease is very rare**. An exception is infection with a genetically distinct strain of EHD-2, which was initially associated with an epizootic of disease of cattle in Japan in 1959, called **Ibaraki disease**, and which resulted in 39 000 sick cattle and 4000 deaths.<sup>8</sup> Disease with this agent was subsequently observed in other Asian countries. Clinically, the disease was characterized by fever, hyperemia and edema of the mucosae, a hemorrhages ulcerative stomatitis with laryngeal and pharyngeal paralysis salivation and dysphagia. At postmortem there were hemorrhages in the pharynx and esophagus and animals commonly died with aspiration pneumonia. Infection of pregnant cattle with Ibaraki virus can also result in abortion and stillbirths and currently this seems a more common clinical manifestation. There is evidence of genetic change in isolates from different outbreaks and the clinical manifestations of infection with different strains can vary.<sup>9,10</sup>

Occasional disease associated with infection with EHDV is recorded in cattle in the late summer in the United States and is also recorded in a recent outbreak on the island of Reunion.<sup>11</sup> It is similar to bluetongue and manifest with fever, lameness, reddening and swelling of the oral mucosa with necrotic ulceration of the dental pad and behind the incisor teeth, cracking and sloughing of the skin of the muzzle and hyperemia of the skin of the teats and udder.<sup>3</sup> Morbidity has ranged from 1–20%.

**Diagnosis** of infection is by virus isolation, nucleic acid identification and serology. AGID will detect antibody but will also detect cross-reacting antibodies with bluetongue. The c-ELISA is specific and sensitive.<sup>12</sup>

### REFERENCES

1. Gorman BM. *Curr Top Microbiol Immunol* 1990; 162:1.
2. McLaughlin BE et al. *Am J Vet Res* 2003; 64:860.
3. Metcalf HE et al. In: Walton TE, Osburn BI (eds) *Bluetongue African horse sickness and related orbiviruses*. Boca Raton: CRC Press, 1992; p. 222.
4. Weir RP et al. *Vet Microbiol* 1997; 58:135.
5. Osburn BI et al. *Bov Practit* 1995; 29:106.
6. Flacke GL et al. *J Wildlife Dis* 2004; 40:288.
7. Gaydos JK et al. *J Wildlife Dis* 2004; 40:383.
8. Inaba Y. *Aust Vet J* 1975; 51:178.
9. Uchinuno Y et al. *J Vet Med Sci* 2003; 65:1257.
10. Ohashi S et al. *J Clin Microbiol* 2002; 40:3684.
11. Breard E et al. *Vet Rec* 2004; 155:422.
12. Afshar A et al. *J Vet Diagn Invest* 1997; 9:309.



## Diseases associated with viruses and *Chlamydia* – II

### VIRAL DISEASES CHARACTERIZED BY RESPIRATORY SIGNS 1307

- Viral infections of the upper respiratory tract of horses 1307
- Equine herpesviruses 1309
- Equine viral rhinopneumonitis (equine herpesvirus 4 infection) 1309
- Equine herpesvirus 1 infection of horses (respiratory disease, myeloencephalopathy, abortion and neonatal septicemia) 1311
- Equine herpesvirus 2 (cytomegalovirus) 1318
- Equine coital exanthema (equine herpes 3 infection) 1319
- Equine viral arteritis (EVA) 1319
- Equine influenza 1322
- Equine Hendra virus infection (formerly equine morbillivirus) 1329
- Caprine herpesvirus-1 infection 1329
- Swine influenza 1331
- Porcine cytomegalic virus (inclusion body rhinitis, generalized cytomegalic inclusion body disease of swine) 1335
- Enzootic pneumonia of calves 1336
- Viral pneumonia in older calves, yearlings and adult cattle (bovine respiratory syncytial viral pneumonia) 1343
- Infectious bovine rhinotracheitis (IBR, red nose), bovine herpesvirus-1 (BHV-1) infection 1349
- Chronic enzootic pneumonia of sheep (chronic non-progressive pneumonia,

- summer pneumonia, proliferative exudative pneumonia) 1361
- Ovine progressive pneumonia (maedi, maedi-visna) 1362
- Ovine pulmonary adenocarcinoma (jaagsiekte, pulmonary adenomatosis) 1366
- Enzootic nasal adenocarcinoma of sheep and goats (enzootic intranasal tumor) 1368

### VIRAL DISEASES CHARACTERIZED BY NERVOUS SIGNS 1368

- Eastern and Western viral encephalomyelitis of horses 1368
- Equine encephalosis 1372
- Venezuelan viral encephalomyelitis of horses 1372
- Japanese encephalitis 1377
- West Nile encephalitis 1378
- Borna disease 1381
- Bunyaviridae (California group, snow shoe hare) 1382
- Getah and Ross River virus 1383
- Rabies 1384
- Pseudorabies (Aujeszky's disease) 1404
- Viral encephalomyelitis of pigs (Teschen disease, Talfan disease in the UK, benign enzootic paresis in Denmark, poliomyelitis suum, porcine enteroviral encephalomyelitis) 1404
- Sporadic bovine encephalomyelitis (SBE, buss disease, transmissible serositis) 1407

- Ovine encephalomyelitis (louping-ill) 1408
- Caprine arthritis encephalitis (CAE) 1410
- Visna 1413
- Border disease (hairy shaker disease of lambs, hairy shakers, hypomyelinogenesis congenita) 1414

### VIRAL DISEASES CHARACTERIZED BY SKIN LESIONS 1418

- Contagious ecthyma (contagious pustular dermatitis, orf, scabby mouth, soremouth) 1418
- Papillomatosis (warts) 1421
- Sarcoid 1423
- Lumpy skin disease (knopvelsiekte, LSD) 1424
- Viral papular dermatitis 1426
- Cowpox 1427
- Pseudocowpox (milkers' nodule) 1427
- Bovine ulcerative mammillitis (bovine herpes mammillitis) 1428
- Sheeppox and goatpox 1430
- Swinepox 1431
- Horsepox 1432
- Uasin gishu 1432
- Ulcerative dermatosis of sheep 1432

### DISEASES ASSOCIATED WITH CHLAMYDIAE 1433

- Chlamydial polyarthritis 1435
- Chlamydia abortion (enzootic abortion of ewes, ovine enzootic abortion) 1435

### Viral diseases characterized by respiratory signs

#### VIRAL INFECTIONS OF THE UPPER RESPIRATORY TRACT OF HORSES

Viral respiratory tract disease is considered by veterinarians in the United States to be second only to colic among medical diseases in importance to the health and welfare of horses.<sup>1</sup> The situation is likely similar in most developed countries and especially those in which equine influenza is endemic. Episodes of upper respiratory tract disease characterized by fever, nasal discharge and cough are common in horses, especially young animals and horses housed in groups in stables and barns. An estimated 17% of equine operations in the United States have one or more horses affected by upper respiratory disease each year, and 1.5% of horses develop the disease every

3 months.<sup>2</sup> Upper respiratory disease is most common in spring and least common in winter.<sup>2</sup> Strangles was an uncommon cause of disease, occurring in only three horses per 1000 per 3 months.<sup>2</sup> Viral respiratory disease is approximately three times more common in horses less than 5 years of age.<sup>2</sup>

With the exception of *Streptococcus equi* and possibly *Mycoplasma* spp., the known causes of infectious upper respiratory disease of horses are viral and include: equine herpesvirus types 1, 2 and 4, equine influenza virus, equine rhinitis virus types A and B (ERAV and ERBV), equine adenovirus, equine viral arteritis, and equine parainfluenza 3 virus. Equine hendra virus and African horse sickness cause signs of severe respiratory disease. Both strangles and equine viral arteritis can be mild and lack outstanding clinical signs, thus closely resembling disease associated with other viral causes of

upper respiratory tract disease. Therefore, differentiation among diseases associated with these agents based on clinical signs and epidemiological characteristics is difficult and definitive diagnosis is only achieved through serological or microbiological examination of blood or nasal discharge.

**Isolation and identification** of a causative organism from nasopharyngeal swabs or airway washings of acutely affected horses provides a definitive diagnosis, although on occasion more than one potential pathogen may be isolated. Demonstration of **seroconversion** or a three- to four-fold increase in titer from serum samples collected during the acute and convalescent (usually 3 weeks after onset of clinical signs) phases of disease is persuasive evidence of infection. Immunofluorescence, enzyme-linked immunosorbent assay (ELISA) and polymerase chain reaction (PCR) tests may provide



rapid diagnosis through detection of viral particles in nasal swabs and tissue specimens. The ability to determine the cause of an outbreak of upper respiratory disease in horses is enhanced by the use of multiple diagnostic tests and obtaining samples from more than one horse in an outbreak.<sup>3</sup> However, definitive diagnosis of the cause of nasal discharge, cough, and fever is often not achieved.<sup>4</sup>

All the agents known to cause upper respiratory disease in horses are relatively sensitive to environmental influences, and spread of the agent is dependent on **transmission from infected horses**, either directly or on fomites. Introduction of an infected horse into a susceptible population of horses may result in an explosive outbreak of upper respiratory tract disease. Such events are common on stud farms and in racing stables, where relatively closed bands of horses are maintained for much of the year. The movement of horses over long distances may facilitate the introduction of pathogens to which the local population of horses is naive.

The opposite situation occurs when young horses are introduced into larger bands of mixed aged animals, such as happens in racing stables or barns of pleasure horses. The younger, possibly naive, horse is then exposed to endemic pathogens to which the resident horses have developed resistance.

Young horses are at particular risk of developing infectious disease of the upper respiratory tract. The diseases are usually a problem only in yearlings and 2-year-olds; young foals acquire a passive immunity from the dam and adults have acquired a permanent immunity through exposure or vaccination. In a horse population it is the average age and the mix of ages which largely determine its herd resistance, and when 30–40% of that population has not previously been exposed to infection then major outbreaks are likely. All of the diseases are transmitted by droplet infection, and over long distances so that limitation of their spread is possible only by rigid isolation and intensive sanitary precautions, and even the best protected studs are likely to be invaded from time to time.

### Equine rhinitis virus (ERV)

There are two, and possibly three, strains of equine **rhinitis virus**, (ERAV, ERBV) that infect horses. ERV is more closely related to foot-and-mouth disease than to other picornaviruses.<sup>5</sup> Almost all the information available on ERV infection of horses is for ERAV. The virus has been well characterized.<sup>6–8</sup> Serologic evidence of infection with ERAV is present in

50–100% of horses.<sup>9,10</sup> The virus is present in nasal discharges, feces and urine of a large proportion (17%) of clinically normal horses. The importance of urine shedding of the virus in transmission of infection is unclear, although the inhalation of aerosols of infected urine might transmit the virus.<sup>4</sup> ERAV might be an important but under recognized cause of acute upper respiratory disease in horses.<sup>9</sup> The **disease** thought to be associated with ERAV is characterized by an incubation period of 3–8 days, fever, pharyngitis, pharyngeal lymphadenitis, and a copious nasal discharge which is serous early and becomes mucopurulent later. **Viremia** is a consistent feature of the early stages of the disease. A cough persists for 2–3 weeks. The uncomplicated disease is mild and self-limiting. Among a group of susceptible horses, there is rapid spread of infection and disease.<sup>11</sup> Studies in England have not identified the virus as an important cause of inflammatory airway disease in race horses.<sup>12</sup> Virus neutralizing antibody develops within 7–14 days of infection and persists for long periods. **Immunity** after natural infection is said to be solid and long-lasting. **Diagnosis** is based on serological testing and tissue culture of the virus, which is environmentally resistant. There is no commercial vaccine available. Planned exposure of young horses to infection has been recommended, but should be reconsidered in light of current knowledge of the prolonged shedding of the virus in urine and feces.<sup>9</sup> The virus appears to have minimal zoonotic potential.<sup>10,13</sup>

**Equine rhinitis virus B** has been characterized and approximately 24% of horses in Australia and 86% of horses in Austria have serum neutralizing antibodies to the virus.<sup>10,14</sup> The role of ERBV in causing disease in horses is unknown.

### Parainfluenza-3 virus

Upper respiratory tract disease associated with equine parainfluenza-3 (PI-3) is characterized by a mild self-limiting disease which is not clinically distinguishable from the others in the group.<sup>15</sup> The epidemiology and economic importance of disease associated with this agent is unknown.

### Equine adenovirus infection

Two antigenic types of equine adenovirus, EAdV-1 and EAdV-2, are recognized that cause **respiratory disease** in foals and adult horses and **diarrhea** in foals, respectively.<sup>16,17</sup> Infection with EAdV is worldwide, based on seroepidemiological studies using virus neutralization and complement fixation tests, and affects up to 70% of horses. Horses less than 1 year of age are most likely to not have

serological evidence of exposure, and are therefore presumably at risk of infection and disease. EAdV usually causes a mild respiratory disease with fever, coughing, nasal discharge and conjunctivitis, although its association with fatal pneumonia in thoroughbred foals is reported. Foals usually acquire the infection from their dams, which secrete the environmentally stable virus in nasal discharge, urine and feces. In Arab foals with inherited combined immunodeficiency adenovirus infection is usually fatal. The virus is not associated with inflammatory airway disease in race horses in England,<sup>12</sup> but has been associated with small outbreak of upper respiratory tract disease.<sup>17</sup>

**Diagnosis** can be made on cell smears taken from conjunctiva or nasal mucosa that reveal characteristic adenoviral intranuclear inclusion bodies. **Serological methods** include serum neutralization, hemagglutination inhibition, complement fixation, or precipitating antibody tests. The serum neutralization test is most accurate, but the hemagglutination inhibition test is most suitable for a screening test. No specific **control measures** are indicated for normal foals.

### Reovirus

A reovirus, or a series of serotypes, cause mild upper respiratory tract disease of horses.<sup>18</sup> Infection with these agents appears to be of little clinical or economic importance.

### Equine coital exanthema

Equine coital exanthema is a **venereal disease** manifested by papular, then pustular, and finally **ulcerative lesions** of the vaginal mucosa, which is generally reddened. The ulcers may be as large as 2 cm in diameter and 0.5 cm deep and are surrounded by a zone of hyperemia. In severe cases the lesions extend onto the vulva and the perineal skin to surround the anus. In the male, similar lesions are found on the penis and prepuce. Many mild cases are unobserved because there is no systemic disease and affected horses eat well and behave normally. The effect on fertility is equivocal although there may be a loss of libido during the active stage of the disease in stallions.<sup>19</sup>

**Transmission** is usually venereal from affected or clinically normal carrier animals in which the infection is thought to be latent in sciatic ganglion.<sup>19</sup> The **incubation period** is 2–10 days and the course up to complete healing of ulcers is about 14 days. Diagnosis can be achieved by use of virus isolation or demonstration of viral DNA in skin lesions.<sup>20</sup> Secondary bacterial infection may lead to suppurative discharge and a longer course. In some outbreaks lesions occur on the skin of the

lips, around the nostrils, and on the conjunctiva. They may also be present on the muzzle of the foal. Ulcerative lesions of the pharyngeal mucosa also occur in infections with EHV-2 and with EAdV. Ulcerative lesions of the oral mucosa are of great importance because of the necessity to diagnose vesicular stomatitis early. Control can be achieved by use of artificial insemination.<sup>10</sup>

## REVIEW LITERATURE

Powell DG. Viral respiratory diseases of the horse. *Vet Clin North Am Equine Pract* 1991; 7:27-51.

## REFERENCES

1. Traub-Dagatz JL et al. *J Am Vet Med Assoc* 1991; 198:1745.
2. Gross DK et al. *Proceedings Am Assoc Equine Pract* 2000; 46:274.
3. Mumford EL et al. *J Am Vet Med Assoc* 1998; 213:385.
4. Burrell MH et al. *Vet Rec* 1994; 134:219.
5. Li F et al. *Proc Natl Acad Sci USA* 1996; 93:990.
6. Hartley CA et al. *J Gen Virol* 2001; 82:1725.
7. Stevenson RA et al. *J Gen Virol* 2003; 84:1607.
8. Varrasso A et al. *J Virol* 2001; 75:10550.
9. Studdert MJ. *Virus infections of vertebrates: virus infections of equines* 6. Amsterdam: Elsevier 1996; p. 213.
10. Seki Y et al. *J Vet Med Sci* 2004; 66:1503.
11. Li F et al. *J Clin Microbiol* 1997; 35:937.
12. Newton JR et al. *Prev Vet Med* 2003; 60:107.
13. Kriegshauser G et al. *Vet Microbiol* 2005; 106: 293.
14. Huang J et al. *J Gen Virol* 2001; 82:2641.
15. Ditchfield J et al. *Can J Comp Med Vet Sci* 1965; 29:18.
16. Studdert MJ. *Virus infections of vertebrates: virus infections of equines* 6. Amsterdam: Elsevier 1996; p. 67.
17. [http://www.ivos.org/special\\_books/Lekeux/studdert/chapter\\_frm.asp?LA=1](http://www.ivos.org/special_books/Lekeux/studdert/chapter_frm.asp?LA=1) Accessed February 14th 2005.
18. Studdert MJ. *Virus infections of vertebrates: virus infections of equines* 6. Amsterdam: Elsevier, 1996; p. 97.

## EQUINE HERPESVIRUSES

Five herpesviruses have been associated with various diseases of horses and foals (equine herpesvirus 1-5, EHV-1 to 5). EHV-1, EHV-3 and EHV-4 are alpha-herpesviruses, whereas EHV-2 and EHV-5 are slow-growing gamma-herpesviruses. Common names are 'equine abortion virus' for EHV-1, 'cytomegalovirus' for EHV-2, 'equine coital exanthema virus' for EHV-3, and 'rhinopneumonitis virus' for EHV-4 (although this term is sometimes used, confusingly, for EHV-1). EHV-1 and EHV-4 show extensive antigenic cross-reactivity and were previously considered subtypes of the same virus (EHV-1), but restriction endonuclease fingerprinting has demonstrated them to be different viruses. EHV-1 is closely related to asinine (donkey) herpesvirus 3, which is suggested to be its progenitor.<sup>1</sup> Related herpesviruses (asinine herpesvirus 1-5) infect and some cause disease in donkeys.<sup>1-3</sup> The recently identified asinine herpesviruses ASV-4 and ASV-5 cause a fatal interstitial

pneumonia in donkeys.<sup>3</sup>

The disease syndromes attributed to equine herpesvirus infection, which are discussed in the following pages, and the viruses associated with them are:

- **Upper respiratory tract disease** of adult horses, weanlings and older foals is caused principally by EHV-4, although disease attributable to EHV-1 occurs. EHV-2 causes respiratory disease, including pneumonia, of foals, and rarely upper respiratory disease of adults
- **Abortion** is almost always associated with EHV-1, although rare sporadic cases are associated with EHV-4
- **Perinatal disease** of foals, including birth of sick and weak foals and development of viral septicemia within 48 hours of birth, is associated with EHV-1
- **Myeloencephalopathy** is associated with EHV-1 and rarely EHV-4
- **Genital disease** is an unusual manifestation of EHV-1 infection
- **Coital exanthema** is associated with EHV-3.

Disease associated with EHV-5 has not been identified, although it is suspected to have a role in interstitial pneumonia of adult horses. The diseases associated with EHV-1-4 are discussed below.

## REFERENCES

1. Ficorilli N et al. *Arch Virol* 1995; 140:1653.
2. Browning GF et al. *Virus infections of vertebrates: virus infections of equines*. 1996; p. 47.
3. Kleiboeker SB et al. *J Vet Diagn Invest* 2002; 14: 273.

## EQUINE VIRAL RHINOPNEUMONITIS (EQUINE HERPESVIRUS 4 INFECTION)

### Synopsis

**Etiology** EHV-4, an alphaherpesvirus  
**Epidemiology** Transmission between horses and by mediate contagion. Lifelong latency of infection with putative periodic reactivation of virus shedding. Respiratory disease occurs as sporadic disease and as outbreaks. Younger animals more commonly affected by disease. Immunity following vaccination or infection is apparently short lived  
**Clinical signs** Upper respiratory disease, rarely abortion or myelencephalopathy  
**Clinical pathology** Seroconversion or increase in titer detected by ELISA able to differentiate EHV-1 from EHV-4  
**Diagnostic confirmation** Virus isolation from, or polymerase chain reaction test on, blood, nasopharyngeal swabs or tissue. Seroconversion or increase in titer detected by ELISA able to differentiate EHV-1 from EHV-4  
**Treatment** There is no specific treatment  
**Control** Vaccination (of minimal efficacy). Quarantine. Hygiene

## ETIOLOGY

Upper respiratory disease of foals and adults is associated with equine herpesvirus 4 (EHV-4), an alphaherpesvirus. The DNA sequence of EHV-4 has been determined.<sup>1</sup> There appear to be strains of EHV-4 that vary in virulence, based on severity of clinical disease, but at present it is not possible to differentiate between strains of low and high virulence by laboratory methods.<sup>2</sup>

## EPIDEMIOLOGY Occurrence

**Infection** with EHV-4 is endemic in horse populations worldwide. The serologic surveys of prevalence of serologic evidence of infection are of limited value as earlier studies used techniques that were unable to differentiate between antibodies to EHV-1 and EHV-4. The few recent serologic surveys using ELISA tests capable of differentiating between antibodies to EHV-1 and EHV-4 demonstrate that almost all horses and foals >60 days of age have evidence of infection by EHV-4.<sup>3-6</sup> Young foals can be seropositive as a result of transfer of immunoglobulins from seropositive dams, making determination of the time of first infection, and active seroconversion, difficult. Furthermore, serologic tests are also unable to differentiate between responses to natural infection and to vaccination.

EHV-4 can be isolated from both clinically normal foals and those with signs of upper respiratory disease with similar frequency.<sup>7</sup> Shedding of virus is more likely in foals with nasal discharge.<sup>7</sup> There is a marked seasonal distribution to the pattern of shedding, with the most frequent detection of shedding being in early autumn (March).<sup>7</sup>

**Upper respiratory tract disease** attributable to EHV-4 is very common and probably affects almost all horses during the first 2 years of life.<sup>8</sup> EHV-4 rarely causes abortion in mares, septicemia in newborn foals, or myelencephalopathy in adult horses.<sup>9</sup>

## Method of transmission

EHV-4 is highly infectious, and transmission probably occurs by the inhalation of infected droplets or by the ingestion of material contaminated by nasal discharges. Foals infected with EHV-4 have prolonged and profuse shedding of virus in nasal secretions. Mediate infection may occur, the virus surviving for 14-45 days outside the animal.

Infections always arise from other horses, both by direct contact and via fomites. Horses and foals are infectious during the active stage of disease and, because horses become latently infected, presumably during subsequent periods of viral reactivation and shedding. The duration of latency is unknown but is

assumed to be lifelong.<sup>10</sup> EHV-4 establishes latency in the trigeminal ganglion, which is the origin of the maxillary branch of the trigeminal (5th cranial) nerve that provides sensory innervation to the nasal mucosae.<sup>11,12</sup> It is assumed that reactivation of the virus and subsequent virus shedding poses a risk to in-contact, susceptible animals, but this has not been definitively demonstrated in field situations. If this were the case, then clinically normal animals harbor latent virus that during periods of reactivation can infect susceptible animals. If true this feature of the disease has obvious importance in the prevention, control, and management of outbreaks of disease.

### Risk factors

#### Immunity

Immunity resulting from natural infection of the respiratory tract is of short duration despite the persistence of serum virus-neutralizing (VN) antibodies.<sup>10</sup> If similar to EHV-1, immunity to EHV-4 is likely associated with cytotoxic T-cell responses because of the importance of cell-associated virus in dissemination of infection throughout the horse. Because of the short duration of immunity an animal can become clinically affected a number of times during its life, although subsequent disease tends to be milder. Foals born to mares with serum antibodies to the virus acquire a protective passive immunity that persists for up to 180 days, provided that they ingest sufficient high quality colostrum. Unfortunately, VN antibodies are not necessarily an indication of resistance to infection.

#### Age

Foals are infected by EHV-4, presumably from the dam or other mares in the band of mares and foals, early in life and excrete large quantities of virus in nasal secretions.<sup>8,13</sup> Horses are infected repeatedly throughout life, with episodes of disease being less frequent and milder with increasing age. EHV-4 is isolated more frequently from younger than from older horses,<sup>8</sup> suggesting an age-associated decrease in susceptibility to disease.

### Economic importance

Disease associated with EHV-4 is apparently of considerable economic importance because of the loss of training time and opportunities to perform during convalescence and quarantine. Although the upper respiratory disease is a mild inflammation of the respiratory tract of horses, characterized by coughing and nasal discharge, the importance of the disease is the large numbers of animals affected in an outbreak. Fatalities in uncomplicated cases of rhinopneumonitis are rare.

### PATHOGENESIS

The pathogenesis of EHV-4 infection and disease is assumed to be similar to that of EHV-1, with the exception that the virus does not commonly cause abortion, neonatal septicemia, or myeloencephalopathy.<sup>14</sup> The virus is inhaled and binds to epithelium of the upper respiratory tract, enters epithelial cells and reproduces. The infection then spreads throughout the respiratory tract, including trachea and bronchioles, and to lymphoid tissues associated with the respiratory tract. There is a viremia, though this may be of short duration. There is cell death and development of intranuclear inclusion bodies in the respiratory tract and associated lymphoid tissues. The EHV-4 virus then becomes latent as evidenced by isolation of virus from lymph nodes associated with the respiratory tract,<sup>15,16</sup> and detection of viral genome in trigeminal ganglia, although this has not been a consistent finding.<sup>17</sup> The factors causing viral recrudescence from these latent sites have not been determined. It should be noted that definitive evidence of viral recrudescence of EHV-4 as a cause of outbreaks of disease is lacking, and experimental induction of recrudescence is achieved only by administration of large doses of corticosteroids.<sup>16</sup>

### CLINICAL FINDINGS

The classical respiratory tract form of the disease (rhinopneumonitis) is virtually indistinguishable on the basis of clinical signs from the other respiratory tract diseases of horses. There is an incubation period of 2–20 days. Fever, conjunctivitis, coughing and mild inflammation of the upper respiratory tract are the cardinal manifestation of the disease, but inapparent infection is common. The temperature varies from 39 to 40.5°C (102.5 to 105.5°F). There is enlargement, but not abscessation, of the submandibular lymph nodes, especially in foals and yearlings. These signs are more likely to occur in young horses or when horses are assembled in sale barns. Edema of the limbs and diarrhea occur rarely. The length of the illness is usually 2–5 days, although the nasal discharge and cough may persist for 1–3 weeks. Secondary bacterial invasion, usually *Streptococcus equi* subsp. *zooepidemicus*, may exacerbate the clinically inapparent viral pneumonia. Young foals can develop primary viral pneumonia.

EHV-4 only rarely causes abortion or neurologic disease.<sup>9</sup>

### CLINICAL PATHOLOGY

Results of hematological and serum biochemical examinations are neither specific nor diagnostic. In adult horses with rhinopneumonitis there may be a pro-

nounced leukopenia, due largely to depression of neutrophils.

**Serological tests** are of critical importance in diagnosis and control of equine herpesvirus infections. Serum antibody levels to EHV-1/4 may be determined by ELISA,<sup>18</sup> virus neutralization (VN),<sup>14</sup> or complement fixation (CF) tests. The CF and VN tests are not able to differentiate between seroconversion associated with EHV-1 and EHV-4, whereas an ELISA using recombinant antigens specific for EHV-1 and EHV-4 is able to differentiate infection by each of these types of equine herpesvirus.<sup>19</sup> Many, if not all, adult horses have serum antibodies to EHV-4 as a result of previous infection or vaccination. Thus the demonstration of antibodies is not in itself sufficient to confirm a diagnosis of the disease. **Complement-fixing antibody** appears on the 10th–12th day after experimental infection but persists for only a few months. Demonstration of a three- to four-fold increase in the serum concentration of specific complement-fixing antibodies in acute and convalescent serum samples provides persuasive evidence of recent infection, albeit by either EHV-1 or EHV-4. Complement-fixing antibodies persist for only a short time (several months) while VN antibodies persist for over a year, and testing for them is therefore a more reliable means of determining that previous infection with the virus has occurred. Until recently, serological differentiation of antibodies to EHV-1 and EHV-4 was not possible. However, highly specific **ELISA** tests based on the variable region of the C terminus of glycoprotein G, at least one of which is commercially available, have been developed that can differentiate between antibodies to EHV-1 and EHV-4 in horse serum.<sup>19–22</sup> The ELISA is reported to be more sensitive, easier to perform, more rapid and more reproducible than the virus neutralization test. Importantly, the ELISA test is able to differentiate between infections associated with EHV-1 and EHV-4.<sup>19</sup>

**Identification of the virus** in nasal swabs, or blood buffy coat by culture or a PCR test provides confirmation of infection.<sup>23</sup> The use of seminested or multiplex PCR provides rapid identification of EHV-4 viral genome in pharyngeal swabs.<sup>23</sup> The test is at least as sensitive as viral isolation in identifying presence of virus. However, the use of rapid and innovative diagnostic techniques based on enzyme-linked immunosorbent assay (ELISA), polymerase chain reaction (PCR), immunohistochemical staining with peroxidase, or nucleic acid hybridization probes is often restricted to specialized reference laboratories. Therefore the method of choice for diagnosis of

rhinopneumonitis by diagnostic virology laboratories handling many routine samples continues to be the traditional methodology of cell culture isolation followed by sero-identification of the isolated viruses.<sup>21</sup> The virus can be isolated in tissue culture, chick embryos and hamsters, from either nasal washings or aborted fetuses.

Samples of nasopharyngeal exudate for virus isolation are best obtained from horses during the very early, febrile stages of the respiratory disease, and are collected via the nares by swabbing the nasopharyngeal area with a 5 × 5 cm gauze sponge attached to the end of a 50 cm length of flexible, stainless steel wire encased in latex rubber tubing. A guarded uterine swab device can also be used. After collection, the swab should be removed from the wire and transported promptly to the virology laboratory in 3 mL of cold (not frozen) fluid transport medium (serum-free MEM [minimal essential medium] with antibiotics). Virus infectivity can be prolonged by the addition of bovine serum albumin or gelatine to 0.1% (w/v).<sup>21</sup>

#### NECROPSY FINDINGS

Fatalities are extremely rare in the respiratory forms of EHV-4 infection.

#### Samples for confirmation of diagnosis

- **Virus isolation or identification** by fluorescent antibody testing or PCR of nasal swabs or blood.

#### DIFFERENTIAL DIAGNOSIS

The upper respiratory diseases of horses are listed in Table 16.4. There is no specific treatment although antibiotics are often administered to horses with respiratory tract disease to prevent or treat secondary bacterial infection. There is, however, no evidence that antibiotic treatment shortens the duration of the disease or prevents complications.

#### CONTROL

Principles of a control program include:

- Enhancing the immunity of individual horses by vaccination
- Minimizing the risk of introducing EHV-4 infection to the farm or stable
- Hygiene to prevent spread of virus on fomites such as clothes and tack
- Rapid isolation of any horse with disease that could be attributable to EHV-4.

#### Vaccination

Vaccines for protection against rhinopneumonitis contain both inactivated EHV-1 and EHV-4 virus,<sup>24</sup> presumably because both viruses cause respiratory disease in

horses. None of the currently available vaccines consistently prevent infection of vaccinated horses or provide complete protection against disease associated with EHV-4 although a combined EHV-1/EHV-4 inactivated virus vaccine attenuated the clinical signs of disease in experimentally infected foals.<sup>25,26</sup> The development of modified live virus vaccines administered intranasally holds promise for effective control of both EHV-1 and EHV-4 in foals and adults.<sup>24</sup>

#### Hygiene

Standard hygienic procedures should be adopted to avoid spread of the disease, with particular attention being given to the isolation of introduced horses.

#### REVIEW LITERATURE

van Maanen C. Equine herpesvirus 1 and 4 infections: an update. *Vet Quart* 2002; 24:57.

Patel JR, Heldens J. Equine herpesviruses 1 (EHV-1) and 4 (EHV-4) – epidemiology disease and immunophylaxis: a brief review. *Vet J* 2005; 170:14.

#### REFERENCES

- 1 Telford EAR et al. *J Gen Virol* 1998; 79:1197.
- 2 Tearle JP et al. *Res Vet Sci* 2003; 75:83.
- 3 Crabb BS, Studdert MJ. *Adv Virus Res* 1995; 45:153.
- 4 Gilkerson JR et al. *Vet Microbiol* 1999; 68:27.
- 5 Gilkerson JR et al. *Aust Equine Vet* 1999; 17:76.
- 6 Dunowska M et al. *New Zealand Vet J* 2002; 50:132.
- 7 Gilkerson JR et al. *Vet Microbiol* 1994; 39:275.
- 8 Matsumura T et al. *J Vet Med Sci* 1992; 54:208.
- 9 van Maanen C et al. *Vet Quart* 2000; 22:88.
- 10 Crabb BS, Studdert MJ. In: Studdert MJ (ed) *Virus infections of vertebrates: virus infections of equines* 6, 1996; p. 11.
- 11 Rizvi SM et al. *J Gen Virol* 1997; 78:1115.
- 12 Borchers K et al. *J Gen Virol* 1997; 78:1109.
- 13 Gilkerson JR et al. *Vet Microbiol* 1994; 39:275.
- 14 Kydd JH et al. *Equine Vet J* 1994; 26:466.
- 15 Edington N et al. *Equine Vet J* 1994; 26:140.
- 16 Browning GG et al. *Vet Rec* 1988; 123:518.
- 17 Carvalho R et al. *Arch Virol* 2000; 145:1773.
- 18 McCartan CG et al. *Vet Rec* 1995; 136:7.
- 19 Hartley CA et al. *Am J Vet Res* 2005; 66:921.
- 20 van Maanen C et al. *Vet Microbiol* 2000; 71:37.
- 21 [http://www.oie.int/eng/normes/mmanual/A\\_00085.htm](http://www.oie.int/eng/normes/mmanual/A_00085.htm) Accessed February 15th 2005.
- 22 Crabb BS et al. *Arch Virol* 1995; 140:245.
- 23 Varrasso A et al. *Aust Vet J* 2001; 79:563.
- 24 Patel JR, Heldens J. *Vet J* 2005; 170:14.
- 25 Minke JM et al. *Vet Res* 2004; 35:425.
- 26 Heldens JGM et al. *Vaccine* 2001; 19:4307.

#### EQUINE HERPESVIRUS 1 INFECTION OF HORSES (RESPIRATORY DISEASE, MYELOENCEPHALOPATHY, ABORTION AND NEONATAL SEPTICEMIA)

##### Synopsis:

**Etiology** Equid herpesvirus-1 (EHV-1) causes respiratory disease of adults, abortion, neonatal septicemia, and myeloencephalopathy

**Epidemiology** Transmission between horses and by mediate contagion. Lifelong latency of infection with periodic reactivation of virus shedding. Respiratory disease, abortion and myeloencephalopathy occur prominently as outbreaks, but can affect sole animals

**Clinical signs** Upper respiratory disease, abortion, neonatal septicemia, and neurologic disease with incontinence, ataxia and recumbency

**Clinical pathology** Seroconversion or increase in titer using an ELISA able to differentiate between EHV-1 and EHV-4

**Diagnostic confirmation** Virus isolation from, or polymerase chain reaction test on, blood, nasopharyngeal swabs or tissue. Seroconversion or increase in titer

**Treatment** There is no specific treatment although acyclovir, an antiviral agent, has been administered. Symptomatic treatment of neurologic signs in horses with myeloencephalopathy

**Control** Management including quarantine, maintaining mares in small bands, and education of staff about importance of control measures. Vaccination for prevention of abortion. Quarantine. Hygiene

#### ETIOLOGY

EHV-1 is an alphaherpesviruses, a DNA virus.<sup>1</sup> EHV-1 and EHV-4 show extensive antigenic cross-reactivity and were previously considered subtypes of the same virus (EHV-1), but restriction endonuclease fingerprinting has demonstrated both the propinquity and difference of the two virus species. There are two recognized strains of EHV-1, although this designation does not appear to have any association with virulence. Currently, it is not possible to differentiate EHV-1 strains of varying virulence based on in vitro characteristic.<sup>2</sup> Virulence is associated with presence of a functional gp2 protein, which is apparently responsible for viral egress from infected cells,<sup>3</sup> and glycoprotein D and cell surface glycosaminoglycans that are needed for efficient entry of EHV-1 into cells.<sup>4</sup>

The most important clinical syndromes associated with EHV-1 infection are abortion, neonatal septicemia, and myeloencephalopathy. Upper respiratory tract disease of adult horses, weanlings and older foals is caused principally by EHV-4, although outbreaks attributable to EHV-1 occur. Genital disease is an unusual manifestation of EHV-1 infection. Infection with EHV-1 causes retinitis and fatal disease in camelids.<sup>5,6</sup> EHV-1 also causes disease in wild equids including zebras.<sup>7</sup>

#### EPIDEMIOLOGY

##### Occurrence

**Infection** with EHV-1 is endemic in horse populations worldwide and many adult horses have serologic evidence of

infection.<sup>8,9</sup> Serologic surveys, which provide an index of the extent of infection in the sampled population, performed before 1995 were hindered by the lack of an assay able to differentiate immune responses to EHV-1 from those to EHV-4. Furthermore, the advent of vaccines eliciting serum antibodies against EHV-1/4, and the inability of diagnostic tests to differentiate between antibodies induced by vaccination or natural infection, complicates assessment of the prevalence of serum antibodies to EHV-1/4. Seroprevalence of EHV-1 specific antibodies is 9–28% in adult Thoroughbred horses, 26% of Thoroughbred brood mares, 11% of Thoroughbred foals, and 46–68% of 1 and 2-year-old Thoroughbred race horses in Australia.<sup>8–11</sup> Sixty-one percent of 82 normal horses and horses with upper respiratory tract disease had antibodies to EHV-1 in New Zealand.<sup>12</sup>

**Upper respiratory tract disease** associated with EHV-1 infection has been suggested to occur as outbreaks<sup>13</sup> although this is not well documented. Signs of infectious upper respiratory disease affected 20% of Thoroughbred race horses at one race track in Canada over a 3-year period, and seroconversion to EHV-1 occurred in 5–18% of these horses whereas the vast majority of horses seroconverted to influenza.<sup>14</sup> However, all horses that seroconverted to EHV-1 also either seroconverted to influenza virus or had been recently vaccinated with a vaccine containing EHV-1. These results suggest that the stress of influenza disease may have triggered reactivation of latent EHV-1 infection in some horses,<sup>14</sup> suggesting that EHV-1 did not have a primary role in the outbreak of respiratory disease. Similarly, in England, EHV-1 was not associated with clinical respiratory disease in Thoroughbred race horses.<sup>15</sup> EHV-1 was isolated from foals with purulent nasal discharge and respiratory disease concurrent with neurologic disease among the dams in Australia.<sup>16</sup>

**Abortion** due to EHV-1 occurs as both sporadic cases and as epizootics (abortion storms). Approximately 3% of abortions in mares are attributable to EHV-1 infection, although the actual incidence probably varies widely among years and geographical regions.<sup>17</sup> Outbreaks of EHV-1 abortion and birth of nonviable foals occurs sporadically on farms with sometimes catastrophic losses. Loss of foals through abortion or birth of nonviable foals can be as high as 28% of pregnant mares on the farm.<sup>18</sup> Initial cases can, in the absence of appropriate control measures, rapidly spread the infection.<sup>18</sup> Vaccination with killed EHV-1 vaccine during late gestation does not reliably

prevent the disease<sup>18</sup> although conventional wisdom is to ensure that mares are well vaccinated (see 'Control' below). EHV-4 rarely causes abortion in mares. Disease of neonates associated with EHV-1 occurs both sporadically and as outbreaks in which up to 25% of foals may be affected.<sup>19</sup> Foals infected in utero usually die soon after birth, while those infected in the period after birth may have milder disease and a lower mortality rate (6%).<sup>19</sup> One-third of viremic foals may not seroconvert, based on the complement fixation test.<sup>19</sup>

**Myeloencephalopathy** occurs as sporadic cases but more often presents as an epizootic within a stable or barn or within a localized area.<sup>16,19–22</sup> Morbidity rates in exposed horses range from 1 to 90% with mortality rates of 0.5–40%.<sup>16,19–22</sup> Pregnant or nursing mares are suggested to be at greater risk of this disease,<sup>8</sup> but outbreaks occur on premises, such as riding schools or race tracks, where there are no foals or pregnant mares.<sup>20–22</sup>

#### Method of transmission

EHV-1 is highly infectious, and transmission probably occurs by the inhalation of infected droplets or by the ingestion of material contaminated by nasal discharges or aborted fetuses. The virus gains access to the body after binding to respiratory mucosal epithelium. Other routes of infection are not recognized.

The virus is efficiently transmitted to in-contact animals and rapid spread of infection results from close contact of an infected animal with susceptible horses. Infection can be spread over short distances in the absence of physical contact or fomite transmission. This likely occurs by airborne spread of virus in droplets of aerosolized nasal secretions.

Infections always arise from other horses, either by direct contact or via fomites. Mediate infection from virus on fomites such as tack, veterinary equipment, vehicles, and housing occurs because the virus survives for 14–45 days outside the animal. The source of the virus is always one of the following:<sup>23</sup>

- a horse or foal with active infection
- a fetus, fetal membranes, or reproductive tract secretions of a mare immediately after abortion or birth of a weak foal
- virus shed by horses in which latent infection has reactivated.

Horses and foals are infectious during the active stage of disease and, because horses become **latently infected**, during subsequent periods of viral reactivation and shedding. There is good circumstantial evidence, such as the occurrence of abortion, neonatal disease, or

myeloencephalopathy in closed herds, to support a role for latency and reactivation in the genesis of the disease. The duration of latency is unknown but is assumed to be lifelong.<sup>1</sup> Latent EHV-1 virus is detectable in the trigeminal ganglion and CD5/CD8 lymphocytes.<sup>24–26</sup> Reactivation of the virus might not result in clinical signs in the host animal but there is shedding of virus in nasal secretions. Consequently, clinically normal animals harbor latent virus that can infect susceptible animals during periods of reactivation. This feature of the disease has obvious importance in the prevention, control, and management of outbreaks of disease.

**Abortion** storms are usually attributable to an index case that is:

- A latently infected mare that sheds virus from the respiratory tract, but does not abort
- A mare that aborts an infected conceptus
- A mare that sheds virus from the respiratory tract, and then aborts.<sup>1</sup>

Mares usually, but not always, abort from EHV-1 infection only once in their lifetime.<sup>1</sup> A likely scenario in abortion storms is the reactivation of latent virus in a resident horse with subsequent shedding of virus in nasal secretions or, if the mare aborts, fetal tissues and uterine fluids. Contamination of the environment or horse-to-horse contact spreads infection to susceptible cohorts (primary transmission). The infected cohorts then further spread the virus to other horses in that band of mares (secondary transmission), which then spread infection among other bands of mares and foals, paddocks or fields of horses, or farms (tertiary transmission).<sup>18,23</sup>

Outbreaks of **myeloencephalopathy** likely occur through similar mechanisms. Most outbreaks are associated with an index case or introduction of a horse with signs of infectious respiratory disease, with subsequent development of new cases in horses that have either direct or indirect (aerosol or fomite) contact with the index case.<sup>16,19,21</sup> It has recently been recognized that horses with clinical signs of myeloencephalopathy can spread the disease, contrary to previous supposition.<sup>22</sup> This has important implications for handling and care of affected horses, especially those severely affected horses that may be referred for intensive or specialized care.

#### Cycling of infection

Studies on Thoroughbred stud farms in Australia have demonstrated the temporal sequence of events that contribute to spread of EHV-1 infection in that region<sup>9</sup>

and these studies likely have relevance to other regions of the globe. There is a cyclical pattern in which horses are infected at a young age and the source of infection is, depending on the age of the foal, either its dam or other foals. Foals are infected by EHV-1 and shedding virus in nasal secretions as young as 11 days of age,<sup>27</sup> often without development of clinical signs but usually associated with mucopurulent nasal discharge.<sup>28,29</sup> Peak incidences of cases of respiratory disease associated with EHV-1 are late during the foaling season before weaning, and again after weaning when foals from several groups are housed together. The source of infection in foals before weaning is mares and, as the number of foals in the herd increases over the course of the foaling season, other foals.<sup>9</sup> Weanlings spread the disease among their herd during the period shortly after weaning when foals from more than one group are mixed. The incidence density of new cases among weanlings can be as high as 13 new cases per 1000 foal weeks.<sup>30</sup> The disease associated with these outbreaks is mild and without long term consequences to the foal or weanling. However, the presence of foals excreting large quantities of EHV-1 has the potential to increase the risk of viral abortion in late term mares in contact with these foals.<sup>9</sup> Furthermore, presence of respiratory disease associated with EHV-1 and shedding of virus by foals is associated with development of myeloencephalopathy in mares.<sup>16</sup>

### Risk factors

#### Immunity

Immunity against respiratory disease and resulting from natural infection of the respiratory tract is of short duration despite the persistence of serum virus-neutralizing (VN) antibodies.<sup>1</sup> The cell-associated nature of the viremia and lack of expression of viral antigens on the surface of infected cells contributes to the poor efficacy of humoral immunity. Immunity to EHV-1 is mediated by cytotoxic T cells, which explains the limited efficacy of inactivated virus vaccines that have minimal effect in stimulating cytotoxic T cells despite being capable of inducing a humoral immune response.<sup>31</sup> The presence of EHV-1 cytotoxic T cell precursors correlates well with protection from experimental infection,<sup>32</sup> and some of the EHV-1 antigens ('early proteins') responsible for this resistance have been identified.<sup>33</sup> Because of the short duration of immunity an animal may become clinically affected by respiratory disease a number of times during its life, although subsequent disease tends to be milder. Mares usually only abort from EHV-1 infection once in their lifetime and there

are no reports of horses developing myeloencephalopathy more than once.

Lack of antibodies to EHV-1 was identified as a risk factor in an outbreak of EHV-1 myeloencephalopathy in a herd of mares with foals at foot.<sup>16</sup> Mares with strong antibody responses to EHV-1 did not develop disease.

### Economic importance

Disease associated with EHV-1 is of considerable economic importance because of the loss of training time and opportunities to perform during convalescence and quarantine, the loss of pregnancies during abortion storms, and deaths due to myeloencephalopathy and infection of neonates.

### PATHOGENESIS

The three organ systems involved in clinical disease associated with EHV-1 infection are the respiratory tract, uterus and placenta, and central nervous system. The common final pathway for injury in each of these body systems is damage to vascular endothelium with subsequent necrosis, thrombosis, and ischemia.

Following EHV-1 exposure to the upper respiratory tract, virus can be detected in the soft palate and main stem bronchus within 12 hours, and at all levels of the respiratory tract by 24 hours.<sup>34</sup> In the respiratory tract there is an initial phase after infection in which there is rapid proliferation of the virus in the nasal, pharyngeal and tonsillar mucosae, with subsequent penetration and infection of local blood vessels.<sup>34</sup> This is followed by a systemic, viremic phase in which the virus is closely associated with blood lymphocytes, from which it can be isolated. Infection induces increased production of interferon gamma by T-lymphocytes.<sup>35</sup> Absence of viral antigens on the surface of EHV-1 infected peripheral blood mononuclear cells explains their ability to avoid complement-mediated lysis.<sup>36</sup> This activity, combined with the immunosuppression that accompanies EHV-1 infection, allows dissemination of the infection to the reproductive tract and central nervous system. Immunosuppression is mediated by production in EHV-1 infected cells of an 'early protein' that interferes with peptide translocation by the transporter associated with antigen processing.<sup>37</sup> Immunosuppression is evident as reduced *in vitro* proliferation of peripheral blood monocytes and down regulation of expression of major histocompatibility complex class I molecules on the surface of infected cells.<sup>38,39</sup> It is from this point that the invasion of lungs, placenta, fetus and nervous tissue occur. Movement of infected mononuclear cells into target tissues is associated with expression of

adhesion molecules by endothelium in the gravid uterus and in leukocytes.<sup>40</sup>

Viral infection of endothelium results in death of endothelial cells, inflammation, activation of clotting factors and formation of blood clots in small vessels. This thrombotic disease causes ischemia of neighboring tissues with subsequent necrosis and loss of function. Another theory is that deposition of antigen-antibody complexes in small vessels results in an Arthus reaction with subsequent ischemia, necrosis and loss of function. However, recent demonstration that mares with no antibody titer to EHV-1 were at increased risk of developing myeloencephalopathy does not support a role for type III hypersensitivity in this disease.<sup>16</sup> Regardless of the underlying mechanism, clinical signs are a result of vasculitis and necrosis of tissue in the central nervous system and reproductive tract. This is in contrast to neurologic disease associated with herpesvirus in other species, in which the nervous system disease is a direct result of infection of neural tissues.

Abortion is caused by damage to the placenta, endometrium or fetus. Placental lesions include vasculitis, focal thrombosis and infarction of the microcotyledons of the pregnant uterus.<sup>41</sup> The fetus is infected and there are diagnostic lesions present in many aborted foals, including massive destruction of lymphocytes in the spleen and the thymus. In those abortions in which there is no lesion or evidence of virus infection in the foal, there may be extensive damage to the endometrium due to an endothelial lesion and its attendant vasculitis, thrombosis and secondary ischemia.<sup>42,43</sup>

**Foals** that are infected in utero but survive to full term may be stillborn or weak and die soon after birth with pulmonary, hepatic, and cardiac lesions. EHV-1 infection in foals not infected before or at birth is usually a self-limiting, mild infection of the upper respiratory tract with an accompanying leukopenia and a transitory immune suppression, although uveitis and occasionally death occur in a small number of foals.<sup>19</sup> Virus can be isolated from the nasal mucus and the buffy coat of the blood for some time after clinical signs have disappeared.<sup>44</sup>

The pathogenesis of **myeloencephalopathy** in horses contrasts with herpesvirus encephalitis of other species in which there is viral infection of neuronal tissue.<sup>1,16</sup> The myeloencephalopathy in horses is, as discussed above, the result of vasculitis, thrombosis and subsequent ischemia of neural tissue. Impairment of blood flow results in hypoxia and dysfunction or death of adjacent neural tissue.

## CLINICAL FINDINGS

EHV-1 infection manifests as several forms of disease on a farm such that nervous system involvement can occur in an outbreak in which abortion and respiratory disease also feature<sup>19</sup> although more commonly one form of the disease (myeloencephalopathy or abortion) occur alone or with mild respiratory disease. Foals, stallions and mares can be affected with one or other form of the disease, although the disease is most commonly seen in adult horses. Onset of neurologic signs is usually, but not invariably, preceded by cases of respiratory disease, fever, limb edema, or abortion.

### Respiratory disease

The classical respiratory tract form of the disease (rhinopneumonitis) is virtually indistinguishable on the basis of clinical signs from the other upper respiratory tract diseases of horses and is identical to that associated with EHV-4.

### Abortion

Outbreaks of abortion might not be preceded by clinically apparent respiratory disease.<sup>18</sup> The incidence of abortion is highest in the last third of pregnancy, particularly in the 8 to 10-month period but can occur as early as the 5th month. Abortion occurs without premonitory signs and the placenta is usually not retained. There is frequently no mammary development. Affected mares sometimes prolapse the uterus. Some foals are stillborn whereas others are weak and die soon after birth.

Abortion storms are often long lasting, with a period of 17–22 days separating the index case from cases caused by secondary transmission of the virus,<sup>18,45</sup> suggesting an incubation period of 2–3 weeks. Experimental infections induce abortion 15 to 65 days after intranasal inoculation of the virus.<sup>46</sup> While most abortions then occur within one month of the first secondary cases, abortions on a farm can continue for many months.<sup>18,45</sup>

### Neonatal viremia and septicemia

In-utero EHV-1 infection causes abortion or the birth of infected foals, some of which are normal at birth, but become weak and die within 3–7 days of birth with signs of respiratory distress and septicemia. A less severe form of the disease, characterized by pyrexia, nasal discharge and chorioretinitis, occurs in slightly older foals that are apparently infected after birth.<sup>19,47</sup> Affected foals that survive sometimes do not have serum antibodies to EHV-1.<sup>19</sup> Death may be associated with secondary bacterial infection with *Escherichia coli* or *Actinobacillus equuli*, although EHV-1 infection alone is sufficient to cause death.

## Myeloencephalopathy

The disease initially occurs in an index case, which might or might not have had signs of infectious respiratory disease alone or with signs of neurologic disease.<sup>16,19–21</sup> Signs of neurologic disease develop in other horses approximately 2 weeks after disease in the index case. Disease then develops in a number of horses over a short period of time (3–10 days).<sup>16,20,21</sup>

Fever, without signs of respiratory disease, often precedes signs of neurologic disease by 24–72 hours.<sup>21</sup> The onset of neurologic signs is usually rapid, with the signs stabilizing within 1–2 days. Signs are variable but usually referable to spinal white matter involvement. Affected horses have variable degrees of ataxia and paresis manifest as stumbling, toe dragging, pivoting and circumduction that is most severe in the hind limbs. Signs are usually symmetrical. There is often hypotonia of the tail and anus.

Fecal and urinary incontinence are common and affected horses often dribble urine, have urine scalding of the skin of the perineum and legs, and require manual evacuation of the rectum. The severity of signs can progress to hemiplegia or paraplegia manifesting as recumbency and inability to rise. Less commonly, cranial nerve deficits, such as lingual or pharyngeal paresis, head tilt, nystagmus or strabismus, are present. Affected horses are usually alert and maintain their appetite.

Severity of neurologic disease varies among horses within an outbreak, and the prognosis is related to the severity of disease. In general, horses that become recumbent have a poor prognosis for both short-term and long-term survival despite intensive nursing care.<sup>16,19–21</sup> However, less severely affected horses have a good prognosis for survival, with case fatality rates are low as 2–3% in some outbreaks.<sup>21</sup> Horses with mild signs of neurologic disease often recover completely and return to their previous level of performance,<sup>20,21</sup> although some have persistent neurologic deficits after one year.

## CLINICAL PATHOLOGY

Results of hematological and serum biochemical examinations are neither specific nor diagnostic. EHV-1 infection of adult horses results in leucopenia that is attributable to both neutropenia and T-cell lymphopenia, with B-cell lymphocytosis occurring during the recovery period.<sup>48</sup> EHV-1 septicemia of foals is characterized by profound leukopenia, neutropenia with a left shift and lymphopenia.

Cerebrospinal fluid (CSF) of horses with EHV-1 encephalomyelopathy is characteristically xanthochromic and has

an increased total protein concentration (>1 g/L) with a normal white cell count.<sup>49</sup> The interpretation of EHV-1 antibody in CSF is uncertain, although normal horses are not expected to have detectable antibodies to EHV-1 in the CSF.<sup>49</sup>

**Serological tests** are of critical importance in diagnosis and control of equine herpesvirus infections. Many horses have serum antibodies to EHV-1 and EHV-4 as a result of previous infection or vaccination. Thus the demonstration of antibodies is not in itself sufficient to confirm a diagnosis of the disease. Complement-fixing antibody appears on the 10th–12th day after experimental infection but persists for only a limited period. Demonstration of a three- to four-fold increase in the serum concentration of specific complement-fixing antibodies in acute and convalescent serum samples provides persuasive evidence of recent infection. Complement-fixing antibodies persist for only a short time (several months) while VN antibodies persist for over a year, and testing for them is therefore a more reliable means of determining that previous infection with the virus has occurred. Until recently, serological differentiation of antibodies to EHV-1 and EHV-4 was not possible. However, highly specific **ELISA** tests based on differences between EHV-1 and EHV-2 in the variable region of the C terminus of glycoprotein G, at least one of which is commercially available, have been developed that can differentiate between antibodies to EHV-1 and EHV-4 in horse serum.<sup>50–53</sup> The ELISA is reported to be more sensitive, easier to perform, more rapid and more reproducible than the virus neutralization test. Importantly, the ELISA test is able to differentiate between infections associated with EHV-1 and EHV-4.<sup>53</sup>

**Identification of the virus** in nasal swabs, or blood buffy coat by culture or a PCR test provides confirmation of infection.<sup>54</sup> The use of seminested or multiplex PCR provides rapid identification of EHV-1 viral genome in pharyngeal swabs.<sup>54</sup> The test is at least as sensitive as viral isolation in identifying presence of virus. However, the use of rapid and innovative diagnostic techniques based on enzyme-linked immunosorbent assay (ELISA), polymerase chain reaction (PCR), immunohistochemical staining with peroxidase, or nucleic acid hybridization probes is often restricted to specialized reference laboratories. Therefore the method of choice for diagnosis of EHV-1-associated disease by diagnostic virology laboratories handling many routine samples continues to be the traditional methodology of cell culture isolation followed by sero-identification of the isolated



viruses.<sup>51</sup> The virus can be isolated in tissue culture, chick embryos and hamsters, from either nasal washings or aborted fetuses.

Samples of nasopharyngeal exudate for virus isolation are best obtained from horses during the very early, febrile stages of the respiratory disease, and are collected via the nares by swabbing the nasopharyngeal area with a 5 × 5 cm gauze sponge attached to the end of a 50 cm length of flexible, stainless steel wire encased in latex rubber tubing. A guarded uterine swab device can also be used. After collection, the swab should be removed from the wire and transported promptly to the virology laboratory in 3 mL of cold (not frozen) fluid transport medium (serum-free MEM [minimal essential medium] with antibiotics). Virus infectivity can be prolonged by the addition of bovine serum albumin or gelatine to 0.1% (w/v).<sup>51</sup>

### NECROPSY FINDINGS

Fatalities are extremely rare in the respiratory forms of EHV-1 infection. Macroscopic findings in **aborted fetuses** include petechial and ecchymotic hemorrhages, especially beneath the respiratory mucosae. The most consistent finding is an excess of clear yellow fluid in the pleural and peritoneal cavities. Focal hepatic necrosis and slight icterus may also be present. In some aborted fetuses the cut surface of the spleen reveals unusually prominent lymphoid follicles, which are swollen due to necrosis and edema. Acidophilic intranuclear inclusion bodies may be evident histologically in a variety of cell types, including the bronchiolar and alveolar epithelium, hepatocytes and dendritic cells of the lymphoid tissues. Although the microscopic pathology is unimpressive, examination of the placenta via immunohistochemical techniques can be a useful aid in the diagnosis of EHV-1 and EHV-4 induced abortions.<sup>55,56</sup> In foals that are alive at birth but die soon afterwards there is usually massive pulmonary congestion and edema, with collapse of the lung and hyaline membrane development in those that survive longer.

In the **nervous or paralytic form** of the disease there is an acute disseminated myeloencephalopathy. Hemorrhages may be visible grossly but often there are no macroscopic changes. Disseminated vasculitis occurs in the experimental disease<sup>57</sup> and the malacic lesions present in the nervous tissue are the result of leakage from these damaged vessels. The virus can be isolated from the brain and the isolation is facilitated by use of an indirect peroxidase stain<sup>58</sup> to establish the location of the virus. The virus infects endothelial cells within the central nervous system (CNS) but has also been

demonstrated within neurons and astrocytes and has been linked to chorioretinitis in a foal.<sup>59</sup> In rare cases the virus may cause lesions in other tissues, such as the intestinal mucosa and spleen<sup>60</sup> or pharynx.<sup>61</sup>

The laboratory examination of aborted fetuses should include a search for virus by tissue culture and immunohistochemical or PCR techniques, as well as a histological examination of the lung and liver for the presence of inclusion bodies. A direct fluorescent antibody test has also been used.<sup>62</sup> A serological examination of the foal may provide useful information in those cases where attempts at isolation are negative but seroconversion has occurred. However, a recent study found that fetal serology was an unreliable means of diagnosing EHV-1 abortion and that IHC was slightly more sensitive than virus isolation.<sup>63</sup>

### Samples for confirmation of diagnosis

- **Virology** – chilled lung, liver, spleen, thymus and thoracic fluid of aborted fetuses or neonates. Spinal cord or brain of horses with nervous disease (VI, PCR, FAT, serology)
- **Histology** – fixed lung, liver, spleen, thymus, trachea from fetuses or neonates
- Fixed brain and spinal cord from several sites, as well as Bouin's-fixed eye should be examined in adults with nervous disease (LM, IHC).

### DIFFERENTIAL DIAGNOSIS

Respiratory disease may be associated with a variety of agents (Table 16.4).

Abortion can be associated with leptospirosis, *Salmonella abortusequi*, pleuritis associated with *Streptococcus zooepidemicus* or *Escherichia coli*, associated with mare reproductive loss syndrome, or congenital abnormalities, among other causes. When other pregnant mares are at risk abortion in a late-term mare should always be considered to be due to EHV-1 until proved otherwise.

Neurologic diseases with clinical presentations similar to that associated with EHV-1 include rabies, equine protozoal myeloencephalitis, neuritis of the cauda equina (equine polyneuritis), trauma, acute spinal cord compression (cervical stenotic myelopathy) and equine degenerative myelopathy. Fever is rare in other neurologic diseases of horses and any horse with neurologic disease and fever or a history of fever within the previous week should be considered to have EHV-1 myeloencephalopathy. Outbreaks of posterior paresis or ataxia, especially in horses without fever, should prompt consideration of ingestion of intoxicants

such as *Astragalus* spp., *Swainsonia* spp., or sorghum. Rye grass staggers can produce similar signs of ataxia.

Neonatal septicemia may be associated with *E. coli*, *Streptococci* spp. and other bacteria, especially in foals with failure of transfer of maternal immunoglobulins.

### TREATMENT

Because of the highly contagious nature of EHV-1 infections, horses with respiratory disease, abortion or neurologic disease, especially if these occur as an outbreak, should be isolated until the cause of the disease is identified.

There is **no specific treatment** for the diseases associated with equine herpesvirus infection although acyclovir was used to treat horses in recent outbreaks of myeloencephalopathy. The drug is effective against EHV-1 in vitro and pharmacokinetic studies suggest that administration of 10 mg/kg orally every 4–6 hours (five times daily) or 10 mg/kg IV every 8 hours results in acceptable concentrations of drug in the blood.<sup>64</sup> However, other studies have not demonstrated adequate concentrations of the drug in blood after oral administration of 20 mg/kg.<sup>77</sup> The efficacy of this drug in treatment of EHV-1 myeloencephalopathy has not been determined.

Antibiotics are often administered to horses with respiratory tract disease to prevent or treat any secondary bacterial infection. There is, however, no evidence that antibiotic treatment shortens the duration of the disease or prevents complications.

Horses with EHV-1 **myeloencephalopathy** require intense supportive care.<sup>65</sup> Administration of corticosteroids to these horses is controversial,<sup>19,65</sup> but many clinicians administer dexamethasone sodium phosphate (0.05–0.25 mg/kg IM every 12–24 h) or prednisolone (1–2 mg/kg orally or parenterally every 24 h) for 3–5 days. Administration of corticosteroids may be contraindicated because of the presence of replicating virus in affected horses. Nursing care to prevent urine scalding, pressure sores and pneumonia is important in horses with myeloencephalopathy. Recumbent or severely ataxic horses should be supported to stand if at all possible. While a rope tied to the tail and slung over an overhead beam may be used to assist the horse to stand, a sling may be necessary to support more severely affected horses.

**Neonatal** foals with septicemia should be treated aggressively with **antibiotics** and **supportive care**, including enteral or parenteral nutrition and fluid administration (see 'Principles of providing care to the critically ill neonate'). Treatment with acyclovir has been reported.<sup>47</sup> Failure

of transfer of passive immunity should be rectified with oral or intravenous administration of colostrum or plasma, respectively.

### CONTROL

Recommendations for programs to prevent introduction of infection and to control disease outbreaks are available from several sources.<sup>12,66</sup>

### Prevention of infection

The principles are:<sup>12</sup>

- enhanced immunity, currently attempted by vaccination
- subdivision and maintenance of the farm population in groups of horses to minimize spread of the infection
- minimize risk of introduction of infection by new horses
- minimize risk of reactivation of latent infection in resident horses
- develop plans for implementation of these routine control measures, and for actions in the event of an abortion
- educate management and staff as to the importance of strict adherence to these procedures.

The relative importance of each of the above measures has not been determined, but implementation of control measures, including allocation of mares to small bands based on anticipated foaling date, quarantine of new introductions, and vaccination of pregnant mares has reduced the incidence of EHV-1 abortion in central Kentucky. The most striking association has been an apparent reduction in the incidence of abortion storms. It must be emphasized that vaccination does not replace any of the other management procedures in control of this disease and that abortions have occurred among vaccinated mares on farms on which the other management procedures have been ignored.

### Vaccination

Vaccination against respiratory disease and abortion associated with EHV-1 is widely practised despite lack of clear cut evidence that vaccination reduces the incidence or severity of either of these diseases. Information regarding field efficacy of equine herpesvirus vaccines is lacking, and that derived from experimental challenge models is often contradictory or incomplete.<sup>67</sup> Give these caveats, the following recommendations are made based on generally accepted practices.

None of the currently available vaccines consistently prevent infection of vaccinated horses or provide complete protection against disease associated with EHV-1. The principal objective of vaccination has been to protect mares against abortion associated with EHV-1, although vaccines intended to prevent rhino-

pneumonitis and containing both EHV-1 and EHV-4 are available. Additionally, vaccination of mares is intended to reduce transmission of EHV-1 to foals in an attempt to interrupt the cyclical nature of infection on stud farms.<sup>9,68</sup> Vaccines consisting of a modified live EHV-1, inactivated EHV-1, or a mixture of inactivated EHV-1 and EHV-4 are available for intramuscular or intranasal administration to horses.<sup>69</sup> Both inactivated and modified live EHV-1 vaccines elicit virus-neutralization and complement fixation antibody responses in horses,<sup>1</sup> although high antibody titers are not necessarily related to resistance to infection.<sup>69</sup>

Resistance to infection might be more closely related to cytotoxic T-cell responses.<sup>33</sup> Widespread use of a combined EHV-1 and EHV-4 killed virus vaccine in Australia has not reduced serologic evidence of infection in foals on farms where mares are vaccinated,<sup>68</sup> although the vaccine was effective in preventing disease induced by experimental infection. Complicating assessment of vaccine efficacy is the variable response to vaccination by some mares and foals, with certain animals having minimal responses to vaccination which in other horses elicits a strong immune response.<sup>70</sup> Efforts are underway to develop modified live vaccines that can be administered intranasally.<sup>67</sup> Intranasal administration of one such EHV-1 vaccine induced protection against experimentally induced EHV-1 (and EHV-4) respiratory disease and abortion in mares, and prevented infection of foals even when administered in the presence of maternally-derived antibodies.<sup>71-73</sup> An alternative approach is the development of subunit vaccines using the envelope glycoprotein D which has been shown to elicit protective immunity in laboratory animal models of EHV-1 disease and administration of which induces virus neutralizing antibody and glycoprotein D-specific ELISA antibodies in horses.<sup>74</sup> However, at the time of writing these products are not commercially available nor has their efficacy in field situations been demonstrated.

Despite the incomplete protection afforded by vaccines, vaccination against EHV-1 is an important part of most equine herd health programs in the vaccination of pregnant and non-pregnant mares, foals, and adult horses. The intent of vaccination of mares is to prevent abortion associated with EHV-1. One inactivated virus vaccine is reported to decrease the incidence of abortion by 65%, although others have not been able to replicate this success and there are reports of abortion storms on farms

of well vaccinated mares.<sup>1,18,75</sup> An inactivated virus vaccine containing EHV-1 and EHV-4 prevented abortion in five of six mares exposed experimentally to EHV-1, whereas all six non-vaccinated mares aborted.<sup>46</sup> Mares are vaccinated with the inactivated vaccine during the 5th, 7th, and 9th months of gestation. Additional vaccinations at breeding and 1 month before foaling are recommended by some authorities.

**Foals** are an important source of infection (see 'Infection cycling' above) and control of infection in foals is considered critical to control of infection on a farm.<sup>9</sup> Consequently, attention has been paid to the responses of foals to vaccination at various ages, given the risk of passive immunity interfering with vaccination and the early age at which foals are infected by EHV-1.<sup>9</sup> Current recommendations vary with some authorities recommending vaccination of foals after 5 months of age, to avoid the interfering effect of passive immunity on response to vaccination.<sup>76</sup> However, vaccination of foals at this age likely misses the period of time when foals are first infected by EHV-1 from their dam or other mares in the band.<sup>9</sup> One recommendation is that foals be vaccinated in their 3rd month, with revaccination 1 month and 6 months later. Modified live virus vaccine is given to foals at 3-4 months of age, non-pregnant mares and other horses as two doses administered 3 months apart, followed by revaccination every 9 months. Because of the short duration of immunity following vaccination, frequent vaccination, perhaps at intervals as short as 3 months, of horses at high risk is recommended. However, the efficacy of such a program is uncertain.

The efficacy of vaccination in preventing myeloencephalopathy appears to be minimal and there is concern that well vaccinated horses might be at increased risk of the disease, although this has not been conclusively demonstrated and there is evidence to the contrary.<sup>16</sup>

### Subdivision of horses on a farm

Maintenance of small groups of horses of similar age and reproductive status is recommended to minimize the chances of spread of infection.<sup>12</sup> Pregnant mares, after weaning of foals, should be maintained in a herd that does not have access to foals, weanlings, nonpregnant mares or other equids (donkeys). Similarly, weaned foals should be separated from horses of other ages in recognition of the high rate of infection and viral shedding in weanlings.<sup>9</sup> Failure to adhere to these procedures can result in rapid spread of infection and abortions among at risk

mares.<sup>18</sup> Pregnant mares should be combined into small groups (~10) early in pregnancy based on their anticipated foaling dates.<sup>12,66</sup> Multiparous mares should not be mixed with mares that are pregnant for the first time.

Management practices should be introduced that minimize the opportunities for viral spread. Ideally, pregnant mares are handled using facilities separate to those used to handle mares with foals or weanlings. If common facilities must be used, pregnant mares should be handled first, after thorough cleaning of the facility, followed by mares with foals and finally weanlings and other horses.

Minimize risk of introduction of infection. The only sources of virus are recrudescence of latent infection and introduction by newly arrived horses shedding virus. All horses must be considered as potentially shedding EHV-1 on arrival at a farm and should be isolated from resident horses. Introduction of new horses to the small groups of pregnant mares should be avoided if at all possible, or if absolutely necessary preceded by a 21 day isolation period.<sup>23,66</sup> If at all possible, avoid mingling resident and non-resident mares even after quarantine of non-resident animals.

Prevention of reactivation of latent infection

The factors inciting reactivation of latent infection and viral shedding are unknown. However, stressful events, such as transportation or other disease, have the potential to cause reactivation of latent infection. For this reason pregnant mares should not be shipped within 8 weeks of expected foaling and all efforts, including vaccination, should be made to prevent other infectious diseases.<sup>66</sup>

### Control of outbreaks

The principles underlying control of abortions due to EHV-1 include:<sup>12,66</sup>

- early and rapid diagnosis
- prevention of spread of infection
- treatment of individual cases

Rapid diagnosis

Every abortion in a late term mare should be considered to be associated with EHV-1 until proven otherwise. Therefore, rapid and early diagnosis of the abortion is important to instituting control measures. Means of diagnosing EHV-1 abortion are detailed above. In regions with large numbers of breeding mares, all abortions in mares should be investigated by detailed post mortem examination of the fetus and serologic examination of the mare.

Prevention of spread

Diligent and concerted efforts must be made to prevent dissemination of infection

from the initial focus. Infected fetal tissues and fluids, and contaminated materials such as bedding, should be placed in impervious containers and either transported to a laboratory for examination or destroyed by incineration. Samples for laboratory examination should be handled in a manner to prevent spread of infection. Facilities and equipment that might have been contaminated should be disinfected by thorough cleaning followed by application of a phenolic or iodophor disinfectant.<sup>23</sup>

The mare should be isolated until results of laboratory examination are negative for EHV-1 or until the second estrus, at which time it is unlikely that there is shedding of virus from the reproductive tract.<sup>66</sup> Other mares in the same band as the mare that aborted should be considered exposed and at risk of abortion. These mares should be held in strict isolation until the results of laboratory examination are negative for EHV-1, or until they foal or abort. Other recommendations for horse movement include:

- When an abortion occurs on the stud, no mares should be allowed to enter or leave it until the possibility of EHV-1 infection is excluded. However, maiden and barren mares, i.e. mares that have foaled normally at home but that are not in foal, coming from home studs where no signs of the disease are occurring, may be admitted because they are considered to be not infected
- If EHV-1 infection is identified on the stud, all pregnant mares due to foal that season (i.e. late pregnant mares) should remain at the stud until they have foaled. The incubation period for EHV-1 abortion ranges between 9 and 121 days
- All non-pregnant animals and mares that have foaled should remain at the stud for 30 days after the last abortion.

The main problem that arises in this program is in deciding what to do with mares that come into contact with the respiratory disease but not the abortion disease. This may occur very early in pregnancy and prolonged isolation would be onerous. The decision usually depends on the owner's risk aversion and the availability of facilities to maintain long-term isolation.

### Control of outbreaks of myeloencephalopathy

Outbreaks of EHV-1 induced neurologic disease often occur in riding schools and similar situations where there is constant movement of horses on and off the property. As such it is exceedingly difficult to institute control measures that prevent

introduction of the disease and that are compatible with the use of the horses. Having said that, the principles outlined above for preventing introduction of infection on to breeding farms also apply for prevention of myeloencephalopathy at riding stables.

Outbreaks of neurological disease attributable to EHV-1 should be handled as follows:<sup>12</sup>

- Affected horses should be isolated as there is strong evidence that these horses are infectious<sup>22</sup>
- The diagnosis should be confirmed by virus isolation, PCR, or histological examination of tissues from affected horses that die or are euthanized
- There should be no movement of horses on or off the premises for at least 21 days after the last case has occurred<sup>12</sup>
- Movement among bands of horses on the farm should be avoided
- Bands of horses should be monitored for clinical, serological or virological evidence of infection
- Animals should leave or move between bands only when there is no evidence of continued active infection in their group
- Vaccination in the face of an outbreak of EHV-1 myeloencephalopathy is not recommended
- Prophylactic use of acyclovir has been reported although the efficacy of this practice is unknown.<sup>64</sup>

### REVIEW LITERATURE

- Smith KC. Herpesviral abortion in domestic animals. *Vet J* 1997; 153:253-268.
- Goehring LS et al. The mystery of equine herpes myeloencephalopathy. *Equine Vet Educ* 2001; 13:36.
- van Maanen C. Equine herpesvirus 1 and 4 infections: an update. *Vet Quart* 2002; 24:57
- Patel JR, Heldens J. Equine herpesviruses 1 (EHV-1) and 4 (EHV-4) - epidemiology, disease, and immunoprophylaxis: a brief review. *Vet J* 2005; 170:14.

### REFERENCES

1. Crabb BS, Studdert MJ. In: Studdert MJ (ed) *Virus infections of vertebrates: virus infections of equines* 6. 1996; p. 11.
2. Tearle JP et al. *Res Vet Sci* 2003; 75:83.
3. von Einem J et al. *J Virol* 2004; 78:3003.
4. Frampton AR Jr et al. *J Virol* 2005; 79:3169.
5. Bildfell R et al. *J Zoo Wildl Manage* 1996; 27:409.
6. House JA et al. *J Vet Diagn Invest* 1991; 3:137.
7. Blunden AS et al. *J Comp Pathol* 1998; 119:485.
8. Crabb BS, Studdert MJ. *Adv Virus Res* 1995; 45:153.
9. Gilkerson JR et al. *Vet Microbiol* 1999; 68:27.
10. Gilkerson JR et al. *Aust Equine Vet* 1999; 17:76.
11. Gilkerson JR et al. *Aust Vet J* 2003; 81:283.
12. Dunowska M et al. *New Zealand Vet J* 2002; 50:132.
13. Matsumura T et al. *J Vet Med Sci* 1992; 54:208.
14. Morley PS et al. *J Am Vet Med Assoc* 2000; 216:535.
15. Newton JR et al. *Prev Vet Med* 2003; 60:107.
16. Studdert MJ et al. *Vet Rec* 2003; 153:417.
17. Hong CB et al. *J Vet Diagn Invest* 1993; 5:560.

18. Barrandeguy ME et al. *Equine Vet Educ* 2002; 14:132.
19. McCartan CG et al. *Vet Rec* 1995; 136:7.
20. van Maanen C et al. *Equine Vet J* 2001; 33:191.
21. Friday PA et al. *J Vet Int Med* 2000; 14:197.
22. Reed SM, Toribio RE. *Vet Clin Nth Am Equine Pract* 2004; 20:631.
23. Allen GP. *Equine Vet Educ* 2002; 14:136.
24. Chesters PM et al. *J Virol* 1997; 71:3437.
25. Rizvi SM et al. *J Gen Virol* 1997; 78:1115.
26. Borchers K et al. *J Gen Virol* 1997; 78:1109.
27. Foote CE et al. *Equine Vet J* 2004; 36:341.
28. Gilkerson JR et al. *Aust Vet J* 1998; 76:677.
29. Gilkerson JR et al. *Aust Equine Vet* 1997; 15:128.
30. Gilkerson JR et al. *Aust Vet J* 2000; 78:277.
31. Minke JM et al. *Vet Res* 2004; 35:425.
32. O'Neill T et al. *Vet Immunol Immunopathol* 1999; 70:43.
33. Soboll G et al. *J Gen Virol* 2003; 84:2625.
34. Kydd JH et al. *Equine Vet J* 1994; 26:466.
35. Breathnach CC et al. *Vet Immunol Immunopathol* 2005; 103:207.
36. van der Meulen KM et al. *J Gen Virol* 2003; 84:93.
37. Ambagala APN et al. *J Gen Virol* 2004; 85:349.
38. Rappaciolo G et al. *J Gen Virol* 2003; 84:293.
39. Hannant D et al. *Viral Immunol* 1999; 12:313.
40. Smith DJ et al. *Equine Vet J* 2001; 33:138.
41. Smith KC. *Vet J* 1997; 153:253.
42. Smith KC et al. *Equine Vet J* 1992; 24:256.
43. Smith KE et al. *Equine Vet J* 2004; 36:79.
44. Gibson JS et al. *Arch Virol* 1992; 123:351.
45. van Maanen C et al. *Vet Quart* 2000; 22:83.
46. Heldens JGM et al. *Vaccine* 2001; 19:4307.
47. Murray MJ et al. *J Vet Int Med* 1998; 12:36.
48. McCulloch J et al. *Vet Microbiol* 1993; 37:147.
49. Donaldson MT, Sweeney CR. *J Am Vet Med Assoc* 1998; 213:671.
50. van Maanen C et al. *Vet Microbiol* 2000; 71:37.
51. [http://www.oie.int/eng/normes/mmanual/A\\_00085.htm](http://www.oie.int/eng/normes/mmanual/A_00085.htm) Accessed February 15th 2005.
52. Crabb BS et al. *Arch Virol* 1995; 140:245.
53. Hartley CA et al. *Am J Vet Res* 2005; 66:921.
54. Varrasso A et al. *Aust Vet J* 2001; 79:563.
55. Szeredi L et al. *J Comp Path* 2003; 129:147.
56. Gerst S et al. 2003; 35:430.
57. Sharma PC et al. *Equine Vet J* 1992; 24:20.
58. Whitwell KE, Blunden AS. *Equine Vet J* 1992; 24:13.
59. Slater JD et al. *Vet Rec* 1992; 131:237.
60. Carman S et al. *J Vet Diag Invest* 1993; 5:261.
61. Del Picco F et al. *Vet Pathol* 2000; 37:672.
62. Gunn HM. *Irish Vet J* 1991; 44:37.
63. Szeredi L et al. *Acta Vet Hung* 2003; 51:153.
64. Wilkins PA. *Proceedings Am Coll Vet Int Med* 2004; 22:170.
65. Wilson WD. *Vet Clin North Am Equine Pract* 1997; 13:53.
66. Anonymous. *Aust Equine Vet* 2002; 20.
67. Patel JR, Heldens J. *Vet J* 2005; 170:14.
68. Foote CE et al. *Aust Vet J* 2003; 81:283.
69. Minke JA et al. *Vet Res* 2004; 35:425.
70. Foote CE et al. *Vet Microbiol* 2002; 88:13.
71. Patel JR et al. *Equine Vet J* 2004; 36:447.
72. Patel JR et al. *Vet Microbiol* 2003; 92:1.
73. Patel JR et al. *Vet Microbiol* 2003; 91:23.
74. Foote CE et al. *Vet Immunol Immunopathol* 2005; 105:47.
75. Burki F et al. *Vet Q* 1990; 12:80.
76. Wilson W, Rosedale PD. *Proc 8th Int Conf Equine Infect Dis* 1999; p. 428.
77. Bentz BG et al. *J Vet Int Med* 2006; 20:589.

## EQUINE HERPESVIRUS 2 (CYTOMEGALOVIRUS)

### ETIOLOGY

EHV-2 is a slow-growing gamma-herpesviruses.<sup>1</sup> The viral genome has been

elucidated.<sup>2</sup> There is considerable antigenic, genetic and biologic heterogeneity among EHV-2 isolates which might reflect variations in pathogenicity.<sup>3</sup>

### EPIDEMIOLOGY

Almost all adult horses and foals over 2 months of age have serologic evidence of infection by EHV-2.<sup>3-6</sup> EHV-2 was cultured from bronchial or other lymph nodes in 97% of horses sampled at an abattoir and from blood of 31–76% of live adult horses (clinically normal or with respiratory disease) in Europe and New Zealand.<sup>3,7,8</sup> Virus was isolated from blood of 76 of 77 normal foals examined in the United States<sup>6</sup> and in all of 16 foals from a stud with endemic respiratory disease in New Zealand.<sup>5</sup> Viral genome was detected in blood of ~70% of live, adult horses in Europe and in trigeminal ganglion of 6 of 12 seropositive ponies.<sup>8,9</sup> Thirty-four virus isolates were obtained from peripheral blood leukocytes of 139 horses in Poland.<sup>10</sup> Viral DNA was detected in blood samples of all foals examined in Europe.<sup>11</sup> These data demonstrate the ubiquitous nature but uncertain clinical significance of EHV-2 infection of horses worldwide.

The frequency with which disease attributable to EHV-2 occurs in horses is uncertain. In one report, 10 of 16 foals naturally infected with EHV-2 developed respiratory disease, and two died.<sup>5</sup> EHV-2 is isolated from tracheal aspirates of foals with respiratory disease much more often than it is isolated from tracheal aspirates of foals without respiratory disease.<sup>6</sup> Isolation of EHV-2 is statistically associated with upper respiratory disease in horses,<sup>8</sup> and experimental infection causes conjunctivitis, lymphadenopathy, and coughing.<sup>12</sup> The virus is isolated more frequently from eyes of horses with keratoconjunctivitis than from eyes of normal horses, suggesting a role for EHV-2 in this disease.<sup>13</sup> The observation that EHV-2 can be isolated more frequently from the blood of horses with upper respiratory disease, ataxia or abortion might indicate a causative role for the virus, or that intercurrent disease induces reactivation of EHV-2 infection.<sup>3</sup>

EHV-2 is highly infectious, and transmission probably occurs by the inhalation of infected droplets or by the ingestion of material contaminated by nasal discharges. Virus is secreted in nasal and ocular discharge of recently infected horses, and in nasal secretions and tracheal fluid of foals with respiratory disease associated with natural infection.<sup>5,6,12</sup> If survival *ex vivo* is similar to that of the other equine herpesviruses, mediate infection may occur for 14–45 days, although this has not been specifically investigated for EHV-2.

Infections always arise from other horses, both by direct contact and by fomites. Horses and foals are infectious during the active stage of disease and, because horses become latently infected, during subsequent periods of viral reactivation and shedding. The duration of latency is unknown but is assumed to be lifelong.<sup>1</sup> Latent EHV-2 virus is detectable in the trigeminal ganglion, lymph nodes, and peripheral blood monocytes of clinically normal horses.<sup>3,7-9</sup> Reactivation after experimental infection can be triggered by administration of dexamethasone.<sup>12</sup> Factors influencing reactivation of the virus and the importance of reactivated infections in dissemination of infection and induction of disease is unknown, but is likely important as for other equid herpesviruses.

It appears that foals are infected at a young age and that infection is persistent into adulthood.<sup>5,6,11</sup> EHV-2 can be isolated by 25 days of age from foals that were seronegative at birth and there is a progressive increase in virus neutralization from 1 to 5 months of age.<sup>6</sup> Viral shedding is persistent until development of high antibody titers at 6–9 months of age.<sup>5</sup>

### PATHOGENESIS

The pathogenesis of EHV-2 has not been defined. However, it is apparent that infection occurs at a young age, as early as several weeks of age, and becomes latent in lymph nodes, especially those draining the respiratory tract, peripheral blood mononuclear cells, and nervous tissue including the trigeminal ganglion. As with EHV-1, there is evidence that EHV-2 causes immunosuppression<sup>14</sup> and it is speculated that this might play a role the development of other infections, including pneumonia associated with *Rhodococcus equi* or other bacteria.<sup>5</sup>

### CLINICAL FINDINGS

EHV-2 or equine cytomegalovirus causes a long-term infection in foals, some of which develop clinical signs of purulent nasal discharge, fever and lymphadenopathy in a syndrome which lasts about 1 week. Affected animals rarely die although deaths of foals from pneumonia have been recorded.<sup>5,6,8</sup> EHV-2 was isolated from 20 of 30 foals with signs of lower respiratory disease including fever, abnormal lung sounds and radiographic abnormalities.<sup>6</sup> Bacteria were isolated from tracheal aspirates of 29 of these foals.

EHV-2 is statistically associated with keratoconjunctivitis in horses of varying ages.<sup>13</sup>

### CLINICAL PATHOLOGY

Results of hematological and serum biochemical examinations are neither specific nor diagnostic. A blocking ELISA has been developed that detects serum

antibody specific for EHV-2, and is useful to detecting new infection in foals.<sup>15</sup> Identification of the virus in nasal swabs, blood buffy coat or fetal tissue by culture or a PCR test provides confirmation of infection.<sup>16</sup>

### NECROPSY FINDINGS

Necropsy findings for diseases associated with EHV-2 infection are poorly reported. Two foals that died of respiratory disease associated with EHV-2 infection had pneumonia, chronic pharyngitis and lymphoid depletion in the thymus and spleen.<sup>5</sup>

### DIFFERENTIAL DIAGNOSIS

Differential diagnosis includes other causes of respiratory diseases in horses (Table 16.4).

### TREATMENT

There is no specific treatment for the diseases associated with equine herpesvirus-2 infection. Antibiotics are often administered to horses with respiratory tract disease to prevent or treat secondary bacterial infection.

### CONTROL

Control is difficult given the ubiquitous nature of infection and uncertain importance of disease associated with EHV-2. There is currently no commercial vaccine to prevent infection or disease associated with EHV-2.

### REFERENCES

- Crabb BS, Studdert MJ. In: Studdert MJ (ed) *Virus infections of vertebrates: virus infections of equines* 6, 1996; p. 11.
- Telford EA et al. *J Mol Biol* 1995; 249:520.
- Borchers K et al. *Arch Virol* 1997; 142:917.
- Browning GF, Studdert MJ. *Vet Bull* 1988; 58:775.
- Edington N et al. *Equine Vet J* 1994; 26:140.
- Fu Z F et al. *NZ Vet J* 1986; 34:152.
- Murray M J et al. *Equine Vet J* 1996; 28:432.
- Nordengrahn A et al. *Vet Res* 2002; 33:251.
- Nordengrahn A et al. *J Vet Diag Invest* 2001; 13:389.
- Dunowska M et al. *New Zealand Vet J* 2002; 50:132.
- Borchers K et al. *Virus Res* 1998; 55:101.
- Kershaw O et al. *Virus Res* 2001; 80:93.
- Rizvi SM et al. *J Gen Virol* 1997; 78:1115.
- Dunowska M et al. *Res Vet Sci* 2001; 71:111.
- Dynon K et al. *Aust Vet J* 2001; 79:695.
- Ruszczuk A et al. *Acta Virol* 2004; 48:189.

### EQUINE COITAL EXANTHEMA (EQUINE HERPES 3 INFECTION)

Equine coital exanthema is a **venereal disease** associated with infection by equine herpesvirus 3 and manifested by papular, then pustular, and finally **ulcerative lesions** of the vaginal mucosa, which is generally reddened. The ulcers may be as large as 2 cm in diameter and 0.5 cm deep and are surrounded by a zone of hyperemia. In severe cases the lesions extend onto the vulva and the perineal skin to surround the anus. In the

male, similar lesions are found on the penis and prepuce. Many mild cases are unobserved because there is no systemic disease and affected horses eat well and behave normally. The effect on fertility is equivocal although there may be a loss of libido during the active stage of the disease in stallions.<sup>1</sup> **Transmission** is usually venereal from affected or clinically normal carrier animals in which the infection is thought to be latent in sciatic ganglion.<sup>1</sup> The **incubation period** is 2–10 days and the course up to complete healing of ulcers is about 14 days. Diagnosis can be achieved by use of virus isolation or demonstration of viral DNA in skin lesions.<sup>2</sup> Secondary bacterial infection may lead to suppurative discharge and a longer course. In some outbreaks lesions occur on the skin of the lips, around the nostrils, and on the conjunctiva. They may also be present on the muzzle of the foal. Ulcerative lesions of the pharyngeal mucosa also occur in infections with EHV-2 and with equine adenovirus. Ulcerative lesions of the oral mucosa are of great importance because of the necessity to diagnose vesicular stomatitis early. Control can be achieved by use of artificial insemination.

### REFERENCES

- Studdert MJ (ed). *Virus infections of vertebrates: virus infections of equines* 6. Amsterdam: Elsevier, 1996; p. 39.
- Kleiboeker SB, Chapman RK. *J Vet Diag Invest* 2004; 16:74.

### EQUINE VIRAL ARTERITIS (EVA)

#### Synopsis

**Etiology** Equine arteritis virus  
**Epidemiology** Outbreaks of disease due to lateral transmission by infected body fluids. Venereal transmission by persistently infected, clinically normal, stallions with subsequent lateral spread among mares  
**Clinical signs** Abortion. Upper respiratory disease with systemic signs including edema and respiratory distress  
**Clinical pathology** Serology. No characteristic changes in hemogram or serum biochemistry  
**Diagnostic confirmation** Virus isolation from blood, sperm-rich fraction of semen, nasopharyngeal swabs or tissue. Seroconversion or increase in complement fixation titer

#### Differential diagnosis:

- The systemic disease – viral respiratory disease
- Abortion – EHV-1, mare reproductive loss syndrome
- Similar disease in neonates – EHV-1 or other septicemia

**Treatment** There is no specific treatment  
**Control** Vaccination, especially of stallions and seronegative mares to be inseminated by seropositive stallions, and to control outbreaks at racetracks. Quarantine. Hygiene

### ETIOLOGY

Viral arteritis of horses, donkeys and mules is associated with an **arterivirus**, formerly classified as a non-arthropod borne togavirus but now recognized as a member of the coronavirus-like superfamily.<sup>1</sup> The virus is single-stranded RNA. There is considerable genomic variation among isolates with EAV of North American and European origin clustering in geographically distinct viral clades.<sup>2,3</sup> Although different isolates of EAV vary in virulence, consistent variations in virulence among clades have not been demonstrated.<sup>2</sup> Novel phenotypic variants of EAV can emerge during persistent infections in stallions and this might be an important feature in the development of disease in exposed mares and foals.<sup>3-5</sup> A strain recently isolated from donkeys and mules in South Africa causes only mild disease in horses.<sup>6</sup> The virus resists freezing but not heat.

### EPIDEMIOLOGY

#### Occurrence

**Serologic evidence** of infection by equine arteritis virus (EAV) is found in horse populations in North and South America, Europe, Africa, Asia, and Australia.<sup>7</sup> Recent disease outbreaks have been identified in North America, Britain, Spain, Italy, France, Poland, The Netherlands, South Africa, and Germany.<sup>7</sup> It is probable that the disease is now present in most countries with substantial populations of horses. International shipment of horses and frozen semen contributes to the spread of the EAV.<sup>8</sup>

The proportion of seropositive horses varies considerably among populations, with there being marked differences among breeds. Overall, 2% of horses in the United States are seropositive to EAV (serum neutralization titer >1:4) with 8.4% of horse operations having seropositive horses.<sup>9</sup> Twenty-five percent of operations whose principal activity was breeding had at least one unvaccinated seropositive horse, whereas 4% of racing operations had at least one unvaccinated seropositive horse.<sup>9</sup> The prevalence of titers to EAV is higher in mares and in horses used for breeding.<sup>9</sup> The frequency with which horses in the United States have serum titers >1:4 varies with breed with 24% of Standardbreds, 4.5% of Thoroughbreds, 3.6% of Warmbloods and 0.6% of Quarter horses being seropositive.<sup>9</sup> Approximately 19% of Warmblood horses imported into the United States have antibodies to EAV, with horses from Germany and the Netherlands having the highest prevalence (21 and 25% respectively).<sup>10</sup> Between 55–93% of Warmblood and Lipizzan breeds in Austria have serologic evidence of exposure to EAV.<sup>11</sup> Disease in Great Britain and North

America has been associated with importation of infected stallions or semen.<sup>8,10</sup> Horses of all age groups are susceptible. The disease spreads rapidly in a group of susceptible horses, and although the course of clinical disease is short, an outbreak in a group of horses may persist for a number of weeks. Naturally acquired infections in newborn foals can occur as an outbreak and cause severe disease.<sup>12</sup>

### Origin of infection and transmission

EAV is spread in two ways:

- 1 **Horizontal transmission** of virus by predominantly nasal fluid, but also by urine, feces, lacrimal fluid and vaginal discharge of infected horses
- 2 **Venereal transmission** from stallions to susceptible (seronegative) mares.

**Horizontal transmission** through infected nasal discharge and body fluid is effective and is the means of disease spread in outbreaks in racing stables, and among mares and foals at breeding farms. Virus is found in the respiratory secretion for 7–14 days and in other tissues for 28 days.<sup>11</sup> Close contact between horses is probably required for transmission of the virus – it has been reported to spread after contact of horses across a fence.<sup>8</sup> Duration of viability of the virus in the environment has not been reported, but the potential for spread of infection on fomites includes clothing and tack should be considered when dealing with an outbreak.

**Venereal transmission: Stallions** are infected by horizontal transmission of the virus, subsequently excrete the virus in semen and infect susceptible mares at the time of mating. Clinically nonnal stallions are also capable of transmitting the virus horizontally to other stallions in a breeding operation, demonstrating the potential for horizontal spread of infection from stallions in the absence of clinical disease or sexual contact.<sup>13</sup> Between 30 and 60% of infected stallions excrete the virus in semen for weeks to months.<sup>14</sup> Some stallions excrete virus for years, and lifelong infection and virus excretion can occur.<sup>11</sup> Prolonged infection of stallions is associated with mutation of the virus and secretion by the stallion of viral strains that vary over time. However, disease resulting from transmission of infection from a stallion to a mare, and subsequent spread of infection to other horses, is associated with a single viral strain.<sup>5</sup> In other words, stallions can excrete a variety of strains of the virus during their life, but outbreaks of disease are associated with a single viral strain; multiple viral strains are not detected during outbreaks of disease.<sup>5</sup>

Prolonged excretion of the virus in semen is likely important in the main-

tenance of the virus in populations of horses. Introduction of a **persistently infected stallion** into a naive population or insemination of seronegative mares with semen from an infected stallion have been implicated as the cause of outbreaks of viral arteritis.<sup>8</sup> The carrier stallion infects mares at mating, the mares develop disease and shed virus in nasal and other body fluids and infect in-contact susceptible horses and foals by horizontal transmission.

### Immunity

Vaccination or recovery from natural infection results in the development of a strong serum antibody virus neutralizing response which is believed to be important in clearance of the virus and resistance to infection.<sup>15</sup> Naive, pregnant mares infected by horizontal transmission may abort or, less commonly, give birth to infected foals that subsequently die.

Foals of immune mares are resistant to infection, and viral neutralization antibodies are present in mare's colostrum and foal's serum after sucking, with persistence of the antibodies to the age of 2–6 months in the foals.<sup>16</sup> Persistence of passive immunity in foals has important implications for resistance to infection and for timing of administration of modified live vaccines.

### Economic importance

The chief impact of the disease on breeding farms is the loss of foals through abortion and the cost of quarantine and control measures. The systemic illness may be severe, but the mortality rate is low. During outbreaks at race tracks the economic impact is a result of lost opportunities for training and racing sick or convalescing horses, and the effect of quarantine and control measures. Additional costs are incurred by the inconvenience and cost of vaccinating mares to be bred to stallions infected with the virus and import regulations controlling movement of horses and semen including the inability to export mares, fillies and non-carrier stallions that are seropositive (perhaps as a result of vaccination), and the limited opportunities for export of semen from infected stallions or export of the stallions themselves.

### PATHOGENESIS

The pathogenesis of disease associated with horizontal transmission of EAV has been elucidated.<sup>17</sup> After inhalation of the virus it binds to the respiratory epithelium and infects alveolar macrophages and is detectable in bronchial lymph nodes by 48 hours after infection. Three days after infection the virus is detectable in circulating monocytes with subsequent systemic distribution of infection. The

virus localized in vascular endothelium and medial myocytes by days 6–9 and there is significant damage to blood vessels by day 10. The virus infects renal tubular epithelium and can persist there for up to 2 weeks. Medial necrosis of blood vessels might cause anoxia of associated tissues. Virus is not detectable in any tissue by 28 days after infection, with the exception of accessory sex glands in intact male horses.

Abortion is caused by a severe necrotizing myometritis and presumed consequent reduction in fetal blood flow. There are usually no lesions in the fetus, although the fetus is sometimes infected with the virus.

### CLINICAL FINDINGS

Infection by EAV is usually **clinically inapparent**, especially after venereal infection of mares. **Abortion** is not necessarily associated with clinical disease in the mare. Systemic disease is usually mild to moderate and self-limiting with recovery in 5–9 days in the vast majority of horses.

**Systemic disease is characterized** by an incubation period of 1–6 days followed by the appearance of fever (39–41°C, 102–106°F). A serous nasal discharge which may become purulent and be accompanied in some horses by congestion and petechiation of the nasal mucosa, urticaria, conjunctivitis, excessive lacrimation developing to purulent discharge, keratitis, palpebral edema, and blepharospasm. Opacity of the aqueous humor and petechiation of the conjunctiva may also occur. Signs of pulmonary disease, such as respiratory distress and coughing are attributable to pulmonary edema and congestion, but are uncommon. The appetite is reduced or absent and, in severe cases, there may be abdominal pain, diarrhea and jaundice. Edema of the limbs is common and more marked in stabled horses than those at pasture. In stallions, edema of the ventral abdominal wall may extend to involve the prepuce and scrotum. Depression is usual and varies in degree with the severity of the syndrome. The disease is acute and severe, and deaths may occur without secondary bacterial invasion. In these cases dehydration, muscle weakness and prostration develop quickly. It must be emphasized that the disease may be much milder than that described above.

**Clinical disease in neonatal foals** is characterized by fever, profound depression, weakness, limb and facial edema, and respiratory distress. Severely affected foals usually die. Foals can be affected at birth, or be born apparently normal and develop disease 1–19 days after birth.<sup>12</sup>

**Abortion** occurs within a few days of the onset of clinical illness, although it

is not usually associated with clinically apparent disease. Abortions may occur in 10–60% of at-risk mares during an outbreak and during the 3rd–10th months of gestation.<sup>11</sup> Abortion occurs 12–30 days after exposure. The abortion is not foreshadowed by premonitory signs, and the placenta is not retained.

#### CLINICAL PATHOLOGY

**Hematological examination** of adults and foals during the acute phase of the systemic disease is characterized by leukopenia and thrombocytopenia.<sup>12</sup>

**Serological confirmation of infection** is achieved using complement fixation, serum neutralization and ELISA tests.<sup>7</sup> Seroconversion occurs within 1 week of infection, and demonstration of a rising antibody titer, based on acute and convalescent serum samples, or seroconversion is considered evidence of recent infection. False-positive results for the virus neutralization test have occurred using OIE prescribed rabbit kidney (RK-13) indicator cells when testing serum from horses vaccinated with an EHV-1/4 tissue cultured derived vaccine.<sup>18</sup> The false-positive results are likely a result of vaccine-induced anticellular antibody response against the RK-13 cells.

**Virus isolation** from blood, body fluids, fetal or placental tissue is readily achieved during the acute phase of the disease. Appropriate samples for virus isolation include nasopharyngeal or conjunctival swabs and anticoagulated whole blood (heparin, EDTA or citrate are suitable anticoagulants).<sup>11</sup> Virus is continuously excreted in the semen of infected stallions and is readily isolated from the sperm-rich fraction of the semen. A nested PCR can detect the presence of virus in naturally infected semen at concentrations as low as 2.5 plaque forming units per mL with a specificity of 97% and a sensitivity of 100%, and may be useful for the rapid diagnosis of EVA shedding stallions.<sup>19</sup>

Antemortem diagnosis of EAV disease can be achieved by examination of skin samples using monoclonal antibody immunoperoxidase histochemistry. Examination of skin samples obtained by biopsy reveals edema and vasculitis and presence of intracytoplasmic EAV antigen.<sup>20</sup>

#### NECROPSY FINDINGS

Gross lesions include edema of the eyelids and petechiation of the upper respiratory tract, and the serosae of the abdominal and thoracic viscera. There is an abundant serofibrinous pleural and peritoneal effusion with generalized edema of the lungs, mediastinum, and abdominal mesenteries. A hemorrhagic enterocolitis, as well as hemorrhage and infarction in the spleen may be noted. Characteristic histological changes are found in the

small arteries and include **fibrinoid necrosis of the tunica media and karyorrhexis of the infiltrating leukocytes**. Fluorescent antibody or immunohistochemical staining demonstrates viral antigen within the endothelial cells of these blood vessels. An immunoperoxidase method has also revealed viral antigen within endothelial cells and macrophages of an aborting mare and her fetus and within skin biopsies of animals exhibiting a maculopapular rash.<sup>20</sup> Serological tests performed on samples collected at necropsy can also be used to confirm that exposure to the virus has occurred.

The virus can be isolated from the lung and spleen of aborted fetuses, but no consistent, specific lesions are present. Necrotizing arteritis, similar to that in the mare, may be detectable.<sup>21</sup>

#### Samples for confirmation of diagnosis

- **Virology** – chilled lung, spleen and thymus (VI, PCR, FAT)
- **Serology** – heart-blood serum or fetal thoracic fluid (VN, ELISA, CF)
- **Histology** – fixed lung, spleen, adrenal, jejunum, colon and heart (LM, IHC).

#### DIFFERENTIAL DIAGNOSIS

Definitive diagnosis is based on isolation of EAV from affected cases, or the demonstration of seroconversion or an increase in serum antibody titer.

The systemic disease must be differentiated from that associated with EHV-1 or EHV-4 infection, equine influenza, strangles (see Table 16.4), infection with Getah virus in Japan, equine infectious anemia, African horse sickness, and purpura hemorrhagica.

Abortion should be differentiated from that associated with EHV-1, *Salmonella abortusequi*, leptospirosis, mare reproductive loss syndrome, and congenital malformations.

Similar disease in neonates can be associated with EHV-1, immaturity or premature birth, and bacterial septicemia.

#### TREATMENT AND CONTROL

There is no specific treatment for equine viral arteritis. Most horses recover without specific care. Severely affected foals require intensive care.

**Control** of EAV infection is based on the strong **immunity** induced by natural infection or vaccination with a modified live virus, and an understanding of the role of carrier stallions in the disease. The following practices are suggested:<sup>9</sup>

1. Isolate all new arrivals (and returning horses) to farm or ranch for 3 to 5 weeks

2. If possible, segregate pregnant mares from other horses
3. Blood test all breeding stallions for EAV antibodies
4. Check semen of any unvaccinated, antibody-positive stallions for EAV to identify carriers before breeding
5. Once tested negative for EAV antibodies, vaccinate all breeding stallions annually
6. Physically isolate any EAV carrier stallions
7. Restrict breeding EAV carrier stallions to vaccinated mares or mares which test positive for naturally acquired antibodies to the virus
8. Vaccinate mares against EVA at least 3 weeks prior to breeding to a known carrier stallion
9. Isolate mares vaccinated for the first time against EVA for 3 weeks following breeding to an EAV carrier stallion
10. In breeds or areas with high rates of EAV infection, vaccinate all intact males between 6 to 12 months of age.

**Testing of mares and stallions** permits identification of serologically negative, and therefore at-risk, animals. Seronegative mares should not be mated with infected stallions nor inseminated with fresh or frozen semen from infected stallions because of the risk of transmission of infection to the mare.<sup>8</sup> Seropositive mares, or mares that have been vaccinated at least 3 weeks, can safely be bred to stallions that have serological evidence of infection. Seropositive mares should be separated from seronegative mares for at least 3 weeks after mating to a seropositive stallion. Seropositive stallions that have not been vaccinated should have their semen cultured to determine if they are excreting the virus. Stallions excreting virus in their semen should be kept isolated from susceptible horses but can be bred to seropositive mares, as described above. Because the virus survives cooling and freezing, similar principles should be applied to the use of artificial insemination in horses. One control program requires that all stallions be vaccinated with a modified live virus vaccine 28 days before the beginning of each breeding season.<sup>11</sup>

**Vaccination with a modified live virus vaccine** induces strong immunity, although revaccination is necessary to insure continuing immunity.<sup>7,11</sup> The vaccine protects mares exposed to stallions shedding the virus in semen and has been used to control outbreaks of the respiratory form of the disease at racetracks.<sup>22</sup> The modified live virus vaccine is



regarded as safe,<sup>11</sup> although there is mild fever and leukopenia, and evidence that the vaccine virus replicates in the vaccinates.<sup>23</sup> A killed virus vaccine has limited availability and its efficacy in the field has not been reported.<sup>21</sup> Antibodies induced by the vaccine cannot be differentiated from those resulting from natural infection, a situation that may be problematic when import restrictions require the horse to be seronegative, presumably as proof of lack of exposure to virulent EAV.

Vaccination of foals from immune mares results in good protection provided that the timing of vaccination is delayed until maternal antibodies to EAV are no longer present in the foal.

## REVIEW LITERATURE

Del Piero F. Equine viral arteritis. *Vet Pathol* 2000; 37:287.

## REFERENCES

- Boon JA et al. *J Virol* 1991; 65:2910.
- Larsen LE et al. *Vet Microbiol* 2001; 80:339.
- Balasuriya EBR et al. *J Gen Virol* 2004; 85:379.
- Hedges JF et al. *J Virol* 1999; 73:3672.
- Balasuriya UBR et al. *J Gen Virol* 1999; 80:1949.
- Paweska JT et al. *Onderstepoort Vet J* 1996; 63:189.
- De Vries AAF et al. In: Studdert MJ (ed) *Viral infections of vertebrates: viral infections of equines* 6, 1996; p. 171.
- Balasuriya UBR et al. *J Am Vet Med Assoc* 1998; 213:1586.
- NAHMS. Equine Viral Arteritis (EVA) and the US Horse Industry. USDA:APHIS:VS, CEAH, National Animal Health Monitoring System. Fort Collins, CO, 2000; #N3150400.
- Hullinger PJ et al. *J Am Vet Med Assoc* 2001; 219:946.
- Timoney PJ, McCollum WH. *Vet Clin North Am Equine Pract* 1993; 9:295.
- Del Piero F et al. *Equine Vet J* 1997; 29:178.
- Guthrie AJ et al. *Equine Vet J* 2003; 35:596.
- Timoney PJ et al. *J Reprod Fertil (Suppl)* 1987; 35:95.
- Castillo-Olivares J et al. *J Gen Virol* 2003; 84:2745.
- Hullinger PJ et al. *J Am Vet Med Assoc* 1998; 213:839.
- Del Piero F. *Vet Pathol* 2000; 37:287.
- Newton JR et al. *Vaccine* 2004; 22:4117.
- Gilbert SA et al. *J Clin Microbiol* 1997; 35:2181.
- Del Piero F. *Vet Pathol* 2000; 37:486.
- Glaser AL et al. *Vet Q* 1996; 18:95.
- Wilson WD et al. *J Am Vet Med Assoc* 1995; 207:426.
- Harry TO, McCollum WH. *Am J Vet Res* 1981; 42:1501.

## EQUINE INFLUENZA

### Synopsis

**Etiology** Influenza virus H3N8 (previously A/equine 2) of two lineages and numerous, evolving, strains. Historically, H7N7 virus  
**Epidemiology** Short incubation period and highly contagious nature of the virus result in explosive outbreaks of disease. Viral shedding by subclinically affected horses is important for introduction of

infection to populations. Prolonged carrier state is not recognized

**Clinical signs** Upper respiratory disease complicated by pneumonia. Abortion is not a feature of the disease

**Clinical pathology** None characteristic  
**Lesions** Rhinitis, pneumonitis. Rarely causes death

### Diagnostic confirmation

Demonstration of virus in nasopharyngeal swab either by culture, ELISA, PCR, or membrane bound immunoassay

**Treatment** Supportive care. There is no specific treatment

**Control** Vaccination, often every 4 months, quarantine and hygiene

## ETIOLOGY

Equine influenza is associated with infection by equine **influenza A/H7N7** (previously referred to as equine influenza A1) or **equine influenza A/H3N8** (previously referred to as equine influenza A2) virus, members of the influenza virus A genus of the family Orthomyxoviridae. Of the two serologically distinct subtypes, all reported outbreaks in the past two decades have been associated with strains of EIV-A/H3N8. There are no reports of disease associated with EIV-A/H7N7 in the past 25 years and reports of seroconversion might be related to use of vaccines containing EIV-A/H7N7 antigen.<sup>1</sup> There are no reports of other influenza viruses, such as the H1N1 avian virus, causing disease in horses, although the avian-like influenza A/I/Jilin89 (H3N8) caused severe disease and high mortality among horses in China in 1989.<sup>2</sup> Equine influenza H3N8 virus can infect dogs and cause serious disease and death.<sup>3</sup>

Currently, two major lineages of EIV-H3N8 circulate in horse populations – a Eurasian lineage and an American lineage. The terms Eurasian and American do not denote geographical isolation of these lineages, and viruses of American lineage circulate in Europe and North America, although to date the only virus of Eurasian lineage isolated in North America was the Saskatoon isolate (1/90).<sup>4</sup> Within the American lineage there is further division of the virus into three distinct lineages (South American, Florida and Kentucky) with the predominant lineage varying from year to year with evidence of cycling.<sup>4,5</sup> Cycling is the predominance of one lineage one year, and the other lineage in the subsequent year, with reversion to the initial lineage in the third year, and so on.<sup>5</sup> This is believed to be a mechanism for viral perpetuation, allowing avoidance of eradication of the virus by changing the immunological target from year to year without viral evolution.<sup>5</sup>

The predominating virus lineage or strain varies from year to year and from

region to region. The important point is that there is continual change in the viral strain in some populations of horses and that constant monitoring of viral strains is vital for appropriate composition of vaccines and for molecular epidemiology. For instance, the majority of viruses from Europe (France, Italy and the UK) and North America characterized antigenically and/or genetically between January 2003 and April 2004 were of the American lineage. Based on hemagglutination inhibition (HI) testing most viruses isolated in Europe, represented by A/equine/Newmarket/5/03, were antigenically closely related to the vaccine strains, A/equine/Newmarket/1/93 (American lineage), A/equine/Kentucky/97 and A/equine/Kentucky/98 (American lineage). Viruses recently isolated in South Africa and the USA were distinguishable from these three vaccine strains and were more closely related to A/equine/South Africa/4/03.<sup>6</sup> The South African strain was identical to an American lineage strain originally isolated in Wisconsin in 2003 (A/Equine/Wisconsin/1/03).<sup>7,8</sup> The HA1 sequences of 2003 American-like viruses fall within a single phylogenetic subgroup referred to as the 'Florida' lineage.<sup>5</sup> In 2003 and 2004 a few viruses, isolated in Benelux, were of the 'European' lineage,<sup>6</sup> and were antigenically similar to some viruses circulating in Europe during 2002, represented by A/equine/Lincoln/1/02, and were distinguishable from the prototype vaccine strain A/equine/Newmarket/2/93.<sup>6</sup> The European lineage viruses circulating in 2002 were heterogeneous in their antigenic and genetic characteristics. Information about EIV strains changes constantly and is available at the equiflunet website.<sup>6</sup>

The existence of lineages and strains of virus is important in the epidemiology of the disease because the antigenic differences among strains can be sufficient to prevent cross-protection provided by natural infection or vaccination. Cross-protection refers to the ability of one antigen (virus strain) to produce immunity in the horse against infection with another type of antigen (virus strain). Infection or challenge with the same type of antigen is referred to as homologous challenge, whereas that with a different antigenic type is referred to as heterologous challenge.<sup>9</sup> Strains of influenza virus circulate between and among populations of horses, with more than one strain of virus circulating at any one time in some horse populations,<sup>10</sup> although individual disease outbreaks are associated with a single viral strain. Many, but not all, of these virus strains are constantly evolving and evolution of the viruses is necessary for perpetuation of cycles of infection

through the emergence, or reemergence by cycling, of heterologous strains.<sup>5,11</sup> Evolutionary stasis, the continued circulation of older strains of virus, occurs and has importance for vaccine composition.<sup>11</sup> However, emergence of new strains is common and of great importance for control of the disease. Evolution of strains of equine H3N8 virus occurs through antigenic drift. **Antigenic drift**, the accumulation of point mutations in the gene coding for the major surface protein hemagglutinin, occurs continuously in virus circulating in horse populations. Antigenic drift occurs most rapidly in hemagglutinin protein but also occurs in M and NS genes.<sup>12</sup> Antigenic drift, by producing heterologous viral strains, contributes to the continuing susceptibility of horses to infection and the reduced efficacy of some vaccines.

Influenza virus is an RNA virus that has eight segments to its genome which encodes ten proteins. The hemagglutinin and neuraminidase proteins are used for antigenic characterization of virus strains. Mutations in these genes or poor fidelity RNA copying results in changes in amino acid composition of viral proteins that may be detected by serological tests (see 'Clinical Pathology') and that might have, as discussed above, important consequences for infectivity and pathogenicity of the virus. **Antigenic shift** is an event in which there is a dramatic alteration in the viral genome occurring by reassortment of viral genes during co-infection of a cell by two different types of virus (for example infection of a pig by both avian and human influenza viruses). Antigenic shift, which has not been documented for influenza viruses infecting horses, has the potential to produce new viruses with markedly different host infectivity and pathogenicity to either parent virus.

## EPIDEMIOLOGY

### Occurrence

Worldwide, the only large horse populations in which **influenza virus infection** does not occur are in Australia and New Zealand. Widespread use of aircraft to move horses between countries in short periods has increased the spread of equine influenza viruses, as exemplified by the 2003 outbreak of equine influenza in horses in South Africa associated with a virus from North America, and an earlier outbreak in Hong Kong. In both cases virus was introduced by imported horses.<sup>8,13,14</sup>

**Epidemics** of equine influenza have occurred in Europe or North America in 1956 (H7N7), 1963 (H3N8), 1969, 1979, and 1989, although this does not represent a comprehensive listing of large scale outbreaks.<sup>15,16</sup> Epidemics affecting

>1 million horses occurred in China in 1989 (associated with the novel H3N8 Jilin virus) and 1993/1994 (associated with a conventional H3N8 virus closely related to 1991 European isolates).<sup>16</sup> Epidemics in Europe and North America have been associated with introduction of a novel virus (for example the 1963 appearance of H3N8 virus in Miami) or antigenic drift of existing viruses and resultant inefficacy of extant vaccines.<sup>15</sup>

**Localized outbreaks** of disease in stables or race courses occur almost annually in countries in which the disease is endemic, likely related to the movement of horses into the training and racing populations, with subsequent introduction of virus and development of disease in at risk horses (see 'Animal Risk Factors'). Disease associated with equine influenza virus usually occurs as outbreaks associated with the introduction of virus into a population of susceptible horses. Virus may be introduced by clinically affected horses or, more commonly, by horses that are not noted to be clinically ill. Vaccinated horses may become infected and shed influenza virus while not becoming ill, especially if vaccinated with heterologous strains, and this is likely a common method of introduction of virus into susceptible populations.

Outbreaks of influenza virus infection may cause clinical disease in nearly all (98%) horses in a susceptible population, although in populations of horses of mixed age and with varying serum titers to equine influenza the morbidity rate may be much lower (16–28%).<sup>17</sup> The incidence of disease in one race track population was approximately 130 cases per 1000 horses at risk per month<sup>18</sup> although this rate likely varies widely among outbreaks. The mortality rate is usually very low (<1%) with most deaths associated with secondary bacterial infections. However, a recent outbreak of disease in China associated with a novel H3N8 (Jilin virus) strain was associated with a morbidity rate of 80% and mortality rate of 20–35%.<sup>2</sup>

The disease in populations of vaccinated or previously exposed horses is associated with a lower morbidity and mortality, and slower spread, due to the milder disease induced by influenza virus infection of immune or partially immune horses. In an outbreak among vaccinated racehorses in Hong Kong, 75% of horses had serological evidence of infection, 37% had clinical signs of infection, and 0.2% died.<sup>14</sup> Horses imported from Australia and New Zealand, where the disease does not occur, had a morbidity rate of 52%, while horses from the northern hemisphere had a morbidity rate of 20%, likely reflecting the effect of previous

exposure to influenza virus or repeated vaccination.<sup>14</sup>

The profile of an epidemic can vary from explosive with a large proportion of a small group of susceptible horses housed in close proximity, such as a small band, developing clinical disease within 24–48 hours, to much more prolonged outbreaks lasting several weeks in larger groups of horses of varying susceptibility housed in multiple barns. During larger outbreaks among horses of varying susceptibility there is a characteristic three phase pattern.<sup>18</sup> The first stage is associated with the first cases of disease and slow spread over 10–14 days. This stage is followed by one of rapid spread of the disease to horses clustered in stalls around horses affected during the first phase of the outbreak. The third phase is characterized by declining numbers of cases.<sup>18</sup>

### Origin of infection and transmission

Equine influenza virus is relatively susceptible to environmental conditions, and during an outbreak infection must originate from an infected horse although the proximate source of virus can be contaminated equipment or other fomites. **Transmission** of equine influenza virus occurs by direct contact, inhalation of aerosols of infected material, and on fomites. Survival of the virus on clothing and surfaces, including vehicles used to transport horses shedding the virus, can result in transmission of infection in the absence of horse to horse contact.<sup>8</sup>

**Fomite transfer** on veterinary clothing, equipment or vehicles was likely responsible for the spread of infection from quarantined horses in both South African outbreaks.<sup>8,19</sup> However, in most instances, horses are infected by other horses that are in close proximity or have physical contact, for instance exercise ponies (horses or ponies used to accompany race horses from the stable to the track in preparation for racing or training gallops) or stable mates.<sup>17</sup> Aerosol spread occurs over distances of 35 meters, possibly further, and is enhanced by the frequent coughing characteristic of the disease. Equine influenza virus in aerosols survives longer (24–36 hours) than human or porcine strains (15 hours).

Clinically affected horses excrete more virus than do horses in which the infection is inapparent. The duration of infectivity of clinically affected horses is 3–8 days and with the short incubation period of 2–3 days combine to produce the potential for a very rapid new infection rate and a characteristic explosive outbreak.

### Risk factors

#### Animal factors

All age groups of horses, including newborn foals, are susceptible. The greatest

risk appears to be between the ages of 2 and 6 months,<sup>20</sup> serum levels of passively acquired antibodies being lost by foals at 2 months of age.<sup>21</sup> A recent survey of >8000 horses in the United States revealed that only 20.2% of horses aged 6 to 17 months had a detectable influenza antibody titer (HI), as compared to 89.0% of horses aged 20 years or more.<sup>22</sup> The percentage of horses that had a high equine influenza antibody titer increased as the horse's age increased such that 45–51% of horses older than 5 years had high titers. This observation is consistent with most cases of the disease occurring in 2-year-old or younger horses, probably because older horses are immune through either natural exposure or vaccination. Thoroughbred race horses ≤2 years were 5–8 times more likely to develop influenza than were horses ≥5 years of age in a well characterized series of outbreaks.<sup>17</sup> Seronegativity to a H3N8 virus (Saskatoon/90) was associated with a 13–38 fold increase in likelihood of developing influenza, independent of the effect of age.<sup>17</sup> It is probable that outbreaks occur as a result of a natural accumulation of young animals which have not been previously exposed, the co-mingling of these susceptible animals with older infected ones at race and show meetings, and to the significant level of antigenic 'drift'. This capacity of the virus to change slightly and continuously in antigenic composition leads to the frequent appearance of new strains which are likely to breach existing natural and induced immunological barriers.

Outbreaks can occur at any time of year, and their timing probably depends on husbandry and management practices, such as yearling sales, transport of horses for racing and sale, and movement of show and breeding animals. These events often provide the combination of a population of susceptible animals housed in crowded, poorly ventilated barns that facilitate transmission of the virus.<sup>23</sup>

**Immunity** depends on the means of exposure (vaccination or natural infection), the strain of the virus, and the time since exposure. After infection, protective immunity to homologous strains of the virus is present and persists for 1 year, possibly up to 2 years. Field studies of disease outbreaks indicated that the concentration of antibodies in serum that provide some resistance to disease might be less than that suggested from experimental studies.<sup>17</sup> Protective immunity induced by natural infection is characterized by production of IgA in nasal secretions and IgGa and IgGb in serum, whereas administration of an inactivated, alum-adsorbed commercial vaccine induces

only a serum IgG(T) response that is not protective against challenge.<sup>24</sup> Immunity after vaccination lasts for a much shorter period of time, 3–4 months, and is specific for the subtypes, and their strains, of virus included in the vaccine. Immunity following infection or vaccination is less protective against infection by a heterologous strain.<sup>23</sup> Similarly, vaccination exposure to a heterologous virus may induce only a poor anamnestic immune response.<sup>23</sup> These observations are consistent with the concurrent circulation of multiple viral strains influenza virus in horse populations, and the cycling of virus strains causing disease in consecutive years.<sup>5</sup>

#### Management factors

Housing of large numbers of horses in close contact, or in enclosed environments such as large barns or stables, provides optimum conditions for facilitating contact and aerosol spread of the virus. Shed barns, which characteristically have poorer ventilation and greater stocking density than pole barns, are associated with a 4-fold increase in risk of influenza.<sup>17</sup>

Presence of small numbers of horses with access to large numbers of at risk horses might impact the course of an epidemic. Track ponies, which have close contact with large numbers of horses on a daily basis, are important in spread of influenza in racing barns.<sup>17</sup>

#### Economic importance

Influenza causes minimal loss through death of horses, but it causes much inconvenience in racing stables because it occurs in explosive outbreaks and affected horses have to break training. Such outbreaks have the capacity to close down the racing industry in a country for a period of months.<sup>14</sup> An additional cost is incurred because of restrictions on international movement of horses and associated quarantine periods.

#### Zoonotic potential

Equine influenza A viruses can infect humans although such infections are unusual and subclinical.<sup>25</sup>

#### PATHOGENESIS

The disease is principally one of inflammation of the upper respiratory tract, although pulmonary lesions are common in adult horses and the disease can cause severe, fatal pneumonia in foals.<sup>7,26,27</sup> The virus is inhaled, attaches to respiratory epithelial cells with its hemagglutinin spikes, fuses with the cell, and is released into the cytoplasm where it replicates. New virions are released from the cell surface and infect other cells or are expelled into the environment. Initial viral infection and replication occurs mainly

in the nasopharyngeal mucosa, but by 3–7 days after infection, virus can be recovered from cells throughout the respiratory tract. Infection of the respiratory mucosa results in death of epithelial cells, inflammation, edema, and loss of the protective mucociliary clearance. Death of cells is a result of influenza virus-induced apoptosis of respiratory epithelial cells and local and systemic increases in interferon and interleukin-6.<sup>28,29</sup> Proliferation by opportunistic bacteria, commonly *Streptococcus zooepidemicus*, occurs because of the disruption of normal clearance mechanisms, and can exacerbate the inflammation and cause bronchopneumonia. Viremia, if it occurs, is mild and brief, although it may be related to some of the systemic signs of the disease. Some speculate that myocarditis, myositis and encephalitis occur occasionally in response to influenza virus infection, but definitive proof is lacking.<sup>23</sup> Influenza virus has not been isolated from tissues other than those of the respiratory tract.<sup>23</sup> Enteritis was reported in horses in the 1989 Chinese outbreak (Jilin/89), but is not reported for disease associated with conventional virus strains.

#### CLINICAL FINDINGS

**Outbreaks of equine influenza** are characterized by a sudden onset and rapid spread of disease. Typically, in a large group of susceptible horses the incidence of the disease peaks about 1 week after the first case is noticed and new cases do not develop after 21–28 days.<sup>14,17,30</sup> The disease may have an attenuated clinical course in a population of vaccinated or previously exposed horses. The milder disease in immune animals may be clinically indistinguishable from upper respiratory diseases associated with other common agents such as EHV-4, equine rhinitis virus and arteritis virus.

Clinically, the disease starts with a fever (38.5–41°C, 101–106°F) after an incubation period of 24–72 hours. Horses may be depressed, refuse feed, and reluctant to move. The dominant sign is cough, which is dry and hacking in the beginning and moist later, and which commences soon after the temperature rise and lasts for 1–3 weeks. It is easily stimulated by manual compression of the upper trachea. During the early stages of the disease, nasal discharge is not a prominent sign and, if it occurs, is watery. There is no marked swelling of the submaxillary lymph nodes but they may be painful on palpation in the early stages of the disease, especially in younger horses. Limb edema or swelling is unusual in horses with influenza. Abnormal lung sounds, characterized by crackles, wheezes, and increased intensity of normal breath

sounds may be apparent in both uncomplicated disease and in horses with secondary bacterial pneumonia. Ultrasonographic examination of lungs of horses with influenza, even clinically mild disease, reveals pulmonary consolidation, fluid bronchograms, and peripheral irregularities.<sup>27,31</sup> Tracheal aspirates are neutrophilic, yield heavy growth of *S. zooepidemicus*, and are consistent with bronchitis and pneumonia.<sup>31</sup> Horses, unwisely, forced to exercise have reduced endurance. Horses that are protected against environmental stress pursue an uncomplicated course with most horses have complete recovery in 7–14 days, although a mild cough can persist for weeks.

The above is a description of the classical disease. However, in outbreaks there is a range of disease severity.<sup>17</sup> Mucopurulent nasal discharge is observed in 75–90% of horses, cough in approximately 60%, fever in 20–50%, inappetence in 20–30%, and signs of depression in 20–40%.<sup>17</sup> Undoubtedly, the proportion of horses showing each of these signs will vary from outbreak to outbreak depending on the age and susceptibility of horses in the population, among other factors.

**Complications** and a more severe disease occurs in a small number of horses. Horses that are worked, transported, or exposed to adverse climatic conditions can experience a worsening of the cough, and severe bronchitis, pneumonia and edema of the legs may develop. Complications are usually associated with secondary bacterial infection, usually *Strep. zooepidemicus*, that results in a mucopurulent nasal discharge, persistent fever, and markedly abnormal lung sounds. Icterus, encephalitic signs, incoordination and myoglobinuria are reported as rare complications.<sup>23</sup> Electrocardiographic abnormalities have been reported in horses with influenza, and were attributed to myocarditis. However, there is no objective evidence of myocarditis secondary to influenza infection of horses nor is there a clear association between influenza infection and electrocardiographic abnormalities.

A more severe form of the disease, associated with an antigenically distinct strain of equine influenza 2, is reported from China. The mortality rate is 35%, and death is due to pneumonia and enteritis.<sup>2</sup>

A severe form of the disease is also reported in young foals. Foals develop fever, severe respiratory distress and acute interstitial pneumonia that is commonly fatal.<sup>10,26,32</sup> The disease is not invariably associated with failure of transfer of passive immunity.

## CLINICAL PATHOLOGY

There are no characteristic changes on hematologic or serum biochemical examination of horses clinically affected by equine influenza virus infection.

**Confirmation of the diagnosis** of infection by equine influenza virus is achieved through virus isolation, indirect demonstration of virus in nasopharyngeal swabs, and/or serology.<sup>33</sup>

Measurement of antibody concentrations against the viral hemagglutinin antigen is important in determining susceptibility to infection, vaccine efficacy, and exposure – factors important in implementing control measures (see below). Documentation of seroconversion, a three- to four-fold increase in **hemagglutination inhibition (HI)** antibody titer, or a doubling in antibody titer measured by the **single radial hemolysis test**, in paired sera collection 14–21 days apart provides retrospective confirmation of the diagnosis. The single radial hemolysis test is more reproducible than the hemagglutination inhibition test and is the preferred test for determining concentrations of antibody against the hemagglutinin antigen.<sup>34</sup> For the single radial hemolysis test virus is coupled to red blood cells that are then included in agarose. Wells are punched in the agar plate filled with test sera. Influenza antibodies then cause lysis of red cells, with the diameter of the zone of hemolysis proportional to the concentration of the strain specific antibody in the serum.<sup>25</sup> Antibodies against the non-structural protein (NS1) are detectable in horses after natural infection, but not after vaccination with an inactivated virus thereby permitting differentiation of immunologic responses to vaccination and infection.<sup>35</sup>

However, because **rapid identification** of the cause of the outbreak is important when instituting control measures, timely demonstration of virus in nasopharyngeal swabs is desirable. Rapid demonstration of viral shedding can be accomplished by use of tests for rapid diagnosis.

**Directigen Flu A** test (Becton Dickinson) is a rapid test designed for use with humans, that identifies influenza viral nucleoprotein by a membrane-bound enzyme immunoassay. It has been validated for use in horses and is effective because of the conserved nature of the target antigen across influenza A strains.<sup>36</sup> Results are available in as little as 15 minutes. The test had sensitivity of 83%, specificity of 78%, positive predictive value of 70%, and negative predictive value of 88% compared to virus culture. Sensitivity was 54%, but specificity and positive predictive value were 100% when compared with serological diagnosis. The

low sensitivity compared to serology was ascribed to inadequate collection of nasopharyngeal swabs, or collection of samples when horses were not excreting virus.<sup>36</sup> The high specificity and positive predictive value of the test mean that a positive result confirms the diagnosis of influenza infection. The relatively low specificity means that samples should be collected from a number of horses in various stages of the disease. Nasopharyngeal swabs should be collected by inserting a cotton gauze swab approximately 30 cm (12 inches) into the nostril or, preferably, nasopharynx of an adult horse and leaving it in place for 60 seconds.<sup>25</sup> The swab should then be transferred to specialized transport media and shipped to the laboratory.<sup>33</sup>

Other rapid diagnostic tests include the **Flu OIA (Biostar)** assay for influenza A and B viral antigen. The test cross reacts with equine herpesvirus 2 and is therefore not useful for diagnosis of upper respiratory disease of horses.<sup>6</sup> The test is more sensitive than the Directigen test, possibly because it detects nonviable viral material present in exfoliated epithelial cells.<sup>37</sup> Other tests include the **ZstatFlu** (ZymeTx), **QuickVue Influenza** (Quidel) and **NOW Flu** (Binax) assays, none of which have been validated for use in horses at the time of writing.<sup>6</sup>

Use of rapid tests is not a substitute for viral isolation, which is important for typing of the isolate and subsequent epidemiological studies and vaccinal applications. Isolation of the virus provides a definitive diagnosis.

Material for viral culture should be collected as early as possible during the illness and inoculated into the transport medium quickly. The transport medium should contain phosphate buffered saline, glycerol, and antibiotics, among other constituents.<sup>25</sup>

Virus can be detected rapidly in clinical specimens by a reverse transcription PCR (RT-PCR) test for nucleoprotein gene, hemagglutinin gene of H3N8 viruses and hemagglutinin gene of H7N7 virus.<sup>33</sup> RT-PCR and viral isolation are more sensitive than use of Directigen assay in detection of virus.<sup>38</sup>

## NECROPSY FINDINGS

Necropsy material is rarely available and the lesions in these fatalities are usually complicated by other pathogens. Histologically, a necrotizing bronchiolitis accompanies widespread pulmonary edema. Foals dying of acute respiratory distress associated with influenza infection have severe diffuse interstitial pneumonia which is characterized histologically by necrotizing bronchitis and bronchiolitis and multifocal interstitial pneumonia.<sup>10</sup>

### Samples for postmortem confirmation of diagnosis

- **Nasal swabs** in viral transport media, and sections of lung and trachea should be submitted for virus isolation or demonstration by fluorescent antibody or PCR testing
- **Formalin-fixed nasopharynx, trachea, and lung** should be submitted for light microscopic examination.

### DIFFERENTIAL DIAGNOSIS

See Table 16.4.

### TREATMENT

Currently, there is no specific treatment of influenza virus infection of horses.

**Amantadine** is used in humans for prophylaxis and treatment of influenza infection in high-risk populations, and it has been investigated for use in horses.<sup>39</sup> Amantadine administered intravenously caused transient neurologic abnormalities in experimental horses.<sup>39</sup> Rimantidine (30 mg/kg PO q 12 hour) administered 12 hours before experimental inoculation of horses with equine influenza KY/91 mitigated signs of disease but did not eliminate viral shedding.<sup>40</sup> However, the safety and efficacy of amantadine and rimantidine in horses with naturally occurring disease have not been demonstrated at this time. Until these issues are resolved, and because the infection has such a low case fatality rate, the use of these drugs in horses cannot be recommended.

**Antibiotic treatment** of uncomplicated cases is probably not warranted but horses that develop prolonged fever (greater than 5 days), signs of pneumonia, or a profuse mucopurulent nasal discharge should be treated with broad-spectrum antibiotics, such as potentiated sulfonamides (15–30 mg/kg, PO, IM, or IV, every 12 h), ceftiofur (2.2 mg/kg, IM, every 12 h), or procaine penicillin (20 000 IU per kg, IM, every 12 h) with or without gentamicin (6.6 mg/kg, IM, every 24 h). The usual cause of secondary bacterial infection is *S. zooepidemicus*, which is susceptible to penicillin.

**Supportive treatment** includes rest, provision of a dust-free environment and, on occasion, administration of non-steroidal anti-inflammatory drugs (NSAIDs). However, NSAIDs should be used judiciously, as their analgesic properties may mask signs of complications, such as pleuritis. Corticosteroids are contraindicated in the treatment of this disease. Cough suppressants are also contraindicated, as coughing is a normal protective mechanism that aids in the

clearance of material from the airway. Mucolytics can be administered but their efficacy is unknown. Clenbuterol administration does not alter the course of the disease and is not recommended.<sup>41</sup>

### CONTROL

The fundamental aims of a control program are to:

- Increase the immunity of both individual animals and the population to infection
- Reduce the opportunities for spread of infection between horses
- Prevent the introduction of novel strains of the virus into a population.

These aims are achieved by vaccination, hygiene and quarantine.

### Immunity and vaccination

Immunity to influenza through administration of inactivated vaccines can be assessed by measurement of serum antibody concentrations against hemagglutinin, using the single radial hemolysis test, whereas immunity gained through natural infection is independent of serum antibody concentration.<sup>34</sup> However, serum antibody concentration is currently used as an indicator of susceptibility of individual horses to infection, and as a guide in the development and application of vaccination protocols, including monitoring of need for vaccination in individual horses. Serum antibody concentrations to hemagglutinin measured by single radial hemolysis are specific for the strain of virus and are strongly predictive for resistance to disease associated with that virus in both experimental and field challenge.<sup>34,42,43</sup> Failure of a commercial inactivated virus multivalent vaccine to induce detectable increases in antibody concentration in Thoroughbred race horses was associated with lack of protection against natural infection by a heterologous influenza virus.<sup>44</sup> It is important to reiterate that resistance to disease after vaccination or natural infection is greatest for homologous virus and minimal for challenge by heterologous virus.<sup>45</sup> Thus, horses with antibody concentrations protective to disease associated with homologous virus are susceptible to disease associated with heterologous virus.<sup>34,42,43</sup>

**Vaccination** against equine influenza is now in general use in countries where the disease occurs, and use of efficacious vaccines is effective in limiting the severity of clinical illness and morbidity during an outbreak.<sup>14,46</sup> Vaccine efficacy is limited by the short duration of immunity induced by vaccination, the presence in horse populations of multiple viral strains and of antigenic drift in these strains, and the poor immunity induced

by vaccines (and natural infection) to challenge by heterologous virus.<sup>34,46</sup> Furthermore, the immune responses induced by administration of inactivated virus or subunit vaccines, which are primarily an increase in serum IgG(T) antibody titer, differ markedly from the immune responses to natural infection, which are production of IgA in nasal secretions and IgG<sub>a</sub> and IgG<sub>b</sub> in serum.<sup>24</sup>

Multiple factors are important in determining the efficacy of a vaccine in protecting against disease. Factors include efficacy of the vaccine in stimulating an immune response, viral strains included in the vaccine amount of antigen in a dose of vaccine adjuvant, and timing and frequency of administration of the vaccine.

### Vaccines

A complete listing of current commercially available vaccines, the viral strains or antigens included, and the adjuvant used is available at the equiflunet website.<sup>47</sup> This site should be consulted for up to date information on equine influenza vaccines as this is a rapidly developing field. For instance, during the period January 2003 to April 2004, H3N8 viruses of the American lineage caused widespread outbreaks in Europe, with well-vaccinated horses frequently affected. Furthermore, viruses responsible for recent outbreaks in South Africa (2003) and circulating in North America were antigenically distinguishable from the currently recommended vaccine strains. On the other hand, viruses of the European lineage were associated with limited, more localized, outbreaks in Europe and were antigenically and genetically similar to some viruses circulating during 2002. Based on these observations, it is recommended that vaccines are updated to contain an A/equine/South Africa/4/03 (H3N8)-like virus (American lineage) and an A/equine/Newmarket/2/93 (H3N8)-like virus (European lineage). A/eq/Suffolk/89 and A/eq/Borlänge/91, currently used vaccine strains, continue to be acceptable.

There are several forms of vaccine available including those that contain one of inactivated virus, modified live virus, hemagglutinin and neuraminidase subunits, or hemagglutinin proteins.<sup>47</sup> Furthermore, the type of adjuvant varies among vaccines with carbomer, aluminum hydroxide, carboxyl, saponin, immune-stimulating complex (ISCOM), and various proprietary products (Meta-stim, PureVax) being used.<sup>47</sup> A comparison of each vaccine is beyond the scope of this text, but several principles should be considered when selecting a vaccine: the vaccine should induce a measurable immune response and demonstrable

protection against disease (natural or experimental), it should contain pertinent viral strains, it should be safe, and it should be practical (i.e. readily administered).

Most vaccines are comprised of inactivated or subunits of virus combined with an adjuvant. Inclusion of an adjuvant is important in maximizing the immune response to vaccination. The important factor in vaccine composition is the inclusion of adequate amounts of antigen of pertinent strains of virus. H7N7 virus is no longer a cause of clinical disease and it should not be included in contemporary vaccines.<sup>34</sup> Inclusion of antigen from both American and Eurasian lineages of H3N8 virus is essential, and vaccine composition should be regularly updated to reflect those viruses currently circulating in the horse population.<sup>34,46,47</sup> The vaccine must include an adequate amount of antigen, measured by the single radial diffusion assay, preferably, the single radial hemolysis assay, as there is a clear relationship between dose of antigen and magnitude and duration of antibody response.<sup>46</sup> There is increasing concern, and some evidence,<sup>45</sup> that inclusion of multiple antigens in vaccines (for example, tetanus toxoid, equine herpesvirus, encephalomyelitis virus) reduces the efficacy of influenza vaccines. While this concern has yet to be proved conclusively, it should be borne in mind when formulating vaccine programs for horses at high risk of influenza.

A modified live virus vaccine is available in North America and has proven to be effective in experimental studies in preventing disease against heterologous virus challenge (both American and Eurasian lineages).<sup>48</sup> Furthermore, the duration of protection is at least 6 months after completion of a course of vaccination. Vaccinated ponies had had significantly lower clinical scores, smaller increases in rectal temperature, and shed less virus over fewer days than did the unvaccinated controls in response to challenge 6 months after vaccination.<sup>49</sup> After challenge at 12 months, vaccinates had rectal temperatures, duration and concentration of virus shed significantly reduced to that in unvaccinated animals. The results of this study showed that 6 months after a single dose of vaccine the duration and severity of clinical signs were markedly reduced amongst vaccinated animals exposed to a severe live-virus challenge. Appropriate use of this vaccine should lead to a marked reduction in the frequency, severity and duration of outbreaks of equine influenza in North America.<sup>49</sup>

A live recombinant canary pox vector vaccine has been introduced in Europe.<sup>46</sup>

The vaccine uses the viral vector to introduce influenza hemagglutinin genes into host cells. The recombinant virus expresses the hemagglutinin gene of both A/eq/Newmarket/2/93 (European lineage) and A/eq/Kentucky/94 (American lineage).<sup>50</sup> The canary pox infection of the host cell is abortive, with no virus produced, but influenza viral gene is expressed and presented through MHC class 1 by the host cell, with subsequent induction of an immune response.<sup>34</sup> In preliminary reports it provides protection against infection by homologous virus, or by A/eq/Newmarket/05/03, the cause of the 2003 outbreak of influenza in Britain, 2 weeks after vaccination.<sup>50</sup> The vaccine was used to aid in the control of the 2003 influenza outbreak in South Africa.

Other novel vaccine strategies include use of DNA or vector vaccines. Although effective in inducing a protective response, technological issues currently limit the widespread use of DNA vaccines.<sup>51,52</sup>

#### Objective

The objective of a vaccination program is to insure that horses have maximal immunity at the times of greatest risk of exposure to influenza virus. Therefore, young horses should be adequately vaccinated before being introduced into larger populations of horses. Older horses should receive frequent booster vaccinations before, and during, the racing or show season. Mares should be revaccinated before being shipped to breeding farms. It is important in any control program that all horses in a herd be vaccinated so that the population immunity to infection is maximal.

#### Timing

##### *Foals*

Timing of vaccination of foals depends on the immune status of the mare, and consequent acquisition of passive immunity by the foal. The presence of even small amounts of maternally derived antibody interferes with the immune response of foals to vaccination.<sup>53,54</sup> Furthermore, vaccination of foals while they continue to have passive immunity can result in impaired responses to subsequent vaccinations.<sup>53,54</sup> The practical significance of this latter observation is unknown but because of its potential importance should be considered when developing vaccination protocols for foals. Therefore, vaccination of foals born to mares vaccinated more than once yearly should be delayed until the foals are at least 24 weeks of age when the immunity resulting from the vaccination is much better; this might leave some foals unprotected because passively acquired immunity is shortlived and some foals of recently vaccinated dams are seronegative by

4 weeks of age.<sup>21</sup> Foals of unvaccinated mares can be vaccinated at less than 1 month of age. Vaccinations are carried out at 6 to 12-week intervals for at least two injections. Subsequently, booster injections are given at least once a year, although more frequent vaccination confers a greater immunity.

#### *Race and show horses*

Yearlings and young horses are at increased risk of disease, and careful attention to their vaccination status is important in reducing the incidence of disease in this group. Yearlings and 2 year olds in racing stables in Great Britain typically have antibody concentrations against influenza prior to vaccination on arrival at the stable that are not protective.<sup>55</sup> Vaccination increases antibody titer such that approximately three quarters of yearlings and 2 year olds have protective titers.<sup>55</sup> For yearlings entering training the important predictors of antibody titer prior to vaccination on arrival at the stable were the time since a previous vaccination, total number of previous vaccinations, and the age at first vaccination.<sup>55</sup> This study demonstrates the need for appropriate vaccination of young horses before they enter larger populations of horses, both to protect the young horse from disease and also to confer herd immunity on the population that they are entering.

Vaccination of race and show horses and other horses at increased risk of exposure should be frequent. Booster vaccines should be timed to maximize immunity at the time of greatest exposure, such as introduction to a new stable or at the beginning of the show season. For maximal protection subsequent booster injections should be administered at intervals of 6, or even 4, months. Measurement of antibody concentrations by single radial hemolysis can be useful in determining the need for booster vaccination. Previously, vaccination during the racing season was disliked by trainers because of transitory swellings at injection sites and an infrequent mild systemic reaction, however administration of contemporary vaccines is rarely associated with these adverse effects. In general, vaccination appears to have no adverse effect on performance.

#### *Schedule*

Various schedules have been proposed for influenza vaccinations of horses, with different regulatory bodies having specific recommendations.<sup>6</sup> The FEI requires all horses competing in FEI competition to provide evidence of sufficient vaccination against equine influenza. This involves regular six monthly booster vaccinations following a primary vaccination course. All horses and ponies for which an FEI

Passport or a National Passport approved by the FEI has been issued must have the vaccination section completed and endorsed by a veterinarian, stating that it has received two injections for primary vaccination against equine influenza, given between 1 and 3 months apart. In addition, a booster vaccination must be administered within each succeeding 6 months ( $\pm$  21 days) following the second vaccination of the primary course. None of these injections must have been given within the preceding 7 days including the day of the competition or of entry into the competition stables.

The UK Jockey Club has strict vaccination requirements which must be complied with to enter horses in their competitions or onto their premises. The program includes a 1st equine influenza vaccination to be followed by a 2nd vaccination 21 to 92 days later, with a 3rd vaccination 150 to 215 days from the 2nd vaccination.<sup>6</sup> Thereafter vaccinations should be annually, with the last permissible day being the same date as the previous year's vaccination. Horses may not race until the 8th day after the day of vaccination.

A schedule proposed for control of influenza in a large area includes the following rules:

- Mandatory vaccination for all horses entering racing premises
- Horses not to race in the 10-day period following vaccination
- Horses coming from international locations must be vaccinated before departure
- All horse events, including shows, sales and gymkhanas, should apply the same restrictions.

The recommended vaccination program using inactivated or subunit vaccine is:

- Mares should be vaccinated during the final 4–6 weeks of gestation to ensure adequate passage of passive immunity to the foal
- Vaccination of foals at 6 months of age
- Two vaccinations initially at 21 days, and not more than 92 days apart
- A booster vaccination 5–7 months later
- Annual boosters or, in the face of increased infection pressure or when the risk of infection is high, boosters should be at 6-month or even 4-month intervals
- When vaccination schedules break down and a horse goes longer than 12 months without a booster, recommence with a two-vaccination schedule
- Yearlings and 2-year-olds may require an additional vaccination between the

second vaccination of the primary series and the booster at 6 months.<sup>53</sup>

### Control measures

**Hygienic precautions** can be of value in limiting the spread of the disease. Vehicles used for the transport of horses are thought to play a large part in transmission and should be thoroughly disinfected between shipments.<sup>19</sup>

**Quarantine** is imperative to prevent introduction of virus by animals in the incubation period of the disease or subclinically infected horses. The most common introduction of infection, especially internationally, is through importation of subclinically infected horses.<sup>23</sup> Also, because vaccinated animals can be infected and be shedding virus but not have signs of infection, isolation of introduced animals is an essential precaution, especially when an outbreak is in progress. The period of isolation should be at least 21 days. The degree of isolation required cannot be specified because of lack of basic information, but it is suggested that droplet infection can occur over a distance of 32 m and that maximum security with regard to clothing, utensils and personnel must be practised. Additional measures are a requirement for recent (4–8 weeks) vaccination, measurement of antibody concentrations in imported horses to ensure that they have protective immunity, and testing of imported horses on arrival for viral shedding.<sup>34</sup> The later can be accomplished through use of rapid diagnostic tests (see above).

**Control measures during an outbreak** are intended to eliminate sources of infection, reduce transmission of virus, enhance the resistance of at-risk horses, and decrease the number of horses at risk.<sup>23</sup> Infected horses (identified by stall-side or rapid laboratory tests) and clinically affected horses should be removed from the group and isolated for 3–4 weeks. Ventilation of shed rows and barns should be optimal to minimize aerosol spread of the virus. No horses should be introduced or allowed to leave until the outbreak is over, probably about 4 weeks after the first case is identified. Movement of horses between barns or paddocks should be avoided. Training and racing should be suspended. The opportunity for fomite transfer on clothing, tack, feed utensils or vehicles should be minimized by strict hygiene. Vaccination of clinically normal horses in the face of an outbreak can enhance the immunity of at-risk horses, and is probably safe.

### REVIEW LITERATURE

Hannat D, Mumford JA. Equine influenza. In: Studdert MJ (ed) *Virus infections of vertebrates: virus infections of equines* 6. Amsterdam: Elsevier, 1996; pp. 285–293.

Van Maanen C, Cullinane A. Equine influenza virus infections: an update. *Vet Quart* 2002; 24:79.

Daly JM et al. Current perspectives on control of equine influenza. *Vet Res* 2004; 35:411.

### REFERENCES

1. Mumford EL et al. *J Am Vet Med Assoc* 1999; 213:385.
2. Webster RG, Yuanji G. *Nature* 1991; 351:527.
3. Crawford PC et al. *Science* 2005; 310:2147.
4. Lai ACK et al. *Arch Virol* 2001; 146:1063.
5. Lai ACK et al. *Virus Res* 2004; 100:159.
6. <http://195.224.162.216/equiflunet> accessed February 10 2005.
7. Peek SF et al. *J Vet Int Med* 2004; 18:132.
8. King EL, MacDonald D. *Aust Equine Vet* 2004; 23:139.
9. Newton JR et al. *Vet Rec* 1999; 145:647.
10. Oxburgh L, Klingeborn B. *J Clin Micro* 1999; 37:3005.
11. Manuquera JC et al. *Vet Micro* 2000; 74:59.
12. Lindstrom S et al. *Arch Virol* 1998; 143:1585.
13. Kawaoka Y, Webster RG. *Arch Virol* 1989; 106:159.
14. Powell DG et al. *Vet Rec* 1995; 136:531.
15. Mumford J et al. *Vet Rec* 2003; 152:405.
16. van Maanen C, Cullinane A. *Vet Quart* 2002; 24:79.
17. Morley PS et al. *J Am Vet Med Assoc* 2000; 216:545.
18. Morley PS et al. *J Am Vet Med Assoc* 2000; 216:345.
19. Guthrie AJ et al. *Rev Sci Tech OIE* 1999; 18:179.
20. Nyaga PN et al. *Comp Immunol Microbiol Infect Dis* 1980; 3:67.
21. Liu IKM et al. *Am J Vet Res* 1985; 6:2078.
22. <http://www.aphis.usda.gov/vs/ceah/ncahs/nahms/equine/Equine98/eq98iurd1.pdf> accessed February 21 2005.
23. Wilson WD. *Vet Clin North Am Equine Pract* 1993; 9:257.
24. Nelson KM et al. *Vaccine* 1998; 16:1306.
25. [www.oie.int/eng/normes/mmanual/A.00083.htm](http://www.oie.int/eng/normes/mmanual/A.00083.htm) accessed February 10 2005.
26. Britton AP, Robinson JH. *Can Vet J* 2002; 43:55.
27. Gross DK et al. *J Vet Int Med* 2004; 18:718.
28. Lin C et al. *Vet Micro* 2002; 84:357.
29. Watrang E et al. *Viral Immunol* 2003; 16:57.
30. Mumford JA. *Proc Am Assoc Equine Pract* 1990; 36:377.
31. Gross DK et al. *Equine Vet J* 1998; 30:489.
32. Gerber H. *Equine Infect Dis* 1969; 2:63.
33. Oxburgh L, Hagstrom A. *Vet Micro* 1999; 67:161.
34. Daly JM et al. *Vet Res* 2004; 35:411.
35. Ozaki H et al. *Vet Micro* 2001; 82:111.
36. Chambers TM et al. *Vet Rec* 1994; 135:275.
37. Adam EN et al. *Equine Vet J* 2002; 34:400.
38. Quinlivan M et al. *J Clin Micro* 2004; 42:759.
39. Rees WA et al. *Equine Vet J* 1997; 29:104.
40. Rees WA et al. *Am J Vet Res* 1999; 60:888.
41. Kastner SB et al. *Equine Vet J* 1999; 31:160.
42. van Maanen C et al. *Vet Micro* 2003; 93:291.
43. Newton JR et al. *Equine Vet J* 2000; 32:65.
44. Morley PS et al. *J Am Vet Med Assoc* 1999; 215:61.
45. Yates P, Mumford JA. *Vet Micro* 2000; 74:173.
46. Minke JM et al. *Vet Res* 2004; 35:425.
47. [www.195.224.162.216/equiflunet/equiflunet\\_vaccines\\_accessed\\_February\\_11\\_2005](http://www.195.224.162.216/equiflunet/equiflunet_vaccines_accessed_February_11_2005)
48. Townsend HG et al. *Equine Vet J* 2001; 33:637.
49. Chambers TM et al. *Equine Vet J* 2001; 33:630.
50. Toulemonde CE et al. *Vet Rec* 2005; 156:367.
51. Soboll G et al. *Vet Immunol Immunopathol* 2003; 94:47.
52. Breathnach CC et al. *Vet Immunol Immunopathol* 2004; 98:127.
53. Cullinane A et al. *Vet J* 2001; 161:174.
54. van Maanen C et al. *Vet Quart* 1992; 14:13.
55. Newton JR et al. *Prev Vet Med* 2000; 46:129.



## EQUINE HENDRA VIRUS INFECTION (FORMERLY EQUINE MORBILLIVIRUS)

### ETIOLOGY

An acute disease of horses transmissible to humans and characterized in horses by fever and respiratory distress occurs uncommonly in northeastern Australia.<sup>1</sup> The disease is associated with the recently recognized equine Hendra virus (Henipavirus in the family Paramyxoviridae, formerly equine morbillivirus) which is closely related to Nipah virus and more distantly related to Menangle virus, both of which cause disease in pigs and humans.<sup>2,3</sup>

### EPIDEMIOLOGY

The disease in horses is uncommon, with four known occurrences between 1994 and 2004 affecting 23 horses with death of 17 horses and 2 humans.<sup>4,5</sup> Serologic evidence of infection in horses is similarly rare – no seropositive horses were detected among 2000 horses examined on 166 properties.<sup>6</sup> Similarly, no serologic evidence of infection was detected in samples from 500 pigs at 100 piggeries.<sup>7</sup>

### Transmission

The source of the virus is a wildlife host, the frugivorous pteropoid bats (fruitbats and flying foxes, *Pteropus* spp.).<sup>3,8</sup> Bats are seropositive for antibodies to the virus, the only seropositive mammals of 34 wildlife species sampled, and the virus can be isolated from pteropoid postpartum uterine fluid and fetal tissue.<sup>3</sup> The mechanism of spread from bats to horses is uncertain, but it is speculated that ingestion by horses of infected bat fetal fluids and tissues might transfer infection from bats to horses. Fruit bats were consistently present in all four occurrences of the disease which occurred during the fruit bat birthing season.<sup>4</sup>

Dissemination of infection between horses by mechanical spread of infected nasal discharge likely occurred in the largest outbreak, and may have been the route of infection of the human fatality.<sup>5</sup> The virus is present in nasal discharges and urine of infected horses and spread from horse to horse might also occur through inhalation of infected urine.<sup>9</sup> Mosquitoes do not appear to be important in the spread of infection.<sup>4</sup> Human to human transmission of infection has not been reported.

Disease occurs in horses, humans, cats, and guinea pigs, though in the latter two species the disease was a result of experimental infection.<sup>10,11</sup> Fruit bats do not develop clinical disease when experimentally infected.<sup>11</sup>

### Zoonotic potential

The disease has important zoonotic implications as two human deaths, one of

encephalitis and the other of pneumonitis and respiratory failure, occurred in people who had close contact with clinically ill or dead horses.<sup>12,13</sup> However, the virus does not appear to be easily transmitted to humans as most people in contact with clinically affected horses did not develop antibodies to the virus.

### CLINICAL SIGNS

The incubation period of the spontaneous disease is 8–11 d, but is much shorter in experimentally-induced disease.<sup>1,12</sup> Clinical signs of the disease in horses include depression, loss of appetite, fever, ataxia, tachycardia, tachypnea and copious frothy nasal discharge.<sup>12</sup> Horses may show aimless pacing, hemorrhagic nasal discharge and swelling of the head.<sup>14</sup> Death in acutely affected horses is associated with severe respiratory distress. Two of the four horses that survived the initial disease displayed localized myoclonic twitches involving the upper forelimb and the lower lip, face and upper hindlimb muscles.<sup>14</sup> Clinically inapparent infections of horses occur.

### CLINICAL PATHOLOGY

Characteristic changes in the hemogram or serum biochemical profile are not reported. If infected animals survive more than a few days after the onset of clinical signs they develop serum neutralizing antibodies. Antibodies are detectable by immunofluorescence<sup>1,12</sup> or a rapid immune plaque assay.<sup>15</sup> Viral genome can be detected by RT-PCR that is highly specific.<sup>16</sup> Viral isolation in Vero cells or imaging using electron microscopy demonstrate presence of the virus. Details of diagnostic tests are available from the OIE.<sup>17</sup>

### NECROPSY

Necropsy examination reveals pulmonary edema with hemorrhage and froth in the airways.<sup>1</sup> Histologic examination reveals an interstitial pneumonia characterized by extensive vascular damage as well as necrosis of alveolar macrophages. Pulmonary vascular changes include edema and hemorrhage within alveoli, plus necrosis and thrombosis of alveolar capillaries and small arterioles. The distinctive histologic feature is the presence of syncytial giant cells within blood vessels of the lungs and other organs.<sup>1</sup> Although only a small number of cases have been examined, it appears unlike most other morbillivirus infections, intracytoplasmic or intranuclear inclusion bodies are not visible using conventional light microscopy.<sup>18</sup> Retrospective diagnosis of the disease can be documented using an immunohistochemical technique or demonstration of viral nucleic acid in tissue by a test based on the PCR.<sup>19</sup>

### TREATMENT AND CONTROL

There is **no specific treatment** for this disease. The **control measures** in the described outbreaks included slaughter of all infected horses, extensive serological testing and control of movement of horses within a defined disease control zone. The disease in index cases is likely attributable to contact of susceptible horses with infected fluids of pteropoid bats and interventions that prevent or reduce the frequency of this occurrence are sensible, although the efficacy of this control technique has not been determined. A vaccine is not available.

### FURTHER READING

Barclay AJ, Paton DJ. Hendra (equine morbillivirus). *Vet J* 2001; 160:169.

### REFERENCES

- Murray K et al. *Science* 1995; 268:94.
- Mackenzie JS, Field HE. *Arch Virol* 2004; 18S:97.
- Halpin K et al. *J Gen Virol* 2000; 81:1927.
- Field HE et al. *Aust Vet J* 2000; 78:279.
- Thornley M. *Aust Vet J* 2005; 83:2.
- Ward MP et al. *Aust Vet J* 1996; 74:241.
- Black PF et al. *Aust Vet J* 2001; 79:424.
- Young PL et al. *Emerg Infect Dis* 1996; 2:239.
- Field H et al. *Microbes Infect* 2001; 3:307.
- Barclay AJ, Paton DJ. *Vet J* 2000; 160:169.
- Williamson MM et al. 1998; 76:813.
- Selvey LA et al. *Med J Aust* 1995; 162:642.
- O'Sullivan JD et al. *Lancet* 1997; 349:93.
- Rogers RJ et al. *Aust Vet J* 1996; 74:243.
- Cramer G et al. *J Virol Methods* 2002; 99:41.
- Smith IL et al. *J Virol Methods* 2001; 98:33.
- Anon. Manual of diagnostic tests and vaccines for terrestrial animals. Available at [http://www.oie.int/eng/normes/mmanual/A\\_00136.htm](http://www.oie.int/eng/normes/mmanual/A_00136.htm) Accessed February 26 2005.
- Hooper PT et al. *Vet Pathol* 1997; 34:312.
- Daniels P et al. *Microbes Infect* 2001; 2:289.

### CAPRINE HERPESVIRUS-1 INFECTION

#### Synopsis

**Etiology** Caprine herpesvirus-1

**Epidemiology** Most infections subclinical. High seroprevalence in Mediterranean countries. Latent infection common and outbreaks of abortion and neonatal mortality with no known precipitating cause

**Clinical findings** Abortion, neonatal disease, vulvovaginitis, balanoposthitis

**Clinical pathology** Leukopenia in systemic disease in kids

**Lesions** Ulceration and necrosis. Multifocal necrosis in intestine and organs. Aborted fetus and young kids

**Diagnostic confirmation** Virus isolation, PCR

**Treatment and control** No effective treatment. Herd biosecurity. Experimental vaccine shows protection

### ETIOLOGY

Caprine herpesvirus-1 (CpHV-1), an alphaherpesvirus within the family Herpesviridae. Restriction endonuclease

analysis indicates that there are different strains but these are not geographically clustered.<sup>1</sup>

## EPIDEMIOLOGY

### Occurrence

The disease is recorded in the United States, Canada, Australia, New Zealand, and some countries in Europe and probably has worldwide distribution. Within the countries where it occurs there is serological evidence that the **infection is widespread**. Seroprevalence is particularly high in Mediterranean countries with high goat populations.<sup>1-3</sup>

In adults, the systemic disease is clinically inapparent, but a genital form of the disease can be transmitted sexually. The virus mostly causes latent or sub-clinical infections, such as vulvovaginitis and balanoposthitis, which may sometimes present as very serious forms. It is also associated with occasional but severe outbreaks of **abortion** where the abortion rate may approach 50%.<sup>4,5</sup> CpHV-1 is also associated with severe systemic disease in 1- to 2-week-old kids.<sup>6,7</sup> This may occur in herds where does are also aborting or occasionally in herds without accompanying abortion.

### Transmission and experimental reproduction

Transmission is thought to be by inhalation and ingestion because of the presence of the virus in nasal, pharyngeal and vaginal discharges and in the feces. The virus is excreted for 7 days after infection. The transmission rate is high, especially in the genital form. Only goats are affected, lambs and calves not succumbing after intranasal instillation although lambs may be infected by IV injection. After primary infection CpHV-1 establishes latent infection. Sites of latent infection sites have been identified as the third and fourth sacral ganglia but it is difficult to reactivate these infections either by experimental or natural means.<sup>8,9</sup> Reactivation has been observed at the time of estrus<sup>10</sup> and outbreaks of vulvovaginitis occur in the post mating period.<sup>2</sup>

However, the factors that precipitate the occasional outbreaks of abortion and disease in young kids are not known.

Abortion has been reproduced by experimental challenge occurring 1-7 weeks after challenge. Challenge of females in early pregnancy is followed by fetal stunting and death but with challenge in mid pregnancy there is no fetal growth impairment and the fetus carried to term but born dead.<sup>11</sup>

### Economic importance

Causes of loss include deaths of young goats, in which the morbidity and case

fatality rates are high, and abortion and stillbirths in ewes. Although the disease is not common abortion rates are high in herds that experience disease.

## PATHOGENESIS

In 1- to 2-week-old unweaned kids a septicemia occurs, with infection developing in various organs, especially the alimentary and respiratory tract. With fetal infection the virus crosses the placenta and infects it, causing placentitis and invading the fetus.

## CLINICAL SIGNS

### Adults

In both the experimentally produced and the natural disease there is no prodromal clinical disease preceding abortion and aborted kids appear full term. Where there are twins one may be born dead and the other alive.<sup>5</sup> In cases of genital disease there is vulvar erythema and edema, and shallow erosions and ulcers on the vulvar and vaginal mucosae. The vaginal discharge is clear to mucopurulent. The lesions heal in approximately a week's time. Outbreaks occur in the post-mating period and are not necessarily followed by abortion. In males, there is hyperemia and ulceration of the penis and prepuce with a purulent exudate.

### Newborn kids

Consistent signs include weakness, anorexia, cyanosis and dyspnea, increases in heart and respiratory rates, abdominal pain, fluid gut contents accompanied by diarrhea and dysentery, in some cases. Vesicles and ulcers may also be present on the coronets. Some show conjunctivitis, a seropurulent nasal discharge, erosions of the oral mucosa, and petechial hemorrhages in the skin.

## CLINICAL PATHOLOGY

Leukopenia is a consistent finding in sick newborn kids. The virus can be isolated from all secretions and can be identified by PCR and restriction endonuclease analysis. In serum, antibodies can be demonstrated by a serum neutralization test, ELISA tests and radioimmunoassay.

## NECROPSY FINDINGS

### Adults

Ulceration and necrosis of the vaginal and vulvar mucosae, and placentitis, are standard findings in ewes. Males show inflammation and **ulceration of the penis and prepuce**. A few adults develop an acute pneumonia with thick fibrinous exudate in the pleural cavity. **Miliary foci of hepatic necrosis** may or may not be grossly visible in aborted fetuses but at the microscopic level multifocal necrosis

is a common change in this tissue, and in adrenal glands, lung and kidney.<sup>4,7</sup> Herpesviral intranuclear inclusions can be found in some of these tissues.

### Newborn kids

Prominent lesions include ulceration and necrosis of the mucosae of rumen, abomasum, intestine, cecum and colon. Lesions are particularly severe in the large intestine. Vesication and ulcers of the skin of the feet may also be seen. Microscopically, foci of necrosis are often also seen in the adrenal glands, urinary bladder, spleen, liver, lungs, and various other tissues. Characteristic **intranuclear inclusion bodies** may be seen in mononuclear cells associated with these lesions.<sup>6</sup>

### Samples for confirmation of diagnosis

- **Virology** – Kids, fetuses – liver, lung, adrenal gland. Adults – genital ulcers, vesicles. Chilled samples (VI, PCR) It may be difficult to isolate from aborted fetuses but can be demonstrated by PCR
- **Histology** – formalin fixed samples of the above tissues.

## DIFFERENTIAL DIAGNOSIS

The systemic disease needs to be differentiated from the severe mycoplasmal infections and bacterial septicemias. Ulcerative dermatosis may be a confusing diagnosis in the genital form.

Causes of abortion for differential diagnosis are in Table 18.8.

## TREATMENT AND CONTROL

There is no treatment, although NSAIDs may ease the discomfort in the genitals caused by the disease. Quarantine and serological examination of all introduced goats seems the only effective control measure that can be adopted at the present time. An inactivated vaccine has been shown to engender protection,<sup>12</sup> but the disease is probably not common enough that this would be commercially available.

## REVIEW LITERATURE

Koptopoulos G. Caprine herpesvirus-1 infection. *Vet Bull* 1992; 62:77-84.

## REFERENCES

1. Keuser V et al. *Vet Rec* 2004; 154:395.
2. Grewal AS, Wells R. *Aust Vet J* 1986; 63:79.
3. Engels M, Thiry E. *Point Vet* 2000; 31:37.
4. Uzal FA et al. *J Vet Diag Invest* 2004; 16:478.
5. Chenier S et al. *Can Vet J* 2004; 45:241.
6. Roperto F et al. *J Comp Pathol* 2000; 122:298.
7. Williams NM et al. *J Am Vet Med Assoc* 1997; 211:89.
8. Tempesta M et al. *J Clin Microbiol* 1999; 37:1598.
9. Tempesta M et al. *Vet Rec* 2002; 150:116.
10. Tempesta M et al. *Vet Rec* 1988; 143:200.
11. Tempesta M et al. *Comp Immunol Microbiol Infect Dis* 2004; 27:25.
12. Tempesta M et al. *Vaccine* 2001; 19:3860.

## SWINE INFLUENZA

### Synopsis

**Etiology** Influenza A virus subtypes H1N1, H1N2 and H3N2 of *Orthomyxovirus*

**Epidemiology** United States, England, Japan, Canada, Belgium. Young pigs. High morbidity, low mortality. During cold months. Antigenic diversity of virus.

Aquatic birds natural reservoirs. Spread between pigs

**Signs** High incidence of anorexia, fever, thumps, muscle stiffness; recovery in several days

**Clinical pathology** PCR test to detect virus. Hemagglutination test and ELISA

**Lesions** Marked congestion of upper respiratory tract. Exudate in bronchi. Atelectasis. Suppurative bronchiolitis

**Diagnostic confirmation** Demonstrate virus in tissues

#### Differential diagnosis list

- Enzootic pneumonia
- Hog cholera
- Inclusion body rhinitis
- Atrophic rhinitis

**Treatment** Antimicrobials for secondary infection

**Control** No effective measures available. Vaccines are in use in certain parts of the world

## INTRODUCTION

Swine influenza is an important cause of bronchointerstitial pneumonia throughout all pig keeping areas of the world. Real problems are associated with the changing viruses that cause disease.

## ETIOLOGY

Classical swine influenza is associated with influenza A virus subtypes H1N1, H1N2 and H3N2 belonging to the *Orthomyxovirus* genus of the *Orthomyxoviridae* family. Other types have been isolated from pigs but as yet have not established as widespread endemic strains.

## EPIDEMIOLOGY

The segmented nature of the viral genome is a critical structural feature that enables them to be reassorted. Since 1998, H, N and PB1 polymerase genes from human viruses, M, NS and NP genes from classical swine viruses and PA and PB2 polymerase genes from avian viruses have also been found.<sup>1,2</sup>

## Occurrence

There are three groups of viruses but only influenza A viruses are important in pigs. They occur in a large number of species including humans, primates, pigs, horses, sea mammals, and birds.<sup>3</sup> When new variants occur in pig husbandry they are usually found in the pig population before they acquire the ability to spread rapidly and become associated with disease. They

are named using the following convention: A/species/localization/isolate number/year of isolation, e.g. A/Wisconsin/125/98. If no species is indicated it is a human virus. They are described with reference to the hemagglutinin (HA or H) and the neuraminidase (NA or N) that project from the surface of the viral envelope. There are 15H and 9N forms that can be distinguished antigenically and genetically and all of these have occurred in waterfowl and shore birds. They provide a permanent source of infection as does the water on which they float.<sup>4</sup> The H binds to sialic acid and mediates the virus infection of the host. It also contains most of the antigenic sites. The N protein catalyses cleavage of sialic acid.

Swine influenza first appeared in the United States immediately following the 1918 pandemic of human influenza, and it was generally believed that it was caused by adaptation of the human influenza virus to swine. Nucleotide sequencing of the genes coding for the internal virus proteins indicates that the human pandemic H1N1 strain and the classic swine strain H1N1 have a common avian ancestor. It is suggested that a virulent avian strain H1N1 entered the human population in 1918 causing the pandemic. The pandemic virus was then introduced into the swine population where it has persisted unchanged. In contrast, swine influenza was seen in the UK in 1941 but then disappeared until it was seen in Czechoslovakia in 1950 and Germany in 1959. Influenza was not seen again until observed in swine in Europe in 1979 possibly following importation of pigs from North America, associated with a virus antigenically related to contemporary avian H1N1 strains found in ducks.<sup>5</sup> These avian like strains have been the most common since 1979.<sup>6</sup>

Swine influenza still occurs in the United States and viruses of the H1N1 lineage were the dominant cause of SIV from 1930 to the 1990s.<sup>2</sup> These were highly conserved (relatively unchanged) but new antigenic and genetic variants did occur.<sup>2,7</sup> Classical H1N1 viruses have also been isolated from pigs from South America, Europe, and Asia. Wild pigs also have H1N1.<sup>8</sup> In the 1980s there were many genetic mixings between avian-like H1N1 and human-like H3N2 viruses.<sup>9</sup> In 1992, many outbreaks of classical swine influenza occurred in England, associated with a group of H1N1 viruses that were distinguishable from classical swine viruses, the European swine viruses, and human H1N1 viruses, all of which are known to be circulating in pigs.<sup>10</sup> Influenza A virus subtypes H1N1 and H3N2 are endemic in pigs in Great Britain.<sup>11</sup> Two distinct antigenic variants of H1N1

viruses have been associated with outbreaks of swine influenza, one of which was probably transmitted from birds to pigs in the early 1990s.<sup>6</sup> The H1N2 subtypes isolated from pigs in Great Britain appear to have originated from a human H1N1 virus, which was circulating in the pig population in the 1980s, and from swine H3N2. It is suggested that the H1N1 viruses have disappeared from the human population, and the pig population provides a reservoir for the virus.<sup>11</sup> Serological surveys indicate that a swine H1N1 influenza virus has circulated in the swine population in North America for many years.<sup>10</sup> Recent isolates from Quebec possess a hemagglutinin distinguishable from subtype H1N1.<sup>12</sup>

Epidemics of swine influenza have also occurred in Japan, Canada, Belgium, and France. In North America, human H3N2 have been found much less often than in the rest of the world but the very recent introduction of H3N2 from humans to pigs was probably the major factor in the emergence of the recent strains.<sup>1</sup>

Mixtures of human and classical virus genes have been isolated from pigs in Asia and the USA.<sup>13</sup> H3N2 viruses with human H and N genes and avian internal protein genes have been isolated from pigs in Asia<sup>14</sup> and H3N2 has been found in Korea<sup>14</sup> and are currently the dominant H3N2 viruses in pigs in Europe.<sup>15</sup> Since 1998 double and triple re-assortants have been isolated from pigs in the USA. The N. Carolina virus had three human genes and five swine genes.<sup>16</sup> They include human H and N genes, genes from swine H1N1 viruses and two others from avians.<sup>17-19</sup>

Soon after the occurrence of the H3N2 viruses, new H1N2 viruses arose in the USA where the human H3 had been replaced by a porcine H1<sup>20</sup> and then spread.<sup>21,22</sup> They had been known elsewhere in the world for some time: Japan<sup>23</sup>; France<sup>24</sup>; Germany<sup>25</sup>; Taiwan.<sup>26</sup> They were described in the UK where they were found to be the most severe cause of pathology associated with the SIV viruses.<sup>27</sup> These were all re-assortants between human H3N2 and classical H1N1.

Human H3N2 and avian H1N1 were isolated in the UK<sup>3,6</sup> and were then found to have spread to Europe.<sup>28-32</sup> They are usually human H and N and the rest avian genes but one Italian virus has an avian H1.<sup>28</sup> They have shown considerable genetic drift in Europe.<sup>33</sup>

Subtype H3N2 has been isolated in Canada from pigs with severe proliferative and necrotizing pneumonia (PNP),<sup>34</sup> although this PNP is probably associated with PRRS and PCV2. Serological surveys indicate the infection is widespread in the swine populations in some countries.

The first unusual virus to be found in pigs was an H9N2 introduced to pigs in SE Asia probably from land-based poultry.<sup>35</sup>

Further problems occurred in the autumn of 1999 when an avian H4N6 was found in pigs with pneumonia on a commercial swine farm in Canada.<sup>36</sup> Since then the avian H5N1 has appeared in pigs in China and is being carried west by bird migrations into Russia. The potential of avian viruses to spread to pigs and persist in pigs is unknown. Even if the viruses do not replicate they can contribute viral genes to other pig viruses. This is the reason for continual surveillance of SIV viruses. These were wholly avian viruses that were of North American lineage. It was the first report of an interspecies transmission of an avian H4 virus to domestic pigs under natural conditions.

The disease usually affects young pigs, but all ages may be affected. Typically, sudden onset epidemics occur with a high morbidity rate but with a low case fatality rate of less than 5%. Loss of body condition is marked, which is usually the important cause of financial loss, although occasionally death losses may be extensive if the pigs are kept under inadequate conditions or if secondary bacterial infections occur. Abortions and deaths of newborn pigs have also been reported as causes of loss in this disease.

### Risk factors

#### Animal risk factors

Young, growing pigs are most susceptible. The viral infection is commonly complicated by bacterial infection due to *Haemophilus parasuis*, *A. pleuropneumoniae*, and possibly other opportunists of the upper respiratory tract of the pig. When an epidemic occurs, most of the pigs in the herd are affected within a few days, which suggests that all animals are previously infected and that some risk factor, such as inclement weather, precipitates the epidemic.

The agent also contributes to the Porcine Respiratory Disease Complex. In a recent study in Korea 14 of 105 cases had SIV,<sup>37</sup> whereas in Iowa it has been reported in 19% of the case of PRDC.<sup>38</sup>

#### Environmental risk factors

Epidemics occur mainly during the cold months of the year, commencing in the late autumn or early winter and terminating with a few outbreaks in early spring. Several days of inclement weather often precede an outbreak. Three risk factors for SIV were identified on a survey of Belgian finishing farms<sup>39</sup> were H1N1 were found in 71% and H3N2 were found in 22%. There was a close association between H1N1 and H3N2. H1N1

appeared to be associated with fully slatted floors, increasing numbers of pigs in the locality and dry feeding. H3N2 was associated with the purchase of pigs from more than two herds, increasing numbers of pigs locally, and natural ventilation.

### Pathogen factors

Molecular microbiology has now revealed the antigenic diversity of the virus. Several different H and N antigens have been identified and grouped on the basis of serological tests, which refine the diagnosis and reveal more about the epidemiological relationships. The H3N2 strain similar to H3N2 strains found in the human population has been isolated from an outbreak in England.<sup>2,3</sup>

Two antigenically distinct H1N1 influenza A viruses were isolated during an outbreak of respiratory disease in swine in Canada in 1990/91.<sup>40,41</sup> One is a variant of the swine H1N1 influenza virus that is widespread in the American Midwest, whereas the other is similar to the virus isolated from swine in 1930. This suggests that influenza viruses can be maintained for long periods in swine herds, especially in certain geographical areas. It is proposed that the antigenic diversity of these viruses may be due to the result of drifts in the population of circulating swine influenza viruses in an area.<sup>7</sup> The antigenic diversity oligonucleotide analysis of strains isolated from outbreaks in Sweden indicated a similarity with the Danish strain. One of the Swedish strains was closely related to the US strain.

The H1N1 strain of the virus can be found in pig tissues at slaughter but it does not persist for more than 2–3 weeks in deep frozen or refrigerated storage.

### Methods of transmission

The natural reservoir of influenza A virus is aquatic birds. Various subtypes have been established in other species, such as influenza A H1N1 viruses, which infect human and different animal species. The influenza viruses may be transmissible between humans and pigs. Swine are the sole animals known to be susceptible to influenza A viruses of human, swine, and avian origin. Swine may become infected with related type A human influenza strains during epidemics of human influenza, but show no clinical signs of infection. The human strains have been isolated from pigs in Hong Kong, and pigs may serve as a reservoir for pandemics in humans as well as a source of genetic information for recombination between human and porcine strains. In Japan, pigs may be seropositive to the H1N1 human viruses relative to human H1N1 influenza epidemics, and

seropositive to human H3N2 viruses unassociated with human epidemics of disease.<sup>42</sup> In Czechoslovakia, influenza A viruses are brought into pig herds by carrier people.

Pigs can be naturally infected with a range of avian influenza viruses. There have been at least three independent introductions of distinct wholly avian viruses into pigs.<sup>43,44</sup> The virus in the late 1970s spread throughout Europe and the UK and became a major cause of SI.<sup>45</sup> These viruses also undergo drift.<sup>45,46</sup>

Elsewhere in the world antibodies against H4, H5, and H9 viruses have been isolated from Asian pigs<sup>47</sup> and avian H4N6, H3N3 and H1N1 viruses have been recovered from pigs in Canada.

Swine are susceptible to both human and avian viruses because they have receptors on their respiratory epithelial cells for both avian (receptor SA  $\alpha$  2, 3 Gal) and human (receptor SA  $\alpha$  2, 6 Gal).<sup>48</sup> Several re-assortants have been isolated from pigs in the USA and other parts of the world.<sup>49,50</sup>

Thus, swine have an important role in the ecology of influenza A viruses and are regarded as a 'mixing vessel' for the introduction of reassortant viruses into the human population.<sup>40,43,51</sup>

There is a report claiming that outbreaks of influenza in turkeys followed outbreaks of swine influenza in pigs from nearby swine herds.<sup>52</sup> Swine and other influenza viruses have also been isolated from cattle, and experimental inoculation of calves has been successful. The swine influenza virus may cause natural infection in cattle and the virus can be transferred to uninoculated calves.

The primary route of infection is through pig to pig contact via the nasopharyngeal route. Peak shedding occurs 2–5 days post-infection ( $>10^7$  infectious particles/mL at a peak).<sup>53,54</sup>

The rapid spread of infection from pig to pig occurs by inhalation of infective droplets. The disease may appear almost simultaneously in several herds within an area following the first cold period in late autumn. The virus can persist in infected swine, which can act as convalescent carriers and be the reservoir of the virus between epidemics. However, the experimental inoculation of a swine influenza virus into specific pathogen-free (SPF) pigs resulted in a mild disease and the period of viral shedding was shorter than 4 weeks.

### Immunity

Both cell-mediated immunity and humoral responses are important. They do not prevent infection but they can mediate the killing of infected cells. The immune response is rapid and completes elimination

of the virus within 1 week. Antibodies decline by 8–10 weeks.<sup>55</sup> The IgA levels in nasal washes are the most important defence.<sup>56</sup> There is limited cross-protection between different viruses<sup>31</sup> and protection after vaccination is more virus specific.<sup>54</sup>

Maternal protection will last from 4–14 weeks with no pigs being completely protected from nasal virus shedding upon challenge but at least the lung is protected.<sup>57,58</sup> Pigs with a high maternal antibody level did not develop an immune response.<sup>58</sup> Maternal antibody does not cross protect between subtypes.<sup>57,59</sup>

### ZOONOTIC IMPLICATIONS

Swine influenzas pose a significant health risk to humans ever since the first human and porcine outbreaks in the USA in 1918.<sup>60</sup> By 1970 there was evidence that people who came into contact with pigs through their jobs became infected with the viruses and a virus was isolated from pigs and stockman.<sup>61,62</sup> There is very little evidence of maintenance of human H1N1 in the pig populations<sup>44</sup> but human H3N2 have been recovered regularly from pigs in Asia and Europe.<sup>44,63</sup> The drift that has taken place in pigs of former human H3N2 has also been minimal compared to the rate of drift in the human population. The viruses from pigs found in humans have been reviewed.<sup>3,49,62</sup>

### PATHOGENESIS

Classical swine influenza was originally described as a disease of the upper respiratory tract, the trachea and bronchi being particularly affected, with secondary bacterial pneumonia due to *Pasteurella multocida*. However, recent descriptions of the lesions in naturally occurring cases and in the experimental disease indicate that the primary lesion is a viral interstitial pneumonia.<sup>64</sup> Viral replication takes place in the epithelial cells of the nasal mucosa, tonsils, trachea, lungs and tracheobronchial lymph nodes.<sup>65</sup> No other sites have been detected<sup>66</sup> and viremia is of low titer. Inoculation of the H1N1 strain of influenza virus isolated in England from pigs with clinical disease into 6-week-old pigs caused fever, coughing, sneezing, and anorexia.<sup>64</sup> A widespread interstitial pneumonia, with lesions in the bronchi and bronchioles, and hemorrhagic lymph nodes was characteristic. The H3N2 swine influenza virus isolated in Canada is associated with a proliferative and necrotizing pneumonia (PNP) of pigs, and there is evidence the strain may be related to A/Sw/Hong Kong/76H3N2 swine influenza virus.<sup>34</sup> There is recent evidence that this PNP is more a feature of PRRS and PCV2 than SIV. A new antigenic variant of H1N1 swine influenza A virus isolated in Quebec has been associated with proliferative and necrotizing pneumonia of pigs.<sup>7,12</sup>

In the United Kingdom there has also been recorded an H1N7 which included both equine and human influenza genes. It was of low pathogenicity for pigs, found on only one farm, and did not establish in the pig world.<sup>67</sup> Re-assortant H3N1 viruses from human and classical swine H1N1 have also been seen in the UK and also in Taiwan.<sup>26</sup>

The virus causes an acute infection with shedding beginning on day 1 and finishing by day 7.<sup>66</sup> Infected cells in the respiratory tract are reduced by 2–3 days post-inoculation. Most of the effects of the infection are caused by the production of proinflammatory cytokines (IFN- $\alpha$ , TNF- $\alpha$  IL-1, and IL-6.) These produce inflammation, fever, malaise, loss of appetite. The depth of infection in the lung probably determines how much of these cytokines are produced.<sup>68,69</sup>

Contrary to widespread belief there is no evidence that the virus causes reproductive failure in swine. The experimental inoculation of seronegative pregnant gilts did not reveal any evidence of trans-placental transmission of the virus to the fetus.

### CLINICAL FINDINGS

It is essentially a herd disease.<sup>1,13,17,44</sup> The signs have not changed over the 80 years. After an incubation period of 1–7 days, (usually 1–3), the disease appears suddenly, with a high proportion of the herd showing fever (up to 41.5°C, 107°F), anorexia and severe prostration. The animal is disinclined to move or rise because of muscle stiffness and pain. Labored, jerky breathing ('thumps') is accompanied by sneezing and a deep, painful cough which often occurs in paroxysms. There is congestion of the conjunctivae with a watery ocular and nasal discharge. Sometimes there is open mouthed breathing and dyspnea especially if the pigs are forced to move. Morbidity is usually 100% but mortality is rarely above 1%. In general, the severity of the illness appears greater than, in fact, it is and after a course of 4–6 days signs disappear rapidly depending, in part, on the level of colostral antibody. However, there is much loss of weight, which is slowly regained. Clonic convulsions are common in the terminal stages in fatal cases. The condition may continue to affect the herd for several weeks as the disease spreads, especially so if the herd is outdoors and the population dispersed. The new H3N2 re-assortants in the USA have been associated with respiratory disease but also spontaneous abortion in sows and death of adult pigs.<sup>13,17</sup> The clinical signs are dependent on immune status, but are also influenced by age, infection pressure, concurrent infections,

climatic conditions, housing and most of all on the secondary infections particularly bacteria. There is some question as to whether other viruses can predispose to SIV but experimentally infection with PRCV and H1N1 or H3N2 SIV has not shown this.<sup>70</sup> Pigs with both *M. hyopneumoniae* and SIV coughed more and had more pneumonia than either of the two agents on their own.<sup>71</sup>

### CLINICAL PATHOLOGY

Within 24 hours of the onset of clinical signs there is a switch of cells in the bronchial lavage from macrophages to over 50% neutrophils.<sup>68</sup>

### Serological tests

After infection has ceased to circulate in the herd SIV AB could still be demonstrated after 28 months post-infection.<sup>72</sup>

It is extremely important to make sure that the antigens that are used in the serological tests are contemporary to the viral strains that may be found in the country.<sup>22,33,67,73,74</sup>

Diagnosis of acute SIV infections requires the use of paired serum samples. The **hemagglutination inhibition test** has been the recommended test for many years and still remains so. However, it is tedious and has only moderate sensitivity but high specificity. It has been adapted and modified.<sup>75</sup> One HI test for H1N1 will detect other H1N1 strains,<sup>76</sup> but this is not true for H3N2 when the Midwest strains are compared with the N. Carolina strains as they differ considerably.<sup>77</sup> Above 1:80 is usually considered positive and within 5–7 days the titers may reach 1:320–1:640 by 2–3 weeks post-infection. An **ELISA**-based test is now available to estimate the hemagglutination titer<sup>5</sup> and can be used at the herd screening level.<sup>78</sup>

### Detection of virus

Virus is likely to be found in the nasopharyngeal area during the acute phase of the disease. Swabs should be taken on Dacron, placed in transport medium stored at 4°C for no more than 48 hours but if for longer freeze at -70°C. Viruses can also be isolated from trachea or lung tissues of pigs. They can be grown in hens' eggs or increasingly in tissue culture. Samples need to be cool and moist. The virus is then detected by hemagglutinating activity in egg fluids about 5 days after inoculation. There are some strains that may not grow in hens' eggs or require more than one cell line to isolate and identify the virus which may require 1–2 weeks.<sup>79</sup>

### Antigen detection

A **PCR** test can be used to detect virus in nasal swab specimens<sup>80</sup> and give results similar to virus isolation.<sup>53,66,81,82</sup> Recently, a gel based multiplex RT-PCR assay was

developed to detect H1 and H3 subtypes of SIV.<sup>83</sup>

The virus can be detected by direct immunofluorescence of lung tissue or lavage fluids.

Immunohistochemistry on fixed tissue is also useful. The positivity is mainly in the bronchial and bronchiolar epithelial cells and less intense in the interstitial cells and alveolar macrophages.<sup>84</sup>

### NECROPSY FINDINGS

Swelling and marked edema of cervical and mediastinal lymph nodes are evident. There is congestion of the mucosae of the pharynx, larynx, trachea, and bronchi. A tenacious, colorless, frothy exudate is present in the air passages. Copious exudate in the bronchi is accompanied by collapse of the ventral parts of the lungs. This atelectasis is extensive and often irregularly distributed, although the apical and cardiac lobes are most affected, and the right lung more so than the left. It may reach 50% by 4–5 days post-infection.<sup>85,86</sup> The affected tissue is clearly demarcated, dark red to purple and often reminiscent of enzootic pneumonia. Surrounding the atelectatic areas the lung is often emphysematous and may show many petechial hemorrhages.

Histologically, in acute swine influenza the major feature is necrotizing bronchiolitis.<sup>87</sup> There is a suppurative bronchiolitis and widespread interstitial pneumonia characterized by the early appearance of neutrophils followed by the accumulation of macrophages and mononuclear cells in the alveolar walls.<sup>64</sup> After a few days there is a peribronchial and peribronchiolar infiltration of lymphocytes.<sup>87</sup> In the variant of H1N1 swine influenza in Canada, there is more diffuse damage to the respiratory epithelium, resulting in firm to meaty lungs that appear thymus-like on cut surface.<sup>12</sup>

Microscopically, there is marked proliferation of type II pneumocytes, in addition to the presence of macrophages and necrotic inflammatory cells in the alveoli. The influenza type A virus can be demonstrated by indirect immunofluorescence staining using monoclonal antibody directed to certain protein parts of the human type A influenza virus.<sup>12</sup> The influenza type A virus can be detected and differentiated from the virus of porcine reproductive and respiratory syndrome in formalin-fixed, paraffin-embedded lung tissue using immunogold staining.<sup>88</sup>

### Samples for confirmation of diagnosis

- **These are best collected** from animals with high fevers and clear nasal discharge. Most pigs may excrete virus for 5–7 days post-infection but the peak load may be around 24 hours post-infection

- **Histology** – formalin-fixed lung, trachea, turbinate (LM, IHC). After 72 hours there is little IFA or IHC positivity. Histopathology may help in the diagnosis for 2 weeks post-infection
- **Virology** – nasopharyngeal swab in viral transport media; lung and trachea (ISO, FAT, PCR) fresh chilled but not frozen. Keep cool. Do not use cotton.

### DIFFERENTIAL DIAGNOSIS

The explosive appearance of an upper respiratory syndrome, including conjunctivitis, sneezing, and coughing, with a low mortality rate, serves to differentiate swine influenza from the other common respiratory diseases of swine.

Enzootic pneumonia of pigs is most commonly confused with swine influenza, but it is more insidious in its onset and chronic in its course.

Hog cholera is manifested by less respiratory involvement and a high mortality rate.

Inclusion body rhinitis in piglets may resemble swine influenza quite closely.

Atrophic rhinitis has a much longer course and is accompanied by characteristic distortion of the facial bones.

### TREATMENT

No specific treatment is available. Treatment with penicillin, sulfadimidine, or preferably a broad-spectrum antibiotic, may be of value in controlling possible secondary invaders. The provision of comfortable, well-bedded quarters, free from dust, is of major importance. Clean drinking water should be available, but feed should be limited during the first few days of convalescence. Medication of the feed or water supplies with a broad-spectrum antibiotic for several days is a rational approach to minimizing secondary bacterial pneumonia.

### CONTROL

There are only two options vaccination and biosecurity. Biosecurity is difficult as there is always the possibility of aerosol infections and wild fowl/poultry infections.

All in/all out systems may remove infection with each group of pigs and the subsequent disinfection may kill out the virus. Good housing and protection from inclement weather help to prevent the occurrence of severe outbreaks. Once the disease has appeared little can be done to prevent spread to other pigs. Recovered animals are immune to subsequent infection for up to 3 months.

Vaccines, both commercial inactivated and adjuvanted SIV for IM use are available in the USA and Europe. Active

immunization occurs in the face of maternal derived antibody when titers are <10 for H1N1 and <40 for H3N2.<sup>63</sup> Some of the vaccines contain the original H1N1 viruses but others such as in the USA contain a monovalent H1N1 virus. Following the outbreaks of H3N2 in the USA in 1998 both monovalent and bivalent H1N1/H3N2 SIV vaccines became available. Autogenous vaccines are used in the USA.

In Europe although the viruses have changed the old vaccines are still used as they produce high antibody titers.<sup>89,90</sup> There is a need to add H1N2 to the vaccines however as there is no cross protection between the European H1N2 and H1N1 and H3N2 viruses and because it was shown<sup>33</sup> that there is no current vaccine protection against H1N2. Evidence from the USA shows that there is cross protection with their strain of H3N2.<sup>91</sup> Most animals with titers >160 are probably protected against viral replication in the lungs and disease.<sup>70,90</sup> Sow vaccination is important in controlling infection in suckling pigs and often controls the infection in nursery pigs. Intranasal or IN/IM vaccination of pigs with formalin inactivated SIV induces very specific IgM, IgG and IgA antibodies in their nasal secretions and sera resulting in complete protection.<sup>92</sup>

A recent trial of a new H1N1/H3N2 vaccine was successful,<sup>93</sup> with reduced viral shedding, and reduced clinical signs and pneumonia.

Experimental vaccines continue to be produced including a human adenovirus 5 recombinant expressing the hemagglutinin and nucleoprotein of H3N2 SIV has been used experimentally to provide protection against challenge with H3N2.<sup>94</sup> Complete protection was shown by lack of nasal shedding and by lack of lung lesions following subsequent challenge.

### REVIEW LITERATURE

- Reeth K van, Nauwynck H. Pro-inflammatory cytokines and viral respiratory diseases of pigs. *Vet Res* 2000; 31:187–213.
- Brown IH. Molecular epidemiology and evolution of influenza viruses in pigs. In: Proceedings of the 4th International Symposium on Emerging and Re-emerging Pig Diseases. Rome, 29 June–2 July, 2003; pp. 245–249.
- Olsen CW, Swayne D, Subbarao K. Human avian and swine viruses – past and current. In: Kawaoka Y (ed) Contemporary topics in influenza virology. Norwich: Horizon Scientific Press, 2004.

### REFERENCES

1. Karasin AJ et al. *J Clin Microbiol* 2000; 38:2453.
2. Olsen CW et al. *Arch Virol* 2000; 145:1539.
3. Alexander DJ, Brown IH. *Rev Sci Tech Off Int Epiz* 2000; 19:197.
4. Hinshaw VS et al. *Can J Microbiol* 1980; 26:622.
5. Lee BW et al. *Am J Vet Res* 1993; 54:1270.
6. Brown IH et al. *Vet Microbiol* 1994; 39:125.
7. Rekić MR et al. *J Clin Microbiol* 1994; 32:515.
8. Saliki JT et al. *J Wildlife Dis* 1998; 34:834.

9. Castrucci MR et al. *Virology* 1993; 193:503.
10. Brown IH et al. *Vet Rec* 1995; 136:328.
11. Brown IH et al. *Vet Rec* 1993; 132:461.
12. Dea S et al. *J Vet Diag Invest* 1992; 4:380.
13. Zhou NN et al. *J Virol* 1999; 73:8851.
14. Song R et al. *J Clin Virol* 2003; 28:51.
15. Campitelli L et al. *Virology* 1997; 232:310.
16. Zhou NN et al. *Vet Med* 2000; 74:47.
17. Karasin AI et al. *Virus Res* 2000; 68:71.
18. Zhou NN et al. *J Virol* 1999; 73:8851.
19. Webby RJ et al. *J Virol* 2000; 74:8243.
20. Karasin AI et al. *J Clin Microbiol* 2000; 38:2453.
21. ChoiYK et al. *Virus Res* 2002; 87:173.
22. Karasin AI et al. *J Clin Microbiol* 2002; 40:1073.
23. Ito T et al. *Arch Virol* 1998; 143:1773.
24. Gourreau JM et al. *Arch Virol* 1994; 135:365.
25. Enneking H et al. *Prakt Tierarzt* 2003; 84:772.
26. Tsai C-P, Pan M-J. *Vet Rec* 2003; 153:408.
27. Done SH et al. *Pig J* 1995; 35:164.
28. Marozin S et al. *J Gen Virol* 2002; 83:735.
29. Schrader C, Suss J. *Intervirology* 2003; 46:66.
30. Reeth van K et al. *Vet Rec* 2000; 146:588.
31. Reeth van K et al. *Vaccine* 2003; 21:1375.
32. Reeth van K et al. *Vet Rec* 2003; 153:9.
33. de Jong JC et al. *Vaccine* 1999; 17:1321.
34. Bikour MH et al. *Can J Vet Res* 1994; 58:287.
35. Katsuda K et al. *J Gen Virol* 1995; 76:1247.
36. Karasin AI et al. *J Virol* 2000; 74:9322.
37. Kim J et al. *Vet J* 2003; 166:251.
38. Harms PA et al. *J Swine Hlth Prod* 2003; 10:27.
39. Maes D et al. *J Vet Med B* 1999; 46:341.
40. Bikour MH et al. *J Gen Virol* 1995; 76:2539.
41. Girard C et al. *Vet Rec* 130:206.
42. Goto H et al. *J Vet Med Sci* 1992; 54:235.
43. Guan Y et al. *J Virol* 1996; 70:8041.
44. Brown IH. *Vet Microbiol* 2000; 74:29.
45. Brown IH et al. *J Gen Virol* 1997; 78:553.
46. de Jong J C et al. *Vaccine* 2001; 19:4452.
47. Peiris JSM et al. *J Virol* 2001; 75:9679.
48. Ito T et al. *J Virol* 2000; 74:9300.
49. Olsen CW et al. In: Morilla A, Yoon K-J, Zimmermann JJ (eds) *Trends in emerging viral infections of swine*. Ames, Iowa: Iowa State Press, 2002; pp. 37-43.
50. Olsen CW. *Virus Res* 2002; 85:199.
51. Scholtissek C et al. In: Nicholson KG, Webster RG, Hay A (eds) *Textbook of influenza*. London: Blackwell Health Care Communications, 1998; pp. 137-145.
52. Andral B et al. *Vet Rec* 1985; 116:617.
53. Landolt GA et al. *J Clin Microbiol* 2003; 41:1936.
54. Reeth van K. *Vet Rec* 2003; 153:9.
55. Reeth van K et al. *Virus Res* 2004; 103:115.
56. Larsen DL et al. *Vet Microbiol* 2000; 74:1117.
57. Labarque G et al. *Proc 18th Int Pig Vet Soc Cong*, 2004; p. 83.
58. Loeffen et al. *Vet Immunol Immunopathol* 2003; 92:23.
59. ChoiYK et al. *Am J Vet Res* 2004; 65:303.
60. Taubenberger JK et al. *Phil Trans Roy Soc Lond (Biol)* 2001; 356:1829.
61. Hinshaw VS. *Virology* 1978; 84:622.
62. Olsen CW et al. *Emerg Infect Dis* 2002; 8:814.
63. Hoover TC, Fricker MD. *Proc Am Assoc Swine Pract* 2004; p. 271.
64. Brown IH et al. *Vet Rec* 1993; 132:598.
65. Heinen PP et al. *Viral Immunol* 2000; 13:237.
66. ChoiY-K et al. *Am J Vet Res* 2004; 65:303.
67. Brown IH et al. *Arch Virol* 1997; 142:1045.
68. Reeth van K et al. *J Inf Dis* 1998; 177:1076.
69. Reeth van K et al. *Viral Immunol* 2002; 15:583.
70. Reeth van K et al. *J Vet Med B* 2001; 48:283.
71. Thacker EL et al. *J Clin Microbiol* 2001; 39:2525.
72. Desrosiers R et al. *J Swine Hlth Prod* 2004; 12:78.
73. Olsen CW. *Vet Microbiol* 2000; 74:49.
74. Richt JA et al. *J Clin Microbiol* 2003; 41:3198.
75. Long BC et al. *J Vet Diag Invest* 2004; 16:264.
76. Janke BH et al. *Proc Am Assoc Swine Pract* 1997; p. 7.
77. Swenson SL et al. *Proc Am Assoc Vet Lab Diag* 1999; p. 242.
78. Skibbe D et al. *J Vet Diag Invest* 2004; 16:86.
79. Erickson G et al. *Proc Am Assoc Vet Lab Diag* 1999; p. 45.
80. Schorr E et al. *Am J Vet Res* 1994; 55:952.
81. ChoiYK et al. *J Virol Methods* 2002; 102:53.
82. Landolt GA et al. *Am J Vet* 2005; Res 66:119.
83. Richt JA et al. *J Vet Diag Invest* 2004; 16:367.
84. Jung T et al. *Vet Pathol* 2002; 39:10.
85. Born B et al. *Proc Am Ass Swine Pract* 1998; p. 63.
86. Richt JA. *J Clin Microbiol* 2003; 41:3198.
87. Done SH et al. *Eur J Vet Pathol* 1996; 2:73.
88. Larochelle R et al. *Can Vet J* 1994; 35:513.
89. Heinen PP et al. *Vet Immunol Immunopathol* 2001; 82:39.
90. Reeth van K et al. *Vaccine* 2001; 19:4479.
91. Rapp-Gabrielsen VJ et al. *Proc 4th Int Symp Emerg Re-emerg Pig Dis* 2003; p. 266.
92. LimY-K et al. *Jap J Vet Res* 2000; 22:3427.
93. Graham M, Rossow K. *Proc Allen D Leman Conf* 2004; p. 69.
94. Wesley RD et al. *Vaccine* 2004; 22:3427.

### **PORCINE CYTOMEGALIC VIRUS (INCLUSION BODY RHINITIS, GENERALIZED CYTOMEGALIC INCLUSION BODY DISEASE OF SWINE)**

Inclusion body rhinitis, associated with a beta herpesvirus (family Herpesviridae), is an extremely common, but generally minor, disease in young pigs. It was first recognized in 1955. The virus is now called porcine herpesvirus 2. The disease has probable worldwide occurrence<sup>1-5</sup> and has also been described in Canada<sup>6</sup> and Japan<sup>7</sup> and clinical and serological<sup>8,9</sup> observations suggest that it is present in most pig herds. SPF herds established by hysterectomy techniques are not necessarily exempt and congenital transmission of the virus has been demonstrated.<sup>10</sup> When the virus first enters a susceptible herd then both trans-placental and horizontal virus transmission takes place. Antibody responses start quickly so there are often no clinical signs but widespread infection.

The virus is present in the upper respiratory tract of pigs and the major infection site is the conchal (turbinate) epithelium. High excretion occurs predominantly in the 2-4-week period after infection.<sup>10</sup> Transmission is via the respiratory route through direct contact and aerosol infection, and possibly also via urine. The virus invades epithelial cells, especially those of the nasal mucous glands, to produce destruction of acinar cells and metaplasia of the overlying epithelium and the major clinical manifestation is that of upper respiratory disease. Following infection, the virus may become generalized. In other pigs, generalization is restricted to epithelial cells of other organ systems, especially those of the renal tubules, and is clinically inapparent. However, in very young pigs

the virus also shows a predilection for reticuloendothelial cells, and generalization may result in further clinical abnormality.<sup>11</sup>

Clinically, the disease affects piglets up to approximately 10 weeks of age but the age at manifestation in any herd can depend upon the method of husbandry. In the UK, it is assumed that approximately 50% of the herds are infected. Within the individual herd there may be up to 98% affected. The disease usually occurs when the virus is introduced into the susceptible herd or if for some reason there is a huge increase in the number of susceptible pigs. A wide age-spectrum of involvement may be seen initially when the disease is introduced into the herd for the first time. In most herds the disease affects pigs in the late suckler and early weaner stage. It is at its most severe in pigs under two weeks of age. Sneezing is the most prominent sign and frequently occurs in paroxysms and following play fighting. There is a minor serous nasal discharge which rarely may be blood-stained, and also sometimes mucopurulent with a brown or black exudation around the eyes. There may be coughing. The clinical course varies approximately from 2-4 weeks. All pigs within the group are affected but there is usually no mortality.

The virus also crosses the placenta so it is possible for intra-uterine infection to produce fetal death, and runting after birth as well as very early pneumonia, rhinitis and poor piglet weights at weaning.

Generalized cytomegalic inclusion body disease may occur in pigs exposed to intra-uterine infection and usually occurs as an outbreak involving several litters. The syndrome is characterized by sudden death and anemia. There is often a history of scouring within the group within the first week of life, and affected pigs show skin pallor and often superficially appear plump and well-developed due to edema, especially in the neck and forequarter regions. Death, resulting primarily from anemia, occurs during the 2nd-3rd week of life, and mortality within the group may approach 50%. Petechial hemorrhages have been a feature of the experimentally produced disease in gnotobiotic pigs<sup>11</sup> but do not necessarily occur in field outbreaks. A moderate anemia producing a check to growth, but without significant mortality, may also be seen in recently weaned pigs experiencing the disease. Many survivors may be stunted.

More serious effects from generalized infection are seen when piglets are exposed to heavy infection at a very young age. It also occurs when there are new imports and when intercurrent disease and poor nutrition reduce resistance. This commonly occurs in large herds with high



density continual throughput farrowing and weaning houses. In addition to upper respiratory disease, infection at this age may result in enteric disease, sudden death, anemia and wasting, with a marked unevenness of growth within the litters.

There may be complete blockage of the nasal passages. It is believed that the olfactory epithelium may be damaged so that there is no sense of smell and that piglets may not then eat and that is the reason so that so many die.

Inclusion body rhinitis is not a primary cause of atrophic rhinitis. However, it is probably contributory in lowering local resistance to infection and in predisposing to more severe infection with *Bordetella bronchiseptica* and other respiratory pathogens.

The diagnosis of inclusion body rhinitis is commonly made following the demonstration of typical intranuclear inclusion bodies in histological sections from electively slaughtered piglets.<sup>12</sup> Large basophilic inclusion bodies are found in the mucous gland cells of the turbinate mucosa and may also be demonstrated in exfoliated cells obtained via nasal swabs from live pigs. Small intra-nuclear inclusion bodies are found in the reticulo-endothelial cells. These are best taken from several pigs at the height of clinical infection. Diagnosis by virus isolation is uncommon, as the virus has proved difficult to grow, but it will establish in porcine lung macrophage cultures.<sup>13</sup> Antibody to infection may be detected by indirect immunofluorescent techniques.<sup>8,9</sup> An ELISA is also a sensitive reproducible and practical test.<sup>6</sup> Recently, a PCR has been developed<sup>14</sup> and this showed that 59% of pigs tested positive. However only 59% of PCR positive pigs had clinical signs and lesions consistent with inclusion body rhinitis.

There is no effective treatment and in most herds none is warranted. With severe rhinitis, antibiotics may temporarily reduce the severity of secondary bacterial infection. Control of severe disease rests with management procedures that avoid severe challenge to very young piglets. It is also possible to produce virus-free pigs from hysterotomy-derived pigs but it is necessary to monitor.

## REFERENCES

1. Done JT. *Vet Rec* 1955; 67:525.
2. Cohrs P. *Dtsch Tierärztl Wochenschr* 1959; 66:605.
3. Corner AH et al. *J Comp Path* 1964; 74:192.
4. Camon-Stephens ID. *Aust Vet J* 1961; 37:87.
5. Rundhuis PR et al. *Tijdschr Diergeneeskd* 1980; 105:56.
6. Assaf R et al. *Can J Comp Med* 1982; 46:183.
7. Tajima T et al. *Vet Med Sci* 1993; J 55:421.
8. Plowright W et al. *J Hyg Camb* 1976; 76:125.
9. Kanitz CL, Woodruff ME. *Proc 4th Intern Cong Pig Vet Soc* 1976; p. 9.

10. L'Ecuyer C et al. *Proc 2nd Intern Cong Pig Vet Soc* 1972; p. 99.
11. Edington N et al. *J Comp Path* 1976; 86:191.
12. Narita M et al. *Am J Vet Res* 1987; 48:1398.
13. Watt R W et al. *Res Vet Sci* 1973; 14:119.
14. Hamel AL et al. *J Clin Microbiol* 1999; 37:3767.

## ENZOOTIC PNEUMONIA OF CALVES

### Synopsis

**Etiology** *Mycoplasma* spp., parainfluenza-3 virus, bovine respiratory syncytial virus, and other viruses; secondary bacterial infection

**Epidemiology** Housed dairy calves under 3–5 months; high morbidity low mortality; veal calves; beef calves crowded in calving grounds; poor colostral immunoglobulin status; inadequately ventilated calf barns; excessive infection pressure on newborn calf because of close proximity to adult cattle in barns; economically important

**Signs** Mild to severe dyspnea, fever, loud breath sounds over cranioventral lungs (consolidation), coughing, high morbidity; low case fatality rate, secondary bacterial pneumonia with toxemia

**Clinical pathology** Isolate pathogens from nasal swabs, transtracheal aspirates. Serology for seroconversion to viruses

### Differential diagnosis:

- Pneumonic pasteurellosis due to *Pasteurella haemolytica*
- *Haemophilus somni* pleuropneumonia
- Aspiration pneumonia
- Dyspnea of enzootic muscular dystrophy
- Chronic cases may resemble congenital cardiac defects

**Treatment** Antimicrobials to prevent and treat secondary bacterial pneumonia

**Control** Insure adequate colostral intake. Good housing and ventilation. Prevent crowding in calf barns. Raise dairy calves separate from adult cattle or in calf hutches

## ETIOLOGY

The cause is multifactorial, associated with various species of viruses, bacteria, mycoplasma, and environmental and host risk factors contributing to the pathogenesis, severity and nature of the pneumonia. Pathogens like mycoplasma and viruses may act as primary pathogens, and certain bacterial species may cause secondary complications.

### *Mycoplasma* spp.

The mycoplasma are considered as primary pathogens and probably the most important and most common etiological agents of calf pneumonia. *Mycoplasma bovis* is a major cause of calf pneumonia.<sup>1</sup> In addition, *Ureaplasma diversum*, *Mycoplasma dispar*,<sup>2</sup> and *M. bovirhinis* are isolated with a high frequency from the lungs of pneumonic

calves.<sup>3</sup> *M. canis* is being isolated with increased frequency. *Acholeplasma laidlawii* and *M. arginini* are also found but of dubious significance.<sup>1</sup> *M. bovis* produces clinical pneumonia experimentally in calves and has been isolated from severe epidemics of pneumonia in calves imported into one country from others.<sup>1</sup> The prevalence of nasal mycoplasmal flora in healthy cows and calves in the same herds is much lower.<sup>4</sup>

### Parainfluenza-3 paramyxovirus

The evidence for viruses as primary etiological agents is based on virus isolation, serological evidence of active infection, lesions of viral pneumonia, and experimental infection. The parainfluenza-3 (PI-3) virus has been isolated most commonly from affected calves and inoculation of the virus into colostrum-deprived calves results in a pneumonia that resembles the naturally occurring disease.

### Bovine respiratory syncytial virus

Bovine respiratory syncytial virus (BRSV) causes pneumonia in both dairy and beef cattle of all ages, but primarily in dairy calves under 6 months of age.<sup>5,6</sup> BRSV isolates belong to an antigenic grouping different from that of human respiratory syncytial virus (HRSV), and two distinct antigenic subgroups of BRSV exist.<sup>5,6</sup>

### Mixed viral and other pathogen infections

A survey of viral infections of the respiratory tract of calves over a 3-year period revealed that only BRSV, the PI-3 virus and bovine virus diarrhoea virus (BVDV) were significantly associated with disease. Seroepidemiological and clinical surveys of calves raised as herd replacements in dairy herds commonly reveals evidence of PI-3 virus and BRSV infections associated with respiratory disease. The rhinoviruses, adenoviruses, reoviruses, and enteroviruses were also isolated but in much lower frequency, and were considered not to be important. *Chlamydia* spp. have been associated with respiratory disease in calves and usually as part of a mixed infection with viruses and bacteria. Bovine coronaviruses have been isolated from calves with respiratory disease but their significance is uncertain.<sup>7</sup>

### Bacteria

*Mannheimia haemolytica* and *Past. multocida* may also be recovered from the lungs of calves with pneumonia and may act synergistically with the *Mycoplasma* spp. to cause a more severe and fatal pneumonia. Several different bacterial species including *Streptococcus* spp., *Staphylococci* spp., *Arcanobacterium pyogenes*, *Histophilus somni* and *Fusobacterium* spp. may also be recovered from pneumonic lungs.<sup>5</sup>

## EPIDEMIOLOGY

### Occurrence

#### Dairy calves

Enzootic pneumonia occurs most commonly in housed dairy calves from 2 weeks to 5 months of age being raised as herd replacements. Pneumonia can be responsible for up to 30% of all deaths of calves in dairy herds from birth to 16 weeks of age,<sup>8</sup> second to enteritis which can account for 44% of all deaths. Some farms report cases of pneumonia, while others have none.

Pneumonia can be the single largest cause of death in veal calf farms.<sup>9</sup> The calves are purchased at about 10 days of age, assembled into large groups of 25–50 per group and fed a milk substitute diet for about 16 weeks and then sent to slaughter. The peak incidence of disease occurs about 5 weeks after arrival in the calf house during which time PI-3 and BRSV are recovered most often.

**BRSV** appears to have assumed major importance as a causative agent of herd epidemics of pneumonia in housed dairy calves<sup>5,6</sup> weaned beef calves, and even adult cows. Serological surveys indicate that the prevalence of infection is high and varies from 60 to 80% of the cattle populations examined. Most mature cattle in some populations have seroconverted to the virus. However, the incidence of clinical respiratory disease associated with BRSV is much lower. Respiratory disease in weaned beef calves 6–8 months of age in North America has also been attributed to BRSV and is characterized by a sudden onset, commonly after the cold weather begins in the fall of the year.<sup>5,6</sup> Affected animals are commonly in good bodily condition and well-nourished. BRSV was the most commonly isolated viral agent in a series of 14 epidemics of pneumonia in housed dairy calves. The disease may be mild, moderate, or severe.

In dairy herds, clinical disease attributed to BRSV may appear initially in the youngest calves from 2 to 8 weeks of age in which the mortality will be highest, followed by disease in the mature lactating cows in which milk production will drop.

#### Beef calves

Enzootic pneumonia occurs in nursing beef calves and can account for significant reductions in weaning weight and a significant cause of economic loss due to disease in the neonatal period.<sup>10</sup> In cow-calf herds in northwestern Quebec, one of the major causes of a low percentage of weaned calf crop was the occurrence of diarrhea and pneumonia in calves under 2 weeks of age.<sup>11</sup> Pneumonia can also occur after beef calves have been housed.<sup>12</sup>

### Morbidity and case fatality

Morbidity rate and case fatality rates vary depending on the quality of housing and management provided, and the kind and concentration of viruses and bacteria that predominate in the environment at any one time. The morbidity rate may reach 100%, and the case fatality rate is usually less than 5%. In dairy calves under 3 months of age, the morbidity rate and case fatality risk for pneumonia were 25.6% and 2.25, respectively.<sup>13</sup> The cumulative risk incidence of respiratory disease in dairy heifers from birth to 8 weeks of age was 8.4%.<sup>14</sup> In acute respiratory syncytial viral pneumonia of calves there may be an unexpected acute onset of respiratory disease in which 80–90% of calves are affected, with a case fatality rate that may reach 30% or higher.

On veal calf farms, pneumonia can be the largest single cause of death, with mortality rates up to 3.7% and culling rates at 5.1%. Peak death and cull losses occur during the 7th and 8th week of production.<sup>9</sup>

In Ontario Holstein dairy herds, 15% of calves were treated for pneumonia before the age of weaning.<sup>15</sup> Treatment rates for pneumonia increased slightly until about the 6th week of life and then declined until weaning. Calves that had pneumonia during the first 3 months of life had an increased risk of mortality before they reached calving age.<sup>16</sup> In Holstein herds in New York, the crude incidence rate for respiratory disease within 90 days of birth was 7.4%.<sup>17</sup> In those same herds, dullness of calves and unspecified diagnosis within 90 days of birth increased the hazard rate of death after 90 days of age 4.3-fold above that for heifers without dullness within 90 days of birth.<sup>18</sup> These data indicate pneumonia in dairy calves in the first 3 months of age can have an adverse effect on long-term survival and subsequent growth rate.<sup>19,20</sup>

### Methods of transmission

**Aerosol infection** and **direct contact** are the methods of transmission and both are accentuated in crowded, inadequately ventilated conditions. The principal mode of transmission of *M. dispar* among calves reared in dairy farms is the airborne route up to several meters in distance.<sup>21</sup> Newborn calves raised in individual pens may become infected within 5–15 days after an experimentally infected calf is placed in the calf house.<sup>21</sup>

*M. bovis* has been isolated from calves exhibiting severe fibrinonecrotic bronchopneumonia that were imported directly from continental Europe into Northern Ireland.<sup>2</sup>

### Risk factors

Because most of the pathogens described under etiology can be found in the respiratory tract of normal calves, it has been generally accepted that environmental risk factors, such as ambient temperature, relative humidity, air quality, and population density, are necessary to precipitate the disease. In addition, several animal risk factors make calves susceptible to the pathogens in their environment. There are also pathogen risk factors that determine the disease outcome.

#### Animal risk factors

The onset of calf pneumonia occurs between 2 and 4 weeks of age when the concentration of serum IgG<sub>1</sub>, IgG<sub>2</sub> and IgA in the nasal secretions are lowest.<sup>22</sup> When the concentrations of serum IgG<sub>2</sub> begin to increase at about 2–4 months of age, the incidence rate of new cases of pneumonia begins to decline. The spectrum of colostral antibodies present in home-raised calves will depend on the spectrum of infection in the adult cows. Most calves that recover from clinical enzootic pneumonia are resistant to further attacks of the disease associated with the same infectious agents. Herd immunity to one or more viruses develops, and severe outbreaks of disease usually occur following the introduction of animals that may be carriers of infectious agents to which the resident animals are non-immune. In commercial veal calf units where market-purchased calves are being introduced on a regular basis, there is commonly a succession of minor epidemics of enzootic pneumonia. The incidence is highest in the recently introduced calves and the disease will occur in a small percentage of resident calves.

In a study of range beef calves from birth to 45 days of age, respiratory disease accounted for a total mortality of 1% and was associated with twins, which may result in a less viable calf at birth that may be neglected and abandoned.<sup>23</sup> The risk of respiratory disease was also higher for male calves. The recent advancement of calving dates of beef cattle herds in the cold areas of North America from April–June to January–March results in crowded conditions in calving yards, which creates the environmental conditions similar to those of housed dairy calves. This has increased the incidence risk for enzootic pneumonia in beef calves.

In herds infected with BRSV, newborn calves acquire colostral antibodies to BRSV, which declines to undetectable levels in an average of about 100 days with a range of 30–200 days.<sup>24</sup> It appears that colostral immunity does not protect calves from experimental or naturally occurring clinical disease, but active

immunity from natural infection with or without evidence of clinical disease will protect the animals from clinical disease but not from reinfection upon later exposures to BRSV.

#### Environmental and management risk factors

Environmental risk factors, such as inadequate housing and ventilation are major contributors to the disease process.<sup>25</sup> These include calving area, calf housing, spatial separation between calves, mixing calves of different age groups, and seasonal effects. Dairy herds that do not house calves in groups prior to weaning, or that house calves in groups of seven or fewer calves per group, are less likely to be affected with high mortality rate due to respiratory disease.<sup>26</sup> The calving area and environment can affect calf health through stress and the degree of exposure to infectious agents. Inadequate ventilation, improper climate control, and poorly constructed facilities can induce stress in calves. Crowding results in close contact and promotes spread of infection, and also results in excess moisture which, in the presence of inadequate ventilation (movement of air) and supplemental heat, causes a high relative humidity and chilling of calves. Many calf barns are old, adapted barns which are occupied for several months without depopulation and disinfection. Monitoring 48 dairy herds over 1 year in the National Animal Health Monitoring System, revealed that mortality was lower in herds that used calf hutches compared to those that did not.<sup>27</sup> In commercial veal units, the longer the disinfection and vacancy break, up to 6–7 days, the lower the incidence of disease in new calf crops entering the unit. Ventilation is commonly inadequate because of poor design of the building.

Rapid changes in weather, particularly during the winter months, are often followed by outbreaks of acute pneumonia because of inadequate ventilation. A common practice during cold weather is to close the air inlets and turn off the ventilating fans in an attempt to maintain the inside temperature at a comfortable level. This results in increased relative humidity, condensation of moisture on walls and on the calves, leading to wet conditions, and the reduced ventilation results in an increase in the concentration of droplet infection.<sup>17</sup> Attempts to correlate meteorological data with the daily morbidity rate have not yet provided evidence for the hypothesis that climatic factors have an influence on incidence. This may be due to the difficulties associated with accurately monitoring meteorological data, and the lack of a direct relationship between the environment

outside a calf barn and the microclimate of the calf inside the barn. The disease appears to be most common during the winter months when calves are housed continuously and when ventilation is commonly inadequate.

Humid weather results in a marked increase in the percentage of bacterial colony-forming particles of less than 4–7  $\mu\text{m}$  in size. This provides the beginnings of a sound physical framework for the explanation of this and other, as yet empirical, relationships between the microenvironment in calf barns and the etiology and epidemiology of calf pneumonia.

The management risk factors that can influence the incidence rate and mortality of calves with pneumonia include:

- Colostrum feeding practices
- General feeding practices
- Quality of perinatal care provided by the personnel
- Age at weaning
- Use of prophylactic antimicrobials
- Health management of the dams.<sup>28</sup>

The feeding of a coccidiostat to pre-weaned calves may be associated with an increase in the risk of pneumonia because herds with a history of disease would be more likely to feed a coccidiostat.<sup>29</sup>

Factors associated with mortality to 21 days of life in dairy heifers in the United States include:

- First colostrum-feeding method, timing and volume
- Time of separation from dam
- Calving ease
- Twin birth.<sup>30</sup>

Up to 31% of mortality is associated with ineffective colostrum feeding. The longer the calf is left with the dam after birth, the greater the mortality, presumably due to greater exposure of the calf to pathogens harbored by the dam. Difficult calving also may interfere with the optimum ingestion of colostrum and absorption of immunoglobulins.

A path model of individual-calf risk factors for calthood morbidity and mortality in New York Holstein herds indicated that management appeared to affect, directly and indirectly, the risk of respiratory disease within 90 days of birth.<sup>31</sup> Being born in loose housing is strongly related to development of clinical signs of calf diarrhea within 14 days of birth, which in turn increases the risk of respiratory disease within 90 days of birth.

Calves reared as herd replacements may be born inside and raised indoors until they are about 6 months of age and then turned out to pasture for the summer. In the case of veal calf-rearing units, the calves are kept and fed indoors

under intensive conditions from a few days of age until they reach 150 kg body weight (BW) at 12 weeks of age. In the barley-beef units, the calves are fed indoors on an intensive basis from weaning until they reach market weight at 10–12 months of age. In all of these situations, young, growing calves are raised together under confined conditions, which promotes the spread of bovine respiratory disease associated with several viruses, *Mycoplasma* spp., and *Pasteurella* spp. Based on serological surveys, most calves raised in close confinement will have become infected by several viruses, including the PI-3 virus, adenoviruses, bovine respiratory syncytial virus, infectious bovine rhinotracheitis, and bovine viral diarrhea. If natural exposure to these viruses, *Mycoplasma* spp., and bacteria is so widespread and inevitable, it raises serious questions about the rationale for vaccination. In most cases the effects of the viruses and *Mycoplasma* spp. are minimal. The stress factors associated with inadequate ventilation, high relative humidity and chilling, and the secondary bacterial complications are responsible for the onset of clinical disease.

#### Pathogen risk factors

The infectious agents are ubiquitous in the respiratory secretions of the animals and in their environment, and more numerous in crowded poorly ventilated conditions. The spectrum of infectious agents that are present and acting in a calf population and the severity of clinical disease will vary between farms, between countries, and from season to season. It has been assumed that the older calves and mature animals in a herd are the source of infection for the young calves. This assumes major importance in control measures that are commonly designed to rear calves separate from older animals.

*Mycoplasma dispar* colonizes the respiratory tract of experimentally infected young calves for several months and can be isolated from nasal swabs and transtracheal samples throughout the period of colonization. *M. dispar* and *Past. multocida* have been cultured from transtracheal aspirates of dairy calves with pneumonia under 3 months of age.<sup>11</sup> In calves aged 1–5 months in calf-rearing farms that purchase calves from dairy farms, the prevalence and level of colonization of the respiratory tracts with *Mycoplasma* spp. can be more than 90% over a 2-year period.<sup>21</sup> *M. dispar*, *M. bovirhinis*, and *Acholeplasma laidlawii* have all been isolated from such calves. A high degree of colonization with *M. dispar* among 1 to 2-month-old calves on these rearing farms indicates the ability of the pathogen to spread among the calves and colonize

the respiratory tract. *M. dispar* is able to spread very rapidly among groups of calves, and airborne transmission is considered to be an important mode of transmission in addition to direct contact. The infection rate in the calves at the farms of origin is small.

The number and types of *Mycoplasma* spp. that colonize the nose and trachea of calves are influenced by the age of calves and not by the environmental temperature or relative humidity. *Mycoplasma* spp. start to colonize the upper respiratory tract of calves within days after birth, and the peak isolation rate from their nasal cavities occurs at about 2–6 weeks of age, and from the trachea at 6–8 weeks of age.<sup>32</sup> Over 92% of calves collected from farms and reared in a controlled environment can harbor *Mycoplasma* spp. in their noses when they are 2 weeks of age. The rate of recovery falls gradually thereafter.

**Parainfluenza-3 virus** is commonly subclinical in a group of calves, and clinical disease may not occur until other pathogens are present or when adverse environmental conditions precipitate clinical disease. Following natural infection of young calves, the PI-3 virus may persist for several weeks. However, the presence of PI-3 infection may predispose to respiratory disease by interfering with normal pulmonary clearance mechanisms and allowing secondary invasion by bacteria or mycoplasmas.

**Bovine respiratory syncytial virus.** Infection with BRSV may be subclinical, mildly clinical, or highly fatal. Raising calves in close proximity to older cattle may result in constant exposure to infectious agents to which the mature animals are immune. The disease may be endemic on particular farms in which almost every calf experiences clinical disease. Herd epidemics may occur following the introduction of a different virus, such as BRSV, or following a breakdown in the ventilation system. The disease occurs specifically in nursing beef calves from 1 to 4 months of age while on pasture.

**Mixed flora.** While a mixed flora of viruses, mycoplasma and bacteria can be isolated from the respiratory tract of calves with pneumonia, and the unpassaged respiratory material can cause disease similar to the naturally occurring disease, the inoculation of pure cultures of *M. dispar*, *M. bovis*, and *Ureaplasma* spp., or pure cultures of BRSV or PI-3, into calves does not produce the severe clinical disease seen in the field. The failure of pure cultures of a pathogen to produce a severe pneumonia may be for one of three reasons:

- Combinations of organisms are required for disease

- Laboratory passage of the pathogens, necessary for purification causes their attenuation
- Material in the respiratory secretion other than the pathogens identified is required for disease, which may include agents that were not detected by routine culture techniques.

#### Economic importance

The economic losses associated with enzootic pneumonia may be considerable. One estimate reports that the disease accounts for 50% of all calf mortality and a reduction of 7.2% in liveweight gain. In commercial veal units, the presence of enzootic pneumonia may be associated with a prolonged time in the unit because of reduced daily liveweight gain.

The economic loss due to calfhood morbidity and mortality is well-recognized by the dairy industry. However, the long-term effects of morbidity from diseases such as enzootic pneumonia on health and performance may constitute an even greater economic loss to the herd. Calfhood diseases occurring in the first 3 months of life may have serious long-term consequences. Heifer calves that are treated for pneumonia during the first 3 months of life are 2.5 times more likely to die after 90 days of age than heifers that are not treated for pneumonia.<sup>16</sup> Heifer calves without respiratory disease are twice as likely to calve, and calved for the first time 6 months earlier, when compared to calves with respiratory illness as calves.<sup>33</sup> Some studies have found no significant independent association with calfhood disease status with first lactation milk production.<sup>34</sup> However, the population selected did not include all heifers affected as calves; a heifer could have a suboptimal rate of growth or unthrifty appearance and would be removed from the herd before milk production was measured.

#### PATHOGENESIS

##### Mycoplasma

The endobronchial or intratracheal inoculation of gnotobiotic calves with *Mycoplasma* spp. does not usually result in significant clinical disease. However, 2 or 3 weeks following inoculation, there is microscopic evidence of pneumonia. The lesions produced by experimental inoculation of calves with *M. bovis*, *M. dispar* or *Ureaplasma* spp. are characterized by **peribronchiolar and perivascular 'cuffing'**, catarrhal bronchiolitis, and atelectasis.<sup>1</sup> Intranasal inoculation of *Ureaplasma diversum* into SPF calves results in thick cuffs of round cells surrounding the bronchi, bronchioli and blood vessels, and a lobular catarrhal pneumonia.<sup>35</sup> However, clinical signs of

pneumonia are not observed. Inoculation of *M. canis* results in only a slight pathological change which disappears 9 days after infection. *M. dispar* produces an alveolitis without cuffing lesions. It is thought that the *Mycoplasma* spp. are synergistic with each other, viruses, and bacteria in producing the lesions of subclinical and clinical enzootic pneumonia.

*M. bovis* pneumonia in calves is characterized by coagulative necrosis and accumulation of catarrhal exudate in the airways resulting in a sudden onset of marked dyspnea, fever, and poor response to therapy. The coagulative necrosis does not cross the interlobular septa, which is in contrast to *Mann. haemolytica* which crosses the septa.

##### Viruses

The respiratory viruses can cause a viral interstitial pneumonia affecting the cranial lobes of the lung which may be subclinical, mildly clinical or severe and highly fatal.

##### Parainfluenza-3

Subclinical viral pneumonia associated with the PI-3 virus uncomplicated by secondary bacterial invasion is usually of minor importance. In subclinical PI-3 infection in calves, seroconversion will occur and at necropsy there are microscopic lesions consisting of bronchiolitis, bronchial and bronchiolar epithelial hyperplasia, alveolar epithelialization, and giant cell syncytial formation. In the mild form there are slight clinical signs such as coughing and polypnea. In the severe form of viral pneumonia, such as in respiratory syncytial viral infection, there is severe dyspnea, with mouth-breathing and an expiratory grunt, but a marked absence of toxemia compared with a bacterial pneumonia. Death can occur without secondary bacterial bronchopneumonia. Atelectasis and consolidation of the anterior lobes of the lungs are characteristic and account for the loud bronchial tones audible on auscultation over the anterior ventral aspect of thorax.

The experimental intranasal inoculation of the PI-3 virus into colostrum-deprived calves results in a pneumonia that is grossly and histologically similar to the naturally occurring disease. Within 2–4 days following infection there is bronchiolitis and bronchitis and cellular exudate in the bronchiolar lumina. These lesions become more severe and are accompanied by alveolar cell thickening and hyperplasia. Beginning at about 14 days following infection, there is healing of the bronchiolar and alveolar lesions. The bronchiolar exudate becomes organized by fibroblasts, and mononuclear cells predominate in the alveolar exudate. Bronchiolitis obliterans is

widespread but re-epithelialization of damaged bronchiolar mucosa and alveoli occur.

Experimentally, the PI-3 virus can affect alveolar macrophages, which may impair the lung clearance mechanisms and allow *Mann. haemolytica* to produce a secondary bacterial bronchopneumonia. However, aerosols of PI-3 followed by *Mann. haemolytica* 7 days later do not necessarily result in significant pulmonary disease.

After the primary viral pneumonia is established, bacterial invasion may occur and the resulting pneumonia will vary with the species of bacteria which are present. Secondary bacterial pneumonias usually respond to treatment, although relapses are common if the viral pneumonia is extensive. Viruses are capable of reducing the resistance of mucous membranes, allowing bacteria such as pasteurellae to invade tissues. They are also capable of destroying the cilia on the bronchial mucosa which act as an escalator and help to keep the lower respiratory tract free of potential pathogens. In animals where there is an uncomplicated viral pneumonia with very extensive lesions there may be minimal clinical signs and almost complete resolution.

**Bovine respiratory syncytial virus**  
Infection with BRSV in calves causes rhinitis, tracheitis, bronchitis, proliferative and exudative bronchiolitis, with accompanying alveolar collapse and multinucleated syncytial giant-cell formation in the epithelial lining and in the lumen of the bronchioles and alveoli.<sup>36</sup> The pulmonary function changes observed during the acute phase of the disease are consistent with a diffuse obstructive disease. This lesion could impair the lung clearance mechanism and predispose to bacterial bronchopneumonia. Experimental inoculation of gnotobiotic calves with BRSV produces macroscopic lesions of the lungs without clinical signs. The lesions consist of proliferative and exudative bronchiolitis, with accompanying alveolar collapse and mononuclear cellular infiltration of the peribronchiolar tissue and alveolar walls. Infected calves respond serologically by 11 days after inoculation. The experimentally induced lesions are commonly resolved by about 30 days after inoculation.

The effects of BRSV on bovine pulmonary alveolar macrophage function have been studied and there is only limited impairment at the *in vitro* level.<sup>37</sup> In experimentally infected calves the virus can be detected in the epithelial cells of bronchioli and alveoli by immunofluorescence.<sup>38</sup>

BRSV can replicate and induce cytopathological changes in airway epithelial cells which include bronchial ciliated and mucous cells and bronchiolar ciliated and non-ciliated epithelial (Clara) cells.<sup>39</sup> Syncytial epithelial cells may be observed in bronchi, bronchioles, alveoli, and in alveolar macrophages. However, syncytial cell formation is not unique to infection with BRSV since it may also occur in other viral infections of the lung. Whether or not BRSV can predispose to bacterial pneumonia is unknown, but the changes in lung tissue associated with the virus may affect lung clearance mechanism and predispose to secondary bacterial infection and inflammation.

The pathogenesis of acute fatal pneumonia due to the BRSV is not well-understood. The characteristic lesions are exudative or necrotizing bronchiolitis, atelectasis, interstitial edema, and emphysema. Field observations have recorded that the acute fatal disease is commonly preceded by a mild respiratory disease several days previously, which suggests that hypersensitivity may be an important pathogenetic mechanism causing lung injury. The second stage may follow initial improvement or recovery from the first stage, and is associated with the onset of extreme respiratory distress. However, these observations have not yet been validated. The acute fatal disease attributed to BRSV has been reproduced experimentally in colostrum-fed, conventionally reared 1-month-old calves.<sup>40</sup>

#### CLINICAL FINDINGS

Regardless of the identity of the causative pathogen, the clinical findings in almost all enzootic pneumonias of calves are similar. In the **experimental viral pneumonia**, a febrile reaction occurs on about the 5th day and is followed by the appearance of rhinitis, pneumonia, and mild diarrhea. The fever is only moderate (40–40.5°C, 104–105°F). A harsh, hacking cough, easily stimulated by pinching the trachea, is characteristic.

In **naturally occurring cases**, the clinical findings are similar, although the fever is usually higher. This may be due to bacterial invasion in the early stages. The nasal discharge is only moderate in amount and is mucopurulent. On auscultation of the thorax the major abnormalities can be detected over the ventral aspects of the apical and cardiac lobes. The breath sounds are loud and harsh and represent breath sounds transmitted through consolidated lung. The intensity of the heart sounds is increased because of shrinkage of lung tissue in the cardiac area. The usual course ranges from 4 to 7 days. Some peracute cases of uncomplicated viral pneumonia

die within 1 day after the onset of signs. Infections with the PI-3 virus generally cause mild respiratory disease characterized by coughing, nasal discharge, slight fever, and recovery in a few days.

*M. bovis* pneumonia in young calves is characterized by the sudden onset of severe dyspnea, fever, and rapid deterioration in spite of therapy.

In **BRSV pneumonia** there may be a sudden onset of acute pneumonia in 80–90% of a group of calves. The clinical findings are characteristic of a severe viral pneumonia. Affected calves are usually mentally alert and there is only a mild fever. There is polypnea and dyspnea which in a few days become worse with mouth-breathing and an expiratory grunt. Loud breath sounds, indicating consolidation, are audible over the anterior lobes of the lung. Squeaky, wheezing sounds due to the bronchiolitis are also commonly audible over the periphery of the consolidated areas. Loud, crackling sounds due to interstitial emphysema may also be audible over the dorsal aspects of the lungs. Death may occur in 2–4 days in spite of intensive therapy.

When secondary bacterial bronchopneumonia occurs, the fever, dyspnea, and toxemia are usually more severe. When secondary infection with *Pasteurella* spp. occurs, the temperature rises to 41–41.5°C (106–107°F), the area of lung affected is much increased, and loud harsh breath sounds due to edema are followed by crackles and a pleuritic friction rub. These cases usually respond rapidly to adequate treatment. When *Arcanobacterium pyogenes* is the secondary invader, consolidation is marked, there is a profound toxemia and loud breath sounds. In cases where *Fusobacterium necrophorum* is present, the clinical findings are similar and pulmonary abscesses are likely to develop. Necrotic lesions are often present in the mouth and pharynx in these cases and the pulmonary infection probably originates from here. With both of these latter infections there may be some response to antibiotic treatment, but there is a predisposition to relapse soon after treatment is terminated. Coughing, dyspnea, anorexia and emaciation continue, and the animal eventually has to be destroyed.

#### CLINICAL PATHOLOGY

##### Isolation of pathogens

Nasopharyngeal swabs, transtracheal aspirates, and lung lavage samples<sup>3,13</sup> may be taken for isolation of viruses, mycoplasmas, and bacteria. Special laboratory media are required to isolate *Mycoplasma* spp.<sup>35</sup> Determination of drug sensitivity to the bacteria may be valuable, particularly

when a number of calves are involved in an outbreak. The isolation of BRSV from natural infections is difficult due to the labile nature of the virus. The immunofluorescent antibody test for antigen detection is one of the most rapid, reliable, and sensitive tests for BRSV from tracheal aspirates, nasal swabs, and lung samples.

### Serology

Serological tests have been more extensively used for confirmation of suspected BRSV infections. The standard serological test is a virus-neutralization test using microtiter plates.<sup>41</sup> Others include a modified indirect fluorescent antibody test,<sup>6</sup> indirect hemagglutination, and an ELISA test, the latter of which is considered to be sensitive and specific and has the advantage of giving test results within several hours whereas the virus-neutralization test requires 5–6 days for completion. The complement fixation test is less specific and less sensitive than the ELISA test.

### NECROPSY FINDINGS

In uncomplicated viral pneumonia, irrespective of the specific cause, there are areas of atelectasis and emphysema in the apical and cardiac lobes, with little macroscopic involvement of the diaphragmatic lobes. In the later stages, a dark red consolidation featuring a hobnail appearance of the pleural surface affects most of the ventral portions of the apical and cardiac lobes. The lesions are always bilateral. Histologically, there is a broncho-interstitial pneumonia. Acute inflammation of the nasal mucosa, particularly on the turbinates and ethmoid bones, is usually accompanied by a marked, mucopurulent exudation. In PI-3 infection, intracytoplasmic inclusion bodies are widespread in the lungs; and after experimental infection, are present on the 5th day, but have disappeared by the 7th day after infection.

In respiratory syncytial viral pneumonia there is severe interstitial pneumonia and interstitial emphysema. Histopathologically, there is severe bronchiolitis, alveolitis with multinucleated syncytia (which often contain eosinophilic intracytoplasmic inclusion bodies), and alveolar epithelial cell hyperplasia.

When bacterial or mycoplasmal invasion has occurred, the lesions vary with the agent present. Extensive hepatization with mottled red and gray lobules, and considerable interlobular aggregations of serofibrinous fluid, often accompanied by a fibrinous pleuritis, is characteristic of *Past. multocida* infection. Extensive consolidation and suppuration occur with *A. pyogenes* and *F. necrophorum* infections. In the latter case there may be necrotic

lesions in the mouth and upper respiratory tract.

Confirmation of this diagnosis at necropsy is somewhat awkward, as the population of pathogens responsible may change between the time of disease onset and the death of the calf. In severe outbreaks it may be necessary to euthanize animals early in the course of the disease, or to perform serological surveys for respiratory pathogens among surviving herdsmates.

### Samples for confirmation of diagnosis

- **Histology** – lung (several sections), trachea, turbinate (LM, IHC)
- **Virology** – lung (several sections), trachea (FAT, ISO)
- **Mycoplasmology** – lung (MCULT, FAT)
- **Bacteriology** – lung (CULT).

### DIFFERENTIAL DIAGNOSIS

Clinically, the diagnosis of pneumonia is usually readily obvious, but the causative agents are usually not determined. Young calves raised indoors and affected with a cough, nasal discharge, and pneumonia are usually affected with enzootic pneumonia associated with the agents described under etiology. The common diseases of the respiratory tract of young calves which may resemble enzootic pneumonia include the following:

- Bacterial pneumonia due to *Mann. haemolytica*, *Klebsiella pneumoniae* or *H. somni* in young calves characterized by severe toxemia, fever, dyspnea, grunting, and a poor response to therapy
- *M. bovis* pneumonia is characterized by sudden onset of dyspnea, fever, depression, and poor response to therapy in a group of calves
- Calf diphtheria usually affects a single calf and is characterized by inspiratory dyspnea, stridor, toxemia, fever, and obvious lesions of the larynx
- Lungworm pneumonia occurs in young calves at pasture, and marked dyspnea, coughing, and a few deaths are characteristic. A fever is common in lungworm pneumonia and there are loud breath sounds over the ventral aspects of the lungs, and loud and moist crackles over the dorsal aspects
- Acute myocardial dystrophy in young calves, following turn out on pasture, is characterized by sudden onset of weakness, polypnea and dyspnea due to pulmonary edema and lesions of the diaphragm, tachycardia and arrhythmia, and skeletal muscular weakness
- Aspiration pneumonia occurs occasionally in calves that have been force-fed colostrum or milk. There is a sudden onset of marked dyspnea, anxiety and distress, and death may occur within a few minutes. However, some calves survive and there is marked

dyspnea with abdominal breathing, and loud breath sounds and crackles over the dorsal and ventral aspects of both lungs. Some calves will recover completely in a few days

- BRSV interstitial pneumonia in weaned beef calves must be differentiated from pneumonic pasteurellosis. In BRSV pneumonia there is a sudden onset of marked dyspnea, fever, anxiety but not toxemia, mouth-breathing in advanced cases, loud breath sounds and wheezes over both lung fields especially over the ventral aspects, and subcutaneous emphysema. Several animals are usually involved. Affected animals fail to respond to treatment with antimicrobials and the case fatality rate is usually over 75%. There may be a history of mild respiratory disease in the affected group about 10 days previously. In pasteurellosis, depression, toxemia, fever, loud breath sounds over the ventral aspects of the lungs, and a favorable response to treatment are characteristic
- Chronic enzootic pneumonia is characterized by bronchiectasis and pulmonary abscessation, causing unthriftiness and a poor response to therapy.

### TREATMENT

#### Antimicrobial therapy

Uncomplicated enzootic pneumonia associated with mycoplasma or viruses is unlikely to respond to treatment, but antimicrobial therapy daily for 3 days is indicated because of the high probability of secondary bacterial pneumonia. Any of the antimicrobials used commonly for the treatment of acute undifferentiated bovine respiratory disease are effective. The short-acting or long-acting oxytetracyclines, the trimethoprim-potentiated sulfonamides, and florfenicol are efficacious and are recommended. Penicillin, tilmicosin, and ceftiofur are also effective for the treatment of secondary bacterial pneumonia. Danofloxacin has excellent in vitro activity against several field isolates of *Mycoplasma* spp. from cattle,<sup>42</sup> and has potential for the treatment of respiratory infections associated with *Mycoplasma* spp.<sup>42</sup> Early treatment is necessary to avoid the development of incurable secondary complications, such as pulmonary abscesses, pleuritis, bronchiectasis, and suppurative pneumonia. In commercial veal calf units, the case fatality rate can be kept to a low level by early and adequate treatment. In some cases it may be sufficient to treat animals once only, but a proportion of cases are likely to relapse after an initial response. Such cases require repeated daily therapy for 3–5 days. If the number of relapses in an area or on a farm is excessive, all cases should receive multiple treatments.

*M. bovis* strains in Europe are becoming resistant to antibiotics traditionally used for mycoplasma infections in particular oxytetracyclines, florfenicol, tilmicosin, and spectinomycin<sup>2,43</sup>; only danafloxacin showed any antimycoplasma activity.<sup>44</sup> Spectinomycin had only partial therapeutic effect in calves experimentally infected with *M. bovis*.<sup>24</sup> The fluoroquinolones are still effective but their use in animals is controversial.<sup>25</sup>

Valnemulin, a pleuromutilin antibiotic with high activity against mycoplasmas had some beneficial effect when added to the milk from four days of age for 3 weeks of one-month-old calves with respiratory disease from which *M. bovis* was isolated in about 80% of cases.<sup>45</sup> Treated animals had less severe clinical disease but individual treatment was still necessary.

#### Adjunctive therapy

Bronchodilators and NSAIDs as adjunctive therapy for enzootic pneumonia in calves are used but their efficacy is questionable.

#### Correction of adverse environmental conditions

The clinical management of an outbreak of enzootic pneumonia in calves must include correction of adverse environmental conditions, which may have precipitated the disease.

#### CONTROL

##### Environmental and managerial

Control of the disease in housed calves is dependent on effective animal and environmental management. Overcrowding, drafty or inadequately ventilated housing, exposure to inclement weather, and sudden changes in environmental temperatures are major risk factors. Recently purchased calves should be isolated for several weeks before being introduced to the group.

##### Ideal environmental conditions

Control is especially difficult and expensive in countries where the calves are housed for several months during the winter months in northern climates. The most comfortable ambient temperature for young calves ranges from 13 to 21°C (55–70°F) with a relative humidity of 70%. To achieve these environmental conditions requires a suitable insulation material in the walls and ceilings, ample bedding to absorb moisture from feces and urine, and adequate movement of air to remove aerosol particles that may be infectious. This requires an adequate air inlet and outlet system, adequate capacity fans, and supplemental heat during very cold periods. The installation of recirculating air filter units can lead to a substantial reduction in the concentration of airborne bacteria to which calves are

exposed. field studies in veal calf units indicate that mean aerial bacteria concentration in filtered barns can be reduced by 45%, the number of calves requiring treatment reduced by 19%, the number of repeat courses of treatment and the total antibiotic usage reduced by 29% and 35%, respectively. At slaughter, the average area of lung consolidation in calves from filtered barns can be reduced by 35%. In general, air filtration can result in a reduction in both the incidence and severity of clinical and subclinical pneumonia in calves and in improved weight gain.

In spite of ideal hygiene and management it may not be possible to prevent the development of new cases if the infection already exists in a herd, or if cattle from other herds are moved into the herd. At present, it is feasible only to be vigilant and treat new cases urgently and vigorously, because a strict hygiene program may not be feasible in the average commercial herd. If management is inadequate and the general resistance of the animals is low, losses due to calf pneumonia with significant bacterial or mycoplasmal invasion can be sufficient to make calf-rearing unprofitable.

##### Calf barns or hutches

Where economics permit, the ideal situation is to construct a calf barn completely removed from the main adult cow barn to minimize the spread of infection from adults that may be symptomless carriers. After the colostrum feeding period, calves are removed from the calving barn and placed in individual pens in the calf barn. The raising of young calves outdoors in calf 'hutches' or 'igloos' is highly satisfactory and economical, even in countries where the outside temperatures go well below freezing. With adequate bedding, protection from the prevailing winds and adequate nutrition, calves will grow satisfactorily. Dairy herds that have had difficulty controlling enzootic pneumonia of calves have found this system to be an excellent alternative to the construction of a stand-alone, well-ventilated calf house. Nutritional deficiencies, usually of energy and protein, are common in young calves and often accentuate the severity of the pneumonia. Young calves should receive a balanced calf starter grain ration supplemented with essential vitamins and minerals, and good quality hay beginning by at least 3 weeks of age.

##### Vaccines and immunization

There is **insufficient information** available from field trials to make recommendations for the use of vaccines for the control of enzootic pneumonia in calves. It is difficult to evaluate the results

of vaccination trials because investigators use so many combinations of vaccines, different vaccination schedules, and there are many different management variables and differences in methods of evaluation. In addition, most vaccination trials are not randomized controlled trials.

Any successful vaccine would have to be multivalent and would have to be effective when given before 2 months of age or earlier to coincide with the decline in immunity and the occurrence of enzootic pneumonia in calves. A study of vaccination of calves in a commercial calf-rearing unit that compared the use of no Vaccine intranasal infectious bovine rhinotracheitis (IBR), intranasal IBR-PI-3, and intranasal IBR-PI-3 plus BRSV on three occasions at 7, 10, and 16 weeks did not have a significant effect on growth rates during a 10-month period to slaughter.<sup>46</sup> There is good field evidence that the colostrum immunological status of the calf has a significant effect on the susceptibility of the calf to pneumonia.<sup>47</sup> There is a clear association between low levels of IgG<sub>1</sub>, IgG<sub>2</sub> and IgA of calves at 2–3 weeks of age, and subsequent susceptibility to pneumonia at 2–3 months of age. Calves with signs of pneumonia had low levels of IgG<sub>1</sub> compared with non-pneumonic calves which had relatively higher levels. In addition, calves with high levels of serum immunoglobulin do not respond normally to vaccine and any vaccine for enzootic pneumonia would have to be administered during this relatively refractory period. However, for veal calves, which are purchased at a few days of age and with low levels of immunoglobulin, this may not be a problem.

The intranasal inoculation of calves with virulent or a modified strain of PI-3 virus stimulates the development of both serum antibody and nasal secretion antibody. The nasal secretion antibody is dose-dependent. Challenge exposure of these calves provides protection against clinical disease. These factors should be considered in the development and administration of PI-3 viral vaccines if the objective is to establish an optimal concentration of antibody in the nasal secretion. The parenteral administration of two sequential doses, 2 weeks apart, of an inactivated PI-3 virus vaccine with adjuvant will induce high levels of serum antibody and prevent virus excretion in nasopharyngeal secretions after challenge. Successful immunization of calves against PI-3 infection may be useful for protection against pneumonic pasteurellosis if PI-3 precedes the bacterial infection. This is presented in greater detail in the section on pneumonic pasteurellosis.



A quadrivalent vaccine containing the inactivated antigens of BRSV, PI-3, *M. dispar*, and *M. bovis*, or a vaccine containing only BRSV, given to two vaccinated groups respectively, and compared to controls, provided protection against naturally occurring pneumonia and non-fatal respiratory disease in a large beef-rearing unit over a period of 2 years in the United Kingdom.<sup>48</sup> Calves were collected from farms in the first few weeks of life and reared in the unit in groups of 100 until slaughter at about 18 months. The proportion of calves receiving treatment for respiratory disease was 38% in the control group, 25% in those vaccinated with the quadrivalent vaccine and 27% in those vaccinated with the BRSV vaccine. Mortality in the control group was 9%, 2% in the quadrivalent vaccine group, and 3% in the BRSV-vaccinated group.

A single dose of an experimental vaccine for *M. bovis* pneumonia, inactivated with saponin, given subcutaneously to 3 to 4-week-old calves followed by experimental challenge 3 weeks later with a virulent strain of *M. bovis* provided protection against clinical pneumonia.<sup>22</sup> Unvaccinated calves developed clinical signs of disease due to lung lesions. The vaccine also reduced the spread of *M. bovis* to internal organs. Calves tested 6 months after immunization had high levels of humoral immunity. The successful use of saponin in vaccines has been demonstrated for other mycoplasma infections such as contagious caprine pleuropneumonia (CCPP) and contagious agalactia. The saponin may preserve the major antigens seen in untreated whole cells.<sup>49</sup>

The evaluations of BRSV vaccines are currently in progress and the preliminary results are inconclusive. A combined vaccine containing *Mann. haemolytica*, *H. somni*, and a modified live-virus for the control of enzootic pneumonia in young beef calves vaccinated at 3 and 5 weeks of age reduced the number of calves requiring treatment.<sup>50</sup>

## REVIEW LITERATURE

- Baker JC, Ellis JA, Clark EG. Bovine respiratory syncytial virus. *Vet Clin North Am Food Anim Pract* 1997; 13: 425-454.
- Larsen LE. Bovine respiratory syncytial virus (BRSV): A review. *Acta Vet Scand* 2000; 41:1-24.
- Nicholas RAJ, Ayling RD. *Mycoplasma bovis*: disease, diagnosis and control. *Res Vet Sci* 2003; 74: 105-112.

## REFERENCES

- Nicholas RAJ, Ayling RD. *Res Vet Sci* 2003; 74:105.
- Tegtmeier C et al. *Vet Microbiol* 2000; 72:229.
- Ter Laak EA et al. *J Vet Med Series B* 1992; 39:553.
- Ter Laak EA et al. *J Vet Med Ser B* 1992; 39:610.
- Larsen LE. *Acta Vet Scand* 2000; 41:1.
- Baker JC et al. *Vet Clin North Am Food Anim Pract* 1997; 13:425.
- Narita M et al. *Vet Pathol* 2002; 39:565.
- Sivula NJ et al. *Prev Vet Med* 1996; 27:155.
- Saargeant JM et al. *Can J Vet Res* 1994; 58:189.
- Wittum TE et al. *Prev Vet Med* 1994; 19:15.
- Ganaba R et al. *Prev Vet Med* 1995; 24:31.
- Scott PR. *Vet Rec* 1994; 134:325.
- Vitula AMK et al. *J Am Vet Med Assoc* 1996; 208:2035.
- Wells SJ et al. *Prev Vet Med* 1996; 29:185.
- Waltner-Toews D et al. *Prev Vet Med* 1986; 4:103.
- Waltner-Toews D et al. *Can J Vet Res* 1986; 50:314.
- Curtis CR et al. *Prev Vet Med* 1988; 5:293.
- Curtis CR et al. *Prev Vet Med* 1989; 7:173.
- Vitula AMK et al. *J Dairy Sci* 1996; 79:1040.
- Vitula AMK et al. *J Dairy Sci* 1996; 208:2043.
- Tanskanen R. *Acta Vet Scand* 1987; 28:209.
- Nicholas RAJ et al. *Vaccine* 2002; 20:3569.
- Wittum TE et al. *Prev Vet Med* 1994; 19:1.
- Poumarat F et al. *Vet Microbiol* 2001; 80:23.
- Nicholas RAJ et al. *Cattle Pract* 2000; 8:115-118.
- Losinger WC, Heinrichs AJ. *J Am Vet Med Assoc* 1996; 209:1756.
- Lance SE et al. *J Am Vet Med Assoc* 1992; 201:1197.
- Brunning-Fann C, Kaneene JB. *Vet Bull* 1992; 62:399.
- Sivula NJ et al. *Prev Vet Med* 1996; 27:173.
- Wells SJ et al. *Prev Vet Med* 1996; 29:9.
- Curtis CR et al. *Prev Vet Med* 1988; 6:43.
- Woldehiwet Z et al. *Br Vet J* 1990; 146:419.
- Correa MT et al. *Prev Vet Med* 1988; 6:253.
- Warnick LD et al. *J Dairy Sci* 1995; 78:2819.
- Ter Laak EA et al. *J Comp Path* 1993; 108:121.
- Bryson DG. *Vet Med* 1993; 88:894.
- Schrijver RS et al. *Arch Virol* 1995; 140:1905.
- Viuff B et al. *Vet Pathol* 1996; 33:383.
- Bryson DG et al. *Vet Pathol* 1991; 28:286.
- Ciszewski DK et al. *Vet Microbiol* 1991; 28:39.
- Dubovi EJ. *Vet Med* 1993; 88:888.
- Cooper AC et al. *Res Vet Sci* 1993; 54:329.
- Thomas A et al. *Vet Rec* 2003; 153:428.
- Ayling RD et al. *Vet Rec* 2000; 146:74:5.
- Stipkovits L et al. *Vet Rec* 2001; 148:399.
- Thomson JR et al. *Vet Rec* 1986; 119:450.
- Corbeil LB et al. *Am J Vet Res* 1984; 45:773.
- Stott FJ et al. *Vet Rec* 1987; 121:342.
- Tola S et al. *Vaccine* 1999; 17:2764.
- Van Donkersgoed J et al. *Can Vet J* 1994; 35:239.

## VIRAL PNEUMONIA IN OLDER CALVES, YEARLINGS AND ADULT CATTLE (BOVINE RESPIRATORY SYNCYTIAL VIRAL PNEUMONIA)

### Synopsis

**Etiology** Bovine respiratory syncytial virus (BRSV). Subtypes A, B

**Epidemiology** Prevalence of infection high; disease most common in cattle under 6 months of age but adult cattle also affected; recurrent infections and disease in herds common; persistent infection in few seropositive cows. Immunity following natural infection or vaccination short-lived. Antibodies following natural exposure are different than those following experimental infection or vaccination. Maternal antibody does not prevent infection but high levels decrease severity of clinical disease

**Signs** Mild, moderate, or severe dyspnea, fever, agalactia, coughing, wheezes of lungs, most animals recover, small percentage develop severe fatal viral interstitial or bacterial pneumonia. Outbreaks occur in cattle under 6 months of age and also in adult cattle

**Clinical pathology** Difficult to isolate, or detect virus in tissues.

Immunohistochemical tests of nasopharyngeal swabs and lung tissue. Serology

**Differential diagnosis** Pasteurella pneumonia. Other viral interstitial pneumonias. Infectious bovine rhinotracheitis. Lungworm pneumonia

**Treatment** Nothing specific

**Control** Minimize stressors. Control by natural exposure and treat secondary bacterial pneumonia. Modified live-virus and inactivated virus vaccines available but efficacy uncertain because lack of field trials

## ETIOLOGY

The bovine respiratory syncytial virus (BRSV) is a cause of a viral pneumonia primarily in cattle under 6 months of age, and also yearlings and adult cattle. The BRSV is a pneumovirus in the family Paramyxoviridae.<sup>1</sup> Isolates of the virus from calves with severe respiratory disease in a region of Britain are more closely related by genetic analysis sequences to US isolates than to earlier British and mainland European isolates.<sup>2</sup> Importation of live cattle from North America to Britain may explain the relatedness of the isolates. The literature of the history and taxonomy of the virus has been reviewed.<sup>1</sup>

## EPIDEMIOLOGY

### Occurrence

Prevalence of infection

The virus is ubiquitous in the cattle population and new infections occur most commonly in autumn and winter annually and may result in severe respiratory disease. In longitudinal studies in dairy herds, 90% of primary infections occur in calves and heifers; very few occur in cattle over 2 years of age, and all cattle in the herds are seropositive when they are over 3 years of age.<sup>1,3</sup> Recurrent infections occurring annually at the same time, and in cows of all ages, without new introductions into the herd, are characteristic of BRSV infections in a herd.<sup>3</sup> There is evidence that the virus circulates during spring or summer at very low levels or not at all. Persistent BRSV infection in some of the cows in a herd might be a means for the virus to survive during the summer, but a steady state of reinfection of seropositive cows throughout the year at a low level might also maintain a reservoir of infection. Monthly data on the prevalence of BRSV antibodies in dairy herds suggest that persistent infection in seropositive cows is more likely than population persistence.<sup>3</sup>

While the prevalence of infection in the cattle population is high, the incidence rate of clinical disease is much

lower.<sup>3</sup> It can be assumed that most mature cattle have been exposed to the virus. Surveys in the United States, England, Denmark, Sweden, and France found seropositive rates in herds ranging from 50 to 80%. Cattle entering feedlots may seroconvert to the virus, which may be associated with an increased risk to subsequent treatment for respiratory disease.<sup>3</sup> A high percentage of young beef bulls aged about 6 months and entering performance test stations may seroconvert to BRSV and adenovirus, both of which may be associated with clinical respiratory disease.

#### Occurrence of clinical disease

In general, calves under 6 months of age are most commonly affected and some BRSV infections are undoubtedly associated with enzootic pneumonia of housed dairy calves. In **dairy herds**, recent introductions of young cattle purchased from public saleyards may introduce the infection to home-farm cattle that have had no previous exposure to the viruses, or in which their immunity to a previous infection with the virus has declined. Thus, adult dairy cows may be affected with a highly fatal pneumonia due to the virus.<sup>4</sup> A high prevalence of infection exists in Swedish cattle and annual outbreaks of disease have occurred in adult cattle, pregnant or recently calved cows being most severely affected.<sup>5</sup> Outbreaks have occurred in beef cattle on pasture.<sup>6</sup> The disease occurs in **nursing beef calves** 1–8 months of age on pasture with their dams without any history of previous stress. A common occurrence is in **weaned beef calves** 6–8 months of age within 2–3 weeks following weaning and commingling in confinement.<sup>6</sup> Yearling cattle in feedlots are also susceptible.

In North America, herd epidemics of clinical disease usually occur during the **fall** and **winter months**.<sup>3</sup> However, nursing beef calves may be affected with clinical disease during the summer months. Some outbreaks have occurred in nursing beef calves between 1 and 2 months of age while they are still in nursery pastures or in the calving areas.

A spontaneous outbreak of respiratory disease in goats due to the BRSV has been described,<sup>7</sup> and sheep can be infected with the virus.<sup>8</sup>

An epidemic of acute respiratory disease associated with the BRSV occurred during the winter and spring of 1995 in Norway.<sup>9</sup> Data from 431 cattle herds were collected. The risk of acute respiratory disease occurring in cattle was related to herd size and type of production and an expressed interaction between these two variables. The risk of a herd outbreak in a mixed

herd of 20 animals was estimated to be 1.7 times greater than in a dairy herd, and 3.3 times greater than in a beef herd of comparable size. On increasing herd size to 50 animals, the risk increased 1.3 fold for a mixed herd, 3.3 fold for a dairy herd, and 2.1 fold for a beef herd, compared to a risk for a corresponding type of herd of 20 animals. The disease spread initially from one location to another during the first 6 to 9 weeks, where the rate of transmission between neighboring farms seemed to be higher than for the other districts included in the study. It was hypothesized that one common source of infection was involved in the outbreak and the case herds were clustered in time as well as spatially.<sup>10</sup> The average daily milk loss was estimated to be 0.70 kg per cow for 7 days after a herd outbreak compared with the period one week before.<sup>11</sup>

#### Morbidity and case fatality

The morbidity rate in herd epidemics of clinical disease can vary from 30 to 50% or higher. The case fatality rate is usually low, 3–5%, but may be higher.<sup>3</sup>

#### Methods of transmission

The mode of transmission has not been defined but aerosol infection and direct contact are probable. Infection spreads rapidly among susceptible cattle.

#### Risk factors

##### Animal risk factors

Naturally occurring BRSV infection affects both dairy and beef cattle and those under 6–10 months of age are most susceptible to clinical disease. Nursing beef calves with colostral BRSV antibody are not protected from infection but the incidence and severity of clinical disease is inversely related to the level of maternal antibodies in calves younger than 3 months.<sup>2</sup> The highest percentage of reinfections occurs most commonly in cows during their first lactation.<sup>12</sup> Older animals may have a more effective immunity because of previous exposure.

Seroepidemiological surveys in **feedlot cattle** found that seroconversion to the virus may occur in up to 70% of animals within 1 month after arrival.<sup>13</sup> Animals with low titers to the virus on arrival are at increased risk of subsequent treatment for respiratory disease, which suggests that the virus may be a factor in bovine respiratory disease. In some situations in feedlot cattle, high BRSV serum antibody levels on arrival were related to a lower risk of respiratory disease.<sup>6</sup>

##### Environmental risk factors

The highest incidence of clinical disease occurs in autumn and winter months. Outbreaks have been associated with

changes in weather, especially declining ambient temperatures and atmospheric pressure.

#### Pathogen risk factors

BRSV has a narrow host range, affecting primarily cattle. Important antigenic differences between BRSV isolates have been described. Subgroups A and AB are associated with severe respiratory disease and circulate in the Dutch cattle population.<sup>1</sup> In natural outbreaks of infection in closed dairy cattle herds and veal calf units in Denmark, using DNA sequence data, identical viruses were isolated within a herd during outbreaks, but viruses from recurrent infections varied by up to 11% even in closed herds.<sup>14</sup> It is possible that a quasispecies variant swarm of BRSV persisted in some of the calves in each herd and that a new and different highly fit virus type (master and consensus sequence) became dominant and spread from a single animal in connection with each outbreak.

Antigenic subtypes may have relevance both in explaining differences in virulence between subtypes and in the development of new vaccines for the control of clinical disease.<sup>15</sup> The production and characterization of monoclonal antibodies to a vaccine strain of BRSV has been described.<sup>16</sup> The respiratory syncytial virus of goats and sheep, caprine respiratory syncytial virus and ovine respiratory syncytial virus are antigenically related, but not identical, to BRSV.

The BRSV may act synergistically with a concurrent experimental challenge of the virus and 3-methylindole to produce more severe pulmonary disease similar to BRSV pneumonia seen in feedlot cattle, than either agent alone.<sup>15</sup> But vaccination of cattle with BRSV vaccines does not protect the potential synergism between the 3-MI and BRSV infection.<sup>17</sup>

Whether or not the virus persists in individual animals in spite of the presence of maternal or naturally-acquired antibodies has been a major question. Serological findings indicate persistence of the virus but the virus could not be detected in lung lavage fluid or nasal swabs.<sup>18</sup> Experimentally, the virus persisted in tracheobronchial and mediastinal lymph nodes for up to 71 days after infection.<sup>19</sup> In vitro, the virus was still able to replicate in bovine B-lymphocyte cell lines 6 months after infection. This may explain the absence of the virus between epidemics, recurrent infections in the same individuals and inapparent re-infection of adults.

#### Immune mechanisms

After a natural BRSV infection, the protection is short-lived and multiple reinfections are common.<sup>1,3</sup> In endemic

areas, the absence of BRSV-associated disease in adult cattle is possibly due to repeated infections. This places a constraint on vaccine development, because one or two vaccinations would have to induce immunity that only repeated natural infections can provide. BRSV infections can occur in the presence of high to moderate levels of maternal antibodies.<sup>3</sup> Maternal antibodies, which are directed against the F, G and N proteins of BRSV, are commonly present in calves, but do not protect against infection.<sup>1,3</sup> However, the incidence and severity are inversely related to the level of specific maternal antibody,<sup>3</sup> and natural infection does not prevent reinfection but appears to offer good protection against clinical disease after infection.

The BRSV colostral antibody of dairy calves varies dependent on season of the year the calves are born.<sup>20</sup> Dairy calves born during the winter months in the Netherlands have lower BRSV colostral antibody titers than those born during the summer months. This may be due to the seasonal periodicity of BRSV circulation or by other factors influencing antibody development or colostrum intake is uncertain. Calves born in the summer have higher antibody titers at 14 to 19 weeks of age most likely attributable to BRSV exposure. Calves born during the season of infection may be primed with BRSV field virus during the period of maternally derived immunity and may be better protected against disease by cellular immunity during the next season of infection.

IgM and IgA are the predominant antibody isotypes in the respiratory tract after BRSV infection, with IgA especially prominent after reinfection.<sup>3</sup> Both serum antibody responses and local antibody responses are suppressed by maternal antibodies.<sup>3</sup> After natural BRSV infection of cattle, antibodies are predominantly directed against the epitope A, whereas after experimental infection, or vaccination with an inactivated vaccine, the antibody responds against epitope B and non-neutralizing epitope C are markedly increased compared with the same epitopes in naturally infected cattle.<sup>1</sup>

The subgroups of the virus are based on antigenic differences of the G protein, and BRSV infection protects against reinfection by homologous strains of the virus. It is also known that a complete BRSV can partially protect against a BRSV infection with a strain that contains an antigenic dissimilar G protein.<sup>1</sup> Therefore, incorporation of representative viruses of different BRSV subgroups in vaccines for cattle does not seem necessary to achieve cross-protection. A gE-negative bovine

herpesvirus-1 (BHV-1) strain can successfully be used as a vector for development of combination vaccines against bovine respiratory disease, and the G protein can induce significant protection against BRSV infection in calves.<sup>21</sup>

Vaccination of calves with a formalin-inactivated BRSV vaccine followed by challenge exposure to virulent virus increased the severity of clinical disease and lesions compared to calves non-vaccinated and challenged.<sup>21</sup> Vaccination did not induce neutralizing antibodies, but IgG antibodies were detected with ELISA. Immunization with formalin-inactivated BRSV vaccine mainly primes a Th2-like inflammatory response characterized by a significant eosinophilic influx in the bronchia alveolar lung field and lung tissues and high levels of immunoglobulin E serum antibodies.<sup>22</sup>

### PATHOGENESIS

BRSV causes rhinitis, tracheitis, bronchitis, bronchiolitis, and mild interstitial pneumonia. In naturally occurring cases, the principal lesions are bronchitis and bronchiolitis in the cranioventral portions of the lungs combined with widespread emphysema and edema throughout the lungs.<sup>1,3</sup> BRSV infection causes airway obstruction and hyperactivity that may persist for up to 30 days following viral exposure.<sup>3</sup> In naturally occurring cases, the cranioventral lung fields are particularly poorly ventilated and there is arterial hypoxemia associated with mismatching of ventilation and perfusion.<sup>3</sup> Radiographic and radionuclide lung perfusion imaging reveals the presence of bullous emphysema and areas of marked atelectasis.

The pathogenesis of acute fatal pneumonia due to BRSV is not clear. The characteristic lesions are exudative or necrotizing bronchiolitis, atelectasis, interstitial edema, and emphysema. The acute fatal disease is commonly preceded by a mild respiratory disease several days previously, which suggests that hypersensitivity may be a pathogenetic mechanism causing lung injury. The second stage may follow initial improvement or recovery from the first stage and is associated with the onset of extreme respiratory distress. The virus-specific IgE antibody may play a role in the pathogenesis of the severe disease as part of a hypersensitivity reaction.<sup>23</sup> The IgM and IgA antibodies are not involved in a hypersensitivity reaction. In experimentally induced infection in calves, there is considerable injury to bronchiolar epithelium including hypertrophy, hyperplasia, and formation of syncytia.<sup>24</sup> In the alveoli, BRSV infection results in necrosis of type I pneumocytes; the response of

type II pneumocytes includes hypertrophy, hyperplasia, and syncytial formation. It is suggested that an immune-mediated mechanism may be responsible for the widespread lesions over the entire lung.

The severe highly fatal form of the disease, also known as the 'malignant' form, or the paroxystic respiratory distress syndrome (PRDS) is associated with extensive pulmonary mast cell degranulation.<sup>25</sup> In a series of naturally-occurring paroxystic respiratory disease in calves, paired serum samples were taken three weeks apart, and lungs examined at necropsy. The serum concentration of tryptase was used as a marker of mast cell degranulation. Tryptase is a preformed serine protease stored in mast cell granules and causes significant changes in the respiratory tract smooth muscle tone and vascular permeability. The substances released by the mast cells are at least partially responsible for the pulmonary edema, in particular by means of vasoconstriction and the increase in the vascular permeability induced by the histamine. (In neonatal calves and young adult cattle, histamine affects respiratory function by contraction of the trachea and pulmonary veins which increases total pulmonary resistance and induce venous hypertension.<sup>26</sup> This would likely result in increased pulmonary capillary pressure and the development of alveolar edema. The main physiopathologic target of pulmonary mast cells in cattle is the pulmonary vein.)

The edema and bronchoconstriction caused by the mast cell leucotrienes impede bronchiolar flow, which causes ventilatory asynchronism. The mechanical constraints caused by the asynchronism are aggravated because the bovine lungs consist of a number of compartments, which prevents any collateral ventilation and any dissipation of interlobular pressure gradients. The breaking point is reached when the level of the mechanical constraints exceeds the level of tissue resistance causing interstitial emphysema.

Calves which die from the BRSV-associated PRDS have a uniform pattern of gross lesions. The trachea and bronchi are filled with a white-to-pink froth and the lungs are heavy and voluminous and fail to collapse. The most characteristic lesions were the dramatic lung distension by edema, alveolar hyperinflation and severe interstitial and subpleural emphysema, often with large dissecting bullae on the dorsal edge of the diaphragmatic lobes.

Microscopically, the most characteristic lesions are bronchitis, bronchiolitis, and alveolar edema, mononuclear cell infiltration, hyaline membrane deposition

and scattered hyperplasia of type-2 pneumocytes. There is a clear gradient in the severity of inflammatory changes in the airway along a cranio-caudal axis, lesions being more frequent and severe in the cranial parts except for hyperinflation and emphysema. Extensive mast cell degranulation occurs in the diaphragmatic lobes where neither the virus nor the epithelial syncytia, nor the bronchiolitis, typically observed in cranio-ventral zones are found.

### Experimental reproduction of BRSV pneumonia

Experimental reproduction of the disease has been difficult; in most cases, infection results in only mild clinical disease with limited lesions.

Severe respiratory tract disease and lesions can be reproduced experimentally in conventionally reared calves and the virus can be recovered from tissues.<sup>24</sup> Severe disease similar to the naturally-occurring disease can be induced with a single aerosol of a low-passage clinical isolate of the virus.<sup>24</sup> Moderate to severe BRSV-induced pneumonia can be reproduced in colostrum-fed calves, and nasal shedding of the virus and demonstration of the antigen in the lungs at necropsy provides evidence that the virus causes the disease.<sup>27</sup>

In neonatal calves with experimental acute infection with BRSV, there is increased pulmonary resistance and decreased compliance, which explains the severe dyspnea observed in some calves. There is no evidence that transplacental infection occurs.<sup>3</sup> Experimental infection of young lambs with BRSV can result in severe pathological changes with only mild clinical disease.<sup>28</sup>

In experimentally infected calves, the virus can be detected in the bronchiolar epithelial cells and in alveolar cells, including bronchial ciliated and mucous cells, and bronchiolar ciliated and non-ciliated epithelial (Clara) cells. Syncytia are often observed in the bronchiolar walls and in the alveoli, and such syncytia were always replicating the virus.<sup>29</sup> However, syncytial cell formation is not unique to infection with BRSV since it may also occur in other viral infections of the lung.

Ultrastructural studies of experimental BRSV pneumonia reveal that ciliated and non-ciliated bronchiolar epithelial cells and alveolar type II pneumocytes are targets of the virus.<sup>1,3</sup> BRSV infection of ciliated cells in the airway can result in the loss of cilia and ciliated cells, which may interfere with lung clearance mechanisms and predispose to bacterial pneumonia. The experimental inoculation of lambs with both BRSV and *Mannheimia haemolytica* results in a more severe acute

respiratory disease than that produced by either agent alone, and the severity of the disease may be a result of synergistic action of the two agents.

Experimental BRSV infection in calves, induces an acute phase protein response.<sup>28</sup> Strong and reproducible acute phase proteins haptoglobin and serum amyloid A will peak at 7–8 days after inoculation of the virus. The pro-inflammatory cytokine, tumor necrosis factor (TNF- $\alpha$ ), can be detected in the broncho alveolar lung lavage fluids and high levels appear on the days when severe lung lesions and clinical signs are obvious.<sup>30</sup> It may be involved in mechanisms leading to increased permeability of endothelium.

### CLINICAL FINDINGS

The clinical findings vary considerably from herd to herd and from year to year. In dairy cattle, disease occurs most commonly in young calves under 6–10 months of age, although outbreaks of severe disease in mature dairy cattle also occur. Clinical signs of infection in older cattle, particularly those with previous exposure to the virus, are less severe. In large dairy herds, episodes of infection are usually mild and often unnoticed, despite cattle having a fever, slight inappetence, and a corresponding decrease in milk production which lasts 3–5 days.<sup>31</sup> Primary infections in lactating dairy cattle may cause a considerable decrease in daily milk production. However, reinfections are not associated with an important loss of milk production.

A **sudden outbreak of acute respiratory disease** in a group of animals is a characteristic of a primary BRSV infection. The disease is more severe in animals with no previous exposure to the virus. A dry, non-productive cough, severe dyspnea and polypnea, and bilateral nasal discharge are characteristic. A fever of 40–42°C (104–108°F) is common and milk production in lactating cows declines markedly. Feed consumption in the affected group declines for a few days. The fever usually persists for 3–5 days in spite of therapy with antimicrobials. Toxemia is not a feature unless there is secondary bacterial pneumonia. On auscultation of the lungs there are loud breath sounds over the ventral aspects indicating consolidation, and wheezes indicating bronchiolitis. These are the findings of a viral interstitial pneumonia. Most animals recover within 5–7 days. About 1–2% of affected animals will develop a fatal viral pneumonia characterized by severe dyspnea with abdominal breathing and an expiratory grunt, mouth-breathing with foamy salivation, marked anxiety, persistent fever, and death within 2–5 days after onset.<sup>4,5</sup> Feed

and water consumption are decreased because of severe dyspnea, which results in a gaunt abdomen and dehydration. Affected animals are reluctant to move or lie down. The loud breath sounds audible over the ventral two-thirds of both lung fields, indicating that extensive consolidation is becoming pronounced. Subcutaneous emphysema over the withers may also occur. Occasionally, some animals that are not being observed closely will die with peracute pneumonia within a few days and represent the index case of an outbreak.

In outbreaks of BRSV infection in **young dairy cattle** under 12–16 months of age, the first clinical abnormalities usually noticed by the owner are coughing and a mild nasal discharge in 50–75% of the animals. Inappetence with a fever of 40°C (104°F) or higher lasts for about 3 days followed by recovery in most cases. Coughing, nasal discharge, and conjunctivitis may persist for several days or a few weeks in 10–30% of the animals with no long-lasting complications. Abdominal breathing, and loud and abnormal lung sounds may occur in about 50% of the animals but these commonly resolve within 10 days.

In an outbreak of BRSV in **recently weaned beef calves** 6–8 months of age, nasal and lacrimal discharge, polypnea and dyspnea, fever of 40–42°C (104–108°F) decreased feed intake, coughing, and lethargy are common. In a small percentage of affected animals, within a few days the dyspnea becomes marked with mouth-breathing and the production of frothy saliva created by the labored respirations. Subcutaneous emphysema over the withers due to severe, interstitial emphysema also occurs. Loud breath sounds, wheezing, and crackling sounds are audible over the ventral aspects of the lungs. Death may occur within a few days after the onset of the dyspnea. Secondary bacterial bronchopneumonia may occur but is uncommon.

### CLINICAL PATHOLOGY

It is difficult to obtain a definitive etiological diagnosis of BRSV infection because the virus is highly labile in tissue samples and virus detection in specimens is poor because of inadequate laboratory techniques. The virus replicates slowly, classical virus isolation is laborious and several blind passages are often necessary before any cytopathic effect can be seen. Nasopharyngeal swabs for virus isolation and paired serum samples are necessary to make a definitive etiological diagnosis. Successful laboratory diagnosis of BRSV is generally based on one of four criteria:

- Virus isolation
- Detection of BRSV antigen in suspected tissues

- Indications of BRSV seroconversion
- Histopathology.

The high prevalence of antibody titers to the virus, and the need for skilled personnel to process and interpret the diagnostic tests, have hindered development of a routine diagnostic test. Successful isolation of the virus from typical clinical cases of disease is often unsuccessful and can take 11–21 days because of the late appearance of any noticeable cytopathic effect. Because of these difficulties, isolation of the virus is not commonly recommended as a routine diagnostic approach.

#### Virus isolation or detection

The ideal sample for **isolation** of the virus is a transtracheal aspirate in the very early stages of the disease. The sample also provides cells for **immunofluorescent antibody (IFA) staining**.<sup>1,3</sup> Nasopharyngeal swabs are also useful, but sampling technique must insure good contact with the most caudal part of the pharyngeal cavity and the samples must be placed in viral transport medium and shipped on cold packs and not frozen.

The fluorescent antibody test for virus **detection** is one of the most rapid, reliable, and sensitive tests for the diagnosis of BRSV infection.<sup>1</sup> For tracheal aspirates, an aliquot of the sample is centrifuged onto a microscopic slide to obtain a cell preparation for the IFA test.

The **PCR assay** is rapid and sensitive and can be recommended as the method of choice in the analysis of clinical specimens.<sup>3</sup> The presence of the virus can be determined by using PCR on nasal swabs taken in the acute phase of a suspected outbreak. The virus can be detected and quantified in cell cultures using real-time quantitative RT-PCR and quantitative competitive RT-PCR assays.<sup>32</sup> A sensitive RT-PCR assay for detection of the virus in lung tissues from calves with natural or experimental infection has been developed.<sup>33</sup>

The virus can be detected in tissues with monoclonal or polyclonal antibodies and avidin-biotin complex immunohistochemistry.<sup>3</sup> This is typically done on formalin-fixed, paraffin-embedded tissues.

#### Serology

The standard serological test for specific BRSV antibodies is the **virus-neutralization (VN) test**, usually done with microtiter plates.<sup>1,3</sup> Paired acute and convalescent samples from both affected and normal animals in the herd are desirable. The **indirect ELISA** is a rapid and reliable test for detecting antibodies to BRSV in milk, bulk tank milk, and serum.<sup>34</sup> A **microneutralization ELISA** has been developed which correlates well with other assays and is useful in assessing antibody responses to the virus

both in naturally occurring disease and in vaccination studies.<sup>35</sup>

A leukopenia and neutropenia are common and are aids to diagnosis.

#### NECROPSY FINDINGS

Affected lungs are voluminous and heavy, and fail to collapse when the thoracic cavity is opened. The cranioventral portions of the lung are consolidated and usually dark red or plum-colored. The interlobular septa are edematous, and mucoid exudate can often be expressed from small bronchi. Severe interstitial emphysema and edema are prominent over the dorsal and caudal lobes. Subpleural emphysema is often obvious in the cranial and caudal lobes. The caudodorsal lung regions may be 'meaty' in consistency. The caudal lobes are often markedly distended because of interstitial emphysema, and large bullae are common. The interlobular septa of the caudal lobes are usually distended because of emphysema and edema. Subcutaneous emphysema over the withers, thorax, and neck are common. Secondary bacterial bronchopneumonia with pleuritis may occur.

Histologically, there is bronchiolitis and bronchitis. Large multinucleated syncytia are present, projecting from the bronchiolar walls or lying free in the lumen. Hyperplasia or necrosis of the bronchiolar epithelium are common. Exudates consisting of neutrophils, macrophages, desquamated epithelial cells, and syncytia are present in the bronchiolar lumina. Small airways are often occluded with exudate. Alveolar changes include cellular infiltration and thickening of alveolar septae with multinucleate giant-cell syncytia in the alveoli. Epithelial syncytia containing eosinophilic intracytoplasmic inclusion bodies are often present on alveolar walls. The presence of epithelial syncytia is a useful feature but the numbers and prominence of these structures can vary considerably. Other viruses can also induce these syncytia. In the caudodorsal lung regions, there is severe emphysema, often with rupture of alveolar walls, alveolar edema, sometimes with hyaline membrane formation and swelling of alveolar epithelial cells.<sup>8</sup>

In experimental BRSV pneumonia, the findings include bronchitis, bronchiolitis, proliferative and necrotizing bronchiolitis, interstitial pneumonia with areas of atelectasis and alveolar edema, epithelial syncytium formation on bronchiolar and alveolar walls, and pneumocyte hyperplasia. The virus antigen can be demonstrated by immunoperoxidase or immunofluorescent staining of bronchiolar and alveolar epithelium.

Isolation of the BRSV from natural field cases has always been difficult because of the long duration required for

the appearance of characteristic cytopathic effects. Fluorescent microscopy can be used for detection of the antigen in the cranioventral lung areas but PCR is a more sensitive technique. It is advisable to collect and **sample several areas of lung** as viral antigen/nucleic acid will be most abundant in areas of acute infection. The virus can also be demonstrated in formalin-fixed paraffin-embedded bovine lung tissue using immunohistochemical techniques.<sup>32</sup>

#### Samples for confirmation of diagnosis

- **Histology** –fixed lung (several sites) (LM, IHC)
- **Virology** – chilled lung (several sites) (FAT, PCR); nasal swab (ELISA, PCR).

#### DIFFERENTIAL DIAGNOSIS

The differential diagnosis includes those infectious diseases of the respiratory tract of young cattle that commonly affect groups of animals in a short period of time.

It is not usually possible to make a definitive etiological diagnosis based on the clinical findings. However, the combination of the epidemiological and clinical findings are usually suggestive of an acute viral respiratory disease. It is not usually possible to be more specific than making a clinical diagnosis of acute undifferentiated respiratory disease.

- Acute respiratory disease due to BRSV infection in weaned beef calves is characterized by marked dyspnea, anorexia, mouth-breathing, fever, subcutaneous emphysema, loud breath sounds, and death in a small percentage of animals in a few days or less. In some cases there may be a history of respiratory disease in the affected group several days previously<sup>36</sup>
- Infectious bovine rhinotracheitis (IBR) is characterized by outbreak of coughing, profuse nasal discharge, fever, inappetence, the presence of typical nasal lesions; pneumonia is not common. Recovery occurs in several days
- Pneumonic pasteurellosis is characterized by anorexia, toxemia, fever, abnormal lung sounds, coughing, nasal discharge, and response to treatment with antimicrobials. fibrinous pneumonia at necropsy is typical
- Lungworm pneumonia occurs most commonly in groups of young cattle on summer pasture and is characterized by coughing, nasal discharge, tachypnea, abdominal breathing, fever and inappetence, and increased breath sounds with crackles. A necropsy diagnosis is usually necessary
- BRSV infection in mature dairy cattle may be mild and is characterized by a slight drop in milk production, fever for a few days, inappetence, and recovery in a few days. Adult cattle lacking immunity may develop severe fatal pneumonia which must be distinguished from pneumonic pasteurellosis, infectious bovine rhinotracheitis, and other causes of interstitial pneumonia.

## TREATMENT

### Antimicrobial therapy

Broad-spectrum antimicrobials given daily for 3–5 days for secondary bacterial pneumonia are commonly administered but may not be necessary. Recovery usually occurs gradually over a period of 3–5 days. Severely affected animals will become worse in spite of therapy.

### Non-steroidal anti-inflammatory agents

These are used for their anti-inflammatory effect but are unnecessary and there is no evidence that they are efficacious.

## CONTROL

Reliable control measures are unavailable. The ubiquitous nature of the virus, the persistency of infection in herds, the movement of cattle between herds, the expansion of herds and the replacement practices used in herds, and recurrent infections make control difficult.

### Management

A rationale approach to control would be management of the herd to minimize stressors such as inadequate ventilation. Herd replacements brought into the herd should be quarantined from the rest of the herd for 2–3 weeks before mixing with the remainder of the herd.

### Vaccines and immunization

Several modified live virus and inactivated virus vaccines are available for the control of respiratory disease due to BRSV infection, but there are few randomized clinical trials evaluating the efficacy of the vaccine under naturally occurring conditions against BRSV infection or clinical disease. Because calves under 6 months of age are most frequently infected with BRSV despite the presence of colostrum antibodies, there is a need for a vaccine which is effective in calves. The presence of passively derived antibodies to BRSV interferes with immunization by vaccination of young calves with commercially available inactivated vaccines. Vaccines must therefore be effective at an early age and be able to overcome the immunosuppressive effects of colostrum antibodies.

Protection has been reported in experimental challenge models in cattle for several vaccines. Field trials, with live or inactivated BRSV vaccines revealed different levels of protection, while others found that vaccination enhanced disease in calves.<sup>37</sup> The intramuscular administration of the vaccine in calves which had colostrum antibodies, was least efficacious, and intranasal inoculation of live virus in colostrum deprived calves proved most effective.<sup>37</sup>

Cattle vaccinated with MLV BRSV vaccines generally develop high concen-

trations of virus neutralizing antibodies (VN) and fusion inhibiting antibodies, compared with low to moderate concentrations of total BRSV-specific IgG.<sup>38</sup> In contrast, cattle receiving inactivated virus vaccines develop lowered concentrations of VN antibodies and high concentrations of virus-specific (non-neutralizing) IgG.

Formalin-inactivated BRSV vaccines have not been successful when tested by experimental challenge of vaccinated calves.<sup>21,39</sup> This is similar to the enhanced disease which may occur in children vaccinated with a formalin-inactivated alum adjuvanted vaccine.<sup>39</sup> However, one adjuvanted inactivated BRSV vaccine did provide protection in vaccinated calves challenged by experimental infection.<sup>38</sup>

A BRSV vaccine inactivated with beta-propiolactone and adjuvanted provided calves with colostrum antibodies to the virus with protection against challenge with the virus.<sup>40</sup> A schedule of three vaccinations in calves with high levels of antibodies or two vaccinations in calves with moderate levels provided protection for nearly 6 months. However, in one study in beef herds, calves vaccinated with an inactivated BRSV vaccine developed clinical, serological, virological and pathological evidence of BRSV pneumonia 2 months after vaccination.<sup>37</sup>

A modified-live BRSV vaccine provided protection in calves against a challenge model that mimics severe naturally occurring disease.<sup>41</sup> Vaccinated calves shed reduced numbers of virus, had less pulmonary disease, and had vaccine-induced cell-mediated immune responses. The cell-mediated immunity was a more consistent measure of protection than prechallenge serum antibody.

A single intranasal dose of MLV BRSV vaccine protected calves from experimental challenge and the vaccine induced cell-mediated immunity characterized by the production of BRSV-specific interferon-gamma (IFN- $\gamma$ ) by mononuclear cells isolated from various tissue specimens.<sup>42</sup>

Subunit vaccines which can overcome maternal antibodies have been examined. The use of immunostimulating complexes (ISCOMs) against BRSV has been evaluated and compared to a commercial inactivated vaccine in calves with BRSV-specific maternal antibodies.<sup>43</sup> Following experimental challenge, vaccinated calves remained healthy, while control calves developed severe clinical disease. Significantly higher BRSV-specific nasal IgG, serum IgG1, and IgG2 titers were detected before and after challenge in calves vaccinated with ISCOMs compared to the results in calves vaccinated with the commercial vaccine. BRSV was isolated from the nasopharynx of control calves none from the calves vaccinated

with ISCOMs. The vaccine overcame the suppressive effect of colostrum antibodies and induced a strong clinical and virological protection against a BRSV challenge.

Vaccination of dairy heifers with a vaccine containing chemically altered temperature-sensitive infectious bovine rhinotracheitis (IBR), PI-3 viruses, two strains of killed bovine virus diarrhea viruses, and a modified live virus BRSV, compared to a similar vaccine but without the BRSV, twice at a 2-week interval with the second vaccine administered at 2–3 weeks before calving, may increase milk production and first insemination conception rates.<sup>31</sup> Milk production was increased in first-parity cows during the first 21 weeks of lactation. Vaccination did not have any effect on milk production after the first 21 weeks of lactation in cows of any parity.

## REVIEW LITERATURE

- Baker JC, Ellis JA, Clark EG. Bovine respiratory syncytial virus. *Vet Clin North Am Food Anim Pract* 1997; 13:425–454.
- Larsen LE. Bovine respiratory syncytial virus (BRSV): A review. *Acta Vet Scand* 2000; 41:1–24.

## REFERENCES

- Larsen LE. *Acta Vet Scand* 2000; 41:1–24.
- Nettleton PF et al. *J Vet Med B* 2003; 50:196.
- Baker JC et al. *Vet Clin North Am Food Animal Pract* 1997; 13:425.
- Ellis JA et al. *Can Vet J* 1996; 37:103.
- Elvander M. *Vet Rec* 1996; 138:101.
- Martin SW et al. *Can Vet J* 1999; 40:560.
- Redondo E et al. *J Vet Med B* 1994; 41:27.
- Bryson DG. *Vet Med* 1993; 88:894.
- Norstrom M et al. *Prev Vet Med* 2000; 44:87.
- Norstrom M et al. *Prev Vet Med* 2000; 47:107.
- Norstrom M et al. *Prev Vet Med* 2001; 51:259.
- van der Poel WHM et al. *Vet Quart* 1995; 17:77.
- Martin SW, Bohac JG. *Can J Vet Res* 1986; 50:351.
- Larsen LE et al. *J Clin Microbiol* 2000; 38:4222.
- Bingham HR et al. *Am J Vet Res* 1999; 60:563.
- Underwood WJ et al. *Vet Microbiol* 1995; 43:261.
- Bingham HR et al. *Am J Vet Res* 2000; 61:1309.
- van der Poel WHM et al. *Archiv Virol* 1997; 142:1681.
- Valarcher J-F et al. *Virology* 2001; 291:55.
- van der Poel WHM et al. *Am J Vet Res* 1999; 60:1098.
- Gershwin LJ et al. *Vaccine* 1998; 16:1225.
- Antonis APG et al. *J Virol* 2003; 77:12067.
- Gershwin LJ. *Vet Clin North Am Food Anim Pract* 2001; 17:599.
- Woolums AR et al. *Am J Vet Res* 1999; 60:473.
- Jolly S et al. *Vet Immunol Immunopathol* 2004; 97:125.
- Jolly S et al. *Am J Vet Res* 2003; 64:819.
- Tjornehoj K et al. *Res Vet Sci* 2003; 74:55.
- Heegard PMH et al. *Vet Immunol Immunopathol* 2000; 77:151.
- Viuff B et al. *Vet Pathol* 1996; 33:383.
- Rontved CM et al. *Vet Immunol Immunopathol* 2000; 76:199.
- Ferguson JD et al. *J Am Vet Med Assoc* 1997; 210:1179.
- Achenbach JE et al. *J Virol Methods* 2004; 121:1.
- Larsen LE et al. *J Vet Diagn Invest* 1999; 11:416.
- Elvander M et al. *J Vet Diagn Invest* 1995; 7:177.
- Ellis JA et al. *J Vet Diagn Invest* 1995; 7:183.
- Baker JC et al. *Am J Vet Res* 1986; 47:246.
- Larsen LE et al. *Acta Vet Scand* 2001; 42:113.



38. Ellis J et al. *J Am Vet Med Assoc* 2001; 218:1973.  
 39. West K et al. *Vaccine* 1999; 17:809.  
 40. Patel JR, Didlick SA. *Am J Vet Res* 2004; 65:417.  
 41. West K et al. *Vaccine* 2000; 18:907.  
 42. Woolums AR et al. *Am J Vet Res* 2004; 65:363.  
 43. Hagglund S et al. *Vaccine* 2004; 23:646.

## INFECTIOUS BOVINE RHINOTRACHEITIS (IBR, RED NOSE), BOVINE HERPESVIRUS-1 (BHV-1) INFECTION

### Synopsis

**Etiology** Bovine herpes virus-1 subtypes: BHV-1.1 (respiratory); BHV-1.2a and 1.2b (genital); BHV-1.3 (BHV-5; encephalitic)

**Epidemiology** Worldwide occurrence in cattle; high prevalence of infection; low incidence of disease; transmitted directly; latent infection characteristic; economic losses due to deaths and abortions, latent infection in breeding animals cause international trade problems and entry into artificial insemination units

**Signs** Rhinitis with typical nasal lesions, tracheitis, fever, conjunctivitis, coughing, nasal discharge, and recovery in few days; severe systemic disease in newborn calves, abortion outbreaks

**Clinical pathology** Isolation or detection of virus with tissue culture or PCR; serology with serum-neutralizing titer, ELISA. Bulk tank milk antibodies

**Lesions** Rhinotracheitis, bronchopneumonia, non-suppurative encephalitis, alimentary tract necrosis in calves with systemic disease, aborted fetuses autolyzed

**Differential diagnosis** All diseases associated with bovine respiratory tract disease: pneumonic pasteurilla, viral interstitial pneumonia, *Haemophilus pleuropneumoniae*, allergic rhinitis

**Treatment** Antimicrobials for secondary bacterial infections

**Control** Vaccination of young breeding herd replacements using modified live virus or inactivated virus vaccines. Subunit and marker vaccines becoming available are superior to conventional vaccines. Some countries eradicating infection by identifying and eliminating seropositive animals

### ETIOLOGY

The bovine herpesvirus type-1 (BHV-1), or the infectious bovine rhinotracheitis (IBR) virus is an alphaherpesvirus and the cause of the respiratory disease, abortion, conjunctivitis, and other clinical forms of the disease complex.<sup>1</sup> Genetic analyses of various clinical isolates has found at least three distinct **BHV-1 subtypes: a respiratory subtype, a genital subtype, and an encephalitic subtype** designated as BHV-1.1, BHV-1.2, and BHV-1.3, respectively. BHV-1.3 has been renamed BHV-5.<sup>1,2</sup> Antigenic differences between isolates of the virus may account for some of the diverse epidemiological and pathological patterns of behavior of this herpesvirus.

The literature on the evolution of the herpesviruses has been reviewed.<sup>3</sup> Four ruminant alphaherpesviruses are related to BHV-1 and have the potential for cross-infection of cattle in Europe: Bovine herpesvirus-5, caprine herpesvirus-1 (CpHV-1), cervine herpesvirus-1 (CvHV-1), and cervine herpesvirus-2 (CvHV-2). Buffalo herpesvirus-1 and elk herpesvirus are also closely related to BHV-1.<sup>4</sup> BHV-5 is the cause of fatal meningoencephalitis in calves.<sup>5</sup> CpHV-1 causes enteritis and generalized infection in neonatal kids. Most CpHV-1 infections in adults are subclinical, the virus can cause vulvovaginitis, balanoposthitis, or abortion. CvHV-1 can cause ocular disease in red deer and is widespread in free-living and farmed red deer. CvHV-2 has been isolated from reindeer in Finland and serological evidence of infection with a virus similar to BHV-1 has been reported in caribou in Canada. Although these viruses differ considerably in their virulence, they are closely related both genetically and antigenically, and can establish latent infections similar to that of BHV-1.<sup>4</sup> An immunofluorescence assay using monoclonal antibodies can discriminate between these related herpesviruses.<sup>4</sup> Restriction endonuclease and monoclonal antibody analysis has been used to analyze Brazilian isolates of BHV-1 and BHV-5.<sup>6</sup>

Bovine herpesvirus 4 has been associated with mastitis in cattle.<sup>7,8</sup>

### EPIDEMIOLOGY

#### Prevalence of infection and occurrence of disease

Disease complexes associated with this virus have been recognized in most cattle-raising countries of Europe, Asia, North America, Africa, and in Australia and New Zealand. The respiratory form of clinical disease is most common in feedlot cattle, and cattle on dairy and beef farms without a routine vaccination program.

Seroprevalence surveys have found that 10–50%, or even higher, of cattle are serologically positive to the virus depending on vaccination practices in individual herds, and the frequency of contact between infected and non-infected animals.<sup>3</sup> The percentage can also vary between dairy and beef cattle in the same geographical area. The seroprevalence in a country or area also changes over time. A serological survey in Belgium found that infection is endemic in the cattle population.<sup>9</sup> In Great Britain in the 1960s, serological surveys indicated that less than 10% of cattle were positive. In the mid- to late-1970s, the incidence of infection increased markedly, and by 1986 35% of the animals and 48% of the herds were positive. In beef herds in northern

Australia, up to 96% of bulls and 52% of cows are seropositive, most of which may be venereal because respiratory disease is uncommon in cattle on extensive range conditions. The genital carrier state is important in the maintenance of venereal IBR virus and in the occurrence of sporadic infectious pustular vulvovaginitis (IPV) and infectious pustular balanoposthitis (IPB) in these herds. Outbreaks of IPV and IBP were not uncommon in Britain in the 1960s and 1970s, and then occurred only rarely after the introduction of stricter control measures in artificial insemination centers.<sup>10</sup> In 1997, an outbreak of IPV and IBP occurred in a dairy herd with 70–80% of the cows manifesting signs of both the respiratory and genital form of BHV infection.<sup>10</sup> Both oculonasal and vaginal isolates were typed as type 2b, which is the same as the Oxford isolate commonly associated with both IPV/IBP and typical low/medium virulence outbreaks of IBR.<sup>10</sup>

The bovine herpesvirus-1 has not been reported in recent years in a number of countries such as Norway, Sweden, Finland, Estonia, Iceland, Denmark, Bulgaria, and Moldova.<sup>11</sup> Since 1994, Norway has been free of BHV-1 and certain defined additional guarantees for cattle to be imported are in place to protect the disease status.<sup>12</sup> IBR/IBV is a reportable disease in Norway. Some countries in Europe are in the process of eradicating the virus from the cattle population. In beef herds in Yucutan, Mexico, where vaccination is not practised, seropositivity was associated with large and older herds.<sup>13</sup>

### Wildlife

Bovine herpesvirus infections exist in wild ruminants.<sup>14</sup> Infections may be endemic in white-tailed deer in certain parts of Canada, and it is suggested a mild form of the disease occurs in these animals. About 29% of both wild and farmed red deer in Britain are seropositive to the closely related herpesvirus of Cervidae 1. Mule deer are susceptible to infection, the disease has occurred naturally in a goat, and antibodies to the virus have been found in pronghorn antelope in western Canada, and in Tanzania in game animals and cattle. According to serological surveys, the virus is widespread in African wildlife, particularly the buffalo, which may be a reservoir of infection among the wildlife population. The virus has been recovered from the wildebeest in Africa, which suggests further that wildlife may serve as reservoirs. Antibodies to the alpha-herpesviruses were found in reindeer (28.5%), roe deer (3.0%) and in red deer (0.5%) in Norway.<sup>15</sup> In Saskatchewan, Canada, 52% of Woodland



Caribou were seropositive to the bovine herpesvirus-1.<sup>16</sup>

### Morbidity and case fatality

The uncomplicated form of the respiratory disease in cattle is not highly fatal, most losses being due mainly to secondary bacterial bronchopneumonia. The morbidity and case fatality rates in dairy cattle are about 8% and 3%, respectively, while in feedlot cattle the morbidity rate is usually 20–30% in unvaccinated cattle and may rarely reach 100%. The case fatality rate in feedlot cattle is invariably associated with secondary bacterial tracheitis and bronchopneumonia and may reach 10%, but is usually no more than 1%. Morbidity and mortality are **higher in feedlot cattle** than in dairy herds because of the frequent introduction of susceptible animals into an enzootic situation. The case fatality rate in the systemic form of the infection in newborn calves is almost 100%.

### Methods of transmission

The main sources of infection are the nasal exudate and coughed-up droplets, genital secretions, semen, and fetal fluids and tissues. Aerosol infection is the method of spread of the respiratory disease. Experimentally, the BHV-1 can be shed from calves into the environment and transported by air over a distance of at least 3.85 m to sentinel calves housed in a separate building.

Venereal transmission is the method of spread of the genital diseases. The virus may survive for up to 1 year in semen frozen at  $-196^{\circ}\text{C}$  ( $-321^{\circ}\text{F}$ ).

Introduction of animals into a group often precedes an outbreak of the disease. However, it can arise simultaneously in a number of dairy farms in an area and spread from these to adjacent farms until the entire area is affected. The same pattern of occurrence simultaneously in a number of foci is seen in feedlots, and from these foci infection spreads to other pens in the lot. An outbreak usually reaches its peak in the 2nd or 3rd week and ends by the 4th–6th week.

To determine whether or not an infection in a herd will spread from a small inoculum, the number of secondary cases resulting from one infectious animal must be estimated. The ratio of secondary cases to originally infected animals is called the reproduction ratio and is commonly denoted by  $R_0$ . When  $R_0 < 1$ , the infection will not spread and the animal population is effectively protected from the infection. When the infection is established, but  $R_0$  is reduced to less than one, the infection will disappear provided that some additional, commonly satisfied assumptions are met. When  $R_0 > 1$ , the

infection can spread. Therefore, a strategy for controlling an infectious agent is effective when, and only when, the ratio for that strategy is less than one. The value of  $R_0$  for a given host population is determined by a number of different factors including: the transmissibility of the infection; the period over which an infected host is infectious; the population density of hosts; and where appropriate, the density of vectors and the capacity of the vectors to transmit the infection.

### Risk factors

Animal risk factors

#### Age and breed susceptibility

All ages and breeds of cattle are susceptible but the disease occurs most commonly in animals over 6 months of age, probably because of their greater exposure. There is no seasonal variation in incidence, except possibly a higher occurrence in feedlot cattle in the fall and winter months when large numbers of susceptible animals are assembled. The disease complexes associated with the virus occur most commonly in animals that lack acquired immunity from previous natural infection or vaccination. **An unvaccinated herd of breeding cattle or a group of feedlot animals are highly susceptible to epidemics of respiratory disease and abortion.** Newborn calves are highly susceptible to the systemic form of infection if the level of specific antibody to the virus in the colostrum is inadequate or if there is failure of transfer of passive immunity.<sup>17</sup>

The analysis of the relationship between interferon genotype and severity of clinical disease in cattle experimentally inoculated with BHV-1 revealed that certain alleles of the interferon were significantly associated with the more severe clinical phenotype. A second allele at another locus was associated with the milder disease genotype. Thus, selective breeding programs aimed at altering the frequency of these alleles in cattle populations may potentially improve animal health and lessen the economic impact of BHV-1 infections.<sup>18</sup>

Environmental and management risk factors

Several managemental factors have been associated with BHV-1 infection in a herd. Infected herds purchase cattle and participate in cattle shows more often than negative farms. The positive farms have more visitors and are situated closer to other cattle farms.<sup>19</sup> The failure to vaccinate regularly and keep reliable records of vaccination dates are commonly associated with inadequate disease control.

In countries with BHV-1 eradication programs, the loss of certification is commonly associated with yearly number of

cattle purchased, farm density within a 1 km radius, and cattle density within a 1 km radius.<sup>20</sup>

Pathogen risk factors

The **IBR-like viruses** are now designated **BHV-1.1**, and the **IPV-like viruses** are designated **BHV-1.2**, with the latter subtype being further divided into two groups given the letter designations a and b.<sup>2</sup> **Subtype 1.2a isolates cause abortion**, 1.2b isolates are not abortifacient.<sup>2</sup> **Subtype 1.3, or BHV-5**, is the encephalitic strain.<sup>21,22</sup> **Inactivation of the thymidine kinase gene from BHV-1** reduces the abortifacient activity of the virus but does not eliminate the abortifacient activity of BHV-1.<sup>2</sup> Currently available vaccines, which are made with 1.1 subtype vaccines, cannot be given to pregnant cattle because they are abortifacient. The currently available MLV BHV-1 vaccines can cause infertility in cattle infected 14 days after breeding.

The BHV-1 genome is not stable during host animal passage, and variations can occur in the restriction endonuclease patterns of the viruses within individual animals during both acute infections, and after viral reactivation or after viral reactivation followed by superinfection with a different subtype of BHV-1 than was used for the primary inoculation.

The virus of IBR is similar to the virus causing IPV in cows and IPB of bulls. Manifestations occurring suggest that strains with differing tissue affinities may exist in the field, and slight differences can be detected by immunological and biochemical means. Only rarely do the respiratory and genital forms of the disease occur together. However, by routine methodology it is difficult, and usually impossible, to distinguish between isolates obtained from the reproductive tract and the respiratory mucosa. Likewise, with the exception of temperature-sensitive mutants, vaccine strains cannot be distinguished from field isolates.

The virulence of several strains of one genotype can vary widely.<sup>23</sup> The outcome of BHV-1 infection can vary from subclinical to a systemic infection in neonatal calves that is often highly fatal.<sup>24</sup> A subclinical infection of bulls in an artificial insemination unit with BHV-1 can last for several months, even in vaccinated animals.<sup>25</sup> Vaccine strains of BHV-1.1 have been associated with outbreaks of meningoencephalitis in feedlot cattle within 7–10 days after routine vaccination intranasally with a vaccine intended for the intramuscular route.<sup>26</sup> Newborn calves under 3 days of age are susceptible to the highly fatal systemic form of IBR if vaccinated intramuscularly with a

modified live virus BHV-1 and PI-3 vaccine.<sup>27</sup>

Using DNA restriction endonuclease and polyacrylamide gel electrophoresis (PAGE) it is now possible to compare the antigenic differences between isolates obtained from different clinical syndromes, different species, tissues, and countries. Several different genotypes of the virus have now been identified, which may explain the emergence of a more severe form of the respiratory form of the disease in some countries as well as the different forms of the disease.<sup>25</sup> The increasing number of BHV-1 isolates recovered in the United Kingdom, and the sudden increase in the incidence of IBR is probably due to the importation of a BHV-1 isolated within imported North American Holsteins.<sup>28</sup> The Colorado and Strichen strains produced the characteristic clinical signs, whereas the Oxford strain produced a mild clinical response with minimal pathological lesions.<sup>25</sup> Based on the evidence of epidemiology, molecular genotype analysis, and experimental pathogenicity, the more severe form of IBR that occurred in cattle in Britain in the mid-1970s was associated with BHV-1.1, which had a greater propensity for spread and was probably introduced in imported cattle.<sup>25</sup> The herpesviruses isolated from reindeer is a distinct species within the family Herpesviridae.<sup>14</sup>

Restriction endonuclease analysis of Australian BHV-1 isolates recovered between 1989 and 1993 revealed emergence of a new BHV-1 genotype, BHV-1.2b, which appears associated with severe respiratory disease.<sup>29</sup> There is no evidence to date of the BHV-1.1 genotype in Australia.

Outbreaks of IBR have occurred in feedlot cattle vaccinated against the infection.<sup>30</sup> The causative viruses were mutants of BHV-1 which did not react with a monoclonal antibody specific for one of the epitopes on glycoprotein D, one of the most important antigens of the virus.

An outbreak of a subclinical form of IBR has been described in a dairy herd of high health status and managed under high standards of biosecurity, and known to be serologically negative for the virus for the previous 15 years.<sup>31</sup> Although 70% of the cows had seroconverted to the virus no clinical signs were observed with the exception of an ocular discharge in a few cows, and their performance and productivity were unaffected. The causative virus was isolated after reactivation with corticosteroids and had the DNA profile of a BHV-1 strain normally associated with severe respiratory disease.

The virulence of the virus or its host tissue specificity changes due to unknown

factors. It has been suggested that the IPV was transmitted to North America from Europe in infected cattle, but continued to cause lesions in only the genital tract until its introduction into dense populations of cattle in feedlots encouraged rapid passage through many hosts and thus encouraged adaptation to the respiratory tract.

Restriction endonuclease DNA fingerprints of herpesviruses isolated from unrelated epidemics of bovine encephalitis have revealed that they are similar to each other, and totally different from BHV-1 and other ruminant herpesviruses.<sup>21</sup> Though antigenically and genetically related to BHV-1, the bovine herpes encephalitis virus is distinctly different.<sup>32</sup> A BHV-5 has been isolated from naturally occurring cases of non-suppurative meningoencephalitis in calves<sup>21</sup> and can be reproduced experimentally.<sup>5</sup>

The glycoprotein E (gE) gene is a virulence factor of BHV-1 is important in the development of gE-negative marker vaccines used in eradication programs.<sup>23</sup> These marker vaccines, either inactivated or live-attenuated, are deleted in the gene coding for the non-essential glycoprotein E (gE) of BHV-1 in order to allow serological differentiation between vaccinated and infected cattle. A glycoprotein E-deleted BHV-1 strain has been isolated from cattle in the field.<sup>33</sup>

### Immune mechanisms

**Immunity to the virus is complex and consists of relationships between local and systemic antibody, and cell-mediated immunity.** Following natural infection or vaccination with the modified live virus (MLV) vaccines, both cell-mediated and humoral components of the immune system are activated. The level of humoral immunity has been used as an indicator of previous infection and an indirect measure of resistance to clinical disease. However, the level of serum neutralizing (SN) antibody is not a reliable indicator of resistance to clinical respiratory disease. Animals with low levels of antibody may be immune because of cell-mediated immunity. The level of cell-mediated immunity can be evaluated using the delayed-type hypersensitivity test. Experimentally, the virus-neutralizing (VN) titers are lower in calves inoculated with both the IBR and parainfluenza-3 (PI-3) viruses than in calves infected with a single virus. This suggests that mixed viral infections may result in greater immunosuppression, although infectious virus synthesis may be suppressed by interference.

Following intranasal infection or the use of a MLV IBR virus vaccine intranasally, local secretory antibody and

interferon are produced. The interferon appears in 3 days and persists for 10 days. The presence of the interferon does not protect calves against experimental challenge 3 days after vaccination. However, the presence of even low levels of antibody in the serum or nasal secretion, which appears by day 7 following vaccination, provides varying degrees of resistance to clinical disease for 9 months.

### Colostrum immunity

Calves acquire colostrum antibodies from dams with humoral antibody. The duration of the colostrum immunity varies from 1 to 6 months of age dependent on the initial level acquired by the calf. Maternal antibody in the calf may interfere with the successful vaccination of calves before 6 months of age.

### Economic importance

BHV-1 infection can cause major economic consequences in a dairy or beef cattle breeding herd, or in a beef feedlot. Losses are incurred due to epidemics of abortion, infertility due to IPV and IPB in bulls, loss of production and deaths from the respiratory form of the disease in all ages of cattle, deaths from the highly fatal systemic form of the disease in newborn calves, and the cost of treatment when secondary bacterial infections of the respiratory tract occur.

### PATHOGENESIS

The virus causes disease through several different pathways including a primary infection restricted to the respiratory tract, eyes, and the reproductive tract. Systemic spread to many organs by viremia occurs as well as neuronal spread. In addition, the virus can establish latency in neuronal or lymphoid cells. Upon reactivation, the viruses re-establish the lytic cycle of replication.

### Respiratory disease

The BHV-1 virus infects the nasal cavities and upper respiratory tract, resulting in rhinitis, laryngitis, and tracheitis. The pharyngeal tonsil is readily infected by the virus and may be an important lymphoid tissue for early anti-viral responses.<sup>34</sup> There is extensive loss of cilia in the trachea leaving the tracheal epithelium covered by microvilli. Intra-tracheal administration of the virus results in almost complete denudation of tracheal columnar cells, which presumably has an adverse effect on the defense mechanisms of the respiratory tract. Spread from the nasal cavities to the ocular tissues probably occurs by way of the lacrimal ducts and causes conjunctivitis with edema and swelling of the conjunctiva, multifocal plaque formation on the conjunctivae, peripheral corneal edema, and deep vascularization. The

virus can also enhance the prevalence and severity of IBR in calves. In neonatal calves, potentially fatal infection, associated with the continued presence of viral antigen and active inflammation, contrasts with repair and clearance of viral antigen in weanling calves.<sup>34</sup> Experimentally, the endobronchial inoculation of calves with the BHV-1 causes an interstitial pneumonia.<sup>35</sup> The viral antigen can be detected in the desquamated cells and macrophages of bronchoalveolar fluid.

### Encephalitis

The mechanism by which the brain is infected is presumed to be spread of the virus from the nasal mucosa via the trigeminal peripheral nerve to the trigeminal ganglion, resulting in a non-suppurative encephalitis. However, a viremia has been suspected. Severe encephalitis can be produced experimentally in colostrum-deprived calves with neurovirulent type BHV-1.3.<sup>22</sup> Experimental infection with BHV-1.1 produces respiratory disease and a mild encephalitis.<sup>22</sup> Intranasal inoculation of young calves and adult cows with BHV-1 can result in non-fatal trigeminal ganglionitis and encephalitis, which may be an important mechanism for latent infection. A rabbit model has been used to study the neuropathogenesis of BHV-5 infection.<sup>36</sup>

### Abortion

Systemic invasion by the virus is followed by localization of the virus in several different tissues. The virus may be transported by peripheral leukocytes to the placenta and transferred to the fetus to cause abortion. The fetus is highly susceptible to the virus, which causes a peracute infection that is usually fatal. Infection in the last trimester of gestation may result in mummification, abortion, stillbirth, or weak calves with the usual lesions of IBR as well as the lesions of the stomachs and intestines that have been produced by experimental administration of the virulent virus to newborn calves.

**The systemic form of the infection in newborn calves** is characterized by severe inflammation and necrosis of the respiratory and alimentary tracts, including the pharynx, esophagus, lungs, larynx, lymph nodes, liver, and nephritis and encephalitis. There is severe laryngeal edema and respiratory distress which results in difficulty in swallowing and aspiration pneumonia. A severe, highly fatal syndrome characterized by diffuse erosion and ulceration of the upper alimentary tract, including the oral cavity, has occurred in beef feedlot cattle.

### Latency

The **BHV-1 virus can become latent** following a primary infection with a field

isolate or vaccination with an attenuated strain.<sup>3,37,38</sup> The virus may remain latent indefinitely and recrudescence, reactivation, and shedding of the virus can occur following the use of large doses of corticosteroids which mimic the effects of stress.<sup>39</sup> Transportation of cattle with latent infection can reactivate the virus, resulting in re-excretion of the virus and a rise in neutralizing antibodies. Attenuated vaccine strains can remain in a latent stage and vaccination does not provide protection against the establishment of latent infection with a wild strain.<sup>40</sup> Vaccination also does not inhibit re-excretion of a wild strain that was in the latent form at the time of vaccination. The vaccine virus and the field isolates can be excreted after live virus vaccination and subsequent field isolate challenge. Colostral antibodies in calves do not prevent initial virus replication, and latency can persist after the decline in colostral immunity and the calves are seronegative.<sup>41</sup>

The location of latency of the virus in the body varies; the virus remains localized near the site of its first multiplication and during recrudescence will be re-excreted by the tissue primarily infected. The BHV-1 can be isolated from the **trigeminal ganglion** of clinically normal cattle during the latent period, and trigeminal ganglionitis can be observed during recrudescence.

Latent infection with virulent BHV-1 virus may occur in the trigeminal ganglion of calves previously vaccinated with the MLV vaccine.<sup>3,38</sup> The virulent virus may spread along the trigeminal peripheral nerve despite the presence of humoral antibodies in vaccinated calves. Recrudescence of the virus from the trigeminal ganglion and spread along the peripheral nerves by intra-axonal flow to the nasal mucosa can occur in calves treated with corticosteroids and, presumably, occurs following stress. The virus has been isolated from the trigeminal ganglia of 10% of clinically normal cattle at slaughter, 40% of which had SN antibody to the virus.

The practical aspect of latency is that all cattle from endemic herds must be considered as potential sources of BHV-1 virus and capable of spreading infection to previously unexposed animals. Some latent carriers do not possess detectable antibodies. The only method of identification is by treatment with dexamethasone to initiate recrudescence and detection of the virus from nasal secretions, or the PCR examination of the trigeminal ganglion at necropsy.

A combined serological and clinical surveillance of 20 dairy herds over three consecutive years revealed wide variations in the circulation of the virus. In some

herds there was no identification of active infection, while in others one or two cycles of infection occurred in calves and yearlings, often without any clinical evidence of disease. Reactivation and shedding of the virus can occur in known carrier bulls at the time of mating, which may explain the higher incidence of titers in bulls than cows in some beef herds. Breeding bulls in an artificial insemination center which were vaccinated with a MLV vaccine were shedding the vaccine virus in the semen, and the virus could be recovered from preputial washings<sup>42</sup> 2–3 months after the last immunization. However, the frequency of recurrent infections and the amount of virus excreted are reduced after vaccination.

The presence of passively acquired antibodies in calves does not prevent virus replication and establishment of latent infection.<sup>43</sup> It is also possible to experimentally produce BHV-1 seronegative passively immunized calves which do not have antibody response after infection but develop a cell-mediated immune response after infection detected by a specific interferon gamma assay. The failure to easily detect such animals presents an epidemiological threat for the control of BHV-1 infections. Marker glycoprotein E-negative vaccines can also establish latency not only in naïve but also in passively immunized neonatal calves after a single intranasal inoculation.<sup>44</sup> This indicates that gE-negative vaccines, when used in calves with passive antibodies can result in seronegative vaccine virus carriers.<sup>45</sup>

The experimental intrapreputial infection of young bulls with BHV-1.2, caused acute balanoposthitis, latent infection, and detection of viral DNA in regional neural (sacral nerve ganglia, pelvic sympathetic plexus) and non-neural tissues (lymph nodes) 50 days after experimental reactivation.<sup>46</sup> Following experimental infection in calves the BHV-5 also can result in latent infection of surviving animals.<sup>5</sup>

Parturition may also be a stimulus for reactivation and shedding of a thermo-sensitive vaccine strain of the virus in vaccinated animals.<sup>22</sup> Reactivation and shedding of the virus has also been observed in cattle that recovered from the respiratory form of the disease and 5 months later were experimentally infected with *Dictyocaulus viviparus*. The placenta may harbor the virus in a latent stage for up to 90 days without transmitting the virus to the fetus. Recrudescence may be differentiated from primary infection and re-exposure by the intranasal route based on the distribution of antiviral antibody activity among serum IgM, IgG<sub>1</sub>, and IgG<sub>2</sub> isotypes.

### Predisposition to pneumonia

The role of the virus in affecting the lung clearance mechanism of cattle in the pathogenesis of pneumonic pasteurellosis has been reviewed and is presented in the section on shipping fever pneumonia in cattle. Experimental aerosol exposure of calves with the BHV-1 virus impairs the function of alveolar macrophages, which allows *Mannheimia haemolytica* to persist and proliferate in the lung and produce the characteristic lesion. In vitro studies indicate that the BHV-1 virus can interfere with the function of effector cells, such as macrophages, neutrophils, and lymphocytes. Aerosol exposure of calves to BHV-1 can affect the composition of alveolar phospholipids, which can alter the function of lung surfactant and compromise pulmonary defense mechanisms.<sup>47</sup> The BHV-1 can cause alteration in the glycoconjugate composition of bovine nasal epithelial surfaces, which may promote *Mann. haemolytica* proliferation in the early stages of pneumonic pasteurellosis.<sup>48</sup> The virus also causes varying degrees of obstructive lung disease, resulting in increased resistance to breathing, retention of carbon dioxide, and increased resting lung volume. Excessive airway constriction and impairment of bronchial relaxation occurs, which may compromise lung defense mechanisms and allow development of secondary bacterial pneumonia. A severe fatal BHV-1 pneumonia can occur.

Experimentally, active BHV-1 infection function affects bovine peripheral blood neutrophils, enhances the binding of *Mannheimia haemolytica* leukotoxin to bronchoalveolar leukocytes, and increases their killing.<sup>47</sup> The virus increases the number of bronchoalveolar leukocytes, resulting in many more leukotoxin-responsive cells being present in the lung.

### Reproductive failure

The **intrauterine inoculation of the BHV-1 into cattle results in an acute necrotizing endometritis** in the uterine body and caudal portions of the uterine horns but minimal lesions in the anterior parts of the horns. Experimental inoculation of the virus into heifers on the day after estrus and insemination can result in lesions of the ovaries consisting of focal necrosis and cellular infiltration. Commercially available vaccinal strains of the BHV-1 virus can produce similar lesions. The ovarian lesions have marked effects on luteal function, and plasma progesterone values in the first estrus after inoculation are markedly lower than those in subsequent normal cycles. Whether the BHV-1 virus causes reproductive failure as a result of necrosis of the

corpus luteum or embryonic infection remains to be determined. Recently hatched bovine embryos can be infected with any of several strains of BHV-1 and such infection in vitro is embryocidal. Experimentally induced infection during early pregnancy (7–28 days) will cause oophoritis and, in some cases, embryonic mortality. The effects of the virus on the genital tract and on reproductive performance in cattle have been reviewed.<sup>1</sup>

### Bovine mastitis

The BHV-1 and BHV-4 have been associated with mastitis in cattle.<sup>7,8</sup> Both viruses, and including the foot-and-mouth disease virus, and the PI-3 virus have been isolated from milk. The BHV-4 has been isolated from cows with clinical mastitis which also developed antibodies against the virus at the time of the mastitis and no bacteria were isolated from the milk samples.<sup>7</sup> Bovine umbilical cord endothelial cells were used to culture the virus. Experimental inoculation of the ductus papillaris of the teat has resulted in replication of the virus and subclinical mastitis after BHV-4 infection.<sup>8</sup> Simultaneous intramammary and intranasal inoculation of lactating cows with BHV-4 did not induce clinical but subclinical mastitis.<sup>49</sup> It is unlikely that BHV-4 is a major mastitis pathogen.

### CLINICAL FINDINGS

#### Rhinitis, tracheitis and conjunctivitis (red nose)

After experimental infection there is an incubation period of 3–7 days, but in infected feedlots the disease occurs 10–20 days after the introduction of susceptible cattle.

There is considerable variation in the severity of clinical signs following natural infection, dependent on the strain of the virus, the age susceptibility, and environmental factors. In North America, where the disease is endemic, the clinical disease is usually mild in dairy cattle and in range beef cattle. A severe form of the disease can occur in feedlots where crowding and commingling from several sources occur. A severe form of upper respiratory tract disease and encephalitis have been reported in neonatal beef calves.<sup>50</sup>

There is sudden onset of anorexia, loud coughing, fever (up to 42°C, 108°F), severe hyperemia of the nasal mucosa, with numerous clusters of grayish foci of necrosis on the mucous membranes of the nasal septum visible just inside the external nares, a serous discharge from the eyes and nose, increased salivation, and sometimes a slight hyperexcitability. A marked fall in milk yield may be the earliest indication in dairy cattle. The

respirations are increased in rate and are shallow, but only an increase in the loudness of breath sounds are audible on auscultation of the lungs unless secondary pneumonia is present. A severe primary viral, or secondary bacterial, tracheitis may cause inspiratory dyspnea with abnormal tracheal breath sounds transmitted to the lungs. Respiratory distress is evident on exercise. A short, explosive cough is characteristic of some outbreaks but not in others. Sudden death within 24 hours after first signs appear can result from extensive obstructive bronchiolitis.

**In dairy cattle**, many animals in a herd become affected within a few days. The disease is usually mild, characterized by inappetence, coughing, profuse bilateral serous nasal discharge, excessive salivation, nasal lesions, moderate fever, moderate drop in milk production, and recovery in a few days. Several animals may have the corneal form of the disease with obvious corneal edema, conjunctivitis, and profuse ocular discharge. The affected animals as a group do not return to full production for 10–14 days. The outbreak of respiratory disease will be followed by abortions in several days up to 90 days after the index case occurred.

**In feedlot cattle** the illness is often more prolonged, the febrile period is longer, the nasal discharge becomes more profuse and purulent, and the convalescent period is longer. Some deaths may occur in the acute febrile period, but most fatalities are due to a secondary bronchopneumonia and occur after a prolonged illness of up to 4 months in which severe dyspnea, complete anorexia, and final recumbency are obvious signs. Some recovered animals may have a persistent snoring respiration and a grossly thickened, roughened nasal mucosa accompanied by nasal discharge.

#### Ocular form of IBR

Conjunctivitis is a common finding in typical 'red nose', but outbreaks of conjunctivitis may occur as the major clinical finding. One or both eyes may be affected, which is easily misdiagnosed as infectious keratoconjunctivitis (pinkeye) associated with *Moraxella bovis*. However, the IBR lesions are confined to the conjunctiva and there are no lesions of the cornea except diffuse edema. The conjunctiva is reddened and edematous, and there is a profuse, primarily serous, ocular discharge. Calves less than 6 months of age may develop encephalitis, which is marked by incoordination, excitement alternating with depression, and a high mortality rate. Salivation, bellowing, convulsions and blindness are also recorded.<sup>1</sup>

### Systemic disease in newborn calves

In newborn calves under 10 days of age, the systemic form of the disease is severe and highly fatal. Sudden anorexia, fever, excessive salivation, and rhinitis, often accompanied by unilateral or bilateral conjunctivitis, are common. The oral mucous membranes are usually hyperemic, erosions of the soft palate covered by tenacious mucus are common, and an acute pharyngitis covered by tenacious mucopurulent exudate is characteristic. The larynx is usually edematous and respiratory distress is common. Bronchopneumonia is common, and loud breath sounds, crackles and wheezes associated with consolidation are present. Outbreaks of the disease commonly occur in highly susceptible herds where the herd immunity has declined, the dams are not vaccinated, and there is minimal, if any, specific colostrum immunity. Diarrhea and dehydration, referred to as the alimentary form of BHV-1 infection, occur in some affected calves. The cause of the diarrhea is uncertain but it may be related to the ruminal lesions.

### Abortion

Abortion is a common sequel and occurs some weeks after the clinical illness or parenteral vaccination of non-immune pregnant cows with the MLV vaccine of bovine tissue culture origin. Abortion may occur up to 90 days following vaccination if the virus becomes latent in the placenta and infects the fetus much later than usual. This raises the possibility that vaccination even with safe vaccines may appear to be the cause of abortion if natural infection preceded vaccination. It is most common in cows that are 6–8 months pregnant. Retention of the placenta often follows, but residual infertility is unimportant. However, endometritis, poor conception and short estrus can occur after insemination with infected semen. The infectious bovine rhinotracheitis virus has been isolated from semen 12 months after storage.

Infectious pustular vulvovaginitis is characterized by frequent urination, elevation of the tail, and a mild vaginal discharge. The vulva is swollen, and small papules, then erosions and ulcers, are present on the mucosal surface. Mucosal ulcers may coalesce and sloughing of brown necrotic tissue may occur. Recovery usually occurs in 10–14 days unless there are complications.

Balanoposthitis is characterized by similar lesions of the glans penis and preputial mucosa.

### CLINICAL PATHOLOGY

#### Virus isolation or detection

Isolation of the virus from nasal swabs using tissue culture, combined with a

four-fold rise in antibody titers, between acute and convalescent phase sera are desirable for a positive diagnosis of the disease.<sup>1</sup> When using nasal swabs, cotton and polyester swabs are recommended rather than calcium alginate swabs, which are viricidal within 2 hours. The virus can be detected in nasal swabs by the use of an ELISA, direct and indirect immunofluorescence techniques, immunoperoxidase, and by electron microscopic examination which may reveal herpes-like viral particles. The sensitivity of the direct immunofluorescence techniques is comparable to the cell culture technique. The ELISA is highly sensitive. A combination of the indirect immunofluorescence test and virus isolation from both ocular and nasal swabs of several animals will increase the recovery rate.<sup>1</sup>

The PCR assay is as sensitive as virus isolation and is a practical alternative for the rapid detection of the virus.<sup>1</sup> The results are available in 1 day, compared to virus isolation which requires 7 days. Virus could be detected in nasal swabs for up to 14 days after experimental infection of cattle, and the assay can also detect the virus in bovine fetal serum and semen samples. The PCR assay can be used for detection of virus in semen and is considered equivalent to that of standard virus isolation and dot blot hybridization.<sup>51</sup> The PCR assay with Southern blot hybridization is considered to be highly sensitive and can detect the virus in semen before they develop any detectable antibody.<sup>52</sup> The PCR assay can also detect five times as many positive semen samples as the virus isolation on egg yolk-extended semen.<sup>53</sup>

Using restriction endonuclease analysis of viral DNA it is now possible to distinguish field isolates of the virus from vaccine strains, which may be useful in the investigation of vaccine-induced epidemics of the disease.

A PCR assay is used to screen large numbers of milk samples for the presence of BHV-4.<sup>54</sup>

### Serology

Several serological tests are available for the detection of antibody and a rise in titer between the acute and convalescent phases of the infection.

The primary immune response to BHV-1 experimental inoculation of cattle is characterized by the formation of IgM and IgG antibodies, primarily IgG<sub>1</sub>, by postinoculation day 7. Secondary immune responses are characterized primarily by the formation of IgG<sub>2</sub> antibody. A secondary immune response resulting from abortion induced by intra-amniotic virus inoculation is characterized by a substantial increase in IgM antibody. A

secondary BHV-1 exposure by the intranasal route does not result in secondary IgM antibody formation.

The VN test has been widely used and is the standard by which other techniques have been evaluated.<sup>55</sup> The ELISA is a specific, sensitive, and practical test for detection of BHV-1 antibodies and has advantages over the SN test. The IgM-ELISA test is useful for the diagnosis of recent infection with BHV-1 in calves.<sup>56</sup> A micro-ELISA test is being used for the control program of BHV-1 infection in Switzerland. The test is simple, rapid, and convenient compared to the SN test, which requires cell culture facilities and is time-consuming.

The detection of latent BHV-1 infection in cattle is important in control programs and in international trade activities. Therefore, tests to detect specific antibodies in serum must be highly sensitive in order to detect low levels of BHV-1-specific antibodies.<sup>57</sup> This emphasizes the need for international standardization of tests to detect BHV-1-specific antibodies in cattle. In a comparison of European laboratories to evaluate a panel of test sera, including negative, weak and strong positive samples as well as international reference sera, VN tests and ELISAs demonstrate high specificity.<sup>57</sup> The quality of most laboratories was adequate. The VN test and the gB-specific ELISAs were most sensitive for the detection of antibodies in serum; the indirect ELISAs are the tests of choice for assaying milk samples. Most of the ELISAs demonstrate 100% specificity. Discrepancies occur with the low amounts of specific antibody. An indirect ELISA using undiluted test serum demonstrated 100% sensitivity. A commercial anti-BHV-1 blocking ELISA test kit is available to differentiate between cattle immunized with a marker BHV-1 vaccine and naturally infected cattle, but the sensitivity is only 74%.<sup>58</sup>

An immunofluorescence assay using monoclonal antibodies can discriminate between the four ruminant alphaherpesviruses related to the BHV-1.<sup>4</sup>

They include the bovine herpesvirus-5, caprine herpesvirus-1 (CpHV-1), cervine herpesvirus-1 (CvHV-1), and cervine herpesvirus-2 (CvHV-2). Buffalo herpesvirus-1 and elk herpesvirus are also closely related to BHV-1.<sup>4</sup>

Four serological tests have been evaluated to detect serum colostrum antibodies to BHV-1 in calves.<sup>59</sup> A blocking ELISA demonstrated superior sensitivity in the detection of antibodies in calves up to 9–11 months of age compared to calves up to 7 months of age.<sup>59</sup>

The serological tests used for the BHV-1 eradication programs in The Netherlands

have been compared.<sup>60</sup> The combination of the gB-ELISA (for screening), and the Danish test – a blocking and an indirect ELISA (for conformation), provides a sensitivity of >99.0 % and a specificity of >99.9%.

Bulk tank milk testing for BHV-1 antibodies may be useful in eradication and monitoring programs because it offers the possibility of rapid and inexpensive screening.<sup>61,62</sup> The correlation between the bulk milk test and the within-herd prevalence of seropositive animals can be as high as 0.86.<sup>61</sup> If BHV-1 is detected in the bulk milk, there is a high probability that more than one animal in a herd is infected and that the infection has spread.<sup>63</sup> The BHV-1 blocking ELISA is in use on bulk milk samples as part of the Danish surveillance system for BHV-1 infection in dairy herds.<sup>64</sup> The test can detect seropositive herds, with prevalence proportions as low as one seropositive cow out of 70 cows.

Specific antibody against BHV-1 may be detectable in fetal fluids and increases the rate of diagnosis of abortion.

#### NECROPSY FINDINGS

In **adult cattle**, gross lesions are restricted to the muzzle, nasal cavities, pharynx, larynx and trachea, and terminate in the large bronchi. There may be pulmonary emphysema or secondary bronchopneumonia, but for the most part the lungs are normal. In the upper respiratory tract there are variable degrees of inflammation, but the lesions are essentially the same in all anatomical regions. In mild cases there is swelling and congestion of the mucosae. Petechiae may be present and there is a moderate amount of catarrhal exudate. In severe cases the exudate is profuse and fibrinopurulent. When the exudate is removed, the mucosa is intact except for small numbers of necrotic foci in the nasal mucosa but there may be diffuse denudation of epithelium in the upper part of the trachea. Lymph nodes in the throat and neck region are usually swollen and edematous. Histologically, there is acute, catarrhal inflammation of the mucosa. Inclusion bodies are rarely seen in natural cases but do occur transiently in the nuclei of respiratory epithelial cells in experimentally infected animals. Secondary bacterial invasion will cause a more severe necrotizing change, which is usually followed by the development of bronchopneumonia. The virus is usually isolated from affected tissues using cell culture techniques. It can also be demonstrated in paraffin-embedded tissues by utilizing immunohistochemical techniques.

In the systemic form in **neonatal calves** a severe epithelial necrosis has been observed in the esophagus and

rumen, the adherent necrotic epithelium having the pultaceous quality of milk curd. The laryngeal mucosa is congested and edematous, with multiple focal lesions in the mucosa. Bronchopneumonia is common with a thick white exudate coating the tracheal lumen and extending into the bronchi. Histologically, there is necrosis of the pharynx, larynx, associated lymph nodes, esophagus, and liver. Inclusion bodies are evident in many surviving epithelial cells.

**Aborted fetuses** show moderately severe autolysis and focal necrotizing hepatitis. Microscopically, foci of necrosis rimmed by very few leukocytes are visible in the liver and many other organs. Occasionally, intranuclear inclusion bodies can be seen. Viral antigen can be demonstrated in sections of the lung, liver, spleen, kidney, adrenal gland, placenta, and in mummified fetuses using the avidin-biotin complex system. Using this system, the viral antigen can be found in fetal tissues from which virus could not be isolated in cell culture.

The **encephalitic form** lacks gross lesions but is characterized microscopically by non-suppurative inflammation, neuronal degeneration and gliosis, located particularly in the cerebral cortex and the internal capsule. Inclusion bodies are sometimes present. Both immunoperoxidase and PCR tests are capable of detecting BHV-5 antigen in formalin-fixed brain tissues affected with bovine herpesviral encephalitis.<sup>65</sup>

#### Samples for confirmation of diagnosis

- **Histology** – formalin-fixed samples: *abortion/neonate*: lung, liver, trachea, kidney, adrenal gland, rumen, esophagus, pharynx; *respiratory form*: nasal turbinate, trachea, pharynx, lung; *encephalitic form*: half of midsagittally-sectioned brain (LM, IHC)
- **Virology** – *abortion/neonate*: lung, liver, kidney, rumen; *respiratory form*: lung, trachea, nasal swab; *encephalitic form*: half of midsagittally-sectioned brain (FAT, ISO, PCR).

#### DIFFERENTIAL DIAGNOSIS

Infectious bovine rhinotracheitis is characterized by acute rhinotracheitis, coughing, profuse nasal discharge, nasal septum lesions, bilateral conjunctivitis, anorexia, fever, and gradual recovery in a few days. Secondary bacterial tracheitis and pneumonia can occur. It must be differentiated from the following:

- Pneumonic pasteurellosis is characterized by marked toxemia and depression, coughing, anorexia, gauntness, fever, abnormal lung sounds, good response to antimicrobials

- Bovine virus diarrhea is characterized by depression, anorexia, salivation, oral erosions and ulcers, persistent diarrhea, dehydration and death in a few days
- Malignant head catarrh is characterized by remarkable mental dejection, prominent lesions of nares, severe erosive lesions in oral cavity, interstitial keratitis, enlarged peripheral lymph nodes, high persistent fever, hematuria, terminal encephalitis and death in several days
- Calf diphtheria occurs usually in a single animal and there is depression, fever, unable to suck or eat, inspiratory dyspnea and stridor, fetid oral and laryngeal lesions and the severe toxemia are typical
- Viral pneumonia of calves occurs in a group of calves and characterized mild depression, inappetence, fever, coughing, dyspnea, abnormal lung sounds, no nasal lesions and recovery in a few days
- Allergic rhinitis occurs in cattle on pasture in summer months and is characterized by sneezing and wheezing with inspiratory dyspnea, mouth breathing, normal temperature, profuse thickened nasal discharge caseous and greenish-orange in color
- Systemic form of IBR in newborn calves must be differentiated from acute pneumonia, septicemia, and toxemias.

#### TREATMENT

##### Antimicrobial therapy

Broad-spectrum antimicrobials are indicated if secondary bacterial tracheitis and pneumonia are present. Affected cattle should be identified, isolated, and monitored frequently for evidence of secondary bacterial disease accompanied by anorexia and toxemia, and treated accordingly. The tracheitis is particularly difficult to treat; antimicrobials daily for several days are necessary and often slaughter for salvage is the most economical course.

##### CONTROL

The diseases associated with the virus may occur unpredictably at any time, and even closed herds with no introductions may remain free of the disease for several years and suddenly experience an outbreak. The current strategies for control are **natural exposure, biosecurity, vaccination, or eradication** of the virus from a herd or even the cattle population of a country.

##### Natural exposure or vaccination

###### Natural exposure

Cattle that have recovered from a natural infection with the virus are immune to further clinical disease. However, to depend on natural exposure of the herd is risky because not all animals will become infected and become immune. Abortion storms occur in herds that are not

vaccinated and depend on natural exposure. Vaccination is therefore recommended in areas where the prevalence of infection is high and eradication is not feasible because of the extensive nature of the cattle population and movement of animals from one area to another.

#### Biosecurity

Biosecurity is any practice or system which prevents the spread of infectious agents from infected animals to susceptible animals or which prevents the introduction of infected animals into a herd, region or country in which the infection has not yet occurred. Biosecurity is an integral part of any successful livestock enterprise, and reduces the risks and consequences of introducing an infectious disease.<sup>66</sup> The components of biosecurity, include management and placement programs, farm layout, decontamination, pest control, and immunization. All of these factors directly affect productivity and profitability.

The introduction of new infections into herds can be prevented or minimized by purchasing animals directly from herds known to be free of a particular disease. The adoption of this principle requires awareness of the possibility of purchasing unknown infected animals and testing animals for the infection before entry into the herd. It may also require keeping the introduced animal in quarantine for several weeks after arrival before it is mixed with the other animals.

Veterinarians need to work with their clients to develop a specific disease control and biosecurity protocol for each farm. The benefits of a rigidly enforced biosecurity program need to be stressed. Veterinarians can assist producers in developing methods to handle livestock and to purchase replacement stock by designing protocols which concentrate on general and specific aspects, such as design and construction of isolation rates.

**Closed herd.** A closed farming system to prevent the introduction of infectious diseases into dairy farms is technically possible and is economical. A closed dairy farming system could prevent the introduction of BHV-1 and can be a good starting point for eradication of infectious diseases from the herd.

In the cattle industry, animals are moved freely from their farms of origin to veterinary clinics, cattle shows and sales, auction markets, 4H club events, and community grazing pastures. Cattle are commonly returned to their farms of origin after being at shows and sales, veterinary clinics and other events where animals from other farms are mixed. Animals may commingle with those from adjacent herds (broken fences or cattle

breaching fences from one pasture to another). Breeding bulls may be leased from their farm or origin, used on another farm, and then returned to the farm of origin. The mixing of animals which occurs in all of the above circumstances provides opportunities for the transmission of important infectious agents.

Biosecurity of veterinary practices and veterinary teaching hospitals is now an important aspect of health management of food producing animals.

#### Vaccination

With currently available diagnostic tests, it is not possible to identify animals which have a latent BHV-1 infection. The next best strategy is to use a well-planned vaccination program.

#### Rationale for vaccination

The rationale for vaccination is based on the following:

- The virus is ubiquitous and the occurrence of the disease unpredictable
- Economic losses from abortion, neonatal disease, and respiratory disease can be high
- Colostral immunity in calves wanes by 4–6 months of age
- The vaccine will prevent abortions due to the virus and provide protection against respiratory disease if given at least 10 days before natural exposure.

Both the aerosol and IM administration of a virulent strain of the virus to colostrum-deprived seronegative cattle (6–12 months of age) results in comparable levels of serum antibody, but no measurable nasal secretory antibody. When these same cattle are challenged later by aerosol exposure they are protected from clinical disease and nasal secretory antibodies will develop.

#### Conventional vaccines

Based on the effectiveness of active immunization following natural exposure, both MLV and **inactivated virus** vaccines have been available.

**Modified live-virus vaccines.** There are two types of MLV vaccines. One is the parenteral Vaccine usually made with bovine fetal kidney tissue culture, and the other is an intranasal vaccine of rabbit tissue culture origin. An intranasal vaccine of bovine tissue culture origin containing a temperature-sensitive mutant is also available.

MLV vaccines offer three advantages over inactivated vaccines:

1. Induction of a rapid immune response
2. Relatively long duration of immunity
3. The induction of local immunity.

Protection from infection and disease has been observed within 40–96 hours following intranasal or IM vaccination with MLV vaccines.<sup>40</sup> This rapid development may be due to interferon induced locally, but intranasal vaccination also induces secretory IgA antibody and cell-mediated immunity. Vaccinational trials have found the traditional MLV vaccines are safe and effective in preventing clinical disease and are more effective than inactivated vaccines.<sup>67</sup>

**Both the parenteral and intranasal vaccines stimulate the production of humoral antibody.** The **intranasal vaccine** stimulates the production of local interferon and local antibody in the nasal mucosae, is safe for use in pregnant cows, and is highly effective for the prevention of abortion, due to the virus. The **parenteral vaccine** of bovine tissue culture origin is abortigenic, especially in non-immune cows. The intranasal vaccine provides protection against respiratory disease induced by experimental challenge 72 hours after vaccination. In general, the intranasal vaccine provides effective protection against the respiratory form of the disease but occasionally disease occurs in vaccinated animals. The intranasal vaccines do not cause a significant systemic reaction, and have been used in the face of an outbreak where all in-contact animals are vaccinated in an attempt to reduce the number of new cases.

**A major requirement of the intranasal vaccine is that the vaccine virus must multiply on the nasal mucous membranes.** If the vaccine is not administered into the nasal cavities carefully, or if the animal is difficult to handle or snorts out the vaccine, vaccination will not occur. The careful administration of a temperature-sensitive vaccine in 2 mL of diluent into one nostril is as effective as a two-nostril vaccination method using a total of 5 mL of diluent. The pre-existence of some local antibody from natural exposure or co-infection with a virulent strain of the virus may also restrict the multiplication of the vaccine virus, especially the temperature-sensitive mutants.

#### Temperature-sensitive BHV-1 MLV

– An intranasal BHV-1 vaccine containing a MLV strain whose growth is restricted to the upper respiratory tract has been developed in Europe. The vaccine strain is chemically treated to produce a temperature-sensitive characteristic, so that it cannot replicate at the body temperature of the animal. Prebreeding vaccination of replacement heifers with the vaccine provides fetal protection.<sup>68</sup> The vaccine is efficacious and safe for use in pregnant cattle. Intranasal vaccination



stimulates both systemic and local cell-mediated immunity and antibody. Dairy cows develop antibodies within 2 months after the vaccination, and 30 months later 91% of the vaccinated animals that responded still had detectable antibodies.<sup>69</sup> A percentage of unvaccinated animals may also seroconvert suggesting, but not proving that vaccine virus has been transmitted to them. Thus vaccine-induced antibodies may persist for years and interfere with control programs that are based on serological monitoring.

**Disadvantages of MLV vaccines** – The extensive use of MLV vaccines has reduced the incidence of clinical disease but there are some potential disadvantages. MLV vaccines must be stored and handled properly to avoid loss of potency. The parenteral MLV vaccine is potentially abortigenic and cannot be used on non-immune pregnant cattle. The virus in MLV vaccines can also become latent following vaccination. Fatal, generalized BHV-1 infection has been associated with vaccination of beef calves under 3 days of age with MLV containing BHV-1 and PI-3.<sup>27</sup> An outbreak of meningoencephalitis occurred in purchased Holstein-Friesian male calves vaccinated intranasally at 1 and 3 weeks of age with a commercial MLV vaccine containing BHV-1, bovine virus diarrhea virus (BVDV), PI-3, bovine adenovirus infection type-7 and bovine respiratory syncytial virus (BRSV).<sup>26</sup> Parenteral vaccination was recommended as the proper vaccination protocol. The isolated virus was classified as BHV-1.1.<sup>26</sup>

**Shedding of virus by vaccinated animals** – There is some concern that vaccinated calves may shed the vaccine virus, which could then spread to pregnant cattle resulting in abortion. In calves vaccinated with the intranasal vaccines, the virus replicates in the respiratory tract and is shed for 7–14 days. In non-immune calves, replicating virus can be detected 9 hours after vaccination, with peak shedding occurring at 4 days. However, the intranasal vaccination of feeder calves at 7 months of age does not result in transmission of the vaccine virus to non-vaccinated animals co-mingled with the vaccinates. Calves vaccinated with a live temperature-sensitive mutant of BHV-1 vaccine were protected against clinical illness from experimental challenge, but excreted the virus 2 months later following treatment with corticosteroids. This emphasizes the general principle that the use of a MLV vaccine implies a continuing commitment to vaccination which may reduce the incidence of disease but is unlikely to eradicate the infection.

**Inactivated vaccines.** Inactivated virus vaccines were developed because of some

of the disadvantages of MLV vaccines. They do not cause abortion, immunosuppression or latency, although they do not prevent the establishment of latency by field strains. They do not cause shedding and are safe for use in and around pregnant animals. They are also relatively stable in storage.

Inactivated vaccines, however, may not be as efficacious as MLV vaccines because of the potential for destruction of some of the protective antigens during the inactivation process. They require two doses of the vaccine and protection is not observed until 7–10 days following the second dose of the vaccine which is usually given 10–14 days after the primary vaccination.

A major disadvantage of both the MLV and inactivated vaccines is that neither allows for differentiation between vaccinated and naturally infected animals. These factors render conventional vaccines ineffective for a concurrent vaccination and eradication strategy, as well as inappropriate for use in breeding bulls for export market or artificial insemination units which demand BHV-1-free animals. These limitations, along with major advances in molecular biology and protein purification techniques, have encouraged the development of genetically engineered attenuated vaccines as well as nucleic acid-free subunit vaccines.

**Subunit vaccines.** A subunit vaccine contains only one or more of the antigens of the pathogen necessary to evoke protective immunity, and lacks the components that might cause unwanted side-effects.<sup>38</sup> The major surface glycoproteins of the BHV-1 are the antigens responsible for stimulating protective immunity. To produce a subunit vaccine containing only surface glycoproteins, the proteins are isolated from the virus of virus-infected cells, or the peptides can be synthesized. The major glycoproteins of BHV-1 originally designated gI, gIII and gIV are now named gB, gC, and gD,<sup>38</sup> and they induce high levels of antibody in cattle that are fully protected from experimental disease. The level of immunity based on serum antibody titers and protection against experimental challenge is much greater with the individual glycoproteins than are those immunized with commercially available inactivated vaccines.

**BHV-1 subunit vaccines provide a number of advantages:**

- They do not contain live virus and therefore cannot be shed to other animals, cause abortion or establish latent infections
- They prevent infection and disease
- They are not immunosuppressive

- Serological assays, based on one or more antigens not present in the vaccine provide a potential to differentiate vaccinates from naturally infected animals.

Prevention of infection by the use of a BHV-1 subunit vaccine combined with the use of a diagnostic test to identify infected cattle, offers the potential for vaccination of breeding bulls for artificial insemination units and export, as well as for eradication of the virus.

**The potential disadvantages of subunit vaccines include:**

- Because of the amount of glycoprotein needed, two immunizations may be necessary for protection
- Subunit vaccines will have to be compatible with the commonly available multivalent vaccines
- The efficiency of subunit vaccines is highly dependent upon the use of an effective adjuvant.

An experimental subunit vaccine containing truncated BHV-1 glycoprotein protected beef calves vaccinated at 3 and 7, or at 6 and 7, months of age from experimental aerosol infection with BHV-1, 12 days after the second vaccination. Vaccinated calves had higher levels of SN antibodies and nasal antibodies than control.<sup>70</sup> Low levels of maternal antibodies did not interfere with the antibody response of calves to two-dose vaccination at 4 and 5 months of age. The level of protection was similar in calves vaccinated at 3 and 7, or at 6 and 7 months of age, which suggests that calves can be primed with the first vaccination at an early age and respond well to revaccination at weaning. This provides a management strategy of the first vaccination at spring branding, and the second vaccination at weaning. The nasal and serum antibody levels in calves vaccinated at 3 and 4 months of age declined to negligible levels 3 months later which may be a disadvantage.

A subunit BHV-1 vaccine containing only the virus glycoprotein IV along with a recombinant *Mann. haemolytica* vaccine was compared with a MLV BHV-1 vaccine for the prevention of respiratory disease in feedlot calves.<sup>71</sup> The subunit vaccine was considered superior to the MLV BHV-1 vaccine in reducing mortality due to respiratory disease.

**Marker vaccines.** A marker vaccine is based on deletion mutants of one or more microbial proteins, which allows the distinction between vaccinated and infected animals based on respective antibody responses.<sup>72</sup> A marker vaccine must be accompanied by a diagnostic test,

which enables distinction of infected from vaccinated animals. These tests detect antibodies against a **glycoprotein that is lacking in the vaccine**. The desirable characteristics of the companion diagnostic test include:

- Antibodies detectable in 2–3 weeks after infection, both in vaccinated and unvaccinated cattle
- Antibodies must persist for at least 2 years, preferably lifelong
- A low level of virus replication gives rise to detectable antibody formation
- Cattle repeatedly given the matching marker vaccine remain negative in the test
- The test should be suitable to detect antibodies in milk
- A high sensitivity and specificity in comparison with conventional antibody tests.<sup>72</sup>

Mutants of BHV-1 have been developed by deleting one or more of the non-essential glycoproteins. Marker vaccines offer the advantage of evaluating the effect of vaccination on the circulation of the field virus under naturally occurring conditions. In a randomized clinical field trial the incidence of infection can be determined by measuring the number of cattle that develop antibodies against gE during the experimental period.<sup>72</sup> Vaccination of calves with a glycoprotein E-negative vaccine for BHV-1 was effective in reducing both the clinical signs and the excretion of challenge virus as early as 7 days after IM vaccination, or 3 days after intranasal vaccination.<sup>73</sup>

Experimental results demonstrate the efficacy of the potential marker vaccines. A thymidine kinase-deficient gC deletion mutant protected calves against disease and reduced shedding of virus following challenge.<sup>74</sup> A double vaccination with a killed gE-negative vaccine prevented clinical disease after challenge infection, and the duration peak of virus shedding was significantly reduced.<sup>75</sup> An intranasal vaccination with a live gE-negative vaccine reduced the challenge virus replication following contact challenge 2 days after vaccination.<sup>76</sup> A double vaccination with an experimental subunit gD BHV-1 vaccine was highly efficacious in preventing clinical signs after challenge, but also prevented replication and subsequent excretion of the challenge virus.<sup>77</sup> In some cases, the inactivated BHV-1 marker vaccine is more efficacious in reducing virus excretion after reactivation than a live marker vaccine.<sup>78</sup>

Using a gE-deleted BHV-1 strain, both a killed virus and MLV marker vaccine have been developed.<sup>79</sup> These vaccines induce all the relevant immune responses against BHV-1-specific immune reactions,

including antibodies against gE. Both vaccines have the capacity to reduce, and even to stop, the spread of BHV-1. A serological test that detects gE-specific antibodies in serum and milk is also available.<sup>79</sup> These vaccines have been tested according to the current European requirements for the development of bovine vaccines. The live vaccine is safe in pregnant cattle and is considered safe for all kind of breeding cattle, including bulls. The live virus marker vaccine is also efficacious in the presence of maternal antibody, and vaccination of very young calves, irrespective of their BHV-1 status, can be recommended. An inactivated BHV-1 gE-negative vaccine resulted in only a slight decrease of about 1.4 liters per cow in milk production after a double vaccination.<sup>80</sup>

#### Combination or multivalent vaccines.

The vaccines available for the control of diseases associated with BHV-1 infection are mostly multivalent antigen vaccines containing other respiratory pathogens such as PI-3, BRSV, and BVDV. Some also contain the antigens for the control of leptospirosis and campylobacteriosis. Vaccines containing only the BHV-1 are not in common use. A Canadian field trial to compare the serological responses in calves to eight commercial vaccines against BHV-1, PI-3, BRSV, and BVDV<sup>81</sup> found some differences. Antibody responses to BHV-1 were higher in calves vaccinated with MLV vaccines than in those vaccinated with the inactivated vaccines.<sup>81</sup> There were no differences in seroconversion rates and titers to BHV-1 between intranasal and MLV IM vaccines following a single vaccination. However, after double vaccination with MLV BHV-1 vaccines, both seroconversion rates and changes in titers to the virus were higher in calves vaccinated IM than in those vaccinated intranasally. Whether or not these differences in antibody titers reflect differences in vaccine efficacy against naturally occurring disease in the field situation is unknown.

The vaccination of calves with multivalent vaccines containing MLV or MLV and inactivated BHV-1 is associated with virus-specific interferon gamma production and protection from clinical disease due to challenge 5 days after a single vaccination.<sup>82</sup>

#### Immunization and latency

Immunization with vaccines, as with natural infection, does not prevent subsequent infection and the possibility of latency.

#### Vaccination programs in herds

**Beef breeding herds.** Beef calves should be vaccinated 2–3 weeks before weaning as part of a preweaning preconditioning

program. Calves vaccinated with the parenteral MLV BHV-1 vaccine before colostrum BHV-1 antibody titers reach low levels do not develop an immediate, active serological response, as indicated by serological titers, but are sensitized to the virus. Revaccination at a later date, when maternal antibodies have decreased to undetectable levels, results in a marked serological response. **Heifer and bull replacements are vaccinated at least 2 weeks before breeding.** When outbreaks of the respiratory disease occur in unvaccinated beef herds, all cattle in the herd may be vaccinated with the intranasal vaccine. Whether or not beef herds should be vaccinated annually following the initial vaccination is uncertain. There are field reports of outbreaks of abortion due to the virus in beef cattle that were vaccinated 3 years previously, which suggests that revaccination of breeding females every 2 years may be indicated. Since both natural infection and vaccination results in latent infection it may be that the persistence of the virus, combined with natural exposure, may result in persistence of antibody. The duration of protective immunity following vaccination is uncertain, but usually lasts 1 year. Antibodies last for at least 5.5 years in heifers following experimental infection and complete isolation during that time.

The MLV BHV-1 vaccine given intranasally or parenterally can enhance the prevalence of infectious bovine keratoconjunctivitis in beef calves vaccinated between 4 and 10 months of age, when the risk for the ocular disease is highest. The explanation for the pathogenetic mechanism is uncertain.

**Feedlot cattle.** Feedlot cattle should be vaccinated at least 10 days before being placed in the lot, especially one in which the disease may be enzootic. If this is not done a high incidence of the respiratory form of the disease may occur in recent arrivals. If vaccination before arrival is not possible, the next best procedure is to vaccinate the cattle on arrival and place them in an isolation starting pen for 7–10 days during which time immunity will develop.

**Prevention of pneumonia.** A field trial of pre-shipment vaccination of cattle with a combination BHV-1 and PI-3 vaccine administered intranasally 3 weeks before shipment from western Canada to Ontario did not have a significant effect on treatment rates of the animals for pneumonia after their arrival in the feedlot. The vaccination trial was designed to examine the hypothesis that vaccination with a BHV-1 virus vaccine prior to the stress of shipment would decrease the incidence of bovine respiratory disease, most of which is pneumonic pasteurellosis.

Experimentally, vaccination of cattle with the BHV-1 virus vaccine prior to inoculation with an aerosol of BHV-1 virus, followed later by an aerosol of *Mann. haemolytica*, provides protection against the bacterial pneumonia. There was no significant difference between vaccinated and non-vaccinated animals in terms of liveweight gains and incidence rate of subclinical disease. A commercially available MLV BHV-1 intranasal vaccine has been used in veal calves for this purpose but the lack of controls makes it difficult to interpret the results.

**Dairy cattle.** The necessity of vaccinating dairy cattle will depend on the prevalence of the disease in the area and in the herd, and the movement of cattle in and out of the herd. A closed herd may remain free of BHV-1 infection indefinitely and vaccination may not be indicated. But to avoid unpredictable abortion storms due to the virus in dairy herds, **heifer replacements should be vaccinated for the disease 2–3 weeks before breeding.** Vaccination of a large dairy herd with a persistent BHV-1 infection has been successful in controlling the respiratory form of the disease. The intranasal vaccine has been used extensively in newborn calves in problem herds, but its efficacy at such an age is unknown. **The parenteral vaccination of beef calves under 3 days of age with a MLV BHV-1 and PI-3 vaccine caused high mortality.**<sup>26</sup> If the systemic form of the disease poses a threat to a potential calf crop, the pregnant cows could be vaccinated with the intranasal vaccine in late pregnancy; this will increase the level of colostral antibody available to the newborn calf and will provide newborn calves with protection against the highly fatal systemic form of the disease.<sup>17</sup>

**Bulls intended for use in artificial insemination centers** present a special problem of disease control because the virus in semen can have severe consequences on reproductive performance. Bulls that are seropositive to the virus must be considered as carriers and potential shedders of the virus, and should not be allowed entry to these centers. Not all bulls that are seronegative can necessarily be considered free of the virus, and regular attempts at the isolation of the virus must be made from preputial washing and semen. Bulls that become infected while at the centers should be kept isolated, and culled and replaced with clean bulls. Bulls from herds that routinely vaccinate against BHV-1 should not be vaccinated with conventional vaccines if destined for an artificial insemination center. Cattle destined for export should not be vaccinated in case importing countries prohibit

the introduction of seropositive cattle. This will not guarantee that such animals will not become positive from natural infection. The use of marker vaccines has some potential in breeding bulls intended for artificial insemination units and for export.

### Eradication

Eradication of the BHV-1 virus from a single herd or the cattle population in a country can be considered as an alternative to vaccination. One of the prerequisites for the exportation of pedigree cattle is that the animals are serologically negative, which requires that the herd be free of infection with BHV-1. With careful planning and health management, it is possible to establish a seronegative herd. In a preliminary study in one closed beef herd in which there was latent BHV-1 infection, the calves were raised in isolation separate from the cows, following weaning. All of the maternally derived BHV-1 titers in the calves decayed to zero at weaning time and remained seronegative while raised in isolation. Serologically positive animals are removed or culled, and only seronegative animals introduced into the herd.

In 1983, Switzerland began a national program for the eradication of IBR.<sup>83</sup> The disease was made notifiable and the use of vaccination was prohibited. The program is based on:

- Annual serological testing of the national herd
- Restrictions on the trade with seropositive animals
- First priority of eradication was given to farms with breeding animals
- Stepwise elimination of seropositive animals.

By 1987, the breeding stock was virtually free of IBR.<sup>84</sup> The virus was also eradicated from a beef feedlot farm in Switzerland that raised 750 calves over a period of 12–13 months for market at 500 kg BW. Seropositive animals were identified serologically, kept separate from seronegative animals, and monitored serologically every 3 months. Eradication was complete within 9 months.<sup>84</sup>

In other countries, control is being attempted by segregation and elimination of seropositive animals and reduction of animal movement to prevent spread. This approach is not feasible in countries with extensive cattle populations and where management practices result in movement of cattle from one region to another.

**Eradication using marker vaccines.** Some countries are beginning an immunization program with the marker vaccines, which will protect the cattle against disease but still allow differen-

tiation between vaccinated animals and those that have been naturally infected and are potential carriers of the latent virus. These infected animals could be eliminated over a period of time. Successful eradication depends not only on the efficacy of the vaccine but also on the quality of the tests. False-positive test results can lead to unnecessary culling of cattle, an increase of costs, and reduced co-operation of farmers in the eradication program.

In The Netherlands, a compulsory eradication program for BHV-1 began in 1998. The program required that farms either vaccinate all cattle twice yearly or be approved for a certified BHV-1 free status – or SPF (specific pathogen free). To become a certified BHV-1 free herd, cattle have to be sampled individually and all seropositive animals culled as soon as their status is known. The BHV-1 free herd status is monitored by monthly bulk milk samples.<sup>85</sup> The spread of BHV-1 between herds can be prevented using a surveillance system of sampling herds annually, both individual milk samples and blood samples.<sup>86</sup>

Herds with BHV-2 infected (seropositive) animals are required to vaccinate with a glycoprotein E (gE)-negative BHV-1 vaccine.<sup>87</sup> The vaccine may be either an inactivated or live vaccine both based on a spontaneous BHV-1 mutant without the complete gE gene.<sup>78</sup> These so-called marker vaccines or 'diva' (differentiating infected from vaccinated animals) vaccines allow the identification of cattle infected with the wild-type BHV-1 within a vaccinated population using a gE-ELISA or a commercially available gE-blocking ELISA (Idexx) which both specifically detect gE antibodies. The eradication program is based on the presumption that all BHV-1 wild-type strains express gE and induce antibodies which can be measured with a gE-blocking ELISA.

The success of the marker vaccines depends on their capability to reduce transmission of the virus in the field. To prevent major outbreaks on a farm, the transmission ratio  $R_0$  between animals must be below 1. If the  $R_0$  between animals is below 1 on all farms eradication of BHV-1 would be certain. However, even when  $R_0$  between animals is not below 1, eradication can still occur when the  $R_0$  between herds is below 1, because the reduced transmission within a farm, makes farms less susceptible and less infectious. For BHV-1 it is possible that vaccination with a live gE-negative vaccine would reduce  $R_0$  in a herd below 1.

The efficacy of a live E-negative BHV-1 vaccine to reduce the transmission of BHV-1 in cattle was evaluated in a randomized, double blind, placebo-

controlled field trial in 84 dairy herds in the Netherlands.<sup>88</sup> The incidence of BHV-1 infections during 17 months was monitored by detecting antibodies against glycoprotein E. The transmission ratio  $R_0$  in the placebo-treated herds was estimated at 2.5 and 1.2 in the vaccinated herds. Thus the use of the live gE-negative BHV-1 vaccine reduces the incidence and transmission of infection in the field.<sup>88</sup>

Before the eradication program began, a large field trial to evaluate the efficacy of the live gE-negative BHV-1 vaccine found that some placebo herds, which were not vaccinated, were seronegative for gE-negative BHV-1, but seropositive for BHV-1 by glycoprotein B (gB) blocking ELISA.<sup>87</sup> The source of the gB seropositive occurrence was undetermined. Antibodies against BHV-5 may be differentiated from those of BHV-1 in a BHV-1 glycoprotein E blocking ELISA.<sup>89</sup> The gE-negative BHV-1 vaccine strain is not re-excreted after corticosteroid treatments, and not transmitted to susceptible cattle.<sup>90</sup>

An epidemiological and economic simulation model to evaluate the spread and control of BHV-1 in the Netherlands indicates that compulsory vaccination would be necessary to reach a BHV-1 free status.<sup>91</sup> Simulation modeling of BHV-1 control programs at the national level with special attention to sensitivity analysis has been described.<sup>92</sup>

### Side effects of BHV-1 marker vaccine in the Netherlands

Between May 1, 1998 and February 22, 1999 it was compulsory for Dutch cattle farmers to take measures to control BHV-1. Cattle on farms not already certified as BHV-1 free had to be vaccinated twice yearly with a gE-negative BHV-1 marker vaccine. In February 1999, the Dutch Animal Service advised all veterinary practices to postpone vaccination against BHV-1 using the marker vaccine.<sup>93</sup> Severe disease had occurred in herds vaccinated with the marker vaccine. Using monoclonal antibodies, bovine virus diarrhoea virus (BVDV) type 2 was found in the vaccine batch. Batches of vaccine which contained the BVDV type induced clinical signs of BVDV when inoculated into susceptible animals.<sup>94</sup> The first clinical signs of illness occurred 6 days after vaccination. Morbidity was up to 70%; on some farms none. During the first week feed intake and milk production decreased. In the second week, some animals become severely ill with fever, nasal discharge, and diarrhoea. By the third week the number of affected animals increased rapidly and some died. Necropsy findings

included erosions and ulcers of the digestive tract. Contamination of the marker vaccine with the BVDV was a consequence of infection of fetal calf serum used in vaccine manufacture. Vaccination of calves with a BHV-1 marker vaccine containing BVDV type 1 did not induce clinical disease.<sup>95</sup>

By the end of 1999, 6997 cattle farmers had lodged complaints related to the vaccine.<sup>96</sup> During the compulsory vaccination period, 13% of the herd vaccinations resulted in clinical disease and complaints.

Following recognition of the outbreaks associated with the marker vaccine some dairy farmers identified a 'chronic wasting' syndrome in their cows which they attributed to the vaccine. Field investigations of these cases could not associate them with the vaccine.<sup>97,98</sup> A review of the research into the chronic wasting syndrome of dairy cows found no evidence to associate the syndrome with the vaccine.<sup>99</sup> Vaccination of pregnant heifers in their third trimester experimentally with a high dose of the marker vaccine did not have any adverse effects.<sup>100</sup> Comparison of performance of dairy herds which were or were not vaccinated with the marker vaccine in 1998 could not discern any differences due to the vaccine.<sup>98</sup>

**Loss of certification.** The probability of and risk factors for the introduction of BHV-1 into SPF Dutch dairy farms has been examined.<sup>85</sup> A total of 95 SPF dairy farms were monitored for 2 years during which time 14 introductions of infectious diseases occurred on 13 of the 95 farms for a total incidence rate per herd-year at risk was 0.09. Outbreaks were usually associated with allowing cattle to return to their farm, more often grazed cattle at other farms, and less often provided protective clothing to the veterinarian. For a successful eradication program, farms should remain BHV-1 free which can be achieved by a more-closed farming system.<sup>101</sup> A more-closed farming system is one which rules out the possibility of direct contact with other cattle from other farms. Also, the farmer requests that professional visitors like veterinarians and AI technicians to wear protective farm clothing when handling cattle. Protective farm clothing are coveralls or overcoats and boots which can be worn over 'off-farm' clothing and which the farmer provides to the visitors before handling cattle. A sanitary barrier is a covered area outside the barn in which visitors put on protective farm clothing over their 'off-farm' clothes. A sanitary barrier has a 'dirty' side, where visitors leave, their 'off-farm' boots and a 'clean' side, where visitors wear protective clothing and can

enter the barn. All of these measures would be economical.<sup>85</sup>

### REVIEW LITERATURE

- Thiry E et al. Van (eds) Infectious bovine rhinotracheitis and other ruminant herpesvirus infections. *Vet Microbiol* 1996; 53:1–212.
- Turin L, Russo S, Poli G. BHV-1: New molecular approaches to control a common and widespread infection. *Mol Med* 1999; 5:261–284.
- Davison AJ. Evolution of the herpesviruses. *Vet Microbiol* 2002; 86:69–88.
- Thiry E, Lemaire M, Kueser V, Schynts F. Recent developments in infectious bovine rhinotracheitis. *Cattle Pract* 2002; 10:43–49.
- Wellenberg GJ, van der Poel WHM, Van Oirschot JT. Viral infections and bovine mastitis: a review. *Vet Microbiol* 2002; 88:27–45.
- Jones C. Herpes simplex virus type 1 and bovine herpesvirus 1 latency. *Clin Microbiol Rev* 2003; 16:79–95.
- Turin L, Russo S. BHV-1 infection in cattle: an update. *Vet Bull* 2003; 15R:21R.

### REFERENCES

- Thiry E et al. (eds). Infectious bovine rhinotracheitis and other ruminant herpesvirus infections. *Vet Microbiol* 1996; 53:1–212.
- Miller JM et al. *Am J Vet Res* 1995; 56:870.
- Davison AJ. *Vet Microbiol* 2002; 86:69.
- Keuser V et al. *J Clin Microbiol* 2004; 42:1228.
- Meyer G et al. *Arch Virol* 2001; 146:633.
- D'Arce RCF et al. *Vet Microbiol* 2002; 88:315.
- Wellenberg GJ et al. *Vet Rec* 2000; 147:222.
- Wellenberg GJ et al. *Vet Microbiol* 2002; 88:27.
- Boelart F et al. *Prev Vet Med* 2000; 45:285.
- Pritchard G et al. *Vet Rec* 1997; 140:587.
- Turin L, Russo S. *Vet Bull* 2003; 15R.
- Paisley LG et al. *Prev Vet Med* 2001; 50:109.
- Solis-Calderson JJ et al. *Prev Vet Med* 2000; 57:190.
- Rimstad E et al. *Arch Virol* 1992; 123:389.
- Lillehaug A et al. *J Wildlife Dis* 2003; 39:779.
- Jordan LT et al. *J Wildlife Dis* 2003; 39:216.
- Mechor S et al. *Can J Vet Res* 1981; 51:542.
- Ryan AM et al. *Am J Vet Res* 1993; 54:73.
- Thiry E et al. *Cattle Pract* 2002; 10:43–49.
- Vonk Noordegraaf A et al. *Prev Vet Med* 2004; 62:51.
- d'Offay JM et al. *Am J Vet Res* 1993; 54:534.
- Belknap EB et al. *Vet Pathol* 1994; 31:358.
- Egyed L et al. *Vet Res Comm* 2000; 24:423.
- van Oirschot JT et al. *Vet Rec* 1995; 137:235.
- Edwards S et al. *Br Vet J* 1991; 147:216.
- Furuoka H et al. *Acta Neuropath* 1995; 90:565.
- Bryan LA et al. *Can Vet J* 1994; 35:223.
- Edwards S et al. *Vet Microbiol* 1990; 22:213.
- Smith GA et al. *Arch Virol* 1995; 140:599.
- van Drunen Little-van den Hurk S et al. *Can J Vet Res* 2000; 65:81.
- Pritchard GC et al. *Vet Rec* 2003; 153:113.
- Miller JM et al. *Am J Vet Res* 1991; 52:458.
- Dipas M et al. *Vet Rec* 2003; 153:209.
- Schuh JCL et al. *J Comp Path* 1992; 106:243.
- Narita M et al. *J Comp Path* 2000; 122:185.
- Meyer G et al. *Vet Microbiol* 1996; 51:27.
- Jones C. *Clin Microbiol Rev* 2003; 16:79.
- Turin L, Russo S, Poli G. 1999; 5:261.
- Winkler MTC et al. *Vet Microbiol* 2002; 86:139.
- Castrucci G et al. *Comp Immunol Microbiol Inf Dis* 2002; 25:205.
- Lemaire M et al. *Vet Rec* 1995; 137:70.
- van Oirschot JT et al. *Vet Rec* 1993; 132:32.
- Lemaire M et al. *J Clin Microbiol* 2000; 38:1885.
- Lemaire M et al. *Vaccine* 2001; 19:4795.
- Schynts F et al. *Vet Microbiol* 2001; 82:211.

46. Vogel FSF et al. *Vet Microbiol* 2004; 98:185.
47. Leite F et al. *Vet Immunol Immunopathol* 2002; 84:97.
48. Mosier DA et al. *Vet Pathol* 1995; 32:140.
49. Wellenberg GJ et al. *Vet Microbiol* 2002; 86:115.
50. Penny CD et al. *Vet Rec* 2002; 151:89.
51. Xia JQ et al. *Can J Vet Res* 1995; 59:102.
52. Masri SA et al. *Can J Vet Res* 1996; 60:100.
53. van Engelenburg FAC et al. *J Clin Microbiol* 1995; 33:308.
54. Wellenberg GJ et al. *J Virol Meth* 2001; 97:101.
55. Perrin B et al. *Rev Sci Tech Off Int Epiz* 1994; 13:947.
56. Ungar-Waron H, Abraham A. *Vet Microbiol* 1991; 26:53.
57. Kramps JA et al. *Vet Microbiol* 2004; 102:169.
58. Perrin B et al. *Vet Rec* 1996; 138:520.
59. Cho HJ et al. *Can Vet J* 2002; 43:43.
60. de Wit JJ et al. *Vet Microbiol* 1998; 61:153.
61. Hartman A et al. *Vet Rec* 1997; 140:484.
62. Pritchard GC et al. *Vet Rec* 2002; 150:182.
63. Frankena K et al. *Vet Rec* 1997; 140:90.
64. Nylin B et al. *Prev Vet Med* 2000; 47:91.
65. Ely R W et al. *J Vet Diag Invest* 1996; 8:487.
66. Wells SJ, J Dairy Sci 2000; 83:2380.
67. Castrucci G et al. *Comp Immunol Microbiol Infect Dis* 2002; 25:29.
68. Cravens RL et al. *J Am Vet Med Assoc* 1996; 208:2031.
69. van der Poel WHM et al. *Vet Rec* 1995; 137:347.
70. van Donkersgoed J et al. *Can J Vet Res* 1996; 60:55.
71. Harland RJ et al. *Can Vet J* 1992; 33:734.
72. van Oirschot JT et al. *Vet Microbiol* 1996; 53:43.
73. Makoschey B, Keil GM. *Vet Rec* 2000; 147:189.
74. Flores EF et al. *J Vet Diag Invest* 1993; 5:534.
75. Kaashoek MJ et al. *Vaccine* 1995; 13:342.
76. Kaashoek MJ, van Oirschot JT. *Vet Microbiol* 1996; 53:191.
77. van Drunen Littel-van den Hurk S et al. *Vaccine* 1994; 12:1295.
78. Bosch JC et al. *Vaccine* 1997; 15:1512.
79. Strube W et al. *Vet Microbiol* 1996; 53:181.
80. Bosch JC et al. *Vet Rec* 1997; 140:196.
81. van Donkersgoed J et al. *Can Vet J* 1991; 32:727.
82. Woolums AR et al. *Vaccine* 2003; 21:1158.
83. Ackerman M et al. *Vet Microbiol* 1990; 23:365.
84. Ackerman M et al. *Prev Vet Med* 1990; 9:121.
85. van Schaik G et al. *Prev Vet Med* 2002; 54:279.
86. Graat EAM et al. *Vet Microbiol* 2001; 79:193.
87. Mars MH et al. *Vet Rec* 2000; 147:328.
88. Mars MH et al. *Vaccine* 2001; 19:1924.
89. Wellenberg GJ et al. *Vet Microbiol* 2001; 78:79.
90. Mars MH et al. *Vaccine* 2000; 18:1975.
91. Vonk Noordegraaf AV et al. *Prev Vet Med* 1998; 36:219.
92. Vonk Noordegraaf AV et al. *Livestock Prod Sci* 2002; 76:153.
93. Barkema HW et al. *Tijdschrift voor Deirgeneeskunde* 2001; 126:158.
94. Brusckhe CJM et al. *Tijdschrift voor Deirgeneeskunde* 2001; 126:189.
95. Antonis AFG et al. *Tijdschrift voor Deirgeneeskunde* 2001; 126:208.
96. Wuijckhuise L Van et al. *Tijdschrift voor Deirgeneeskunde* 2001; 126:173.
97. De Kruif A. *Tijdschrift voor Deirgeneeskunde* 2001; 126:166.
98. Bartels CJM et al. *Tijdschrift voor Deirgeneeskunde* 2001; 126:191.
99. Meijer GAL et al. *Tijdschrift voor Deirgeneeskunde* 2001; 126:223.
100. Brusckhe CJM et al. *Tijdschrift voor Deirgeneeskunde* 2001; 126:211.
101. van Schaik G et al. *Prev Vet Med* 2001; 51:289.

## CHRONIC ENZOOTIC PNEUMONIA OF SHEEP (CHRONIC NON-PROGRESSIVE PNEUMONIA, SUMMER PNEUMONIA, PROLIFERATIVE EXUDATIVE PNEUMONIA)

### Synopsis

**Etiology** Unknown, multifactorial  
**Epidemiology** Affects sheep under 12 months of age. Seasonal occurrence, summer and autumn in southern hemisphere. Common disease affecting most flocks but severity varies between farms  
**Clinical findings** Insidious onset. Coughing, nasal discharge and uneven weight gain  
**Lesions** Consolidation of anteroventral lobes of lung. Pleuritis  
**Diagnostic confirmation** Postmortem lesions  
**Treatment** Antimicrobials for severely affected individual sheep  
**Control** No effective control procedure established

Enzootic pneumonia is defined here as the common, lowly pathogenic disease of sheep, particularly lambs, which is common in all sheep populations. The disease is recognized by different names in different areas of the world. It can be differentiated from the acute fibrinous pneumonia and pleurisy associated with *Mannheimia (Pasteurella) haemolytica*, which is often called enzootic pneumonia in the British literature, and from the chronic progressive pneumonias, maedi and jaagsiekte.

### ETIOLOGY

Although the disease is well-known, its cause is not well defined. This is partly due to its **non-fatal** character, which leads to incomplete examination of early cases; most of those submitted for examination or necropsy are distorted by the addition of secondary bacterial invaders. It has a multi-factorial etiology. *Mycoplasma ovipneumoniae*, *Bordetella parapertussis*, chlamydia, parainfluenza-3 (PI-3) virus, adenovirus, a respiratory syncytial virus, and reovirus have been nominated as causes. *Mann. haemolytica* is a common secondary infection and may lead to more acute respiratory disease. The disease, which might be most accurately identified as **chronic undifferentiated enzootic pneumonia of sheep**, is probably a collection of etiologically specific diseases.

### *M. ovipneumoniae*

*M. ovipneumoniae* is considered to be important in the disease complex and may be the initiating cause.<sup>1-4</sup> It is

commonly isolated in large numbers from the lungs of affected sheep, but can also be isolated from the nasal cavity of some normal sheep and less occasionally from normal lung. Experimental challenge with pure cultures of the organism produces minimal lesions, but aerosol or intra-bronchial challenge with homogenates of affected lung that contain the organism produces proliferative interstitial and lymphoid pneumonic lesions indistinguishable from the natural disease.<sup>3,5</sup> *M. ovipneumoniae* is a facultative pathogen that requires compromised lung defense mechanisms in order to initiate lesions; infection with this organism subsequently predisposes the lung to secondary infection with organisms such as *Past. haemolytica*.<sup>1,3</sup> There is considerable heterogeneity in *M. ovipneumoniae* and several different strains may be isolated from a pneumonic lung.<sup>5</sup> Differences between strains in pathogenicity are not determined. Other mycoplasma, including *M. mycoides* subsp. *mycoides*, *M. mycoides* subsp. *capri*, *M. putrifasciens*, and *M. arginini* may be associated with chronic enzootic pneumonia in tropical zones.<sup>6</sup>

### *B. parapertussis*

*B. parapertussis* is a common isolate from the nasal cavities and lungs of sheep with chronic enzootic pneumonia and is also believed to have an initiating role in the disease.<sup>7</sup> It produces a cytotoxin that damages ciliated epithelium in the trachea and experimental challenge of colostrum-deprived lambs produces mild pulmonary lesions similar to those seen early in the natural disease. *B. parapertussis* also can predispose pneumonic pasteurellosis.<sup>8</sup>

### Parainfluenza-3 (PI-3) virus

PI-3 is a cause of a mild undifferentiated pneumonia in sheep, and surveys around the world have shown that it is a widespread infection.<sup>2-4</sup> The disease is clinically mild and marked by the presence of interstitial pneumonia. Antibodies to PI-3 are present in lambs soon after birth, but the half-life is short and lambs are susceptible by the time they are weaned and mixed with other lambs, which is when clinical disease often occurs. In the experimentally produced disease in lambs<sup>9</sup> there is a slight seromucosal nasal discharge, coughing, increased sensitivity to tracheal compression, and fever of 40–41°C (104–106°F). At necropsy there is obvious hyperemia of the upper respiratory mucosa, including the trachea, the bronchial lymph nodes are enlarged, and there are small foci of catarrhal inflammation of pulmonary parenchyma of the apical and cardiac lobes.<sup>9</sup> However, challenge of lambs at 2 weeks of age with this

virus and *Mann. haemolytica*, while producing disease, did not result in prolonged disease lasting to slaughter, and it was concluded that these agents, without other factors, were not the cause of enzootic pneumonia.<sup>10</sup> This conclusion is supported by the results of vaccine trials with PI-3 against enzootic pneumonia.<sup>11</sup>

### Bovine respiratory syncytial virus (BRSV)

BRSV has resulted in pneumonia following experimental challenge of sheep and is evidenced clinically by fever and hyperpnea, and pathologically by multifocal pulmonary consolidation and necrosis of epithelial cells. There is little evidence for BRSV as a cause of significant respiratory disease in sheep.<sup>3,4,12</sup>

### Other agents

*Adenovirus*<sup>13</sup> and a type-3 *reovirus*<sup>14</sup> have been used experimentally to produce pneumonic lesions, and a vaccine has been produced to protect lambs against the adenovirus infection.<sup>15</sup> Similarly, sheep herpesvirus, *caprine herpesvirus-1*, will produce an interstitial pneumonia in experimentally challenged SPFLambs, but there is no evidence of a causal association with chronic enzootic pneumonia.

Autoantibodies to upper respiratory cilia have been detected in sheep colonized with *M. ovipneumoniae* and it is suggested that they contribute to the pathogenesis of coughing in this disease.<sup>16</sup>

## EPIDEMIOLOGY

### Occurrence

Enzootic pneumonia affects animals up to 12 months but may commence as early as 6 weeks of age. The disease can occur in both lambs at pasture and housed lambs. In many affected flocks, 80% of 4–5-month-old lambs have clinical signs and lesions, and the disease is credited with causing a significant **depression in growth rate** after weaning in lamb flocks with a high prevalence. This has been confirmed in controlled studies on the effect of the experimentally produced disease on weight gain in housed and pasture-fed lambs.<sup>2–4</sup>

Enzootic pneumonia has a **seasonal pattern** which differs according to locality and management. In Australia and New Zealand, the period of peak prevalence is in the late summer and autumn. In a longitudinal slaughter study of lambs in New Zealand the prevalence of pneumonic lesions was found to increase from early summer to early autumn with an overall prevalence of pneumonia of 42%. There were significant differences in prevalence between different regions of the country.<sup>17</sup> Factors such as **co-mingling** sheep from different sources and environmental stress can precipitate clinical disease.

### Environmental risk factors

In Australia and New Zealand, clinical outbreaks of enzootic pneumonia in lambs aged 5–8 months are often associated with heat stress, frequent yarding after weaning, use of plunge or shower dips, and transport or mustering of sheep in hot dry conditions. Cases commence within 1–3 weeks after transport. In contrast in the United Kingdom and Europe this disease occurs primarily in the late winter and early spring and in the Northern hemisphere the disease is commonly associated with problems in the housing environment. In Ireland, an association has been made between the occurrence of lesions at slaughter and the extent of rain and windchill experienced by the sheep in the 2 months prior to slaughter.<sup>18</sup>

### Economic importance

Death loss from this disease is minor but economic loss is considerable and includes reduced growth rate, prolonged periods on the farm before reaching slaughter weight, the drug and labor costs associated with treatment, slaughterhouse wastage, and downgrading of carcasses with pleural adhesions and an effect on carcass quality. The situation is similar to that with enzootic pneumonia of pigs.

### CLINICAL FINDINGS

The disease is insidious in onset and persists in a group of lambs for 4–7 months. The **disease is mild** in its clinical manifestations, and the primary signs are poor and uneven weight gains, an increased nasal discharge, coughing, an increased respiratory rate, and respiratory distress with exercise. Increased intensity and a higher pitch of breath sounds are heard on auscultation over the region of the bronchial hilus, and sounds of fluid in the airways are heard in some cases at rest but can usually be elicited by inducing the lamb to cough. There may be periods of fever.

There is a relationship between the proportion of the lung affected with pneumonia and average daily gain and in one study weight gain was reduced by 50% when greater than 20% of the lung was affected.<sup>17</sup> The weight loss is most apparent clinically soon after the disease commences.

### NECROPSY FINDINGS

At postmortem there are clearly demarcated areas of consolidation in the anteroventral lobes and there may be pleuritis with pleural adhesions. The diagnosis is on gross lesions and the presence of typical lesions on histological examination.<sup>3,4</sup>

## TREATMENT AND CONTROL

Treatment is not usually undertaken unless there is secondary infection to produce acuterespiratory disease. Control is based on the avoidance of stress factors that can exacerbate existing infection.

### REVIEW LITERATURE

- Jones GE et al. A review of experiments on the reproduction of chronic pneumonia in sheep. *Vet Bull* 1986; 56:251–263.
- Alley MR. Pneumonia in sheep. *Vet Ann* 1991; 31:51–57.
- Alley MR. Pneumonia in sheep. *Vet Ann* 1991; 31:51–57.
- Martin WB. *Comp Immun Microbiol Infect Dis* 1996; 19:171–179.
- Watt NJ. Non-parasitic respiratory disease in sheep. *Vet Ann* 1996; 36:391–398.
- Alley MR, Ionas G, Clarke JK. Chronic non-progressive pneumonia of sheep in New Zealand – a review of the role of *Mycoplasma ovipneumoniae*. *NZ Vet J* 1999; 47:155–160.
- Ruffin DC. *Mycoplasma* infections in small ruminants. *Vet Clin North Am Food Anim Pract* 2001; 17:315–332.

### REFERENCES

- Alley MR. *Vet Ann* 1991; 31:51.
- McAuliffe L et al. *Vet Rec* 2003; 153:687.
- Martin WB. *Comp Immun Microbiol Infect Dis* 1996; 19:171.
- Watt NJ. *Vet Ann* 1996; 36:39.
- Alley MR, Clark JK. *NZ Vet J* 1980; 28:77.
- Oros J et al. *J Vet Med B* 1997; 44:99.
- Chen W et al. *NZ Vet J* 1988; 36:138.
- Porter JF. *J Comp Path* 1995; 112:381.
- Cutlip RC, Lehmkuhl HD. *Am J Vet Res* 1982; 43:2101.
- Cutlip RC et al. *Small Rumin Res* 1993; 11:171.
- Davies DH et al. *NZ Vet J* 1983; 31:87.
- Bryson DG. *Am J Vet Res* 1988; 49:1424.
- Cutlip RC, Lehmkuhl HD. *Vet Path* 1986; 23:589.
- McFarran JB et al. *Res Vet Sci* 1974; 17:356.
- Palfi V, Belak S. *Vet Microbiol* 1979; 3:191.
- Niang M et al. *Vet Immunol Immunopathol* 1988; 64:191.
- Goodwin KA et al. *NZ Vet J* 2004; 52:175.
- McIlroy SG et al. *Vet Rec* 1989; 125:79.

## OVINE PROGRESSIVE PNEUMONIA (MAEDI, MAEDI-VISNA)

**Ovine progressive pneumonia** and **maedi** are North American and European terms for slow virus diseases of sheep in which a **chronic progressive pneumonia** is a major manifestation. The name **maedi** is derived from the Icelandic term for dyspnea. **Maedi-visna** virus can also produce **visna** which is a disease of the nervous system and is discussed elsewhere under that heading. Additional manifestations of infection are arthritis, indurative mastitis, and ill-thrift. These diseases have a close relationship with caprine arthritis encephalitis. **La bouhite** and **Graff-Reinert** disease are local names for **maedi** in France and South Africa, respectively. In the United States it was originally described as **Montana progressive pneumonia**, and in Holland as **zwoegersiekte**.

## Synopsis

**Etiology** Ovine retroviruses

**Epidemiology** Most sheep infected as lambs. Persistent infection. High prevalence of infection in many countries but low prevalence of clinical disease. Transmission is via infected colostrum and milk but lateral transmission also occurs

**Clinical findings** Clinical disease of mature sheep, long incubation, long clinical course. Dyspnea and respiratory distress, initially with exercise but eventually also at rest. Some sheep also manifest chronic wasting and/or indurative mastitis

**Necropsy findings** Lungs uniformly increased in bulk with enlargement of bronchial and mediastinal lymph nodes. Lymphocytic interstitial pneumonia. Discrete or diffuse hardening of mammary glands with lymphoid infiltration

**Diagnostic confirmation** Clinical signs, pathology and serology. Serology provides confirmation of infection. PCR

**Treatment** None

**Control** Segregated rearing. Test and cull

## ETIOLOGY

Maedi-visna virus and ovine progressive pneumonia virus are ovine lentiviruses; **non-oncogenic ovine retroviruses** which constitute a species of the lentivirus genus. They induce a **persistent infection** in sheep that may cause lymphoproliferative changes in the lung, mammary tissues, brain, and joints. There is a high degree of **relatedness** with the lentivirus associated with caprine arthritis encephalitis, and the ovine and caprine lentiviruses share nucleotide homology and serological properties.<sup>1,2</sup>

Although they belong to a single virus species, isolates obtained from naturally infected sheep are genetically heterogeneous, **antigenic drift** is common, and antigenic variation of the surface protein facilitates the persistence of the virus in the host. There is evidence for variation in pathogenic potential between isolates.

There is some evidence that the North American strains of ovine lentivirus may have originated from cross-species transmission of caprine arthritis-encephalitis virus rather than from maedi lentivirus,<sup>3</sup> but the similarity in clinical manifestation of maedi and ovine progressive pneumonia permits the discussion of these diseases as a single entity.

## EPIDEMIOLOGY

## Occurrence

The earliest reports of the disease were from South Africa and the United States, but it now occurs in **all major sheep-producing countries** with the **exception** of Australia, New Zealand, Iceland, and Finland. The disease was present in Iceland but was eradicated in 1965. Maedi

virus was introduced into Iceland in 1933 by the importation of infected sheep, and because of breed susceptibility of the local sheep and management practices it developed to a problem of major national significance. In individual flocks the annual mortality was often 15–30% and in these circumstances sheep farming was not economically feasible. Approximately 105 000 sheep are believed to have died of the disease and 650 000 sheep had to be slaughtered in order to eradicate it from the country.<sup>4</sup>

The **international movement** of sheep has facilitated the spread of the disease and it is believed to have been introduced into Denmark, Norway, Sweden, and Great Britain since the 1970s through the importation of infected sheep. No other country has experienced the severity of disease that occurred in Iceland.

## Host range

**Sheep and goats** are the only species known to be susceptible and infection cannot be established by experimental challenge in cattle, deer, pigs, dogs, horses, chickens, mice, and rats.<sup>5</sup> Rabbits are susceptible, but infection is limited to the acute stage prior to the production of antibody, and chronic infection does not occur as it does in sheep and goats.<sup>5</sup> A serological survey of **wildlife** in the United States has shown no evidence of infection in bighorn sheep, elk, white tail deer, or antelope.<sup>5</sup> All breeds of sheep appear to be susceptible to infection, but there may be differences in **breed susceptibility** based on breed differences in seroprevalence in flocks with more than one breed of sheep.<sup>6,7</sup> Differences in breed susceptibility are not consistent and it is possible that in any one flock they reflect differences in the susceptibility of family lines within the breed.<sup>7</sup> Apparent differences in breed susceptibility in surveys could also be a reflection of management differences between flocks and regions.<sup>7,8</sup>

## Prevalence

The prevalence of infection varies between farms, breeds and countries. In the United States, true prevalence is not known, but a seroprevalence of 26% is recorded in samples voluntarily submitted from sheep in 29 States, and 48% of flocks had one or more seropositive sheep. An earlier study found 1–68% reactors in culled ewes from different States. Infection appears more common in western States.<sup>9</sup> A random nationwide survey in Canada<sup>10</sup> found 19% of sheep over 1 year of age with antibodies; 63% of flocks were infected, and the mean flock prevalence was 12%; similar prevalence rates are recorded for the province of

Ontario.<sup>11</sup> The disease does not have significant national occurrence in countries such as the United Kingdom where infection has been introduced relatively recently, but there is concern that the prevalence may be increasing.<sup>12,13</sup> Prevalence rates vary markedly between countries and between flocks in the same country.<sup>4,8,11,14</sup>

There is considerable variation in the prevalence of seropositive sheep between flocks. Rates of seropositivity increase with age, and flock seroprevalence is influenced by the average age of the flock. **Flock seroprevalence** also has been positively associated with the use of foster ewes, allowing lambs older than 1 day to have contact with other lambing ewes, flock size, close contact during confinement for lambing, stocking density on pasture, and the length of time that the flock has been in existence.<sup>10,11</sup> Rates of seropositivity are much higher in flocks that also are infected with pulmonary adenomatosis than in those which are not.<sup>15</sup>

## Transmission

The disease is spread by the respiratory route, by ingestion of infected milk and by in utero infection. The relative importance of these routes appears to vary with the flock and its management, but lateral transmission is important in all.

**Lambs** may contract the infection at birth, or shortly following, from contact with infected ewes or from ingestion of infected colostrum and milk. Mononuclear cells in the colostrum and milk of infected ewes are infected with virus and virus from these cells may pass through the intestinal wall to infect the lamb.<sup>16</sup> Lambs born to seropositive ewes have a significantly greater risk for infection than those from seronegative ewes, and lambs born to ewes that have been infected for a long time are at greater risk for infection. The chance of transmission to lambs from infected ewes increases with the period of contact but can occur within the first 10 hours of life.<sup>7,11</sup>

Lateral transmission can also occur in **older sheep**. Lateral transmission appeared an important method of transmission of the disease in Iceland and the Basque area and has been a significant component of the spread of infection of the virus in flocks in the United Kingdom since its initial introduction.<sup>12,13,17</sup> In some flocks, the spread of infection can be rapid and the majority of the flock can seroconvert within a few years of the introduction of infected sheep.<sup>12,18</sup>

Infection can be transmitted in utero but the relative importance of this route in the spread of the disease in flocks is debated.<sup>13,19</sup> Virus is also shed in the semen of infected rams that have leukospermia.<sup>8</sup>



The spread of infection is frequently very rapid in flocks that are concurrently infected with the retrovirus causing pulmonary adenomatosis.<sup>12,20</sup> Macrophages are numerous in the lungs of sheep affected with pulmonary adenomatosis, and these cells will be infected with ovine progressive pneumonia virus where there is a dual infection. The copious lung fluid produced by sheep with pulmonary adenomatosis contains maedi-visna virus in dual-infected sheep and is believed to increase the risk for lateral transmission.

#### Economic importance

The economic importance of the disease rests with losses associated with decreased longevity, mortality with clinical disease, decreased value of cull animals and possible effects of subclinical infection on productivity.

**Clinical disease** occurs in sheep 2 years old or older, usually in sheep 3 to 4 years of age and is more likely to appear when the infection prevalence exceeds 50%.<sup>4</sup> The **case fatality rate** is 100%. Whereas infection is common in many flocks, the occurrence of clinical disease is commonly rare as most infections are subclinical. High mortality rates occurred in infected flocks in Iceland and have been recorded in Texel flocks in The Netherlands and in some flocks in the USA, but this is the exception and in most infected flocks clinical disease is rare. Despite the high serological prevalence in areas of Canada, ovine progressive pneumonia is not a common diagnosis in the region's diagnostic laboratories.<sup>21</sup>

It is possible that the major economic loss associated with infection with these viruses rests with the effects of subclinical infection on **productivity** of infected flocks. Subclinical infection of breeding ewes in some flocks has been associated with a reduction in conception rate, as well as lowered birth weights in some flocks and/or reduced growth rates in their lambs.<sup>14,18,21</sup> The reduction in growth rate of the lamb has a significant association with changes in the udder of the ewe and probably results from lowered milk intake.<sup>18</sup> This may be reflected in depression of growth rate only in lambs from older parity ewes.<sup>14</sup> In other flocks there has been no evidence of effect on the birth weight or growth rate of lambs born of infected ewes.<sup>6</sup> Subclinical infection has no effect on mature ewe body weight or greasy fleece weight.<sup>6</sup>

#### PATHOGENESIS

The virus infects cells of the monocyte-macrophage lineage and attaches to cells by the binding of its envelope glycoprotein to specific receptors on the cell surface. The virus replicates its RNA genome via a DNA intermediate provirus

which is integrated into the chromosomal DNA of infected cells. With initial infection there is virus replication; this is followed by an immune response that restricts viral replication but fails to eliminate the virus completely.<sup>1</sup> The immune response occurs between 2 and 8 weeks after infection, with antibody to different viral antigens emerging at different times during this period. Serological latency, with some sheep not developing an antibody response until several months after infection, is recorded.<sup>8</sup>

Replication is restricted and does not proceed beyond the synthesis of provirus in most infected cells. The principal virus replication is in the macrophage, and pulmonary secretions and milk containing infected macrophages are the main source of virus for natural transmission. Diseases such as **pulmonary adenomatosis**, which increases the number of macrophages in lung secretions, will facilitate transmission of ovine progressive pneumonia virus.

There is **persistence and replication** of virus in the presence of viral-specific immune responses, with the development of immune-mediated lesions in various organ systems. Persistent production of viral antigen results in lymphocytic hyperplasia. The infected macrophages in the various tissues are surrounded by an inflammatory response creating a focus of mononuclear cell aggregation. The lungs, mammary gland, brain, joints, lymph nodes, and blood vessels are affected by the maedi-visna/ovine progressive pneumonia viruses and, whereas any or all of these organs can be affected in a single sheep, breed and virus differences often lead to a predominance of a single syndrome in a flock.

In the **lung** there is a gradual development of an interstitial pneumonia without any evidence of healing or shrinkage of tissue, so that the lungs continue to increase in size and weight. The alveolar spaces are gradually filled so that anoxia develops. The pathological lesions develop very slowly during the preclinical and clinical stages of the disease, so that they are very widespread and uncompensatable when clinical signs appear. In the **central nervous system** there is infiltration of the meninges and white matter with lymphocytes. The demyelination that occurs in visna is believed to result from the direct effect of the virus on oligodendrocytes and astrocytes as well as being the result of an inflammatory response provoked by the presence of viral antigen in these cells.<sup>22</sup> Similar infiltrations occur in the **udder**. Lymphoid follicles are found in the alveolar parenchyma, often with atrophy of the alveolar tissue. Numerous lymphocytic

follicles also occur around the lactiferous ducts, some of which may be occluded by lymphocytic aggregates protruding into their lumens.<sup>22,23</sup>

#### CLINICAL FINDINGS

There is a long incubation period and clinical disease, if it occurs, does not develop before 2 years of age. Most clinical sheep are older than 3 years. The clinical signs develop insidiously, progress slowly, and there is a **long clinical course**. The earliest signs are usually listlessness and loss of body condition which progresses to **emaciation**. The presenting syndrome can be one of an increased cull rate of ewes in poor condition. Signs of respiratory involvement are not evident in the initial stages of the disease, but there is exercise intolerance and affected sheep will fall back behind the flock when the flock is moved.

**Dyspnea** with an increase in respiratory rate and flaring of the nostrils, or open mouth breathing, develops later. There is no evidence of excess fluid in the lungs. The respiratory rate is increased to 80–120/min at rest. There may be coughing and some nasal discharge but in most instances this occurs in sheep with secondary bacterial pneumonia. There may be inflammation of the third eyelid. The body temperature is in the high normal range. Clinical illness lasts for 3–10 months and the disease is always fatal. Clinically affected sheep are more prone to diseases such as pregnancy toxemia. In some sheep, clinical respiratory disease is minimal and the major manifestation is wasting and the **thin ewe syndrome**.

The involvement and induration of the **mammary glands** is also insidious in onset, and ewes are usually in their third or later lactation by the time the disease fully manifests, although histological change is evident earlier.<sup>18,24</sup> In early stages it is more easily detected at the time of drying off. In advanced cases the udder is enlarged and uniformly very firm, but the teats are limp and there is very little milk in the teat cistern. The milk is normal in appearance. Mammary involvement may occur, along with signs of respiratory infection, or affected ewes may show no other clinical abnormality. It is called colloquially **hard bag** or **hard udder**. The lambs of ewes with less severe involvement may show growth retardation.

Arthritis is occasionally seen in naturally infected sheep but this manifestation appears restricted to the United States. It occurs in sheep from 1 to 6 years of age. The carpal joints are most commonly involved and show obvious

swelling.<sup>25</sup> Affected sheep become lame and emaciated.

### CLINICAL PATHOLOGY

There is a progressive, moderate hypochromic anemia, with hemoglobin levels falling from 12–14 g/dL down to 7–8 g/dL and some depression of the red cell count. There is a tendency to leukocytosis, and in experimental cases this is observed to be quite marked in the period between exposure and the onset of clinical disease, but the count returns to normal when signs appear. There is also hypergammaglobulinemia. Lymphocytes and neutrophils in bronchoalveolar lavage fluid are increased in number, with an increase in CD<sup>+</sup>8 cells and decrease in CD<sup>+</sup>4 cells and an inversion of the CD<sup>+</sup>4/CD<sup>+</sup>8 ratio.<sup>26</sup>

In clinical cases diagnosis is by the presence of the appropriate clinical syndrome, supported by the presence of a positive serological test for the virus. A positive serological test, by itself, has limited value as an aid to diagnosis of disease in the individual sheep, as there is a high prevalence of seropositivity in many flocks, especially in the older animals. A positive test does indicate that the animal is infected but does not indicate that signs or lesions are attributable to infection with the virus. Thus, for example, a positive serological test in a wasting ewe could only be considered as supportive for a diagnosis of this disease as the cause of the chronic wasting.

**Flock status** with respect to the presence or absence of infection and the determination of the infection status of an individual sheep currently relies on serological testing.

**Antigen detection.** Antigen can be detected by PCR but this detection method for this disease is not commonly available. PCR is a sensitive method for detection of small amounts of viral nucleic acid<sup>27</sup> but its expense is likely to preclude its use in routine diagnosis. It has been used to detect antigen in the third eyelid of infected sheep.<sup>28</sup>

**Serological tests. Flock status** with respect to the presence or absence of infection and the determination of the infection status of an individual sheep currently relies on serological testing. Agar gel immunodiffusion (AGID) tests, and ELISA tests are used in most countries. The AGID test is easy to perform and is inexpensive, and for these reasons is probably the most common test in use for routine diagnostic testing. The AGID test with the appropriate antigen is considered to have high specificity, but may lack in sensitivity.<sup>8,27</sup> Indirect ELISA and competitive ELISA

tests may have better sensitivity, depending on the antigen used.<sup>8,27</sup> The slow development of antibody following infection must be considered in the interpretation of a negative test. An analysis of currently available test systems showed high specificity but sensitivities that were inadequate for diagnosis of infection in individual animals – varying from 64% to 97%.<sup>29</sup> A competitive-inhibition ELISA for the detection of antibodies to the surface envelope antigens has a reported high sensitivity and specificity.<sup>30</sup>

The value of serological testing with current methodologies rests primarily with the establishment of the infection status of the flock. A negative test in an individual sheep could mean that the sheep is free of infection, but can also occur in an infected animal that has not yet responded to infection.

### NECROPSY FINDINGS

Lesions may be present in the lungs and associated lymph nodes, brain, joints, mammary gland and blood vessels, but gross lesions in most sheep are confined to the lungs and, in some cases, the mammary glands. In advanced cases, the lungs are larger and two to four times as heavy as normal lungs. They collapse much less than normal when the chest is opened, and are gray-blue to gray-yellow in color. There is a diffuse thickening of the entire bulk of both lungs, and the abnormal color and consistency are generalized and unvarying in all lobes. Enlargement of the bronchial and mediastinal lymph nodes is constant. Histopathological changes are characteristic of a chronic interstitial pneumonia, with proliferation of lymphoid tissue and the presence of numerous lymphoid follicles. There is infiltration of lymphocytes and macrophages in the inter-alveolar septa, which are thickened, and the bulk of the alveolar space is replaced by the thickened alveolar walls. Larger airways are unaffected. There is a complete absence of healing, suggesting that the disease is a progressive one and never reaches a healing stage. A vasculitis is often a significant lesion.

There are frequently associated lesions of arthritis, encephalitis, and mastitis. The mastitic lesion comprises an interstitial accumulation of lymphocytes and the presence of periductal lymphoid nodules with atrophy of alveolar tissue.<sup>18</sup> Culture of the virus is difficult, and confirmation of the diagnosis is often limited to the presence of characteristic microscopic lesions, preferably supported by a positive serologic titer to the virus. Nucleic acid probe techniques discussed above are not yet widely available.

### Samples for confirmation of diagnosis

- **Virology** – lung, mammary gland, synovial membrane, brain (ISO)
- **Serology** – heart blood serum (AGID, ELISA)
- **Histology** – formalin-fixed lung, bronchial lymph node, mammary gland, synovial membrane, half of midsagittally-sectioned brain (LM).

### DIFFERENTIAL DIAGNOSIS

There are several chronic pneumonias requiring differentiation from maedi:

- Jaagsiekte
- Parasitic pneumonia
- Chronic suppurative pneumonia
- Caseous lymphadenitis
- Post-dipping pneumonia
- Enzootic pneumonia (pp. 1336–1343)
- Melioidosis (pp. 1082–1083).

Chronic wasting conditions:

- Johne's disease (pp. 1017–1044)
- Caseous lymphadenitis.

### TREATMENT

No treatment has been successful.

### CONTROL

In the past, the only control attempted has been eradication of the disease by complete destruction of all sheep in the area and subsequently restocking. However, it is possible to greatly reduce the prevalence by either of two methods.

### Segregated rearing

This requires a management system of separating the lambs from the ewes at birth, giving them no colostrum, or bovine colostrum, and rearing them on milk replacer quite separately from other sheep. This method is effective in establishing an infection-free flock<sup>31,32</sup> and is of particular value where there is a requirement to retain genetic lines in the eradication procedure. However, it is very labor-intensive and expensive, and there is no cash flow unless the infected sheep are maintained in production pending the establishment of a mature infection-free flock. This can create a considerable potential for reinfection of the artificially reared flock.

### Test and cull

This involves the detection and culling of seropositive animals and is the preferred method where lateral transmission is the dominant mode of transmission in the flock.<sup>17</sup> All sheep (and goats) on the farm are serologically tested annually or twice a year, and seropositive animals and their progeny of less than 1 year of age are culled. Ideally they should be slaughtered

but this may not be economically feasible, in which case they must be kept separate from the seronegative sheep. The seronegative flock must subsequently be kept isolated from infected sheep, as well as people and equipment in contact with the seropositive animals. Testing is continued semiannually or annually until there are at least two consecutive negative tests. The offspring of older seronegative ewes are kept for replacements.

Future flock introductions with both methods should be from a seronegative flock.

#### Other control procedures

Control procedures that attempt to limit or delay the spread of infection, and consequently the occurrence of clinical disease within an infected flock, have limited success. Shed lambing and close lambing is thought to be very conducive to spread of the disease and its discontinuance is recommended in infected flocks. In flocks that have a high incidence of clinical disease, the determination of the age of onset of clinical disease and the establishment of a culling policy based on this information can reduce the economic impact of the disease.

In countries where the disease is enzootic, there is often a great deal of movement of animals between farms, especially of rams, and in some management systems of replacement ewes. Flock introductions should be from seronegative flocks where possible. In several countries, breed societies, or other bodies, have established certification programs for flocks free of this infection. In the absence of such programs, severe restriction of inter-farm movement and outdoor housing may limit the spread of the disease.

The fact that some sheep in infected flocks retain freedom from infection in the face of continual exposure to infection suggests that there is a genetic resistance to infection. The identification of these determinants may prove to be the future method for the control of this disease. There is currently no effective vaccine.<sup>8</sup>

#### Flock biosecurity

Once infection is introduced to a flock it is difficult and expensive to eradicate and all efforts should be directed to prevent its introduction. The specificity and sensitivity of most currently available serological tests are inadequate to determine the infection status of an individual and the results of flock tests of a potential source of replacement sheep should be used coupled with an examination of postmortem records in the potential source flock, if available. Rams and replacement ewes should be acquired from accredited free flocks in countries where these are registered. The sheep

should be transported directly from the source farm rather than through a market.

#### REVIEW LITERATURE

- Cheevers WP, McGuire TC. The lentiviruses: maedi-visna caprine arthritis encephalitis and equine infectious anemia. *Adv Virus Res* 1988; 34:189.
- Cutlip RC et al. Ovine progressive pneumonia (maedi-visna) in sheep. *Vet Microbiol* 1988; 17:237–250.
- Bulgin M. Ovine progressive pneumonia caprine arthritis encephalitis and related lentiviral diseases of sheep and goats. *Vet Clin North Am Food Anim Pract* 1990; 6:691–704.
- Watt N, Scott P, Collie D. Maedi-visna infection in practice. In *Practice* 1994; 16:239–247.
- Concha-Bermejillo A. Maedi-visna and ovine progressive pneumonia. *Vet Clin North Am: Food Anim Pract* 1997; 13:13–33.
- Knowles DP. Laboratory diagnostic tests for retrovirus infections of small ruminants. *Vet Clin North Am Food Anim Pract* 1997; 13:1–11.
- Tripathy BN. Diseases of the mammary gland of goats and sheep. *Vet Bull* 2000; 70:1117–1142.
- Knowles DP, Rurangwa FR. Caprine arthritis/encephalitis maedi-visna. *Manual of standards diagnostic tests and vaccines*. OIE, 2000.

#### REFERENCES

- Clements JE, Zinc MC. *Clin Microbiol Rev* 1996; 9:100.
- Herrmann LM et al. *Virus Res* 2004; 102:215.
- Karr BM et al. *Virology* 1996; 225:1.
- Petursson G, Hoff-Jorgensen R. Maedi-visna and related diseases. Boston: Kluwer Academic, 1990; pp. 185.
- Cutlip R et al. *Am J Vet Res* 1991; 52:189.
- Snowder GD et al. *J Am Vet Med Assoc* 1990; 197:475.
- Houwens DJ et al. *Res Vet Sci* 1989; 46:5.
- Concha-Bermejillo A. *Vet Clin North Am Food Anim Pract* 1997; 13:13.
- Cutlip RC et al. *J Am Vet Med Assoc* 1992; 200:802.
- Simard C, Morley RS. *Can J Vet Res* 1991; 55:269.
- Campbell JR et al. *Can Vet J* 1994; 35:39.
- Dawson M et al. *Vet Rec* 1995; 137:443.
- Watt N et al. In *Practice* 1994; 16:5 239.
- Arsenault J et al. *Prev Vet Med* 2003; 59:125.
- Gonzales L et al. *Schweiz Arch Tierheilkd* 1990; 132:433.
- Preziuso S et al. *Vet Microbiol* 2004; 104:157.
- Berriatua E et al. *Prev Vet Med* 2003; 60:265.
- Pekelder JJ et al. *Vet Rec* 1994; 134:348.
- Brodie SJ et al. *J Infect Dis* 1994; 169:653.
- Pritchard GC, Done SH. *Vet Rec* 1990; 127:197.
- Dohoo IR et al. *Prev Vet Med* 1987; 4:471.
- Dawson M. *J Comp Path* 1988; 99:401.
- Perl S et al. *Israel J Vet Med* 1989; 46:34.
- Tripathy BN. *Vet Bull* 2000; 70:1117.
- Bulgin M. *Vet Clin North Am Food Anim Pract* 1990; 6:3 691.
- Lujan L et al. *Vet Immunol Immunopathol* 1995; 49:89.
- Knowles DP. *Vet Clin North Am Food Anim Pract* 1997; 6:3 691.
- Cappucchio MT et al. *J Comp Path* 2003; 129:37.
- DeMartini JC et al. *Vet Immunol Immunopathol* 1999; 71:29.
- Herrmann LM et al. *Clin Diag Lab Immunol* 2003; 19:862.
- Light MR. *J Anim Sci* 1979; 49:1157.
- Cutlip RC, Lehmkuhl HD. *J Am Vet Med Assoc* 1986; 188:1026.
- Petursson G et al. *Vaccine* 2005; 23:3223.

## OVINE PULMONARY ADENOCARCINOMA (JAAGSIEKTE, PULMONARY ADENOMATOSIS)

### Synopsis

**Etiology** Jaagsiekte sheep retrovirus  
**Epidemiology** Disease of mature sheep with geographic clustering but low prevalence. Spread probably mainly by respiratory route  
**Key signs** Dyspnea, profuse watery pulmonary discharge, loud fluid sounds on auscultation, long clinical course with progressive emaciation  
**Pathology** Tumors in lung  
**Diagnostic confirmation** Histological changes are diagnostic and histopathological confirmation is the only method currently available  
**Treatment** None  
**Control** Culling

Jaagsiekte is Afrikaans for 'driving disease' because of the tendency for affected sheep to show clinical signs when driven. The disease manifests clinically as a chronic progressive pneumonia and is a contagious disease of sheep resulting from the development of a **bronchioalveolar adenocarcinoma** in the lungs.

#### ETIOLOGY

The disease is associated with an infectious betaretrovirus, jaagsiekte sheep retrovirus (JSRV) of the family Retroviridae. JSRV has two forms, an exogenous infectious form that alone can produce the disease and an endogenous RSRV-related provirus that is present in all sheep genomes.<sup>1</sup> The disease has been transmitted experimentally with partially purified retrovirus from infected lungs, by infection with cloned JSRV,<sup>2,3</sup> and supportive evidence for retrovirus as the causative agent includes an inverse dose relationship between reverse transcriptase activity in the infectious inoculum and the incubation period of the experimental disease.<sup>2–4</sup>

The presence of retrovirus has been demonstrated in the lungs of sheep with jaagsiekte in **different countries**, there is serological cross-reactivity and strains from different countries have been sequenced.<sup>4</sup>

A herpesvirus has also been isolated in several countries from the lungs of sheep with jaagsiekte but epidemiological studies show that it is not the causative agent.<sup>3</sup>

#### EPIDEMIOLOGY

##### Occurrence

The disease has worldwide distribution and is recorded in most countries that have significant sheep populations, with

the exception of Australia and New Zealand.<sup>3</sup> Until recently there has been no practical method to detect infected sheep and estimates of the prevalence of jaagsiekte are largely based on clinical or postmortem observations. The prevalence of the disease appears to vary depending upon the breed of sheep and the type of flock management. In most endemically infected flocks annual losses attributable to jaagsiekte are between 2% and 10%, although the tumor is present in a much higher proportion of the flock and infection without lesions is also common.<sup>3-6</sup> Annual mortality can be higher in flocks where the infection has recently been introduced and before the disease becomes endemic. PCR analysis of peripheral blood leukocytes of sheep in infected flocks show significantly higher rates of non-clinical infection.

**Prevalence** varies between countries and there can be **areas of high prevalence** within countries; in Britain, the Borders and the east coast of Scotland, and East Anglia in England, appear to be foci of infection from which other outbreaks arise.<sup>3,6</sup> The prevalence may be higher than generally recognized and, in a biased sample, histological evidence of jaagsiekte was detected in 25% of cases of pneumonia in sheep submitted to a diagnostic laboratory in Scotland over a 6-year period.<sup>7</sup> The disease is also a significant cause of mortality in adult sheep in South Africa and Peru, but is a minor disease in the United States and Canada.

The disease occurred in epizootic proportions in Iceland during the same period of time as the maedi-visna epizootic but has been eradicated by a rigorous slaughter policy.

#### Animal and environmental risk factors

**Mature sheep**, 2 to 4 years of age are most commonly affected but the disease can occur in younger animals. There are reports of the occurrence of jaagsiekte in goats at very low prevalence rates in India and Greece, and the disease has been experimentally transmitted to goat kids.<sup>8,9</sup> The lesions produced were small and circumscribed, and **goats have low susceptibility** to infection.<sup>9</sup>

Jaagsiekte has a prolonged clinical course and is **uniformly fatal**. In some reports there is a greater prevalence of onset of clinical disease in the winter months but in others there is no seasonal variation in clinical onset. Ewes may show a sudden onset of clinical disease in late pregnancy.

The **incubation period** in natural cases is 1–3 years, but may be as short as 5–12 months after experimental transmission. Clinical disease is rare in sheep

younger than 2 years and is most common at 3–4 years of age. Very rarely, cases occur in lambs 3–6 months old and disease can be reproduced in lambs of this age by challenge of very young lambs.<sup>3</sup> A genetic or familial susceptibility to the disease is suspected.<sup>3,6</sup>

Because of the method of spread, the disease is likely to assume more importance in systems of sheep husbandry where there are significant periods of **close contact** as, for example, occurs with intensified lamb-rearing systems. Close housing during the winter is a potent predisposing cause and probably accounted for the occurrence of the disease in epizootic form in Iceland. However, the disease occurs commonly in range sheep in other countries. Sheep that have a **combined infection** with jaagsiekte and the maedi-visna lentivirus have an increased ability to transmit maedi-visna infection,<sup>10</sup> and flocks with the combined infection can suffer high losses from pneumonic disease.<sup>11</sup>

#### Transmission

Experimental transmission has been effected by pulmonary or IV injection, or by intratracheal inoculation of infected lung material.<sup>3</sup> The incubation period of the experimental disease in young lambs is much shorter than that in mature sheep. The disease has also been transmitted by inhalation of infected droplets when sheep are kept in close contact, and it is assumed that the natural mode of transmission is by droplet infection from respiratory secretions, which are copious in sheep with clinical disease. A longitudinal study of the natural transmission showed that infection established readily and rapidly in young lambs and also horizontally in adult sheep, but that the majority of infected sheep did not show clinical disease during their commercial life span.<sup>5</sup>

#### PATHOGENESIS

The virus replicates in the **type II pneumocytes** in the alveolus. Type II pneumocytes and Clara cells in the terminal bronchioles are transformed, and their growth produces intra-alveolar and intrabronchiolar polypoid ingrowths. These cells are surfactant-producing secretory cells and there is also copious production of fluid. The excessive surfactant-like protein produced in the tumor provides a stimulus for the accumulation of macrophages seen in association with this disease. The adenomatous ingrowths of alveolar epitheliums encroach gradually upon alveolar air space so that anoxic anoxia occurs. The lesions produced by experimental inoculation are identical with those of the naturally occurring disease.<sup>3</sup>

#### CLINICAL FINDINGS

Affected sheep are afebrile and show progressive respiratory distress with loss of weight. Clinical signs are not evident until a significant proportion of the lung is compromised by the tumor. Occasional coughing and some panting after exercise are the earliest signs but coughing is not a prominent sign in this disease unless there is concurrent parasitic pneumonia. Emaciation, **dyspnea**, lacrimation and a **profuse watery discharge from the nose** follow. Death occurs 6 weeks to 4 months later. A diagnostic test, colloquially known as the **wheelbarrow test**, in this disease is to hold the sheep up by the hind legs: in affected animals a quantity of watery mucus (up to about 200 mL) runs from the nostrils. **Moist crackles** are audible over the affected lung areas and may be heard at a distance, so that a group of affected animals are said to produce a sound like slowly boiling porridge. There is no elevation of body temperature unless there is secondary infection, and the appetite is normal. Advanced cases may have cor pulmonale. Pasteurellosis (*Mannheimia haemolytica*) is a common complication and often the cause of death.

#### CLINICAL PATHOLOGY

No immune reaction can be detected in affected animals and there is no serological test. Sheep in advanced stages of the disease may show neutrophilia and lymphocytopenia. The pulmonary fluid contains round or spherical clusters of epithelial cells, which have the hyperplastic adenomatous epithelium typical of pulmonary lesions and increased numbers of macrophages. Earlier reports of a consistent elevation in circulating immunoglobulin concentrations have not been substantiated. JSRV can be detected by exogenous JSRV specific PCR in peripheral blood leukocytes.<sup>12,13</sup>

#### NECROPSY FINDINGS

Lesions are usually restricted to the thoracic cavity. As in maedi, the lungs are grossly increased in size and in weight (up to three times normal). There are extensive areas of **neoplastic tissue**, particularly of the anteroventral regions of one or both lungs, with smaller lesions in the diaphragmatic lobes. The affected areas are solid and slightly raised above the adjacent normal lung. This, with the excess frothy fluid in the bronchi, is characteristic. The bronchial and mediastinal lymph nodes are enlarged and hyperplastic, and occasionally contain small metastases. Pneumonic pasteurellosis is a frequent complication, and secondary pulmonary abscesses and pleurisy may develop. Histologically, the alveolus is lined by cuboidal and columnar epithelial

cells that form characteristic **adenomatous ingrowths** of alveolar epithelium into the alveolar spaces.

### Samples for confirmation of diagnosis

- **Histology** – formalin-fixed lung, bronchial lymph node (LM).

### DIFFERENTIAL DIAGNOSIS

Chronic pneumonias requiring differentiation from jaagsiekte:

- Maedi
- Parasitic pneumonia
- Chronic suppurative pneumonia
- Caseous lymphadenitis
- Post-dipping pneumonia
- Enzootic pneumonia
- Melioidosis.

### TREATMENT

No treatment is available.

### CONTROL

In Iceland, where the disease assumed epizootic proportions, eradication was effected by complete slaughter of all sheep in the affected areas. In areas where the prevalence is lower, the disease can be satisfactorily controlled, but not eradicated, by slaughter of the clinically affected sheep. There is evidence that the disease is spreading in sheep populations in some countries, and flocks that are free of disease should attempt to obtain replacement sheep from flocks that are free of jaagsiekte. Infected flocks can reduce the prevalence of disease by culling sheep at the onset of clinical signs, and also culling the progeny of affected ewes. PCR can detect infection in the preclinical stages but there has been no trial to establish if eradication from a flock can be achieved with this technology.

### REVIEW LITERATURE

- Wandera JG. Sheep pulmonary adenomatosis (jaagsiekte). *Adv Vet Sci* 1971; 15:251–283.
- Verwoerd DW, Turbin RC, Payne AL. Jaagsiekte: an infectious pulmonary adenomatosis of sheep. In: *Comparative pathobiology of viral diseases*. Boca Raton Florida: CRC Press 1985; pp. 53–76.
- Sharp JM, Angus KW. Sheep pulmonary adenomatosis: clinical pathological aspects. In: Petursson G, Hoff-Jorgensen R (eds) *Developments in veterinary virology maedi-visna and related diseases*. Boston: Kluwer Academic 1990; pp. 157–176.
- Hecht SJ, Sharp JM, De Martini JC. Retroviral aetiopathogenesis of ovine pulmonary carcinoma: a critical appraisal. *Br Vet J* 1996; 152:395–409.
- De Martini JC, York DF. Retrovirus-associated neoplasms of the respiratory system of sheep and goats. *Vet Clin North Am Food Anim Pract* 1997; 131:55–70.
- Fan H (ed). Jaagsiekte sheep retrovirus and lung cancer. *Curr Topics Microbiol Immunol* 2003; 275:1:248.
- Salvatori D, De Las Heras M, Sharp M. Ovine pulmonary adenocarcinoma: the story to date. In *Practice* 2004; 26:387–392.

### REFERENCES

1. York DF, Querat G. *Curr Topics Microbiol Immunol* 2003; 275:1.

2. Palmarini M et al. *J Virol* 1999; 73:10071.
3. Palmarini M, Fan H. *Curr Topics Microbiol Immunol* 2003; 275:81.
4. Sharp JM, Angus KW. In: Petursson G, Hoff-Jorgensen R (eds) *Developments in veterinary virology. Maedi-visna and related diseases*. Boston: Kluwer Academic 1990; pp. 129:157.
5. Caporale M et al. *Virology* 2005; 338:144.
6. Sharp JM, DeMartini JC. *Curr Topics Microbiol Immunol* 2003; 275:55.
7. Hunter AR, Munro R. *Br Vet J* 1983; 139:153.
8. Sharp JM et al. *Vet Rec* 1986; 119:245.
9. Turtin RC et al. *Onderstepoort J Vet Res* 1988; 55:27.
10. Dawson M et al. *Br Vet J* 1990; 146:531.
11. Pritchard GC, Done SH. *Vet Rec* 1990; 127:197.
12. Gonzales L et al. *J Gen Virol* 2001; 82:1355.
13. Uzal FA et al. *Vet Res Commun* 2004; 28:159.

### ENZOOTIC NASAL ADENOCARCINOMA OF SHEEP AND GOATS (ENZOOTIC INTRANASAL TUMOR)

Intranasal adenocarcinoma has been recorded as a sporadic disease of sheep and goats for many years but it is now recognized that it is a contagious neoplasm in these species. The disease in sheep and goats is associated with related but different retroviruses, the ovine nasal adenocarcinoma virus (ENT-1) and the caprine adenocarcinoma virus respectively. These retroviruses are highly homologous with the retrovirus that causes jaagsiekte (JSVR) but can be distinguished by unique sequences of the genome.<sup>1</sup> Nasal adenocarcinoma is not a component of the disease jaagsiekte, nor are pulmonary tumors present in sheep and goats with nasal adenocarcinoma. Infections with the viruses of enzootic nasal adenocarcinoma and jaagsiekte can occur in the same sheep and this can potentiate the proliferation of jaagsiekte virus in the infected sheep.<sup>2</sup>

Enzootic nasal adenocarcinoma is recorded in the United States, Canada, Europe, Japan, India, and Africa<sup>3</sup> and is believed to occur on all continents except Australia and New Zealand and is not present in the UK.<sup>1</sup> The disease occurs sporadically but is often clustered in certain flocks and herds, and is assumed to transmit by the respiratory route. The prevalence in affected flocks varies in different countries. It is generally less than 2% but can be as high as 10–15%.<sup>1</sup>

There is no seasonal occurrence and no apparent breed or genetic predisposition.

There is no apparent influence of nasal myiasis on the prevalence of nasal adenocarcinoma in infected flocks.<sup>4</sup>

**Clinical disease** is recorded occurring as early as 7 months of age but most occurs in mature sheep between 2 and 4 years-of-age. Affected animals are afebrile, have a profuse seromucous or seropurulent nasal discharge, and sneeze and shake their head frequently. There is depilation around the nostrils. The tumor may be unilateral or bilateral.

As the disease progresses, there is dyspnea, stertorous breathing with flaring of the nostrils at rest, and open-mouthed breathing following exercise. Some animals develop facial deformity and protrusion of one or both eyes from tumor growth, and the tumor may protrude from the nostril. There is progressive loss of weight, emaciation, and death after a clinical course of 3–6 months. There is no detectable immune response in affected animals.

At **postmortem**, the tumor masses are in the ethmoid turbinates, with metastasis to regional lymph nodes in some cases. The tumors may be unilateral or bilateral and are gray or pink in color with a granular surface. The tumors originate in the serous glands of the turbinates and have the histological features of adenocarcinoma.<sup>1</sup>

The disease has been transmitted experimentally in both goats and sheep with challenge of young kids resulting in disease at 12–16 months of age.<sup>5,6</sup>

### REFERENCES

1. De Las Has M et al. *Curr Topics Microbiol Immunol* 2003; 275:203.
2. Ortin A et al. *J Comp Pathol* 2004; 131:253.
3. De Martini JC, York DF. *Vet Clin North Am Food Anim Pract* 1997; 131:55.
4. Dorchies P et al. *Vet Pathol* 2003; 113:169.
5. De las Heras M et al. *Vet Rec* 1993; 132:441.
6. De las Heras M et al. *Vet Pathol* 1995; 32:19.

## Viral diseases characterized by nervous signs

### EASTERN AND WESTERN VIRAL ENCEPHALOMYELITIS OF HORSES

#### Synopsis

**Etiology** Eastern encephalitis and Western encephalitis viruses

**Epidemiology** Disease limited to the Americas. Arthropod, usually mosquito, borne virus. Mammals, including horses, are accidental hosts. Horse is dead-end host for EEE and WEE. Case fatality rate 5–70%. WEE and EEE occur as sporadic cases and as outbreaks

**Clinical signs** Fever, muscle fasciculation, severe depression, head pressing, incoordination, recumbency, opisthotonos and paddling, and death

**Clinical pathology** Leukopenia

**Lesions** Non-suppurative encephalomyelitis

**Diagnostic confirmation** Virus isolation and identification. Identification of viral antigen by indirect immunofluorescence. Serological confirmation of exposure, preferably demonstrating an increase in hemagglutination inhibition, virus neutralization, or complement fixation titer

**Treatment** No specific treatment.

Supportive care

**Control** Vaccination with formalin-inactivated vaccines (EEE, WEE). Insect control

## ETIOLOGY

Equine encephalomyelitis is associated with one of the two immunologically distinct arthropod borne alphaviruses (family *Togaviridae*): **Eastern equine encephalomyelitis virus (EEE)**, **Western equine encephalomyelitis virus (WEE)**.

- There is one EEE virus strain, but two antigenic variants of it: North American and South American<sup>1</sup>
- WEE likely arose as a recombinant of EEE and Sindbis virus.<sup>2</sup> There are strains of WEE from Argentina, Brazil, and South Dakota that differ antigenically<sup>2</sup> and there are 4 major lineages of WEE in California whose geographical distributions overlap.<sup>1,2</sup>

All the viruses are extremely fragile and disappear from infected tissues within a few hours of death. **WEE** is the least virulent of these viruses in horses and humans.

## EPIDEMIOLOGY

These encephalitis viruses cause disease in horses, humans, pigs, and various birds including ratites and domestic pheasants.<sup>3</sup>

### Distribution

Equine Eastern and Western encephalomyelitis viruses are restricted to the Americas. The two viruses have distinct geographical ranges that may overlap: **EEE** is restricted to South America and North America generally east of the Mississippi river whereas **WEE** is found west of the Mississippi river and predominantly in the western United States and Canada, although it also occurs in Florida and South America.

### Viral ecology

Humans, horses, cattle, pigs, dogs, and ratites are accidental hosts of the virus. The EEE and WEE viruses are normally maintained in a host-vector relationship by cycling between mosquitoes, and some other hematophagous insects, and the definitive host. However, there are some important differences in the ecology of the different viruses.

### Western equine encephalomyelitis

The definitive hosts of endemic WEE are wild birds, which are not clinically affected, and the vectors are the mosquitoes *Culex tarsalis* (in the western United States) and *Culiseta melanura* (in the eastern and southern United States).<sup>4</sup> Infected mosquitoes bite susceptible birds, usually nestlings or fledglings, that then develop viremia. Mosquitoes are infected by feeding on viremic birds or by vertical transmission.<sup>5</sup> Vertical transmission is likely an important over-wintering mechanism in WEE, and possibly EEE.

Epidemics of WEE are uncommon, but sporadic individual cases are not. Epidemics of WEE are associated with factors that

increase the number of infected mosquitoes or their feeding on susceptible (unvaccinated) horses. The disease in horses occurs in mid-summer and fall, and is associated with a change in the feeding habits of *Culex tarsalis*.<sup>6</sup> Horses, and humans, are dead-end hosts, as the viremia in these species is not sufficiently severe to allow infection of feeding mosquitoes.

### Eastern equine encephalomyelitis

The primary **maintenance cycle of EEE virus** is transmission between passerine birds by the mosquito *Culiseta melanura*, an inhabitant of drainage ditches and swamps.<sup>4</sup> However, other mosquitoes, including *Aedes sollicitans* and *A. vexans*, can propagate the virus through infection of large shore birds. The Carolina chickadee and yellow-crowned night-heron are the most common avian hosts in the southeastern United States.<sup>7</sup> Horses are usually dead-end hosts, although viremia may be sufficiently severe in some horses to permit infection of mosquitoes.<sup>4</sup> The reservoir of the virus during winter is not known, but may involve the vertical transmission of infection to larvae that survive the winter.

**Epidemics** of EEE have occurred in the provinces of Ontario and Quebec, in virtually all the states of the United States east of the Mississippi River, and in Arkansas, Minnesota, South Dakota, and Texas, in many of the Caribbean Islands, in Guatemala, Mexico, and Panama, and in Argentina, Brazil, Columbia, Ecuador, Guyana, Peru, Suriname, and Venezuela.<sup>1</sup> Eastern equine encephalomyelitis continues to cause significant death losses annually in horses in Florida, primarily in unvaccinated horses.<sup>8</sup> It is suggested that the incidence of clinical disease due to EEE in Florida is much higher than reported, and there is a need to increase public awareness about the importance of vaccination, particularly in foals.<sup>8</sup> **Unexpected epizootics** occur in inland States of the United States, and frequently the source of the infection is undetermined, although **meteorological factors** that allow rapid movement of infected mosquitoes may be important. For instance, in 1972, outbreaks of EEE occurred in Quebec, Canada and in Connecticut, USA that originated with mosquitoes carried on surface winds from Connecticut to Quebec, a distance of 400 km, in 14–16 hours at a speed of 25–30 km/h and a temperature of 15°C.<sup>9</sup> There may be a continual cycle of EEE virus in mosquitoes and birds in the southeastern US, from where the virus could be distributed by infected mosquitoes on the wind along the Gulf and Atlantic Coasts and up the Mississippi Valley.<sup>10</sup>

## Animal risk factors

**Recovered horses** are resistant to infection for at least 2 years, and vaccination confers immunity of variable duration (see under 'Control'). **Unvaccinated horses** are at increased risk of disease – the risk of a vaccinated horse contracting EEE is only 0.14 that of an unvaccinated horse.<sup>8,11</sup> The disease is more severe, and mortality is higher, in unvaccinated horses than in vaccinated horses.<sup>12</sup> The mortality in young foals from non-immune mares, that are infected with WEE, is always high, often as high as 100%.

**Housing and exposure to mosquitoes** are important risk factors for EEE, and presumably WEE. During an outbreak in 1831, only horses kept at pasture were affected.<sup>13</sup> The use of **insect repellants** reduces the odds of a horse being infected with EEE to 0.04 that of an unprotected horse.<sup>11</sup> Similarly, keeping horses at pasture near woods increases the risk of disease by almost four times, and the presence of **swamp land** increases the risk by over two times.<sup>11</sup> Horses kept in areas with **high precipitation** have an increased risk of the disease, presumably because of the density of mosquitoes in these areas.<sup>14</sup>

## Morbidity and case fatality

Morbidity varies widely depending upon seasonal conditions and the prevalence of insect vectors; cases may occur sporadically or in the form of severe outbreaks affecting 20% or more of a group. The prevalence of infections, as judged by serological examination, is much higher than the clinical morbidity. The **case fatality rate** differs with the strain of the virus; in infection with the WEE virus it is usually 20–30% and with the EEE it is usually between 40 and 80% and may be as high as 90%.

## Zoonotic implications

The **susceptibility of humans** to the causative virus gives the disease great public health importance. Humans can become infected with the EEE virus and the WEE virus.<sup>1</sup>

## PATHOGENESIS

**Inapparent infection** is the mildest form of the disease and may be characterized by only a transient fever. A more severe form of the disease is manifested by tachycardia, depression, anorexia, occasional diarrhea, and fever.

A transitory **viremia** occurs at the height of the fever. Penetration of the virus into the **brain** does not occur in all cases and the infection does not produce signs, other than fever, unless involvement of the central nervous system occurs. The lesions produced in nervous tissue are typical of a viral infection and

are localized particularly in the **gray matter of the cerebral cortex, thalamus and hypothalamus**, with minor involvement of the medulla and spinal cord. It is this distribution of lesions that is responsible for the characteristic signs of mental derangement, followed at a later stage by paralysis. The early apparent blindness and failure to eat or drink appear to be cortical in origin. True blindness and pharyngeal paralysis occur only in the late stages.

#### CLINICAL FINDINGS

The diseases associated with EEE and WEE viruses are **clinically indistinguishable**. The **incubation period** for EEE is 1–3 days and 2–9 days for WEE. Uncomplicated disease usually lasts about 1 week. In the initial viremic stage there is fever, which may be accompanied by anorexia and depression, but the reaction is usually so mild that it goes unobserved. In the experimental disease, the temperature may reach 41°C (106°F) persisting for only 24–48 hours, with signs of neurologic dysfunction appearing at the peak of the fever. Animals that have signs of neurologic disease for more than 24 hours are often not pyrexic.

Initial signs of neurologic disease include hypersensitivity to sound and touch, and in some cases transient periods of excitement and restlessness, with apparent blindness. Horses can have a period of anorexia and colic before onset of signs of neurologic disease. Affected horses may walk blindly into objects or walk in circles and in severe cases can mimic signs of horses with catastrophic intestinal disease. Involuntary muscle movements occur, especially tremor of shoulder and facial muscles and erection of the penis. A stage of severely depressed mentation follows. Affected horses stand with the head hung low; they appear to be asleep and may have a half-chewed mouthful of feed hanging from the lips. At this stage the horse may eat and drink if food is placed in its mouth. The pupillary light reflex is still present. The animal can be aroused, but soon relapses into a state of somnolence.

A stage of **paralysis** follows. There is inability to hold up the head, and it is often rested on a solid support. The lower lip is pendulous and the tongue protrude from the mouth. Unnatural postures are adopted, the horse often standing with the weight balanced on the forelegs or with the legs crossed. Head-pressing or leaning back on a halter are often seen. On walking, there is obvious incoordination, particularly in the hindlegs, and circling is common. Defecation and urination are

suppressed and the horse is unable to swallow. Complete paralysis is the terminal stage. The horse goes down, is unable to rise and usually dies within 2–4 days from the first signs of illness. A proportion of affected horses do not develop paralysis and survive, but have persistent neurological deficits.

#### Pigs

EEE causes an encephalitis and myocarditis of piglets less than 2 weeks of age.<sup>3</sup> The disease is characterized by incoordination, seizures, vomiting, weight loss, and paddling. Recovered piglets can have retarded growth.<sup>3</sup>

#### CLINICAL PATHOLOGY

There are no characteristic hematological or biochemical abnormalities. The absence of biochemical indication of liver disease (hyperbilirubinemia, increased activity in serum of liver-specific enzymes such as sorbitol dehydrogenase or gamma glutamyl transferase, absence of hyperammonemia) rules out hepatic encephalopathy.

**Diagnostic confirmation** is achieved by one or more of several means:<sup>6</sup>

- Isolation of virus from an affected animal
- Detection of viral antigen or nucleic acid in an animal with appropriate clinical signs
- Seroconversion or an increase in serum titer of sick or recovered animal.

**Virus isolation** provides definitive proof of infection. However, viremia may have resolved by the time nervous signs have developed, and it may be advantageous to sample febrile animals instead of animals showing more advanced signs of the disease. Virus can be cultured in intracranially inoculated suckling mice, weanling mice, guinea pigs, cell culture, newly hatched chicks, or embryonated eggs.<sup>1</sup> Virus isolates can be identified by complement fixation, hemagglutination inhibition, virus neutralization, PCR, IFA, and antigen capture ELISA.<sup>1,6</sup> Acute and convalescent sera taken 10–14 days apart for the presence of neutralizing, hemagglutination-inhibiting, or complement-fixing antibodies in the serum of affected or in-contact horses, is of value in detecting the presence of the virus in the group or in the area. A four-fold increase in complement-fixing antibodies is considered positive.

Demonstration of viral nucleic acid in tissue, blood or insects by PCR test may be a useful indicator of the presence of the virus.<sup>15</sup> There may be sufficient viral antigen to be detected by ELISA in clinical material, and this may provide a useful test in the early stages of an epidemic.<sup>6</sup>

The presence of a high hemagglutination-inhibition, complement fixation and neutralizing antibody in a **single serum sample** obtained from a horse during the acute phase of illness associated with the WEE virus can be used as presumptive evidence of infection with this virus.<sup>16</sup> However, antibodies against the WEE virus can persist for years, and produced after vaccination with WEE/WEE/EEE bivalent vaccines, and in foals might be due to colostral immunity. Therefore, a single serum sample cannot be used to make a confirmed diagnosis of WEE using the hemagglutination-inhibition, complement fixation or neutralization tests. Horses infected experimentally or naturally with either the WEE or the EEE virus do not produce detectable hemagglutination inhibition or neutralizing antibody for 5–10 days after infection.

Circulating antibody appears only near the day of onset of clinical illness. Infection with the WEE virus results in the production of serum IgM specific to WEE and the ELISA test is a rapid, sensitive and specific test for IgM against WEE and EEE viruses.<sup>3</sup> Additionally, the ratio of titers of EEE and WEE can be useful in detecting infection by EEE – ratios of >8:1 are highly suggestive of EEE infection.<sup>17</sup>

#### NECROPSY FINDINGS

The brain meninges may appear congested, but there are generally no gross changes. Histological examination of the brain reveals perivascular accumulation of leukocytes and damage to neurons. The gray matter of the forebrain and midbrain are the most severely affected areas. Lesions associated with EEE antigens are also present in myocardium, stomach, intestine, urinary bladder, and spleen.<sup>19</sup>

Cell culture and transmission experiments utilizing brain tissue as inoculum are the traditional means of confirming a diagnosis, and require that the brain be removed within an hour of death. Transmission is by intracerebral inoculation of brain tissue into suckling mice or duck embryo tissue culture. Fluorescent antibody tests have been developed to detect EEE virus in brain tissue.<sup>20</sup> A PCR-based diagnostic test is available for EEE virus.<sup>21</sup> Lesions are generally similar to those seen in horses and have also been described in a beef calf infected with EEE.<sup>22</sup> **The disease in piglets** is characterized by disseminated perivascular cuffing, gliosis, focal necrosis of the cerebral cortex, and multifocal myocardial necrosis.<sup>3</sup>

#### Samples for postmortem confirmation of diagnosis

- One half of midsagittally-sectioned brain and liver and spleen should be



submitted for fluorescent antibody and PCR testing, virus isolation and bioassay

- One half of midsagittally-sectioned brain, fixed in formalin, should be submitted for light microscopic examination.

**Note the zoonotic potential of these organisms when handling the carcass and submitting specimens.**

#### DIFFERENTIAL DIAGNOSIS

Clinically, the disease has very great similarity to the other viral encephalomyelitides, from which it can often be discriminated by the geographical location of the horse, and to the hepatic encephalopathies and a number of other diseases (see below and in Table 22.1).

West Nile encephalitis – predominantly a myelitis with later development of signs of neurologic disease whereas EEE and WEE have predominant signs of encephalopathy.

- Rabies
- Borna disease – occurs in Europe
- Japanese encephalitis – occurs in Asia
- Various other viral infections that are geographically restricted
- Hepatic encephalopathy, such as that associated with poisoning by *Crotalaria*, *Senecio*, and *Amsinckia* spp.; acute serum hepatitis or hepatopathy
- Botulism causes weakness evident as muscle fasciculation, recumbency and dysphagia, but does not cause cerebral signs (irritation, behavioral abnormalities)
- Yellow star thistle poisoning (*Centaurea solstitialis*, and poisoning by fumonisins (*Fusarium moniliforme*) can produce similar clinical signs to that of the encephalitides, with the exception of fever.

#### TREATMENT

There is no definitive or specific treatment. Supportive treatment may be given with the intention to prevent self-inflicted injury, and maintain hydration and nutritional status.

#### CONTROL

Control of viral encephalomyelitis of horses is based on:<sup>16,23,24</sup>

- Accurate clinical and laboratory diagnosis of the disease in horses
- Use of sentinel animals to monitor the presence of the virus in the region
- Quarantine of infected horses to stop movement of virus donors
- Insect abatement when deemed necessary
- Vaccination of all horses.

#### Vaccination

Vaccination of horses is important not only because it minimizes the risk of disease in vaccinated horses but also because of the possibility that for EEE it prevents viremia, subsequent infection of feeding mosquitoes, and propagation of the epidemic.

Formalin-inactivated EEE and WEE virus vaccines are available and are effective although over 50% of horses with EEE had been vaccinated within the previous year.<sup>17,25</sup> This apparent poor protection can be explained by many horses not developing a detectable change in antibody titer after vaccination with a bivalent vaccine and rapid decreases in antibody titer from a peak value achieved 2–4 weeks after vaccination.<sup>17</sup> Vaccines are available as univalent or bivalent preparations and in combination with other antigens (for instance, tetanus toxoid). Horses should be vaccinated well in advance of the anticipated encephalomyelitis season in a given area. Vaccination against both strains of the virus is advisable in areas where the strain has not been identified or where both strains exist. The currently recommended vaccination schedule consists of two doses of the vaccine initially, 10 days apart, followed by annual revaccination using two doses. **Annual revaccination** is currently recommended because the duration of effective immunity beyond 1 year is not known. It is probable that the initial two-dose vaccination lasts for up to 3–4 years. The emphasis in a vaccination program should be on the young horses.

**Colostrum antibody** can be detected in the blood of foals from vaccinated dams for up to 6–7 months, after which time it declines rapidly. Foals from vaccinated dams should be vaccinated at 6–8 months of age and revaccinated at 1 year of age. Foals from unvaccinated dams may be vaccinated at 2–3 months of age and again at 1 year of age. Colostrum antibodies in the foal will prevent the development of autogenous antibodies, and foals vaccinated when less than 6 months should be revaccinated when they are 1-year-old or, in high-risk areas, foals from vaccinated mares should be vaccinated at 3, 4, and 6 months of age.

Experimental DNA vaccines hold promise for the prevention of WEE.<sup>26</sup>

#### Protection from insects

Housing of horses indoors at night, especially in flyproofed stables, and the use of insect repellents may restrain the spread of the virus. Use of insect repellents decreases the risk of EEE in horses to 0.04 that of unprotected horses.

Widespread spraying of insecticides to reduce the population of the vector

insects has been used in the control of VEE, however, such measures are not practical for preventing sporadic cases of EEE or WEE, and the environmental impact of widespread insecticide use should be considered.

Complete eradication of the virus appears to be impossible because of the zoonotic nature of the ecology of the virus. The horse being an accidental host for EEE and WEE virus make elimination of the virus impossible with methods currently available.

#### Zoonotic aspects of control

**Control of the disease in humans** in areas where the disease may occur is dependent on insect control, and a monitoring and surveillance early warning system is necessary to decide whether or not to take control measures. In areas where WEE occurs, clinical cases of the disease in unvaccinated horses usually precede the occurrence of the disease in human.<sup>27</sup> The establishment of a reporting system whereby practicing veterinarians report all clinical cases of the disease in horses will also assist in predicting potential epidemics of WEE virus infection in the human population. Serological surveys of wildlife may also serve as good indicators of the geographical distribution and seasonality of circulation of these viruses and provide an early warning system prior to the detection of human cases.

#### REVIEW LITERATURE

- Walton TE. Arboviral encephalomyelitis of livestock in the western hemisphere. *J Am Vet Med Assoc* 1992; 200:1385–1389.
- Calisher CH, Walton TE. Japanese Western Eastern and Venezuelan encephalitides. In: Studdert MJ (ed) *Virus infections of vertebrates: virus infections of equines*. Amsterdam: Elsevier, 1996; pp. 141–155.

#### REFERENCES

1. Walton TE. *J Am Vet Med Assoc* 1992; 200:1385.
2. Kramer LD, Fallah HM. *Am J Trop Med Hyg* 1999; 60:708.
3. Elvinger F et al. *J Am Vet Med Assoc* 1994; 205:1014.
4. Hayes CG, Wallis RC. *Adv Virus Res* 1977; 21:37.
5. Fulhorst CF et al. *Science* 1994; 263:676.
6. Calisher CH, Walton TE. In: Studdert MJ (ed) *Virus infections of vertebrates: virus infections of equines* 6. Amsterdam: Elsevier, 1996; p. 141.
7. Hassan HK et al. *Am J Trop Med Hyg* 2003; 69:641.
8. Wilson JH et al. *Prev Vet Med* 1986; 4:261.
9. Sellers RF. *Can J Vet Res* 1989; 53:76.
10. Ross WA, Kaneene JB. *Prev Vet Med* 1995; 24:157.
11. Neufeld JL, Nayar GPS. In: Sekla L (ed) *Western equine encephalitis in Manitoba*.
12. Winnipeg, Manitoba: Department of Health, 1982; pp. 62–79.
13. Chamberlain RW. *Am J Trop Med Hyg* 1987; 37:8S.
14. Ross WA, Kaneene JB. *J Am Vet Med Assoc* 1996; 208:1988.
15. Linssen B et al. *J Clin Micro* 2000; 38:1527.
16. Calisher CH et al. *J Am Vet Med Assoc* 1983; 183:438.

17. Waldrige BM et al. *Vet Therapeut* 2003; 4:242.
18. Erickson GA, Mare CJ. *Am J Vet Res* 1975; 36:167.
19. Del Piero F et al. *Vet Pathol* 2001; 38:451.
20. Weaver SC. *Factors in the emergence of arbovirus diseases*. Amsterdam: Elsevier, 1997; p. 241.
21. Vodkin MH et al. *Am J Trop Med Hyg* 1993; 49:772.
22. McGee ED et al. *Vet Pathol* 1992; 29:361.
23. Wong FC, Lillie LE. *Can J Publ Health* 1976; 67 Suppl 1:15.
24. Omohundro RE. *J Am Vet Med Assoc* 1971; 161:1516.
25. Byrne RJ. *Proc 3rd Intern Conf Equine Infect Dis* 1973; 115.
26. Nagata LP et al. *Vaccine* 2005; 18:2280.
27. McLintock J. *Can J Publ Health* 1976; 67 Suppl 1:8.

## EQUINE ENCEPHALOSIS

Seven serotypes<sup>1-7</sup> of equine encephalosis virus (EEV) infect equids of southern Africa including Kenya, Botswana and South Africa.<sup>1</sup> The virus is an insect-borne orbivirus that is transmitted by a variety of *Culicoides* spp.<sup>2</sup> and is closely related to bluetongue and epizootic hemorrhagic disease viruses. It has characteristics in cell culture similar to African Horse Sickness.<sup>5</sup> The virus replicates in midges although the rate differs depending on species of midge and strain of the virus. The genetic and phenotypic stability of strains of the virus are unknown and there exists the potential for emergence, or recognition, of new strains. Variations in pathogenicity are not recognized, perhaps because of incomplete knowledge of this importance of this virus, but might exist. There is independent persistence of virus serotypes in a maintenance cycle based on observation of increased rates of seasonal seroconversion to a specific serotype with ongoing low level of infection by other serotypes.<sup>1</sup> Horses, donkeys, and zebra in southern Africa frequently have antibodies to a group epitope of the virus indicating widespread infection of these Equidae. Seventy seven percent of 1144 horses, 57% of 518 horses, 49% of 4875 donkeys and up to 88% of zebra in South Africa have antibody to EEV.<sup>1-4</sup> Elephant seldom have antibodies to EEV.<sup>4</sup>

The virus was originally isolated from a horse with signs of neurologic disease, hence the name. However, the disease associated with infection by EEV is poorly documented and, given the high prevalence of infection, EEV might be falsely incriminated in some situations. Most infections are subclinical based on the high seroprevalence rate and lack of reports of outbreaks of the disease. Clinical signs commonly attributed to EEV infection include fever, lassitude, edema of the lips, acute neurologic disease and enteritis. Abortion has been associated with infection by EEV. Disease associated with EEV has not been

recorded in donkeys or zebra.<sup>2</sup> Characteristic abnormalities in serum biochemistry or hematology are not reported. Antibodies to the virus are detected by serum neutralization assays (which are serotype specific) and ELISA, which is not serotype specific. A group specific, indirect sandwich ELISA detects EEV antigen and does not cross react with African Horse Sickness virus, Bluetongue virus, or epizootic hemorrhagic disease virus.<sup>6</sup> Necropsy examination reveals cerebral edema, localized enteritis, degeneration of cardiac myofibers and myocardial fibrosis but whether all these abnormalities are attributable to EEV is unclear.<sup>5</sup> Definitive diagnosis is difficult, if not impossible, at the current time because of the high prevalence of seropositive animals and the ill-defined clinical and necropsy characteristics of the disease. There are no recognized treatment, control or preventive measures. There is no vaccine.

## REFERENCES

1. Howell PG et al. *Ond J Vet Res* 2002; 69:79.
2. Paweska JT, Venter GJ. *Med Vet Entomol* 2004; 18:398.
3. Venter GJ et al. *Equine Infect Dis III*. R & W Publications, Newmarket, England, 1999.
4. Barnard BJH. *Ond J Vet Res* 1997; 64:95.
5. Laegrid WW. *Virus infections of equines*. Amsterdam: Elsevier, 1996; 125.
6. Crafford JE et al. *J Virol Methods* 2003; 112:129.

## VENEZUELAN VIRAL ENCEPHALOMYELITIS OF HORSES

### Synopsis

**Etiology** Venezuelan encephalitis virus (types 1AB, 1C, and, to a lesser extent, 1E)

**Epidemiology** Disease limited to the Americas. Arthropod, usually mosquito, borne virus. Mammals, including horses, are accidental hosts. Horse are amplifying hosts and can spread VEE. Care fatality rate 5-70%. VEE occurs as epidemics

**Clinical findings** Fever, muscle fasciculation, severe depression, head pressing, incoordination, recumbency, opisthotonos and paddling, and death

**Clinical pathology** Leukopenia

**Lesions** Non-suppurative encephalomyelitis

**Diagnostic confirmation** Virus isolation and identification. Identification of viral antigen by indirect immunofluorescence. Serological confirmation of exposure, preferably demonstrating an increase in hemagglutination inhibition, virus neutralization, or complement fixation titer

**Treatment** No specific treatment. Supportive care

**Control** Vaccination with formalin-inactivated or modified live virus. Insect control

## ETIOLOGY

Venezuelan equine encephalomyelitis is associated with an arthropod borne alphavirus (family *Togaviridae*) Venezuelan equine encephalomyelitis virus (VEE). The VEE complex has one virus, VEE, with six antigenically related subtypes: I, VEE; II, Everglades; III, Mucambo; IV, Pixuna; V, Cabassou; and VI, AG80-663. Within subtype I are at least five variants. Epidemic (pathogenic) VEE in horses is associated with variants IAB (originally identified as distinct variants, A and B are now considered the same variant) and IC; all other subtypes of I (D-F), and other variants of VEE virus, are usually non-pathogenic for horses and are found in sylvatic or enzootic, non-equine cycles. The epidemic variants are exotic to the United States. **Outbreaks** occurred in Mexico in 1993 and 1996, and in Venezuela and Columbia in autumn 1995.<sup>1,2</sup> The Columbian outbreak affected 90 000 people and killed an estimated 4000 horses.<sup>1</sup> The strain involved in the Columbian outbreak was IC, while that involved in the Mexican outbreaks was a variant of the usually non-pathogenic IE.<sup>2</sup> The outbreak in Mexico was associated with a variant of VEE that did not cause viremia in horses, although it was capable of causing neurologic disease in this species, and it might have been this attribute that abbreviated the course of the epidemic.<sup>3</sup> There is evidence of continuing enzootic circulation of VEE IE in southern Mexico.<sup>4</sup>

The viruses is extremely fragile and disappear from infected tissues within a few hours of death.

## EPIDEMIOLOGY

The encephalitis viruses cause disease in horses, humans, pigs, and various birds including ratites and domestic pheasants.<sup>5</sup>

## Distribution

Pathogenic or epidemic VEE is found in northern South America, Central America, Mexico and, rarely, in the southern United States.<sup>5</sup> Non-pathogenic, or endemic, strains of VEE are found in South and Central America and in parts of the southern United States.

## Viral ecology

VEE exists as both non-pathogenic and pathogenic strains. **Non-pathogenic VEE viruses** persist in sylvatic cycles in northern South America, Central America and parts of the southern United States, and are important because they are the source of the epizootic strains of the virus that emerge at infrequent intervals.<sup>2,6-8</sup> The enzootic strains also confound the diagnosis of VEE because of the extensive

serological cross-reactivity among endemic and epidemic VEE viruses. However, recent advances in diagnostic techniques may have solved this diagnostic problem. The non-pathogenic viruses are maintained in rodents associated with swamps, and transmitted by mosquitoes of the genus *Culex*, and perhaps other hematophagous insects. Humans, horses, cattle, pigs, dogs, and raites are accidental hosts of the virus. **Epidemics of VEE** occur irregularly, the latest being in northern Columbia in 1995, and Mexico in 1993 and 1996.<sup>1,2</sup> The source of virus during outbreaks is infected horses. **Horses** develop a profound viremia and are **amplifying hosts** that aid in the spread of the epizootic; other domestic species, including cattle, pigs, and goats are not considered to be amplifiers of the virus. During epizootics, all species of mosquitoes that feed on horses, including *Aedes*, *Psorophora* and *Deinocerites* species, are thought to be capable of spreading the infection. Epizootics end as the population of susceptible horses decreases below a critical level, either by death or vaccination. The **reservoir of the virus between outbreaks**, which may be up to 19 years, was unknown until it was demonstrated that epidemic VEE type IAB virus arises by **mutation of endemic strains** (types ID-F and II-vi), or that type IE (enzootic) mutates into an epizootic form serologically very similar to IE. This mutation of the endemic virus into the epidemic form has occurred on at least three occasions associated with epidemics of VEE.<sup>2,6-8</sup> It is likely that pathogenic strains of VEE will continue to emerge in areas where the non-pathogenic strains of the virus are endemic.<sup>8</sup>

#### Animal risk factors

**Recovered horses** are resistant to infection for at least 2 years, and vaccination confers immunity of variable duration (see under 'Control'). **Housing and exposure to mosquitoes** are important risk factors for EEE, and presumably VEE.

Morbidity varies widely depending upon seasonal conditions and the prevalence of insect vectors; cases may occur sporadically or in the form of severe outbreaks affecting 20% or more of a group. The prevalence of infections, as judged by serological examination, is much higher than the clinical morbidity. The **case fatality rate** is usually 40–80% and may be as high as 90% with VEE.

#### Zoonotic implications

The **susceptibility of humans** to the causative virus gives the disease great public health importance. Humans can

become infected with sylvatic and epizootic VEE subtypes.<sup>1</sup> A recent outbreak of VEE in Columbia caused 75 000 human cases, 300 fatalities and killed approximately 4000 horses.<sup>1</sup> **Human infections** generally follow equine infections by approximately 2 weeks. The infection in humans is usually a mild, influenza-like illness in which recovery occurs spontaneously. When clinical encephalitis does occur it is usually in very young, or older, people. Occurrence of the disease in humans can be limited by the use of a vaccine in horses, thus limiting the occurrence of the disease in horses in the area. There is a strong relationship between the **mosquito population** and the incidence of the disease in horses and in humans.<sup>10</sup> The occurrence of the disease in humans may be predicted by an unusually high activity of virus in mosquitoes. There are usually, but not always, widespread mortalities in horses before the disease occurs in humans.<sup>10</sup> VEE infections have occurred among **laboratory workers** as a result of aerosol infections from laboratory accidents and from handling of infected laboratory animals. The TC83 live attenuated VEE virus vaccine may be **teratogenic** in humans.<sup>11</sup>

#### PATHOGENESIS

**Inapparent infection** is the mildest form of the disease and may be characterized by only a transient fever. A more severe form of the disease is manifested by tachycardia, depression, anorexia, occasional diarrhea, and fever.

**Viremia** persists throughout the course of the disease in VEE and the blood provides a source of infection for biting insects. Transplacental transmission of the VEE virus can occur in pregnant mares infected near term.<sup>12</sup> The virus is present in saliva and nasal discharge, and this material can be used to transmit the disease experimentally by intranasal instillation.

Penetration of the virus into the **brain** does not occur in all cases and the infection does not produce signs, other than fever, unless involvement of the central nervous system occurs. The lesions produced in nervous tissue are typical of a viral infection and are localized particularly in the **gray matter of the cerebral cortex, thalamus and hypothalamus**, with minor involvement of the medulla and spinal cord. It is this distribution of lesions that is responsible for the characteristic signs of mental derangement, followed at a later stage by paralysis. The early apparent blindness and failure to eat or drink appear to be cortical in origin. True blindness and pharyngeal paralysis occur only in the late stages.

#### CLINICAL FINDINGS

The diseases associated with the different viruses are **clinically indistinguishable**. The **incubation period** for VEE is 1–6 days. Uncomplicated disease usually lasts about 1 week. In the initial viremic stage there is fever, which may be accompanied by anorexia and depression, but the reaction is usually so mild that it goes unobserved. In the experimental disease, the temperature may reach 41°C (106°F) persisting for only 24–48 hours, with nervous signs appearing at the peak of the fever. Animals that have shown nervous signs for more than 24 hours may then have a temperature within the normal range.

**Early nervous signs** include hypersensitivity to sound and touch, and in some cases transient periods of excitement and restlessness, with apparent blindness. Affected horses may walk blindly into objects or walk in circles. **Involuntary muscle movements** occur, especially tremor of shoulder and facial muscles and erection of the penis. A stage of **severe mental depression** follows. Affected horses stand with the head hung low; they appear to be asleep and may have a half-chewed mouthful of feed hanging from the lips. At this stage the horse may eat and drink if food is placed in its mouth. The pupillary light reflex is still present. The animal can be aroused, but soon relapses into a state of somnolence.

A stage of **paralysis** follows. There is inability to hold up the head, and it is often rested on a solid support. The lower lip is pendulous and the tongue may hang out. Unnatural postures are adopted, the horse often standing with the weight balanced on the forelegs or with the legs crossed. **Head-pressing** or leaning back on a halter are often seen. On walking, there is obvious incoordination, particularly in the hindlegs, and circling is common. Defecation and urination are suppressed and the horse is unable to swallow. Complete paralysis is the terminal stage. The horse goes down, is unable to rise and usually dies within 2–4 days from the first signs of illness. A proportion of affected horses do not develop paralysis and survive, but have persistent neurological deficits.

In the experimental infection of horses with the endemic strain of the **VEE virus**, a fever and mild leukopenia occurs.<sup>13</sup> Following infection with the epidemic strain of the virus, a high fever and severe leukopenia are common, and a high level of neutralizing antibodies develop about 5–6 days after infection. Clinical findings include profound depression, accompanied by flaccidity of lips, partially closed eyelids, and drooped ears; some horses

chew continuously and froth at the mouth. In the terminal stages, there is recumbency and nystagmus.

### CLINICAL PATHOLOGY

There are no characteristic **hematological or biochemical abnormalities**. The **absence of biochemical indication of liver disease** (hyperbilirubinemia, increased activity in serum of liver-specific enzymes such as sorbitol dehydrogenase and gamma glutamyl transferase, absence of hyperammonemia) rules out hepatic encephalopathy.

**Diagnostic confirmation** is achieved by one or more of several means:<sup>14</sup>

- Isolation of virus from an affected animal
- Detection of viral antigen or nucleic acid in an animal with appropriate clinical signs
- Seroconversion or an increase in serum titer of sick or recovered animal.

**Virus isolation** provides definitive proof of infection. However, viremia may have resolved by the time nervous signs have developed, and it may be advantageous to sample febrile animals instead of animals showing more advanced signs of the disease. Virus can be cultured in intracranially inoculated suckling mice, weanling mice, guinea pigs, cell culture, newly hatched chicks, or embryonated eggs.<sup>9</sup> Virus isolates can be identified by complement fixation, hemagglutination inhibition, virus neutralization, PCR, IFA, and antigen capture ELISA.<sup>9,14</sup> A recently developed indirect fluorescent test using monoclonal antibodies enables the differentiation of endemic from epidemic strains of VEE.<sup>15</sup> Interpretation of the results of serological tests of horses in an area where endemic, non-pathogenic VEE virus exists is difficult because of the cross-reaction between endemic and epidemic strains of the virus. Therefore, in areas where there is endemic, non-pathogenic VEE, demonstration of the presence of antibodies should not be considered persuasive evidence of the presence of the disease.

**Acute and convalescent sera** taken 10–14 days apart for the presence of neutralizing, hemagglutination-inhibiting, or complement-fixing antibodies in the serum of affected or in-contact horses, is of value in detecting the presence of the virus in the group or in the area. A four-fold increase in complement-fixing antibodies is considered positive.

**Demonstration of viral nucleic acid** in tissue, blood or insects by PCR test may be a useful indicator of the presence of the

virus. There may be sufficient viral antigen to be detected by ELISA in clinical material, and this may provide a useful test in the early stages of an epidemic.<sup>14</sup>

### NECROPSY FINDINGS

The brain meninges may appear congested, but there are generally no gross changes. Histological examination of the brain reveals perivascular accumulations of leukocytes and damage to neurons.<sup>16</sup> The gray matter of the forebrain and midbrain are the most severely affected areas. In some cases of VEE, liquefactive necrosis and hemorrhage are visible in the cerebral cortex.<sup>17</sup> Cell culture and transmission experiments utilizing brain tissue as an inoculum are the traditional means of confirming a diagnosis, and require that the brain be removed within an hour of death. Transmission is by intracerebral inoculation of brain tissue into sucking mice or duck embryo tissue culture. Fluorescent antibody tests have been developed to detect VEE virus<sup>6</sup> and EEE virus in brain tissue.<sup>6</sup>

### Samples for postmortem confirmation of diagnosis

- One half of midsagittally-sectioned brain and liver and spleen should be submitted for fluorescent antibody and PCR testing, virus isolation and bioassay
- One half of midsagittally-sectioned brain, fixed in formalin, should be submitted for light microscopic examination.

**Note the zoonotic potential of these organisms when handling the carcass and submitting specimens.**

### DIFFERENTIAL DIAGNOSIS

Clinically, the disease has very great similarity to the other viral encephalomyelitides, from which it can often be discriminated by the geographical location of the horse, and to the hepatic encephalopathies and a number of other diseases (see below and in Table 22.1).

- Rabies
- West Nile virus encephalomyelitis
- Borna disease – occurs in Europe
- Japanese encephalitis – occurs in Asia
- Various other viral infections that are geographically restricted
- Hepatic encephalopathy, such as that associated with poisoning by *Crotalaria*, *Senecio*, and *Amsinckia* spp.; acute serum hepatitis or hepatopathy

- Botulism causes weakness evident as muscle fasciculation, recumbency and dysphagia, but does not cause cerebral signs (irritation, behavioral abnormalities)
- Yellow star thistle poisoning (*Centaurea solstitialis*) and poisoning by fumonisins can produce similar clinical signs to that of the encephalitides, with the exception of fever.

### TREATMENT

There is no definitive or specific treatment. Supportive treatment may be given with the intention to prevent self-inflicted injury, and maintain hydration and nutritional status.

### CONTROL

Control of VEE of horses is based on:<sup>18–20</sup>

- Accurate clinical and laboratory diagnosis of the disease in horses
- Use of sentinel animals to monitor the presence of the virus in the region
- Quarantine of infected horses to stop movement of virus donors
- Insect abatement when deemed necessary
- Vaccination of all horses.

### Vaccination

**Vaccination** of horses is important not only because it minimizes the risk of disease in vaccinated horses but also because it prevents viremia, subsequent infection of feeding mosquitoes, and propagation spread of VEE.

One of the most important aspects of the control of VEE is the vaccination of the horse population to minimize the number of horses that are viremic and serve as amplifying hosts. A **tissue culture-attenuated virus vaccine TC83**, is available for immunization of horses against VEE. The vaccine is considered to be safe and efficacious<sup>21</sup>; concerns about reversion of the virus to virulence appear unfounded,<sup>9</sup> but should be reconsidered in light of the observation that the source of epidemic VEE virus is mutation of endemic strains.<sup>2,6,8</sup>

A **highly effective immunity** is produced within a few days following vaccination, and serum neutralizing antibodies persist for 20–30 months.<sup>1</sup> The vaccine causes a mild fever, leukopenia and a viremia and, because of conflicting reports about its capacity to cause abortion, should not be used in pregnant mares.<sup>1</sup> Antibodies to the heterologous alphaviruses, WEE and EEE, existing at the time of TC83 vaccination, may suppress the VEE antibody response to the vaccine.

Table 22.1 Diseases of horses characterized by signs of intra-cranial or disseminated lesions of the central nervous system

Disease	Etiology and epidemiology	Clinical and laboratory findings	Treatment and control
<b>Infection causes</b>			
Viral encephalomyelitis (Western, Eastern, Venezuelan: WEE, EEE, VEE)	Summer season. Insect vector, usually mosquitoes. Young non-vaccinated horses at greatest risk, outbreaks may occur	Stage of slight hyperexcitability and mild fever initially, impaired eyesight, circling and walking. Stage of mental depression, somnolence, leaning, feed hanging from mouth, unsteady. Stage of paralysis, unable to swallow, weakness, recumbency; dies 2–4 days after onset. Serology for diagnosis	Supportive therapy, thick bedding. Recovery rate 60–75%. Vaccinate foals at 6 months of age and other horses for the first time, twice 2 weeks apart and once or twice annually thereafter
Rabies	All age groups, knowledge of disease in area, wildlife. Usually single animal affected. Not common	Ascending paralysis, hyper-salivation, will bite. Ataxia and paresis of hindlimbs, lameness, recumbency, pharyngeal paralysis, colic, loss of tail and sphincter tone, fever. Dies in 1 week. Immunofluorescent antibody testing on brain for positive diagnosis	No treatment. All die. Vaccinate horses if anticipate outbreak
Herpesvirus myeloencephalopathy (EHV-1)	Can occur as outbreaks. Neurologic disease usually preceded by fever. Mature horses	Symmetrical ataxia and paresis, bladder paralysis, recumbency may occur, spontaneous recovery possible, CSF (hemorrhage or xanthochromia). Vasculitis with subsequent focal malacia in gray and white matter of brain and spinal cord	No specific therapy. Anti-inflammatory drugs may be useful. Use of corticosteroids is controversial. Recovery may occur spontaneously
West Nile encephalomyelitis (WNE)	West Nile virus. Late summer in temperate regions. Can occur as epizootics. Now enzootic in most of North America	Fever, muscle fasciculations, weakness, ataxia, depression, cranial nerve disease, recumbency. Prominent signs of spinal cord precede sign of intracranial disease in most cases	Supportive. Antiserum. Interferon. Anti-inflammatory drugs including corticosteroids. Prevention by vaccination
Borna	Virus. Direct transmission. Germany and other European countries. Disease is recorded in Japan. Low morbidity, high case fatality rate	Pharyngeal paralysis, muscle tremor, flaccid paralysis, course 1–3 weeks. Viral encephalomyelitis with inclusion bodies	No treatment
Japanese encephalitis	Japanese encephalitis virus. Sporadic. Asia including Japan and China, parts of Oceania including New Guinea and Torres Strait. Pig is mammalian amplifying host. Vector mosquitoes, birds infected	Fever, lethargy, jaundice, dysphagia, incoordination, staggering, recovery in 1 week. Serology	Spontaneous recovery. Vaccination in endemic areas
Protozoal myeloencephalitis	<i>Sarcocystis neurona</i> . Single animal affected. Infectious but not contagious	Any central nervous system disorder. Usually causes ataxia but can cause cerebral and cranial nerve disease	Antiprotozoal medications (pyrimethamine + sulphonamide, ponazuril, or nitazoxanide). Vaccine available in USA but not recommended. Ivermectin or moxidectin at usual doses. High dose benzimidazole. Anti-inflammatory drugs. Parasite control
Cerebrospinal nematodiasis (verminous encephalitis)	Migration of larval stages of <i>Strongylus vulgaris</i> , <i>Habronema</i> sp., and <i>Filaroides</i> . <i>Micronema deletrix</i> ( <i>Helicephalobolus</i> ) <i>deletrix</i> . Not common	Clinical signs referable to gray matter lesions are common. Hypalgesia, hyporeflexia, hypotonia, muscle atrophy and cerebral, cerebellar and cranial nerve involvement. Progressive encephalitis, incoordination, sensory deficits, blindness in one or both eyes, course of several days. Pleocytosis of CSF. Hemorrhage and malacia of thalamus, brain stem, cerebellum	Obtunded mentation, variable signs of intracranial disease. Leukocytosis. Variable pleocytosis and increased protein concentration in CSF. CT scan
Brain abscess	Sporadic. Often a complication of strangles	Obtunded mentation, variable signs of intracranial disease. Leukocytosis. Variable pleocytosis and increased protein concentration in CSF. CT scan	Antimicrobials. Surgical drainage. Prognosis is poor
<b>Physical</b>			
Traumatic injury to the brain	History of traumatic injury (falling, rearing-up and falling backwards)	Coma, depression, hemorrhage from nose and ears, blindness, cranial nerve deficits. Often rupture of longus capitus muscle	Anti-inflammatory drugs, mannitol. Fair to poor prognosis
Facial nerve paralysis	Associated with prolonged surgical recumbency and compression of facial nerve	Facial nerve paralysis lasting several days. Paralysis of ear, eyelid, lip, nostril on one side. No alteration in sensation or vestibular function	Supportive

Table 22.1 (Cont'd) Diseases of horses characterized by signs of intra-cranial or disseminated lesions of the central nervous system

Disease	Etiology and epidemiology	Clinical and laboratory findings	Treatment and control
Lightning strike	Observed lightning strike or history of recent thunderstorm activity	Death is most common. Horses that survive strike often have prominent signs of vestibular disease	Supportive. Recovery is possible
Fracture or arthritis of the temporal-stylohyoid articulation, otitis media	Sporadic in older horses	Acute onset circling, head tilt, nystagmus, unilateral facial paralysis, dysphagia	Antibiotics, anti-inflammatory drugs, supportive care
<b>Intoxications</b>			
Horsetail poisoning ( <i>Equisetum arvense</i> )	Ingestion of plants mixed with hay. Not common	Incoordination, swaying from side to side, muscle tremor recumbency, bradycardia, cardiac arrhythmia	Thiamine parenterally. Good response
Equine leukoencephalomalacia (fumonisin toxicosis)	Horses eating moldy corn grain contaminated with <i>Fusarium moniliforme</i> fungus	Muscle tremor, weakness, staggering gait, dysphagia, depression	Nil
Hepatoencephalopathy associated with hepatotoxic plants ( <i>Crotalaria</i> , <i>Senecio</i> and <i>Amsinckia</i> )	Horses on inadequate pasture forced to eat poisonous plants. More than one animal may be affected. Geographical distribution	Develops slowly, commonly ill for 2–3 weeks previously, depression, pushing, ataxia, hypertonic face and lips, yawning, compulsive walking, loss of weight, icterus, photosensitization occasionally. Serum liver enzymes elevated and liver function tests abnormal. Hyperammonemia. Gross and histopathological liver lesions	No treatment. Prevent access to poisonous plants
Lead poisoning	Grazing on pastures contaminated by atmospheric lead from nearby factories, not common now	Usually a chronic disease. Inspiratory dyspnea due to paralysis of recurrent laryngeal nerve. Pharyngeal paralysis, dysphagia, aspiration pneumonia, paralysis of lips, weakness and recumbency. Ingestion of large amounts causes subacute form similar to that seen in cattle	Calcium versenate
Yellow-star thistle poisoning ( <i>Centaurea</i> sp., anigropallidal encephalomalacia of horses)	Ingestion of yellow-star thistle in California and Australia. Summer months on weedy pasture	Difficult prehension, fixed facial expression with mouth held half open, hypertonic face and lips, persistent chewing movements and rhythmic protrusion of tongue, yawning and somnolence but easily aroused, aimless walking, slight stiffness of gait, high mortality	No treatment. Prevent access to poisonous plants
Botulism	Ingestion of preformed toxin of <i>Cl. botulinum</i> in decaying grass or spoiled silage, hay or grain. Sporadic in horses. Endemic in foals in some areas of North America	Flaccid paralysis of skeletal muscles leading to weakness, stumbling and recumbency. Mentation normal. Skin sensation normal. Paralysis of tongue and thoracic muscles. Die in 2–4 days. Some recover. Filtrates of intestinal tract into laboratory animals	Supportive therapy, antitoxins. Vaccination in enzootic areas. Prevent contamination of feed by animal carcasses
Tetanus	Wounds infected with <i>Cl. tetani</i> . Sporadic	Generalized tetany of all skeletal muscles. Fever, hyperesthesia, protrusion of third eyelid, trismus, recumbency followed by tetanic convulsions, die in 5–10 days	Prognosis unfavorable. Dark stall, penicillin, muscle relaxants, supportive therapy and antitoxin parenterally or into subarachnoid space Toxoid vaccination
<b>Metabolic and idiopathic</b>			
Lactation tetany	Lactating mares, suckling foals Hypocalcemia	Acute onset of generalized stiffness, trismus, no hyperesthesia, no prolapse of third eyelid, diaphragmatic flutter, soft heart sounds. Serum hypocalcemia	Rapid response to calcium borogluconate intravenously
Idiopathic epilepsy of Arabians	Single horse. first noticed from shortly after birth up to 6 months of age. Etiology unknown	Recurrent episodes of typical clonic tonic convulsions lasting 10–15 minutes, loss of consciousness, sweating, tachycardia, spontaneous defecation. No lesions	Control seizures with phenobarbital or potassium bromide. Spontaneous recovery as foals mature
Idiopathic epilepsy of adult horses	Sporadic disease. Unknown cause. Can be associated with brain lesions detectable on EEG or CT	Tonic-clonic convulsions. Variable periodicity and intensity	Control seizures acutely with diazepam and in long term with phenobarbital and/or potassium bromide. Spontaneous recovery unlikely

Table 22.1 (Cont'd) Diseases of horses characterized by signs of intra-cranial or disseminated lesions of the central nervous system

Disease	Etiology and epidemiology	Clinical and laboratory findings	Treatment and control
Cerebellar hypoplasia of Arabian and Swedish Gotland foals	Inherited. Signs noticeable from 2 to 6 months of age	Defective eye blinks, ataxia, headnodding, slight tremor of head and neck, intention tremor of the head, high-stepping gait, difficulty in rising, legs wide apart, difficulty in jumping over obstacles, fall backwards if dorsiflex head and neck. Cerebellar hypoplasia grossly or histologically	Eliminate carrier animals
Lower motor neuron disease	Associated with stabling and no access to pasture. Sporadic. North America and Europe. Low serum vitamin E concentrations	Weight loss, weakness, muscle fasciculations, maintained appetite. Normal mentation. Low serum vitamin E concentration. Diagnosis by muscle biopsy	No definitive cure. Some cases stabilized with administration of oral vitamin E. Poor prognosis for return to function

**Note:** Other less common diseases affecting the nervous system of horses include: space-occupying lesions (cholesteatomas of old horses, tumors), intracranial myiasis due to migration of *Hypoderma bovis*, hydrocephalus in young horses, the accidental injection of an ataractic drug into the carotid artery and bacterial meningitis in young horses as a sequel to streptococcal infection.

However, the response to the vaccine is adequate to provide protection against VEE, and the interference is not considered significant.<sup>22</sup> There is inconclusive evidence that WEE and EEE antibodies protect horses against infection with virulent VEE virus, or conversely that VEE antibodies protect against infection with WEE and EEE viruses.<sup>23</sup> Simultaneous vaccination using formalin-inactivated EEE, WEE, and VEE (the TC83 strain of VEE) is effective and recommended in areas where all three viruses may be present.

#### Protection from insects

**Housing of horses indoors at night**, especially in flyproofed stables, and the use of **insect repellents** might restrain the spread of the virus.

Widespread spraying of insecticides to reduce the population of the vector insects has been used in the control of VEE in humans, along with vaccination of horses.<sup>24</sup> **Complete eradication** of the virus appears to be impossible because of the enzootic nature of the ecology of the virus: epidemic VEE arising by chance mutation of endemic strains of VEE, make elimination of the virus impossible with methods currently available.

#### REVIEW LITERATURE

Calisher CH, Walton TE. Japanese, Western, Eastern, and Venezuelan encephalitis. In: Studdert MJ (ed) *Virus infections of vertebrates: virus infections of equines*. Amsterdam: Elsevier, 1996; pp. 141–155.

Weaver SC et al. Venezuelan equine encephalitis. *Ann Rev Entomol* 2004; 49:141.

#### REFERENCES

1. Rivas F et al. *J Infect Dis* 1997; 175:828.

2. Smith JF, Oberste MS. Factors in the emergence of arbovirus diseases. Amsterdam: Elsevier, 1997; p. 235.
3. Gonzalez-Salazar D et al. *Emerg Infect Dis* 2003; 9:16.
4. Estrada-Franco JG et al. *Emerg Infect Dis* 2004; 10:2113.
5. Elvinger F et al. *J Am Vet Med Assoc* 1994; 205:1014.
6. Weaver S. Factors in the emergence of arbovirus diseases. Amsterdam: Elsevier, 1997; p. 241.
7. Powers AM et al. *J Virol* 1997; 71:6697.
8. Rico-Hesse R et al. *Proc Natl Acad Sci USA* 1995; 92:5278.
9. Walton TE. *J Am Vet Med Assoc* 1992; 200:1385.
10. Grady GF et al. *Am J Epidemiol* 1978; 107:170.
11. Casamassima AC et al. *Teratology* 1987; 36:287.
12. Justines G et al. *Am J Trop Med Hyg* 1980; 29:653.
13. Walton TE et al. *J Infect Dis* 1973; 128:271.
14. Calisher CH, Walton TE. In: Studdert MJ (ed) *Virus infections of vertebrates: virus infections of equines*. Amsterdam: Elsevier, 1996; p. 141.
15. Roehrig JT, Bolin RA. *J Clin Microbiol* 1997; 35:1887.
16. Erickson GA, Mare CJ. *Am J Vet Res* 1975; 36:167.
17. Monath TP et al. *Am J Vet Res* 1981; 42:1418.
18. Calisher CH et al. *J Am Vet Med Assoc* 1983; 183:438.
19. Wong FC, Lillie LE. *Can J Publ Health* 1976; 67 Suppl 1:15.
20. Omohundro RE. *J Am Vet Med Assoc* 1971; 161:1516.
21. Baker EF et al. *Am J Vet Res* 1978; 39:1627.
22. Ferguson JA et al. *Am J Vet Res* 1978; 39:371.
23. Ferguson JA et al. *Am J Vet Res* 1977; 38:425.
24. Sudia WD, Newhouse VF. *Am J Epidemiol* 1975; 101:117.

#### JAPANESE ENCEPHALITIS

Japanese encephalitis is associated with the **Japanese encephalitis flavivirus** (JEV), a member of the *Flaviviridae* family.<sup>1</sup> Antigenically related viruses include Murray valley encephalitis virus, Kunjin virus, and West Nile virus. There appear to be a number of variants of JEV, with there being genetic and antigenic

differences between endemic and non-endemic strains, and isolates of different years.<sup>1,2</sup> The virus cycles between avian and mammalian amplifying hosts and the mosquitoes.<sup>1</sup> The pig is the principal mammalian amplifying host among domestic animals. Horses and humans become infected but likely play only a minor role in the spread of the virus. The disease is listed by the OIE.

The disease occurs **throughout the Orient and South-East Asia** and has extended into Papua New Guinea, the Torres Strait, and northern Australia. Outbreaks of disease occurred in the Torres Strait in 1995 and disease in humans has occurred rarely in northern Australia.<sup>3</sup> Outbreaks of disease have not occurred in Australia, despite large populations of wild pigs, wading birds, and mosquitoes probably because the mosquitoes prefer to feed on marsupials, which are poor hosts for JEV.<sup>3</sup>

Horse deaths are now uncommon in Japan, due to vaccination of most horses, but 15–70% of race horses have antibodies to JEV that are not induced by vaccination.<sup>4</sup> Seroepidemiological surveys of cattle in Japan reveal that about 68% of animals are positive.<sup>5</sup> Disease in horses and humans occurs in China.<sup>1</sup> The prevalence of the disease is related to the population of pigs, the main amplifying host, the mosquito vector, and susceptible human and equine hosts.<sup>1</sup> Factors affecting the number of mosquitoes include availability of suitable habitat, such as rice field in which survival of mosquito larvae is enhanced by application of nitrogenous fertilizers and the presence of phytoplankton which provide food and shelter for the larvae.<sup>6,7</sup>

The **clinical manifestations** of the disease in horses vary widely in severity.



Mild cases show fever up to 39.5°C (103°F), anorexia, sluggish movements, and sometimes jaundice for 2–3 days only. More severe cases show pronounced lethargy, mild fever, and somnolence. Jaundice and petechiation of the nasal mucosa are usual. There is dysphagia, incoordination, staggering, and falling. Transient signs include neck rigidity, radial and labial paralysis, and blindness. In the most severe cases there is high fever (40.5–41.5°C, 105–107°F), hyperexcitability, profuse sweating, and muscular tremor. Violent, uncontrollable activity may occur for a short period. This severe type of the disease is uncommon, representing only about 5% of the total cases, but is more likely to terminate fatally. In most cases complete recovery follows an illness lasting from 4 to 9 days. A variety of tests are available to detect antibodies to JEV.<sup>8</sup> A latex agglutination test provides accurate detection of antibodies in the field.<sup>9</sup> However, definitive diagnosis of Japanese viral encephalitis should not be based exclusively on serology because infection with antigenically related viruses including Murray Valley encephalitis virus, Kunjin virus, and West Nile virus can cause false-positive (from the perspective of JEV) results.<sup>8</sup>

The disease in **cattle, sheep and goats** is usually clinically inapparent and of little overall significance. Widespread losses, however, have been reported in **swine**, particularly in Japan. The disease occurs as a non-suppurative encephalitis in pigs under 6 months of age. Sows abort or produce dead pigs at term.<sup>10</sup> There are no characteristic gross changes. As is typical of most viral encephalitides, microscopic changes include a nonsuppurative encephalomyelitis, focal gliosis, neuronal necrosis, and neuronophagia. Isolation of this flavivirus is difficult and bioassay techniques are comparatively slow. As a result, detection via PCR is likely to be increasingly utilized. Immunohistochemistry can be used to demonstrate this virus in formalin-fixed, paraffin-embedded sections

#### Samples for confirmation of diagnosis

- **Virology** – 5 mL chilled CSF fluid, chilled brain (split along midline) (ISO, BIOASSAY, PCR)
- **Histology** – fixed samples of other half of brain, lung, spleen, liver, heart (LM, IHC).

**Note the zoonotic potential of this organism when handling carcass and submitting specimens.**

There is no specific treatment for the disease. **Control** is by vaccination. Formalinized **vaccines** afford excellent protection in pigs and horses.<sup>4</sup>

#### REFERENCES

1. Calisher CH, Walton TE, Studdert MJ (eds). Getah virus infection. In: virus infections of vertebrates: virus infections of equines 6. Amsterdam: Elsevier, 1996; p. 141.
2. Yamada A et al. *Vet Pathol* 2004; 42:62.
3. van den Hurk AF et al. *Med Vet Entomol* 2003; 17:403.
4. Konishi E et al. *Vaccine* 2004; 22:1097.
5. Sakai T, Horimoto M. *Prev Vet Med* 1989; 7:39.
6. Sunish IP, Reuben R. *Med Vet Entomol* 2001; 15:381.
7. Sunish IP, Reuben R. *Med Vet Entomol* 2001; 16:1.
8. Anon. OIE Manual of diagnostic tests and vaccines for terrestrial animals. [http://www.oie.int/eng/normes/mmanual/A\\_00092.htm](http://www.oie.int/eng/normes/mmanual/A_00092.htm) Accessed February 26 2005.
9. Xinglin J et al. *Vet Res Comm* 2002; 26:495.
10. Burns KF. *Proc Soc Exp Biol Med* 1950; 75:621.

#### WEST NILE ENCEPHALITIS

**Etiology** West Nile virus, a flavivirus

**Epidemiology** Maintained in a bird–mosquito cycle. Mammals are incidentally infected. Endemic in Africa and, recently, North America. Epizootics in the Mediterranean littoral and southern Europe. Affects a wide variety of species including horses, humans, sheep, camels, and dogs

**Clinical signs** Weakness, incoordination, altered mentation, muscle fasciculations, recumbency

**Clinical pathology** MAC-ELISA for diagnosis

**Lesions** Polioencephalomyelitis

**Diagnostic confirmation** MAC-ELISA, clinical signs, lesions

**Treatment** None specific. Supportive care

**Control** Vaccination. Mosquito control

#### ETIOLOGY

Encephalitis in horses, humans, and other species is associated with West Nile virus, an arthropod borne flavivirus in the Japanese encephalitis virus group. Other viruses in the group include Japanese encephalitis virus (Japan and South-East Asia), St Louis encephalitis virus (United States), Kunjin virus (now considered a subtype of West Nile virus, Australia), Murray Valley encephalitis virus (Australia), and Rocio virus (Brazil).<sup>1</sup> The virus was first isolated in 1937 from a human with fever in Uganda. There are at least two lineages of the virus, with one lineage (lineage 1) isolated from animals in central and North Africa, Europe, Israel, and North America whereas the other (lineage 2) is enzootic in central and southern Africa.<sup>2</sup> The recent outbreak in North America was associated with a virus identical to that isolated from diseased geese in Israel.<sup>3</sup> Viruses of both lineages can circulate at the same time in the same geographic region.<sup>1</sup> Virus of

either lineage can cause disease, although that of lineage 1 appears to be associated with more severe disease in horses and other species. There are anecdotal reports of Kunjin virus being associated with isolated cases of encephalomyelitis in horses in Australia.

The West Nile virus causes disease in humans, horses, birds (including geese, raptors, and corvids), sheep, alpacas, and dogs.<sup>2,4-6</sup>

#### EPIDEMIOLOGY

##### Distribution

West Nile encephalitis virus is enzootic to Africa and sporadic outbreaks of the disease occurred in the 1960s in Africa, the middle East and southern Europe.<sup>7</sup> Recently, outbreaks affecting horses and other animals have occurred in southern France, Tuscany, Israel and other parts of southern Europe.<sup>8-11</sup> The virus was introduced into New York city in North America in 1999 and subsequently spread widely across the continent, including Canada, Mexico and the Caribbean, in the next several years, and reaching the west coast by 2004.<sup>12</sup> The virus caused widespread deaths of wild birds and disease and death in humans, horses and other species in North America during this period.<sup>13</sup>

Introduction of the infection to North America was associated with an epizootic of disease that over several years moved across the continent. During the initial years of the epizootic there were large numbers of cases in horses (15 000) and humans (4000) and death of at least 16 500 birds.<sup>14</sup> As the front of the epizootic moved across the country, the infection became enzootic and the number of cases in horses in these regions decreased markedly over those in the first year.

##### Viral ecology

The virus is maintained by a cycling between amplifying hosts, usually birds, and insect vectors. Large mammals, including horses and humans, are incidentally infected and are not important in propagation of the virus. Amplifying hosts are those in which the viremia is of a sufficient magnitude and duration (1–5 days) to provide the opportunity to infect feeding mosquitoes. Mammals, and in particular horses, are in general not amplifying hosts because of the low level of viremia.<sup>15</sup> The virus is spread by the feeding of ornithophilic mosquitoes, usually of the genus *Culex*. Infected mosquitoes carry the virus in salivary glands and infect avian hosts during feeding. The virus then multiplies in the avian host causing a viremia that may last for up to 5 days. Mosquitoes feeding on the avian host during the viremic phase are then infected by the virus. This pattern of infec-

tion of amplifying hosts and mosquitoes is repeated such that the infection cycles in these populations. Increases in mosquito number, such as occur at the end of the summer, and enhanced viral replication in mosquitoes at higher ambient temperatures, increase the likelihood that avian hosts, or incidental hosts, will become infected. This results in an increase in the incidence of disease in late summer and early autumn.<sup>16-19</sup>

The principal avian host and vector species vary markedly between geographic regions. In North America the house sparrow (*Passer domesticus*) is the principal amplifying host and *Culex pipens* is the principal vector. *Culex pipens*, and other mosquito vectors, feed almost exclusively on passerine and columbiform birds early in the season, but later in the summer in temperate regions switch to feeding on mammalian hosts.<sup>20</sup> This change in feeding behavior is associated with increased frequency of infection and disease in mammals, including horses and humans, in the late summer.

The virus cycles between the avian host and insect vectors year round in tropical regions. However, in temperate regions in which mosquitoes do not survive during the winter the mechanism by which the virus survives over winter is unknown.<sup>13</sup>

#### Transmission

Transmission is only by the bite of infected insect vectors. There is no evidence of horizontal spread of infection among horses. The disease can be spread in humans by transfusion of blood or transplantation of organs obtained from an infected person.<sup>21</sup>

#### Animal risk factors

The disease occurs in parts of the world as epidemics apparently associated with sporadic introduction of the virus into non-endemic regions, such as the Mediterranean littoral. Introduction of the virus to these regions occurs infrequently enough that horses have no active immunity and are susceptible to infection and disease. Horses immune through either natural infection or vaccination are resistant to the disease. The effect of immunity was evidenced in North America by the marked decrease in morbidity and mortality among horses after the epizootic waned and the disease became enzootic. The decrease in morbidity was attributed to both natural and vaccinal immunity. Interestingly, although the number of cases in horses decreased rapidly there was not a similar decrease in the number of human cases, perhaps because of the lack of a vaccine for use in humans.<sup>13</sup>

Horses of all ages appear to be equally susceptible to infection. Disease is report

in horses aged from 5 months to >20 years. There does not appear to be any predilection based on breed or sex.<sup>16</sup>

#### Morbidity and case fatality

The incidence of the disease during an epizootic can be as high as 74 cases per 1000 horses at risk.<sup>17</sup> The case fatality rate among horses treated in the field is 22-38%<sup>16,17,22</sup> whereas it is 30-43% of horses in referral centers.<sup>19,23</sup>

#### Zoonotic implications

Infection of humans by West Nile virus can result in fatal encephalitis, although less severe disease or inapparent infection is more common. The virus has zoonotic potential and tissues from potentially infected animals and virus cultures should be handled in containment level 3 facilities, particularly material from potentially infected birds.<sup>24</sup>

#### PATHOGENESIS

Horses are infected by the bite of infected mosquitoes. Feeding by as few as 7 infected mosquitoes is sufficient to cause infection in seronegative horses.<sup>15</sup> Viremia, which persists for less than 2 days, occurs 2 to 5 days after feeding by infected mosquitoes.<sup>15</sup> West Nile encephalitis occurs in only a small proportion of infected horses. The virus localizes in cells in the central nervous system where it induces a severe polioencephalomyelitis with the most severe lesions being in the spinal cord.<sup>25</sup> Lesions are often evident in the ventral horn of the spinal cord, which is consistent with clinical signs of weakness.

#### CLINICAL FINDINGS

The incubation period after natural infection is estimated to be 8-15 days. Fever occurs early in the disease but is uncommon at the time that signs of neurologic disease become evident.<sup>16,17</sup> Affected horses are often somnolent, listless, or depressed although hyperexcitability has been reported. The signs of neurologic disease, including muscle fasciculation, weakness, and incoordination, develop within a period of hours and may progress over several days. Muscle fasciculations are common in the head and neck, but can occur in any muscle group. Weakness is most pronounced in limb and neck muscles and severely affected horses are recumbent with flaccid paralysis. Signs of neurologic disease are usually, but not reliably, bilaterally symmetrical. Altered mentation, blindness, and cranial nerve abnormalities, if they occur, usually become evident after signs of spinal cord disease are apparent.

Weakness with or without ataxia is present in almost all affected horses, whereas altered mentation is detected in approximately 66% of horses.<sup>19</sup> Cranial

nerve abnormalities are evident in approximately 40% of horses, whereas apparent blindness or lack of menace reflex occurs in 3-7% of horses.<sup>17,19</sup>

Median recovery time for horses treated in the field is 7 days, with a range of 1-21 days.<sup>17</sup>

The prognosis depends on the severity of clinical signs. Horses that become recumbent and unable to rise are approximately 50 times more likely to die than are horses that remain able to stand while affected by the disease.<sup>22</sup> Most horses that survive the initial disease do not have signs of neurologic dysfunction 6 months later.<sup>19</sup>

#### Other species

Disease associated with West Nile virus is documented in small numbers of other species, including squirrels, chipmunks, bats, dogs, cats, reindeer, sheep, alpacas, alligator and a harbor seal during intense periods of local viral activity.<sup>24</sup> The disease in camelids is characterized by acute recumbency and altered mentation.<sup>25</sup>

#### CLINICAL PATHOLOGY

Affected horses are often mildly lymphopenic, and hyperbilirubinemic (likely due to anorexia), and occasionally azotemic.<sup>19</sup> These changes are not diagnostic of West Nile encephalitis.

Cerebrospinal fluid is abnormal in approximately 70% of horses with signs of neurologic disease. Abnormalities include mononuclear pleocytosis and elevated total protein concentration.<sup>26</sup>

#### Serological tests

Antibody can be identified in equine serum by IgM capture enzyme-linked immunosorbent assay (IgM capture ELISA, MAC-ELISA), hemagglutination inhibition (HI), IgG ELISA or plaque reduction neutralization (PRN).<sup>23</sup> Equine WN-specific IgM antibodies are usually first detectable 7-10 days after infection and persist for 1-2 months.<sup>15</sup> Because the incubation period of the disease after infection by bite of infected mosquitoes is at least 8 days, West Nile-specific IgM is usually present at the time of development of clinical signs of the disease. The MAC-ELISA is therefore a useful test in the diagnosis of the disease.<sup>19</sup>

WNV neutralizing antibodies are detectable in equine serum by 2 weeks post-infection and can persist for more than 1 year. In some serological assays, antibody cross-reactions with related flaviviruses (St Louis encephalitis virus or Japanese encephalitis virus), can be encountered.<sup>23</sup> The PRN test is the most specific among WN serological tests and all affected horses have titers  $\geq 1:100$  4-6 weeks after recovering from the

disease, and 90% of horses maintain this titer 5–7 months after recovery.<sup>27</sup>

Detection by MAC-ELISA of West Nile specific IgM in serum at dilutions greater than 1:400, in the presence of appropriate clinical signs, is considered diagnostic of WNV.<sup>28</sup> Similarly, a four-fold increase in PRN titer in serum collected during the acute and convalescent stages of the disease, in the absence of vaccination and in the presence of appropriate clinical signs is considered diagnostic.

#### Identification of WNV

The virus can be grown in cell culture and viral nucleic acid can be demonstrated in tissues of infected animals by RT-PCR.<sup>29</sup> Note that infected horses have much lower concentrations of virus than do infected birds, and failure to demonstrate viral antigen in infected horses is not uncommon, especially if less sensitive techniques, such as immunohistochemistry, are used.<sup>24,25</sup>

#### NECROPSY FINDINGS

Gross lesions are infrequently seen. When present they consist of multifocal areas of congestion and hemorrhage within the medulla oblongata, midbrain, and spinal cord. Histopathologic changes include a nonsuppurative poliomyelomyelitis with multifocal glial nodules and neuronophagia. The inflammatory changes and viral distribution are concentrated in the rhombencephalon and spinal cord, with comparatively little damage to the cerebrum. One immunohistochemical study of naturally infected horses concluded that examination of the spinal cord is required to accurately identify WNV infection.<sup>25</sup> Another report, in which RT-PCR was employed, concluded that high quality samples of medulla were sufficient to detect the presence of the virus.<sup>30</sup> Post-mortem confirmation of the diagnosis through virus isolation is possible but the sensitivity is generally inferior to molecular biology-based techniques. RT-PCR is generally superior to IHC. The processing of tissue from multiple CNS sites is recommended in order to increase the chances of finding a virus-rich focus. High concentrations of WNV are not found in non-CNS tissues of infected equids, in contrast to the distribution of the virus in many other species.

#### Samples for confirmation of diagnosis

- **Virology** – minimum sample is one half of sagittally sectioned hindbrain (*must include medulla*). Ideally a segment of thoracolumbar spinal cord as well. Submit samples chilled (VI, RT-PCR)
- **Histology** – same samples, fixed in formalin (LM, IHC, RT-PCR).

**Note the zoonotic potential of this disease when collecting and submitting specimens. Some authorities recommend using containment level 3 precautions when handling potentially infected tissues, such as that from birds.**<sup>24</sup>

#### DIFFERENTIAL DIAGNOSIS

Differential diagnoses for West Nile encephalitis include (Table 22.1):

- Eastern and Western encephalitis
- Venezuelan equine encephalitis
- Equine herpesvirus 1 myeloencephalopathy
- Rabies
- Botulism
- Hepatic encephalopathy
- Borna disease
- Equine protozoal myeloencephalitis
- Leucoencephalomalacia
- Lower motor neurone disease

#### TREATMENT

There is no specific treatment for West Nile encephalitis although administration of interferon or hyperimmune globulin has been advocated. Affected horses are often administered non-steroidal anti-inflammatory drugs such as flunixin meglumine, dimethyl sulfoxide, or corticosteroids in an attempt to reduce inflammation in neural tissue.<sup>19</sup> Administration of corticosteroids minimally but statistically significantly increases the likelihood of survival<sup>22</sup> but this practice is controversial. Treatment is based on supportive care and prevention of complications of neurologic disease and includes assistance to stand, including use of a sling support, administration of antimicrobials, and maintenance of hydration and nutrition.

#### CONTROL

Control of disease associated with West Nile virus is achieved by vaccination and minimization of exposure. Elimination of the virus is not practical given that it cycles through avian and insect vectors and that the horse is incidentally infected.

**Vaccination** is believed to be effective in preventing development of disease, and has been demonstrated to reduce the likelihood of death in horses with West Nile encephalitis by approximately 2–3 times.<sup>17,22</sup> Efficacy of vaccination in preventing disease in horses has not been formally demonstrated although there is general agreement that vaccination is an important aspect to control of the disease.<sup>13</sup> There is no evidence that administration of the inactivated virus vaccine increases the risk of fetal loss in mares.<sup>31</sup> Vaccination prevents viremia in most horses following exposure to WNV-infected mosquitoes.<sup>32</sup>

Both inactivated virus vaccine and a live canarypox-vectored recombinant vaccine are available in North America. The inactivated virus vaccine should be administered in two doses at an interval of 3–6 weeks in early summer in the first instance, and then again once to twice yearly before the season of peak disease incidence. Foals from unvaccinated mares should be administered the vaccine beginning at 2–3 months of age, and foals of vaccinated mares should be administered the vaccine beginning at 7–8 months of age.

Administration of the recommended two doses of inactivated virus vaccine fails to induce an adequate plaque reduction titer in approximately 14% of horses 4–6 weeks after vaccination, and in 30% of horses 5–7 months after vaccination.<sup>27</sup> This effect was especially evident in horses >10 years of age.<sup>27</sup> These results indicate that some horses will not develop protective immunity against WNV despite administration of vaccine in the recommended dose and interval.

**Minimization of exposure** of horses to the virus includes reducing the population density of mosquitoes and protecting horses from being bitten. Reducing the population of mosquitoes includes widespread spraying with insecticides and elimination of mosquito breeding sites. Widespread spraying in cities is employed when the disease is a risk for humans but is not practical for controlling mosquitoes in rural areas. Environmental concerns make this approach to control unacceptable in many regions.

Removal of larval habitat by draining standing water is recommended for control of WNV, although the efficacy of this approach has not been demonstrated. Standing water includes not just dams and ponds but also poorly maintained outdoor swimming pools, bird baths, discarded vehicle tires, and other receptacles that could hold water. Use of larvicidal compounds in standing water is recommended by some authorities.

Minimizing the frequency with which horses are bitten by mosquitoes has the potential to reduce the risk of contracting the disease. However specific recommendations are not available. Housing during periods of peak mosquito activity, especially at dawn and dusk, might reduce the risk of disease.

#### REVIEW LITERATURE

- McLean RG. West Nile virus in livestock and wildlife. *Curr Top Microbiol Immunol* 2002; 267:271.  
Saville WJA et al. West Nile virus encephalitis in horses. *Comp Cont Educ Pract Vet* 2003; 25:220.

#### REFERENCES

1. Solomon T. *New Engl J Med* 2004; 351:4.
2. Kutzler MA et al. *J Am Vet Med Assoc* 2004; 225:921.

Table 22.2 Differential diagnosis of diseases characterized by lesions of the teat skin only

Disease	Epidemiology			
	Method of spread	Course of disease	Lesions	Clinical pathology
Cowpox (usually vaccinia) virus	Very rare. More commonly vaccinia from recently vaccinated people. Contact spread via teat injuries	2–4 weeks. In immune herd heifers only. Mastitis sequel	Vesicle, pustule, ulcers to 1–2 cm, thick red brown scabs on teats and udder. Rarely to perineum, vulva mouth of calves. Scrotum of bull	Electron microscopy of swab from lesion. Tissue culture
Pseudocowpox	Very common. Morbidity 5–10% affects whole herd. Little immunity and recurs quickly. Spread by contact, hand, cloth, teat cup. On milker's hands as nodule	Slow spread, long healing time, and cyclical recurrence in individual cows, disease lasts up to 18 months in herd	Erythema, vesicle, pustule scab in ring or horseshoe pattern. Elevated due to granulation tissue. 0.5–2.5 cm. Heal in 7–10 days. Rare lesions in mouth	Electron microscopy of vesicle fluid. Tissue culture
Bovine ulcerative mammillitis	Affects 20–100% (average 50%). Insect transmission into herd. Seasonal autumn. Milking machine spread plus teat injury. Recurs in herd after 13 months	Self-limiting. Persists 6–14 weeks. Many cows culled because of bad ulcers and mastitis; subsequently heifers only affected	Test swollen, painful, exudes serum, skin sloughs, leaving raw ulcer covering most of teat. Mild cases have 0.5–2 cm ring-like erythema around nodule or ulcer. Lesions heal 10 days to 2 months. Fresh cows have extensive sloughing of teat and udder. Rarely lesions in mouth of calves sucking cows	Tissue culture of herpesvirus from early lesion. High antibody titer. Tissue culture of herpesvirus DN599
Udder impetigo	Spread during milking by contact. Pustules on milker's hands	Disappears quickly from each cow but recurs within 6 months and may persist in herd	Small 2–4 mm diameter pustules (may be large boils) at teat base, spread to teat and udder skin	Microbiological culture of swab of pus: <i>Staphylococcus aureus</i>
Black pox	Sporadic only. Due to poor milking machine technique	Intractable to treatment. Mastitis common sequel	Deep crater-shaped ulcer with black spot in center. At teat tip, involve sphincter	Culture of <i>Staphylococcus aureus</i>
Teat fibropapilloma	Contact at milking time via teat cups, hands etc. to abrasions of teat skin. May be 20% of herd affected	Disappear spontaneously 2–3 up to 5 months. Cause annoyance	Small white slightly elevated nodules 0.3 cm dia or elongated tags 1 cm long removable by traction	

3. Banet-Noach C et al. *Virus Genes* 2003; 26:135.
4. Tyler JW et al. *J Vet Int Med* 2003; 17:242.
5. Dunkel B et al. *J Vet Int Med* 2004; 18:365.
6. Buckweitz S et al. *J Vet Diag Invest* 2003; 15:324.
7. Burt FJ et al. *Emerg Infect Dis* 2002; 8:820.
8. Steinman A et al. *Vet Rec* 2002; 151:47.
9. Autorino GL et al. *Emerg Infect Dis* 2002; 8:1372.
10. Murgue B. *Emerg Infect Dis* 2001; 7:692.
11. Cantile C et al. *Equine Vet J* 2000; 32:31.
12. Petersen LR, Hayes EB. *New Eng J Med* 2004; 351:2257.
13. Castillo-Olivares J, Wood J. *Vet Res* 2004; 35:467.
14. Anon. *Morb Mort Weekly Report* 2003; 52:1160.
15. Bunning ML et al. *Emerg Infect Dis* 2002; 8:380.
16. Ward MP et al. *J Am Vet Med Assoc* 2004; 225:84.
17. Schuler LA et al. *J Am Vet Med Assoc* 2004; 225:1084.
18. Steinman A et al. *Vet Rec* 2002; 151:47.
19. Forster MB et al. *J Am Vet Med Assoc* 2003; 222:1241.
20. Bernard KA, Kramer LD. *Viral Immunol* 2001; 14:319.
21. Pealer LN et al. *New Eng J Med* 2003; 349:1236.
22. Salazar P et al. *J Am Vet Med Assoc* 2004; 225:267.
23. Weese JS et al. *Can Vet J* 2003; 44:469.
24. [http://www.oie.int/cng/normes/mmanual/A\\_00133.htm](http://www.oie.int/cng/normes/mmanual/A_00133.htm) Accessed March 11 2005.
25. Cantile C et al. *Vet Pathol* 2001; 38:414.
26. Wamsley HL et al. *J Am Vet Med Assoc* 2002; 221:1303.
27. Davidson AH et al. *J Am Vet Med Assoc* 2005; 226:240.
28. Tardei G et al. *J Clin Micro* 2000; 38:2232.
29. Johnson DJ et al. *J Vet Diag Invest* 2003; 15:488.
30. Kleiboeker SB et al. *J Vet Diag Invest* 2004; 16:2.
31. Vest DJ et al. *J Am Vet Med Assoc* 2004; 225:1894.
32. Siger L et al. *Am J Vet Res* 2004; 65:1459.

## BORNA DISEASE

Borna disease is an **infectious encephalomyelitis** of horses and sheep first recorded in Germany. It is associated with a negative sense, single-stranded RNA virus classified as *Bornaivirus* within the order Mononegavirales.<sup>1</sup> The disease and the virus are indistinguishable from near Eastern equine encephalomyelitis. Borna disease is now recognized as a subacute meningoencephalitis in horses, cattle, sheep, rabbits, and cats in Germany, Sweden and Switzerland.<sup>2–4</sup> There are reports of encephalitis with Borna disease virus genome detected in lesions by PCR in a horse and a cow in Japan.<sup>5,6</sup> Encephalitis associated with BDV was detected in young ostriches in Israel.<sup>8</sup>

**Borna disease virus (BDV)** is suspected of causing disease in humans, including lymphocytic meningoencephalitis, but BDV infection is not associated with an increased prevalence of psychiatric disorders.<sup>8,9</sup> Others suggest that the presence of circulating BDV immune complexes (BDV antigen and specific antibodies) is associated with severe mood disorders in humans.<sup>10</sup> The role, if any, of BDV in human neurologic or psychiatric disease has not been established with any certainty.

Detection of **BDV genome** by PCR analysis suggests that, while the spontaneous disease in horses and sheep occurs predominantly if not exclusively in Europe, clinically unapparent BDV infection is widespread in a number of species including horses, cattle, sheep, cats, and foxes.<sup>11,12</sup> However, concern has been raised that some of these reports might be based on flawed laboratory results as a consequence of contamination of PCR assays.<sup>11</sup> **Antibodies** to BDV in serum or cerebrospinal fluid have been detected in horses in the eastern United States, Japan, Iran, Turkey, France, and China,<sup>11,13–17</sup> and in healthy sheep and dairy cattle in Japan.<sup>18,19</sup> In areas in which the disease is not endemic between 3% (US) and 42% (Iran) of horses have either antibodies or BDV nucleic acid, detected by PCR, in blood or serum. Similarly, approximately 12–20% of horses have serological evidence of exposure to BDV in areas of Europe where the disease is endemic. Antibodies to BDV and nucleic acid have been detected in humans in North America, Europe, and Japan.<sup>20,21</sup> Closed flocks of sheep and herds of horses have evidence of persistent infection of some animals, based on serological testing.<sup>22,23</sup> It is worth noting that animals infected

with the virus and clinically ill may have undetectable to very low antibody titers.<sup>22</sup>

The method of transmission of infection between animals is unknown, but it is thought to be horizontal by inhalation or ingestion. Seropositive, clinically normal horses and sheep can excrete virus in conjunctival fluid, nasal secretions and saliva,<sup>22,24</sup> suggesting that they might be important in the transmission of infection. Removal of all seropositive and BDV RNA positive sheep from a closed flock did not prevent seroconversion of other animals in the flock the following year.<sup>22</sup> The possibility of vertical transmission is raised by the finding of BDV RNA in the brain of a fetal foal of a mare that died of Borna disease.<sup>25</sup>

There is a seasonal distribution to the prevalence of the disease, with most cases in horses occurring in spring and early summer.<sup>21</sup> The virus has not been isolated from arthropods, including hematophagous insects.

The **morbidity** in Borna disease is not high, approximately 0.006–0.23% of horses affected per year in endemic areas of Germany,<sup>21</sup> but most affected animals die.

The **pathogenesis** of the disease involves infection of cells of the central nervous system. It is assumed that the virus gains entry to the central nervous system through trigeminal and olfactory nerves, with subsequent dissemination of infection throughout the brain.<sup>27,28</sup> Viral transcription and replication occurs within the cell nucleus.<sup>28</sup> Viral replication does not appear to result in damage to the infected neuron. However, infected cells express viral antigens on their surface which then initiate a cell-mediated immune response by the host that then destroys infected cells – immunosuppression prevents development of the disease.<sup>29</sup> The inflammatory response is largely composed of CD3<sup>+</sup> lymphocytes.<sup>30</sup> The disease is subacute; infection and the development of lesions may take weeks to months. Clinically inapparent infection appears to be common in a number of species, including horses.

In **field outbreaks** the incubation period is about 4 weeks, and possibly up to 6 months.<sup>28</sup>

**Clinical signs** of the disease in horses include:

- Moderate fever
- Pharyngeal paralysis
- Lack of food intake
- Muscle tremor
- Defects in proprioception
- Hyperesthesia.<sup>27</sup>

Lethargy, somnolence and flaccid paralysis are seen in the terminal stages, and death occurs 1–3 weeks after the first appearance of clinical signs. Infection without detectable clinical signs is

thought to be common on infected premises. The frequency with which BDV is detected in horses with gait deficits is greater than in clinically normal horses, suggesting a role for the virus in inducing subtle disease.<sup>31,32</sup>

The disease in cattle has a similar presentation as that in horses, with affected animals having reduced appetite, ataxia, paresis, and compulsive circling.<sup>2,3</sup> The disease ends in the death of the animal after a 1–6-week course.<sup>2</sup>

Hematology and routine serum biochemistry are typically normal, with the exception of fasting induced hyperbilirubinemia in anorexic horses. Clinico-pathological identification of exposed animals is achieved with the complement fixation, ELISA, western blot, or indirect immunofluorescent tests.<sup>33</sup>

At **necropsy** there are no gross findings, but histologically there is a lymphocytic and plasmacytic meningoencephalitis, affecting chiefly the brain-stem, and a lesser degree of myelitis. The highest concentration of virus is in the hippocampus and thalamus.<sup>27</sup> The diagnostic microscopic finding is the presence of intranuclear inclusion bodies within neurons, especially in the hippocampus and olfactory bulbs. The virus can be grown on tissue culture and demonstrated within tissues by immunofluorescence and immunoperoxidase techniques.<sup>28</sup> BDV can also be detected in formalin-fixed, paraffin-embedded brain tissues using a nested PCR.<sup>34</sup>

Specific **control measures** cannot be recommended because of the lack of knowledge of means of transmission of the virus. The role of inapparently infected horses in transmission of the disease is unknown, and there is no widespread program for testing for such horses. An attenuated virus vaccine was produced by continued passage of the virus through rabbits and used in the former East Germany until 1992.<sup>21</sup> However, its use was discontinued because of questionable efficacy.

#### REVIEW LITERATURE

Ludwig H, Bode L. The neuropathogenesis of Borna disease virus infections. *Intervirology* 1997; 40:185–197.

Richt JA, Rott R. Borna disease virus: a mystery as an emerging zoonotic pathogen. *Vet J* 2001; 161:24.

#### REFERENCES

1. Torre JC. *J Virol* 1994; 68:7669.
2. Bode L et al. *Vet Rec* 1994; 135:283.
3. Caplazi P et al. *J Comp Path* 1994; 111:65.
4. Lundgren AL, Ludwig H. *Acta Vet Scand* 1993; 34:101.
5. Taniyama H et al. *Vet Rec* 2001; 148:480.
6. Okamoto M et al. *Vet Rec* 2002; 150:16.
7. Ashash E et al. *Avian Dis* 1996; 40:240.
8. Kubo K et al. *Clin Diag Lab Immunol* 1997; 4:189.
9. Richt JA et al. *J Neurovirol* 1997; 3:174.
10. Bode L et al. *Mol Psych* 2001; 4:481.
11. Kao M et al. *Vet Rec* 1993; 132:241.

12. Staeheli P et al. *J Gen Virol* 2000; 81:2123.
13. Dauphin G et al. 2001; 82:2199.
14. Nakamura Y et al. *Vaccine* 1995; 13:1076.
15. Bahmani MK et al. *Virus Res* 1996; 45:1.
16. Galabru J et al. *Vet Rec* 2000; 147:721.
17. Hagiwara K et al. *Vet Microbiol* 2001; 80:383.
18. Hagiwara K et al. *Med Microbiol Immunol* 1996; 185:145.
19. Hagiwara K et al. *Clin Diag Lab Immunol* 1997; 4:339.
20. Takahashi H et al. *J Med Virol* 1997; 52:330.
21. Durwald R, Ludwig H. *J Vet Med B* 1997; 44:147.
22. Vahlenkamp TW et al. *J Virol* 2002; 76:9735.
23. Inoue Y et al. *J Vet Med Sci* 2002; 64:445.
24. Richt JA et al. *Med Microbiol Immunol* 1993; 182:293.
25. Hagiwara K et al. *Vet Microbiol* 2000; 72:207.
26. Bilzer T et al. *Tierarztl Prax* 1996; 24:567.
27. Becht H, Richt J. Borna disease. In: Studdert MJ (ed) *Virus infections of vertebrates: virus infections of equines* 6. Amsterdam: Elsevier, 1996; p. 235.
28. Morimoto K et al. *Proc Natl Acad Sci USA* 1996; 93:13345.
29. Caplazi P, Ehrensperger F. *Vet Immunol Immunopathol* 1998; 61:203.
30. Berg AL et al. *Arch Virol* 1999; 144:547.
31. Hagiwara K et al. *Vet Microbiol* 2002; 84:367.
32. Richt JA, Rott R. *Vet J* 2001; 161:24.
33. Sorg I, Metzler A. *J Clin Microbiol* 1995; 33:821.

#### BUNYAVIRIDAE (CALIFORNIA GROUP, SNOW SHOE HARE)

There are a number of Bunyaviridae that cause disease in horses in the western hemisphere.<sup>1</sup> The viruses are maintained in a mosquito-vertebrate host-mosquito or midge-vertebrate host-midge cycles with horses being infected and developing signs of neurologic disease occasionally.

The **California serogroup** of viruses are mosquito-transmitted viruses of the family Bunyaviridae which can cause acute encephalitis in horses.<sup>1,2</sup> There are 12 serotypes isolated in Africa, Europe, Asia, and North and South America. Snowshoe hare and Jamestown Canyon are two of these serotypes that have been isolated in Canada and California, and that have the potential to cause disease in humans. The **snowshoe hare virus** is the most widely occurring arbovirus in Canada and is maintained in an amplification cycle involving small mammals, such as snowshoe hares, and mosquitoes, primarily of the genus *Aedes*.<sup>2</sup> In one reported case, the horse recovered completely within 1 week and there was seroconversion to the snowshoe hare serotype of the California serogroup of viruses.<sup>3</sup> Approximately 15% of horses in California have antibodies to **Jamestown Canyon virus** in horses in southern California.<sup>4</sup> The virus has been isolated from vesicular lesions in a horse.<sup>5</sup>

The **Cache Valley virus** has been isolated from a clinically normal horse and the high seroprevalence of specific antibody suggests enzootic transmission.<sup>6</sup>

The **Main Drain virus** has been isolated from a horse with severe

encephalitis in California.<sup>1</sup> Clinical findings included incoordination, ataxia, stiffness of the neck, head-pressing, inability to swallow, fever, and tachycardia. The virus is transmitted by rabbits and rodents and by its natural vector, *Culicoides varipennis*.

#### OTHER VIRUSES

The **Powassan virus**, a flavivirus, occurs in Ontario and eastern United States, and produces a non-suppurative, focal necrotizing meningoencephalitis in horses.<sup>7</sup> Approximately 13% of horses sampled in Ontario in 1983 were serologically positive to the virus. Experimental intracerebral inoculation of the Powassan virus into horses resulted in a neurological syndrome within 8 days.<sup>8</sup> Clinical findings include a 'tucked-up' abdomen, tremors of the head and neck, slobbering and chewing movements resulting in foamy saliva, stiff gait, staggering, and recumbency. Pathologically, there is a non-suppurative encephalomyelitis, neuronal necrosis, and focal parenchymal necrosis. The virus has not been isolated from the brain.

**Nigerian equine encephalitis**, a disease with low morbidity but high mortality, is characterized by fever, generalized muscle spasms, ataxia, and lateral recumbency of 3–5 days duration. The virus has not been identified.<sup>9</sup>

**Nipah virus** is a cause of encephalitis in humans and pigs in south-east Asia.<sup>10</sup> The virus is a member of the henipavirus family, which includes Hendra virus, which is transmitted from frugivorous bats (*Pteropus* sp.) to pigs, among which it spreads horizontally to other pigs and humans. Horses can be exposed and develop antibodies to the virus, and there is one anecdotal report of dilated meningeal vessels in a horse from which Nipah virus was isolated.<sup>11</sup>

**Salem virus** has been isolated from horses, but does not appear to cause disease in this species.<sup>12</sup>

#### REFERENCES

- Emmons RW et al. *J Am Vet Med Assoc* 1983; 183:555.
- Lynch JA et al. *J Am Vet Med Assoc* 1985; 186:389.
- Heath SE et al. *Can Vet J* 1989; 30:669.
- Nelson DM et al. *Comp Immunol Microbiol Infect Dis* 2004; 27:209.
- Sahu SP et al. *J Vet Diag Invest* 2000; 12:80.
- McLean RG et al. *Am J Vet Res* 1987; 48:1039.
- Keane DP, Little PB. *Can Vet J* 1987; 28:497.
- Little PB et al. *Vet Pathol* 1985; 22:500.
- Adeyefa CA et al. *Vet Rec* 1996; 138:323.
- Nor MNM *Disease Information* 1999; 12:20.
- Hooper PT, Williamson MM. *Vet Clin North Am Equine Pract* 2000; 16:597.
- Glaser AL et al. *Vet Microbiol* 2002; 8:205.

#### GETAH AND ROSS RIVER VIRUS

Getah virus and Ross river virus are both alphaviruses within the Semliki Forest complex of togaviruses. These are small

enveloped viruses with a single-stranded, positive sense RNA genome. Getah virus causes disease in horses and pigs, whereas Ross River virus causes disease in humans and, arguably, horses.

The geographic range of the viruses is distinctive, with Getah virus reported from Japan, Hong Kong, south-east Asia, Korea, and India, and Ross River virus found in most areas of continental Australia, Tasmania, West Papua and Papua New Guinea, New Caledonia, Fiji, Samoa, and the Cook Islands.<sup>1</sup> Reports from the 1960s document antibodies to Getah virus in animals in Australia, but the presence of this virus in Australia has not been confirmed using modern techniques that are able to differentiate antibodies to Getah virus from those of the related Ross River virus and other viruses in this complex. There are no reports of disease caused by Getah virus in Australia. There is considerable sequence homology between Getah and Ross River virus genomes.<sup>2</sup> There is geographic genetic variability among isolates of Ross River virus, and temporal, but not geographic, variability among isolates of Getah virus from South-east Asia and Japan.<sup>3,4</sup>

Both viruses are arthropod-borne, and infection is through the bite of an infected mosquito. The virus is maintained in the mosquito-vertebrate-mosquito host cycle typical of arboviruses. The definitive, amplifying vertebrate host for Getah virus is unknown although a number of vertebrates including horses, cattle and pigs can be infected by the virus. Horses and pigs become viremic and presumably can infect mosquitoes, although this does not appear to have been confirmed experimentally. The life cycle of Getah virus has not been explicated. The virus is assumed to be maintained in a mosquito-pig-mosquito cycle in those areas in which there is mosquito activity year round.<sup>5</sup> Persistence of the virus in areas in which mosquito activity is seasonal has not been explained, and whether trans-ovarial or transtadial transmission occurs within the mosquito population is not reported.<sup>5</sup> The vertebrate hosts of Ross River virus include a large number of eutherian, marsupial, and monotreme mammals and birds.<sup>1</sup> Macropod species, including kangaroos and wallabies, are assumed to be the most important amplifying hosts, although this is debated.<sup>1</sup>

There is suspicion that during outbreaks of disease Getah virus is spread by horse-to-horse contact, based on the rapidity of spread among horses, the short duration of the outbreak, and the lack of mosquito activity at the time that some horses developed the disease.<sup>6,7</sup> However, experimental evidence suggests that this route of spread is likely of limited

importance in propagation of epidemics because of the low concentration of virus in nasal and oral secretions of infected horses, and the large inoculum required to cause disease in horses by the intranasal route.<sup>8</sup>

The prevalence of serological evidence of infection of horses by Getah virus in Japan ranges from 8 to 93%, depending on the region of the country in which the samples were collected and the disease history of the band or stable of horses.<sup>6,9</sup> Seroprevalance was 17% in India and 25% in Hong Kong.<sup>8,10</sup> These results confirm the widespread incidence of subclinical infection of horses by Getah virus in endemic areas.

There is a similar high incidence of Ross River virus infection of horses in endemic regions of Australia. Prevalence of seropositive horses in Queensland, an area in which year-round mosquito activity was likely, is approximately 80%, whereas that of horses around the Gippsland lakes in southern Australia, a region with seasonal mosquito activity, is 50%.<sup>11</sup> These high rates of infection, in the absence of similarly high rates of clinical disease, suggest that the virus is minimally pathogenic in horses, and increases the likelihood that sero-conversion or virus isolation from horses with clinical abnormalities is a chance event and not causally related.

The **disease syndrome** caused by infection by **Getah virus** is better defined than that of Ross River virus, but infection by either virus appears to cause disease in horses that has a number of clinical features in common.<sup>6,7,11,12</sup> Disease associated with Getah virus infection is characterized by pyrexia, edema of the limbs, and an abnormal gait, often described as 'stiffness'.<sup>6,7</sup> Eruptions of the skin, urticaria, and submandibular lymphadenopathy are reported in some horses with the disease in Japan, but not in India.<sup>6,7</sup> The clinical disease persists for 7–10 days. Abortion is not a feature of the disease and foals born of mares that have had the disease during gestation are normal.<sup>13</sup> Subclinical infection is very common.

Hematological abnormalities induced by Getah virus infection in horses include lymphopenia.<sup>6</sup> Increases in serum activity of muscle derived enzymes, such as creatine kinase, are not characteristic of the disease. Affected horses can have mild to moderate hyperbilirubinemia secondary to inappetance.<sup>6</sup>

The disease associated with **Ross River virus infection of horses** is typified by pyrexia, lameness including 'stiffness', swollen joints, inappetance, reluctance to move, and mild colic.<sup>11,12</sup> The duration of disease caused by Ross River virus in horses is uncertain, and some veterinarians consider that the

disease can persist for weeks to months, or recur in horses. There is some skepticism regarding the pathogenicity of Ross River virus in horses because, at least in part, the disease syndrome associated with Ross River virus infection of horses is not well characterized. Descriptions of the disease are based on a very small number of horses in which there was demonstrated viremia concurrent with development of clinical signs of disease, or larger number of horses with serum antibodies to the virus. Horses infected experimentally with Ross River virus have minimal clinical signs of disease.<sup>14</sup> There are insufficient reports of disease to determine if characteristic or diagnostic abnormalities in serum biochemistry or hematology occur in affected horses.

Diagnosis of infection by Ross River virus is achieved by virus isolation from serum or heparinized blood samples collected during the acute phase of the disease, or detection in serum of antibodies to the virus.<sup>12</sup> Detection of IgM antibodies to Ross River virus is indicative of recent infection whereas detection of IgG antibodies is indicative of more distant infection.<sup>12</sup> Seroconversion confirms exposure, and presumably infection, by the virus. Isolation of Ross River virus has been achieved from horses with IgM antibody to the virus, but not with IgG antibody, likely because of the temporal pattern of antibody appearance in blood of infected horses.<sup>12</sup> In addition to culture of the virus in mice or tissue culture, Ross River virus can be detected in blood and synovial fluid using an RT-PCR.<sup>14</sup> It is important to remember that subclinical infection of horses in endemic regions is very common and that this high rate of subclinical infection increases the risk of incorrect attribution of clinical abnormalities to infection by the virus – it is possible that clinical abnormalities in a horse with Ross River viremia or serum antibodies to the virus are not attributable to infection by Ross River virus.

There are not reports of postmortem examination of horses with disease confirmed to be caused by Ross River Virus.

Diagnosis of disease caused by **Getah virus** is achieved by detection of clinical signs consistent with the disease, isolation of the virus from blood of affected horses, and seroconversion to the virus.<sup>4</sup> Interpretation of serological data from horses in Japan is hindered by the widespread use of a vaccine against Getah disease that induces detectable antibodies to Getah virus in serum.<sup>9</sup>

Reports of postmortem examination of horses with disease caused by Getah virus are limited to experimental studies because the disease is typically not fatal. Horses with disease induced by inoculation with

pathogenic Getah virus typically have mild changes including atrophy of splenic and lymphoid tissue with destruction of lymphocytes, and perivascular and diffuse infiltration of focal skin lesions by lymphocytes, histiocytes, and eosinophils. Lesions in the central nervous system are equivocal and limited to mild perivascular cuffing in the cerebrum and small hemorrhagic foci in the spinal cord.<sup>13</sup>

Treatment of affected horse is supportive. Affected horses might benefit from administration of analgesics and antipyretics such as phenylbutazone. Administration of antimicrobials is not indicated in uncomplicated cases.

An inactivated virus vaccine is available in Japan for immunization of horses against disease caused by Getah virus.<sup>9</sup> The vaccine, which is combined with that for Japanese encephalitis, is considered effective. For both Getah virus and Ross River virus minimizing the exposure of horses to infected mosquitoes is prudent although the efficacy of this technique in preventing infection is unknown. During outbreaks of disease caused by Getah virus it is prudent to isolate affected horses, given the potential for horse-to-horse spread of the virus.

There is no vaccine to prevent infection or disease of horses by Ross River virus.

### Zoonotic implications

Disease of humans caused by Getah virus has not been documented.

Disease associated with Ross River virus infection is common in humans in Australia with an estimated 4800 cases per year, and much larger numbers during epidemics of the disease.<sup>15</sup> The horse is believed to be an amplifying host of the virus because experimentally infected horses can infect mosquitoes.<sup>16</sup> The disease in humans is characterized by mild pyrexia and constitutional signs initially, with subsequent development of a rash on the skin and oral lesions. Arthritis or arthralgia is common and affects primarily the wrists, knees, ankles and small joints of the extremities. These signs and symptoms can persist for 2–3 months, and the disease can relapse.

### REFERENCES

1. Russell RC. Annual Rev Entomol 2002; 47:1.
2. Strauss JH, Strauss EG. Microbiol Rev 1994; 58:491.
3. Lindsay MDA et al. J Virol 1993; 67:3576.
4. Wekesa SN et al. Vet Microbiol 2001; 83:137.
5. Calisher CH, Walton TE. In: Studdert MJ (ed) Virus infections of equines. New York: Elsevier, 1996; pp. 157.
6. Brown CM, Timoney PJ. Trop Anim Health Prod 1998; 30:241.
7. Sentsui H, Kono Y. Res Vet Sci 1980; 29:157.
8. Kamada M et al. J Vet Med Sci 1991; 53:855.
9. Sugiura T, Shimada K. J Vet Med Sci 1999; 61:877.

10. Shortbridge KF et al. Vet Rec 1994; 134:527.
11. Azuolas JK. Aust Equine Vet 1998; 16 volume 2.
12. Azuolas JK et al. Aust Vet J 2003; 81:344.
13. Wada R et al. Jpn J Vet Sci 1982; 44:411.
14. Studdert MJ et al. Aust Vet J 2003; 81:76.
15. [www.health.gov.au/internet/wcms/publishing/content/health-ross\\_river\\_virus](http://www.health.gov.au/internet/wcms/publishing/content/health-ross_river_virus) Accessed January 2 2006.
16. Kay BH et al. Aust Vet J 1987; 64:52.

## RABIES

### Synopsis

**Etiology** *Lyssavirus* of family Rhabdoviridae

**Epidemiology** Occurs in all farm animals worldwide except Australia and New Zealand. Major zoonoses. Transmitted by bites of infected animal. Many different wildlife are vectors depending on geographic location; vampire-bats in South America, foxes in Europe and North America, skunks in North America, mongoose in Africa, raccoon in the United States recently

**Signs** Incubation period varies from 2 weeks to several months. **Cattle** – Paralytic form: bizarre mental behavior (yawning, bellowing), incoordination, decreased sensation of hindquarters, drooling saliva, recumbency, and death in 4–7 days. **Furious form**: hypersensitive, belligerent, then paralysis and death as in paralytic form. **Sheep** – Outbreaks common; sexual excitement, wool pulling, attacking, incoordination, and then paralysis. **Horses** – Abnormal postures, lameness or weakness, depression, ataxia, pharyngeal paralysis, recumbency, hyperesthesia, biting, loss of anal sphincter tone, death in 4–6 days. **Pigs** – Excitement, attack, twitching of nose, clonic convulsions, paralysis

**Clinical pathology** No antemortem test

**Lesions** Non-suppurative encephalomyelitis

### Differential diagnosis list:

- **Cattle**: Lead poisoning, lactation tetany, hypovitaminosis-A, listerial meningoencephalitis, polioencephalomalacia, nervous acetoneemia
- **Horse**: Viral encephalomyelitis, herpes viral paralysis, cerebrospinal nematodiasis, equine degenerative myeloencephalopathy, protozoal encephalomyelitis, neuritis of cauda equina, horsetail poisoning, Borna, Japanese encephalitis, botulism
- **Sheep**: Enterotoxemia, pregnancy toxemia, louping-ill, scrapie
- **Pig**: Pseudorabies, Teschen's disease, Glasser's disease, and other meningitides (*E. coli* and *Streptococcus suis*).

**Diagnostic confirmation** Fluorescent antibody test of brain. Negri bodies histologically

**Treatment** None. All rabies cases are fatal  
**Control** Prevention of exposure. Vaccination of domestic animals and wildlife. Quarantine and biosecurity to prevent entry of virus into country



## ETIOLOGY

Rabies is associated with the rabies virus of the genus *Lyssavirus* of the family Rhabdoviridae.<sup>1</sup> The genus is composed of at least six genotypes.

It was recognized long ago that the strain of virus known as the 'street' rabies virus differed in some way from 'fixed' strains which had been cultivated for vaccine production (grown in cell culture or passaged through serial generations of laboratory animals). It is now known that there are several strains of rabies virus, which are adapted to particular host species but remain infective for any warm-blooded mammal.<sup>2</sup>

## EPIDEMIOLOGY

### Occurrence

Rabies occurs in all warm-blooded animals.<sup>1,3</sup> The disease occurs in cattle, sheep, pigs, and horses in most countries, except the insular countries that exclude it by rigid quarantine measures or prohibition of the entry of dogs. However, the genus *Lyssavirus* can still cause surprises. In 1996 and 1998, two women died in Queensland, Australia, from infections with a newly discovered rabies-related virus (Australian bat lyssavirus).<sup>4</sup> In 2002, a man died in Scotland after contracting European bat lyssavirus rabies indicating that after a century of apparent freedom from rabies, the disease is now enzootic in the UK.<sup>4</sup>

South America, Latin America and the Caribbean

Rabies in cattle is a major economic and public health problem in South America, where vampire bat-transmitted rabies results in cyclic outbreaks. Bovine paralytic rabies is endemic in the tropical regions extending from northern Mexico, to northern Argentina, and on the island of Trinidad.<sup>1</sup> An outbreak in cattle in Guyana was associated with a large number of bats that had inhabited a culvert that was not cleaned regularly because of excessive rainfall.

Europe

In Europe, sylvatic rabies is a major problem where the **red fox** is the principal vector. The disease is still spreading from a focal point that developed in Poland in the mid-1930s. It is endemic in Yugoslavia and Turkey, and has spread westward to Germany, Denmark, Belgium, Czechoslovakia, Austria, Switzerland, and France. Spread continues at the rate of about 30–60 km (18–37 miles) per year and the threat to the United Kingdom increases each year. Finland had been free of rabies since 1959, but in 1988 sylvatic rabies occurred with the raccoon dog as the vector. Monoclonal antibody indicated the virus was an Arctic-type strain possibly related to the red fox. France

reported more than 2000 cases of rabid cattle between 1968 and 1982, and had more cases in sheep than in either dogs or cats during the same time period. In former East Germany, sheep were the second most frequent animal diagnosed with rabies after foxes.

Epidemiological studies of rabies in Lithuania from 1990 to 2000 found that rabies among wildlife comprised 54% with the majority of cases in foxes (27%), followed by raccoon dogs (21%).<sup>5</sup> The incidence of rabies in foxes and raccoon dogs increased over the period of study. Also, the number of humans attacked by domestic animals and wild animals has increased.

Africa

Rabies occurs in most countries in the African continent, but the reported incidence is surprisingly low for an area with such a high population of wild carnivores. The incidence of rabies, and the range of species involved, is increasing in Africa, and a number of wildlife hosts has been identified, including wild dogs, jackals and mongoose. Because of displacement of civilian life, rabies in Zimbabwe has increased in prevalence and geographical distribution in recent years.

Rabies is now a very serious zoonotic disease in South Darfur, Sudan.<sup>16</sup>

South Africa

Over a 4-year period, of all the domestic animal rabies cases reported, cattle accounted for one-half of the rabies cases in South African domestic animals. The **mongoose** accounted for 70% of the wild animal cases reported.<sup>7</sup> Widespread distribution of the rabies virus occurs when the young mongooses are evicted from their parents' territory during the winter months, forcing them to scatter over a wide area. This increases the probability of domestic animals coming in contact with rabid animals.

Canada

The arctic fox variant of rabies invaded most of Canada south of 60°N and east of the Rocky Mountains in the early 1950s largely by the migration of **arctic foxes** into the populated areas.<sup>8</sup> It died out in most of that range, but persisted for over 40 years in southern Ontario with sporadic incursions into narrow adjacent strips in western Quebec and northern New York. The principal vectors were red foxes (*Vulpes vulpes*) and, to a lesser extent, striped skunks (*Mephitis mephitis*). During the period 1957 to 1989, Ontario experienced more animal rabies cases than any almost every North American jurisdiction almost every year, and over 95% of those cases were limited to the southernmost 10% of the province's land area.

A second major outbreak, involving **striped skunks**, progressed from North Dakota into the prairie provinces during the late 1950s and 1960s. In the 1990s, the endemic areas in Canada are southern Ontario, which accounts for 85% of the Canadian diagnoses, and the prairie provinces where rabies is endemic in skunks. In western Canada, the main reservoirs of the rabies virus are skunks, bats, and foxes.

In southern Ontario, Canada, the ecogeographic patterns of rabies indicate that townships could be aggregated into 12 rabies units or clusters.<sup>9</sup> The units had different behaviors in terms of species composition, persistence, and periodicity. The ratio of rabid skunks to rabid foxes varied between areas which may be due to seasonal factors and urban development. This information is useful for planning rabies control programs.

United States

Information on rabies surveillance in the United States is published annually by the Centers for Disease Control and Prevention.<sup>10–14</sup> From 1999 to 2003, more than 90% of cases occurred in wild animals, 6 to 9% in domestic animal species. The disease occurred in humans, raccoons, skunks, bats, foxes, cats, dogs, cattle, sheep and goats, horses and mules, mongoose, rodents and lagomorphs.

Most cases of rabies reported annually in the United States occur among three groups of carnivores: raccoons, skunks, foxes, and among bats.<sup>15</sup> However, between 1960 and 2000, a total of 2851 cases of rabies in 17 other carnivore taxa were reported to the Centers for Disease Control and Prevention, Atlanta, Georgia.<sup>15</sup> Three species of other carnivores (mongooses, coyotes, and bobcats) accounted for 92% of the cases reported among other carnivorous mammals.

The most frequently reported rabid wildlife cases occurred in raccoons, skunks, bats, and foxes.<sup>10</sup> The relative contributions of those species continue to change in recent decades because of fluctuations in enzootics of rabies among animals infected with several distinct variants of the rabies virus.

During the past 30 years, rabies in domestic animals has steadily decreased in the United States, whereas annual occurrence in wild animals has increased. Wild animals accounted for 92% of all reported cases of rabies in 1995, a decrease from 1994. Raccoons were the most frequently reported rabid animal (50.3% of all animal cases), followed by skunks (22.5%), bats (10.0%), foxes (6.5%) and other wild animals, including rodents and lagomorphs (2.7%). Domestic animals accounted for nearly 8% of all rabid animals in the United States in

1995. In recent years, the number of rabid cattle was equal to, or greater than, the number of rabid dogs. The incidence of rabies in horses is low compared to wildlife or domestic small animals but some yearly fluctuations occur.

In 1990, for the first time since surveillance began in 1950, the number of cases in raccoons exceeded that in skunks. Raccoon rabies spread from Florida to raccoons in Georgia, Alabama, South Carolina, and North Carolina by natural spread.<sup>2</sup> A separate focus in the northeastern States was caused by a translocation of raccoons from Florida, with legal permits to Virginia for restocking of hunting preserves.<sup>2</sup> From the index case in a raccoon in 1977, near the Virginia–West Virginia border, over the next 17 years, 20 000 cases of rabies were recorded in raccoons, and several thousand associated cases in domestic dogs and other animals. In Canada, the rabies virus isolates from rabies-positive raccoons from 1982 to 1994 were the same strains found in foxes and skunks in eastern Canada,<sup>8</sup> and is different from the 'Mid-Atlantic' strain found in raccoons in the eastern United States. Local dynamics of epidemics of rabies in raccoons in the United States can be predicted.<sup>16</sup>

Historically, in North America, the number of cases of rabies in skunks exceeded that in either raccoons or foxes. Endemic skunk rabies occurs mainly in four geographical regions: southern Ontario and Quebec and upper New York State; the north central United States and the Canadian provinces of Manitoba, Saskatchewan, and Alberta; California; and south central United States. Within these broad areas, the disease persists in enzootic foci and erupts every 6–8 years. Experimental studies suggest that the species specificity of endemic rabies is due to differences in the pathogenicity of variants of rabies virus. Skunk rabies peaks in the spring and early winter, which is probably a reflection of certain life history events within the skunk population.

The prevalence of rabies in bats in the United States is about 6%, and transmission to humans is rare even though sensational journalism has caused many people to consider bats as a serious threat to health. All of the confirmed cases of rabies in bats in Michigan in 1993 were associated with the big brown bat; in New York the prevalence in 1993 was 4.6% and nearly 90% of rabid bats were the common big brown bat. However, the silver-haired bat was associated with two human cases of rabies.

Trends in national surveillance for rabies among bats in the United States from 1993 to 2000 have consistently

found a diffuse geographic pattern of rabies in bats throughout the continental United States.<sup>17</sup> Although spillover infection of bat variants of rabies among terrestrial animals such as dogs and cats are rare, these variants of rabies virus have been associated with 92% of the indigenously acquired human rabies infections in the United States since 1990.<sup>11</sup> Data from 37 states from 1993 to 2000 indicate an increased risk of rabies among certain groups of bat species was consistently found across season and most geographic regions of the US.<sup>17</sup> The Brazilian free-tailed, eastern pipistrelle, and the silver-haired bats, when considered as a single group, were more rabid more frequently than were other bat groups.

All warm-blooded animals, with the possible exception of opossums, are susceptible, and there is no variation in susceptibility with age; 1-day-old pigs have been affected. Variation in susceptibility between species is noticeable. Foxes, cotton rats, and coyotes are extremely susceptible; cattle, rabbits, and cats are highly susceptible; dogs, sheep, and goats are moderately susceptible; and opossums little if at all.

#### Distribution of virus variants

The *Lyssavirus* genus belongs to the *Rhadoviridae* family of the *Mononegavirales* order and includes unsegmented RNA viruses causing rabies encephalomyelitis. They are well fitted to vectors belonging to the orders *Carnivora* (flesh-eating mammals including skunks), and *Chiroptera* (the order which comprises all of the 178 genera in 16 families of bats). Seven genotypes have so far been delineated within the genus. These genotypes are divided into two immunopathologically and genetically distinct phylogroups. Phylogroup I includes two African genotypes: *Mokola virus*, which has been isolated from shrews and cats, although its reservoir remains unknown, and *Lagos bat virus*, which has been found mainly in frugivorous bats but also in an insectivorous bat. Phylogroup II has five genotypes: *Duvenhage virus* (Africa), *European bat lyssavirus I* (EBLV-1; Europe), *EBLV-2* (Europe), *Australian bat lyssavirus* (Australia), and the classical *Rabies virus* (RABV, worldwide). Members of the genotypes *Duvenhage virus*, *EBLV-1*, and *EBLV-2* are exclusively found in insectivorous bats, members of the genotype *Australian bat lyssavirus* are found in both insectivorous and frugivorous bats, and member of the genotype *RABV* are found in carnivorous and American bats (insectivorous, frugivorous, and hematophagus). The fact that lyssaviruses are well established in two ecologically

distinct mammal orders may very likely be the consequence of successful host switching.

Analysis of 36 carnivoran and 17 chiropteran lyssavirus representing the main genotypes and variants strongly supports the hypothesis that host switching occurred in the history of the lyssaviruses. In fact, lyssaviruses evolved in chiroptera long before the emergence of carnivoran rabies, very likely following spillovers from bats.<sup>18</sup> Using dated isolates, the emergence of carnivoran rabies from chiropteran lyssaviruses is estimated to have occurred 888 to 1459 years ago.

In Europe, bat rabies is associated with two specific virus strains: European bat lyssavirus type 1 and European bat lyssavirus type 2. European bat lyssavirus type 1 isolates have been found in serotine bats in France.<sup>19</sup> European bat lyssavirus type 2 virus have now been found in *Daubenton's* bats in England and Scotland.<sup>20</sup>

In North America, variants of rabies virus are maintained in the wild by several terrestrial carnivore species, including raccoons, skunks, and a number of bat species.<sup>21</sup> Each antigenically and genetically distinct variant of the virus in mammalian species occurs in geographically discrete areas and is strongly associated with its reservoir species.<sup>11</sup> Within each area, a spillover of rabies into other species occurs, especially during epidemics. Temporal and spatial analysis of skunk and raccoon rabies in the eastern United States, indicated that epidemics in raccoons and skunks moved in a similar direction from 1990 to 2000. However, to date there is no evidence that the raccoon rabies virus variant is cycling independently in the skunk population of the eastern United States or that the variant has undergone any genetic adaptations among skunks.<sup>21</sup>

Within broad geographic regions, rabies infections in terrestrial mammals can be linked to distinct virus variants, identified by panels of monoclonal antibodies or by genetic analysis.<sup>2</sup> These analyses have demonstrated substantial differences between isolates from various parts of the world. Most outbreaks of rabies tend to be host species-specific. Each variant is maintained primarily by **intraspecific transmission** within a dominant reservoir, although spillover infection of other species may occur within the region. Geographic boundaries of the currently recognized reservoirs for rabies in terrestrial mammals have been established. Reservoirs for rabies virus are found worldwide. The virus is maintained at endemic and epidemic levels in a wide variety of *Carnivora* and *Microchiroptera*

(bats) species. There are also antigenically similar rabies-like viruses, including the Makola virus, the Lagos bat virus, Duvenhage virus, European bat lyssavirus 1 and European bat lyssavirus 2 rabies, which are found principally in small mammals (rodents, insectivores, insectivorous or frugivorous bats). These strains appear to be limited in their geographical distribution to regions in Africa, unlike rabies virus which is distributed worldwide. The rabies-related viruses represent potential public and veterinary threats because of the lack of effective vaccines and the difficulties with diagnosis.

The geographic boundaries of the currently recognized reservoirs for rabies in terrestrial species in North America are as follows:

- Raccoons in the southeastern United States
- Red and arctic foxes in Alaska, resulting in spread across Canada as far east as Ontario, Quebec, and the New England states
- Striped skunks in California, the north central States, and the south central States
- Gray foxes in small reservoirs in Arizona
- Coyotes in south Texas as a result of spread from domestic dogs in a long-standing reservoir at the Texas–Mexico border.

The first reported occurrence of rabies in a human being infected with the raccoon rabies virus was from Virginia in 2002.<sup>14</sup>

In Ontario, wildlife rabies persists in two predominant species: the red fox and the striped skunk. Molecular epidemiology studies indicate that there is no host specificity, but rather there are very clear and consistent differences in the virus from distinct geographical regions. Such analyses will allow further epidemiological study of the behavior of the virus in different regions.

Overlying the disease in terrestrial mammals are multiple, independent reservoirs for rabies in several species of insectivorous bats. Distinct viral variants can be identified for different bat species, but geographical boundaries cannot be defined for rabies outbreaks in the highly mobile bat species.

Certain antigenic variants exist in nature against which conventional vaccines do not fully protect. In Canadian studies, two major antigenic groups can be distinguished among the rabies virus isolates examined. One group is found in Ontario, Quebec and the Northwest Territories and is represented in the wild by endemic red fox and striped skunk rabies that originated in northern

Canada. The second group is found in Manitoba where striped skunk rabies is endemic.

The epidemiology of rabies in Chile and the animal species which serve as rabies reservoirs have been examined.<sup>22</sup> None of Chilean isolates segregated with viruses from the terrestrial reservoirs. No non-rabies lyssaviruses were found, and the Chilean samples were not related to viruses of the sylvatic cycle maintained by the common vampire bat. The Brazilian free-tailed bat was identified as the reservoir for the rabies genetic variant most frequently isolated in Chile from 1977 to 1998. The close association of a group of rabies viruses obtained from a domestic dog, Brazilian free-tailed bats, and a red bat with viruses maintained by red bat species in North America implicated species of this genus as the possible reservoirs of this particular genetic variant in Chile.

In Trinidad, bovine rabies is common and is due to the bat type.<sup>23</sup>

#### Methods of transmission

The source of infection is always an infected animal, and the method of spread is almost always by the **bite** of an infected animal, although contamination of skin wounds by fresh saliva may result in infection. Not all bites from rabid animals result in infection because the virus is not always present in the saliva and may not gain entrance to the wound if the saliva is wiped from the teeth by clothing or the coat of the animal. The virus may appear in the milk of affected animals, but spread by this means is unlikely as infection. The rabies virus is relatively fragile, susceptible to most standard disinfectants, and dies in dried saliva in a few hours.

One of the most important parameters in rabies models is the transmission rate, or the number of susceptible animals infected by a diseased animal per unit of time. In a population of 19 raccoons feeding at a concentrated, common food source available during the summer in rural eastern Ontario, raccoons bite and are bitten an average of 0.99 to 1.28 times per hour, respectively.<sup>24</sup>

Because of the natural occurrence of rabies in animals in caves inhabited by infected insectivorous bats, inhalation as a route of infection came under suspicion. It is now accepted that interbat spread, and spread from bats to other species is principally by bites, but that infection by inhalation also occurs. That infection can occur by ingestion has been put to use in devising systems of vaccinating wildlife by baiting them with virus-laden baits. This also has implications for epidemiological study generally. For example,

attenuated viruses used in baits could be taken by other than the target species, thus creating an unexpected seropositive segment of the animal population. It is also considered likely that outbreaks occurring naturally amongst carnivores may originate by them eating bats that have died of rabies.

#### Animal vectors

Traditionally, the dog, and to a minor extent the cat, have been the main source animals. However, native fauna, including foxes, skunks, wolves, coyotes, vampire, insectivorous and fruit-eating bats, raccoons, mongoose, and squirrels provide the major source of infection in countries where domestic carnivora are well-controlled. In general, foxes are less dangerous than dogs, foxes tending to bite only one or two animals in a group, while dogs will often bite a large proportion of a herd or flock. Raccoons and skunks are major reservoir of rabies in North America.

Bats are the important species in which subclinical carriers occur. Multiplication of the virus without invasion of the nervous system is known to occur in fatty tissues in bats, and may be the basis of the 'reservoiring' mechanism in this species. Violent behavior is rare in rabid animals of this species, but has been observed. Bats represent a serious threat of spread of rabies because of their migratory habits. Most spread is within the species, but the threat to humans and animal species by bats cannot be completely disregarded. Although rodents can be infected with the rabies virus they are not thought to play any part in the epidemiology of rabies, either as multipliers or simply as physical carriers of the virus. Many of the viruses they carry are rabies-like rather than classical rabies.

Rabies has occurred in swine herds where the skunk population is high, where farms were settled from rough terrain resulting in considerable interface between wildlife and domestic animals, and in which the management system allows the pigs to run free on the premises. The disease has occurred in pigs reared in a closed feeder barn where access by wildlife was very unlikely.

There is a difference in role between vectors. For example, in Europe it is thought that foxes carry the infection into a new area, but other species disseminate it within an area.<sup>25</sup> Foxes are the principal vectors and, as in Canada, cattle are the principal receptors. In western Canada, the main reservoirs of infection are skunks, bats, and foxes. This would have important consequences for control programs based on wildlife surveillance.

Domestic livestock like cattle are rarely a source of infection, although chance

transmission to humans may occur if the mouth of a rabid animal is manipulated during treatment or examination. The virus may be present in the saliva for periods up to 5 days before signs are evident.

#### Seasonal spread

Spread of the disease is often seasonal, with the highest incidence in the late summer and autumn because of large-scale movements of wild animals at mating time and in pursuit of food. In Canada, the frequency of rabies infection in livestock populations increases in the fall when adolescent foxes mature, begin mating behavior, and travel over large areas.

#### Latent infection

Because of rapid developments in virological techniques, especially serological screening of animal populations to obtain presumptive diagnoses of the presence of a virus in the population, the question of latent infection and inapparent carriers of rabies has assumed some importance. The presence of rabies antibodies in animals in a supposed rabies-free area is likely to arouse concern. Inapparent carriers do occur in bats and there is some evidence that latent infections can occur in other species.

#### Zoonotic implications

The prime importance of rabies is its transmissibility to humans, with veterinarians being at special risk. European data indicate that by far the greatest proportion of humans requiring pre-treatment for rabies have been exposed to a rabid domestic animal, not a wild one.<sup>1,3</sup>

Human rabies is extremely rare in countries where canine rabies is controlled by regular vaccination. In the United States, a total of 28 cases of human rabies occurred from 1980 to 1995. Most were due to viral variants associated with bats. Rates of post-exposure prophylaxis in developing countries are about 10 times higher than those in the United States, and rates of human rabies are approximately 100 times higher. According to the WHO, over 30 000 people die each year from rabies and more than 10 million undergo post-exposure treatment, having been bitten by a rabid animal.<sup>3</sup> In 1987, according to surveillance conducted by the World Health Organization, dogs were responsible for 91% of all human rabies cases; cats, 2%; other domestic animals, 3%; bats, 2%; foxes, 1%; and all other wild animals, fewer than 1%. The disease is a major occupational hazard for veterinarians who should receive pre-exposure prophylaxis. Because horses will bite each other and their handlers, rabid horses that

are aggressive pose a serious threat to humans.

There is a lack of general rabies knowledge among the public.<sup>26</sup> The laissez-faire attitude toward rabies by Americans causes instances of rabies exposure to be commonplace. A survey of middle school children in Texas found a lack of basic knowledge about rabies. Only 0.3% of children achieved a minimum score of 75% on a survey of knowledge about rabies.<sup>26</sup> Respondents lacked knowledge about the disease is transmitted, and less than one-third were even aware of rabies epidemic in southern Texas despite the fact that a rabies epidemic had been occurring in southern Texas for the previous 13 years. Even more astonishing was the finding that 80% knew of the risk of acquiring rabies from an unvaccinated pet but 57% claimed to own unvaccinated pets.

Rabies is not of major economic importance in farm animals, although individual herds and flocks may suffer many fatalities. The disease in human has always been considered **fatal**. Since 1970, there have been reports of five patients said to have survived rabies encephalitis.<sup>4</sup> All patients had received some rabies vaccine before the onset of clinical signs but none had had rabies immunoglobulin.

A 15-year-old girl who developed rabies one month after being bitten by a bat survived following intensive medical therapy including induced coma while a native immune response matured, and treatment with ketamine, midazolam, ribarvirin, and amantadine.<sup>27</sup> Probable drug-related toxic effects included hemolysis, pancreatitis, acidosis, and hepatotoxicity. The patient was discharged to her home after 76 days, and at nearly 5 months after her initial hospitalization she was alert and communicative, but with choreoathetosis, dysarthria, and an unsteady gait.

**Rabies in the Americas.** Between 1993 and 2002, the number of human and canine rabies cases in the Americas Region fell by approximately 80%.<sup>28</sup> There were 39 human cases in 2002, 63% of them transmitted by dogs. Human rabies transmitted by wildlife, mostly by bats is a risk to inhabitants in many countries in the Region. This sharp reduction is attributable mainly to the control measures implemented by the countries in the Region, such as mass vaccination of dogs and prophylactic treatment of people who have been exposed.

#### Economic importance

The economic costs of rabies in a country are associated with pet animal vaccinations, animal bite investigations, confinement and quarantine of domestic

animals which bite humans or which are suspected of exposure to rabid animals, salaries of animal control officers, laboratory diagnosis, the costs of pre-exposure and post-exposure prophylaxis and treatment and consultation, public education, staff training and clerical costs.

The cost of the '**point infection control**' program as a response to raccoon rabies introduction in Ontario in 1999 was \$363 000 (Cdn) or \$500 Cdn/km<sup>2</sup>. The costs were justified as by containing the spread of raccoon rabies, annual savings to Ontario are estimated at \$8 to 12 million.<sup>29</sup> The reported associated costs in Ontario before raccoon rabies occurred were estimated at about \$6 million annually, excluding pet vaccination costs.

#### PATHOGENESIS

Following the deep introduction of rabies virus by the bite of a rabid animal, initial virus multiplication occurs in striated muscle cells at the site. The neuromuscular spindles then provide an important site of virus entry into the nervous system. Entry into the nervous system may also occur at motor end plates. In the olfactory end organ in the nares, neuroepithelial cells are in direct contact with the body surface and these cells extend without interruption into the olfactory bulb of the brain. Following entry of the virus into nerve endings, there is invasion of the brain by passive movement of the virus within axons, first into the spinal cord then into the brain.<sup>1,4</sup> The immune response during this phase of the infection is minimal and explains why neutralizing antibody and inflammatory infiltration are usually absent at the time of onset of encephalitic signs. Antibody titers reach substantial levels only in the terminal stages of the disease. Following entry of rabies virus to the central nervous system (CNS), usually in the spinal cord, an ascending wave of neuronal infection and neuronal dysfunction occurs.

The primary lesions produced are in the CNS, and spread from the site of infection occurs only by way of the peripheral nerves. This method of spread accounts for the extremely variable incubation period, which varies to a large extent with the site of the bite. Bites on the head usually result in a shorter incubation period than bites on the extremities. The severity and the site of the lesions will govern to a large extent whether the clinical picture is primarily one of irritative or paralytic phenomena. The two extremes of the paralytic or dumb form and the furious form are accompanied by many cases that lie somewhere between the two. Gradually ascending paralysis of the hindquarters may be followed by

severe signs of mania, which persist almost until death. Destruction of spinal neurons results in paralysis, but when the virus invades the brain, irritation of higher centers produces manias, excitement, and convulsions. Death is usually due to respiratory paralysis. The clinical signs of salivation, indigestion and pica, paralysis of bladder and anus, and increased libido all suggest involvement of the autonomic nervous system, including endocrine glands. At death, there are viral inclusions and particles in almost all neurons in the brain, spinal cord and ganglia, but none in the supportive cells of the CNS. Electron microscopic examination also shows the presence of the virus in the cornea, which it reaches centrifugally along the peripheral nerves.

Virus reaches the salivary glands and many other organs in the same way, but the highly infective nature of saliva arises from passage of the virus along the olfactory nerve to taste buds and other sensory end organs in the oropharynx, rather than from the salivary glands. Experimentally, infection of non-nervous tissues in skunks and foxes has been reproduced in the adrenal medulla, cornea, and nasal glands.<sup>19</sup> The virus may be found in milk, in some organs and in fetuses, but the virus cannot be demonstrated in the blood at any time.

Variations in the major manifestations as mania or paralysis may depend upon the source of the virus. Virus from vampire bats almost always causes the paralytic form. 'fixed' virus that has been modified by serial intracerebral passage causes ascending paralysis in contrast to 'street' virus, which more commonly causes the furious form. The site of infection and the size of the inoculum may also influence the clinical course. There is also geographical difference in the proportion of animals affected by the furious or paralytic form of the disease. In the Americas most cases are paralytic. In Africa and India most cases in farm animals are the furious form.

The disease is always fatal, but infrequently an experimentally infected animal shows clinical signs of the disease but recovers. There are two recent records of spontaneous recovery in man, and the occurrence of non-fatal rabies in all species has been reviewed. There appears to be no field occurrence in domestic animals of the finding in experimentally infected mice that some strains of virus invade only peripheral nerves and spinal ganglia leaving a number of survivors with permanent nervous disability. The pathogenesis of recovery from rabies is important relative to vaccination and serological testing to determine the incidence and prevalence of the disease. The

literature on the animal models used for the study of the pathogenesis and treatment of rabies has been reviewed.<sup>1</sup>

## CLINICAL FINDINGS

### Cattle and sheep

#### Cattle

Among farm animals, cattle are most commonly affected. The incubation period in naturally occurring cases is about 3 weeks, but varies from 2 weeks to several months in most species, although incubation periods of 5 and 6 months have been observed in cattle and dogs. In one large-scale outbreak in sheep, deaths occurred 17–111 days after exposure.

Experimentally, in cattle the average incubation period was 15 days and the average course of the disease was 3.7 days. Unvaccinated cattle had shorter incubation and clinical duration of disease than vaccinated cattle. Major clinical findings included excessive salivation (100%), behavioral change (100%), muzzle tremors (80%), vocalization (bellowing 70%), aggression, hyperesthesia and/or hyperexcitability (70%), and pharyngeal paralysis (60%). The furious form occurred in 70%.

In sheep, experimentally, the average incubation period was 10 days, and the average course of the disease was 3.25 days. Major clinical findings included muzzle and head tremors (80%), aggressiveness, hyperexcitability and hyperesthesia (80%), trismus (60%), salivation (60%), vocalization (60%), and recumbency (40%). The furious form occurred in 80% of sheep.

In the **paralytic form**, knuckling of the hind fetlocks, sagging and swaying of the hindquarters while walking, often deviation or flaccidity of the tail to one side, are common early signs. Decreased sensation usually accompanies this weakness and is one of the best diagnostic criteria in the detection of rabies. It is most evident over the hindquarters. Tenesmus, with paralysis of the anus, resulting in the sucking in and blowing out of air, usually occurs late in the incoordination stages just before the animal becomes recumbent. This is a characteristic finding but it may be transient or absent. Drooling of saliva is one of the most constant findings. The **yawning movements** are more accurately described as voiceless attempts to bellow. When paralysis occurs, the animal becomes recumbent and unable to rise. Bulls in this stage often have paralysis of the penis. Death usually occurs 48 hours after recumbency develops and after a total course of 6–7 days. The paralytic form of rabies has been reproduced experimentally by the IM injection of brain tissue from naturally occurring cases of paralytic rabies ('derriengue') in cattle in Mexico.

In **furious rabies** the animal has a tense, alert appearance, is hypersensitive to sounds and movement, and is attracted to noise so that it may look intently or approach as though about to attack. In some cases, it will violently attack other animals or inanimate objects. These attacks are often badly directed and are impeded by the incoordination of gait. Frequently, loud bellowing is usual at this stage. The sound is characteristically hoarse and the actions are exaggerated. Sexual excitement is also common, bulls often attempting to mount inanimate objects. Multiple collections of semen for artificial insemination have been made during very short periods from bulls that later proved to be rabid. With this violent form of the disease the termination is characteristically sudden. Severe signs may be evident for 24–48 hours and the animal then collapses suddenly in a paralyzed state, dying usually within a few hours.

There is no consistent pattern in either the development or the range of signs. Body temperatures are usually normal but may be elevated to 39.5–40.5°C (103–105°F) in the early stages by muscular activity. Appetite varies also. Some animals do not eat or drink, although they may take food into the mouth. There is apparent inability to swallow. Others eat normally until the terminal stages. The course may vary from 1 to 6 days. So wide is the variation in clinical findings that any animal known to be exposed and showing signs of spinal cord or brain involvement should be considered rabid until proved otherwise.

#### Sheep

In **sheep**, rabies often occurs in a number of animals at one time due to the ease with which a number of sheep can be bitten by a dog or fox. Clinically, the picture is similar to that seen in cattle. The minority show sexual excitement, attacking humans or each other, and vigorous wool pulling; sudden falling after violent exertion, muscle tremor, and salivation are characteristic. Excessive bleating does not occur. Most sheep are quiet and anorectic. Goats are commonly aggressive, and continuous bleating is common.

#### Horses

Most recorded cases in horses are lacking in distinctive nervous signs initially, but incline to the paralytic form of the disease. Experimentally, the average incubation period was 12 days and the average duration of disease was 5.5 days.<sup>30</sup> Unvaccinated animals had shorter incubation periods and duration of clinical disease. Muzzle tremors were the most frequently observed and most common initial signs. Other clinical findings

included pharyngeal paresis (71%), ataxia or paresis (71%), and lethargy or somnolence (71%). The furious form occurred in 43% of cases, some of which began as the dumb form. The paralytic form was not observed.

In naturally occurring cases, the initial clinical findings may include abnormal postures, frequent whinnying, unexplained aggressiveness and kicking, biting, colic, sudden onset of lameness in one limb followed by recumbency the next day, high-stepping gait, ataxia, apparent blindness, and violent head-tossing. Lameness or weakness in one leg may be the first sign observed, but the usual pattern of development starts with lassitude, then passes to sternal recumbency and lateral recumbency, followed by paddling convulsions and terminal paralysis.

In a series of 21 confirmed cases in horses, the clinical findings at the time of initial examination included ataxia and paresis of the hindquarters (43%), lameness (24%), recumbency (14%), pharyngeal paralysis (10%), and colic (10%).<sup>31</sup> The major clinical findings observed over the course of hospitalization included recumbency (100%), hyperesthesia (81%), loss of tail and anal sphincter tone (57%), fever  $\sim 38.5^{\circ}\text{C}$  (52%), and ataxia and paresis of the hindquarters (52%). Mean survival time after the onset of clinical signs was 4.47 days (range, 1–7 days). Clinical findings of the furious form of rabies, such as aggressiveness (biting), compulsive circling, and abnormal vocalization, were evident in only two horses. Supportive therapy, given to nine horses, had no effect on survival time and did not correlate with the detection of Negri bodies at necropsy. Horses developing the furious form show excitement, become vicious, and bite and kick. Their uncontrolled actions are often violent and dangerous and include blind charges, sudden falling and rolling and chewing of foreign material or their own skin. Hyperesthesia and muscular twitching of the hindlimbs followed by crouching and weakness are also recorded in the horse.

#### Pigs

Pigs manifest excitement and a tendency to attack, or dullness and incoordination. Affected sows show twitching of the nose, rapid chewing movements, excessive salivation, and clonic convulsions. They may walk backward. Terminally, there is paralysis and death occurs 12–48 hours after the onset of signs. The clinical findings in pigs are extremely variable, and individual cases may present in a variety of ways and only one or two of the classical findings may occur.

#### CLINICAL PATHOLOGY

No antemortem laboratory examination is of diagnostic value, but tests for lead in blood, urine, and feces may help to eliminate lead poisoning as a possible diagnosis. Virus neutralization tests are available, but the presence of antibodies is not diagnostic. Other available tests are passive hemagglutination, complement fixation, radioimmunoassay, and indirect fluorescent antibody staining. These are used to determine immune status rather than as a diagnostic aid. An ELISA is available for measurement of rabies-specific antibody in the sera of major domestic and wildlife reservoirs in North America.

#### NECROPSY FINDINGS

Confirmation of a diagnosis of rabies depends on careful laboratory examination of fresh brain. The recommended laboratory procedure includes the following three tests and it is recommended that at least two of them be used on all specimens.

- A fluorescent antibody test (**FAT**) on impression smears from the brain – current recommendations include sampling of the hippocampus, **medulla oblongata**, cerebellum or gasserian ganglion. However, a recent publication stipulates that the hippocampus and cerebellum are less desirable samples than the thalamus, pons, or medulla for the detection of viral antigen, and that the current sampling recommendations stem from the visibility of Negri bodies, rather than the true distribution of viral antigen.<sup>32</sup> An FAT can be completed in approximately 2 hours and is highly accurate when done routinely by experienced personnel. The reliability of FAT confirmed by the mouse inoculation test is over 99%.<sup>14</sup> Those specimens that are negative on FAT, and have contact with humans, are inoculated into experimental mice. The incubation period in mice before clinical signs are seen averages 11–12 days (range of 4–18 days), and death occurs in 7–21 days. The mouse brain is harvested as soon as signs appear and is submitted to the same tests described above. Thus a positive result can be obtained as soon as 4–7 days after inoculation. Some mice must be left for the full 21 days because only a negative result at that time can give a complete negative to the test. A tissue culture infection test is now available, which allows demonstration of the virus in stained tissue culture cells within 4 days. This may replace the mouse inoculation test

- A dot **ELISA** is available for the detection of rabies antigen in animals.<sup>33</sup> It is rapid, simple, economical and, in comparison with the FAT, the agreement is 95%.

A **histological search** for Negri bodies in tissue sections with results available in 48 hours. Because of false-positive diagnoses the technique is in some disrepute. An **immunoperoxidase** test for rabies can be used on formalin-fixed, paraffin-embedded brain tissues of domestic animals and wild animals when fresh tissues are not available.<sup>16,23</sup> In some cases, the brain tissue may be negative for the rabies virus using standard diagnostic techniques but immunohistochemical tests may detect the presence of antigen.<sup>20</sup> A reverse transcriptase polymerase chain reaction test has been found of value in detecting rabies infection in decomposed brain samples that were negative by the direct fluorescent antibody test.<sup>34</sup>

The histopathologic changes of rabies infection include a non-suppurative encephalomyelitis and ganglioneuritis, with neuronal necrosis and the formation of glial nodules. Negri bodies are most commonly found in the Purkinje cells of the cerebellum in ruminants. Spongiform change has also been reported in the brain of a heifer infected with rabies virus.<sup>35</sup>

#### Samples for confirmation of diagnosis

- **Histology** – one half of midsagittally-sectioned brain, cervical spinal cord (including root ganglia), gasserian ganglion, parotid salivary gland (LM, IHC)
- **Virology** – one half of midsagittally-sectioned brain, cervical spinal cord (FAT, ISO, BIOASSAY).

**Note the zoonotic potential of this organism when handling carcass and submitting specimens.**

#### DIFFERENTIAL DIAGNOSIS

The diagnosis of rabies is one of the most difficult and important duties that a veterinarian is called upon to perform. Since in most cases there is a probability of human exposure, failure to recognize the disease may place human life in jeopardy. It is not even sufficient to say that if rabies occurs in the area one will classify every animal showing nervous signs as rabid, because nervous signs may not be evident for some days after the illness commences. In addition, many animals suffering from other diseases will be left untreated. The best policy is to handle all suspect animals with extreme care but continue to treat them for other diseases if such treatment appears to be indicated. If the animal is rabid, it will die and the diagnosis can then be confirmed by laboratory examination.

Several diseases are characterized by signs of abnormal mental state or paralysis, or a combination of both (see Table 22.1 for the horse; Table 32.3 for cattle). Rabies must be differentiated from the following common diseases affecting the nervous system, according to species:

#### Cattle and sheep

- Lead poisoning. In acute and subacute lead poisoning in cattle the clinical findings are similar to those of furious and dumb rabies. In acute lead poisoning, the common clinical findings are blindness, convulsions, champing of the jaws with the production of frothy saliva, and twitching of the eyelids and ears. In subacute lead poisoning in cattle there is blindness, stupor, head-pressing, grinding of the teeth, and almost no response to treatment. Rabid cattle are usually not blind, and signs of motor irritation such as convulsions and twitching of the facial muscles usually do not occur. However, there are signs of bizarre mental behavior, such as wild gazing, bellowing, yawning, attacking, and compulsive walking
- Lactation tetany occurs in lactating cattle on lush pasture in the spring during cold wet and windy weather, and is characterized by hyperesthesia, tremors, convulsions, recumbency, and rapid death
- Vitamin A deficiency occurs in groups of young cattle from 6 months to 18 months of age not receiving adequate carotene intake or vitamin A supplementation and is characterized by blindness in the ocular form and episodes of tremors and convulsions
- Polioencephalomalacia in cattle and sheep is characterized by blindness, nystagmus, opisthotonos, and convulsions; bellowing, loss of sensation, and tenesmus do not occur
- Listeriosis in cattle and sheep is manifested by localizing signs of circling and facial nerve paralysis
- Enterotoxemia in sheep is usually confined to lambs on heavy carbohydrate diets
- Pregnancy toxemia is a disease of pregnant ewes and is readily differentiated by the presence of ketonuria
- Louping-ill in sheep is transmitted by insects, has a seasonal occurrence, and a localized geographical distribution.

#### Pigs

In pigs, rabies must be differentiated from pseudorabies, Teschen's disease, and involvement of the brain in several other diseases of the pigs, such as hog and African swine fever, meningitis associated with *Streptococcus suis* type II, *Haemophilus* spp., Glasser's disease, *Escherichia coli*, septicemia, and erysipelas.

#### Horses

In horses, rabies must be differentiated from several diseases of the nervous system (summarized in Table 22).

The most common include: viral encephalomyelitis, herpes virus myeloencephalopathy, cerebrospinal nematodiasis, equine degenerative myeloencephalopathy, equine protozoal myeloencephalitis, neuritis of the cauda equina, horsetail poisoning, Borna, Japanese encephalitis, botulism.

## TREATMENT

No treatment should be attempted after clinical signs are evident. If the bite is seen, immediately after exposure, irrigation of the wound with 20% soft soap solution or a solution of Zephiran may prevent the establishment of the infection. Immediate and thorough washing of all bite wounds and scratches with soap and water is perhaps the most effective measure for preventing rabies in veterinarians bitten by rabid animals. In experimental animals, simple local wound cleansing has been shown to markedly reduce the likelihood of rabies. Post-exposure vaccination is unlikely to be of value in animals, as death usually occurs before appreciable immunity has had time to develop. Euthanasia of suspect animals must be avoided, particularly if human exposure has occurred, since the development of the disease in the animals is necessary to establish a diagnosis. Antirabies serum may become available for animal treatment at some future date. **In some countries, cases of rabies in farm animals are notifiable to the animal health and disease regulatory bodies.**

## CONTROL

The major goal of rabies control in domestic and wild animals is the reduction or elimination of human rabies. The most rational approach to reducing human rabies is to reduce the prevalence and incidence of disease in animals. In developed countries, this has been accomplished by vaccination of dogs and cats, leaving much rabies in wildlife to be controlled. In countries without wildlife reservoirs, such as the Philippines, it would be economically advantageous to eliminate dog rabies. In Africa, where the incidence of rabies as well as the range of species involved is increasing, there is a need to develop new and economical methods of vaccinating domestic animals.

Pre-exposure immunization for individuals, like veterinarians, who are at high risk to rabies, has been recommended by the World Health Organization, since it reduces risk and provides a more rapid anamnestic response, eliminating the need for human globulin should exposure occur. Rabies pre-exposure vaccination is now mandatory in many veterinary colleges. Despite some mild adverse reactions, immunization against rabies is an important prophylaxis measure well-accepted by veterinary students.

For farm animals, there are two useful control techniques: the **prevention of exposure** and **pre-exposure vaccination**.

### Prevention of exposure to the virus

This can be achieved by controlling access of wildlife species which are likely to come into contact with the farm livestock

in particular areas or through vaccination of the wildlife. Foxes accounted for a very large proportion (85% in Europe) of wildlife rabies, and a control program aimed at reducing their population using poison or traps was attempted until the 1970s.<sup>36</sup> This method of population reduction failed to control outbreaks or reduce enzootic rabies.

**Point infection control.** To control the introduction of raccoon rabies in Ontario in 1999, 'point infection control' was used to control the epidemic.<sup>29</sup> This involves the use of three tactics: population reduction, trap-vaccinate-release, and oral vaccination with baits to control the spread of raccoon rabies. Some raccoons were captured and euthanized which resulted in an 83 to 91% reduction in the raccoon population in an area of 225 km<sup>2</sup> around the location of the three original cases of raccoon rabies. Raccoon density in the population reduction zones declined from 5.1 to 7.1 km<sup>2</sup> to 0.6 to 1.1 km<sup>2</sup> following control. Cats were also captured, vaccinated and released. Raboral V-RG oral rabies vaccine was distributed aurally to vaccinate free ranging raccoons. The point infection control program is considered to be highly successful and will continue to be used to contain isolated cases of raccoon rabies.<sup>29</sup>

### Pre-exposure vaccination of humans

The most successful form of rabies prevention is pre-exposure vaccination. In human medicine, there are no reported cases of rabies deaths in anyone who has had pre-exposure vaccination followed by a booster vaccination if exposed.<sup>4</sup>

The Centers for Disease Control (CDC) and Prevention has published the recommendations of the Advisory Committee on Immunization Practices (ACIP) for human rabies prevention, which indicate that rabies pre-exposure vaccination should be offered to persons more likely to be exposed to rabies virus than the population of the United States at large.<sup>37</sup> The recommendations of the ACIP for pre-exposure prophylaxis and maintenance of a detectable antibody titer differ depending on the estimated degree of risk of exposure to the virus. Four risk categories have established: continuous; frequent; infrequent; and rare. The classification depends on factors such as the occupation of the individual and geography.<sup>38</sup>

With directed continuing education, common sense, first aid, and the availability of modern biological agents, human rabies is nearly always preventable.<sup>1</sup> Rabies pre-exposure vaccination is recommended for anyone at increased risk of exposure to rabies, including veterinarians, veterinary students who



work in university veterinary teaching hospitals, laboratory staff working with rabies, vaccine producers, animal and wildlife control personnel, and zoologists.

The standard pre-exposure regimen is three doses of vaccine IM or ID on days 0, 7, and 28 (or 21). A booster dose after 1 year increases and prolongs the antibody response.<sup>4</sup> This pre-exposure vaccination permits post-exposure vaccination to consist of two doses of vaccine on days 0, and 3 instead of 5 on days 0, 3, 7, 14, and 28 and avoids the need for postexposure of administration of human rabies immunoglobulin.

A large proportion of at-risk staff members working in veterinary clinics, animal shelters, and wildlife rehabilitation centers in a study area did not receive rabies pre-exposure vaccination according to the recommendations of the ACIP of the CDC.<sup>37,38</sup> Cost may be factor because many of these employees are commonly short-term, part-time, or volunteer workers.

#### Post-exposure vaccination of humans

Modern post-exposure treatment is highly successful if done adequately. Wound care with passive and active rabies immunization are essential especially after severe exposure. Post-exposure treatment is assumed to neutralize or inactivate virus while it is still in the wounds, before it gains access to the nervous system where it is protected from the immune system. Therefore, treatment after exposure to rabies virus is very urgent, even if the patient was bitten months before. Thorough washing of rabies-infected wounds with soap and water can increase survival by 50%.<sup>3</sup> However, this inexpensive, readily available treatment is omitted in most cases.

The World Health organization recommends a multi-site intradermal regimen of 0.1 mL of vaccine at eight sites on day 0, at four sites on day 7, and at one site each on days 28 and 90.<sup>39</sup>

Passive immunization with human rabies immunoglobulin lowers mortality after severe exposure.

#### Post-exposure vaccination of domestic animals

An effective post-exposure protocol for unvaccinated domestic animals exposed to rabies includes immediate vaccination against rabies, a strict isolation period of 90 days, and administration of booster vaccinations during the third and eighth weeks of the isolation period.<sup>40</sup> The protocol has been effective in dogs, cats, cattle, and horses.<sup>40</sup>

#### Vaccination of domestic animals

*A Compendium of Animal Rabies Control* is published annually by the National

Association of State Public Health Veterinarians, Inc. in the United States and Canada.<sup>25</sup> It provides recommendations for immunization procedures in domestic animals, the vaccines licensed and marketed in the United States. Detailed information is provided on pre-exposure vaccination, management of dogs and cats and livestock, post-exposure management, and control methods in wild animals. Such publications should be consulted when necessary. In general, for cattle, sheep, and horses the primary vaccination is given at 3 months of age and boosters given annually. Farm livestock in endemic areas where clinical cases of rabies occur commonly should be vaccinated.

In countries where vampire bats are a major vector for rabies in farm livestock, vaccination of livestock is necessary but in countries such as Argentina, vaccination does not support a cost benefit analysis.<sup>41</sup>

#### Vaccines

Almost all rabies vaccines for domestic animals are inactivated.<sup>25</sup> Inactivated tissue culture cell vaccines given to cattle result in neutralizing antibodies in 1 month after the primary vaccination. A booster given 1 year later increases the titers, which are detectable 1 year after the booster. A vaccine inactivated with binary-ethylenimine, and containing aluminum hydroxide adjuvant, provides excellent protection for up to 3 years and is very useful for the control of rabies in cattle in Latin America where the vampire bat is the main vector.

Vaccinal antibodies are present in the colostrum of vaccinated cows and it is recommended that, where cattle are vaccinated annually, calves be vaccinated at 4 months of age and again when 10 months of age. Calves from unvaccinated dams can be protected by vaccinating them at 17 days of age. Postvaccinal paralysis does not occur after its use.

A post-exposure vaccination protocol including immediate rabies vaccination, with a minimum of one booster vaccination prior to release from quarantine, and 90 days strict isolation, was 99.7% successful in unvaccinated cattle, horses, sheep, goats, and pigs.

#### Vaccination of wildlife

The literature on oral rabies vaccination of wild carnivores in the United States has been reviewed.<sup>42</sup> Mass oral vaccination of terrestrial wild animals is a rabies control method that is feasible, effective, and internationally accepted.<sup>36,42,43</sup> It is based on the concept of applied herd immunity. The vaccines are efficacious when fed as vaccine-baits. The factors affecting acceptance of baits for delivery of oral rabies vaccine to raccoons have been examined.<sup>44</sup>

The oral immunization of foxes has resulted in a substantial decrease in the number of rabies cases in Europe. As a result of oral vaccination of the red fox (*Vulpes vulpes*) against rabies, using hand and aerial distribution of vaccine-laden baits, the rabies virus has almost been completely eradicated from Western and Central Europe.<sup>45</sup> The same dramatic decrease occurred in southern Ontario, Canada. In most countries, vaccine baits were distributed twice yearly; during the spring (March to May) and autumn (September to October). Several European countries have become rabies-free: Belgium, Luxembourg, France, Italy, Switzerland, Finland and the Netherlands.<sup>43</sup> With the European Union consisting of 25 countries from May 2004, all the scientific knowledge is available for establishing efficient and adapted oral vaccination programs aimed at eliminating terrestrial rabies from this area.

Progress has been made in applying oral rabies vaccination to contain and eliminate some strains of terrestrial rabies in North America.<sup>42</sup> Notable examples include near elimination of rabies from red foxes in southern Ontario. Containment and elimination of canine rabies coyotes from south Texas, containment and near elimination of raccoon rabies from Ohio, prevention of raccoon rabies spread through the Lake Champlain Valley in New York and across northern Vermont and New Hampshire, and reduced incidence of rabies where other oral rabies vaccination projects targeting raccoons have occurred. As of 2005, both Ontario and New Brunswick were free of raccoon rabies for greater than 10 months and 2 years, respectively, after implementation of 'point infection control' strategies<sup>29</sup> but continued surveillance is critical to monitor effectiveness.

Raboral V-RG is the only rabies vaccine licensed for use in the United States. It has not produced sufficient levels of population immunity in skunks in the wild at the current dose and V-RG may be less effective in skunks than other species. Skunks are a major contributor to rabies in North America with 38% of cases associated with the raccoon variant of rabies virus involved skunks in 2001.<sup>12</sup>

This has raised concerns about an independent maintenance cycle for raccoon rabies in skunks. The national rabies management goals of virus containment and elimination of will likely remain elusive until an oral vaccine is licensed that is immunogenic in all terrestrial rabies reservoir species. Skunk rabies virus, which has the broadest geographic distribution of all terrestrial rabies variants in the USA can currently be addressed only through local trap-

vaccinate-release or population suppression programs.<sup>42</sup>

A satisfactory vaccine for oral mass vaccination of skunks has not yet been developed. Many experimental and commercial-produced live-modified or recombinant-based oral rabies virus vaccines have been tested in skunks with contradictory results. An oral modified live rabies virus Vaccine SAD B19, used in striped skunks was innocuous and may be safer and more effective in skunks after oral vaccination than previously considered.<sup>46</sup> An attenuated SAG-2 vaccine was efficacious in challenge studies in skunks and raccoons and may satisfy both safety and efficacy concerns for oral rabies vaccination of major North American rabies reservoirs.<sup>47</sup>

During the 1990s in the United States, oral vaccination programs concentrated upon raccoons, gray foxes, and coyote, with similar success. As a result, raccoon rabies has not spread west of its initial concentration in the eastern states, and grey fox rabies is contained in the west central Texas, and no recent cases of rabies have been reported in coyotes away from the Mexican border for several years. However, vaccination is not a panacea and should be considered as an important adjunct to traditional prevention and control techniques in human and veterinary medicine.

It is notable that no practical vaccination methods have been developed for bats.<sup>36</sup> Phylogenetic analyses of viruses from bats and carnivores suggest a historical basis for still existing viral origins due to interactions between these taxa. Thus the possibility for pathogen emergence resulting from transmission by rabid bats with subsequent perpetuation among other animals cannot be discounted easily on any continent. Vampire bats have been vaccinated IM, scarification, oral, or aerosol routes using a vaccina-rabies glycoprotein recombinant vaccine.<sup>48</sup> The highest antibody titers occurred in animals vaccinated by the IM and scarification routes. All animals vaccinated by the IM, scarification, and oral routes survived experimental challenge, except 1 of 8 receiving the aerosol vaccination died.

Most consistent progress was achieved and maintained where:

- Large coherent territories covering certain sized areas were treated simultaneously
- All areas of fox habitat were included by using both manual and aerial distribution
- Vaccination zones were progressively expanded towards the infected area
- At least two vaccinations were done
- The bait density was a certain minimum.

The vaccination will succeed in reducing or eradicating rabies only if a sufficient proportion of the target population can be immunized. Mathematical modeling techniques are now being tested to examine the population biology of rabies in wildlife species such as raccoons and skunks.<sup>49</sup> Mass immunization of foxes by aerial distribution of vaccine-baits containing liquid rabies vaccine was highly successful in controlling rabies in both urban and rural areas of Ontario.<sup>36,42</sup>

In 1989, the Ontario began a 5-year experiment to eliminate terrestrial rabies from a study area in the eastern end of southern Ontario.<sup>50</sup> Baits containing oral rabies vaccine were dropped annually in the area at a density of 20 baits/km<sup>2</sup> from 1989 to 1995. The experiment was successful in eliminating the arctic fox variant of rabies from the entire area. In the 1980s, an average of 235 rabid foxes per year were reported in the study area. Between 1993 and 2001, no cases were reported. Cases of fox rabies in other species also disappeared. In 1995, the last bovine and companion animal cases were reported and in 1996 the last rabid skunk occurred. Only bat variants of rabies were present until 1999, when the raccoon variant entered from New York.

#### Quarantine and biosecurity

The most effective method of preventing the entry of rabies into a country free of the disease is the imposition of a quarantine period of 4–6 months on all imported dogs. This system has successfully prevented the entry of the disease into island countries, but has obvious limitation in countries that have land borders. The occurrence of the disease in two dogs in the United Kingdom in 1969–1970 in which the incubation period appeared to last 7–9 months suggests that the more usual period of 6 months may give incomplete protection. Therefore, vaccination on two occasions with an inactivated vaccine while the animal is still in quarantine for 6 months is the current recommendation. To require a longer period of quarantine would encourage evasion of the law by smuggling. The situation in the United Kingdom, and in any country where the disease does not occur, is a vexed one. It is possible to rely chiefly on quarantine and act swiftly to stamp the disease out if it occurs. The shock eradication program would include quarantine of, and vaccination in, a risk area, ring vaccination around it, and destruction of all wildlife. This procedure is likely to be adopted in countries where the risk is small, such as Australia. Where the risk is great, consideration must be given to mass vaccination of wildlife by baits, because

wildlife are the cracks in the defense armor. The use of combined vaccines containing rabies vaccine in other vaccines used in dogs would be an effective and panic-free way of increasing the immune status of the pet population.

#### REVIEW LITERATURE

- Frost AK, Hamir AN. The North American Raccoon Rabies. *Epizootic Vet Bull* 1998; 68:1343–1349.
- Krebs JW, Rupprecht CE, Childs JE. Rabies surveillance in the United States during 1999. *J Am Vet Med Assoc* 2000; 217:1799–1811.
- Krebs JW et al. Rabies surveillance in the United States during 2000. *J Am Vet Med Assoc* 2001; 219:1687–1699.
- Krebs JW et al. Rabies surveillance in the United States during 2001. *J Am Vet Med Assoc* 2002; 221:1690–1701.
- Rupprecht CE, Hanlon CA, Hemachudka T. Rabies re-examined. *Lancet Infect Dis* 2002; 2: 327–343.
- Woldehiwet Z. Rabies: recent developments. *Res Vet Sci* 2002; 73:17–25.
- Krebs JW, Wheeling JT, Childs JE. Rabies surveillance in the United States during 2002. *J Am Vet Med Assoc* 2003; 223:1736–1748.
- Krebs JW et al. Rabies surveillance in the United States during 2003. *J Am Vet Med Assoc* 2004; 225:1837–1849.
- Warrell MJ, Warrell DA. Rabies and other lyssavirus diseases. *Lancet* 2004; 363:959–969.
- Bellotto A et al. Overview of rabies in the Americas. *Virus Res* 2005; 111:5–12.
- Slate D et al. Status of oral rabies vaccination in wild carnivores in the United States. *Virus Res* 2005; 111:68–76.

#### REFERENCES

1. Rupprecht CE, Hanlon CA, Hemachudka T. *Lancet Infect Dis* 2002; 2:327.
2. Frost AK, Hamir AN. *Vet Bull* 1998; 68:1343.
3. Woldehiwet Z. *Res Vet Sci* 2002; 73:17.
4. Warrell MJ, Warrell DA. *Lancet* 2004; 363:959.
5. Zienius D et al. *Vet Microbiol* 2003; 93:91.
6. Ali YH. *Vet Rec* 2002; 130:610.
7. Chaparro F, Esterhuysen JJ. *Onderst J Vet Res* 1993; 60:373.
8. Casey G A et al. *Can Vet J* 1996; 37:347.
9. Tinline RR, MacInnes CD. *J Wildlife Dis* 2004; 40:212.
10. Krebs JW et al. *J Am Vet Med Assoc* 2000; 217:1799.
11. Krebs JW et al. *J Am Vet Med Assoc* 2001; 219:1687.
12. Krebs JW et al. *J Am Vet Med Assoc* 2002; 221:1690.
13. Krebs JW et al. *J Am Vet Med Assoc* 2003; 223:1736.
14. Krebs JW et al. *J Am Vet Med Assoc* 2004; 225:1837.
15. Krebs JW et al. *J Wildlife Dis* 2003; 39:253.
16. Childs JE et al. *Proc Natl Acad Sci US* 2000; 97:13666.
17. Mondul AM et al. *J Am Vet Med Assoc* 2003; 222:633.
18. Badrane H, Tordo N. *J Virol* 2001; 75:8096.
19. Picard-Meyer E et al. *Vet Rec* 2004; 134:589.
20. Brookes SM et al. *Emerg Infect Dis* 2005; 11:572.
21. Guerra MA et al. *Emerg Infect Dis* 2003; 9:1143.
22. de Mattos CA et al. *J Wildlife Dis* 2000; 36:231.
23. Wright A et al. *Vet Microbiol* 2002; 87:95.
24. Totton SC et al. *J Wildlife Dis* 2002; 38:313.
25. Jenkins S et al. *J Am Vet Med Assoc* 2005; 226:1304.
26. Kresta AE, Henka SE. *J Anim Vet Advan* 2002; 1:63.
27. Willoughby RE et al. *New Eng J Med* 2005; 352:2508.

28. Bellotto A et al. *Virus Res* 2005; 111:5.
29. Rosatte R et al. *J Wildlife Dis* 2001; 37:265.
30. Hudson LC et al. *J Vet Med B* 1996; 43:277.
31. Green SL et al. *J Am Vet Med Assoc* 1992; 200:1133.
32. Bingham J, van der Merwe M. *J Virol Methods* 2002; 101:85.
33. Jayakumar R et al. *Comp Immunol Microbiol Infect Dis* 1995; 18:269.
34. David D et al. *Vet Microbiol* 2002; 87:111.
35. Aslan A et al. *Vet Rec* 2004; 155:550.
36. Rupprecht CE et al. *Dev Biol (Basel)* 2004; 119:173.
37. Trevejo RT. *J Am Vet Med Assoc* 2000; 217:1647.
38. Murray KO, Arguin PM. *J Am Vet Med Assoc* 2000; 216:188.
39. Madhusudana SN et al. *Int J Infect Dis* 2004; 8:339.
40. Wilson PJ, Clark KA. *J Am Vet Med Assoc* 2001; 218:522.
41. Larghi OP. *Dev Biol (Basel)* 2004; 119:205.
42. Slate D et al. *Virus Res* 2005; 111:68.
43. Cliquet F, Aubert M. *Dev Biol (Basel)* 2004; 119:185.
44. Rosatte RC, Lawson KF. *J Wildlife Dis* 2001; 37:730.
45. Vos A. *J Vet Med B* 2003; 50:477.
46. Vos A et al. *J Wildlife Dis* 2002; 38:428.
47. Hanlon CA et al. *J Wildlife Dis* 2002; 38:420.
48. Aguilar-Setien A et al. *J Wildlife Dis* 2002; 38:539.
49. Broadfoot JD et al. *Ecol Appl* 2001; 11:295.
50. MacInnes CD et al. *J Wildlife Dis* 2001; 37:119.

## PSEUDORABIES (AUJESZKY'S DISEASE)

**Etiology** Aujeszky's disease virus (suid herpesvirus 1) (SHV-1)

**Epidemiology** In pigs worldwide and major economic importance in swine-raising areas. High prevalence of infection; lower incidence of disease. Infected pig source of infection; latent infection is characteristic; spread occurs within herds, between herds, and due to infected carriers; long-distance aerosol transmission occurs from area to area; immunity follows infection or vaccination

**Signs** Fever, incoordination, recumbency, convulsion and death in piglets. Coughing, nasal discharge, sneezing, and dyspnea in older growing pigs. In cattle and sheep, intense pruritus at site of bite, excitement, circling, convulsions, fever, recumbency, paralysis, and death in 48 hours or less

**Clinical pathology** Serology for virus neutralizing antibodies. Detection of virus in tissues

**Lesions** Viral encephalitis

**Diagnostic confirmation** Detection of virus in tissues; serology; inclusion bodies in nervous tissue and respiratory tract

### Differential diagnosis

*Swine:*

- Viral encephalomyelitis (Teschen disease)
- Rabies
- Streptococcal meningitis
- Hog cholera
- African swine fever
- Glasser's disease
- Septicemias (*Escherichia coli*, erysipelas, salmonella)

- Bowel edema
- Salt poisoning
- Reproductive insufficiency (parvovirus).

*Cattle and sheep:*

- Nervous form acetonemia
- Rabies C
- Acute lead poisoning.

**Treatment** None

**Control** Depopulation and repopulation, test and removal, segregation of progeny, and vaccination with subunit vaccines which distinguish between infected and vaccinated pigs

## ETIOLOGY

Pseudorabies is associated with porcine herpesvirus-1, Aujeszky's disease virus, or pseudorabies virus, a member of the family of Herpesviridae, subfamily Alpha-herpesvirinae. The biological functions of the virus in the pathogenicity, immunogenicity, and transmission of vaccine strains of the virus in pigs have been described and reviewed.<sup>1</sup>

## EPIDEMIOLOGY

### Occurrence

Pseudorabies primarily affects pigs and occurs incidentally in other species. Pseudorabies had a wide geographical distribution including the United States, Britain, Europe, North Africa, Asia, South America, New Zealand, and Ireland. Recently, many countries have achieved freedom from the disease and those that have not have started some form of control and eradication scheme.

Epidemiologic modeling of the herd-to-herd transmission of pseudorabies over a 20-year period in the United States concluded that, if there is no eradication program in place, the projected prevalence would be 43% in high-risk States, 22% in moderate-risk States, and 5% in low-risk States by 2012.<sup>2</sup> The current program of eradication projected 23% prevalence rate in high-risk States, 10% in moderate-risk States, and 1% in low-risk States. With an increase in expenditure for eradication programs of 25%, the respective prevalence rates by 2012 would be 14%, 3% and <0.3%. In Belgium the overall herd prevalence was deemed to be 35%.<sup>3</sup> Many countries including Australia, Canada, and Norway are free of the infection.

Pseudorabies is primarily a disease of pigs, and naturally occurring cases in cattle and horses are rare and usually fatal. Cases in cattle occur only sporadically but a number of animals may be affected when cattle and pigs are commingled. An outbreak of clinical disease occurred in sheep in Northern Ireland after the sheep had been shorn and housed adjacent to pigs excreting the virus<sup>4</sup>; cats on the same

farm were also affected. The disease has occurred in goats that have been housed with swine, and the virus has been isolated from horses with neurological disease.<sup>5</sup> Pseudorabies infection has been recorded in feral swine in Florida, and may undermine eradication efforts in domestic swine.<sup>6</sup>

### Morbidity and case fatality

Typically, the disease spreads rapidly in infected herds over a period of 1–2 weeks and the acute stage of the outbreak lasts 1–2 months. In sucking pigs, the morbidity and mortality rates approach 100%, but in mature swine there may be no clinical signs, and affected animals usually recover. The highest morbidity occurs initially in unweaned piglets, but as the outbreak continues and piglets become passively immunized through the sow's colostrum, the major incidence may occur in weanlings.

In recent years there has also been an increase in the morbidity and case fatality rates in older pigs associated with the intensification of pig rearing and the dominance of more virulent strains.

### Risk factors

**Animal risk factors**

The seroprevalence of infection varies widely between herds, and between breeding and finishing pigs within herds.<sup>7</sup> The most important animal risk factors of virus persistence are **herd size** and the **population density** of the sows in the herd.<sup>8</sup> Endemic infection is more likely in herds of breeding sows with more than 66 sows. In Belgium, when testing 720 herds, 40% of the herds with young sows were highly positive.<sup>3</sup> Herds over 70 sows were also more likely to be infected.<sup>3</sup> In breeding herds, spread of infection is positively associated with increasing size of the herd, having the gilts in the same barn as the sows (gestation barn), and serological evidence of infection in the finishing pigs.<sup>9</sup> The seroprevalence of infection is low in quarantined breeding herds, which makes them prime candidates for elimination of the disease by test and removal.<sup>10</sup>

In the early period of a compulsory vaccination program with gI-deleted vaccines, in an area endemically infected with the disease, the seroprevalence of infected breeding females is higher in farrow–finish than farrow–feeder herds.<sup>11</sup> Mandatory vaccination is beneficial in both herds but the pattern is linear in farrow–feeder herds and curvilinear in farrow–finish herds, being more rapid in the early period of the program. In the farrow–finish herds, the odds of infected breeding females were associated positively with seropositivity in the finishing pigs of the herd and with the density of the pigs in the county in which the herd is located.<sup>11</sup>

In Belgium the presence of finishing pigs in the same herd increased the chances of being infected.<sup>3</sup> The spread and transmission of the virus between herds can be reduced by a reduction in the contact rate between the herds and their size and by a reduction of the transmission within the herd.<sup>12</sup>

The factors associated with circulation of the virus within herds include:

- Confinement of finishing pigs
- Concurrent infection with *Actinobacillus pleuropneumoniae*
- The length of time since the herd has been under quarantine
- The presence of clinical disease.

In general, pseudorabies does not increase the susceptibility of animals to infection with other pathogens.<sup>7</sup> In an experimental situation it has been shown that the virus is transmitted between vaccinated conventional pigs but not amongst vaccinated SPF pigs.<sup>13</sup>

The primary risk factors associated with seroprevalence of the virus in 500 swine herds in Illinois included **total confinement** and **density of infected herds** in the geographical area.<sup>14</sup> For counties with a high regional density of pseudorabies infection, the prevalence of infection within a county increased with increasing average herd size and increasing geographical density of swine herds in the county.<sup>15</sup> In Minnesota, there was a high geographical density of pseudorabies infected herds within 5 km.<sup>16</sup> Similarly it was calculated that in Belgium if there were over 455 pigs/km<sup>2</sup> then there was a 10-fold increase in the risk of PRV.<sup>3</sup> Total confinement is associated with higher seroprevalence, presumably because of increased density of population and increased risk of transmission. In Pennsylvania, decreased density of pseudorabies-quarantined herds was associated with reduced risk of a herd becoming quarantined, whereas increased density of non-quarantined, uninfected herds was associated with a decreased probability of a herd becoming quarantined.<sup>17</sup> A farrow-finish herd was associated with increased probability of becoming quarantined, compared with being a feeder pig herd. Seroprevalence is higher in vaccinated herds, increases over the course of the eradication program, and decreases with an increased time between quarantine and the development of a herd plan.

In The Netherlands, the risk factors contributing to seroprevalence of infection in breeding herds included:

- Presence of finishing pigs
- Production type (producers of finishing pigs had a higher prevalence than producers of breeding stock)

- Vaccination of sows during nursing (in comparison to vaccinating all sows simultaneously at 5-month intervals, or vaccination during the second half of gestation)
- Pig density in the municipality where the herd was located (seroprevalence increased with higher pig density)
- Herd size of fewer than 100 sows
- Average within-herd parity (seroprevalence increased with higher within-herd parity)
- Replacement pigs raised on the premises
- Vaccine strain administered to the sows.<sup>18</sup>

#### Environmental risk factors

The survival capabilities of the virus under various environmental conditions influences the methods of transmission and control procedures.<sup>19</sup> The virus may survive for 2–7 weeks in an infected environment, dependent on temperature fluctuations and pH level, and for up to 5 weeks in meat. The stability of the virus suspended in aerosol under different conditions of temperature and relative humidity has been examined.<sup>20</sup> The infectivity of the virus in an aerosol decreases by 50% in 1 hour. Environments at 4°C supported the survival of the virus in aerosol better than at 22°C. The virus is lipophilic and sensitive to several commonly used disinfectants. Sodium hypochlorite (5.25%) is the most desirable and practical disinfectant. Suspensions of the virus in saline G solution and on the solid fomites, whole corn, and steel remained infectious for at least 7 days. Loam soil, straw, and concrete supported survival of the virus at 25°C for up to 1 week.<sup>19</sup> During shipment of pigs, bedding material and surfaces in contact with pigs may become contaminated. Rinsing a needle between sampling may reduce the probability of mechanically transmitting the disease.<sup>21</sup>

#### Pathogen factors

Field strains of the virus differ in virulence. Numerous genomically different strains of the virus exist, and restriction endonuclease (RE) analysis can distinguish between virus isolates, which is useful for identifying new isolates of the virus as they appear in pig populations.<sup>22</sup> A retrospective analysis of virus isolates from England and Wales over a 22-year period revealed considerable homogeneity of certain RE sites (*Bam*HI), both in number and size. The appearance of an isolate with a new DNA fragment in 1981 coincided with a marked increase in the number of outbreaks of disease.<sup>22</sup> A PCR assay was able to discriminate between the established strains and the new type.

By relating this type to pig movement records it was possible to trace the spread of the new type virus which was isolated in 65% of the new outbreaks of pseudorabies in England and Wales in 1982.<sup>22</sup> In Denmark, restriction fragment analyses of older clinical isolates, and of isolates from all the virologically confirmed outbreaks since 1985, indicated the introduction of foreign strains. Strain variation in virulence has been observed in field isolates and produced by laboratory attenuation. The viral proteins that determine virulence of the virus have been described.<sup>1</sup> Some field strains of the virus from Poland and Hungary have been identified by restriction fragment pattern analysis as derivatives of conventionally attenuated vaccine strains.<sup>23</sup> This is considered a rare event but must be considered in relation to trade in semen from vaccinated boars or trade in live animals between disease-free areas and areas where vaccination with live attenuated strains is practiced.

#### Methods of transmission

Pigs, and possibly rodents, appear to be the primary host for the virus. The virus is present in the nasal discharge and in the mouth of affected pigs on the first day of illness and for up to 17 days after infection.

#### Within herds

Transmission within herds occurs by direct oral–nasal contact between infected and susceptible pigs, and aerosols from projection of discharges during sneezing, but may also occur via contaminated drinking water and feed. Transmission within herds is independent of the size of the population.<sup>24</sup>

The spread of virus from infected animals to contact-exposed animals can be predicted using a reproduction ratio. The ratio of secondary cases to originally infected animals is called the basic reproduction ratio denoted as  $R_0$ . In the model,  $R_0$  has a threshold property. When  $R_0 > 1$ , the infection can spread; when  $R_0 < 1$ , the infection will not spread and will disappear, and the animal population is effectively protected.<sup>25</sup> Experimentally, the quantification of vaccine-induced reduction in virus transmission indicates that vaccinating twice with a marker vaccine significantly reduced virus transmission. In unvaccinated groups, the  $R_0$  was 10.0; in the vaccinated group the  $R_0$  was 0.5.<sup>26</sup> Thus, it is possible to measure transmission experimentally.

The transmission of virus decreases rapidly following the start of a vaccination program<sup>27</sup> but extensive spread can still occur even among finishing pigs vaccinated twice.<sup>28</sup> Vaccinated pigs may shed more virulent virus than mildly virulent virus

but there are no significant differences in magnitude of transmission.<sup>29</sup> Mixing of chronically infected pigs with seronegative pigs may not result in seroconversion in the seronegative pigs until a clinical outbreak of disease occurs.<sup>30</sup>

Between herds

**Transmission between herds** is due to introduction of infected animals, and the virus may still be introduced into vaccinated breeding herds.<sup>31</sup> Other methods of transmission of the virus into uninfected herds have been suggested, including farm laborers, vehicles, feed-stuffs, rodents, and wild or domestic animals.

Within an area

**Transmission within an area** is a major problem and not well-understood. Spread is occurring across the United States despite an intensive eradication program.<sup>16</sup> Some evidence indicates that area spread may be associated with which swine market is used and the frequency of delivery of pigs to market per year.<sup>32</sup> In France it has been suggested that the presence of an infected herd within 1 km is an important factor in the spread of PRV.<sup>33</sup> The concurrent occurrence of an outbreak of disease on many farms in the same area in Denmark suggested long-distance airborne transmission of the virus.<sup>32</sup>

Infection is spread by **airborne transmission**.<sup>34</sup> Exposing pigs to aerosols of the virus results in respiratory and other clinical signs similar to field cases.<sup>35</sup> Sneezing probably generates the airborne virus. In a series of outbreaks in Britain between 1981–1982, seven of 11 were found to be likely to have been transmitted by aerosol on meteorological grounds.<sup>36</sup> Airborne spread occurred between herds 2–9 km apart. An epidemic in Denmark in 1987–1988, associated with foreign strains of the virus, suggests that airborne transmission occurred across the German–Danish border<sup>34</sup> especially as a southerly wind was blowing during the period of transmission. An epidemic occurred in 10 herds located within close proximity of each other in Indiana, and the clinical and meteorological data supported aerosol transmission of the virus.<sup>37</sup> An epidemic during the winter of 1987/88 was associated with an unusual predominance of southerly winds, supporting the hypothesis of airborne transmission of the disease.<sup>32</sup>

Computer modeling based on the mean dose of virus received by an animal at a farm downwind can be used to predict the airborne spread of the virus.<sup>38</sup> To test the hypothesis that the virus can be spread by aerosol, the application of a Gaussian diffusion model has been

applied to an epidemic of pseudorabies in 10 herds located in Indiana.<sup>39</sup> The epidemic spread through 10 farms across an area of 150 km. The county was free of infected herds for 2 years prior to the epidemic, which was well-documented. The transport of the virus was assumed to occur during the prepatent period from 3 to 7 days prior to the onset of clinical signs. Estimates of the virus dose received at a given barn indicate that transport of the virus was more efficient during the night than during the day. The low temperatures during the night resulted in decreased ventilation of the barn and greater cycling of air contaminated with the virus over the pigs.

The infection is transmitted in **feral swine** through the venereal route.<sup>40</sup> Following commingling of uninfected gilts with virus infected boars, the virus could be recovered from the reproductive tracts of the gilts and could not be recovered from the upper respiratory tract.

Virus is excreted in the milk of infected sows and in utero infection occurs. The virus is inactivated in meat after 35 days of storage at  $-18^{\circ}\text{C}$  ( $0.5^{\circ}\text{F}$ ). Meat from infected pigs may cause infection when fed to dogs. Venereal transmission of latent infection in sows and boars has been suspected, but there is no direct evidence. The effects of pseudorabies infection in adult boars are related to the effects of the clinical disease rather than any direct effect on semen quality. The virus cannot usually be isolated from the urine or semen from infected boars, and therefore the preputial secretions and the ejaculate are unlikely vehicles for shedding of the virus.

Latency

Pigs that recover from infection are latent carriers of the virus for life. Reactivation, followed by shedding and spreading the virus, may occur following stress such as transport or farrowing, or by the administration of corticosteroids.<sup>41,42</sup> Serological testing of latent carriers detects the antibody response to the whole virus or to a pseudorabies virus glycoprotein.<sup>43</sup> During natural infection, the virus replicates at the site of infection, usually in the oronasal areas. The virus gains entry into the nerve endings and ascends by retrograde axonal transport, to the cell body in the trigeminal ganglion. Viral components can be found in both the trigeminal ganglion and the tonsils.<sup>41</sup> The tonsil is a primary site of virus replication and serves as an area for monitoring virus shedding during acute infection and reactivation. The virus can be isolated from tissue fragments of pigs clinically recovered from disease for up to

13 months and followed by a challenge with the live virus, which may be shed by sows for up to 19 months after initial infection. Virus gene products can be found in the trigeminal ganglia and tonsils for many weeks following acute infection.<sup>44</sup> Latent infection can also occur in vaccinated pigs.

Other species

The rarity of spread to other species is due to the scanty nasal discharge and the improbability of the discharge coming into contact with abraded skin or nasal mucosa of animals other than pigs. The disease has occurred in sheep and cattle following the use of a multiple-dose syringe previously used in infected swine. The disease may spread from normal or clinically affected pigs to animals of other species, but does not usually spread between animals of the other species. For example, sheep and calves can be infected experimentally, but there is no evidence that they excrete the virus. The disease may occur in pigs, sheep, and cattle on the same farm. Brown rats may be a minor source of infection but are unlikely to be an important reservoir; they are capable of spreading the disease to dogs. The wild Norway rat is thought to have only a minor role in the transmission of the disease to farm animals. The virus causes fatal disease in dogs, which are usually infected from close association with infected pigs. The raccoon can be infected experimentally, but is not considered to be a long-term subclinical carrier of the virus. The possible role of wild animals in transmission of pseudorabies in swine has been examined with inconclusive results. It has been seen in Kodiak, Polar and Himalayan bears fed on a diet of raw pig's heads.<sup>45</sup> Five viral isolates were recovered from latently infected wild boar originating from two regions of East Germany<sup>46</sup> but in the Netherlands the wild boar were said to be rarely affected.<sup>47</sup> The PRV infections in the wild boar in Germany are said to exist in the country as an endemic infection and persist completely separately to the domestic population and also do not appear to affect it.<sup>48</sup> The sacral ganglia and trigeminal ganglia of wild pigs were said to be a source of infection.<sup>49</sup> The latency was shown in 9/16 sacral ganglia, 7/16 trigeminal ganglia and 5/13 tonsils<sup>49</sup> from feral swine in the USA, but even so most of the transmission in feral swine is expected to be venereal. There seems to be little evidence of a high infection rate in the wild boar of the Netherlands but they are in contact with the wild boar of Germany.<sup>50</sup> It seems quite common in Spanish wild boar with 36% of a study of 78 being serologically positive. The wild

boar strain is adapted to the wild boar pig.<sup>51</sup> A group 1 virus was isolated from a wild boar in 1993 and it was suggested that the virus persisted for several years in the wild boar population in Italy<sup>52</sup> and that the species should be considered a reservoir.<sup>52</sup> In Croatia approximately 55% of tested wild boars were found to be seropositive.<sup>53</sup> The experimental infection of wild boars and domestic pigs with different strains has been carried out<sup>51</sup> and the clinical signs depended on the strain but the wild boar could infect the domestic strains and vice versa. The low virulence strains were highly adapted to the wild boar.

### Immune mechanisms

When infected with a virulent strain of the virus, pigs develop an immune response that can completely, or almost completely, prevent the virus from replicating after the pig becomes reinfected.<sup>1</sup> Following natural infection, sows acquire immunity, which is transferred to their piglets in the colostrum and persists in the piglets until 5–7 weeks of age. Following intranasal challenge, piglets with colostrum immunity from naturally infected sows are protected from clinical disease, but not against subclinical infection.

Vaccination of pigs with attenuated pseudorabies virus prevents clinical disease and death that may otherwise follow exposure to the virulent virus. Vaccination does not, however, prevent either acute or latent infection with virulent virus. As a consequence, vaccinated pigs, as well as non-vaccinated pigs that survive infection with the virulent virus, can become virus carriers and a source of the virus following reactivation of a latent infection. This is of vital importance in eradication programs wherein it is necessary to identify infected pigs regardless of their vaccination status. Maternal immunity interferes with inactivated virus vaccination much more than with live virus vaccination.<sup>54</sup>

Vaccination of pregnant sows induces a maternal immunity, which protects piglets from experimental disease. However, latent infection of young pigs with highly virulent virus can develop in the absence of clinical signs. The virus can reach the uterine and fetal tissues, via infected mononuclear cells, the presence of circulating antibodies induced on vaccination.<sup>55</sup> Vaccination of piglets before challenge exposure has little or no effect on the rate of establishment of virus latency, but vaccination does reduce shedding after subsequent experimental reactivation of the virus with dexamethasone. Attenuated thymosine kinase-negative vaccine strains of the virus can

also establish a reactivatable, latent infection.<sup>56</sup>

In growing and finishing pigs in quarantined herds, the serological status is unpredictable because the infection may continue to spread, may cease temporarily, or may cease altogether. Evaluation of the serological status of the boars in a breeding herd does not accurately reflect the serostatus of the herd.

It has been suggested that the T cells are more important than the B cells in the clearance of PRV from the host<sup>57</sup> and it has been shown that strong T-cell mediated responses after challenge produce the best protection.<sup>58</sup>

### Economic importance

The economic losses associated with pseudorabies in swine are due to clinical disease, and the costs of serological analysis and vaccination programs.<sup>32</sup> Because of the variability of expression of the infection in different herds, a description of a single farm's experience with pseudorabies is difficult to put into a larger perspective regarding the impact of disease at a state or national level.<sup>59</sup> Economic loss estimates must include the measurement of losses during and immediately after clinical outbreaks of disease, and the indirect losses incurred until after eradication of the disease. Losses have been estimated at US\$25–50/sow per year; these include only losses during the period of the outbreak and the direct losses attributable to death and abortions. When expanding the observations of economic losses to 3 months after the termination of the outbreak, estimated losses may be as high as US\$145/sow per year.<sup>32</sup> Economic analyses of the losses in a commercial farrow-finish herd of 240 breeding age sows in the United States revealed that the major part of the loss was caused by death of suckling pigs at 76% of total loss, nursery pig mortality accounted for 12.6% of total net loss, sow culling and deaths accounted for 9.4% of net loss, and market pig deaths accounted for 1.2% of net losses.<sup>32</sup>

The costs of eradicating pseudorabies vary depending on the methods employed.

**Depopulation-repopulation** is the most expensive method because it requires culling of animals, clean-up costs, and downtime which represents the largest proportion of expense. In addition, the probability of reinfection following repopulation is a risk.

**Test and removal** is the most inexpensive, and segregation of offspring is intermediate in costs. The cost of eradicating the virus from a swine herd can be in excess of US\$220/inventoried

sow; some estimates are much higher.<sup>60</sup> In large breeding herds or finishing herds with the continual influx of susceptible pigs, the disease may become endemic. Pseudorabies may also be a significant cause of reproductive inefficiency in pig herds, and infection within the herd may be initially manifest by abortions in the sow herd, followed later by the more typical occurrence of neurological disease in suckling and growing pigs. The economic losses due to the disease can be very high because of mortality in young pigs, decreased reproductive performance, and the necessity to depopulate to eradicate the disease from a herd. An economic assessment of an epidemic of pseudorabies in a 150-sow farrow-finish operation on selected production and economic variables has been made. The mean litter size remained the same throughout the period of observation, but there was a two-fold increase in suckling pig mortality and 3.5-fold increase in stillbirths during the months of the epidemic compared with the period before the epidemic. Following the epidemic, suckling pig mortality was 14% greater and stillbirth rate was 71% greater than during the months preceding the outbreak. The major economic losses (88% of the total loss) were related to breeding herd removal/depopulation and production downtime.

### PATHOGENESIS

The portal of entry is through abraded skin or via the intact nasal mucosa. The virus is pantropic and affects tissues derived from all embryonic layers. Receptor and receptor-binding virion proteins which can mediate the virus entry into the cell and cell to cell spread have been described.<sup>61</sup> The various glycoproteins of the virus are required for various stages of virion morphogenesis. For example deletion of glycoproteins gE, gI, and gM inhibits the virion maturation.<sup>62</sup> Pseudorabies glycoprotein gK is a virion structural component involved in virus release from the cell but not viral entry and its presence is important to prevent immediate reinfection.<sup>63</sup> Viremia occurs with localization of the virus in many viscera, but with multiplication occurring primarily in the upper respiratory tract. Spread to the brain occurs by way of the olfactory, glossopharyngeal, or trigeminal nerves i.e. via the autonomic nerves.<sup>64</sup> Cells with the common leukocyte antigen CD45<sup>+</sup> populate the CNS infected areas from the local capillaries and the number of cells is increased in proportion to the number of infected neurons.<sup>65</sup> Virus disappears from the brain by the 8th day, coinciding with the appearance of neutralizing antibody in the blood. When

the virus gains entry through a skin abrasion, it quickly invades the local peripheral nerves, passing along them centripetally and causing damage to nerve cells. It is this form of progression that causes local pruritus in the early stages of the disease, and encephalomyelitis at a later stage when the virus has invaded the central nervous system. In pigs, pruritus does not develop after IM injection, but a local paralysis indicative of damage to low motor neurons occurs prior to invasion of the central nervous system in some pigs. In cattle, pruritus of the head and neck is usually associated with respiratory tract infection, while perianal pruritus is usually due to vaginal infection.

Inoculation of the virus into the nasal cavities or brain results in signs of encephalitis rather than local pruritus. With oral inoculation there is an initial stage of viral proliferation in the tonsillar mucosa, followed by systemic invasion, localization, and invasion of the central nervous system along peripheral and autonomic nerve trunks and fibers. Lesions of Auerbach's myenteric plexus and the skin may also occur.<sup>66</sup> The peripheral blood mononuclear cells, tonsil, lymph nodes and bone marrow are a poor source of virus after experimental infection.<sup>67</sup> The trigeminal ganglia and olfactory bulb are good sources of virus.<sup>67</sup> The virus may be present in the trigeminal ganglion of a naturally infected sow without any history of clinical disease. Experimental inoculation of the virus into young pigs can result in a mild pneumonia which may progress to a severe suppurative bronchopneumonia.<sup>68</sup>

The virus can invade the uterus and infect pre-implantation embryos, which can lead to degeneration of the embryo and reproductive failure.<sup>69</sup> Virulent pseudorabies virus can cause lesions in the uterine endothelium and ovarian corpora lutea of pigs in early pregnancy, and gene-deleted mutant virus vaccine given IV during estrus can cause ovarian lesions, which may affect fertility.<sup>69</sup> Through the use of embryo transfer procedures, infected embryos may disseminate the virus from donors to recipients.

### CLINICAL FINDINGS

The incubation period in natural outbreaks is about one day.

#### Pigs

The major signs are referable to infection of the respiratory, nervous and reproductive systems. There is considerable variation in the clinical manifestation, depending on the virulence and tropism of the infecting strain. Nervous system disease is the major manifestation, but with some

strains, respiratory disease may be the initial and prime presenting feature. There is also strain variation in the pattern of age susceptibility.

Young pigs a few days to a month old are most susceptible. Very young sucklings develop an indistinct syndrome, but prominent nervous signs occur in older piglets. A febrile reaction, with temperatures up to 41.5°C (107°F), occurs prior to the onset of nervous signs. Incoordination of the hindlimbs causing sideways progression is followed by recumbency, fine and coarse muscle tremors, and paddling movements. Lateral deviation of the head, frothing at the mouth, nystagmus, slight ocular discharge, and convulsive episodes appear in a few animals. A snoring respiration with marked abdominal movement occurs in many, and vomiting and diarrhea in some affected pigs. Deaths occur about 12 hours after the first signs appear. In California, a consistent sign has been blindness due to extensive retinal degeneration.

In growing and adult pigs, the disease is much less severe but there is considerable variation depending upon the virulence of the infecting strain. In growing pigs, mortality falls with increasing age and is generally less than 5% in pigs at 4–6 months of age. With some strains, fever is a prominent sign, while depression, vomiting, and sometimes marked respiratory signs, including sneezing, nasal discharge, coughing, and severe dyspnea are common. Trembling, incoordination, and paralysis and convulsions follow, and precede death. With others, the disease may be manifest at this age by mild signs of posterior incoordination and leg weakness. Concurrent infection has been described with both PCV2 and ADV.<sup>70</sup> In adults, fever may not be present and the infection may cause only a mild syndrome of anorexia, dullness, agalactia, and constipation. However, virulent strains may produce acute disease in adults, characterized by fever, sneezing, nasal pruritus, vomition, incoordination and convulsions, and death. Infection in early pregnancy may result in embryonic death, or abortion, and early return to heat. An abundant vaginal discharge may occur. Infection in late pregnancy may result in abortion, or in the subsequent birth of mummified fetuses, which may involve all or only part of the litter. Abortion may result from the effects of fever or from viral infection of the fetus.

#### Cattle, sheep, and goats

There may be sudden death without obvious signs of illness. More commonly, there is intense, local pruritus with violent licking, chewing, and rubbing of the part. Itching may be localized to any part of the

body surface, but is most common about the head, the flanks, or the feet, the sites most likely to be contaminated by virus. There is intense excitement during this stage, and convulsions and constant bellowing may occur. Maniacal behavior, circling, spasm of the diaphragm, and opisthotonos are often evident. A stage of paralysis follows in which salivation, respiratory distress, and ataxia occur. The temperature is usually increased, sometimes to as high as 41–41°C (106–107°F). Final paralysis is followed by death in 6–48 hours after the first appearance of illness. A case of non-fatal pseudorabies in a cow is recorded. There is also a report of pseudorabies occurring in feedlot cattle in which there were nervous signs, bloat, and acute death, but no pruritus. In young calves, it is characterized clinically by encephalitis, no pruritus, erosion in the oral cavity and esophagus, and a high case fatality rate. An outbreak in sheep was associated with skin abrasions acquired at shearing. Affected ewes were dull, inappetent, and had a fever of 41.1°C. About 23 of 29 affected sheep developed the 'mad itch', with nibbling of their fleece and frenzied attempts to bite one area of the skin and rub it against the wall and bars of their pen. Terminally, recumbency, tremors, and opisthotonos were common, and death occurred within 12–24 hours after onset.<sup>4</sup> Five farm cats also became ill and died; the virus was isolated from the brain of one cat. In goats, rapid deaths, unrest, lying down and rising frequently, crying plaintively, profuse sweating, and spasms and paralysis terminally are characteristic. There may be no pruritus.

The clinical findings in dogs and cats are similar to those in cattle, with death occurring in about 24 hours.<sup>9</sup> In France, cases in dogs have been linked to strains of virus from wild boars.<sup>71</sup>

### CLINICAL PATHOLOGY

#### Serology

The commonly used serological tests for pseudorabies-specific antibodies are the serum-neutralization (SN) and ELISA.

#### Serum neutralization test

The SN test using the Shope strain has been the 'gold standard' against which other serological tests are compared and has been most widely used because of its sensitivity and specificity. Specific virus-neutralizing antibodies are detectable in the serum of recovered pigs, and this test is in routine use for herd diagnosis and survey purposes. Antibody is detectable on the 7th day after infection, reaches a peak about the 35th day, and persists for many months. Paired serum samples taken as early as possible, and about 3 weeks later, show a marked antibody



rise. However, the SN test lacks the sensitivity necessary for detection of pigs with low levels of humoral titers of specific SN antibodies which can be enhanced by using the Bartha gIII strain.<sup>72</sup>

Some herds may have no serological evidence of previous infection or current spread of the virus, but have single reactors in the herd which may be infected with the virus.<sup>73</sup> Such singleton reactors may be found in herds being monitored serologically for presence of infection. These singleton reactors may be infected with strains of the virus that are relatively avirulent.

#### Enzyme-linked immunosorbent assay

The ELISA is more sensitive than the SN test, especially early in the immune response to pseudorabies antigens. However, because of its high sensitivity, screening ELISAs yield some false-positives which must be confirmed by another test, such as another ELISA, SN test or latex agglutination test.<sup>74</sup> False-positives are unlikely to be due to infection with other herpesviruses. ELISA has also been used as a meat juice test<sup>75,76</sup> with high sensitivity (93%) and specificity (98%). The indirect ELISA is a more rapid and convenient procedure, offering many advantages over the SN test for routine serodiagnostic work. An indirect ELISA, using whole blood collected onto paper discs, is a rapid and convenient test and eliminates the costs of using vacutainer tubes and separating the blood. An indirect ELISA based on recombinant and affinity-purified glycoprotein E of PRV to differentiate vaccinated from naturally infected animals has been developed.<sup>77</sup> An indirect ELISA has been developed in the Czech Republic<sup>78</sup> that can be used because of its high sensitivity and specificity for blood serum or frozen pork samples. It has allowed the demonstration of ADV in meat juice with only marginal titers in the blood. Commercial ELISA kits are available and some are more specific than others.<sup>74</sup> A highly sensitive and specific competitive ELISA based on baculovirus expressed pseudorabies virus glycoprotein gE and gI complex has been described.<sup>79</sup> This allows detection as early as 2 weeks post-infection and can handle large numbers of tests without the need to handle live virus.

In countries where vaccination is regularly used for control of the disease, an assay to serologically distinguish infected from vaccinated pigs is critical. While a vaccination program will reduce the circulation of virus in the field, it will not eliminate the virus from the pig population. To eradicate the virus, the ability to differentiate infected from

vaccinated pigs is crucial. Several commercial ELISA kits can differentiate between vaccinated and naturally infected pigs.<sup>80</sup> Differentiation is possible when vaccine virus strains have either a natural, or a genetically engineered, deletion that encodes for either glycoprotein-I (gI), gIII, or gX genes. Commercial ELISA kits that specifically detect antibody responses to gI of the virus offer considerable advantages as diagnostic tests for the virus, with a sensitivity of 99.2% and specificity of 100%.<sup>80</sup> The gI ELISA is able to distinguish infected pigs from those vaccinated with gI-negative vaccines.<sup>81,82</sup> The field strains of the virus produce antibodies to gI when inoculated into pigs. Unvaccinated pigs, or pigs vaccinated with gI-negative vaccines, that become subclinically infected with field strains of the virus may be detected with the gI-ELISA for a long time after infection. Thus, pigs that are seropositive in the gI-ELISA have either been infected with the pseudorabies virus or have been vaccinated with gI-positive vaccines; gI-seronegative pigs can be considered to be uninfected. Eradication of the virus from swine herds is possible by gI-ELISA testing, and culling gI-seropositive pigs in herds using gI-negative vaccines.

Detection of pigs in the latent phase of infection can be done serologically.<sup>43</sup> Pigs of any age that survive the acute infection phase become latent carriers for life, and serologic testing consistently detects animals in the latent phase of infection if the test detects the antibody response to the whole virus or to a reliable pseudorabies-virus glycoprotein.<sup>43</sup> Of several serological tests examined, the glycoprotein-I and glycoprotein-III marker systems, which performed with similar sensitivity as the screening tests, were superior to the glycoprotein-X marker system in detecting antibodies in infected pigs.

#### Detection of virus

In infected pigs the virus is usually present in nasal secretions for up to 10 days. A common method for the diagnosis of pseudorabies in sows is to take swabs from the nasal mucosa and vagina. Polyester and wire swabs shipped in 199 tissue culture medium supplemented with 2% fetal bovine serum (FBS) buffered with 0.1% sodium bicarbonate and HEPES will yield optimum recovery of the virus. Wooden applicator sticks with cottonwool have antiviral activity and recovery of the virus may not be possible after 2 days, which is of practical importance if the samples are shipped by mail. The virus can be demonstrated in nasal cells by immunofluorescence and immunoperoxidase techniques.<sup>83</sup> The

virus can be detected by direct filter hybridization of nasal and tonsillar specimens from live pigs.<sup>44</sup> The virus survives on tonsil swabs taken with Dacron-tipped applicators for up to 72 hours in cell culture medium under transport.<sup>84</sup>

New PCR techniques have been used<sup>67</sup> and have been used to differentiate between true and false serological positives when single reactor pigs have been found.<sup>85</sup>

#### NECROPSY FINDINGS

There are no gross lesions typical and constant for the disease, and diagnosis must rely on laboratory examination. When pruritus has occurred there is considerable damage to local areas of skin, and extensive subcutaneous edema. The lungs show congestion, edema, and some hemorrhages. Hemorrhages may be present under the endocardium and excess fluid is often present in the pericardial sac. In pigs, there are additional lesions of visceral involvement. Slight splenomegaly, meningitis, and excess pericardial fluid are observed, and there may be small necrotic foci in the spleen and liver. Foci of hepatic necrosis may also be seen in aborted fetuses. Histologically, in all species, there is severe and extensive neuronal damage in the spinal cord, paravertebral ganglia, and brain. Perivascular cuffing and focal necrosis are present in the gray matter, particularly in the cerebellar cortex. Intranuclear inclusion bodies occur infrequently in the degenerating neurons and astroglial cells, particularly in cerebral cortex in the pig. These inclusions are of considerable importance in differential diagnosis. Necrotizing lesions with inclusion-body formation in the upper respiratory tract and lungs is strongly suggestive of porcine pseudorabies. Ultrastructural observations have been made which included syncytia, cellular debris and macrophages and lymphocytes with vacuoles in their cytoplasm.<sup>86</sup> Virus may be detected by direct fluorescent antibody examination or by growth in tissue culture. The tissues of the head and neck regions of non-immune pigs yield virus most consistently and in the highest concentration after challenge. The immunoperoxidase test can be used to study the distribution of the virus in different tissues. Latent virus can be detected using a DNA hybridization dot blot assay. Where possible, whole carcasses and fetuses should be submitted for laboratory examination. The location of the optimal neural samples, including the paravertebral ganglia, has been described for sheep.<sup>87</sup> The placental lesions in pregnant sows that have aborted from

natural infection with pseudorabies consist of necrotizing placentitis and the presence of intranuclear inclusions. In an experimental infection of loops of intestine it was shown<sup>88</sup> that there was necrosis of the follicles in the Peyer's patches and degeneration of the epithelial cells in the crypts and villi and degeneration of the cells in the myenteric plexuses. Intranuclear inclusion bodies were found 2–4 days after inoculation. The primary target of the wild ADV was the macrophages of the sub-epithelial area of the dome of the Peyer's patch.

### Samples for confirmation of diagnosis

- **Histology** – one half of midsagittally-sectioned brain, spinal cord with paravertebral ganglia, Gasserian ganglion, placenta, liver, lung, spleen, tonsil, retropharyngeal lymph node (LM). Immunohistochemistry has been used to confirm rare cases in countries where the disease is rare<sup>89</sup> and other corroborating evidence is lacking.<sup>90</sup> Can also collect muscle samples for meat juice ELISAs<sup>91</sup>
- **Virology** – brain, spinal cord, liver, spleen, tonsil, retropharyngeal lymph node (FAT, ISO). CSF is not good for virus isolation.<sup>67</sup>

### DIFFERENTIAL DIAGNOSIS

The different clinical forms of pseudorabies in pigs and ruminants resemble several diseases.

**Teschen disease** occurs in similar forms in certain areas; the diagnosis is dependent on serology and pathology.

**Rabies** is rare in pigs and is usually accompanied by pruritus at the site of the bite.

**Streptococcal meningitis** is restricted to sucking pigs of 2–6 weeks of age, the lesions are usually obvious at necropsy, and the causative organism is readily cultured from the meninges. The response to treatment with penicillin is good and is of value as a diagnostic test.

**Encephalopathy** associated with hog cholera, African swine fever, salmonellosis, Glasser's disease, *Escherichia coli* septicemia and erysipelas are considerations, and are usually obvious at necropsy.

**Bowel edema** causes typical edema of the head and eyelids, and typical circumstances in weaner pigs and rapid death.

**Salt poisoning** causes typical intermittent nervous signs, with a typical history of water deprivation.

**Respiratory form of pseudorabies** should be considered in any outbreak of respiratory disease that is poorly responsive to usually effective therapeutic measures.

**Reproductive inefficiency associated with enterovirus (SMEDI)** and parvovirus infections closely resembles that associated with pseudorabies, and requires laboratory differentiation by virus isolation and serological testing.

In **cattle** the local pruritus is distinctive, but the disease may be confused with the nervous form of acetoneemia in which paresthesia may lead to excitement. The rapid recovery that ordinarily occurs in this form of acetoneemia is an important diagnostic point. The furious form of rabies and acute lead poisoning cause signs of mania, but pruritus does not occur.

### TREATMENT

There is no treatment.

### CONTROL

The control of pseudorabies is difficult and currently unreliable because normal healthy pigs may be infected and shed the virus for up to several months.

An important principle in control and eradication of the disease is the reproduction ratio,  $R_0$ , which is defined as the average number of new infections caused by one typical infectious animal. When  $R_0 > 1$ , the infection can spread; when  $R_0 < 1$ , the infection will disappear. In eradication programs it is essential that  $R$  be less than 1 and the infection will die out in the herd.

### Strategies available

The methods of control or eradication include depopulation and repopulation, test and removal, segregation of progeny, and vaccination. The selection of a strategy for the control or elimination of the disease depends on the following:

1. Source of the herd infection
2. Method of transmission of the virus
3. Survival of the virus in the environment
4. Sensitivity and specificity of the diagnostic test
5. Risk factors in the herd,<sup>92</sup> which include:
  - type of operation
  - degree of herd isolation
  - prevalence of infection
  - value of the genetic material
  - level of management expertise
  - availability of suitable virus-free replacement swine if depopulation and repopulation is chosen as a strategy.

The eradication of the disease from small herds was described in Hungary.<sup>93</sup> In this country the shared use of boars, the pig density and the infection in the surrounding area were the most significant influences on the spread and control of the disease.

Breeding stock producers favor eradication, farrow–finish producers that do

not sell breeding stock or feeder pigs are generally more concerned with the reduction of losses from clinical pseudorabies infection than with eradication. In the USA offsite all in/all out finishing was more frequent amongst the successful farms than the unsuccessful.<sup>94</sup> The unsuccessful also had other infected herds within 3.2 km (2 miles) and often no cleaning or disinfection.<sup>94</sup>

### Economics of control and eradication

Depopulation–repopulation is the most expensive, segregation of progeny method is next, and the test and removal the most inexpensive per sow.<sup>60</sup> A computerized decision-tree analysis and simulation modeling can evaluate the economics of control and eradication strategies. The optimal alternative is to test and remove seropositive animals if the initial prevalence is ~57%; otherwise vaccination of sows only is preferred. Vaccination may be recommended at lower prevalence rates as a conservative approach. Eradication by test and removal combined with the use of gene-deleted vaccines is advantageous at any prevalence rate of infection.<sup>95</sup> Depopulation and repopulation is not the best option under any circumstances. Once formulated, a decision-tree analysis can be adapted to the prevailing economic or epidemiological conditions.

An epidemiological model projected future herd–herd disease transmission under alternative eradication or control programs over 20 years, from 1993 to 2012.<sup>60</sup> With current eradication program funding in the United States, the prevalence of infection would be 23% in high-risk states, 10% in moderate-risk states, and 1% in low-risk states. Increased funding for the eradication program would substantially reduce the prevalence of infection. Profitability for the average size farrow–finish herd was estimated to be US\$6 per cwt of swine produced for virus-infected herds than for uninfected herds. Estimates of the value of economic welfare indicated that consumers would be the major beneficiaries of eradication because of reduced prices and increased consumption of pork.

In Sweden, it was estimated that an eradication program is economically viable.<sup>96</sup> The maximum benefits are derived where the Swedish agricultural sector is deregulated and consumers obtain about 50% of the benefits excluding program costs. In the current case where Sweden is a member of the European Union, the benefits are reduced mainly due to lower prices of inputs and pork.

An economic analysis of alternative control programs found that, for regions of high pig density, the most economical strategy is to lower herd prevalence by

intensive vaccination before completing eradication by test-and-removal of remaining positive animals.<sup>97</sup>

Eradication and control programs used in France have been reviewed.<sup>97</sup> The eradication of PRV in a 170 sow herd was described<sup>98</sup> in which the affected animals were killed and the rest were then vaccinated and the total cost to the farm was about \$50 000.

#### Determination of prevalence of infection

In large herds, the virus must be eliminated from the growing-finishing pigs and the breeding herd. Large herds that are virus-positive are infected in both groups; smaller herds are frequently infected in only the breeding herd.<sup>99</sup> An initial step in eradication is to determine the prevalence of infection. Representative samples of finishing pigs older than 4 months, and of breeding sows, gilts, and boars are tested. On the basis of the test results and the risk factors in the herd, a cost-effective plan can be devised for the individual herd.

#### Depopulation and repopulation

When the prevalence of infection in the herd is over 50%, eradication can be achieved by depopulation and repopulation with virus-free breeding stock. However, depopulation is the most expensive method and is not compatible with the retention of valuable pedigree stock. The entire herd is depopulated over a period of months as the animals reach market weight. After removal of the animals the entire premises are cleaned and disinfected. Repopulation should be delayed at least 30 days after the final disinfection, and swine should originate from a pseudorabies-free qualified herd and be isolated on the premises and retested 30 days after introduction. All herd additions should be isolated and tested 30 days after introduction.

#### Test and removal

The test and removal program is recommended when the prevalence of infection in the herd is below 50%. This method requires testing of the entire breeding herd and immediate removal of all seropositive animals; 30 days after removal of seropositive animals, the herd is retested, and if necessary at 30-day intervals, until the entire herd tests are negative. Following a second negative test, the testing regimen may be changed to test only 25% of the herd every 4 months. Seropositive animals are identified and culled. The test and removal method is superior to the vaccination system as a method of control. Valuable genetic material from breeding stock that are seropositive may be salvaged using

embryo transfer techniques. Embryos may be transferred safely to susceptible recipient gilts from sows that have recovered from infection, but not from sows that are in the active stages of infection. The virus does not penetrate the outer covering of the embryo, but it can become attached to it so that it may physically transfer to the uterus of the recipient. This transfer of infection may occur if the donor sow is in the active phase of infection.

#### Offspring segregation

The objective of this strategy is to raise a pseudorabies-negative breeding herd to replace the infected herd. Once the herd is diagnosed as pseudorabies-infected, a regular schedule of vaccination is instituted. Gilts are vaccinated at first breeding, and both sows and gilts are vaccinated 2-4 weeks before farrowing to provide a high level of colostral immunity to their piglets. Offspring are removed at weaning and raised apart from the infected herd. At 4 months of age, and then again before breeding, the segregated replacements are tested for antibody. Since colostral immunity is no longer detectable by 4 months of age, any animals over 4 months of age that are seropositive are considered pseudorabies infected. As the gilts reach reproductive maturity, the old sow herd is replaced. Segregation between the infected sow herd and the clean gilt herd is maintained until all positive sows have been removed and the facilities disinfected. Groups of seronegative pigs are identified and combined into larger groups to establish a new herd. The original herd is gradually depopulated, and the premises cleaned and disinfected. The new herd is then monitored on a regular basis.

#### Control programs in effect

Pseudorabies was first diagnosed in the North Island of New Zealand in 1976, an eradication program started in 1989 and the virus was cleared from the North island in 1997.<sup>100</sup>

A pseudorabies control program was introduced in England in 1983 when the infection was spreading rapidly. New legislation imposed restrictions on the movement of pigs where clinical signs of the disease were present in the herd. The first part of the eradication scheme involved testing all of those herds previously known to have pseudorabies. Within several months after the beginning of the eradication campaign, 417 herds had been slaughtered, involving 342 275 pigs, of which 72.5% were salvaged. Only 121 herds had been known to be previously infected, while the remaining 296 herds had been identified through tracebacks and reports of new cases. By 1985 it was

concluded that the disease was well-controlled in England with only 10-14 infected herds remaining. Farmers were compensated for all animals slaughtered and also for consequential loss associated with the loss of stock. The cost of the eradication program was financed by a levy on all pigs normally marketed for slaughter in England. In 1995, England was free of Aujeszky's disease. Following the successful use of the gene deletion vaccination and eradication program the Netherlands is now free<sup>101</sup> and also Germany.<sup>102</sup> There were originally 70% seropositive sows in 1993, 1% in 1998 and now none (as above). In Sweden the herds were declared free from 12-53 months after the start of the programme.<sup>103</sup> Now in Northern Ireland, pseudorabies is more widespread than it ever was in Britain before the eradication program. Because the infection rate is over 50%, an eradication program based on slaughter of infected herds would destroy the swine industry. Thus the control program in Northern Ireland is based on the use of vaccination, the culling of seropositive animals, and the gradual introduction of seronegative animals.

In the United States, the national pseudorabies eradication program was implemented in 1989 as a joint State-Federal-Industry-sponsored program.<sup>104</sup> Pilot projects were conducted in Iowa, Illinois, Pennsylvania, Wisconsin, and North Carolina from 1984 to 1987. In the pilot projects, 97.5% of 116 herds that were initially pseudorabies-positive were successfully cleared of infection. This indicated that eradication of pseudorabies virus from herds of swine can be efficiently achieved, and is most effective applied on an area basis. The introduction of the gene-deleted pseudorabies vaccines in the program was the technical breakthrough needed to be able to offer the national eradication program, since it was now possible to distinguish between naturally infected and vaccinated animals.<sup>104</sup> The program consisted of:

- Stage I, preparation
- Stage II, control
- Stage III, mandatory herd clean-up
- Stage IV, surveillance
- Stage V, free.

In Ohio, the eradication has made progress and eradication is expected in 1996 at a minimum cost to the public and the process in Illinois has also been described.<sup>105</sup> In practice what it meant was that all were at stage I by 1991, stage II was in states with over 1% affected and stage III in the states with less than 1% affected, there were still 10 states in stage IV on 1/1/2000 but on the 1/1/2000 33

states were free and all were cleared by 2002. When an outbreak of the disease occurs in a susceptible herd the mortality may be very high, and the first consideration is to prevent spread to uninfected sows and litters and pregnant sows from infected pigs. They should be attended by separate personnel, or adequate barriers to mechanical transmission of infection should be arranged. On affected premises, cattle should be separated from pigs, and dogs and cats should be kept from the area. The affected herd should be quarantined, and all pigs sold off the farm should be for slaughter only.

### Vaccines and vaccination

Vaccination is used to reduce clinical disease when outbreaks occur or when the disease is endemic in the herd. An effective immunity develops after natural infection or vaccination, and piglets from immune sows are protected from clinical disease during the nursing period by colostrum immunity. **However, the presence of circulating antibody does not prevent infection, the development of latency and subsequent activation and excretion of the virus.** However, vaccination reduces viral shedding after natural infection. On farms in which the disease is endemic or outbreaks have occurred, vaccination of the sows, and management procedures to reduce the spread of infection, have markedly reduced preweaning mortality and reproductive failures. Field studies in large numbers of herds where the sows were vaccinated three times annually show that the reproduction ratio was below 0.66, which is significantly below 1,<sup>106</sup> and massive spread of the virus does not occur.

It is often virtually impossible to prevent the spread of infection in a susceptible herd and vaccination of all pigs at risk, especially pregnant sows, is recommended. The vaccine reduces losses in infected herds, limits the spread of infection, and decreases the incidence in endemic areas. With a properly controlled and monitored vaccination and culling program in a breeding herd it is possible to control clinical disease and reduce the infection pressure. All breeding stock present during an outbreak are subsequently vaccinated regularly until they are all culled, which removes the major sources of virulent virus. Following this phase, newly introduced gilts and boars are tested, and monitored regularly. This is considered to be less costly than the test and slaughter policy.

However, in vaccinated herds, the virus continues to circulate and an accurate epidemiological analysis is not possible because titers caused by

vaccination cannot be distinguished from those caused by natural infections.

Control of the diseases in many countries has always been based on compulsory intensive vaccination of the entire population.<sup>102,107</sup>

### Vaccines

**Conventional modified live virus and inactivated virus vaccines** have been available. Both vaccines will reduce the incidence rate and severity of clinical disease in an infected herd. They also reduce the field virus shedding and latency in the trigeminal ganglion after exposure to field virus.<sup>108</sup> The vaccine efficiency is however markedly influenced by the modified live virus vaccine strain and the route of administration. The vaccine genotype plays a very important role in the effectiveness of the vaccine program. Recently needle-free transdermal vaccination using a modified live PRV vaccine has been described thereby preventing the loss of any needles in the carcass.<sup>109</sup> Cell mediated immunity in the form of cytotoxic T-cells may play an important part in the effectiveness of the vaccine.<sup>110</sup> The deficiencies of inactivated vaccines in producing virus specific interferon gamma (IFN) can be enhanced by the use of simultaneous administration of IL-12 which appears to upregulate Th1/Th2 expression.<sup>111</sup>

### Pregnant sows

**Vaccination of pregnant sows** induces SN antibodies, which are transferred to the newborn piglets and provide protection against infection. Vaccination during pregnancy produces more protection against PRV for piglets than sow vaccination before mating.<sup>112</sup> A better protection was observed in sows vaccinated with an attenuated virus than in sows vaccinated with inactivated virus.<sup>113</sup> Piglets rely on colostrum and milk antibodies for protection, and the vaccination of piglets born from vaccinated sows does not produce a significant serological response until the piglets are about 12 weeks of age. Earlier vaccination of piglets from infected or vaccinated sows is ineffective because high levels of maternal antibodies interfere with a serological response stimulated by the vaccine.<sup>114</sup> Maternal immunity interferes with the development of active immunity from vaccination until at least 15 weeks of age, even when the colostrum titers are low. Thus, in a situation in which the majority of sows have been infected or vaccinated, vaccination of weaned pigs may not yield desirable results. Both inactivated virus and attenuated live virus vaccines provide similar results when piglets born from vaccinated sows are vaccinated before colostrum immunity has waned.

### Growing and finishing pigs

The optimal vaccination strategy for growing and finishing pigs in an eradication program is controversial. In eight persistently infected herds vaccinations, both I/N and I/M<sup>115</sup> were made at 4 and 10 weeks of age.<sup>116</sup> Only one vaccination is given to finishing pigs in endemic areas in Europe. However, this does not reduce the prevalence of infection in finishing pigs in herds with a high prevalence. Double vaccination of finishing pigs will reduce the spread of the virus, but extensive spread can still occur.<sup>28</sup> The presence of maternal antibodies may interfere with the induction of antibodies, and double vaccination 4 weeks later may boost immunity. Mean daily weight gain was also improved by a second vaccination with a direct economic benefit.

### Marker or subunit vaccines

A major development in vaccination against pseudorabies has been the introduction of genetically engineered live vaccine strains used to make marker or subunit vaccines. Vaccination with modified live gene-deleted vaccines is now an integral part of pseudorabies eradication programs worldwide.<sup>117</sup> The most common gene deletions are for **glycoproteins E (gE) or gI and G (gG) or gX, and gIII.**<sup>118</sup> A gD/gE negative vaccine was described.<sup>119</sup> In Europe, use of **gE-**vaccines has become the standard. In the United States, a **gG-gE-** pseudorabies vaccine has been introduced.<sup>63</sup> These vaccines in conjunction with a **companion diagnostic test, can distinguish between naturally infected and vaccinated animals.** Colostrum can also be used to monitor antibodies against gI protein of the virus.<sup>120</sup>

A study comparing I/N and I/M vaccination showed that pigs given both vaccines (I/N and I/M) had a significantly better clinical and virological protection after challenge than the single I/N vaccination.<sup>121</sup> The recombinant vaccines are able to circumvent the inhibition of active immunity that occurs when maternally derived antibody is still present.<sup>117,122</sup> Animals vaccinated with a deleted vaccine are not able to mount an immune response against the protein whose gene has been deleted in the vaccine virus genome. In contrast, wild-type virus-infected animals produce antibodies against all the viral glycoproteins. Differentiating ELISAs, specific for the deleted marker protein, then allow discrimination between infected animals, which can be culled from the herd, and vaccinated animals. These vaccines reduce the severity of clinical disease and viral shedding. However, the presence of colostrum antibodies in growing pigs may

interfere with an immune response, which may result in increased virus excretion on challenge exposure. Repeated vaccination is needed to provide some protective immunity against challenge exposure to virulent virus.

These mutants have also been rendered thymidine kinase-deficient (TK-) mutants, and are avirulent and immunogenic. Pigs inoculated with these mutants are resistant to experimental challenge with the virulent virus, and the virulent virus cannot be recovered from the ganglia, which suggests that vaccination reduced colonization of the ganglia. The ideal vaccine strain should prevent clinical disease and mortality, should not be transmitted to non-immunized animals, should prevent colonization of the ganglia by a potential superinfecting virulent virus and thereby reduce the natural reservoir of the virus. The TK-mutant virus possesses these desirable characteristics. The high efficacy of recently constructed gI-negative deletion mutant vaccines of pseudorabies virus provide a sound basis for implementing the 'gI' approach to the future control of the disease.

Piglets born from sows vaccinated with deleted (gIII-, TK) strains at 3 days and 9 and 11 weeks of age developed detectable antibodies that lasted up to 100 days of age when vaccinated.<sup>123</sup> Maternal antibodies in piglets from sows vaccinated with gIII-deleted vaccine decay to undetectable levels at 7 weeks of age. Vaccination of these piglets at 3 days of age with the same vaccine results in a priming effect, which protects the piglets against virulent virus challenge at 7 weeks of age.<sup>124,125</sup> Thus, effective protection could be provided by active immunization from birth through weaning, in the nursery and into the growing and finishing stages of production.

Although genetically engineered live virus vaccines have been shown to be efficacious and safe, there is a possibility of spread between vaccinated and unvaccinated animals, of persistence in the field and of recombination between different vaccine strains, which can lead to enhanced virulence. New viral mutants lacking glycoproteins gD, gE, gG, and gI may form the basis for the development of new vaccines that do not recombine.<sup>126</sup> A gB deletion vaccine has been described for I/N use and has been shown to produce both local and serum antibodies.<sup>127</sup> Recently, a DNA vaccine was shown to give as good a response as gD plasmid vaccine but the DNA vaccine had to be given intradermally.<sup>128</sup> It can overcome maternally derived antibody<sup>129</sup> and the vaccine described in this case still gave protection against infectious PRV

challenge at the end of the finishing period.

Even more radical is a vaccine with a granulocyte-macrophage colony stimulating factor (GM-CSF) which has also been given in a DNWA formulation.<sup>130</sup>

Experimentally, immunized pigs can be latently infected with the wild-type virus without being detected by the gE-specific ELISA routinely used to discriminate between infected and vaccinated pigs.<sup>124</sup> Thus, gE seronegative pigs may still be infected and be a source of infection.

Remarkable progress has been made with the use of gI-deleted vaccines. Intensive regional vaccination of finishing pigs with a gI-deleted vaccine along with companion diagnostic tests, reduced the seroprevalence in infected finishing herds from 81% to 19% in 2 years.<sup>131</sup> Vaccination increases the virus dose needed for establishment of infection, and decreases the level and duration of virus excretion after infection. In the control group, with routine disease control, no significant change in seroprevalence occurred. The consistent application of intensive vaccination of all breeding herds in a region, including those herds participating in a production chain, can also decrease the prevalence of infection in heavily infected areas.<sup>132</sup> The intensive regional vaccination did not completely eliminate virus infections within these herds; the source of infection was not determined.<sup>31</sup> It is suggested that the virus either circulated at a low level within herds, or its introduction or reactivation did not lead to an extensive spread of the virus. A voluntary vaccination program on individual farms was unsuccessful in reducing the prevalence of virus-infected breeding pigs. The importation of breeding stock from outside the area is associated with a higher prevalence of virus-infected pigs because of lack of vaccination. The introduction of infections can be reduced by purchasing virus-free animals and by increasing farm biosecurity procedures.

Vaccination of breeding herds three times annually to insure a high level of immunization can lead to elimination of the disease when the reproduction ratio is less than 1.<sup>133</sup>

The method used for vaccination may influence the effect of the vaccine.<sup>134</sup> Using glycoprotein vaccines, IM vaccination in the neck, and six-point ID vaccination in the back provided the best protection; six-point ID injections resulted in a better vaccination than two-point injections. Body weight changes and viral excretion after challenge were compared with virus-neutralizing titers, antigen-specific IgG and IgA responses in

serum, and virus-specific lymphoproliferative responses in peripheral blood during the immunization period.

An intensive eradication program in farrow-finish herds using a gI-deleted vaccine in breeding and growing-finishing pigs, and decreases of movement, and mixing of growing-finishing pigs was successful in 3 years.<sup>135</sup> The initial goal was to decrease viral spread in the growing-finishing pigs, which enabled production of seronegative replacement gilts. Increases in the number of sows culled, combined with an increase in the number of seronegative replacement gilts, resulted in a decrease in seroprevalence of sows. Bimonthly serological monitoring indicated minimal spread of the virus in the growing-finishing pigs after 1 year. Beginning at 18 months after initiation of the program, test and removal of seropositive sows commenced in all herds. All herds were released from quarantine within 3 years, indicating that eradication can be achieved by vaccination and management changes designed to minimize the spread of virus combined with test-and-removal procedures.

An attenuated gI-deleted-TK-deleted vaccine was used to eradicate the virus from a large farrow-finish herd in Sweden.<sup>136</sup> At the start of the program, 86% of the breeding animals were seropositive. The breeding stock was vaccinated every 4 months and monitored serologically. Seropositive sows and boars were culled at an economic rate. The herd was declared gI-negative 39 months after the start of the program. Monitoring the herd for another 4 years, until all vaccinated animals had been culled, revealed the herd free of the virus.

In New Zealand, progress towards eradication using a subunit vaccine is reported.<sup>137</sup> Those farms that combined vaccination with good management techniques, intensive testing and culling eradicated the wild virus infection within 2 years; those that made little or no progress has less than satisfactory standards of hygiene and did not practise an intensive testing and culling program.

Vaccination of both breeding stock and growing pigs is recommended. A combined vaccination-eradication program for the disease would generally comprise four phases:

1. A systematic and intensive vaccination campaign
2. Screening of pigs for gI-antibodies
3. Economic culling of infected breeding pigs
4. Final ending of vaccination.

Piglets at 3 days of age can be vaccinated with one of these genetically engineered vaccines and be protected

from experimental challenge at 5 weeks of age.

A recent study has shown that infection with PRRSV does not inhibit the development of a vaccine-induced protection against PRV.<sup>138</sup>

• **Vaccination of cattle** with an inactivated vaccine is recommended where they are in close contact with swine and where a low level of exposure is likely.

## REVIEW LITERATURE

- Mulder WAM et al. Pseudorabies virus infections in pigs. Role of viral proteins in virulence pathogenesis and transmission. *Vet Res* 1997; 28:1–17.
- Vannier P. A review of Aujeszky's disease in Europe. *Pig J* 1998; 41:39–53.
- Vannier P. Licensing of vaccines in the European Union. *Adv Vet Med* 1999; 4:615–634.

## REFERENCES

- Mulder WAM et al. *Vet Res* 1997; 28:1.
- Miller GY et al. *Am J Vet Res* 1994; 55:628.
- Boelaert F et al. *Prev Vet Med* 1999; 41:239.
- Henderson JP et al. *Vet Rec* 1995; 136:555.
- Kimman TG et al. *Vet Rec* 1991; 128:103.
- Leek ML van der et al. *J Wild Dis* 1993; 29:403.
- Hall WF et al. *J Am Vet Med Assoc* 1991; 198:1927.
- Duffy SJ et al. *J Am Vet Med Assoc* 1991; 199:61.
- Duffy SJ et al. *J Am Vet Med Assoc* 1991; 199:66.
- Morrison RB et al. *J Am Vet Med Assoc* 1991; 199:580.
- Leontides L et al. *Prev Vet Med* 1995; 23:73.
- Nes A et al. *Prev Vet Med* 1998; 33:39.
- Nes A et al. *Vet Microbiol* 2001; 80:303.
- Siegel AM et al. *Prev Vet Med* 1993; 16:295.
- Austin CC et al. *Prev Vet Med* 1993; 17:161.
- Marsh WE et al. *Prev Vet Med* 1991; 11:249.
- Norman HS et al. *Am J Vet Res* 1996; 57:1563.
- Stegman A et al. *Prev Vet Med* 1995; 22:273.
- Schoenbaum MA et al. *J Am Vet Med Assoc* 1991; 198:
- Schoenbaum MA et al. *Am J Vet Res* 1990; 50:331.
- Rumsey CW. *Swine Hlth Prod* 1998; 6:80.
- Banks M. *Br Vet J* 1993; 149:155.
- Christensen LS et al. *Arch Virol* 1992; 124:225.
- Bouma A et al. *Prev Vet Med* 1995; 23:163.
- DeJong MCM, Dickmann OA. *Prev Vet Med* 1992; 12:269.
- DeJong MCD, Kimman TG. *Vaccine* 1994; 12:761.
- Leontides L et al. *Prev Vet Med* 1994; 20:63.
- Stegman A et al. *Am J Vet Res* 1995; 56:573.
- Bouma A et al. *Am J Vet Res* 1996; 57:43.
- Engel M et al. *Prev Vet Med* 1995; 24:245.
- Stegman A et al. *Prev Vet Med* 1996; 27:29.
- Bech-Nielsen S et al. *Prev Vet Med* 1995; 23:53.
- Heliez S. *Proc 3rd Int Symp PRRS and Aujeszky's Dis*. Ploufragan, France, 1999; p. 371.
- Christensen LS et al. *Vet Rec* 1993; 132:317.
- Gillespie RR et al. *Res Vet Sci* 1996; 60:228.
- Gloster J. *Vet Rec* 1984; 114:234.
- Scheidt AB et al. *J Am Vet Med Assoc* 1991; 199:725.
- Casal J et al. *Vet Rec* 1997; 140:672.
- Grant RH et al. *Int J Biometeorol* 1994; 38:33.
- Romero CH et al. *Vet Microbiol* 1997; 55:131.
- Chung AK. *Am J Vet Res* 1995; 56:45.
- Mengeling WL et al. *Am J Vet Res* 1992; 53:2164.
- White AK et al. *Am J Vet Res* 1996; 57:608.
- Brown TT et al. *Am J Vet Res* 1995; 56:587.
- Banks M et al. *Vet Rec* 1999; 145:362.
- Muller T et al. *Vet Rec* 1998; 143:337.
- Elbers ARW. *Tijdschr Diergen* 2001; 126:779.
- Muller T et al. *J Wild Dis* 1998; 34:251.
- Romero CH et al. *J Wild Dis* 2003; 39:367.

- Elbers ARW. *Revue Scient Tech Off IE* 2000; 19:848.
- Muller T et al. *Am J Vet Res* 2001; 62:252.
- Capua I et al. *Vet Microbiol* 1997; 57:143.
- Zupanec Z et al. *J Vet Med* 2002; B 49:253.
- Boersma WJA et al. *Vet Quart* 1998; 20:589.
- Nauwynck HJ, Pensaert MB. *Am J Vet Res* 1992; 53:489.
- Mengeling WL et al. *Arch Virol* 1991; 120:57.
- Bouma A et al. *Vet Microbiol* 1997; 58:145.
- Rooij EMA et al. *Vet Immunol Immunopathol* 2004; 99:113.
- Ebel ED et al. *J Am Vet Med Assoc* 1991; 198:2070.
- Miller GY et al. *J Am Vet Med Assoc* 1996; 208:208.
- Karger A. *J Virol* 1998; 72:7341.
- Brack AR. *J Virol* 1999; 73:5364.
- Klupp BG et al. *J Virol* 1998; 72:1949.
- Narita M et al. *J Comp Path* 1998; 118:329.
- Rassnick S et al. *J Virol* 1998; 72:9181.
- Ezura K et al. *J Vet Diag Invest* 1995; 7:451.
- Balasz G et al. *Vet Microbiol* 1998; 60:99.
- Iglesias GJ et al. *Can J Vet Res* 1992; 56:74.
- Parker RF et al. *Vet Pathol* 1997; 34:199.
- Rodriguez-Arriola GM et al. *Vet Rec* 1999; 144:152.
- Bastian S et al. *Epidem Sante Anim* 1999; 38:109.
- Scherba G et al. *J Vet Diag Invest* 1991; 3:306.
- Anelli J F et al. *Vet Rec* 1991; 128:49.
- Goyal SM, Laughlin TL. *J Vet Diag Invest* 1990; 2:350.
- Potier MF et al. *Vet Rec* 1998; 143:385.
- Atkinson G, Motha J. *Surveill* 1999; 26:8.
- Morenkov OS. *Acta Vet Hung* 1999; 47:137.
- Rodak L et al. *Vet Med* 2000; 45:13.
- Gut M. *Proc 16th Int Pig Vet Soc Cong* 2000; p. 555.
- Motha MXJ, Eernisse KA. *Vet Rec* 1992; 130:539.
- Duffy SJ et al. *J Am Vet Med Assoc* 1992; 200:499.
- Van Oirschot JT. *J Clin Microbiol* 1991; 29:5.
- Jestin A et al. *Res Vet Sci* 1990; 48:129.
- McCaw MB et al. *J Vet Diag Invest* 1995; 7:56.
- Jacobs L et al. *Res Vet Sci* 1999; 67:305.
- Szweda W, Przybylska-Gomowicz B. *Med Vet* 1997; 53:159.
- Schmidt SP et al. *J Vet Diag Invest* 1992; 4:206.
- Narita M et al. *J Vet Diag Invest* 1998; 10:36.
- Spencer Y, Done SH. *Pig J* 1999; 43:13.
- Grieco V et al. *J Vet Diag Invest* 1997; 9:326.
- Lange K de et al. *Vet Rec* 2003; 153:621.
- Siegel AM, Weigel RM. *Prev Vet Med* 1999; 40:243.
- Pallaghy A, Szabo I. *Pig J* 2000; 47:22.
- Deen J et al. *Swine Hlth Prod* 1999; 7:147.
- Rodrigues CA et al. *J Am Vet Med Assoc* 1990; 197:1316.
- Anderson H et al. *Prev Vet Med* 1997; 29:311.
- Vannier P et al. *Vet Microbiol* 1997; 55:167.
- Stewart D. *Pig J* 2001; 47:148.
- Thawley DG, Morrison RG. *J Am Vet Med Assoc* 1988; 193:184.
- Pannett GR et al. *Vet Rec* 1999; 144:765.
- Duinhof TF, Vesseur PC. *Proc 18th Int Pig Vet Soc Cong* 2004; p. 375.
- Muller T et al. *J Vet Med B* 2003; 50:207.
- Engel M, Wierup M. *Acta Vet Scand* 1999; 40:213.
- Bech-Nielsen S et al. *Prev Vet Med* 1995; 22:41.
- Siegel AM, Weigel RM. *Prev Vet Med* 1999; 40:243.
- Van Nes A et al. *Vet Microbiol* 1997; 55:147.
- Visser N. *Vet Microbiol* 1997; 55:61.
- Vilnis A et al. *Vet Microbiol* 1998; 62:81.
- Thacker B et al. *Proc Am Ass Swine Vet* 2003; p. 87.
- Katayama S et al. *Am J Vet Res* 1997; 59:657.
- Zuckermann FA et al. *Vet Immunol Immunopathol* 1998; 63:57.
- Casal J et al. *J Vet Med B* 2004; 51:8.
- Nauwynck HJ et al. *Zentbl Vet Med B* 1997; 44:609.

- Arelanno PE et al. *J Am Vet Med Assoc* 1992; 200:685.
- Labarque GG et al. *Vet Quart* 1999; 21:104.
- Maes DG et al. *Vet Rec* 1999; 145:607.
- firkins LD et al. *Am J Vet Res* 1997; 58:976.
- Gerdis V. *Vet Microbiol* 1999; 66:1.
- Peters B et al. *J Gen Virol* 1997; 78:3311.
- Boukamp FT et al. *Vet Rec* 1993; 133:591.
- Nauwynck HJ et al. *J Vet Med B* 1999; 46:713.
- Brockmeier SL, Brockmeier SL. *Vet Microbiol* 1997; 58:93.
- Elvinger F et al. *Vet Microbiol* 1994; 42:341.
- Jacobs L et al. *Am J Vet Res* 1996; 57:1525.
- Lawhorn B et al. *Vaccine* 1994; 12:601.
- Mettenleiter TC et al. *J Gen Virol* 1994; 75:1723.
- Takada A et al. *Jap J Vet Res* 1999; 47:25.
- Rouo E et al. *Vet Immunol Immunopathol* 1998; 66:113.
- Fischer L et al. *Vaccine* 2003; 21:1732.
- Somasundaram C et al. *Vet Immunol Immunopathol* 1999; 70:277.
- Stegeman JA et al. *Vaccine* 1994; 12:527.
- Stegeman A et al. *Am J Vet Res* 1994; 55:1381.
- Van Nes A et al. *Vaccine* 1996; 14:1042.
- Vanderpoten A et al. *Vet Microbiol* 1997; 55:81.
- Lehman J R et al. *J Am Vet Med Assoc* 1994; 205:1581.
- Engel M, Wierup M. *Vet Rec* 1997; 140:493.
- Motha MXJ et al. *Vet Rec* 1994; 135:204.
- Bruin MGM et al. *Vet Immunol Immunopathol* 2000; 76:125.

## VIRAL ENCEPHALOMYELITIS OF PIGS (TESCHEN DISEASE, TALFAN DISEASE IN THE UK, BENIGN ENZOOTIC PARESIS IN DENMARK, POLIOMYELITIS SUUM, PORCINE ENTEROVIRAL ENCEPHALOMYELITIS)

### Synopsis

**Etiology** Porcine enteroviruses capable of causing encephalomyelitis. Teschen virus, Talfan virus, and others

**Epidemiology** Certain European countries, Scandinavia, and North America. Morbidity 50%; case fatality 70–90%.

Teschen in Europe. Talfan in UK. Viral encephalomyelitis in North America.

Transmitted by direct contact

**Signs** Acute: Teschen. Fever, stiffness, unable to stand, tremors, convulsions, and death in few days

Subacute: Talfan. Milder than acute form. Most common in pigs under 2 weeks of age. Morbidity and case fatality rate 100%. Outbreaks. Hyperaesthesia, tremors, knuckling of fetlocks, dog-sitting, convulsions, blindness, and death in a few days. Milder in older growing pigs and adults

**Clinical pathology** Virus-neutralization tests

**Lesions** Non-suppurative encephalomyelitis

**Diagnostic confirmation** Demonstrate lesion and identify virus

**Differential diagnosis list:**

- Pseudorabies
- Hemagglutinating encephalomyelitis virus.

**Treatment** None

**Control** Outbreaks will cease and herd immunity develops

## ETIOLOGY

A number of closely related, but antigenically different, enteroviruses, capable of growth in tissue culture, are causes of encephalomyelitis in pigs.<sup>1</sup> Porcine enteroviruses comprising at least 13 serotypes are grouped into three groups.<sup>2,3</sup> They can cause neurological disturbances, infertility and dermal lesions in pigs. **Teschen virus**, initially isolated in Czechoslovakia, is the most virulent and there have been a number of independent isolates, such as the Konratice and Reporyje strains.<sup>4</sup> **Talfan virus**, isolated from England, and other unnamed isolates appear less virulent. Teschen and Talfan virus occur in subgroup 1, which is now called porcine enterovirus group 1 (PEV-1) but isolates from encephalomyelitis are also associated with other subgroups. In 2001 it was proposed that the teschoviruses be regrouped into three<sup>5</sup> with group 1 being the teschoviruses, group 2 the old PEV8 (V13 virus) and group 3 the old PEV9. In the system proposed<sup>6</sup> these are PEV-A and PEV-B. It is now proposed that the PEV-1 Talfan group be regarded as a new genus for the family Picornaviridae.<sup>7</sup> A recent study of group 2 suggests that it may have unique features and may be better called a new picornavirus genus.<sup>8</sup> Within subgroups, strains may be further differentiated using a complement fixation test and monospecific sera. There is variation in virulence between strains, and with many strains, clinical encephalitis following infection appears to be the exception rather than the rule.

## EPIDEMIOLOGY

### Occurrence and prevalence of infection

Prior to the early 1940s, the incidence of porcine viral encephalomyelitis was restricted to certain districts in Czechoslovakia. Since then, reports of the disease have come from many countries and there is serological evidence that the disease occurs throughout the world. The most severe form of the disease – Teschen disease – appears to be limited to Europe and Madagascar, but the milder forms – Talfan disease, poliomyelitis suum, and viral encephalomyelitis – occur extensively in Europe,<sup>9</sup> Scandinavia, and North America and recently in Japan.<sup>10</sup> A recent outbreak in Indiana has been described<sup>8</sup> and it was ascribed to porcine enterovirus serogroup 5 or 6 with the only characteristic feature being the histological lesions of polioencephalomyelitis. Losses due to the disease result primarily from deaths.

Serological surveys in areas where the disease occurs indicate that a high proportion of the pig population is infected without any clinical evidence of

the disease. In the majority of field occurrences, porcine encephalomyelitis is a sporadic disease affecting either one or a few litters, or a small number of weaned pigs.

### Morbidity and case fatality

The morbidity rate is usually about 50% and the case fatality rate 70–90% in Teschen disease as it is described in eastern Europe. The disease in Denmark and the United Kingdom is much milder, and the morbidity rate about 6%.

### Methods of transmission

Infection is transmitted by ingestion and the aerosol routes. The virus replicates primarily in the intestinal tract but also in the respiratory tract. When infection first gains access to a herd the spread is rapid and all ages of pigs may excrete virus in feces.

### Risk factors

#### Animal risk factors

Depending upon the virulence of the infecting strain, clinical disease primarily affects young pigs but may occur in older pigs at the same stage. As infection becomes endemic and herd immunity develops, excretion of the virus is largely restricted to weaned and early grower pigs. Adults generally have high levels of serum antibody, and suckling piglets are generally protected from infection by colostral and milk antibody. Sporadic disease in suckling pigs may occur in these circumstances in the litters of non-immune or low antibody sows, and may also occur in weaned pigs as they become susceptible to infection. In the recent outbreak in the USA the major factor was the rapid decline of the maternal antibody in the piglets (<21 days). Seroconversion then coincided with the increased mortality in the herd.

#### Pathogen risk factors

The causative viruses will infect only pigs and are not related to any of the viruses that cause encephalomyelitis in other species. They are resistant to environmental conditions, including drying, and are present principally in the central nervous system and intestine of affected pigs.

### PATHOGENESIS

The virus multiplies in the intestinal and respiratory tracts and may invade to produce viremia. Invasion of the CNS may follow, depending upon the virulence of the strains and the age of the pig at the time of infection.<sup>1</sup> There is some strain difference in the areas of the CNS primarily affected, which accounts for variations in the clinical syndrome, and it is possible for histopathological evidence of encephalitis to be present in pigs that

have shown no clinical signs of the disease. This may also occur with adenovirus infection.

## CLINICAL FINDINGS

### Acute viral encephalomyelitis (Teschen disease)

An incubation period of 10–12 days is followed by several days of fever (40–41°C, 104–106°F). Signs of encephalitis follow, although these are more extensive and acute after intracerebral inoculation. They include stiffness of the extremities, and inability to stand, with falling to one side followed by tremor, nystagmus, and violent clonic convulsions. Anorexia is usually complete, and vomiting has been observed. There may be partial or complete loss of voice due to laryngeal paralysis. Facial paralysis may also occur. Stiffness and opisthotonos are often persistent between convulsions, which are easily stimulated by noise and often accompanied by loud squealing. The convulsive period lasts for 24–36 hours. A sharp temperature fall may be followed by coma and death on the 3rd–4th day, but in cases of longer duration the convulsive stage may be followed by flaccid paralysis affecting particularly the hind limbs. In milder cases, early stiffness and weakness are followed by flaccid paralysis without the irritation phenomena of convulsions and tremor. In a recent case in the UK the pigs were off-color, showed anterior limb paralysis and were reluctant to rise and were therefore euthanased. Pigs were bright and keen to eat and drink.

### Subacute viral encephalomyelitis (Talfan disease)

This is called Talfan disease in the United Kingdom, viral encephalomyelitis in North America and Australia, and poliomyelitis suum in Denmark. The subacute disease is milder than the acute form, and the morbidity and mortality rates are lower. The disease is most common and severe in pigs less than 2 weeks of age. Older sucking pigs are affected also, but less severely and many recover completely. Sows suckling affected litters may be mildly and transiently ill. The morbidity rate in very young litters is often 100% and nearly all the affected piglets die. In litters over 3 weeks old there may be only a small proportion of the pigs affected. The disease often strikes suddenly – all litters in a piggery being affected within a few days – but disappears quickly, subsequent litters being unaffected. Clinically, the syndrome includes anorexia, rapid loss of condition, constipation, frequent vomiting of minor degree, and a normal or slightly elevated temperature. In some outbreaks, diarrhea may precede the onset of nervous signs. Nervous signs



appear several days after the illness commences. Piglets up to 2 weeks of age show hyperesthesia, muscle tremor, knuckling of the fetlocks, ataxia, walking backwards, a dog-sitting posture and terminally lateral recumbency, with paddling convulsions, nystagmus, blindness, and dyspnea. The Dresden type of Teschovirus caused an ataxia and recumbency in a large group of pigs about 5 days after removal of the sows and housing in the production unit.<sup>11</sup> Older pigs (4–6 weeks of age) show transient anorexia and posterior paresis, manifested by a swaying drunken gait, and usually recover completely and quickly. In the Japanese outbreak the pigs had at 40 days of age a flaccid paralysis of the hind limbs and became recumbent although they could move using their forelegs.<sup>10</sup> After the initial group of affected piglets the disease disappeared.

Individual instances or small outbreaks of 'leg weakness' with posterior paresis and paralysis in gilts and sows may also occur with this disease.

## CLINICAL PATHOLOGY

### Serology

Virus-neutralization and complement fixation are useful serological tests. Antibodies are detectable in the early stages and persist for a considerable time after recovery.

### Detection of virus

Virus is present in the blood of affected pigs in the early stages of the disease, and in the feces in very small amounts in the incubation period before signs of illness appear, but brain tissue is usually used as a source of virus in transmission experiments. A nested-PCR has recently been described in which all 13 serotypes and field isolates were detected<sup>2</sup> using three sets of primer pairs. It is more rapid and less time-consuming as a test than tissue culture and serotyping.

## NECROPSY FINDINGS

There are no gross lesions. Microscopically, there is a diffuse non-suppurative encephalomyelitis and ganglioneuritis with involvement of gray matter predominating. This takes the form of perivascular cuffing with mononuclear cells,<sup>10</sup> focal gliosis, neuronal necrosis and neuronophagia. The brain stem and spinal cord show the most extensive lesions, often with the most severe lesions in the cord. These take the form of degenerated or necrotic nerve cells in the ventral horns, glial nodules, occasional hemorrhage, and a diffuse infiltration of mononuclear cells. In the white matter the changes were not so severe.<sup>10</sup> Infiltration of mononuclear cells was also seen in the dorsal root ganglia (together

with degenerated ganglion cells and neuronophagia) spinal nerves and sciatic nerves. Swollen myelin sheaths and axonal spheroids were seen in the peripheral nerves. Meningitis, particularly over the cerebellum, is an early manifestation of the disease. No inclusion bodies are visible in neurons, in contrast to many cases of pseudorabies. Virus can be isolated from the brain and spinal cord early in the disease course, or from the blood during the incubation period. Recovery of the virus from the gastrointestinal tract does not confirm the diagnosis, as asymptomatic enteric infection is common. Isolation attempts may prove unrewarding, necessitating the correlation of clinical, serological and necropsy findings in order to confirm the diagnosis.<sup>2</sup> Recently, an experimental infection with PEV3 produced tremors and paralysis 3–7 days post-infection with all the animals having pericarditis and myocarditis.<sup>12</sup>

### Samples for confirmation of diagnosis

- **Histology** – one-half of mid-sagittally-sectioned brain, spinal cord including spinal ganglia, gasserian ganglion (LM)
- **Virology** – one-half of mid-sagittally-sectioned brain, spinal cord (ISO, FAT). In the recent German cases<sup>11</sup> the virus was isolated from all the tissues examined but not from the blood. A technique using monoclonal antibodies has been described that can be used either as an immunofluorescent agent or for immuno-electron microscopy.<sup>13</sup> New techniques using the reverse transcription polymerase chain reaction (RT-PCR) have recently been described that allow the distinction of both Porcine Teschoviruses (group I) and viruses of PEV1 and 2.<sup>14</sup> In the recent Japanese description cytopathogenic agents were recovered from the tonsil, brainstem and cerebellar homogenates. The PCR products from these were then sequenced and the isolate confirmed as PTV. Isolation of virus is not easy and needs to be from the brain and spinal cord. There are no firm indications of when to take material and a good consistent site in the brain for isolation as yet.<sup>15</sup>

## DIFFERENTIAL DIAGNOSIS

The diagnosis of diseases causing signs of acute cerebral disease in pigs is difficult because of the difficulty in neurological examination of pigs, and the diagnosis usually depends on extensive diagnostic laboratory work.

Pseudorabies and hemagglutinating encephalomyelitis virus disease are similar clinical syndromes. In general, viral diseases, bacterial diseases, and intoxications must be considered as possible groups of causes; careful selection of material for laboratory examination is essential. The differentiation of the possible causes of diseases resembling viral encephalomyelitis is described under pseudorabies.

## TREATMENT

There is no treatment.

## CONTROL

The sporadic occurrence of the disease in a herd is usually an indication that infection is endemic. When outbreaks occur the possibility that introduction of a new strain has occurred should be considered. However, by the time clinical disease is evident it is likely that infection will be widespread and isolation of affected animals may be of little value. A closed herd policy will markedly reduce the risk of introduction of new strains into a herd, but there is evidence that they can gain access by indirect means. The sporadic nature of the occurrence of most incidents of porcine encephalomyelitis does not warrant a specific control program.

Teschen disease is a different problem. Vaccines prepared by formalin inactivation of infective spinal cord and adsorption onto aluminium hydroxide have been used extensively in Europe. Two or three injections are given at 10- to 14-day intervals and immunity persists for about 6 months. A modified live virus vaccine is also available.

In the event of its appearance in a previously free country, eradication of the disease by slaughter and quarantine should be attempted if practicable. Austria reported eradication of the disease which had been present in that country for many years. A slaughter policy was supplemented by ring vaccination around infected premises.

## REVIEW LITERATURE

Long JF. Pathogenesis of porcine polioencephalomyelitis. In: Olsen RG et al. (ed) Comparative pathobiology of viral diseases, Vol. 1. Boca Raton: CRC Press, 1985; pp. 179–197.

## REFERENCES

1. Long JF. Pathogenesis of porcine polioencephalomyelitis. In: Olsen RG et al. (ed) Comparative pathobiology of viral diseases, Vol. 1. Boca Raton: CRC Press, 1985; pp. 179.
2. Zell R et al. *J Virol Meth* 2000; 88:205.
3. Zell R et al. *J Virol* 2001; 75:1620.
4. Edington N et al. *J Comp Path* 1972; 82:393.
5. Kaku Y et al. *J Gen Virol* 2001; 82:417.
6. Faquet CM, Pringle CR. *Arch Virol* 1999; 144:393.
7. Kaku Y et al. *Arch Virol* 1999; 144:1845.
8. Krumbholz A et al. *J Virol* 2002; 76:5813.
9. Done SH et al. *Pig J* 2005; 55:106.

10. Yamada M et al. *Vet Rec* 2004; 155:304.
11. Roost H et al. *Tierarztl Umsch* 2002; 57:653.
12. Shin T et al. *J Vet Med Sci* 2001; 63:1017.
13. Dauber M. *Vet Microbiol* 1999; 67:1.
14. Palmquist JM et al. *J Vet Diag Invest* 2002; 14:476.
15. Lynch JA et al. *Can J Comp Med* 1984; 48:233.

## **SPORADIC BOVINE ENCEPHALOMYELITIS (SBE, BUSS DISEASE, TRANSMISSIBLE SEROSITIS)**

Sporadic bovine encephalomyelitis (SBE) is associated with a chlamydia, and characterized by inflammation of vascular endothelium and mesenchymal tissue. There is secondary involvement of the nervous system, with nervous signs, in some cases.

### **ETIOLOGY**

The disease is associated with *Chlamydophila (Chlamydia) pecorum*.<sup>1,2</sup> It resists freezing but is highly susceptible to sodium hydroxide, cresol, and quaternary ammonium compounds in standard concentrations. The chlamydia can be passaged in guinea-pigs and hamsters, and adapted to grow in the yolk sac of developing chick embryos.

### **EPIDEMIOLOGY**

#### **Occurrence**

The disease has been reported only from the United States, Japan, and Israel but a provisional diagnosis has been made in Australia, where it is thought that the disease may have been present for some time, and in Canada, South Africa and Hungary. In the United States, it occurred most commonly in the midwestern and western States but there have been no reports of its occurrence for the last 30 years.

Sporadic cases or outbreaks occur in individual herds. Although the disease has not reached serious economic proportions in the endemic, there is some serological evidence that widespread subclinical infections occur.<sup>1</sup>

Only cattle and buffalo are affected, and calves less than 6 months of age are most susceptible. Other domestic and experimental species appear to be resistant. There is no seasonal incidence, cases appearing at any time of the year. A strong and apparently persistent immunity develops after an attack of the disease.

#### **Prevalence of infection**

##### **Morbidity and case fatality rates**

The occurrence is sporadic, but outbreaks have occurred resulting in severe loss due to both deaths of animals and loss of condition. Morbidity rates average 12.5% (5–50%), being highest in calves (25%) and lowest in animals over a year old (5%). Mortality rates average about 31% and are higher in adults than in calves. In

affected herds a stage of herd immunity is reached when only introduced animals and newborn calves are susceptible.

### **Method of transmission**

The method of spread is not known. Spread from farm to farm does not occur readily. On some farms only sporadic cases may occur, but on others one or two cases occur every year. In still other herds the disease occurs in outbreak form, with a number of animals becoming affected within a period of about 4 weeks. The epidemiology of SBE resembles in many ways that of bovine malignant catarrh (BMC). The organism can be isolated from many organs, including liver, spleen and central nervous system, and from the blood, feces, urine, nasal discharges, and milk in the early stages of the disease. There is some evidence that the organism is eliminated in the feces for several weeks after infection.

### **PATHOGENESIS**

The causative agent is not specifically neurotropic and attacks principally the mesenchymal tissues and the endothelial lining of the vascular system, with particular involvement of the serous membranes. Encephalomyelitis occurs secondarily to the vascular damage.

### **CLINICAL FINDINGS**

Affected calves are depressed and inactive, but the appetite may be unaffected for several days. Nasal discharge and salivation with drooling are frequently observed. A fever is common (40.5–41.5°C, 105–107°F), and remains high for the course of the disease. Dyspnea, coughing, a mild catarrhal nasal discharge, and diarrhea may occur. During the ensuing 2 weeks, difficulty in walking and lack of desire to stand may appear. Stiffness with knuckling at the fetlocks is evident at first, followed by staggering, circling, and falling. Opisthotonos may occur but there is no excitement or head-pressing. The course of the disease varies between 3 days and 3 weeks. Animals that recover show marked loss of condition and are slow to regain the lost weight.

### **CLINICAL PATHOLOGY**

#### **Hematology**

In experimental cases, leukopenia occurs in the acute clinical stage. There is a relative lymphocytosis and depression of polymorphonuclear cells.

#### **Detection of agent**

The causative agent can be isolated from the blood in the early clinical phase, and can be used for transmission experiments in calves and guinea pigs, and for culture in eggs. Elementary bodies are present in the guinea-pig tissues and yolk-sac preparations.

### **Serology**

Serological methods, including a complement fixation test for the detection of circulating antibody, are available although there is difficulty in differentiating antibodies to the chlamydia from those to the typical psittacosis virus.

### **NECROPSY FINDINGS**

A fibrinous peritonitis, pleurisy and pericarditis, accompanied by congestion and petechiation are characteristic. In the early stages, thin serous fluid is present in the cavities, but in the later stages this has progressed to a thin fibrinous net covering the affected organs, or even to flattened plaques or irregularly shaped masses of fibrin lying free in the cavity. Histologically, there is fibrinous serositis involving the serosa of the peritoneal, pleural, and pericardial cavities. A diffuse encephalomyelitis involving particularly the medulla and cerebellum, and a meningitis in the same area are also present. Minute elementary bodies are present in infected tissues and in very small numbers in exudate. The necropsy findings are diagnostic for SBE and confirmation can be obtained by the complement fixation test or serum neutralization tests.

### **DIFFERENTIAL DIAGNOSIS**

Clinically, the disease resembles other encephalitis of cattle. The epidemiology and pathogenesis resembles bovine malignant catarrh (BMC), but the mortality rate is much lower, there are no ocular or mucosal lesions, and the serositis of SBE does not occur in bovine malignant catarrh. A viral encephalomyelitis of calves (Kunjin virus) has been identified, but has not been associated with clinical signs of disease of the nervous system. An encephalomyocarditis virus, a primary infection of rodents that also occurs in primates and causes myocarditis in pigs, has been transmitted experimentally to calves but without causing significant signs of disease.

**Listeriosis** is usually sporadic and is accompanied by more localizing signs, especially facial paralysis and circling.

**Rabies** may present a very similar clinical picture, but the initial febrile reaction and the characteristic necropsy findings as well as the epizootiological history of SBE should enable a diagnosis to be made.

**Lead poisoning** can be differentiated by the absence of fever, the more severe signs of motor irritation, and the shorter course of the disease. Because of the respiratory tract involvement, SBE may be easily confused with pneumonic pasteurellosis, especially if outbreaks occur, but in the latter disease nervous signs are unusual and the response to treatment is good.

## TREATMENT

Broad-spectrum antimicrobials control the agent *in vitro*. However, clinical results with chlortetracycline and oxytetracycline have been irregular, but may be effective if used in the early stages of the disease.

## CONTROL

Control measures are difficult to prescribe because of lack of knowledge of the method of transmission. It is advisable to isolate affected animals. No vaccine is available.

## REFERENCES

1. Jee J et al. *J Clin Microbiol* 2004; 42:5664.
2. Longbottom D. *Vet J* 2004; 168:9.

## OVINE ENCEPHALOMYELITIS (LOUPING-ILL)

### Synopsis

**Etiology** Louping-ill virus, flavivirus  
**Epidemiology** Disease of sheep (and red grouse), and occasionally other domestic animals and man, transmitted by *Ixodes ricinus*. Occurs predominantly in lambs and yearling sheep in Great Britain and Europe in the spring, associated with tick rise  
**Clinical findings** Fever, neurological dysfunction, muscle tremor, incoordination, bounding gait. Recovery or convulsions and death  
**Lesions** Non-suppurative encephalitis  
**Diagnostic confirmation** Serology, demonstration of virus  
**Control** Vaccination, tick control

## ETIOLOGY

Louping-ill virus belongs to the genus *Flavivirus*, which is divided into eight groups, one of which is the tick-borne encephalitis group. Louping-ill is antigenically related to the tick-borne encephalitis viruses most of which cause disease in man but not in sheep. Louping-ill virus occurs in Great Britain and Norway, but similar disease occurs elsewhere and there is antigenic diversity between isolates from different geographic areas. Viruses that are closely related to louping-ill virus, and that cause very similar disease but in different regions of the world, include **Russian spring-summer encephalitis virus, Turkish sheep encephalitis virus, Spanish sheep encephalitis virus** and **Greek goat encephalomyelitis**.<sup>1-3</sup> In sheep, concurrent infection with the agent of tick-borne fever *Ehrlichia (Cytoecetes) phagocytophila* enhances the pathogenicity of the virus.<sup>4</sup>

## EPIDEMIOLOGY

### Occurrence

#### Geographic occurrence

Louping-ill was originally considered to be restricted to the border counties of Scotland and England but is now

recognized as also occurring in **upland grazing areas** of Scotland, in Ireland, south west England, and in Norway; related viruses and disease occur in Spain, Bulgaria, and Turkey.<sup>2,3,5</sup> The distribution of the disease is regulated by the occurrence of the **vector tick** *Ixodes ricinus*, which requires suitable hosts and a ground layer microclimate of high humidity throughout the year. In these areas, louping-ill can be a common infection and may be a significant cause of loss.

### Host occurrence

Louping-ill virus can infect and produce disease in a wide variety of vertebrates including man, but **predominantly sheep** are affected because of their susceptibility and the fact that they are the main domestic animal species that graze the tick-infested areas.

While sheep (and red grouse) are the only animals that commonly develop clinical disease, *Ixodes ricinus* feeds on a number of different hosts and the adult tick requires a large mammalian host. As a consequence, seropositivity and occasional clinical disease occur in all **other domestic species**, especially goat kids, but also cattle, horses,<sup>6</sup> pigs,<sup>7</sup> and humans.<sup>8</sup>

Traditionally, pigs have not been free-ranged on upland tick-infested areas,<sup>7</sup> but they are susceptible to experimental infection by all routes.

Red deer (*Cervus elaphus*) and roe deer (*Capreolus capreolus*) are hosts for the tick in Scotland,<sup>9</sup> and the elk (*Alces a. alces*) may be in Sweden. Infection in these species is usually sub-clinical; however, when these animals are subjected to the stress of captivity, clinical illness is more likely to occur. This may be important to commercial deer farmers.<sup>10</sup>

## Transmission

### Tick transmission

The reservoir for the disease and the major vector is the **three host tick** *I. ricinus*, which requires a single blood meal at each stage of development. The tick feeds for approximately 3 weeks every year and completes its life cycle in 3 years. The larval and nymphal stages will feed on any vertebrate but the **adult female** will engorge and mate only on larger mammals.<sup>3,9</sup> The tick becomes infected by feeding on a viremic host and the virus translocates to the salivary gland of the subsequent stage to provide a source of infection at feeding in the following year. Transtadial transmission of the virus occurs, but transovarial transmission does not, and thus only the nymph and adult ticks are capable of transmitting the disease. The activity of the tick is **seasonal**. The tick is active at temperatures between

7 and 18°C, and most ticks feed in the spring with peak activity dependent upon the latitude and elevation of the pasture but generally occurring in April and May. In some areas there is a second period of activity of a separate population of *I. ricinus* in the autumn during August and September. While infected ticks can transmit the infection to a large number of vertebrate hosts, only sheep, red grouse (*Lagopus scoticus*), and possibly horses attain a viremia sufficient to infect other ticks and act as **maintenance hosts**.<sup>3,4,9</sup> Grouse amplify the virus, deer amplify the vector and hares (*Lepus timidus*) amplify both. Infection in red grouse is accompanied by a high mortality, and the louping-ill virus is essentially maintained in an area by a sheep-tick cycle and hare tick cycle.<sup>9</sup>

### Non-tick transmission

Although the major method of spread is by the bites of infected ticks, spread by **droplet infection** is of importance in man, and the infection can be transmitted in animals by hypodermic needle contamination and other methods. The virus is not very resistant to environmental influences and is readily destroyed by disinfectants. Pigs fed the carcasses of sheep that had died of louping-ill become infected with the louping-ill virus. The virus is excreted in the **milk** of experimentally infected female goats, and infects sucking kids to produce an acute disease.<sup>11</sup> Virus is also excreted in the milk of ewes during the acute stages of infection but, paradoxically, does not result in the transmission of the infection to lambs. Grouse can be infected by eating infected ticks and this is considered a major mechanism of infection for grouse.<sup>11</sup>

## Host and environmental risk factors

The epidemiology of disease is dictated by the biology of the tick, and disease is **seasonal** with occurrence during spring when the ticks are active. The prevalence of infection, as measured by seropositivity, is high in areas where the disease is enzootic. In these areas, the annual incidence of disease varies but there are cases every year and they occur predominantly in **yearlings and in lambs**. In enzootic areas, the majority of the adult sheep have been infected and are immune. Colostral immunity from these ewes will protect their lambs for approximately 3 months and these lambs are resistant to infection during the spring rise of the ticks. Ewe lambs that are retained in the flock are susceptible to infection at the second exposure the following spring.

The proportion of infected animals that develop clinical disease in any year is estimated to vary from 5 to 60% and

is influenced by the intensity of the tick vector, the immune status of the flock, the age at infection, nutritional status, and factors such as cold stress, herding and transport, and the occurrence of intercurrent disease.<sup>3,4,9</sup> **Naive animals** introduced to an enzootic area are at high risk for infection and clinical disease.

**Intercurrent infection** with *Ehlichia* (*Cytoecetes*) *phagocytophilia* and *Toxoplasma gondii* have been shown to increase the severity of experimental tick-borne fever in young lambs, but the relevance of this association to naturally occurring disease is uncertain. It would appear that concurrent infection with louping-ill and tick-borne fever is unlikely to occur in the field in young lambs because colostral immunity will protect against infection with the louping-ill virus, whereas colostral immunity is not protective against tick-borne fever. Similarly, the superinfection of *Rhizomucor pusillus* on this concurrent infection has been observed in experimental conditions, but is not a commonly recorded observation in natural disease.

#### Zoonotic implications

Louping-ill is a zoonosis.<sup>8</sup> The major risk for veterinarians is with the **postmortem** examination and handling of tissues from infected animals. Laboratory workers are also at risk. Shepherds and abattoir persons who handle infected sheep are also at risk. The occurrence of virus in the milk of goats and sheep is a risk for human disease where **raw milk** is consumed.

#### PATHOGENESIS

After tick-borne infection, the virus proliferates in the regional lymph node to produce a **viremia** which peaks at 2–4 days and declines with the development of circulating antibody prior to the development of clinical disease. Invasion of the central nervous system occurs in the early viremic stage in most if not all infected animals, but in most the resultant lesions are small and isolated and there is no clinical neurological disease.<sup>12</sup> The occurrence of clinical disease is associated with the replication of the virus in the brain, severe inflammation throughout the central nervous system, and necrosis of **brainstem** and **ventral horn neurons**. The reason for more severe disease in some animals appears to be related to the rapidity and extent of the immune response. Animals that survive exposure to louping-ill virus have an earlier immune response to the infection and have high concentrations of antibody in the cerebrospinal fluid.

In experimental studies, there is a more severe and prolonged viremia and a higher mortality from louping-ill when there is concurrent infection with tick-

borne fever. Sheep with tick-borne fever have severe neutropenia, lymphocytopenia, defective cellular and humoral immunological responses,<sup>13</sup> and the high mortality associated with concurrent infection with this agent is believed due to enhanced viral replication of the louping-ill virus.<sup>3</sup>

The dual infection in experimental sheep also facilitates fungal invasion and a systemic mycotic infection with *Rhizomucor pusillus*.<sup>4</sup>

#### CLINICAL FINDINGS

In most **sheep**, infection is inapparent. There is an incubation period of 2–4 days followed by a sudden onset of high fever (up to 41.5°C, 107°F) for 2–3 days followed by a return to normal. In animals that develop **neurological disease** there is a second febrile phase during which nervous signs appear. Affected animals stand apart, often with the head held high and with twitching of the lips and nostrils. There is marked tremor of muscle groups and rigidity of the musculature, particularly in the neck and limbs. This is manifested by jerky, stiff movements and a **bounding gait**, which gives rise to the name 'louping-ill'. Incoordination is most marked in the hindlimbs. The sheep walks into objects and may stand with the head pressed against them. Hypersensitivity to noise and touch may be apparent. Some animals will recover over the following days, although there may be residual torticollis and posterior paresis. In others, the increased muscle tone is succeeded by recumbency, convulsions and paralysis, and death occurs as early as 1–2 days later. Young lambs may die suddenly with no specific nervous signs.

The clinical picture in **cattle** is very similar to that observed in sheep, with hyperesthesia, blinking of the eyelids and rolling of the eyes, although convulsions are more likely to occur in cattle, and in the occasional animals that recover from the encephalitis there is usually persistence of signs of impairment of the central nervous system.

**Horses** also show a similar clinical picture to sheep, with some showing a rapidly progressing nervous disease with a course of approximately 2 days and others a transient disorder of locomotion with recovery in 10–12 days.

The infection is usually subclinical in adult **goats** but the virus is excreted in the milk and kids may develop severe acute infections. In **humans** an influenza-like disease followed by meningoencephalitis occurs after an incubation period of 6–18 days. While recovery is common, the disease can be fatal and residual nervous deficiencies can occur.<sup>8</sup>

#### CLINICAL PATHOLOGY

The initial viremia that occurs with infection declines with the emergence of serum antibody and virus is no longer present in the blood at the onset of clinical signs. Hemagglutination inhibition, complement-fixing and neutralizing antibodies can be detected in the serum of recovered animals. Hemagglutination inhibition and complement-fixing antibodies are relatively transient, but neutralizing antibodies persist. **Hemagglutination inhibition** IgM antibody develops early in the disease and can be used as an aid to diagnosis in animals with clinical disease.<sup>3</sup> Analysis of CSF is usually not considered because of the zoonotic risk.

#### NECROPSY FINDINGS

No gross changes are observed. Histologically, there are perivascular accumulations of cells in the meninges, brain and spinal cord, with neuronal damage most evident in cerebellar Purkinje cells and, to a lesser extent, in the cerebral cortex. Louping-ill virus can be demonstrated in formalin-fixed tissues by the **avidin-biotin-complex immunoperoxidase** technique.<sup>14</sup>

#### Samples for confirmation of diagnosis

- **Virology** – chilled brain, halved mid-sagittally (VI)
- **Histology** – fixed brain, other half (LM, IHC).

#### DIFFERENTIAL DIAGNOSIS

The disease is restricted to areas where the vector tick occurs and this allows or denies a possible diagnosis.

- In lambs, the disease has clinical similarities with delayed swayback, spinal abscess, and some cases of tick pyemia. Spinal abscess occurs shortly following a management procedure such as docking or castration or with tick pyemia; it has a longer clinical course, is commonly present at C7–T2, and can be established by radiographic examination. Tick pyemia can also occur in flocks that have louping-ill and the determination of the contribution of each disease to flock mortality relies on clinical, epidemiological, and postmortem examination
- In yearlings, the disease has similarities to spinal ataxia due to trauma, to gid (*Coenuris cerebialis*), and to the early stages of polioencephalomalacia
- In adults, the disease in sheep bears resemblance to some stages of scrapie, tetanus, hypocalcemia, hypomagnesemia, pregnancy toxemia, and ovine kangaroo gait.

## TREATMENT

An antiserum has been used and affords protection if given within 48 hours of exposure, but is of no value once the febrile reaction has begun. It is not available commercially. Animals with clinical disease should be sedated if necessary during the acute course of the disease, and should be kept in a secluded and dark area with general supportive care.

## CONTROL

The prevention of louping-ill requires either the prevention of exposure of sheep to tick-infested pastures or the immunization of animals prior to exposure. **Immunization** has been the traditional approach.

Historically, a formalinized tissue vaccine derived from brain, spinal cord, and spleen was used, and provided excellent immunity in enzootic areas. The vaccine was not without risk for persons manufacturing it and at one stage led to an outbreak of scrapie where the vaccine was prepared from sheep incubating the disease. Currently, vaccination is with a formalin-killed tissue culture derived vaccine where the virus has been concentrated ten-fold by methanol precipitation or ultrafiltration.<sup>15</sup> The vaccine is administered in an oil adjuvant. A single dose of this vaccine will give protection for at least 1 year and possibly up to 3 years, and has been shown to give excellent results in field trials. The vaccine is used in the autumn, or in the early spring 1 month before the anticipated tick rise, in all ewe lambs that will be held for flock replacements. Vaccination of pregnant ewes twice in late pregnancy is recommended to insure adequate passive immunity to the lambs via the colostrums.<sup>15</sup> A recombinant vaccine has also been shown to offer protection against infection.<sup>16</sup>

The limited geographical occurrence of this disease and commercial economics has, and may, restrict the availability of vaccines. Consequently **tick control**, or the elimination of infection from pastures, may be the required approach in the future. The intensity of tick infestation of pastures can be reduced by influencing the microclimate that they require for survival. In some areas this can be achieved by ditching and drainage of the pastures. The control of the causative tick using acaricides is detailed in the section on ticks and provides some protection against disease.

Epidemiological, modeling, and experimental studies indicate that sheep and red grouse and hares are the only maintenance hosts for the virus<sup>9,11</sup> and this, coupled with the fact that there is no transovarial transmission of the virus in the tick, offers a potential method for eradication of the infection from an area.

This approach, the elimination of grouse and hares, would be radical and would require an economic assessment of its benefit-cost in relation to alternate methods of control.

## REVIEW LITERATURE

- Brodie TA, Holmes PH, Urquhart GM. Some aspects of tick-borne diseases of British sheep. *Vet Rec* 1986; 118:415-418.
- Reid HW. Ticks and tick-borne diseases. *Goat/Vet Soc J* 1986; 7:21-25.
- Reid HW. Controlling tick-borne diseases of sheep in Britain. In *Practice* 1987; 9:185-191.
- Hudson PJ et al. Persistence and transmission of tick-borne viruses: *Ixodes ricinus* and louping-ill in red grouse populations. *Parasitology* 1995; 111:S49-S58.
- Reid HW. Louping ill. In: Monath T (ed) *The arboviruses: epidemiology and ecology*, Vol III. Boca Raton, Florida: CRC Press, 1988; pp. 117-135.
- Reid HW. Louping ill. In *Practice* 1991; 13:157-160.
- Gritsun TS, Lashkevich VA, Gould EA. Tick-borne encephalitis. *Antiviral Res* 2003; 57:129-146.

## REFERENCES

- Hubalek Z et al. *Acta Virol* 1995; 39:251.
- Martin MS et al. *Res Vet Sci* 1995; 58:11.
- Reid HW. In *Practice* 1993; 13:157.
- Reid HW et al. *Res Vet Sci* 1986; 41:56.
- Gonzales L et al. *Vet Rec* 1987; 121:12.
- Reid HW et al. *Vet Rec* 1981; 108:497.
- Ross HM et al. *Vet Rec* 1994; 134:99.
- Davidson MM et al. *J Infect* 1991; 23:241.
- Gilbert L et al. *J Anim Ecol* 2001; 70:1953.
- Reid HW et al. *Vet Rec* 1987; 102:463.
- Gilbert L et al. *Proc Royal Soc Lond B* 2004; 271 (Suppl 4): S202.
- Sheahan BJ et al. *J Comp Pathol* 2002; 126:137.
- Larson HJS et al. *Res Vet Sci* 1994; 56:216.
- Krueger N, Reid HW. *Vet Rec* 1994; 135:224.
- Reid HW, Pow I. *Vet Rec* 1995; 136:638.
- Morris-Downs MM et al. *Vaccine* 2001; 19:3877.

## CAPRINE ARTHRITIS ENCEPHALITIS (CAE)

### Synopsis

**Etiology** Retrovirus

**Epidemiology** Persistent infection with perinatal and horizontal spread. Management of herd influences extent of seropositivity

**Clinical findings** This disease of goats is characterized by arthritis, especially of the carpal joints (big knee), in mature goats, and acute leukoencephalomyelitis in young goats. Indurative mastitis, and less commonly chronic pneumonia and chronic encephalomyelitis, occur in older goats

**Clinical pathology** Increased mononuclear cell count in CSF. Lower or inverted CD4:CD8 ratio in peripheral blood

**Lesions** Chronic polysynovitis, degenerative joint disease in adults. Non-suppurative demyelinating encephalomyelitis. Interstitial pneumonia

**Diagnostic confirmation** Microscopic lesions and agar gel immunodiffusion test (AGID)

**Treatment** None

**Control** Segregation of the newborn from seropositive animals, and feeding of virus-free colostrum and milk. Prevention of horizontal transmission. Regular testing with segregation or culling

## ETIOLOGY

Caprine arthritis encephalitis (CAE) viruses are non-oncogenic retroviruses belonging to the subfamily Lentivirinae. The causal viruses are not identical but are of a single virus type, and genetically distinct isolates may have different virulence. Antigenic drift is common and may facilitate the persistence of the virus in the host and the development of disease. There is a high degree of relatedness with the lentivirus associated with maedi-visna and ovine progressive pneumonia in sheep; the ovine and caprine lentiviruses share nucleotide homology and serological properties,<sup>1</sup> and there is a similarity in the disease pathogenesis.

## EPIDEMIOLOGY

### Geographic occurrence

There is serological evidence of infection in most areas of the world, including Europe, the United Kingdom, North America, Africa, Arabia, Australia, New Zealand, and South America.<sup>2</sup> While there is sampling bias, one global study indicates that there are marked differences in prevalence between countries and that the prevalence is noticeably less in developing countries that have not had importations of dairy-type goats from North America or Europe. Other countries, such as New Zealand, have a low prevalence with a distribution related to exotic importations.<sup>3</sup>

There may also be variation in seroprevalence within countries. In the United States, the prevalence of infection in goats in the western and middle parts of the country is approximately 50% of all goats tested, which is about twice that in the eastern and Rocky Mountain areas.<sup>3,4</sup> Herd seroprevalence is greater than 60% in all regions. The seroprevalence within herds shows clustering, with most herds falling into either high or low seroprevalence groups. There are area differences in age prevalence of seropositivity, with some surveys showing no difference and others showing an increasing prevalence with increasing age.<sup>3,5,6</sup>

Clinical disease is much less common than infection and the annual incidence of disease in heavily infected flocks is usually low and approximates 10%.

### Host risk factors

Breeds

**All breeds** are susceptible to infection but several studies have recorded apparent differences in breed susceptibility, which may reflect differences in management practices such as feeding practices of colostrum and milk, or genetic differences in susceptibility.<sup>2,4,6,7</sup> There is a higher prevalence of seropositive goats in family-owned farms as compared to institutional herds, which might reflect a greater movement of goats among the former.<sup>3</sup>

### Age

There is no age difference in susceptibility to experimental infection. Some herds show similar seroprevalence across age groups, while others show an increasing seroprevalence with increasing age. These differences probably reflect differences in management between herds and differences in the relative importance of the mechanisms of transmission between herds. Increasing prevalence with age reflects management systems that increase the risk of acquiring infection from horizontal transmission. Leukoencephalomyelitis occurs predominantly in young kids and arthritis in older goats.

### Method of transmission

Greater than 75% of kids born to infected dams may acquire infection, and infection can potentially be transmitted to them by several routes. Infection can also occur in older goats by different routes.

#### Colostrum and milk

Observation of the natural disease and experimental studies indicate that the **primary mode** of transmission is through the colostrum and milk. The presence of antibody in colostrum does not prevent infection. The virus can be isolated both from the cells in the milk and from cell-free milk from infected dams; kids born of non-infected dams but fed colostrum and/or milk from infected dams become infected.<sup>7</sup> A single feeding of infected milk can be sufficient to infect a kid.<sup>8</sup> Conversely, the risk of infection is much lower in kids that are removed from the doe immediately after birth and reared on pasteurized milk, and some can be reared free from infection.<sup>9</sup>

#### Other perinatal transmission

It is probable that intrauterine infection can occur, but this appears to be of infrequent occurrence and not of significance to the control of the disease.<sup>4,7</sup> The disease can be transmitted by contact both during and following the perinatal period, and perinatal transmission is important in the epidemiology of the disease. Perinatal transmission could result from contact with vaginal secretions, blood, saliva or respiratory secretions but the relative importance of these is not known.

#### Contact transmission

Horizontal transmission occurs at all ages and older goats can be infected by oral challenge with virus.<sup>10</sup> Contact transmission will result in the spread of the disease when an infected animal is introduced into an infection-free herd and has been one cause of spread in countries where the infection has been introduced with imported animals.

Prolonged **co-mingling** of uninfected with infected animals is likely to promote horizontal transmission.

#### Other routes

Milk contains free virus and virus-infected cells and shared **milking** facilities increase the risk of cross-infection. Possibly this results from the transfer of infected cells in milk during the milking process. **Iatrogenic** and **venereal** transmission are possible but appear of limited significance.<sup>7</sup>

### Experimental reproduction

**Arthritis and mastitis** have been reproduced by oral, intravenous and intra-articular challenge with virus; however, pneumonia is not a feature of the experimental disease. **Leukoencephalomyelitis** in young lambs can be reproduced by intracerebral challenge but this form of the disease has not been reproduced by more natural challenge routes. Strains of the virus can be **neuroadapted** by passage and show increased neurovirulence but not neuroinvasiveness, suggesting that these are separate characteristics.<sup>10,11</sup>

The relatedness of the caprine and the ovine lentiviruses is evident with experimental infections. Experimentally, infection with the caprine virus has been transferred to lambs by feeding them infected colostrum or by injection. Experimental infection of lambs is followed by viremia and seroconversion, but some strains of the virus produce no clinical or histopathological evidence of disease. Kids have been similarly infected with the maedi virus. The arthritic form of the disease has been produced experimentally in Cesarean-derived kids injected with virus isolated from the joints of infected goats. Despite these experimental cross-species transmissions, there is no evidence for cross-species transmission in the field.<sup>7</sup>

### Economic importance

There is a high prevalence of infection in many countries, and several of these have opted for national or breed-associated control programs. There is a higher **cull rate** in infected herds, as high as 5–10% of goats are culled each year for arthritis, and affected animals cannot be entered for show. Seropositive herds have a higher incidence of disease.<sup>12</sup>

There are conflicting reports on the effect of infection on **productivity** in goat herds,<sup>12–15</sup> but seropositive goats are reported to have significantly lower milk production, a reduced length of lactation, lower 300-day yields of milk, and impaired reproductive performance.<sup>13,14</sup>

### PATHOGENESIS

Animals infected at birth remain persistently infected for life, although only a

proportion develop clinical disease. The virus persistently infects a proportion of cells of the monocyte-macrophage type, and the expression and shedding of virus occurs as infected monocytes mature to macrophages.<sup>16,17</sup> Disease is the result of inflammation resulting from the reaction of the host immune system to expressed virus. The development of neutralizing antibody does not arrest viral replication because of the continual expression of antigenic variants of the virus with differing type-specific neutralization epitopes.<sup>18,19</sup> However, the immune complexes are believed to be the basis for the chronic inflammatory changes in tissues.<sup>20</sup> Goats that are vaccinated with the virus develop more severe clinical disease following challenge than non-vaccinated controls. The lesions are **lymphoproliferative** in nature and the virus causes a multisystem disease syndrome, which primarily involves synovial-lined connective tissue causing chronic arthritis, the udder causing swelling and hardening of the glands, with or without mastitis, and the lungs causing a chronic interstitial pneumonia.

A retrovirus infection, detected by electron microscopy and the presence of reverse transcriptase activity is suspected as the cause of an immunodeficiency syndrome in llamas characterized by failure to thrive, anemia, leukopenia, and recurrent infection.<sup>21</sup>

### CLINICAL FINDINGS

#### Joints

**Arthritis** occurs predominantly in adult goats and is a chronic hyperplastic synovitis, which is usually noticeable only in the **carpal joints**, giving rise to the lay term of **big knee**. Tarsal joints may also be clinically affected. The onset may be insidious or sudden, and unilateral or bilateral. If the goat is lame in the leg, lameness is not severe. Affected goats may live a normal life span but some lose weight gradually, develop poor hair coats, and eventually remain recumbent most of the time with the consequent development of decubitus ulcers. Dilatation of the atlantal and supraspinous bursae occurs in some cases. The course of the disease is long, lasting several months. The arthritis may be accompanied by enlargement and hardening of the udder and by interstitial pneumonia, although this may be clinically inapparent. There can be **herd and area differences** in the clinical expression of the disease, and in some outbreaks in Australia pneumonia has been a prominent feature.

**Radiographically**, there are soft tissue swellings in the early stages, and calcification of periarticular tissues and osteophyte production in the later stages.

Quantitative joint scintigraphy provides an accurate non-invasive method for assessing the severity of the arthritis in a live animal.<sup>22</sup>

### Brain

**Leukoencephalitis** occurs primarily in kids from 1 to 5 months of age. The syndrome is characterized by unilateral or bilateral posterior paresis and ataxia. In the early stages, the gait is short and choppy, followed by weakness and eventually recumbency. In animals that are still able to stand, there may be a marked lack of proprioception in one hindlimb. Brain involvement is manifested by head tilt, torticollis and circling. Affected kids are bright and alert, and drink normally. Kids with unilateral posterior paresis usually progress to bilateral posterior paresis in 5–10 days. The paresis usually extends to involve the forelimbs so that tetraparesis follows. Most kids are euthanized. The interstitial pneumonia that commonly accompanies the nervous form of the disease is usually not sufficiently severe to be obvious clinically.

### Udder

**Indurative mastitis**, or **hard bag**, is often initially detected a few days after kidding. The udder is firm and hard but no milk can be expressed. There is no systemic illness and no bacterial mastitis. Recovery is never complete but there may be some gradual improvement.

### CLINICAL PATHOLOGY

The **synovial fluid** from affected joints is usually brown to red-tinged, and the cell count is increased up to 20 000  $\mu\text{L}$  with 90% mononuclear cells. The cerebrospinal fluid may contain an increased mononuclear cell count. There is a reduction in monocytes in peripheral blood, a decrease in the number of CD4<sup>+</sup> lymphocytes, and a lower or inverted CD4:CD8 ratio.<sup>23</sup>

### Serological testing

For the live animal there are a number of test systems available whose sensitivity and specificity varies.<sup>24</sup> **Agar gel immunodiffusion test (AGID)** is widely used for detection of infection. Seropositive animals are considered to be infected with the virus, maternal antibody is lost by approximately 3 months of age, a seropositive test in a goat older than 6 months of age is considered evidence of infection and most, but not all, animals have a persistent antibody response and remain seropositive for life.

A negative test does not rule out the possibility of infection. There may be a considerable delay between infection and the production of test reactive antibody. It is possible that in some infected goats

there is insufficient virus expression to lead to an antibody response.<sup>10,25</sup>

A competitive-inhibition ELISA that detects antibody to the surface envelop of the virus has very high sensitivity and specificity and may aid considerably in the determination of the infection status for animal movement.<sup>29</sup> Tests with possibly greater sensitivity and/or specificity are described,<sup>24</sup> but are not generally available.

Identification of the presence of CAE is usually provided by isolation of the virus from tissue explants into tissue culture.<sup>1</sup> PCR techniques can be used to detect the presence of antigen.<sup>26,30</sup>

### NECROPSY FINDINGS

At necropsy of a case of the **arthritic form** there is emaciation and chronic polysynovitis. Typically, degenerative joint disease affects most of the joints of animals submitted for necropsy. Per-articular tissues are thickened and firm and there is hyperplasia of the synovium. The local lymph nodes are grossly enlarged and a diffuse **interstitial pneumonia** is usually present. Mammary glands are frequently involved although gross changes are restricted to induration and increased texture. Microscopically, lymphoplasmacytic infiltrates of the interstitial tissues of mammary gland, lung and synovium are characteristic. In the **neural form** the diagnostic lesions are in the nervous system and involve the white matter, especially of the cervical spinal cord and sometimes the cerebellum and the brain stem. The lesion is a bilateral, **non-suppurative demyelinating encephalomyelitis**. The infiltrating mononuclear leukocytes tend to be more numerous in the periventricular and subpial areas. There is usually also a mild, diffuse, interstitial pneumonia in this form of the disease. In some cases, a severe lymphoplasmacytic interstitial pneumonia with extensive hyperplasia of type II pneumocytes can occur in the absence of neurologic disease.

Culture of the virus is difficult but can be attempted. A variety of nucleic acid recognition tests, including in situ hybridization and PCR have been developed.<sup>30</sup> An immunohistochemical technique for detection of the virus has also been reported.<sup>27</sup> For most cases, confirmation of the diagnosis is based on the characteristic microscopic lesions, preferably supported by antemortem serologic results.

### Samples for confirmation of diagnosis

- **Histology** – formalin-fixed lung, bronchial lymph node, mammary gland, synovial membranes, one-half of midsagittally-sectioned brain, spinal cord (LM, IHC)
- **Serology** – heart blood (ELISA, AGID)

- **Virology** – lung, synovial membrane, mammary gland, hindbrain (PCR, VI)

### DIFFERENTIAL DIAGNOSIS

The differential diagnosis of the arthritic form of the disease includes the other infectious arthritides, such as those associated with mycoplasma and chlamydia.

Leukoencephalitis must be differentiated from:

- Swayback due to copper deficiency
- Spinal abscess
- Cerebrospinal nematodiasis
- Listeriosis
- Polioencephalomalacia.

### TREATMENT

There is no treatment likely to be of value for any form of the disease.

### CONTROL

A measure of control can be achieved by testing the herd every 6 months, and segregating or culling of seropositive animals. More complete control is dependent on preventing/minimizing perinatal transmission of infection to the kid, particularly colostrum and milk transmission, coupled with identifying infected animals and maintaining them physically separate from the non-infected animals or culling them from the herd.

### Prevention of perinatal transmission

Early recommendations for control concentrated on control of milk transmission but it is now recognized that this must be coupled with segregation. Newborn kids should be removed from the dam immediately at birth. There should be **no contact with the dam**, and fetal fluids and debris should be rinsed off the coat. **Heat-treated** goat colostrum or cow colostrum should be fed, followed by pasteurized milk or a commercial milk replacer. The kid should be segregated from the doe and other infected animals. There is a significant difference in subsequent seroconversions in herds that feed pasteurized colostrum and milk between those that segregate the kids at birth and those that do not.<sup>7</sup>

### Test and segregate/cull

Animals over 3 months of age should be **tested by AGID** every 6 months, and seropositive animals should be segregated or culled from the herd. The interval between infection and seroconversion varies between goats, and the optimum interval for testing has not been determined. More frequent testing may be required for large herds with high seroprevalence.<sup>7</sup> Segregation of seropositive and seronegative goats is essential, and



horizontal spread in adult goats is important in maintaining and increasing infection rates in some herds and even a brief contact time can allow transmission.<sup>28</sup> Seropositive goats should be **milked** after seronegative goats where culling is not practised. The use of common equipment should be avoided.

Several countries have programs for **herd accreditation** of freedom from infection. The stringency of these schemes varies and they may be governmental or breed society accreditation programs. In general, they require that all adults in the herd test negative on two herd tests at a 6-month interval. There are also restrictions on the movement and purchase of animals, and periodic serological surveillance.

## REVIEW LITERATURE

- Robinson WF, Ellis TM. Caprine arthritis-encephalitis virus infection; from recognition to eradication. *Aust Vet J* 1986; 63:237-241.
- Cheever WP, McGuire TC. The lentiviruses: maedi/visna caprine arthritis encephalitis and infectious equine anemia. *Adv Virus Res* 1988; 34:189-215.
- Dawson M. The caprine arthritis encephalitis syndrome. *Vet Ann* 1989; 29:98-102.
- Bulgin MS. Ovine progressive pneumonia caprine arthritis encephalitis and related lentivirus diseases of sheep and goats. *Vet Clin North Am Food Anim Pract* 1990; 63:691-704.
- McGuire TC, O'Rourke K, Knowles DF, Cheever WP. Caprine arthritis encephalitis lentivirus. Transmission and disease. *Curr Top Microbiol Immunol* 1990; 160:61-75.
- Knowles DP. Laboratory diagnostic tests for retrovirus infections of small ruminants. *Vet Clin North Am Food Anim Pract* 1997; 131:1-11.
- Rowe JD, East NE. Risk factors for transmission and methods for control of caprine arthritis-encephalitis virus infection. *Vet Clin North Am Food Anim Pract* 1997; 131:35-53.

## REFERENCES

- Clements JE, Zinc MC. *Clin Microbiol Rev* 1996; 9:100.
- Adams DS et al. *Vet Rec* 1984; 115:493.
- Cutlip RC et al. *J Am Vet Med Assoc* 1992; 200:802.
- Rowe JD et al. *Am J Vet Res* 1991; 52:510.
- MacDiarmid SC. *NZ Vet J* 1984; 32:165.
- Grewal AS et al. *Aust Vet J* 1986; 63:245.
- Rowe JD, East NE. *Vet Clin North Am Food Anim Pract* 1997; 13:35.
- East NE et al. *Small Rumin Res* 1993; 10:251.
- East NE et al. *Am J Vet Res* 1992; 53:2386.
- McGuire TC et al. *Curr Top Microbiol Immunol* 1990; 160:61.
- Craig LE et al. *J Neurovirol* 1997; 3:417.
- Nord K, Adnoy T. *J Dairy Sci* 1997; 80:2391.
- Smith MC, Cutlip R. *J Am Vet Med Assoc* 1988; 193:63.
- Greenwood PL. *Prev Vet Med* 1995; 22:71.
- Kreig A, Peterhan E. *Schweiz Arch Tierheilkd* 1990; 132:345.
- Ellis TM. *Aust Vet J* 1990; 67:302.
- Zink MC et al. *Am J Pathol* 1990; 136:843.
- Cheever WP et al. *J Infect Dis* 1991; 164:679.
- Knowles D et al. *J Virol* 1990; 64:2396.
- Wilkerson MJ et al. *Am J Pathol* 1995; 146:1433.
- Underwood WJ et al. *J Am Vet Med Assoc* 1992; 200:358.

- Papageorges M et al. *Vet Radiol* 1991; 32:82.
- Jolly PE et al. *Vet Immunol Immunopathol* 1997; 56:97.
- Knowles DP. *Vet Clin North Am Food Anim Pract* 1997; 131:1.
- Hanson J et al. *Acta Vet Scand* 1996; 37:31.
- Clavijo A, Thorsen J. *Small Rumin Res* 1996; 22:69.
- Storset AK et al. *Vet Pathol* 1997; 34:180.
- Greenwood PL et al. *Aust Vet J* 1995; 72:341.
- Herrmann IM et al. *Clin Diag Lab Immunol* 2003; 10:267.
- Johnson LK et al. *Clin Immunol Immunopathol* 1992; 65:254.

## VISNA

Synopsis
<p><b>Etiology</b> Neurovirulent strains of maedi-visna virus, a lentivirus</p> <p><b>Epidemiology</b> Occurs in association with maedi but endemic visna only recorded in Iceland</p> <p><b>Clinical findings</b> Afebrile disease with insidious onset. Progressive ataxia and wasting, long clinical course</p> <p><b>Clinical pathology</b> Pleocytosis and elevated protein, virus, virus proteins, and antiviral antibody in cerebrospinal fluid</p> <p><b>Lesions</b> Chronic demyelinating encephalomyelitis</p> <p><b>Diagnostic confirmation</b> Histology, demonstration of virus</p> <p><b>Treatment</b> None</p> <p><b>Control</b> As for ovine progressive pneumonia</p>

## ETIOLOGY

Visna is associated with an ovine lentivirus and is the neurological manifestation of maedi-visna disease. Ovine lentivirus consists of a variety of strains that vary in their ability to infect target cells and cause disease. There are neurovirulent and non-neurovirulent strains,<sup>1</sup> and neurovirulence can be enhanced by intracerebral passage of virus.<sup>2</sup> Visna usually occurs in conjunction with maedi lesions in the lungs, and 10-18% of sheep with maedi have histological lesions of visna in the brain.<sup>3,4</sup>

## EPIDEMIOLOGY

### Occurrence

Visna is a disease of sheep and rarely of goats. Visna was originally recorded in Iceland and was a significant cause of death in the epizootic of maedi-visna that occurred in that country. It always occurred in association with maedi and was generally of sporadic occurrence and lesser importance than the pulmonary manifestation of the infection although in some flocks it was the major manifestation of the complex.<sup>4</sup> Visna has not been seen in Iceland since 1951 and maedi-visna has since been eradicated from Iceland.

Despite the widespread occurrence of

maedi-visna or ovine progressive pneumonia in many countries visna is a very **uncommon disease** and a significant occurrence of clinical disease has seldom been recorded in countries other than Iceland.<sup>4-8</sup> The reason for this is not known but might be due to an increased susceptibility of the Icelandic breed of sheep to the neurological form of the disease, or to differences in maedi-visna virus strain neuroinvasiveness and neurovirulence. Maedi-visna virus was first reported in Britain in the late 1970 and the clinical expression since that time had largely been maedi occasionally with coexistent visna. However, recently there has been the occurrence of visna with no evidence of respiratory disease suggesting that a neurotropic strain might be emerging in that country.<sup>9</sup>

### Experimental transmission

Experimental transmission of the infection and the disease is effected by intracerebral inoculation and spread occurs from these to commingled sheep.<sup>10</sup> The **incubation period** and the course of the disease are very long; clinical signs may not appear for 2 years after experimental inoculation.

## PATHOGENESIS

The virus infects cells of the monocyte-macrophage lineage and replicates its RNA genome via a DNA intermediate provirus which is integrated into the chromosomal DNA of the host cell. Replication is limited and does not proceed beyond the synthesis of provirus in most cells. Persistent production of viral antigen results in lymphocytic hyperplasia. Although age has little effect on the development of disease, fetal and neonatal lambs have slightly greater permissiveness for replication of the virus. However, free infectious virus is present only in small quantities, but over very long periods. The genotype of the host is important and all breeds of sheep do not react to the same degree. Thus, Icelandic sheep react much more severely than English breeds.

There are two basic lesions, an inflammatory lesion which is not related to the occurrence of nervous signs, and a focal demyelination in the brain and spinal cord, the occurrence of which is related to the appearance of paresis.<sup>11</sup> Experimental immunosuppression greatly reduces the severity of lesions, by suppressing the cellular proliferative response without suppressing the growth of the virus and post-infection immunization enhances the severity of experimental visna.<sup>12</sup> Viral nucleic acid and proteins are present in oligodendrocytes, and demyelination is believed to result from the direct effect of the virus on these cells as well as being the result of an inflammatory response provoked by the presence

of these antigens.<sup>13</sup>

### CLINICAL FINDINGS

The disease has an **insidious onset** and the early clinical signs include lagging behind the flock because of **ataxia and body wasting**. The body wasting and the hindlimb ataxia are progressive. Affected animals show hypermetria and may stumble or fall as they traverse uneven ground or when making sudden turns. There is no fever, and a normal appetite and consciousness are retained. Additional signs include severe tremor of the facial muscles, and knuckling of the distal limbs so that the animal stands on the flexed tarsi. Some animals may show a head tilt. Aimless wandering and blindness occur in some sheep.<sup>7</sup>

The clinical picture is not unlike that of scrapie without the pruritus. During the course of the disease, periods of relative normality may occur. Affected animals may show clinical signs for several months before final paralysis necessitates slaughter. The disease is **always fatal**. The clinical syndrome in goats is the same as that for sheep.

### CLINICAL PATHOLOGY

There is an increased number of mononuclear cells in the cerebrospinal fluid, an elevated protein, and positive Pandy test.<sup>4,8</sup> The **pleocytosis** is variable during the course of the disease.<sup>4</sup> Virus, virus antigen, and antibody are also demonstrable in cerebrospinal fluid.<sup>3</sup> Serological tests are detailed under the section on ovine progressive pneumonia.

### NECROPSY FINDINGS

Muscle wasting and an interstitial pneumonia may be visible but there are no gross changes in the central nervous system. The characteristic histological lesion is patchy, demyelinating encephalomyelitis. The inflammatory infiltrate is predominantly comprised of lymphocytes and macrophages. Demyelination occurs in the white matter of the cerebrum and cerebellum, and in the spinal cord. The histological character of the lung is typical of ovine lentivirus-associated pneumonia. Isolation of the virus is difficult. Typical neural lesions and a positive serological titer usually suffice for confirmation of the diagnosis. Immunohistochemical tests and PCR-based assays have been successfully employed to confirm this lentiviral infection in lung, mammary gland,<sup>14</sup> and even third eyelid<sup>15</sup> but the use of these tests to confirm of the infection in CNS tissues is not well documented.

### Samples for confirmation of diagnosis

- **Histology** – fixed spinal cord, one-half of midsagittally-sectioned brain,

lung, mammary gland, joint synovium (IHC, LM)

- **Serology** – heart blood serum (AGID, ELISA)
- **Virology** – chilled brain, spinal cord, lung, mammary gland (PCR, ISO).

### DIFFERENTIAL DIAGNOSIS

Visna is a sporadic disease of mature sheep with an insidious onset of muscle wasting, progressive ataxia and having a long clinical course. These characteristics differentiate it from other diseases of sheep manifest with ataxia. Differentials include:

- Scrapie
- Delayed organophosphate toxicity
- Cerebrospinal nematodiasis
- Segmental axonopathy (Murrurundi disease).

### TREATMENT AND CONTROL

There is no treatment. Visna is a rare disease. Iceland achieved control by slaughter eradication; other control procedures are those for ovine progressive pneumonia.

### REFERENCES

1. Torsteinsdottir S et al. *Virology* 1997; 229:370.
2. Craig LE et al. *J Neurovirol* 1997; 3:417.
3. Brodie SJ et al. *Clin Immunol Immunopathol* 1995; 77:14.
4. Petursson G, Hoff-Jorgensen R. *Maedi-visna and related diseases*. Boston: Kluwer Academic, 1990; pp. 185.
5. Bulgin MS. *Vet Clin North Am Farm Anim Pract* 1990; 6:691.
6. Biescas E et al. *J Comp Pathol* 2005; 132:107.
7. Pritchard GC et al. *Vet Rec* 1995; 137:443.
8. Constable PR et al. *J Am Vet Med Assoc* 1996; 208:117.
9. Payne JH et al. *Vet Rec* 2004; 154:94.
10. Palsson PA et al. *Acta Vet Scand* 1977; 18:122.
11. Georgeson G et al. *Acta Neuropathol* 1982; 57:171.
12. Cheever WP, McGuire TC. *Adv Virus Res* 1988; 34:189.
13. Dawson M. *J Comp Pathol* 1988; 99:401.
14. Preziuso S et al. *Eur J Histochem* 2003; 47:373.
15. Capucchio MT et al. *J Comp Pathol* 2003; 129:37.

### BORDER DISEASE (HAIRY SHAKER DISEASE OF LAMBS, HAIRY SHAKERS, HYPOMYELINOGENESIS CONGENITA)

**Etiology** Pestivirus strains in the border disease and bovine virus diarrhea genotypes  
**Epidemiology** Congenital disease transmitted by persistently infected sheep, rarely cattle  
**Clinical findings** Abortions, stillbirths, barren ewes and the birth of small weak lambs some of which have an abnormally hairy birthcoat, gross tremor of skeletal muscles, inferior growth and a variable degree of skeletal deformity  
**Clinical pathology** None specific  
**Lesions** Hypomyelination in brain and spinal cord of lamb

**Diagnostic confirmation** Detection of virus and/or demonstration of serological response

**Treatment** Supportive

**Control** Avoid infection of pregnant sheep. Identify and cull persistently infected animals

### ETIOLOGY

The causal agent, border disease virus (BDV), is a **pestivirus** in the family *Flaviviridae*. **Four different species of genotypes** have been identified in the pestivirus genus; bovine virus diarrhoea virus (BVDV) types 1 and 2, classical swine fever virus (CSFV) and border disease virus (BDV). Isolates from border disease predominantly fall within the BDV genotype but sheep and goat isolates also fall in the BVDV genotypes.<sup>1,2</sup> It is proposed that the BDV genotype can be divided into BDV-1, BDV-2, BDV-3 based on host origin and genetic and antigenic characteristics.<sup>3</sup>

Strains of BDV have differing pathogenicity, and variations in pathogenicity also result from interactions between the virus and different host genotypes specifically between different breeds of sheep.<sup>1-4</sup> Persistent infections in sheep are associated with non-cytopathic strains of virus. An isolate of BDV is thought to have caused a leukopenic enterocolitis in sheep and growing lambs in the Aveyron region of France (**Aveyron disease**). The disease caused high mortality in sheep in this region in 1984 but has not occurred subsequently.<sup>2</sup>

### EPIDEMIOLOGY

#### Occurrence

Border disease was originally described in the border country between England and Wales. It has subsequently been reported from most of the **major sheep producing countries**<sup>2,4-6</sup> and probably occurs in all. The disease occurs naturally primarily in sheep and occasionally in goats. The prevalence of infection is much higher than the incidence of clinical disease as the latter only occurs where there is infection during pregnancy.

Studies on **seroprevalence** vary in design but suggest that pestivirus infections in sheep and goats are less common than in cattle and that there are considerable differences in seroprevalence between different geographical areas and flocks. Flock seroprevalence in different regions or countries generally falls within the range of 5 to 50%. The prevalence of seropositive females within positive flocks is influenced by age with a lower seroprevalence in sheep 4 to 8 months of age than in older sheep. Seroprevalence is higher in flocks with persistently infected sheep but there can still be a

significant proportion of seronegative sheep present in a flock containing persistently infected sheep.<sup>7</sup>

### Source of infection

Infection can be introduced into a flock with the purchase of **persistently infected** replacement sheep. Persistently infected sheep excrete virus in nasal secretions, saliva, urine and feces,<sup>2,6</sup> and provide the major source of infection. A proportion of persistently infected sheep may survive to adulthood and may breed successfully to produce further persistently infected sheep.<sup>8</sup> However, the breeding efficiency of persistently infected sheep is poor and the probability of establishing lines of persistently infected sheep appears less than with the equivalent infection in cattle.<sup>8,9</sup>

Virus is also present in the **placenta and fetal fluids** at the birth of persistently infected lambs, and in the products of abortions resulting from infection with the virus in early pregnancy. In flocks where there is a long lambing period it is possible that this could provide a source for clinical disease in late lambing ewes. Field observations suggest that transmission during the lambing period is limited.

**Calves** persistently infected with BVDV can infect sheep,<sup>10</sup> and in countries where pregnant sheep and cattle are housed in close proximity during the winter this can be an important source of infection for outbreaks of border disease. In some countries it appears the major source and recent studies in both Northern Ireland and the Republic of Ireland suggest that cattle are the primary source of infection for sheep in those countries.<sup>11,12</sup> In contrast BDV is the predominant ovine pestivirus in Great Britain and New Zealand.<sup>13</sup>

There is also evidence that bovine strains are important in goat infections.<sup>1,14</sup>

**Free-living deer** are also a potential source of infection. Outbreaks of disease are also recorded as the result of vaccinating pregnant goats with a pestivirus contaminated Orf vaccine.<sup>15</sup>

### Transmission

Transmission is by sheep-to-sheep contact and experimental transmission has been effected with both oral and conjunctival challenge.<sup>2,6</sup>

The speed of spread of infection in a susceptible flock will vary with the management, and will be facilitated by factors such as close contact at mating time or gathering for any purpose. There is an increased risk for explosive outbreaks of border disease where animals are housed in early pregnancy.

### Host risk factors

Border disease may occur as an outbreak or as a sporadic disease. When infection is

introduced into a susceptible flock in early pregnancy, an outbreak with infertility, abortion and congenital disease in lambs from all ages of ewes is likely. Subsequently, older sheep in the flock will have immunity and disease is only common in introduced sheep and maiden ewes. Persistently infected ewes have reduced fertility but will give birth to congenitally affected lambs throughout their breeding life.<sup>8,9</sup> The disproportional occurrence of outbreaks of clinical disease in certain breeds suggests that these breeds have higher rates of persistently infected individuals.

### Experimental reproduction

Border disease is readily reproduced by the experimental infection of pregnant ewes prior to 80 days' gestation and can be effected by oral, conjunctival and parenteral challenge.<sup>6,9</sup> Experimental disease can be produced with **both BDV and BVDV** strains.

The following have been produced experimentally, although there are strain differences in clinical and pathological manifestations:

- Placentitis
- Abortions
- Mummified fetuses
- Congenital malformations, including hydrocephalus, porencephaly, cerebellar hypoplasia and dysplasia, and arthrogryposis
- Fetal growth retardation
- Hypomyelination
- Birth of weak lambs with nervous disorders
- A hairy birthcoat.

Experimental infections of pregnant cows with BDV results in similar defects with placentitis, mummification and abortion of fetuses, intrauterine growth retardation with abnormal osteogenesis, and hypomyelination.

The disease has also been produced experimentally in goat kids by inoculation of pregnant goats but there are no abnormalities of hair coat, and embryonic mortality and abortion are more common than in the experimental disease in ewes.<sup>16</sup>

### Economic importance

The effect of infection varies with the immune status of the flock and whether infection occurs during pregnancy. In fully susceptible flocks, abortion and neonatal lamb loss resulting from infection can be 25–75% of the expected lamb crop depending upon the strain of the virus.<sup>9</sup> An assessment of the economic losses due to infertility, abortion, neonatal losses, and low carcass weight indicate that an outbreak of border disease can result in a potential reduction of income in excess of 20%.<sup>17</sup>

### PATHOGENESIS

#### Non-pregnant sheep

In adolescent and adult non-pregnant sheep, infection and viremia are **sub-clinical**. The IM inoculation of immunocompetent lambs with BDV results in a mild transient disease and a subsequent reduction in growth rate, but no gross or microscopic lesions.

#### Pregnant sheep

When BDV infects susceptible pregnant ewes the virus infects the placenta to produce an **acute necrotizing placentitis** and it subsequently invades the fetus. This may result in early embryonic death, abortion and stillbirth, the birth of lambs with malformations and/or neurological abnormalities, the birth of small weak lambs which are immunosuppressed, or the birth of lambs with no clinical abnormality. The ultimate **outcome** of the infection depends on the age of the fetus, the properties of the strain of the virus, the dose of the virus, the genotype of the host, and the ability of the fetus to respond to the virus. **Fetal age** at the time of infection is most important, as it is the determinant of the ability of the fetus to mount an immune response to the infection.<sup>2,6,9,18</sup> Immune competence to the virus in sheep develops between approximately 61 and 80 days of gestation.

#### Infection in early pregnancy

**Fetal death** occurs when there is infection of the fetus with virulent strains prior to the development of immune competence and uncontrolled viral replication. Prenatal death is more likely to follow infections in early pregnancy but is recorded with infections from 45 to 72 days of gestation.

**Persistent infections** occur in lambs that survive infection in early pregnancy prior to the development of immune competence and result from maternal infections between 21 and 72 days of gestation but never later.<sup>19</sup> The virus is present in all organs, and lambs born persistently infected will remain so for their lifetime, with few exceptions; persistent infections have been recorded to at least 5 years of age.<sup>9</sup>

Most persistently infected sheep are unable to produce specific antibody to BDV but some show intermittent seropositivity with low antibody levels or occasionally undergo frank seroconversion.<sup>19</sup> The humoral response to other pathogens and antigens is normal. However, cell-mediated immunity is compromised, with change in T-cell populations and a deficiency in lymphocyte function.<sup>20</sup> Persistently infected lambs are more susceptible to intercurrent disease and commonly die before reaching maturity.

**Hypomyelination** occurs in persistently infected lambs and resolves spontaneously in lambs that survive to the age of 6 months.<sup>21</sup> Most of these lambs exhibit neurological dysfunction at birth, varying from a continuous light tremor to tonic-clonic contraction of the skeletal muscles involving the whole body and head (**shakers**).

**Thyroid.** A deficiency of the thyroid T<sub>3</sub> and T<sub>4</sub> hormones has been detected in lambs affected with border disease and may be the basic cause of the amyelination. The enzyme 2,3-cyclic nucleotide-3-phosphodiesterase is associated with normal myelination and depends upon normal amounts of thyroid hormone.<sup>20</sup> The deficiency in thyroid hormones may also result in the reduced rate of weight gain that occurs in infected lambs. Other studies suggest a direct infection of oligodendroglia with the virus as the cause of the defective myelination.<sup>22,23</sup>

**Fleece abnormality** also occurs in persistently infected lambs and results from an enlargement of the primary hair follicles and a concurrent reduction in the number of secondary follicles. The resulting hairiness is due to the presence of large medullated primary fibers. BDV appears to have no effect on the skin and birthcoat of coarse-fleeced breeds of sheep or on goats.

**Intrauterine growth** retardation is a common feature of infection with BDV and is initiated shortly after infection.<sup>23</sup> Deformities of the skeleton include abnormally shortened long bones, a reduction in crown-rump length and the long axis of the skull, which results in lambs appearing more compact and short-legged than normal (**goat lambs**). In the long bones there is evidence of growth arrest lines and disturbed osteogenesis and ossification.

Some persistently infected lambs have neither nervous signs nor abnormalities of the fleece and are phenotypically normal. This limits the value of identification of infected lambs based on the presence of clinical abnormality at birth.

In mid-pregnancy

When fetal infection occurs during the period of development of the ability to mount an immune response (between approximately 61 and 80 days of gestation) the effect is variable. Some fetuses infected at this stage respond with a severe inflammatory process in the CNS with nodular periarteritis, necrosis, and inflammation of the germinal layers of the brain. Resultant lesions are hydranencephaly, cerebellar dysplasia and multifocal retinal atrophy; such lambs exhibit behavioral abnormalities and more severe neurological disease than shaker lambs.<sup>9,19,21</sup>

Infection in late pregnancy

Infection of the fetus after 80 days of gestation is likely to be controlled or eliminated by a fetal immunological response. Such lambs are born without clinical disease and are virus-negative but have precolostral circulating antibody.

**Goats**

In goats, fetal death is the major outcome of infection of the pregnant doe with both BDV and BVDV, and infections prior to 60 days' gestation almost invariably result in reproductive failure.<sup>16</sup> Persistently infected shaker kids and clinically normal kids are born with infections around 60 days' of gestation but are a less common manifestation of the disease than occurs in sheep. The caprine fetus develops immune competence against pestiviruses between 80 and 100 days' gestation.<sup>21</sup>

### Enteric disease

Experimental inoculation of a homologous strain of the BDV into persistently infected, but clinically recovered lambs results in a severe clinical syndrome characterized by persistent diarrhea and respiratory distress associated with an inflammatory lymphoproliferative response in the central nervous system, intestines, lungs, heart, and kidney. A similar syndrome is seen at weaning in some persistently infected sheep that survive early life.<sup>29</sup> This syndrome resembles certain aspects of mucosal disease in cattle, in which it is postulated that superinfection of persistently viremic immunotolerant cattle with a homologous strain of BVDV results in fatal mucosal disease. In such animals a specific and dynamic equilibrium exists between an attenuated form of the virus and the immunotolerant host. Disturbance of this equilibrium either by injection of the homologous strain of BDV, or some other factor, results in fatal disease.<sup>9</sup>

### CLINICAL FINDINGS

The most obvious and characteristic features of border disease are evident at birth and relate to conformation and growth, fleece type, and neurological dysfunction.

#### Conformation

Affected lambs may have a lower birth weight than uninfected lambs, a decreased crown-rump length, and a shorter tibia/radius length so that they have a boxy appearance. The head has a shortened longitudinal axis and the cranium may be slightly domed (**goat lambs**).

#### Fleece

The fleece, when dry, appears **hairy** and rough due to long hairs rising above the fleece to form a halo, especially over the nape, back, flanks and rump.<sup>24</sup> This

feature is most evident in medium- and fine-wool breeds and is not observed in the coarse kempy-fleeced breeds, such as the Scottish Blackface. The halo kemp fibers are shed with time and are most evident in the first 3 weeks of life. Some lambs have abnormal pigmentation occurring as patches of pigmented fleece or hair, or a totally pigmented fleece. This can occur in white-faced sheep.

#### Neurological dysfunction

Neurological dysfunction is manifest, with rhythmic tremors of the muscles of the pelvis and upper parts of the hindlimbs, or of the whole body, resulting in a characteristic jerking movement, and of the head and neck with rhythmic bobbing of the head (**shaker lambs**). In some less severe cases, only fine tremors of the ears and tail are evident. Tremors are most apparent during movement, and are absent while the lamb is sleeping. The tremors usually decline in severity as the lamb matures and may seem to disappear unless the animal is stressed. More severely affected lambs have difficulty in rising, and if able to stand with assistance exhibit an erratic gait especially of the hindquarters. Paralysis does not occur. Affected lambs are often unable to nurse the ewe because they cannot hold onto the teat. Affected lambs appear languid and lie around listlessly. They do not suck as they should and bloat continuously, and the ewes' udders become engorged with milk.

**Behavioral and visual defects** with circling, head-pressing, nystagmus, and gross incoordination are seen in lambs with the type of infection producing hydranencephaly and cerebellar dysplasia. These lambs are of lighter birth weight but have normal birthcoats.

#### Growth rate

Growth rate is reduced, affected lambs are unthrifty, and the majority will die before or at weaning time from parasitism, pneumonia, a mucosal disease-like syndrome, or nephritis.<sup>9,20</sup> With good nursing care they can be reared but deaths may occur at any age. Puberty may be delayed and, in males, the testes are flabby and may not develop normally.

#### Reproductive performance

Impaired reproductive performance of the flock occurs from low fertility, abortion, and poor viability of lambs. Abortions usually are not noticed until lambing when it is evidenced by an unexpected increase in barren ewes. In goats, where there is often closer observation, the aborted fetuses may be reasonably well-developed, small and underdeveloped, or autolyzed and unrecognizable as a fetus in expelled fetal fluid.<sup>16</sup>

## CLINICAL PATHOLOGY

There are no consistent changes in hematology or blood chemistry. Persistently infected lambs have changes in lymphocyte subpopulations, with a reduction in T-lymphocytes and an altered CD8:CD4 ratio.<sup>6</sup>

Virus can be detected by virus isolation, by antigen ELISAs, by PCR techniques and antibody by antibody ELISAs, or by serum neutralization tests.<sup>2,25</sup> A combination of serology and virus isolation can aid in the diagnosis of border disease.

### Detection of persistently infected sheep

For diagnosis of border disease in newborn lambs, precolostral blood samples should be taken from both clinically normal and affected lambs. Persistently infected sheep are seronegative and BDV can be isolated from leukocytes in the blood buffy coat. Lambs infected late in gestation will be seropositive but virus-negative. Persistently infected lambs that have received colostrum from their dam will be seropositive until they lose the maternal passive immunity.

Persistently infected adolescent and adult sheep in a flock can be identified by the detection of virus in blood; however, this is expensive in large flocks and an alternative is test all sheep for antibody and then culture the buffy coat of seronegative sheep. Antigenic differences between laboratory strains and field virus can result in false-negative serologies and serological studies are best done with the homologous virus.<sup>4,26</sup>

### Abortion

Serological tests are of limited value as an aid to the diagnosis of abortion associated with BDV infection. The infection of the ewe that results in abortion occurs several weeks before clinical disease is apparent, and unless prospective samples can be taken there is little chance of a rise in antibody titers in paired samples. Seropositivity in ewes indicates that the flock has been exposed to pestivirus but does not incriminate it in a disease process. Seronegativity indicates that BDV is not the cause of the abortion, with the exception that aborting ewes, who themselves are persistently infected, will have no antibody titer.

### NECROPSY FINDINGS

Gross findings may be normal, or may include an abnormal wool coat and a reduction in the size of the brain and spinal cord. Arthrogryposis, hydranencephaly, porencephaly, and cerebellar dysplasia may also be present. Histologically, there is a deficiency of stainable central myelin, with neurochemical and

histochemical evidence of demyelination or myelin dysmorphogenesis. In most sheep the myelin defect resolves substantially during the first few months of life. The brain, which has been very small, returns to normal weight, and chemical composition and degree of myelination. The histological lesions of the skin consist of primary follicle enlargement, increased primary fiber size, and an increased number of medullated primary fibers.

Virus can be demonstrated by immunofluorescent staining of cryostat sections of tissues from affected lambs or by immunohistochemical staining of formalin-fixed material. Preferred tissues for such tests include brain, thyroid gland, and skin. Virus titers reach high levels in the placentomes, so caruncles or cotyledons should be cultured for virus. Isolates are non-cytopathic and the presence of viral antigens must be demonstrated by direct or indirect immunofluorescence or immune peroxidase techniques.

Owing to the closely related character of this pestivirus and BVDV, diagnostic tests to confirm infection parallel those for BVDV. Fetal serology can be useful to confirm exposure in abortions and stillbirths. PCR and ELISA techniques may be substituted for virus isolation if available.

### Samples for confirmation of diagnosis

- **Histology** – formalin-fixed skin, spinal cord, one-half of midsagittally sectioned brain, skin, thyroid, distal ileum, colon, cecum, thymus, spleen, liver, heart, kidney (LM, IHC)
- **Serology** – heart blood serum/thoracic fluid (VN)
- **Virology** – placenta/caruncle, thymus, lymph node, spleen, thyroid, brain, ileum (ISO, FAT, ELISA, PCR).

### DIFFERENTIAL DIAGNOSIS

#### Congenital disease:

- Swayback (copper deficiency)
- Caprine encephalomyelitis.

#### Abortion:

- Enzootic abortion
- Listeriosis
- Toxoplasmosis
- Leptospirosis
- Rift Valley fever
- Akabane disease.

### TREATMENT

There is no specific treatment. With care and nursing, many affected lambs will survive the immediate neonatal period but they grow poorly, are very susceptible to intercurrent disease during the growing period, and it is generally not economic to attempt to raise these lambs.

## CONTROL

The principles are to attempt to engender a flock immunity and to avoid exposing sheep to infection in early pregnancy. Persistently infected sheep are a continuous source of infection and those that survive to breeding age can perpetuate the disease. They should be identified and culled.

The problem is with their identification, as some persistently infected lambs show no clinical or phenotypic abnormality. Lambs that are clinically affected at birth should be permanently identified since the tremor and fleece abnormality disappear at 1–2 months of age and the lambs may no longer be recognizable as infected. Persistently infected animals can be identified by serological screening of the ewe lambs intended for replacement stock at 6 months of age (after maternal passive immunity has waned), followed by virus isolation in seronegative animals, but this is expensive and only practical in small flocks. An alternative is to keep no replacement ewes from an affected lamb crop.

Persistently infected sheep can be run with the flock when it is not pregnant, particularly with the replacement ewes, in an attempt to produce infection and immunity prior to pregnancy. They should be removed prior to breeding. While this can result in 'natural vaccination' the rates of infection and seroconversion in replacement females can be low.<sup>7</sup> In theory, cattle BVDV vaccines could be used to produce immunity but their efficacy would depend upon a significant relatedness to the BDV under consideration.

In most flocks a serious outbreak of the disease is followed by minor disease in subsequent years, the flock developing immunity in the initial outbreak.

In flocks that are free of infection, replacement ewes and rams should be screened for infection prior to purchase, or quarantined after arrival on the farm. Newly introduced sheep should be kept separate from the main flock until after lambing. Ideally, cattle should not be pastured or housed with pregnant sheep.

### REVIEW LITERATURE

- Terpstra C. Border disease: a congenital infection of small ruminants. *Prog Vet Microbiol Immunol* 1985; 1:175–198.
- Moennig V. Pestiviruses: a review. *Vet Microbiol* 1990; 23:35–54.
- Leiss B, Moennig V, Pöhling J, Trautwein G. Ruminant pestivirus infections. *Virology pathogenesis and perspectives of prophylaxis. Arch Virol Suppl* 1991; 3:1–271.
- Hussin AA, Woldehiwet Z. Border disease virus: a review. *Vet Bull* 1994; 64:1131–1151.
- Loken T. Border disease in sheep. *Vet Clin North Am Food Anim Pract* 1995; 113:579–595.
- Nettleton PF, Entrican G. Ruminant pestiviruses. *Br Vet J* 1995; 151:615–642.

## REFERENCES

1. Becher P et al. J Gen Virol 1997; 78:1357.
2. Nettleton PF, Entrigan G. Br Vet J 1995; 151:615.
3. Becher P et al. Virology 2003; 311:96.
4. Kelling CL et al. Am J Vet Res 1990; 51:2019.
5. Nettleton PF et al. Vet Res 1998; 29:227.
6. Hussin AA, Woldehiwet Z. Vet Bull 1994; 64:1131.
7. Berriatua E et al. Vet J 2004; 168:336.
8. Woldehiwet Z, Nettleton PF. Arch Virol Suppl 1991; 3:267.
9. Nettleton PF et al. Comp Immunol Microbiol Infect Dis 1992; 153:179.
10. Carlsson U. Vet Rec 1991; 128:145.
11. Graham DA et al. Vet Rec 2001; 148:69.
12. O'Neill RG et al. Irish Vet J 2004; 57:525.
13. Vilcek S et al. Vet Microbiol 1999; 69:227.
14. Loken T. J Comp Path 1990; 103:1.
15. Loken T et al. J Comp Path 1991; 104:195.
16. Loken T, Bjerkas I. J Comp Path 1991; 105:123.
17. Sharp MW, Rawson BC. Vet Rec 1986; 119:128.
18. Osburn B, Castrucci G. Arch Virol 1991; 3:71.
19. Roeder PL et al. Res Vet Sci 1987; 43:28.
20. Sawyer MM. Comp Immunol Microbiol Infect Dis 1992; 153:171.
21. Jeffery M, Roeder PL. Res Vet Sci 1987; 43:22.
22. Jeffery M et al. Neuropathol Appl Neurobiol 1990; 16:501.
23. Caffrey JF et al. Res Vet Sci 1997; 62:245.
24. Campbell JR et al. Can Vet J 1995; 36:307.
25. Vilcek S, Paton DJ. Vet Res 2000; 31:437.
26. Lees VW et al. Can Vet J 1991; 32:678.

## Viral diseases characterized by skin lesions

### CONTAGIOUS ECTHYMA (CONTAGIOUS PUSTULAR DERMATITIS, ORF, SCABBY MOUTH, SORE MOUTH)

**Etiology** Orf virus. Genus *Parapoxvirus*. Family Poxviridae

**Epidemiology** Primarily young lambs and kids. Morbidity may reach 100% and case fatality rate 5–15%. Rapid spread in flock by contact or via inanimate objects such as feed troughs, ear tag equipment and emasculators. Scabs from lesions remain infective in the environment for a long time. Orf can cause considerable set back when young lambs are affected and also has economic importance due to restriction of movement and trade of affected sheep. May infect humans

**Signs** Papules, pustules, scabs covering ulceration, granulation, proliferation and inflammation. Lesions begin at oral mucocutaneous junction, oral commissures and spread to muzzle, oral cavity. Lambs cannot suck or graze. Malignant form occurs with invasion of alimentary tract. Severe systemic reaction can occur and lesions on coronets, ears, anus, and vulva. Lesions can be multifocal in goats

**Clinical pathology** Electron microscopy. PCR

**Lesions** Scabs, pustules, granulation tissue and secondary lesions. Eosinophilic cytoplasmic inclusion bodies

**Diagnostic confirmation** Clinical recognition and identify virus by PCR

#### Differential diagnosis list:

- Ulcerative dermatosis
- Proliferative dermatitis (strawberry foot rot)
- Blue tongue
- Foot and mouth disease
- Sheep pox.

**Treatment** Nothing specific; general care of lesions

**Control** Isolation of affected animals. Vaccination

#### ETIOLOGY

Orf is associated with the orf virus, a type species of the genus *Parapoxvirus* (family Poxviridae). In addition to the orf virus (parapox ovis) the genus includes the viruses of bovine papular stomatitis (parapox bovis 1) pseudocowpox (parapoxvirus bovis 2) and a parapox virus of deer.<sup>1–3</sup> The orf virus withstands drying and is capable of surviving at room temperature for at least 15 years. Restriction endonuclease digests of DNA shows considerable heterogeneity between different field isolates.

#### EPIDEMIOLOGY

##### Occurrence

The disease occurs in sheep and goats and causes unthriftiness, varying degrees of pain, and some economic loss. It occurs most commonly in lambs 3–6 months of age when at pasture, although lambs 10–12 days of age and adult animals can be severely affected, and outbreaks involving the lips and face of young lambs and the udders of the ewes also are common. Outbreaks occur at any time but they are most common in dry conditions when the sheep are at pasture, or in penned sheep being fed from feed troughs. The disease has occurred in musk ox in which it causes heavy losses, reindeer, mountain goats and bighorn sheep, chamois, caribou, Dall sheep, buffalo, wild goats, and camels. The virus can be passaged in rabbits if large doses are placed on scarified skin or injected ID. Mild lesions develop on the chorioallantois of the 9 to 12-day chick embryo. Guinea-pigs and mice are not susceptible.

The disease also occurs in humans working among infected sheep. In abattoir workers it is commonest in those handling wool and skins.<sup>4</sup>

##### Morbidity and case fatality

Outbreaks may occur in sheep and goats, with morbidity rates approaching 100% and case fatality rates from 5 to 15%.<sup>5,6</sup> The deaths that occur are due to the extension of lesions in the respiratory tract, but the case fatality rate may reach 15% if severely affected lambs are not provided with adequate care and support, or if secondary infection and cutaneous

myiasis are allowed to occur. In the rare outbreaks where systemic invasion occurs the case fatality rate averages 25% and may be as high as 75%. Under field conditions recovered animals are immune for 2–3 years, but no antibodies appear to be passed in the colostrum, and newborn lambs of immune ewes are susceptible.<sup>5</sup>

#### Methods of transmission

Scabs that fall off from healing lesions contain virus and remain highly infective for long periods in dry conditions, but survival of the disease in a flock may be the result of chronic lesions that exist for long periods on individual animals. Infection can be from environmental persistence of the virus or from infected sheep. Spread in a flock is very rapid and occurs by contact with other affected animals or by contact with contaminated inanimate objects, such as feed troughs, ear-tagging pliers.<sup>8</sup> An outbreak of lesions on the tails is recorded in association with the use of docking instruments.<sup>9</sup>

It has been assumed that natural infections on pasture are the result of invasion of the virus after skin damage induced by prickly plants or stubble; application of a viral suspension to scarified skin is the established method of inducing orf.<sup>10</sup> However, an outbreak has occurred in a large group of lambs collected from several farms and transported in a vehicle over a period of 23 hours.<sup>11</sup> There was no evidence of injury to their mouths.

#### Experimental reproduction

The disease is readily reproduced by introduction of virus onto scarified areas of skin. Immunity to re-infection is relatively solid at the site of initial infection, but shorter duration lesions can be reproduced by re-challenge of these sheep at other sites.<sup>10,12</sup>

#### Risk factors

The primary risk factors are the presence of the virus and the immune status of the sheep.

A simulated shipping exercise has examined these risks.<sup>13</sup> Initially, the prevalence of scabby mouth on participating sheep farms was determined. The proportion of farms with evidence of the disease in weaner sheep was 23.6%, and on those farms with the disease the overall prevalence was 6.1%. Sheep from different farms are mixed, held at high stocking densities for approximately 3 weeks, and offered pelleted feed that can abrade the lips and mouth to promote development of the lesions. The major risk factor for the prevalence of the disease in sheep arriving in a feedlot after transportation from the farm was immunity to the disease. The arrival and mixing in the feedlot was also important for

transmission of the infection to occur. Sheep vaccinated on the farm before road transportation to the feedlot had a lower prevalence at the end of the simulated shipping exercise.<sup>13</sup>

Inter-current infections may exacerbate the occurrence disease on rare occasions.

The disease has spread from clinically normal ewes to susceptible 2–4 years of age which were persistently infected with border disease virus<sup>14</sup> and lambs experimentally infected with *Ehrlichia phagocytophilia* and subsequently challenged with orf virus developed more severe lesions with a longer course than those in control lambs.<sup>15</sup>

#### Economic importance

The disease produces a minor setback except when it affects young sucking lambs with associated lesions on the teats and udders of their ewes. Loss from lamb mortality and secondary mastitis in these circumstances can be significant.

The disease assumed economic importance for Australia when shipments of sheep exported from Australia in 1989–1990 were rejected at some ports in the Middle East because of the disease<sup>13</sup> and this problem continues. Litigation is a concern when zoonotic infections occur at petting zoos or fairs.

#### Zoonotic implications

Orf virus is readily transmitted to humans. In the agricultural environment typical lesions occur at the site of infection, usually an abrasion infected while handling diseased sheep for shearing, crutching or drenching or by accidental means when vaccinating. Lesions progress from macular to papular stages, are usually single and localized on the hands, arm or face. The lesions are self limiting and heal without scarring after 6 to 7 weeks. They are pruritic and respond poorly to local treatment. Orf is also a zoonotic consideration in 'petting zoos' and fairs where children allow lambs to suck their fingers or otherwise become infected from handling sheep exhibits. Historically, orf has been a risk for industrial workers handling raw wool.

#### PATHOGENESIS

Damage to the skin is essential for the establishment of orf infection and the development of typical lesions.<sup>10</sup> Following viral challenge of mildly abraded skin, the virus does not establish in the damaged epidermis, but replicates in the cells of an underlying replacement epidermal layer derived from the walls of the wool follicles. Following scarification of ovine skin and topical application of the orf virus, antigen cannot be detected in the skin during the period when the epidermis is being renewed.<sup>16</sup> Virus can

first be detected in the center of the newly differentiated epidermis immediately below the stratum corneum, 72 hours after infection. The location of the virus during the eclipse stage is unknown. The infection spreads laterally and uniformly from the new epidermis, initially in the outer stratum spinosum and subsequently throughout the entire depth of the epidermis. The skin reaction consists of a cellular response with necrosis and sloughing of the affected epidermis and underlying stratum papillare of the dermis. The cutaneous response to infection includes a delayed-type hypersensitivity reaction and an influx of inflammatory cells involving neutrophils, basophils, and possibly mast cells.<sup>17</sup> Class II dendritic cells are also involved and appear to form the basis of a highly integrated local dermal defense mechanism.<sup>18</sup> The lesions evolve through the stages of macule, papule, vesicle, pustule, scab formation, and resolution. The pustules develop within a few days, and rupture resulting in ulcers and subsequently a thick overlying crust or scab forms which is shed within 3–4 weeks leaving no scar.<sup>10</sup> Immunity is solid but will last only about 8 months. While there is an antibody immune response to the virus<sup>19</sup> recovery is the result of cell-mediated immune mechanisms.<sup>12</sup> Experimentally, a secondary infection, following recovery from a primary infection, is milder and accelerated.<sup>20</sup> During the secondary challenge, pustules and scabs develop earlier, the lesions resolve more rapidly, and no vesicular stage may occur.<sup>17</sup>

#### CLINICAL FINDINGS

##### Sheep

Lesions develop initially as papules and then pustules, stages which are not usually initially observed, and progress to raised **moderately proliferative** area of granulation, and inflammation covered with a thick, tenacious scab. Time progression from the initial lesions to the formation of scabs is approximately 6 to 7 days. New lesions will develop during the first 10 days of infection. The first lesions develop at the **oral mucocutaneous junction**, usually at the oral commissures and are accompanied by swelling of the lips. From here they spread on to the muzzle and nostrils, the surrounding haired skin and, to a lesser extent, on to the buccal mucosa. They may appear as discrete, thick scabs 0.5 cm in diameter, or coalesce and be packed close together as a continuous plaque. fissuring occurs and the scabs are sore to the touch. They crumble easily but are difficult to remove from the underlying granulation. Affected lambs suffer a severe setback because of restricted sucking and grazing. In benign

cases the scabs dry and fall off, and recovery is complete in about 3 weeks. Affected lambs sucking ewes may cause spread of the disease to the udder where a similar lesion progression is seen. Lesions on the **teats** predispose to mastitis and secondary infection of the skin lesions by bacteria or fly larvae occurs in some cases. In rams, lesions on the **scrotum** may be accompanied by fluid accumulation in the scrotal sac and associated temporary infertility. A high incidence of infection can also occur where the dominant lesions are on the feet, occurring around the coronary band, the dew claws and on the volar areas of the intervening skin.

Rarely, systemic invasion occurs and lesions appear on the coronets and ears, around the anus and vulva or prepuce, and on the nasal and buccal mucosae. There is a severe systemic reaction, and extension down the alimentary tract may lead to a severe gastroenteritis, and extension down the trachea may be followed by bronchopneumonia. Lesions may also occur in the **mouth** involving the tongue, gums, dental pad or a combination of those sites.<sup>21</sup> These are more commonly seen in outbreaks affecting lambs less than 2 months of age. In the mucosa of the mouth these lesions do not scab but are papular erosive and surrounded by an elevated zone of hyperemia. Extensive painful and proliferative lesions occur on the gingival margins of the incisor teeth.

In some outbreaks the lesions on the skin are highly proliferative and present as raw raised granulating lesions without an overlying scab. This manifestation appears more common in Suffolk sheep and lesions are present on the lips, bridge of the nose and around the eyes. Cases of this proliferative form involving the feet are also recorded.<sup>22</sup>

A **malignant form** of the disease has also been observed in sheep. It begins with an acute episode manifested by oral vesicles, and extension of these lesions down the gastrointestinal tract, followed later by granulomatous lesions and shedding of hooves.

An atypical case of the disease in sheep after extensive cutaneous thermal injury has been described.<sup>23</sup> The virus was present in proliferative verrucous tissue lesions at the periphery of the original thermal injury.<sup>23</sup> The lesions consisted of tightly packed 0.5 mm-diameter papillary projections.

##### Goats

An unusual case of contagious ecthyma in a group of female goats has been described.<sup>24</sup> Multifocal lesions occurred over the head, neck, thorax, and flanks of



each animal. The lesions developed approximately 2 weeks after the animals returned from a local summer show at which the does were housed for 3 days in pens previously occupied by sheep. The lesions began as plaques, followed by epidermal proliferation and severe encrustation. Affected areas were discrete and approximately 2–7 cm in diameter. There were no lesions of the muzzle, lips, udder or teats. Recovery occurred uneventfully within 3–6 weeks without treatment. The skin crusts gradually dried and fell off, leaving areas of alopecia and depigmented skin. Regrowth of hair followed.

**Persistent orf** is recorded in a proportion of Boer goats following an outbreak. The disease in the majority of the animals in the herd was classical and ran a clinical course of 3–4 weeks but in 2% of animals it persisted for several months and lesions disseminated over the body. There were no particular distinguishing differences of the virus genome to those of other orf viruses and the persistence was possibly a result of individual host susceptibility factors.<sup>25,26</sup>

#### CLINICAL PATHOLOGY

Electron microscopic identification of the virus is quick and generally reliable with multiple samples from an affected herd or flock. Virus can also be detected by PCR and restriction enzyme analysis of viral DNA and gene sequencing.<sup>26,27</sup> Recovered animals have a high level of neutralizing antibodies in their serum and this is detectable by a gel diffusion test and other serological tests but has little clinical value.

#### NECROPSY FINDINGS

In malignant cases there are irregularly-shaped lesions, with a hyperemic border in the oral cavity and the upper respiratory tract, with rare involvement of the mucosae of the esophagus, abomasum, and small intestine. Typical lesions are actually proliferative, with subsequent loss of centrally located cells creating an ulcer-like appearance. Microscopically, the hyperplastic epithelium contains swollen degenerate cells, some of which may house eosinophilic cytoplasmic inclusion bodies.

#### Samples for confirmation of diagnosis

- **Histology** – formalin-fixed lesions (LM)
- **Virology** – vesicle fluid, scraping from lesion (EM).

#### DIFFERENTIAL DIAGNOSIS

In most outbreaks of ecthyma, the cases are sufficiently mild to cause no real concern about losses or about diagnosis.

Dramatic outbreaks of a very severe form of the disease may occur, however, and are likely to be confused with bluetongue. Very severe cases are also commonly seen in housed experimental sheep especially colostrum-free lambs.

**Ulcerative dermatosis** is sufficiently similar to cause confusion in diagnosis, but this disease has not been reported in many years.

**Mycotic dermatitis** usually occurs on woolled skin but lesions can occur on the lips and feet (strawberry foot rot), have a thick dry asbestos-like scab and are easily differentiated by laboratory culture.

**Facial eczema** is distinguished by diffuse dermatitis and severe edema and damage to the ears.

**Papillomatosis (warts)** need also to be considered in the differential diagnosis for the proliferative manifestations of contagious ecthyma, although warts are extremely uncommon in sheep.

**Bluetongue** is always accompanied by a high mortality rate, a severe systemic reaction, and lesions occur on the muzzle, the coronets, and extensively on the buccal mucosa. It is more common in adults than sucking lambs. Because it is transmitted by insect vectors, the morbidity rate is usually much less than the 90% commonly seen in contagious ecthyma.

**Sheeppox** may present a rather similar clinical picture, but the lesions are typical, there is a severe systemic reaction and heavy mortality rate.

**Foot and mouth disease.** The classic developed lesions of orf are easily differentiated from foot and mouth disease but the papular and vesicular stages seen early in the course of orf, particularly lesions in the mouth, can be difficult to differentiate especially when a prompt on-farm differentiation is required. The raised firm papular erosive nature of the lesion with the surrounding zone of hyperemia is a crucial differentiating feature in the field.<sup>28</sup>

#### TREATMENT

There is no specific treatment. Removal of the scabs and the application of ointments or astringent lotions are practiced but delay healing in most cases. The provision of soft, palatable food is recommended. The combined use of diathermy debridement and cryosurgery is claimed to be effective for the proliferative intraoral lesions in young lambs.<sup>29</sup>

#### CONTROL

In the early stages of an outbreak, the affected animals should be isolated and the remainder vaccinated. Vaccination is of little value when a large number of animals are already affected. Persistence of the disease in a pastured flock from year to year is common and in such circumstances the lambs should be vaccinated at 6–8 weeks of age. Vaccination when a few days old evokes a protective

response, but prelambling vaccination of the ewe does not and is not recommended.<sup>30</sup> Vaccination of housed lambs should be timed to avoid the usual occurrence of the disease that has been observed in previous years.

The vaccine is prepared from a suspension of scabs in glycerol saline and is painted onto a small area of scarified skin inside the thigh, or by pricking the ear with a needle dipped in the vaccine. Vaccination is completely effective for at least 2 years, but the lambs should be inspected 1 week after vaccination to insure that local reactions have resulted. Absence of a local reaction signifies lack of viability of the vaccine or the existence of a prior immunity. The immunity is not solid until 3 weeks after vaccination. A small proportion of vaccinated lambs may develop mild lesions about the mouth because of nibbling at the vaccination site. The efficiency of this vaccine is greater than that of the standard commercial vaccine containing live attenuated virus.<sup>31</sup> As a further protective measure, removal of abrasive material from the environment is recommended but is not usually practicable. For live sheep being transported from Australia to the Middle East, it is suggested animals be vaccinated well in advance of shipment to allow immunity to develop, which is probably at least 3 weeks.

Because the vaccines are live virus vaccines, and shed scabs are contaminated, routine vaccination against orf in flocks that have not experienced the disease is not recommended.

Outbreaks have occurred from vaccine virus.

#### REVIEW LITERATURE

Robinson AJ, Balassu TC. Contagious pustular dermatitis (orf). *Vet Bull* 1981; 51:771

#### REFERENCES

1. Delhoun G et al. *J Virol* 2004; 78:168.
2. Robinson AJ, Mercer AA. *Arch Virol* 1988; 101:255.
3. Rziha HJ et al. *J Gen Virol* 2003; 84:1111.
4. Robinson AJ, Petersen GV. *NZ Med J* 1983; 96:81.
5. Robinson AJ, Balassu TC. *Vet Bull* 1981; 51:771.
6. Housawi FMT et al. *Vet Rec* 1991; 128:550.
7. McKeever DJ, Reid HW. *Vet Rec* 1986; 118:613.
8. Allworth MB et al. *Aust Vet J* 1987; 64:61.
9. Ames T et al. *J Am Vet Med Assoc* 1984; 184:88.
10. McKeever DJ et al. *J Comp Path* 1988; 99:317.
11. Gumbrell RC, McGregor DA. *Vet Rec* 1997; 141:150.
12. Anderson IE et al. *Vet Immunol Immunopathol* 2001; 83:161.
13. Higgs A et al. *Aust Vet J* 1996; 74:215.
14. Nettleton PF et al. *Vet Rec* 1996; 139:364.
15. Gokce HI, Woldehiwet Z. *J Comp Path* 1999; 121:227.
16. McEwan D et al. *Vet Dermatol* 1990; 1:189.
17. McEwan D et al. *Vet Dermatol* 1990; 1:139.
18. McEwan D et al. *Vet Dermatol* 1991; 2:1.
19. McKeever DJ, Reid HW. *Vet Microbiol* 1987; 14:3.
20. Yirrell D et al. *Vet Immunol Immunopathol* 1989; 22:321.

21. Hawkins CD et al. Aust Vet J 1991; 68:210.
22. Smith GW et al. J Vet Internal Med 2002; 16:287.
23. Hooser SB et al. J Am Vet Med Assoc 1989; 195:1255.
24. Coates JW, Hoff S. Can Vet J 1990; 31:209.
25. Concha-Bermejillo A et al. J Vet Diag Invest 2003; 25:423.
26. Guo J et al. Virus Res 2003; 93:169.
27. Torfason EG, Guonadottir S. J Clin Virol 2002; 24:79.
28. Watson P. In Practice 2004; 26:182.
29. Meynink SE et al. Vet Rec 1987; 121:594.
30. Buddle BM, Pulford HD. Vet Microbiol 1984; 9:515.
31. Gilray JA et al. Vet Rec 1998; 143:237.

## PAPILLOMATOSIS (WARTS)

### Synopsis

**Etiology** Papillomaviruses. Host specific, and in cattle, some types have site and lesion-type specificity

**Epidemiology** Occur in all countries in all species but most common in young cattle and horses. Transmission is by direct contact and fomites

**Clinical findings** Solid outgrowths of epidermis, may be sessile or pedunculated. Most common type in cattle occurs on head and neck and has cauliflower-like appearance, but lesion site and appearance varies with papilloma type. In the horse, lesions are on the face and lips

**Clinical pathology** None specific

**Lesions** Papilloma or fibropapilloma

**Diagnostic confirmation** Histology and DNA identification by PCR in biopsy or tissue scraping

**Treatment** Removal by surgery or cryosurgery. Vaccination with autogenous vaccine

### ETIOLOGY

Cutaneous warts in cattle, horses, sheep and goats are benign tumors induced by host-specific papillomaviruses. These infect epithelial cells causing hyperproliferative lesions that are benign, self-limiting and, in most cases, spontaneously regress. Differentiation of types is based on the histological features of the lesion and DNA identification by hybridization or PCR. There has been little research on the papilloma virus of horses or small ruminants, but in cattle six types have been identified: bovine papilloma virus (BPV)-1, BPV-2 and BPV-5, which cause fibropapillomas; and BPV-3, BPV-4 and BPV-6, which cause true epithelial papillomas.<sup>1,2</sup>

Cattle types show some site predilection or site specificity. Their detailed roles are:

- BPV-1 – frond fibropapillomas of teat skin and penile fibropapilloma
- BPV-1 and BPV-2 – fibropapilloma of the skin of the anteroventral part of the body including the forehead, neck and back, the common cutaneous wart

- BPV-2 – cauliflower-like fibropapillomas of the anogenital and ventral abdominal skin
- BPV-2 – associated with bladder cancer in cattle in association with the ingestion of bracken fern (*Pteridium* spp.)<sup>3,4</sup>
- BPV-3 – cutaneous papilloma
- BPV-4 – papilloma of the esophagus, esophageal groove, forestomachs and small intestine; this is capable of becoming malignant, particularly in animals fed bracken fern.<sup>4-6</sup> BPV-4 has site specificity to the upper alimentary tract
- BPV-5 – rice grain fibropapilloma on the udder. BPV-5 has also been demonstrated in cutaneous skin warts<sup>7</sup>
- BPV-6 – frond epithelial papillomas of the bovine udder and teats.

Although a single BPV type is detected in an individual papilloma, a single animal may have papillomas at different sites associated with different BPV types.<sup>8</sup>

Other papilloma of cattle that have regional distribution and may have separate antigenic identity are:

- Oral papillomas, mostly in adult cattle and apparently reaching a high incidence, up to 16% in some areas<sup>9</sup>; these are probably BPV-4<sup>8</sup>
- Papilloma of the larynx in steers
- Papillomavirus has been observed in squamous cell carcinoma of bovine eyes.<sup>10</sup>

Other skin lesions in which papillomavirus plays an etiological role are:

- Equine sarcoid which associated with BPV-1 and BPV-2
- Ear cancer of sheep.<sup>11</sup>

Papillomas in horses may be associated with a distinct equine papillomavirus.<sup>12</sup>

### EPIDEMIOLOGY

#### Occurrence

Papillomatosis has an international occurrence in all animal species.

#### Origin of infection and transmission

The method of spread is by **direct contact** with infected animals, infection gaining entry through **cutaneous abrasions**. Virus can also persist on inanimate objects in livestock buildings and infect animals rubbing against them.<sup>8</sup>

Crops of warts sometimes occur around ear tags, at branding sites or along scratches made by barbed wire, and can be spread by tattooing implements, dehorning shears, and by procedures such as tuberculin testing.<sup>13-16</sup>

An extensive outbreak of perianal warts is recorded in beef heifers, the infection having been spread by rectal examination for pregnancy. A high prevalence of

papillomas on the larynx of feedlot steers is ascribed to implantation of the virus in contact ulcers, which are also entry sites for *Fusobacterium nodosus* (a cause of calf diphtheria), so that the two diseases may occur in the one animal. An outbreak of periorbital papillomatosis in cattle is recorded in association with a heavy periorbital infestation with *Haematopinus quadripertusus*.<sup>17</sup>

#### Animal risk factors

All species may be affected but the disease is commonest in cattle and horses. With cattle, usually several animals in an age group are affected. Outbreaks have been recorded in sheep and goats,<sup>13,18</sup> but the disease is uncommon in sheep. It is also uncommon in pigs, usually affecting the genitalia. Amongst wildlife, it occurs in white-tailed deer (*Odocoileus virginianus*) and mule deer (*O. hemionus*).

#### Age

Cutaneous papillomas of the head and neck occur predominantly in young animals, the lack of susceptibility of adults to natural infection being ascribed to immunity acquired by apparent or inapparent infection when young. The occurrence of cutaneous warts and their severity can be influenced by factors that induce immunosuppression, and latent infection has converted to clinical disease with the administration of immunosuppressive agents.<sup>8,19</sup> Congenital infection is recorded in the foal and calf, but is rare.<sup>20</sup>

Alimentary papillomas associated with BPV-4 in cattle, rice grain teat papillomas associated with BPV-5 in cattle, and papillomas on the mammary glands of goats occur, or persist, at all production ages.

#### Experimental production

The supernatant from a suspension of wart tissue, injected ID, or applied to skin scarifications, is an effective means of experimental production of the disease.<sup>8,19</sup> Lesions are restricted to the site of inoculation. Cutaneous and oral papillomas have been transmitted in cattle, and cutaneous papilloma transmitted in sheep and horses. The incubation period after experimental inoculation in cattle is 3–8 weeks but is usually somewhat longer after natural exposure.

#### Economic importance

Cutaneous warts are quite common in young cattle, especially when they are housed, but ordinarily they cause little harm and regress spontaneously. In purebred animals they may interfere with sales and shows because of their unsightly appearance. Animals with extensive lesions may lose condition, and secondary bacterial invasion of trau-

matized warts may cause concern. Warts on the teats of dairy cows often cause interference with milking. In horses, the lesions are usually small and cause little inconvenience, but they are esthetically unattractive. In all species, the development of warts on the genitalia requires immediate treatment.

### PATHOGENESIS

The virus infects the basal keratinocytes, replicating its genome in the differentiating spinous and granular layers causing the excessive growth that is characteristic of wart formation. Expression of the late structural proteins of the virus is limited to the differentiated cells of the squamous layer where the new virus particles are encapsulated and shed into the environment as the cells die. The tumor contains epithelial and connective tissues and can be a papilloma or a fibropapilloma, depending on the relative proportions of epithelial and connective tissue present; papillomas contain little connective tissue, and fibropapillomas are mostly fibrous tissue, with very little epithelial tissue. Papillomas are the result of basal cell hyperplasia without viral antigen production. fibropapillomas are uncommon in horses, but are the common lesion in cattle, sheep, and wild ruminants.<sup>21</sup> Latent infection in the skin and lymphocytes has been demonstrated in cattle.<sup>5</sup>

### CLINICAL FINDINGS

Warts are solid outgrowths of epidermis and may be sessile or pedunculated.

#### Cattle

In cattle, warts occur on almost any part of the body, but when a number of animals in a group is affected it is common to find them all affected in the same part of the body. The most common papillomas occur in the skin of cattle under 2 years of age, most commonly on the head, especially around the eyes, and on the neck and shoulders, but may spread to other parts of the body. They vary in size from 1 cm upwards and their dry, horny, cauliflower-like appearance is characteristic. In most animals they regress spontaneously, but the warts may persist for 5–6 months, and in some cases for as long as 18 months, with serious loss of body condition.

Warts on the **teats** manifest with different forms depending on the papilloma virus type and may show an increasing frequency with age. The **frond form** have filiform projections on them and appear to have been drawn out into an elongated shape of about 1 cm in length by milking machine action. If sharp traction is used they can often be pulled out by the roots.

Other forms are a flat, round type which is usually multiple, always sessile

and up to 2 cm in diameter. The third form has an elongated structure appearing like a **rice grain**. Teat warts may regress during the dry period and recur with the next lactation.

**Perianal** warts are esthetically unattractive, but do not appear to reduce activity or productivity. **Genital warts** on the vulva and penis make mating impracticable because the lesions are of large size, are friable, and bleed easily. They commonly become infected and flyblown. They occur on the shaft or on the glans of the penis in young bulls, may be single or multiple, are pedunculated and they frequently regress spontaneously.

**Alimentary tract** warts are rarely observed clinically in farm animals in most countries, but are recorded in abattoir cattle at a high incidence in some localities<sup>9</sup> and have been reproduced experimentally.<sup>8</sup> Papillomas occur on the lateral and dorsal aspects of the tongue, the soft palate, oropharynx, esophagus, esophageal groove, and rumen. Papillomas occurring in the esophageal groove and in the reticulum are a cause of chronic ruminal tympany.

Less common manifestations of papillomatosis in cattle include lesions in the **urinary bladder**, which cause no clinical signs but may predispose to enzootic hematuria. BPV-4 papillomas in the upper alimentary tract of cattle being fed bracken fern are the focus for transformation to squamous cell carcinomas. Cattle fed bracken fern are immunosuppressed, which promotes the persistence and spread of the papilloma virus, and mutagens in bracken fern cause neoplastic transformation of papilloma cells.<sup>4</sup>

#### Goats

Papillomas most commonly occur on the face and ears but may occur on the skin generally, especially on unpigmented skin. Most completely regress, others regress and recur, and occasional lesions progress to carcinomas. Papillomas that occur on the teats are persistent and may spread through the herd.

#### Horses

Warts are confined to the lower face, the muzzle, nose and lips, and are usually sessile and quite small, rarely exceeding 1 cm in diameter. They may also occur on the penis and vulva, in the mouth, and on the conjunctiva. All ages can be affected. Spontaneous recovery is usual, but the warts may persist for 5–6 months.

### CLINICAL PATHOLOGY

There are no specific changes in the hemogram or blood chemistry but cattle with papilloma have lower numbers of CD2 and CD4 lymphocyte subpopulations

and higher numbers of gamma/delta+ T-lymphocytes and lymphocytes expressing IgM molecules.<sup>22</sup>

Biopsy of a lesion can be used, but is rarely necessary to confirm a diagnosis. However, it may be advisable when large growths are found on horses in order to determine if the lesion is a verrucose form of sarcoid. Microscopically, true papillomas consist of a hyperplastic epidermis with scant dermal tissue, whereas in fibropapillomas the dermal component tends to predominate. The need to identify the specific virus in a crop of warts creates a requirement for serological and histological examinations. An ELISA is available but BPV type can be determined by PCR on biopsy material or tissue scrapings<sup>7</sup> and is more accurate where a wart problem occurs in a vaccinated population.

### DIFFERENTIAL DIAGNOSIS

Clinically, there is little difficulty in making a diagnosis of papillomatosis with the possible exception of atypical papillomas of cattle, probably associated with an unidentified type of the papillomavirus. These lesions are characterized by an absence of dermal fibroplasia, and are true papillomas rather than fibropapillomas. All ages of animals can be affected and the lesions persist for long periods. They are characteristically discrete, low, flat and circular, and often coalesce to form large masses. They do not protrude like regular warts and the external fronds are much finer and more delicate.

#### Horses:

- Sarcoid
- Melanoma.

### TREATMENT

Warts can be removed by surgery or cryosurgery. Crushing of a proportion of small warts, or the surgical removal of a few warts, has been advocated as a method of hastening regression but the tendency for spontaneous recovery makes assessment of the results of these treatments very difficult. Partial resection of a wart(s) in a horse does not always promote resolution of the residue.<sup>23</sup> Surgical removal can be followed by vaccination with an autogenous vaccine. Surgical intervention, and even vaccination, in the early stages of wart development may increase the size of residual warts and prolong the course of the disease.

#### Vaccination

For cattle, autogenous vaccines prepared from wart tissues of the affected animal are effective in many cases. Commercially available vaccines are available for cattle but may be less efficacious; an autogenous vaccine prepared for a specific problem has the advantage of including the local virus types. The vaccine is prepared from

homogenized wart tissue that is filtered and inactivated with formalin. Because of the different BPV types, care is required in the selection of the tissues. In general terms they can be selected on tumor type, location, and histological composition. The alternative is to use many types of tissue in the vaccine. Animal to animal variation in regression following vaccination of a group of calves with a vaccine prepared from a single calf in the group has been attributed to more than one BPV type producing disease in the group.<sup>24</sup> The stage of development is also important, and virus is present in much greater concentration in the epithelial tissue of older warts than young ones.<sup>2</sup> The vaccine can be administered SC, but better results are claimed for ID injection. Dosing regimes vary, but 2–4 injections 1–2 weeks apart are commonly recommended. Recovery in 3–6 weeks is recorded in 80–85% of cases where the warts are on the body surface or penis of cattle, but in only 33% when the warts are on the teats. The response of low, flat, sessile warts to vaccination is poor.

Other treatments no longer commonly used include the injection into the wart of proprietary preparations containing antimony and bismuth or the intralesional injection of bacille Calmette–Guérin (BCG).<sup>25</sup>

## CONTROL

Specific control procedures are usually not instituted or warranted because of the unpredictable nature of the disease and its minor economic importance.

Vaccination has been shown experimentally to be an effective prevention and gives complete protection in cattle against stiff experimental challenge.<sup>26</sup> The vaccine must contain all serotypes of the papillomavirus because they are very type-specific.<sup>27</sup>

Avoidance of close contact between infected and uninfected animals should be encouraged, and the use of communal equipment between affected and uninfected animals should be avoided.

## REVIEW LITERATURE

- Hunt E. fibropapillomatosis and papillomatosis. *Vet Clin North Am Large Anim Pract* 1984; 6:163–167.  
 Jarrett WFH. The natural history of bovine papillomavirus infection. *Adv Viral Oncol* 1985; 5:83–102.  
 Campo MS. Bovine papillomavirus and cancer. *Vet J* 1997; 154:175–188.

## REFERENCES

- Jarrett WFH et al. *Virology* 1984; 136:255.
- Jarrett WFH et al. *J Natl Cancer Inst* 1984; 73:499.
- Borzacchiello G et al. *J Gen Virol* 2003; 84:2921.
- Campo MS et al. *Carcinogenesis* 1994; 15:1597.
- Tsirimoniaki E et al. *J Comp Path* 2003; 129:93.
- Borzacchiello G et al. *J Comp Path* 2003; 128:203.
- Bloch N et al. *Vet Res Commun* 1997; 21:63.
- Campo MS et al. *Res Vet Sci* 1994; 56:151.

- Samuel JL et al. *Zentralbl Veterinarmed B* 1985; 32:706.
- Rutten VPMG et al. *Am J Vet Res* 1992; 53:1477.
- Trenfield K et al. *Vet Microbiol* 1990; 25:103.
- Narechania A et al. *J Gen Virol* 2004; 85:1243.
- Studdert MJ. *Aust Vet J* 1988; 65:399.
- Yeruham I et al. *J Comp Path* 1994; 114:101.
- Johnstone AC et al. *NZ Vet J* 1994; 42:233.
- Otter A, Leonard D. *Vet Rec* 2003; 153:570.
- Yeruham I et al. *J Vet Med B* 2001; 48:133.
- Uzal FA et al. *Vet Res Commun* 2000; 24:197.
- Olson C et al. *J Am Vet Med Ass* 1992; 201:56.
- Desrochers A et al. *Can Vet J* 1994; 35:646.
- Hamada M et al. *J Comp Path* 1990; 102:393.
- Levkutova M et al. *Acta Vet Hung* 1998; 46:13.
- Sundberg JP et al. *Vet Med* 1985; 80:71.
- Ndarathi CM, Mbuthia PG. *Indian J Anim Sci* 1994; 64:218.
- Hill FWG et al. *Cancer Immunol Immunother* 1994; 39:49.
- Jarrett WFH et al. *Vet Rec* 1990; 126:449.
- Jarrett WFH et al. *Vet Rec* 1990; 126:473.

## SARCOID

### Synopsis

**Etiology** Locally aggressive benign fibroblastic tumors of the skin associated with bovine papillomavirus BVP1 and BVP2

**Epidemiology** Common tumor of horses, donkeys and mules. Breed differences in prevalence. Transmission by close contact and infection of wounds

**Clinical findings** Single or multiple lesions in the skin of limbs, lips, eyelids, eye, penile sheath, and base of the ears. May present as warty growth or have the appearance of granulation tissue or as nodules beneath the skin. Spontaneous regression is rare

### Diagnostic confirmation

**Histopathology**

**Treatment** No single treatment modality has an advantage. Surgical excision, cryosurgery, immunotherapy, radiation, and local chemicals are used

**Control** None recognized

## ETIOLOGY

The cause of sarcoid in horses, mules, and donkeys is almost certainly bovine papilloma virus (BPV) types 1 or 2.<sup>1–3</sup> DNA of both types can be demonstrated in sarcoid tumors by PCR, as can the major transforming gene of BPV, E5, although papillomavirus has not been isolated from these tumors, nor have papillomavirus particles been demonstrated.<sup>4–6</sup> It is assumed that this is a non-productive infection in which viral DNA exists episomally.<sup>3</sup>

However, given the demonstration of genetic susceptibility to sarcoid, the cause is almost certainly multifactorial, with virus infection being an inciting event in susceptible animals.<sup>7</sup> There does not appear to be a role for mutation in the tumor suppressor gene, *p53*, in the development of sarcoid in horses.<sup>8</sup>

## EPIDEMIOLOGY

### Occurrence and prevalence

Equine sarcoid is the **commonest neoplasm** in horses, representing about 20% of all equine tumors diagnosed at necropsy. Horses, donkeys, and mules are affected. Sarcoid tumors occur in 0.7% of Swiss warmblood, and 0.4% of Freiburger horses in Switzerland.<sup>1</sup> Of the horse **breeds**, Appaloosa, Arabian, and Quarter horses are at more risk than are Standardbreds or Thoroughbreds.<sup>9</sup>

### Methods of transmission

Transmission can be by infection of wounds and castration is believed a risk factor, with flies as possible vectors.<sup>10</sup> Close contact may facilitate transmission.<sup>2</sup> BPV DNA has been detected in face flies (*Musca autumnalis*) associated with horses with sarcoids.<sup>3</sup>

### Experimental reproduction

The disease has been transmitted with sarcoid tissue and cell free supernatant from minced sarcoid tumors. The disease has also been reproduced with bovine papillomavirus although the experimentally produced tumors subsequently regressed which seldom occurs with natural sarcoid.<sup>3</sup>

### Animal risk factors

There is a **genetic-based susceptibility** to the disease,<sup>7</sup> and the predisposition of horses to sarcoid is associated with the type of **major histocompatibility complex**.<sup>11</sup> Approximately 40% of the susceptibility to the disease in Swedish Halfbred horses is attributable to an autosomal, dominant equine leukocyte antigen (ELA)-linked gene.<sup>7</sup> The prevalence in quarter horses is greater than that in thoroughbreds, and in both is higher than that in standardbreds.<sup>9</sup> Sarcoids are very rare in horses less than 1 year of age, and the prevalence is highest in horses 1 to 6 years-of-age. Young males appear more at risk, possibly related to castration.<sup>10</sup>

### Environmental risk factors

Lesions commonly occur on traumatized areas.

## PATHOGENESIS

Sarcoids are localized proliferations of epidermal and dermal tissue which may remain small and dormant for many years and then undergo a stage of rapid cancer-like growth. The lesions show moderate malignancy but do not metastasize to other sites, although there may be multiple cutaneous lesions. The virus infects fibroblasts and the infection is non-productive. It is believed that virus capsids of BVP are not found in equine sarcoids because papillomavirus are usually host specific and the expression of virus capsids of the bovine papillomavirus

requires the cellular environment of keratinocytes of the host species.<sup>3</sup> Sarcoids do not regress, in contrast to the majority of papillomavirus infections, probably because expression of BPV in equine cells elicits immune evasion mechanisms.<sup>12</sup>

### CLINICAL FINDINGS

Sarcoids occur as single, or more commonly, multiple lesions or clusters in the skin. The lesions occur most commonly on the lower limbs but also on the lips, eyelids, eye, penile sheath, and around the base of the ears.

Several forms of sarcoid are described:<sup>13</sup>

- Verrucous (warty) sarcoid is a dry, horny, cauliflower-like surface that is usually partially or completely hairless. It may be broad based (sessile) or pedunculated. Verrucous sarcoids occur most commonly on the face, body, groin and sheath area. It has a predilection
- Fibroblastic sarcoid has a similar appearance to that of proud flesh or excessive granulation tissue. It is often a firm, fibrous nodule in the dermis, although the surface may be ulcerated. It is found most commonly at sites of previous wounds and also the eyelid and limbs
- A combination of both of the forms described above
- Occult sarcoid is typically an area of slightly thickened skin that has a roughened surface. It is usually partially hairless. Interference with these slow-growing sarcoids, including attempts at treatment, should be avoided; as such interference can cause the tumor to proliferate. They occur most commonly around the mouth and eyes and on the neck.

### CLINICAL PATHOLOGY

Confirmation of the diagnosis requires a **biopsy specimen** for histologic examination. Because sarcoids are usually associated with excessive granulation tissue and pyogranulomatous debris, the preferred specimen is a **transverse section of the excised tumor**. If punch biopsies are to be collected, then care should be taken that they include a representative section of the tumor, and not just peripheral granulation tissue and edematous non-tumor material. Examination by a pathologist accustomed to examining equine skin sections is important, as the tumor has some features in common with papillomas and sarcomas and may be easily misdiagnosed.

PCR has been used to detect BPV DNA but the sensitivity is less than optimal.<sup>4,5</sup>

### DIFFERENTIAL DIAGNOSIS

- Cutaneous habronemiasis
- Phycomycosis
- Fibromas
- Granulation tissue
- Squamous cell carcinoma, especially of the penis and eyelid
- Other skin tumors, including melanoma by examination of a biopsy of the lesion
- Papillomatosis is a disease of young horses, and unlike sarcoid, commonly spontaneously regresses.

### TREATMENT

**Surgical excision** results in the return of the tumor in a significant proportion of animals within 6 months, often with over proliferation. BPV DNA can be detected in normal skin immediately surrounding sarcoids and the recurrence reflects activation of latent BPV in normal tissue surrounding the tumor.<sup>14</sup>

**Cryotherapy** is associated with a much lower recurrence rate<sup>1</sup> but its use is limited by the anatomical location of the tumor. For instance, cryotherapy is not recommended for periocular lesions because of the risk of damaging nearby ocular tissues. The efficacy of cryotherapy may be enhanced by the use of thermocouples to monitor the temperature of the lesion to insure adequate freezing. At least two or three freeze-thaw cycles are necessary.

**Radiation therapy** using radon-222, gold-198, radium-226, cobalt-60 or iridium-192 has been used and is indicated for recurrent or surgically inaccessible sarcoids such as periocular sarcoid.<sup>15,16</sup> Radiation therapy is also useful for treating sarcoids of the body and legs.<sup>17</sup> Local hyperthermia induced by a radiofrequency current of 2 MHz is also reported to be effective.<sup>18</sup>

**Immunotherapy**, by injection of live organisms, killed bacilli, or cell wall extract of the bacillus of Calmette and Guerin (BCG) have been successful on occasion, but their efficacy depends on the size of the lesion, its anatomical location, and possibly its type.<sup>1</sup> Immunotherapy may work by inducing tumor-specific immunity. Side-effects include local reactions characterized by edema and systemic anaphylactoid reactions after the second or third injections if commercial, whole-cell vaccines are used. Vaccines composed of cell-wall fractions in oil are free of such reactions and have given good results in periocular lesions, but sarcoids of the axilla did not react favorably.<sup>19</sup> Large sarcoids or cases with multiple lesions may also respond poorly.<sup>20</sup> Immunotherapy using mycobacterial cell wall skeleton combined with trehalose dimycolate has resulted in total tumor regression.<sup>21</sup>

Autogenous vaccines may result in the regression of existing sarcoids but have risk of inducing new tumors and are not recommended for routine therapy.<sup>16</sup>

A variety of chemical agents have been used for treatment but there are no controlled trials.<sup>16</sup>

As yet, no single treatment modality is universally successful in the treatment of sarcoid. In a study in 92 horses comparing outcome, a successful outcome was obtained in 79% of horses treated with cryosurgery, 67% of those treated with BCG vaccination, 82% of those treated with conventional excision and 71% of those treated using carbon dioxide laser.<sup>22</sup>

### REVIEW LITERATURE

Marti E et al. Report of the first international workshop on equine sarcoid. *Equine Vet J* 1993; 25:397-407.

Foy JM, Rashmir-Raven AM, Brashier MK. Common equine skin tumors. *Comp Cont Educ Pract Vet* 2002; 24:242-253.

Chambers G et al. *J Gen Virol* 2003; 84:1055-1062.

### REFERENCES

1. Marti E et al. *Equine Vet J* 1993; 25:397.
2. Reid SWJ et al. *Vet Rec* 1994; 135:430.
3. Chambers G et al. *J Gen Virol* 2003; 84:1055.
4. Martens A et al. *Vet J* 2001; 161:280.
5. Carr EA et al. *Am J Vet Res* 2001; 62:741.
6. Chambers G et al. *Virus Res* 2003; 96:141.
7. Brostrom H et al. *Vet Immunol Immunopathol* 1988; 19:215.
8. Bucher K et al. *Res Vet Sci* 1996; 61:114.
9. Angelos J et al. *Anim Genet* 1988; 19:417.
10. Reid SWJ, Mohammed HO. *Can J Vet Res* 1997; 61:89.
11. Lazary S et al. *Equine Vet J* 1985; 17:283.
12. O'Brien PM, Campo MS. *Virus Res* 2002; 88:103.
13. Tarwid JN et al. *Compend Cont Educ Pract Vet* 1985; 7:S293.
14. Martens A et al. *Vet Surg* 2001; 30:460.
15. Theon AP, Pascoe JR. *Equine Vet J* 1994; 27:117.
16. Foy JM et al. *Comp Cont Educ Pract Vet* 2002; 24:242.
17. Wyn-Jones G. *Equine Vet J* 1983; 15:361.
18. Hoffman KD et al. *Equine Pract* 1983; 5:24.
19. Owen RR, Jagger DW. *Vet Rec* 1987; 120:548.
20. Vanselow B et al. *Equine Vet J* 1988; 20:444.
21. Schwartzman SM et al. *Equine Pract* 1984; 6:13.
22. Martens A et al. *Vet Rec* 2001; 149:665.

### LUMPY SKIN DISEASE (KNOPVELSIEKTE, LSD)

#### Synopsis

**Etiology** Lumpy skin disease virus, of the genus *Capripoxvirus*

**Epidemiology** Enzootic in sub-Saharan Africa and Middle East with recent incursion into Israel. Epizootics interspersed with periods of sporadic occurrence. Transmission by contact and arthropod vector

**Clinical findings** Fever, nodular lesions on the skin and mucous membranes and lymphadenopathy. Proportion of cattle develop generalized infection with high mortality

**Clinical pathology** Intracellular, eosinophilic inclusion bodies in biopsy material. Virus isolation. Fluorescent antibody and serum neutralization tests  
**Necropsy findings** Nodules in skin, upper alimentary, respiratory tract  
**Diagnostic confirmation** Biopsy and histology. Virus isolation  
**Treatment** Supportive  
**Control** Vaccination

## ETIOLOGY

Lumpy skin disease (LSD) is a severe, systemic disease of cattle associated with the Neethling poxvirus, a **capripoxvirus**. It has close antigenic relationship to sheeppox and goatpox viruses which are also in the same genus. There appears to be a difference in virulence between strains.

## EPIDEMIOLOGY

### Occurrence

The disease used to be confined to sub-Saharan Africa, but it is now enzootic in Egypt, and has occurred in Israel<sup>1</sup> where it was eradicated by slaughter of infected and in-contact animals. Some field outbreaks are associated with severe and generalized infections and a high mortality, while with others there are few obviously affected animals and no deaths but in general outbreaks are more severe with the initial introduction of the infection to a region and then abate, probably associated with the development of widespread immunity. **Morbidity rates** reach 80% during epizootics, but are nearer 20% in enzootic areas. Morbidity rates of 31% are recorded in Egypt, and a morbidity of 10% in the recent incursion into Israel.<sup>1</sup> In Kenya, the disease is characterized by a much lower morbidity rate and the disease is much milder. **Case fatality rates** average 2%, but vary with the outbreak. Israel has experienced no direct mortality from the disease. There has been a resurgence of the disease in South Africa in the past decade probably due to higher rainfall and a decrease in the use of vaccination consequent to a previously low incidence.<sup>2</sup>

### Origin of infection and transmission

Cattle can be infected by drinking water, but ingestion and direct contact transmission are not common routes, even though the virus is present in nasal and lacrimal secretions, semen, and milk of infected animals. Most cases are believed to result from transmission by an **arthropod vector**. Historically, LSD virus has been isolated from *Stomoxys calcitrans* and *Musca confusata* and transmitted experimentally using *S. calcitrans* but other vectors are also suspect including *Biomysia*, *Culicoides*, *Glossina* and *Musca* spp. However, in a recent study, despite the detection of virus in mosquitoes (*Anopheles*

*stephensi*, *Culex quinquefasciatus*) the stable fly and a biting midge (*Culicoides nebeculosis*) after they had fed on cattle with lumpy skin disease, the infection did not transmit to susceptible cattle when these arthropods were allowed to re-feed on them.<sup>3</sup>

## Risk factors

### Animal risk factors

All ages and types of cattle are susceptible to the causative virus, except animals recently recovered from an attack, in which case there is a solid immunity lasting for about 3 months. In outbreaks, very young calves, lactating and malnourished cattle develop more severe clinical disease.<sup>2</sup>

**British breeds**, particularly Channel Island breeds, are much more susceptible than zebu types, both in numbers affected and the severity of the disease. **Wildlife species** are not affected in natural outbreaks, although there is concern that they might be reservoir hosts. Typical skin lesions, without systemic disease, have been produced experimentally with Neethling virus in sheep, goat, giraffe, impala, and Grant's gazelle, but wildebeest were resistant. Serological evidence of naturally acquired infection has been observed only in African buffalo (*Syncerus caffer*).<sup>4</sup> There is only one report of the natural occurrence of LSD in a species other than cattle, in water buffalo (*Bubalis*), but no further such cases are recorded.

### Environmental risk factors

Outbreaks tend to follow waterways and extensive epizootics are associated with high rainfall and concomitant high levels of insect activity with a peak of disease in the late summer and early autumn.<sup>2</sup>

### Pathogen risk factors

Capripox viruses are generally resistant to drying, survive freezing and thawing. Resistance to heat is variable but most are inactivated at temperatures above 60°C.

## Experimental production

Experimental transmission can be accomplished using ground-up nodular tissue and blood, or tissue culture virus. Disease is produced following intranasal, ID or IV challenge.<sup>5</sup> While lumpy skin disease is characterized by generalized nodular skin lesions, less than 50% of natural or experimental infections develop generalized skin nodules and the length of the viremic period does not correlate with the severity of the clinical disease.

## Economic importance

The mortality rate is low, but the economic loss is high. In all cattle there is severe loss of milk production and the occurrence of secondary mastitis predisposed by the development of lesions on the teats. Loss also occurs from damage

to hides, the loss of bodily condition during the course of the disease, and the loss of fertility in affected bulls. Cow may abort in the course of the disease. Lumpy skin disease is considered to be one of the high risk diseases for spread out of Africa to the outside world and a potential agent of agroterrorism.

## PATHOGENESIS

In the generalized disease there is viremia accompanied by a febrile reaction, and localization in the skin occurs with development of inflammatory nodules. In the experimental disease, following ID inoculation, local lesions can develop at the site of challenge without viremia and generalization of the infection.<sup>5</sup>

## CLINICAL FINDINGS

An **incubation period** of 2–4 weeks is common in field outbreaks and 7–14 days following experimental challenge.<sup>5</sup> In severe cases there is an initial rise of temperature, which lasts for over a week, sometimes accompanied by lacrimation, nasal discharge, salivation, and lameness.

**Multiple nodules** appear suddenly about a week later, the first ones usually appearing in the perineum. They are round and firm, varying from 1 to 4 cm in diameter, and are flattened and the hair on them stands on end. They vary in number from a few to hundreds; they are intradermal and, in most cases, are confined to the skin area. Other manifestations that may be observed in severe cases include lesions in the nostrils and on the turbinates, causing mucopurulent nasal discharge, respiratory obstruction and snoring; plaques, later ulcers, in the mouth causing salivation; nodules on the conjunctiva, causing severe lacrimation, and on the prepuce or vulva, and spreading to nearby mucosal surfaces. The limbs may become grossly distended with edema fluid.

In most cases the nodules disappear rapidly, but they may persist as hard lumps or become moist, necrotic, and slough.

Lymph nodes draining the affected area become enlarged and cause local edema. When sloughing of the yellow center of nodules occurs there is often exposure of underlying tissues, e.g. testicles or tendons. Lesions where skin is lost may remain visible for long periods, and where lesions have coalesced, large areas of raw tissue may be exposed. The skin lesions provide an excellent point of entry for screw worms. Pneumonia is a common sequel in cases where lesions occur in the respiratory tract.

A convalescence of 4–12 weeks is usual. Pregnant cows may abort.

## CLINICAL PATHOLOGY

**Antigen detection.** Diagnosis is most commonly made by electron microscopic

demonstration of typical capripox virions in full thickness skin biopsies or scabs coupled with the clinical findings of a generalized nodular skin disease with enlarged superficial lymph nodes. Biopsy of lesions reveals a granulomatous reaction in the dermis and hypodermis. In the earlier acute stages, there are intracellular, eosinophilic **inclusion bodies**.<sup>6</sup> Virus can be cultivated from lesions. Antigen can also be detected by antigen detection ELISA with samples taken early in the course of the disease before the development of neutralizing antibodies and by fluorescent antibody tests and PCR. The AGID test can be used but the antigen will also react with parapox virus. A recent study in experimentally infected cattle found that virus in skin lesions could be detected by PCR for 90 days after infection, much longer than detection by virus isolation.<sup>7</sup>

**Serology.** Virus neutralization the indirect fluorescent antibody tests are commonly used. AGID tests may give false-positive reactions due to cross reaction with bovine papular stomatitis virus and pseudocowpox virus.

#### NECROPSY FINDINGS

The cutaneous lesions are described under clinical pathology. Similar lesions are present in the mouth, pharynx, trachea, skeletal muscle, bronchi and stomachs, and there may be accompanying pneumonia. The superficial lymph nodes are usually enlarged. Respiratory distress and death are often the result of respiratory obstruction by the necrotic ulcers and surrounding inflammation in the upper respiratory tract and/or concurrent aspiration pneumonia. Histologically, a widespread vasculitis reflects the viral tropism for endothelial cells. Intracytoplasmic viral inclusion bodies may be seen in a variety of cell types.

#### Samples for confirmation of diagnosis

- **Histology** – formalin-fixed lesions from skin, alimentary and respiratory tissue, lymph node (LM)
- **Virology** – lymph node, skin lesion (ISO).

#### DIFFERENTIAL DIAGNOSIS

The rapid spread of the disease and the sudden appearance of lumps in the skin after an initial fever make this disease quite unlike any other affliction of cattle.

Pseudo-lumpy skin disease (also known as Allerton virus infection and 'general infection of cattle with bovine herpesvirus-2'), is associated with bovine herpesvirus-2, the agent of bovine mammillitis. It occurs primarily in southern Africa, but very occasional cases are recorded in the United States, Australia, and the United

Kingdom<sup>8-10</sup> and is stated to occur more commonly in the southern United States than formally recognized.<sup>10</sup> Multifocal lesions are distributed over the body, and are circular, up to 2 cm in diameter, with loss of hair and an intact central area and raised edges. Some lesions show a circular ring of necrosis around a central scab. The scabs fall off leaving discrete hairless lesions that may be depigmented. The disease runs a course of approximately 2 weeks and there is no mortality. Only the superficial layers of skin are involved. This is in contrast to the lesions of lumpy skin disease, which are often deep enough to expose underlying tissues. Herpesvirus can be isolated from the periphery of the lesions. Diagnosis can be made by PCR on full-thickness skin biopsy.<sup>10</sup>

#### TREATMENT

No specific treatment is available, but prevention of secondary infection is essential. The use of antibiotics or sulfonamides is recommended.

#### CONTROL

Lumpy skin disease moves into new territory principally by means of the movement of infected cattle or possibly by wind-borne vectors.<sup>1</sup> In the new territory further spread is accepted as being via an insect vector. Control of cattle movement from uninfected to infected territory is an important control measure. Further control can only be by vaccination.

#### Vaccination

A safe and effective vaccine has been produced by 60 passages of the virus through lamb kidney culture. It is administered to all animals over 6 months of age and is effective, but is associated with considerable local reaction that may persist over 1 month and may predispose fly strike. Local response to the vaccine is usually correlated with good antibody response.<sup>2</sup> A freeze-dried, living attenuated virus vaccine is also available. Vaccination of cattle with sheeppox virus, also attenuated by passage through tissue culture, is effective in preventing infection with the lumpy skin disease virus and is currently the most common method of protection.<sup>11,12</sup> A small percentage of cattle develop granulomatous local reactions but there is no spread of the sheeppox to sheep running with the cattle. Vaccination of a herd at the start of an outbreak has limited efficacy as most animals will already be incubating the disease. Poor needle hygiene in these circumstances may spread the disease.

Cattle vaccinated with a recombinant capripox-rinderpest vaccine are immune to experimental challenge with both viruses but for a different length of time with each agent.<sup>13</sup>

Slaughter of affected and in-contact animals and destruction of contaminated

hides, coupled with vaccination of at-risk animals, is used when the disease gains access to a previously free country.

#### REVIEW LITERATURE

- House JA. Lumpy skin disease. Am Anim Health Assoc Proc 93 Ann Gen Mtg 1989; 305-314
- Davies FG. Lumpy skin disease, an African capripox virus disease of cattle. Br Vet J 1991; 147:489-502
- Davies FG. Lumpy skin disease of cattle: a growing problem in Africa and the Near East. World Anim Rev 1991; 68:37-42
- Carn V. Lumpy skin disease. Manual of standards diagnostic tests. Ann Vaccines OIE, 2000.

#### REFERENCES

1. Yerahum I et al. Vet Rec 1995; 137:91.
2. Hunter P, Wallace D. J Sth Afr Vet Assoc 2001; 72:68.
3. Chihota CM et al. Med Vet Entomol 2003; 17:294.
4. Davies FG. J Hyg Camb 1982; 88:95.
5. Carn VM, Kitching RP. Arch Virol 1995; 140:503.
6. Prozesky L, Barnard BJH. Onderstepoort J Vet Res 1982; 49:167.
7. Tuppurainen ESM et al. Onderstepoort J Vet Res 2005; 72:153.
8. St George TD et al. Aust Vet J 1980; 56:47.
9. Woods JA et al. Vet Rec 1996; 138:113.
10. d'Offay JM et al. J Am Ver Med Assoc 2003; 222:1404.
11. Brenner B et al. Israel J Vet Sci 1982; 47:17.
12. Carn VM. Vaccine 1993; 11:1275.
13. Ngichabe CK et al. Epidemiol Infect 2002; 128:343.

#### VIRAL PAPULAR DERMATITIS

This disease of horses occurs in the United States, United Kingdom, and Australia. It is a contagious disease characterized by cutaneous lesions in the form of firm papules 0.5–2 cm in diameter. No vesicles or pustules are formed, but after 7–10 days a dry crust is detached, leaving small circumscribed areas of alopecia. The lesions are not itchy, there is no systemic disease and the distribution of the lesions, and the way in which they can develop simultaneously in large numbers in introduced horses, is suggestive of an insect-borne disease.

The course of the disease varies between 10 days and 6 weeks. An unidentified virus has been isolated from lesions and cultured on eggs. A febrile reaction, up to 40.2°C (104.5°F), precedes the appearance of skin lesions by about 24 hours. There is no histological description. Recovery is usually complete and uncomplicated. The disease is clinically similar to **molluscum contagiosum** in horses associated with poxvirus. This disease has similar papular lesions, which are hypopigmented and covered by tufts of raised hair but the disease has a long clinical course. Histologically, these show proliferation of keratinocytes containing large intracytoplasmic inclusions, known as molluscum bodies, which are composed of numerous pox virions.



## COWPOX

### Synopsis

**Etiology** Cowpox virus is a member of the genus *Orthipoxvirus* in the family Poxviridae

**Epidemiology** Endemic infection of certain rodents in Europe and east Asia. Cattle are a rare and incidental host. Spread in cattle by contact

**Clinical findings** Typical pox lesions on the teats and udder. Erythema, papules with a zone of hyperemia around the base, vesiculation, pustular stage and scab

**Clinical pathology** Electron microscopy

**Diagnostic confirmation** Electron microscopy and virus isolation

**Treatment** Palliative

**Control** Sanitation to prevent spread between cows

### ETIOLOGY

Cowpox virus is a member of the genus *Orthipoxvirus* in the family Poxviridae. Other orthipoxviruses infecting agricultural animals include horsepox, Uasin Gishu, buffalopox and camelpox.<sup>1</sup> All orthipoxviruses are antigenically extremely similar, but they can be identified by a combination of phenotypic and genetic tests.

### EPIDEMIOLOGY

#### Occurrence

Cowpoxvirus could be considered to be misnamed. Infection with this virus is **endemic in wild rodents** such as voles (*Microtus* spp.) in **Great Britain, Europe and western Asia**, with infection in different rodent species acting as the reservoir host in different geographic areas.<sup>2,3</sup> Domestic cats are commonly infected from hunting rodents, but cowpoxvirus infection can occur in a number of different mammalian species,<sup>2</sup> one of which is cattle. The clinical syndrome of cowpox in **cattle** is now **extremely rare** but it occurs sporadically in Europe. Seroprevalence in British cattle is less than 1%.

#### Origin of infection and transmission

The origin of infection is most probably from infected farm cats or humans. **Transmission** from cow to cow within a herd is effected by milkers' hands or teat cups. Spread from herd to herd is probably effected by the introduction of infected animals, by carriage on milkers' hands, and in the absence of either of the above methods, transport by biting insects is possible. In a herd in which the disease is enzootic, only heifers and new introductions develop lesions. Milkers recently vaccinated against smallpox may serve as a source of infection for cattle, although the **vaccinia virus**, the smallpox vaccine virus, is a different virus.

It is generally assumed that the virus gains access to tissues through injuries to teat skin, and extensive outbreaks of cowpox are likely to occur when the environment is conducive to teat injuries. Spread is rapid within a herd and immunity is solid, so that the disease tends to occur in sharp **outbreaks** of several months' duration with subsequent immunity protecting the cattle for at least several years.

#### Economic importance

Losses are due to inconvenience at milking time because of the soreness of the teats and from occasional cases of mastitis, which develop when lesions involve teat sphincters. Milk from affected cows is suitable for human consumption.

#### Zoonotic implications

Human cowpox is not common and usually consists of one or a few lesions on the hand and face with minimal systemic reaction.<sup>4</sup> Infection is more likely to come from an infected cat than cattle.<sup>4,5</sup>

### PATHOGENESIS

In cowpox, the five stages of a **typical pox eruption** can be observed. After an incubation period of 3–6 days, a roseolar erythema is followed by firm, raised papules light in color but with a zone of hyperemia around the base. Vesiculation, a yellow blister with a pitted center, follows. The subsequent pustular stage is followed by the development of a thick, red, tenacious scab.

In experimentally produced **vaccinia virus** mammillitis (produced by inoculation of smallpox vaccine), the lesions have three zones: a central brown crusty area of necrosis, surrounded by a gray-white zone of microvesicle formation, again surrounded by a red border due to congestion. The lesions are essentially hyperplastic.

### CLINICAL FINDINGS

Typical **lesions** may be seen at any stage of development, but are mostly observed during the scab stage, the vesicle commonly having been ruptured during milking. True cowpox scabs are 1–2 cm in diameter and are thick, tenacious, and yellow-brown to red in color. In cows being milked, scab formation is uncommon, the scab being replaced by a deep ulceration.

**Distribution** of the lesions is usually confined to the teats and lower part of the udder. Soreness of the teats develops and milk letdown may be interfered with; the cow usually resents being milked. Secondary mastitis occurs in a few cases. Individual lesions heal within 2 weeks, but in some animals fresh crops of lesions may cause the disease to persist for a month or more. In severe cases, lesions

may spread to the insides of the thighs, and rarely to the perineum, vulva and mouth.<sup>6</sup> Sucking calves may develop lesions about the mouth. In bulls, lesions usually appear on the scrotum.

### CLINICAL PATHOLOGY

The virus can be propagated in tissue culture, and differentiation is possible by electron microscopy.<sup>7</sup>

### DIFFERENTIAL DIAGNOSIS

A number of skin diseases may be accompanied by lesions on the udder and can easily be confused with cowpox if the lesions are advanced in age. The differential points are listed in Table 22.2. Most outbreaks of teat skin disease that clinically resemble classical cowpox are associated with vaccinia virus from contact with a recently vaccinated person.

- Pseudocowpox
- Bovine ulcerative mammillitis associated with bovine herpesvirus-2 and bovine herpesvirus-4
- Vesicular stomatitis, and foot and mouth disease
- Udder impetigo
- Teat chaps and frostbite
- Black spot.

### CONTROL

Prevention of spread is difficult, since the virus responsible for the disease is readily transmitted by direct or indirect contact. Udder cloths, milking machines and hands should be disinfected after contact with infected animals. Dipping of the teats in an alcoholic tincture of a suitable disinfectant, such as quaternary ammonium compounds, is usually satisfactory in preventing immediate spread. The prevalence and significance of the disease in cattle is too low to warrant the development of vaccines.<sup>7</sup>

### REFERENCES

1. Smith SA, Kotwal GJ. Crit Rev Microbiol 2002; 28:149.
2. Bennett M, Baxby D. J Med Microbiol 1996; 45:157.
3. Hazel SM et al. Epidemiol Infect 2000; 124:551.
4. Baxby D et al. Br J Dermatol 1994; 131:598.
5. Bennett M, Baxby D. Vet Ann 1995; 35:229.
6. Yerahum I et al. Rev d'Elev Med Vet Pays Trop 1996; 49:299.
7. Kitching RP. Vet Ann 1987; 27:109.

### PSEUDOCOWPOX (MILKERS' NODULE)

#### Synopsis

**Etiology** Parapoxvirus

**Epidemiology** Primarily affects cows in early lactation. Low, but progressive, morbidity in herd. Spread during milking

**Clinical findings** Vesicles, pustules, formation of a thick scab elevated by

granulating tissue. Horseshoe-shaped ring of small scabs surrounding granulating tissue

**Clinical pathology** Vesicle fluid for electron microscopy

**Diagnostic confirmation** Electron microscopy

**Treatment** Antiseptics and emollient ointment

**Control** Milking hygiene

## ETIOLOGY

Pseudocowpox virus is a member of the genus *Parapoxvirus*, with close similarity to the viruses of infectious papular stomatitis and contagious ecthyma. It is possible that *Parapoxvirus* may be a single virus adapted to different species of ruminants.

## EPIDEMIOLOGY

### Occurrence

Pseudocowpox is reported from **most countries**. In an affected herd the rate of spread is relatively slow and may result in the disease being present in the herd for up to a year. The **morbidity** rate approximates 100%, but at any given time varies between 5 and 10%, and occasionally up to 50%.

### Origin of infection and transmission

The source of infection is **infected cattle**. The method of **transmission** includes physical transport by means of contaminated milkers' hands, wash cloths, and teat cups. The virus cannot penetrate mucosa, and a pre-existing discontinuity of it is necessary for the virus to gain entry. Transmission by biting insects seems likely. The virus can be isolated from the mouths of calves sucking affected calves, and from the semen of bulls.

### Animal risk factors

**Freshly calved and recently introduced cattle** are most susceptible, but **all adult cattle** in a herd, including dry cows, are likely to be affected. The disease does not appear to occur in animals less than 2 years of age unless they have calved. There is no seasonal variation in incidence. Little immunity develops and the disease is likely to recur in the herd within a short time.<sup>1</sup>

### Economic importance

Pseudocowpox is relatively benign, most losses occurring as a result of difficulty in milking and an increase in the incidence of mastitis.

### Zoonotic implications

The disease is transmissible to humans, infection usually resulting in the development of milkers' nodule on the hand.

## PATHOGENESIS

The disease can be reproduced by the introduction of the virus onto scarified areas of

skin. The lesions are characterized by hyperplasia of squamous epithelium.

## CLINICAL FINDINGS

Acute and chronic lesions occur, and there may be up to ten lesions on one teat. **Acute lesions** commence as erythema followed by the development of a vesicle or pustule, which ruptures after about 48 hours, resulting in the formation of a thick scab. Pain is moderate and present only in the pre-scab stage. The scab, varying in size from 0.5 to 25 cm in diameter, becomes markedly elevated by developing granulating tissue beneath it; 7-10 days after lesions appear the scabs drop off, leaving a **horseshoe-shaped ring** of small scabs surrounding a small, wart-like granuloma, which may persist for months. The disease tends to disappear from a herd after 18-21 days but may recur cyclically about 1 month later. There are reports of lesions occurring occasionally in cows' mouths.

**Chronic lesions** also commence as erythema, but progress to a stage in which yellow-gray, soft, scurfy scabs develop. The scabs are readily rubbed off at milking, leaving the skin corrugated and prone to chapping. There is no pain and the lesions may persist for months.

**Milkers' nodules** are clinically indistinguishable from human lesions associated with ecthyma virus. The lesions vary from multiple vesicles to a single, indurated nodule.

## CLINICAL PATHOLOGY AND NECROPSY FINDINGS

Material for examination by tissue culture or electron microscopic examination, the latter being highly recommended as a diagnostic procedure, should include fluid from a vesicle.

## DIFFERENTIAL DIAGNOSIS

Differentiation of those diseases in which lesions of the teat are prominent is dealt with in the preceding section on cowpox.

## TREATMENT

Locally applied ointments of various kinds appear to have little effect on the lesions. The recommended treatment includes the removal of the scabs, which should be burned to avoid contaminating the environment, application of an astringent preparation, such as triple dye, after milking and an emollient ointment just before.

## CONTROL

Recommended measures, such as treatment and isolation of affected cows, or milking them last, the use of disposable paper towels for udder washing, and disinfection of teat cups, appear to have

little effect on the spread of the disease. An iodophor teat dip is recommended as the most effective control measure.<sup>2</sup> An effort should be made to reduce teat trauma because infection is facilitated by discontinuity of the skin.

## REVIEW LITERATURE

Gibbs EPJ. Viral diseases of the skin of the bovine teat and udder. *Vet Clin North Am Large Anim Pract* 1984; 6:187-202.

## REFERENCES

- Gibbs EPJ. *Vet Clin North Am Large Anim Pract* 1984; 6:187.
- Puddle BM et al. *NZ Vet J* 1986; 34:16.

## BOVINE ULCERATIVE MAMMILLITIS (BOVINE HERPES MAMMILLITIS)

### Synopsis

**Etiology** Bovine herpesvirus-2, rarely bovine herpesvirus-4

**Epidemiology** Occurs as an outbreak in cows, particularly heifers, usually within 2 weeks after calving. Commonly followed by persistent infection in the herd

**Clinical findings** Lesions confined to teats and udder. Vesicles leading to sloughing of skin and necrotic ulceration. Prolonged clinical course

**Clinical pathology** Virus isolation and electron microscopy on fresh lesions, serology

**Treatment** Antiseptic and emollient ointments

**Control** Isolation and milking hygiene, but not effective. Control of periparturient udder edema

## ETIOLOGY

The causative virus, **bovine herpesvirus-2** (BHV-2), is an alphaherpesvirus. Infection with BHV-2 can produce two distinct syndromes in cattle, **bovine herpes mammillitis** where there are vesicular and erosive lesions with necrotic ulceration on the skin of the udder and teats and **pseudo-lumpy skin disease** (Allerton virus) manifest with generalized superficial skin lesions over the body. Pseudo-lumpy skin disease is uncommon. The difference in clinical manifestations between the two diseases may be due to the strain of the virus, or the method of infection. **BHV-4** (DN599 strain), which is usually associated with respiratory disease in cattle, is also capable of causing mammary pustular dermatitis.<sup>1</sup>

## EPIDEMIOLOGY

### Occurrence

Herpes mammillitis is recorded in North America, Australia, Europe and Africa, but probably has **widespread occurrence**. Herds infected for the first time have a high morbidity rate. Subsequently, the incidence is low and is limited to fresh

heifers. The **morbidity** rate varies between 18 and 96%, susceptible herds recording more than 30% affected. The **mortality** rate is negligible.

#### Origin of infection and transmission

Introduction of bovine ulcerative mammillitis into a herd may occur with the introduction of infected animals, but outbreaks have been observed in self-contained herds. **Spread** within the herd is probably by direct and fomite-mediated transmission, although experimentally the virus must be deposited in the deep layers of the skin, and even rubbing it into pseudocowpox lesions is not an efficient way of transmitting the disease. Milking machine liners, hands, and udder cloths may act as carriers of virus when a large amount of it is being released.

Seasonal and circumstantial evidence in the **United Kingdom** and **Australia** suggest an insect vector, but this has not been confirmed by attempts at transmission with the stable fly (*Stomoxys calcitrans*), and in the mid-west of the **United States**, disease is more common in the winter months between November and April.<sup>2</sup>

Survival of the virus for long periods in carrier animals occurs and it is thought that this may be the means of survival of the virus within a herd that has become immune.<sup>3</sup> Infection in some cows is suspected to result in chronic infection at the teat end with the cows becoming '**hard milkers**' and **carriers** of the disease.<sup>2</sup>

#### Animal and pathogen risk factors

Lesions are most common in animals within the **first 2 weeks after calving**, particularly in **heifers**, and the disease is more severe in heifers. Heifers that have **udder edema** at calving are particularly prone to develop severe lesions. Occasionally, lesions may be seen on the teats of replacement heifers and calves sucking infected dams often develop mouth lesions.

The disease is **usually self-limiting**, persisting in a herd for 6–15 weeks, the severity of the lesions decreasing as the outbreak progresses. Immunity appears to last about a year, herds infected naturally can suffer recurrences a year later. **Large herds** may have **persisting** disease, particularly in heifers.

The virus is relatively resistant to environmental influences and can survive freezing. It is susceptible to **iodophor disinfectants** and less so to hypochlorites.

#### Economic importance

Forms of loss include a much higher incidence of mastitis, reduction in milk in affected herds by up to 20%, the **culling** of some cows because of severe mastitis and of heifers because of intrac-

table ulcers, and a great deal of interference with normal milking procedure.

#### Zoonotic implications

There are anecdotal reports of herpetic lesions in farmers exposed to infected cattle.<sup>4</sup>

#### PATHOGENESIS

Typical clinical lesions and histopathological changes can be produced locally by introduction of the virus into scarifications of the skin of the teat and the oral mucosa, and by ID and IV injection. There is no viremia and spread is by local extension. In contrast to the poxes, the characteristic lesion in mammillitis is destructive. The higher incidence of the disease and the greater severity of the lesions close to calving are thought to be due to the immunosuppression caused by parturition and to greater predisposition from periparturient udder edema.

#### CLINICAL FINDINGS

There is an **incubation period** of 5–10 days. There is no systemic illness, and lesions are confined to the teats and udder. When the disease occurs in a herd for the first time the first case is usually in a cow that has calved during the previous 2–3 days. Rapid lateral spread then occurs to other cows.

In cows calved more than a few weeks previously, the characteristic lesions are almost entirely confined to the skin of the teats; in recently calved cows they are restricted to the skin of the teats and the udder. The severity of the disease in recently calved cattle appears to be directly proportional to the degree of postparturient edema which is present. **Vesicles** occur but are not commonly seen. They are characteristically thin-walled, 1–2 cm in diameter, variable in outline, and often commence at the base of the teat and spread over much of the udder surface. Rupture and confluence of the vesicles leads to weeping and extensive **sloughing** of the skin.

In the most **severe cases**, the entire teat is swollen and painful, the skin is bluish in color, exudes serum and sloughs, leaving a raw ulcer covering most of the teat. In less severe cases, there are raised, deep red to blue, circular plaques, 0.5–2 cm in diameter, which develop shallow ulcers. In most cases, scab formation follows but machine milking causes frequent disruption of them, resulting in frequent bleeding. The least severe lesions are in the form of lines of erythema, often in circles and enclosing dry skin or slightly elevated papules, which occasionally show ulceration. Mild lesions tend to heal in about 10 days but severe ulcers may persist for 2 or 3 months. The severity of lesions on the teats on longer-calved cows varies,

but in all cases the lesions are sufficiently painful to make milking difficult. Lesions on the skin of the udder heal more rapidly because of the absence of trauma.

Ulcers in the mouth of affected cows have been observed rarely, and calves sucking affected cows develop lesions on their oral mucosae and muzzles. Ulcerative lesions on the vaginal mucosa have been recorded rarely. During the recovery phase there is obvious scar formation and depigmentation.

The generalized skin disease associated with BHV-2, '**pseudo-lumpy skin disease**' is discussed in the differential diagnosis of lumpy skin disease.

#### CLINICAL PATHOLOGY AND NECROPSY FINDINGS

Material for tissue culture, electron microscopy, or cutaneous transmission tests is best obtained by syringe from early vesicles, or as swabs from early ulcers or oral lesions. The virus may be difficult to demonstrate if the lesions are as old as 7 days, and if there has been intensive application of teat disinfectants such as iodophors.

**Serology** is more commonly used for diagnosis. The presence of high virus-neutralizing antibody titers in serum taken during the acute phase of the disease, and a four-fold increase or decrease in titer in paired samples, are all supportive for diagnosis.<sup>3,5</sup> Titers of 1:16 or higher for BHV-2 and 1:20 for BHV-4 indicate exposure. Antibody to both viruses should be tested for diagnostic purposes.<sup>2</sup>

Necropsy is not commonly performed and no necropsy reports of cases of bovine ulcerative mammillitis are available.

#### DIFFERENTIAL DIAGNOSIS

Differentiation of other diseases of the skin of the teat and udder is dealt with in the section on cowpox.

#### TREATMENT

There is no specific treatment and the aim should be to develop scabs that can withstand machine milking. This is most easily effected by the application of a water-miscible, antiseptic ointment just before putting the cups on, followed by an astringent lotion, such as triple dye, immediately after milking. Crystal violet dyes have an excellent reputation as treatments.

#### CONTROL

Isolation of affected animals and strict hygiene in the milking parlor are practiced but have little effect on the spread of the disease, nor does milking heifers first. An **iodophor** disinfectant is recommended

for use in the dairy to prevent spread. Reducing the incidence and severity of **periparturient edema** in heifers may reduce the severity of herpes mammillitis. Inoculation of the natural virus away from the teats produces a local lesion and good immunity, but the method has not been tested as a control procedure.

### REVIEW LITERATURE

Gibbs EPJ, Rweyemamu MM. Bovine herpesvirus 2, 3. *Vet Bull* 1977; 47:411-417.

Wellenberg GL et al. Viral infections and bovine mastitis: A review. *Vet Microbiol* 2002; 88:27-45.

### REFERENCES

1. Reed DE et al. *Am J Vet Res* 1977; 38:1631.
2. Farnsworth RJ. *Bovine Pract* 1995; 29:89.
3. Martin WB, Scott FMM. *Arch Virol* 1979; 60:51.
4. Pepper TA et al. *Vet Rec* 1966; 78:569.
5. O'Conner M et al. *Irish Vet J* 1994; 47:168.

## SHEEPOX AND GOATPOX

### Synopsis

**Etiology** *Capripoxvirus*. Strains vary in virulence and host specificity

**Epidemiology** Highly contagious, spread by aerosol, contact and flies. Young and non-indigenous animals more susceptible. Morbidity and case fatality rates are high

**Clinical findings** Fever, generalized skin and internal pox lesions, lymphadenopathy, mucopurulent nasal discharge, high mortality

**Clinical pathology** Fluorescent antibody and electron microscopy of biopsy material, serology, virus isolation

**Necropsy findings** Pox nodular lesions in alimentary and respiratory tract

**Diagnostic confirmation** Fluorescent antibody staining, virus isolation

**Control** Vaccination

### ETIOLOGY

Three viruses are named on the basis of their host specificity in natural outbreaks. **Sheeppox virus** and **goatpox virus** are mainly highly host specific in natural infections, but exceptions exist and **Kenya sheep and goatpox virus**, and Yemen and Oman sheep isolates infect both sheep and goats. All are members of the genus *Capripoxvirus*, are closely related on the basis of genome mapping, and many cross species barriers in experimental infections<sup>1-3</sup> although not in natural occurrence. Recombination may occur naturally between isolates from different host species.<sup>4,5</sup> The diseases they produce are also collectively called **capripox infections**.<sup>2</sup>

### EPIDEMIOLOGY

#### Occurrence and prevalence of infection

Sheeppox and goatpox are prevalent in North and Central Africa, the Indian subcontinent, Middle Eastern countries,

China, Southwest Asia and the former Soviet Union. Sporadic outbreaks occur in southern Europe and elsewhere.<sup>6</sup> The capripoxvirus infections of small ruminants are the **most serious** of all the pox diseases in animals. In susceptible flocks and herds morbidity is 75-100% with outbreaks often causing death in 10-85% of affected animals depending on the virulence of the infecting strain.<sup>2,6-9</sup>

### Methods of transmission

Sheeppox and goatpox are **highly contagious**. The virus enters via the respiratory tract and transmission commonly is by aerosol infection associated with close contact with infected animals. The virus is present in nasal and oral secretions for several weeks after infection and can live in scabs that have fallen off the animal for several months. Spread can also occur from contact with contaminated materials and through skin abrasions produced iatrogenically or by insects. Capripox has been shown to spread via the bites of *Stomoxys calcitrans* and the tsetse fly.<sup>10</sup>

### Experimental reproduction

The disease can be transmitted by intradermal, intravenous and subcutaneous inoculation and by virus aerosols.

### Risk factors

#### Animal risk factors

Both sheep pox and goat pox affect sheep and goats of all ages, breeds and sex but young and old animals and lactating females are more severely affected. In areas where sheeppox is enzootic, **imported breeds** such as Merinos or some European breeds may show greater susceptibility than the native stock. **Young animals** are more susceptible.

#### Pathogen risk factors

The virus is resistant to drying and survives freezing and thawing. It is sensitive to extremes of pH and 1% formalin. Sensitivity to heat varies between strains but most are inactivated at 60°C for 60 min.<sup>6</sup> Isolates from most regions are host specific but isolates from Kenya, Yemen and Oman naturally infect both goats and sheep. Scabs shed by infected animals remain infective for several months.

### Economic importance

Loss is from mortality, abortions, mastitis, loss of wool, skin condemnation and loss of exports. In ewes and does, severe losses may occur if the udder is invaded because of the secondary occurrence of acute mastitis. In some outbreaks, adult sheep are affected with the more severe form of the disease.<sup>11</sup> Sheeppox is a potent threat to countries that have big sheep populations, and where the disease does not occur, because of its ineradicability and heavy mortality rate.

### Zoonotic implications

Human infections in people handling infected animals are not a consideration.<sup>9</sup>

### PATHOGENESIS

During an initial viremia, the virus is deposited in most tissues, including the skin. The development of typical pox lesions, as in vaccinia, is characteristic of the disease. The virus is present in greatest quantities between the 7th and 14th day after inoculation. Passive protection by serum will protect against challenge. Circulating antibody limits spread of infection, but does not prevent replication of virus at the site of inoculation.

### CLINICAL FINDINGS

In **sheeppox** in sheep there is an incubation period of 12-14 days. In lambs, the **malignant form** is the most common type. There is marked depression and prostration, a very high fever and discharges from the eyes and nose. Affected lambs may die during this stage before typical **pox lesions** develop. These, when they develop, occur on unwooled skin and on the buccal, respiratory, digestive, and urogenital tract mucosae. They commence as papules, then become nodular, occasionally become vesicular, pustular and finally scab. Some progress from nodules to tumor-like masses.<sup>12</sup> The mortality rate in this form of the disease may reach 50%. In the **benign form**, more common in adults, only skin lesions occur, particularly under the tail, and there is no systemic reaction and animals recover in 3-4 weeks. Abortion and secondary pneumonia are complications. Goatpox in sheep is more severe than sheeppox, and lesions occur on the lips and oral mucosa, the teats and udder.

**Goatpox** in goats is very similar clinically to sheeppox in sheep. Young kids suffer a systemic disease, with lesions spread generally over the skin, and on the respiratory and alimentary mucosae. Adult goats may have systemic disease and extensive lesions,<sup>7,10</sup> but in adult goats the disease is usually mild and lesions are as described above for the benign form in sheep. A flat hemorrhagic form of capripox is seen in some European goats and this has a high case fatality.

### CLINICAL PATHOLOGY

#### Antigen detection

Diagnosis is based on typical clinical signs combined with laboratory confirmation of the presence of the virus or antigen. Using electron microscopy, large numbers of characteristic 'sheeppox cells' containing inclusion bodies and typical capripox virions can be seen in biopsies of the skin. The virus can be cultured in tissue culture but virus isolation as a method of rapid

diagnosis is limited by the time it takes for virus cytopathic effects to develop and the need, with some strains, for several blind passages before this develops. Direct fluorescent antibody test is used to detect the presence of pox virus in the edema fluid and the antigen can be detected in biopsies of lymph glands by AGID using specific immune sera. An antigen detection ELISA is also available.

### Serology

In India a 'soluble antigen fraction', which is non infectious, has replaced infectious virus for serological tests which avoids the risk of accidental spread of the virus from diagnostic laboratories and from the postal supply of diagnostic agents.<sup>6</sup> However, serological tests such as AGPT, serum neutralization and agar gel diffusion are confounded due to cross reaction with orf virus. A capripox-specific capture-ELISA is reported to have sufficient sensitivity, specificity and speed to have utility in rapid diagnosis using biopsy samples.<sup>13</sup> Serological testing can be by virus neutralization, which is specific or by an indirect fluorescent antibody test or an agar gel precipitation (AGPT), however both of the latter cross react with antibody to contagious pustular dermatitis virus. Virus-specific analysis of antibody response by Western blot analysis can differentiate the infections.<sup>14</sup>

A capripox PCR for detection of antigen is used in some countries which do not have the disease and do not hold live virus.<sup>15,16</sup>

### NECROPSY FINDINGS

In the malignant form, pox lesions extend into the mouth, pharynx, larynx, and vagina with lymphadenopathy and a hemorrhagic spleen. Lesions may also appear in the trachea. Lesions in the lung are severe manifesting as lentil sized white pox nodules to a consolidating necrotizing pneumonia. Lesions occasionally reach the abomasum and are accompanied by a hemorrhagic enteritis.

### DIFFERENTIAL DIAGNOSIS

- Contagious ecthyma (orf)
- Bluetongue.

### TREATMENT

No specific treatment is advised, but palliative treatment may be necessary in severely affected animals.

### CONTROL

Control in free countries or regions necessitates prohibition of importation from infected areas, and if the infection is introduced, ring vaccination, the destruc-

tion of affected flocks and the quarantine of infected premises should be instituted.

**Vaccination** with natural lymph has been practised in some affected areas, but is capable of spreading the disease. Natural infection with one capripox strain imparts immunity to all capripox infections and vaccination with a **single capri pox vaccine** will give protection across all species and against all capripox infections.<sup>2</sup>

A large variety of commercial vaccines is now available, and there is no easy basis for comparison.<sup>3</sup> Killed virus vaccines elicit, at best, temporary protection but available live attenuated vaccines appear to give excellent protection for periods greater than 1 year.<sup>2,3,17,18</sup> Colostral antibody interferes with response to vaccination before 6 months of age. A subunit capripox virus vaccine has been developed.<sup>19</sup>

Vaccination in the face of outbreak is unlikely to prevent deaths during the subsequent 2 weeks and, if needle hygiene is poor, may facilitate the spread of the disease.

### REVIEW LITERATURE

Singh IP, Srivastava RN. Sheeppox: A review. *Vet Bull* 1979; 49:145.

Rao TVS, Bandyopadhyay SK. A comprehensive review of goat pox and sheep pox and their diagnosis. *Anim Health Rev* 2000; 1:127-136.

Tulman ER et al. The genomes of sheeppox and goatpox viruses. *J Virol* 2002; 76:6054-6061.

### REFERENCES

1. Hosamani M et al. *Virus Genes* 2004; 29:73.
2. Carn VM. *Vaccine* 1993; 11:1275.
3. Bhat PP. *Indian J Anim Sci* 1993; 63:857.
4. Gershon PD et al. *J Gen Virol* 1989; 70:485.
5. Tulman ER et al. *J Virol* 2002; 76:6054.
6. Rao TVS, Bandyopadhyay SK. *Anim Health Rev* 2000; 1:127.
7. Okaiyeto SO et al. *Israel J Vet Med* 1995; 50:65.
8. Reddy YR et al. *Indian Vet J* 2003; 80:1298.
9. Joshi RK et al. *Indian Vet J* 1999; 76:279.
10. Kitching RP, Mellor PS. *Res Vet Sci* 1986; 40:255.
11. Solyom F et al. *Acta Vet Acad Sci Hungary* 1980; 28:389.
12. Afshar A et al. *Can Vet J* 1986; 27:301.
13. Ngichabe CK et al. *Vet Rec* 1999; 145:231.
14. Chand P et al. *Epidemiol Infect* 1994; 113:377.
15. Heine HG et al. *J Immunol Methods* 1999; 227:187.
16. Ireland DC, Binopal YS. *J Virol Methods* 1998; 74:1.
17. Kitching RP et al. *Res Vet Sci* 1987; 42:53.
18. Bhanuprakash BK et al. *Trop Anim Hlth Product* 2004; 36:307.
19. Carn VM et al. *Vet Rec* 1994; 135:434.

### SWINEPOX

#### Synopsis

**Etiology** Swinepox virus

**Epidemiology** Widespread sporadic disease that is generally benign with low morbidity and low mortality in older pigs. High case fatality in congenitally infected and very young sucking piglets. Transmitted mechanically and by the hog louse

**Clinical findings** Characteristic pox lesions mainly on skin of head, legs and belly

**Clinical pathology** Demonstration of typical lesions by histology and virus by electron microscopy

**Lesions** Typical pox lesions

**Diagnostic confirmation**

Demonstration of typical lesions by histology and virus by electron microscopy

**Treatment** None

**Control** Control of hog louse

### ETIOLOGY

The cause is swinepox virus, the sole member of the *Suipoxvirus* genus of Chordopoxvirinae subfamily of Poxviridae.<sup>1</sup>

### EPIDEMIOLOGY

#### Occurrence

Swine pox (pig pox) occurs worldwide where swine are raised and is more common in swine units where there is poor sanitation.

#### Methods of transmission

Transmission is by contact transmission and mechanically by the pig louse (*Haematopinus suis*), and possibly by flies and other insects.<sup>2</sup> Young sucking pigs may have lesions on the face, with similar lesions on the udder of the sow, with spread by direct contact. The virus can survive in scab material for several months.

#### Animal risk factors

The virus infects only swine and can infect all ages but clinical disease is most commonly seen in young piglets. It is usually a sporadic disease with occasional outbreaks affecting a cluster of litters within a herd and of short duration. Some or all pigs in a litter may show clinical signs.<sup>3</sup> The disease may appear apparently spontaneously or may occur only in pigs brought into the contaminated environment of a herd in which the indigenous pigs are immune.

The incidence in individual herds may be high. Mortality is usually low except in very young piglets and congenitally affected piglets where mortality rates can be high.<sup>2,3</sup> Congenital infection presents with a low morbidity but high case fatality.<sup>3-6</sup> Older animals seem to suffer little ill effect.<sup>2</sup>

### PATHOGENESIS

In field cases, the lesions progress through the classical phases of poxvirus infections but do not usually proceed past the pustular or vesicle stage. At this time there is rupture and the formation of scabs which heal and drop off. Congenital infection is believed to occur when naive pregnant sows become infected and develop viremia with infection of the

fetal membranes. Not all fetuses are born affected and compartmentalization of placentas may restrict further uterine spread as occurs with parvovirus infections.<sup>3</sup>

### CLINICAL FINDINGS

Small 1 to 1.5 cm diameter papules develop first and may pass through the pustular and vesicular stage very quickly with the formation of red-brown, round scabs. In neonatal pigs, the rupture of many vesicles at one time may cause wetting and scab formation over the cheeks, and conjunctivitis and keratitis are present in many affected animals. In most cases the lesions are restricted to the belly and inside the upper limbs, but may involve the back and sides and sometimes spread to the face. Lesions may coalesce. A slight febrile reaction may occur in the early stages in young animals, and in sucking pigs deaths are observed. In adult pigs, detectable skin lesions are less well defined, restricted to the non haired softer skin areas and frequently do not progress through the developmental stages to form scabs. Congenital swinepox is characterized by striking lesions present in piglets at birth involving the skin and also commonly the tongue and hard palate.<sup>3,4-6</sup> Affected piglets were born from healthy sows. Affected piglets may be stillborn or die within a few days after birth.

### CLINICAL PATHOLOGY

The diagnosis is confirmed by examination of skin biopsies.<sup>2</sup> Focal superficial erosions, marked epidermal hyperplasia with acanthosis, ballooning of epidermal cells, and occasional large eosinophilic intracellular inclusion bodies are present on histological examination.<sup>2,4,5</sup> Electron microscopy can be used to detect the viral particles and the virus can be cultivated in primary pig kidney cell tissue culture.<sup>2,4,5</sup>

### DIFFERENTIAL DIAGNOSIS

The distribution of the pox-like lesions and the association of the disease with louse infestations suggest the diagnosis. Swinepox may resemble swine vesicular disease, which is characterized by vesicles on the coronary bands, lips, tongue, and snout.

Lesions associated with *Tyroglyphus* spp. mites are usually larger and occur anywhere on the body, and like those of sarcoptic mange, are usually accompanied by itching. The causative mites are detectable in skin scrapings. Ringworm and pityriasis rosea have characteristic lesions that do not itch, occur in older pig than typically does swine pox, and fungal spores are present in scrapings in the former disease.

A vesicular disease with necrosis resembling swine pox has been attributed to infection with parvovirus<sup>7</sup> but there is little evidence that parvovirus is a primary skin pathogen.<sup>8</sup>

### TREATMENT

No specific treatment is available and lesions cause so little concern to the pig, and heal so rapidly, that none is attempted.

### CONTROL

Vaccination is not usually practiced and control of the pig lice is the principal prophylactic measure attempted in most outbreaks.

### REFERENCES

1. Afonso CL et al. *J Virol* 2001; 76:783.
2. Jubb TF et al. *Aust Vet J* 1992; 69:99.
3. Barlow AM, Grist C. *Pig J* 2000; 46:118.
4. Thibalt S et al. *Swine Health Product* 1998; 6:276.
5. Paton DJ et al. *Vet Rec* 1990; 127:204.
6. Borst GHA et al. *Vet Rec* 1990; 127:61.
7. Kreesse JI et al. *Vet Microbiol* 1985; 10:525.
8. Lager KM, Mengeling WL. *J Vet Diag Invest* 1994; 6:357.

### HORSEPOX

Horsepox is a benign disease characterized by the development of typical pox lesions either on the limbs, or on the lips and buccal mucosa.<sup>1</sup> The causative ungulate **poxvirus** is identical to the virus of true cowpox and is transferable to cattle and to humans. Infection of a foal by **cowpox** was associated with streptococcal septicemia and death.<sup>2</sup> Horsepox is rare. It is a benign disease, but badly affected horses become debilitated and occasionally young animals may die. It is spread by contact with infected grooming tools, harness, and by handling. Immunity after an attack is solid.

Typical pox lesions develop in a '**leg form**', or in a '**buccal form**'. In the '**leg form**' nodules, vesicles, pustules, and scabs develop, in that order, on the back of the pastern and cause pain and lameness. There may be a slight systemic reaction with elevation of temperature. In the '**buccal form**' similar lesions appear first on the insides of the lips and spread over the entire buccal mucosa, sometimes to the pharynx and larynx and occasionally into the nostrils. In very severe cases, lesions may appear on the conjunctiva, the vulva, and sometimes over the entire body. The buccal lesions cause a painful stomatitis, with salivation and anorexia as prominent signs. Most cases recover with lesions healing in 2-4 weeks.

Cowpox was associated with severe ulcerative glossitis, stomatitis, esophagitis and gastritis in a foal.<sup>2</sup> Other lesions included polyarthritis and nephritis, though these later lesions could have been caused by streptococcal septicemia.

Differential diagnoses include greasy heel, vesicular stomatitis; viral papular dermatitis, molluscum contagiosum<sup>3</sup> and Uasin gishu. See Tables 22.3 and 22.4.

There is **no specific treatment**. Local wound care may hasten healing. Because

of the contagious nature of the disease, rigid isolation and hygiene in the handling of infected horses is essential. No vaccine is available.

### REFERENCES

1. Fenner F. In: Studdert MJ (ed). *Virus infections of vertebrates: virus infections of equines* 6. Amsterdam: Elsevier, 1996; p. 5.
2. Ellenberger C. et al. *J Comp Pathol* 2005; 132:101.
3. Rahaley RS, Mueller RE. *Vet Path* 1983; 20:274.

### UASIN GISHU

This is a skin disease of horses of the Uasin gishu plateau of Kenya and neighboring areas associated with a pox virus.<sup>1</sup> Lesions on the head, neck, and flanks resemble papillomas.<sup>2,3</sup> The source of the virus, and its method of transmission, are unknown, although a wildlife host is presumed.<sup>1</sup> Various stages of the lesions can be present in the same horse, and lesions may develop and regress intermittently for years.<sup>4</sup> There is no specific treatment and no control methods are reported.

### REFERENCES

1. Fenner F. Poxvirus infections. In: Studdert MJ (ed) *Virus infections of vertebrates: virus infections of equines* 6. Amsterdam: Elsevier, 1996; p. 5.
2. Kaminjolo JS et al. *Zbl Vet Med B* 1974; 21:202.
3. Kaminjolo JS et al. *J Comp Path* 1975; 85:391.
4. Kaminjolo JS et al. *Bull Anim Health Prod* 1975; 23:225.

### ULCERATIVE DERMATOSIS OF SHEEP

Ulcerative dermatosis of sheep is an infectious disease characterized by the destruction of epidermal and subcutaneous tissues, and the development of raw, granulating ulcers on the skin of the lips, nares, feet, legs, and external genital organs. The lesions on the **lips** occur between the **lip and the nostril**, those on the **feet** occur in the interdigital space and above the coronet, and the **genital lesions** occur on the glans and the external opening of the prepuce of rams, and the vulva of ewes.

A virus, very similar but antigenically different to the ecthyma virus, is the cause of the disease, which is likely to be confused with contagious ecthyma. However, the lesions are ulcerative and destructive rather than proliferative as in ecthyma. It is not highly infectious like bluetongue or sheeppox, and the '**lip-and-leg**' distribution of the lesions differentiates it from balanoposthitis of wethers, strawberry foot rot, foot rot, and interdigital abscess. The presence of lesions on the glans penis, and their absence from mucosae, the typical ulcerative form of the lesion, the absence of pus and the susceptibility of recovered animals to infection with ecthyma virus are diagnostic features of ulcerative dermatosis.

Table 22.3 Differential diagnosis of diseases of horses characterized by discrete lesions of the skin only

Disease	Epidemiology			Clinical pathology
	Method of spread	Behavior in herd	Lesions	
Horsepox	Extremely rare, benign. Spread by contact, rugs, grooming tools	Solid immunity after attack. No recurrence. lesions heal 2–4 weeks	Typical pox lesions in mouth or behind pasterns. Rare cases have lesions in mouth, nostrils, vulva	Electron microscopy of swab from lesion unguulate poxvirus present
Vesicular stomatitis	Occurs horses, cattle, pigs. Spread by insect or contact. Clustered outbreaks summer and autumn	Lesions last only 3–4 days. Solid immunity for 6 months	On tongue and lips. Uncommon on udder or prepuce. Vesicles up to 2 cm rupture leaving raw area, profuse rosey saliva. Heal quickly	Virus isolation, PCR. Many serological tests available
Viral papular dermatitis	Insect vector. May affect many horses at one time. Local horses immune. Summer and autumn.	Recovered in 10 days to 6 weeks. Benign, disappears without trace	Generalized cutaneous papules 0.5–2 cm dia, dry crust at 7–10 days, then spot of alopecia	Virus in lesions culturable in eggs
Staphylococcal dermatitis	Sporadic. Lesions under harness suggest pressure or spread by contact. A common disease	No information, does not spread much. But very difficult to cure in individual. Horse will not work under harness	5-mm nodules then pustules. slough taking small scab and hair. Very painful to touch	<i>Staphylococcus aureus</i> culture from swab of lesion
Deep ringworm	Diffuse ringworm more common. Spread easily by direct contact or harness or tools	Sporadic usually. Difficult to cure	3-mm dia follicular nodule, hair loss leaving bald patch. No extensive lesions. Sore to touch, itchy. Spreads from axilla	<i>Trichophyton</i> or <i>Microsporum</i> spp. on swab
Demodectic mange	Spread via grooming tools and rugs. Rare	Slow spread	Lesions around face and eyes initially	<i>Demodex</i> spp. in scraping
Mycotic dermatitis	Wet humid weather predisposes. Prolonged wetness. Mud leads to foot lesions. Biting flies may spread other forms	May be number affected if weather conditions suitable	Lesions commence on head at muzzle, around eyes, lacrimation and mucopurulent nasal discharge, on lower legs – or generalized. Not itchy, may be sore. Matted hair and scab can be lifted off an ovoid, slightly bleeding area	Branching filamentous <i>Dermatophilus congolensis</i> on smear of lesion
Tyroglyphosis	In horses fed recently harvested, infested grain, or at pasture	Transient self-limiting disease	Dermatitis, itchy, scaly with rubbing get alopecia and scab formation on muzzle and face, lower limbs at flexures	Larvae of chigger mites <i>Prediculoides</i> and <i>Trombicula</i> spp. in scraping
Photosensitization	Rare in horses. Feeling on St John's wort or liver damage-producing plants, due to cholangitis	Occurs only in sunlight. Disappears on removal from damaging feed and sun	Extensive edema, weeping dermatitis or skin sloughing on white parts. May also be signs of hepatic insufficiency	Nil
Queensland itch	Sporadic. During insect season. Only in horses outdoors	Only hypersensitive horses affected. Disease persists as long as insects present. Interferes with work and grazing	Intensely itchy. Lesions at tail butt, along back, withers, crest, poll, ears, down sides. Papules, hair rubs off. Pachydermia, no weeping	Hypersensitivity indicated by eosinophilia in skin biopsy
Ringworm	Ready transmission by contact and with equipment and premises. Most serious in winter	Spontaneous recovery in about 3 months. Spread in herd can be very rapid	Thick, dry crumbly scab, 2–3 cm dia, or diffuse alopecia with scaliness begin at girth or under head stall	<i>Trichopyton</i> and <i>Microsporum</i> spp. on scraping

Note: See also cutaneous globidiosis, multiple abscess caused by *Corynebacterium pseudotuberculosis*, anhidrosis, congenital absence of skin.

A morbidity rate of 15–20% is usual, but up to 60% of a flock may be affected. Mortality is low if the sheep are in good condition and the lesions are treated. Physical contact at breeding time seems to be the most probable method of spread.

The lip cutaneous form of this disease is very rare and possibly has disappeared since its original description, or is very uncommon. A clinically similar disease to the genital infection of ulcerative dermatosis, with balanoposthitis and vulvovaginitis, is associated with *Mycoplasma mycoides*.<sup>1</sup>

## REFERENCE

1. Trichard CJV et al. 1993; Onderstepoort J Vet Res 60:29.

## Diseases associated with Chlamidiae

The Phylum Chlamidiae consists of obligate intracellular bacterial pathogens and contains four families of which two have members that are associated with agricultural animal disease. The family Chlamydiaceae and has recently been reclassified into two genera with

*Chlamydomphila abortus*, *Chlamydomphila pecorum* and *Chlamydomphila pneumoniae* and *Chlamydia suis* associated with animal disease. A different family within the Chlamidiae contains *Waddlia chondrophila* that has been isolated from aborted fetuses.

The prominent farm animal and horse diseases associated with Chlamydiaceae are chlamydial polyarthritis (*Cp. pecorum*) and chlamydial abortion (*Cp. abortus*) which are described below, and sporadic bovine encephalomyelitis (*Cp. pecorum*) which is described elsewhere under that heading. *Cp. pecorum* may also be an



Table 22.4: Differential diagnosis of diseases of horses characterized by lesions of the skin of the lower limbs only

Disease	Epidemiology			Clinical pathology
	Method of spread	Behavior in herd	Lesions	
Glanders	Contact with infected horses. Ingestion from contaminated environment.	This is chronic form. Other cases of classical glanders with pulmonary and nasal mucosal involvement	Nodules and ulcers on nasal mucosa, purulent discharge. Stellate scars on septum. Limb lesions mostly at hock (medial aspect): nodules 1–2 cm, discharge honey-like pus	Mallein test. Complement fixation tests on serum. Transmission to guinea-pigs. <i>Pseudomonas mallei</i> in smears
Epizootic lymphangitis (equine blastomycosis)	Occurs in out-breaks. Spread by spores on contaminated bedding. May survive in soil. Entry through skin abrasions	Horses cannot be worked. Common in large groups, e.g. military horses	Ulcers at hocks, lymph nodes at hocks swell and discharge creamy pus. Lymphangitis. Some cases generalized with pulmonary abscesses	<i>Histoplasma farciminosum</i> in smears of pus. Skin sensitivity test
Sporotrichosis	Slow spread. Sporadic cases. Spread by contact and contamination of environment	Lesions heal 3–4 weeks but new crops keep disease going	Painless nodules at fetlocks ulcerate then heal. Lymphangitis in some animals	<i>Sporotrichum schenkii</i> on smear
Swamp cancer (Pythiosis)	Sporadic. Infection or invasion of wound	Does not spread	On lower limbs, or ventral abdomen, or below medial canthus of eye, lips. Papules to plaques 1 cm thick, connective tissue with ulcers up to 20 cm, with inspissated pus in pockets	Biopsy and scrapings for hyphae of <i>Pythium insidiosum</i> , <i>Entomophthora coronata</i> , larvae of <i>Habronema megastoma</i>
Greasy heel	Sporadic cases only. Horses standing in manure and urine	Not contagious. But can be chronic and incapacitating	Horizontal cracks and fissures behind pastern, very lame. Much sebaceous exudate. May develop cellulitis	Nil
Ulcerative lymphangitis	Infection of skin wounds in dirty stable	Lesions heal 1–2 weeks. New lesions develop for up to 12 months	Painful nodules around pastern rupture, creamy green pus. Lame. Lymphangitis with ulcers	No lymph node involvement. <i>Corynebacterium pseudotuberculosis</i> in pus. Other organism can cause similar disease.
Chorioptic mange	Widespread. Mostly draft and other working horses	Most horses in group affected	Violent stamping, rubs back of pasterns, swollen, scabby, cracked, greasy, painful to touch; lame	Scrapings reveal mites <i>Chorioptes equi</i>

Note: See also horsepox (Table 22.3).

etiological agent in some outbreaks of ovine contagious ophthalmia which is described under that heading.

Other infections and possible diseases associated with these agents and with *C. suis* and *C. pneumoniae* are less commonly reported although it is possible that they are underdiagnosed.<sup>1</sup>

The standard method of diagnosis of chlamydial disease is by isolation in embryonated eggs or in cell culture. However, some strains are difficult to grow and require specialist facilities and expertise. Also the complement fixation test, which is the standard serological test for chlamydial disease, lacks sensitivity and specificity because of cross reaction between chlamydial species.<sup>1</sup> The organisms are obligate intracellular pathogens and depend on the host cell for energy in the form of adenosine triphosphate (ATP). Outside of the host cell they exist as metabolically inactive elementary bodies, which have a rigid cell wall and are unable to grow or divide. The elementary bodies attach to host cells and

are taken in by phagocytosis. Inside the phagosome they become the metabolically active reticulate body (initial bodies), which have flexible cell walls and grow and divide to form an intravacuolar microcolony called a chlamydial inclusion. Nascent elementary bodies are formed, the host cell is lysed, and the elementary bodies are released with the cycle being accomplished in 36 to 96 hours, depending on species. The current development of new and more sensitive and specific molecular and serological tests such as PCR and the use of recombinant major outer membrane proteins as antigens can allow species specific laboratory diagnosis and should allow a better definition of the importance of *C. pecorum* and *C. pneumoniae* and *C. suis* to agricultural animal disease.<sup>1,2</sup>

#### REPRODUCTIVE DISEASE

In addition to enzootic abortion in ewes Chlamydiaceae have been associated with reproductive inefficiency in swine and cattle.

In **swine**, infection with *Cp. pecorum* and *Cp. abortus* have been associated with increased rates of returns to estrus, abortion, mummification, stillbirth and increased perinatal and neonatal mortality. Some studies of swine in herds with and without a problem of early embryonic death have found no significant difference in the seroprevalence of antibodies to Chlamydiaceae but have found a significant difference in the presence and proportion of *Cp. abortus* in cervical swabs and in the uterus and oviducts at slaughter. A dual infection with *C. suis* was also demonstrated in some cervical swabs in these studies but, whereas an association of *Cp. abortus* and reproductive inefficiency was evident, the contribution of *C. suis* to reproductive inefficiency was less clear.<sup>3–5</sup>

Reports of reproductive inefficiency in swine are largely from Germany and Switzerland, but in large industrial piggeries in eastern European countries, in addition to being implicated in severe outbreaks of abortion and production of

weak piglets, infections with Chlamydiaceae are reported to produce reproductive disease in boars, polyarthritis and polyserositis in young pigs, arthritis in finishing pigs, and pneumonia and conjunctivitis.<sup>6</sup> In contrast other studies suggest that chlamydial infections are endemic in pigs and that the significance of Chlamydiaceae as pathogens in swine remains to be determined.<sup>7</sup>

In **cattle**, *Cp. abortus* is a cause of bovine abortion but much less commonly than in small ruminants and not causing enzootic disease. Infertility and **endometritis** in cattle has been associated with the organism and has been reproduced experimentally.<sup>8</sup> However, there is debate as to the importance of Chlamydiaceae as major reproductive pathogens in cattle as non-clinical infection of the reproductive tract is common. A recent study using PCR found a high (53%) prevalence of *Cp. abortus* and *Cp. pecorum* infection in the vagina of virgin heifers.<sup>9</sup> A subsequent study established that infection occurred in calves at a very young age. In this study *Cp. pecorum* infection was fivefold more prevalent than *Cp. abortus* infection and was most frequently detected by vaginal swabs compared to rectal or nasal swabs.<sup>10</sup>

*Waddlia chondrophila* was initially isolated from an aborted calf in the USA and has subsequently been demonstrated in aborted fetuses in other countries. Serological studies suggest that it might have a role in the causation of bovine abortion. Free living amoeba may serve as hosts.<sup>11-13</sup>

#### OTHER DISEASE ASSOCIATIONS

*C. suis* has been associated with enteric disease in pigs but is also present in the intestines of clinically normal finishing and adult pigs.<sup>3,14</sup>

*C. suis* has also been associated with respiratory disease in swine and this has been reproduced experimentally in conventional pigs by aerogenous challenge.<sup>15</sup>

*Cp. psittaci* has also been demonstrated in domestic and wild pigs (*Sus scrofa*).<sup>16,17</sup> Other miscellaneous occurrences are cases of **pneumonia** in most animal species, including horses,<sup>18</sup> cattle, sheep, goats and pigs, and **orchitis** and **epididymitis** in male ruminants and intestinal infections in ruminants and pigs.<sup>19,20</sup> It is not possible to classify the Chlamydiae associated with some of these reports. The horse respiratory isolate is closely related to human isolates of *Cp. pneumoniae*.<sup>21</sup> Enteritis and diarrhea in calves, from which *Cp. pecorum* can be isolated, are usually mixed infections and the pathogenicity of the chlamydia as a cause of enteritis is open to doubt.

#### REVIEW LITERATURE

- Longbottom D, Coulter LJ. Animal chlamydioses and zoonotic implications. *J Comp Path* 2003; 128: 217-244.
- Corsaro D, Venditti D. Emerging chlamydial infections. *Crit Rev Microbiol* 2004; 30:75-106.

#### REFERENCES

- Longbottom D. *Vet J* 2004; 168:9.
- Hoelzle LE et al. *Vet Microbiol* 2004; 103:85.
- Camenisch U et al. *Vet Rec* 2004; 155:593.
- Eggermann G et al. *Deutsche Tierarztl Wschr* 2000; 107:3.
- Hoelzle LE et al. *Epidemiol Infect* 2000; 125:427.
- Pospisichil A et al. *Pig J* 1996; 37:9.
- Vanrompay D et al. *Vet Microbiol* 2004; 99:59.
- Wittenbrink MM et al. *J Vet Med B* 1993; 40:437.
- DeGraves FJ et al. *J Clin Microbiol* 2003; 41:1726.
- JunBae J et al. *J Clin Microbiol* 2004; 42:5664.
- Rurangirwa FR et al. *Int J Syst Bacteriol* 1999; 49:577.
- Dilbeck-Robertson P et al. *J Vet Diag Invest* 2003; 15:568.
- Michel R et al. *Acta Protozool* 2004; 43:37.
- Szeredi L et al. *Vet Pathol* 1996; 33:369.
- Sasche K et al. *Comp Immunol Microbiol Infect Dis* 2004; 27:7.
- Hoetzel H et al. *Vet Microbiol* 2004; 103:121.
- Vanrompay D et al. *Vet Microbiol* 2004; 99:59.
- McChesney SL et al. *Cornell Vet* 1982; 72:92.
- Fukushi H, Hirai K. *Int J System Bact* 1992; 42:306.
- Clarkson MJ, Phillips HL. *Vet J* 1997; 153:307.
- Pettersson B et al. *J Bact* 1997; 179:4195.

#### CHLAMYDIAL POLYARTHRITIS

Virulent chlamydia, including *Chlamydia pecorum*, can be isolated from the joints of calves, lambs, and foals clinically affected by polyarthritis. The experimental disease in calves begins as a chlamydiaemia, followed by localization in the joints. In calves, the disease is uncommon but often fatal. In lambs, it is a common disease in sheep feedlots in the United States, but the mortality rate is low.<sup>1</sup> The strain associated with arthritis is not common in the United Kingdom<sup>2</sup> and polyarthritis in the UK has been associated with a chlamydial strain distinct from *Cp. pecorum*.<sup>3</sup>

In pastured sheep, the morbidity may be as high as 80% but deaths are usually less than 1%. In calves, the disease is more commonly sporadic but response to treatment is poor and affected calves are often destroyed on humane grounds. Intestinal infection with *Chlamydia pecorum* is common in pastured lambs between 3 and 9 months of age, but is not associated with clinical disease.<sup>4</sup>

The clinical signs in calves and lambs include gross swelling of most limb joints but especially the larger joints, lameness, stiffness, unwillingness to move, recumbency, depression, conjunctivitis, and fever of 39-42°C (102-108°F). The navel is unaffected but there may be signs caused by localization of the infection in other organs, e.g. pneumonia, encephalomyelitis,

and renal abscess. Clinically, the disease is indistinguishable from polyarthritis caused by other infections such as *Mycoplasma* and *Haemophilus* spp.

#### REVIEW LITERATURE

- Nietfeld JC. Chlamydial infections in small ruminants. *Vet Clin N Am Food Anim Pract* 2001; 17:301.

#### REFERENCES

- Perez-Martinez JA, Storz J. *Mod. Vet Pract* 1985; 66:517.
- Andrews AH et al. *Vet Rec* 1987; 120:238.
- Twomey DF et al. *Vet Rec* 2003; 152:340.
- Clarkson MJ, Phillips HL. *Vet J* 1997; 153:307.

#### CHLAMYDOPHILA ABORTION (ENZOOTIC ABORTION OF EWES, OVINE ENZOOTIC ABORTION)

Synopsis
<p><b>Etiology</b> <i>Chlamydia abortus</i></p> <p><b>Epidemiology</b> Prevalence varies with country. Major source of infection is the placenta and uterine discharge of aborting ewes, and infection is by the oral route. Pregnant sheep infected by contact with aborting ewes usually do not abort until the next lambing season. Zoonotic</p> <p><b>Clinical findings</b> Abortion, stillborn and weak-born lambs</p> <p><b>Necropsy findings</b> Necrotic and hemorrhagic placental cotyledons, intercotyledonary areas thickened, edematous and leathery</p> <p><b>Diagnosic confirmation</b> Demonstration of the organism in the placenta and a rising titer in paired serum samples</p> <p><b>Control</b> Isolation of aborting ewes. Killed adjuvanted vaccine gives short-term protection. Live attenuated vaccines</p>

#### ETIOLOGY

*Chlamydia abortus* (previously *Chlamydia psittaci* bioype1/serotype1) has a tropism for ruminant placenta and causes the disease commonly referred to as ovine enzootic abortion (OEA). The organism causes a similar disease in goats, and while this organism also can produce abortion in cattle, pigs and horses, abortion associated with this organism is not common in these species.

There is considerable genetic diversity amongst strains that cause abortion.<sup>1,2</sup>

#### EPIDEMIOLOGY

##### Occurrence

The disease is one of the commonest causes of diagnosed abortion in sheep and goats in the United Kingdom, the United States,<sup>3</sup> and in other countries. In the UK it accounts for approximately 45% of abortions, and it is particularly common in lowland flocks that are intensively

managed at lambing time. However, its importance varies from country to country. It is an uncommon cause of abortion in Northern Ireland,<sup>4</sup> and the disease does not occur in Norway or New Zealand.<sup>5</sup>

There have been several studies of seroprevalence in Europe which show a high seroprevalence in both domestic and wild ruminants but, until recently, most surveys have used the complement fixation test which is not specific for *Cp. abortus* and the seroprevalence rates for *Cp. abortus* in different countries are not well established.<sup>6</sup>

#### Source of infection and transmission

Infection is introduced into a flock by the purchase of latently infected replacements which usually abort at the end of their first pregnancy.

Within a flock, the **major source of infection** is the placenta and the uterine discharge of aborting ewes. The main routes of transmission of *Cp. abortus* are through ingestion of organisms shed in vaginal fluids and placental membranes at the time of abortion or lambing, or through inhalation of aerosols from the environment.<sup>7</sup> Pasture and the environment are contaminated by vaginal discharges, placenta and aborted fetuses, and infected ewes shed the organism for a week before aborting and for 2 weeks afterwards. The elementary body of *Cp. abortus* is resistant to both physical and chemical influences as it is metabolically inactive and the rigid cell envelope is osmotically stable and poorly permeable. As a consequence the organism is believed to survive for several days on pasture and longer in cold weather.

Infection of the ewe lamb may occur at birth, shortly following, or at subsequent lambing periods. Infection of pregnant ewes in early or mid gestation results in either abortion in the final 2–3 weeks of gestation, or the birth of stillborn or weak lambs that frequently die in the first few days of their life. Abortion always appears in the last weeks of gestation regardless of the time of infection. Infection of ewes in the last 5–6 weeks of pregnancy usually leads to the development of a latent infection, where ewes appear to be uninfected until the next lambing season, when they abort. Thus, late pregnant sheep may be infected by contact with aborting ewes but usually do not themselves abort until the next lambing season.

The common pattern of infection and disease is the a small number of abortions in year 1 usually resulting from the introduction of infected replacement ewes, followed by an epidemic abortion storm where up to 35% of ewes abort in the last 3 weeks of gestation or give

premature birth to weak or dead lambs. After abortion, the ewes develop a protective immunity and, in endemically infected flocks, 5–10% of the ewes abort annually. Surviving lambs born to infected mothers may be affected by EAE in their first pregnancy.<sup>8–10</sup>

Sheep that have aborted, subsequently re-breed successfully, do not have further abortions, and the organism is not present in the placenta or vaginal discharge of subsequent pregnancies. However, levels of immunity vary and some may excrete organisms at estrus or seasonally for up to 3 years.<sup>11</sup>

In chronically infected sheep, **persistent infection** can be demonstrated in the endometrial cells of the reproductive tract,<sup>12</sup> and the organism is excreted in vaginal fluids during **estral periods**.

Vaginal challenge of ewes at breeding time will result in infection and subsequent abortion, and venereal or passive venereal transmission is a possible route of infection,<sup>13,14</sup> but it does not appear to be a common or important route. Chronic infection of the male genital tissues has been recorded and infection may impair fertility in both rams and bulls.<sup>8</sup>

The epidemiology of abortion with this agent in cattle is unknown but it may transmit to cattle from infected sheep on the same farm.<sup>2,15</sup>

#### Experimental reproduction

The disease is readily reproduced experimentally.<sup>16,17</sup> Following subcutaneous injection there are no signs of clinical disease other than a modest increase in rectal temperature for two days after infection. There is a systemic antibody response that peaks 2 weeks after infection and then decreases until just before abortion or parturition, when there is a second increase in the antibody levels to *Cp. abortus*. Experimental infection at 70 to 75 days pregnancy can result in abortion in the last 2 to 3 weeks of pregnancy or the birth of stillborn or live lambs. There is variation in the severity of the placental lesions in experimental infections. Abortion is associated with severe placental lesions but the reason for the variation in severity and fetal manifestations is not known.<sup>17</sup>

#### Economic importance

Enzootic abortion is the most common infectious cause of abortion in lowland flocks that are intensively managed at lambing time, and has a major economic impact on agricultural industries worldwide. There are no recent estimates of economic impact but losses in the UK were estimated in the early 1990s at £15–20 million per annum.<sup>10</sup>

#### Zoonotic implications

There is some risk for shepherds, and those in allied fields such as abattoir workers, to contract respiratory infection with this organism but the major zoonotic risk is to pregnant women because of the ability of *Cp. abortus* to colonize the human placenta. Human infection in early pregnancy results in abortion whereas later infection can result in stillbirth or pre-term labor.<sup>8,18</sup> Infection is believed by the oral route from infected hands or food following direct handling of infected sheep or goats or infected clothing. Practices at lambing such as mouth to mouth resuscitation of weak lambs or bringing weak lambs into the house to be warmed promote zoonotic spread. Infected placentas and dead lambs should be handled using gloved hands and disposed of by burning or burial.

The organism can be detected in milk both in sheep and in cattle and raw milk could also pose a risk for zoonotic infection.<sup>19,20</sup>

#### PATHOGENESIS

Following infection, it is thought that the organism resides first in the tonsil, and is then disseminated by blood and lymph to other organs although the site of latent infection is not known. The latent state is maintained under the control of the proinflammatory cytokine interferon-gamma (IFN- $\gamma$ ).<sup>21</sup> Release from the latent state during pregnancy is believed due to immune modulation and leads to bacteremia and infection of the placenta.<sup>8,10</sup>

The organisms invade the trophoblast cells of the fetal cotyledon following which infection spreads to the inter-cotyledonary regions of the chorion to produce a suppurative necrotic placentitis with impairment of the maternal-fetal exchange of nutrients and oxygen and fetal death and abortion. An inflammatory response in the fetus may also contribute to fetal death.<sup>16,17</sup>

It is not known why, regardless of the time of infection, pathological changes in the placenta do not commence before 90 days gestation<sup>17</sup> or even as late as 120 days.<sup>16</sup>

#### CLINICAL FINDINGS

There are generally no premonitory indications of the impending abortions. Abortion occurs in late pregnancy; ewes appear to suffer no systemic effects, but retained placenta and metritis can be sequel in goats. Additional losses are caused by stillbirths and weak-born lambs and kids which die soon after birth.

A vaginal discharge lasting up to 3 weeks following the abortion is common.

In **cattle**, the infection causes abortion in the last third of pregnancy. Infected calves born alive may show lethargy, depression, and may be stunted.

### CLINICAL PATHOLOGY

Infection in aborting animals can be demonstrated serologically by rising titers in paired serum samples and by culture of the organism.<sup>15</sup>

The **complement fixation test** is commonly used to identify flocks free of infection. It has moderately good sensitivity but is not specific for the agent of due to a common antigen shared by all members of the family and also to some Gram-negative bacteria.<sup>22</sup> For samples testing positive, a Western blot examining for antibody against specific antigens can be used as a reference test in flock accreditation.<sup>23</sup> **ELISA tests**, based on whole cell chlamydial elementary bodies or extracts of them, have better specificity than the complement fixation test but poorer sensitivity. A comparison of tests in common use in the United Kingdom in the mid 1990s found that none were both highly sensitive and specific.<sup>23</sup> ELISA tests that are based on segments of the membrane outer protein or synthetic peptide antigens have greater sensitivity and specificity and are now used in diagnostic, epidemiologic and seroprevalence studies.<sup>7,22,24,25</sup>

### NECROPSY FINDINGS

Aborted fetuses typically have no gross abnormalities. Fetal fluid may contain chlamydophilal antibody and although less sensitive than either isolation in McCoy cells or detection of chlamydial LPS antigen, can be of particular use when placenta is not available. Histologically, there may be mononuclear cell infiltration of hepatic portal areas and multifocal areas of hepatitis. In both cattle and sheep, the placenta is critical for diagnosis of the condition. Placental cotyledons are necrotic and hemorrhagic, and the **intercotyledonary areas** are thickened, edematous, and leathery. This is in direct contrast to the targeting of cotyledons seen with toxoplasmosis. The *Chlamydoiphila* organisms can be observed in tightly-packed sheets within the cytoplasm of swollen trophoblasts in formalin-fixed tissue samples, or in direct placental smears via modified Gimenez, Koster's, or other appropriate staining

methods. Well-preserved, fresh placenta should be examined as the organisms are difficult to demonstrate in the fetus. Immunohistochemical stains perform well on formalin-fixed specimens. Most laboratories are reluctant to culture *Chlamydoiphila* spp. due to the zoonotic potential of these agents.

### Samples for confirmation of diagnosis

- **Bacteriology** – chilled liver, lung, placenta (CYTO, PCR, ELISA)
- **Histology** – fixed placenta, liver (LM, IHC)

**Note the zoonotic potential of this organism when handling carcasses or submitting specimens.**

### DIFFERENTIAL DIAGNOSIS

Other causes of abortion in cattle and ewes are given in (Tables 18.7 and 18.8).

### CONTROL

Ewes that have aborted should be **isolated** from the rest of the flock. There should be proper hygiene of the lambing areas and in the disposal of aborted materials. Tetracycline has been used in early pregnant sheep within an aborting flock to attempt to reduce subsequent abortions but the efficacy is questionable.

### Vaccines

Two types of vaccine are currently available but there is yet no vaccine that has excellent efficiency against this disease.

**Killed vaccines**, composed of egg-grown or tissue culture grown organisms of one or two strains have been used for several decades. They are variably effective and can reduce the frequency of abortion and the shedding of the organism. However, outbreaks have occurred in vaccinated sheep and strain variation is a possible cause of failure of monovalent vaccines.<sup>1</sup>

The addition of Freund's incomplete **adjuvant** has provided a vaccine that provides better protection<sup>26</sup> and it has been recently claimed that specific adjuvants can markedly improve the efficiency of killed vaccines against naturally occurring enzootic abortion.<sup>27,28</sup>

A **live vaccine** containing a temperature-sensitive attenuated strain of *C. psittaci* has shown to engender

excellent, but not complete, protection against challenge; with five different abortigenic strains of *Cp. abortus* there was a marked reduction in the number of ewes aborting and marked increase in live-born lambs compared to controls.<sup>29</sup> It is labeled for sheep but not for goats. Concern has been expressed for the zoonotic potential of an attenuated vaccine.<sup>27</sup>

Recombinant and DNA vaccines have shown disappointing protection in studies with experimental challenge.<sup>30,31</sup>

### REVIEW LITERATURE

- Perez-Martinez JA, Storz J. Chlamydial infections in animals. *Modern Vet Pract* 1985; 66:517-522, 603-608.
- Aitken I. Chlamydial abortion in sheep. *In Practice* 1986; 8:236-237.
- Nietfeld JC. Chlamydial infections in small ruminants. *Vet Clin N Am Food Anim Pract* 2001; 17:301.
- Longbotton D, Coulter LJ. Animal chlamydiosis and zoonotic implications. *J Comp Path* 2003; 128:217-244.
- Kerr K et al. Immunopathology of *Chlamydoiphila abortus* infection in sheep and mice. *Res Vet Sci* 2005; 78:1-7.

### REFERENCES

1. Vretou E et al. *Vet Microbiol* 1996; 51:275.
2. Griffiths PC et al. *Br Vet J* 1995; 151:683.
3. Kirkbride CA. *J Vet Diag Invest* 1993; 5:398.
4. Markey BK et al. *Vet Rec* 1993; 132:389.
5. Stanislawek W et al. *Surveillance* 1995; 224:14.
6. Borela N et al. *Prev Vet Med* 2004; 65:205.
7. Amin JD, Wilemore AJ. *Res Vet Sci* 1995; 59:136.
8. Longbotton D, Coulter LJ. *J Comp Path* 2003; 128:217.
9. Entrican G et al. *J R Soc Med* 2001; 94:273.
10. Kerr K et al. *Res Vet Sci* 2005; 78:
11. Papp JR et al. *Infect Immun* 1994; 62:3786.
12. Papp JR, Shewen PE. *J Infect Dis* 1996; 174:1296.
13. Papp JR, Shewen PE. *Infect Immun* 1996; 64:1116.
14. Appleyard WT et al. *Vet Rec* 1985; 116:535.
15. Holliman A et al. *Vet Rec* 1994; 19:50.
16. Navarro JA. *Vet Pathol* 2004; 41:498.
17. Buxton D et al. *J Comp Pathol* 2002; 127:133.
18. Buxton D. *Vet Rec* 1986; 118:510.
19. JunBae J et al. *J Clin Microbiol* 2004; 42:5664.
20. Ongor H et al. *J Vet Med B* 2004; 51:43.
21. Brown J et al. *Vet Immunol Immunopathol* 2001; 82:107.
22. Buendia AJ et al. *Vet Microbiol* 2001; 78:229.
23. Jones E et al. *Vet Rec* 1997; 141:164.
24. Kaltenboeck B et al. *J Clin Microbiol* 1997; 35:2293.
25. Salti-montesanto V et al. *Am J Vet Res* 1997; 58:228.
26. Wilemore HJ et al. *Br Vet J* 1990; 146:341.
27. Garcia JN. *Vet Microbiol* 2004; 100:65.
28. Caro MR et al. *Vaccine* 2003; 21:3126.
29. Clarkson MJ, Phillips HL. *Vet J* 1997; 153:307.
30. Hechard C et al. *Vet Res* 2002; 33:313.
31. Hechard C et al. *Vet Res* 2003; 34:119.



2

## Diseases associated with prions

Introduction 1439  
Scrapie 1440

Bovine spongiform encephalopathy  
(BSE) 1446

BSE and sheep 1452  
Chronic wasting disease 1454

**INTRODUCTION**

The transmissible spongiform encephalopathies (TSEs) are a group of progressive neurological disorders that are transmissible and affect a number of animal species and humans (Table 23.1). They are non-febrile with long incubation periods and a long course of disease.

There is debate of the nature of the infective agent causing TSEs. An abnormal folded isoform, designated PrP<sup>Sc</sup>, of a host encoded cell-surface glycoprotein (prion protein, PrP<sup>C</sup>) accumulates during disease and is associated closely with infectivity. The function of PrP<sup>C</sup> is not known and the mechanism whereby PrP<sup>C</sup> is converted to PrP<sup>Sc</sup> is uncertain. PrP<sup>Sc</sup> is rich in  $\beta$  sheets and can be isolated as insoluble aggregates. A theory is that the transmissible agent is the abnormal isoform of the prion protein and that, in the infected host, this can recruit further alternatively folded prion protein. With this theory the long incubation period of prion diseases reflects the rise in level and deposition of PrP<sup>Sc</sup> in a variety of tissues, including brain, eventually resulting in fatal spongiform encephalopathy.

Scrapie affects sheep and goats and is the prototypic disease for the group.

Although scrapie in sheep has been recognized for over 200 years the recent epidemic of bovine spongiform encephalopathy has focused public attention and scientific research on the TSEs. With scrapie, and other TSEs, transmission can be effected by crude or purified extracts of brain or other tissues from affected

animals, and the infective agent is very resistant to ionizing and ultraviolet irradiation and to reagents that damage or modify nucleic acids. This, along with other experimental findings, has led to proposals that the infectious agent in scrapie, and other TSEs, is the PrP<sup>Sc</sup> itself, and not a small, unconventional virus or virino as previously proposed. The structure of the infecting PrP<sup>Sc</sup> is believed to imprint upon the normal cellular precursor PrP<sup>C</sup>, resulting in a change to the abnormal isoform which is protease-resistant and accumulates in cells.

Naturally occurring TSEs, such as sporadic CJD in humans or transmissible mink encephalopathy in mink, are associated with individual species or with closely related species as with scrapie in sheep, goats and mouflon (*Ovis musinum*) and chronic wasting disease in mule deer (*Odocoileus hemionus*), white-tailed deer (*Odocoileus virginianus*) and elk (*Cervus elaphus nelsoni*).

The results of attempts at inter-species transmission of these diseases are variable. While, by definition, each TSE is transmissible, the species to which they will transmit varies between the TSE, and can be influenced by the route of challenge, and the tissues that contain infection also varies according to the particular TSE. Frequently they do not transmit. Successful primary transmission between different mammalian species typically requires larger dose to effect disease than would be required for transmission to the same species. Also, usually, parenteral or intracerebral routes are required and

success is greater with young animal recipients. This is the so-called 'species barrier', which may be absolute or partial in that it will affect only a proportion of animals on first passage, or may result in an extended incubation period on first passage.

When using transmission studies to detect the presence of one of these agents optimal sensitivity is with a recipient host the same species. Transgenic mice may eliminate this barrier.

The 'gold-standard' technique for the diagnosis of TSE agents is the passage of tissue in panels of inbred mice, a technique known as 'strain typing'. Until recently this was the only way to differentiate scrapie and BSE. BSE presents with a characteristic incubation period, pattern of distribution and relative severity of the changes in the brain of the different mouse strains – the lesion profile – which is distinct from all scrapie strains tested to date.

When examining TSEs as a group, one cannot extrapolate the transmission particulars of one TSE to another nor can one extrapolate risk factors or epidemiology from one to another and certainly generalizations from an experimental model to a natural disease across a species barrier is scientifically inappropriate.

The literature on this subject is large. This chapter will discuss scrapie in sheep and goats, and bovine spongiform encephalopathy, which are the two TSEs of agricultural animals. It will also discuss the risk for BSE in sheep, particularly as this is a current cause for concern.

Table 23.1 Transmissible spongiform encephalopathies in animals and humans

Disease	Acronym	Species	Etiology	First described
Creutzfeldt–Jakob disease	CJD	Man	Sporadic	1920
Gerstmann–Straussler–Scheinker disease	GSS	Man	Familial	1936
Kuru		Man	Acquired	1957
Fatal familial insomnia	FFI	Man	Familial	1992
Variant Creutzfeldt–Jakob disease	vCJD	Man	Acquired	1996
Scrapie		Sheep, goats, mouflon	Natural	1738
Transmissible mink encephalopathy	TME	Mink	Acquired	1964
Chronic wasting disease	CWD	Deer, elk	Natural	1980
Bovine spongiform encephalopathy	BSE	Cattle	Acquired	1986
Zoo ungulate TSE		Nyala, kudu, gemsbok, oryx	Acquired	1986
Feline spongiform encephalopathy	FSE	Zoo cats (puma, cheetah and domestic cats)	Acquired	1990

Chronic wasting disease in deer is briefly described but has not shown any evidence for transmission to agricultural animals other than deer.

### REVIEW LITERATURE

- Brown P et al. bovine spongiform encephalopathy and variant Creutzfeldt-Jakob disease: background, evolution and current concerns. *Emerg Infect Dis* 2001; 7:6-16.
- Hunter N. Prion diseases: Meat safety and human health implications. In: D'Mello JPF (ed) *Food safety: contaminants and toxins*. CAC International, 2003; pp. 315-328.
- Lasmezas CI. The transmissible spongiform encephalopathies. *Rev Sci Tech Off Int Epizoot* 2003; 22:23-31.
- Manuelidis L. Transmissible encephalopathies: Speculations and realities. *Viral Immunol* 2003; 16:123-139.
- Weissman C. *Nature Rev Microbiol* 2004; 2:861-871.

### SCRAPIE

#### Synopsis

**Etiology** A transmissible agent that is highly resistant to chemical and physical agents, and appears not to contain DNA. Proposed to be due to a prion, a proteinaceous infectious particle. Susceptibility of sheep determined by genetics

**Epidemiology** Transmitted primarily by contact with infected sheep and from environmental contamination; very long incubation period

**Clinical findings** Non-febrile disease of adult sheep and goats with insidious onset and long clinical course. Affected animals show behavioral change, tremor, pruritus and locomotor disorder, and wasting

**Clinical pathology** Demonstration of scrapie prion protein by immunostaining of lymphoid tissue

**Lesions** Vacuolation of gray matter neuropil and neuronal perikarya, neuronal degeneration, gliosis

**Diagnostic confirmation** Demonstration of scrapie prion protein

**Treatment** None

**Control** Slaughter eradication. Genetic testing and selection/culling. Selection/culling based on detection of scrapie prion protein in lymphoid tissue

Scrapie is a non-febrile, fatal, chronic disease of adult sheep and goats, characterized clinically by pruritus and abnormalities of gait, and by a very long incubation period. It is the prototypic disease for a group of diseases known as **transmissible spongiform encephalopathies**. This group also includes chronic wasting disease of deer and elk, transmissible mink encephalopathy, and feline spongiform encephalopathy, Creutzfeldt-Jakob disease and other spongiform encephalopathies of humans, and the relatively new disease, bovine spongiform encephalopathy, which is

described separately under that heading. In Iceland scrapie is known as **rida**, in France as **La tremblante** and in Germany as **Traberkrankheit**.

### Etiology

There has been a significant historical debate over the etiology of this disease, centered on whether the disease is inherited or associated with an infectious agent, and centered also on the nature of the infectious agent. Currently, it is believed that scrapie is associated with an infectious agent, but that the incubation period for clinical manifestation of the disease and the susceptibility of the host is determined by genetics.

Scrapie can be transmitted experimentally to other sheep and to certain laboratory animals, and infection induces the production in the brain, and some other tissues, of amyloid fibrils called scrapie-associated fibrils or prion rods. The main constituent of these is a disease-specific, protease-resistant neuronal membrane glycoprotein termed the **prion protein**, or PrP<sup>Sc</sup>. PrP<sup>Sc</sup> is an abnormal isoform of a host-coded membrane glycoprotein, PrP<sup>C</sup>, and the transmissible spongiform encephalopathies are characterized by the accumulation of PrP<sup>Sc</sup> in neuronal and other tissue.

Transmission can be effected by crude or purified extracts of brain or other tissues from affected sheep, and the infective agent is very resistant to ionizing and ultraviolet irradiation and to reagents that damage or modify nucleic acids. This, along with other experimental findings, has led to proposals that the infectious agent in scrapie is PrP<sup>Sc</sup> itself, and not a small, non-replicative virus or virino as previously proposed. The structure of the infecting PrP<sup>Sc</sup> is believed to imprint upon the normal cellular precursor PrP<sup>C</sup>, resulting in a change to the abnormal isoform which is protease-resistant and accumulates in cells. The experimental studies and the arguments for this are reviewed elsewhere.<sup>1-5</sup>

More than 20 different strains of scrapie have been identified based on:

- Strain typing by differences in incubation time of the experimental disease in inbred strains of mice of different genotype
- The type, pattern, severity, and distribution of lesions in the brain of the different strains of experimental animals (lesion profiles)
- Resistance to thermal inactivation
- The type of disease produced in sheep and experimental animals (e.g. drowsy versus pruritic manifestations in goats)

- The ability of a strain to produce disease in different species of experimental animals.<sup>3,6</sup>

It is proposed that strain differences reflect differences in replicating information carried within the conformational state of the PrP<sup>Sc</sup>.<sup>2</sup>

Co-infection can occur with scrapie. It is common for more than one strain to infect sheep but since one will have a shorter incubation period, it will predominate and be expressed first. The masked strains can be revealed by passage in different mice strains.<sup>6,7</sup>

### EPIDEMIOLOGY

#### Occurrence

Geographic occurrence and incidence  
Scrapie in sheep occurs enzootically in the United Kingdom, Europe, and North America. Outbreaks have been reported in Australia, New Zealand, India, the Middle East, Japan, and Scandinavia, principally in sheep imported from enzootic areas.<sup>8,9</sup> Australia and New Zealand used vigorous importation, quarantine, and culling policies to prevent subsequent entry of the disease and are considered free of disease.<sup>8</sup>

The true prevalence of the disease both within and between countries is not known as there has been no test to detect the presence of infection in individual sheep or in flocks at all stages of infection. This is further confounded by secrecy about its existence in many flocks and breeds. This secrecy results from a fear of economic penalties that could result from the admission of infection.

In Great Britain, where the disease is enzootic and has been recognized for over 250 years, the true incidence is unknown, although a questionnaire survey in 1988 suggests that one-third of sheep flocks are infected.<sup>9</sup> In infected flocks the annual incidence ranges from 0.4 to 10 cases/100 sheep per year, with a mean of 1.1 cases/100 sheep per year.<sup>9</sup> However, the annual incidence can approach 20% of the adult flock (10), on occasions up to 40%, and in flocks where there is no selection against the disease the annual incidence and mortality can reach a level that results in disbandment of the flock or its non-survival.<sup>11</sup>

However, there is a difficulty in determining the occurrence of scrapie with any accuracy. In Britain, subsequent to the survey mentioned above, a large survey in 1998 found 15% of flocks reporting a case of scrapie sometime in the past, with 2.7 reporting a case in the past year.<sup>12,13</sup> The authors of this survey, and of a subsequent follow-up survey which gave even lower numbers of flocks infected,<sup>14</sup> believe that the disease is grossly underreported, despite the fact



that scrapie has been notifiable in Britain since 1993.

Farmer-consultation with a veterinarian about a case of scrapie and farmer-reporting of cases of scrapie is notoriously low. Historically, this has been due to factors such as the stigma associated with having scrapie diagnosed in a purebred flock and concerns for future sales or, in the case of commercial flocks, a lack of incentive to consult and a lack of concern since nothing can be done to cure the present case or prevent future cases. In England, it has been estimated that only 13% of farmers who had a suspect case of scrapie in the past 12 months reported it.<sup>13</sup> Possibly, the chance of improvement through genetic selection will alter this farmer trait.

The limitation of postal survey responses and their reliance on the recognition and diagnosis of scrapie by the farmer, coupled with the farmers reluctance to notify scrapie has prompted targeted surveillance using fallen stock and abattoir surveys throughout Europe. For most European countries, this targets a random sample of 6000 fallen sheep and 60 000 routinely slaughtered adult native sheep and uses the cattle-validated rapid tests.<sup>15</sup>

The determination of the spatial occurrence of scrapie at the holding (farm) level is important in view of current thrusts at control and eradication. Surveillance of fallen stock is relatively efficient but has a low capture rate for infected holdings and abattoir surveys also show a lack of sensitivity.<sup>15</sup>

It has been observed that scrapie-affected flocks show a **scrapie signature**, in which older sheep with genotypes at greater risk for scrapie are under-represented,<sup>7,16</sup> and it has been proposed that this signature could be a way of identifying infected flocks. This observation has not been validated by other studies<sup>17</sup> and, for a scrapie signature to operate, it would require loss from scrapie to outweigh all other causes of attrition of older ewes in a flock and a relatively constant ram-allele input. The latter would be unlikely given ram turn over and variation in ram working lifespans.<sup>17</sup>

In the United States, the disease is believed to have been introduced in 1947, and between 1947 and 1992 was found in 657 flocks in 39 states.<sup>18,19</sup>

#### Host occurrence

##### Age

Scrapie is a disease of **mature sheep** although most are exposed as young sheep and the incidence decreases with age at exposure. The age-specific incidence in **sheep** is highest between 2.5 and 4.5 years of age and cases rarely occur under 18 months of age.<sup>11</sup> Natural disease

in **goats** is rare. The age at death is similar to that in sheep, with a range from 2 to 7 years. The **case fatality rate**, with time, is 100%. The death loss is added to by the slaughter of infected and in-contact animals in countries where control and eradication is a practice.

##### Breed

Scrapie occurs in both sexes and in the majority of breeds, although the incidence is higher in some breeds than others.<sup>12</sup> Breed differences in prevalence occur in several countries; an example would be the high prevalence in the Suffolk breed in the United States relative to white-faced breeds and in some Hill breeds in the UK. These probably reflect breed and flock differences in genetic susceptibility to the development of clinical disease. Similarly, the occurrence of outbreaks of scrapie may result from the introduction of infection to a genetically susceptible flock or to a change in the genetic structure of flocks that are infected.<sup>20,21</sup>

#### Methods of transmission

Knowledge of transmission of scrapie is based primarily on the experimental disease and observations of the natural disease in experimental flocks and has been reviewed.<sup>10</sup>

##### Sources and routes of infection

The usual method of introduction into unaffected flocks is by the purchase of pre-clinically infected sheep. Infectivity can be demonstrated in the placenta and fetal fluids of naturally occurring cases, but has not been demonstrated in the saliva, colostrum, milk, urine or feces of natural cases, even though it can be demonstrated in the intestine and nasal mucous membrane.<sup>10,22</sup> Ingestion of infected material appears the most likely route of infection, but scarification of the skin and conjunctival inoculation will also allow infection. Hay mites have been found to harbor the agent on scrapie infected properties and have been proposed as a reservoir for infection.<sup>23</sup>

##### Horizontal transmission

This is the usual method of spread and the placenta is considered the major source of infection for the mother to her lamb, and to other lambs in close contact. Under natural conditions the disease in flocks often runs in families, and whether or not a lamb contracts scrapie appears to depend primarily on the current or future scrapie status of its dam. It is common for all the VQR/VQR lambs from dams dying of scrapie to themselves develop scrapie.

Scrapie can also transmit between sheep in close contact and this can occur from sheep in the preclinical phase of the disease.<sup>10,24</sup>

Under natural conditions, scrapie occurs in sheep and occasionally spontaneously in goats. Under experimental conditions, scrapie has been observed to spread from sheep to goats by contact, and the little evidence available on the natural disease in goats is consistent with the view that the scrapie can be maintained by contagion in a herd of goats living apart from infected sheep.<sup>25,26</sup>

##### Vertical transmission

There is a greater risk for scrapie in lambs born to infected dams but this most probably reflects horizontal transmission at birth from placentas. There are conflicting results between studies that have examined transmission by embryo transfer, and the importance of vertical transmission to the epidemiology of the natural disease remains to be determined. However, epidemiological studies suggest that it is of rare occurrence and there is significant evidence against the occurrence of in-utero transmission.<sup>10,20,27</sup> The agent has not been demonstrated in the testes or semen of rams.

##### Environment

An infected environment can also be the source, and scrapie-free sheep can develop disease after grazing pasture previously grazed by scrapie-infected sheep, with infection by ingestion or possibly via abrasive lesions. Environmental infection can occur from the products of parturition and, although the scrapie agent has not been demonstrated in feces, it is suspected as being so in infected animals. The duration of infectivity on inanimate materials such as pasture has not been defined, but field and experimental observations<sup>5</sup> indicate that it is a long time, probably in excess of 3 years. A paired case-control study of risk factors in 61 scrapie affected flocks in Ireland found increased odds of scrapie occurring in flocks associated with the spreading sheep compost on the pasture and disposing of the placenta in the compost.<sup>28</sup>

##### Iatrogenic transmission

An outbreak of scrapie occurred in the 1930s following the use of a vaccine against louping ill prepared from the brains of sheep. More recently, the use of a vaccine against contagious agalactia has been epidemiologically linked to an outbreak of scrapie in sheep and goats in Italy where there was a high attack rate and high mortality affecting several birth cohorts.<sup>29</sup>

#### Genetics

Scrapie is recorded in most breeds of sheep but there are breed, family, and individual differences in susceptibility. There is substantial genetic control of the

incidence of disease, and in both the natural and experimental disease, genetics is a major determinant of susceptibility with the susceptibility of sheep strongly linked to certain polymorphisms in the sheep PrP gene.<sup>27,30</sup>

In earlier studies, experimental challenge and breeding showed that sheep could exhibit a long or short incubation period following challenge and that this difference in incubation period or susceptibility was determined by a single gene called *Sip* (scrapie incubation period). There is a similar gene in mice (*Sinc*) that determines incubation period and susceptibility following experimental challenge. The *Sip* gene has two alleles, *sA* and *pA*, which respectively shorten or prolong the experimental incubation period for most strains of the scrapie agent. The subsequent recognition of prion protein (PrP) and its association with scrapie led to the recognition of the gene that encodes PrP which was found congruent to *Sip* in sheep and *Sip* genetics have been entirely superseded by PrP genetics.<sup>27</sup>

Sheep have one pair of genes that influence susceptibility to scrapie known as the prion protein genes. These code for a normal prion protein in the cell (PrP<sup>C</sup>), which has 254 amino acids with each codon in the gene encoding for a specific amino acid at a particular location on PrP<sup>C</sup>. PrP<sup>C</sup> can be converted to scrapie prion protein molecule (PrP<sup>Sc</sup>) in infected sheep which, when it accumulates in the central nervous system, causes disease. The susceptibility of sheep to this conversion, and thus to scrapie, is strongly associated with certain polymorphisms at codons 136, 154, and 171. It is thought that there are at least two groups of scrapie TSE strains, one of which is influenced primarily by the amino acid

at codon 136 and the other group by the amino acid at codon 171. Within these there may be subtypes, as resistance to some 136-type TSEs can be affected by the amino acid at codon 154.<sup>31</sup>

- At codon 136 valine (V) is linked to scrapie susceptibility and alanine (A) is linked with resistance
- At codon 154 histidine (H) is linked to susceptibility and arginine (R) to resistance
- At codon 171 glutamine (Q) and histidine (H) are linked to susceptibility and arginine (R) to resistance.

- The notations used for descriptions of the prion protein (PrP) genotype vary in different countries
- The susceptibility of sheep to scrapie is strongly associated with polymorphisms at codons 136, 154, and 171 in the prion protein gene
- The amino acids associated with these polymorphisms are Alanine, Valine, Histidine, Arginine and Glutamine
- In the description of the PrP genotype these are given the letters A, V, H, R and Q respectively
- The PrP genotype is listed in the order of codon 136 followed by 154 and then 171
- The amino acid at each codon is listed according to the letter designation for each of the two alleles separated by a backslash. Examples are ARR/ARR or ARR/VQR. These could also be expressed as AA<sub>136</sub>RR<sub>154</sub>RR<sub>171</sub> and AV<sub>136</sub>RQ<sub>154</sub>RR<sub>171</sub>
- In sheep in the United States the polymorphisms at codon 171 are the major determinant of scrapie susceptibility. Polymorphisms at codon 154 play a minor role and are usually not listed as part of the PrP genotype

- Genotypes in the US are usually referred to using the letters of the amino acids in numerical order codon 136 followed by codon 171
- The examples above would be AA RR, and AV RR
- They can also be referred to using the codon number followed by the corresponding amino acid 136AA, 171RR and 136AV, 171RR or the amino acid followed by the codon
- Often only the amino acids at codon 171 are listed.

Of the possible alleles from these polymorphisms only five, ARR ARQ, VRQ, AHQ, ARH, are commonly seen and the relationship between PrP genotype and susceptibility to scrapie is shown in Table 23.2 using the groupings of the British National Scrapie Plan.

It can be seen from Table 23.2 that in the Britain, the VQR allele confers the greatest degree of susceptibility and that ARR is associated with resistance. Estimates that quantify risk in the British national flock based on genotypes of the sheep, and those of scrapie affected sheep are available but they are not strongly concordant.<sup>16,17</sup> There is also an effect of PrP genotype on incubation period with the most susceptible genotypes (VQR) having the shortest incubation period and dying of scrapie at a younger age.

The frequency and distribution of the various PrP genotypes varies considerably between flocks and between breeds of sheep.<sup>7,17,32</sup>

For example, in 15 flocks scrapie-affected flocks, the flock frequency of sheep with VQR-containing genotypes ranged from 2 to 82%.<sup>17</sup>

Table 23.2 PrP genotype and susceptibility to scrapie in National Scrapie Program (NSP) in Great Britain

NSP Type	Main characteristic	Genotypes	Comments
1	<b>ARR homozygous</b>	ARR/ARR	Genetically most resistant
2	<b>ARR heterozygous non-VQR</b>	ARR/AHQ ARR/ARQ ARR/ARH	Sheep that are genetically resistant to scrapie, but will need careful selection when used for further breeding
3	<b>Non-ARR and non-VQR</b>	AHQ/AHQ ARQ/AHQ AHQ/ARH ARH/ARH ARQ/ARH ARQ/ARQ	Sheep that genetically have little resistance to scrapie and will need careful selection when used for further breeding. Group 3 risk varies and can depend on breed, e.g. ARQ/ARQ Suffolk are highly susceptible. ARQ/ARQ Cheviots relatively resistant
4	<b>ARR/VQR heterozygous</b>	ARR/VRQ	Sheep that are genetically susceptible to scrapie and should not be used for breeding unless in the context of a controlled breeding
5	<b>VQR and non-ARR</b>	AHQ/VRQ ARQ/VRQ ARH/VRQ VRQ/VRQ	Sheep that are highly susceptible to scrapie and should not be used for breeding

Adapted from Refs 7 & 17.

**Table 23.3** Scrapie susceptibility and genotype as defined by the USA scrapie eradication plan<sup>27</sup>

Genotype	Susceptibility
1. AA RR	Sheep which are resistant
2. AA QR	Sheep which are rarely susceptible
3. AV QR	Sheep that are susceptible to some scrapie strains that are believed to occur with low frequency in the USA
4. AA QQ	Sheep which are highly susceptible
5. AV QQ	Sheep which are highly susceptible
6. VV QQ	Sheep which are highly susceptible

There are also some marked between-breed differences in susceptibility with the same PrP genotype.<sup>27</sup>

Susceptibility in the Suffolk breed appears less complex than in other breeds and is strongly associated with sheep that are homozygous for glutamine at the 171 codon (171QQ) of the PrP gene but is rare in sheep heterologous for glutamine and arginine (171QR) or homozygous for arginine (171RR) at codon 171.<sup>33</sup> Suffolks are the predominant breed affected with scrapie in the USA. They lack the VRQ allele and the ARQ/ARQ genotype is the genotype that confers the greatest susceptibility<sup>24,27,34</sup> The association between genotype and susceptibility as defined in the scrapie eradication plan of the USDA in the USA is shown in Table 23.3.

Factors other than the PrP genotype influence susceptibility to scrapie as not all sheep with a susceptible genotype challenged with scrapie subsequently develop the disease. Also there are some breed differences in the level of resistance or susceptibility conferred by a given genotype. For example ARQ/ARQ Suffolk sheep are highly susceptible to scrapie whereas ARQ/ARQ Cheviots relatively resistant. Breed differences in PrP genotype scrapie disease linkage and disease pattern differences with atypical strains of scrapie may be associated with polymorphisms in the PrP gene promoter.<sup>35</sup>

There is little information on the genetics of scrapie in **goats**. There is high variability in the goat PrP gene which possibly can be exploited to select for goat-specific scrapie-resistant PrP genotypes but as yet these are not known.<sup>36</sup>

### Risk factors

#### Exposure factors

There is a dose-response relationship in naturally occurring scrapie.<sup>10</sup> The high incidence in some Icelandic flocks is attributed to a high level of exposure, resulting from a long winter housing period with a higher risk for disease in lambs born in the winter housing period.

Factors that influence exposure risk will vary with the management systems, which can vary markedly between countries. With that caveat, risk factors that have been identified in case control studies<sup>13,28,37</sup> include:

- A higher risk for scrapie in larger flocks and in pedigree flocks
- A greater risk in flocks that lamb communally in group pens compared to those that in those that lamb in individual pens or outside on pasture
- A greater risk in flocks that disposed of the placenta in the compost and spread sheep compost on the land
- A lower risk in flocks where cow compost is spread on the land
- A greater risk in flocks that purchased replacement sheep through the market
- A greater risk where different flocks share pastures or rams.

Age at exposure

Lambs exposed at birth have a shorter incubation period and higher risk for scrapie than lambs exposed at 6–9 months of age. Similarly, lambs or goats removed from infected dams at birth to a scrapie-free environment have a lower incidence of scrapie than those removed at later times.

#### Infection status of parents

Lambs born to affected ewes are at increased risk for scrapie, and the offspring from an infected ewe and an infected ram are at greater risk than those born from an infected ewe and an uninfected ram. However, even in high-incidence herds a considerable proportion of disease cannot be attributed to parental scrapie status and results from horizontal transmission.<sup>10</sup> Also the number of genetically susceptible sheep in an affected flock can increase the infection pressure.

#### Infection status of parents

Lambs born to affected ewes are at increased risk for scrapie, and the offspring from an infected ewe and an infected ram are at greater risk than those born from an infected ewe and an uninfected ram. However, even in high-incidence herds a considerable proportion of disease cannot be attributed to parental scrapie status and results from horizontal transmission.<sup>10</sup> Also the number of genetically susceptible sheep in an affected flock can increase the infection pressure.

#### Goats

**Scrapie in goats** is rare and most cases arise in goats that are in close contact with infected sheep. Scrapie can spread from goat to goat with no sheep contact.<sup>18</sup>

### Experimental reproduction

The agent is present in the brain, spinal cord, lymph nodes, intestinal tract tissue, and spleen of infected sheep, and has been extracted from sheep and goat brain. Experimentally, the disease can be transmitted to sheep, goats, mice and other laboratory animals using these tissues, and by a variety of routes of inoculation. The experimental disease has a long incubation period that varies with the strain of the agent and the genetics of the

recipient. Transmission of the disease to sheep has also been effected by the oral or intracerebral administration with fetal membrane material from known infected ewes. Accidental transmission is recorded following vaccination against louping-ill, with vaccine contaminated by the agent of scrapie, and resulted in widespread dissemination of the disease.

### Pathogen risk factors

The scrapie agent can be maintained in tissue culture, and infectivity is retained with passage.<sup>21</sup> It can also be perpetuated in experimental animals. Infectivity also survives for remarkable periods in dead and formalinized tissues; infected brain homogenates buried in soil for 3 years retain their infectivity.<sup>5</sup> It is highly resistant to physical and chemical influences and can survive decontamination processes that are effective against conventional viruses.<sup>38</sup> It is capable of withstanding the usual virucidal procedures and is not destroyed by boiling, by rapid freezing and thawing, or by exposure to ether or 20% formalin. Conventional heat treatments may reduce infectivity, but the agent is remarkable resistant to heat<sup>39</sup> and steam sterilization at 27 psig (132°C) is required to totally destroy it. Chemical inactivation can be achieved with sodium hypochlorite providing 2% (20 000 ppm) of available chlorine acting for 1 hour, and by 4% sodium hydroxide.

### Economic importance

Scrapie is of major concern to pedigree flocks and, if present and public, will curtail the sale of sheep and effectively result in the dissolution of the flock. Some countries have, or have had, eradication schemes. The disease is also of major international importance because of the embargos maintained by several countries against sheep from enzootic areas. The recent occurrence of bovine spongiform encephalopathy in Great Britain and one theory of its putative origin from scrapie has emphasized the need for control of this disease.

### Zoonotic implications

There is no evidence for transmission of scrapie to humans or for a risk to public health.<sup>40</sup> However the concern that BSE might be established in sheep as a result of feeding of infected meat-and-bone meal, and be indistinguishable from scrapie, has led some countries to establish an active TSE surveillance program in sheep. As part of this, all sheep that are over 18 months of age and intended for human consumption are tested at slaughter by a rapid test for scrapie and BSE.

### PATHOGENESIS

In both sheep and mice, the agent shows a predilection for tissues of the lympho-

reticular system where it replicates during the incubation period before invading the nervous system. In naturally infected sheep, replication begins in the tonsil, retropharyngeal and Peyer's patches and gut-associated lymphoid tissue, which probably reflects the oral route of infection. PrP<sup>Sc</sup> subsequently becomes disseminated to other lymph nodes and the spleen. There may be a considerable period, ranging from 14 months to 7 years, before there is infection of the brain, and during this during infection in the lymphoreticular system probably provides the reservoir for maternal and horizontal transmission.<sup>24,41,42</sup> The action of the PrP genotype may be to delay neural invasion, in which case it is possible that a non-clinical carrier state may exist for scrapie.<sup>43</sup>

How the scrapie agent reaches the central nervous system is not certain but is probably through infection of the autonomic nervous system. Gut-associated lymphoid nodules in the Peyer's patches have a substantial network of nerve fibers and are probably the site for neuroinvasion and the scrapie agent has been detected in lymphoid nodules of the Peyer's patches of the gut as early as 5 months after oral infection.<sup>44</sup>

Infection in the brain of sheep is initially in the diencephalon and medulla oblongata, with subsequent spread and replication in other areas of the brain. Characteristically, there is a non-inflammatory, vacuolar degeneration of gray matter and the presence of PrP<sup>Sc</sup> in scrapie-associated fibrils. Infection results in the post-translational modification of this protein so that it becomes resistant to proteinases and to normal clearance and consequently accumulates in the cell.

PrP<sup>Sc</sup> is also present in the placenta and is present in the trophoblast cells of the placentomes but not in the endometrium, myometrium, associated nerve plexuses nor is it in fetus. The presence of PrP<sup>Sc</sup> in the placenta is determined by the fetal PrP gene and PrP<sup>Sc</sup> is not present in the placenta of fetuses carrying one or two ARR alleles.<sup>24,34</sup>

## CLINICAL FINDINGS

### Incubation

**The incubation period** varies from several months to several years. Scrapie is a non-febrile disease and the onset is insidious, but as the disease progresses clinical signs become more obvious and severe. The **clinical course** is protracted, varying from 2 to 12 months, but lasting in most cases for about 6 months. Affected animals usually show **behavioral change, tremor, pruritus, and locomotor disorder.**

### Early signs

**The earliest signs are transient,** nervous phenomena occurring at intervals of several

weeks or under conditions of stress. These episodes include sudden collapse and sudden changes of behavior, with sheep charging at dogs or closed gates.

Rubbing and biting at the fleece then begin but are often unobserved because of their infrequent occurrence. The apparent **pruritus** is manifested chiefly over the rump, thighs, and tail base. The poll and dorsum of the neck may also be involved and, less commonly, the neck in front of the shoulder and the ribs behind the elbow. The affected areas have approximate bilateral symmetry. In this early stage a stilted gait is often observed. A general loss of condition may also be observed as an early sign, although the appetite may not be severely affected.

### Advanced cases

**More advanced cases** show intense pruritus, muscle tremor and marked abnormalities of gait, and severe emaciation. **Persistent rubbing** causes loss of wool over the areas mentioned above. Scratching with the hindfeet and biting at the extremities also occur. Hematoma of the ears and swelling of the face may result from rubbing. Light or deep pressure, pinpricking, and application of heat or cold may elicit the characteristic 'nibbling or scrapie scratch' reaction, during which the animal elevates the head and makes nibbling movements of the lips and licking movements with the tongue. The sheep's expression suggests that the sensations evoked are pleasant ones. The reaction may not be observed consistently, often disappearing when the sheep is excited or in new surroundings.

Simultaneously with the development of pruritus there is serious **impairment of locomotion.** Hindlimb abnormalities appear first. There is incomplete flexion of the hock, shortening of the step, weakness, and lack of balance. The sense of spatial relationship appears to be lost and the sheep is slow to correct abnormal postures. Adduction occurs during extension, and abduction during flexion. When the animal is attempting to evade capture, gross incoordination of head and leg movements is likely and the animal often falls. Convulsions, usually transient but occasionally fatal, may occur at this time.

General hyperexcitability is evident. In the animal at rest an intermittent nodding and jerking of the head and fine tremor of superficial muscles may also be observed. In some cases, nystagmus can be produced by rotating the head sideways. Other clinical signs include inability to swallow, although prehension is unaffected, vomiting, loss of bleat, and blindness. A change of voice to a trembling note is often most noticeable.

Anorexia is not evident in most cases until the last 4–5 weeks and results in rapid loss of body weight. Abomasal distension and impaction occurs in some cases. Pregnancy toxemia may occur as a complication in pregnant ewes during this stage of scrapie. Finally, the sheep reaches a stage of extreme emaciation and inability to move without becoming readily fatigued. Sternal recumbency follows and lateral recumbency with hyperextension of the limbs is the final stage. Pyrexia is not evident at any time.

In a detailed study in 129 sheep with scrapie the proportional occurrence of signs was: hindlimb ataxia 71%; head tremor 61%; altered mental status 57%; positive nibble reflex 51%; crouching position 51%; teeth grinding 44%; low head carriage 38%; body condition score of less than 1.5, 38%; and conscious proprioceptive deficits of limbs 36%.<sup>45</sup> The occurrence of clinical signs were examined in relation to PrP genotype. The nibble reflex was strongly associated with PrP genotypes ARQ/ARQ and ARQ/ARH.

**In goats,** the clinical course in naturally occurring cases lasts from 2 to 24 weeks. Clinical signs are similar to those in sheep, and hyperesthesia, ataxia and pruritus are common, but loss of weight is less common.<sup>22</sup> In lactating goats the first sign may be a reluctance to permit milking. Dribbling and regurgitation of ruminal contents are also recorded in one-third of cases.

In most countries the disease is reportable to government authorities.

## CLINICAL PATHOLOGY

There are no changes in hematologic or serum biochemistry parameters. It has been suggested that the disease could be diagnosed antemortem by electroencephalography but this has been disputed.<sup>42</sup>

Until recently there has been no antemortem test for scrapie; however, PrP<sup>Sc</sup> can be detected in cells by immunohistological methods and is present in the lymphoid tissue of sheep with scrapie in the preclinical phase of the disease. **Tonsillar biopsy** has detected PrP<sup>Sc</sup> in lambs of susceptible genotypes as young as 5 months of age<sup>46</sup> and in the tonsils of non-challenged susceptible lambs at 9–10 months of age that were born and maintained in a scrapie environment.<sup>47</sup> However, tonsil biopsy requires general anesthesia and is not a practical on-farm technique. Biopsy of lymphoid follicles in the third eyelid is more practical, requires only restraint and local anesthesia, and can be a valuable tool for the preclinical diagnosis of scrapie in surveillance programs.<sup>48</sup>

In scrapie positive sheep, PrP<sup>Sc</sup> can usually be detected by 14 months. A sample of a single protuberance on the

palpebral side of the third eyelid will usually give sufficient follicles for analysis.<sup>49</sup> Histamine-containing eyedrops improve the success of collecting a sample with adequate follicles for examination.<sup>50</sup>

### NECROPSY FINDINGS

Significant gross findings are restricted to traumatic lesions caused by rubbing, and to emaciation and loss of wool; gross distension of the abomasum has been recorded in some natural cases.

The essential histopathological lesion in scrapie is the **vacuolation of gray matter neuropil** in the spinal cord, medulla, pons and midbrain, and the consequential Wallerian degeneration in dorsal, ventral and ventrolateral columns of the spinal cord, and in nerve fibers in the cerebellar peduncles and the optic nerve. In addition, there is degeneration of the cerebellar and hypothalamoneurohypophyseal systems. There are different strains of the scrapie agent that can result in differing clinical signs and pathology.<sup>51</sup> Scrapie-associated fibrils are present in infected brain. Histological findings are diagnostic in many cases but can be supplemented with the immunodetection of PrP<sup>Sc</sup> in brain tissue by *in situ* immunohistochemistry and Western immunoblots.<sup>51</sup> The breed of the sheep affects the magnitude of neuropil vacuolation and variation also is associated with the PRP genotype within breeds.<sup>52</sup>

Atypical strains of scrapie (Nor98) are recognized that differ from the usual strains in their vacuolation patterns and their disease-specific, protease-resistant PrP<sup>Sc</sup> disposition patterns.<sup>53</sup> These strains can also produce disease in PrP genotypes not normally affected, including Prp genotype ARR/ARR.

### DIFFERENTIAL DIAGNOSIS

The characteristic signs of behavioral change, tremor, pruritus, and locomotor disorder occurring during a period of prolonged illness should suggest the possibility of this disease. The long incubation period, slow spread and high case fatality rate should also be considered when making a diagnosis. Diseases that may require differentiation include:

#### Diseases with signs of nervous dysfunction:

- Louping ill
- Pregnancy toxemia
- Rabies
- Pseudorabies
- Visna.

#### Skin diseases:

- External parasites
- Wool loss.

#### Treatment

No treatment has proved capable of changing the course of the disease.

### CONTROL

#### Individual flocks

The maintenance of a closed ewe flock is critical to the control of this disease. If ewes need to be purchased from outside flocks they should be from certified flocks or better still, selected on by PrP genotype testing for 171RR or 171QR genotype. The rams should be 171RR or 171 QR rams. Ewes should be isolated at lambing and lambled individually with disposal of placenta by burning.

#### National eradication

In countries that do not have the disease, and where it is inadvertently introduced with imported sheep, the approach is slaughter eradication of the infected flock and all in-contact animals. The aim is to eliminate the disease from the country and the approach is usually successful because it has the full support of the sheep industry and the government.<sup>8</sup>

#### Flock eradication

The eradication of scrapie in countries where it is enzootic has less chance of success. Eradication programs vary and may involve the whole flock or just the family lines of the infected sheep. Programs in the United States since 1952 have varied from compulsory slaughter eradication of the affected flock and source flocks, to bloodline eradication, and finally from discontinuation to a voluntary certification scheme.<sup>18</sup>

During this period there was no ante-mortem diagnostic test for scrapie and the identification of infected farms and flocks relied upon owners submitting suspect or clinical cases for postmortem and histological diagnosis. Owners are unlikely to put their flocks at risk if there is inadequate compensation for the results of their action, if they perceive that other flock owners are not cooperating with the control program, or if they question the validity of the eradication policy, which is attested to by the experience in the United States.

Iceland is currently attempting an eradication program which involves depopulation of infected farms and areas. The farms are left without sheep for a 2-year period during which there is extensive cleaning and disinfection of the farm area prior to repopulation with scrapie-free sheep. The program is a national thrust but very expensive.<sup>54</sup> This approach has also been apparently successful in virtually eliminating, if not eradicating the disease in Iceland. Norway is also attempting eradication in a similar manner. In both countries the disease was geographically clustered.

### Genetic control and national programs

The occurrence of scrapie and the concern for BSE in sheep has led many countries to develop of national breeding programs for the control of scrapie and potential BSE. Examples are the National Scrapie Plan in the UK and the National Scrapie Eradication Program in the US National Scrapie Plan. The overall aim is to identify sheep genetically resistant to scrapie on the basis of their genotype (ARR) and to breed them so as to create a national flock with scrapie resistance. Genetic testing will allow the selection of resistant sheep for breeding and the culling of susceptible sheep, particularly in breeds such as the Suffolk where the genetics of susceptibility appear relatively simple.

The **UK** has a Voluntary **National Scrapie Flocks Scheme** and a National Scrapie Plan which, under EU regulations, has recently become compulsory for flocks that have had a case of scrapie after July 2004. Under the Compulsory Scrapie Flocks Scheme farmers with confirmed scrapie cases on their farms will either have their sheep flocks genotype tested so that those animals more susceptible to disease (groups 3 to 4) can be identified and removed or the whole flock slaughtered and disposed of. All goats on affected holdings will be slaughtered and disposed of. Testing of breeding rams will also become compulsory for all purebred flocks and any other flocks producing and selling homebred rams for breeding. All rams carrying VRQ PrP genotypes will be slaughtered or castrated. Allied to this will be a voluntary ewe-testing scheme.

A mathematical model of the program has examined the time that it would take to eliminate scrapie from the national flock.<sup>55</sup> The results suggest eradication feasible but the process could take decades and would be expensive. Surprisingly whole flock culling was more efficient in terms of time to eradication than genetic typing and selective culling. Not surprising was the finding that the **most important factor** influencing the efficacy of control at the national level was the ability to identify affected flocks. It was suggested that investing money in obtaining better notifications and in conducting trace backs and active surveillance of animals slaughtered for human consumption and animals found dead on farms would be a good investment.

In the **USA**, all breeding sheep must be individually identified with a unique flock and individual number. The **Scrapie Flock Certification** program monitors flocks over time and the assigns certified status to flocks with no evidence of scrapie. While this program has strict require-

ments of identification and reporting it is not based on genetic testing.

The USA also has a **USDA Genetics Based Flock Clean-Up and Monitoring Plan**. This program targets scrapie infected and source flocks. The sheep in these flocks are genotyped, sheep with susceptible genotypes are removed (as are all goats) and the flock is placed under surveillance for five years. Flocks that are exposed to scrapie are placed on a monitoring program and if scrapie is detected would begin the genetics based clean up program. The eyelid biopsy test can be used for selected monitoring for preclinical disease in these flocks.<sup>48</sup>

There is concern that breeding for the selection for certain PrP genotypes and reduction or elimination of other PrP genotypes could affect other **desirable genetic characteristics** and reduce the overall 'genetic pool'. This will need to be determined for individual breeds but preliminary analyses, that have involved several breeds, suggest that reproductive traits, muscle mass, wool quality, live weight gain, carcass characteristics, is not affected, at least in some breeds.<sup>56-58</sup>

There has also been concern that **rare breeds** could be threatened in the face of an occurrence of scrapie and flock with subsequent disposition of the flock based on PrP genotype. Interestingly there is a good representation of ARR with some breeds having very high frequencies.<sup>59</sup>

## REVIEW LITERATURE

- Pary HB. Scrapie disease in sheep: historical, clinical, epidemiological, pathological, and practical aspects of the natural disease. London: Academic Press. 1983; pp. 192.
- Aiken JM, Mark RF. The search for scrapie nucleic acid. *Microbiol Rev* 1990; 54:242-246.
- Kimberlin RH. Transmissible encephalopathies in animals. *Can J Vet Res* 1990; 54:30-37.
- Chesebro BW. Transmissible spongiform encephalopathies. *Curr Top Microbiol Immunol* 1991; 172:1-280.
- Prusiner SB. Molecular biology of prion diseases. *Science* 1991; 252:1515-1522.
- Detwiler LA et al. Scrapie: a review. *Sheep Goat Res J* 1996; 123:111-131.
- Hoinville LJ. A review of the epidemiology of scrapie in sheep. *Rev Sci Tech Off Int Epiz* 1996; 153:827-852.
- Parsonson JM. Scrapie: recent trends. *Aust Vet J* 1996; 74:383-387.
- Chesebro B. Introduction to the transmissible spongiform encephalopathies or prion diseases. *Br Med Bull* 2003; 66:1-20.
- Detwiler LA, Baylis M. The epidemiology of scrapie. *Rev Sci Tech Off Int Epiz* 2003; 22:121-143.

## REFERENCES

- Prusiner SB. *New Eng J Med* 2001; 334:1516.
- Ridley RM, Baker HF. *Neuropathol Appl Neurobiol* 1997; 23:273.
- Aiken JM, Mark RF. *Microbiol Rev* 1990; 54:242.
- Prusiner SB et al. *Cornell Vet* 1991; 31:35.
- Brown P et al. *Lancet* 1991; 337:169.
- Bruce BE et al. *J Gen Virol* 2002; 83:695.
- Baylis M et al. *Trends Microbiol* 2002; 10:12:563.
- Bruere AN. *Surveillance Wellington* 2003; 304:3.

- Morgan KL. *Vet Rec* 1990; 127:373.
- Hoinville LJ. *Rev Sci Tech Off Int Epiz* 1996; 153:827.
- Foster JD, Dickinson AG. *Vet Rec* 1989; 125:415.
- McLean AR et al. *Proc Royal Soc Lond B* 1999; 266:2531.
- Hoinville LJ et al. *Vet Rec* 2000; 146:455.
- Sivam SK et al. *Vet Rec* 2003; 153:782.
- del Rio Vilas VJ et al. *Prev Vet Med* 2005; 67:303.
- Baylis M et al. *J Gen Virol* 85:2004; 2735.
- Tongue SC et al. *Vet Rec* 2004; 154:9.
- Detwiler LA et al. *Sheep Goat Res J* 1996; 123:111.
- Wineland NE et al. *J Am Vet Med Assoc* 1998; 212:713.
- Hunter N et al. *Vet Rec* 1997; 141:137.
- Race R. *Curr Top Microbiol Immunol* 1991; 172:181.
- Haurrigan JL. *J Am Vet Med Assoc* 1990; 196:1678.
- Wisniewski HM et al. *Lancet* 1996; 347:1114.
- Caplazi P et al. *J Vet Diag Invest* 2005; 166:489.
- Wood JNL et al. *Vet Rec* 1992; 131:66.
- Taylor DM. *Vet Rec* 1989; 125:413.
- Detwiler LA, Baylis M. *Rev Sci Tech Off Int Epiz* 2003; 22:121.
- Healey AM et al. *Prev Vet Med* 2004; 64:73.
- Caramelli M et al. *Vet Rec* 2001; 148:531.
- Hunter N. *Curr Top Microbiol Immunol* 1991; 172:165.
- Hunter N et al. In: Kretzschmar H (ed) *Prion diseases: diagnosis and pathogenesis*. Austria: Springer-Verlag, 2000; p. 181.
- Kutzer T et al. *J Anim Breed Genet* 2002; 119:201.
- Hunter N et al. *Vet Rec* 1997; 140:59.
- Tuo W et al. *Proc Natl Acad Sci USA* 2002; 99:6310.
- O'Neill GT et al. *J Anim Breed Genet* 2005; 122:86.
- Goldmann W et al. *Vet Rec* 2004; 155:177.
- Hopp P et al. *Prev Vet Med* 2001; 51:183.
- Taylor DM et al. *Vet Microbiol* 1997; 58:87&167.
- Brown P et al. *Proc Natl Acad Sci USA* 1999; 97:3418.
- Hunter N et al. *Vet Rec* 1997; 140:59.
- Klein MA et al. *Nature* 1997; 390:687.
- O'Rourke KI et al. *J Gen Virol* 1994; 75:1511.
- Hadlow WJ. *Curr Top Vet Med Anim Sci* 1991; 55:117.
- Hegge R et al. *J Gen Virol* 2003; 84:1327.
- Healy AM et al. *J Vet Int Med* 2003; 17:908.
- Schreuder BEC et al. *Vet Rec* 1998; 142:564.
- Schreuder BEC et al. *Nature* 1996; 381:563.
- O'Rourke KI et al. *J Clin Microbiol* 2000; 38:3254.
- Thuring CMA et al. *Vet Rec* 2000; 147:631.
- Bender S et al. *Vet Rec* 2004; 154:662.
- Wood JNL et al. *Vet Rec* 1997; 140:167.
- Begara-McGorum I et al. *J Comp Pathol* 2002; 127:59.
- Onnash H et al. *Vet Rec* 2004; 155:636.
- Sigurdson S. *Curr Top Vet Med Anim Sci* 1991; 55:233.
- Gubbins S, Webb CR. *Prev Vet Med* 2005; 69:175.
- de Vries F et al. *Vet Rec* 2004; 155:140.
- de Vries F et al. *Anim Sci* 2004; 79:397.
- Brandsma JH. *Livestock Product Sci* 2004; 851:59.
- Townsend SJ et al. *Vet Rec* 2005; 156:131.

## BOVINE SPONGIFORM ENCEPHALOPATHY (BSE)

Bovine spongiform encephalopathy (BSE) is an afebrile neurological disorder affecting adult cattle. It is a subacute transmissible spongiform encephalopathy and is believed due to a single stable cattle-adapted strain of a scrapie-like agent and

## Synopsis

**Etiology** An agent related to the transmissible agent of scrapie. Major concern for zoonotic potential

**Epidemiology** Has occurred as an epidemic in Great Britain associated with the feeding of infected meat-and-bone meal. Sporadic in other countries

**Clinical findings** Non-febrile disease of adult cattle, with long clinical course. Disturbance in behavior, sensitivity, and locomotion

**Clinical pathology** None specific

**Diagnostic confirmation** Histology, demonstration and prion protein

**Treatment** None

**Control** Slaughter eradication. Avoidance of feeding ruminant-derived protein to ruminants

occurred as the result of the exposure of cattle to animal protein feeds containing the scrapie agent.

The disease is of considerable importance mainly because it has zoonotic potential and has spread to many countries. The cost of control is very high.

## ETIOLOGY

BSE is a prion-associated transmissible spongiform encephalopathy.

The stability of the lesion profile in cattle and the lesion profiles in mice strongly suggests that the epidemic in Britain, and the subsequent extended epidemic in other countries, is due to a single stable cattle-adapted strain of a scrapie-like agent.<sup>1</sup> There is debate as to whether the transmissible agent is a strain of scrapie that has modified to infect cattle or whether it originated from a sporadic spongiform encephalopathy pre-existent in the cattle population. There is evidence of characteristics that distinguish it from conventional scrapie strains.<sup>2,3</sup> In view of the high susceptibility of certain African ungulates and zoo carnivores to infection it has also been postulated that the agent could have entered into meat-and-bone meal from the carcass of an animal that died in a zoo or a safari park in the UK. A further hypothesis promotes meat and bone meal from the Indian sub-continent as a source. The British government has conducted several enquiries into the source of the agent and the cause of the outbreak including the Phillips report in 2000,<sup>5</sup> and the Horn report in 2001<sup>6</sup> but there has been no conclusion and the source may never be known.

The mass exposure of cattle in Great Britain to this agent, and the subsequent development of a disease epizootic in cattle in the latter half of the 1980s and the early 1990s is believed to have been the consequence of a change in the method of processing of meat-and-bone meal (MBM) prepared from slaughter sheep (o

cattle) latently infected with the agent so as to allow it to persist in this feed.<sup>6-8</sup>

Subsequent recycling of the agent in meat-and-bone meal prepared from latently infected slaughter cattle amplified its occurrence.

## EPIDEMIOLOGY

### Occurrence

#### Geographic occurrence

BSE was first described in Great Britain in 1987 but the BSE Inquiries considered it likely that there had been several undetected cycles of BSE in the South West of England in the 1970s and early 1980s. Following its description in 1987, the disease developed to an epizootic with over 183 000 cases, of which more than 95% were detected before 2000. The epidemic peaked at an annual total of more than 37 000 clinical cases in 1992. The disease was recognized in Northern Ireland, in 1998 and in the Republic of Ireland in 1999. The disease was subsequently recognized in Switzerland, Portugal and France in the early 1990s and is now widespread.

Cases have occurred in imported British cattle in Oman and the Falkland and Channel Islands Countries that have had cases of BSE in native cattle are Austria, Belgium, Canada, Czech Republic, Denmark, Finland, Germany, Greece, Ireland, Israel, Italy, Japan, Luxembourg, Netherlands, Poland, Portugal, Slovakia, Slovenia, Spain, Switzerland, United Kingdom, and the United States of America.<sup>9</sup>

The OIE Terrestrial Animal Health Code describes five BSE risk categories for countries. In order of increasing incidence of BSE these categories are: BSE free, BSE provisionally free, minimal BSE risk, moderate BSE risk, high BSE risk. These classifications can be important in trade.

#### Occurrence in cattle

##### Great Britain

In Great Britain, the first known clinical case probably occurred in 1985. The annual incidence subsequently increased and the disease became a major epizootic in the late 1980s. The disease was declared notifiable, and a statutory ban on the feeding of ruminant-derived protein to ruminants was introduced in 1988. A more extensive ban on feeding any animal protein to any agricultural animal was later implemented to avoid feed cross-contamination. The annual incidence peaked in 1992 and has fallen every year since to produce a bell-shaped epidemic curve at approximately the year 2000, with some cases every year since. The reduction from the peak in 1992 is attributed to the 1988 ruminant-feed ban with the delay in response an effect of the incubation period of this disease. Britain

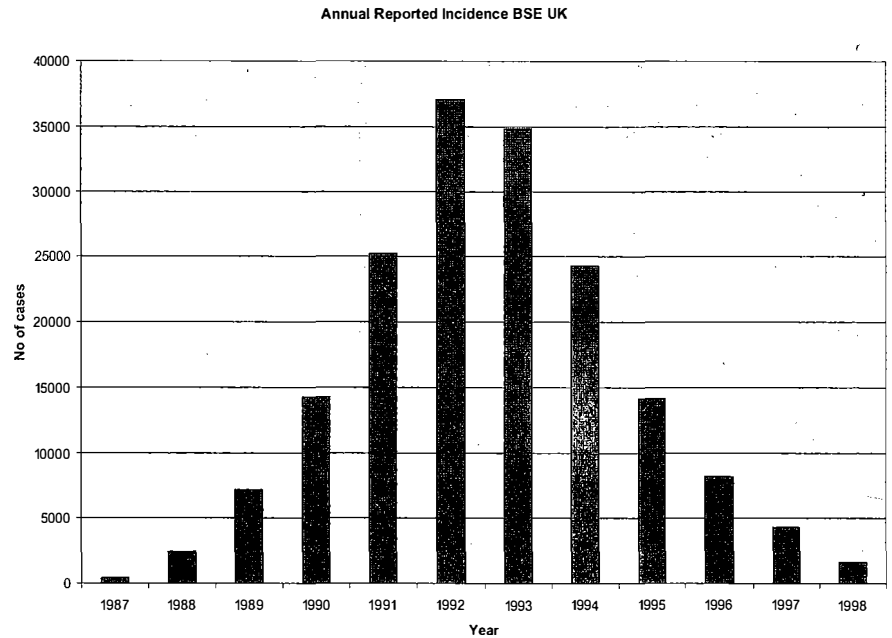

Fig. 23.1 Annual reports of incidence of BSE in the UK (1987–1998).

has had the greatest number of affected cattle and provides the most information on the disease.

#### Herd type

The great proportion of cases have occurred in **dairy and dairy crossbred herds**, and by 2002 61.7% of dairy herds in Great Britain had experienced one or more cases.<sup>10</sup> In contrast, 17.1% of **beef** herds had cases in the same time period. There has been no apparent breed predisposition. In both herd types, the risk for cases increased significantly with increasing herd size. A significant proportion of the cases in beef cattle herds have occurred in animals purchased into the herds from dairy herds. The reason for this difference in herd type is believed to be the greater use of concentrates in dairy cattle.

The disease has occurred in all regions of the country but was most prevalent in southwest England. Although the disease developed to an epizootic within the country, the disease does not occur as an epizootic within affected herds and most experience either single cases or a limited number of cases. The average **within-herd incidence** has remained below 2% since the disease was first described.

#### Northern Ireland and Republic of Ireland

In Northern Ireland the disease was recognized in 1998 and in the Republic of Ireland in 1999 but **epizootic disease** occurred Great Britain and Northern Ireland.<sup>10-12</sup> The epidemiological features in both countries were similar to that in Great Britain, but the incidence has been lower. In Northern Ireland the incidence was approximately one tenth of that in Britain.<sup>11</sup> The yearly incidence of the

disease peaked in 1994 in Northern Ireland but jumped unexpectedly in the Republic of Ireland in 1996 to 1998 and has remained high since. The source of infection in both countries is believed to have been meat-and-bone meal imported from Great Britain. In the Republic of Ireland there has been geographic clustering with a higher incidence in two counties<sup>13</sup> possibly associated with the location of feed suppliers.

#### European continent and Iberian Peninsula

On the European continent the disease was recognized in Switzerland in 1999 and shortly after on the Iberian peninsula in Portugal. Both countries showed a case incidence with evidence of an epidemic curve. However this was not mirrored in European Union (EU) member states in the continent, where only sporadic cases were reported in the 1990s, and it appears that the disease in this region was unrecognized, under-reported, and was more widespread than recorded.<sup>14,15</sup> Apparently cattle with typical clinical manifestations and fallen stock with clinical signs that should have led to a suspicion of BSE were misdiagnosed or not reported.<sup>16</sup>

Switzerland established a surveillance system in 1999 testing fallen cattle, emergency slaughter and normal cattle using Prionics western blot rapid testing methods.<sup>17</sup> This surveillance method was rapidly adopted EU member countries so that all but two had recorded cases by the end of 2001. In France, between the first notified case in the 1991 and the establishment of mandatory testing in 2000 there were 103 cases detected by passive surveillance but it is estimated that 301 200 cattle were infected with BSE during this period.<sup>18</sup>



### North America

Canada experienced a case of BSE in a cow imported from Great Britain in 1993 but the first case in an indigenous Canadian cow occurred in 2003 in Alberta. Trace back on 40 herds and slaughter of over 2000 suspects were all negative. The molecular profile of the BSE agent from this case was very similar to the UK BSE strains and had no relation to the agent associated with **chronic wasting disease** in deer and elk.<sup>19</sup> In 2003 a Canadian cow that had been exported to the USA as a young cow developed complications at parturition, was shipped as a non-ambulatory cow, and was discovered as a BSE case under a routine monitoring program of downer cows.<sup>20</sup> Canada had two more cases of BSE in 2005. The US had had a case in a native born cow in 2005. Trace backs and slaughter study of birth contemporaries have proven negative for BSE. Affected animals in both countries were born before the ban on feeding MBM in 1997.

### Age incidence

BSE, like scrapie, has a **long incubation period**, 2.5 to at least 8 years and possibly for the lifespan of cattle, and is a disease that affects mature animals. Epidemiological studies suggest that most affected cattle have been infected as calves.<sup>7</sup> Risk is greatest in the first 6 months of life and between 6 and 24 months of age risk is related to feeding patterns of proprietary concentrates. Adult cattle are at low risk for infection.<sup>21</sup>

The **modal age at onset** of clinical signs is between 4 and 5 years but there is a skewed distribution with the youngest age at onset recorded at 22 months and the oldest at 15 years.<sup>10,22</sup> During the course of the outbreak in the UK there has been a change in the age distribution of cases in both Britain and Northern Ireland, consistent with a sudden decrease in exposure as a result of the bans on ruminant protein feeding. The clinical course is variable but the case fatality is 100%. There is a variation in risk associated with the calendar month of birth related to seasonal differences in calf management and exposure to ruminant protein in calf feeds.<sup>11</sup>

### Other species

Spongiform encephalopathies have been identified in seven species of **ungulates** in zoos or wildlife parks in Great Britain since the occurrence of the disease in cattle. These animals had been fed meat-and-bone meal but the apparently shorter incubation period suggests that they might be more susceptible to infection than cattle and there is evidence for horizontal transmission.<sup>23</sup>

**Feline spongiform encephalopathy** (FSE) is also recorded in **domestic cats** in Great Britain since 1990 and in zoo felids. The **zoo felids** had been fed cattle

carcasses unfit for human consumption, or the zoo had a history of BSE in exotic ruminants and fed culled carcasses to other zoo animals.<sup>24,25</sup> Transmission studies in mice with the agents associated with these encephalopathies in zoo ungulates and felids suggest that they are the same strain as causes BSE.<sup>3</sup> The initial concern that there would be an outbreak of FSE in domestic cats did not occur and only 89 cases were confirmed to the end on 2003.<sup>26</sup>

### Method of natural transmission

Ingestion of meat-and-bone meal

The initial epidemiological studies suggested that the disease in the UK was an extended common-source epidemic and the only common source identified in these initial studies was the feeding of proprietary concentrate feedstuffs.<sup>7</sup> Epidemiological studies also suggested that presence of meat-and-bone meal in proprietary concentrates was the proxy for affected cattle to have been exposed to a scrapie-like agent,<sup>7,10,11</sup> and this conclusion is supported by case-control studies examining feeding practices to calves that subsequently developed the disease.<sup>27</sup> This hypothesis explains **breed differences** in incidence, as concentrates are not commonly fed to beef calves in the UK, and also can account for geographical differences in incidence. The oral route of challenge is known to be an inefficient route for the transmission of the agents associated with spongiform encephalopathies<sup>28</sup> and this is believed the reason for the low within-herd incidence of the disease in the face of a common exposure.<sup>27</sup>

**Meat-and-bone meal** is manufactured by the rendering industry from tissues discarded in slaughterhouses, and also from down and dead livestock. The outbreak of BSE in Britain was temporarily preceded by a change in the method of processing of meat-and-bone meal to a continuous process with a cessation of the use of hydrocarbon fat solvents. It is postulated that this change, coupled with the high sheep to cattle ratio in Great Britain, allowed the greater survival of a scrapie-like agent in scrapie-infected sheep carcasses processed to meat-and-bone meal to reach a level that was infective for cattle. An alternate hypothesis is that the agent came from existing, but low incidence and unrecognized, cases of BSE. The initial exposure occurred in 1981/82 and, subsequently, the agent recycled from infected cattle carcasses and offal used in the preparation of meat-and-bone meal.<sup>8,29,30</sup>

Rendering procedures have subsequently been devised to minimize survival of the agent.<sup>31</sup>

The marked fall in disease incidence following the introduction of the feed ban in 1987 in the UK substantiated the import-

ance of ingestion of meat-and-bone meal as the major method of infection. Bans in Europe were largely introduced in 1990.

### Born-after-the-ban

In the UK and in other countries a number of cattle that were born-after-the-ban (BAB, French acronym NAIF) have developed the disease. Most of these were born in the years immediately following the ban and their numbers have decreased in subsequent years but still continue at low levels.<sup>32,33</sup> A case-control study found that vertical or horizontal transmission was not an important cause of these cases.<sup>34</sup> It is believed that meat-and-bone meal that was already in the food chain at the time, in mills and on the farm, was fed until it was depleted.

In several countries the occurrence of born-after-the-ban cases has been geographically clustered, and also associated with certain birth-cohorts.<sup>32-34,36</sup> In the UK the clustering was related to areas with high concentrations of pigs and poultry and it is believed that there was cross-contamination of feedstuffs in feedmills.<sup>37</sup> This is certainly possible with an infective dose of one gram or less.

More recently there has been concern at cattle in the UK that have developed BSE but that were born after the implementation of the reinforced feed ban in 1996 (BARBs). To 2005 there have been approximately 100 cases. Again there is no evidence of maternal or lateral transmission and the inadvertent use of illegal feed material residual on farms is suspected.

### Non-feedborne transmission

There is no epidemiological evidence for significant horizontal or vertical transmission of the disease in cattle<sup>7,10,34</sup> although the studies suggest that minor horizontal transmission may occur to birth cohorts of calves that subsequently develop BSE. This type of transmission is of minor importance to the perpetuation of the disease in a country, but it may be of significance to human health and birth cohorts are included in trace backs of infection in the USA and Canada.

### Vertical transmission

In the absence of other mechanisms of transmission, vertical transmission is not considered significant for the perpetuation of the disease in an epidemic form.<sup>28</sup> There is an **enhanced risk** for the disease in calves born to infected cows, and this is higher in calves born after the onset of clinical disease in the cow.<sup>38,39</sup> This may be the result of exposure, at birth, to high infectivity in birth products as there is no evidence for infection and transmission in embryo transplants.<sup>39</sup> However, no detectable infectivity has been found in placentas from cows with the disease.

A very elegant experiment that examined the risk for transmission of BSE via embryo transfer and which used recipient cattle sourced from New Zealand and donor cows clinically affected with BSE, bred to bulls that did and did not have clinical BSE, concluded, after a 7-year observation period on the progeny, that embryos were unlikely to carry BSE.<sup>40</sup>

### Risk for occurrence of disease in countries

Changes in the method of processing meat-and-bone meal have occurred in countries other than the UK and scrapie occurs in sheep in other countries. However, the major risk for the occurrence of the disease in other countries is the importation of latently infected cattle and/or the importation of infected meat-and-bone meal. This risk can be substantially avoided by prohibiting the feeding meat-and-bone meal to cattle.

An assessment in 1996 of risk for the occurrence of BSE in the United States concluded that the potential risk of an epizootic was small and that there are substantial differences in the strength of the risk factors between the USA and the UK.<sup>41</sup> These result from differences in proportional numbers of sheep and cattle, differences in the nature of the beef and dairy industries, the type of animal used for beef production and the age at slaughter, differences in the prevalence of scrapie, differences in the rendering industry with a much lower proportion of rendered animal protein originating from sheep in the USA, and differences in the practice of feeding ruminant-derived protein in calf rations, which is uncommon in the USA.<sup>12,41</sup> An analysis published in 2004 concluded the same.<sup>42</sup>

Thus the risk of an outbreak similar to that in the UK was considered negligible. However a case in a native cow in the US has occurred in 2005. This, and the recent cases in Canada suggests that infected meat-and-bone meal was imported to the North American continent at some time. The cases in both countries occurred in cattle that were born before the ban on feeding meat-and-bone meal imposed in both countries in 1997.

Countries with largely pastoral cattle are at low risk.<sup>43</sup>

The International Animal health code of the OIE describes five BSE risk categories for countries based on the importation of cattle from at-risk countries, the importation of potentially infected meat-and-bone meal, the consumption of meat-and-bone meal by cattle and other animals, animal feeding practices, livestock population structure, rendering practices and the potential for recycling of BSE. In order of increasing incidence of BSE these categories are: BSE free, BSE provisionally

free, minimal BSE risk, moderate BSE risk, high BSE risk.<sup>44</sup>

### Experimental reproduction

While studies on the transmissibility and experimental reproduction of BSE were established before the occurrence of human cases of BSE (vCJD) they have been **critical in determining the risk** of cattle products for human disease and the risk for disease in other species.

In cattle, disease has been experimentally reproduced by oral, and intracerebral inoculation with infected cattle brain homogenates.

Oral, intravenous and intracerebral inoculation of sheep with infected cattle brain homogenates also results in disease. Disease has also been reproduced in goats and mink by parenteral challenge. In pigs, disease has been produced by intracerebral challenge with infected brain homogenates but not oral challenge. It has not been produced by any route of challenge in poultry and is not produced by oral challenge in farmed deer.<sup>45</sup>

The disease can also be produced and passed in a variety of laboratory mice strains.

Some details of the results of the temporal infectivity of tissues produced in cattle by oral challenge with homogenates of infected brain tissue are given below under the heading pathogenesis.

In the initial oral challenge studies, cattle were challenged with a 100 g dose of brain homogenate that contained 10<sup>3.5</sup> intracerebral/intraperitoneal LD/50/g of BSE.<sup>46</sup> There is currently a study in progress that examines the effect of dose on the incubation period of BSE and the distribution of infectivity. Dose rates of brain of 1 g have produced the disease and studies will continue with lower doses.

### Infectivity of tissues

Brain, spinal cord and retina are tissues that are infective to cattle or laboratory animals from natural cases of BSE. The tissues that are infective to cattle or laboratory animals from experimentally infected cattle are brain, spinal cord, retina, distal ileum, bone marrow, trigeminal nerve and lingual lymph tissue.<sup>46-48</sup>

#### Parenteral injection of BSE brain:

- transmits from cattle to cattle, mice, goats, sheep, pigs, mink, guinea pig

#### Orally fed BSE brain:

- transmits from cattle to cattle, mice, mink, sheep and goats
- not to pigs or farmed deer

Other tissues including the major visceral organs, striated muscle and tissue common for human consumption were

negative by mouse bioassay, indicating that no infectivity could be detected. These tissue are currently being re-examined for infectivity using the most sensitive assay known, intracerebral infection into the host species – in this case cattle. These studies are on-going but, at last report<sup>49</sup> have only confirmed the results of the negative mouse bioassays. There is no evidence of infectivity in milk based on the fact that calves suckling cows with clinical BSE do not themselves develop BSE when mature and also on the lack of infectivity with intracerebral injection of mice.<sup>50,51</sup>

Strongest evidence of absence of infection in milk is the study that examined and found no increase in incidence of BSE in calves born to dams with BSE that suckled these cows during clinical disease compared to calves that suckled clinically normal dams. There is species susceptibility (no barrier) strength in this study.

### Economic importance

BSE is not of major economic significance to individual herds in countries in which it is endemic because of the low within-herd incidence. In most countries, compensation will cover cases detected by passive surveillance and, with active surveillance, most the costs if there is selective culling in affected and trace back herds.

However, it is arguable that this disease is the **most economically devastating** agricultural animal disease in the developed world.

The disease has been of major economic importance in the UK and is estimated to have cost £600 billion.<sup>52</sup> This has been due to the national cost associated with detection and control procedures, the cost of compensation and disposal of affected animals. These costs, along with the cost of loss of export markets are very high.

Worldwide, the public has developed an extreme concern for the public health risk associated with BSE infection in cattle and consequently all countries have been mandated or encouraged to develop active surveillance programs. Not to do so runs the risk of loss of overseas markets and loss of home consumption of beef in favor of other meats.

Further, the detection of a single case of BSE by these active surveillance programs results in loss of export markets for the country and a severe fall in cattle prices for countries that rely on exports in their cattle industries.

BSE is also arguably the disease that has been used most to influence trade in live cattle and cattle products with no science-base or attention to the internationally adopted OIE Terrestrial Animal

Health Code. This largely because of the success of local political influence of ranches and farmers.

It is further arguable that the money spent, for reasons of public health, on this relatively minor zoonotic disease, by far outweighs its relative importance as a cause of human disease.

### Zoonotic implications

Concerns that this disease could transmit to man were raised a very short time after its initial diagnosis. These unfortunately proved true in 1996 when a new form of CJD was reported. While, with the initial cases, there was reservation as to causality, studies showed the agent associated with this disease is similar to that associated with BSE and the feline spongiform encephalopathies and there is now no doubt that this is a form of BSE in man. It differs from CJD in that it affects young people with a mean age onset in the third decade of life. In humans there is evidence for genetic susceptibility and all cases have been homozygous for methionine at codon 129. The disease has been termed **variant CJD (vCJD)**.

The disease occurred in the UK despite the progressive bans on human consumption of beef products that contained infectivity that were implemented in 1998 and subsequently tightened further as new information on potential infectivity became available. It is possible that exposure of affected humans occurred in the early and mid 1980s, prior to the recognition of the disease. There was initially extreme concern that there would be a very large outbreak in humans. However, this has not occurred. The total number of deaths from vCJD in the UK has reached 150. The peak number of deaths occurred in the year 2000 and the outbreak appears to have reached a plateau and is possibly in decline<sup>53</sup> although the nature of the outbreak will be dependant on the range of incubation periods in humans.<sup>54</sup>

Also, cases of vCJD are more recently being reported from the European continent and the Iberian peninsula.

While there is no evidence of direct transmission to humans, veterinarians and animal handlers should take appropriate precautions when handling nervous system tissues of infected animals.

### PATHOGENESIS

Information on the pathogenesis and development of BSE in cattle derives almost entirely from studies published from Britain in the 1990s that studied the spatial and temporal development of infectivity and pathological change in cattle after oral challenge with a 100 g dose of BSE-affected brain homogenate sourced from naturally clinically affected

cattle.<sup>49</sup> The experimental cattle were killed sequentially following challenge and infectivity in tissues subsequently determined by initially by infectivity assays by intracerebral and intraperitoneal injection into panels of inbred mice, and subsequently by infectivity studies by intracerebral challenge of cattle to exclude any species barrier effects.

- Long incubation period (5 years)
- Oral infection
- Infection of Peyer's patches, to brainstem via vagus nerve
- Accumulation of abnormal prions destroys brain slowly

Following oral challenge of calves, infectivity was initially detectable in the distal ileum, in the Peyer's patches,<sup>47</sup> but no infection is demonstrable in other lymphoreticular organs.<sup>49,55</sup> Infectivity was demonstrable in the cervical and thoracic dorsal root ganglia at 32–40 months after infection and in the trigeminal ganglion at 36–38 months. Traces of infectivity were shown in sternal bone marrow in cattle killed 38 months post exposure. The earliest presence of abnormal PrP and infectivity in the CNS occurred 32 months post-exposure, prior to any typical diagnostic histopathological changes in the brain. The onset of clinical signs and pathological change in the brain occur at approximately the same time.

### CLINICAL FINDINGS

The disease is insidious in onset and the clinical course progresses over several weeks, varying from 1 to 6 months in duration. There is a **constellation of clinical signs** with alterations in behavior, temperament, posture, sensorium and movement, but the clinical signs are variable from day to day although they are progressive over time. Cattle that show behavioral, sensory and locomotor abnormality together are highly suspect for BSE.<sup>7,50,55–58</sup> The predominant **neurological signs** are apprehensive behavior, hyperesthesia and ataxia, and a high proportion of cases lose body condition and have a diminishing milk yield during the clinical course of the disease.

#### Clinical signs in BSE

- Change in temperament and behavior
  - apprehension, excitable, unusual kicking, head tossing when haltered, separation from group
- Change in posture and movement
  - abnormal posture and ataxia
- Fall in milk production
- **No ante-mortem test available**

**Behavioral changes** are gradual in onset and include changes, such as a reluctance to pass through the milking shed or to leave a vehicle or a pen, a change in milking order and a reluctance to pass through passageways. Affected cattle are disoriented and may stare, presumably at imaginary objects, for long periods. There is hyperesthesia to sound and touch, with twitching of the ears or more general muscle fasciculation and tremors. Many throw their head sideways and show head shaking when the head or neck is touched.

Other changes in **temperament** include the avoidance of other cows in loose housing, but antagonistic behavior to herd mates and humans when in confined situations. Affected animals may kick during milking and show resistance to handling. Some cows show excessive grooming and licking, and may show the equivalent of the scrapie scratch reflex.

Bradycardia, associated with increased vagal tone and not occurring due to decreased food intake is reported and may persist despite the cow's nervousness during clinical examination.<sup>58,59</sup>

Relatively early in the course of the disease there is **hindlimb ataxia** with a shortened stride, swaying gait, and difficulty in negotiating turns.

This should be especially examined as animals exit transport vehicles or are trotted through an area. Knuckling, stumbling and falling, with subsequent difficulty in rising is common in the later stages of the disease. Cows show **progressive weakness**, with ataxia and weight loss, and prior to the common recognition of the disease, they were sent to slaughter because of locomotor disabilities or changes in temperament.

It has been recommended<sup>58</sup> that the animals reaction to sudden noise, sudden light, sudden movement and sudden touch be used as a test. Sudden noise is tested by clanging two metal objects together out of sight of the animal – the bang test; sudden light by testing with a camera flash – the flash test; sudden movement tested by waving a clipboard towards the cow from a short distance – the clipboard test and sudden touch by touching the animal on the hind limbs a soft stick – stick test.

Abnormal reactions to these tests include being startled, head tossing, salivation, snorting, running away or panicky circling and kicking out on touch. These tests have been found positive in BSE suspects that had a history of behavioral change but did not show abnormalities of gait.<sup>58</sup>

Cattle with BSE do not always show neurological signs in the initial stages of the disease and animals with BSE may be sent to slaughter for poor production

prior to the onset of clinical nervous signs.<sup>17</sup>

### Clinical signs and passive surveillance

There is yet no preclinical test for BSE and clinical recognition of BSE is the major component of passive surveillance.

At the peak of the outbreak in Britain, BSE was confirmed in 85% of suspects picked by passive surveillance. This percentage fell to 56% later in the outbreak. Farmers were fully compensated at notification and well informed and so were probably motivated to contact their veterinarian. Veterinarians were also very aware of the clinical presentation of BSE and observant at livestock markets and while TB testing and at abattoirs.<sup>35</sup> Relatively high success rates were also found in Switzerland where approximately 59% of animals notified with BSE were confirmed.<sup>60,61</sup> However, in other countries, passive surveillance was an utter failure.<sup>15,62</sup>

While an aid to surveillance of a disease, passive surveillance of BSE based on clinical signs is an insensitive method of disease detection and targeting surveillance of emergency slaughtered cattle and fallen stock is 40 times more likely to detect case of BSE than notification on the basis of clinical signs. One study found that the odds of finding a BSE case was 49 times higher in the fallen stock and 58 times higher in emergency slaughtered cattle greater than 24 months of age when compared with passive surveillance of clinical disease.<sup>61</sup>

### CLINICAL PATHOLOGY

There is no specific test for the ante-mortem diagnosis of this disease. Apolipoprotein E and two unidentified proteins are present in the cerebrospinal fluid from clinical cases but not normal cattle, and the presence of a 30 kDa, 14–3–3 protein in cerebrospinal fluid in affected cows is reported, but there is no information of specificity.<sup>63,64</sup> Electroencephalographic and evoked potential diagnostic methods have been proposed as antemortem diagnostic test methods<sup>65</sup> but require further evaluation and would seem impractical.

### NECROPSY FINDINGS

There are no abnormalities in gross pathology, and diagnosis is dependent upon histological findings.<sup>66</sup> Major changes are in the brain stem, and the pathognomonic lesion is a bilaterally symmetric intracytoplasmic vacuolation of neurons and gray matter neuropil. The occurrence of vacuolation in the solitary tract and the spinal tract of the trigeminal nerve in the medulla oblongata is the basis of statutory diagnosis of the disease in Great Britain. In Great Britain, statutory diagnosis is achieved by an examination

of a single brain stem section obtained via the foramen magnum and obviating the need of extracting the brain with the associated risk of aerosol production.<sup>28</sup>

Histological findings are diagnostic in many cases but can be supplemented with the immunodetection of PrP<sup>Sc</sup> in brain tissue by in situ immunohistochemistry and Western immunoblots.

There are a number of validated rapid tests for BSE.<sup>67</sup> Recently it has been established that the sensitivities of detection of BSE-specific PrP by immunohistochemistry and the detection of infectivity by mouse inoculation are equivalent and similar to the sensitivity of the rapid method (BSE Bio-Rad) for detection of PrP<sup>Sc</sup>.<sup>47,68</sup>

Scrapie-associated fibrils can be visualized by electron microscopy. Government regulatory agencies are usually responsible for the confirmation of this diagnosis and typically distribute specific protocols regarding the collection of samples and disposal of carcasses from suspect animals.

### Samples for confirmation of diagnosis

- **Histology** – formalin-fixed brain, including midbrain and entire medulla oblongata (LM).

**Note the zoonotic potential of this disease when handling carcass and submitting specimens.**

### DIFFERENTIAL DIAGNOSIS

The disease should be considered in the differential diagnosis of any progressive neurological disease in cattle. Primary differentials on clinical signs include:

- Hypomagnesemia
- Nervous acetonemia
- Rabies
- Lead poisoning
- Listeriosis
- Polioencephalomalacia
- Tremorogenic toxins.
- **Bovine amyloidotic spongiform encephalopathy.** In both Italy and France a form of spongiform encephalopathy different from BSE has been detected in brains collected as part of the active surveillance program in those countries. The cases were in older cattle and pathologically characterized by the presence of PrP-immunopositive amyloid plaques, as opposed to the lack of amyloid deposition in typical BSE cases, and by less involvement of the brainstem. There was some similarity to CJD in humans. There is no information on clinical presentation.<sup>69</sup> Other atypical forms have been reported in Belgium, and Japan.<sup>70</sup>

### TREATMENT AND CONTROL

There is no treatment for the disease.

### Detection of BSE in surveillance and control programs

**Passive surveillance** has been used in many countries. Suspect disease is

notifiable with compulsory slaughter and compensation and disposal of the carcass by incineration. The limitations of passive surveillance are described above in the section on clinical findings and, in most countries, passive surveillance has been replaced with some form of active surveillance.

Commonly, **active surveillance** is directed at a targeted proportion of culled animals, animal manifesting neurological disease, rabies-suspects negative for rabies, and a proportion of cattle, or all cattle, over 24 to 30 months (depending on country) that are presented for slaughter for human consumption. In slaughter cattle, the sampling frame is set to detect BSE at a prevalence rate of one mature animal in a million mature animals. The ability to conduct active surveillance, particularly on slaughter cattle, has been allowed by the development of rapid tests that can be conducted and read while the carcass is being held so that positive test cattle are not released for human consumption. Positive rapid tests need to be confirmed by histology and immunohistochemistry.<sup>15,71</sup>

In the US, following the case of BSE in an imported cow, the USDA implemented an intensive national testing program for BSE that concentrated on a targeted high-risk population. The purpose is to help define if BSE is in the US and, if so, at what level. The intention is to sample as many cattle over a 12 to 18 month period as possible with the goal of examining 268 500 cattle which would allow a detection rate of 1 in 10 million with a 99% confidence level.<sup>72</sup> The cattle will be over 30 months-of-age and include non-ambulatory cattle, cattle that are too weak to walk, cattle that are moribund, cattle with neurological signs, rabies suspects that are negative and dead cattle. At the time of writing (2005) the survey is in currently in progress but has identified one native born BSE cow.

### Control of BSE in cattle

Control programs have the following assumptions:

- Infection and disease in cattle is introduced through feeding contaminated feed containing infected meat-and-bone meal or greaves
- The source of infection to cattle can be eliminated by effective prohibition on feeding infected feed
- There is no significant horizontal or vertical transmission.

Based on this, most countries have established a ban on the feeding of ruminant protein to ruminants. This was done in the 1987 in the UK, the mid 1990s in most European countries and in 1997

in Canada, the US and Mexico. There is however a strong argument for banning all mammalian protein for feeding to all livestock. The experience of several countries with animals that were 'born after the ban' shows that cross contamination in feed mills can occur. While the removal of **specified-risk-materials** (SRM), (brain, spinal cord, eyes, tonsil, thymus, spleen, and intestines) from cattle carcasses should reduce the risk of BSE agent being in the subsequent rendered carcass it obviously does not eliminate it. More detail of the regulations and of control procedures is available.<sup>15,28,71,73</sup>

These control procedures, initiated in the UK, were effective in changing the course of their epidemic which is now on the wane.

### Measures to protect human health

High risk animals, such as **downer cows**, should be kept out of the humans food chain and not rendered for meat-and-bone meal. Infection is present in the tissues listed as **SRM** (brain, spinal cord, eyes, tonsil, thymus, spleen, and intestines) which are removed from the carcass at slaughter. The removal of SRM also protects against the risk posed by cattle that may be incubating the disease yet do not show any symptoms. Together with a ban on products such as mechanically recovered meat that could be contaminated with SRM, excluding SRM from the human food chain is the most important food safety measure to protect public health.

However, this may not be sufficient. The method of slaughter with captive bolt guns can result in the widespread dissemination of brain within the carcass with dissemination by blood into the pulmonary tissues and elsewhere. Also, the method of splitting the carcass and spinal cord can result in significant carcass contamination and contamination of the slaughterhouse environment.<sup>54</sup> Methods to decrease the risk of contamination of the carcass at slaughter have been suggested.<sup>74</sup>

Based on transmission and infectivity experiments cattle under 30 months of age<sup>46-48</sup> are considered to have very low risk of being infected but there can be a risk in endemic countries with cattle over this age. Some countries with a high incidence of BSE have banned cattle over 30 months for human consumption.

### REVIEW LITERATURE

Taylor DM. Bovine spongiform encephalopathy and human health. *Vet Rec* 1989; 125:413-415.  
 Kimberlin RH. Transmissible encephalopathies in animals. *Can Vet J* 1990; 54:30-37.  
 Prusiner SB, Torchia M, Westaway D. Molecular biology and genetics of prions: implications for sheep scrapie 'mad cows' and the BSE epidemic. *Cornell Vet* 1991; 81:85-101.  
 Wilesmith JW, Wells GAH. Bovine spongiform encephalopathy. *Curr Top Microbiol Immunol* 1991; 177:21-38

Bradley R. Bovine spongiform encephalopathy: the current situation and research. *Eur J Epidemiol* 1991; 7: 532-544.  
 Taylor KC. The control of bovine spongiform encephalopathy in Great Britain. *Vet Rec* 1991; 129:522-526.  
 Anonymous. Bovine spongiform encephalopathy: an update. *Rev Sci Tech Off Int Epiz* 1996; 153:1087-1118.  
 Taylor DM. Bovine spongiform encephalopathy - the beginning of the end? *Br Vet J* 1996; 155:501-518.  
 Prince MJ et al. Bovine spongiform encephalopathy. *Rev Sci Tech Off Int Epiz* 2003; 221:37.  
 Matthews D. BSE: a global update. *J Appl Microbiol* 2003; 94: 120S-125S.

### REFERENCES

- Green R et al. *J Comp Pathol* 2005; 132:117.
- Bruce MA et al. *J Gen Virol* 2002; 83:695.
- Bruce ME et al. *Nature* 1997; 388:498.
- <http://www.bseinquiry.gov.uk/index.htm>
- [www.defra.gov.uk/animalh/bse/publications/bseorigin.pdf](http://www.defra.gov.uk/animalh/bse/publications/bseorigin.pdf)
- Wilesmith JW, Ryan JBM. *Vet Rec* 1992; 130:491.
- Wilesmith JW et al. *Vet Rec* 1988; 123:638.
- [www.defra.gov.uk/animalh/bse/publications/bseorigin.pdf](http://www.defra.gov.uk/animalh/bse/publications/bseorigin.pdf)
- [http://www.oie.int/eng/info/en\\_esb.htm](http://www.oie.int/eng/info/en_esb.htm)
- Wilesmith JW et al. *Vet Rec* 1992; 130:90.
- Denny GO, Hueston WD. *Vet Rec* 1997; 140:302.
- Walker KD et al. *J Am Vet Med Assoc* 1991; 199:1554.
- Sheridan HA et al. *Can J Vet Res* 2005; 69:19.
- Schreuder BEC et al. *Vet Rec* 1997; 141:187.
- Heim D, Kihm U. *Rev Sci Tech Off Int Epizoot* 2003; 221:179.
- Cazeau G et al. *Vet Rec* 2004; 154:133.
- Doherr MG et al. *Vet Rec* 1999; 145:672.
- Supervie V, Costagliola D. *Vet Res* 2004; 35:349.
- Stack MJ et al. *Can Vet J* 2004; 45:825.
- Nolen RS. *J Am Vet Med Assoc* 2004; 224:345.
- Arnold ME, Wilesmith JW. *Prev Vet Med* 2004; 66:35.
- Wilesmith JW, Wells GAH. *Curr Top Microbiol Immunol* 1991; 172:21.
- Kirkwood JK et al. *Vet Rec* 1994; 134:167.
- Pleet RL, Curran JM. *Aust Vet J* 1992; 69:171.
- Kirkwood JK et al. *J Zoo Wildlife Med* 1995; 26:577.
- Kelly DF et al. *Vet Rec* 2005; 156:472.
- Wilesmith JW et al. *Res Vet Sci* 1992; 52:325.
- Taylor KC. *Vet Rec* 1991; 129:522.
- Wilesmith JW. *J Am Vet Med Assoc* 1990; 196:1674.
- Taylor DM. *Vet Rec* 1989; 124:291.
- Taylor DM et al. *Vet Rec* 1997; 141:643.
- Doherr MG. *Vet Rec* 2000; 151:467.
- Abrial D et al. *Prev Vet Med* 2005; 67:69.
- Hoinville LJ et al. *Vet Rec* 1995; 136:312.
- Prince MJ et al. *Rev Sci Tech Off Int Epiz* 2003; 221:37.
- Morignat EM et al. *Vet Rec* 2004; 155:481.
- Taylor DM. *Br Vet J* 1996; 152:501.
- Wilesmith JW et al. *Vet Rec* 1997; 141:239.
- Wrathall AE, Brown KFD. *Curr Top Vet Med Anim Sci* 1991; 55:243.
- Wrathall AE et al. *Vet Rec* 2002; 150:365.
- Houston WD. *Proc Ann Meet US Anim Health Assoc* 1996; 100:283.
- Donnelly CA. *New Eng J Med* 2004; 350:539.
- Schudel AA. *Prev Vet Med* 1996; 25:271.
- Morley RS et al. *Rev Sci Tech Off Int Epiz* 2003; 221:157.
- Mathews D, Cooke BC. *Rev Sci Tech Off Int Epizoot* 2003; 221:283.
- Wells GAH et al. *Vet Rec* 2005; 156:401.
- Terry LA et al. *Vet Rec* 2003; 152:387.
- Wells GAH et al. *Vet Rec* 1999; 144:292.
- Wells GAH. *Vet Res Commun* 2003; 27 (suppl 1):25.

- Wilesmith JW et al. *Vet Rec* 1992; 130:197.
- Taylor DM et al. *Vet Rec* 1995; 136:592.
- Pretty JN et al. *Agric Systems* 2000; 65:113.
- <http://www.dh.gov.uk/assetRoot/04/10/94/42/04109442.pdf>.
- Ramantanis SB. *Vet Bull* 2004; 74:1N.
- Wells GAH et al. *Vet Rec* 1998; 142:103.
- Wells GAH. *Vet Ann* 1989; 27:59.
- McElroy MC, Weavers ED. *Vet Rec* 2001; 149:747.
- Konold T et al. *Vet Rec* 2004; 155:659.
- Austin AR et al. *Vet Rec* 1996; 139:631.
- Doherr MG et al. *Vet Rec* 2002; 150:347.
- Doherr MG et al. *Prev Vet Med* 2001; 51:3.
- Supervie V, Costagliola D. *Vet Res* 2004; 35:349.
- Lee KH, Harrington MG. *Vet Rec* 1997; 140:206.
- Jones V et al. *Vet Rec* 1996; 139:360.
- Strain GM. *J Am Vet Med Assoc* 1991; 198:360.
- Davis AJ et al. *J Vet Diag Invest* 1991; 3:266.
- Moynagh J, Schimmel H. *Nature* 1999; 400:105.
- Grassi J et al. *Vet Rec* 2001; 149:577.
- Casalone C et al. *Proc Natl Acad Sci USA* 2004; 101:3065.
- Boschere H-de et al. *J Appl Res Vet Med* 2004; 2:52.
- Kellar JA, Lees VW. *Rev Sci Tech Off Int Epiz* 2003; 22:201.
- [http://www.aphis.usda.gov/lpa/issues/bse\\_testing/faq.html](http://www.aphis.usda.gov/lpa/issues/bse_testing/faq.html)
- [www.aphis.usda.gov/lpa/issues/bse/bse.html](http://www.aphis.usda.gov/lpa/issues/bse/bse.html)
- Ramantanis SB. *Vet Bull* 2003; 74:15N.

### BSE AND SHEEP

There is considerable speculation and concern that the agent of BSE could have become established in small ruminants. BSE can be readily experimentally transmitted to sheep and goats and produces clinical signs and lesions similar to scrapie. There is further concern following a recent report of the transmission of the agent from challenged ewes to their lambs.<sup>1</sup> Further, the risk to human health from the ingestion of meat from sheep may be even greater than that from cattle because of the widespread distribution of the BSE agent in the lymphoid tissue of infected sheep.

In the UK and Europe concentrates are commonly fed to meat producing breeds of sheep in late pregnancy and early lactation and less commonly to their lambs. They are also fed to milk-producing sheep breeds and to lactating goats. Concentrates fed during the 1980s and 1990s could have contained infected meat-and-bone meal and this risk would have lasted until the total ban on feeding MBM to all farm animals in 1996 in the UK and 2001 in Europe.

The inclusion of meat-and-bone meal in concentrate rations for small ruminants was less than that for cattle and the proportion of concentrate ration fed was also lower. This, coupled with the fact that prion diseases require a larger infective dose to produce disease in a cross-species to that required to produce the disease in the same species, the **species barrier** effect, may have resulted in an infective dose to sheep was too low to establish infection.<sup>2,3</sup>

The possibility that BSE did establish in sheep during the BSE epidemic in Britain is not supported by a study that examined the incidence and new infection rates of scrapie flocks in Britain covering the period from 1962 to 1998.<sup>2,4</sup> This study found no evidence of a change in scrapie occurrence prior to, during, or following the BSE epidemic and no temporal or spatial correlations of scrapie occurrence with the BSE epidemic. There have been other studies that have examined the risk factors for transmission of BSE to sheep and the possibility that it could be perpetuated by sheep to sheep transmission. Most have concluded that the risk that BSE has established in sheep is low but, with current knowledge, cannot rule out the possibility.<sup>2,3,5,6</sup>

There are no reports of naturally occurring cases of BSE detected in sheep. However, there is a recent report of a transmissible spongiform encephalopathy in a goat in France that was found to have immunohistochemical and immunoblotting characteristics compatible with BSE, and, following injection into mice, incubation times compatible with those recorded for experimental ovine BSE.<sup>7</sup>

#### Experimental transmission

BSE can be experimentally transmitted to sheep and goats by intracerebral, oral and intravenous routes using BSE-infected cow brain.<sup>8-13</sup> The PrP genotype affects the incubation period in both Cheviot and Romney sheep.<sup>9,13</sup> PrP genotypes ARQ/ARQ and AHQ/AHQ are associated with short incubation periods (approximately 18 to 36 months) following challenge and also with disease susceptibility. One study further suggests that AHQ/ARQ sheep have a similar susceptibility to infection and that sheep homozygous for alanine (A) at codon 131 and glutamine (Q) at codon 171 are more susceptible to BSE than any other genotype.<sup>12</sup> In contrast the PrP genotype ARR/ARR is associated with a long incubation period in sheep challenged intracerebrally and ARR/ARR sheep are resistant to BSE challenged orally and do not have infectivity in their tissues.<sup>6,11</sup> The ARR allele appears dominant in this respect as sheep carrying at least one ARR allele in combination with any other allele have a longer incubation period.<sup>9,10</sup> PrP genotype VRQ/VRQ appears to have an intermediate incubation period.<sup>12</sup>

Texel and Lacaune sheep with PrP ARQ/ARQ genotypes are susceptible.<sup>3</sup> However, in these studies the survival of some sheep with susceptible genotypes suggests that factors other than the PrP genotype has influence on survival. Challenge dose in all of these studies has been high.

In a recent study, 30 ewe lambs were dosed orally, at 6 months-of age, with 5 g

of infected cattle brain and subsequently mated. Twenty-four developed clinical disease between 655 and 1065 days post-inoculation and two lambs, born before their dams had clinical disease, also subsequently developed clinical disease. This study indicated that the agent of BSE can transmit either in utero or perinatally in sheep. There is no information on other routes of transmission and if they exist.

#### PATHOGENESIS

Following challenge of sheep with BSE, infectivity has been found in intestinal Peyer's patches as early as 5 months post-infection and in enteric nerves and spinal cord after 10 months with widespread dissemination throughout the lymphoreticular system and peripheral nervous system by 21 months.<sup>10</sup>

#### CLINICAL SIGNS

The clinical signs reported in affected experimental animals are not well described in many of the experimental challenge studies but have varied in different studies. In one study, sheep and goats showed sudden onset of ataxia which progressed rapidly to recumbency. There was little evidence of pruritus and the clinical course was very short, lasting between 1 and 5 days in the majority of animals with one goat showing progressive weight loss over 3 weeks before it was culled. Genotype had no influence on the duration of the clinical course.<sup>9</sup> In another study in sheep only, the clinical course was approximately 3 months and affected sheep showed pruritus with fleece loss and ataxia and behavioral change.<sup>8</sup> Ataxia, weight loss, pruritus were considered constant in another.<sup>13</sup>

In an experiment designed to test specifically if clinical signs could be used for differentiation between scrapie and BSE two different groups of sheep were inoculated with each agent. The duration of clinical signs varied quite markedly within both groups with a mean of approximately nine days for each group but a variation in both from 1 to over 80 days. As with natural scrapie, there was considerable variation in the nature of the clinical signs, but there was no marked difference in the frequencies of clinical signs between the two groups, with exception that ataxia was the first sign noticed in a significantly greater proportion of the BSE-challenged group whereas pruritus was the first noticed sign in a significantly greater proportion of the scrapie-challenged group.<sup>14</sup>

#### DISPOSITION OF DISEASE-ASSOCIATED PrP

Genotype and route of inoculation influence the disposition of disease-associated PrP in lymphoreticular system

tissues (tonsil, spleen, mesenteric lymph node). The most conspicuous effect is the absence of disease-associated PrP in peripheral lymph tissue in ARR/ARR genotype sheep and lack of infectivity<sup>6,10-12</sup> and there appears to be an inverse relation between this disposition and the incubation period. Route of inoculation influences the relative intensity of disposition in tonsil, spleen and mesenteric lymph node.

Following experimental infection of sheep with BSE, disease-associated PrP can be detected in tonsils biopsies 11 to 20 months after challenge but, in contrast to scrapie, disease-associated PrP is not detected in biopsies of lymphoid tissue from the third eyelid.<sup>15</sup>

#### DIAGNOSIS

The diagnosis of BSE in clinically affected cattle can be achieved with several techniques, including the analysis of symptoms, histopathology and the detection of the disease-associated form of the prion protein, by immunocytochemistry, western blot or ELISA. The profiling of vacuoles in affected host had shown a remarkable uniformity over the year and from different geographic regions.<sup>16,17</sup> However this is not true with scrapie and the variation in the host brain with scrapie would not allow differentiation from BSE on histological findings. The diagnosis of BSE in sheep presents problems and the similarity of the clinical signs and pathology between scrapie and BSE could easily result in naturally occurring cases of BSE in sheep being misdiagnosed as scrapie.

#### Strain typing

The 'gold-standard' technique for the diagnosis of TSE agents is the passage of tissue in panels of inbred mice, a technique known as 'strain typing'.<sup>18</sup> Until recently this was the only way to differentiate the two diseases. BSE presents with a characteristic range of incubation periods and a pattern of distribution and relative severity of changes in the brain of the different mouse strains – the lesion profile – which is distinct from all scrapie strains tested to date. However, this method of diagnosis is both expensive and time consuming.

There has been a wide search for a differential test system in including prion protein profiling, studies in glycosylation and glycoform ratios and other molecular and biochemical studies that are detailed elsewhere.<sup>3</sup> A recent promising set of studies suggests that the site of truncation of disease-associated PrP during partial digestion by proteases located in lysosomes, appears different for sheep scrapie and experimental BSE. After digestion by exogenous enzymes, the BSE PrP molecule is shorter than that of scrapie stains giving

rise to different immunohistochemical patterns<sup>19</sup> and this is supported by western blot studies.<sup>20</sup> Unlike scrapie, the intracellular truncation site of ovine BSE PrP is influenced by the cell type in which it accumulates giving distinct patterns of immunolabeling with different PrP antibodies. Epitope labeling shows that the shortest fragment of disease-associated PrP occurs in tangible body macrophages followed glial cells and neurons. It appears that this difference in truncation of PrP in experimentally infected BSE sheep is not influenced by route of inoculation or by genotype or by sheep bred, and it is proposed that truncation patterns, as detected by immunoblotting and immunohistochemistry, can be used in surveys for BSE in sheep.<sup>12,21</sup>

### CONTROL

If BSE is or does establish in small ruminants in a country there is a significant concern for human health. The distribution of BSE infection in the carcasses of cattle is limited and can be removed by the ban of the use of specified risk materials (largely brain spinal cord and offals). In contrast, the distribution of the BSE agent in infected sheep is widespread and it would be virtually impossible to remove this by trimming or selective organ removal from a carcass for human consumption. Also lymphocytes in milk could be infected.

In the UK, a worst case scenario, published in 2001 in a contingency plan to address BSE in sheep, threatened the national herd with slaughter, largely on the grounds that an epidemic of BSE in sheep could be harder to contain than was the case for BSE in cattle, and that lamb could present a greater risk to consumers than beef. A more recent UK contingency plan<sup>22</sup> would allow PrP genotype ARR homozygous sheep and ARR heterozygous sheep for human consumption. This plan is the same as the EU, except that there are differences in the maximum age allowed at slaughter between the UK and the EU recommendations.

The risk for BSE in sheep was a major incentive for the development of national breeding programs for the control of scrapie, and possible BSE, including the National Scrapie Plan in the UK, launched in 2001, and the National Scrapie Eradication Program in the US. The purpose in these breeding programs is to select against highly susceptible genotypes and select for the highly resistant genotype.

### REFERENCES

1. Bellworthy SJ et al. *Vet Rec* 2005; 157:206.
2. Baylis M et al. *Trends Microbiol* 2002; 10:563.
3. Schreuder BEC, Somerville RA. *Rev Sci Tech Off Int Epiz* 2003; 22:103.

4. Gravenor MB et al. *Proc Royal Soc Lond Ser B* 2001; 268:587.
5. Kao RR et al. *Science* 2002; 295:332.
6. Kao RR et al. *J Gen Virol* 2003; 84:3503.
7. Eloit M et al. *Vet Rec* 2005; 156:523.
8. Baron TGM et al. *Neurosci Lett* 2000; 284:175.
9. Foster JD et al. *Vet Rec* 2001; 148:165.
10. Jeffrey M et al. *J Comp Pathol* 2001; 124:280.
11. Houston F et al. *Nature* 2003; 423:498.
12. Martin S et al. *J Gen Virol* 2005; 86:839.
13. Bellworthy SJ et al. *Vet Rec* 2005; 156:197.
14. Houston EF, Gravenor MB. *Vet Rec* 2003; 152:333.
15. Thuring CMA et al. *J Comp Pathol* 2005; 132:59.
16. Orge L et al. *Vet Rec* 2000; 147:486.
17. Simmons MM et al. *Vet Rec* 1996; 138:175.
18. Bruce BE et al. *J Gen Virol* 2002; 83:695.
19. Jeffrey M et al. *J Gen Virol* 2003; 84:1033.
20. Thuring CMA et al. *J Clin Microbiol* 2004; 42:972.
21. Gonzales L et al. *J Gen Virol* 2005; 86:1339.
22. <http://www.defra.gov.uk/corporate/consult/bseinsheep/index.htm>

### CHRONIC WASTING DISEASE

Chronic wasting disease (CWD) has recently emerged, or been recognized, in the USA as a transmissible spongiform encephalopathy of captive and free-ranging cervids. The ability of this infection to transmit laterally between cervids, coupled with the longevity of the agent in the environment and the common grazing land of infected cervids and cattle and sheep have resulted in concern that CWD in cervids might be a risk to livestock, and subsequently to humans, similar to bovine spongiform encephalopathy. There has also been concern that it might be transmitted directly from infected cervids to hunters dressing carcasses or consuming deer meat. To date there is no evidence for either of these risks.

The known natural hosts for CWD are mule deer (*Odocoileus hemionus*), white-tailed deer (*Odocoileus virginianus*) and Rocky Mountain elk (*Cervus elaphus nelsoni*). CWD was originally recorded in the late 1960s as a chronic wasting syndrome of unknown etiology in captive mule deer in research facilities in Colorado and Wyoming.<sup>1,2</sup> It was subsequently established that the disease was a transmissible spongiform encephalopathy and CWD has subsequently been found affecting cervids in captivity in several states in the USA and also in the provinces of Saskatchewan and Alberta in Canada. The occurrence in captive and farmed cervids in these different geographical areas is likely the result of transfer of animals between them,<sup>2</sup> and the disease has recently been reported in Korea in cervids imported from North America.<sup>3</sup>

The disease has a focus, and may have originated, in free ranging deer and elk in north-central Colorado and southeastern Wyoming<sup>4</sup> however, in recent years it has been detected in free ranging cervids east of the Mississippi and in a much broader area of North America. It is not certain

if this is due to spread or because of improved surveillance. Based on comparisons of the central nervous system lesions and the glycoform patterns, the CWD agent is the same in captive and free-ranging deer.<sup>5</sup>

There is strong evidence from outbreaks in captive deer that lateral transmission is of major importance in the transmission of CWD.<sup>6</sup> The agent accumulates in gut-associated lymphoid tissues early in the infection and saliva and feces are the likely source of infection with contamination of the environment.

The disease can be transmitted experimentally between cervids and there is evidence for genetic susceptibility.<sup>7,8</sup> The prion associated with CWD is not the same as that associated with BSE.<sup>9</sup> In a recent study, it was shown that infection, with amplification of prion protein in brain tissue, can be transmitted to cattle by intracerebral inoculation of CWD-infected deer brain. Six years following challenge less than 50% of the challenged cattle showed amplification of the infection and none had histological evidence of spongiform encephalopathy.<sup>10</sup> It was concluded that if infection via the oral route did occur in cattle it would be unlikely that it would result in amplification of the abnormal prion within the lifespan of cattle.

Clinically the disease in cervids is manifest initially by changes in behavior, not commonly observed in free-ranging cervids, with the major manifestation being a marked fall in body condition. In the terminal stages there may be ataxia and excitability. The clinical course varies from a few days to a year but averages 4 months.<sup>2</sup> Diagnosis is by histological examination of the brain or more commonly by the demonstration of PrP<sup>CWD</sup> in brain tissue by immunohistochemistry.

### REVIEW LITERATURE

- Williams ES, Miller MW. Chronic wasting disease in deer and elk in North America. *Rev Sci Tech Off Int Epiz* 2002; 212:305-316.
- Williams ES et al. Chronic wasting disease of deer and elk; a review with recommendations for management. *J Wildlife Manag* 2002; 66:551-562.
- Miller MW, Williams ES. Chronic wasting disease of cervids. *Curr Top Microbiol Immunol* 2004; 284:193-214.

### REFERENCES

1. Williams ES, Miller MW. *Rev Sci Tech Off Int Epiz* 2002; 212:305.
2. Miller MW, Williams ES. *Curr Topics Microbiol Immunol* 2004; 284:193.
3. Kim-TaeYung et al. *J Vet Med Sci* 2005; 67:753.
4. Miller MW et al. *J Wildlife Dis* 2000; 36:676.
5. Spraker TR et al. *Vet Pathol* 2002; 39:110.
6. Miller MW, Williams ES. *Nature* 2003; 425:35.
7. O'Rourke KI et al. *J Gen Virol* 2004; 85:1339.
8. Jewell JE et al. *J Gen Virol* 2005; 86:2127.
9. Stack MJ et al. *Can Vet J* 2004; 45:825.
10. Hamir AH et al. *J Vet Diag Invest* 2005; 17:276.



## Diseases associated with Rickettsiales

Anaplasmosis 1455  
 Tick-borne fever 1459  
 Heartwater or cowdriosis 1462  
 Equine granulocytic anaplasmosis  
 (equine granulocytic ehrlichiosis,

*Anaplasma phagocytophila*) 1464  
 Equine neorickettsiosis (equine  
 monocytic ehrlichiosis, equine  
 ehrlichial colitis, Potomac horse  
 fever) 1466

'Q' fever 1468  
 Bovine petechial fever (Ondiri disease)  
 1469

## ANAPLASMOSIS

## Synopsis

**Etiology** *Anaplasma marginale* in cattle and wild ruminants, and *A. ovis* in sheep and goats. *A. centrale* causes mild anaplasmosis in cattle

**Epidemiology** Common in tropical and sub-tropical regions; sporadic in temperate regions. Carrier animals are the source of infection. Disease transmitted by ticks, mechanically by tabanid vectors, iatrogenically, and transplacentally. Disease can be endemic in tick areas or sporadic in interface regions between endemic and free areas

**Clinical findings** In cattle death or severe debility, emaciation, anemia and jaundice are the major clinical signs. The disease is usually subclinical in sheep and goats

**Clinical pathology** Anemia, demonstration of organism in red cells by microscopy, fluorescent stains or PCR, serology

**Necropsy findings** Anemia and attendant findings. Demonstration of organism

**Diagnostic confirmation** Detection of the organism in blood smears, positive serology, PCR, and in some circumstances positive transmission tests. The sensitivity, in a group of animals, can be increased by using parallel blood smears and serological tests

**Treatment** Clinical cases treated with tetracycline or imidocarb. Blood transfusion. Carrier state cannot be eliminated by treatment with tetracycline

**Control** Tetracycline provides temporary or prolonged protection in face of an outbreak. Vaccination with killed *A. marginale* vaccine or live *A. centrale* vaccine used in endemic areas as is weekly dipping in acaricides. In non-endemic areas, serological identification of carriers and culling or treatment of reactors. Prevention of iatrogenic transmission

## ETIOLOGY

*Anaplasma* spp. are obligate intracellular parasites belonging to the order Rickettsiales and infecting ruminants. Analyses of 16S rRNA, groESL, and surface proteins have resulted in reclassification of the order Rickettsiales. The genus

*Anaplasma*, of which *A. marginale* is the type species, now also includes *A. bovis*, *A. platys*, and *A. phagocytophilum*, which were previously known as *Ehrlichia bovis*, *E. platys*, and *E. phagocytophila*.<sup>1</sup>

*Anaplasma marginale* is the causative agent of anaplasmosis in cattle and wild ruminants, and *A. ovis* in sheep and goats. *A. centrale* is closely related to *A. marginale* and causes mild anaplasmosis in cattle. It was originally isolated in Africa but has been introduced as an immunizing agent in Australia, South America and Asia. There are antigenic variants among isolates of *A. marginale*, the six major surface protein antigens being antigenically polymorphic.<sup>1,2</sup>

## EPIDEMIOLOGY

## Geographic occurrence

Anaplasmosis in cattle is common on all six continents, being present in South Africa, Australia, Asia, the former USSR, South America and the United States. It is transmitted by a diverse group of biological and mechanical vectors. Infection in cattle is endemic in tropical and subtropical areas that support large populations of these vectors. Infection occurs more sporadically in temperate climate areas.

In the United States, and in other countries, the disease has occurred beyond the boundaries of tick-infested areas and the area distribution in Europe has been advancing northward in recent years with sporadic cases in France, Switzerland, the Netherlands, Hungary, and Austria.<sup>3</sup> Anaplasmosis of sheep and goats has a distribution similar to that of cattle.

In the USA anaplasmosis is enzootic throughout the southern Atlantic states, the Gulf Coast states and many of the midwestern and western states.<sup>3,4</sup> Disease occurs sporadically in the northern states and Canada.

In Australia infection is closely related to the distribution of *Boophilus microplus*, which is restricted to the northern areas. Seropositivity is negligible in cattle south of the tick line but above the tick line increases from south to north. Differences in enzootic and epizootic areas in South

America and South Africa are also largely related to tick distribution and climate.

In most countries there is wide geographical variation in seroprevalence and this variability contributes to the development of geographically stable or unstable enzootic regions.

There is concern, and some evidence, that the global warming trend will expand the boundaries and movement of host ticks.<sup>1</sup>

## Host occurrence

Cattle are susceptible to *A. marginale* and *A. centrale* and sheep to *A. ovis*. *A. marginale* will establish in sheep by experimental infection but *A. ovis* will not infect cattle.<sup>5</sup>

A variety of species of wild ruminants in both North America and Africa can be infected and may have significance as reservoirs for *A. marginale*.<sup>6,7</sup> In the United States the black-tail deer (*Odocoileus columbianus*) in the West Coast region is believed a reservoir and a number of species of antelope play a similar role in South Africa. Bighorn sheep (*Ovis canadensis*) may be a reservoir for *A. ovis* in the western United States.<sup>8</sup>

The prevalence of infection in cattle in endemic areas is very high with seropositivity rates exceeding 60% and often approaching 90%. Seropositivity is much lower in regions that interface between endemic and non-endemic regions.<sup>9</sup>

## Source and methods of transmission

The source of infection is always the blood of an infected animal. Recovery from acute infection results in persistent infection characterized by repetitive cycles of rickettsemia. Persistent carriers are the reservoir for herd infection. The level of parasitemia is often too low for detection by microscopy but can be detected by nucleic acid probe analysis.<sup>10</sup> Transmission is biologically by ticks but can also occur transplacentally and can also be effected mechanically by biting flies or blood-contaminated fomites.

Hematophagous insect transmission  
 Spread from animal to animal occurs chiefly by insect vectors. A variety of arthropods

may act as vectors but significant natural vectors are ticks in the family **Ixodidae** and flies in the family **Tabanidae**. Of the ticks, the one-host **Boophilus spp.** are of major importance in tropical and subtropical regions and the three-host **Dermacentor spp.** of major importance in the western US.

The organism undergoes a complex developmental cycle in the gut cells of ticks and the final infective stage is present in the salivary gland.<sup>11</sup> **Trans-stadial** transmission of the organism occurs in ticks but there is little evidence for transovarial transmission. **Intrastadial** transmission is significant with some species and transmission occurs as the ticks move from one host to another while they are engorging, including from cow to calf. Male *D. andersoni* can act as effective vectors in this manner for at least 120 days.<sup>12</sup>

There appears to be no developmental sequence of *Anaplasma* spp. in flying insects. **Tabanids** are efficient mechanical vectors and can transmit infection for 2 hours after feeding.

Over 20 species of tick have been incriminated as vectors world-wide.<sup>13</sup> In **Australia** the ticks *Boophilus microplus* and *Rhipicephalus sanguineus*<sup>14</sup> are the vectors and in **South Africa** it is *B. microplus*, *B. decoloratus*, and *Rhipicephalus simus*. In the **United States** *Boophilus annulatus*, *Dermacentor andersoni*, *D. variabilis*, *Argas persicus* and biting flies of tabanid species and eye gnats (*Hippelates pusio*)<sup>15,16</sup> also act as vectors. The male ticks of *Dermacentor albipictus* (the winter tick) and *D. occidentalis* (the Pacific Coast tick) parasitize both deer and cattle and have been suspected as vectors.<sup>17</sup>

#### Iatrogenic transmission

Anaplasmosis may also be spread mechanically by infected **hypodermic needles**, by castrating, spaying and dehorning **instruments**, and by **blood transfusions** and embryo transplants. The ease with which the infection is spread mechanically may vary with the virulence of the protozoan strain and this method of spread may be more important in some countries than others. Anaplasmosis may also be spread when cattle, used as donors of infected blood for immunization against babesiosis, are infected with *A. marginale*, the reaction occurring some 3 weeks later than that due to the babesia.

#### Transplacental transmission

Intra-uterine infection also occurs in **cattle** but much less frequently in field cases than in experimental ones.<sup>18</sup> Abortion or neonatal infection may result. In **ewes** intra-uterine infection appears to occur with ease in experimental cases provided the ewe is exposed during the latter two-thirds of pregnancy.<sup>19</sup>

## Animal and environmental risk factors

### Breed

*Bos indicus*, *Bos taurus* and their crosses have **equal susceptibility** to infection and show the same age susceptibility, but under field conditions *Bos indicus* are not as commonly affected, probably because of their relative resistance to heavy tick infestation. However, the effects of the disease on body weight and clinicopathological parameters are the same for the two races of cattle.<sup>20</sup> Breeds with black or red **coat color** have a higher risk of infection than those with white coats in regions where biting flies are the insect vector.<sup>4,9</sup> Dairy breeds may be at greater risk for iatrogenic transmission.

### Nutritional status

Clinical disease is less severe in cattle on a low plane of nutrition. Exposure of infected, clinically normal animals to devitalizing environmental influences, particularly shortage of feed, and the presence of other diseases, may result in the development of acute anaplasmosis. For example, cattle introduced into feedlots are highly susceptible and outbreaks among them are not uncommon 2–3 weeks after entry.

### Season

In temperate climates a seasonal occurrence of disease occurs in association with seasonal occurrence of the insect vectors.<sup>4,16,21,22</sup> Winter outbreaks are likely associated with iatrogenic transmission<sup>9</sup> or possibly the winter tick, *D. albipictus*.<sup>16</sup>

### Age at infection

All cattle are susceptible to infection but age at infection is a **major determinant** of the severity of clinical disease. Young calves are less susceptible to infection with *A. marginale* than older cattle and, when infected, are less susceptible to clinical disease. The reason for, this is not understood but splenectomized calves are fully susceptible to infection, which may be more severe than in the adult. Infection between six months and three years of age has increasing risk of clinical illness and animals infected **after 3 years** of age are commonly affected by a peracute fatal form of the disease. The **age-specific incidence** of clinical disease recorded in an outbreak in the USA showed 81% of cases in cattle aged between 2–4 years with 94% of cases in cattle 3 years of age or older.<sup>4</sup>

### Geographic region

Clinical disease is rare in **enzootic areas** because the infection pressure is high and cattle are infected at an age when they are age-resistant to clinical disease. The average age at which calves in enzootic areas become infected is 11 (4–24) weeks and the clinical and hematological changes in them are mild and brief. Animals in an infected environment which have become

seronegative for whatever reason are fully susceptible to infection.<sup>23</sup> Clinical disease occurs where there is **introduction** of susceptible animals into endemic areas or the **expansion** of the vector population into previously free areas or into the **interface** between endemic and non-endemic regions.

Case fatality rates are usually high in outbreaks but the mortality rate varies widely depending on susceptibility, and may be 50% or more in cattle introduced to enzootic areas. Case fatality rates of 29–49% are recorded in outbreaks in the USA; recovered animals are emaciated and there is a prolonged convalescence.<sup>4</sup>

## Pathogen risk factors

Phylogenetic analysis of *A. marginale* geographic isolates support the existence of clades.<sup>1</sup> Australian isolates do not appear to differ significantly in antigenicity or virulence.<sup>24</sup> In contrast in other countries there can be significant differences between isolates in antigenic composition, the protection afforded against heterologous challenge and virulence.<sup>25–29</sup>

Recent research has demonstrated that the phenomenon of infection exclusion occurs with *A. marginale*. Infection of tick cells and bovine erythrocytes with one genotype of *Anaplasma marginale* excluded infection with other genotypes and in herds of cattle from endemic areas where many genotypes were detected only one genotype was found per animal. Further cattle inoculated with two *A. marginale* isolates became infected with only one isolate.<sup>28,29</sup>

## Economic importance

Costs are from death and abortion in clinical cases, loss of production in sick and recovered animals, and costs associated with preventive measures such as tick control. There have been few recent estimates of cost, the most recent estimates in 1977 and were of a cost of \$875 millions in Latin American nations.<sup>30</sup>

In developed countries with the disease exports of cattle to countries that do not have it are constrained. A major cost in developing countries is the constraint to efficient production and the limit to the introduction of susceptible cattle breeds with superior genetics.<sup>4,31</sup>

## PATHOGENESIS

*Anaplasma* are obligate intra-erythrocytic bacteria. They infect **mature erythrocytes** by an endocytic process and reproduction occurs by binary fission to produce 2–8 infective initial bodies which leave by exocytosis to infect other erythrocytes. The number of infected erythrocytes doubles every 24–48 hours and the infection becomes patent 2–6 weeks after infection,<sup>32</sup> the time influenced by the initial challenge dose.<sup>33</sup> Depending upon the strain and

the susceptibility of the host, from 10–90% of erythrocytes may be parasitized in the acute stage of the infection. At least 15% have to be parasitized before there is clinical disease. Parasitized erythrocytes are removed by phagocytosis in the reticular endothelial system, with release of acute-phase inflammatory reactants and the consequent development of fever. Continued erythrocyte destruction occurs resulting in the development of mild to severe anemia and icterus without hemoglobinemia and hemoglobinuria. Anaplasmosis is primarily an **anemia**, the degree of anemia varying with the proportion of erythrocytes which are parasitized. The first appearance of the protozoa in the blood coincides with a fall in the hematocrit and erythrocyte levels, the appearance of immature erythrocytes in blood smears and the development of fever. Acutely affected animals may die shortly after this phase is reached. The appearance of anti-erythrocyte antibodies late in the acute stage may exacerbate the anemia.<sup>32</sup>

If the animal recovers from the initial acute attack, periodic attacks of parasitic invasion of mature erythrocytes occur regularly, but with diminishing intensity. The degree of anemia varies widely in young cattle up to 3 years of age but is always severe in adults and in splenectomized animals. Cattle that survive the disease become carriers and serve as reservoirs of *A. marginale* because they provide a source of infective blood for both mechanical and biological transmission by ticks. They have lifelong immunity and are resistant to clinical disease on challenge exposure.

Carrier animals have **cycles of parasitemia**, possibly associated with the development of new antigenic variants to allow new cycles of invasion and multiplication.<sup>34</sup> These occur at approximate 5-week intervals during which the new variants replicate and are then controlled by a variant-specific immune response.

## CLINICAL FINDINGS

### Cattle

In cattle, the **incubation period** varies with the challenge dose but is generally about 3–4 weeks with tick-borne infection and 2–5 weeks with the inoculation of blood. In most cases the disease is subacute, especially in young animals. **Rectal temperature** rises rather slowly and rarely to above 40.5°C (105°F). It may remain elevated or fluctuate with irregular periods of fever and normal temperature alternating for several days to 2 weeks. Anorexia is seldom complete. **Death** can occur at this stage but many **survive in an emaciated condition**, and their fertility is impaired. The mucous membranes are jaundiced and show marked pallor, particularly after the acute stage is passed, but there is **no hemoglobinuria**.

Peracute cases, with a sudden onset of high fever, anemia, icterus, severe dyspnea and death, often within 24 hours, are not uncommon in adult dairy cows. Affected animals are often **hyperexcitable** and tend to attack attendants just before death. Pregnant cows frequently abort. In convalescent bulls there may be depressed testicular function for several months.

### Sheep and goats

In sheep and goats, infection is usually **subclinical** but in some cases, particularly in goats, a severe anemia may occur and a clinical picture similar to that found in cattle may be seen. Severe reactions of this type in goats are most frequent when the animals are suffering from concurrent disease. Goats may show hyperexcitability and may bite at inanimate objects. The experimental disease in lambs includes fever, constipation or diarrhea, pale, icteric conjunctivae and severe anemia 15–20 days after inoculation. The anemia is not completely resolved in 3–4 months.

## CLINICAL PATHOLOGY

### Hematology

Erythrocyte destruction may be so severe that the erythrocyte count is reduced to 1.5 million/ $\mu$ L. Immature red cells are common at this stage and their presence is considered to be a favorable sign. The small dot-like protozoa are discernible at the periphery of up to 10% of the red cells in subacute cases, but in peracute cases more than 50% of the cells may be parasitized. *A. ovis* are usually situated at the periphery of erythrocytes but as many as 40% of infested cells may show submarginal protozoa. Diff-Quik staining of blood smears is as accurate as Giemsa in the detection of *A. marginale* and can be completed in 15 seconds as compared to nearly an hour<sup>35</sup> for Giemsa. There are no diagnostic clinical chemistry findings.

### Serology

The complement fixation test is the standard test for the detection of carrier animals. It is satisfactory for use in cattle, goats and sheep but the antibody titer is highest during the active phase of the disease and sufficiently low in carrier animals to give a proportion of false negative results. False positive reactions can occur because of erythrocyte contamination of the *A. marginale* antigen and the presence of antibodies to erythrocytes in some cattle sera. A rapid card agglutination test, which tests serum or plasma for antibodies against *A. marginale*, is cheap and quick, and sufficiently accurate to be used as a herd test. Currently, in most countries, the card agglutination and complement fixation tests are routinely available.

There are a number of other tests that have been developed. A capillary tube

agglutination test of comparable efficiency is available, is more economical and faster than the CF test<sup>36</sup> and is particularly suited to testing in extensive field situations. An indirect fluorescent antibody test is also accurate<sup>37</sup> and has a particularly suitability for testing blood which has been dried onto paper for passage through the mails. It is also an accurate test for selecting recently affected animals. A dot-ELISA with high sensitivity, specificity and predictive value is also described and could be particularly applicable to field examinations.<sup>10,38</sup> A competitive inhibition ELISA test, with high sensitivity and specificity, has been developed that detects antibody to a major surface protein that is conserved among anaplasma species; this test can be used to detect cattle persistently infected for as long as six years.<sup>39–41</sup> Vaccinated animals may react to all of the serological tests for periods of over one year.

### Other methods

**Nucleic probe analysis** can be used to detect low levels of parasitemia.<sup>10,42–44</sup>

**Transmission** to splenectomized animals has been used to detect carriers but is expensive and is now replaced by PCR in countries where this technology is available.

## NECROPSY FINDINGS

The most obvious findings are emaciation, pallor of the tissues, and thin, watery blood. There is mild jaundice and the liver is enlarged and orange. The kidneys are congested and there may be myocardial hemorrhages. The spleen is enlarged with a soft pulp. The bone marrow cavity may be reddened by increased hematopoietic tissue in acute cases but there may be serous atrophy of marrow fat in chronic cases. Postmortem identification of *A. marginale* can be established by staining blood smears with Giemsa or direct fluorescent stains. Peripheral blood is superior to organ smears. Brain smears are unsatisfactory. The technique is applicable to fetuses suspected of being aborted as a result of infection with *Anaplasma* sp. Nucleic acid-based tests may be used but are rarely needed for routine diagnosis at necropsy.

### Samples for confirmation of diagnosis

- **Clinical pathology** – blood smears from cut surface of an ear (CYTO, FAT)
- **Histology** – fixed spleen, liver, bone marrow.

## DIFFERENTIAL DIAGNOSIS

Other causes of hemolytic anemia .

## TREATMENT

Treatment is with **tetracyclines**. Treatment of **clinical disease** can be with oxytetracycline, 6–10 mg/kg BW daily for three days, or a single injection of long-acting oxytetracycline at a dose of 20 mg/kg intramuscularly. The convalescent period is long. Concurrent administration of **estradiol cypionate** (14.3 mg/kg BW intramuscularly) appears to improve the rate of recovery by promoting parasitemia during treatment.<sup>45</sup> Tetracycline treatment will not eliminate infection and immunity will persist.<sup>32</sup> **Blood transfusions** are indicated in animals with a PCV less than 15%. Rough handling must be avoided.

**Imidocarb** (3 mg/kg BW) is also an effective treatment for clinical cases and does not interfere with the development of acquired immunity to *A. marginale*.<sup>46</sup>

The risk for infection in the rest of the herd should be assessed and, if necessary, temporary or prolonged protection should be provided. Protection can be provided by tetracyclines, or by vaccination.

**Temporary protection** in the face of an exposure risk can be achieved with a single intramuscular injection at 20 mg/kg BW of long-acting tetracycline.<sup>32</sup> The results generally are good except when the cattle are exposed to infection during the 14 days prior to the treatment. **Prolonged protection** can be achieved by the intramuscular injection at 20 mg/kg BW of long-acting tetracycline every 28 days or by chlortetracycline in the feed at 1.1 mg/kg BW daily.<sup>32</sup>

**Elimination of infection** cannot be achieved with tetracycline therapy. A trial testing the ability of oxytetracycline therapy to eliminate the carrier state examined therapy with 300 mg/mL oxytetracycline solution of administered at 30 mg/kg, by intramuscular (IM) injection for one day; the same preparation administered at 30 mg/kg, IM on day 0 and again on day 5; and a treatment with a 200 mg/mL solution of oxytetracycline administered at 22 mg/kg, intravenously (IV), q 24 h for 5 days (a treatment dose that corresponds with current Office International des Epizooties (OIE) recommendations for treatment prior to export). All treated cattle were still, PCR and cELISA positive 60 days after therapy and their carrier status was confirmed by inoculation of blood in splenectomized calves.<sup>47</sup>

## CONTROL

Methods for the control of anaplasmosis have not changed greatly over the past several decades and consist of arthropod control with acaricides, chemotherapy for prevention and vaccination. The eradication of anaplasmosis is not a practicable procedure in most countries at the present time because of the wide range of insects which are capable of carrying the disease,

the long period of infectivity of carrier animals, and, in some areas, the presence of carriers in the wild animal population. In enzootic areas some benefit is derived from the control of ticks and other vectors and weekly dipping in an **acaricide** is used in tropical areas to control this and other tick-borne diseases.

## General measures

The introduction of the disease into herds by carrier animals should be prevented by prior **serological testing**. Attention should also be given to preventing **iatrogenic transmission** with instruments used for injections or surgical operations by disinfection after use on each animal. This is particularly important in feedlots where introduced groups are often subjected to multiple vaccinations and implantation at a time when their resistance is lowered by transport and change of feed.

## Movement of animals

Exposure-naïve animals that are to be introduced into an enzootic area should be vaccinated. Some advantage can be gained when introducing animals into an enzootic area by limiting the introductions to animals of less than 2 years of age and by bringing them in when the insect population is least numerous.

## Elimination of carriers

This is feasible in regions that are subject to only periodic incursions of infection and that do not have endemic tick vectors. It can be achieved by serologic testing and **culling of reactors** or treating them as outlined above to eliminate the carrier state.

## Outbreaks

If an outbreak does occur, affected animals should be treated vigorously as described above and in-contact animals vaccinated and/or placed on a regimen of prolonged tetracycline protection. Subsequently all exposed animals should be tested serologically and the reactors treated or preferably salvaged. Prolonged treatment regimens can be used to provide protection to cattle in seasonal risk periods of transmission.

## Chemotherapy

Chemotherapy for control is more commonly used in the United States than in other areas of the world. It can be of value in feedlot cattle but is not applicable to range cattle. It is expensive and carries the risk of causing selection of resistant strains.<sup>1</sup>

## Vaccination

Vaccines for the control of anaplasmosis are either live or killed vaccines. Both types use *A. marginale* from infected bovine erythrocytes and while both types induce protective immunity that reduces or prevents clinical disease neither type prevents cattle from becoming persistently infected with *A. marginale*. Cattle that have recovered

from acute infection or immunized with killed vaccines are solidly protected against challenge with the homologous strain but are only partially protected against challenge with heterologous strains.<sup>48</sup>

Most control programs in enzootic areas are based on increasing the resistance of the population by immunization. In any vaccination program particular attention should be paid to the **animals at high risk**, particularly animals brought in from non-enzootic areas, those in surrounding similar areas to which infection may be spread by expansion of the vector population under the influence of suitable climatic conditions, and animals within the area which are likely to be exposed to climatic or nutritional stress.

## Killed vaccines

Killed *A. marginale* are usually in an adjuvant vehicle. The vaccine requires two doses, four weeks apart, the last dose given at least two weeks before the vector season. Subsequently, **booster** doses should be given two weeks before the next vector season. The vaccine does not prevent infection but does significantly **reduce the severity** of the disease. It does have the advantage over the other vaccines of having a relatively short post-vaccination period when animals remain positive to serological tests. The duration of the immunity is at least 5 months.

There is a risk for **neonatal isoerythrolysis**. This can be reduced by vaccinating only empty cows and avoiding unnecessary booster injections. When this vaccine is used in the face of an outbreak, tetracyclines can also be given to provide temporary protection during the period of development of immunity; tetracyclines do not interfere with the development of this immunity.

Preliminary reports of the efficacy of DNA vaccines are not encouraging.<sup>49</sup>

## Live vaccines

**A living *A. centrale*** vaccine is used extensively in Australia, Africa, Israel, and Latin America, but not in the United States and there is some reluctance to introduce it into areas where *A. centrale* does not already occur.

Living *A. centrale* vaccine is prepared from the blood of infected splenectomized donor calves and is stored chilled or frozen. The vaccine causes a mild, inapparent disease, but does cause severe reactions in occasional animals. It is generally safe in young cattle. A **single vaccination** is used in endemic areas and the immunity is reinforced by continuous challenge and considered to persist for life in tick areas. *A. centrale* and *A. marginale* share immunodominant epitopes and have similar antigenic variation in major surface proteins which may play a role in the cross immunity

that occurs.<sup>50,51</sup> It is unclear whether *A. centrale* infection and immunity induced by the live vaccine in cattle prevents subsequent infection with *A. marginale* by the infection exclusion phenomenon.<sup>28,29,51</sup>

The efficacy of this vaccine varies geographically.<sup>52</sup> Vaccination with *A. centrale* reduces the severity of the reaction when infection with *A. marginale* occurs but does not give absolute protection. Protection against challenge in Australia is adequate in most cases, and certainly sufficiently effective enough to justify its use. In contrast the use of the same vaccine in countries other than Australia, where there are more antigenically diverse and highly virulent strains is often inadequate and better vaccines are required.<sup>52</sup>

Tetracyclines will prevent establishment of infection and immunity by the vaccine and should not be administered for 3 weeks before vaccination.

Living *A. marginale* has been used as a vaccine but its administration is limited to the relatively resistant age group below 1 year of age, to the winter months when vectors are sufficiently rare to avoid the chance of spread to other age groups, and to circumstances where animals which react severely can be restrained and treated adequately. The method has the serious disadvantage of creating a large population of carrier animals which may subsequently spread the disease.<sup>53</sup>

Attenuated vaccines have been attempted by irradiation of strains and passage of the organism through sheep or deer and the use of naturally low virulence isolates. While most have been received with initial enthusiasm some have proved not effective while others have been associated with adverse reactions. Some, while effective against strains in some geographic regions, give unsatisfactory protection against clinical disease in other regions.<sup>54-56</sup>

#### Problems with live vaccines

All vaccines currently must be produced in live animals, which is expensive. With non-inactivated vaccines there is a risk of transmitting blood-borne viruses. In Australia, a single calf infected with bovine leukosis virus was unsuspectingly used in the production of *A. centrale* vaccine. The contaminated vaccine was given to 22 627 cattle in 111 herds and resulted in a high rate of infection with bovine leukosis virus in the vaccinated cattle.<sup>14</sup>

It is highly probable that a safe subunit vaccine, containing epitopes critical to effective immunity, will be developed in the near future.

#### REVIEW LITERATURE

- Rogers RJ, Shiels IA. Epidemiology and control of anaplasmosis in Australia. *J S Afr Vet Assoc* 1979; 50:363-366.
- McHardy N. Immunization against anaplasmosis: a review. *Prev Vet Med* 1984; 2:135.

- Palmer GH. Anaplasmosis vaccines. In: Wright ?? (ed) *Veterinary protozoan and hemoparasitic vaccines*. Boca Raton, Florida: CRC Press, 1989; pp. 1-29.
- Richey EJ, Palmer GH. Bovine anaplasmosis. *Comp Cont Educ Pract Vet* 1990; 12:1661-1668.
- Pipano E, Frank M, Shkap V. Current methods for the control of tick fever in cattle. *Israel J Vet Med* 1991; 46:79-88.
- Mahoney DF. The development of control methods for tick fevers of cattle in Australia. *Aust Vet J* 1994; 71:283-289.
- Kocan KM, Blouin EF, Barbet AF. Anaplasmosis control: past present and future. *Ann NY Acad Sci* 2000; 916:501-509.
- Kocan KM et al. Antigens and alternatives for control of *Anaplasma marginale*. *Infection in cattle*. *Clin Microbiol Rev* 2003; 16:698-712.

#### REFERENCES

- Kocan KM. *Clin Microbiol Rev* 2003; 16:698.
- Palmer GH et al. *Infect Immun* 1994; 6:3808.
- Baumgartner W et al. *J Vet Med B* 1992; 3:97.
- Morley RS, Hugh-Jones ME. *Vet Res Commun* 1989; 13:287.
- Jorgensen WK et al. *Aust Vet J* 1993; 70:192.
- Zaugg JL. *Am J Vet Res* 1985; 46:438.
- Kuttler KL. *J Wildlife Dis* 1984; 20:12.
- Goff W et al. *J Wildlife Dis* 1993; 29:540.
- Hungerford LL, Smith RD. *Vet Res Commun* 1997; 21:9.
- Eriks IS et al. *J Clin Microbiol* 1989; 27:279.
- Kocan KM et al. *Am J Vet Res* 1992; 53:499.
- Stiller D, Coan ME. *Vet Parasit* 1995; 57:97.
- Kocan KM. *Vet Parasit* 1995; 57:121.
- Rogers RJ et al. *Aust Vet J* 1988; 65:285.
- Stiller D et al. *Proc US Anim Hlth Assoc* 1983; 87:59.
- Palmer GH et al. *Intern J Parasitol* 1988; 18:33.
- Ewing SA et al. *J Vet Diag Invest* 1997; 9:206.
- Zaugg JL. *Am J Vet Res* 1985; 46:570.
- Zaugg JL. *Am J Vet Res* 1987; 48:100.
- Bock RE et al. *Aust Vet J* 1997; 75:337.
- Guglielmono AA et al. *Vet Q* 1997; 19:32.
- Wenshun L et al. *Trop Anim Hlth Prod* 1997; 29:165.
- Lincoln SD et al. *J Am Vet Med Assoc* 1987; 190:171.
- Bock RE, De Vos A. *J Aust Vet J* 2001; 79:832.
- Tebele N, Palmer GH. *Trop Anim Hlth Prod* 1995; 23:197.
- Eriks IS et al. *J Vet Diag Invest* 1994; 6:435.
- Palmer GH et al. *Parasitol Today* 1999; 15:281.
- Palmer GH. *J Clin Microbiol* 2001; 39:631.
- de la Fuente JJ. *Clin Diag Lab Immunol* 2002; 9:658.
- Brown DCG. *Trop Anim Health Prod* 1997; 29:15.
- Meléndez RD. *Ann NY Acad Sci* 2000; 916:253.
- Richey EJ, Palmer GH. *Comp Cont Educ Pract Vet* 1990; 12:1661.
- Kier KR et al. *Int J Parasit* 1996; 12:1417.
- Kieser ST et al. *Infect Immunol* 1990; 58:1117.
- Hart LT et al. *Am J Vet Res* 1992; 53:1732.
- Hart LT et al. *Am J Vet Res* 1992; 53:1732.
- Kroon JFEM et al. *Vet Q* 1990; 12:124.
- Montenegro-Jones S et al. *Am J Vet Res* 1990; 51:1518.
- Knowles D et al. *J Clin Microbiol* 1996; 34:2225.
- Torioni S et al. *J Clin Microbiol* 1998; 36:777.
- McGuire TC et al. *J Clin Microbiol* 1991; 29:788.
- Visser ES et al. *Vet Microbiol* 1991; 28:313.
- Gale KR et al. *Int J Parasitol* 1996; 26:1103.
- Figueroa JV, Buening GM. *Vet Parasitol* 1995; 75:75.
- Zaugg JL. *Vet Rec* 1998; 142:44.
- de Vos AJ. *Aust Vet J* 1987; 64:81.
- Coetzee JF et al. *Vet Parasitol* 2005; 127:61.
- Palmer GH et al. *Parasitol Today* 1999; 15:281.
- Andrade GM et al. *Ann NY Acad Sci* 2004; 1026:257.

- Shkap V et al. *Infect Immunol* 2002; 70:642.
- Shkap V. *Parasitol Res* 2002; 88:546.
- Bock RE, de Vos AJ. *Aust Vet J* 2001; 79:832.
- Tebele N, Palmer GH. *Trop Anim Health Prod* 1991; 23:197.
- Pipano E et al. *Israel J Vet Med* 1991; 46:79.
- Kocan KM et al. *Ann NY Acad Sci* 2000; 916:501.
- Benavides E et al. *Ann NY Acad Sci* 2000; 916:613.

#### TICK-BORNE FEVER

##### Synopsis

**Etiology** *Anaplasma phagocytophila*  
**Epidemiology** Occurs in the northern latitudes and is transmitted by *Ixodes ricinus* in UK and Europe and *Ixodes scapularis* and *Ixodes pacificus* in the USA. Disease in cattle and sheep primarily reported from the UK and Europe. Seasonal occurrence associated with the feeding activity of the vector. More severe disease in naive introduced animals. Increases susceptibility to other infections  
**Clinical findings** Fever, depression, lethargy, polypnea and fall in milk production in cattle. Abortion  
**Clinical pathology** Thrombocytopenia followed by more prolonged neutropenia and lymphocytopenia. The organism is demonstrable in the neutrophils and monocytes during each febrile period  
**Diagnostic confirmation** Demonstration of the *E. phagocytophila* in leukocytes at acute stage of the disease or by serology retrospectively  
**Treatment** Oxytetracycline  
**Control** Oxytetracycline during risk period. Tick control

#### ETIOLOGY

Tick-borne fever (also called pasture fever in cattle) is associated with infection with *Anaplasma phagocytophila*, (*Ehrlichia phagocytophila*, *Cytoecetes phagocytophila*) which is an obligate intracellular parasite in the family *Anaplasmataceae*. *Anaplasma phagocytophila* and the human granulocytic ehrlichial agent (HGE) and *Ehrlichia equi* are morphologically identical, they have only minor variations in their 16S rRNA genes and 100% identity in their GroESL amino acid sequences, and so are now all classified as *Anaplasma phagocytophila*.

There are strains (variants) of *A. phagocytophila* that have biological and ecological differences, including variations in host pathogenicity, vectors, and geographical distribution.<sup>1,2</sup> In sheep, different variants of *A. phagocytophilum* may exist simultaneously in the same sheep flock.<sup>3</sup>

Tick-borne fever is also used as a name for similar, but less well defined, diseases of ruminants that are associated with infection with related organisms such as *Anaplasma (Ehrlichia) bovis*. These are reported from other areas of the world such as India and Africa, and are transmitted by the ticks *Rhipicephalus appendiculatus*, *Amblyomma variegatum* and *Hyalomma truncatum*.<sup>4,5</sup>

This description is of tick-borne fever associated with *A. phagocytophila*.

## EPIDEMIOLOGY

### Occurrence

Infection with *A. phagocytophilum* occurs in a wide range of mammalian hosts including humans, dogs, sheep, cows, horses, wild deer and rodents. The association of *A. phagocytophilum* with human granulocytic ehrlichiosis in the mid-1990s has led to much activity defining its geographical occurrence by serological surveys or detection in ticks by molecular methods. These studies have determined that the organism is present where the host ticks are present in Europe, Iran, North America and probably Asia.<sup>6</sup>

However, the disease tick-borne fever, as apposed to infection, occurs primarily in certain areas of the United Kingdom, Ireland, Norway, Finland, France, Germany, Spain, and Switzerland.<sup>7,8</sup> Because ticks favor particular optimal environmental conditions, the geographic distribution of the ticks is usually restricted to a specific area (small or large) and tick-borne fever only occurs in these areas. Within these areas infection can be intense and in the endemic coastal area of Norway close to 100% of sheep grazing *Ixodes* infested pastures are infected.<sup>9</sup> Tick-borne fever has a **seasonal occurrence** in association with the feeding activity of the vector tick. Infection can be endemic in affected areas.

Sheep, cattle, goats, deer and reindeer may be infected. The disease has long been known as a disease of sheep but in recent years is being recognized as a common infection in cattle in at-risk areas.<sup>7</sup> The incidence rate of infection is high but clinical disease may be mild and not easily observed in many areas where this disease occurs, as these areas are commonly wild with little human habitation and little frequent observation of at-risk livestock. Infection, as determined by seropositivity, can occur in sheep that have had no clinical evidence of disease because of the existence of variants with low pathogenicity.<sup>2</sup>

### Source of infection and transmission

In Europe, *E. phagocytophila* is transmitted by the three host tick *Ixodes ricinus* which requires a single blood meal at each stage of development. The tick feeds for approximately 3 weeks every year and completes its life cycle in 3 years. The larval and nymphal stages will feed on any vertebrate but the adult female will engorge and mate only on larger mammals.

*A. phagocytophila* infect and multiply in the organs of ticks, in particular the salivary glands which enables the transmission to vertebrate hosts during feeding. The tick becomes infected by feeding on an infected host and there is **trans-stadial** but not transovarial passage of the

organism. It is estimated that the majority of ticks are infected with the organism in enzootic areas<sup>10</sup> and one study of ticks from a field site found 44% of nymphs and 32% of adults infected but no infected larval stages.<sup>11</sup> There is a close relation tick density and the proportion of sheep and ticks infected with *A. phagocytophila* but it is non-linear and complex.<sup>12,13</sup>

In the USA, *Ixodes scapularis* has been implicated in transmission of the organism in eastern USA and *Ixodes pacificus* on the west coast,<sup>14</sup> as have *Ixodes persulcatus* and *Haemaphysalis longicornis* in Asia<sup>15</sup> but clinical disease in ruminants is not a feature in these locations.

**Congenital infection** of a calf has occurred following experimental infection of the dam in late pregnancy<sup>16</sup> and the organism is also present in leukocytes in **milk** during the acute phase of the disease,<sup>17</sup> but the significance of this in the epidemiology of the disease is not known.

A few as one *A. phagocytophila*-infected cell may be enough to transmit infection and use of a single needle between sheep in a group could possibly transmit infection.<sup>18</sup>

It has been suggested that the presence of ticks in migratory birds could spread infection of this agent to other geographic regions.<sup>19</sup>

### Experimental reproduction

The disease can be readily reproduced experimentally. The severity of the clinical response of sheep following experimental infection is not dose dependant and there is no dose effect on the degree of parasitemia or neutropenia.<sup>18</sup>

### Host risk factors

Calves and lambs are much more susceptible than adults although clinical disease may be less severe in very young lambs<sup>4,20</sup> possibly due to mitigating effects of colostral antibody. Hyperimmunization of the pregnant ewe will produce high levels of colostral antibody that will protect the lamb against experimental challenge. However, in the field colostral immunity does not protect against infection and lambs born of ewes raised in endemic areas become infected. Natural infection is followed by a state of low-grade **premunity** due to the presence of the organism in the blood which provides partial resistance to subsequent infections, the disease manifesting itself in a less severe form. Once infected, animals probably remain carriers for life and act as reservoirs of infection for new generations of ticks.

The case fatality is very low and most reported mortality is in association with **intercurrent disease**. A significant indirect effect of tick-borne fever is that it increases the susceptibility of lambs to **staphylococcal pyemia, staphylococcal pneumonia, septicemic and pneumonic paterellosis**,<sup>20</sup>

louping-ill and possibly other diseases. The mortality rate is negligible in cattle but may be higher in sheep.

### Pathogen risk factors

The activity of the tick is seasonal and consequently tick-borne fever has a seasonal occurrence. The tick is active at temperatures between 7–18°C and most ticks feed in the **spring**, with peak activity dependent upon the latitude and elevation of the pasture but generally occurring in April and May. In some areas there is a second period of activity of a separate population of *I. ricinus* in the **autumn** during August and September. Clinical signs in cattle occur predominantly in spring, one to two weeks after they start to graze.

### Zoonotic implications

Human granulocytic ehrlichiosis is associated with *A. phagocytophila* and was first described in the USA in 1994 and in Europe in Slovenia in 1997. It presents most commonly as an undifferentiated, febrile, potentially severe illness occurring in summer or spring associated occupational or recreational activities that allow exposure to infected ticks. There is no recognized direct zoonotic risk from exposure to infected animals but there is evidence that sheep may be one of the maintenance hosts for the organism.<sup>2,6,9</sup>

The organism is also present in leukocytes in **milk** during the acute phase of the disease,<sup>17</sup> but the risk to humans consuming this is not known.

## PATHOGENESIS

*A. phagocytophilum* infect and replicate within **neutrophils** where they live in cytoplasmic vacuoles to form clusters called morulae. They are able to evade activation of the cytotoxic arsenal of the neutrophil but they do perturb neutrophil function.<sup>21</sup> Tissue pathology is not associated with direct *A. phagocytophilum*-mediated injury but results from immunopathologic mechanisms associated with cytokine and chemokine production.

Fever develops in association with parasitemia and is the prominent clinical abnormality in the experimental disease. It persists for approximately 8 days, may exceed 41°C, and is accompanied by depression. While this syndrome is of limited importance in the experimental setting, the occurrence of fever, dullness, and depression of the sucking drive can be a significant influence on the viability of lambs in the cold, wet, rough-grazing areas where this disease commonly occurs and may contribute to **lamb mortality**.

Tick-borne fever produces profound effects on **immunological defense** systems. There is a significant lymphocytopenia that develops 6 days after infection and which affects all T- and B-lymphocyte

subsets.<sup>22</sup> There is also a prolonged neutropenia lasting for 2–3 weeks combined with a thrombocytopenia. Up to 70% of the neutrophils are parasitized from the onset of the parasitemia and have **impaired function**.<sup>18</sup> The **antibody response** of infected sheep to immunogens such as tetanus toxoid is also impaired.<sup>23</sup>

Field observations and experimental challenge has shown that infected lambs are more susceptible to disease and mortality from **intercurrent infections**. The ability of an infection with *A. phagocytophila* to predispose to secondary disease varies with the strain of the organism<sup>2</sup> which may explain why secondary complications are not observed in all flock infections with tick-borne fever. There is a clear relationship between infection with *E. phagocytophila* and susceptibility to infection with *Staphylococcus aureus* and the resultant disease, **tick pyemia**. This is established both by epidemiological and experimental studies.<sup>24</sup>

Concurrent infection of sheep with the agent of tick-borne fever potentiates the pathogenicity of **louping-ill** virus, in experimental infections, to result in more severe disease and a higher mortality. Both diseases are transmitted by *I. ricinus*. However, in areas where both diseases are endemic, colostral immunity will delay infection of lambs with the louping-ill virus until the second year of exposure to the vector tick while allowing infection with tick-borne fever. Simultaneous primary infection with both agents may be uncommon in nature.

Infection also facilitates invasion and systemic mycotic infection with *Rhizomucor pusillus* resulting in diarrhea and dysentery and a high mortality rate.<sup>25</sup> Concurrent experimental infection of sheep with *E. phagocytophila* and *Chlamydia psittaci* results in **chlamydial pneumonia**<sup>26</sup> and simultaneous infection with parainfluenza-3 (PI-3) virus potentiates the pathogenic effect of PI-3 virus.<sup>27</sup> The immunosuppressive effect of tick-borne fever is believed to have resulted in the exacerbation of latent *Brucella abortus* in a naturally occurring abortion outbreak in cattle.<sup>28</sup> Concurrent infection of tick-borne fever and *Listeria monocytogenes* or *Pasteurella haemolytica* promotes the respective **septicemic disease** in lambs.

### CLINICAL FINDINGS

Disease is generally benign but infection can produce abortion and can cause significant loss of weight in lambs and calves.

#### Cattle

In cattle there is an incubation period of 5–9 days followed by a rise in temperature to about 40.5°C (105°F) which persists for 2–12 days and for a longer period in late pregnant cows than in lactating cows.<sup>29</sup>

The temperature falls gradually and is followed by a secondary febrile period and, in some cases, yet further episodes of **pyrexia**. During each febrile period there is a marked fall in milk yield, lethargy and polypnea and in experimentally produced cases, a mild cough although feed intake is not reduced. The fall in **milk production** can be severe and may be the first indication of infection.<sup>30</sup> Pregnant cattle, in the last two months of pregnancy, and placed on tick-infected pastures for the first time, commonly **abort** and occasionally animals die suddenly. The abortions occur shortly after the systemic disease. Some calves are born alive but they are weak and die.

#### Sheep

In sheep the syndrome is similar to that observed in cattle except that respiratory distress is not observed. However, there can be marked differences in clinical manifestation, neutropenia, antibody response, with different variants of *A. phagocytophilum*.<sup>2</sup>

The reaction in young lambs is quite mild and manifested only by a fever which fluctuates between 40–42°C for up to 10 days. Ewes exposed to the disease for the first time commonly experience outbreaks of abortion and affected rams are temporarily infertile.

Abortion is a major manifestation in northern Spain<sup>8</sup> whereas in the Scandinavian countries the main consequence of infection is immunosuppression leading to secondary infections with *Staph. aureus* (tick pyemia) and *Pasteurella hemolytica*.<sup>31</sup>

#### Goats

Tick-borne fever in goats is characterized by high fever, dullness and tachycardia.<sup>32</sup> See page 1464 for a description of the disease in horses.

### CLINICAL PATHOLOGY

At the commencement of the fever there is a severe but transient **thrombocytopenia** and this is followed by more prolonged **neutropenia and lymphocytopenia**. The anaplasmae are demonstrable in the neutrophils and monocytes during each febrile period and for a few days afterwards in cattle and for several weeks in sheep; they can be detected as **intracytoplasmic inclusion bodies** in Giemsa stained blood smears, or by PCR.<sup>17,33,34</sup>

**Serological diagnosis** is possible using counter-immunoelectrophoresis which detects IgM antibody<sup>35</sup> or indirect immunofluorescence using cytospin preparations of blood granulocytes, which detects IgG.<sup>7,36</sup> Antibody is at a high level at the second week after experimental infection with both tests and is detectable for 6–8 weeks with counter-immunoelectrophoresis and for at least 18 weeks with the indirect

fluorescent antibody test.<sup>36</sup> ELISA is also available for serological diagnosis.<sup>9</sup>

Transmission of the disease for diagnosis may be effected by the intravenous injection of blood taken at the height of the fever.

### NECROPSY FINDINGS

There are no gross changes other than **splenomegaly** in sheep, and histologically the only characteristic lesion is a depletion of lymphocytes from lymphoid tissue.

Multifocal leucomalacia spongy change of white matter and swelling of oligodendrocytes is found in the brain of aborted lambs probably the result of fetal anoxia.<sup>37</sup>

### DIFFERENTIAL DIAGNOSIS

- The geographical restriction of the disease and its relation to tick infestation are diagnostic features but the clinical signs are quite non-specific.
- The disease in cattle has some similarity to bovine petechial fever (Ondiri disease), associated with *E. ondiri*, which occurs only in Kenya.

### TREATMENT

The best results are with **tetracyclines** or sulfadimidine although cattle may recover without therapy.<sup>29</sup> In sheep, a single dose of long acting tetracyclines (20 mg/kg IM) or a 5-day course with oxytetracycline (10 mg/kg IV daily) given during the acute phase of the disease is effective in treatment but infection is not eliminated in a significant proportion of sheep.<sup>38</sup> In goats good results are provided by single doses of oxytetracycline (10 mg/kg BW intravenously) or a potentiated sulfonamide containing trimethoprim and sulfadimidine, and sulfamethylphenazole (20, 50, and 50 mg/kg BW respectively); ampicillin is ineffective. The anaplasmae persist in treated animals which may subsequently suffer a relapse.

### CONTROL

Control of tick-borne fever depends upon control of the tick population. The annual dipping of ewes with organophosphates or synthetic pyrethroid acaricides will help reduce tick numbers and the double **dipping of lambs** during the tick season will help reduce disease in the lambs but can be difficult to achieve in the terrain and with the management practices of affected areas.<sup>10</sup> Disease is reduced if the flock can be kept off the tick-infested pastures until the lambs are 6 weeks old and if the flock is dipped prior to introduction to the pasture. In some areas it may be possible to reduce tick numbers by pasture management systems that disturb the pasture microclimate required by the tick.

The disease can be more severe when adult animals are exposed to infection for



the first time and **naive late pregnant cattle** should not be introduced to tick-infested pastures during the tick rise periods. A single administration of 20 mg/kg of long-acting tetracycline is reported to provide protection against experimental challenge for periods up to 3 weeks.<sup>10</sup> The prophylactic administration of **long-acting tetracycline** to lambs<sup>10</sup> and to calves<sup>39</sup> during the season of tick activity is reported to reduce mortality and improve growth rates over untreated controls.

## REVIEW LITERATURE

- Scott GR. Tick-borne fever in sheep. *Vet Ann* 1984; 24:100–106.
- Brodie TA et al. Some aspects of tick-borne disease of British sheep. *Vet Rec* 1986; 118:415–418.
- Vaughan M. Control of tick-borne diseases in cattle. *In Pract* 1988; 102:79–84.
- Ogden NH et al. A review of studies on the transmission of *Anaplasma phagocytophilum* from sheep: Implications for the force in endemic cycles. *Exp Appl Acarol* 2002; 28:195–202.
- Parola P. Tick-borne rickettsial diseases: emerging risks in Europe. *Comp Immunol Microbiol Infect Dis* 2004; 27:297–304.

## REFERENCES

- Massung RF et al. *Emerg Infect Dis* 2002; 8:467.
- Stuen S et al. *Clin Diag Lab Immunol* 2003; 10:692.
- Stuen S et al. *J Clin Microbiol* 2002; 40:3192.
- Stuen S et al. *Res Vet Sci* 1992; 52:211.
- Kolte SW et al. *Indian Vet J* 2003; 80:399.
- Parola P. *Comp Immunol Microbiol Infect Dis* 2004; 27:297.
- Pusterla N et al. *Schweiz Arch Tierhkl* 1997; 139:392.
- Garcia-Perez A et al. *Ann NY Acad Sci* 2003; 990:429.
- Stuen S et al. *Acta Vet Scand* 2001; 42:347.
- Brodie TA et al. *Vet Rec* 1986; 118:415.
- Webster KA, Mitchell GBB. *Res Vet Sci* 1989; 47:30.
- Ogden NH. *Exp Appl Acarology* 2002; 28:195–202.
- Ogden NH. *Parasitol* 2002; 124:127.
- Barlough JE. *J Clin Microbiol* 1997; 35:2018.
- ChulMin K et al. *Vector-Bourne Zoonot Dis* 2003; 3:17.
- Pusterla N et al. *Vet Rec* 1997; 141:101.
- Pusterla N et al. *Clin Diag Lab Immunol* 1997; 4:643.
- Stuen S, Artursson K. *Vet Rec* 2000; 146:669.
- Habalek Z. *J Wildlife Dis* 2004; 40:639.
- Overas J et al. *Vet Rec* 1993; 133:398.
- Sciafe H et al. *Infect Immun* 2003; 71:1995.
- Waldchiwet Z. *Res Vet Sci* 1991; 51:40.
- Larsen HJS et al. *Res Vet Sci* 1994; 56:216.
- Webster KA, Mitchell GBB. *Vet Parasitol* 1989; 34:129.
- Reid HW et al. *Res Vet Sci* 1986; 41:56.
- Munro R et al. *J Comp Pathol* 1982; 92:117.
- Batungbacal MR, Scott GR. *J Comp Pathol* 1982; 92:415.
- Juste RA et al. *Vet Rec* 1989; 124:636.
- Pusterla N, Braun U. *J Vet Med A* 1997; 44:385.
- Cranwell MP, Gibbons JA. *Res Vet Sci* 1986; 119:531.
- Stuen SI, Bergstrom K. *Acta Vet Scand* 2001; 42:331.
- van Miert ASJPAM et al. *Vet Parasitol* 1984; 16:225.
- Ogden NH. *Parasitol* 2002; 124:127.
- Hulinska D et al. *Acta Path Microbiol Scand* 2004; 112:239.
- Pascton EA, Scott GR. *Vet Microbiol* 1989; 21:133.

- Webster KA, Mitchell GBB. *Res Vet Sci* 1988; 45:28.
- Scholes SFE, Watson PJ. *Vet Rec* 2004; 154:32.
- Stuen S, Bergstrom K. *Acta Vet Scand* 2001; 42:339.
- Cranwell MP. *Vet Rec* 1990; 126:334.

## HEARTWATER OR COWDRIOSIS

### Synopsis

#### **Etiology** *Ehrlichia (Cowdria)*

*ruminantium*, a rickettsial organism

**Vectors** *Amblyomma variegatum* and *A. habraeum*

**Epidemiology** Endemic disease of cattle, sheep, goats and wild ruminants in Africa and the Caribbean; high mortality in exotic animals

**Pathogenesis** Tick inoculation → local lymph node → blood → endothelial cells → vascular permeability → clinical signs and lesions.

**Clinical signs** High fever, nervous signs, diarrhea and death if acute; may be mild and inapparent

**Clinical pathology** Non-specific

**Diagnostic confirmation** Rickettsial colonies in capillary endothelium (brain preparations)

**Lesions** Ascites, hydrothorax, hydropericardium and severe pulmonary edema

**Differential diagnosis list** Anthrax, rabies, cerebral babesiosis, cerebral theileriosis, meningitis or encephalitis

**Treatment** Short- and long-acting tetracyclines

**Control** Vaccination based on infection and treatment methods, tick control and chemoprophylaxis

## ETIOLOGY

*Ehrlichia (Cowdria) ruminantium* is a Gram-negative, intracellular rickettsial organism in the tribe Ehrlichiae. It occurs in colonies or morulae with a predilection for the vascular endothelium and stains blue with Giemsa stain. The organism is coccoid, 0.2–0.5 microns in diameter. It can now be cultivated in vitro<sup>1</sup> and it can also grow in mice. Cyclical development is believed to take place in intestinal and salivary epithelia of ticks. Although strain differences exist, all isolates possess a major antigenic protein 1 (MAP1) that is used for diagnosis. However, the antigen cross-reacts with other *Ehrlichia* spp., including *Ehrlichia equi*, the cause of equine granulocytic ehrlichiosis.

## EPIDEMIOLOGY

### Occurrence

Heartwater is limited in its occurrence to sub-Saharan Africa, Madagascar and three Caribbean islands of Guadeloupe, Marie-Galante, and Antigua. It is one of the main causes of death in imported breeds of cattle, sheep and goats in endemic areas. Heartwater has been diagnosed

recently in the island of Mayotte in the Indian Ocean.<sup>2</sup>

### Measures of disease occurrence

In endemic areas, morbidity and mortality rates are low, but the percentage of sera positive titers for heartwater could be as high as 100% in adults,<sup>3</sup> depending on the abundance of tick vectors. Case mortality can be as high as 100% in peracute cases in sheep and goats and as low as 0–10% in cattle. The disease is less severe in indigenous breeds and related game animals reared in enzootic areas, some of which may become symptomless carriers. The N'Dama breed in West Africa is said to be well adapted to heartwater, partly because it can resist tick burdens under traditional farming system.<sup>4</sup>

### Method of transmission

Heartwater is transmitted by many ticks of the *Amblyomma* genus, especially *A. variegatum* (the tropical bont tick) and *A. habraeum*, and their geographic distribution is spreading. A single infected tick can transmit the disease to cattle. In the Caribbean, cattle egrets are suspected to spread *A. variegatum* between islands. Consequently, heartwater is considered a threat to the American mainland where potential vectors are present but do not harbor the disease or where the vector may be introduced and become established. Infection in ticks is transmitted trans-stadially and possibly transovarially. Vertical transmission to calves in colostrum milk has also been reported.<sup>5</sup> Several wild ruminants can be infected and become subclinical carriers and reservoirs. Ticks feeding on them can transmit the disease to domestic ruminants.<sup>6</sup> The organism does not infect humans.

### Risk factors and immune mechanisms

Animals at greatest risk are exotics imported into endemic areas and at times when the vector population is high, usually during the rains. Angora goats are also highly susceptible and therefore difficult to immunize by the current method of infection and treatment. Cattle and sheep recovering from the disease are immune for 6 months to 4 years but may be carriers for 8 months or longer. An age-dependent resistance has long been recognized and young animals were believed to have innate resistance. This was later shown to be due to low-grade infection of the young in colostrum cells.<sup>7</sup>

### ECONOMIC IMPORTANCE

Heartwater is the most important rickettsial infection of ruminants in Africa and the second most important tick-borne disease after East Coast fever. In southern Africa, it is regarded as the most important disease of ruminants. In general, heart-

water is a more serious problem where *A. habraeum* is the vector.<sup>8</sup> In countries or regions where there is endemic stability, losses from heartwater are minimal until new animals are introduced. On the other hand, since most losses are in exotic animals, heartwater is a major constraint to livestock improvement in sub-Saharan Africa. Furthermore, it has the potential to spread from the Caribbean to the American mainland.

#### Biosecurity concerns

Heartwater requires the vector tick to get established in any community. Therefore, there is concern about possible illegal importation of infected animals or ticks to southern United States where potential vectors exist.

#### PATHOGENESIS

The rickettsial organisms are introduced into the host in the saliva of an infected tick. They multiply in reticulo-endothelial cells of the local lymph node, rupture the cells and are released into the circulation from where they invade endothelial cells of blood vessels in all organs. Organisms can be found in phagosomes of circulating neutrophils,<sup>9,10</sup> but are more abundant in endothelial cells. They cause increased vascular permeability, leading to edema especially in the lungs, body cavities and the brain, by mechanisms that are not understood, since infected endothelial cells show minimal cytopathic effects. In goats, renal ischemia and nephrosis have been described and irreversible kidney damage may be the cause of death in such cases.<sup>11</sup>

#### CLINICAL FINDINGS

The incubation period is 1–3 weeks after transmission in tick saliva. Depending on the susceptibility of individual animals and the virulence of the infecting organism, the resulting disease may be peracute, acute, subacute or mild and inapparent. Peracute cases show only high fever, prostration and death with terminal convulsions in 1–2 days. Acute cases are more common and have a course of about 6 days. A sudden febrile reaction is followed by inappetence, listlessness and rapid breathing followed by the classical nervous syndrome which is characteristic of heartwater. It comprises ataxia, chewing movements, twitching of the eyelids, circling, aggression, apparent blindness, recumbency, convulsions and death. Profuse, fetid diarrhea is frequent. Subacute cases are less severe but may terminate in death in 2 weeks or the animal may gradually recover. The mild form is often subclinical and is seen mainly in indigenous animals and wild ruminants with high natural or induced resistance. The case mortality rate in peracute cases is 100%, in acute cases 50–90% and in

calves below 4 weeks of age it is 5–10%; most animals recover in mild cases.

#### CLINICAL PATHOLOGY

Hematological changes in heartwater are not specific but there may be thrombocytopenia, neutropenia, eosinopenia and lymphocytosis. Confirmatory diagnosis is based on identifying the rickettsia in capillary endothelial cells using a Giemsa-stained squash preparation of brain tissue at postmortem. The rickettsiae occur as blue to reddish-purple colonies or morulae of five to several hundred coccoid organisms (0.2–0.5 microns in diameter) in the cytoplasm of the cells. An immunohistochemical staining technique has also been described.<sup>12</sup> Injection of blood into sheep may also be used as a diagnostic procedure. The available serological test is an indirect fluorescent antibody test used for surveys but the close antigenic relationship with other *Ehrlichia* spp. often leads to false positives. An ELISA based on recombinant MAP1 protein of *C. ruminantium* was reported to be more sensitive.<sup>13</sup> In general, clinical detection of heartwater is not always easy because all serological assays so far available have poor sensitivity or specificity.<sup>14</sup> A polymerase chain reaction assay has therefore been suggested as the method of choice for detection of *E. ruminantium* infection.

#### NECROPSY FINDINGS

Standard lesions are ascites, hydrothorax and hydropericardium. Pulmonary edema is often severe, accompanied by copious froth in the tracheobronchial airways. There may be subserosal hemorrhages in most cavities. Lymph nodes are swollen and wet and the spleen is markedly enlarged. In goats with nephrosis, the kidneys will be soft. Although hemorrhages have been described in the brain, it often has no remarkable gross lesions but microscopically, there is perivascular mononuclear infiltration and edema along with presence of rickettsial colonies in capillary endothelial cells. Foci of malacia may be present. Tissues for histopathology should include brain, lungs, lymph nodes, spleen and kidneys.

#### DIFFERENTIAL DIAGNOSIS

- In endemic areas, heartwater should be suspected in susceptible animals infected with *Amblyomma* and having a fever of unknown origin, especially when accompanied by nervous signs. The clinical and pathological findings are not specific and the diagnosis must be based on detection of rickettsial organisms.
- The peracute form should be differentiated from anthrax and the acute form from rabies, sporadic bovine encephalomyelitis,

tetanus, cerebral forms of theileriosis, babesiosis, trypanosomosis, meningitis, listeric or other encephalitis, hypomagnesemia and poisoning with strychnine, lead and organophosphates. Appropriate laboratory tests are utilized to eliminate these differentials.

#### TREATMENT

Field cases of heartwater are difficult to treat successfully because available drugs are effective only in early febrile stages before neurological signs develop. In the early stages, short-acting tetracyclines at 10–20 mg/kg BW and long-acting forms at reduced doses are effective. Sulphonamides can also be used in the early stages but are less effective. Hyperimmune serum is said to be of no curative value. Supportive therapy to reduce either the pulmonary edema or the neurologic signs or to stabilize membranes in general are being investigated but with little success.

Chemoprophylaxis involves administration of tetracyclines or subcutaneous implantation of doxycycline in susceptible animals when they are introduced into an endemic area. Results are not always predictable.

#### CONTROL

Past efforts to control heartwater were based on intensive acaricide treatment in endemic areas. It involved frequent use of acaricides (plunge dipping) up to 52 times a year. This has now been shown to be environmentally unfriendly, economically unsustainable, and would invariably lead to animals that remained always susceptible.<sup>15</sup> For example, it was observed in Zimbabwe that large farms applying acaricides very frequently (more than 30 times per annum) had higher morbidity and mortality than farms applying acaricides less frequently.<sup>16</sup> What is advocated today is integrated control based on the establishment of endemic stability by vaccination or natural challenge. Vaccination is based on infection and treatment regimen that was first developed more than 50 years ago.<sup>17</sup> It involves an intravenous injection of virulent organisms in cryopreserved sheep blood, followed by treatment with tetracyclines at the first indication of fever. The exposure of calves and lambs up to 3 weeks of age, without treatment, is considered optimal for the development of resistance but kids may still be susceptible. Vaccination may lead to some deaths, the immunity may wane in absence of reinfection, and animals may become carriers.<sup>1,18</sup> More recently, cattle were successfully immunized for up to 10 months with a killed vaccine from a lysate of *E. rumi-*

*nantium* formulated in Freund's adjuvant.<sup>19</sup> In another study, the use of inactivated vaccines from cell-cultured *E. ruminantium* combined with an adjuvant led to a reduction in mortality from heartwater in cattle, sheep, and goats exposed to field challenges in Botswana, Zambia, Zimbabwe, and South Africa.<sup>20</sup> Experimental studies using DNA recombinant vaccines so far have met with only limited success.<sup>17,21</sup>

For tick control, flumenthrin 1% pour-on at 45 days interval was found to provide effective protection of Friesian/Zebu crossbred cattle against important ticks, but it must be applied correctly at the recommended dose.<sup>22</sup> Pure Zebu and N'Dama cattle would probably require less frequent applications. Flumenthrin pour-on is gradually replacing plunge dipping for the control of ticks and tickborne diseases in general. Other than routine surveillance, there are no special biosecurity concerns with heartwater, since transmission requires presence of the vector.

## REVIEW LITERATURE

- Bigalke RD. Heartwater: past present and future. Onderstepoort J Vet Res 1987; 54:163-546.
- Scott GR. Cowdriosis. In: Sewell MMH, Brocklesby DW (eds) Handbook on animal diseases in the tropics, 4th edn. London: Baillière Tindall, 1990; pp. 234-237.
- Bezuidenhout JD et al. Heartwater. In: Coetzer JAW, Thomson GR, Tustin RC (eds) Infectious diseases of livestock with special reference to Southern Africa, vol 1. Cape Town: Oxford University Press, 1994; pp. 351-370.
- OIE Manual of diagnostic tests and vaccines for terrestrial animals. Chapter 2.27 [http://www.oie.int/eng/normes/mmanual/A\\_00046.htm](http://www.oie.int/eng/normes/mmanual/A_00046.htm).

## REFERENCES

- Yunker CE. Onderstepoort J Vet Res 1996; 63:159.
- Camus E et al. Rev Elev Med Vet Pays Trop 1998; 51:282.
- Gueye A et al. Rev Elev Med Vet Pays Trop 1993; 46:449.
- Knopf L et al. Prev Vet Med 2002; 53:21.
- Deem S L et al. Vet Parasitol 1996; 61:133.
- Peter TF et al. Trends in Parasit 2002; 18:214.
- Deem SL et al. Vet Parasitol 1996; 61:119.
- Mahan SM et al. Epidemiol Infect 1995; 115:345.
- Brown CC et al. Am J Vet Res 1990; 51:1476.
- Logan LL et al. Onderstepoort J Vet Res 1987; 54:197.
- Gueye A et al. Rev Elev Med Vet Pays Trop 1984; 37:268.
- Jardine JE et al. Onderstepoort J Vet Res 1995; 62:277.
- van-Vliet AH et al. Ann NY Acad Sci 1996; 791:35.
- Simbi BH et al. Onderstepoort J Vet Res 2003; 70:231.
- Meltzer MI et al. Trop Anim Health Prod 1995; 27:129.
- Chamboko T et al. Prev Vet Med 1999; 39:191.
- Collins NE et al. Vaccines for OIE list A and emerging diseases. Proceedings of a symposium, Ames, Iowa, USA, September 2002. 2003; p. 121.
- Andrew HR, Norval RA. Vet Parasitol 1989; 34:261.
- Totte P et al. Infect Immun 1997; 65:236.
- Mahan SM et al. Vet Parasit 2001; 97:295.
- Sumpton KJ. Trop Anim Health Prod 1997; 28:65s.
- Mekonnen S. Onderstepoort J Vet Res 2000; 67:225.

## EQUINE GRANULOCYTIC ANAPLASMOSIS (EQUINE GRANULOCYTIC EHRLICHIOSIS, ANAPLASMA PHAGOCYTOPHILA)

*Anaplasma phagocytophila* causes disease of horses, humans, dogs, cattle, cats, and other mammalian species, that is characterized in horses by fever, depression, limb edema, icterus and ataxia. The disease is described here with emphasis on that occurring in horses. See 'Tick-bone fever' for a description of the disease in other species.

## ETIOLOGY

The disease in horses is associated with the same agent that causes human granulocytic ehrlichiosis (HGE).<sup>1</sup> The organisms *Ehrlichia equi*, *E. phagocytophila*, and the HGE agent are now classified as *Anaplasma phagocytophila*.<sup>1</sup> The variety of species affected and geographical distribution of the disease suggests strains of *Anaplasma phagocytophila* of varying pathogenicity and host specificity. For example, while *A. phagocytophila* is a recognized cause of tick-borne fever in cattle, sheep, and goats in Europe, the disease has not been recognized in the United States despite the widespread occurrence of this organism in North America. *A. phagocytophila* infects some domestic and wild ruminants, including deer, without inducing clinical signs.<sup>1</sup> The HGE agent causes tick-borne disease in horses identical to that associated with *E. equi* and horses infected with HGE are resistant to subsequent challenge with *E. equi*.<sup>2,3</sup> *Anaplasma phagocytophila* is an obligate intracellular bacterium that replicates in cells derived from the bone marrow (granulocytes).

*Anaplasma phagocytophila* also causes disease in humans, dogs, domestic ruminants, and cats.<sup>1,4</sup> As mentioned above, the geographic distribution of *A. phagocytophila* does not match the distribution of disease in all species, suggesting that strains of differing pathogenicity for various species occur. Indeed, strains of *A. phagocytophila* that cause disease in dogs and horses in southern Sweden differ slightly in their genetic composition from isolates derived from North America.<sup>5</sup> Similarly, nucleotide sequences of strains of *A. phagocytophila* from the west coast of the United States differ from those of strains originating from the east coast.<sup>6</sup>

## EPIDEMIOLOGY

### Distribution

The disease in horses occurs in the Americas (the United States including California, Washington, Oregon, Minnesota, Wisconsin, and the southeastern and the northeastern states, and Brazil), France, Italy, Switzerland, Sweden, Germany, and the United Kingdom.<sup>4,7-9</sup>

The prevalence of horses with serum antibodies to *E. equi* (*A. phagocytophila*) in endemic areas of California is 10%, compared with 3% in areas where the disease is uncommon.<sup>10</sup> On farms where the disease occurs frequently, 50% of horses have serum antibodies to *E. equi* (*A. phagocytophila*).<sup>10</sup> Approximately 18% of horses in areas of the upper Midwest of the United States in which *Ixodes* sp. ticks are endemic have antibodies to *E. equi* (*A. phagocytophila*) whereas 4% of horses in areas in which the tick does not occur are seropositive.<sup>11</sup> A survey of 563 horses in Lazio region of Italy (near Rome), where the disease in horses occurs, revealed a seroprevalence of 0.3%.<sup>12</sup>

There is extensive evidence of exposure of dogs to *A. phagocytophila* and of disease consistent with granulocytic ehrlichiosis. 47% of dogs in endemic areas in California have antibodies to *E. equi* (*A. phagocytophila*) and some show clinical signs consistent with the disease.<sup>13,14</sup>

A total of 0.2% of 2725 serum samples from cattle in California had detectable antibodies to *A. phagocytophila*.<sup>15</sup> Forty-three to 96% of deer and moose, respectively, in Norway are seropositive to *E. equi* (*A. phagocytophila*), indicating the widespread extent of exposure of these species to the organism.<sup>16</sup>

### *Anaplasma* and *Ixodes* ecology

*A. phagocytophila* is maintained by infection in wild cervids (such as the white tailed deer in North Eastern United States) and small mammals such as the white footed mouse or dusky-footed wood rat.<sup>1,4</sup> Infection of horses, dogs, and humans occurs through the bite of *A. phagocytophila*-infected ticks.<sup>4</sup> *E. equi* (*A. phagocytophila*) is detectable using a polymerase chain reaction test in *I. pacificus* that have fed on *E. equi* infected horses<sup>17</sup> and infected *I. pacificus* can cause granulocytic ehrlichiosis in previously unexposed horses.<sup>18</sup>

The organism is transmitted by hard ticks that are members of the *Ixodes persulcatus* complex, which includes *Ixodes pacificus*, *Ixodes scapularis*, and *Ixodes ricinus*.<sup>1,4</sup> Transstadial, but not transovarial, transmission occurs. The tick vectors of *A. phagocytophila* pass through four stages in their life-cycle:<sup>4</sup> egg, larva, nymph, and adult. Maturation from larva to nymph and from nymph to adult, and egg laying, all require the ingestion of a blood meal. As transovarial transmission of infection does not occur, larvae or uninfected nymphs become infected by feeding on an infected mammal. The engorged and infected immature tick then dismounts and matures to the next life stage away from a mammalian host. When the immature tick reaches the nymph or adult stage, it again seeks a mammalian host. Transmission of

the infection from the tick to a mammal occurs through feeding of an infected nymph or adult on a susceptible host.

#### Animal risk factors

Horses that have not been exposed to *A. phagocytophilum* are susceptible to infection and disease. There is a marked seasonality of the disease in California with most cases occurring in late autumn, winter, and spring.<sup>19</sup>

*Anaplasma phagocytophilum* infects domestic ruminants in Europe where it causes tick-borne fever.<sup>20</sup> However, cattle infected with HGE agent or *A. phagocytophilum* isolated from horses with the disease in the United States do not develop clinical signs of disease nor do they have detectable *A. phagocytophilum* morulae in blood, although they do seroconvert.<sup>15</sup> This study, and the low seroprevalence of antibodies to *A. phagocytophilum* in cattle in California indicate the organism rarely, if ever, causes disease in cattle in these geographic regions.

Infection in horses is followed by a solid immunity and recovered animals are resistant to the disease for at least 20 months although it is suggested that reinfection and disease can occur.<sup>21</sup> Serum antibodies persist for at least 300 days after infection in some horses but decrease to low levels in most horses by 200 days after infection.<sup>21-23</sup>

#### Transmission

As discussed above, transmission is through the bite of an infected tick. Transmission through use of blood contaminated veterinary equipment or by blood transfusion is possible, the later being used to induced disease in experimental challenges. Perinatal transmission of *A. phagocytophilum* is reported in humans.

#### Morbidity and mortality

The **case fatality rate** is low, approximately 4%, and deaths of horses with uncomplicated disease are rare.<sup>19</sup>

#### Zoonotic potential

There is no evidence that infection spreads directly from infected horses or dogs to humans. However, dogs have been suggested to be sentinel animals in that humans in areas in which dogs have a high prevalence of antibodies in serum to *A. phagocytophilum* might be at increased risk of infection from bites of infected ticks.<sup>14</sup>

#### PATHOGENESIS

The pathogenesis of the disease is poorly understood. Following experimental infection, horses have organism detectable by PCR beginning 5 days after infection, with development of fever and depression 7-8 days after infection. Inclusions in granulocytes are detectable beginning 9 days after infection, at which time there is edema of the limbs.<sup>24</sup> The disease in horses is associ-

ated with rapid changeover of expressed p44 genes such that there is marked antigenic variation in the major surface protein, p44, during infection in an animal.<sup>25</sup> The rapid changeover of expression of p44 is attributed to development of specific antibody to the hypervariable region of p44.<sup>25</sup> Infection in sheep results in immune suppression secondary to granulocytic and lymphocytic leukopenia, impaired antibody production, reduced lymphocyte response to mitogens, and a decreased oxidative burst activity of neutrophils.<sup>26</sup> The prominent clinical sign of edema is likely related to the vasculitis that is characteristic of the disease.

#### CLINICAL SIGNS

The **incubation period** for the spontaneous disease is less than 2 weeks. Subclinical infections are believed to be common, based on the number of horses with serologic evidence of infection but no history of disease.

Clinically there is high fever of 40-42°C (104-107°F) followed by mucosal pallor, jaundice, anorexia, depression, increased respiratory movement, incoordination and reluctance to move and, after 3-4 days, **edema** and heat of the extremities.<sup>24</sup> There may be petechial hemorrhages on mucosal membranes. The edema persists for 7-10 days and clinical signs resolve in 14 days. Clinical disease is more severe in horses over 3 years of age and is minor in young horses.<sup>19</sup> Severely affected horses can have signs consistent with neurologic disease, including ataxia, defects in conscious proprioception, and recumbency.<sup>23</sup>

**Arrhythmias** may occur during the acute phase of the disease. Chronic infection and disease is not recognized.

#### CLINICAL PATHOLOGY

Hematological examination may reveal a mild anemia and leukopenia. **Thrombocytopenia** is common in the acute stage of the disease. There are no consistent serum biochemical abnormalities.

**Positive identification** of the disease is made on the presence of inclusion bodies (morulae) in the cytoplasm of neutrophils and eosinophils. Careful and protracted microscopic examination of a blood smear, stained with Giemsa, may be necessary to identify the inclusions (morulae). The inclusions are apparent as pleomorphic, blue-gray color bodies, often in a spoke wheel formation, in the cytoplasm of granulocytes.<sup>19</sup> The number of infected cells may be quite small and examination of a buffy coat preparation may increase the sensitivity of the test.

**Diagnosis** is achieved through use of a polymerase chain reaction test to identify *Anaplasma phagocytophilum* DNA in blood samples of infected horses and by demonstration of an increase in antibody

titer detected by indirect fluorescent antibody staining.<sup>10</sup> However, antibody titers are low to undetectable in approximately 44% of horses with at the onset of clinical signs, and reach a maximum within one month of infection.<sup>23,24</sup> An ELISA that detects antibodies against the p44 surface antigen of *A. phagocytophilum* is suitable for use in dogs and horses.<sup>27</sup>

#### NECROPSY EXAMINATION

At **neuropsis** there are petechiae and edema of the legs and at histological examination there is a vasculitis. There are often inflammatory lesions in the brain, heart and kidneys.

#### DIFFERENTIAL DIAGNOSIS

##### Differential diagnoses include:

equine infectious anemia, which has a much more protracted course and does not respond to treatment; purpura hemorrhagica, which is often associated with infectious upper respiratory tract disease; liver disease, viral encephalitis; equine herpesvirus 1 myeloencephalopathy, **rabies**, botulism, and equine viral arteritis.

#### TREATMENT

The specific treatment is oxytetracycline (7 mg/kg BW IV, every 24 hours) for approximately 5-7 days. Penicillin, streptomycin and chloramphenicol are not effective. The response to treatment with oxytetracycline is rapid and the fever is reduced or eliminated in 12-24 hours, and signs of the disease resolve within 5-7 days in most horses. Inclusion bodies are difficult to find 24 hours after beginning treatment. Without treatment the disease is usually self-limiting to 2-3 weeks.

#### CONTROL

There is no **vaccine**, and specific control measures cannot be recommended at this time, although minimizing access of ticks to horses would appear prudent. There is no need to isolate infected horses.

#### REFERENCES

- Dumler JS et al. Int J Syst Evol Microbiol 2001; 51:2145.
- Madigan JE et al. J Infect Dis 1995; 172:1141.
- Pusterla N et al. J Vet Med B 2002; 49:484.
- McQuiston JH et al. J Am Vet Med Assoc 2003; 223:1750.
- Bjoersdorff A et al. Clin Diag Lab Immunol 2002; 9:341.
- Chae J et al. J Clin Microbiol 2000; 38:1364.
- Shaw S et al. Vet Rec 2001; 149:127.
- Bermann F et al. Vet Rec 2002; 150:787.
- Magnarelli LA et al. J Am Vet Med Assoc 2000; 217:1045.
- Madigan JE et al. J Am Vet Med Assoc 1990; 196:1962.
- Bullock PM et al. J Vet Int Med 2000; 14:252.
- Scarpilla M et al. Ann NY Acad Sci 2003; 990:250.

13. Magnarelli LA et al. J Am Vet Med Assoc 1997; 211:1134.
14. Foley JE et al. Am J Vet Res 2001; 62:1599.
15. Pusterla N et al. J Am Vet Med Assoc 2001; 218:1160.
16. Stuenkel S et al. J Wildlife Dis 2002; 38:1.
17. Barlough JE et al. Vet Parasitol 1996; 63:319.
18. Richter PJ et al. J Med Entomol 1996; 33:1.
19. Madigan TE, Gribble D. J Am Vet Med Assoc 1987; 190:445.
20. Woldehiwet Z. Vet Res Commun 1983; 6:163.
21. Van Andel AE et al. J Am Vet Med Assoc 1998; 212:1910.
22. Nyindo MBA et al. Am J Vet Res 1978; 39:15.
23. Artursson K et al. Equine Vet J 1999; 31:473.
24. Franzen P et al. J Vet Intern Med 2005; 19:232.
25. Wang XQ et al. Inf Immunity 2004; 72:6852.
26. Whist SK et al. Vet Immunol Immunopathol 2003; 94:163.
27. Magnarelli LA et al. Am J Vet Res 2001; 62:29.

## EQUINE NEORICKETTSIOSIS (EQUINE MONOCYTC EHRlichiosis, EQUINE EHRlichial COLITIS, POTOMAC HORSE FEVER)

### Synopsis

**Etiology** *Neorickettsia risticii*, a rickettsia. Infection occurs by ingestion of aquatic insects (caddis flies) infected by the organism

**Epidemiology** An infectious, but not contagious, sporadic disease of horses in North and South American and parts of Europe. Localized epidemics may occur. Disease is most common near large rivers, but can occur elsewhere

**Clinical signs** Fever and diarrhea with colic and laminitis in severe cases. Abortion is a sequela of clinical disease in mares

**Lesions** No gross lesions, except for laminitis. Histologic evidence of typhlitis and colitis

### Diagnostic confirmation

Demonstration of *N. risticii* by PCR or cultivation, in blood or feces of sick horses. More commonly the presence of a high antibody titer in horses with appropriate clinical signs is considered diagnostic

**Treatment** Oxytetracycline (6.6 mg/kg, IV every 24 hours), fluids, and supportive care. Prophylaxis for laminitis

**Control** Vaccination, of questionable efficacy

### ETIOLOGY

The causative agent is *Neorickettsia risticii*, formerly named *Ehrlichia risticii*, a small Gram-negative coccus that is closely related to the agents of human ehrlichiosis (*E. sennetsu*) and salmon poisoning of dogs (*Neorickettsia helminthoeca*).<sup>1</sup>

### EPIDEMIOLOGY

The disease is infectious, but not contagious, and usually has a sporadic occurrence. Localized epidemics may occur.

### Occurrence

Equine neorickettsiosis is recorded in the United States, Canada, Europe, Uruguay and southern Brazil.<sup>2</sup> While it might have wider occurrence, evidence of infection based on the commonly used indirect fluorescent antibody test should be interpreted with caution because of the high rate of false positive results.<sup>3</sup> The highest prevalence of disease is near large rivers, apparently related to the infection of horses by ingestion of infected aquatic insects, although the disease can occur elsewhere.<sup>4</sup>

Clinical disease is sporadic and seasonal with the predominance of cases occurring during the summer and the autumn periods in areas with cool to cold winters.<sup>5</sup> In warmer areas, such as Florida and Texas, cases occur year round. The prevalence of horses in the mid-west and east coast of the United States with antibodies to *N. risticii* varies with geographical region, but can be as high as 86% of horses tested, although the overall rate appears to be closer to 25%.<sup>4</sup> The prevalence of horses with serological evidence of exposure is much less in California.<sup>3</sup> There is a marked seasonal variation in the prevalence of seropositive horses, with the highest prevalence being in the summer months (July and August) and the lowest prevalence being in the winter.<sup>6</sup>

### Animal risk factors

Clinical disease is believed to be uncommon in horses under 1 year of age, although peracute disease can occur in foals,<sup>7</sup> and there is no age difference in prevalence of disease in adult horses.<sup>5</sup> Similarly, there is no evidence that breed and sex influence susceptibility to disease.<sup>5</sup> The risk for disease is greater in horses housed on premises with a history of previous infection or those that have other livestock.<sup>5</sup>

The clinical attack rate varies considerably, but estimates range between 0.44 and 19 cases per year per 1000 horses at risk.<sup>5,8</sup> During epidemics, the clinical attack rate may be as high as 20–50% of horses on affected farms.<sup>9</sup> **Case fatality** rates as high as 30% were initially reported for horses with clinical disease but with the subsequent improved recognition and early treatment the case fatality rate is currently closer to 7%.

The risk of horses being seropositive in some areas is related to breed (Thoroughbreds are three times more likely to be seropositive than are non-Thoroughbreds and non-Standardbreds), sex (females are 2.7 times more likely to be exposed than are stallions and geldings), and age (increasing risk up to 12 years of age).<sup>10</sup> Horses that have had clinical signs compatible with neorickettsiosis are more likely to be seropositive than are horses with no such history.<sup>11</sup>

### Transmission

The disease is infectious but not contagious.<sup>5</sup> Horses develop infection and disease after ingestion of aquatic insects including caddis flies (*Dicosmoecus gilvipes*).<sup>12,13</sup> The disease can be transmitted experimentally to horses by parenteral administration of *N. risticii* or blood from infected horses.<sup>14</sup> Studies of a tick (*Dermacentor variabilis*), black flies (*Simulium* spp.), fleas, flies (*Tabanus* spp., *Hybomitra* spp., *Stomoxys* spp., *Haematobia* spp.), and mosquitoes, have failed to demonstrate transmission of infection.

The complete life cycle of *Neorickettsia risticii* has not been elucidated, but it is known that the organism infects trematode stages (cercariae and xiphidocercariae) found in freshwater snails (*Juga* sp. in California and *Elimia* sp. in Ohio).<sup>15,16</sup> *Neorickettsia risticii* infects metacercariae found in adults and juveniles of aquatic insects including caddis flies (Trichoptera), mayflies (Ephemeroptera), damselflies (Odonata, Zygoptera), dragonflies (Odonata, Anisoptera), and stoneflies (Plecoptera).<sup>17</sup> *N. risticii* DNA has been detected in trematodes (Lecithodendriidae) infecting bats and swallows.<sup>18,19</sup> *N. risticii* DNA is present in eggs of the trematodes (*Acanthatrium oregonense*) found in bats demonstrating vertical (adult to egg) transmission of infection in trematodes.<sup>19</sup> Furthermore, *N. risticii* DNA was detected in the blood, liver or spleen of bats infected with the trematode, suggesting that *N. risticii* can also be transmitted horizontally from trematode to bat.<sup>19</sup> These results indicate that the trematode *A. oregonense* is a natural reservoir and probably a vector of *N. risticii*. This information suggests that insectivorous bats and birds are the definitive hosts of trematodes that maintain the natural reservoir of *N. risticii*.<sup>18</sup> Briefly, it appears that horses are accidentally infected by *N. risticii* that normally cycles between trematode life stages in bats, fresh water snails, and aquatic insects.

Infected horses develop a sterile immunity and so are unlikely to be a source of subsequent infection.

### PATHOGENESIS

Infection is followed by monocyte-associated bacteremia and the organism is present in monocytes, macrophages and the glandular epithelial cells of the intestinal tract. The number of *N. risticii* in blood is greatest before the development of clinical signs, which in experimentally infected horses and ponies occurs approximately 19 days after infection by ingestion of infected aquatic insects.<sup>13</sup> The prominent clinical sign of diarrhea is due to colitis and typhlitis and is associated with an neorickettsia-induced disruption of sodium and chloride absorption by the large

colon.<sup>20</sup> Fluid and electrolyte losses associated with the diarrhea cause dehydration, hyponatremia and acidosis. Transplacental infection with *N. risticii* occurs and causes abortion.<sup>21</sup>

### CLINICAL FINDINGS

The classic manifestation of *N. risticii* infection in horses is fever, depression, anorexia, diarrhea, colic, and laminitis. However, infection can result in a variety of clinical abnormalities ranging from inapparent infection, through transient fever and depression, to the severe signs described above. Equine neorickettsiosis should be considered in any horse living in an endemic area that demonstrates fever and depression.

In naturally occurring cases of severe clinical disease there is typically an acute onset with depression, anorexia, tachycardia, congested mucous membranes and fever up to 107°F. There are decreased intestinal sounds on abdominal auscultation in the early stages of the syndrome and subsequently tinkling sounds prior to the onset of diarrhea which usually occurs 24–72 hours later. The severity of the diarrhea varies but it is usually profuse and projectile. It persists for up to 10 days and there may be sufficient fluid loss to result in severe and rapid dehydration and hypovolemic shock. Colic is a presenting sign in some horses and may be mild or present as an acute abdomen. Laminitis occurs in up to 40% of horses and is usually apparent within 3 days of initial signs of disease. There can also be subcutaneous edema in the ventral abdomen and limbs. Less severe clinical manifestations of infection include the occurrence of fever and anorexia without other signs, or the occurrence of mild colic or subcutaneous edema.

Abortion occurs as a result of *N. risticii* infection and, in experimental infections, occurs 65–111 days after infection of the dam. The dams that aborted all became clinically ill after infection, but clinical signs of disease had resolved at the time they aborted.<sup>21</sup> Abortion was presaged by ventral edema and enlargement of the udder, and placenta was retained in some cases.<sup>21</sup>

### CLINICAL PATHOLOGY

**Hematological examination** usually reveals leukopenia (<5000 leukocytes per  $\mu$ l) with neutropenia and a marked left shift, mild thrombocytopenia, and hemoconcentration (hematocrit 50–60%, 0.5–0.6 L/L). **Serum biochemical analysis** often reveals hyponatremia, hyperkalemia, hypochloremia, metabolic acidosis and azotemia. **Peritoneal fluid** is usually normal.

**Diagnostic confirmation** is achieved by demonstration of *N. risticii* in blood or feces, or serological evidence of infection, in horses with clinical signs compatible

with the disease. Routine diagnosis is based on demonstration of a high serum antibody titer on the indirect immunofluorescent antibody (IFA) test.<sup>11</sup> Most horses with disease due to *N. risticii* have titers  $\geq$ 1:80 at the onset of clinical signs while horses with titers  $\leq$ 1:40 probably do not have the disease.<sup>11</sup> The presence of a high titer at the time of onset of clinical signs is a result of the 8–12 day incubation period during which there is a high level neorickettsemia and the production of a strong IgM antibody response.<sup>22</sup> The IgM antibody response wanes rapidly and may be undetectable by 60 days after infection, although a prominent IgG response occurs.<sup>22</sup> Therefore, by the time clinical signs are apparent the horse has a high titer that might decline, making the use of acute and convalescent (2 weeks after clinical signs resolve) serum titers potentially misleading. A rising titer in samples collected several days apart soon after the onset of disease is indicative of the disease, but a declining titer does not rule it out. The IFA test performed in some laboratories has a high rate of false-positive reactions.<sup>3</sup>

Detection of the organism in white blood cells by microscopic examination of stained blood smears is usually not possible because of the low level of infection of blood monocytes. The organism can be cultivated but this is time consuming and expensive. However, a test that detects the presence of *N. risticii* nucleic acid by the polymerase chain reaction has a sensitivity similar to that of blood culture in experimental infection.<sup>23</sup> Similarly, *N. risticii* can be detected by a polymerase chain reaction test in feces of horses with disease.<sup>24</sup>

### NECROPSY FINDINGS

The gross changes in horses dying of EME usually include subcutaneous edema of the ventral body wall and a very fluid consistency to the contents of the large bowel. Congestion, hemorrhage and mucosal erosions can occur throughout the alimentary tract but are concentrated in the cecum and colon. The mesenteric lymph nodes are often swollen and edematous. There may be lesions of laminitis. Histologic examination confirms the alimentary mucosal erosion and ulceration, which is accompanied by an infiltrate of a mixed population of leukocytes within the lamina propria and submucosa. The causative organisms can be demonstrated in tissue sections using Steiner's silver stain. Detection using electron microscopic or PCR techniques are other options.

Fetuses that are aborted as a result of *N. risticii* infection of the dam have histologic evidence of enterocolitis, periportal hepatitis and lymphoid hyperplasia with necrosis of mesenteric lymph nodes.<sup>21</sup>

### Samples for postmortem confirmation of diagnosis

The parasite can be demonstrated in cecum, colon, and mesenteric lymph node by a polymerase reaction test or electron microscopy. Formalin-fixed tissue for light microscopy should include cecum, colon, liver and mesenteric lymph node.

### DIFFERENTIAL DIAGNOSIS

The main differentials are as follows (Table 5.14):

- Diarrhea due to: salmonellosis, *Clostridium difficile* colitis, massive emergence of hypobiotic cyathostomes, colitis X, and antibiotic-induced colitis
- Abortion due to: EHV-1, leptospirosis, congenital anomalies, and *Salmonella abortusequi*.

### TREATMENT

The specific treatment of equine neorickettsiosis is oxytetracycline (6.6 mg/kg BW IV every 24 hours for 5 days) and horses treated early in the disease respond well. Given the effectiveness of oxytetracycline in the treatment of the disease and the lack of clear evidence that oxytetracycline at the recommended dose induces or exacerbates diarrhea, this drug should be administered to all horses that live in an endemic area and that develop signs consistent with equine neorickettsiosis. Treatment does not interfere with the development of immunity.<sup>25</sup> Other antibiotics that have been used include combinations of a sulfonamide and trimethoprim or rifampin and erythromycin. Doxycycline has been used, but intravenous administration is associated with cardiovascular abnormalities and sudden death.<sup>26</sup>

Treatment of horses with acute diarrhea is discussed under Acute diarrheas of horses. Prophylaxis for laminitis may be useful.

### CONTROL

Control centers on vaccination although it is of unproved efficacy in field situations. The apparent lack of efficacy of vaccination in the United States might be due to the inclusion of only one strain of *N. risticii* in the vaccine. There is evidence of the presence of a number of strains of the organism and the vaccine might not confer immunity to all these strains.

Infection is followed by the development of a neutralizing antibody response that is associated with clearance of *N. risticii* and the presence of a sterile immunity which persists for at least 20 months.<sup>27,28</sup> An inactivated whole cell adjuvanted vaccine is available and vaccinated animals have resistance to experimental challenge.<sup>25</sup> However, protection from vaccination is



not complete and wanes within 6 months. In an area with a low attack rate of the disease (0.44–1.7 horses/1000 per year) the risk of neorickettsiosis in horses vaccinated once per year is almost identical (odds ratio = 0.93) to that of unvaccinated horses, and there is no difference in the severity of the disease in vaccinated and unvaccinated horses.<sup>29</sup> Furthermore, it is more economical *not* to vaccinate horses in areas with a low attack rate.<sup>30</sup> In areas with a high attack rate it may be appropriate to provide an initial vaccination of two doses 3 weeks apart with revaccination at 4-month intervals during the disease season.<sup>25</sup>

## REFERENCES

- Dumler JS et al. *Int J Syst Evol Microbiol* 2001; 51:2145.
- Dutra F et al. *J Vet Diag Invest* 2001; 13:433.
- Madigan JE et al. *J Am Vet Med Assoc* 1995; 207:1448.
- Atwill ER et al. *Equine Vet J* 1994; 26:143.
- Goetz TE et al. *Am J Vet Res* 1989; 50:1936.
- John GA. *Equine Vet Sci* 1989; 9:250.
- Perry BD et al. *Prev Vet Med* 1986; 4:69.
- Atwill ER et al. *Prev Vet Med* 1995; 23:41.
- Palmer JE et al. *J Am Vet Med Assoc* 1986; 189:197.
- Atwill ER et al. *Am J Vet Res* 1992; 53:1931.
- Farrar WP et al. *Vet Microbiol* 1993; 34:345.
- Madigan JE et al. *Equine Vet J* 2000; 32:275.
- Mott J et al. *J Clin Microbiol* 2002; 40:690.
- Pusterla N et al. *J Clin Microbiol* 2000; 38:1293.
- Barlough JE et al. *Vet Parasitol* 1997; 68:367.
- Kanter MJ et al. *J Clin Microbiol* 2000; 38:3349.
- Chae J et al. *J Med Entomol* 2000; 37:619.
- Pusterla N et al. *J Helminthol* 2003; 77:335.
- Gibson KE et al. *Environ Microbiol* 2005; 7:203.
- Rikihisa Y et al. *Res Vet Sci* 1992; 52:353.
- Long MT et al. *Am J Vet Res* 1995; 56:1307.
- Pretzman C et al. *J Clin Microbiol* 1987; 25:31.
- Mott J et al. *J Clin Microbiol* 1997; 35:2215.
- Biswas B et al. *J Clin Microbiol* 1994; 32:2147.
- Palmer JE. *Cornell Vet* 1989; 79:201.
- Riond JL et al. *Equine Vet J* 1992; 24:41.
- Palmer JE et al. *Am J Vet Res* 1990; 51:763.
- Rikihisa Y et al. *Vet Microbiol* 1993; 36:139.
- Atwill ER et al. *J Am Vet Med Assoc* 1996; 208:1290.
- Atwill ER et al. *J Am Vet Med Assoc* 1996; 208:1295.

## 'Q' FEVER

### Synopsis

**Etiology** *Coxiella burnetii*

**Epidemiology** High seroprevalence in ruminants. Latent infection with recrudescence and excretion at parturition. Infection by direct contact and inhalation. Important zoonotic disease

**Clinical findings** Infection in ruminants common but clinical disease is rare and presents mainly as abortion in sheep

**Necropsy findings** Placentitis. Organisms demonstrable in trophoblast cells by fluorescent antibody

**Diagnostic confirmation** Fluorescent antibody staining and PCR. Serology for herd infection status

**Control** Isolation of aborting ruminants. Vaccination possible

## ETIOLOGY

Q fever is a zoonosis associated with *Coxiella burnetii* which is an obligate intracellular parasite classified within the family Rickettsiaceae and which can be divided into six genomic groups on the basis of restriction fragment length polymorphism. Unlike other *Rickettsiae* members *C. burnetii* it is quite resistant to environmental influences and is not dependant upon arthropod vectors for transmission. *C. burnetii* displays two antigenic phases, phase 1 and phase 11. Phase 1 organisms are more infectious.

## EPIDEMIOLOGY

### Occurrence

The organism has **worldwide distribution** although a large serological survey argues that it is not present in New Zealand.<sup>1</sup>

*C. burnetii* cycles in a wide variety of wildlife species and their ectoparasites. The infection also cycles in domestic animals; cattle, sheep and goats are the main livestock reservoirs of infection for humans.<sup>2,3</sup> Rates of infection in farm animals vary considerably between locations, between countries and with time as there appears to be cycles of infection within regions.

In cattle, prevalence figures range from 6–82% of cattle and 23–96% of herds seropositive depending upon location and country.<sup>4–7</sup> Seropositivity rates in sheep and goats are similar but also vary according to year and region.<sup>8–11</sup> There is little information on management or other factors that might influence this variation in prevalence but one study found a significantly higher prevalence in housed cattle compared to cattle at pasture kept at pasture.<sup>7</sup>

### Source of infection and transmission

**Infection and transmission** is by direct contact and by inhalation. Infection of non-pregnant animals is clinically silent and is followed by latent infection until pregnancy when there is recrudescence with infection in the intestine, uterus, placenta and udder and excretion from these sites at parturition. The organism is present in high concentration in the **placenta** and **fetal fluids**, and subsequent vaginal fluids, is also excreted in **urine** and is present in the **feces** of sheep from 11–18 days post partum.<sup>2,12</sup> Infection can result in abortion, stillbirths or poorly viable lambs but commonly the neonates of infected, excreting, ewes are born clinically normal. Abortion usually does not occur at successive pregnancies but there can be recrudescence of infection and excretion at these pregnancies, especially the one immediately following.<sup>13,14</sup>

**Goats** also excrete the organism in vaginal discharges for up to 2 weeks, and it is present in goat milk for up to 52 days after kidding and also in feces.<sup>15</sup> Maximum shedding in **cattle** also occurs at partur-

ition and for the following two weeks but cattle excrete the organism in the milk for at least several months and up to 2 years<sup>2</sup> and infection is common in bulk tank milk.

As with sheep, infection in goats can be accompanied by abortion but abortion in cattle is rare although it is recorded.<sup>9,16</sup>

There is a significant contamination of the environment of infected animals at the time of parturition and this is probably a major period for transmission of the disease within herds and flocks.<sup>17</sup>

The organism is present in the semen of seropositive bulls and venereal transmission is suspected.<sup>18</sup>

### Pathogen risk factors

*C. burnetii* is very **resistant** to physical and chemical influences and can survive in the environment and soil for several months. It can resist common chemical disinfectants but is susceptible to sodium hypochlorite, 1:100 lysol solution and formalin fumigation provided a high humidity is maintained.<sup>19</sup>

There is strain variation in the organism and differences in plasmid sequence types have been correlated with differences in the type of disease occurring in humans. The organism is highly infectious and it is estimated that the infective dose for humans approximates one organism.<sup>20</sup>

### Zoonotic implications

In humans infection is primarily by **inhalation**. Sources of infection include such diverse materials as soil, air-borne dust, wool, bedding and other materials contaminated by urine, feces or birth products of animals. The potential for human infection from these sources is substantial; for example, ovine manure used as a garden fertilizer has been incriminated as a source.<sup>21</sup>

Sheep have traditionally been incriminated as the major reservoir of infection for humans but the trend for urban populations to locate in close proximity to large dairy herds suggests that cattle could become an increasingly significant reservoir.

The organism is present in the **milk** of infected cattle, sheep and goats. A significant proportion of seropositive cattle excrete the organism in milk and periods and duration of excretion are variable but may persist at least 2 years.<sup>2</sup> *C. burnetii* is destroyed by pasteurization but there is a risk for the farm family that consumes raw milk and a particular concern for the occurrence of the organism in raw sheep and goats' milk.

Rates of seropositivity in humans vary markedly between surveys but there is a higher rate of seropositivity in people (farm workers, veterinarians, livestock dealers, dairy plant and slaughter house workers, shearers, etc.) that are associated with



domestic animals and their products and with farm environments.<sup>8,22-24</sup> Several incidents of infection in humans have been linked to exposure to **parturient** sheep and goats.<sup>2,8,10,25</sup>

The infection in humans is also commonly asymptomatic but can result in disease characterized by fever, general malaise, headache, and less commonly, pneumonitis, hepatitis and meningoencephalitis. Endocarditis and hepatitis are manifestations of chronic disease. Immunocompromised persons are at greater risk for disease. There is a concern that the prevalence of infection in farm animals is increasing and spreading geographically and that there is a subsequent greater risk for infection in humans.<sup>10,14,26</sup>

*C. burnetii* is considered a potential agent for bioterrorism because of its survival in the environment, the ease with which it can transmit by aerosol and windborne means and the very low infectious dose.

### CLINICAL FINDINGS

Infection of ruminants can occur at any age and is usually clinically inapparent. In the experimental disease in cattle, anorexia is the only consistent clinical finding. *C. burnetii* is a cause of abortion in sheep and goats. Abortion occurs during the latter part of the lambing period in the flock and in the latter period of pregnancy in individual ewes. The dam shows no signs of impending abortion. In cattle the organism is a rare cause of abortion. Correlations between herd level seroprevalence and herd fertility are equivocal.<sup>5,6,27</sup>

### CLINICAL PATHOLOGY

There are a number of serological tests available including complement fixation, micro agglutination, ELISA and indirect immunofluorescence.<sup>28</sup>

The immunofluorescence assay is used as the sero-reference test for the serodiagnosis of Q fever. It can detect antibody to phase variants and can provide epidemiological information as phase 11 antibody is associated with recent and acute infections and phase 11 antibody with chronic infections.<sup>14</sup>

### NECROPSY FINDINGS

There are seldom gross lesions in aborted fetuses, but foci of necrosis and inflammation are occasionally seen in the liver, lung, and kidney microscopically. The placenta from aborting animals is usually thickened and a purulent exudate or large, red-brown foci of necrosis are typically seen in the thickened intercotyledonary areas. Microscopically, large numbers of necrotic neutrophils are usually visible on the chorionic surface and swollen trophoblasts filled with the organisms can also be found in well-preserved specimens. Examination of placental impression smears

stained with Gimenez, Koster's, or other appropriate techniques provides a means of rapid diagnosis. However, care must be taken to avoid confusing *Coxiella*-infected trophoblasts with cells containing *Chlamydomydia* organisms. Coxiellosis can be confirmed fluorescent antibody staining of fresh tissue or immunohistochemical staining of formalin-fixed samples. In most laboratories, culture is not attempted due to the zoonotic potential of this agent.

### Samples for confirmation of diagnosis

- **Bacteriology** – chilled placenta (CYTO, FAT)
- **Histology** – fixed placenta, lung, liver, kidney (LM, IHC).

**Note the zoonotic potential of this agent when handling carcasses and submitting specimens.**

### DIFFERENTIAL DIAGNOSIS

- The diagnosis of the disease in farm animals, other than abortion, suspected as associated with this agent is difficult and relies upon the detection of the organism
- A positive serological test in an animal or herd is indicative of infection at some time but does not indicate an association with the problem at hand
- PCR or PCR-ELISA has been used for detection of the organism in milk.<sup>29</sup>

### CONTROL

**Abortng animals** should be isolated for 3 weeks and aborted and placental-contaminated material burnt. Ideally, manure should be composted for 6 months before application to fields. Feed areas should be raised to keep them free from contamination with feces and urine.

While Q fever has significant implications for human health, it is not significantly important enough to have generated national or regional control strategies based on control in the animal population.

**Milk** and milk products should be pasteurized. Veterinarians dealing with herds that provide raw milk should insure that these herds are seronegative for *C. burnetii*.

**Vaccine** trials with killed vaccines in animals show a good and persistent antibody response and suggest that vaccination can limit the excretion of the organism.<sup>30</sup> However, there is little economic incentive for a vaccination program involving livestock and livestock vaccines are not available in most countries.

Vaccination of humans has reduced infection rates in high risk groups and has been used in the appropriate circumstances in Australia.<sup>31</sup> As defined by recognized infections, personnel in research facilities that contain sheep are at greatest risk for

infection and management guidelines for the control of 'Q' fever in research facilities containing agricultural animals are available.<sup>32</sup>

### REVIEW LITERATURE

- Lang GH. Q fever: an emergency public health concern in Canada. *Can J Vet Res* 1989; 53:1-6.
- Marrie TJ. Q fever: A review. *Can Vet J* 1990; 31:555-563.
- Marrie TJ. Q Fever. Boca Raton, Florida: CRC Press, 1990.
- Woldehiwet Z. Q fever (coxiellosis): epidemiology and pathogenesis. *Res Vet Sci* 2004; 77:93-100.

### REFERENCES

1. Hikbink F, Penrose M. *Surveillance* 1993; 202:39.
2. Marrie TJ. *Can Vet J* 1990; 31:555.
3. Samuel JE et al. *Infect Immun* 1985; 49:775.
4. Salman MD et al. *Prev Vet Med* 1990; 9:143.
5. Literak I, Kroupa L. *Prev Vet Med* 1998; 33:261.
6. Wittenbrink MM et al. *Berl Munch Tierarztl Wschr* 1994; 107:185.
7. Capuano F et al. *Vet Rec* 2001; 149:669.
8. Lang G et al. *Can J Vet Res* 1991; 55:139.
9. Masala G et al. *Vet Microbiol* 2004; 99:301.
10. Dolce P et al. *Can J Infect Dis* 2003; 14:97.
11. Cetinkaya B et al. *Vet Rec* 2000; 146:131.
12. Lang G et al. *Can J Vet Res* 1991; 55:139.
13. Berri M et al. *Vet Microbiol* 2002; 85:55.
14. Hatchett et al. *Vector Borne Zoonot Dis* 2003; 3:11.
15. Bouvery NA et al. *Vet Res* 2003; 34:423.
16. Bildfell RJ et al. *J Vet Diag Invest* 2000; 12:419.
17. Sanford SE et al. *Can Vet J* 1994; 35:376.
18. Kruszewska D et al. *Res Vet Sci* 1997; 62:299.
19. Scott GH, Williams JC. *Ann NY Acad Sci* 1990; 590:291.
20. Boca OG, Paretsky D. *Microbiol Rev* 1983; 47:127.
21. Berri M et al. *Vet Rec* 2003; 153:269.
22. Febody RG et al. *CDR Rev* 1996; 69:R128.
23. Thomas DR et al. *Occupat Environ Med* 1995; 52:644.
24. McQuiston JH, Childs JE. *Vector Borne Zoonot Dis* 2002; 2:179.
25. Behmer D, Riemann HP. *J Am Vet Med Assoc* 1989; 194:764.
26. Hatchette T et al. *Can Vet J* 2002; 43:363.
27. Sting R et al. *Tierarztl Umsch* 2003; 58:518.
28. Woldehiwet Z. *Res Vet Sci* 2004; 77:93.
29. Muramatsu Y et al. *Appl Environ Microbiol* 1997; 63:2141.
30. Lang GH et al. *Can Vet J* 1994; 35:373.
31. Taylor R et al. *Commun Dis Intellig* 2001; 25:285.
32. Harrison RJ et al. *Ann NY Acad Sci* 1990; 590:283.

### BOVINE PETECHIAL FEVER (ONDIRI DISEASE)

Bovine petechial fever is associated with *Ehrlichia ondiri* and occurs in **Kenya**, and possibly **Tanzania**, in cattle grazing thick scrub land or indigenous forest areas at 1500-3000 m altitudes. Characteristically, disease occurs in cattle that break out from fenced pastures and graze the adjacent forest or bushland areas, or when they are grazed on these areas at the end of the dry season.<sup>1</sup>

Bovine petechial fever occurs in **cattle** that have been **recently introduced** to these areas and indigenous cattle appear to acquire resistance. Epidemics occur in cattle imported to infected areas, last

1–2 months to involve 60–80% of the group with significant losses. Dairy cattle have significant drop in milk yield which persists for several weeks.<sup>1</sup>

Infection can be **experimentally transmitted** to cattle, sheep, goats, wildebeest and impala but natural disease is seen only in cattle.<sup>1,2</sup> Bushbuck (*Tragelaphus scriptus*) are suspected as the reservoir for infection but the vector is not known although epidemiological findings suggest a tick vector of restricted distribution.<sup>3</sup>

The **disease in cattle** is characterized by high fever and the occurrence of petechial hemorrhages in mucous membranes for periods up to 10 days; epistaxis, melena, and hyphema occur in more severely affected animals. Pregnant animals may abort and there is a fall in milk production in lactating animals. Anemia may be severe enough to result in death 3–4 weeks after infection.<sup>1</sup> There is a profound lymphocytopenia by the second day of infection followed by leukopenia and thrombocytopenia. The organism is

demonstrable in granulocytes and monocytes during the febrile period but cannot be cultured.

Tetracyclines are effective in treatment. Recovered animals may be latently infected and are immune to reinfection for at least 2 years.

#### REFERENCES

1. Davies G. *Vet Microbiol* 1993; 34:103.
2. Snodgrass DR et al. *J Hyg Camb* 1975; 74:245.
3. Young AS. *Parasitologia* 1990; 32:41.

## Diseases associated with algae and fungi

**ALGAL DISEASES 1471**

Algal bacteremia 1471  
Protothecosis 1471

**FUNGAL DISEASES 1471**

Aspergillosis, candidiasis, zygomycosis, and malasseziosis 1471  
Aspergillosis in horses (*Aspergillus* spp.) 1474

Coccidioidomycosis 1475  
Histoplasmosis 1475  
Rhinosporidiosis 1475  
Cryptococcosis (European blastomycosis, torulosis) 1475  
North American blastomycosis 1476

**DERMATOMYCOSES 1476**

Ringworm 1476

Epizootic lymphangitis (pseudoglanders, equine blastomycosis, equine histoplasmosis) 1478

Sporotrichosis 1479  
Equine phycomycosis (swamp cancer, pithyosis, hyphomycosis destruens, Florida horse leech, bursattee) 1480  
Maduromycosis 1481  
Murcomycosis 1481

**Algal diseases****ALGAL BACTEREMIA**

Asymptomatic systemic infections and lymphadenitis associated with the alga *Prototheca zopfii* are extremely rare in cattle<sup>1</sup> and sheep. More common are mastitis and poisoning by algae.

**REFERENCE**

1. Taniyama H. et al. *Vet Pathol* 1994; 31:123.

**PROTOTHECOSIS**

Protothecosis is associated with a species of algae belonging to the genus *Prototheca*.<sup>1</sup> *Prototheca wickerhammi* and *P. zopfii* are the only species reported to be pathogenic for animals and man. Single cases have been reported in deer and cats, a few in dogs, and numerous cases in cattle. In cows, all infections have been restricted to the mammary glands and corresponding lymph nodes associated with a long-standing infection and chronic mastitis which is not curable with antimicrobials. One or more cows may be infected in the same herd. Details on mastitis associated with these algae are given in the chapter on Mastitis.

**REFERENCE**

1. Fier AC et al. *Med Mycol* 2000; 38 Suppl 1: 47.

**Fungal diseases**

Identifiable specific infectious mycoses are set out under separate headings below. Other miscellaneous mycotic diseases described in other chapters are:

- Pythiosis of nasal mucosal sites, associated with *Basidiobolus ranarum* and *Conidiobolus coronatus*
- Guttural pouch mycosis
- Rhinosporidiosis associated with *Rhinosporidium seeberi*, *Bipolaris* spp., or *Drechslera* spp. in cattle or *Conidiobolus incongruus* in sheep

- Bovine mastitis, usually a sequel to intramammary medication with a contaminated infusion, is a constant occurrence
- Fungi also appear in the lists of causes of many diseases associated with mixed infections such as neonatal septicemia, enterocolitis, endocarditis, pneumonia and lymph node abscessation.

**ASPERGILLOSIS, CANDIDIASIS, ZYGOMYCOSIS, AND MALASSEZIOSIS**

Mycoses including aspergillosis, candidiasis and zygomycosis in animals are usually sporadic infections and cause non-specific syndromes because of variation in the organs in which they localize.<sup>1</sup> Peracute, septicemic infections are very rare in adults, except in the occasional case in a parturient female, but are not infrequent in newborn calves and foals.<sup>2</sup>

**ETIOLOGY**

*Aspergillus* and *Candida* spp., and the zygomycetes *Absidia corymbifera*, *Rhizopus oryzae*, *Rhizomucor* (*Mucor*) *pusillus* and *Mortierella wolfii* are the common infections which cause systemic mycotic disease. Rare infections occur with *Scopulariopsis* spp. The infections most commonly recorded in bovine mycotic abortion are *Mucor*, *Aspergillus* spp., *Petriellidium* (*Allescheria*) *boydii*, *Candida parapsilosis* and *Mortierella wolfii*.

Yeasts of the genus *Malassezia* inhabit the skin of a variety of mammals and birds and are considered as opportunistic pathogens in animals and man.<sup>3</sup> In a survey of a sample of domestic animals in Spain, *Malassezia* spp. were isolated from 60% of horses, 28% of sheep, 44% of goats, and 58% of cows. The species isolated included: *M. sympodialis*, *M. globosa* and *M. restricta* from sheep. *M. pachydermatis*, *M. fufur*, *M. sympodialis*, *M. obtusa*, *M. globosa*, and *M. restricta* from goats and *M. furfur*,

*M. slooffiae*, *M. obtusa*, *M. globosa* and *M. restricta* from horses.<sup>3</sup>

Many different species of fungi have been isolated from the conjunctival sac horses, including *Aspergillus* spp., and other molds such as *Cladosporium*, *Mucor*, *Fusarium*, *Alternaria*, and *Candida* spp.<sup>4</sup>

**EPIDEMIOLOGY**

This is distinctive in fungal diseases; they are not contagious, with the exception of maternal infections which cause the disease in their calves.<sup>5</sup> Each infection arises from the fungal habitat as a saprophyte in organic matter, commonly moldy hay or straw or moist feeds such as beet pulp or brewers' grains which are allowed to go moldy. Risk factors thought to increase the prevalence of oral-gastric mycosis in young pigs and calves are continued and heavy oral dosing with antibiotics and feeding on poorly formulated or administered artificial diets. *Candida glabrata* may have been associated with fungal gastritis and ulcerative colitis in a foal treated with rifampin and spiramycin for rhodococcal bronchopneumonia.<sup>6</sup>

An outbreak of neurological disease in dairy cattle associated with consumption of beer residues contaminated with *Aspergillus clavatus* has been described in Brazil.<sup>7</sup> Beer residues from malting and brewing factories are widely used for dairy cattle feeding in southern Brazil. The affected farm had been feeding beer residues successfully for 15 years.

Fecal samples and intestinal contents of preweaned dairy calves contain yeasts, among which *Candida glabrata* is most common and may be associated with some cases of diarrhea.<sup>8</sup> Feeding calves their dam's milk reduced the shedding of the yeasts compared to commercial milk replacer.

The incidence of mycotic abortions is much greater (up to 30% of all abortions in the herd) in the winter months in housed cows than in any other group,

probably because they are exposed to an environment which is likely to be heavily contaminated with spores from moldy hay and ensilage. A correlation also occurs between the abortion rate and a high rainfall in the haymaking season prior to conception.

The increasing incidence of mycotic placentitis leading to abortion may be related to the general use of antibiotic-treated semen in artificial insemination programs but the incidence is no higher in artificially bred cows than in those mated naturally. It is more likely that a transient systemic infection is followed by localization in the pregnant uterus causing placentitis and abortion. In humans there is an increasing prevalence of systemic mycoses because of the increasing frequency of immunodeficiency states, but prolonged and intensive antibiotic therapy is a commoner precursor in farm animals, especially in aspergillosis.

Microbiological investigations of the guttural pouch of horses affected with mycotic infections have frequently demonstrated the presence of several different *Aspergillus* spp.<sup>9</sup> *Candida krusei* has been isolated from a case of bronchopneumonia in one-year old heifer which was incurable and had to be euthanized.<sup>10</sup>

Fungal keratitis (keratomycosis) in horses has been regarded as rare but now account for about 30% of horses diagnosed with keratitis.<sup>4</sup> In the northern hemisphere the disease is more common in the summer and autumn, possibly because climatic and environmental factors favor the proliferation of fungal spores.

Human zygomycosis has been on the increase, and this trend is expected to continue due to increases in the number of immunocompromised hosts. The literature on the animal models of *Zygomycosis-Absidia*, *Rhizopus*, *Rhizomucor*, and *Cunninghamella* has been reviewed.<sup>11</sup> Zygomycetes are filamentous fungi which are natural inhabitants of soil and fairly common in the environment. They comprise Mucorales and Entomophthorales.

Mucormycosis due to *Absidia corymbifera* has been described occurring in ponies and 4 of 15 animals died within a few days of onset.<sup>13</sup>

## PATHOGENESIS

Although inhalation of dust containing fungal elements is an obvious portal of entry for the fungi, with a primary focus developing in a lung, it is generally believed that the more common portal is in the alimentary tract, where the mycosis establishes in a pre-existing abomasal or gastric ulcer or is established in the normal lining of the forestomachs, abomasum and intestines. Hematogenous

spread from these foci occurs to all organs, especially splanchnic lymph nodes, liver, lungs and the placenta in pregnant females. Only the placenta is invaded and subsequent fertility is not impaired. Infection of the placenta and uterus can be established by intravenous injection during pregnancy but not by of the injected animals develop placentitis and granulomas in the liver and lungs, and this proportion can be increased by increasing the dose of spores injected.

In **keratomycosis** in horses, traumatic injury to the cornea by plant material, the prolonged use of topical antibiotics may cause a shift in the normal conjunctival flora from Gram-positive to Gram-negative organisms, and the use of topical corticosteroids can all contribute to fungal growth.<sup>4</sup> In temperate climates keratomycosis is normally a chronic disease associated with ocular trauma. Small corneal ulcers may heal, trapping the organisms deep within the stroma, and result in the development of a stromal abscess. Large stromal ulcers may fail to heal and be slowly progressive, and the corneal stroma may melt. Various categories of stromal ulcers occur including: superficial fungal keratitis (punctate lesions of the epithelium and sub-epithelium stroma); keratomycosis with a surrounding furrow; keratomycosis with a 'cake frosting' appearance; and stromal abscess.<sup>4</sup>

Neurological disease in cattle associated with the consumption of beer residues contaminated with *Aspergillus clavatus* is due to the neuromycotoxicosis effect of the mycotoxins of the fungi.<sup>7</sup> Additional information is available in the chapter dealing with mycotoxicoses.

## CLINICAL FINDINGS

### Pneumonia

Mycotic pneumonia is uncommon in farm animals but occasional cases or outbreaks occur in all species, sometimes with generalization. A high prevalence can be expected in calves and lambs kept indoors in intensive housing units. The pneumonia may be chronic, subacute or acute – a fibrinous pneumonia of very short duration. All forms are fatal and are characterized by mouth-breathing dyspnea, profuse salivation and a mucopurulent nasal discharge and accompanying crusting and erosion. Vesication or ulceration of the muzzle, profuse lacrimal discharge without any apparent eye lesion, abnormal lung sounds and fever are seen and all signs do not improve with antibiotic therapy.

In some cases of mycotic pneumonia in cow associated with *Moreierella wolfii* death occurs within 24 hours after clinical signs of inappetence and lethargy.<sup>13</sup>

Mucormycosis in ponies has been characterized by sudden death, diarrhea, fever, and circling and convulsions. Large ulcers may develop in some cases on the muzzle, nostrils and lips, and on the knees and hocks. Skin lesions consist of erythematous indurated areas with a central area of necrosis.<sup>12</sup>

### Encephalopathy

An outbreak of encephalopathy has been described in dairy cattle fed beer residue contaminated with *Aspergillus clavatus*.<sup>8</sup> Clinically affected cattle by flaccid paralysis and gait abnormalities. Clinical signs were more pronounced after exercise and included stiff and unsteady gait, knuckling of the fetlocks of the hindlimbs, frequent falling, inability to rise, muscular tremors especially of the head and hind-quarters, and drooling. The clinical course varied from 2 days to 2 weeks; most animals died or were euthanized; the population mortality rate of herd was 15%. New cases stopped after the feeding of beer residue was discontinued.

Rhinocerebral zygomycosis has been recorded in a sheep.<sup>14</sup>

### Guttural pouch disease of horses

Guttural pouch disease affects mature horses but it may occur in animals as young as 6 to 12 months of age. The most common clinical findings are mucopurulent nasal discharge (unilateral or bilateral), dysphagia, Horner's syndrome, laryngeal hemiplegia or atrophy of the tongue. The diagnosis is made with endoscopy and biopsies may be taken for histological examination and fungal culture.

### Keratomycosis in horses

Fungal keratitis is normally very painful with marked corneal change accompanied by a severe uveitis, blepharospasm, photophobia and lacrimation.<sup>4</sup> There is corneal ulceration with a 'cake frosting' appearance, ulceration with or without furrowing, or stromal abscessation. The duration is commonly several weeks even with treatment. The differential diagnosis of infectious ulcerative keratitis includes: recurrent uveitis, bacterial or viral ulcerative keratitis, stromal abscesses associated with fungi or bacteria.<sup>4</sup>

### Pharyngitis/gastroenteritis

Mycotic pharyngitis and gastroenteritis in pigs and calves results in diarrhea, and, in pigs, vomiting. There is commonly a white pseudomembrane at the back of the pharynx and extending down the esophagus to the stomach. Cases of mycotic omasitis, rumenitis and enteritis in adult ruminants show anorexia, fever and diarrhea. Mycotic rumenitis secondary to carbohydrate engorgement is a separate issue dealt with elsewhere.

## Abortion

Fungal placentitis resulting in abortion occurs in cows usually at months 6–8 of their pregnancy. Placental lesions are described below and hyphae can be seen on examination of direct smears of the cotyledon or the fetal stomach, preferably the former. A dermatomycosis occurs rarely in the aborted fetal calves, with discrete patches of alopecia, and a raised, grayish, felted covering occurring all over the body. Congenital infection may also occur, granulomatous lesions containing the fungus may be found in the lungs of day-old lambs.

## Mammary aspergillosis

Aspergillar mastitis, associated with *Aspergillus fumigatus*, occurs in ewes causing a severe infection resulting in destruction of the infected mammary tissue<sup>15</sup>

## Other manifestations

- **Preputial catarrh** accompanied by slowness of service and masturbation has been associated with infection in bulls by an *Absidia* sp. fungus thought to be transmitted at coitus
- **Dermatitis** associated with *Candida* spp. can occur in pigs kept in a damp environment
- **Cutaneous mycotic granulomata**, causing lesions similar to those of cutaneous tuberculosis, occurs rarely in cattle
- **Intramammary *Aspergillus fumigatus*** infection in dairy ewes has been associated with antibiotic dry therapy.<sup>16</sup> Severe debilitating mastitis was observed and it contamination of the teat ends at the time of administration of the antibiotic was suspected.

## CLINICAL PATHOLOGY

Sophisticated laboratory techniques are now available to diagnose systemic mycosis and to identify the pathogen. These include immunostaining of tissues<sup>17</sup> and serological methods.<sup>18</sup> All of the following techniques have been used but there is no clearly defined, superior set of tests:

- Polymerase chain reaction
- Murine monoclonal and rabbit polyclonal antibodies in histochemistry
- Immunoblotting
- ELISA of antibodies in serology.

In ewes with Aspergillar mastitis, the detection of antibody by ELISA in sera is a reliable method for the diagnosis.<sup>15</sup>

In mycotic pneumonia, radiodense areas in the lung, representing typical granulomata, are characteristic and transtracheal washes contain many fungal bodies.

In keratomycosis in horses, samples must be taken from the lesions and submitted for culture of fungi on Sabouraud's agar.<sup>4</sup> Deep corneal biopsies may be necessary to confirm the diagnosis.

## NECROPSY FINDINGS

### Alimentary tract

Lesions in pigs are edema, hemorrhage, and ulceration of the gastric (or abomasal in the case of calves), intestinal and sometimes the esophageal mucosa. Lesions of the forestomachs in adult ruminants include acute hemorrhagic mucosal necrosis.

### Encephalopathy and myopathy

In cattle affected with *Aspergillus clavatus* in beer residue, gross lesions consisted of degeneration and necrosis of large muscle groups of the hindquarters. Histologically, there was degeneration and necrotic neuronal changes in the brainstem and neurons of the ventral horns of the spinal cord.<sup>7</sup>

### Respiratory tract

Lesions include severe fibrinous pneumonia in very acute cases, and multiple discrete granulomata, often appearing as small abscesses, often with necrotic centers giving a superficial resemblance to tuberculosis in the lungs. In lambs the granulomata appear as very small nodules (1–3 mm diameter) and resemble those associated with infestation with *Muellerius capillaris*.

In mycotic pneumonia in a cow associated with *Mortierella wolffii*, the lung was firm, dark red, had bilateral adhesions between the caudal aspects of the lungs and the diaphragm. Histologically, there is severe acute fibrinous bronchopneumonia with multifocal necrosis. Large numbers of non-septate, non-dichotomous, irregular branching hyphae are present in the alveoli.<sup>13</sup>

### Lymph node granulomata

These are a common finding, often in normal animals on the slaughter floor and are seen in the mesenteric, mediastinal and submandibular lymph nodes. These are of importance in the differential diagnosis of tuberculosis.

### Reproductive tract

Placentitis characterized by necrosis of the maternal cotyledons, the adherent necrotic material giving the placental cotyledon the appearance of a soft, yellow, cushion-like structure, and small yellow, raised leathery lesions on the intercotyledonary areas are diagnostic. Corresponding lesions occur on the endometrium, and ringworm-like lesions occur on the fetal skin. Hyphae can be seen on examination of direct smears of cotyledons, fetal stomach and skin. If mycotic abortion is suspected the pla-

cental cotyledons offer the best source of material. Every effort should be made to obtain the entire placenta as the infection may be patchy and involve only a few cotyledons. The fungi can be cultured on suitable media.

## Equine mucormycosis

Systemic mucormycosis in a horse due to *Absidia corymbifera* has been described.<sup>12</sup> Pulmonary congestion, pleural hemorrhages and a brain infarct were present.

## TREATMENT

Treatment of systemic mycoses has been largely by amphotericin and nystatin but the newer azole compounds (enilconazole, fluconazole, itraconazole, ketoconazole) administered orally appear to be highly effective and easy to administer. Any attempt at control of systemic fungal infections is disadvantaged by the lack of a reliable typing system for the causative fungi.

The treatment of keratomycosis in horses is a special topic and the reader should consult the literature in veterinary ophthalmology. Treatment consists of topical antifungal agents, systemic non-steroidal anti-inflammatory agents to control ocular pain, the placement of a lavage system for the regular administration of drugs into the eye, and a consideration of keratectomy and conjunctival graft as necessary.<sup>4</sup>

## REVIEW LITERATURE

- Derepentigny L et al. Immunodiagnosis of invasive fungal infections. *J Med Vet Mycol* 1994; 32 Suppl 1:239–252.
- Jensen HE et al. Gastrointestinal aspergillosis and zygomycosis of cattle. *Vet Pathol* 1994; 31:28.
- Pitt JI. The current role of *Aspergillus* and *Penicillium* in human and animal health. *J Med Vet Mycol* 1994; 32 Suppl 1:17–32.
- Richard JL et al. Advances in veterinary mycology. *J Med Vet Mycol* 1994; 32 Suppl 1:169–187.
- Hill PB et al. A review of systemic fungal agents. *Vet Dermatol* 1995; 6:59–66.
- Kamei K. Animal models of *Zygomycosis-Absidia*, *Rhizopus*, *Rhizomucor* and *Cunninghamella*. *Mycopathologica* 2000; 152:5–13.
- Pier AC et al. Prominent animal mycoses from various regions of the world. *Med Mycol* 2000; 38 Suppl 1:47–58.

## REFERENCES

1. Jensen HE et al. *Vet Med Ser B* 1993; 40:55.
2. Reilly LK, Palmer JE. *J Am Vet Med Assoc* 1994; 205:464.
3. Crespo MJ et al. *Mycoses* 2002; 45:333.
4. Sansom J et al. *Vet Rec* 2005; 156:13.
5. Sarfati J et al. *J Med Vet Mycol* 1996; 34:379.
6. De Bruun CM, Wunberg ID. *Vet Rec* 2004; 155:26.
7. Loretto AP et al. *J Vet Diagn Invest* 2003; 15:123.
8. Elad D et al. *Vet J* 2002; 164:275.
9. Lepage OM et al. *Vet J* 2004; 168:60.
10. Kano R et al. *Vet Rec* 2001; 148:636.
11. Kamei K et al. *Mycopathologica* 2000; 152:5.
12. Guillot J et al. *Equine Vet J* 2000; 32:453.
13. Gabor LJ. *Aust Vet J* 2003; 81:409.
14. Morris M et al. *Can Vet J* 2001; 42:227.
15. Garcia ME et al. *Vet Microbiol* 2004; 98:17.
16. Las Heras A et al. *Vet Rec* 2000; 147:578.

17. Jensen HE et al. *Vet Pathol* 1994; 31:28.  
 18. Jensen HE et al. *J Comp Pathol* 1994; 110:65.

### ASPERGILLOSIS IN HORSES (*ASPERGILLUS* SPP.)

Diseases of horses associated with infection with *Aspergillus* spp. are characterized by either localized infections with slow progression or fulminant systemic or pulmonary disease. Localized infections are of the nasal cavities and paranasal sinuses, eye, reproductive tract including placenta, mediastinum, or guttural pouch. Systemic disease can affect any organ, including brain, liver and kidney, but the most common manifestation is as acute pulmonary disease with or without infection of other tissues.

The causative organism is *Aspergillus* spp. usually *A. fumigatus* but occasionally one of *A. flavus*, *A. deflexus*, *A. nidulans*, *A. niger* or *A. clavulatus*.<sup>1</sup> *Aspergilli* reproduce both sexually and asexually and hence are classified as dimorphic fungi. Asexual reproduction is by production of conidiophores and conidia. The organism is ubiquitous in organic material and infections are opportunistic and associated with heavy contamination with the organism or decreased host defenses, although obvious risk factors are not always identified. Because its ubiquitous, the organism is often recovered from tracheal aspirates performed using contaminated equipment in horses with mild signs suggestive of non-infectious respiratory disease, such as heaves. In this instance recovery of the organism is of no clinical importance.

Risk factors for development of aspergillosis include heavy contamination with conidia, and decreased host resistance, such as in horses with immune suppression associated with myeloproliferative disease (lymphoma), enterocolitis, and administration of immunosuppressive drugs such as corticosteroids.<sup>2-4</sup> Specific risk factors for guttural pouch mycosis and infections of the nasal cavity or paranasal sinuses have not been identified with the exception of an association between surgical resection of ethmoidal hematoma and subsequent nasal aspergillosis.<sup>5</sup> Keratomycosis associated with *Aspergillus* spp. is usually secondary to other ocular lesions, or ocular instillation of immunosuppressant drugs. The ocular disease can also occur in horses housed in barns with heavy contamination with *Aspergillus* spp. Systemic or pulmonary aspergillosis is commonly associated with enterocolitis or administration of immunosuppressive drugs in adult horses.<sup>2,6</sup>

*Aspergillus* spp. causes both localized and systemic disease in horses. Localized diseases include **guttural pouch my-**

**cosis**, which is discussed in detail elsewhere in this text. Fungal granulomas in the **paranasal sinuses** or **nasal passages** of horses are caused by a number of organisms, including *Cryptococcus neoformans*, and rarely by *Aspergillus* spp.<sup>7,8</sup> The disease is evident as nasal discharge that is usually unilateral, distortion of the contour of the head over the affected sinus, and lesions detectable on endoscopic examination of the nasal passages. Radiography can reveal the presence of a mass in the paranasal sinuses or nasal cavity associated with lysis and proliferation of bone. There is hyperfibrinogenemia and leukocytosis.

**Keratomycosis** due to *Aspergillus* spp. infection is infrequent in horses. The disease is characterized by blepharospasm, photophobia, epiphora, and corneal ulceration and opacity. *Aspergillus* spp. infections of the reproductive tract include mycotic **placentitis** and abortion and mycotic **endometritis**.<sup>9</sup>

**Systemic aspergillosis**, including **aspergillus pneumonia**, is a severe disease usually evident as acute death without localizing signs in horses with other preexisting systemic disease, such as enterocolitis, or those receiving immunosuppressive drugs.<sup>6,9</sup> Horses with aspergillus pneumonia often have a very brief clinical course once signs of respiratory disease develop. Most commonly, horses with pulmonary aspergillosis die without signs of respiratory disease. Signs of pulmonary aspergillosis include fever, tachypnea, crackles and wheezes on thoracic auscultation, epistaxis, and frothy nasal discharge. Radiography reveals diffuse, miliary, nodule interstitial pneumonia. Ultrasonographic examination demonstrates numerous small intrapulmonary masses adjacent to the pleural surface. Affected horses have hyperfibrinogenemia and leukocytosis at the time of development of the disease, but usually have had neutropenia as a result of the enterocolitis. *Aspergillus* spp. can be isolated from tracheal aspirates of affected horses. The prognosis is very poor.

**Disseminated aspergillosis** has a variety of manifestations but is always a severe disease with a brief clinical course. Affected horses often have severe depression and can have signs of brain disease as a result of mycotic vasculitis and encephalitis.<sup>11</sup> The prognosis is very poor.

*Aspergillus* spp. is also associated with development of granulomas in the **mediastinum** of horses without apparent predisposing factors.<sup>12-14</sup> Affected horses have progressively worsening respiratory distress, cough, fever, and occasional nasal discharge. Horner's syndrome can develop if the mass encroaches on the

vagosympathetic trunk within the thorax.<sup>14</sup> The mass is evident on radiographic examination of the thorax. Cultures of tracheal aspirates yields *Aspergillus* spp. Affected horses have neutrophilia, hyperfibrinogenemia, hyperglobulinemia and mild anemia.

Definitive diagnosis of the disease is based on demonstration of organisms within lesions, either by histologic examination or by culture, and by demonstration of high titers in serum of antibodies specific for *Aspergillus* spp. Antemortem demonstration of high concentrations of antibodies to *Aspergillus* spp. provides persuasive, but not definitive, evidence of infection. Both agar gel immunodiffusion assays and ELISA assays are available. These assays might not be useful in immunocompromised animals or in those with fulminant disease.

Acute lesions are characterized by purulent, necrotizing inflammation.<sup>1,2</sup> Chronic lesions are granulomas that contain macrophages, neutrophils and giant cells.<sup>1</sup> Pulmonary lesions are characterized by an acute necrohemorrhagic alveolitis.<sup>2</sup> Organisms morphologically consistent with *Aspergillus* spp. are detected in the lesions as fungal hyphae, although these must be differentiated from *Pseudoallescheria boydii* or *Fusarium* spp.<sup>1</sup> Reagents for immunofluorescent detection of *Aspergillus* spp. in lesions are available and useful in confirming the diagnosis.<sup>1</sup>

**Treatment** of systemic or pulmonary disease is usually unrewarding. Localized disease can be treated by surgical resection and administration of antifungal agents. Antifungal agents reported to be effective in treatment of localized disease associated with *Aspergillus* spp. include itraconazole (3 mg/kg q 12 h, PO for 3-5 months).<sup>8</sup> Topical treatment with enilconazole (10 mg/mL of solution) after surgical resection resulted in resolution of aspergillosis of the frontal sinus of a horse.<sup>7</sup> Topical administration of natamycin (25 mg) was used for varying periods of time to treat mycotic rhinitis in three horses.<sup>5</sup>

Amphotericin is likely effective against *Aspergillus* spp. and is cheaper than the azole class of drugs, but is potentially nephrotoxic and must be administered intravenously. Fluconazole is not effective against the filamentous fungi, including *Aspergillus* spp.

There are no specific control measures or means of preventing disease associated with *Aspergillus* spp.

### REVIEW LITERATURE

- Bloome E et al. Aspergillosis in horses: a review. *Equine Vet Educ* 1998; 10:86.

## REFERENCES

1. Bloome E et al. *Equine Vet Educ* 1998; 10:86.
2. Slocombe RF et al. *Vet Pathol* 1988; 25:277.
3. Blue J et al. *J Am Vet Med Assoc* 1987; 190:1562.
4. Buechner-Maxwell V et al. *J Vet Int Med* 1994; 8:258.
5. Greet TC. *Vet Rec* 1981; 109:487.
6. Sweeney CR, Habecker PL. *J Am Vet Med Assoc* 1999; 214:808.
7. Des Lions JA et al. *Equine Vet Educ* 2000; 12:248.
8. Korenek NL et al. *J Vet Int Med* 1994; 8:224.
9. Hong CB et al. *J Vet Diagn Invest* 1993; 5:56.
10. Johnson PJ et al. *Vet Rec* 1999; 145:16.
11. Tunev SS et al. *Vet Pathol* 1999; 36:347.
12. Moore BR et al. *Cornell Vet* 1993; 83:97.
13. Schar DL et al. *J Am Vet Med Assoc* 2004; 224:1757.
14. Firshman AM et al. *Equine Vet Educ* 2003; 15:82.

## COCCIDIOIDOMYCOSIS

### ETIOLOGY

*Coccidioides immitis* is associated with the disease in all species including humans.

### EPIDEMIOLOGY

Coccidioidomycosis is a comparatively benign disease of farm animals, usually causing no apparent illness.<sup>1</sup> Sporadic cases are recorded in all species but are most common in dogs and in cattle and to a much less extent in pigs, sheep, and horses. Pulmonary coccidioidomycosis has been described in a 13-day-old foal.<sup>2</sup>

The disease is enzootic in the southwestern United States and up to 20% of cattle finished in feedlots in the area may harbor the fungus. The incidence of the disease in humans in the area provides a major problem in public health. It is not contagious, infection occurring by inhalation of spores of the fungus which grows in the soil, and possibly by ingestion and through cutaneous abrasions.

### CLINICAL FINDINGS

In horses<sup>3</sup> findings include weight loss up to severe emaciation, a fluctuating temperature, persistent cough, muscle pain, and superficial abscesses, often recurring, and most commonly in the pectoral area. Increased lung sounds, wheezing, and dullness are audible over the ventral chest. Other signs include edema of the legs, anemia and intermittent colic due to internal abscesses and peritoneal adhesions. Liver rupture may cause death. Affected sheep show fever and abscesses in peripheral lymph nodes.

### CLINICAL PATHOLOGY

A leukocytosis is usual. An extract of the fungus, coccidioidin, has been used in an intradermal sensitivity test, and complement fixation and immunodiffusion tests are used diagnostically in humans.

### NECROPSY FINDINGS

The lesions produced in cattle and pigs are granulomatous, contain a cream-

colored pus, and are sometimes calcified and are found in the bronchial, mediastinal and rarely the mesenteric, pharyngeal and submaxillary lymph nodes and in the lungs. In a neonatal foal, the lungs were diffusely infiltrated with a miliary pattern of multiple, coalescing, pale tan to red, irregularly shaped, slightly raised, firm foci, 0.1 to 0.5 cm in diameter.<sup>2</sup>

### DIFFERENTIAL DIAGNOSIS

Microscopic or cultural examination may be used to identify the disease. Isolation of the organism is preferred as evidence because of the non-specificity of coccidioidin.

#### Differential diagnosis list:

- Cattle and pigs – tuberculosis
- Sheep and goats – caseous lymphadenitis.

### TREATMENT

No effective treatment is available. Because infection occurs by the inhalation of soil-borne spores, control of dust in feedlots may help to prevent the spread of the disease. Dust control is a major factor in prevention of human coccidioidomycosis because there is no vaccine or effective therapeutic agent available and the eradication of *C. immitis* from the soil is not practicable.

### REFERENCES

1. Pier AC. *Medical Mycol* 2000; 38 Suppl 1:47.
2. Maleski K et al. *Vet Rec* 2002; 151:505.
3. Ziemer EL et al. *J Am Vet Med Assoc* 1992; 201:910.

## HISTOPLASMOSIS

Histoplasmosis, associated with infection with *Histoplasma capsulatum*, is a rare systemic mycosis in farm animals, with a high prevalence in specific geographic localities, e.g. the Mississippi river system. Cases have been recorded in horses, cattle and pigs. The fungus is able to survive for periods as long as 4 months in soil and water. Infection occurs by the inhalation of contaminated dust, and primary invasion usually takes place in the lung. The disease may spread from animals to humans. Attempts at experimental infection in cattle, sheep, horses and pigs have resulted in non-fatal infections, unless the agent is given intravenously, but the test animals become positive to the histoplasmin cutaneous sensitivity test.

Clinical syndromes vary greatly and include pneumonia, with dyspnea and nasal discharge, hepatic insufficiency with jaundice and anasarca, placentitis with abortion, and widespread lesions in neonates, especially foals.<sup>1</sup> As a diagnostic aid for herd or area the histoplasmin skin test appears to be satisfactory. Keratitis

due to *Histoplasma* spp. has been described.<sup>2</sup> Histoplasmosis may be secondary to Yersiniosis in the horse.<sup>3</sup>

Necropsy lesions are as variable as the clinical syndrome and include gross hepatic enlargement containing necrotic foci, pulmonary consolidation and granulomatous pneumonia, and enlargement of splanchnic lymph nodes. Aggregation of the fungal bodies in lymphoid tissue and other tissues in which large numbers of phagocytes are in residence is characteristic of the disease; the lesions consist of groups of macrophages packed with fungal cells.

The disease associated with infection with *H. farciminosum* is dealt with under the heading of epizootic lymphangitis.

### REFERENCES

1. Rezaback GB et al. *J Comp Path* 1993; 109:47.
2. Richter M et al. *Vet Ophthal* 2003; 6:99.
3. Katayama Y et al. *J Vet Med Sci* 2001; 63:1229.

## RHINOSPORIDIOSIS

Rhinopsporidiosis is a chronic disease of the nasal mucosa in cattle and horses causing formation of large polyps in the posterior nares and interference with respiration. The causative fungus, *Rhinopsporidium seeberi*, can be found in large sporangia in the polyps.

A related condition in cattle also thought to be caused by an unidentified fungus, similar to *Rhinopsporidium* spp., is nasal granuloma, in which the lesions are small (0.5–2.0 cm diameter) mucosal nodules in the anterior third of the nasal cavity. Histologically there is a marked eosinophilic reaction and yeast-like bodies are present in cells or free in the tissue spaces. Clinical signs include severe dyspnea with loud stertor and a mucopurulent or blood-stained nasal discharge. A high incidence of the disease may occur on some farms and in particular areas.

Other diseases with similar clinical profiles include nasal obstruction associated with the blood fluke, *Schistosoma nasalis* and chronic allergic rhinitis.

## CRYPTOCOCCOSIS (EUROPEAN BLASTOMYCOSIS, TORULOSIS)

Infection with the yeast *Cryptococcus neoformans* occurs in most species, either as a generalized disease or as a granulomatous meningoencephalitis. Nervous system involvement is manifested by stiffness, hyperesthesia, blindness or incoordination. Systemic involvement includes cases of myxomatous lesions of nasal mucosa, pulmonary abscess or pneumonia, jejunal granuloma, lymphadenitis, placentitis with abortion and



systemic involvement in the fetus. *C. neoformans* is listed as a cause of bovine mastitis. In human medicine an accurate serological test is used in diagnosis.

## NORTH AMERICAN BLASTOMYCOSIS

The fungus associated with this important zoonosis is *Blastomyces dermatitidis*. It is relatively common in dogs but appears to have been recorded only once in large animals causing perineal abscessation, emaciation and death in a horse. In humans and dogs the characteristic lesions are cutaneous or pulmonary granulomata.

## Dermatomycoses

### RINGWORM

#### Synopsis

Invasion of cutaneous keratinized epithelial cells and hair fibers by dermatophytes.

**Etiology** *Trichophyton*, *Microsporum* spp. fungi

**Epidemiology** Carrier animals are the source; spread is via direct contact or contact with infected inanimate objects. Housed animals most susceptible

**Clinical signs** Circumscribed areas of hairless skin, thick gray crumbly crusts (cattle), or shiny, bald areas (horse), heavy pityriasis; common locations where infection likely to contact e.g. neck, sides

**Clinical pathology** Spores and mycelia in skin scraping, or in culture

**Necropsy lesions** Mycelia identifiable in skin sections

**Diagnostic confirmation** Lab typing of fungus in scraping or tissue

**Treatment** Spontaneous recovery usual. Topical fungistat, systemic griseofulvin, parenteral iodide all used. Vaccination widely used in European countries. and supportive treatment

#### ETIOLOGY

The listed associated fungi which grow on the hair, skin or both are:

- **Horse:** *Trichophyton equinum*, *Tr. quinckeanum*, *Tr. mentagrophytes*, *Tr. verrucosum*, *Microsporum equinum*, *M. gypseum*
- **Donkey:** *Tr. mentagrophytes*, *Tr. verrucosum*
- **Cattle:** *Tr. verrucosum*, *Tr. mentagrophytes*, *Tr. megninii*, *Tr. verrucosum* var. *album*, *Tr. verrucosum* var. *discooides*
- **Pig:** *Tr. mentagrophytes*, *Tr. rubrum*, *Tr. verrucosum* var. *discooides*, *M. canis*, *M. nanum*
- **Sheep:** *Tr. verrucosum* var. *ochraceum*, *Tr. quinckeanum*, *Tr. mentagrophytes*,

*Tr. gypseum* ('club lamb fungus' in show lambs in the US), *M. canis*

- **Goat:** *Tr. verrucosum*.

Uncommon dermatophytes also found in skin lesions in farm animals and horses are: *M. gypseum* and *Keratinomyces allejo* in horses; *Scopulariopsis brevicaulis* in cattle; *M. nanum* in adult pigs, in which it is most common, and in which the lesions are often so mild as to go unnoticed by the farmer; *Alternaria alternata* in horses, goats, pigs, sheep and cattle.

A rare but similar disease is tinea versicolor, a fungal dermatomycosis associated with *Malassezia furfur* (syn. *Pityrosporum orbiculare*) on the teats of goats. The lesions are circular, discrete, slightly thickened and scaly at the edges but not painful. They are characterized by an alteration in the color of the surrounding skin, either darker or lighter. The infection persists on a patient for at least a year and in a flock for a longer period. Hyphae are distinguishable in sections of the lesions.

#### EPIDEMIOLOGY

##### Occurrence, source of infection and transmission

Ringworm occurs in all animal species in all countries but more commonly where animals are accommodated in dense groups, especially indoors.

Direct contact with infected animals is the common method of spread of ringworm, but indirect contact with inanimate objects, particularly bedding, harness, grooming kits and horse blankets, is probably more important. Spores can exist on the skin without causing lesions, and up to 20% of normal animals in an infected group will act as 'carrier animals'. Premises and harness may remain infective for long periods because fungal spores remain viable for years provided they are kept dry and cool. Moderate heat and desiccation destroy them.

A dermatophytosis in lambs in the United States, called 'club lamb fungus' affects lambs during lamb show season.<sup>1</sup> Approximately one-third of families reported children or owners involved in showing these lambs developed skin lesions consistent with dermatophytosis.

Ringworm in yearling horses can interfere with training causing economic losses because of the isolation required to prevent spread of infection to other horses and humans and to decrease environmental contamination.<sup>2</sup>

##### Risk factors

Pathogen factors

*M. gypseum*, *K. allejo* and *M. nanum* are soil saprophytes and the reasons for their assumption of pathogenicity are not understood.

##### Environment and host factors

A high incidence of clinical cases in the winter and of spontaneous recovery in the spring is common, but outbreaks also occur during the summer months, so that close confinement and possibly nutrition seem to be more important in the spread of the disease than other environmental factors such as temperature and sunlight. Humidity is known to be important, a high humidity being conducive to multiplication of the fungus. In calf-rearing and vealing units the prevalence is greater in units which continuously add or remove calves from the stock; an 'all-in all-out' program is less conducive to spread of the disease.

Animal susceptibility is determined largely by immunological status, so that young animals are most susceptible.

##### Zoonotic considerations and economic importance

Spread between species occurs readily and in rural areas 80% of human ringworm may derive from animals. *Trichophyton* spp. infections are commonly contracted from horses and cattle and *M. canis* infections from dogs. Ringworm of animal origin affects adult humans as well as children and diagnosis and treatment are often very difficult. Between 1962 and 1994, 32 isolates of *Trichophyton verrucosum* from cases tinea corporis, tinea faciei and tinea captis were identified in Victoria, Australia.<sup>3</sup> Infected patients were mainly from rural areas and frequently had a history of contact with cattle. Isolates included those from dairy and beef cattle farmers, children who lived on dairy or cattle farms or in a dairy farming area, a slaughterhouse employee and a veterinarian.

Injury to affected animals is of a minor nature but sufficient damage to hides occurs to warrant some attempt at control of the disease.

##### PATHOGENESIS

Ringworm fungi chiefly attack keratinized tissues, particularly the stratum corneum and hair fibers, resulting in autolysis of the fiber structure, breaking off of the hair, and alopecia. Exudation from invaded epithelial layers, epithelial debris and fungal hyphae produce the dry crusts which are characteristic of the disease. The lesions progress if suitable environmental conditions for mycelial growth exist, including a warm humid atmosphere, and a slightly alkaline pH of the skin. Ringworm fungi are all strict aerobes and the fungi die out under the crust in the center of most lesions, leaving only the periphery active. It is this mode of growth which produces the centrifugal progression and the characteristic ring form of the lesions.

The significance of skin pH in the development of ringworm is widely known. The susceptibility of humans to ringworm infection is much greater before puberty than afterwards when the skin pH falls from about 6.5 to about 4.0. This change is largely due to excretion of fatty acids in the sebum and these fatty acids are often highly fungistatic. Calves are more commonly infected than adult cattle but whether this is due to increased susceptibility in calves or the development of immunity in adults has not been determined.

There is some experimental evidence that traumatic injury of the skin is an important factor for the development of ringworm lesions in calves.<sup>4</sup> Different numbers of microconidia of *Trichophyton verrucosum* are required to induce ringworm depending on the degree of shearing of the hair and scarification of the skin.

Secondary bacterial invasion of hair follicles is common. The period after experimental infection before distinct lesions appear is about 4 weeks in calves, but considerably less in horses. Spontaneous recovery occurs in calves in 2–4 months, the duration and severity of the disease often depending upon the nutritional status of the host. A resistance to reinfection occurs after recovery from experimental or natural infection even though a local mycotic dermatitis may occur at the reinfection site. The immunity is specific to the fungal species concerned, and in horses lasts up to 2 years.

## CLINICAL FINDINGS

### Cattle

The typical lesion is a heavy, gray-white crust raised perceptibly above the skin. The lesions are roughly circular and about 3 cm in diameter. In the early stages the surface below the crust is moist, in older lesions the scab becomes detached and pityriasis and alopecia may be the only obvious abnormalities. Lesions are most commonly found on the neck, head and perineum but a general distribution over the entire body may occur, particularly in calves, and in severe cases the lesions may coalesce. Itching does not occur and secondary acne is unusual.

### Horses

The lesions may be superficial or deep. Superficial infections are more common. Lesions due to *Tr. equinum* commence as round patches of raised hair and soreness of the lesions to touch. This stage is followed about 7 days later by matting of the hair, which becomes detached leaving a bald, gray, shining area about 3 cm in diameter. Fine scabs appear and recovery with regrowth of hair commences in 25–30 days. Heavier scabs and

larger lesions are usually due to rubbing by harness. Lesions associated with *M. gypseum* are smaller, about 10 mm in diameter, and are manifested either by the development of thick crusts, or more generally a diffuse moth-eaten appearance with desquamation and alopecia. Less commonly, deeper structures are infected through the hair follicles, causing small foci of inflammation and suppuration. A small scab forms over the follicle and the hair is lost but extensive alopecia and crust formation do not occur. Some irritation and itching may be caused by this type. The distribution of lesions in the horse differs from that in cows, lesions usually appearing first on the axillary girth area and spreading generally over the trunk and over the rump and may spread to the neck, head and limbs.

### Pigs

Regular ringworm lesions in pigs develop as a centrifugally progressing ring of inflammation surrounding a scabby, alopecic center. The lesion produced by *M. nanum* is different – there is no pruritus or alopecia and cutaneous reaction is minimal, but the centrifugal enlargement of each lesion may cause it to reach an enormous size. Superficial, dry, brown crusts cover the affected area but are not obviously raised except at the edges in some cases. The crusts are formed of flakes or dust composed of epithelial debris. Most lesions occur on the back and sides. Spontaneous recovery does not occur in adult pigs.

### Sheep

In sheep the lesions occur on the head, rarely in the fleeced areas and, although they usually disappear in 4–5 weeks, the disease may persist in the flock for some months. The lesions are discrete, round, almost bald patches covered with a grayish crust. Similar lesions occur in goats, but they are distributed generally over all parts of the body. The exception to this description is a new ringworm associated with an unidentified *Trichophyton* which has appeared in sheep in western States of USA plus Georgia and Kentucky since 1989. Lesions occur extensively in fleeced areas and are characterized by shedding of the wool staple and exudation from the skin surface. Serious spread of the infection to human attendants occurs.<sup>5</sup>

Outbreaks of ringworm in sheep flocks associated with *Trichophyton verrucosum* have been reported in Scotland.<sup>6</sup> The outbreaks have been unusual because of the high morbidity rates and persistence of active lesions for up to 6 months. The presence of ringworm lesions precluded the sale of rams in affected flocks.

In 'club lamb fungus' in show lambs in the US, gross lesions typical of ovine dermatophytosis were located on all parts of the body, and consisted of circular areas of matted wool, crusts and discoloration.

## CLINICAL PATHOLOGY

Laboratory diagnosis depends upon the demonstration of spores and mycelia in skin scrapings and in culture. Skin scrapings should be made after defatting the skin with ether or alcohol and gently warming the scraping in a 20% solution of either potassium or sodium hydroxide. Spores are the diagnostic feature and appear as round or polyhedral, highly refractive bodies in chains (*Trichophyton* spp.) or mosaics (*Microsporum* spp.) in hair follicles, epithelial scales, and in or on the surface of hair fibers. A hair perforation test, which measures the capacity of a fungal isolate to perforate human hair fibers in the laboratory, is used in the differentiation of dermatophytic species.

Examination of the skin of infected animals to detect the fluorescence associated with some fungal infections can also be a useful clinical aid but many trichophyton fungi do not fluoresce, whereas petroleum jelly and other oily skin dressings may do so. Fungal hyphae in tissues can be identified, even down to the genus, by the use of immunofluorescent staining. The technique was devised for use on necropsy material but should have application for biopsy material and scrapings. Specimens to be sent for laboratory examination should be packed in envelopes, as airtight jars and cans favor the growth of non-pathogenic fungi.

## DIFFERENTIAL DIAGNOSIS

The diagnosis of ringworm depends on evidence of infectivity, the appearance of characteristic lesions and the presence of fungal mycelia and spores. Diagnostic confirmation is by demonstration of fungal elements in a scraping or biopsy.

The differential diagnosis list of ringworm which may be confused with diseases with similar clinical profiles.

### Cattle

- Mycotic dermatitis, which has tenacious scabs which cover a raw area of skin
- Inherited parakeratosis, characterized by tenacious thick crusts which respond quickly and completely to dietary supplementation with zinc
- Sarcoptic mange, in which mites can be demonstrated in scrapings; there is intense pruritus and a quick response to standard insecticides
- Psoroptic mange, identifiable by the presence of mites in scrapings, pruritus, occurrence in housed cattle, and the location of the lesions over the hindquarter

**Pigs**

- Pityriasis rosea, in which no mites can be demonstrated and the disease is limited to a particular age group
- Exudative epidermitis has extensive lesions with a characteristic greasy covering
- Tyroglyphosis is self-limiting, associated with a new source of grain, and characterized by pruritus
- Sarcoptic mange, identifiable by the mites in scrapings, the intense pruritus and the prompt response to treatment with insecticide

**Horses**

- Mycotic dermatitis which is limited in its distribution to the back of the horse, and *Dermatonomus congolensis* can be cultured
- Queensland itch diagnosable on its occurrence only in summer, only along the back, and the associated intense pruritus
- Other equine dermatitides.

**TREATMENT**

Many recorded cures are no doubt due to strategic treatment just prior to spontaneous recovery, but treatment is widely practised, and recommended because it greatly reduces contamination of the environment by infected animals. Local or systemic treatments are used, the latter when lesions are widespread.

**Local application**

The crusts should be removed by scraping or brushing with a soft wire brush and burned; the medicament should be brushed or rubbed in vigorously. Suitable topical applications include a weak solution of iodine, Whitfield's ointment, 10% ammoniated mercury ointment, and solutions of quaternary ammonium compounds (1:200–1:1000), propionic and undecylenic acid ointments, solutions of 0.25% hexadecamethylene-1, 16-bis-isoquinolinium chloride (Tinevet), Hexetidine (bis-1,3 beta-ethylhexyl-5 methyl-5-amino-hexahydropyrimidine) borotannic complex, thiabendazole 1–5% ointment, the antibiotics (natamycin and nanomycin A), povidone-iodine, thiabendazole and captan ointments, and ointments containing one of theazole compounds such as imidazole or miconazole. These topical treatments are probably of greater value in the early stages of an outbreak when the lesions are small and few in number.

**Sprays, washes**

When infection in a group is widespread, washes or sprays which can be applied over the entire body surface of all animals are used, although the efficacy of the preparations is less than that of ointments, and daily application for at

least 5 days is required. Sprays have a big advantage if prophylactic treatment of all in-contact animals is recommended. Examples are agricultural Bordeaux mixture, 5% lime sulfur (20% w/v polysulfides diluted 1:20), captan (N-(trichloromethylthio)-cyclohex-4-ene-1, 2-dicarboxamide) 3%, N-trichloromethylthio-tetrahydrophthalimide, iodofors, 0.5% sodium hypochlorite, natamycin (100 ppm).

**Systemic treatment**

Systemic treatments recommended for use in farm animals include the intravenous injection of sodium iodide (1 g/14 kg body weight) as a 10% solution repeated on several occasions, and, if the high cost of the treatment can be overlooked, the oral administration of griseofulvin.

Spontaneous recovery is common in individual animals and careful appraisal of results in clinical trials is necessary. Many farmers overtreat their animals with irritant preparations administered daily for long periods. A crusty dermatitis, or even a neoplastic acanthosis may result.

**CONTROL Hygiene**

Failure to control an outbreak of ringworm is usually due to the widespread contamination of the environment before treatment is attempted. Isolation and treatment of infected animals, the provision of separate grooming tools, horse blankets and feeding utensils, and disinfection of these items after use on affected animals are necessary if the disease is to be controlled. Cleaning and disinfection of stables with a commercial detergent or a strong solution (2.5–5%) of phenolic disinfectant, 5% lime sulfur, 5% formalin, 3% captan or 5% sodium hypochlorite is advisable where practicable. Good results are also claimed for the disinfection of buildings with a spray containing 2.0% formaldehyde and 1.0% caustic soda.

**Vaccination**

Vaccination has achieved a great deal of success in preventing infection in cattle and horses<sup>7</sup> in most countries of Europe and Scandinavia. Vaccines include those containing highly immunogenic, non-virulent strains, or attenuated<sup>8</sup> strains of fungi, or those killed vaccines containing specific fractions of mycelia. Vaccination of all animals in the group is recommended, and isolation and treatment of infected animals and disinfection of premises and gear must be carried out at the same time.

The vaccine is almost totally without side effects except for very rare deaths due to anaphylaxis, apparently related to keeping reconstituted vaccine for too long

a period. Existing cases of ringworm may be exacerbated.

**Nutrition**

Although ringworm occurs in well-nourished as well as poorly fed animals, there does seem to be a tendency for the latter to become infected more readily and to develop more extensive lesions. Supplementation of the diet, particularly with vitamin A to young housed animals, should be encouraged as a preventive measure.

**REVIEW LITERATURE**

- Pier AC, Zancanella PJ. Immunization of horses against dermatophytosis caused by *Trichophyton equinum*. *Equine Pract* 1993; 15:23–27.
- Pier AC et al. Animal ringworm – its etiology public health significance and control. *J Med Vet Mycol* 1994; 32 (Suppl 1):133–150.
- Richard JL et al. *J Med Vet Mycol* 1994; 32 (Suppl 1): 169–187.
- Gudding R, Lund A. Immunoprophylaxis of bovine dermatophytosis. *Can Vet J* 1995; 36:302–306.
- Hill PB et al. A review of systemic antifungal agents. *Vet Dermatol* 1995; 6:59–66.
- Smith JMB, Griffith JFT. Strategies for the development of a vaccine against ringworm. *J Med Vet Mycol* 1995; 33:87–91.

**REFERENCES**

1. Hullinger GA et al. *Vet Dermatol* 1999; 10:73.
2. Hernandez J, Hawkins DL. *Am J Vet Res* 2001; 62:1418.
3. Maslen MM. *Austral J Dermatol* 2000; 41:90.
4. Oborilova E, Rybnikar A. *Mycoses* 2005; 48:187.
5. Pier AC et al. *J Med Vet Mycol* 1994; 32 (Suppl 1): 133.
6. Sargison ND et al. *Vet Rec* 2002; 150:755.
7. Pier AC, Zancanella PJ. *Equine Pract* 1993; 15:23.
8. Gordon PJ, Bond R. *Vet Rec* 1996; 139:395.

**EPIZOOTIC LYMPHANGITIS (PSEUDOGLANDERS, EQUINE BLASTOMYCOSIS, EQUINE HISTOPLASMOSIS)****Synopsis**

**Etiology** *Histoplasma capsulatum* var. *farcinosum*, a fungus

**Epidemiology** Epizootic disease of low mortality of horses in Asia, Africa and the Mediterranean

**Clinical signs** Nodules, lymphadenopathy and lymphangitis usually of the hindlimbs. Nodules discharge creamy pus. Conjunctivitis and pneumonia may occur. Spontaneous resolution, after a long course, is usual

**Clinical pathology** Organism in pus, fluorescent antibody test. Histofarcin skin test

**Lesions** Lymphangitis, lymphadenitis

**Differential diagnosis** Glanders (farcy), ulcerative lymphangitis, sporotrichosis

**Diagnostic confirmation** Demonstration of organism in pus. Clinical characteristics of the disease

**Treatment** Parenteral iodides.

Amphotericin

**Control** Hygiene, slaughter, vaccination

## ETIOLOGY

The cause is a fungus, *Histoplasma capsulatum* var. *farciminosum*, a dimorphic fungal soil saprophyte. The organism has also been classified by the genus name *Zymonema*, *Cryptococcus*, *Saccharomyces*, or *Blastomyces*.

The disease is listed by the OIE, to which it is notifiable.

## EPIDEMIOLOGY

The disease occurs as outbreaks in horses, donkeys and mules in parts of Iran, Asia, India, Northern Africa, and the Mediterranean littoral. Most outbreaks occur in autumn and winter or when large numbers of horses are gathered together for military or other purposes. The disease was detected in 1.0 to 19% of horses in Ethiopia over a 6-month period.<sup>1,2</sup> The mortality rate is 10–15%, but the course is prolonged. Cattle and camels are rarely affected.

Fungal spores are carried from infected animals by direct contact or on bedding, grooming utensils, horse blankets or harness, and gain entry through abrasions, usually on the lower limbs. A saprophytic stage in the soil has been suggested to account for the difficulty experienced in eradicating the disease. The organism has been isolated from the alimentary tract of biting flies and they may play a role in the transmission of the disease.

## Zoonotic potential

Infection is reported in humans.<sup>3</sup>

## PATHOGENESIS

After gaining entry through wounds, the fungus invades subcutaneous tissue, sets up a local granuloma or ulcer and spreads along the lymphatic vessels. The ocular form of the disease results from inoculation of the organism into the eye, likely by biting flies.

## CLINICAL FINDINGS

The disease is primarily an ulcerating, suppurative, pyogranulomatous dermatitis and, in most cases, lymphangitis.<sup>4</sup> An ocular form of the disease is characterised by an ulcerating conjunctivitis.

In the **cutaneous form** of the disease an indolent ulcer develops at the portal of entry, making its appearance several weeks to 3 months after infection occurs. A spreading dermatitis and lymphangitis, evident as corded lymphatics with intermittent nodules, develops. Nodules rupture, discharging a thick creamy pus. Local lymph nodes also enlarge and can rupture. Thickening of the skin in the area and general swelling of the whole limb are common. The lesions are quite painless.

The lesions usually develop on the limbs, particularly about the hocks, but

may also be present on the back, sides, neck, vulva and scrotum. Occasionally lesions appear on the nasal mucosa just inside the nostrils and do not involve the nasal septum. Ocular involvement is manifested by keratitis and conjunctivitis. Sinusitis and pneumonia occur in other forms of the disease.

The disease is chronic, persisting for 3–12 months. Spontaneous recovery occurs and immunity is solid after an attack but many animals are destroyed because of the chronic nature of the disease.

## CLINICAL PATHOLOGY

Gram-positive, yeast-like cells, with a characteristic double-walled capsule, are easily found in discharges. The organisms are located both extracellularly and intracellularly in giant cells and macrophages. The agent can be cultured on special media but the fungus dies quickly in specimens unless these are collected in antibiotic solutions, refrigerated and cultured promptly. The specimen should be collected into a solution containing 500 units/mL penicillin.

The mallein test is negative but a sterile filtrate of a culture of *H. capsulatum* var. *farciminosum* has been used in a cutaneous sensitivity test<sup>5</sup> and several serological tests, including a fluorescent antibody test,<sup>6</sup> are available. Antibodies to *H. capsulatum* var. *farciminosum* are detectable in serum before or at the time of development of lesions.<sup>4</sup>

## NECROPSY FINDINGS

Lesions are usually confined to the skin, subcutaneous tissues, and lymph vessels and nodes. In some cases granulomatous lesions may be found in the lungs, liver and spleen. Histologically, the lesion is quite characteristic and consists of pyogranulomatous inflammation with fibroplasia. Langerhans giant cells are common. The presence of numerous organisms, some of which show budding, in both intra- and extracellularly in tissue sections stained with H&E, Periodic acid–Schiff reaction and Gomori methenamine–silver stain is of diagnostic value.<sup>4</sup>

## DIFFERENTIAL DIAGNOSIS

See Table 22.3.

- Glanders (*Burkholderia mallei*)
- Ulcerative lymphangitis (*Corynebacterium pseudotuberculosis*)
- Sporotrichosis (*Sporothrix schenckii*)
- Histoplasmosis (*Histoplasma capsulatum*).

## TREATMENT AND CONTROL

Many treatments have been tried, largely without success. Parenteral iodides have

been reported as effective in some cases as has amphotericin. Sodium iodide is administered as a 10% solution at a dose of 1 mL per 5 kg intravenously once weekly for 4 weeks.<sup>7</sup> Amphotericin is administered at a dose of 0.2 mg/kg body weight every 48 hours for 3 treatments.

Outbreaks in uninfected areas are probably best controlled by **slaughter of affected animals**. In enzootic areas severe cases should be destroyed and less severe cases kept in strict quarantine while undergoing treatment. All infected bedding, harness and utensils should be destroyed or vigorously disinfected. Formalinized aluminum hydroxide adsorbed, and heat-attenuated vaccines<sup>8</sup> have been widely used, apparently with success.

## REVIEW LITERATURE

Al-Ani FK. Epizootic lymphangitis: a review of the literature. *Rev Sci Tech Off Int Epiz* 1999; 18:691.

## REFERENCES

1. Ameni G. *Vet J* 2006; 172:160.
2. Endebe B, Roger F. *J Appl Res Vet Med* 2003; 1:219.
3. Guerin C et al. *J Mycol Med* 1992; 2:1–5.
4. [http://www.oie.int/eng/normes/mmanual/A\\_00091.htm](http://www.oie.int/eng/normes/mmanual/A_00091.htm) Accessed May 2 2005.
5. Ameni G et al. *Vet J* 2006; 171:358.
6. Abou-Gagal M. et al. *Zentralbl Veterinarmed* 1983; 30:283.
7. Al-Ani FK. *Rev Sci Tech Off Int Epiz* 1999; 18:691.
8. Zhang WT et al. *Chin J Vet Sci Technol* 1986; 8:67:3.

## SPOROTRICHOSIS

Sporotrichosis is a contagious disease of horses, cats, cattle and humans characterized by the development of **cutaneous nodules and ulcers** on the limbs that may be accompanied by lymphangitis.

## ETIOLOGY

*Sporotrichum schenckii* (*Sporothrix beurmannii*, *S. schenckii*, *S. equi*), is a Gram-positive dimorphic fungus that forms single-walled spores.<sup>1</sup> The organism survives in a mycelial phase on living or decaying plant material but changes to a yeast phase when it enters a mammalian body through a puncture wound or bite.

## EPIDEMIOLOGY

The disease is reported to occur in Europe, India and the United States and likely occurs throughout the world. The host range includes humans, horses, cattle, cats, camels, mice, rats, and chimpanzees.<sup>1</sup> Economic loss caused by sporotrichosis is not great because the disease spreads slowly, the mortality rate is low, and treatment is effective. Outbreaks of sporotrichosis in dairy cattle caused reduced milk production.<sup>2</sup>

The causative agent persists in organic matter, and contamination of cutaneous wounds can occur either by contact with discharges from infected animals, or from contaminated surroundings. The disease is readily spread from affected cats to humans.<sup>3</sup> Transmission from horses to humans has not been reported.

### Pathogenesis, clinical findings and clinical pathology

Local invasion through wounds results in the development of abscesses and discharging ulcers. Multiple, small, cutaneous nodules develop on the lower parts of the legs, usually about the fetlock. The nodules may follow lymphatics and extend to the proximal limb. The nodules are painless, develop a scab on the summit, discharge a small amount of pus and heal in 3–4 weeks. Succeeding crops of lesions may cause the disease to persist in the animal for months. Lymphangitis, causing cording of the lymphatics occurs.

Demonstration of Gram-positive spores in discharges is diagnostic, but difficult because of their low number in horses and cattle, as opposed to the high number of spores present in lesions in cats. The organism can be demonstrated in air dried smears of exudate stained with Wright's stain or Romanowsky stain.<sup>1</sup> The hyphal stage is rare in tissues. Injection of pus into rats or hamsters produces a local lesion containing large numbers of the yeast-like cells. The organism can be cultured on Sabourard's agar.

### DIFFERENTIAL DIAGNOSIS

- Glanders
- Epizootic lymphangitis
- Ulcerative lymphangitis.

### TREATMENT AND CONTROL

Systemic treatment with **iodides** (potassium iodide orally or sodium iodide intravenously) is the most effective treatment. Local application of tincture of iodine daily to ulcers may suffice in mild cases. **Itraconazole** might be effective.<sup>1</sup>

Prophylactic treatment of all cuts and abrasions, isolation and treatment of clinical cases, and disinfection of bedding, harness and gear will prevent spread of the disease in enzootic areas. Thorough washing of hands and arms with povidone iodine or chlorhexidine is recommended for humans handling infected animals or plant material.<sup>1</sup>

### REFERENCES

1. Welch RD. J Am Vet Med Assoc 2003; 223:1123
2. Pradham RK et al. Indian Vet J 1994; 71:1140.
3. Barros MB et al. Int J Dermatol 2003; 42:677.

## EQUINE PHYCOMYCOSIS (SWAMP CANCER, PITHYOSIS, HYPHOMYCOSIS DESTRUENS, FLORIDA HORSE LEECH, BURSATTEE)

### Synopsis

**Etiology** *Pitythium insidiosum*, *Basidiobolus haptosporus*, or *Conidiobolus coronatus*

**Epidemiology** Tropical and subtropical areas of the world. Pythiosis occurs during the wet time of the year, but there is no seasonal distribution to *B. haptosporus* or *C. coronatus*

**Clinical signs** All cause ulcerative granulomas. *P. insidiosum* causes lesions on the legs and ventral abdomen; *B. haptosporus* on the side of the body, neck and head; *C. coronatus* causes lesions in the oral, nasal, pharyngeal, and tracheal mucosae

**Clinical pathology** Agar gel double diffusion test and histologic examination and immunohistochemical staining of tissue sections

**Lesions** Ulcerative granulomas with sinus tracts containing yellow coagulated material

**Diagnostic confirmation** Histologic examination of tissue

**Treatment** Surgical excision. Sodium or potassium iodide. Vaccination

**Control** None

### ETIOLOGY

The causes are fungi including *Pythium insidiosum* (syn. *Hyphomyces destruens*), *Basidiobolus haptosporus* (syn. *B. haptosporus* var. *minor*), *Conidiobolus coronatus* (syn. *Entomophthora coronata*) and *Rhinosporidium* spp. *Pseudoallescheria boydii* causes granulomatous lesions of the nasal cavity.<sup>1</sup> *Alternaria alternata* causes small granulomatous lesions on the head of horses.<sup>2</sup> *Scedosporium prolificans* is associated with arthritis and osteomyelitis in horses.<sup>3</sup> Unidentified fungi also cause lesions containing black-colored granules or grains, the so-called 'black-grain mycetomas'. *B. haptosporus* is a terrestrial fungus which lives in decaying vegetation.

### EPIDEMIOLOGY

#### Occurrence

The disease occurs most commonly in **tropical and semitropical climates** but can occur in animals housed in temperate climates. Although the disease is recorded most commonly in horses it does occur in young cattle, dogs, and humans.<sup>4,5</sup>

Pythiosis occurs mostly during the monsoonal season, whereas infection by *B. haptosporus* and *C. coronatus* occur year round.<sup>6</sup> A survey in tropical northern Australia showed that granulomas of horses were caused by *Pythium insidiosum*

in 77%, *B. haptosporus* in 18% and *C. coronatus* in 5% of cases.<sup>6</sup>

### Animal risk factors

The fungi gain access to the subcutaneous tissues through wounds or other disruptions of the integrity of the skin or mucosa. A strong correlation between the occurrence of the lesions and frequent wetting and exposure to water is reported and is consistent with the concept of an aquatic life cycle and **motile zoospores** of *P. insidiosum*.<sup>5</sup> There is no breed, age or sex predilection.<sup>6</sup> Multiple cases can occur in horses maintained in the same enclosure.<sup>7</sup>

### Zoonotic potential

Many of these fungi cause disease in humans, for instance, *Pseudoallescheria boydii* infection causes granulomas of the lower extremities of people in tropical regions and is referred to colloquially as Madura foot. However, there is no evidence of spread of infection from horses or other infected animals to humans, although appropriate caution should be exercised when handling infected tissues, especially by individual with compromised immune function.

### PATHOGENESIS AND CLINICAL FINDINGS

The **life cycle** of *P. insidiosum* involves colonization of leaves of aquatic plants where the organism undergoes sexual reproduction and produces sporangia.<sup>5</sup> Motile zoospores, released from the sporangia, are attracted to plant and animal tissue, to which they adhere. Zoospores are attracted to damaged tissue on which they encyst and develop germ tubes. The hyphae invade tissue and produce the granulomatous reaction and ulceration. Ejected kunkers (necrotic material infected with hyphae) may produce sporangia.<sup>5</sup>

The large (20 cm), rapidly growing, circular, fibrotic, ulcerative granulomas caused by *Pythium insidiosum* usually develop on the lower limbs, ventral abdomen or thorax and contain yellow concretions in sinus tracts (leeches or kunkers). The lesions are pruritic and grow rapidly, often becoming >20 centimeters in diameter in one month. *P. insidiosum* lesions may involve underlying bone and **osteomyelitis** may be a common feature of chronic pythiosis of the lower limbs.<sup>8</sup> *Pitythium* sp. infection of the small intestine causes **eosinophilic enteritis** and granuloma formation resulting in colic and the need for surgical resection. Dissemination of infection from subcutaneous sites to liver, lung and spleen occurs and results in a progressive weight loss and eventual death.<sup>9</sup>

*C. coronatus* causes lesions similar, but smaller, to those of pityriasis. However, lesions are only on the nares, nasal passages, oral cavity, pharynx, or trachea.<sup>10</sup> The lesions can be very slow growing and take 1–2 years to become invasive, whereas others grow rapidly. *Pseudoallescheria boydii* causes granulomatous lesions of the nasal cavity in horses.<sup>1</sup> *B. haptosporus* causes ulcerative, granulating lesions that have a hemorrhagic, edematous surface, in contrast to the fibrotic lesions caused by *Pythium* sp., on the sides of the **trunk, thorax, neck, and head**. Lesions caused by *B. haptosporus* are pruritic.

*Alternaria alternata* causes cutaneous nodules that are not painful or pruritic on the head of horses. The nodules may be solitary but are usually multiple and slowly progressive.<sup>2</sup>

*Scedosporium prolificans* causes infection of musculoskeletal structures including joints and bone, usually secondary to puncture wounds or surgery.<sup>3</sup> This organism causes disseminated lesions and a fatal disease in immunosuppressed humans.

#### CLINICAL PATHOLOGY

Culture of the causative fungus is a laborious task but is necessary to demonstrate presence of the organism, although PCR detection is becoming available and could replace culture as the definitive diagnostic test. A PCR test has been developed for the identification of *Pythium* spp., this test also is useful for the detection of *C. coronatus*.<sup>11</sup> Horses infected with *Pythium insidiosum* have a positive reaction to an **agar gel double diffusion test**, and complement fixation and intradermal hypersensitivity tests are also of diagnostic value.<sup>12</sup>

Examination of a biopsy specimen is also of value but care is needed to include a portion of necrotic tissue in which hyphae are most likely to be found. *Pseudoallescheria boydii* is indistinguishable from *Aspergillus* spp. on microscopic examination of tissue. **Immunohistochemical** staining methods, using indirect peroxidase techniques, are of value in distinguishing *Pythium* spp. from other fungi in swamp cancer lesions.<sup>13</sup>

Necropsy examination of horses with disseminated pythiosis reveals small, firm, irregularly branched, yellow-white masses in the regional lymph nodes draining cutaneous lesions and in liver, lungs and spleen. Histologically the masses are eosinophilic granulomas containing hyphal elements of *Pythium* spp.<sup>9</sup>

#### DIFFERENTIAL DIAGNOSIS

- Habronemiasis
- Granulation tissue
- Sarcoid
- Fibrosarcoma

- Amyloidosis of the nasal septum
- Squamous cell carcinoma
- Aspergillosis of the nasal septum
- Osteomyelitis.

#### TREATMENT

The most **efficacious treatment** for pythiosis and conidiobolomycosis is excision, although recurrence is common (30%) with larger lesions.<sup>14</sup> Laser ablation of the bed of the granuloma may reduce the rate of recurrence.<sup>15</sup> Larger lesions are usually treated medically. Fungal lesions respond to treatment of **sodium iodide** (20–40 mg/kg body weight, iv, q 24 h, as a 20% solution) followed by oral administration of **potassium iodide** (10–40 mg/kg po q 24 h for 7–120 days). Potassium iodide can also be administered at a dose of 10 g/425 kg once daily with the dose increasing by 2 g/day until the horse exhibits feed refusal or a dose of 20 g/day is achieved. Treatment should continue until signs of mycotic disease have resolved, which is often weeks to months. An alternative to potassium iodide is ethylene-diamine dihydroiodide (1.3 mg/kg, oral q 12 h for up to 4 months and q 24 h for up to one year).<sup>1</sup> Iodism is a potential adverse effect of administration of sodium or potassium iodide although this is rarely observed.

**Amphotericin** also gives good results as a systemic treatment (intravenously 0.4 mg/kg body weight increasing to 1.5 mg/kg/day for 10–40 days) combined with local infiltration and after surgical excision in extensive lesions. Administration of amphotericin can be limited by its nephrotoxicity, which should be monitored during treatment. **Itraconazole** (3 mg/kg orally every 12 hours for 3–4 months) is effective in the treatment of *C. coronatus* infections of the nasal septum.<sup>16</sup> **Fluconazole** (14 mg/kg oral loading dose followed by 5 mg/kg q 12 h orally for 6 weeks) is effective in the treatment of nasal conidiobolomycosis in horses.<sup>17</sup> The pharmacokinetics of fluconazole in horses have been determined, permitting rationale dosing of this drug.<sup>18</sup> Ketoconazole is not effective for the treatment of *C. coronatus* in horses.

**Miconazole** (5 grams of 2% solution) infused for 4 weeks into lesions in the nasal cavity, in combination with systemic administration of iodides, was effective in treatment of nasal lesions caused by *Pseudoallescheria boydii*.<sup>1</sup>

*Scedosporium prolificans* is resistant to commonly used antifungal drugs.

A **vaccine** composed of elements of *Pythium insidiosum* causes recovery or improvement in most cases.<sup>19</sup> It also causes a severe reaction, sometimes a

cold abscess, at the injection site. Other complications include osteitis and laminitis which necessitate euthanasia.<sup>19</sup>

#### REVIEW LITERATURE

Poole HM, Brashier MK. Equine cutaneous pythiosis. *Comp Cont Educ Pract Vet* 2003; 25:229.

Taintor J et al. Conidiobolomycosis in horses. *Comp Cont Educ Pract Vet* 2003; 25:872.

#### REFERENCES

1. Davis R et al. *J Am Vet Med Assoc* 2000; 217:707.
2. Genovese LM et al. *Vet Rec* 2001; 148:55.
3. Swerczek TW et al. *J Am Vet Med Assoc* 2001; 218:1800.
4. Miller RI et al. *J Am Vet Med Assoc* 1985; 186:984.
5. Mendoza L et al. *J Clin Microbiol* 1993; 31:2967.
6. Miller RI, Campbell RSF. *Aust Vet J* 1982; 58:221.
7. Dowling BA et al. *Aust Vet J* 1999; 77:780.
8. Worster AA et al. *J Am Vet Med Assoc* 2000; 216:1795.
9. Reis JL et al. *Vet Microbiol* 2003; 30:289.
10. Steiger RR, Williams MA. *J Vet Int Med* 2000; 14:311.
11. Grooters A, Gee MK. *J Vet Int Med* 2002; 16:147.
12. Miller RI, Campbell RSF. *Aust Vet J* 1982; 58:227.
13. Brown CC et al. *Am J Vet Res* 1988; 49:1866.
14. Miller RI. *Aust Vet J* 1981; 57:377.
15. Sedrishi SA et al. *J Am Vet Med Assoc* 1997; 211:464.
16. Korenek NL et al. *J Vet Int Med* 1994; 8:224.
17. Taintor J et al. *J Vet Int Med* 2004; 18:363.
18. Latimer FJ et al. *Am J Vet Res* 2001; 62:1606.
19. Miller RI. *J Am Vet Med Assoc* 1983; 182:1227.

#### MADUROMYCOSIS

A skin disease of horses characterized by cutaneous granuloma caused by a variety of fungi including *Helminthosporium spiciferum*, *Brachycladium spiciferum*, *Curvularia geniculata* and *Monosporium apiospermum*. One or more lesions 1–2.5 cm in diameter appear anywhere on the skin but with a special frequency at the coronet. The incised lesion has a mottled appearance and drains pus containing the fungus.

#### MUCORMYCOSIS

A rare disease of humans, horses, cattle, and pigs caused by coenocytic fungi of the order Mucorales.<sup>1</sup> *Absidia corymbifera* causes severe disease and death of horses.<sup>1</sup> The disease is usually acute and progressive and antemortem diagnosis is difficult. Clinical signs include fever, diarrhea, circling, convulsions, and acute death.<sup>1</sup> Horses can have ulcerating skin lesions of the muzzle, nostrils, knees and hocks can develop in animals that survive the acute disease. Necropsy examination reveals demarcated necrotic or hemorrhagic lesions in the respiratory and gastrointestinal mucosa, lungs, spleen, and brain. Thin walled hyphae are visible in routine sections of tissue examined microscopically. There is no effective treatment or control.

#### REFERENCE

1. Lope%-Sanroman J et al. *Vet Dermatol* 2000; 11:151.

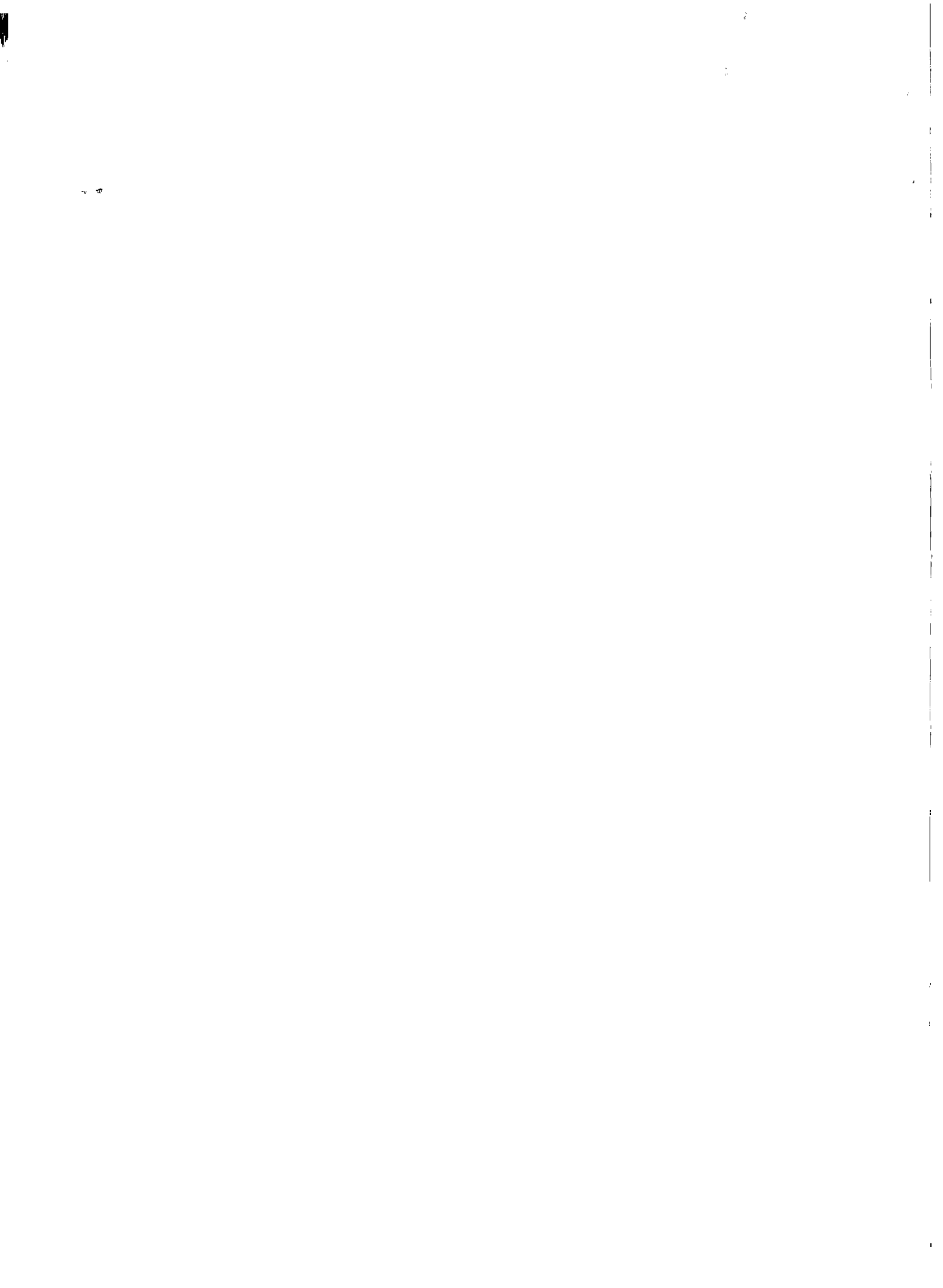



## Diseases associated with protozoa

Babesiosis (Texas fever, redwater fever, cattle tick fever, equine piroplasmosis) 1483  
 Coccidiosis 1498  
 Sarcocystosis (sarcosporidiosis) 1507  
 Neosporosis 1509  
 Cryptosporidiosis 1512  
 Giardiasis (lambliasis) 1515

Besnoitiosis (elephant skin disease) 1517  
 Toxoplasmosis 1518  
 Equine protozoal myeloencephalitis 1522  
 Theileriosis 1526  
 East Coast fever (ECF) 1527  
 Tropical theileriosis (Mediterranean Coast fever) 1530

## DISEASES ASSOCIATED WITH TRYPANOSOMES 1531

Nagana (Samore, African trypanosomiasis/trypanosomosis, tsetse fly disease) 1531  
 Surra (mal de caderas, murrina) 1537  
 Dourine (maladie du coit) 1538

## BABESIOSIS (TEXAS FEVER, REDWATER FEVER, CATTLE TICK FEVER, EQUINE PIROPLASMOSIS)

*Babesia* spp. are a diverse group of tick-borne, obligate, intra-erythrocytic Apicomplexan parasites infecting a wide variety of organisms. Infection of a vertebrate host is initiated by inoculation of sporozoite stage parasites into the bloodstream during the taking of a blood meal. Most babesial sporozoites directly invade circulating erythrocytes without a tissue stage of development. A few, notably, *Babesia equi* and *Babesia microti*, first invade lymphocytes where they form motile merozoites, which then invade erythrocytes. Once erythrocyte invasion occurs, a seemingly perpetual cycle of asexual reproduction is established, despite the rapid development of a strong immune response.

## Synopsis

**Etiology** *Babesia* spp.

**Epidemiology** Disease of tropical and subtropical countries. Occurs in cattle, sheep and goats, horses, cervids, and pigs. Transmission by blood-sucking ticks. Young calves have innate resistance. Endemic stability occurs in herds with sufficient inoculation rate to immunize a high percentage of animals.

**Zoonotic implications** *Babesia bigemina* and *B. microti* occurs in humans where tick is found. Human donor blood may be infected.

**Clinical signs** Anemia, hemoglobinuria, jaundice, fever, high case fatality rate.

**Clinical pathology** Parasites in stained blood smear, positive serology. PCR for detection of parasite in blood.

**Necropsy lesions** Thin, watery blood, pallor, jaundice.

**Diagnostic confirmation** Parasites in blood smear; vector present in environment.

**Differential diagnosis list**

A syndrome of acute hemolytic anemia should suggest the following alternative diagnoses:

**Cattle**

Theileriosis  
 Postparturient hemoglobinuria  
 Bacillary hemoglobinuria  
 S-methyl-L-cysteine-sulfoxide (SMCO) poisoning  
 Leptospirosis.

**Horses**

Equine infectious anemia  
 Paralytic myoglobinuria  
 Foals with alloimmune hemolytic anemia  
 Cardiac form of African horse sickness.

**Treatment** Diminazene and imidocarb.

**Control** Tick control, vaccination with live vaccine, chemoprophylaxis with imidocarb.

## ETIOLOGY

The nomenclature of these intra-erythrocytic parasites is still subject to change; the current list is:

- **Cattle:** There are four species of bovine *Babesia* now recognized: *Babesia bovis* (includes *B. argentina*, *B. berbera*, *B. colchica*), *B. bigemina*, *B. divergens* (*B. cauxsica*, *B. occidentalis*, *B. karelica*) and *B. major*<sup>1</sup>
- **Sheep and goats:** *B. motasi*, *B. ovis*
- **Pigs:** *B. trautmanni*, *B. perroncitoi*
- **Horses:** *B. equi*, *B. caballi*. *B. equi* might be more accurately classified as a member of the Theileriidae family.

## EPIDEMIOLOGY

**Geographical occurrence**

The distribution of the causative protozoa is governed by the geographical and seasonal distribution of the insect vectors that transmit them (Table 26.1).

**Host occurrence**

Bovine babesiosis  
 Bovine babesiosis associated with *B. bigemina* and *B. bovis* is an important disease of tropical and subtropical regions in the world, including the Americas. Both species are transmitted transovarially by *Boophilus* ticks, but only tick larvae transmit *B. bovis*, whereas nymphs and adults transmit *B. bigemina*.

In general terms, *B. bigemina* and *B. bovis* are infections which occur in countries in the tropics and subtropics between 40°N and 32°S. *B. major* and *B. divergens* occur in temperate regions.<sup>1,2</sup> Thus, *B. bigemina* occurs in South America, the West Indies, Australia, and Africa; *B. argentina* in the tropics including South and Central America, Australia, Asia, and southern Europe. *B. divergens* occurs in north-west Europe, Italy,<sup>3</sup> Spain, Eire, and is the principal cause of babesiosis in the United Kingdom. *B. bovis* occurs in Europe, South America, and Africa; *B. berbera* in Mediterranean Europe and North Africa; *B. major* in the United Kingdom and Europe. The first report of *B. bovis* in Spain occurred in 2000.<sup>4</sup>

*Babesia divergens* bovine babesiosis transmitted by *Ixodes ricinus* is widespread and reported often in France.<sup>5</sup> The clinical incidence is low at 0.4% for the entire cattle population. The endemic situation is unstable and clinical cases occur more frequently with certain farming systems. Serology using immunofluorescence antibody test (IFAT), 7% of the cattle population is seropositive.<sup>6</sup> Using the PCR, prevalence rate of carriers is 20%.

Bovine babesiosis is widespread in South Africa, and the distribution of both *B. bovis* and *B. bigemina* is determined by the distribution of their vectors. The seroprevalence of *B. bigemina* in non-vaccinated cattle is due to the high vector tick population and the endemically stable situation which can be achieved by adopting a tick-control method which allows a reasonable number of ticks on cattle rather than relying entirely on intensive tick control and vaccination.<sup>7</sup>

**Sheep and goats**

In sheep and goats, babesiosis is associated with *B. ovis*, *B. motasi*, and occurs in southeastern Europe, North Africa, and South America.<sup>8</sup> In Iran, *B. ovis*, and *B. motasi*, occur in sheep and goats.<sup>9,10</sup> The prevalence of *B. ovis* and *B. motasi* in sheep and goats were 23.5%, 0.5%, and 14%, 0.5%, respectively. In Iran, the clinical signs

Table 26.1 Major *Babesia* species infective to domestic animals, their tick vectors and geographical distribution<sup>22</sup>

<i>Babesia</i> spp.	Major ixodid vectors	Known distribution	Domestic species affected
<i>Babesia bigemina</i>	<i>Boophilus microplus</i> <i>Boophilus decoloratus</i> <i>Boophilus annulatus</i> <i>Boophilus geigy</i> <i>Rhipicephalus everti</i>	Africa, Asia, Australia, Central and South America and Southern Europe	Cattle, buffalo
<i>Babesia bovis</i>	<i>Boophilus microplus</i>	As for <i>Babesia bigemina</i> , but less widespread in Africa due to <i>B. microplus</i> competition with <i>B. decoloratus</i>	Cattle, buffalo
<i>Babesia divergens</i>	<i>Ixodes ricinus</i> <i>Ixodes persulcatus</i>	North-west Europe, Spain, Great Britain, Ireland	Cattle
<i>Babesia major</i>	<i>Haemaphysalis punctata</i>	Europe, North West Africa, Asia	Cattle
<i>Babesia ovata</i>	<i>Haemaphysalis longicornis</i>	Eastern Asia	Cattle
<i>Babesia ovis</i>	<i>Rhipicephalus bursa</i>	South-eastern Europe, North Africa and Asia	Sheep and goat
<i>Babesia motasi</i>	<i>Rhipicephalus bursa</i>	South-eastern Europe, North Africa and Asia	Sheep and goat
<i>Babesia caballi</i>	<i>Dermacentor</i> spp. <i>Hyalomma marginatus</i> <i>Hyalomma truncatum</i> <i>Rhipicephalus evertsi evertsi</i>	Africa, South and central America and southern USD, Europe, Asia	Horses, donkey, mule
<i>Babesia canis</i>	<i>Rhipicephalus sanguineus</i> <i>Dermacentor</i> spp., <i>Haemaphysalis</i> spp. <i>Hyalomma</i> spp.	Southern Europe, North America, Asia, Africa, Australia	Dog
<i>Babesia gibsoni</i>	<i>Haemaphysalis</i> spp., <i>Rhipicephalus sanguineus</i>	Africa, Asia, Europe, North America.	Dog
<i>Babesia traubmanni</i>	<i>Rhipicephalus</i> spp.	Southern Europe, former USSR, Africa	Pig

of babesiosis occurred in 8% of infected sheep and 6.8% of infected goats. Splenectomized sheep can be used as a model for *B. divergens* chronic infection.<sup>11</sup>

Sheep babesiosis is of considerable economic importance in the areas infested with *Rhipicephalus bursa* which is widely distributed in the Palaearctic region between 31–45° parallels North including the Mediterranean basin,<sup>8</sup> the Balkans, the southern former USSR, Iraq, and Iran.

#### Porcine babesiosis

Associated with *B. traubmanni* and *B. perroncitoi*, porcine babesiosis occurs in southeastern Europe and Africa.

#### Equine babesiosis (piroplasmosis)

Babesiosis in the equine species is also known as **equine piroplasmosis**. In horses, donkeys, mules, and zebras the disease is associated with *B. equi* and *B. caballi*. It occurs in much of southern Europe, Asia, and the Americas. Equine piroplasmosis due to *B. equi* and *B. caballi* are widespread in China<sup>12,13</sup> and cause for serious concern in northeast China. Australia is free of equine piroplasmosis but did allow the temporary importation of seropositive horses into the country for the Sydney Olympic games of 2000.<sup>14</sup> While in Australia, seropositive horses were kept at certain restricted sites.

Seroepidemiologic studies of horse breeding farms in Brazil indicate the prevalence of *Babesia caballi* at 79%, *Babesia equi* 49% in mares; 36% of foals became

infected with *B. equi* within 12 months but 100% with *B. caballi* within 10 months.<sup>15</sup> Maternal antibodies against *B. equi* and *B. caballi* in foals were 44 and 68%, respectively. Titers persisted for 1–5 months for *B. equi* and 1–4 months for *B. caballi*.

In South Africa, equine piroplasmosis is a tick borne disease of horses, mules, donkeys and zebras, associated with *Babesia caballi* and *Theileria equi*. Equine piroplasmosis is widespread in South Africa. A serological survey indicated that of all serum samples collected from all parts of the country, nearly 80% were positive for *T. equi*, and 50% were positive for *B. caballi* which was cultured from horses.<sup>16</sup>

#### Wildlife babesiosis

*Babesia odocoilei* infects the cervid family including the white-tailed deer (*Odocoileus virginianus*) and the American elk and the American woodland caribou (*Rangifer tarandus caribou*).<sup>17</sup> Desert bighorn sheep (*Ovis canadensis nelsoni*) and red deer (*Cervus elaphus elaphus*) are also susceptible to infection but do not exhibit clinical signs of disease.<sup>17</sup> *B. odocoilei* is transmitted by ticks, *Ixodes scapularis* and *Ixodes dammini*.

Fatal babesiosis in domestic reindeer associated with *Babesia tarandirangiferis* was first described in northern Russia in 1909. *B. divergens* has caused babesiosis in reindeer in Scotland.<sup>18</sup> Two morphologically dissimilar *Babesia* spp. have been cultured from reindeer in California.<sup>19</sup>

#### Origin of infection and transmission

Viable protozoa are present only in the bloodstream of animals in the active stages of the infection. Ticks are the natural vectors of babesiosis; the causative parasites persist and pass through part of their life cycle in the invertebrate host. Both *B. bovis* (Argentina) and *B. bigemina* pass part of their life cycle in the tick *Boophilus microplus* (recently reclassified as *Rhipicephalus* sp., but the name *Boophilus* will be used). *Boophilus* (*Margaropus*) *annulatus* and *B. microplus* are the major vectors of babesiosis, but other *Boophilus*, especially *B. decoloratus* in South Africa, *Rhipicephalus*, and *Haemaphysalis* spp. also act as vectors. *Boophilus microplus* is the main vector babesiosis associated with *B. bovis* and *B. bigemina* in cattle production systems in Central and South America.<sup>20</sup> *Ixodes ricinus* is the common carrier of *B. divergens* in the United Kingdom. *Rhipicephalus bursa*<sup>8</sup> and *Haemaphysalis punctata* spp. are the vectors in sheep; *Dermacentor*, *Rhipicephalus*, and *Hyalomma* spp. in horses; and *Rhipicephalus* and *Boophilus* spp. in pigs.

Information on the natural or experimental tick vectors of equine babesiosis is limited. *Dermacentor nitens* is the only tick species that transmits *B. caballi* in horses in the New World. In Brazil, *Ambylomma cajennense* and *Anocenter* (*Dermacentor*) *nitens* are the most common and widespread ticks infesting horses, *A. nitens* is an important natural vector of

*B. caballi*. *Boophilus microplus*, is the dominant tick in some areas where *B. equi* infection is endemic. Using conventional diagnostic methods, *B. microplus* collected from horses were negative for both *B. equi* and *B. caballi*. Using a nested PCR, *B. equi* and *B. caballi* DNA were detected in the blood samples of horses and in the ticks. The detection of specific *B. equi* and *B. caballi* DNA in the eggs and larvae of *B. microplus* suggests the possibility of both transovarial and transtadial parasite transmission.<sup>21</sup>

In Iran, five ixodid species of ticks have been collected from sheep and goats.<sup>9</sup> The *Rhipicephalus sanguineus* and *Hyalomma marginatum* are the most common species in sheep and goats. Other tick vectors include *Dermacentor daghestanicus* in goats and *Hyalomma anatolicum*, *Hyalomma asiaticum* in sheep.<sup>10</sup>

When adult animals become infected they act as carriers for variable periods, up to 2 years. If they are constantly reinfected, as they are in an endemic environment, they act as carriers for life.

A knowledge of the life history of the tick is most important in applied control. Those ticks that parasitize only one host are easier to eradicate and cause less spread of the disease than those parasitizing two or three hosts. Control of ticks capable of surviving on both domestic and wild animals presents a major problem.

### Life cycle and development of *Babesia*

The development of *B. bovis* and *B. bigemina* follow similar patterns in adult *Boophilus* spp. *Babesia* spp. do not parasitize any vertebrate host cell other than erythrocytes. Each sporozoite (merozoite) penetrates the cell membrane of an erythrocyte with the aid of a specialized apical complex. Once inside, it transforms into a trophozoite from which two merozoites develop by a process of merogony (binary fission) (see Fig. 26.1).

In the passage of host blood to the midgut of the tick vector, the development of two populations of ray bodies from the gamonts (gametocytes) occurs.<sup>22</sup> The ray bodies undergo further multiplication within the erythrocytes which continues after they have emerged. Large aggregations of multinucleated ray bodies form, but once division is complete, single-nucleated ray bodies that are now haploid and assumed to be gametes emerge from the aggregates and then fuse together in pairs (syngamy) to form a spherical cell (zygote). The zygote selectively infects the digestive cell of the tick gut where they multiply and then the basophilic cells where further multiplication occurs with development to kinetes that escape into the tick hemolymph. In

the gut cells, schizogony occurs with the formation of polyploid kinetes (large merozoites). These motile club-shaped kinetes then escape into the hemolymph and infect a variety of cell types and tissues, including the oocytes where successive cycles of secondary schizogony occurs. Thus, transovarial transmission occurs with further development occurring in the larval stage. Kinetes enter the salivary glands and are transformed into multinucleated stages (sporogony) and these then break up to form sporozoites. In all species, sporozoite development usually only begins when the infected tick attaches to the vertebrate host. In *B. bigemina*, some development occurs in the feeding larvae, but infective sporozoite take about 9 days to appear and therefore only occur in the nymphal and adult stages of the tick. Transmission can occur throughout the rest of the nymphal stage and by adult females and males. For *B. bovis*, the formation of infective sporozoites usually occurs within 2 to 3 days of larval tick attachment.

Contaminated needles and surgical instruments can transmit the infection physically. The ease with which infection can be transmitted in this way depends largely on the degree of parasitemia occurring with each species. Thus, the chances of physical transmission are slight with *B. bovis* and high with *B. equi* and *B. bigemina*.

### Immunity and susceptibility to infection

The immune response of cattle to infection with *B. bovis* or *B. bigemina* involves both innate and acquired immune mechanisms.<sup>22</sup> The immune response directed against infections with *Babesia* involves both humoral and cellular mechanisms and is T-cell dependent. In addition, an age-related immunity to initial infection with *B. bovis* in cattle is well established, characterized by strong innate immunity in young calves. Mononuclear phagocytes are engaged as the primary effector cells on innate and primary immune responses and nitric oxide has been identified as at least one babesiacidal molecule produced by activated mononuclear phagocytes. When *B. bovis* infected erythrocytes grown in culture are exposed to nitric oxide, death of the parasites occurs rapidly within the erythrocyte.

### Innate immune mechanisms

There is an age-related immunity to primary infection of cattle with *B. bovis* and *B. bigemina*. Young calves possess this strong innate immunity against *B. bovis* infection that lasts for approximately 6 months after birth and is abrogated with the removal of the spleen.<sup>23</sup> Interleukin IL-12 and IL-10 are important

immunoregulatory cytokines.<sup>24</sup> The protective innate response in young calves to infection with virulent *B. bovis* involves the early appearance of IL-12 and interferon- $\gamma$  (IFN- $\gamma$ ) transcripts in the spleen. This is followed by a brief period of inducible nitric oxide synthase expression.<sup>23</sup> In contrast, IL-12 and IFN- $\gamma$  (mRNA) expression in the spleens of adult cattle which died from infection was delayed and depressed and occurred within the context of IL-10 expression. Also, in contrast to calves, there was no detectable antibody response before death in adults.

### Acquired immune mechanisms

Following *B. bovis* infection, antibodies directed against protective and non-protective parasite antigens and host antigens are produced.<sup>22</sup> Hyperimmune serum from cattle infected with *B. bovis* many times, or a mixture of IgG1 and IgG2 prepared from hyperimmune serum of cattle can be used to immunize naïve calves passively against *B. bovis* infection, and the protection is strain specific. Splenectomized calves given hyperimmune serum and challenged with *B. bovis* recover as effectively as intact calves.

Strong immunity occurs after natural infection with most *Babesia* spp. There appears to be little relationship between the degree of immunity and the level of antibodies in the serum. If the infection recurs repeatedly the immunity is permanent. If the illness is treated urgently and efficiently, and the protozoa are killed before antibodies are produced, no immunity occurs. If the infection is not repeated the protozoa survive in the host for a variable time, usually about 6 months, and then disappear. A sterile immunity persists for a further 6 months and the host is susceptible again about a year after infection occurred. These periods of latent infection and resistance to reinfection are subject to significant variation and to different responses between breeds of cattle and the species of *Babesia*.

Despite the potential severity of the acute infection, individuals who survive generally develop immunity against disease, but not against infection, and could remain persistently infected. In the case of *B. bovis*, infections can persist for years, and even for the lifetime of the animal. Babesial infections have adapted well to survival in immune hosts. At least five different phenomena are known to contribute to parasite survival: rapid antigenic variation; cytoadhesion and sequestration; binding of host proteins to the infected red blood surfaces; the monoallelic expression of different members of multigene families; and establishment of transient immunosuppression.<sup>25</sup>

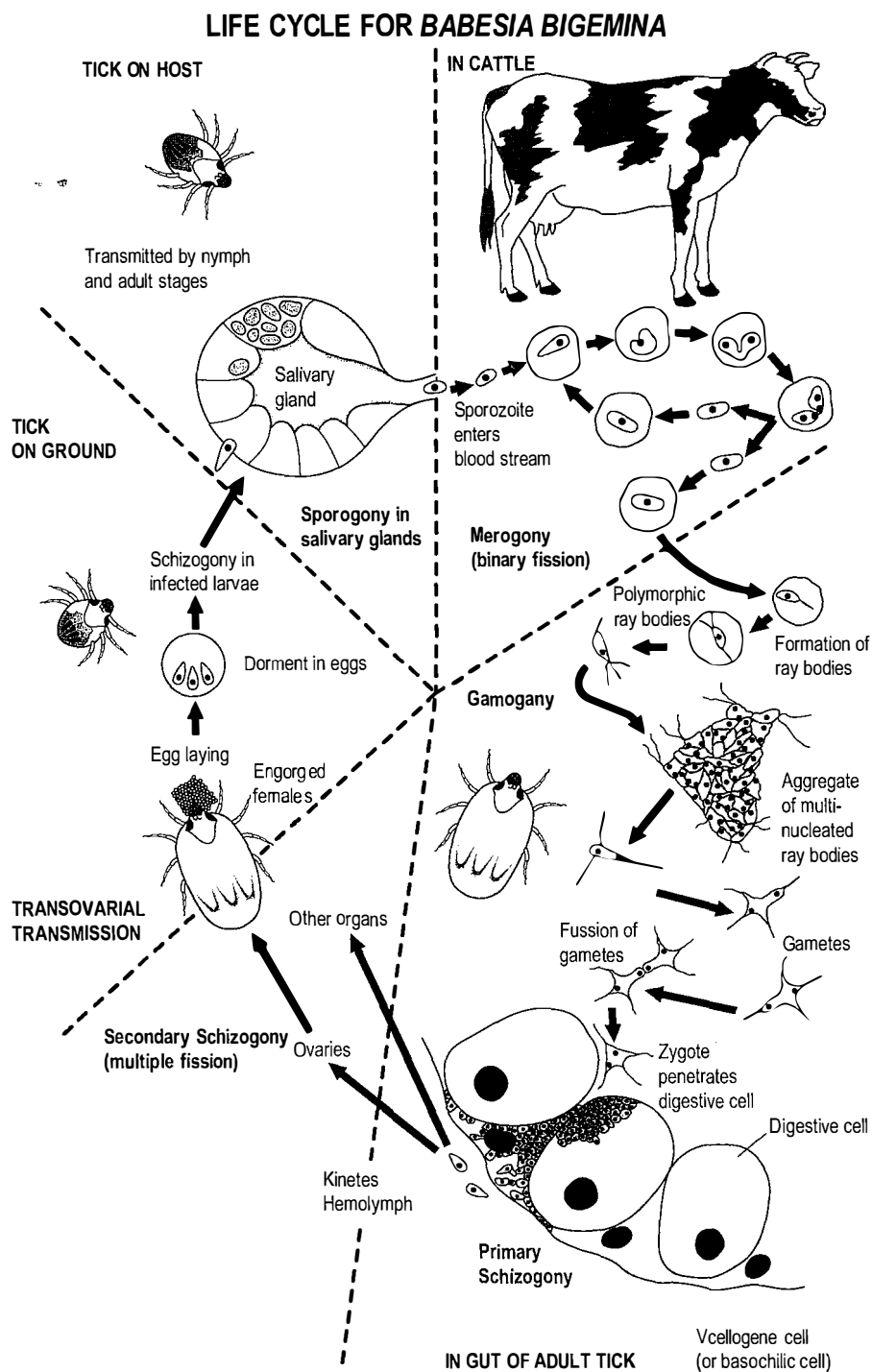

**Fig. 26.1** The development life cycle of *Babesia bigemina* in cattle and the ixodid tick vector *Boophilus microplus* (adapted from Mehlhorn, Shein 1984; Mackenstedt et al. 1995; Gough et al. 1998).

The inoculation rate measures the daily probability of infection. This is based on the knowledge that animals exposed to the parasite in the first 9 months of life become infected, immune and seropositive without showing any clinical signs of disease.<sup>20</sup> Inoculation rates of 0.0005 and 0.005 are endemically unstable because a high percentage will reach the age of 9 months without having been exposed to the hemoparasite. This results in a high risk of disease (**endemic instability**), as primary infections in older animals are usually severe and can be fatal. A sero-

logical survey of cattle in Bolivia for *B. bovis* and *B. bigemina* to estimate the risk of outbreaks by calculating the inoculation rates of each hemoparasite. The results indicated the area surveyed is endemically unstable as *h* values were below 0.005.<sup>20</sup> In such unstable conditions, calfhooed vaccination against hemoparasites is recommended to ensure that the herd is immune. Alternatively, cattle producers may use tick control to break the transmission cycle; however, tick control is much more costly and risky if tick control fails.

**Endemic stability** is defined as the state where the relationship between host, agent, vector and environment is such that clinical disease occurs rarely or not at all.<sup>22</sup> Endemic stability (herd immunity) in bovine babesiosis occurs when the rate of transmission (inoculation rate) of *Babesia* spp. by the tick vector is sufficient to immunize a majority of susceptible calves before the loss of calfhooed resistance.<sup>26</sup> In tropical areas with a high vector population, natural exposure usually occurs at an early age and cattle are therefore immune to subsequent challenges as adults. If at least 75% of calves are exposed to *B. bovis* infection by 6 to 9 months of age the disease incidence will be very low and a state of natural endemic stability would exist.

***B. bovis* and *B. bigemina* cross protection.** Protective cross species immunity against infection cannot be induced with *B. bovis* and *B. bigemina*.<sup>22</sup>

**Duration of immunity.** Cattle develop a durable long-lasting immunity after a single infection with *B. divergens*, *B. bovis*, or *B. bigemina*. Immunity to both *B. bovis* and *B. bigemina* lasts at least 4 years. There is evidence in the literature suggesting the presence of antibodies is not necessarily an indication of immunity nor is absence of detectable antibodies necessarily an indication of a lack of immunity.<sup>22</sup>

### Risk factors

#### Host factors

***Bos indicus* breeds of cattle are much more resistant to babesiosis than *Bos taurus* breeds.** This phenomenon is thought to be a result of the evolutionary relationship between *Bos indicus* cattle, *Boophilus* spp. and *Babesia*.<sup>22</sup> Zebu and Afrikaner cattle have a higher resistance to *B. bovis* than British and European breeds; Santa Gertrudis and cross-bred cattle occupy an intermediate position. Zebu-type cattle also enjoy a relative freedom from the disease because of their resistance to heavy infestations with ticks.

In Australia, *B. bigemina* is usually of lower pathogenicity than *B. bovis* and rarely lethal even when fully susceptible adult cattle are introduced to an endemic area.<sup>27</sup> Inoculation studies with *B. bigemina* in Australia have shown that *B. indicus* and *B. indicus* cross cattle are more resistant than the *B. taurus* cattle.<sup>27</sup>

**Age resistance** There is a variation in susceptibility to infection according to age in cattle. The severity of clinical babesiosis increases with age. Calves and foals from naive dams are highly susceptible to infection and clinical illness from birth to 2 months of age, at which time they develop an innate resistance that persists to about 6 months of age. Calves and foals from immune dams

receive antibodies via the colostrum, and this passive immunity persists for 3–4 months after birth. The greatest infection rate is in animals in the 6 to 12-month age group; infection is uncommon in animals over 5 years of age. Animals under 1 year of age are infected predominantly with *B. bigemina* and those over 2 years of age by *B. bovis*. Calves up to 1 year of age, although fully susceptible to infection, are resistant to disease.<sup>2</sup> The average age at which calves in endemic areas become infected is 11 weeks (2–34 weeks), but at this early age clinical signs and pathological changes are mild and short-lived. After 6 months of age the number of infected animals in enzootic areas increases.

In **housed cattle**, the level of antibodies in the patient are at their lowest when the cattle come out of the barn in the spring, and gradually increase as they are exposed to vector ticks.

In **enzootic areas**, the animals most commonly affected by clinical disease are susceptible cattle introduced for breeding purposes, for slaughter, or in transit. Cattle indigenous to these areas are rarely affected because the natural resistance of the very young, and passive immunity via colostrum from immune dams is gradually replaced by a state of active immunity. Severe clinical cases occurring in these cattle are usually caused by exposure to some stress, such as parturition, starvation or intercurrent disease. Such breakdowns in immunity are most likely to occur if there is a superimposed infection with a different parasite, especially *Anaplasma marginale*.

#### Environmental factors

There is a **seasonal variation** in the prevalence of clinical babesiosis, the greatest incidence occurring soon after the peak of the tick population. For example, in England babesiosis is largely a disease of spring, summer, and autumn for this reason. Of the climatic factors, air temperature is the most important because of its effect on tick activity – higher temperatures increase it; humidity and rainfall have little effect – and even with temperature the effect is limited once a threshold of 7–100°C (44–50°F) minimum temperature is exceeded. Heaviest losses occur in **marginal areas** where the tick population is highly variable depending on the environmental conditions. In seasons when the tick population decreases, infection may die out and immunity be lost. Then in favorable seasons when ticks multiply, the infection spreads quickly amongst what has become a susceptible population. Comparable circumstances may be created artificially by an inefficient dipping program, which reduces the tick

population to a low level and is subsequently unable to keep it under control.

#### Pathogen factors

Many intra-erythrocytic hemoparasites survive the host immune system through rapid antigenic variation which has been demonstrated for *Babesia bovis* and *Babesia rodhaini*.<sup>28</sup> The molecular basis for antigenic variation in babesial parasites and its possible connection with cytoadherence and sequestration have been examined.<sup>28</sup> The existence of different strains and antigenic variation occur in both *B. bovis* and *B. bigemina*. Babesial infections in cattle by antigenic variation and by superinfection with antigenically different parasite populations. Each change in antigenic type provides a temporary respite from attack by the host immune system and prolongs the infection period. The number of antigenically distinct relapses which can occur in a herd with babesial infection could be more than 100.

Strain differences and antigen variation do not appear to be of major importance as a cause of disease or in vaccines, since cross-immunity tests between strains usually provide adequate clinical protection against each other. *Babesia bigemina* sporozoites expressing specific antigens which induce protective immunologic responses in cattle have been characterized.<sup>29</sup>

New sequences of Spanish isolates of *B. caballi* and *B. equi* show a relatively high degree of genetic divergence within the group of piroplasms.<sup>30</sup> The immunoreactive polypeptides of *B. equi* merozoite antigen have been identified.<sup>31</sup>

#### Economic importance

Bovine babesiosis is the most economically important of these diseases, because of direct losses of production and because of restriction of movement of cattle for trade by quarantine laws. Many animals die or undergo a long period of convalescence entailing loss of meat and milk production. Incidental costs of immunization and treatment add to the economic burden. With early, effective treatment the mortality rate can be reduced to 5%.

The mortality rates in outbreaks of equine babesiosis are high, but the big losses in this species result from the interference with racing and pleasure horse meetings and competitions. This is especially the case at present with the movement of horses between countries to compete in increasingly international equine competitions. An additional form of loss is the death of foals infected in utero. In the 1960s with an outbreak of clinical equine babesiosis in the United States, several cases in Australia, and several seropositive identifications in the

United Kingdom, it appeared to be an emerging disease which threatened to be of major importance to the horse industry, but this has not eventuated.

The morbidity and mortality rates and the losses associated with babesiosis in other animal species are difficult to determine because they exist as enzootic diseases in areas where they occur.

#### Zoonotic implications

Human cases of *B. divergens* infection have been reported in France, Britain, Ireland, Spain, Sweden, Switzerland, the former Yugoslavia, and the former USSR.<sup>2</sup> Geographically, they coincide with *B. divergens*-infected cattle populations and *Ixodes ricinus*-infested areas, involving inhabitants of rural areas who are exposed to ticks by virtue of their occupation or their recreational activities. Most cases are reported between May and October, during main season of tick activity. *B. divergens* is the primary cause of human babesiosis in Europe, resulting in fatality rates of 42% among persons who have been splenectomized and 5% among those with intact spleens. *B. divergens* has caused human babesiosis in North America in a splenectomized person which suggests that *B. divergens* may be emerging in North America in areas where such infections are not endemic.<sup>32</sup> The known vector tick, *I. ricinus* is not indigenous to North America.

There is evidence that human babesiosis in the US has been associated with *B. microti*, a parasite of white-footed mice, is transmitted by deer ticks.<sup>33</sup> Deer-associated zoonoses have become a major public health concern in the United States because human contact with deer ticks has increased as a result of the proliferation of deer, abandonment of farmland that reverts to thick secondary vegetation, and increased use of coastal sites for human recreation. This explains the increasing frequency of reported human cases of Lyme disease, babesiosis and human granulocytic ehrlichiosis.<sup>32</sup>

*Babesia* represent a potential threat to the blood supply for transfusion since asymptomatic infections in humans are not uncommon and spread of the parasite via blood transfusions has been reported from various countries.<sup>34</sup> Using the microaerophilous stationary phase (MASP) culture technique, the parasites proliferate in a settled layer of blood cells. This provides the opportunity to examine the basic biology of the organism, as well as the host-microbe interactions, immune factors triggered by the parasite, factors involved in innate resistance of young animals to infection, and antimicrobial susceptibility. Their in vitro cultivation can produce quantities of parasite nucleic acid

needed for defining phylogenetic relationships of these species, developing methods for detection of the parasite in otherwise asymptomatic individuals, and producing parasite antigens and attenuated strains of *Babesia* that could be used for immunization.

### PATHOGENESIS

*Babesia* spp. are a diverse group of tick-borne, obligate, intra-erythrocytic Apicomplexan parasites infecting a wide variety of organisms. Infection of a vertebrate host is initiated by inoculation of sporozoite stage parasites into the bloodstream during the taking of a blood meal. Most babesia sporozoites directly invade circulating erythrocytes without a tissue stage of development. Once erythrocyte invasion occurs, a perpetual cycle of asexual reproduction is established despite the rapid development of a strong immune response.<sup>25</sup>

### Acute cases

When an animal becomes infected, multiplication of the protozoa in the peripheral vessels (*B. bigemina*, *B. ovis*), or in the visceral vessels (*B. bovis*), reaches a peak with the development of clinically detectable hemolysis, the principal pathogenic effect, after an incubation period of 7–20 days. The hemolysis results in profound anemia, jaundice, and hemoglobinuria. A fatal outcome due to anemic anoxia commonly follows. In longer surviving animals there are ischemic changes in skeletal and heart muscle.

In *B. bovis* infections there is also a profound vasodilation and hypotension, resulting from stimulation of production of vasoactive substances, and an associated increase in vascular permeability. Circulatory stasis and shock follow; disseminated intravascular coagulation (DIC) and subsequent, fatal pulmonary thrombosis are also features. Cerebral babesiosis is possible.

*B. bigemina* is an uncomplicated hemolytic agent and does not exert these vascular and coagulation effects.

Susceptibility to infection with *Babesia* spp. decreases with age, but the severity of the clinical disease increases. For example, calves up to 5–6 months of age, and infected with *B. bovis*, show little effect; cattle of 1–2 years of age have a moderately severe disease; and aged cows suffer a severe, often fatal, clinical disease. Intrauterine infection of 2-day-old calf with *Babesia bovis* has been reported.<sup>35</sup>

*B. odocoilei* infection in elk causes an acute hemolytic anemia which may be fatal.<sup>17</sup>

Animals which survive become **carriers**, a state in which a harmless, subclinical infection is maintained by a delicate immunological balance between protozoa and

antibodies. This balance is readily disturbed by the stress of transport, deprivation of food, pregnancy, or intercurrent disease. Carrier animals are resistant to infection with *B. bovis* for up to 2 years. With **constant reinfection**, such as occurs in an enzootic situation, the protection is continuous, but the virulence of the blood in transmission experiments varies due to periodic disappearance of infective forms of the parasite from the peripheral blood.

The ability of cattle to infect ticks is much longer (1 year) with *B. bovis* than *B. bigemina* (4–7 weeks). Similarly, the peak incidence is at a younger age and the reinfection rate is faster with *B. bigemina*.

In **pregnant cows** there is no apparent infection of the calf in utero, but passive immunity is transferred via colostrum to the newborn calf.

### Immunology

Calves less than 9 to 12 months of age are as susceptible as adult cattle to infection with *B. divergens* but are less likely to exhibit clinical disease. This phenomenon known as inverse age resistance is due to innate resistance in calves and is independent of the maternal immune status. Although offspring of resistant dams acquire specific antibodies (mainly IgG) via colostrum, these immunoglobulins are not necessary for protection because calves of susceptible dams without specific antibodies are equally resistant. In vitro studies with *B. bovis* show that erythrocytes of very young calves were unfavorable to parasitic development, possibly because of the inhibitory effect of fetal hemoglobin.<sup>2</sup>

Cattle that recover, either naturally or after chemotherapy, from acute infection with *B. bigemina* or *B. bovis* remain persistently infected and resistant to further disease upon reinfection with the same strain.<sup>36</sup> Immunization with killed parasites or parasite extracts can afford protection against homologous and heterologous strain challenge, indicated by low parasitemias and diminished reduction in packed cell volume.

Immunity does not last indefinitely, and in the absence of exposure to further infection, the animal becomes susceptible to reinfection. Specific immune mechanisms include both cellular and humoral components. Monocytes and lymphocytes are the main agents of cell-mediated immunity. Experimentally, the exposure of cattle to avirulent and virulent strains of *B. bovis* causing a primary infection, results in considerable antimicrobial activity in peripheral blood monocytes and neutrophils.<sup>37</sup> The elevated antimicrobial activity is coincident with the time that parasite numbers peaked in the circulation and occurs prior to parasite clearance. This suggests that peripheral blood

monocytes and neutrophils are active mediators in the innate immune response to a primary infection with *B. bovis*. In cattle vaccinated against *B. divergens*, protection is correlated with elevated mononuclear cell proliferation.

In cattle infected with *B. divergens*, antibodies can be demonstrated even before infected erythrocytes appear in blood smears, indicating that they have no inhibitory effect on parasite multiplications. During secondary infections, protection seems to depend on the high specificity of some antibodies rather than the total level of anti-*B. divergens* antibodies, as resistant animals frequently have very low levels of specific antibodies.

The importance of the spleen in the specific immune response is illustrated by the fact that removal of the spleen following recovery may result in clinical relapse.

Specific antibodies to the parasites are produced and are used in serological diagnosis. The highest titers are obtained in the sera of cows that have had a series of infections and reinfections, but the degree of immunity resulting is not related to the antibody titer. The antibodies can be passively transferred via serum or colostrum. The immunity to each strain of *B. bovis* is specific. However, when an infection with a heterologous strain of the protozoa occurs, there is an increased immune response.

Experimental transmission of *B. ovis* infection in sheep produces an acute attack of clinical illness, parasitemia, and the subsequent development of immunity, as in cattle. Experimental infection of pregnant cattle with *B. bigemina* results in an immune response similar to nonpregnant animals.<sup>38</sup>

## CLINICAL FINDINGS

### Cattle

***Babesia bovis*.** The acute disease generally runs a course of 3 to 7 days and a fever of >40°C is usually present for several days before other signs become obvious.<sup>22</sup> This is followed by inappetence, depression, polypnea, weakness and a reluctance to move. Hemoglobinuria is often present (known as redwater in some countries); urine is dark-red to brown in color and produces a very stable froth. Anemia and jaundice develop especially in more prolonged and severe cases. Diarrhea may occur. Muscle wasting, tremors and recumbency develop in advanced cases followed terminally by coma. Many severely affected animals die precipitately at this point, after an illness of only 24 hours. Metabolic acidosis is present in a significant percentage of cases of bovine babesiosis in Ireland.<sup>39</sup> During the fever stage, pregnant cattle

may abort and bulls may become sterile for 6 to 8 weeks. Cerebral babesiosis is manifested by incoordination followed by posterior paralysis, or by mania, convulsions and coma. The mortality rate in these cases is high in spite of treatment.

In those that survive, the febrile stage usually lasts for about a week and the total course about 3 weeks. Animals that survive recover gradually from the severe **emaciation** and anemia, which are inevitable sequelae.

A **subacute** syndrome also occurs, especially in young animals, in which the fever is mild and hemoglobinuria is absent. The syndrome in infection with *B. divergens* is similar to the above, except that in addition, there is spasm of the anal sphincter causing the passage of feces with great force in a long, thin stream, even in the absence of diarrhea. The sign is referred to as '**pipe-stem**' feces.

**Babesia bigemina.** Hemoglobinuria is present earlier and more consistently than in *B. bovis* infections and the fever is less of a feature. Acutely affected animals are usually not as severely affected as those with *B. bovis* infections. There is no cerebral involvement and recovery in non-fatal cases is usually rapid and complete. However, in some cases the disease can develop very rapidly with sudden and severe anemia, jaundice and death.<sup>22</sup> Animals which recover from *B. bigemina* remain infective for ticks for 4 to 7 weeks and carriers for only a few months.

### Sheep

Anemia, fever, icterus and hemoglobinuria are common.<sup>8</sup>

### Horses

The incubation period is 8–10 days. **Acute** cases in adults show a sudden onset of immobility and reluctance to move; some are in lateral recumbency and do not respond to stimuli. There is complete anorexia and fever of 40°C (104°F), although the fever often subsides after 1 day and becomes intermittent. Edema of the fetlocks occurs and may also be present on the head and ventral abdomen. Fecal balls are covered with thick mucus, and colic occurs frequently. Often there is no hemoglobinuria; bronchitis occurs occasionally. The mucosae are pale pink and tinged with jaundice. In **young horses**, the signs are more severe – jaundice, mucosal pallor and weakness are marked, and mucosal petechiae are evident. The course is 8–10 days. Afflicted horses may die within 24–48 hours of the first signs appearing. **Chronic** cases may survive for months and 'carriers' may persist for as long as 4 years. The experimental disease produced by *B. equi* is mild. A high percentage of erythrocytes

are parasitized by the protozoa and the horses are anemic, but there is no clinical evidence of anemia. Newborn **foals** develop severe jaundice and severe prostration, sometimes delayed in onset by 2 or 3 days after birth.

### Wildlife

Babesiosis in elk and caribou are characterized clinically by lethargy, hemoglobinuria, icterus, fever, recumbency, and sudden death.<sup>17</sup> Elk infected with *B. odocoilei* may not have any clinical signs of disease, but may become ill during periods of stress, such as the rutting season, calving, transportation, or overcrowding.

### Other species

In all other species the syndrome observed is clinically similar to that described for cattle.

## CLINICAL PATHOLOGY

### Clinical cases

#### Hematology

Severe anemia with erythrocyte counts as low as 2 million/ $\mu$ L and hemoglobin levels down to 3 g/dL occur in clinical cases in cattle and horses, the anemia peaking 9–16 days after infection occurs. Significant falls in platelet counts and a depression in the fibrinogen content of the blood also occur.

#### Demonstration of Babesia

**Direct examination of blood smears.** A diagnosis of existing babesiosis in clinically affected animals of all species depends on the demonstration of protozoa in a Giemsa-stained smear of capillary blood; venous blood may give a false-negative in *B. bovis* infections. There is no exact correlation between the percentage of erythrocytes containing protozoa and the severity of the clinical signs. Also in *B. bigemina* infections, protozoa are numerous in peripheral capillaries; *B. bovis* is much less readily found. This difficulty can be largely overcome by the use of thick blood smears. Microscopic examination can detect parasitemia of about  $10^5$  in thin blood films and  $10^6$  in thick blood films.

For best results, blood films should be prepared from capillary blood collected after pricking the tip of the tail or margin of the ear. Blood from the general circulation may contain 20 times fewer *B. bovis* than capillary blood. Thick blood films are 10 times more sensitive and are more reliable for the detection of low level *B. bovis* infection.<sup>22</sup>

**Transmission test.** Subinoculation of blood to susceptible splenectomized calves is highly sensitive technique for direct detection of *Babesia* infection. In **transmission tests**, 50–100 mL of blood are injected into the recipient either SC or IV. In the latter case, the incubation period

will be shorter. The recipients are examined daily and the blood examined for protozoa at the peak of the febrile reaction.

**Carrier cattle** infected with *B. bovis* and *B. bigemina* are difficult to detect because of the small number of parasites in peripheral blood. Microscopic examination of blood films is not reliable technique for detection of *Babesia*-carrier animals. The evaluation of persistence of *B. bovis* and *B. bigemina* infections require subinoculation of blood into splenectomized calves, and measurement of the anti-babesial antibody level.<sup>40</sup>

**Culture of Babesia.** *Babesia divergens* from the blood of **carrier cattle** can be isolated using an in vitro culture technique in sheep erythrocytes.<sup>41</sup> The protozoa could be isolated 9 months after the acute babesiosis phase, and can be successfully subcultured, cryopreserved and resuscitated using culture medium. This will allow for more detailed examination of the organism.

**Preservation of live protozoa** can be effected by cryopreservation, by culture in a medium containing infected bovine erythrocytes, and in simple culture media in special machinery for long periods and in large quantities.

### PCR detection and identification of Babesia spp.

A universal PCR assay for the detection and identification of nine of the most common pathogenic bovine, equine, and rodent piroplasms, including *B. divergens*. Following specific amplification of the parasite DNA by nested PCR, the parasite species is identified by PCR-restriction fragment length polymorphism.<sup>2</sup> Various applications of the PCR have detected *B. bovis* and *B. bigemina* parasitemias at levels of  $10^{-7}$  to  $10^{-9}$ .

The most recently introduced tests are an ELISA using a recombinant *B. bovis* antigen, PCR and a DNA probe, which can detect specific parasitemias at very low levels of infection. The DNA probe has the added advantage of being able to detect protozoa in necropsy specimens and in tick tissues. The PCRs are most useful because of their high sensitivity, which makes them ideal for the detection of carrier animals.

A PCR assay can detect *B. equi* and *B. caballi* from the blood of horses which have recovered from the acute phase of babesiosis. The may assume a subclinical, chronic course and the animals are carriers and may act as reservoirs of infection, and parasites are present in very low numbers in the blood and generally not detectable in Giemsa-stained blood-smears.<sup>42</sup> In these horses the complement fixation test which is the official test for the diagnosis of babesiosis in horses may be negative and the PCR test is positive. A nested



PCR assay has been used to detect natural infection of *Boophilus microplus* and the blood of horses with *B. equi* and *B. caballi* in Brazil.<sup>21</sup> The nested PCR is considered superior to both Wright–Giemsa-stained and primary PCR methods for the routine detection of *B. equi* in horses.<sup>43</sup>

### Serology

Diagnosis of **past or present infection** is adequately demonstrated by any one of a wide range of serological tests.

#### Bovine

Because of the difficulty in finding protozoa in smears in animals during the sub-clinical stages of the disease, especially in surveillance studies for the detection of the infection in herds or areas, much attention has been directed to serological tests. These are now well-established, but none of them enjoys a completely satisfactory reputation.

**Complement fixation test (CFT).** The CFT has been the most used serological test for bovine babesiosis. Other tests being assessed in field conditions include a passive agglutination test, an indirect fluorescent antibody test (IFAT), an indirect hemagglutination test, an ELISA, a microplate enzyme immunoassay (EIA), a latex agglutination test, a capillary agglutination, a slide agglutination, and a card agglutination test. All of the tests have good reputations, with the EIA being probably the most sensitive.

**Immunofluorescence antibody test (IFAT).** The IFAT has been a popular test used to distinguish between *Babesia* spp. and to demonstrate the presence of antibodies in a population. IFAT clearly differentiates between antibodies to *B. divergens* and other bovine babesias but not between *B. divergens* and *B. capreoli* from red deer.

**ELISA.** An ELISA system using a crude antigenic preparation of *B. bovis* has been standardized for the detection of IgM antibodies with a specificity of 94% and sensitivity of 100%.<sup>44</sup> Specific IgM antibodies against *B. bovis* first appeared on the 11th day post-inoculation in animals infested with *B. microplus* ticks and on the 19th day post-inoculation in which animals had been inoculated with infected blood.

A competitive ELISA (cELISA) is an accurate, reliable, easily standardized, and high-throughput method for detecting hemoparasite infections.<sup>45</sup> The gene encoding *B. bovis* rhoptry-associated protein 1 (RAP-1) was used to develop the assay.<sup>46</sup> The cELISA accurately differentiated animals with *B. bovis*-specific antibodies from uninfected animals and from animals with antibodies against other tick-borne hemoparasites (sensitivity 98.5%, 98.7% specificity).

#### Sheep

An ELISA is available for the detection of *B. ovis* in sheep.

#### Equine

In the horse, the tests used include the widely used complement fixation test, and the recently introduced, still undergoing testing, ELISAs and DNA probes. Important aspects of serological testing in horses is its application in the implementation of **import and export** regulations, in deciding the action to be taken in releasing very valuable horses from quarantine, and in deciding whether or not to permit entry of individual horses into non-enzootic areas.

A **latex agglutination test (LAT)** using recombinant *B. equi* merozoite antigen 1 (EMA-1) has been developed for the detection of antibodies to *B. equi*.<sup>47</sup> It is a simple, rapid, sensitive, specific and inexpensive alternative to IFAT or ELISA.

Because of the importance of testing individual horses, in the process of babesiosis control the **culture of blood** from suspect horses is now used to determine whether or not they are carriers of *B. equi*.

### NECROPSY FINDINGS

In **acute cases** of babesiosis in all species, in which patients die after a brief illness and during an anemic crisis, the typical lesions are jaundice, thin watery blood, pale tissues, enlargement of the spleen which has a soft, pulpy consistency, and gross enlargement and dark brown discoloration of the liver. The gallbladder is distended with thick, granular bile, the kidneys are enlarged and dark, and the bladder contains red-brown urine. Ecchymotic hemorrhages are present under the epicardium and endocardium, and the pericardial sac contains an increased quantity of blood-stained fluid. A characteristic lesion in both cattle and horses is severe intravascular clotting.

In **subacute or chronic cases** of fairly long duration, the carcass is emaciated but hemoglobinuria is absent; the other changes observed in acute cases are present but less pronounced. **Laboratory examination** of smears taken from peripheral blood, from kidney and heart muscle and, in the case of suspected *B. bovis* infection, from the brain, is mandatory for clinching the diagnosis. The smears from blood and most tissues must be made within 8 hours of death, in the case of brain within 28 hours, and stained with Giemsa for the detection of *B. bovis*.

Direct fluorescent antibody staining of smears permits the use of slightly older tissues. Organ smears are still usable 5 days after collection provided they are kept stored at 22°C (72°F). With *B. bigemina*

the morphology of the parasite changes quickly after the host's death so that they resemble *B. bovis*. Blood serum collected after death can also be used for detection of antibodies in serological tests.

### DIFFERENTIAL DIAGNOSIS

For diagnostic confirmation the presence of the insect vector must be verified before the diagnosis of babesiosis can be made, unless the animal has left an enzootic area within the preceding month. Clinically, a high morbidity and case fatality rate in cases showing jaundice with hemoglobinuria and fever are suggestive, but confirmation of the diagnosis by examination of blood smears or by transmission experiments is essential. A necropsy showing splenomegaly, jaundice, hemoglobinuria, swollen dark kidneys and liver, and myocardial ecchymoses, while highly suggestive, should also be confirmed by laboratory examination of tissues for the presence of the causative protozoa.

#### Differential diagnosis list

A syndrome of acute hemolytic anemia should suggest the following alternative diagnoses:

#### Cattle (see Table 26.2):

- Theileriosis (*Theileria annulata*) – very similar clinically and differentiable only on laboratory examination
- Postparturient hemoglobinuria – does not require the presence of vectors, occurs only in recently calved cows in full milk and on low phosphorus diets, and is characterized by the absence of protozoa from blood and tissues
- Bacterial hemoglobinuria – characterized by a necrotic infarct under the diaphragmatic surface of the liver in cattle grazing lush pasture
- S-methyl-L-cysteine-sulfoxide (SMCO) poisoning – occurs only in cattle grazing crops of rape or other *Brassica* spp.
- Leptospirosis – occurs only in this form of the disease in calves kept in unsanitary conditions which are wet underfoot. Diagnosis of this disease depends on isolation of the leptospire.

#### Horses (see Table 26.3)

- Equine infectious anemia – has a much longer, recurrent course, occurs in sporadic cases only and is not associated with protozoa in body fluids and tissues
- Paralytic myoglobinuria – red urine is due to myoglobinuria, always associated with recent vigorous exercise and elevation of serum creatine phosphokinase levels
- Foals with alloimmune hemolytic anemia – detectable only on laboratory examination for evidence of incompatibility between the serum of the dam and the foal's erythrocytes
- Cardiac form of African Horse Sickness – edematous lesions occur similar to those in babesiosis, but in which there is no hemoglobinuria or jaundice.

Table 26.2 Differential diagnosis of diseases of cattle in which red urine is a principal manifestation

Disease	Epidemiology	Clinical and laboratory findings		
		General	Urinary	Clinical pathology
<b>Diseases with hematuria</b>				
Enzootic hematuria	Subjects older than 1 year. Endemic to specific areas with access to bracken.	Persistent intermittent hematuria, hemorrhagic anemia, acute or chronic. Rectal in acute cases nil; chronic cases have local or diffuse thickening. Long course, death by anemia.	Persistent, intermittent hematuria.	Urine has no pus, eukocytes or bacteria.
Enzootic bovine pyelonephritis	Adults only. Sporadic cases usually. May be a series suggesting origin in one bull and relationship to mating events.	Mild fever. Frequent painful urination, toxemia. Late cases, rectal examination shows cystitis, ureters thickened and enlarged, kidneys the same. Pain on palpation. Long course, death by uremia.	Intermittent hematuria and pyuria.	Urine has pus, erythrocytes, eukocytes, <i>Co: renale</i> on culture catheter sample.
<b>Diseases with hemoglobinuria</b>				
Babesiosis ( <i>B. bigemina</i> and <i>B. bovis</i> )	Outbreaks in marginal areas in heavy tick seasons in calves. Incubation 2–3 weeks. 90% morbidity and mortality.	High fever, pallor, severe jaundice terminally.	Red urine, hemoglobinuria.	Babesia in red cells in smear. Transmission test. Many serological tests.
Tropical Theileriosis ( <i>Theileria annulata</i> )	Transmitted only by ticks of <i>Hyalomma</i> spp.	Fever, anorexia, lymph node enlargement.	Hemoglobinuria.	Piroplasm in red cells; schizonts in lymphocytes from liver biopsy. Serological tests. <i>Hyalomma</i> spp.
Postparturient hemoglobinuria	Postcalving 2–4 weeks. Adult dairy cows in 3rd–6th lactation. Sporadic but tends to endemicity on individual farms. Low phosphorus or low copper diet.	Acute onset, weakness, tremor, pallor, bounding pulse, loud heart sounds, tachycardia. No jaundice. Mortality 50%. Long convalescence. Die of anemia, especially if stressed.	Deep brown to black frothy.	No cells in urine but good deposit on standing. Severe hemolytic anemia. Serum inorganic P < 1.5 mg/dL and down to 0.1 mg/dL.
Bacillary hemoglobinuria	Summer time on irrigated pasture. Sporadic. Very few cases. Endemic to particular farms. Mortality 100%.	Often found dead. Very acute onset, hemolytic anemia plus toxemia. Fever 41°C (105°F). Abdominal pain, pain on percussion right anterior abdomen. Diarrhea. Shallow, rapid respiration due to diaphragmatic pain.	Deep red brown, no cells.	Hemolytic anemia, increased serum bilirubin.
Leptospirosis ( <i>L. interrogans pomona</i> only, not <i>L. hardjo</i> )	Calves high mortality 50%. Adults low mortality <5%. Abortion storm more common in adults. Many subclinical infections in adults.	Hemolytic disease mostly in young calves. Sudden onset septicemia with red urine. Severe toxemia, fever 40.5–41.5°C (104.5–106°F). Mucosal petechiae, pallor and jaundice. Adults have thick orange milk all quarters.	Red urine, hemoglobinuria	Initially leptospiruria 3 days. Leptospiruria by intraperitoneal injection into guinea-pigs. Rising titer leptospira antibodies with peak 4 weeks after infection.
Chronic copper poisoning	Rarely if at pasture. Copper supplement in a swine diet by mistake.	Sudden onset, weakness, pallor, jaundice, death usually in 24–48 hours.	Hemoglobinuria, some methemoglobinuria	High liver copper on biopsy 2000 ppm dry material. High plasma ceruloplasmin and copper.

## TREATMENT

**Primary treatment** is aimed at destruction of the protozoa in the patient. Effective drugs are available for this purpose in cattle, but the initial phase of the disease is acute; if treatment is delayed for too long the animal may succumb to the anemia in spite of sterilization of the blood. When the illness is a consequence of vaccination with live vaccine, care must be taken to avoid complete sterilization of the blood before sufficient antibody is produced to provide

a durable immunity. Treatment has no suppressing effect on the protozoa that are residing in the ticks parasitizing the cattle at the time.

A summary of the recommended drugs follows, but diminazene aceturate, imidocarb dipropionate, amicarbalide diisethionate, and phenamidine are most often used. Parvaquone, buparvaquone, and alovaquone are recent introductions with good reputations from clinical trials. Tetracyclines have been used extensively, but their use in acutely sick animals has

been discontinued. They find some use in simultaneous administration with living babesia in a chemosterilant situation; the parasite is controlled but effective immunization is achieved.

## Cattle

For many years, three babesicides, quinuronium sulfate and several generics of it, amicarbalide isoethionate, and diminazene aceturate were available in most countries for the treatment of bovine babesiosis. In the 1970s a fourth,

Table 26.3 Differential diagnosis of anemia, with or without edema, in horses

Disease	Epidemiology	Clinical findings	Clinical pathology	Treatment
<b>Anemia</b> Chronic blood loss	Sporadic. Parasitism. Intestinal blood loss e.g. gastric squamous cell carcinoma. Guttural pouch mycosis.	Lethargy, tachycardia, pale mucous membranes. Other signs consistent with underlying disease.	Hypochromic, microcytic anemia. Low serum iron concentrations. Increased serum iron binding capacity, and low serum ferritin concentration. Thrombocytopenia. Other results specific for underlying disease. Bone marrow – decreased myeloid: erythroid ratio	Correct underlying disease. Administer ferrous sulfate 10–20 mg/kg per os once daily until serum iron concentration is normal and anemia has resolved.
Anemia of chronic disease (inflammation)	Sporadic. Associated with chronic, inflammatory disease (neoplasia, strangles abscess).	Lethargy. Signs consistent with underlying disease	Normocytic, normochromic mild anemia. Low serum iron concentration, low to unchanged total serum iron binding capacity, increased serum ferritin concentration. Bone marrow normal.	Treat underlying disease.
Aplastic anemia	Sporadic. Can occur as an outbreak in stables in which horses are administered recombinant human erythropoietin (rhEPO).	Lethargy, tachycardia, pale mucous membranes. Other signs consistent with underlying disease.	Normochromic, normocytic anemia. Normal to high serum iron concentration. Antibodies to rhEPO Bone marrow – very high myeloid to erythroid ratio due to lack of red cell series	Correct underlying disease. Prognosis for rhEPO-induced anemia is very poor.
Red Maple ( <i>Acer rubrum</i> ) intoxication	Ingestion of green or wilted leaves of red maple trees. Sporadic or several horses in one field. Regional according to distribution of tree.	Jaundice, hemoglobinuria, depression, colic, renal failure.	High (>1.5%) concentration of methemoglobin in blood. Heinz bodies in red blood cells.	Supportive care. Blood transfusion. Vitamin C suggested
Neonatal isoerythrolysis	Foals <4–5 days of age. Multiparous mares. Ingestion of colostrum containing isoantibodies to foal's red blood cells.	Weakness, depression, exercise intolerance, jaundice, hemoglobinuria.	Anemia, hyperbilirubinemia, positive Coombs test. Positive jaundiced foal agglutination test. Blood typing of mare and stallion and detection of isoantibodies in dam.	Conservative. Rest. Limit exercise. Severely affected foals require transfusion of blood or packed red cells from compatible donor.
Fell pony syndrome	Fell ponies <18 weeks of age. Suspected heritable defect.	Weakness, depression, ill-thrift, pneumonia, diarrhea and other opportunistic infections.	Normocytic, normochromic anemia. B-lymphocyte leucopenia. Decreased concentrations of immunoglobulins as foal's age.	None
Autoimmune hemolytic anemia	Secondary to other disease or drug administration. Penicillin-induced anemia	Depression, pallor of mucous membranes. Signs of underlying disease.	Anemia. Hemoglobinemia or hemoglobinuria. Coombs positive.	Corticosteroids or immunosuppressant drugs. Withdraw inciting cause.
Clostridial myonecrosis	Sporadic. Associated with intramuscular administration of medications or vaccinations.	Acute disease – fulminant myonecrosis with fever, depression and hemolytic anemia. Chronic disease associated with abscessation at site of injection, jaundice, hemoglobinemia, hemoglobinuria.	Anemia. Agglutination of red cells. Detection of IgM or IgG on red cell surface in chronic disease.	Treat underlying disease. Blood transfusion. Poor prognosis
Liver failure	Sporadic. Associated with risk factors for liver disease.	Terminal phases of liver failure. Depression, weight loss, jaundice.	Consistent with liver disease (bilirubin, AST, bile acids, GGT).	None specific. Treat liver disease. Poor prognosis
Bone marrow hypoplasia in Standardbreds	Specific family line of Standardbred horses in North America.	Exercise intolerance, infections.	Anemia, pancytopenia	None.
Myelophthistic disorders	Sporadic. Bone marrow neoplasia (myeloproliferative disease, lymphosarcoma).	Exercise intolerance.	Depends on underlying disease. Normochromic normocytic anemia Profound leukocytosis in some diseases. Hypergammaglobulinemia	Treat specific disease.

Table 26.3 (Cont'd) Differential diagnosis of anemia, with or without edema, in horses

Disease	Epidemiology	Clinical findings	Clinical pathology	Treatment
Idiopathic folate deficiency	Sporadic. Horses treated with drugs that inhibit folate metabolism and are administered synthetic folate orally, such as for treatment of equine protozoal myeloencephalitis.	Signs of underlying diseases. Unusual bacterial infection. Depression, exercise intolerance, lethargy.	Mild anemia. Lymphopenia, neutropenia. Low blood folate concentrations.	Stop oral administration of folate. Administer folate parenterally.
<b>Anemia with edema</b> Babesiosis ( <i>Theileria equi</i> , <i>Babesia caballi</i> )	Regional disease related to presence of vector ticks. Adult horses. Infected carrier state. <i>T. equi</i> transmitted transplacentally in addition to tick bite.	Incubation period of 5–30 days. Depression, reluctance to move, recumbency, fever. Dependent edema. Colic. Mild jaundice and petechiation. Young horses most severely affected. Course 8–10 days.	<i>B. equi</i> in erythrocytes. Serologic testing using IFA or CF. PCR to detect organism.	Imidocarb
Equine infectious anemia	Virus. Acute disease followed by life-long infection. Insect vector (Tabanid flies) or mechanical transmission (veterinary instruments).	Acute disease of fever, anemia, dependent edema, and jaundice. Apparent recovery followed by intermittent relapses of usually less severe disease.	Thrombocytopenia. Anemia. AGID (Coggin's) test. CELISA.	None specific. Control includes destruction of horses with a positive AGID or CELISA test in many jurisdictions.
Purpura hemorrhagica	Immune-mediated (antigen-antibody complex) secondary to respiratory disease. Adult horses. Sporadic occurrence.	Non-painful, cool, asymmetric subcutaneous swellings. Mild fever. Severe cases have multiple organ involvement including rhabdomyolysis.	Leucocytosis. Normal platelet count. High serum anti-streptococcal M protein antibody titer.	Penicillin. Corticosteroids. Supportive care.
Congestive heart failure	Sporadic.	Murmur of valvular insufficiency. Irregular heart rhythm (atrial fibrillation). Edema that is symmetrical, cool, and of dependent parts.	None specific.	None specific. Digitalis and furosemide in short term.
Strongylosis	Small strongyles (cyathostomes). Historically large strongyles.	Young horses. Mild fever, depression, diarrhea, edema.	Anemia, hypoproteinemia. In patent infestations fecal egg count.	Anthelmintics (ivermectin, moxidectin, benzimidazoles). Resistance an increasing occurrence.

imidocarb dipropionate was introduced, and it rapidly became the drug of choice in those countries that licensed it, because in addition to its therapeutic utility, it also proved to be an effective prophylactic at twice the therapeutic dose.<sup>2</sup> Currently, it is the only babesicide on the market in most of Europe. Quinuronium sulfate and amicarbilide have been withdrawn because of manufacturing safety issues, and diminazene, which is widely used in the tropics as both a babesicide and a typanocide, was withdrawn in Europe for marketing reasons.

Imidocarb is most toxic when given IV, and IM and SC administration is generally recommended. Side effects include coughing, muscular tremors, salivation, colic, and local irritation at the site of injection following high doses. While it is regarded as being slower in action than quinuronium sulfate it is the only babesicide that consistently clears the host of parasites. In the past, the persistence of small numbers of parasites in the bloodstream was deemed necessary for the maintenance of resistance to reinfection. However, the concept of premunition is no longer accepted. Premunition is used to describe resistance

that is established after the primary infection has become chronic and is only effective if the parasite persists in the host. It was thought that only cattle actually infected with *Babesia* were resistant to clinical disease. If all organisms were removed from an animal, resistance was thought to wane immediately. However, cattle cured of *Babesia* infection by chemotherapy are resistant to challenge with the homologous strain of that organism for several years. But the presence of infection does appear to be mandatory for protection against heterologous strains.

While a certain period of antigenic exposure is necessary before treatment to facilitate the establishment of immunity, cattle treated with imidocarb dipropionate ultimately have a solid sterile immunity. Long-term persistence of low-level parasitemia is now considered a disadvantage. Remaining parasites may give rise to recrudescence under adverse conditions, treated cattle may act as a source of infection, and parasites surviving at low levels of babesicide may acquire resistance.

Imidocarb, provides protection from clinical disease for 3 to 6 weeks but allows a sufficient level of infection for

immunity to develop. This strategy is highly effective if the host is assured to be exposed to babesiosis during the period of protection, either through a tick bite in areas where babesiosis is endemic or by inoculation of live parasites. Acquired immunity then takes over from the passive drug protection, and the animal passes smoothly to a resistant state without an intermediate clinical stage. However, if infection rates are sporadic or if very high doses of imidocarb are used, as a complete inhibition of parasite development will hinder the mounting of an adequate immune response. The major problem associated with this approach is concern about drug residues in milk and beef, which has led to the withdrawal of imidocarb in several European countries.<sup>2</sup>

#### Imidocarb (Imizol)

This, and the allied drug amidocarb, are effective babesicides for cattle at the dose rate of 1 mg/kg BW. At 2 mg/kg BW it completely eliminates the parasites from the host and maintains some residual activity; non-infected cattle derive a month's resistance to clinical infection but can be infected subclinically. It can

therefore be used to protect cattle when vaccination is undesirable, e.g. pregnancy, or when exposure to infection is short lived, and as a temporary protection while awaiting vaccination. The drug can be given SC, but the hydrochloride is inclined to be irritant; the propionate is less so.

### Horses and donkeys

The preferred treatment of equine babesiosis is not well-established. Many drugs have been used, but a combination of imidocarb and buparvaquone appears to be the only efficient treatment capable of eliminating *B. equi* infection. *B. caballi* is more susceptible, but it is expected to develop resistance quickly. **Imidocarb** must be given in a strict treatment regimen (four IM injections of 10% solution at a dose of 4 mg/kg BW at intervals of 72 hours). For *B. caballi*, a regimen of 2 mg/kg BW on two occasions 24 hours apart is sufficient to control an acute infection, but does not completely eliminate the babesia, and the patient may become a carrier. The hydrochloride salt of imidocarb is strongly acidic and may provoke severe local reactions in horses, therefore, the dipropionate is being used more. A note of warning is necessary about the treatment of donkeys, which are very susceptible to imidocarb (the LD<sub>50</sub> is less than 2 mg/kg BW). **Buparvaquone** 4–6 mg/kg BW parenterally is also capable of controlling acute babesiosis due to *B. equi*, but also on its own, like imidocarb, it does not eliminate the infection, allowing the horses to remain carriers. Some initial research has been done on the use of triclosan on equine and bovine *Babesia* infections.<sup>48</sup>

The therapeutic efficacy of imidocarb, artesunate, arteether, buparvaquone and arteether + buparvaquone combination was evaluated against *B. equi* of Indian origin in splenectomized donkeys with experimentally induced infection.<sup>49</sup> Imidocarb had deleterious effects on liver function, and the arteether + buparvaquone combination was found to be safe and may be a superior drug for treating *B. equi* infection.

### Sheep

Diminazene aceturate is effective as a treatment in sheep (3.5 mg/kg BW on two successive days, or 12 mg/kg BW as a single dose).

### Supportive treatment

In all species, treatment regimens for severely affected patients should include blood transfusions and anti-shock preparations. In chronic cases and convalescent patients, hematinics should be provided.

## CONTROL (BOVINE BABESIOSIS)

### Prevention and biosecurity

**Prevention of introduction** of the disease into a non-enzootic area depends on effective quarantine to prevent the introduction of the vector tick, and laboratory testing to ensure freedom of the importee from infection with the pathogen. The international movement of animals has become a very important matter to the horse industry where teams of pleasure horses attend competitions in other countries, and where valuable stallions move to another country for a brief period to stand at stud. There is a tendency for some countries to be very restrictive in their quarantine procedures for horses, and international relations would be enhanced if more was known about the relationship between a positive serological test and infectivity for other horses.

### Eradication

**Eradication** of bovine babesiosis from an area depends upon eradicating the vector tick – a problem in applied entomology. It was achieved in the United States but is unlikely to be attempted again because of the high cost to local wildlife, which are potential hosts to the ticks. Other problems encountered in the eradication process include:

- Difficulty of getting a complete muster of all cattle on every dipping day
- Multihost ticks, which can be infective but temporarily not resident on a beast on dipping day
- Spread of ticks or infested cattle due to environmental activity, e.g. floods, windstorms
- Illegal movement of cattle without a permit.

A major problem is encountered when the protozoan persists through succeeding generations of the vector tick. The resistance of ticks to acaricides is also a factor relating to the infestation level of cattle.<sup>50</sup>

The effect of three tick (*Boophilus microplus*) control strategies (none, threshold, and strategic) on endemic stability and the likelihood of babesiosis (*Babesia bovis*) has been examined using a spreadsheet age-class computer simulation model based on weekly tick counts from Brazil and Uruguay.<sup>26</sup> The Brazil bovine population was in a naturally occurring state of enzootic stability with an inoculation rate exceeding 0.005 throughout the year. Threshold dipping strategies did not increase the risk of babesiosis. Strategic dipping resulted in an extended period of enzootic instability lasting 30 weeks which required protec-

tion of the herd by vaccination. Because of the more prolonged low winter temperature conditions in Uruguay, the bovine population was in a naturally occurring state of endemic instability, characterized by a 28-week period in which the inoculation rate was below 0.005. Strategic dipping would lead to eradication of the babesial parasite from tick and bovine populations, but would not result in eradication of the tick vector. This could lead to subsequent outbreaks if *Babesia* carrier animals were introduced into the herd. In both populations, strategic tick control could be accompanied by concurrent babesiosis vaccination.

### Limitation of prevalence

To accomplish limitation of prevalence at economically sustainable levels requires different solutions in different circumstances as set out below. It is largely dependent on tick control by the frequent application of acaricides, chemotherapy to kill the babesia in the cattle host and, to a lesser degree, by immunization of the host cattle. These measures are only partly effective, and are time-consuming and expensive. The reason for the poor performance of vaccination procedures after a great deal of research is that the mechanisms of immunity to protozoa, especially *Babesia* spp. is the lack of knowledge on how immunity to these parasites works.

- Susceptible cattle moving into an enzootic area need prior **vaccination**
- Marginal areas next to enzootic areas where tick populations vary with climatic change so that resident cattle lose their immunity after some dry years, and are then exposed to infection when wet years foster the migration of vector ticks back into the area. Recommended techniques are **vaccination** before outbreaks commence, if forecasting is available, plus temporary **chemoprophylaxis** after outbreaks have commenced
- Enzootic areas where losses are occurring due to environmental stress or, especially, concurrent infection with a second pathogen, e.g. *Anaplasma marginale*, or where the tick population has been decimated by overzealous dipping; **chemoprophylaxis** and relaxation of the dipping program are recommended. An adequate tick population is one ensuring that all cattle are infected and reinfected early and sufficiently often to maintain them in a state of constant of infection and therefore of immunity.

### Vaccination

Vaccination has been done with varying degrees of success with live and dead

whole parasites, crude parasite extracts, and isolated parasite antigens.<sup>2</sup> Several findings support the development of vaccines against babesiosis. First, cattle which recover from a primary *Babesia* infection or that have been immunized with attenuated parasites are resistant to challenge infection. Second, immunization of cattle with native *Babesia* antigen extracts or culture-derived supernatants containing secreted *Babesia* antigens elicit protective immunity against both homologous and heterologous challenge.

The features of cattle farms on which the exposure of young cattle to tick fever organisms is sufficient to ensure that immunity is high and the risk of clinical disease is low (see **endemic stability, under Epidemiology**) can be compared with those farms on which exposure is insufficient (endemic instability) can be compared to examine the relationships between the management of ticks and tick fever.<sup>51</sup> In Queensland, Australia, the majority of cattle herds do not have sufficient exposure to *B. bovis*, *B. bigemina* or *A. marginale* to confer endemic stability for tick fever.<sup>51</sup> For *B. bovis*, the major cause of outbreaks of clinical disease in Queensland, fewer than half the herds had evidence of endemic stability. The decision to leave a few ticks on cattle in an effort to induce endemic stability did increase the likelihood of endemic stability to *A. marginale*. However, it was ineffective, because only 26% of herds had endemic stability against all three organisms. Thus given the low proportion of herds with endemic stability to tick fever organisms and the high likelihood of clinical disease, vaccination is recommended to protect dairy cattle from tick fever throughout the tick-infested area of Queensland.

#### Vaccination with living immunogens

Vaccines incorporating live, attenuated strains of *B. bovis* and *B. bigemina* have been used routinely or experimentally in Australia and a number of other countries.<sup>52</sup> The literature on designing blood-stage vaccines against *Babesia bovis* and *Babesia bigemina* has been reviewed.<sup>36</sup> The data available on the efficacy, degree and duration of immunity provided by live vaccines against *B. bovis* and *B. bigemina* infections in Australia have been reviewed.<sup>53</sup> Most of the available live vaccines are produced in government-supported production facilities, in Australia, Argentina, South Africa, Israel, and Uruguay. These vaccines include bovine erythrocytes infected with selected strains. The risk of contamination of blood-derived vaccine is real and makes post-production quality control essential, and unfortunately beyond the means of many

countries in endemic regions. Techniques developed in Australia over many decades have formed the basis for production of live *Babesia* vaccines in most countries where they are used.<sup>22</sup>

#### Origin and purification of strains.

Since 1990, three strains of *B. bovis*, and one of *B. bigemina* (G strain) have been used to produce vaccines in Australia. After testing for virulence, immunogenicity and purity, suitable strains are preserved as master stabilates in liquid nitrogen.<sup>22</sup>

#### Attenuation of parasites

***Babesia bovis*.** The most reliable method of reducing the virulence of *B. bovis* is the rapid passage of strains through susceptible splenectomized calves. Attenuation usually occurs after 8 to 20 calf passages.

***Babesia bigemina*.** Rapid passage in splenectomized calves is not reliable but the virulence of *B. bigemina* decreases during prolonged residence in latently infected animals. A single *B. bigemina* isolate (G strains) has been used in the Australian and South African vaccines since 1972 and the early 1980s, respectively.<sup>22</sup>

#### Vaccine specifications

Live vaccines have proven very effective and reasonably safe, particularly when vaccination is restricted to cattle less than 1 year of age, when they still have natural resistance to the disease. Parasites for vaccines are derived from splenectomized donor calves infected with attenuated strains or parasites grown *in vitro*.<sup>52</sup> The vaccines are provided either chilled or cryopreserved. Despite the disadvantages, live vaccines provided greater than 95% protection for the life of the animals.

**Frozen vaccine.** Frozen vaccine is superior to chilled vaccine because of long shelf-life which allows post-production testing of potency and safety before dispatch. Glycerol is used as cryoprotectant in Australia in preference to dimethyl sulphoxide because it allows post-thaw storage life of the vaccine for at least 8 hours. Frozen vaccine is the only product available in South Africa and Israel, and demand for it is growing in Australia. Frozen vaccines are transported in suitably insulated containers with liquid N<sub>2</sub> or solid CO<sub>2</sub> as refrigerant which limits the ability to supply vaccines to all destinations. To ensure infectivity, the prepared vaccine must be used within 8 hours of thawing, and once thawed should not be refrozen. If glycerol is used, a thawed vaccine can remain viable for only 8 hours at temperatures ranging from 4 to 30°C. A frozen bivalent *B. bovis* and *B. bigemina* vaccine and frozen monovalent *B. bovis* and *B. bigemina* vaccines using dimethyl sulphoxide as the cryoprotectant are produced in South

Africa and Israel, respectively. If dimethyl sulphoxide is used, a vaccine should be used within 30 minutes of thawing.

**Chilled vaccine.** Most of the babesiosis vaccines produced to date have been provided in a chilled form. In Australia, 35 million doses were supplied between 1996 and 2003. It is popular because of ease of production, ease of transportation even with limited resources, ease of use, and low cost. The chilled vaccines currently used in Australia contain  $1 \times 10^7$  *B. bovis*,  $2.5 \times 10^6$  *B. bigemina* and  $1 \times 10^7$  *Anaplasma centrale* organisms per 2 mL dose. Chilled vaccine has a very short shelf-life, which is currently 4 days in Australia, which requires rapid, reliable means of communication and transportation to ensure viability. Chilled vaccines can remain viable for up to a week if stored at 4°C.

To reduce the risk of neonatal hemolytic disease in calves (**alloimmune hemolytic anemia**) of vaccinated dams, the vaccine should not be used repeatedly; most owners vaccinate only young animals seldom more than twice. Reduction of the dose rate from 5 to 2 mL and use of a cell free diluent has eliminated the problem in Australia.<sup>22</sup>

The procedures to ensure quality assurance of the vaccines has been described.<sup>22</sup>

The development of effective living vaccines against bovine babesiosis in Australia required laboratory and field research over the period from 1959 to 1996 is a remarkable success story of veterinary medicine.<sup>54</sup> The most significant change occurred in 1964 with the traditionally used carriers of *Babesia* being replaced as vaccine donors by acutely infected splenectomized calves. This ensured the infectivity of the vaccine and was fortuitously associated with a reduction in the virulence of the *Babesia bovis* vaccine. The vaccine reduced serious losses from babesiosis in vaccinated cattle in Australia to very low levels and gained acceptance worldwide.

The demand for live trivalent tick fever vaccine containing *B. bovis*, *B. bigemina* and *Anaplasma centrale* produced by the Department of Primary Industries, Queensland, has increased from less than 10 000 doses in 1988 to 500 000 doses in 2001.<sup>55</sup> The challenge to obtain *B. bigemina* parasitized erythrocytes on a large enough scale from infected splenectomized calves to meet the demand was achieved by reducing the dose rate of infected cells without affecting immunogenicity and still leave a safety margin of at least 50-fold for infectivity. This change quadrupled the potential yield of doses per calf and allowed the Department to meet the increased demand for *B. bigemina* vaccine.

Use of live vaccine

### Cattle born in vector-infested regions.

Any factor affecting the survival of the tick vectors will affect the risk of babesiosis occurring. An increased number of ticks will increase the threat of disease until an endemically stable situation develops. Conversely, reduced tick numbers will increase the longer-term risk of babesiosis due to the reduced natural exposure of calves. Therefore, cattle owners in endemic areas in Australia are advised to supplement natural exposure by vaccinating calves at weaning age. Vaccination is also recommended if cattle are being moved within the endemic area.

### Susceptible cattle imported into vector-infested country or region.

Large numbers of cattle, predominantly of *Bos taurus* breeds are being imported into tropical, developing countries to upgrade local livestock industries. This has resulted in significant economic losses due to tick-borne diseases, including babesiosis. Vaccination of naïve cattle moving from tick-free to endemic areas within Australia is usually very effective. This practice has played a crucial role in making the livestock industries in these countries more sustainable and competitive in meeting market demand with regard to breed type.

K strain *B. bovis* and G strain *B. bigemina* from Australia have been shown experimentally to be protective in South Africa and Sri Lanka. Vaccine containing these strains has also been used with beneficial results in countries such as Zimbabwe and Swaziland in Africa, Venezuela and Ecuador in South America, Malaysia and the Philippines in Southeast Asia, and islands of the Caribbean.

**Control of outbreaks.** Use of a vaccine in the face of an outbreak is common practice in Australia.<sup>22</sup> Superimposing vaccination in this way on a natural infection will not exacerbate the disease, but will pre-empt the development of virulent infections in the proportion of the herd not yet exposed to field challenge. To prevent further exposure, the group should also be treated with an acaricide capable of preventing tick attachment from the time of diagnosis to 3 weeks after vaccination. Injectable or pour-on formulations of ivermectin and moxidectin as well as fluazuron are highly effective acaricides but do not prevent transmission of *Babesia*.

Clinically affected cattle should be treated as soon as possible with a suitable babesiacide. In the case of a severe outbreak, it may be advisable to treat all the cattle with a prophylactic compound (imidocarb or diminazene) and to vaccinate them later when the drug residue will not affect vaccine parasite multiplication.

Hazards and precautions of live vaccine use

**Severe reactions.** The likelihood of vaccine-induced reactions has been reduced with the development of attenuated strains but there is always the risk of reactions when highly susceptible, adult cattle are vaccinated. Calves 3 to 9 months of age have a high level of natural resistance and a low risk of reactions. In Argentina, vaccination is only recommended for calves while in Australia and South Africa, adult cattle can be vaccinated, provided proper precautions are taken. Concurrent infections may increase the likelihood of reactions.<sup>22</sup> The fever associated with reactions in pregnant cows may cause abortion and in large bulls a temporary loss of fertility. In the case of valuable cows and bulls, their body temperatures should be monitored during the reaction and those with prolonged fever should be treated with a babesiacide.

**Potential for spread of *Babesia* following vaccination.** There is no reliable evidence that current live vaccines may spread the disease from vaccinated to unvaccinated cattle.<sup>22</sup>

**Lack of protection.** Since the introduction of a standardized method of production in Australia, live babesiosis vaccines have generally proved to be highly effective. In most cases, a single vaccination provided lasting, probably life-long immunity against field infections with antigenically different strains. However, some failures have occurred and are thought to be associated with loss of immunogenicity by frequent passaging of the vaccine strains in splenectomized calves. This was corrected by replacing the vaccine strain. To prevent future recurrences of failure, the number of passages of the vaccine strains of *B. bovis* is limited by frequently reverting to a master stabilate with a low passage number. Other failures may be associated with the immune responsiveness of the host and the immunogenicity of the vaccine strain subpopulations.

A single inoculation of an attenuated vaccine containing *B. bovis* and *B. bigemina* at 6 to 9 months of age provides good, long-lasting protection both in Australia and overseas.<sup>53</sup> At that age, the risk of vaccine reactions is minimal. The immunity following use of live *B. bovis* vaccine lasts for at least 4 years, and possibly less for *B. bigemina*.<sup>52</sup> It is known to persist even after elimination of *Babesia* infections and studies on drug cured cattle suggest that the degree of acquired immunity is related to the degree of antigenic stimulation (duration of prior infection) rather than the presence of live parasites. There is no evidence of a loss of immunity with time

and revaccination is unnecessary. Revaccination is advisable when there is uncertainty over the accuracy of previous procedures, to ensure all animals seroconvert or when there has been a change in the strains used in the vaccine.

An attenuated frozen vaccine containing *in vitro* culture-derived stains of *B. bovis* and *B. bigemina*, provided protection to 90% of vaccinated cattle against the virulent *Babesia* spp. field strains.<sup>56</sup>

The persistence of *Babesia bovis* and *B. bigemina* infection in Friesian cows, following vaccination with attenuated live vaccines has been shown by subinoculation of blood into splenectomized calves.<sup>40</sup> *B. bigemina* persisted in some cows vaccinated 10 and 46 months, previously, and *B. bovis* persisted in 50% of cows vaccinated 10 and 47 months previously. Parasites of both species persisted among the serologically negative cows, whereas blood obtained from serologically positive cows failed to transmit infection. Thus in the absence of reinfection, Friesian cattle may spontaneously eliminate *B. bigemina* and *B. bovis* infection after various periods of time.

The inherent disadvantages of vaccines derived from blood of animals include the risk of reactions or contamination with pathogenic organisms, sensitization against blood groups, tick transmissibility of vaccine strains and need for a **cold chain transportation**.

Vaccinated cattle should be housed or kept under close observation for a month in case excessive reactions occur. A major problem in vaccination with living protozoa is the occasional apparent **failure to transmit the protozoa**. This may be due to the absence of the protozoa from the bloodstream of the donor at the time that the blood is drawn, or to the presence of a prophylactic drug – for example, imidocarb dipropionate – or low levels of antibody in the animal's tissues. Revaccination is necessary in these circumstances, preferably with blood from a donor that is undergoing a severe reaction at the time.

The attenuated organisms used in unfrozen South Africa *B. bovis* and *B. bigemina* vaccines are susceptible for longer periods to the residual effect of the anti-babesial drugs diminazene and imidocarb dipropionate than the virulent field strains. The waiting periods before administration of the frozen *B. bovis* and *B. bigemina* vaccines in animals which have been treated with diminazene at 3.5 mg/kg BW, compare favorably with unfrozen vaccines at 4 and 8 weeks. The inhibitory effect of imidocarb dipropionate at 3.0 mg/kg BW on the infectivity of both frozen *B. bovis* and *B. bigemina* vaccines is longer, and requires minimum waiting



periods before administration of these vaccines of 12 weeks and 24 weeks, respectively.<sup>57</sup>

**Vaccination with subunit vaccines**  
Subunit vaccines offer an attractive alternative to virulent or attenuated parasites.<sup>58</sup> The vaccines are based on recombinant antigens derived from cloned DNA of protozoan parasites.<sup>58</sup> Several protective antigens associated with merozoites or merozoite-infected erythrocytes of *B. bigemina* and *B. bovis* have been identified as possible approaches.<sup>58</sup> Rhopty-associated proteins may become the first targets of generic recombinant vaccines.<sup>2</sup>

#### Non-living vaccines

Non-living vaccines would overcome many of the inherent difficulties in production, transport and use of live vaccines.<sup>22</sup> However, they have not been sufficiently efficacious and more research is required.

#### Vector control

Vector control was first used successfully to control and eventually eradicate the cattle tick *Boophilus annulatus* and *Babesia* from the United State.<sup>59,60</sup> In 1906, an eradication program began which involved livestock owners, state officials, and the US Department of Agriculture specialists.<sup>60</sup> The program involved three tactics. First, some pastures were rendered tick-free by excluding all host animals until the ticks had starved to death. The second and more common tactic was to retain the livestock on the infested pastures and to disinfect the animals at regular 2-week intervals by immersion in an arsenic solution which killed the engorged female ticks. Third, the interstate movement of tick-infested cattle was prohibited through quarantine. The campaign to eradicate cattle ticks from the United States is the most sustained, extensive, coordinated area-wide attack ever made against an arthropod pest. The tick was removed from over a million square km during a period of 34 years. The tick is confined to the lower Rio Grande River in Texas, where reinfestation occurs via animal movement from Mexico. This necessitates continual control of fringe populations of cattle.

In Africa, babesiosis is only part of very important complexes of ticks and tick-borne disease, and intensive government-regulated tick control programs have been used for many years. In other continents, the situation is much less complex and where babesiosis is endemic, disease control rather than eradication is more realistic. Eradication of the tick vectors is a permanent solution to the problem but is rarely considered practical, environmentally sustainable, or economi-

cally justifiable on either a national or a local basis.

#### Natural endemic stability

Natural endemic stability can seldom be relied upon as a disease control strategy. First, in endemic areas, climatic effects, genetic make-up of hosts and management strategies, inevitably have a major effect on the rate of transmission and ultimately on the likelihood of endemic stability developing. Second, endemic stability is an economic concept that incorporates risk management and loss thresholds. The climatic, animal, and management parameters which allow endemic stability can change on a seasonal and annual basis. Third, the model for endemic stability was developed in Australia and the Americas where disease/vector interactions are relatively simple. The African situation is much more complex and less predictable with four main diseases, several vectors, presence of game reservoirs, and larger range of susceptibility of bovine breeds.<sup>22</sup>

#### Control of babesiosis in species other than cattle

For the most part, control of babesiosis in other species is carried out similarly to the procedures used in control of the disease in cattle. Most attention is focused on eradicating the vector tick, selecting infected and carrier animals by an appropriate laboratory test, and sterilizing the positive reactors by appropriate treatments. Control of ticks in pleasure horses by periodic spraying and inspection is a practical proposition when the animals are in constant use. No vaccines have been produced for use in horses. An attenuated vaccine produced by rapid passage through splenectomized lambs produces solid immunity in sheep.

#### REVIEW LITERATURE

Bock R et al. Babesiosis in cattle. *Parasitol* 2004; 129:S247-S269.

Bock RE, DeVos AJ. Immunity following the use of Australian tick fever vaccine: a review of the evidence. *Aust Vet J* 2001; 79:832-839.

De Vos AJ, Bock RE. Vaccination against bovine babesiosis. *Ann NY Acad Sci* 2000; 916:540-545.

Brown WC, Palmer GH. Designing blood-stage vaccines against *Babesia bovis* and *B. bigemina*. *Parasitol Today* 1999; 15:275-280.

Bose R et al. Current state and future trends in the diagnosis of babesiosis. *Vet Parasitol* 1995; 57:61-74.

Bruning A. Equine piroplasmosis. Update on diagnosis treatment and prevention. *Br Vet J* 1996; 152:139-151.

Zintl A et al. *Babesia divergens*, a bovine blood parasite of veterinary and zoonotic importance. *Clin Microbiol* 2003; 16:622-636.

Wagner GG, Holman P, Waghela S. Babesiosis and heartwater: threats without boundaries. *Vet Clin North Am Food Anim Pract* 2002; 18:417-430.

Yeruham I, Hadani A, Galker F. Some epizootiological and clinical aspects of ovine babesiosis caused by *Babesia ovis* - a review. *Vet Parasitol* 1998; 74:153-163.

Allred DR. Antigenic variation in babesiosis: is there more than one 'why'? *Microbes Infect* 2001; 3:481-491.

Allred DR. Babesiosis: persistence in the face of diversity. *Trends Parasitol* 2000; 19:51-55.

Jenkins MC. Advances and prospects for subunit vaccines against protozoa of veterinary importance. *Vet Parasitol* 2001; 101:291-310.

Callow LL, Dalgleish RJ, DeVos AJ. Development of effective living vaccines against bovine babesiosis - the longest field trial? *Int J Parasitol* 1997; 27:747-767.

Schuster FL. Cultivation of *Babesia* and *Babesia*-like blood parasites: agents of an emerging zoonotic disease. *Clin Microbiol Rev* 2002; 15:365-373.

Pegram RC, Wilson DD, Hansen JW. Past and present national tick control program. *Ann NY Acad Sci* 2000; 916:546-554.

Myers JH, Savoie A, van Randen E. Eradication and pest management. *An nu Rev Entomol* 1998; 43:471-491.

#### REFERENCES

- Angus B. *Int J Parasitol* 1996; 26:1341.
- Zintl A et al. *Clin Microbiol* 2003; 16:622.
- Cringoli G et al. *Vet Res* 2002; 33:421.
- Almeria S et al. *Vet Rec* 2001; 149:716.
- L'Hostis M, Seegers H. *Vet Res* 2002; 33:599.
- Devos J, Geysen D. *Vet Parasitol* 2004; 125:237.
- Regassa A et al. *Vet Parasitol* 2003; 116:267.
- Yeruham I et al. *Vet Parasitol* 1998; 74:153.
- Razmi GR et al. *Small Rum Res* 2003; 50:39.
- Razmi GR et al. *Vet Parasitol* 2002; 108:109.
- Chauvin A et al. *Vet Res* 2002; 33:429.
- Xuan X et al. *Vet Parasitol* 2002; 108:179.
- Xu Y et al. *J Vet Med Sci* 2003; 65:1015.
- Martin R. *Aust Vet J* 1999; 77:308.
- Heuchert CMS et al. *Vet Parasitol* 1999; 85:1.
- Zweygarth E et al. *Parasitol Res* 2002; 88:460.
- Gallatin LL et al. *J Am Vet Med Assoc* 2003; 223:1027.
- Langton C et al. *Parasitol Res* 2003; 89:194.
- Holman PJ et al. *Parasitol Res* 2002; 88:405.
- Carrique JJ et al. *Vet J* 2000; 160:162.
- Battsetseg B et al. *Vet Parasitol* 2002; 107:351.
- Bock R et al. *Parasitol* 2004; 129:S247.
- Goff WL et al. *Parasite Immunol* 2001; 23:463.
- Goff WL et al. *Ann NY Acad Sci* 2002; 969:164.
- Allred DR. *Trends Parasitol* 2000; 19:51.
- Smith RD et al. *Ann NY Acad Sci* 2000; 916:510.
- Bock RE et al. *Aust Vet* 1999; 77:465.
- Allred DR. *Microbes Infect* 2001; 3:481-491.
- Mosqueda J et al. *Ann NY Acad Sci* 2004; 1026:222.
- Criado-Fornelio A et al. *Vet Parasitol* 2004; 119:337.
- Kumar S et al. *Vet Parasitol* 2002; 107:295.
- Holman PJ et al. *New Eng J Med* 2002; 347:697.
- Thompson C et al. *Clin Infect Dis* 2001; 33:676.
- Shuster FL. *Clin Microbiol Rev* 2002; 15:365.
- Yeruham I et al. *J Vet Med B* 2003; 50:60.
- Brown WC, Palmer GH. *Parasitol Today* 1999; 15:275.
- Court RA et al. *Int J Parasitol* 2001; 19:29.
- Garcia TD et al. *Ann NY Acad Sci* 2004; 1026:298.
- Sherlock M et al. *Vet Rec* 1999; 152:687.
- Pipano E et al. *Vet J* 2002; 164:64.
- Malandrino L et al. *Vet Res* 2004; 35:131.
- Bashiruddin JB et al. *Vet Parasitol* 1999; 84:75.
- Rampersad J et al. *Vet Parasitol* 2003; 114:81.
- Goncalves PM et al. *Vet Parasitol* 1999; 82:11.
- Goff WL et al. *Clin Diag Lab Immunol* 2003; 10:38.
- Boonchit S et al. *J Clin Microbiol* 2002; 40:3771.
- Xuan X et al. *Clin Diag Lab Immunol* 2001; 8:645.
- Bork S et al. *Am J Trop Med Hyg* 2003; 68:334.
- Kumar S et al. *J Vet Med Sci* 2003; 65:1171.
- Bianchi MW et al. *Vet Parasitol* 2003; 112:75.
- Serugga JN et al. *Aust Vet J* 2003; 81:147.

52. De Vos AJ, Bock RE. *Ann NY Acad Sci* 2000; 916:540.
53. Bock RE, DeVos AJ. *Aust Vet J* 2001; 79:832.
54. Callow LL et al. *Int J Parasitol* 1997; 27:747.
55. Standfast NF et al. *Vet Parasitol* 2003; 115:213.
56. Alvarez JA et al. *Ann NY Acad Sci* 2004; 1026:277.
57. Combrink MP et al. *Ann NY Acad Sci* 2002; 969:169.
58. Jenkins MC. *Vet Parasitol* 2001; 101:291.
59. Pegram RG et al. *Ann NY Acad Sci* 2000; 916:546.
60. Myers JH et al. *Annu Rev Entomol* 1998; 43: 471.

## COCCIDIOSIS

### Synopsis

**Etiology** Many different *Eimeria* spp., *Isospora* spp.

**Epidemiology** Young calves, lambs, piglets, kids and, rarely, foals. Infection rate is high, clinical disease much less common; high morbidity with low case fatality rate. Occurs most commonly in crowded conditions both in barns and on pasture, especially in calves and lambs moved from pasture to feedlot. Transmitted by fecal-oral route; oocysts shed from infected animals. Immunity develops after infection; clinical disease occurs rarely in adult cattle.

**Signs** Diarrhea, dysentery, tenesmus, appetite normal or inappetence, mild abdominal pain in lambs, nervous signs in calves with coccidiosis in cold climates, loss of body weight, anemia in some cases but not common. Epidemics occur in calves and lambs, especially feedlot animals. Diarrhea without blood in feces of piglets. Diarrhea with large amount of blood in foals.

**Clinical pathology** Diagnostic number of oocysts in feces.

**Lesions** Ileitis, cecitis, colitis.

**Diagnostic confirmation** Oocysts in feces; merozoites in intestinal tissues.

### Differential diagnosis

**Calves:** Rotavirus and coronavirus diarrhea; *Clostridium perfringens* Type C enterotoxemia; colibacillosis due to attaching and effacing *Escherichia coli*.

**Lambs:** Salmonellosis; helminthiasis; *Clostridium perfringens* Type C enterotoxemia.

**Piglets:** Transmissible gastroenteritis; colibacillosis; *Strongyloides ransomi*; *Clostridium perfringens* Type C enterotoxemia.

**Foals:** Salmonellosis; foal-heat diarrhea; Rotavirus diarrhea; *Clostridium perfringens* type B enterotoxemia.

**Treatment** Supportive therapy. Coccidiostats.

**Control** Control population density to minimize number of oocysts ingested while immunity develops. Use of coccidiostats in feed and water supplies.

## ETIOLOGY

The pathogenic coccidial species are as follows:

- **Cattle:** *Eimeria zuernii*, *E. bovis* (*smithii*) and *E. ellipsoidalis*. *E. alabamensis*,<sup>1</sup>

*E. auburnensis* and *E. wyomingensis* may also cause disease in calves

- **Sheep:** *E. arloingi* A (*ovina*), *E. weybridgei* (*E. arloingi* B), *E. crandallis*,<sup>2</sup> *E. ahsata* and *E. ovinoidalis* (previously known as *E. ninakohlyakimovae*)<sup>2</sup> and *E. gilruthi*<sup>3</sup>
- **Goats:** *E. arloingi*, *E. faurei* and *E. gilruthi*, *E. caprovina*, *E. ninakohlyakimovae*<sup>1</sup> and *E. christenseni*
- **Pigs:** *Isospora suis*, *E. deblicieki*, *E. scabra* and *E. perminuta*
- **Horses and donkeys:** *E. leuckarti*.<sup>4</sup>

The eimeriid coccidia are one of the more controversial groups of protozoa, and their taxonomy and classification have been debated for more than 50 years.<sup>5</sup> A Controversial Roundtable was held in 2001 to initiate discussion on how a new and more comprehensive classification of eimeriid coccidia can be devised.

## EPIDEMIOLOGY

### Occurrence and prevalence of infection

Coccidiosis occurs universally, most commonly in animals housed or confined in small areas contaminated with oocysts. The coccidia are host-specific and there is no cross-immunity between species of coccidia. Clinical disease is most common in cattle and sheep. Coccidiosis causing diarrhea in newborn piglets is a major problem in some swine herds. Coccidiosis is less common in horses, but sporadic clinical cases and deaths do occur, especially in weaning age foals.

Coccidiosis occurs most commonly in young animals, with a seasonal incidence that may be associated with the time of year young calves and lambs are brought together for weaning or moved into feedlots or fed in small areas for the winter months. The prevalence of infection and the incidence of clinical disease are also age related. In housed dairy cattle, the prevalence of infection is 46% in calves, 43% in yearlings, and 16% in adult cows.<sup>6</sup>

### Calves

In North America, the disease occurs most commonly in beef calves after weaning in the fall of the year and when confined and fed in small overcrowded areas during the winter months. Infection occurs commonly when weaned calves are fed on the ground resulting in continuous fecal contamination of the feed. The prevalence of infection in calves in the northwestern and midwestern part of the United States is highest in summer, fall and spring compared to midwinter (January) and early summer (June). In Canada, winter coccidiosis

occurs in beef calves 6–10 months of age most commonly following a prolonged cold period or a sudden change from a moderate winter to severely cold temperature.<sup>7</sup> Cold weather may act as a stressor to precipitate clinical disease in animals previously infected. Acute coccidiosis and a marked increase in the numbers of oocysts discharged will occur following the treatment of infected calves with a corticosteroid on the 20th day after infection when clinical signs are apparent, or from the 12th–15th day after infection.<sup>8</sup>

Occasional outbreaks occur in nursing beef calves on pasture when they mingle near water supplies. Post-weaning coccidiosis occurs in beef calves grazing pasture in the subcostal dry tropics of northern Queensland, Australia. It may be more severe in dry years suggesting that the oocyst challenge is less important than the immunosuppressive effect of weaning and dietary stress in precipitating clinical disease. Calves are usually weaned and yarded for 3 weeks and then turned out to graze. Severe *Eimeria zuernii* coccidiosis causing diarrhea, dysentery, weight loss, and death occurs with up to 10% of calves being clinically affected. The disease is most severe in hot, dry and sunny conditions when, despite heavy fecal contamination, the yard conditions remain dry and dusty, and oocysts are difficult to find.

In South Africa, the prevalence is highest in calves and the most prevalent species are *Eimeria zuernii*, *Eimeria ellipsoidalis*, and *Eimeria bovis*.<sup>9</sup> The oocyst levels in the feces of adult cows were low.

In Sweden, coccidiosis due to *E. alabamensis* along with other species is a common cause of diarrhea and unthriftiness in calves 2–4 months of age within the first few weeks after being placed on permanent pasture in the spring.<sup>11</sup> The onset of the diarrhea coincides with the preparturient period of 6–8 days of *E. alabamensis*. Overwintered sporulated oocysts of several different species are the source of infection.<sup>10</sup> The incidence of diarrhea is much higher in first-season grazing calves placed on pastures that had been used for cattle in the previous 5 years compared to those calves placed on different pastures not previously used by cattle.<sup>9</sup> The likely primary source of infection is the calves or previous occupants of pens, with the mature cows being unimportant.<sup>12</sup> Clinical coccidiosis can be reproduced by inoculation of calves with a pathogenic dose of *E. alabamensis*,<sup>13</sup> and is most severe in calves receiving the highest number of oocysts.

In dairy calves, the disease occurs in overcrowded and dirty, wet conditions,

and when fecal contamination of the feed is common. Surveys of dairy farms in Pennsylvania reveal that coccidiosis was found the third most common health-related problem observed by dairy farmers.<sup>14</sup> Over 16% of dairy farmers were treating animals, or feeding a coccidiostat, for the control of coccidiosis.

### Adult cattle

Coccidiosis is uncommon in adult cattle, but occasional cases and even epidemics do occur, especially in dairy cows that have calved 6–8 weeks earlier.<sup>3</sup> Surveys of farms in Maryland found that 2.3% of dairy cows, 21.7% of dairy heifers, and 32.9% of beef cattle were all infected with *E. bovis* and all were subclinical.<sup>15</sup> These older animals serve as source of infection for younger calves in the herd.

### Lambs

Coccidiosis in lambs is a common disease in housed flocks.<sup>16</sup> In Germany, the cumulative incidences of *E. ovinoidalis* and *E. weybridgei/crandallii* increased rapidly resulting in almost 100% incidence in 8 week-old lambs.

Acute coccidiosis in intensively grazed lambs in Britain occurs at about 6–8 weeks of age when the oocyst output is very high in healthy, as well as in clinically affected, lambs. There is no periparturient rise in oocyst output by the ewes. The oocyst output by grazing lambs is very large compared to the output by ewes.

Coccidiosis occurs commonly in lambs following introduction into a feedlot situation where overcrowding and other stressors are operative. Lambs moved directly from range have had almost no previous exposure to coccidia, making them highly susceptible to infection and outbreaks of clinical disease. Coccidiosis is also a major problem in rearing housed lambs in the United Kingdom.<sup>17</sup>

### Goats

Coccidiosis is one of the most important diseases of goats kept in large numbers under intensive management conditions.<sup>18</sup> The prevalence of infection may be as high as 100% in some goat farms, and higher infection rates occur in young goats in large herds.<sup>19</sup> Kids are the major source of pasture contamination, and newly weaned kids have high oocyst counts.<sup>20</sup> Over 13 different species of coccidia have been identified in goats from different parts of the world. Surveys in Zimbabwe reveal a population mortality of 20–40% among kids on different farms; coccidiosis is thought to be a major cause of these deaths.<sup>18</sup> Coccidial and helminth infections may occur concurrently in goats of varying ages surveyed on farms but nematode infections do not occur in kids.<sup>21</sup> Goat kids concurrently infected with

third-stage *Haemonchus contortus* may gain weight more slowly.<sup>22</sup> Goats do not shed as many oocysts and helminth eggs as do sheep,<sup>23</sup> which may be related to their mode of feeding (browsing versus grazing).

In the Czech Republic, where the majority of goats are dairy goats, the overall prevalence of *Eimeria* oocysts in feces was 92%.<sup>24</sup> Nine *Eimeria* spp. were identified and *E. arloingi* was the most common with a prevalence of 84%. The number of oocysts was lower in adults and the highest in kids and clinical coccidiosis occurred in kids 2 to 4 weeks after weaning. The disease occurs in goats in Poland where 81% of adults and 100% kids are infected, and clinical coccidiosis occurs in 50% of the kids.<sup>25</sup> In West African Dwarf goats in Ghana, *Eimeria* oocysts appeared at about 20 days after birth and oocyst output in some kids reached 2.7 million oocysts per gram of feces by about 39 days after birth, followed by declines to 23 840 per gram by 5.5 months of age.<sup>26</sup>

### Pigs

Observations suggesting the presence of neonatal porcine coccidiosis include: repeated epidemics of diarrhea in piglets 5–15 days of age; no response to therapy with antimicrobials; and failure of vaccination of the pregnant sow with *E. coli* bacterins to control neonatal piglet diarrhea. The peak incidence occurs between 7 and 10 days of age, and most commonly during the warm summer months when high temperatures favor the sporulation of the oocysts. *Isospora suis* is a common parasite on pig farms; it may be found in 90% of herds and from 25 to 50% of litters.<sup>27,28</sup> The prevalence may be higher when piglets and their sows are raised on solid cement floors compared to self-cleaning floors.<sup>27</sup> The morbidity rates are variable and the case fatality rates may be up to 20%. Rotavirus infection may occur concurrently with *Isospora suis* infection in piglets 1–3 weeks of age and may be important causes of steatorrhea, or unspecified diarrhea known as milk scour, white scour, or 3-week diarrhea. Coccidiosis associated with *E. scabra* has also occurred in a 40 kg finishing pig affected with severe diarrhea and weight loss, and an outbreak of severe enteritis with dysentery in grower pigs from 7 to 16 weeks of age, due to a mixture of *Eimeria* spp. including *E. porci* has occurred. Coccidiosis has occurred in 20-week-old gilts moved from a high health status environment to a dirt lot, which suggests that high-health-status pigs are highly susceptible to coccidiosis.<sup>29</sup>

*I. suis* infection occurs widely in large pig-producing farming systems in Germany

where the highest rate of infection occurs in litters at 3 to 4 weeks of age.<sup>30</sup> Surveys of intestinal parasites in pigs from intensive farms in China have found *I. suis* infections along with other parasites.<sup>31</sup>

Surveys of pig farms in Germany, Switzerland, and Austria found 76% of the farms were positive for *I. suis* and oocysts were more commonly found on farms which reported diarrhea and uneven weight gain. Disinfection, floor types or treatment with toltrazuril did not affect the frequency of observations.<sup>32</sup>

### Foals

*Eimeria leuckarti* is a ubiquitous protozoal parasite of horses that has been reported in North America and elsewhere. In a survey of horse farms in Kentucky, 41% of foals examined were oocyst-positive, and 85% of farms had oocyst-positive foals.<sup>4</sup> The incidence of clinical disease is much less common in foals than other species, but clinical cases and deaths do occur, particularly in recently weaned foals.

### Morbidity and case fatality

In general, for **most species** of farm animals, the infection rate is high, and rate of clinical disease is usually low (5–10%), although epidemics affecting up to 80% may occur. The case fatality rate is usually low, with the exception of the high case fatality rate in calves with winter coccidiosis accompanied by nervous signs.<sup>7</sup> The case fatality rate may be high in calves or lambs with no previous exposure to coccidia after suddenly being introduced to a high level of infection. In calves, body weight gains and feed consumption are commonly reduced for many weeks after acute clinical coccidiosis, and affected calves do not regain losses in body weight compared to controls.

In **lambs on pasture**, subclinical infections are common but there is no documented evidence that growth rate is affected even with high levels of infection. While medication with a coccidiostat may lower the infection rate, there is no difference in performance between the medicated and non-medicated groups. In lambs raised under crowded conditions indoors, the acquisition of a natural multiple species infection had no effect on growth rate, but an artificial infection with *E. ninakohlyakimovae* resulted in severe clinical disease and a case fatality rate of 50%.

**Piglets** infected with *I. suis* have significantly reduced body weight at 7, 14, and 21 days of age. The reduction in 21-day-old weight is economically important because this weight is a component of the sow productivity index which is used as a management aid to help producers quantitatively determine the potential value of gilts as replacement animals.

### Methods of transmission

The **source of infection** is the feces of clinically affected or carrier animals, and infection is acquired by ingestion of contaminated feed and water, or by licking the hair coat contaminated with infected feces.<sup>37</sup> Oocysts passed in the feces require suitable environmental conditions to sporulate. **Moist, temperate, or cool conditions favor sporulation, whereas high temperatures and dryness impede it.** In general, oocysts sporulate at a range of 12–32°C (53.5–89.5°F) and require oxygen. They resist freezing down to about –7 to –8°C (19.5–17.5°F) for 2 months, but –30°C (–22°F) is usually lethal.<sup>33</sup> It has been suggested that oocysts might sporulate in the winter months on the hair coats of animals contaminated with feces. This may explain the continual production of several different species of coccidia during the cold winter months when sporulation on the ground is not possible.<sup>33</sup> Dry conditions and high temperatures also destroy sporulated oocysts within a few weeks but the oocysts may survive for up to 2 years under favorable conditions. Temperatures above 35°C, humidity below 25%, and sunlight for 4 hours are fatal for *E. zuernii*. Under simulated yard conditions in Queensland, Australia, where it is hot, dry, and sunny, when the yard floor materials reach up to 48°C and when air temperatures did not exceed 27°C, oocyst numbers fall by 50% after 24 hours, by 98% after 48 hours, and are undetectable after 72 hours.<sup>33</sup>

Ingestion of the sporulated oocysts results in infection, but very large numbers must be taken in before clinical disease results. **Large numbers of oocysts arise by continual reinfection and building up the degree of environmental contamination.** This occurs commonly when calves or lambs are crowded into small pens or confined in feedlots. Lambs can become infected within a few weeks after birth from lambing grounds heavily contaminated by the ewes. Overcrowding of pastured animals on irrigated pasture, or around surface water holes in drought conditions, may also cause heavy infestations. Feeder lambs and calves brought into feedlots from sparse grazing may carry a few oocysts, which build up into heavy infestations in the lots, especially if conditions are moist. In such situations, clinical signs of the disease usually appear about a month after the animals are confined. Young calves and lambs on pasture may shed large numbers of oocysts for long periods, which may be a factor in the development of large coccidial populations.

In cow-calf herds in Germany, the prevalence and intensity of oocyst excretion varied with time resulting in peak values around the time of parturition (peripar-

ture rise), particularly in the case of *Eimeria bovis*.<sup>34</sup> Oocysts of *E. zuernii*, *E. auburnensis* were first observed in calves 3 weeks of age and the prevalence of infection increased up to 67% by 9 weeks of age. The serum antibody levels in the cows were inversely correlated with *E. bovis* oocyst excretion which may reflect the degree of immunity developed against the infection in the cows. Antibodies to *E. bovis* were present in the sera calves after the ingestion of colostrum; the levels decreased from the first week of life until the third week. Subsequently, antibody levels increased until 9 weeks of age in direct correlation with oocyst excretion.<sup>34</sup>

Lambs may become infected soon after birth (before 4 weeks of age) from three possible sources of infective oocysts:

- Oocysts surviving in old fecal contamination of the lambing area from previous occupation
- Fresh oocysts constantly shed by ewes
- Fresh oocysts shed by other lambs.

The fecal oocyst burden is high at 4 weeks of age but gradually declines, so that by 5 months of age the oocyst count is similar to that of their parent ewes.

**Sows** do not play a significant role in the transmission of *I. suis* infections transmitted from one generation of piglets to the next through contamination of the farrowing pen. Infection levels as low as 100 sporulated oocysts can result in oocysts per gram values of 100 000 and induce clinical signs of coccidiosis within 2 weeks of infection.<sup>35</sup> Oocysts of *I. suis* cannot usually be found in the feces of sows on swine farms where neonatal coccidiosis occurs. In one survey, no oocysts of *I. suis* were found in sows on farms with a history of neonatal coccidiosis due to *I. suis*, but 82% of the sows were infected with *Eimeria* spp. On farms without a history of neonatal coccidiosis, the prevalence of *I. suis* in the sows was 0.6%. In a survey in Papua New Guinea, 83% of sows raised on concrete were infected with *I. suis*. In another study, of two swine herds where neonatal coccidiosis due to *I. suis* occurred, the sows either began to excrete oocysts, or oocyst excretion rose to a detectable level from 5 days before to 3 days after farrowing. The oocysts of *I. suis* can sporulate and become infected within 12–16 hours at temperature ranges of 32–35°C (89.5–95°F), which are common in modern farrowing units.

### Risk factors

#### Animal risk factors

Acute coccidiosis occurs primarily in **young animals**, but may occur at any age when resistance is affected by intercurrent disease or inclement weather. The prevalence of infection is usually higher

in calves than yearlings or adults in the same herd, but there is also evidence of variation in *Eimeria* species-specific age resistance.<sup>6</sup> A concurrent experimental infection of calves with the coronavirus and *E. bovis* may result in clinical disease and lesions that are more severe than those caused by either infection alone.<sup>36</sup>

**Nutritional status of the animal** as a risk factor for clinical coccidiosis is well known. Early weaning of lambs at 21 days of age, followed by experimental infection, results in a failure of growth. Field observations have shown that early weaned lambs are more susceptible to coccidiosis than those weaned at a later date. This may be a reflection of lack of immunity in the younger lambs, but dietary stress in early weaned lambs may contribute to the disease. In sheep with naturally occurring coccidiosis, animals on moderate and high planes of nutrition may have more dual infections than those on a low plane of nutrition, whereas the latter group have triple and quadruple infections. Considerable numbers of oocysts can be excreted into the environment even by well-fed sheep of 14–16 months of age. Lambs kept on a low plane of nutrition were less affected by clinical coccidiosis than those kept on a high plane of nutrition. The planes of nutrition were also associated with differences in the prevalences of *Eimeria* spp.

In the United Kingdom, coccidiosis occurs commonly in **housed lambs weaned at 6–8 weeks of age** and reared on straw with a high stocking density, which provides an ideal environment for oocyst survival and sporulation.<sup>17</sup> The use of coccidiostats does not affect the oocyst excretion rate, which suggests either inconsistencies in the effect of in-feed medication or the infection may be controllable in non-medicated flocks without the use of coccidiostats.

Epidemics of post-weaning coccidiosis occur in beef calves under hot and dry tropical conditions where the ingestion of oocysts is small because the conditions are unsuitable for oocyst development. Such calves have usually commenced shedding oocysts within a month of birth and can shed up to nine different species by 3–4 months. Calves developing clinical coccidiosis following weaning may be more physiologically susceptible than others.

#### Environmental and management risk factors

Coccidiosis occurs in all species of farm animals when environmental and management conditions result in **oral exposure** of large numbers of sporulated oocysts to non-immune animals. Overcrowding and feeding animals on the ground, or in

situations in which the feed and water supplies can become heavily contaminated with feces and oocysts increases the infection pressure and promotes the fecal-oral route cycle of infection. The disease occurs commonly in small beef cattle herds that raise their own replacements and finish their own feedlot cattle in small outside pens that are crowded, and the feed becomes heavily contaminated by feces. Grazing calves for the first time on permanent pastures is associated with clinical coccidiosis due to the ingestion of overwintered oocysts.<sup>1</sup>

The occurrence of clinical coccidiosis in housed dairy cattle in The Netherlands is rare.<sup>6</sup> This may be associated with management practices in which calves are individually housed during the first few weeks and subsequently housed in small groups in relatively large pens. General hygienic standards are high, and manure is frequently removed. These measures reduce the intake of high numbers of oocysts and are favorable because the intensity of coccidial infections is directly related to the number of oocysts in the environment and ingested by the animals. A low level of oocyst infection will induce immunity.

The production system can influence the development of subclinical and clinical coccidiosis. In Germany, two production systems of fattening lambs are common. In the extensive system, lambs are not weaned until slaughter with little or no concentrate feeding. In the intensive system, the lambs receive a high level of concentrates.<sup>37</sup> In lambs naturally infected with *Eimeria* spp., the mean fattening period was significantly shorter in the intensively managed groups compared with an extensively managed group. Even if no clinical signs of coccidiosis were observed in any of the systems, based on reduced daily weight gains, the lambs were subclinically affected by coccidiosis in all systems. The highest oocyst output occurred in the extensive group which may be related to intake of straw and hay from the ground. Straw and high stocking density predispose a heavy contamination of an environment which is ideal for oocyst survival and rapid sporulation. The risk of coccidiosis increased markedly if animals have a higher intake of contaminated straw from the ground.

#### Pathogen risk factors

Multiple infections are most common in natural infections. A single species of coccidia may be the major pathogen, but others contribute to the disease. In some cases, clinical coccidiosis in cattle occurs only when *E. bovis* and *E. zuernii* occur together. At least 13 species of coccidia oocysts have been found in the feces of

cattle in the United States, with *E. bovis* being the most prevalent. In sheep and goats, the prevalence of multiple species can be as high as 95% and 85%, respectively. In a single sheep flock, there may be as many as 10 species of *Eimeria*.<sup>38</sup> *E. ovinoidalis*, *E. ovina*, *E. ahsata*, and *E. parva* are highly pathogenic, whereas *E. faurei*, *E. intricata*, *E. crandallis*, and *E. weybridgeensis* are only moderately pathogenic. Similar results have been obtained in surveys done in feeder cattle brought from different geographical locations in the United States to a feedlot. While *E. bovis* and *E. zuernii* are the species most commonly associated with bovine coccidiosis, as many as 11 different species may be present in the cows and calves of one beef herd. *I. suis* is a major cause of neonatal or weanling diarrhea in pigs, while *E. deblickei* is not considered a pathogen. This provides evidence that coccidia have a widespread distribution wherever animals are kept.

#### Immune mechanisms

Immunity against intestinal coccidia consists of both cellular and humoral components. Cellular immunity is more important in resistance against reinfection than humoral immunity. Field observations suggest that coccidiosis in cattle is immunosuppressive, which may increase their susceptibility to other common infections. In experimental coccidiosis, neutrophil function may be inhibited and the feeding of decoquinatone may prevent this inhibition.

The administration of dexamethasone to calves suppresses the immunological response of the animal and allows the life cycle of the coccidia to proceed uninterrupted.<sup>8</sup> Estradiol and progesterone can enhance cell-mediated immunity and provide some protection against the often severe wasting and debilitation in calves associated with *E. bovis* infection.<sup>39</sup>

In Norway, coccidiosis is an important disease in young lambs on pasture. Most lambs spend the first few weeks of their life indoors and have little exposure to infective oocysts, and little or no immunity is acquired. When the lambs are turned out to pastures grazed by sheep in the previous grazing season, they rapidly become infected with overwintered oocysts, mainly as a result of their habit of eating soil. Coccidiosis develops in these non-immune lambs 2-3 weeks later. The immunity induced by the first infection seems to protect most lambs from reinfections later in the grazing season. In lambs treated with sulfadimidine at 200 mg/kg BW on days 12, 13, and 14 after turnout, there is a marked reduction in the severity of the coccidial infections.

Specific immunity to each coccidial species develops after infection, so that young animals exposed for the first time are often more susceptible to a severe infection and clinical disease than other animals. In lambs, natural infection acquired at pasture and artificial infections acquired by experimental inoculation result in immunity to challenge. A single initial infection of as few as 50 oocysts will provoke a solid immunity to reinfection with the same species, and oocyst production ceases after about 10 days. Under field conditions, lambs are probably continually ingesting oocysts from pastures that become increasingly contaminated as the season progresses. Thus, immunity to a range of species of coccidia is boosted by frequent reinfection.<sup>40</sup>

Very young lambs are relatively resistant to infection with a mixture of pathogenic species of coccidia, but susceptibility increases progressively up to at least 4 weeks of age.<sup>2</sup> Lambs inoculated at 4-6 weeks of age, develop severe diarrhea, whereas the same inoculum given at 1 day of age causes no clinical disease. Early subclinical infection improves the resistance of lambs to later challenge. When lambs receive a relatively heavy inoculation of oocysts during their first week of life they are relatively resistant to the pathogenic effects of some coccidia, are able to respond immunologically, and are protected from subsequent challenges.<sup>2</sup> This suggests that a challenge with coccidia, before the lamb becomes susceptible to their pathogenic effects, may help to reduce the incidence and severity of clinical coccidiosis later. Resistance to *E. zuernii* infection in calves occurs after chemotherapy, or experimental infection, with monensin or amprolium. Both drugs suppress the development of the experimental disease, during which time immunity develops. An effective immunity develops in piglets following natural or experimental infection with *I. suis*, which is the most immunogenic species of swine coccidium. Susceptible piglets are exposed to this species of infection in older swine. Piglets develop a more severe clinical disease when infected with *I. suis* at 1-3 days of age than when infected at 2 weeks of age.

#### Economic importance

Coccidiosis is sufficiently important economically in calves to warrant control measures. One estimate suggests that the economic losses from coccidiosis in calves amounts to US\$1.00 per animal less than 1 year of age annually.

#### PATHOGENESIS

The coccidia of domestic animals pass through all stages of their life cycle in the alimentary mucosa and do not invade

other organs, although schizonts have been found in the mesenteric lymph nodes of sheep and goats. The different species of coccidia localize in different parts of the intestine. *E. zuernii* and *E. bovis* occur primarily in the cecum, colon and the distal ileum, whereas *E. ellipsoidalis* and *E. arloingi* affect the small intestine. *E. gilruthi* localizes in the abomasum and occasionally the duodenum.<sup>41</sup>

### Life cycle

The coccidial life cycle is self-limiting. The unsporulated oocysts are passed in the feces and develop into the infective stage in the environment. The original single cell divides, forming four sporoblasts, each of which develops into one sporocyst, and within each sporocyst two sporozoites develop. When ingested, the wall of the oocyst breaks down and the sporocysts are released. The sporocysts then enter epithelial cells. Once within the cells the sporozoites undergo asexual multiple fission (schizogony) and become **first-generation schizonts**, which form numerous merozoites. After the schizont matures, the merozoites are released by rupture of the epithelial cell. New epithelial cells are again invaded and **second-generation schizogony** occurs in the large intestine. This is followed by the release of another generation of merozoites, which invade epithelial cells and produce the sexual stages, **the macrogametocyte and the microgametocyte**. The second-generation schizogony and fertilization of the macrogametocyte by the microgametocyte (**gametogony**) are the stages of the life cycle that cause functional and structural lesions of the large intestine. As the second-generation schizonts or gamonts mature, the cells containing them slough from the basement membrane and cause hemorrhage and destruction of the cecum and colon. The oocysts are the result of fertilization of the gametocytes and are discharged at the time of rupture of the cells, which usually coincides with the onset of clinical signs of dysentery. The prepatent period varies with the species of coccidia; with *E. bovis* it is 5–20 days, and with *E. zuernii* 15–17 days. Oocyst production in calves infected with *E. zuernii* reaches peak numbers on the 19th and 20th day after experimental infection. The prepatent period of *E. alabamensis* varies from 6 to 8 days.

*E. zuernii* and *E. bovis* are most pathogenic to **cattle** and their life cycles are similar. In calves infected with *E. zuernii*, first-generation schizogony occurs in the lower ileum, and second generation schizogony and gametogony occurs in the cecum and proximal colon. The gametocytes are the pathogenic stages and cause rupture of the cells they invade, with

consequent exfoliation of the epithelial lining of the intestine. It is notable that the oocyst count is often low when the disease is at its peak, as the oocysts have not yet formed. Exfoliation of the mucosa causes diarrhea, and in severe cases, hemorrhage into the intestinal lumen, and the resulting hemorrhagic anemia may be fatal. If the animal survives this stage, the life cycle of the coccidia terminates without further damage and the intestinal mucosa will regenerate and return to normal. The patent period for *E. bovis* and *E. zuernii* varies from 5 to 12 days depending on the infecting dose of oocysts.

Treatment of calves with a corticosteroid can convert subclinical infection in calves into a peracute clinical form of the disease, which suggests that environmental, nutritional, and management factors may also act as stressors in producing clinical disease. The pathophysiological changes associated with experimental infection of calves with *E. zuernii* include a decrease in packed cell volume and reduction in plasma sodium and chloride levels. However, these are not remarkable; in naturally occurring cases the changes are not significant.

In **lambs**, most natural infections are composed of several different species of coccidia and there is a wide range of values in the production of oocysts from individual lambs, either in the feces from the same lamb over a period of time or in the feces from a number of lambs on any one occasion. Under practical conditions, constant reinfection occurs and waves of pathogenic stages succeed each other. The occurrence of villous atrophy in the intestinal mucosa of lambs affected by coccidiosis is probably related to the recurrence of diarrhea and loss of body weight.

However, in lambs at least, there is some doubt about the effects of coccidial infection on growth rate, feed consumption, and clinical signs in the experimental disease. There may be no obvious relationship between infective dose, the fecal oocyst production, and clinical disease. This suggests that, in lambs, the mere presence of large numbers of fecal oocysts does not constitute a diagnosis of coccidiosis and that other pathogenetic factors may be involved in conversion to clinical disease. It is also possible that the large number of oocysts may represent non-pathogenic coccidia.

Severely affected calves surviving the acute phase of the disease do not regain losses in body weight unless they are fed for an additional 3–4 weeks, suggesting that bovine coccidia can have a marked effect on performance. A subclinical coccidial infection superimposed on an established, low-grade, subclinical nema-

tode infection in the small intestine may have a marked effect on the mineralization of the skeletal matrix in young adult ruminants, predisposing these animals to osteodystrophy.

The fact that multiple infections are so common may explain the variations in oocyst discharge from infected animals, but more importantly in groups of animals. New cases may develop every few days for a few weeks because of the variations in the length of the prepatent period between species of coccidia.

The **pathogenesis of the nervous signs of coccidiosis** in calves is unknown. Detailed examination of a series of cases excluded possible explanations such as:

- Alterations in serum electrolytes
- Vitamin A and thiamin deficiencies
- Lead poisoning
- Uremia, *Haemophilus somnus* meningoencephalitis
- Severity of clinical disease
- Gross alteration in intestinal bacterial flora and hepatopathy.<sup>7</sup>

A labile neurotoxin in the serum of calves with 'nervous coccidiosis' has been identified using laboratory mice as test subjects, but its significance is unknown.<sup>7</sup>

The **pathogenesis of bovine winter coccidiosis**, which occurs during or following very cold weather in Canada and the northern United States, is not understood. In January, February, and March, the outside temperatures may reach -40°C (-40°F) with daily mean temperatures of -10 to -15°C (14–5°F) for several days consecutively. Such temperatures should be too cold for sporulation of oocysts in feces on the ground. There is speculation that sporulation could occur on the moist hair coats of cattle, or the endogenous stages of *E. zuernii* may be in a latent phase and reactivated by the stress of cold weather.

*Isospora suis* has at least three asexual, and one sexual, intra-intestinal multiplication cycles. All stages are most prominent in the distal half of the small intestine, but also occur in the proximal small intestine, cecum and spiral colon. The prepatent period extends from 8 to 16 days and the shedding of oocysts occurs in a cyclic pattern, with 2–3 peaks separated by intervals of about 5 days.<sup>35</sup> This biphasic disease course results in diarrhea, villous atrophy and necrosis of intestinal epithelium at 4–6 and 8–10 days after infection. **The feces may also be negative for oocysts between the biphasic peaks.** Under temperature ranges of 32–35°C (89.5–95°F) the oocysts of *I. suis* can sporulate and become infective within 12–16 hours. An extra-intestinal stage of the life cycle related to the second patent period is postulated. The lesions are most

pronounced in the small intestine, and consist of villous atrophy and focal ulceration from the destruction of villous epithelial cells, principally during the peak of asexual reproduction. A fibrinonecrotic pseudomembrane may develop in severe cases. A combined experimental infection of *I. suis* and rotavirus in gnotobiotic and conventional pigs results in a synergistic action based on a competition of rotavirus and the coccidia for mature, enzymatically active absorptive villous cells.<sup>42</sup> The effects of neonatal *I. suis* infection on protein dynamics may persist after clinical recovery and could contribute to suboptimal weight gains.

**Experimental reproduction.** The effects of experimental *Eimeria bovis* infection on the metabolism of water, sodium, and potassium in calves has been examined.<sup>43</sup> Although acute sublethal bovine coccidiosis alters electrolyte and water metabolism, the overall balance of electrolytes and water is largely maintained by physiologic adaptation. This supports field observations that most cases of clinical coccidiosis do not require supportive fluid and electrolyte therapy.

Piglets experimentally inoculated with *I. suis* at 3 days of age develop a strong level of resistance to reinfection. Piglets develop more severe clinical signs of coccidiosis when inoculated with *I. suis* at 3 days of age than at 19 days of age. This suggests that maturation of non-specific components of the immune system is more important in the resistance of neonatal piglets to *I. suis* infection than specific immune mechanisms.<sup>44</sup>

### CLINICAL FINDINGS

The incubation period after experimental dosing varies between species of coccidia and animals infected. It ranges from 16 to 30 days in cattle infected with *E. zuernii* and *E. bovis*, from 14 to 18 days in sheep, and as short as 5 days in piglets. The clinical syndromes associated with the various coccidia are similar in all animal species.

#### Cattle and sheep

A mild fever may occur in the early stages, but in most clinical cases the temperature is normal or subnormal. The first sign of clinical coccidiosis is the sudden onset of diarrhea with foul-smelling, fluid feces containing mucus and blood. Blood may appear as a dark, tarry staining of the feces or as streaks or clots, or the evacuation may consist entirely of large clots of fresh, red blood. The perineum and tail are commonly smudged with blood-stained feces. Severe straining is characteristic, often accompanied by the passage of feces, and rectal prolapse may occur. The degree of hemorrhagic anemia is variable depending on the amount of blood lost,

and in most naturally acquired cases in calves anemia is not a feature. In experimental cases of coccidiosis in lambs, due to *E. ninakohlyakimovae*, although 50% of the animals died, there was no evidence of blood loss, but there was significant hemoconcentration. However, in exceptional cases, anemia is severe with pale mucosa, weakness, staggering, and dyspnea. Dehydration is common, but is not usually severe if affected animals continue to drink water.

Inappetence is common and in exceptional cases there may be anorexia. The course of the disease is usually 5–6 days, but some animals undergo a long convalescent period during which feed consumption and body weight gains are subnormal. Severely affected calves do not quickly regain the body weight losses which occurred during the clinical phase of the disease. In mild cases there is diarrhea and reduced growth rate, but not necessarily dysentery too. Subclinical cases show inferior growth rate and chronic anemia only.

Clinical coccidiosis occurs only rarely in adult cattle, and the few reports describe several animals affected over a short period of time.<sup>45</sup> Young dairy cows may be affected commonly within 6–8 weeks after calving. Diarrhea, dysentery, tenesmus, pale mucous membrane, thickening and corrugation of the rectal wall, and rapid recovery often without treatment are common.

#### Coccidiosis with nervous signs

Nervous signs consisting of muscular tremors, hyperesthesia, clonic-tonic convulsions with ventroflexion of the head and neck and nystagmus, and high mortality rate (80–90%) occurs in calves with acute clinical coccidiosis.<sup>7</sup> Outbreaks of this 'nervous form' have occurred in which 30–50% of all susceptible calves are affected. It has occurred most commonly during, or following, severely cold weather in midwinter in Canada and the northern United States. Affected calves may die within 24 hours after the onset of dysentery and the nervous signs, or they may live for several days, commonly in a laterally recumbent position with a mild degree of opisthotonos. In spite of intensive supportive therapy, the mortality is high. Nervous signs have not been reported in experimental clinical coccidiosis in calves, which suggests that the nervous signs may be unrelated to the dysentery or, indeed, even to coccidiosis.

#### Lambs

Coccidiosis in lambs is generally similar to that in calves, but with much less dysentery. In groups of lambs raised and fed under intensified conditions, inferior growth rate, diarrhea with or without

blood, low-grade abdominal pain, gradual onset of weakness, inappetence, fleece damage, mild fever, recumbency, emaciation, and death with a course of 1–3 weeks were noted. The diarrhea may escape cursory examination of the animals, but clinical examination of affected lambs reveals a perineum smudged with feces, and soft feces in the rectum. Lambs moved directly from range pasture to a feedlot with little or no previous exposure to coccidia often develop acute disease with a high morbidity and case fatality rate.

#### Horses

In the horse, while there is some doubt about the pathogenicity of *E. leuckarti*, diarrhea of several days duration, and acute massive intestinal hemorrhage leading to rapid death have been described in foals and young horses.<sup>4</sup>

#### Piglets

In piglets, severe outbreaks of coccidiosis occur between 5 and 15 days of age.<sup>42</sup> Anorexia and depression are common. There is profuse diarrhea and the feces are yellow, watery, and sometimes appear foamy. The diarrhea may persist for several days when dehydration and unthriftiness are obvious. Although affected piglets continue to suck, they become dehydrated and lose weight. Vomition may occur. Entire litters may be affected, and the case fatality rate may reach 20%. The disease may persist in a herd for several weeks or months, particularly where a continuous farrowing program is used.

### CLINICAL PATHOLOGY

#### Oocyst count

A count of over 5000 oocysts/g of feces of ruminants is considered significant. Although counts below 5000/g of feces do not usually suggest clinical disease, they may indicate a potential source of severe infection if environmental conditions for spread become favorable. Oocyst counts of over 100 000/g are common in severe outbreaks, although similar counts may also be encountered in normal sheep. The output of oocysts following an acute infection falls sharply after the peak, which may result in a critically affected animal with dysentery and low oocyst count. If oocysts are not found and the disease is suspected, merozoites can be looked for in direct smears; they do not float on the conventional concentrated sugar or salt solutions used for flotation of oocysts. The several species of coccidia can be differentiated, up to a point, by the characteristics of the oocysts.

#### Calves

Affected animals exposed to a large number of oocysts may develop severe dysentery a few days before oocysts appear in the



feces. However, this is not commonly observed when the feces from several affected animals are examined, and usually within 2–4 days after the onset of dysentery the oocysts will appear in the feces. The period during which oocysts are discharged in significant numbers (patent period) will vary between species of coccidia, the age of the animal, and the degree of immunity, which often makes it necessary to examine a number of animals in a group or herd rather than rely on the results from a single animal.

### Lambs

In lambs at pasture, oocysts first appear in the feces at about 2 weeks of age. The oocyst count continues to rise in the lambs until about 8–12 weeks when the counts will be  $10^5$ – $10^6$ /g of feces. Thereafter, the count declines to about 500/g when the lambs are 6–12 months of age. There is also considerable variation, both between lambs and in day-to-day samples from individuals, in the numbers and species of oocysts present in the feces. Hence the need for examination of several samples over a period of several days to assess the burden.

### Piglets

In piglets, the prepatent period varies from 4 to 7 days (most commonly 5 days) and oocysts are shed in the feces for 5–8 days after the onset of clinical signs. Piglets may develop the disease at 5 days of age, and oocysts may not be present in the feces until 3 days later. The use of a saturated sodium chloride with glucose as a flotation solution is recommended when examining piglet feces for *I. suis*.<sup>46</sup>

Necropsy examination of selected untreated clinical cases is often necessary to make the diagnosis. The disease should be suspected when piglets 5–8 days of age develop a diarrhea that responds poorly to treatment. Outbreaks of diarrhea in piglets under 5 days of age are usually associated with *Escherichia coli* or transmissible gastroenteritis. However, mixed infections are common and extensive laboratory investigations are often necessary to isolate the causative agents. The diagnosis often requires a combination of consideration of the history of diarrhea in piglets 5–15 days of age, gross and microscopic lesions, the presence of coccidial stages in mucosal smears and histological sections, and identification of oocysts in intestinal contents and feces. In heavy infections, piglets may die before the sexual stages of the parasite develop and the diagnosis is dependent upon finding lesions, schizonts, and merozoites of *I. suis* in the middle jejunum and ileum. The developmental stages can be detected by the mucosal smear technique. A rapid field diagnostic procedure consists of

staining glass slide impression smears of the mucosa of the ileum and jejunum.

**Autofluorescence microscopy.** This technique is superior to bright field microscopy in detecting *I. suis* oocysts after flotation and is significantly more sensitive when direct smears are examined.<sup>47</sup> It does not require purification of samples and requires no agents to prepare them. The calculated detection limit of autofluorescence is 10 oocysts per gram (using 100 mg of feces per smear); the flotation technique provides a lower detection rate of 334 oocysts per gram of feces.

**PCR detection.** The PCR test is the most sensitive technique for the detection of *I. suis* and can be used when large numbers of samples are examined, and in experimental situations.<sup>48</sup> The PCR can also be used to differentiate *Eimeria polita*, *Eimeria porci*, and *Eimeria scabra* from *I. suis*.<sup>49</sup>

### NECROPSY FINDINGS

Carcasses often have generalized tissue pallor and there is usually fecal staining of the hindquarters. In **cattle**, congestion, hemorrhage, and thickening of the mucosa of the cecum, colon, rectum, and ileum are the characteristic gross changes at necropsy. The thickening may be severe enough to produce ridges in the mucosa. Small, white cyst-like bodies, formed by large schizonts, may be visible on the tips of the villi of the terminal ileum. Ulceration or sloughing of the mucosa may occur in severe cases. The lesions associated with experimental *E. bovis* infection in the small and large intestines are characterized by a fibrinous typhilitis and colitis. Clotted blood or bloodstained feces may be present in the lumen of the large intestine. Histologically, there is denudation of the epithelium, and merozoites may be observed in some cells. Smears of the mucosa or intestinal contents should be examined for the various developmental stages.

The necropsy findings in **sheep** are marked by more severe involvement of the small intestine than in cattle. Atrophy of the villi in the proximal ileum occurs in both natural and experimental infection in lambs. In experimental *E. crandallii* infection in lambs, there is loss of surface epithelial cells, atrophy of villi in the small intestine, and severe diffuse crypt hyperplasia in the small and large intestines.<sup>41</sup> *E. ovinoidalis* infection in lambs causes massive invasion of the cecum, with destruction of crypt stem cells leading to denudation of the cecal mucosa. In naturally acquired coccidiosis of lambs, three types of macroscopic intestinal lesions may be recognized:

1. Flat oocyst patches, which are whitish spots 1–2 mm in diameter
2. Raised oocyst patches on enlarged villi

3. Polyyps which are proliferative lesions protruding into the lumen.

All three lesions contain heavy concentrations of gamonts and oocysts. In sheep affected with *E. gilruthi*, the abomasum contains numerous nodules, 1–2 mm in diameter, similar in gross appearance to ostertagiasis. These nodules contain the large schizonts of *E. gilruthi*-containing merozoites.<sup>3</sup>

In **piglets**, the small intestines are usually flaccid, but occasionally a fibrinonecrotic enteritis may be noted. Clinical signs precede the production of oocysts, so mucosal scrapings should be examined for the presence of earlier stages of the life cycle.

### Samples for confirmation of diagnosis

- **Parasitology** – feces (FECAL); segments of jejunum, ileum, colon (DIRECT SMEAR)
- **Histology** – formalin-fixed duodenum, jejunum, ileum, cecum, colon (LM).

### DIFFERENTIAL DIAGNOSIS

**Calves** In calves, clinical coccidiosis is characterized by dysentery, tenesmus, mild systemic involvement and dehydration. The presence of large numbers of oocysts supports the diagnosis, and necropsy findings are usually characteristic. When nervous signs occur in calves appearing to have coccidiosis, differentiation from other diseases causing brain dysfunction must be made.

**Sheep** In sheep, the diagnosis is dependent on the clinical findings of diarrhea and dysentery, the presence of large numbers of oocysts in the feces, and the intestinal lesions at necropsy. Large numbers (100 000/g) of oocysts may occur in the feces of normal lambs, and thus the observation of large numbers of oocysts in the feces of lambs affected with diarrhea and/or dysentery may not, in itself, constitute a diagnosis of coccidiosis. In lambs that have had previous contact with coccidia, and that may be relatively immune, other causes of diarrhea such as helminthiasis, salmonellosis, *Clostridium perfringens* type C enterotoxemia, and helminthiasis should be considered. See Table 26.3 for epidemiological and clinical features of the diseases causing diarrhea in sheep and goats.

**Piglets** In piglets, diarrhea due to coccidiosis must be differentiated from enteric colibacillosis, transmissible gastroenteritis, rotavirus infection, *Strongyloides ransomi*, and *Clostridium perfringens* type C. See Table 26.3 for epidemiological and clinical features of the diseases causing diarrhea in pigs.

**Foals** See Table 26.3 for the epidemiological and clinical features of the diseases causing diarrhea in foals. The common causes of diarrhea of foals include those associated with: *Salmonella* spp., *Actinobacillus equuli*, and rotaviruses.

## TREATMENT

Coccidiosis is a self-limiting disease, and spontaneous recovery without specific treatment occurs commonly when the multiplication stage of the coccidia has passed. Many treatments have been recommended without taking this into account and it is unlikely that any of the chemotherapeutic agents in common use for clinical coccidiosis has any effect on the late stages of the coccidia. Most of the coccidiostats have a depressant effect on the early, first-stage schizonts and are used for control.

In an outbreak, the clinically affected animals should be isolated, and given supportive oral and parenteral fluid therapy as necessary. The population density of the affected pens should be reduced. All feed and water supplies should be high enough off the ground to avoid fecal contamination. Mass medication of the feed and water supplies may be indicated in an attempt to prevent new cases and to minimize the effects of an epidemic. Cattle with coccidiosis and nervous signs should be brought indoors, kept well-bedded and warm, and given fluid therapy orally and parenterally. However, the case fatality is high in spite of intensive supportive therapy. Sulfonamide therapy parenterally may be indicated to control the development of secondary bacterial enteritis or pneumonia, which may occur in calves with coccidiosis during very cold weather. Corticosteroids are contraindicated.<sup>8</sup>

**Calves and lambs.** The chemotherapeutic agents recommended for treatment and control of coccidiosis in calves and lambs are summarized in Table 26.4. There is insufficient information available to make reliable recommendations for the specific treatment of acute clinical coccidiosis. None of these chemotherapeutic agents has been adequately tested in clinical trials. Sulfadimidine is used widely empirically for the treatment of acute clinical coccidiosis in calves. **Amprolium** is also used for treatment, and there may be a beneficial effect in terms of increased body weight gains and

feed consumption compared to untreated controls recovering spontaneously.

**Piglets.** Symmetrical triazintriones are effective against the asexual and sexual stages of experimental *I. suis* infection in piglets and is most effective before the onset of clinical signs.<sup>50</sup>

## CONTROL

The control of coccidiosis assumes greatest importance in calves and lambs, and has been difficult to achieve with reliability.

### Management of environment

Successful economical control will depend on avoiding the overcrowding of animals while they develop an immunity to the coccidial species in the environment. Only small numbers (50/day) of oocysts are required for the development of solid immunity in lambs. Lambing and calving grounds should be well drained and kept as dry as possible. Lambing pens should be kept dry, cleaned out frequently, and bedding disposed of so that oocysts do not have time to sporulate and become infective.<sup>51</sup> All measures that minimize the amount of fecal contamination of hair coats and fleece should be practiced regularly. Feed and water troughs should be high enough to avoid heavy fecal contamination. Feeding cattle on the ground should be avoided if possible, particularly when overcrowding is a problem.

### Lambs at pasture

In groups of lambs at pasture, the frequent rotation of pastures for parasite control will also assist in the controls of coccidial infection. However, when lambs are exposed to infection early in life as a result of infection from the ewe and a contaminated lambing ground, a solid immunity usually develops and only when the stocking density is extremely high will a problem develop.

### Feedlot cattle and lambs

Control of coccidiosis in feeder calves and lambs brought into a crowded feedlot depends on management of population density, or use of chemotherapeutics, to control the numbers of oocysts ingested by the animals while effective immunity

develops. Management procedures include establishing the optimum stocking density, which can be assessed by visual inspection. When animals are overcrowded they usually become dirty, there is excessive competition for feed supplies, and growth rate may be affected.

### Piglets

The control of coccidiosis in newborn piglets infected with *I. suis* has been unreliable. The use of coccidiostats in the feed of the sow for several days or a few weeks prior to, and following, farrowing has been recommended and used in the field, but the results are variable. Amprolium and monensin have been evaluated for the prevention of experimental coccidiosis in piglets and are ineffective. A control program designed to decrease the number of oocysts has been recommended and consists of proper cleaning, disinfection, and steam cleaning of the farrowing housing. Amprolium (25% feed grade) at the rate of 10 kg/tonne of sows' feed beginning 1 week before farrowing and continued until the piglets are 3 weeks of age has been recommended, but the results are unsatisfactory. A single oral dose of 1.0 mL of toltrazuril given to piglets 3–6 days of age reduced the occurrence of coccidiosis from 71% to 22%, and the number of days that oocysts were excreted in the feces reduced from 4.9 to 2.5.<sup>52</sup>

A single treatment of toltrazuril at 20 mg/kg BW at an early stage of infection (2 days post-infection) controlled a large experimental infection with *I. suis* in suckling pigs.<sup>53</sup>

### Coccidiostats

Coccidiostats are used for the control of naturally occurring coccidiosis in calves and lambs. The ideal coccidiostat suppresses the full development of the life cycle of the coccidia, allows immunity to develop, and does not interfere with production performance. Those that have been used for treatment and control are summarized in Table 26.4.<sup>54</sup>

To be effective, coccidiostats must be given beginning early in the life cycle of the coccidia. In any group of animals,

Table 26.4 Chemotherapeutics recommended for treatment and control of coccidiosis in calves and lambs

Chemotherapeutic agent	Treatment	Prevention
Sulfadimidine (sulfamethazine)	Calves and lambs: 140 mg/kg BW orally daily for 3 days individually	Calves: in feed 35 mg/kg BW for 15 days Lambs: daily dose 25 mg/kg BW for 1 week
Amprolium	Calves: individual dose at 10 mg/kg BW daily for 5 days or 65 mg/kg BW one dose	Calves: in feed at 5 mg/kg BW for 21 days Lambs: in feed, 50 mg/kg BW for 21 days
Monensin	Lambs: 2 mg/kg BW daily for 20 days beginning on 13th day following experimental inoculation	Lambs: 20 mg/kg feed fed continuously Calves: 16.5 or 33 g/tonne for 31 days
Lasalocid		Lambs: 25–100 mg/kg feed from weaning until market. Also, in ewe's diet from 2 weeks before and until 60 days after lambing.

there will be several different species of coccidia at different stages of the cycle: some at the drug-susceptible stage (before 13–15 days in calves) and some beyond the drug-susceptible stage (after 16–17 days), which explains why coccidiostats appear to be effective in some epidemics and ineffective in others. In an epidemic in calves, new cases may develop for up to 12–15 days after the commencement of feeding of an effective coccidiostat to in-contact calves. However, the stage of the prepatent period is unknown at any particular point in time in the affected group, and the most that can be done is to medicate the feed and water supplies with the coccidiostat of choice, treat new cases that develop, and avoid the stressors of overcrowding and nutritional disorders.

Some comments about some of the coccidiostats are made here. Routine prophylactic medication of the feed and water supplies of feeder calves and lambs with an effective coccidiostat will usually control the disease and allow the development of effective immunity.

#### Antimicrobials

**Sulfonamides** in the feed at a level of 25–35 mg/kg BW for at least 15 days are effective for the control of coccidiosis in calves and lambs. Sulfadimidine at 55 g/tonne is also effective in goats. A combination of chlortetracycline and a sulfonamide has provided protection in calves and lambs

#### Ionophores

**Monensin** is an effective coccidiostat and growth promotant in cattle, sheep, and goats. The recommended levels are 16–33 g/tonne feed for calves and 20 g/tonne of feed for lambs. Levels of 11 g/tonne feed are not as reliable as the higher dose for calves. The recommended level for goats is 16 g/tonne of feed. A concentrated ration containing monensin at 15 g/tonne can be fed to ewes from 4 weeks before lambing until weaning, and to lambs from 4 to 20 weeks of age. Monensin can markedly reduce the oocyst output of ewes and lambs when fed before and after lambing. Withdrawal of the monensin may be followed by the development of fatal coccidiosis in some animals, presumably because the drug suppressed the development of immunity. Postweaning coccidiosis in beef calves has been controlled using monensin from intraluminal continuous release devices. The toxic level of monensin for lambs is 4 mg/kg BW.

**Lasalocid** is related to monensin and is also an effective coccidiostat for ruminants. For maximum benefit, lasalocid should be used daily in the feed of coccidia-susceptible lambs for as long as

possible. An effective method of control is to medicate the feed of the ewes beginning about 2 weeks before lambing and continue the medication until the lambs are weaned. The lambs begin to receive lasalocid in their creep ration, and later in their rations from weaning until market. For maximum control of coccidiosis and improved feedlot performance, lasalocid should be given before and during the time that coccidia-naive lambs are first exposed to the natural occurrence of oocysts. A level as low as 25 mg/kg of feed will control coccidiosis and improve performance when fed to lambs in early life. Similar improvements in feedlot performance do not occur in heavier lambs already passing oocysts and being fed lasalocid at 25 mg/kg feed.

Lasalocid fed at a rate of 40 mg/kg of starter to dairy calves beginning at 3 days of age, and up until 12 weeks of age, is effective in reducing fecal oocysts and increasing mean daily body weight gain, dry-matter intake, and improved feed efficiency.<sup>55</sup> Mixing lasalocid in the milk replacer of calves beginning at 2–4 days of age is an effective method of controlling coccidiosis.<sup>56</sup> It is also effective as a coccidiostat when fed free-choice in salt at a level of 0.75% of the total salt mixture. Lasalocid at levels from 0.75 to 3 mg/kg BW are effective in preventing experimental coccidiosis in calves. The level of 1 mg/kg BW is the most effective and rapid, and is recommended when outbreaks of coccidiosis are imminent in cattle. Lasalocid and decoquinate are effective in reducing coccidia infections in young calves under conditions of apparent low exposure and good management. However, neither lasalocid nor decoquinate, or both, added to the feed of 16-week-old dairy calves naturally infected with subclinical coccidiosis for 56 days had any significant effect on weight performance.<sup>57</sup>

Monensin, lasalocid and decoquinate at the manufacturer's recommended levels are equally effective. A combination of monensin and lasalocid at 22 and 100 mg/kg of diet, respectively, is an effective prophylactic against naturally occurring coccidiosis in early weaned lambs under feedlot conditions. The ionophores are used in the feed continuously from weaning to market, and provide control of coccidiosis and improve feedlot performance. The continuous feeding of lasalocid, decoquinate or monensin will effectively control coccidiosis; cessation of medication may result in the appearance of oocysts in the feces and diarrhea.

**Decoquinate** in the feed at 0.5–1.0 mg/kg BW suppressed oocyst production in experimentally induced coccidiosis of calves.<sup>58</sup> It is most effective in preventing coccidial infections when fed

continuously in dry feed at 0.5 mg/kg BW.<sup>59</sup> When fed to dairy calves from 9 weeks to 24 weeks of age, there was an improvement in growth rate, height at withers, and heart girth measurement.<sup>10</sup> A level of 0.5 mg/kg BW is effective in goats.

**Toltrazuril** at 20 mg/kg BW as a single dose, 10 days after being turned out to pasture, will almost completely prevent coccidiosis, which occurred commonly without prophylactic medication. A dose of 15 mg/kg BW is effective to control experimental infections of calves with *E. bovis*.<sup>60</sup> In addition, medication of naturally infected lambs with toltrazuril on day 10 after turnout will markedly reduce the excretion of oocysts for a prolonged period, and thus lessen the contamination of the pasture with oocysts. A single treatment of toltrazuril can significantly reduce the oocyst output in naturally infected lambs for a period of approximately 3 weeks after administration. Weekly oral treatment of suckling lambs with 20 mg/kg BW of toltrazuril reduced the oocyst output and improved weight gain over a 10-week period.<sup>61</sup>

#### Vaccines

The literature on the prospects for subunit vaccines against protozoa of veterinary importance has been reviewed.<sup>62</sup> Although subunit vaccines offer many theoretical advantages, the lack of understanding of immune mechanisms to primary and secondary infection and the capacity of many protozoa to evade the host immunity remain obstacles to developing effective vaccines.

#### REVIEW LITERATURE

- Tenter AM et al. The conceptual basis for a new classification of the coccidian. *Int J Parasitol* 2002; 32:595–616.
- Yun CH, Lillehoj HS, Lillehoj EP. Intestinal immune responses to coccidiosis. *Dev Comp Immunol* 2000; 24:303–324.
- Jenkins MC. Advances and prospects for subunit vaccines against protozoa of veterinary importance. *Vet Parasitol* 2001; 101:291–310.
- Step DL, Streeter RN, Kirkpatrick JG. Bovine coccidiosis: A review. *Bov Pract* 2002; 36:126–135.

#### REFERENCES

1. Svensson C et al. *Vet Parasitol* 1994; 53:33.
2. Gregory MW, Catchpole J. *Vet Rec* 1989; 124:458.
3. Fox MT et al. *Vet Rec* 1991; 129:141.
4. Lyons ET et al. *Am J Vet Res* 1988; 49:96.
5. Tenter AM et al. *Int J Parasitol* 2002; 32:595.
6. Cornelissen AWCA et al. *Vet Parasitol* 1995; 56:7.
7. Isler CM et al. *Can J Vet Res* 1987; 51:261.
8. Niilo L. *Can J Comp Med* 1970; 34:325.
9. Matijila PT, Penzhorn BL. *Vet Parasitol* 2002; 104:93.
10. Svensson C et al. *Acta Vet Scand* 1993; 34:175.
11. Svensson C et al. *Acta Vet Scand* 1995; 36:9.
12. Svensson C. *Acta Vet Scand* 1993; 34:77.
13. Hooshmand-Rad P et al. 1994; 53:23.
14. Heinrichs AJ et al. *J Dairy Sci* 1990; 73:1851.
15. Fayer R et al. *Vet Parasitol* 2000; 93:103.
16. Reeg KJ et al. *Vet Parasitol* 2005; 127:209.
17. Berriatua E et al. *Vet Parasitol* 1994; 54:337.

18. Chhabra RC, Pandey VS. *Vet Parasitol* 1991; 39:199.
19. De La Fuente C, Alunda JM. *Vet Parasitol* 1992; 41:7.
20. Penzhorn BL et al. *Vet Parasitol* 1994; 55:137.
21. Borgsteede FHM, Derksen DP. *Vet Parasitol* 1996; 61:321.
22. Rahman WA. *Vet Rec* 1994; 134:235.
23. Kanyari PWN. *Vet Parasitol* 1993; 51:137.
24. Koudela B, Bokova A. *Vet Parasitol* 1998; 76:261.
25. Balicka-Ramis A. *Vet Parasitol* 1999; 81:347.
26. Ageyi AD et al. *Small Rum Res* 2004; 51:29.
27. Sayd SMO, Kawazoe U. *Vet Parasitol* 1996; 67:169.
28. Eysker M et al. *Vet Q* 1994; 16:203.
29. Henry SC, Tokach LM. *Swine Health Prod* 1995; 3:200.
30. Meyer C et al. *Vet Parasitol* 1999; 82:277.
31. Weng YB et al. *Vet Parasitol* 2005; 127:333.
32. Mundt H-C et al. *J Vet Med B* 2005; 52:93.
33. Parker RJ, Jones GW. *Vet Parasitol* 1990; 35:269.
34. Faber J-N et al. *Vet Parasitol* 2002; 104:1.
35. Christensen JPB, Henriksen SA. *Acta Vet Scand* 1994; 35:165.
36. Hoblet KH et al. *Am J Vet Res* 1992; 53:1400.
37. Gauly M et al. *Small Rum Res* 2004; 55:159.
38. Silva NRS Da, Miller JE. *Vet Parasitol* 1991; 40:147.
39. Heath HL et al. *Am J Vet Res* 1997; 58:891.
40. Catchpole J et al. *Vet Rec* 1993; 132:56.
41. Gregory MW, Catchpole J. *Intern J Parasitol* 1990; 20:849.
42. Vitovec J et al. 1991; *J Vet Med B* 38:215.
43. Dauschies A et al. *Parasitol Int* 1997; 46:159.
44. Koudela B et al. *Vet Parasitol* 1999; 82:93.
45. Gunning RF, Wessels ME. *Vet Rec* 1996; 139:497.
46. Henriksen SA, Christensen JPB. *Vet Rec* 1992; 131:443.
47. Dauschies A et al. *Parasitol* 2001; 87:409.
48. Joachim A et al. *J Vet Med B* 2004; 51:140.
49. Rutkowski B et al. *Vet Parasitol* 2001; 95:17.
50. Bach U et al. *Parasitol Res* 2003; 91:27.
51. Taylor M. *In Practice* 1995; 174:172.
52. Driesen SJ et al. *Aust Vet J* 1995; 72:139.
53. Mundt HC et al. *Parasitol Res* 90 (Suppl 3):s160.
54. Step DL et al. *Bov Pract* 2002; 36:126.
55. Sinks GD et al. *J Am Vet Med Assoc* 1992; 200:1947.
56. McMeniman NP, Elliott R. *Aust Vet* 1995; *J* 72:7.
57. Waggoner JK et al. *J Dairy Sci* 1994; 77:349.
58. Heinrichs AJ, Bush GJ. *J Dairy Sci* 1991; 74:3223.
59. Fitzgerald PR, Mansfield ME. *Am J Vet Res* 1989; 50:961.
60. Mundt H-C et al. *Parasitol Res* 2003; 90:S166.
61. Stafford K J et al. *NZ Vet J* 1994; 42:117.
62. Jenkins MC. *Vet Parasitol* 2001; 101:291.

## SARCOCYSTOSIS (SARCOSPORIDIOSIS)

### Synopsis

**Etiology** *Sarcocystis* species. There are a number of species, with a number of different carnivore species as their final host but generally a specific intermediate host.

**Epidemiology** High prevalence of infection in most areas. Source of infection is feces of carnivore, primarily farm dogs and cats fed raw meat, or other carnivores if they have access to ruminant carcasses.

**Clinical findings** Severity of disease dose-dependent. The vast majority of infections are sub-clinical. Abortion, depressed growth rate. Neurological disease and ataxia in sheep. Severe infection with some species results in carcass condemnation.

**Clinical pathology** Anemia and elevated blood concentrations of enzymes associated with tissue damage in acute disease.

**Lesions** Non-suppurative encephalitis in sheep with neurological signs. Non-suppurative encephalitis, myocarditis, and hepatitis in aborted fetus. Cysts in carcass in chronic cases.

**Diagnostic confirmation** Identification of parasite microscopically in biopsy or postmortem material.

**Treatment and control** No effective treatment, amprolium or salinomycin may aid in control. Proper disposal of carcasses. Raw meat not to be fed to farm dogs and cats. Coyote control.

### ETIOLOGY

*Sarcocystis* species are obligate two-host sporozoan parasites in the phylum Apicomplexa. There are a number of species, each with definitive omnivorous or carnivorous species as final hosts. One system of naming the species identifies the intermediate and definitive host in the name, i.e. *S. bovisfelis*, and has been commonly used in the literature. However, currently the organisms are identified by their original names. Table 26.5 shows the currently accepted name of *Sarcocystis* species of importance in agricultural animals and their definitive hosts.

### EPIDEMIOLOGY

#### Occurrence

In all countries where there have been surveys, the prevalence of infection in cattle, sheep, and horses approaches 100% with a lower, but significant infection rate in swine.<sup>1</sup> Clinical disease is rare.

#### Source of infection

*Sarcocystis* spp. have an obligatory prey-predator live-host life cycle in which the definitive host is a predator or scavenger.<sup>1,2</sup> The **carnivorous definitive**

**host** becomes infected by ingesting tissue of the intermediate host that contains mature sarcocysts. Following ingestion, bradyzoites are released from the sarcocyst in the stomach and intestine, and they transform into micro- and macrogamonts. The male microgamonts mature to release microgametes, which fertilize the macrogamont to form an oocyst. The oocyst subsequently sporulates to release **sporocysts** which are passed in the feces and contain infective sporozoite.

The prepatent period is variable, approximately 14 days, and there is no illness in the carnivore host in association with this cycle. However, the replicative cycle of the parasite in the intestine results in the presence of large numbers of sporocysts in the feces and the infection is **patent for a long period**. Intermediate hosts become infected by **ingesting sporocysts** in the food or water.<sup>1,2</sup>

### Risk factors

#### Climate

Sporocysts are not dependent on weather conditions for maturation, and are quite resistant to environmental influences. Under experimental conditions they can survive freezing, but they are susceptible to drying.<sup>2</sup> Consequently they can probably **overwinter** in the environment. Field studies have shown a lower herd prevalence of sarcocystosis in cattle in arid and semi-arid environments compared to cattle from temperate and tropical areas, which is probably a consequence of the relative aridity as well as the lower density of the definitive and intermediate hosts in arid areas.<sup>3,4</sup>

#### Species of *Sarcocystis*

Individual species vary in their **pathogenicity** and in their ability to produce clinical disease in the intermediate host. In cattle, for example, *S. cruzi* is considerably more pathogenic than *S. hominis*.<sup>1,2</sup>

Table 26.5 Definitive and intermediate hosts for *Sarcocystis* sp.-associated infections in agricultural animals

Intermediate host	<i>Sarcocystis</i> spp.	Synonyms	Definitive host
Cattle	<i>S. cruzi</i>	<i>S. bovicanis</i>	Dog, wolf, fox, raccoon, coyote
	<i>S. hirsuta</i>	<i>S. bovisfelis</i>	Cat
	<i>S. hominis</i>	<i>S. bovi-hominis</i>	Humans
Sheep	<i>S. tenella</i>	<i>S. ovicanis</i>	Dog, coyote, fox
	<i>S. arieticanis</i>	–	Dog
	<i>S. gigantea</i>	<i>S. ovifelis</i>	Cat
	<i>S. medusifformis</i>	–	Cat
Goats	<i>S. capracanis</i>	–	Dog, coyote, fox
	<i>S. hericanis</i>	–	Dog
	<i>S. moulei</i>	–	Cat
Pigs	<i>S. miescheriana</i>	<i>S. suicanis</i>	Dog, raccoon, wolf
	<i>S. sui-hominis</i>	–	Human
	<i>S. porcifelis</i>	–	Cat
Horses	<i>S. bertrami</i>	<i>S. equicanis</i>	Dog
	–	<i>S. fayeri</i>	–
	<i>S. neurona</i>	–	New world opossums

*S. tenella* is the most pathogenic species for sheep, and *S. capricanis* for goats and naturally occurring clinical disease in sheep is not observed with *S. gigantea* or *S. medusiformis*.<sup>5</sup> There is a strong correlation between the number of sporocysts ingested and the severity of disease. The size of the sarcocyst that occurs in the tissues of the intermediate host also varies with the infecting species. Those from cats and occurring in sheep (*S. gigantea*, *S. medusiformis*) or cattle (*S. hirsuta*) are of particular economic importance, as they produce macroscopically visible sarcocysts that can result in meat condemnation. *S. cruzi* produces microscopic sarcocysts in muscle and will escape gross detection at meat inspection.

#### Farm dogs

There is a positive association between herds infected with *Sarcocystis* and the presence of working dogs on the farm, the practice of leaving carcasses in the field and the feeding of dogs with raw meat,<sup>4</sup> and virtually all of the reported clinical cases of sarcocystosis in cattle in the literature record that the dogs on the farm were fed offal or uncooked beef. Housing of dogs and cattle in the same shed or area can have increased risk for infection and clinical disease,<sup>1,6</sup> and cattle pastured close to farm buildings where there are dogs are at greater risk. The presence of foxes on farms is also strongly associated with *Sarcocystis* infection in those herds that leave carcasses on the field.<sup>4</sup>

#### Cats

The main risk for cat-associated sarcocystosis is the farm cat that is fed raw meat. Farm cats use hay barns as dens and can contaminate hay and other feedstuffs.<sup>7</sup> Feral cats have the potential to distribute sporocysts widely in the grazing environment; however, the presence of feral cats on a farm may not increase the risk for *Sarcocystis* infection of cattle,<sup>4</sup> as scavenged sheep or cattle carcasses are a relatively unimportant part of the diet of feral cats.<sup>7</sup>

#### Stocking density

Risk for infection with *Sarcocystis* is higher with higher stocking densities,<sup>4</sup> which may reflect a more intense contamination of pastures by working dogs. Cattle on farms that graze sheep and cattle on the same pastures are less likely to be infected.

#### Economic importance

The major economic loss occurs with those sarcocysts that produce macroscopic cysts and meat condemnation. More severe infection depresses the growth rate, and there is a greater risk for abortion in infected herds.<sup>4,8,9</sup>

## PATHOGENESIS

In the intermediate host, sporozoites are released from ingested sporocysts in the small intestine where they penetrate the mucosa and enter the endothelial cells of blood vessels. The stages of schizogony and the distribution of merozoites vary according to the species, but in cattle endothelial infection is followed by **parasitemia**, with merozoites subsequently localizing in striated muscle and nervous tissue where they develop into sarcocysts. Immature sarcocysts can be found in muscle 45–60 days following ingestion of sporocysts and are infective at about 70 days.<sup>2</sup>

Schizogony in the endothelial cells of the arterioles and capillaries results in **widespread hemorrhage** and anemia. Fever is associated with the parasitemia, and in the experimental disease coincides with the time of maturation of the first- and second-generation schizonts.<sup>1</sup> The **vascular lesion** appears to be an essential part of the disease's pathogenesis. It is proposed that the parasite produces growth retardation as a result of changes in plasma concentrations of somatostatin and growth hormone, and changes in cytokine interactions with the endocrine system.<sup>10</sup>

The severity of the illness and the degree of infection of tissues at postmortem examination in experimentally induced cases increase with the size of the **infective dose**. The number of asymptomatic infections probably reflects the early ingestion of a few sporocysts that provoke a strong immunity to later challenge. When groups of animals that have not been exposed to infection previously are suddenly brought into contact with heavy contamination, especially from dogs and cats, outbreaks of clinical disease are likely to occur.

## CLINICAL FINDINGS

Infection and disease can occur at all ages. Clinical disease may be more severe where there is **intercurrent nutritional stress**, and copper deficiency may be an exacerbating factor. Monensin is suspected of being able to potentiate recent infections to cause a severe myositis.<sup>11</sup>

### Cattle

**Acute illness** is recorded with experimental infections but is rarely seen, or recognized, in the field. Illness commences with a rise in temperature and heart rate, followed by anorexia, anemia, weight loss, a fall in milk production, nervousness, muscle twitching, hypersalivation, lameness, abortion, and, in heavy infections, death. The agent is an occasional cause of non-suppurative encephalomyelitis in cattle and manifest with ataxia and recumbency.

**Chronic disease** in cattle is manifest by poor weight gains, loss of hair of the

neck, rump and the switch of the tail ('**rat-tail**'), anemia, and abortion.

### Sheep

In sheep, naturally occurring sarcocystosis has been associated with *S. tenella* and *S. arieticanis* and presents primarily as a **neurological disorder**, with muscle weakness, trembling, ataxia of varying severity, followed by hind limb paresis or flaccid paralysis and lateral recumbency. All ages of sheep can be affected, although lambs under 6 months are most susceptible. Attack rates in a susceptible group can be as high as 75% with a high case fatality rate.<sup>12–16</sup>

Infection may also be manifest with depressed growth, reduced wool growth, and anemia.<sup>8,13</sup> Less common manifestations include signs of congestive heart failure associated with endocardial and myocardial infection.<sup>17</sup> Infestation of the muscle of the esophagus in sheep is believed a cause of **esophageal dysfunction** and regurgitation in sheep.<sup>18</sup>

### Swine

Natural clinical disease is not recognized. Sarcocystosis produced experimentally in pigs is manifested by cutaneous purpura on the snout, ears, and buttocks, and dyspnea, tremor and weakness or recumbency.<sup>19</sup> There is evidence that breed of pig affects the severity of clinical disease with experimental infections and also the subsequent severity of the parasite load.<sup>20</sup>

### Abortion and perinatal fatality

Fetal infection, with abortion or neonatal mortality, is recorded in both cattle and sheep when pregnant animals are infected experimentally or naturally with pathogenic strains.<sup>1,5,9,13</sup>

## CLINICAL PATHOLOGY

Characteristic laboratory findings in the systemic disease include a responsive anemia, a prolonged prothrombin time, and high titers of antibody to *Sarcocystis*. Blood creatine phosphokinase, lactic dehydrogenase, and aspartate aminotransferase are significantly elevated.<sup>19</sup> An indirect hemagglutination test (IHA) and an ELISA test are available for serological surveys. Titers of antibodies are not high at the time of an acute illness, but are at diagnostic levels 1 week to 3 months afterwards.<sup>14</sup> An ELISA based on antigens from merozoites has high sensitivity and specificity for detection of infection in individual animals, and a 100% sensitivity for detecting herd infection with small sample size.<sup>21</sup> Most animals have been exposed to *Sarcocystis* spp., and serological examination cannot differentiate clinical disease from asymptomatic infection.

## NECROPSY FINDINGS

Emaciation, lymphadenopathy, laminitis, anemia and ascites are present, but the

most obvious feature is the petechial and echymotic hemorrhages throughout the body.<sup>22</sup> There are also erosions and ulcerations in the oral cavity and esophagus, likely as a result of microvascular damage. Microscopically, schizonts are found in endothelial cells throughout the body, and hemorrhages, lymphocytic infiltration, and edema are seen in heart, brain, liver, lung, kidney, and striated muscle.<sup>22</sup> Death is probably a result of the severe necrotizing myocarditis that occurs. There is an association between **eosinophilic myositis** and sarcosporidiosis, but this relationship is not proven in all cases.<sup>1</sup>

In sheep presenting with **neurological disease** there may be no findings at gross postmortem, but a non-suppurative encephalomyelitis on histological examination.<sup>12,14,15</sup> Aborted bovine fetuses show non-suppurative encephalitis, myocarditis, and hepatitis.<sup>5</sup>

A number of options are available to achieve a definitive diagnosis of the species present, including animal transmission studies, immunohistochemistry, electron microscopy and PCR. Such techniques are seldom required for routine diagnostic cases.

#### Samples for confirmation of diagnosis

- **Histology** – formalin-fixed heart, skeletal muscle (several sites, including tongue, masseter muscle) (LM).

#### DIFFERENTIAL DIAGNOSIS

Diagnosis in clinical cases is difficult because of the non-specific signs observed and the widespread prevalence of infection. Sarcosporidiosis is a consideration in the examination of problems of fever and anemia of undetermined origin in cattle and of ill-thrift in cattle and sheep.

Muscle biopsy may aid in the determination of the presence of infection, but still begs the question of its significance to the clinical disease.

The differential diagnoses for abortion in cattle are covered under brucellosis, and sheep under brucellosis. Causes of encephalitis and ataxia in sheep are listed under those headings.

#### TREATMENT

No approved treatment is available, but **amprolium** or **salinomycin** may relieve the signs. Amprolium 100 mg/kg given daily from the time of inoculation reduces the severity of infection in experimentally infected calves and sheep,<sup>13,23</sup> and has been used to control an outbreak in sheep.<sup>12</sup> Treatment of experimentally infected calves with salinomycin (4 mg/kg BW daily in divided doses for 30 days) reduced the severity of the illness.<sup>24</sup> Monensin may have a similar ameliorating effect,<sup>9,25</sup>

but is also suspected of exacerbating muscle lesions.<sup>10</sup> Oxytetracycline, at very high dose rates, and halofuginone may be effective in acute infections.<sup>13</sup>

#### CONTROL

Control is difficult as it involves the **separation of carnivores and stock**, which is not possible on most farms. However, infection in farm dogs and cats could be avoided if all meat fed to them was thoroughly cooked. Freezing will not destroy the infectivity. Coyotes and wild dogs should be controlled and livestock carcasses not left on fields. Prior exposure to small numbers of pathogenic sarcocysts produces a strong immunity, but there is no vaccine available.

#### REVIEW LITERATURE

- Dubey JP, Speer CA, Fayer R. Sarcocystosis of animals and man. Boca Raton, Florida: CRC Press, 1989.
- Dubey JP. A review of *Neospora caninum* and *Neospora-like* infections in animals. J Protozool Res 1992; 2:40–52.
- Anderson ML, Barr B, Conrad PA. Protozoal causes of reproductive failure in domestic animals. Vet Clin North Am Food Anim Pract 1994; 103:439–461.

#### REFERENCES

1. Fayer R, Dubey JP. In: Sarcocystosis of animals and man. Boca Raton, Florida: CRC Press, 1989.
2. Fayer R, Dubey JP. Comp Cont Educ 1986; 8:F180.
3. Savini G et al. Epidemiol Infect 1992; 108:107.
4. Savini G et al. Prev Vet Med 1994; 19:137.
5. Anderson ML et al. Vet Clin North Am Food Anim Pract 1994; 103:439.
6. Carrigan MJ. Aust Vet J 1986; 63:22.
7. Langham NPE, Charleston WAG. NZ J Agric Res 1990; 33:429.
8. Munday BL. Vet Parasitol 1986; 21:21.
9. Dubey JP et al. J Parasitol 1989; 75:422–980.
10. Fayer R, Elsasser TH. Parasitol Today 1991; 7:250.
11. Jeffrey M et al. Vet Rec 1989; 124:422.
12. Fitzgerald SD et al. J Vet Diag Invest 1993; 5:291.
13. Jeffrey M. In Practice 1993; 15:12.
14. Henderson JM et al. Can Vet J 1997; 38:168.
15. Sargison ND et al. Vet Rec 2000; 146:225.
16. Caldow GL et al. Vet Rec 2000; 146:7.
17. Scott PR, Sargison ND. Vet Rec 2001; 149:240.
18. Braun U et al. Can Vet J 1990; 31:391.
19. Braun U et al. Can Vet J 1990; 31:392.
20. Reiner G et al. Vet Parasitol 2002; 106:99.
21. Savini G et al. Prev Vet Med 1997; 32:35.
22. Johnson A J et al. Am J Vet Res 1975; 36:995.
23. Fayer R, Johnson AJ. J Parasitol 1975; 61:932.
24. Boy MG et al. J Am Vet Med Assoc 1990; 196:632.
25. Foreyt WJ. Am J Vet Res 1986; 47:1674.

#### NEOSPOROSIS

##### Synopsis

**Etiology** The protozoan parasite *Neospora caninum*. The dog is identified as the definitive host for *N. caninum* but the major route of infection in cattle is by vertical transmission.

**Epidemiology** An infection of cattle worldwide and associated with epidemic and endemic abortion. Point source and congenital infection occurs.

**Clinical findings** Abortion in cows, perinatal mortality and encephalomyelitis in congenitally infected calves.

**Clinical pathology** IFAT and ELISA serology on maternal serum and fetal fluids.

**Necropsy findings** Fetal lesions of multifocal non-suppurative encephalitis, myocarditis, and periportal hepatitis. Infection confirmed by immunohistochemistry.

**Diagnostic confirmation** A presumptive diagnosis can be based on the fetal histological lesions and seropositivity of the dam, but the definitive diagnosis requires the demonstration of the protozoa in fetal tissues by immunohistochemical labeling coupled with herd serological examinations.

**Control** Feed hygiene and calving hygiene. Cull congenitally infected cattle.

#### ETIOLOGY

*Neospora caninum*, a protozoan parasite of the phylum Apicomplexa in the family Sarcocystidae. *N. caninum* primarily infects dogs and cattle but has a **wide host range** and infects all the major domestic livestock species, as well as companion animals and certain wildlife species. Dogs are the only known definitive host with cattle as the major intermediate agricultural animal host. Natural infections are infrequently reported in sheep, goats and deer.<sup>1</sup> *N. caninum* is a sporadic cause of encephalomyelitis and myocarditis in several species but its importance is its association with **endemic and epidemic abortion in cattle**. It is now the most common diagnosis for abortion in cattle in most countries. The organism can be isolated, with difficulty, from infected calves.<sup>2</sup>

#### EPIDEMIOLOGY

##### Occurrence

*N. caninum* was initially associated with abortion in the early 1990s in pastured cattle in Australia and New Zealand, and as a major cause of abortion in large dry-lot dairies in southern California, and dairies in New Mexico, Washington, and Arizona in the United States. Since then, abortion associated with *N. caninum* has been reported from many countries in cattle under varying management conditions, and has **worldwide occurrence**.

Abortion may be **epizootic or sporadic**. In epizootic abortion the number of cows aborting varies. It is usually between 5 and 10%, but up to 45% of cows may abort within a short period. The period of abortion may be a few weeks to a few months. There is no major seasonal occurrence and abortion occurs in both beef and dairy cows.<sup>3,4</sup> Sporadic abortions occur predominantly in cows that have been infected congenitally and seropositive cows have greater risk for repeat

abortions. Seropositivity in herds can be high, but varies widely. One study in dairy herds reports a within herd **seroprevalence** ranging from 7 to 70%<sup>3</sup> and another in beef herds a within-herd seroprevalence ranging from 6.5 to 67%.<sup>5</sup> Seropositive dams have a 3–7 fold higher risk of abortion than seronegative dams.<sup>6,7</sup>

### Methods of transmission

There are two routes of infection of cattle. The dog is identified as the definitive host for *N. caninum* and infection of cattle can occur from the ingestion of oocytes in the dog feces contaminating feed or water. However vertical transmission occurs in both cattle and dogs and vertical (congenital) transmission appears the major route for infection in most cattle.<sup>1,8</sup>

Live-born calves from congenitally infected cows are themselves congenitally infected and the infection is believed to be **persistent and lifelong**. One study conducted on two dairies found 81% of seropositive cows gave birth to congenitally infected calves. Seroprevalence did not increase with cow age on either dairy, and was stable through the study period. The probability of a calf being congenitally infected was not associated with dam age, dam lactation number, dam history of abortion, calf gender, or length of gestation. Other studies have shown that this route of transmission is highly efficient resulting in infection of 50–95% of the progeny of seropositive dams.<sup>9</sup>

Congenital infection can result in abortion, or the birth of a normal, infected calf, and an infected cow can give birth to a normal, infected calf at one pregnancy and abort in the subsequent pregnancy.<sup>3</sup> The occurrence of infection in some herds can be associated with specific family lines.<sup>10</sup>

Whereas vertical transmission is the major route of infection that leads to sporadic abortions in cattle associated with *N. caninum* epidemiological evidence suggests that postnatal (point) infection is often the cause of outbreaks of abortion. Where dog feces are the source of infection many cattle are often exposed and this point source of infection commonly results in outbreaks of abortion. Farm dogs have been shown to have a higher seroprevalence to *N. caninum* than urban dogs suggesting that the disease cycles between cattle and dogs in rural environments.<sup>11</sup>

The importance of postnatal infection versus vertical infection in the genesis of abortion may vary between countries associated with differences in management systems.<sup>12</sup>

### Experimental reproduction

Abortion has been produced by experimental challenge of fetuses and pregnant

cattle with culture derived tachyzoites of *N. caninum*.<sup>13</sup> Fetal death and resorption or abortion has been reproduced in ewes challenged at 45, 65, and 90 days' gestation, but not 120 days, and lesions resemble those of ovine toxoplasmosis.<sup>14</sup> The disease has also been reproduced experimentally in goats,<sup>15</sup> but the importance and prevalence of this infection in naturally occurring abortions in small ruminants remains to be determined. Contaminated placenta, milk, and colostrum can result in infection of calves under one week of age.<sup>16</sup>

### Risk factors

Outbreaks of abortion often appear to be point source infections, but the risk factors, other than probable mass exposure to infected dog feces, are not known. With suspect point source infection the disease in dairy herds frequently occurs as an epizootic, with multiple abortions occurring in a 1 to 2-month period. Severely autolytic fetuses are aborted in the 5th–7th month of pregnancy in most reports, but earlier abortions are recorded in some, and the agent has been associated with outbreaks where the gestational age of fetal loss has ranged from **3 to 8.5 months**.<sup>3,6,17–20</sup> Heifers may abort earlier in pregnancy than older cows.

Endemic abortion is more likely associated with the presence of **congenitally infected** cattle in the herd, which are at **high risk of aborting**, particularly in the initial pregnancy and in the pregnancy during the first lactation.<sup>6,20</sup> Cows that have aborted have higher risk for abortion in subsequent pregnancies, but the risk decreases with each subsequent pregnancy. The true frequency of repeat abortions is unknown because cows may be culled for abortion.

It has been postulated that immunosuppression resulting from concurrent infection with agents such as BVD virus may increase the risk for infection with *N. caninum* and precipitate outbreaks of abortion. Concurrent *N. caninum* and BVD infections in aborted fetuses have been observed in some studies and one study has found a significant association between abortion and cows with antibody to both *N. caninum* and BVD.<sup>21</sup> Others have found no association<sup>22</sup> and whereas concurrent BVD infection might be a risk factor in some outbreaks, it is not in all.

### Economic importance

Economic loss is occasioned by the direct cost of abortions and the indirect costs associated with establishing the diagnosis and re-breeding or replacement costs. Seropositivity is also associated with increased risk of stillbirth and increased risk of retained placenta.

Seropositive heifers have been reported to produce less milk than seronegative herd mates.<sup>1,3,23</sup> However, this difference in milk production between seropositive and seronegative animals is not apparent in herds that are not experiencing an abortion problem.<sup>24</sup> In beef cattle seropositivity has been associated with reduction in average daily weight gain of 0.05 to 0.17 kg/head/day compared with seronegative cohorts and reduced food conversion efficiency rather than decreased food intake appeared the cause.<sup>25</sup> However, a subsequent study found no difference in production performance and carcass measures between seropositive and seronegative feedlot cattle.<sup>26</sup>

Estimates of economic loss associated with epidemic abortion include US\$35 million/year in California, AUS\$85/year to dairy and AUS\$25 for beef cattle in Australia and NZ\$17.8 for the dairy industry in New Zealand.<sup>9</sup>

### PATHOGENESIS

The organism has a predilection for fetal chorionic epithelium and fetal placental blood vessels producing a fetal vasculitis and inflammation and degeneration of the chorioallantois, and widespread necrosis in the placentome.<sup>14</sup> Tachyzoites penetrate host cells and are located in a parasitophorous vacuole. They can be found in macrophages, monocytes, vascular endothelial cells, fibroblasts, hepatocytes, renal tubular cells, and in the brain of infected animals. With neuromuscular disease, cranial and spinal neural cells are infected. Cell death is by the active multiplication of tachyzoites.

### CLINICAL FINDINGS

Abortion is the only clinical sign observed in infected **cows**. Fetuses may die in utero, be reabsorbed, be mummified, stillborn, born alive but diseased, or born clinically normal but chronically infected. Cows that are infected have **decreased milk production** in the first lactation, producing approximately 1 liter less of milk/cow/day than uninfected cows, are prone to abort, and have a higher risk of being culled from the herd at an early age.

In addition to the occurrence of early abortion, the disease in beef herds is associated with the birth of live-born, premature, **low-birth-weight** calves. Depending upon the degree of prematurity, these calves can be kept alive with intensive care during the neonatal period.

Most congenitally infected calves are born alive without clinical signs. Congenital infection can occasionally be manifest with ataxia, loss of conscious proprioception, paralysis, and other **neurological deficits** in the new-born calf,<sup>27</sup> but the majority of congenitally infected calves are clinically normal and, surprisingly,



epidemiological studies suggest that congenital infection does not necessarily have a detrimental effect on calf health and survival.<sup>28</sup>

*N. caninum* infection has been demonstrated in the nervous system of a horse with progressive debilitation, followed by sudden onset of neurological disease with paraplegia.<sup>29</sup> It appears a rare cause of neurological disease in horses but should be considered in the differential diagnosis of equine protozoal myeloencephalitis.

#### CLINICAL PATHOLOGY

Serological examination is with the indirect antibody fluorescent antibody test (IFAT), or by ELISA, and there is good agreement between the two tests. ELISA tests based on recombinant protein have higher sensitivities and specificities than that based on whole-tachyzoite lysates.<sup>30</sup> The IFAT is highly sensitive and specific for detection of maternal infection<sup>31</sup> and is commonly used. One study compared IFAT titers in maternal sera from 40 cows whose fetuses had been examined for neosporosis by immunohistochemistry. Of the 22 confirmed cases, 21 cows had titers of >1 in 640, whereas only one of the 18 negative cases had a titer of this magnitude.<sup>32</sup> The persistence of titers following infection is uncertain, and they may fluctuate during pregnancy. A positive titer in a cow that has aborted indicates exposure but not causality. Recently, IgG avidity patterns have been used to determine the duration of infection.<sup>33,34</sup>

Diagnosis is also made by the detection of antibody in fetal pleural fluid or sera,<sup>31</sup> and IFAT antibody has been found in the sera of from 50 to 65% of immunohistochemistry-confirmed cases of neospora infection, but not in fetuses under 4 months of gestational age.<sup>35,36</sup> Antigen can also be detected by PCR.<sup>37</sup>

#### NECROPSY FINDINGS

Gross findings are of autolysis. The brain may be autolysed, but should still be submitted for examination along with heart, liver, and placenta if available. Histological lesions are of multifocal encephalitis, myocarditis, and periportal hepatitis. Liver lesions may be more prominent in epizootic abortions. Immunohistochemistry using anti-*N. caninum* serum is used to identify tachyzoites in tissues, and the brain is the organ with the highest detection rate.<sup>38</sup> Immunohistochemistry is specific, but insensitive, in diagnosing fetal neosporosis, and maternal serology should be used in conjunction.

#### TREATMENT

There is no treatment that can be used to curtail an ongoing abortion epidemic and

#### DIFFERENTIAL DIAGNOSIS

Serology using IFAT can confirm infection in individual cows.

Because of the high prevalence of infection, and the occurrence of congenital infection, care must be taken in extrapolating the results of a single positive diagnosis to problems of abortion.<sup>3</sup> The high rate of natural congenital infection means that evidence of infection in an aborted fetus is not proof of causation of abortion, and fetal examination should be coupled with serological examination of aborting and non-aborting animals in the herd for statistical differences.

- Other causes of abortion in cattle
- Weak calf syndrome.

possible drug therapies are generally not considered an option because of likely unacceptable milk and meat residues and withdrawal problems.<sup>9</sup>

#### CONTROL

All efforts should be made to exclude the possibility of dog fecal contamination of cattle feed and water and of the grazing environment.<sup>39</sup> Placentas, aborted fetuses, and dead calves should be removed and disposed of so that the definitive host and cattle cannot get access to them.

Congenitally infected cows are at high risk for abortion, and abortion rates in infected herds can be substantially reduced by culling these animals.<sup>34,40,41</sup> Congenitally infected calves can be identified by serology on precolostral blood samples and culled at a young age. If precolostral blood sampling is not feasible, examination of sera at 6 months of age will determine infected calves, positive titers indicating either congenital infection or postnatal infection.<sup>42</sup> Animals purchased into the herd should be seronegative.

It is possible that strategic therapy of pregnant cows with an appropriate anti-protozoal drug could abort the infection. This could be effective in beef cattle, but would probably not be legal, or appropriate, in lactating dairy cattle.

Whereas evidence for increased risk for neospora abortion due to immunosuppression resulting from concurrent infection with BVD virus is equivocal control of BVD infections should be a component of control programs for neosporosis.

A killed tachyzoite vaccine has been approved in the United States for use in pregnant cows and is available commercially. At present there are no controlled studies in the United States on its efficacy in mitigating the effects of bovine neosporosis in dairy cattle. A field trial in dairy herds in Costa Rica measuring

abortion as the outcome showed a reduction in the incidence of abortion.<sup>43</sup> A study in growing beef cattle showed no significant effects between vaccinated and control animals in cumulative average daily gain or in food conversion efficiency.<sup>44</sup> Studies in sheep have shown that vaccination significantly reduces fetal loss in experimentally infected ewes. However, they showed that there was little protection against vertical transmission of *N. caninum* to the fetuses.<sup>45,46</sup>

Vaccination of dairy cattle may interfere with a herd test and cull policy.

#### REVIEW LITERATURE

- Dubey JP, Lindsay DS. A review of neospora and neosporosis. *Vet Parasitol* 1996; 67:1-59.
- Dubey JP. Neosporosis in cattle: biology and economic impact. *J Am Vet Med Assoc* 1999; 214:1160-1163.
- Barr BC (convenor). Neosporosis. Report of the International Neospora Workshop. *Comp Cont Educ Pract Vet* 1997; 19 Suppl 4:S120-S126.
- Antony A, Williamson NB. Recent advances in understanding the epidemiology of *Neospora caninum* in cattle. *NZ Vet J* 2001; 49:42-47.
- Buxton D, McAllister MM, Dubey JP. The comparative pathogenesis of neosporosis. *Trends Parasitol* 2002; 18:546-552.
- Dubey PJ. Redescription of *Neospora caninum* and its differentiation from related coccidian. *Int J Parasitol* 2002; 32:929-946.
- Larson RL, Hardin DK. Review: *Neospora caninum*-induced abortion in cattle. *Bovine Pract* 2003; 37:121-126.
- Haddad JPA, Dohoo IR, VanLeewen JA. A review of *Neospora caninum* in dairy and beef cattle - a Canadian perspective. *Can Vet J* 2005; 46:230-243.

#### REFERENCES

1. Dubey JP. *J Am Vet Med Assoc* 1999; 214:1160.
2. Miller CMD et al. *Aust Vet J* 2002; 80:620.
3. Thurmond MC et al. *J Vet Diag Invest* 1997; 9:44.
4. Crawshaw WM, Brocklehurst S. *Vet Rec* 2003; 152:201.
5. Sanderson MS et al. *Vet Parasitol* 2000; 90:15.
6. Thurmond MC, Hietela SK. *Am J Vet Res* 1997; 58:1381.
7. Atkinson RA et al. *Aust Vet J* 2000; 78:262.
8. Schares G et al. *Vet Parasitol* 1998; 80:87.
9. Reichel MP, Ellis JT. *NZ Vet J* 2002; 50:86.
10. Bjorkman C et al. *J Am Vet Med Assoc* 1996; 208:1441.
11. Antony A, Williamson NB. *N Z Vet J* 2003; 51:232.
12. Antony A, Williamson NB. *NZ Vet J* 2001; 49:42.
13. Conrad PA et al. *Vet Rec* 1992; 130:147.
14. Buxton D et al. *J Comp Path* 1998; 118:267.
15. Lindsay DS et al. *Am J Vet Res* 1996; 56:1176.
16. Davison HC et al. *Res Vet Sci* 2001; 70:163.
17. McAllister MM et al. *J Vet Diag Invest* 1996; 8:355.
18. Thornton RN et al. *NZ Vet J* 1991; 39:129.
19. Otter A. *Vet Rec* 1997; 140:239.
20. Hernandez J et al. *J Am Vet Med Assoc* 2002; 221:1742.
21. Bjorkman C et al. *Vet J* 2000; 159:201.
22. Quinn HE. *Aust Vet J* 2004; 82:99.
23. Hernandez J et al. *J Am Vet Med Assoc* 2001; 219:632.
24. Hobson JC et al. *J Am Vet Med Assoc* 2002; 221:1160.
25. Barling KS et al. *J Am Vet Med Assoc* 2001; 219:1259.
26. Schmidt PL, O'Connor AM. *Proc Am Assoc Bov Practit* 2004; 37:164.
27. Gunning RF et al. *Vet Rec* 1994; 134:558.

28. Pare J et al. *Can J Vet Res* 1996; 60:133.
29. Daft BM et al. *Equine Vet J* 1997; 29:240.
30. Louie K et al. *Clin Diag Lab Immunol* 1997; 4:692.
31. Otter A et al. *Vet Rec* 1997; 141:487.
32. McNamee PT et al. *Vet Rec* 1996; 138:419.
33. Bjorkman C et al. *Vet Parasitol* 2005; 128:195.
34. Frossling J et al. *Vet Parasitol* 2005; 128:209.
35. Wouda W et al. *J Parasitol* 1997; 83:508.
36. Barr BC et al. *Vet Rec* 1995; 137:611.
37. Ho MSY et al. *J Parasitol* 1997; 83:508.
38. Wouda W et al. *J Vet Diag Invest* 1997; 9:180.
39. Rinaldi L et al. *Vet Parasitol* 2005; 128:219.
40. Hall CA et al. *Vet Parasitol* 2005; 128:231.
41. Weston JF et al. *NZ Vet J* 2005; 53:142.
42. Thurmond MC, Hietela SK. *Bovine Pract* 1995; 29:60.
43. Romero JJ et al. *Vet Parasitol* 2004; 123:149.
44. Barling KS et al. *J Am Vet Med Assoc* 2003; 222:624.
45. O'Handley RM et al. *Am J Vet Res* 2003; 64:449.
46. Jenkins MC. *Am J Vet Res* 2004; 65:1404.

## CRYPTOSPORIDIOSIS

### Synopsis

**Etiology** *Cryptosporidium parvum* bovine genotype 2 and *C. andersoni*.

**Epidemiology** Infection common in ruminant neonates. May cause diarrhea, especially if there is intercurrent infection with other enteropathogens, nutritional, or environmental stress.

**Clinical findings** Malabsorption-type diarrhea.

**Clinical pathology** Oocysts in feces demonstrated by immunofluorescent assay.

**Lesions** Villous atrophy.

### Diagnostic confirmation

Demonstration of lesions and organism.

**Treatment** Supportive. Halofuginone or paromomycin if approved.

**Control** Hygiene and management to ensure passive transfer of colostral antibodies and minimization of infection pressure.

## ETIOLOGY

*Cryptosporidium* are protozoan parasites in the Phylum Apicomplexa. Currently, up to 14 species of *Cryptosporidium*, infecting mammals, fish, and birds, have been proposed but only two of these are of importance to agricultural animals. These include *C. parvum* which infects many different hosts including cattle, swine, horses, and small ruminants, and the calf genotype of *C. muris*, now called *C. andersoni*, which infects cattle.<sup>1,2</sup> *C. parvum* has two distinct genotypes known as human genotype 1 (also known as *C. hominis*) and bovine genotype 2. Both genotypes are capable of causing disease in humans. Livestock and horses are not commonly infected with genotype 1, although recently infections have been experimentally produced in lambs and piglets<sup>3</sup> and mixed infections with genotypes 1 and 2 have been observed in calves.<sup>4</sup>

*Cryptosporidium parvum* is a **common infection** in young ruminants and is found in many species of mammals including humans. There has been controversy about the role of *C. parvum* as a causative agent of diarrhea because infection can be found in normal healthy animals. However, it is considered a significant cause of varying degrees of naturally occurring diarrhea in neonatal farm animals. Most commonly, the agent acts in concert with other enteropathogens to produce intestinal damage and diarrhea.

## EPIDEMIOLOGY

### Occurrence and prevalence

Cryptosporidiosis has been recognized worldwide, primarily in neonatal calves, but also in lambs, goat kids, foals, and piglets.<sup>5-9</sup> Many studies report prevalence of infection but this does not imply clinical disease.

### Calves

Infection is common in calves but reported prevalence rates of *Cryptosporidium* in feces vary widely. Prevalence ranging from 1.1% in a random sample of adult cattle feces in California<sup>10</sup> to 79% in symptomatic calves in Maryland, USA have been reported.<sup>11</sup> *Cryptosporidia* have been detected in 70% of 1 to 3-week-old dairy calves based on a single examination of feces.<sup>12</sup> A single sampling in a nationwide survey of 7369 calves on 1103 farms in the United States found infection on 59.1% of farms, and in 22.4% of calves.<sup>13</sup> Daily sampling of calves in the first 4 weeks of life show higher rates of infection and a **period prevalence** of infection as high as 100%.<sup>14-17</sup> There is also **high site prevalence**.

A 6 year longitudinal study, on a lowland farm in the United Kingdom, of patterns of fecal excretion of *C. parvum* in beef cattle, dairy cows, home bred and purchased calves, lambs, rodents in the farm building environment and in the pastures, showed that the parasite was endemic and persistently present in all animal species tested. It found that patterns of infection were variable and that short-term or point prevalence sampling would be unlikely to provide a representative picture of infection rates. Prevalence rates and oocyst numbers in feces were highest in young animals.<sup>17</sup>

Infection can be detected as early as 5 days of age, with the greatest proportion of calves excreting organisms between days 9 and 14.<sup>14-17</sup> This is also the period of greatest **intensity** of excretion of the organism in the feces of individual calves.

Infection of the calf is followed by the development of resistance to reinfection, and oocyst excretion is less common and intermittent in older and adult cattle,<sup>18,19</sup> although high excretion rates are found in adult cattle in some herds.<sup>20</sup>

Most prevalence studies have found little association between infection and diarrhea, but there are many reports that associate infection in calves with diarrhea occurring between 5 and 15 days of age.

### Sheep and goats

*C. parvum* is also a **common** enteric infection in **young lambs and goats**, and diarrhea can result from a monoinfection, but more commonly is associated with mixed infections. The age pattern of infection and excretion of the organism is similar to that in calves.<sup>21</sup> Infection can be associated with severe outbreaks of diarrhea, with high case fatality in lambs from 4 to 10 days of age<sup>21-24</sup> and goat kids from 5 to 21 days of age.<sup>21</sup>

### Pigs

Cryptosporidial infection in pigs occurs over a **wider age range** than in ruminants and has been observed in pigs from 1 week of age through to market age. In a retrospective study of piglets submitted to a diagnostic laboratory over a 4-year period, cryptosporidia were detected histologically in 5.3% of about 3500 piglets.<sup>25</sup> Infection is most common between 6 and 12 weeks of age.<sup>26</sup> The majority of infections are **asymptomatic**, and the organism does not appear to be an important enteric pathogen in this species,<sup>26,27</sup> although it may contribute to postweaning malabsorptive diarrhea.

### Foals

Cryptosporidial infection in foals appears **less prevalent** and occurs at a later age than in ruminants, with excretion rates peaking at 5-8 weeks of age.<sup>28</sup> Infection is not commonly detected in yearlings or adults.<sup>28,29</sup> Most studies indicate that cryptosporidiosis is not a common disease in foals, and infections in immunocompetent foals are usually subclinical.<sup>26,28</sup> Diarrhea is recorded in foals from 5 days to 6 weeks of age including a report of an outbreak lasting one month where 9 of 30 foals aged between 4 days and 3 weeks of age were affected with a case fatality rate of 33%.<sup>30</sup> Persistent clinical infections occur in Arabian foals with inherited **combined immunodeficiency**.<sup>31</sup>

### Farmed deer

Cryptosporidiosis is also recorded in young deer and can be a cause of diarrhea in artificially reared orphans. Infection has also been recorded in red deer calves dying at 24-72 hours of age following a syndrome of severe weakness and depression accompanied by a terminal uremia.<sup>32</sup>

### Source of infection and transmission

Experimental infections have shown that a small number of oocysts are required for infection. The replicative cycle in the

intestine amplifies a minor infective dose and studies in gnotobiotic lambs indicate a minimum **infectious dose** as low as one oocyst. The source of infection is **feces** which contain oocysts that are fully sporulated and infective when excreted. Large numbers are excreted during the patent period in calves resulting in heavy environmental contamination. Transmission may occur directly from calf to calf, indirectly via fomite or human transmission, from contamination in the environment or fecal contamination of the feed or water supply. Infection into the environment of newborn animals, and an increase in contamination of their immediate environment occurs as the result of a **periparturient rise** in the fecal excretion of oocysts by the dam. This has been recorded in ewes,<sup>33</sup> in a beef cattle herd where the rate of infection and the number of oocysts in cattle feces increased significantly at one week post calving<sup>34</sup> and in some dairy herds.<sup>35,36</sup> Genotype 1 of *C. parvum* is not host-specific and infection from **other species**, such as rodents or farm cats, contaminating calf feeds, is also possible.

#### Risk factors

The factors that make animals susceptible to infection and that predispose infected animals to develop clinical disease are not well understood. Disease in agricultural animals associated with infection with *Cryptosporidium* is associated with infection with *C. parvum* and there is little evidence that infection with *C. andersoni* is associated with disease. Commonly, other enteric infections are present where there is disease attributed to *Cryptosporidium*. The site of infection with *C. parvum* is on the enterocyte where it results in cell damage, loss of brush border enzymes and a reduction of villous surface area.

#### Pathogen risk factors

Oocysts are resistant to most **disinfectants** and can reportedly remain viable for about 18 months in a cool, damp or wet environment, can survive for several months in soil and slurry<sup>11,37</sup> but are susceptible to desiccation and temperatures above 60°C.<sup>38</sup> The infectivity of the oocysts can be destroyed by ammonia, formalin, freeze-drying and exposure to temperatures below 0°C (32°F) and above 65°C (149°F). Ammonium hydroxide, hydrogen peroxide, chlorine dioxide, 10% formol saline and 5% ammonia are effective in destroying the infectivity of the oocysts. The infectivity of oocysts in calf feces is reduced after 1–4 days of drying.<sup>39,40</sup>

#### Concurrent infections

Concurrent infections with other enteropathogens, especially rotavirus and

coronavirus, are common and epidemiological studies suggest that diarrhea is more severe with mixed infections. The rates of single and mixed infections vary with different studies. In general, mixed infections are most common, but cryptosporidial infection can be significant in its own right. For example, in two studies involving diarrheic calves submitted to diagnostic laboratories, cryptosporidia were the only pathogens isolated in 51% and 55% of the cases, while in 25% and 39% of cases the protozoan agent was found in combination with rotavirus and/or coronavirus.<sup>41,42</sup> **Immunologically compromised** animals are more susceptible to clinical disease than immunocompetent animals, but the relationship between disease and failure of passive transfer of colostrum immunoglobulins is not clear. The disease can be reproduced in both colostrum-deprived and colostrum-fed calves and, in the field, clinical disease can occur in calves and foals with adequate passive transfer of colostrum immunoglobulins. However, the shedding of the organism has been observed to be higher in calves with low absorptive efficiency of IgG from colostrum and low serum IgG concentrations.<sup>43</sup>

#### Season

In one series of observations there was a tendency for the prevalence of infection to be higher during the winter months of the year when the calves were confined, which suggests a build-up of contamination,<sup>44</sup> but seasonal difference in prevalence is not marked and clinical disease can occur at all seasons.

#### Interactions

Case fatality rates in cryptosporidiosis are generally low unless there are other complicating factors. In addition to concurrent infections, these include energy deficits from inadequate intake of colostrum and milk, and chilling from adverse weather conditions.

#### Age

Age-related resistance, unrelated to prior exposure, has been observed in lambs<sup>45</sup> but not calves.<sup>46</sup> Infection results in the production of parasite-specific antibody, but both cell-mediated and humoral antibody are important in protection, as well as local antibody in the gut of the neonate.<sup>47,48</sup>

#### Experimental reproduction

The disease has been reproduced in colostrum-deprived calves, lambs and kids, in many studies.

#### Zoonotic implications

Infections in domestic animals and pets may be a reservoir for infection of susceptible humans. In humans, cryptosporidium

is considered to be a relatively common non-viral cause of self-limiting diarrhea in immunocompetent persons, particularly in children. In symptomatic immunocompetent patients, cryptosporidiosis most commonly presents with diarrhea that can lead to rapid weight loss and dehydration and require parenteral fluid therapy. The disease is usually self-limiting, symptoms normally lasting between 3 and 12 days. In **immunologically compromised** persons, clinical disease may be severe. This is particularly serious in human patients with acquired immune deficiency syndrome. The infection is transmitted predominantly from person to person, but direct infection from animals, and indirect water-borne infection from contamination of surface water and drinking water by domestic or wild animal feces can also be important. Animal manures and slurry may contain *C. parvum* and there is potential for contamination of the food chain as a result of run-off into adjacent surface waters or from direct application of the untreated wastes to crops. Recently, this risk for human infection has been a cause of public concern but this concern has been somewhat mitigated by the recognition that the cattle genotype does not infect humans.

Direct animal contact can result in human infection where there is hand to mouth transmission and infection and disease is recorded in veterinary students<sup>49</sup> and is a concern for children at fairs, petting zoos and in educational visits in farm settings.<sup>50</sup> Cryptosporidiosis is one of a number of zoonotic infections that have recently emerged in these settings. The apparent increase in prevalence of these infections could be due to the general movement of populations from rural to urban communities and the consequent removal from early exposure to farm animal-derived zoonotic agents. Equally, it could result from better detection and reporting by public health authorities. Regardless, the risk for transmission of zoonotic agents associated with petting zoos, farm animal exhibits, and fairs etc, is real and veterinarians are increasingly asked for advice on this issue. This can be in association with an official capacity as a fair veterinarian or in consultation with farm owners, who desire to bridge the increasing estrangement of urban populations to farm activities by allowing farm tours which frequently involve younger ages and more susceptible humans.

Animal handlers on a calf farm can be at high risk of diarrhea due to cryptosporidiosis transmitted from infected calves, and immunocompromised people should be restricted from access to young

animals, and possibly from access to farms.

### PATHOGENESIS

The life cycle of *Cryptosporidium* consists of six major developmental events. Following ingestion of the oocyst there is excystation (release of infective sporozoites), merogony (asexual multiplication), gametogony (gamete formation), fertilization, oocyst wall formation, and sporogony (sporozoite formation).<sup>1,2,38</sup> Thus the oocysts of *Cryptosporidium* spp. can sporulate within the host cell, in contrast to the oocysts of *Eimeria* and *Isoospora* spp., which do not sporulate until they are passed from the host, and they are infective when passed in the feces.<sup>3</sup> The infection persists until the immune response of the animal eliminates the parasite. In natural and experimentally produced cases in calves, the cryptosporidia are most numerous in the lower part of the small intestine and occasionally in the cecum and colon. The prepatent periods range from 2 to 7 days in calves, and from 2 to 5 days in lambs. Oocysts are usually passed in the feces of calves for 3–12 days.

The intracellular stages of the organism are within a parasitophorous vacuole, which is confined to the microvillous region of the host cell. The cryptosporidia appear free in the lumen of the intestine and attached to the microvilli of the villous epithelial cells. The parasitophorous envelope of the trophozoites and schizonts are derived from the microvilli, and the intracellular location of the organism is confined to fusion of the organism, with the apical cytoplasm of the epithelial cells and their enclosure by host membranes. Thus the organism is intracellular but extracytoplasmic.

The pathogenesis of the diarrhea is unknown, but the varying degrees of villous atrophy suggest that digestion and absorption may be impaired, resulting in diarrhea. The experimental inoculation of gnotobiotic calves with a mono-infection of *Cryptosporidium* species treated with peracetic acid to destroy other possible enteropathogens results in lesions of villous atrophy and diarrhea, which indicates that the organism can cause intestinal lesions<sup>51</sup> without concurrent infection with other enteropathogens. There is also evidence of hyperplastic crypt epithelium, which along with damaged villous epithelium and atrophic villi indicates that the lesions develop as a result of accelerated destruction or loss rather than decreased production of epithelial cells.<sup>51</sup>

### CLINICAL FINDINGS

There are no clinical findings characteristic of diarrhea due to infection with *C. parvum* in calves. In general, calves are

usually 5–15 days old and have a mild to moderate diarrhea which persists for several days regardless of treatment. The age at onset is later, and the duration of diarrhea tends to be a few days longer, than the diarrheas associated with rotavirus, coronavirus, or enterotoxigenic *Escherichia coli*. Feces are yellow or pale, watery, and contain mucus. The persistent diarrhea results in marked loss of body weight and emaciation in some cases. In most cases, the diarrhea is self-limiting after several days. Varying degrees of apathy, reduced feed intake and dehydration are present. Only rarely does severe dehydration, weakness and collapse occur, in contrast to other causes of acute diarrhea in neonatal calves. Case fatality rates can be high in herds with cryptosporidiosis when the calf feeder withholds milk and feeds only electrolyte solutions during the episode of diarrhea. The persistent nature of the diarrhea leads to a marked energy deficit in these circumstances and the calves die of inanition at 3–4 weeks of life. This syndrome may be particularly common in the winter months where there is additional cold stress affecting energy requirements.

In the experimental disease in calves, depression and anorexia are the earliest and most consistent clinical findings. Feed intake is reduced and, combined with the persistent diarrhea over several days, may cause emaciation. Recovery occurs between 6 and 10 days after the onset of diarrhea.

In the experimental disease in lambs and kids, depression, diarrhea, and reduced feed intake are common and recovery occurs within a few days. More severe clinical manifestations have been observed in the field in lambs subject to environmental cold stress and those that are energy deficient due to an inadequate intake of colostrum.

### CLINICAL PATHOLOGY

Diagnosis of cryptosporidiosis is traditionally based on the detection of fecal oocysts. The oocysts can be detected in the feces by examination of fecal smears with certain stains, by fecal flotation, or by immunologically assisted methods. Current diagnostic techniques used in most clinical laboratories include the immunofluorescent assay visualization of fecal oocysts. It has been suggested that, if the diarrhea is associated with cryptosporidia, the feces should contain  $10^5$ – $10^7$  oocysts per mL of feces.<sup>52</sup> The oocysts are small (5–6  $\mu$ m in diameter), relatively non-refractile, and difficult to detect by normal light microscopy. They are readily detected by phase-contrast microscopy. The demonstration of oocysts concentrated from fecal samples is by centrifugal

flotation in high specific-gravity salt or sugar solutions.

The modified Ziehl–Neelsen is a simple and rapid procedure well suited for large-scale routine diagnosis of cryptosporidia.<sup>14,15</sup> An immunofluorescence technique on fecal smears is available, as are immunoassays.<sup>14,15,53</sup>

### NECROPSY FINDINGS

Varying degrees of dehydration, emaciation, and serous atrophy are present in calves that have had persistent diarrhea for several days. There is atrophy of villi in the small intestine. Histologically, large numbers of the parasite are embedded in the microvilli of the absorptive enterocytes. In low-grade infections, only a few parasites are present, with no apparent histological changes in the intestine. The villi are shorter than normal, and there is crypt hyperplasia and infiltration with a mixture of inflammatory cells.<sup>51</sup>

### Samples for confirmation of diagnosis

- **Parasitology** – feces (microscopic examination, ELISA, FAT)
- **Histology** – formalin-fixed jejunum, ileum (several sites), colon.

### DIFFERENTIAL DIAGNOSIS

The disease must be differentiated from other common infectious diarrheas in calves, which are covered in the section on acute undifferentiated diarrhea.

### TREATMENT

#### Specific therapy

Several different types of antiprotozoal drugs and antimicrobials have been evaluated with no therapeutic effect.<sup>54–56</sup> The exceptions are halofuginone and paromomycin.

**Halofuginone** is reported to markedly reduce oocyst output and the severity of diarrhea and/or mortality in infected lambs<sup>24</sup> and naturally and experimentally infected calves.<sup>57–59</sup> Therapy with this drug significantly reduced the severity of diarrhea and dehydration compared with sulfadimidine therapy in calves<sup>60</sup> and a randomized double blind trial in calves has shown a significant prophylactic effect when given for 7 days from 1 day of age.<sup>61</sup> Preliminary studies suggest that an oral dose of 60–125  $\mu$ g/kg BW daily for 7 days will protect against clinical disease and will markedly reduce oocyte excretion, but will allow some intestinal infection and thus the development of immunity. The results of these studies suggest that the drug prevents reinfection of the gut by sporozoites and recycling merozoites.

**Paromomycin sulfate** given orally at a dose of 100 mg/kg BW daily for 11

consecutive days from the second day of age proved successful in preventing natural disease in a controlled clinical field trial in goat kids<sup>21</sup> and to reduce but not completely prevent diarrhea in infected lambs.<sup>62</sup>

### Supportive therapy

Affected calves should be supported with **fluids and electrolytes**, both orally and parenterally as necessary until spontaneous recovery occurs. Cows' **whole milk** should be given in small quantities several times daily to optimize digestion and to minimize loss of body weight. It is important to **continue to feed** milk to the full level of requirement despite the presence of diarrhea, as a reduction in intake may lead to death from inanition. Several days of intensive care and feeding may be required before recovery is apparent. **Parenteral nutrition** could be considered for valuable calves.

### CONTROL

The disease is difficult to control. The rational approach to prevention is to **minimize transmission** between the source of the organism and neonatal farm animals, and between the animals. Reducing the number of oocysts ingested may reduce the severity of infection and allow immunity to develop. Calves should be born in a clean environment and adequate amounts of colostrum should be fed at an early age. Calves should be kept separate without calf-to-calf contact for at least the first 2 weeks of life, with strict hygiene at feeding. Disinfectants detailed above should be employed in hygiene.

Diarrheic calves should always be **isolated** from healthy calves during the course of the diarrhea, and for several days after recovery. Sick calves are commonly treated by the same person who feeds the healthy calves and great care must be taken to avoid mechanical transmission of infection. Calf-rearing houses should be vacated and cleaned out on a regular basis; an all-in all-out management system, with thorough cleaning and several weeks of drying between batches of calves, should be used.

Rats and mice and flies should be controlled where possible and rodents and pets should not have access to calf grain and milk feed storage areas.

### Immunoprophylaxis

Hyperimmune bovine colostrum can reduce the severity of diarrhea and the period of oocyst excretion in experimentally infected calves and lambs.<sup>63-66</sup> Protection is not related to circulating levels of specific antibody but requires a high titer of *C. parvum* antibody in the gut lumen for prolonged periods.

Vaccination with lyophilized *C. parvum* given orally shortly after birth has given partial protection to experimental calves challenged at 1 week of age.<sup>66,67</sup> It was not effective in protecting against natural challenge in a field trial, presumably because natural infection occurred too early to allow development of immunity.<sup>68</sup> In the same trial, lactic acid-producing probiotics had no protective effect.

### REVIEW LITERATURE

- Tzipori S. Cryptosporidiosis in perspective. *Adv Parasitol* 1988; 27:63-129.
- Dubey JP, Speer CA, Fayer R. Cryptosporidiosis of man and animals. Boca Raton, Florida: CRC Press, 1990; pp. 1-191.
- Casey MJ. *Cryptosporidium* and bovine cryptosporidiosis: a review. *Irish Vet J* 1991; 44:2-7.
- Odonoghue PJ. *Cryptosporidium* in man and animals. *Int J Parasitol* 1995; 25:139-195.
- Fayer R, Morgan U, Upton SJ. Epidemiology of *Cryptosporidium*: transmission detection and identification. *Int J Parasitol* 2000; 30:1305-1322.
- Xiao LH, Fayer R, Ryan U, Upton SJ. *Cryptosporidium* taxonomy: recent advances and implications for public health. *Clin Microbiol Rev* 2004; 17:72-97.

### REFERENCES

- Fayer R et al. *Internat J Parasitol* 2000; 30:305.
- Xiao LH et al. *Clin Microbiol Rev* 2004; 17:72.
- Ebeid M et al. *Parasitol Res* 2003; 90:232.
- Tanriverdi S et al. *Mol Biochem Parasitol* 2003; 130:13.
- Casey MJ. *Irish Vet J* 1991; 44:2-7.
- Dubey JP et al. Boca Raton, Florida: CRC Press, 1990; pp. 1-191.
- Fayer R, Ungar BLP. *Microbiol Rev* 1986; 50:458-483.
- Odonoghue PJ. *Int J Parasitol* 1995; 25:139.
- Tzipori S. *Adv Parasitol* 1988; 27:63.
- Hoar BR et al. *Epidemiol Infect* 2001; 127:147.
- Fayer R et al. *Internat J Parasitol* 2000; 30:305.
- Markovics A et al. *Refuah Vet* 1984; 41:134.
- Garber LP et al. *J Am Vet Med Assoc* 1994; 205:86.
- McCluskey BJ et al. *Vet Parasitol* 1995; 60:185.
- Farrington M et al. *Vet Parasitol* 1995; 60:7.
- Korinek J, Chroust K. *Acta Vet Brno* 1988; 57:39.
- Sturdee A P et al. *Vet Parasitol* 2003; 116:97.
- Villacorta I et al. *Vet Parasitol* 1991; 38:249.
- Olson ME et al. *Can Vet J* 1997; 38:703.
- Scott CA et al. *Vet Rec* 1994; 134:172.
- Chartier C et al. *Prev Vet Med* 1996; 25:357.
- Angus KW. Cryptosporidiosis in ruminants. Boca Raton, Florida: CRC Press, 1990; p. 83.
- Castro-Hermida JA et al. *J Parasitol* 2002; 88:185.
- Causape AC et al. *Res Rev Parasitol* 1999; 59:41.
- Sanford SE. *J Am Vet Med Assoc* 1987; 190:695.
- Kim CW. Cryptosporidiosis in pigs and horses. Boca Raton, Florida: CRC Press, 1990; p. 105.
- Lindsay DS, Blagburn BL. *Comp Cont Educ* 1991; 13:891.
- Xiao L, Herd RP. *Equ Vet J* 1994; 26:14.
- Forde KN. *J Equine Vet Sci* 1998; 18:38.
- Grinberg A et al. *Vet Rec* 2003; 153:628.
- Bjorneby JM et al. *Infect Immun* 1991; 59:3823.
- Simpson VR. *Vet Rec* 1992; 130:116.
- Xiao L et al. *J Parasitol* 1994; 80:55.
- Ralston BJ et al. *Vet Parasitol* 2003; 114:113.
- Atwill ER et al. *J Parasitol* 2003; 89:1234.
- Faubert GM, Litvinsky Y. *J Parasitol* 2000; 86:495.
- Barrick RS et al. *J Dairy Sci* 2003; 86:784.
- Chappell CL, Okhuysen PC. *Current Opinion Infect Dis* 2002; 15:523.
- Tzipori S. *Microbiol Rev* 1983; 47:84.
- Anderson BC. *Am J Vet Res* 1986; 47:2272.

- Moore DA, Zeman DH. *J Am Vet Med Assoc* 1991; 11:1969.
- Krogh HV, Henriksen SA. *Nord Vet Med* 1985; 37:42.
- Lopez JW et al. *J Dairy Sci* 1988; 71:1288.
- Henriksen SA, Krogh HV. *Nord Vet Med* 1985; 37:34.
- Ortega-Mora LM, Wright SE. *Infect Immun* 1994; 62:5003.
- Harp JA et al. *Infect Immun* 1990; 58:2237.
- Whitmire WM, Harp JA. *Infect Immun* 1991; 59:990.
- Peeters JE et al. *Infect Immun* 1993; 61:4440.
- Preiser G et al. *J Am College Health* 2003; 51:213.
- Stefanogiannis N et al. *N Z Vet J* 2001; 114:144.
- Heine J et al. *J Infect Dis* 1984; 150:768.
- Moon HW, Woodmansee DB. *J Am Vet Med Assoc* 1986; 189:643.
- Anusz KS et al. *J Clin Microbiol* 1990; 28:2770.
- Koudela B, Bokova A. *Vet Res* 1997; 28:405.
- Moon HW et al. *Vet Rec* 1982; 110:181.
- Tzipori SR et al. *Aust J Exp Biol Med Sci* 1982; 60:187.
- Jarvie BD et al. *J Dairy Sci* 2005; 88:1801.
- Naciri M et al. *Vet Parasitol* 1993; 45:199.
- Jarvie BD et al. *Proc Am Assoc Bov Practit* 2004; 37:220.
- Joachim A et al. *Vet Parasitol* 2003; 112:277.
- Lefay D et al. *Vet Rec* 2001; 148:108.
- Viu M et al. *Vet Parasitol* 2000; 90:163.
- Fayer R et al. *Infect Immun* 1990; 58:2962.
- Naciri M et al. *Int J Vet Parasitol* 1994; 25:139.
- Martin-Gomez S et al. *Vet Parasitol* 2005; 129:11.
- Harp JA et al. *Am J Vet Res* 1996; 57:1586.
- Wyatt CR. *Anim Hlth Rev* 2000; 1:25.
- Harp JA, Goff JP. *J Parasitol* 1995; 81:54.

## GIARDIASIS (LAMBLIASIS)

### Synopsis

**Etiology** *Giardia duodenalis*. Zoonotic and livestock-specific assemblages.

**Epidemiology** High prevalence of infection in young farm animals. Fecal-oral cycle of infection from excreting young animals, the dam and fomite contamination in environment. Cross species and water transmission possible.

**Clinical findings** Most infections asymptomatic. May result in intermittent pasty feces and growth suppression.

**Clinical pathology** Demonstration of organism in feces by phase microscopy or fluorescent antibody.

**Necropsy findings** Villus atrophy.

**Treatment and control** Benzimidazoles, hygiene.

### ETIOLOGY

*Giardia duodenalis* (synonyms *intestinalis*, *lamblia*) is a flagellate binucleated protozoan that infects a variety of vertebrates including mammals, reptiles, and birds. It is a major cause of diarrhea in humans and has been suspected of causing diarrhea in agricultural animals. Human and animal isolates are similar on the basis of morphology, enzyme activities, and restriction enzyme analysis, although there are differences in DNA banding patterns. Currently the numerous genetic

variants from mammals are all placed in the one species and the genotypic designation of *G. duodenalis* is evolving, with groups, assemblages and genotypes all used. Cattle are susceptible to infection with genotypes in the zoonotic genotype Assemblage A, which infect several different animal species, and the livestock genotype, Assemblage E, which appears restricted to hoofed animals.<sup>1</sup>

The organism develops in the small intestine where it multiplies by binary fission on the surface of the intestinal mucosa in the trophozoite stage and is excreted in feces as a cyst.

## EPIDEMIOLOGY

### Occurrence

Giardial infection, as opposed to disease, has been reported from most continents and has been identified in **all of the common agricultural animals**. There is a wide variation in reported prevalence between regions, which probably reflects sampling strategies and detection methodologies.<sup>2</sup> Excretion of giardial cysts may be continual or intermittent in young animals. Most prevalence studies have been in calves, and reported point prevalence infection rates in different countries range from 1 to 100%, with the majority of studies showing between 20% and 80% of calves infected and **high farm prevalence rates**.<sup>3-5</sup>

A similar large range is evident in more limited studies in lambs, kids, foals, and piglets.<sup>5</sup> Longitudinal studies of excretion patterns in grazing beef cattle, feedlot cattle, dairy cattle, calves, and foals show infection rates approaching 100%.<sup>1,6-10</sup>

### Source of infection

**Young animals** are the primary source of infection, infection being transmitted through the oral-fecal route. High excretion rates and excretion intensities in young animals result in the contamination of the **environment** and infection via fomites.

The **dam** is also a source of infection for the young. Relaxation of immunity in terminal pregnancy and a **periparturient rise** in giardial cyst shedding has been shown in ewes where cyst excretion increased 2 weeks prepartum, peaked at 0-4 weeks postpartum and fell to low levels at 6-8 weeks postpartum.<sup>11</sup> A similar periparturient rise is suspected to occur in mares.<sup>6</sup> Cross-infection from other species and infection from contaminated water and feed are other sources of infection.

### Pathogen risk factors

The infectious dose of giardia is thought to be very small.<sup>2</sup> Giardia are relatively resistant to environmental influences and at 4°C can survive for 11 weeks in water, 7 weeks in soil and 1 week in cattle

feces.<sup>12</sup> They do not survive freezing. They are resistant to chlorination and extensive disinfection of the environment of calves does not prevent reinfection.<sup>2</sup>

### Animal and management risk factors

**Age** is a major determinant of infection, and excretion rates are much higher in the young of all livestock species than in adults.<sup>13,14</sup> Excretion rates in groups of calves are highest between 3 and 10 weeks of age with the number of cysts in feces highest at 1-6 weeks of age.<sup>5</sup> Cyst excretion falls after weaning, but may persist intermittently into adulthood.<sup>14</sup> Similar patterns are seen in lambs.<sup>11</sup> Infection in foals may initiate later than in ruminants and new infections can occur as late as 22 weeks of age.<sup>6</sup> The influence of age on infection in pigs may be confounded by prophylactic medicants routinely used in pig operations.<sup>15</sup> No effect of housing, feeding water management or season has been observed in cattle<sup>4,13</sup> but hygiene in management practices can affect the age at exposure and the exposure intensity, and can influence infection dynamics. The high and early infection rates in calves and lambs compared with other livestock species are probably a reflection of this. Pigs reared on wire floors are infected later in life than pigs reared on porous concrete floors.<sup>16</sup> The prevalence of infection is higher in calves left with their dams to nurse colostrum for 3 days than in calves removed from the dam at birth to individual housing and fed colostrum by nipple bottle.<sup>17</sup>

### Experimental reproduction

Following experimental challenge in calves, there is a prepatent period of 7-8 days and the calves subsequently excrete large number of cysts for periods varying from 60 to 112 days without evidence of clinical disease.<sup>18</sup> Infection of 6-week-old specific-pathogen-free (SPF) lambs with *Giardia* trophozoites has resulted in the occurrence of episodes of diarrhea and soft feces that are temporally associated with the detection of *Giardia* cysts in feces.<sup>19</sup> When compared with controls, infected lambs had reduced rate of gain without reduction in food intakes and took longer to reach market weight.

### Economic importance

Evidence for a significant pathogenic and economic importance for the majority of giardial infections in agricultural animals is not convincing.

### Zoonotic implications

The majority of giardial infections in cattle are with the livestock-associated assemblage with a small proportion of infections with the zoonotic Assemblage A.<sup>3,4,10</sup> Contact with farm livestock is one

risk factor for disease in humans.<sup>20</sup> This is a considerable concern in public health circles that infection of humans could also occur via water bodies receiving agricultural effluent and pasture run off leading to drinking water contamination. There is also concern for fecal dispersion of *Giardia* in back country watersheds from pack animals.<sup>21</sup>

### PATHOGENESIS

Ingested cysts release trophozoites, which multiply and colonize the small intestine. These adhere to the villi of the small intestine by means of a suction disc on the trophozoite's ventral surface to result in inflammatory cell infiltration, villus atrophy, a reduced **villus to crypt ratio** and a reduction in brush border disaccharidase enzymes.<sup>18,22</sup> Disease, if it occurs in domestic animals, is believed to result from nutrient malabsorption and consequent diarrhea.

### CLINICAL FINDINGS

There are several reports that detail the demonstration of giardial infection in individual animals with a chronic, malabsorptive type of diarrhea, and most imply an association with diarrheal disease.<sup>5,13</sup> Most of these are in young animals at an age when both undifferentiated diarrhea and *Giardia* cyst excretion are common, but the evidence for a causal association is not convincing. There are also a number of studies on the incidence of infection in animals that comment that infection is not accompanied by evidence of clinical disease.<sup>3-5</sup>

A controlled study demonstrating loose feces and reduced rate of gain in experimentally infected lambs gives some credibility to a pathogenic role for this organism.<sup>19</sup>

In calves and lambs, giardial infection has been associated with a semi-fluid, pasty, intermittent diarrhea containing mucus, lasting 2-3 days but up to 6 weeks in some animals, and growth depression despite a normal appetite.

### CLINICAL PATHOLOGY

*Giardia* cysts can be demonstrated in feces by phase contrast microscopy or immunofluorescent microscopy following flotation. Saturated salt or sugar solutions may disfigure the cyst, and the demonstration of infection is best conducted by sucrose gradient or zinc sulfate solution flotation. Cesium chloride density gradient centrifugation may be more sensitive.<sup>2</sup> Immunofluorescence is more sensitive than microscopy for the detection of cysts.<sup>2</sup>

### NECROPSY FINDINGS

Findings are in the upper small intestine and are **non-specific**. Reported changes are an increase in intraepithelial lympho-

cytes in the jejunum, with moderate to severe diffuse inflammation, villus atrophy, crypt distortion and a reduction in the villus to crypt ratio.<sup>18,22</sup> Trophozoites are present in the mucosa and mucosal scrapings of the small intestine.

### TREATMENT AND CONTROL

Giardial infections in agricultural animals have been successfully treated with dimetridazole at a dose of 50 mg/kg BW daily for 5 days<sup>17</sup> and is also susceptible to furazolidone, but both drugs are illegal for use in food animals in many countries.

The **benzimidazoles**, albendazole (20 mg/kg BW daily for 3 days) or fenbendazole (10 mg/kg BW daily for 3 days) are effective in eliminating infection in calves.<sup>23,24</sup> The 3-day course is required for effective elimination and some calves become reinfected following treatment.<sup>25</sup>

Continuous therapy by the incorporation of fenbendazole in a free choice mineral to a concentration of 0.55% was not effective in reducing giardial infection in grazing steers.<sup>26</sup>

In the absence of an association with significant disease, control procedures for giardiasis have not been developed for livestock. Those described for reduction of exposure in the section on undifferentiated diarrhea are appropriate.

### REVIEW LITERATURE

- Xiao L. *Giardia* infection in farm animals. *Parasitol Today* 1994; 1011:436-438.
- Lane S, Lloyd D. Current trends in research into the waterborne parasite *Giardia*. *Critical Rev Microbiol* 2002; 28:123-147.
- Olsen ME et al. Update on *Cryptosporidium* and *Giardia* infections in cattle. *Trends in Parasitol* 2004; 20:185-191.

### REFERENCES

1. Olson ME et al. *Trends Parasitol* 2004; 20:185.
2. Lane S, Lloyd D. *Crit Rev Microbiol* 2002; 28:123.
3. O'Handley RM et al. *Vet Parasitol* 2000; 90:193.
4. Hunt CL et al. *Vet Parasitol* 2000; 91:7.
5. Xiao L. *Parasitol Today* 1994; 10:436.
6. Xiao L, Herd RP. *Equine Vet J* 1994; 26:14.
7. Xiao LH, Herd RP. *Vet Parasitol* 1994; 55:257.
8. Ralston BJ et al. *Can J Anim Sci* 2003; 83:153.
9. Nydam DV et al. *Am J Vet Res* 2001; 62:1612.
10. Applebee AJ et al. *Vet Parasitol* 2003; 112:289.
11. Xiao LH et al. *J Parasitol* 1994; 80:55.
12. Olson ME. *J Environ Qual* 1999; 28:1991.
13. Wade SE et al. *Vet Parasitol* 2000; 93:1.
14. Fayer R et al. *Vet Parasitol* 2000; 93:103.
15. Olson ME et al. *Vet Parasitol* 1997; 68:375.
16. Xiao LH et al. *Vet Parasitol* 1994; 52:331.
17. Quigley JD et al. *J Dairy Sci* 1994; 77:3124.
18. Taminelli V et al. *Schweiz Arch Tierhkd* 1989; 131:551.
19. Olson ME et al. *Am J Vet Res* 1995; 56:1470.
20. Warburton ARE et al. *CDC Rev* 1994; 43:R32.
21. Atwill ER et al. *Equine Vet J* 2000; 32:247.
22. Ruest N et al. *Vet Parasitol* 1997; 69:177.
23. St Jean G et al. *J Am Vet Med Assoc* 1987; 191:831.
24. Xiao L et al. *Vet Parasitol* 1996; 61:165.
25. O'Handley RM et al. *Am J Vet Res* 1997; 58:384.
26. Grossino KC et al. *Vet Parasitol* 2005; 129:35.

## BESNOITIOSIS (ELEPHANT SKIN DISEASE)

### Synopsis

**Etiology** Intermediate host-specific tissue cysts of *Besnoitia besnoiti*, *B. caprae*, and *B. bennetti*.

**Epidemiology** Endemic disease in some tropical and subtropical areas with high morbidity and low mortality. Rare disease elsewhere. Definitive host not known. Possible insect transmission of disease in cattle and goats.

**Clinical findings** Anasarca, alopecia, hyperpigmentation and scleroderma and infertility.

**Inspiratory dyspnea and loss of condition** Pin-point nodules (cysts) on the scleral conjunctiva, nasal, pharyngeal, and laryngeal mucosa.

**Lesions** Parasitic cysts in dermis, subcutaneous, and other fascia.

### Diagnostic confirmation

Demonstration of bradyzoites in skin biopsy or scleral conjunctival scrapings.

**Treatment and control** Little information available.

Besnoitiosis is a parasitic disease of cattle, goats, horses, and certain wild animals, and infections in the chronic cystic stage can result in severe production loss.

### ETIOLOGY

*Besnoitia* are coccidian parasites in the family Sarcocystidae. The life cycle involves a definitive host and an intermediate host. There are seven classified species, of which three occur in domestic livestock. These are *B. besnoiti* in cattle, *B. caprae* in goats, and *B. bennetti* in horses, donkeys, and mules. The other four *Besnoitia* species infect wildlife species. Cats are the definitive host for some *Besnoitia* infecting wildlife, but the definitive host(s) for the three domestic livestock species are unknown.<sup>1-3</sup> Recent studies suggest that *B. besnoiti* and *B. capri* are genetically identical, that they also have identical bradyzoite ultrastructure and that they may not be separate species.<sup>2,3</sup>

### EPIDEMIOLOGY

#### Occurrence

Besnoitiosis in livestock occurs as outbreaks in some tropical and subtropical regions and sporadically in other areas. In endemic areas, the disease can affect a large proportion of the herd and cause significant economic loss.<sup>1,4-6</sup> **Bovine** besnoitiosis is recorded in the African continent, southern Europe, South America, Israel, Asia, and the Soviet Union; **caprine** besnoitiosis in Kenya, Uganda, Iran, and Kazakhstan; **equine** besnoitiosis in north and east Africa.

#### Risk factors

*Besnoitia* are relatively host specific. *B. besnoiti* infects cattle and in Africa also

infects goats and wild ruminants. The Kenyan species of *B. caprae* does not infect cattle or sheep.<sup>6</sup> The natural means of transmission is not known, but is presumed to be by ingestion of oocysts from the definitive host(s). Infection with *B. besnoiti* and *B. caprae* can be transmitted experimentally with endozoites and bradyzoites, and mechanically by infections or biting flies.<sup>1,4,5</sup> Outbreaks of clinical disease in cattle or goats occur in fly seasons and it is postulated that biting insects may be important vectors. Transmission via semen from infected males is also postulated.<sup>6</sup>

#### Economic importance

*B. besnoitia* is an economically important parasite of cattle in Africa and Israel. Attack rates can be high and although mortality is generally low it can approach 10% in the chronic stages. There is loss of condition and fertility of males in both cattle and goats can be significantly impaired from chronic scrotal skin lesions. Skins have no value for tanning. Equine besnoitiosis appears to have rare occurrence.

### PATHOGENESIS

Following infection of the intermediate host, the endozoites (tachyzoites) proliferate in macrophages, fibroblasts, and endothelial cells, causing **vasculitis** and thrombosis, particularly in capillaries and small veins of the dermis, subcutis, and testes. They then mature to form bradyzoite cysts (cystozoites) within fibroblasts. Replication is accompanied by cellular destruction and the release of inflammatory mediators resulting in anorexia, lethargy, testicular degeneration, generalized edema of the skin, alopecia, and scleroderma.<sup>7,8</sup> *Besnoitia* cysts form in high numbers in the dermis and subcutaneous tissue. Inspiratory dyspnea is associated with infection in the upper respiratory tract.

### CLINICAL FINDINGS

#### Bovine besnoitiosis

Typical signs occur in two stages: the acute anasarca stage associated with the proliferation of endozoites and the chronic scleroderma stage associated with cyst formation.

#### Acute stage

There is fever, an increase in pulse and respiratory rates, and warm, painful swellings appear on the ventral aspects of the body, interfering with movement. There is also generalized edema of the skin. The superficial lymph nodes are swollen, diarrhea may occur, and pregnant cows may abort. Lacrimation and an increased nasal discharge are evident and small, whitish, elevated macules may be observed on the conjunctiva and nasal mucosa. The nasal discharge is serous



initially, but becomes mucopurulent later and may contain blood.

#### Chronic stage

As the disease becomes more chronic, the skin becomes grossly thickened, corrugated, and there is alopecia. A **severe dermatitis** is present over most of the body surface. Affected bulls often become sterile for long periods, especially if the scrotal skin is affected. Cystic stages of the *Besnoitia* have been found in vascular lesions in the testes of affected animals and may be a major contributor to the sterility. **Cysts on the scleral conjunctiva** are considered to be of particular diagnostic significance.<sup>4</sup>

The case fatality rate is about 10% and the convalescence in survivors is protracted over a period of months. In endemic areas, the signs that attract clinical attention are alopecia, and severely thickened and wrinkled skin which is often thrown into folds around the neck, shoulder, and rump region and the carpal and tarsal areas. Small, subcutaneous, seed-like lumps can be palpated.<sup>4</sup> In cattle, infections of the teat skin may result in lesions around the mouth in suckled calves.

#### Caprine besnoitiosis

The acute stage is not commonly seen in goats, and the disease presents like the chronic stage in cattle,<sup>5,9</sup> with dyspnea and cutaneous lesions. The cutaneous lesion is a chronic dermatitis of the legs, particularly the carpal and tarsal areas, and the ventral surface of the abdomen. It varies from mild thickening with superficial scaling to marked thickening with hyperpigmentation and a serous discharge. The hair is sparse.

#### Equine besnoitiosis

Horses may show exercise intolerance, nasal discharge, and inspiratory dyspnea. Skin lesions, like those in cattle and goats, are present on the ventral abdomen and legs or the whole body surface.<sup>8,10</sup> Pinpoint white nodules can be seen by endoscopy on the soft palate, pharynx, and larynx.<sup>10</sup>

#### CLINICAL PATHOLOGY

There is little information on hematology and blood chemistry. Hypergammaglobulinemia has been reported in one horse.<sup>10</sup>

Bradyzoite cysts containing a number of banana or spindle-shaped spores can be detected in scrapings or sections of skin, or scleral conjunctival scraping.<sup>4</sup> Ear-tip biopsies are commonly used in surveys of goats, and many infected animals show no clinical signs of infection. Serum antibodies to *Besnoitia* spp. are identifiable by an indirect immunofluorescence technique and by an ELISA, but the tests have only moderate sensitivity.<sup>11,12</sup>

#### NECROPSY FINDINGS

Necropsy lesions in cattle with the severe form of the disease are characterized by widespread vascular lesions and secondary lesions in skeletal and heart muscle, and lungs.

The parasite is evident in lesions on histological examination. In the chronic form in goats, multiple grayish-white cysts are found in the subcutis of the neck, limbs, thoracic region, and the intermuscular fascia. Cysts are also present in the nasal mucosa, larynx, soft palate, and trachea, and the scrotum and testes of males.<sup>1,5</sup>

#### DIAGNOSTIC CONFIRMATION

The most efficient and cost-effective method of diagnosis of clinical disease is the demonstration of *Besnoitia* bradyzoites in skin biopsy smears or scleral conjunctival scrapings.<sup>4</sup>

#### TREATMENT AND CONTROL

There is little information on treatment. Clinical cure of a donkey with a 9-month history of chronic skin disease is reported following prolonged oral administration of trimethoprim-sulfamethoxazole.<sup>8</sup> Animals should receive supportive therapy and be treated symptomatically for enteritis or dermatitis.

A vaccine containing *Besnoitia besnoiti*, grown on tissue culture, and originally isolated from blue wildebeest, has been used to vaccinate cattle. A durable immunity to the clinical form of the disease was produced in 100% of vaccinates, but subclinical infection at a low level did occur.<sup>13</sup>

#### REFERENCES

1. Bwangamoi O et al. Zimbabwe Vet J 1993; 24:23.
2. Dubey JP et al. J Eukaryotic Microbiol 2000; 50:240.
3. Ellis JT et al. Protist 2000; 151:329.
4. Sannusi A. Vet Parasitol 1991; 39:185.
5. Bwangamoi O et al. Zimbabwe Vet J 1996; 27:1.
6. Oryan A, Sadeghi MJ. Vet Res Commun 1997; 21:559.
7. Diesing L et al. Parasitol Res 1988; 75:114.
8. Davis WP et al. Vet Dermatol 1997; 8:139.
9. Bwangamoi AB et al. Vet Rec 1989; 125:461.
10. Van Heerden J et al. J S Afr Vet Assoc 1993; 64:92.
11. Janitschke K et al. Onderstepoort J Vet Res 1984; 51:239.
12. Shkap V et al. Vet Immunol Immunopathol 1985; 6:53.
13. Bigalke RD et al. J S Afr Vet Assoc 1974; 45:207.

#### TOXOPLASMOSIS

##### Synopsis

**Etiology** *Toxoplasma gondii*.

**Epidemiology** infection from the ingestion of oocysts excreted by cats. Swine can also acquire infection from ingestion of tissue stages of parasites in carrion.

**Clinical findings** Abortion and stillbirths in ewes is the major veterinary manifestation, minor manifestations in all species are encephalitis, pneumonia, and neonatal mortality. Major importance as a zoonosis from organisms in meat.

**Clinical pathology** Serological tests, which vary in sensitivity and specificity.

**Lesions** Granulomatous lesions in organs of all species, with abortions, placentitis, and focal necrotic lesions in brain, liver, and kidney of aborted fetus.

#### Diagnostic confirmation

Demonstration of organism. PCR.

**Treatment** Not usually indicated. Sulfamethazine and pyrimethamine in abortion outbreak.

**Control** Reduce exposure to oocysts. In pregnant sheep, prophylactic feeding of monensin or decoquinate, vaccination.

#### ETIOLOGY

The causative agent *Toxoplasma gondii* is a systemic coccidian, a universal parasite, a sporozoan, and a member of the suborder *Eimeriina*. It is a specific parasite of the **definitive host (members of the Felidae family)**, but has a wide range of intermediate hosts. There are three clonal lineages designated type I, II, and III which differ in virulence and epidemiological pattern. Strains isolated from animals are mostly genotype III.<sup>1</sup>

*T. gondii* has three infective stages:

1. Tachyzoites – the rapidly multiplying form of the parasite present during the acute stage of infection in the intermediate host
2. Bradyzoites – present in the tissue cysts
3. Oocysts (containing sporozoites) – present only in cat feces.

Oocysts are the **infective stage** of importance in farm animals, and the only environmental infective stage for herbivores. Oocysts excreted in the feces of cats can survive in soil for many months and are ingested by the intermediate (livestock) host, and the parasite invades tissues to produce tissue cysts. The invasion can include the fetus. An inoculum containing as few as ten oocysts can be infective for goats. Tissue cysts in the intermediate host cause damage to the nervous system, myocardium, lung tissue, and placenta. Bradyzoites in animal tissues are a source for toxoplasmosis in humans and pigs.

#### EPIDEMIOLOGY

##### Occurrence

Toxoplasmosis occurs in domesticated and wild animals and birds in most parts of the world, although surveys indicate differences in area prevalence. The studies in farm animals have been summarized in the literature.<sup>2-4</sup>

A national survey in **swine** in the United States found a seroprevalence of

20%.<sup>5</sup> The rate of seropositivity was higher in breeding swine than in feeders, and there were geographical differences with the percentage of positive farms varying from 22% to 89% in different States. On a worldwide basis, the seropositive prevalence in swine is 22% with a range of 0–97%.<sup>6</sup> Equivalent figures for other species are: **sheep**, 21%; **goats**, 25%; **horses**, 15%.<sup>3</sup> The true seroprevalence of toxoplasmosis in **cattle** is not known due to the inaccuracy of the standard serological tests for cattle.<sup>2</sup> The true seroprevalence in cattle is believed to be low, reflective of the relative unimportance of toxoplasmosis in cattle.<sup>3</sup>

While seroprevalence studies indicate relatively high rates of infection in farm animals, the infection is subclinical and *T. gondii* has virtually no importance as a cause of clinical disease in farm animals with the exception of that associated with abortion and neonatal disease in sheep. A major importance of toxoplasmosis in farm animals is its **zoonotic potential**.

### Source of infection

#### Cat feces

The source of infection for sheep, cattle and horses is the **oocyst** passed in the feces of the cat family. In almost all agricultural areas the feces originate from the domestic cat or feral cats.

Cats become infected, and shed oocysts in their feces, as a result of ingesting tissues of intermediate hosts infected with the parasite. Commonly, these are rodents and small birds, but **all animals can be intermediate hosts** for *T. gondii*. Rodents pass the organism from generation to generation through congenital infection and thus can provide a reservoir of infection in an area for a long time with the potential for infection of cats and the triggering of massive oocyst contamination of the environment.<sup>7</sup>

The prevalence of infection is highest in young cats hunting for the first time. Following infection of the cat, the period of excretion of oocysts is short, approximately 2 weeks, but it is intense and several million oocysts are excreted in the feces. In a given environment the number of cats excreting oocysts in their feces at any point in time is likely to be quite small, but the contamination of the environment over time is significant.

**Domestic and barn cats** in farm environments tend to nest and to defecate in hay and straw mows, grain stores, or other loose piles of commodity feeds, thus providing the potential for direct infection of livestock feeds with *T. gondii*. Fields fertilized with manure and bedding from buildings that contain cats can also be a source of infection.<sup>8</sup> **Feral cats** bury feces superficially in the

soil, but the action of earthworms and other soil inhabitants can bring infection to the surface to contaminate pastures. Feral cat families can have territories of up to 250 acres and are capable of widely distributing the infective stage of the parasite.<sup>7,9</sup> Oocysts can be found in feed, water, and soil in the vicinity of livestock units.<sup>10</sup>

#### Other sources

Oocysts are also the major source of infection for swine, although it is possible for swine to be infected by the ingestion of tachyzoites or bradyzoites present in meat (**dead rodents**, cannibalized piglets, etc.) or through the ingestion of blood while **tail- or ear-biting**.<sup>11</sup> Toxoplasma infection has been shown in all wildlife mammalian species tested in the environment of swine units.<sup>10</sup> Direct sheep-to-sheep transmission by close contact with grossly infected placenta and transmission via the semen of infected rams could occur but are not believed to be of significance. However, a recent study in sheep has shown *T. gondii* to be present in the placental tissue of a high percentage of successful pregnancies and congenital infection may be an important method of maintenance of infection in sheep flocks in the absence of cats.<sup>12</sup>

### Risk factors

#### Pathogen risk factors

Oocysts are extremely resistant to external influences and can survive in the environment for at least 1 year. They can **overwinter** in cold climates, but are less viable in arid environments. Fifty grams of infected cat feces can contain as many as 10 million oocysts and infection in farm animals can be established by the ingestion of fewer than 40 oocysts.<sup>3,13</sup> Oocysts are destroyed by exposure to temperatures between 90°C (194°F) for 30 seconds and 50°C (122°F) for 2.5 minutes.

#### Environmental and management risk factors

In sheep, a high rate of infection has been shown to be related to a **high rainfall**, which allows longer survival of oocysts on pasture. The prevalence of infection in small ruminants is much lower in hot, dry arid countries than in those with wet climates.<sup>14</sup>

Sheep raised in **cat-free areas** have almost no toxoplasmosis, whereas sheep raised in similar environments with cats can have an infection rate as high as 32%.<sup>15</sup> In many recorded outbreaks with high prevalence rates in sheep and goats there has been serious exposure to stored feed containing cat feces. Cat access to sows is also a risk factor for disease in swine.<sup>16</sup>

Other management risk factors include **housing**. Swine housed outdoors are at significantly greater risk for infection in some areas,<sup>17</sup> and prevalence is lower in sows that are kept totally confined.<sup>18</sup> Pig meat is a significant source of infection in humans and the trend to 'animal friendly' outdoor rearing may increase the risk to humans.

Seroconversion may occur more frequently in sheep during the summer pasturing period than during winter housing.<sup>19</sup>

### Experimental reproduction

#### Sheep

Experimental disease can be achieved by challenge with oocysts, tissue cysts and tachyzoites.<sup>13</sup> The ewe may show a febrile response during the parasitemic phase 5–12 days following infection. Abortion and fetal mortality occur in sheep that suffer a primary infection during pregnancy. The organism invades the placenta and can be detected in the fetus between 5 and 10 days after the onset of the parasitemia.<sup>7</sup> Infection may result in resorption, abortion or the birth of stillborn or congenitally infected live lambs. Infection in early pregnancy (less than 60 days) before the fetus acquires immunological competence usually results in embryonic death and resorption and a barren ewe. Infection in mid-pregnancy generally results in abortions and the birth of stillborn lambs whereas ewes infected in late pregnancy (greater than 110 days) may give birth to live but congenitally infected lambs.

#### Cattle

Cattle are **relatively resistant** to infection. Diarrhea, anorexia, poor weight gain, depression, weakness, fever, and dyspnea follow challenge of calves with pathogenic strains. With strains of low virulence there is a mild fever and lymphadenopathy, and the organisms are detectable only in the lymph nodes and for only a few weeks. Adult cows are also relatively insusceptible and it is apparent that cattle do not readily acquire persistent *T. gondii* infections, probably because of **rapid elimination** of parasites from the tissues.<sup>2,9,20</sup> Many historical reports of outbreaks of toxoplasmosis in cattle were probably sarcocystosis, as serological tests employed in most studies lacked sufficient specificity for diagnosis of toxoplasmosis.<sup>1,2</sup> *T. gondii* is not important in causing abortion or clinical disease in cattle, but is recorded.<sup>21</sup>

#### Other ruminants

Large doses of oocysts fed to goats cause a febrile, anorectic, fatal illness, and pregnant does abort.<sup>9</sup> The pathogenesis of the abortion is as for sheep. The reaction

in buffalo calves is described as peracute, with pulmonary consolidation, necrotic foci in all organs, and fluid accumulations in body cavities.

#### Pigs

Infection is relatively easily established in pigs, but is generally not associated with clinical disease or only with a short period of fever and growth suppression. There is a greater susceptibility to infection in young pigs, with piglets below the age of 12 weeks much more susceptible than older animals. With a mild strain and pigs of 8–10 days of age, the reaction is minor, but day-old pigs may have a high mortality rate.<sup>22</sup> Infections induced by tissue cysts are generally less severe than those induced by the ingestion of oocysts and consist of inflammatory and degenerative changes in numerous organs as with other animal species. Congenital toxoplasmosis is not easily reproduced experimentally despite its association with syndromes of neonatal mortality in the field.<sup>23</sup>

#### Horses

These appear to be **relatively non-susceptible** to the development of the disease or the persistence of infection, and attempts at experimental transmission are rarely successful.

#### Economic importance

Abortion and neonatal mortality in sheep and goats are the major clinical manifestations of infection with *T. gondii* and result when primary infection occurs during pregnancy. Ovine abortion and neonatal mortality due to *T. gondii* are important problems in New Zealand, Australia, Canada, United States, and the United Kingdom; in most countries they are second in importance only to chlamydial abortion. Perinatal mortality rates (including abortions and neonatal deaths) in affected flocks may be as high as 50%, and in non-clinical flocks may still result in low rates of loss. In the United Kingdom, toxoplasmosis is the primary cause of loss in 10–20% of flocks with an abortion problem, and has an annual incidence of 2% in the breeding ewe population.<sup>7</sup> Abortion, with associated mummification of fetuses and perinatal deaths, due to toxoplasmosis also occurs in goats.<sup>2,21</sup>

#### Zoonotic implications

Humans are intermediate hosts for *T. gondii*, and approximately one-half the population of the United States is infected.<sup>3</sup> Infection can result from the ingestion of oocysts from cat feces that contaminate waterways and food, that contaminate the hair of domestic dogs and cats, or that are inadvertently ingested because of poor hygienic practices. However, the

major risk for human infection rests with ingestion of bradyzoites and tachyzoites in **meat** or tissues that are eaten or handled. The risk is with raw or undercooked meats. Beef is a minor source of infection, with pig and to a lesser degree sheep meat having greater risk.<sup>3</sup>

Tachyzoites are secreted in the milk of goats challenged with oocysts and **raw goats' milk** has a public health risk for toxoplasmosis, although the risk is minimal.<sup>3,24</sup>

There is usually no clinical disease in humans infected with *T. gondii*, or the disease is mild and self-limiting.<sup>3</sup> Significant disease can occur in humans suffering from acquired **immune deficiency (AIDS)** or malignancy, in those treated with cytotoxic or immunosuppressive drugs, and in the very young and the very old. There is also the risk in **pregnant women** for abortion or congenital infection of the fetus with resultant hydrocephalus, intracranial calcification, and retinochoroiditis. Maternal infection in the first and second trimester may result in severe congenital toxoplasmosis and death of the fetus in-utero and abortion. Later infection may result in the birth of apparently normal children that have a risk for developing chorioretinitis later in life.

Toxoplasmosis poses an **occupational risk** for veterinarians, farmers, and slaughterhouse workers who handle infected material. The risk is particularly high with contact with lambing ewes in infected flocks; veterinarians and farm workers, especially if pregnant or immunocompromised, should take precautions to avoid infection when handling infected material.

#### PATHOGENESIS

*T. gondii* is an **intracellular parasite** that attacks most organs, with predilection for the **reticuloendothelial and central nervous systems**. Sporozoites from oocysts, or bradyzoites from tissue cysts, invade and penetrate cells by an active process<sup>25</sup> and multiply in the intestinal epithelium. After invasion of a cell, the parasite multiplies and eventually fills and destroys the cells. Liberated toxoplasma reach other organs via the bloodstream after release from their development site. The stage of **parasitemia** commences approximately 5 days after initial infection and declines with the development of immunity 2–3 weeks after infection, at which stage the organism localizes in tissue cysts.

The clinical character of the disease varies with the organs attacked, which itself varies depending on whether the disease is congenital or acquired. The principal manifestations are encephalitis

when infection is **congenital**, and febrile exanthema with pneumonitis and enterocolitis when very heavy infections occur **postnatally**. However, the vast majority of infections occur without any clinical signs, and tissue cysts can be found in many animals and appear to cause no harm. When the immunity of the animal falls because of stress, disease or immunosuppressive therapy, tissue cysts rupture and large numbers of inflammatory cells invade surrounding tissue. The characteristic granulomatous lesions are thought to be the result of a hypersensitivity reaction.

#### Pregnant sheep and goats

Abortion and fetal mortality occur in sheep that suffer a primary infection during pregnancy. In the ewe, the infection is limited by the developing immune response; however, this does not limit the infection in the placenta. The fetus and the ability of the fetus and its associated placenta to respond with a protective response depends upon the age of the fetus at the time of infection.

**Immunocompetence to *T. gondii*** is not present before 60 days of gestation<sup>7</sup> and infection in early or mid-pregnancy results in fetal death, with resorption or mummification. Some lambs infected in mid-pregnancy may survive to near term and be stillborn, or may survive to parturition but are weak and die shortly following birth. Parasite multiplication in the placenta results in multiple foci of necrosis, and placental abnormality may contribute to abortions and to the birth of weak lambs. Also, congenital brain infection may result in locomotory and sucking dysfunction. Only those sheep that become infected during pregnancy abort. With infection in late pregnancy, the fetus can mount an immune response and is usually born live, infected, and immune. Infection of pregnant and non-pregnant sheep provokes sufficient immunity to prevent abortion in future pregnancies.

#### CLINICAL FINDINGS

The clinical syndrome and the course of toxoplasmosis vary a great deal between species and between age groups. The only clinical syndrome recognized with any regularity in the field is abortion and neonatal mortality in sheep. The other, less common, syndromes are as follows.

#### Cattle

In cattle, the disease usually runs an acute course – fever, dyspnea, and nervous signs, including ataxia and hyperexcitability, in the early stages, followed by extreme lethargy. Stillborn or weak calves that die soon after birth may also be observed. Toxoplasmosis plays no significant role

in bovine abortion. Congenitally affected calves show fever, dyspnea, coughing, sneezing, nasal discharge, clonic convulsions, grinding of the teeth, and tremor of the head and neck. Death occurs after a course of 2–6 days.

### Pigs

Pigs are **highly susceptible**, and in outbreaks pigs of all ages can be affected. In adult pigs there is debility, weakness, incoordination, cough, tremor, and diarrhea, but no fever. Young pigs are often acutely ill with a high fever of 40–42°C (104–107°F), they develop diarrhea, and die after a course of several weeks. Pigs of 2–4 weeks of age have additional signs, including wasting, dyspnea, coughing, nervous signs, especially ataxia. Pregnant sows commonly **abort**, piglets are premature or **stillborn**, or survive and develop the above syndrome at 1–3 weeks of age. Toxoplasmosis may be the cause of a resident problem of abortions and stillbirths in a pig herd.

### Sheep

In sheep, although a syndrome of fever, dyspnea, generalized tremor, abortions, and stillbirths can occur, the clinical manifestation of the systemic disease in the ewe is rare. The principal manifestations of toxoplasmosis in sheep are fetal resorption, abortion, the birth of mummified or stillborn lambs, neonatal death, and the birth of full-term lambs that show locomotor and sucking disorders.

Abortion commonly occurs during the last 4 weeks of pregnancy and the rate may be as high as 50%. Full-term lambs from infected ewes may be born dead, or alive but weak, with death occurring within 3–4 days of birth. Lambs affected after birth show fever and dyspnea, but a fatal outcome is uncommon. Fetal resorption can occur in ewes infected in early pregnancy.

### Goats

In goats, caprine toxoplasmosis is manifested by perinatal deaths, including abortions and stillbirths. Systemic disease, with a high case fatality rate, can occur, especially in young goats.

### Horses

Clinical disease is **rare** in horses.

## CLINICAL PATHOLOGY

**Serological tests** available for the detection of humoral antibodies to *T. gondii* include the Sabin–Feldman dye test, the indirect hemagglutination assay, the indirect fluorescent antibody test (IFAT), the modified agglutination test (MAT), the latex agglutination test (LAT), the enzyme-linked immunosorbent assay (ELISA), and the immunosorbent agglutination assay test (IAAT). Serological tests are commonly used to determine the

presence of toxoplasmosis, but the **sensitivity and specificity vary** with the test and with the same test between species. Tests in cattle pose a particular problem.<sup>1,2,26–28</sup> In cattle and swine, agglutination tests that use whole *T. gondii* tachyzoites are suitable, but the latex agglutination tests that use soluble antigens, and the Sabin–Feldman dye test lack sensitivity and specificity.<sup>26,27</sup>

### Sheep abortion

**Serological testing** to establish toxoplasmosis as the cause of abortion is of limited value. A negative titer will rule out toxoplasmosis but, since antibody persists for years, a positive titer will only indicate that the animal has been exposed to infection at some stage of her life. Seroprevalence rates are normally high in sheep and swine. **Rising titers** in paired samples are more informative, but may be of limited value in the diagnosis of abortion in sheep where infection and antibody response may precede the abortion storm. In sheep, it is more informative to test **pleural or peritoneal fluid** of aborted fetuses for the presence of antibody. An IgG avidity ELISA using a dominant membrane protein (P30) of *T. gondii* is claimed to be able to differentiate between acute and chronic infections in sheep.<sup>29</sup> Polymerase chain reaction assay (PCR) can be used to detect *T. gondii* in infected fetal tissues.<sup>30</sup>

### Infection in pigs

MAT, IFAT and a commercially available ELISA test have been shown to have equivalent sensitivity and specificity in swine and can be used for serological and epidemiological studies in this species.<sup>31,32</sup> Meat juice taken from heart or tongue from pig carcasses after slaughter can be tested for antibody and a PCR for detection of the infection in meat is described.<sup>33</sup>

## NECROPSY FINDINGS

Multiple, proliferative, and **necrotic granulomata** are characteristic of toxoplasmosis, and in cattle the lesions may undergo calcification. The lesions occur most commonly in the nervous system, myocardium, and lungs. When there is visceral involvement, pneumonitis, hydrothorax, ascites, lymphadenitis, intestinal ulceration, and necrotic foci in the liver, spleen, and kidneys may be observed.

### Abortion

In **sheep**, there may be involvement of the uterine wall, the **placenta**, and the fetus. The lesions in the fetal lambs are usually limited to focal necrotic lesions in brain, liver, kidney, and lungs; pathological lesions are much more common and severe in the **placenta**.<sup>12,34</sup> The characteristic lesions are confined to the cotyledons and consist of foci of inflam-

mation and necrosis, which may produce macroscopically visible **white foci**. On histological examination, granulomatous, necrotic lesions can be found in the viscera and in the brain. Toxoplasma can be found in the cells of most organs, particularly the lungs and brain. The organism is not easily demonstrated in aborted sheep fetuses or in their placentas.

In **swine**, the prominent lesions are necrotic placentitis, non-suppurative encephalomyelitis, and myocardial degeneration. In contrast to sheep, grossly visible areas of necrosis are not present in the placenta, but numerous organisms may be visible on microscopic examination of the placenta.<sup>23</sup> Experimentally, there is also myocardial degeneration, necrosis, and mineralization. It is probable that many cases previously diagnosed as **bovine toxoplasmosis** were actually cases of neosporosis or sarcosporidiosis.

Immunohistochemical staining can be used to identify the parasite in formalin-fixed material. Serological testing of fetal thoracic fluid can be useful in those fetuses that are immunocompetent at the time of abortion. A PCR can be used for the detection of antigen in ovine tissue and can be used on autolysed tissue.<sup>24</sup>

On rare occasions, bioassay must be performed to confirm the identity of the parasite and is the most sensitive method of detecting infection. Aseptically collected brain, lung, and diaphragm is administered orally, or by intracerebral or intraperitoneal injection, to mice, or orally to cats. A positive diagnosis depends upon the presence of toxoplasma cysts in the brains of the mice 8 weeks after the injection or the secretion of oocysts by the cat. Cats are a more sensitive assay because of the volume of tissue that can be tested.

### Samples for confirmation of diagnosis

- **Parasitology** – fresh or chilled brain, lung, placenta (BIOASSAY) (rarely required)
- **Serology** – fetal thoracic fluid (IHA)
- **Histology** – placental cotyledons, lung, liver, brain, spinal cord, kidney, heart (LM, IHC).

## DIFFERENTIAL DIAGNOSIS

Toxoplasmosis is rarely considered in a primary diagnostic list other than with problems of abortion and associated neonatal mortality. The differential diagnosis of abortion in cattle is dealt with under brucellosis, in sheep under brucellosis, and in pigs under leptospirosis. The causes of encephalitis in animals are listed under that heading, and of pneumonitis under pneumonia.

## TREATMENT

Treatment with a combination of sulfamethazine and pyrimethamine has proved effective in mitigating the effects of experimentally induced toxoplasmosis in pregnant ewes; it should be considered for therapy in the face of an outbreak of toxoplasma abortion. Treatment was administered over 3 days for three periods with an interval of 5 days between the start of each treatment period.<sup>35</sup> These drugs are effective against the proliferating parasites in the acute stage of the disease, but will usually not eradicate infection and have limited activity on the organisms in tissue cysts.

## CONTROL

There are two concerns in the control of toxoplasmosis in agricultural animals. The first is the concern to reduce the economic effects of infection in agricultural animals, and the second is to reduce the risk for human disease associated with consumption of infected meat.

### Farms

#### Cat control

The elimination of cats in the farm environment will preclude feed contamination and contamination of pasture areas. While it is possible to **ban domestic cats** from the farm, this will not, in general, totally eliminate the risk for toxoplasmosis due to the range of activities of cats from adjacent areas, the presence of feral cats and the occurrence of wind-borne spread of oocysts.<sup>9</sup> Nevertheless, risk for infection will be reduced by eliminating cats from the farm environment or restricting them to **neutered** animals. Where possible, feeds should be stored in **cat-proof areas**. In swine units, control of rodents and of access of pigs to any **carion** is an important control measure. On all farms, the carcasses of infected or suspect animals should be totally destroyed, or at least be made inaccessible to carnivores.

#### Serological testing

With sows housed both indoors and outside, serological testing to determine seroprevalence and seroconversion associated with the two housing areas may determine if housing management needs change. Serological testing can also be used to determine housing/pasture areas of risk for sheep, risk for abortion in sheep, and whether anti-toxoplasma drugs or vaccination should be used for protection.

There is an effective and long-lasting immunity following primary toxoplasma infection and ewes that have aborted should be kept in the flock. Exposure of ewes to natural infection in a contaminated environment prior to breeding would be

an effective method of preventing reproductive disease, but is difficult to achieve with certainty.

### Prophylaxis

Feeding **monensin** at a dose of 15 mg/head per day during the first 100 days of pregnancy has been shown to reduce lamb loss following experimental infection, as has decoquinatate fed at 2 mg/kg daily.<sup>12,28</sup>

**Decoquinatate** is more palatable and has less risk of toxicity,<sup>28</sup> and medication offers an option for control in ewes that are seronegative for *T. gondii* antibodies and likely to be exposed in pregnancy to feed, water or an environment contaminated with toxoplasma oocysts. Both drugs are best fed to ewes before they encounter infection and are not effective as therapeutic agents.

### Vaccination

Tachyzoites from an incomplete strain, S48, of *T. gondii* are used in a vaccine for sheep which is available commercially in some countries. S48 tachyzoites readily infect seronegative sheep, but do not initiate chronic infection or tissue cysts and the parasite cannot be demonstrated in muscle or brain 6 weeks after vaccination.<sup>36,37</sup> Ewes should be vaccinated at least 3 weeks before mating, and a single injection will protect the life of the sheep. In flocks where toxoplasmosis is a cause of lamb loss, initial vaccination of the whole flock followed by vaccination of replacement ewes is a better economic option than that of just vaccinating replacement ewes.<sup>38</sup> Vaccination does not entirely protect the pregnant ewe against parasitemia or the infection of the fetus following challenge with virulent *T. gondii* oocysts, but there is a significant reduction in the birth rates of non-viable lambs. It has been postulated that vaccination results in reduced numbers of tachyzoites invading the gravid uterus or fetus, with a consequent reduced potential for inducing significant pathology in the placenta and the fetus.<sup>36</sup> The immunity appears to be cell-mediated.<sup>37</sup> Experiments with an adjuvanted vaccine in pigs show protection from clinical challenge and a reduction in recoverable toxoplasma from tissues of vaccinated challenged pigs.<sup>39</sup>

### Reduction of zoonotic risk from meat

Oocysts from cat feces are a major cause of infection in man, but the ingestion of cysts in meat from sheep, swine and, to a lesser extent, cattle is also a major cause of human infection. The implementation of control procedures on the farm will reduce that risk and the major influence will be by the reduction or elimination of cats on the farm.<sup>37</sup> The infectivity of meat can be destroyed by irradiation and proper cooking. Discussions of other

strategies for control of food-borne toxoplasmosis are available.<sup>3,40</sup>

## REVIEW LITERATURE

- Dubey JP, Beattie CP. Toxoplasmosis in animals and man. Boca Raton, Florida: CRC Press, 1988; pp. 220.
- Reports of the scientific program; section on toxoplasmosis. J Am Vet Med Assoc 1990; 196:177-384.
- Smith JL. Food-borne toxoplasmosis. J Food Safety 1991; 12:17-58.
- Buxton D, Innes EIA. A commercial vaccine for ovine toxoplasmosis. Parasitology 1995; 110:S11-S16.
- Hill D, Dubey JP. *Toxoplasma gondii*. Transmission diagnosis and prevention. Clin Microbiol Infect 2002; 8:634-640.

## REFERENCES

- Ajzenberg D et al. Int J Parasitol 2004; 34:1185.
- Dubey JP. Vet Parasitol 1986; 22:177.
- Smith JL. J Food Safety 1991; 12:17.
- Dubey JP. J Am Vet Med Assoc 1990; 196:257.
- Patton S et al. J Eukaryotic Microbiol 1996; 43:121.
- Dubey JP. Vet Parasitol 1986; 19:181.
- Buxton D. J Roy Soc Med 1990; 83:509.
- Faull WB et al. Vet Rec 1986; 119:491.
- Langham NPE, Charlerton WAG. NZ J Agric Res 1990; 33:429.
- Dubey JP et al. J Parasitol 1995; 81:723.
- Dubey JP et al. J Am Vet Med Assoc 1986; 189:55.
- Duncanson P et al. Int J Parasitol 2001; 31:1699.
- Buxton D. Vet Ann 1993; 33:45.
- Deconinck P et al. Rev Med Vet 1996; 157:377.
- Munday BL. Res Vet Sci 1972; 13:100.
- Weigal RM et al. J Parasitol 1995; 81:736.
- Dubey HR et al. J Parasitol 2002; 88:1234.
- Smith KE et al. Vet Parasitol 1992; 42:199.
- Lunden A et al. Acta Vet Scand 1994; 35:273.
- Munday BL, Dubey JP. Aust Vet J 1988; 65:150.
- Canada N et al. J Parasitol 2002; 88:1247.
- Beverley JKA et al. Res Vet Sci 1978; 24:139.
- Dubey JP et al. Vet Pathol 1990; 27:411.
- Steuber S et al. Dtsch Tierarztl Wschr 1995; 102:291.
- Dowse T, Solda D. Current Opin Microbiol 2004; 7:388.
- Dubey JP et al. Am J Vet Res 1995; 56:1030.
- Dubey JP et al. Am J Vet Res 1993; 54:270.
- Buxton D et al. Vet Rec 1996; 138:434.
- Sager H et al. Parasitol Res 2003; 91:171.
- Hurtado A et al. Vet Parasitol 2001; 102:17.
- Gamble HR et al. Vet Parasitol 2005; 128:177.
- Minho AP et al. Pesquisa Vet Brazil 2004; 24:199.
- Jauregui LH et al. J Clin Microbiol 2001; 39:2065.
- Buxton D, Findlayson J. J Comp Pathol 1986; 96:319.
- Buxton D et al. Vet Rec 1993; 132:409.
- Buxton D et al. Vet Rec 1991; 129:89.
- Buxton D, Innes EA. Parasitology 1995; 110:S11.
- Rolfe SJ et al. Proc 20th Proc Soc Vet Epidemiol Prev Med 2002; 20:31, Cambridge.
- Kringel H et al. Vet Parasitol 2004; 123:55.
- Leighty JC. J Am Vet Med Assoc 1990; 196:89.

## EQUINE PROTOZOAL MYELOENCEPHALITIS

### Synopsis

**Etiology** *Sarcocystis neurona*, a protozoa. *Neospora* spp. is an uncommon cause.

**Epidemiology** Sporadic disease occasionally occurring as localized

epidemics. Endemic throughout most of the Americas. Disease is infectious but not contagious. The definitive host is the opossum (*Didelphis* spp.).

**Clinical signs** Variable, but commonly asymmetric spinal ataxia, focal, neurogenic muscle atrophy, and/or cranial nerve dysfunction.

**Clinical pathology** No characteristic changes in blood or cerebrospinal fluid. Western blot of blood or CSF has high sensitivity but low specificity.

**Diagnostic confirmation** Histologic demonstration of *S. neurona* in nervous tissue.

**Lesions** Non-suppurative myeloencephalitis with schizonts and merozoites in neurons, glial cells and leukocytes.

**Treatment** Antiprotozoal agents, including ponazuril, nitazoxanide, or a combination of a sulfonamide and pyrimethamine.

**Control** Prevent exposure to *S. neurona* by minimizing fecal contamination by opossums of feed. A vaccine is available but not recommended.

## ETIOLOGY

The cause is *Sarcocystis neurona*, an ampicomplexan protozoan.<sup>1-3</sup> Isolates of *S. neurona* can vary in their antigenic composition, such that variable responses are observed on immunoblot tests,<sup>4</sup> but the importance of this variation in terms of pathogenicity of the organism is unknown. *Neospora* spp., including *N. hughesi*, cause myeloencephalitis rarely in horses.<sup>5,6</sup>

## EPIDEMIOLOGY

**Equine protozoal myeloencephalitis** (EPM) occurs in horses and ponies in Canada, United States, Central America, and Brazil. Reports of neurological disease in horses with antibodies to *S. neurona* in France have yet to be confirmed, but might represent cases of EPM in native horses outside of the Americas.<sup>7</sup> The disease is reported in other countries in only horses imported from the Americas.<sup>8</sup> Distribution of the disease appears to correlate with the range of the definitive host, *Didelphis virginiana* in North America, or the related species *D. marsupialis* and *D. albiventris* in South America.<sup>9</sup> The disease has not been reported in donkeys and mules. Neurological disease associated with *S. neurona* has been reported in armadillos, sea otters, harbor seals, skunks, raccoons, zebra, lynxes, and cats.<sup>9</sup>

The disease usually occurs sporadically in endemic areas, although epidemics on individual farms are reported.<sup>10</sup> The incidence of EPM is estimated to be 14 new cases per 10 000 horses per year.<sup>11</sup> The **case fatality rate** is approximately 7%, although up to 14% of horses are sold or given away because they are affected by EPM.<sup>11</sup> Approximately 40% of horses

recover completely and another 37% improve but do not recover from the disease.<sup>11</sup> Another study reports that only 55% of horses with EPM examined at a referral hospital were alive a minimum of 3 years after diagnosis and treatment.<sup>12</sup>

Seroepidemiological studies, based on detection by Western immunoblot test of multiple antibodies to *S. neurona* in serum,<sup>13</sup> indicates that 45–60% of horses in the United States are exposed to the agent but do not develop disease.<sup>14-17</sup>

Vaccination with a product containing killed *S. neurona* induces a detectable antibody response in both serum and, in approximately 50% of horses, in the cerebrospinal fluid.<sup>18</sup>

## Risk factors

Risk factors for development of EPM include season of the year, with the highest incidence of new cases being in summer and fall<sup>11,19</sup>; age; use; protection of feed; and presence of opossums on the farm.<sup>19</sup> The disease occurs in horses from 2 months to 19 years of age.<sup>20</sup> Horses <1 year of age are at lower risk of developing disease than are horse 1–4 years of age.<sup>19</sup> Older horses are less likely to develop the disease.<sup>19</sup> Protection of feed from contamination by opossum feces is associated with a decreased risk of disease, whereas presence of opossums on the premises was associated with an increased risk of disease.<sup>19</sup> Horses used primarily for racing and showing are at increased risk of developing EPM with an annual incidence of 38 new cases per 10 000 horses for horses used for racing compared to an incidence of 6 cases per 10 000 horses for horses used for pleasure or farm work.<sup>11</sup> Horses used for showing or competition have the highest annual incidence of 51 cases per 10 000 horses per year.<sup>11</sup> The presence of previous illness is a risk factor for development of EPM.<sup>19</sup> Transportation for 55 hours increases the susceptibility to EPM of horses experimentally infected with *S. neurona*.<sup>21</sup>

## Transmission

*S. neurona* is believed to have the two-host life cycle (predator–prey) typical of other *Sarcocystis* and *Toxoplasma* spp. The definitive host is the opossum, *D. virginiana*, and intermediate hosts include raccoons, cats, skunks, sea otter, and armadillo. The domestic cat, 9-banded armadillo, raccoon, and skunk can be infected by ingestion of sporocysts and develop sarcocysts in muscle which when fed to opossums induce shedding of sporocysts,<sup>22-26</sup> thereby confirming the potential for these species to serve as intermediate hosts. Cats living on farms at which EPM has been diagnosed in horses have a higher rate of seroprevalence (40%) than do cats living

in a city (10%),<sup>27</sup> providing evidence for a role of cats in the epidemiology of the disease. However, others have detected a lower prevalence of seropositivity (5%) to *S. neurona* among cats in Texas and conclude that cats are not likely to play an important role in the epidemiology of EPM.<sup>28</sup> At least in those areas where raccoons are present they are probably the most important intermediate host.

The definitive host is infected by ingestion of sarcocysts of *S. neurona* encysted in muscle of the intermediate host. The intermediate host is infected by ingestion of sporocysts derived from rupture oocysts passed in the feces of the definitive host. Sporocysts can remain infective in the environment for months, but are probably, based on behavior of other *Sarcocystis* spp. oocysts, killed by drying, high humidity, or freezing and thawing.<sup>29</sup> Birds and insects also serve as transport hosts. Sporocysts ingested by the intermediate host undergo schizogony and ultimately form infective sarcocysts in muscle. Recently, *S. neurona* sarcocysts were detected in muscle of a 4-month-old filly, suggesting that horses might serve as intermediate hosts of the organism.<sup>30</sup> This finding needs to be confirmed as the conventional wisdom is that in horses, *S. neurona* does not complete schizogony and remains as uninfected merozoites in neural tissue.<sup>31</sup> *S. neurona* sarcocysts do not occur in the muscle of horses and horses are therefore not infective to other animals.

There is no evidence of transplacental infection of foals.<sup>32</sup>

The definitive and intermediate hosts of *N. hughesi* have not been determined. Dogs are the definitive host of the closely related *N. caninum*.

## PATHOGENESIS

Details of the pathogenesis of EPM are unknown. It is assumed that after infection, probably by ingestion, sporocysts excyst and release sporozoites which penetrate the gastrointestinal tract and enter endothelial cells. Subsequently, meronts (schizonts) develop which on maturation rupture and release merozoites. Schizonts are present in cells of the central nervous system, including neurons, glial cells, and intrathecal macrophages. Schizonts multiply in the infected cells, as evidenced by the presence of merozoites. Infection induces a non-suppurative inflammation, characterized by accumulations of lymphocytes, neutrophils, eosinophils, and gitter cells. Infection of neurons, and the associated inflammatory reaction, disrupt normal nervous function and contribute to the clinical signs of weakness, muscle atrophy, and deficits in proprioception.

Mechanisms permitting infection and proliferation of the organism have not been well defined. Horses with EPM have lesser cell-mediated immunity than do asymptomatic horses,<sup>33</sup> and the decrease in cell mediated immunity appears to be due to *S. neurona* suppressing immune responses to parasite-derived antigens.<sup>34,35</sup> However, foals with severe combined immunodeficiency administered *S. neurona* do not develop neurologic disease, despite prolonged parasitemia and infection of visceral organs by the organism, whereas immunocompetent horses do not have prolonged parasitemia but do develop neurologic disease.<sup>36,37</sup>

### CLINICAL FINDINGS

The incubation period after experimental infection of young horses ranges between 28 and 42 days,<sup>3</sup> but is not known for the spontaneous disease. The clinical findings of EPM in horses are protean, and in endemic areas EPM should be considered as a diagnosis in any horse with clinical signs referable to the nervous system. *S. neurona* can infect any area of the brain and spinal cord, and may affect more than one site in an individual horse. Clinical signs of EPM range from barely perceptible changes in gait or behavior to recumbency, muscle atrophy, or seizures. The onset of **signs** may be insidious and gradual, or acute and rapidly progressive. Affected horses do not have increased temperature or heart rate, unless complications of the nervous disease occur.

**Spinal ataxia**, evident as weakness, hypometria or hypermetria, and defects in proprioception are common manifestations of EPM. Multifocal spinal or cervical disease causes all four limbs to be affected, while lesions caudal to the cervical intumescence cause signs in the rear limbs only. Signs of spinal ataxia range from subtle changes in gait which are difficult to differentiate from obscure lameness due to musculoskeletal disease, through obvious spinal ataxia evident as truncal sway, toe dragging, and circumduction of feet, to spontaneous falling and recumbency. **Asymmetry** of clinical signs, in which one limb is affected more than the contralateral limb, is highly suggestive of EPM, as cervical stenotic myelopathy and equine degenerative myelopathy usually cause symmetrical ataxia.

Lesions in the sacral cord cause signs of **cauda equina syndrome**, including tail paresis and urinary and fecal incontinence.

Lesions affecting spinal cord gray matter cause focal, **asymmetric muscle atrophy**, absent reflexes, or focal areas of **sweating**. Muscles frequently affected include the quadriceps, biceps femoris, epaxial muscles, and the supraspinatus/infraspinatus group. Equine protozoal myeloencephalitis

can present as a brachial plexus injury evident as radial nerve paralysis.

**Cranial nerve disease** is a common manifestation of EPM. Common syndromes include:

- **Vestibular disease** (CN VIII), evident as circling, nystagmus, head tilt, and falling toward the affected side
- **Unilateral facial nerve paralysis** (CN VII), evident as ear droop, lack of palpebral or corneal reflex and menace on the affected side, and displacement of the upper lip and nares away from the side of the lesion
- **Dysphagia** (CN IX, X, XII) and persistent dorsal displacement of the soft palate
- **Tongue paralysis** (CN XII)
- **Masseter atrophy** and weakness (CNV)
- **Hypalgesia** (Lack of sensation) of the nostrils and skin of the face (CNV).

EPM may also manifest as changes in personality and behavior, headshaking, and seizures.

### CLINICAL PATHOLOGY

There are no characteristic changes in the hemogram or serum biochemical variables. **Diagnosis** has focused on the demonstration of antibodies to *S. neurona* in serum or CSF by western blot, indirect fluorescence testing, or IgM capture ELISA.<sup>13,38-40</sup>

Interpretation of the results of **western blot** analysis of **CSF** for IgG antibodies to *S. neurona* is problematic because of the potential for blood contamination of the sample during collection,<sup>41</sup> and the high sensitivity but low specificity of the test.<sup>13</sup> Blood contamination of the sample is problematic in horses that are seropositive for antibodies to *S. neurona* and in which it is desired to know if antibodies are present in cerebrospinal fluid. Contamination of cerebrospinal fluid with blood can introduce antibodies from serum into the otherwise antibody free cerebrospinal fluid thereby causing a 'false' positive test.<sup>41</sup> Contamination of cerebrospinal fluid with small quantities of blood with high concentrations of antibodies to *S. neurona* might not be detectable using red blood cell counts, albumin quotient, or immunoglobulin index, but could yield a positive result on western blot testing.<sup>41</sup>

The western blot test for detection of antibodies to *S. neurona* is sensitive (87%) but has poor specificity (44-60%).<sup>13</sup> The utility of the test therefore depends on the pretest probability that the horse has EPM. The high sensitivity of the test means that the **positive predictive value** of a positive test in a horse with unequivocal signs of neurologic disease consistent with EPM, and from an area in

which the disease is endemic, is very good.<sup>42</sup> However, the positive predictive value of a positive test is very poor in horses with vague, or no, signs of nervous disease, or in horses from areas in which the disease is not endemic.<sup>42</sup> The **negative predictive value** is good in either instance in that horses that test negative for the presence of antibodies are unlikely to have EPM.<sup>42</sup> A negative result on a western blot analysis of serum or CSF, therefore, virtually eliminates the disease from the potential diagnoses, whereas a positive test in a horse with a high pretest probability of the disease contributes little to confirming the diagnosis. A positive test in a horse with a low probability of having the disease, such as presale testing of a clinically normal horse, does not mean the horse has the disease and is virtually useless in any assessment of the horse.

Foals of seropositive mares acquire antibodies, but not infection, by ingestion of colostrum from the dam.<sup>29</sup> These antibodies can be detected in both serum and cerebrospinal fluid of foals.<sup>29,43</sup> The mean time for foals to become seronegative for antibodies to *S. neurona* is 4.2 months.<sup>29</sup> Detection of antibodies to *S. neurona* in serum or cerebrospinal fluid of foals less than 4-6 months of age, even those with neurologic disease, should be interpreted with caution as the antibodies are likely derived from the dam.

An **indirect fluorescent antibody** test reliably detects antibodies to *S. neurona* in serum and cerebrospinal fluid of infected horses.<sup>33,44</sup> This test has the advantages of providing quantitative results, cheaper to perform, and is more accurate than immunoblots in the detection of antibodies. An IgM capture ELISA detects the presence of IgM antibodies to a *S. neurona*-specific antigen in serum and cerebrospinal fluid of naturally and experimentally infected horses, thereby providing evidence of recent infection.<sup>39</sup> Demonstration of recent infection in a horse with signs of neurologic disease increases the probability that the horse has EPM.

Examination of other variables in CSF is of limited use in the diagnosis of EPM, and measurement of creatine kinase activity in CSF has no diagnostic usefulness.<sup>45</sup> The use of the **albumin quotient** or **IgG index** to detect blood contamination of cerebrospinal fluid, or the intrathecal production of IgG is unreliable and not useful in the diagnosis of EPM.<sup>46</sup>

### NECROPSY

Lesions are limited to the spinal cord and brain, with the exception of neurogenic muscle atrophy. Gross lesions of hemorrhage and malacia may be visible in the central nervous system tissue. The lesions are asymmetrical, but may be more frequently encountered in the cervical and



lumbar intumescences of the spinal cord. Histological examination reveals multifocal necrosis of the nervous tissue with an accompanying infiltration of macrophages, lymphocytes, neutrophils, and occasional eosinophils. This reaction is predominately non-suppurative and usually includes a degree of perivascular cuffing. Schizonts or free merozoites may be evident in tissues but are difficult to locate without immunohistochemical stains. The sensitivity of screening for the parasite in hematoxylin and eosin-stained sections of nervous tissue from cases with histologic changes suggestive of EPM was only 20%. The sensitivity improved to 51% when immunohistochemical staining of the tissue was employed.<sup>32</sup> The same interpretative problems encountered when testing antemortem CSF samples apply when the fluid is collected at postmortem. Isolation in cell culture systems is possible but rarely attempted in diagnostic laboratories. PCR tests for these apicomplexan parasites can yield false negatives due to the random distribution of the parasite within CNS tissue.

#### Samples for confirmation of diagnosis

- **Histology** – fixed spinal cord (several levels, including cervical and lumbar intumescences) and half of brain, including the entire brain stem, CN VII in some cases (LM, IHC, PCR).

#### DIFFERENTIAL DIAGNOSIS

The clinical diagnosis of EPM should be based on the detection of unequivocal neurological abnormalities consistent with EPM and the detection of antibodies to *S. neurona* in an uncontaminated sample of cerebrospinal fluid or blood.<sup>46</sup> A favorable response to treatment specific for EPM increases the likelihood that the horse has EPM. A definitive diagnosis can only be achieved by necropsy.<sup>46</sup>

- Spinal ataxia: see Table 35.1.
- Cauda equina syndrome: EPM should be differentiated from polyneuritis equi; equine herpesvirus-1 myelopathy; and injection of long-acting anesthetics or alcohol around sacral nerve roots.
- Peripheral nerve lesions: Other causes of focal muscle atrophy, such as brachial plexus injury, damage to the supraspinatus nerve, or disuse atrophy can be differentiated from EPM on history and clinical signs.
- Cranial nerve disease: Signs of vestibular disease, facial or trigeminal nerve dysfunction and dysphagia associated with EPM should be differentiated from:
  - Middle ear infection
  - Guttural pouch mycosis
  - Arthritis and fracture of the temporohyoid articulation
  - Head trauma.

#### TREATMENT

**Specific treatment** of EPM involves the administration of **antiprotozoal drugs** including ponazuril, diclazuril, nitazoxanide, or the combination of pyrimethamine and sulfadiazine. **Ponazuril**, an active metabolite of toltrazuril, is usually administered at a dosage of 5 mg/kg body weight orally once daily for 28 days. At this dosage, and at 10 mg/kg orally once daily for 28 days, administration of the drug results in resolution of clinical signs in approximately 60% of horses with EPM.<sup>47</sup> The initial dosage is 5 mg/kg q 24 h which is continued for 28 days if signs of improvement are evident after 14 days. If signs of improvement are not seen after 14 days, the dosage is increased to 10 mg/kg orally q 24 for 14 days.<sup>48</sup> Few adverse effects are noted, even at 30 mg/kg orally once daily for 28 days.<sup>49</sup>

**Nitazoxanide** is administered at 25 mg/kg bodyweight orally for the first 5 days of treatment and then at 50 mg/kg orally for days 6–28 of treatment. Adverse effects noted include fever, anorexia, diarrhea, and worsening of clinical signs of neurologic disease.<sup>50</sup> Nitazoxanide is apparently effective in the treatment of EPM, based on a study of seven horses with the disease, but there are no reports of treatment of large numbers of horses.<sup>50</sup>

Administration of the combination of sulfadiazine (or similar drug, 20 mg/kg, PO) and pyrimethamine (1–2 mg/kg, PO) every 24 hours given 1 hour before feeding is effective in approximately 60–70% of cases.<sup>9</sup> This treatment is continued for at least 90 days if complete resolution of clinical abnormalities occurs, or longer if the signs of EPM do not resolve. **Side-effects** of the administration of a combination of a sulfonamide and pyrimethamine include enterocolitis, anemia, and abortion.<sup>10</sup> Folic acid is often added to the diet of horses being treated for EPM, but this cannot be recommended because of its lack of efficacy in preventing anemia in treated horses,<sup>10,51</sup> and its ability to cause severe congenital abnormalities in foals born to treated mares<sup>52</sup> and anemia and leucopenia in adult horses.<sup>51</sup> Orally administered synthetic folates interfere with normal folate metabolism in horses being administered anti-folate drugs resulting, paradoxically, in folate deficiency.<sup>51</sup> Adequate intake of folates in antiprotozoal-treated horses can be assured by feeding a diet containing good quality green foliage.

The decision to **stop treatment** in horses that do not completely recover is difficult. Some authorities recommend resampling CSF and continuing treatment until antibodies to *S. neurona* are no longer detectable. However, given that normal horses often have antibodies in their CSF, and that some treated horses never lose

their positive western blot test, the decision to stop treatment should not be based entirely on this variable.

Some horses have a transient worsening of clinical signs in the first week of treatment. This is presumed to be due to the effect of the antiprotozoal agent causing death of protozoa with subsequent inflammation and further impairment of neurologic function. Relapse of the disease occurs in some horses when administration of antiprotozoal medication is stopped.

**Supportive treatment** of affected horses includes anti-inflammatory drugs (flunixin meglumine, 1 mg/kg IV, every 8–12 h; dimethyl sulfoxide, 1 g/kg as a 10% solution in isotonic saline IV, every 24 h for 3 days) and nutritional support for horses that cannot eat. Flunixin meglumine is often administered twice daily for the first 3–5 days of treatment with ponazuril or nitazoxanide, purportedly to reduce the inflammatory effects of death of protozoa in the central nervous system.

#### CONTROL

A vaccine composed of killed *S. neurona* is available in the United States. However, the efficacy of this vaccine has not been demonstrated. Furthermore, because the vaccine induces detectable antibody in serum and cerebrospinal fluid of vaccinated horses, there is concern that it can impair the diagnosis of EPM.<sup>18</sup> Given the lack of demonstrated efficacy and potential for interference with diagnosis of EPM, use of the vaccine currently available in the United States (2005) is not recommended.

Sporocysts of *S. neurona* are resistant to usual concentrations of many of the conventional disinfectants including sodium hypochlorite (bleach), 2% chlorhexidine, 1% betadine, 5% benzyl chlorophenol, 13% phenol, 6% benzyl ammonium chloride, and 10% formalin.<sup>53</sup> The organism is killed by heating to 55°C for 15 min or 60°C for one minute.<sup>53</sup>

Because protection of feed from contamination by opossums has been demonstrated to reduce the risk of horses developing EPM<sup>19</sup> it is prudent to employ measures to reduce the exposure of animals and feed to opossum feces, and possibly feces of birds that might act as transport hosts.

There is interest in pharmacologic means of preventing infection of horses by *S. neurona*. Pyrantel pamoate has some efficacy against *S. neurona* in vitro but daily administration (2.6 mg/kg body weight in feed) does not prevent *S. neurona* infection of horses.<sup>54</sup>

#### REVIEW LITERATURE

Dubey JP et al. A review of *Sarcocystis neurona* and equine protozoal myeloencephalitis (EPM). *Vet Parasitol* 2001; 95:89.

Furr M et al. ACVIM consensus statement: Clinical diagnosis of equine protozoal myeloencephalitis (EPM). *J Vet Int Med* 2002; 16:618.

## REFERENCES

- Dubey JP et al. *J Parasitol* 1991; 77:212.
- Fenger CK et al. *J Parasitol* 1994; 80:966.
- Fenger CK et al. *Vet Parasitol* 1997; 68:199.
- Marsh AE et al. *Vet Parasitol* 2001; 95:143.
- Marsh AE et al. *J Am Vet Med Assoc* 1996; 209:1907.
- Daft BM et al. *Equine Vet J* 1996; 28:240.
- Pitel PH et al. *Int J Parasitol* 2002; 32:481.
- Katamyama Y et al. *J Vet Med Sci* 2003; 65:757.
- Dubey JP et al. *Vet Parasitol* 2001; 95:89.
- Fenger CK et al. *J Am Vet Med Assoc* 1997; 210:923.
- NAHMS. USDA: APHIS, Fort Collins, CO. 2001; #N312.0401.  
Available at NAHMSweb@aphis.usda.gov
- Saville WJ et al. *J Am Vet Med Assoc* 2000; 217:1181.
- Daft BM et al. *J Am Vet Med Assoc* 2002; 221:1007.
- Saville WJ et al. *J Am Vet Med Assoc* 1997; 210:519.
- Bentz BG et al. *J Am Vet Med Assoc* 1997; 210:517.
- Blythe LL et al. *J Am Vet Med Assoc* 1997; 210:525.
- Rossano MG et al. *Prev Vet Med* 2001; 48:113.
- Witonsky S et al. *J Vet Int Med* 2004; 18:98.
- Saville WJ et al. *J Am Vet Med Assoc* 2000; 217:1174.
- Fayer R et al. *J Vet Int Med* 1990; 4:54.
- Saville WJA et al. *Vet Parasitol* 2001; 95:211.
- Dubey JP et al. *J Parasitol* 2000; 86:1276.
- Cheadle MA et al. *Int J Parasitol* 2001; 31:330.
- Tanhauser SM et al. *Int J Parasitol* 2001; 31:325.
- Cheadle MA et al. *Int J Parasitol* 2001; 31:843.
- Dubey JP et al. *Vet Parasitol* 2001; 100:117.
- Staneck JF et al. *Vet Parasitol* 2003; 117:239.
- Rossano MG et al. *J Am Vet Med Assoc* 2002; 221:511.
- Grimsley Cook A et al. *Vet Parasitol* 2001; 95:187.
- Mullaney T et al. *Vet Parasitol* 2005; 133:27.
- Bowman DD et al. *Cornell Vet* 1992; 82:41.
- Duarte PC et al. *J Parasitol* 2004; 90:1345.
- Tornquist SJ et al. *Equine Vet J* 2001; 33:726.
- Spencer JA et al. *J Parasitol* 2004; 90:428.
- Spencer JA et al. *Clin Diag Lab Immunol* 2005; 12:644.
- Sellon DC et al. *Clin Diag Lab Immunol* 2004; 11:1134.
- Rossano MG et al. *Vet Parasitol* 2005; 127:3.
- Furr M et al. *J Vet Int Med* 2002; 16:618.
- Murphy J et al. *J Vet Int Med* 2006; 20:322.
- Duarte PC et al. *J Parasitol* 2004; 90:379.
- Miller MM et al. *J Am Vet Med Assoc* 1999; 215:67.
- Cohen ND, MacKay RJ. *Comp Cont Educ Pract Vet* 1997; 19:1176.
- Grimsley Cook A et al. *J Am Vet Med Assoc* 2002; 220:208.
- Duarte PC et al. *J Vet Diag Invest* 2003; 15:8.
- Jackson C et al. *J Vet Int Med* 1996; 10:246.
- Furr M et al. *J Vet Int Med* 2002; 16:618.
- Furr M et al. *Vet Therapeut* 2001; 2:215.
- Lech PJ. *Comp Cont Educ Pract Vet* 2002; June:484.
- Kennedy T et al. *Vet Therapeut* 2001; 2:223.
- Vatistas N et al. *Equine Pract* 1999; 21:18.
- Piercy RJ et al. *Equine Vet J* 2002; 34:311.
- Toribio R et al. *J Am Vet Med Assoc* 1998; 212:697.
- Dubey JP et al. *J Parasitol* 2002; 88:1252.
- Rossano MG et al. *Am J Vet Res* 2005; 66:846.

## THEILERIOSES

Theilerioses are those tick-borne protozoan diseases associated with *Theileria* spp. in

cattle, sheep, and goats as well as in wild and captive ungulates. The genus *Theileria* belongs to the Amplicomplexa group which includes *Babesia*, *Toxoplasma*, *Neospora*, *Plasmodium*, among others. The life cycle of *Theileria* spp. involves cyclical development in ticks to form sporozoites which, on being injected with tick saliva into the mammalian host, develop into schizonts in leukocytes and then piroplasmids (merozoites) in erythrocytes. The diseases in ruminants are characterized by fever and lymphoproliferative disorders and are associated with varying degrees of leukopenia and/or anemia.

*Theileria* spp. are found throughout the world and their nomenclature and classification, though still controversial, are being gradually elucidated through molecular characterization. The important pathogens of cattle are restricted to certain geographical regions after which the diseases are named<sup>1-3</sup> (Table 26.6). **East coast fever (ECF)** associated with *T. parva* and **tropical theileriosis (or Mediterranean coast fever)** associated with *T. annulata* are the most important and are dealt with separately below. Japanese bovine theileriosis associated with *T. sergenti* is probably next in importance.

*T. orientalis* is responsible for **oriental theileriosis**, a milder disease than ECF or bovine tropical theileriosis, and hence also called **benign theileriosis**. It has been proposed that the species found worldwide and responsible for benign theileriosis be named *T. buffeli* (replacing *T. orientalis* in Asia and *T. sergenti* in Japan<sup>1</sup>) but genetic differences have been shown between *T. buffeli* and *T. sergenti*.<sup>4,5</sup> Furthermore, *T. sergenti* causes a more severe disease in southeastern Asia, also called Japanese bovine theileriosis. Both *T. buffeli* and *T. sergenti* are transmitted by *Haemophysalis* ticks which occur in Europe, the Mediterranean basin, Asia, and Australia. Although this tick does not occur in the United States of America, *T. buffeli* was diagnosed in a herd of beef cattle in Missouri and was associated with severe clinical illness and death (by euthanasia) in a pregnant cow.<sup>6</sup>

In general, benign theileriosis is characterized by moderate to severe anemia in heavily parasitized cattle and moderate enlargement of lymph nodes. More severe clinical signs and economic losses have been reported from eastern Asia. The pathogenesis of the anemia is not clear but a hemolytic factor has been reported in the serum of acutely affected cattle.<sup>7</sup> In addition, it has been shown that oxidative bursts of macrophages in experimentally infected cattle can damage red blood cells and that this may contribute to the anemia in Japanese bovine

theileriosis.<sup>8</sup> European breeds are more susceptible than zebu breeds. Even for the more pathogenic *T. sergenti*, native and crossbred cattle in Korea were found to be more resistant to infection than Holsteins.<sup>9</sup> Furthermore, transplacental (vertical) transmission of *T. sergenti* from pregnant cows to calves has been reported.<sup>10</sup> Transmission to the calves was confirmed by parasitological, serological, and polymerase chain reaction (PCR) assays. These are also the methods generally recommended for diagnosis.<sup>5</sup> Calves used for the production of live vaccines against babesiosis and anaplasmosis should be free of benign theileriosis. In Australia, concurrent treatment with primaquine phosphate (six doses at 2 mg/kg) and halofuginone lactate (two doses at 1 mg/kg) was effective for this purpose.<sup>11</sup>

*T. mutans*, confined to Africa and the Caribbean Islands, causes a usually innocuous disease, but it may be manifested by fever, anorexia, and anemia. Another species, *T. velifera*, is associated with very mild theileriosis in tropical Africa. Both are transmitted by *Amblyomma* ticks. *T. taurotragi* of the eland antelope is generally non-pathogenic to cattle, but is one of the causes of **cerebral theileriosis (turning sickness)** in southern Africa (cerebral theileriosis can also be associated with *T. parva*). Parasitized lymphoblasts accumulate in cerebral, spinal, and meningeal arteries, with resultant thrombosis and infarction of affected organs. *T. taurotragi* is transmitted by *Rhipicephalus* spp.

The important pathogen of sheep and goats is *T. hirci* (synonym *T. lestoquardi*), the cause of **malignant ovine theileriosis**. The disease is enzootic from North Africa through the Middle East to India and China, approximately the same geographical region as bovine tropical theileriosis. Malignant theileriosis in sheep and goats is similar to bovine tropical theileriosis due to *T. annulata*. Like the latter, it is also transmitted by *Hyalomma* spp. but in China, the main vector is *Haemophysalis* spp. The disease can be acute, subacute, or chronic, depending on the resistance of the sheep or goats, and is seasonal, depending on availability of ticks. The acute disease is characterized by fever and very high mortality in 3-6 days.<sup>12,13</sup> Anemia, jaundice, and enlargement of lymph nodes are characteristic, and both piroplasmids and schizonts can be demonstrated in smears of blood and tissues, respectively. In subacute and chronic cases, signs are generally less marked except for anemia and emaciation. An indirect fluorescent antibody test is available. Parvaquone and buparvaquone may be used to treat early cases. **Benign ovine theileriosis** is caused either by *T. ovis* or by *T. separata* in

Table 26.5 Summary of the theilerioses of domestic ruminants<sup>1-3</sup>

Disease	Distribution	<i>Theileria</i> spp.	Main vector
<b>Cattle</b>			
East coast fever	East and central Africa	<i>T. parva</i>	<i>Rhipicephalus appendiculatus</i>
Turns sickness (cerebral theileriosis)	Southern Africa	<i>T. parva</i> , <i>T. taurotragi</i>	<i>Rhipicephalus</i> spp.
Tropical theileriosis (Mediterranean coast fever)	Mediterranean countries	<i>T. annulata</i>	<i>Hyalomma anatolicum</i>
Benign theileriosis	Worldwide	<i>T. buffeli</i> ( <i>T. sergenti</i> , <i>T. orientalis</i> )	<i>Haemophysalis</i> spp.
Japanese bovine theileriosis	Africa/Caribbean	<i>T. mutans</i>	<i>Amblyomma</i> spp.
	Africa	<i>T. velifera</i>	<i>Amblyomma</i> spp.
	Asia	<i>T. buffeli</i>	<i>Haemophysalis</i>
	Japan	<i>T. sergenti</i>	<i>longicornis/H. punctata</i> <i>Haemophysalis</i> spp.
<b>Sheep and goats</b>			
Malignant ovine theileriosis	North Africa, Middle East, India	<i>T. hirci</i> ( <i>T. lestoquardi</i> )	<i>Hyalomma</i> spp./ <i>Haemophysalis</i> spp.?
Benign theileriosis	Worldwide	<i>T. ovis</i>	<i>Rhipicephalus</i> spp.?
	East and South Africa	<i>T. separata</i>	<i>Rhipicephalus</i> spp.

Africa. Piroplasms are found in blood but there are no overt clinical signs.

In general, the pathogenesis of various forms of theileriosis is dependent on the production of schizonts in lymphocytes and piroplasms in erythrocytes. Thus, *T. parva*, *T. annulata*, and *T. hirci* produce numerous schizonts and piroplasms and are very pathogenic; *T. mutans*, *T. buffeli*, and *T. ovis* rarely produce schizonts but may cause varying degrees of anemia when piroplasms are many in red blood cells; and with *T. velifera* and *T. separata*, no schizonts have been described, the parasitemia is usually scanty and the infection is mild or subclinical.

## REFERENCES

- Uilenberg NP et al. *Trop Anim Health Prod* 1996; 28:81.
- Coetzer JAW, Tustin RC (eds). *Infectious diseases of livestock*, 2nd edn. Cape Town: Oxford University Press, 2004; vol 1, pp. 448–501.
- Brown CGD. Theileriosis. In: Sewell MMH, Brocklesby DW (eds) *Handbook on animal diseases in the tropics*, 4th edn. London: Baillière Tindall, 1990; pp. 183–199.
- Chansiri K et al. *Vet Parasitol* 1998; 79:143.
- OIE. *Manual of diagnostic tests and vaccines for terrestrial animals*, 5th edn. 2004; chapter 2.3.11, [http://www.oie.int/eng/normes/mmanual/A\\_00062.htm](http://www.oie.int/eng/normes/mmanual/A_00062.htm)
- Stockman SL et al. *Vet Pathol* 2000; 37:11.
- Hagiwara K et al. *Parasitol Res* 1995; 81:470.
- Shiono H et al. *Parasitol Res* 2003; 89:228.
- Kim GH et al. *J Protozool Res* 1999; 9:103.
- Baek BK et al. *Can J Vet Res* 2003; 67:278.
- Stewart NP et al. *Trop Anim Health Prod* 1990; 22:109.
- Tageldin MH et al. *Trop Anim Health Prod* 1992; 24:15.
- Gou SZ et al. *Parasitol Res* 2002; 88:S36.

## EAST COAST FEVER (ECF)

### Synopsis

**Etiology** *Theileria parva*, an apicomplex protozoan. Vector is *Rhipicephalus appendiculatus* and, rarely, *R. zambeziensis*.

**Epidemiology** Endemic disease of cattle in east and central Africa; high mortality and great economic importance.

**Pathogenesis** Tick inoculation of sporozoites → lymphocytes in local lymph node → schizogony → lymphoid proliferation → parasitemia → more lymphoid proliferation → merozoites → erythrocytes → piroplasms → ticks. Damage mainly by schizonts.

**Clinical signs** Fever, enlarged superficial lymph nodes, dyspnea, wasting, and terminal diarrhea.

**Clinical pathology** Schizonts in lymphoblasts, piroplasms in erythrocytes, serology.

**Lesions** Massive pulmonary edema, hydrothorax, hydropericardium, emaciation, hemorrhages, lymphadenopathy, and widespread proliferation of lymphoblastoid cells.

### Differential diagnosis list

- Trypanosomiasis/babesiosis/anaplasmosis
- Heartwater
- Malignant catarrhal fever/bovine virus diarrhea/Rinderpest.

**Treatment** Limited success with halofuginone, parvoquone, and tetracyclines.

**Control** Integrated approach involving resistant animal breeds, strategic application of acaricides, and vaccination by infection-and-treatment methods.

## ETIOLOGY

*Theileria parva* is an apicomplex protozoan parasite of the class Sporozoa and order Piroplasmida. There has been considerable naming and renaming of *T. parva* and the associated diseases in Africa.<sup>1</sup> 'Classic' East Coast Fever (ECF) occurs in East Africa and is associated with *T. parva* transmitted from cattle to cattle by the brown ear tick, *Rhipicephalus appendiculatus*. ECF also occurs either as **Corridor disease** in eastern and southern Africa or as **January disease** in central Africa. Corridor disease is transmitted from buffalo to cattle by either *R. appendiculatus* or *R. zambeziensis* and the agent responsible used to be called *T. parva lawrencei*. Close contact between buffalo, cattle, and ticks

is essential. The disease is more acute than classical ECF, but after serial passage in cattle, it is indistinguishable from classical ECF.<sup>2</sup> January disease occurs mainly between January and March and the agent was named *T. parva bovis*. The disease is also more acute than classical ECF, death sometimes occurring within 4 days. These three clinical diseases are otherwise indistinguishable from one another, hence the causative agents are currently referred to simply as *T. parva*.

## EPIDEMIOLOGY

### Occurrence

ECF affects mainly cattle but also buffalo, and occurs in 13 countries in eastern, central, and southern Africa.<sup>3</sup> Its occurrence is related to the distribution of the vector tick which has been recorded from large areas extending from southern Sudan in the north to western Zambia and eastern Zaire in the west, and to Mozambique and Zimbabwe in the south.<sup>4,5</sup> The disease is prevalent throughout the wetter areas favoring the development of the tick, but is absent from the wet highlands in the horn of Africa.<sup>6</sup> It has been eradicated from southern Africa up to the Zambezi River. The endemic scenarios range from a stable situation with high prevalence of herd infection but low fatality rates (endemic stability), to a low prevalence/high fatality scenario (endemic instability).<sup>7</sup> Endemic stability develops in indigenous zebu cattle exposed to constant tick challenge as in wetter areas whereas endemic instability is seen with commercial production systems utilizing imported breeds or crossbreeds and in areas with a unimodal rainfall pattern that restricts tick activity.<sup>8</sup> Epidemics occur when there is a breakdown in tick control especially during the rainy season or when susceptible animals are introduced into an endemic area.

### Morbidity and case fatality

All susceptible cattle in endemic areas are at the risk of contracting ECF unless

they are vaccinated or the tick population is under stringent control. The morbidity and case fatality rates are very high, approaching 90–100% in recently introduced exotic (*Bos taurus*) breeds and in previously unexposed or naive indigenous cattle.<sup>9</sup> However, indigenous zebu cattle (*Bos indicus*) and African buffalo in endemic areas have a strong resistance to the disease and calfhood mortality is around 5%.<sup>9</sup>

#### Methods of transmission

The vector of ECF is *Rhipicephalus appendiculatus* and in the field, the disease occurs only where this tick is found, except for Corridor disease which may be transmitted by *R. zambeziensis*. Other species of *Rhipicephalus* and *Hyalomma* spp. can transmit ECF experimentally, but they are not significant. Developmental stages of the parasite occur in the tick and they pass trans-stadially through the stages of larva, nymph and adult, but there is no transovarian transmission. Consequently, larvae or nymphs become infected and transmit infection as nymphs or adults. Adults are more efficient vectors than nymphs. Mechanical transmission is of no significance. The epidemiology of the disease is thus largely dependent on the distribution and habitat of the tick and its ability to complete development to the adult stage, usually during the rainy season. Ticks may live for 1–2 years, but they lose their infection within 11 months.

#### Risk factors

The most important risk factors relate to the presence of the brown ear tick in a given area and the level of tick burden per animal, even though it takes only one tick to establish an infection that could be fatal. At low infestation rates, an average of five ticks per head (two to three per ear) will sustain endemicity; one to four per head will invite epidemicity; while an average of less than one can allow sporadic outbreaks.<sup>10</sup> In addition, there is evidence that *R. appendiculatus* populations that originate from eastern Africa tend to become more highly infected with *T. parva* than those that originate from southern Africa, and consequently the disease they transmit is more virulent.<sup>11</sup>

The infection rate in ticks in endemic areas is usually low (1–2%) even though the immunity conferred on recovered or vaccinated animals is no longer thought to be sterile. However, soon after ECF becomes established in susceptible herds, infection rates in ticks become much higher.

Young animals are less susceptible, and indigenous breeds and buffaloes are less clinically affected than exotic breeds, but buffaloes are the carriers of Corridor disease. Other wild Bovidae may help to

sustain the population of the tick vector but are not carriers of *T. parva*. Asiatic or water buffalo is fully susceptible.

#### Environmental factors

In eastern Africa, *R. appendiculatus* normally occurs in grass-covered savannah and savannah woodlands, but is usually absent from extensive heavily wooded forest habitats.<sup>5</sup> Areas that are too high, too cold, or too dry will not allow the tick to undergo more than one life cycle in a year, thereby reducing the period of transmission of the parasitic by the nymphs or adults. For example, the disease is most prevalent in eastern Africa where adult and immature stages of the tick occur simultaneously on cattle, leading to rapid and continuous transmission.<sup>11</sup> In southern Africa, by contrast, there is a seasonal life cycle for the tick so that there is little overlap between the activity periods of adults (January to March) and immature stages, thereby reducing the frequency of disease transmission.

#### Immune mechanisms

Cattle recovering from ECF have a solid immunity to homologous challenge, but the immunity is not sterile. In endemic areas, premunity is established early and this provides lifelong protection if reinfection continues and the cattle are not moved to a different location where they may be exposed to a different strain of the parasite. Indigenous cattle are able to limit explosive multiplication of schizonts during the acute phase.<sup>12</sup> Nutritional or climatic stress may seriously reduce the animal's premunity, even among resistant breeds. While antibody responses to the sporozoite may play some part in protection, immunity is mediated mainly by cellular mechanisms involving cell-mediated cytotoxic T-cell (CTL) responses against surface antigens of macroschizont-infected cells.<sup>13</sup> The CTL response is parasite-specific and genetically restricted (major histocompatibility complex or MHC antigens) and the protection can be transferred between immune and naïve calves in the CD8<sup>+</sup> T-cell fraction emanating from a responding lymph node.<sup>7</sup>

#### Experimental reproduction

ECF can easily be reproduced by feeding infected ticks on susceptible cattle or by inoculating cattle with infected tick material, sporozoites or macroschizont-infected tissue culture cells. This is used as a method of immunization. When working with ticks or tick materials, care should be taken to avoid the risk of contracting other tick-borne diseases.

#### Economic importance

ECF has a major impact on cattle production in eastern, central, and southern

Africa. It is estimated that in 1989, ECF killed 1.1 million head of cattle and caused US\$168 million in losses.<sup>14</sup> Serious losses occur in exotic and indigenous cattle, mainly from reduced production of milk and meat due to morbidity and mortality, as well as from the heavy costs incurred in implementing effective tick control. *T. parva* does not infect human beings.

#### Biosecurity concerns

The vector of ECF has strict requirements which limit the spread and establishment of the disease beyond the geographic areas where it normally occurs. It is not contagious.

#### PATHOGENESIS

Sporozoites of *T. parva* are injected into the bovine host by the tick in its saliva. Ticks must feed for 2–4 days before sporozoites in their salivary glands will mature and become infective to cattle. One tick can transmit sufficient sporozoites to cause a fatal infection in a susceptible animal. The sporozoites then enter lymphocytes and develop into schizonts in the lymph node draining the area of attachment of the tick, usually the parotid node. Infected lymphocytes are transformed to lymphoblasts which continue to divide synchronously with the schizonts so that each daughter cell is also infected. Eventually, infected lymphoblasts are disseminated throughout the lymphoid system and in nonlymphoid organs where they continue to proliferate. Later, some schizonts differentiate into merozoites, are released from the lymphoblasts and invade erythrocytes where they are referred to as piroplasms and are infective to ticks. Piroplasms ingested by ticks undergo several developmental stages and eventually form sporozoites in salivary glands, thus completing the cycle.

The dominating pathological lesion is generalized lymphoid proliferation resulting from uncontrolled proliferation of T-lymphocytes containing schizonts. This is followed later by necrosis of infected lymphoblasts induced by cytotoxic T-lymphocytes. The severe lymphocytolysis often leads to immunosuppression. Terminally, the animal develops severe pulmonary edema, probably due to release of vasoactive substances from lymphocytes disintegrating in the lungs. Erythrocytic indices are usually unchanged, but there may be terminal anemia in January disease.

#### CLINICAL FINDINGS

The basic syndrome associated with *T. parva* infection lasts for a few weeks. The incubation period is 1–3 weeks, depending on the virulence of the strain and the size of the infecting dose. Experimentally,

the first clinical sign is enlargement of lymph nodes in the area draining the site of tick attachment (i.e. 8–16 days after attachment). One or 2 days later, there is fever, depression, anorexia, and a drop in milk in dairy animals. In later stages, there may be nasal and ocular discharges, dyspnea, generalized lymph node enlargement, and splenomegaly. In severe cases, diarrhea occurs, sometimes with dysentery, but usually only late in the course of the disease. Emaciation, weakness, and recumbency lead to death from asphyxia in 7–10 days. Terminally, there is often a frothy nasal discharge. Occasional cases of brain involvement occur and are characterized by circling, hence 'turning sickness' or cerebral theileriosis.

In southern Africa, cerebral theileriosis is associated with an aberrant form of *T. taurotragi* originating from the eland. There are localized nervous signs and convulsions, tremor, profuse salivation, and head pressing. Infection with the strain of *T. parva* (formerly *T. parva lawrencei*) responsible for Corridor disease causes a similar acute syndrome, with the additional lesion of keratitis and accompanying blepharospasm. ECF in Zimbabwe (formerly attributed to *T. parva bovis*) is generally slightly less virulent but is still frequently fatal.

### CLINICAL PATHOLOGY

The parasites are evident as schizonts, sometimes in circulating lymphocytes, but mainly in biopsy smears of enlarged lymph nodes stained with Giemsa. Piroplasms are also easily visible in erythrocytes from day 16 after tick attachment and they increase in number until death. Over 30% of the red cells may be infected, but the level of intra-erythrocytic piroplasms is not correlated with the severity of the disease. *T. parva* piroplasms are difficult to differentiate from other piroplasms, hence the necessity to find schizonts. Blood counts will reveal a panleukopenia and thrombocytopenia with little or no anemia. The protozoa can be grown on a tissue culture of lymphoblastoid cells.

A range of serological tests is available, including indirect immunofluorescent antibody test (IFAT), complement fixation test, indirect hemagglutination test, and enzyme-linked immunosorbent assay (ELISA). The ELISA test is increasingly being used for seroepidemiological studies<sup>14</sup> and the polymerase chain reaction (PCR) technology is available but IFAT is the most widely used test.<sup>3</sup>

### NECROPSY FINDINGS

The most striking lesion is massive pulmonary edema, hyperemia and emphysema, along with hydrothorax and

hydropericardium. Copious froth is present in the airways. The carcass is emaciated and hemorrhages are evident in a variety of tissues and organs. There is enlargement of the liver, lymph nodes and spleen, and ulceration of abomasum and intestines. Small lymphoid nodules (the so-called pseudo-infarcts) are present in liver, kidney, and alimentary tract. In protracted cases, animals may have small, exhausted lymphoid organs.

Microscopic lesions are characterized by proliferating lymphoblastoid cells and varying amounts of necrosis in lymphoid organs, lungs, liver, kidneys, the gastrointestinal tract and other tissues, somewhat similar to a multicentric lymphoid tumor. Some lymphoblasts contain schizonts, which are better seen in impression smears stained with Giemsa stain. In cerebral theileriosis, infected lymphoblasts sequester in cerebral blood vessels and cause infarction.

Specimens to submit for pathology should include lymph nodes, lungs, kidneys, liver, and any other organ with gross lesions.

### DIFFERENTIAL DIAGNOSIS

The fever, depression, and lymphadenopathy of ECF can be confused with such diseases as theileriosis due to *T. annulata*, trypanosomiasis, heartwater, malignant catarrhal fever, bovine virus diarrhea, and rinderpest. The lymphoid hyperplasia may also simulate lymphoma. A knowledge of the disease history, coupled with hematological and lymph node smear examinations are usually adequate to make a definitive

### TREATMENT

Once an animal is manifesting clinical signs of ECF, treatment is generally considered to be either unsatisfactory or too expensive.<sup>15</sup> Tetracyclines were the recommended treatment for many years, but they have only moderate efficacy, especially if the disease has been present for a few days. Two recently introduced drugs, halofuginone lactate and parvaquone, have had a much higher success rate, but recovered animals may become carriers unless the correct dose is used. Halofuginone lactate is an effective oral treatment for the acute syndrome at two doses, 1.2 mg/kg BW. Parvaquone (10 mg/kg BW, two doses 48 h apart) or the related buparvaquone (2.5 mg/kg BW, two doses 48 h apart) given IM is effective in most cases. In field trials, buparvaquone gives results comparable to those of parvaquone<sup>16</sup> and cure rates are maximized by accurate diagnosis and prompt treat-

ment of both ECF and intercurrent infections.<sup>17</sup> Cure rates are even higher if the animals are also treated for pulmonary edema with dexamethasone<sup>18</sup> or the diuretic, frusemide.<sup>19,20</sup>

### CONTROL

Until recently, the main method of control of ECF was to break the transmission cycle between cattle and ticks. This was achieved through widespread and strict application of acaricides at 3-, 5-, or 7-day intervals throughout the year (intensive dipping), adherence to legislation on cattle movements and quarantine, and good livestock and pasture management. With the ever rising costs of acaricides, their effect on the environment, the development of acaricide resistance, and frequent political problems in the affected regions, this strategy to control ECF and other tick-borne diseases in Africa has been revised.<sup>21–23</sup> Furthermore, it has been observed that indigenous cattle, constituting the majority of the herds in some of the affected countries, may lose their endemic stability with intensive dipping<sup>24</sup> and the process is not cost-effective. An integrated approach is now advocated involving the use of genetically resistant breeds, a judicious and selective application of acaricides at 3-week intervals (strategic dipping) or when there are at least 100 ticks per animal (tactical dipping), and the use of vaccines. It was reported that monthly applications of deltamethrin-based pour-on insecticide significantly reduced the incidence of ECF and other hemoparasitic diseases in smallholder dairy farms in Kenya.<sup>25</sup>

The technique used for vaccination is immunotherapy or 'infection-and-treatment method'. Initially, cryopreserved suspensions of *T. parva* sporozoites from ground-up infected ticks were injected into the patient. Now, sporozoites from cell culture are used. The infection they cause is controlled with long-acting oxytetracycline (20 mg/kg BW IM), or preferably parvaquone given at the same time, so that premunity is established. It is preferably to use a cocktail of different stocks of parasites. Vaccination, coupled with strategic dipping only when ticks are abundant, is usually successful and economically attractive,<sup>23</sup> provided local stocks of *Theileria* are included. Large-scale field trials of these vaccines are being carried out throughout East and Central Africa. Initial reports indicate that calves in high risk areas should be vaccinated at 1–2 months of age<sup>26</sup>; that immunization campaigns are more efficient when concentrated in the period of low adult tick activity<sup>27</sup>; and that immunization is of no benefit in herds under intensive tick control but is of high value

when combined with strategic tick control.<sup>28</sup> Strategic control plus immunization can markedly reduce the risk of clinical ECF but immunized animals are carriers and all stages of *R. appendiculatus* can transmit infection from them to naïve animals.<sup>29</sup>

Limited studies have indicated that cattle could be successfully immunized without concurrent tetracycline therapy by using low pathogenicity isolates as vaccines, for example, *T. parva* (Boleni),<sup>30</sup> or low infectivity sporozoite stabilates stored at -196°C for over 6 months.<sup>31</sup> Because of the high cost of tetracyclines, this procedure would reduce the cost of vaccination by more than three-fold in the first year of field application. Furthermore, the *T. parva* (Boleni) isolate was reported to induce protection against a wide spectrum of *Theileria* stocks.

It needs to be stated that immunity is engendered so far only with live parasites that can establish an infection, but can also produce carriers. Hence, the risk inherent in the widespread use of such vaccines across national boundaries warrants further consideration. On the other hand, this process may accelerate progress to endemicity.<sup>32</sup> The possibility of immunizing cattle with recombinant surface molecules from either the sporozoite (the p67 antigen) or the schizont, or a mixture of several antigens derived from both stages, is still being investigated.<sup>33,34</sup> Such a recombinant vaccine would avoid the breakdowns that occur with any immunotherapeutic technique and if the right antigens are found for the vaccine, the immunity engendered is likely to be broad, robust, and not parasite stock-specific.<sup>33,35,36</sup>

## REVIEW LITERATURE

- Brown CGD. Theileriosis. In: Sewell MMH, Brocklesby DW (eds) Handbook on animal diseases in the tropics, 4th edn. London: Baillière Tindall, 1990; pp. 183-199.
- Lawrence JA, Perry BD, Williamson SM. East coast fever. In: Coetzer JAW, Tustin RC (eds) Infectious diseases of livestock, 2nd edn. Cape Town: Oxford University Press, 2004; vol 1, pp. 448-467.
- Losos GJ. Theileriosis. In: Infectious tropical diseases of domestic animals. London: Longman 1986; pp. 98-181.
- Norval RAI, Perry BD, Young AS. The epidemiology of theileriosis in Africa. San Diego: Academic Press, 1992; pp. 481.

## REFERENCES

- Perry B D Young A S 1993; Vet Rec 133:613.
- Potgieter FT et al. 1988; J S Afr Vet Assoc 59:155.
- OIE. Manual of diagnostic tests and vaccines for terrestrial animals, 5th edn. 2004; chapter 2.3.11, [http://www.oie.int/eng/normes/mmanual/A\\_00062.htm](http://www.oie.int/eng/normes/mmanual/A_00062.htm)
- Lessard P et al. Vet Rec 1990; 126:255.
- Penny D et al. Parasitol Today 1990; 6:1.
- Norval RAI et al. Prev Vet Med 1991; 10:163.
- McKeever DJ. Res Vet Sci 2001; 70:77.

- Billioux M et al. Trop Med International Health 1999; 4:A28.
- Dolan TT. Parasitol Today 1987; 3:4.
- Yeoman GH. Vet Rec 1991; 129:414.
- Norval RAI et al. Parasitology 1991; 102:347.
- Paling RW et al. Trop Anim Health Prod 1991; 23:203.
- Morrison WI et al. In: Morrison WI (ed) The ruminant immune system in health and disease. Cambridge: Cambridge University Press, 1986; p. 555.
- Anonymous. ILRAD Reports 1991; 9:1.
- Young AS et al. Parasitology 1988; 96:403.
- Dolan TT et al. Vet Rec 1992; 130:536.
- Muraguri GR et al. Vet Parasit 1999; 87:25.
- Matovelo JA et al. Trop Anim Hlth Prod 2000; 32:353.
- Mbwambo HA et al. Vet Parasit 2002; 108:195.
- Musoke RA et al. Trop Anim Hlth Prod 2004; 36:233.
- Mukhebi AW. Vet Rec 1995; 137:17.
- Pegram RG et al. Trop Anim Health Prod 1996; 28:99.
- Kariuki DP et al. Trop Anim Health Prod 1995; 27:15.
- Soldan AW et al. Vet Rec 1991; 129:179.
- Muraguri GR et al. Insect Science and its Application 2003; 23:69.
- Maloo SH et al. Prev Vet Med 2001; 52:31.
- Billioux M et al. Vet Parasit 2002; 107:51.
- Minjauw B et al. Prev Vet Med 1999; 38:35.
- Marcotty T et al. Vet Parasit 2002; 110:45.
- Kanhai G K et al. Trop Anim Health Prod 1997; 29:92.
- Mbassa GK et al. Vet Parasit 1998; 77:41.
- Minjauw B et al. Prev Vet Med 1998; 35:101.
- Musoke A et al. Proc Natl Acad Sci USA 1992; 89:514.
- Bishop R et al. Vaccine 2003; 21:1205.
- Nene V et al. Infect Immun 1996; 64:2056.
- Moarzarria S et al. Annals NY Acad Sci 2000; 916:464.

## TROPICAL THEILERIOSIS (MEDITERRANEAN COAST FEVER)

### Synopsis

**Etiology** *Theileria annulata*, an apicomplex protozoan. Vectors are *Hyalomma* ticks.

**Epidemiology** Endemic disease of cattle in Mediterranean basin and parts of Asia.

**Pathogenesis** As in ECF, but damage is by both schizonts and piroplasms.

**Clinical signs** Inapparent in local stock; fever, lymphadenopathy, wasting, anemia, and jaundice in exotics.

**Clinical pathology** Schizonts in macrophages and lymphocytes especially in liver smears; piroplasms in erythrocytes.

**Lesions** As in ECF, also anemia and jaundice.

### Differential diagnosis list

- Other theilerioses
- Babesiosis
- Anaplasmosis
- Trypanosomosis
- Malignant catarrhal fever.

**Treatment** Buparvaquone is effective.

**Control** None required for indigenous cattle; vaccination and strategic tick control for exotics.

## ETIOLOGY

*Theileria annulata* is a member of the apicomplex group, like *T. parva* the cause of east coast fever. It is highly virulent for European dairy cattle. Infection in local zebu cattle is often subclinical.

## EPIDEMIOLOGY

### Occurrence and methods of transmission

The disease occurs from Morocco and Portugal in the west through the Mediterranean basin and the Middle East to India and China in the east. *T. annulata* affects cattle and is transmitted transstadially by the three-host tick *Hyalomma anatolicum* in central-western Asia and north-eastern Africa, and by the two-host tick *H. detritum* in the Mediterranean basin. The extent of its distribution may overlap with that of *T. parva* in Sudan and Eritrea and with *T. sergenti* in the Far East. In endemic areas, virtually all adult animals are infected, but case fatality is about 10-20% and is confined mainly to calves. Exotic animals recently introduced may have 20-90% mortality. The disease occurs when there is much tick activity, mainly in summer and the rainy seasons, and in crossbred animals. A single tick can cause fatal infection since its salivary glands usually contain numerous sporozoites. An outbreak occurred recently in a Scottish dairy farm and was believed to have been due to mechanical transmission from experimentally infected calves on a research institute associated with the farm. In the absence of natural vectors, that outbreak was quickly controlled.<sup>1</sup>

### Risk factors and immune mechanisms

The normal state is that of endemic stability. This balance is disturbed when exotic animals are introduced and heavier losses occur. Recovered animals show a solid, long-lasting immunity, but they remain as carriers. Buffaloes are believed to be the natural hosts and may also act as carriers whereas yaks are highly susceptible. As with *T. parva*, immunity is mainly cell-mediated but is poor in calves. Experimental reproduction is by feeding infected ticks on cattle or by needle inoculation of sporozoites in macerated ticks, schizonts in lymphocytes, or merozoites in erythrocytes. Humans are not affected.

### Economic importance

The disease is a major constraint to livestock improvement programs in many parts of the Middle East and Asia<sup>2</sup> and about 200 million cattle are at risk.<sup>3</sup>

### Biosecurity concerns

There are none.

### PATHOGENESIS

The life cycle of *T. annulata* is cattle-tick-

cattle as for *T. parva* but unlike *T. parva*, the sporozoites of *T. annulata* invade and form schizonts mostly in macrophages/monocytes that express major histocompatibility (MHC) class II antigens, rather than in lymphocytes.<sup>4</sup> Schizont infected cells multiply in the draining lymph nodes and disseminate rapidly throughout the lymphoid tissues and in non-lymphoid organs including the liver, kidney, lung, abomasum, and brain. Later, schizonts differentiate into merozoites and invade erythrocytes (as piroplasms). The pathogenesis therefore involves proliferation of lymphocytes and macrophages induced by schizonts and anemia with icterus induced mostly by the piroplasms. The lymphoproliferation is controlled by suppressor macrophages as a protective mechanism leading to recovery.<sup>5</sup> Over 90% of erythrocytes may be parasitized, each by one or more merozoites. Immunosuppression may occur in the acute phase of lymphoproliferation, but is generally less marked than in ECF,<sup>3</sup> probably because leukocyte numbers return to normal soon after the acute phase.

#### CLINICAL FINDINGS

In a stable endemic situation, there may be only mild or no clinical disease in local zebu cattle.<sup>4</sup> Clinical signs are acute and severe in exotic cattle and less severe in crossbreeds, and are similar to those in ECF. However, the course is longer in tropical theileriosis and may last for weeks before death. Clinical signs include marked fever, swelling of superficial lymph nodes, inappetence, tachycardia, dyspnea, pale mucous membranes and icterus. Others are diarrhea, weight loss, convulsions, torticollis and other nervous signs.<sup>6,7</sup> In chronic cases, there may be small subcutaneous nodules from which schizonts can be demonstrated in smears.<sup>8</sup>

#### CLINICAL PATHOLOGY

As with ECF, examination of smears of blood and lymph node biopsy will reveal piroplasms in erythrocytes and schizonts in lymphocytes. Schizonts of *T. annulata* tend to be more common in the liver than in lymph node smears, but are otherwise indistinguishable from those of *T. parva*. Furthermore, the piroplasms are predominantly round and oval, as opposed to *T. parva* which has comma- and rod-shaped piroplasms. Anemia is a significant feature of tropical theileriosis, unlike in ECF, and is associated with bilirubinemia, hemoglobinuria, and bilirubinuria. The anemia results from destruction of erythrocytes containing piroplasms but other factors may include autoimmune hemolysis and poor bone marrow response. Reduction in white cell and platelet

counts is less severe than in ECF, but animals dying from the disease show persistent and severe lymphocytopenia involving mainly T-lymphocytes.<sup>6</sup>

The most commonly used serological diagnostic technique is the indirect fluorescent antibody test. For surveys, an indirect enzyme-linked immunosorbent assay (ELISA) test using a recombinant *T. annulata* surface protein has been described.<sup>9</sup> The ELISA tests provide higher sensitivity and specificity than IFAT.<sup>10</sup> Carriers can be detected by the polymerase chain reaction (PCR),<sup>11</sup> a test that can also be used to detect infected ticks.

#### NECROPSY FINDINGS

Apart from pallor of mucous membranes and yellowish discoloration of tissues, the postmortem lesions in animals dying from tropical theileriosis are similar to those of ECF. Liver, spleen and lymph nodes should be submitted for laboratory examination to detect schizonts whereas merozoites are detected in blood smears.

#### DIFFERENTIAL DIAGNOSIS

Tropical theileriosis may be confused with the other theilerioses that may occur in the region, and with babesiosis, anaplasmosis, trypanosomosis, and malignant catarrhal fever. Liver biopsy and blood examination will help to confirm a clinical diagnosis.

#### TREATMENT

Buparvaquone is the most effective agent available, and the recommended dose is 2.5 mg/kg BW.<sup>12</sup> In calves, supportive treatment for anemia is indicated. Halofuginone at 1.2 mg/kg is also effective but tetracycline at 20 mg/kg is less so.

#### CONTROL

Indigenous cattle live with the disease and do not require any intensive tick control or treatment. For valuable exotic stock or their crossbreeds, vaccination and strategic tick control are recommended. Vaccines can be made from either the sporozoite or the schizont. The sporozoite vaccine is based on the infection-and-treatment method using schizont-infected cell lines and simultaneous tetracycline treatment as for *T. parva*. It has been suggested that the most economical way to control theileriosis in India is to vaccinate calves and to reserve buparvaquone for treating clinical cases.<sup>13</sup> The schizont vaccine was formerly blood containing a mild strain of the parasite. The newer vaccines are prepared from live schizonts grown in lymphoid cell culture and attenuated by prolonged passage. They cause virtually no adverse reactions and vaccinated cattle show good resistance to the disease for

at least 3.5 years. Therefore, it is necessary to revaccinate, preferably with a different cell line vaccine, if tick population is too low to establish endemic stability. The risk for spread of the vaccine strains in the field is very low.<sup>14</sup>

#### REVIEW LITERATURE

Brown CGD. Theileriosis. In: Sewell MMH, Brocklesby DW (eds) Handbook on animal diseases in the tropics, 4th edn. London: Baillière Tindall, 1990; pp. 183–199.

Pipano E, Shkap V. *Theileria annulata* theileriosis. In: Coetzer JA, Tustin RC (eds) Infectious diseases of livestock, 2nd edn. Cape Town: Oxford University Press, 2004; vol 1, pp. 486–487.

#### REFERENCES

- Williamson S et al. State Vet J 2003; 12:1.
- Hashemi-Fesharki R. Parasitol Today 1988; 4:36.
- Hall FR. Parasitol Today 1988; 4:257.
- Forsyth LMG et al. J Comp Pathol 1999; 120:39.
- Preston PM et al. Parasit Res 2002; 88:522.
- Preston PM et al. Res Vet Sci 1992; 53:230.
- Omer OH et al. J Vet Prev Med 2003; 50:200.
- Manickam R et al. Ind Vet J 1984; 61:13.
- Bakheit MA et al. Parasit Res 2004; 92:299.
- OIE. Manual of diagnostic tests and vaccines for terrestrial animals, 5th edn. 2004; chapter 2.3.11, [http://www.oie.int/eng/normes/mmanual/A\\_00062.htm](http://www.oie.int/eng/normes/mmanual/A_00062.htm)
- d'Oliviera C et al. J Clin Microbiol 1995; 33:2665.
- Sharma NN, Mishra AK. Trop Anim Health Prod 1990; 22:63.
- Singh J et al. Trop Anim Health Prod 1993; 25:75.
- Gubbels MJ et al. Annals NY Academy Sci 2000; 916:521.

### Diseases associated with trypanosomes (trypanosomoses)

Trypanosomes are flagellated protozoan parasites that live in the blood and other body fluids of vertebrate hosts. With the help of the flagellum, they swim in body fluids, boring their way between cells. They generally possess a kinetoplast and undergo cyclical development in an arthropod vector. Their biological adaptations, morphology, and pathogenicity are fascinating and are being extensively studied. Each of the parasites causes a disease (now termed trypanosomosis rather than trypanosomiasis) in animals and humans as summarized in Table 26.7. Trypanosomoses of veterinary importance are discussed below.

#### NAGANA (SAMORE, AFRICAN TRYPANOSOMOSIS, TSETSE FLY DISEASE)

##### ETIOLOGY

*Trypanosoma vivax*, *T. congolense*, *T. brucei* and *T. simiae* are the four main species responsible for African trypanosomoses affecting virtually all domestic mammals. *T. vivax* and *T. congolense* are the main pathogens of cattle. The four species are members of the *Salivaria*



Table 26.7 Summary of the trypanosomoses of domestic animals and humans

Disease	Distribution	Trypanosoma spp.	Main vector
<b>Animals</b>			
Nagana or African trypanosomosis (most mammals)	Tropical Africa	<i>T. brucei brucei</i> <i>T. congolense</i> <i>T. vivax</i> <i>T. simiae</i>	<i>Glossina</i> spp. Other biting flies
Surra (horses, camels, buffaloes)	Africa, Asia, South and Central America	<i>T. evansi</i>	Biting flies
Dourine (horses and donkeys)	Africa, Asia, South and Central America	<i>T. equiperdum</i>	None (venereal transmission)
Non-pathogenic (cattle and sheep)	Worldwide	<i>T. theileri</i> <i>T. melophagium</i>	Biting flies
<b>Humans</b>			
Rhodesian sleeping sickness	East, central and southern Africa	<i>T. brucei rhodesiense</i>	<i>Glossina</i> spp.
Gambian sleeping sickness	West and central Africa	<i>T. brucei gambiense</i>	<i>Glossina</i> spp.
Chagas' disease (also in dogs, cats and pigs)	South and Central America, southern United States	<i>T. cruzi</i>	<i>Rhodnius</i> spp. <i>Triatoma</i> spp.

### Synopsis

**Etiology** *Trypanosoma congolense*, *T. vivax*, *T. brucei* and *T. simiae*, all salivarian trypanosomes. Parasites undergo cyclical development in tsetse flies (*Glossina* spp.), the vector, but they can also be transmitted mechanically by other biting flies.

**Epidemiology** Endemic disease of all mammals in tropical Africa, also Central and South America; of greatest economic importance in cattle.

**Pathogenesis** Fly inoculation of metacyclic trypanosomes → chancre → trypomastigotes → intermittent parasitemia → anemia with or without tissue invasion → other clinical signs and immunosuppression.

**Clinical signs** Fever, apathy, pale mucous membranes, swollen lymph nodes, progressive emaciation, cachexia and death. May be acute, subacute or, often, chronic.

**Clinical pathology** Progressive anemia, parasite detection in blood by various methods.

**Lesions** Not definitive but include palor, emaciation, enlargement of liver, spleen and lymph nodes.

#### Differential diagnosis list

- Malnutrition
- Helminthosis
- East coast fever
- Babesiosis
- Anaplasmosis
- Hemorrhagic septicemia.

**Treatment** Trypanocides such as Berenil, Samorin, Suramin, and Antrycide, but drug resistance is a problem.

**Control** Integrated methods involving tsetse fly control, prophylaxis, good husbandry and use of trypanotolerant breeds, no vaccine.

group of trypanosomes and are transmitted cyclically via the mouthparts of tsetse flies, hence the name salivarian trypanosomes. *T. vivax* is usually numerous

in bovine blood, and can be identified by its very fast movement in wet films. In stained smears, it is a long, slender, monomorphic parasite with a rounded posterior end, a terminal kinetoplast, and a long free flagellum, but no prominent undulating membrane. *T. congolense* is smaller, sluggish in wet films, and often adheres to red blood cells by the anterior end. In stained smears, it is a short parasite with a marginal kinetoplast, no free flagellum, and no prominent undulating membrane. *T. brucei* is large like *T. vivax*, but its rapid movement is in confined areas of the wet film. In stained smears, it is pleomorphic and may occur as long and slender forms, intermediate forms, or short and stumpy forms. The slender and intermediate forms have a long free flagellum, pointed posterior end, subterminal kinetoplast and a prominent undulating membrane, whereas the stumpy forms resemble *T. congolense*, but are bigger and have a prominent undulating membrane. *T. simiae* is morphologically indistinguishable from *T. congolense*, but the organism will be swarming in the blood of pigs.

### EPIDEMIOLOGY

#### Occurrence

The epidemiology of African trypanosomosis is determined mainly by the ecology of the tsetse fly which is found only in tropical Africa. *T. vivax* is also transmitted mechanically by biting flies and occurs also in Central and South America. Affected countries include Bolivia, Brazil, Colombia, French Guiana, Guyana, Peru, Suriname, and Venezuela where it affects mainly cattle and sheep.<sup>1</sup> Whereas *T. congolense* and *T. vivax* are responsible for severe disease in cattle, sheep and goats, *T. brucei brucei* usually causes a subclinical infection in cattle, but a severe disease in sheep, goats, horses and,

occasionally, pigs. *T. simiae* causes a very acute and highly fatal disease in exotic pigs. It is not pathogenic to cattle, sheep, or goats.

#### Prevalence

Infection rates in cattle in endemic areas vary considerably and could be over 60%. However, as a result of various control methods, the prevalence is decreasing in many African countries, particularly in West Africa, and was as low as 10% in Mali in the 1980s.<sup>2</sup> In a 1989–1991 survey involving approximately 20 000 cattle, 3000 sheep, and 3000 goats in Nigeria, the prevalence was 4.3% in cattle, 1.6% in sheep, and 1.0% in goats, based on parasite detection.<sup>3</sup> Higher prevalence rates are obtained if diagnosis is based on serology, but this does not reflect current infection. *T. vivax* and *T. congolense* are the species most frequently encountered in ruminants, but with serology *T. brucei* is also frequently reported. Mixed infections with two or three species are common. Pigs and horses are less frequently affected than ruminants, perhaps because they are less exposed to tsetse flies than cattle that normally graze over long distances. In Central and South America, *T. vivax* infections appear to be spreading to new areas where they cause periodic outbreaks of serious disease in cattle.

#### Morbidity and case fatality

Morbidity rates during outbreaks are variable and may reach 70% in cattle infected with *T. vivax* and up to 100% in pigs infected with *T. simiae*. It is usually much lower in sheep, goats, and horses since these are not often the preferred hosts for tsetse or are less exposed to tsetse challenges. Sheep and goats are more vigorous than cattle in defending themselves against successful feeding by tsetse flies. Case fatality also depends on

parasite species, host, and its level of resistance. *T. simiae* is invariably fatal in exotic pigs. Some strains of *T. vivax* in East Africa cause similar heavy mortalities in exotic dairy cows, and infected horses are likely to die if left untreated. However, most infections in cattle in endemic areas run a chronic course and are not invariably fatal, but the animal may remain unproductive and unthrifty.

### Methods of transmission

#### Cyclical

African trypanosomes can be transmitted by 23 species of tsetse (*Glossina*) found only in sub-Saharan Africa between latitudes 14°N and 29°S, excluding areas of high altitude, extreme drought or cold temperatures where tsetse cannot survive. Tsetse species can be grouped according to their preferred habitats as savannah species, riverine species, and forest species. The savannah species (including *G. morsitans*, *G. austeni*, *G. pallidipes*, *G. swynnertoni*, and *G. longipalpis*) pose the greatest threat to livestock because they inhabit grasslands where cattle are traditionally reared, they can easily adapt to other ecological niches, they feed primarily on cattle and pigs, and they are efficient vectors of trypanosomes. They are also the main vectors of Rhodesian sleeping sickness associated with *T. brucei rhodesiense* in humans (Table 26.7). The riverine species (*G. palpalis*, *G. tachinoides*, and *G. fuscipes*) are important as vectors of bovine and porcine trypanosomosis, as well as of Gambian sleeping sickness due to *T. brucei gambiense*. On the other hand, the 13 or so forest species (including *G. fusca*, *G. brevipalpis*, and *G. longipennis*) are not frequently incriminated vectors of trypanosomes even though their preferred food hosts are ruminants and suids.

The life cycle of trypanosomes in tsetse involves cyclical development for a varying length of time, depending on species and ambient temperatures. *T. vivax* completes its developmental cycle in the proboscis and pharynx and can be transmitted (as metacyclic trypanosomes) within a week of the initial infective feed. The cycle of *T. congolense* involves the midgut and proboscis and is completed in about 2 weeks. That of *T. brucei* is more complex: it takes 3 or more weeks and involves the midgut and salivary glands. Once infected, flies remain so for life (1–2 months). It follows that for any fly, its vectorial capacity and efficiency are highest for *T. vivax* and least for *T. brucei*.

#### Non-cyclical

After trypanosomes have been introduced into a herd, transmission is possible even in the absence of *Glossina*. Biting flies

such as Tabanidae, Stomoxyinae, and Hippoboscidae are capable of mechanically transmitting trypanosomes in their mouth parts if they feed on more than one host within a short interval. This is how *T. vivax* is spread in areas outside the tsetse belt in Africa, as well as in Central and South America. Mechanical transmission can also occur through the needle during inoculations and in carnivores feeding on infected carcasses. Intrauterine infections occasionally occur.<sup>4</sup>

#### The carrier state

Reservoirs of infection are found in many wild animals, in trypanotolerant animals, and in chronically infected animals. Tsetse caught in and around game reserves tend to have relatively high infection rates and the relative abundance of wildlife in East Africa as compared to West Africa may explain, at least in part, why the prevalence of the disease appears to be declining more rapidly in the west.

### Risk factors

#### Host factors

The effect of infection varies with the host in that most wild animals, and some domestic ones, establish a balance with the parasite and remain as clinically normal carriers for long periods. Specifically, some breeds of cattle indigenous to Africa can tolerate light to moderate challenge with tsetse flies by limiting the multiplication of trypanosomes in their blood and by apparently warding off the infection, especially *T. vivax*.<sup>5</sup> The phenomenon is called **trypanotolerance**, it is both genetic and environmental in origin, and the level of tolerance varies. Thus, the indigenous taurine breeds, such as the N'Dama, Baoule and Muturu, are more tolerant than the West African zebu,<sup>6</sup> and amongst East African zebu cattle, the Orma Boran and Maasai zebu have superior tolerance when compared with Galana Boran and Friesian breeds.<sup>5,7</sup> Crossbreeds of indigenous taurine and zebu animals are also more tolerant than purebred zebu. However, due to the uncertain genetic makeup of animals within these so-called breeds and crossbreeds, the level of trypanotolerance may also vary with individual animals within a given category and it can be overcome by heavy tsetse challenge, malnutrition, or other stress factors. Trypanotolerance also occurs in some indigenous breeds of small ruminants, notably the West African Dwarf sheep and goats and the East African goats, whereas the Toggenburg, British Alpine, Saanen, and Anglo-Nubian breeds of goats are fully susceptible.

#### Environmental factors

The density of tsetse population in the area, and the level of their contact with

the host, will determine the level of infection. This is further influenced by the vectorial capacity of the fly and the availability of its preferred host, which may not be livestock. Trekking of cattle through tsetse-infested vegetation is a risk nomadic farmers face from time to time and the risk is even greater where cattle routes converge, for example, at major bridges or watering holes. Agricultural and industrial developments generally lead to a lowering of tsetse density by destroying its habitat, whereas the establishment of game or forest reserves provides large numbers of preferred hosts or a suitable habitat for tsetse, respectively. Herds located near such reserves are therefore at a higher risk. So also are tourists visiting game parks.

#### Pathogen factors

In cattle, *T. vivax* generally produces a higher level of parasitemia than other species. And since its life cycle in the tsetse is also shorter, *T. vivax* is more readily transmitted than the others when animals are newly introduced into a tsetse infested area. Higher parasitemias also facilitate mechanical transmission. On the other hand, *T. brucei* is rarely detectable by direct examination of cattle blood, even though infection can be confirmed through other diagnostic methods. Furthermore, some animals carry infection without showing clinical signs, especially if they are trypanotolerant like the Muturu in Nigeria,<sup>8</sup> or if infected with non-pathogenic genetic types, for example, *T. congolense* kilifi type in cattle.<sup>9</sup>

#### Immune mechanisms

Animals recovering from infection with one strain/serodeme or species of trypanosome are not immune to infection with another strain/serodeme or species. This is due to the ability of trypanosomes to readily change their surface coat antigens through a process called **antigenic variation**. The glycoprotein surface coat is continuously shed and replaced by mechanisms not fully understood, but probably induced by antibodies. During each peak parasitemia, a mixture of variable antigenic types of parasites is present, but the dominant antigens determine the specific antibody response. These antibodies kill off the dominant population, leaving others with different dominant antigens; these multiply, and the process continues in cycles until the animal dies or the immune mechanisms catch up with the parasite and the animal recovers. This phenomenon is also responsible for the successive waves of parasitemia in infected animals. Following repeated episodes of infection and recovery (with or without treatment) in an endemic area,

animals will encounter a variety of antigenic types and therefore become less susceptible to strains/serodemes in that area.

Infected animals are more susceptible to secondary infections by other microorganisms, particularly bacteria. The mechanisms involved are not fully understood, but may vary with the species of animals. In ruminants, the state of immunosuppression is abrogated once the trypanosomes are eliminated by chemotherapy.

### Experimental reproduction

Infection can be easily reproduced by inoculation of infected blood or other body fluid into a susceptible host. Infected flies can also be fed on the host to transmit the disease. Several laboratory animal models are available and lots of studies are done with mice and rats.

### Economic importance

Tsetse flies infest 10 million square kilometers of Africa involving 37 countries. Hence, nagana is today the most important disease of livestock in the continent. The added risk of human infections has greatly affected social, economic, and agricultural development of rural communities. Since nagana is a wasting disease, affected animals are chronically unproductive in terms of milk, meat, manure, and traction, and the mortality rate can be high. The disease in Africa costs livestock producers and consumers an estimated US\$1340 million each year.<sup>10</sup> The anticipated losses due to *T. vivax* in South America exceed \$160 million.<sup>1</sup> Furthermore, the disease may impact on various immunization campaigns in endemic areas due to the fact that it can cause immunosuppression.

### Zoonotic implications

The animal pathogens do not infect humans, but animals can serve as reservoirs of *T. brucei rhodesiense* and *T. brucei gambiense*, the causes of human sleeping sickness, which are morphologically indistinguishable from *T. brucei brucei*. Human infections result from tsetse bites, generally in game parks, forest reserves, and along streams or other rural setting. The incidence has fallen greatly since the early part of the 20th century, but outbreaks still occur from time to time, especially when civil unrests force people into tsetse-infested areas. Up to 100 000 cases are reported per year and *T. brucei gambiense* sleeping sickness has re-emerged as a major public health problem in Central Africa, especially in the Democratic Republic of the Congo, Angola, and Southern Sudan, where civil wars have hampered control efforts.<sup>11</sup>

A rash (chancre) develops at the site of tsetse bite and this is soon followed by fever, persistent headache, and swelling

of lymph nodes, spleen, and liver. Weakness and signs of cardiac involvement may be noticed early in the Rhodesian form and the disease is rapidly fatal. The Gambian form is more chronic, lasting for 3 or more years during which the patient gradually wastes away or dies from secondary infection. The parasite invades the cerebrospinal fluid leading to progressive non-suppurative meningoencephalitis which causes the patient to fall asleep often, hence the name sleeping sickness.

### Biosecurity concerns

There are none because the vector requires strict environmental conditions to survive. People working with *T. b. gambiense* and *T. b. rhodesiense* should take precautions to avoid accidental inoculation of themselves or their co-workers with infected material in syringes or tsetse flies.

### PATHOGENESIS

Nagana in most species is a progressive, but not always fatal disease and the main features are anemia, tissue damage, and immunosuppression. Metacyclic trypanosomes are inoculated intradermally as the fly feeds. They multiply at this site provoking a local skin reaction (chancre), which is most pronounced in a fully susceptible host and may be slight or absent with some strains or species of trypanosomes. Within the chancre, metacyclic parasites change to trypomastigote form, enter the bloodstream directly or through the lymphatics, and initiate characteristic intermittent parasitemias. Their behavior thereafter depends largely on the species of trypanosome transmitted and the host. *T. vivax* usually multiplies rapidly in the blood of cattle, sheep and goats, and is evenly dispersed throughout the cardiovascular system, whereas *T. congolense* tends to be aggregated in small blood vessels and capillaries of the heart, brain, and skeletal muscle, and rarely causes heavy parasitemias in ruminants. Both species exert their effect mainly by causing severe anemia and mild to moderate organ damage. The anemia has a complex pathogenesis involving mainly increased erythrophagocytosis, some hemolysis, and dys-hemopoiesis. Very acute infections with *T. vivax* in cattle or *T. simiae* in pigs result in fulminating parasitemias and disseminated intravascular coagulation with hemorrhages. Such syndromes resemble a septicemia, and anemia may not be severe.

*T. brucei* and, rarely, *T. vivax*, have the added capability of escaping from capillaries into interstitial tissues and serous cavities where they continue to multiply. Such infections result in more severe organ damage in horses, sheep, and goats, in addition to anemia. The cerebrospinal fluid is often invaded by *T. brucei* alone<sup>12,13</sup>

or mixed with other species, or as a relapse after an apparently successful treatment.<sup>12,14</sup>

Animals chronically infected with any pathogenic trypanosome may develop concurrent and even fatal bacterial, viral, and other protozoan infections as a result of immunosuppression. Pregnant animals may abort, and transplacental fetal infections occasionally occur. Trypano-tolerant animals control parasitemias better and have less severe anemia and organ damage. They usually recover from the disease, but may act as carriers.

### CLINICAL FINDINGS

There are no pathognomonic signs that would help in pinpointing a diagnosis. The general clinical picture is as follows but there are many variations determined by the level of tsetse challenge, the species and strain of the trypanosome, and the breed and management of the host. Acute episodes last for a few days to a few weeks from which the animal dies or lapses into a subacute to chronic stage, or the illness may be chronic from the beginning. Chronic cases may run a steady course, may be interrupted by periodic incidents of severe illness, or undergo spontaneous recovery.

The basic clinical syndrome appears after an incubation period of 8–20 days. There is fever, which is likely to be intermittent and to last for a long period. Affected animals are dull, anorexic, apathetic, have a watery ocular discharge, and lose condition. Superficial lymph nodes become visibly swollen, mucous membranes are pale, diarrhea occasionally occurs, and some animals have edema of the throat and underline. Estrus cycles become irregular, pregnant animals may abort, and semen quality progressively deteriorates.<sup>15,16</sup> The animal becomes very emaciated and cachectic and dies within 2–4 months or longer. Thin, rough-coated, anemic, lethargic cattle with generalized lymph node enlargement are said to have a 'fly-struck' appearance.<sup>17</sup>

In general, *T. congolense* is more pathogenic to cattle in eastern and southern Africa, whereas *T. vivax* produces a more serious disease in West Africa. However, severe outbreaks of *T. vivax* involving exotic dairy animals in East Africa occur; affected animals show mucosal petechiation, rhinorrhagia, dysentery, and death after an illness of only a few weeks. Mixed infections are common and are usually more severe. Furthermore, inter-current bacterial, viral, or other parasitic infections may mask or complicate the basic clinical syndrome. Immune response to bacterial, and some viral, vaccines is also depressed but is restored if trypanocidal therapy is given at the time of vaccination.<sup>18</sup>

Clinical findings peculiar to the individual trypanosome are as follows:

- *T. vivax* affects all agricultural species except pigs. Acute and chronic outbreaks occur, anemia is severe, and fever is usually associated with high parasitemia. A chronic form of the disease is more usual in East Africa, but an acute hemorrhagic form can occur with exotic cattle. *T. vivax* is less commonly seen in trypanotolerant cattle breeds
- *T. congolense* affects all species, usually with an acute disease lasting 4–6 weeks, but some chronic cases occur, especially in West Africa. Anemia and emaciation are severe
- *T. brucei* affects all species with a subacute to chronic disease in which subcutaneous edema and keratoconjunctivitis may be marked. Nervous signs are manifested in horses, pigs, and small ruminants by ataxia, circling, head pressing, and paralysis.<sup>19,20</sup> Cattle are usually asymptomatic, with few exceptions<sup>21</sup>
- *T. simiae* affects exotic pigs with a fulminating infection in which the animal dies within hours or a few days of first appearing ill. There is fever, stiff gait, dyspnea, and cutaneous hyperemia, but no significant anemia.

#### CLINICAL PATHOLOGY

The anemia results in a progressive drop in packed cell volume, a non-specific but useful indicator in endemic areas. The classic method of confirming diagnosis is to demonstrate parasites in a wet blood film, and in a thin or thick blood smear stained with Giemsa. This is easiest in the early stages of the disease when parasitemic peaks correspond with fever. As the disease progresses, parasitemias become infrequent and the intervals between peaks grow longer, even though the animal is still sick. To increase the accuracy of parasitological diagnosis, it is now routine to concentrate the parasites in the buffy coat layer of a microhematocrit capillary tube. The buffy layer is then examined directly at low power (Woo's method) or in a wet preparation with a dark ground/phase contrast microscope (Murray's method). Both tests are simple, sensitive, and applicable to field use on individual animals as well as in herds. Blood should be examined fresh but may be refrigerated for up to 24 hours, beyond which most parasites will die and disappear from the sample.<sup>22</sup>

In chronic cases, blood can also be inoculated into experimental animals, usually rodents, but this is cumbersome and is accurate for only *T. brucei*, and possibly *T. congolense*, but not *T. vivax*.

Another alternative is a series of standard serological tests to detect anti-trypanosome antibodies in sera or other body fluids. The three tests used most often are the indirect immunofluorescent antibody test (IFAT), the capillary agglutination test (CAT), and the ELISA. These tests have the disadvantage that they indicate past as well as present infections, are difficult to standardize for different laboratories, and are not species-specific. The ELISA technique was modified to detect circulating trypanosome antigens (antigen-ELISA) using monoclonal antibodies that would distinguish between *T. vivax*, *T. congolense*, and *T. brucei*, and would detect only current or very recent infections.<sup>23</sup> Extensive field trials in Africa and the Caribbean have shown that the test is not sufficiently sensitive or specific and that it needs to be combined with other parasitological methods to provide reliable results.<sup>24</sup>

The polymerase chain reaction (PCR) technique can be used to detect trypanosome DNA in tissue and in blood.<sup>25</sup> The test is sensitive and species specific and can be combined with ELISA.<sup>26</sup> Under experimental conditions, it can also be used to monitor therapy, especially relapses, since treated animals should become PCR negative 1–2 days after treatment.<sup>27</sup> It is also possible to do retrospective epidemiological survey using serum banks.<sup>28</sup> Dried blood spots on filter papers are also a useful source of DNA for the detection of *T. congolense* and *T. brucei* by PCR.<sup>29</sup> But the test is expensive and can only be done in specialized laboratories.

#### NECROPSY FINDINGS

##### Gross pathology

The postmortem lesions are, like the clinical findings, not definitive. The carcass is marked by anemia, emaciation, anasarca, and enlargement of the liver, spleen, and lymph nodes. Body fat stores are depleted or show marked serous atrophy, especially around the heart and in bone marrow. There may be corneal opacity and testicular degeneration. In acute cases, there will be a general congestion of the viscera and extensive hemorrhages in all tissues. Chronic cases show cachexia, often complicated with secondary bacterial or other parasitic diseases.

Microscopic lesions are also not specific, except in very acute infections in which clumps of trypanosomes mixed with fibrin thrombi are found in blood vessels. Lymphoid organs are usually hyperplastic and may show varying degrees of erythrophagocytosis or hemosiderosis. Bone marrow macrophages may engulf red cells as well as other immature and mature cells.<sup>30</sup> The interstitial tissues of

various parenchymatous organs may contain a lymphoplasmacytic infiltrate. This tends to be most marked with *T. brucei* in which the parasites often localize extravascularly in the interstitial tissue. A severe non-suppurative meningoencephalitis or myocarditis may result. Degenerative changes may also be present in the liver, testis, and pituitary gland.

#### Specimens for pathology

Smears from tissues, usually the cut surface of a lymph node or heart muscle, are examined for trypanosomes. With *T. brucei*, smears of body fluids, including the cerebrospinal fluid may contain many parasites even when they are undetectable in blood. Trypanosomes die and disintegrate soon after the host dies and will not be seen in smears if postmortem examination is delayed for even a few hours. The following organs should be taken for histopathology: lymph nodes, spleen, liver, heart, kidney, brain, and any other organ showing gross lesions. The immediate cause of death is often a combination of trypanosomosis and a concurrent bacterial or parasitic infection.

#### DIFFERENTIAL DIAGNOSIS

Diagnosis is based on detecting parasites in blood. Since parasitemias fluctuate, multiple samples from a herd or repeated sampling of a suspected case may be required before a specific diagnosis can be made. Furthermore, infected animals may be suffering from a concurrent disease. Emaciation and anemia can also be associated with:

- Malnutrition
- Helminthosis
- Babesiosis
- Anaplasmosis
- East coast fever

Acute trypanosomosis may be confused with hemorrhagic septicemia and anthrax. Laboratory examination of blood, feces, and other tissues is required to confirm diagnosis.

#### TREATMENT

The number of trypanocidal drugs available for treating and preventing infections in endemic areas is limited, and about 6 million doses are administered yearly in Africa.<sup>31</sup> The drugs have been in the market for over 30 years, their range of therapeutic safety is small, many of them cause severe local reactions especially in horses, and some may be fatal in high doses. Furthermore, as drugs are not always available and they are expensive, underdosing is common. These, plus the fact that some drugs are used both prophylactically and therapeutically, have led to cases of drug resistance.

Ideally, each country or region establishes a group of sanative drugs which are to be used only as a break in a course of one of the more common drugs. The sanative drug should provide moderate prophylaxis and avoid the development of resistance to the prime drug. These measures have not been well-executed in many countries and this may explain the increasing reports of multiple resistance to curative, sanative, and prophylactic drugs.<sup>32,33</sup> Nevertheless, the prevalence of drug-resistant trypanosomes in the field still remains unclear as there are no suitable methods for the detection of resistant field isolates.<sup>34</sup> For example, drug resistance has been reported to be very low in eastern Zambia<sup>35</sup> but widespread in Burkina Faso<sup>36</sup> and Ethiopia.<sup>37</sup>

Strains are regarded as resistant when they fail to respond to the drug or when they relapse some time after an apparent cure. Relapses are more likely to occur if the commencement of treatment is delayed or the dose rate is inadequate. However, in field situations, there is hardly any regular monitoring of drug efficacy and animals may be reinfected with the same or other species of trypanosomes soon after an otherwise effective cure.

The common drugs in use against trypanosomes are set out below. The specific dose rates vary with animal species, the specific trypanosome, and the specific purpose (curative, prophylactic, or sanative).<sup>31,38</sup>

- Diminazene aceturate (Berenil) is used widely against *T. vivax* and *T. congolense* as a curative and sanative drug at 3.5–7 mg/kg BW. It is well-tolerated by ruminants and it is one of the two recommended drugs for bovine trypanosomiasis. It is not well-tolerated by horses
- Homidium bromide (ethidium) and homidium chloride (novidium) are also widely used against *T. congolense* and *T. vivax* as curative and sanative drugs at 1 mg/kg BW
- Isometamidium (Samorin or Trypamidium) is the other preferred drug against *T. vivax* and *T. congolense* in ruminants. It is used as a curative and prophylactic drug at 0.25–1 mg/kg BW. At much higher doses (12.5–35 mg/kg BW) it can be used prophylactically against *T. simiae* in pigs but not without the risk of death from acute cardiovascular collapse<sup>39</sup>
- Pyrithidium bromide (prothridium) is less widely used against *T. congolense* and *T. vivax* as prophylaxis at 2 mg/kg BW

- Quinapyramine sulfate (Antrycide) is no longer used extensively in cattle, but it is the preferred curative drug (at 5 mg/kg BW) against *T. brucei* in horses. Quinapyramine sulfate and chloride (Antrycide prosalt) is used prophylactically at 7.4 mg/kg BW
- Suramin (naganol) may also be used against *T. brucei* as a curative and prophylactic drug at 10 mg/kg BW in horses and camels
- Antrycide–Suramin complex is the only other drug against *T. simiae* in pigs and it is used prophylactically at 40 mg/kg BW.

### CONTROL

The control of trypanosomiasis in enzootic countries involves control of tsetse fly population, prophylactic treatment, good husbandry of animals at risk, and use of trypanotolerant animals. There is no vaccine against the disease and, in spite of intensive research, none appears likely in the near future because of the ability of trypanosomes to readily change their glycoprotein surface coat through a process called antigenic variation.

Control of tsetse has been successfully attempted in some African countries, but reinvasion is frequent if the land is not properly utilized. The earliest methods involved bush clearing and elimination of game animals on which tsetse feed. These methods were effective in eradicating or controlling tsetse in some parts of the continent, especially in southern Africa, but they resulted in destroying valuable plant and animal resources, and also led to soil erosion. More recent methods involved the use of insecticides, especially DDT and endosulfan, applied strategically in the form of ground and aerial spraying over large expanses of land. As tsetse are sensitive to insecticides and no resistance has developed, considerable successes were achieved in some countries. However, spraying insecticides is costly and harmful to the environment. These harmful effects are considerably reduced if the insecticides, for example, synthetic pyrethroids, are applied directly on the animal in the form of spray or pour-on formulation. The latter offers great promise<sup>40</sup> and also reduces tick infestation in treated animals.

Other effective methods involve targets impregnated with insecticides and traps that attract and catch tsetse. These are simple and cheap and can be constructed and maintained by local communities.<sup>41</sup> Furthermore, they do not pollute the environment and are suitable for both small- and large-scale farming. They have been used to reduce tsetse fly population by over 97% within 7 months in a community in the Congo<sup>42</sup> and to

greatly reduce the incidence of trypanosomiasis in another community in south-western Kenya over a 12-year period.<sup>43</sup> Another method is the sterile male technique. Since the female tsetse only mates once in a lifetime, this technique is theoretically able to eradicate a targeted tsetse species in areas where other methods have been used to reduce its density. But it is expensive. Finally, it should be stated that development of the land for agriculture, industries, highways, etc. will effectively destroy the habitat for tsetse flies. This has occurred significantly in Nigeria where there were rapid economic activities and expanding human population in the 1970s and 1980s.<sup>44</sup>

Attempts at trypanosomiasis control have also been directed to prophylactic dosing with chemicals such as suramin, prothridium, and isometamidium (Samorin). Prophylaxis is used along with other methods in areas where there is a heavy tsetse challenge. The prophylactic effect is supplemented by the development of antibodies, and the total period of protection may be as long as 5 months. However, it is customary to give four or five treatments per year. The productivity response to this pattern of treatment is good if general husbandry is also adequate. The downside of this approach is that it has reportedly led to drug resistance in many countries.

Trypanotolerant animals are being used to establish ranches in areas where tsetse challenge is not too heavy, but they have not been readily accepted in some countries, supposedly because they are smaller in size and they produce less milk than other indigenous breeds and crosses with exotic breeds.

For effective control of trypanosomiasis in Africa and in Central and South America, an integrated approach will mostly likely produce the desired results in each region. In the absence of a vaccine, control methods must combine reduced exposure to the vectors (large scale tsetse trapping and pour-on applications) with strategic treatment of exposed animals (chemotherapy and chemoprophylaxis) along with use of trypanotolerant animals when feasible.

### REVIEW LITERATURE

- Anosa VO. Haematological and biochemical changes in human and animal trypanosomiasis. *Rev Elev Med Vet Pays Trop* 1988; 41:65–78, 151–164.
- Connor RJ, Van den Bossche P. African animal trypanosomiasis. In: Coetzer JAW, Tustin RC (eds) *Infectious diseases of livestock*, 2nd edn. Cape Town: Oxford University Press, 2004; vol 1, pp. 251–296.
- Desquesnes M. *Livestock trypanosomiasis and their vectors in Latin America*. Paris: OIE (World Organization for Animal Health), 2004.

- Hunter AG, Luckins AG. Trypanosomosis. In: Sewell MMH, Brocklesby DW (eds) Handbook on animal diseases in the tropics, 4th edn. London: Baillière Tindall, 1990; pp. 204–226.
- Ikede BO. African trypanosomes. In: Honigberg BM. Mechanisms of pathogenicity among Protozoa. Insect Sci Applic 1986; 7:363–378.
- Jordan AM. Trypanosomiasis control and African rural development. London: Longman, 1988.
- Losos G. Trypanosomiasis. In: Infectious tropical diseases of domestic animals. London: Longman, 1986; pp. 182–318.
- Stephen LE. Trypanosomiasis: A veterinary perspective. Oxford: Pergamon Press, 1986.

## REFERENCES

- Davila AMR et al. Ann NY Acad Sci 2000; 916:199.
- Awan MAQ et al. Bull Anim Health Prod Afr 1988; 36:330.
- Anosa VO et al. In: Control of animal trypanosomiasis in Nigeria. Progress Report by VO Anosa, 1993.
- Ikede BO et al. Acta Trop 1988; 45:5.
- Njogu AR et al. Vet Rec 1985; 117:632.
- Akol GWO et al. Vet Immunol Immunopathol 1986; 11:361.
- Mwangi EK et al. Ann NY Acad Sci 1998; 849:195.
- Uza DV et al. Bull Anim Health Prod Afr 1998; 46:125.
- Bengaly Z et al. Vet Parasit 2002; 108:1.
- Kristjansson PM et al. Agric Systems 1999; 59:79.
- Aksoy S et al. Adv Parasit 2003; 53:1.
- Moulton JE. Vet Pathol 1986; 23:21.
- Whitelaw DD et al. Parasitology 1985; 90:255.
- Masake RA et al. Acta Trop 1984; 41:237.
- Akpavie SO et al. Res Vet Sci 1987; 42:1.
- Sekoni VO et al. Anim Reprod Sci 1991; 24:249.
- Connor RJ, Van den Bossche P. In: Coetzer JAW, Tustin RC (eds) Infectious diseases of livestock, 2nd edn. Cape Town: Oxford University Press, 2004; vol 1, p. 251.
- Mwangi DM et al. Trop Anim Health Prod 1990; 22:95.
- Agu WE, Bajeh ZT. Trop Vet 1986; 4:25.
- Onah DN, Uzoukwu M. Trop Anim Health Prod 1991; 23:39.
- Welde BT et al. Ann Trop Med Parasit 1989; 83:151.
- Ekwuruke JO et al. Acta Trop 1985; 42:273.
- Nantulya VM et al. Parasite Immunol 1987; 9:421.
- Mattioli RC, Faye JA. Acta Trop 1996; 62:71.
- Penchenier L et al. Parasite 1996; 3:387.
- Masake RA et al. Vet Parasit 2001; 96:101.
- Bengaly Z et al. Vet Parasit 2002; 108:1.
- Desquesnes M. Acta Trop 1997; 63:139.
- Katakura K et al. Parasit Res 1997; 83:241.
- Anosa VO et al. Vet Pathol 1992; 29:33.
- Finelle P. FAO Anim Prod Health Paper 1983; 37:1.
- Ainanshe OA et al. Trop Anim Health Prod 1992; 24:65.
- Joshua RA. Rev Elev Med Vet Pays Trop 1988; 41:359.
- Chitambo H et al. Res Vet Sci 1992; 52:243.
- Sinyangwe L et al. Vet Parasit 2004; 119:125.
- McDermott J et al. Acta Tropica 2003; 86:93.
- Assefa E, Abebe G. Vet Parasit 2001; 99:261.
- Barry JD, Turner CMR. Parasitol Today 1991; 7:207.
- Kinabo LDB et al. Res Vet Sci 1991; 50:6.
- Lohr K-F et al. Trop Med Parasitol 1991; 42:131.
- Dransfield RD et al. Parasitol Today 1991; 7:287.
- Noireau F et al. Rev Elev Med Vet Pays Trop 1990; 43:93.
- Brightwell R et al. Bull Entomol Res 1997; 87:349.
- Ikede BO et al. Proc Intern Sci Council Trypanosomiasis Res Control, 19th Meeting, Lome, Togo, publ no 114, 1987; p. 289.

## SURRA (MAL DE CADERAS, MURRINA)

### Synopsis

**Etiology** *Trypanosoma evansi* (synonym *T. equinum*), morphologically similar to *T. brucei*. Parasites are transmitted mechanically by biting flies, mainly tabanids, and in Latin America, by vampire bats.

**Epidemiology** Endemic disease of mainly horses and camels in the tropics and subtropics, seasonality is related to fly population.

**Pathogenesis** Fly inoculation → parasite multiplication in blood and body fluids → clinical signs.

**Clinical signs** Fever, progressive emaciation, anemia, subcutaneous edema, nervous signs, death. May be acute, subacute, or chronic.

**Clinical pathology** Progressive anemia, parasite detection in blood by various methods, serology.

**Lesions** Not definitive but include palor, emaciation and jaundice.

### Differential diagnosis list

- Nagana
- Malnutrition
- Helminthosis
- Babesiosis
- Anaplasmosis
- Hemorrhagic septicemia.

**Treatment** Trypanocides as in nagana, but less effective.

**Control** Chemotherapy and prophylaxis, no vaccine.

## ETIOLOGY

*Trypanosoma evansi*, the first pathogenic trypanosome to be identified in 1880 in India, belongs to the *brucei* group (subgenus *Trypanozoon*) but is not capable of cyclical development in tsetse *Glossina* spp. In blood smears, *T. evansi* is morphologically indistinguishable from *T. brucei*, but at the molecular level, the structure of the kinetoplast DNA of *T. evansi* is different.<sup>1</sup> *T. equinum* in South America is now accepted as a dyskinetoplastic variant of *T. evansi* rather than a separate species.

## EPIDEMIOLOGY

### Occurrence

Surra has a wide distribution in areas of Africa north of the tsetse belt and in the Middle East, Asia, and Central and South America. The disease in South America is called 'mal de caderas' or 'murrina'. In some countries, the incidence of surra increases significantly during the rainy season when there are large biting fly populations, the so-called 'surra season'. The disease affects mainly camels and horses, but buffaloes and cattle are also affected. In South America, surra has not been reported in New World camelids, even though they are susceptible.<sup>2</sup>

## Morbidity and case fatality

Infection rates of 20% are not uncommon in camels living in the northeastern parts of Africa, and they can be as high as 70%.<sup>3</sup> The case fatality in horses and camels is nearly 100% if untreated, but is much lower in cattle and buffalo where the disease tends to run a chronic course.

## Method of transmission

Several hematophagous flies can transmit *T. evansi* mechanically, but the most important is the horse fly (*Tabanus* spp.), followed by the stable fly (*Stomoxys* spp.). Transmission is enhanced when horses or camels congregate or are closely herded and when they have high numbers of parasites in their blood. In South America, the vampire bat also transmits the disease in its saliva. The process can be mechanical as for flies but also biological in that parasitemia occurs in the bats which may die from the infection or recover and serve as carriers. Therefore, vampire bats are simultaneously hosts, reservoirs, and vectors of *T. evansi*.<sup>4</sup> Carnivores can also be infected perorally when they feed on an infected carcass.

Indigenous cattle, buffalo, and several species of wildlife may act as reservoirs of infection for horses and camels. Immune mechanisms are related to antigenic variation of the parasite and the production of antibodies by the host, as in *T. brucei*. The disease can be reproduced experimentally by blood inoculation. Humans are not susceptible.

## Economic importance

Surra is one of the most important diseases of camels. Camel raising in Africa and buffalo production in Asia are severely affected by the disease. As in nagana, losses are due to reduced productivity, mortality, and cost of treatment. In Indonesia, surra is ranked as the third most important livestock disease, with losses in 1984 estimated at more than US\$20 million.<sup>5</sup>

## Biosecurity concerns

There are none.

## PATHOGENESIS

Trypanosomes are inoculated into the host from the contaminated mouthparts of biting insects or the saliva of vampire bats. Parasite multiplication in the blood and body fluids causes inflammatory changes and anemia just like *T. brucei*.<sup>6</sup> The parasite frequently localizes extravascularly in tissues including the central nervous system where it is less exposed to chemotherapeutic agents.

## CLINICAL FINDINGS

The main clinical findings are intermittent fever, progressive anemia, edema of

dependent parts of the body, dullness, listlessness, loss of body condition despite a good appetite, nasal and ocular discharge, and terminal nervous signs, including paraplegia, paralysis, delirium, and convulsion.<sup>1-4</sup> Surra is invariably fatal in camels and horses, death occurring within a few days or a few months, but camels may exhibit chronic signs for years. These signs include a reduction in milk yield and capacity for work, and a high abortion rate in pregnant females.<sup>7</sup> Cattle and buffalo in endemic areas usually have mild infections which may be exacerbated by stress from adverse climatic conditions, work, or intercurrent disease. Signs may include irregular estrus, abortion, and stillbirth in cows, and poor semen quality in bulls. Outbreaks of a more severe disease in indigenous zebu cattle have been reported in Thailand, characterized by nervous signs and high mortality rate; the signs included circling, excitation, jumping, aggressive behavior, lateral recumbency, convulsion, and finally death.<sup>8</sup>

#### CLINICAL PATHOLOGY

As with *T. brucei*, parasite detection including the buffy coat method is easier in the acute phase. In the chronic phase, repeated sampling for some days may be required. In addition, suspected blood samples may be inoculated into rats or mice both of which are highly susceptible. A number of non-specific serological tests can also be used but are more reliable in areas where other forms of trypanosomes do not exist. These include mercuric chloride, formol gel, or stilbamidine test for increased serum protein levels. Specific antibody detection tests are also available, but await large-scale evaluation and standardization.<sup>9</sup> They include direct card agglutination test (CAAT) for antibodies, the latex agglutination test (Suratex) for circulating antigens, the indirect fluorescent antibody test (IFAT), and the enzyme-linked immunosorbent assay (ELISA). In a study in Kenya, CAAT and Suratex were reported to be more sensitive than parasitological methods in revealing the true extent of surra in camel herds,<sup>10</sup> contrary to an earlier study from Chad.<sup>11</sup> Techniques involving the polymerase chain reaction (PCR) have been described; they are more sensitive and specific, but too expensive for routine use.<sup>4,12</sup>

#### NECROPSY FINDINGS

The carcass is emaciated and pale and may be icteric but, as in *T. brucei* infections, there are no pathognomonic gross and microscopic lesions. However, a lymphoplasmacytic infiltrate of various organs, including the brain and spinal cord, is characteristic. Parasites are detect-

able in body fluids if the carcass is fresh. Tissues for laboratory examination should include blood, brain, lymph nodes, spleen, and liver.

#### DIFFERENTIAL DIAGNOSIS

Laboratory services are required to confirm a diagnosis, and even then surra cannot be easily distinguished from *T. brucei* infection where both coexist. Clinical signs and gross and microscopic lesions of both diseases in horses and camels are identical.

#### TREATMENT

Drugs used for treating nagana could be used for surra, but the outcome is less favorable owing to their low trypanocidal activity against *T. evansi* and their specific toxicity for camels and horses. Furthermore, the drugs are not able to cross the blood-brain barrier to reach parasites in the cerebrospinal fluid and nervous tissue. As a result, drug resistance readily occurs, especially if the accurate dose is not given.

Quinapyramine sulfate (quintrycide) is used curatively for camels, and diminazene aceturate (Berenil) for horses and camels. On the other hand, quinapyramine prosalt (trypacide), suramin (naganol) and isometamidium chloride (samorin or trypanidium) are used both curatively and prophylactically. The new drug is a water-soluble arsenical, RM110 or Cymerlasan (melarsomine), given SC at 0.3–0.6 mg/kg BW. It is as effective as berenil in infected camels.<sup>7,13</sup>

#### CONTROL

Unlike in nagana, control measures are aimed primarily at the host rather than the vector, which is abundant. The measures include detection and treatment of infected animals, prophylactic treatment of susceptible animals, and their protection from biting flies and bats, where possible. As in nagana, there is no vaccine.

#### REVIEW LITERATURE

- Desquesnes M. Livestock Trypanosomoses and their vectors in Latin America. Paris: OIE (World Organization for Animal Health), 2004.
- Hunter AG, Luckins AG. Trypanosomosis. In: Sewell MMH, Brocklesby DW (eds) Handbook on animal diseases in the tropics, 4th edn. London: Baillière Tindall, 1990; pp. 204–226.
- Stephen LE. Trypanosomiasis: A veterinary perspective. Oxford: Pergamon Press, 1986.

#### REFERENCES

1. Donelson JE et al. J Protozool Res 1998; 8:204.
2. Kinne J et al. J Camel Pract Res 2001; 8:93.
3. Zelleke D et al. Trop Anim Health Prod 1989; 21:223.
4. Desquesnes M. Livestock trypanosomoses and their vectors in Latin America. Paris: OIE (World Organization for Animal Health), 2004.
5. ILRI (International Livestock Research Institute). ILRI 1995. Nairobi, Kenya: ILRI, 1996; p. 4.
6. Ikede BO et al. Trop Vet 1983; 1:151.

7. Schillinger D, Rottcher D. Wild Anim Rev 1986; 60:26.
8. Tuntasuva D et al. Vet Parasitol 1997; 73:357.
9. OIE. Manual of diagnostic tests and vaccines for terrestrial animals, 5th edn. 2004; chapter 2.5.15, [http://www.oie.int/eng/normes/mmanual/A\\_00093.htm](http://www.oie.int/eng/normes/mmanual/A_00093.htm).
10. Ngaira JM et al. Vet Parasit 2003; 114:131.
11. Delafosse A, Doutoum AA. Rev Elev Med Vet Pays Trop 2000; 53:249.
12. Wuyts N et al. Ann Soc Belg Med Trop 1995; 75:229.
13. Akbar ST et al. J Protozool Res 1998; 8:249.

#### DOURINE (MALADIE DU COIT)

**Etiology** *Trypanosoma equiperdum*.

**Clinical signs** Primary genital signs, secondary cutaneous signs and tertiary nervous signs.

**Epidemiology** Venereal disease of horses, mules, and donkeys, endemic in southern and northern Africa, Asia, and possibly South and Central America.

**Pathogenesis** Transmission during coitus → infection of genital mucosa → parasitemia → localization in skin and nervous system → edema and nervous signs.

**Clinical pathology** Serology; rarely, parasite detection in edema fluid and blood.

**Lesions** Edematous swelling and later, depigmentation of external genitalia, emaciation, anemia and subcutaneous edema.

#### Differential diagnosis list

- Nagana
- Surra
- Coital exanthema
- Equine infectious anemia.

**Treatment** Chronic cases unresponsive to trypanocides and they often become carriers.

**Control** Elimination of reactors, control of breeding and movement of animals in affected regions or countries.

#### ETIOLOGY

*Trypanosoma equiperdum* belongs to the *brucei* group, subgenus *Trypanozoon*, but occurs only as long, slender, and monomorphic forms and is morphologically indistinguishable from *T. evansi*. It is the only pathogenic trypanosome that does not require an arthropod vector for its transmission and it resides more in extravascular tissue fluid than in blood.

#### EPIDEMIOLOGY

##### Occurrence

Dourine is endemic in northern and southern Africa and Asia, and possibly South and Central America. However, it has not been reported in Latin America for over 15 years, possibly due to very strict international regulations which tend to discourage official notification of the disease.<sup>1</sup> Dourine has been eradicated from North America and there are no recent reports of outbreaks in Europe,



probably because of strict control measures. It is rare in sub-Saharan Africa, other than Ethiopia and Namibia. All Equidae are susceptible and natural infection is known to occur only in horses, mules and donkeys.

#### Measures of disease occurrence

The prevalence of dourine has declined generally since the horse is no longer that important militarily, economically, and agriculturally, and because of strict control measures in many countries. Recent reports, based on clinical signs and serology, indicate a prevalence in some herds to be as high as 7% in Mongolia,<sup>2</sup> 28% in Ethiopia,<sup>3</sup> and 29% in Namibia.<sup>4</sup> In South and Central America and in Europe, the disease occurs sporadically. Case mortality rate varies; in Europe it could be as high as 50–75%, but is much less elsewhere although many animals may have to be destroyed as a means of control.

#### Methods of transmission

Natural transmission occurs only by coitus, but infection can also be acquired through intact oral, nasal and conjunctival mucosae in foals at birth. The source of infection may be an infected stallion or mare actively discharging trypanosomes from the urethra or vagina, or an uninfected male acting as a physical carrier after serving an infected mare. The trypanosomes inhabit the urethra and vagina, but disappear periodically so that only a proportion of potentially infective matings result in infection. Invasion occurs through intact mucosa, no abrasion being necessary.

#### Risk factors

*T. equiperdum* is incapable of surviving outside the host and, like other trypanosomes, it dies quickly in cadavers. Some animals may be clinically normal but act as carriers of the infection for many years. Since the disease does not require an arthropod vector for its transmission, and in view of the extensive movement of horses across continents that now takes place, the risk of infection, though small, is present in every country, as with any other venereal disease. Thoroughbred horses are more susceptible than indigenous horses, and donkeys tend to show more chronic signs.

#### Immune mechanisms

Infected animals produce antibodies to successive antigenic variants, as in *T. brucei*. Recovered animals often become carriers. Blood from infected horses is rarely infective to other horses, and the disease is not easily transmitted to ruminants under experimental conditions. Humans are not affected.

#### Biosecurity concerns

There are none.

#### PATHOGENESIS

*T. equiperdum* shows a remarkable tropism for the mucosa of genital organs, the subcutaneous tissues, and the peripheral and central nervous systems. Trypanosomes deposited during coitus penetrate the intact genital mucosa, multiply locally in the extracellular tissue space, and produce an edematous swelling which may later undergo fibrosis. Subsequent systemic invasion occurs and localization in other tissues causes vascular injury and edema, manifested clinically by subcutaneous edema. Invasion of the peripheral nervous system and the spinal cord leads to incoordination and paralysis.

#### CLINICAL FINDINGS

The severity of the clinical syndrome varies depending on the strain of the trypanosome and the general health of the horse population. The disease in Africa and Asia is much more chronic than in South America or Europe and may persist for many years, often without clinical signs, although these may develop when the animals' resistance is lowered by other disease or malnutrition.

The incubation period varies between 1 and 4 weeks, but could extend to more than 3 months in some animals. Initial signs may not be recognized until the breeding season. The ensuing disease will manifest genital signs in the primary stage, cutaneous signs in the secondary stage, and nervous signs in the tertiary stage.<sup>5</sup>

In the stallion, the **initial signs** are swelling and edema of the penis, scrotum, prepuce, and surrounding skin, extending as far forward as the chest. Paraphimosis may occur and inguinal lymph nodes are swollen. There is a moderate mucopurulent urethral discharge. In mares, the edema commences in the vulva and is accompanied by a profuse fluid discharge, hyperemia, and sometimes ulceration of the vaginal mucosa. The edema spreads to the perineum, udder, and abdominal floor. In Europe, the disease is more severe, genital tract involvement often being accompanied by sexual excitement and more severe swelling.

In the **secondary stage**, cutaneous urticaria-like plaques, 2–5 cm in diameter, develop on the body and neck and disappear within a few hours up to a few days. These so-called 'silver dollar spots' are pathognomonic for dourine but are not always present, and are uncommon in endemic areas. Succeeding crops of plaques may result in persistence of the cutaneous involvement for several weeks.

The **tertiary stage** is characterized by progressive anemia, emaciation, weakness, and nervous signs appearing at a variable time after genital involvement. Stiffness

and weakness of the limbs are evident and incoordination develops, progressing terminally to ataxia and paralysis. Marked atrophy of the hindquarters is common and in all animals there is loss of condition, in some to the point where extreme emaciation necessitates destruction. Lack of coordination of the hind legs, swelling of the external genitalia, and emaciation were the most common clinical signs in horses suspected to have dourine in Ethiopia.<sup>3</sup>

#### CLINICAL PATHOLOGY

Trypanosome detection is difficult, but should be attempted in edema fluid, subcutaneous plaques, and vaginal or urethral washings or blood in early stages. Inoculation of blood into laboratory rodents is not as helpful as with other members of the *brucei* group. An efficient complement fixation test (CFT) is available and was the basis for a successful eradication program in Canada, but there are discrepancies in some of the CFT results.<sup>6</sup> Other serological tests that can be used include the indirect fluorescent antibody test (IFAT), the capillary agglutination test for trypanosomes (CATT), and the enzyme linked immunosorbent assay (ELISA), but the CFT remains the most reliable.<sup>5,7</sup> Serological tests do not distinguish between members of the *brucei* group and hence they are of limited value in areas where *T. brucei* or *T. evansi* is endemic, even when monoclonal antibodies are used. The polymerase chain reaction (PCR) has been used to detect trypanosome DNA and is an indication of an active infection, unlike the CFT which detects past and current infections. But the PCR test cannot yet distinguish *T. equiperdum* from *T. evansi*. Furthermore, it has not been possible to isolate new strains of *T. equiperdum* from clinical cases that have appeared in various parts of the world since 1982.<sup>6,8</sup> Therefore, new internationally recognized tests for the diagnosis of dourine are needed urgently.

#### NECROPSY FINDINGS

Emaciation, anemia, and subcutaneous edema are always present, and edema of the external genitalia may be evident or the external genitalia may have healed, leaving the characteristic depigmented scars of permanent leukodermic patches.<sup>5</sup> Lymph nodes are enlarged and there is softening of the spinal cord in the lumbosacral region.

Histological lesions consist of lymphoplasmacytic infiltration in the spinal nerves, ganglia, and meninges of the lumbar and sacral regions, and in affected skin and mucosa. Trypanosomes can be found in sections of the skin and genital mucosa during the primary and secondary phases of the infection.

Affected lymph nodes show non-specific lymphoid hyperplasia.

#### DIFFERENTIAL DIAGNOSIS

The full clinical syndrome is diagnostic, when present, since no other disease has the clinical and epizootiological characteristics of dourine. However, when the full clinical picture is not developed, other diseases like nagana, surra, coital exanthema, equine infectious anemia, and purulent endometritis should be considered. Recent reports of the disease have been based on clinical signs, serology and detection of trypanosome DNA, but not on parasitological detection.

#### TREATMENT

Many trypanocidal drugs have been used in the treatment of dourine, but results are variable, chronic cases in particular being unresponsive to treatment. Berenil (diminazene) at 7 mg/kg BW as a 5% solution injected IM, with a second injection of half the dose 24 hours later, or suramin (10 mg/kg IV for two to three treatments at weekly intervals), or

quinapyramine sulfate (3–5 mg/kg in divided doses injected SC) have been tried. The main drawback is that treated animals may remain inapparent carriers.

#### CONTROL

In dourine-free countries, an embargo should be placed on the importation of horses from countries where the disease is endemic, unless the animals have been properly tested and found negative. Eradication on an area or herd basis is by the application of the CFT, along with strict control of breeding and movement of horses. Positive reactors are disposed of, and two negative tests not less than a month apart can be accepted as evidence that the disease is no longer present. Castration or neutering of infected animals is not adequate because mating can still occur.

#### REVIEW LITERATURE

Barrowman P et al. Dourine In: Coetzer JAW, Thomson GR, Tustin RC (eds) *Infectious diseases of livestock with special reference to southern Africa*. Cape Town: Oxford University Press, 1994; vol 1, pp. 206–212.

Hunter AG, Luckins AG. Trypanosomosis. In: Sewell MMH, Brocklesby DW (eds) *Handbook on animal*

*diseases in the tropics*, 4th edn. London: Baillière Tindall, 1990; pp. 204–226.

Luckins AG et al. Dourine. In: Coetzer JAW, Tustin RC (eds) *Infectious diseases of livestock*, 2nd edn. Cape Town: Oxford University Press, 2004; vol 1, pp. 297–304.

OIE. Manual of diagnostic tests and vaccines for terrestrial animals, 5th edn. 2004; chapter 2.5.2, [http://www.oie.int/eng/normes/mmanual/A\\_00080.htm](http://www.oie.int/eng/normes/mmanual/A_00080.htm)

Stephen LE. Trypanosomiasis: A veterinary perspective. Oxford: Pergamon Press, 1986.

#### REFERENCES

1. Desquesnes M. Livestock trypanosomoses and their vectors in Latin America. Paris: OIE (World Organization for Animal Health), 2004.
2. Clausen PH et al. *Vet Parasit* 2003; 115: 9.
3. Clausen PH et al. *Tokai J Exp Clin Med* 1998; 23:303.
4. Kumba FF et al. *Onderstepoort J Vet Res* 2002; 69:295.
5. Hagebock JM. *Foreign Anim Dis Report* 1991; 19:9.
6. Zablotskij VT et al. *Rev Sci Techn OIE* 2003; 22:1087.
7. Williamson CC et al. *Onderstepoort J Vet Res* 1988; 55:117.
8. OIE. Manual of diagnostic tests and vaccines for terrestrial animals, 5th edn. 2004; chapter 2.5.2, [http://www.oie.int/eng/normes/mmanual/A\\_00080.htm](http://www.oie.int/eng/normes/mmanual/A_00080.htm)

## Diseases associated with helminth parasites

27

**NEMATODE DISEASES OF THE ALIMENTARY TRACT 1541****PARASITIC GASTROENTERITIS IN RUMINANTS 1541****HEMONCHOSIS IN RUMINANTS 1548****BUNOSTOMOSIS (HOOKWORM DISEASE) IN RUMINANTS 1552****OESOPHAGOSTOMOSIS (NODULE WORM DISEASE) IN RUMINANTS AND PIGS 1553****PARASITIC GASTRITIS IN PIGS 1555****ASCARID INFECTIONS IN PIGS, HORSES AND CATTLE 1556****STRONGYLOSIS (REDWORM INFESTATION) IN HORSES 1558****MISCELLANEOUS ROUNDWORM INFESTATIONS 1562***Oxyuris* (pinworm) 1562*Strongyloides* (threadworm) 1562*Trichuris* (whipworm) 1563*Chabertia* 1563*Habronema* and *Draschia* 1563*Macracanthorhynchus* (thorny-headed worm) 1563**NEMATODE DISEASES OF OTHER ORGANS 1564****LUNGWORM INFESTATION 1564**

Lungworm in cattle 1564

Lungworm in horses 1568

Lungworm in sheep and goats 1568

Lungworm in pigs 1569

**KIDNEY WORM DISEASE IN PIGS 1570****NEMATODE INDUCED SKIN CONDITIONS 1571**

Summer sores in horses 1571

Rhabditid dermatitis 1572

Onchocercosis 1573

Elaeophorosis (filarial dermatitis) in sheep 1573

Parafilariosis 1574

Stephanofilariosis 1574

**NEMATODES AFFECTING EYES OR NERVOUS SYSTEM 1575***Thelazia* (eyeworm) 1575*Halicephalobus* 1575*Elaphostrongylus* 1575*Setaria* 1575**DISEASES ASSOCIATED WITH TREMATODES AND CESTODES 1576****HEPATIC DISEASES ASSOCIATED WITH TREMATODES 1576**

Fasciolosis (liver fluke disease) 1576

*Fascioloides* 1580*Dicrocoelium* 1580**STOMACH FLUKE DISEASE (INTESTINAL AMPHISTOMOSIS) 1580****TAPEWORM INFESTATIONS 1581**

Adult tapeworm infestation 1581

Larval tapeworm infestation 1582

## Nematode diseases of the alimentary tract

**Parasitic gastroenteritis in ruminants****Synopsis****Etiology** The nematode genera *Trichostrongylus*, *Ostertagia* (including *Teladorsagia*), *Cooperia*, and *Nematodirus*.**Epidemiology** Transmission is by ingestion of infective larvae. Disease risk is determined by factors influencing the susceptibility of the host, the numbers of infective larvae accumulating on pasture and the numbers of larvae undergoing hypobiosis within the host. Calves and lambs are most vulnerable, as are goats of all ages. Type I disease follows recent infestation; Type II disease is delayed until hypobiotic larvae resume development.**Signs** Diarrhea and weight loss, production losses.**Clinical pathology** High fecal egg count (in young animals) (unless disease caused by immature worms), elevated plasma pepsinogen and gastrin concentrations (in abomasal infections only).**Lesions** Raised nodules on gastric mucosa and/or inflammation and villous atrophy in anterior small intestine.**Diagnostic confirmation** Worm counts at necropsy, otherwise largely reliant on clinical signs and history. Fecal egg counts and plasma pepsinogen concentrations confirmatory in some instances.**Treatment** Avermectins/milbemycins; benzimidazoles/probenzimidazoles; levamisole and morantel. Not all compounds are suitable for controlling hypobiotic larvae.**Control** Methods differ widely according to climatic region and management. The major aim is to maintain safe grazing by reducing pasture contamination. Integrated management schemes which reduce dependence on drug usage are preferred as anthelmintic resistance is a serious or emerging problem in many areas, particularly in sheep and goats.**ETIOLOGY**The nematode genera *Trichostrongylus*, *Ostertagia*, *Cooperia*, and *Nematodirus* (known locally as scour worms or hair worms) often occur together in the alimentary tract of ruminants. Their combined effects on the host, together with those of other alimentary nematodes such as *Oesophagostomum* and the hookworms, are commonly known as parasitic gastroenteritis (PGE). The main species are listed in Table 27.1 together with their hosts and anatomical preferences. The listed worms are from the same nematode family and are collectively known as the trichostrongylids. *Haemonchus* also belongs to this group but is considered separately as the disease processes itprovokes are more complex. Taxonomists now believe that the *Ostertagia* species of sheep should be assigned to a different genus, *Teladorsagia* and *Nematodirus* to a different family, but the clinical convenience of the older nomenclature has been retained for the purposes of this chapter. Related species from other hosts, for example *Ostertagia leptospicularis* from deer, sometimes cause disease outbreaks in cattle.<sup>1</sup>**LIFECYCLE**The trichostrongylids all have direct lifecycles (i.e. there is no intermediate host). Eggs passed in the feces hatch under suitable environmental conditions, producing two non-parasitic larval stages and then the infective third-stage larva. This is ensheathed, i.e. it retains the shed cuticle from the previous molt for protection. The eggs of *Nematodirus* spp. are different from the others. They are larger and do not hatch initially. Instead, an infective ensheathed larva develops within the egg thereby gaining even greater resistance to harsh environmental conditions. When infective trichostrongylid larvae are ingested by the host, they exsheath and depending on species, enter either the gastric glands of the abomasum or the crypts of the small intestine. Here they molt, return to the lumen and

Table 27.1 Anatomical distribution of trichostrongylid worms in ruminants

Parasite	Cattle		Sheep, goats	
	Abomasum	Small intestine	Abomasum	Small intestine
<i>Trichostrongylus</i> spp.				
<i>T. axei</i> †	*		*	
<i>T. colubriformis</i> ,		*		*
<i>T. longispicularis</i>				*
<i>T. falculatus</i> , <i>T. vitrinus</i> ,				*
<i>T. capricola</i> , <i>T. rugatus</i> ,				
<i>T. probolurus</i>				
<i>Ostertagia</i> spp.				
<i>O. ostertagi</i>	*			
<i>O. circumcincta</i> ,‡			*	
<i>O. trifurcata</i> ‡				
<i>Cooperia</i> spp.				
<i>C. punctata</i> ,		*		*
<i>C. oncophora</i>				
<i>C. pectinata</i>		*		
<i>C. curticei</i>				*
<i>Nematodirus</i> spp.				
<i>N. spathiger</i> ,		*		*
<i>N. battus</i> ,				
<i>N. filicollis</i> ,				
<i>N. abnormalis</i> ,				
<i>N. helvetianus</i>				

†*Trichostrongylus axei* also occurs in the stomach of horses.

‡The genus name *Teladorsagia* is often used in place of *Ostertagia* for these species.

after a fourth molt mature to become adult. The time from ingestion of larvae to appearance of egg-laying females (the prepatent period) normally takes about 3 weeks, except for *Nematodirus*, which takes a week or so more. This period may become extended as third- or early fourth-stage larvae, depending on species, can become arrested in development (hypobiotic) thereby delaying emergence from the mucosa for weeks or months.

**Hypobiosis** is probably an adaptation phenomenon similar to diapause in insects and happens during periods of adverse pasture conditions. For example, strains of *O. ostertagi* from northern Europe, the northern United States, and New Zealand undergo hypobiosis in autumn with worms resuming development in spring, while strains in the southern United States and Australia hypobiose in spring to emerge after the dry season in autumn.<sup>2</sup> Thus, hypobiosis ensures that a new generation of adults is ready to lay eggs when the external environment again becomes favorable. The environmental stimuli that condition infective larvae to become hypobiotic in the host vary with species and locality, and in most cases are unknown. For *O. ostertagi* in Europe, exposure of infective larvae to low temperatures in the autumn is the trigger. The proportion of ingested larvae becoming arrested varies greatly with locality and, in some places, also from year to year.

## EPIDEMIOLOGY

Natural trichostrongylid infestations mostly comprise a mixture of species. The relative importance of each varies with locality and season. In sheep and cattle, *Ostertagia* tends to be of greatest clinical significance in winter rainfall areas while *Haemonchus* is predominant in summer rainfall zones. Other genera may dominate in some areas or under some management practices. Sheep and goats share many trichostrongylid species but cross-infection between sheep and cattle occurs only to a limited extent. Patterns of disease are determined by factors influencing the susceptibility of the host, the numbers of infective larvae accumulating on the pasture and the numbers of larvae undergoing hypobiosis in the host.

**Resistance** to trichostrongylid infections is complex and involves genetically determined physiological and acquired immunological components. Age resistance is seen particularly in the case of *Nematodirus*, where 3 to 4-month-old lambs are better able to withstand larval challenge than younger animals. Differences in susceptibility occur between breeds and between individuals within a group.<sup>3</sup> Acquired immunity in sheep and cattle develops quickly after exposure to *Nematodirus* but takes much longer with other gastrointestinal trichostrongylids. Consequently, disease associated with *Nematodirus* is only likely to occur at first exposure, but animals remain susceptible

to the other trichostrongylids for most or all of the first grazing season. In cattle, exposure to *Cooperia* leads to immunity earlier in the season than is the case with *Ostertagia*.<sup>4</sup> Lambs can develop high resistance to *Trichostrongylus* by about 6 months of age when larval intake is high, but this period is extended when challenge is low.<sup>5</sup> Immunity may be expressed as:

- A reduction in parasite numbers
- Stunted surviving worms
- Lowered egg output by females
- A smaller establishment of incoming larvae.

The term '**resilience**' is used to describe the ability of an animal to withstand the damaging effects of parasitic infestation (as distinct from limiting worm numbers). Resistance and resilience can be affected adversely by stress and nutritional deficiencies. Moderate infestations can be tolerated by animals on a good plane of nutrition when similarly infected but poorly nourished animals would succumb. In weaner lambs, the reduction of food intake at weaning increases susceptibility, while the poor quality of winter feed has the same effect in older stock. Massive infestations can overwhelm even well-fed animals.

**A relaxation in immunity** to trichostrongylid infection occurs in sheep but not cattle before or at the time of parturition and reaches a peak 6–8 weeks after lambing. This happens because priority is given for allocation of scarce metabolizable protein to milk production over immune functions.<sup>6</sup> As a result, ewes pass large numbers of worm eggs onto the pasture over a period of several weeks. This is known as the periparturient egg rise (PPER) and is an important source of pasture contamination.

***Nematodirus* spp. behave differently** from other trichostrongylids. This genus does not contribute to the PPER in ewes and so lambs are the sole source of contamination on sheep pastures. *Nematodirus* eggs containing the infective third-stage larvae hatch only after exposure to specific stimuli, particularly warmth after a period of low temperatures. Thus, most hatch in the spring of the year following that in which they were deposited (although a proportion may hatch in the autumn of the first year).<sup>7</sup> Unlike the other trichostrongylids, therefore, *Nematodirus* is transmitted from one lamb crop to the next. *N. battus* is more pathogenic than the other species because its hatching requirements are more precise. This results in many eggs hatching simultaneously to produce a sudden overwhelming wave of pasture contamination.

The eggs and free-living larvae of *Trichostrongylus*, *Ostertagia*, *Cooperia*, and *Nematodirus* can survive and develop at much lower temperatures than those of *Haemonchus*. The eggs and larvae of *Ostertagia* and *Nematodirus* are particularly resistant to cold temperatures. The eggs of the latter worm contain trehalose, which acts as an antifreeze.<sup>8</sup> All these trichostrongylids can survive a moderate winter but the spectrum of endemic species declines as regional winter conditions become more severe.<sup>9</sup> Snow cover however protects infective larvae from extreme cold. Upper temperature limits for survival are also lower than for *Haemonchus* and this is why the clinical importance of *Ostertagia* spp. diminishes in warmer climates. Moisture is necessary for infective larvae to ascend the herbage and so transmission by all species is low in the absence of dew, rain or irrigation. Desiccation will kill larvae on the pasture but those still within fecal deposits can survive to emerge when rainfall resumes. Severe outbreaks of disease may occur after the first rains following a prolonged drought. Summer storms during a dry period reduce risk as released larvae quickly die when the pasture dries out.<sup>10</sup> In temperate climates, larvae leaving accumulated dung pats in the autumn after a dry summer may be conditioned for hypobiosis, thereby increasing risk of Type II disease (see 'Outbreaks of disease' below).

**Potential sources of contamination** on sheep pastures at the start of the grazing season are larvae that have overwintered on the herbage and, most importantly, larvae from eggs more recently shed by ewes during the PPER. On cattle pastures, overwintered larvae are of greatest significance as yearling and adult cattle generally deposit insignificant numbers of trichostrongylid eggs. In both cases, overwintered larvae do not survive long in the warmer spring weather as the food stores on which they depend are soon exhausted. In the meantime, however, some will be ingested by susceptible lambs or calves. Disease does not occur at this stage unless massive numbers of larvae have survived the winter. Most often, these first infections are small and asymptomatic. They are nevertheless of great epidemiological significance as the eggs produced are responsible for the infective larvae that appear on the pasture later in the season.

**The rate of larval development** is temperature dependent, occurring faster in warmer weather. The lifespan of infective larvae is, however, shorter at higher temperatures as food stores are used more quickly. The number of larvae

accumulating on pasture is therefore a balance between these two opposing factors and tends to follow a stereotyped pattern in each locality. Computer models are being developed to investigate these trends in different climatic zones and under different husbandry systems.<sup>11</sup> The general pattern of pasture infectivity may however be temporarily disrupted by short-term weather fluctuations. For example, with *O. ostertagi* in grazing calves in temperate climates, the new wave of infective larvae (the 'autoinfection peak') will not appear before mid-summer, but this event may be delayed or interrupted by periods of dry weather. As larvae of each trichostrongylid species have different optimum developmental conditions, peak numbers will occur at different times. In England, for example, the 'succession of species' in sheep is *N. battus* followed by *O. circumcincta* then *H. contortus* and finally *Trichostrongylus* spp.<sup>12</sup>

**Outbreaks of disease** due to trichostrongylid infection can occur in different ways. Clinical signs are normally initiated when developing worms emerge from the mucosa of the alimentary tract. With normally developing mucosal larvae, this will happen when the daily intake of infective larvae has risen to a level sufficient to overwhelm any immunity that may have developed. This is sometimes termed 'Type I' disease. The onset of clinical signs will be considerably delayed however when damage is produced by previously hypobiotic larvae resuming their development. This often occurs during the winter housing period and is known as 'Type II' disease. Additionally, hypersensitivity responses to incoming larvae can occur under some circumstances when immune animals graze heavily contaminated pasture. This has been proposed as an explanation for the so-called 'non-parasitic scouring syndrome' in southern Australia, which occurs in pregnant and lactating ewes grazing contaminated pasture.<sup>13</sup>

**Trichostrongylosis in sheep** is favored by cool, wet weather and is a disease of the winter months in those areas where rainfall occurs chiefly at this time of the year. Although the eggs and larvae of *Trichostrongylus* spp. tolerate cold, they are not resistant to freezing temperatures. Consequently, in very cold climates disease may be more common in the late summer and autumn. In arid areas the disease is of little significance except in unusually wet years. *T. axei* can infect a range of species but is primarily a parasite of cattle and is usually only seen in other hosts when grazing cattle pastures.

**The epidemiology of bovine ostertagiosis** is complex. Type I disease

is mostly seen in first-season grazing animals particularly dairy calves heavily stocked on permanent calf paddocks. Large numbers of adult worms are present and egg counts are high. In areas with warm climates, Type I ostertagiosis may be seen in almost any season but is particularly important in winter and spring. In areas with harsher winters, as in northern Europe, larvae overwinter in sufficient numbers to infect autumn-born calves after spring turnout. The resulting small worm burdens produce eggs that give rise to a new generation of infective larvae. These 'autoinfection larvae' are responsible for the disease outbreaks that occur from mid-July to the end of the grazing season. Type I ostertagiosis also occurs in beef cattle if placed on heavily infected pastures immediately after weaning. It is less often seen in calf suckler or extensive management systems because of the relatively low number of susceptible animals per unit area of grazing land.

**When hypobiosis occurs**, many fourth-stage larvae accumulate in the gastric glands. Few if any clinical signs will be apparent and egg counts will be zero or low. This condition is called pre-Type II ostertagiosis and occurs at a definite time each year depending on the region – autumn in northern Europe and spring in Australia. Type II disease occurs when waves of hypobiotic larvae emerge from the parasitized glands some 4–5 months later. This is typically when cattle are 12–24 months of age, although Type II disease is sometimes seen in older animals. Few adult worms will be present and egg counts will be correspondingly low.

**Goats** do not build up an effective immune response against trichostrongylid worms and so remain susceptible to disease throughout their lives. The risk is enhanced if they are forced to graze rather than browse. Problems are frequently encountered on hobby farms where goats are overstocked on small paddocks.

## PATHOGENESIS

Each trichostrongylid species differs in its habit and in the damage it causes and so details of the corresponding disease processes will vary correspondingly. The major mechanisms leading to diarrhea, weight loss and production deficits can however be described in general terms.

**In abomasal infection** with *Ostertagia* spp., developing larvae distend the gastric glands and produce small white nodules on the mucosal surface, but these are of little clinical significance. More important changes take place

18–21 d after infection when worms start to emerge from the glands.<sup>14</sup> This triggers a hyperplastic reaction in neighboring glands causing larger nodular lesions which, if numerous, may coalesce. Many of the cells lining affected glands are non-functional. The resulting reduction in acid-secreting parietal cells leads to increased gastric pH, which may rise to 6–7. This produces several domino effects. First, incoming bacteria and ruminal protozoa are not killed. Second, pepsinogen is not converted to pepsin as this only happens in an acid environment, thus, no pepsin is available for protein digestion. Accumulating amounts of the precursor molecule are reflected in elevated blood pepsinogen concentrations. Third, blood gastrin rises as the body attempts to stimulate more acid secretion. The hyperplastic mucosal reaction also results in increased permeability of the epithelial sheet. This leads to protein loss into the lumen of the abomasum. In mild uncomplicated cases, this protein leak and the disrupted protein digestion are both compensated by digestive/absorptive intestinal mechanisms. In severe cases, hypoalbuminemia, tissue edema and weight loss are apparent. Between these extremes, these processes lead to reduced muscle protein synthesis and consequent productivity losses.<sup>15</sup>

**Intestinal trichostrongylid infections** are associated with inflammatory changes, a thickening of the mucosa and a stunting or flattening of the villi. Epithelial enzyme activity is reduced. *Nematodirus* and *Cooperia* lie in close contact with the mucosa but *Trichostrongylus* spp. larvae and adults form superficial tunnels, causing additional tissue disruption. Lesions are confined to the anterior small intestine and their severity is determined by the density of worms. Surprisingly, malabsorption is not a marked feature of pathogenesis as unaffected parts of the intestine can usually compensate. Consequently, protein digestibility and absorption may be normal. There is, nevertheless, poor retention and utilization of nitrogen due to a protein-losing enteropathy, together with excessive losses from sloughed cells and mucus production. This contributes to production losses and causes hypoalbuminemia and edema in severe cases. Wool growth is affected and the fleece becomes brittle. Mineral absorption is impaired, resulting in reduced skeletal growth, bone density and mineralization.<sup>16</sup> *T. colubriformis* infection reduces the absorption of phosphorus and increases the loss of endogenous phosphorus, thus leading to a phosphorus deficiency.<sup>17</sup> As with abomasal parasitism, the precise

reason for the diarrhea associated with these infections is unknown.

**Reduced productivity** in both abomasal and intestinal parasitism is mostly due to a reduction in appetite that is a constant feature of these infections. In one field study,<sup>18</sup> untreated heifers spent on average 105 min less per day grazing as compared with a matched treated group and their daily herbage intake was 0.78 kg dry matter per day lower. Experimental studies show that inappetence accounts for over 60% of the difference in weight gains between *Ostertagia*-infected and worm-free sheep and cattle. The associated mobilization of adipose tissue gives rise to increased non-esterified fatty acid levels. Voluntary feed intake may be significantly depressed even in parasitized animals showing no clinical signs. The elevated gastrin levels in abomasal trichostrongylid infections impair reticulo-ruminal motility and slow abomasal emptying, leading to a stasis of ingesta and hence a reduction in feed intake.<sup>15</sup> Other, as yet unknown, mechanisms must also be involved as gastrin levels are not affected by intestinal worms, yet these also depress appetite.

#### CLINICAL FINDINGS

In sheep the two most susceptible age groups are weaner lambs and yearlings. Those over 18 months of age are less prone because of immunity gained from previous infestation. The onset of disease is generally insidious with young animals initially failing to grow satisfactorily and later becoming unthrifty, and lacking in vitality and bloom. If they are observed sufficiently closely their food intake can be seen to be reduced. This may be the full clinical picture in many flocks which are considered to have 'weaner illthrift'. More severely affected sheep pass dark green, almost black, soft feces which foul the wool of the breech. Lamb and yearling flocks are most seriously affected and a constant mortality begins, a few animals dying each day. The losses are not acute but may eventually exceed 35%. A more dramatic picture occurs when young lambs, especially those in the 6 to 12-week age group, are exposed to sudden pasture challenge with *Nematodirus* spp. There is profuse watery diarrhea and the lambs quickly become dehydrated. Mortality can be high and deaths may start within 2 d of the first observed illness.

**In cattle**, calves are most vulnerable in their first grazing season, although yearlings and, less often, adults are sometimes affected. They:

- Lose weight rapidly
- Pass soft feces which eventually become very thin and dark green to yellow in color

- Develop a long, dry hair coat
- Become dehydrated with sinking of the eyes in the terminal stages.

Until the last they continue to eat, although the amount of food taken is much below normal. Gross anemia is not evident but the mucosae are pale and dry. Submandibular edema is common, especially in Type II disease. The temperature may be elevated (39.5°C; 103°F) and the heart rate increased (120 bpm) in calves showing dehydration. In the terminal stages the calves become weak and emaciated. Type I ostertagiosis in calves is characterized by high morbidity and low mortality. Although morbidity is low in Type II disease, clinical signs are generally more severe and the prognosis poorer.

#### CLINICAL PATHOLOGY

Fecal egg counts have to be interpreted with caution as they are only well correlated with worm burdens in young animals. Egg counts are however often over 1000 epg (eggs per gram feces) in Type I ostertagiosis. Zero or low epg values may be recorded if:

- The worm burden comprises mainly immature stages (as in Type II disease or some outbreaks of nematodiosis)
- Intestinal damage persists after the worm population has been expelled by immunity or anthelmintic treatment
- Disease is associated with hypersensitivity to incoming larvae.

Different trichostrongylid eggs, other than *Nematodirus*, cannot easily be differentiated and cultures must be made if species determination is necessary.

**Plasma pepsinogen** estimations are performed routinely in many laboratories as an aid in the diagnosis of ostertagiosis. Elevated values also occur in hemonchosis. The test is difficult to standardize so results from different laboratories cannot be compared but, in calves, levels higher than 3000 iu tyrosine are generally considered to indicate a pathogenic worm burden. Pepsinogen levels decline after effective anthelmintic treatment but do not return to pre-infection values. Older immune cattle may show elevated values when grazing contaminated pasture, even though few incoming larvae are able to establish. Plasma gastrin concentrations reflect the size of the abomasal worm burden in both young and older animals, but currently can only be measured by radioimmunoassay, which limits their field application. Gastrin occurs in several molecular forms and, consequently, test kits have to be validated before use with bovine blood as not all are suitable for this purpose.

**Moderate anemia** often occurs with hemoglobin levels around 6–8 mg/dL and is more evident in *Cooperia* and *Ostertagia* spp. infestations than in trichostrongylosis where there may be polycythemia. Serum protein concentrations may be as low as 4–5 mg/dL with a marked reduction in serum albumin values.

**Species-specific enzyme-linked immunosorbent assay (ELISA)** tests are being developed for use with samples from bulk milk tanks but are currently only available for epidemiological research.<sup>19</sup>

## NECROPSY FINDINGS

Adult worms are found in the abomasum or small intestine depending on the predilection site of the individual species. A total worm count is the critical measure of the degree of infestation. Counts less than 2000 in mixed species of sheep are considered to be light, while counts over 10 000 are heavy, but massive counts of 50 000 and more are often seen. In cattle, burdens of 40 000 and above are seen in Type I ostertagiosis outbreaks (the majority are adults), while in Type II disease worm numbers may be 100 000–200 000, with occasional animals harboring a million or more. In these cases about 90% are in the fourth larval stage. Trichostrongylids are small, translucent and threadlike so even adults can easily evade detection by the naked eye at necropsy. Worm counting therefore involves washing the mucosa, sieving the washings and luminal contents, re-suspending the residue, taking aliquots and picking out and identifying the nematodes. A more rapid but effective field technique for demonstrating intestinal worms is to:

- Roll a loop of duodenum inside out over a test tube or glass rod
- Immerse this first in aqueous iodine solution (iodine 30 g, potassium iodide 40 g, water 100 mL) for several minutes
- Immerse in a 5% solution of sodium thiosulfate for a few seconds.

The mucosa is decolorized but the brown-stained worms retain their color and are easily seen.<sup>20</sup> Mucosal larval stages have to be released by digesting the tissues with acid-pepsin.

**Gross pathological findings** are often not striking, apart from the non-specific lesions of emaciation, dehydration, moderate anemia and evidence of scouring. In severe cases, the mucosa of the abomasum and upper small intestine may be hyperemic and swollen, and local lymph nodes enlarged. In ostertagiosis there will be numerous raised nodules which may be discrete or confluent forming a 'morocco-leather' appearance.

Abomasal folds are edematous and diphtheresis may sometimes be apparent. A putrid smell may reflect the growth of microorganisms in the ingesta and estimation of the pH will confirm loss of acidity.

Heavy *T. axei* infection in lambs, calves, and horses causes circumscribed raised plaque-like hyperplastic lesions on the abomasal mucosa, sometimes with an eroded center. Close inspection is needed to see the villous atrophy associated with intestinal *Trichostrongylus* species. Initially this is diffuse but later appears as discrete patches ('fingerprint lesions').

## DIAGNOSTIC CONFIRMATION

PGE should not be diagnosed on the basis of a fecal egg count alone. In sheep, a total worm count should be performed whenever possible, preferably with a peptic digest of the mucosa. The results should be considered together with the:

- Clinical signs
- Age of the animal
- Season of the year
- Nutritional status
- Grazing history.

The critical test in an outbreak of disease is the response to treatment. Because the epidemiology of the various species differ, it is important that the main contributing species be determined so that adequate control measures can be taken. In calves, clinical diagnosis can be confirmed by plasma pepsinogen estimation, but this assay is less helpful in adult cattle.

## DIFFERENTIAL DIAGNOSIS

PGE has to be differentiated from other common causes of emaciation and diarrhea in groups of young animals such as:

- Malnutrition
- Copper deficiency (in cattle)
- Coccidiosis (in particular, nematodiosis and coccidiosis occur in lambs of the same age)
- Johne's disease
- Chronic fascioliosis.

## TREATMENT

Many broad-spectrum anthelmintics are now available that combine high efficiency against larval and adult worms with low toxicity in sheep and cattle. Most however belong to just three major chemical groups:

1. Avermectins/milbemycins, also known as the macrocyclic lactone anthelmintics (MLs), which interfere with nerve transmission by opening chloride channels

2. Benzimidazoles (BZDs)/probenzimidazoles, which bind to tubulin and disrupt nutrient uptake
3. Imidazothiazoles/tetrahydropyrimidines, which act as cholinergic agonists.

**Dosage rates and label claims** may vary with formulation and from country to country according to local conditions and regulatory requirements. Figures given in this chapter should therefore be regarded only as a general guide.

## Cattle

In cattle, ivermectin, doramectin, and moxidectin are given at 0.2 mg/kg by injection or 0.5 mg/kg as a pour-on formulation. Eprinomectin pour-on 0.5 mg/kg is the compound of choice for adult dairy cattle as it has a nil milk withdrawal period.<sup>21</sup> Albendazole 7.5 mg/kg, febantel 7.5 mg/kg, fenbendazole 7.5 mg/kg, netobimin 7.5 mg/kg, and oxfendazole 4.5 mg/kg are given orally. Levamisole can be used orally or by injection at 7.5 mg/kg or as a pour-on at 10 mg/kg.

Sustained release intraruminal devices ('boluses') for use in cattle provide extended periods of protection. For example, fenbendazole is released for up to 140 d from one bolus, while a biodegradable bolus releases morantel tartrate for at least 90 d. There are also pulse-release boluses containing oxfendazole, which release five or six anthelmintic doses at 3-week intervals.

## Sheep

In sheep, the dose rate for ivermectin, doramectin, and moxidectin (which are given orally or parenterally) is 0.2 mg/kg. Dose rates for the BZDs (given orally) are: albendazole 5 mg/kg, febantel 5 mg/kg, fenbendazole 5 mg/kg, netobimin 7.5 mg/kg, mebendazole 15 mg/kg, and oxfendazole 5 mg/kg. Levamisole can be used orally and parenterally at 7.5 mg/kg. Morantel citrate monohydrate is also used as a drench in sheep. Pour-on formulations are not used in sheep as the wool grease does not allow absorption through the skin. Intraruminal devices for use in sheep have been developed which release albendazole or ivermectin over 100 d.<sup>22,23</sup>

## Goats

Goats metabolize some anthelmintics more rapidly than do sheep and elevated dose rates are sometimes required to obtain a satisfactory level of control. Even then, there may be more surviving worms and consequently anthelmintic resistance tends to develop much more quickly in goats than sheep. Examples of special dose-rates for goats include: albendazole 10 mg/kg and levamisole (which should



be used with caution in goats) 12 mg/kg. Ivermectin can be given at the normal dose-rate of 0.2 mg/kg.

### CHOICE OF ANTHELMINTIC

The choice of anthelmintic depends on a number of considerations. Anthelmintic resistance is a real or emerging problem in many sheep-rearing areas. Side resistance occurs within chemical groups and multiple-resistant strains have been reported. This can impose a severe constraint on product choice. Other factors include:

- Price
- Safety (including meat and milk residues and effect on environment)
- Ease of administration
- Spectrum of activity.

Older products were most active against adult worms, but many now have activity against larval stages. Fewer however have consistently high efficacy against hypobiotic larvae and care is needed in selecting a suitable product to treat or prevent Type II disease. Products with claims for this purpose at standard dose-rates include avermectins/milbemycins, albendazole, fenbendazole, oxfendazole, and thiophanate, while netobimin is active at an elevated dose-rate (20 mg/kg). The benzimidazoles are ovicidal, which may be beneficial if stock are moved to a new pasture after treatment. Animals with PGE may also be harboring other parasites. The avermectins/milbemycins have a very broad spectrum of activity including some ectoparasites but are inactive against cestodes and trematodes. Some broad-spectrum BZDs are effective against cestodes and one, albendazole, is also active against mature *Fasciola hepatica*. The avermectins/milbemycins are excreted in the feces and may affect insects colonizing the dung pat.<sup>24</sup> The environmental impact of this has probably been overstated as only a small proportion of the fecal mass on a property will contain anthelmintic, allowing adequate refugia for maintenance of insect populations. This class of compound should however be used with caution if there is concern that beneficial insects may be vulnerable, for example, dung-beetles in some arid zones.

**Novel methods for increasing drug availability** and anthelmintic effect within the body are under investigation<sup>25</sup> and should be adopted by veterinarians as they become available. There is uncertainty when, or even if, new chemical classes will become commercially available for nematode control and so it is essential that existing products are used as efficiently as possible to extend their effective life. Using measures which

maximize the potency of anthelmintics can slow the onset of resistance and increase efficacy against partially resistant strains. The efficacy of the BZDs and orally administered avermectins depends on their residence time in the rumen and some simple measures can be taken to increase this. Correct drenching procedure (gun tip over tongue and drench dispensed directly into esophagus) will avoid stimulation of the esophageal groove reflex<sup>26</sup> and ensure that the dose does not bypass the rumen. As there is an inverse relationship between feed intake and ruminal residency time, a reduction in feed intake (e.g. by penning) for 24 h before prophylactic drenching retards transit time and significantly enhances the activity of BZDs and ivermectin. With BZDs, drug residency time in the rumen can be further increased and efficacy enhanced by dividing the dose and giving it at 12- or 24-hour intervals. This principle is reflected in medicated lick-blocks and intraruminal boluses which provide daily low-level BZD doses.

**Continued protection** must be given to animals after treatment for clinical PGE. Irrespective of the drug used, treated animals should be moved to a clean paddock (i.e. one not contaminated with large numbers of infected larvae) which provides an adequate plane of nutrition. The ovicidal action of the BZDs is particularly useful if animals are being placed on very clean areas such as cereal stubble. However, it is probably of lesser importance on many farms where residual pasture contamination is always present. If clean pasture is not available, protection can be provided by use of an anthelmintic with persistent activity against incoming larvae. In cattle, ivermectin provides up to 21 days' protection against *O. ostertagi* and up to 14 days' against *Cooperia* spp. Corresponding figures for eprinomectin are: 28 and 21 d; for doramectin: 35 and 21 d (by injection) and 35 and 28 d (pour-on); and for moxidectin: up to 28 days against *O. ostertagi*. The persistent anthelmintic effect of avermectins in sheep is much shorter and there is probably little useful effect against intestinal trichostrongylids.

Moxidectin given by injection has a label claim for 5 weeks protection against *O. circumcincta* and 2 weeks against *T. colubriformis*.

### CONTROL

Control measures are aimed at reducing pasture contamination in order to minimize the uptake of infective larvae, thereby preventing disease and allowing optimal productivity. The cost of any program and treatments must accord with potential economic benefits. Where individual animals are valuable, labor-intensive

strategies may be justified. Many husbandry systems however will support only low input solutions and treatments may only be feasible when animals are handled for other management procedures. Epidemiological patterns differ for each worm species and vary considerably from region to region, with subtle variations often occurring from locality to locality. It is therefore beyond the scope of this text to make specific recommendations for control but it is possible to describe general principles which can be adapted to local needs.

**Knowledge of local epidemiology** is a necessary prerequisite for designing a control program. In particular, the animals providing the major source of contamination should be identified, the period of development from egg to infective larvae and the availability of infective larvae throughout the year known. It is essential to formulate clear and precise control objectives, otherwise much time and expense can be wasted. Management may have to be adjusted to aid control. On organic farms, where anthelmintic usage is greatly restricted, worm control may be a major factor in determining stocking density and grazing management. Often, control measures are aimed primarily at protecting the most susceptible group, that is, young animals up to 18 months of age exposed to infestation for the first time.

**Anthelmintic resistance** is an important consideration influencing the choice and intensity of control measures. Even if economically justified, frequent routine treatments impose strong selection pressure on worm populations and encourage the development of resistant strains. As only three major chemical groups are currently available for the treatment of gastrointestinal and pulmonary nematodes, it is imperative that their usefulness is conserved for as long as possible. Many anecdotal field reports of resistance are erroneous, the problem being one of reinfestation or incorrect anthelmintic usage. Nevertheless, resistant and multi-resistant strains are already prevalent in many sheep-rearing areas.<sup>27</sup> So far, there have been few reports from cattle. The following recommendations have been made to slow the onset of resistance<sup>28</sup>:

1. Use an effective drug in the most efficient manner:
  - Check fecal egg counts regularly to confirm that chosen products remain effective
  - If a worm population is already partly resistant to a compound, continued use of products based on that chemical group will endanger the health of the animals and reinforce the resistance.

2. Do not underdose (this may encourage resistance):
  - Weigh each animal or the heaviest individuals in a group
  - Comply with all label recommendations
  - Ensure good maintenance and calibration of dosing equipment.
3. Use the minimum number of doses needed to maintain health:
  - Strike a balance between encouraging resistance by treating too intensively and allowing pasture contamination to rise to unacceptable levels.
4. Use sound epidemiological principles:
  - Utilize an integrated approach to worm control which maximizes the potential of management techniques and minimizes reliance on anthelmintics.
5. Rotate the chemical group annually (to ensure that worms are exposed to compounds with a different mode of action each year):
  - Remember there is no benefit in rotating compounds within a chemical group, nor in using a group already rendered ineffective by anthelmintic resistance.
6. Avoid introducing resistant worms onto a property (obvious, but often overlooked):
  - Place all new stock into quarantine and treat with an effective compound
  - Do not graze goats on sheep pastures (as caprine worm populations often have a higher prevalence of resistance genes).
7. Make sure that the farmer is aware of the problem and the consequences of anthelmintic resistance.

**The concept of maintaining parasite refugia** is assuming greater prominence as a means of conserving anthelmintic efficacy in modern control strategies. The theoretical background and clinical application are discussed in detail in Abbott et al. (2004) – see Review Literature below. Worms 'in refugia' are those not exposed to anthelmintic when the flock is treated. They thereby escape selection pressure for resistance. When the flock subsequently becomes re-infected, the genetic material from parasites surviving treatment will be diluted by susceptibility genes from worms 'in refugia' at that time. This slows the rate at which resistance develops and extends the period over which the drug maintains clinical efficacy on the farm. The refugia concept is best illustrated by an example. In cooler temperate climates, infective *Ostertagia* larvae overwinter on grass in large numbers but most *Haemonchus*

larvae succumb to the cold. If ewes are dosed during the winter to eliminate the periparturient egg-rise, only a small proportion of the *Ostertagia* population (those in the animal) are exposed to the anthelmintic, while the remainder (those on the pasture) are 'in refugia'. In contrast, a high proportion of the total *Haemonchus* population is exposed to the drug (as there are few larvae 'in refugia' on the pasture) and in consequence there is an enhanced risk of anthelmintic resistance developing. From this viewpoint, therefore, it could be beneficial in the longer term to withhold the winter treatment from some ewes. This would ensure that the majority of eggs subsequently dropped onto the pasture are produced by susceptible worms. Similarly, dose and move systems encourage resistance as all eggs dropped onto the new pasture are from worms that have survived treatment. It could therefore be advantageous to use a short-acting drug and to delay the move. This would ensure that the animals acquire a small burden of susceptible worms before the move. These strategies involve obvious inherent risks and all aspects of a particular situation must be carefully considered before implementation.

**Protocols for detecting anthelmintic resistance** in a herd or flock are available.<sup>29</sup> The fecal egg-count reduction test can be performed easily without sophisticated equipment. The epg value should be reduced by 95% or more, but false negatives may be obtained with BZDs (if female worms are sterilized but not killed) and false positives with levamisole (if large numbers of mucosal larvae present at the time of dosing survive treatment). Laboratory tests include egg-hatch assays for BZDs and larval development tests for avermectins and levamisole. Improved assays, including polymerase chain reaction (PCR)-based tests for BZDs, are being developed.

**The Principles of Control** generally fall into three categories<sup>30</sup>:

1. Preventive
2. Evasive
3. Diluting.

Preventive measures are those that place livestock on clean pasture or that use early season chemoprophylaxis to ensure clean grazing later in the season.

Evasive strategies are those in which pasture contamination is allowed to build up naturally but susceptible stock are moved on to clean grazing before pathogenic numbers of infective larvae have accumulated.<sup>31</sup> An anthelmintic dose can be given at the time of the move. This 'dose and move' system is effective and reduces anthelmintic dosage very con-

siderably. It may however encourage resistance as discussed in the previous paragraph.

Diluting systems reduce the effective stocking density of susceptible animals by grazing them alongside non-susceptibles (older immune stock or alternative species). In cow-calf systems, for example, adults produce at least four times as much feces as their calves but their average egg count is typically no more than 15 epg. The number of trichostrongylid eggs and the subsequent accumulation of infective larvae on the herbage will therefore be considerably smaller than if the pasture was fully utilized by calves alone.

**In cool temperate regions**, control measures can take advantage of the fact that overwintered larvae die away in early summer. Hay or silage pastures therefore provide safe grazing after the grass has been cropped. Alternatively, suppressive anthelmintic therapy over the first 90–100 d of the grazing season will prevent overwintered larvae establishing in the host and thereby stop the subsequent accumulation of infective larvae on the herbage. This strategy is very effective on set-stocked permanent calf paddocks provided that no untreated animals are introduced. The required effect can be obtained by use of an intraruminal anthelmintic device administered around the time of spring turnout or by giving two or more doses of an anthelmintic with prolonged activity against incoming larvae. As the object is to prevent egg excretion, the required treatment interval is calculated by adding the length of the protective effect (which varies with the product) and the prepatent period of the worms (about 3 weeks). Ivermectin given 3, 8, and 13 weeks after turnout and doramectin given at turnout and 8 weeks later are very effective for this purpose, as are the intraruminal boluses listed earlier.

**Controlled field studies** have demonstrated significant weight-gain advantages from this approach but, as with cattle lungworm, there is concern that the level of immunity acquired during the first grazing season may be reduced. Usually this is of no clinical consequence but results from an epidemiological survey of 87 farms in Holland suggest a beneficial relationship between immunity to nematodes gained during the first grazing season and the growth rate of cattle during their second grazing season.<sup>32</sup> It seems that optimal protection has to balance risk of production losses in first and subsequent grazing seasons but there is currently no objective way of doing this.<sup>33</sup> One suggestion is that rumen boluses would

be better employed if used to provide anthelmintic cover in the second half of the grazing season when pasture contamination is high ('metaphylaxis'). Good immunity would be assured but the growth rate advantage may be inferior to that obtained with the early season prophylaxis described earlier.<sup>34</sup> If cattle have been exposed to high pasture challenge in the autumn, they should be dosed with a product active against hypobiotic larvae at housing or during the winter to prevent Type II ostertagiosis. In countries where *Dictyocaulus viviparus* is a problem, control of PGE and lungworm must be integrated.

**Elimination of the periparturient egg rise** is the most important feature of worm control in sheep. Ideally, ewes should be dosed towards the end of gestation and again 1 month after parturition with a product active against hypobiotic larvae. Lambs should be dosed at weaning and if possible moved to clean pasture. In most cases, further treatments will be necessary to maintain health until marketing but these should be kept to a minimum. The number will depend on the stocking density, initial pasture contamination and weather. A compromise has to be struck between an acceptable level of disease control and the risk of inducing anthelmintic resistance. Fecal egg counts can be used to check the adequacy of the dosing interval and the efficacy of the treatments.

**Control of *Nematodirus*** differs from that of other forms of PGE because the ewe is not a source of contamination. The simplest form of control is to avoid putting the new lamb crop onto pasture contaminated by the previous year's lambs. Often however this is not feasible and prophylactic anthelmintic doses at 3-week intervals are necessary to cover the limited period of risk (May to early June, for example, in Scotland). Waiting for the first clinical signs before starting treatments is not recommended as deaths can occur very quickly. The precise timing of the egg hatch varies from year to year according to prevailing weather conditions, but forecasting systems are in operation in some countries.

**In warm temperate regions**, PGE control strategies are more difficult to design as animals graze all year round. The main transmission period is late winter and early spring. Treatment of beef cattle at weaning and once or twice at locally determined intervals thereafter is often sufficient to reduce pasture contamination.<sup>35</sup> In sheep, an effective program is to dose lambs at weaning and move them onto safe pasture. Two or three subsequent treatments at 8-week intervals may be needed. In summer rain-

fall areas, *Haemonchus* is an additional hazard and systems have to be designed to combat this as well as other gastrointestinal worms.

**In regions with a prolonged dry season**, larvae will be killed on the ground and, providing there are no foci of infection around water holes etc., a single strategic anthelmintic dose at this time with a product active against hypobiotic larvae may be more effective at maintaining low pasture contamination around the year than repeated dosing throughout the wet season. This single dose may, however, apply greater selection pressure for resistance, since the whole parasite population is exposed to the drug and survivors are likely to carry resistance genes.

**Reduced reliance on anthelmintics** can be achieved in a number of ways. For example, alternate grazing with sheep and cattle can be employed to good effect. In Australia, the number of anthelmintic drenches can be substantially reduced by alternation at 2–6 month intervals.<sup>30</sup> In northern Britain annual stock rotations, sometimes with an arable crop grown in the third year, have been successfully evaluated. Host specificity however is not absolute and calves can become infected with *N. battus*. If this happens, they may drop sufficient numbers of eggs to cause clinical problems in lambs the following year. Lambs have also been known to succumb to *T. axei* on calf paddocks. An exciting future prospect is the use of nematophagous fungi. Orally administered fungal spores produce hyphae in the feces that trap and kill nematode larvae. Field experiments show that pasture contamination can be substantially reduced in this way.<sup>36</sup> Feed supplementation to enhance host resilience and resistance to infection, vaccination and future prospects for breeding lines of sheep with innate host resistance are described under *Haemonchus*.

**Breakdowns in control programs** are usually due to:

- Failure to prevent worm egg-output at times critical to the accumulation of infective larvae on the pasture.
- Failure, after treatment, to move animals on an already contaminated pasture to a clean environment
- Use of an insufficient dose or incorrect anthelmintic
- Failure to repeat treatment or repeating treatment at overlong intervals at times of high risk
- Failure to appreciate that not all anthelmintics kill all immature stages, particularly hypobiotic forms
- Introduction of susceptible sheep from a worm-free environment into a high risk area

- Failure to protect young animals adequately.

## REVIEW LITERATURE

- Abbott KA, Taylor M, Stubbins LA. Sustainable Worm Control Strategies for Sheep: a Technical Manual for Veterinary Surgeons and Advisers SCOPS, 2004; available free of charge from the National Sheep Association at [www.nationalsheep.org.uk](http://www.nationalsheep.org.uk)
- Armour J. The epidemiology of helminth disease in farm animals. *Vet Parasitol* 1980; 6:7–46.
- Armour J, Ogbourne CP. Bovine ostertagiosis: a review and annotated bibliography. Farnham Royal, England: Commonwealth Agricultural Bureau, 1982.
- Sangster N. 2003; Sustainable control of internal worms of sheep [www.sheepwormcontrol.com](http://www.sheepwormcontrol.com)
- Snyder DE, Klesius PH. Special issue: Ostertagia. *Vet Parasitol* 1993; 46:1–4.
- Taylor MA et al. Anthelmintic resistance detection methods. *Vet Parasitol* 2002; 103:183–194.
- Williams JC et al. Special issue: 4th Ostertagia workshop: nematode parasites of importance to ruminant livestock. *Vet Parasitol* 1997; 72:3.

## REFERENCES

1. Hertzberg H et al. *Res Vet Sci* 1995; 58:14.
2. Armour J, Duncan J. *Parasitol Today* 1987; 3:171.
3. Stear MJ, Wakelin D. *Rev Sci Tech Off Int Epiz* 1998; 17:143.
4. Vercruyse J, Claerebout E. *Vet Parasitol* 1997; 72:309.
5. Waller PJ, Thomas RJ. *Vet Parasitol* 1981; 9:47.
6. Houdijk JG et al. *Int J Parasitol* 2003; 33:327.
7. Boag B, Thomas RJ. *Res Vet Sci* 1975; 19:263.
8. Ash C, Atkinson HJ. *Exp Parasitol* 1986; 62:24.
9. Rose CH, Jacobs DE. *Acta Vet Scand* 1990; 31:339.
10. Stromberg BE. *Vet Parasitol* 1997; 72:247.
11. Bishop SC, Strear MJ. *Vet Parasitol* 2003; 115:147.
12. Boag B, Thomas RJ. *Res Vet Sci* 1977; 22:62.
13. Larsen JWA et al. *Aust Vet J* 1994; 71:365.
14. Simpson HV. *Vet J* 2000; 160:177.
15. Fox MT et al. *Vet Parasitol* 2002; 105:285.
16. Thamsborg SM, Hauge EM. *J Comp Pathol* 2001; 125:192.
17. Poppi DP et al. *J Comp Pathol* 1985; 95:453.
18. Forbes AB et al. *Vet Parasitol* 2000; 90:111.
19. Charlier J et al. *Vet Parasitol* 2005; 129:67.
20. Arundel JH. *Aust Vet J* 1967; 43:592.
21. Shoop WL. *Int J Parasitol* 1996; 26:1237.
22. Rehbein S. *Vet Rec* 1998; 142:331.
23. Rehbein S et al. *Vet Parasitol* 2000; 88:293.
24. McKellar QA. *Vet Parasitol* 1997; 72:413.
25. Hennessy DR. *Vet Parasitol* 1997; 72:367.
26. Waller PJ. *Int J Parasitol* 1997; 27:1193.
27. Bartley DJ et al. *Vet Parasitol* 2004; 123:189.
28. Coles GC, Rouch RT. *Vet Rec* 1992; 130:505.
29. Coles GC et al. *Vet Parasitol* 1992; 44:35.
30. Barger I. *Vet Parasitol* 1997; 72:493.
31. Eysker et al. *Vet Parasitol* 2005; 129:95.
32. Ploeger HW et al. *Vet Parasitol* 1990; 36:57.
33. Vercruyse J, Claerebout E. *Vet Parasitol* 2001; 98:195.
34. Taylor SM et al. *Vet Parasitol* 1995; 56:75.
35. Barger I. *Vet Parasitol* 1993; 46:23.
36. Chandrawathani P et al. *Vet Parasitol* 2003; 117:173.

## Haemonchosis in ruminants

### ETIOLOGY

Sheep, cattle, and goats are all affected by species of the nematode genus *Haemonchus*, which is closely related to the other trichostrongylids of ruminants.

### Synopsis

**Etiology** The nematode parasite *Haemonchus contortus* in sheep and goats and *H. placei* in cattle.

**Epidemiology** Female worms produce large numbers of eggs; infective larvae develop rapidly in warm wet conditions; dangerous levels of pasture contamination can therefore accumulate rapidly.

**Signs** *Acute*: sudden death, anemia; *Chronic*: wasting, anemia, anasarca.

**Clinical pathology** Anemia, hypoproteinemia; often high fecal egg count.

**Lesions** Anemic carcass; abomasal mucosa hyperemic with many red-colored worms.

**Diagnostic confirmation** 'Barber's pole' appearance of female worms (if fresh).

**Treatment** All modern broad-spectrum anthelmintics; also, closantel, rafoxanide, nitroxylin, disophenol and some organophosphates; care needed in selection as resistant and multiresistant strains of *H. contortus* occur.

**Control** Strategic dosing schemes using broad-spectrum anthelmintics; closantel or disophenol can be used to reduce dependence on broad-spectrum products.

*H. contortus* is the species most commonly found in sheep and goats, but *H. placei* is the usual species in cattle. Molecular studies have confirmed that these are distinct taxa.<sup>1</sup> Even so, cross-infection may occur when small ruminants and cattle graze together but the infestations are usually of lesser severity. Another abomasal trichostrongylid, *Mecistocirrus digitatus*, occurs in sheep, cattle, and buffalo in the Orient and in Central America, causing a disease very similar to hemonchosis.

### LIFECYCLE

*Haemonchus contortus* inhabits the abomasum. It is easily seen as it is 1–2.5 cm long and a little stouter than most other trichostrongylids. Adult males are homogeneously red but the females have a spiral red and white appearance as the intestine and uterus intertwine. Adult *H. contortus* are prolific egg layers. Egg production increases until maximum output is reached 25–30 d after infection, after which individual females lay up to 10 000 eggs per day for several months. The egg hatches and passes through two non-infective larval stages in 4 d under optimal conditions but in less suitable environments, this period may be prolonged. For example, in Scotland the shortest time required for development from egg to third stage larva is 2 weeks but development takes a great deal longer over most of the year. Infective larvae migrate away from fecal pellets, some

traveling 90 cm in 24 h. More than 90% however are found within 10 cm of the fecal mass and this number decreases logarithmically as the distance increases.<sup>2</sup> Motility is greatest in hot, moist conditions. Larvae are susceptible to desiccation and do not withstand cold temperatures well.<sup>3</sup> Where hostile external conditions occur regularly, such as winter in temperate regions or the dry season in some tropical climates, *H. contortus* larvae on pasture are conditioned at the appropriate time to become hypobiotic after uptake by a host. Transmission occurs when the host ingests infective larvae while grazing. After developing through the fourth larval stage in the abomasal glands, the adult worms emerge to commence egg laying in about 18 d after infection. Hypobiotic larvae resume their development so that egg laying is coordinated with the start of spring or the wet season.

The lifecycle of *H. placei* is similar except that the first eggs do not appear in the feces of cattle until the 26th day after infestation, rising to a peak at 6–7 weeks and declining rapidly to low levels by 11–14 weeks.

### EPIDEMIOLOGY

The epidemiology of hemonchosis is largely determined by the high fecundity of the female worms and the speed with which infective larvae can develop in warm, humid conditions. Thus, when conditions are favorable, large numbers of infective larvae can accumulate very rapidly on pasture. Opportunities for transmission are however restricted by the susceptibility of the larvae to desiccation and cold.

**Hemonchosis is an important disease** of sheep, goats, and cattle in all but the coldest regions. The greatest economic impact is seen in sheep in tropical and warmer temperate countries, especially where there is good summer rainfall. It is not uncommon for serious outbreaks to occur in cooler climates during periods of high humidity in summer. The disease is uncommon in semi-arid regions unless there are opportunities for transmission to occur in, for example, irrigation schemes. In sheep, losses occur mostly in lambs, especially those recently weaned, but yearlings and mature sheep may also be affected. Goats of any age are susceptible but their browsing habit may protect them from the heaviest sources of contamination. Dairy calves are the most commonly involved group amongst cattle but steers and other young cattle up to 3 years of age may also be affected.

**Predisposing causes** for hemonchosis include overcrowding, lush pasture,

hot and humid climatic conditions and a low plane of nutrition. Disease can be precipitated in several ways. An important causal mechanism in sheep is when lambs, that may be in excellent condition on good grazing, are overcome by a sudden massive wave of pasture contamination. Sheep in poor condition may be clinically affected by worm burdens too small to harm an otherwise healthy animal. Outbreaks of disease may occur in sheep overwintered indoors if large numbers of hypobiotic larvae mature simultaneously.<sup>4</sup> Cattle harboring sub-clinical infestations while on a good plane of nutrition may show clinical signs if the pasture subsequently fails because of drought or overgrazing. In goats, *Trypanosoma congolense* infection has been shown to increase the susceptibility to *H. contortus*.<sup>5</sup>

The climatological conditions that permit the development of hemonchosis in sheep have been the subject of much research. Bioclimatographs have been produced for many different geographic areas. In regions with narrow diurnal temperature fluctuations, outbreaks are likely during months with a mean maximum temperature of 18°C (64°F) and more than 5.25 cm rain.<sup>6</sup> In areas with regular summer rainfall, larval availability increases from late spring to reach maximum levels by late summer to early autumn and quickly declines in winter. A similar trend, but with fluctuating larval numbers, occurs in areas with more variable rainfall patterns.

**The self-cure phenomenon** is a sudden naturally occurring expulsion of adult *H. contortus* which may also, although not invariably, eliminate incoming larvae. In some areas, this may be associated with changes in the pasture<sup>7</sup> but more often it occurs in sheep when a large uptake of infective larvae is superimposed on an established worm burden in a sensitized animal. Self-cure may also expel existing *Ostertagia circumcincta* and *Trichostrongylus axei* from the abomasum and *Trichostrongylus* spp. from the small intestine. Strain or breed differences occur and a genetic resistance operating primarily against worm establishment and probably controlled by the immune response has been reported.<sup>8</sup> There is no complete self-cure with *H. placei* in calves but after an initial infection there is a rapid decline in egg laying, adults are expelled and subsequent larval development is retarded. Immunity is much stronger in calves than in sheep.

### PATHOGENESIS

Vigorous bloodsucking by both fourth-stage larvae and adults is the main factor differentiating the pathogenesis

of *H. contortus* from that of other abomasal nematodes. The histological changes and biochemical sequelae associated with *Ostertagia* infections also occur in hemochosis but in addition a hemorrhagic anemia evolves due to the daily loss of around 0.05 mL of whole blood per worm. The course of the disease depends on the numbers of worms present and the ability of the animal to compensate for acute or chronic losses of plasma proteins, hemoglobin and other blood constituents. In continuing infections, the increased rate of red cell production is maintained at the expense of the animals' iron stores and a state of iron deficiency occurs. Death may be acute and result purely from blood loss or may be more gradual and accompanied by weight loss, anemia, and hypoproteinemia.<sup>9</sup> Poor growth in young lambs can result from a reduction in their ewes' milk production. Susceptibility to hemochosis varies with breed. Those with superior resistance include the Scottish Blackface, Red Maasai, Florida Native, St Croix, and Barbados Blackbelly, whereas the Hampshire Down is relatively susceptible. Individuals within a flock also vary in vulnerability. This natural resistance to infection is heritable.<sup>10</sup>

**The role of nutrition** in modifying the pathogenesis of hemochosis in lambs is undergoing intense investigation. There is experimental evidence that lambs on a high protein diet are better able to withstand *H. contortus* infestation.<sup>11</sup> There are considerable breed differences; in some cases, animals with a higher protein intake mount a more effective immune response, in others they are better able to tolerate and compensate for the blood losses associated with the infection.<sup>12</sup>

### CLINICAL FINDINGS

Hemochosis causes heavy losses due to animal deaths and reduced production. Lambs and young sheep are commonly affected by the acute form of the disease. Often only a few individuals will be seriously affected but in very severe outbreaks, a large proportion of the flock may suffer if not treated.<sup>13</sup> Animals may be found dead without premonitory signs having been observed. The mucosae and conjunctivae of such sheep are always extremely pale. More chronic cases show lethargy and muscular weakness, pallor of the mucosae and conjunctivae, and anasarca, particularly under the lower jaw and to a lesser extent along the ventral abdomen. Affected sheep are often noticed for the first time when the flock is being driven: they lag behind, breathe faster, have a staggering gait and often go down. Some sheep may die as a result of exercise but most can rise and

walk a little further after rest. Grazing animals lie down a good deal of the time, often around the water troughs; the energy needed to walk and eat appears to be lacking. Most affected sheep show constipation rather than diarrhea. There is a loss of body weight and a detrimental effect on wool growth and quality. In sheep with the chronic condition, there may be extreme weight loss during the dry season, even though larval uptake is negligible at this time. Sheep not fatally affected develop a break in the wool and the fleece may be lost at a later date.

**In calves**, the disease is characterized clinically by severe anemia and anasarca. Heavy infestations occurring in summer may not manifest clinically until winter when the plane of nutrition declines.

### CLINICAL PATHOLOGY

As *Haemonchus* is a prolific egg layer, fecal egg counts tend to be high (10 000 egg in severe cases), but it must be remembered that low egg counts may be encountered in the early part of the evolution of the disease when the bulk of the pathogenic worms are in the larval stage. There is a significant rise of abomasal pH soon after infection accompanied by increased plasma pepsinogen and gastrin concentrations.<sup>14</sup> Worm counts and hemoglobin levels are correlated.

### NECROPSY FINDINGS

Gross necropsy findings include severe anemia, gelatinization of fat deposits, general anasarca and the presence of large numbers of readily visible *H. contortus* or *H. placei* in the abomasum. If the cadaver is fresh, the worms may still be attached or swimming actively in the ingesta, but a careful search may be necessary if the animal has been dead for some time. The abomasal wall is hyperemic and blood clots may be present in the mucosa. Small ulcerations may be present where adult worms have been attached. The abomasal contents usually have a distinct brownish color due to the presence of free blood.

### DIAGNOSTIC CONFIRMATION

In mixed infections, eggs of *Haemonchus* spp cannot be easily differentiated from those of many other gastrointestinal nematodes. Identification and quantification therefore depend on counting larvae in fecal cultures, a procedure not readily applicable in routine diagnosis. The number of worms required to depress hemoglobin levels varies with the weight of the sheep. In Merino sheep up to 20 kg, a hemoglobin level of 10.5 g/dL has been associated with 112 worms and 8.0 g/dL with 355 worms. However, in sheep over 50 kg, 355 and 1259 worms

were required to give similar values.<sup>15</sup> At necropsy, counts of 3000 *H. contortus* in lambs and 9000 in adult sheep are usually associated with heavy mortalities.

### DIFFERENTIAL DIAGNOSIS

#### Sheep

Other causes of sudden death, such as lightning strike, snakebite, anthrax or enterotoxemia are often suggested by the farmer and can only be differentiated by necropsy. The other common causes of anemia include:

- Fasciolosis
- Eperythrozoonosis
- Nutritional deficiencies of copper and cobalt
- Diarrhea is a much more prominent sign in other parasitic infestations, particularly trichostrongylosis and coccidiosis.

#### Calves

Hemochosis has to be differentiated from:

- Babesiosis
- Anaplasmosis
- Coccidiosis
- Hookworm infection
- Other causes of anemia including heavy infestations with sucking lice, hemolytic anemia caused by drinking large quantities of cold water, the ingestion of rape, kale, and chou moellier, bacillary hemoglobinuria and leptospirosis.

### TREATMENT

All the broad-spectrum ruminant anthelmintics are effective against *Haemonchus* provided that resistance has not developed to that chemical group. Ivermectin given by injection provides up to 14 days' protection against re-infection with *H. placei* in cattle and up to 10 days' protection with *H. contortus* in sheep. Moxidectin, by mouth or by injection, gives up to 35 days' persistent activity against *H. contortus*.<sup>16</sup> Some compounds active against *Fasciola hepatica* that bind to plasma proteins are also active against blood-sucking nematodes such as *Haemonchus* and are useful for use where resistance to broad-spectrum products is a problem. These include closantel, rafoxanide and nitroxylin. Closantel and disophenol, another narrow-spectrum product, exert a persistent protective effect in sheep for up to 4 weeks. With closantel, this period can be extended by reducing feed intake for 24 h before treatment to enhance the uptake of the drug.<sup>17</sup> Organophosphate anthelmintics are available in some localities for use against resistant strains. *H. contortus* strains resistant to benzimidazoles (BZDs), levamisole, morantel, naphthalophos, ivermectin, moxidectin, and closantel have been reported and strains with

multiple resistance to two or more of these chemicals are common in some areas.<sup>18,19</sup> To date, resistance problems have not been reported with *H. placei*.

### CONTROL

In sheep flocks, a late winter treatment will remove hypobiotic larvae before they resume development and start to shed eggs onto the pasture. Where winters are severe enough to kill most of the free-living stages, this single drench will considerably reduce subsequent pasture contamination but may also expose the parasite population to a high level of selection pressure, thereby encouraging the onset of resistance. In areas where larvae overwinter on pasture and infest lambs in early spring, further treatments may be needed in spring and early summer to prevent an accumulation of infection in the sheep and a subsequent build-up of pasture contamination.

If no routine control is practised and pasture contamination becomes high, stock should be dosed and moved to clean grazing areas. If this is not possible, anthelmintic cover must be provided by using a sustained acting compound such as closantel, disophenol, or moxidectin. Sustained release intraruminal devices for sheep containing ivermectin or albendazole are used in some countries.<sup>20</sup> In cattle, protection can be given by avermectin/milbemycin treatment or an intraruminal bolus. If none of these are available or economically justified, other broad-spectrum compounds can be given at 2 to 4-week intervals throughout the risk period.

In the wet tropics, a rotational grazing system has been devised based on the observation that infective *H. contortus* larvae are relatively short lived at high ambient temperatures. Small ruminants are grazed sequentially for up to 4 d on a series of suitably sized small plots, each of which is rested for at least 30 d before re-use.<sup>21</sup> Where fencing is not feasible, a similar rotation can be based on a planned tethering system. This approach is not effective in temperate areas however as under these conditions infective larvae have a prolonged lifespan and substantial numbers will still be present when the grass needs to be re-grazed.

**Frequent treatments** with broad-spectrum anthelmintics can lead to the development of anthelmintic resistance. Control programs have therefore been devised which reduce dependence on broad-spectrum products by utilizing the sustained action of closantel against *H. contortus*. Treatment with closantel in late winter kills hypobiotic larvae and, subsequently, overwintering larvae from

the pasture as they are ingested. In the case of ewes which lamb in early spring, further treatments in late spring and late summer can provide excellent cover. As closantel has no effect against *O. circumcincta* or *Trichostrongylus* spp., strategic treatments with a broad spectrum compound must also be incorporated into the scheme. Lambs can be treated with closantel and a broad-spectrum compound when they are about 12 weeks of age and again 12 weeks later. This procedure has been designated the 'Wormkill' program and variations on the theme, tailor made for particular localities and management systems, have been widely accepted in parts of Australia where BZD-resistant strains of *H. contortus* are prevalent.<sup>22</sup> Use over a number of years has reduced *H. contortus* to negligible levels on many farms, but closantel resistance is starting to emerge.<sup>23</sup> Disophenol has been used for a similar purpose in other areas.<sup>24</sup>

**A BZD-resistant *H. contortus* population** on a farm is unlikely to revert to susceptibility even if this class of compound is withheld from use for a protracted period.<sup>25</sup> This is due to the genetic mechanisms involved in the selection process.<sup>26</sup> In a novel and partly successful attempt to find a solution to this problem, resistant *H. contortus* were diluted experimentally by spraying a susceptible strain onto pasture at different times in the grazing calendar.<sup>27</sup> This approach however raises obvious ethical questions.

**The FAMACHA system for managing hemonchosis** is a more easily applied field technique for reducing selection pressure for anthelmintic resistance. It was developed in South Africa<sup>28</sup> and recently validated in the USA.<sup>29</sup> It utilizes the fact that a high proportion of the total parasitic *H. contortus* population is found in just a small proportion of individual sheep within a flock. These will be the most anemic animals and will be shedding the greatest number of eggs onto the pasture. They are identified by comparing the ocular conjunctivae of each animal against a graded color chart. By confining treatment to these individuals, the general health of the flock is maintained with fewer anthelmintic doses, while pasture contamination is substantially reduced and is largely derived from untreated sheep.

**Natural resistance to gastrointestinal nematodes** can be enhanced by breeding from rams selected for low fecal egg-counts. This provides a feasible method of reducing reliance on chemical control. Heritability for this trait, which is mediated by IgA-induced retardation of

worm growth, is between 0.2 and 0.4. Selection for genetic resistance may however reduce capacity to select for other production attributes in some circumstances.<sup>10</sup>

**Vaccination** is an attractive future possibility and considerable progress is being made in this direction. An experimental molecular vaccine based on an *H. contortus* gut membrane antigen has been shown to reduce fecal egg counts by 90% and worm numbers by 72–80%.<sup>30</sup> Young lambs can be protected by the passive transfer of colostral antibodies from vaccinated ewes.<sup>31</sup> There is no cross-immunity with other gastrointestinal nematodes and so anthelmintic therapy will still be necessary if these pose a health risk.

**In poorer farming regions**, the routine use of modern anthelmintics or vaccination may be prohibitively expensive and alternative sustainable methods are being sought.<sup>32</sup> This may involve identifying more resistant indigenous breeds to replace more productive but more vulnerable imported breeds. Another option is the provision of a supplementary diet containing locally available protein. This enhances the ability of breeds more susceptible to *H. contortus* to withstand the pathogenic effects of infection<sup>12</sup> and may be economically feasible in some agricultural systems. Some native forages contain substances, for example tannins, that are naturally deleterious to gastrointestinal worm populations.<sup>33</sup> Alternate or mixed grazing systems can also be employed.

### REVIEW LITERATURE

- Gill HS, LeJambre LF. Special issue: novel approaches to the control of helminth parasites of livestock. *Int J Parasitol* 1996; 26:(8/9).
- Waller PJ. Sustainable helminth control of ruminants in developing countries. *Vet Parasitol* 1996; 71:195–207.
- Williams JC et al. Special issue: 4th Ostertagia workshop: nematode parasites of importance to ruminant livestock. *Vet Parasitol* 1997; 72:3,4.

### REFERENCES

- 1 Stevenson LA et al. *Int J Parasitol* 1995; 25:483.
- 2 Skinner WD, Todd KS Jr. *Am J Vet Res* 1980; 41:395.
- 3 Levine ND et al. *Am J Vet Res* 1974; 35:1413.
- 4 Field AC et al. *Parasitology* 1960; 50:387.
- 5 Griffin L et al. *J Comp Pathol* 1981; 91:85.
- 6 Swan RA. *Aust Vet J* 1970; 46:485.
- 7 Allonby EW, Urquhart GM. *Parasitology* 1973; 66:43.
- 8 Altaif KI, Dargie JD. *Parasitology* 1978; 77:161.
- 9 Allonby EW, Dargie JD. In: Urquhart GM, Armour J (eds) *Helminth diseases of cattle sheep and horses in Europe*. Glasgow: Robert MacLehose, 1973.
- 10 Stear MJ et al. *Res Vet Sci* 2001; 71:1.
- 11 Wallace DS et al. *Res Vet Sci* 1996; 60:138.
- 12 Wallace DS et al. *Res Vet Sci* 1995; 58:232.
- 13 Roberts JL, Swan RA. *Vet Parasitol* 1982; 9:211.
- 14 Simpson HV. *Int J Parasitol* 1997; 27:825.
- 15 Roberts JL, Swan RA. *Vet Parasitol* 1982; 9:201.

- 16 Keboeuf D et al. *Vet Rec* 1995; 137:399.
- 17 Hennessy DR, Ali DN. *Int J Parasitol* 1997; 27:1081.
- 18 van Wyk JA et al. *Onderstepoort J Vet Sci* 1999; 66:273.
- 19 Terrill TH et al. *Vet Parasitol* 2001; 97:261.
- 20 Rehbein S et al. *Vet Rec* 1998; 142:331.
- 21 Barger L. *Vet Parasitol* 1997; 72:493.
- 22 Dash KM et al. In: Anderson N, Waller PJ (eds) *Resistance in nematodes to anthelmintic drugs*. Glebe, Australia: CSIRO, 1985.
- 23 Rolfe PF et al. *Aust Vet J* 1990; 67:29.
- 24 Schillhorn van Veen TW. *Bull Anim Hlth Prod Afr* 1981; 29:279.
- 25 Borgsteede FHM, Duyn SPJ. *Res Vet Sci* 1989; 47:270.
- 26 Roos MH. *Parasitol Today* 1990; 6:125.
- 27 Wyk JA van et al. *Vet Parasitol* 1990; 35:61.
- 28 Wyk JA van, Bath GF. *Vet Res* 2002; 33:509.
- 29 Kaplan RM et al. *Vet Parasitol* 2004; 123:105.
- 30 Knox DP, Smith WD. *Vet Parasitol* 2001; 100:21.
- 31 Andrews SJ et al. *Int J Parasitol* 1995; 25:839.
- 32 Waller P. *Int J Parasitol* 1997; 27:1193.
- 33 Paolini V et al. *Vet Res* 2003; 34:331.

## Bunostomosis (hookworm disease) in ruminants

### Synopsis

**Etiology** Nematodes of the genus *Bunostomum* and related hookworms.

**Epidemiology** Transmission is generally by skin penetration and is favored by warm, humid conditions.

**Signs** Anemia, diarrhea, and anasarca.

**Clinical pathology** Eggs and occult blood in feces, anemia, hypoproteinemia; none of these signs is specific.

**Lesions** Red worms attached to mucosa of small intestine, nearby ingesta often blood-stained.

**Diagnostic confirmation** Necropsy is only certain method.

**Treatment** Most modern broad-spectrum ruminant anthelmintics are effective as well as those narrow-spectrum compounds that bind to plasma protein.

**Control** General preventive programs for parasitic gastroenteritis are also effective against hookworm.

### ETIOLOGY

All farm animals other than horses harbor hookworms. The main species are:

- **Cattle:** *Bunostomum phlebotomum* is the most widespread but *Agrisostomum vryburgi* may occur in cattle in Asia and South America
- **Sheep:** *B. trigonocephalum* is found worldwide while *Gaigeria pachyscelis* occurs in India, Indonesia, South America and Africa.

Additionally, *Globocephalus* spp. occur in pigs but are rarely of clinical importance.

### LIFECYCLE

Hookworms are reddish-colored nematodes, 1–2.5 cm long, and inhabit the

small intestine of their hosts. The females are prolific egg layers and the lifecycle is direct. The eggs hatch and two free-living, non-parasitic larval stages follow, which are very susceptible to desiccation. An infective larva is produced in about 1 week under favorable conditions. Transmission is by skin penetration alone in the case of *G. pachyscelis* but *Bunostomum* spp. larvae can enter the body via the skin or the mouth.<sup>1</sup> After cutaneous penetration, larvae:

- Enter the bloodstream
- Are carried to the heart and lungs
- Enter the alveoli where the fourth-stage larvae develop
- Pass up the air passages to the pharynx
- Are swallowed
- Reach the small intestine.

Ingested larvae penetrate the intestinal wall and return to its lumen without further migration. In *B. trigonocephalum* infestations, the fourth-stage larvae reach the intestine in about 11 d and egg-laying adults are present about 7 weeks after infestation. The prepatent period in *B. phlebotomum* infestations is about 8 weeks and in *G. pachyscelis* 10 weeks.

### EPIDEMIOLOGY

The chances of infestation occurring by percutaneous entry are greatly enhanced when the surroundings are wet, and this, together with the susceptibility of the larvae to desiccation, leads to a higher incidence of the disease in humid subtropical or warm temperate countries such as the southern United States, Africa, northern Australia, and parts of Europe. Heavy infestations of sheep or cattle are uncommon in cooler temperate countries but do occur occasionally when animals are winter housed in dirty surroundings with insufficient bedding. Immunity to *B. phlebotomum* in cattle appears to develop with age and animals affected one year appear to be completely immune the next. Calves 4–12 months of age are most commonly affected and the degree of infestation is always greatest in the winter months.

### PATHOGENESIS

Hookworms are active bloodsuckers and cause severe anemia in all animal species. Total worm numbers as low as 100 may cause clinical illness<sup>2</sup> and 2000 may cause death in young cattle. There is a loss of whole blood and hypoproteinemic edema may result. Some irritation to the intestinal mucosa is inevitable and mild or intermittent diarrhea follows. Penetration of the skin by larvae may cause signs of irritation and lead to the introduction of pathogenic bacteria.

### CLINICAL FINDINGS

In mild infestations in stabled cattle, fidgeting, stamping, and licking of the feet may be observed. Constipation, accompanied by mild abdominal pain is seen in the early stages and is followed by bouts of diarrhea. The cattle are unthrift and anemic. In severe infestations there is obvious pallor of mucosae, weakness, anasarca under the jaw and along the belly, prostration and death in 2–3 d. The signs in sheep are similar to those in cattle. The convalescent period, even after treatment, is prolonged unless the diet is supplemented to stimulate erythrocyte production.

### CLINICAL PATHOLOGY

The eggs in feces are similar in appearance to many other gastrointestinal nematodes. Hookworm egg counts of 400–500 epg are usually associated with fatal infestations. As both larvae and adult worms are avid bloodsuckers, clinical signs are often evident before eggs appear in the feces. The degree of anemia and the presence of occult blood in the feces can be used as a measure of the severity of the infestation.

### NECROPSY FINDINGS

Hookworms attached to the mucosa are easily found but they may be few in number. In calves, total worm counts of 100 or more suggest a significant level of infestation; counts of over 2000 worms indicate a degree of infestation likely to be fatal. In sheep and goats, 24 adult *G. pachyscelis* have been reported to be fatal, but the usual fatal figure is probably closer to 100. Most of the worms are found in the first few feet of the small intestine and the intestinal contents nearby are often deeply bloodstained. Hookworms often form part of a mixed infection comprising several or many gastrointestinal nematodes.

### DIAGNOSTIC CONFIRMATION

Anemia, diarrhea, and anasarca are signs common to several diseases and so necropsy is the only certain method of diagnosis.

### DIFFERENTIAL DIAGNOSIS

- Hepatic fasciolosis
- Hemochochosis
- Coccidiosis
- *Mycoplasma ovis*
- Dietary deficiency of cobalt or copper and chronic molybdenosis.

### TREATMENT

Most newer broad-spectrum anthelmintics including the benzimidazoles, avermectin/milbemycins, levamisole, and morantel are effective against adult *Bunostomum*



spp. in sheep and cattle, but not all products have label claims against larval stages. Moxidectin by injection gives 4 weeks residual protection in sheep against *Gaigeria*. Nitroxyruyl and rafoxanide, which bind to blood protein and are ingested by bloodsucking worms, are effective. Doramectin has a label claim for *G. pachyscelis* and moxidectin has been shown to protect sheep from reinfection for at least 35 d.<sup>3</sup>

**Supportive treatment** is essential in this disease because of the severe anemia which occurs. The provision of a mineral mixture containing iron, copper and cobalt is recommended and a general improvement in the quality of the diet, particularly in respect of protein, may shorten the convalescent period.

### CONTROL

Preventive programs to protect against *Haemonchus* or *Ostertagia* infections will usually give adequate protection against hookworms. Wet surroundings – in pastures, in yards and in barns – should be avoided to reduce the chances of percutaneous infestation and reduce the viability of the free-living larvae. Pens should be cleaned frequently and ample bedding provided. Heavy stocking of sheep or calves in small pens should be avoided. Under conditions of heavy risk, periodic treatment should be administered. The hookworm of cattle will not infect sheep and vice versa, and so alternate grazing may be advantageous although it has been suggested that some species of deer may act as a source of infection for *B. phlebotomum*.

### REFERENCES

- 1 Petrov Yu F, Koslov YN. *Vet Moscow* 1988; 3:41.
- 2 Graham JM, Charleston WAG. *Vet Med Rev* 1971; 4:452.
- 3 Peters RJ et al. *J S Afr Vet Assoc* 1994; 65:167.

## Oesophagostomosis (nodule worm disease) in ruminants and pigs

### Synopsis

**Etiology** Nematodes of the genus *Oesophagostomum*.

**Epidemiology** In sheep, disease mostly confined to warmer summer rainfall regions; pigs of all ages are susceptible but overt disease uncommon, except in undernourished sows.

**Signs** In sheep, failure to thrive, soft droppings, diarrhea and abdominal pain in severe cases; in sows, weight loss during lactation.

**Clinical pathology** No specific laboratory findings.

**Lesions** Nodules in the wall of intestine.

**Diagnostic confirmation** Necropsy is most reliable; otherwise need to incubate feces and identify infective larvae.

**Treatment** *Sheep*: all modern broad-spectrum wormers listed for parasitic gastroenteritis; *Pigs*: all wormers listed for stomach worms; not all compounds are active against mucosal larvae.

**Control** General preventive programs for parasitic gastroenteritis are also effective against *Oesophagostomum*. In sows, ensure adequate nutrition.

### ETIOLOGY

All farm animals except horses can harbor nematodes of the genus *Oesophagostomum*, causing a condition known as 'nodule worm disease' or 'pimply gut'. The important species are:

- **Sheep and goats:** *O. columbianum*, *O. venulosum*, and *O. asperum*
- **Cattle:** *O. radiatum* and *O. venulosum*
- **Pig:** *O. dentatum* and *O. quadrispinulatum*.

*Oesophagostomum* spp. are generally host specific but *O. venulosum* is found in both sheep and cattle. *O. columbianum* can develop in cattle to the point of penetrating the mucosa and producing lesions similar to those in lambs, but without any apparent effect on health.

### LIFECYCLE

In appearance, *Oesophagostomum* species are stout, white roundworms, the largest growing to 2.5 cm in length. The lifecycle is direct. Eggs passed in the feces hatch and, after undergoing two molts, become infective third-stage larvae. Infestation is thought to occur only by ingestion, but skin penetration has been demonstrated experimentally. The larvae invade the intestinal wall at any level, provoking a nodular host reaction, and some may undergo hypobiosis. They return to the lumen as fourth-stage larvae and egg laying in most species commences in about 40–50 d.

### EPIDEMIOLOGY

*O. columbianum* eggs and larvae are particularly susceptible to cold and dryness, but under optimum conditions can reach the infective stage in 6–7 d. Prevalence is therefore highest in warmer temperate or subtropical climates with summer rainfall. If sufficient larvae are ingested, acute disease may occur during the summer months. Lighter infestations or exposure of older animals to infection may give rise to a chronic condition that presents clinically in the following winter when animals are on a low plane of nutrition. Disease in cattle is similarly most common in warmer summer rainfall areas. Nevertheless, the more chronic form of the disease is quite common in ruminants in

eastern Canada and the New England states of the United States.

In pigs, *Oesophagostomum* infections are cosmopolitan. The female worms produce large numbers of eggs and in pig houses only the highest standards of hygiene will prevent infections from persisting. Outdoors, the larvae thrive best when sheltered by thick vegetation. Numbers decline markedly during dry summers on bare soil or during the winter.<sup>1</sup> Some larvae, however, can overwinter even in Scandinavia, but cold Canadian winters kill all free-living stages.<sup>2</sup> A periparturient rise in fecal egg counts has been described in sows but it is not as constant a feature as the similar phenomenon in ewes. The periparturient egg-rise (PPER) is closely related to lactation and terminates when the piglets are weaned. When it occurs, it can be an important source of contamination in the farrowing house.<sup>3</sup> *Oesophagostomum* has been associated with the thin sow syndrome, in which sows rapidly lose condition late in pregnancy and while they are lactating. Fecal egg counts may be very high but parasitism is only a contributory factor. The primary cause is inadequate nutrition. In group-fed animals, timid sows not able to secure an adequate share of the ration satisfy their hunger by eating fecal bedding, thereby increasing their intake of infective larvae.

### PATHOGENESIS

The size of the nodules in the intestinal wall, and hence their pathogenicity and economic importance to the meat industry, varies with the worm species and immunity of the host. In ruminants, for example, *O. columbianum* provokes a massive host response while *O. venulosum* does not produce visible lesions. In pigs, *O. quadrispinulatum* nodules are larger than those of *O. dentatum*.

*O. columbianum* larvae in young sheep exposed for the first time stay in the wall of the anterior small intestine for about 5 d. Some subsequently enter the mucosa a second time in the large intestine, while others develop directly to adults. In second and subsequent infections, few larvae develop directly to adults and most are arrested in either the first or second mucosal phases.<sup>4</sup> Persistence of larvae in the intestinal wall for long periods is thought to indicate host immunity, thus in older sheep, nodules develop in the intestinal wall at any level and may occasionally be present in nearby organs. Larvae may remain alive in these nodules for periods of up to 1 year but many are destroyed by the host response. When the resistance of the animal is lowered, due for example to poor nutrition, larvae leave

the nodules, re-enter the intestinal lumen and pass down to the colon to become adults. This is the probable explanation for three common findings at necropsy:

1. Young sheep with many adult worms and no nodules
2. Adult sheep with many nodules and no adult worms
3. Adults with both.

Oesophagostomosis is sometimes implicated as a primary cause of intussusception in young sheep.

**Young susceptible ruminants** generally suffer as a result of the emergence of larvae from the mucosa, which provokes a catarrhal colitis, and the feeding activities of the adults, which produce small ulcers and some mucosal bleeding.<sup>5</sup> In older, immune animals the nodular reaction plays a more important role. *O. radiatum* and *O. columbianum* cause:

- Anorexia
- Severe and persistent mucoid diarrhea
- Loss of weight
- Anemia
- Hypoproteinemia
- Death.

The hypoproteinemia follows edema of the cecum and colon and is caused by loss of albumin into the lumen.<sup>6</sup> Anemia results from blood loss when mucosal larvae re-enter the lumen. The fall in plasma fibrinogen levels and platelet numbers observed 6–7 d after primary infection of calves probably aggravates this loss.<sup>7</sup> Nodules eventually caseate and calcify and may cause interference with intestinal motility or local peritonitis and adhesion formation, which leads to intussusception or stenosis. In sheep the nodules can cause considerable pain and result in an arched back ('humpy back') and a stilted gait. The nodules in pigs are much smaller, although edema and thickening of the colon and cecum can develop in the case of heavy infestation. Outbreaks of necrotic enteritis may be activated in pigs carrying *Salmonella* spp. populations.<sup>8</sup>

### CLINICAL FINDINGS

In heavily infested sheep, severe persistent diarrhea may occur in young animals. More commonly, older sheep in the winter months will show an intermittent passage of semi-soft droppings which contain excessive amounts of mucus and occasionally blood. There is rapid loss of condition, hollowing of the back, stiffness of gait and elevation of the tail. Nodules may be palpated on rectal examination. Anemia is not characteristic and is never marked.

Young calves may show anorexia, diarrhea, emaciation, and anemia. Initially

the diarrhea may alternate with constipation, but later it is continuous and is dark and fetid.

In pigs, clinical signs are less severe. Loss of condition and diarrhea in weaners and growers have been attributed to heavy infection, but deleterious effects, if any, are normally found at a subclinical level. In the 'thin sow' syndrome, lactating sows become thin or in severe cases emaciated, even though they have a good appetite but there is usually no diarrhea.

### CLINICAL PATHOLOGY

There are no specific laboratory tests. The eggs in feces are similar in appearance to those of many other gastrointestinal nematodes. Also, the severity of the disease may bear no relation to the number of eggs in the feces; counts vary widely with the season and the stage of development of the disease. In the early stages of a massive infestation, signs may be evident but there may be no eggs in the droppings. After the prepatent period in young sheep, eggs are usually present in large numbers and may be accompanied by living adult worms. In chronic cases however, very few eggs may be passed. Serum albumin concentrations are low in severe cases and anemia may be detected in cattle.

### NECROPSY FINDINGS

In early acute cases there is a mild catarrhal enteritis and larvae may be detectable in scrapings of intestinal mucosa. In the later more chronic stage, adult worms are easily visible in the colon. They are usually lying in thick mucus overlying a chronic catarrhal colitis. *O. columbianum* is very pathogenic and 200 adult females is considered a heavy infestation. Nodules, when they are present, may be found at all levels of the intestine; they measure up to 6 mm in diameter and, depending on their age, contain green, pasty or yellow-brown, crumbly, partly calcified material. There may be a great deal of thickening of the intestinal wall and local peritonitis.

### DIAGNOSTIC CONFIRMATION

A definite diagnosis of oesophagostomosis can only be made by necropsy examination or identification of larvae from a fecal culture.

### DIFFERENTIAL DIAGNOSIS

- Trichostrongylosis in sheep is also at its peak during the winter but diarrhea is more evident
- Hyostrongylosis also causes emaciation in lactating sows but is confined to outdoor herds
- Malnutrition, especially when sheep are housed and poorly fed.

### TREATMENT

All modern broad-spectrum compounds are effective against adult *Oesophagostomum*. Moxidectin provides up to 4 weeks' protection from reinfection with *O. columbianum* in sheep. *Oesophagostomum* spp. strains resistant to pyrantel have been detected on some pig farms in Denmark.<sup>9</sup>

### CONTROL

In sheep and cattle, the principles of control described under parasitic gastroenteritis in ruminants apply also to *Oesophagostomum* infections.

In pigs, the thin sow syndrome is unlikely to be cured or prevented by anthelmintic treatments alone; due consideration must also be given to the nutritional requirements of the animals at risk. To prevent contamination of the farrowing house, sows should be treated before entry. Pigs should be treated at weaning and each time they are moved on to new accommodation. Boars should be treated at least once a year.<sup>10</sup> Alternatively, it may be more convenient to treat all pigs on a premises simultaneously with a medicated feed. The dosing interval should be determined by fecal egg-counts performed on a representative sample of all age groups in the herd. Overdependence on anthelmintic therapy should be avoided as resistance can develop in *Oesophagostomum* populations.<sup>9</sup> The demonstration that diets containing highly degradable and rapidly fermentable carbohydrates can considerably reduce *O. dentatum* burdens and fecal egg-counts<sup>11</sup> indicates the possibility of an alternative approach to control.

In grazing pigs, the ability of the eggs and larvae to survive on the pasture must be considered. In the United Kingdom, eggs deposited in the winter and early spring do not reach the infective stage but infective larvae can survive for a year in feces or on pasture. Under these conditions treatment of pigs in the autumn with a move to clean pasture will reduce pasture contamination through the following spring and early summer.<sup>12</sup> An additional treatment in spring may give additional security.

### REVIEW LITERATURE

Roepsdorff A, Nansen P. FAO Animal Health Manual No 3: Epidemiology, diagnosis and control of helminth parasites of swine. Rome: FAO, 1998.

### REFERENCES

1. Roepsdorff A, Murrell KD. Int J Parasitol 1997; 27:553
2. Smith HJ. Can Vet J 1979; 20:184.
3. Jacobs DE, Dunn AM. Nord Vet Med 1968; 20:258.
4. Dash KM. Int J Parasitol 1973; 3:843.
5. Bremner KC, Keith RK. Exp Parasitol 1970; 28:416.
6. Bremner KC. Exp Parasitol 1969; 24:364.
7. Bremner KC, Fridemanis R. J Comp Pathol 1975; 85:383.
8. Stockdale PHG. Br Vet J 1970; 126:526.

9. Bjorn H et al. *Vet Parasitol* 1990; 37:21.
10. Batte EG. *J Am Vet Med Assoc* 1977; 170:343.
11. Petkevicius S. *Parasitology* 2003; 127:61.
12. Rose JH, Small AJ. *Vet Rec* 1980; 107:223.

## Parasitic gastritis in pigs

### Synopsis

**Etiology** The nematodes *Hyostrongylus rubidus*, *Ascarops*, and *Physocephalus*.

**Epidemiology** Infections occur in outdoor husbandry systems; *Hyostrongylus rubidus* has a direct lifecycle, but *Ascarops* and *Physocephalus* use dung beetles as intermediate hosts.

**Signs** Generally asymptomatic but heavy infections can produce gastritis; sows with *H. rubidus* may become thin during lactation.

**Clinical pathology** Eggs of *Ascarops* and *Physocephalus* in feces are characteristic; those of *H. rubidus* are similar to *Oesophagostomum*.

**Lesions** Excess mucus; gastritis; often ulceration of glandular part of stomach; nodular hyperplasia in hyostrongylosis.

### Diagnostic confirmation

Demonstration of eggs of *Ascarops* or *Physocephalus*; examination of larvae from fecal culture for *H. rubidus*.

**Treatment** *H. rubidus*: doramectin, ivermectin, fenbendazole, flubendazole, febantel, oxbendazole, thiophanate, levamisole, and dichlorvos; *Ascarops*: ivermectin.

**Control** Good husbandry practices, such as rotating pastures, normally suffice.

### ETIOLOGY

Three categories of nematode inhabit the stomach of the pig. The first is a trichostrongylid, *Hyostrongylus rubidus*. This is closely related to the *Ostertagia* spp. of ruminants and occurs in most countries where pigs are kept. The next group comprises members of several related genera including *Ascarops strongylina*, *A. dentata*, and *Physocephalus sexalatus*, which occur in the United States, Southeast Asia, and Australia, and *Simondsia paradoxa*, found in parts of Europe and India. Finally, *Ollulanus tricuspis* is a very small nematode (0.7–1.0 mm) that causes gastritis on rare occasions in pigs, cats, foxes, and dogs.

### LIFECYCLES

*H. rubidus* is a small (0.5–1.25 cm) thin, red worm which has a lifecycle very similar to that of *O. ostertagi*. Eggs develop at temperatures between 10 and 27°C (50 and 80°F). In the United Kingdom, eggs deposited outdoors from May to October develop into infective larvae. These larvae survive on pasture for up to 10 months but are rapidly killed by desiccation and by freezing. Transmission occurs by ingestion of the infective

larvae, which spend the next 13–14 d in the gastric glands. They then return to the lumen and the first eggs are passed 20–25 d after infection. In some circumstances larvae become hypobiotic and remain in the gastric mucosa for several months.

*Ascarops* and *Physocephalus* are thick, white worms 1–2.5 cm long. They have indirect lifecycles; eggs passed in the feces of the pig are eaten by dung beetles, in which hatching and development to infective larvae occur. Infestation of the final host occurs when pigs eat infested beetles. Little is known of the biology of *Simondsia paradoxa*.

### EPIDEMIOLOGY

The stomach worms of pigs are almost exclusively confined to outdoor management systems. The reason for this is different in each group. With *Ascarops* and *Physocephalus*, it is a consequence of the essential role of the dung-beetle in the lifecycle. In the case of *H. rubidus*, it is because the daily output of eggs by each female is so sparse that the lifecycle is unlikely to persist in pig houses practising a reasonable standard of hygiene. Young pigs are the most susceptible to hyostrongylosis but adult sows, especially when lactating, may also be affected. Hypobiosis is seasonal but disease outbreaks analogous to Type II ostertagiosis have not been reported.

### PATHOGENESIS

Developing *H. rubidus* provoke hyperplastic nodular lesions in the glandular part of the stomach. These and consequent biochemical and physiological sequelae are similar to those described for *O. ostertagi*. *Ascarops* and *Physocephalus* lie close to the gastric mucosa where they stimulate excessive mucus production. Heavy infections cause a catarrhal gastritis.

### CLINICAL FINDINGS

The effect of *H. rubidus* on young pigs is not usually clinically apparent.<sup>1</sup> Heavy infestations may be associated with anemia, unthriftiness, poor growth and diarrhea.<sup>2</sup> Signs in adult sows are usually seen during lactation. Affected animals lose more weight than normal and are slow to regain condition after weaning. In severe cases, sows may become emaciated. There may be pallor due to anemia and often a depraved appetite, but no diarrhea. Adult sows often carry heavy infestations without clinical illness but sudden death due to hemorrhage from gastric ulcers or to peritonitis by ulcerative perforation has been observed on rare occasions.<sup>3</sup> Although *Ascarops* and *Physocephalus* are common in many

areas, most infections are low grade and without clinical effect. Heavy infections can lead to inappetence and other signs of gastritis.

### CLINICAL PATHOLOGY

Fecal examination is not very useful for the diagnosis of hyostrongylosis as the eggs of *H. rubidus* are indistinguishable from those of the less pathogenic but more prolific *Oesophagostomum* spp. *Physocephalus* and *Ascarops* spp. eggs are small, thick-shelled and contain a larva when laid.

### NECROPSY FINDINGS

The presence of *H. rubidus* is easily missed as the worms are slender and often lie beneath a thick layer of mucus. The gastric mucosa is hyperemic and nodular lesions are present. There may be one or more deep ulcers in the glandular region of the stomach. These may contain clusters of adult *H. rubidus*. In severe cases the mucosa is thickened and edematous, and covered with a diphtheritic pseudomembrane. In *Physocephalus* and *Ascarops* infections, adult worms are readily visible lying in mucus on the gastric mucosa. There is an obvious gastritis in heavy infections and ulceration may occur.

### DIAGNOSTIC CONFIRMATION

Confirmation of infection with *H. rubidus* is made by examination of larvae from fecal cultures. Those of *H. rubidus* are longer and more vigorously motile than those of *Oesophagostomum* spp. As *H. rubidus* produces so few eggs, even small numbers of larvae may indicate a pathogenic worm burden. Elevated serum pepsinogen concentrations may also be indicative of infection.<sup>4</sup>

### DIFFERENTIAL DIAGNOSIS

*H. rubidus* must be differentiated from other causes of unthriftiness or emaciation such as:

- Swine dysentery
- Necrotic enteritis
- Coccidiosis
- Infestation with *Oesophagostomum* spp.
- Thin sow syndrome
- Malnutrition

### TREATMENT

Doramectin (0.3 mg/kg by injection), ivermectin (0.3 mg/kg by injection or 0.1 mg/kg/d for 7 d in feed), fenbendazole (5 mg/kg in feed as a single dose or divided over 7–14 d) and flubendazole (5 mg/kg as a single dose or 30 g/t finished feed given for 5–10 d) are active against fourth-stage and adult *H. rubidus*. Additionally, febantel (5 mg/kg), oxbendazole (15 mg/kg or 1.6 mg/kg/d for 10 d) and thiophanate have label claims

only for the adult worm. Levamisole and dichlorvos have also been widely used in the treatment of pig nematodes. In-feed ivermectin is also effective against *A. strongylina*.

### CONTROL

Standard hygienic precautions including frequent removal of manure, the provision of drainage in outside pens and rotation of pastures will reduce environmental contamination. Control of the dung beetle intermediate hosts of *Physocephalus* and *Ascarops* is impracticable.

Hyostrongylosis is most likely to affect sows during lactation and so animals at risk should be dosed before farrowing.<sup>5</sup> The behavior of *H. rubidus* larvae on pasture is similar to that described for *Oesophagostomum* and control schemes should be effective for both parasites.<sup>6</sup>

### REVIEW LITERATURE

Roepsdorff A, Nansen P. FAO Animal Health Manual No 3: Epidemiology diagnosis and control of helminth parasites of swine. Rome: FAO, 1998.

### REFERENCES

1. Baskerville A, Ross JG. Br Vet J 1970; 126:538.
2. Dodd DC. NZ Vet J 1960; 8:100.
3. Mouwen JMVM et al. Tijdschr Diergeneeskd 1986; 93:211.
4. Banga-Mboko H et al. Vet Res Commun 2003; 27:595.
5. Connan RM. Vet Rec 1967; 80:424.
6. Roepsdorff A, Murrell K. Int J Parasitol 1997; 27:553.

## Ascarid infections in pigs, horses and cattle

### Synopsis

**Etiology** Nematode worms from the ascarid family: *Ascaris suum* in pigs, *Parascaris equorum* in horses and *Toxocara vitulorum* in buffalo and cattle.

**Epidemiology** Transmission is by ingestion of highly resistant and long-lived larvated eggs; *T. vitulorum* is also transferred via colostrum.

**Signs** Heavy infestation leads to poor growth and afebrile diarrhea, sometimes with obstructive jaundice, intestinal obstruction and respiratory signs.

**Clinical pathology** Characteristic eggs in feces and a marked eosinophilia.

**Lesions** Petechial hemorrhages in lungs and fibrotic spots on the liver.

### Diagnostic confirmation

Demonstration of characteristic eggs in feces.

**Treatment** Pigs: ivermectin, doramectin, flubendazole, febantel, oxbendazole, thiophanate, pyrantel tartrate, and levamisole. Horses: ivermectin, moxidectin, febantel, fenbendazole, mebendazole, oxbendazole, and pyrantel embonate.

**Control** Pigs, horses: Keep young stock away from sites where eggs may accumulate. Cattle/buffalo: prophylactic anthelmintic treatment of 10–16 day old calves.

### ETIOLOGY

Each species has its own ascarid: *Ascaris suum* in pigs and *Parascaris equorum* in horses are cosmopolitan, while *Toxocara vitulorum* is an important cause of mortality in buffalo calves in India and Southeast Asia. Genetic studies show that although *A. suum* of the pig is very similar to *A. lumbricoides* of man, host-specific differences do exist<sup>1</sup> and cross-infections occur only infrequently.<sup>2,3</sup> There is no ascarid specific for sheep but they may rarely become infected with *A. suum*.

### LIFECYCLE

*A. suum* and *P. equorum* have similar lifecycles. The adult worms are long (20–50 cm), cylindrical, pointed at both ends and have a thick, glistening, yellow-white cuticle. They live in the small intestine and lay very large numbers of thick-shelled eggs. These are not infective until a larva has developed inside. This process needs suitable warmth and humidity and takes place over a period of several weeks. When swallowed, infective eggs hatch quickly in the intestine of the host and the larvae migrate through the intestinal wall, reach the portal vein and are transported to the liver. They cross to the hepatic venous system and travel to the lungs, are passed up the bronchi and trachea to the pharynx, are swallowed and come to rest in the intestine where they mature. The prepatent period (time from infestation to the appearance of eggs in the feces) is 6–8 weeks for *A. suum* and 11–15 weeks for *P. equorum*.<sup>4</sup>

*Toxocara vitulorum* has a more complex lifecycle. When eggs are ingested by cattle or buffalo more than 4–5 months of age, the larvae instead of traveling to the intestine settle in somatic tissues without developing or growing. Subsequently they become activated around calving and migrate to the udder. They transfer to the calf in the colostrum and grow to the adult stage in the intestine.

### EPIDEMIOLOGY

In pigs and horses the only route of infection is by ingestion of larvated eggs. Because the eggs have very thick walls the infective stage is protected from deleterious environmental influences. Few disinfectants will harm them and they are very resistant to cold but survive most readily in cool, moist surroundings. Periods of survival of up to 5 years have been recorded. In the United Kingdom, *A. suum* eggs shed from September to May become infective more or less synchronously in July and the number of eggs becoming infective then falls away rapidly. This coincides with the prevalence of damaged livers recorded at bacon

factories.<sup>5</sup> Transmission is therefore seasonal but as ascarid eggs are very resistant and can overwinter, pigs and horses may in the absence of good hygiene become infected at all periods of the year.<sup>6</sup> Clinical ascariasis is usually associated with conditions that allow infective eggs to accumulate. This may happen where, for example, the stocking rate is high and the same paddocks are used year after year,<sup>7</sup> or when indoor pens are inadequately cleaned.

**Protective immunity** develops and consequently only the young are seriously affected. Under field conditions, eggs are passed by foals from 12–13 weeks of age and spontaneous expulsion of worms occurs 6–9 weeks later. Eggs are seen occasionally in the feces of very young foals but this is thought to be due to the ingestion of uninfected eggs during coprophagia. In older animals no clinical signs are observed but infested animals, particularly adult sows and yearling horses, continue to contaminate their surroundings and are an important link in the chain of infection.

*T. vitulorum* larvae are present in greatest numbers in the colostrum 2–5 d after calving and few are present after day 9.<sup>8</sup> Mature worms are present in the intestine of the calf by 10 d of age and eggs are passed by 3 weeks. Worms are expelled by 5 months of age, thus toxocarosis is a calfhood disease.

### PATHOGENESIS

Migration of larvae through the liver results in hemorrhage and fibrosis, the latter appearing as white spots under the capsule. In heavy infection diffuse fibrosis may occur. The most serious damage occurs in the lungs where the larvae provoke alveolar injury with edema and consolidation. This damage can exacerbate pre-existing lung infections or provide a portal of entry into the body for pyogenic organisms. Immunity to migrating larvae is acquired and can be transferred through colostrum or immune serum.

**In animals other than pigs**, *A. suum* larvae migrate and develop but the worms do not normally reach the small intestine. During this process severe clinical signs of pulmonary involvement may appear. The disease has been produced experimentally in lambs and calves and has also been observed as a field occurrence in yearling cattle.<sup>9–11</sup>

**Foals with *P. equorum*** have reduced gut motility, an increase in the ratio of body water to body solids and a lowering of the body pool of albumin.<sup>12</sup>

### CLINICAL FINDINGS

In pigs up to 4–5 months old, clinical signs associated with heavy infestation are poor growth, an afebrile diarrhea

and lowered resistance to other disease. There is some evidence that exposure to parasites during the growing phase without anthelmintic treatment causes permanent damage to growth potential.<sup>13</sup> Adult worms may be vomited up and occasional cases of obstructive jaundice and intestinal obstruction or rupture occur. There may be coughing while larvae are passing through the lungs but this is not marked and there is seldom sufficient damage to cause a noticeable increase in respiratory rate or depth. In rare cases the infestation may be so severe that pigs manifest severe dyspnea or die of acute hepatic insufficiency. Enzootic pneumonia of pigs and swine influenza are reported to be much more serious diseases when accompanied by heavy *A. suum* infections, and breaks in hog cholera vaccination with live virus have been attributed to this cause. *A. suum* in other host species produces fever, dyspnea, and anorexia about the 8th day after infestation.<sup>9</sup>

Effects in foals and calves due to heavy infestation with *P. equorum* and *T. vitulorum* are similar to those observed in young pigs and include poor coat, diarrhea, and occasionally colic. In addition, in foals, convulsions, intestinal obstruction, and perforation may occur. Lung damage may give rise to fever, coughing and a mucopurulent nasal discharge. In calves, anemia and steatorrhea are additional signs.

#### CLINICAL PATHOLOGY

Characteristic eggs are usually present in large numbers in the feces of clinically affected animals. A marked eosinophilia often accompanies the early stages of infestation in pigs and in other species and has been shown to persist in calves for at least 1 year.

#### NECROPSY FINDINGS

In the early stages of a massive infestation, there are subpleural hemorrhages, and edema and congestion of the lungs. The pleural cavity may contain blood-stained fluid. The liver is enlarged and congested and there may be hemorrhages under the capsule. Microscopically, necrotic tracts and sections of larvae are observed. In species other than the pig, infestation with *A. suum* is accompanied by emphysema, alveolar wall thickening with fibrin, eosinophils and hemorrhage in the lungs, and necrotic tracts in the liver.

In chronic cases the capsule of the liver is marked with white spots of small diameter which may, in severe cases, be confluent and constitute a network of connective tissue. Histologically, the necrotic tracts have been replaced by fibrous tissue. The carcass is usually in poor condition and may be jaundiced. Large

numbers of mature worms may almost fill the lumen of the small intestine.

#### DIAGNOSTIC CONFIRMATION

Ascarid eggs are brown and have thick walls with a pitted surface. Fecal egg counts in excess of 1000 epg are considered to be indicative of significant infection. Migrating larvae are too small to be observed by the naked eye at postmortem examination. They can be recovered from macerated lung tissue by the Baermann technique or seen microscopically in scrapings of bronchial mucus.

#### DIFFERENTIAL DIAGNOSIS

##### Early stages of massive infection:

- Enzootic pneumonia in pigs
- Chronic form of *Rhodococcus equi* pneumonia in young foals
- Other forms of pneumonia in calves.

##### Chronic infection:

- Other causes of unthriftiness including malnutrition and chronic enteritis due to infections with *Salmonella* and *Brachyspina* spp.

#### TREATMENT

##### Pigs

In pigs, ivermectin or doramectin at 0.3 mg/kg and flubendazole 5 mg/kg are effective against adult and fourth-stage (intestinal) larvae of *A. suum* while fenbendazole 5 mg/kg, febantel 5 mg/kg, oxibendazole 15 mg/kg, thiophanate, pyrantel tartrate, and levamisole are effective against the adult worm. Ivermectin, fenbendazole, flubendazole, thiophanate, and pyrantel may be given in feed as divided doses over several days. Ivermectin may have some activity against migrating larvae.<sup>14</sup>

##### Horses

In horses, ivermectin 0.2 mg/kg, moxidectin 0.4 mg/kg, febantel 6 mg/kg, fenbendazole 7.5 mg/kg, mebendazole 5–10 mg/kg, oxibendazole 10 mg/kg, and pyrantel embonate 19 mg/kg are all effective against adult *P. equorum*. Ivermectin, moxidectin, and fenbendazole are also active against immature forms in the intestine.

##### Buffalo calves

In buffalo calves, the limited data available suggest that pyrantel has good efficacy against both immature and adult worms. A dose of 250 mg for a calf has given good results.<sup>8</sup> Other compounds such as levamisole, febantel, oxfendazole, and even piperazine can be used for treatment but may not expel all worms.

#### CONTROL

Important lifecycle features which must be taken into account when devising a control program for ascarid infections are:

- The worms are prolific egg layers
- The infective eggs are very resistant and long lived
- Young animals are most susceptible.

Emphasis must be placed on preventing the environment from becoming contaminated. This is achieved by periodic treatment of the animals likely to be shedding eggs – asymptomatic adult carriers as well as the more vulnerable young stock. Exposure of young pigs and foals to contaminated soil or bedding should be avoided.

Unnecessary treatments can be avoided by regular monitoring with fecal egg counts. In intensive pig-raising systems on concrete floors, the risk of ascarid infestation can be greatly reduced, but rarely eliminated, with good standards of hygiene. In the case of straw yards, epidemiological studies in the United Kingdom<sup>5</sup> suggest that all bedding should be removed at the end of June (to remove eggs shed in preceding months before they become infective) and again at the end of August (to remove eggs deposited in the summer). If pigs are allowed access to small earthen yards, these must be kept well drained and the manure removed frequently. Control is difficult in free-range systems as the eggs become infective in 4–6 weeks in summer and may persist over the winter.<sup>15</sup> Deep ploughing of contaminated soil after use will reduce risk of *A. suum* and *Trichuris suis* eggs infecting future batches of pigs.

If farrowing pens are regularly cleaned with high-pressure water and sows are treated immediately prior to entry, it may be possible to control infection in piglets without anthelmintic treatment. Break-downs may occur as ascarid eggs are adhesive and not all will be washed away by hosing. For the same reason, eggs are easily introduced from outside on boots etc. It may therefore be necessary to treat piglets at weaning. Ascarids may be controlled in growing pigs by periodic anthelmintic treatments, but this has to be combined with rigorous hygiene to eliminate liver damage caused by migrating larvae.

Young foals present more of a problem as they often run on permanent pasture used by foals in previous years. Such pastures may become heavily contaminated with eggs. Recommendations for control include<sup>16</sup>:

- Thorough cleaning and disinfection of the maternity stall after each foaling
- Use of small exercise paddocks which should preferably have been rested from occupation by horses for a year
- Weekly removal of manure from the pasture. The foals should be routinely treated at about 10–12 weeks of age

when the worms are first becoming mature and again at bimonthly intervals. In this way heavy egg contamination of the pasture can be avoided.

Early signs of the possible development of anthelmintic resistance in *P. equorum* are starting to appear.<sup>17</sup>

In buffalo calves, a single anthelmintic treatment at 10–16 d of age using a compound with high activity against larval stages gives good control of *T. vitulorum*.

## REVIEW LITERATURE

- Arundel JH. Parasitic diseases of the horse. Vet Rev 28. Postgraduate Foundation in Veterinary Science University of Sydney Australia, 1985.
- Roepsdorff A, Nansen P. FAO Animal Health Manual No 3. Epidemiology diagnosis and control of helminth parasites of swine. Rome: FAO, 1998.
- Roberts J. *Toxocara vitulorum* in ruminants. Helminthol Abstr 1993; 62:151.

## REFERENCES

- Zhu XQ et al. Int J Parasitol 1999; 29:469
- Nejsum P et al. J Clin Microbiol 2005; 43:1142.
- Gunn A. Vet Rec 1980; 107:581
- Clayton HM, Duncan JL. Int J Parasitol 1979; 9:285.
- Connan RM. Vet Rec 1977; 100:421.
- Chapman MR et al. J Parasitol 2001; 87:1371.
- Thomsen LE et al. Vet Parasitol 2001; 99:129.
- Roberts JA. J Vet Pharmacol Ther 1989; 12:5.
- Fitzgerald PR. Am J Vet Res 1962; 23:731.
- Greenway JA, McCraw BM. Can J Comp Med 1970; 34:227.
- McCraw BM, Lautenslager JP. Can Vet J 1971; 12:87.
- Clayton HM et al. Equine Vet J 1980; 12:23.
- Urban JF et al. J Anim Sci 1989; 67:1668.
- Alva-Valdes R et al. Am J Vet Res 1989; 50:1392.
- Roepsdorff A, Murrell KD. Int J Parasitol 1997; 27:563.
- Herd RP. Mod Vet Pract 1986; 67:893.
- Hearn FP, Peregrine AS. J Am Vet Med Assoc 2003; 223:482.

## Strongylosis (redworm infestation) in horses

### Synopsis

**Etiology** Two nematode subfamilies: the Strongylinae (large strongyles) and Cyathostominae (known variously as small strongyles, small redworms, trichonemes, cyathostomes, or cyathostomins).

**Epidemiology** Eggs are shed by horses of all ages; the lifecycle is direct; infective larvae develop seasonally on pasture; hypobiotic cyathostomin larvae can cause severe disease when they resume development in late winter.

**Signs** General strongylosis: ill-thrift, weight loss, poor hair coat, and impaired performance. Verminous arteritis (associated with *Strongylus vulgaris*): variable, including colic and diarrhea. Larval cyathostominosis: rapid weight loss, often with sudden onset diarrhea.

**Clinical pathology** Strongylid eggs in feces (except disease caused by larvae); reduced hemoglobin, erythrocyte counts and packed cell volumes; leukocytosis; eosinophilia (with migrating larvae); hyperglobulinemia, particularly IgG(T); hypoalbuminemia.

**Lesions** *General strongylosis*: large numbers of adult worms in cecum and colon; hemorrhagic inflammation of mucosa with multiple small ulcers, large and small nodules. *Larval cyathostominosis*: mucosa grossly inflamed with large numbers of larvae appearing as brown specks. Verminous arteritis: wall of cranial mesenteric artery greatly thickened, organizing thrombi and larvae on internal surface; ischemia or necrosis of parts of intestinal wall due to emboli.

*Migratory larvae*: seen in various subserosal sites; some cause nodules in the liver.

**Diagnostic confirmation** Few pathognomonic indicators; judgment made on overall appraisal of clinical history, presenting signs and laboratory findings; arteritis of cranial mesenteric artery sometimes palpable *per rectum*; immature worms sometimes in feces in larval cyathostominosis.

**Treatment** *General strongylosis*: ivermectin, moxidectin; benzimidazoles, e.g. febantel, fenbendazole, mebendazole, oxbendazole; pyrantel. *Migrating strongyles*: ivermectin, moxidectin; fenbendazole (special dose). *Larval cyathostominosis*: fenbendazole (special dose), moxidectin.

**Control** Twice-weekly removal of feces from pastures; mixed or alternate grazing; routine dosing to prevent contamination of pasture with eggs. *Larval cyathostominosis*: 5-day preventive fenbendazole treatment in early winter.

## ETIOLOGY

The redworms (strongyles) are nematodes commonly found in the large intestine of horses and other Equidae. They belong to two subfamilies: the Strongylinae (large strongyles) and Cyathostominae (small strongyles, small redworms, trichonemes, cyathostomes or cyathostomins). The large strongyles include *Strongylus vulgaris*, *S. edentatus*, and *S. equinus*, which migrate extensively through the body, and *Triodontophorus* spp. and *Oesophagodontus robustus*, which do not. The cyathostomins comprise more than 40 non-migratory species belonging to genera including *Cylicostephanus*, *Cyathostomum*, *Cylicocyclus*, *Cylicodontophorus*, *Poteriostomum*, *Gyalocephalus*, and *Cylindropharynx*.<sup>1</sup> Of these, about 10 species occur commonly.

## LIFECYCLE

Eggs are passed in the feces and under suitable climatic conditions produce infective third-stage larvae from 7 days

onwards. As in many other parasitic conditions, the survival of eggs and larvae is favored by shade, moisture and moderate temperature. Desiccation is particularly detrimental to their development. Some eggs and larvae may withstand freezing temperatures but development ceases below 7.5°C (46°F) to be resumed when temperatures increase. Optimum chances for infection of the host occur in the early morning or evening, when dew produces a moisture film on plants, or after rain, both of which give conditions that encourage larvae to migrate onto pasture. The lifecycle of all species is direct; horses become infected by ingestion of the infective larvae.

After ingestion, the larvae of non-migratory strongyles, such as the cyathostomins, exsheath and enter the walls of the cecum and colon, where they remain in small subserous nodules for 7–18 weeks before breaking out into the lumen of the intestine. The time spent in the mucosa depends on:

- The species
- The season of the year
- The age and degree of immunity of the host.

They can become arrested in their mucosal development and their synchronous emergence some weeks later may provoke severe clinical signs. This may occur spontaneously, particularly in late winter, or may be induced by anthelmintic treatment. Expulsion of the adult worm population seems to remove an inhibitory feed-back mechanism and may provoke clinical signs.<sup>2</sup> Hypobiotic early third stage larvae are present in the mucosa at all seasons of the year.<sup>3</sup>

**Larvae of *S. edentatus*** penetrate the intestine and travel via the portal vessels to the liver, where larvae remain and produce hemorrhagic tracts for a month or so. They then migrate via the hepatorenal ligament to the connective tissue under the peritoneum and form hemorrhagic nodules. After about 3 months, they return via the root of the mesentery to the large bowel wall and again form hemorrhagic nodules, which finally rupture and release the worms into the lumen. Adult egg-laying females are present from 40 weeks.<sup>4</sup> Larvae may be found in other organs, e.g. the testes, but these larvae do not return to the intestine. *S. equinus* migrates via the liver to the pancreas and peritoneal cavity but how they return to the intestine is uncertain.

**Larvae of *S. vulgaris*** penetrate the intestinal wall, molt to the fourth larval stage in the submucosa and then pass into and up small arteries. By day 14, they have reached the cranial mesenteric

artery, where they develop to late fourth-stage larvae. In 3–4 months they molt and the young adults then return to the intestine via the lumina of the arteries. Nodules are formed in the intestine wall and later rupture, releasing adults into the lumen of the intestine. The prepatent period is 6 months.

## EPIDEMIOLOGY

Strongylosis is a common disease of horses throughout the world and causes deaths when control measures are neglected. In areas with cold winters and mild summers, egg deposition peaks in spring and remains high over summer.<sup>5</sup> At this time, temperatures are suitable for larval development and massive contamination of infective larvae may occur in late summer and early autumn, when young susceptible horses are present. *S. vulgaris* larvae can overwinter in considerable numbers in Europe.<sup>6</sup> If the summers are hot and dry, only a small proportion of strongyle eggs develop to larvae and these may be shortlived, but continual reinfestation keeps pasture contamination high.

In subtropical regions, eggs can hatch throughout the year and larval availability is influenced more by rainfall than temperature. For example, in Florida in the United States, fecal egg counts remain high throughout the year and there is an autumn rise in infective larvae.<sup>7</sup> Such associations between disease risk and local climate have important implications in the timing of treatments.

The onset of disease following ingestion of large numbers of larvae depends on the maturation period of the parasite in the host and whether it is the immature or adult stages that are pathogenic. Outbreaks of disease due to the emergence of small strongyles after hypobiosis are commonly seen in Europe in late-winter and early-spring (winter or larval cyathostominosis),<sup>8,9</sup> while arterial lesions due to larval *S. vulgaris* are first seen in late summer and reach a maximum by midwinter.

Mares are the main source of infection for younger horses<sup>10</sup> as many adults carry appreciable strongyle burdens and pass large numbers of eggs. Nevertheless, horses do gain some acquired immunity to infection and so young stock are the most susceptible.<sup>11</sup> Possibilities for vaccination are being investigated<sup>12</sup> but a commercial product seems an unlikely prospect in the short term.

The extensive use of anthelmintics with high efficacy at regular intervals has resulted in a marked decline in the prevalence of *S. vulgaris* in many regions.<sup>13</sup> The cyathostomins, on the other hand, are becoming increasingly important. This

may be due to any of the following factors<sup>14</sup>:

- Insusceptibility of mucosal cyathostomins to many drugs
- Selection for benzimidazole-resistant worms
- Selection for shorter egg reappearance periods.

## PATHOGENESIS

The disease processes associated with the strongyles can be divided into those produced by migrating larvae, those provoked by the mass emergence of mucosal larvae and those associated with adult worms. Heavy intestinal infection can alter intestinal motility, permeability, and absorption.

The larvae of *S. vulgaris* are the most pathogenic, causing arteritis, thrombosis and thickening of the wall of the cranial mesenteric artery. Emboli may break away and lodge in smaller blood vessels, leading to partial or complete ischemia in part of the intestine, thus producing colic. The result of this depends on the length of the segment of intestine affected and the ability of the collateral blood supply to become established before necrosis and gangrene occur. It is not clear whether the ischemia is due directly to the mechanical effects of embolism or to consequent pathophysiological events.<sup>15</sup> Whatever the cause, greatly enhanced mobility proximal to the lesion follows and can cause volvulus or torsion.<sup>16</sup> Intussusception is seen occasionally. Colic may also be caused by pressure of the thickened cranial mesenteric artery on the mesenteric plexus.

Other arterial lesions associated with migrating *S. vulgaris* larvae include aneurysm of the cranial mesenteric artery but this is a relatively rare occurrence. More often, larvae aberrantly migrating beyond the cranial mesenteric artery cause migratory tracts and thrombi in other blood vessels. Multiple lesions may be seen in the cecal and colic arteries which may completely occlude the lumen and cause gangrene in parts of the bowel. Smaller lesions are occasionally seen in iliac, renal, splenic, hepatic and coronary arteries. Aortic and iliac thrombosis may result in hind-limb lameness.<sup>17</sup> Field and experimental cases of cerebrospinal nematodosis due to *S. vulgaris* invasion of the central nervous system have been reported.<sup>18</sup>

*Strongylus sp. larvae* returning to the intestine cause large nodules in the wall of the cecum and colon. Considerable hemorrhage may follow when these rupture to release the worm into the lumen of the intestine. In very heavy burdens, bleeding sufficient enough to cause death can occur.

**Developing cyathostomin larvae** provoke the formation of small nodules which may be superficial or submucosal, depending on species. In heavy infections, the emergence of large numbers of larvae over a short period causes inflammation of the cecum or ventral colon, with small ulcers where larvae have emerged, hemorrhages of varying sizes and excess mucus production. Typically, this leads to weight-loss, diarrhea and sometimes a variety of other clinical manifestations including colic and cecocecal intussusception.<sup>19</sup> Affected animals may sometimes secrete *Salmonella*.<sup>9</sup>

**Adult strongyles** can be divided into those that cause blood losses and those that are superficial tissue feeders. *Strongylus* spp. have large buccal cavities which they use to draw in and digest plugs of mucosa, while secreting anticoagulants to aid the ingestion of blood. Hemorrhage continues from feeding points after worms detach to find a new attachment sites. *Triodontophorus* spp. and *O. robustus* feed similarly but are less harmful as they have smaller buccal capsules. An exception is *T. tenuicollis* as this species attaches in groups in the right dorsal colon and can cause large ulcers. The small strongyles (cyathostomins) have even smaller buccal cavities and produce only superficial damage so that even relatively large numbers (tens or hundreds of thousands) of adults often cause little apparent harm.

## CLINICAL FINDINGS

In natural infestations it is often impossible to quantify the effects of individual strongyle species as the clinical picture usually represents the combined effects of a mixed infestation. Ill-thrift, poor hair coat, impaired performance, weight loss and anemia are signs associated with a 'wormy' horse. The greatest losses are probably due to the failure of young horses to grow optimally and the less efficient performance of moderately parasitized working horses and donkeys.<sup>20</sup>

**Clinical syndromes caused by arteritis** in the cranial mesenteric artery, aorta and iliac artery are described in other chapters. Experimentally, the migratory phase of *S. vulgaris* infection is associated with pyrexia, inappetence, depression, leukocytosis, and intermittent or continuous colic.<sup>21</sup> In more chronic cases there is a:

- Persistent low-grade fever
- Poor appetite
- Intermittent colic
- Poor weight gain.

Diarrhea may be present. Adult mares exposed to heavy *S. vulgaris* in late pregnancy may become very weak to the



point of recumbency. On clinical examination the mucosae are pale, the heart rapid and loud and respiration moderately increased. Intestinal sounds are increased although the feces are normal. Abortion may occur and the mare usually dies.

The simultaneous maturation of large numbers of hypobiotic larvae induces the condition known as winter or larval cyathostominosis. This is usually characterized by rapid loss of weight, often accompanied by sudden onset diarrhea which becomes chronic. Subcutaneous edema frequently occurs. Numerous cyathostomin larvae may be passed with the feces or may be seen adhering to the glove after rectal examination. Larval cyathostominosis can occur in horses of all ages but occurs most commonly in adults under 5 years old. Unless treated early, prognosis is guarded.

### CLINICAL PATHOLOGY

Examination of feces for strongylid eggs confirms the presence of adult strongyles but does not differentiate species. To do this it is necessary to hatch the eggs and examine the infective larvae.<sup>22</sup> This has to be done by an expert parasitologist and delays results by at least 10 d. Experimentally, specific amplification of ribosomal DNA in feces can be used for the detection and identification of strongyle infections and may lead to diagnostic tests.<sup>23</sup>

Hematological values, particularly reduced hemoglobin levels, erythrocyte counts and packed cell volumes are often taken as a non-specific indication of the degree of infestation with strongyles. Leukocytosis is a feature of heavy infection while eosinophilia may reflect the presence of migrating larvae. Serum analysis reveals a marked increase in beta-globulins, particularly IgG(T), and a decrease in albumin.<sup>24</sup>

### NECROPSY FINDINGS

Adult strongyle worms may be seen attached or close to the mucosal surface. The three *Strongylus* spp. are red in color and 2–5 cm long. *Triodontophorus* and *Oesophagodontus* are smaller, up to 2 cm. Less easy to see are the small strongyles (cyathostomins) which are more slender and generally under 2 cm long with smaller buccal capsules. Because most cases of strongylosis are caused by mixed infestations with all genera, necropsy findings usually include most of the lesions characteristic of each worm.

In cases of general strongylosis, very large numbers of adult worms will be found in the cecum and colon. There may be so many that they appear to form a living cover to the contents of these organs. Catarrhal, hemorrhagic or

fibrinous inflammation of the cecum and ventral colon with multiple small ulcers is associated with the emergence of cyathostomin larvae. There may be edema with excessive mucus production or numerous punctate hemorrhages. Fewer adult worms may be present in winter cyathostominosis but large numbers of larvae (several per cm<sup>2</sup>) can be seen as brown specks in the mucosa, especially if this is illuminated from behind. Adult *T. tenuicollis* are often found in large numbers in the right dorsal colon in association with small circular hemorrhages, and they are sometimes attached in groups at the base of deep mucosal ulcers.

*Strongylus* larvae occur in many subserous sites, especially in nodules in the intestinal wall, and the body cavities may contain an excess of blood-stained fluid. Verminous arteritis lesions of varying size associated with *S. vulgaris* are common at the root of the cranial mesenteric artery and occasionally in the iliac artery. The affected arterial wall is greatly thickened and contains loculi on its internal surface, many of which contain living larvae. Lamellated thrombi are also common at this site and these are sometimes infected. The thickening of the arterial wall often extends along the cecal and colic arteries and complete occlusion of these may be followed by gangrene of a segment of intestine. Similar lesions of arteritis may be present at the base of the aorta. Spontaneous rupture of the vessel occasionally occurs. A significant correlation has been reported between lesions in the proximal aorta and the presence of focal ischemic lesions in the myocardium.<sup>25</sup> These are thought to be caused by microembolization causing arteriosclerotic lesions in the myocardial arterioles.

Larvae of *S. edentatus* cause hemorrhagic tracts and nodules in the liver and adhesions and disruptions of omental architecture. Hemorrhagic nodules 1–3 cm in diameter are produced in the subperitoneal region and these are reported to cause colic and anemia.

### DIAGNOSTIC CONFIRMATION

A specific diagnosis is difficult to achieve in every case. Few clinical observations or laboratory results are pathognomonic for the disease syndromes associated with strongyle infection. Often a judgment has to be made on an overall appraisal of clinical history, presenting signs and laboratory findings. For example, only 7 out of 14 cases of larval cyathostominosis were diagnosed ante-mortem in a series of adult horses with chronic diarrhea investigated at university referral clinics.<sup>11</sup>

A diagnosis of general strongylosis should be considered when poor growth, inappetence, diarrhea and some degree of anemia are the presenting signs. It is generally accepted that strongylosis is an important cause of anemia in horses. Fecal egg counts are generally high (over 800 epg) but are difficult to interpret. They have little direct correlation with worm burden as they are influenced by immunity and species composition. Also, they do not differentiate between different strongyle genera nor between these and *Trichostrongylus axei* infection of the stomach. In foals, eggs observed during the first few weeks of life are obtained by coprophagia and are not indicative of a patent infection.

The diagnosis of verminous arteritis also presents difficulty. The thickening of the cranial mesenteric artery may be palpable *per rectum*; the artery is situated below the aorta at the level of the posterior pole of the kidneys. Low serum albumin and increased beta-globulins particularly IgG(T) are the most useful laboratory tests while arteriography may demonstrate lesions in a number of arteries.<sup>26</sup> Transrectal ultrasonography may also be useful.<sup>27</sup>

In larval cyathostominosis marked weight loss, diarrhea, leukocytosis, hyperglobulinemia and hypoalbuminemia are usually seen. Peripheral edema is present in a proportion of cases. Fecal egg counts may be low or zero as it is the immature stages that cause this disease and owners have often wormed the animal before advice is sought. Consequently, serological diagnostic tests utilizing larval-antigen specific IgG(T) are under development.<sup>28</sup>

### DIFFERENTIAL DIAGNOSIS

#### General strongylosis:

- Other causes of anemia in the horse, including:
  - Babesiosis
  - Equine infectious anemia
  - Dietary deficiency in stabled stock and the effect of racing for long periods
- Other causes of ill thrift in horses, including:
  - Ascariasis in the foal
  - Gross nutritional deficiency or agalactia in the mare.

#### Larval cyathostominosis:

- Other causes of chronic diarrhea including:
  - Other parasitic infections, particularly migratory strongyles
  - Granulomatous enteritis
  - Alimentary neoplasia
  - Salmonellosis
  - Chronic liver disease
  - Peritonitis
  - Sand enteropathy
  - Hyperlipidemia.

## TREATMENT

Treatment may be targeted against immature and adult large and small strongyle worms in the lumen of the intestine, against migrating *Strongylus* larvae, particularly *S. vulgaris*, or against cyathostomin larvae in the intestinal mucosa. The latter may be developing third or fourth stage, or hypobiotic early third stage larvae. Anthelmintics vary in their efficacy against these larval stages. This influences the egg reappearance period (i.e. the time from treatment to the reappearance of eggs in the feces as new adult worm populations establish). This in turn determines the treatment interval in control programs.

**For elimination of adult worms** there is a wide choice of compounds and formulations for use in feed, as pastes or by tubing. Most of these however belong to just three chemical groups:

1. Avermectin/milbemycins, also known as macrocyclic lactones, (ivermectin 0.2 mg/kg, moxidectin 0.4 mg/kg)
2. Benzimidazoles (febantel 6mg/kg, fenbendazole 7.5 mg/kg, mebendazole 5–10 mg/kg, oxbendazole 10 mg/kg)
3. Tetrahydropyrimidines (pyrantel 19 mg pyrantel embonate (pamoate)/kg or 6.6 mg pyrantel base/kg).

Cyathostomin populations resistant to the benzimidazoles are common in many countries. Such populations are sometimes, but not always, susceptible to oxbendazole. A resistant population may be slow to revert, as parasites were still resistant in one study after non-benzimidazole compounds had been used for 3 years.<sup>29</sup> Pyrantel-resistant strains are becoming increasingly common but there is little evidence of ivermectin resistance after 20 years of use.<sup>30</sup> Where resistance to any of the three groups is a problem, the choice of effective anthelmintics can be extended by use of products containing piperazine, which may be synergized with phenothiazine. An alternative to use of these products is the cautious use of selected organophosphorus compounds such as dichlorvos or haloxon (which should not be given to foals).

**Mucosal cyathostomin larvae** are more problematic. Publications on this topic are difficult to interpret as results may be influenced by experimental design and methodology. Moxidectin 0.4 mg/kg has activity against hypobiotic and developing third-stage larvae as well as the fourth stage.<sup>31</sup> Consequently, this compound has a prolonged egg reappearance period allowing a treatment interval of 13 weeks for prevention of egg output onto pasture. Ivermectin

seems at best to be variable in its activity against mucosal stages<sup>32,33</sup> and a treatment interval of 8–10 weeks is generally recommended. Other anthelmintics at adulticidal doses have little or no effect on mucosal cyathostomin larvae and treatment intervals of 4–6 weeks are necessary during periods of heavy pasture challenge.

Fenbendazole at a single dose of 30 mg/kg or, more reliably, 7.5 mg/kg daily for 5 d is efficacious against mucosal larvae. One study has shown the latter treatment program to kill over 90% of hypobiotic and 95–99% of normally developing mucosal larvae.<sup>34</sup> The 5-day treatment is used in the early winter to prevent larval cyathostomiasis. A second treatment may be required later in the winter if animals have continued access to contaminated pasture.

**Migrating *S. vulgaris* and *S. edentatus*** can be controlled with ivermectin 0.2 mg/kg or fenbendazole at 60 mg/kg (single dose) or, more reliably, 7.5 mg/kg daily for 5 d.<sup>35</sup> In cases of verminous arteritis, it may take some months after removal of the parasites for the lesion to resolve.<sup>36</sup>

## CONTROL

Eradication of all horse strongyles is not feasible as infections are ubiquitous and no drug currently available can completely eliminate the mucosal larvae. Adult horses can pass substantial numbers of eggs throughout their lives, stocking densities are often high and foals usually graze with their dam. Infective larvae on grass can be long lived and there are usually few opportunities for the long-term resting or reseedling of pastures on horse farms. Consequently, the primary objective of control programs is to minimize the numbers of infective larvae accumulating on pasture. There is no pasture treatment that is economically or environmentally acceptable. The possibility of using nematophagous fungi that will destroy larvae in the feces is an exciting prospect.<sup>37</sup> Options for control by grazing management are limited. Alternate or mixed grazing with ruminants can reduce pasture infectively as horse strongyles will not establish in these hosts. The stomach worm *T. axei* however is a shared parasite. Removal of all horse feces from fields twice weekly is highly effective<sup>38</sup> provided heavy rainfall does not disperse the material. This approach can be cost effective where valuable animals are at risk or labor is relatively inexpensive. Tractor-mounted mechanical devices are available for this purpose. A further benefit of fecal removal is that the area within the field grazed by the horses is enlarged i.e. the ratio of lawn to rough increases.<sup>39</sup> Harrowing is effective in hot,

dry conditions when eggs and larvae are quickly desiccated but at other times is likely to have a deleterious effect by spreading infective larvae.

**Prophylactic chemotherapy** is employed to a greater or lesser extent at most stables as land and labor constraints often limit the effectiveness of non-chemical approaches. The latter should nevertheless be used wherever possible to minimize the number of treatments needed during the year, which in turn reduces the risk of development of anthelmintic resistance. The purpose of prophylactic chemotherapy in the control of strongylosis is to prevent the output of strongylid eggs onto the pasture. Under conditions of heavy pasture challenge, regular dosing at 4–6 weeks with benzimidazoles or pyrantel, 8–10 weeks with ivermectin, or 13–16 weeks with moxidectin is necessary throughout the period of risk. Once pasture larval counts have been reduced to insignificant levels, the time between doses can be extended. Routine fecal egg counts are an important component of any control strategy as they are a direct measure of the rate at which pasture contamination is taking place. They also confirm the continuing efficacy of the drugs used and can be used to determine optimum treatment intervals.

**Parasitism is a herd problem** and all horses on a property should be treated simultaneously, even if they have different owners. If routine fecal examinations are performed, dosing can be restricted to those horses with significant egg counts.<sup>40</sup> Untreated animals then provide parasite refugia for conserving anthelmintic efficacy. As horses and ruminants generally harbor different worm parasites, disease risk can be reduced by grazing these species together or by alternating the use of paddocks between each species. As most eggs are deposited on the pasture in spring and summer in temperate regions, concentration of treatments at this time should reduce contamination and give much lower pasture larvae counts in the following autumn and winter.<sup>5</sup> Intensive treatment programs are often adopted on stud farms, where maximum reduction of contamination is required. Less frequent dosing may be necessary on properties with lower stocking intensities or where horses are run with other stock. As the mare is the main source of contamination for the foal, she should be treated about 2 months before foaling, again at foaling and regularly thereafter. Treatment of foals should commence at 10 weeks of age to remove small strongyles before they start to lay eggs, and should be repeated at intervals depending on the choice of drug.

An alternative strategy for maintaining low pasture infectivity is use of continuous low-level in-feed prophylactic therapy with pyrantel tartrate 2.64 mg/kg/d. This has been shown to control cyathostomins effectively but may be less reliable in foals against large strongyles.<sup>41</sup> Treated foals may be more sensitive to challenge later in life.

Delaying the onset of resistance is an important consideration in the design of any control program. The major equine anthelmintics belong to just three chemical groups and worm populations resistant to one compound are usually unsusceptible to, or more tolerant of, the effects of others in that chemical group. The level of resistance in a herd can be estimated by means of the fecal egg count reduction technique (FECRT). At least six horses with high egg counts are weighed (e.g. with a weigh band) and treated with an accurately measured dose of anthelmintic. A reduction in mean egg count after 7–14 d of less than 90% is suggestive of resistance. More stringent tests are required for confirmation. Recommendations for extending the useful life of existing products similar to those listed earlier for ruminants have been published for horse anthelmintics.<sup>42</sup>

## REVIEW LITERATURE

- Arundel JH. Parasitic diseases of the horse. Veterinary Review 28. Postgraduate Foundation in Veterinary Science University of Sydney Australia, 1985.
- Lyons ET, Drudge JH, Tolliver SC. Larval cyathostomiasis. *Vet Clin North Am Equine Pract* 2000; 16:501–513.
- Ogbourne CP, Duncan JL. *Strongylus vulgaris* in the horse: its biology and veterinary importance. Farnham Royal Bucks UK: Commonwealth Agricultural Bureau, 1984.
- Love S. Treatment and prevention of intestinal parasite-associated disease. *Vet Clin North Am Equine Pract* 2003; 19:791–806.

## REFERENCES

- Lichtenfels JR. *Proc Helminthol Soc Wash* 1975; 42 (Special issue on helminths of domestic equids).
- Lyons ET et al. *Vet Med* 1994; 89:1146.
- Klei TR. *Vet Parasitol* 1996; 64:163.
- Klei TR et al. *Equine Vet J* 1989; Suppl 7:2.
- Herd RP et al. *Equine Vet J* 1985; 17:202.
- Eysker M, Wemmenhove R. *Vet Parasitol* 1987; 87:69.
- Courtney CH. *Vet Parasitol* 1999; 85:173.
- Mair TS. *Vet Rec* 1994; 135:598.
- Love S et al. *Vet Parasitol* 1999; 85:113.
- Love S et al. *Vet Rec* 1992; 130:217.
- Duncan JL. *Vet Rec* 1974; 94:337.
- Love S, Duncan JD. *Vet Parasitol* 1992; 44:127.
- Swiderski CE et al. *Adv Vet Med* 1999; 41:389.
- Herd RP. *Compend Cont Educ Pract Vet* 1990; 12:732.
- Herd RP. *Equine Vet Educ* 1990; 2:41.
- Davies JV, Gerring EL. *Equine Vet J* 1985; 17:219.
- White NA. *Comp Cont Educ Pract Vet* 1985; 7:S156.
- Maxie MG, Physick-Sheard PW. *Vet Pathol* 1985; 22:238.
- Little PB et al. *Am J Vet Res* 1974; 35:1501.

- Khallaayoune K. In: Fielding D, Pearson RA (eds). *Donkeys mules and horses in tropical agricultural development*. Edinburgh: University of Edinburgh, 1991; p. 174.
- Duncan JL. *Equine Vet J* 1973; 5:20.
- Arundel JH. Parasitic diseases of the horse. *Vet Rec* 1985; 28:16. Sydney, Australia: Postgraduate Foundation in Veterinary Science, University of Sydney.
- Hodgkinson JE et al. *Parasitol Res* 2005; 95:287.
- Patton S et al. *Am J Vet Res* 1978; 39:19.
- Cranley JJ, McCullagh KG. *Equine Vet J* 1981; 13:35.
- Slocombe JOD et al. *Can J Comp Med* 1977; 41:137.
- Wallace KD et al. *Am J Vet Res* 1989; 50:1699.
- Matthews JB et al. *Vet Res* 2004; 35:371.
- Uhlinger C, Johnstone C. *J Equine Vet Sci* 1984; 4:7.
- Kaplan RM. *Vet Res* 2002; 33:491.
- Bairden K et al. *Vet Rec* 2001; 148:138.
- Xiao L et al. *Vet Parasitol* 1994; 53:83.
- Love S et al. *Vet Rec* 1995; 136:18.
- Duncan JL et al. *Vet Rec* 1998; 142:268.
- Duncan JL et al. *Equine Vet J* 1977; 9:146.
- Slocombe JOD et al. *Can J Vet Res* 1987; 5:232.
- Silvina Fernandez A et al. *Equine Vet J* 1999; 31:488.
- Herd RP. *Equine Vet J* 1986; 18:447.
- Herd RP et al. *Equine Vet J* 1985; 17:235.
- Dopfer D et al. *Vet Parasitol* 2004; 124:249.
- Monahan CM. *Vet Parasitol* 1997; 73:277.
- Herd RP, Coles GC. *Vet Rec* 1995; 136:481.

## Miscellaneous roundworm infestations

### *OXYURIS EQUI* (PINWORM)

*Oxyuris equi* is a nematode that provokes irritation of the perianal region of horses, causing them to rub and bite their tails. This can result in hair loss and sometimes physical damage to the tissues of the area. The parasite is ubiquitous but of greater prevalence in areas of high rainfall.<sup>1</sup>

The life cycle is direct. The mature worms are gray in color and inhabit the cecum and colon. The male is 1–2 cm long, but the female is much longer, up to 15 cm, and has a long tapering tail. When full of eggs, the female migrates down the gut and crawls onto the perianal area, where she exudes her eggs onto the skin in yellow clusters and then shrivels up and dies. An embryo develops in about 3 d within the egg which is then infective. Eggs may be licked off the skin and swallowed or they may eventually fall to the ground. They resist desiccation, may become airborne in dust and remain viable in stables for long periods. Transmission then occurs via contaminated feedstuffs.

Diagnosis is by detection of operculated eggs, slightly flattened on one side, on transparent adhesive tape that has been pressed against the perianal skin and then placed on a microscope slide for examination, or by the chance observation of an adult worm in the feces.

Treatment comprises the application of a mild disinfectant ointment to the perianal region and the administration of ivermectin, moxidectin, any of the newer broad-spectrum benzimidazoles or pyrantel at the standard dose rate for horses. Piperazine salts are also effective.

## REFERENCE

- Bucknell DG et al. *Int J Parasitol* 1995; 25:711.

## *STRONGYLOIDES* (THREADWORM)

Farm animals in many countries are exposed to infection with the nematode genus *Strongyloides*. Disease outbreaks occur in young pigs, foals, calves, and lambs but the overall economic importance of this parasite does not appear to be very great. Different species occur in each host: *Strongyloides ransomi* in pigs, *S. westeri* in horses, and *S. papillosus* in sheep and cattle. All are parasites of the small intestine. They are thread-like and less than 1 cm in length.

Only female worms are present in the intestine and so eggs are produced by parthenogenesis. The eggs are thin shelled and contain an embryo. The larvae that hatch out may develop into infective or non-parasitic forms. The latter become free-living males and females which live in decaying organic material and produce fertilized eggs that give rise to infective larvae. Transmission occurs when infective larvae enter the host either by ingestion or by skin penetration. In older animals they accumulate in subcutaneous tissues and migrate to the mammary gland when lactation starts.<sup>1,2</sup> Neonates are thereby infected via the milk and egg-laying females may be present in the intestine from about 1 week after birth. Infective larvae penetrating the skin of young animals travel via the blood to the lungs, where they break into alveoli, ascend the air passages to the pharynx and are then swallowed.

Diarrhea in young animals is the most common clinical sign but the passage of massive numbers of larvae through the skin may also provoke dermatitis. Experimental infections in calves cause pallor and coughing<sup>3</sup> but cases of sudden death without previous symptoms have been ascribed to heavy burdens with many migratory larvae.<sup>4</sup> In bulls, balanoposthitis may be seen. In lambs, dermatitis, pulmonary hemorrhage, and enteritis occur. Sheep may also develop lameness or be more susceptible to foot rot when subject to heavy infestations. Experimental infection of young goats produced transient diarrhea, dehydration, cachexia, gnashing of teeth, foaming at mouth, anemia and nervous

signs.<sup>5</sup> Pigs may show anorexia, listlessness and anemia but diarrhea is the principal clinical sign. Infestation in pigs has been shown to reduce intestinal enzyme activity, to increase intestinal plasma and blood loss and to reduce protein synthesis in the liver.<sup>6</sup> In foals, high egg counts may be recorded in apparently healthy animals but may coincide with the onset of diarrhea (independent of the first heat of the mare) in other individuals. Episodes of frenzy in foals lasting approximately 30 min have been attributed to percutaneous larval invasion.<sup>7,8</sup> Within 2 d skin lesions developed on the lower limbs which persisted for 2–3 weeks.

Most broad-spectrum anthelmintics are effective in eliminating this parasite. In foals, ivermectin is used at the standard equine dose but elevated doses of fenbendazole (50 mg/kg) and oxbendazole (15 mg/kg) are needed. The treatment of mares with ivermectin on the day of parturition did not prevent transmammary transmission but markedly reduced egg counts in the foals. Treatment of infected sows was effective in removing arrested larvae from the subventral fat.<sup>9</sup> Use of the ivermectin controlled-release bolus in lambs prevented establishment of intestinal *Strongyloides* infections.<sup>10</sup>

Control depends on the elimination of warm, moist areas such as damp litter or bedding, suitable for parasite multiplication.

## REFERENCES

1. Lyon ET et al. *J Parasitol* 1973; 59:780.
2. Stewart TB et al. *Am J Vet Res* 1976; 37:541.
3. Stewart TB et al. *Vet Med* 1968; 63:1145.
4. Taira N, Ura S. *Vet Parasitol* 1991; 39:313.
5. Pienaar JG et al. *Onderstepoort J Vet Res* 1999; 66:191.
6. Dey-Hazra A et al. *Vet Parasitol* 1979; 5:339.
7. Dewes HF. *NZ Vet J* 1989; 37:69.
8. Dewes HF, Townsend KG. *NZ Vet J* 1990; 38:34.
9. Murrell KD. *Am J Vet Res* 1981; 42:1915.
10. Rehbein S. *Vet Parasitol* 2000; 88:293.

## TRICHURIS (WHIPWORM)

Three species of whipworms are found in ruminants: *Trichuris ovis*, *T. discolor*, and *T. globulosa*, while *T. suis* occurs in pigs. Whipworms in farm livestock are usually considered to be relatively innocuous. Indeed, induced *T. suis* infections are being evaluated in human medicine for amelioration of chronic inflammatory bowel disease, since whipworm induced Th2 immune responses dampen harmful Th1 activity in some patients.<sup>1</sup> Heavy infestations can nevertheless produce serious disease with diarrhea and dysentery<sup>2,3</sup> and the mortality rate can be high in recently weaned pigs. Severely affected animals are anorexic and rapidly lose weight. The feces may contain blood-stained mucus and strips of necrotic mucosa. The nematodes lie with their thin

anterior end superficially embedded in the wall of the cecum and in heavy infections the colon may also be involved. The activities of the worms produce little tissue reaction *per se* but enable microorganisms in the gut microflora to become invasive. This is the main cause of the severe inflammation and clinical signs associated with whipworm infestation.<sup>4</sup> A synergy has also been demonstrated between *T. suis* and *Campylobacter jejuni*.<sup>5</sup>

**The life cycle** is direct. The eggs are very resistant to external environmental conditions and can survive for up to 6 years in old pigsties, and for at least 2 years on pasture in the south of England.<sup>6</sup> An infective larva develops inside the egg but a relatively high temperature is required for rapid growth. In temperate climates, embryonation of *T. suis* eggs may take more than 1 year.<sup>7</sup> When swallowed by a suitable host, the eggs hatch and develop to mature adults in about 12–20 weeks after infection in lambs and goats and 7 weeks in pigs. The disease in sheep occurs most commonly after hot, dry weather, which effectively cleanses the pasture of other nematode larvae but the resistant *Trichuris* spp. eggs survive and are ingested when the sheep eat close to the ground to obtain grain given as drought feed.

**Diagnosis** depends on detection in the feces of the yellow oval eggs, which have a transparent plug at each end. The eggs are heavier than many others and do not always float well in saturated salt (NaCl) solution. An alternative flotation fluid such as zinc sulfate or sugar is more reliable. At necropsy, the adult worms which are 2–5 cm long are easily recognized by their whip-like appearance – the anterior third is much thinner than the handle-like posterior end.

**Chemotherapy** may give variable results as *Trichuris* is only distantly related to the usual target species. Most modern broad-spectrum anthelmintic compounds can be used but not all are active against immature forms and repeat dosing may be necessary.

## REFERENCES

1. Summers RW et al. *Am J Gastroenterol* 2003; 98:2034.
2. Batte EG. *Am J Vet Res* 1977; 38:1075.
3. Wideman GN. *Can Vet J* 2004; 45:511.
4. Rutter JM, Beer RJS. *Infect Immunol* 1975; 11:395.
5. Mansfield LS et al. *Am J Trop Med Hyg* 2003; 68:70.
6. Burden DJ, Hammet NC. *Res Vet Sci* 1979; 26:66.
7. Roepsdorff A, Murrell KD. *Int J Parasitol* 1997; 27:563.

## CHABERTIA

Chabertiosis of sheep, goats, and cattle is associated with *Chabertia ovina* a worm 1–2 cm in length, which inhabits the colon and causes a clinical syndrome

similar to that of oesophagostomosis. Disease is mainly seen in sheep in colder areas during the winter months. Infections do occur in cattle but are rarely pathogenic. The lifecycle is direct and resembles that of other strongylid worms. Infective larvae are relatively resistant to cold and heavy infestations may occur in mild winters. After ingestion, larvae undergo a period of development in the wall of the small intestine before passing to the cecum and then to the colon. Unlike *Oesophagostomum*, the larvae do not cause any significant damage. The infection becomes patent in about 7 weeks.

Clinical signs are first seen when immature adults start to attach to the mucosa about 26 d after infection.<sup>1</sup> Soft blood flecked feces with excess mucus are passed. A protein-losing enteropathy occurs with lowered blood albumin and weight loss. Death may occur in heavy infections.<sup>2</sup> Fecal egg counts do not always correlate well with clinical signs as these may occur before the worms mature. Immunity can also reduce the fecundity of adult *Chabertia*.

Changes at necropsy are thickening, edema and petechiation of the wall of the colon with blood sometimes present in the intestinal contents. The worms, which are easily recognized by their large buccal cavities, are usually confined to the first 25–30 cm of the coiled colon, except in very heavy infections. The number of worms present is often surprisingly small and severe morphological changes may be evident with only five to 10 worms. More than 100 worms is considered to be a heavy infestation. All the newer broad-spectrum anthelmintics are effective against *C. ovina*.

## REFERENCES

1. Herd RP. *Int J Parasitol* 1971; 1:189.
2. Smith, HJ, Archibald RM. *Can Vet J* 1967; 8:173.

## HABRONEMA AND DRASCHIA

These gastric nematodes of the horse are described in 'Summer sores in horses'.

## MACRACANTHORHYNCHUS (THORNY-HEADED WORM)

*Macracanthorhynchus hirudinaceus* is included in this section for convenience but it is not a nematode. It belongs to a different phylum, the acanthocephalans. These resemble roundworms in appearance but in some ways are more similar to tapeworms as they lack, for example, a digestive tract. The name 'thorny-headed worm' denotes the hook-covered proboscis which they all possess.

*M. hirudinaceus* infestations in pigs are not usually heavy and cause relatively little loss. The worms have thick bodies

(0.5–1.25 cm), are long (up to 38 cm) and transversely wrinkled. They inhabit the small intestine and pass eggs which are very resistant to environmental stress and survive for up to 2 years. The lifecycle is indirect with a variety of beetles acting as intermediate hosts. Transmission occurs when a pig eats an infested grub or adult beetle and eggs are passed some 2–3 months later. The female worm is a prolific egg layer and lives in the host for about 1 year.

Heavy infestations cause slow growth or loss of body weight. The head of the worm pushes deeply into the intestinal mucosa and causes nodules that are clearly visible from the serous surface. Occasional deaths may occur due to intestinal perforation. Sedimentation techniques are better than flotation methods for detecting eggs in feces. Treatment is rarely given as the condition is usually only diagnosed at necropsy. Ivermectin given in the feed to provide

0.1 or 0.2 mg/kg for 5 d gives good results.<sup>1</sup> A single dose of doramectin is only partly effective.<sup>2</sup> Control, if necessary, involves suitable disposal of pig manure and avoidance of contact with the intermediate hosts, beetles.

#### REFERENCES

1. Alva-Valdes R et al. *Am J Vet Res* 1989; 50:1392.
2. Yazwinski TA et al. *Vet Parasitol* 1997; 70:123.

## Nematode diseases of other organs

### Lungworm infestation

#### LUNGWORM IN CATTLE

##### Synopsis

**Etiology** The nematode *Dictyocaulus viviparus* (the bovine lungworm).

**Epidemiology** Disease seen mostly in dairy calves; immunity develops relatively quickly but cattle will succumb if exposed to overwhelming numbers of infective larvae while grazing.

**Signs** Coughing, tachypnea, dyspnea.

**Clinical pathology** Characteristic larvae in feces (but not present during all stages of disease); eosinophilia; enzyme-linked immunosorbent assay (ELISA) tests for serum antibodies.

**Lesions** Large volumes of consolidation in diaphragmatic lobes of lung, emphysema, worms up to 8 cm long in bronchi (only in patent phase of disease).

**Diagnostic confirmation** Clinical pathology as above; at necropsy, distribution of lesions in lungs and demonstration of worms in bronchi.

**Treatment** Benzimidazoles and avermectins/milbemycins are active against all parasitic stages of *D. viviparus*; the latter also have a persistent protective effect; levamisole also used.

**Control** Vaccination; early season anthelmintic prophylactic programs using suitable intraruminal boluses or multiple doses of avermectins/milbemycins; keep susceptible animals off potentially dangerous pasture.

#### ETIOLOGY

The nematode *Dictyocaulus viviparus* is the only lungworm of cattle. The disease it causes has many local names including:

- Parasitic bronchitis
- Verminous pneumonia
- Verminous bronchitis
- Husk
- Hoose.

Bovine lungworm has a very wide distribution through temperate and cold areas and, depending on climatic con-

ditions and season, can cause serious losses.<sup>1</sup> The disease reaches its greatest importance in mild, damp regions of the British Isles and parts of western Europe. Deer carry similar parasites, including *D. eckerti* and *D. capreolus*. It is uncertain whether deer play a role in the transmission of *D. viviparus* but lungworm species are generally host specific.<sup>2</sup>

#### LIFECYCLE

Adult lungworms live in the trachea and bronchi. The females are prolific egg producers and it has been estimated that a single infested calf may contaminate a pasture with 33 million larvae. The eggs are coughed up and swallowed. They hatch in the air passages or alimentary canal and larvae are passed in the feces. These develop in the dung pat through to the infective third stage, which is protected by cuticles retained from both first and second molts. As the ensheathed larvae cannot feed, glycogen granules are stored in the intestinal cells. Moisture is essential for the survival and development of the larvae and a moderate temperature of 18–21°C (65–70°F) permits their full development to the infective state in 3–7 d. Larvae survive best in cool, damp surroundings, especially when the environment is stabilized by the presence of long herbage or free water. Under optimum conditions, larvae may persist for over 1 year. They can overwinter in climates as cold as Canada and Germany. When warmer spring weather arrives, the larvae resume their motility but quickly die once their food stores are depleted.

Transmission occurs when cattle ingest third-stage larvae while grazing. These migrate through the intestinal wall to reach the mesenteric lymph nodes. From here they pass via the lymphatics to the venous bloodstream and through the heart to the lungs, where they break into the alveoli. They migrate up the bronchioles to their predilection site in the larger air passages and start to lay eggs some 3–4 weeks after infestation. Most adult

worms succumb to immune expulsion within a few weeks. These events determine the progression of the clinical syndrome and their approximate timing is as follows<sup>3</sup>:

1. Penetration phase (ingestion to arrival of larvae in lung), days 1–7
2. Prepatent phase (larvae in lung), days 7–25
3. Patent phase (mature worms in lung) days 25–55
4. Postpatent phase (lungworms disappearing from lung), days 55–70.

#### EPIDEMIOLOGY

Bovine parasitic bronchitis is a sporadic and largely unpredictable disease. This is because immunity develops more quickly than is the case with many other nematode infections, but nevertheless can remain incomplete for many weeks and may wane in the absence of reinfection. In most grazing seasons, immunity will develop fast enough to protect calves against the accumulating numbers of infective larvae on the grass. The farmer may not even realize that his land is contaminated. Clinical outbreaks occur when weather patterns, management or other factors result in sudden exposure to a pasture challenge sufficient to overwhelm any immunity that has already developed. In comparison with the gastrointestinal nematodes of cattle, relatively few worms (i.e. a few hundred or thousand) are required to produce clinical signs. Thus, the disease is almost entirely confined to grazing cattle and occurs most frequently in young animals in their first year on grass, although outbreaks are becoming more common in adults. The epidemiology of lungworm disease is largely concerned with factors determining the number of infective larvae on the pasture and the rate at which they accumulate.

Infective *D. viviparus* larvae are relatively inactive and are incapable of traveling more than 5 cm from the dung pat. Factors that disperse the larvae more widely over the pasture include mechanical spread by:

- Rain
- Earthworms
- Wheeled vehicles
- Human and animal feet.

A fungus, *Pilobolus*, plays a particularly important role in this process and can transfer larvae across field boundaries. Fungal spores on grass pass through the grazing animal and germinate in the feces. *Dictyocaulus* larvae climb onto the sporangium (fruiting body), which fills with water and bursts, propelling the fungal spore and the lungworm larvae for distances of up to 3 m.<sup>4</sup>

Dairy calves are most vulnerable to lungworm disease as they are often reared indoors until 4–5 months of age and then placed on paddocks grazed each year by successive calf crops. If the paddocks are heavily contaminated, acute disease may occur in 1 week or so. Usually however only sufficient larvae survive the winter to induce low-grade asymptomatic infections in the susceptible calves, which then start to recontaminate the pasture and recycle the infection. With the high stocking densities commonly used, pasture challenge can reach pathogenic levels within 2–4 months. This model does not satisfactorily explain all outbreaks and it has been suggested that larvae may be washed into the soil to emerge later, e.g. onto hay aftermath.<sup>5</sup> Beef calves at grass with their dams are less likely to be affected as this system provides fewer opportunities for large numbers of larvae to accumulate, but outbreaks can occur particularly after weaning in the autumn.

In older animals larvae ingested in the autumn become hypobiotic and resume their development in the following spring. This event occasionally causes disease in housed cattle<sup>6</sup> but such infections are usually asymptomatic and provide a source of pasture contamination when these carrier animals are put out to graze. This is thought to be the main source of infection in more severe climates where overwintering larvae may not survive on the pasture, but carrier animals have also been incriminated in disease outbreaks in, for example, Louisiana in the United States.<sup>7</sup>

**Immunity to reinfestation** occurring after initial exposure to *D. viviparus* is variable in degree and duration. It normally provides protection during the first grazing season and is boosted by exposure to overwintered larvae at the beginning of each subsequent grazing season. Cattle removed from infected pastures for long periods can suffer clinical disease when re-exposed. Recently, the number of outbreaks of parasitic bronchitis in yearling and adult cattle in the United Kingdom,

Denmark and some other countries has been rising.<sup>8</sup> Reasons for this are speculative but include:

- A decline in the use of vaccination
- Changes in weather patterns and management systems
- Use of highly effective anthelmintic strategies in the first grazing season that may prevent adequate antigenic exposure.

#### **PATHOGENESIS**

Migrating *D. viviparus* larvae provoke little damage until they reach the lungs. Thereafter, passage of larvae up the bronchioles causes them to become blocked by mucus, eosinophils, and other inflammatory cells, leading to collapse of the alveolae that they supply.<sup>3</sup> Coughing and dyspnea occur if a sufficiently large volume of lung tissue is affected. This is accompanied by pulmonary edema and interstitial emphysema. As no structural damage has yet occurred, treatment at this stage in the disease produces an immediate clinical response. Later however when mature parasites are in the major bronchi, eggs and fragments of worms killed by immunity are aspirated and provoke a foreign body pneumonia. Secondary bacterial infections establish and sequelae such as bronchiectasis occur. Such lesions are slow to resolve and treated animals will require a long recovery period. Later still, once all or most of the worms have been expelled, the alveolar lining cells of some 25% of recovering animals become cuboidal and non-functional. The reason for this is unknown but may be a response to substances released by the dead worms. As this reaction is irreversible many animals affected in this way will die.

**The response of the lung** varies widely depending on the number of larvae ingested, the nutritional status and age of the host, and whether or not it is exposed to lungworm infection for the first time. Vaccinated animals or those that have recovered from clinical or sub-clinical infection may cough and even become tachypneic if grazed on contaminated pasture.<sup>9</sup> This is known as the 're-infection syndrome' and occurs as many larvae reach the lungs before succumbing to the immune response. Exposure of older previously infected animals to massive challenge may invoke a severe or fatal hypersensitivity reaction.<sup>10</sup>

#### **CLINICAL FINDINGS**

Outbreaks vary in severity from sporadic coughing with no apparent production loss to acute cases with a rapidly fatal outcome. Individuals within a group are usually affected to varying degrees. Poorly nourished animals appear less able

to withstand lungworm infection. Nevertheless, it is not unusual for severe infestations to be fatal in well-fed calves.

**Acute cases** have rapid shallow abdominal breathing of sudden onset that may reach a rate of 60–100 breaths/min. There is a frequent bronchial cough, a slight nasal discharge, a temperature of 40–41°C (104–105°F) and a heart rate of 100–120 bpm. The animal is bright and active and will attempt to eat, although respiratory distress often prevents this. Progress of the disease is rapid and within 24 h dyspnea may become very severe, accompanied by mouth breathing with the head and neck outstretched, a violent respiratory heave and grunt, cyanosis and recumbency. On auscultation, lung consolidation is evidenced by loud breath sounds and crackles are heard over the bronchial tree. The crackling of interstitial emphysema commences over the dorsal two-thirds of the lung but is never as evident as in less acute cases. Fever persists until just before death, which usually occurs in 3–14 d and is greatly hastened by exercise or excitement. The case-fatality rate in this form of the disease is high, probably of the order of 75–80%.

**Subacute disease** is more common in calves than the very acute form. The onset is usually sudden, the temperature is normal or slightly elevated and there is an increase in the rate (60–70 breaths/min) and depth of respiration. An expiratory grunt is heard in severe cases and expiration may be relatively prolonged. There are frequent paroxysms of coughing. The course of the disease is longer, 3–4 weeks, and auscultation findings vary widely with the duration of the illness and the area of lung involved. In general, there is consolidation and bronchitis ventrally, and marked emphysema dorsally. Affected animals lose weight very quickly and are very susceptible to secondary bacterial bronchopneumonia. The mortality rate is much less than in the acute form but many surviving calves have severely damaged lungs. Consequently, they may remain stunted for long periods and breathing may be labored for several weeks. Some surviving calves may show a sudden exacerbation of dyspnea around 7–8 weeks after the initial onset of disease. In these relapsed cases the prognosis is grave.

**Adult dairy cattle** are usually immune but sporadic outbreaks do occur due to waning immunity. Mortality is low but morbidity can be high with reduced milk yields causing significant economic loss. Coughing is a constant feature but other clinical signs are variable and may include dyspnea, nasal discharge, and weight loss. Sudden exposure of immune adults to massive challenge can cause severe interstitial pneumonia.

### CLINICAL PATHOLOGY

The presence of *D. viviparus* larvae in feces confirms lungworm infestation but their absence does not necessarily exclude the possibility of parasitic bronchitis. No larvae will be passed in the early stages of disease when the causal worms are still immature, nor will they be a constant finding when partially immune animals (e.g. dairy cows) succumb to challenge. In general, larvae can be found about 12 days after signs appear, i.e. around 24 days after infestation occurs. They are few in number at first but may become more numerous later.

**Enzyme-linked immunosorbent assay (ELISA) tests** using adult or larval worm antigen to demonstrate exposure to lungworm infection are available in some countries.<sup>8</sup> Care is required with interpretation as antibodies to adult antigen may not be detectable until several weeks after primary challenge<sup>11</sup> and do not correlate with the immune status of the animal. Eosinophilia is a fairly consistent finding but not pathognomonic.

**An alternative method**, if disease is suspected but the lungworms are still in the prepatent stage, is to examine pasture clippings for larvae. This is a laborious procedure because large amounts of herbage (0.5–1kg) must be used and the yield of larvae is low.

### NECROPSY FINDINGS

Adult *D. viviparus* are up to 8 cm long and easily seen when the trachea and bronchi are cut open. Worms may also be recovered by lung perfusion.<sup>12</sup> Up to several thousand may be present in severely affected animals. In prepatent disease however careful microscopic examination of bronchial mucus is necessary to find larvae. Adult worms may be few or absent if the case is of sufficient duration for immune expulsion to have taken place.

**In acute cases**, morphological changes include:

- Enlargement of the lungs due to edema and emphysema
- Widespread areas of collapsed tissue of a dark pink color
- Hemorrhagic bronchitis with much fluid filling all the air passages
- Enlargement of the regional lymph nodes.

Histologically, the characteristic signs are:

- Edema
- Eosinophilic infiltration
- Dilatation of lymphatics
- Filling of the alveoli and bronchi with inflammatory debris

- Larvae in the bronchioles and alveoli.

**In subacute cases**, interstitial emphysema is usually gross. Areas of dark pink consolidation are present in the diaphragmatic lobe and may also occur in other lobes. They can occupy two-thirds of the lung volume. There is froth in the bronchi and trachea. The regional lymph nodes are enlarged. Histologically, eggs and larvae can be seen in the air passages, the bronchial epithelium is much thickened, the bronchioles are obstructed with exudate and the alveoli show epithelialization and foreign-body giant-cell reaction.

**The reinfection syndrome** is characterized by the presence of numerous 5 mm gray-green nodules formed by lymphoreticular cells clustering around dead larvae.

### DIAGNOSTIC CONFIRMATION

*D. viviparus* larvae may be demonstrated by placing feces on a fine sieve or dental gauze on the top of a water-filled funnel (the Baermann technique). The larvae that swim into the water and collect at the bottom of the funnel are less than 0.5 mm long, sluggish and often appear curved or coiled. Their most important diagnostic feature is the presence of easily visible refractile granules in the intestinal cells. As not all animals will be shedding larvae, samples should be taken from all, or at least a representative proportion of the group. Grass samples are washed in water with a surfactant and the sediment Baermannized as above. A technique which effectively separates larvae from plant debris by migration through agar gel has been reported.<sup>13</sup> Gathering grass close to dung pats maximizes chances of finding larvae. Cattle with parasitic bronchitis are likely to have eosinophilia and serological tests can be used to rule out some other respiratory diseases such as infectious bovine rhinotracheitis (IBR).

**In view of the uncertainties** associated with laboratory tests for parasitic bronchitis and the need for prompt treatment, diagnosis often has to be based on clinical history, signs and auscultation. Affected animals have usually grazed alongside potential carriers or had access to pasture previously used by susceptible calves or older carrier animals. The timing of the outbreak may coincide with that expected from recycling of an infection initiated by overwintered larva (often 2–4 months after turnout) or recent exposure to heavily contaminated land. Many of the clinical signs of parasitic bronchitis are common to pneumonias of bacterial and viral origin. One feature which may be of value in differentiation is

the relative softness and paroxysmal nature of the cough in parasitic infection.

### DIFFERENTIAL DIAGNOSIS

- Bacterial bronchopneumonia
- Acute and chronic interstitial pneumonia
- Viral pneumonia
- Acute interstitial pneumonia (fog fever)
- Heavy infestations with ascarid larvae on pastures contaminated with pig feces.

**In adult cattle**, the major problem in diagnosis is to differentiate the acute form of the disease from acute interstitial pneumonia due to other causes. Clinically, the diseases are indistinguishable, and a history of movement onto a new pasture 1–2 weeks before the onset of the disease may be common to both. It is necessary to demonstrate *D. viviparus* antibodies in blood, worms at necropsy, and larvae in the herbage or in the feces of animals that previously grazed the pasture.

### TREATMENT

Anthelmintics may be used prophylactically to prevent disease from occurring, as a curative treatment once disease strikes, or to prevent reinfection following an outbreak. Avermectins and milbemycins are particularly useful for prophylaxis and prevention of reinfection as they are not only highly effective against the lungworms present in the animals at the time of treatment but have prolonged activity against subsequent incoming larvae. The duration of this persistent effect varies with compound and formulation.

**Most modern broad-spectrum drugs** are active against *D. viviparus*. Dosage rates and label claims vary from country to country according to local conditions and regulatory requirements. Avermectins and milbemycins (macrocyclic lactones) are particularly potent against immature and mature stages; doses of ivermectin, for example, as low as 0.05 mg/kg are effective. At commercial dose rates, ivermectin by injection or as a pour-on formulation provides residual protection for up to 28 d; corresponding figures are up to 35 d for doramectin by injection and 42 d both for doramectin as a pour-on formulation and moxidectin by either route of administration. These compounds are given at 0.2 mg/kg by injection and 0.5 mg/kg as a pour-on formulation. Eprinomectin is the compound of choice for adult dairy cattle as it has a nil milk withdrawal period<sup>14</sup> and provides residual protection of up to 28 d when given topically (0.5 mg/kg). Albendazole



(7.5 mg/kg), febantel (7.5 mg/kg), fenbendazole (7.5 mg/kg), netobimin (7.5 mg/kg), and oxfendazole (4.5 mg/kg), which are given orally, are active against all stages of the parasite but have no residual activity. Levamisole (oral or injection – 7.5 mg/kg; pour on – 10 mg/kg) also has activity against lungworm but no persistent effect.

Sustained-release intraruminal devices ('boluses') provide extended periods of protection. For example, fenbendazole is released for up to 140 d from one bolus. There are also pulse release boluses containing oxfendazole which release five or six anthelmintic doses at 3-week intervals. Most boluses normally protect against disease but may allow some worms to establish (in the case of the fenbendazole bolus) or to reach the lungs between pulses (oxfendazole bolus), which may allow immunity to develop.

**For veterinarians in the field** the outcome of therapeutic treatment is often unpredictable as it depends on the amount of structural damage in the lungs. Best results are obtained early in the course of disease when most pathological changes can be quickly resolved. In severe cases, treatment may initially exacerbate clinical signs as the death and disintegration of many worms in the air passages releases antigens and adds to the mass of foreign material that can be aspirated. Because of animal welfare considerations and the high risk of mortality, anthelmintic treatments are often combined with an antihistamine or non-steroidal anti-inflammatory drug (NSAID) such as flunixin to reduce the severity of the reaction to the larvae and an antibiotic or sulfonamide to prevent secondary bacterial infection. Severely affected animals should be brought indoors for nursing and all other members of the group removed from the contaminated pasture and placed on clean grazing ground.

## CONTROL

Two major strategies of control derive from the premise that the main factor governing the occurrence of disease is the density of *D. viviparus* larvae on pasture grazed by susceptible cattle. Firstly, cattle grazing potentially contaminated pasture can be protected by vaccination or anthelmintic cover. Alternatively, steps can be taken to ensure that pastures are safe for grazing. This is usually achieved by prophylactic anthelmintic programs, but delaying spring turnout until overwintered larvae have died away is a theoretical option on organic farms.<sup>15</sup>

**Sensible grazing management** is important in all systems but cannot be

relied upon, *per se*, for controlling parasitic bronchitis in view of the unpredictable nature of the disease. Although natural immunity provides adequate protection on many farms, it cannot be accurately measured nor predetermined.<sup>16</sup> With the possible exception of beef suckler systems, calves should not be run with or follow older cattle as these may harbor asymptomatic patent infections and contaminate the pasture. An important consideration is that clean pasture can be contaminated by larvae from neighboring fields carried on windborne fungal spores (see epidemiology paragraph earlier). Although the numbers of larvae spread in this way are likely to be small, they can initiate the epidemiological cycle culminating in disease after some weeks.

**Vaccination** of calves with two doses of 1000 infective larvae attenuated by irradiation is a long-established and effective method of preventing disease. Only healthy calves should be vaccinated and they should be at least 8 weeks old. The vaccine is given 6 and 4 weeks prior to turnout. Exposure to lightly contaminated pasture will boost immunity but low-grade patent infections may develop in some animals. Vaccinated and non-vaccinated calves should not be grazed together as the former may contaminate the pasture enabling lungworm to cycle through the susceptible animals. The vaccine gives a high level of protection under most conditions but vaccinated calves should not be put onto heavily contaminated pasture. Coughing may occur when immune responses kill lungworm larvae in the lungs. Overt disease can occur in cases of overwhelming challenge. To avoid such problems on severely affected farms, vaccinated calves should be allowed only gradual access to pasture.

**In some endemic areas**, for example in the south of Ireland which has mild winters and an early start to the grazing season, the ideal vaccination program described earlier may be inconvenient and it is possible, by cautiously avoiding periods when massive pasture contamination are likely to occur, to vaccinate at pasture.<sup>17</sup> Calves are sometimes vaccinated at less than 8 weeks old to allow spring-born calves to graze during late summer and autumn<sup>18</sup> but optimal protection may not be afforded in all cases.

**Strategic anthelmintic programs** provide an alternative to vaccination. The aim is to suppress the infection initiated by overwintered larvae and thereby prevent subsequent contamination of the pasture. This can be done by application of a suitable intraruminal bolus at or just

before spring turnout or by giving two or three doses of an avermectin/milbemycin during the early grazing season. These systems are designed to control parasitic gastroenteritis as well as lungworm. Clinical field experiments have demonstrated good results with ivermectin, fenbendazole, and oxfendazole boluses and with ivermectin treatments given at 3, 8, and 13 weeks after turnout, or doramectin administered at turnout and again 8 weeks later. Calves may become vulnerable after the period of anthelmintic cover if pasture contamination occurs (e.g. because of fungal spread). An extra anthelmintic treatment may be indicated in regions with a very long grazing season. Calves which are exposed to infection but protected by chemoprophylaxis during their first grazing season generally have substantial resistance to reinfection in their second year.<sup>19</sup> Nevertheless, field experiments have shown that immunity can be compromised to a degree related to the level of protection provided.<sup>20</sup> There is concern that such intensive treatment may provoke anthelmintic resistance but no resistant strains of *D. viviparus* have yet been reported.

## REVIEW LITERATURE

- Jorgensen RJ, Ogbourne CP. Bovine dictyocauliasis: a review and annotated bibliography Farnham Royal, UK: Commonwealth Agricultural Bureau, 1985.
- Ploeger HW. *Dictyocaulus viviparus*: re-emerging or never been away? Trends Parasitol 2002; 18:329–332.
- Urquhart GM, Armour J. Helminth diseases of cattle sheep and horses in Europe. Glasgow: MacLehose, 1973.

## REFERENCES

- Hoglund J. Vet Parasitol 2004; 125:343.
- Divina BP, Hoglund J. J Helminthol 2002; 76:125.
- Urquhart GM et al. In: Urquhart GM, Armour J (eds) Helminth diseases of cattle sheep and horses in Europe. Glasgow: MacLehose, 1973; pp. 23–30.
- Somers CJ et al. Vet Rec 1985; 116:657.
- Duncan J L et al. Vet Rec 1979; 104:274.
- Oakley GA. Vet Rec 1979; 104:460.
- Eddi CS et al. Vet Parasitol 1989; 31:37.
- McKeand J. Parasitology 2000; 120:517.
- Jarrett WHF, Sharp NCC. J Parasitol 1963; 49:177.
- Jacobs DE et al. Res Vet Sci 1987; 43:273.
- Cornelissen AWCA et al. Vet Parasitol 1997; 70:153.
- Oakley GA. Res Vet Sci 1980; 29:395.
- Jorgensen RJ. Vet Parasitol 1975; 1:61.
- Shoop WL. Int J Parasitol 1996; 26:1237.
- Jorgensen RJ et al. Vet Parasitol 1987; 10:331.
- Vercryusse J, Claerebout E. Vet Parasitol 2001; 98:195.
- Downey NE. Vet Rec 1968; 82:338.
- Benitez-Usher C et al. Vet Parasitol 1976; 2:209.
- Taylor SM et al. Vet Parasitol 2000; 88:219.
- Fisher MA, Jacobs DE. Vet Rec 1995; 137:581.

## LUNGWORM IN HORSES

### Synopsis

**Etiology** The nematode parasite *Dictyocaulus arnfieldi*.

**Epidemiology** Infection is by ingestion of larvae on herbage; donkeys and foals shed most larvae, but adult horses can perpetuate lifecycle.

**Signs** Chronic cough in adult horses.

**Clinical pathology** Eggs or larvae in feces (but often absent in affected adults); eosinophils in tracheal mucus.

**Lesions** Discrete areas of hyperinflation in lung tissue.

**Diagnostic confirmation** Response to treatment if no eggs/larvae in feces.

**Treatment** Ivermectin, fenbendazole (elevated dose); mebendazole over 5 d for donkeys.

**Control** Avoid grazing donkeys and horses on same pasture.

### ETIOLOGY

Lungworm disease in horses is associated with the nematode parasite *Dictyocaulus arnfieldi*.

### LIFECYCLE

The lifecycle of *D. arnfieldi* is direct and is almost identical to that of *D. viviparus* except that the eggs do not hatch until shortly after they are passed in the feces.

### EPIDEMIOLOGY

Infestations with *D. arnfieldi* are recorded more commonly in donkeys than in horses and the former are considered to be the more normal host. Patent infections may persist in donkeys throughout their lives but in horses are generally confined to foals. These animals therefore provide the most important sources of pasture contamination. Nevertheless, a small proportion of infected adult horses shed low numbers of eggs and this may be sufficient to perpetuate the lifecycle even in the absence of donkeys and foals. As with *D. viviparus*, larvae can cross field boundaries by fungal transfer.

### PATHOGENESIS

Adult worms are found in the smaller bronchi which they almost completely block.<sup>1</sup> In adult horses however, few larvae reaching the lungs develop to this stage. Bronchioles in affected areas are surrounded by dense infiltrations of inflammatory cells, the epithelium becomes hyperplastic and excessive mucus is produced. The consequent interference with air flow leads to patches of hyperinflation in the lung tissue.

### CLINICAL FINDINGS

Lungworm disease in horses is characterized by a chronic cough. Experimental infections produce an afebrile condition

with coughing, increased respiratory rates and forced expiration being most intense during weeks 3–5 after infection. Thereafter the signs decrease in severity but coughing may persist for several months.<sup>2</sup> Heavy infestations in donkeys do not cause clinical illness. Horse foals may also be symptomless although some show clinical signs.

### CLINICAL PATHOLOGY

Characteristic eggs may be found in the feces of a small proportion of cases. Eosinophils and sometimes eggs or larvae may be demonstrated in tracheal mucus.<sup>3</sup>

### NECROPSY FINDINGS

The most obvious lesions at necropsy are discrete patches of overinflation.

### DIAGNOSTIC CONFIRMATION

*D. arnfieldi* eggs in fresh feces are oval, thin shelled and contain a larva.<sup>4</sup> As the eggs may have hatched before arrival at the laboratory, it is usual to harvest larvae with the Baermann technique. The larvae resemble those of *D. viviparus* but the tail ends in a small spine. As many clinical cases are non-patent and as tracheal mucus is difficult to sample, confirmation of diagnosis is often dependent on response to treatment.

### DIFFERENTIAL DIAGNOSIS

- Recurrent airway obstruction (heaves)
- Pulmonary abscessation and pneumonia
- Inflammatory airway disease.

### TREATMENT

Ivermectin at the standard equine dose is highly effective against immature and mature stages. For donkeys, mebendazole may be used at 15–20 mg/kg daily for 5 d, but this should not be attempted within the first 4 months of pregnancy.

### CONTROL

Donkeys and horses should not be grazed on the same pasture. If this is impossible, the former should be treated regularly for lungworm. If there is a problem in a closed herd of adult horses, individuals with patent infection can be identified by fecal screening and treated.

### REFERENCES

1. Nicholls JM et al. Vet Rec 1979; 104:567.
2. Mackay RJ, Urquhart KA. Equine Vet J 1979; 11:110.
3. Clayton H, Murphy J. In Pract 1980; 2:25.
4. Burks BS. Compend Cont Educ Prac Vet 1998; 20:378.

## LUNGWORM IN SHEEP AND GOATS

### Synopsis

**Etiology** The nematode parasites *Dictyocaulus filaria*, *Muellerius capillaris*, and *Protostrongylus rufescens*.

**Epidemiology** Infective *D. filaria* larvae are found on grass but *M. capillaris* and *P. rufescens* are transmitted when molluscan intermediate hosts are accidentally ingested by grazing animals.

**Signs** *D. filaria* and *P. rufescens* can cause bronchitis and loss of condition.

*M. capillaris* is asymptomatic in sheep but may be pathogenic in goats.

**Clinical pathology** Characteristic larvae in feces.

**Lesions** *D. filaria* and *P. rufescens*: scattered patches of consolidation; *M. capillaris*: small fibrous nodules up to 5 mm in diameter.

**Diagnostic confirmation**

Characteristic larvae in feces.

**Treatment** Avermectins/milbemycins, benzimidazoles or levamisole.

**Control** No specific measures available.

### ETIOLOGY

Infestations with the nematode *Muellerius capillaris* are ubiquitous. *Dictyocaulus filaria* and *Protostrongylus rufescens* are encountered sporadically. *Cystocaulus ocreatus* and *Neostongylus linearis* have been recorded in some countries.

### LIFECYCLE

*D. filaria* has a direct lifecycle like that of *D. viviparus* in cattle. The lifecycles of the other (protostrongylid) species are similar except that they have different predilection sites in the lung and have indirect lifecycles with molluscan intermediate hosts. Transmission occurs when infected slugs or snails are accidentally ingested during grazing.

### EPIDEMIOLOGY

*D. filaria* infestations in sheep appear to follow the same pattern as those of *D. viviparus* in calves but the number of lungworms is usually low. The third-stage larvae are long-living in damp, cool surroundings. The lambs of one season are the main source of infection for the next season's lambs, but larvae passed by ewes and yearlings also contribute to pasture contamination. The prevalence of infection is low in spring and summer but rises rapidly in the autumn and winter, when most clinical cases are seen. Warm, wet summers give rise to heavier burdens in the following autumn and winter.<sup>1</sup> Immunity after natural exposure is strong and durable in sheep but less so in goats.<sup>2</sup>

*M. capillaris* infestations in sheep have been recorded from most parts of the

world and in many temperate areas almost all sheep are infected. Massive invasion with larvae is uncommon because the intermediate hosts are not usually ingested in large numbers nor are they grossly infested with larvae. Massive infestations with this worm do not develop acutely and heavy infestations, when they occur, appear to develop over a long period of time. Infected sheep carry patent infection from one year to the next.

#### PATHOGENESIS

The relative pathogenicity of each lungworm is dependent on its predilection site. *D. filaria* lives in the trachea and bronchi so aspirated eggs, larvae, and debris can affect a large volume of lung tissue. It is therefore the most pathogenic species and provokes changes resembling those described for *D. viviparus*. The volume of damaged lung is however usually insufficient to cause severe dyspnea. Adult *P. rufescens* are found in smaller bronchioles and so associated lesions are much smaller. *M. capillaris* is found in the lung parenchyma where it becomes encysted in fibrous nodules. Lesions are thereby confined to its immediate surroundings. Consequently, this worm is generally considered to be relatively innocuous. Heavy mixed protostrongylid infections can impair pulmonary gaseous exchange.<sup>3</sup>

#### CLINICAL FINDINGS

Lambs 4–6 months of age are most severely affected with lungworms but sheep of all ages are susceptible. Clinically *D. filaria* is associated with bronchial irritation which results in coughing, moderate dyspnea and loss of condition. There may be added fever and evidence of toxemia if secondary bacterial infection occurs. It is highly pathogenic in young goats. *P. rufescens* infestations in sheep and goats cause clinical signs similar to those of *D. filaria*.

#### CLINICAL PATHOLOGY

Laboratory diagnosis depends upon the detection of first-stage larvae in the feces by the Baermann technique. *D. filaria* larvae have refractile granules in their intestinal cells and a conical tail. *P. rufescens* has a wavy tail as does *M. capillaris* which, in addition, has a spine just anterior to the tail.

#### NECROPSY FINDINGS

*D. filaria* lesions are similar to those of the subacute form of parasitic bronchitis in calves with exudate in the bronchioles and scattered patches of consolidation, but widespread lesions are not common. *M. capillaris* is found in small fibrous nodules up to 5 mm in diameter. Most of these are in the parenchyma of the

lung immediately under the pleura. Many of them are calcified and often contain only one live or dead worm. Infestation of goats leads to a diffuse infection quite different to the nodular reaction in sheep and to the production of an interstitial pneumonia.<sup>4</sup> Whether this is due solely to *M. capillaris* infection or whether a chlamydial or viral agent is involved has not been determined.

#### DIAGNOSTIC CONFIRMATION

The presence of larvae in the feces confirms lungworm infection but their number is often no indication of the degree of infestation.

#### DIFFERENTIAL DIAGNOSIS

Lungworm infestation in sheep needs to be differentiated from maedi and jaagsiekte.

#### TREATMENT

Ivermectin, moxidectin, the benzimidazoles and levamisole are effective against *D. filaria* at normal dose rates. Ivermectin, in addition, has a label claim for *P. rufescens*. It is doubtful whether treatment of sheep for *M. capillaris* is ever justified. In goats, one or two doses of ivermectin (0.2 mg/kg) or elevated doses of benzimidazoles destroys the adult worms but not the immature stage,<sup>5,6</sup> but regular doses of fenbendazole (up to 5.0 mg/kg/d) in the feed for 1–2 weeks or albendazole (1.0 mg/kg for 2 weeks) are highly effective against all stages.<sup>6</sup>

#### CONTROL

An attenuated vaccine for *D. filaria* is available in a few countries where this worm is a particular problem. With most forms of sheep husbandry, there are few precautionary measures that can be taken, particularly against lungworms with molluscan intermediate hosts.

#### REFERENCES

1. Ayalew L et al. Can J Comp Med 1974; 38:448.
2. Wilson GI. Res. Vet Sci 1970; 11:7.
3. Berrag B, Cabaret J. Int J Parasitol 1996; 26:1397.
4. Nimmo JS. Can Vet J 1979; 20:49.
5. Helle O. Vet Parasitol 1986; 22:293.
6. McCraw BM, Menzies PI. Can Vet J 1988; 29:453.

#### LUNGWORM IN PIGS

##### ETIOLOGY

The lungworms which infest pigs are *Metastrongylus apri* (*M. elongatus*), *M. salmi*, and *M. pudendotectus*. *M. apri* is the most common species but mixed infestations are not uncommon.

##### LIFECYCLE

Adult *Metastrongylus* spp. appear much like *D. viviparus* in the bronchi of their

#### Synopsis

**Etiology** The nematode parasites *Metastrongylus apri* (*M. elongatus*), *M. salmi*, and *M. pudendotectus*.

**Epidemiology** Transmission is by ingestion of the earthworm intermediate host.

**Signs** Check in growth rate; barking cough.

**Clinical pathology** Characteristic eggs in feces.

**Lesions** Grayish nodules near the ventral border of the diaphragmatic lobes of the lung.

##### Diagnostic confirmation

Characteristic eggs in feces.

**Treatment** Doramectin, ivermectin, fenbendazole, flubendazole, levamisole.

**Control** Difficult, unless pigs reared on concrete.

host. Their lifecycles are also similar except that *Metastrongylus* spp. eggs are passed in the feces and earthworms act as intermediate hosts. Here development to infective larvae takes about 2 weeks and transmission occurs when the earthworm is eaten by a pig.

#### EPIDEMIOLOGY

The disease is most prevalent in pigs 4–6 months of age in husbandry systems that allow access to earthworms. The eggs first appear in the feces 3–4 weeks after infestation and at their peak reach levels of 25–50 egg. The eggs are very resistant to cold temperatures and can survive for over 1 year in the soil. Larvae may survive in the earthworm for up to 7 years. The primary host must ingest an intermediate host to become infested and this is an important factor influencing the spread of the disease. Once ingested the infective larvae migrate to the lungs in much the same manner as do *D. viviparus* larvae. Many infestations are asymptomatic and induce immunity against re-infection.

#### PATHOGENESIS

The pathogenesis is similar to that of *D. viviparus*. These worms may provide a route of transmission for swine influenza virus, and possibly hog cholera virus, from pig to pig, but this is unproven.

#### CLINICAL FINDINGS

Lungworm infection in pigs can cause a marked check in growth rate. The bronchitis is accompanied by sporadic bouts of a barking cough, which is easily stimulated by exercise. Pneumonia is a feature of severe cases.

#### CLINICAL PATHOLOGY

Laboratory diagnosis is by demonstration of the characteristic eggs in feces.

## NECROPSY FINDINGS

Early lesions comprise small areas of consolidation due to verminous pneumonia. More chronic cases have bronchitis, emphysema, peribronchial lymphoid hyperplasia and bronchiolar muscular hypertrophy, often accompanied by areas of overinflation. The lesions are small and discrete, appearing as grayish nodules up to 1 cm in diameter and are present particularly at the ventral border of the diaphragmatic lobes.<sup>1</sup>

## DIAGNOSTIC CONFIRMATION

The *Metastrongylus* egg is embryonated (larvated), has a thick shell and a wavy outline. They may be missed on routine screening as they are usually passed in small numbers and do not float well in saturated salt (NaCl) solution. A flotation fluid with a higher specific gravity should be used. There will always be a history of access to yards or paddocks where earthworms exist.

## DIFFERENTIAL DIAGNOSIS

- Other swine pneumonias
- Migrating larvae in heavy *Ascaris* infestation.

## TREATMENT

A number of anthelmintics are effective at normal pig dose rates including doramectin, ivermectin, fenbendazole, and flubendazole. Levamisole (8 mg/kg) has been used in the water or feed.

## CONTROL

Rearing pigs on concrete reduces the risk considerably but, in view of the longevity of the eggs and larvae in the earthworm, little can be done if pigs are kept on contaminated land. Pastures which are known to be contaminated should be left for at least 6 months before restocking, although infested earthworms may persist in hog lots for up to 4 years.

## REVIEW LITERATURE

Roepsdorff, A., Nansen, P. The epidemiology, diagnosis and control of helminth parasites of swine: FAO Animal Health Manual No. 3. Rome: FAO, 1998.

## REFERENCE

1. Kruse GOW, Ferguson DJ. Vet Med Rev 1980; 2:113.

## Kidney worm disease in pigs

### ETIOLOGY

Stephanurosis is a disease of swine caused by the migration of larvae and young adults of the nematode parasite *Stephanurus dentatus* through the body.

### Synopsis

**Etiology** The nematode parasite *Stephanurus dentatus*.

**Epidemiology** Eggs are shed in urine; infective larvae enter pig when swallowed or by skin penetration; earthworms can act as transport hosts; prepatent period at least 6 months.

**Signs** Poor growth; emaciation in severe cases with stiffness of gait.

**Clinical pathology** Eggs in urine; eosinophilia.

**Lesions** Fibrosis and abscess formation in perirenal tissues; fibrotic scarring of liver; lesions may occur in other organs.

**Diagnostic confirmation** Eggs in urine; characteristic necropsy appearance.

**Treatment** Adults and larvae: fenbendazole, ivermectin, doramectin; adults only: levamisole.

**Control** Regular anthelmintic treatments at 4-month intervals; breeding only from gilts; keeping paddocks bare and dry.

## LIFECYCLE

*S. dentatus* are large (2–5 cm) thick roundworms which inhabit the perirenal tissues, and less commonly the other abdominal organs and spinal canal of the pig. Adult worms lie in cysts around the renal pelvis and the wall of the ureter. The cysts communicate with the urinary passages and the eggs are passed out into the urine of the host. They are very prolific egg layers and an infective adult sow may void as many as a million eggs in a day. Under suitable environmental conditions the eggs hatch and, after undergoing two molts, the larvae develop to the infective third stage in about 4 d. The eggs and larvae are very sensitive to cold and desiccation; eggs in a dry situation die within an hour. Exposure to temperatures below 10°C (50°F) is damaging and 4°C (40°F) is lethal. Most larvae in optimum conditions of moisture, warmth, and shelter from sunlight survive for about 3 months, some for as long as 5 months. Larvae may survive for long periods as facultative parasites in earthworms and this may enable the larvae to survive even when the soil microclimate is adverse.

**Larvae may penetrate the skin** or be ingested. Larvae that are ingested cross the wall of the stomach, or more commonly the small intestine, and reach the liver via the portal vessels; from the skin the larvae reach the systemic circulation and pass to the liver via the lungs in 1–6 weeks.<sup>1</sup> In the liver the larvae migrate from the blood vessels through the parenchyma and eventually, about 3 months after infestation, having undergone a fourth molt, penetrate the capsule of the liver and reach the perirenal tissues to establish themselves as adults. Egg laying usually commences about 6 months

after infestation but the prepatent period may be very much longer and individual worms appear to live as long as 2 years.<sup>2</sup>

**During their migration** the larvae often follow an erratic path and cause the development of atypical lesions and clinical signs. These larvae often reach maturity in these aberrant sites and prenatal infection can occur in this way.<sup>3</sup>

## EPIDEMIOLOGY

Kidney worms occur commonly in most tropical and subtropical countries such as Africa, the East and West Indies, Brazil, Hawaii, Philippines, the southern United States, and Australia, where the climate is sufficiently mild to permit the survival of eggs and larvae.

## PATHOGENESIS

The principal effect of these worms is the damage caused by the migrating larvae and young adults. The migrating worms cause a great deal of necrosis, fibrosis, and occasional abscess formation along the path of their migration and this is most marked in the perirenal tissues and the liver. *S. dentatus* have been observed rarely in cattle. Experimentally dosed calves develop severe hepatic injury similar to that which occurs in pigs but the lifecycle is not completed and no perirenal lesions develop.

## CLINICAL FINDINGS

The mortality rate is not high; production losses and condemnation of parts or all of the infested carcass are of greatest economic significance. Poor growth in spite of a good appetite may be the only sign in mild cases.<sup>4</sup> Badly affected animals become emaciated and develop ascites. In the early stages, nodules in the skin of the belly wall and enlargement and soreness of the peripheral lymph nodes may be evident.<sup>5</sup> Many apparently unrelated clinical signs are produced by aberrant larvae. For example, thrombi may be induced in blood vessels such as the portal veins, hepatic artery and posterior vena cava, while paralysis may result if larvae invade the spinal cord. Involvement of the psoas muscles, causes local pain and stiffness of gait. The passage of larvae through the peritoneum and pleura gives rise to adhesions. Larvae may also become encysted in the lung. Weakness and eventual paralysis of the hindlegs occur in a number of cases. Passage through the peritoneum and pleura causes the formation of adhesions and many larvae become encysted in the lung.

## CLINICAL PATHOLOGY

Large, thin-walled, embryonated eggs are present in the urine when adult worms

are present in the ureter wall. An eosinophilia is seen 2–3 weeks after infection, peaking at 6–7 weeks and still elevated at 20 weeks.<sup>5</sup> However, this has little specific diagnostic significance. Anemia does not occur. Only a transient rise in aspartate aminotransferase is seen and serum enzymes seem to be of little value in diagnosis.<sup>5</sup>

### NECROPSY FINDINGS

The common findings include<sup>1</sup>: fibrosis and abscess formation in perirenal tissues with large adult worms present here and occasionally in the pelvis of the kidney and ureter,<sup>2</sup> infarcts and scars in the kidney and enlargement and scarring of the liver, sometimes accompanied by ascites. The hepatic lesions include irregular whitish tracks in the parenchyma, extensive fibrosis, hemorrhage and eosinophilic abscess formation. The liver may be covered with a diphtheritic membrane. Larvae may also be present in peripheral lymph nodes and cutaneous nodules, in small abscesses in the lung and pancreas and in thrombi of blood vessels, particularly in the liver and lungs. Pleurisy and peritonitis if they are present are usually manifested by adhesions.

### DIAGNOSTIC CONFIRMATION

A definite diagnosis of stephanurosis may be made by finding eggs in the urine or by necropsy. Young pigs with a heavy infestation of larvae may present a problem in diagnosis because adult worms and characteristic renal lesions may not yet be present. An ELISA test can detect infection from 2 weeks after infection,<sup>6</sup> but serological tests are not likely to become a routine diagnostic procedure.

### DIFFERENTIAL DIAGNOSIS

- Other causes of poor growth and emaciation in pigs, e.g. poor nutrition and chronic bacterial diseases such as necrotic enteritis and swine dysentery, but these are accompanied by intermittent diarrhea
- Other parasitic diseases such as ascariasis and hyostrongylosis
- Other causes of posterior weakness in pigs such as vitamin A deficiency, osteodystrophia, sometimes fracture of a lumbar vertebra, brucellosis, erysipelas when intervertebral joints are involved, or by spinal cord abscess or lymphoma.

### TREATMENT

Single doses of ivermectin or doramectin at 0.3 mg/kg, or fenbendazole at 3 mg/kg in the feed for 3 d are effective against migrating and adult stages,<sup>7,8</sup> while levamisole at 8 mg/kg removes the adults

only but thereby prevents egg output for at least 4 weeks.<sup>9</sup>

### CONTROL

Regular anthelmintic treatment of all pigs with fenbendazole or ivermectin at 4-month intervals should prevent further contamination of the environment with eggs. The free-living stages should then eventually die out, but this may take some time as infected earthworms may survive for at least 1 year.

Management techniques may also be used for controlling kidney worm. As the prepatent period of *S. dentatus* is at least 6 months, one method is to breed entirely from gilts until the transmission cycle is broken.<sup>10</sup> Under this system the gilts are raised, allowed to farrow and sent to market as soon as the litter is weaned and before any eggs are shed. Boars are confined on concrete to prevent contamination of the soil by eggs in their urine. This technique has the advantage of maintaining a fully stocked farm while control is being achieved but has obvious economic penalties.

Other management techniques depend on the provision of dry ground where eggs and larvae are less likely to survive. Sleeping shelters should be placed on high ground, preferably bare of vegetation. Because pigs in yards commonly urinate against fences, a 2–3 m strip of earth inside the boundary should be kept free of herbage. Muddy spots and water holes should be filled in and drainage provided. Water and feed troughs should be on a concrete apron. Young animals should be segregated from adults and fields rested for 3–6 months after the adults are removed. Such programs are rewarding if carried out diligently and intelligently, but the extra work involved has militated against general acceptance of this approach. Because of the importance of mature animals as sources of infestation, early replacement of breeding stock is recommended in problem herds.

### REVIEW LITERATURE

Stewart TB et al. Eradication of the swine kidney worm *Stephanurus dentatus* from experimental pastures by herd management. *Am J Vet Res* 1964; 25:1141–1150.

### REFERENCES

1. Waddell AH. *Aust J Zool* 1969; 17:607.
2. Tromba FG, Romanowski RD. *J Parasitol* 1976; 62:250.
3. Batte EG et al. *J Am Vet Med Assoc* 1966; 149:758.
4. Hale OM, Marti OG. *J Anim Sci* 1983; 56:616.
5. Hutchinson GW et al. *Aust Vet J* 1983; 60:171.
6. Partoutomo S et al. *Int J Parasitol* 1983; 13:45.
7. Becker HN. *Am J Vet Res* 1986; 47:1622.
8. Stewart TB et al. *Vet Parasitol* 1996; 66:95.
9. Stewart TB et al. *Am J Vet Res* 1981; 42:1627.
10. Stewart TB et al. *Am J Vet Res* 1964; 25:1141.

## Nematode induced skin conditions

### SUMMER SORES IN HORSES

#### Synopsis

**Etiology** Three nematode species, *Habronema muscae*, *H. majus* (syn. *H. microstoma*), and *Draschia megastoma* infect the horse.

**Epidemiology** Larvae from eggs in the feces are ingested by fly larvae; adult flies deposit infective larvae on skin.

**Signs** Larvae deposited in wounds or in eye cause local inflammation and the development of extensive granulation tissue.

**Clinical pathology** Larvae may be found in skin scrapings, biopsies or discharges; marked local eosinophilia.

**Lesions** Adult *D. megastoma* cause tumorlike lesions in stomach; other species cause a catarrhal enteritis.

**Diagnostic confirmation** Gastric form: eggs difficult to find in feces; Cutaneous form: demonstration of larvae, eosinophils in biopsy or scraping.

**Treatment** Ivermectin.

**Control** Protect horses from flies; treat all skin wounds promptly.

### ETIOLOGY

The various forms of cutaneous habronemosis, with local names such as 'summer sores', 'swamp cancer', and 'bursattee', involve three nematode species, *Habronema muscae*, *H. majus* (syn. *microstoma*), and *Draschia megastoma*, the adults of which infest the stomach of horses.

### LIFECYCLE

*Habronema* spp. adults are larger (1–2.5 cm long) than those of *D. megastoma* (1.25 cm). The lifecycles are indirect; all species use flies as their intermediate hosts. *H. muscae* and *D. megastoma* mainly use the house fly (*Musca domestica*) but can use other muscid species, while *H. majus* usually passes through the stable fly (*Stomoxys calcitrans*), although *Haematobia irritans exigua*, *Sarcophaga melanura*, and the house fly can also be used. The thin-walled larvated eggs hatch in the manure and are ingested by maggots in which they develop. The infective form is reached about the time the adult fly emerges from the puparium. Horses become infected by swallowing dead flies with feed or water or, alternatively, infective larvae may pass through the proboscis of the fly when it is feeding on the lips or on wounds. Larvae that are swallowed reach maturity in the stomach while those deposited in wounds cause cutaneous habronemosis. Stray larvae may be found anywhere throughout the body but

occasionally massive invasion of the lungs is seen.<sup>1</sup>

### EPIDEMIOLOGY

*Habronema* and *Draschia* have a worldwide distribution. They are of importance only in warmer climates, where they are commonly found, especially in wetter areas where the intermediate hosts are common. Elsewhere they tend to be a sporadic nuisance. Gastric granulomas and most cutaneous lesions appear to be associated with *D. megastoma*, although typical cutaneous lesions do occur naturally and have been produced experimentally by the cutaneous implantation of *H. majus* or *H. muscae* larvae. The latter however only cause a transitory reaction. Horses of all ages are susceptible but the disease is most common in adults.

### PATHOGENESIS

Two types of gastric habronemosis occur. The more serious is associated with *D. megastoma*. Larvae invade the gastric mucosa and cause the development of large granulomatous masses which later fibrose. These tumors contain adult worms and have a central orifice through which eggs and larvae escape into the lumen. In many horses, the lesions cause only a mild chronic gastritis. In rare cases perforation occurs and is followed by a local peritonitis, which may involve the intestine causing constriction or the spleen causing abscesses. *H. majus* and *H. muscae* do not cause tumors but penetrate the stomach glands and cause a catarrhal gastritis with the production of a thick tenacious mucus. Heavy burdens may cause ulceration.

In cutaneous and conjunctival habronemosis, *Habronema* spp. larvae deposited in wounds cause local inflammation and the development of extensive granulation tissue. Secondary bacterial or mycotic invasions may occur. In the eye, similar lesions form on the inner canthus, the nictitating membrane or the eyelid. These can cause profuse laceration and other signs of local irritation.

### CLINICAL FINDINGS

Gastric habronemosis does not usually provoke clinical signs, but affected animals may, on occasion, have a poor coat and a variable appetite. Large tumors may cause pyloric obstruction and gastric distension. When perforation occurs there is depression, a fever of 39.5–40.5°C (103–105°F) and pain and heat on the left side just behind the costal arch. Mild-to-moderate colic may be evidenced when intestinal stenosis is present. If the spleen is involved there is marked anemia and a gross increase in the total leukocyte count with a shift to the left.

Cutaneous habronemosis is manifested by the appearance of lesions on

those parts of the body where skin wounds or excoriations are most likely to occur and where the horse cannot easily displace the vector flies. Thus they are most common on the face below the medial canthus of the eye and on the midline of the abdomen, extending in males onto the prepuce and penis. Less commonly, lesions may be found on the legs and withers but those occurring in the region of the fetlocks and coronary band are especially serious. The cutaneous lesions commence as small papules with eroded, scab-covered centers. Development is rapid and individual lesions may increase to 30 cm in diameter in a few months. The center is depressed and composed of coarse, red granulation tissue covered with a grayish necrotic membrane and the edges are raised and thickened. Although the lesions do not usually heal spontaneously, they may regress in colder weather and recur the following summer. There is little discharge. The sores are unsightly, inconvenient and cause some irritation.

In conjunctival habronemosis lesions on the nictitating membrane may be as large as 5 mm in diameter. The conjunctivitis is manifested by small, yellow, necrotic masses about 1 mm in diameter,<sup>2</sup> accompanied by soreness and laceration, which do not respond to standard treatments for bacterial conjunctivitis.

### CLINICAL PATHOLOGY

Diagnosis is difficult in the gastric form of the disease because the eggs and larvae are not easy to find in the feces. Biopsy of a cutaneous lesion reveals connective tissue containing small, yellow caseous areas up to 5 mm in diameter. Larvae may be found in skin scrapings or biopsies and ocular lesions can be found in the conjunctival sac or discharges. A marked local eosinophilia occurs.<sup>3</sup>

### NECROPSY FINDINGS

Tumor-like lesions of *D. megastoma* bulge into the lumen of the stomach and may reach the size of a golf ball. Adult *Habronema* are stout worms but their presence is often masked by a thick tenacious layer of mucus. This is on the glandular part of the stomach and often close to the margo plicatus.

Granulomatous lesions may be found in all the sites mentioned in the description of clinical signs, and although varying in size are of essentially the same composition as described under biopsy earlier. Horses which have had the cutaneous form of the disease may have small nodules in the parenchyma of the lung. These are hard, yellowish and contain inspissated pus and larvae.

### DIAGNOSTIC CONFIRMATION

A biopsy will confirm clinical diagnosis of the cutaneous and conjunctival forms of the condition. Molecular techniques are being developed for detection and specific identification of parasite DNA in feces and biopsies.<sup>4</sup>

### DIFFERENTIAL DIAGNOSIS

The gastric form of habronemosis is difficult to differentiate from infestation with stomach bot (*Gasterophilus*) larvae or *Trichostrongylus axei*. These parasites often co-exist in the same animal. Cutaneous habronemosis must be distinguished from:

- Fungal granulomata associated with *Hyphomyces destruens*
- Overgrowth of granulation tissue following a wound
- Equine sarcoids.

### TREATMENT

Few anthelmintics have been adequately tested against *Habronema* spp. and *D. megastoma*. Ivermectin 0.2 mg/kg will remove these species from the stomach with a single treatment<sup>5</sup> but a second dose is sometimes necessary to promote healing in cutaneous lesions.<sup>6</sup> Moxidectin (0.4) is active against adult *Habronema muscae*.<sup>7</sup> Fenbendazole used at 10 mg/kg for 5 d is reported to have high efficiency against *D. megastoma* and possibly *Habronema* spp.<sup>8</sup>

### CONTROL

Interruption of the lifecycle by careful disposal of horse manure and control of the fly population are obvious measures. In enzootic areas all skin wounds and excoriations should be treated promptly to promote healing and protect them against flies.

### REFERENCES

1. Bain AM et al. Aust Vet J 1969; 45:101.
2. Rebhun WC et al. J Am Vet Med Assoc 1981; 179:469.
3. Gasthuys FMR et al. Vet Rec 2004; 154:757.
4. Traversa D et al. Parasitol 2004; 129:733.
5. Klei TR et al. Vet Parasitol 2001; 98:315.
6. Herd RP, Donham JC. Am J Vet Res 1981; 42:1953.
7. Bauer C et al. Vet Rec 1998; 143:558.
8. Lyons ET et al. Am J Vet Res 1983; 44:1058.

### RHABDITID DERMATITIS

*Pelodera* is a sub-genus of the soil nematode *Rhabditis*. Dermatitis associated with the larvae of *P. strongyloides* is rare. It is recorded most commonly in the dog but outbreaks have been observed in cattle, sheep and horses.<sup>1-3</sup> It has also been an incidental finding in other skin diseases associated with poor husbandry practices.<sup>4</sup> Alopecia is marked, particularly on the neck and flanks. In moderate cases the skin on affected areas is thickened,

wrinkled and scurfy and some pustules are present on the ventral abdomen and udder.<sup>5</sup> Pustules are up to 1 cm in diameter and contain thick, yellow caseous material and worms. There is marked irritation and, in severe cases, affected areas are swollen, raw and exude serum.

*Pelodera strongyloides* is a free-living soil nematode found particularly in decaying leaf mould and similar material. When warm blooded animals lie on its habitat for prolonged periods it takes the opportunity to invade the skin. Thus, infestation is encouraged by housing animals on warm, wet bedding. Under favorable conditions the disease may spread rapidly.<sup>3</sup> In these circumstances the lesions occur most commonly where the skin contacts the bedding. The nematodes are easily detected in skin scrapings or biopsy specimens, and in samples of the bedding, preferably taken from the top few centimeters in the pen.

**Control measures** include the regular removal of soiled bedding and steps to ensure that the litter is kept dry. Spontaneous recovery usually occurs if these precautions are taken but local application of a parasiticide and symptomatic therapy will speed recovery.

#### REFERENCES

1. Levine ND et al. J Am Vet Med Assoc 1950; 116:294.
2. Ramos JJ et al. Vet Rec 1996; 138:474.
3. Rhode EA et al. North Am Vet 1953; 34:634.
4. Rashmir-Raven AM et al. J Vet Diagn Invest 2000; 12:287.
5. Farrington DD et al. Vet Med 1976; 71:1199.

#### ONCHOCERCOSIS

*Onchocerca* spp. are filamentous, thread-like nematodes found mostly as convoluted masses in fibrous tissues. They vary in length; those of the horse are 15–18 cm long, while bovine species may be as long as 75 cm. They are filarial worms and the females produce motile embryos (microfilariae). These congregate in the skin and subcutaneous tissues at the favored feeding site of their intermediate host. Each *Onchocerca* species uses a particular biting fly, usually a species of *Culicoides* (midge) or *Simulium* (blackfly). Transmission takes place when infective larvae that develop in the fly are deposited on the skin of their host at a subsequent feed.

Infestation by adult worms is often symptomless and prevalence tends to increase with age. Relatively non-pathogenic species of widespread occurrence in cattle include *O. gutturosa* in the ligamentum nuchae and *O. lienalis* in the gastrosplenic ligament, while horses often harbor *O. cervicalis* in the ligamentum nuchae and *O. reticulata* around the flexor tendons. Some cause rejection of meat

for human consumption. *O. gibsoni* in Australian cattle, for example, provokes nodules up to 3 cm across in subcutaneous tissues, especially in the brisket. *O. ochengi* produces subcutaneous nodules in African cattle, most commonly on the scrotum and udder. Other species may be more pathogenic such as *O. armillata*, which lives in the aorta of cattle, buffalo and goats in India and Iran.<sup>1</sup>

**Losses caused by adult worms** are slight although *O. gibsoni* in cattle causes unsightly lesions and rejection of beef carcasses from the high-class meat trade. The characteristic nodules of *O. gibsoni* are usually freely movable and consist of fibrous tissue canalized by the long body of the worms. With *O. armillata*, the inner wall of the aorta may be corrugated and swollen. In horses, new infections with *O. reticulata* may cause swelling of the suspensory ligament and a hot edematous swelling of the posterior part of the cannon which persists for 3–4 weeks. After the swelling subsides, the suspensory ligament remains thickened and small caseated or calcified nodules may be palpated. Affected animals are lame while the area is edematous and swollen, but many recover when the swelling disappears. *O. cervicalis* causes fibrotic, caseous and calcified lesions in the ligamentum nuchae but clinical signs are not seen. The conditions known as 'poll evil' and 'fistulous withers' are no longer thought to be associated with this parasite.

**Microfilariae** may sometimes be damaging. Those of *O. cervicalis*, for example, are occasionally observed in the cornea of horses but the proposed causal relationship with periodic ophthalmitis is no longer thought to be valid. They can however induce hypersensitivity reactions in the skin of some individuals. Lesions are characterized by alopecia, scaliness and pruritus, particularly along the ventral abdomen. They may extend between the forelegs and backlegs to include the thigh, and in severe cases they may extend up the lower abdominal wall. Some horses have lesions on the face, neck, or thorax.<sup>2</sup> The lesions may be confused with those associated with hornfly feeding but these are more likely to include crusting and ulcerating dermatitis.<sup>3</sup> In onchocercosis, microfilariae are not detectable in the bloodstream but may be found in skin biopsies. *O. ochengi* in African cattle has been associated with a dermatitis resembling demodectic mange and pox,<sup>4</sup> while in Turkey microfilariae of *O. gutturosa*, *O. lienalis*, and an unidentified species have recently been reported in association with teat lesions including sores, chaps, and nodules.<sup>5</sup>

**Control** of the intermediate hosts is virtually impossible but valuable horses

prone to hypersensitivity to *O. cervicalis* microfilariae can be partially protected by housing at night as most *Culicoides* species feed during twilight hours and/or at night. The use of insect repellents and avoidance, if possible, of grazing areas where the insects are likely to be in large numbers will also be beneficial. There is no specific treatment for the adult worms. A novel approach has been the experimental use of tetracycline to eliminate *O. ochengi* by killing the symbiotic bacterium *Wolbachia* which is found in many, but not all, filarial species.<sup>6</sup> Ivermectin 0.2 mg/kg<sup>2,7</sup> or moxidectin 0.4 mg/kg<sup>8</sup> can be used to eliminate microfilariae in horses. About 10% of treated horses develop an edematous reaction within 24 h.<sup>2</sup> This is usually restricted to the area of the lesion but some may develop a pruritic ventral edema.

#### REVIEW LITERATURE

Gortel K. Equine parasitic hypersensitivity. Equine Pract 1994; 20:14.

#### REFERENCES

1. Cheema AH, Ivoghli B. Vet Pathol 1978; 15:495.
2. Herd RP, Donham JC. Am J Vet Res 1983; 44:1102.
3. Foil LD et al. Equine Pract 1990; 12:6.
4. Bwangamoi O. Bull Epizoot Dis Afr 1969; 17:435.
5. Beytut E et al. Res Vet Sci 2005; 78:45.
6. Langworthy NG et al. Proc R Soc Lond B Biol Sci 2000; 267:1063.
7. Mogg TD et al. Aust Vet J 1990; 87:399.
8. Mancebo OA et al. Vet Parasitol 1997; 73:243.

#### ELAEOPHOROSIS (FILARIAL DERMATITIS) IN SHEEP

*Elaeophora* spp. are filarial nematodes that inhabit blood vessels. Relatively non-pathogenic species include *E. bohmi*, which has been reported in horses in Austria and *E. poeli*, which occurs in cattle in Africa and Asia. Of greater clinical significance is *E. schneideri*, which is primarily a parasite of mule deer in North America. Elk, white-tailed deer, and moose may act as reservoir hosts.<sup>1</sup> This species causes chronic disease in adult sheep grazing at high altitudes during the summer months. Horse flies such as *Hybomitra* and *Tabanus* spp. are intermediate hosts.<sup>2</sup> In sheep, larvae develop in the leptomenigeal arteries for 4–5 weeks after which they migrate into the common carotid and internal maxillary arteries, although they may also be found in other arteries. The adults grow to 120 mm in length and mature in about 5 months.<sup>3</sup>

**Elaeophorosis** usually produces no detectable effects in the natural host, the mule deer. Clinical signs in abnormal hosts attributable to migrating worms are thought to be the result of the prolonged sojourn of the larvae in smaller blood vessels. This reduces blood flow and may result in blindness, deafness, and circling.



It also means that the larvae are larger when they pass through the cerebral retina to get to the common carotid and rupture of a rete artery, hemorrhage and death may follow. Further signs are caused by the microfilariae. Sheep usually show a severe dermatitis on the poll, forehead, face, feet, and ventral abdomen. Initially the lesions are small and circumscribed but the irritation produced by them is so intense that scratching causes extensive areas of bleeding, with a granular surface containing numerous small abscesses. On the feet, the lesions extend from the coronary band to above the fetlock and cause much local swelling. Recurrent periods of quiescence occur and scabs form over the lesions, but 2–3 d later, scratching recommences and the lesions are spread further. The course is long, often 7 months and up to 3 years, but recovery may eventually occur. Residual lesions include deformity of the hooves and bare, thickened patches of skin. Lesions also occur in the nasal and oral mucosae and on the cornea. Abnormalities of the eye include cataract, iridocyclitis and corneal opacity. While sight often remains adequate in sheep, it is usually lost in elk.

#### DIFFERENTIAL DIAGNOSIS

The distribution of lesions and pruritus help to distinguish elaeophorosis from:

- contagious ecthyma
- mycotic dermatitis
- strawberry foot rot.

Photosensitization lesions may have a very similar distribution and appearance to those caused by the elaeophorid filaria but there is usually marked edema and swelling and a history of access to photosensitizing or hepatotoxic plants.

**Microfilariae** may be detected in skin biopsies but skin scrapings and blood examinations are not satisfactory. The number of microfilariae in the skin of sheep is always low and negative results may be obtained in known positive sheep.

**Treatment** with piperazine (220 mg/kg) has been suggested. Unfortunately the death of adult parasites in heavily infected sheep may cause the death of the host, presumably by blocking branches of the carotid arteries. Information is lacking on the activity of modern drugs on this infection.

#### REVIEW LITERATURE

Anderson RC. In: Samuel WM, Pybus MJ, Kocan AA (eds) *Parasitic diseases of wild mammals*. Iowa State University Press, 2001; pp. 342–349.

#### REFERENCES

1. Corn JL, Nettles VF. *J Wildl Dis* 2001; 37:413.
2. Clark CG, Hibler CP. *J Wildl Dis* 1973; 9:21.
3. Hibler CP, Metzger CJ. *J Wildl Dis* 1974; 10:361.

#### PARAFILARIOSIS

Horses in Europe, particularly eastern Europe, China, South America, and North Africa, are sometimes infected with *Parafilaria multipapillosa*, a 3–6 cm long nematode. The female lives in a nodule in the skin which it pierces to lay eggs on the surface. The subcutaneous nodules ulcerate, bleed, heal, and disappear spontaneously. The hemorrhagic exudate from the lesion attracts bloodsucking flies such as *Haematobia*, which ingest the eggs and act as the intermediate host. The condition is relatively benign, occurring in the spring, summer, and autumn. Many nodules may occur on a horse but although unsightly they do little harm unless they interfere with harness straps.

Similar lesions in cattle are associated with *P. bovicola*, which is endemic in eastern and some western European countries, India, the Philippines, Japan, and South Africa. It has recently become established in Canada, Ireland, and Sweden, where it spread at a rate of 50 km/year.<sup>1,2</sup> Muscid flies, for example *Musca autumnalis* in Sweden, act as the intermediate host<sup>3</sup> and the prepatent period in cattle is 7–10 months. The condition is seen mostly in late winter, spring, and summer and causes widespread economic losses due to carcass trimming and hide damage. The majority of lesions are superficial and localized but sometimes they cover the whole carcass. In such cases intermuscular lesions will be found within the fascia of adjacent muscles. Subperitoneal, abdominal, subpleural, and thoracic lesions may also occur and cause condemnation of the whole carcass. *Suifilaria suis* causes similar lesions in the pig in South Africa.

Clinical signs are restricted to the presence of bleeding points and a diagnosis may be made by examining a smear of the exudate microscopically for larvated eggs. Ivermectin markedly reduces the area of the lesions and the mass of affected tissue.<sup>4</sup> A control program for *P. bovicola* using ivermectin has been evaluated.<sup>5</sup> Blood spots were dramatically reduced but transmission was not stopped. Nitroxynil 20 mg/kg twice at 72-hour intervals is effective in reducing the number and area of lesions but care must be taken to ensure accuracy of dosing or toxic signs of drug overdose may be seen.<sup>6</sup> Topical levamisole may also be effective.<sup>2</sup>

#### REFERENCES

1. Bech-Nielsen S. et al. *Am J Vet Res* 1982; 43:945.
2. Torgerson PR et al. *Irish Vet J* 1998; 51:27.
3. Bech-Nielsen S et al. *Am J Vet Res* 1982; 43:948.
4. Soll MD et al. *Prev Vet Med* 1991; 10:251.

5. Nevill EM et al. *Onderstepoort J Vet Res* 1987; 54:547.
6. Wellington AC. *J S Afr Vet Assoc* 1980; 51:243.

#### STEPHANOFILARIOSIS

*Stephanofilaria* spp. are very small (up to 8 mm) filarial nematodes living in cysts at the base of hair follicles. They are associated with subcutaneous tissue lesions in cattle and buffalo. There are a number of species including *S. dedoisi* (synonyms *S. assamensis*, *S. kaeli*, and *S. okinawaensis*), which provokes a dermatitis ('cascado') affecting the eyes, neck, withers, shoulders and dewlap in parts of Asia as well as 'humpsore' in India, leg sores on cattle in Malaysia and muzzle and teat lesions in Japan. *S. zaheeri* causes 'earsore' in India and *S. stilesi* is responsible for dermatitis of the ventral abdomen in parts of the United States and Russia. A similar species in Queensland, Australia affects the head, neck, dewlap, and sternum. *S. boomkeri* has recently been described in pigs in Africa.<sup>1</sup> The adult worms release microfilariae which later develop in flies that feed on the sores. The vector for *S. dedoisi* is *Musca conducens*, while the horn fly *Haematobia irritans* is intermediate host for *S. stilesi* in the United States. The Australian species is probably spread by the buffalo fly, *Haematobia irritans exigua*.<sup>2</sup>

**Cutaneous stephanofilariosis** starts with small papules which later coalesce to produce lesions varying from 3 to 15 cm in diameter. They are an extreme irritant and evidence of rubbing is present. Part but not all of the hair is lost and dried exudate forms a thick, crumbly scab which may crack to expose blood-stained fluid. Skin scrapings taken from beneath the scab may reveal worm fragments. If healing occurs, the scab disappears leaving a scar. Infection does not affect growth rate, and treatment and control is required only in stud cattle where lesions are esthetically undesirable. Ivermectin is an effective microfilaricide in buffaloes and reduces the number of adult worms.<sup>3</sup> Oral levamisole 7.5 mg/kg once or twice at 3 to 4-week intervals is reported to be effective.<sup>4</sup> Ointments containing insecticides may aid control. The Asian species require a pre-existing wound for infection to take place. Simple wound prevention and treatment would therefore reduce the risk of disease in this region.

#### REVIEW LITERATURE

Johnson SJ. *Stephanofilaria* – a review. *Helminthol Abstr (Ser A)* 1987; 568:287–299.

#### REFERENCES

1. Bain O et al. *Parasite* 1996; 3:377.
2. Johnson SJ et al. *Aust Vet J* 1986; 63:121.
3. Gill BS et al. *Vet Parasitol* 1991; 40:159.
4. Ueno H, Chibana T. *Vet Parasitol* 1980; 7:59.

## Nematodes affecting eyes or nervous system

### THELAZIA (EYEWORM)

A number of species of the nematode genus *Thelazia* occur in the conjunctival sac and tear ducts of mammals throughout the world. *T. gulosa* and *T. skrjabini* are the main species in cattle in the New World while *T. rhodesi* is the commonest in the Old World and *T. lacrymalis* is cosmopolitan in horses. They are thin worms up to 2 cm long. Infestation is often inapparent but they may cause excessive lacrimation, photophobia, conjunctivitis, keratitis, corneal ulceration, and abscess formation on the eyelids.<sup>1-3</sup> In horses, this condition mainly occurs in young animals. One survey in Kentucky, in the United States, found 43% of horses up to 4 years old to be infected.<sup>4</sup> In those species that have been studied, the lifecycles are indirect with muscid flies, particularly the face fly *Musca autumnalis*,<sup>5</sup> being the intermediate hosts. These flies deposit larvae on the conjunctiva when feeding on fluid around the eye. The disease is mainly seen in summer and autumn when the flies are active. It is usually more common in cattle than horses<sup>3</sup> and worms may be more abundant in beef than in dairy cattle.<sup>6</sup> Eyeworm in cattle is differentiated from infectious keratitis by observing the adult worm in the conjunctival sac or demonstrating first-stage larvae in eye washings. Ivermectin and doramectin are active against the adult worm in cattle<sup>7,8</sup> but anecdotal reports suggest that it may be less effective in horses.

### REVIEW LITERATURE

Otranto D, Traversa D. Thelazia eyeworm: an original endo- and ecto-parasitic nematode. *Trends Parasit* 2005; 211:1-4.

### REFERENCES

1. Ladouceur CA, Kazacos KR. *J Am Vet Med Assoc* 1981;178:385.
2. Arbuckle JBR, Khalil LF. *Vet Rec* 1978; 102:207.
3. Patton S, McCracken MD. *Equine Pract* 1981; 3:53.
4. Lyons ET et al. *Am J Vet Res* 1986; 47:315.
5. Giangaspero et al. *Parassitologia* 2004; 46:257.
6. Kennedy MJ et al. *J Parasitol* 1990; 76:196.
7. Kennedy MJ et al. *Vet Parasitol* 1994; 55:263.
8. Marley SE et al. *Am J Vet Res* 1999; 60:665.

### HALICEPHALOBUS

*Halicephalobus gingivalis* (*H. delatrix*; *Micronema delatrix*) is a small nematode which has been found in horses on rare occasions. Like *Pelodera*, it is a free-living saprophytic organism that has the ability to become an opportunistic parasite. *H. gingivalis* however invades the deeper tissues where it reproduces. Enormous numbers may be seen in granulomatous

lesions that grow to several cm in diameter. Lesions may be found near the eye, in the prepuce, nares or the maxilla. The latter may be sufficiently large to cause the hard palate to bulge, displacing the molars and causing difficulty in mastication.<sup>1</sup> Putative hematogenous spread gives rise to similar lesions in the kidney which may be misdiagnosed as renal neoplasia. The worm also invades the brain and spinal cord<sup>2</sup> but here the lesions are usually microscopic and consist of discrete granulomata with a vascular orientation. Affected horses may show a wide variety of clinical signs including lethargy, ataxia, and incoordination leading to recumbency and death.<sup>3</sup> Diagnosis of superficial lesions is by demonstration of worms and larvae in biopsy samples, but more often *H. gingivalis* infection is identified retrospectively in histological sections following necropsy.<sup>4</sup> The worms are 250-430 µm long, have a characteristic bilobed pharynx and often contain a single large egg. This infection must be considered in the differential diagnosis of equine cerebrospinal nematodosis.<sup>3,4</sup> Treatment with ivermectin at the maximum safe dose has been attempted although the susceptibility of the worm to this compound is uncertain.

### REVIEW LITERATURE

Pearce SG. Treatment of a granuloma caused by *Halicephalobus gingivitis* in a horse. *J Am Vet Med Assoc* 2001; 219:1735-1738.

### REFERENCES

1. Cho DY et al. *J Am Vet Med Assoc* 1985; 187:505.
2. Blunden AS et al. *Equine Vet J* 1987; 19:255.
3. Alstad AD, Berg IF. *J Am Vet Med Assoc* 1979; 174:264.
4. Pletcher JM, Howerth E. *J Am Vet Med Assoc* 1980; 177:1090.

### ELAPHOSTRONGYLUS

Cerebrospinal elaphostrongylosis (CSE) or neurofilariosis is a disease of sheep, goats, and camelids caused by infestation of the brain and spinal cord with the nematode *Elaphostrongylus* and related genera. This genus is closely related to the lungworms of small ruminants but is found in the cranial subarachnoid space, cranial venous sinuses and occasionally in the spinal subarachnoid space. *Parelaphostrongylus tenuis* occurs in white-tailed deer in eastern North America and parts of western Canada, *E. cervi* in deer in Europe and New Zealand, and *E. rangiferi* in reindeer in Scandinavia. Eggs or larvae are carried to the lungs, undergo a tracheal migration and the first-stage larvae are passed in the feces. The larvae are quite resistant to adverse environmental conditions and enter slugs or snails to develop into infective larvae.

The lifecycle is complete when infected molluscs are ingested by deer and the larvae penetrate the abomasum, migrate, possibly along spinal nerves, to the spinal cord where they develop into adults and migrate into the subarachnoid space.<sup>1</sup>

Clinical signs are not seen in infected deer, but in sheep and goats the worm continually moves through nervous system tissue causing limping and incoordination followed by almost complete paralysis of the hindlimbs or of the neck, body, and all four legs.<sup>1-3</sup> There are no signs of cerebral involvement and affected animals remain bright and continue to eat. If given supportive treatment they may survive for at least 1 month. *P. tenuis* also transmits to moose and is responsible for the nervous signs in 'moose sickness', including<sup>4</sup>:

- Weakness
- Incoordination
- Circling
- Impaired vision
- Blindness
- Abnormal carriage of the head
- Paralysis
- Lack of fear of man
- Aggressiveness.

**No reliable treatment** is available for CSE. Ivermectin has no effect on the adult worms, possibly because the large molecules of this compound cannot pass the blood-brain barrier.<sup>5</sup> One clinical report describes the treatment of 17 light to moderately affected goats with an NSAID (flunixin meglumine) together with ivermectin and fenbendazole for 5 days.<sup>6</sup> Complete recovery occurred in three, partial recovery in eight, but euthanasia was necessary for the remainder.

### REVIEW LITERATURE

Lankester MW. In: Samuel WM, Pybus MJ, Kocan AA (eds) *Parasitic diseases of wild mammals*. Iowa State University Press, 2001; pp. 252-278.

### REFERENCES

1. Handeland K et al. *J Comp Path* 2000; 123:248.
2. Kopcha M et al. *J Am Vet Med Assoc* 1989; 194:1439.
3. Pusterla N et al. *Schweizer ArchivTierheilk* 1997; 139:282.
4. Smith HJ, Archibald R McG. *Can Vet J* 1967; 8:173.
5. Soll MD. In: Campbell WC (ed) *Ivermectin and abamectin*. New York: Springer-Verlag, 1989; p. 272.
6. Pusterla N et al. *Dtsch Tierarztl Wochenschr* 1999; 106:22.

### SETARIA

*Setaria* spp. are long (5-10 cm) thread-like filarial nematodes commonly found in the peritoneal cavity of most domestic animals. *S. labiato-papillosa* is a cosmopolitan parasite of cattle while *S. digitata* and the closely related, and perhaps synonymous, species *S. marshalli* occur only in Asia.

*S. equina* is found worldwide in horses. Adult females produce motile embryos (microfilariae) which circulate in the peripheral blood of the infected animal and are taken up by mosquitoes.<sup>1</sup> Infective larvae develop in the intermediate host and are released when the mosquito subsequently feeds. *S. labiato-papillosa* reaches maturity in cattle in 8–10 months. Despite their size, the presence of these worms in the abdominal cavity causes no significant clinical effect.

**Serious disease** may result if *S. labiato-papillosa* or *S. digitata* infect animals other than their own natural host, especially horses, sheep, goats, and humans. In these hosts, they migrate in an abnormal manner causing epizootic cerebrospinal nematodosis (with local names including Lumbar Paralysis and Kumri) when they invade the brain and spinal cord. Juvenile *S. digitata* may also invade the eye. Although *Setaria* is found in cattle in many countries, cerebrospinal nematodosis is largely restricted to Israel, Japan, China, Korea, India, and Sri Lanka. The incidence is increasing in Taiwan<sup>1</sup> and a single case has been reported from the United States.<sup>2</sup> Ocular filariosis is seen most

commonly in Japan. These are diseases of the summer and autumn when the vectors are most prevalent. The cerebrospinal form sometimes occurs in epidemic proportions, causing deaths in horses, sheep, and goats.

**Cerebrospinal nematodiosis** may be rapid in onset with affected animals dying within a few days or it may occur gradually over a few days. There may be acute or subacute paresis with weakness and incoordination or paralysis involving the hindlegs most commonly, but sometimes all four legs. Recovery is only partial in many animals but others show only a mild neurological disorder, which gradually becomes indiscernible. There are no systemic signs and the animals may continue to eat. Other diseases causing similar clinical signs include enzootic equine ataxia in horses and paralytic rabies in sheep and goats as lesions due to traumatic injury, spinal cord abscess, warble fly larvae, *Strongylus vulgaris*, or *Halicephalobus gingivalis*.

At necropsy, there are no macroscopic changes and sections need to be taken from many levels of the spinal cord to find histological lesions. Focal areas of

malacia or microcavitation are seen and in adjacent sites there may be loss of myelin, axonal swelling, degeneration and gitter cell formation.<sup>2</sup> Migratory pathways are indicated by necrotic tracts. Where nervous signs have been present for only a few days, a worm or worm fragments may occasionally be found. Molecular techniques have been developed for identifying the responsible species.<sup>3</sup>

Anthelmintics will not resolve existing lesions but may prevent further damage. Little has been published on treatment or control. Ivermectin gave moderate efficacy (80–88%) against adult *S. equina* in ponies.<sup>4</sup> In a field study, none of 221 goats and sheep injected twice with ivermectin at a dose of 0.2 mg/kg developed setariosis, while 17 of 303 non-injected animals suffered from the disease.<sup>5</sup>

## REFERENCES

1. Tung KC et al. *Vet Parasitol* 2004; 123:279–284.
2. Frauenfelder HC et al. *J Am Vet Med Assoc* 1980; 177:359.
3. Jayasinghe DR, Wijesundera WS. *Vet J* 2003; 165:136–142.
4. Klei T et al. *J Parasitol* 1980; 66:859.
5. Shirasaka S et al. *J Vet Med Sci* 1994; 56:1213.

## Diseases associated with trematodes and cestodes

### Hepatic diseases associated with trematodes

#### FASCIOLOSIS (LIVER FLUKE DISEASE)

##### Synopsis

**Etiology** *Fasciola hepatica* and, in warmer climates, *F. gigantica*.

**Epidemiology** Infection by ingestion of metacercariae on herbage; geographical distribution, seasonality and disease risk determined by occurrence of intermediate hosts (Lymnaeid mud snails).

**Signs** *Acute syndrome* (sheep): sudden death; *chronic syndrome* (sheep and cattle): weight loss, reduced milk yield, pallor, submandibular edema.

**Clinical pathology** *Acute syndrome*: raised serum glutamate dehydrogenase concentrations, anemia; *chronic syndrome*: characteristic eggs in feces, anemia, hypoalbuminemia, raised serum gamma-glutamyl transpeptidase concentrations.

**Lesions** *Acute syndrome*: pale friable liver with parasitic tracts and hemorrhage; *chronic syndrome*: fibrous liver, bile ducts grossly distended and thickened.

**Diagnostic confirmation** *Acute syndrome*: immature flukes in liver parenchyma at necropsy; *chronic syndrome*: characteristic eggs in feces, immunoassay of blood or milk.

**Treatment** Albendazole, clorsulon, closantel, netobimin, nitroxynil, oxcyclozanil, triclabendazole; not all are equally effective against all stages of fluke development.

**Control** Avoidance or drainage of snail habitats; strategic anthelmintic dosing programs.

#### ETIOLOGY

*Fasciola hepatica* is the most common and important liver fluke and has a cosmopolitan distribution in cooler climates. Lymnaeid mud snails are intermediate hosts and release the infective form, the metacercaria, onto herbage. Hepatic fasciolosis is mainly of economic importance in sheep or cattle but other species may provide a reservoir of infection. *F. hepatica* may infest all domestic animals, including Equidae<sup>1</sup> and many wildlife species, but chronically infected sheep are the most important source of pasture contamination.<sup>2</sup> Human cases are usually associated with the ingestion of marsh plants such as watercress. A similar but larger fluke, *F. gigantica*, is restricted to warmer regions including parts of Africa and Asia.

#### LIFECYCLE

Adult *Fasciola* live in bile ducts producing eggs that are excreted with the feces. Hatching occurs in moist conditions only

after the first larval stage, the miracidium, has formed and when ambient temperatures rise above 5–6°C (41–43°F). Miracidia must find and invade the tissues of a suitable host snail within 24–30 h. After several cycles of asexual multiplication, the flukes leave the snail as cercariae. These attach to herbage and transform into metacercariae by secreting a tough protective cyst wall. After ingestion by the final host, each metacercaria releases an immature fluke which crosses the intestinal wall and migrates across the peritoneal cavity to the liver. The migration is sometimes misdirected and ectopic flukes can be found in the lungs, particularly in cattle. The young *F. hepatica* migrate through the hepatic parenchyma for about 4–5 weeks, growing from 0.1 to 10 mm. After entering the bile ducts, they more than double in size before egg laying starts about 10–12 weeks after infestation. Adult sheep and cattle may remain carriers for many years because of the longevity of the adult flukes.

#### EPIDEMIOLOGY

The risk of hepatic fasciolosis is determined by the numbers of infected lymnaeid snails in the grazing area. The disease has a predictable seasonal pattern in regions where snails are active for only

part of the year. Some lymnaeid snails have a more aquatic habit than others but all are restricted to damp or wet environments. In general, they prefer non-acidic low-lying swampy areas with slowly moving water, but land with small streams, springs, blocked drainage or spillages from, for example, water troughs may also be potentially hazardous for grazing stock. Land frequently irrigated is also highly suitable for infection to take place. Snails burrow into the soil to survive dry periods and release cercariae when free water is present. Snail habitats may be permanent or temporary. The latter expand and contract depending on water availability. Construction works, such as road building may alter drainage patterns and disease risk. Improvement of peaty pastures by lime application may increase risk by reducing soil acidity and allowing snail colonization.

**Important host snails** for *F. hepatica* include *Lymnaea truncatula* in the United Kingdom and Europe and *Galba bulimoides*, *G. B. techella* and others in the United States. *L. columella* has been identified as an intermediate host in Canada and more recently in Brazil. In New Zealand, *L. tomentosa* and *L. truncatula* have occurred without fasciolosis becoming a major problem but the introduction of *L. columella* markedly increased the range and severity of the disease.<sup>3</sup> *L. tomentosa* is the major host snail in Australia, although *L. columella* has been reported to be present in non-farming areas and *L. viridis* has also been found.

**The main factors** determining the timing and severity of hepatic fasciolosis are those that influence the number of metacercariae accumulating on herbage. In particular, temperature and rainfall affect both the spatial and temporal abundance of snail hosts and the rate of development of fluke eggs and larvae.<sup>4</sup> Temperatures above 10°C (50°F) are necessary before the snail hosts will breed or before *F. hepatica* can develop within the snail. No development therefore takes place during the winter in most countries.

**The 'summer infection of the snail'** by miracidia hatching from eggs in spring and early summer results in the emergence of cercariae and the consequent contamination of herbage some 5–8 weeks later.<sup>5</sup> For any climatic region, cercarial shedding is a fairly regular occurrence with minor differences in timing determined by year-to-year variations in weather patterns.

**The 'winter infection of the snail'** is a separate cycle occurring when snails are exposed to miracidia in the autumn. Fluke development ceases in the snail during winter but resumes as temperatures rise the following spring. The relative import-

ance of this cycle depends on the mortality rate of the snails during the winter,<sup>6</sup> which varies from region to region and from year to year.

The availability of metacercariae is generally greatest in the late summer and autumn. Massive numbers can accumulate in wetter parts of the British Isles and Europe.<sup>7</sup> Metacercariae may overwinter in milder climates to infect stock in spring, but they do not survive under severe winter conditions. In hot, dry regions, metacercariae die quickly and so in Australia, for example, infections are usually due to a recent release of cercariae.<sup>8</sup> Stock are also vulnerable in dry conditions if forced to feed in swampy areas to obtain green feed. Metacercariae are normally killed during the preparation of hay or silage, but can remain infective for up to 8 months if hay is harvested in moist conditions and not properly dried.

The clinical outcome of infection depends largely on the density of metacercariae on the herbage. This will be greatest when weather conditions have been favorable for snail reproduction and survival. A high intake of metacercariae over a short time will produce acute disease; lower numbers over a longer period lead to chronic disease. The degree to which immunity influences the course of infection differs with species. Sheep and goats do not develop a strong protective immune response to *F. hepatica* and remain vulnerable throughout their lives. Cattle eventually expel most but not all of their fluke burden and gain partial but not complete protection against reinfection.<sup>9</sup> *F. hepatica* has a number of survival mechanisms for evading host immune responses, including changing its surface antigen during migration,<sup>10</sup> releasing a proteolytic enzyme that can cleave immunoglobulins,<sup>11</sup> and modulating the host immune response.<sup>12</sup>

#### **PATHOGENESIS**

Acute hepatic fasciolosis is caused by the passage of young *F. hepatica* through the liver parenchyma. Clinical signs occur 5–6 weeks after the ingestion of large numbers of metacercariae. By this time, the migrating flukes are large enough to do substantial mechanical damage to the liver. Acute hepatic insufficiency and hemorrhage result.<sup>13</sup>

**Quiescent spores** of *Clostridium novyi* may become activated by the anaerobic necrotic conditions created in the liver parenchyma by migrating *F. hepatica*, causing infectious necrotic hepatitis ('black disease') in sheep and cattle.<sup>14</sup> This migration has also been thought to stimulate the development of occasional cases of bacillary hemoglobinuria in cattle.

**Chronic hepatic fasciolosis** develops only after the adult flukes establish in the bile ducts. Here they cause cholangitis, biliary obstruction, fibrosis, and a leakage of plasma protein across the epithelium. Although this protein can be re-absorbed in the intestine, there is poor utilization and retention of nitrogen leading to hypoalbuminemia. There is also a loss of whole blood due to the feeding activities of the flukes. This exacerbates the hypoalbuminemia and eventually gives rise to anemia. It places a continuous drain on iron reserves<sup>6</sup> so that the anemia, which is initially normochromic, becomes hypochromic. These changes are more severe in sheep on a low plane of nutrition.<sup>15</sup> Chronic infection may limit growth rate and feed conversion in growing heifers and growth rate in beef cattle. *F. hepatica* infection has been reported to increase the susceptibility of cattle to *Salmonella dublin* and predispose to prolonged infection and fecal excretion.<sup>16</sup> Infected ewes may have reduced fertility, growth rate, and wool production.<sup>17,18</sup> Food intake is reduced and this leads to a reduction in efficiency of utilization of metabolizable energy and a reduction in calcium and protein deposition in the carcass.<sup>19</sup>

**The fibrotic response** of the liver to fluke-induced damage varies with the host and may partially account for differing species susceptibilities.<sup>13</sup> The severe reaction in cattle, which includes calcification of the bile ducts, appears to hinder the establishment and feeding of challenge infections thereby reinforcing immune responses.<sup>7</sup> Both horses and pigs are generally highly resistant to infection with *F. hepatica* but differ in their mode of resistance. Horses overcome the migrating fluke at an early stage so that few reach the liver, while in the pig the resistance mechanism operates in the liver parenchyma.<sup>20</sup>

#### **CLINICAL FINDINGS**

##### **Acute fasciolosis**

Acute fasciolosis in sheep most often occurs as sudden death without other apparent clinical abnormality. It is usually seen in the summer and autumn but may occur at any time when sheep have the opportunity to graze heavily contaminated herbage. If the disease is observed clinically in sheep it is manifested by:

- Dullness
- Weakness
- Lack of appetite
- Pallor and edema of mucosae and conjunctivae
- Pain when pressure is exerted over the area of the liver. Death occurs quickly and may be accompanied by

the passage of blood-stained discharges from the nostrils and anus. Outbreaks are usually of relatively short duration; most deaths occur within a period of 2–3 weeks. Acute fasciolosis rarely occurs in cattle.

### Subacute fasciolosis

Acute and chronic fasciolosis are opposite ends of the clinical spectrum. Intermediate forms occur and a subacute syndrome has been described in sheep. The major clinical signs are weight loss and pallor of the mucous membranes. Submandibular edema will be seen in only a few cases, but many animals will resent palpation over the region of the liver.

### Chronic fasciolosis

Chronic fasciolosis does not become apparent until several weeks after the danger of acute disease has receded. Affected sheep lose weight, develop submandibular edema (bottle jaw), and pallor of the mucosae over a period of weeks. Shedding of the wool may occur. The course of the disease is often as long as 2–3 months in those which die; many survive but may remain in poor condition for longer periods. Cattle also lose weight, especially if lactating, milk production falls and anemia may develop.

### CLINICAL PATHOLOGY

In acute fasciolosis there is a severe normochromic anemia, eosinophilia, and a severe hypoalbuminemia. Blood concentrations of a number of serum enzymes indicating liver damage are elevated. Glutamate dehydrogenase is of particular value when the young flukes are migrating through the liver parenchyma but concentrations fall after they enter the bile ducts.<sup>21</sup> Increases in aspartate aminotransferase can be measured from 4 weeks and are useful as a measure of immature infection.<sup>22</sup> Eggs will not be present in the feces as the flukes are still juvenile.

In subacute and chronic disease weight loss is associated with a severe hypochromic, macrocytic anemia, hypoalbuminemia and hyperglobulinemia. Submandibular edema and ascites occur only occasionally in the subacute condition but more frequently in the chronic disease.<sup>6</sup> Serum gamma-glutamyl transpeptidase concentrations are raised by the activities of adult *F. hepatica* in the bile ducts.<sup>23</sup> Other liver function tests are not significantly affected. A diagnosis of chronic hepatic fasciolosis can be confirmed by the detection of large numbers of characteristic, operculated fluke eggs in the feces. These eggs are thin-walled and stained yellow-brown by biliary pigments. They are dense and do not rise satisfactorily in all flotation solutions. Zinc sulfate solution (specific

gravity 1.36) is recommended. Sedimentation tests are more accurate.<sup>24</sup> Operculated fluke eggs are also characteristic of paramphistome infections and care is needed to differentiate the two.

### NECROPSY FINDINGS

#### Acute hepatic fasciolosis

Acute hepatic fasciolosis is characterized by a badly damaged, swollen liver. The peritoneal cavity may contain an excess of blood-stained serum. The liver capsule has many small perforations and subcapsular hemorrhages. The parenchyma shows tracts of damaged tissue and is more friable than normal. The immature flukes are often so small that they are not readily discernible. They are most easily demonstrated by slicing a piece of liver thinly and shaking in water, permitting the flukes to settle to the bottom. The size of the flukes may allow estimation of the duration of the infection and this may help to determine which pastures are hazardous.

#### Chronic hepatic fasciolosis

Leaf-like flukes, measuring some 3.5 × 1 cm, are present in grossly enlarged and thickened bile ducts, particularly in the ventral lobe of the liver. The bile ducts may protrude above the surface of the liver and cysts may be present due to blockage of ducts with flukes and desquamated epithelial cells. Calcification of the bile duct walls is a common finding in cattle but not in sheep. The hepatic parenchyma is extensively fibrosed and the hepatic lymph nodes are dark brown in color. Anemia, edema, and emaciation are attendant abnormalities.

### DIAGNOSTIC CONFIRMATION

In fluke endemic areas, fasciolosis must be considered as a possible factor in any outbreak of chronic ill health in sheep, either as the main cause or as a contributory factor along with other debilitating disease processes. To support a diagnosis, account should be taken of grazing history and the seasonality of fasciolosis in that locality. There should be fluke eggs in the feces and characteristic hepatic lesions at necropsy. As these may be ubiquitous findings in endemic areas, a judgment is necessary to determine whether the severity of the lesions is sufficient to incriminate the fluke as the sole or major contributing etiological factor. Enzyme-linked immunoassays (ELISA) are available for use with blood or milk and are particularly useful for the diagnosis of infection in cattle on an individual or herd basis. A rise in antibody can be detected by 2 weeks after infection and keeps rising until week 6.<sup>25</sup> Coproantigen tests are being developed.

Acute disease can only be confirmed at necropsy.

### DIFFERENTIAL DIAGNOSIS

#### Acute fasciolosis

- Hemonchosis
- Infectious necrotic hepatitis
- Eperythrozoonosis
- Anthrax
- Enterotoxemia.

#### Chronic fasciolosis

- Nutritional deficiencies of copper or cobalt
- Other internal parasitisms, including parasitic gastroenteritis (particularly hemonchosis) in sheep and ostertagiosis in cattle
- John's disease.

### TREATMENT

Not all compounds are equally effective against all stages of development of *F. hepatica* in the body. At the time of writing triclabendazole comes closest to this ideal. For treatment of acute fasciolosis, it is essential to choose a product highly effective against the juveniles that damage the liver parenchyma. For chronic disease, a compound active against the adult fluke is required. Product safety is an important consideration as hepatic detoxicating mechanisms are already impaired. Flukicides can be used therapeutically for treating disease or prophylactically to prevent outbreaks. Some bind to plasma proteins (e.g. closantel) or erythrocytes (clorsulon), thereby extending their period of protection. All flukicides either have milk-withholding periods or are prohibited from use in animals providing milk for human consumption and so the best time to treat dairy cattle is at the drying off stage. Many products combine a flukicide with a nematocide, but these should only be used when there is simultaneous risk from the two types of parasite.

Triclabendazole is a compound specifically for use against *F. hepatica* in sheep (10 mg/kg) and cattle (12 mg/kg). Higher doses are required for the control of *F. gigantica* in buffalo.<sup>26</sup> It is highly effective against all stages of fluke from 2 days old in sheep and 2 weeks in cattle<sup>27</sup> and is the drug of choice in outbreaks of acute fluke disease. An 8 to 10-week dosing interval is recommended for use in control programs. Fluke populations resistant to triclabendazole have developed following intensive control regimens.<sup>28</sup> Triclabendazole has been used with success in horses and donkeys (12 mg/kg) but is not licensed for this purpose.<sup>29,30</sup>

Albendazole is a broad-spectrum compound also active against nematodes and

cestodes. It is effective against adult *F. hepatica* at a dose-rate of 7.5 mg/kg in sheep and 10 mg/kg in cattle. It is ovicidal and will kill any *F. hepatica* eggs present in bile ducts or the alimentary tract at the time of treatment. Netobimin (20 mg/kg) is metabolized to albendazole in the body and has similar activity against *F. hepatica*.

Closantel will kill the majority of flukes older than 4 weeks in sheep at a dose rate of 10 mg/kg and will delay fluke egg output by animals grazing contaminated pasture for up to 12 weeks. It also has a residual effect against *H. contortus*.

Clorsulon is supplied in combination with ivermectin for combined fluke and roundworm control in cattle. At the recommended dose rate of 2 mg/kg by SC injection, clorsulon is effective against adult and 12 to 14-week immature flukes but activity against 8-week-old *F. hepatica* is variable.

Nitroxylnil is given subcutaneously at 10 mg/kg and has good efficiency against the adult fluke but the dose has to be increased by up to 50% to obtain adequate control of acute disease. In sheep, spillage stains the fleece yellow. It cannot be given orally as the rumen microflora reduce the compound to an inactive metabolite.

Oxyclozanide used in cattle (10 mg/kg) has a shorter milk withholding period than most other flukicides. It has a significant effect against adult fluke but is inactive against immature forms. It may cause transient softening of feces. This compound has been combined with levamisole to provide activity against fluke and gastrointestinal nematodes.

## CONTROL

Preventive measures are required in endemic areas as fasciolosis can cause death without warning or significant production losses. An integrated strategic approach is more cost beneficial than reliance on routine dosing and is less likely to induce anthelmintic resistance, but requires detailed knowledge of the local epidemiological cycle. In some countries where risk varies from year to year, predictions of likely disease levels are issued based on analysis of meteorological data and field observations. This enables control measures to be intensified when necessary. Computer models have been devised to assist this process.<sup>31</sup>

Segregation of stock from sources of infection is the ideal method of control but not always feasible in practice. Identification and mapping of snail habitats may enable grazing plans to be devised that avoid danger areas at times of high risk. Where habitats are restricted

in size and clearly defined, it may be possible to exclude stock by fencing.

Stock on heavily contaminated land may be protected from acute fasciolosis by taking advantage of the interval between the ingestion of metacercariae and the onset of disease. Treatment during this period with a product effective against young flukes will eliminate the migrating parasites before they cause serious liver damage. A further dose may be necessary depending on the duration of metacercarial intake and residual activity of the chosen product. Some metacercariae will continue to be ingested after the main danger period has passed and so treatment with a product active against adult *F. hepatica* will be needed some weeks later to insure against possible losses from chronic fasciolosis. Additional strategic doses may be required in regions where the winter infection of the snail is of significance. The precise timing of each of these doses depends on the local epidemiological pattern.

Reduction of pasture contamination with metacercariae will reduce future risk. This can be done by preventing the snails from becoming infected with *F. hepatica* or by diminishing the size of the snail population. To achieve the first objective, adult flukes should be eliminated from the bile ducts of all grazing stock in spring and early summer. This prevents egg excretion and minimizes the numbers of snail-seeking miracidia at this crucial stage in the epidemiological cycle.<sup>32</sup> There may however be wildlife sources of *F. hepatica* eggs which cannot be controlled in this way. Snail numbers can be reduced by restricting the size of their habitat. This can be done, where feasible, by draining boggy areas and by making sure that ditches, land drains, water troughs etc. are well maintained.

With stall-fed buffaloes in the tropics advantage can be taken of the fact that the metacercariae of *F. gigantica* concentrate on the lower part of forage plants, for example rice straw. This can be cut off and used for other purposes while the upper, uninfected, part is fed to the farm stock.<sup>33</sup>

Chemical snail control was widely practised before reliable animal treatments became available. Lymnaeid snails have enormous reproductive capacity and can quickly recolonize wet land. Application therefore has to be very thorough to have a significant season-long effect and there must be no possibility of invasion from neighboring land. Chemicals can be applied in spring for maximum impact on the snail population before breeding starts, or later in the season when snails are plentiful but

before cercariae start to emerge. Efficacy is reduced if luxuriant plant growth hinders penetration to soil level. Inorganic compounds such as copper sulfate or sodium pentachlorophenate are effective but may be potentially hazardous to humans, stock, and the environment. Safer and more selective low-volume molluscicides such as *n*-trityl morpholine<sup>34</sup> have been developed but are not commercially available at the time of writing.

Vaccines for *F. hepatica* are under development. One of these which uses recombinant fluke cathepsin L proteinases has given up to 79% protection against infection in cattle and sheep.<sup>35</sup> Successful vaccination strategies elicit Th1 rather than the Th2 immune responses induced by natural infection.

## REVIEW LITERATURE

- Dalton JP (ed) Fascioliasis. Wallingford, UK: CAB International, 1998.
- Roberts JA, Suhardono Approaches to the control of fascioliasis in ruminants Int J Parasitol 1996; 26:971-981.
- Malone JB. Fascioliasis and cestodiasis in cattle. Vet Clin North Am Food Anim Pract 1986; 22:261-275.
- Westcott RB, Foreyt WJ. Epidemiology and control of trematodes in small ruminants. Vet Clin North Am Food Anim Pract 1986; 22:373-381.

## REFERENCES

- Owen JM. Equine Vet 1977; J 9:29.
- Boray JC. In: Gaafar SM et al. (ed) World animal science series B2: Parasites pests and predators. Amsterdam: Elsevier, 1985; p. 179.
- Harris RE, Charleston WAG. Vet Parasitol 1980; 7:39.
- Ollerenshaw CB. In: Taylor AER, Muller R (eds) The effects of meteorological factors upon parasites. Oxford: Blackwell Scientific Publications, 1974; p. 33.
- Ollerenshaw CB. In: Urquhart GM, Armour J (eds) Helminth diseases of cattle sheep and horses in Europe. Glasgow: MacLehose, 1973; p. 132.
- Reid JFS. In: Urquhart GM, Armour J (eds) Helminth diseases of cattle sheep and horses in Europe. Glasgow: MacLehose, 1973; p. 81.
- Ross JG, Todd JR. Vet 1968; Rec 82:695.
- Meek AH, Morris RS. Aust Vet J 1979; 55:58.
- Doyle JJ. Res Vet Sci 1973; 14:97.
- Hanna REB. Exp Parasitol 1980; 50:155.
- Chapman CB, Mitchell GF. Vet Parasitol 1982; 11:65.
- Clery D et al. Vet Parasitol 1996; 62:71.
- Boray JC. Ann Trop Med Parasitol 1967; 61:439.
- Sewell MMH. In: Grunsell CS, Hill FWG (eds) The Veterinary Annual, 15th issue. Bristol: Sciencetechnica, 1975; p. 79.
- Dargie JD, Berry CI. Int J Parasitol 1979; 9:17.
- Aitken MM et al. J Comp Pathol 1978; 88:75.
- Cawdery MJH. Br Vet J 1976; 132:568.
- Meek AH, Morris RS. Aust Vet J 1979; 55:61.
- Sykes AR et al. Res Vet Sci 1980; 28:63.
- Nansen P et al. Exp Parasitol 1975; 37:15.
- Thorpe E, Ford EJH. J Pathol 1969; 97:619.
- Wyckoff JH, Bradley RE. Am J Vet Res 1985; 46:1015.
- Rowlands DT, Clampitt RB. Vet Parasitol 1979; 5:155.
- Boray JC, Pearson IG. Aust Vet J 1960; 36:331.

25. Salimi-Bejestani MR et al. Res Vet Sci 2005; 78:177.
26. Sanyal PK, Gupta SC. Vet Parasitol 1996; 63:75.
27. Owen IL. Aust Vet J 1987; 64:59.
28. Borgsteede FHM et al. Vet Rec 2005; 156:350.
29. Holtmann W et al. Tierarztl Umschau 1990; 45:437.
30. Trawford AF, Tremlett JG. Vet Rec 1996; 139:142.
31. McLroy SG et al. Prev Vet Med 1990; 9:27.
32. Parr SL, Gray JS. Vet Parasitol 2000; 88:187.
33. Mahato SN, Harrison LJ. Trop Anim Health Prod 2005; 37:285.
34. Crossland ND. Vet Rec 1976; 98:45.
35. Dalton JP et al. Int J Parasitol 2003; 33:1173.

## FASCIOLOIDES

*Fascioloides magna* is a large liver fluke found mainly in North America but it also occurs in some European countries. It is a parasite of moose and deer but it can also infect other animals grazing the same pastures. Sheep and goats are particularly susceptible to infection. The prevalence of infestation in cattle may be high in endemic areas but they are seldom affected clinically.

The lifecycle in normal hosts is similar to that of *Fasciola hepatica* except that it grows up to 10 cm long and 3 cm broad in thin-walled cysts in the liver parenchyma. Connections between the cysts and the bile ducts allow the passage of eggs with the feces. Lymnaeid snails act as intermediate hosts and the final host is infected by ingesting metacercariae encysted on herbage. The fluke enters the liver after spending 3–4 weeks in the peritoneal cavity.

In sheep and goats the fluke continually migrates, never becoming encapsulated but forming large, black tracts. Hepatic damage and hemorrhage are so severe that one or two flukes can be fatal. In cattle, necrotic tracts are seen in the parenchyma as well as dark, thick-walled cysts 4 cm in diameter. These have no connection to the bile ducts. Clinical signs in sheep and goats are similar to acute hepatic fasciolosis and infected animals can die without warning. Infestations in cattle are usually inapparent but may cause signs similar to chronic hepatic fasciolosis. Eggs may be found in the feces. These resemble *F. hepatica* eggs but are larger and have a small appendage at the blunter end.

Most anthelmintics effective against *F. hepatica* are also active against *F. magna*<sup>1</sup> but few confirmatory reports have been published. Albendazole 10 mg/kg removed 74% of *F. magna* in naturally infected cattle,<sup>2</sup> closantel 15 mg/kg had good efficacy in sheep 8 weeks after infection,<sup>3</sup> clorsuron gave variable results in cattle at 21 mg/kg,<sup>4</sup> while triclabendazole 20 mg/kg was 99% effective in sheep when given 12 weeks postinfection.<sup>5</sup>

## REVIEW LITERATURE

Anderson RC. In: Samuel WM, Pybus MJ, Kocan AA (eds) Parasitic diseases of wild mammals. Iowa State University Press, 2001; pp. 121–136.

## REFERENCES

1. Boray JC. In: Gaafar SM et al. (eds) World animal science series B2: Parasites, pests and predators. Amsterdam: Elsevier, 1985; p. 179.
2. Craig TM et al. Am J Vet Res 1992; 53:1170.
3. Stromberg BE et al. Am J Vet Res 1985; 46:2527.
4. Foreyt WJ. Am J Vet Res 1988; 49:1004.
5. Foreyt WJ. Am J Vet Res 1989; 50:431.

## DICROCOELIUM

*Dicrocoelium dendriticum* is a small trematode widespread in Europe and Asia but with restricted distribution in North America and the British Isles. Its lifecycle differs from that of *Fasciola hepatica* in several ways. Eggs passed in the feces are eaten by land snails such as *Helicella* spp. and *Cochlicopa lubrica*. Cercariae are passed in slime balls used as food by ants of the genus *Formica*. Grazing animals become infected when they swallow ants containing metacercariae. The flukes travel up the common bile duct to settle in bile ducts within the liver. In contrast to *F. hepatica*, the intermediate hosts of *D. dendriticum* are not associated with wet habitats. Transmission can therefore occur on well drained farmland and even dry heathland pastures. Protective immunity is poor and heavy infections (tens of thousands) can accumulate.

Pathogenicity is low as *D. dendriticum* does not migrate across the liver parenchyma. Very heavy infections may cause ill-thrift. Lesions comprise fibrosis of the parenchyma and a proliferation and thickening of smaller bile ducts.<sup>1</sup> Infectious necrotic hepatitis may develop as a result of infestation. At necropsy, *D. dendriticum* infection can be recognized as the flukes are smaller (0.5–1.5 cm) than *F. hepatica*, are lanceolate in shape and confined to the bile ducts. Eggs in feces are small, operculate, asymmetrical and dark brown in color. They are dense structures and flotation fluids with a high specific gravity, such as potassium iodomercurate solution (SG 1.44), are recommended.<sup>2</sup>

Treatment with albendazole at 15 mg/kg is effective<sup>3</sup> as is netobimin at 20 mg/kg.<sup>4</sup>

## REVIEW LITERATURE

Otranto D, Traversa D. Dicrocoeliosis of ruminants: a little known fluke disease. Trends Parasitol 2003; 19:12–15.

## REFERENCES

1. Camara L et al. Vet Res 1996; 27:87.
2. Cringoli G et al. Vet Parasitol 2004; 123:121.
3. Himonas CA, Liakos V. Vet Rec 1980; 107:288.
4. Rojo-Vazquez FA et al. Vet Rec 1989; 124:512.

## Stomach fluke disease (Intestinal amphistomosis)

### Synopsis

**Etiology** *Paramphistomum cervi*,

*P. microbothrioides* and related flukes.

**Epidemiology** Infection by ingestion of metacercariae on herbage; geographical distribution, seasonality, and disease risk determined by occurrence of intermediate hosts (aquatic planorbid snails).

**Signs** Severe enteritis, fetid diarrhea.

**Clinical pathology** Hypoalbuminemia; immature flukes may be passed in feces.

**Lesions** Duodenal mucosa thickened, mucus blood stained with large numbers of small, flesh-colored flukes.

**Diagnostic confirmation**

Demonstration of immature flukes in feces.

**Treatment** Oxytoclozanide.

**Control** Avoidance or drainage of snail habitats; anthelmintic treatments to prevent contamination of pastures with eggs.

## ETIOLOGY

Intestinal amphistomosis is associated with paramphistome flukes in the duodenum migrating towards the forestomachs. Cattle and, to a lesser extent, sheep are at risk of infection. The paramphistomes are cosmopolitan but disease is most common in warmer regions, particularly Australasia, Africa, and India. Commonly recorded paramphistome species include *Paramphistomum cervi*, *P. microbothrioides*, *P. liorchis*, *P. ichikawai*, *P. microbothrium*, *Calicophoron calicophorum*, *Ceylonocotyle streptocoelium*, *Calicophoron ijimai*, and *Cotylophoron cotylophoron*.

## LIFECYCLE

The lifecycle is similar to that of *Fasciola hepatica* except that the intermediate hosts are planorbid snails and the immature flukes migrate proximally along the duodenum and through the abomasum to reach their predilection site in the rumen and reticulum. The period required for maturation varies from 6 weeks to 4 months.

## EPIDEMIOLOGY

Planorbid snails are aquatic. They are more adaptable and occupy more diverse habitats than lymnaeid snails. Thus zones of endemicity for intestinal amphistomosis and hepatic fasciolosis do not necessarily coincide. Most outbreaks of disease occur during the late summer, autumn, and early winter when pastures are heavily contaminated with encysted cercariae. Planorbid snails multiply very rapidly in warm, watery environments but can subsequently survive dry conditions. Metacercariae are therefore found on



pastures prone to flooding as well as on herbage in and around ponds, streams and other water sources.<sup>1</sup> All ages of cattle, sheep, goats, and wild ruminants grazing near water or on land liable to flooding may be affected but young cattle in the yearling class are the usual subjects. It is possible that some degree of immunity develops.

### PATHOGENESIS

The immature flukes excyst in the duodenum or mid-to-proximal jejunum. As they migrate they attach firmly to the mucosa and may penetrate as far as the muscularis mucosa. Damage is related to the numbers of migrating flukes and increases in intensity from localized enteritis through patches of villous atrophy to severe destruction of the mucosa.<sup>2</sup> Clinical and production effects are dependent upon the extent of the lesions as some compensation for functional deficiency can take place in the undamaged lower small intestine. The presence of mature flukes in the rumen does not usually elicit any significant response but in massive infections papillae are short and red, becoming fused into aggregations with ruminal contents adhering firmly to the surface.<sup>2</sup>

### CLINICAL FINDINGS

Severe enteritis associated with enormous numbers of migrating flukes in the duodenum seems to be the only manifestation of disease. A characteristic and persistent fetid diarrhea is accompanied by weakness, depression, dehydration and anorexia. There may also be submaxillary edema and obvious pallor of the mucosae. Death usually occurs 15–20 d after the first signs appear. The mortality rate in heavily infested animals may be high. Mature flukes in the forestomachs of animals normally cause little harm, although loss of weight, anemia, a rough dry coat, and a drop in production have been ascribed to heavy infestations.<sup>3</sup>

### CLINICAL PATHOLOGY

A sedimentation and decanting technique may be used to find immature flukes passed in feces. The larvae are round with prominent anterior and posterior suckers. Because the disease is caused by immature forms, eggs are not usually present in the feces, although they may be detectable in older animals in the same herd. Paramphistome eggs are dense structures and so sedimentation methods for detection are preferred to flotation.<sup>4</sup> The eggs have a distinct operculum and resemble those of *F. hepatica*, but the shell is colorless. Blood biochemistry reveals a marked drop in total plasma protein, due largely to a fall in plasma albumin.<sup>5</sup>

### NECROPSY FINDINGS

There is muscular atrophy, subcutaneous edema and accumulations of fluid in the body cavities, and the fat deposits are gelatinous. In the upper part of the duodenum the mucosa is thickened, covered with blood-stained mucus and there are patches of hemorrhage under the serosa. Large numbers of small, flesh-colored flukes (3–4 mm long and 1–2 mm wide) are present in this area but decrease in number towards the ileum. There may be none in the abomasum and forestomachs. There may be a few in the peritoneal cavity and on histological examination the young flukes are present not only on the mucosal surface but are also embedded in the mucosa and deeper layers.<sup>5</sup>

### DIAGNOSTIC CONFIRMATION

The occurrence in yearling cattle of a severe enteritis, unaccompanied by fever, in environmental conditions suitable for the propagation of flukes and where host snails can be found should arouse suspicion of intestinal amphistomosis. Confirmation depends on demonstration of immature flukes in feces or at necropsy. Care is needed as the small parasites are easily missed.

### DIFFERENTIAL DIAGNOSIS

- Nutritional deficiency of copper
- Infestation intestinal roundworms
- Infectious enteritides, but these are usually accompanied by fever
- Johne's disease in adult animals, but this is a much more chronic disease
- Poisonings, including many weeds, inorganic arsenic and lead.

### TREATMENT

Few drugs are highly effective.<sup>6</sup> Two doses of oxytoclozanide 18.7 mg/kg 2 days apart, or a single dose of hexachlorophene 20 mg/kg, give consistent results against immature paramphistomes in cattle, but hexachlorophene may show toxicity at this dose rate.<sup>7</sup> Niclosamide 160 mg/kg as a single dose or as two doses 3 d apart is effective but somewhat variable<sup>7</sup>; however, it has good activity at 100 mg/kg against immature paramphistomes in sheep.<sup>8</sup> Bithionol has been used in Asia and Africa.

### CONTROL

Animals should, where possible, be denied access to contaminated areas. Otherwise, regular treatments will be needed. Snails quickly repopulate pastures once they become wet and stock should be removed before the intermediate hosts start to shed large numbers of cercariae

(1–2 months from infection of the snail depending on temperature). Metacercariae may persist on pasture for up to 2 or 3 months after flood water has dried out.

In areas where paramphistomes are a regular problem, knowledge of the local epidemiological cycle will help determine optimum times for prophylactic treatments. These are aimed at killing migrating immature flukes before they cause disease and at reducing egg-output by adult worms, thereby minimizing opportunity for snails to become infected. Drainage of low-lying areas and destruction of host snails by the use of molluscicides could be considered.

### REVIEW LITERATURE

- Horak IG. Paramphistomiasis of domestic ruminants. In: Dawes B (ed) *Advances in parasitology*, Vol 9. London: Academic Press, 1971; pp. 33–72.
- Pfukukenyi DM et al. Epidemiology and control of trematode infections in cattle in Zimbabwe: a review. *J S Afr Vet Assoc* 2005; 76:9–17.

### REFERENCES

1. Rolfe PF et al. *Int J Parasitol* 1991; 21:813.
2. Rolfe PF et al. *Int J Parasitol* 1994; 24:995.
3. McFadden GM. *Vict Vet Proc* 1968/69; 27:69.
4. Bonita R, Taira N. *Vet Parasitol* 1996; 67:269.
5. Boray JC et al. *Aust Vet J* 1969; 45:133.
6. Rolfe PF, Boray JC. 1993; *Aust Vet J* 70 265.
7. Rolfe PF, Boray JC. *Aust Vet J* 1987; 64:328.
8. Rolfe PF, Boray JC. *Aust Vet J* 1988; 65:148.

## Tapeworm infestations

### ADULT TAPEWORM INFESTATION

#### Synopsis

**Etiology** Cestodes belonging to the anoplocephalid family, including *Moniezia* spp. in ruminants and *Anoplocephala* spp. in horses.

**Epidemiology** Transmission by ingestion of infected free-living pasture (oribatid) mites.

**Signs** Little pathogenicity but heavy infestation may cause failure to thrive and, in horses, increased risk of ileocecal colic.

**Clinical pathology** Demonstration of tapeworm eggs in feces.

**Lesions** Horse: mild inflammation of intestinal mucosa with small ulcers.

**Diagnostic confirmation** Tapeworm segments around tail base or on feces; eggs in feces.

**Treatment** Ruminants: albendazole, febantel, fenbendazole, mebendazole, netobimin, oxfendazole, praziquantel.

Horses: pyrantel, praziquantel.

**Control** If necessary, periodic dosing is the only feasible option.

### ETIOLOGY

The common anoplocephalid tapeworms of ruminants, *Moniezia expansa*, *M. benedeni*, and *Thysaniezia* (syn. *Helictometra giardi*) also known as *T. ovilla*) are cosmopolitan,

while *Avitellina* spp. occur mainly in Mediterranean countries and India, *Stilesia hepatica* in Africa and *Thysanosoma actinioides* in North America.

In horses, *Anoplocephala magna*, *A. perfoliata*, and *Anoplocephaloides* (syn. *Paranoplocephala mamillana*) are cosmopolitan in their distribution.

### LIFECYCLE

The lifecycles of all the anoplocephalid tapeworms are very similar. Eggs, which are immediately infective, pass in the feces of the host, either singly or protected within a tapeworm segment. These are ingested by free-living pasture (oribatid) mites and the intermediate stage (the metacestode) forms.<sup>1</sup> Mature tapeworms develop when the primary host accidentally swallows infected mites while grazing. Most species establish in the small intestine, but *T. actinioides* also invades biliary and pancreatic ducts, while *A. perfoliata* is found around the ileocecal junction and *S. hepatica* lives in the bile ducts. Lengths vary with species: *A. perfoliata* grows to 4–8 cm while *Moniezia* may be over 2 m.

### EPIDEMIOLOGY

Oribatid mites are ubiquitous but most numerous on permanent pastures in the summer months. All grazing animals are therefore potentially at risk.

### PATHOGENESIS

In ruminants, anoplocephalid tapeworms have little apparent effect on health.<sup>2</sup> In heavy infestations, it has been postulated that they may compete for nutrients, excrete toxic materials or, because of their length, interfere with the motility of the gut. Very heavy burdens of *M. expansa* in lambs have been associated with outbreaks of enterotoxemia.<sup>3</sup> Pancreatic and biliary duct species cause little harm but liver damage may cause rejection at meat inspection.

In horses, *A. perfoliata* causes a mild local inflammatory response around its site of attachment. Where 20 or more tapeworms are clustered, ulceration and other degenerative changes may occur. This may be accompanied by diphtheritis, granulomatosis and occasionally polyp formation.<sup>4,5</sup> The ileocecal valve may be thickened. Heavy infestations may interfere with gut motility and increase the risk of ileocecal colic. A recent matched case-control study indicated that 22% of a series of spasmodic colic cases were likely to have been tapeworm associated.<sup>6</sup> Evidence is accumulating to implicate *A. perfoliata* as a significant risk factor in ileal impaction cases.<sup>6,7</sup>

### CLINICAL FINDINGS

In ruminants, there is disagreement over the importance of anoplocephalid tapeworms in causing disease; farmers usually

overemphasize their importance while veterinarians underestimate it. Most infestations are asymptomatic but, on occasion, heavy burdens may result in unthriftiness, poor coat, vague digestive disturbances including constipation, mild diarrhea, and dysentery and sometimes anemia. These signs are restricted chiefly to animals less than 6 months of age on an inadequate diet. With *T. actinioides*, signs may be delayed until the animal reaches a later age. Infested animals may be more susceptible to the effects of other internal parasites and to other diseases or adverse environmental conditions.

Infections in horses are usually asymptomatic but, occasionally, heavy infestations may be associated with a range of abdominal conditions including colic, perforation of the cecum, ileocecal, cecocolic, and ileoileal intussusception, colonic, and cecal torsion, ileal thickening and obstruction.<sup>8,9</sup>

### CLINICAL PATHOLOGY

Shed tapeworm segments may be visible macroscopically on the skin and hair around the tail base or in the feces. Eggs may be present in feces.

### NECROPSY FINDINGS

The site of attachment on the intestinal mucosa may be indicated by the presence of a small ulcer and a mild inflammatory response. In the case of infestations with *T. actinioides* and *S. hepatica*, the presence of worms in the biliary and pancreatic ducts is accompanied by fibrosis and thickening of duct walls.

### DIAGNOSTIC CONFIRMATION

Shed segments are much wider than they are long. They can be seen to be full of characteristic eggs if broken in a drop of water on a slide and examined microscopically. Anoplocephalid eggs are roughly D-shaped, thick-shelled, and contain an embryo within a chitinous ring. They are not easy to find in feces. Centrifugation/flotation using a saturated sugar solution is recommended for diagnosis in horses. At best the sensitivity of such techniques is only 60% for light infections rising to 90% for heavy burdens, and so repeat samples may be needed to demonstrate the presence of the parasite.<sup>10</sup> Methods have been devised for detection of specific antibodies in serum<sup>11</sup> or antigen in feces<sup>12</sup> but are not as yet generally available.

### DIFFERENTIAL DIAGNOSIS

- Other causes of unthriftiness
- In horses, other causes of colic.

### TREATMENT

For ruminants, praziquantel 3.75 mg/kg is highly effective against *Moniezia* but

higher doses are required for *Thysaniezia* spp. (5 mg/kg), *Avitellina* (7.5 mg/kg) and *Stilesia hepatica* (15 mg/kg). Some benzimidazole and pro-benzimidazole drugs have cestocidal activity in ruminants,<sup>13</sup> including albendazole, febantel, fenbendazole, mebendazole, netobimin, and oxfendazole. The efficacy of some of these compounds against *Moniezia* may be variable. Albendazole at 7.5 mg/kg is effective against cestodes in the bile ducts.<sup>14</sup>

For horses, pyrantel embonate at 38 mg/kg (i.e. double the standard dose for roundworm control) is an established treatment for *A. perfoliata* but is ineffective against *A. mammillana*. More recently praziquantel has been shown to provide high efficacy against *A. perfoliata* at doses of 1–2.5 mg/kg<sup>15,16</sup> and *A. mammillana*.<sup>16,17</sup> Such treatment may half the estimated risk of tapeworm associated colic.<sup>18</sup>

### CONTROL

Control of the mites which act as intermediate hosts is impractical. If a potential problem is perceived in, for example, valuable horses, consideration could be given to reducing the numbers of oribatid mites by ploughing permanent pasture and reseeded. Otherwise stabling or tactical dosing, in early summer and autumn, are the only options.

### REVIEW LITERATURE

- Gasser RB, Williamson RMC, Beveridge I. Anoplocephala perfoliata of horses – significant scope for further research improved diagnosis and control Parasitology 2005; 131(1):13.
- Proudman CJ, Trees AJ. Tapeworms as a cause of intestinal disease in horses. Parasitol Today 1999; 15:156–159.

### REFERENCES

1. Schuster R et al. Onderstepoort J Vet Res 2000; 67:49.
2. Elliott DC. NZ Vet J 1986; 34:61.
3. Thomas PL et al. NZ Vet J 1956; 4:161.
4. Pearson GR et al. Vet Rec 1993; 132:179.
5. Fogarty U et al. Vet Rec 1994; 134:515.
6. Proudman CJ et al. Equine Vet J 1998; 30:194.
7. Little D, Blikslager AT. Equine Vet J 2002; 34:464.
8. Barclay WP et al. J Am Vet Med Assoc 1982; 180:752.
9. Beroza G A et al. J Am Vet Med Assoc 1983; 183:804.
10. Proudman CJ, Edwards GB. Vet Rec 1992; 131:71.
11. Proudman CJ, Trees AJ. Vet Parasitol 1996; 61:239.
12. Kania SA, Reinemeyer CR. Vet Parasitol 2005; 127:115.
13. Bauer C. Vet Rec 1990; 127:353.
14. Craig TM, Shepherd E. Am J Vet Res 1980; 41:425.
15. Grubbs ST et al. Vet Ther 2003; 4:249.
16. Rehbein S et al. Vet Ther 2003; 4:220.
17. Proudman CJ et al. Vet Rec 1995; 137:45.
18. Barrett EJ et al. Vet Rec 2004; 154:323.

### LARVAL TAPEWORM INFESTATION

Livestock may act as the intermediate hosts for the tapeworms of humans and other animals. The larval tapeworms

(metacestodes) develop as fluid-filled cysts, each at a typical site in the body. They act as space-occupying lesions and cause condemnation at meat inspection. Cattle around the world may harbor the metacestode of *Taenia saginata* (the beef tapeworm of humans), also known as *Cysticercus bovis*, in their striated musculature. *T. solium* (the pork tapeworm of humans) occurs similarly in pigs (known as *C. cellulosae*), mainly in poorer regions.<sup>1</sup> The recently discovered *T. asiatica*, found only in East Asia, is closely related to *T. saginata* but uses pigs as its intermediate host.<sup>2</sup> Cysts in the musculature of sheep (known as *C. ovis*) are the intermediate form of a dog cestode (*T. ovis*). Hydatid cysts (*Echinococcus granulosus*), which develop in the lungs

and/or liver of sheep, cattle and horses are also acquired from tapeworm eggs excreted by infected dogs and wild canids. These metacestodes rarely cause clinical disease in veterinary species (although some are serious zoonoses) and so the reader is referred to parasitology textbooks for detailed information.

Clinical disease is, however, associated with two other metacestodes. That of *Taenia (Multiceps) multiceps* causes coenurosis ('gid') in sheep, which is described under diseases of the nervous system. *Taenia hydatigena* metacestodes are normally asymptomatic but if a sheep or goat swallows a whole tapeworm segment, which may contain 100 000 eggs, sudden death may occur as massive numbers of developing metacestodes

(known as cysticerci) migrate through the liver parenchyma.<sup>3,4</sup> This condition (hepatitis cysticercosis) resembles acute hepatic fasciolosis but is an individual rather than a flock problem.

#### REVIEW LITERATURE

Palmer SR, Soulsby E JL, Simpson DIH (eds). Zoonoses: Biology, clinical practice and public health control. Oxford: Oxford University Press, 1998.

Thompson RCA. Echinococcus and hydatid disease. Wallingford: CAB International, 1995.

#### REFERENCES

1. Flisser A. Parasitol Today 1988; 4:131.
2. Ito A et al. Lancet 2003; 362:1918.
3. Kelly JD. Veterinary review no. 17: Canine parasitology. Sydney: University of Sydney Postgraduate Foundation in Veterinary Science, 1977; pp. 22-23.
4. Everett G, de Gruchy PH. Vet Rec 1982; 111:565.

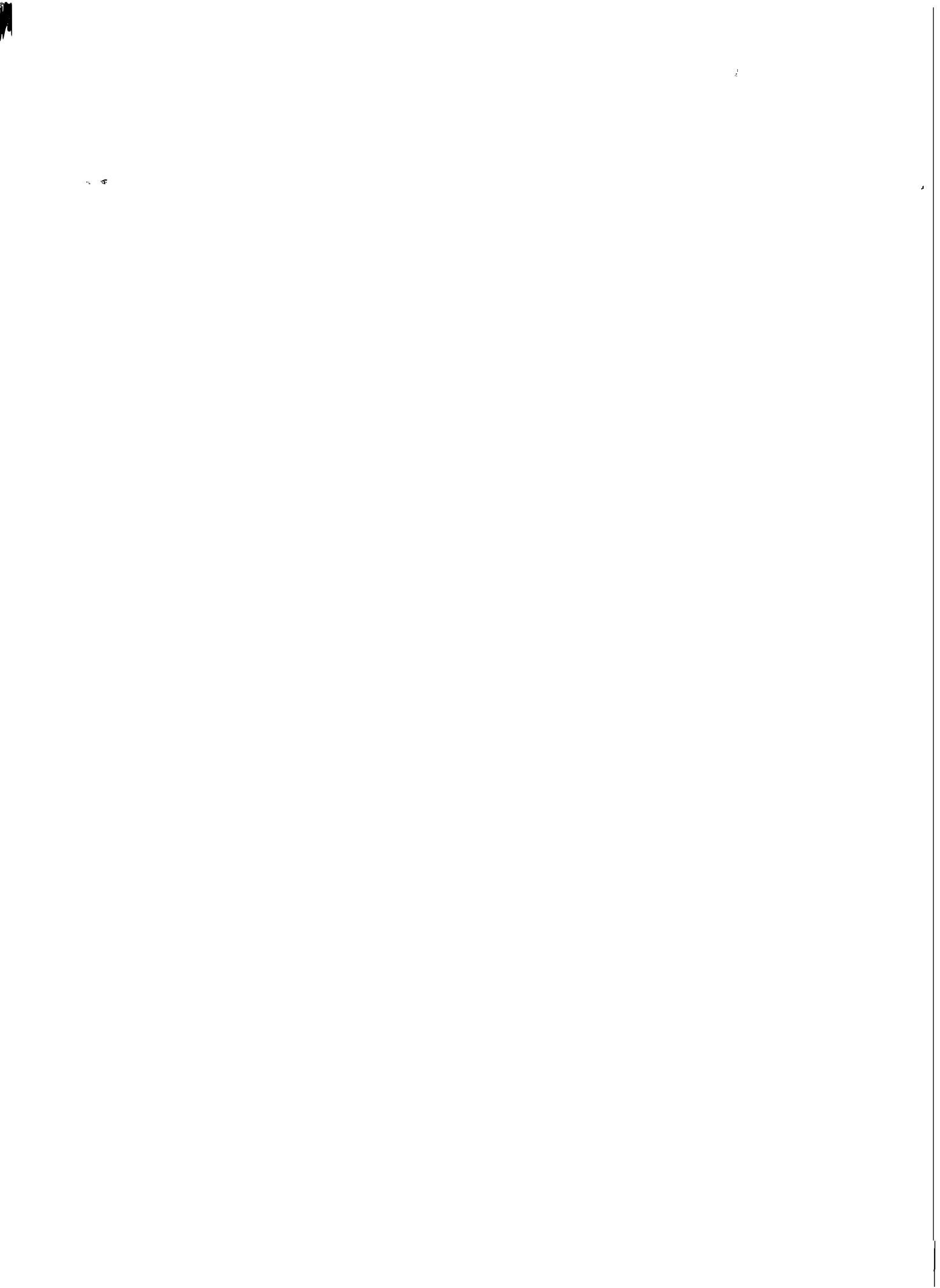

## Diseases associated with arthropod parasites

*Gasterophilus* spp. infestation (stomach bot) 1585  
*Oestrus ovis* infestation (nasal bots) 1586  
*Hypoderma* spp. infestation (warble flies) 1587

### CUTANEOUS MYIASIS 1589

Blowfly strike 1590  
 Screwworm (*Cochliomyia hominivorax* and *Chrysomya bezziana*) 1593  
 Wohlfahrtiosis (flesh fly) 1595

### KED AND LOUSE INFESTATIONS 1596

Sheep ked (*Melophagus ovinus*) 1596  
 Louse infestations (pediculosis) 1596

### GASTEROPHILUS SPP. INFESTATION (STOMACH BOT)

Infestations with larvae of *Gasterophilus* spp. have a widespread distribution. They cause a chronic gastritis and a loss of condition in infested horses, donkeys, and mules. Reduced performance is often attributed to this infestation. On rare occasions they cause perforation of the stomach and death.

#### Synopsis

**Etiology** Five species of *Gasterophilus* spp. which inhabit the gastrointestinal tract of horses.

**Epidemiology** Eggs are laid on hair of the body or around the lips; eggs hatch spontaneously or are stimulated to hatch by oral grooming, larvae penetrate oral mucosa or external epithelium of cheek and migrate to inner regions of mouth, congregate at epithelial surface around teeth for 6–10 weeks before migration to the stomach and intestine. Larvae attach in stomach or intestine and remain there for some months before being passed in the feces. One species attaches near the rectum. Larvae pupate and adults emerge after 3–5 weeks. Adults only live a few days and are mainly active in the summer, the fly surviving as larvae in the stomach over the colder months.

**Clinical signs** Adult flies frighten horses while larvae cause non-specific signs of unthriftiness.

**Clinical pathology** Eggs can be seen on hairs on legs or around the lips by direct inspection.

**Lesions** Area of larval attachment is pitted and the gastric wall may be thickened.

**Diagnostic confirmation** Eggs present on hairs, characteristic lesions at autopsy.

**Differential diagnosis** Unthriftiness usually associated with helminth infection.

### TICK INFESTATIONS 1599

### MISCELLANEOUS FLIES, MIDGES, AND MOSQUITOES 1603

Stable flies 1603  
 Horse flies; March flies or breeze flies (*Tabanus* spp.); deer flies (*Chrysops*, *Haematopota*, and *Pangonia* spp.) 1603  
 Buffalo flies; horn flies (*Haematobia* spp.) 1603  
 Horse louse flies (*Hippobosca equina*, *H. ruficipes*, and *H. maculata*) 1604  
 Biting midges 1604  
 Black flies; buffalo gnats; sandflies 1605  
 Mosquitoes 1605

House flies (*Musca domestica*) 1605  
 Bush flies (*Musca vetustissima*) 1606  
 Face flies (*Musca autumnalis*) 1606  
 Head flies (*Hydrotea irritans*) 1606

### MITE INFESTATIONS 1606

Harvest mites (chigger mites) 1606  
 Itch mites (*Psorergates ovis*, *P. bos*) 1607  
 Demodectic mange (follicular mange) 1608  
 Sarcoptic mange (barn itch) 1608  
 Psoroptic mange (sheep scab, body mange, ear mange) 1610  
 Chorioptic mange (tail mange, leg mange, scrotal mange) 1611

**Treatment** Ivermectin, trichlorphon, moxidectin.

**Control** Treatment given when fly activity has ceased and when larvae are in stomach – usually two treatments in mid and late winter. Fringes and tassels protect against worry associated with one species of fly.

### ETIOLOGY

Five species of flies of are known to parasitize domestic equids; *Gasterophilus nasalis*, *G. intestinalis*, *G. haemorrhoidalis*, *G. pecorum*, and *G. inermis*. Their larvae are the 'stomach bots' of horses, donkeys, and mules. Three species, *G. intestinalis*, *G. nasalis*, and *G. haemorrhoidalis*, are the most important and have a world wide distribution. The later larval stages inhabit the stomach and duodenum. These creamy pink larvae are thick, segmented, and about 5–15 mm long. The adult flies are golden brown, hairy, and about the size of a bee with two wings and vestigial mouth parts.

### LIFE CYCLE AND EPIDEMIOLOGY

Flies do not feed and only live a few days.<sup>1</sup> They are active during the summer months and there may be overlap among the species in their periods of activity. In areas with mild winters the flies may be active throughout the year. In colder regions fly activity ceases with the first frost and there is usually only a single generation per year. In these regions the second and third instars remain in the stomach over the winter.

Eggs are attached to hairs while the fly hovers close to the horse. Fecundity is roughly correlated to the size of the fly. *G. haemorrhoidalis* matures about 50–200 eggs, *G. nasalis* 300–500 eggs, and

*G. intestinalis* up to 1000.<sup>1</sup> Eggs of the various species are laid in specific locations and are attached in a specific manner, allowing identification of eggs to species. The eggs are laid on the horse's coat except for *G. pecorum* which lays up to 2000 eggs in batches of 100–200 on pasture plants. The eggs of *G. pecorum* and *G. haemorrhoidalis* are dark brown; the eggs of the others are yellow and are readily visible glued to the hairs, usually one to a hair. The eggs of *G. intestinalis*, the most common fly, are laid on the front legs, particularly the lower parts; those of *G. nasalis* in the intermandibular area; the others species' eggs are laid on the cheeks and lips.

The eggs are ready to hatch in about 2–10 days and the first instars enter the mouth either by host biting or licking or by subcutaneous migration from the cheeks into the oral cavity. The eggs of *G. intestinalis* and *G. pecorum* require a stimulus, provided by licking (moisture) or rubbing (friction), before they will hatch. The larvae penetrate oral mucosa, migrate to inner surfaces and emerge in the inter-dental spaces. The larvae of *G. intestinalis* penetrate the anterior end of the tongue and burrow in the buccal mucosa for about 3–4 weeks before invading pockets between the teeth or between the gum and molars.<sup>2</sup> *G. nasalis* may also accumulate in pockets alongside the molars and cause mouth irritation. *G. haemorrhoidalis* can penetrate the skin of the cheek and after wandering in the tissues of the mouth may attach in the pharynx. The second instar of *G. intestinalis* may also attach for a few days to the pharynx and the sides of the epiglottis before passing to the stomach. The first

instars of *G. pecorum* burrow into the mucous membranes of the hard palate, cheek and tongue where they develop into second instars. They then move to the pharynx where they develop into the third instar.<sup>3</sup> Occasional larvae migrate to abnormal sites including the brain, the cranial sinuses, the heart, and lungs.

Third instars of *G. intestinalis* are found attached to the mucosa, usually in bunches, at the junction of the glandular and non-glandular portion of the stomach, where they become attached to the mucosa. *G. nasalis* larvae are found in the pyloric region of the stomach and the duodenum. *G. pecorum* larvae may be found in the pharynx and upper part of the esophagus and in the fundus of the stomach. *G. haemorrhoidalis* larvae are found in the tongue, the pharynx, and the gastric fundus.

In the host, two molts are made and the larvae pass out in the droppings 10–12 months after infestation, usually in the spring and early summer. Some larvae may attach temporarily to the rectal mucosa on their way through. The larvae migrate into the ground, pupate, and adult flies emerge after 3–5 weeks to recommence the late summer attacks on horses.

#### PATHOGENESIS

The adult fly causes considerable annoyance when ovipositing. The droning noise and the sudden attacks to lay eggs causes head tossing and running in the host. *G. nasalis* is particularly troublesome as it darts at the lips and throat.

There is some doubt as to the importance of the lesions associated with the larvae. At the sites where they adhere there is an area of thickening and inflammation and in rare cases gastric perforation occurs. It is probable that there is some chronic gastritis and interference with digestion in most infestations. *G. intestinalis*, the most common species, attaches to the squamous epithelium and this has a relatively slight impact on digestion in the horse. However, the ulceration, edema, and abscessation associated with this species cannot be overlooked and one must expect some effect from such lesions although it is difficult, in practice, to separate these findings from those associated with a concurrent worm burden. Occasional perforation of the gut has been documented.<sup>4</sup> The larvae do not remove sufficient blood to cause anemia, feeding mostly on tissue exudate. In rare cases pleurisy may occur following perforation of the esophagus close to the cardia.<sup>5</sup> In very heavy infestations with *G. pecorum* the presence of large numbers of larvae (100–500) on the soft palate and base of the tongue can cause stomatitis and some deaths. Migration of first instars in the tongue and interdental gingiva and the

aggregation of larvae in periodontal pockets may produce irritation or pain and may prevent foals eating.

#### CLINICAL FINDINGS

A non-specific syndrome of unthriftiness, poor coat, occasional mild colic, and lack of appetite, plus bad temper and unwillingness to work is usually ascribed to bot infestations. Adult flies frighten horses by their hovering, darting flight, especially around the head of the horse, and may be a cause of shying and balking.

#### CLINICAL PATHOLOGY

The eggs on the hairs can be seen by direct inspection but the presence of larvae in the stomach and intestines can only be detected after treatment with a suitable boticide.

#### NECROPSY FINDINGS

A few larvae are present in the stomach of most horses at necropsy but clinical illness is usually associated with very large numbers. The areas of larval attachment are pitted and the gastric wall thickened. There may be an adhesive peritonitis with attachment and abscessation of the spleen over such areas.

#### DIFFERENTIAL DIAGNOSIS

The syndrome produced is not sufficiently characteristic to make antemortem diagnosis possible and bot infestations are commonly associated with helminth infestations which produce most of the signs observed. A tentative diagnosis of infestation of the gums can be made by signs of pain on mastication and the presence of bot-fly eggs on the horse at that time. A variety of serologic tests, including an ELISA, have been evaluated<sup>5</sup> and found to be generally specific and sensitive. There has been no further development of a practical test. Endoscopy using a video gastroscope has been applied to the diagnosis of gasterophilosis, although its use has been confined to use in drug efficacy studies.<sup>6</sup>

#### TREATMENT

Many of the organophosphates are effective. Trichlorfon 40 mg/kg is effective and is usually given with a benzimidazole to control strongyles as a common broad-spectrum mixture in the horse. It can also be used as a paste. Ivermectin 0.2 mg/kg has high efficacy against the oral and gastric *Gasterophilus* larvae<sup>7</sup> as well as all gastrointestinal nematodes, including migrating and hypobiotic large strongyles, microfilaria of *Onchocerca cervicalis* and larval stages of *Habronema* spp. and *Draschia megastoma* in the skin. Ivermectin has gained high acceptance in horse practice. Moxidectin 2% oral gel has been shown to have excellent efficacy.<sup>6,8</sup>

#### CONTROL

Treatment should preferably be administered after fly activity has ceased and the larvae have reached the stomach but before gastric damage has occurred. In most districts two doses should be given in winter, or in late winter and early spring. In foals showing pain on mastication, treatment with ivermectin paste or dichlorvos should be given as needed throughout the fly season.

The use of repellents or agents to kill the larvae in manure has not been successful, nor has bathing the affected hairs to encourage mass hatching and death of the larvae. The use of fringes, veils and tassels on the head harness helps protect horses against fly worry but is of little use in preventing bot infestation.

#### REFERENCES

1. Cope SE, Catts EP. *J Med Entomol* 1991; 28:67.
2. Cogley TP. *Vet Parasitol* 1989; 31:317.
3. Zayed AA et al. *Vet Med J Giza* 1993; 41:53.
4. Cogley TP, Cogley M. *Vet Parasitol* 1999; 86:127.
5. Escartin-Pena M, Bautista-Garfias CR. *Med Vet Entomol* 1993; 7:233.
6. Reinemeyer CR et al. *Vet Parasitol* 2000; 88:287.
7. van der Kolk JH et al. *Tijdschr Diergeneesk* 1989; 114:769.
8. Scholl PJ et al. *J Parasitol* 1998; 84:656.

#### OESTRUS OVIS INFESTATION (NASAL BOTS)

Infestation of sheep and goats with larvae of the nasal bot fly has a serious effect on the productivity and welfare of both sheep and goats. Adult activity induces stress responses and significant behavioral change. Larval infestation induces moderate to severe pathology that reduces productivity.

Similar flies are known to affect horses, donkeys, and mules (*Rhinoestrus* spp.) in the Mediterranean region and to affect camels (*Cephenemyia titillator*) in Africa as well as Australia. Wild ungulates are affected by nasal bots (e.g. *Cephenemyia* spp.). Very little is known about the pathology and impact of these later groups of flies, but similarities in life history suggest their affects will be similar to that discussed below.

#### Synopsis

**Etiology** One species, *Oestrus ovis*, which inhabits the nasal passages and sinuses of sheep and goats.

**Epidemiology** Larvae are sprayed onto the nares of hosts by passing females. Flies are active during spring and summer, inducing behavioral changes in hosts under attack. In temperate climates there is only a single generation per year, but in warmer climates two generations are known. First instars in the nasal passages undergo hypobiosis during winter or hot summer when survival of pupae or adults is low,

resuming development when conditions are more favorable.

**Clinical signs** Shortly after arrival of the larvae an increase in nasal discharge and sneezing are evident. As the infestations develop the amount of discharge increases and the nostrils may become caked with dust and debris forcing the infested animals to breathe through their mouth.

**Clinical pathology** Changes are noted to the mucosa of the ethmoid and sinus regions. Inflammation of these surface tissues is evident and increases as the larvae become mature. Changes to the epithelial structure are noted including the erosion of the surface ciliary covering and a breakdown in epithelial cell integrity. Abrasive action of the body armature as well as the activity of proteolytic enzymes excreted/secreted by the larvae are responsible for the pathology. Secondary effects include the induction of lung lesions and the activation of latent 'orf' infections. Diagnostic confirmation. Behavioral changes during fly season and nasal discharge.

**Differential diagnosis** Unthriftness usually associated with helminth infection.

**Treatment** Macrocytic lactone endectocides, dorlison.

**Control** Treatment given when fly activity has ceased.

## ETIOLOGY

A single species, known as the sheep nose bot, affects sheep and goats in most regions, but is particularly significant in the Mediterranean basin, central America southern Africa, and eastern Europe. The larvae inhabit the nasal passages and sinuses, eventually being expelled through the nares. Goats are less dramatically affected than sheep. The slightly dorso-ventrally flattened, segmented larvae are light cream in color, but as they reach maturity dark bands appear on each segment.

## LIFE CYCLE AND EPIDEMIOLOGY

The adult fly is stout, mottled gray in color, and about 1 cm long. Its mouthparts are rudimentary and it does not feed. In North America, flies emerge in the late spring, mate, and the females begin larviposition activities approximately 2–3 weeks later.<sup>1</sup> Adult flies attempting to deposit larvae on the nares annoy the sheep and cause them to bunch or seek shelter. Stamping of the feet and shaking of the head are common. Sheep may bunch together and press their heads into the fleece of others. Fly activity occurs primarily during the warmer parts of the day, but still may result in the loss of a good deal of grazing time. Behavioral changes in goats are less dramatic,<sup>2</sup> presumably because of their browsing habit.<sup>2</sup>

Larval development takes place within the dorsal turbinates and frontal sinuses. The period of development can vary from 3 weeks to several months after which they migrate to the nostrils. Larvae feed on the

mucosal secretions and cells eroded from the mucosal epithelium. The larvae are thick, yellow-white in color and when mature there is a dark dorsal band on each segment. The ventral surface has rows of small spines on each segment. Mature larvae exit the host, usually during a bout of sneezing, and actively burrow beneath the upper layers of soil and ground litter. Pupation occurs at these locations and development of the adults requires 4–5 weeks, but may take longer at low temperatures.<sup>3</sup> In temperate areas there may be one or two generations per year but several generations may be completed in hot areas. *O. ovis* are adapted to the various climates prevailing wherever sheep and goats are kept. When winters are cold, the larvae can overwinter by remaining dormant in the first instar (hypobiosis), but in warmer climates development may continue throughout the winter. In those regions where summer temperatures are extreme the larvae will also undergo hypobiosis.

*O. ovis* are an important zoonosis as the females may larviposit in the eye, nose or on the lips of humans. In some countries ophthalmomyiasis or infection of the upper respiratory tract is a common occurrence.

## PATHOGENESIS

The stress of the larviposition attacks can be significant with reduced grazing time and over-heating resulting from bunching. Herdsmen find the animals are more nervous and difficult during the fly activity periods.

Larvae induce a gradually increasing rhinitis and sinusitis as the infestation persists. Marked changes in the structure of the epithelial tissues are noted with a marked cellular degeneration and a loss of the ciliary layer. The changes are a result of both mechanical activity of the larval spines and mouthhooks as well as the effect of proteolytic enzymes excreted or secreted.<sup>4</sup> Varying degrees of mucous discharge are observed in the later stages of the infestation. This can lead to the nostrils being occluded by adherent straw and dust.

## CLINICAL FINDINGS

Early in the infestation there is a distinct rhinitis accompanied by a muco- to mucopurulent discharge. Later as larvae mature, a sinusitis is evident. Presence of mature larvae in nasal cavities may induce excessive sneezing which assists larval exit.

Activity of the larvae in the nasal cavities and the changes they induce lead to an increased incidence of secondary pathology. The number and severity of lung abscess are more significant in nose bot infested sheep.<sup>5</sup> The presence of bots also is correlated with increased carcinomas<sup>6</sup> and may lead to reactivation of latent 'orf' symptoms.

## DIFFERENTIAL DIAGNOSIS

The behavioral changes during fly activity, including bunching and burying of noses in neighbors' fleece is a reliable indicator of fly attack. Nasal discharge and excessive sneezing are highly suggestive, but not definitive. Infested sheep and goats develop some level of immunity from exposure to larval antigens. An ELISA for detection of antibodies to larvae secretions has been developed.<sup>7</sup>

## TREATMENT

Closantel 7.5 mg/kg<sup>8</sup> and ivermectin 0.2 mg/kg<sup>9</sup> as well as other macrocyclic lactones<sup>10,11</sup> are effective and the use of these compounds for fluke or worm control also controls nasal bots.

## CONTROL

Treatment should preferably be applied after the cessation of fly activity, although it may be necessary to apply treatments during prolonged fly activity in order to give relief.

## REFERENCES

1. Cepeda-Palacios R, Scholl PJ. J Med Entomol 1999; 36:435.
2. Hoste H et al. Vet Parasitol 2001; 101:127.
3. Biggs HC. Preventive Vet Med 1999; 33:267.
4. Tabouret G et al. Vet Parasitol 2003; 114:305.
5. Dorchies Ph et al. Vet Rec 1993; 133:325.
6. Bergeaud et al. Rev de MédVét 1994; 145:863.
7. Tabouret G et al. Vet Res 2003; 34:231.
8. Dorchies Ph et al. Vet Rec 1993; 135:600.
9. Roncalli RA. Vet Med 1984; 79:1095.
10. Dorchies Ph et al. Vet Parasitol 1996; 65:163.
11. Dorchies Ph et al. Vet Parasitol 2001; 96:14.

## HYPODERMA SPP. INFESTATION (WARBLE FLIES)

Infestations of cattle with the larvae of *Hypoderma* spp. cause serious damage to hides and carcasses, as well as production losses. Occasional deaths from anaphylactic shock or toxemia and damage to the central nervous system or esophagus. Several other flies with very similar life histories similarly affect goats (*Przhevalskiana silenus*), and semi-domestic reindeer (*Hypoderma tarandi*) in addition to affecting the well-being of wild ruminants.

### Synopsis

**Etiology** *Hypoderma bovis* and *H. lineatum* in cattle, *H. sinense* in cattle and yaks, *H. diana* in deer, *H. tarandi* in reindeer and caribou, *Przhevalskiana silenus* in goats. Horses are occasionally affected.

**Epidemiology** Eggs attached to hair in spring to late summer, larvae penetrate skin and migrate to esophagus (*H. lineatum*) or spine (*H. bovis*) where they stay for 6–7 months; they then move to subdermal tissue along the back and after



2–3 months emerge from the breathing hole, fall to the ground, pupate and emerge as adult flies 3–5 weeks later.

**Clinical signs** Poor growth and production. Larvae in the back causes obvious swellings while larvae in the spinal cord may cause posterior paralysis.

Treatment of larvae while they are in the esophagus may cause massive edema, and edema and paraplegia may occur if animals are treated when larvae are in the spinal canal.

**Clinical pathology** An ELISA is available.

**Lesions** Larvae are found in discolored tissue.

**Diagnostic confirmation** Swellings along back characteristic. Paraplegia occurs about 72 hours after treatment.

**Differential diagnosis** Traumatic injury to the spine; aberrant *S. vulgaris* larvae in the horse.

**Treatment** Organophosphates, macrocyclic lactone endectocides.

**Control** Treatments are given so as to avoid treating when larvae are in the esophagus or spinal canal. (Usually treated in autumn and spring but varies with location.)

## ETIOLOGY

There are two species which specifically parasitize cattle: *Hypoderma bovis* and *H. lineatum*. A third species, *H. sinense*, affects cattle and yaks in central Asia.<sup>1</sup> The adult flies are robust and hairy, about the size of a bee (12–18 mm long), are yellow-orange in color and have two wings. They are not easily seen because of the rapidity of their flight. Repeated infestation results in an acquired immunity that results in older animals being less severely affected than younger animals.

Horses are occasionally infected with *Hypoderma* species of cattle. The larvae are found in subcutaneous cysts on the back, but have not been reported to complete development. This location causes problems if they are in the saddle region.

Losses to the cattle industry associated with warble fly have not been estimated recently, but in 1965 the loss was estimated to be US\$192 million per annum in the United States, and in 1976 approximately CAN\$100 million in Canada. In 1982 the cost of warble fly was estimated as £35 million for Great Britain, but the parasite has now been eradicated from the UK and Ireland. Advent of the macrocyclic lactone endectocides have greatly reduced the prevalence of the cattle species in North America, but they persist in localized areas.<sup>2</sup>

*Hypoderma tarandi*, *H. acteon*, and *H. diana* infect reindeer/caribou and deer respectively. *H. diana* is found throughout Europe in several deer species but may also occur in sheep. *H. actaeon*, also found throughout Europe, is known only from the red deer. These species do not undergo

deep tissue migrations that characterize the lifecycle of the cattle species.

*Przhevalskiana silenus* is similar to the above and parasitizes goats in the Mediterranean basin, parts of eastern Europe as well as in Pakistan and India. This species also does not have a deep tissue migration and larvae tend to develop subcutaneously very near the site of initial skin penetration. The losses resulting from this parasite are significant and result from reductions in carcass quality and reduced animal health.

The larvae of *Dermatobia hominis*, a small (12 mm long) related fly, parasitize a wide variety of hosts and cause major economic losses to cattle production in South America. They also affect man and are a major zoonosis for travelers in the region. Mature larvae are about 2.5 cm long and develop in a subcutaneous cyst that can be quite painful. Female *Dermatobia* oviposit on zoophilous, 'porter' flies such as mosquitoes and stable flies which they catch 'on the wing'. The eggs are transported to mammalian hosts where they hatch in response to increased temperature as the fly lands. Larvae penetrate the skin, but do not migrate. Treatment and control measures are the same as for *H. bovis*.

## LIFE CYCLE AND EPIDEMIOLOGY

Warble flies are common parasites of cattle in the northern hemisphere, including North America, Europe, and Asia. Precise distribution of these parasites have been changing recently with the widespread use of macrocyclic lactone endectocides and the adoption of eradication programs in many European countries. Infestations south of the equator are rare and are the result of imported cattle, although endemic cases have occurred in Chile.

Adult flies are active in the spring to late summer, *H. lineatum* usually appearing 3–4 weeks before *H. bovis*. *H. lineatum* attaches up to 600 eggs, in strings of 5–25, to hairs on the legs or lower parts of the body while *H. bovis* attaches eggs, one at a time, to hairs on the rump and upper parts of the hindleg. The oviposition flight of *H. bovis*, darting in to lay each egg, will terrorize cattle. Eggs hatch in 4–6 days. The larvae penetrate the skin using protease enzymes and migrate through connective tissues to reach the esophagus (*H. lineatum*) or the epidural fat in the spine (*H. bovis*) where they stay, feeding and growing, for 2–4 months. They subsequently continue their migration to reach the subdermal tissue of the back in the early spring. Here they make a breathing hole and become encased in a granulomatous cyst. They complete development in 1–2 months, passing through second and third instars and emerge through the hole, fall to the

ground and pupate. Adult flies emerge some 3–5 weeks later. The fully developed larvae are thick and long (25–30 mm), light cream in color, but darkening to almost black as mature third instars. A single animal may have up to 300 larvae each developing with granulomatous cysts, with breathing holes, under the skin of the back.

The timing of the life cycle, i.e. the period when grubs are present in the animals and the time at which the flies are present in large numbers, varies with the climate and is of importance in a control program. *H. lineatum* generally is 1–2 months ahead of *H. bovis* and where the two flies are present both 'grub' and 'fly' seasons may be very long. In the southern United States the 'fly season' is February and March; in Canada it is June to August. The period when grubs are present in the back is December in the south and February to May in Canada. In Europe the larvae begin to move to the back in January to July.

## PATHOGENESIS

Migrating first instars cause little damage as they use their proteolytic enzymes to migrate through connective tissue. The enzymes, however, have an anti-inflammatory effect, partially through cleavage of complement components.<sup>3</sup> Larvae maturing under the skin of the back form holes in the skin and the reaction of the host encloses each grub within a granulomatous cyst. On rare occasions an anaphylactic reaction may occur in a sensitized animal as the result of death of migrating larvae; chance migration into the brain may also occur. Intracranial myiasis due to *H. bovis* has also been recorded in the horse. Treatment of animals when the first instars are in the esophagus may cause a massive inflammatory edema which may prevent feeding and swallowing of saliva; eructation may stop and bloating may occur. Treatment of *H. bovis* while it is in the spinal canal may also cause edema and mild to severe paraplegia.

## CLINICAL FINDINGS

If the fly population is heavy, cattle at pasture may be worried by their attacks which disrupt grazing and breeding behavior. Avoidance behavior, called gadding, may result in injury as cattle run into fences and other natural obstructions. Heavy infestations with larvae are commonly associated with poor growth, condition and production but such heavy infestations are often complicated by other forms of mismanagement including malnutrition and parasitic gastroenteritis. Immunosuppression results from the effect of larval secretions. Infected cattle milk poorly and a considerable increase in milk production and milk fat occurs after treatment.

The presence of the subcutaneous larvae causes obvious swelling with pain on touch. The swellings are usually soft and fluctuating. There may be as many as 200–300 such lesions on the back of one animal.

With involvement of the spinal cord there is a sudden onset of posterior paralysis without fever and without other systemic signs. The suddenness of onset and the failure of the disease to progress usually suggest traumatic injury. A similar disease can occur in horses and is reputed to be more common in horses than in cattle.

#### CLINICAL PATHOLOGY

An ELISA which detects antibodies to the secreted enzymes of *H. lineatum* and *H. bovis* has been developed. It has been used in the eradication program in Great Britain<sup>4</sup> and in France.<sup>5</sup> In addition, an antigen capture ELISA, used to detect the presence of circulating quantities of the predominant larval enzyme has been developed.<sup>6</sup> This will be useful in differentiating active from cleared infestations and will be useful in detailed surveillance programs.

#### NECROPSY FINDINGS

The first instars, migrating within connective tissue, are usually surrounded by a zone of yellow-green discoloration. Later larval stages lie in a subcutaneous, granulomatous cyst which may contain a pale fluid. Rarely the cyst will contain a large amount of purulent discharge.

#### DIFFERENTIAL DIAGNOSIS

- No other disease causes the characteristic swellings on the back
- The differential diagnosis of posterior paralysis and anaphylaxis are discussed in detail under the respective headings of disease of the spinal cord and anaphylaxis
- The clinical signs of organophosphorus poisoning usually occur within 12–24 hours following application of the compound
- Posterior paralysis due to destruction of the larvae in the epidural space usually occurs approximately 72 hours after application of the organophosphorus insecticide.

#### TREATMENT

##### Organophosphorus compounds

Organophosphorus insecticides kill migrating larvae and can be applied by spray or a 'pour-on' technique, by individual oral dosing or by mixing in the feed. They are highly effective, but unless used in strict accordance with the recommendations of the manufacturer damaging side-effects may occur.

The time of their administration is regulated by the stage of larval development and their location within the host.

Hence the timing varies with climate. The emphasis is to deliver treatment shortly after all eggs have hatched and larvae are small and their death releases the least amount of enzymes into the host system. If treatment is delayed until these larvae have reached their maximum size, the sudden release of large amounts of proteolytic enzymes causes tissue damage that results in severe swelling. This swelling and inflammation affect the function of the esophagus (*H. lineatum*) resulting in bloat or swelling around the spinal chord leading to hind quarter paralysis (*H. bovis*). Severity of the reaction also appears to be related to the number of larvae present. These insecticides are not effective against second and third instars within the subcutaneous cysts.

Application in the form of a spray should insure that the skin is wetted by using a pressure spray (20–30 kg/cm<sup>2</sup>), and spraying the flat body surfaces such as the neck, back, shoulders, sides, and thighs. Use of a low pressure spray or wash should be followed by vigorous use of a curry comb or brush. Pour-on applications should be made carefully along the midline in a thin stream which penetrates the hair coat.

Although these compounds disappear very quickly from tissues, recommendations are that they should not be administered to milking animals, and beef animals should not be slaughtered for at least 60 days after dosing. Milking cattle with back lesions can be treated with derris dust (containing rotenone) but this must be brushed in vigorously or sprayed under pressure so that the material penetrates to the larvae.

Toxic effects of organophosphates have been described elsewhere. The pitfalls in their use in warble control are related chiefly to the time of administration.

##### Macrocytic lactone compounds

All larval stages of cattle grubs are very sensitive to these endectocides. Their widespread use in nematode control programs plays a major role in controlling warble flies. They remain effective for about 4 weeks.<sup>2</sup>

##### Manual removal

When small numbers of cattle are affected with relatively few warble grubs, manual removal of the larvae is practised. Incomplete removal or breaking the larvae during removal may cause a severe systemic reaction. This reaction and the one which sometimes occurs after systemic treatment of cattle infected with warble fly have been ascribed to anaphylaxis. However, there is evidence that it is due directly to toxins liberated from dead warble maggots and that phenylbutazone may control this toxin.<sup>3</sup> The clinical signs

include dullness, salivation, lacrimation, dyspnea, wrinkling of skin on the side of the neck, and edema under the jaw.

#### CONTROL

While rotenone has been used successfully to kill the larvae in the subcutaneous tissues in the back, this technique does not prevent damage to the hide and has been largely superseded by the use of organophosphate insecticides and the macrocyclic lactone endectocides. In general, systemic treatments are given in the autumn (between September 15 and November 30) and in the spring after March 1.

Warble fly has been eradicated in Norway, Sweden, Denmark, Malta, Ireland, and Great Britain. Eradication programs have commenced in France. A joint Canadian-US study using sterile male *Hypoderma* species eradicated these species from the test area, but the difficulty of mass producing flies, in the absence of an in vitro rearing system, makes this technique impractical for large scale warble fly control.<sup>7</sup>

Vaccination of cattle using crude larval extracts has reduced both the number of warbles in the back and the number of larvae that could pupate.<sup>8</sup> Results of vaccination studies with recombinant antigens have been variable,<sup>9</sup> but show promise although there has been no commercial development.

#### REFERENCES

1. Otranto et al. *J Parasitol* 2004; 90:958.
2. Colwell DD. *Vet Parasitol* 2000; 94:127.
3. Boulard C, Benacharif F. *Parasite Immunol* 1984; 6:459.
4. Tarry DW et al. *Vet Rec* 1992; 131:310.
5. Boulard C, Villejoubert C. *Vet Parasitol* 1991; 39:171.
6. Panadero-Fontan R et al. *Vet Parasitol* 2002; 108:85.
7. Kunz SE et al. *J Med Entomol* 1990; 27:523.
8. Baron RW, Weintraub J. *Vet Parasitol* 1986; 21:43.
9. Colwell DD. *Mange and myiasis of livestock*. COST 2002; 833: 7.

## Cutaneous myiasis

Cutaneous infestation by fly larvae or maggots (known as myiasis) causes serious loss to the livestock industries across the world. Losses include mortality, increased morbidity and reduced production of meat, milk, and fiber. The disease is associated with larvae of flies in two major dipteran families, Calliphoridae and Sarcophagidae.

Two types of cutaneous myiasis can be distinguished; primary, in which the fly larvae are obligate parasites feeding on living tissues and secondary, in which the larvae feed primarily on necrotic tissues and only secondarily invade uninjured tissue. Clearly, primary myiasis

is most significant to animal health and therefore the most costly, not only in terms of mortality, morbidity and reduced productivity, but in terms of cost of control. However, it may be difficult to differentiate primary from secondary myiasis because the larvae are superficially similar.

Three primary fly strike disease states, resulting from the activities of different species, are well known and described. Blowfly strike by calliphorids such as *Lucilia cuprina* and *L. sericata* is a major problem, particularly for sheep producers, in Australia, New Zealand, and Great Britain. The second group are the screwworms, *Cochliomyia hominivorax* (in the New World) and *Chrysomya bezziana* (in southern Europe, Africa, and Asia) which are of importance across the livestock species and result in great costs for control. The sarcophagid (flesh fly) *Wohlfahrtia magnifica* causes traumatic myiasis in a wide range of livestock species, but has most impact in goat and sheep production. This species occurs in southern Europe, particularly the Mediterranean and the steppe regions of the continent. Because of differences in the nature of the disease state and control practices for each of these three groups they will be dealt with as separate entities.

## BLOW FLY STRIKE

The cost of blow fly control and production losses in Australia for 1985 have been estimated as \$200 million. A review of blow fly strike in Australia has been published and is given here as a review reference. Blow fly strike is a very important cause of losses in sheep in most countries where large numbers are kept. In bad years many sheep may die (up to 30% of a flock) and the expense of controlling the flies and failure of wool to grow after recovery may be a serious strain on the local sheep economy. Merino sheep, especially those with heavy skin wrinkles, are by far the most susceptible breed.

### Synopsis

**Etiology** *Lucilia cuprina* and *L. sericata* are the most important primary flies while other calliphorids act as secondary invaders.

**Epidemiology** Fly numbers depend on temperature. Flies are attracted to wool that has been wetted or to areas affected by fleece rot, mycotic dermatitis, diarrhea or urine staining. Incidence of strike is positively correlated with fly numbers, rainfall, humidity, cloud cover, and pasture growth. Covert strikes provide larvae for future generations.

**Clinical signs** Sheep are restless, bite at the affected area, and wriggle their tails. Affected area is moist and malodorous, body temperatures may reach 42°C, pulse and respiratory rates increase.

**Clinical pathology** A clinical examination is all that is necessary.

**Lesions** Moist, malodorous areas containing active larvae. Predisposing diseases such as dermatophilosis, fleece rot, parasitic gastroenteritis, and footrot are easily identified.

**Diagnostic confirmation** Clinical signs are diagnostic.

**Differential diagnosis** Lice, sheep scab, screwworm fly infestations.

**Treatment** Organophosphates, macrocyclic lactone endectocides, or cyromazine.

**Control** Cyromazine or triflubenzuron protect for 10–12 weeks while organophosphates kill larvae and protect for 2–3 weeks. Breeding for resistance and control of predisposing diseases is important. Conduct mules operation on lambs at marking, cut tails to the correct length, institute a proper gastrointestinal nematode control program, and give a mid-season crutching to control breech strike.

## ETIOLOGY

Despite there being a large number of species capable of causing the disease, grouped geographically below, there are two species that are the primary agents of blow fly strike: *Lucilia cuprina* and *L. sericata*.

- Australia: *Lucilia cuprina*, *L. sericata*, (*Calliphora stygia*, *C. novica*, *C. augur*, *C. hilli*, *C. albifrontalis*, *Chrysomya rufifacies*, *Ch. varipes*)
- New Zealand: *Lucilia sericata*, *L. cuprina*, (*Calliphora stygia*)
- Great Britain and northern Europe: *Lucilia sericata* (*Calliphora erythrocephala*, *C. vomitoria*, *Phormia terraenovae*)
- North America: (*Phormia regina*, *P. terra-novae*).

## LIFE CYCLE AND EPIDEMIOLOGY

The primary agents of fly strike are obligate parasites. *Lucilia cuprina* is overwhelmingly important in the initiation of strike in sheep from Australia, and South Africa. *L. cuprina* was introduced to New Zealand in 1988 and fly strike is now a major disease in that country. In northern Europe the primary agent of fly strike is *Lucilia sericata* although there are some other minor species that have been reared from struck sheep.<sup>1</sup>

In sheep, the incidence varies widely depending largely on the climate, warm humid weather being most conducive to a high incidence. In summer rainfall areas fly strike may be seen most of the year, being limited only by dry winter conditions; while in winter rainfall areas it is usually too cold in the winter and too dry in the summer for outbreaks to occur. Under these conditions abnormally heavy summer or autumn rains may be necessary before an outbreak will occur.

## The fly population

Primary flies are of particular importance as these initiate the strike and provide suitable conditions for subsequent invasion by secondary flies. These latter flies are not of economic importance but may infest wool matted with dried exudate or feed on necrotic tissue surrounding healing strike. In warm areas pupal development may continue throughout the year but as soil temperatures fall an increasing number of larvae fail to pupate and larvae may overwinter until the following spring. In the spring adult flies emerge and after one or two breeding cycles, numbers build up to a peak in summer. Numbers may remain high if climatic conditions are suitable, moisture being of prime importance, but may fall dramatically in hot dry conditions. An increase in numbers may occur again in the autumn.

All adult flies require carbohydrate and water, but females require protein for ovarian development. The flies are attracted to sheep that have undergone prolonged wetting so that bacterial decomposition of the skin has occurred. The association of fly strike with fleece rot, mycotic dermatitis, diarrhea, urine staining, and footrot is related to the excessive moisture deposited on the skin or to the production of serous exudates. Fractions of *Pseudomonas aeruginosa* infected fleece have been shown to stimulate oviposition.<sup>2</sup>

*Lucilia cuprina* deposit eggs in batches of up to 300, the actual number depending on the fly's size and its ability to locate sufficient protein for egg development. Similarly, *L. sericata* deposit eggs in batches of approximately 200. The average female longevity in the field in Australia is about 2 weeks and females rarely live long enough to mature more than two or three batches of eggs. In the UK mean female longevity is shorter at 5 days.

The eggs hatch in 12–24 hours and the first instars feed on protein-rich serous exudate that has been provoked by bacterial damage or some other irritation. Larval mouthhooks and enzymes present in the saliva and excreta will further digestion of the skin. Large groups of larvae, particularly second and third instars, further damage of the skin which extends the lesion and insures a continuing supply of food. The second and third instars are 6–12 mm long, thick, yellow and white in color and move actively. Larvae reach maturity after approximately 72 hours. They leave the feeding lesion, fall to the ground, wander briefly and then burrow into the earth to pupate. The length of the life cycle is highly temperature dependent; it be completed in as little as 8 days but

may require up to 6 weeks in temperate regions such as the UK.<sup>2</sup> Eggs and larval stages are highly susceptible to desiccation and mortality will be high if the relative humidity in the fleece falls below 60%. In temperate climates such as the UK, as photoperiods decline the larvae that have left the host, will burrow into the ground and cease development, thereby overwintering as mature larvae.

Several generations of primary flies are necessary before numbers are high enough to cause severe outbreaks and therefore warm humid weather must persist for some time before severe outbreaks occur. The incidence of body strike increases with the increase in the number of gravid flies and is positively correlated with rainfall, cloud cover, and rate of pasture growth.<sup>3</sup> Other primary flies are not as effective as *L. cuprina* in initiating a strike, and in Australia at least 85–90% of all primary strikes are due to *L. cuprina*. Larvae of primary flies, other than *L. cuprina*, and secondary flies develop in carrion or in rotting vegetation and their main role is to invade and extend the primary strike. *Ch. rufifacies* is the most important secondary fly in Australia. It requires higher temperatures than the other flies, is found later in the season and is the first to disappear as temperatures fall.

Detailed population models have been developed for the strike by *Lucilia* spp. in Australia<sup>4</sup> and northern Europe<sup>5</sup> and both have been used to predict onset of fly strike in sheep populations. The latter model has been extensively validated and is sufficiently accurate to establish an early warning system for alerting producers of the impending onset of fly strike and thus allowing well timed prophylactic treatments.

Distribution of fly strike in flocks is highly aggregated with a small number of sheep having high numbers of larvae in lesions, a moderate number of sheep with low numbers of larvae and the majority of sheep being unstruck.<sup>6</sup> In part this is a result of the attractiveness of already struck sheep to ovipositing flies, although other factors such as innate attractiveness play a role.

#### Susceptibility of sheep

By far the most common site for fly strike is the breech: infestation occurs here because of soiling and excoriation by soft feces and the urine of ewes. Lush pasture, parasitic gastroenteritis and fleece length are predisposing factors but individual sheep are predisposed because of the conformation of this part of their anatomy. Excessive wrinkling of the skin on the back of the thighs and the perineum, a narrow perineum and crutch and an

excessively long or short tail favor continuous soiling of the area and encourage 'crutch or breech strike' or 'tail strike'. Less common sites for infestation are around the prepuce ('pizzle strike'), on the dorsum of the head when there is excessive folding of the skin ('poll strike'), and along the dorsum of the body ('body strike') in wet seasons when fleece rot or dermatophilosis is common. Sheep grazing on tall, dense pasture are commonly affected by body strike because of the way in which the wet plants keep the fleece on the lower part of the body wet. Wounds, especially castration incisions, docking wounds and head wounds on rams caused by fighting, are also likely to provide good sites for blow fly strike. Young sheep are more susceptible.

#### PATHOGENESIS

The first instars feed on the exudate produced by the bacterial infection on the skin, but the larvae also produce excretory/secretory enzymes which may cause some skin degradation after egg hatch and provide soluble molecules on which the first instars can feed.<sup>7,8</sup> Later instars can cause severe skin damage to provide themselves with food. Larvae may also migrate from the original area of strike, along the surface of skin to establish additional focal lesions.

Many primary strikes remain small and are unnoticed by the farmer.<sup>6</sup> Such covert strikes may outnumber overt strikes and are important as a source of future generations of flies. Once the initial strike is made, the site becomes suitable for the secondary flies that now invade and extend the lesion. The effects of strike include toxemia due to absorption of toxic products of tissue decomposition, loss of skin and subsequent fluid loss, and secondary bacterial invasion.

#### CLINICAL FINDINGS

Individual sheep may be 'struck' at any time provided they are in a susceptible condition. Massive outbreaks tend to be confined to periods of humid, warm weather and are therefore in temperate areas usually limited in length to relatively short periods of 2–3 weeks, but in sub-tropical areas characterized by summer rainfall severe strikes may occur over many months.

The clinical effects of 'blowfly' strike vary with the site affected but all struck sheep have a basic pattern of behavior caused by the irritation of the larvae. The sheep are restless, moving about from place to place with their heads held close to the ground and they become anorexic. They tend to bite or kick at the 'struck' area and continually wriggle their tails.

If the area is large there is an obvious odor and the wool can be seen to be slightly lifted above normal surrounding wool.

The affected wool is moist and usually brown in color although in wet seasons when fleece rot is prevalent other colors may be evident. In very early cases the maggots may still be in pockets in the wool and not yet in contact with the skin. When they have reached the skin it is inflamed and then ulcerated and the maggots begin burrowing into the subcutaneous tissue.

Three days after the primary oviposition feed intake is reduced, rectal temperature rises to about 42°C (108°F) and pulse and respiratory rates increase. Some sheep may die. The wool may be too hot to handle as a result of the inflammation caused by the mass of maggots that can be seen when the wool over the strike is opened. When primary strikes are invaded by secondary flies, particularly *Ch. rufifacies*, the affected area is extended and the maggots may burrow deeply into the tissues. Affected sheep may lose their fleece over the affected area and may suffer a break in the remaining fleece. Tracts of discolored wool may lead to other affected areas of skin. As the struck area extends a scab forms over the center, the wool falls out and the maggots are active only at the periphery.

#### CLINICAL PATHOLOGY AND NECROPSY FINDINGS

A clinical examination is all that is necessary to make the diagnosis but identification of the flies responsible may be important if epidemiology is being considered. Identification of larvae should be carried out by a specialist. Molecular techniques for accurate identification are available from specialists.<sup>9</sup> Preservation of the larval stages is critical to these techniques and larvae should be rapidly frozen or preserved in 70% ethanol. Fly trapping may not correlate with larval findings as not all flies are equally attracted by commonly used baits.

#### DIFFERENTIAL DIAGNOSIS

Attention will be drawn to affected sheep by their foot stamping, tail twitching, and biting at the affected part. Affected sheep can easily be diagnosed by finding the moist, malodorous, maggot-infested area. Many covert strikes may be present without producing clinical signs. Predisposing diseases such as footrot, wound infections, dermatophilosis and diarrhea resulting from parasitic gastroenteritis are usually easily detected and fleece rot is indicated by matting of the wool and discoloration.

#### TREATMENT

A local dressing containing a larvicide and an antiseptic is applied. The prevention of reinfestations is also an important aim and as repellents have been largely unsatisfactory, it has become apparent

that the larvicide in a suitable dressing must be one with maximum retention in the treated area. Modern dressings usually contain organophosphate insecticides but most products do not kill all the organophosphate resistant larvae and some perform poorly even against susceptible larvae. Variations in effectiveness with the same compound sold by different companies is probably related to formulation.<sup>10</sup> Ivermectin at 0.03 mg/kg applied by hand jetting is highly effective in killing all larval stages.<sup>11</sup> Powder and liquid dressings containing diazinon, tetrachlorfenvinphos, propetamphos, and ivermectin are most generally favored.

Cyromazine, an insect growth regulator, is now widely used. It is particularly active against second and third instars, but is slow-acting and so live larvae may be seen in the fleece for some days after treatment.

### CONTROL

Practical control of crutch strike in extensive farming areas depends on the use of the Mules operation to extend the bare areas around the perineum and tail, good worm control to prevent contamination of the perineal region, correct tail length and a midseason crutching. Control of strike in other situations is based on insecticidal treatment and treatment of wounds as they occur. Under conditions of extensive sheep raising, such as occur in Australia and South Africa and where climatic conditions are conducive to the development of the disease, the control of blow fly strike is a major undertaking and an extensive bibliography on the subject is available. Only a summary can be presented here.

The subject can be divided into three phases: reduction in fly numbers; prediction of fly waves followed by prophylactic crutching and application of larvicides; and reduction in susceptibility of sheep.

### Reduction of fly numbers

Reducing the fly population has been of limited value as there are usually enough flies present to strike all susceptible sheep if suitable conditions are present. However, if the primary fly responsible for initiating strikes can be controlled the importance of secondary flies is greatly reduced. The measures used include trapping, early treatment of clinical cases and the proper disposal of carcasses and wool waste. Biological control by the use of insects parasitizing blow flies has been generally unsuccessful. Trapping, provided the traps are carefully looked after and satisfactory baits are used, can reduce the number of blow flies.<sup>12</sup> Recent work with synthetic attractants have shown reduction of strikes by up to 55%,<sup>13</sup> which suggests this approach will make a good adjunct to the overall fly management practices.

It is important to identify clinically affected sheep, particularly those affected early in the season, and to treat the infestations. If these early season strikes are not treated they serve to multiply the fly population and outbreaks will occur later in the season. When affected areas are clipped, the clippings should be disposed of and larvae on the sheep destroyed with a suitable dressing.

Control by genetic means offers promise for long-term control. Chromosome translocation to produce reduced fertility in male flies and lethal mutants, such as flies with yellow or white eyes which will be blind under field conditions and die, has been reported.<sup>14</sup> This technique is logistically and economically feasible and more cost-effective than the irradiated male technique used for screwworm control, as only two or three early-season releases of males would be required rather than continuous release. Future development of transgenic males that would be useful in male-only sterile insect releases also shows some promise.

### Prediction of fly waves

Sporadic cases of body strike may occur in sheep at any time and cannot reasonably be prevented, but if the environmental circumstances conducive to high fly populations and high susceptibility of sheep are recognized fly 'waves' can be predicted and short-term prophylactic measures taken. Warm, showery weather extending over several weeks allows several generations to be completed and sufficient flies to be available to cause an outbreak of strike. Once sufficient flies are present, an outbreak of cutaneous myiasis may occur whenever the sheep become susceptible. Warm humid weather, rain over 2–3 days, or grazing in long wet grass, may provide suitable conditions for the sheep to become susceptible to body strike. Sheep with yellow fleece, i.e. high suint content, comprised of pointed, thin staples less tightly packed and with a low wax content, would be most susceptible. Measurement of simple fleece values has been suggested as a means of predicting the susceptibility of flocks to fleece rot and flystrike. Sheep with long fleeces are more susceptible and the time at which shearing is carried out may exert an influence on the frequency and severity of outbreaks.

Outbreaks of breech strike will occur if the sheep have diarrhea, or if ewes have urine splashing onto the breech area because the tails are too long. If an outbreak is predicted or has begun, 'crutching' and the prophylactic application of larvicides will reduce the severity of the infestation. 'Crutching' refers to clipping of the wool around the breech or crutch of the sheep to avoid it becoming

wet with urine and feces and providing a focus of attraction for flies. It is carried out routinely before lambing and immediately prior to a strike wave but provides protection for no more than 6 weeks. All the wool from above the tail, to the posterior aspect of the thighs and down to the hocks, must be removed. Because of the labor and loss of wool involved most sheep farmers depend on prophylactic dressing with a larvicide.

Predictive models incorporating climatic and production components have been developed in the UK. These are used to give producers warning of impending fly strike (see above)

### Treatment and prevention

Prophylactic treatment with a larvicide has been a major part of blow fly control for many years but the preparations used and the methods of their administration have undergone many important changes. The triazine, Vetrazin, gives 8–10 weeks of protection and can be applied by jetting, as a pour-on<sup>15</sup> or as an intraruminal slow-release bolus.<sup>16</sup> Triflubenuron, another insect growth regulator, also gives good protection.<sup>17</sup> Their action is specific to dipteran larvae. It should be noted that they are slow to kill as they affect the development of the subsequent life cycle stage. Diazinon, tetrachlorfenvinphos, propetamphos, fenthion ethyl, coumaphos, and other organophosphorus insecticides are widely used, but the period of protection gained by their use has markedly declined as the resistance to these compounds has increased. Further, the organophosphorus insecticides may be degraded by *Pseudomonas aeruginosa*. However, most fly waves are of short duration, and if the insecticide is applied thoroughly at the time an outbreak commences, these compounds may still give sufficient protection to minimize losses.

Three avermectins and the synthetic pyrethroids act as oviposition suppressants. Deltamethrin is more active than the avermectins but the avermectins also produce significant mortality in the adult flies. They can be applied to the fleece as pour-ons or by spray races to prevent egg-laying.

The methods of application include dipping, jetting, and tip spraying. Dipping has the advantage of thorough wetting but requires high equipment and labor costs. Jetting is still recommended for crutch strike and if the jetting piece is combed through the wool from the poll to the rump with the solution at high pressure (500–900 kPa), good control of body strike will also be achieved. Tip spraying, which is the deposition of a higher concentration of insecticide onto the tip of the fleece, is only of use with dieldrin or aldrin as it

relies on the ability of these compounds to diffuse down the wool fibers. The latter compounds are now banned in most countries. Tip spraying is not effective with organophosphates.

It is recommended that sheep should be treated early in the spring. This protects sheep against the early season strikes, many of which are covert, and prevents the build-up of fly populations in spring and early summer which leads to outbreaks.

### Reduction in susceptibility of sheep

The primary method for reduction of sheep susceptibility to fly strike is the Mules operation. This technique, originally developed to remove the wrinkled region of the breech has been modified to address concerns regarding animal welfare which must be balanced against the impact of fly strike. The technique is still recommended in the recently established codes of practice. Other good management practices are essential to prevention of fly strike. These include management of gastrointestinal nematodes to prevent scouring, tails cut to the correct length and a midseason crutching to reduce soiling that predisposes animals to strike. Pizzle strike will be reduced by the use of testosterone implants and by pizzle dropping (surgical separation of the preputial sheath from the belly) although this procedure may cause some difficulty at shearing unless the shearers are warned. Ringing (shearing of the pizzle area) will give 6–8 weeks protection. Fleece rot occurs most commonly on the withers of sheep, and the conformation that allows accumulation of moisture and the development of fleece rot and fly strike have been shown to be hereditary. Sheep with these faults should be culled. Although control is mainly a matter of management, in periods particularly suitable for fly strike the periodic application of an insecticide is still essential.

The modified Mules operation is best performed at marking (tailing and castration) as the lambs heal more quickly and suffer little, if any, setback in growth. Further, minimum death rates due to fly strike and maximum wool weights are obtained when sheep are mulesed as lambs. The technique has been developed extensively in Australia and is not described in detail here. In the hands of an experienced technician the time required to improve the perineal topography need be no longer than 1–2 minutes. The improvement is permanent and reduces crutch strike by 80–90%. Mulesing is accompanied by some pain, but current data unequivocally establish the positive health and welfare benefits conferred upon sheep in the Australian environment. The protection gained by mulesing

surpasses that afforded by breeding and is immediate and permanent.

The Mules operation is often supplemented by including a tail-strip operation in which a thin strip of woolled skin is removed from each side of the tail to above its butt. This results in a reduction of the amount of wool on the tail and less chance of fecal and urinary contamination. Since the introduction of elastic rings for castration and removal of the tail, a tendency has developed to remove the tail at the butt. This allows wool to grow in around the anus where it may become soiled and struck and, when combined with the Mules operation which slightly everts the vulva, has caused a dramatic increase in carcinomas of the mucocutaneous junction in the vulva. Tail stripping is important when tails are left at the longer recommended length, that is to the tip of the vulva. Docking so that the tail is of the correct length and so that a flap of ventral wool-less skin is left to seal over the stump is important. The latter can be effected by pushing the skin back with the back of the docking knife before severing the tail.

Removal of the wool and skin wrinkles from the breech of sheep by surgical means or by selective breeding reduces the susceptibility of sheep to crutch strike and when combined with:

Alternatives to mulesing are seen as highly desirable, but remain elusive. A breeding program aimed at the selection of plain-bodied animals suggests itself as a suitable control measure, but progress would be slow.

Vaccination of sheep with proteases and extracts of peritrophic matrix from the larvae causes retardation of larval growth and in some cases leads to larval mortality.<sup>18</sup> In practice it is difficult to envisage sufficient antibody being secreted through the skin to protect against the initial strike. However, it could reduce the number of third instars leaving the sheep and reduce subsequent fly numbers. Enhanced approaches utilizing recombinant proteins delivered cutaneously have shown additional promise.<sup>19</sup> Vaccination against *Ps. aeruginosa* to protect against fleece rot and the likelihood of body strike has given encouraging results.<sup>20</sup>

### REVIEW LITERATURE

Arundel JH, Sutherland AK. Ectoparasitic diseases of sheep cattle goats and horses, vol 10. Animal Health in Australia, Canberra: Australian Government Publishing Service, 1988.

### REFERENCES

1. Wall R et al. *Med Vet Entomol* 1992; 6:177.
2. Wardhaugh HG, Morton R. *Aust J Agric Res* 1990; 41:1155.
3. Watts JE et al. *Aust Vet J* 1981; 57:450.
4. Ward MP. *Prev Vet Med* 2001; 49:115.
5. Wall R et al. *Med Vet Entomol* 2002; 16:335.

6. Fenton A et al. *Med Vet Entomol* 1999; 13:453.
7. Casu RE et al. *Int J Parasitol* 1996; 26:623.
8. Young AR et al. *Int J Parasitol* 1996; 26:245.
9. Stevens J, Wall R. *Biochem Sys Ecol* 1997; 25:81.
10. Levot GW, Barchia I. *Aust Vet J* 1995; 72:245.
11. Thompson DR et al. *Aust Vet J* 1994; 71:42.
12. Dymock JJ, Forgie SA. *Aust J Exp Agric* 1995; 35:699.
13. Ward MP, Farrell R. *Prev Vet Med* 2003; 59:21.
14. Foster GG et al. *Aust J Biol Res* 1985; 38: 275.
15. Lonsdale B et al. *Vet Rec* 1990; 126:207.
16. Anderson N et al. *Res Vet Sci* 1989; 46:131.
17. Hughes PB, Levot GW. *Vet Parasitol* 1987; 24:275.
18. East IJ, Eisemann CH. *Immunol Cell Biol* 1993; 71:453.
19. Colditz IG et al. *Vet Parasitol* 2002; 104:345.
20. Burrell DH. *Aust Vet J* 1985; 62:55.

## SCREWORM (*COCHLIOMYIA HOMINIVORAX* AND *CHRYSOMYIA BEZZIANA*)

Cutaneous myiasis associated with the screwworm maggots has been a cause of great financial loss in livestock in the western hemisphere, Africa, and Asia. Deaths may be heavy in groups of livestock which are at range and seen infrequently.

### Synopsis

**Etiology** *Cochliomyia hominivorax* in the New World (New World Screwworm) and *Chrysomya bezziana* (Old World Screwworm) in Africa and Asia.

**Epidemiology** Eggs laid in fresh wounds. Flies most active at 20–30°C. Disease spread by dispersal of flies or transport of infested animals.

**Clinical signs** Larvae invade the tissue producing characteristic large lesions containing mature larvae and foul smelling brown exudate.

**Clinical pathology** Not applicable.

**Lesions** Deep wound containing foul smelling brown material and third instars.

**Diagnostic confirmation** Rows of spines are present on the anterior part of each segment of the third instar.

**Differential diagnosis** No other disease causes such lesions.

**Treatment** Ivermectin 0.2 mg/kg subcutaneously kills many larvae and provides protection for 16–20 days. Other insecticides used as gels or ointments twice weekly are also effective. Doramectin subcutaneously.

**Control** Eradication has been achieved in North and Central America by the mass release of sterile males. Chemical attractant baits will reduce the prevalence of flies and strikes. Breeding and management procedures such as castration and shearing should be carried out in the cold weather.

### ETIOLOGY

Larvae of the flies *Cochliomyia hominivorax* and *Chrysomya bezziana* cause myiasis or 'screwworm disease' of animals. The flies are typical blow flies, *C. hominivorax* (New World Screwworm) being blue-

green with an orange head; *Ch. bezziana* (Old World Screwworm) is of similar coloring. *C. hominivorax* occurs in the Americas, *Ch. bezziana* in the Persian Gulf, Africa, and Asia. The occurrence of *Ch. bezziana* in Papua New Guinea provides a constant threat to livestock on the Australian mainland. A similar fly is *Callitroga (Cochliomyia) macellaria* which is not a true 'screw-fly' in that the larvae feed only on carrion or necrotic tissues.

### EPIDEMIOLOGY

The screwworm maggots are obligatory parasites with no host-specificity. Thus, all domestic and wild, mammals, marsupials, and birds are potential hosts. Females are attracted to fresh wounds where they will oviposit. The navel of a newborn animal is a favored site, but fresh accidental or surgical wounds, such as those produced by castration, docking, and dehorning, are readily infested. Wounds which have already been infested are markedly attractive to the flies because of their odor. In bad seasons the flies will lay eggs on minor wounds such as areas of excoriation, tick bites, running eyes, peeling brands, and on the perineum soiled by vaginal and uterine discharges in animals which have recently given birth. Injury is not necessarily a prerequisite for screwworm strike in sheep, which can be struck in the intact infraorbital fossa and vulva. Wool loss and tenderness may occur and the remaining fleece may be stained.

The development of the fly is favored by hot, humid weather. The optimum temperature range for *C. bezziana* is 20–30°C (68–86°F). Below this the flies become sluggish and at 10°C (50°F) and below the flies will not move. Temperatures above 30°C (86°F) can be tolerated provided shade is available. *C. hominivorax* is active all year in areas where temperatures exceed 16°C and disperses rapidly from these areas as the temperature increases in the neighboring colder areas. The disease can be spread either by migration of flies or their carriage in livestock ships or commercial aircraft,<sup>1</sup> by shipment of infested cattle or other livestock, and by movement of affected wildlife. The mean distance that *C. bezziana* can travel and deposit eggs is 11 km. The maximum distance is 100 km, but long distances are probably wind assisted. In the new environment the flies may die out if the climate is unsuitable or persist to set up a new enzootic area. Persistence of the fly in an area may depend upon persistence in wildlife or in neglected domestic animals, although the latter do not usually survive unattended for more than about 2 weeks.

In many enzootic areas it is common for the fly to persist in neighboring warmer areas during winter, returning to its

normal summer habitat as the temperature rises. This pattern is exemplified by the introduction of screwworms into the southeastern United States in 1933 where they had not previously occurred. The flies died out in most areas in winter but persisted in southern Florida. In succeeding summers migrations of flies northwards caused outbreaks. The disease has since been eradicated from the area.

The disease is of importance in tropical and subtropical areas of Africa, Asia, North and South America, especially Central America, the Caribbean islands, Mexico, and American states bordering on Mexico. The prevalence of the fly in enzootic areas places severe restriction on the times when prophylactic surgical operations can be carried out.

The potential worldwide geographical distribution and abundance of *Ch. bezziana* has been assessed using a computer program. The differences in the observed global distribution and the potential predicted distribution indicate the areas at risk of colonization.<sup>2</sup>

### LIFE CYCLE

The screwworm flies have a typical fly lifecycle with eggs, three larval instars, and a pupal stage. Females lay 150–500 white eggs in shingle-like clusters at the edges of fresh wounds. Larvae hatch in about 12 hours and penetrate the tissues surrounding the wound. The larvae preferentially feed on fresh, living tissue which is digested by regurgitation of a wide variety of salivary enzymes. Oviposition by other screwworm flies is encouraged by the presence of larvae already in the wound. The larvae feed as a group and at their time of maturation will have created a deep lesion 10–12 cm in diameter. Larval development is complete in 5–7 days, after which they leave the wound and fall to the ground. These mature third instars burrow into the upper soil layers and pupate. On the ground, pupal development is highly temperature dependent requiring from 3–60 days. Emerging flies commence egg-laying in about 1 week, having completed the life cycle, under optimum environmental conditions, in less than 3 weeks. There may be 15 or more generations per year.

The temperature sensitivity of the pupal stage, which is unable to survive freezing for more than short periods, limits the distribution of this parasite. As with all flies pupal development is highly temperature regulated. The screwworm pupal development is inhibited at soil temperatures below 15°C (60°F). Temperatures below this point for more than 2 months cause death of the pupa. Thus the occurrence of the disease is limited to warm climates.

Pupae are also affected by the moisture content of the soil. The emergence of adults is reduced when the moisture content is more than 50%, while temporary floods can drown pupae.

### PATHOGENESIS

Following invasion of the wound a cavernous lesion is formed, characterized by progressive liquefaction, necrosis and hemorrhage. Anemia and decreased total serum protein results from hemorrhage into the wound. Secondary bacterial infection, toxemia, and fluid loss contribute to the death of the animal. Surviving calves frequently develop infectious polyarthritis.

### CLINICAL FINDINGS

The young larvae invade the nearby healthy tissues vigorously and do not feed on necrotic superficial tissue. A profuse brownish exudate, composed of larval excreta, and host fluids, pours from the wound and an objectionable odor is apparent. This is highly attractive to other flies and multiple infestations of a single wound may occur within a few days. The resulting tissue damage may be so extensive that the animal is virtually eaten alive. Affected animals show irritation in the early phase of the infestation and by day 3 show pyrexia. Animals do not feed but wander about restlessly, seeking shade and shelter.

### CLINICAL PATHOLOGY

It is imperative to differentiate screwworm infestation from infestation with other fly larvae. The appearance and smell of the wound are significant but careful examination of the larvae is necessary to confirm the diagnosis. Mature larvae are 1–2 cm long and pink in color; they are pointed anteriorly and blunt posteriorly; two dark lines are visible reaching from the blunt posterior to the middle of the body and they have rows of dark fine spines on the anterior part of each segment. Specimens forwarded to a laboratory for identification should be preserved in 70% alcohol.

### NECROPSY FINDINGS

Superficial examination of infested wounds is usually sufficient to indicate the cause of death.

### DIFFERENTIAL DIAGNOSIS

The presence of maggots in the wound is usually apparent. It is important to differentiate them from blow fly larvae as described above.

### TREATMENT

Affected wounds should be treated with a dressing containing an efficient larvicide and preferably an antiseptic. The larvicide should be capable of persisting in the wound for some time to prevent



reinfestation. A number of proprietary preparations and some of the newer insecticides have been compared.<sup>3</sup> Lindane 3% and coumaphos 3% were the most effective but fenclorophos 2.5%, diazinon 1.5%, chlorfenvinphos 0.05% and fenthion-methyl 0.2% were also very efficient. Stirofos (15%) and dichlorvos (20%) give season-long protection in the ears of cattle against *C. hominivorax* and *Amblyomma maculatum*.<sup>4</sup> An ointment or gel base is preferred so that as much of the active ingredient as possible is left in the site. It should be liberally and vigorously applied with a paint brush to insure that larvae in the depths of the wound are destroyed. To avoid reinfestation in extensive lesions or in bad seasons the treatment should be repeated twice weekly.

When large numbers of animals are affected and individual treatment is impractical, spraying with a 0.25% solution of coumaphos, chlorfenvinphos, or fenclorophos, using a power sprayer, is recommended. The spray is directed forcibly into wounds and, except for young calves, applied generally over the body to provide protection for about 2 weeks. Young calves may show signs of toxicity if sprayed too liberally and application should be restricted to the belly. These sprays can be used to protect animals which are not infested but are exposed to considerable risk or are to be shipped to free areas. In the latter situation dusts are also available if spraying is undesirable in cold weather. A pyrophyllite dust containing 5% coumaphos and 2% mineral oil is effective as a protectant if applied at the rate of 60–180 g per animal. Residual protection lasts for 3–7 days.

Thirteen acaricides, commonly used for *Boophilus microplus* control, have been tested against *Ch. bezziana* larvae. While they are not sufficiently active to use as a primary treatment, their continued use for tick control would reduce screwworm populations.

Ivermectin 200 mg/kg given subcutaneously kills all *Ch. bezziana* larvae up to 2 days old and many older larvae. It provides residual protection for 16–20 days. Bull calves treated with ivermectin at the time of castration were completely protected against strike.<sup>5</sup> A preliminary study showed that closantel at 15 mg/kg body weight was effective with a residual protection of 8–15 days.<sup>6</sup> Doramectin 200 mg/kg subcutaneously caused complete expulsion of *C. hominivorax* larvae within 8 days.<sup>7</sup> Prophylactic use of ivermectin and doramectin significantly reduced occurrence of screwworm strike in cattle.<sup>8</sup> Fipronil had a prophylactic effect, reducing occurrence of screwworm infestations in cattle and providing

efficacious treatment in those that did become infested.<sup>9</sup>

## CONTROL

The eradication of screwworm by genetic means, chemical control, trapping techniques and lures, and dispersal of flies has been reviewed.<sup>10</sup> In an enzootic area the incidence of the disease can be kept at a low level by the general institution of measures designed to break the life cycle of the fly. Surgical procedures should be postponed where possible until cold weather. In the warm months all wounds including shearing cuts must be immediately dressed with one of the preparations described under **TREATMENT**. All range animals should be inspected twice weekly and affected animals treated promptly. Infestation of fresh navels is common and newborn animals should be treated prophylactically. If possible the breeding program should be arranged so that parturition occurs in the cool months. The routine use of ivermectin for internal parasite control provides protection for about 2 weeks.<sup>5</sup>

In the United States, the Caribbean, and central America an eradication program has been successfully carried out against *C. hominivorax* using the sterile insect technique (SIT). Huge numbers of pupae are mass reared on semi-artificial media and exposed to the sterilizing effects of cobalt 60. The resulting sterile male flies are released over large areas, primarily by aerially drops, where they compete with wild males for available females which mate only once. *C. hominivorax* has now been eliminated from the United States, the Caribbean, and all of Central America, up to the Darien Gap in Panama.<sup>11</sup> *C. hominivorax* appeared in Libya in 1988, apparently with a load of sheep transported from South America, but has been eradicated using sterile male flies from the USA.<sup>12</sup>

Attractants may also be used to reduce the fly population. A chemical bait has been developed, and when combined with an insecticide forms a screwworm adult suppression system (SWASS) which reduces the fly population and the incidence of strikes. An examination of the efficacy of various methods of baiting showed that polythene sachets containing swarm-lure 2, a pungent mixture of 11 chemicals, attracted flies (not *C. bezziana*) for at least 2 weeks and was as efficient as jar baits.<sup>13</sup> This result needs confirming in a screwworm endemic country.

## REFERENCES

1. Rajapaksa N, Spradbery JP. Aust Vet J 1989; 66:94.
2. Sutherst RW et al. Med Vet Entomol 1989; 3:273.
3. Spradbery JP et al. Aust Vet J 1991; 68:338.
4. Gladney WJ. J Econ Entomol 1976; 69:757.
5. Spradbery JP et al. Aust Vet J 1985; 62:311.

6. Spradbery JP, Owen I. Aust Vet J 1990; 67:340.
7. Soerensen B et al. Unimax-Ciencias 1994; 3:19.
8. Benitez-Usher C et al. Vet Parasitol 1997; 72:217.
9. Lima WS et al. Vet Parasitol 2004; 125:373.
10. Spradbery JP, Evans K. Agric Zool Rev 1994; 6:1.
11. Chaudhury MF. Vet Parasitol 2004; 125:99.
12. Reichard RE et al. World Health Forum 1992; 13:130.
13. Berky AG von, Mayer RJ. Aust Vet J 1993; 70:230.

## WOHLFAHRTIOSIS (FLESH FLY)

Cutaneous infestation by larvae of the sarcophagid fly, *Wohlfahrtia magnifica*, has become a major disease of domestic livestock, including birds managed extensively (e.g. geese) in the Mediterranean basin, eastern Europe, and western regions of China.<sup>1</sup> The disease is particularly significant for sheep in these regions where it is more prevalent than strike by the calliphorid fly, *Lucilia sericata*.

Other species of this genus are known from North America, but they do not infest domestic species. They are predominantly reported from very young rodents and birds, although there are occasional reports from infants.<sup>2</sup> Mortality of infested hosts tends to be very high.

## LIFE CYCLE AND EPIDEMIOLOGY

Larvae of this species are obligatory parasites developing only in the living flesh of warm-blooded vertebrates. They are not host specific. Adults are typical for this group of flies, being dark gray in color with three distinct black stripes on the thorax where the wings are attached.

Female flesh flies, which are active during the warm parts of the day, deposit first instar larvae on the host, usually in small groups of 15–20. Each female may produce up to 170 larvae. Completion of the three larval stages takes from 5 to 7 days after which the mature third instars leave the lesion and fall to the ground where they pupate. Development of the fly within the pupa is regulated by temperature and may require between 7 and 21 days.

Larvae are usually deposited near small wounds (bites of blood-feeding arthropods are sufficient to attract the larvae), but the favored sites appear to be the genitalia.<sup>3</sup> Irritation of the vulva associated with the use of vaginal sponges for estrus synchronization may be a predisposing factor in sheep.

Flies are active between April and October with several generations being produced. Little information is available on overwintering. Wildlife are suspected as being reservoir hosts, but little information is available on which are the most important.

## PATHOGENESIS

Larvae have well developed mouthhooks which are used to abrade the skin surface and with the aid of a wide variety of salivary enzymes they quickly produce

a dramatic lesion. Lesions increase in size as the larvae grow and require additional fresh tissue. Each animal may have one or more focal lesions, each packed with larvae. In severe cases several lesions may coalesce into one larger site.

Animals are often struck multiple times during a season, suggesting the absence of protective immunity. This adds to the impact of this disease as animals must be constantly monitored.

### CLINICAL PATHOLOGY AND NECROPSY FINDINGS

A clinical examination is all that is necessary to make the diagnosis. Larvae can be distinguished from those of the screwworm or the strike flies by the presence of a large posterior cavity surrounded by a number of prominent tubercles. However, specific identification should be done by a specialist. Larvae should be preserved in 70% ethanol.

Affected animals are clearly stressed, showing restlessness and anorexia.<sup>3</sup> Lesions formed at the vulva or prepuce are the most significant causing great discomfort and dysfunction. Lightly infested animals shown no impairment of productivity.<sup>3</sup> Infested animals develop strong antibody responses to salivary secretions, particularly of the third instars.<sup>4</sup>

### TREATMENT

There are currently no products specifically registered for management of this disease. Evaluations of several drugs and treatment approaches have been made. Of particular interest is the equivocal results of trials with macrocyclic lactones. In sheep, ivermectin and moxidectin had no effect on existing infestations and no prophylactic effect<sup>5</sup> or only short protection against early instars.<sup>6</sup> In contrast, doramectin provided complete prophylactic protection for 21 days and significant reductions for 40 days.<sup>7</sup> The pyrethroid, cypermethrin, was less effective.<sup>7</sup>

The insect growth regulator dicyclanil has also been evaluated and shown to reduce prevalence of infestation in sheep.<sup>3</sup> The reduction not only occurred in treated animals, but was seen in untreated herd mates possibly as a result of the overall reduction in fly numbers.

### REFERENCES

1. Colebrook E, Wall R. *Vet Parasitol* 2004; 120:251.
2. Colwell DD, O'Connor M. *J Med Ent* 2000; 37:854.
3. Sotiraki S et al. *Vet Parasitol* 2005; 131:107.
4. Farkas R et al. *Vet Parasitol* 1997; 69:133.
5. Farkas R et al. *Parasitol Res* 1996; 82:82.
6. Ruiz-Martinez J. *Res Rev Parasitol* 1995; 55:185.
7. Sotiraki S et al. *Vet Parasitol* 2003; 116:327.

## Ked and louse infestations

Infestations with these insects cause irritation resulting in skin or wool damage. Blood loss may occur with some species.

## SHEEP KED (*MELOPHAGUS OVINUS*)

This flat brown wingless fly, about 6–7 mm in length, was found in sheep throughout the world, but is now rarely reported in many countries. For example it wasn't mentioned in a review of livestock ectoparasites of Europe and the Mediterranean,<sup>1</sup> although anecdotal evidence suggests it may be present in isolated pockets associated with organic production.<sup>2</sup> In Australia it is now rarely seen. The ked may transmit *Trypanosoma melophagium* and *Rickettsia melophagi*, harmless blood parasites of the sheep. Staining of the wool by the feces of the ked reduces its value and gives it a peculiar musty odor. Heavy infestations cause skin blemishes which are costly to the leather industry. Sheep in poor condition suffer most from infestations. Goats may also be infested.

### LIFE CYCLE

Keds live their entire life cycle on the host. Adults of both sexes are blood feeders and although the degrees of infestation usually encountered cause only irritation with resulting scratching, biting, and damage to the fleece, very heavy infestations may cause severe anemia. Spread is generally the result of direct contact between hosts. A recent review<sup>2</sup> suggests this exchange is primarily between dams and their offspring and that it is predominantly the newly emerged adults that migrate to new hosts. Larvae develop within the female one at a time and are deposited on the host as mature third instars which pupate within a few hours. The female ked lives for 4–5 months and may lay up to 10–15 larvae, so build-up of infection is slow. The larvae are attached to the wool fiber some distance above the skin and many larvae and pupae are removed at shearing. The young ked usually emerges in 20–22 days but this period may be prolonged for up to 35 days in winter. The complete life cycle takes 5–6 weeks under optimal conditions. Heavy infestations usually occur in winter months and they decline in the summer. The parasite is mainly seen in colder, wetter areas and infestations may be lost when sheep are moved to hot dry districts. Resistance is acquired in time and resistant sheep grow better and produce more wool.

A seasonal pattern of infestation occurs. Keds are sensitive to hot, dry weather and numbers decrease markedly over the summer. Populations increase slowly over the autumn and winter. While keds that have been dislodged from the host can live for up to 2 weeks if in mild moist conditions, most die in 3–4 days and probably do not play a part in reinfesting sheep.

### CONTROL

At shearing a large proportion of adults and pupae will be removed. This can provide effective control on adult sheep particularly where a combination of hot conditions and a short fleece will kill most of the remaining keds. However, some may remain alive in protected places such as the ventral neck and breech regions and on younger stock. If treatment is carried out within the next 2–4 weeks eradication will be achieved as long as all sheep are included and the insecticide used has a residual protection longer than the time taken for the last pupae to hatch.

Keds are particularly susceptible to organophosphates and most of those used to eliminate lice will also remove keds. They can also be used in higher dose rates in pour-on applications. Diazinon used as a pour-on removed all keds and prevented re-establishment for 9 weeks.<sup>3</sup> The synthetic pyrethroids are also active against keds; deltamethrin, cyhalothrin and cypermethrin are used. Cyfluthrin 2 mg/kg pour-on in sheep also eradicates ked and protects for 50 days. Amitraz will kill adult keds but has little residual action and is therefore usually combined with another compound to provide sufficient residual action to eliminate infections. Ivermectin given at the standard anthelmintic dose will also eliminate keds. Closantel which is mainly used against *Haemonchus* or *Fasciola* is effective against keds.

### REFERENCES

1. Colebrook E, Wall R. *Vet Parasitol* 2004; 120:251.
2. Small RW. *Vet Parasitol* 2005; 130:141.
3. Heath ACG, Bishop DM. *NZ Vet J* 1988; 31:9.

## LOUSE INFESTATIONS (PEDICULOSIS)

Lice infestations are common throughout the world. The species are host-specific and are divided into biting and sucking lice.

### Synopsis

- Etiology** Species-specific sucking and chewing lice affecting all animals.
- Epidemiology** Transmission from host to host. Lice show a marked seasonal periodicity rising from low numbers after summer to a peak in the following late spring. Foot lice infested from pasture.
- Clinical signs** Irritation which causes rubbing, damage to the fleece or skin, and loss of milk production. Some species cause anemia. Foot lice cause stamping.
- Clinical pathology** Hair loss may result from hypersensitivity.
- Lesions** Skin lesions due to rubbing, fleeces have tufts protruding and lose their brightness.
- Diagnostic confirmation** Lice can be seen on careful inspection. Preferred site varies with host and species of louse.

**Differential diagnosis** In sheep must be differentiated from *Psorergates*, ked and *Psoroptes* infections. In other animals separate from allergic dermatitis.

**Treatment** Organophosphates, synthetic pyrethroids and macrocyclic lactones.

**Control** Pour-on and injectable treatments control lice on cattle, horses, sheep, and pigs. Good husbandry practices, will reduce infestations. Plunge or shower dips used on sheep, all sheep should be treated and sheep must be thoroughly wetted. Treatment should follow shearing which removes many lice; sheep in short wool are also easier to wet.

## ETIOLOGY

The important species are:

### • Cattle:

Sucking lice – *Linognathus vituli* (long-nosed sucking louse), *Solenopotes capillatus* (small blue sucking louse), *Haematopinus eurysternus* (short-nosed sucking louse), *H. quadripertusus* (tail louse), *H. tuberculatus* (buffalo louse)  
Chewing lice – *Damalinia (=Bovicola) bovis*

### • Sheep:

Sucking lice – *Linognathus ovillus* (sucking face louse), *L. africanus*, *L. stenopsis* (sucking goat louse), *L. pedalis* (sucking foot louse)  
Chewing lice – *Damalinia ovis*

### • Goats:

Sucking lice – *Linognathus stenopsis* (sucking blue louse), *L. africanus*  
Chewing lice – *Damalinia caprae*, *D. limbata*, *D. crassiceps*

### • Pigs:

Sucking lice – *Haematopinus suis*

### • Horses:

Sucking lice – *Haematopinus asini*  
Chewing lice – *Damalinia equi*

## LIFE CYCLE AND EPIDEMIOLOGY

### Sucking lice

All life cycle stages are found on the host. Both sexes are obligate blood feeders, taking small meals from capillaries in the upper skin. Survival off the host is limited although some species, such as the foot lice of sheep, may survive away from the host for up to 2 weeks. Females lay 2–6 eggs per day which are attached to individual hair shafts. Eggs complete embryonation and hatch within 8–11 days of deposition. Lice have three nymphal stages, which bear a morphological similarity to the sexually mature adult stage. Each nymphal stage will take 2–4 days to complete. Louse development rate, at all stages, is highly temperature dependent and requires a narrow temperature range. Temperatures above 41°C and 46°C are lethal for eggs and adults, respectively, of *Linognathus vituli*. Optimal

development takes place between 33°C and 37°C. Lice therefore show a seasonal periodicity with very low numbers in the summer when conditions are hot. Populations begin to increase with cooler fall temperatures, reaching maximum levels in late winter.

### Chewing lice

All life cycle stages are found on the host. Lice feed on dead skin cells, hair, and oil secretions which they abrade from the surface using their chewing mouthparts. There may be some abrasion of the upper skin layers and there has been demonstration that sheep develop antibodies to salivary sections of *Damalinia (=Bovicola) bovis*.<sup>1</sup> Sex ratios are highly female biased and there are suggestions that parthenogenesis occurs in some species. Females deposit <1 egg per day. Embryonation is completed in 7–10 days producing nymphs which molt three times before reaching sexual maturity. As with the sucking lice development is highly regulated by temperature with a narrow range for optimal development and survival. Chewing lice can survive off the host for up to 2 weeks

Transmission of both types of lice occurs by direct contact but inert objects such as blankets, grooming tools and harness may remain infective for several days.<sup>2</sup> Sheep may become infested with foot lice from the pasture. Young pigs may become infected some 10 hours after birth. Newborn calves also rapidly acquire infestations from their dams.

## CLINICAL FINDINGS AND DIAGNOSIS

### Sucking lice

All species cause irritation of the skin and stimulate scratching, rubbing and licking leading to restlessness, damage to hair coat or fleece and hides and loss of milk production. These behavioral changes<sup>3</sup> result in reduced efficiency, particularly in feedlot cattle.

Lice appear to be present on a large proportion of cattle,<sup>4,5</sup> but measurement of their impact on productivity has produced equivocal results. It is often believed that infestation has little or no effect on weight gains and hematological values.<sup>6,7</sup> However, there appears to be a synergistic effect between louse infestations and the presence of gastrointestinal nematodes that does have an impact on weight gain.<sup>8</sup> Anemia is rare but has been described for heavy infestations of *H. eurysternus*. Treatment, however, may be warranted to reduce the damage to hides and prevent damage to fences and other fixtures. Hairballs may be present in infested calves due to continual licking.

The pig louse spreads swinepox and while weight loss may not occur, even with heavy burdens, some pigs develop an

allergic dermatitis and the consequent rubbing leads to skin lesions.

Foot lice of sheep are believed to live on blood. Light infestations may not cause clinical signs, but moderate to severe infestations cause stamping and biting the affected parts. Lice cause goats to rub or to bite their coat, which becomes matted and damaged. Angora goats can damage the hair shaft and lose their coats. Signs of infestation are restlessness, hair loss, and decreased milk production. In horses *H. asini* is the more serious species as it removes blood and may cause some anemia.

### Chewing lice

Sheep body lice cause irritation and rubbing. The wool loses its brightness, becomes cotted and more yellow. There is evidence that a pelt defect called cackle is associated with infestation with body lice.<sup>9</sup> The quantity and quality of the fleece is reduced and losses up to AUS\$3.20 per infested sheep have been measured.

Chewing lice on cattle also cause an increase in rubbing and licking which contributes to reduction of efficiency and damage to facilities. Hair loss has been attributed to this infestation, but it is a controversial association as many other causes are likely.

Diagnosis of lice on cattle and horses requires close visual inspection with particular attention being paid to known predilection sites.<sup>10</sup> These include the head, the sides of the neck, the dewlap, the escutcheon, and tail switch. Effective diagnosis requires that hair be parted and skin examined at several locations at each of the predilection sites. Use of a supplementary light source and restraint of the animal is very helpful.

Chewing lice of cattle, sheep, and horses are recognized by their rounded head and light brown color. These lice are highly mobile and will move away from inspection sites. Their eggs are difficult to see unless on dark haired cattle or horses. Sucking lice are recognized by their gray or blue-gray color and their pointed head. They tend to remain fixed to the skin.

Chewing lice may congregate on the dorsal surface and flanks, while sucking lice are found on the head and in the long hair of the mane and tail but, in heavy winter infestations, lice may be found on any part of the body. In sheep with long wool, greatest numbers of *D. ovis* may be seen on the midside, particularly the shoulders, from where they spread to the back and rump. After shearing, small residual infestations may be found on the ventral neck. Foot lice are usually found in clusters on those parts covered with hair, mainly on the lower limbs, but in heavy infestations they can be found in clusters

above the hock, on the scrotum, in the belly wool, and more rarely on the face.

### TREATMENT AND CONTROL

Self-grooming and grooming by headmates effectively regulates louse populations on most hosts, but the effectiveness is limited when hair coat or fleece become too long for the tongue surface to effectively remove the lice and eggs. Similarly, shearing is an important factor in reducing body lice populations on sheep. Between 30 and 50% of the population is removed with the fleece and those remaining are subjected to a more variable microclimate. Populations are at their lowest 30–60 days after shearing. Reversing temperature gradients as sheep move in and out of shade, and very wet conditions, will also reduce lice numbers.

Body lice of sheep are relatively easy to eradicate if a clean muster is achieved, if the sheep are thoroughly treated and reinfestation is avoided. However, in practice, failure to eradicate commonly occurs due to the inability to thoroughly wet the fleece because of poor maintenance of dips or poor formulation of products, or because the lice are resistant to the chemical used. The most difficult problem when attempting to eradicate lice from flocks over a large area is the diagnosis of lice in lightly infested flocks. Dipping clean sheep is wasteful but if lightly infested flocks are not dipped the infestation will build up and may cause serious economic loss in the next year. Techniques have been devised to test for lice by digesting the wool and examining the residue for lice, but the delays inherent in such a system often mean that by the time the farmer obtains the results, the optimum time to treat sheep has passed. On-farm tests have been examined but none are yet sufficiently accurate.<sup>11</sup>

Affected sheep can be effectively treated in a plunge or shower dip with organophosphate insecticides (diazinon, coumaphos, chlorfenvinphos, carbophenothion, propetamphos), synthetic pyrethroids, or carbamates. The synthetic pyrethroids, cypermethrin and cyhalothrin, have been shown to be effective in sheep and give good residual protection. Products formulated as emulsifiable concentrates wet the fleece better and give better results than wettable powders.<sup>12</sup> Cypermethrin, alphamethrin, and deltamethrin are marketed as pour-ons for sheep and goats. They must be used immediately after shearing. A small proportion of sheep show irritation after application and some may show fleece damage. Further, most of the chemical that is applied remains in the tip of the fleece and grows out with the wool and so is not in contact with the lice.<sup>13</sup>

The spread of synthetic pyrethroid following backline treatment of sheep

is slower than in cattle and horses and takes some days to reach maximum concentrations along the midside. However, the ease of application, low capital outlay required, and the need for only one muster has led to rapid acceptance of backline treatments. It is important that the pour-on is applied along the spine from the poll to the tail. Failures to eradicate occur if the sheep are not cleanly shorn, and in large-bodied sheep with extensive neck folds which are difficult to shear cleanly. The presence of unshorn lambs, cotted or *Dermatophilus*-affected fleeces, wrinkly sheep or inexperienced shearers make backline pour-on application an inappropriate method. Heavy rain following application may also cause failure. Some lice remain alive for up to 6 weeks after backline treatment and so sheep are infective for this time. Jetting races have been used to treat sheep because of their ease of use and the speed with which sheep can be treated. However none of the machines marketed in Australia is able to eradicate lice even from sheep with short wool.<sup>14</sup>

The manufacturer's recommendations should be accurately followed, particularly when using shower dippers. The most common cause of failure when using shower dippers is poor maintenance of the pump so that insufficient volume of dip wash is applied from the overhead sprays. Blocked jets, incorrect speed of rotation of the top spray and leaving sheep in the shower for insufficient time are also common faults.

Infested long-woolled sheep can be jetted to reduce the population until the sheep can be shorn and dipped. Treatment of sheep in long wool leads to residue problems in the wool presented for sale. Every effort should be made to treat sheep properly in the first 2 weeks after shearing to insure eradication of lice and to prevent wool without insecticidal residues. Cyhalothrin has been shown to eradicate body lice from long-woolled sheep when applied by jetting at 20 ppm, but in field use eradication is rarely achieved. Phoxim 125 mg/L has also been reported to eliminate lice in long-woolled sheep, while 250 mg/L gave at least 4 months of protection against reinfestation. An ivermectin 0.03% jetting fluid was reported to have high efficacy in treating lice in sheep with 3–9 months wool, but failed to eradicate. High concentrations of cyhalothrin (1500 ppm) and diazinon (36 000 ppm) in 100 mL applied to sheep has also proved effective but requires a practical method of application. No treatment is known that can eradicate lice from long-woolled sheep under field conditions. Following treatment of foot lice, sheep should be moved to a paddock that has been free of sheep for a month.

Treatment of goats has not been studied extensively and the treatments used on sheep and cattle are thought to be effective in goats. Lactating goats should not be treated.

Organophosphates (e.g. fenthion, famphur, chlorpyrifos, temephos, methidathion, fenclorophos, phosmet) and pyrethroids (e.g. deltamethrin and flumethrin) have been used in pour-on application on cattle.<sup>12,13</sup> While pour-on applications are easy to use, none will kill all lice; they are expensive compared with sprays if large numbers are to be treated, and in many countries they should not be used on lactating cows. Similarly, organophosphates (diazinon, coumaphos, ethion) and pyrethroids (cypermethrin) or combinations (bromophos-ethyl combined with chlorfenvinphos) are used as sprays or dippers for cattle. Macrocytic lactone based products (ivermectin, moxidectin, doramectin and eprinomectin) are available as pour-on or injectable formulations for cattle and have shown excellent efficacy against both sucking and chewing lice. Persistence of activity is one of the exceptional benefits of these products.<sup>14,15</sup>

Fenthion 2% has been widely used on horses in Australia with good results although coat color changes and, rarely, hair loss does occur. A single subcutaneous injection of 0.2 mg/kg ivermectin will remove sucking lice but is not completely effective against chewing lice. Moxidectin, a compound with ivermectin-like activity, performs similarly.<sup>12</sup> Treatment of horses with a shampoo containing 1% selenium sulfide three times at 10 day intervals eradicated lice; most horses showed a marked improvement after treatment.<sup>13</sup>

Sheep lice have been shown to quickly develop insecticide resistance and strains of *D. ovis* which are resistant to the chlorinated hydrocarbon insecticides are common in the United Kingdom, while strains of lice resistant to the synthetic pyrethroids have followed inappropriate backline use of these compounds.<sup>14</sup> Resistance management strategies that involve rotational use of the various insecticide/parasiticide active ingredient categories should be adopted wherever practical. For example, if pyrethroid-resistant lice are present an organophosphate or macrocytic based product should be used. Subsequent treatments should involve another change of compound class.

Treatments should be timed to coincide with the beginning of population growth (i.e. autumn or early winter). Extremely early treatments often result in spring outbreaks that result from very small residual populations on a few animals. When products with short residual activity

are used (e.g. organophosphates) two treatments separated by 10–14 days are required. The second treatment will kill any newly hatched nymphs. Products with persistent activity in excess of 21 days (e.g. macrocyclic lactones) do not require a second application.

Effective management of lice in a herd requires that new animals be isolated for a period of time sufficient for all lice to be eliminated by treatment. The introduction of one or two lousy sheep to a flock, such as occurs when stray infested sheep enter a clean mob, leads to a slow build-up of infestation.

**REFERENCES**

1. James PJ, Moon Int J Parasitol 1998; 28:419.
2. Crawford S et al. Vet Parasitol 2001; 94:205.
3. Weeks et al. 1995; Vet Rec 137:33.
4. Colwell et al. Can Vet J 2001;
5. Milnes, Green. Vet Rec 1999; 145:357.
6. Bailey PJ et al. Aust J Exp Agric Anim Husb 1984; 24:140.
7. Nelson WA. Exp Parasitol 1970; 28:263.
8. Devaney et al. 1992; J Econ Entomol 85 144.
9. Heath ACG et al. Vet Parasitol 1995; 59:53.
10. Watson et al. Vet Parasitol 1997; 69:283.
11. Morcombe PW et al. Aust Vet J 1996; 73:170.
12. Johnson PW et al. Int J Parasitol 1995; 25:1457.
13. Wilkinson FC. Aust Adv Vet Sci 1986; VOL?:130.
14. Clymer B et al. Vet Rec 1998; 143:193.
15. Colwell DD. Vet Parasitol 2002;104:319.

**Tick infestations**

**Synopsis:**

**Etiology** Many species of ticks act as vectors of disease or cause death from anemia; others cause paralysis. Heavy burdens cause loss of production.

**Epidemiology** Life cycles vary widely both in the number of hosts required and the host specificity. Animals are infested by larval or nymphal states on the ground.

**Clinical signs** Anemia, paralysis, tick fever, and tick worry.

**Clinical pathology** Ticks obvious on clinical examination. Blood smears for tick fevers (*Babesia*, *Theileria*, and *Anaplasma*).

**Lesions** Skin damage due to biting and rubbing, anemia. See other chapters for lesions due to diseases transmitted by ticks.

**Diagnostic confirmation** Ticks easily found, should be identified to species.

**Treatment** Dipping, pour-ons and injectable acaricides.

**Control** Regular treatment at intervals dependent on the life-cycle of the tick, pasture spelling to destroy free-living stages, the use of resistant cattle and vaccination all play a part.

Tick infestations are of great importance in the production of animal diseases. In addition to their role as vectors of infectious diseases, as outlined below, heavy infestations can cause direct losses. Many are

active blood feeders and may cause death from anemia. Some species cause tick paralysis and it is possible that other ticks may elaborate toxins other than those causing paralysis.<sup>1</sup> Heavy tick burdens cause sufficient irritation and stress such that affected animals become anorexic which may lead reduced productivity. One tick, *Boophilus microplus*, is reported to affect in excess of 75% of the world cattle population.<sup>2</sup> The economic impact has been estimated at \$7 (US) per animal per year and in Brazil with the fifth largest cattle herd, the losses are estimated at \$2billion per year.<sup>3</sup>

The life cycles of the ticks vary widely. Some species pass their entire life on the one host, others pass different stages of the cycle on successive hosts, and others are parasitic only at certain stages. The eggs are laid in the soil and larvae attach themselves to a passing host on which they may develop through one or more nymphal stages before becoming adults. Adult females engorge on blood or lymph and drop to the ground to lay their eggs. One-host ticks are more easily controlled than those which pass part of their life cycles away from the host. A list of the single and multiple host ticks is shown in Table 28.1.

Although many ticks favor a particular host they are usually not completely host-specific and many parasitize a wide variety of animals. In the limited space available here the species are listed according to whether they cause worry only or transmit infectious diseases of large domestic animals.

For more detailed information on transmission of infectious diseases and the biology and distribution of ticks the papers by Neitz<sup>4</sup> and Theiler<sup>1</sup> should be consulted, while the role of ticks in disease is covered well by Sonenshine.<sup>5</sup>

**Ticks causing paralysis**

Paralysis is not uncommon in young domestic animals which are heavily infested with ticks. A review lists 31 species in seven

**Table 28.1 Single and multiple host ticks**

<b>One-host ticks</b>
<i>Boophilus</i> spp.
<i>Margaropus winthemia</i>
<i>Otobius megnini</i> (adults are not parasitic)
<i>Dermacentor albipictus</i>
<b>Two-host ticks</b>
<i>Rhipicephalus evertsi</i>
<i>R. bursa</i>
<i>Hyalomma</i> spp. (most have two or three hosts)
<b>Three-host ticks</b>
<i>Ixodes</i> spp.
<i>Rhipicephalus</i> spp. (except <i>R. evertsi</i> and <i>R. bursa</i> )
<i>Haemaphysalis</i> spp.
<i>Amblyomma</i> spp.
<i>Hyalomma</i> spp. (most have two or three hosts)
<i>Ornithodoros</i> spp. – many hosts
<i>Dermacentor</i> spp.

genera of ixodid ticks and seven species in three genera of argasid ticks as being implicated in tick paralysis.<sup>6</sup> The most important species are given in Table 28.2. Details of the clinical syndromes are provided in Chapter 32. Recovery is usual in early<sup>7</sup> mild cases if the ticks are removed but antiserum against some (e.g. *Ixodes holocyclus*) is available.

**Ticks which transmit protozoan diseases**

Ticks are the most important vectors of many protozoan diseases, the protozoan in most instances surviving from generation to generation of ticks by infecting their eggs. Where control of these diseases is to be undertaken it is necessary to know which ticks are vectors, how many hosts the tick parasitizes during a life cycle and which animals can act as host. Much of the information on these points is fragmentary and only a summary is presented in Table 28.3.

**Bacterial, viral and rickettsial diseases transmitted by ticks**

The transmission of diseases associated with these agents may be effected by means

**Table 28.2 Ticks reported to cause paralysis**

Animal	Tick	Country
Sheep, calves, goats	<i>Dermacentor andersoni</i>	United States, Canada
	<i>D. occidentalis</i>	United States
Calves, lambs, foals, goats	<i>Ixodes holocyclus</i>	Australia
Sheep, goats, calves	<i>I. pilosus</i>	South Africa
Sheep, goats, calves, antelopes	<i>I. rubicundus</i>	South Africa
Lambs	<i>Rhipicephalus evertsi</i>	South Africa
Calves, sheep, goats	<i>Haemaphysalis punctata</i>	South Africa, Europe, Japan
Sheep	<i>Ornithodoros lahorensis</i>	Central Asia
Sheep	<i>Hyalomma aegyptium</i>	Yugoslavia
Sheep, goats	<i>Ixodes ricinus</i>	Crete, Israel
Cattle, sheep, goats	<i>Amblyomma cajannense</i>	Central, South America
Cattle	<i>Rhipicephalus evertsi</i>	Africa

Table 28.3 Ticks reported to transmit protozoan disease<sup>11</sup>

Disease	Protozoan	Vector ticks	Country
<b>Babesiosis</b> <b>Cattle</b>	<i>Babesia bigemina</i>	<i>Boophilus annulatus</i>	N. America, Australia and S. America Africa
		<i>B. microplus</i>	
		<i>B. (annulatus) calcaratus</i> , <i>B. decoloratus</i> , <i>Rhipicephalus appendiculatus</i> , <i>R. bursa</i> , <i>R. evertsi</i> , <i>Ixodes ricinus</i>	
	<i>Babesia bovis</i>	<i>Haemaphysalis punctata</i>	Europe
		<i>Ixodes persulcatus</i>	USSR
		<i>I. ricinus</i>	Europe
	<i>Babesia berbera</i>	<i>Boophilus annulatus</i>	Iran
		<i>B. microplus</i>	Australia
		<i>B. annulatus (calcaratus)</i> , <i>Rhipicephalus bursa</i>	Africa
<b>Sheep and goats</b>	<i>Babesia motasi</i>	<i>Dermacentor silvarum</i> , <i>Rhipicephalus bursa</i> , <i>Haemaphysalis punctata</i> , <i>Ixodes ricinus</i>	Europe
		<i>Babesia ovis</i>	<i>Rhipicephalus bursa</i>
<b>Horses</b>	<i>Babesia ovata</i> <i>Babesia caballi</i>	<i>Haemaphysalis bispinosa</i>	India
		<i>Haemaphysalis longicornis</i>	Japan
	<i>Babesia equi</i>	<i>Hyalomma dromedarii</i>	Africa
		<i>Dermacentor (reticulata) marginatus</i> , <i>D. pictus</i> , <i>D. silvarum</i> ,	USSR and the Balkans, S. America and Florida, United States
		<i>Hyalomma (excavatum) anatolicum</i> , <i>H. marginatum</i> , <i>H. volgense</i> , <i>Rhipicephalus bursa</i> , <i>R. sanguineus</i>	Africa, the Balkans, S. America, Australia
		<i>Hyalomma dromedarii</i> , <i>Rhipicephalus evertsi</i> , <i>R. sanguineus</i> , <i>Dermacentor marginatus</i> , <i>D. pictus</i> , <i>Hyalomma anatolicum</i> , <i>H. marginatum</i> , <i>H. uralense</i> , <i>Rhipicephalus bursa</i> , <i>R. sanguineus</i>	
		<i>R. sanguineus (turanicus)</i>	USSR
		<i>Theileria parva</i>	Africa
		<i>Theileria annulata</i>	Africa, Asia, USSR, Europe, China, India
		<i>Theileria sergenti</i>	Japan, Asia
		<i>Theileria mutans</i>	Africa, Asia Europe, USSR, North America
		<i>Theileria buffeli</i>	Australia
<b>Sheep</b>	<i>Theileria ovis</i>	<i>Haemaphysalis spp.</i>	
		<i>Rhipicephalus bursa</i> <i>Rhipicephalus evertsi</i> <i>Hyalomma spp.</i>	Africa, Asia Europe
	<i>Theileria hirci</i>	<i>Rhipicephalus spp.</i> <i>Hyalomma anaticolicum</i>	Africa, Middle East USSR

other than ticks. *Anaplasma marginale* can be spread by biting flies if large numbers are present when the animals are experiencing a heavy parasitemia. Outbreaks of anaplasmosis can also occur following the use of unclean instruments for dehorning, vaccination, castration or blood sampling, and is easily caused by blood transfusions. The ticks involved more commonly in transmitting bacteria, viruses, and rickettsia are given in Table 28.4. Transmission of *Anaplasma* may be transovarially, one stage becoming infected and a subsequent stage passing the infection to a new host, or ticks may transmit infection within

the one stage if they detach and feed on a new host.

#### Ticks which cause direct losses

Ticks cause damage to hides and loss of production, anemia and death when they are present in large numbers. They also cause greater morbidity and mortality during periods of drought, as well as delays in fattening resulting in animals held longer before they can be sold. A list of ticks which have this effect on production but which are not known to cause paralysis or transmit infectious diseases in farm animals, is given below.

- *Otobius megnini* – the 'spinose ear tick' of the United States and Canada
- *Amblyomma americanum* – the 'Lone Star tick' of the United States
- *A. maculatum*, – the 'Gulf Coast tick' of the United States
- *Margaropus winthemi* – of South America and Africa
- *Ornithodoros moubata* – of Africa and southeast Asia
- *O. savignyi* – of Africa and southeast Asia
- *Haemaphysalis longicornis* – of Australia and New Zealand.

#### TREATMENT AND CONTROL OF TICK INFESTATIONS

Four methods are now available to control ticks:

- Treating with acaricidal agents
- Pasture spelling
- Vaccination
- Use of resistant cattle.

Crude vaccines made from extracts of semi-engorged adult female *B. microplus* give effective immunity. Antibody destroys cells lining the tick's gut and allows blood to escape into the hemocele, some ticks die and the fertility of those remaining is reduced by up to 70%. The fertility of males is also reduced.<sup>7</sup> A recombinant vaccine based on a membrane bound glycoprotein Bm86 has been isolated and shown to be as effective as the native antigen, and to be effective against acaricidal resistant ticks.<sup>8</sup> Its major effect is a progressive control in tick numbers in successive generations through a decrease in their reproductive capacity.<sup>9</sup> Because the vaccine acts against an antigen in the tick's gut to which cattle are never exposed, they must be given booster injections at regular intervals.

This was the first recombinant parasite vaccine sold commercially and is marketed in Australia as Tickgard. A similar product, using the same antigen produced in a eukaryotic expression system, was produced in Cuba and has been trialed in other countries.<sup>10</sup> A second antigen has now been added to the vaccine (Tickgard 2). This significantly enhances efficacy and does not impair the response to Bm86. Addition of a saponin adjuvant has greatly increased the efficacy of the vaccine.<sup>2</sup>

Although vaccines offer long term control, they need to be used with pasture management, dips and tick resistant cattle as part of an integrated pest management control system. Certain *Stylosanthes* spp., tropical legumes, can kill or immobilize larval ticks and the use of these plants may simultaneously improve pasture quality and reduce the pasture contamination of larval ticks if high legume to grass ratios are achieved. *Brachiaria brizantha* has also been shown to be lethal to *Boophilus* larvae.<sup>11</sup>

Table 23.4 Diseases associated with bacteria, viruses, and rickettsia and reported to be transmitted by ticks<sup>27</sup>

Disease	Causative agent	Vector ticks	Country
Tick pyemia (lambs)	<i>Staphylococcus aureus</i>	<i>Ixodes ricinus</i>	Great Britain
Tularemia (sheep)	<i>F. tularensis</i>	<i>Haemaphysalis leporispalustris</i> , <i>H. otophila</i> , <i>Dermacentor andersoni</i> , <i>D. variabilis</i> , <i>D. pictus</i> , <i>D. marginatus</i> , <i>Ixodes luguri</i>	United States Norway, Europe, Russia, and states of the former USSR
Anaplasmosis Cattle	<i>Anaplasma marginale</i>	<i>Boophilus annulatus</i> , <i>Argas persicus</i> , <i>Dermacentor albipictus</i> , <i>D. andersoni</i> , <i>D. occidentalis</i> , <i>D. variabilis</i> , <i>Ixodes scapularis</i> , <i>Rhipicephalus sanguineus</i> <i>Boophilus microplus</i> <i>B. decoloratus</i> , <i>Hyalomma excavatum</i> , <i>Rhipicephalus bursa</i> , <i>R. simus</i> , <i>Haemaphysalis punctata</i> , <i>Ixodes ricinus</i>	North America  Australia and S. America Africa
Sheep and goats	<i>Anaplasma ovis</i>	<i>Boophilus (annulatus) calcaratus</i> <i>Dermacentor silvarum</i> , <i>Rhipicephalus bursa</i> , <i>Ornithodoros lahorensis</i>	Europe Russia, and states of the former USSR Russia, and states of the former USSR
Brucellosis	<i>Brucella abortus</i> and <i>Br. melitensis</i>	Many ticks may be infected but infection of host appears to occur only if ticks or their feces are eaten	Russia, and states of the former USSR
Heartwater	<i>Ehrlichia ruminantium</i>	<i>Amblyomma</i> spp.	Africa and Caribbean
African swine fever	Virus	<i>Ornithodoros</i> spp.	Africa, Spain, Portugal
Louping-ill	Virus	<i>Rhipicephalus appendiculatus</i> (lab only) <i>Ixodes ricinus</i>	Africa England
Tick-borne fever	<i>Anaplasma</i> <i>phagocytophila</i>	<i>I. ricinus</i> <i>Rhipicephalus haemaphysaloides</i>	Great Britain, Norway India
Caseous lymphadenitis of sheep	<i>Corynebacterium</i> <i>pseudotuberculosis</i>	<i>Dermacentor albipictus</i>	North America
Epizootic bovine abortion	<i>Spirochete</i>	<i>Ornithodoros coriaceus</i>	United States
Nairobi sheep disease	Virus	<i>Rhipicephalus appendiculatus</i>	Africa
Lyme disease	<i>Borrelia burgdorferi</i>	<i>Ixodes dammini</i> , <i>I. pacificus</i> , <i>I. ricini</i>	United States, Europe, Australia

Integrated management of ticks requires the use of several complementary approaches to reduce populations below acceptable thresholds. One component of these strategies is the development of acaricidal pathogens that may augment other approaches such as vaccination and selective acaricide application. Fungal pathogens are under evaluation for use in this type of program, in particular *Metarhizium anisopliae* and *Beauveria bassiana*.<sup>12,13</sup>

#### Choice of acaricide

Individual animals can be effectively treated by the application of any one of a number of acaricides applied either as a spray or by dipping. The choice of acaricide depends largely on three factors:

- The persistence of the compound on the skin and hair coat
- The likelihood of residues toxic to man appearing in the milk or meat
- Whether or not the ticks in the area have developed resistance to the particular acaricide.

The same criteria apply in control as in treatment except that cost becomes a limiting factor when large numbers of animals require frequent treatments and it is obvious in some circumstances that the effect of tick infestation on Brahman-cross steers is insufficiently great to

warrant treatment. It is impossible to make specific recommendations on methods of application and the most efficient insecticide to use because these vary widely between species of ticks. However, whenever possible, treatment should be given systematically in a program based on the life cycle and epidemiology of the tick. A number of treatments may be used early in the tick season to prevent the increase in tick numbers. Care must be taken in areas where tick fevers also occur, not to disrupt the transmission of the tick fever organisms and leave the cattle susceptible to later infection.

Amitraz, a formamidine, and the synthetic pyrethroids have been used widely in Australia and have proved to be efficient, active against organophosphate resistant strains and safe. In a study in the USA 0.025% amitraz applied as a whole body spray or by dipping gave 86.0–99.8% control respectively.<sup>14</sup> Ticks resistant to DDT are also resistant to the synthetic pyrethroids, and to overcome this the pyrethroids can be combined with an organophosphate. Successful combinations in Australia are cypermethrin plus chlorfenvinphos and deltamethrin plus ethion. A synthetic pyrethroid, flumethrin, has been marketed by itself at higher use concentrations for both plunge dipping and as a pour-on treatment. As a 1% pour-on 1 mL per 10 kg body weight gave

97% efficacy while 0.0033% as a spray gave 99% and acted more quickly.<sup>15</sup> The efficacy of synthetic pyrethroid impregnated eartags has been reported but these are likely to lead to resistance. Cyhalothrin also controls multiresistant strains and is used in plunge dips.

Bioassay results show lambdacyhalothrin to be as effective as cyhalothrin as a whole body spray, although the 1% pour-on was less than 50% effective.<sup>16</sup> Resistance to all pyrethroids has been reported.<sup>17</sup> Three pyrethroid acaricides have been shown to markedly reduce the hatching of eggs. Permethrin 0.1% or cypermethrin and cyfluthrin 0.05% could be useful in cleansing and disinfecting premises.<sup>18</sup>

The organophosphates as a group are effective but strains resistant to many of them have appeared. Other drugs in current use include dioxathion, diazinon, carbophenothion, coumaphos, ethion, bromophos-ethyl, chlorpyrifos, and phosmet. Pour-on applications of chlorpyrifos and phosmet have been tested but were not as effective as spray applications. Addition of acaricides to the feed has also been tried but has not been successful, while eartags impregnated with tetrachlorvinphos did not give satisfactory control and increased the risk of resistance developing to the drug.<sup>19</sup> Ivermectin given subcutaneously gives satisfactory control of *Boophilus microplus*



for 21 days following an initial lag period of 2 days. As little as 0.015 mg/kg per day gives complete control and raises the possibility of a slow-release subcutaneous implant. Two treatments of 0.2 mg/kg at 4-day intervals is considered satisfactory in cleansing cattle under field conditions.<sup>20</sup> However, ivermectin may not be effective against *Ixodes ricinus*<sup>21</sup> but a slow release bolus active for 90 days did give good control of a variety of ticks.<sup>19</sup> If given topically 0.5 mg/kg was required to give the efficiency achieved by 0.2 mg/kg subcutaneously.<sup>22</sup>

Moxidectin 200 mg/kg subcutaneously at 4-week intervals or 500 mg/kg as a pour-on along the back gives good protection against *B. microplus* resistant to organophosphorous insecticides and DDT, and each treatment gave a rapid knockdown effect on populations of buffalo fly after treatment.<sup>23</sup> Doramectin 200 mg/kg is highly efficacious in removing *B. microplus* and preventing re-establishment.<sup>24</sup> Closantel 22.2 mg/kg orally to cattle disrupted the life cycle of *Rhipicephalus appendiculatus*; those that oviposited laid few eggs and most of these did not hatch. Few larvae or nymphs molted.<sup>25</sup>

Ticks in the ear of horses should be treated by the insertion of a few drops of an oily acaricidal preparation.

Preparations vary in the duration of the protection they afford and local conditions of rainfall and tick population must be taken into account when determining the time intervals between sprayings or dippings. A special case is that of young lambs which are exposed to tick pyemia. Sprays, dips, and ointments are too toxic and the most effective procedure is the application of a liquid emulsion cream containing the insecticide to the wool-less parts of the body. Chlorpyrifos 0.48 kg/ha markedly reduces the number of ticks on the pasture, but is too expensive for routine use.

Resistance to chemical acaricides has become a major issue for the effective management of one cattle tick, *Boophilus microplus*. In many cases cross-resistance between chemical families occurs, further complicating the use of rotational scheme aimed at managing the development and degree of resistance. The development of strains of this tick resistant to macrocyclic lactone has been reported.<sup>26</sup>

## CONTROL AND ERADICATION

In most countries all that is attempted is reduction of the tick population by periodic dipping or spraying. Complete eradication is extremely difficult because of the persistence of ticks, especially multihost ticks, on wild fauna, and the ability of adult ticks to live for very long periods away from

a host. On the other hand, continuous treatment to restrain the tick population is highly conducive to the development of resistance, a problem which has become apparent in many tick areas. *Boophilus annulatus* was eradicated from the southeastern United States by a program of continuous dipping at short intervals of all livestock in the area. *B. microplus* was also eradicated from Florida by a similar procedure but 20 000 deer, the important alternate host in the area, had to be slaughtered. Concern has been expressed that deer and other wildlife species may threaten efforts to prevent *B. microplus* and *B. annulatus* becoming re-established in southern USA after they are introduced from Mexico.<sup>27</sup> Attempts to eradicate other single-host ticks in other countries have not been generally successful.

Although both dipping and spraying are recommended for the control of ticks, complete wetting of the animals, which can only be effected by dipping, is essential if eradication is to be undertaken. This adds another impediment to eradication plans because of the cost of constructing proper dips and yards. When one considers that dipping may have to be carried out every 14 days for 15 months, that every animal in the eradication area must be dipped, and that a strict quarantine of the area must be maintained, it is obvious that eradication cannot be undertaken lightly. The use of pour-on applications, which allow a longer period between treatments, and of ivermectin, will necessitate a review of control and eradication techniques.

Measures other than the application of insecticides used in the control of tick infestation include burning of pasture, removal of native fauna, plowing of fields, and rotational grazing. So little is known of the bionomics of specific ticks in specific areas that these measures have been largely unsuccessful and it is impossible to provide details for their proper implementation.<sup>1</sup>

In those areas where the epidemiology is known it has been shown that in regions with a cold winter the females stop laying eggs, and that the development of eggs is prolonged. This results in few larvae being available in the spring, and if repeated treatments are given at this time, pasture contamination will remain low for some months. In hot tropical areas where the required temperatures for tick breeding are always present, the dry period may cause mortality by desiccation.

Pasture spelling and rotational grazing have been shown to be capable of greatly reducing the tick population on farms in some areas. If cattle are placed on spelled pastures early in winter when the ticks are producing few or no progeny and then alternated at 4-monthly intervals, the tick population can be controlled with a

markedly lower number of treatments. The practicability of the procedure depends upon a full-scale financial assessment of the increased weight gains relative to the costs of management. Duration of the spelling period varies between 2 and 3 months in summer to 3–4 months in the winter, but these intervals need to be determined for each district. In practice, pasture spelling is rarely used.

It is possible to reduce the impact of ticks and tick-borne diseases by the introduction of Brahman and Brahman-cross cattle which are more resistant than British breeds. The resistance has been shown to be largely acquired, and is mainly expressed against the larvae in the first 24 hours after attachment.<sup>28</sup> In Australia the possibility that *B. microplus* might escape from its control area because of increased resistance to acaricides has been realized. For this reason a great deal of attention is being paid to the possibility of selecting cattle for tick resistance. In most tick-infested areas, cattle should have up to 50% *Bovis indicus* breeding, as this allows a reduction in the frequency of treatments. Penalties such as reduced liveweight gains, late maturity and poor temperament become evident when cattle have more than 50% *B. indicus*. With successive infestations cattle differ in their response to *Boophilus microplus*. Thus there is increased irritation and more licking<sup>28</sup> and a decrease in the number of ticks carried. Resistance to ticks has been shown to be heritable<sup>29</sup> and can be increased by breeding from cows and bulls selected for resistance. Selection for tick resistance does not affect milk production.<sup>30</sup>

Other special cases include *Otobius megnini*, the nymphs of which drop off to molt and lay eggs in protected spots, necessitating the spraying of buildings, fence posts, feed troughs, and tree trunks in feedlots where heavy infestations are most common. *Ornithodoros* spp. ticks are difficult to control because the nymphs and adults attach to feed for brief periods only. Where ticks which cause paralysis are common it may be necessary to apply an insecticide as a dust and dip at short intervals.

## REFERENCES

- Theiler G. J South Afr Vet Med Assoc 1959; 30:195.
- Sales-Junior PA et al. Vet Immunol Immunopath 2005; 107:281.
- Grissi IA. Hora Vet 2002; 21:8.
- Neitz WD. Onderstepoort J Vet Res 1956; 27:115.
- Sonenshine DE. The biology of ticks, vol 2. New York: Oxford University Press, 1993.
- Murnaghan MF, O'Rourke FJ. In: Bettini S (ed) Handbook of experimental pharmacology. Berlin: Springer-Verlag, 1978; 48:419.
- Willadsen P et al. J Immunol 1989; 143:1346.
- Tellam R L et al. Vaccination against ticks. In: Yong WK (ed) Animal parasite control utilising biotechnology. Boca Raton: CRC Press, 1992; p. 303.

9. Willadsen P et al. The role of vaccination in current and future strategies for tick control. In: Resistencia y control en garrapatas y moseas de importancia veterinaria. Seminario Internacional de Parasitologia Animal Acapulco, 1995; p. 88.
10. Rodriguez M et al. Vaccine 1995; 13:1804.
11. Barros ATM et al. Pesq Vet Brazil 1989; 9:17.
12. Kirkland BH et al. Biol Cont 2004; 31:414.
13. Guedes-Frazzon AP et al. Vet Parasitol 2000; 94:117.
14. Ahrens EH et al. J Econ Entomol 1989; 82:850.
15. Ahrens EH et al. J Econ Entomol 1988; 81:1133.
16. Davey RB et al. J Econ Entomol 1993; 85:3286.
17. Nolan J et al. Aust Vet J 1989; 66:179.
18. Davy RB. J Agric Entomol 1995; 12:67.
19. Owen LG. Aust Vet J 1985; 62:24.
20. Nolan J et al. Aust Vet J 1985; 62:386.
21. Giles MB de C. Vet Rec 1986; 118:82.
22. Cram LT et al. Vet Parasitol 1988; 29:341.
23. Sibson GJ. Aust Vet J 1994; 71:381.
24. Gonzales JC et al. Vet Parasitol 1993; 49:197.
25. Kariuki DP, Mbogo SK. Bull Anim Health Prod Afr 1988; 36:59.
26. Martins JR, Furlong J. Vet Rec 2001; 149:64.
27. George JE. J Agric Entomol 1990; 7:119.
28. Wagland BM. In: Ticks and tick-borne diseases. Proc 56th Ann Gen Mtg Aust Vet Assoc, Townsville, 1980; p. 55.
29. Hewetson RW. Aust Vet J 1972; 48:299.
30. Utech KBW, Wharton RH. Aust Vet J 1982; 58:41.

## Miscellaneous flies, midges, and mosquitoes

Although these insects differ quite markedly they are dealt with together because they exert similar deleterious effects. Their activity causes stress and induces behavioral changes and in many cases are important vectors for a variety of parasites and infectious diseases.

### STABLE FLIES

The stable fly, *Stomoxys calcitrans*, has a cosmopolitan distribution, occurring in most countries. Other species, including *S. nigra*, occur in South Africa. *S. calcitrans* is about the size of a house fly, is gray in color. These flies are the most economically important species affecting confined livestock in North America. Flies rest on fences and structural surfaces in a characteristic head upwards position and can readily be recognized by the prominent, forward-directed, pointed proboscis between short palps. Stable flies of both sexes are blood feeders, attacking particularly horses, cattle, to a lesser extent pigs and people. Bites are quite painful and often bleed freely when fresh. The flies are intermittent feeders, spending only short periods on the host, while most of their time is spent resting on fences and building sides. Eggs are laid in high moisture areas of rotting hay or straw, along the edge of silage pits, on the edges of manure pack of feedlots and compost piles. Mature larvae leave the high moisture sites to pupate in drier sites nearby. Development times are regulated by

temperature, with higher temperatures resulting in more rapid development. A complete life cycle will require 3–4 weeks in summer. In temperate climates flies exhibit a distinct seasonality with peak populations in mid to late summer.<sup>1</sup> Larvae will overwinter in warmer areas of silage piles. The flies are highly mobile traveling up to 20 km in search of suitable hosts.

Feeding activity by the flies results in stress to the animals and reduced efficiency through reductions in feeding time. When large numbers of flies are present the animals will bunch to reduce biting rates. At high temperatures the bunching may result in cattle overheating. A localized sensitivity of the forelimbs of cattle may develop and result in the formation of intradermal blisters which coalesce to form bleeding sores. With very heavy infestations some deaths may occur. Populations can be assessed by counting the number of flies on the front legs of cattle. When the average number exceeds 5–10 per animal significant losses are occurring and population management is required.

*Stomoxys calcitrans* are mechanical vectors for anthrax, infectious equine anemia, bovine virus, diarrhea virus, and surra. They are intermediate hosts for the nematode *Habronema majus* which is reputed to be a cause of allergic dermatitis in horses in Japan.

Effective management of stable flies requires removal of high moisture, rotting organic matter from the environment.<sup>2</sup> Edges of silage pits, manure, and compost piles should be kept dry and manure-contaminated bedding should be removed regularly. Insecticide treatments must be applied to all exterior surfaces (i.e. barn sides, fences, and exterior of feed bunks). Diflubenzuron 0.5 g/m<sup>2</sup> sprayed in a cow barn completely inhibited breeding of the house fly and stable fly.<sup>3</sup> Spraying of fixtures and walls, particularly sunlit walls where the flies often remain unnoticed, with long-acting compounds such as tetrachlorvinphos, diazinon, crotoxyphos, and propoxur reduces infestations for 2 weeks or longer.

Application of insecticides or repellants directly on animals is generally impractical because of the short duration of efficacy. Low frequency of insecticidal application, when necessary, slows the development of insecticide resistance. Crotoxyphos and methoxychlor can also be sprayed onto cattle giving about 4 days of protection. Fenchlorphos can be used but requires daily spraying or daily or alternate daily wipe-on application for good control. Permethrin applied as a microencapsulated formulation gave longer protection than an emulsifiable concentrate.<sup>4</sup> Affected horses can be treated locally with an analgesic cream, and if the

irritation is severe they can be tranquilized with acetylpromazine.

### HORSE FLIES; MARCH FLIES OR BREEZE FLIES (*TABANUS* SPP.); DEER FLIES (*CHRYSOPS*), *HAEMATOPOTA*, AND *PANGONIA* SPP.)

These large, robust blood feeding flies are widespread in both temperate and tropical regions. Only the females take blood meals, but the bites are savage and cause significant distress to large animals, particularly horses and cattle. These flies can act as mechanical vectors of diseases associated with viruses (equine infectious anemia, bovine leukosis, vesicular stomatitis, hog cholera), bacteria (anthrax, tularemia), and trypanosomes (surra). Eggs are laid on the leaves of plants growing in or near standing water. The larval and pupal stages occur in the water or mud and the life cycle takes 4–5 months to complete. The flies are active in summer and attack animals principally on the legs and ventral abdomen. Duration of activity can be relative short (i.e. 3–4 weeks), but stress on the animals can be very high during that time. Fly attacks lead to bunching of animals<sup>5</sup> with the attendant likelihood of overheating and in some cases resulting in animals stampeding through fences. Control is difficult unless wet areas can be drained or livestock kept away from these areas where the flies are most active. Repellents have been used and are reasonably effective in horses subject to fly-worry. The use of *o*-diethyl toluamide (DEET) affords protection for only a few days and is costly, but its use in milking cattle gives increased milk yield and butter fat. Permethrin, a synthetic pyrethroid, used as a spray or as a dust on cattle and horses, killed 90% of flies for about 2 weeks after treatment. Synthetic pyrethroid impregnated ear tags give very little protection against these flies.

### BUFFALO FLIES; HORN FLIES (*HAEMATOBIA* SPP.)

These small (6 mm) grayish flies have distinct geographical distributions, *H. irritans exigua* in Australia and South-east Asia, *H. irritans irritans* throughout North and South America and Hawaii, and *H. minuta* in Africa. *Haematobia irritans irritans* is common in Europe where it causes few problems. This species was transported to North America in the late 1800s, where it rapidly established and spread. It has subsequently moved into South America where it has also become a major problem. They have similar life cycles and habits. Both sexes of these flies are obligate blood feeders, primarily attacking pastured cattle and water buffalo.

They do not survive off the host, other than for short periods. They are not known as vectors for any disease agents other than the nematodes *Stephanofilaria* spp. They cause significant reductions in productivity of pastured cattle through induction of stress, changes in grazing patterns and, in extreme cases, blood loss. Burdens of 200–500 flies will reduce weight gains of beef cattle (up to 14% reduction)<sup>6</sup> and milk yield of dairy cows. Heavy infestations (over 1000 flies) can cause serious loss of condition and rarely, deaths. Control results in higher feed efficiency, increased growth rate and increased calf weaning weights.

The flies congregate chiefly on the withers, shoulders and flanks as well as around the horns and eyes. Flies take numerous (15–20) small blood meals per day. In North America feeding often takes place on the ventral midline and several 2–5 cm diameter feeding lesions are often observed. Zebu cattle are less affected by the flies than British breeds and although they may carry large populations of flies, they show fewer feeding lesions.

The flies are easily recognized by the way in which the wings are held at rest, slightly divergent and angled upwards away from the body. Adult flies stay on the host most of the time, unless disturbed. Females leave the host, as feces are passed, to deposit eggs around edges of the freshly deposited dung. Larvae develop within the dung pat, feeding primarily on bacteria. Development is regulated by environmental temperatures and the larvae are stimulated to enter diapause (arrested development) if temperatures become too low.<sup>7</sup> Mature larvae exit the dung to pupate in the dry soil below and around the pat. A complete life cycle may require up to 3 weeks under optimal environmental conditions. Thus, at higher temperatures in excess of 15 generations may be produced in a single season. In more temperate climates such as Canada and the upper United States, only five generations may occur.

While adults rarely leave the host except for oviposition the newly emerged flies of *H. irritans irritans* will travel up to 20 km in search of new hosts. They may be dispersed also by prevailing strong winds, and they are carried long distances by the movement of cattle to new pastures. The distribution of *H. irritans exigua* is controlled by environmental factors, particularly temperature and humidity. Below 21°C (70°F) the flies become sluggish and at 5°C (41°F) they become comatose.

Infestations have been controlled by traps, insecticide sprays, back rubbers, dust bags, or eartags impregnated with insecticides. Traps have been designed for use with dairy cattle that walk through them

on their way to and from the dairy. The flies, dislodged by gauze strips, are retained in the trap and killed when they rest on the insecticide-coated walls. Traps are rarely used today but recent work with modified traps has given 80–90% control.<sup>8</sup>

Back rubbers consist of absorbent material, impregnated with insecticide or oil, wrapped around a cable or chain suspended from a central pole and attached to ground level supports or as a cable suspended a little over a meter above the ground between two posts 4–5 m apart. Cattle quickly learn to use rubbers to dislodge flies and their coats become smeared with insecticide. Ethion 1% in fuel oil is commonly used against *H. irritans exigua* while coumaphos 1 or 2% has been shown to be effective against horn flies. Insecticide-impregnated eartags attached to back rubbers and dust bags controlled horn fly for about 6 weeks, while fenvalerate tags were still effective 18 weeks after application.<sup>9</sup>

Eartags impregnated with organophosphorus compounds and synthetic pyrethroids have been widely used, but resistance has built up to levels that make this technique ineffective.<sup>10</sup> Discontinuing the use of pyrethroid impregnated eartags for one season does not allow substantial reduction in resistance to occur.<sup>9</sup> Recent work reported that eartags impregnated with 20% diazinon gave 90–100% control of *H. irritans exigua* in dairy and beef herds and allowed better weight gains,<sup>11</sup> but if continued will lead to resistance as resistance to diazinon has been reported in eastern Canada and in the United States. Eartags impregnated with compounds of both classes have been effective in managing increases in pyrethroid resistance. Current recommendations for use of impregnated eartags note that tags should be applied to the cows (because they harbor the most flies and present the largest surface area for exposure to the insecticide) at the maximum recommended rate. While this is less convenient it helps to avoid one of the leading causes of insecticide resistance which is the dilution of the insecticide as it spreads from calves to cows. Flies can also be controlled by dipping, but this technique is rarely used solely for flies. Organophosphorus compounds have a residual protection of only a few days and products are combined with synthetic pyrethroids to extend the protective period. In areas where cattle ticks require regular treatment adequate control of flies may be gained incidentally, but if treatments are not effective cattle can be oversprayed with pyrethroids.

Macrocytic lactone endectocides are highly effective against larval horn flies,<sup>12</sup> as well as larvae of face flies, stable flies,

and house flies, often killing larvae for periods in excess of 8 weeks. However, in terms of practical control, where flies immigrate from surrounding herds, the duration of efficacy is not more than 2 weeks.<sup>13</sup> In addition, the macrocytic lactones generally cause significant reductions of non-target insects in the dung community, many of which are beneficial as they are natural enemies of the horn fly and buffalo fly.<sup>13</sup> The various macrocytic lactone products have differential effects on flies and other dung insects and it appears that moxidectin has the least impact.<sup>14</sup>

Pour-on formulations of pyrethroids are highly effective as evidenced by application of 1% cyfluthrin.<sup>15</sup> Insect growth regulators (e.g. Diflubenzuron) applied as a bolus give 80% control of the immature stages of the face fly-horn fly in the manure for at least 20 weeks but reduced the number of dung beetles for 7 weeks. A 3% methoprene bolus was also active against flies but had no apparent effect on the dung beetles.<sup>16</sup>

### HORSE LOUSE FLIES (*HIPPOBOSCA EQUINA*, *H. RUFIPES*, AND *H. MACULATA*)

The horse louse fly, *Hippobosca equina*, is a common parasite of horses and cattle in many tropical countries. It is a flat, glossy, reddish-brown fly, slightly bigger than a housefly. These flies are blood feeders and live most of the time on the host, particularly on the perineum and between the hindlegs. Female flies deposit single mature third instars which pupate in dry humus; the puparia mature to adult flies. The flies appear to cause little annoyance in horses which are accustomed to them but horses experiencing them for the first time manifest fright and irritation. Being blood feeders they may act as mechanical vectors for infectious diseases. Topical spraying of susceptible areas of the body with chlorinated hydrocarbons appears to keep these parasites in check. Local application of 0.2% coumaphos solution quickly kills flies but only gives protection for 3 days. *H. maculata* was controlled for 1 year by mass application of 0.005% deltamethrin to cattle and horses.<sup>17</sup>

### BITING MIDGES

These tiny flies (1–3 mm long) are members of the family Ceratopogonidae, the important genus being *Culicoides*. These flies are blood feeders and as such induce stress in hosts and, can transmit infectious diseases such as bluetongue in sheep, horse sickness, ephemeral fever in cattle. They are also intermediate hosts for nematodes of the genus *Onchocerca*. Because of their importance as vectors of arboviruses,<sup>18</sup> studies have been done on their feeding habits. Cattle and sheep are the most

common hosts attacked but some species also feed on birds or dogs. Hypersensitivity to the bites of *Culicoides brevitarsis* results in an allergic dermatitis (Queensland itch or sweet itch) in horses in Australia and North America and is discussed elsewhere. Cattle also show considerable irritation during attacks by large numbers of midges. They react with vigorous stamping of the feet, switching of the tail and continuous movement.

The flies are plentiful in the warmer months and are most active at dawn and dusk. Because of their small size they are capable of being carried long distances by wind. Control of the flies is virtually impossible and most measures to reduce their importance are based on preventing access of the flies to the animals. Repellents, especially dimethyl phthalate or *o*-diethyl toluamide (DEET), are effective on a short-term basis. Antihistamines can be used regularly but are too expensive for general use. Keeping horses away from areas where the flies are present in large numbers is advisable. Backline pour-on treatment of horses with 40 mL of a 4% high CIS permethrin three times weekly gave a good response in 86% of horses.<sup>19</sup> Ivermectin at the recommended dose of 0.2 mg/kg would not produce the serum concentration that would have noticeable effects on blood-feeding *C. variipennis*.<sup>20</sup>

### BLACK FLIES; BUFFALO GNATS; SANDFLIES

These small gray to black flies (5 mm) are members of the family Simuliidae and include a number of species and genera. The important flies appear to be *Cnephia pecuarum* which is common in the southern states of the United States, *Simulium arcticum* in northern Canada, *Austrosimulium pestilens* and *A. bancrofti* in Australia, and *Simulium ornatum* in Great Britain. These very small flies occur in most parts of the world. With the exception of *S. arcticum* and two or three other species common in northern regions of North America black flies are primarily a concern in tropical regions.

Female flies are voracious blood feeders. They are active in the summer months when large numbers emerge from streams and rivers where they have spent their larval and pupal stages.

*Austrosimulium pestilens* has adapted to reach large numbers, mate, and oviposit within a very short time to utilize the flood situations that occur in northern Australia. The flies congregate in swarms and attack all animals, causing much worry and annoyance. They tend to bite animals around the legs, on the belly and around the head, causing wheals and papules. The annoyance may be so intense that

animals stampede or mill about and young animals may be injured or even trampled to death and are frequently separated from their dams. Cattle may spend much of their time wallowing in mud or kicking up dust to keep the flies away. Herding of cattle onto bare areas reduces fly attacks as the flies commonly rest in tall grass, but this reduces feeding. The cause of death is unknown although swelling of the throat causing suffocation, anaphylaxis or direct toxicity are suspected. Filarid worms of *Onchocerca* spp. are transmitted by these flies and their role as an intermediate host of nematodes has been discussed.<sup>21</sup>

A similar situation occurs in northern Canada where large numbers of *Simulium arcticum* have caused severe stress and occasional deaths of cattle introduced into the area of the Athabasca River and similar regions in the province of Saskatchewan. When black fly populations are extreme, previously unexposed cattle develop symptoms of shock resulting from blood loss and cumulative effects of the fly salivary secretions.

Because the larval stages of these flies are passed in flowing streams, large-scale control measures must be directed at killing the larvae at this stage. Aerial distribution of DDT has been effective when added to streams and water supplies or control can be effected by adding insecticides into rivers and canals. However, rapid reinfestation occurs with increased rate of water flow after heavy rains. Annual injection of methoxychlor upstream from major larval sites proved effective in reducing black fly populations, but off-target effects were undesirable.<sup>22</sup> For less ambitious control programs, efforts should be directed towards keeping flies away from animals by the application of repellents or the use of smudge fires. Repellents are of limited use but alcoholic or aqueous solutions and dusts of permethrin, cypermethrin and resmethrin applied to the whole body repelled black flies for some days.<sup>23</sup>

### MOSQUITOES

A number of mosquitoes including *Psorophora*, *Aedes*, *Mansonia*, *Culex*, and *Anopheles* spp. are important parasites of domestic animals. When the blood feeding females are present in large numbers they cause stress to animals and have been known to kill young pigs and puppies by the severe anemia they produce. Although such occurrences are rarely recorded the blood loss that can occur in severe infestations is surprising. The stress associated with mosquito attack is sufficient to cause reductions in efficiency, even in mature large animals.

Their most important role is as vectors of disease. *Culex tarsalis*, *Aedes dorsalis*,

and *A. nigromaculis* transmit equine encephalomyelitis. *Culex tritaeniorhynchus* is the principal vector of Japanese B encephalitis in Japan. Various *Culex* species vector Western Equine Encephalitis, Eastern Equine Encephalitis, and West Nile Virus. These viruses can have serious effects on unprotected horses and are transmissible to humans via mosquito bites. Vaccines are available to protect against all of these arboviruses. *Psorophora confinnis* is instrumental in spreading the eggs of *Dermatobia hominis*, the tropical warble fly; and *Mansonia* spp. transmit Rift Valley fever. The filarid worm *Setaria digitata* is also spread by mosquitoes.

Control over a large area must include drainage of collections of still surface water or destruction of the larvae by the addition of any one of a number of insecticides, particularly DDT or Abate. For small groups of animals protection from the attacks of mosquitoes can only be satisfactorily effected by mosquito-proof screens. Temporary protection by repellents such as dimethyl phthalate is partial only. Permethrin, 100 mL of a 0.5% emulsion, applied with an electrostatic sprayer provided greater than 70% protection for at least 72 hours.

### HOUSE FLIES (*MUSCA DOMESTICA*)

The common house fly has a worldwide distribution and achieves veterinary importance because it is capable of transmitting, in a mechanical manner, the causative bacteria of many infectious diseases. It is often cited as a means whereby anthrax, erysipelas, and brucellosis are spread but its importance in this regard is largely unproven. House flies are intermediate hosts for the larvae of *Habronema muscae* and *Draschia megastoma*.

The eggs are laid in decaying organic matter of any kind. Larval development is temperature dependent and a life cycle may be completed in 12–14 days so that in warm, wet summers the fly population may increase very rapidly, causing annoyance to livestock and farm workers.

House fly population management requires frequent and thorough removal of manure and other rich organic matter. In dry weather the manure can be spread thinly on fields but a more dependable method is to place it in a special fly trap, e.g. Baber's fly traps, from which larvae and adult flies cannot escape. Chemical treatments to control flies require application to resting sites on buildings and other facilities, or the placement of baits containing methomyl, propoxur, naled, or dichlorvos at appropriate locations. Development of insecticide resistance can occur rapidly and there are numerous

examples of resistance to multiple classes of insecticide at a single location. Rotational use of insecticide classes is absolutely essential in the management of resistance.

Management of house fly populations can be augmented through release of parasitic wasps (Family Pteromalidae) that kill pupae. These tiny wasps (1–2 mm long) actively search for the fly pupae and lay one or more eggs inside. The developing wasps devour the fly within the pupa. They have been found useful adjuncts to other fly control measures when used in confined facilities such as hog barns.<sup>24</sup> Inundative releases at feedlots, where thousands of wasps are released at regular intervals throughout the fly season, has shown some efficacy<sup>25</sup> but requires an integrated approach with good manure management and selective application of insecticides.

To reduce the fly population in buildings is an important procedure in public health work and many measures are recommended. It is not possible to give details of them here because so many factors have to be taken into consideration, including toxicity of the products used for man and animals, development of resistance to the insecticides, and contamination of food products such as milk by the insecticides.

### BUSH FLIES (*MUSCA VETUSTISSIMA*)

These flies occur commonly in Australia, in drier areas, and are a cause of stress to livestock in the summer months. Bush flies die out in southern Australia each winter but breeding continues in the north and the regular northern winds that commence about September each year blow flies southwards and repopulate the areas that are now suitable for breeding. *Musca vetustissima* occur in very large numbers and during the day congregate around the eyes, on the lips, on any visible mucous membrane and on wounds to obtain moisture. They are thought to carry contagious ophthalmia of sheep, infectious keratoconjunctivitis of cattle and contagious ecthyma of sheep, to delay the healing of wounds, to contribute to the lesions produced by buffalo flies (*Haematobia irritans exigua*) and to act as intermediate hosts for the larvae of *Draschia megastoma*, *Habronema muscae*, and *Thelazia* spp. Control of the fly population is virtually impossible in the areas where it occurs but individual animals may be protected by repellents such as dimethyl phthalate or *o*-diethyl toluamide (DEET). Sprays containing 1% of dichlorvos or crotoxyphos are effective but must be applied daily. Fenvalerate and cypermethrin give excellent relief and lasting protection against the related *Musca autumnalis*. Dung beetles,

introduced from Africa, breakup dung pats which will aid in reducing fly numbers.

### FACE FLIES (*MUSCA AUTUMNALIS*)

This small fly, indigenous to Europe and Asia, first appeared in North America in 1952 and is now present over large areas of eastern Canada and northeastern and north-central United States. The flies resemble the house fly but are slightly larger. They congregate on the face of cattle, feeding on nasal and lacrimal secretions and saliva. Very large numbers cause a certain amount of stress, cause petechiation in the eye, and are thought to be instrumental in transmitting infectious keratoconjunctivitis (pinkeye) of cattle. Face flies are vectors for the eyeworms, *Thelazia* spp. which infest the conjunctival sacs and lacrimal ducts of domestic animals.

Flies oviposit on fresh cattle manure where larval development takes place. As with all flies development is temperature dependent. In temperate latitudes the flies will over-winter as adults, resting inside homes and other farm structures.

Fly numbers are greatest in summer and cattle are worried particularly when outdoors. Repellents have been extensively used but are not highly successful. Self-applied or hand-applied dusts containing organophosphate insecticides are more extensively used. A dose of 10 mL per animal of 1% cyfluthrin applied as a pour-on reduced fly numbers by 90% and treatment was effective for about 4 weeks.<sup>14</sup> Fenvalerate and cypermethrin give immediate relief, and a lasting reduction in fly numbers when used on fly breeding sites.<sup>26</sup> Reduction of face fly populations on cattle can be achieved through use of synthetic pyrethroids impregnated eartags, but their use is complicated by the presence of insecticide resistant horn flies. Diflubenzuron boluses give 80% control of the immature stages of *M. autumnalis* in the manure for up to 20 weeks.<sup>15</sup>

### HEAD FLIES (*HYDROTOEA IRRITANS*)

This small fly, similar in appearance to the house fly but having an olive abdomen and yellow wing bases, is found in the United Kingdom and Europe. It is a non-biting muscid fly that swarms around animals and man from late June to September. Breeding is in soil and litter and there is only one life cycle per year. The lesions on sheep are self-inflicted trauma in attempts to alleviate fly irritation. Sores are often large, open, and may be made more severe by bacterial invasion. The wounds may predispose to blowfly strike by *Lucilia sericata*. The pathogens of summer mastitis of cattle can be

spread mechanically by muscid flies, and *Areanobacterium pyogenes* has been shown to persist in *H. irritans* for up to 4 days.<sup>27</sup>

Control is difficult and is similar to that used for the other non-biting muscid fly, *M. autumnalis*. Eartags impregnated with 8.5% cypermethrin or 10% permethrin reduce the severity of fly damage in sheep, and tagged ewes give protection to their lambs. However, it is likely that resistance will quickly occur in the same manner as in the face fly. Pour-on applications of synthetic pyrethroids are easier to apply, are cheaper and leave a higher concentration than a spray or an eartag.<sup>28</sup> Cyfluthrin 1% applied as a pour-on at a dose rate of 10 mL per animal reduced fly numbers by 90% and gave 4 weeks protection.<sup>14</sup> Crotoxyphos cream is effective but at least two applications are needed. Head-caps are most effective but are tedious to apply.

### REFERENCES

- Lysyk TJ. J Med Entomol 1995; 32:508.
- Thomas GD. J Econ Entomol 1996; 89:411.
- Demény A. Parasitol Hung 1989; 22:87.
- Meyer JA, Hunter JS. MedVet Entomol 1991; 3:359.
- Ralley W et al. Can J Zool 1993; 71:725.
- Haufe WO. Can J Anim Sci 1982; 62:567.
- Lysyk TJ. Environ Entomol 1992; 21:1134.
- Sutherland RW, Tozer RS. Aust J Agric Res 1995; 46:269.
- Harvey TL et al. J Econ Entomol 1983; 76:96.
- Cilek JE et al. J Econ Entomol 1991; 84:756.
- Mwangala FS, Galloway TD. Can Entomol 1993; 125:839.
- Floate KD et al. MedVet Entomol 2001; 15:117.
- Lysyk TJ, Colwell DD. J Econ Entomol 1996; 89:1513.
- Floate KD et al. Bull Entomol Res 2002; 92:471.
- Leibisch G et al. Proc 18th World Buiatrics Congr Bologna, Italy, 1994; 1:765.
- Fincher GT. Environ Entomol 1991; 20:77.
- Parashar BD et al. MedVet Entomol 1991; 5:363.
- Cybinski DH, Muller MJ. Aust J Zool 1990; 38:25.
- Stevens DP et al. Vet Rec 1988; 122:308.
- Holbrook TR, Mullens BA. J Am Mosquito Control Assoc 1994; 10:70.
- Poinar PO. Bull WHO 1977; 55:509.
- Haufe WO, Croome GCR. Alberta Environ Spec Pub, 1980.
- Shemanchuk JA. Pesticide Sci 1981; 12:412.
- Weintraub J. Research Highlights - 1984 Ag Canada Res Str 1985; 26.
- Floate KD. Can Entomol 2003; 135:599.
- Supperer R, Heimbucher J. Wien Tierarztl Monatsschr 1982; 69:229.
- Hillerton JE et al. BrVet J 1990; 146:147.
- Titchener R. Vet Rec 1984; 114:386.

## Mite infestations

### HARVEST MITES (CHIGGER MITES)

Infestations with trombidiform mites cause dermatitis in all species. Except for *Psorergates ovis*, *P. bos*, and *Demodex* spp. they are all harvest or grain mites. These mites are primarily predatory on other arthropods associated with harvested

grain and infesting animals only secondarily and usually transiently. It is usually the larval stages which are found feeding on animals while the nymphs and adults are free-living.

The larvae of *Pyemotes ventricosus*, *Neotrombicula autumnalis*, *Eutrombicula alfreddugesi*, *E. splendens*, *E. batatas*, *Trombicula* spp., and some species of *Leptotrombidium* and *Schoengastia* are parasitic on man and most animals, causing dermatitis and, in man, transmitting rickettsial diseases. Nymphs and adults are free-living predators feeding mainly on arthropods in grain and hay. The larvae are most active in the autumn at harvest time and may cause dermatitis in animals grazing at pasture or those confined in barns and being fed newly harvested grain.

Horses and cattle are usually affected on the face and lips, which, in white-faced horses, may suggest a diagnosis of photosensitization, and about the feet and lower limbs, especially in the flexures. Affected areas are itchy and scaly but, with rubbing, small fragile scabs and absence of hair may become apparent. Infestation of horses with *Trombicula sarcina* causes a severe pruritus and yearlings show irritation by lip-biting their legs and rubbing against stable walls. Stamping is uncommon, and usually occurs when yearlings are stabled on fresh, contaminated bedding.<sup>1</sup> Sheep, when first affected, stamp their feet repeatedly and bite their legs. The skin at the heels, coronet, and pasterns, and sometimes the shank, becomes erythematous and weeps fluid. The mites detach after 3–5 days and leave a small ulcerated area. In light infestations the mites may be confined to the area between the accessory digits, but in heavy infestations the skin over the whole of the lower limbs may be swollen and thickened. The infestation is self-limiting and treatment is not usually necessary but the legs can be washed in 0.25% maldison. Area control of the mite may be obtained by the use of chlorpyrifos either as 0.5% granules, 1.1 kg/ha, or the 22.4% spray at 1.6 kg/ha.<sup>2</sup>

Infestation with *Tyroglyphus* spp. in pigs appears to be manifested by itchiness and the development of fragile scabs about 3 cm in diameter scattered over the body. Unlike the thick scabs of sarcoptic mange, the skin beneath appears normal. The infestations occur in pigs eating dry ground grain from automatic feeders, lesions appearing several weeks after the dry feeding is begun and disappearing spontaneously about 3 weeks later. No treatment is necessary although spraying with malathion is usually recommended. Affected pigs show no ill-effects but the lesions may be mistaken for those of swinepox or sarcoptic mange. The ingestion of large numbers of mites appears to have no ill-effects.

## REFERENCES

1. Pascoe RR. Equine dermatitis. Vet Rev 1981; 22, University of Sydney: Postgrad Found Vet Sci.
2. Mount GA et al. J Econ Entomol 1978; 71:27.

## ITCHMITES (*PSORERGATES OVIS*, *P. BOS*)

The 'itchmite' has been recorded as a parasite of sheep in Australia, New Zealand, South Africa, the United States, Argentina, and Chile. *Psorergates bos* has also been recorded from cattle in the UK.<sup>1</sup>

### LIFE CYCLE AND EPIDEMIOLOGY

The entire lifecycle of this mite, eggs, larvae, two nymphal stages, and adults, takes place entirely on the host. In sheep the cycle takes 4–5 weeks. All stages occur in the superficial layers of the skin. The adults are extremely small and can be seen only with the aid of a microscope. Only the adults are mobile on the skin surface and they effect spread of the disease by direct contact. In sheep this often occurs between recently shorn animals when contact is close and prolonged such as when shorn sheep are packed in yards after shearing, or from ewe to lamb while suckling. Mite feeding activity, in addition to excreta causes skin irritation leading to rubbing and biting of the affected parts (principally the sides, flanks, and thighs) and raggedness, sometimes shedding, of the fleece. Wool over these areas becomes thready and tufted and contains dry scales.<sup>2</sup>

### PATHOGENESIS

The skin shows no gross abnormality other than an increase in scurf. Histologically there is hyperkeratosis, desquamation, and increased numbers of mast cells.<sup>3</sup> The irritation appears to be a hypersensitivity and results in biting and chewing of the fleece on the flanks and rump behind a line approximately from the elbow to the hips. In the individual sheep and in flocks the disease spreads slowly so that it may be several years before clinical cases are observed and an appreciable number are visibly affected. The incidence of clinical cases in a neglected flock may be as high as 15%. Sheep on poor nutrition have significantly higher mite populations, more scurf and greater fleece derangement.<sup>3</sup> Affected sheep may become tolerant after 1–2 years and show no signs, even though they remain infested.

Amongst sheep, Merinos are most commonly affected. The highest incidence is observed in this breed, particularly in areas where the winter is cold and wet. There is a marked seasonal fluctuation in the numbers of mites; the numbers are very low in summer, commence to rise in the autumn, and peak numbers are found in the spring. Spring or summer shearing exacerbates the decline in numbers. Clinically, the disease resembles

louse infestation, but may be distinguished on the smaller proportion of the flock affected (10–15%), the less severe irritation and tendency of the sheep to bite those areas it can reach. Hence lesions are confined to parts of the flank and the hindquarters and the wool tufts have a chewed appearance.

### CLINICAL FINDINGS

Diagnosis depends on finding the mites in a skin scraping. The selection of sheep with excess scurf and fleece derangement increases the chance of finding mites and in the absence of lice, ked, and grass seed infestation, about 75% of such sheep prove positive for *P. ovis*. The wool should be clipped as close as possible, the skin smeared lightly with oil and scraped over an area of about 25 cm<sup>2</sup>. The mites have a seasonal incidence and may be very difficult to find in summer and autumn. For best results the scraping should be made on the ribs or shoulder in winter or spring. Scrapings are usually teased out in oil and examined microscopically without digestion. A number of scrapings may be needed from each sheep before mites can be demonstrated. Because of the difficulty of finding mites in summer and autumn, sheep dipped at that time cannot be said to be free of infestation until they prove negative on skin scraping in the following spring, when mite numbers should be at the highest levels.

### TREATMENT AND CONTROL

There is no compound available that will eradicate itchmite after a single treatment. Arsenic, lime sulfur, or finely divided sulfur have been used and markedly reduce the number of mites. Because the mites are slow to build up, dipping every second year will mask the signs of infestation. However, arsenic is no longer used in most countries. Finely divided rotenone by itself or mixed with the synergist piperonyl butoxide reduces the mite population. It is usually combined with an organophosphate to include lice and ked control in the one product. Phoxim, an organophosphorus compound, has good activity but two dippings 1 month apart are necessary to eradicate infestations. Amitraz causes a marked reduction in mites that will be maintained for some months.

A single subcutaneous injection of 0.2 mg/kg ivermectin freed sheep of mites up to 56 days post-treatment.<sup>4</sup> However these sheep would have to be examined over a longer period to insure eradication. Other macrocyclic lactone products, in various formulations, have been shown to have good efficacy.

## REFERENCES

1. Andrews AH et al. Vet Rec 1997; 140:183.
2. Sinclair AN. NZ Vet J 1986; 24:149.



3. Johnson PW. *MedVet Entomol* 1996; 10:121.  
 4. Soll MD, Carmichael IH. *Parasitol Res* 1988; 75:81.

## DEMODECTIC MANGE (FOLLICULAR MANGE)

Mites of *Demodex* spp. infest hair follicles of all species of domestic animals. The disease causes little concern but in cattle and goats there may be significant damage to the hide and, rarely, death that may result from gross secondary bacterial invasion.

### ETIOLOGY

Mites infesting the different host species are considered to be specific and are designated as *Demodex bovis* for cattle, *D. ovis* for sheep, *D. caprae* for goats, *D. equi* for horses, and *D. phylloides* for pigs.

Demodicosis may occur in farm animals of any age, especially those in poor condition but most cases in cattle occur in adult dairy cattle in late winter and early spring. This differs from the well-known condition in the dog which occurs in young, immunodeficient animals.

### LIFE CYCLE AND EPIDEMIOLOGY

The entire life cycle is spent on the host. Adult mites invade the hair follicles and sebaceous glands which become distended with mites and inflammatory material. The life cycle consists of the egg, larval, and two nymphal stages. The disease spreads slowly and transfer of mites is thought to take place by contact, probably early in life. Calves can acquire mites from an infected dam in half a day.<sup>1</sup> However in horses grooming instruments and rugs may transmit infection.

### PATHOGENESIS

Invasion of hair follicles and sebaceous glands leads to chronic inflammation, loss of the hair fiber and in many instances the development of secondary staphylococcal pustules or small abscesses. It is these foci of infection which cause the small pinholes in the hide which interfere with its industrial processing as well as reducing the value dramatically. In most farm animals the lesions are difficult to see externally and only the advanced ones will be diagnosed.

### CLINICAL FINDINGS

The important sign is the appearance of small (3 mm diameter) nodules and pustules which may develop into larger abscesses, especially in pigs and goats. The small lesions can be seen quite readily in short-coated animals and on palpation feel like particles of bird-shot in the hide. In severe cases there may be a general hair loss and thickening of the skin in the area, but usually there is no pruritus and hair loss is insufficient to attract attention. The contents of the pustules are usually white in color and cheesy in consistency. In large abscesses the pus is more fluid. In cattle

and goats the lesions occur most commonly on the brisket, lower neck, forearm, and shoulder, but also occur on the dorsal half of the body, particularly behind the withers. Larger lesions are easily visible but very small lesions may only be detected by rolling a fold of skin through the fingers. In horses the face and around the eyes are predilection areas. Demodicosis in pigs usually commences on the face and spreads down the ventral surface of the neck and chest to the belly. There is little irritation and the disease is observed mainly when the skin is scraped at slaughter. The disease may be especially severe in goats, spreading extensively before it is suspected and in some instances causing deaths. Severe cases in goats commonly involve several skin diseases such as mycotic dermatitis, ringworm, besnoitiosis and myiasis. Demodicosis is rare in sheep. In this species pustules and scabs appear on the coronets, nose, tips of the ears, and around the eyes, but clinical signs are not usually seen and mites may be found in scrapings from areas of the body not showing lesions.

### CLINICAL PATHOLOGY

The characteristically elongated mites are usually easy to find in large numbers in the waxy material which can be expressed from the pustular lesions. They are much more difficult to isolate from squamous lesions. Lesions in hides can be detected as dark spots when a fresh hide is viewed against a strong light source. However, lesions may not be readily seen until the hair has been removed and the skin has been soaking for some time.

### DIFFERENTIAL DIAGNOSIS

- The commonest error is to diagnose the disease as a non-specific staphylococcal infection
- In cattle and goats the disease often passes unnoticed unless the nodules are palpated
- Deep-seated ringworm in horses has much in common with demodicosis
- A satisfactory diagnosis can only be made by demonstration of the mite.

### TREATMENT AND CONTROL

Repeated dipping or spraying with the acaricides recommended for other manges is usually carried out but is more to prevent spread than cure existing lesions. Ivermectin which does not eradicate the infection in dogs, possibly because of the difficulty in getting the acaricide to the mite, has been reported to cure 98% of beef bulls when used at 0.3 mg/kg.<sup>2</sup> Ivermectin in a premix, fed for 7 consecutive days has been reported to clear the infestation in pigs.<sup>3</sup>

### REFERENCES

1. Fisher WF et al. *Vet Parasitol* 1980; 7:233.
2. Yakubovskii MV, Ananchikov MA. *Vet Moskva* 1989; 9:44.
3. Santerem VA et al. *Vet Parasitol* 2005; 131:169.

## SARCOPTIC MANGE (BARN ITCH)

Sarcoptic mange occurs in a wide variety of host species causing a severe pruritic dermatitis. While in most countries it has been a major problem and was a reportable disease the advent of macrocyclic lactone endectocides has reduced the incidence of disease dramatically.

### ETIOLOGY

The causative mite, *Sarcoptes scabiei*, is usually considered to have a number of varieties each generally specific to a particular host species. Morphological, immunological and molecular research confirms the close relationship among the varieties,<sup>1</sup> but do not explain the biological differences, particularly with respect to host specificity. Because host specificity is not strict and transference from one host species to another can occur there is some concern when attempting to control the disease.

Animals in poor condition appear to be most susceptible, but conditions, especially overcrowding, in which sarcoptic mange occurs often go hand in hand with poor feeding and general poor husbandry. The disease is most active in cold, wet weather and spreads slowly during the summer months.

### LIFE CYCLE AND EPIDEMIOLOGY

Female mites form shallow burrows in the lower stratum corneum of the skin in which they deposit eggs. Development for both sexes includes a larval stage, two nymphal stages prior to molting to the adult. All life cycle stages, except the eggs, can be found moving on the skin surface and are thus easily transferred to other hosts. The normal exfoliation of the skin eventually exposes the tunnels exposing eggs as well. The life cycle from egg to egg takes 10–13 days.

Although direct contact between hosts is the most effective method of transmission inert materials such as bedding, blankets, grooming tools, and clothing may act as carriers. Adult mites do not usually survive for more than a few days away from the host but in optimum laboratory conditions they may remain alive for up to 3 weeks. In pigs adult sows are often the source of infestation for young pigs even though they show no signs of the disease. Large numbers of mites can often be found in the ears of normal sows and the mites are transmitted soon after farrowing. Significant scratching does not occur until a hypersensitivity develops some 8–10 weeks later and may continue until slaughter.<sup>2</sup>



A small proportion of young pigs do not develop a hypersensitivity and these become chronically affected.<sup>2</sup>

Amongst domestic species pigs are most commonly affected, but it is an important disease in cattle and camels and occurs in sheep. It has been a notifiable disease in most countries, because of its severity, but a decline in prevalence accompanying the advent of new therapeutics has resulted in the removal of this requirement in some countries. People handling infested animals may become infected but lesions will disappear if further contact is prevented.

Infested animals develop protective immunity<sup>3</sup> and are able to clear challenge infestations rapidly. A proportion of infested hosts do however remain chronically infested and mite populations may show a post-partum recrudescence thereby facilitating transfer to the susceptible offspring.

### **PATHOGENESIS**

Young animals, in particular piglets, become infected in the first few weeks of life and develop a hypersensitivity within 8–10 weeks. This allergic phase lasts for 8–9 months<sup>4</sup> and during this time affected animals are constantly itchy. The disease, if untreated, progress to a localized crust formation characteristic of a chronic hyperkeratotic state.

Many infestations in pigs have little or no effect on weight gain although there is some controversy<sup>5</sup> and treatments improve productivity (see below). There are suggestions in other hosts of reduced feed efficiency. In some pigs the loss of condition, production and vitality may be severe, and the appearance of affected animals is esthetically displeasing. Erythema, papules and intense pruritis may be seen. Few mites may be necessary to cause a reaction in a previously sensitized animal. A chronic condition is uncommon but is seen in pigs with an immunodeficiency.

In cattle and camels, severe hypersensitivity lesions occur and often lead to death. Sheep initially show an intense pruritis and rub the affected part against fences or bite at the skin. Later papules and vesicles occur and the skin becomes thickened, covered with pale scabs and the hair is lost.<sup>6</sup>

### **CLINICAL FINDINGS**

Early lesions are characterized by the presence of small red papules and general erythema of the skin. The affected area is intensely itchy and frequently excoriated by scratching and biting. Loss of hair, thick brown scabs overlying a raw surface, and thickening and wrinkling of surrounding skin soon follow. In pigs the lesions commence on the trunk, in sheep and goats on the face, in cattle on the inner surface of

the thighs, the underside of the neck and brisket and around the root of the tail, and in horses and camels on the head and neck. Except in sheep where the lesions do not spread to the woolled skin, lesions become widespread if neglected and such animals may show systemic effects including emaciation, anorexia, and weakness, and in neglected cases death may occur.

The course of sarcoptic mange is rather more acute than in the other forms of mange and may involve the entire body surface of cattle in a period as short as 6 weeks.

### **CLINICAL PATHOLOGY**

Necropsy examinations are not usually undertaken. Deep scrapings which draw blood are required for accurate diagnosis and must be taken from the edges of any evident lesions (scrapings taken from the central portions of lesions are very often negative). Examination of scrapings either directly or after digestion in 10% potassium hydroxide will reveal mites and/or eggs. When practical multiple scrapings from affected animals should be taken. Examination of the ear wax of pigs often shows mites when none can be seen in scrapings.

Change in behavior, a result of the intense pruritis, have been used in swine as an initial diagnostic tool. An increase in the rubbing index is indicative of infestation, but other clinical confirmation is required.<sup>7</sup>

An ELISA for detection of antibodies to *Sarcoptes scabiei* has been developed.<sup>8</sup> The test has high specificity and moderate sensitivity, being more sensitive in young animals undergoing their first infestation. It has been shown to work well in herd level eradication programs and functions afterward as an effective surveillance tool.<sup>9</sup>

### **DIFFERENTIAL DIAGNOSIS**

- Sarcoptic mange is the only mange which occurs in pigs. It can be confused with infestation with *Tyroglyphus* spp. mites or lice, or with swinepox, parakeratosis, infectious dermatitis, pityriasis rosea, and ringworm. In most of these diseases there are clinical features which are characteristic and final diagnosis can be made on the presence or absence of the mite
- The same comments apply to the differentiation in cattle of sarcoptic mange from chorioptic and psoroptic mange and from chlorinated naphthalene poisoning and ringworm
- Horses may be affected by psoroptic or chorioptic mange but the lesions are most common at the base of the mane and tail and at the back of the pastern respectively
- Infestation with the trombidiform mites and photosensitization may resemble sarcoptic mange
- The disease is uncommon in sheep.

### **TREATMENT AND CONTROL**

Macrocyclic lactone endectocides (including ivermectin, eprinomectin, moxidectin, and doramectin) are the preferred products for treatment of sarcoptic mange. Use of these products in pour-on or injectable formulations are highly efficacious when used at the label recommended dose. Because of the residual activity of these compounds<sup>10</sup> retreatment is not usually necessary although moxidectin given subcutaneously at 0.2 mg/kg to infested sheep resulted in a rapid clinical improvement but did not eliminate the mites. Two doses 10 days apart resulted in negative skin scrapings by 14 days post-treatment.<sup>11</sup> A single injection to cattle eliminated the mites by day 14.<sup>12</sup> The resolution of the lesions may take considerable time, but should not be misconstrued as product failure.

Prefarrowing treatment with ivermectin to prevent transmission to the newborn piglets improves weight gains and early feed conversion.

If other treatments are used they must be thoroughly applied so that all parts of the skin, especially under the tail, in the ears and between the legs are wetted by the acaricide. Although buildings, bedding, and other inert materials do not support the mite for more than a few days they should also be treated unless they can be left in a dry state for 3 weeks.

Treatments should be repeated three times at 7-day intervals. For sows this should commence 3 weeks before farrowing. Special attention should be paid to the ears. Trichlorfon, maldison (0.5%), diazinon (0.02%), coumaphos (0.05–0.1%), fenclorophos, chlorfenvinphos, amitraz (0.1%), and phoxim (0.025%) have been used. All animals should be treated. Phosmet 20% applied as a pour-on at weaning eliminated *Sarcoptes* and allowed 12% increase in live weight gain.<sup>13</sup>

### **REFERENCES**

1. Zahler M et al. *Int J Parasitol* 1999; 29:759.
2. Davis DP, Moon RD. *J Med Entomol* 1990; 27:727.
3. Arlian LG et al. *Vet Parasitol* 1996; 62:133.
4. Sheahan BJ. *Vet Rec* 1974; 94:202.
5. Arends JJ et al. *J Anim Sci* 1990; 68:1495.
6. Abu-Samra MT et al. *Ann Trop Med Parasitol* 1981; 75:639.
7. Hollanders W et al. *Vet Parasitol* 1995; 58:117.
8. Hollanders W et al. *Vet Parasitol* 1997; 69:117.
9. Jacobson M et al. *Vet Parasitol* 1999; 81:249.
10. Arends JJ et al. *Vet Parasitol* 1999; 582:71.
11. Corba J et al. *Vet Parasitol* 1995; 56:339.
12. Losson B, Lonneux JF. *Vet Parasitol* 1993; 51:113.
13. Hewett GR. *Vet Parasitol* 1985; 18:265.

## PSOROPTIC MANGE (SHEEP SCAB, BODY MANGE, EAR MANGE)

Psoroptic mange is of greatest importance in sheep, in which it causes sheep scab, but it is also responsible for body mange in cattle and horses and ear mange in horses, sheep, goats, and rabbits. The disease is a major animal welfare concern.<sup>1</sup>

### ETIOLOGY

The various species of *Psoroptes* have now been reduced to two or three species.<sup>2</sup> Based on molecular evidence<sup>3</sup> *P. ovis*, *P. cuniculi*, and *P. cervinus* are identical despite differences in morphology and biology. It is clear that *P. ovis* from cattle and sheep are identical<sup>4</sup> although cross-transmission is not always successful.<sup>5</sup> *P. equi* occurs on horses, donkeys, and mules in Great Britain and *P. natalensis* on cattle and the water buffalo. The ear mites are all *P. cuniculi* and recent work has suggested this is a variant of *P. ovis* adapted to the aural environment. *P. cervinus* assumes a dual role, being an ear mite of the American bighorn and a body mite of the wapiti.

### LIFE CYCLE AND EPIDEMIOLOGY

Psoroptic mange is a major disease in sheep which was once virtually eliminated in most progressive countries where wool production is an important industry. With the cessation of organophosphate dips in the UK there has been a resurgence of the problem. The disease in cattle was widespread in the United States but has now largely been brought under control. It can spread rapidly and cause serious losses in cattle if neglected as shown by the serious losses that can occur in feedlots. The ear manges cause irritation and, in horses, a touchiness around the head.

Psoroptic mites abrade the surface and feed on lipid exudate, bacteria, and skin debris.<sup>6</sup> Erythrocytes are not normally a constituent of the diet and may be accidentally ingested when host scratching results in skin breakage.<sup>6</sup> They cause the formation of scabs, under which they live. The eggs are laid on the skin at the edge of a scab and hatch in 1–3 days, although this is prolonged if eggs are not in contact with the skin. There are the usual larval and nymphal stages and the whole life cycle is complete in 10–11 days.<sup>7</sup> All stages are capable of survival away from the host for up to 10 days and under optimum conditions adult females may survive for 3 weeks.

Optimum conditions for development include high humidity and cool temperatures. Thus the disease is most active in autumn and winter months. This is a result of not only increased activity of the mites but also the more rapid development in

housed animals and the tendency for the disease to be most severe in animals in poor condition. When conditions are adverse, as in summer, mites survive in sheep in protected parts in the perineum, in the inguinal and interdigital regions, the infraorbital fossae, inside the ear and the scrotum. Spread occurs from sheep to sheep but transmission from infected premises and by passive spread of pieces of wool also occurs.

While *P. ovis* has been shown to survive for up to 17 days away from the host,<sup>8</sup> no natural transmission has taken place where premises have been rested for more than 10 days.<sup>5</sup> Premises left free of sheep for at least 2 weeks can be assumed to be safe.<sup>5</sup> If cattle are housed in stanchions that prevent grooming infestation will be more severe.<sup>7</sup> Although individual mites survive for only 4–6 weeks the disease is continuous and a very rapid increase in mite numbers may occur.<sup>7</sup>

The life cycle of the other species is thought to be similar. Spread of ear mite in horses can occur by grooming or by the use of infected harness.

### PATHOGENESIS

The mite migrates to all parts of the skin and prefers areas covered with hair or wool. Salivary secretions and mite excreta contain proteinases that result in a severe allergic pruritis. The exudation of serum accumulates to form a crust. In cattle the mites are most active at the edge of the crust and the lesion spreads peripherally. Infested calves have lower weight gains, lower feed conversion and lower energy retention than non-infested calves.<sup>7</sup> In sheep the mites are more generally distributed and bacterial invasions of the skin are more common.<sup>4</sup>

### CLINICAL FINDINGS

#### Sheep

Cutaneous lesions may occur on any part of the body but characteristically in badly affected sheep they are most obvious on the sides. Very early lesions are small (6 mm diameter) papules which ooze serum. Attention may be attracted to the area by raggedness of the wool caused by biting and scratching. In older lesions thin yellow crusts are present and the wool commences to shed. The wool may contain large masses of scab material which bind the fibers together in a mat. Under suitable conditions the infestation spreads rapidly and in 6–8 weeks three-quarters of the body may be affected.

In a typical outbreak of sheep scab many animals are affected and show itchiness and shedding of the fleece. Some become markedly emaciated and weak, and deaths may occur. However, it is possible to have the disease in a flock at a very low level of incidence and with minimal lesions. This

usually occurs when the sheep are highly resistant because of good nutrition, or climatic conditions are adverse for mite development, or treatment has been carried out but has been incomplete. In such cases there may be little or no clinical evidence of the disease and a careful search for latent cases may be necessary. This is facilitated by packing the animals into a confined space, so that the mites become active, and watching for signs of itchiness.

Behavioral changes in infested sheep are dramatic with sheep biting at the affected areas, rubbing or scratching. In addition infested sheep exhibited stereotypic behaviors typical of animals under stress.<sup>1</sup> These changes combine to reduce productivity. Animals exhibiting these changes should be carefully examined by palpating the surface of the skin in search of papules and scabs. Special attention should be paid to the ears, the base of the horns, the infraorbital fossa and the perineal and scrotal areas in rams.

#### Goats

Lesions can vary from a dry crusty scab on the external ear canal with no clinical signs to severe lesions covering much of the body and causing death. However, it is commonly an ear mite, feeding on whole blood, and causing the production of scabs which vary from a single layer lining the large sulcus at the base of the concha to abundant laminated scab formation occluding the meatus. In severe cases the poll may be affected, and scabs may also be found on the pasterns. Female goats serve as the source of infection for the kid; mites may be found by 5 days and clinical signs are seen by the 3rd week of life.<sup>9</sup> *Raillietia* may also be found in the ear of goats but *Raillietia caprae* is easily differentiated microscopically as all legs are on the anterior part of the body.

#### Horses

*P. equi* causes the production of large, thick crusts on those parts of the body carrying long hair, the base of the mane and the root of the tail, and hairless areas such as the udder, prepuce, and axilla. Affected parts are itchy, the hair is lost and with constant rubbing the surrounding skin becomes thickened. *P. cuniculi* infestations in horses cause severe irritation in the ear accompanied by discharge, shaking of the head, rubbing of the head, and tenderness of the poll.

#### Cattle

Typical lesions appear first on the withers, neck, and around the root of the tail. In severe cases they may spread to the rest of the body. The lesions are intensely itchy. They commence as papules but soon are covered with a scab which enlarges peripherally and coalesces with other

lesions so that very large areas of skin may become involved. The hair is lost, the skin becomes thickened, wrinkled, and covered with scabs. Badly affected animals become weak and emaciated, and may die.

### CLINICAL PATHOLOGY

The mites can be easily demonstrated in scrapings taken from the edges of the lesions. Examination is facilitated by prior digestion of the scraping in warm, 10% potassium hydroxide solution.

An ELISA has been developed for diagnosis of *Psoroptes* infestation in sheep.<sup>10</sup> It has been applied to monitoring of infestations as part of efficient control programs.<sup>11</sup>

### DIFFERENTIAL DIAGNOSIS

- Severe cases of psoroptic mange in sheep are similar to mycotic dermatitis except that there is no itching in the latter. Disease causing itchiness such as scrapie, ked, and louse infestations and infestations with *Psorergates ovis* and harvest mites do not have typical cutaneous lesions and the latter group can usually be detected by examination for the causative parasites
- In horses attention is drawn to the condition because of the horse rubbing its head, by swelling around the base of the ear, or by resentment to the bridle passing over the ears. In some horses the affected ear may droop.

### TREATMENT AND CONTROL

Macrocyclic lactone endectocides are used most frequently for control of psoroptic scabies. Cattle treated with ivermectin must be separated from non-infested cattle for between 9 and 14 days, otherwise spread and re-infection<sup>12</sup> may occur. In sheep two treatments of ivermectin 0.2 mg/kg subcutaneously are necessary to eliminate infestations.<sup>13</sup>

Moxidectin applied as a 0.5% pour-on at 0.5 mg/kg to cattle is effective against *P. ovis* as well as lice and *Chorioptes bovis*<sup>14</sup> and was equally effective against *P. ovis* as 0.2 mg/kg by subcutaneous injection.<sup>15</sup> In sheep, although a single subcutaneous dose of 0.2 mg/kg moxidectin gave a rapid clinical improvement, two doses 7 days apart were necessary to eliminate mites.<sup>16</sup> In large scale field use, sheep receiving a single injection in the autumn remained free of the infestation throughout the winter, while two injections 10 days apart were effective in treating outbreaks.<sup>17</sup>

Doramectin injectable at 200 µg/kg was highly effective in eliminating mites in scrapings of infested cattle.<sup>18</sup> The same treatment was found to protect cattle from infestation for up to 3 weeks.<sup>18</sup>

If sheep are to be dipped, it is important to wet the skin thoroughly and pay special

attention to severe cases where mites are likely to be present in inaccessible sites on the body. Thus a plunge dip is almost essential and the sheep must be kept immersed in the dipping fluid for at least one minute. Prior shearing may be advisable but may lead to further spread of the infestation. Care must be taken to insure that the concentration of the acaricide in the dip is maintained, especially when large numbers of sheep are being treated. Badly affected animals should be set aside and inaccessible sites including ears, horn bases, and perineum treated manually with the dipping fluid. Dipped sheep should not be returned to their pastures, nor to the barn unless the latter has been thoroughly cleaned and sprayed with the dipping fluid.

Diazinon (0.01%), propetamphos (0.0125%), and flumethrin (0.055%) will all eliminate *P. ovis* from sheep with a single dipping and will give at least 4 weeks of protection.<sup>19</sup> Coumaphos (0.1%), phoxim (0.05%), and amitraz (0.05%) require two treatments at 7–10 day intervals to eliminate infestations. The synthetic pyrethroids are variable in their efficacy. Flumethrin, used as a non-stripping dipping compound, eradicated *P. ovis* from sheep when used at 55 ppm and gave at least 7 weeks of protection.<sup>20</sup> Fenvalerate (0.05%) used twice will also clear infested cattle, but another synthetic pyrethroid, cypermethrin, when used at 150 ppm did not eliminate infestations after three treatments.<sup>21</sup>

In horses, affected ears should be cleaned of all wax and ear preparations containing benzene hexachloride should be used at weekly intervals. Local treatment of diazinon or propetamphos could also be used. Benzyl benzoate is a safe and effective treatment when given every 5 days for three treatments. Ivermectin is highly effective against *P. equi*.<sup>22</sup>

Eradication of sheep scab on an area basis is usually undertaken by quarantine and compulsory treatment of all susceptible animals in the area at the same time. Now that there are effective treatments that do not require dipping, eradication of scab from areas should be more easily accomplished. The necessity to dip all animals in the area during a short period presents difficulties and the cost of construction of dips and lack of desire to dip in cold climates are other obstructing factors. The use of pour-ons or injections is an attractive alternative to autumn dipping, and has the added advantage of providing helminth control in late season lambs and in ewes. Further, even pregnant animals can be yarded and treated by subcutaneous injection or pour-on as long as care is taken in the yards. Where it is desired to keep the disease at a low level

short of eradication, the disease is made notifiable, movement of stock is restricted and infested farms are quarantined.

### REFERENCES

1. Cork MJ, Broom DM. *Vet Parasitol* 1999; 83:291.
2. Bates PG. *Vet Parasitol* 1999; 83:201.
3. Zahler M et al. *Int J Parasitol* 1998; 28:1713.
4. Losson et al. *Vet Parasitol* 1999; 83:219.
5. O'Brien DJ et al. *Vet Res Comm* 1994; 18:113.
6. Rafferty DE, Gray JS. *J Parasitol* 1987; 73:901.
7. Guillot FS. *J Med Entomol* 1981; 18:44.
8. Strong KL, Halliday RB. *Exp Appl Acarol* 1992; 15:153.
9. Heath ACG et al. *NZ Vet J* 1989; 37:56.
10. Ochs H et al. *Vet Parasitol* 2001; 96:233.
11. Falconi F et al. *Vet Parasitol* 2002; 109:119.
12. Lonneux J-F et al. *Vet Parasitol* 1997; 69:319.
13. Bates PG. *Vet Rec* 1994; 134:334.
14. Losson B, Lonneux J-F. *Vet Parasitol* 1996; 63:119.
15. Lonneux J-F et al. *Vet Parasitol* 1997; 49:67.
16. Parker LD et al. *Vet Parasitol* 1999; 83:301.
17. O'Brien DJ et al. *Vet Rec* 1994; 139:437.
18. Clymer BC et al. *Vet Parasitol* 1997; 72:79.
19. Kirkwood AG, Bates PG. *State Vet J* 1987; 41:42.
20. Kirkwood AG, Bates PG. *Vet Rec* 1987; 120:197.
21. Palmer CR, van Amelsfoort A. *J South Afr Vet Assoc* 1983; 54:99.
22. Mukhtar T et al. *Equine Vet J* 1987; 19:143.

### CHORIOPTIC MANGE (TAIL MANGE, LEG MANGE, SCROTAL MANGE)

Chorioptic mange is the commonest form of mange in cattle and horses. While the primary effect on cattle is esthetic damage there are production effects in dairy animals.<sup>1,2</sup> In horses leg mange is a source of annoyance and inefficiency at work. In sheep it affects the scrotum and may cause a decrease in fertility.<sup>1</sup>

### ETIOLOGY

Chorioptic mites were formerly named according to the host species but those on cattle, horses, goats, and sheep are now considered to be one species, *Chorioptes bovis*. Another species, *C. texanus*, has been reported on goats, cattle, and Canadian reindeer. In cattle, the mites are much more active in the latter part of the winter and tend to disappear in cattle at pasture. This diminution in activity is not noted in cattle kept housed in the summer.

### LIFE CYCLE AND EPIDEMIOLOGY

*Chorioptes bovis* feed on the skin surface, abrading the upper layers with their mouthparts and contaminating the area with salivary secretions and excreta. Developmental stages are similar to that of *Psoroptes* and a complete cycle, from egg to adult, requires approximately 3 weeks. The number of parasites is influenced by temperature and humidity; the mite populations beginning to increase on sheep in early autumn, numbers reach a peak in late autumn or early winter and decline in spring. In cattle the cycle is longer, peak numbers occurring in late winter and early spring and declining in summer.

Transmission is probably effected by direct contact in most instances although in animals housed in barns, grooming tools may be an additional method of spreading the disease. Infestation of bedding is not a common method of transmission.

In horses, the parasites occur almost entirely in the long hair on the lower parts of the legs and are rarely found on other parts of the body. In cattle the disease is most evident in the winter, lesions occurring most commonly on the perineum, and back of the udder, extending in severe cases to the backs of the legs and over the rump. In the summer months the mites persist in the area above the hooves, particularly the pasterns of the hind leg. In sheep, lesions are confined to the wool-less areas, chiefly the lower parts of the hindlegs and scrotum. Rams are more heavily infected than ewes and probably infect ewes while copulating. Lactating ewes probably act as the source of infection for lambs.

### PATHOGENESIS

The mites cause an allergic, exudative dermatitis; the yellowish serous exudate coagulates and breaks as the hair grows so that small scabby lesions are seen on the hair. In horses the mites cause severe irritation and itchiness. The initial lesion in cattle is a small nodule which exudes serum causing matting of the hair. In severe cases these coalesce to form heavy scabs and cause thickening and wrinkling of the skin. Mites can be isolated from many animals which show no clinical evidence of the disease. While most cases do not cause any symptoms, a rapidly spreading syndrome characterized by coronitis, intense irritation and a marked fall in milk production has been reported. *C. bovis* is a common parasite of sheep in the United States, New Zealand, and Australia, and causes an allergic exudative dermatitis on the scrotum of rams. This may cause a rise in temperature of the scrotal contents and a severe testicular degeneration if the lesion has an area greater than 10 cm<sup>2</sup>.<sup>1</sup>

### CLINICAL FINDINGS

The first sign in horses is usually violent stamping of the feet and rubbing of the back of the hind pasterns on wire, rails, or stumps. This is most evident during periods of rest and at night. Examination of the area is difficult because of the long hair present and the horses may resent manipulation. In cases of long duration the skin is seen to be swollen, scabby, cracked, and usually greasy; small amounts of serous exudate may be attached to most hair in the affected area.

Cattle show little evidence of cutaneous irritation but the small crusty scabs (3 mm diameter) on the escutcheon, udder, and thighs are unsightly. Although the mites appear to cause little trouble in the summer, occasional animals are seen which have thick, crusty scabs on the skin, just above the coronets and around the muzzle.

The main lesion in sheep is seen on the scrotum of rams where an allergic dermatitis results in the production of a yellowish serous exudate over areas from a few millimeters to several centimeters.<sup>1</sup>

### CLINICAL PATHOLOGY

Scrapings from the affected areas usually contain large numbers of mites.

### DIFFERENTIAL DIAGNOSIS

- Greasy heel in horses resembles chorioptic mange except that pain is more evident in the former and itchiness in the latter. It has been suggested that the two diseases are etiologically related
- The lesions in cattle may go unnoticed but are not likely to be mistaken for those of any other disease with the possible exception of other manges. The presence of chorioptic mites in footrot and mucosal disease lesions may be purely coincidental, but cases of chorioptic mange which have lesions around the coronet and muzzle may be mistaken for one of the erosive diseases
- Sheep with itchy, scabby legs may be infested with other forms of mange or have contagious ecthyma or strawberry footrot.

### TREATMENT AND CONTROL

The macrocyclic lactone endectocides have shown efficacy against *Chorioptes* spp., but eradication of the parasites from a herd is difficult. Moxidectin 0.5 mg/kg applied as a pour-on eliminated *C. bovis* as well as sucking lice and *Psoroptes ovis*.<sup>3</sup> When given as a single injection of 0.2 mg/kg there was a marked decline in the number of mites but few cattle were cleared of infection.<sup>4</sup> Doramectin has high efficacy at the label rate in cattle, but a single treatment did not clear mites from all of the trial animals.<sup>5</sup> Treatment with eprinomectin at recommended rates was completely effective, but mites persisted for at least 14 days.<sup>2</sup>

Two doses of 2 mg/kg flumethrin applied to the whole body 1 week apart eliminates mites from cattle, while treatment of 2 mg/kg was successful if applied to the caudal region.<sup>6</sup> Fenvalerate 0.05% also killed all mites while amitraz 0.05% removed 98%.<sup>7</sup> Phoxim 0.05% and 0.1% used twice at 10-day intervals has also eradicated the infection from cattle.<sup>8</sup> Other compounds if used repeatedly will reduce mite numbers but recrudescences may occur. Ivermectin 0.2 mg/kg given subcutaneously on two occasions reduced but did not eliminate the infestation on cattle. A single treatment of infested horses with ivermectin paste did not remove all mites but when combined with hair removal, washing encrusted areas with oil of salicylic acid and the later removal of crusts with a stiff brush, eradication was achieved.<sup>9</sup>

### REFERENCES

1. Rhodes AP. Aust Vet J 1976; 52:250.
2. Barth D et al. Am J Vet Res 1997; 58:1257.
3. Losson B, Lonneux JF. Vet Parasitol 1996; 63:119.
4. Losson B, Lonneux JF. Vet Parasitol 1993; 51:113.
5. Losson B. et al. Vet Rec 1998; 142:18.
6. Liebisch A. Vet Med Rev 1986; 1:17.
7. Wright FC et al. Am J Vet Res 1988; 49:903.
8. Stendel W. Prakt Tierarztl 1980; 61:240.
9. Warner G, Matthes MF. Monatsch Veterinarmed 1989; 44:332

# Metabolic diseases

## INTRODUCTION 1613

### PRODUCTION DISEASES 1618

Compton metabolic profile test 1618  
 Metabolic profiles for individual cows 1619  
 Parturient paresis (milk fever) 1626  
 Downer cow syndrome (non-ambulatory cows with non-progressive neurological findings) 1644  
 Acute hypokalemia in cattle 1650  
 Transit recumbency of ruminants 1651  
 Lactation tetany of mares (eclampsia, transit tetany) 1651  
 Hypomagnesemic tetanies 1652

Hypomagnesemic tetany (lactation tetany, grass tetany, grass staggers, wheat pasture poisoning) 1652  
 Hypomagnesemic tetany of calves 1659  
 Ketosis, subclinical ketosis, acetonemia 1661  
 Pregnancy toxemia in sheep 1668  
 Fatty liver in cattle (fat cow syndrome, hepatic lipidosis, pregnancy toxemia in cattle) 1671  
 Equine hyperlipemia 1678  
 Steatitis 1680  
 Neonatal hypoglycemia 1680  
 Postparturient hemoglobinuria in cattle 1682

Rhabdomyolysis of horses 1683  
 Sporadic acute exertional rhabdomyolysis in horses (azoturia, tying-up) 1683  
 Masseter myonecrosis 1686  
 Atypical myopathy (myoglobinuria) in grazing horses 1686  
 Low milk fat syndrome 1686  
 Equine pars intermedia dysfunction (adenoma of the pars intermedia of the pituitary, equine Cushing's disease) 1686  
 Disorders of thyroid function (hypothyroidism, hyperthyroidism, congenital hypothyroidism, thyroid adenoma) 1688

## Introduction

Among domestic farm animals, the metabolic diseases achieve their greatest importance in dairy cows and pregnant ewes. In the other species, these diseases occur only sporadically. The high-producing dairy cow always verges on abnormal homeostasis and the breeding and feeding of dairy cattle for high milk yields is etiologically related to metabolic disease so common in these animals.

The salient features of the common metabolic diseases of farm animals are summarized in Table 29.1.

### Periparturient period in cattle and sheep

As milk production in dairy cows increases and as herds become larger, the incidence of metabolic disease increases. In dairy cows, the incidence of metabolic diseases is highest in the period commencing at calving and extending until the peak of lactation is reached and their susceptibility appears to be related to the extremely high turnover of fluids, salts and soluble organic materials during the early part of lactation. With this rapid rate of exchange of water, sodium, calcium, magnesium, chlorides and phosphates, a sudden variation in their excretion or secretion in the milk or by other routes, or a sudden variation in their intake because of changes in ingestion, digestion or absorption, may cause abrupt, damaging changes in the internal environment of the animal. It is the volume of the changes in intake and secretion and the rapidity with which they can occur that affects the metabolic stability of the cow. In addition, if the continued nutritional demands of

pregnancy are exacerbated by an inadequate diet in the dry period, the incidence of metabolic disease will increase. The effect of pregnancy is particularly important in ewes, especially those carrying more than one lamb.

### Transition period in dairy cows

The literature on managing the transition period of the cow from 3 weeks before parturition to 3 weeks after parturition to optimize health and productivity has been reviewed.<sup>1</sup> It is a crucial stage in the production cycle of the dairy cow; no other period can affect subsequent production, health, and reproductive performance so greatly.<sup>1,2</sup> The success of the transition period effectively determines the profitability of the cow during that lactation. Nutritional or management limitations during this time may impede the ability of the cow to reach maximal milk production. The primary challenge faced by cows is a sudden and marked increase of nutrient requirements for milk production, at a time when dry matter intake and thus nutrient supply, lags far behind. Dry matter intake typically declines during the final week before parturition. This decline and changes in endocrine profiles contribute to elevated blood nonesterified fatty acids which have been related to the occurrence of lipid-related metabolic diseases such as fatty liver and ketosis. The magnitude of the decline in intake as parturition approaches may be a better indicator of metabolic health of postpartum cows than level of intake. Diet, body condition score and parity influence dry matter intake and energy balance. The occurrence of diseases during the transition period results in lost milk production during

the time of illness and often for the entire lactation.

A key area of the biology of transition cows is lipid metabolism.<sup>3</sup> Excessive lipid metabolism from adipose tissue is linked with greater incidences of periparturient diseases. Fatty livers have been described in ketotic cows in the 1950s. Hepatic fat accumulation was then noted in normal cows during early lactation. This was followed by a description of a 'fat mobilization syndrome' in early lactation, in which cows mobilized body lipids from adipose tissue and deposited lipids in the liver, muscle, and other tissues. This was followed by descriptions of elevated non esterified fatty acid concentrations during the last 7 days before calving being associated with a greater incidence of ketosis, displaced abomasum and retained fetal membranes but not of milk fever. Understanding the metabolism of NEFA by the liver is a critical component of understanding the biology of the transition cow. Extreme rates of lipid mobilization lead to increased uptake of NEFA by the liver and increases triglyceride accumulation. If this lipid infiltration becomes severe, the syndrome of hepatic lipidosis or fatty liver may result, which can result in a prolonged recovery from other diseases, increased incidence of other diseases, and increased susceptibility to induction of ketosis.

It is now known that lipid metabolism in the prepartum dairy cow is important in the occurrence of displaced abomasum.<sup>4,5</sup> Significant risk factors for displaced abomasum included a negative energy balance prepartum (as estimated from plasma NEFAs), a high body condition score, suboptimal feed bunk management

Table 29.11 Salient features of metabolic diseases of farm animals

Disease	Etiology and epidemiology	Diagnosis	Treatment	Control
Milk fever of cattle	Hypocalcemia. Occurs primarily in dairy cows after 3rd lactation. Also in beef cows. 48 hours before or after calving and in mid-lactation	Low levels of serum calcium	Calcium salts IV, SC	Dietary management of anions-cations
Downer cow	Complication of milk fever; recumbent too long before treatment	Clinical findings. Serum levels of CPK	Supportive therapy	Early treatment of milk fever cases
Acute hypokalemia of cattle	In lactating dairy cows treated with corticosteroids for recurrent ketosis, and mastitis	Low levels serum potassium	Potassium chloride IV	Avoid excessive use of isoflupredone for recurrent ketosis
Lactation tetany of mares	High producing lactating mares being nursed by vigorous well-nourished foal a few weeks of age	Low levels serum calcium	Calcium borogluconate	No reliable method available
Hypomagnesemic tetany (lactation tetany)	Lactating dairy cows on lush fertilized pastures. Also in beef cows before and after calving	Low levels of serum magnesium	Magnesium salts IV	Supplementation of diets at strategic times with magnesium salts
Ketosis of cattle	Before and after parturition in cattle	Blood, urine and milk levels of ketone bodies during the transition period 3 weeks before and after parturition	Glucose IV. Propylene glycol and electrolyte solutions orally. Propylene glycol orally	Prepartum dietary management of energy intake
Pregnancy toxemia of sheep	Declining plane of nutrition in ewes in late pregnancy	Urinary ketones. Hypoglycemia. Metabolic acidosis and terminal uremia	Caesarean section or induction of parturition	Nutritional management of pregnant ewes to ensure a rising plane of nutrition in the second half of pregnancy.
Fatty liver of cattle	High-producing dairy cows overfed during the dry period. In well-conditioned beef cattle in late pregnancy when energy intake suddenly decreased	Ketonemia, ketonuria, hypoglycemia	Poor prognosis in severe cases. Fluid and electrolyte therapy, glucose IV, propylene glycol orally and insulin	Nutritional management of pregnant cows to avoid excessive weight gain. Avoid situations which reduce feed intake at time of parturition
Equine hyperlipidemia	Deranged fat metabolism. Pregnant or lactating middle-aged ponies, donkeys, and American miniature horses worldwide. Sporadic	Hyperlipidemia	Enteral or parenteral feeding, insulin, heparin. Treat underlying disease	Maintain optimal body condition. Prevent disease and nutritional stress in pregnancy
Post parturient hemoglobinuria	Dietary deficiency in high-producing dairy cows 2–4 weeks after calving. Copper deficient area. Cruciferous crops	Low serum inorganic phosphorus. Low PCV. Hemoglobinuria	Whole blood transfusion. Sodium acid phosphate IV. Dicalcium phosphate orally	Ensure adequate dietary phosphorous intake

prepartum, prepartum diets containing >1.65 Mcal of net energy for lactation/kg of dry matter, winter and summer seasons, high genetic merit and low parity.<sup>5</sup>

Metabolic tests can now be used to predict displaced abomasum in dairy cattle.<sup>4</sup> In cows which develop a left-side displacement of the abomasum, mean NEFA concentrations begin to diverge from the mean in cows without LDA 14 days before calving, whereas mean serum  $\beta$ -hydroxybutyrate (BHBA) concentrations did not diverge until the day of calving.<sup>4</sup> Prepartum, only NEFA concentration was associated with risk of subsequent LDA. Between 0 and 6 days before calving, cows with NEFA concentrations  $\geq 0.5$  mEq/L were 3.6 times more likely to develop a LDA after calving. For prospective application, among samples taken 4–10 days before expected calving, the optimum NEFA cutpoint remained 0.5 mEq/L. The sensitivity, specificity and likelihood ratio were 46%, 82%, and 2.6, respectively. Between 1 and 7 days post

partum, retained placenta, metritis and increasing serum concentrations of BHBA and NEFA were associated with increased risk of subsequent LDA. The odds of LDA were eight times greater in cows with serum BHBA  $\geq 1200$   $\mu$ mol/L. Cows with BHBA concentrations  $\geq 1200$   $\mu$ mol/L were 3.4 times more likely to develop LDA. Serum calcium concentrations were not associated with LDA. In summary, strategic use of metabolic tests to monitor transition dairy cows should focus on NEFA in the last week prepartum and BHBA in the first week post partum.

The nutritional management strategies to optimize the metabolic health of transition cows has been reviewed.<sup>6</sup> During the transition period, dairy cows undergo large metabolic adaptations in glucose, fatty acid, and mineral metabolism.<sup>6</sup> The practical goal of nutritional management during this period is to support these metabolic adaptations. A 2-group nutritional strategy for dry cows to minimize overfeeding of nutrients during

the early dry period but increase nutrient supply during the late dry period is now being recommended.<sup>6</sup> Increasing the amount of energy supplied through dietary carbohydrate during the prepartum period results in generally positive effects on metabolism and performance of transition cows. But the form of that carbohydrate (whether starch or highly digestible neutral detergent fiber) may be of lesser importance. Attempts to increase energy supply by feeding dietary fat sources or decrease energy expenditure by supplying specific fatty acids such as *trans*-10, *cis*-12 conjugated linoleic acid to decrease milk fat output during early lactation do not decrease the release of nonesterified fatty acids (NEFA) from adipose tissue.

In addition to nutritional management strategies to optimize health of the transition cow, certain feed additives are in use to reduce subclinical ketosis and reduce the incidence of displaced abomasum.<sup>7</sup> Monensin is a carboxylic polyether ionophore produced by a

naturally occurring strain of *Streptomyces cinnamomensis*. Monensin exerts its many effects by shifting the microbial populations in the rumen. It changes the ratio of volatile fatty acids in the rumen, increasing propionic acid and reducing the molar percentages of butyric acid and acetic acid. Improved rumen propionic acid improves gluconeogenesis. When administered in controlled release capsule (CRC) 2–4 weeks before calving, monensin reduced the incidence of both clinical ketosis and displaced abomasum postcalving.<sup>8</sup> In a large dataset, monensin showed a trend for a 25% reduction in the incidence of retained placenta. Monensin improves energy metabolism which reduces the incidence of all three 'energy associated diseases', retained placenta, displaced abomasum and clinical ketosis. In Canada, the monensin-controlled release capsule (CRC) is approved as an aid in the prevention of subclinical ketosis in lactating dairy cattle. The capsule delivers 335 mg of monensin daily for 95 days.<sup>9</sup> Cows treated with the monensin CRC 3 weeks before calving had decreased NEFA and BHBA and increased concentrations of serum cholesterol and urea in the week immediately pre-calving. Monensin has no effect on calcium, phosphorus, or glucose in the pre-calving period. After calving, concentrations of phosphorus were lower and BHBA lower and cholesterol and urea higher in monensin-treated cows. The lower NEFA values indicate less fat mobilization and the higher cholesterol suggest greater lipoprotein export from the liver. The higher urea levels are thought to be due to a protein-sparing effect in the rumen, resulting in an increased supply of amino acids in the small intestine. There was no effect of treatment on NEFA, glucose, or calcium in the first week post-calving. Monensin treatment administered pre-calving significantly improved indicators of energy balance in both the immediate pre-calving and post-calving periods.

Abnormalities of the blood levels of the four macrominerals, calcium, phosphorus, magnesium, and potassium in the cow during the transition period are involved in subclinical hypocalcemia, clinical milk fever, hypomagnesemia, and acute hypokalemia.<sup>10</sup>

Knowledge of the complex behavioral needs of the dairy cow is essential in order to provide adequate housing during the transition period. In North American dairy herds, the flow of cows through the transition period often necessitates many changes of pens, which are disruptive to the social organization of cow groups. Stocking rates that exceed stall and feed bunk capacity place even greater challenges on the dairy cow at this time. Alternative

strategies for cow grouping and improvements in pen and stall design which provide greater behavioral freedom for the dairy cow and improvements in health and productivity have been described.<sup>11</sup>

Management of the dairy cow at calving time is a major topic which requires that the veterinarian educate the animal attendants and owners.<sup>12</sup> The objective is to ensure the delivery of a viable, live calf and smooth transition of the cow without complications, from the dry period to the lactation period. The two major problems encountered at calving time are dystocia and perinatal mortality.

The diagnosis and treatment of dairy cows with periparturient diseases requires a program suited to the particular herd.<sup>13</sup> Particularly in large herds, there is a need for collaboration between the veterinarian, nutritionist, manager of the herd, and the animal attendants. Specific procedures should be developed for each herd based on past experience with the problems of recently-calved cows, the facilities, the skills of the workers, the priorities of management, and the flow patterns of cows in the herd. Every effort must be made to prevent periparturient diseases in the cows. In general, diseases in the early post partum period originate in the feeding and management of the dry cow. Important principles include a protocol of grouping parturient cows according to the feeding program and handling facilities on the farm. Groups of cows can be screened for mastitis, visual evidence of illness, daily milk yield, body temperature, urine pH, palpated for evidence of metritis. Individual cows which have been identified by a screening method must be examined individually to make a diagnosis and decide on a treatment protocol based on the particular diagnosis.

The use of reliable records to monitor the health and production of dairy cows during the transition period is essential to evaluate the efficacy of programs at the farm level.<sup>14</sup> Monitors of transition cow management programs will assist in determining how well cows are prepared for milk production and good health in the coming lactation. Appropriate monitoring will focus on three areas: **cows that die or are culled in early lactation, the productivity of the surviving cows in early lactation, and the rates of disease in the periparturient period.**

Cows which leave the herd in the first 60 days of lactation are usually culled because of disease or injury.<sup>14</sup> Removal rates and their causes can be a critical monitor of the efficacy of transition cow management programs. Measuring productivity and health of cows in early lactation involves monitoring peak milk, daily milk yields, first test mature equivalent 305-day

projected milk, milk components at first Dairy Herd Improvement Association (DHIA) test day, milk fat percentage, ratios of test-day components, somatic cell count at first DHIA test day.<sup>14</sup> DHIA records also allow comparison of the performance of each cow in early lactation to her performance in the prior lactation. Comparisons can be made of the changes in somatic cell count between the last test of the prior lactation and the first test of the current lactation and mature equivalent 305-day difference from the prior lactation to the first test of the current lactation

Health and production records in dairy herds have traditionally emphasized reproductive events and treatments given. The records should capture the information about the common diseases which occur in most dairy herds.<sup>14</sup> The record system should be set up to:

- Monitor rates of well-defined disease events as a measure of the effectiveness of health and production programs and to aid problem solving
- Determine the clinical efficacy of treatments by monitoring retreatment rates for specific diseases
- Maintain an individual cow history record for cow-side use to enhance treatment decisions
- Measure compliance and consistency of implementation of the health program being used
- Reconcile pharmaceutical purchases with treatment protocol entries and to meet regulatory requirements on the use of pharmaceuticals in food animals
- Determine the costs of certain disease rates over achievable targets. The costs of specific diseases are compelling to most dairy herd producers. Good records can generate an incidence rate of common diseases. These costs include the immediate cost of treatment, the cost of the veterinarian's and herdsman's time and the cost of milk withheld from the market. For the majority of diseases of recently-calved cows, the cost per disease in the USA is about US\$320.00 with a range from \$150 to \$450 as from the year 2001.

An adequate record system will allow producers and veterinarians to determine the differences between actual performance and benchmark performance and then determine the causes of the shortfall. The most important determinants of profitability on dairy farms are milk income and feed cost and the difference between milk income and feed costs is the return over feed index (ROF).<sup>15</sup> Many factors affect the ROF index. These include: three times daily milking, component percentages in the herd milk test, milk fat and protein percentages, use of an *E. coli* mastitis vaccine



and use of monensin in the lactating cow diet.<sup>15</sup> One of the most important factors associated with profitability is milk production. From 80% to 95% of the income on dairy farms is derived from milk sales. Thus, it is critical that the producer, the veterinarian and other advisors collaborate to plan the animal health and production program which will result in the optimum ROF.

Other recent developments indicate that environmental and management factors can be manipulated to ease the transition into lactation.<sup>16</sup> The photoperiod, defined as the duration of light exposure an animal receives within a day, can be adjusted to produce dramatic effects on periparturient health and subsequent lactational efficiency. Increasing the frequency of milking in the immediate post partum period also produces persistent increases in milk yield and improvements in mammary health. In both techniques, evidence is emerging to support the concept that alteration of prolactin sensitivity is the mechanism underlying health and production responses.

The prospect of 0 days for dry periods are being explored as a possible alternative management scheme in dairy herds.<sup>17</sup> In high-producing dairy cows, the dry period is influenced by parity and management practice. Multiparous cows that were continuously milked and treated with bovine somatotrophin (bST) demonstrated negligible production losses in the next lactation. First-calf heifers, however, demonstrated large reductions in milk yield.

### Voluntary dry matter intake in periparturient dairy cattle

The factors affecting voluntary dry matter intake (VMDI) of lactating cattle are extremely important and have received much attention for many decades. The literature on the integration of metabolism and intake regulation in animals has been reviewed.<sup>18</sup> A substantial dip in VMDI is initiated in late pregnancy and continues into early lactation.<sup>18</sup> Pregnancy in dairy heifers has been shown to reduce VMDI from week 26 of pregnancy by 1.53% (approximately 0.17 kg) per week until 3 weeks before calving. In one study, in which the energy density of the diet remained constant during the last 168 days of pregnancy, a similar decline in energy intake during the last trimester of pregnancy both in heifers and lactating cows when diet energy was high (11.6 MJ of metabolizable energy/kg of DM), while the decline was much smaller or insignificant at lower energy densities (10.3 or 8.3 MJ of metabolizable energy/kg of DM).<sup>18</sup> The lowest VMDI occurs at calving. Post partum VMDI increases, but the rate varies

widely. In cows given diets of constant composition, the milk yield typically peaks at 5–7 weeks post partum, while the maximum intake is reached between 8 and 22 weeks after calving. The increase in intake from week 1 post partum to time of peak intake varies from between 2% and 111%. These differences in intake are affected by the diet fed during lactation but may also depend on prepartum feeding by way of, at least in part, the influence and the degree of fatness and or body condition score (BCS) of the animal. Voluntary dry matter intake is considerably higher in multiparous cows compared with primiparous cows. The intake capacity of primiparous cows calving at an age of 2 years is only about 80% of that of multiparous cows in the first part of lactation. The normal pattern of intake may be severely influenced by disease states. Both clinical and subclinical infections are known to substantially reduce appetite and performance.

The dip in VMDI has traditionally been attributed to physical constraints such as the enlarging uterus but this role may be overemphasized. The dip coincides with changes in reproductive status, fat mass and metabolic changes in support of lactation. A number of metabolic signals may have a role in intake regulation. These signals include nutrients, metabolites, reproductive hormones, stress hormones, leptin, insulin, gut peptides, cytokines and neuropeptides such as neuropeptide Y, galanin and corticotrophin-releasing factor.<sup>18</sup>

During late pregnancy and lactation, energy requirements increase considerably. Fetal energy requirements on day 250 of pregnancy have been calculated at 2.3 Mcal/d for Holstein cows. During lactation, energy requirement is increased to 26 Mcal net energy in cows producing 30 kg milk/day. Major changes in metabolism occur to cope with this increase in nutrient requirements. On a diet high in energy density, pregnant heifers will have a relatively high plasma concentration of glucose and a relatively low concentration of NEFA. Post partum, the concentration of NEFA is high while glucose is reduced. These changes reflect the large need for glucose and nutrients by the mammary gland and that dairy cows increase the use of lipid as a source of energy to support lactation. The NEFA begins to rise 2–3 weeks before calving and peaks at calving or during the first week of lactation. Glucose increases during the last week before calving and drops abruptly post partum to reach a minimum of 1–3 weeks into lactation. Post partum changes in the plasma concentration of BHBA are generally opposite those of glucose.

### Immunosuppression during the transition period

In addition to the adaptations in classical metabolism which occurs during the transition period, cows during this period undergo a period of reduced immunological capacity during the periparturient period.<sup>19</sup> The immune dysfunction is broad in scope, affects multiple functions of various cell types and lasts about 3 weeks prior to calving until about 3 weeks after calving. Cows during this period are more susceptible to mastitis. The etiology of periparturient immunosuppression is multifactorial and not well understood but seems to be related to physiologic changes associated with parturition and the initiation of lactation and to metabolic factors related to these events. Glucocorticoids are immunosuppressants, are elevated at parturition and have been postulated to have a role in periparturient immunosuppression.

The effects of parturition on cytoplasmic glucocorticoid expression (GR) in neutrophils and the correlation of the expression with serum cortisol concentration and total leukocyte count and neutrophil counts in periparturient cows has been examined.<sup>20</sup> Neutrophils from periparturient cows had a 49% reduction in GR expression at calving, compared with GR expression 2–4 weeks before calving and 39% reduction, compared with neutrophils from cows in mid-pregnancy. The reduction in neutrophil GR expression is detectable 1 week before calving and most severe at calving and 24 h after calving. Multiparous cows have prolonged GR down-regulation of their neutrophils compared with primiparous cows which may be associated with a higher incidence of mastitis in older cows. Serum cortisol concentrations and total leukocyte and neutrophil counts were significantly increased at calving and returned to baseline value by 24 h after calving. Thus, a cortisol-induced neutrophil GR down-regulation and neutrophil migration dysfunctions occur in periparturient dairy cows. There is impaired expression of adhesion molecules and decreased migration capacity of blood neutrophils. Rapid recruitment of neutrophils into newly infected mammary tissue is the key immunologic defense against mastitis-causing pathogens in ruminants.

Experimentally, nonesterified fatty acids *in vitro* significantly reduces immunosuppressiveness of mononuclear cells of ewes which may be associated with the impairment of cell-mediated and humoral immunity in sheep and cattle with ketosis.<sup>21</sup>

Because vitamin E is a fat-soluble membrane antioxidant which enhances the functional efficiency of neutrophils by

protecting them from oxidative damage following intracellular killing of ingested bacteria, the parenteral administration of vitamin E has been explored for the prevention of peripartum diseases such as retained placenta, metritis, and clinical mastitis. Only cows with marginal vitamin E status (serum  $\alpha$ -tocopherol  $<2.5 \times 10^{-3}$ ) 1 week before calving will have a reduction in the risk of retained placenta following a subcutaneous injection of 3000 IU of vitamin E.<sup>22</sup> In cows with an adequate level of serum vitamin E there was no reduction and primiparous animals were most likely to benefit from vitamin E 1 week before parturition. The associations between peripartum serum vitamin E, retinol and  $\beta$ -carotene in dairy cattle and disease risk indicated that an increase in  $\alpha$ -tocopherol of 1  $\mu\text{g}/\text{mL}$  in the last week prepartum reduced the risk of retained placenta by 20%, whereas serum NEFA concentrations  $\geq 0.5$  mEq/L tended to increase the risk of retained placenta by 80%. In the last week prepartum, a 100 ng/mL increase in serum retinol was associated with a 60% decrease in the risk of early lactation clinical mastitis.<sup>23</sup>

#### Diseases of lactation

In the next phase of the production cycle, parturition is followed by the sudden onset of a profuse lactation which, if the nutrient reserves have already been seriously depleted, may further reduce them to below critical levels and clinical metabolic disease then occurs. The essential metabolite which is reduced below the critical level determines the clinical syndrome which will occur. Most attention has been paid to variations in balances of calcium and inorganic phosphates relative to parturient paresis; magnesium relative to lactation tetany; blood glucose and ketones and hepatic glycogen relative to ketosis; and, potassium relative to hyperkalemia on cereal grazing, but it is probable that other imbalances are important in the production of as yet unidentified syndromes.

The vast majority of production diseases of dairy cows occur very early in lactation. At this time, the cow is producing milk at a rate which is substantially less than her maximum. In terms of rate, high and low milk yielding cows are producing rather similar amounts at this time. However, in terms of acceleration, the change in milk yield per day, it is highest immediately after calving.

During the succeeding period of lactation, particularly in cows on test schedules and under the strain of producing large quantities of milk, there is often a variable food intake, especially when pasture is the sole source of food and instability of the internal environment inevitably follows. The period of early

lactation is an unstable one in all species. Hormonal stimulation at this stage is so strong that nutritional deficiency often does not limit milk production and a serious drain on reserves of metabolites may occur.

#### Recombinant bovine somatotrophin.

Recombinant bovine somatotrophin (rBST) is a synthetically derived hormone that may be identical to naturally occurring bovine growth hormone, or slightly modified by the addition of extra amino acids. The product was approved in the USA in 1993 and its use began commercially in 1994 in dairy herds to increase milk production.<sup>24</sup> A meta-analysis of the effects of rBST on milk production, animal health, reproductive performance and culling has been done in Canada and the drug was not approved for use. Recombinant bovine somatotrophin was found to increase milk production by 11.3% in primiparous cows and 15.3% in multiparous cows; although there was considerable variation between studies. While some statistically significant effects on milk composition (percentage of butterfat, protein, and lactose) were found, they were all very small. Treatment increased dry matter intake by an average of 1.5 kg/d during the treatment period and dry matter intake remained elevated on into the first 60 days of the subsequent lactation. Despite the increase in dry matter intake, treated animals had lower body condition scores at the end of the treatment period and the reduced scores persisted through until the start of the subsequent lactation. Recombinant bovine somatotrophin increased the risk of clinical mastitis by approximately 25% during the treatment period but there was insufficient data to draw firm conclusions about the effects of the drug on the prevalence of subclinical intramammary infections. Use of rBST increased the risk of a cow failing to conceive by approximately 40%. For cows which did conceive, there was no effect on services per conception and only a small increase in average days open. Use of the drug had no effect on gestation length, but the information about a possible effect on twinning was equivocal. Cows treated with rBST had an estimated 55% increase in the risk of developing clinical signs of lameness. There appeared to be an increased risk of culling in multiparous cows. Use of the drug in one lactation period appeared to reduce the risk of metabolic diseases (particularly ketosis) in the early period of the subsequent lactation. The reproductive effects of the drug could be controlled by delaying its use until the cows were confirmed pregnant.

In 1998, an expert panel appointed by the Canadian Veterinary Medical

Association at the request of Health Canada, found a number of legitimate animal welfare concerns associated with the use of rBST. In 1999, Health Canada announced that it would not approve the use of rBST for sale in Canada. The Royal College of Physicians and Surgeons of Canada Expert Panel on Human Safety of rBST found no biologically plausible reason for concern about human safety if rBST were to be approved for sale in Canada.

In 1999, a working group from within the Scientific Committee on Animal Health and Animal Welfare of the European Commission presented a more extensive report which summarized similar results and engaged substantive discussion of animal welfare from the points of view of physiologists and epidemiologists. It concluded that rBST should not be used in dairy cattle. In October 1999, the European Commission banned the use of and marketing of rBST in the European Union as of 1 January, 2000.<sup>25</sup> The animal welfare aspects of the use of rBST and the laws and ethical issues, data analysis, epidemiologic evaluation, and public policies involved for the different reasons made in the USA, Canada, and Europe with regard to the use of rBST in dairy cattle have been reviewed and discussed elsewhere.<sup>25,26</sup>

A comprehensive econometric model was developed to evaluate the potential effects of rBST approval on the Japanese dairy industry.<sup>27</sup> Simulation results indicate that rBST approval would accelerate structural change in Japan's dairy industry toward fewer, larger farms. Negative effects of rBST on farm income are projected to be more severe for smaller farms, because of higher costs, lower profit-earning ability, lower milk yields, and lower adoption rates of rBST. Larger farms would benefit from rBST adoption if milk demand is maintained. However, if public health concerns about rBST induce significant milk demand decreases, even the largest farms' income and cow numbers would decrease. Thus, Japan's dairy industry could be caught in a double downward spiral of declining milk prices and production.

#### Breed susceptibility

The fact that some dams are affected much more by these variations than others is probably explainable on the basis of variations in internal metabolism and degree of milk production between species and between individuals. Between groups of cows, variations in susceptibility appear to depend on either genetic or management factors. Certainly, Jersey cows are more susceptible to parturient paresis than cows of other breeds and Guernseys seem to be more susceptible to

ketosis. Even within breeds, considerable variation is evident in susceptibility between families. Under these circumstances, it seems necessary to invoke genetic factors, at least as predisposing causes.

### Management practices

The management practices of most importance are housing and nutrition. In those sections of North America where cattle are housed during the winter and in poor pasture areas, ketosis is prevalent. In the Channel Islands, local cattle are unaffected by lactation tetany, whereas the disease is prevalent in the UK. In New Zealand, metabolic diseases are complex and the incidence is high, both probably related to the practice of having the cows calve in late winter when feed is poor and to the practice of depending entirely on pasture for feed and to the high proportion of Jerseys in the cattle population.

A knowledge of these various factors is essential before any reasonable scheme of prevention can be undertaken. It should also indicate that although the more common disease entities are presented in this chapter, there is high probability that a disturbance of more than one of the metabolites mentioned may occur simultaneously in the one animal and give rise to complex syndromes which are not described here. The disease entities dealt with must be considered as arbitrary points in a long scale of metabolic disturbances.

### Occurrence and incidence of metabolic diseases

A knowledge of the etiological and epidemiological factors involved will help in understanding the occurrence and incidence of the various metabolic diseases.<sup>28</sup> Largely because of variations in climate, the occurrence of metabolic disease varies from season to season and from year to year. In the same manner, variations in the types of disease occur. For example, in some seasons, most cases of parturient paresis will be tetanic; in others, most cases of ketosis will be complicated by hypocalcemia. Further, the incidence of metabolic disease and the incidence of the different syndromes will vary from region to region. Ketosis may be common in areas of low rainfall and on poor pasture. Lactation tetany may be common in colder areas and where natural shelter is poor. Recognition of these factors can make it possible to devise a means whereby the incidence of the diseases can be reduced.

The metabolic diseases, because of high prevalence and high mortality rate, are of major importance in some countries, so much so that predictive systems are

being set up. Rapid analysis of stored feed samples, pasture and soil is commonly used in Europe and North America but the interesting development has been the recognition of 'production diseases' and the consequent development of metabolic profile tests, particularly in the UK and in Europe.

## Production diseases

The term 'production disease' includes those diseases previously known as 'metabolic diseases', such as parturient paresis (milk fever), hypomagnesemia, acetonemia, and perhaps some other conditions, all of which are attributable to an imbalance between the rates of **input** of dietary nutrients and the **output** of production. When the imbalance is maintained, it may lead to a change in the amount of the body's reserves of certain metabolites, or their 'throughput' and sufficiently large changes in throughput. The generalization applies principally to the hypoglycemias (ketosis) and hypomagnesemias and partly to the hypocalcemias. In these diseases, output is greater than input either because of the selection of cattle which produce so heavily that no naturally occurring diet can maintain the cow in nutritional balance, or because the diet is insufficient in nutrient density or unevenly balanced. For example, a ration may contain sufficient protein for milk production but contains insufficient precursors of glucose to replace the energy excreted in the milk. While agreeing with the generalization on which the term 'production disease' is based, we propose to continue to use the expression 'metabolic disease' because of common usage.

### Relationship between lactational performance and health of dairy cattle

The literature on the relationship between lactational performance and health in dairy cattle has been reviewed.<sup>29</sup> Based on a review of 11 epidemiological and 14 genetic studies there was little evidence that high yielding cows have increased risk of dystocia, retained placenta, metritis, and left-side displacement of the abomasum. The results for periparturient diseases were inconsistent. While no phenotypical relationship between milk yield and the risk of ketosis and lameness was found, selection for higher milk yield will probably increase the lactational incidence risk for these diseases. Mastitis was the only disease where there was a clear relationship between milk yield and risk of infection. Continued selection for high milk yield will worsen this situation.

However, some authors claim that 'Reviewing existing literature, even with structured literature selection, is inadequate to the task of elucidating the relationship between the lactational performance and risk of production diseases'.<sup>29</sup> The most notable feature of the literature evaluation is the large variability that exists between studies. This strongly suggests that there are important factors that need to be considered before meaningful conclusions concerning the relationship between lactational performance and risk of disease can be drawn.

## COMPTON METABOLIC PROFILE TEST

Because of the emphasis on health management beginning in the 1970s, it became popular to explore methods of predicting the occurrence of metabolic disease in advance, so that control strategies could be considered and put into place. It was thought possible to predict the occurrence of production disease in a dairy herd by monitoring certain components of the blood on a regular basis. If the blood level fell below 'normal', it was assumed that intake needed to be increased to compensate for the negative balance created by excessive output.

The Compton metabolic profile is based on the concept that the laboratory measurement of certain components of the blood will reflect the nutritional status of the animal, with or without the presence of clinical abnormalities. For example, a lower than normal mean blood glucose in a group of dairy cows in early lactation may indicate an insufficient intake of energy which may or may not be detectable clinically. On a theoretical basis, the ability of the laboratory to make an objective assessment of the input-output (nutrient-productivity) relationships is an attractive tool for the veterinarian engaged in providing a complete health management service to a herd. The test would theoretically be able to detect the qualitative and quantitative adequacy of the diet of cows expected to produce a certain quantity of milk or return to estrus within a desirable length of time following parturition. A reliable test for the early diagnosis of nutritional deficiency or metabolic disease would be a major step forward in attempting to optimize livestock production and obtain maximum yields at minimum costs.

Some of the literature on metabolic profile testing in dairy cows has been reviewed.<sup>30-32</sup> The use and interpretation of metabolic profiles in dairy herds in the Dairy Herd Health and Productivity Service (DHHPS) have been reviewed.<sup>33</sup>

Methods are needed to monitor nutritional and metabolic status of dairy

herds. The most valuable methods will be those which are sensitive enough to detect change before clinical or economic consequences are manifested. A major challenge in the application of metabolic profile testing is dealing with extraneous sources of variation. Successful management of extraneous variation requires sampling strategies based on animal grouping and testing of multiple animals. Larger herds may be more suitable because they are able to better design sampling strategies and to spread the costs of testing across more animals. In addition, the cost-benefit may be greater in larger herds because of the high cost of inadequate feeds and feeding programs. Statistical Process Control methods offer a unique approach to interpretation which may increase the usefulness of metabolic profiles.<sup>30</sup>

There was considerable interest in the test following its earlier descriptions which stimulated considerable field research. The results of the research have thus far indicated that the test may be useful only as an aid in the diagnosis of nutritional imbalance and production diseases. The results of the test are usually difficult to interpret without a careful conventional assessment of the nutritional status and reproductive performance of the herd and it appears doubtful that the test would reveal significant abnormalities which could not be detected using conventional clinical methods. There was considerable controversy about the practicality of the test. Because of costs of the test, the profile testing must be carefully planned with specific objectives. A regional diagnostic laboratory with automated analytical equipment should be available and this is often a major limiting factor. The test should not be undertaken unless normal values for each laboratory measurement are available from the population within the area. The results from the groups within the herd are compared with local population means. Metabolic profiles have also been suggested as an aid in the selection of superior individuals.

### **METABOLIC PROFILES FOR INDIVIDUAL COWS**

The prediction of whether an individual cow is metabolically within normal range to undergo a stressful lactation at a high level of production would seem to be a useful undertaking. This could be particularly important under management conditions of heavy concentrate feeding, lead feeding, or zero grazing or even indoor housing. There are no well-established protocols for conducting such profile tests. The 'parturition syndrome', dealt with later under the 'fat cow syndrome'

is considered to be predictable by the estimation of blood levels of total cholesterol and glutamic oxalate transaminase. In pastured cattle in New Zealand, the test has been found to be ineffective. Similar tests conducted on individual cows using many serum enzymes and electrolytes as indicators have not proved to be useful if used on only one occasion.

### **Usefulness of metabolic profile testing**

Metabolic profiles in dairy cows were used initially in Britain in the 1960s. Success was limited primarily by the unjustified expectation that all biochemical concentrations in the blood of cows would reflect nutritional intake and status at all times.<sup>34</sup> However, the practical value was found in the approach as an aid to nutritional management. Later, in the 1970s the approach was reassessed and reinstated, culminating in a program for farmers evaluating health and productivity using metabolic profile testing as an integral part of a health management program involving a multidisciplinary approach. The system now depends on a team approach involving farmer, veterinarian, and agricultural adviser. The blood testing part, if useful information is to be obtained, depends critically on following a set of firm criteria for selection of small groups of typical cows within each herd, the timing of testing in relation to concentrate feeds, feed changes, and stage of lactation and the collection of other data about the cows such as body weight and condition, productivity and feeding. The successful approach has been to look, following specific times of nutritional change, at metabolite levels in strictly defined small representative groups of cows within each herd in conjunction with information on body condition and weight, milk performance, and feeding. Comparison with optimum values, the degree of variation from them and comparisons between groups within herds have allowed information about nutritional constraints on productivity to be made available to farmers more quickly and more specifically than by other means.

Most metabolic profile testing has been used in temperate climates. The effectiveness of the technique for identifying constraints on productivity in small herds in tropical and sub-tropical countries has been examined.<sup>34</sup> The study involved 13 projects with 80 cows in each, done in six Latin American, six Asian, and one southern European countries. Data were also collected on feeding, body condition score and weight change, parasitism, and reproduction. In Chile, Mexico, Paraguay, Philippines, Uruguay, and Venezuela, globulin levels were high in >17% of cows

samples on each occasion. In Paraguay, 49% of cows had high globulin levels at 2-3 months after calving. This suggests that inflammatory disease was present although this was not always investigated. In all countries except Mexico and Venezuela, high  $\beta$ -hydroxybutyrate levels before calving in many cows highlighted the presence of body condition loss in late pregnancy, an important potential constraint on productivity and fertility. Fewer cows had high BHB levels in lactation, whereas change in BCS and weight was more sensitive for measuring negative energy balance. Urea concentrations were low in only small numbers of cows suggesting that dietary protein shortages were not common. Albumin levels were low mainly in cows where globulin values were high and therefore did not provide additional information. In China, pregnant yaks over winter had high BHB and low albumin values, suggesting that they were seriously underfed. This resulted in a successful nutritional intervention in the following winter. Inorganic phosphorus values were within the reference range in most countries most of the time, suggesting, contrary to expectation, that this mineral was not commonly a constraint. In summary, the use of metabolic profile testing proved valuable in drawing attention to important potential constraints on productivity in dairy cows in tropical and subtropical environments and in confirming those which were not.<sup>34</sup>

Metabolic profile testing has been used for the prevention of periparturient diseases in dairy cows in Japan.<sup>35</sup> In herds with a high incidence of periparturient disease, low blood values of hematocrit, albumin, glucose, cholesterol, calcium, and magnesium were observed in the dry period. The values correctly diagnose malnutrition as the cause of the periparturient diseases. Following feeding management changes, there was a low incidence of these diseases and the metabolic profiles were normal indicating that feeding management had improved. Because the traditional metabolic profile test is difficult to apply to peripartum cows because they are in state of physiological abnormality and the results are difficult to interpret, doing a test every 10 days during the dry and lactation periods has been evaluated.<sup>36</sup> The criteria were interpreted by the deviations from the reference mean values of metabolites rather than the actual values. The body condition score, albumin, blood urea nitrogen, glucose, total cholesterol, non-esterified fatty acids,  $\gamma$ -glutamyl transpeptidase, and aspartate aminotransferase, fluctuated during the dry and early lactation periods and there were large changes in the hematocrit, blood urea nitrogen, total cholesterol, and

magnesium and high nonesterified fatty acids in herds with a high incidence of peripartum diseases.

The values of the variables which deviated from the reference values for the metabolic profile components were able to assess milk production and feeding which is a practical tool for auxiliary feeding evaluation.<sup>37</sup>

The Dairy Herd Health and Productivity Service (DHHPS) in the UK provides the opportunity for veterinarians to lead a multidisciplinary team which can monitor health, fertility, and production and can plan, when necessary, corrective action.<sup>38</sup> Metabolic profiling and body condition scoring found that at least a third of the cows sampled were mobilizing excessive fat during the transition from the dry period to early lactation. Improving both health and nutrition, before and after calving, would improve reproductive performance in many herds. A team approach, with farmers, veterinarians, nutritionists, and other advisors working together with well defined goals and objectives, is necessary if progress is to be made in improving reproductive performance. High milk yields cannot always be the excuse for suboptimal fertility.<sup>38</sup>

### Biological and statistical basis for herd testing

The interpretation of herd-based tests for metabolic diseases is different from interpreting laboratory tests for metabolites from individual cows.<sup>39</sup> Test results from individual cows are interpreted by comparing the value to a normal reference range established by the laboratory that did the testing. Normal ranges are often derived by calculating a 95% confidence interval (or a similar statistic) of test results from 100 or more clinically normal animals.

Herd test results for metabolic diseases can be interpreted as either the mean test result of the subgroup sampled or as the proportion of animals above or below a certain cut point within the subsample. If a metabolite is associated with disease when it is above or below a biologic threshold (cut point) then it should be evaluated as a proportional outcome. For example, subclinical ketosis in dairy herds can be monitored by testing for  $\beta$ -hydroxybutyrate (BHBA) or other ketone bodies in blood or milk. Subclinical ketosis is a threshold disease and cows are affected only when ketone concentrations are elevated. Blood BHBA concentrations above 1400  $\mu\text{mol/L}$  is the most commonly used cut point for subclinical ketosis. Early lactation cows with BHBA concentrations above this cut point are a threefold greater risk to develop either clinical ketosis or displaced abomasum. Non-esterified fatty acids (NEFA) concentrations in blood are an

indicator of negative energy balance in prepartum cows. Elevated NEFAs before calving are associated with increased risk for displaced abomasum after calving. A threshold above 0.400 mEq/L for cows between 2 and 14 days of calving is suggested as an appropriate cut point.

It is also necessary to determine the alarm level for the proportion of animals above or below the described cut point. The alarm level is determined from research results or clinical experience. The suggested alarm level proportions for BHBA with a cut point of =1400  $\mu\text{mol/L}$  is >10% and for NEFAs with a cut point of =0.400 mEq/L is >10%.

Herd-based testing is useful only when a sufficient number of cows within the herd are tested, which gives reasonable confidence that the results truly represent the entire population of eligible cows in the herd. The minimum sample size for herd-based tests with proportional outcomes is 12 cows. Cows to be sampled need to be selected from the appropriate eligible or at risk group.

The 'proper' use of metabolic profiles depends on care with the timing of blood tests, the selection of cows to be included and the collection and use of background information about the farm, feeding, and feeding system and physical state and performance of the cows.<sup>40</sup>

As of 2005, for 5 years the Dairy Herd Health and Productivity Service (DHHPS) in the UK have been using the metabolic profile approach as an aid to the management of dairy cow nutrition. Effectively the approach has been to 'ask the cows' what they think of their nutrition – by following a set of 'rules' on timing, cow selection and the use of background information.<sup>33</sup> The involvement of a team approach at the farm, including private veterinarian and nutritional adviser, to put the findings in the correct context and to identify the appropriate responses has been vital. Data on health and fertility from many of these farms has also been collected.

### Variables in dairy-herd metabolic profile testing

#### Energy balance

#### Non-esterified fatty acids (NEFAs)

Non-esterified fatty acids are a sensitive indicator of energy balance. They are useful for monitoring energy status of dry cows in the last month of gestation, when rapid changes in energy balance status may not be detectable from changes in body condition score.<sup>31</sup> High values of NEFAs indicate negative energy balance which occurs in animals which are inappetent for any illness.

The serum levels of NEFAs have been monitored in dairy cows as predictors

of displaced abomasum.<sup>41</sup> In cows with LDA, mean NEFA concentration began to diverge from the mean in cows without LDA 14 d before calving, whereas mean serum  $\beta$ -hydroxybutyrate (BHBA) concentrations did not diverge until the day of calving. Prepartum, only NEFA concentration was associated with risk of LDA. Between Day 0 and 6 days after calving, cows with NEFA concentration of  $\geq 0.5$  mEq/L were 3.6 times more likely to develop LDA after calving. Strategic use of metabolic tests to monitor transition dairy cows should center on NEFA. In the last week prepartum and BHBA in the first week post partum.<sup>41</sup> In another study, cows with plasma NEFA  $>0.3$  mEq/L between 3 and 35 days before calving were twice as likely to subsequently have an LDA.<sup>42</sup> In cows with serum BHBA  $\geq 1200$  or 1400  $\mu\text{mol/L}$  in the first week post partum the odds of LDA were three and four times greater, respectively, than in cows with BHBA below the cut points.<sup>43</sup>

#### Serum $\beta$ -hydroxybutyric acid (BHBA)

Serum BHBA concentrations are affected by energy and glucose balance and are a less specific indicator of energy balance than plasma NEFA. High values are associated with reduced milk production, increased clinical ketosis and LDA and reduced fertility.<sup>30</sup> The gold standard test for subclinical ketosis is blood BHBA which is more stable ketone body than acetone or acetoacetate. Subclinical ketosis may start at serum concentrations above 1000  $\mu\text{mol/L}$ . The alarm level for the proportion of cows above the cut-point of 1400  $\mu\text{mol/L}$  has not been determined but it is suggested that no more than 10% subclinical ketosis should be tolerated in early lactation cows.<sup>32</sup> Serum concentrations of 1400  $\mu\text{mol/L}$  or greater in the first 2 weeks post-calving was found to cause a three-fold greater risk for cows to subsequently develop either clinical ketosis or LDA.<sup>44</sup>

Between 1 and 7 days post partum, retained placenta, metritis and increasing serum concentrations of BHBA and NEFA were associated with increased risk of subsequent LDA. The odds of LDA were eight times greater in cows with serum BHBA = 1200  $\mu\text{mol/L}$  were 3.4 times more likely to develop LDA.<sup>41</sup>

#### Blood glucose

Blood glucose concentrations are usually lower in early lactation and during the winter months; in early lactation, there is a heavy demand for glucose and during the winter the energy intake is likely to be lower than necessary to meet requirements. One major cause of variation in blood glucose may be the major fluctuations in daily feed intake. Investigations of feed intake of dairy cows on commercial farms

have shown that concentrate dispensers are commonly incorrectly adjusted and errors of more than 50% in feed intake are sometimes found. In situations of marginal energy imbalance, blood glucose concentration levels may be unreliable as an index of the adequacy of energy intake. Several factors may cause short-term changes in blood glucose. Blood glucose decreases at the time of milk secretion, which makes sampling time critical. Blood glucose may also be influenced by the chemical nature of the carbohydrate and physical form of the feed and the roughage content of the feed. In addition, elevation of blood glucose has been associated with excitement and low environmental temperature.

There is some conflicting evidence about the relationship between mean values of blood glucose of a lactational group and insufficient energy intake and reproductive inefficiency. In some work, there is an expected relationship between low blood glucose and an increased incidence of ketosis. In others, the relationship is not clear, however there was a more consistent relationship between the actual energy intake as a percentage of requirement and the plasma non-esterified fatty acids, but this finding was not sufficiently reliable to be useful. The mean plasma glucose concentrations within 3 days before or after first service of cows which conceived on first service was higher than that of cows which returned, but the difference was only approaching significance at the 5% level and it is doubtful whether this could be of practical value. Although free fatty acids are more sensitive than blood glucose as an indicator of energy status of the lactating cow, the excessive variability of this relationship during early lactation limits its usefulness. Free fatty acids begin to increase several weeks prepartum, peak at parturition and decrease gradually to normal levels after several weeks of lactation. Blood glucose levels follow a similar pattern; however, there may be a period in early lactation when blood metabolite levels and particularly free fatty acids, are not entirely responsive to energy intake, but are perhaps under additional hormonal regulation.

#### Protein nutrition and metabolism

##### *Urea nitrogen testing to evaluate protein*

Milk urea N (MUN) can be used as a management aid to improve dairy herd nutrition and monitor the nutritional status of lactating dairy cows. Urinary N (UN) excretion has been shown to have a positive linear relationship with MUN. Elevated MUN indicates excess protein has been fed to the dairy cow for her given level of production. When adequate energy is in the diet of ruminants, both

blood urea nitrogen and milk urea nitrogen have long been known to be indicators of their protein status. Increases in plasma urea concentration and ammonia occur primarily as a result of inefficient nitrogen utilization. An excess of rumen degradable protein results in an increase in the concentration of rumen ammonia, which is absorbed through the rumen wall and transported to the liver, where it is converted to urea. The catabolism of body protein for gluconeogenesis can also result in the production of ammonia, which is also converted to urea in the liver. Plasma urea has been the most commonly used blood constituent for monitoring protein status and intake. Urea moves passively from the blood into the milk and there is a close relationship between its concentrations in the two fluids. Thus, milk urea has been used as a non-invasive substitute for the measurement of the protein status and protein intake of ruminants. There is also a relationship between urinary nitrogen excretion (UN) and milk nitrogen (MUN). It has been estimated that when dietary energy remained unchanged, milk urea concentration increased by 12–18 mg/L for each additional 60 g of digestible crude protein fed to cows already receiving adequate protein.<sup>45</sup> Milk samples should be submitted to an accredited diagnostic laboratory for MUN analysis. The Azotest Strip, an on-farm dipstick test, lacks accuracy and is not recommended.<sup>46</sup>

The milk urea nitrogen target concentrations for lactating dairy cows fed according to National Research Council Recommendations have been evaluated.<sup>47</sup> Target N ranges from approximately 150 to 200 g/d. The target MUN concentrations are now 8.5–11.5 mg/dL for most dairy herds compared with the previous target concentrations of 12–16 mg/dL.<sup>47,48</sup> Milk urea, together with percentage milk protein is being used increasingly as an indicator of the dietary protein–energy balance. In many European countries and North American states and provinces, UREA analyses are available in Dairy Herd Improvement (DHI) programs. The somatic cell count did not lower UREA concentrations in quarters with elevated SCC.<sup>49</sup> The time of sampling can have a significant effect on UREA concentrations; the highest in the morning and the diurnal pattern was not influenced by intrinsic factors like parity, days post partum or daily milk yield.<sup>49</sup> The levels were significantly increased after refrigeration for 1 week.

Providing dairy farmers with information regarding their herd's MUN should result in more accurate feed management and change toward target values. A survey of dairy farmers in a region in Virginia

and Maryland indicated that 89.5% did not routinely use MUN prior to participating in the project, but most (88%) extension agents and nutritionists in the region recommended it. Providing MUN results and interpretive information to farmers changed feeding practices and subsequent MUN results.<sup>50</sup>

High milk yield in dairy cows is dependent on high intakes of dietary protein (17–19% crude protein) and energy. However, in the ruminant, high protein diets may be associated with reduced reproductive performance. In the UK, dairy cattle are housed over the winter months and turned out to graze in the spring. Spring turnout coincides with the first flush of new pasture growth which can contain very high levels of rapidly degradable protein. Many dairy herds in the UK experience a short-term fall in pregnancy rates at spring turnout. It has been suggested that the problem at turnout is worst on pastures heavily fertilized with nitrogenous fertilizers.

Several reviews of the literature have examined the effect of protein nutrition on reproduction in dairy cows. The reported effect of high nitrogen intake on fertility is inconsistent. Experimentally, the ingestion of a high level of degradable protein commencing 10 days before insemination in lactating dairy cows had no effect on reproductive performance of the lactating high yielding dairy cow.<sup>51</sup> The relationship between milk urea concentration and the fertility of dairy cows from 250 herds in the UK found no relationship between bulk milk urea concentration and fertility, or between changes in bulk milk urea concentrations and fertility.<sup>45</sup> Also, the relationship between the milk urea concentration 5 days after service and the fertility of individual cows was examined. There was no significant difference between the milk urea concentration of the cows which became pregnant and those that did not.

A meta-analysis of the literature evaluated the associations between dietary requirements for protein for dairy cattle, the metabolism of protein in cattle, factors influencing the degradability of protein in ruminant feeds, and factors influencing milk urea concentrations.<sup>52</sup> There are good correlations between dietary protein intake and rumen ammonia, blood urea, and milk urea concentrations. The effect of increasing dietary protein on milk production has been defined through feeding trials and modeling methods used to provide feeding standards. Ryegrass clover pastures provide feed in many of the temperate dairy regions of the world and for much of the year pasture crude protein may exceed 30%, of which a high proportion is rapidly degradable. High dietary protein intakes may have a negative effect on reproductive

performance in lactating dairy cows, but the role of milk urea as a predictor of fertility needs further definition given the high conception rates in many Australasian dairy herds.<sup>52</sup> High intakes of dietary protein may induce adaptations in urea metabolism and the negative relationship identified between high intakes of dietary protein and fertility for Northern Hemisphere dairy herds may not necessarily apply in Australasian dairy herds. Because of the potential for cows to adapt to high protein diets, the use of single milk urea determination on a herd will have limited value as an indicator of nutritional status and little value as a predictor of fertility.<sup>52</sup> The differing observations between various production systems indicate the need for careful consideration in applying recommendations for dietary protein management based on milk urea concentrations. Milk urea determinations may, however, have value, particularly when used in conjunction with other herd and nutritional data to assess the protein nutrition of dairy herds. It is highly unlikely that single or even serial determinations of milk urea in single cows or bulk tank milk will have a high predictive value for determining the risk of conception in the cow or herd.<sup>52</sup>

#### Serum albumin

Serum albumin is related to protein status of the animal. Lactation stage has a substantial effect on serum albumin. Animals should be grouped into dry cows, early lactation (1–10 weeks) and later lactation. Minimal values for dry cow means are from 2.9 to 3.1 g/dL, for recently calved cows from 2.7 to 2.9 g/dL and 3.0 to 3.2 g/dL for cows in later lactation.

#### Hematology

##### *Hematocrit (packed cell volume)*

The hematocrit can be used as a general reflection of health. In most dairy herds, a low hematocrit may be a reflection of suboptimal energy and protein nutrition. Mean values of packed cell volume (PCV), hemoglobin and serum iron are consistently higher in non-lactating cows than in lactating cows. Parasitism causing blood loss will result in a low hematocrit. The hematocrit varies with lactation stage, being highest in dry cows and lowest in early lactation. Cows should be grouped by lactation stage.

#### Mineral nutrition

##### *Serum inorganic phosphorus*

Serum inorganic phosphate levels tend to fall following long-term insufficient dietary intake and hyperphosphatemia may occur in cattle grazing on highly fertilized pasture.

##### *Serum calcium*

Serum calcium levels vary only within narrow limits and are not sensitive

indicators of input–output balance. However, abnormally low levels in late pregnancy indicate a dangerous situation.

##### *Serum magnesium*

Serum magnesium levels are usually low during the winter months and subclinical hypomagnesemia exists in many herds, especially pregnant beef cattle. This can be converted into clinical hypomagnesemia with a sudden deprivation of feed or a sudden fall in environmental temperature. Supplementation of the diet with magnesium salts is protective.

##### *Serum sodium*

Low levels of serum sodium occur in early lactation in cows grazing on summer pastures without supplementation with salt. Levels down to 135 mmol/L may be associated with depraved appetite and polydipsia and polyuria.

##### *Serum potassium*

Serum potassium levels have been difficult to interpret because the levels of the electrolyte in serum are not necessarily indicative of potassium deficiency. Its normal serum concentration is much more variable than sodium and its average concentration in roughages of all kinds is nearly always in excess of requirements; any abnormalities are usually in the direction of excess.

#### Timing of blood tests

##### *In relation to feed changes*

As changes in the diet of ruminants require changes in the character of rumen activity, blood samples for metabolic profiles should not be done until 2 weeks after a major change and activity has had time to adapt. Minor changes such as an increase in the quantity of an existing component or in access to the same ration do not require a wait of more than 7–10 days. Changes in forage type, such as turnout to pasture, housing, or the introduction of silage require the full 2 weeks. The same applies for introduction of concentrates or of a new type of concentrate.

##### *In relation to feeding*

There can be changes in biochemical values in blood associated with feeding. These are most marked in cows receiving all their concentrate ration at milking time. In such cases, 2 h should be allowed to elapse after milking before blood sampling. In circumstances where the major part of the concentrate input is mixed with the forages and is available for most of each 24 h, the timing of tests in relation to feeding is less critical. If lower yielding mid lactation cows are included (see later), their results can be used as a check to see if there is an effect of feeding on the biochemical values in the blood samples.

Cows should not be separated at milking time and confined for hours without access to food waiting for blood sampling as this can also affect the results.

##### *In relation to calving pattern and seasonal feeding changes*

The cow in early lactation is the most important because what happens to her in the first few weeks after calving has the major influence on her subsequent productivity, including her future fertility efficiency. Therefore, blood sampling for metabolic profiles should be carried out at the beginning of each new calving season, with the first cows checked so that the majority can benefit from the information derived.

Of equal importance is the need to test as soon as possible after the introduction of a new ration, so that evaluation of the cows' biochemistry can be made available as quickly as possible, i.e. **what the cows, the end users, think of the ration.**

Therefore planning of metabolic profile tests needs to be done in advance and should take in to account both expected calving pattern and feed changes. Without planning along these lines, time may be lost and productivity with it.

#### Selection of cows

Picking appropriate cows for blood sampling is very important. This is because some of the metabolites looked at, particularly those relating to energy balance, can quickly return to the optimum range as cows adapt themselves, including their productivity, to a nutritional constraint. It is possible for cows to experience a significant energy deficit in the first 2–3 weeks of lactation because of intake problems, lose excessive body condition, perhaps modify their milk yield, and have their subsequent fertility efficiency suppressed but yet still arrive at 4 weeks calved with all biochemical measurements within the optimum ranges. This is because the common appetite constraint of the new calved has worked its way out and there is plenty of food available for lower performance than anticipated. If blood is sampled at 4 weeks calved or longer, a farmer could see thin, under-producing cows with poor fertility but with nothing abnormal about their biochemistry. Thus, the farmer would be entitled to feel the metabolic profile test was of no value. However, if those cows had been blood sampled at 14 days calved instead of 27, the blood results would have been quite different and would have identified the nutritional constraint on productivity.<sup>53</sup>

The 'Rules' for metabolic profiling of dairy cattle recommend sampling from the following groups:



- Early lactation (EL): between 10 and 20 days of lactation
- Mid lactation (ML): between 50 and 120 days of lactation
- Dry period (D): between 7 and 10 days of calving.

Individual variations in biochemical values are such that single cows should not be tested. **Groups of no less than five should be sampled.** They should not be picked at random but rather should be typical, average cows of their stage of lactation. Cows with extremes of performance – either very high or very low – should not be selected. Cows with problems should also not be included because the type of analysis carried out is not designed to clarify individual problems. It is important to make all this clear to farmers in advance because they cannot be expected to appreciate the limitations of the analyses made. Experience in the Dairy Herd Health and Productivity Service in the UK<sup>33</sup> suggests that selecting cows for metabolic profiles may be best done by the veterinarian in advance of the test after looking at the calving and production records. If there is a specific concern such as a poor conception rate, farmers may expect only cows which have failed to conceive to be sampled. This hardly ever delivers helpful information as any nutritional constraints have by then been compensated for and blood biochemical values are usually within optimum ranges. The best approach may be to include such cows as the mid-lactation group.

#### Early lactation group (EL)

The definition used for this group is most critical for the reasons given in the previous paragraph. Since the original Compton metabolic profile where high yielding cow was used as the definition, the importance of this group has become increasingly apparent. The definition also has had to be changed to take into account changes in farm practice. The way cows are fed now – total mixed rations, increased out of-parlor concentrate feeding – has reduced the time after calving by when they can adapt themselves to an unsatisfactory diet. **To be sure of detecting the presence of an energy constraint in particular, blood sampling should be carried out between 10 and 20 days calved** – less than 10 days and the yield is still too far below peak for the test to be a realistic one for early lactation performance; more than 20 days and some cows will be thin, unproductive and subfertile but have compensated for their nutrition and they may have normal blood metabolite values.

#### Mid-lactation group (ML)

Some cows which are passed the period of peak yield and so passed the greatest

period of potential nutritional stress should always be included. **They should be between 50 and 120 days calved** so that they are still relatively high yielding. This group provides a within-herd comparison with the early lactation cows. Without this it is very difficult to distinguish between problems caused by constraints on intake of food or protein and energy content; to identify changes in biochemical values caused by mistiming of tests in relation to feeding or by oddities in the diet such as silage with a high butyric acid content; and to make judgments on concentrate/forage usage within the herd.

#### Dry cow group (D)

As the dry period is so important to the success of the following lactation, blood sampling to make sure nutrition is adequate is essential. However, the nature of the measurements which can be made means that primarily **cows in the last 7–10 days of pregnancy should be sampled.** Cows tested with longer to go than that tend to have normal measurements of energy balance even though they can still get in to difficulty. This is because the period of greatest risk is when the volume of the pregnant uterus increases to the point that it can seriously inhibit food intake. It follows that, in a seasonal calving herd, the first dry cows which come in to these last 7–10 days ought to be blood sampled, so that the information can be used for the benefit of the others still to come in to the maximum risk period.

Blood sampling a group of dry cows with 1 month or longer to go to calving at the same time can sometimes provide a useful within herd comparison with respect to energy balance. It may also identify the presence of dietary protein inadequacy – specifically rumen degradable – in the early part of the dry period.

In the DHHPs program, a majority of farms do metabolic profiles 3–4 times a year at critical times as a check '**ask-the-cows-what-they-think**' exercise. Thus metabolic profiles as part of a pro-active preventive health and productivity programme. Some of the larger farms may do more than 10 tests a year to cover feed changes and to check on the success of any corrective action.

In the DHHPs program, a standard DHHPs metabolic profile includes analysis on blood plasma for  $\beta$ -hydroxybutyrate (BHB), glucose, non-esterified fatty acid (NEFA), urea-nitrogen (urea N), albumin, globulin, magnesium, and inorganic phosphate.<sup>33</sup> Analyses for copper and glutathione peroxidase (GSHPx) are done on approximately one-third of samples received and thyroxine T4 on even fewer. Biochemical analysis is performed using two Bayer Opera auto-analysers, with

**Table 29.2** Metabolic profile parameters in cattle. Optimum values

Parameter	SI units
Butyrate	Milkers Dry cows
	Below 1.00 mmol/L Below 0.60 mmol/L
Plasma glucose	Over 3.00 mmol/L
NEFA	Milkers Dry cows
	Over 0.70 mmol/L Below 0.40 mmol/L
UreaN	1.70–5.00 mmol/L
Albumin	Over 30.00 g/L
Globulin	Under 50.0 g/L
Magnesium	0.80–1.30 mmol/L
Phosphate (inorganic)	1.40–2.50 mmol/L
Copper	9.40–19.00 $\mu$ mol/L
Thyroxine T4 (iodine)	Over 20.00 nmol/L
GSHPx (selenium)	Over 50 units/g Hb

standard internal controls. It also employs an independent, external quality control system. Derivation of optimum metabolite values are summarized in Table 29.2. They are BHB <1.0 mmol/L in cows in milk, <0.6 mmol/L in dry cows; glucose >3.0 mmol/L; NEFA <0.7 mmol/L in cows in milk and <0.5 mmol/L in dry cows; ureaN >1.7 mmol/L; albumin >30 g/L; globulin <50 g/L; magnesium >0.7 mmol/L; inorganic phosphate >1.3 mmol/L; copper >9.2  $\mu$ mol/L; glutathione peroxidase (GSHPx) >50 U/g HB; thyroxine T4 >20 nmol/L.

**Energy.** The data in Table 29.3 uses only the cows fitting precisely the definitions of EL, ML, and D. It shows that, overall, an average of 30% EL cows had metabolite results reflecting satisfactory energy status as did 61% of ML and 43% of D. In both EL and ML groups, glucose is the metabolite most commonly outside its optimum range, followed by BHB and NEFA. The percentage of NEFA values above optimum is low in ML cows. The most common finding is high BHB and low glucose in the same cow. In tests showing most cows in an EL group with results like that, there is usually one or two with high NEFAs as well. Some EL cows show only low glucose or only high NEFA. Where low glucose only predominates in EL cows, ML cows often show the same picture.

**Protein.** UreaN results in Table 29.3 show that the EL stage is more vulnerable to low values than later in lactation, even though the cows would have been on the same diets in virtually every case. In fact an even greater average percentage<sup>51</sup> in 1361 cows blood sampled between 0 and 9 days after calving over the 5 years showed low ureaN.

The proportion of low ureaN results in D cows is high (Table 29.3). In addition to the category shown of 10 days or less before calving, 4335 cows were sampled at more than 10 days prepartum over the 5 years and 22% of them had low ureaN values too.

**Table 29.3** Annual (April–March) percentages outside optimum ranges of metabolite results in blood plasma in adult dairy cows<sup>33</sup>

	Early lactation (EL) (10–20 days calved)					Mid lactation (ML) (50–120 days calved)					Dry (D) (7–10 days prepartum)				
	1999	2000	2001	2002	2003	1999	2000	2001	2002	2003	1999	2000	2001	2002	2003
	/00	/01	/02	/03	/04	/00	/01	/02	/03	/04	/00	/01	/02	/03	/04
β-hydroxybutyrate (BHB)	19.5	16.6	22.3	22.9	17.5	11.2	10.5	14.3	10.6	9.6	34.5	24.7	38.5	28.5	22.7
Glucose	46.0	48.7	43.1	49.0	59.3	21.8	25.9	14.5	22.5	25.4	23.9	27.3	21.7	27.3	33.8
Non-esterified fatty acid (NEFA)	19.1	22.2	24.9	27.4	28.0	0.6	2.1	1.8	2.7	3.1	10.8	15.0	14.2	13.0	14.8
One or more energy metabolite per cow	65	70	67	72	78	34	39	32	40	44	59	57	63	46	63
Urea-nitrogen (UreaN)	0.8	17.3	18.3	16.7	16.7	4.4	6.4	6.0	5.3	5.6	18.4	20.4	20.2	20.8	22.3
Number of cows	1295	1421	1248	1285	1530	914	1066	849	1179	1494	1160	1379	1253	1358	1543

Results outside the optimum ranges for albumin (0.6%), magnesium (2.5%), inorganic phosphate (1.0%), copper (10%), GSHPx (3%) are relatively uncommon. Thyroxine T4 analysis was carried out in 836 samples on specific request and only 3% were below optimum.

#### Background information

So that full value can be obtained by the farmer from the metabolic profile approach, information about the cows and the farm should accompany the blood samples to the laboratory. This should include cow identification; last calving date for milkers/expected for dry cows; body weight – by calculation from heart-girth measurement with a weighband pulled to a constant 5 kg tension is the best, because it is not affected by gutfill and usually most practical, because no mechanical weighing device/crush is required; body condition score by a palpation method; current daily milk yield; expected current daily milk yield; lactation number; daily supplementary feed intakes; daily estimated forage intakes; analytical description of feeds and current herd milk solids percentages. It is useful to have information on herd size, breed, feeding systems, and health and fertility. A note of what concerns the farmer has, if any, should also be made.

#### Interpretation of results at the farm

Circumstances where the diagnosis of a nutritional constraint from blood samples is clearly correct, but the cause(s) are unclear from a distance and could be many, are common. Therefore it is very important that a final interpretation of what is not working and what are the best and most economic solutions ought to be made at the farm with the information from the laboratory to hand. Farm advisory visits should be made as soon as the results are available and discussions made, including farm staff and any other advisers involved. Experience in the DHPS suggests that such a team approach produces a more balanced strategy and is more beneficial than each party working in isolation.

#### Written advice

Any advice given should be recorded concisely in writing and copies given to all participants on the farm. This ensures that the agreed path is followed, keeps a record, and ensures that the fee is for something tangible.

#### Body condition score (BCS)

Managing body reserves is critical for successful cow management and requires an accurate assessment of the cow's 'condition'. Body condition scoring is an important aspect of metabolic diseases of farm animals. Body weight alone is not a valid indicator of body reserves, as cows of a specific weight may be tall and thin or short and fat. The energy stores may vary by as much as 40% in cows of similar body weight, which emphasizes the futility and inaccuracy of relying on body weight alone as an index of cow condition. In addition, because tissue mobilization in early lactation occurs as feed intake is increasing, decreases in body tissue weight can be masked by enhanced fill of the gastrointestinal tract, so that body weight changes do not reflect changes in adipose tissue and lean tissue weight.<sup>54</sup>

There is a strong positive relationship ( $r^2 = 0.86$ ) between body condition score (BCS) and the proportion of physically dissected fat in Friesian cows. Therefore, the visual or tactile (palpation) appraisal of the cow's body condition score provides a good assessment of body fat reserves, ignoring, or minimizing the effect of, frame size and intestinal contents. Most animal and dairy scientists acknowledge successfully manipulating BCS as an important management factor, influencing or having a relationship to animal health, milk production, and reproduction in the modern dairy cow. For example, cows which lost 0.5–1.0 point in BCS between parturition and first service achieved pregnancy rate to first service of 53%, while those losing >1.0 point achieved a rate of 17%.<sup>55</sup> In a seasonal pasture-based system for Holstein–Friesian cows, it is necessary

to maintain a BCS at  $\geq 2.75$  during the breeding season. Body condition score is important in achieving good reproductive performance. Loss of body condition between calving and first service should be restricted to 0.5 BCS to avoid a detrimental effect on reproductive performance.<sup>55</sup>

BCS is a subjective method of assessing the amount of metabolizable energy stored in fat and muscle (body reserves) on a live animal. BCS in dairy cows is done using a variety of scales and systems. This method involves palpating the cow to assess the amount of tissue under the skin. Scoring body condition and assessing changes in the body condition of dairy cattle have become strategic tools in both farm management and research. BCS is being researched worldwide. But international sharing, comparing, and use of data generated are limited because different BCS systems are used. There is difficulty in interpreting the literature because of variability in the way authors apply scoring methods. In the USA, Canada, and Ireland a 5-point BCS system is used for dairy cows, whereas Australia and New Zealand use 8- and 10-point scales, respectively.<sup>56</sup> The following scoring method is recommended for the 0–5 scale. The BCS chart adapted from Edmonson et al. appears in Figure 29.1.<sup>54</sup>

#### Score: 0

- Condition: Very poor
- Tailhead area: Deep cavity under tail and around tailhead. Skin drawn tight over pelvis with no tissue detectable in between
- Loin area: No fatty tissue felt. Shapes of transverse processes clearly visible
- Animal appears emaciated.

#### Score: 1

- Condition: Poor
- Tailhead area: Cavity present around tailhead. No fatty tissue felt between skin and pelvis, but skin is supple

	SCORE	1	2	3	4	5	6	7	8
		Spinous processes SP (anatomy varies)	Spinous to Transverse processes	Transverse processes	Overhanging shelf (care-rumen fill)	Tuber coxae (hooks) & Tuber ischii (pins)	Between pins and hooks	Between the hooks	Tailhead to pins (anatomy varies)
SEVERE UNDERCONDITIONING (emaciated)	1.00	individual processes distinct, giving a saw-tooth appearance	deep depression	very prominent >1/2 length visible	definite shelf, gaunt, tucked	extremely sharp, no tissue cover	severe depression, devoid of flesh	severely depressed	bones very prominent with deep "V" shaped cavity under tail
	1.25								
	1.50								
FRAME OBVIOUS	1.75			1/2 length of process visible					
	2.00	individual processes evident	obvious depression		prominent shelf	prominent	very sunken		bones prominent "U" shaped cavity formed under tail
	2.25								
FRAME & COVERING WELL BALANCED	2.50	sharp, prominent ridge		between 1/2 to 1/3 of process visible					
	2.75			1/3 - 1/4 visible	moderate shelf		thin flesh covering	definite depression	first evidence of fat
	3.00		smooth concave curve	<1/4 visible	slight shelf	smooth	depression	moderate depression	bones smooth, cavity under tail shallow & fatty tissue lined
	3.25			appears smooth, TP's just discernible					
	3.50	smooth ridge, the SP's not evident	smooth slope	distinct ridge, no individual processes discernable		covered	slight depression	slight depression	
	3.75						sloping		
FRAME NOT AS VISIBLE AS COVERING	4.00	flat, no processes discernable	nearly flat	smooth, rounded edge	none	rounded with fat	flat	flat	bones rounded with fat and slight fat-filled depression under tail
	4.25								
	4.50			edge barely discernable		buried in fat			bones buried in fat, cavity filled with fat forming tissue folds
SEVERE OVERCONDITIONING	4.75								
	5.00	buried in fat	rounded (convex)	buried in fat	bulging		rounded	rounded	

Fig. 29.1 Body condition scoring chart adapted from Edmonson et al. (1989).

- Loin area: Ends of transverse processes sharp to touch and dorsal surfaces can be easily felt. Deep depression in loin.

#### Score: 2

- Condition: Moderate
- Tailhead area: Shallow cavity lined with fatty tissue apparent at tailhead. Some fatty tissue felt under the skin. Pelvis easily felt
- Loin area: Ends of transverse processes feel rounded but dorsal surfaces felt only with pressure. Depression visible in loin.

#### Score: 3

- Condition: Good
- Tailhead area: Fatty tissue easily felt over the whole area. Skin appears smooth but pelvis can be felt

- Loin area: Ends of transverse processes can be felt with pressure but thick layer of tissue dorsum. Slight depression visible in loin.

#### Score: 4

- Condition: Fat
- Tailhead area: Folds of soft fatty tissue present
- Patches of fat apparent under skin. Pelvis felt only with firm pressure
- Loin area: Transverse processes cannot be felt even with firm pressure. No depression visible in loin between backbone and hip bones.

#### Score: 5

- Condition: Grossly fat
- Tailhead area: Tailhead buried in fatty tissue. Skin distended. No part of pelvis felt even with firm pressure

- Loin area: Folds of fatty tissue over transverse processes. Bone structure cannot be felt.

#### Relationships among international body condition scoring

The New Zealand 10-point scale was compared with the scoring systems in the USA, Ireland, and Australia by trained assessors.<sup>35</sup> Cows were assessed visually in the USA and Australia and in Ireland, cows were assessed by palpating key areas of the cow's body. Significant positive linear relationships were found between the New Zealand 10-point scale and the other scoring systems. The relationship between the 10-point BCS scale used in New Zealand and Ireland and the USA are summarized in Table 29.4.

**Table 29.4 Relationship between the 10-point BCS scale used in New Zealand and the 5-point BCS scale used in Ireland and the USA, and the 8-point scale used in Australia**

New Zealand	USA	Ireland	Australia
1.0	1.83	1.21	2.74
1.5	1.98	1.41	3.01
2.0	2.14	1.61	3.28
2.5	2.30	1.81	3.55
3.0	2.46	2.01	3.82
3.5	2.62	2.21	4.09
4.0	2.78	2.41	4.36
4.5	2.94	2.61	4.63
5.0	3.10	2.81	4.90
5.5	3.26	3.01	5.17
6.0	3.42	3.21	5.44
6.5	3.58	3.41	5.71
7.0	3.74	3.61	5.98
7.5	3.90	3.81	6.25
8.0	4.06	4.01	6.52
8.5	4.22	4.21	6.79
9.0	4.38	4.41	7.06
9.5	4.54	4.61	7.33
10.0	4.70	4.81	7.60

## REVIEW LITERATURE

- Dohoo IR et al. A meta-analysis review of the effects of recombinant bovine somatotrophin. 1. Methodology and effects on production. *Can J Vet Res* 2003; 67:241-251.
- Dohoo IR et al. A meta-analysis review of the effects of recombinant bovine somatotrophin. 2. Effects on animal health, reproductive performance and culling. *Can J Vet Res* 2003; 67:252-264.
- Westwood CT, Lean IJ, Kellaway RC. Indications and implications for testing of milk urea in dairy cattle: A quantitative review. Part 1. Dietary protein sources and metabolism. *N Z Vet J* 1998; 46:87-96.
- Westwood CT, Lean IJ, Kellaway RC. Indications and implications for testing of milk urea in dairy cattle: A quantitative review. Part 2. Effect of dietary protein on reproductive performance. *N Z Vet J* 1998; 46:123-130.
- Overton TR, Waldron MR. Nutritional management of transition dairy cows: strategies to optimize metabolic health. *J Dairy Sci* 2004; 87:E105-E119.
- Cook NB, Nordlund KV, guest editors. Managing the transition cow to optimize health and productivity. *Vet Clin North Am Food Anim Pract* 2004; 20:447-701.
- Herdth TH, guest editor. Metabolic disorders in ruminants. *Vet Clin North Am Food Anim Pract* 2000; 16:215-403.
- Grummer RR, Mashek DG, Hayirli A. Dry matter intake and energy balance in the transition period. *Vet Clin North Am Food Anim Pract* 2004; 20:447-470.
- Goff JP. Macromineral disorders of the transition cow. *Vet Clin North Am Food Anim Pract* 2004; 20:471-494.
- Cook NB, Nordlund KV. Behavioral needs of the transition cow and considerations for special needs facility design. *Vet Clin North Am Food Anim Pract* 2004; 20:495-520.
- Mee JF. Managing the dairy cow at calving time. *Vet Clin North Am Food Anim Pract* 2004; 20:521-546.
- Guterbock WM. Diagnosis and treatment programs for fresh cows. *Vet Clin North Am Food Anim Pract* 2004; 20:605-626.
- Nordlund KV, Cook NB. Using herd records to monitor transition cow survival, productivity and

health. *Vet Clin North Am Food Anim Pract* 2004; 20:627-649.

Oetzel GR. Monitoring and testing dairy herds for metabolic disease. *Vet Clin North Am Food Anim Pract* 2004; 20:651-674.

Dahl GE, Auchtung TL, Reid ED. Manipulating milk production in early lactation through photoperiod changes and milking frequency. *Vet Clin North Am Food Anim Pract* 2004; 20:675-685.

Collier RJ, Annen EL, Fitzgerald AC. Prospects for zero days dry. *Vet Clin North Am Food Anim Pract* 2004; 20:687-701.

Herdth TH. Ruminant adaptation to negative energy balance. Influences on the etiology of ketosis and fatty liver. *Vet Clin North Am Food Anim Pract* 2000; 16:215-230.

Duffield T. Subclinical ketosis in lactating dairy cattle. *Vet Clin North Am Food Anim Pract* 2000; 16:231-253.

Geishauser T, Leslie K, Duffield T. Metabolic aspects in the etiology of displaced abomasum. *Vet Clin North Am Food Anim Pract* 2000; 16:255.

Gerloff BJ. Dry cow management for the prevention of ketosis and fatty liver in dairy cows. *Vet Clin North Am Food Anim Pract* 2000; 16:283-292.

Rook JS. Pregnancy toxemia of ewes, does and beef cows. *Vet Clin North Am Food Anim Pract* 2000; 16:293-321.

Goff JP. Pathophysiology of calcium and phosphorus disorders. *Vet Clin North Am Food Anim Pract* 2000; 16:319-337.

Martens H, Schweigel M. Pathophysiology of grass tetany and other hypomagnesemias. Implications for clinical management. *Vet Clin North Am Food Anim Pract* 2000; 16:339-368.

Oetzel GR. Management of dry cows for the prevention of milk fever and other mineral disorders. *Vet Clin North Am Food Anim Pract* 2000; 16:369-386.

Herdth TH. Variability characteristics and test selection in herd-level nutritional and metabolic profile testing. *Vet Clin North Am Food Anim Pract* 2000; 16:387-403.

Herdth TH, Dart B, Neuder L. Will large dairy herds lead to revival of metabolic profile testing? *Proc Am Assoc Bov Pract* 2001; 34:27-34.

Drackley JK. Biology of dairy cows during the transition period: the Final Frontier? *J Dairy Sci* 1999; 82:2259-2273.

Ingvarsen KL, Dewhurst RJ, Friggens NC. On the relationship between lactational performance and health: is it yield or metabolic imbalance that cause production diseases in dairy cattle? A position paper. *J Dairy Sci* 2003; 83:277-308.

Ingvarsen KL, Andersen JB. Integration of metabolism and intake regulation: A review focusing on periparturient animals. *J Dairy Sci* 2000; 83:1573-1597.

## REFERENCES

- Cook NB, Nordlund KV, guest editors. *Vet Clin North Am Food Anim Pract* 2004; 20:447-701.
- Grummer RR, Mashek DG, Hayirli A. *Vet Clin North Am Food Anim Pract* 2004; 20:447-470.
- Drackley JK. *J Dairy Sci* 1999; 82:2259.
- LeBlanc SJ et al. *J Dairy Sci* 2005; 88:159.
- Cameron REB et al. *J Dairy Sci* 1998; 81:132.
- Overton TR, Waldron MR. *J Dairy Sci* 2004; 87:E105-E119.
- Duffield TF, Bagg RN. *Can Vet J* 2000; 41:388.
- Duffield T et al. *J Dairy Sci* 2002; 85:397.
- Duffield TF et al. *J Dairy Sci* 2003; 86:1171.
- Goff JP. *Vet Clin North Am Food Anim Pract* 2004; 20:471-494.
- Cook NB, Nordlund KV. *Vet Clin North Am Food Anim Pract* 2004; 20:495-520.
- Mee JF. *Vet Clin North Am Food Anim Pract* 2004; 20:521-546.

13. Guterbock WM. *Vet Clin North Am Food Anim Pract* 2004; 20:605-626.

14. Nordlund KV, Cook NB. *Vet Clin North Am Food Anim Pract* 2004; 20:627-649.

15. McLaren CJ. *J Dairy Sci* 2005; 88:419.

16. Dahl GE, Auchtung TL, Reid ED. *Vet Clin North Am Food Anim Pract* 2004; 20:675-685.

17. Collier RJ, Annen EL, Fitzgerald AC. Prospects for zero days dry. *Vet Clin North Am Food Anim Pract* 2004; 20:687-701.

18. Ingvarsen KL, Andersen JB. *J Dairy Sci* 2000; 83:1573-1597.

19. Mallard BA et al. *J Dairy Sci* 1998; 81:585.

20. Preisler MT et al. *Am J Vet Res* 2000; 61:14.

21. Lacetera N et al. *Am J Vet Res* 2002; 63:414.

22. LeBlanc SJ et al. *J Dairy Sci* 2002; 85:1416.

23. LeBlanc SJ. *J Dairy Sci* 2004; 87:609.

24. Dohoo IR et al. *Can J Vet Res* 2003; 67:241, 252.

25. Kronfeld DS. *J Am Vet Med Assoc* 2000; 216:1719.

26. Fetrow JP. *J Am Vet Med Assoc* 2001; 218:1886.

27. Kinoshita J et al. *J Dairy Sci* 2004; 87:1565.

28. Herdth TH. *Vet Clin North Am Food Anim Pract* 2000; 16:215-403.

29. Ingvarsen KL et al. *Prev Vet Med* 2003; 83:277.

30. Herdth TH, Dart B, Neuder L. Will large dairy herds lead to revival of metabolic profile testing? *Proc Am Assoc Bov Pract* 2001; 34:27-34.

31. Herdth TH. *Vet Clin North Am Food Anim Pract* 2000; 16:387-403.

32. Oetzel GR. Herd-based biological testing for metabolic disorders. *Preconvention Seminar 7. Am Assoc Bov Pract* 2003; 36:1-16.

33. Whitaker DA et al. *Cattle Practice* 2005; 13:27.

34. Whitaker DA et al. *Prev Vet Med* 1999; 38:119.

35. Kida KJ. *Vet Med Sci* 2002; 64:557.

36. Kida KJ. *Vet Med Sci* 2002; 64:1003.

37. Kida KJ. *Vet Med Sci* 2003; 65:677.

38. Kelly JM, Whitaker DA. *Br Soc Anim Sci* 2000; 26:209-222.

39. Oetzel GR. Monitoring and testing dairy herds for metabolic disease. *Vet Clin North Am Food Anim Pract* 2004; 20:651-674.

40. Whitaker DA. Use and interpretation of metabolic profiles. In: Andrews AH, ed. *The health of dairy cattle*. Oxford, Malden, MA: Blackwell Science, 2000: 89-107.

41. LeBlanc SJ et al. *J Dairy Sci* 2005; 88:159.

42. Cameron REB et al. *J Dairy Sci* 1998; 81:132.

43. Geishauser T et al. *Vet Clin North Am Food Anim Pract* 2000; 16:255.

44. Duffield T. *Vet Clin North Am Food Anim Pract* 2000; 16:231-253.

45. Cottrill B et al. *Vet Rec* 2002; 151:413.

46. Godden S et al. *Bov Pract* 2003; 37:36.

47. Jonker JS et al. *J Dairy Sci* 1999; 82:1261.

48. Kohn RA et al. *J Dairy Sci* 2002; 85:227.

49. Eicher R et al. *Can Vet J* 1999; 40:487.

50. Jonker JS et al. *J Dairy Sci* 2002; 85:939.

51. Dawuda PM et al. *Anim Reprod Sci* 2004; 81:195.

52. Westwood CT et al. *N Z Vet J* 1998; 46:87, 123.

53. Whitaker D. *J Vet Postgrad Study* 2005; 27:43.

54. National Research Council. In: *Nutrient requirements of dairy cattle*, 7th revised ed. Washington DC: National Academy Press, 2001: 13-27.

55. Buckley F et al. *J Dairy Sci* 2003; 86:2308.

56. Roche JR et al. *J Dairy Sci* 2004; 87:3076.

## PARTURIENT PARESIS (MILK FEVER)

A disease of cattle, sheep, and goats occurring around the time of parturition and caused by hypocalcemia and characterized by weakness, recumbency, and ultimately shock and death.

### Synopsis

**Etiology** Hypocalcemia just before or after parturition.

**Epidemiology** Adult dairy cows in third parity and older; 4–9% with low case fatality. Most commonly within 48 h after calving but also occurs several weeks before or after. Occurs in beef cattle in epidemics. Occurs in sheep and goats in epidemics usually following stressors. Prepartum diets high in calcium.

**Signs** Three progressively worse stages including the following signs:

- Anorexia
- Ruminal atony
- Scant feces
- Inactivity
- General muscular weakness leading to sternal recumbency with lateral kink of neck
- Circulatory collapse with collapsed veins and weak pulse
- Dry muzzle
- Mental depression
- Hypothermia
- Weak heart sounds
- Dilated and sluggish pupils
- Ruminal stasis and bloat
- Lateral recumbency
- Tachycardia
- Death in few to several hours.

**Clinical pathology** Hypocalcemia, hypophosphatemia, variable serum magnesium. Increased creatine phosphokinase (CPK) and aminotransferase (AST) due to ischemic muscle necrosis.

**Necropsy findings** No specific lesions. Ischemic muscle necrosis of large muscles of pelvic limbs because of prolonged recumbency.

### Differential diagnosis list

#### Cattle

Metabolic and nutritional disease

- Hypophosphatemia
- Hypomagnesemia
- Downer cow syndrome
- Fat cow syndrome
- Carbohydrate engorgement.

#### Toxemias

- Peracute coliform mastitis
- Aspiration pneumonia
- Acute diffuse peritonitis.

#### Injuries to pelvis and pelvic limbs

- Maternal obstetrical paralysis
- Dislocation of coxofemoral joint.

#### Sheep and goats

- Pregnancy toxemia
- Enterotoxemia.

#### Diagnostic confirmation

Hypocalcemia and response to treatment with calcium borogluconate.

**Treatment** Calcium borogluconate IV. Calcium chloride in oral gel.

**Control** Dietary management to reduce prepartum intake of calcium. Dietary cation-anion difference program. Calcium gel oral dosing before calving, at calving and 12 and 24 h after calving. Parenteral vitamin D and analogs.

### ETIOLOGY

A depression of the levels of ionized calcium in tissue fluids is the basic biochemical defect in milk fever. A transient period of subclinical hypocalcemia (total plasma calcium <1.9 mmol/L) occurs at the onset of lactation caused by an imbalance between calcium output in the colostrum and influx of calcium to the extracellular pool from intestine and bone. The onset of lactation results in a sudden large demand on the calcium homeostasis. A cow producing 10 kg of colostrum (2.3 g of Ca/kg) will lose 23 g of calcium in a single milking. This is about nine times as much calcium as that present in the entire plasma calcium pool of the cow.<sup>1</sup> Calcium lost from the plasma pool must be replaced by increasing intestinal absorption and bone resorption of calcium. During the dry period, calcium requirements are minimal at about 10–12 g/d. At parturition, the cow must mobilize about 30 g or more of calcium into the calcium pool per day. Hypocalcemia occurs in spite of apparently adequate function of the parathyroid and vitamin D endocrine system and most cows adapt within 48 h after calving by increases in plasma concentrations of parathyroid hormone and 1,25-(OH)<sub>2</sub>D vitamin at the onset of the hypocalcemia and mobilize calcium by increasing intestinal absorption and bone resorption.

About 5–20% of adult cows are unable to maintain plasma calcium and consequently develop severe hypocalcemia (total plasma calcium, 1.0–1.4 mmol/L) or clinical milk fever which requires treatment.<sup>2</sup>

### EPIDEMIOLOGY

#### Occurrence

Cattle

The disease occurs most commonly in high-producing adult lactating dairy cattle. Lactating beef cows are affected but less commonly.

**Age.** Mature dairy cows are most commonly affected in the 5–10-year age group, although rare cases have been observed at the first and second calvings. The hypocalcemia at calving is also age related and most marked in cows at their 3rd to 7th parturition; it is infrequent at the first parturition.

**Breed.** There are differences in susceptibility between the breeds but the differences are small.<sup>2</sup> Field observations have for many years suggested that Jersey's are most susceptible but the reported 33% was observed in a sample compared with 9.6% incidence in other breeds may be associated with the older age of many Jersey cows. The disease in beef cattle breeds occurs either in individual cows or in herd outbreaks.<sup>3</sup>

**Individual cows.** Individual cows and to some extent families of cows, are more

susceptible than others; the disease tends to recur at successive parturitions. The heritability of susceptibility to milk fever and hypocalcemia has been assessed as insignificant; in several breeds examined it was of the order of 6–12%. Complete milking in the first 48 h after calving, as opposed to normal sucking by a calf, appears to be a precipitating factor. Several studies have reported that the incidence of milk fever is positively associated with the level of milk production.<sup>2</sup>

**Time of occurrence.** In cattle, milk fever occurs at three main stages in the lactation cycle. Most prepartum cases occur in the last few days of pregnancy and during parturition but rare cases occur several weeks before calving. Some cases will occur a few hours before parturition or at the time of parturition when the attendant expects the cow to calve and the second stage of parturition does not occur because of uterine inertia due to hypocalcemia. Most cases occur within the first 48 h after calving and the danger period extends up to about the 10th postpartum day. Up to 20% of cases can occur subsequent to the 8th day after calving. In such cases the declines in serum calcium and phosphorus levels are smaller and the increases in serum magnesium levels are greater than in parturient cows. The clinical signs are also less severe and there are fewer relapses after treatment. Occasional cases occur 6–8 weeks after parturition (mid-lactation). Such cases are most often recurrences of the disease in highly susceptible cows which were affected at calving. Undue fatigue and excitement may precipitate such attacks and there is a special susceptibility at estrus. In the latter case, the depression of appetite by the elevation of blood estrogen levels may be a significant factor.

The plasma levels of phosphorus also decrease and the plasma levels of magnesium increase as occurs in cows at the time of parturition. Hypocalcemic episodes lasting 1–2 days may occur two or three times with a periodicity of about 9 days. These cows are referred to as 'calcium cyclers' and the magnitude of the cycling was increased by feeding cows 200 g/d of 1,25-dihydroxyvitamin D for 5 days around the time of parturition. Fluctuations in the intestinal absorption of calcium during this period may be the cause of calcium cycling. Subclinical hypocalcemia is of major significance because it inhibits reticulorumen motility, which affects appetite and exacerbates the negative energy balance already existing in the cow in 1st month of lactation.

Episodes of subclinical hypocalcemia occur in up to 50% of adult cows during the first few weeks of lactation. It is suggested that these calcium cyclers are

animals whose calcium homeostatic mechanisms have not adapted well enough.

**Stressors.** Starvation for 48 h also causes severe depression of serum calcium levels and this may be of importance in the production of hypocalcemic paresis in this species at times other than in the postparturient period. Pregnant beef cattle may develop hypocalcemic paresis during the winter months when they are fed on poor-quality roughage; within a group of such cows the less aggressive ones may suffer selective malnutrition. The disease has also occurred in beef cows affected with diarrhea of undetermined etiology. As another explanation of the heightened susceptibility of cows at estrus, a possible depression of the degree of ionization of calcium under the influence of increased serum estrogens is suggested. However, there were no significant differences in total serum calcium or plasma ionized calcium values in cows from 48 h before and after estrus.

Hypocalcemic syndromes in ruminants are also observed at times other than related to parturition. Thus, it can be part of an early or mild overeating of fermentable carbohydrate. The IV administration of certain aminoglycosides, especially neomycin, elihydrostreptomycin and gentamicin, may cause a reduction in the degree of ionization of serum calcium and a syndrome similar to milk fever. Oral dosing with zinc oxide (40 or 120 mg Zn/kg BW) as a prophylaxis against facial eczema in ewes causes a serious fall in serum calcium levels 24 h later. Caution is recommended with the use of these drugs in parturient cows.

#### Sheep and goats

In sheep, the disease commonly occurs in outbreaks in groups of ewes exposed to forced exercise, long-distance transport, sudden deprivation of food and grazing on oxalate-containing plants or green cereal crops. These circumstances commonly precipitate outbreaks of hypocalcemic paresis in sheep, mature ewes are the most susceptible, particularly in the period from 6 weeks before to 10 weeks after lambing. Up to 25% of the flock may be affected at one time. The disease also occurs in young sheep up to about 1 year old, especially when they graze green oats, but also when pasture is short in winter and spring, as in southeast Australia. The disease is manifested by paresis but in the rest of the flock poor growth, lameness and bone fragility can be detected. A sudden deprivation of feed or forced exercise of ewes can cause marked depression of the serum calcium levels. However, ewes are in a susceptible state in early lactation because they are in negative calcium balance. In late lactation a state of positive balance is

due to a low rate of bone resorption. There is an unexplained occurrence of hypocalcemia in sheep fed on hay when they are supplemented with an energy-rich concentrate which increases their calcium intake. Some of the concentrates fed to ewes in feedlots contain supplementary magnesium as a prevention against hypomagnesemia, which may affect calcium absorption and precipitate hypocalcemia in susceptible ewes. Another occurrence in ewes is at the end of a drought when the pasture growth is lush and very low in calcium content. The incidence may be as high as 10% and the case-fatality rate 20% in ewe flocks in late pregnancy or early lactation.

Hypocalcemia in sheep depresses endogenous glucose production and in late pregnancy in combination with hyperketonemia, facilitates the development of pregnancy toxemia.<sup>4</sup>

In goats, a depression in serum levels of calcium and phosphorus occurs similar to that in cows but in ewes no such depression occurs at lambing and the intervention of a precipitating factor appears to be necessary to further reduce the serum calcium level below a critical point.

Milking goats become affected mostly during the 4–6-year age group. Cases occur before and after kidding, some later than 3 weeks after parturition. Clinical syndromes are identical to those in cows, including the two stages of ataxia and recumbency. Serum calcium levels are reduced from normal levels for parturient does of 9.4–3.6 mg/dL (2.35–0.9 mmol/L).

#### Morbidity and case fatality

Several epidemiological studies of milk fever have shown an incidence risk of 5–10%, calculated either as the lactational incidence or incidence per cow year.<sup>2</sup> Generally the disease is sporadic but on individual farms the incidence may rarely reach 25–30% of high-risk cows. In Victoria, Australia, 85% of dairy herds calve in the spring and the incidence of milk fever ranges from 2% to 5%.<sup>5</sup> With early treatment relatively few deaths occur in uncomplicated cases but incidental losses due to aspiration pneumonia, mastitis, and limb injuries may occur. From 75% to 85% of uncomplicated cases respond to calcium therapy alone. A proportion of these animals require more than one treatment, either because complete recovery is delayed, or because relapse occurs. The remaining 15–25% are either complicated by other conditions or incorrectly diagnosed.

**Subclinical hypocalcemia.** Subclinical hypocalcemia (total plasma calcium <1.9 mmol/L) occurs in dairy cattle during the first few weeks of lactation. The incidence of subclinical hypocalcemia based

on measurement of blood calcium around the time of calving and later in lactation ranges from 23% to 39%.<sup>2</sup> Up to 50% of aged cows may be unable to maintain plasma calcium above the lower normal limit (2.18 mmol/L) as defined by the 99% confidence interval of plasma calcium concentrations in cows outside the first month of lactation. In New Zealand, up to 40% of apparently normal cows may have subclinical hypocalcemia during the first 12 days of lactation.<sup>6</sup> Up to 33% of cows grazing pasture in New Zealand may have subclinical hypocalcemia on the day of calving.

In the USDA National Animal Health Monitoring System Dairy study of 2002, 1446 cows from 480 dairy herds in 21 states were sampled within 48 h of parturition. Subclinical hypocalcemia increased with advancing age and represented 25.3%, 43.9%, and 57.8% of first, second, and third lactation cows, respectively.<sup>7</sup> Of the groups studied, 38.7% were on a DCAD program and the incidence of hypocalcemia was significantly less in those animals on the DCAD program. Also, with normal calcium levels had lower serum NEFAs indicating that their energy status was better than those with hypocalcemia.

#### Risk factors

The literature on the risk factors associated with milk fever has been reviewed.<sup>2</sup>

##### Animal risk factors

Serum calcium levels decline in all adult cows at calving due to the onset of lactation. Serum calcium levels decline to lower levels in some cows than in others and it is this difference which results in the varying susceptibility of animals to parturient paresis.<sup>6</sup> First-calf heifers rarely develop milk fever because while some degree of hypocalcemia occurs during the first few days of lactation, they are able to adapt rapidly to the high demands of calcium for lactation. With increasing age, this adaptation process is decreased and results in moderate-to-severe hypocalcemia in most adult cows. The adaptation mechanism is directly related to the efficiency of intestinal absorption of calcium, which decreases with increasing age.

**Calcium homeostasis.** Three factors affect calcium homeostasis and variations in one or more of them may be important in causing the disease in any individual:

1. Excessive loss of calcium in the colostrum beyond the capacity of absorption from the intestines and mobilization from the bones to replace. Variations in susceptibility between cows could be due to variations in the concentration of calcium in the milk and the volume of milk secreted.

2. Impairment of absorption of calcium from the intestine at parturition.
3. Mobilization of calcium from storage in the skeleton may not be sufficiently rapid to maintain normal serum levels. The calcium mobilization rate and the immediately available calcium reserves are sufficiently reduced in cows in later pregnancy to render them incapable of withstanding the expected loss of calcium in the milk. In older cows, bone resorption makes only a minor contribution to the total rate of calcium mobilization at parturition and is therefore of minor importance for the prevention of periparturient hypocalcemia. Osteoblasts are the only type of bone cell to express the 1,25-(OH)<sub>2</sub>D receptor protein and the decrease in the numbers of osteoblasts with increasing age could delay the ability of bone to contribute calcium to the plasma calcium pool.<sup>1</sup>

It was once postulated that failure to secrete sufficient levels of parathyroid hormone or 1,25-dihydroxyvitamin D was the primary defect in cows which developed milk fever. While it is accepted that the calcium homeostatic mechanisms, regulated by parathyroid hormone and 1,25-dihydroxyvitamin D, fail to maintain normal blood calcium concentrations resulting in severe hypocalcemia, the nature of the endocrine defect is not well understood. It was also once thought that calcitonin, a hormone which inhibits bone calcium resorption was a cause of milk fever but this has not been demonstrated in cows with milk fever.<sup>1</sup> Recent studies have shown that the secretion of parathyroid hormone and the production of 1,25-dihydroxyvitamin D is similar in most cows with or without milk fever.<sup>1</sup> However, about 20% of cows treated for parturient paresis experience relapsing episodes of hypocalcemia which require further treatment. These cows fail to produce adequate levels of 1,25-dihydroxyvitamin D at the onset of lactation.<sup>6</sup> Both relapsing and non-relapsing cows develop the same degree of hypocalcemia and secondary hyperparathyroidism, but production of 1,25-dihydroxyvitamin D is about two-fold greater in non-relapsing cows than relapsing cows. Following treatment of parturient hypocalcemia with calcium salts IV and restoration of ruminal and intestinal motility, non-relapsing cows establish calcium homeostasis over the next 3-4 days by increasing intestinal absorption of calcium which is activated by a sufficient level of 1,25-dihydroxyvitamin D. In relapsing cows, even when rumen and intestinal motility are restored after treatment,

hypocalcemia and paresis are likely to occur because of insufficient plasma 1,25-dihydroxyvitamin D. These cows may remain in this stage of prolonged hypocalcemia for several days and only after a few days and several repeated treatments with calcium will the plasma levels of 1,25-dihydroxyvitamin D increase to an adequate level to maintain calcium homeostasis. It is also unlikely that the parathyroid hormone-related protein in the colostrum of milk fever cows is involved in the disease.<sup>6</sup>

Tissue 1,25-dihydroxyvitamin D receptor concentrations decline with age, which renders older cows less able to respond to 1,25-dihydroxyvitamin D.<sup>1</sup> The intestinal 1,25-(OH)<sub>2</sub>D receptor numbers decline with age in the cow and thus the older cow is less able to respond to the hormone and will take longer to adapt intestinal calcium absorption mechanisms to meet lactational demands for calcium.<sup>6</sup>

A perplexing situation in dairy practice is the recently calved cow with peracute coliform mastitis which may also be mildly hypocalcemic and have some of the clinical signs of milk fever. The *Escherichia coli* endotoxin given IV depresses serum calcium and phosphate levels so that coliform mastitis may contribute to a degree of hypocalcemia in individual cows. However, there is no evidence that cows with peracute coliform mastitis require calcium therapy similar to that used in typical milk fever.

**Body condition score (BCS).** A high BCS increases the risk of milk fever. The odds ratio of milk fever with a BCS >4/5 on the first milk recording day after calving was 4.3<sup>2</sup> and cows with milk fever had a postpartum pre-disease 12 kg higher body weight compared with healthy cows indicating an increased risk of milk fever due to higher body weight. Cows with subclinical hypocalcemia in the winter period had significantly higher mean body weight over the 60 days post partum than normocalcemic cows but the effect was not significant in cows calving during the summer months.

#### Dietary and environmental risk factors

Several dietary factors of the pregnant cow during the prepartum period (last 4 weeks) can influence the incidence of milk fever in cattle.

**Dietary calcium.** Feeding more than 100 g of calcium daily during the dry period is associated with an increased incidence of milk fever.<sup>2</sup> A 500 kg cow requires only about 31 g of calcium to meet daily maintenance and fetal demands in late gestation. When a cow is fed a high calcium diet (>100 g Ca/d), its daily requirement for calcium can be met almost entirely by

passive absorption of dietary calcium. The active transport of calcium from the diet and bone calcium resorption mechanisms are homeostatically depressed and become quiescent. As a consequence, at calving the cow is unable to use bone calcium stores or intestinal calcium absorption mechanisms and is susceptible to severe hypocalcemia until these mechanisms can be activated, which may take several days.

Feeding prepartum diets containing a low concentration of calcium prevents milk fever by activating calcium transport mechanisms in the intestine and bone prior to parturition, thus allowing the animal to adapt more rapidly to the lactational drain of calcium. Feeding diets high in calcium just before parturition may also lower the incidence of milk fever by increasing the absorption of calcium. This will provide sufficient calcium to overcome the relative lack of calcium from bone resorption which results from a high calcium intake.<sup>9</sup>

In sheep, hypocalcemia may occur in pregnant ewes fed a calcium-deficient diet over a prolonged period. A high dietary level of magnesium in late pregnancy may also predispose to hypocalcemia in pregnant ewes but this has not been documented. Ewes fed a diet with a fixed cation excess (82.3 mEq/100 g DM) had higher urine pH and lower urine calcium concentrations, lower blood ionized calcium concentrations after an overnight fast and tended to develop hypocalcemia more rapidly after an ethylenediamine tetra-acetate (NaEDTA) infusion. This suggests that a dietary fixed cation-anion balance may be a risk factor for hypocalcemia in pregnant ewes.

**Dietary phosphorus.** Prepartum diets high in phosphorus (>80 g P/d) also increases the incidence of milk fever and the severity of hypocalcemia.<sup>10</sup> High dietary levels of phosphorus increase the serum level of phosphorus which is inhibitory to the renal enzymes that catalyze production of 1,25-(OH)<sub>2</sub>D, which when decreased reduce the intestinal calcium absorption mechanisms prepartum.

**Dietary cation-anion difference (DCAD).** The anion-cation dietary difference exerts a strong, linear effect on the incidence of milk fever. The dietary cation-anion balance in the prepartum diet may be more important than the level of dietary calcium as a risk factor for milk fever.<sup>2</sup> Prepartum diets high in cations such as sodium and potassium are associated with an increased incidence of milk fever, while diets high in anions, especially chloride and sulfur, are associated with a decrease in the incidence of the disease. Alkaline diets containing an excessive concentration of sodium and potassium can result in an increased incidence of the disease. Most forages such as legumes



and grasses are high in potassium and are alkaline. Metabolic alkalosis predisposes cows to milk fever. Under most circumstances the alkalosis is induced by the potassium in the diet.<sup>11</sup> The addition of anions to the diet of dairy cows prior to parturition effectively reduced the incidence of milk fever by inducing a metabolic acidosis which facilitates bone resorption of calcium.

The quantitative relationship between feed cations and anions predict the alkylogenic or acidogenic response in the animal or the DCAD. The difference between the number of cation and anion particles absorbed from the diet determines the pH of the blood. The cation-anion difference of a diet is commonly described in milliequivalents (mEq) per kg (dry matter) DM (mEq/kg DM) feed. This value is calculated as:  $DCAD = (Na^+ + K^+) - (Cl^- + S^-)$ .<sup>10</sup> Calcium, magnesium and phosphorus content of feeds will also affect acid-base status but are considered to have minor importance in the calculation of the DCAD. The DCAD equation describes how the ions contained in the feeds affect the metabolic processes in the body by the absorption and further metabolism and thereby causing changes in the systemic acid-base status. Systemic acidification induced by anionic supplementation affects the function of the parathyroid (PTH) hormone. The major effect of systemic acidification is to cause an increased response to PTH which results in increased retention of calcium and enhanced mobilization of calcium from bone. A total DCAD in the range of -100 to -200 mEq/kg feed DM is effective in controlling milk fever. Most natural feedstuffs fed to dairy cows will, on a molar basis, have a surplus of sodium and potassium compared with chloride and sulfur. A composite ration, with a negative DCAD value, is difficult to achieve in commercial dairy herd conditions.

A meta-analysis of 75 feeding trials designed to study the nutritional risk factors for milk fever in dairy cattle found that the prepartum dietary concentrations of S and dietary anion-cation balance  $[(Na + K) - (Cl + S)]$  were the two nutritional factors most strongly correlated to the incidence of milk fever.<sup>2</sup> Dietary S acts as a strong anion and reduces the risk of milk fever and increasing the dietary S concentrations lowers the odds ratio of developing milk fever. Increasing dietary Na and crude protein increased the odds ratios, but to a lesser extent.

The incidence of milk fever has been decreased by the addition of chloride and sulfur in excess relative to sodium and potassium in the prepartum diet of Holstein cows. High anion diets increase the plasma levels of  $1,25-(OH)_2D$  prior to parturition,

activating intestinal calcium absorption and possibly bone calcium resorption mechanisms prior to onset of lactation.<sup>10</sup> Monitoring the pH of urine is a sensitive method for assessing the risk of milk fever.<sup>12</sup> The urine pH within 48 h prior to parturition has a significant negative correlation with serum calcium and inorganic phosphorus. The sensitivity, specificity, positive and negative predictive values of urine pH test prior to parturition, using a cut off level of above pH 8.25, were 100%, 81%, 55%, and 100%, respectively.<sup>12</sup>

**Effects of milk fever and subclinical hypocalcemia.** There are several consequences of milk fever and subclinical hypocalcemia including its economic importance and the disease complications which may occur.

#### ECONOMIC IMPORTANCE

Unlike many years ago, the economic losses from milk fever have decreased because calcium borogluconate is an effective treatment which many owners can administer. Significant costs are associated with veterinary intervention and losses due to complications. However, while veterinarians now treat fewer cases of uncomplicated milk fever, there may be an increase in cases which are complicated by factors other than hypocalcemia.

The literature on the effects of clinical milk fever and subclinical hypocalcemia is difficult to interpret because of the complex relationships between milk production, parity of lactation, breed of cattle, epidemiological methods used, management systems being used, and the reproducibility of the clinical observations and the accuracy of the recording systems used.<sup>2</sup> In general, there is insufficient information available to document the consequences of milk fever and subclinical hypocalcemia. A summary of several consequences which have been examined follows here.

**Milk fever relapses.** Milk fever cases which need repeat treatment because of relapses increase the costs.

**Downer cow complications.** The downer cow syndrome associated with milk fever cases which fail to respond within a few hours and remain recumbent for several hours or several days before subsequently standing, or die, or are euthanized represents an important cause of economic loss because of treatment costs, long-term care costs, loss of milk production and loss of the value of the animal. Acute mastitis due to environmental pathogens is a common complication of prolonged recumbency in downer cows associated with milk fever. Some studies have found downer cows had a probability of 35% of being culled in the first 150 days of lactation and a relative risk of being culled of 29.2.<sup>2</sup>

**Dystocia and reproductive disease.** Hypocalcemia at the time of parturition can result in uterine inertia which may cause dystocia and uterine prolapse. In general, there is an increased risk of dystocia associated with milk fever whether the farmer or the veterinarian attends to the dystocia.<sup>2</sup>

**Retained placenta.** Several studies have found an increased risk of retained placenta following milk fever.<sup>2</sup>

**Metritis.** A few studies have found an indirect relationship between milk fever and subsequent metritis.<sup>2</sup>

**Milk production.** There is no reliable evidence that the occurrence of milk fever or subclinical hypocalcemia in cows which recover following treatment affects milk production in the subsequent lactation. Some studies have found a limited effect, no effect or even positive effect of milk fever on milk production.

**Mastitis.** An odds ratio of 8.1 or mastitis has been estimated; for coliform mastitis an odds ratio of 9.0 and for acute clinical mastitis a relative risk of 1.5 following milk fever have been found.<sup>2</sup>

**Displacement of abomasum.** Odds ratios ranging from 2.3 to 3.4 for left side displacement of the abomasum occurring in dairy cows with hypocalcemia at parturition have been estimated.<sup>2</sup>

**Ketosis.** Studies on the occurrence of ketosis following milk fever have found relative risks or odds ratios ranging from 1.3 to 8.9 and using all the confidence intervals the relative risks/odds ratios range from 1.1 to 15.3.<sup>2</sup>

**Body weight.** A temporary drop in body weight occurs in cows with milk fever but there is no long-term effect. In cows with subclinical hypocalcemia in early lactation there may be some weight loss compared with cows with normal levels of calcium.<sup>2</sup>

**Culling.** There may be an increased probability of culling cows which have had milk fever because of the complications or direct or indirect consequences associated with the disease.<sup>2</sup> There is some evidence of culling cows in early lactation because of milk fever but not in late lactation.

#### PATHOGENESIS

The literature on the role of acid-base physiology on the pathogenesis of parturient hypocalcemia and the application of the DCAD in theory and practice has been reviewed.<sup>11</sup>

#### Hypocalcemia

Plasma calcium concentration is normally maintained between 2.1 and 2.6 mmol/L (8.5–10.4 mg/dL). Almost all dairy cows will experience subclinical hypocalcemia, <1.8 mmol/L (7.5 mg/dL) within 24 h after calving. In some cows, the hypocalcemia is more severe, <1.25 mmol/L (5 mg/dL)

causing neuromuscular dysfunction resulting in clinical milk fever. Without treatment, levels may continue to decline to about 0.5 mmol/L (2 mg/dL) which is usually incompatible with life.<sup>13</sup>

Hypocalcemia is the cause of the signs of typical 'milk fever'. Atony of skeletal muscle and plain muscle are well-known physiological effects of hypocalcemia. Hypophosphatemia and variations in levels of serum magnesium also occur and have secondary roles. In experimental hypocalcemia in cattle, there is:

- A marked reduction in the stroke volume and cardiac output
- A 50% reduction in arterial blood pressure
- A reduction in ruminal and abomasal tone and motility.

Total plasma calcium concentration at calving is not significantly related to fat and protein-corrected milk yield at any lactation period.<sup>14</sup>

In rare cases, pathological changes in the myocardium of hypocalcemic parturient cows have been reported.<sup>9</sup> The cows were hypocalcemic, recumbent, with tachycardia, arrhythmia, and dyspnea and failed to respond to calcium therapy, however, the cause of the lesions was not determined. The plasma natriuretic peptide concentrations were elevated indicating myocardial injury.<sup>15</sup>

#### Experimental hypocalcemia

The literature of Na<sub>2</sub> EDTA induced hypocalcemia has been reviewed.<sup>16</sup> A standardized flow rate of 1.2 mL/kg per hour of a 5% solution of Na<sub>2</sub> EDTA until recumbency, results in changes in plasma ionized calcium, total calcium, inorganic phosphate and magnesium comparable with spontaneous milk fever.<sup>17</sup> Induced hypocalcemia in cows results in a depression of frequency and amplitude of rumen contractions as early as 1.0 mmol/L of ionized serum calcium well before any clinical signs of hypocalcemia are detectable and while feeding behavior and rumination are still normal.<sup>18</sup> The induction of subclinical hypocalcemia in cows results in a linear decrease in feed intake and chewing activity as the plasma ionized calcium decreases.<sup>18</sup> The reduced feed intake was observable at ionized calcium below 0.9 mmol/L before the cows had developed other signs of hypocalcemia.<sup>18</sup> Feed intake approached zero when ionized calcium declined to 0.6 mmol/L. This suggests that hypocalcemia may contribute to the reduction in feed intake prepartum and depresses the rumination process ultimately leading to anorexia. Hypercalcemia induced with calcium borogluconate depresses the frequency of rumen contractions but not the amplitude.<sup>19</sup>

In experimental hypocalcemia in sheep, blood flow is reduced by about 60% to all tissues except kidney, heart, lung, and bladder in which the reduction is not as high. During periods of prolonged hypocalcemia in cows and ewes, blood flow to skeletal muscles and the alimentary tract may be reduced to 60–70% of normal for a long period and predispose to the downer cow syndrome. In both cows and sheep there is a significant increase in PO<sub>2</sub> causing an impairment of oxygen uptake by the pulmonary blood flow and an impairment of peripheral tissue uptake of oxygen during hypocalcemia in cows and sheep. Serum calcium and serum phosphate levels are significantly lower in clinical cases than in normal, comparable cows and there is some relationship between the severity of the signs and the degree of biochemical change. The complete response to the parenteral administration of calcium salts in most cases and the occurrence of tetany coincident with hypocalcemia after the IV administration of NaEDTA is further evidence of the importance of hypocalcemia. In addition, some signs indicative of parathyroid tetany in other species are observed in the initial stages of milk fever:

- Early excitement
- Muscle twitching
- Tetany, particularly of the hindlimbs
- Hypersensitivity and convulsive movements of the head and limbs.

The IV infusion of EDTA into cows over a period of 4–8 h results in severe hypocalcemia and paresis which is a reliable model for the reproduction of the disease. In the experimental disease, there are additional signs such as excessive salivation, excessive lip and tongue actions and tail lifting. The serum muscle enzyme levels of creatine phosphokinase (CPK) and aminotransferase (AST) increase due to muscle injury associated with prolonged recumbency. Blood glucose levels increase and serum phosphorus and potassium levels decrease. A prolongation of the ST interval of the electrocardiogram (ECG) occurs, which may be useful as a diagnostic aid if suitable mini-ECG recorders could be made available for field use.

The prolonged infusion of EDTA in sheep over 18 h at a rate to induce hypocalcemia and maintain recumbency resulted in prolonged periods of recumbency ranging from 36 to 64 h before the animals were able to stand. There are also decreases in plasma sodium, plasma potassium, and erythrocyte potassium and prolonged increases in packed cell volumes, which suggests that fluid replacement therapy may be indicated in cattle with prolonged recumbency associated with hypocalcemia. A 4-h IV infusion of EDTA in high

erythrocyte potassium and low erythrocyte potassium dairy cows causes decreases in plasma inorganic phosphorus and plasma potassium which are still below normal 24 h later.<sup>20</sup> The AST(SGOT), CPK and packed cell volumes (PCVs) and white blood cell (WBC) counts are also elevated 24 h later. Plasma magnesium and erythrocyte sodium and potassium were decreased but this action was delayed. The increase in PCV was most pronounced in the low erythrocyte potassium cows, which may provide some clues about the pathogenesis of the downer cow syndrome. Some cows may have a more precipitate increase in PCVs due to loss of plasma volume and an inability to mobilize calcium. A 200 mL solution of 10 g of sodium chloride and 0.5 g of potassium chloride can be given IV to sheep safely over a period of 4–8 min to study the effects of administering such hypertonic solutions in downer animals.<sup>20</sup>

#### Hypomagnesemia

When hypomagnesemia coexists with hypocalcemia the clinical signs continue but with normal or higher than normal levels, relaxation, muscle weakness, depression, and coma supervene. It is likely that the hypocalcemic tetany is overcome by the relative hypermagnesemia (the ratio of Ca:Mg may change from 6:1 to 2:1) approximating the ratio at which magnesium narcosis develops. There is normally a rise in serum magnesium levels at calving but in those cases of parturient paresis in which tetany is a feature serum magnesium levels are low. These low levels are in many cases expressions of a seasonal hypomagnesemia.

#### Hypophosphatemia

Low serum phosphorus levels occur in milk fever and contribute to the clinical signs. Some cases of milk fever may not respond to calcium injectins even though the serum calcium levels return to normal but may appear to recover when the udder is inflated and serum phosphorus levels rise. Field observations indicate sodium acid phosphate given orally or IV may result in recovery of cases not responding initially to calcium salts. However, it is difficult to reconcile the biochemical and clinical findings with low serum phosphorus levels because of the absence of recumbency in other animals with profound hypophosphatemia for long periods. A possible explanation is that the hypophosphatemia which occurs in milk fever is secondary to the hypocalcemia and recumbency rather than being a concurrent event. There is experimental evidence to support this and it also seems probable that the hypophosphatemia could prolong the duration of recumbency.

## CLINICAL FINDINGS

### Cattle

Three stages of milk fever in cattle are commonly recognized and described.

#### Stage 1

In the first stage, the cow is still standing. This is also the brief stage of excitement and tetany with hypersensitivity and muscle tremor of the head and limbs. The animal is disinclined to move and does not eat. There may be a slight shaking of the head, protrusion of the tongue, and grinding of the teeth. The rectal temperature is usually normal to slightly above normal. Stiffness of the hindlegs is apparent, the animal is ataxic and falls easily and, on going down, the hindlegs are stuck out stiffly.

Careful observations by owners and veterinarians have revealed an even earlier stage than the first one. It is characterized by anorexia, agalactia, rumen stasis, scant feces and a normal temperature, heart rate and respirations. There are no obvious signs of excitement and hypersensitivity characteristic of the first stage. Affected cows may remain in this prodromal stage for several hours; they are perplexing diagnostically and respond quickly to calcium therapy. Cows with this form of hypocalcemia may be the 'calcium cyclers' described earlier.

#### Stage 2

The second stage is prolonged sternal recumbency. Consciousness is usually depressed; the cow has a drowsy appearance in sternal recumbency, usually with a lateral kink in the neck or the head turned into the flank. When approached, some of these cows will open their mouths, extend their head and neck and protrude their tongues, which may be an expression of apprehension and fear in an animal unable to stand. The tetany of the limbs present in the first stage is not present and the cow is unable to stand. The muzzle is dry, the skin and extremities cool, and the rectal temperature subnormal (36–38°C, 97–101°F). There is a marked decrease in the absolute intensity of the heart sounds and an increase in rate (about 80 bpm). The arterial pulse is weak and the venous pressure is also low, making it difficult to raise the jugular veins. The respirations are not markedly affected, although a mild forced expiratory grunt or groan is sometimes audible.

The eyes are usually dry and staring. The pupillary light reflex is incomplete or absent and the diameter of the pupil varies from normal to maximum dilatation. A detailed examination of the pupils of cows with parturient paresis, non-parturient disorders, and non-parturient paresis found that the mean sizes of the pupils were not significantly different from one another.<sup>21</sup> Rather, disparity of the size of the pupils was common. Rumen stasis and secondary

bloat are common and constipation is characteristic. There is also relaxation of the anus and loss of the anal reflex.

In cows which develop hypocalcemia a few hours before or at the time of parturition, the second stage of parturition may be delayed, which is unexpected in a mature cow. Examination of the reproductive tract usually reveals a fully dilated cervix and normal presentation of the fetus. The cow may be in any stage of milk fever and administration of calcium borogluconate IV will usually result in a rapid beneficial response and normal parturition.

Prolapse of the uterus is a common complication of milk fever and often the calcium levels are lower than in parturient cows without uterine prolapse. Thus it is standard practice to treat cases of uterine prolapse with calcium salts IV.

#### Stage 3

The third stage is lateral recumbency. The cow is almost comatose and although the limbs may be stuck out there is complete flaccidity on passive movement and the cow cannot assume sternal recumbency on its own. In general, the depression of temperature and the cardiovascular system are more marked. The heart sounds are almost inaudible and the rate increased up to 120 bpm; the pulse is almost impalpable and it may be impossible to raise the jugular veins. Bloat is usual because of lateral recumbency. Without treatment, a few animals remain unchanged for several hours but most become progressively worse during a period of several hours and die quietly from shock in a state of complete collapse.

**Concurrent hypomagnesemia.** Mild to moderate tetany and hyperesthesia persisting beyond the first stage suggests a concurrent hypomagnesemia. There is excitement and fibrillary twitching of the eyelids and tetanic convulsions are readily precipitated by sound or touch. Trismus may be present. The heart and respiratory rates are increased and the heart sounds are much louder than normal. Without treatment death occurs during a convulsion.

**Concurrent hypophosphatemia.** With a concurrent hypophosphatemia, the clinical findings are typical of milk fever which responds to calcium therapy in all respects except that the cow is unable to stand after treatment.

### Sheep and goats

The disease in pastured ewes is similar to that in cattle. The early signs include a stilty, proppy gait and tremor of the shoulder muscles. Recumbency follows, sometimes with tetany of the limbs but the proportion of ewes with hypocalcemia which are recumbent in the early stages is much less than in cattle. A similar generalization applies to female goats. The characteristic

posture is sternal recumbency, with the legs under the body or stretched out behind. The head is rested on the ground, there may be an accumulation of mucus exudate in the nostrils. The venous blood pressure is low and the pulse impalpable. Mental depression is evidenced by a drowsy appearance and depression of the corneal reflex. There is loss of anal reflex, constipation, tachycardia, hyposensitivity, ruminal stasis and tympany, salivation and tachypnea.<sup>22</sup> Response to parenteral treatment with calcium salts is rapid, the ewe is normal 30 min after a SC injection. Death often occurs within 6–12 h if treatment is not administered. The syndrome is usually more severe in pregnant than in lactating ewes, possibly because of the simultaneous occurrence of pregnancy toxemia or hypomagnesemia. Fat late pregnant ewes on high grain diets indoors or in feedlots show a similar syndrome accompanied by prolapses of the vagina and intestine.

### Pigs

As in cattle, signs develop within a few hours of farrowing. There is restlessness, a normal temperature and anorexia followed by inability to rise and later lateral recumbency and coma. Milk flow is decreased.

## CLINICAL PATHOLOGY

Total serum calcium levels are reduced to below 8 mg/dL (2.0 mmol/L), usually to below 5 mg (1.2 mmol/L) and sometimes to as low as 2 mg (0.5 mmol/L). The reduction is usually, but not always, proportional to the severity of the clinical syndrome. Average figures for total serum calcium levels in the three species are cows 5.2 ± 1.2 mg/dL (1.30 ± 0.30 mmol/L), ewes 4.6 ± 1.5 mg/dL (1.15 ± 0.37 mmol/L), goat does 3.8 ± 0.6 mg/dL (0.94 ± 0.15 mmol/L).

Total serum calcium levels are a basis for comparison between species. Blood levels of ionized calcium are a better indicator of calcium status but their estimation has been too difficult until recently. Although total serum calcium levels are used to express the animals' status with regard to calcium, it is possible that differences between the ionized and non-ionized compartments of total calcium may be more important than the total level. The development of a reliable calcium ion-selective electrode now makes it possible quickly and directly to determine the biologically active portion of calcium in plasma or serum. However, the correlation between ionized and total calcium is excellent. Equine, bovine, and ovine blood may be stored for up to 48 h without any clinically relevant alteration of blood calcium ion concentration.

Normal levels of **ionized calcium** (as CaF) in venous whole blood of cows are 4.3–5.1 mg/dL (1.06–1.26 mmol/L)

serum, slight hypocalcemia 4.2–3.2 mg/dL (1.05–0.80 mmol/L), moderate 3.2–2.0 mg/dL (0.79–0.50 mmol/L) and severe hypocalcemia <2.0 mg/dL (<0.50 mmol/L) serum. Total serum calcium levels are reduced below normal in all cows at calving whether they have milk fever or not, but not in ewes.

A commercially available water hardness test kit can be used as a rapid, inexpensive method of estimating serum calcium concentrations for the diagnosis of hypocalcemia in dairy cattle.<sup>23</sup> There is a high correlation and linear relationship between the test kit results and a standard laboratory based method. However, the blood sample must be centrifuged to obtain serum for use in the test kit.

Serum **magnesium** levels are usually moderately elevated to 4–5 mg/dL (1.65–2.06 mmol/L) but in some areas low levels may be encountered, especially in cows at pasture.

Serum **inorganic phosphorus** levels are usually depressed to 1.5–3.0 mg/dL (0.48–0.97 mmol/L).

Blood glucose levels are usually normal, although they may be depressed if ketosis

occurs concurrently. Higher than normal blood glucose levels are likely to occur in cases of long duration and are therefore an indication of a poorer than normal prognosis.

#### Serum muscle enzymes

Prolonged recumbency results in ischemic muscle necrosis and increases in the serum muscle enzymes creatine phosphokinase (CPK) and aspartate aminotransferase (AST) or SGOT. During prolonged recumbency following treatment for milk fever, the levels of CPK will remain elevated if muscle necrosis is progressive in animals which are not rolled from side to side every few hours to reduce the effects of compression on the large muscle groups of the pelvic limbs (see Downer cow syndrome).

#### Hemogram

Changes in the leukocyte count include an eosinopenia, a neutrophilia, and a lymphopenia suggestive of adrenal cortical hyperactivity, but similar changes occur at calving in cows which do not develop parturient paresis. High plasma cortisol levels and packed cell volumes occur

in cows with milk fever and are higher still in cows that do not respond to treatment. They are expressions of stress and dehydration. Clinicopathological findings in the other species are not described in detail except with regard to depression of total serum calcium levels:

#### NECROPSY FINDINGS

There are no gross or histological changes unless concurrent disease is present.

#### DIFFERENTIAL DIAGNOSIS

A diagnosis of milk fever is based on the occurrence of paresis and depression of consciousness in animals following parturition. The diagnosis is supported by a favorable response to treatment with parenteral injections of calcium solutions and by biochemical examination of the blood. In ewes, the history usually contains some reference to recent physical stress and the disease is more common in the period preceding lambing.

In the immediate postpartum period, there are several diseases which cause recumbency in cows and their differentiation is summarized in Table 29.5.

**Table 29.5** Differential diagnosis of common causes of recumbency in parturient adult cattle

Disease	Epidemiology	Clinical signs	Clinical pathology	Response to treatment
Milk fever (parturient paresis)	Mature cows, within 48 h of calving, some in mid-lactation	Early excitement and tetany. Then depression, coma, hypothermia, flaccidity, pupil dilatation, weak heart sounds. No rumen movements. HR increases as state worsens	Hypocalcemia, <5 mg/dL (1.25 mmol/L) calcium. High serum magnesium, >3 mg/dL (1.25 mmol/L) low inorganic phosphate, <3 mg/dL (0.9 mmol/L)	Rapid, characteristic response (muscle tremor, sweating on muzzle, defecation, urination, pulse amplitude and heart sound intensity improves first) after IV injection soluble calcium salt
Downer cows following milk fever	Most common in situation where milk fever and lactation tetany are common and intensity of treatment is lax; cows are left down too long before treatment	Moderately bright, active, eating. Temp. slightly raised, HR 80–100. Unable to stand but tries – 'creepers'. When dull and depressed, are 'non-alert downers'. Long course 1–2 weeks	Variable. May be low inorganic phosphate, or potassium, or glucose. Ketonuria, usually proteinuria CPK and SGOT elevated	Variable response to calcium, phosphorus and potassium salts. Fluid therapy and provision of deep bedding and hourly rolling from side to side are necessary
Carbohydrate engorgement	Access to large amount readily fermentable carbohydrate when not accustomed. Enzootic in high grain rations in feedlots. Intensive IV fluid and electrolyte therapy necessary for survival	Severe gastrointestinal atony with complete cessation of ruminal activity. Fluid splashing sounds in rumen Severe dehydration, circulatory failure. Apparent blindness, then recumbency and too weak to rise. Soft odoriferous feces	Hemoconcentration with severe acidosis, pH of rumen juice below 5, serum phosphorus levels up to 3–5 mmol/L, serum calcium levels depressed. No living protozoa in rumen	Rumenotomy or rumen lavage may be necessary. Alkalinizing agents
Hypomagnesemia (lactation, grass tetany)	All classes of cattle, but most recently calved cows Age no barrier and cases occur up to several months after calving. May occur in pregnant beef cattle	Excitement, hypersensitivity, muscle tremor, tetany. Recumbent with tetanic convulsions, loud heart sounds, rapid rate. Subacute cases remain standing	Low serum magnesium, <1.2 mg/dL (0.5 mmol/L)	Even after IV injection response in a severe case may take 30 min, much slower than response to calcium in milk fever
Severe toxemia (acute diffuse peritonitis, coliform mastitis)	Sporadic only. Mastitis most common where hygiene poor. Peritonitis due to foreign body perforation of reticulum, rupture of uterus or vagina	Recumbency, depression to coma, sleepy, dry nose, hypothermia, gut stasis, HR over 100/min, may be grunting. Examine mammary gland. Examine abdomen for abdominal disease	Profound leukopenia. Serum calcium may be as low as 7–8 mg/dL (1.75–2.0 mmol/L). Examine milk (CMT)	Require supportive response for toxemia and shock. Response is poor and temporary. Prognosis very bad. May die if treated IV with calcium or magnesium salts.

Table 29.5 (Cont'd) Differential diagnosis of common causes of recumbency in parturient adult cattle

Disease	Epidemiology	Clinical signs	Clinical pathology	Response to treatment
Fat cow syndrome	Fat dairy or beef cows in late gestation or at parturition. Some predisposing cause precipitates illness in fat animals	Excessive body condition, anorexia, apathy, depression, recumbency and looks like milk fever, scant soft feces, ketonuria	Evidence of hepatic disease.	Will recover if begin to eat. Treat with fluids, glucose, insulin. Provide good quality palatable roughage
Physical injuries	Ruptured gastrocnemius, dislocation of hip, etc. Sporadic sequelae to milk fever, may be contributed to by osteoporosis, slippery ground surface, stimulating to rise too early	As for MOP with ruptured gastrocnemius, hock remains on ground when standing. Excessive lateral mobility of limb with hip dislocation	Increase CPK and SGOT	Supportive therapy, deep bedding, and frequent rolling.
Acute hypokalemia	Dairy cattle treated for ketosis with isoflupredone acetate. Calved within previous 30 days	Recumbent, very weak, appear flaccid, in sternal or lateral recumbency, unable to support head off ground, hold head in flank, anorexia; cardiac arrhythmia may present. Most die or are euthanized	Serum potassium below 2.3 mEq/L. Muscle necrosis at necropsy	Potassium chloride IV or orally
Bovine spongiform encephalopathy	Mostly in dairy cattle. Eating concentrate made from animals with BSE. Long incubation period.	Insidious onset, clinical course several weeks, changes in behavior, hyperesthesia, ataxia, loss of weight, kick during milking, knuckling, progressive weakness leading to recumbency	Laboratory examination of brain for presence of prions	Nil

Several diseases which occur at the time of parturition must be differentiated from milk fever in cattle. These are grouped here according to:

- Other metabolic diseases
- Diseases associated with toxemia and shock
- Injuries to the pelvis and pelvic limbs
- Degenerative myopathy
- Downer cow syndrome.

#### Metabolic diseases

Hypomagnesemia may occur as the sole cause of recumbency or it may accompany a primary hypocalcemia so that the case presented is one of parturient paresis complicated by lactation tetany. Hyperesthesia, tetany, tachycardia, and convulsions are common instead of the typical findings of depression and paresis in milk fever.

Hypophosphatemia, which commonly accompanies milk fever, is suggested as a cause of continued recumbency in cows after partial response to calcium therapy; serum inorganic phosphorus levels are low and return to normal if the cow stands or following treatment with phosphate salts. A sudden onset of recumbency in dairy cows associated with a marginal deficiency of phosphorus has been reported.<sup>24</sup>

Hypokalemia in dairy cows is characterized by extreme weakness or recumbency, especially after treatment for ketosis with isoflupredone. Hypokalemia is marked as ranging from 1.4 to 2.3 mEq/L. The case-fatality rate is high in spite of therapy with potassium. Hypokalemic myopathy is present at necropsy.

Ketosis may complicate milk fever, in which case the animal responds to calcium therapy by standing but continues to manifest the clinical signs of ketosis, including in some cases the nervous signs of licking, circling, and abnormal voice.

#### Diseases associated with toxemia and shock

During the immediate postparturient period, several diseases occur commonly and are characterized by toxemia.

Peracute coliform mastitis is characterized by:

- Fever initially followed by hypothermia
- Tachycardia
- Dehydration
- Weakness and recumbency
- Depression
- Ruminal stasis
- Diarrhea in some
- Enlarged mammary gland(s) with watery and serous-like secretions with small particles barely visible.

Aspiration pneumonia secondary to regurgitation and aspiration of rumen contents may occur as a complication of thirdstage milk fever. Fever, dyspnea, expiratory grunt, severe depression and anxiety are common. Auscultation of the lungs reveals the presence of abnormal lung sounds. Aspiration pneumonia should be suspected if the animal has been lying on its side, especially if there is evidence of regurgitation of ruminal contents from the nostrils, no matter how small the

amount, or if there is a history of the animal having been drenched. Abnormal auscultatory findings may not be detectable until the second day. Early diagnosis is imperative if the animal is to be saved and the mortality rate is always high.

Acute diffuse peritonitis resulting from traumatic perforation of the reticulum or uterus is characterized by:

- Severe depression
- Fever
- Weakness and recumbency
- Ruminal stasis
- Dehydration
- Grunting or groaning with each respiration
- Tachycardia
- Fluid splashing sounds on ballottement of the abdomen (paralytic ileus).

Carbohydrate engorgement results in:

- Depression
- Weakness
- Sternal recumbency
- Dehydration
- Tachycardia
- Ruminal stasis and moderate bloat
- Fluid-splashing sounds over rumen
- Low rumen juice pH
- Diarrhea
- Hypothermia
- Cool extremities
- Progressive worsening if not treated.

Many cases resemble second-stage milk fever.

Toxic septic metritis occurs most commonly within a few days after parturition and is characterized by:

- Depression
- Anorexia
- Fever
- Tachycardia (100–120 bpm)
- Ruminal stasis
- Presence of foul-smelling uterine discharge found on vaginal examination.

The fetal placenta may be retained. Some affected cows are weak and prefer recumbency, which resembles milk fever. Prolapse and rupture of uterus causes varying degrees of:

- Shock with tachycardia
- Hypothermia and cool extremities
- Weakness and recumbency
- Rapid death.

A history of difficult parturition or assisted dystocia with fetotomy may be associated with rupture of the uterus. The administration of calcium salts may cause ventricular fibrillation and sudden death.

Although some elevation of the temperature may be observed in these severe toxemic states, it is more usual to find a subnormal temperature. The response to calcium therapy is usually a marked increase in heart rate and death during the injection is common. Every case of recumbency must be carefully examined as these conditions may occur either independently or as complications of parturient paresis. In our experience, about 25% of cases of postparturient recumbency in cows are due primarily to toxemia or injury rather than to hypocalcemia.

#### **Injuries to the pelvis and pelvic limbs**

Injuries to the pelvis and pelvic limbs are common at parturition because of the marked relaxation of the ligaments of the pelvic girdle. Seven types of leg abnormality have been described in this group at an incidence level of 8.5% in 400 consecutive cases of parturient paresis. The abnormalities included radial paralysis, dislocation of the hips and rupture of gastrocnemius muscle. In most instances the affected animals are down and unable to stand but they eat, drink, urinate and defecate normally, have a normal temperature and heart rate and make strong efforts to stand, particularly with the forelimbs.

Maternal obstetrical paralysis is the most common injury. Although this occurs most frequently in heifers after a difficult parturition, it may also occur in adult animals following an easy birth and occasionally before parturition, especially in cows in poor body condition. The mildest form is evidenced by a frequent kicking movement of a hindleg, as though something was stuck between the claws. All degrees of severity from this, through

knuckling and weakness of one or both hindlegs, to complete inability to rise may occur, but sensation in the affected limb is usually normal. There is traumatic injury to the pelvic nerves during passage of the calf. There are often gross hemorrhages, both deep and superficial and histopathological degeneration of the sciatic nerves. In individual animals, injury to the obturator nerves is common and results in defective adduction of the hindlimbs. The position of the hindlimbs may be normal but in severe cases, especially those with extensive hematoma along the sciatic nerve trunk, the leg may be held extended with the toe reaching the elbow as in dislocation of the hip; however in the latter case there is exaggerated lateral mobility of the limb. Additional injuries causing recumbency near parturition include those associated with degenerative myopathy, dislocation of the hip and ventral hernia.

Dislocation of the coxofemoral joint can cause recumbency and inability to stand in some cows, while others can stand and move around. Recumbent cows are usually in sternal recumbency and the affected limb is abducted excessively. In standing cows, the affected limb is usually extended, often difficult to flex and often rotated about its long axis. The diagnostic criteria are:

- Sudden onset of lameness with the affected limb extended and possibly rotated
- Displacement of the greater trochanter of the femur from its normal position relative to the ischiatic tuber and coxal tuber of the pelvis
- Ability to abduct the limb manually beyond its normal range
- Crepitus in the hip on abduction and rotation of the limb
- Ability to palpate the femoral head per rectum or per vaginum against the cranial border of the ilium or pubis in cases of cranioventral dislocation, or in the obturator foramen in cases of caudoventral dislocation.

Manual replacement by closed reduction is successful in 80% of craniodorsal dislocation and 65% in caudodorsal dislocation. The ability to stand before reduction is the most useful prognostic aid.

#### **Degenerative myopathy (ischemic muscle necrosis)**

Degenerative myopathy affecting primarily the large muscles of the thighs, occurs commonly in cattle which have been recumbent for more than several hours. At necropsy, large masses of pale muscle are present surrounded by muscle of normal color. Clinically it is indistinguish-

able from sciatic nerve paralysis. Markedly increased serum levels of CPK occur in cows recumbent for several hours following the initial episode of milk fever due to ischemic necrosis. Persistent elevation of CPK indicates progressive ischemic muscle necrosis due to continued compression of large muscle masses of the pelvic limbs. Rupture of the gastrocnemius muscle or separation of its tendon from either the muscle or the tuber calcis may also cause myopathy.

#### **Downer cow syndrome**

Downer cow syndrome is a common sequel to milk fever in which the cow was in sternal recumbency for several hours before being treated with calcium. Following treatment, most of the clinical findings associated with milk fever resolved except the animal was unable to stand. Clinically, the animal may be normal except for recumbency and will commonly recover and stand normally within several hours or a few days. Most downer cows eat and drink normally, their vital signs are within the normal range and their alimentary tract function is normal. However, some are anorexic, may not drink, exhibit bizarre movements of lying in lateral recumbency, and dorsally extend their head and neck frequently, moan and groan frequently, assume a frog-legged posture with their pelvic limbs and crawl or creep around the stall and may die or are euthanized for humane reasons in a few days. The diagnostic dilemma with these cows is that they resemble milk fever and whether or not to treat them with additional amounts of calcium salts is questionable.

#### **Non-parturient hypocalcemia**

Paresis with mental depression and associated with low total serum calcium levels can occur in cows at times other than at parturition. The cause is largely unexplained but the syndrome occurs rarely in animals other than ruminants. Hypocalcemia may occur after gorging on grain and may be a significant factor in particular cases. Sudden rumen stasis due to traumatic reticulitis may rarely cause hypocalcemic paresis. Diarrhea, particularly when cattle or sheep are placed on new lush pasture, may also precipitate an attack. Access to plants rich in oxalates may have a similar effect, particularly if the animals are unaccustomed to the plants. Affected animals respond well to calcium therapy but relapse is likely unless the primary cause is corrected. The differential diagnosis of diseases of non-parturient cows manifested principally by recumbency is also summarized in Table 29.5.

### Hypocalcemic paresis in sheep and goats

Hypocalcemia in sheep must be differentiated from pregnancy toxemia in which the course is much longer, the signs indicate cerebral involvement and the disease is restricted to pregnant ewes. There is no response to calcium therapy and a positive test for ketonuria is almost diagnostic of the disease. At parturition, goats are susceptible to enterotoxemia and hypoglycemia (rarely), both of which present clinical signs similar to parturient paresis.

### Hypocalcemia in sows

Hypocalcemia is rare in sows. The disease must be differentiated from the mastitis, metritis and agalactia complex, which is characterized by:

- Fever
- Agalactia
- Anorexia
- Toxemia
- Enlarged mammary glands.

### Treatment

Every effort should be made to treat affected cows as soon as possible after clinical signs are obvious. Treatment during the first stage of the disease, before the cow is recumbent, is the ideal situation. The longer the interval between the time the cow first becomes recumbent and treatment, the greater the incidence of the downer cow syndrome due to ischemic muscle necrosis from prolonged recumbency. Complications of milk fever occur when cows have been in sternal recumbency for more than 4 h. Farmers must be educated to appreciate the importance of early treatment. Cows found in lateral recumbency (third stage) should be placed in sternal recumbency until treatment is available. This will reduce the chances of aspiration if the cow regurgitates. Cows that have difficulty finding solid, non-slip footing beneath them, for example, a slippery barn floor or slippery mud, will often not try to stand and may develop ischemic myonecrosis. Avoidance of this complication necessitates the placement of rubber or other mats under the cow or transportation of the cow to a piece of pasture with a dense sward on it. A temperature of greater than 39°C (102°F) is an indication of a higher than average mortality rate due to pre-existing complications.

### Standard treatment

Calcium borogluconate at 10–200 g is the treatment of choice. The solutions available vary from 18 to 40% calcium borogluconate. Most cows with milk fever can be treated successfully with 8–10 g of calcium (calcium borogluconate is 8.3% calcium). For cattle, 400–800 mL of a 25% solution is the usual dose. The dose

rate of calcium is frequently under discussion. There is a general tendency for veterinarians to underdose with calcium salts, largely because of toxic effects which tend to occur when all of the calcium is given IV. As an initial dose a large cow (540–590 kg) requires 800–1000 mL of a 25% solution and a small cow (320–360 kg) 400–500 mL. Underdosing increases the chances of incomplete response, with inability of the cow to rise, or of relapse. In general, 12 g of calcium is superior to 8 g, which in turn is superior to 6 g.

The standard rate of administration is a rapid intravenous administration of the calculated dose of calcium borogluconate (often supplemented with phosphorus, magnesium, and glucose) over a period of 15 min. Hypercalcemia (up to 22 mg/dL) occurs following IV administration of calcium borogluconate over a period of 12–15 min. The plasma calcium concentration will gradually decline over a period of several hours by which time calcium homeostasis should begin to occur and levels return to normal by 12–24 h following treatment. However, in some cows calcium homeostasis is ineffective and subclinical or clinical hypocalcemia may recur.

Because up to 50% of cows may not respond to the initial rapid administration, it has been postulated that the increases in electrolytes are only transient and that slower IV infusion would be more effective.<sup>25</sup> The slow infusion of a calcium solution via an IV indwelling catheter over 6 h was compared with the conventional single IV administration of 600 mL of a 40% calcium borogluconate solution containing 18.78 g calcium gluconate and borogluconate with 6% magnesium hypophosphite (11.82 g magnesium hypophosphite) over 15 min in cows recumbent with milk fever.<sup>25</sup> Cows receiving the rapid infusion responded more quickly and stood sooner and their demeanor returned to normal more quickly. The slow infusion consisted of 200 mL IV over a 10 min period and the remaining 400 mL added to 10 L of a solution of 90 g sodium chloride and 500 g glucose and given via IV drip over a 6 h period at a rate of 1.7 L/h. In cows treated rapidly, the serum calcium and magnesium levels increased rapidly compared with the infused cows.<sup>26</sup> In both groups, the serum inorganic phosphorus increased slowly with the mean concentration reaching a maximum at 3 h and then decreasing slightly. Some cows are still hypophosphatemic several hours later.

In sheep and goats, the recommended amount is 15–20 g IV with an optional 5–10 g SC. Sows should receive 100–150 mL of a similar solution IV or SC.

### Routes of administration

IV and SC routes

The intravenous (IV) route is preferred because the response is rapid and obvious. The heart should be auscultated throughout the intravenous administration for evidence of gross arrhythmia, bradycardia, and tachycardia. If any of these occurs, the intravenous administration should be interrupted and continued only after the heart sounds return to normal. If the cardiac irregularity continues, the remainder of the solution can be given subcutaneously. The best recommendation is to give as much of the solution as possible intravenously and the remainder subcutaneously. The common practice of giving half the dose intravenously and half subcutaneously is a reasonable compromise because with this method there are fewer relapses. If a cow has been previously treated subcutaneously by the farmer, additional calcium given intravenously may cause toxicity if the improved circulation enhances the absorption of the subcutaneous calcium.

### SC route

The subcutaneous (SC) route is commonly used by farmers who treat affected cows at the first sign of hypocalcemia, preferably during the first stage when the cow is still standing or as prophylaxis to all high-risk cows immediately after calving. The SC route has also been used by veterinarians when the effects of IV administration of calcium are uncertain or if an unusual response occurs during IV administration. There are limitations to the effectiveness of SC calcium solutions given to cows with milk fever.<sup>27</sup> Cows given 300 mL of 33.3% or 40% calcium borogluconate SC had serum calcium levels of 1.4 mmol/L; those receiving 600 mL had serum calcium levels of 2.1 mmol/L, at mean intervals of 4.8 and 12.0 h between treatments by the herdsman and veterinary attention.<sup>27</sup> At the time of sampling, 48% of cows receiving 600 mL of calcium borogluconate had a serum calcium level below 2.0 mmol/L. If the veterinarian is unable to treat the cow within 1 h, a dose of 600 mL of 40% calcium borogluconate should be given SC in two sites and massaged well to promote absorption. Waiting for more than 1 h to assess the effect of one treatment SC is regarded as conducive to development of the downer cow syndrome. The cow should then be placed in a dry area with her limbs positioned to minimize ischemic necrosis and covered with straw and tarpaulins until the veterinarian arrives.

Toxic cows are very susceptible to the IV administration of calcium borogluconate and death may occur. In such cases the heart rate increases markedly (up to 160 bpm), there is respiratory distress,



trembling and collapse and the cow dies within a few minutes. SC or IP administration is preferred in cows with severe toxemia due to aspiration pneumonia, metritis, and mastitis.

#### Oral route

A further aid to parenteral therapy with solutions of calcium salts, especially for the purpose of increasing recovery rates and preventing relapses, is the oral administration of gels containing calcium chloride, which are described under prevention.

#### Typical response to calcium borogluconate

Cows with milk fever exhibit a typical pattern of response to calcium borogluconate IV if the response is favorable, including:

- Belching
- Muscle tremor, particularly of the flanks and often extending to the whole body
- Slowing and improvement in the amplitude and pressures of the pulse
- Increase in the intensity of the heart sounds
- Sweating of the muzzle
- Defecation.

The feces are in the form of a firm fecal ball with a firm crust and covered with mucus, occasionally with a few flecks of blood. Urination usually does not follow until the cow stands. A slight transitory tetany of the limbs may also be observed. Many cows will eat and drink within minutes following successful treatment if offered feed and water.

The rate of response to treatment is affected by many factors as set out below and it is unwise to quote what might be expected as an acceptable rate of recovery after treatment. This is particularly true if cows are treated by the farmer and only difficult cases are presented to the veterinarian. In general, if all cases are considered and there are no exceptional circumstances, recovery can be expected immediately after treatment in about 60% of cases and in a further 15% after 2 h; 10% have recoveries complicated by one of the diseases discussed earlier and 15% can be expected either to die or to require disposal. Of those which recover after one treatment, 25–30% can be expected to relapse and require further treatment.

#### Unfavorable response to calcium borogluconate

An unfavorable response is characterized by a marked increase in heart rate in cows affected with toxemia and acute heart block in apparently normal animals especially with overdosage, with too rapid injection and in cases in which treatment has been unduly prolonged. In the latter, the maximum tolerated dose of calcium borogluconate by IV administration is

about 250 mL of a 25% solution. Overdosage may occur when farmers treat cases unsuccessfully by multiple SC injections and these are followed by an IV dose. When the peripheral circulation is poor, it is probable that the calcium administered SC is not absorbed until the circulation improves following the IV injection and the large doses of calcium then absorbed cause acute toxicity. In all cases of IV injection, the circulation must be monitored closely. Some degree of arrhythmia occurs in most cases but if there is gross arrhythmia or a sudden increase in heart rate, the injection should be stopped temporarily or continued with great caution. In normal circumstances at least 10 min should be taken to administer the standard dose. The acute toxic effect of calcium salts seems to be exerted specifically on heart muscle with a great variety of defects occurring in cardiac action; the defect type depends on the specific calcium salt used and the speed of injection. ECG changes after induced hypercalcemia show increased ventricular activity and reduced atrial activity. Atropine is capable of abolishing the resulting arrhythmia.

Sudden death may also occur after calcium injections if the cow is excited or frightened, which may be due to an increased sensitivity to epinephrine. When affected cows are exposed to the sun or a hot, humid atmosphere, heatstroke may be a complicating factor. In such cases an attempt should be made to reduce the temperature to below 39.5°C (103°F) before the calcium is administered. The incidence of cardiac arrhythmia and other abnormalities as detected by ECG during treatment with calcium salts IV is so high that there are doubts expressed about the suitability of this form of treatment.

Chronic toxicity may also occur. In laboratory animals, severe uremia due to extensive calcium deposits in the kidney occur after the SC injection of calcium chloride and borogluconate and similar deposits are often seen at necropsy in cows dying after multiple injections of calcium salts administered at short intervals.

#### Failure to respond to treatment

A failure to respond favorably to treatment may be due to an incorrect or incomplete diagnosis, or inadequate treatment. A poor response to treatment includes: (1) no observable changes in the clinical findings immediately following the calcium administration or (2) the animal may respond to the calcium in all respects with the exception of being unable to stand for varying periods of time following treatment. An inadequate response also includes

relapses after successful recovery, which usually occur within 48 h of the previous treatment. Relapses are more common in certain individual cows such as mature Jersey cows, which may experience as many as five or six episodes around one calving. Also, the incidence of relapse is much higher in cases which occur just before calving than in those which occur afterwards. The needs of individual animals for calcium replacement vary widely, depending on their body weight and the degree of hypocalcemia. Incomplete responses may be more common in older cows and may be associated with diminished skeletal reserves of calcium and inability of the normal mechanisms to maintain serum calcium levels during the period of excessive demands of lactation. The duration of the illness and the posture of the cow also affect the response. In an extensive field study, there were no downer cows or deaths in cows still standing when first treated, 13% of downers and 2% of deaths occurred in cows in sternal recumbency and 37% of downers and 12% of deaths occurred in cows in lateral recumbency when first treated.<sup>28</sup> Therefore, in general, the longer the period from onset of milk fever to treatment, the longer the period of post-treatment recumbency and the higher the case-fatality rate. In another study, 67% of cows recovered after a single treatment, 90% after two treatments, and 92–99% after three treatments. After routine treatment, 37% of cases rose unassisted within 10 min, 23% required some assistance, 26% recovered after longer periods of recumbency, and 14% died or were destroyed or sold for slaughter. The best procedure to follow if response does not occur is to revisit the animal at 12-hourly intervals and check the diagnosis. If no other cause of the recumbency can be determined, the initial treatment can be repeated on a maximum of three occasions. Beyond this point, further calcium therapy is seldom effective. A low body temperature, due probably to exposure to low environmental temperature and increased wind velocities, is positively correlated with a high proportion of deaths and poor responses.

At the second visit, solutions containing either phosphorus, magnesium, or dextrose may be administered, depending upon the clinical signs presented and the results of available biochemical tests. Glucose is usually administered as 500 mL of a 40% solution, sodium acid phosphate as 200 mL of a 15% solution, and magnesium sulfate as 200–400 mL of a 15% solution. Composite solutions containing calcium, magnesium, phosphorus and glucose are also in common use as initial treatments. There is controversy about these so-

called 'polypharmacy' preparations. They have no advantage, but are likely to remain popular when milk fever cases are complicated by metabolic disorders other than hypocalcemia. They have no effect on the relapse rate when compared with calcium salts alone.

#### Udder insufflation

Insufflation of the udder with air was an alternative treatment for cows which continued to relapse following repeated calcium injections. With the availability and effectiveness of orally administered calcium gels, udder insufflation cannot be recommended.

#### GENERAL MANAGEMENT AND CLINICAL CARE PROCEDURES

The care of the cow and the calf following milk fever is important. The calf should be removed from the cow and for the first 48 h only sufficient milk should be drawn for the calf's maintenance. A gradual return to full milking can then be permitted. If the cow is recumbent for any length of time, she must be kept propped up in sternal recumbency and not left in lateral recumbency, which may result in regurgitation and aspiration pneumonia. The cow should be rolled from side to side every few hours and provided with adequate bedding or moved to a suitable non-slip ground surface. In extreme climatic conditions, erection of a shelter over the cow is advisable if she cannot be moved to permanent shelter. If a cow is recumbent for more than 48 h, assisted lifting using appropriate cow lifters several times daily should be considered. However, heroic measures to get cows to stand should be avoided. Gentle nudging in the ribs or the use of an electric prod are the maximum stimulants advised. The best assistance that can be given to a cow attempting to stand is a good heave at the base of the tail when she is halfway up.

#### CONTROL

Various methods for the control of milk fever in ruminants, especially dairy cows, are available. They include dietary management during the transition period before and after calving, administration of calcium gels orally at the time of parturition and administration of vitamin D and its metabolites and analogs immediately before parturition to enhance the mobilization of calcium. When the incidence of milk fever increases to above 10% of high-risk cows (third or later lactations), a specific control program is necessary. When the incidence is low, a specific control program may not be economical and the alternative is to monitor cows carefully at the time of parturition and for 48 h after parturition

and treat affected animals during the first stage of the disease if possible.

Various aspects of the literature on the principles of control of milk fever in cattle, under different circumstances have been reviewed.<sup>29-31</sup> The different strategies for the control of milk fever in dairy cows has been examined by expert opinions.<sup>32</sup> The two control strategies predicted to be most relevant were calcium gel orally peripartum used alone and in combination with a low-calcium diet. Several control strategies for milk fever in dairy herds have been evaluated by stochastic simulation in order to analyze the technical and economic effects at the herd level and to assess frameworks for decision support system development.<sup>33</sup> The simulated technical and economic effects indicated a complex interaction between herd and control strategy. In general, the most comprehensive control strategies were economically inferior to similar but less comprehensive control strategies.

#### Dietary management during prepartum period

For purposes of optimal nutritional management of dairy cows which are fed prepared feeds (not pasture-based), the dry period is divided into at least two distinct categories – cows in the early and middle portion of the dry period (*far-off* or *regular* dry cow group) and cows in the final 3 weeks prior to their calving date (*pre-fresh*, *transition*, *close-up*, *near*, *lead feeding*, or *steam-up* group).<sup>31</sup> Large herds may have additional subgroups of dry cows depending on management circumstances and facilities available. Special attention must be given to the mineral nutrition of the close-up group. Minerals should be provided to close-up cows in known quantities, either as part of a grain mixture or total mixed ration (TMR).

#### Calcium and phosphorus nutrition Level of calcium in diet

Diets high in calcium during the prepartum period can result in a high incidence of milk fever and diets low in calcium will reduce the incidence of milk fever in dairy cows. Feeding more than 100 g of calcium daily during the dry period is associated with an increased incidence of milk fever. A cow weighing 500 kg requires only about 33 g/daily of calcium to meet maintenance and fetal calcium demands in the last 2 months of late gestation.<sup>30</sup> Low calcium diets (20 g Ca/d) fed during the last 2 weeks before parturition are highly reliable and effective. The low levels of dietary calcium activate the calcium homeostatic mechanisms before calving and the cow is more able to absorb calcium from the digestive tract and to mobilize calcium from bone reserves. At least 14 days of a low calcium

diet are required to be effective in minimizing the incidence of milk fever. Feeding dry cows rations low in calcium results in activation of the calcium homeostatic mechanisms before calving making the cow able to mobilize the large quantities of calcium for the final stages of prenatal growth and colostrum production. When dietary calcium availability is decreased below calcium requirements, the cow is brought into negative calcium balance. This leads to a secretion of parathyroid (PTH) which increases renal reabsorption of calcium within minutes, stimulates calcium resorption from bone within hours to days, and stimulates renal vitamin D metabolism to towards production of 1,25-dihydroxyvitamin D (1,25-(OH)<sub>2</sub>D) within hours or days. The (1,25-(OH)<sub>2</sub>D) stimulates the active transport of calcium across the intestinal epithelial cells. During bone resorption, urinary excretion of pyridinoline and deoxypyridinoline, derived from collagen breakdown, is increased.

#### Practicality of feeding diets low in calcium

There are practical problems with the implementation of the recommendation to feed diets low in calcium. It is difficult to reduce the amounts of calcium and phosphorus fed to cows for several reasons:

- Inability to grow sufficient quantities of feeds, such as corn silage, for the entire herd
- Suitability of land for legume crops which are high in calcium
- Inability to add sufficient phosphorus to lower the ratio of calcium to phosphorus to palatability when quantities of phosphorus are added to the ration.

Most farms utilizing home-grown forages, especially alfalfa, find it difficult to obtain forages which are low in calcium. A low calcium diet can be achieved by replacing some or all alfalfa hay in the dry cow diet with grass hay and using additional corn silage and concentrates. While feeding diets low in calcium during the prepartum period is very effective, the very low calcium intake required necessitates that the cow be in negative calcium balance and in a state of withdrawal of calcium from bone.

#### Binding dietary calcium

It is possible to prevent milk fever and subclinical hypocalcemia by adding a substance to the feed capable of binding dietary calcium and making it unavailable for absorption. The oral administration of sodium aluminum silicate or zinc oxide to cows in late lactation results in a decrease in total serum calcium.<sup>34</sup> Supplementing the dry cow ration with sodium aluminium silicate (zeolite A) at the rate of 1.4 kg of

zeolite pellets per day (0.7 kg of pure zeolite) for the last 2 weeks of pregnancy results in an increase in plasma calcium around calving.<sup>35</sup> Plasma magnesium and inorganic phosphate levels were decreased and serum 1,25-(OH)<sub>2</sub>D was significantly increased.<sup>35</sup> Feed intake was decreased among zeolite-treated cows during the last 2 weeks of pregnancy but there was no effect on milk yield, milk fat, and milk protein in the subsequent lactation. The addition of zeolite to the daily ration during the last month of pregnancy prevented parturient paresis and subclinical hypocalcemia in Jersey cows.<sup>36</sup> Feeding a vegetable oil supplement (soya bean oil) to pregnant pastured dairy cattle during the last 2–3 weeks of pregnancy is effective in preventing milk fever and increases milk solids production in early lactation.<sup>37</sup> The same supplement has been used to stimulate calcium absorption and reduction in susceptibility to fasting-induced hypocalcemia in pregnant ewes.<sup>38,39</sup> Following supplementation, the ewes are fasted overnight to challenge calcium homeostasis. Following fasting, there is a greatly increased capacity to absorb calcium.

#### Level of phosphorus in diet

Increased levels of dietary phosphorus, >80 g/head per day, can also increase the incidence of milk fever. The increased intake increases the serum level of phosphorus which has an inhibitory effect on renal enzymes. These enzymes catalyze the production of 1,25-(OH)<sub>2</sub>D, which when lowered will reduce intestinal calcium absorption. If the reduction of calcium is impractical, the lowering of phosphorus to below requirements may be beneficial.

#### Calcium and phosphorus ratio in diet

If the ration is low in calcium, the resulting negative balance of calcium can be expected to stimulate activity of the parathyroid gland. Early researchers made use of this physiological mechanism by feeding a high phosphorus/low calcium ration to cows during the last month of pregnancy. With a Ca:P ratio of 6:1, 30% of cows developed parturient paresis; at a Ca:P ratio of 1:1, 15% developed the disease; and at a ratio of 1.3:3, no cases occurred. Although there is no apparent effect on the subsequent lactation there is the possibility, if the negative balance of calcium is prolonged or repeated frequently, that such a ration may contribute to the development of osteoporosis. Dietary phosphorus concentrations can have an influence on calcium homeostasis.

Acidifying rations in the prepartum diet: Cation–anion difference (DCAD)

A more reliable method of controlling milk fever in dairy cows when the calcium

Table 29.6 Molecular weights, equivalent weights, and conversions from percent to milliequivalents (%–mEq) of anions and cations used in calculating dietary cation–anion difference

Element	Molecular weight	Valence	Equivalent weight (g)	To convert from % diet DM to mEq. Multiply by: (mEq/kg)
Sodium	23.0	1	23.0	434.98
Potassium	39.1	1	39.1	255.74
Chloride	35.5	1	35.5	282.06
Sulfur	32.1	2	16.0	623.75
Calcium	40.1	2	20.0	499.00
Magnesium	24.3	2	12.2	822.64
Phosphorus	31.0	1.8	17.2	581.14

intake exceeds NRC requirements is to manipulate the dietary cation–anion difference (DCAD) during the prepartum period.<sup>11,40</sup> Diets high in cations, especially sodium and potassium, tend to induce milk fever compared with those high in anions, primarily chloride and sulfur, which can reduce the incidence. Because most legumes and grasses are high in potassium, many of the commonly used prepartum diets are alkaline resulting in metabolic alkalosis. The feeding of diets which are high in ratio of calcium to phosphorus and containing an excess of anions relative to cations will result in mild metabolic acidosis completely compensated by nonrespiratory mechanisms (decreased blood bicarbonate and base excess:  $P_{CO_2}$  and pH are unaffected).<sup>41</sup> There is increased concentration of serum calcium due to an increase in the intestinal absorption of calcium. Two parathyroid hormone (PTH) dependent functions, bone resorption, and renal production of 1,25-dihydroxyvitamin D, are enhanced in cows fed diets with added anions which increase their resistance to milk fever and hypocalcemia.<sup>11</sup>

The DCAD is expressed using the equation  $DCAD \text{ in mEq/kg DM} = (Na + K) - (Cl + S)$ . The equation does not include other dietary cations and anions such as  $Ca^{2+}$ ,  $Mg^{2+}$ , and  $PO_4$  which have a minor role. Most studies indicate that a DCAD of –50 to 100 mEq/kg DM is optimal for the prevention of milk fever.<sup>1</sup> Supplementation of diets in the last 3 weeks prepartum with anionic salts at a rate sufficient to decrease DCAD to –15 mEq/100 g of dietary DM and urine pH to 6.0 prevented most cases of parturient hypocalcemia.<sup>42</sup> Except for cows pregnant with twins, that rate of supplementation did not affect DM intake and energy balance. A moderate rate of supplementation to reduce the DCAD to 0 mEq/100 g dietary DM and urine pH to 7.3 also did not decrease feed intake or energy status but was less effective in preventing parturient hypocalcemia. Monitoring urine pH can be a useful aid to find the effective intermediate inclusion rate and it is suggested

that a urine pH of about 6.5 is ideal.<sup>42</sup> Commercial anionic products fed to non-lactating dairy cows in a total mixed ration, after 4 days reduced urine pH below the desired threshold of 6.5.<sup>43</sup>

The equation assigns the same acidification potency to each mEq of Cl and  $SO_4$ , but Cl is absorbed to a greater extent than  $SO_4$ . Calculation of the DCAD of a diet requires use of the equivalent weights of the electrolytes. The equivalent weight is equal to the molecular weight divided by the valence. A milliequivalent (mEq) is used to express equivalent weights: 1 mEq equals 1/1000 of an equivalent. Table 29.6 provides reference values for calculating equivalent weights of important electrolytes and converting from percent diet dry matter (DM) to mEq/kg. Once mEq are calculated, the DCAD can then be determined by subtracting the anions from the cations.<sup>31</sup>

The DCAD is calculated from the percent element in the diet dry matter. The equation is as follows:  $mEq/100 \text{ g DM} = [(\% Na \div 0.023) + (\% K \div 0.039)] - [(\% Cl \div 0.0355) + (\% S \div 0.016)]$ . Based on current evidence, the range which achieves the lowest incidence of milk fever is a DCAD of –10 to –15 mEq/100 g DM or –100 to 150 mEq/kg DM.

Most typical diets fed to dry cows have DCADs of about 100–250 mEq/kg DM. Addition of a cationic salt such as sodium bicarbonate to the dry cow diets increases the DCAD and increases the incidence rate of milk fever. Adding an anion source or a mixture of anionic salts containing Cl and S relative to Na and K to the diet lowers the DCAD and reduces the incidence of milk fever. Commonly used sources of anion salts include the Cl and  $SO_4$  salts of calcium, ammonium and magnesium. The phosphate salts have not been used because they are only weakly acidifying.

The addition of anions to the diet to reduce dietary DCAD is limited because of problems with palatability of the anionic salt sources commonly used. If the diet DCAD is >250 mEq/kg, it is difficult to add enough anionic salts to

lower the DCAD to the recommended -100 mEq/kg of the diet without affecting palatability.

In one study, the incidence of milk fever was 47% when prepartum cows were fed a ration with a DCAD of +330.5 mEq/kg dietary DM and 0% when the prepartum ration had a balance of -128.5 mEq/kg dietary DM.<sup>40</sup> The incidence of milk fever was reduced by the addition of chloride and sulfur in excess relative to sodium and potassium in the diet.<sup>40</sup> Because anions are considered acidogenic and cations alkylogenic, an excess of acid-forming elements in periods of calcium stress will increase the concentration of calcium in the blood, either by intestinal absorption or bone mobilization.<sup>31</sup> Cows fed prepartum diets containing alfalfa haylage with added chlorides of magnesium, ammonia, and calcium tended to have higher plasma calcium concentrations of calcium and a lower incidence of milk fever than did cows fed either of two cationic diets. Plasma hydroxyproline, an index of bone resorption, also increases prior to parturition in cows fed a high anion diet. The plasma levels of 1,25-(OH)<sub>2</sub>D also increase prior to parturition in cows fed a high anion diet, which increases calcium absorption and bone resorption.<sup>31</sup> Feeding rations with reduced mEq of dietary ([Na<sup>+</sup> + K<sup>+</sup>] - [Cl<sup>-</sup> + SO<sub>4</sub><sup>=</sup>]) to -4 mEq/kg dietary DM to dry cows significantly affected some of the parameters of bone formation but did not enhance the rate of bone resorption. Feeding acid diets to pregnant cows during the last 28 days of pregnancy increased the mobilization of calcium by 13% 14 days before parturition and 28% by the time of parturition, whereas it had declined by 14% at 14 days before parturition in alkali-fed cows. The increased concentrations of 1,25-(OH)<sub>2</sub>D were responsible for the stimulation of both intestinal calcium absorption and bone resorption, which helped to prevent severe parturient hypocalcemia.

#### *Anion salts for acidification of prepartum diets for dairy cows*

Several anion salts are available for addition to the ration of prepartum dairy cows to prevent milk fever.<sup>44</sup> Generally, acidification of the cows occurs in approximately 36 h following addition of the anionic salts to the ration; it also takes less than 36 h for the cow to return to an alkaline state following removal of the salts from the diet. The relative acidifying activity of anionic salts commonly used to prevent milk fever has been evaluated.<sup>44</sup> Salts of chloride have about 1.6 times the acidifying activity of sulfate. Calcium and magnesium, which are usually not included in the DCAD equation, have a small but significant alkalizing effect when

accompanied by chloride or sulfate. The ranking of the anion sources tested at a dose of 2 Eq/day, from most to least potent urine acidifier was **hydrochloric acid, ammonium chloride, calcium chloride, calcium sulfate, magnesium sulfate, and sulfur**. Magnesium sulfate is the most palatable of the anionic salts commonly supplemented and calcium chloride is the least palatable. Sulfates are poor acidifiers and should be limited in use. It is best to add the anionic salts to a total mixed ration. Because of the low incidence of milk fever in heifers there is no need to feed anionic salts to heifers.<sup>42</sup>

Anionic salts can reduce dry matter intake when more than 300 mEq of anions/kg diet DM are supplemented in the diet.<sup>31</sup> The reductions in dry matter intake are commonly ascribed to decreased palatability but may represent a response to the metabolic acidosis induced by the salts.<sup>41</sup> The duration of feeding anion salts ranges from 21 to 45 days before expected parturition. At least 5 days of consumption are necessary for maximal benefit.

**Ammonium chloride.** Ammonium chloride is more effective than most other salts as an acidifier. The addition of ammonium chloride salts to prepartum diets offers considerable promise as a practical and reliable method of control of milk fever. Experimentally, the addition of ammonium chloride and ammonium sulfate, each at 100 g/head per day, to the prepartum diets 21 days prior to parturition, decreased the incidence of milk fever from 17% in the unsupplemented group to 4% in the supplemented group.

The advantages of ammonium salts are that they:

- Do not require the use of diets low in calcium
- Are relatively inexpensive
- Are convenient to use
- Are safe to feed.

#### *Strategies for supplementing anion sources*

A systematic protocol for the addition of anions to a prepartum diet and monitoring its effects is as follows:

1. Macromineral analysis of all available forages for prepartum cows.
2. Select feed ingredients with a low DCAD especially those low in potassium.
3. Calculate the DCAD of the diet without any supplemental anion sources. If the DCAD is more than 250 mEq/kg, then it is too high. Replace some of the forage with a lower DCAD forage.
4. Balance dietary magnesium at 0.40%, DM by adding additional

magnesium chloride or magnesium sulfate. Magnesium chloride is preferred.

5. Evaluate the feeding management of the prepartum cows. Ensure adequate feeding space and quality of feed.
6. Add supplemental chloride to the prepartum cow diet to lower DCAD to about -150 mEq/kg DM.
7. Evaluate dietary non-protein nitrogen (NPN) and degradable intake protein (DIP) of the diet. If NPN is more than 0.50% of the diet DM or DIP is more than 70% of crude protein, then reduce the amount of ammonium salts or other NPN or DIP sources in the diet.
8. Elevate the dietary calcium to 1.5–1.8% DM or provide daily intake of about 150 g/head per day. Negative DCAD diets increase urinary calcium excretion and thus more dietary calcium is necessary to meet requirements.
9. Monitor dry matter intake of the prepartum cow group. Consider more palatable anion sources or a reduced dose of anion sources if dry matter intake is depressed. Low dry matter intakes in prepartum cows increases the risk for fatty liver and ketosis after calving.
10. After 1 week of feeding anionic salts, monitor the pH of close-up dry cows. Urinary pH is an accurate indication of optimal dietary acidification. Collect urine from at least six cows at one time and average the urinary results. Adjust the dose of supplemental anions to achieve an average urinary pH of between 6.0 and 7.0.

#### *DCAD and acid-base balance of dairy cows on pasture-based diets*

The literature on the nutritional strategies for the prevention of hypocalcemia for dairy cows in pasture-based systems has been reviewed.<sup>6</sup> The dairy industries of southern Australia and New Zealand are based largely on fresh pasture and pasture silage and grazed pasture is the key determinant of the DCAD. The concentration of potassium is often in excess of 4% and the DCAD >500 mEq/kg DM, in pasture-based diets yet the incidence risk of milk fever is not higher than those in other countries where dietary potassium is much lower. For a considerable part of spring and early summer, the DCAD of pasture in those countries may be in excess of +500–700 mEq/kg DM.<sup>5,29</sup> The variation in the DCAD of pasture and the difficulty in accurately assessing dry matter intake makes an accurate reduction in DCAD difficult to achieve practically.<sup>5,45</sup> Pasture

cation-anion difference in those conditions is not greatly influenced by stocking rate or associated management practices. The urine pH of grazing dairy cows in south-eastern Australia remains relatively constant throughout the year despite changes in stage of lactation, management practices, season, weather, and large changes in DCAD. It appears that a very low DCAD ( $< +150$  mEq/kg DM) is required to alter systemic pH substantially. The DCAD of pasture throughout the year in south-eastern Australia ranges from 0 to 800 mEq/kg DM and is often outside the levels previously recommended for optimal performance of lactating cows. A high DCAD at the time of parturition, for spring-calving herds on pasture, presents practical problems in administering the large amounts of anionic salts required to lower urine pH and to decrease the incidence of hypocalcemia.<sup>5,29</sup>

The dietary cation-anion difference and the health and production of pasture-fed dairy cows in early lactation in southeastern Australia has been examined in an indoor feeding experiment.<sup>46</sup> The dairy industry there is largely perennial ryegrass-based and supplemented with cereal grains, pasture hay, and pasture silage. The DCAD can range from 0 to  $+76$  mEq/100 g. Blood pH and urine pH are reduced when a low DCAD ration is fed, but there is a threshold level, between  $+52$  and  $+102$  mEq/100 g, above which little change in systemic pH occurs.<sup>46</sup> As DCAD increased from  $+21$  to  $+127$  mEq/100 g, DMI intake and milk yield decreased. In nonlactating periparturient cows fed freshly cut pasture supplemented with varying levels of salts to alter the DCAD which ranged from  $-12$  to  $+69$  mEq/100 g.<sup>47</sup> With decreasing DCAD, the pH of the blood and urine decreased resulting in a nonrespiratory systemic acidosis. When the DCAD was negative, the urinary output of calcium increased. No differences in milk production due to alteration of the DCAD. Due to the high DCAD in the base diet offered to pasture-fed dairy cows and the requirement for a negative DCAD to increase calcium absorption, it is unlikely that the DCAD concept is a practical means of preventing milk fever in pasture-fed cows.

In these pasture-based systems, sulfur (S) is considered a more important dietary constituent in determining the risk of hypocalcemia than either chloride or potassium.<sup>45</sup> The absorption efficiency of S is less than either Cl or K and would not be expected to incur the same change in systemic pH. Thus its importance in hypocalcemia prevention, does not fit with the current understanding of how manipulation of DCAD influences calcium homeostasis. Studies indicate that pre-

calving dietary S is more important in the control of hypocalcemia than either K or Cl concentration. Although the effects of a systemic acidosis on Ca absorption is accepted, the effect of S on periparturient Ca homeostasis when absorption of S is low in comparison to Cl, Na, or K suggest that there are mechanisms involved that are not related to acid-base balance. Dietary S concentration was more important in the control of hypocalcemia than either dietary K or Cl concentration.

An increased incidence of milk fever may occur in pastured-based dairy when the diet is supplemented with Cl and S, even though calcium absorption, as indicated by urine calcium concentration increases. The increased incidence may be due to a greater demand for dietary calcium after calving following a reduction in the pH of body fluids pre-calving and the fact that pasture-based diets, as opposed to total mixed rations, are generally low in calcium. Supplementation of cows with calcium after calving increased plasma calcium concentration on the day of calving and during the subsequent 14 days.<sup>48</sup> Milk production was not affected by pre- or post-calving treatments.

Experimentally, the application of potassium fertilizer on pasture resulted in a DCAD ranging from 350 to 535 mEq/kg DM but calcium homeostasis in pasture-based dairy cows was not changed.<sup>45</sup> Plasma concentrations were increased and the risk of clinical periparturient hypocalcemia was reduced by  $\text{MgCl}_2$  and  $\text{MgSO}_4$  delivered by 150 g  $\text{MgCl}_2$ , 200 g  $\text{MgSO}_4$ , and 35 g  $\text{MgO}$ /head daily for 21 days prepartum.<sup>45</sup> After calving cows were supplemented with 150 g  $\text{CaCO}_3$ /head per day for 4 days. Improvements in calcium homeostasis were not due to an altered systemic pH.

The optimum DCAD for lactating cows grazing fresh pasture and the effect of deviating from the optimum on milk production has been examined under experimental manipulating the dietary DCAD using a drench in early-lactation dairy cows in New Zealand.<sup>49</sup> Dietary cation-anion differences ranged from  $+23$  to  $+88$  mEq/100 g of DM. As DCAD increased, there was a linear increase in blood pH and  $\text{HCO}_3^-$  concentration and blood base excess. Plasma concentrations of Mg, K, Cl declined as DCAD increased and Na increased. Urinary excretion of Ca decreased as DCAD increased. Increasing DCAD did not significantly affect milk yield or milk protein but the concentration and yield of milk fat increased linearly. Milk production results suggest that DCAD for optimal production on pasture diets may be higher than the  $+20$  mEq/100 g DM previously identified for total mixed rations.

*Summary of macromineral nutritional strategies for the prevention of hypocalcemia in the soon-to-calve, or transition dairy cow in pasture-based systems. (Transition period is defined as 3-4 weeks prepartum and 3-4 weeks postpartum)*

Circumstances and principles:

- When dairy cows are dried off, they are commonly moved onto nonirrigated pastures until calving. In the summer, dry cows would be put onto actively growing tropical pasture, whereas in autumn, winter and spring, the pasture is most likely to be tropical pasture carried over from the previous summer. This carryover pasture is likely to be supplemented with medium quality hay, silage and grain or molasses 2-3 weeks before calving. Anionic salts have been added to these diets
- The DCAD on a yearly basis ranges from 0 to 80 mEq/100 g DM<sup>5</sup>
- The incidence of milk fever in Australia ranges from 1.6 to 5.4% but in some years, the incidence in individual herds may reach 20%. The incidence of subclinical hypocalcemia can range widely; up to 40% of apparently normal cows had subclinical hypocalcemia (total plasma calcium  $<1.9$  mmol/L during the first 12 days of lactation)
- The concentration of ionized calcium in blood plasma is under elaborate homeostatic control. This provides for the maintenance of a pool of readily available calcium which can be drawn on for the deposition of maternal and fetal bone and for colostrum and milk
- The traditional method of preventing hypocalcemia has been to restrict calcium intake during the dry period which stimulates renal synthesis of 1,25-dihydroxyvitamin D<sub>3</sub> prior to calving. The cow must be in negative calcium balance
- In temperate climates, reducing dietary calcium to recommended low levels can be difficult to achieve but in tropical pastures the levels are already low
- Excessive levels of potassium may be the most important dietary risk factor for milk fever in Australian feeding systems. Potassium contents of pastures may be as high as 4-5% of DM. The use of potassium fertilizers exacerbates the problem. Potassium and dietary DCAD peak in winter and are lowest in autumn. The majority of cows in Victoria, Australia, calve in winter to early spring when the potassium levels are high. Excess potassium results in alkalosis which reduces the sensitivity of bone and renal tissue to PTH

- Hypomagnesemia influences calcium homeostasis and diets high in potassium reduce the concentration of plasma magnesium. Magnesium supplementation of the transition diet should be done to ensure that magnesium requirements are met (0.2–0.4% of DM)
- Excessive dietary phosphorus increases the concentration of phosphorus in plasma which can induce hypocalcemia and increase the incidence of milk fever at calving. Supplements likely to increase the dietary intake of phosphorus above 35 g/day should not be fed to cows in the weeks prior to calving
- Excessive intakes of sodium can contribute to the development of metabolic alkalosis and should be avoided.

Options for reducing the risk of hypocalcemia in pasture-fed dairy cows:

**Low calcium intake prepartum.** A low calcium diet in the prepartum period will activate calcium homeostasis at calving. An alternative is to feed calcium binding agents for 1–3 weeks prepartum.

**Magnesium supplementation.** Hypomagnesemia influences calcium homeostasis, potentially predisposing the cow to milk fever at calving. Diets high in potassium can reduce the concentration of plasma magnesium and may be a mechanism linking high dietary potassium to hypocalcemia. Recommended concentrations for dietary magnesium levels are within the range of 0.2–0.4% of total DM intake. Plasma levels are readily elevated when magnesium is added to the diet.

**Calcium supplementation.** Oral administration of gels of calcium chloride or calcium propionate immediately after calving is effective in preventing milk fever. Feeding cows an excess of calcium in the form of calcium carbonate during the first few weeks of lactation is beneficial. Increasing dietary concentration of calcium from 0.68% to 1.02% DM within 8 h of calving has an immediate effect on plasma calcium.<sup>6</sup>

#### *Manipulating dietary DCAD with anion feeds*

The concept of manipulating the DCAD to reduce hypocalcemia under North American and European circumstances is well documented.<sup>6</sup> Addition of anionic salts to the diet of transition dry cows to achieve a metabolic acidosis improves the ability of the cow to mobilize calcium at parturition. The pH of both blood and urine consistently fall in response to an appropriate decline in dietary cation excess. For the transition dry cow, the DCAD must fall to between –10 and –15 mEq/100 g DM to prevent milk fever.

In pasture-fed systems, such as in Australia and New Zealand, the pasture diets are high in DCAD (+50 mEq/100 g DM). The more positive the pasture DCAD, the more difficult it is to balance it with anionic salts. Because anionic preparations are relatively unpalatable, cows will not eat enough for total DCAD to fall below 0 mEq/100 g DM.

An alternative to anionic salts is to select feedstuffs with low to moderate DCAD. Lower quality hays and straws have a lower DCAD than high quality forages. However, the feedstuffs must be analyzed before making such a recommendation. Lower quality roughages are also low in calcium. Concentrates with high negative DCAD include molasses and brewer's grain. Molasses is high in potassium but also high in sulfur.

Measurement of urine pH as a method of monitoring the efficacy of DCAD manipulations and its on-farm use should be encouraged. Urine pH is unlikely to fall to any degree until DCAD of the diet drops below approximately 10–20 mEq/100 g DM. For protection against milk fever, the urine pH needs to be maintained between 5.5 and 6.2 in the last weeks before calving.<sup>1</sup> This could be reduced to a cut-off in the range of pH 6.5–7.0.<sup>13,31</sup>

#### *Calcium gel dosing*

The oral administration of easily absorbed calcium salts such as calcium chloride providing 40–50 g calcium per dose as a bolus, a gel, a paste or a liquid, given in 3–4 doses beginning 12–24 h before calving, to 24 h after calving will prevent a significant proportion of milk fever cases.<sup>30</sup> The oral administration of one or two doses as a supplement to intravenous calcium borogluconate is also effective in reducing the incidence of relapses. Calcium chloride is caustic and can cause oral lesions. The use of calcium formate (350 mL of 48.6% aqueous suspension), four times at approximately 12 h intervals, had no adverse effects on cows and is considered a safe form of calcium supplementation on adult dairy cows.<sup>50</sup> Oropharyngeal abscesses secondary to trauma and laceration caused by the administration of the boluses may occur.

Vitamin D and its metabolites or analogs Vitamin D<sub>3</sub> (cholecalciferol) administered parenterally was historically, a popular prophylactic against milk fever. However, because of the potential for toxicity of vitamin D injections and expense of its analogs, these are no longer used. The literature on the role of vitamin D in calcium homeostasis and its use in the prevention of periparturient paresis in cattle has been reviewed.<sup>6</sup> Their uses are summarized here and advantages and disadvantages outlined.

In an attempt to reverse the negative calcium balance of susceptible cows the administration of vitamin D and its analogs have been used to increase intestinal absorption of calcium. Vitamin D<sub>3</sub> is hydroxylated in the liver and the resulting metabolite is 25-hydroxycholecalciferol. This is metabolized in the kidney to 1,25-dihydroxycholecalciferol, which has an active hypercalcemic effect but is difficult to synthesize. One of its analogs, 1- $\alpha$ -hydroxycholecalciferol is as active, is easy to prepare, and is used pharmacologically.

Oral dosing with vitamin D<sub>2</sub> and the parenteral administration of vitamin D<sub>3</sub> and dihydrotachysterol all have their proponents. Oral dosing with 20 million IU of vitamin D<sub>2</sub>/d for 5 days to cows immediately prior to calving can markedly reduce the expected incidence of milk fever. The exact date of calving is often difficult to determine and if the administration is discontinued for up to 4 days before calving, an unusually high incidence of the disease may follow, probably because of the depression of parathyroid activity which follows the administration. The danger of causing metastatic calcification also exists as this has been produced with smaller doses (10–20 million IU daily for 10 days). Pregnant cows are more susceptible to calcification than non-pregnant animals. Treatment with larger doses or for longer periods than those recommended earlier should be avoided because of the danger of toxic effects. Smaller doses reduce the risk of calcification but also reduce the degree of calcium retention.

A single dose of 10 million IU of vitamin D<sub>3</sub> IM given 2–8 days before parturition has been considered as optimal. A dose of 1 million units per 45 kg BW has given consistently better results. This may explain the variable results and why results have been more favorable in Jersey cattle. If the cow fails to calve after the 8th day, another 10 million units may be administered and repeated every 8 days until the cow calves. Subclinical calcification may occur in vessel walls but this is unlikely if dietary calcium and phosphorus intake is adequate. Single doses of 40 million units of vitamin D can be lethal. One of the disadvantages of this method is the likelihood that cows which do not calve at the anticipated time can be more seriously affected than if they receive no treatment. The hypercalcemic effect of cholecalciferol is injection is very much longer when it is administered by IM injection (up to 25 days) than by IV injection (up to 3 days) for this reason and because occasional cases of shock occur after the IV administration, especially if more than one injection is given, the IM route is preferred. The injection of vitamin D is preferred to feeding it and

a protection rate of up to 80% can be anticipated. It is estimated that 95% of Jersey cattle are protected.

Other compounds with vitamin D activity but which avoid the possibility of causing hypervitaminosis D and are therefore useful in the prevention of milk fever are:

- **25-Hydroxycholecalciferol** injected IM at 8 mg 3–10 days before calving and repeated at weekly intervals. Single doses of 4 mg are not effective in reducing the occurrence of parturient hypocalcemia or milk fever.
- **1,25-Dihydroxyvitamin D<sub>3</sub>** given at 200 µg daily, orally, to calving cows reduces the development of hypocalcemia but does not completely prevent milk fever. When 1,25-(OH)<sub>2</sub>D is given IM between 1 and 4 days of calving, it is effective in preventing milk fever. When administered less than 24 h or more than 4 days before calving, parturient paresis is not effectively prevented. Repeated injections at 4–7 day intervals until calving can be used, but toxicity can be a problem. A third problem with this metabolite is that the IM injection can result in milk fever 1–2 weeks after parturition because the exogenous metabolite may inhibit the endogenous production in some cows and when the exogenous product is cleared from the body, the cow is unable to produce sufficient 1,25-(OH)<sub>2</sub>D to maintain enhanced intestinal absorption of calcium.
- **24-F-1,25-dihydroxyvitamin D<sub>3</sub>** given at 100–150 µg 5 days before the expected date of parturition was effective.<sup>23</sup> Cows which did not calve within 7 days were given a second dose. The incidence of milk fever in untreated controls, those receiving 100 and 150 mg, was 85%, 43%, and 29%, respectively. The use of SC-released product implanted 7 days before parturition and repeated at 7 day intervals until calving resulted in milk fever in 80% of controls and 9% in treated cows. The SC pellet maintained levels of the vitamin D metabolite for about 10 days, compared with the IM injection, which results in very high concentrations in the plasma in the first 48 h after injection.
- **1-α hydroxyvitamin D<sub>3</sub>** at 350 µg IM is effective as a preventive to milk fever if given 72 and 24 h before parturition. If calving has not occurred naturally within 72 h, a second injection is given. Parturition is induced if calving has not occurred 2 days after the second injection. The preferred site of injection is the serratus muscle of the neck, which results in a more effective response. To avoid the

problems created by cows not calving at the predicted time, a combined regimen including induction of parturition by the administration of corticosteroid with the injection of 1-α-hydroxycholecalciferol is reported to be successful. Injection of cows with the same vitamin D analog plus a prostaglandin (cloprostenol) was unsuccessful in preventing milk fever. A dose of 700 µg given 6–8 days before calving is also recommended. Another recommendation suggests 500 µg at 2–5 days prior to parturition. An evaluation of routine use of 1-α-hydroxyvitamin D<sub>3</sub> indicated that cows which developed retained placenta and metritis may be at greater risk of not conceiving within 150 days from calving. There is some transfer of the metabolite from the maternal to fetal plasma. Injection within 24 h of the onset of milk fever is ineffective, but if it is given more than 24 h and less than 1 week before the onset of the disease, the protection is excellent.

### General management practices

The following management practices are suggested:

- Avoid overfattening by either reducing the energy concentration of the ration or restricting the intake during the prepartum period. This also appears to stimulate appetite, thus keeping cows on feed
- Avoid stresses at the time of parturition
- Provide a clean well-bedded box stall with conditions conducive to cow comfort and allow the animal to exercise
- Make frequent observations of cows prone to milk fever from 48 h before to 48 h after parturition for evidence of milk fever and **immediate treatment** will reduce the incidence of the downer cow syndrome associated with milk fever
- At calving the cow should receive an oral dose of a calcium salt in a gel, as set out later, followed by a diet with a high calcium content (over 1% of dry matter). The critical day is the day of calving and a sharp increase in calcium intake on this day can significantly reduce the occurrence of milk fever
- If hypomagnesemia is a likely concomitant, the diet should be supplemented with 60 g magnesium oxide daily.

### REVIEW LITERATURE

- Enemark JMD, Thilising T, Jorgensen RS. Proceedings of the Abildgaard Symposium on hypocalcemia, acidosis and calcium homeostasis. *Acta Vet Scand* 2003; 97:1–160.
- Nielsen K. On the founder of the Danish Veterinary School: Peter Christian Abildgaard and the inventor

- of the first efficient treatment for milk fever: Jorgen Jorgensen Schmidt. *Acta Vet Scand* 2003; 97:7–8.
- Block E. Manipulation of dietary cation-anion difference on nutritionally related production diseases, productivity and metabolic responses of dairy cows. *J Dairy Sci* 1994; 77:1437–1450.
- Horst RL, Goff JP, Reinhardt TA. Calcium and vitamin D metabolism in the dairy cow. *J Dairy Sci* 1994; 77:1936–1951.
- Horst RL et al. Strategies for preventing milk fever in dairy cattle. *J Dairy Sci* 1997; 80:1269–1280.
- Jorgensen RJ et al. Induced hypocalcemia by Na EDTA infusion. A review. *J Vet Med* 1999; 46:389–407.
- Houe H et al. Milk fever and subclinical hypocalcemia—An evaluation of parameters on incidence risk, diagnosis, risk factors and biological effects as input for a decision support system for disease control. *Acta Vet Scand* 2001; 42:1–29.
- Horst RL, Goff JP, Reinhardt TA. Role of vitamin D in calcium homeostasis and its use in prevention of bovine periparturient paresis. *Acta Vet Scand* 2003; 97:35–50.
- Goff JP, Horst RL. Role of acid-base physiology on the pathogenesis of parturient hypocalcemia (milk fever) – the DCAD theory in principle and practice. *Acta Vet Scand* 2003; 97:51–56.
- Roche JR. Hypocalcemia and DCAD for the pasture-based transition cow – a review. *Acta Vet Scand* 2003; 97:65–74.
- Goff JP. Pathophysiology of calcium and phosphorus disorders. *Vet Clin North Am Food Anim Pract* 2000; 16:319–337.
- Goff JP. Treatment of calcium, phosphorus, and mineral balance disorders. *Vet Clin North Am Food Anim Pract* 2000; 16:619–639.
- Thilising-Hansen T, Jorgensen RJ, Ostergaard S. Milk fever control principles: A review. *Acta Vet Scand* 2002; 43:1–19.
- Oetzel GR. Management of dry cows for the prevention of milk fever and other mineral disorders. *Vet Clin North Am Food Anim Pract* 2000; 16:369–386.
- McNeill DM et al. *Aust J Agri Res* 2002; 53:755–770.

### REFERENCES

1. Horst RL et al. *J Dairy Sci* 1997; 80:1269–1280.
2. Houe H et al. *Acta Vet Scand* 2001; 42:1–29.
3. Moisan PG. *Can Vet J* 1994; 35:714.
4. Schlumbohm C, Harmeyer J. *J Dairy Sci* 2003; 86:1953.
5. Roche JR et al. *Grass Forage Sci* 2000; 55:26.
6. McNeill DM et al. *Aust J Agri Res* 2002; 53:755.
7. Horst RL et al. *Int Conf Prod Dis Farm Animals* 2004.
8. Horst RL et al. *Acta Vet Scand Suppl* 2003; 97:35–50.
9. Yamagishi N et al. *Vet Rec* 1999; 144:67.
10. Goff JP. *Vet Clin North Am Food Anim Pract* 2000; 16:319–337.
11. Goff JP, Horst RL. *Acta Vet Scand* 2003; 97:51–56.
12. Seifi HA et al. *Vet J* 2004; 167:281.
13. Goff JP. *Vet Clin North Am Food Animal Pract* 2000; 15:619.
14. Ostergaard S, Larsen T. *J Dairy Sci* 2000; 83:2438.
15. Yamagishi N et al. *Vet Rec* 2001; 148:628.
16. Jorgensen RJ et al. *J Vet Med* 1999; 46:389.
17. Mellau LSB et al. *Acta Vet Scand* 2000; 42:251.
18. Hansen SS et al. *Vet Res Comm* 2003; 27:193.
19. Jorgensen RJ et al. *Acta Vet Scand* 1998; 39:331.
20. Fenwick DC. *Br Vet J* 1992; 148:413.
21. Fenwick DC. *Can Vet J* 1989; 30:426.
22. Cockcroft PD, Whiteley P. *Vet Rec* 1999; 144:529.
23. Matsas DJ et al. *J Am Vet Med Assoc* 1999; 214:826.
24. Gerloff BJ, Swenson EP. *J Am Vet Med Assoc* 1996; 208:716.
25. Braun U et al. *Vet Rec* 2004; 154:336.
26. Braun U et al. *Vet Rec* 2004; 154:666.
27. Fenwick DC. *Vet Rec* 1994; 134:446.
28. Fenwick DC. *Aust Vet J* 1969; 45:111, 454.
29. Roche JR. *Acta Vet Scand* 2003; 97:65–74.



30. Thilising-Hansen T et al. *Acta Vet Scand* 2002; 43:1.
31. Oetzel GR. *Vet Clin North Am Food Anim Pract* 2000; 16:369.
32. Sorensen JT et al. *Prev Vet Med* 2002; 55:69.
33. Ostergaard S et al. *Prev Vet Med* 2004; 86:209.
34. Jorgensen RJ et al. *J Dairy Sci* 2001; 84:609.
35. Thilising-Hansen T et al. *J Dairy Sci* 2002; 85:1855.
36. Thilising-Hansen T et al. *J Dairy Sci* 2001; 84:691.
37. Wilson GF. *N Z Vet J* 2001; 49:78.
38. Wilson GF. *J Dairy Sci* 2001; 49:115.
39. Wilson GF. *Acta Vet Scand* 2003; 97:77.
40. Block E. *J Dairy Sci* 1994; 77:1437.
41. Vagnoni DB et al. *J Dairy Sci* 1998; 81:1643.
42. Moore SJ et al. *J Dairy Sci* 2000; 83:2095.
43. Bowman GR et al. *Can J Anim Sci* 2003; 83:319.
44. Goff JP et al. *J Dairy Sci* 2004; 87:1245.
45. Roche JR et al. *J Dairy Sci* 2002; 85:3444.
46. Roche JR et al. *J Dairy Sci* 2003; 86:970.
47. Roche JR et al. *J Dairy Sci* 2003; 86:979.
48. Roche JR et al. *J Dairy Sci* 2003; 86:2658.
49. Roche JR et al. *J Dairy Sci* 2005; 88:264.
50. McIntyre LH, Weston SJ. *N Z Vet J* 2002; 50:195.

### **DOWNER COW SYNDROME (NON-AMBULATORY COWS WITH NON-PROGRESSIVE NEUROLOGICAL FINDINGS)**

**Etiology** Ischemic necrosis of large muscles of pelvic limbs secondary to prolonged recumbency associated with milk fever. Other causes of recumbency can also result in downer cow syndrome.

**Epidemiology** Most common in dairy cows which have had milk fever but are unable to stand following treatment with calcium. Delay of more than 4 h in treatment for recumbent milk fever cows. Hypophosphatemia and/or hypokalemia may be risk factors.

**Signs** Unable to stand following treatment for milk fever. Sternal recumbency. Normal mental status, vital signs and alimentary tract. Appetite and thirst normal. Most will stand in few days if provided good clinical care and secondary muscle necrosis minimized. Some cases have bizarre behavior of lateral recumbency, abnormal position of legs, groaning, anorexia, and die in several days.

**Clinical pathology** Increased serum levels of creatine phosphokinase (CPK) and aminotransferase (AST); serum phosphorus and potassium levels may be subnormal.

**Necropsy findings** Ischemic necrosis, edema and hemorrhage of large medial thigh muscles.

**Diagnostic confirmation** Increased serum levels of CPK, AST, proteinuria; necropsy lesions in cow unable to rise with no other lesions.

#### **Differential diagnosis list**

- See differential diagnosis of milk fever and Table 29.5.
- Common causes of recumbency in dairy cows around time of parturition include:
  - Milk fever
  - Hypomagnesemia
  - Peracute coliform mastitis
  - Maternal obstetrical paralysis
  - Fat cow syndrome
  - Physical injuries of pelvic limbs (dislocation of hip joints, rupture of gastrocnemius, femoral fracture)

- Acute diffuse peritonitis (ruptured uterus, other causes).

**Treatment** Provide feed and water and excellent bedding or ground surface like sand or dirt pack. Roll animal from side to side every few hours. Fluid and electrolyte therapy as necessary.

**Control** All recently calved dairy cows which are at high risk for milk fever must be observed closely 12–24 h before and after calving for evidence of milk fever and while still standing; if recumbent do not delay treatment for more than 1 h. Can treat all high-risk cows with calcium chloride gel orally to prevent clinical milk fever.

### **ETIOLOGY**

Most commonly, the downer cow is a complication of milk fever.<sup>1</sup> Ischemic necrosis of the large muscles of the pelvic limbs and injuries to the tissues around the hip joint and of the obturator muscles are common in cows which do not fully recover and stand but remain recumbent following treatment for milk fever. Injuries to the musculoskeletal system are also common as a result of cows 'spread-eagling' their hindlimbs if they are unsteady during parturition or forced to stand or walk on a slippery floor immediately before or following parturition. Dystocia due to an oversized calf may result in extensive edema of the pelvic tissues and vulva, and failure of the cow to stand following parturition. If these cows develop milk fever, it is unlikely they will be able stand following treatment with calcium.

### **EPIDEMIOLOGY**

#### **Occurrence**

The disease occurs most commonly within the first 2 or 3 days after calving in high-producing dairy cows immediately following milk fever. Cattle may also become persistently recumbent for many reasons other than complications of milk fever such as peracute coliform mastitis and carbohydrate engorgement.

Downer cows can be divided generally into non-ambulatory cows with non-progressive neurological findings and non-ambulatory with progressive neurological findings indicative of the presence of lesions in the nervous system as the cause of the recumbency.<sup>2</sup>

A survey of bovine veterinarians in the USA in 1998 collected data on non-ambulatory dairy and beef cows with non-progressive neurological findings, and non-ambulatory with progressive neurological findings.<sup>2</sup> Of the population studied, 0.25% developed a non-ambulatory non-progressive neurological disorder for a case rate of 0.66 animals/10<sup>6</sup> cow years or 10<sup>6</sup> cows/year. Of these, 74.3% failed to recover. In non-ambulatory dairy cows with non-progressive neurological

findings, 85% of cases fit into three categories: injury/trauma, septicemia/toxemia, or non-responsive milk fevers. Of the total, 3.3% remain undiagnosed. In non-ambulatory beef cows with non-progressive neurological findings, trauma/injury, septicemia, and other neurological cases accounted for 78% of cases. Of the population studied, 0.12% of cows developed non-ambulatory non-progressive neurological findings syndrome for a case rate of 2476/10<sup>6</sup> cows. Of the total, 73% failed to recover. Of the beef cows, 0.0053% remain undiagnosed, which implies that 4.3% of all beef cows with non-ambulatory non-progressive CNS findings were unknown and undiagnosed and 96% were diagnosed.

Of the total number of non-ambulatory progressive CNS cases reported for dairy cattle, the percentage was 0.027% for a case rate of 554/10<sup>6</sup>. Of these, 17.7% were unknown or undiagnosed indicating that 82% of progressive CNS dairy cattle cases were diagnosed. The progressive CNS cases of unknown cause represented 0.0047% of the study's cattle population, or a rate of 94 cases/10<sup>6</sup> dairy cows. Seventy-one of the cases failed to recover for a mortality of 375 cases per million dairy cows in the study.

The profile of a progressive CNS dairy cow case found that other known CNS diseases, septicemia/toxemia, unknown CNS diseases, and non-responsive milk fever to be the most frequently reported cases.

Of the total number of non-ambulatory progressive CNS cases reported in beef cattle, the percentage was 0.018%. Of these, 9.0% were of unknown etiology indicating that 91% of progressive CNS beef cow cases were diagnosed by veterinarians. The unknown progressive CNS case rate was 32 cases/10<sup>6</sup> beef cattle. The total deaths in progressive CNS cases accounted for a mortality rate of 282/10<sup>6</sup>.

The profile of progressive CNS beef cow cases found that four categories accounted for 83.4% of the total causes: injury/trauma, known infectious agent, septicemia, toxemia, and known CNS disease.

### **Incidence**

The incidence as a complication of milk fever is high because many affected animals are high producers and of high economic value. Accurate data on the incidence are not available because of variations in the nomenclature used and the accuracy of diagnoses. For example, some observations report that all cases are caused by nerve injury.<sup>3</sup> Cases included in this classification are classified by others as maternal obstetrical paralysis, obturator paralysis, or hypophosphatemia. Because it is a

syndrome lacking in clinical definition and includes all those 'other cases' which cannot be otherwise classified, the incidence varies depending on the clinical acuity of the individual veterinarian, and on various environmental factors in different areas. However, the incidence seems to be increasing, particularly in intensive dairy farming areas, although this impression could arise from the increased necessity to effect a cure in valuable animals.

A mail survey of 723 dairy herds in Minnesota found a downer cow incidence of 21.4/1000 cow years at risk.<sup>3</sup> The overall outcome was that 33% recovered, 23% were slaughtered and 44% died. The owners perceived that downer cows were high producers (48%) or average producers (46%), with only 6% being low producers. Approximately 58% occurred within 1 day of parturition and 37% occurred during the first 100 days of lactation. The incidence was highest (39%) during the three coldest months: December, January, and February. In New Zealand, the prevalence ranges from 3 to 5% of all dairy cows at calving time.<sup>4</sup>

In a clinical and laboratory survey of 433 periparturient recumbent cows in New Zealand, 39% recovered, 30% died, and 32% were destroyed.<sup>4</sup> The case-fatality rate was 11% higher in pre-calving recumbent cows than post-calving cows.

An audit of 21 slaughter plants in the USA in 1993 found 1.1% of arriving dairy cows were non-ambulatory, and in 1999, 1.5%.<sup>5</sup> In 1993, 1.0% of beef cows arriving at slaughter plants were non-ambulatory and in 1999, 0.7%.<sup>5</sup>

### Risk factors

Animal risk factors

**Complication of milk fever.** Prolonged recumbency after a long delay in the treatment of milk fever is a major risk factor. Prolonged recumbency before treatment for milk fever (more than 4-6 h) results in ischemic necrosis due to obstruction of the blood supply, especially in a heavy cow if she lies on one leg for a long period.<sup>6</sup> Cows which develop milk fever while in a standing tie-stall may slide backwards into the gutter behind the stall, resulting in extreme pressure to their pelvic limbs and leading to ischemic necrosis.

A case-control study to identify risk factors for the development of downer cow syndrome within 30 days post partum in 12 dairy herds over 2705 lactations found that clinical hypocalcemia and stillbirth increased the risk of the disease five-fold.<sup>7</sup> Cows with retained placenta and dystocia were also more likely to develop downer cow syndrome than cows without either problem.

A marked increase in the CPK levels in cows with milk fever and failure to stand

after repeated treatments is supporting evidence for ischemic necrosis associated with prolonged recumbency as a major cause of downer cow syndrome.<sup>1</sup> The CPK levels increase markedly between the first and second treatments, which indicates that muscle damage has occurred and the levels are highest in cows which do not recover.

Experimentally, enforced recumbency of cattle for 6, 9, or 12 h with one hindlimb positioned under the body results in downer cow syndrome. Affected cows are unable to stand and the affected limb is swollen and held rigid similar to the injured limbs of human patients with compartmental/crush syndrome.

Surveys have shown that downer dairy cattle have 3.3-fold-higher prevalence of *E. coli* 0157:H7 than healthy cattle within a certain time frame and geographic area.<sup>8</sup> Culled dairy cows account for approximately 17% of the ground beef produced in the US and thus downer cattle harboring *E. coli* 0157:H7 may be an important source of contamination of ground beef which is commonly processed from downer cattle.

**Traumatic injuries to pelvis and pelvic limbs.** Traumatic injuries to the nerves of the pelvis and hindlimbs are present in 25% or more of downer cows.<sup>1</sup> The sciatic and obturator nerves are vulnerable to injury by pressure from the calf moving through the pelvic canal during parturition. Pressure injuries on the superficial nerves (radial and peroneal) of the extremities also occur in recumbent cows.

**Serum electrolyte imbalances.** Serum electrolyte imbalances or deficits may be associated with prolonged recumbency following treatment for parturient paresis.

**Hypocalcemia.** A persistent hypocalcemia following treatment for milk fever may exist in a downer cow but is unlikely to be the principal cause because treatment with calcium salts does not resolve the signs, even temporarily. However, the use of an insufficient amount of calcium for the initial treatment of milk fever in large, heavy cows may result in an incomplete response and failure of the cow to stand. If these cows are not retreated soon enough with an adequate amount of calcium, ischemic necrosis of the limb muscles occurs and leads to prolonged recumbency. In many cases, even after the cow is given a sufficient amount of calcium, prolonged recumbency occurs due to the ischemic necrosis.

**Hypophosphatemia.** The serum levels of inorganic phosphorus decline to below normal along with a hypocalcemia in cases of milk fever. Following treatment of milk fever with calcium borogluconate, the levels of serum calcium and phosphorus return to normal if the animal responds favorably and stands normally. Following

treatment for milk fever, some cows do not or are unable to stand and their serum phosphorous levels are subnormal. This persistent hypophosphatemia has been regarded as a cause of downer cow syndrome associated with milk fever. Many veterinarians claim that these cows respond to treatment with phosphorus. However, persistent recumbency is associated with subnormal levels of serum phosphorus which increase to normal if the cow stands regardless of treatment with or without phosphorus. Mature dairy cows may become recumbent in early lactation and subnormal levels of serum phosphorus may be present.<sup>9</sup> Other cows in the herd may be lame due to demineralization of bones associated with a dietary deficiency of phosphorus.

**Hypomagnesemia.** A long-term low-level hypomagnesemia has been associated with the downer cow, especially when it accompanies hypocalcemia. But it is usually manifested by a tetanic hyperesthetic state which is not part of downer cow syndrome. Hypokalemia is, with hypophosphatemia, the most commonly quote cause, especially in the so-called 'creeper' cows, which are bright and alert and crawl about, but are unable to rise.<sup>10</sup>

**Hypokalemia.** Ischemia due to prolonged recumbency associated with milk fever, may increase the cell membrane permeability of muscle fibers and allow the loss of potassium from the cell; this in turn causes the myotonia, which appears to be the basis of downer cow syndrome. This view is supported by the low serum and muscle potassium levels in downer cows. Claims are made that potassium salts are successful in treatment but these have been difficult to evaluate.<sup>4</sup>

Hypokalemia occurs in dairy cows which have been treated with isoflupredone acetate for ketosis.<sup>11</sup> Affected animals are weak, recumbent and severely hypokalemic with serum potassium levels ranging from 1.4 to 2.3 mEq/L.

Environmental and management risk factors

A slippery ground surface is a major risk factor. Cattle which must walk across slippery floors, especially at the time of calving, may slip and fall and injure the large muscles of the pelvic limbs, resulting in an inability to stand. Prolonged recumbency results in ischemic necrosis and downer cow syndrome.

### Summary

Downer cow syndrome is a complication of the recumbency associated with milk fever. A delay of 4 h or more in that treatment of cows with milk fever may result in ischemic necrosis of the muscles of the pelvic limbs. Traumatic injury to leg muscles at the time of parturition or when the

cow is unsteady and falls during the first stage of milk fever will also result in the inability of the cow to stand following treatment of milk fever.

### **PATHOGENESIS**

Several different primary factors or diseases can result in recumbency.

#### **Prolonged recumbency before treatment**

A long delay in the treatment of milk fever can result in pressure damage and the subsequent inability to stand after treatment for the primary disease. Prolonged recumbency results in pressure damage, which occurs secondarily and is a factor common to all cases.<sup>3</sup>

Regardless of the cause, the prolonged recumbency results in varying degrees of ischemic necrosis of major muscles of the hindlimbs, particularly the semitendinous muscle and muscles caudal to the stifle. Prolonged compression of the muscle leads to tissue anoxia, cell damage and inflammation which causes swelling; the swelling causes a further increase in pressure which limits tissue perfusion and leads to a detrimental cascade of events. The thick fascial boundaries of the semitendinous muscle prevent expansion which results in pressure-induced compartmental syndrome. Sciatic nerve damage due to pressure also occurs and may contribute to downer cow syndrome. Experimental external compression of the pelvic limb of the goat, to simulate limb compression in recumbent cows, resulted in a marked reduction in nerve conduction velocity of the peroneal nerve which was associated with clinically evident limb dysfunction. Damage to the peroneal nerve will result in hyperflexion of the fetlock if and when the cow is able to stand.

Traumatic injury to limb muscles and nerves immediately prior to parturition or at the time of parturition can also result in prolonged recumbency and subsequent pressure damage.<sup>1</sup>

#### **Experimental sternal recumbency**

Experimentally induced sternal recumbency with one hindlimb positioned under the body to simulate prolonged recumbency will result in a swollen rigid limb within 6–9 h.<sup>12</sup> Following injury to the muscle cells, the serum levels of CPK are markedly elevated at about 12 h after the onset of recumbency. Proteinuria and in some severe cases myoglobinuria occur between 12 and 36 h after the onset of prolonged recumbency, due to the release of myoglobin from damaged muscles. In cows which make efforts to stand but cannot do so, continued struggling results in rupture of muscle fibers and hemorrhage which increases the severity.

Acute focal myocarditis may occur in about 10% of cases resulting in tachycardia, arrhythmia, and the unfavorable response to IV calcium salts observed in some cases. The cause of the myocardial lesion is unknown but repeated administration of calcium salts has been suggested.<sup>1</sup> Downer cows with a poor prognosis also have greatly enhanced adrenocortical function.<sup>10</sup>

The prolonged recumbency can result in additional complications such as acute mastitis, decubitus ulcers, and traumatic injuries of the limbs.

The pathogenesis of the non-alert downer cow is not understood.<sup>13</sup> Most have had an initial episode of milk fever but do not respond satisfactorily. Within 1 or 2 days, affected cows have a preference for lateral recumbency and exhibit expiratory moaning and groaning. They represent about 2% of all cases of milk fever.

#### **Experimental prolonged hypocalcemia**

Experimental prolonged hypocalcemia may provide some clues about the pathogenesis of downer cow syndrome as a complication of milk fever. The prolonged infusion of ethylenediamine tetra-acetic acid (EDTA) in sheep over 18 h at a rate to induce hypocalcemia and maintain recumbency results in prolonged periods of recumbency, ranging from 36 to 64 h before the animals are able to stand.<sup>14</sup> There are also decreases in plasma sodium, plasma potassium, and erythrocyte potassium and prolonged increases in packed cell volumes, which suggests that fluid replacement therapy may be indicated in cattle with prolonged recumbency associated with hypocalcemia.<sup>15</sup> A 4-h IV infusion of EDTA in high erythrocyte potassium and low erythrocyte potassium dairy cows causes decreases in plasma inorganic phosphorus and plasma potassium which are still below normal 24 h later.<sup>16</sup> The AST, CPK, and PCVs and WBC counts are also elevated 24 h later. Plasma magnesium and erythrocyte sodium and potassium were decreased but this was delayed. The increase in PCV was most pronounced in the low erythrocyte potassium cows, which may provide some clues about the pathogenesis of downer cow syndrome. Some cows may have a more precipitate increase in PCVs due to loss of plasma volume and an inability to mobilize calcium. As a basis for studying the effects of hypertonic solutions to correct these abnormalities in downer animals, a 200 mL solution of 10 g of sodium chloride and 0.5 g of potassium chloride can be given IV to sheep safely over a period of 4–8 min.<sup>17</sup>

#### **CLINICAL FINDINGS**

The downer cow syndrome may occur independently, or follow apparent recovery after treatment for milk fever, except for

the prolonged recumbency. In the typical case, affected cows either make no effort or are unable to stand following treatment for parturient paresis. About 30% of cows treated for milk fever will not stand for up to 24 h following treatment. Those which are unable to stand after 24 h and after two treatments are classified as downers. They are usually bright and alert and, although the appetite is reduced, the cow eats and drinks moderately well. The temperature is normal and the heart rate may be normal or elevated to 80–100 bpm. Tachycardia and arrhythmia occur in some cows, especially immediately following the administration of calcium IV and sudden death has occurred. Respirations are usually unaffected. Defecation and urination are normal but proteinuria is common and if marked may indicate extensive muscle damage.

Some affected cows may make no effort to stand. Others will make frequent attempts to stand but are unable to fully extend their pelvic limbs and lift their hindquarters more than 20–30 cm from the ground. These frequent attempts to stand result in 'crawling' or 'creeping' along the ground with both hindlegs in a partially flexed position and displaced posteriorly – the frogleg attitude. On a non-slippery surface (bare ground, sand pack, or deep bedding) some cows are able to stand with some assistance by lifting on the tail head or with the use of hip slings. Those cows which do not make an effort to stand usually cannot stand even with assistance and if supported with hip slings will usually make no effort to bear weight with either the hindlimbs or the forelimbs. Their limbs appear stiff, painful, or numb and they are unable or reluctant to bear weight. Damage to the peroneal nerve is usually present when there is hyperflexion of the fetlock joints, which is evident if and when the cow is able to stand and bear weight on the hindlimbs.

In some cases, the hindlimbs are extended on each side of the cow and reach up to the elbows on each side. In this position, the cow is bearing considerable weight on the medial thigh musculature and causing ischemic necrosis. This abnormal position of the legs may also be due to dislocation of one or both hip joints or associated with traumatic injuries surrounding the hip joints with or without rupture of the ligamentum teres. Regardless of the cause, the cow prefers this leg position and invariably will shift the legs back to the abnormal position if they are placed in their normal position.

In some cows, the signs may be more marked and bizarre, including a tendency to lie in lateral recumbency with the head drawn back. When placed and propped up in sternal recumbency, these cows appear

almost normal but, when they are left alone, within a short period of time they revert to the position of lateral recumbency. Still more severe cases are hyperesthetic and the limbs may be slightly stiff but only when the cow is lying in lateral recumbency. These severe cases do not usually eat or drink, have been described as 'non-alert downers', and are thought to have brain damage which has not been documented.<sup>13</sup>

Complications in the downer cow syndrome are common and often result in death or the need for euthanasia. Coliform mastitis, decubitus ulceration, especially over the prominences of the hock and elbow joint, and traumatic injuries around the tuber coxae caused by the hip slings are common. When these complications occur in the early stages of the disease, they commonly interfere with any progress being made and become the focus of clinical attention.

The course of the disease is variable and dependent on the nature and extent of the lesions and the quality of the care and comfort which is provided for the cow during the first few days. About 50% of downer cows will stand within 4 days or less if cared for properly. The prognosis is poor for those which are still recumbent after 7 days, although some affected cows have been down for 10–14 days and subsequently stood up and recovered. Death may occur in 48–72 h following the onset and is usually associated with myocarditis.

#### **Clinical examination of the downer cow**

Clinical examination of the downer cow can be very difficult and challenging depending on the environmental circumstances and the physical size of the animal. Many different metabolic, nutritional, musculoskeletal, toxic, neurological, neoplastic, inflammatory, and infectious diseases can cause recumbency in cattle.<sup>18–20</sup> It is very important to obtain an adequate history of the case on the first visit to the animal. Key aspects of the history include age of the animal, duration of recumbency, any previous clinical abnormalities before the recumbent stage such as neurological in the case of bovine spongiform encephalopathy, or spinal cord lymphomatosis, any previous treatments with particular attention to mineralocorticoids which may cause hypokalemia, the anatomical location of any parenteral injections, time since recent parturition, diet and accidental access to new feeds, sudden unaccustomed exercise, and an assessment of the management provided.

The environment and the ground surface surrounding the recumbent animal may provide clues about the

possibility that the animal slipped, fell, and was injured.

A systematic physical examination of all accessible body systems is necessary. The animal should be examined visually from a distance for evidence of abnormalities of the carriage of the head and neck, the position of the limbs, observe any attempts of the animal to stand or creep along the ground surface.

The details of the clinical examination are presented in Chapter 1. The standard close clinical examination is necessary to determine body temperature, heart rate and pulse, respiratory rate, and the state of the major body systems such as the respiratory tract, cardiovascular system, central nervous system for mental state, and gastrointestinal tract, mammary gland, reproductive tract, any of which may indicate the presence of abnormalities associated with shock which results in recumbency.

In the recently calved cow, particular emphasis must be given to adequate examination of the udder for mastitis, the uterus for metritis, and the gastrointestinal tract for diseases associated with toxemia and dehydration and shock (acute diffuse peritonitis, carbohydrate engorgement), which results in recumbency. A urine sample must always be obtained and tested for ketones, and the presence of myoglobinuria. A vaginal examination of the uterus should always be done along with a rectal examination.

Careful systematic examination of the musculoskeletal system includes palpating the muscles, bones, joints, and feet of each limb, including passive flexion and extension of each limb is necessary. The coxofemoral joints are examined for evidence of dislocation. The vertebral column is examined for evidence of painful sites or displacement of vertebrae. It is important to examine both sides of the animal which means rolling the cow over from side to side; often the animal may have to be rolled over more than once to repeat a particular examination.

A neurological examination includes examination of the withdrawal reflexes and sensation of all four limbs, reflex arcs of the spinal cord, careful examination of lumbar and sacral areas including sensation and tone in the tail, and examination of the cranial nerves.

The examination can be extended by lifting the downer cow with appropriate lifters and observing if the animal extends its limbs and attempts to bear weight. While the animal is being assisted to stand, additional examinations of other parts of the body can be made.

#### **CLINICAL PATHOLOGY**

The calcium, phosphorus, magnesium and glucose levels of the blood are within

the normal range and the results of hematological examinations are usually consistent with those found in normal cows which have recently calved. The CPK and AST levels are usually markedly elevated by 18–24 h after the onset of recumbency and continue to elevate within the next few days. Continued elevation of CPK levels indicates continued muscle damage. In experimentally induced recumbency in cows, the CPK levels remained within normal limits for the first 6 h. However, by 12 h there was a marked increase to mean values of 12 000 U/L rising to 40 000 U/L by 24 h. There may be moderate ketonuria. A marked proteinuria is usually evident by 18–24 h after the onset of recumbency. The proteinuria may persist for several days or be absent within a few days. In severe cases, the urine may be brown and turbid because of severe myoglobinuria. Low arterial blood pressures and abnormal electrocardiograms (ECGs) have been observed in some animals.

Elevations of serum urea, muscle enzymes, and laboratory evidence of inflammation are considered the best prognostic indicators of an unfavorable recovery.<sup>4</sup> The recovery rate was lower in cows with a total protein:fibrinogen ratio less than 10:1, and evidence of neutropenia and/or left shift.<sup>4</sup> Cows with a serum urea level above 25 mmol/L and serum creatinine levels above 130 mmol/L had a poor prognosis.

The CPK levels need to be interpreted in relation to the days of recumbency when the sample was taken. Critical levels may be highest initially (up to 50 times the upper normal reference range) and reduce to 10 times normal range at 7 days of recumbency.

In a series of 262 recumbent dairy cows serum samples were analyzed for creatine phosphokinase (CPK), lactate dehydrogenase (LDH) and aspartate aminotransferase (AST) to evaluate the value of serum enzyme activities for predicting a failure to recover.<sup>21</sup> The most common diagnosis was milk fever 61.1%, dystocia 11.1%, mastitis 8.4%, and trauma 6.9%. The prior probability of the cow not recovering was 0.24, 0.69, and 0.81 on days 1, 2, 3, and 4 of recumbency. The optimal cut-off points maximizing the sensitivity and specificity of the tests were 2330, 2225, and 171 U/L for CPK, LDH, and AST, respectively. The predictive value of AST was significantly better with optimal cut-off points of 128 and 189 U/L, respectively. AST provided the best predictive indicator of whether a recumbent cow would not recover, the best results being obtained with serum samples taken on the first day of recumbency.

## NECROPSY FINDINGS

Hemorrhages and edema of the skin of traumatic origin are common. The major pathological changes consist of hemorrhages and degeneration of the medial thigh muscles. Hemorrhages around the hip joint with or without rupture of the ligamentum teres are also common. Local areas of ischemic necrosis of the musculature (gracilis, pectineus, and adductor muscles) occur at the anterior edge of the pelvic symphysis.<sup>1</sup> Eosinophilic infiltration of ruptured necrotic thigh muscles of downer cows has been described.<sup>22</sup> Hemorrhages and edema of the nerves of the limbs (obturator, ischiatic, peroneal, radial) are also common and usually associated with severe muscle damage. The heart is dilated and flabby and histologically, there is focal myocarditis. There is fatty degeneration of the liver and the adrenal glands are enlarged. Histologically, there are also degenerative changes in the glomerular and tubular epithelium of the kidneys.

## DIFFERENTIAL DIAGNOSIS

The diagnosis of downer cow syndrome is made after all other known causes of recumbency have been eliminated in a cow which had milk fever and failed to stand within 24 h following two successive courses of treatment. The other common causes of prolonged recumbency are described under the differential diagnosis of milk fever (Table 29.5). It is difficult and time consuming to examine a downer cow thoroughly to eliminate all other causes of recumbency. Only by repeated careful clinical examination will the clinician avoid the embarrassment of failing to detect the presence of coliform mastitis, a fractured leg or a dislocated hip.

## TREATMENT

The prognosis of a downer cow depends on the cause of the recumbency and whether or not treatment is indicated or if euthanasia should be recommended because of the presence of abnormalities which are unlikely to respond favorably to treatment and also be economical. If the prognosis is poor, euthanasia on the farm should be recommended.

If the prognosis is favorable, the clinician should inform the owner about the nature of the treatment which will be necessary and its duration which may be several days of supportive care and therapy, and should outline the costs which will be incurred.

### Fluid and electrolyte therapy

Many treatments including the injections of magnesium salts, phosphates, corticosteroids, stimulant tonics, and vitamin E and selenium have been used without consistent success. The use of parenteral

solutions containing potassium, calcium, magnesium, and phosphorus has been recommended<sup>10</sup> but there is no scientific evidence that these electrolytes, in addition to what was probably given to the cow already, are indicated or are of any beneficial value. Large quantities of fluid and multiple electrolyte therapy by the oral or parenteral route is indicated for cows which may not be drinking normal quantities of water. Multiple electrolytes can be added to the drinking water if the cow is drinking normally.

### Bedding and clinical care

The most important aspect of treatment is to provide the most comfortable bedding possible and to roll the cow from side to side several times daily to minimize the extent of ischemic necrosis and paranalgesia which results from prolonged recumbency. With conscientious care and the provision of good bedding, palatable feed and liberal quantities of water, most cows will attempt to stand with some difficulty and assistance within 24 h, and will stand unassisted and normally 1 or 2 days later. A sand or dirt pack is the ideal ground surface which facilitates standing when downer cows attempt to stand.<sup>12</sup> If affected cows are left on a slippery ground surface, they will not make an effort to stand and will become progressively worse. Cows should be milked normally and the udder kept clean by washing with germicide soap before milking, and post-milking teat dips applied.

### Assisted lifting to aid standing

The clinician and farmer are commonly faced with the questions of whether or not to lift a recumbent cow which has not attempted to stand within a few hours after treatment for milk fever. The guiding principle should be the behavior of the cow. If the cow makes an effort to stand on her own or by some coaxing such as a gentle nudge in the ribs, she should be assisted to stand by insuring a good non-slip ground surface, deep bedding, and lifting up on the tailhead when she attempts to stand. The cow should be rolled from side to side every few hours and encouraged to stand a few times daily. With good clinical care, most cows with the uncomplicated form of downer cow syndrome secondary to milk fever will stand in 12–24 h.

### Lifting devices

Several different kinds of cow-lifting devices have been used to assist downer cows to stand. Hip lifters, which fit and tighten over the tuber coxae, and body slings like harnesses are designed to fit around the abdomen and thorax of the animal. These devices can assist a downer

cow to stand if she makes some effort on her own and it appears that 'if she were given some help she could stand'. For those cows which make some effort to stand, the hip lifters or slings can be applied and the animal lifted to the standing position. If the animal bears weight on all four legs, she should be allowed to stand with the aid of the devices for 20–30 min and then lowered down. This procedure should be repeated several times daily. In most cases, such downer cows will stand on their own within a few days. While the cow is in the standing position, she can be milked and other clinical examinations can be carried out.

The hip lifters can result in traumatic injuries to the tissues surrounding the tuber coxae if not used judiciously. Animals which make no effort to stand and bear weight on their own must not be left suspended in the lifter for more than a few minutes but lowered immediately. If the hip lifters are not applied carefully, the animal may slip out of the device while she is being lifted, which commonly results in tissue injury around the tuber coxae; fractures of the coxae have even occurred. These injuries are often unnoticed clinically, contribute to persistent recumbency and the true extent of the lesions are evident at necropsy. Lifting devices must be used carefully by experienced personnel.

Body slings which fit around the abdomen and thorax of the animal appear to be the ideal 'animal lifter' because they distribute the weight over several sites in contrast to the hip lifters, which concentrate the weight over the tuber coxae. However, the body slings are cumbersome to apply to a recumbent animal, and require more time and experienced personnel to insure proper application. When the slings are applied properly, they do appear to allow the lifted animal to stand comfortably for 30 min or more and promote recovery.

Lifting cows which make no effort to stand on their own is usually unsuccessful. When lifted, they usually do not bear any significant weight.

A water flotation tank has been designed for the management of downer cows.<sup>23</sup> A prototype consists of a metal tub with inside dimensions of 92 in long, 43 in wide, and 51 in deep. The system is affordable, portable, durable, effective, and simple to use. The downer cow is pulled into the tub on a mat and the ends of the tub closed to make a water-tight container with an open top like a bath tub. With the cow's head held up by a halter, the tub is filled with water at 100–102°F as quickly as possible. Cows in lateral recumbency will roll into sternal recumbency when 12–24 in of water are in the container and will usually attempt to stand when the

tub is one-half to two-thirds full. Cows are allowed to stand in the water for 6–8 h. If the water temperature falls below 95°F, more hot water is added. When the decision is made to remove the cow, the water is drained and the end of the tub opened, which allows the cow to walk out preferably onto a ground or grass surface. A success rate of 46% has been reported.<sup>23</sup> However, the success rate could be higher if the selection of cases for flotation are more rigorous. Cows with ruptured tendons, fractures, luxated coxofemoral joints, septic polyarthritis, and other physical injuries of the musculoskeletal system are not good candidates for flotation. The most suitable case for flotation would appear to be the downer cow as a sequel to milk fever.

#### **Handling, transportation, and disposition of non-ambulatory cattle**

There has been considerable controversy and disparity among veterinarians and livestock producers about the handling, transportation, and disposition of non-ambulatory cattle.<sup>24</sup> Economics has a major influence on decision making in these cases. There has been no common understanding of whether or not they are fit for transportation and which ones are fit for slaughter for salvage. When the owner and veterinarian are faced with a downer cow which is valuable, and the cause of the recumbency is uncertain, the tendency is to either attempt to provide treatment for several days and assess the progress, or consider slaughter for salvage. In the case of valuable breeding animals which are recumbent as a complication of milk fever, or a disease such as acute carbohydrate engorgement, peracute mastitis, supportive, and specific therapy are commonly selected. In the case of downer cattle of commercial value, slaughter for salvage has been a common option. Cattle producers would like to obtain as much financial return as possible by slaughter for salvage. Cattle affected with complications of milk fever (ischemic necrosis of the pelvic limbs), traumatic injuries of the musculoskeletal system and other diseases not associated with toxemia or septicemia were commonly submitted to slaughter for salvage. Transportation of these compromised animals has always been an animal welfare issue because of the difficulty of loading them humanely because of their size. The mere act of lifting, pulling, dragging, and by other means of forcefully loading an animal weighing 500–800 kg onto a truck cannot be done without considerable pain and discomfort to the animal. However, beginning in the 1990s worldwide, concern emerged from the public about the handling and disposition

of non-ambulatory animals particularly downer cows regardless of the cause of their recumbency. Government animal health regulatory agencies, livestock associations, and veterinary associations began drafting regulations on the care and handling of non-ambulatory recumbent animals like the downer cow.<sup>24</sup>

The downer cow syndrome is an animal welfare issue and the veterinarian should be proactive about the problem. Society is concerned about how downer animals are cared for and handled and the methods used for their disposition.<sup>25</sup> If recovery does not occur within a few days the prognosis is uncertain and the owner and veterinarian must decide whether to continue providing clinical care to the downer cow or if the animal should be euthanized. In the USA in 1990–1992, 117 301 recumbent cattle were slaughtered at federally inspected abattoirs. Many consumers believe that meat derived from any non-ambulatory animal is unwholesome.

**Disposition of downer cows in the USA**  
In December 2003, the US Department of Agriculture issued a ban on the slaughter and sale of non-ambulatory cattle for food. The ban applies to all states and at all federally-inspected slaughter plants.

**Disposition of downer cows in Canada**  
In Canada, the Health of Animals Regulations states 'no person shall load or cause to be loaded on any railway car, motor vehicle, aircraft, or vessel and no one shall transport or cause to be transported an animal (a) that by reason of infirmity, illness, injury, fatigue or any other cause cannot be transported without undue suffering during the expected journey'.

The Canadian Veterinary Medical Association's position statement regarding non-ambulatory livestock states: 'If the animal is to be moved to a suitable processing facility, a veterinary inspection of the non-ambulatory animal must be performed on the premises of origin. The animal must be accompanied by an antemortem veterinary certificate declaring whether the animal can or cannot be humanely loaded, that the animal is fit for slaughter and that the owner has observed all applicable withdrawal times for drugs used. The loading and transportation of non-ambulatory animals must be performed in a manner to avoid pain, suffering and distress to the animal and upon arrival at the processing facility, the animal must be humanely stunned or euthanized on the vehicle prior to unloading. Equipment currently being used includes slide boards and mats, forklifts, front-end loaders, hand carts, slings, 'cow caddys' and stone boats or sleds. In those situations where the non-ambulatory animal is passed for slaughter,

but where the veterinarian deems loading and transportation inhumane, the Canadian Veterinary Medical Association recommends on-farm slaughter. Non-ambulatory animals deemed unfit for slaughter should be humanely euthanized on-farm and the carcass disposed of in accordance with local regulations'.<sup>24</sup>

In order to quantify the frequency of non-ambulatory cattle being transported to federally inspected slaughter plants and auction markets, the Canadian Food Inspection Agency conducted a national, non-statistical survey, focusing on inspection sites at 19 slaughter facilities and 3 auction markets across Canada.<sup>24</sup> These represent only a portion of all such federally inspected facilities. During the year 2001, 7382 non-ambulatory cattle were observed to arrive at these sites. Of this total, 89.8% were classified as dairy carcasses, while 10.2% were beef carcasses. The data strongly suggested that the vast majority of non-ambulatory animals originate on-farm, with less than 1% becoming non-ambulatory in transit or accidentally. Inspection led to carcass condemnation in 37% of non-ambulatory dairy animals.

In 2003, the Canadian Food Inspection Agency (CFIA) conducted stakeholder consultations on the evaluation of non-ambulatory livestock for fitness for transport. Stakeholder comments indicated that the small potential salvage value does not justify the animal suffering, human health hazards, reduced meat quality and negative impact on the image of the Canadian livestock industry that are associated with the loading of non-ambulatory livestock.

Most often, producers ship non-ambulatory livestock because they see no alternative – be it due to provincial restrictions, lack of inspectors, or missing infrastructure. Veterinarians have a professional responsibility to educate producers in the prevention, proper care, handling, and humane disposition of the non-ambulatory animal.

On 18 December, 2004 a proposal to amend the Health of Animals Regulations was published in Canada Gazette I. The proposed amendment would define a non-ambulatory animal as 'an animal of the bovine, caprine, cervid, camelid, equine, porcine, or ratite species that is unable to stand without assistance or to move without being dragged or carried'. It would also clarify that:

- no person shall load or cause to be loaded on a conveyance or unload or cause to be unloaded a non-ambulatory animal for any purpose other than for transport for veterinary treatment or diagnosis on the advice of a veterinarian, and that

- non-ambulatory animal may be loaded on a conveyance or unloaded for purposes other than for veterinary treatment or diagnosis if the animal has first been rendered unconscious.

The Canadian Food Inspection Agency declared its Compromised Animals Policy, which is accessible at <http://www.inspection.gc.ca/english/anim/heasan/transport/polie.shtml>

#### Definitions used

**Compromised animal.** An animal with reduced capacity to withstand the stress of transportation, due to injury, fatigue, infirmity, poor health, distress, very young or old age, impending birth, or any other cause. Some animals can be transported under certain conditions without being exposed to additional suffering. Others, such as non-ambulatory animals, animals with a body condition score indicating emaciation or weakness, or animals with severe lameness, would endure additional suffering during the transportation process and must not be transported except for veterinary treatment or diagnosis. This is true of any condition associated with pain that will be aggravated by transport.

**Non-ambulatory animal.** 'Non-ambulatory animal' means livestock or an animal that is unable to stand without assistance or to move without being dragged or carried, regardless of size or age. Non-ambulatory animals are also called 'downers'.

Disposition of downer cows in Europe  
A proposed Council Regulation on the protection of animals during transport and related operations would define fitness for transport and ban the transport of animals deemed unfit. Animals that are injured or that present physiological weaknesses or pathological processes shall not be considered fit for transport. This includes animals that are unable to move independently without pain or to walk unassisted, and animals with severe open wounds. All member states of the EU would have to comply with the New Council Regulation. Access at: [www.europa.eu.int/eur-lex/en/com/pdf/2003/com2003\\_0425en03.pdf](http://www.europa.eu.int/eur-lex/en/com/pdf/2003/com2003_0425en03.pdf)

#### CONTROL

The early detection and treatment of milk fever will reduce the incidence and severity of downer cow syndrome. Under ideal conditions, cows should be treated during the first stage of milk fever before they become recumbent. Once recumbent, cows should be treated as soon as possible and not delayed for more than 1 h. Cows with milk fever should be well-bedded with liberal quantities of straw, or moved to a soft-ground surface. Recumbent cows should be coaxed and assisted to

stand if possible after treatment for milk fever. If they are unable to stand, they should be rolled from one side to the other every few hours if possible. It is usually difficult to get owners to comply with this recommendation but frequent rolling from side to side is necessary to minimize the ischemic necrosis. Dairy cows should be placed in a comfortable well-bedded box stall prior to calving and should be left in that box stall until at least 48 h after parturition in the event that milk fever develops.

#### REVIEW LITERATURE

- Grandin T. Welfare of cattle during slaughter and the prevention of non-ambulatory (downer) cattle. *J Am Vet Med Assoc* 2001; 219:1377-1382.
- Van Metre DC, Callan RJ, Garry FB. Examination of the musculoskeletal system in recumbent cattle. *Compendium of continuing education for the practicing veterinarian* 2001; 23:S5-S24.
- Van Metre DC et al. Downer cows - diagnosis and assessment. *Melbourne Conf Proc Aust Assoc Cattle Vet* 2001; 14-21.
- Van Metre DC. Downer cows - prognostic indicators and treatment options. *Melbourne Conf Proc Aust Assoc Cattle Vet* 2001; 42-48.
- Poulton PJ, Steinfort JJ. Examination techniques to improve the diagnosis of and determine the prognosis for 'downer cows'. *Melbourne Conf Proc Aust Assoc Cattle Vet* 2001.
- Cox VS. Nonsystemic causes of the downer cow syndrome. *Vet Clin North Am: Food Anim Pract* 1988; 4:413-433.

#### REFERENCES

1. Cox VS. *Vet Clin North Am: Food Anim Pract* 1988; 4:413.
2. Hansen D, Bridges V. *Bov Pract* 1999; 33:179.
3. Cox VS et al. *Prev Vet Med* 1986; 4:249.
4. Clark RG et al. *N Z Vet J* 1991; 35:126.
5. Grandin T. *J Am Vet Med Assoc* 2001; 219:1377.
6. Fenwick DC. *Aust Vet J* 1969; 45:184.
7. Correa MT et al. *J Dairy Sci* 1993; 76:3460.
8. Byrne CM et al. *Appl Environ Microbiol* 2003; 69:4683.
9. Gerloff BJ, Swenson EP. *J Am Vet Med Assoc* 1996; 208:716.
10. Nakao T, Grunnert E. *J Vet Med Series A* 1990; 37:610.
11. Sielman ES et al. *J Am Vet Med Assoc* 1997; 210:240.
12. Cox VS, Marion RS. *Vet Rec* 1992; 130:74.
13. Fenwick DC et al. *Vet Rec* 1986; 118:124.
14. Fenwick DC, Daniel RCW. *Br Vet J* 1992; 148:425.
15. Fenwick DC, Daniel RCW. *Br Vet J* 1992; 148:301.
16. Fenwick DC, Daniel RCW. *Br Vet J* 1992; 148:283.
17. Fenwick DC. *Br Vet J* 1992; 148:413.
18. Van Metre DC et al. *Melbourne Conf Proc Aust Assoc Cattle Vet* 2001; 14.
19. Van Metre DC. *Melbourne Conf Proc Aust Assoc Cattle Vet* 2001; 42-48.
20. Poulton PJ, Steinfort JJ. *Melbourne Conf Proc Aust Assoc Cattle Vet* 2001.
21. Shpigel NY et al. *Vet Rec* 2003; 152:773.
22. Bindseil E. *Vet Rec* 1987; 120:183.
23. Smith BP et al. *Proc Am Assoc Bov Pract* 1997; 30:43.
24. Doonan G et al. *Can Vet J* 2003; 44:667.
25. Stark DA. *Bov Pract* 1995; 29:125.

#### ACUTE HYPOKALEMIA IN CATTLE

Hypokalemia in cattle may occur secondary to:

- Anorexia

- Diarrhea
- Upper gastrointestinal obstruction
- Right-sided displacement and torsion of the abomasum
- Impaction of the abomasum.

In most cases, the hypokalemia is not severe enough to cause weakness and recumbency.

Hypokalemia resulting in severe weakness and recumbency has occurred in dairy cattle treated with isoflupredone acetate for ketosis.<sup>1</sup> Serum potassium levels were below 2.3 mEq. Cows ranged in age from 2 to 7 years, all had a history of moderate to severe ketosis and had calved within the previous 30 days. Most had been also treated with insulin, IV glucose, and oral propylene glycol for the ketosis. However, not all cases have been treated with corticosteroids.<sup>2,3</sup> The disease has occurred in cattle of all age groups and a common history was the occurrence of a fever or infectious disease. Potential contributory factors to the development of significant hypokalemia in the chronically ketotic cow include reduced potassium intake subsequent to metabolic alkalosis and hyperglycemia, kaluresis resulting from hyperglycemic osmotic diuresis, and increased potassium loss from the mineralocorticoid effects of exogenously administered corticosteroids. Excessive use of corticosteroids with mineralocorticoid activity in cows with mastitis may also lead to hypokalemia.

Affected cows are recumbent, profoundly weak, appeared flaccid and lay in sternal or lateral recumbency. They are unable to support the weight of their heads off the ground and commonly hold them in their flanks. Profound weakness of the lateral cervical muscles may occur.<sup>4</sup> Anorexia is common. Cardiac arrhythmias are detectable on auscultation and atrial fibrillation is present on electrocardiography.

Treatment includes IV and oral administration of potassium chloride and fluid therapy but the response is commonly ineffective. Addition of potassium chloride to a 0.9% saline solution given as a continuous IV infusion at rates of up to 300 mmol of potassium per hour (approximately 0.4 mmol/kg per h) has been used in a 3-year-old cow. Oral supplementation with potassium chloride salt at 230 g two to three times daily for 3 days was associated with recovery.<sup>4</sup> Palatable hay and propylene glycol orally are recommended. In a series of 14 cases, treatment consisted of potassium chloride given IV and orally at an average total daily dose of 42 g/100 kg BW (26 g orally and 16 g IV) for an average of 5 days, resulting in recovery in 11 cases after an average of 3 days.<sup>3</sup> During recumbency,



affected cattle require special attention to minimize ischemic necrosis of muscles of the pelvic limbs.

At necropsy, muscle necrosis is present in the pelvic limbs and histological examination of non-weight bearing muscle reveal multifocal myonecrosis with microphage infiltration and myofiber vacuolation, which is characteristic of hypokalemic myopathy in man and dogs. It is important to note that myopathy is also present in muscles not subject to ischemia of recumbency.

Potassium excretion by the kidneys is via secretion by the distal tubular cells. Aldosterone or other steroids with mineralocorticoid activity enhance distal tubular secretion of potassium by increasing permeability of the tubular luminal membranes to potassium and increasing losses of potassium in the urine.

Glucocorticoids are often used to treat ketosis and the most commonly used are dexamethasone and isoflupredone acetate. Dexamethasone has little mineralocorticoid activity compared with prednisone and prednisolone, which are related chemically to isoflupredone. Dexamethasone is recommended for the treatment of ketosis in dairy cattle at a single dose of 10–20 mg IM, and repeated if necessary, 12–24 h later. Field observations indicate that repeated doses of isoflupredone acetate decrease plasma concentrations of potassium by 70–80%, which suggests a strong mineralocorticoid activity. It is recommended that isoflupredone be used judiciously and animals be monitored for plasma potassium and any evidence of weakness and recumbency. Treatment with oral potassium chloride may be required but treatment may be ineffective.

## REFERENCES

1. Sielman ES et al. *J Am Vet Med Assoc* 1997; 210:240.
2. Peek SF et al. *Vet Ther* 2000; 1:235.
3. Sattler N et al. *Vet Rec* 1998; 143:503.
4. Johns IC et al. *Aust Vet J* 2004; 82:413.

## TRANSIT RECUMBENCY OF RUMINANTS

Transit recumbency (tetany) occurs after prolonged transport, usually in cows and ewes in late pregnancy. It is also recorded in lambs transported to feedlots,<sup>1</sup> and in cows,<sup>2</sup> and sheep<sup>3</sup> delivered to abattoirs. It is characterized by recumbency, alimentary tract stasis, and coma, and is highly fatal. It occurs in most countries. Large losses are encountered when cows and ewes in late pregnancy are moved long distances by rail, truck, or on foot.

Although cows of any age in late pregnancy are most commonly affected, the disease has also been recorded in cows recently calved, bullocks, steers, dry cows, and lambs. Risk factors include:

- Heavy feeding before shipment
- Deprivation of feed and water for more than 24 h during transit
- Unrestricted access to water
- Exercise immediately after unloading.

There is an increased incidence of the disease during hot weather. The cause is unknown, although physical stress is an obvious factor. In lambs there is:

- Restlessness
- Staggering
- Partial paralysis of hindlegs
- Early assumption of lateral recumbency.

Death may occur quickly, or after 2–3 days of recumbency. There is a mild hypocalcemia (7–7.5 mg/dL; 1.75–1.87 mmol/L). The recovery rate even with treatment is only fair.

Clinical signs may occur while the cattle are still on the transportation vehicle or up to 48 h after unloading. In the early stages, animals may exhibit excitement and restlessness, trismus, and grinding of the teeth. A staggering gait with paddling of the hindlegs and recumbency occur, and are accompanied by stasis of the alimentary tract and complete anorexia. Animals that do not recover gradually become comatose and die in 3–4 days. There may be a moderate hypocalcemia and hypophosphatemia in cattle. In sheep of various ages, some are hypocalcemic and hypomagnesemic and some are hypoglycemic, but some have no detectable biochemical abnormality.<sup>3</sup> There are no lesions at necropsy other than those related to prolonged recumbency. Ischemic muscle necrosis is the most obvious of these lesions. The relationship of the disease to transport or forced exercise is diagnostic.

Some cases respond to treatment with combined calcium, magnesium, and glucose injections. Repeated parenteral injections of large volumes of electrolyte solutions are recommended. In lambs, the SC injection of a solution of calcium and magnesium salts is recommended but the response is usually only 50%, due probably to an intercurrent myonecrosis.<sup>4</sup>

If prolonged transport of cows or ewes in advanced pregnancy is unavoidable, they should be fed on a moderately restricted diet for several days beforehand and provided with adequate food, water, and rest periods during the trip. The administration of an ataractic before loading is highly recommended, especially for nervous animals.<sup>5</sup> On unloading, they should be allowed only limited access to water for 24 h and should be allowed a minimum of exercise for 2–3 days.

## REFERENCES

1. Pierson RE, Jensen R. *J Am Vet Med Assoc* 1975; 166:260.

2. Warnock JP et al. *Aust Vet J* 1978; 54:566.
3. Shorthose WR, Shaw FD. *Aust Vet J* 1977; 53:330.
4. Lucas MJ. *Mod Vet Pract* 1983; 64:213.
5. van der Walt K. *J S Afr Vet Med Assoc* 1961; 32:283.

## LACTATION TETANY OF MARES (ECLAMPSIA, TRANSIT TETANY)

Lactation tetany of mares is caused by hypocalcemia and is characterized by abnormal behavior progressing to incoordination and tetany. The precise cause of the hypocalcemia has not been determined, but the cause of the clinical signs is a marked reduction in serum concentration of ionized calcium. The effect of feeding diets high in calcium, such as alfalfa hay, during late pregnancy, and of abrupt changes in diet after parturition, have not been investigated in horses as they have in cattle (see Milk fever).

The disease was most common when draft horse breeding was widely practiced but is uncommon now. The mortality rate is high in untreated animals. Most cases occur in lactating mares, either at about the 10th day after foaling or 1–2 days after weaning. High-producing mares grazing on lush pasture are most susceptible and in many instances are engaged in hard physical work. The housing of wild ponies, or prolonged transport may precipitate an episode. The latter has been a particularly important factor in the etiology of the disease in Britain and has been credited with precipitating it even in stallions and dry mares. Occasional cases occur without there being any apparent cause.<sup>1</sup> The disease has occurred in a 20-year-old gelding pony.<sup>2</sup> Hypocalcemia with clinical signs also occurs in horses used for prolonged exercise, such as endurance racing or 3 day eventing.<sup>3</sup>

Many mild cases which recover spontaneously occur after transport but the mortality rate in some shipments may be greater than 60%. Mares that develop the disease at the foal heat or at weaning are usually more seriously affected and the mortality rate is high if mares are not treated in a timely fashion.

Severely affected animals sweat profusely and have difficulty in moving because of tetany of the limbs and incoordination. The gait is stiff and the tail is slightly raised. Rapid, labored respirations and wide dilatation of the nostrils are often accompanied by synchronous diaphragmatic flutter ('thumps') evident as a distinct thumping sound from the thorax. Muscular fibrillation, particularly of the masseter and shoulder region, and trismus are evident but there is no prolapse of the membrana nictitans.<sup>4</sup> Affected animals are not hypersensitive to sound but handling may precipitate increased tetany. The temperature is normal or slightly elevated, and although

the pulse is normal in the early stages, it later becomes rapid and irregular. The mare may make many attempts to eat and drink but appears to be unable to swallow and passage of a stomach tube can be difficult. Urination and defecation are in abeyance, and peristalsis is reduced.

Within about 24 h the untreated mare becomes recumbent, tetanic convulsions develop and become more or less continuous; the mare dies about 48 h after the onset of illness. The tetany and excitement in the early stages may suggest tetanus but there is no prolapse of the third eyelid and there is the usual relationship to recent foaling or weaning and physical exertion. The anxiety and muscle tremor of laminitis may also be confused with those of lactation tetany, especially as it may occur in mares which have foaled and retained the placenta. Pain in the feet is the diagnostic feature of this latter disease.

Hypocalcemia occurs with serum levels in the range of 4–6 mg/dL (1–1.50 mmol/L) and the degree of hypocalcemia has been related to the clinical signs.<sup>5</sup> When serum calcium levels are higher than 8 mg/dL (2 mmol/L) the only sign is increased excitability. At levels of 5–8 mg/dL (1.25–2 mmol/L) there are tetanic spasms and slight incoordination. At levels of less than 5 mg/dL (1.25 mmol/L), there is recumbency and stupor. It is the concentration of ionized calcium that is important and some animals, such as horses used for 3 day eventing, can have normal total calcium concentrations but abnormally low ionized calcium concentrations as a result of changes in acid:base status. If possible, serum concentrations of ionized calcium should be measured in horses with clinical signs suggestive of hypocalcemia. Hypomagnesemia with serum magnesium levels of 0.9 mg/dL (0.37 mmol/L) has been observed in some cases but only in association with recent transport. Hypermagnesemia has been reported in other cases.

Treatment by IV administration of calcium borogluconate as recommended in the treatment of parturient paresis in cattle results in rapid, complete recovery. The dose for a 500 kg mare is 300–500 mL of a 25% solution of calcium borogluconate or gluconate administered slowly (over 15–30 min) intravenously. One of the earliest signs of recovery is the voiding of a large volume of urine. Occasional cases which persist for some days are recorded.

## REFERENCES

1. McAllister FS. *J Equine Med Surg* 1977; 1:230.
2. Richardson JD et al. *Vet Rec* 1991; 129:98.
3. Geiser DR et al. *Am J Vet Res* 1995; 56:1502.
4. Scanail TO. *Irish Vet J* 1990; 43:66.
5. Muylle E et al. *Vlaams Diergeneesk Tijdschr* 1973; 42:44.

## HYPOMAGNESEMIC TETANIES

Tetany associated with depression of serum magnesium levels is a common occurrence in ruminants. The syndrome associated with hypomagnesemia is relatively constant, irrespective of the cause, but the group of diseases in which it occurs has been divided into hypomagnesemic tetany of calves, which appears to be due specifically to a deficiency of magnesium in the diet, and a group of hypomagnesemias in ruminants characterized by lactation tetany, in which there may be a partial dietary deficiency of magnesium but in which nutritional or metabolic factors reduce the availability, or increase the body's loss, of the element so that serum magnesium levels fall below a critical point. In general, the occurrence of hypomagnesemic tetany is related to three sets of circumstances. Most common is the occurrence in lactating cows turned out on to lush, grass-dominant pasture in the spring after wintering in closed housing – the classic lactation or grass tetany of Holland. Wheat pasture poisoning may occur when any type of cattle or sheep is grazed on young, green cereal crops. The third occurrence is in beef or dry dairy cattle running at pasture in the winter, usually when nutrition is inadequate and where no shelter is provided in changeable weather rather than in severe, prolonged cold. Less common forms occur in housed animals on poor feed. Hypomagnesemia of sheep, although it is less common, occurs in the same general groups of circumstances as the disease in cattle. A chronic hypomagnesemia, without manifestations of tetany, can be a cause of suboptimal production efficiency and may predispose to hypocalcemia.

## HYPOMAGNESEMIC TETANY (LACTATION TETANY, GRASS TETANY, GRASS STAGGERS, WHEAT PASTURE POISONING)

**Etiology** The etiology is multifactorial, related to magnesium concentration in the diet and the presence of competing cations such as potassium and sodium that affect either herbage magnesium status or magnesium absorption.

**Epidemiology** Disease of all classes of ruminants but reaches its highest incidence in older lactating cows exposed to bad weather or grazing green cereal crops or lush grass-dominant pasture.

**Clinical findings** Incoordination, hyperesthesia and tetany, tonic-clonic muscular spasms and convulsions. High case fatality without treatment.

**Clinical pathology** Serum, urine, or cerebrospinal fluid (CSF) magnesium concentrations. Hypomagnesemia, and in some circumstances hypocalcemia.

**Necropsy findings** None specific.

**Diagnostic confirmation** Response to treatment, serum or urinary magnesium concentrations.

**Treatment** Magnesium or combined calcium/magnesium solutions administered IV and/or SC.

**Control** Magnesium supplementation but a palatable and practical delivery method is a problem. Magnesium applied to pastures. Avoidance of movement and food deprivation at risk periods.

## ETIOLOGY

Magnesium is the major **intracellular divalent cation**, and is an essential element in a large number of enzymic activities in the body. For this reason it might be expected that hypomagnesemia would be rare. However, because of the peculiarities of absorption of magnesium in the ruminant forestomachs, and the use of animal and pasture management systems that can lead to marginal magnesium uptake, ruminants are at risk of hypomagnesemia.

## Magnesium homeostasis

There is **no feedback regulatory mechanism** to control concentrations of magnesium in the body of ruminants. As a consequence, magnesium concentrations in blood and extracellular fluid are essentially determined by the balance between dietary intake of magnesium, loss in feces and milk, and the modulating effect of magnesium **homeostasis by the kidney**.<sup>1</sup>

## Dietary intake

In normal circumstances, magnesium absorbed from the diet is sufficient to meet the requirements of the body and excess amounts are excreted in the urine.

## Renal excretion

The kidney is the major organ of homeostasis and can act to conserve magnesium. Magnesium is freely filtered across the renal glomerulus and is reabsorbed within the renal tubules, the degree of reabsorption acting in homeostasis. When the dietary intake of magnesium is decreased, blood and interstitial fluid magnesium concentrations fall; excretion of magnesium in the urine will cease when **serum concentrations fall below 1.8 mg/dL**. The renal threshold for magnesium excretion is partially under the control of parathyroid hormone and increased levels of parathyroid hormone will act to conserve magnesium.

## Magnesium reserves

There are large stores of magnesium in the body, especially in bone. These

are available to the young calf but mobilization decreases with age and in the adult ruminant there is little mobilization in response to short-term deficits of magnesium.<sup>1</sup> In ruminants, this control mechanism for magnesium can maintain adequate concentrations of magnesium in bodily fluids in most production circumstances but it can fail where there is a high requirement for magnesium coupled with a decreased intake. This combination leads to hypomagnesaemia and hypomagnesemic tetany is a possible outcome.

#### Lactation

Increased requirement for magnesium is almost always associated with the loss of magnesium in the milk during lactation. Whereas the amount of magnesium in milk is not high (12 mg/kg) the loss of magnesium to milk represents a significant proportion of the dietary intake of magnesium. As a consequence of this drain, most instances of hypomagnesaemia occur in lactating animals around the period of peak milk production, although in some circumstances the demands of late pregnancy are the cause of the increased requirement. The decreased intake of magnesium can result from an absolute deficiency of magnesium in the diet or because the availability or absorption of magnesium from the diet is impaired. These factors determine the circumstances of occurrence of the disease and are the **factors that can be manipulated for control**.

#### Factors influencing absorption of magnesium

In the adult ruminant, magnesium absorption occurs in the forestomach with little absorption in the abomasum and small intestine. Some absorption occurs in the large intestine, particularly in sheep,<sup>2</sup> however it cannot compensate for malabsorption in the forestomach.

#### Na:K ratio in rumen

Magnesium is transported across the epithelium of the forestomachs by an active sodium-linked ATPase-dependent transport system. Absorption, and the serum magnesium concentration, is influenced by the Na:K ratio in the rumen, which is determined by the dietary and salivary concentrations of sodium and potassium.<sup>3,4</sup> Absorption of magnesium increases with an increasing Na:K ratio to plateau at a ratio of 5:1. Absorption is significantly impaired if the Na:K ratio is less than 3:1.

Young rapidly growing grass is low in sodium and high in potassium, can result in **sodium deficiency** in ruminants that graze it, and can significantly depress the Na:K ratio in the rumen fluid, causing

impairment of magnesium absorption. Depression is observed at dietary potassium concentrations of greater than 22 g/kg dry matter.

**Saliva** normally has a high Na:K ratio but where there is a deficit of sodium in the diet, a proportion of sodium in saliva may be replaced with potassium under the influence of aldosterone, which further negatively influences the uptake of magnesium.

Approximately 40% of the total magnesium available in extracellular fluid is secreted daily in saliva and 20% of this is reabsorbed in the forestomach. When animals are on tetany-prone grass, this absorption is impaired, which accounts for the susceptibility of ruminants to hypomagnesaemia compared with monogastric animals.<sup>3</sup>

#### Other factors influencing absorption

Young grass fertilized with nitrogenous fertilizers has an increased crude protein which is readily fermentable and leads to increased ammonia concentrations. A sudden rise in ruminal concentrations of ammonia impairs magnesium absorption in the rumen.<sup>5,6</sup> The uptake of magnesium is also influenced by the carbohydrate content of the diet, magnesium absorption is improved with increasing amounts of readily degradable carbohydrates.<sup>7</sup> The mechanism of this action is not known but low concentrations of readily degradable carbohydrate in tetany-prone pastures in combination with high concentrations of protein may be important to the occurrence of the syndrome.<sup>5</sup> Volatile fatty acids provide the energy for the active transport of magnesium across the rumen wall and increase magnesium absorption.

Other dietary substances have been proposed to influence the absorption of magnesium including calcium and phosphorus, organic acids such as citric acid and transaconitate, fatty acids, and aluminum, but the significance of their role is controversial.<sup>5</sup>

#### Magnesium in pastures and tetany hazard

The dietary intake of magnesium in grazing animals is directly related to the magnesium concentration in pastures but other elements in pastures also influence magnesium absorption by the ruminant as detailed earlier.

#### Required magnesium concentrations

Hypomagnesaemia can result from the ingestion of pastures that have insufficient magnesium to meet dietary requirements. The estimated magnesium concentration in pasture required to meet the dietary requirement for pregnant or lactating cattle varies from 1.0 to 1.3 g/kg dry matter (DM) for pregnant cattle, depending upon

the stage of pregnancy, and 1.8–2.2 g/kg DM for lactating cattle with both estimates assuming minimal interference of absorption by other elements in the pasture.<sup>8</sup>

The recommended minimal 'safe' concentration of magnesium in pastures is 2 g/kg DM for lactating and pregnant cattle with a preference for a concentration of 2.5 g/kg DM.

#### Magnesium availability in pastures and hazard

Hypomagnesaemia can also occur in animals grazing pastures with adequate concentrations of magnesium but that contain high concentrations of potassium and nitrogen, which as detailed earlier, impair absorption of magnesium in the rumen. Pastures with concentrations of **potassium** of greater than 30 g K/kg DM and **nitrogen** greater than 40 g N/kg dry matter are considered hazardous.

An alternate method for estimating the potential **hazard of a pasture** is to calculate the **K/(Ca + Mg) ratio** using milliequivalent (mEq) values for this estimate. Pastures with ratios above 2.2 are considered a risk.<sup>9</sup>

#### Winter hypomagnesaemia

The occurrence of hypomagnesaemia is not restricted to cattle grazing lush pastures and it also occurs in the winter periods. In **housed lactating dairy** cattle being fed conserved feeds, hypomagnesaemia probably has the same genesis as that in grazing cattle being associated with a high lactational drain of magnesium in combination with the feeding of conserved feeds prepared from pastures with marginal magnesium concentrations. It also occurs in **cattle outwintered** on poor quality feed.

#### Hypomagnesaemia and hypocalcemia

In some outbreaks of hypomagnesemic tetany, there is also hypocalcemia and, although it is of less severe degree than in parturient paresis, there is increasing evidence that the actual onset of clinical tetany may be associated with a rapid fall in serum calcium levels superimposed on a pre-existing hypomagnesaemia. This is particularly true for wheat pasture poisoning but can also apply to outbreaks with different predisposing factors.

Chronic hypomagnesaemia can have a profound effect on calcium homeostasis. Hypomagnesaemia reduces the production and secretion of parathyroid hormone, reduces hydroxylation of vitamin D in the liver, and also causes target organ insensitivity to the physiological effects of parathyroid hormone and 1,25-dihydroxyvitamin D<sub>3</sub>.<sup>6,10,11</sup> Chronic sub-clinical hypomagnesaemia can increase susceptibility to milk fever and can predispose to episodes of **milk fever and**

**downer cows in lactating dairy cows** during the period of peak lactation.

### Summary of etiology

In summary, it appears that a number of factors are capable of causing hypomagnesemia in ruminants and that under particular circumstances one or other of them may be of major importance.

**In lactation tetany of cows and ewes** turned on to lush pasture in the spring, a primary dietary deficiency of magnesium or the presence of high relative concentrations of potassium and nitrogen in the diet reduces the absorption of magnesium and possibly calcium.

**In wheat (cereal) pasture poisoning**, the ingestion of abnormally large amounts of potassium and low levels of calcium in the diet leads to hypomagnesemia and also hypocalcemia.

**Hypomagnesemic tetany in cattle wintered at pasture** and exposed to inclement weather is associated with low magnesium intake and inadequate caloric intake, and possibly to the resultant hyperactivity of the thyroid gland.

Although the above suggestions as to the most important etiological factors in each set of circumstances in which lactation tetany occurs may be valid, undoubtedly **combinations** of these and other factors have etiological significance in individual outbreaks of the disease. The **worst combination** of causative factors, and the most common circumstances in which the disease occurs, is inadequate energy intake with a low dietary content of magnesium (grass pasture) in recently calved cows during a spell of cold, wet, and especially windy weather.

One other important factor is the **variation between individual animals in susceptibility** to hypomagnesemia and to the clinical disease. These variations are quite marked in cattle and in intensively managed, high-producing herds it is probably worthwhile to identify susceptible animals and give them special treatment.<sup>12</sup>

### EPIDEMIOLOGY

#### Occurrence and risk factors for lactation tetany

Lactation tetany in dairy and beef cattle turned out to graze on lush, grass dominant pasture after winter housing is common in northern Europe, the UK, and the northern parts of North America. Grass tetany also occurs in Australia and New Zealand, where the cows are not housed in winter but have access to a phenomenal flush of pasture growth in the spring.<sup>13</sup> This also commonly occurs in beef cattle in all countries.

With housed cattle, or cattle fed conserved feed during the winter, most cases occur during the first 2 weeks after the cattle are turned out to **spring pasture**.

Pasture which has been heavily top-dressed with fertilizers rich in nitrogen and potash is potentially the most dangerous. The disease may also occur on this type of pasture even when the cattle have wintered on pasture in temperate regions. In regions where there is an autumn flush of pasture, a high incidence of hypomagnesemic tetany may occur in the **autumn** or early winter.

Cattle in the **first 2 months of lactation** and **4–7 years of age** are most susceptible, which probably reflects an increased risk due to a higher loss of magnesium in milk. **Friesian** cows have lower magnesium concentrations than **Jerseys** grazed under the same conditions.<sup>14</sup>

In the northern parts of the USA, outbreaks commonly occur during periods of **low barometric pressure** when the **ambient temperature** ranges between 7°C (45°F) and 15.5°C (60°F) and **soil temperatures** are below 7°C (45°F). Outbreaks may be precipitated by inclement weather. In beef cattle there is commonly a history of poor nutrition and falling body condition in the past few weeks due to diminishing hay supplies.

#### Occurrence and risk factors for wheat (cereal) pasture poisoning

Wheat pasture poisoning is a misnomer as it can occur with grazing of any small-grain cereal pasture. It has been recorded in many countries but is most prevalent where **young cereal crops** are utilized for 'winter grazing'. The southwestern USA has experienced heavy losses of cattle caused by this disease. This pasture can induce hypomagnesemia in **pregnant and lactating cattle and sheep**. The risk is with young rapidly growing pasture, either in the **spring**, or in the **autumn and winter** with pastures planted in late summer. The pasture is usually dangerous for only a few weeks but heavy losses may occur in all classes of sheep and cattle. *Bos taurus* breeds are more susceptible to the development of hypomagnesemia than *Bos indicus*.<sup>15</sup>

#### Occurrence and risk factors for winter hypomagnesemia

Hypomagnesemic tetany in cattle wintered in the open causes some losses in the UK, New Zealand, southern Australia, and the east-central states and Pacific slope of the USA. It occurs in cattle grazed on pasture in the winter with **minimal supplemental hay** and in cattle grazed on **aftermath crops** and corn stover. The disease occurs in regions with temperate climates, and risk is increased by **exposure to bad weather**, which is exacerbated by absence of trees or other **shelter** in fields and by failure to supply supplementary feed during these cold spells. The disease does not seem to occur in cattle kept outside in

prolonged winters where environmental temperature is consistently very low and there is adequate feed. Hypomagnesemia, commonly presenting as chronic hypomagnesemia and sudden death, has been recognized as occurring in housed cattle in the winter in Europe for many years and recently has also been reported in the USA.

#### Morbidity and mortality

In all of these forms of the disease, the morbidity rate is highly variable, reaching as high as 12% in individual herds, and up to 2% in particular areas. The incidence varies from year to year depending largely on climatic conditions and management practices, and the disease is often limited in its occurrence to particular farms and even to individual fields.

Although an effective treatment is available, the **case-fatality rate is high** because of the short course. Since animals die before they are observed to be ill, there are not accurate figures on case fatality, but it is probably of the order of 30% in dairy cattle and considerably higher in beef cattle.

There have been few epidemiological studies specifically addressing the importance of the syndrome. In Finland, a **lactational incidence rate** varying between 0.1% and 0.3% is recorded, with an **increase in parity** to at least six for lactation tetany occurring on pasture but not for indoor tetany.<sup>15</sup> No association with other diseases was found other than for milk fever. In Northern Ireland, approximately 10% of dairy cows and 30% of beef cows have subnormal or deficient blood magnesium concentrations during the grazing season and hypomagnesemia is considered the cause of 20% of the 'sudden death' mortality in beef cattle.<sup>16,17</sup> Surveys of beef cattle owners of the relative importance of different diseases invariably rate hypomagnesemia high in importance.

#### Pasture risk factors

In most areas of the world, there is a strong association between risk for hypomagnesemia and systems of pasture improvement and pasture fertilization to increase forage yield. There are a number of influences on the concentration of magnesium and other elements in pasture.

#### Pasture species

Hypomagnesemia is a problem on grass-dominant pastures. Concentrations of calcium and magnesium are higher in legumes and forbs than in grasses. Within the grasses, different genotypes of the same species can differ markedly in calcium and magnesium concentrations and most **cool season grasses** have the potential to produce hypomagnesemia. However, there are some differences and grasses with a

high ratio of potassium to calcium and magnesium (e.g. *Dactylis glomerata*, *Lolium perenne*, *Phalaris arundinacea*) are more likely to cause grass tetany than those with low ratios (e.g. *Bromus inermis*, *Poa pratensis*, *Agrostis* spp.).<sup>9</sup> On soil types where the disease is common, cool-season grass pastures top-dressed with **nitrogenous fertilizers** are dangerous and their toxicity may be increased by the **application of potash**. **Warm-season grasses** do not have the same risk and grass tetany is not a problem in cattle grazing tropical grasses.

#### Cereal pastures

The greater tendency of cereal grazing to cause hypomagnesemia, is related to a high content of potassium as well as a low content of magnesium. Tetany hazard, in order of decreasing hazard, is wheat, oats, barley, rye.<sup>14</sup>

#### Season

High concentrations of potassium and nitrogen and low concentrations of sodium and soluble carbohydrates occur in pastures during the early growing season and during rapid growth following cold, wet periods. Pasture magnesium concentrations may not be depressed but the K/(Ca + Mg) ratio is increased.<sup>18</sup>

#### Fertilization

Application of potash and nitrogenous fertilizers to pastures will decrease the concentration of calcium and magnesium in plants and will also increase the concentration of potassium and nitrogen. There is some evidence that nitrate sources of nitrogen depress magnesium less than ammonium sources of nitrogen.

#### Soil type

The availability of magnesium to the plant is influenced by soil type and some deficiencies in plant magnesium can be corrected by soil fertilization with magnesium.<sup>19</sup> There is no strong association with any one soil type but high potassium concentrations are consistently associated with increased risk for tetany.

Highly leached, acid, sandy soils are particularly magnesium deficient and the most likely to respond to liming and magnesium fertilization.<sup>8</sup> In very acidic soils, high aluminum concentrations may depress magnesium uptake by plants.

A local knowledge of soil type and its influence on magnesium, potassium, calcium, and nitrogen uptake by pastures can allow the judicious selection or avoidance of the use of pastures for at-risk groups during periods of risk for hypomagnesemia.<sup>12</sup>

### Animal and management risk factors

#### Dry matter intake

The dry matter and energy intake of ruminants can influence susceptibility

to hypomagnesemia.<sup>20</sup> A reduction in dry matter intake must reduce the magnesium intake and, in situations where hypomagnesemia is already present, a further depression of serum magnesium levels can be anticipated when complete or partial starvation occurs. An insufficient intake of **fiber** in the winter months can precipitate hypomagnesemia in pastured cows and ewes and lipolysis is accompanied by a fall in serum magnesium.

#### Period of food deprivation

Many outbreaks of hypomagnesemia are preceded by an episode of stress or temporary starvation. Whether chronic hypomagnesemia pre-exists or not, a period of starvation in lactating cows and ewes is sufficient to produce a marked hypomagnesemia and the fall may be sufficiently great to cause clinical tetany. A period of **bad weather, yarding, transport, or movement** to new pastures or the introduction to **unpalatable pastures** may provide such a period of partial starvation.

#### Alimentary sojourn

Diarrhea is commonly associated with lactation tetany on spring pasture and by decreasing the alimentary sojourn may also reduce magnesium absorption.

#### Climate

A close association between climatic conditions and serum magnesium levels has also been observed. Reduced levels occur in adult cattle and sheep exposed to cold, wet, windy weather with little sunshine and no access to shelter or supplementary feed. Supplementary feeding appears to reduce the effect of inclement weather on serum magnesium levels and it is possible that failure to eat, or depression of appetite, and a negative energy balance during bad weather may be a basic contributing cause to hypomagnesemia in these circumstances.

#### Animal movement

Epinephrine release will result in a precipitous fall in serum magnesium and this may explain the common observation that clinical cases are often precipitated by excitement or movement of the herd.

#### Intensive dairies

Intensive dairies that apply effluent on a limited land base can build soil potassium to high concentrations. Silage from these grounds can have a high risk for inducing hypomagnesemia.

#### Hypomagnesemia in sheep

Hypomagnesemia occurs in sheep, particularly in Australia and the United Kingdom. The disease is not common but appears to be increasingly associated with pasture improvement practices, and can cause heavy losses in individual flocks. It is more common in ewes bred for milk and

lamb production. In outbreaks, **ewes with twins** are more liable to develop clinical disease than those with singles and the main occurrence is in ewes **1–4 weeks after lambing** with cases up to 8 weeks after lambing.

Disease is often precipitated by a **management procedure** involving movement and temporary food deprivation and cases will occur within the first 24 h following this and for a few days afterwards. As in cattle, disease occurs when ewes are placed on lush grass pastures but it is especially common where ewes in early lactation are placed on young cereal pastures. Losses usually cease when the flock is moved onto rough, unimproved pasture.

Cases also occur in sheep which are exposed to inclement weather when on low nutritive intake. Simultaneous hypomagnesemia and ketosis can occur in ewes after lambing if they are exposed to low feed availability. These cases do not respond well to treatment. Hypomagnesemia in ewes is predisposed by **prior pregnancy toxemia** in the flock.

### PATHOGENESIS

Most evidence points to hypomagnesemia as the cause of the tetanic signs observed but the concurrent hypocalcemia may have a contributory effect and in many instances may even be the dominant factor. Most clinical cases of the disease have serum magnesium levels below 1 mg/dL (0.41 mmol/L) compared with the normal levels in cattle of 1.7–3 mg/dL (0.70–1.23 mmol/L) and there is a striking relationship between the incidence of the clinical disease and the occurrence of a seasonal hypomagnesemia.

The reduction in serum levels of magnesium is concurrent with a marked fall in the excretion of magnesium in the urine. In affected herds and flocks, many clinically normal cows and sheep have low serum magnesium levels. In some of these circumstances a concurrent hypocalcemia may be the precipitating cause.

Magnesium has many influences on impulse transmission at the neuromuscular system, including effects on the release of acetylcholine, on the sensitivity of the motor end plate, on the threshold of the muscle membrane and on activation of the cholinesterase system. These offer an attractive hypothesis for the muscular irritability seen with the disease. However, it has also been established that magnesium concentrations in the cerebrospinal fluid are more predictive of clinical disease than those in serum, which would indicate that alterations in CNS function are more important than alterations in peripheral nerve function. It is also evident that CSF levels of magnesium in hypomagnesemic

animals rise significantly after treatment with a magnesium salt.<sup>21</sup> The need for this to happen would explain the delay of about 30 min after an IV injection before recovery occurs.

### CLINICAL FINDINGS

For convenience, lactation tetany is described in acute, subacute and chronic forms.

#### Acute lactation tetany

The animal may be grazing at the time and suddenly cease to graze, adopt a posture of **unusual alertness** and appear uncomfortable; twitching of the muscles and ears is also evident. There is severe **hyperesthesia** and slight disturbances precipitate attacks of continuous bellowing, frenzied galloping, and occasionally aggression. The gait becomes **staggering** and the animal falls with obvious tetany of the limbs, which is rapidly followed by **clonic convulsions** lasting for about a minute. During the convulsive episodes there is:

- Opisthotonos
- Nystagmus
- Champing of the jaws
- Frothing at the mouth
- Pricking of the ears
- Retraction of the eyelids.

Between episodes, the animal lies quietly but a sudden noise or touch may precipitate another attack.

The temperature rises to 40–40.5°C (104–105°F) after severe muscle exertion; the pulse and respiratory rates are also high. The absolute intensity of the heart sounds is increased so that they can be heard some distance away from the cow. Death usually occurs within 5–1 h and the mortality rate is high because many die before treatment can be provided. The response to treatment is generally good if the animal is treated early.

#### Subacute lactation tetany

In this form of the disease, the onset is more gradual. Over a period of 3–4 days, there is slight inappetence, **wildness of the facial expression** and **exaggerated limb movements**. The cow often resists being driven and throws her head about as though expecting a blow. **Spasmodic urination** and frequent defecation are characteristic. The appetite and milk yield are diminished and ruminal movements decrease. **Muscle tremor** and mild tetany of the hindlegs and tail with an unsteady, straddling gait may be accompanied by retraction of the head and trismus. Sudden movement, noise, the application of restraint or insertion of a needle may precipitate a violent convulsion.

Animals with this form of the disease may recover spontaneously within a few

days or progress to a stage of recumbency with a similar but rather milder syndrome than in the acute form. Treatment is usually effective but there is a marked tendency to relapse.

#### Chronic hypomagnesemia

Many animals in affected herds have low serum magnesium levels but do not show clinical signs. There may be sudden death.<sup>22</sup> A few animals do evidence a rather vague syndrome including dullness, unthriftiness and indifferent appetite and may subsequently develop one of the more obvious syndromes. In lactating cows, this may be the development of paresis and a milk fever-like syndrome that is poorly responsive to calcium treatment. Depressed milk production has also been attributed to chronic hypomagnesemia in dairy herds in New Zealand.<sup>23</sup> The chronic type may also occur in animals which recover from the subacute form of the disease.

#### Parturient paresis with hypomagnesemia

This syndrome is described under parturient paresis and consists of paresis and circulatory collapse in an adult cow which has calved within the preceding 48 h but in which dullness and flaccidity are replaced by hyperesthesia and tetany.

### CLINICAL PATHOLOGY

Serum or urinary magnesium concentrations can be used for clinical cases. Where an animal is dead and hypomagnesemia is suspect, a presumptive diagnosis can be made from samples taken from other at-risk animals in the group, or from the vitreous humor of the dead animal. An acute phase inflammatory response with leukocytosis and increased numbers of neutrophils and monocytes has been recorded in ruminants and laboratory animals fed magnesium deficient diets.<sup>24</sup>

#### Serum magnesium concentrations

Normal serum magnesium concentrations are 1.7–3 mg/dL (0.70–1.23 mmol/L). These levels in cattle are often reduced in seasonal subclinical hypomagnesemia to between 1 and 2 mg/dL (0.41 and 0.82 mmol/L) but risk for tetany is not present until the level falls to below 1.2 mg/dL (0.49 mmol/L).

The average level at which signs occur is about 0.5 mg/dL (0.21 mmol/L) and in sheep it is suggested that clinical tetany does not occur until the serum magnesium level is below 0.5 mg/dL (0.21 mmol/L).

Serum magnesium in some animals may fall to as low as 0.4 mg/dL (0.16 mmol/L) without clinical illness. This may be due to individual animal variation in the degree of ionization of the serum magnesium and in the difference between serum and CSF concentrations. It is also possible that a transitory elevation of serum concen-

trations occurs after violent muscular exercise.

Total serum calcium levels are often reduced to 5–8 mg/dL (1.25–2.00 mmol/L) and this may have an important bearing on the development of clinical signs. Serum inorganic phosphate levels may or may not be low.

In wheat pasture poisoning of cattle there is hypocalcemia, hypomagnesemia, and hyperkalemia. In acute tetany, serum potassium levels are usually dangerously high and may contribute to the high death rate.

#### CSF magnesium concentrations

Magnesium concentrations in CSF can be used as a diagnostic procedure but CSF is not easily or safely collected in tetany cases. Fluid collected up to 12 h after death can be used diagnostically.

Levels in CSF of 1.25 mg/dL (0.51 mmol/L) magnesium were found in tetanic cows with hypomagnesemia (serum magnesium levels of 0.54 ± 0.41 mg/dL; 0.22 ± 0.17 mmol/L). In clinically normal cows with hypomagnesemia comparable levels in CSF were 1.84 mg/dL (0.74 mmol/L) and in serum 0.4 mg/dL (0.16 mmol/L). In normal animals CSF levels are the same as in plasma, i.e. 2.0 mg/dL (0.82 mmol/L) and up. The magnesium content of ventricular CSF may be quite different to that of lumbar CSF. It is also more responsive to changes in magnesium levels of the blood and is preferred for diagnosis at necropsy.<sup>25</sup>

#### Urine magnesium concentrations

The occurrence of low urine magnesium levels is good presumptive evidence of hypomagnesemia.<sup>26</sup>

#### Herd diagnosis

The kidney is the major organ of homeostasis and it has been argued that analysis of urine magnesium status is a more accurate method of assessing herd magnesium status than serum magnesium concentrations.<sup>27</sup> The magnesium status of a herd, and the need to supplement the diet to prevent lactation tetany, can be established from:

- serum magnesium levels
- urinary magnesium fractional clearance ratios
- creatinine-corrected urinary magnesium concentrations
- urine magnesium concentrations.

Laboratory charges for urinary magnesium fractional clearance ratios are expensive. The determination of the **creatinine-corrected urinary magnesium concentration** from 10 cows in a herd has been found to be a more sensitive indicator of magnesium status of the herd than estimates from serum, and a better predictor

of response to supplementation. Values of less than 1.0 mmol/L indicate that a positive response to supplementation is likely.<sup>27</sup> **Urine magnesium concentrations** below 1.0 mg/dL (0.4 mmol/L) indicate a danger for tetany.

### NECROPSY FINDINGS

There are **no specific findings**. Extravasations of blood may be observed in SC tissues and under the pericardium, endocardium, pleura, peritoneum, and intestinal mucosa. Agonal emphysema may also be present.

The magnesium content of the bovine vitreous humor is considered to be an accurate estimate of magnesium status for 72 h after death, provided the environmental temperature does not exceed 23°C (73°F) and there is not growth of bacterial contamination after sampling which can result in a false low magnesium concentration.<sup>25,28</sup> The addition of a small amount of 4% formaldehyde (3% of the vitreous humor volume) will allow accurate analysis for periods up to 72 h after sampling.<sup>28</sup>

Concentrations in the aqueous humor are not stable after death.<sup>27</sup>

### DIFFERENTIAL DIAGNOSIS

#### Cattle

- Acute lead poisoning
- Rabies
- Nervous ketosis
- Bovine spongiform encephalopathy).

#### Sheep

- Hypocalcemia
- Phalaris poisoning
- 'Stagger' syndromes.

### TREATMENT

IV administration of preparations containing magnesium or magnesium and calcium are used. The efficiency of the various treatments appears to vary from area to area, and even within areas under different conditions of management and climate. Response rates and recovery rates are much higher in cases treated early in the clinical course. IV chloral hydrate may be administered to reduce the severity of convulsions during treatment with magnesium. Case fatality, even with therapy, can be high, especially in advanced cases.

Combined calcium/magnesium therapy  
The safest general recommendation is to use a combined calcium–magnesium preparation (e.g. 500 mL of a solution containing 25% calcium borogluconate and 5% magnesium hypophosphite for cattle, 50 mL for sheep) IV followed by a SC injection of a concentrated solution of a magnesium salt. The details and risks of

administration of the type of solution is given in the section on parturient paresis. A combination of 12% magnesium adipate and 5% calcium gluconate at a dose rate of 500 mL is also used.

#### Magnesium therapy

When magnesium solutions are used 200–300 mL of a 20% solution of magnesium sulfate may be injected **IV**; this is followed by a rapid rise in serum magnesium concentration which returns to preinjection levels within 3–6 h. A much slower rise and fall occurs after **SC injection** and for optimum results the SC injection of 200 mL of a 50% solution of magnesium sulfate has been recommended. A rise in serum magnesium of 0.5 mg/dL (0.21 mmol/L) occurs within a few minutes and subsequent levels do not go above 5 mg/dL (2.06 mmol/L). In cases where serum magnesium levels are low because of a seasonal hypomagnesemia, the injection of magnesium salts is followed by a rise and then a return to the subnormal preinjection levels.

The IV injection of magnesium salts is not without danger. It may induce cardiac dysrhythmia, or medullary depression may be severe enough to cause respiratory failure. If signs of respiratory distress or excessive slowing or increase in heart rate are noticed, the injection should be stopped immediately and, if necessary, a calcium solution injected.

The substitution of magnesium lactate for magnesium sulfate has been recommended to provide a more prolonged elevation of serum magnesium levels. A dilute solution (3.3%) causes minimal tissue injury and can be administered IV or SC. Magnesium gluconate has also been used as a 15% solution at dose rates of 200–400 mL. High serum magnesium levels are obtained more slowly and are maintained longer than with magnesium sulfate.

The feeding of magnesium-rich supplements, as described under control later, is recommended after parenteral treatment.

#### Provision for further cases

The predisposing factors that lead to a case of hypomagnesemia apply to the herd as a whole and it is probable that further clinical cases will occur before the effects of corrective strategies are in effect. In extensive range situations, it is advisable to instruct the owner on how to treat cases as a delay in treatment can markedly increase the rate of treatment failures. SC treatment is within the realm of most, but successful therapy is also recorded by the rectal infusion of 30 g of magnesium chloride in a 100 mL solution; serum concentrations of magnesium return to normal levels within 10 min of administration.<sup>29</sup>

### CONTROL

Where possible, animals at high risk should be moved to low-risk pastures during the grass tetany season. High-risk pastures can be grazed by low-risk animals, steers or yearling heifers for example, during this period.

The occurrence of hypomagnesemia can be corrected by the provision of adequate or increased amounts of magnesium in the diet. A requirement as high as 3.0 g/kg DM diet may be required for lactating cows on spring pasture. The problem is in determining an **adequate delivery system** and this will vary according to the management system. Thus blocked minerals containing magnesium or foliar dressing of magnesium may be adequate delivery systems where there is a high stocking density of cattle, but they are totally inadequate or economically unfeasible on range with one cow per 20 acres.

Magnesium oxide is commonly used for supplementation but other magnesium salts can be used and they have an approximate equivalent availability.<sup>30</sup> The biological **availability** of magnesium from magnesium carbonate, magnesium oxide, and magnesium sulfate for sheep is influenced by particle size but has been determined as 43.8%, 50.9%, and 57.6%, respectively.

#### Feeding of magnesium supplements

The preventive measure which is now universally adopted is the feeding of magnesium supplements to cows during the danger period. The feeding of magnesite (containing not less than 87% magnesium oxide), or other sources of **magnesium oxide**, prevents the seasonal fall in serum magnesium levels. Daily administration by drenching, or in the feed, of at least 60 g of magnesium oxide per day is recommended to prevent the disease. This is not always completely effective and in some circumstances large doses may be necessary. Daily feeding of 120 g is safe and effective but 180 g daily may cause diarrhea. The dose for sheep is 7 g daily or 14 g every second day. Magnesium phosphate (53 g/d) is also a safe and effective way of insuring a good intake of magnesium. The protection afforded develops within several days of commencing administration and terminates abruptly after administration ceases.

#### Problems with palatability

The problem with magnesium supplements is with getting the stock to eat the required amount as they are unpalatable. This can be partially countered by mixing the supplement with molasses in equal parts and allowing free access to the mixture, or feeding it in ball feeders, but uniform intake by all animals does not



occur and at-risk animals may still develop hypomagnesemic tetany. Similarly, magnesium blocks may have limited efficacy in preventing hypomagnesemia.<sup>16,17</sup> **Salt blocks** can help repair the sodium deficiency associated with young spring grasses and improve the Na:K ratio in the rumen. If they also contain Mg they can be an aid in prevention but usually, by themselves, do not guarantee freedom from risk for tetany.

#### Spraying on hay

One method of attempting to insure an adequate intake of magnesium is to spray it on hay and to feed this hay as a supplement during periods of grass tetany risk. The common practice is to:

1. Mix magnesite with molasses
2. Dilute mixture with water
3. Spray mixture onto hay in the windrows when it is being made
4. Inject mixture into the bales before feeding or spray onto the hay at feeding
5. Determine the level of application by the amount of hay intended to be fed.

Depending upon local circumstances, this method may or may not be effective, as cattle and sheep will frequently not eat hay when on spring pasture unless they are confined for that purpose.

#### Pellets

Magnesium-rich pellets suggest themselves as a means of supplementation when the additional cost can be borne. Palatability is again a problem and care needs to be taken to include palatable material in the pellets; alternatively they may be mixed with other grain or molasses for feeding. Calves should be restricted from access as magnesium oxide at high levels of intake (2% and 4% of the ration) is toxic to calves and causes diarrhea with much mucus in the feces.

In some high-risk situations it may be advisable to provide magnesium in several forms to insure adequate intake.

#### Routine daily drenching

A once-daily oral administration of magnesium oxide or magnesium chloride to lactating dairy cows (to provide 10 g magnesium per cow), administered with a drenching gun just before the cows leave the milking parlor, is used in New Zealand to insure adequate supplemental magnesium during periods of high risk. The cows become used to the procedure (and the farmers adept at carrying it out) and it causes minimal disruption of management.

#### Heavy magnesium 'bullets'

The use of heavy 'bullets' of magnesium to prevent hypomagnesemia has been effective in laboratory trials and they are available commercially in some countries.

The objective is to place a heavy 'bullet' of magnesium in the reticulum from which site it constantly liberates small amounts of magnesium – about 1 g/d. This objective is achieved and the occurrence of the clinical disease is usually greatly reduced but not eliminated. In dangerous situations, it is customary to administer up to four bullets at a time. As with all bullets, there is a proportion lost by regurgitation and by passage through the gut. A special sheep-sized 'bullet' is used in ewes with similar results.

#### Top dressing of pasture

This, together with magnesium-rich fertilizers, raises the level of magnesium in the pasture and decreases the susceptibility of cattle to hypomagnesemia. For top dressing, calcined magnesite (1125 kg/ha) or magnesian limestone (5600 kg/ha) are satisfactory, the former resulting in a greater increase in pasture magnesium.

Other magnesium-containing fertilizers can be used depending on cost. The duration of the improved magnesium status varies with the type of soil: greatest on light sandy loams on which a dressing of 560 kg/ha of calcined magnesium can provide protection for 3 years. On heavy soils protection for only 1 year is to be expected. To avoid unnecessary expense, it may be possible to top dress one field with the magnesium fertilizer and keep this field in reserve for spring grazing. Fertilization with magnesium is expensive and the response of pastures varies markedly with the soil type. It is advisable to seek agronomic advice.

#### Foliar dusting and spraying

The magnesium content of pastures can be raised much more quickly by spraying with a 2% solution of magnesium sulfate at fortnightly intervals or by application of very finely ground magnesium oxide to the pasture (30 kg/ha) before grazing commences. The technique is referred to as 'foliar dusting or spraying' and has the advantage over feed supplementation that the intake is standard. It is very effective in cattle in maintaining serum magnesium levels and preventing the occurrence of the clinical disease.

Dusting is with 20–50 kg MgO/ha can provide protection for up to 3 weeks but the duration is adversely influenced by wind and rain. A MgO-bentonite-water slurry sprayed onto pastures (26 kg MgO and 2.6 kg bentonite/ha) is effective in providing protection in high rainfall periods.

#### Provision in drinking water

The problem with water medication is that the water intake of the group to be treated is not known but may be minimal

on rapidly growing pastures. However, water medication may provide a delivery system for magnesium on management systems such as extensive range pastures where other methods may have limited success. Water sources other than the medicated supply need to be fenced off or otherwise restricted. The addition of magnesium sulfate (500 g/100 L) or magnesium chloride hexahydrate (420 g/100 L) to the water supply during the risk period for hypomagnesemia has proved effective.

#### Management of pasture fields

The economics of daily farming make it necessary to produce maximum pasture growth, and the development of tetany-prone pastures is unavoidable in many circumstances. In some areas it may be possible to reduce the danger of such pastures by encouraging the development of legumes. In other areas the period of legume growth does not coincide with the period of maximum risk for grass tetany.

Restricting the amount of potash added to pastures, especially in the period immediately preceding the risk period for tetany, or using potash fertilizers in the autumn or late spring after the period of risk, can reduce risk of the disease. The grazing of low-risk animals on high-risk pastures is another strategy. Insuring that ample salt is available during the danger period to counteract the high intake of potassium can also reduce risk of the disease.

Plant geneticists are developing cultivars of cool-season grasses with high magnesium content that could be used for grazing during the tetany season. Lactating sheep grazing a **high magnesium cultivar** of perennial rye grass (*Lolium perenne cv Radmore*) in the spring have shown higher blood magnesium concentrations than sheep grazing control cultivar<sup>31</sup> and cultivars of tall fescue (*Festuca arundinacea*) with high Mg and Ca concentrations and low tetany potential are also available.<sup>32</sup>

#### Provision of shelter

In areas where winter pasturing is practiced, the observation that serum magnesium levels fall during the winter and in association with inclement weather suggests that cattle and sheep should be provided with shelter at such times. If complete housing is impractical, it may be advisable to erect open access shelters in those fields that have no tree cover or protection from prevailing winds. Fields in which lactating cows are kept should receive special attention in this regard. Unfortunately, the disease is most common on highly improved farms, where most natural shelter has been removed and it is desired to keep the cows on the highly improved pasture to maintain milk production or fatten calves rapidly.

### Time of calving

In areas where the incidence of the disease is high, it may be advisable to avoid having the cows calve during the cold winter months when seasonal hypomagnesemia is most likely to develop. Unfortunately it is often important to have cows calve in late winter to take advantage of the flush of spring growth when the cows are at the peak of their lactation.

### Feeding on hay and unimproved pasture

Because of the probable importance of lush, improved, grass pasture in producing the disease, the provision of some grain, hay or rough grazing may reduce its incidence. It is most important that the periods of fasting, such as occur when cattle or sheep are yarded or moved or during bad weather, should be avoided, especially in lactating animals and when seasonal hypomagnesemia is likely to be present.

### REVIEW LITERATURE

- Rendig VV, Grunes DL. Grass tetany. Wisconsin: American Society of Agronomy, 1979: Special Publication No. 35.
- Rogers PAM. Hypomagnesemia and its clinical syndromes in cattle: a review. *Irish Vet J* 1979; 33:115.
- Littledike ET, Young JW, Beitz DC. Common metabolic diseases of cattle: ketosis, milk fever, grass tetany, and the downer cow complex. *J Dairy Sci* 1981; 64:1465-1482.
- Roberson DL, Koppel LC, Boling JA. Management practices to overcome the incidence of grass tetany. *J Anim Sci* 1989; 67:3470-3484.
- Fontenot JP et al. Factors influencing magnesium absorption and metabolism in ruminants. *J Anim Sci* 1989; 67:3445-3455.
- Hoffis GE, Saint-Jean G, Rings DM. Hypomagnesemia in ruminants *Comp Cont Educ Pract Vet* 1989; 11: 519-526.
- McCaughan CJ. Treatment of mineral disorders in cattle. *Vet Clin North Am: Food Anim Pract* 1992; 8:107-145.
- Dua K, Care AD. Impaired absorption of magnesium in the aetiology of grass tetany. *Br Vet J* 1995; 151:413-426.
- Oetel GR. Management of dry cows for the prevention of milk fever and other mineral disorders. *Vet Clin North Am: Food Anim Pract* 2000; 16:369-386.
- Edneades DC. The magnesium requirements of pastures in New Zealand: a review. *N Z J Agric Res* 2004; 47:363-380.

### REFERENCES

- Martens H et al. *Vet Clin North Am Food Anim Pract* 2002; 16:369.
- Robson AB et al. *Br J Nutr* 1997; 78:975.
- Mann GE, Lamming GE. *Br Vet J* 1995; 151:427.
- Dalley DE et al. *J Agric Sci* 1997; 129:99.
- Fontenot JR et al. *J Anim Sci* 1989; 67:3445.
- Schnieder KM et al. *Aust Vet J* 1985; 62:82.
- Giduch SP et al. *J Anim Sci* 1988; 66:532.
- Robinson DL et al. *J Anim Sci* 1989; 67:3470.
- Wilkerson SR et al. *Magnesium* 1987; 6:74.
- Van de Braak AE et al. *Res Vet Sci* 1986; 42:101.
- Van Mosel M et al. *Res Vet Sci* 1990; 48:280.
- McCaughan CJ. *Vet Clin North Am Food Anim Pract* 1992; 8:107.
- Morris CA. *N Z J Agric Res* 1994; 37:59.
- Greene LW et al. *J Anim Sci* 1989; 67:3463.
- Erb HN, Grohn VT. *J Dairy Sci* 1988; 71:2557.

- McCoy MA et al. *Vet Rec* 1996; 138:41.
- Menzies FD et al. *Vet Rec* 1995; 137:531.
- Cheyney DJR, Robinson DL. *Argon J* 1985; 77:827.
- Mayland HF, Wilkerson SR. *J Anim Sci* 1989; 67:3437.
- Feyter C et al. *N Z J Exp Agric* 1986; 14:183.
- Meyer H. *Vet Sci Commun* 1977; 1:43.
- Donovan GA et al. *J Am Vet Med Assoc* 2004; 224:96.
- Caple IW, Halpin CG. Sydney Part Grad Course Dairy Production 1985; 76:307.
- McCoy PB et al. *Vet Rec* 2002; 150:176.
- McCoy MA et al. *Vet Rec* 2001; 148:268.
- Allsop TF, Pauli JV. *Res Vet Sci* 1985; 38:61.
- Sutherland RJ et al. *N Z Vet J* 1986; 34:133.
- McCoy MA et al. *Vet Rec* 2001; 148:313.
- Bacon JA et al. *J Dairy Sci* 1990; 73:470.
- Davenport GM et al. *J Anim Sci* 1990; 68:3765.
- Binnie RC et al. *Grass Forage Sci* 1996; 51:456.
- Sleper DA et al. *Crop Sci* 2002; 42:318.

## HYPOMAGNESEMIC TETANY OF CALVES

### Symptoms

**Etiology** Hypomagnesemia, resulting from inadequate magnesium in the diet.

**Epidemiology** Most commonly calves 2-4 months of age, on whole milk or milk replacer diets and poor or no roughage. Diarrhea and chewing bedding or other coarse fiber may exacerbate the deficiency.

**Clinical findings** Apprehension, agitation, hypersensitivity to all external stimuli, fine muscle tremors progressing to spasticity and violent convulsions. Rapid course and high case-fatality rate.

**Clinical pathology** Serum magnesium levels below 0.8 mg/dL, bone calcium:magnesium ratio above 90:1.

**Necropsy findings** Calcification of the spleen, diaphragm and endothelium of the aorta and endocardium. Enzootic muscular dystrophy is often concurrent.

**Diagnostic confirmation** Blood magnesium and response to treatment. Bone calcium:magnesium ratios.

**Treatment and control** Magnesium injection and dietary supplementation with magnesium compounds.

### ETIOLOGY

The disease results when the dietary intake of magnesium is inadequate for the requirements of the calf. Affected animals may have concurrent hypocalcemia.

### Magnesium homeostasis in the calf

Milk has low concentrations of magnesium. A milk diet provides adequate magnesium for the requirements of a growing calf up to a body weight of approximately 50 kg, but if milk is the sole diet, the intake of magnesium will be inadequate for requirements once his body weight is reached.<sup>1</sup> The deficit will perpetuate if the other feeds that are fed are also low in magnesium.

In the young calf, magnesium is absorbed in the intestine; however, the efficiency of magnesium absorption decreases markedly up to about 3 months

of age, when maximum susceptibility to the disease occurs. The efficiency of absorption is decreased by a reduction in transit time in the intestine caused by diarrhea.

In contrast to adult cattle, young calves can mobilize body stores of magnesium, which are principally located in the skeleton. Approximately 40% of the magnesium stored in the skeleton can be mobilized, which will protect against a short-term deficit.<sup>1</sup>

Hypomagnesemic tetany in calves is often complicated in field cases by the coexistence of other diseases, especially enzootic muscular dystrophy.

### EPIDEMIOLOGY

#### Occurrence

The disease is not common. Cases may occur sporadically or a number of deaths may occur on the one farm within a short period of time.

#### Risk factors

The disease can occur under a number of different circumstances.

Most commonly, hypomagnesemic tetany occurs in calves 2-4 months of age or older which are fed solely on a diet of whole milk, and calves receiving the greatest quantity of milk and growing most rapidly are more likely to be affected because of their greater need for magnesium for incorporation into developing soft tissues. It is most likely to occur in calves being fattened for veal. Those cases which occur on milk replacer appear to be related to chronic scours and low magnesium content of the replacer. This problem is less common than it once was because most modern commercial milk replacers have added adequate magnesium.

A significant loss of magnesium in the feces also occurs in calves allowed to chew fibrous material such as bedding; the chewing stimulates profuse salivation and creates greater loss of endogenous magnesium. Peat and wood shavings are bedding materials known to have this effect.

Cases have also been reported in calves fed milk-replacer diets or milk, concentrates, and hay, and in calves running at pasture with their dams. Deaths due to hypomagnesemic tetany have also occurred in 3-4-month-old calves whose hay and silage rations were low in magnesium content.<sup>2</sup>

Hypomagnesemia also occurs in young cattle, about 6 months of age, which are being fattened intensively indoors for the baby beef market. The phosphorus content of their diet is high and a lack of vitamin D is probable. The situation is exacerbated by a shortage of roughage. The hypomagnesemia is accompanied by a hypocalcemia.

### Experimental reproduction

A condition closely resembling the field syndrome has been produced experimentally by feeding an artificial diet with a very low content of magnesium; a high calcium content and biochemical hypomagnesemia is readily produced in calves with a diet based on skim milk and barley straw.<sup>3</sup> Hypomagnesemia has also been produced experimentally in very young foals by feeding a diet with a very low magnesium content. The clinical signs are similar to those in calves, and the calcification found in the walls of vessels of calves also occurs in foals.

### PATHOGENESIS

On affected farms, calves are born with normal serum magnesium levels of 2–2.5 mg/dL (0.82–1.03 mmol/L) but the levels fall gradually in the succeeding 2–3 months, often to below 0.8 mg/dL (0.33 mmol/L). Tetany does not occur until the serum magnesium falls below this concentration and is most severe at concentrations below 0.6 mg/dL (0.25 mmol/L), although some calves in a group may have concentrations even lower than this and show few clinical signs.

Magnesium deficiency inhibits the release and action of parathyroid hormone and this is believed to be the genesis of the concurrent hypocalcemia.<sup>4</sup> It is probable that depression of the serum calcium level precipitates tetany in animals rendered tetany prone by low serum magnesium levels. Tetanic convulsions can occur in hypocalcemic calves in the absence of hypomagnesemia.

Hypomagnesemic tetany is not related in any way to enzootic muscular dystrophy, although the diseases may occur concurrently.

### CLINICAL FINDINGS

The first sign in the experimental disease is constant movement of the ears. The temperature is normal and the pulse rate accelerated. Hyperesthesia to touch, and grossly exaggerated tendon reflexes with clonus, are present. Shaking of the head, opisthotonos, ataxia without circling and a droopy, backward carriage of the ears are constant. There is difficulty in drinking due to the animal's inability to get to the bucket.

Initially, the calves are apprehensive, show agitation and retraction of the eyelids when approached, and are hypersensitive to all external stimuli but show no tetany. Later, fine muscle tremors appear, followed by kicking at the belly, frothing at the mouth and spasticity of the limbs. Convulsions follow, beginning with stamping of the feet, head retraction, champing of the jaws and falling.

During the convulsions the following signs are present:

- Jaws are clenched
- Respiratory movements cease
- There are tonic and clonic movements of the limbs
- There is involuntary passage of urine and feces
- There are cycles of protrusion and retraction of the eyeballs.

The pulse rate rises to 200–250/min and the convulsions disappear terminally. The pulse becomes impalpable and cyanosis appears before death.

In field cases the signs are almost identical but are rarely observed until the terminal tetanic stage. Older calves usually die within 20–30 min of the onset of convulsions but young calves may recover temporarily only to succumb to subsequent attacks. Cases which occur in young calves with scours, usually at about 2–4 weeks of age, show ataxia, hyperesthesia, opisthotonos and convulsions as the presenting signs.<sup>5</sup> The convulsion is usually continuous and the calves die within 1 h.

### CLINICAL PATHOLOGY

Serum magnesium levels below 0.8 mg/dL (0.33 mmol/L) indicate severe hypomagnesemia and clinical signs occur with levels of 0.3–0.7 mg/dL (0.12–0.29 mmol/L). Normal values are 2.2–2.7 mg/dL (0.9–1.11 mmol/L). Erythrocyte magnesium concentrations are also low, indicating a chronic deficiency. Serum calcium levels tend to fall when serum magnesium levels become very low and are below normal in most clinical cases.

The estimation of the magnesium in bone (particularly ribs and vertebrae) is a reliable confirmatory test at necropsy. Values below a ratio of 70:1 for calcium:magnesium may be regarded as normal and above 90:1 are indicative of severe magnesium depletion. In the normal calf the ratio is about 55:1. Absolute bone calcium values are not decreased and are often slightly elevated. An incidental change is the marked increase in serum creatinine phosphokinase levels observed in calves after an acute attack of hypomagnesemic tetany.

### NECROPSY FINDINGS

There is a marked difference between the necropsy lesions of some natural cases and those in the experimental disease. In field cases, there is often calcification of the spleen and diaphragm, and calcified plaques are present in the aorta and endocardium, together with hyaline degeneration and musculature. In other cases necropsy lesions similar to those in enzootic muscular dystrophy occur.

In experimentally produced cases these lesions are not evident but there is extensive

congestion in all organs, and hemorrhages in unsupported organs, including the:

- Gallbladder
- Ventricular epicardium
- Pericardial fat
- Aorta
- Mesentery wall
- Intestinal wall.

The lesions are obviously terminal and are associated with a terminal venous necrosis. Some field cases present a picture identical to this.

### DIFFERENTIAL DIAGNOSIS

- Acute lead poisoning
- Enterotoxemia caused by *Clostridium perfringens* Type D
- Polioencephalomalacia
- Tetanus
- Vitamin A deficiency
- Meningitis.

### TREATMENT

Response to magnesium injections (100 mL of a 10% solution of magnesium sulfate) is only transitory because of the severe depletion of bone reserves of magnesium. This dose provides only a single day's requirements. Follow-up supplementation of the diet with magnesium oxide or carbonate as described later is advisable. Chloral narcosis or tranquilization with an ataractic drug may be essential to avoid death due to respiratory paralysis during convulsions.

### CONTROL

The provision of a hay that is high in magnesium, such as alfalfa, helps to prevent the disease as will well-formulated concentrates.

Supplementary feeding of magnesium  
If begun during the first 10 days of life, supplementary magnesium feeding will prevent excessive falls of serum magnesium, but if begun after the calf is 7 weeks old, may not prevent further depression of the levels. Supplementation should continue until at least 10 weeks of age. Daily feeding of the magnesium compound and fairly accurate dosing are necessary to avoid scouring or inefficient protection. For calves of average growth rate appropriate dose rates are 1 g/d for calves to 5 weeks of age, 2 g/d for calves 5–10 weeks of age and 3 g/d for calves 10–15 weeks of age of magnesium oxide or twice this dose of carbonate. Supplementation of the diet with magnesium restores serum calcium levels to normal as well as correcting the hypomagnesemia.

Magnesium alloy bullets  
Two bullets of the sheep size (together releasing approximately 1 g/d of mag-

nesium) per calf, have shown high efficiency in preventing the clinical disease and also the hypomagnesemia which precedes it. Calves kept indoors and fed largely on milk should get adequate mineral supplement and vitamin D (70 000 IU vitamin D<sub>3</sub>/d). Magnesium utilization will not be affected but calcium absorption, which is often sufficiently reduced to cause a concurrent hypocalcemia, will be improved.

## REFERENCES

1. Sansom BF. *Vet Ann* 1981; 21:74.
2. Rayssiguier PJ et al. *Vet Sci Commun* 1977; 1:235.
3. Mulei CM, Daniels RCW. *J Vet Med* 1989; 36:783.
4. Schnieder KM et al. *Aust Vet J* 1985; 62:82.
5. Mills J. *Vet Rec* 1992; 131:60.

## KETOSIS, SUBCLINICAL KETOSIS, ACETONEMIA

### Synopsis

**Etiology** A multifactorial disorder of energy metabolism. Negative energy results in hypoglycemia and ketonemia (the accumulation in blood of acetoacetate,  $\beta$ -hydroxybutyrate and their decarboxylation products acetone and isopropanol).

**Epidemiology** Primary ketosis and subclinical ketosis occurs predominantly in well-conditioned cows with high lactation potential, principally in the first month of lactation with a higher prevalence in cows with a higher lactation number. Loss of body condition in the dry period and immediately post partum. Secondary ketosis occurs where other disease reduces feed intake.

**Clinical findings** Cattle show wasting with decrease in appetite, fall in body condition and milk production. Some have short periods of bizarre neurological and behavioral abnormality. Response to treatment is good. Subclinical ketosis is detected by tests for ketones, usually in milk or urine.

**Clinical pathology** Hypoglycemia, ketonemia, ketonuria, or elevated ketones in milk.

**Necropsy findings** None specific.

**Diagnostic confirmation** Ketonemia, ketonuria or elevated ketones in milk.

**Treatment** In cattle, parenteral glucose with corticosteroid and oral glucose precursors such as propylene glycol, occasionally insulin. In cattle, the disease responds readily to treatment and is self-limiting.

**Control** Correction of energy imbalance. Herd biochemical monitoring coupled with condition scoring.

## ETIOLOGY

### Glucose metabolism in ruminants

The maintenance of adequate concentrations of glucose in the blood is critical to the regulation of energy metabolism. The ruminant absorbs very little dietary carbohydrate as hexose sugar because dietary carbohydrates are fermented in the

rumen to short chain fatty acids, principally acetate (70%), propionate (20%) and butyrate (10%). Consequently, glucose needs in ruminants must largely be met by gluconeogenesis. **Propionate and amino acids are the major precursors** for gluconeogenesis with glycerol and lactate of lesser importance.<sup>1</sup>

**Propionate** is produced in the rumen from starch, fiber, and proteins. It enters the portal circulation and is efficiently removed by the liver, which is the primary glucose-producing organ. Propionate is the **most important glucose precursor**; an increased availability can spare the hepatic utilization of other glucose precursors,<sup>2</sup> and production of propionate is favored by a high grain inclusion in the diet.<sup>3</sup>

**Amino acids.** The majority of amino acids are glucogenic and are also important precursors for gluconeogenesis. Dietary protein is the most important quantitative source but the labile pool of body protein is also an important source; together they contribute to energy synthesis and milk lactose synthesis as well as milk protein synthesis.<sup>1</sup>

**Dietary acetate** is transported to peripheral tissues and to the mammary gland and metabolized to long chain fatty acids for storage as lipids or secretion as milk fat.

### Energy balance

In high-producing dairy cows there is often a negative energy balance in the first few weeks of lactation. The highest dry matter intake does not occur until 8–10 weeks after calving but peak milk production is at 4–6 weeks and energy intake may not keep up with demand. In response to a negative energy balance and low serum concentrations of glucose and insulin, cows will mobilize adipose tissue with consequent increases in serum concentrations of non-esterified fatty acids (NEFA) and subsequently BHBA. The hepatic mitochondrial metabolism of fatty acids promotes both gluconeogenesis and ketogenesis. Cows partition nutrients during pregnancy and lactation and are in a lipolytic stage in early lactation and at risk for ketosis during this period.

### Hepatic insufficiency in ketosis

Hepatic insufficiency has been shown to occur in bovine ketosis but it does not occur in all cases.<sup>3,4</sup> It has been suggested that ketosis can be divided into two types.<sup>3,5</sup> In Type I, or 'spontaneous' ketosis, it is proposed that the gluconeogenic pathways are maximally stimulated and ketosis occurs when the demand for glucose outstrips the capacity of the liver for gluconeogenesis because of an insufficient supply of glucose precursors. Rapid entry of non-esterified fatty acids (NEFA) into hepatic mitochondria occurs and

results in high rates of ketogenesis and high blood ketones. There is little conversion of NEFA to triglycerides resulting in little fat accumulation in the liver. In Type II ketosis, manifest with fatty liver, gluconeogenic pathways are not maximally stimulated and consequently mitochondrial uptake of NEFA is not as active and NEFA become esterified in the cytosol, forming triglyceride. The capacity of cattle to transport triglyceride from the liver is low, resulting in accumulation and fatty liver.<sup>3</sup> The occurrence of a fatty liver can further suppress hepatic gluconeogenic capacity. Hepatic insufficiency may occur more commonly in those cows predisposed to ketosis by overfeeding in the dry period.<sup>5</sup>

### Ketone formation

Ketones arise from two major sources: butyrate in the rumen and mobilization of fat. A large proportion of butyrate produced by rumen fermentation of the diet is converted to  $\beta$ -hydroxybutyrate (BHBA) in the rumen epithelium and is absorbed as such. Free fatty acids produced from the mobilization of fat are transported to the liver and oxidized to produce acetyl-CoA and NADH.

Acetyl-CoA may be oxidized via the TCA cycle or metabolized to acetoacetyl-CoA. Its oxidation via the TCA cycle depends upon adequate supply of oxaloacetate from the precursor propionate. If propionate, and consequently oxaloacetate, is deficient, oxidation of acetyl-CoA via the TCA cycle is limited and it is metabolized to acetoacetyl CoA and subsequently to acetoacetate and BHBA.<sup>1</sup>

The ketones BHBA and acetoacetate can be utilized as an energy source. They are normally present in blood and their concentration is a result of the balance between production in the liver and utilization by the peripheral tissues.

### Role of insulin and glucagon

The regulation of energy metabolism in ruminants is primarily governed by insulin and glucagon. Insulin acts as a gluco-regulatory hormone stimulating glucose use by tissues and decreasing hepatic gluconeogenesis. Blood insulin concentrations decrease with decreasing blood concentrations of glucose and propionic acid. Insulin also acts as a liporegulatory hormone stimulating lipogenesis and inhibiting lipolysis. Glucagon is the primary counter-regulatory hormone to insulin. Their counteracting effects play a central role in the homeostatic control of glucose. A low **insulin: glucagon ratio** stimulates lipolysis in adipose tissue and ketogenesis in the liver. Cows in early lactation have low insulin: glucagon ratios because of low blood insulin and are in a catabolic state.<sup>5</sup> Elevated ketones may

stimulate insulin production and may act as a negative feedback.<sup>5,6</sup> Regulation is also indirectly governed by **somatotropin**, which is the most important determinant of milk yield in cattle and is also lipolytic. Factors that decrease the energy supply to ruminants, that increase the demand for glucose, or that increase the utilization of body fat as an energy source are likely to increase ketone production and ketonemia. There is however considerable cow-to-cow variation in risk for clinical ketosis.

### ETIOLOGY OF BOVINE KETOSIS

It is not unreasonable to view clinical ketosis as the top end of a spectrum of a metabolic state that is **common in heavily producing cows in the post-calving period**. This is because high-yielding cows in early lactation are in negative energy balance and are subclinically ketotic as a result. This can be predisposed by nutrition inadequacies during the dry period.

Ruminants are particularly vulnerable to ketosis because, although very little carbohydrate is absorbed as such, a direct supply of glucose is essential for tissue metabolism, particularly the formation of lactose. The utilization of volatile fatty acids for energy purposes is also dependent upon a supply of available glucose. This vulnerability is further exacerbated, particularly in the cow, by the tremendous rate of turnover of glucose.

In the period between calving and peak lactation, the demand for glucose is increased and cannot be completely restrained. Cows will reduce milk production in response to a reduction of energy intake, but this does not follow automatically nor proportionately in early lactation because hormonal stimuli for milk production overcome the effects of reduced food intake. Under these circumstances, lowered blood glucose levels result in a lowered blood insulin. Long chain fatty acids are released from fat stores under the influence of both a low blood insulin:glucagon ratio and the influence of high somatotropin concentration, and this leads to increased ketogenesis.

### Individual cow variation

The rate of occurrence of negative energy status, and therefore the frequency of clinical cases, has undoubtedly increased sharply in the recent past because of the steep increase in the lactation potential of the modern dairy cow. Because of the mammary gland's metabolic precedence in the partitioning of nutrients, especially glucose, milk production continues at a high rate, causing an energy drain. In many individual cows, the need for energy is beyond their capacity for dry matter intake but there is between-cow

variation in risk under similar nutritional stress.<sup>1-3,5</sup> Clinical ketosis has been produced in recently calved dairy cows by reducing the daily feed intake by 15-20% *ad libitum* and supplementing it with 1,3-butanediol, a ketogenic substrate. The biochemical characteristics of ketosis including depletion of hepatic glycogen and major increases in hepatic stores of triglycerides and ketone bodies were produced but ketosis was only produced in those cows that had a predisposition to the disease.<sup>7,8</sup>

### Types of bovine ketosis

There are many theories on the cause, biochemical and hormonal pathogenesis of ketosis, and the importance of predisposing factors. Reviews of these studies are cited at the end of this disease section. In general, it can be stated that clinical ketosis occurs in ruminants when they are subjected to demands on their resources of glucose and glycogen that cannot be met by their digestive and metabolic activity.

Lean<sup>1</sup> has presented a classification of the disease based on its natural presentation in intensively and extensively managed dairy herds, and one that accounts for the early lactational demand for glucose, a limited supply of propionate precursors and preformed ketones or mobilized lipids in the pathogenesis. Such a classification includes the following geneses of ketosis, which will be discussed in turn:

- Primary ketosis (production ketosis)
- Secondary ketosis
- Alimentary ketosis
- Starvation ketosis
- Ketosis due to specific nutritional deficiency.

#### Primary ketosis (production ketosis)

This is the ketosis of most herds, the so-called estate acetonemia. It occurs in cows in good to excessive body condition that have high lactation potential and are being fed good-quality rations but that are in a negative energy balance. There is a tendency for the disease to recur in individual animals, which is probably a reflection of variation between cows in digestive capacity or metabolic efficiency. A proportion of cases appear as **clinical ketosis** but a much greater proportion occur as cases of **subclinical ketosis** in which there are increased levels of circulating ketone bodies but no overt clinical signs.

#### Secondary ketosis

This occurs where **other disease** results in a **decreased food intake**. The cause of the reduction in food intake is commonly the result of abomasal displacement, traumatic reticulitis, metritis, mastitis,

or other diseases common to the post-parturient period. A high incidence of ketosis has also been observed in herds affected with fluorosis. An unusual occurrence reported was an outbreak of acetonemia in a dairy herd fed on a ration contaminated by a low level (9.5 ppm) of lincomycin, which caused ruminal microbial dysfunction.<sup>9</sup> The proportion of cases of acetonemia which are secondary, and their diagnosis as such, are both matters of great interest as a significant proportion of cases of ketosis are secondary to other disease.

#### Alimentary ketosis

This form is due to excessive amounts of **butyrate in silage** and possibly also due to decreased food intake resulting from poor palatability of high butyrate silage. Silage made from succulent material may be more highly ketogenic than other types of ensilage because of its higher content of preformed butyric acid.<sup>10</sup> Spoiled silage is also a cause and toxic biogenic amines in silage, such as putrescine, may also contribute.<sup>11</sup> This type of ketosis is commonly subclinical but it may predispose to the development of production or primary ketosis.

#### Starvation ketosis

This occurs in cattle that are in poor body condition and that are fed poor-quality feedstuffs. There is a deficiency of propionate and protein from the diet and a limited capacity of gluconeogenesis from body reserves. Affected cattle recover with correct feeding.

#### Ketosis due to specific nutritional deficiency

Specific dietary deficiencies of **cobalt** and possibly phosphorus may also lead to a high incidence of ketosis. This may be due in part to a reduction in the intake of total digestible nutrients (TDN), but in cobalt deficiency, the essential defect is a failure to metabolize propionic acid into the tricarboxylic acid (TCA) cycle. The problem is restricted to the cobalt deficient areas of the world, although the occurrence of cobalt deficiency in high-producing dairy cows in non-deficient areas has been described.<sup>12</sup>

There is a marked nadir in food intake around calving, followed by a gradual increase. This increase is quite variable between cows, but in the great majority of cases does not keep pace with milk yield. The net result is that high-yielding dairy cows are almost certain to be in negative energy balance for the first 2 months of lactation.<sup>13</sup>

### EPIDEMIOLOGY

#### Occurrence

Ketosis is a disease of dairy cattle and is prevalent in most countries where intensive farming is practiced. It occurs mainly

in animals housed during the winter and spring months and is rare in cows that calve on pasture. In housed or free-stalled cattle it occurs year around. The occurrence of the disease is very much dependent upon management and nutrition and varies between herds. As might be expected, **lactational incidence rates** vary between herds and a recent review of eleven epidemiological studies showed a lactation incidence rate for ketosis that varied from 0.2–10.0%.<sup>14</sup>

Rates of **subclinical ketosis** are influenced by the cut-point of plasma BHBA used for definition but are much higher, especially in undernourished herds, and can approach 40%.<sup>2,15–19</sup>

#### Animal and management risk factors

There are conflicting reports on the significance of risk factors for ketosis and subclinical ketosis which probably reflect that the disease can be a cause or effect of interacting factors. The disease occurs in the immediate postparturient period with 90% of cases occurring in the first 60 days of lactation.<sup>15–20</sup> Regardless of specific etiology, it occurs most commonly during the **first month** of lactation, less commonly in the second month, and only occasionally in late pregnancy. In different studies, the median **time to onset following calving** has varied from 10 to 28 days,<sup>20,21</sup> with some recent studies showing a peak prevalence of subclinical ketosis in the first 2 weeks post-calving.<sup>2,15</sup> A prolonged previous inter-calving interval increases risk.<sup>2</sup>

**Age.** Cows of any age may be affected but the disease increases from a low prevalence at the first calving to a peak at the fourth. Lactational incidence rates of clinical ketosis of 1.5% and 9%, respectively were found in a study of 2415 primiparous and 4360 multiparous cows.<sup>22</sup> Clinical ketosis can also recur in the same lactation.

**Herd differences** in prevalence are very evident in clinical practice, and in the literature, with some herds having negligible occurrence. Although apparent differences in breed incidence are reported, evidence for an heritable predisposition within breeds is minimal.<sup>17,20,23</sup> Feeding frequency has an effect with the prevalence much lower in herds that feed TMR *ad libitum* compared with herds that fed roughage and concentrate separately of that feed twice a day.

**Body condition score (BCS).** There are conflicting reports on the relation between BCS at calving and ketosis but it is suggested that studies that have found no relationship have not had many fat cows in the herds examined.<sup>24,25</sup> Fat body condition post partum was observed to be associated with a higher first test day milk yield, milk fat to protein ratio of >1.5,

increased body condition loss and a higher risk for ketosis.<sup>25</sup> In another study, cows with a BCS >3.25 at parturition and that lost 0.75 BCS in the first 2 months of lactation developed subclinical ketosis.<sup>26</sup> Body condition loss during the dry period also increases risk for ketosis in the following lactation.<sup>2,27,28</sup>

**Season.** There is no clear association with season. In some but not all summer grazing areas, a higher risk is generally observed in cattle during the winter housing period.<sup>2,29</sup> Higher prevalence has been observed in the late summer and early winter in Scandinavian countries.<sup>30</sup>

**Other interactions.** There is a **greater risk** for the development of ketosis in cows that have an extended long dry period, that develop milk fever, retained placenta, lameness or hypomagnesaemia.<sup>21,25,28,31–35</sup> Cows with twins are also at risk for ketosis in the terminal stages of pregnancy.<sup>36,37</sup> There is a bidirectional relation between risk for displaced abomasum and risk for ketosis, but in a field study of 1000 cows in 25 herds, cows that had a serum BHBA greater than 1400 µmol/L in the first 2 weeks of lactation had odds of 4:1 that displaced abomasums would be diagnosed 1–3 weeks later.<sup>38</sup> In another study of 1010 cows a serum concentration of 1500 µmol/L or greater in the first 2 weeks of lactation was found to be associated with a threefold increase in ketosis or displaced abomasums.<sup>2</sup>

#### Economic significance

Clinical and subclinical ketosis are major causes of loss to the dairy farmer.<sup>2,19,39</sup> In rare instances the disease is irreversible and the affected animal dies but the main economic loss is due to the loss of production while the disease is present, the possible failure to return to full production after recovery and the increased occurrence of periparturient disease.<sup>1,2</sup> Both clinical and subclinical ketosis are accompanied by **decreased milk yields** and lower milk protein and milk lactose<sup>1,2,16,35,40</sup> and **increased risk** for delayed estrus and lower first service conception rates, increased inter-calving intervals<sup>10,41</sup> and increased risk of cystic ovarian disease, metritis and mastitis and increased involuntary culling.<sup>11,35,42</sup> A year 2001 report has estimated the loss from a single case of subclinical ketosis at US\$145.<sup>19</sup>

#### PATHOGENESIS

Bovine ketosis

The principal metabolic disturbances observed, hypoglycemia and ketonemia, may both exert an effect on the clinical syndrome. However, in the experimental disease in cattle, it is not always clear what determines the development of the clinical signs in cases that convert from

subclinical to clinical ketosis.<sup>43</sup> In many cases, the severity of the clinical syndrome is proportional to the degree of hypoglycemia and this, together with the rapid response to parenterally administered glucose in cattle, suggests hypoglycemia as the predominant factor. This hypothesis is supported by the development of prolonged hypoglycemia and a similar clinical syndrome to that of ketosis, after the experimental, IV or SC injection of insulin (2 units/kg BW).

However, in most field cases the severity of the clinical syndrome is also roughly proportional to the degree of ketonemia. This is an understandable relationship as ketone bodies are produced in larger quantities as the deficiency of glucose increases. However, the ketone bodies may exert an additional influence on the signs observed. Acetoacetic acid is known to be toxic and probably contributes to the terminal coma in diabetes mellitus in man.

The **nervous signs** which occur in some cases of bovine ketosis are thought to be caused by the production of isopropyl alcohol, a breakdown product of acetoacetic acid in the rumen, although the requirement of nervous tissue for glucose to maintain normal function may also be a factor in these cases.

Spontaneous ketosis in cattle is usually **readily reversible** by treatment; incomplete or temporary response is usually due to the existence of a primary disease with ketosis present only as a secondary development, although fatty degeneration of the liver in protracted cases may prolong the recovery period. Changes in ruminal flora after a long period of anorexia may also cause continued impairment of digestion.

**Immunosuppression** has been demonstrated with energy deficiency and ketosis.<sup>44,45</sup> The higher susceptibility of ketotic postpartum cows to local and systemic infections may be related to impairment of the respiratory burst of neutrophils which occurs with elevated levels of BHBA.<sup>46</sup>

#### CLINICAL FINDINGS

Two major clinical forms of bovine ketosis are described – wasting and nervous – but these are the two extremes of a range of syndromes in which wasting and nervous signs are present in varying degrees of prominence.

**The wasting form** is the most common of the two and is manifest with a gradual but moderate decrease in appetite and milk yield over 2–4 days. In herds that feed components separately, the pattern of appetite loss is often unusual in that the cow first refuses to eat grain, then ensilage but may continue to eat hay. The appetite may also be depraved.

Body weight is lost rapidly, usually at a greater rate than one would expect from the decrease in appetite. Farmers usually describe affected cows as having a 'woody' appearance due to the apparent wasting and loss of cutaneous elasticity due presumably to disappearance of subcutaneous fat. The feces are firm and dry but serious constipation does not occur. The cow is moderately depressed and the hangdog appearance and disinclination to move and to eat may suggest the presence of mild abdominal pain.

The temperature and the pulse and respiratory rates are normal and although the ruminal movements may be decreased in amplitude and number, they are within the normal range unless the course is of long duration when they may virtually disappear. A characteristic odor of ketones is detectable on the breath and often in the milk.

Very few affected animals die, but without treatment the milk yield falls and although spontaneous recovery usually occurs over about a month, as equilibrium between the drain of lactation and food intake is established, the milk yield is never fully regained. The fall in milk yield in the wasting form may be as much as 25% and there is an accompanying sharp drop in the solids-not-fat content of the milk. In the wasting form, nervous signs may occur in a few cases but rarely comprise more than transient bouts of staggering and partial blindness.

**The nervous form.** Signs are usually bizarre and begin quite suddenly. The syndrome is suggestive of delirium rather than of frenzy and the characteristic signs include:

- Walking in circles
- Straddling or crossing of the legs
- Head pushing or leaning into the stanchion
- Apparent blindness
- Aimless movements and wandering
- Vigorous licking of the skin and inanimate objects
- Depraved appetite
- Chewing movements with salivation.

Hyperesthesia may be evident, the animal bellowing on being pinched or stroked. Moderate tremor and tetany may be present and there is usually an incoordinate gait. The nervous signs usually occur in **short episodes** which last for 1 or 2 h and may recur at intervals of about 8–12 h. Affected cows may injure themselves during the nervous episodes.

#### Subclinical ketosis

Many cows that are in negative energy balance in early pregnancy will have ketonuria without showing clinical signs, but will have diminished productivity

including depression of milk yield and a reduction in fertility. Clinical diagnosis is not effective and in one study,<sup>22</sup> diagnosis by routine urine testing at 5–12 days post partum was considerably more efficient (15.6% detected) than diagnosis by the herdsman (4.35% detected). In a British study of 219 herds the annual mean rate of reported clinical ketosis was 0.5 per 100 adult cows but the rate of subclinical ketosis, as defined by high blood concentrations of BHBA and non-esterified fatty acids, was substantially higher.<sup>47,48</sup>

**Potential milk production** is reduced by 1–9%.<sup>17,20</sup> Surveys of large populations show a declining prevalence of ketosis-positive cows after a peak in the period immediately after calving, and a positive relationship between hyperketonemia and high milk yield.<sup>15,49</sup> **Infertility** may appear as an ovarian abnormality, delayed onset of estrus or as endometritis resulting in an increase in calving to conception interval and reduced conception rate at first insemination.

#### CLINICAL PATHOLOGY

Hypoglycemia, ketonemia and ketonuria are characteristic of the disease.

#### Glucose

Blood glucose levels are reduced from the normal of approximately 50 mg/dL to 20–40 mg/dL. Ketosis secondary to other diseases is usually accompanied by blood glucose levels above 40 mg/dL and often above normal. Conversion factors are shown in Table 29.7.

#### Blood ketones

Most commonly, plasma or serum  $\beta$ -hydroxybutyrate (BHBA) measured in SI units is used for analysis of ketonemia. BHBA is the predominant circulating ketone body. Plasma concentrations of BHBA significantly correlate with plasma concentrations of acetoacetate but acetoacetate is unstable in samples whereas BHBA is relatively stable.<sup>2</sup> Normal cows have plasma BHBA concentrations less than 1000  $\mu$ mol/L, cows with subclinical ketosis have concentrations greater than 1400  $\mu$ mol/L, and cows with clinical ketosis have concentrations often in excess of 2500  $\mu$ mol/L. Plasma BHBA shows some diurnal variation in cows fed twice daily with peak concentrations occurring approximately 4 h after feeding

and higher concentrations in the morning than in the afternoon. This is not seen in cows fed a total mixed ration *ad libitum*.<sup>50,51</sup>

Plasma BHBA is not a cost effective or convenient analysis for routine analysis and cow side monitoring and the content of acetoacetate or BHBA in urine and milk are used for these purposes. Concentrations of BHBA and acetoacetate in urine and milk are less than those in blood and the correlation coefficients for blood and milk BHBA and blood and milk acetoacetate are 0.66 and 0.62, respectively.<sup>52</sup>

#### Milk and urine cowside tests

Cowside tests have the advantage of being inexpensive, giving immediate results, and they can be used as frequently as necessary. A minor source of error is that the concentration of ketone bodies in these fluids will depend not only on the ketone level of the blood but also on the amount of urine excreted or on the milk yield. Milk is less variable, easier to collect and may give fewer false negatives with subclinical ketosis.

Milk and urine ketone levels have been traditionally detected by the reaction of acetone and acetoacetate with sodium nitroprusside and can be interpreted in a semi-quantitative manner based on the intensity of the reaction. Several products are available commercially as test powders or strips are commonly accompanied by a color chart that allows a classification in grades such as negative, trace, small, moderate, large, based on the intensity of the color of the reaction.

Conventional wisdom is that milk powder tests are not sensitive for detection of subclinical ketosis (report too many false negatives) and urine tests are not sufficiently specific (report too many false positives).<sup>53</sup>

**Milk testing.** The sensitivity and specificity of the nitroprusside powder test with milk in various studies is reported as 28–90% and 96–100%, respectively.<sup>16,53,54</sup> More recently, a milk strip test detecting the presence of BHBA in milk is available and is graded on the concentration of BHBA in  $\mu$ mol/L. In different studies it has a reported sensitivity and specificity of 73–96% and 69–96%, respectively.<sup>53–57</sup> These variations are, in part, due to different plasma BHBA reference values (1200 and

Table 29.7 To convert from the SI unit to the conventional unit divide by the conversion factor. To convert from the conventional unit to the SI unit multiply by the conversion factor

Substrate	Conventional unit	Conversion factor	SI unit
$\beta$ -hydroxybutyrate	mg/dL	96.05	$\mu$ mol/L
Acetoacetate	mg/dL	97.95	$\mu$ mol/L
Acetone	mg/dL	172.2	$\mu$ mol/L



1400  $\mu\text{mol/L}$ ) for designation of subclinical ketosis and different cut points used in urine BHBA. Somatic cell counts greater than 1 million cells/mL will cause an elevation in reading of both the BHBA strip test and the nitroprusside tests.

**Urine testing.** A nitroprusside tablet has a reported sensitivity and specificity of 100% and 59%, respectively, compared with serum BHBA concentrations above 1400  $\mu\text{mol/L}$  and a nitroprusside strip test a reported sensitivity and specificity of 78% and 96% with a urine cut point corresponding to 'small' on the color chart or 49% and 99% with a urine cut point corresponding to 'moderate' on the color chart.<sup>53</sup> BHBA test strips when used with urine has a reported sensitivity and specificity of 73% and 96%, respectively at a urine cut point of 100  $\mu\text{mol/L}$  BHBA and 27% and 99% at a urine cut point of 200  $\mu\text{mol/L}$  BHBA.<sup>53</sup>

One author has suggested that the nitroprusside urine strip test or the BHBA milk strip test are best for screening individual cows for ketosis in herds with average prevalence but that the nitroprusside powder test would have limited application.<sup>53</sup>

**Milk fat to protein ratio.** Milk fat concentration tends to increase and milk protein concentration tends to decrease during postpartum negative energy balance. A fat to protein ratio  $>1.5$  in first day teat milk is indicative of a lack of energy supply in the feed and of risk for ketosis.<sup>25</sup>

**Clinical chemistry and hematology.** White and differential cell counts are variable and not of diagnostic value for ketosis.

There are usually elevations of liver enzymes but liver function tests are within the normal range. Liver biopsy is the only accurate method to determine the degree of liver damage.<sup>58</sup> Plasma concentrations of non-esterified fatty acids are elevated as are cholesterol concentrations and bilirubin. Bilirubin is not a sufficiently sensitive indicator to assess the extent of fat mobilization and liver function.<sup>26,27</sup> Liver glycogen levels are low and the glucose tolerance curve may be normal. Volatile fatty acid levels in the rumen are much higher in ketotic than in normal cows and the ruminal levels of butyric acid are markedly increased relative to acetic and propionic acids. There is a small but significant fall in serum calcium levels (down to about 9 mg/dL (2.25 mmol/L)), due probably to increased loss of base in the urine to compensate for the acidosis.

#### NECROPSY FINDINGS

The disease is not usually fatal in cattle but fatty degeneration of the liver and secondary changes in the anterior pituitary gland and adrenal cortex may be present.

#### DIFFERENTIAL DIAGNOSIS

##### Cattle

The clinical picture is usually too indefinite, especially in cattle, to enable a diagnosis to be made solely on clinical grounds. General consideration of the history, with particular reference to the time of calving, the duration of pregnancy in ewes and the feeding program, and biochemical examination to detect the presence of hypoglycemia, ketonemia, and ketonuria are necessary to establish a diagnosis.

##### Wasting form

- Abomasal displacement
- Traumatic reticulitis
- Primary indigestion
- Cystitis and pyelonephritis
- Diabetes mellitus.

##### Nervous form

- Rabies
- Hypomagnesemia
- Bovine spongiform encephalopathy.

#### TREATMENT

In cattle, a number of effective treatments are available but in some affected animals, the response is only transient; in rare cases, the disease may persist and cause death or necessitate slaughter of the animals. Most of these cases are secondary and failure to respond satisfactorily to treatment is due to the primary disease.

The rational treatment in ketosis is to relieve the need for glucose formation from tissues and allow ketone body utilization to continue normally. Theoretically, the simplest means of doing this is by the administration of glucose replacement therapy. The effect of the administration of glucose is complex but it allows the reversal of ketogenesis and the establishment of normal patterns of energy metabolism.<sup>12</sup> Ideally, treatment should be at an early stage of the disease to minimize loss and with subclinical ketosis this requires biochemical testing.<sup>52</sup>

##### Replacement therapy

Glucose (dextrose)

The IV injection of 500 mL of a 50% solution of glucose results in transient hyperglycemia, increased insulin and decreased glucagon secretion, and reduced plasma concentration of non-esterified fatty acids. It effects a marked improvement in most cows but relapses occur commonly unless repeated treatments are used. This is probably due to the transience of the hyperglycemia or insufficient dosing – the dose required varies directly with the amount of lactose being lost in the milk. A significant proportion of the administered glucose is lost to urinary excretion. SC injections prolong the response but are not recommended as they cause

discomfort, and large unsightly swellings, which often become infected, may result. IP injections of 20% solution of dextrose may be used alternatively but are also accompanied by risk of infection.

##### Other sugars

Other sugars, especially fructose, either alone or as a mixture of glucose and fructose (invert sugar), and xylitol, have been used in an effort to prolong the response but idiosyncrasies to some preparations, in the form of polypnea, muscle tremor, weakness and collapse, can occur while the injection is being given.

##### Propylene glycol and glycerine/glycerol

To overcome the necessity for repeated injections, propylene glycol can be administered as a drench. The traditional dose is 225 g twice daily for 2 days, followed by 110 g daily for 2 days to cattle, but higher volumes are also used. Propylene glycol (200–700 g daily), or **salts of propionic acid**, can be administered in the feed and give good results. Administration in feed is preferred by some because this method avoids dangers of aspiration with drenching; however, cows not used to its inclusion in the feed may show feed refusal. It is recommended that for best results, dosing with these preparations be preceded by an IV injection of glucose.

Parenteral infusions of glucose solutions and the feeding of glycerol depress the fat content of milk, and the net saving in energy may favorably influence response to these drugs. Glycerol and propylene glycol are not as efficient as glucose because conversion to glucose does utilize oxaloacetate. Propylene glycol is absorbed directly from the rumen and acts to reduce ketogenesis by increasing mitochondrial citrate concentrations; its metabolism to glucose occurs via conversion to pyruvate with subsequent production of oxaloacetate via pyruvate carboxylase.<sup>12</sup>

##### Other glucose precursors

Because of its glucogenic effect, sodium propionate is theoretically a suitable treatment but when administered in 110–225 g doses daily, the response in cattle is often very slow. Lactates are also highly glucogenic but both calcium and sodium lactate (1 kg initially, followed by 0.5 kg for 7 days) and sodium acetate (110–500 g/d) have given less satisfactory results than those obtained with sodium propionate. Ammonium lactate (200 g for 5 days) has however, been used extensively with reported good results.

Lactose, in whey, or in granular form in the diet, can increase dry matter intake but increases ruminal butyrate and plasma BBHA concentrations.<sup>59</sup>

### Hormonal therapy

**Glucocorticoids.** The efficiency of glucocorticoids in the treatment of bovine ketosis has been demonstrated in both experimental and field cases. Hyperglycemia occurs within 24 h of administration and appears to result from a repartitioning of glucose in the body rather than from gluconeogenesis.<sup>7</sup> Historically, many preparations have been used successfully but current drugs are more potent, require lower dosage, and have fewer side-effects. A hyperglycemic state is produced for 4–6 days in ketotic cows given 10 mg of dexamethasone 21-isonicotinate and other preparations such as dexamethasone sodium phosphate (40 mg) and flumethasone (5 mg) are also used. Label regulations vary between countries and in general, the recommendations of the manufacturer with regard to use and dosage should be followed. Profound hypokalemia with high case fatality is a potential sequel to prolonged repeated therapy of ketosis with isoflupredone acetate.<sup>60</sup> Response of cows with primary ketosis to treatment with **corticosteroids and IV glucose is superior**, with fewer relapses, than therapy with corticosteroids or glucose alone.<sup>61</sup>

**Insulin** facilitates cellular uptake of glucose, suppresses fatty acid metabolism and stimulates hepatic gluconeogenesis. It is administered in conjunction with either glucose or a glucocorticoid and may be of particular value in early-onset cases of ketosis that are unresponsive to glucose or corticosteroid therapy<sup>6</sup> but is not commonly used. The dose of protamine zinc insulin is 200–300 IU per animal administered SC every 24–48 h as required.

**Anabolic steroids** have also been used for treatment of lactational ketosis and ketosis in late pregnant cows that are overfat, stressed, or have twin fetuses. Experimentally, 60 mg and 120 mg of trenbolone acetate are effective as single injections but no extensive field trials are recorded and the drug is banned for use in food animals in most countries.

**Miscellaneous treatments.** Vitamin B<sub>12</sub> and cobalt are indicated in regions where cobalt deficiency is a risk factor for ketosis. They are sometimes administered to cattle with ketosis in regions where cobalt deficiency does not occur but their therapeutic value is not proven. Cysteamine (a biological precursor of coenzyme A) and also sodium fumarate have been used to treat cases of the disease. Reported results were initially good but the treatment has not been generally adopted. The recommended dose rate of cysteamine is 750 mg IV for three doses at 1–3 day intervals.

**Glucagon** although ketogenic is strongly gluconeogenic and glycolytic

and glucagon concentrations are decreased in the blood of fat cows at calving and cows with ketonemia. It could be of value in prevention and therapy but it would require a prolonged delivery system as it has a very short physiologic half life and its effects following a single injection are short-lived.<sup>62</sup>

### CONTROL

The control of clinical ketosis is integrally related to the adequate nutrition of the cow in the dry and lactating period. This encompasses details such as:

- Dry matter intake
- Fiber digestibility
- Particle size distribution
- Energy density
- Fat incorporation in early lactation rations
  - Protein content
- Feeding systems
- Rumen size
- Other factors better covered in texts on nutrition.

It is difficult to make general recommendations for the control of the disease because of the many conditions under which it occurs, its probable multiple etiology, and feeding systems that vary from those that feed components separately to those that feed total mixed rations. Cows should neither have been starved nor be overfat at calving. Careful estimation of diets by reference to feed value tables is recommended and detailed recommendations on diet and management are available with the caveat that planned rations can deviate from feed bunk rations and feed bunk dry matter and actual dry matter intake may not be the same. Too low a feeding frequency and the feeding of concentrates separate from roughage rather than as a total mixed ration can lead to an increase in rates of ketosis.

In the USA, dry cows are typically divided into two groups; 'far off' and 'close up' cows. 'Far off' cows are generally fed to National Research Council (NRC) dry cow feeding guidelines and 'close up' cows are given a ration that is halfway between the dry cow and early lactation ration starting 3 weeks before estimated calving and aiming to maximize dry matter intake and provide adequate energy.<sup>2,63–65</sup> Practical recommendations based on British feeding standards and units are also available.<sup>66,67</sup>

In high-producing cows being fed stored feeds, poor quality roughage commonly leads to acetonemia. Wet ensilage containing much butyrate, and moldy or old and dusty hay, are the main offenders. In concentrates, it is the change of source which creates off-feed effects and precipitates attacks of acetonemia.

Cows that are housed should get some exercise each day and in herds where the disease is a particular problem during the stabling period, the cattle should be turned out to pasture as soon as possible in the spring.

The ration should contain adequate amounts of cobalt, phosphorus and iodine.

If there is a high incidence in a herd receiving large quantities of ensilage, reduction of the amount fed for a trial period is indicated.

### Energy supplements

Propylene glycol is used for the prevention of clinical and subclinical ketosis. Traditionally, propylene glycol has been drenched to cattle in early lactation at doses varying from 350 to 1000 mL daily for 10 days after calving. There is a linear effect of dose on plasma glucose.<sup>68</sup> Propylene glycol can also be added to feed and is frequently present in commercial feed product but a bolus dose of propylene glycol is more effective in raising blood glucose than incorporation in feed.<sup>2</sup> A dose of 1 L per day given as an oral drench for 9 days prior to parturition has also been shown efficacious.<sup>69</sup> At doses above 500 mL administered by drench or present in feed some cows may develop rapid and shallow respiration, ataxia, salivation, and somnolence.

Glycerol can be substituted for propylene glycol at equivalent dose rates. A preliminary report of a small experimental study with larger doses of glycerol showed that glycerol given orally at a dose of 1, 2, or 3 L elevated blood glucose concentrations to 16, 20, and 25% of pre-treatment values at 0.5 h after treatment and that these concentrations remained elevated for 8 h. Staggering, depression and diuresis were observed in some cows given the 2 or 3 L dose but this could be prevented by administering the glycerol in a large (37 L) volume of water. It concluded that a dose of 1 L was effective in increasing milk production and reducing urinary ketones.<sup>70</sup> Glycerol, fed as a constant component in the transition dairy cow diet is not effective, and possibly may be ketogenic when fed continually.<sup>71</sup> Glycerol should only be used as drench in hypoglycemic cows and not fed as a component of the diet.

### Propionic acid and its salts

Propionic acid absorbed across the rumen wall is transported to the liver where it is converted to glucose via gluconeogenesis to result in an increase in serum blood glucose levels. Older literature reports that 110 g/d fed daily for 6 weeks, commencing at calving, has given good results in reducing the incidence of clinical bovine ketosis and improving production, but is not palatable and has the risk of reducing

feed intake. In controlled trials, feeding energy supplements containing propionic acid and/or its salts for 3 weeks prepartum and 3 weeks post partum had a beneficial effect on milk production but a variable effect on reducing subclinical ketosis.<sup>72,73</sup>

#### Ionophores

Ionophores alter bacterial flora of the rumen, leading to decreases in Gram-positive bacteria, protozoa, and fungi and increases in Gram-negative bacteria. The net effect of these changes in bacterial flora is increased propionate production and a decrease in acetate and butyrate production providing increased gluconeogenic precursors. Field trials with monensin have demonstrated a reduction in plasma BHBA and a reduced prevalence of clinical ketosis.<sup>29,74,75</sup> It can be administered as a slow release capsule to cattle 2–4 weeks before calving. The capsule contains 32 g of monensin and releases approximately 335 mg monensin a day for 95 days. Ionophores are not labeled for inclusion in lactating cow rations in some countries.

#### Niacin

Niacin is antilipolytic and induces increases in blood glucose and insulin but there is conflicting evidence that **niacin** given in the feed has a beneficial effect on subclinical ketosis in cattle.<sup>120,76</sup> It has been suggested that it should be supplemented from 2 weeks prior to parturition to 12 weeks post partum.<sup>77</sup>

#### General control

**Herd monitoring.** Biochemical monitoring of herds for subclinical ketosis and adequacy of periparturient feeding can be conducted using blood glucose estimations on a sample of cows in their second week of lactation.<sup>55</sup> Blood glucose levels of below 35 mg/dL (1.9 mmol/L) suggest subclinical ketosis. For individual cows, blood glucose estimations should be done at about 14 days after calving. This method of monitoring is expensive.

More commonly, testing for ketones in urine or milk of cows in their first or second week of lactation is recommended for early detection of ketosis and early treatment to prevent milk loss and ketosis-associated diseases. One recommendation is to routinely test such cows on a specific day each week.<sup>19</sup> This should be coupled with body condition scoring to monitor the efficacy of the nutritional program. Condition scoring at dry off, mid dry period, calving, calving plus 20–50 days, and two to three subsequent periods in lactation have been suggested.<sup>28,67</sup> Plasma glucose coupled with plasma BHBA are the best predictive model for monitoring energy balance of cattle on a pasture diet with milk acetone the best 'on-farm' predictor. However, the variation in milk

acetone is high and frequent sampling is required for accurate estimation.<sup>78</sup>

Automated monitoring by in-line measurements of ketone bodies in milk have been studied and may be of particular value in large dairies. BHBA is proposed as the candidate as it is the more robust in milk, and where cows are fed a TMR, is not subject to significant diurnal variation. It can be measured with a fluorometric method that requires no pretreatment of the milk.<sup>79,80</sup>

#### REVIEW LITERATURE

Littledike ET, Young JW, Beitz DC. Common metabolic diseases of cattle: ketosis, milk fever, grass tetany and downer cow complex. *J Dairy Sci* 1981; 64:1465–1482.

Kronfield DS. Major metabolic determinants of milk volume, mammary efficiency, and spontaneous ketosis in dairy cows. *J Dairy Sci* 1982; 65:2204–2212.

Baird GD. Primary ketosis in the high-producing dairy cow: clinical and subclinical disorders, treatment, prevention and outlook. *J Dairy Sci* 1982; 65:1–10.

Kelly JM, Whitaker DA. Subclinical ketosis and dairy cows. *Vet Ann* 1984; 24:83–93.

Brockman RP, Looft B. Hormonal regulation of metabolism in ruminants; a review. *Livestock Prod Sci* 1986; 14:313–334.

Herdth TH, Emery RS. Therapy of diseases of ruminant intermediary metabolism. *Vet Clin North Am Food Anim Pract* 1991; 8:91–106.

Lean JJ et al. Bovine ketosis: a review. I Epidemiology and pathogenesis. *Vet Bull* 1991; 61:1209–1218.

Lean et al. Bovine ketosis: a review. II Biochemistry and prevention. *Vet Bull* 1992; 62:1–13.

Gerloff BJ. Dry cow management for the prevention of ketosis and fatty liver in dairy cows. *Vet Clin North Am Food Anim Pract* 2000; 16:283–292.

Duffield T. Subclinical ketosis in lactating dairy cattle. *Vet Clin North Am Food Anim Pract* 2000; 16:231–253.

Herdth TH. Ruminant adaptation to negative energy balance influences on the etiology of ketosis and fatty liver. *Vet Clin North Am Food Anim Pract* 2000; 16:215–230.

Geishauser T et al. Monitoring for subclinical ketosis in dairy herds. *Comp Cont Educ Pract Vet: Food Anim Pract* 2001; 23:565–571.

Nielsen NI, Ingvarsen KL. Propylene glycol for dairy cows. A review of the metabolism of propylene glycol and its effects on physiological parameters, feed intake, milk production and risk of ketosis. *Anim Feed Sci Technol* 2004; 115:191–213.

Huxley J. Optimising health, productivity and welfare of dairy cattle: on-farm nutrition. *In Practice* 2004; 26:466–475.

Hayirli A, Grummer RR. Factors affecting the dry matter intake prepartum in relationship to etiology of peripartum lipid-related metabolic disorders: a review. *Can J Anim Sci* 2004; 84:337–347.

Oerzel GR. Monitoring and testing herds for metabolic disease. *Vet Clin North Am Food Anim Pract* 2004; 20:651–674.

#### REFERENCES

- Lean JJ et al. *Vet Bull* 1992; 62:1.
- Duffield T. *Vet Clin North Am Food Anim Pract* 2000; 16:231.
- Herdth TH. *Vet Clin North Am Food Anim Pract* 2000; 16:215.
- Steen A et al. *J Vet Med Assoc* 1997; 44:521.
- Holtenuis P, Holtenuis K. *J Vet Med Assoc* 1996; 43:579.
- Herdth TH, Emery RS. *Vet Clin North Am Food Anim Pract* 1992; 8:91.
- Mills SE et al. *J Dairy Sci* 1986; 69:362.

- Drackley JK et al. *J Dairy Sci* 1992; 75:1622.
- Rice DA et al. *Vet Rec* 1983; 113:495.
- Andersson L, Lyndstrom K. *Zentralbl Veterinarmed* 1985; 32:15.
- Tveit B et al. *J Dairy Sci* 1992; 75:2421–2433.
- Sanders DE. *Comp Cont Educ Pract Vet* 1989; 11:757.
- Knight CH. *Proc Nutr Soc* 2001; 60:527–537.
- Ingvarsen KL et al. *Livestock Product Sci* 2003; 83:277.
- Duffield TF et al. *Can Vet J* 1997; 38:713.
- Nielsen M et al. *Can Vet J* 1994; 35:229.
- Dohoo IR, Martin SW. *Can J Comp Med* 1984; 48:1.
- Carrier J et al. *J Dairy Sci* 2004; 87:3725.
- Geishauser T et al. *Comp Cont Educ Pract Vet: Food Anim Pract* 2001; 23:565.
- Lean JJ et al. *Vet Bull* 1991; 61:1209.
- Bigras-Poulin M et al. *Prev Vet Med* 1992; 10:79.
- Nir O. *Acta Vet Scand Suppl* 2003; 98:21.
- Uribe HA et al. *J Dairy Sci* 1995; 78:421.
- Gillund P et al. *J Dairy Sci* 2001; 84:1390.
- Heuer C et al. *J Dairy Sci* 1999; 82:295.
- Busatol A et al. *J Vet Med A* 2002; 49:455.
- Ill-Hwa K, Gook-Hyun S. *Theriogenol* 2003; 60:1445.
- Markusfeld O et al. *Vet Rec* 1997; 141:67.
- Duffield TF et al. *J Dairy Sci* 1998; 81:2866.
- Tweitt B et al. *J Dairy Sci* 1992; 75:2421.
- Dohoo IR et al. *Prev Vet Med* 1984; 2:665–671.
- Eriksson JA, Wretler E. *World Rev Anim Prod* 1990; 25:29.
- Grohn YT et al. *J Dairy Sci* 1989; 72:1876.
- Smith TR et al. *J Dairy Sci* 1997; 80:1569.
- Lean JJ et al. *Res Vet Sci* 1994; 57:200.
- Morris CA et al. *Proc N Z Soc Anim Prod* 1992; 52:21.
- Tyler JW et al. *J Am Vet Med Assoc* 1994; 204:1665.
- Geishauser T et al. *Vet Clin North Am Food Anim Pract* 2000; 16:255.
- Vagirlholm I et al. *Prev Vet Med* 1991; 10:195.
- Miettinen PVA, Setälä JJ. *Prev Vet Med* 1993; 17:1.
- Harman JL et al. *Am J Vet Res* 1996; 57:640.
- Miettinen PVA. *J Vet Med Assoc* 1994; 41:102.
- Veenhuizen JJ et al. *J Dairy Sci* 1991; 74:4238.
- Goff JP et al. *J Dairy Sci* 1997; 80:1260.
- Lacetera N et al. *Am J Vet Res* 2002; 63:958.
- Hoeben D et al. *Vet Immunol Immunopath* 1997; 58:165.
- Whitaker DA et al. *Vet Rec* 2004; 155:43.
- Laven R, Howe M. *Vet Rec* 2004; 155:63.
- Anderson L, Emanuelson LI. *Prev Vet Med* 1985; 3:449.
- Eicher R et al. *Acta Vet Scand* 1999; 60:1493.
- Nielsen N et al. *Acta Vet Scand* 2003; 98:305.
- Enjalbert FMC et al. *J Dairy Sci* 2001; 84:583.
- Carrier J et al. *J Dairy Sci* 2004; 87:3725.
- Geishauser TK et al. *J Dairy Sci* 1988; 81:438.
- Geishauser TK et al. *J Dairy Sci* 2000; 83:296.
- Osborne TM et al. *Proc Am Assoc Bov Practit* 2002; 35:188.
- Dirksen G, Breitner WJ. *Vet Med Assoc* 1993; 40:779.
- Grohn Y et al. *J Dairy Sci* 1983; 66:2320.
- DeFrain JM et al. *J Dairy Sci* 2004; 87:2486.
- Sielman ES et al. *J Am Vet Med Assoc* 1997; 210:240.
- Shpigiel NY. *J Am Vet Med Assoc* 1996; 208:1702.
- Hippen AR. *Vet Clin North Am Food Anim Pract* 2000; 16:267.
- Oerzel GR. *Comp Cont Educ Pract Vet: Food Anim Pract* 1998; 20:391.
- Gerloff B. *J Vet Clin North Am Food Anim Pract* 2000; 16:283.
- Sniffen CJ, Herdth TH. *Vet Clin North Am Food Anim Pract* 1992; 8:1:1.
- Baird GD et al. *Br Vet J* 1974; 130:214–318.
- Huxley J. *In Practice* 2004; 26:466.
- Nielsen NI, Ingvarsen KL. *Anim Feed Sci Technol* 2004; 115:191.

69. Studer VA et al. J Dairy Sci 1993; 76:2931.
70. Goff JP, Horst RL. Acta Vet Scand Suppl 3003; 98:214.
71. DeFrain JM et al. J Dairy Sci 2004; 87:4195.
72. Ballard C et al. Anim Feed Sci Technol 2001; 93:55.
73. Mandevvu P et al. Anim Feed Sci Technol 2003; 105:81.
74. Heifer YH et al. J Dairy Sci 2001; 84:1085.
75. Duffield TF, Bagg RN. Can Vet J 2000; 41:388.
76. Neilsen N, Ingvarstsen KL. Acta Vet Scand Suppl 2003; 98:306.
77. Hutjens MF. Vet Clin North Am Food Anim Pract 1992; 81:525.
78. Clark CE et al. Livestock Prod Sci 2005; 94:199.
79. Neilsen NI et al. J Dairy Sci 2005; 88:2441.
80. Larson T, Nielsen NI. J Dairy Sci 2005; 88:2004.

## PREGNANCY TOXEMIA IN SHEEP

### Synopsis

**Etiology** A multifactorial disorder of energy metabolism. Negative energy to hypoglycemia and ketonemia (the accumulation in blood of acetoacetate,  $\beta$ -hydroxybutyrate and their decarboxylation products acetone and isopropanol).

**Epidemiology** The disease in sheep is associated with a falling plane of nutrition, principally in the last month of pregnancy, in ewes bearing twins and triplets but can be induced by other stress at this time.

**Clinical findings** Sheep have encephalopathy with blindness, muscle tremor, convulsions, metabolic acidosis and a clinical course of 2–8 days, usually terminating fatally unless treated early.

**Clinical pathology** Hypoglycemia, ketonemia, ketonuria.

**Necropsy findings** None specific. Twin lambs and fatty liver.

**Diagnostic confirmation** Ketonemia, ketonuria or elevated ketones in milk. Elevated  $\beta$ -hydroxybutyrate (BHBA) in aqueous humor of dead sheep.

**Treatment** Parenteral glucose with corticosteroid and oral glucose precursors such as propylene glycol, occasionally insulin, or oral glucose and electrolyte therapy. Caesarean section or induction of parturition in sheep. Case fatality high.

**Control** Correction of energy imbalance. Flock biochemical monitoring coupled with condition scoring.

### ETIOLOGY

Hypoglycemia and hyperketonemia are the primary metabolic disturbances in pregnancy toxemia. The precipitating cause is the energy demand of the conceptus in the latter part of pregnancy but there is a great deal of variation between sheep flocks in incidence of the naturally occurring disease under conditions which appear to be conducive to its development. The most important etiological factor in pregnancy toxemia is a **decline in the plane of nutrition** during the last 4 to 6 weeks of pregnancy. This is the period when fetal growth is rapid and the demands for energy markedly increased, particularly in ewes that are carrying **twins or triplets**.

The disease also occurs in **goats** during late pregnancy with the same initiating causes.

The following classification of pregnancy toxemia is according to cause as the determination of the management cause is critical to control and prevention. These are further described below.

- Primary pregnancy toxemia
- Fat ewe pregnancy toxemia
- Starvation pregnancy toxemia
- Secondary pregnancy toxemia
- Stress-induced pregnancy toxemia.

### EPIDEMIOLOGY

#### Primary pregnancy toxemia

This is the most common manifestation and results in most flocks from a combination of a **fall in the plane of nutrition** during the latter half of pregnancy often coupled with a **short period of food deprivation** in conjunction with a management procedure in late pregnancy such as crutching, shearing, change of environment, or drenching. In pastoral sheep, the fall in the plane of nutrition can result from factors such as inadequate pasture management and improper stocking densities. In pastoral flocks, the occurrence is more common in early-lambing flocks where there is no provision for added feed in years where there is a long winter. In some outbreaks the ewes have been moved on to better pasture during late pregnancy to prevent the occurrence of ketosis but it occurs because the ewes are unaccustomed to the type of feed and do not eat well. With sheep housed in late pregnancy, the provision of poor quality hay may predispose pregnancy toxemia. A change in feed type and the feeding of moldy feed or feed contaminated with manure can also lead to decreased intake, especially with goats. Competition for inadequate trough space can also be important. Goats exhibit greater dominant/submissive characteristics than sheep and this can result in lower food intake in submissive goats in groups that are hand fed.

In all management systems, failure to identify and separate ewes bearing twins and triplets and to feed them separately from ewes bearing singles and a general failure to increase the nutritional plane of pregnant sheep in the last 6 weeks of pregnancy are predisposing factors.

#### Fat ewe pregnancy toxemia

This occurs without a stress induction in ewes that are very well fed and are in an **overfat condition in late pregnancy**. Fat ewes will experience a **voluntary fall in food intake** in late pregnancy, due to the reduction of the rumen volume by the pressure of intra-abdominal fat and the developing fetus. This can occur especially if there is reliance at this time on high

water content feeds such as silage or root crops. Traditionally, a lack of exercise is also believed to predispose this type of pregnancy toxemia. Commonly there is concurrent hypocalcemia.

#### Starvation pregnancy toxemia

This occurs in ewes that are excessively thin. It is relatively uncommon but occurs in extensive grazing systems where there is prolonged drought and no alternative feed supply and can be seen in any production system where there is mismanagement.

#### Secondary pregnancy toxemia

This usually occurs as a sporadic disease as the result of the effect of an intercurrent disease such as foot rot or foot abscess, which affects food intake. Heavy worm infestation, e.g. with *Haemonchus contortus*, would add a similar drain on glucose metabolism and increase the chances of development of the disease.

#### Stress-induced pregnancy toxemia

This is the least common cause of the disease, one where stress is the initiator. Examples are the close shepherding or housing of late-pregnant sheep of breeds not used to being housed, the transport of late pregnant sheep and outbreaks that occur following a period of flock attack by dogs.

Pregnancy toxemia occurs in ewes in the last 6 weeks of pregnancy with the peak incidence in the last 2 weeks of pregnancy. It occurs primarily in ewes carrying triplet or twin lambs.

#### Occurrence

Pregnancy toxemia occurs wherever sheep are raised but it is primarily a disease of sheep raised in intensive farming systems, either grazing or housed during the winter. In part, this is because the breeds of sheep used in intensive farming are more likely to bear twins or triplets. In contrast, sheep breeds in extensive grazing systems commonly bear single lambs and significant outbreaks of pregnancy toxemia are uncommon except where there is drought or poor pasture management. The **attack rate** in a flock varies with the nature and severity of the nutritional deprivation and the proportion of the flock at risk. It can be very high in starvation pregnancy toxemia, whereas fat ewe pregnancy toxemia is generally of sporadic occurrence. In outbreaks that follow management procedures or other stressors, clinical disease is not manifest until 48 h afterwards and new cases will develop over several days. **Intercurrent disease** in late pregnant ewes, such as foot rot or foot abscess, may predispose pregnancy toxemia.

The natural incidence in intensively farmed sheep is approximately 2% of pregnant ewes but where there are severe

management deficiencies of the disease, the disease may affect the majority of late pregnant ewes. In a study of sheep diseases in Canada, 19% of flocks were reported to have the disease.<sup>1</sup> The case fatality is high unless treatment is initiated early in the clinical course. Even with early treatment case fatality can be high.<sup>2,3</sup>

### Experimental reproduction

Hypoglycemia and ketosis can be experimentally produced in pregnant sheep by under-nourishment but the resultant syndrome has biochemical and clinical differences to spontaneously occurring pregnancy toxemia. For example, loss of appetite is an early sign in spontaneous occurring disease whereas starved experimental animals, even though hypoglycemic and ketotic, will eat feed when offered and there is debate that hypoglycemia is the primary precipitating cause of the clinical signs in the naturally occurring disease.<sup>3-5</sup>

There is a great deal of variation between sheep in the ease with which the hypoglycemia and ketosis can be produced experimentally, and in the variation in incidence of the naturally occurring disease in conditions which appear to be conducive to its development.

It is probable that the difference between sheep depends upon the metabolic efficiency of the liver

### Animal risk factors

#### Pregnancy

The disease occurs only in ewes in the **last 6 weeks of pregnancy**, usually during the last month, with the peak incidence in the last 2 weeks of pregnancy. It occurs primarily in ewes carrying **triplet or twin lambs**, although ewes bearing a single, large lamb may also be affected.

#### Parity

The disease is uncommon in maiden ewes because of their low fecundity and increases in prevalence up to parity three.

#### Breed

Breed differences largely reflect differences in fecundity and differences in management systems. Thus, the disease is more common in British lowland breeds and their crosses than the Merino. British hill-breeds are traditionally believed more resistant to the development of pregnancy toxemia in the face of nutritional deprivation of the ewe but resistance is achieved at the expense of lamb birth weight and has the penalty of higher neonatal mortality. There are however differences in the susceptibility of individual sheep that appear to be related to differences in rates of hepatic gluconeogenesis.<sup>6</sup>

### Economic significance

The economic effect of the disease is considerable. Without treatment, the

case-fatality rate can approach 100% and in individual flocks, the disease can reach a level of incidence sufficient to be classed as an outbreak. Treated ewes that recover may have dystocia and die during parturition or develop retained placenta and metritis. Flocks that experience pregnancy toxemia also have a significantly higher than normal mortality in neonatal lambs and often a severe decrease in wool quality. Flocks that experience pregnancy toxemia are predisposed to the subsequent occurrence of hypomagnesemia in the lactating period.

### PATHOGENESIS

Pregnancy toxemia results from inadequate energy intake in late pregnancy in ewes with more than one fetus. Approximately 60% of fetal growth takes place in the last 6 weeks of pregnancy. Ewes that are predisposed to the disease have an ineffective gluconeogenic response to the continued, preferential demands for glucose by the growing fetuses resulting in hypoglycemia, lipid mobilization and the accumulation of ketone bodies and cortisol. The reason for this predisposition is not known. The subsequent disease and metabolic changes are associated with excessive lipid mobilization.<sup>7-9</sup> Elevated concentrations of  $\beta$ -hydroxybutyrate further suppress endogenous glucose production and exaggerates the development of ketosis and the negative feedback of hyperketonemia on glucose production can result in a vicious circle.<sup>10,11</sup>

The disease manifest with an encephalopathy, believed to be a hypoglycemic encephalopathy resulting from hypoglycemia in the early stages of the disease.<sup>12-14</sup> The encephalopathy and the disease are frequently **not reversible** unless treated in the early stages. The onset of clinical signs is always preceded by hypoglycemia and hyperketonemia, although the onset of signs is not related to minimum blood glucose or maximum ketone levels and hypoglycemia may not be the initial precipitating cause of the syndrome.<sup>3-5</sup> In affected ewes, there is an abnormally high level of cortisol in plasma and it has been suggested that adrenal steroid diabetes contributes to the pathogenesis.<sup>5</sup>

The increase of plasma concentrations of non-esterified fatty acids results in a depression of cellular and humoral immune responses in the experimentally produced disease<sup>15</sup> but the clinical significance of this to naturally occurring disease is not clear. Renal dysfunction is also apparent in the terminal stages of ovine ketosis, and contributes to the development of clinical signs and the fatal outcome.

Those ewes which are carrying only one lamb and have been well fed prior to

a short period of undernutrition may develop a subacute syndrome both clinically and biochemically.<sup>4,9</sup>

### CLINICAL FINDINGS

#### Ovine ketosis

The earliest signs of ovine ketosis are **separation from the group**, failure to come up for feeding in pastoral animals or standing near the trough with the group of sheep but not eating, in housed animals, altered mental state and apparent **blindness**, which is manifested by an alert bearing but a disinclination to move.

The ewe will stand still when approached by attendants or dogs and will turn and face them but make no attempt to escape. It is easily captured but more difficult to restrain than normal sheep. If it is forced to move, it blunders into objects and when an obstacle is encountered, presses against it with its head. Many affected ewes stand in water troughs all day and lap the water. Constipation is usual, the feces are dry and scanty and there is grinding of the teeth.

In later stages, marked drowsiness develops and episodes of more severe nervous signs occur but they may be infrequent and are easily missed. In these episodes, **tremors** of the muscles of the head cause twitching of the lips, champing of the jaws and salivation, and these are accompanied by a cog-wheel type of clonic contraction of the cervical muscles causing dorsiflexion or lateral deviation of the head, followed by circling. The muscle tremor usually spreads to involve the whole body and the ewe falls with tonic-clonic **convulsions**. The ewe lies quietly after each convulsion and rises normally afterwards but is still blind.

In the periods between convulsions there is marked drowsiness which may be accompanied by head pressing, the assumption of **abnormal postures** including unusual positions of the limbs and elevation of the chin – the 'stargazing' posture – and incoordination and falling when attempting to walk. A smell of ketones may be detectable on the breath of the ewe.

Affected ewes usually become recumbent in 3-4 days and remain in a state of profound depression or coma for a further 3-4 days, although the clinical course is shorter in fat ewes with pregnancy toxemia. Terminally there may be a fetid diarrhea.

Fetal death occurs commonly and is followed by transient recovery of the ewe, but the toxemia caused by the decomposing fetus soon causes a relapse.

Affected ewes commonly have difficulty in lambing. Recovery may ensue if the ewe lambs or the lambs are removed by caesarean section in the early stages of the disease. In an affected flock, the disease

usually takes the form of a prolonged outbreak; a few ewes become affected each day over a period of several weeks. Recovered ewes may subsequently show a wool break.

### CLINICAL PATHOLOGY

Hypoglycemia, ketonemia, and ketonuria are characteristic of the disease. The initial changes are similar to ketosis in cattle but the sequel is not. **Hypoglycemia** can be used as a diagnostic aid in the early stages of the disease but is of limited value later in the course as by the time that sheep become recumbent, blood glucose levels may be normal or grossly elevated. This may be the result of fetal death which has been shown to remove the suppressing effect of the fetus on hepatic neoglucogenesis.<sup>6</sup>

**Ketonemia and ketonuria** are constant and serum  $\beta$ -hydroxybutyrate concentrations are in excess of 3000  $\mu\text{mol/L}$ .<sup>13</sup> Sheep develop a severe **metabolic acidosis**, renal failure with a **terminal uremia**, and become dehydrated. Liver function tests show liver dysfunction.<sup>16</sup> Elevation of plasma cortisol occurs in pregnancy toxemia and concentrations above 10 ng/mL are indicative of pregnancy toxemia,<sup>17</sup> but pregnancy toxemia and clinical hypocalcemia can both cause sufficient stress to promote such an elevation.

### NECROPSY FINDINGS

Pregnancy toxemia in ewes is almost always fatal without treatment intervention. At necropsy, there is severe fatty degeneration of the liver and there is usually evidence of constipation, but some have fetid light coloured diarrhetic feces. A large single but more commonly twin or greater number of fetuses are present. Fetuses may have died before the ewe and show autolysis.

Histopathologically there is also a poorly defined renal lesion and there may be evidence of neuronal necrosis.<sup>18</sup> The lambs may be dead and in varying stages of decomposition. Hepatic glycogen levels are usually very low. Concentrations of  $\beta$ -hydroxybutyrate in the aqueous humor or the CSF >2500 or 500  $\mu\text{mol/L}$  respectively, are supportive of a diagnosis of pregnancy toxemia.<sup>13</sup>

### DIFFERENTIAL DIAGNOSIS

#### Sheep

Pregnancy toxemia is usually suspected in late pregnant ewes which show nervous signs and die within 2–7 days and there may be a history of exertion, stress or sudden deprivation of food. Hypocalcemia can occur under similar circumstances but:

1. The onset is within 12 h of the stress
2. A considerable proportion of the flock will be affected at the same time

3. The disease is manifest with myasthenia
  4. It has a much shorter course of 12–24 h
  5. Affected animals respond well to treatment with solutions of calcium salts.
- Listeriosis
  - Cerebral abscess
  - Acidosis
  - Uterine torsion or impending abortion
  - Rabies.

### TREATMENT

#### Treatment in sheep

Sheep treated very early in the course of the disease generally respond favorably, but response to therapy is poor once sheep have become recumbent and the IV administration of 50% dextrose at this time may hasten death. Therapy requires the correction of fluid, electrolyte, and acid–base disturbances in addition to replacement therapy with glucose.

#### Parenteral therapy

Ideally, individual sheep should be examined biochemically and the corrective therapy based accordingly, with fluids, **electrolytes and glucose (dextrose)** given over a prolonged period of time. One recommendation for glucose therapy is the administration of 5–7 g of glucose IV 6–8 times a day in conjunction with 20–40 units of zinc protamine **insulin** given IM every other day for 3 days.<sup>7</sup> In many sheep-raising areas, intensive laboratory monitoring and therapy is not possible because of access, expense, or the number of sheep involved in an outbreak. In the absence of biochemical monitoring, therapy with glucose should be accompanied by the IV injection of isotonic sodium bicarbonate or lactated Ringer's solution and the administration of further fluids by a stomach tube.

Standard doses of **corticosteroids** have **little therapeutic effect** in sheep and therefore treatment with these drugs is not recommended although they are commonly used. Very large doses are effective in ewes still able to stand but the success probably rests in the removal of the glucose drain by the induction of premature parturition. Treatment with **recombinant bovine somatotrophin** (0.15 mg/kg body weight) in conjunction with dextrose and electrolytes may result in a shorter duration of treatment, improve ewe survival and result in a greater viability of lambs born<sup>4,19,20</sup> but reported results are not impressive.

#### Oral therapy

Traditionally, **propylene glycol or glycerine** (110 g/d) given by mouth is used to support parenteral glucose therapy. Less intensive therapy includes the use of propylene glycol or glycerine alone which has given excellent results for some workers but poor results for others.

Success is reported with the oral drenching, every 4–8 h, of 160 mL of a solution containing 45 g glucose, 8.5 g sodium chloride, 6.17 g glycine and electrolytes, which is available commercially as a concentrated oral rehydration solution for calves with diarrhea.<sup>21</sup> This therapy is now commonly used in the UK.<sup>22</sup> Drenching of non-pregnant sheep with this solution is followed by higher blood concentrations of glucose than those achieved following drenching with glycerol or propylene glycol. Reported recovery rates in pregnancy toxemia are 90% in early cases and 55% in advanced cases.<sup>21</sup> Vasopressin has been used to induce closure of the esophageal groove in conjunction with the oral administration of glucose. Treatment with insulin in addition to treatment with oral glucose precursors and electrolytes showed a significantly higher survival rate (87%) compared with treatment with oral glucose precursors and electrolytes alone.<sup>3</sup>

#### Caesarean

**Caesarean section** can be used as an alternate to replacement therapy. Provided ewes are in the early stages of the disease, removal of the lambs by caesarean section is probably the therapy that has the greatest success rate. The demand for glucose by the lambs is immediately removed and both the ewe and the lambs have a high chance of survival providing the caesarean section is conducted before there is irreversible brain damage in the ewe and providing the lambs are close to term. If the ewe is in the recumbent stage then her chance of survival is low. Caesarian section can still offer the chance for survival of the lambs but also less viable at this stage and may be dead. Ultrasound to determine if the lambs are alive, aids in the decision for caesarean section.

**Induction of parturition** is a further option but should only be used if the ewe is in the early stage of the disease as lambs will be delivered no earlier than 36 h after therapy, and often later. If the ewe is judged unlikely to survive this period, caesarean section is a better option. Induction with corticosteroids has been effected with dexamethasone 21-isonicotinate or the sodium phosphate form at a dose rate of 16–25 mg per ewe but dexamethasone trimethylacetate appears to be ineffective. Lambs will be born 48–72 h after injection.

Induction of parturition in normal sheep is reported with 10 mg of betamethasone or 2.5 mg of flumethasone<sup>23</sup> but there are no reports of their efficacy in sheep with pregnancy toxemia.

#### CONTROL

When clinical cases occur, the rest of the flock should be examined daily for any evidence of ketosis and affected animals

treated immediately with propylene glycol or glycerol or oral glucose/glycine/electrolyte solutions. Supplementary feeding of the flock should be commenced immediately, with particular attention given to an increase in carbohydrate intake. Cereal grain starting at 0.5 lb/head per day and increasing to 2 lb/head per day (0.25–1 kg/head per day) for large frame breeds is recommended.

### Prevention

Ensure that the plane of nutrition is rising in the second half of pregnancy, even if it means restricting the diet in the early stages. Ewes that are in condition score 2.5–3.0 on a 1.0–5.0 scale at 90 days of gestation and are in an ideal situation to respond to increased feeding in the latter part of gestation.<sup>22,24</sup> If necessary, ewes with higher condition scores at the end of the first month of pregnancy can be fed to lose 0.5 condition score during the period to the third month of pregnancy without any significant effect on the ewe or lamb size or viability. Many small farm sheep producers have sheep in too high a condition score early in pregnancy.

The last 2 months are particularly important in the prevention of pregnancy toxemia as 70% of the lamb's birth weight is gained during the last 6 weeks of pregnancy. During this period, the provision of cereal grain or a concentrate containing 10% protein at the rate of 0.25 kg/d, increasing to 1 kg/d in the last 2 weeks, has provided good protection. During this period, the ewe should gain an increase of body weight of 10% for ewes with single lambs and 18% in ewes carrying twins. For the flock this represents a flock body condition score that maintains or gains to 3.0–3.5 during this period. Higher body condition scores can result in higher birth weight of lambs but other than in stud flocks these are not economic and the standard commercial flock runs the risk of fat ewe pregnancy toxemia with higher targeted body condition scores.

At the beginning of the fourth month of pregnancy, the flock can be conditioned scored and divided into three groups; those with acceptable condition scores, those with sub-optimal condition scores, and those that are fat and the groups fed accordingly. Response should be evaluated by condition scoring at 2 weekly intervals through the fourth and fifth month of pregnancy. Maiden ewes should be fed as a separate group in order to provide for the requirement for growth in addition to the requirement for pregnancy. Attention should also be given to broken-mouthed ewes to ensure that they are maintaining an adequate body condition.

There are managerial difficulties in any nutritional program for sheep because

of the way they are husbanded. Ideally, sheep should be divided into a number of sub-flocks and fed depending on whether there are one, two or three, or no fetuses present. Ultrasound offers a method for this selection.

When feeding sheep, account needs to be taken of those ewes (and does) who are timid and for this, or other reasons, slow feeders. If supplementary feeding is practiced in a confined space, with insufficient trough space for all the flock to eat at one time, and if the feed fed is in small amounts and highly edible, a proportion of ewes will get little or no feed.

Before embarking on a nutritional support program, it is advisable to estimate cost effectiveness. In sheep breeds with low twinning rates that are well managed, it is often more profitable to do nothing and to let the disease occur in the very occasional sheep and treat it accordingly.

Sudden changes in type of feed should be avoided and extra feed provided during bad weather. Shelter sheds should be available, and in purely pastoral areas, lambing should not be planned before the pasture is well grown. A high incidence is often encountered in small, well-fed flocks where the ewes get insufficient exercise. In such circumstances the ewes should be walked 30 min daily and, if pasture is available, only concentrate should be fed so that they will be encouraged to forage for themselves.

**Flock monitoring** for latent pregnancy toxemia during the last 6 weeks of pregnancy can be conducted using serum  $\beta$ -hydroxybutyrate as an indicator with concentrations of 800  $\mu$ mol/L indicating adequate energy intake, 800–1600  $\mu$ mol/L inadequate energy intake and levels greater than 1600  $\mu$ mol/L indicating severe undernourishment. Pooled samples have been used to reduce the cost of analysis.<sup>9</sup> Serum glucose and  $\beta$ -hydroxybutyrate concentrations have been found to vary significantly between flocks within the normal range.

### REVIEW LITERATURE

- Martenuik JW, Herdt TH. Pregnancy toxemia and ketosis of ewes and does. *Vet Clin North Am Food Anim Pract* 1988; 4:307–315.
- Andrews A. Pregnancy toxemia in the ewe. In *Practice* 1997; 19:306–311.
- Rook JS, Herdt TH. Metabolic disorders of ruminants. *Vet Clin North Am Food Anim Pract* 2000; 16:293–317.

### REFERENCES

- Dohoo IR et al. *Can J Comp Med* 1985; 49:239.
- Scott P. In *Practice* 1995; 17:266.
- Henze P et al. *J Vet Med A* 1998; 45:255.
- Andrews AH et al. *Small Rum Res* 1996; 23:191.
- Sigurdsson H. *Acta Vet Scand* 1988; 29:407.
- Wastney ME et al. *Aust J Biol Sci* 1983; 36:271.
- Martenuik JV et al. *Vet Clin North Am Food Anim Pract* 1988; 4:307.
- Rook JS, Herdt TH. *Vet Clin North Am Food Anim Pract* 2000; 16:293.

- Van Saun RJ. *J Am Vet Med Assoc* 2000; 217:1536.
- Schlumbohm C, Harmeyer J. *J Dairy Sci* 2004; 87:350.
- Schlumbohm C, Harmeyer J. *J Dairy Sci* 2003; 86:1953.
- Jeffrey M, Higgins R. *J Vet Rec* 1992; 301.
- Scott PR et al. *Br Vet J* 1995; 151:587–589.
- Sargison ND et al. *Br Vet J* 1994; 150:271.
- Lacetera N et al. *Am J Vet Res* 2002; 63:958.
- West HJ. *Br J Nutr* 1996; 75:593.
- Ford EJR. *Br Vet J* 1990; 146:539.
- Jeffrey M, Higgins RJ. *Vet Rec* 1992; 301.
- Scott PR et al. *Vet J* 1998; 155:197.
- Andrews AH, Wilkinson J. *Large Anim Pract* 1998; 19:31.
- Burwell JF et al. *Vet Rec* 1986; 118:208.
- Andrews A. In *Practice* 1997; 19:306.
- Ingoldby L, Jackson P. In *Practice* 2001; 23:228.
- Russel A. In *Pract* 1985; 7:123.

## FATTY LIVER IN CATTLE (FAT COW SYNDROME, HEPATIC LIPIDOSIS, PREGNANCY TOXEMIA IN CATTLE)

Fatty liver or hepatic lipidosis is a major metabolic disease of dairy cows in early lactation and is associated with decreased health status and reproductive performance.

### Synopsis

**Etiology** Mobilization of excessive body fat to liver during periods of negative energy balance at time of parturition or in early lactation of dairy cows and late pregnancy of beef cows.

**Epidemiology** High-producing dairy cows overfed during dry period may develop fatty liver syndrome just before or after calving precipitated by any factor or disease which interferes with feed intake. Occurs in well-conditioned beef cattle in late pregnancy when energy intake suddenly decreased. Moderate and subclinical degrees of fatty infiltration may adversely affect reproductive performance of dairy cows.

**Signs** Inappetence to anorexia, ruminal atony, lethargic, inactive, ketonuria, fat body condition, weakness and recumbency if worsens. Recover if continue to eat and appetite improves.

**Clinical pathology** Increase in serum hepatic enzyme levels, increase in ketone bodies; increased fat in liver biopsy.

**Necropsy findings** Fatty infiltration of liver.

**Diagnostic confirmation** Liver biopsy.

### Differential diagnosis list

- Left-sided displacement of abomasum
- Right-sided displacement of abomasum
- Milk fever
- Parturition syndrome
- Abomasal impaction
- Vagus indigestion
- Peritonitis.

**Treatment** Fluid and electrolyte therapy including glucose IV. Propylene glycol orally. Provision of palatable feed.

**Control** Avoid overfeeding during late lactation and dry period. Avoid situations which reduce feed intake at time of parturition.



## ETIOLOGY

Fatty liver is caused by the mobilization of excessive quantities of fat from body depots to the liver. It develops when the hepatic uptake of lipids exceeds the oxidation and secretion of lipids by the liver. Excess lipids are stored as triacylglycerol in the liver and are associated with decreased metabolic functions of the liver. It occurs because of a sudden demand of energy in the immediate postpartum period in well-conditioned lactating dairy cows. It also occurs because of a sudden deprivation of feed in fat pregnant beef cattle, and is especially severe in those bearing twins. The disease is an exaggeration of what is a common occurrence in high-producing dairy cows which are in a state of negative energy balance in early lactation.<sup>1</sup> A substantial drop in voluntary dry matter intake (VMDI) is initiated in late pregnancy and continues into early lactation.<sup>2</sup> This decrease has traditionally been interpreted as caused by physical constraints which role may be over-emphasized. The decline in intake coincides with changes in reproduction status, fat mass and metabolic changes in support of lactation and metabolic signals may have an equally important role in intake regulation. These signals include nutrients, metabolites, reproductive hormones, stress hormones, leptin, insulin, gut peptides, cytokines, and neuropeptides. Body fat, especially subcutaneous is mobilized and deposited primarily in liver but also muscle and kidney. Whether or not the cow is truly fat at parturition may not be important in determining the degree of fat mobilization, but the degree of negative energy balance in early lactation is critical.

## EPIDEMIOLOGY

**Occurrence and incidence.** Fatty infiltration of the liver is common in high-producing dairy cattle from a few weeks before and after parturition and is associated with several periparturient diseases, and an increase in the calving-to-conception interval. In dairy cows, fatty liver occurs primarily in the first 4 weeks after calving when up to 50% of all cows have some accumulation of triacylglycerol in the liver. A severe form of fatty infiltration of the liver immediately before or after parturition is known as the **fatty liver** or **fat cow syndrome** or **pregnancy toxemia** of cattle which can be highly fatal. In beef cattle, the disease occurs most commonly in late pregnancy when the nutrient intake is decreased in cattle which were previously well fed and in good body condition. The prevalence of fatty liver (more than 50 mg triacylglycerol/1 g wet liver tissue) in a sample of commercial dairy herds was 54.1%.<sup>3</sup>

In a field study, the percentage of cattle dying or being culled because of disease was affected by the amount of hepatic triglyceride: 15%, 31%, and 42% for cattle with mild, moderate, and severe hepatic lipidosis, respectively.<sup>1</sup> **Outbreaks of the disease have occurred in dairy herds** in which up to 25% of all cows were affected with a case-fatality rate of 90%.

Cattle have been classified into three groups on the basis of liver fat content determined histologically 1 week after parturition.<sup>1</sup> Less than 20% lipid corresponds to less than 50 mg/g liver by weight, 20–40% lipid, 50–100 mg/g liver, and greater than 40% represents more than 100 mg/g liver.<sup>1</sup> These concentrations correspond to mild, moderate, and severe cases of fatty infiltration. Cows with less than 20% lipid in the liver at 1 week after calving are considered normal, and those with more than 20%, are considered to have a fatty liver. About 30% of high-yielding dairy cows in the UK are considered to have a fatty liver 1 week after calving. Clinical evidence of hepatic disease may not occur consistently until liver lipid concentrations are in the range of 35–45% or more.

## Risk factors

### Host factors

Fatty infiltration of the liver is part of a generalized fat mobilization syndrome which occurs in early lactation, particularly in high-yielding dairy cows, as milk production outstrips appetite and body reserves are used to meet the energy deficit.<sup>1</sup>

Diseases which occur commonly in early lactation predispose to fatty liver include **ketosis**, **left-side displacement of the abomasum**, **mastitis**, **retained fetal membranes**, **milk fever**, and the **downer cow syndrome**. Any disease of early lactation which affects appetite and voluntary intake can contribute to fatty liver.

The deficit occurs because dietary intake cannot meet the energy requirements for the high yield. Peak yields of milk are reached 4–7 weeks after calving, but the highest levels of voluntary feed intake are not reached until 8–10 weeks after calving. As a result of the energy deficit, the cow mobilizes body reserves for milk production and may lose a large amount of body weight.

In about 30% of high-producing cows, the infiltration is severe and is associated with reversible but significant effects on liver structure and function. In some populations of cows, the incidence of fatty liver is much lower and insignificant.<sup>1</sup>

The body condition score at calving can have a direct effect on the health, milk yield, and fertility of cows. It represents the cumulative effects of the dry period, the body condition score at drying off and

the loss of body condition during the dry period. The risk of retained placenta may be greater for cows underconditioned at drying, whereas cows that lost more body condition during the dry period may be more affected by both retained placenta and metritis; the two effects are independent of each other. The risk of ketosis is increased in cows overconditioned at calving, which may be due to a long dry period. Cows calving in a higher body condition score produced more milk, fat, and protein in the first 90 days of lactation and the effect was most pronounced on milk fat content. Cows with a higher body condition score at calving were less prone to anestrus but did not conceive more successfully to first service. A reduction of 6 open days in primiparous cows was estimated for each additional unit of body condition score at calving. Multiparous cows which lost more body condition during the dry period are more prone to inactive ovaries and are more likely to be open 150 days after calving in the next lactation.

Dairy cows with abnormally long, dry periods also have a tendency to become obese and develop the fatty liver syndrome of parturition. The feeding of dairy cows in large groups as in loose housing systems has been associated with an increase in the incidence of the disease. The disease has occurred in pregnant heifers within 31 days after being turned on to grass.<sup>4</sup>

The disease can occur in **non-lactating dairy cows** by the imposition of a partial starvation diet in late pregnancy in an attempt to reduce the body weight of cows which are considered to be too fat. Changing the diet of pregnant beef cows from silage to straw in an attempt to reduce their body weight and the incidence of dystocia has resulted in outbreaks of the disease.

In beef cattle in North America, the severe form of the disease, pregnancy toxemia, is seen most commonly in the last 6 weeks of pregnancy in cows which are fat and pregnant with twins. The affected cows are usually well fed until late pregnancy when an unexpected shortage of feed occurs, or the cows are too fat and cannot consume sufficient low-energy feed to meet the demands of pregnancy. Under usual circumstances, the disease in beef cattle occurs sporadically: the morbidity is about 1% but the mortality is usually 100%.

**Pregnancy toxemia** of cattle has occurred in pregnant beef cattle in Australia and the UK. First-calf heifers were more commonly affected than older cows and most were in late pregnancy (7–9 months) or had just recently calved. Cows pregnant with twins are particularly susceptible.

### *Genetics of lipid mobilization*

Cows generally mobilize body lipid reserves in early lactation and regain these reserves during subsequent pregnancy. Lipid mobilized from body reserves makes a substantial contribution to the energetic cost of milk production in early lactation. It is usually assumed that this mobilization of body energy reserves is entirely a response to a deficit in feed energy intake relative to milk energy output. This implies that increasing the energy content of the feed being offered would decrease body energy mobilization in early lactation. A number of studies indicate that this is not always the case.<sup>5</sup> A recent proposal indicates that both mobilization of body reserves in early lactation, and the subsequent gain in body reserves during pregnancy, are to a large extent genetically driven. Thus, body energy mobilization is not a response but rather a natural component of the reproductive cycle.<sup>5</sup> Ignoring this preprogrammed body mobilization has important consequences for the prediction of energy requirements and the intake necessary to meet these requirements. Most methods used to predict energy requirements are based on estimates of milk production and maintenance. They do not explicitly allow for any genetically driven body energy metabolism. Prediction of the cow's energy requirements can be substantially improved, particularly in early lactation, by incorporating genetically driven body energy mobilization.

Genetically driven body lipid change is defined as that which would occur in cows kept in an environment that was in no way constraining. It then follows that environmentally driven body lipid change is defined as that which occurs in response to an environment that is constraining. A simple method to predict the genetically driven pattern of body lipid change through pregnancy and lactation in dairy cattle has been described.<sup>5</sup> The rationale and evidence for genetically driven body lipid change have their basis in evolutionary considerations and in the hemorrhagic changes in lipid metabolism through the reproductive cycle.<sup>6</sup> The inputs required to predict body lipid changes are body lipid mass at calving (kg) and the date of conception (days in milk). Body lipid mass can be derived from body condition score and live weight.

### *Relationship between body lipid reserves and the reproductive cycle*

Based on consideration of the cyclic nature of reproductive priorities and strategies for dealing with environmental constraints, a conceptual framework describing the relationship between body lipid reserves and the reproductive cycle in dairy cattle has been developed.<sup>7</sup> Female reproductive

performance is affected by mobilization of body energy reserves. In dairy cattle, an increase rate of body energy mobilization is associated with an increase in the duration of post-calving anestrus. Also, very thin cows show a delay in post-calving return to estrus and conception rates are affected by these factors.

### *Environmental and dietary factors*

In North America, the introduction of the system of **challenge feeding** of dairy cows was associated with an increased incidence of the disease. The overall effect of the system is to provide excess energy in the diet during late pregnancy or during the dry period generally. The diets fed may contain a high percentage of the cereal grains, corn ensilage, or brewer's grains. In this system, high-energy rations are fed beginning a few weeks before parturition. The total daily amount of feed is increased by regular increments to reach a high level at parturition and peak levels to coincide with the peak in the lactation curve several weeks after parturition. This resulted in some excessively fat cows at the time of parturition, when energy demands are high. The disease has also occurred in dairy cows which were fed excessive amounts of high-energy rations throughout the dry period. In dairy herds, the fatty liver syndrome has also been associated with an increase in the incidence of milk fever, ketosis, and left-sided displacement of the abomasum, all of which are much more difficult to treat successfully because of the fatty liver.

Overfeeding during the dry period predisposes cows to accumulate fat in adipose tissue during the prepartum period.<sup>8</sup> Before parturition, adipose tissue from overfed cows has higher rates of esterification than the adipose tissue of cows fed a restricted energy intake. In the fatty liver of these overfed cows, the rate of gluconeogenesis is not optimal, which results prolongation of lipolysis, particularly during the first few weeks after parturition.<sup>9</sup> The increased lipolysis after parturition leads to a major increase in the hepatic triacylglycerol concentration and to a shift in hepatic fatty acid composition.<sup>10</sup> Unrestricted feed intake during the dry period impairs postpartum oxidation and synthesis of fatty acids in the liver of dairy cows.<sup>11</sup>

In Australia, only beef cattle have been involved in pregnancy toxemia; the fat and the obese are most commonly affected. The disease occurred most notably when there was a shift to autumn calving (February to April) when feed supplies were low because of low, late summer rainfall. The cows were in good to fat body condition because of lush

pastures in the spring and early summer, but by autumn when the calving season approached, the feed supplies were low and the nutritive value of the pasture inadequate. The lack of feed combined with the expensive nature of supplementary feeding resulted in an inadequate level of nutrition during late pregnancy. Similarly, the control of internal parasitism, especially ostertagiasis, is not intensively practiced. The morbidity is usually from 1 to 3% but may be as high as 10% and the disease is usually fatal.

### **PATHOGENESIS**

Fatty liver is associated with a negative energy balance which is essentially universal in dairy cow in the first few weeks of lactation.<sup>12</sup> Most cows adapt to the negative energy balance through an intricate mechanism of metabolic adaptation. Fatty liver develops because of failure of these adaptive mechanisms. Under normal physiological conditions, the total amount of fat increases in the liver beginning a few weeks before calving, rises to an average of about 20% (of wet weight basis) 1 week after calving and declines slowly to the normal level of less than 5% by 26 weeks after calving. However, the levels vary from almost none to 70% among cows 1 week after calving. Fat mobilization begins about 2–3 weeks before calving and is probably induced by a changing hormonal environment prior to calving rather than an energy deficit. After calving, there is a larger increase in fat accumulation. The changes in the liver in dairy cows are functional and reversible and related to the metabolic demands of late pregnancy and early lactation. In experimentally induced fatty liver in periparturient dairy cows the capacity for hepatic gluconeogenesis before parturition is much lower than in cows without fatty liver.<sup>13</sup> The low glucogenic capacity leads successively to low blood glucose concentrations, low insulin levels and high rates of mobilization of fatty acid, causing severe hepatic lipidosis. In subclinical fatty liver in cows, lower plasma glucose and higher mean plasma NEFA concentrations were closely related to the amount of triglyceride in the liver, and cows with increasing levels of triglyceride in the liver are less capable of maintaining concentrations of glucose and NEFAs within a small margin.<sup>14</sup> Also insulin loses its regulatory control on the glucose concentration and the accumulation of triglyceride in the liver of the early lactating cow.

Fatty liver develops when the uptake of lipids exceeds the oxidation and secretion of lipids by the liver. Excess lipids are stored as triacylglycerol in the liver and are associated with decreased metabolic functions of the liver.<sup>1</sup> Non-esterified

fatty acids (NEFAs) incorporated into the liver and secreted as very low-density lipoproteins, or, alternatively, are oxidized in mitochondria and peroxisomes. In cattle, the major site for fatty acid synthesis is adipose tissue, not the liver. The ability to secrete hepatic triglycerides as very low-density lipoproteins is very low compared with non-ruminant animals.<sup>15</sup> When the amount of incorporated NEFA oxidation exceeds the amount secreted as triglycerides, by and oxidized in the liver, triglycerides accumulate in the liver and fatty liver develops. During the peripartum period, plasma concentrations of steroid hormones are considerably altered to adapt to the transition from the pregnant, non-lactating state to the non-pregnant, lactating state. The hormonal alteration, particularly of estradiol (E2) and glucocorticoids, is thought to be an additional factor for fatty liver development.

Lipoproteins consist of lipids and apoproteins. Lipoprotein lipid concentrations are quickly altered by conditions such as time of feeding, whereas apoprotein concentrations are relatively stable, thereby providing apoprotein concentrations and enzyme activity as diagnostic markers for fatty liver and related diseases. Apolipoproteins (apo) include apoB-100, apoA-I, apoC-III, lecithin:cholesterol acyltransferase, haptoglobin and serum amyloid A (apoAA). Haptoglobins and apoAA, usually categorized as acute phase proteins, are intimately related to the lipoprotein metabolism.

The apolipoproteins are decreased in are decreased in cows with fatty liver, ketosis, retained placenta, milk fever, and the downer cow syndrome.<sup>15</sup>

The gradual increase in plasma non-esterified fatty acids (NEFAs) during the final prepartum days may explain the gradual depression in dry matter intake and a contributing factor to triglyceride accumulation in the liver.<sup>1,12</sup> During this period there is also an elevated level of plasma glucose and a lowered plasma  $\beta$ -hydroxybutyrate (BHBA) concentration. The serum levels of lecithin:cholesterol acyltransferase activity in spontaneous cases of fatty liver in cows are also decreased, which may be associated with reproductive performance because cholesteryl esters are utilized for the synthesis of steroid hormones.

The heavy demands for energy in the high-producing dairy cow immediately after parturition, or in the pregnant beef cow which may be bearing twins, result in an increased rate of mobilization of fat from body reserves, usually SC fat, to the blood which transports it to body tissues, particularly liver but also muscle and kidney. **Any decrease in energy intake**

**caused by a shortage of feed or an inability of the cow to consume an adequate amount of feed during the critical periods of late pregnancy or early lactation would result in the mobilization of an excessive amount of free fatty acids.** This results in increased hepatic lipogenesis with accumulation of lipid in enlarged hepatocytes, depletion of liver glycogen and inadequate transport of lipoprotein from the liver.<sup>1</sup> Most of the lipid infiltration of the liver in dairy cows after calving is in the form of triacylglycerols because of the increased uptake of NEFAs and a simultaneous increase in diacylglycerol acyltransferase; the activity of this enzyme is activated by fatty acids.

Ruminants may be prone to fatty liver because their hepatic tissue has limited capacity to export very low density lipoprotein.<sup>1</sup> Also, a prepartum surge of estrogen may contribute to the development of fatty liver in ruminants by increased fatty acid esterification along with limited export of triglyceride. The serum concentrations of triacylglycerol-rich lipoproteins are reduced in cattle with naturally occurring hepatic lipidosis.

During fat mobilization, there is a concurrent loss of body condition and SC adipose tissue. The degree of mobilization will be dependent on the fatness of the cow and extent of the energy deficit. Fat and thin cows respond differently to the metabolic demands of early lactation. Fat cows appear less able to utilize mobilized fatty acids and as a result accumulate esterified fat in tissues. This can adversely influence susceptibility to disease and the response of the cow to that disease imposes further metabolic demands, particularly on muscle and protein metabolism.

Both SC fat and skeletal muscle mass are decreased after calving and fat cows lose 2.5 times more muscle fiber area than thin cows. Thus, the loss of body condition is due to total tissue mobilization (protein and fat) rather than fat alone. There appears to be a higher rate of protein mobilization in fat cows than in thin cows.

The severity of fatty liver has been arbitrarily classified into severe, moderate and mild, based on the amount of triglyceride present in the hepatocytes.<sup>1</sup> Fatty infiltration of muscle also occurs and appears to be correlated with the degree of hepatic lipidosis; this condition may also be related to the weakness and recumbency seen in severe cases of cows with fatty liver syndrome. In severe hepatic lipidosis, the accumulation of triglyceride in the cytoplasm is accompanied by disturbances in hepatic structure and function which may result in hypoglycemia and ketonemia; these signs are manifested as anorexia and depression and there may be clinical evidence of nervous signs. Some

severe cases appear to develop hepatic failure, do not respond to therapy, and become weak and recumbent and die. Terminally there is a marked hyperglycemia. leukopenia has been observed in dairy cows with more than 20% liver fat in the second week after calving. This may be related to the increased incidence of postparturient diseases such as mastitis and endometritis observed in cows with subclinical fatty liver. In cows with fatty liver, there is decreased functional capacity of the polymorphonuclear cells.<sup>16</sup> However, this is not necessarily a cause-and-effect relationship. The case-fatality rate in severe cases may reach 50% or more.

Cows which are not fat initially do not develop fatty liver syndrome. Pregnant beef cows in thin body condition on pasture can become extremely emaciated and eventually recumbent and die of starvation, but they do not develop pregnancy toxemia.

The pathogenesis of the relationship between reduced reproductive performance and mild or moderately severe fatty liver in dairy cows within the first 2 weeks after calving is unclear.

#### CLINICAL FINDINGS

In dairy cattle, fat cow syndrome occurs usually within the first few days following parturition and is commonly precipitated by any condition which interferes with the animal's appetite temporarily, such as:

- Parturient hypocalcemia
- Left-sided displacement of the abomasum
- Indigestion
- Retained fetal membranes
- Dystocia.

Affected cows are usually excessively fat with body condition scores of 5/5 or higher. Excessive quantities of SC fat are palpable over the flanks, the shoulder areas and around the tailhead. The affected cow usually does not respond to treatment for some of these diseases and becomes anorexic. The temperature, heart rate, and respiration are within normal ranges. Rumen contractions are weak or absent and the feces are usually scant. Periods of prolonged recumbency are common and affected cows may have difficulty in standing when they are coaxed to stand. A severe ketosis which does not respond to the usual treatment may occur. There is marked ketonuria. Affected cows will not eat and gradually become weaker, totally recumbent and die in 7–10 days. Some cattle exhibit nervous signs consisting of a staring gaze, holding the head high and muscular tremors of the head and neck. Terminally there is coma and tachycardia.

In cattle with moderately severe fatty liver, the clinical findings are much less severe and most will recover within several

days if they continue to eat even small amounts of hay.

In fat beef cattle shortly before calving, affected cows are aggressive, restless, excited, and uncoordinated with a stumbling gait, and sometimes have difficulty in rising and they fall easily. The feces are scant and firm and there is tachycardia. When the disease occurs 2 months before calving, the cows are depressed for 10–14 days and do not eat. Eventually they become sternally recumbent. The respirations are rapid, there may be an expiratory grunt, and the nasal discharge is clear but there may be flaking of the epithelium of the muzzle. The feces are usually scant but terminally, there is often a fetid yellow diarrhea. The disease is highly fatal; the course is 10–14 days and terminally there may be coma with cows dying quietly.

In dairy cattle, there is a relationship between the occurrence of a subclinical fatty liver within the first few weeks after parturition and inferior reproductive performance due to a delay in the onset of normal estrus cycles and a reduction in the conception rate which results in an increase in the average days between calving and conception.<sup>17</sup> There may be differences in reproductive performance between cows with mild and moderate fatty livers early after calving.<sup>5,6</sup> However, an examination of the postpartum hormone profiles of cows with fatty liver did not reveal the pathogenetic mechanism of the reduced fertility. The fat cow syndrome may also be associated with an increased incidence of parturient paresis and unresponsive treatment for ketosis in early lactation.

## CLINICAL PATHOLOGY

### Serum biochemistry

The biochemical changes associated with fatty liver syndrome in cows have been described based on blood and liver samples taken from cows during abdominal surgery, transcutaneous liver biopsy, or at the abattoir immediately after slaughter.

The serum biochemical abnormalities will depend on the severity of the fatty liver. There is a significant trend toward increasing values with increasing amounts of liver fat, although there may be considerable overlap in the distribution of individual test values in a population of animals with suspected fatty liver.<sup>18</sup>

The serum biochemical abnormalities and liver tissue of 59 anorectic, ketotic, lactating Holstein heifers and cows with suspected varying degrees of fatty liver were studied retrospectively.<sup>18</sup> Only 50% of the animals required treatment for ketosis, and only 50% had serum biochemical evidence of liver diseases, as determined by the presence of a test value of two-fold or

greater than the upper limit of the reference range for at least two of the four serum tests: gamma-glutamyl transferase (GGT), aspartate aminotransferase (AST), and sorbitol dehydrogenase (SDH) activities and bile concentrations. Although cattle with severe fatty liver had significantly higher serum bilirubin concentrations and AST and SDH than cattle with less severe fatty liver, the specificity of abnormally high SDH or bilirubin concentrations for severe fatty liver was only 8%.<sup>18</sup> Abnormally high serum AST was 83% sensitive and 62% specific for severe fatty liver. Serum glucose and total carbon dioxide concentrations were significantly lower in cattle with severe fatty liver than in those with mild or moderate fatty liver. Low serum glucose or total carbon dioxide concentrations were rare in cattle without severe fatty liver. Thus the use of a single biochemical or histopathologic criterion to define severity of disease or degree of liver compromise in anorectic, ketotic cows results in misidentification of many animals.<sup>18</sup> It cannot be assumed that the same degree of fatty liver is of identical importance in cattle whose fatty liver developed under different circumstances or over a different time period.

### Milk ketones

Several cowside milk ketone tests are available for the detection of subclinical ketosis in postpartum dairy cows.<sup>19</sup> The Pink test liquid and the Ketolac test strip are highly sensitive for subclinical ketosis when used with milk. The routine testing of cows postpartum for subclinical ketosis would provide a screening test for cows in the early stages of fatty liver.

### Liver biopsy and analysis

A liver biopsy can be used to determine the severity of the fatty liver and the concentration of triglyceride and is the most reliable method of accurately estimating the degree of fatty infiltration of the liver.

The triglyceride concentration of liver in normal cows ranges from 10% to 15% on a wet weight (WW) basis.<sup>1</sup> Estimation of the lipid content of bovine liver samples obtained by biopsy may be made by biochemical or histological methods. Both methods provide reasonable estimates of liver fat content over a wide range of values. The lipid content of bovine liver is highly correlated with its specific gravity and the submersion of needle biopsy specimens into water, and copper sulfate solutions with specific gravities of 1.025 and 1.055 can be used as a test to estimate lipid content.<sup>20</sup> For routine clinical diagnosis, three solutions of specific gravities of 1, 1.025, and 1.055 can be used. Liver samples which float in all three solutions contain greater than 34% lipid, those that sink in

water but float in 1.025 and 1.055 specific gravity solutions contain less than 34% but greater than 25% lipid, whereas those that float only in 1.055 specific gravity solutions contain less than 25% but greater than 13% lipid. Samples which sink in all three solutions contain less than 13% lipid. Some limited evidence indicates that cows with liver lipid concentrations above 34% are severely affected and can be expected to have clinical manifestations of hepatic insufficiency. Those with liver lipid levels between 34% and 25% are moderately affected and might have some clinical evidence of hepatic insufficiency. Those between 25% and 13% are mildly affected, which is the range of most postpartum dairy cows without any evidence of disease. Liver lipid concentrations below 13% are inconsequential.<sup>20</sup>

### Ultrasonography of liver

Ultrasonography of the liver has been used to evaluate fatty infiltration in dairy cattle<sup>21–23</sup> and has the highest sensitivity, specificity, accuracy, and positive and negative predictive values. In the normal cow, the hepatic ultrasonogram consists of numerous weak echoes distributed homogeneously over the entire area of the liver. The echo beam gradually attenuates as it passes through the normal liver tissue. The portal and hepatic veins can be seen within the normal echotexture, and the parenchymal edges are normally visible.<sup>24</sup> In the fatty liver, there is a diffuse nature and echogenicity are roughly proportional to the volume of fat vacuoles and the amount of triglyceride in the liver.

### Hemogram

In cattle with subclinical fatty liver, there may be a leukopenia, neutropenia, and lymphopenia.

### NECROPSY FINDINGS

In severe fatal cases, the liver is grossly enlarged, pale yellow, friable, and greasy. Mild and moderate cases are usually not fatal unless accompanied by another fatal disease such as peracute mastitis. The degree of fatty infiltration in these is much less obvious. The histological changes include the occurrence of fatty cysts or lipogranulomas, enlarged hepatocytes, compression of hepatic sinusoids, a decreased volume of rough endoplasmic reticulum and evidence of mitochondrial damage.<sup>1</sup> The latter two changes are reflected in reduced albumin levels and increased activities of liver enzymes in the blood. The proportion of the various fatty acids in the liver are altered considerably. Palmitic and oleic acid proportions are higher in fatty liver cows than in normal cows, while stearic acid is lower.<sup>25</sup>

**DIFFERENTIAL DIAGNOSIS**

In **dairy cows, fatty liver** must be differentiated from those diseases which occur commonly immediately following parturition. **Left-sided displacement of the abomasum** results in a secondary ketosis, inappetence, and pings over the left abdomen.

**Retained placenta and metritis** may be accompanied by fever, inappetence to anorexia, ruminal atony and a foul-smelling vaginal discharge. A degree of fatty liver may occur in these cows, making it indistinguishable from the effects of the retained placenta and metritis.

**Primary ketosis** may occur immediately after parturition or within several days rather than at the most common time, at 6–8 weeks of lactation. Inappetence, ruminal hypotonicity, marked ketonuria and a good response to glucose and propylene glycol are characteristic.

In **beef cattle, pregnancy toxemia** before parturition must be differentiated from abomasal impaction, vagus indigestion and chronic peritonitis.

**TREATMENT**

The prognosis for severe fatty liver is unfavorable and there is no specific therapy. In general, cows with the severe fat cow syndrome which are totally anorexic for 3 days or more usually die in spite of intensive therapy. The prognosis for cases with nervous signs is very poor. Liberal quantities of highly palatable good quality hay and an ample supply of water should be provided. Those which continue to eat in increasing daily amounts will recover with supportive therapy and palatable feeds. Several different therapeutic approaches have been tried based on empirical experience.

**Fluid and electrolyte therapy.** Intensive therapy directed at correcting the effects of the ketosis and the fatty liver is required. The recommended treatment includes continuous IV infusion of 5% **glucose and multiple electrolyte solutions**, and the intraruminal administration of rumen juice (5–10 L) from normal cows in an attempt to stimulate the appetite of affected cows. Water and multiple electrolytes (10–30 L) can be administered intraruminally.

**Glucagon.** The subcutaneous injection of 15 mg/d of glucagon for 14 days beginning at day 8 post partum decreases liver triglyceride concentrations in cows older than 3.5 years.<sup>26,27</sup> Glucagon, containing 29 amino acids, is a pancreatic hormone which improves carbohydrate status of cows by stimulating hepatic gluconeogenesis, glycogenolysis, amino acid uptake and ureagenesis. The effect of glucagon on lipid metabolism is both direct and indirect

because it directly increases lipolysis in adipose tissue but indirectly decreases lipolysis by increasing concentrations of plasma glucose and insulin. Intravenous infusions of glucagon are not practical for on-farm use.

**Glucocorticoids.** Prednisolone at 200 mg IM daily for days decreased liver triglyceride concentrations.<sup>1</sup>

**Propylene glycol** given orally at 1 L/day promotes gluconeogenesis and is used for the treatment of ketosis.

**Insulin** as zinc protamine at 200–300 SC twice daily promotes the peripheral utilization of glucose.

**Outbreaks in a herd.** When outbreaks of fat cow syndrome occur in pregnant beef cattle, all remaining cows should be sorted into groups according to body conditions and fed accordingly. Excessively fat cows should be fed the best quality hay which is available with a supplement. Fat cows should be exercised by feeding them on the ground and forcing them to walk.

**CONTROL**

Control and prevention of fatty liver in cattle will depend on decreasing or eliminating most of the potential risk factors for the disease.<sup>1</sup> The early recognition and treatment of diseases which affect the voluntary dietary intake in late pregnancy and immediately after parturition is necessary to minimize the mobilization of body fat stores to meet the overall energetic requirements of the cow during the period of negative energy balance, and to maintain or increase hepatic gluconeogenesis. Diseases such as ketosis, displaced abomasum, retained placenta, acute mastitis, milk fever, and the downer cow syndrome must be treated as early as possible to avoid varying degrees of hepatic lipidosis.

**Dry matter intake and energy balance in the transition period**

The literature on dry matter intake and energy balance in the transition period of the dairy cow has been reviewed.<sup>28</sup>

The transition from late gestation to early lactation in the dairy cow is a critical period in the lactation–gestation cycle. During this period, feed intake is at the lowest level in the production cycle. In addition to the drop in feed intake there is a concurrent transition from late gestation to lactation with huge increases in energy demands. This leads to a negative energy balance which can result in ketosis or fatty liver. Voluntary dry matter intake may decrease 25% and 52% during the final 14 days of gestation for first and second parity animals and aged (third and fourth or greater) cows.<sup>28</sup> A negative energy balance can occur before parturition, and is more likely to occur in heifers than cows because heifers have a lower DMI and the additional need for energy

requirement for growth. The fall in DMI is the usual cause of a negative energy balance rather than an increase in energy requirements for fetal growth.

**Metabolic adaptations during the transition period**

The primary goal of nutritional management strategies of dairy cows during the transition period should be to support the metabolic adaptations which occur. The hallmark of the transition period of dairy cattle is the dramatic change in nutrient demands that necessitate exquisite coordination of metabolism to meet requirements for energy, amino acids, and calcium by the mammary gland after calving. Estimates of the demand for glucose, amino acids, fatty acids, and net energy by the gravid uterus at 250 days of gestation and the lactating mammary gland at 4 days post partum indicate approximately a tripling of demand for glucose, a doubling of demand for amino acids, and approximately a five-fold increase in demand for fatty acids during this period. In addition, the requirement for calcium increases approximately four-fold on the day of parturition.<sup>7</sup> The literature on the integration of metabolism and intake regulation in periparturient animals has been reviewed.<sup>2</sup>

**Glucose metabolism**

The primary homeorhetic adaptation of glucose metabolism to lactation is the concurrent increase in hepatic gluconeogenesis and decrease in oxidation of glucose by peripheral tissues to direct glucose to the mammary gland for lactose synthesis.<sup>7</sup> The major substrates for hepatic gluconeogenesis are propionate from ruminal fermentation, lactate from Cori cycling, amino acids from protein catabolism or net portal-drained visceral absorption and glycerol released during lipolysis in adipose tissue.

**Lipid metabolism**

The primary homeorhetic adaptation of lipid metabolism to lactation is the mobilization of body fat stores to meet the overall energetic requirements of the cow during a period of negative energy balance in early lactation. Body fat is mobilized into the blood stream in the form of NEFA which are used to make upwards of 40% of milk fat during the first days of lactation. Skeletal muscle uses some NEFA for fuel, particularly as it decreases its reliance on glucose as a fuel during early lactation. Given that NEFA concentrations increase in response to increased energy needs accompanied by inadequate feed intake, DMI and plasma NEFA concentrations usually are inversely related. The liver takes up NEFA in proportion to their supply but the liver

typically does not have sufficient capacity to completely dispose of NEFA through export into blood or catabolism for energy. Therefore, cows are predisposed to accumulate NEFA as triglycerides within liver when large amounts of NEFA are released from adipose tissue into the circulation.<sup>7</sup>

### Nutritional management to support metabolic adaptations during the transition period

#### Grouping strategies

The primary goal of nutritional management strategies of dairy cows during the transition period should be to support the metabolic adaptations just described. Industry-standard nutritional management of dairy cows during the dry period consists of a two-group nutritional scheme. The NRC Nutrient Requirements of Dairy Cattle, 7th ed., 2001<sup>29</sup> recommends that a diet containing approximately 1.25 Mcal/kg of NE<sub>L</sub> be fed from dry off until approximately 21 days before calving, and that a diet containing 1.54–1.62 Mcal/kg of NE<sub>L</sub> be fed during the last 3 weeks before calving. The primary rationale for feeding a lower energy diet during the early part of the dry period is to minimize body condition score gain during the dry period. During the last 3–4 weeks prepartum, a diet higher in energy and protein concentration than current NRC recommendations should be fed so that adequate nutrient intake occurs within the limits of the reduced voluntary dry matter intake.<sup>30</sup>

Supplying excessive energy to dairy cows during the early dry period may have detrimental carryover effects during the subsequent early lactation. Managing cows to achieve a BCS of approximately 3.0 at drying off rather than the traditional 3.5 is now recommended.

### Strategies to meet glucose demands and decrease NEFA supply during the transition period

**Carbohydrate formulation of the prepartum diet.** Feeding diets containing higher proportions of non-fiber carbohydrate (NCF) promotes ruminal microbial adaptation to NFC levels typical of diets fed during lactation and provide increased amounts of propionate to support hepatic gluconeogenesis and microbial protein (providing the diet contains sufficient ruminally degradable protein) to support protein requirements for maintenance, pregnancy, and mammogenesis.

**Direct supplementation with glucogenic precursors.** Propylene glycol is a glucogenic precursor which has been used as an oral drench in the treatment of ketosis. Decreased concentrations of plasma NEFA and BHBA follow oral administration of propylene glycol. The

administration of an oral drench of propylene glycol for 2 days beginning at calving decreased concentrations of NEFA in plasma and increased milk yield during early lactation. However, in general, the lack of consistent production responses does not support a recommendation for routine use.<sup>7</sup> Propionate supplements added to the diet to supply substrate for hepatic gluconeogenesis have also been used but with inconsistent results.

Glycerol given orally is an effective treatment for lactational ketosis in dairy cattle. Feeding glycerol to dairy cows from 14 days prepartum to 21 days in milk did not have the glucogenic effect attributed to it when given orally as a drench to individual cows.<sup>31</sup>

Monensin provided in controlled release capsules (CRC) administered 2–4 weeks prepartum has been shown to decrease the incidence of 'energy associated diseases' subclinical ketosis and left-side displaced abomasum by 40%, and a 25% reduction in retained placenta.<sup>32</sup> The capsule delivers 335 mg/d of monensin for 95 days. The common mechanism for reduction of the incidences of these 'energy associated diseases' is likely to be improved energy metabolism during the transition period. The net effect of monensin within the rumen is to increase ruminal propionate production at the expense of ruminal acetate and methane production so that propionate supply is increased and the overall energetic efficiency of ruminal fermentation is increased.

**Added fat in transition diets.** It has been proposed that dietary fat may partially decrease concentrations of NEFA and prevent the occurrence of ketosis. Dietary long-chain fatty acids are absorbed into the lymphatic system and do not pass first through the liver. The fat can provide energy for peripheral tissues and the mammary gland and the increased energy availability would in turn decrease mobilization of body fat and decrease NEFA concentrations. However, available evidence indicates that added fat fed to cows during the prepartum period does not decrease plasma NEFA concentrations.<sup>7</sup>

**Effects of specific fatty acids on NEFA supply.** A substantial amount of research has examined the metabolic roles of individual fatty acids in transition cow nutrition and metabolism. Feeding *trans*-10, *cis*-12 conjugated linoleic acid or *trans*-octadecanoic acid experimentally may decrease the negative energy balance but the ultimate metabolic effects in transition cows are as yet uncertain.

Because of the large economic losses associated with pregnancy toxemia in cattle, every economic effort must be made to prevent the disease. The principal method of control is to prevent pregnant

cattle from becoming fat during the last trimester of pregnancy, particularly during the dry period in dairy cattle. During pregnancy, mature cattle should receive sufficient feed to meet the needs for maintenance and pregnancy and the total daily nutrient intake must increase throughout the last trimester to meet the needs of the fetus. However, this increase is usually difficult to control without some cows getting fat and others losing weight. Sorting cows into groups on the basis of size and condition and feeding accordingly is recommended. Metabolic profiles may be used as a means of assessing energy status and correspondingly the likelihood of occurrence or otherwise of acetonemia or pregnancy toxemia. Both blood glucose and BHBA levels can be used.

**Body condition scoring of dairy cows** at strategic times can be used to monitor the nutritional status of the herd and minimize the incidence and severity of fatty liver syndrome. The scoring should be done throughout the production cycle as part of a herd health program. Scoring done at calving, at 21–40 days, and 90–110 days postpartum can be used to monitor the nutritional status of the herd. Scoring done at 100–60 days before drying off provides an opportunity for management to make appropriate adjustments in the feeding program so that optimal body condition goals are achieved. The optimum body condition score of a cow at calving which will result in the most economical amount of milk has not yet been determined. On a scale of 5, the suggested optimum score at calving has ranged from 3 to 4. The optimum score will probably depend on the characteristics of the individual herd which include type of cow, type of feedstuffs available, season of the year, environmental temperature, and the people doing the actual body condition scoring.

### REVIEW LITERATURE

Grummer RR, Mashek DG, Hayirli A. Dry matter intake and energy balance in the transition period. *Vet Clin North Am Food Anim Pract* 2004; 20:447–470.

Bobé G, Young JW, Beitz DC. Invited review: Pathology, etiology, prevention, and treatment of fatty liver in dairy cows. *J Dairy Sci* 2004; 87:3105–3124.

Friggens NC, Ingvarsen KL, Emmans GC. Prediction of body lipid changes in pregnancy and lactation. *J Dairy Sci* 2004; 87:988–1000.

Overton TR, Waldron MR. Nutritional management of transition dairy cows: Strategies to optimize metabolic health. *J Dairy Sci* 2004; 87:E105–E119.

Ingvarsen KL, Andersen JB. Integration of metabolism and intake regulation: A review focusing on periparturient animals. *J Dairy Sci* 2000; 83:1573–1597.

Friggens NC. Body lipid reserves and the reproductive cycle: towards a better understanding. *Livestock Prod Sci* 2003; 83:219–236.

- Herdth TH. Ruminant adaptation to negative energy balance influences on the etiology of ketosis and fatty liver. *Vet Clin North Am Food Anim Pract* 2000; 16:215–230.
- Katoh N. Relevance of apolipoproteins in the development of fatty liver and fatty-liver related peripartum diseases in dairy cows. *J Vet Med Sci* 2002; 64:293–307.
- Gerloff BJ. Dry cow management for the prevention of ketosis and fatty liver in dairy cows. *Metabolic Disorders of Ruminants. Vet Clin North Am Food Anim Pract* 2000; 16:283–292.
- Hippen AR. Glucagon as a potential therapy for ketosis and fatty liver. *Metabolic Disorders of Ruminants. Vet Clin North Am Food Anim Pract* 2000; 16:267–282.

## REFERENCES

1. Bobe G et al. *J Dairy Sci* 2004; 87:3105.
2. Ingvarsen KL, Andersen JB. *J Dairy Sci* 2000; 83:1573.
3. Jorritsma H, Jorritsma R. *Tijdschr Diergeneesk* 2003; 128:374.
4. Jorritsma R et al. *Livestock Prod Sci* 2001; 68:53.
5. Friggens NC et al. *J Dairy Sci* 2004; 87:988.
6. Friggens NC. *Livestock Prod Sci* 2003; 83:219.
7. Overton TR, Waldron MR. *J Dairy Sci* 2004; 87:E105–E119.
8. Rukkamsuk T et al. *J Dairy Sci* 1999; 82:1164.
9. Rukkamsuk T et al. *J Dairy Sci* 1999; 82:500.
10. Rukkamsuk T et al. *J Dairy Sci* 1999; 82:280.
11. Murondoti A et al. *J Dairy Sci* 2004; 87:672.
12. Herdt TH. *Vet Clin North Am Food Anim Pract* 2000; 16:215.
13. Murondoti A et al. *J Dairy Res* 2004; 71:129.
14. Jorritsma R et al. *Vet Rec* 2004; 155:151.
15. Katoh N. *J Vet Med Sci* 2002; 64:293.
16. Zerbe H et al. *Theriogenol* 2000; 54:771.
17. Jorritsma R et al. *Theriogenol* 2000; 54:1065.
18. Cebra K et al. *J Vet Intern Med* 1997; 11:231.
19. Geishauser T et al. *J Dairy Sci* 2000; 83:296.
20. Herdt TH et al. *J Am Vet Med Assoc* 1983; 182:953.
21. Braun U et al. *Compen ContEducVet Pract* 1996; 18:1255.
22. Mohamed T et al. *J Vet Med Sci* 2004; 66:341.
23. Acorda JA et al. *Vet Radiol Ultrasound* 1994; 35(120):400.
24. Braun U. *Am J Vet Res* 1990; 51:1522.
25. Sato H et al. *J Vet Med Sci* 2004; 66:85.
26. Bobe G et al. *J Dairy Sci* 2003; 86:3138.
27. Hippen AR. *Vet Clin North Am Food Anim Pract* 2000; 16:267.
28. Grummer RR et al. *Vet Clin North Am Food Anim Pract* 2004; 20:447.
29. National Research Council. In: *Nutrient Requirements of Dairy Cattle*, 7th revised ed. Washington DC: National Academy Press; 2001: 13–27.
30. Gerloff BJ. *Vet Clin North Am Food Anim Pract* 2000; 16:283.
31. DeFrain JM et al. *J Dairy Sci* 2004; 87:4195.
32. Duffield T et al. *J Dairy Sci* 2002; 85:397.

## EQUINE HYPERLIPEMIA

### Synopsis

**Etiology** Deranged energy metabolism secondary to inadequate caloric intake.

**Epidemiology** Pregnant or lactating middle-aged, overweight ponies, donkeys, and American Miniature horses. Worldwide. Sporadic.

**Clinical signs** Depression, anorexia, weight loss, ventral edema, muscle fasciculation, mania, recumbency.

**Clinical pathology** Hyperlipidemia (triglyceride >500 mg/dL, 5 mmol/L).

**Necropsy findings** Widespread lipidosis, swollen liver, hepatic rupture.

**Treatment** Enteral or parenteral feeding. Treat underlying disease.

**Control** Maintain optimal body condition. Prevent disease and nutritional stress including changes in diet and prolonged transportation.

## ETIOLOGY

The disease hyperlipemia is associated with hyperlipidemia (an abnormal concentration of lipids in blood). The disease is due to a derangement in fat metabolism secondary to nutritional stress.<sup>1</sup>

## EPIDEMIOLOGY

### Occurrence

The disease occurs worldwide. Although its occurrence is sporadic, multiple cases can occur on a farm. The annual incidence of the disease in ponies in southeastern Australia is 5%,<sup>2</sup> but less than 2% in donkeys in the UK.<sup>3</sup> The case-fatality rate is 40–80%.<sup>2</sup> Incidence varies with season and locality; the disease in ponies in Europe occurs most commonly during late gestation (January–March), while in southern Australia, the disease is more common in ponies during early lactation (November–January).

### Animal risk factors

The disease does not occur in full sized horses and is recognized in Shetland and other ponies, donkeys and miniature donkeys, and American Miniature Horses.<sup>4–6</sup> The disease is most common in females (90% of cases), uncommon in pony stallions and geldings, and rare in foals.<sup>1,2,5,7</sup> Most affected ponies are more than 4 years old and the peak incidence occurs in 9-year-olds.<sup>2,8</sup> In donkeys, the incidence of disease increases with age.<sup>3</sup>

Pregnancy and lactation increase the risk of the disease in ponies<sup>1,2</sup> but not in donkeys.<sup>3</sup> The disease in Miniature Horses is always associated with underlying disease, such as colic which is apparently an important risk factor.<sup>4,5</sup> Underlying disease is identified in 50% of cases in ponies, however many cases occur in pregnant or lactating mares without evidence of other disease.<sup>2,8</sup> Overweight ponies and donkeys are at increased risk, and the onset of disease is often preceded by some sort of stress, typically transport, lactation, food deprivation, or a combination of these factors.<sup>2,3</sup> Characteristically the disease occurs in fat, middle-aged, pregnant, or lactating ponies that experience a decrease in feed intake. However, the disease is not restricted to this demographic and thin ponies can develop the disease.

**Hypertriglyceridemia** is detected in horses with evidence of systemic inflam-

matory response syndrome (severe illness associated with decreased feed intake). There is no opacity of the plasma or serum and the hypertriglyceridemia has not been demonstrated to worsen the outcome of the underlying disease.<sup>9</sup>

## PATHOGENESIS

The combination of the innate insulin resistance of ponies and a nutritional stressor, such as disease, pregnancy, lactation, or food deprivation, results in excessive mobilization of fatty acids from adipose tissue at a rate that exceeds the gluconeogenic and ketogenic capacity of the liver. Adipocytes of ponies, in response to norepinephrine, release fatty acids at a rate 6.5 times greater than those of horses,<sup>10</sup> possibly providing at least a partial explanation for the difference in likelihood of differing breeds developing the disease. Lipolysis is mediated by  $\beta_2$ -adrenergic receptors in ponies and horses.<sup>11</sup> The induction of excessive fat mobilization in ponies is likely associated with the well characterized insulin resistance of this breed, especially in obese individuals.<sup>11,12</sup> There is no difference between ponies and horses in the extent to which lipolysis is inhibited by insulin.<sup>11</sup> The effect of insulin resistance on glucose uptake from the blood might be exacerbated in sick ponies by the increase in serum cortisol concentrations associated with stress or disease.<sup>12</sup>

Equids have little propensity to produce ketones and so the excess fatty acids are re-esterified in the liver to triglycerides and released into the circulation as very low-density lipoproteins (VLDL). The **fundamental defect** in the disease is in the regulation of free fatty acid release from fat stores due to a defect in control of hormone-sensitive lipase, the enzyme responsible for hydrolysis of triglycerides to free fatty acids and glycerol in adipose tissue. Unchecked activity of this enzyme results in mobilization of fatty acids in hyperlipemic ponies that is 40 times the rate in normal ponies. There is no dysfunction of lipoprotein lipase, the enzyme mediating uptake of plasma free fatty acids by extra-hepatic tissues, and its activity can be 300% of that of unaffected ponies.<sup>1</sup>

Hyperlipidemia causes widespread lipidosis and organ dysfunction.<sup>1</sup> Hepatic lipidosis compromises liver function resulting in accumulation of toxic metabolites and derangement in coagulation.

## CLINICAL FINDINGS

The clinical course varies between 3 and 22 days but is generally 6–8 days. The unchecked disease progresses from mild depression and inappetence, through profound depression, weakness and jaundice, to convulsions or acute death in 4–7 days. Depression, weight loss, and



inappetence are the initial signs in 90% of cases.<sup>2</sup> Approximately 50% of cases have fasciculation of muscles of the limb, trunk, or neck. Ventral edema unrelated to parturition occurs in approximately 50% of cases. Inappetence progresses to anorexia and the depression which is followed by somnolence and hepatic coma. Compulsive walking or mania develop in 30% of cases. Signs of mild colic, including flank watching, stretching and rolling, are evident in 60% of cases. The incidence of jaundice is variable. Many animals show a willingness to drink but are unable to draw water into the mouth and swallow. Others continually lap at water. The temperature is normal or moderately elevated and heart rate and respiratory rates are increased above normal. Diarrhea is an almost constant feature in the terminal stages.

Visual examination of the plasma or serum phase of a blood sample collected from an affected animal reveals cloudy, milky, mildly opalescent plasma.

#### CLINICAL PATHOLOGY

There is usually leukocytosis with neutrophilia. Hyperlipidemia is a consistent feature of the disease. Serum triglyceride concentrations will be at least 5 mmol/L (500 mg/dL) and may be 20 times that of normal. Serum cholesterol and free fatty acid concentrations are also increased, although less so than triglycerides. The plasma triglyceride concentration is of minimal prognostic use in ponies, but most American Miniature horses with triglyceride concentrations above 1200 mg/dL (12 mmol/L) die.<sup>5,8,13</sup>

Plasma glucose concentration is usually low. Ketonemia and ketonuria do not occur. Biochemical evidence of liver disease is characteristic of the advanced disease. Serum activity of GGT may be elevated before clinical signs of disease are apparent. Serum creatinine and urea nitrogen concentrations increase as renal function declines. Blood clotting time increases. Metabolic acidosis develops terminally. Hematological and biochemical variables may also be affected by any underlying disease.

Diagnostic confirmation of hyperlipidemia is achieved by demonstration of hyperlipidemia (plasma triglyceride concentrations above 5 mmol/L (500 mg/dL)) in a horse with appropriate clinical signs.

#### NECROPSY FINDINGS

Extensive fatty change is present in most internal organs, but especially in the liver, which is yellow to orange, swollen, and friable. Liver rupture with intra-abdominal hemorrhage may be present. Tissue pallor due to lipid accumulation is also prominent in the kidney, heart, skeletal muscle and adrenal cortex. Serosal hemorrhages of

the viscera reflect disseminated intravascular coagulation. The necropsy should also include an examination for lesions which might predispose the animal to hyperlipidemia, such as pancreatic damage or laminitis. Histologically, widespread microvascular thrombosis as well as intracellular lipid in various tissues are evident.

#### Samples for postmortem confirmation of diagnosis

Formalin-fixed liver, kidney, heart, adrenal, skeletal muscle, and pancreas for light microscopic examination.

#### DIFFERENTIAL DIAGNOSIS

- Parasitism
- Anemia
- Liver disease including pyrrolizidine toxicosis
- Serum hepatitis
- Aflatoxicosis.

Hyperlipemia should be considered in any pony with a history of weight loss, inappetence, and progressive somnolence, especially in late pregnancy or early lactation.

#### TREATMENT

The principles of treatment are:

- Treatment of the underlying or inciting disease
- Restoration and maintenance of a positive energy balance
- Correction of any defects in hydration, acid-base and electrolyte status
- Reduction of the hyperlipidemia.

Every effort should be made to determine if there is an underlying disease, and it should be treated aggressively. Parasitism is a common inciting disease, as are equine Cushing's disease and neoplasia (lymphosarcoma, gastric squamous cell carcinoma) in older ponies.

The negative energy balance must be corrected. A mature, non-pregnant, and non-lactating 200 kg (440 lb) pony has energy requirements (digestible energy intake) of 9.3 Mcal/d (38 MJ/d) whereas a lactating pony has energy requirements of 13.7 Mcal/d (57.2 MJ/d).<sup>14</sup> Affected animals should be encouraged to eat and must be supplemented either orally or intravenously if they will not eat a sufficient quantity. Supplements, either oral or intravenous, are unlikely to meet all the animal's energy requirements, but normalization and stabilization of blood glucose concentrations, and the apparent consequent changes in hormonal milieu, inhibit lipolysis and enhance clearance of triglycerides from plasma and hepatic and renal tissues.

Oral supplementation using commercial equine or human enteral nutrition preparations has been successful for treatment of the disease in American Miniature

horses and donkeys.<sup>4</sup> If these products are not available, a home made gneel consisting of alfalfa pellets and cottage cheese can be used.<sup>4</sup> These preparations are administered every 6 h through a nasogastric tube. Alternatively, glucose can be given orally (1 g/kg, as 5% solution every 6 h, about 5 L to a 250 kg pony) or intravenously (5% solution, 100 mL/kg per day as a continuous intravenous infusion). As noted above, this dose of glucose will not meet the energy needs of the pony but might be sufficient, along with treatment of the underlying disease and supportive care, to restore normal fat metabolism. Provision of parenteral nutrition is feasible and apparently effective, but expensive and technically demanding thereby restricting its use to veterinary hospitals.

Mares in late pregnancy should be aborted and lactating mares should have the foal removed.

Dehydration and abnormalities in electrolyte and acid-base status should be corrected by oral or IV administration of isotonic fluids (lactated Ringer's solution) and, if necessary, sodium bicarbonate.

Encephalopathy associated with liver failure should be treated with oral neomycin (20 mg/kg, every 6 h) or lactulose (1 mL/kg, every 6 h).

Hyperlipidemia should be reduced by minimizing free fatty acid production by adipose tissue and enhancing triglyceride removal from plasma. Free fatty acid production is minimized by insuring adequate energy intake and normal plasma glucose concentrations. Use of insulin and heparin has been recommended for reduction of plasma free fatty acids concentration. However, the efficacy of these treatments is not clear and the emphasis should be placed on provision of adequate energy intake rather than administration of these hormones. Insulin (protamine zinc insulin) is administered at 0.1 to 0.3 IU/kg SC every 12–24 h. Blood glucose concentrations should be monitored and the insulin dose may need to be adjusted. Heparin (40–100 IU/kg SC every 6–12 h) can be given to increase lipoprotein lipase activity and promote the clearance of triglycerides from plasma. It should be noted that lipoprotein lipase activity is not deficient in affected ponies<sup>8,10</sup> and therefore the administration of heparin to ponies with hyperlipidemia is not recommended. Severely affected ponies may have an increase in clotting time that could be exacerbated by heparin.

Corticosteroids and adrenocorticotrophic hormone are contraindicated in treatment of this disease.

#### CONTROL

A mature, non-pregnant and non-lactating 200 kg (440 lb) pony has energy require-

ments of 9.3 Mcal/d (38 MJ/d) whereas a lactating pony has energy requirements of 13.7 Mcal/d (57.2 MJ/d) and every effort should be made to meet these requirements.<sup>14</sup> This might require dietary supplementation during periods of nutritional stress, such as drought, late pregnancy, peak lactation, or transportation. Ponies should be maintained in optimal body condition, and nutritional stress avoided. A parasite and disease control program should be instituted. Transport of pregnant and lactating ponies should be avoided.

#### REVIEW LITERATURE

Hughes KJ et al. Equine hyperlipemia: a review. *Aust Vet J* 2004; 82:136.

#### REFERENCES

1. Watson TDG, Love S. *Comp Cont Educ Pract Vet* 1994; 16:89.
2. Jeffcott LB, Field JR. *Aust Vet J* 1984; 62:140.
3. Reid SW, Mohammed HO. *J Am Vet Med Assoc* 1996; 209:1449.
4. Moore BR et al. *J Vet Intern Med* 1994; 8:376.
5. Mogg TD, Palmer JE J. *Am Vet Med Assoc* 1995; 207:604.
6. Schotman AJH, Wagenaar G. *Zentralbl Veterinarmed* 1969; A16:1.
7. Hughes KJ et al. *Aust Vet J* 2002; 80:350.
8. Watson TDG et al. *Vet Rec* 1992; 131:48.
9. Dunkel B, McKenzie HC. *Equine Vet J* 2003; 35:590.
10. Breidenbach A et al. *J Vet Med A* 1999; 46:39.
11. Carrington EF et al. *Comp Biochem Physiol A* 2003; 136:311.
12. Jeffcott LB, Field JR. *Vet Rec* 1985; 116:461.
13. Hughes KJ et al. *Aust Vet J* 2003; 81:260.
14. Ott EA. *Nutrient requirements of horses*. Washington, DC: National Research Council 1989; 5.

#### STEATITIS

Generalized fat necrosis and steatitis occur rarely in foals.<sup>1,2</sup> The cause is unknown. There are widespread inflammatory changes in adipose tissue which are characterized clinically by firm plaque-like swellings under the skin. Panniculitis, an unusual form of steatitis limited to the subcutaneous tissues has been reported in an aged pony mare.<sup>1</sup> Generalized steatitis has also been reported in an adult pony mare.<sup>2</sup> The affected animal had lost weight in spite of having a normal appetite. Soft swellings 2–4 cm in diameter may be present under the skin of the abdominal wall and over the back. Hard plaque-like swellings may also be present over the upper cervical area. Polypnea and dyspnea may be present and ventral abdominal edema and fever may be present. Biopsy of some of the SC swelling reveals histopathological evidence of fat necrosis with mineralization. At necropsy, the SC fat is hard, dry, and yellow-white with areas of necrosis forming abscess-like lesions up to 3 cm deep and 10 cm in diameter. The fat lining the abdominal wall may contain firm yellow-white and red

tissue nodules up to 3 cm in diameter. Generalized steatitis with fat necrosis ('yellow fat disease') has been recognized in many species at various ages and is thought to be related to a dietary deficiency of vitamin E and selenium along with an intake of polyunsaturated fatty acids.

#### REFERENCES

1. Dyson S, Platt H. *Equine Vet J* 1985; 17:145.
2. Taylor FGR et al. *Vet Rec* 1988; 122:349.

#### NEONATAL HYPOGLYCEMIA

##### Synopsis

**Etiology** Insufficient milk ingestion by newborn piglets in their first few days of life or piglets affected with any disease which interferes with milk intake or that have enteropathy and are unable to digest milk.

**Epidemiology** Most common in piglets under 3 days old. Sows have insufficient milk. Morbidity 30–70%; mortality 100%. Occurs in twin or triplet lambs exposed to hypothermia. Occurs rarely in calves with diarrhea. Occurs in premature foals.

**Signs** Incoordination, shivering, dull, plaintive squeal, cold periphery, pale skin, weak, recumbent, terminal convulsions, and death.

**Clinical pathology** Hypoglycemia.

**Necropsy findings** No gross lesions.

Stomach may be empty.

**Diagnostic confirmation** Response to treatment with glucose.

##### Differential diagnosis list

##### Piglets

- Coliform septicemia
- Transmissible gastroenteritis
- Viral encephalomyelitis
- Other septicemias.

##### Lambs

- Watery mouth disease
- Hypothermia.

##### Calves

- Coliform septicemia
- Bacterial meningitis
- Dehydration and acidosis associated with enterotoxigenic colibacillosis.

**Treatment** IV or IP glucose solutions.

**Control** Insure adequate colostrum and milk intake for newborn piglets, lambs, and calves.

#### ETIOLOGY

An inadequate intake of milk is the primary cause of hypoglycemia in piglets. This may be due to failure of the sow's milk supply or to failure of the piglets to suck. Failure to suck may be due to such diseases as coliform septicemia, TGE, streptococcal infections, myoclonia congenita, and hemolytic disease of the newborn.<sup>1</sup> Piglets under 4 days old rapidly develop hypoglycemia under fasting conditions; older pigs do not.<sup>2</sup>

In piglets affected with transmissible gastroenteritis (TGE), there is decreased digestion of lactose, reduced absorption of glucose following the severe and diffuse intestinal villous atrophy and, combined with the low-energy reserves of the newborn piglet, severe hypoglycemia can occur.<sup>3</sup> Hypoglycemia may occur in newborn calves with acute severe diarrhea and when they are deprived of milk or a source of carbohydrates for more than a few days.

Hypoglycemia occurs in twin or triplet lambs which become hypothermic after 12 h of age.<sup>4</sup>

#### EPIDEMIOLOGY

**Newborn pigs** encounter several challenges to their survival during the initial hours of life. One is the inherent problem of glucose homeostasis with the first day of life being the most critical period. Liver glycogen is rapidly depleted postnatally (12–24 h) for the maintenance of blood glucose. Little insulation against heat loss is provided by the sparse hair coat and the 1–2% total body fat at birth. There is only a small amount of carcass fat and no brown fat, and consequently the piglet is dependent almost exclusively on carbohydrate metabolism for subsistence. Therefore, maintenance of the physiologically critical energy metabolite, glucose, depends on the ability of the neonatal pig to compete with its littermates for regular nourishment from its dam.

**Neonatal hypoglycemia in piglets** occurs primarily during the first 3 days after birth. The disease has been recorded mainly from North America and the UK. Most affected piglets die if left untreated; the morbidity is usually 30–70% and may be as high as 100% in individual litters. Apart from deaths due to hypoglycemia, many piglets are too weak to avoid the sow and are killed by overlaying. Piglets which fail to ingest sufficient colostrum or milk because of a failure of the sow's milk supply or because of an inability of the piglet to suck normally are the most common primary circumstances. A secondary determinant occurs when piglets affected with an enteritis, such as transmissible gastroenteritis, are unable to properly digest the lactose in milk and absorb sufficient glucose.

**Hypoglycemia occurs in twin and triplet lambs** which may be immature or undersized and are subjected to cold exposure and hypothermia.<sup>4</sup> About 50% of the total lipid present in the newborn lambs is in the adipose tissue in the form of brown fat which is used by the lambs for non-shivering thermogenesis during the first 24 h following birth.<sup>5</sup> However, the lipid content of newborn lambs can vary from 1.5 to 4.5% of birth weight and

small lambs have low levels. Neonatal viability of lambs decreases as birth weight decreases, which may be related to their low lipid content in relation to body size.<sup>5</sup> Additional factors include mismothering and complete absence of the ewe in lambs only a few days of age.

**Hypoglycemia in calves** has been recorded as a concurrent disease with diarrhea.<sup>6,7</sup> The hypoglycemia may be secondary to the interference with absorption and digestion caused by the diarrhea. The signs are characteristic but the hypoglycemia does not respond to glucose therapy as quickly, if at all, as in other species.<sup>6</sup> However, hypoglycemia in diarrheic calves is not considered to be a significant problem if affected calves receive a supply of milk or milk replacer during the convalescent period.

**Hypoglycemia occurs in foals** which are born prematurely and unable to suck the mare, those with septicemias, and those exposed to hypothermia.

#### **PATHOGENESIS**

The piglet is born with liver glycogen levels which may be as high as 200 mg/g WW, while muscle glycogen may reach 120 mg/g WW. The blood glucose level at birth is low at 30–60 mg/dL (1.66–3.33 mmol/L) and increases rapidly after feeding on colostrum to 95 mg/dL (5.25 mmol/L).<sup>8</sup> Satisfactory gluconeogenesis does not develop in piglets until the 7th day after birth, and during this period glycogen stores are likely to be rapidly exhausted if the intake of milk is restricted. The blood glucose level is then extremely unstable and dependent entirely upon dietary sources. The first week of life is thus the danger period.<sup>1</sup> Deprivation of food after this produces only loss of weight and has no effect on blood glucose levels. This particular susceptibility to hypoglycemia in the early postnatal period seems to be characteristic of the pig and may play a major role in causing losses in piglets by contributing to the effects of various infectious and non-infectious agents.

Signs appear first when blood glucose levels fall to about 50 mg/dL (2.775 mmol/L), although further depression to levels as low as 7 mg/dL (0.388 mmol/L) has been observed. Even in such extreme cases, complete recovery is possible after the administration of glucose.<sup>1</sup> The hypoglycemic comatose state induced in piglets by fasting occurs as blood glucose values fall below 40 mg/dL (2.2 mmol/L).<sup>3</sup> Experimental hypoglycemia produced by the injection of insulin causes a clinical syndrome similar to that of the naturally occurring disease.

In piglets with TGE, the blood glucose levels decreased from a normal of

119 mg/dL (6.6 mmol/L) to 36 mg/dL (2.0 mmol/L).<sup>9</sup> This hypoglycemia coincides with the onset of lethargy followed by a comatose state in a few hours.

#### **CLINICAL FINDINGS**

The disease is most characteristic in piglets under a few days of age. Incoordination is apparent first and the piglet has progressive difficulty in maintaining balance until recumbency becomes permanent. There is shivering, dullness, and anorexia, and often a typical weak squeal. A characteristic feature is the subnormal rectal temperature and the cold, clammy skin which also evidences marked pallor and ruffling of the hair. The pallor is related to the failing circulation. The heart rate becomes increasingly feeble and slow and may fall as low as 80/min. In many cases, there are few additional signs but convulsions are recorded as a common occurrence by some observers.<sup>1</sup> These vary from aimless movements of the head and forelimbs to severe tetanic convulsions. In the latter, there are violent galloping movements, particularly with the hindlegs, opisthotonos, and champing of the jaws. Tortuous movements and rigidity of the neck and trunk also occur. Terminally, coma develops and death follows 24–36 h after the onset of signs. The clinical findings are similar in other species with weakness, incoordination, hypothermia, eventual recumbency, and coma being characteristic. The nervous signs are most common in the piglet and not seen in the other species.

#### **CLINICAL PATHOLOGY**

Blood glucose levels of less than 50 mg/dL (2.8 mmol/L) in piglets are considered to indicate clinical hypoglycemia. The hypoglycemic comatose state induced in piglets by fasting occurs as blood glucose values fall below 40 mg/dL (2.2 mmol/L).<sup>3</sup> Significant rises in blood non-protein nitrogen and urea nitrogen are often observed but appear to be related to catabolism rather than to renal dysfunction.<sup>10</sup>

In calves with acute severe diarrhea, the blood glucose may fall to below 40 mg/dL (2.2 mmol/L) in 30–50% of cases.<sup>7</sup>

#### **NECROPSY FINDINGS**

There are no visible lesions. Absence of curd in the stomach is good contributory evidence of lack of intake of milk but in many cases, it will be obvious that some milk was consumed. Hepatic glycogen levels are usually negligible.

#### **TREATMENT**

Piglets with primary hypoglycemia should be given glucose (15 mL of 20% solution) IP, repeated every 4–6 h until the animal will suck a foster dam or drink

#### **DIFFERENTIAL DIAGNOSIS**

Unless blood glucose levels are estimated, the predominantly nervous signs may lead to an error in diagnosis. However, hypoglycemia and a good response to treatment with glucose may occur when the hypoglycemia is secondary to another disease. A definite diagnosis of neonatal hypoglycemia must depend on elimination of other diseases as primary causes.

##### *Piglets*

**Coliform septicemia and enterotoxigenic colibacillosis** are characterized by weakness, recumbency, collapse and dehydration. **Viral encephalomyelitis and pseudorabies** cause an almost identical clinical picture but are not restricted in occurrence to pigs less than 1 week old.

**Bacterial meningoenzephalitis**, including streptococcal septicemia and listeriosis, may also affect pigs of this age. Necropsy examination should make definition of viral and bacterial infections a relatively easy task.

##### *Lambs*

**Watery mouth disease** is characterized by weakness, drooling from the mouth, hypothermia, distended fluid abdomen and hypoglycemia.

##### *Foals*

**Premature foals** born several days before term, are weak and unable to stand and suck, and are hypoglycemic.

**Septicemias** occur in foals born at term and are characterized by depression, failure to suck, inactivity, fever, dehydration, petechiation, and death in several hours if not treated intensively.

an artificial diet. Protection from cold is important and an environmental temperature of 27–32°C (80–90°F) will improve the survival rate of piglets.<sup>10</sup> The combined use of oral fluid therapy and the IP administration of 5% dextrose at a rate of 25 mL/kg body weight to piglets affected with hypoglycemia associated with TGE did not correct the hypoglycemia.<sup>9</sup> A newborn piglet weighing 1250 g requires 170 kcal (711 kJ) per day when maintained at 30°C (88°F); 30 mL of a 5% dextrose solution would provide approximately 1.5 g of glucose, which would yield only 5.6 kcal (23 kJ) per dose. It would be difficult to provide the energy requirements by parenteral administration of 5% dextrose because the amount of fluid injected per day should not exceed 8% of their body weight.<sup>9</sup>

Hypoglycemia and hypothermic lambs can be resuscitated by an IP injection of a 20% solution of glucose at a rate of 10 mL/kg body weight followed by rewarming the air at 40°C (104°F).<sup>11</sup>

#### **CONTROL**

Avoidance of the causative factors described earlier constitutes prevention.

Piglets should be carefully observed during the first week of life for early signs of any disease and treatment instituted promptly. Maintenance of a stable environmental temperature at 32°C (90°F) may delay the onset of the disease, or in marginal circumstances prevent its occurrence.

Lambs require between 180 and 210 mL colostrum/kg body weight during the first 18 h after birth in order to provide sufficient energy for heat production.<sup>12</sup> The administration of colostrum at a rate of 30 mL/kg body weight within a few minutes after birth, directly into the stomach using a catheter and syringe, is recommended to boost the energy supply of the small lamb.<sup>5</sup> Ewes which are well fed during late pregnancy produce more colostrum than their lambs need, those with singletons have enough for a second lamb, but in most underfed ewes, the lamb requirements for colostrum exceed the ewe's production. Colostrum can be readily obtained by milking those ewes with excess production. The effects of feeding ewe colostrum, cow colostrum, or ewe milk replacer, on plasma glucose in newborn lambs have been compared.<sup>13</sup> Both ewe and cow colostrum resulted in a two-fold increase in plasma glucose within 1–3 h; the milk replacer caused marked hyperglycemia.

## REFERENCES

1. Goodwin RFW. *Br Vet J* 1955; 111:301.
2. Goodwin RFW. *Vet Rec* 1957; 69:1290.
3. Drolet R et al. *Can J Comp Med* 1984; 48:282.
4. Eales FA et al. *Vet Rec* 1982; 110:118.
5. Robinson JJ. *Livestock Prod Sci* 1981; 8:273.
6. Tennant B et al. *Cornell Vet* 1968; 58:136.
7. Lewis LD et al. *Am J Vet Rec* 1975; 36:413.
8. Mersmann HJ. *J Anim Sci* 1974; 38:1022.
9. Drolet R et al. *Can J Comp Med* 1985; 49:357.
10. Morrill CC. *Am J Vet Res* 1952; 13:164, 171, 322, 325, 327.
11. Eales FA et al. *Vet Rec* 1982; 110:121.
12. Mellow DJ, Murray L. *Vet Rec* 1986; 118:351.
13. Eales FA et al. *Vet Rec* 1982; 111:451.

## POSTPARTURIENT HEMOGLOBINURIA IN CATTLE

### Synopsis

**Etiology** Dietary phosphorus deficiency. Feeding cruciferous plants. May occur in copper deficiency area. Ingestion of cold water.

**Epidemiology** High-producing dairy cows, 2–4 weeks after calving. Feeding cruciferous crops. Copper deficient area.

**Signs** Hemoglobinuria, inappetence, reduced milk production, pallor of mucous membranes, tachycardia, dyspnea, icterus late stages. Death may occur. Recovery takes several days.

**Clinical pathology** Low serum inorganic phosphorus, low packed cell volume (PCV), dark red urine.

**Necropsy findings** Icterus, hepatomegaly, red urine in bladder.

**Diagnostic confirmation** Low serum phosphorus, low PCV, hemoglobinuria.

**Differential diagnosis** (See Table 20.3).

**Treatment** Whole blood transfusion. Sodium acid phosphate IV. Dicalcium phosphate orally.

**Control** Ensure adequate intake of dietary phosphorus and copper.

## ETIOLOGY

In North America, diets low in phosphorus or unsupplemented with phosphorus are usually associated with the disease in dairy cattle. In New Zealand, one form of the disease may be related to copper and selenium nutrition.

The feeding of cruciferous plants has been associated with the disease<sup>1</sup> but many cases occur unassociated with such diets and their role as a cause is uncertain. The current hypothesis is that ingested hemolytic agents, some of them identified, for example in rape, some of them not, cause erythrocyte lysis in some circumstances.

## EPIDEMIOLOGY

Only adult cows develop the typical hemolytic syndrome, usually in the period 2–4 weeks after calving. High-producing dairy cows in their third to sixth lactations are most commonly affected. The disease does not occur commonly in beef cattle. Phosphorus-deficient soils and drought conditions are considered predisposing causes, and the disease is often a problem on particular farms. In areas of severe phosphorus deficiency, the disease may occur at pasture, but in Europe and North America, it is more common during prolonged periods of housing.

Although this disease has been observed in many countries, its relatively low incidence makes it a minor disease. The case-fatality rate may be as high as 50% but only one or two animals in a herd are affected at a time.

Experimental production of the disease in one cow has been reported after feeding a low phosphorus diet for three successive pregnancies.<sup>2</sup> However, other signs of phosphorus deficiency occurred 18 months before hemoglobinuria developed, and the case responded well to supplementary feeding with bone meal. A prolonged hypophosphatemia is thus considered to be a predisposing cause. For example, in a group of animals in which the disease occurs, the dry cows and yearlings may have normal serum inorganic phosphorus levels, milking cows are in the low-normal range, and cows which have calved within the preceding 2 months have low levels.

In New Zealand, two distinct forms have been observed.<sup>1</sup> In one situation,

young cattle at about 2 years of age are affected with subclinical anemia of the Heinz-body type and hypophosphatemia is not a feature. In the other, the North American type of the disease is also seen in which older mature high-producing cows are affected and hypophosphatemia is common in the affected animals and in healthy herd mates.<sup>1</sup> In New Zealand, copper deficiency is considered an important etiological factor because copper supplementation reduces the incidence of the disease in herds in marginally copper-deficient areas.<sup>3</sup> The particular circumstances in which the erythrocytes of a cow become more sensitive than normal to these hemolysins include hypophosphatemia and hypocupremia, and in New Zealand possibly in selenium deficiency.<sup>1</sup> However, no abnormality in copper status is present in most cases of postparturient hemoglobinuria in other countries. Low levels of copper in the blood and liver of cows with the Heinz-body anemia and in the pasture grazed are also observed. The low copper status appears to be related to the application of molybdenum and lime.

The ingestion of cold water or exposure to extremely cold weather may precipitate an episode of hemoglobinuria.<sup>4</sup> A similar condition accompanied by hypophosphatemia has been observed in late pregnancy in Egyptian buffalo<sup>5</sup> and in the postparturient period in Indian buffalo.<sup>6</sup>

Cases may also occur when cows graze rape, turnips, or other cruciferous plants or when large quantities of beet pulp are fed. These diets are normally low in phosphorus, beet pulp (0.10% dry matter) and turnips (0.22% dry matter).

## PATHOGENESIS

There is an association with hypophosphatemia and a low dietary intake of phosphorus, and it is presumed that the drain of lactation causes further depletion of phosphorus reserves. The dependence of mammalian red blood cells on glucose metabolism for the main source of energy for viable function and structure makes them highly vulnerable to factors inhibitory to the glycolytic pathways. Hypophosphatemia results in a decrease in red blood cell glycolysis and adenosine triphosphate (ATP) synthesis. Subnormal concentrations of ATP predispose red blood cells to altered function and structure, a loss of normal deformability, and an increase in fragility and hemolysis with resultant hemoglobinemia and hemoglobinuria.<sup>7,8</sup> The changes in the red blood cells are irreversible and the lifespan of the cells is probably diminished because they are unable to regain their previous structure and function. Copper and

selenium may be important because they are commonly deficient in feedstuffs. Both copper and selenium may also provide some protection against the effects of orally acquired hemolytic agents in cruciferous plants.<sup>2,9</sup> The clinical findings are those of acute hemolytic anemia and in fatal cases, death is due to anemic anoxia.

### CLINICAL FINDINGS

Hemoglobinuria, inappetence, and weakness develop suddenly and there is a severe depression of the milk yield, although in some less acute cases, the cow continues to eat and milk normally for 24 h after discoloration of the urine is evident. Dehydration develops quickly, the mucous membranes are pallid, and the cardiac impulse and jugular pulse are much augmented. A moderate temperature rise (40°C; 103.5°F) often occurs. The feces are usually dry and firm. Dyspnea may be obvious and tachycardia is common. Jaundice may be apparent in the late stages. Pica may be observed in the other animals in the group. The course of the acute disease extends from 3 to 5 days; the cow becomes weak and staggy and finally recumbent. Gangrene and sloughing of the tip of the tail or the digits has been observed occasionally. Death may occur within a few days. In non-fatal cases, convalescence requires about 3 weeks and recovering animals often show pica. Ketosis commonly occurs coincidentally.

In a herd where the disease occurs, there may be additional signs of phosphorus deficiency, although when the deficiency is marginal the general condition of the herd may be excellent. A similar acute syndrome to that described earlier, and less severe cases of anemia, may occur sporadically in animals on lush spring pasture.

### CLINICAL PATHOLOGY

In marginal phosphorus-deficient areas, normal non-lactating animals in an affected herd may have serum inorganic phosphorus levels within the normal range. Lactating cows in an affected herd may have moderately low levels of 2–3 mg/dL (0.65–0.97 mmol/L) and affected animals extremely low levels of 0.4–1.5 mg/dL (0.13–0.48 mmol/L). Erythrocyte counts and hemoglobin levels are also greatly reduced. Heinz bodies may be present in erythrocytes in the New Zealand disease.<sup>10</sup> The urine is dark red-brown to black in color and usually moderately turbid. No red cells are present in the urine. A low copper status of the blood and liver of affected cows and the pasture grazed is also recorded.<sup>11</sup>

### NECROPSY FINDINGS

The blood is thin and icterus is widespread throughout the body. The liver is swollen,

and fatty infiltration and degeneration are evident. Discolored urine is present in the bladder.

### DIFFERENTIAL DIAGNOSIS

Postparturient hemoglobinuria is characterized by an acute hemolytic anemia in cows calved within the preceding 4 weeks. Other causes of acute hemolytic anemia are not confined to the post-calving period. Laboratory examination is usually necessary to confirm the diagnosis and to eliminate hematuria as a cause of the discoloration of the urine. The differential diagnosis of red urine in cattle is summarized in Table 20.3.

### TREATMENT

A transfusion of whole blood is indicated in severe cases. A delay of 12 h often seems to lead to an irreversible state. A minimum of 5 L of blood to a 450 kg cow is recommended. This will usually suffice for up to 48 h by which time an additional transfusion may be necessary if the cow is weak and the mucous membranes pale. Following successful blood transfusions, fluid therapy is recommended as both supportive therapy and to minimize the danger of hemoglobinuric nephrosis. The administration of phosphorus to acutely ill animals should include the IV administration of 60 g of sodium acid phosphate in 300 mL of distilled water and a similar dose SC, followed by further SC injections at 12-hourly intervals on three occasions and similar daily doses by mouth. Oral dosing with bone meal (120 g twice daily) or dicalcium phosphate or a suitable source of calcium and phosphorus daily for 5 days is recommended followed by inclusion in the ration. Hematinics during convalescence are recommended. Ketosis is a common complication of the disease and additional treatment for it may be required.

### CONTROL

An adequate intake of phosphorus according to the requirements for maintenance and milk production should be insured, particularly in early lactation. A decrease in the incidence of the disease is reported after copper supplementation of cattle in a copper-deficient area.<sup>3</sup>

### REVIEW LITERATURE

MacWilliams PS et al. Postparturient hemoglobinuria: a review of the literature. *Can Vet J* 1982; 23:309–312.

### REFERENCES

1. Ellison RS et al. *N Z Vet J* 1986; 34:7.
2. MacWilliams PS et al. *Can Vet J* 1982; 23:309.
3. Smith B et al. *N Z Vet J* 1975; 23:73:109.
4. Penny RH *CVet Rec* 1956; 68:238.
5. Awad FI, El-Latif KA. *Vet Rec* 1963; 75:11:298.
6. Kurundkar VD et al. *Ind J Anim Sci* 1981; 51:35.
7. Ogawa E et al. *Am J Vet Res* 1987; 48:1300.
8. Wang XL et al. *Res Vet Sci* 1985; 39:333.

9. Wang XL et al. *Res Vet Sci* 1985; 39:373.
10. Martinovich D, Woodhouse DA. *N Z Vet J* 1971; 19:259.
11. Gardner DE et al. *N Z Vet J* 1976; 24:107.

### RHABDOMYOLYSIS OF HORSES

Rhabdomyolysis occurs in horses as a manifestation of a variety of diseases and usually, but not always, in response to exercise.<sup>1</sup> Metabolic diseases including polysaccharide storage myopathy, mitochondrial myopathy, glycogen branching enzyme deficiency in foals, or vitamin E/selenium deficiency in foals and rarely adults, and malignant hyperthermia in halothane-anesthetized horses of a particular genotype all have rhabdomyolysis as a prominent feature of their presentation. Rhabdomyolysis also occurs sporadically in response to unaccustomed exercise by horses of any breed or usage, or as a recurrent disease in Thoroughbred and Standardbred race horses. A familial syndrome of recurrent exertional rhabdomyolysis is recognized in Thoroughbred race horses. A syndrome of idiopathic rhabdomyolysis occurs in horses at pasture in Europe. There is a specific syndrome involving primarily muscles of mastication.

Acute exertional rhabdomyolysis is a rapidly evolving disease of horses manifest as signs of acute muscle damage. The sporadic disease occurs on a single occasion whereas the recurrent disease occurs repeatedly in susceptible horses. Clinical manifestations of the disease during acute episodes are identical regardless of the cause or nature (sporadic versus recurrent) of the disease.

### REFERENCE

1. Valberg S et al. *Equine Vet J Suppl* 1999; 30:533.

### SPORADIC ACUTE EXERTIONAL RHABDOMYOLYSIS IN HORSES (AZOTURIA, TYING-UP)

The disease discussed here is that of sporadic acute exertional rhabdomyolysis that occurs as a single event in a horse and does not have a tendency to recur. The recurrent disease is discussed elsewhere.

### ETIOLOGY

The etiology of most cases of sporadic acute exertional rhabdomyolysis is unknown although suggested causes include: hypothyroidism, sodium or potassium deficiency, viral infection, high carbohydrate diets, and abnormalities in metabolic function. The most common cause is performing exercise of unaccustomed intensity or duration, which can result in metabolic exhaustion and hyperthermia. However, the disease is not

always associated with severe exertion or hyperthermia, and it can occur with as little exercise as slow draft work or turn out to pasture after stabling. An important contributing factor is a prolonged period (days to weeks) of rest in a horse previously accustomed to regular exercise. The disease occurs in young horses as a result of vitamin E/selenium deficiency although this is an uncommon cause in adult horses.<sup>1</sup>

Rhabdomyolysis not associated with exercise occurs during general anesthesia maintained by inhalation of halothane in horses of a specific genotype or in horses at pasture in Europe. Rhabdomyolysis also occurs in horses with *Streptococcus equi* infection (strangles).

Recurrent exertional rhabdomyolysis is a recognized syndrome in Thoroughbred horses and is dealt with separately.

It is likely that most cases of sporadic exertional rhabdomyolysis are a result of a combination of predisposing factors with the disease precipitated by a bout of exercise. The difficulty in detecting the presence of predisposing factors contributes to the sporadic nature of the disease.

#### EPIDEMIOLOGY

The sporadic disease is almost always associated with exercise that is either enforced, as with horses in training or competition, or spontaneous, as with young horses turned out to pasture after a prolonged period of stabling. Clinical signs occur in horses within minutes to hours of the cessation of exercise, although signs can be apparent in horses during prolonged exercise. The epidemiology of the sporadic disease has not been well defined, in contrast to that of recurrent exertional rhabdomyolysis.

Interpretation of reports of prevalence and risk factors for exertional rhabdomyolysis is difficult because studies to date have mostly not differentiated between the recurrent exertional rhabdomyolysis of Thoroughbreds, polysaccharide storage myopathy of Quarterhorses and related breeds, and the sporadic disease in other breeds. The **incidence** or 1 year period prevalence of exertional rhabdomyolysis is: 1.5% in ponies in Australia; 4.9% in Thoroughbred racehorses in the USA, Australia, and Great Britain; 6.1% in National Hunt Thoroughbreds in Great Britain; and up to 13.5% in polo ponies in the USA and Great Britain.<sup>2-5</sup> Polo, racing, rodeo, Western, and show jumping are all associated with a high period prevalence (>5% per annum) of exertional rhabdomyolysis.<sup>2</sup>

**Risk factors** for exertional rhabdomyolysis include exercise, breed and use, and sex. Overall, horses that exercise are approximately 10 times more likely to

develop the disease than are sedentary horses, and among breed/use groups, polo horses are approximately 3 times more likely to develop the disease than are horses used for racing.<sup>2</sup> Horses used for racing are more likely to have episodes of the disease than are horses used for pleasure riding or 'other' uses,<sup>2</sup> although racing and breed (Thoroughbred or Standardbred) are confounding factors. Female race horses are three times more likely to have episodes of exertional rhabdomyolysis than are male (intact or castrated) race horses,<sup>2,6</sup> and young, female Thoroughbreds are at greatest risk.<sup>2,3,6</sup> Among National Hunt horses in Great Britain, females are 24 times as likely to have an episode of the disease as are males.<sup>5</sup> Female polo ponies are not more likely to develop the disease.<sup>4</sup> Thoroughbred racehorses and polo ponies, but not National Hunt horses, with a nervous or 'flighty' temperament are more likely to experience episodes of the disease.<sup>2,4-6</sup> Other apparent risk factors include a rest day before hard exercise,<sup>2,4</sup> feeding >4.5 kg of grain per day,<sup>2</sup> lameness,<sup>2</sup> playing polo at a level for which the horse is not fit,<sup>4</sup> and playing early in the season.<sup>4</sup>

The disease occurs repeatedly in 74% of affected Thoroughbred race horses in Great Britain<sup>6</sup> and in 20% of affected polo ponies.<sup>4</sup>

The disease is of considerable **economic impact** because of its frequent occurrence in athletic horses, recurrent nature, and need to rest affected horses. On average, affected Thoroughbred race horses cannot train for 6 days after an episode, and approximately two-thirds of affected horses are unable to race because of the disease.<sup>3,6</sup> Polo ponies lose an average of 7 days of training after an episode of exertional rhabdomyolysis.<sup>4</sup> The effect of the loss of training days for each episode is magnified because of the recurrent nature of the disease in a large proportion of affected horses. Approximately 6% of the wastage of Thoroughbred race horses in Australia is attributable to exertional rhabdomyolysis.<sup>7</sup>

#### PATHOGENESIS

The disease is due to dysfunction and death of myocytes with subsequent release of cellular constituents, including the enzymes creatine kinase, aspartate aminotransferase and carbonic anhydrase, and myoglobin. The proximate cause of myocyte death is uncertain, but is not related to accumulation of lactic acid,<sup>8</sup> as previously supposed. Proposed mechanisms include oxidant injury to cells as a result of increased oxidant formation during exercise or inadequate antioxidant activity.<sup>9,10</sup> Apart from horses deficient in vitamin E and/or selenium, which are

rare, there is no indication that oxidant injury is a common cause of rhabdomyolysis in horses.<sup>9</sup>

Cell death is likely linked to abnormal accumulation of calcium in intracellular fluids secondary to deranged energy and/or membrane function.<sup>11</sup> Necrosis of myocytes caused pain and inflammation in the muscle, with infiltration of inflammatory cells. Healing and regeneration of myocytes occurs over a period of weeks in the absence of further episodes of myonecrosis.

Release of cellular constituents results in electrolyte abnormalities, primarily a hypochloremic metabolic alkalosis, a systemic inflammatory response, and pigmenturia. Severely affected horses can have a metabolic acidosis. Myoglobin, and possibly other cell constituents, are nephrotoxic and acute renal failure can develop as a result of myoglobinuric nephrosis. Pain and loss of muscle function cause a stilted, short stepping gait.

#### CLINICAL FINDINGS

The clinical findings are variable and range from poor performance to recumbency and death. Signs can be mild and resolve spontaneously within 24 h or be severe and progressive.

The most common presentation is of a horse that does not perform to expectation and displays a stiff or **short stepping gait** that may be mistaken for lower leg lameness. The horse may be reluctant to move when placed in its stall, be apprehensive and anorexic, paw, and frequently shift its weight. More severely affected horses can be unable to continue to exercise, have **hard and painful muscles** (usually gluteal muscles), sweat excessively, tremble or have widespread muscle fasciculations, be apprehensive, refuse to walk, and have elevated heart and respiratory rates. Affected horses may be hyperthermic, especially soon after exercise. Signs consistent with abdominal pain are present in many severely affected horses. Deep red urine (myoglobinuria) occurs but is not a consistent finding. Severely affected horses may be recumbent.

#### CLINICAL PATHOLOGY

Mildly or inapparently affected horses have moderate increases in **serum creatine kinase (CK)** (20 000–50 000 IU/L), **aspartate aminotransferase (AST)**, and **lactate dehydrogenase (LDH)** activity. Severely affected horses have large increases in CK (>100 000 IU/L) and other muscle-derived enzymes. Serum CK and AST activities peak approximately 5–6 and 24 h after exercise, respectively<sup>12,13</sup> and in the absence of further muscle damage serum AST might not return to normal levels for 7–10 days. The half-life of CK activity in serum is approximately

12 h and in the absence of continuing muscle damage serum CK declines rapidly.<sup>13</sup> The persistence of increased AST activity, compared with CK, is useful in identifying affected horses days or weeks after the episode.<sup>12</sup>

**Serum myoglobin** concentrations increase markedly during exercise in affected horses, and decline within 24–48 h.<sup>12</sup> Serum carbonic anhydrase III activity is increased in horses with exertional rhabdomyolysis.<sup>14</sup>

Severely affected horses are often **hyponatremic** (<130 mEq/L), **hyperkalemic** (>5.5 mEq/L), **hypochloremic** (<90 mEq/L), azotemic (increased serum urea nitrogen and creatinine concentrations), and **acidotic** or **alkalotic**. Hemoconcentration (hematocrit >50%, 0.5 L/L) and increased serum total protein concentration (>80 g/L) indicative of dehydration are common. Serum bicarbonate concentration can be falsely markedly elevated in animals with severe rhabdomyolysis because of cellular constituents released from damaged muscle that interfere with the analytical method when automated clinical chemistry analyzers are used.<sup>15</sup> **Myoglobinuria** is detectable either grossly or on chemical analysis and should be differentiated from hemoglobinuria or hematuria. Measurement of **urinary excretion of electrolytes**, although popular in the past, is of no use in diagnosing, treating, or preventing exertional rhabdomyolysis.

**Muscle biopsy** during the acute or convalescent stages reveals myonecrosis of Type II (fast twitch, oxidative) fibers, mild myositis, and fibrosis.

#### NECROPSY FINDINGS

Horses dying of exertional rhabdomyolysis have widespread degeneration of striated muscle, principally the muscles of exertion, but often involving the diaphragm and heart. Affected muscles tend to be dark and swollen, but may have a pale, streaked appearance. The kidneys are swollen and have dark brown medullary streaks. Dark brown urine is present in the bladder. Histologic examination reveals widespread necrosis and hyaline degeneration of predominantly Type II (fast twitch, oxidative) fibers. In horses with recurrent disease, there may be evidence of myofiber regeneration. Myoglobinuric nephrosis is present in severely affected horses.

#### Samples for postmortem confirmation of diagnosis

- Formalin-fixed kidney and affected muscle for light microscopic examination.

#### DIAGNOSTIC CONFIRMATION

Biochemical confirmation of muscle damage by demonstration of increased

serum CK or AST activity, in conjunction with appropriate clinical signs, provides the diagnosis.

#### DIFFERENTIAL DIAGNOSIS

- Ear tick (*Otobius megnini*) induced muscle cramping<sup>16</sup>
- Polysaccharide storage myopathy of Quarter horses
- Ionophore intoxication (monensin, lasalocid, salinomycin, narasin, maduramicin)<sup>17</sup>
- Equine lower motor neurone disease (acute form)
- *Cassia occidentalis* toxicosis
- Hyperkalemic periodic paralysis
- Laminitis
- Colic
- Pleuritis
- Aorto-iliac thrombosis.

#### TREATMENT

The treatment chosen depends on the severity of the disease. The **general principles** are rest, correction of dehydration and electrolyte abnormalities, prevention of complications including nephrosis and laminitis, and provision of analgesia.<sup>18</sup>

**Mildly affected horses** (heart rate <60 bpm, normal rectal temperature and respiratory rate, no dehydration) may be treated with rest and phenylbutazone (2.2 mg/kg, orally or IV every 12 h for 2–4 d). Horses should be given mild exercise with incremental increases in workload as soon as they no longer have signs of muscle pain. Access to water should be unrestricted.

**Severely affected horses** (heart rate >60 bpm, rectal temperature >39°C (102°F), 8–10% dehydrated, reluctant or unable to walk) should not be exercised, including walking back to their stable, unless it is unavoidable. Isotonic, polyionic fluids, such as lactated Ringer's solution, should be administered IV to severely affected horses to correct any hypovolemia and to insure a mild diuresis to prevent myoglobinuric nephropathy. Less severely affected horses can be treated by administration of fluids by nasogastric intubation (4–6 L every 2–3 h). Although it has been recommended that urine should be alkalized by administration of mannitol and sodium bicarbonate (1.3% solution IV, or 50–100 g of sodium bicarbonate orally every 12 h) to minimize the nephrotoxicity of myoglobin, this therapy is not effective in humans at risk of myoglobinuric nephrosis.<sup>19</sup> Affected horses should not be given diuretics (e.g. furosemide).

**Phenylbutazone** (2.2–4.4 mg/kg, IV or orally, every 12–24 h), **flunixin meglumine** (1 mg/kg IV every 8 h) or

**ketoprofen** (2.2 mg/kg IV every 12 h) should be given to provide **analgesia**. **Mild sedation** (acepromazine 0.02–0.04 mg/kg IM, or xylazine, 0.1 mg/kg IM, both with butorphanol, 0.01 to 0.02 mg/kg) may decrease muscle pain and anxiety. Tranquilizers with vasodilatory activity, such as acepromazine (acepromazine), should only be given to horses that are well hydrated. **Muscle relaxants**, such as methocarbamol, are often used but have no demonstrated efficacy.

**Recumbent** horses should be deeply bedded and repositioned by rolling every 2–4 h. Severely affected horses should not be forced to stand.

#### CONTROL

Prevention of the sporadic, idiopathic disease centers on insuring that horses are fed a balanced ration with adequate levels of vitamin E, selenium and electrolytes, and have a regular and consistent program of exercise. Despite lack of clear evidence for a widespread role for **vitamin E or selenium** deficiency in exertional rhabdomyolysis, horses are often supplemented with 1 IU/kg vitamin E and 2.5 µg/kg selenium daily in the feed. Care should be taken not to induce selenium toxicosis.

**Sodium bicarbonate** (up to 0.5 to 1.0 g/kg body weight daily in the ration) and other electrolytes are often added to the feed of affected horses, but their efficacy is not documented. **Phenytol** has proven useful in the treatment of recurrent rhabdomyolysis. It is administered at a dose rate of 6–8 mg/kg, orally, every 12 h, and the dose adjusted depending on the degree of sedation produced (a reduced dose should be used if the horse becomes sedated) or lack of effect on serum CK or AST activity. Phenytoin can be administered to horses for months. **Dimethylglycine, dantrolene, altrenogest, and progesterone** are all used on occasion in horses with recurrent rhabdomyolysis, but again without demonstrated efficacy.

The feeding of high fat, low soluble carbohydrate diets is useful in the prevention of recurrent exertional rhabdomyolysis in Thoroughbred horses and polysaccharide storage myopathy in Quarter horses. The usefulness of this practice in preventing sporadic, idiopathic exertional rhabdomyolysis has not been demonstrated.

#### REFERENCES

1. Perkins G et al. J Vet Intern Med 1998; 12:173.
2. Cole FL et al. Vet Rec 2004; 155:625.
3. MacLeay JM et al. Am J Vet Res 1999; 60:1562.
4. McGowan CM et al. Vet Rec 2002; 150:535.
5. Upjohn MM et al. Vet Rec 2005; 156:763.
6. McGowan CM et al. Vet Rec 2002; 151:623.
7. Bailey CJ et al. Vet Rec 1999; 145:487.



8. Valberg S et al. *Equine Vet J* 1993; 25:17.
9. Chiaradia E et al. *Comp Biochem Physiol B* 1998; 119:833.
10. Sacheck JM, Blumberg JB. *Nutrition* 2001; 17:809.
11. Piercy RJ, Rivero JL. *Equine sports medicine and surgery*. London: Elsevier, 2004: 77.
12. Valberg S et al. *Equine Vet J* 1993; 25:11.
13. Toussaint PL et al. *J Vet Pharmacol Ther* 1995; 18:226.
14. Nishita T et al. *Am J Vet Res* 1995; 56:162.
15. Collins ND et al. *Vet Clin Pathol* 1998; 27:85.
16. Madigan JE et al. *J Am Vet Assoc* 1995; 207:74.
17. Blomme EAG et al. *Equine Vet Educ* 1999; 11:153.
18. Andrews FM. *Vet Clin North Am Equine Pract* 1994; 10:567.
19. Brown CV et al. *J Trauma* 2004; 56:1191.

## MASSETER MYONECROSIS

Degeneration of the masseter muscles causes dysphagia and trismus in adult horses.<sup>1,2</sup> The disease is associated with abnormally low serum or blood concentrations of vitamin E or selenium in some affected horses.<sup>1</sup> Muscles of locomotion and cardiac muscle can be affected in addition to disease of the masseter muscle. Clinical signs include dysphagia, trismus, weight loss, gait abnormalities, atrophy of the masseter muscle, teeth grinding or quidding of feed, and unexpected death. Horses with extensive involvement of other muscles can have myoglobinuria.<sup>1</sup> Signs of dysphagia and trismus are related to dysfunction of the masseter muscle. Gait abnormalities are related to disease in muscles of locomotion and unexpected death is probably due to the cardiac lesions. Serum activity of creatine kinase and aspartate aminotransferase is elevated in acute cases.<sup>1</sup> Necropsy examination reveals diffuse swelling, muscle pallor, and white streaking of masseter muscle in acutely affected animals.<sup>1</sup> Lesions are also detected in muscles of locomotion and myocardium in some horses.<sup>1</sup> Chronic cases have atrophy of affected muscle. Histological changes include swelling, fragmentation and loss of striations of myocytes in acute cases and degenerating fibers replaced by fibrosis in chronic cases.<sup>1</sup> Treatment is symptomatic and affected horses can require enteral or parenteral delivery of nutrients. Vitamin E and selenium status should be determined and administered if indicated. Prevention should focus on ensuring that horses in geographic regions in which vitamin E or selenium are deficient in feeds are supplemented with these micronutrients.

## REFERENCES

1. Pearson EG et al. *Vet Rec* 2005; 156:642.
2. Step DL et al. *J Am Vet Med Assoc* 1991; 198:117.

## ATYPICAL MYOPATHY (MYOGLOBINURIA) IN GRAZING HORSES

A syndrome of acute myoglobinuria occurring in horses at pasture is reported

from Great Britain and Europe,<sup>1-4</sup> and is suspected to occur in North America and Australia. Occurrence of the disease is sporadic but usually affects more than one animal in a band of horses. Localized outbreaks involving large numbers of horses are reported.<sup>1,4</sup> The case fatality rate is usually very high, approaching 100%.<sup>1,4</sup> The disease occurs more commonly in the autumn or winter although cases have been reported from most months of the year. There does not appear to be a breed or sex predilection to development of the disease. Younger horses might be at greater risk of the disease but this could simply reflect the age distribution of horses at pasture in areas in which the disease occurs. Atypical myopathy occurs almost exclusively in horses at pasture and is not associated with enforced exercise.

Clinical signs are those characteristic of acute rhabdomyolysis and include an abrupt onset of stiffness and reluctance to move. Progression to lateral recumbency is rapid, occurring within hours of the initial onset of signs. Recumbency is often the first indication of this disease observed in horses at pasture.<sup>3</sup> Horses forced to stand have tremors and difficulty walking. Lumbar and gluteal muscles can be firm. Affected horses are tachycardic and tachypneic. Respiratory distress, presumably secondary to degeneration of intercostal muscle and diaphragm, is common in recumbent horses in the terminal stages of the disease. There is discolored urine (pigmenturia). Affected horses die within 24–72 h of onset of clinical signs. Serum biochemical abnormalities include massively increased serum activities of creatine kinase, lactate dehydrogenase, and aspartate aminotransferase.<sup>2-4</sup> Serum concentrations of troponin T, a marker of myocardial damage, are above normal in most affected horses.<sup>4</sup> Serum concentrations of vitamin E and/or selenium and red cell activity of glutathione peroxidase are not consistently abnormally low.<sup>2-4</sup>

Necropsy examination does not reliably reveal gross evidence of muscle disease although there can be swelling, edema and localized hemorrhage into muscles. There are hemorrhagic or pale areas in the ventricular myocardium of some horses.<sup>2</sup> Histologic examination reveals the presence of widespread degeneration of myocytes, without inflammation, in muscles of locomotion and respiration.<sup>2,3</sup> Within a muscle group some fibers are severely affected while other neighboring fibers are apparently normal.<sup>3</sup> The ventricular myocardium has lesions of muscle degeneration in some horses.<sup>2,4</sup> Myoglobinuric nephrosis is a consistent finding in horses that die spontaneously or are euthanized in the terminal stages of the disease.

Definitive diagnosis is based on the presence of clinical signs of muscle disease, large elevations in serum activity of muscle derived enzymes and necropsy examination.

Treatment is supportive and largely ineffectual and should follow the guidelines provided under acute rhabdomyolysis. There are no documented effective control measures although ensuring normal vitamin E and selenium status is advisable.

## REVIEW LITERATURE

Votion DM et al. Atypical myopathy. In: *IVIS Reviews in veterinary medicine*, 2004. Available at: [www.ivis.org](http://www.ivis.org) (accessed August, 2005).

## REFERENCES

1. Anonymous. *Vet Rec* 1985; 116:86.
2. Whitwell KE et al. *Equine Vet J* 1988; 20:357.
3. Hosie BD et al. *Vet Rec* 1986; 119:444.
4. Brandt K et al. *Pferdheilkunde* 1997; 13:27.

## LOW MILK FAT SYNDROME

The secretion of a normal volume of milk but with its milk fat reduced, often to less than 50% of normal, is a significant cause of wastage in high-producing cows. It occurs most commonly in cows on low-fiber diets, for example, lush, irrigated pasture or grain rations that are ground very finely or fed as pellets.<sup>1</sup> It is assumed that a decreased formation of acetate in the rumen is the cause of a depletion of fatty acid precursors and the fall in butterfat. Treatment is achieved by administration of sodium bicarbonate or magnesium oxide, which increase fiber digestibility and hence the propionate:acetate ratio.<sup>2</sup> Magnesium oxide also increases the activity of lipoprotein lipase in the mammary gland and increases uptake of triglycerides by the mammary gland from the plasma.<sup>3</sup>

## REFERENCES

1. van Beukelen P et al. *Bovine Pract* 1982; 17:150.
2. Shimada Y. *Magnes Res* 1991; 4:177.
3. Thivierge MC et al. *J Dairy Sci* 1998; 81:2001.

## EQUINE PARS INTERMEDIA DYSFUNCTION (ADENOMA OF THE PARS INTERMEDIA OF THE PITUITARY, EQUINE CUSHING'S DISEASE)

A slowly progressive disease of older horses caused by non-malignant hypertrophy and hyperplasia of melanotropes of the pars intermedia of the pituitary gland and characterized by polyuria, polydipsia, hirsutism, and laminitis.

## ETIOLOGY

The disease appears to be attributable to degeneration of the periventricular hypothalamic dopaminergic neurons with subsequent development of a non-malignant functional tumor comprised of

melanotropes of the pars intermedia of the pituitary gland.<sup>1</sup>

Cushing's syndrome caused by adrenocortical tumors is exceedingly rare in horses.<sup>2</sup>

### EPIDEMIOLOGY

The disease occurs worldwide in all breeds of horses and ponies. It is sporadic, non-infectious, and non-contagious. The prevalence of the disease is approximately 0.1%.<sup>3</sup> The case-fatality rate is high (approaching 100%) after a prolonged course because of the advanced age of most affected horses, the severity of the disease and the cost of palliative treatment.

There is no apparent sex or breed predisposition, although the disease might be more common in ponies. Affected animals are usually at least 7 years old, and the average age at presentation is 20 years.

### PATHOGENESIS

There is a loss of inhibitory effect of dopamine with subsequent hypertrophy and hyperplasia of **melanotropes** of the pars intermedia of the pituitary gland which results in unchecked secretion of **pro-opiomelanocortin** and compression of the neurohypophysis, hypothalamus and optic chiasma. Production of pro-opiomelanocortin by melanotropes is not under the negative feedback control of glucocorticoids and as a result affected horses produce large quantities of pro-opiomelanocortin, melanocyte stimulating hormone,  $\beta$ -endorphin, and smaller but still excessive quantities of adrenocorticotrophic hormone (ACTH).<sup>4,5</sup> Production of ACTH results in loss of the normal circadian rhythm in serum cortisol concentration and **hyperadrenocorticism**, and **secondary diabetes mellitus**. The space-occupying effects of the tumor can cause blindness because of compression of the optic chiasma, and **diabetes insipidus**, because of neurohypophyseal dysfunction.

### CLINICAL FINDINGS

Affected horses exhibit one or more of hirsutism, hyperhidrosis, polyuria, polydipsia, polyphagia, and a docile demeanor. There is often central obesity, characterized by excessive fat deposition in the crest of the neck and in the supraorbital fossae. Rarely, affected horses are blind or have seizures. Hirsutism, the presence of a long, often curly hair coat that is not shed during the warmer months, is a relatively consistent and specific finding in affected horses. Laminitis is a frequent finding in horses with equine pars intermedia dysfunction, and as many as 70% of horses with idiopathic laminitis (i.e. not clearly associated with an inducing disease such as colic or diarrhea) have evidence of pars

intermedia dysfunction.<sup>6</sup> Affected horses are often infertile and heal poorly.

### CLINICAL PATHOLOGY

There is often mild neutrophilia and lymphopenia. Serum biochemical analysis may demonstrate **hyperglycemia** and an increase in alkaline phosphatase activity. Resting serum cortisol concentrations of affected and normal horses are similar and not useful in diagnosis. **Glucosuria** is often present.

### DIAGNOSTIC CONFIRMATION

**Antemortem diagnosis** is achieved on the basis of clinical signs and one of several diagnostic tests. It is important that testing be based on the presence of clinical signs compatible with the disease in order to minimize the frequency of false positive diagnoses. Laboratory tests for the disease are not infallible and the results of these tests should be viewed only in the context of the horse's clinical signs. Further complicating diagnosis of equine pars intermedia dysfunction is the slow and progressive onset of the disorder. It is therefore likely that attempting a definitive dichotomous answer (disease present or disease absent) based on laboratory testing is unreasonable—some mildly affected horses will test normal while some apparently healthy horses with histologically normal pituitary glands will test positive.<sup>7</sup>

**Laboratory tests** used to diagnose pars intermedia dysfunction include measurement of serum or plasma cortisol, ACTH, glucose, or insulin concentrations, the ACTH stimulation test, the thyrotropin-releasing hormone stimulation test, measurement of urinary and salivary corticoid concentrations and combinations of these tests.<sup>8</sup> The most widely accepted laboratory tests are the overnight dexamethasone suppression test and measurement of serum ACTH concentration.<sup>8</sup> Other tests have been suggested, but either their sensitivity and specificity have not been determined, or they involve measurement of multiple variables or of hormones for which assays are not readily commercially available.<sup>9,10</sup> Measurement of basal serum insulin concentration is not a useful diagnostic test for equine pars intermedia dysfunction.<sup>11</sup> Measurement of urine or salivary cortisol concentrations has been suggested as a means of diagnosing equine pars intermedia dysfunction, but neither has been validated in a sufficient number of horses to permit assessment of their clinical utility.<sup>12,13</sup>

Diagnosis with a high degree of accuracy is achieved by the **overnight dexamethasone suppression test**.<sup>4</sup> After collection of a serum sample for measurement of cortisol, dexamethasone (40  $\mu$ g/kg

IM) is administered at about 5 p.m. A second blood sample is collected 15 h later, with the option to collect a third sample 19 h after dexamethasone administration. Normal horses will have a serum cortisol concentration of less than 1  $\mu$ g/dL (28 nmol/L) in the second and third blood samples, whereas affected horses will not show a significant reduction in serum cortisol concentration from that of the initial sample. The sensitivity and specificity of this test are apparently high with both reported to be approximately 100%.<sup>8</sup> However, recent studies of healthy horses demonstrate that there is considerable seasonal variation in the dexamethasone suppression test, with all of 39 healthy aged ponies and horses having normal tests in January (winter) but 10 of the same 39 (26%) having abnormal tests in September (autumn).<sup>7</sup> These results suggest that these diagnostic tests should be interpreted with caution when conducted in the autumn.

Measurement of serum or plasma adrenocorticotrophic hormone (ACTH) concentration has been proposed as an accurate laboratory indicator of equine pars intermedia dysfunction.<sup>14</sup> The upper ACTH concentration from normal horses is 35–55 pg/mL.<sup>14</sup> However, there is considerable seasonal variation in aged normal horses, with all of 39 horses having plasma ACTH concentration <35 pg/mL in January (winter), and May (late spring) but in only three of the same 39 horses in September (autumn).<sup>7</sup> These results demonstrate the need for caution when assessing the diagnostic importance of plasma ACTH concentrations in aged horses.

The combined dexamethasone suppression/TRH stimulation test has reported sensitivity and specificity of 88% and 79%, respectively.<sup>15</sup> The test is performed by administering 40  $\mu$ g/kg of dexamethasone phosphate (or similar dexamethasone salt) intravenously between 8 a.m. and 10 a.m. Cortisol concentration in serum is then measured 3 h later and thyroid releasing hormone (TRH, 1 mg) administered intravenously. Serum cortisol concentration is measured 30 min after TRH administration. Serum cortisol concentrations of healthy horses 30 min after TRH administration are unchanged from those at the time of TRH administration, while serum cortisol concentrations in horses with equine pars intermedia dysfunction increase by >66% of the baseline value.<sup>15</sup>

### NECROPSY FINDINGS

The pituitary gland is usually enlarged due to the increased numbers of melanocortin cells comprising an adenoma of the pars intermedia.<sup>18</sup> The adrenal cortices are

usually of normal width but may be thickened in some cases. With the appropriate clinical history, the observation of a well-defined nodule within the pituitary gland is usually sufficient for confirmation of the diagnosis, but histology and immunohistochemical testing of the mass can be performed. There is only fair ( $\kappa = 34\%$ ) agreement among pathologists for histologic diagnosis of the disease.<sup>19</sup>

#### DIFFERENTIAL DIAGNOSIS

- Insulin resistance
- Diabetes insipidus  
Both of these diseases are exceedingly rare in horses
- Obesity
- Psychogenic polydipsia or salt eating
- Chronic renal failure.

#### TREATMENT

Treatment is palliative. There is no effective treatment of the pars intermedia adenoma and the aim of treatment is to reduce secretion of the products of the melanotropes through the use of dopamine agonists or serotonin antagonists. Treatment must be continued for the life of the horse.

The **treatment of choice** is administration of pergolide, a dopamine agonist, at 1.7–5.5  $\mu\text{g}/\text{kg}$  orally every 24 h. The recommended starting dose is 3.0  $\mu\text{g}/\text{kg}$  once daily for 2 months, at which time clinical and laboratory (plasma ACTH concentration, dexamethasone suppression test) signs of the disease should be evaluated. This treatment is superior to cyproheptadine in terms of reducing plasma ACTH concentrations and improving clinical signs of disease<sup>16</sup> although this is not a uniformly reported observation.<sup>17</sup> Cyproheptadine, a serotonin antagonist, is administered at 0.25 mg/kg orally every 24 h for 1 month. If an acceptable response is achieved then this dose is continued, if not, then the dose is increased to 0.25 mg/kg every 12 h.

Symptomatic treatment should include clipping of the hair coat in spring, treatment of laminitis and wounds, and prevention of injuries and infection.

#### CONTROL

None.

#### REVIEW LITERATURE

Schott HC. Pituitary pars intermedia dysfunction: equine Cushing's disease. *Vet Clin North Am* 2002; 18:237.

#### REFERENCES

1. McFarlane D. et al. *J. neuro-endocrinol* 2005; 17:73
2. van der Kolk JH et al. *Equine Vet J* 2001; 33:110.
3. Evans DR *Proc Am Assoc Equine Pract* 1972; 18:417.
4. Dybdal NO et al. *J Am Vet Med Assoc* 1994; 204:627.
5. Orth DN et al. *Endocrinology* 1982; 110:1430.
6. Donaldson MT et al. *J Am Vet Med Assoc* 2004; 224:1123.
7. Donaldson MT et al. *J Am Vet Med Assoc* 2005; 19:217.

8. Toribia RE. *J Vet Intern Med* 2005; 19:145.
9. van der Kolk JH et al. *Domest Anim Endocrinol* 1995; 12:35.
10. Eiler H et al. *J Am Vet Med Assoc* 1997; 211:79.
11. Reeves HJ et al. *Vet Rec* 2001; 149:449.
12. Chandler KJ, Dixon RM. *Vet Rec* 2002; 150:773.
13. van der Kolk JH et al. *Equine Vet J* 2001; 33:211.
14. Couetil L et al. *J Vet Intern Med* 1996; 10:1.
15. Andrews FM et al. *Proc Am Assoc Equine Pract* 2004; 50:338.
16. Donaldson MT et al. *J Vet Intern Med* 2002; 16:742.
17. Perkins GA et al. *Equine Vet J* 2002; 34:679.
18. van der Kolk et al. *Am. J vet res* 2004; 65:1701
19. McFarlane D. *Am J vet res* 2005; 66:2055

### DISORDERS OF THYROID FUNCTION (HYPOTHYROIDISM, HYPERTHYROIDISM, CONGENITAL HYPOTHYROIDISM, THYROID ADEMONA)

Disorders of thyroid function due to abnormalities in the thyroid gland, pituitary gland or hypothalamus are uncommon in the domestic species and are best documented for the horse. Thyroid disorders secondary to excessive or inadequate intake of iodine, or selenium deficiency are discussed under those headings.

#### ETIOLOGY

Disorders of thyroid function result in hypothyroidism or hyperthyroidism. Hypothyroidism can result from diseases of the thyroid gland (primary hypothyroidism), pituitary gland (secondary hypothyroidism due to reduced secretion of thyroid stimulating hormone), or hypothalamus (tertiary hypothyroidism, decreased thyrotropin [thyroid releasing hormone] secretion). Autoimmune thyroiditis has not been described in horses. Lymphocytic thyroiditis occurs in goats.<sup>1</sup> Consumption of propylthiouracil (4 mg/kg body weight orally once daily for 4–6 weeks) induces hypothyroidism in adult horses.<sup>2,3</sup> Administration of trimethoprim-sulfadiazine (30 mg/kg orally q. 24 h for 8 weeks), which can induce hypothyroidism in humans and dogs, does not impair thyroid function of most horses.<sup>4</sup>

**Hereditary congenital hypothyroidism** secondary to defects in thyroglobulin production occurs in sheep, goats, and Afrikaner cattle.<sup>5</sup> The disease is inherited as an autosomal recessive trait.<sup>5</sup> The cause of congenital hypothyroidism in foals is uncertain, although ingestion of nitrates by the pregnant dam is strongly suspected.<sup>6</sup> Partial thyroidectomy of equine fetuses results in birth of foals with clinical and pathological characteristics similar to the spontaneous disease.<sup>7</sup>

Hyperthyroidism in horses is attributable to functional adenocarcinoma or adenoma of the thyroid gland<sup>8,9</sup> but most thyroid tumors, are not functional.<sup>10,11</sup>

#### EPIDEMIOLOGY

The frequency with which hypothyroidism occurs in adult horses is unknown. It is

relatively common practice to administer thyroid hormone or iodinated casein to fat horses, those with laminitis, rhabdomyolysis, or anhidrosis, or to enhance fertility, but documentation of abnormal thyroid function in these animals is rare. None of 79 clinically normal brood mares had an abnormal response to thyroid stimulating hormone administration,<sup>12</sup> indicating that hypothyroidism is uncommon. Importantly, horses with non-thyroid related illness often have low concentrations of thyroid hormones in blood without evidence of thyroid dysfunction – this is referred to as the euthyroid sick or non-thyroidal illness syndrome and is not indicative of thyroid disease.<sup>13</sup>

Abnormalities of the thyroid gland were detected in 12% of 1972 **goats** examined in India.<sup>1</sup> Of thyroid glands examined from 1000 goats in India, 2.4% had colloid goiter, 39% parenchymatous goiter, 1.8% lymphocytic thyroiditis, and 2.1% were fibrotic.<sup>1</sup>

**Congenital hypothyroidism** in foals occurs in western Canada and the western and northern USA. One survey of necropsy records of almost 3000 equine fetuses and neonatal foals in western Canada found that 2.7% had histologic evidence of thyroid and musculoskeletal abnormalities consistent with congenital hypothyroidism.<sup>14</sup> Congenital hypothyroidism occurs in Dutch goats, Merino sheep, and Afrikaner cattle.<sup>5,15</sup> Hypothyroidism is reported in an East Friesian ram.<sup>16</sup>

Hyperthyroidism is a sporadic disease of older horses for which other risk factors are not identified.<sup>9,17</sup>

Thyroid tumors are common in older horses with ~50% having adenomas evident on histologic examination of the thyroid gland.<sup>11</sup> The clinical course of such tumors is benign, although their size can be quite impressive. Thyroid adenocarcinoma is much less common but has a malignant course.<sup>10,11</sup>

#### CLINICAL FINDINGS

Clinical characteristics of hypothyroidism in adult horses are poorly defined, largely because of the difficulty of confirming the diagnosis and the pharmacological effect of exogenous thyroid hormones. Clinical abnormalities anecdotally attributed to hypothyroidism include exercise intolerance, infertility, weight gain, maldistribution of body fat, agalactia, anhidrosis, and laminitis, among others. Definitive association of these clinical syndromes with abnormalities of thyroid function is lacking.

Thyroidectomy of horses causes a reduction in resting heart rate and body temperature, docility, decreased food intake, increased cold sensitivity, dull hair

coat, and delayed shedding of hair.<sup>18,19</sup> Blood and plasma volumes of horses increased after removal of the thyroid glands.<sup>19</sup> Effects of thyroidectomy were reversed by administration of thyroxine, with the exception of blood and plasma volume which did not return to euthyroid values.<sup>19</sup> Thyroidectomized horses did not become obese or develop laminitis.

Induced hypothyroidism in goats is evident as a loss of body weight, facial edema, weakness, profound depression, and loss of libido.<sup>20</sup>

**Congenitally hypothyroid** foals have a prolonged gestation but are born with a short silky hair coat, soft pliable ears, difficulty in standing, lax joints, and poorly ossified bones. The foals are referred to as dysmature. Characteristic musculoskeletal abnormalities include inferior (mandibular) prognathism, flexural deformities, ruptured common and lateral extensor tendons, and poorly ossified cuboidal bones.<sup>14</sup>

Horses with **hyperthyroidism** are tachycardic, cachexia, and have hyperactive behavior.<sup>9,17</sup> There is usually detectable enlargement of the thyroid gland.

Thyroid adenomas are evident as unilateral, non-painful, enlargement of

the thyroid gland of older (>15 years) horses. Thyroid adenocarcinoma presents as metastatic disease with both local and distant spread. Some affected horses have signs of hyperthyroidism, although this is unusual.

#### CLINICAL PATHOLOGY

Hematologic abnormalities in hypothyroid horses are not well documented. Induced hypothyroidism in horses causes increases in serum concentrations of very low density lipoprotein, triglycerides, and cholesterol, and decreased concentrations of non-esterified fatty acids.<sup>21</sup> Induced hypothyroidism in goats caused hypoglycemia, hypercholesterolemia, and anemia.<sup>20</sup> Hypothyroidism in a ram caused hypercholesterolemia.<sup>16</sup>

#### Thyroid hormone assays

Assays are available for measurement of serum concentrations of T3, T4, free T4 (radioimmunoassay or equilibrium dialysis), and TSH.<sup>13</sup> Values of each of these analytes varies depending on the method of analysis, physiologic status of the animal, and administration of other compounds (Table 29.8). Serum concentrations of thyroid hormones is high at birth and declines with age.<sup>22-25</sup> There are

statistically significant **diurnal variations** in serum concentrations of T3 and T4 in adult horses with lowest concentrations observed during the early morning hours, likely coincident with the time at which metabolic rate is lowest (Table 29.8).<sup>26</sup>

**Feed restriction** for 3-5 days lowers serum concentrations of T3, T4, and fT4 in horses by 24-42%.<sup>27</sup> Administration of **phenylbutazone** decreases concentrations of fT4 (measured by equilibrium dialysis) and T4 by 4 days of treatment, and can persist for up to 10 days after discontinuation of phenylbutazone.<sup>28</sup> The decrease in T4 is suggested to be attributable to displacement of T4 from protein binding sites by phenylbutazone, but this does not explain the decrease in fT4. The clinical significance of phenylbutazone-induced decreases in thyroid hormones is uncertain, but should be considered when assessing thyroid function in horses.

Because of the number of analytical and physiological factors that affect serum thyroid hormone concentrations, values considered normal vary considerably, as illustrated by the finding that 44 of 79 clinically normal non-pregnant broodmares had serum T4 concentrations below the reference range, although responses to

Table 29.8 Serum or plasma concentrations of thyroid hormones and thyroid stimulating hormone (TSH) in foals and horses

Physiologic status	Serum or plasma T3	Serum or plasma T4	fT4 <sup>a</sup>	TSH
Age				
Birth (<10 h)	991 ng/dL <sup>24</sup> 12.8 ± 7.4 mmol <sup>23</sup> 366 ± 222 ng/L <sup>25</sup>	28.8 µg/dL <sup>24</sup> 493 ± 58 nmol/L <sup>23</sup> 13.3 ± 5.1 µg/dL <sup>25</sup>	12.1 ng/dL <sup>24</sup>	
1-3 days	940 ng/dL <sup>24</sup>	28.0 µg/dL <sup>24</sup>	12.1 ng/dL <sup>24</sup>	
4 days	935 µg/dL <sup>24</sup> 7.8 ± 4.2 mmol <sup>23</sup>	11.2 µg/dL <sup>24</sup> 232 ± 61 nmol/L <sup>23</sup>	5.9 ng/dL <sup>24</sup>	
5-11 days	631 µg/dL <sup>24</sup>	7.45 µg/dL <sup>24</sup>	3.30 ng/dL <sup>24</sup>	
20 days	4.2 ± 0.9 mmol <sup>23</sup>	36.7 ± 17.4 nmol/L <sup>23</sup>		
22-90 days	192 µg/dL <sup>24</sup>	2.57 µg/dL <sup>24</sup>	1.76 µg/dL <sup>24</sup>	
28 days	3.1 ± 0.4 mmol <sup>23</sup>	30.6 ± 17.4 nmol/L <sup>23</sup>		
1.5-4 months	193 ± 9 ng/dL <sup>22</sup>	4.02 ± 0.19 µg/dL <sup>22</sup>		
2-5 years	120 ± 8 ng/dL <sup>22</sup>	2.9 ± 0.1 µg/dL <sup>22</sup>		
6-10 years	86 ± 7.5 ng/dL <sup>22</sup>	1.7 ± 0.1 µg/dL <sup>22</sup>		
11-25 years	84 ± 9 ng/dL <sup>22</sup>	1.6 ± 0.1 µg/dL <sup>22</sup>		
Adult mares and geldings	0.99 ± 0.51 nmol/L <sup>3</sup>	12.9 ± 5.6 nmol/L <sup>3</sup>	12.2 ± 3.5 pmol/L (RIA) <sup>3</sup>	0.39 ± 0.30 ng/mL <sup>3</sup>
Adult mares and geldings		19 (17.6-22.1) nmol/L <sup>13</sup>	11 (10.5-11.8) pmol/L (RIA) <sup>13</sup>	
Adult mares and geldings		19 (17.6-22.1) nmol/L <sup>13</sup>	22 (20.9-25.1) pmol/L (ED) <sup>13</sup>	
Adult geldings, 16.00 h	53.2 ± 12.4 ng/dL <sup>26</sup>	2.43 ± 0.81 µg/dL <sup>26</sup>		
Adult geldings, 04.00 h	42.0 ± 11.5 ng/dL <sup>26</sup>	1.79 ± 0.63 µg/dL <sup>26</sup>		
Adult horses	1.02 ± 0.16 nmol/L <sup>27</sup>	19.9 ± 1.7 nmol/L <sup>27</sup>	11.6 ± 0.7 pmol/L <sup>27</sup>	
Sex				
Mare	89.9 ± 7.9 ng/dL <sup>22</sup>	1.7 ± 0.1 µg/dL <sup>22</sup>		
Gelding	92.9 ± 9.7 ng/dL <sup>22</sup>	1.69 ± 0.1 µg/dL <sup>22</sup>		
Stallion	123 ± 9.7 ng/dL <sup>22</sup>	1.97 ± 0.2 µg/dL <sup>22</sup>		
Broodmare (not pregnant)	62 ± 2.7 ng/dL <sup>12</sup>	1.47 ± 0.47 µg/dL <sup>12</sup>		
Disease				
Induced hypothyroidism (PTU) <sup>13</sup>		4 (1-10) nmol/L <sup>13</sup>	4.5 (1.5-13) pmol/L (RIA) <sup>13</sup>	
Induced hypothyroidism (PTU) <sup>13</sup>			8 (1-20) pmol/L (ED) <sup>13</sup>	
Euthyroid sick horses <sup>13</sup>		2 (2-24) nmol/L <sup>13</sup>	5 (2-13) pmol/L (RIA) <sup>13</sup>	
Euthyroid sick horses <sup>13</sup>			19 (4-48) pmol/L (ED) <sup>13</sup>	

fT4 = free T4; TSH = thyroid stimulating hormone. Mean ± SD or median (95% confidence interval). To convert µg/dL to nmol/L for T4 or fT4, multiply by 12.87.

To convert ng/dL to nmol/L for T3 or T3, multiply by 0.0154.

<sup>a</sup>fT4 determined by radioimmunoassay (RIA) or equilibrium dialysis (ED).

TRH were normal.<sup>12</sup> This example illustrates the need to determine reference ranges based on the methodology used and with well defined definition of the physiological state of the animals being tested.

Diagnosis of hypothyroidism is aided by demonstration of inappropriate responses of the thyroid gland to administration of TSH or TRH, although the use of these tests depends on determining the increase in serum T3 and/or T4 that is expected in normal horses and in horses with thyroid disease. Of 79 clinically normal mares, all had some increase in T3 and 77 had an increase in T4 2 hours after IV administration of 1 mg of TRH intravenously.<sup>12</sup> The mean increase in serum T3 concentration was 4.5 times that of resting values (from 0.62 ng/mL to 2.44 ng/mL), whereas serum T4 concentration increased to a mean of 2.1 times that of resting value (from 14.7 ng/mL to 28.6 ng/mL).<sup>12</sup> While responses to administration of TSH are reported, responses, other than complete lack of response, indicative of abnormal thyroid function have not been determined and the utility of the test has been questioned.<sup>27</sup>

The TSH response test involves administration of 5 IU of TSH intravenously. Blood samples are collected before, 30 min and 2 and 4 h after administration.<sup>29</sup> Serum concentrations of T3 and T4 in healthy horses double after administration of TSH. An alternative involves administration of 5 IU intramuscularly and collection of blood before and 3 and 6 h after a TSH administration.<sup>30</sup> TSH is currently unavailable.

The TRH response test requires administration of 0.5–1 mg of TRH intravenously. Serum concentrations of T3 and T4 at 2 and 4 h are double those before TRH administration in horses with normal thyroid function.<sup>31</sup>

Measurement of fT4 in serum is useful for assessment of thyroid function.<sup>3</sup> fT4 concentrations can be normal in horses with low concentrations of T3 and T4, and in this situation are likely indicative of normal thyroid function.

Measurement of serum concentrations of TSH is useful in determining thyroid responsiveness to endogenous TSH. Elevated TSH concentrations in horses with low serum concentrations of T3, T4, or fT4 is indicative of thyroid dysfunction.<sup>13,32</sup>

**Diagnosis of hypothyroidism** in horses should be based on the presence of compatible clinical signs, low serum concentrations of thyroid hormones (T3, T4, fT4); elevated concentrations of thyroid stimulating hormone, lack of an increase in serum concentrations of thyroid hormones in response to administration of thyroid releasing hormone (TRH), and

increased TSH concentration in serum in response to TRH administration. Diagnosis of hypothyroidism should not be based solely on clinical signs, or on the measurement of resting (unstimulated) serum T3 or T4 concentrations. At a minimum, appropriate clinical signs and documentation of an abnormal response to stimulation testing (TSH or TRH) are essential for diagnosis of hypothyroidism in horses. Measurements of fT4 concentrations determined by equilibrium dialysis are useful in determining thyroid function in sick horses in which T3 and T4 concentrations are low as fT4 concentrations will be normal in horses without thyroid disease.<sup>13</sup>

Foals with congenital hypothyroidism have abnormally low concentrations of T3 and T4, and less than expected increases in serum concentrations of these hormones in response to TSH administration.<sup>33</sup>

Horses with hyperthyroidism have markedly elevated concentrations of T3 and T4.<sup>9,17</sup> Concentrations of T4 do not decline in response to administration of T3.<sup>17</sup> T3 (2.5 mg) is administered intramuscularly twice daily for 3 days and serum concentrations of T3 and T4 measured. T4 concentrations in serum of healthy horses decline by approximately 80% whereas those of horses with hyperthyroidism do not decline.

#### NECROPSY FINDINGS

Findings on necropsy examination of hypothyroid horses have not been reported. Foals with congenital hypothyroidism have histologic evidence of thyroid hyperplasia, but no gross signs of goiter.

#### TREATMENT

Treatment of confirmed hypothyroidism in horses is achieved by administration of levo-thyroxine (20 µg/kg PO q24 h).<sup>34</sup> Serum T3 concentrations peak in 1 h and then decline while concentrations of T4 peak in 2 h and persist for 24 h.<sup>34</sup> The clinical status of the horse should be monitored during treatment and serum concentrations of T3 and T4 measured every several months. Iodinated casein, which is no longer readily available in the USA, is administered at 5 g/450 kg body weight orally once daily. Administration of thyroxine or iodinated casein for treatment of low serum thyroid hormone concentrations in horses with non-thyroidal illness syndrome (euthyroid sick syndrome) should be done judiciously.

A response to thyroxine administration is not necessarily confirmation of hypothyroidism as thyroxine can have marked effects in horses with normal thyroid function. Administration of thyroxine (up to 96 mg/470 kg horse, orally once daily) increases serum concentrations of T4 and, to a lesser extent, fT4, and

decreases concentrations of TSH.<sup>35</sup> The increases in T4 are associated with a loss of body weight, decreases in serum concentrations of triglycerides, cholesterol, and very low density lipoproteins, and an increase in whole body insulin sensitivity.<sup>35,36</sup> Thyroxine should be administered with caution to horses with normal thyroid function.

#### CONTROL

There are no recognized control measures for hypothyroidism in adult horses. Minimizing intake of nitrates by pregnant mares appears warranted, but definitive proof of the efficacy of this practice is lacking. Pregnant mares should not be fed fodder or supplements that interfere with thyroid function.

The inherited disorder in sheep, cattle, and goats can be prevented by selective breeding.

#### REVIEW LITERATURE

Frank N et al. Equine thyroid dysfunction. *Vet Clin North Am* 2002;18:305.

#### REFERENCES

- Ramakrishna C et al. *Ind Vet Med J* 1992; 16:37.
- Johnson PJ et al. *Equine Vet J* 2003; 35:296.
- Breuhaus BA. *J Vet Intern Med* 2002; 16:109.
- Rothschild CM et al. *J Vet Intern Med* 2004; 18:370.
- Veenboer GJM et al. *Endocrinol* 1993; 132:377.
- Allen AL et al. *Can Vet J* 1996; 37:349.
- Allen AL et al. *Equine Vet J* 1998; 30:53.
- Alberts MK et al. *J Am Vet Med Assoc* 2000; 217:1051.
- Ramirez S et al. *J Vet Intern Med* 1998; 12:475.
- Hovda LR et al. *J Am Vet Med Assoc* 1990; 197:1187.
- Dalefield RR, Palmer DN. *J Comp Pathol* 1994; 110:57.
- Meredith TB, Dobrinski I. *J Am Vet Med Assoc* 2004; 224:892.
- Breuhaus BA et al. *J Vet Intern Med* 2006; 20:371.
- Allen AL et al. *Can Vet J* 1994; 35:31.
- Dolling CE, Good BF. *J Endocrinol* 1976; 71:179.
- Sipos W et al. *J Vet Med A* 2004; 51:90.
- Alberts MK et al. *J Am Vet Med Assoc* 2000; 217:1051.
- Lowe JE et al. *Cornell Vet* 1974; 64:276.
- Vischer CM et al. *Am J Vet Res* 1999; 60:14.
- Ramakrishna C et al. *Ind Vet J* 1995; 71:1107.
- Frank N et al. *Am J Vet Res* 1999; 60:730.
- Chen CL et al. *Am J Vet Res* 1981; 42:1415.
- Murray MJ, Luba NK. *Equine Vet J* 1993; 25:237.
- Irvine CHG, Evans MJ. *J Reprod Fertil Suppl* 1975; 23:709.
- Shaftoe S et al. *J Equine Vet Sci* 1988; 8:310.
- Duckett WM et al. *Equine Vet J* 1989; 21:123.
- Messer NT et al. *Am J Vet Res* 1995; 56:116.
- Ramirez S et al. *J Vet Intern Med* 1997; 11:371.
- Held JP, Oliver JW. *J Am Vet Med Assoc* 1984; 184:326.
- Morris DD, Garcia M. *Am J Vet Res* 1983; 44:503.
- Lothrop CD, Nolan HL. *Am J Vet Res* 1986; 47:942.
- Rothschild CM et al. *J Vet Intern Med* 2004; 18:370.
- McLaughlin BG et al. *Can Vet J* 1986; 27:264.
- Chen CL et al. *J Equine Vet Sci* 1984; 4:5.
- Sommardahl CS et al. *Am J Vet Res* 2005; 66:1025.
- Frank N et al. *Am J Vet Res* 2005; 66:1032.

# Diseases associated with nutritional deficiencies

## INTRODUCTION 1691

- Evidence of existence of deficiency 1691
- Evidence of a deficiency associated with the disease 1692
- Evidence based on cure or prevention by correction of the deficiency 1692

## DEFICIENCIES OF ENERGY AND PROTEIN 1697

- Deficiency of energy 1697
- Deficiency of protein 1698

## DISEASES ASSOCIATED WITH DEFICIENCIES OF MINERAL NUTRIENTS 1698

- Incidence and economic importance 1698
- Diagnostic methods and strategies 1699
- Deficiencies in developing countries 1699
- Pathophysiology of trace element deficiency 1699
- Laboratory diagnosis of mineral deficiencies 1700
- Cobalt deficiency 1701
- Copper deficiency 1707

- Iodine deficiency 1722
- Iron deficiency 1725
- Sodium chloride deficiency 1729
- Magnesium deficiency 1730
- Zinc deficiency (parakeratosis) 1730
- Manganese deficiency 1733
- Potassium deficiency 1734
- Selenium and/or vitamin E deficiencies 1735
- Dietary deficiency of phosphorus, calcium, and vitamin D and imbalance of the calcium:phosphorus ratio 1755
- Calcium deficiency 1756
- Phosphorus deficiency 1758
- Vitamin D deficiency 1763
- Vitamin D toxicity 1766
- Rickets 1766
- Osteomalacia 1768
- Osteodystrophia fibrosa 1769
- 'Bowie' or 'Bentleg' 1770
- Degenerative joint disease 1771

## DISEASES ASSOCIATED WITH DEFICIENCIES OF FAT-SOLUBLE VITAMINS 1771

- Vitamin A deficiency (hypovitaminosis-A) 1771

- Vitamin K deficiency 1777

## DISEASES ASSOCIATED WITH DEFICIENCIES OF WATER-SOLUBLE VITAMINS 1778

- Thiamin deficiency (hypothiaminosis) 1778
- Riboflavin deficiency (hyporiboflavinosis) 1779
- Nicotinic acid deficiency (hyponiacinosis) 1780
- Pyridoxine (vitamin B<sub>6</sub>) deficiency (hypopyridoxinosis) 1780
- Pantothenic acid deficiency (hypopantothenosis) 1780
- Biotin (vitamin H) deficiency (hypobiotinosis) 1780
- Folic acid deficiency (hypofolicosis) 1782
- Choline deficiency (hypocholinosis) 1782
- Vitamin B<sub>12</sub> deficiency (hypocyanocobalaminosis) 1782

## Introduction

The following criteria are suggested for the assessment of the importance of nutrition in the etiology of a disease state in a single animal or in a group of animals:

- Is there evidence from an examination of the diet that a deficiency of a specific nutrient or nutrients may be occurring?
- Is there evidence from an examination of the animals that a deficiency of the suspected essential nutrient or nutrients could cause the observed disease?
- Does supplementation of the diet with the essential nutrient or nutrients prevent or cure the condition?

The difficulties encountered in satisfying these criteria and making an accurate and reliable diagnosis of a nutritional deficiency have increased as investigations have progressed into the area of trace elements and vitamins. The amounts of such substances as selenium present in feedstuffs and body tissues are exceedingly small and their estimation difficult and expensive. Because of these difficulties it is becoming more

acceptable to describe individual syndromes as responsive diseases, i.e. which satisfy only the third of the above criteria. The practice leaves much to be desired but has the advantage that applicable control measures are more readily available.

## EVIDENCE OF EXISTENCE OF DEFICIENCY

General evidence will include either evidence of deficiency in the diet, or abnormal absorption, utilization or requirement of the nutrient under consideration. Special evidence may be obtained by chemical or biological examination of the feed.

### Diet

The diet for a considerable period prior to the occurrence of the disease must be considered because body stores of most dietary factors may delay the appearance of clinical signs. Specific deficiencies are likely to be associated with particular soil types, and in many instances soil and geological maps may predict the probable occurrence of a nutritional disease.<sup>1</sup> Diseases of plants may also indicate specific soil deficiencies, e.g. 'reclamation disease' of oats indicates a copper deficiency in the soil. Domination of the pasture by particu-

lar plant species may also be important, e.g. subterranean clover selectively absorbs copper, legumes selectively absorb molybdenum, and *Astragalus* spp. are selector plants for selenium.

Farming practices may have a marked bearing on the presence or absence of specific nutrients in livestock feed. For example, heavy applications of nitrogen fertilizer can reduce the copper, cobalt, molybdenum, and manganese content of the pasture. On the other hand, many applications of lime reduce plant copper, cobalt, zinc, and manganese levels, but increase the molybdenum content. Effects such as these are sufficiently severe to suggest that animals grazing the pasture might suffer trace element deficiency. Modern hay-making methods, with their emphasis on the artificial drying of immature forage, tend to conserve vitamin A but may result in a gross deficiency of vitamin D. Soil and pasture improvement by exaggeration of the depletion of nutrients, particularly trace elements, from marginally deficient soil may give rise to overt deficiency disease. Thus, local knowledge of farming and feeding practices in a particular area is of primary importance in the diagnosis of nutritional deficiency states.

### Abnormal absorption

Even though a diet may contain adequate amounts of a particular nutrient, some other factor, by decreasing the absorption of the nutrient, may reduce the value of the dietary supply. For instance, excess phosphate reduces calcium absorption, excess calcium reduces the absorption of iodine, and absence of bile salts prevents proper absorption of the fat-soluble vitamins. Chronic enteritis reduces the absorption of most dietary essentials. The list of antagonisms that exist between elements grows all the time, most of them being interferences with absorption. For example, excess calcium in the diet interferes with the absorption of fluorine, lead, zinc, and cadmium, so that it may cause nutritional deficiencies of these elements, but it also reduces their toxic effects when they are present in the diet in excessive amounts.

### Abnormal utilization of ingested nutrients

This may also have an effect on the development of conditioned deficiency diseases. For example, molybdenum and sulfate reduce copper storage, vitamin E has a sparing effect on vitamin A, and thiamine reduces the dietary requirements of essential fatty acids.

### Abnormal requirement

Stimulation of the growth rate of animals by improved nutrition or other practices may increase their requirement of specific nutrients to the point where deficiency disease occurs. There seems to be little doubt that there is a genetic variation in mineral metabolism and it has even been suggested that it may be possible to breed sheep to 'fit' actual deficiency conditions, but the significance of the inherited component of an animal's nutritional requirement is unknown and probably small. It should not be overlooked, however, when policies of upgrading livestock in deficient areas are initiated.

### REFERENCE

1. Oetzel GR, Berger LL. *Comp Cont Educ Pract Vet* 1985; 7:5672.

### EVIDENCE OF A DEFICIENCY ASSOCIATED WITH THE DISEASE

Evidence is usually available from experimental work to indicate the clinical signs and necropsy findings one can expect to be produced by each deficiency. Several modifying factors may confuse the issue. Deficiencies under natural circumstances are unlikely to be single and the clinical and necropsy findings will be complicated by those caused by deficiencies of other factors or by intercurrent infections. In addition, most of the syndromes are both variable and insidious in onset and the

minimal nature of the necropsy lesions in many nutritional deficiency diseases adds further difficulty to the making of a diagnosis.

Special clinical and laboratory examinations of the animals are valuable aids to diagnosis in many instances. However, the ranges of blood or tissue concentrations of minerals and vitamins, or their biochemical markers, in normal animals and those values which indicate deficiency have not been well-established. In other words, the cut-off values above which animals are normal and below which they are abnormal or deficient have not been adequately determined in naturally occurring nutritional deficiencies. Experimentally induced nutritional deficiencies provide an indication of the changes that occur in the concentrations of a particular nutrient marker, but variations due to age, genotype, production cycle, length of time on the inadequate diet, previous body stores of the element and other stressors commonly complicate the results and render them difficult to interpret accurately and with repeatability.

In most cases, nutritional deficiencies affect a proportion of the herd or the flock at the same time and the clinicopathological examination should include both normal and clinically affected animals. Comparison of the laboratory results of normal and abnormal animals allows for more accurate and reliable interpretation and the making of a diagnosis.

### EVIDENCE BASED ON CURE OR PREVENTION BY CORRECTION OF THE DEFICIENCY

The best test of the diagnosis in suspected nutritional deficiency is to observe the effects of specific nutrient additions to the ration. Confounding factors are frequently encountered. Spontaneous recoveries may occur and adequate controls are essential. Curative responses may be poor because of an inadequate dose rate, because of advanced tissue damage, or because the abnormality may have been only a predisposing factor or secondary to a complicating factor that is still present. Another common cause of confusion in therapeutic trials is the impurity of the preparations used, particularly when trace elements are involved. Finally, the preparations used may have intrinsic pharmacological activity and produce some amelioration of the disease without a deficiency having been present.

### Monitoring of nutritional status

The feeds and feeding program have a major influence on reproductive performance, growth rate, and milk production and must be monitored regularly. The veterinarian must be aware of any changes in the feeding program that have occurred

since the last farm visit or that are intended in the near future. On breeding farms, there are several different age groups of animals at different levels of growth and production. This requires close surveillance to avoid undernutrition or overnutrition. Scoring of the body condition of dairy cattle, beef cows, sheep, and pigs is becoming commonplace as an indicator of the adequacy of the diet. Veterinary clinical nutrition is now a veterinary medical specialty that should provide new and useful information for the practitioner working with a particular species or class of food animals. The American College of Veterinary Nutrition also provides consultants in veterinary nutrition who can be called on for advice in solving nutritional problems. An experienced and competent nutritionist should be consulted to assist with complex nutritional problems.

### Nutritional management in dairy herds

Advising farms about nutrition is a key activity for dairy cattle practitioners. Feed costs constitute approximately 60% of the total cost of producing milk, and even minor improvements in feeding efficiency can be profitable. Some dairy practitioners function as the nutritional specialists for the dairy farms they serve. They may collect feed samples for nutrient analysis, formulate rations, and advise the farmer regarding crop and harvesting conditions. These veterinarians often devote a considerable amount of their professional time to nutritional management.

It is common for farms to employ a professional nutritionist or to use a nutritionist employed by a feed company or local cooperative. These professional nutritionists generally formulate the rations and submit feed samples for nutrient analysis. On these herds, the veterinarian can have an important role in ensuring that the diet described on paper is adequately formulated and delivered to the cows. Routine scheduled activities such as measuring the dry matter of forages, hand mixing total mixed rations (TMR) for one cow and comparing it with the machine-mixed TMR ('TMR test mix'), and scoring the feed bunk to assess feed sorting and dry matter intake are important procedures that help to ensure the successful delivery of a nutritional program. Assessing pasture conditions by periodic inspection of pasture is an important component of managing the nutritional program of herds that use management-intensive grazing. These quality control activities should be conducted routinely as part of the health and production management program.

There is probably no aspect of a dairy enterprise that has a wider impact than the feeding program. Dairy farm feeding



programs have direct effects on production and growth and set the stage for future productive potentials. Many health problems on a dairy relate in some way to the feeding program. Feed costs on the average dairy account for more than 60% of total operating expenses in the USA. A significant part of the average dairy's labor force devotes its time to planting, growing, harvesting, mixing, and feeding rations to a variety of animals. Investments in equipment used in feeding programs are an important part of the dairy's debt load. Small changes in feeding programs may bring about large changes in productivity, health, income, feed costs, labor allocation, and debt load. The total savings from small changes can be substantial. Without considering improved production or health effects, one study has shown that routine nutritional consultation by veterinarians can save 14% of total feed costs on dairies.

For all these reasons, veterinarians who intend to serve their dairy clients on a herd basis must become actively involved in the herd's feeding program. Dairy herds are commonly fed unbalanced, expensive rations. By serving as independent consultants, veterinarians can provide unbiased advice to their clients. Those veterinarians who wish to serve their clients at a herd level constantly find their attention focused on the feeding program. The next recumbent, hypocalcemic cow raises questions about dry cow feeding. The next anestrous, thin cow with smooth ovaries raises questions about early lactation energy levels in the ration and dry matter intake (DMI). The next time the herd average mature equivalent milk production falls by 500 lb, the problem generates the same sense of urgency as a cow with a prolapsed uterus. As a profession, dairy veterinary medicine must come to grips with the fact that it cannot truly serve client needs by practicing therapeutic medicine separately from nutritional consulting. Veterinarians must train themselves to deal with nutrition directly, consistently and knowledgeably.

In recent years, as herd size has increased, many dairies have come to rely on a team of advisors rather than only one or two. A nutritional consultant, local veterinarian, and outside consultant may all be providing advice to a dairy. In these circumstances, communication about the feeding program and resulting performance is critical. It is imperative that the veterinarian be knowledgeable about dairy nutrition and involved in ration formulation. The veterinarian needs to maintain their involvement as part of the advisory team.

#### Levels of nutritional service

Having decided to be involved in a dairy's feeding program, the veterinarian and client should first agree on the level of nutrition

service that is to be provided. The level varies from herd to herd, depending on the veterinarian's expertise, the client's ability and interest, and the role being played by other consultants to the farm. There are essentially four levels of service that might be provided:

##### Level 1: Problem identification and analysis

At level 1, the veterinarian takes on the task of monitoring the dairy herd for indicators that there might be nutrition-related problems. Many areas need to be monitored: production, milk components, DMI, body scores, disease rates, growth rates, and feed costs. Based on these monitored areas, the veterinarian can call attention to problems as they arise, form and test hypotheses about likely causes, and interact with other farm service personnel as the problems are addressed.

##### Level 2: Ration analysis

At level 2, the veterinarian evaluates the nutritional adequacy of diets as they are fed to the cows. If problems of balance or economics are identified, they are referred to the appropriate person for reformulation. This level is difficult to sustain over time because, after a while, the person formulating the ration is likely to resent being 'second-guessed'. It can work well if the 'team approach' is part of the procedure on the dairy.

##### Level 3: Ration formulation

At level 3, the veterinarian takes on the responsibility of formulating the ration. To operate responsibly at this level, veterinarians need several additional skills beyond those traditionally taught at veterinary colleges. The veterinarian must know how to use a computer to formulate a balanced, deliverable, cost-effective ration. The veterinarian should have experience in the daily mechanics of how feeds are handled and how cows are fed. It requires an intimate knowledge of the farm and its personnel. The veterinarian must maintain daily contact with the feed industry, so that feed prices and availability can be factored into the farm's overall feeding program.

If not managed carefully, this level of service has several pitfalls. It lacks the on-farm follow-up, supervision of implementation, and monitoring of results that are included in level 4. There is a truism about feeding dairy cows that every cow has three rations: the one formulated, the one delivered, and the one actually eaten. The best feeding programs minimize the difference among these three rations. If the veterinarian's role stops at formulation, then mistakes can occur in delivery and feed bunk management that can doom the program to failure. If the program fails, the

veterinarian's formulation is likely to be blamed.

##### Level 4: Total program consulting

Level 4 of nutritional service includes those aspects missing in level 3. The veterinarian plays an active role in implementing the feeding recommendations. Attention is paid to areas such as bunk management, cow comfort, feeding frequency and scheduling, quality control and consistency of feeding management. Working closely with the producer, plans for future forage production can be generated, including attention to factors such as timing the harvest for maximum feed value. The monitoring described in level 1 is sustained, and timely adjustments and feed-back are provided to ensure that the rations are accomplishing the desired ends. In the long term, this is the level of service that is most desirable for both the veterinarian and the client. The producer benefits from the added supervision and support, and the veterinarian can assure the client that the program is carried out as designed. If the program is not working, it can be modified. Total program consulting can be accomplished with the veterinarian as a part of the team that would include the nutritionist, as well as by the veterinarian alone. With many larger herds, particularly, multiple outside consultants are used, and a team approach provides the owner with the best opportunity for expert advice. In many herds, the veterinarian is best suited to be the 'team leader'.

#### Nutritional management of the beef breeding herd

Good nutrition provides the essential basis for optimum productivity in cattle breeding operations. Despite this, nutritional expertise has not been a traditional strength of many food-animal veterinarians.

Throughout the world, beef-breeding operations are generally range or pasture based. These operations are conducted in diverse environments, with great variation in nutritional management. Even within the USA, the area of pasture or rangeland required to maintain a cow-calf unit may vary from 3 acres or more in the south-west to 1 or 2 acres in more intensive regions. In parts of Australia, the corresponding area may be measured in square miles. However, in general, the area of land, or amount of pasture, necessary for production is related to local economic realities. This, in turn, is related to levels of managerial and resource inputs that can differ with regions, markets, and enterprise priorities. Notwithstanding such caveats, there are a number of principles of good nutritional management that may be universally applied to cattle breeding operations. Regardless of region, an important consideration is that of maintaining or

improving production while reducing costs. In simple terms, financial return from a beef breeding operation is a function of number of calves, their weaning weight, and price. On the cost side of the ledger is the maintenance cost of the breeding females. This varies considerably, both within and between regions. Market price, in general, is usually unmanageable at the farm level. However, both the number of calves born and their weaning weights are strongly influenced by nutrition. For example, good nutritional management helps to ensure that as many females as possible are cycling at the start of the breeding season. This, in turn, helps to ensure that calves are born early with the result that they are older, and heavier, at weaning than later-born calves.

In general, nutrition is the most important limiting factor of beef breeding performance. For veterinarians, an understanding of the principles underlying the nutritional management of breeding females is necessary. Effective counseling and troubleshooting does not necessarily require a higher degree in nutrition, although it should include sufficient knowledge and wisdom to know when such expertise is needed. A starting point is to have a working knowledge of the different energy measuring systems (total digestible nutrients (TDN), metabolizable energy (ME) and net energy, NE) that are commonly used, their applications for different classes of animals, activities and feedstuffs, and to identify one with which the veterinarian can work best. The Nutrient Requirements of Beef Cattle from the National Research Council (NRC) in the USA is a useful document revised in 2000. This is packaged with a computer program that includes ration formulators as well as a library of feeds and feedstuffs. A number of computer programs are now available for least-cost-ration formulation in beef herds.

#### Nutritional advice for beef feedlots

Feedlots frequently consult a qualified nutritionist to assist in the formulation of cost-effective diets. The veterinarian should communicate regularly with the nutritionist to be aware of the composition of the diets and any changes that are being planned. Because feed is the major portion of the cost per unit of body weight gain, it is imperative that the diet be the lowest-cost diet possible while providing nutrients that allow optimum growth and finishing. Most of the emphasis in feedlot nutrition has been on the development of cost-effective diets that support a maximum growth rate without any deleterious effects. Considerable information is available on the nutrient requirements for feedlot cattle and on the feeds and feeding systems used.

The precise specifications of the diets are the responsibility of the nutritionist,

but the feedlot veterinarian frequently is in a position to evaluate the quality of the feed delivery system. This means checking to determine whether cattle are fed on time, whether the feed is mixed properly, and whether the feed intake is intermittent because of inclement weather or muddy ground surfaces. Any deviations should be communicated to the consulting nutritionist.

Nutritional deficiency diseases are uncommon in feedlot cattle, because cattle usually receive a diet that contains the nutrients required for maintenance and promotion of rapid growth. Diets prepared according to the Nutrient Requirements of Beef Cattle should meet all the requirements under most conditions.

Specific nutrient deficiencies are extremely rare, because diets are prepared every few days or daily and it would be highly unusual for a feedlot to use a feedstuff deficient in a specific nutrient for a prolonged period. However, such a situation may occur in a small farm feedlot that prepares its own feedlot diet with little or no attention to the necessity for supplementation of homegrown feeds. Thus, there are only a few nutrition-related diseases that may affect a well-managed feedlot, but these diseases may cause large economic losses when they occur. They include the following:

- Carbohydrate engorgement (grain overload or D-lactic acidosis)
- Feedlot bloat or ruminal tympany
- Feeding errors (i.e. accidental incorporation of an excessive amount of a feed additive, such as monensin or urea, or sudden unintended changes in the ingredient composition of the diet).

#### Nutritional advice for swine-herds

Veterinarians involved in health management of swine-herds must be well informed about the nutrient requirements of the different age groups of pigs. Since feed constitutes 60–80% of the cost of producing a market pig, every effort must be made to increase the economic efficiency of feed use. Some surveys of well-managed pig farms in Alberta, Canada, found a 20% difference in feed costs, and it is estimated that in the industry the range in feed costs is likely to be near 50%. Reduction of the feed cost of the highest costing farm to that of the lowest costing farm would save that farm more than US\$23 000 annually, which is equivalent to a cost reduction in production of \$6.80/pig. The trend is to use complete feeds formulated by feed company nutritionists who are familiar with the nutrient composition of local feedstuffs. With complete diets, specific nutrient deficiencies are uncommon.

The major problem is the efficiency of utilization of the different feeds throughout the life cycle of the pig. The nutrient requirements of the pig at various phases of growth from birth to market weight and of breeding stock are well established. The remaining questions appear to be about the levels of feed that should be provided during the different phases of the growth of the pig in order to achieve optimum production and to yield the best carcass. Proper nutrition can greatly increase the efficiency of pig production, because feed represents such a large percentage of the cost involved. The following are some recommended practices for increasing efficiency of feed utilization with pigs:

- Provide well-balanced diets with adequate levels of amino acids, energy, vitamins, and minerals necessary to meet the particular demands of the pig at each stage of its life cycle. The diet depends on the demands, usually characterized as the growth rate or lean deposition. Feed intake is the supply function. Feed intake is limited by appetite, and thus other nutrients are matched to expected energy intake and subsequent growth
- Use least-cost formulation to the extent that it is feasible. The least-cost energy source in most of the pig-rearing areas is corn, and the most common protein source is soybean meal
- Restrict the level of a properly balanced diet for sows during gestation to avoid overfeeding. Sows that have lost excessive body weight in the previous lactation need supplemental feed during the dry period to avoid the thin-sow syndrome
- Ad-lib feeding for growing pigs is usually optimum, unless the genotype deposits excess fat during the latter stages of growth
- Market pigs as close to optimum slaughter weight as possible to maximize margin over feed costs
- Avoid feed wastage by using well-designed feeding systems and proper adjustment of those feeders
- Use pelleting of diets to increase digestibility, especially of small grains, and to decrease feed wastage. However, pelleting also predisposes pigs to gastroesophageal ulcers.

The feed efficiency of the pigs from weaning to market should be monitored regularly. It is often difficult to obtain accurate data on this item for specific groups of pigs, because the amount fed to each group may not be calculable when a

common feeding system is in use. However, the total amount of feed used and the total weight of pigs marketed will give an estimate of feed efficiency.

The National Research Council (NRC) in the USA provides an important service in establishing the nutrient requirements of swine and other species. The 10th revised edition of the Nutrient Requirements of Swine was published in 1998. The 200-page edition incorporates the wealth of new research information that has emerged over the past 10 years since the 8th edition, and addresses new areas such as modeling nutrient requirements and reducing nutrient excretion.

Even though the nutrient requirements of pigs are well known, they do continue to change because of changes in growth and production characteristics of pigs. Pigs with high lean-growth rates require higher levels of amino acids to support their increased rate of body protein deposition. Similarly, high milk-producing sows nursing large litters have increased amino acid requirements.

In the 10th edition, a new approach is used to produce estimates of nutrient requirements that take into consideration not only the pig's body weight, but also its accretion rate of lean (protein) tissue, gender, health status, and various environmental factors. To accurately estimate nutrient needs of gestating and lactating sows, there is a need to account for body weight, weight gain during gestation, weight loss during lactation, number of pigs in the litter, weight gain of the litter (a reflection of milk yield), and certain environmental factors.

A series of integrated mathematical equations was used to account for the many factors now known to influence nutrient requirements. These equations provide the framework for modeling the biological basis of predicting requirements. The NRC models predict the levels of nutrients (outputs) needed to achieve a certain level of production under a given set of environmental conditions (inputs).

Five principles were used to develop the models. The models: (1) were made for ease of use by people with varying levels of nutritional expertise and with limited information; (2) were developed for continued relevance for several years to come; (3) were intended to be structurally simple, so they could be understood readily by users; (4) were developed to be transparent so that all of the equations could be available to the user and (5) were firmly anchored to empirical data at the whole-animal level rather than being simply based on theoretical values. Three independent models were developed for growth, gestation, and lactation. The growth model estimates amino acid requirements

of pigs from weaning to market weight, and the gestation and lactation models estimate energy and amino acid requirements of gestating and lactating sows.

Few revisions were made in the previously published mineral requirements. Based on recent findings, higher dietary requirements for sodium and chloride in the young pig were established. The manganese requirements were increased from 10 to 20 ppm for gestating and lactating sows.

Several changes were made in the feed composition tables. Nutrient composition of feeds was obtained from as many data bases as possible, including from the feed industry and from data sets outside the USA and Canada.

The information on water was expanded considerably, with more detailed information on the factors that influence water intake. There is additional new information on non-nutritive feed additives, such as antimicrobial agents, anthelmintics, microbial supplements, oligosaccharides, enzymes, acidifiers, flavors, odor control agents, antioxidant pellet binders, flow agents, high-mineral supplements, and carcass modifiers.

A new chapter on minimizing nutrient excretion is included in the 10th edition. It addresses environmental issues and the importance of reducing the excretion of nutrients, particularly nitrogen and phosphorus, which can potentially contribute to environmental pollution.

### **Nutritional advice for sheep flocks**

The influence of nutrition on the reproductive performance of ewes has been a matter of concern to sheep farmers and sheep production research workers throughout the world. It is clear that the relationship between nutritional provision and nutrient requirements for optimum reproductive performance is seldom ideal because of the wide range of environmental conditions and the seasonality of breeding that most sheep breeds exhibit. Prolonged periods of undernutrition during mid-pregnancy are partly the result of the decline in feed availability and quality over that stage of the reproductive cycle.

Prolonged duration of moderate to severe undernutrition of ewes bearing twins in mid-pregnancy can reduce placental development causing significant reductions in lamb birth weight with increased mortality. Considerable progress has been made in understanding the principles of nutrition of sheep and in defining their nutrient requirements for maintenance, pregnancy, and lactation.

The sensitivity of lamb birth weight, particularly in twins and triplets, to the ewe's plane of nutrition during late pregnancy is well known. It has been estab-

lished that mortality rates are high in lambs with birth weights below the breed norm, and that after birth the absolute growth rates are lower in surviving light lambs than in heavier lambs of the same breed. The plane of nutrition and the size of the placenta have been recognized as major determinants of the fetal growth rate. Fetal growth retardation in undernourished ewes has a placental component, and the factors that affect placental growth are relevant here.

The 21-week gestation can be divided into a number of periods to consider the effects of nutrition on reproduction within each period. In the first month of gestation, embryonic loss is the main sequel to inadequate nutrition. During this period, it is generally recommended that the BCS of the ewe be maintained at 2.5–3.5 (scale of 1 to 5) to minimize embryonic and early fetal losses. This is followed by a period of 2 months in which there is rapid growth of the placenta, but during which growth of the fetus in absolute terms is still small. Over this period, it is normal to advocate that losses in body weight should not exceed 5%. Finally, there is the phase from 90 days to parturition, in which gain in the mass of the fetus amounts to 85% of its birth weight; during this period, nutrient intake must be increased.

Placental development in the pregnant ewe begins about 30 days after conception, the number of placentomes associated with each fetus is fixed at this time, and the total weight of the placentomes increases until about 90 days of gestation, after which there is little change. The factors that influence the ultimate size of the placenta and its weight include hormonal and nutritional factors, prolonged environmental heating of pregnant ewes, parity of ewes, and possibly genotype, but the most important determinant is nutrition of the ewe. Moderately severe undernutrition during early pregnancy and midpregnancy significantly reduces placental weight at or near term and causes chronic intrauterine growth retardation.

The size of the placenta is a major determinant of fetal growth. In well-fed ewes, the fetal growth rate before 120 days of gestation is not correlated positively with placental weight, but fetal growth rate in the last 3 to 4 weeks of pregnancy is limited by the size of the placenta. Earlier placental influences on fetal growth are evident, however, when ewes are underfed. Placental weight and fetal growth rate are correlated positively during periods of maternal underfeeding, which starts before 90, at 95, or at 112 days of gestation. During the first 90 days of pregnancy, placental growth is reduced when ewes are moderately underfed. Low-weight fetuses in ewes with placenta weights near the bottom of the

normal range are affected with chronic and progressive hypoxemia and hypoglycemia, which affect fetal metabolism. The consequences are fetal death during late pregnancy, fetal hypoxemia during parturition, premature birth, and a high perinatal mortality rate caused by hypoglycemia and hypothermia.

The extent to which ewes maintained on a fixed ration draw on their own body reserves in an attempt to meet the energy costs of pregnancy is determined by fetal weight. In well-fed ewes, fetal growth rate remains constant until at least 120 days of gestation and decreases thereafter. However, its absolute growth rate increases markedly during the last 8 weeks of gestation, when fetal growth is most rapid, exceeding 100 g/day near birth. The growth rate among fetuses is highly variable, which accounts for birth weights ranging from 2 kg to over 7 kg. When ewes that have been well fed are severely underfed at any stage during the last 40 to 50 days of pregnancy, the fetal growth rate decreases within 3 days, by 30% to 70%. This illustrates that the mobilization of maternal reserves is substantially less than fetal requirements and emphasizes the importance of ensuring a continuous supply of good-quality feed during late pregnancy. The larger the fetal burden, the more susceptible a ewe is to hypoglycemia during underfeeding.

Re-feeding after severe underfeeding can reverse the reduced growth rate of fetuses, but the response depends on the duration of the underfeeding. If the period of underfeeding is 16 days or less, the growth rate increases when ewes are re-fed, but there is no change when re-feeding occurs after 21 days of severe underfeeding. Moderate underfeeding of pregnant ewes for 85 days reduces the fetal growth rate irreversibly, and refeeding them in late pregnancy does not cause the fetal growth rate to increase but does prevent further decreases after 120 days.

The major consequences of prenatal growth retardation are on lamb survival. The neonatal mortality of lambs increases markedly in many environments as the birth weight falls below 3–3.5 kg. Compared with normal lambs, low-birth-weight animals have reduced insulation because of the smaller number of wool fibers, greater relative heat loss because of their larger surface area per unit of body weight, and a reduced capability to maintain heat production because of their lower fat and energy reserves. All these factors increase their susceptibility to environmental stress and reduce their ability to compete with normal-sized siblings. Underfeeding during pregnancy can also reduce available body lipids in lambs by about 47% and also decreases the lactose, lipid, and protein

available in colostrum during the first 18 h by about 50%. Newborn lambs have to draw on body reserves of glycogen in order to maintain heat production during the first 18 h after birth, and thus depend heavily on colostrum intake and supplemental feeding to avoid hypoglycemia and hypothermia.

The effects of maternal nutrition on udder development and on the production and yield of colostrum and milk in ewes have also been examined. In the last 30 days before birth, there is a marked increase in the rate of mammary tissue growth in the ewe. In well-fed ewes with one or two lambs, large volumes of colostrum accumulate in the mammary glands during the last few days of pregnancy and copious milk secretion begins soon after birth, with averages of 1800 to 2800 mL of colostrum and milk being produced during the first 18 h. Udder growth rates are proportional to fetal growth rates in that the greatest increase in udder weight occurs in the last 30 days of gestation and the weight of udder tissue is 30–40% of the total weight of the litter. Colostrum production is proportional to udder weight, and re-feeding of ewes a few days before lambing fills the udder tissue present but does not increase udder tissue weight. In underfed ewes, prenatal colostrum accumulation is reduced markedly, lactogenesis is delayed, and the total production of colostrum and milk during the first 18 h averages about 1000 mL. Subsequently, in both types of ewe, milk production increases, reaching a peak about 1–2 weeks after birth. Underfeeding ewes beginning at 105 days of gestation can reduce the total yield of colostrum during the first 18 h after birth by decreasing mammary tissue growth. Thus, the prepartum accumulation of colostrum and its subsequent rates of secretion are reduced. Improving the ewe's nutrition from 1 h after birth can increase the secretion rates of colostrum between 10 and 18 h.

The growth rate of lambs during the first few weeks of life is correlated positively with birth weight. Low planes of maternal nutrition during late pregnancy and early lactation are generally associated with low birth weights, milk yields, and postnatal growth rates, and high planes of nutrition with the opposite effects. A marked increase in the plane of maternal nutrition at birth can overcome the inhibitory effects on lactation and lamb growth rate of underfeeding in late pregnancy.

At breeding time, the aim is to achieve a body score of 3.0–3.5, which ensures maximum ovulation rate. For ewes with a BCS of 3.5 at breeding, it is desirable to allow them to lose no more than 5% of their body weight steadily, equivalent to approximately 0.5 to 1 unit of condition

score during the second and third months of pregnancy. This mild degree of undernutrition enhances placental growth and establishes the basis for maximum fetal growth in the 4th and 5th months of pregnancy, the period during which the fetus achieves over 80% of its growth. During these final 2 months of pregnancy, there is a limit to the extent to which body fat reserves can be used, because excessive mobilization of depot fats as a consequence of inadequate dietary energy supply leads to pregnancy toxemia. In late gestation, the optimum BCS ranges from 2.5 to 3.0. In contrast, early lactation is a period in which body fat can be safely used to meet some of the high energy demands of lactation. During this period, a loss of BCS of 1.0 (equivalent to 5 kg fat for a 70 kg ewe at mating) is acceptable, and during lactation it ranges from 1.5 to 2.5. The replacement of the body fat that is used before the next breeding cycle is important in achieving a maximum ovulation rate and subsequently optimum reproductive performance.

Winter shearing of pregnant ewes during the final 10 weeks of pregnancy has been shown to cause a significant increase in lamb birth weight. Shearing pregnant sheep at 8 weeks before lambing leads to a chronic increase in energy requirements, which are met by oxidizing body fat depots without risks of clinical ketosis. Fetal growth is enhanced as a result of these metabolic adaptations.

The nutrient requirements for maintenance, breeding, pregnancy, and lactation of ewes have been catalogued, and optimum feeding strategies for the breeding ewe can be formulated. The evaluation of the ewes' ration during late gestation by monitoring plasma concentrations of the ketone body 3-OH butyrate has been described with accurate guidelines, which have been used as the basis for flock nutritional advice during late gestation.

The achievement of optimum reproductive performance involves changing feeding strategies and adjusting the nutrient value of the diet as necessary throughout the reproductive cycle to meet the needs of the particular stage. The requirements for metabolizable energy begin to increase steadily above maintenance levels beginning at between 8 and 12 weeks of pregnancy and continuing into late pregnancy and lactation. During early lactation, when the energy requirements of prolific ewes exceed those required by the voluntary consumption of all but the highest-quality diets, the body fat reserves are used and then replenished toward the end of lactation, when milk yield declines, and in the period leading up to rebreeding.

In contrast to the ability of the ewe, particularly in early lactation, to use body reserves when the intake of energy fails to

meet her needs, there is little scope for sustaining production by drawing on body protein. For example, lactating ewes can lose up to 7 kg of body fat during a 4-week period in early lactation, when energy intake is below requirements. For ewes on a low-protein intake, the maximum daily loss of protein was 26 g. Thus, it is important to meet the protein needs of the ewe at all times during pregnancy, but especially during late pregnancy, for fetal growth, udder development, and colostrum production. The estimates for protein are also based on the important principle of distinguishing between the needs of the rumen microflora for rumen-degradable protein and of the host animal for additional undegraded dietary protein when rumen-degradable protein fails to meet those requirements; this represents the minimum protein needs of the animal. In practice, the dietary allowances for late pregnancy and early lactation are higher than the sum of the rumen-degradable protein and undegradable protein.

The rapid growth of the fetus after 90 days of pregnancy requires an increased allowance of dietary energy, which can be met with concentrates if only hay is available. This is particularly true for ewes carrying twins or triplets. The daily dietary energy requirement of ewes of varying body weights and fetal number ranging from singletons to triplets has been described in conjunction with a monitoring program for dietary energy supply based on plasma concentration of the ketone body 3-OH butyrate. This system forms the basis of flock advisory visits made by veterinarians during late gestation in UK flocks. Correct nutrition during late gestation guarantees appropriate lamb birth weights despite litter size and sufficient accumulation of protective immunoglobulin in the udder.

## REVIEW LITERATURE

- Subcommittee on Dairy Cattle Nutrition, Committee on Animal Nutrition, Board on Agriculture, National Research Council Subcommittee on Dairy Cattle Nutrition. Nutrient requirements of dairy cattle, 7th ed. Washington, DC: National Academy Press, 2000.
- Subcommittee on Beef Cattle Nutrition, Committee on Animal Nutrition, Board on Agriculture, National Research Council. Nutrient requirements of beef cattle, 7th revised ed. Washington, DC: National Academy Press, 2000.
- Subcommittee on Swine Nutrition, Committee on Animal Nutrition, Board on Agriculture, National Research Council. Nutrient requirements of swine, 10th revised ed. Washington, DC: National Academy Press, 1998.
- Subcommittee on Horse Nutrition, Committee on Animal Nutrition, Board on Agriculture, National Research Council. Nutrient requirements of horses, 5th revised ed. Washington, DC: National Academy Press, 1989.
- Subcommittee on Sheep Nutrition, Committee on Animal Nutrition, Board on Agriculture, National Research Council. Nutrient requirements of sheep, 6th revised ed. Washington, DC: National Academy Press, 1985.

## DEFICIENCIES OF ENERGY AND PROTEIN

### DEFICIENCY OF ENERGY

#### ETIOLOGY

Insufficient quantity or quality of feed is a common nutritional deficiency and practical problem of feeding livestock.<sup>1,2</sup> The term **protein-energy malnutrition** is used to describe a form of incomplete starvation in which energy and protein are present in the diet in suboptimal quantities. Protein and energy deficiencies usually occur concurrently in underfed livestock and often cannot be strictly separated.

#### EPIDEMIOLOGY

A deficiency of energy is the most common nutrient deficiency limiting performance of farm animals. There may be inadequate amounts of feed available, or the feed may be of low quality. Supplies of feed may be inadequate because of overgrazing, drought, snow covering, or it may be too expensive to be fed to the animals. Available feed may be of such low quality and digestibility that animals cannot consume enough to meet energy requirements. In some cases, forage may contain a high concentration of water, which limits total energy intake.

#### CLINICAL FINDINGS

The clinical findings of an energy deficiency depends on the age of the animal, whether or not it is pregnant or in lactation, the presence of concurrent deficiencies of other nutrients and environmental influences. In general, an insufficient supply of energy in **young animals** results in retarded growth and delay in the onset of puberty. In **mature animals**, there is a marked decline in milk production and a shortened lactation. A prolonged energy deficiency in pregnant beef heifers will result in a failure to produce adequate quantities of colostrum at parturition. In mature animals, there is also a marked loss of body weight, especially during high demands for energy as in late pregnancy and early lactation. There are **prolonged periods of anestrus** lasting up to several months, which has a marked effect on reproductive performance in the herd. Primigravid females are particularly susceptible to protein-energy malnutrition because of growth and maintenance requirements.<sup>1</sup> A **prolonged deficiency of energy during late gestation** may result in undersized, weak neonates with a high mortality rate. A **deficiency of energy during prolonged periods of cold weather**, especially in pregnant beef cattle, and ewes being wintered on poor quality roughage, may result in abomasal impaction. Heat loss from the animal to the environment increases remarkably during

cold weather, and when ambient temperatures are below the critical temperatures, the animal responds by increasing metabolic rate to maintain normal body core temperature. If sufficient feed is available when temperatures are below the lower critical temperature, ruminants will increase their voluntary feed intake to maintain body temperature. If sufficient feed is not available, the animal will mobilize energy stored as fat or muscle to maintain body temperature and thus lose body weight. In the case of ruminants and horses, if the feed is of poor quality, for example, poor quality roughage, the increased feed intake may result in impaction of the abomasum and forestomachs in cattle and of the large intestine in the horse.

**Cold, windy, and wet weather** will increase the needs for energy and the effects of a deficiency are exaggerated, often resulting in weakness, recumbency and death. A sudden dietary deficiency of energy in fat, pregnant beef cattle and ewes can result in starvation ketosis and pregnancy toxemia. Hyperlipemia occurs in fat, pregnant or lactating ponies that are on a falling plane of nutrition.

**Protein-energy malnutrition occurs in neonatal calves** fed inferior quality milk replacers that may contain insufficient energy or added non-milk proteins which may be indigestible by the newborn calf. A major portion of the body fat present at birth can be depleted in diarrheic calves deprived of milk and fed only fluids and electrolytes for 4-7 days. Feeding only fluids and electrolytes to normal, healthy newborn calves for 7 days can result in a significant loss of perirenal and bone marrow fat, and depletion of visible omental, mesenteric and subcutaneous fat stores.<sup>3</sup> The amount of body fat present in a calf at birth is an important determinant of the length of time an apparently healthy calf can survive in the face of malnutrition. Calves born from dams on an adequate diet usually have sufficient body fat to provide energy for at least 7 days of severe malnutrition. The absence of perirenal fat in a calf at 2-4 days of age suggests inadequate reserves of fat at birth and chronic fetal malnutrition.<sup>3</sup>

## REVIEW LITERATURE

- Oetzel GR, Berger LL. Protein-energy malnutrition in domestic ruminants. Part 1. Predisposing factors and pathophysiology. *Comp Cont Educ Pract Vet* 1985; 7:S672-S679.
- Oetzel GR, Berger LL. Protein-energy malnutrition in domestic ruminants. Part 2. Diagnosis, treatments and prevention. *Comp Cont Educ Pract Vet* 1986; 8:S16-S21.

## REFERENCES

- Oetzel GR, Berger LL. *Comp Cont Educ Pract Vet* 1985; 7:S672.
- Oetzel GR, Berger LL. *Comp Cont Educ Pract Vet* 1986; 8:S16.
- Schoonderwoerd M. et al. *Can Vet J* 1986; 27:365.

## DEFICIENCY OF PROTEIN

A deficiency of protein commonly accompanies a deficiency of energy. However, the effects of the protein deficiency, at least in the early stages, are usually not as severe as those of energy. Insufficient protein intake in young animals results in reduced appetite, lowered feed intake, inferior growth rate, lack of muscle development, and a prolonged time to reach maturity. In mature animals, there is loss of weight and decreased milk production. In both young and mature animals, there is a drop in hemoglobin concentration, packed cell volume, total serum protein, and serum albumin. In the late stages, there is edema associated with the hypoproteinemia. Ruminants do not normally need a dietary supply of essential amino acids, in contrast to pigs which need a natural protein supplement in addition to the major portion of total protein supplied by the cereal grains. The amino acid composition of the dietary protein for ruminants is not critical because the ruminal flora synthesize the necessary amino acids from lower quality proteins and non-protein sources of nitrogen.

### CLINICAL FINDINGS

The clinical findings of an energy deficiency are similar to those of a protein deficiency and the clinical findings of both resemble many other specific nutrient deficiencies and subclinical disease. Protein-energy malnutrition in beef cattle occurs most commonly in late gestation and is characterized clinically by weakness, clinical recumbency, marked loss of body weight, a normal mental attitude, and a desire to eat.<sup>1,2</sup> Cows with concurrent hypocalcemia will be anorexic. If the condition occurs at the time of parturition, there will be an obvious lack of colostrum. Calves of these cows may attempt to vigorously suck their dams, attempt to eat dry feed, drink surface water or urine and bellow continuously. Affected cows and their calves may die within 7–10 days.

Protein-energy malnutrition is less common in dairy cattle because they are usually fed to meet the requirements of maintenance and milk production. Dairy calves fed inferior quality milk replacers during periods of cold weather will lose weight, become inactive, lethargic, and may die within 2–4 weeks. Affected calves may maintain their appetites until just before death. Diarrhea may occur concurrently and be confused with acute undifferentiated diarrhea due to the enteropathogenic viruses or cryptosporidiosis. Affected calves recover quickly when fed cow's whole milk.

Protein-energy malnutrition also occurs in sheep and, less commonly, in goats. Excessive dental attrition is a common

cause in grazing sheep, which is exacerbated by the excessive ingestion of soil.

### DIFFERENTIAL DIAGNOSIS

The diagnosis will depend on an estimation of the concentration of energy and protein in the feed, or a feed analysis, and comparing the results with the estimated nutrient requirements of the affected animals. In some cases, a sample of feed used several weeks earlier may no longer be available or the daily amount of feed intake may not be known. Marginal deficiencies of energy and protein may be detectable with the aid of a metabolic profile test. Specific treatment of livestock affected with protein-energy malnutrition is usually not undertaken because of the high cost and prolonged recovery period. Oral and parenteral fluid and electrolyte therapy can be given as indicated. The provision of high-quality feeds appropriate to the species is recommended.

### PREVENTION

The prevention of protein-energy malnutrition requires the provision of the nutrient requirements of the animals according to age, stage of pregnancy and production, the environmental temperature and the cost of the feeds. Body-condition scoring of cattle and sheep can be used as a guide to monitor body condition and nutritional status. Regular analysis of feed supplies will assist in the overall nutritional management program. The published nutrient requirements of domestic animals are only guidelines to estimated requirements since they were determined in experimental animals selected for uniform size and other characteristics. Under practical conditions, all of the common factors that affect requirements must be considered.

### REVIEW LITERATURE

- Oetzel GR, Berger LL. Protein-energy malnutrition in domestic ruminants. Part 1. Predisposing factors and pathophysiology. *Comp Cont Educ Pract Vet* 1985; 7:S672–S679.
- Oetzel GR, Berger LL. Protein-energy malnutrition in domestic ruminants. Part 2. Diagnosis, treatments and prevention. *Comp Cont Educ Pract Vet* 1986; 8:S16–S21.

### REFERENCES

- Oetzel GR, Berger LL. *Comp Cont Educ Pract Vet* 1985; 7:S672.
- Oetzel GR, Berger LL. *Comp Cont Educ Pract Vet* 1986; 8:S16.

## Diseases associated with deficiencies of mineral nutrients

An enormous literature exists on the subject of mineral nutrient deficiencies in animals and it is not possible to review it all here. However, some general comments

should be made. The era of large-scale deficiencies affecting very large numbers of animals and comprising single elements has now largely passed in developed countries. The diagnostic research work has been done and the guidelines for preventive programs have been outlined and put into action in the field, so that the major breakthroughs have already been made, and what remains is in many ways a tidying-up operation after large-scale control campaigns. The loose edges needing to be refined include correcting overzealous application of minerals, which can produce toxicoses, sorting out the relative importance of the constituent elements in combined deficiencies, which are characterized by incomplete response to provision of single elements, and devising means of detecting marginal deficiencies.

At least 15 mineral elements are nutritionally essential for ruminants. The macrominerals are calcium, phosphorous, potassium, sodium, chlorine, magnesium, and sulfur. The trace elements, or micro-minerals, are copper, selenium, zinc, cobalt, iron, iodine, manganese, and molybdenum. Improving trace element nutrition of grazing livestock, in a way that is cost effective and that meets consumer perceptions and preferences, is a continuing challenge.<sup>1</sup>

### INCIDENCE AND ECONOMIC IMPORTANCE

Despite increasing experimental evidence that anomalies in trace element supply can influence growth, reproductive performance, or immunocompetence of livestock, few data exist from which the incidence and economic significance of such problems can reliably be assessed. Most published reports of the more readily recognized trace element-related diseases continue to provide insufficient quantitative information to assess their incidence and true economic impact. Despite these deficiencies in information, the FAO/WHO Animal Health Yearbooks indicate that, of the countries providing nutritional diseases of moderate or high incidence, and trace element deficiencies or toxicities are involved in more than half of those whose causes were identified. In the UK, it has been estimated that, despite the activities of its nutritional and veterinary advisory services and extensive policies of ration supplementation, characteristic clinical signs of copper deficiency develop annually in about 0.9% of the cattle population. In light of recently described evidence that copper deficiency can predispose to increased mortality due to infectious diseases in lambs, the

economic losses from copper deficiency may be grossly underestimated.

## DIAGNOSTIC METHODS AND STRATEGIES

In developed countries with highly developed animal industries, the emphasis is on disease prevention rather than therapy, and elimination or economical control of trace element deficiencies is a matter of education rather than research. However, because copper, cobalt, selenium, and iodine deficiencies can affect reproductive performance, appetite, early postnatal growth, and immunocompetence on a herd or flock basis, increasing emphasis is being placed on diagnostic methods that will identify a developing risk long before specific clinical manifestations appear. In addition, it is not good enough to merely define the distribution of animal populations with an abnormal trace element status indicated by blood or tissue analysis, or to detect a deficiency of the trace element in the diet. The only feasible way of monitoring the pre-clinical stages of trace element deficiency is the identification of a biochemical indicator which reflects changes in the activity of the enzyme involved or the concentration in tissues of its substrate or products. The demand is growing for techniques that will predict when the likely pathological outcome of such anomalies justifies the introduction of protective measures. For example, recent observations indicate that a high proportion of grazing cattle become hypocupremic if maintained on forage, but fail to develop characteristic clinical signs of deficiency and, furthermore, only a small percentage of these animals exhibit any physiological response to the administration of copper. This illustrates the lack of understanding of the variables involved in the development of clinical manifestations of copper deficiency and whether they are induced by a simple dietary deficiency of copper or by specific copper antagonists present in the diet.<sup>1</sup> A relatively new and interesting area of development is the observation of genetic variation in dietary requirements for copper among different breeds of sheep and that sheep can be selected for a high or low concentration of plasma copper, which in turn will have profound physiological consequences in the low group. There is now evidence that heredity is involved in the utilization of trace elements by animals. A small amount is necessary, but a larger amount may be toxic, and there is a need to determine the optimal economic balance.

Thus, it is likely that trace element deficiencies are widespread, but their incidence and importance are probably

underestimated because subclinical forms of deficiency can occur and go unnoticed for prolonged periods.

## DEFICIENCIES IN DEVELOPING COUNTRIES

In developing countries, the trace element problem is confounded by the common deficiencies of energy, protein, phosphorus, and water, which affect postnatal growth and reproductive performance. Undernutrition is commonly accepted as the most important limitation to herbivore livestock production in tropical countries. However, mineral deficiencies or imbalances in soils and forages have long been held responsible for low production and reproduction problems among grazing tropical cattle. Cattle grazing forages in areas severely deficient in phosphorus, cobalt, or copper are even more limited by lack of these elements than either that of energy or protein.

## PATHOPHYSIOLOGY OF TRACE ELEMENT DEFICIENCY

The physiological basis of trace element deficiency is complex.<sup>1</sup> Some elements are involved in a single enzyme, some in many more, and a lack of one element may affect one or more metabolic processes. Furthermore, there are wide variations in how individual animals respond clinically to lowered blood or tissue levels of a trace element. For example, two animals in a herd or flock with the same copper levels in their blood may be in different bodily condition. The susceptibility

to clinical disease may be a function of the stage of physiological development at which they occur, genetic differences within a species, and interrelationships with other trace elements. There is now good evidence to show that the amounts of dietary copper adequate for some breeds of sheep were deficient for others, and even toxic to others.

A dietary deficiency does not necessarily lead to clinical disease. Several factors predispose the animal to clinical disease and they include:

- The age at which the deficiency occurs (for example fetal lambs are highly susceptible to demyelination due to copper deficiency in late fetal life)
- Differences in genotype requirements
- Discontinuous demands for trace elements because of changes in environment
- The challenge of infections, diet, and production demands
- Individual variations in response to the deficiency, the use of alternative pathways by the body in the face of a deficiency
- Size of the functional reserves.

The trace elements are involved as component parts of many tissues, and one or more enzyme activities and their deficiency leads to a wide variety of pathological consequences and metabolic defects. These are summarized in Table 30.1.

The **soil-plant-animal interactions** in relation to the incidence of trace element deficiencies in livestock are being examined. The soil and its parent materials

Table 30.1 Principal pathological and metabolic defects in essential trace element deficiencies

Deficiency	Pathological consequence	Associated metabolic defect
Copper	Defective melanin production	Tyrosine/DOPA oxidation
	Defective keratinization; hair, wool	-SH oxidation to S-S
	Connective tissue defects	Lysyl oxidase
	Ataxia, myelin aplasia	Cytochrome oxidase
	Growth failure	?
	Anemia	?
	Uricemia	Urate oxidase
Cobalt	Anorexia	Methyl malonyl CoA mutase
	Impaired oxidation of propionate	Tetrahydrofolate methyl transferase
	Anemia	
Selenium	Myopathy; cardiac/skeletal	Peroxide/hydroperoxide destruction
	Liver necrosis	Glutathione peroxidase
	Defective neutrophil function	OH; O <sub>2</sub> generation
Zinc	Anorexia, growth failure	?
	Parakeratosis	Polynucleotide synthesis, transcription, translation?
	Perinatal mortality	
	Thymic involution	
Iodine	Defective cell-mediated immunity	
	Thyroid hyperplasia	Thyroid hormone synthesis
	Reproductive failure	
	Hair, wool loss	
Manganese	Skeletal/cartilage defects	Chondroitin sulfate synthesis
	Reproductive failure	?



are the primary sources of trace elements on which soil-plant-animal relationships are built. The natural ranges in concentration of most trace elements in soils are wide and range from deficient soils to those which are potentially toxic. The availability of trace elements to plants is controlled by their total concentration in the soil and their chemical form. Certain species of plants take up more trace elements than do others. The ingestion of soil can have a profound effect on trace element nutrition and metabolism. Geochemical surveys can now assist in the identification of areas in which livestock are exposed to excessive ingestion or deficiencies of trace elements.

The **dose-response trial** will continue to play a significant role in the delineation of trace element deficiencies because it is often difficult to determine the role of individual trace elements. A deficiency of one trace element may result in clinical disease, which may be indistinguishable from a deficiency of more than one trace element. Many of the trace element deficiencies may produce non-specific as well as specific effects.

A **dose-response trial** can be defined as the application of a test and a control substance to a group, or replicates, of individuals and the measurement of the response to the treatment. The requirements for a reliable dose-response trial include a careful appraisal of the basis for conducting the trial, a suitable form of the test substance for treatment, the careful selection of animals for the test, a reliable biochemical method for monitoring the response to the trace element, a measurable production response, an adequate system for measurement of the variable that may influence the response, and a means of measuring the economic impact.

The **ad hoc field observations** made by veterinarians who make a diagnosis of a trace element deficiency, followed by treatment or dietary changes, are subjective and usually lack controls but are nevertheless of value in indicating the magnitude and variability of response that might be expected in future experimental studies. Dose-response trials help to establish a link between a trace element and certain clinical signs; they may identify factors which modify the response to a trace element and, of paramount importance, give an indication of the economic importance of adequate supplementation of the element in the diet.

There are major problems in the diagnosis and anticipation of trace element deficiencies in grazing livestock. Because of the interplay between the constituents of the diet and the homeostatic mechanisms of the body, it is often impossible to predict from dietary composition alone

whether a particular nutritional regimen will result in clinical disease. The assessment of the absorbable, rather than the total, concentration of elements in the diet is now considered to be more important in understanding the nutritional basis for the deficiencies.

### LABORATORY DIAGNOSIS OF MINERAL DEFICIENCIES

The diagnosis of mineral deficiencies, particularly trace element deficiencies, will depend heavily on the interpretation of the biochemical criteria of the trace element status. This is because deficiencies of any one or more of several trace elements can result in non-specific clinical abnormalities, such as loss of weight, growth retardation, anorexia, and inferior reproductive performance.

The interpretation of biochemical criteria of trace element status are governed by three important principles: **relationship with intake, time, and function.**

1. **Relationship between the tissue concentrations of a direct marker and the dietary intake of the element** will generally be sigmoid in shape (a dose-response curve). The important point on the curve is the intake at which the requirement of the animal is passed, which is the intake of the nutrient needed to maintain normal physiological concentrations of the element and/or avoid impairment of essential functions. For several markers of trace element status, the position on the x-axis at which requirement is passed coincides with the end of the lower plateau of the response in marker concentration. Under these conditions, the marker is an excellent index of sufficiency and body reserves, but an insensitive index of a deficiency. If requirement is passed at the beginning of the upper plateau, the marker is a poor index of sufficiency, but a good index of deficiency. This principle allows direct markers to be divided into **storage** and **non-storage** types corresponding to the former and latter positions on the x-axis.
2. **Non-storage criteria can be divided into indicators of acute and chronic deficiency** and two types of relationships can be distinguished: a **rapid, early decline** in marker concentration followed by a plateau, and a **slow, linear rate** of decline. Markers with a slow, linear response will be good indices of a chronic deficiency, but unreliable indices of acute deficiency, because they cannot respond quickly enough. Conversely,

the marker with a rapid, early decline will be a good index of acute deficiency, but an unreliable indicator for chronic deficiency if the low plateau is reached before functions are impaired. Those biochemical criteria that are based on metalloenzyme or metalloprotein concentrations in erythrocytes are of the slow type because the marker is incorporated into the erythrocyte before its release into the bloodstream, and thereafter its half-life is determined by that of the erythrocyte that is 150 days or more. Metalloenzymes or metalloproteins in the plasma with short half-lives provide markers of the rapid type.

3. A deficiency can be divided into four phases: depletion, deficiency (marginal), dysfunction, and clinical disease.

**Depletion** is a relative term describing the failure of the diet to maintain the trace element status of the body, and it may continue for weeks or months without observable clinical effects when substantial body reserves exist. When the net requirement for an essential element exceeds the net flow of absorbed element across the intestine then depletion occurs. The body processes may respond by improving intestinal absorption or decreasing endogenous losses. During the depletion phase, there is a loss of trace element from any storage sites, such as the liver, during which time the plasma concentrations of the trace element may remain constant. The liver is a common store for copper, iron, and vitamins A and B<sub>12</sub>.

If the dietary deficiency persists, eventually there is a transition from a state of depletion to one of **deficiency**, which is marked by biochemical indications that the homeostatic mechanisms are no longer maintaining a constant level of trace elements necessary for normal physiological function. After variable periods of time, the concentrations or activities of trace element-containing enzymes will begin to decline leading to the phase of **dysfunction**. There may be a further lag period, the **subclinical phase**, before the changes in cellular function are manifested as **clinical disease**. The biochemical criteria can be divided, according to the phase during which they change, into indicators of marginal deficiency and dysfunction. The rate of onset of clinical disease will depend on the intensity of the dietary deficiency, the duration of the deficit and the size of the initial reserve. If reserves are non-existent, as with zinc metabolism, the effects may be acute and the separate phases become superimposed. The application of these principles to the interpre-

tation of biochemical criteria of trace element status are presented later in this chapter where applicable, under each mineral nutrient.

The **definitive etiological diagnosis** of a trace element deficiency will depend on the response in growth and health obtained following parenteral treatment or supplementation of the diet. The concurrent measurement of biochemical markers will aid in the interpretation and validation of those markers for future diagnosis. The strategies for anticipating and preventing trace element deficiencies include regular analysis of the feed and soil, which are not highly reliable; and monitoring samples from herds and flocks to prevent animals from entering the zone of marginal trace element deficiencies which precedes the onset of functional deficiency. The decision to intervene can be safely based on the conventional criteria of marginal trace element status.

## REVIEW LITERATURE

Underwood EJ, Suttle NF. Cobalt. In: The mineral nutrition of livestock, 3rd ed. Wallingford, Oxon: CAB International 1999; 251–282.

Lee J, Masters DG, White CL, Grace ND, Judson GJ. Current issues in trace element nutrition of grazing livestock in Australia and New Zealand. *Aust J Agric Res* 1999; 50:1341–1364.

## REFERENCE

1. Lee J et al. *Aust J Agric Res* 1999; 50:1341.

## COBALT DEFICIENCY

Cobalt deficiency is a disease of ruminants ingesting a diet deficient in cobalt, which is required for the synthesis of vitamin B<sub>12</sub>. The disease is characterized clinically by inappetence and loss of body weight. Some effects on reproductive performance in sheep have been reported. Cobalt was first shown to be an essential nutrient for sheep and cattle as an outcome of Australian investigations in the 1930s of two naturally occurring diseases, 'coast disease' of sheep, and 'wasting disease' or **enzootic marasmus**, of cattle.<sup>1</sup>

### Synopsis

**Etiology** Dietary deficiency of cobalt resulting in a deficiency of vitamin B<sub>12</sub>.

**Epidemiology** Occurs primarily in cattle and sheep unsupplemented with cobalt worldwide where soils are deficient in cobalt. Associated with ovine white liver disease.

**Signs** Inappetence, gradual loss of body weight, pica, marked pallor of the mucous membranes. Wool and milk production decreased. Decreased lambing percentage.

**Clinical pathology** Cobalt, or vitamin B<sub>12</sub> concentration of liver. Cobalt concentrations. Methylmalonic acid in plasma and urine. Formiminoglutamic acid in urine. Anemia.

**Necropsy findings** Emaciation, hemosiderosis of spleen.

**Diagnostic confirmation** Vitamin B<sub>12</sub> and cobalt of liver.

### Differential diagnosis list

Common causes of ill-thrift in ruminants:

- Copper deficiency
- General nutritional deficiency (protein and energy)
- Johne's disease
- Intestinal helminthiasis.

**Treatment** Oral dosing with cobalt or parenteral injections of vitamin B<sub>12</sub>.

**Control** Dietary supplementation with cobalt. Cobalt-heavy pellets.

## ETIOLOGY

The disease is caused by a deficiency of cobalt in the diet which results in a deficiency of vitamin B<sub>12</sub>.

## EPIDEMIOLOGY

### Occurrence

The literature on the diagnosis, treatment, control of cobalt deficiency in ruminants in New Zealand has been reviewed.<sup>2</sup> The literature on the occurrence of cobalt deficiency, and the use of diagnostic tests in sheep, and their limitations and reference ranges for various age groups has also been reviewed.<sup>3</sup>

Cobalt deficiency occurs in Australia, New Zealand, the UK, North America, the Netherlands,<sup>4</sup> and probably occurs in many other parts of the world.<sup>5</sup> Where the deficiency is extreme, large tracts of land are unsuitable for the raising of ruminants, and in certain areas suboptimal growth and production may be limiting factors in the husbandry of sheep and cattle.

Historically, in severely cobalt deficient areas in New Zealand, ill-thrift was so marked that calves and lambs died. In those that survived, growth rates were markedly depressed and often zero over summer months compared with cobalt supplemented lambs.<sup>6</sup> In New Zealand, cobalt deficiency is now mainly confined to lambs, because severely deficient areas, where the deficiency occurred in adult sheep and cattle, and in lambs, have had cobalt fertilizer applied for many decades.<sup>2</sup> Cobalt responsive ill-thrift in lambs still occurs where cobalt fertilizer applications or vitamin B<sub>12</sub> injections to lambs are haphazard. Live weight gains to supplementary vitamin B<sub>12</sub> injections of up to 180 g/d have been reported.<sup>6</sup>

The concentration of cobalt in the soil can vary widely as, for example, in Irish cattle farms where the soil cobalt content varied between 0.2 and 18 mg/kg dry matter (DM), the forage had marginal to normal cobalt content, and low or very low blood vitamin B<sub>12</sub> status was found in 55% of herds sampled.<sup>7</sup> However, the

significance of the cobalt deficiency clinically is uncertain.<sup>8</sup>

Cattle and sheep are similarly affected and the signs are similar in both species. Cattle are slightly less susceptible than sheep, and lambs and calves are more seriously affected than adults. Cobalt/vitamin B<sub>12</sub> deficiency occur in grazing lambs in the Netherlands and chronic hepatitis or ovine white liver disease are manifestations of the deficiency.<sup>4</sup> It has been described in beef cattle in the Netherlands.<sup>9</sup>

Although the disease occurs most commonly in ruminants at pasture in severely deficient areas, sporadic cases occur in marginal areas, especially after long periods of stable feeding. Bulls, rams, and calves are the groups most commonly affected, although dairy cows kept under the same conditions may develop a high incidence of ketosis.

A disease of moose called '**moose sickness**' occurs in Eastern North America is related to a cobalt- and vitamin B<sub>12</sub> deficiency.<sup>10</sup> Affected moose are geographically localized mainly to the regions of the Tobeatic and Cape Breton Highlands of Nova Scotia in Canada. There are low concentrations of cobalt and vitamin B<sub>12</sub> in liver and increased concentrations of methylmalonic acid in the plasma. There are striking similarities between the North American moose sickness and the 'mysterious' moose disease in Sweden, which is caused by molybdenosis.<sup>10</sup>

Frank deficiency is unlikely to occur in pigs, or in other omnivores or carnivores, because vitamin B<sub>12</sub> is present in meat and other animal tissues, but there are some reports of improved weight gains following supplementation of the ration with cobalt. Horses appear to be unaffected.

## Risk factors

Dietary and environmental factors

Pastures containing less than 0.07 and 0.04 mg/kg DM result in clinical disease in sheep and cattle, respectively. The daily requirement for sheep at pasture is 0.08 mg/kg DM of cobalt; for growing lambs the need is somewhat greater and at pasture levels of less than 0.10 mg/kg DM inefficient rates of gain are likely. For growing cattle, an intake of 0.04 mg/kg DM in the feed is just below requirement levels.<sup>11</sup> Variations in the cobalt content of pasture occur with seasonal variations in pasture growth and with drainage conditions. The increased incidence of the disease, which has been observed in the spring, may be related to domination of the pasture by rapidly growing grasses, which have a lower cobalt content than legumes. There is also a great deal of variation between years in the severity of the

losses encountered due to variations in the cobalt status of the animals. Forage grown on well-drained soils has a greater cobalt content than that grown on poorly drained soils of the same cobalt status. Plant growth is not visibly affected by a low cobalt content of the soil, but the addition of excessive quantities may retard growth.

Cobalt is also protective against the liver damage in sheep exposed to annual ryegrass.<sup>12</sup>

**Primary cobalt deficiency occurs only on soils which are deficient in cobalt.** Such soils do not appear to have any geological similarity, varying from wind-blown shell sands to soils derived from pumice and granite. Japanese soils composed largely of volcanic ash are seriously deficient. A survey in New Brunswick, Canada, revealed the average value for grass samples was 0.028 mg/kg DM, and for legume samples, 0.088 mg/kg DM, which justifies supplementation of ruminant diets with cobalt. The soils in New Brunswick are naturally acidic and with the heavy annual rainfall of 120 cm the cobalt content of the soil is decreased by leaching.

After the introduction of domestic livestock into New Zealand, it was realized that in some areas livestock did not thrive, or were affected with particular diseases not occurring in other areas. Large parts of New Zealand were subsequently discovered to be trace-element deficient (cobalt, selenium, and copper) and these deficiencies have been a significant part of the agricultural scene ever since.<sup>6</sup> Livestock grazing pastures grown on such soils may be deficient in one or more of these trace elements.

In New Zealand, soil types are categorized as severe, moderate or marginal. In total, of the land considered suitable for farming, about 1 million hectares in the North Island and 918,000 hectares in the South Island have been defined as cobalt deficient.<sup>6</sup>

Outbreaks of cobalt deficiency have occurred in cattle grazing on pastures on the granite-derived northern tablelands of New South Wales in Australia, and in sheep grazing pasture on soils derived from weathered rhyolite and ignimbrite, the former being inherently low in cobalt. Cobalt deficiency is now occurring in areas where it has never before been diagnosed, and in seasons of lush spring and summer pasture growth, cobalt deficiency should be suspected as a cause of unthriftiness. Lambs grazing cobalt-deficient pastures of the Northern Netherlands are 6.7 times more likely to die if unsupplemented with cobalt than supplemented lambs.<sup>13</sup> In the Netherlands, on farms with a history of ill-thrift caused by cobalt/vitamin B<sub>12</sub> deficiency, the acetic acid-extractable soil

cobalt content of the pastures was above the reference value for cobalt deficiency ( $\leq 0.30$  mg Co/kg dried soil).<sup>4</sup> These concentrations are below the minimum requirement for sheep (0.07 mg/kg DM). The high soil pH (6.5) and the good drainage conditions on the farm were probably primary factors responsible for the low soil cobalt availability.

Although soils containing less than 0.25 mg/kg cobalt are likely to produce pastures containing insufficient cobalt, the relationship between levels of cobalt in soil and pasture is not always constant. The factors governing the relationship have not been determined, although heavy liming is known to reduce the availability of cobalt in the soil. Manganese appears to have a similar action, but the agricultural significance of the relationship is unknown.

#### Ovine white liver disease

A specific hepatic dysfunction of sheep has been described in New Zealand, Australia, the UK,<sup>14</sup> Norway,<sup>15</sup> and in grazing lambs in the Netherlands.<sup>4</sup> It has been called 'white liver disease' because of the grayish color of the liver. Clinically, it is manifested by photosensitization when the disease is acute, and anemia and emaciation when the disease is chronic. It seems likely that the disease is a toxic hepatopathy against which adequate levels of dietary cobalt are protective.<sup>16</sup>

#### Hepatic lipidosis in goats

Hepatic lipidosis has occurred in Omani goats in many parts of Oman for many years but the cause was unknown.<sup>17,18</sup> It is now known that low levels of serum vitamin B<sub>12</sub> or low levels cobalt in the liver are associated with the liver lesion, and it can be experimentally reproduced using low levels of cobalt intake.<sup>19</sup> Abattoir surveys of goat livers found that hepatic lipidosis was one of the most frequent cause of their condemnation.<sup>18</sup> Because the goat is the predominant domesticated animal type raised for meat in the Sultanate of Oman, the condemnation of goat livers at slaughter represents a significant economic loss.<sup>18</sup>

#### Experimental reproduction of cobalt deficiency in sheep

Cobalt deficiency can be reproduced in sheep diet containing less than 70  $\mu\text{g/kg}$  cobalt. Feeding a diet containing 4.5  $\mu\text{g/kg}$  to lambs produced a severe vitamin B<sub>12</sub> deficiency, characterized by subnormal plasma and liver concentrations of vitamin B<sub>12</sub> and reduced growth rate, serous ocular discharge, alopecia, and emaciation, similar to naturally occurring outbreaks of cobalt deficiency in sheep.<sup>20</sup> Fatty degeneration of the liver was associated with reduced concentrations of vitamin B<sub>12</sub> (14.5 pmol/g) at

necropsy. Liver lesions included accumulation of lipid droplets and lipofuscin particles in hepatocyte, dissociation and necrosis of hepatocyte, and sparse infiltration by neutrophils, macrophages, and lymphocytes. Ultrastructural hepatocytic alterations included swelling, condensation and proliferation of mitochondria, hypertrophy of smooth endoplasmic reticulum, vesiculation and loss of arrays of rough endoplasmic reticulum, and accumulation of lipid droplets and lipofuscin granules in cytoplasm of hepatocytes. Co-factors are not a prerequisite to development of hepatic damage in cobalt-deficient sheep. Reduced activities of the vitamin B<sub>12</sub> dependent enzymes, methylmalonyl CoA mutase and methionine synthesis, and lipid peroxidation are likely pathogenetic importance in the development of the lesions.

#### PATHOGENESIS

Cobalt is unique as an essential trace element in ruminant nutrition because it is stored in the body in limited amounts only and not in all tissues. In the adult ruminant, its only known function is in the rumen and it must, therefore, be present continuously in the feed.

The effect of cobalt in the rumen is to participate in the production of vitamin B<sub>12</sub> (cyanocobalamin), and compared with other species the requirement for vitamin B<sub>12</sub> is very much higher in ruminants. In sheep, the requirement is of the order of 11  $\mu\text{g/d}$ , and probably 500  $\mu\text{g/d}$  are produced in the rumen, most being lost in the process. Animals in the advanced stages of cobalt deficiency are cured by the oral administration of cobalt or by the parenteral administration of vitamin B<sub>12</sub>. On cobalt-deficient diets, the appearance of signs is accompanied by a fall of as much as 90% in the vitamin B<sub>12</sub> content of the feces, and on oral dosing with cobalt the signs disappear and vitamin B<sub>12</sub> levels in the feces return to normal. Parenteral administration of cobalt is without appreciable clinical effect, although some cobalt does enter the alimentary tract in the bile and leads to the formation of a small amount of cobalamin.

**The essential defect in cobalt deficiency in ruminants is an inability to metabolize propionic acid.** A key biochemical pathway for propionic acid from rumen fermentation involves adenosyl cobalamin, one of several cobalt-containing coenzymes of the vitamin B<sub>12</sub> complex that is required for the conversion of methylmalonyl coenzyme A to succinyl coenzyme A, both intermediates in the utilization pathway of propionate. Lack of vitamin B<sub>12</sub> results in accumulation of methylmalonic acid which can be measured in the serum. The

clinical and pathological signs of cobalt deprivation are preceded by characteristic biochemical changes in tissues and fluids of the body. As soon as depletion begins, the concentration of cobalt and vitamin B<sub>12</sub> fall in rumen fluid. Vitamin B<sub>12</sub> values in serum also show an early decline, because they measure vitamin which is in transit, which is largely a reflection of the adequacy of current rumen synthesis. Serum vitamin B<sub>12</sub> declines before liver vitamin B<sub>12</sub> which confirms that the liver does not serve as an active storage pool.

A prolonged moderate cobalt deficiency in beef cattle (83 µg/kg) for 43 weeks results in several changes in lipid metabolism in addition to impaired growth.<sup>21</sup> There is severe accumulation of plasma homocysteine, and a marked increase of trace elements iron and nickel in the liver.<sup>22</sup>

The efficiency of cobalt in preventing staggers in sheep grazing pasture dominated by (*Phalaris tuberosa*) and possibly by canary grass (*Phalaris minor*) or rhompa grass, a hybrid *Phalaris* spp., is unexplained. A suggestion that a dietary deficiency of cobalt can lead to the development of polioencephalomalacia appears not to be valid.

The pathogenesis of **ovine white liver disease** is unclear. It is unknown if the disease is a simple cobalt deficiency, or a hepatotoxic disease in cobalt/vitamin B<sub>12</sub>-deficient lambs. Marginal to deficient cobalt-deficient grass is essential for the development of the disease.<sup>15</sup> Cobalt fertilization of deficient pastures results in an increase in vitamin B<sub>12</sub> in lambs.<sup>16</sup> Hepatic dysfunction occurs in affected sheep.<sup>23</sup> Affected lambs generally have higher serum levels of copper than in cobalt/vitamin B<sub>12</sub>-supplemented lambs grazing the same pastures.<sup>24</sup> Dosing affected lambs with copper oxide needles resulted in toxic levels of liver copper.<sup>25</sup> It is suggested that the disease is a manifestation of B<sub>12</sub> deficiency made worse by factors triggering early hepatic fatty change, resulting in more severe liver damage and loss of intracellular homeostasis, rendering the hepatocytes more vulnerable to other elements such as copper.<sup>26</sup> The amount of fructan in the pasture may be an important factor in the pathogenesis of the lesion.<sup>11</sup> One hypothesis suggests that the high level of fructan may initiate hepatic lipodystrophy, leading to hepatic insufficiency, growth reduction and ovine white liver disease.<sup>11</sup> Vitamin B<sub>12</sub> is therapeutic.<sup>27</sup>

The pathological changes in lambs grazing cobalt-deficient pastures are related to blood concentrations of vitamin B<sub>12</sub>, methylmalonic acid, and homocysteine, and lesions are confined mainly to the liver and brain.<sup>28</sup> Acute and chronic hepa-

titis are characteristic and the liver lesions are associated with polymicrocavitation of the brain.

Hepatic encephalopathy associated with cobalt deficiency and white liver disease has been described in lambs.<sup>29</sup> Symmetrical vacuolation and status spongiosus of the neuropil in the brain were characteristic and hyperammonemia secondary to the hepatic lesion is considered to be the cause of the brain lesions.

Caprine hepatic lipidosis has been induced experimentally using low intakes of low levels of dietary cobalt.<sup>19</sup> Goats provided with a diet which contains the minimum daily requirement of cobalt as specified for sheep not only developed a syndrome characterized by reduced weight gains, dry scruffy hair goat and a decline in erythrocyte indices but also lesions consistent with hepatic lipidosis. Goats fed diets containing levels of cobalt less than 0.1 mg/kg DM could experience even greater clinical and pathological consequences.

In '**Moose sickness**' there are low concentrations of cobalt and vitamin B<sub>12</sub> in liver and increased concentrations of methylmalonic acid in plasma.<sup>10</sup>

#### CLINICAL FINDINGS

No specific signs are characteristic of cobalt deficiency. A gradual decrease in appetite is the only obvious clinical sign. It is accompanied by loss of body weight, emaciation, and weakness, and these are often observed in the presence of abundant green feed. Pica is likely to occur, especially in cattle. There is marked pallor of the mucous membranes and affected animals are easily fatigued. Growth, lactation, and wool production are severely retarded, and the wool may be tender or broken. In sheep, severe lacrimation with profuse outpouring of fluid sufficient to mat the wool of the face is one of the most important signs in advanced cases. Signs usually become apparent when animals have been on affected areas for about 6 months and death occurs in 3–12 months after the first appearance of illness, although severe wasting may be precipitated by the stress of parturition or abortion.

Cobalt deficiency in pregnant ewes can result in decreased lambing percentage, increased percentage of stillbirths, and increased neonatal mortality.<sup>30</sup> Lambs from deficient ewes are slower to start sucking, have reduced concentrations of serum colostral immunoglobulins, and have lower serum vitamin B<sub>12</sub> and higher methylmalonic acid concentrations than lambs from cobalt-adequate dams.

'**Moose sickness**' in Nova Scotia is characterized by a loss of fear of man, weakness, and a staggering gait, apparent blind-

ness, drooping of the ears, and emaciation and infestation by ticks.<sup>10</sup> A decreased intake of food, increasing lethargy and collapse, accompanied by loss of use of one or more limbs, precedes death.

#### CLINICAL PATHOLOGY

##### Biochemical criteria to determine cobalt and vitamin B<sub>12</sub> status

Changes in the concurrent serum concentrations of methylmalonic acid and vitamin B<sub>12</sub> of ewes and their lambs on cobalt deficient pastures, and their response to cobalt supplementation can be evaluated and monitored.<sup>31</sup> Those same changes can be evaluated during supplementation of lambs while suckling and after weaning on farms in the South Island of New Zealand considered to be cobalt-deficient.<sup>32</sup> These measurements are commonly done along with recording live weight gains, and analysis of pasture for cobalt content at the sampling times for blood MMA and vitamin B<sub>12</sub>.

Growth responses to cobalt or vitamin B<sub>12</sub> supplementation is anticipated when cobalt levels in herbage fall below 0.08–0.1 mg/K DM.<sup>31</sup>

##### Serum and hepatic cobalt and vitamin B<sub>12</sub> concentrations

**Serum cobalt.** Cobalt concentrations in the serum of normal sheep are of the order of 1–3 µg/dL (0.17–0.51 µmol/L), and in deficient animals these are reduced to 0.03–0.41 µmol/L.

**Serum vitamin B<sub>12</sub>.** Clinical signs of cobalt deficiency in sheep are associated with serum vitamin B<sub>12</sub> levels of less than 0.20 mg/mL, and serum vitamin B<sub>12</sub> levels are used as a laboratory test of cobalt status in animals. Levels of 0.2–0.25 µg/L are indicative of cobalt deficiency. These rise rapidly to 0.5–1.0 µg/L on treatment. The value of serum vitamin B<sub>12</sub> assay as a diagnostic tool is in some doubt, but correctly interpreted they appear to be worthwhile. Serum vitamin B<sub>12</sub> values greater than 0.2 µg/L are indicative of a normal vitamin B<sub>12</sub> status in cattle. Deprivation of feed from sheep for 24 h results in a marked increase in serum vitamin B<sub>12</sub>. The serum vitamin B<sub>12</sub> levels of sheep at pasture are unreliable indicators of liver vitamin B<sub>12</sub>.

##### Concurrent serum MMA and vitamin B<sub>12</sub> concentrations

Concurrent changes in serum MMA and vitamin B<sub>12</sub> concentrations in cobalt supplemented ewes and their lambs on cobalt-deficient farms were monitored. Serum concentrations of vitamin B<sub>12</sub> fell below 250 pmol/L during early lactation, and as low as 100 pmol/L.<sup>31</sup> MMA concentration was maintained below 2 µmol/L in serum from supplemented ewes but increased to mean concentrations ranging from 7 to 14 µmol/L at the nadir of serum vitamin B<sub>12</sub> concentration during

peak lactation.<sup>31</sup> A significant live weight response to supplementation occurred in ewes, and the vitamin B<sub>12</sub> concentration in the ewe's milk and in the livers of their lambs more than doubled. Serum MMA concentration provides a more precise indication of responsiveness to vitamin B<sub>12</sub> or cobalt supplementation than serum vitamin B<sub>12</sub> concentrations in ewes and lambs. Neither very low serum vitamin B<sub>12</sub> concentrations nor elevated MMA concentrations are necessarily indicative of responsiveness to supplementation in suckling lambs, but MMA gave an early indication of impending responsiveness. Supplementation of the ewe with a cobalt bullet appears to protect the growth performance of the lamb for 90 days and influence the subsequent serum vitamin B<sub>12</sub> response in the lamb to vitamin B<sub>12</sub> supplementation.<sup>31</sup>

In New Zealand, the serum vitamin B<sub>12</sub> and MMA have been compared as indices of cobalt/vitamin B<sub>12</sub> deficiency in lambs on cobalt-deficient farms, around lambing, and supplemented with either cobalt bullets, or short- or long-acting vitamin B<sub>12</sub> preparations.<sup>32</sup> Serum MMA concentrations in excess of 9–14 µmol/L provide a more reliable diagnostic test for cobalt deficiency. However, there may be considerable variation between farms.

A critical evaluation of serum MMA and vitamin B<sub>12</sub> concentrations for the assessment of cobalt deficiency in growing lambs in New Zealand indicates that the current reference ranges for vitamin B<sub>12</sub> responsiveness are conservatively high and result in over-diagnosis of vitamin B<sub>12</sub> deficiency in ill-thriftiness of sheep.<sup>33</sup> It would be preferable if vitamin B<sub>12</sub> weight gain response trials were compared with reference curves.<sup>34</sup>

Serum concentrations of MMA allow better differentiation of a responsive condition than vitamin B<sub>12</sub> concentrations. Serum MMA concentrations >13 µmol/L indicate responsiveness to supplementation while concentrations of <7 µmol/L indicate unresponsiveness. In the range 7–13 µmol/L, variation in response was observed and predictability of response is less certain but supplementation is advisable.

**Hepatic cobalt.** Normal hepatic cobalt levels in lambs range between 0.03 and 0.1 µg/g WW.<sup>35</sup> Levels below 0.02 µg/g WW (0.07 µg DM) are associated with clinical cobalt deficiency, and 0.015 µg/g WW (0.05 µg DM) is considered as a critical level. In lambs with clinical signs of ovine white liver disease, mean hepatic cobalt concentrations ranged from 0.013 to 0.024 µg/g WW. An average cobalt level below 0.025 µg/g WW in a sheep flock is considered marginal.<sup>35</sup> In a survey of the cobalt and copper concentrations of lamb

livers at slaughter in Norway, the average hepatic levels of cobalt varied from <0.003 to 0.22 µg/g WW, and of copper from 5 to 240 µg/g WW.<sup>35</sup>

#### Serum methylmalonic acid

Because of some of the difficulties with the interpretation of serum vitamin B<sub>12</sub> levels, other biochemical tests, especially methylmalonic acid (MMA) in plasma and urine as diagnostic and prognostic indicators and formiminoglutamic acid (FIGLU) tests are now used.<sup>33,36</sup> The determination of MMA has the potential to distinguish between subclinically and clinically affected animals, which serum vitamin B<sub>12</sub> cannot do. Methylmalonic acid is ordinarily metabolized in ruminants by a vitamin B<sub>12</sub> enzyme system. An elevated plasma concentration of MMA is a comparatively early indicator of functional vitamin B<sub>12</sub> deficiency.<sup>37</sup> It is recommended that 10 µmol/L be an upper limit of normality for plasma MMA in barley-fed animals, and 5 µmol/L be the upper limit for grass-fed animals.<sup>37</sup> Measurement of serum MMA as diagnostic measures of cobalt status in cattle indicates that a level <2 µmol/L is normal, 2–4 µmol/L represents subclinical deficiency, and >4 µmol/L represents deficiency.<sup>38</sup> In a cobalt-deficient animal the methylmalonic content of urine is abnormally high and this has some merit as a test for the presence of the deficiency.<sup>16</sup> Cobalt-adequate lambs have plasma MMA levels of less than 5 µmol/L, urinary MMA less than 120 µmol/L and urinary MMA/creatinine values of less than 0.022 µmol MMA/mmol of urinary creatinine. An unequivocal result for methylmalonic acid is a concentration of greater than 30 µg/mL for ten animals selected randomly from a flock. If the urine is kept for more than 24 h it should be acidified to avoid degradation of the methylmalonic acid. Commercial kits are now available for assay of vitamin B<sub>12</sub> in ruminant blood.

#### Formiminoglutamic acid

The concentration of formiminoglutamic acid in urine is a reliable indicator of the cobalt status of lambs. Levels of 0.08–20 µmol/mL in the urine of affected lambs return to 0 rapidly after treatment. However, the concentration of formiminoglutamic acid increases in the urine of lambs only in the later stages of cobalt deficiency when there is weight loss and ill-thrift. Animals with subclinical cobalt deficiency do not produce urinary formiminoglutamic acid at levels that would be useful diagnostically. Neither MMA nor formiminoglutamic acid is a normal constituent of urine and their presence in urine, without the need for a quantitative measurement, is probably a positive indication of cobalt deficiency.

#### Hematology

Affected animals are anemic, but their hemoglobin and erythrocyte levels are often within the normal range because of an accompanying hemoconcentration. The anemia is normocytic and normochromic. There is also a decrease in cellularity of the bone marrow in cobalt-deficient sheep. It is not repaired by the administration of vitamin B<sub>12</sub> or by the parenteral administration of cobalt. Affected animals are also hypoglycemic (<60 mg glucose/dL plasma) and have low serum alkaline phosphatase levels (<20 U/L). The response to cobalt administration is matched by a very rapid return to normal of these levels. Unfortunately, there are too many other factors affecting their concentration for them to be of much value in diagnostic work.

#### NECROPSY FINDINGS

At necropsy, emaciation is extreme. The livers of sheep affected with white liver disease are pale and fatty. In most cases of cobalt deficiency, the spleen is dark due to the accumulation of hemosiderin. The microscopic changes of ovine white liver disease include hepatocellular dissociation and intracytoplasmic accumulations of lipid and ceroid-lipofuscin within hepatocytes. The ultrastructural changes of experimentally-induced ovine white liver disease have also been documented.<sup>20</sup>

Biochemical assays revealed very high iron levels in the liver and spleen, and low cobalt levels in the liver. In normal sheep, cobalt levels in the liver are usually above 0.20 mg/kg DM, but in affected sheep are typically less than 0.05 mg/kg DM. Liver cobalt levels in cattle fed excessive amounts of cobalt and thought to be affected by cobalt poisoning can be as high as 69 mg/kg DM.

Normal levels of vitamin B<sub>12</sub> in the liver are of the order of 0.3 mg/kg, falling to 0.1 mg/kg in deficient lambs. In cattle, clinical signs occur with liver vitamin B<sub>12</sub> levels of less than 0.10 mg/kg, and levels of more than 0.3 mg/kg of liver are necessary for optimum growth. Normal levels of the vitamin of cattle in New Zealand are 0.70–1.98 mg/kg of liver. After oral dosing with cobalt, the level of the element in the liver rises, but returns to the pretreatment level in 10–30 days. Since serum B<sub>12</sub> levels reflect cobalt status, it is often useful to submit sera from surviving herdsmates when attempting to confirm the diagnosis.

#### Samples for confirmation of diagnosis

- **Toxicology** – 50 g liver (ASSAY (Co)), 2 mL serum (ASSAY (B<sub>12</sub>))
- **Histology** – formalin-fixed liver (LM).

## DIFFERENTIAL DIAGNOSIS

Cobalt deficiency must be differentiated from other causes of 'ill-thrift' or 'enzootic marasmus'.

### *Ill-thrift*

In young animals, in which this situation is most often encountered, nutritional deficiencies of copper, selenium, and vitamin D are possible causes of ill-thrift. Lack of total digestible nutrients is the most common cause of thin animals, but owners are usually aware of the shortage and do not present their animals for diagnosis. However, it does happen, especially with urban people who become farmers and are unaware of the actual needs of animals. So it is best to check the feed supply and also to check whether or not the animals have any teeth. These circumstances are seen so commonly in today's era of hobby farms that a new disease category 'hobby farm malnutrition' is warranted.

### *Internal parasitism*

Careful necropsy or fecal examination will determine the degree of helminth infestation, but cobalt-deficient animals are more susceptible to parasitism and the presence of a heavy parasite load should not rule out the diagnosis of primary cobalt deficiency. It is also common for parasitic disease and cobalt deficiency to occur together in the one animal. It is then necessary to make two diagnoses and conduct two control programs. In sheep, special care is needed to differentiate the disease from Johne's disease. The differential diagnosis of anemia has been discussed elsewhere.

### *Dietary supplementation response*

The most conclusive method of determining if animal production is being affected by the deficiency of a trace mineral is to measure the response of a production parameter, such as weight gain, milk production, wool production, or reproductive performance following supplementation of animals with the element under consideration.<sup>39</sup> However, if the degree of response can be related to a tissue level of the element, or its metabolites, then tissue analyses can replace the need for field trials, which require considerable expertise and resources and can take several months to monitor the results and obtain a quantitative outcome.

### *Growth response curve to supplementation*

A new approach to defining mineral deficiencies is based on constructing response curves for any specified level of serum vitamin B<sub>12</sub> that can be used to determine live weight response to supplementation and the probability of obtaining a response.<sup>39</sup> The technique closely relates the tissue mineral or biochemical indicator with the degree of production response to treatment. The advantages of this method over the traditional method have been described.<sup>39</sup> The results from published and unpublished cobalt/vitamin B<sub>12</sub> weight response trials in young sheep grazing pasture in New Zealand have been reviewed.<sup>39</sup> No significant weight gain

responses occurred to vitamin B<sub>12</sub> or cobalt treatment in trials with serum vitamin B<sub>12</sub> levels above 500 pmol/L or liver vitamin B<sub>12</sub> levels greater than 500 nmol/kg. The fitted response curve approached 0 g/day at 500 pmol/L for serum vitamin B<sub>12</sub> and 375 nmol/kg for liver vitamin B<sub>12</sub>. The minimum vitamin B<sub>12</sub> at which an economic response to treatment (10 µg/day BW gain) is not likely is 336 pmol/L for serum and 282 nmol/kg for liver.<sup>39</sup> Variable responses to cobalt or vitamin B<sub>12</sub> include age, breed, sex, energy intake, concurrent disease, and length of pasture. Higher soil contamination on short pastures may result in increased cobalt intake and reduced response to vitamin B<sub>12</sub> or cobalt. Serum vitamin B<sub>12</sub> levels may also increase following prolonged yarding, and within 24–48 h after changes in dietary cobalt.

## TREATMENT

### **Cobalt and vitamin B<sub>12</sub>**

Affected animals respond satisfactorily to oral dosing with cobalt or the IM injection of vitamin B<sub>12</sub>. Oral dosing with vitamin B<sub>12</sub> is effective, but much larger doses are required. Oral dosing with cobalt sulfate is usually at the rate of about 1 mg cobalt/d in sheep and can be given in accumulated doses at the end of each week. Intervals of 2 weeks between dosing are inadequate for the best possible response. On the other hand, the monthly dosing of lambs with oral doses of 300 mg cobalt is sufficient greatly to reduce deaths and permit some growth at suboptimal levels. The response to dosing is very quick, significant elevation of serum vitamin B<sub>12</sub> levels being evident within 24 h. When large doses of cobalt are administered to some sheep, other undosed sheep on the same pasture may find sufficient additional cobalt on the pasture from the feces of their flockmates to meet their needs. No exact data are available on dose rates for cattle but ten times the prophylactic rate should be effective. Vitamin B<sub>12</sub> should be given in 100–300 µg doses for lambs and sheep at weekly intervals. Vitamin B<sub>12</sub> therapy is not likely to be used generally because of the high cost and the comparable effect of oral cobalt administration. However, vitamin B<sub>12</sub> (hydroxocobalamin) may be a suitable therapeutic agent. One injection of 1 mg provides protection to lambs for 14 weeks, and for weaners, protection for up to 40 weeks. Treatment of lambs with ovine white liver disease with hydroxocobalamin results in an immediate beneficial response and treatment is repeated 10 days later.<sup>14</sup>

### **Cobalt toxicity**

Overdosing with cobalt compounds is unlikely, but toxic signs of loss of weight, rough hair coat, listlessness, anorexia, and

muscular incoordination appear in calves at dose rates of about 40–45 mg of elemental cobalt per 50 kg BW/d. Sheep appear to be much more resistant to the toxic effects of cobalt than are cattle. Pigs have tolerated up to 200 mg cobalt/kg of diet. At intakes of 400 and 600 mg/kg there is growth depression, anorexia, stiff legs, incoordination and muscle tremors. Supplementation of the diet with methionine, or with additional iron, manganese and zinc alleviates the toxic effects.

## CONTROL

### **Supplement diet with cobalt**

The recommended level of cobalt in the diet for sheep and cattle has for many years been about 100 µg/kg DM. Based on the levels of homocysteine and methylmalonic acid together with the vitamin B<sub>12</sub> and hepatic folate status as predictors of the magnitude of cobalt-vitamin B<sub>12</sub> status in assessing the cobalt requirements in cattle, the recommended levels of dietary cobalt to achieve maximum vitamin B<sub>12</sub> levels are 250 µg/kg DM.<sup>40</sup> If such levels are not available, supplementation of the diet with cobalt is necessary. Calves reared on cobalt-deficient pastures require cobalt or vitamin B<sub>12</sub> supplementation prior to weaning.<sup>41</sup>

### **Top dressing of pastures with cobalt**

Cobalt deficiency in grazing animals can be prevented most easily by the top-dressing of affected pasture with cobalt salts. The amount of top-dressing required will vary with the degree of deficiency. Recommendations include 400–600 g/ha cobalt sulfate annually or 1.2–1.5 kg/ha every 3–4 years. The response to pasture treatment is slow, requiring some weeks to complete. Affected animals should be treated orally or by injection of vitamin B<sub>12</sub> to obtain a quick, interim response.

In New Zealand, the requirement for cobalt of ruminants grazing on the pumice soils of the Central Plateau was established in the 1930s and top-dressing to increase the cobalt intake was widely practiced for many years. An on-farm survey conducted in 1978–1979 indicated that cobalt inputs could be halved because adequate reserves of soil cobalt had accumulated. However, the economic downturn in agriculture resulted in less use of cobalt, and follow-up surveys indicated a general overall decline in soil and pasture cobalt levels, which was pronounced in areas with a poor history of cobalt top-dressing. There is now a need to increase the soil level of cobalt to prevent cobalt deficiency in grazing ruminants. A regular cobalt input is required to build up reserves. This input requirement is about 350 g cobalt sulfate/ha for 7–10 years on

the most deficient areas. Individual farm to farm variation exists within an area and it is necessary to monitor their soil, pasture, and animal cobalt status. To achieve a level of cobalt of 0.08 mg/kg DM in pasture (the critical level for sheep) a soil cobalt level of 1.7 and 2.2 mg/kg DM is required for the yellow-brown pumice soils and yellow-brown loams, respectively.<sup>42</sup>

Supplementation of the diet with 0.1 mg cobalt/d for sheep and 0.3–1.0 mg/d for cattle is required, and can be accomplished by inclusion of the cobalt in salt or a mineral mixture. Cobalt can also be supplied to cattle in their drinking water supply.

### Cobalt-heavy pellet

The use of 'heavy pellets' containing 90% cobalt oxide is an alternative means of overcoming the difficulty of maintaining an adequate cobalt intake in a deficient area. The pellet is in the form of a bolus (5 g for sheep, 20 g for cattle) which, when given by mouth, lodges in the reticulum and gives off cobalt continuously in very small but adequate amounts. Reports on their use in sheep and cattle indicate that they are effective. Administration of the pellets to lambs and calves less than 2 months old is likely to be ineffective because of failure to retain them in the undeveloped reticulum. The problem of cobalt deficiency in sucking animals can be overcome in part if the dams are treated because of the increased vitamin B<sub>12</sub> content of their milk, but the daily intake of the lambs will still be much below the minimal requirement. In about 5% of animals, the pellets do not lodge in the reticulum and approximately 20% are rejected during the year after administration. If no response occurs, re-treatment is advisable. A further possible cause of failure is where pellets become coated with calcareous material, particularly if the drinking water is highly mineralized or if pasture top-dressing is heavy. The effects of pellet coating can be overcome by simultaneous dosing with an abrasive metal pellet. The cost is relatively high and, where top-dressing of pastures is practiced, addition of cobalt to the fertilizer is the cheaper form of administration. Pellets are preferred in extensive range grazing where top-dressing is impracticable and animals are seen only at infrequent intervals.

### Controlled release glass boluses of cobalt

Boluses of controlled release glass containing cobalt are available for oral administration to cattle and sheep. The boluses are retained in the forestomachs for up to several months and slowly release cobalt.

### Combine cobalt with administration of anthelmintics

Anthelmintics are convenient and efficient vehicles for supplementing the diet with selenium and cobalt on a regular basis, because both the selenium and cobalt status of lambs decline as they become dependent on forage, with its adherent nematode larvae, for their nutrients. As a result, the periods of highest incidence of cobalt and selenium deficiency and helminthiasis coincide. In one trial, there were lasting responses to selenium but transient, though significant, responses to the cobalt in the form of increases in plasma vitamin B<sub>12</sub>. In some trials, the administration of a monthly bolus of 250 mg cobalt was more effective than the cobalt in the anthelmintic. The optimum level of cobalt supplementation of an anthelmintic ranges from 20 to 100 mg cobalt per treatment. When the anthelmintic is given at 3-weekly intervals, there may be a cumulative effect. A comparison of giving 500 µg cyanocobalamin subcutaneously to one group of lambs, with 2.5 mg cobalt orally in an anthelmintic to another group, revealed that even the lowest dose of cobalt in anthelmintics will be of some nutritional benefit.<sup>43</sup>

### Vitamin B<sub>12</sub> injections

The relationship in lambs between daily weight gains and vitamin B<sub>12</sub> status in the serum and liver vitamin B<sub>12</sub> concentrations is well defined. Lambs with serum vitamin B<sub>12</sub> concentrations >335 pmol/L and liver vitamin B<sub>12</sub> concentrations <280 nmol/kg fresh tissue are cobalt deficient and will show a marked increase in growth rates when supplemented with cobalt or vitamin B<sub>12</sub>.

The subcutaneous injection of a soluble vitamin B<sub>12</sub> in lambs was effective in increasing and maintaining the vitamin B<sub>12</sub> status for about 24 days.<sup>44</sup> In cobalt deficient areas lambs should be given a 2 mg dose of vitamin B<sub>12</sub> at least bi-monthly to reduce the risk of vitamin B<sub>12</sub> deficiency.<sup>45</sup>

A *microencapsulated vitamin B<sub>12</sub> in lactide/glycolide copolymers* is able to increase and maintain vitamin B<sub>12</sub> status of lambs for at least 210 days.<sup>46</sup> The treatment of ewes grazing cobalt deficient pastures 4–5 weeks prior to mating should ensure an increase in the storage of vitamin B<sub>12</sub> in the fetal liver and an increase in the vitamin B<sub>12</sub> content of colostrum and milk. The growth rates of cobalt deficient lambs, 4–6 weeks of age, were markedly improved by injections of 3.0, 4.5, or 6.0 mg of microencapsulated vitamin B<sub>12</sub> and live weights were maintained for at least 260 days.<sup>47</sup> An injection of 3 mg microencapsulated vitamin B<sub>12</sub> given to lambs at tailing will prevent cobalt deficiency and increase and main-

tain live weight gains in a flock for up to 8 months.

The vitamin B<sub>12</sub> status of ewes can be increased during gestation and lactation by three injections of a long-acting preparation of vitamin B<sub>12</sub> microencapsulated in an organic acid polymer given subcutaneously at 120 days prepartum (30 days after the ram had bred the ewes), 40 days prepartum, and 40 days post partum.<sup>48</sup> Compared with controls, serum and liver vitamin B<sub>12</sub> concentrations of the treated ewes were increased by 70% during gestation. Fetal liver vitamin B<sub>12</sub> concentrations were increased 270%. Over the lactation, ewe serum and milk vitamin B<sub>12</sub> concentrations were increased at least 200% and 44%, respectively. The liver vitamin B<sub>12</sub> stores of the newborn lambs from vitamin B<sub>12</sub> treated ewes were depleted within 58 days. Ewes with a high vitamin B<sub>12</sub> status will ensure an adequate supply of vitamin B<sub>12</sub> to their lambs for at least the first 30 days of life.

A long-acting injectable microencapsulated vitamin B<sub>12</sub> at a dose rate of 0.12–0.24 mg/kg BW will increase and maintain the vitamin B<sub>12</sub> in dairy calves for at least 110 days.<sup>2,49</sup>

### REVIEW LITERATURE

- Clark RG. Cobalt deficiency-diagnosis, treatment, control and soil factors. Proceedings of the 25th Seminar of the Society of Sheep & Beef Cattle Veterinarians of the New Zealand Veterinary Association, 1995: 99–110.
- Clark RG. Cobalt/Vitamin B<sub>12</sub> deficiency from lamb to adult ewe. Proceedings of the 28th Seminar of the Society of Sheep & Beef Cattle Veterinarians of the New Zealand Veterinary Association, 1998: 105–122.
- Underwood EJ, Suttle NF. Cobalt. In: The mineral nutrition of livestock, 3rd ed. Wallingford, Oxon: CAB International, 1999: 251–282.
- Lee J, McMasters DG, White CL, Grace ND, Judson GJ. Current issues in trace element nutrition of grazing livestock in Australia and New Zealand. Aust J Agric Res 1999; 50:1341–1364.
- Vellema P. Cobalt/vitamin B<sub>12</sub> deficiency in beef cattle: a short review. Tijdschr Diergeneesk 2000; 125:190–192.

### REFERENCES

- Underwood EJ, Suttle NF. Cobalt. In: The mineral nutrition of livestock, 3rd ed. Wallingford, Oxon: CAB International 1999: 251–282.
- Clark RG. Proceedings of the 25th Seminar of the Society of Sheep & Beef Cattle Veterinarians of the New Zealand Veterinary Association, 1995: 99–110.
- Clark RG. Proceedings of the 28th Seminar of the Society of Sheep & Beef Cattle Veterinarians of the New Zealand Veterinary Association, 1998: 105–122.
- Vellema P. Cobalt/Vitamin B<sub>12</sub> deficiency in lambs on pasture. A randomized trial. Thesis. Department of Ruminant Health, Animal Health Service, The Netherlands 1996.
- McDonald IW. Aust J Agric Res 1993; 44:347.
- Ellison RS. N Z Vet J 2002; 50:35–40.
- Mee JF, Rogers PAM. Irish Vet J 1996; 49:160.
- Mee JF, Rogers PAM. Irish Vet J 1996; 49:529.
- Vellema P Tijdschr Diergeneesk 2000; 125:190.



10. Frank A et al. *Sci Total Environ* 2004; 318:389.
11. Uvlund MJ, Pestalozzi M. *Acta Vet Scand* 1990; 31:373.
12. Davies SC et al. *Aust Vet J* 1993; 70:1866.
13. Vellema P et al. *Vet Quart* 1997; 19:1.
14. Dannatt L, Porter TA. *Vet Rec* 1996; 139:371.
15. Uvlund MJ, Pestalozzi M. *Acta Vet Scand* 1990; 31:257.
16. Uvlund MJ. *Acta Vet Scand* 1990; 31:267.
17. Johnson EH et al. *Vet Res Comm* 1999; 23:215.
18. Johnson EH et al. *Vet J* 1999; 158:216.
19. Johnson EH et al. *Vet J* 2004; 168:174.
20. Kennedy S et al. *Vet Pathol* 1997; 34:575.
21. Stangl GI et al. *Nutr Res* 1999; 19:415.
22. Stangl GI et al. *Int J Vit Nutr Res* 1999; 69:120.
23. Uvlund MJ. *Acta Vet Scand* 1990; 31:277.
24. Uvlund MJ. *Acta Vet Scand* 1990; 31:297.
25. Uvlund MJ. *Acta Vet Scand* 1990; 31:287.
26. Uvlund MJ. *Acta Vet Scand* 1990; 31:309.
27. Uvlund MJ. *Acta Vet Scand* 1990; 31:369.
28. Vellema P et al. *Vet Q* 1999; 3:93.
29. Sargison ND et al. *Vet Rec* 2001; 149:770.
30. Fisher GE, MacPherson A. *Res Vet Sci* 1991; 50:319.
31. Gruner TM et al. *N Z Vet J* 2004; 52:117.
32. Gruner TM et al. *N Z Vet J* 2004; 52:129.
33. Gruner TM et al. *N Z Vet J* 2004; 52:137.
34. Clark RG, Wright DF. *N Z Vet J* 2005; 53:265-266.
35. Siverson T, Plassen C. *Acta Vet Scand* 2004; 45:69.
36. McGhie TKJ. *Chromatograph Biomed Appl* 1991; 566:215.
37. O'Harte FPM et al. *Br J Nutr* 1989; 62:729.
38. Paterson JE, MacPherson A. *Vet Rec* 1990; 126:329.
39. Clark RG et al. *N Z Vet J* 1989; 37:7.
40. Stangl GI et al. *Br J Nutr* 2000; 84:645.
41. Stangl GI et al. *Br J Nutr* 2000; 83:3.
42. Hawke MF et al. *Proc N Z Grassland Assoc* 1994; 56:249.
43. Suttle NF et al. *Vet Rec* 1990; 126:192.
44. Grace ND et al. *N Z Vet J* 1998; 46:194.
45. Judson GJ, Babidge PJ. *Aust Vet J* 2002; 80:777.
46. Grace ND, Lewis DH. *N Z Vet J* 1999; 47:3.
47. Grace ND et al. *N Z Vet J* 2003; 51:89.
48. Grace ND. *N Z Vet J* 1999; 47:97.
49. Grace ND, West DM. *N Z Vet J* 2000; 48:70.

## COPPER DEFICIENCY

### Synopsis

**Etiology** Primary copper deficiency due to inadequate levels in diet. Secondary copper deficiency due to conditioning factors such as excess molybdenum and sulfur in the diet.

**Epidemiology** Primarily in young pastured ruminants (cattle, sheep, goats, and farmed deer) in spring and summer. Primary deficiency occurs in sandy soil and heavily weathered areas; secondary in peat or muck soil areas. Feed and water supplies may contain molybdenum, sulfate and iron salts, which interfere with copper metabolism. May be congenital in newborn lambs (swayback) if ewes deficient or delayed in nursing lambs (enzootic ataxia). Some breeds of sheep highly susceptible.

**Signs** Herd problem. Young growing ruminants on pasture. Unthriftiness, changes in hair color, chronic diarrhea in molybdenosis (secondary deficiency), chronic lameness, neonatal ataxia, anemia later stages of deficiency and falling disease in adult cattle.

**Clinical pathology** Low serum and hepatic copper. Ceruloplasmin. Anemia.  
**Necropsy findings** Anemia, emaciation, hemosiderosis, osteodystrophy, demyelination in enzootic ataxia, myocardiopathy.

**Diagnostic confirmation** Low serum and hepatic copper and response to treatment.

### Differential diagnosis list

Copper deficiency must be differentiated from herd problems associated with the following clinical findings:

- Unthriftiness due to intestinal parasitism
- Malnutrition due to energy-protein deficiency
- Lameness caused by osteodystrophy due to calcium, phosphorus, and vitamin D imbalance
- Anemia due to pediculosis
- Neonatal ataxia in lambs (congenital swayback and enzootic ataxia) from border disease; cerebellar hypoplasia (daft lamb disease); hypothermia; meningitis
- Sudden death due to other causes.

**Treatment** Copper sulfate orally; copper glycinate parenterally.

**Control** Provide source of copper by oral dosing or dietary supplementation in feed or on pasture. Parenteral administration of copper at strategic times. Copper oxide needles orally for prolonged effectiveness. Controlled-release boluses. Genetic selection. Removal of sulfates from water supply.

### ETIOLOGY

Copper deficiency may be primary, when the intake in the diet is inadequate, or secondary (conditioned) when the dietary intake is sufficient but the utilization of the copper by tissues is impeded.

#### Primary copper deficiency

The amount of copper in the diet may be inadequate when the forage is grown on deficient soils or on soils in which the copper is unavailable.

#### Secondary copper deficiency

In secondary copper deficiency, the amount of copper in the diet is adequate, but conditioning dietary factors interfere with the utilization of the copper. Such secondary copper deficiencies are summarized in Table 30.2. The administration of copper is preventive and curative. The conditioning factor is known only in some instances, but a **dietary excess of molybdenum** is one of the most common. A high molybdenum intake can induce copper deficiency even when the copper content of the pasture is quite high and a higher copper intake can overcome the effect of the molybdenum. Conversely, supplementation of the diet with molybdenum can

be used to counteract the copper intake when its content in the diet is dangerously high. There are species differences in response to high copper and molybdenum intake; sheep are much more susceptible to copper poisoning, cattle to excess molybdenum.

**Zinc, iron, lead, and calcium carbonate** are also conditioning factors and in New Zealand, the administration of selenium to sheep on copper-deficient pastures increases copper absorption and improves the growth rate of lambs. The use of zinc sulfate for the control of facial eczema may cause a depression of plasma copper levels, which can be alleviated by the injection of copper glycinate.

**Dietary inorganic sulfate** in combination with molybdenum has a profound effect on the uptake of copper by ruminants. Sheep consuming a complete diet, low in sulfur and molybdenum and with a modest 12–20 mg copper/kg dry matter (DM), may die from copper toxicity, while others grazing pasture of similar copper content but high in molybdenum and sulfur can give birth to lambs affected with the copper deficiency disease swayback.<sup>1</sup> An increase of sulfate concentration in a sheep diet from 0.1% to 0.4% can potentiate a molybdenum content as low as 2 mg/kg (0.02 mmol/kg) to reduce copper absorption to below normal levels. Additional sulfate in the diet also has a depressing effect on the absorption of selenium so that areas of a country with marginal copper and selenium levels in the soil may produce deficiency syndromes in animals if sulfate is added; this is likely to happen when heavy dressings of superphosphate are applied. Such combined deficiencies are becoming more common. The possibility of interaction between copper and selenium must also be considered because of the reported failure of animals to respond to treatment unless both elements are provided.

### EPIDEMIOLOGY

#### Occurrence

Copper deficiency is endemic in ruminants worldwide and causes diseases of economic importance that may be severe enough to render large areas of otherwise fertile land unsuitable for grazing by ruminants of all ages, but primarily young, growing ruminants. Based on serum copper surveys of cattle herds in Britain, copper deficiency constitutes a serious problem requiring vigilance. It is estimated that characteristic clinical signs of copper deficiency develop annually in about 0.9% of the cattle population in the UK. In some surveys, the lowest levels of serum copper were in heifers being reared as heifer replacements. Although heavy mortalities occur in affected areas, the major loss is due to

failure of animals to thrive. Enzootic ataxia may affect up to 90% of a lamb flock in badly affected areas and most of these lambs die of inanition. In falling disease, up to 40% of cattle in affected herds may die.

Copper deficiency is the most common trace element deficiency in farmed deer in New Zealand.<sup>2</sup> The deficiency in deer is widespread and is a problem in many herds. It can be diagnosed from clinical signs such as enzootic ataxia and osteochondrosis.

### Geographical distribution

#### Primary copper deficiency

The diseases caused by a primary deficiency of copper in ruminants are **enzootic ataxia** of sheep in Australia, New Zealand, and the USA, **licking sickness**, or *liksucht* of cattle in Holland and **falling disease** of cattle in Australia.

Copper deficiency occurs naturally in grazing livestock in many parts of the world. It has long been recognized as an endemic disease in the Salado's river basin in Buenos Aires Province, Argentina, affecting over 50% of the cattle population.<sup>3</sup> Some 81% of this wide area of 56 000 km<sup>2</sup> is devoted to breeding over 6.5 million head of beef cattle. The copper content in the grass is inadequate for most of the year and is most critical in autumn.<sup>4</sup>

A concurrent deficiency of both copper and cobalt occurs in Australia (**coast disease**) and Florida in the USA (**salt sickness**) and is characterized by the appearance of clinical signs of both deficiencies in all species of ruminants. The disease is controlled by supplementation of the diet with copper and cobalt.

In the USA, copper deficiency is not restricted to a single geographic region.<sup>5</sup> In a survey of 2007 beef cows and heifers from 256 herds, 1.7% were deficient and 38% were marginally deficient. In herds, 36% were marginally deficient and 0.8%, deficient. Approximately 50% of the producers reported use of copper supplements, but a significant portion of cattle from those herds were classified as marginally deficient or deficient.

A survey in Saskatchewan, Canada, found that 67% of slaughter cattle had liver levels lower than 10 mg copper/kg on a wet weight (WW). A survey of the copper status of the fetuses and livers from adult animals found that 20% of steers, 54% of pregnant cows, 52% of heifers, and 77% of non-pregnant cows had liver levels <25 mg/kg DM. The concentrations of copper in the liver of the fetuses were directly proportional to the liver copper concentrations in the dams. Liver copper levels of fetuses from dams with liver copper >25 mg/kg DM were higher than those in fetuses from dams

with liver copper levels <25 mg/kg DM. During gestation, the level of copper progressively increased in the fetal liver and decreased in the maternal liver. The concentration of copper in fetal livers increased with increasing fetal age and at term, the newborn calf has high levels of liver copper to meet postnatal requirements because cows' milk is a poor source of copper. The magnitude of copper deficiency in some areas is extensive and emphasizes the importance of adequate copper nutrition in pregnant cattle in order to maintain adequate fetal levels of copper.

Copper deficiency has been diagnosed in Canada in a herd of captive musk-oxen, which had originated in the Northwest Territories.<sup>6</sup>

Copper deficiency may also cause anemia in sucking pigs and reduced growth rate and cardiac disease in growing pigs. Adult horses are unaffected, but abnormalities of the limbs and joints of foals reared in copper-deficient areas do occur. Osteochondrosis is associated with a copper deficiency in young, farmed red deer and wapiti X red deer hybrids in New Zealand.<sup>7</sup>

#### Secondary copper deficiency

The diseases caused by secondary copper deficiency, mostly due to high dietary intakes of molybdenum and sulfate, are listed in Table 30.2. They include syndromes characterized by diarrhea or by unthriftiness. **'Yellow calf'**, a disease of nursing calves occurs on Hawaii's rangeland where copper content of forages ranges from 2.6 to 11.8 mg/kg and the molybdenum from <1 to 39 mg/kg. **Swayback** of lambs in the UK has been classed as a secondary copper deficiency, but no conditioning factor has been determined. While swayback is a naturally occurring disease caused by a primary deficiency of copper, identical lesions occur experimentally by feeding molybdenum and sulfate to the ewes. There is some evidence that heavy lime dressing of a pasture may predispose to swayback. A wasting

disease similar to **peat scours** and preventable by the administration of copper and unthriftiness ('pine') of calves, occur in the UK, but in both instances the copper and molybdenum intakes are normal. Molybdenum appears to be the conditioning agent in enzootic ataxia in the USA. A dietary excess of molybdenum is known to be the conditioning factor in the diarrhetic diseases, peat scours in New Zealand, California, and Canada and 'teart' in Britain.

High concentrations of molybdenum in forage (21–44 mg/kg DM) have been identified in several reclaimed mining areas in British Columbia but cattle have grazed these areas for 12-week periods yearly for 3 years without developing secondary copper deficiency.<sup>8</sup> One-half of the animals received a copper supplement and there were no differences in weight gain, liver molybdenum, serum copper, and molybdenum and milk copper and molybdenum between the two groups. The results indicated that the upper tolerable dietary concentrations of 5–10 mg molybdenum described by the National Research Council and the minimum safe copper to molybdenum ratio of 2:1 are not universal.<sup>8</sup>

**Moose sickness** is a disease of moose (*Alces alces L.*) in Sweden.<sup>9</sup> The disease has also been known as **'Alvsborg disease'** and **'wasting disease'**. About 4–5% of the moose population is affected annually. The appearance of the disease coincided with intensified liming of wetlands, lakes, and forests during the 1980s, undertaken to counteract the deleterious effects of acid rain. The increase in pH caused by the liming affected the availability of nutrients in the soil, reducing copper availability and increasing molybdenum.

Copper deficiency may be a factor contributing to the population decline of moose in North-western Minnesota.<sup>10</sup> In moose found dead, the copper concentrations based on criteria set for cattle, were deficient in 39.5% of livers, marginally deficient in 29.5% and adequate in 31%.<sup>10</sup>

Table 30.2 Secondary copper deficiency status

Disease	Country	Species affected	Copper level in liver	Probable conditioning factor
Swayback	Britain, USA	Sheep	Low	Unknown
Renguerra	Peru	Sheep	Low	Unknown
Teart	Britain	Sheep and cattle	Unknown	Molybdenum
Scouring disease	Holland	Cattle	Unknown	Unknown
Peat scours	New Zealand	Cattle	Low	Molybdenum
Peat scours	Britain	Cattle	Unknown, low level in blood	Unknown
Peat scours	Canada	Cattle	Unknown	Molybdenum
Salt sick	Florida (USA)	Cattle	Unknown	Unknown
'Pine' (unthrifty)	Scotland	Calves	Low	Unknown

The lower concentrations of copper in moose from bog and forest areas compared with the agricultural and prairie areas of North-western Minnesota coincide with a lower calf-to-cow ratio in the north-west forest area compared with the northwestern prairies.

### Seasonal incidence

Both primary and secondary copper deficiency occur most commonly in spring and summer coinciding with the lowest levels of copper in the pasture.

Large monthly variations occur in the serum levels of copper in both beef and dairy cattle and are commonly correlated with the rainfall; the higher the rainfall the lower the copper level.

The incidence of secondary copper deficiency may be highest at other times, depending upon the concentration of the conditioning factor in the forage. For example, the molybdenum content may be highest in the autumn when rains stimulate a heavy growth of legumes.

### Risk factors

Several factors influence the plasma and tissue concentrations of copper, particularly in ruminants, including:

- Age of animal
- Demands of pregnancy and lactation
- Stage of growth
- Copper sources available to the animals
- Mineral composition of feed
- Season of the year
- Soil characteristics and its mineral composition
- Breed of animal
- Concentration of minerals, such as sulfur and molybdenum, which can interfere with the availability of copper.

### Animal factors

#### Age susceptibility

Young animals are more susceptible to primary copper deficiency than adults. Calves on dams fed deficient diets may show signs at 2–3 months of age. As a rule, the signs are severe in calves and yearlings, less severe in 2-year-olds and of minor degree in adults. Enzootic ataxia is primarily a disease of sucking lambs whose dams receive insufficient dietary copper. Ewes with a normal copper status take some time to lose their hepatic reserves of copper after transfer to copper-deficient pastures and do not produce affected lambs for the first 6 months. The occurrence of the disease in sucklings and its failure to appear after weaning, point to the importance of fetal stores of copper and the inadequacy of milk as a source of copper. Milk is always a poor source of copper and when it is the sole source of nourishment the intake of copper will be low. Milk from normal ewes contains

20–60 µg/dL (3.1–9.4 µmol/L) copper, but under conditions of severe copper deficiency this may be reduced to 1–2 µg/dL (0.16–0.31 µmol/L).

#### Breed and species susceptibility

There are marked genetic differences in copper metabolism between breeds of sheep. The Welsh Mountain ewe can absorb copper 50% more efficiently than the Scottish blackface,<sup>11</sup> and the Texel cross blackface 145% more efficiently than pure blackface lambs.<sup>11</sup> The susceptibility to, or protection from, the effects of copper deficiency and also copper poisoning, is influenced from birth by genetic effects. These affect copper status of the lamb at birth, through the maternal environment controlled by the dam's genes and through the effect of the lamb's own genes. Later in life, the animal's own genes become the predominant influence determining its copper status on any given nutritional regimen. These genetic differences reflected in differences in the incidence of swayback, both between and within breeds and in effects on growth and possibly on reproduction. The differences observed are due to genetic differences in the efficiency of absorption of dietary copper.

The genetic effects determining the copper status of the lamb are already present in utero and the effects are not controlled by the lamb's own genotype but by that of its dam. The maternal effect is still present at weaning at 9 weeks of age, but disappears after weaning when the genetic differences are due to the sheep's own genotype.

The existence of genes determining plasma copper has been shown by the successful continued selection for high and low concentrations in closed lines of a single breed type. Ram selection is made on the basis of plasma copper concentrations at 18 and 24 weeks of age. The proportion of the normal variation in plasma copper that is heritable is 0.3. The high-line female sheep retain more copper in the liver than the low-line females, caused by a positive correlation between the concentration of copper in plasma and the efficiency of absorption.

The genetic variation in the copper metabolism of sheep has important physiological consequences. Breeds show wide variation in their susceptibility to swayback; the incidence of swayback may vary from 0 to 40% between breeds within one flock and the incidence according to breed type is closely related to the differences in the concentration of copper in the liver than in blood. When these high and low female lines are placed on improved and limed pasture, which can induce a severe copper deficiency, soon after birth there

are indications of swayback, general dullness, lack of vigor and mortality in the lambs. By 6 weeks of age, the mortality rate is higher in the lambs from the low copper line than in those from the high copper line. In addition, at 6 weeks of age, lambs from the low line are 2 kg lighter than those in the high line.

There are significant differences in the copper requirements and tolerance between goats and sheep.<sup>12</sup> The dietary copper requirements of goats are uncertain but may be higher than in sheep. Dietary levels of copper which could cause copper toxicity in sheep, do not cause toxicity in goats. Some limited data on growth performance indicates a stimulatory effect of 100–300 ppm copper in the diet of Nubian goats. Extra copper accumulated in liver and to a lesser extent in other tissues and was excreted through the biliary system and into the feces.

Certain breeds of cattle, e.g. the Simmental and Charolais, may have higher copper requirements than other breeds, e.g. Angus and these differences may be related to differences in copper absorption in the gastrointestinal tract. Angus heifers have a lower minimal copper requirement than Simmental.<sup>13</sup> Based on liver copper, the control diets containing 4.4 mg or 6.4 mg of copper/kg DM did not meet the copper requirement of either breed during gestation and lactation or growth. Addition of 7 mg of copper/kg DM to the control diets met the copper requirements of both breeds.

#### Fetal liver copper

During gestation, the copper concentration increases progressively in the ovine and bovine fetal liver and decreases in the maternal liver. The developing bovine fetus obtains its copper by placental transfer and at birth, the liver concentration of copper is high and declines postnatally to adult levels within the first few months. Placental transfer is less efficient in sheep and lambs are commonly born with low liver reserves, making the neonatal lambs susceptible to copper deficiency. In copper-deficient cattle, the accumulation of liver copper in the fetus continues independent of the dam's liver copper until the fetus is about 180 days, then a gradual decline in fetal liver copper occurs. The liver copper concentration in fetuses from dams on a copper-adequate diet continues to increase and not decline at 180 days of gestation. All of this indicates an increase in copper requirements by the dam during pregnancy; during the last month of pregnancy, the daily requirement for copper in cattle increases to approximately 70% above the maintenance requirements, which means that the dietary allowance of 10 mg/kg DM needs to be increased up to 25 mg/kg

DM during pregnancy. The concentrations of copper, iron, manganese, and zinc are consistently lower than normal in the livers of aborted fetuses, indicating a non-specific change in trace element status which is probably an effect of abortion and not a cause.

Colostrum is rich in copper, allowing the newborn with its preferential ability to absorb copper to increase hepatic stores. Later, the copper content of milk declines rapidly so that it is usually insufficient to meet the requirements of the sucking neonate for copper. The young milk-fed animal is able to absorb about 80% of its copper intake, but the efficiency of absorption declines with age as the rumen becomes functional, when only 2–10% of available copper is absorbed.

### Dietary factors

#### Pasture composition

The absorption (or availability) of copper is influenced by the type of diet, the presence of other substances in the diet such as molybdenum, sulfur, and iron, the interaction between the type of diet and the chemical composition of the diet and the genetic constitution of the animals. Copper is well-absorbed from diets low in fiber, such as cereals and Brassicas, but poorly absorbed from fresh forage. Conservation of grass as hay or silage generally improves its availability. This explains why copper deficiency is a problem of the grazing animal and seen only rarely in housed ruminants receiving diets that are commonly adequate in copper.

#### Molybdenum and sulfur

Only small increases in the molybdenum and sulfur concentration of grass will cause major reductions in the availability of copper. This is especially notable in ruminants grazing improved pastures in which the molybdenum and sulfur concentrations were increased. The copper content of feedstuffs should be expressed in terms of available copper concentration, using appropriate equations, which permits a more accurate prediction of clinical disease and can be used for more effective control strategies.

The effect of changes in molybdenum and sulfur concentrations in grass on the availability of copper is changed by conservation. At a given concentration of sulfur, the antagonistic effect of molybdenum is proportionately less in hay than in fresh grass. At a low concentration of molybdenum, the effect of sulfur is more marked in silage than in fresh grass. The use of formaldehyde as a silage additive may weaken the copper sulfur antagonism and yield material of high availability. Thus, fields of herbage high in molybdenum should be used for conservation when possible and sulfuric acid should not be

used as an additive for silage unless accompanied by a copper salt because it significantly raises the sulfur concentration of the silage.

#### Copper in diet

For general purposes, pasture containing <3 mg/kg DM of copper will result in signs of deficiency in grazing ruminants. Levels of 3–5 mg/kg DM can be considered as dangerous and levels >5 mg/kg DM (preferably 7–12) are safe unless complicating factors cause secondary copper deficiency. The complexity of minimum copper requirements, affected as they are by numerous conditioning factors, necessitates examination under each particular set of circumstances. For example, plant molybdenum levels are related directly to the pH reaction of the soil. Grasses grown on strongly acidic molybdenum-rich soils are characterized by low molybdenum values (<3 mg/kg DM), whereas those associated with alkaline molybdenum-poor soils may contain up to 17 mg/kg DM. Thus, it seems likely that conditioned copper deficiency can be related to regionally enhanced levels of plant available rather than soil molybdenum. Heavily limed pastures are often associated with a less than normal copper intake and a low copper status of sheep grazing them. Secondary copper deficiency is also recorded in pigs whose drinking water contains very large amounts of sulfate.

#### Dietary iron

A dietary intake of iron can interfere with copper metabolism.<sup>14</sup> Dietary levels of iron in the range of 500–1500 mg/kg DM, within the range of their fluctuation in silage and forage and higher levels, are a risk of inducing copper deficiency in ruminants, especially when the copper intake is marginal. Ruminants obtain iron from ingested soil and mineral supplements and, in areas where hypocuprosis is likely to occur, the risk can be minimized by avoiding the use of mineral supplements of high iron content, minimizing the use of bare winter pasture and avoiding the excessive contamination of silage with soil during harvesting.

Molybdenum-induced secondary copper deficiency in cattle occurred when motor oil containing molybdenum bisulfide was spilled on a pasture located on the side of a railway bed near the farm.

#### Stored feeds

Livestock that are housed have a slightly different dietary intake to those on pasture. Concentrates and proprietary feeds usually contain adequate copper. Pasture is less likely to contain sufficient copper, especially in early spring when the grass growth is lush and silage and haylage may be deficient. Hay is more mature and usually con-

tains more of all minerals, so that animals housed for the winter are protected against copper deficiency for a few weeks after they come out onto pasture in the spring. Young, growing animals will be first affected. These comments should not be interpreted to mean that housed or feedlot animals cannot be affected by hypocuprosis; they can if the locally produced feed is copper-deficient, or more likely has a high concentration of molybdenum. Both are likely to be prevented, or less severe, if there is some supplementary feeding.

#### Soil characteristics

##### *Copper deficiency*

In general, there are two types of soil on which copper-deficient plants are produced. Sandy soils, poor in organic matter and heavily weathered, such as on the coastal plains of Australia and in marine and river silts, are likely to be deficient in copper as well as other trace elements, especially cobalt.

The second important group of soils is 'peat' or muck soils reclaimed from swamps and are soils more commonly associated with copper deficiency in the USA, New Zealand, and Europe. Such soils may have an absolute deficiency of copper, but more commonly, the deficiency is relative in that the copper is not available and the plants growing on the soils do not contain adequate amounts of the element.

The cause of the lack of availability of the copper is uncertain, but is probably the formation of insoluble organic copper complexes. An additional factor is the production of secondary copper deficiency on these soils due to their high content of molybdenum. A summary of the relevant levels of copper in soils and plants is given in Table 30.3.

##### *Molybdenum excess*

Pastures containing <3 mg/kg DM of molybdenum are considered to be safe, but disease may occur at 3–10 mg/kg DM if the copper intake is low. Pastures containing >10 mg/kg DM of molybdenum are dangerous unless the diet is supplemented with copper. Excess molybdenum may occur in soils up to levels of 10 and even 100 mg/kg. Perhaps more dangerous is the risk that overzealous application of molybdenum to pasture to increase bacterial nitrogen fixation may have similar effects, which are likely to be long-lasting.

In the UK, appreciable land is underlain by marine black shales rich in molybdenum, resulting in a high content of molybdenum in the soil and pastures and in a secondary copper deficiency that, potentially, limits livestock performance. Secondary (conditioned) copper deficiency is now recognized in cattle in many parts of Canada. Large areas of west-central Manitoba are underlain by molyb-

Table 30.3 Copper levels of soils and plants in primary and secondary copper deficiency

Condition	Area	Soil type	Soil copper (mg/kg)	Plant copper (mg/kg DM)
Normal	-	-	18-22	11
Primary copper deficiency	West Australia	Various	1-2	3-5
	New Zealand	Sand	0.1-1.6	3
	New Zealand	Peat	-	3
	Holland	Sand	-	<3
Secondary copper deficiency	New Zealand	Peat	5	7
	Britain	Peat	-	7-20
	Britain	Limestone	-	12-27
	Britain	Stiff clay	-	11
	Ireland	Shale deposits, peat marine, alluvial soils	-	-
	Holland	Sand	-	>5
Canada	Burned-over peat	20-60	10-25	

deniferous shale bedrocks and the soil contain up to 20 mg/kg of molybdenum. However, in the same geographical location, hypocupremia may be associated with a primary deficiency of copper in the forage, or a secondary copper deficiency due to molybdenum in the forages.

In New Zealand, soil types have been identified which produce pastures that have molybdenum concentrations, varying from 3.5 to 20 mg/kg DM.<sup>2</sup> In some deer herds, copper deficiency may be molybdenum induced rather than due to low copper intake alone. Increasing the pasture molybdenum concentrations from 2 mg/kg DM to 4.6 mg/kg DM significantly reduced serum and liver copper concentrations in grazing red deer.<sup>2</sup> Reduced growth rate occurred when pasture molybdenum >10 mg/kg DM.

## PATHOGENESIS

### Effects on tissues

The consequences of hypocuprosis include a failure of copper metalloenzymes, many of which form part of the antioxidant defense system such as copper/zinc superoxide dismutase (Cu/Zn SOD) and ceruloplasmin.<sup>15</sup> Copper, as well as other essential trace elements, is an atypical antioxidant because it functions indirectly. Copper is a catalytic cofactor for Cu/Zn SOD and ceruloplasmin. Cu/Zn SOD catalyzes dismutation of the superoxide anion, producing molecular oxygen and hydrogen peroxide, with the latter product usually metabolized by glutathione peroxidase and catalase. The ferroxidase activity of ceruloplasmin mediates the oxidation of ferrous ions to the ferric state, thereby preventing ferrous ion-dependent formation of hydroxyl radicals via the Fenton reaction. Thus, in enabling Cu/Zn SOD and ceruloplasmin to function as described, copper can be classified as part of the antioxidant defense system of cells.

Copper deficiency can affect the antioxidant defense system resulting in oxidative damage to cellular components.

The activity of Cu/Zn SOD and glutathione peroxidase is decreased in animals with copper deficiency. Copper deficiency in cattle has been associated with a decrease in Cu/Zn SOD, ceruloplasmin and cytochrome oxidase activity and with an increase in lipid peroxidation. Collectively, this indicates that copper deficiency weakens the antioxidant defense systems.<sup>15</sup>

Ceruloplasmin is the copper-containing enzyme through which copper exerts its physiological function. The pathogenesis of most of the lesions of copper deficiency has been explained in terms of faulty tissue oxidation because of failure of these enzyme systems. This role is exemplified in the early stages of copper deficiency by the changes in the wool of sheep.

### Chromosomal abnormalities

The association between copper deficiency and DNA damage in cattle has been examined.<sup>3,15</sup> The Comet assay is a sensitive, reliable and rapid method for the detection of DNA double- and single-strand breaks and alkali-labile sites detection.<sup>16</sup> In naturally-occurring copper deficiency in Aberdeen Angus cattle in Argentina, cytogenetic analysis of peripheral lymphocyte cultures showed a significant increase in the frequency of abnormal metaphases in moderate to severe copper deficient groups. Thus, copper deficiency in cattle is associated with an increase in the frequency of chromosomal aberrations (clastogenic effect) as well as in DNA migration.

### Wool

The straightness and stringiness of this wool is due to inadequate keratinization, probably due to imperfect oxidation of free thiol groups. Provision of copper to such sheep is followed by oxidation of these free thiol groups and a return to normal keratinization within a few hours.

### Body weight

In the later stages of copper deficiency, the impairment of tissue oxidation causes

interference with intermediary metabolism and loss of condition or failure to grow.

### Diarrhea

The pathogenesis of copper deficiency in causing diarrhea is uncertain and there is little evidence that a naturally-occurring primary copper deficiency will cause diarrhea. There are no histological changes in gut mucosa, although villous atrophy is recorded in severe, experimentally produced cases. Diarrhea is usually only a major clinical finding in secondary copper deficiency associated with molybdenosis.

### Anemia

The known importance of copper in the formation of hemoglobin accounts for the anemia in copper deficiency. The presence of hemosiderin deposits in tissues of copper-deficient animals suggests that copper is necessary for the reutilization of iron liberated from the normal breakdown of hemoglobin. There is no evidence of excessive hemolysis in copper-deficiency states. Anemia may occur in the later stages of primary copper deficiency, but is not remarkable in the secondary form unless there is a marginal copper deficiency, as occurs in peat scours in New Zealand. The unusual relationship in New Zealand between copper deficiency and postparturient hemoglobinuria is unexplained. Heinz body anemia in lambs with deficiencies of copper or selenium and moved from improved pasture to rape (*Brassica napus*) has been reported.

### Bone

The osteoporosis that occurs in some natural cases of copper deficiency is caused by the depression of osteoblastic activity.<sup>11</sup> In experimentally induced primary copper deficiency, the skeleton is osteoporotic and there is a significant increase in osteoblastic activity. There is a marked overgrowth of epiphyseal cartilage, especially at costochondral junctions and in metatarsal bones. This is accompanied by beading of the ribs and enlargement of the long bones. There is also an impairment of collagen formation. When the copper deficiency is secondary to dietary excesses of molybdenum and sulfate, the skeletal lesions are quite different and characterized by widening of the growth plate and metaphysis and active osteoblastic activity.

Copper deficiency in foals causes severe degenerative disease of cartilage, characterized by breaking of articular and growth plate cartilage through the zone of hypertrophic cells, resulting in osteochondrosis of the articular-epiphyseal complex (A-E complex).<sup>11</sup> The incidence and severity of osteochondrosis in foals can be decreased by supplementation of the diets of mares during the last 3-6

months of pregnancy and the first 3 months of lactation. Foals from non-supplemented mares have separation of the thickened cartilage from the subchondral bone. Clinical, radiographic, and biochemical differences occur between copper-deficient and copper-supplemented foals and there may be a relationship between low copper intakes in rapidly growing horses, inferior collagen quality, biomechanically weak cartilage, and osteochondritis.<sup>17</sup>

Copper is essential for metalloenzyme lysyl oxidase, which produces aldehydic groups on hydroxylysine residues as a prerequisite for eventual cross-link formation in collagen and elastin. Similar lesions in foals have been attributed to zinc toxicity from exposure of affected animals to pasture polluted by smelters. Experimentally, the addition of varying amounts of zinc to the diet of foals containing adequate copper will result in zinc-induced copper deficiency, but there are no effects with zinc intakes up to 580 ppm and it is suggested that 2000 ppm or higher are necessary to affect copper absorption in horses.<sup>18</sup> Similar lesions of osteochondrosis have occurred in young farmed red deer and wapiti X red deer hybrids in New Zealand.<sup>7</sup>

#### Connective tissue

Copper is a component of the enzyme lysyl oxidase, secreted by the cells involved in the synthesis of the elastin component of connective tissues and has important functions in maintaining the integrity of tissues such as capillary beds, ligaments, and tendons.

#### Heart

The myocardial degeneration of falling disease may be a terminal manifestation of anemic anoxia, or be due to interference with tissue oxidation. In this disease, it is thought that the stress of calving and lactation contribute to the development of heart block and ventricular fibrillation when there has already been considerable decrease in cardiac reserve. Experimentally induced copper deficiency in piglets causes a marked reduction in growth and hematocrit and cardiac pathology and electrical disturbances.

#### Blood vessels

Experimentally produced copper deficiency has also caused sudden death due to rupture of the heart and great vessels in a high proportion of pigs fed a copper-deficient diet. The basic defect is degeneration of the internal elastic laminae. There is no record of a similar, naturally occurring disease. A similar relationship appears to have been established between serum copper levels and fatal rupture of the uterine artery at parturition in aged mares.

#### Pancreas

Lesions of the pancreas may be present in normal cattle with a low blood copper status. The lesions consist of an increase in dry matter content and a reduction in the concentrations of protein and copper in wet tissue. The cytochrome oxidase activity and protein:RNA ratio are also reduced. There are defects in acinar basement membranes, splitting, and disorganization of acini, cellular atrophy and dissociation and stromal proliferation.

#### Nervous tissue

Copper deficiency halts the formation of myelin and causes demyelination in lambs, probably by a specific relationship between copper and myelin sheaths. Defective myelination can commence as early as the midpoint of the fetus's uterine life. The focus of lesions in the white matter shifts from the cerebrum in lambs affected at birth (congenital swayback) to the spinal cord in delayed cases, which may reflect respective peaks of myelin development at those sites at 90 days' gestation and 20 days after birth. The postnatal development of delayed swayback has been confirmed through its control by copper supplementation after birth. In experimental animals, it has been shown that copper deficiency does interfere with the synthesis of phospholipids. While anoxia is a cause of demyelination, an anemic anoxia is likely to occur in highly deficient ewes and anemic ewes produce a higher proportion of lambs with enzootic ataxia, there is often no anemia in ewes producing lambs with the more common subacute form of the disease. Severely deficient ewes have lambs affected at birth and in which myelin formation is likely to have been prevented. The lambs of ewes less severely deficient have normal myelination at birth and develop demyelination in postnatal life.

#### Reproductive performance

There is no evidence that copper deficiency causes reproductive failure in dairy cows. Copper glycinate given to dairy cattle does not affect the average interval in days between calving and first observed heat, services per conception, or first service conception rate compared with untreated cows in the same population. Experimentally, the addition of molybdenum to the diet of heifers delayed the onset of puberty, decreased the conception rate and caused anovulation and anestrus in cattle without accompanying changes in copper status or in live weight gain. Thus, the presence of molybdenum rather than low copper status may affect reproductive performance of cattle. Geochemical data indicate that approximately 10% of the cultivated area of England and Wales has soils that may result in forage molyb-

denum concentrations similar to those used in the above experimental diet. It appears inadvisable to ascribe poor reproductive performance to subclinical hypocuprosis on the evidence of blood copper analysis alone. Other factors, such as management and energy and protein intake, should be examined.

#### Immune system

Copper is an essential trace mineral with an important role in the immune response but the precise mechanism is not well understood. In experimental secondary copper deficiency in cattle induced by molybdenum at 30 ppm and sulfate at 225 ppm, the intracellular copper content of peripheral blood lymphocytes, neutrophils, and monocyte-derived macrophages was reduced between 40% and 70%.<sup>19</sup> In copper deficient animals, the serum ceruloplasmin activity decreased to 50% of control values. Both the copper-zinc-superoxide dismutase and the cytochrome c oxidase activities are significantly reduced in leukocytes. Thus, copper deficiency alters the activity of several enzymes, which mediate antioxidant defenses and ATP formation. These effects may impair cell immune function, affecting the bactericidal capacity and making the animals more susceptible to infection.

Copper deficiency results in decreased humoral and cell-mediated immunity, as well as decreased non-specific immunity regulated by phagocytic cells, such as macrophages and neutrophils.<sup>20,21</sup> The decreased resistance to infection in sheep is amenable to treatment with copper and genetic selection. In lambs genetically selected for low and high concentrations of plasma copper, the mortality from birth to 24 weeks of age in the high line was half that in the low line. Most of the losses were due to a variety of microbial infections. Experimental viral and bacterial infections of cattle can cause a rapid, though transient, increase in serum ceruloplasmin and plasma copper in copper-replete animals, suggesting a major protective role for copper in infectious diseases. These changes in copper metabolism evolve from an interleukin-1 mediated increase in hepatic synthesis and release of ceruloplasmin, an acute phase protein. Copper concentrations in organs involved in immune regulations such as liver, spleen, thymus, and lung are substantially reduced by copper deficiency, suggesting that copper-deficient animals are at greater risk for infection than copper-adequate animals. However, experimental low copper diets with or without supplemental molybdenum does not alter the specific immunity of stressed cattle.<sup>22</sup>

The severity of copper depletion needed for immune dysfunction is less than

required to induce clinical signs of copper deficiency and endogenous copper may contribute to the regulation of both non-immune and immune inflammatory responses. Low molecular weight complexes may have an anti-inflammatory effect in animal models of inflammation and it is postulated that the elevation of plasma copper-containing components during inflammatory disease represents a physiological response.

In experimental coliform mastitis in dairy cattle, copper in the diet at 20 ppm reduced the clinical response but not duration of the mastitis compared with animals receiving 6.5 ppm beginning 60 days prepartum through 42 days of lactation.<sup>23</sup> Liver copper in the supplemented group was 162 and 33 ppm at calving and 256 and 45 ppm at 42 days post partum, respectively.

Copper deficiency in heifers in Northern India was associated with significant reduction in the candidacidal activity of neutrophils compared with copper supplemented animals.<sup>24</sup>

#### Sequence of clinical signs development

In experimental copper deficiency in calves, beginning at 6 weeks of age, sub-clinical and clinical abnormalities appear after the following intervals: hypocupremia at 15 weeks, growth retardation from 15 to 18 weeks, rough hair coat at 17 weeks, diarrhea at 20 weeks and leg abnormalities at 23 weeks. These signs correlate well with the onset of hypocupremia and are indicative of a severe deficiency. Even with these signs of deficiency, the histological abnormalities may be only minor in degree.

In experimental primary copper deficiency in calves, beginning at 12 weeks of age, clinical signs of the deficiency may not become apparent for about 6 months. Musculoskeletal abnormalities include a stilted gait, a 'knock-kneed' appearance of the forelimbs, overextension of the flexors, splaying of the hooves and swellings around the metacarpophalangeal and carpometacarpal joints. Changes in hair pigmentation occur after about 5 months and diarrhea between 5 and 7 months. The diarrhea ceased 12 h after oral administration of a small amount (10 mg) of copper.

#### Copper-molybdenum-sulfate relationship

The interaction between copper, molybdenum, and sulfur in ruminant nutrition is unique in its effects on health and production. Copper, molybdenum, and sulfur from organic or inorganic sources can combine in the rumen to form an unabsorbable triple complex, copper tetrathiomolybdate and deplete the host tissues of copper.<sup>1</sup>

**Secondary or conditioned copper deficiency occurs when the dietary intake of copper is adequate, but absorption and utilization of the copper are inadequate because of the presence of interfering substances in the diet.**<sup>1</sup> Molybdenum and sulfate alone or in combination can affect copper metabolism and the mechanisms by which this occurs are now being clarified. This effect also operates in the fetus and interferes with copper storage in the fetal liver. Besides the relationship with molybdenum, an interaction between the absorption of copper and selenium has been demonstrated, the administration of selenium to sheep on copper-deficient pastures causing an improvement in copper absorption.

The toxicity of any level of dietary molybdenum is affected by the ratio of the dietary molybdenum to dietary copper. The critical copper:molybdenum ratio in animal feeds is 2 and feeds or pasture with a lower ratio may result in conditioned copper deficiency. In some regions of Canada, the copper:molybdenum ratio will vary from 0.1 to 52.7. Higher critical ratios closer to 4.1–5.1 have been recommended for safety. The influence of dietary molybdenum on copper metabolism in ponies has been examined experimentally.

The copper status of growing calves can also be affected to a similar degree by the inclusion of appropriate levels of supplementary iron or molybdenum in the diet. Following such inclusion, the liver and plasma concentrations of copper will decline within 12–16 weeks to levels indicating severe copper deficiency. The clinical signs of copper deficiency, as indicated by reduced growth rate and changes in the hair texture and color, are evident after 16–20 weeks only in animals supplemented with molybdenum. The reduced growth rate was accompanied by a decreased feed intake and reduced efficiency of feed utilization.

#### Copper absorption

On the basis of a response to copper injections and no response to copper administered orally to sheep on a high molybdenum intake, it is suggested that interference occurs with the absorption of copper from the gut.

It is proposed that thiomolybdates form in the rumen from the reaction of dietary molybdenum compounds with sulfides produced from the reduction of dietary sulfur compounds by rumen bacteria. The thiomolybdates reduce the absorption of dietary copper from the intestine and also inhibit a number of copper-containing enzymes, including ceruloplasmin, cytochrome oxidase, superoxide dismutase and tyrosine oxidase.

#### Copper utilization

Sulfate and molybdate can interfere with mobilization of copper from the liver, inhibition of copper intake by the tissues, inhibition of copper transport both into and out of the liver and inhibition of the synthesis of copper-storage complexes and ceruloplasmin.

The clinical signs of hypocuprosis (such as steely wool) can occur in sheep on diets containing high levels of molybdenum and sulfate, even though blood copper levels are high. This suggests that under these circumstances copper is not utilizable in tissues and the blood copper rises in response to the physiological needs of the tissues for the element. In pigs, a copper-molybdenum complex can exist in animals and that in this form the copper is unavailable. This would interfere with hepatic metabolism of copper and the formation of copper-protein complexes such as ceruloplasmin.

#### Hepatic storage

The copper status of the liver depends on whether the animals are receiving adequate dietary copper. With adequate dietary levels, the liver copper levels are less in the presence of molybdate and sulfate. If the animals are receiving a copper-deficient diet such that copper is being removed from the liver, then the molybdate plus sulfate animals retain more copper in their liver than copper-deficient animals not receiving sulfate plus molybdate. This supports the hypothesis that molybdate and sulfate together impair the movement of copper into or out of the liver, possibly by affecting copper transport. Sulfate alone exerts an effect. An increase in intake reduces hepatic storage of both copper and molybdenum.

#### Phases of copper deficiency

The development of a deficiency can be divided into four phases:

1. Depletion
2. Deficiency (marginal)
3. Dysfunction
4. Disease.

During the depletion phase, there is loss of copper from any storage site, such as liver, but the plasma concentrations of copper may remain constant. With continued dietary deficiency, the concentrations of copper in the blood decline during the phase of marginal deficiency. However, it may be some time before the concentrations or activities of copper-containing enzymes in the tissues begin to decline and it is not until this happens that the phase of dysfunction is reached. There may be a further lag before the changes in cellular function are manifested as clinical signs of disease.



### Summary

The overall effect of these interactions is as follows. Molybdate reacts with sulfides to produce thiomolybdates in the rumen. The subsequent formation of copper-thiomolybdate complexes isolates the copper from being biologically available.<sup>1</sup> The thiomolybdates reduce the effectiveness of enzymes containing copper and there are some significant interactions between copper, zinc, and iron.

### CLINICAL FINDINGS

The general effects of copper deficiency are the same in sheep and cattle, but in addition to these general syndromes, there are specific syndromes more or less restricted to species and to areas. What follows is a general description of the disease caused by copper deficiency, in turn followed by the specific syndromes of enzootic ataxia, swayback, falling disease, peat scours, teart, and unthriftiness (pine).

#### Cattle

##### Subclinical hypocuprosis

No clinical signs occur, blood copper levels are marginal or below 57 mg/dL (9.0 mmol/L) and there is a variable response in productivity after supplementation with copper. Some surveys in copper-deficient areas found that about 50% of beef herds and 10% of dairy herds within the same area have low blood levels of blood copper associated with low copper intake from natural forages. The deficiency is likely to be suspected only if production is monitored and found to be suboptimal.

A perplexing feature of subclinical hypocuprosis is the wide variation in improved growth rate obtained when cattle of the same low copper status are given supplementary copper under field conditions.

##### General syndrome

##### *Primary copper deficiency*

Primary copper deficiency causes unthriftiness, loss of milk production, and anemia in adult cattle. The coat color is affected, red and black cattle changing to a bleached, rusty red and the coat itself becomes rough and staring. In severely deficient states, which are now uncommon, calves grow poorly and there is an increased tendency for bones to fracture, particularly the limb bones and the scapula. Ataxia may occur after exercise, with a sudden loss of control of the hindlimbs and the animal falling or assuming a sitting posture. Normal control returns after rest. Itching and hair-licking are also recorded as manifestations of copper deficiency in cattle. Although diarrhea may occur, persistent diarrhea is not characteristic of primary copper deficiency and its occurrence should arouse suspicion of molybdenosis or helminthiasis. In some affected areas,

calves develop stiffness and enlargement of the joints and contraction of the flexor tendons causing the affected animals to stand on their toes. These signs may be present at birth or occur before weaning. Paresis and incoordination are not evident.

An increased occurrence of postparturient hemoglobinuria is also recorded, but only in New Zealand and may be unrelated to copper deficiency.

##### *Secondary copper deficiency*

This syndrome includes the signs of primary copper deficiency, except that anemia occurs less commonly, probably due to the relatively better copper status in the secondary state, anemia being largely a terminal sign in primary copper deficiency. For example, anemia occurs in peat scours of cattle in New Zealand, but in this instance, the copper intake is marginal. In addition to the other signs, however, there is a general tendency for diarrhea to occur, particularly in cattle. Because diarrhea is not a major sign in naturally occurring primary copper deficiency it is possible that it is due to the conditioning factor, which reduces the availability of copper. For example, the severity of the diarrhea is roughly proportional to the level of intake of molybdenum.

##### Falling disease

The characteristic behavior in falling disease is for cows in apparently good health to throw up their heads, bellow, and fall. Death is instantaneous in most cases, but some fall and struggle feebly on their sides for a few minutes with intermittent bellowing and running movement attempts to rise. Rare cases show signs for up to 24 h or more. These animals periodically lower their heads and pivot on the front legs. Sudden death usually occurs during one of these episodes.

##### Peat scours ('teart')

Persistent diarrhea with the passage of watery, yellow-green to black feces with an inoffensive odor occurs soon after the cattle go on to affected pasture, in some cases within 8–10 days. The feces are released without effort, often without lifting the tail. Severe debilitation is common, although the appetite remains good. The hair coat is rough and depigmentation is manifested by reddening or gray flecking, especially around the eyes, in black cattle. The degree of abnormality varies a great deal from season to season and year to year and spontaneous recovery is common. Affected animals usually recover in a few days following treatment with copper.

##### Unthriftiness (pine) of calves

The earliest signs are a stiffness of gait and unthriftiness. The epiphyses of the distal ends of the metacarpus and metatarsus may be enlarged and resemble the

epiphysitis of rapidly growing calves deficient in calcium and phosphorus or vitamin D. The epiphyses are painful on palpation and some calves are severely lame. The pasterns are upright and the animals may appear to have contracted flexor tendons. The unthriftiness and emaciation are progressive and death may occur in 4–5 months. Grayness of the hair, especially around the eyes in black cattle, is apparent. Diarrhea may occur in a few cases.

#### Sheep

##### General syndrome

##### *Primary copper deficiency*

Abnormalities of the wool are the first observed signs and may be the only sign in areas of marginal copper deficiency. Fine wool becomes limp, glossy and loses its crimp, developing a straight, steely appearance. Black wool shows depigmentation to gray or white, often in bands coinciding with the seasonal occurrence of copper deficiency. The straight, steely defect may occur in similar bands and the staple may break easily. There appear to be some differences between breeds in susceptibility to copper deficiency, Merino sheep appearing to have a higher copper requirement than mutton sheep. The fleece abnormalities of Merino sheep in Australia have not been observed in Romney Marsh sheep in copper-deficient areas in New Zealand, but this may be due in part to the difficulty of detecting abnormality in wool that is normally rather straight and steely. Anemia, scouring, unthriftiness and infertility may occur in conditions of extreme deficiency, but in sheep, the characteristic findings are in the lamb, the disease enzootic ataxia being the major manifestation. Retardation of growth, diarrhea, delay to marketing, and increased mortality are common clinical findings in lambs genetically selected for low plasma copper and placed on improved and limed upland pastures. Osteoporosis, with increased tendency of the long bones to fracture, has also been recorded under conditions of copper deficiency insufficient to cause enzootic ataxia.

##### Swayback and enzootic ataxia in lambs and goat kids

These diseases have much in common, but there are differences in epidemiology and some subtle clinical ones.

**Swayback** is the only authentic manifestation of a primary nutritional deficiency of copper in the UK. The incidence can vary greatly among breeds of sheep, reflecting the genetic differences in copper metabolism both between and within breeds of sheep. The disease occurs in several forms.

A congenital form, cerebrosplinal swayback, occurs only when the copper

deficiency is extreme. Affected lambs are born dead or weak and unable to stand and suck. Incoordination and erratic movements are more evident than in enzootic ataxia and the paralysis is spastic in type. Blindness also occurs occasionally. There is softening and cavitation of the cerebral white matter and this probably commences about day 120 of gestation.

Progressive (delayed) spinal swayback begins to develop some weeks after birth with lesions and clinical signs appearing at 3–6 weeks of age.

Postnatal acute fatal swayback may be a third form of the disease and appears to occur only in Wales. It resembles the more usual delayed form, but develops suddenly. There is a sudden onset of recumbency with death occurring 1–2 days later due to acute swelling of the cerebrum.

**Enzootic ataxia** affects only unweaned lambs. In severe outbreaks, the lambs may be affected at birth, but most cases occur in the 1–2-month age group. The severity of the paresis decreases with increasing age at onset. Lambs affected at birth or within the first month usually die within 3–4 days. The disease in older lambs may last for 3–4 weeks and survival is more likely, although surviving lambs always show some ataxia and atrophy of the hindquarters. The first sign to appear in enzootic ataxia is incoordination of the hindlimbs, appearing when the lambs are driven. Respiratory and cardiac rates are also greatly accelerated by exertion. As the disease progresses, the incoordination becomes more severe and may be apparent after walking only a few yards. There is excessive flexion of joints, knuckling over of the fetlocks, wobbling of the hindquarters and finally falling. The hindlegs are affected first and the lamb may be able to drag itself about in a sitting posture. When the forelegs eventually become involved recumbency persists and the lamb dies of inanition. There is no true paralysis, the lamb being able to kick vigorously even in the recumbent stage. The appetite remains unaffected.

### Goats

Enzootic ataxia due to copper deficiency has been reported in young goat kids. The disease is similar in most respects to the disease in lambs. Kids may be affected at birth, or the clinical signs may be delayed until the animals are several weeks of age. Cerebellar hypoplasia is a frequent finding in goats.

### Other species

#### Deer

Enzootic ataxia in red deer is remarkably different from the disease in lambs in that it develops in young adults well past weaning age, and in adults. The clinical signs include ataxia, swaying of the hind-

quarters, a dog-sitting posture and, eventually, inability to use the hindlimbs. Spinal cord demyelination and midbrain neuronal degeneration are characteristic. Osteochondrosis of young, farmed deer with copper deficiency is characterized by lameness, one or more swollen joints and an abnormal 'bunny-hopping' gait or 'cow-hocked' stance.<sup>7</sup> Copper deficiency in red deer in Australia during a period of drought caused loss of weight in lactating hinds after calving and steely hair coats (the hair had a lustre resembling that of so-called steely wool of copper-deficient sheep). Both adult and yearling stags had normal hair coats but those of the yearling hinds were patchy, with large areas of harsh, light colored, steely hair.<sup>21</sup> The high sulfur content of the diet and possible accidental iron ingestion from being fed on the ground may have resulted in secondary copper deficiency.

#### Pigs

Naturally occurring enzootic ataxia has occurred in growing pigs 4–6 months of age. Posterior paresis progresses to complete paralysis in 1–3 weeks. Dosing with copper salts had no effect on the clinical conditions, but hepatic copper levels were 3–14 mg/kg (0.05–0.22 mmol/kg). Copper deficiency in piglets 5–8 weeks of age has been reported and was characterized clinically by ataxia, posterior paresis, nystagmus, inability to stand, paddling movements of the limbs and death in 3–5 days. Demyelination of the spinal cord and degenerative lesions of the elastic fibers of the walls of the aorta and pulmonary arteries are present.

The inclusion of copper sulfate, at levels of 125–250 mg/kg of copper, in the diets of pigs 11–90 kg live weight and fed ad libitum, results in slight improvements in growth rate and feed efficiency, but has no significant effect on carcass characteristics. The supplemental copper causes a marked increase in liver copper concen-

tration which poses a potential hazard and it is recommended that copper supplementation be limited to starter and grower diets fed to pigs weighing less than 50 kg live weight.

#### Horses

Adult horses are unaffected by copper deficiency, but there are unconfirmed reports of abnormalities of limbs of foals. Foals in copper-deficient areas may be unthrifty and slow-growing, with stiffness of the limbs and enlargement of the joints. Contraction of the flexor tendons causes the animal to stand on its toes. There is no ataxia or indication of involvement of the central nervous system. Signs may be present at birth or develop before weaning. Recovery occurs slowly after weaning and foals are unthrifty for up to 2 years.

Geophagia or soil eating in horses in Australia has been associated with larger concentrations of iron and copper in soil samples compared to paired control samples, suggesting that these elements provide the stimulus for geophagia.<sup>25</sup>

### CLINICAL PATHOLOGY

The laboratory evaluation of the copper status of farm animals is complex because the biochemical values are often difficult to interpret and to correlate with the clinical state of the animal. Interpretation of the copper status of an individual animal is more difficult than of a herd.

The guidelines for the laboratory diagnosis of primary and secondary copper deficiency in cattle and sheep are summarized in Table 30.4.

**Herd diagnosis.** The diagnosis of copper deficiency in a herd of animals is based on a combination of collection and interpretation of the history, clinical examination of the affected animals, laboratory tests on serum and liver samples, and examination of the environment including analysis of the feed and water supplies and perhaps soil analysis.<sup>11</sup>

Table 30.4 Copper levels in body tissues and fluids in primary and secondary copper deficiency

Species and tissue	Normal level	Primary copper deficiency	Secondary copper deficiency
<b>Cattle</b>			
Blood plasma ( $\mu\text{g}/\text{mL}$ ) (convert to SI units by multiplying by 15.7 which gives $\mu\text{mol}/\text{L}$ )	1.26 $\pm$ 31	<0.5 and as low as 0.1–0.2	<0.5 and as low as 0.2–0.3
Adult liver ( $\mu\text{mol}/\text{kg DM}$ )	>100 (usually 200)	<20 and as low as 4	<10
Milk ( $\text{mg}/\text{L}$ )	0.05–0.20	0.01–0.02	–
Hair ( $\text{mg}/\text{kg}$ )	6.6–10.4	1.8–3.4	5.5
<b>Sheep</b>			
Blood plasma ( $\mu\text{g}/\text{mL}$ )	0.7–1.3	0.1–0.2	0.4–0.7
Adult liver ( $\mu\text{mol}/\text{kg DM}$ )	>200 (usually >350)	20	15–19

It is necessary to be especially careful when collecting specimens for copper analysis to avoid contamination by needles, copper distilled water, vial caps, cans for liver specimens and other possible sources of copper. An additional problem is the possible effect of intercurrent disease on plasma levels of copper.

**Treatment response trial.** A comparison of health and production variables in a group of animals treated with copper and a similar group not treated with copper, is also desirable. Variables include calf growth rates, calf mortality and reproductive performance.<sup>26</sup>

**Copper status of herd.** In order to assess the copper status of herd, a standard practice is to take blood samples at random from at least 10% of clinically affected animals and from 10% of normal animals. However, this may be inappropriate when there may be a wide variation in the serum copper concentration within a herd. In some cases, a 10% sample may be too large and in other cases too small. The minimal sample size for random samples from a finite population of a normal continuously distributed variable has been calculated as follows:

$$[n = t_2 cv_2 / ((\tilde{N}1)E_2 t_2 cv_2)]$$

Where  $n$  = minimal sample size;  $N$  = herd size;  $t$  = Student's  $t$  value;  $cv$  = coefficient of variation; and  $E$  = allowable error.

Initial testing can be used to estimate variability of serum copper concentration within a herd and a minimal sample size may be calculated. Each class of animal according to age groups, diet and production status should also be sampled. Follow-up samples should be taken from the same animals following therapy or the institution of control measures.

### Laboratory diagnosis

Historically, the laboratory diagnosis of copper deficiency in cattle and sheep centered on the determination of serum or plasma copper and liver copper. However, serum copper levels alone are not reliable as indicators of copper status and liver samples collected either by liver biopsy or at slaughter should be used to accurately assess copper status in cattle. Clinically normal animals may have marginal levels of serum copper, or unthrifty animals may have marginal or deficient serum levels of copper. Furthermore, when either the normal animals with the marginal levels of copper or the unthrifty animals with the marginal or deficient levels are treated with copper there may or may not be an improvement in weight gain as might be expected in the former, or improvement in clinical condition in the latter.

### Phases

The development of a deficiency can be divided into four phases<sup>11</sup> (Fig. 30.1):

1. Depletion
2. Deficiency (marginal)
3. Dysfunction
4. Disease.

During the depletion phase, there is loss of copper from any storage site, such as liver, but the plasma concentrations of copper may remain constant. With continued dietary deficiency, the concentrations of copper in the blood will decline during the phase of marginal deficiency. However, it may be some time before the concentrations or activities of copper-containing enzymes in the tissues begin to decline and it is not until this happens that the phase of dysfunction is reached. There may be a further lag before the changes in

cellular function are manifested as clinical signs of disease.

**Interpretation of laboratory results**  
The three principles governing the interpretation of biochemical criteria of trace element status include:

- The relationships between the concentration of the marker and the intake of the element
- The time the animal is on an adequate diet
- Disturbances of tissue function.

From these principles, the concentrations of liver copper are insensitive indices of deficiency, but good indicators of excess. Plasma copper  $<57 \mu\text{g/dL}$  ( $9 \mu\text{mol/L}$ ) is a good index of marginal deficiency, but values may have to fall to below  $19 \mu\text{g/dL}$  ( $3 \mu\text{mol/L}$ ) before there is a risk of dysfunction and loss of production in sheep and cattle. However, these are only guidelines. The range of values and the cut-off levels above which animals are normal, or below which they are deficient, have not been well-established. There is considerable biological variation dependent on the species, the breed of animal, the length of time over which the depletion has occurred and the presence of intercurrent disease.

Serum copper concentration in cattle is fairly specific for detection of low liver copper but only marginally sensitive when serum copper concentration of  $0.45 \mu\text{g/g}$  is used as a test endpoint.<sup>27</sup> The value of serum copper concentration as a diagnostic indicator depends on the prevalence of copper deficiency in the particular area.

The interpretation of serum copper can change depending on what liver copper concentration is considered low.<sup>28</sup> With a liver copper  $<20 \mu\text{g/g DM}$  as indicative of copper deficiency, serum copper concentrations  $=9 \text{ mmol/L}$  will be a good indicator of copper deficient status but concentrations  $>9 \text{ mmol/L}$  will be a poor indicator of copper sufficient status. If  $10 \mu\text{g/g DM}$  is used as liver copper cut-off, then serum concentrations  $>9 \text{ mmol/L}$  are reliable as indicative of copper sufficient status but not on concentrations  $=9 \text{ mmol/L}$  as indicative of copper deficiency.

Concentrations of copper in liver and blood may be of diagnostic value but should be interpreted with caution since clinical signs of copper deficiency may appear before there are significant changes in the levels of copper in the blood and liver. Conversely, the plasma levels of copper may be very low in animals that are otherwise normal and performing well. There is a tendency to overestimate the presence of copper deficiency because veterinarians use a diagnostic threshold for copper deficiency that is too high.<sup>11,26</sup> Among veterinary laboratories, there is a

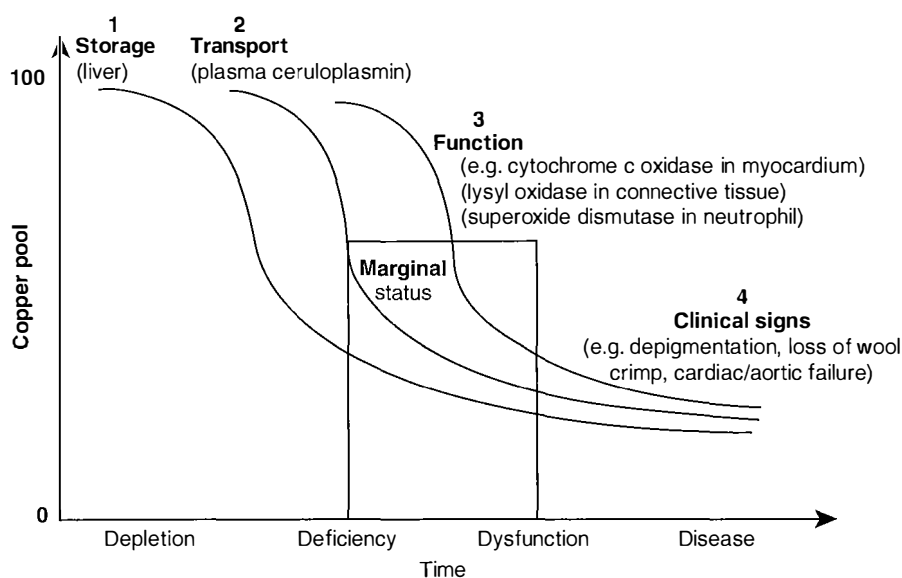

Fig. 30.1 The four phases of copper deficiency.

wide variation in the normal range currently used for equine serum copper values.

Very low levels of both blood and liver copper in a group of animals need not be associated with clinical abnormalities. In a study in the Netherlands, in a group of dairy heifers, the copper status was determined at regular intervals over an 18-month period.<sup>29</sup> One group was supplemented with copper sulfate and the other was not. The copper and molybdenum levels in the grass were within normal limits as accepted in the Netherlands; copper 7–15 mg/kg DM and molybdenum <5 mg/kg DM. The levels of copper in both the blood and liver were much below the reference ranges used in the Netherlands (6–15 µmol/L in blood and >30 mg/kg DM in liver). No clinical signs of copper deficiency occurred and there were no differences in growth rate and reproductive performance.

### Plasma and liver copper levels

#### Cattle and sheep

In cattle and sheep, plasma copper levels between 19 µg/dL and 57 µg/dL (3.0 and 9.0 µmol/L) represent marginal deficiency and levels below 19 µg/dL (3 µmol/L) represent functional deficiency or hypocuprosis. The internationally recognized threshold to assess copper deficiency is 9.4 µmol/L. In both species a value for plasma or serum of 11.0 µmol/L can be associated with a liver concentration from 789 to 3786 µmol/kg DM (50–240 mg/kg). By contrast, a value of 9.3 µmol/L will usually be associated with liver copper values of 315–789 µmol (20–50 mg/kg DM), which are regarded as marginally inadequate. Plasma copper levels of 49.9 µg/dL (7.85 µmol/L) or less are indicative of low liver copper levels. Plasma copper levels above 90.2 µg/dL (14.2 µmol/L) are usually associated with liver levels above 38.1 mg/kg (0.6 mmol/kg) DM. Of the two estimations, that on liver is the most informative as levels in blood may remain normal for long periods after liver copper levels commence to fall and early signs of copper deficiency appear. Levels of copper in adult liver above 200 mg/kg DM (3.14 mmol/kg) in sheep and above 100 mg/kg DM (1.57 mmol/kg) in cattle are considered to be normal. Levels of less than 80 mg/kg DM (1.5 mmol/kg) in sheep and less than 30 mg/kg DM (0.5 mmol/kg) in cattle are classed as low. Liver copper levels in fetuses and neonates are usually much higher than in adults and normal foals have had levels of 219 mg/kg (3.4 mmol/kg DM) compared with a normal of 31 mg/kg (0.49 mmol/kg DM) in adults.

#### Liver copper

Because the liver is a storage compartment for copper, the concentrations of liver cop-

per indicate the state of depletion rather than deficiency. There is no particular threshold value for liver copper below which the performance and health of livestock are likely to be impaired. A broad range of values may, for example, coincide with the marginally deficient state, e.g. 5.1–20.3 mg (0.08–0.32 mmol) copper/kg liver DM. The concentration of hepatic copper in sheep is uniform and a single biopsy sample should be representative of the whole liver. The technique of liver biopsy for assessing the copper status of sheep has been evaluated. Frequency of biopsy does not affect copper concentration, the variability between successive samples is small and the biopsy procedure does not reduce body weight or rate of gain. Copper concentrations in the kidney cortex may be of more diagnostic value because concentrations are normally within a narrow range of 12.7–19.0 mg/kg DM (0.2–0.3 mmol/kg DM). Thus, concentrations below 12.7 mg/kg DM (0.2 mmol/kg DM) in the kidney may be a more reliable indicator of dysfunction than liver copper concentration.

The concentrations of copper in the livers of calves vary according to age and production class (dairy or beef) with no evidence of copper toxicosis or deficiency. In calves submitted for necropsy, the liver copper concentrations were as much as 60 mg/kg WW higher in dairy calves than beef calves.<sup>30</sup> The concentration increased for the first 2 months of age, then declined until 9 months of age, after which it began to increase. Thus, the diagnosis of copper imbalances based on liver copper concentration in calves should take into account the diagnostic covariates of age and production class.

#### Ceruloplasmin

The difficulty of interpreting plasma levels of copper led to the estimation of plasma levels of copper-protein complexes, especially ceruloplasmin. Ceruloplasmin contains greater than 95% of the circulating copper in normal animals. There is a highly significant correlation between plasma copper levels and plasma ceruloplasmin activity, which is a less complicated and more rapid procedure than plasma copper. The regression analyses indicate a strongly positive correlation coefficient of ceruloplasmin with serum of cattle and sheep of 0.83 and 0.92, respectively. The correlation between serum ceruloplasmin activity and hepatic copper concentrations in cattle was only 0.35, indicating an unreliable relationship. Normal plasma ceruloplasmin levels in sheep are in the region of 45–100 mg/L. Normal levels of serum ceruloplasmin activity in cattle range from 120 to 200 mg/L. The mean copper and cerulo-

plasmin levels are higher in plasma than serum; the percentage of copper associated with ceruloplasmin is less in serum (55%) than in plasma (66%). Normal plasma ceruloplasmin levels in sheep range from 4.5 to 10 mg/dL. In experimental primary copper deficiency in calves, rapid decreases occur in plasma ceruloplasmin activity at least 80 days before overt clinical signs of deficiency.

#### Erythrocyte dismutase

The measurement of the activity of erythrocyte superoxide dismutase (ESOD), a copper-containing enzyme, is now being evaluated as a procedure for the diagnosis of copper deficiency. The activity of this enzyme decreases more slowly than plasma or liver copper in copper-deficient animals and may be more closely correlated with the presence of imminence of hypocuprosis. In marginal deficiency, the ESOD value ranges from 2 to 5 U/mg hemoglobin and in functional deficiency the value is below 2.

#### Milk and hair copper

The levels of copper in milk and hair are also lower in deficient than in normal cattle and estimation of the copper content of hair is now acceptable as a diagnostic aid. It has the advantage of providing an integrated progressive record of nutritional intake. The levels of copper in bovine hair are more markedly depressed when extra molybdenum is fed.

#### Horses

A threshold level of plasma copper of 16 µmol/L is used to distinguish between the normal and subnormal values.<sup>31</sup> Liver copper from horses sampled at slaughter vary widely about a mean of 113.7 µmol/kg WW.<sup>31</sup> The threshold of 52.5 µmol/kg WW of copper in liver is proposed to distinguish deficient from marginal liver copper status. Many healthy horses have serum values between 12 and 16 µmol/L.

The mean hepatic copper concentrations of horses fed diets containing 6.9–15.2 mg copper/kg DM were 17.1–21.0 µg/g DM (0.27–0.33 µmol/g DM) tissue. The plasma copper concentrations ranged from 3.58 to 4.45 µg/dL (22.8–28.3 µmol/L). There was no simple mathematical relationship between plasma and hepatic copper concentrations. The range of serum copper concentrations in Thoroughbred horses at grass was 63–196 µg/dL (9.91–30.85 mmol/L) and in stabled Thoroughbreds the range was 47–111 µg/dL (7.40–17.47 mmol/L).

#### Farmed red deer (*Cervus elaphus*)

The suggested reference ranges for serum and liver copper concentrations to categorize the copper status of deer are: serum concentrations (µmol/L): <5, deficient; 5–8 marginal and; >8, adequate; and liver

copper concentrations ( $\mu\text{mol/kg}$  weight wet, WW): <60, deficient; 60–100, marginal and >100, adequate.<sup>32</sup> Enzootic ataxia and osteochondrosis occur when liver copper concentrations are <60  $\mu\text{mol/kg}$  fresh tissue and serum copper concentrations are below 3–4  $\mu\text{mol/L}$ .<sup>33</sup> Growth responses to copper supplementation are equivocal when blood copper concentrations are <3–4  $\mu\text{mol/L}$ , but are significant when mean blood copper concentrations are 0.9–4.0  $\mu\text{mol/L}$ . No antler growth or body weight response to copper supplementation occurs when blood ceruloplasmin (ferroxidase) levels averaged 10–23 IU/L (equivalent to serum copper concentrations of 6–13  $\mu\text{mol/L}$ ) and liver concentrations averaged 98  $\mu\text{mol/kg}$  fresh tissue. This suggests deficient, marginal and adequate ranges for serum copper concentrations should be <5, 5–8 and >8  $\mu\text{mol/L}$ , respectively and those for liver copper concentrations should be <60, 60–100 and >100  $\mu\text{mol/kg}$ , respectively.<sup>33</sup>

#### Hematology

Anemia may occur in advanced cases of primary copper deficiency, hemoglobin levels being depressed to 50–80 g/L and erythrocytes to  $2\text{--}4 \times 10^{12}/\text{L}$ . A high proportion of cows in problem herds may have a Heinz-body anemia without evidence of hemoglobinuria and the severity of the anemia will be related to the hypocupremia.

#### NECROPSY FINDINGS

The characteristic gross findings in copper deficiency of ruminants are those of anemia and emaciation. Hair and wool abnormalities may be present as already described. Extensive deposits of hemosiderin can cause darkening of the liver, spleen and kidney in most cases of primary copper deficiency and in the secondary form if the copper status is sufficiently low. In lambs, there may be severe osteoporosis and long bone fractures. Osteoporosis is less evident in cattle, but can be confirmed radiographically and histologically. In naturally occurring secondary copper deficiency in cattle, associated with high dietary molybdenum and sulfate, there is widening of the growth plates due to abnormal mineralization of the primary spongiosa, resulting in a grossly rachitic appearance to the bones.

The most significant finding in enzootic ataxia is the degeneration of axons and myelin within the cerebellar and motor tracts in the spinal cord, a change only evident at the microscopic level. Chromatolysis of neurons in a variety of locations within the central nervous system is usually detectable. In a few extreme cases and in most cases of swayback, the myelin loss also involves the cerebrum, where there is destruction and cavitation of the white matter. There is marked internal hydro-

cephalus in such cases and the convolutions of the cerebrum are almost obliterated. Acute cerebral edema with marked brain swelling and cerebellar herniation, reminiscent of polioencephalomalacia, may also accompany the more typical myelopathy and multifocal cerebral leukomalacia in lambs with hypocuprosis.

In falling disease, the heart is flabby and pale. There is generalized venous congestion and the blood may appear watery. The liver and spleen are enlarged and dark. Histological examination reveals atrophy of the cardiac muscle fibers and considerable cardiac fibrosis. Deposits of hemosiderin are present in the liver, spleen and kidney.

Necropsy findings associated with copper deficiency in non-ruminant species are not well-documented. Degenerative changes with subsequent rupture of the aorta have been experimentally induced in pigs, but this has not been described as a naturally occurring disease. A myelopathy with white matter changes similar to those of enzootic ataxia has also been reported in 4–5-month-old copper-deficient pigs. Musculoskeletal changes similar to those described for calves have also been reported in foals with hypocuprosis.

Necropsy examinations should include assay of copper in viscera. The levels of copper in liver are usually low (see Table 30.4) and in secondary copper deficiency, there may be a high level of copper in the kidney and high levels of molybdenum in the liver, kidney and spleen. Copper levels in body tissues and fluids in primary and secondary copper deficiency are listed in Table 30.4.

#### Samples for confirmation of diagnosis

- **Toxicology** – 50 g liver, kidney (ASSAY (Cu) (Mo))
- **Histology** – formalin-fixed samples of: long bone (including growth plate), skin, liver, spleen. Enzootic ataxia/swayback: half of midsagittally-sectioned brain, lumbar and cervical spinal cord. Falling disease: heart (several sections), bone marrow, spleen (LM).

#### DIFFERENTIAL DIAGNOSIS

The clinical findings which are common in young, growing ruminants, include a **herd problem** of unthriftiness and progressive loss of weight, changes in hair coat color or texture of wool, chronic lameness, neonatal ataxia in lambs and kids and terminal anemia. In adult cattle on pasture with excess molybdenum, chronic diarrhea is characteristic. A combination of serum and liver copper and serum molybdenum, are major diagnostic aids in distinguishing between copper deficiency and the other diseases.

Several disease complexes that are herd or flock problems in cattle and sheep may resemble both primary and secondary copper deficiency. The emphasis is on many animals being affected at about the same time, with a chronic debilitating disease complex, under the same dietary and seasonal circumstances.

A scheme for the differential diagnosis of mineral and vitamin responsive disorders in beef cattle herds with suboptimal performance should include three major directions: malnutrition (lack of feed); chronic infectious disease; and, lack of specific micronutrients.<sup>34</sup>

#### Cattle

Unthriftiness and progressive **weight loss** may be due to protein-energy malnutrition and examination of the diet will reveal the cause.

**Changes in hair coat color** in young growing cattle is caused only by copper deficiency.

**Chronic lameness** in young growing cattle may be caused by a calcium, phosphorus and vitamin D imbalance, which is determined by examination of the diet and radiography of the long bones. The radiographic changes in cattle with secondary copper deficiency consist of widened irregular epiphyseal plates with increased bone density in the metaphysis and metaphyseal lipping. These findings are similar to those described for rickets and secondary nutritional hyperparathyroidism in cattle.

**Chronic diarrhea** in young cattle may be due to intestinal parasitism and fecal examination and response to therapy are diagnostic. Diarrhea in a group of adult cattle on pasture known to be high in molybdenum is probably due to secondary copper deficiency and response to therapy is diagnostic.

Winter dysentery of cattle, salmonellosis, coccidiosis, and mucosal disease are acute diseases characterized by diarrhea but are accompanied by other signs and clinicopathological findings which facilitate their identification. Many poisons, particularly arsenic, lead, and salt, cause diarrhea in ruminants but there are usually additional diagnostic signs and evidence of access to the poison. Assay of feed and tissues helps to confirm a diagnosis of poisoning.

A diagnosis of **peat scours** is usually made if there is an immediate response to oral dosing with a copper salt.

**Falling disease** occurs only in adult cattle and must be differentiated from other causes of sudden death. Poisoning by the gidgee tree (*Acacia Georginae*) produces a similar syndrome in cattle.

#### Sheep and goats

**Unthriftiness** and **abnormal wool** or hair as a flock or herd problem are characteristic of copper deficiency in sheep and goats, which must be differentiated from protein-energy malnutrition, intestinal parasitism, cobalt deficiency, and external parasites.

**Lameness in a group of lambs** several weeks of age must be differentiated from nutritional osteodystrophy due to a

calcium, phosphorus and vitamin D deficiency or imbalance, stiff lamb disease due to enzootic muscular dystrophy.

Neonatal ataxia caused by congenital swayback and enzootic ataxia in newborn lambs and kids due to maternal copper deficiency must be differentiated from border disease of newborn lambs, characterized by an outbreak of newborn lambs with hairy fleece and tremors, cerebellar hypoplasia (daft lamb disease) and hypothermia.

## TREATMENT

The treatment of copper deficiency is relatively simple, but if advanced lesions are already present in the nervous system or myocardium complete recovery will not occur. Oral dosing with 4 g of copper sulfate for calves from 2 to 6 months of age and 8–10 g for mature cattle given weekly for 3–5 weeks is recommended for the treatment of primary or secondary copper deficiency. Parenteral injections of copper glycinate may also be used and the dosages are given under control.

The diet of affected animals should also be supplemented with copper. Copper sulfate may be added to the mineral-salt mix at a level of 3–5% of the total mixture. A commonly recommended mixture for cattle is 50% calcium-phosphorus mineral supplement, 45% cobalt-iodized salt, and 3–5% copper sulfate. This mixture is offered free of choice or can be added to a complete diet at the rate of 1% of the total diet.

## CONTROL

### Dietary requirements

The minimum dietary requirement for copper for cattle is 10 mg copper/kg DM and 5 mg/kg DM for sheep.

The requirement necessary to prevent subclinical or clinical copper deficiency will depend on the presence of interfering substances such as molybdenum, sulfur, and iron in the diet and possibly the genotype of the animal. Copper sulfate is considered a better supplement than copper oxide or injectable copper for cattle consuming diets containing excess molybdenum or molybdenum plus sulfur. Although there is a marked difference between breeds of sheep in their susceptibility to hypocuprosis, this would not seem to have an immediate practical application. The estimated copper requirement in the diet of mature ponies is 3.5 mg/kg DM. The levels of copper in liver samples of 50% of cull ewes and 40% of market lambs were high to toxic indicating that monitoring the dietary levels of copper is essential.<sup>35</sup>

The copper requirements may also vary according between breeds within a species. Angus heifers have a lower minimal cop-

per requirement than Simmental heifers.<sup>13</sup> Based on liver copper, diets containing copper at 4.4 or 6.4 mg/kg DM, did not meet the requirement of either breed during gestation and lactation or growth. Supplementation of copper at 7 mg/kg DM to the control diets provided the requirements of both breeds.

There are significant differences in the copper requirements and tolerance between goats and sheep.<sup>12</sup> The dietary copper requirements of goats are uncertain but may be higher than in sheep. Dietary levels of copper which could cause copper toxicity in sheep, do not cause toxicity in goats. Some limited data on growth performance indicates a stimulatory effect of 100–300 ppm copper in the diet of Nubian goats. Extra copper accumulated in liver and to a lesser extent in other tissues and was excreted through the biliary system and into the feces.

Supplementation of diets with copper of feedlot cattle under some circumstances can affect performance. As little as 20 mg/kg DM of supplemental copper can reduce performance in finishing steers.<sup>36</sup> The addition of 10 or 20 mg/kg DM of supplemental copper to a high-concentrate diet containing 4.9 mg/kg DM alters lipid and cholesterol metabolism in steers but does not alter ruminal fermentation.<sup>37</sup> Decreasing cholesterol and altering fatty acid composition (saturated to unsaturated) in beef produced for human consumption has potential health benefits.

Copper can be supplied by several different methods as outlined below. The dose rates given are those recommended for the control of primary copper deficiency and these may have to be increased or treatment given more frequently in some instances of secondary copper deficiency. In these circumstances it is often necessary to determine the most satisfactory dosing strategy by a field trial.

### Copper toxicity

The incidence of copper toxicity in dairy cattle in the UK has increased recently.<sup>38</sup> Apparent subclinical hepatopathy, with no clinical disease, due to excess copper intake in lactating dairy cattle has been described. On average, each cow received 963 mg copper daily from the mineral supplement alone. Calculation of the total dietary copper found that high producing cow had an estimated intake of 1325 mg copper daily, while each low producing cow received 1250 mg daily. The estimated copper requirements of the cows were 290 and 217 mg/cow per day, respectively. Thus oversupplementation of dairy cows with copper may be a significant problem in dairy herds without overt clinical signs of toxicity.

## Copper sulfate

### Oral dosing

Oral dosing with copper sulfate (5 g to cattle, 1.0 g to sheep, weekly) is adequate as prophylaxis and will prevent the occurrence of swayback in lambs if the ewes are dosed throughout pregnancy. Lambs can be protected after birth by dosing with 35 mg of copper sulfate every 2 weeks. However, regular oral dosing with copper sulfate is laborious and time-consuming and is no longer widely practiced.

### Dietary supplementation

**Mineral mixture in feed.** The copper sulfate may be mixed with other minerals into a mineral premix, which is then incorporated into the concentrate part of the ration. The final concentration of copper is usually adjusted to provide an overall intake of at least 10 ppm of copper in the DM of the final ration. If the forage components of the ration contain much less than 10 ppm, the concentrate part of the ration may need to contain much larger concentrations of copper. Where a secondary copper deficiency is due to molybdenum in the forage, up to 1200 mg copper (approximately 5 g of hydrated copper sulfate) is added to the concentrate daily. When sheep are grazing toxic lupin stubble, the signs of lupinosis may be exacerbated by the supplementation of only 10 mg copper/kg DM as copper sulfate and therefore the supply of copper in the absence of suitable amounts of molybdenum and sulfur should be kept to a minimum.<sup>39</sup>

**Salt-lick ad libitum.** If animals are not receiving concentrates containing copper, an alternative is to provide free access to a mineral mixture or salt-lick containing 0.25–0.5% of copper sulfate for sheep and 2% for cattle, which will supply sufficient copper provided an adequate intake of the mixture is assured. The mineral mixture usually contains iodized salt, cobalt, calcium, phosphorus, and other trace minerals.

**Top-dressing pastures.** In some deficient areas, an effective method of administering copper is by the annual top-dressing of pasture with 10 kg/ha copper sulfate, although the amount required may vary widely with the soil type and the rainfall. Top-dressing may cause copper poisoning if livestock are turned onto pasture while the copper salt is still adherent to the leaves. Treated pasture should be left unstocked for 3 weeks or until the first heavy rain. It is also possible that chronic copper poisoning may result if the copper status of the soil increases sufficiently over a number of years.

Top-dressing grazing pastures of farmed red deer was compared with oral administration of copper oxide wire particles to some deer.<sup>40</sup> Top-dressing pastures with

copper sulfate at a rate of 12 kg/ha, but not 6 kg/ha, in mid-March was effective increasing the copper status of weaning hinds; while pastures top dressed the 12 kg/ha copper sulfate in mid-March and dosing hinds with 10 g copper oxide in late July were effective in increasing the copper status of pregnant hinds and in the case of the yearling hinds, significantly improved the copper status of their progeny from birth to weaning.

#### Drinking water supplementation.

Addition of copper salts to drinking water is usually impractical because the solution corrodes metal piping and maintenance of the correct concentration of copper in large bodies of water is difficult. However, if the need is great, some way around these difficulties can usually be found and a system has been devised for automatic supplementation for short periods via the drinking water and has been effective in controlling copper deficiency in cattle. Copper pellets which provide 2–3 mg copper/L of water have been recommended for cattle. Calves can tolerate copper in milk replacers at a concentration of 50 ppm but there is no advantage in providing more than 10 ppm.

**Molasses based mineral supplements.** Copper can be provided in molasses-based supplements. However, the high sulfur concentrations in the molasses may affect the availability, through the formation of ruminal thiomolybdates and result in lower liver copper concentrations. A dietary copper concentration greater than 10 ppm may be necessary to ensure absorption in beef cattle fed molasses-based supplements.<sup>41</sup>

#### Removal of sulfates

The removal of sulfates from drinking water by water purification, using a process of reverse osmosis, may have a positive effect on the copper status of beef cows. Cows drinking desulfated water had an increased availability of copper compared with those drinking water containing a large concentration of sulfates.

#### Parenteral injections of copper

To overcome the difficulty of frequent individual dosing or top-dressing of pasture, periodic parenteral injection of copper compounds that release copper gradually has given good results. They can be given at strategic times depending on the circumstances. They also have the advantage of avoiding fixation of copper by molybdenum in the alimentary tract. Injectable preparations of copper are now the method of choice for the prevention of swayback in lambs. The following have been evaluated under field conditions:

- Copper calcium ethylenediamine tetra-acetate (copper calcium edetate)

- Copper methionate
- Copper heptonate
- Copper glycinate
- Copper oxyquinoline sulfonate
- Copper phenylalanine complex.

The criteria used to judge these injections are minimal damage at the site of injections, satisfactory liver storage (90–100%) of the administered dose and a safe margin between therapeutic and toxic doses. The dose of copper in any of the compounds for cattle is 400 mg and for sheep 150 mg.

**Copper heptonate** at the rate of 25 mg of copper in 2 mL of preparation given by IM injection to ewes in mid-pregnancy was successful in preventing swayback in lambs. The IM injection of 1 or 2 mg Cu/kg BW as copper heptonate does not result in any signs of toxicity such as weakness, lethargy, or icterus. The copper is lost from the injection site within 7 days and most is transferred to the liver with little or no deposition in the skeletal muscle. The higher dose raised mean liver copper values to within the range of 13–52 mmol/kg DM, which is associated with copper toxicity.

In sheep on pasture of high molybdenum content, a single IM injection of copper heptonate providing 37.5 mg copper to adults or 25 mg copper to weaners increases the liver copper reserves for at least 9 and 3 months, respectively and is considered an acceptable alternative to copper oxide wire particles for preventing copper deficiency in sheep in southern Australia.<sup>42</sup>

**Copper calcium edetate** has the advantage of giving maximum copper storage very quickly – 1 week after injection – and blood levels are elevated within a few hours.

Because of the rapidity of the absorption, toxic effects can be encountered unless proper dose levels are observed. As well as deaths from serious overdosing, some deaths occur in groups of sheep for unexplained reasons. It is suggested that stress be minimized and simultaneous other therapy be avoided.

A marked local reaction occurs at the site of injection so that SC injection is preferable in animals to be used for meat, although to avoid an unsightly blemish, breeding animals should receive an IM injection. The injections are a small risk for precipitating blackleg in cattle on farms where this disease occurs. For sheep, a single injection of 45 mg of copper as copper glycinate in mid-pregnancy is sufficient to prevent swayback in the lambs.

The SC injection of copper calcium edetate or **copper oxyquinoline sulfonate** into sheep results in a rapid increase in the concentration of copper in whole blood, serum, and urine within the first

24 h. Following the injection of copper methionate, the concentration of copper in blood and serum rises steadily over a period of 10 days and there is no detectable increase in urinary copper. After the injection of any of the three compounds, there is a steady increase in serum ceruloplasmin activity over a period of 10–20 days, followed by a slow fall to preinjection activity by 40 days. The lower toxicity of copper injected as methionate compared with that as copper calcium edetate or copper oxyquinoline sulfonate is due to the slower absorption and transport of the copper to the liver and kidney. Death has occurred in sheep following the parenteral administration of diethylamine oxyquinoline sulfonate at recommended doses. Affected sheep manifested signs of hepatic encephalopathy and at necropsy, there was acute, severe, generalized, centrilobular hepatocellular necrosis. The use of copper disodium edetate at recommended doses in calves has also resulted in deaths associated with liver necrosis and clinical signs of hepatic encephalopathy.

Injectable **copper glycinate** is an excellent source of supplementary copper for increasing the concentration of copper in the serum of copper-deficient cattle and maintaining grazing cattle in an adequate copper status. One dose of copper glycinate will maintain adequate copper levels for about 60–90 days. The recommended dose in beef herds is 120 mg of copper for adult cattle and 60 mg of copper for calves. A supplemental source of copper is required for the calf during the pasture season because milk is a poor source of copper, particularly from copper-deficient cows and calves do not have the opportunity to increase or maintain body stores of copper while grazing. When the dam is severely hypocupremic in the spring, the calf is also severely hypocupremic or copper-deficient. Insufficient copper is secreted into the milk of copper-treated cows. Therefore, where the dam has not received an adequate copper intake during pregnancy, direct treatment of the calf will be required in early life. The copper reserves of newborn calves are increased in fetal liver at the expense of copper stores in the dam's liver, which are dependent on the availability of dietary or supplemental copper to the dam. Calves usually have sufficient liver copper at birth and do not need an injection of 50 mg until they are 6 weeks old. Because of the higher requirements for copper during the last trimester of pregnancy (demands of the fetal liver), a program of copper supplementation should involve the use of copper supplements, throughout the year as required.

One dose of copper glycinate is sufficient when cattle are grazing forage that contains no more than 3 mg/kg DM of



molybdenum and 3g/kg DM of sulfur. With higher levels of molybdenum and sulfur, repeated injections of copper glycinate are recommended. The injectable copper may be supplemented by the use of copper sulfate in a mineral supplement at a level of 1%. The inclusion of copper sulfate in the mineral supplement may be adequate for cows, but the calves may not consume an adequate amount of mineral and injectable copper. The level of supplementation required to prevent a drop in serum copper over the pasture season will depend upon the concentration of dietary molybdenum and sulfur and their effect upon the coefficient of absorption of copper.

Injectable copper complex compounds have been evaluated as supplementary copper for grazing beef cattle under Canadian conditions. Copper edetate at 100 mg of copper, copper glycinate at 120 mg, and copper methionate at 120 mg were used and were equally effective in improving copper status of copper-deficient cattle and maintaining them in an adequate copper status for 90 days. The copper methionate was least acceptable because of the incidence and severity of reactions at the site of injection.

The use of injectable copper edetate in horses has been investigated as a method of increasing liver copper in foals at birth to reduce the incidence and severity of developmental bone and joint disease in newborn foals. The administration of 100 mg and 250 mg copper edetate IM to mares during the 9th and 10th months of gestation had no effect on the liver concentration of their foals at birth.<sup>43</sup>

**Copper phenylalanine** in a single injection to dairy cows in Uruguay maintained serum copper levels at an adequate level for at least 100 days.<sup>44</sup>

#### Controlled-release glass

Death due to poisoning is one of the dangers of parenteral administration because it is difficult to control the rate at which the supplement releases the copper, especially if the controlling mechanism is chemical binding. Methods used to control the release include the development of soluble controlled-release glass for oral administration to sheep and cattle. The copper is slowly released, absorbed, and stored in the liver. Initial field evaluations indicate that the boluses may not contain sufficient copper to maintain normal levels of copper for a sufficient length of time compared to the use of copper oxide needles.

Boluses of a soluble copper-containing controlled-release glass have been developed and evaluated. The boluses are based on a phosphate-type glass into which appropriate quantities of trace elements are incorporated. The boluses lodge in the

rumen and release copper at a slow rate. They can provide additional supplies of copper to ruminants at an almost uniform rate for many months. One commercial product contains selenium and cobalt and in one experiment increased ceruloplasmin activity for at least 1 year. In one field study, the administration of two commercial soluble glass boluses containing copper and selenium, the selenium levels were increased from marginal to adequate, but adequate copper levels were not maintained.

A soluble glass bolus containing copper, cobalt, and selenium given to extensively grazed sheep in the North East of Scotland, under two different situations: lowland finishing lambs and upland sheep in their non-productive year between being a lamb and being a productive ewe (gimmer) was able to prevent or correct deficient and/or marginal cobalt and selenium status of sheep throughout the trial period. The bolus has little measured effect on the already adequate blood indicators of copper status, although the liver copper concentrations of the bolused sheep were higher.<sup>45</sup>

#### Copper oxide needles

Copper oxide needles or wire particles (fragments of oxidized copper wire up to 8 mm in length and 0.5 mm in diameter) are used for oral dosing and one of the most effective and safest methods for the control of copper deficiency in ruminants. Its major advantages are prolonged effectiveness and low cost. A single treatment can be effective for an entire summer or winter season. The needles are retained in the forestomachs and abomasum for up to 100 days or more and the copper is slowly released, absorbed and stored in the liver.

#### Sheep

A dose of 0.1g/kg live weight (5g) in sheep is safe and does not induce copper toxicity in the susceptible North Ronaldsay breed. The response in liver copper concentrations is dose-dependent. In sheep given doses ranging from 2.5 to 20 g per animal, the liver copper concentrations will peak 10 weeks after administration and will thereafter decline in a linear fashion over the next 40 weeks.

The administration of a single dose of 2 g cupric oxide needles orally to lambs between 3 and 5 weeks of age is an effective method for the prevention of induced hypocuprosis manifested as ill-thrift in lambs grazing pastures improved by liming and reseeded. The treatment maintained the lambs in normocupremia, provided adequate liver copper reserves, prevented clinical signs of hypocuprosis and produced a live weight gain advantage. The administration of the needles to ewes in the first half of pregnancy is also effective for the prevention of swayback in

their lambs. The administration of cupric oxide needles to ewes at parturition is effective in preventing hypocupremia for up to 17 weeks in animals on pasture previously shown to cause a molybdenum-sulfur-induced copper deficiency. The treatment of the ewes at parturition also resulted in higher concentrations of copper in the milk in the initial weeks of lactation.

However, this increase in milk copper will not be effective in preventing hypocupremia and hypocuprosis in the lambs, which can be treated with cupric oxide needles at 6 weeks of age. Because some breeds of sheep may have a propensity to concentrate excess quantities of copper in the liver, it is important to adhere to the recommended dosage. Cupric oxide needles at a dose of 4 g per animal have also been used for the prevention of swayback in goats and to maintain liver copper levels for up to 5 months in farmed red deer grazing on a marginally copper deficient pasture.

Copper oxide needles given to ewes in early pregnancy increases their liver copper status through gestation and early lactation and the copper status of their lambs from birth to 36 days old.<sup>46</sup> Serum copper concentration was not affected by treatment but a marked rise was observed in all lambs between birth and 10 weeks of age.

#### Cattle

A single dose of 20 g of copper oxide needles to hypocupremic suckler cows was sufficient to maintain adequate copper status for at least 5 months. The use of 20 g of copper oxide needles to young cattle weighing 190 kg effectively prevented growth retardation and severe hypocupremia, which occurred in an undosed control over a 70-day trial period. The currently recommended doses for beef cattle are 5 g for calves, 10 g for yearlings and 20 g for heavier or adult cattle, which will give protection for at least 6 months. A single oral dose of 20 g of copper oxide needles at the beginning of the grazing season is effective in increasing or maintaining stores of copper in the liver of grazing cows and calves consuming low-copper, high-molybdenum forage, and high-sulfate water supplies. The use of 50 g of needles in adult cows (55 kg BW) sustained higher levels of plasma concentrations than the SC injection of copper glycinate and 100, 200, or 300 g of needles given orally did not cause clinical effects.

#### Farmed red deer

The administration of 20 g boluses of copper-oxide wire particles to rising 2-year-old red deer stags did not significantly alter velvet antler weight, daily velvet antler growth rate, days from casting to removal, grade or value, or stag live weight gain.<sup>47</sup> Copper supplementation

increased mean serum ceruloplasmin (ferroxidase) concentrations by approximately 10 IU/L. Mean liver copper concentrations in control deer was 99 µmol/kg and ranged from 194 to 386 µmol/kg in the treated groups.

Field trials on New Zealand deer farms using 5 g of copper oxide wire particles given to deer 4–7 months old found no effect on live weight gain despite evidence of hypocupremia in 38% of non-supplemented animals, which gained weight at similar rates to those which had adequate plasma copper levels.<sup>48</sup> This suggests that the extent of the hypocupremia was either not sufficiently severe, or not maintained for a long enough period to cause copper deficiency resulting in live weight gain. This indicates that deer farmers need to reassess the need for copper supplementation in young deer.

### Copper oxide powder

Copper oxide powder administered in the form of experimental, sustained-release rumen boluses significantly increased blood and liver copper concentrations in growing sheep, in out-wintered suckler cows during late pregnancy and early lactation and in growing cattle at grass in the summer periods over periods of at least 170 and 123 days, respectively.

### Genetic selection

It is now possible to manipulate trace element metabolism by genetic selection in farm animals. Within a period of 5 years, selection of sheep based on plasma concentration of copper resulted in two divergent sets of progeny, one with a high level of copper status, the other with a low level, which resulted in clinical manifestations of copper deficiency in the low level and protection in the high level.

### General guidelines

Several rules of thumb are important and useful.

- A dietary intake of copper equivalent to 10 mg/kg DM will prevent the occurrence of primary copper deficiency in both sheep and cattle
- Diets containing less than 5 mg/kg DM will cause hypocuprosis
- Diets with copper:molybdenum ratios of less than 5:1 are conducive to conditioned (secondary) hypocuprosis
- The newborn calf is protected against neonatal hypocuprosis by donations from the dam, but newborn lambs assume the same copper status as the ewe
- Cattle are more susceptible to copper deficiency than are sheep.

### REVIEW LITERATURE

Underwood EJ, Suttle NF. Copper. In: The mineral nutrition of livestock, 3rd ed. Wallingford, Oxon: CAB International 1999: 283–342.

- Lee J, Masters DG, White CL, Grace ND, Judson GJ. Current issues in trace element nutrition of grazing livestock in Australia and New Zealand. *Aust J Agric Res* 1999; 50:1341–1364.
- Frank A. A review of the 'Mysterious' wasting disease in Swedish Moose (*Alces alces L*) related to molybdenosis and disturbances in copper metabolism. *Biol Trace Element Res* 2004; 102:143–159.
- Spears JW. Micronutrients and immune function in cattle. *Proc Nutr Soc* 2000; 59:587–594.
- Mattioli GA et al. Characterization of cattle copper deficiency in the Magdalena district. *Livestock Prod Sci* 1996; 47:7.
- Wildman REC et al. Aspects of cardiomyopathy in copper-deficient pigs. Electrocardiography, echocardiography and ultrastructural findings. *Biol Trace Element Res* 1996; 55:55
- Judson GJ, Babidge PJ. An assessment of the safety of copper heptonate for parenteral therapy in sheep. *Aust Vet J* 2004; 82:75.

### REFERENCES

1. Suttle NF. *Ann Rev Nutr* 1992; 11:121.
2. Grace ND et al. *N Z Vet J* 2005; 53:137.
3. Abba M et al. *Mutation Res* 2000; 466:51.
4. Spears JW. *Proc Nutr Soc* 2000; 59:587.
5. Dargatz DA et al. *J Am Vet Med Assoc* 1999; 215:1828.
6. Blakley BR et al. *Can Vet J* 1998; 39:293.
7. Thompson KG et al. *N Z Vet J* 1994; 42:137.
8. Gardner WC et al. *Can J Anim Sci* 2003; 83:479.
9. Frank A. *Biol Trace Element Res* 2004; 102:143.
10. Custer TW et al. *Sci Total Environ* 2004; 330:81.
11. Underwood EJ, Suttle NF. Copper. In: The mineral nutrition of livestock, 3rd ed. Wallingford, Oxon: CAB International, 1999: 283–342.
12. Solaiman SG et al. *Small Rum Res* 2001; 41:127
13. Mullis LA et al. *J Anim Sci* 2003; 81:865.
14. Schonewille JT et al. *Vet Q* 1995; 17:14.
15. Picco SJ et al. *Mutagenesis* 2004; 19:453.
16. Picco SJ et al. *Mutation Res* 2001; 498:1.
17. Hurtig, M et al. *Equine Vet J* 1993; 16, Suppl:66.
18. Hoyt ZK et al. *J Equine Vet Sci* 1995; 15:357.
19. Cerone SI et al. *Biol Trace Element Res* 2000; 73:269.
20. Minatel I, Carfagnini JC. *Nutr Res* 2000; 30:1519.
21. Fyffe JJ. *Aust Vet J* 1996; 73:188.
22. Ward JD, Spears JW. *J Anim Sci* 1999; 77:230.
23. Scalleti RW et al. *J Dairy Sci* 2003; 86:1240.
24. Sharma MC et al. *Res Vet Sci* 2005; 79:113.
25. McGreevy PD et al. *Appl Anim Behav Sci* 2001; 71:119.
26. Laven RA, Livesey CT. *Cattle Pract* 2004; 13:55
27. Tessman RK et al. *J Am Vet Med Assoc* 2001; 218:756.
28. Minatel L, Carfagnini JC. *Prev Vet Med* 2002; 53:1.
29. Wentink GH et al. *Vet Rec* 1999; 145:258.
30. Puschner B et al. *J Vet Diagn Invest* 2004; 16:382.
31. Suttle NF et al. *Equine Vet J* 1996; 28:497.
32. Grace ND, Wilson PR. *N Z Vet J* 2002; 50:252
33. Wilson PR, Grace ND. *N Z Vet J* 2001; 49:126.
34. Suttle NF. *Cattle Pract* 2003; 11:161.
35. Menzies PI et al. *Can Vet J* 2003; 44:898.
36. Engle TE, Spears JW. *J Anim Sci* 2000; 78:2446.
37. Engle TE, Spears JW. *J Anim Sci* 2000; 78:2452.
38. Laven RA et al. *Vet Rec* 2004; 155:120.
39. White CL et al. *Aust J Agric Res* 1994; 45:279
40. Grace ND et al. *N Z Vet J* 2004; 53:31.
41. Arthington JD et al. *J Anim Sci* 2003; 81:1357.
42. Judson GJ, Babidge PJ. *Aust Vet J* 2002; 80:630.
43. Gee EK et al. *Aust Vet J* 2000; 78:347.
44. Torre MH et al. *Livestock Prod Sci* 2005; 95:45.
45. Kendall NR et al. *Livestock Prod Sci* 2005; 95:45.
46. Grace ND et al. *N Z Vet J* 2004; 52:189.
47. Walker IH et al. *N Z Vet J* 2002; 50:177.
48. Nicol AM et al. *N Z Vet J* 2003; 51:14.

## IODINE DEFICIENCY

### Synopsis

**Etiology** Primary dietary deficiency of iodine or secondary to conditioning factors such as calcium, *Brassica* plants, or bacterial pollution of water.

**Epidemiology** In all species, most common in continental land masses. Neonatal animals. Diets of dams deficient in iodine or containing conditioning factors such as certain plants.

**Signs** Goiter as palpable enlargement of thyroid gland. Neonatal mortality due to stillbirths, weak neonates may not be able to suck and die in few days, alopecia at birth, myxedema.

**Clinical pathology** Blood iodine levels.

**Necropsy findings** Thyroid enlargement, alopecia, myxedema.

**Diagnostic confirmation** Goiter and iodine deficiency.

### Differential diagnosis list

- Weak calf syndrome
- Abortion
- Congenital defects.
- Hypothyroidism

**Treatment** Not usually undertaken.

**Control** Insure dietary intake of iodine in pregnant animals

## ETIOLOGY

Iodine deficiency may be due to deficient iodine intake or secondarily conditioned by a high intake of calcium, diets consisting largely of *Brassica* spp., or gross bacterial pollution of feedstuffs or drinking water. A continued intake of a low level of cyanogenetic glycosides, e.g. in white clover, is commonly associated with a high incidence of goitrous offspring. Linamarin, a glycoside in linseed meal, is the agent producing goiter in newborn lambs born from ewes fed the meal during pregnancy. A continued intake of the grass *Cynodon aethiopicus* with low iodine and high cyanogenetic glucoside contents may cause goiter in lambs. Rapeseed and rapeseed meal are also goitrogenic.

Goiter or hypothyroidism in newborn lambs occurs when pregnant ewes have a low iodine intake or ingest goitrogens<sup>1</sup>

## EPIDEMIOLOGY

### Occurrence

Goiter caused by iodine deficiency occurs in all of the continental land masses. It is not of major economic importance because of the ease of recognition and correction, but if neglected may cause heavy mortalities in newborn animals. **The most common cause of iodine deficiency in farm animals is the failure to provide iodine in the diet.** The sporadic occurrence of the disease in marginal areas attracts most attention. An epidemiological survey in Germany found up to 10% of cattle and sheep farms, and 15% of swine herds

were affected with iodine deficiency, which were both primary and secondary due to the presence of nitrates, thiocyanates, or glucosinolates in the diet.<sup>2</sup>

The importance of subclinical iodine deficiency as a cause of neonatal mortality could be much greater than clinical disease. For example, in southern Australia, ewes supplemented with iodine by the single injection of iodine in oil, have had less mortality in the lambs, have grown larger lambs, or performed the same as controls. In New Zealand, subclinical iodine deficiency has been recognized in a sheep flock in which fertility and lamb perinatal mortality occurred and corrected by supplementation of the ewes with iodine.<sup>3,4</sup> The annual cost associated with iodine deficiency in one Manawata Romney flock was conservatively estimated at \$6.00 per ewe.<sup>3</sup> Iodine supplementation has been shown to reduce perinatal mortality and increased lambing percentage by 14–21% in pasture-fed ewes.<sup>3</sup> Thus subclinical iodine deficiency can affect reproductive performance and perinatal lamb mortality rates.<sup>3</sup>

Young animals are more likely to bear goitrous offspring than older ones and this may account for the apparent breed susceptibility of Dorset Horn sheep, which mate at an earlier age than other breeds.

A survey of crossbred cows in the Punjab of India, found that 35.9% of cows were iodine deficient with considerable geographic variation from 0 to 86% within Punjab.<sup>5</sup> The cardinal clinical signs of iodine deficiency were absent and basal plasma T3 (triiodothyronine) and T4 (plasma thyroxine) concentrations and their ratio did not differ between deficient and control cows. The response to injection of 1 mL of 78% ethiodized oil can prevent the deficiency for more than 70 days.<sup>5</sup>

### Risk factors

Dietary and environmental factors  
A simple deficiency of iodine in the diet and drinking water may occur and is related to geographical circumstances. Areas where the soil iodine is not replenished by cyclical accessions of oceanic iodine include large continental land masses and coastal areas where prevailing winds are offshore. In such areas, iodine deficiency is most likely to occur where rainfall is heavy and soil iodine is continually depleted by leaching. Over a 3-year period, several calves were born with goiter in a dairy herd located 200 km from the sea on sandy soil.<sup>6</sup> The calves were born from first-calf heifers which had not received any iodine supplementation.

Soil formations rich in calcium or lacking in humus are also likely to be relatively deficient in iodine. The ability of soil to retain iodine under conditions of

heavy rainfall is directly related to their humus content, and limestone soils are, in general, low in organic matter. A high dietary intake of calcium also decreases intestinal absorption of iodine, and in some areas, heavy applications of lime to pasture are followed by the development of goiter in lambs. This factor may also be important in areas where drinking water is heavily mineralized.

There are several situations in which the relationship between iodine intake and the occurrence of goiter is not readily apparent. Goiter may occur on pasture containing adequate iodine; it is then usually ascribed to a secondary or conditioned iodine deficiency. A diet rich in plants of the *Brassica* spp., including cabbages and brussels sprouts, may cause simple goiter and hypothyroidism in rabbits, which is preventable by administered iodine. Severe iodine deficiency can occur when ewes are fed Brassica crops for long periods. Brassicas such as swedes, turnips, and kale have low iodine content and contain goitrogens, and may result in weak newborn lambs with enlarged thyroid glands.<sup>7</sup> Goiter occurred in 85% of lambs examined at necropsy, born from ewes on the Brassica crop and not supplemented with iodine.

Diffuse hyperplastic goiter has occurred in calves in beef cows in Japan which were on pasture or being fed feed containing *Rorippa indica*, Hiern, genus Brassica, family Crucifera, 'Inugarash', which contains thiocyanate.<sup>8</sup> The iodine content of the waters on affected farms was low at 0.361 µg/L and 0.811 µg/L and that of the pastures, 87 and 121 µg/kg, on two different farms.

Hypothyroidism has also been produced in rats by feeding rapeseed, and in mice by feeding rapeseed oil meal. Feeding large quantities of kale to pregnant ewes causes a high incidence of goiter and hypothyroidism, also preventable by administering iodine in the newborn lambs. The goitrogenic substance in these plants is probably a glucosinolate capable of producing thiocyanate in the rumen. The thiocyanate content, or potential content, varies between varieties of kale, being much less in rape-kale, which also does not show the two-fold increase in thiocyanate content other varieties show in autumn. Small young leaves contain up to five times as much thiocyanate as large, fully formed leaves. Some of these plants are excellent sources of feed, and in some areas, it is probably economical to continue feeding them, provided suitable measures are taken to prevent goiter in the newborn. Although kale also causes mild goiter in weaned lambs this does not appear to reduce their rate of gain.

**A diet high in linseed meal** (20% of ration) given to **pregnant ewes** may

result in a high incidence of goitrous lambs, which is preventable with iodine or thyroxine. Under experimental conditions, groundnuts are goitrogenic for rats, the goitrogenic substance being a glycoside-arachidoside. The goitrogenic effect is inhibited by supplementation of the diet with small amounts of iodine. **Soybean byproducts** are also considered to be goitrogenic. **Gross bacterial contamination of drinking water** by sewage is a cause of goiter in humans in countries where hygiene is poor. There is a record of a severe outbreak of goitrous calves from cattle running on pasture heavily dressed with crude sewage. Prophylactic dosing of the cows with potassium iodide prevented further cases. Feeding sewage sludge is also linked to the occurrence of goiter.

**Goiter in lambs** may occur when permanent pasture is plowed and resown. This may be due to the sudden loss of decomposition and leaching of iodine-binding humus in soils of marginal iodine content. In subsequent years the disease may not appear. There may be some relation between this occurrence of goiter and the known variation in the iodine content of particular plant species, especially if new pasture species are sown when the pasture is plowed. The maximum iodine content of some plants is controlled by a strongly inherited factor and is independent of soil type or season. Thus, in the same pasture, perennial rye grass may contain 146 µg iodine per 100 g dry matter (DM) and Yorkshire for grass only 7 µg/100 g DM. Because goiter has occurred in lambs when the ewes are on a diet containing less than 30 µg iodine per 100 g DM, the importance of particular plant species becomes apparent. A high incidence of goiter associated with heavy mortality has been observed in the newborn lambs of ewes grazing on pasture dominated by white clover and by subterranean clover and perennial rye-grass.

**Congenital goiter has been observed in foals** born to mares on low iodine intake, but also to mares fed an excessive amount of iodine during pregnancy.

### PATHOGENESIS

Iodine deficiency results in a decreased production of thyroxine and stimulation of the secretion of thyrotropic hormone by the pituitary gland. This commonly results in hyperplasia of thyroid tissue and a considerable enlargement of the gland. Most cases of goiter of the newborn are of this type. The primary deficiency of thyroxine is responsible for the severe weakness and hair abnormality of the affected animals. Although the defect is described as hairlessness, it is truly hypoplasia of the hairs, with many very slender hairs present and a concurrent absence and

diminution in size of hair follicles. A hyperplastic goiter is highly vascular and the gland can be felt to pulsate with the arterial pulse and a loud murmur may be audible over the gland. Colloid goiter is less common in animals and probably represents an involutinal stage after primary hyperplasia.

Other factors, particularly the ingestion of low levels of cyanide, exert their effects by inhibiting the metabolic activity of the thyroid epithelium and restricting the uptake of iodine. Thiocyanates and sulfo-cyanates are formed during the process of detoxication of cyanide in the liver and these substances have a pronounced depressing effect on iodine uptake by the thyroid. Some pasture and fodder plants, including white clover, rape and kale, are known to have a moderate content of cyanogenetic glucosides. These goitrogenic substances may appear in the milk and provide a toxic hazard to both animals and man. The inherited form in cattle is due to the increased activity of an enzyme that deiodinates iodotyrosines so rapidly that the formation of thyroxine is inhibited.

Iodine is an essential element for normal fetal brain and physical development in sheep. A severe iodine deficiency in pregnant ewes causes reduction in fetal brain and body weight from 70 days of gestation to parturition. The effects are mediated by a combination of maternal and fetal hypothyroidism, the effect of maternal hypothyroidism being earlier than the onset of fetal thyroid secretion.<sup>9</sup> There is also evidence of fetal hypothyroidisms, and absence of wool growth and delayed skeletal maturation near parturition.

### CLINICAL FINDINGS

Although loss of condition, decreased milk production, and weakness might be anticipated, these signs are not usually observed in adults. Loss of libido in the bull, failure to express estrus in the cow, and a high incidence of aborted, stillborn or weak calves have been suggested as manifestations of hypothyroidism in cattle, whereas prolonged gestation is reported in mares, ewes, and sows.

A high incidence of **stillbirths and weak, newborn animals** is the most common manifestation of iodine deficiency. Partial or complete **alopecia** and palpable enlargement of the thyroid gland are other signs that occur with varying frequency in the different species. Affected foals have a normal hair coat and little thyroid enlargement, but are very weak at birth. In most cases, they are unable to stand without support and many are too weak to suck. Excessive flexion of the lower forelegs and extension of lower parts of the hindlegs has also been observed in affected foals.

Defective ossification has also been reported, the manifestation is collapse of the central and third tarsal bones leading to lameness and deformity of the hock. Enlargement of the thyroid also occurs commonly in adult horses in affected areas, Thoroughbreds and light horses being more susceptible than draft animals.

In **cattle**, the incidence of thyroid enlargement in adults is much lower than in horses and the cardinal manifestations are gross **enlargement of the thyroid gland and weakness in newborn calves**. If they are assisted to suck for a few days, recovery is usual, but if they are born on the range during inclement weather, many will die. In some instances, the thyroid gland is sufficiently large to cause obstruction to respiration. Affected calves have a thick neck and appear to be suffocating.<sup>6</sup> Lethargy, weakness, and difficulty in consuming colostrum are common. Partial alopecia is a rare accompaniment.

In **pigs**, the characteristic findings are birth of **hairless, stillborn or weak piglets often with myxedema** of the skin of the neck. The hairlessness is most marked on the limbs. Most affected piglets die within a few hours of birth. Thyroid enlargement may be present but is never sufficiently great to cause visible swelling in the live pig. Survivors are lethargic, do not grow well, have a waddling gait and leg weaknesses due to weakness of ligaments and joints.

Adult **sheep** in iodine-deficient areas may show a high incidence of thyroid enlargement but are clinically normal in other respects. Newborn lambs manifest weakness, extensive alopecia, and palpable, if not visible, enlargement of the thyroid glands. The gestation length of ewes may be increased and increased perinatal mortality, especially in inclement weather.<sup>1</sup> Marginal iodine deficiency can result in non-specific production losses from embryonic mortality or high perinatal lamb death and are difficult to diagnose.<sup>3</sup>

**Goats** present a similar clinical picture, except that all abnormalities are more severe than in lambs. Goat kids are goitrous and alopecic. The degree of alopecia varies from complete absence of hair, through very fine hair, to hair that is almost normal.

Animals surviving the initial danger period after birth may recover, except for partial persistence of the goiter. The glands may pulsate with the normal arterial pulse and may extend down a greater part of the neck and cause some local edema. Auscultation and palpation of the jugular furrow may reveal the presence of a murmur and thrill, the 'thyroid thrill', due to the increased arterial blood supply of the glands.

Experimental hypothyroidism produced in horses by surgical excision of the gland

results in a syndrome of poor growth, cold sensitivity, long, dull hair coat, docility, lethargy, edema of hindlimbs, and a coarse, thick appearance of the face. The rectal temperature is depressed and blood cholesterol levels are high. Administration of thyroprotein reverses the syndrome. Congenital hypothyroidism has been induced in guinea pigs using a low-iodine diet to compare the developmental abnormalities which occur in horses with congenital hypothyroidism.<sup>10</sup> Many of the abnormalities in guinea pig pups from the experimentally treated dams were similar to those described in foals.

Goiter has occurred in newborn foals whose mares were supplemented with excess iodine during the last 24 h of pregnancy.<sup>11</sup>

### CLINICAL PATHOLOGY

Several criteria have been used for the laboratory diagnosis of iodine deficiency in sheep.<sup>12</sup> They include thyroid weight, lamb thyroid to body weight ratio, comparison of serum T4 (serum thyroxine) concentrations in lamb and dam (T4 concentrations are lower in the lamb than in the dam when iodine deficiency is present, serum T4 concentrations in the ewe and pasture iodine concentrations.<sup>12</sup> In New Zealand, pasture iodine, and serum thyroxine (T4) and tri-iodothyronine (T3) concentrations of ewes were unreliable in predicting the occurrence of increased litter size and reduced perinatal mortality in response to iodine supplementation.<sup>12</sup> Newborn lambs from ewes unsupplemented with iodine, had mean thyroid weight (g) to body weight (kg) ratio of 0.40 g/kg or greater.<sup>12</sup> Other tests are concentrations of iodine in plasma, milk, and urine all of which measure current iodine status.

Estimations of iodine levels in the blood and milk are reliable indicators of the thyroxine status of the animal. Organic or protein-bound iodine is estimated in serum or plasma and used as an index of circulating thyroid hormone, provided access to exogenous iodine in the diet, or as treatment, is adequately controlled. There may be between-breed differences in blood iodine levels but levels of 2.4–14 µg of protein-bound iodine per 100 mL of plasma appear to be in the normal range. In ewes, an iodine concentration in milk of below 8 µg/L indicates a state of iodine deficiency. Bulk tank milk iodine content should be greater than 300 µg/L.

Levels of thyroxine in the blood have not been used much to measure thyroid gland sufficiency in animals. Work in ewes has shown that normal lambs at birth have twice the serum thyroxine levels of their dams, but goitrous lambs have levels

less than those of their dams. However, low mean thyroxine levels (50 nmol/L is normal) are not a definitive indication of iodine deficiency because of the variety of factors affecting thyroxine levels. These levels fall rapidly soon after birth and approximate the dam's levels at 5–6 weeks of age.

Changes in serum thyroid hormone levels in newborn calves have been used as a diagnostic index in endemic goiter but their high variation has been unreliable.<sup>13</sup> The T4/T3 ratio of calves with goiter was lower than in healthy calves and adult cows, and may be a useful diagnostic aid.

In determining the iodine status of an area, iodine levels in soil and pasture should be obtained but the relationship between these levels, and between them and the status of the grazing animal, may be complicated by conditioning factors.

### NECROPSY FINDINGS

Macroscopic thyroid enlargement, alopecia and myxedema may be evident. The weights of thyroid glands have diagnostic value. In full-term normal calves the average fresh weight is 6.5 g, in lambs 2 g is average. Newborn lambs from ewes unsupplemented with iodine, had mean thyroid weight (g) to body weight (kg) ratio of 0.40 g/kg or greater.<sup>12</sup> In calves with severe thyroid hypertrophy, the gland may be heavier than 20 g.<sup>6</sup>

The iodine content of the thyroid will also give some indication of the iodine status of the animal. At birth, a level of 0.03% of iodine on a wet weight basis (0.1% on dry weight) can be considered to be the critical level in cattle and sheep. On histological examination, hyperplasia of the glandular epithelium may be seen. Follicles depleted of colloid, infolded and lined by columnar epithelium are indicative of hypothyroidism in lambs born from ewes unsupplemented with iodine.<sup>1</sup>

The hair follicles will be found to be hypoplastic. Delayed osseous maturation, manifested by absence of centers of ossification, is also apparent in goitrous newborn lambs.

### Samples for confirmation of diagnosis

- **Toxicology** – 1 thyroid gland (ASSAY (Iodine))
- **Histology** – skin, thyroid (LM).

### DIFFERENTIAL DIAGNOSIS

Iodine deficiency is easily diagnosed if goiter is present but the occurrence of stillbirths without obvious goiter may be confusing. Abortion due to infectious agents in cattle and sheep must be considered in these circumstances. In stillbirths due to iodine deficiency, gestation is usually prolonged beyond the

normal period, although this may be difficult to determine in animals bred at pasture. Inherited defects of thyroid hormone synthesis are listed under the heading of inherited diseases. Hyperplastic goiter without gland enlargement has been observed in newborn foals in which rupture of the common digital extensor tendons, forelimb contracture, and mandibular prognathism also occur. The cause of the combination of defects is unknown.

### TREATMENT

Treatment of neonates with obvious clinical evidence of iodine deficiency is usually not undertaken because of the high case fatality rate. When outbreaks of iodine deficiency occur in neonates, the emphasis is usually on providing additional iodine to the pregnant dams. The recommendations for control can be adapted to the treatment of affected animals.

### CONTROL

The recommended dietary intake of iodine for cattle is 0.8–1.0 mg/kg DM of feed for lactating and pregnant cows, and 0.1–0.3 mg/kg DM of feed for non-pregnant cows and calves.

Pastures in New Zealand which contain 0.24 mg iodine/kg DM provide an adequate intake for dairy cows.<sup>14</sup> The injection of iodine (iodized oil) IM three times at a dose of 2370 mg iodine/dose at the start of lactation and at 100-intervals increased iodine concentrations in milk to 58 µg/L for at least 98 days after each treatment.<sup>14</sup> Two iodine injections at 100-day intervals increased milk iodine concentrations to 160 µg/L and 211 µg/L at least 55 days after each treatment but had no effect on serum thyroid hormone concentrations. Iodine supplementation had no effect on milk, milkfat, or milk protein yield. Increasing iodine concentration in milk by IM injection of iodine could provide a method for increasing iodine intakes of humans, especially children.

Iodine can be provided in salt or a mineral mixture. The loss of iodine from salt blocks may be appreciable and an iodine preparation that is stable but contains sufficient available iodine is required. Potassium iodate satisfies these requirements and should be provided as 200 mg of potassium iodate per kg of salt. Potassium iodide alone is unsuitable, but when mixed with calcium stearate (8% of the stearate in potassium iodide) it is suitable for addition to salt – 200 mg/kg of salt.

Individual dosing of pregnant ewes, on two occasions during the 4th and 5th months of pregnancy, with 280 mg potassium iodide or 370 mg potassium iodate has been found to be effective in the prevention of goiter in lambs when the ewes are on a heavy diet of kale. For individual

animals, weekly application of tincture of iodine (4 mL cattle, 2 mL pig and sheep) to the inside of the flank is also an effective preventive. The iodine can also be administered as an injection in poppy seed oil (containing 40% bound iodine): 1 mL given IM 7–9 weeks before lambing is sufficient to prevent severe goiter and neonatal mortality in the lambs. Control of goiter can be achieved for up to 2 years. The gestation period is also reduced to normal. A similar injection 3–5 weeks before lambing is less efficient.

The administration of long-acting injectable iodine (iodized oil) at a dose of 390 mg iodine to ewes, 5 weeks pre-mating, prevented goiter in newborn lambs from ewes fed swedes or swedes/turnips/kale as winter supplement.<sup>7</sup>

A device to release iodine slowly into the forestomachs, while still retaining its position there, has given good results in preventing congenital goiter in lambs when fed to ewes during late pregnancy.

### REVIEW LITERATURE

Underwood EJ, Suttle NF. Iodine. In: The mineral nutrition of livestock, 3rd ed. Wallingford, Oxon, CAB International 1999: 343–373.

### REFERENCES

1. Clark RG. *N Z Vet J* 1998; 46:223.
2. Korber R et al. *Mh Vet Med* 1985; 40:220.
3. Sargison ND et al. *N Z Vet J* 1998; 46:72.
4. Sargison ND et al. *N Z Vet J* 1997; 45:208.
5. Randhawa CS, Randhawa SS. *Aust Vet J* 2001; 79:349.
6. van Wuikckhuse L et al. *Tijdschr Diergeneesk* 2003; 128:348.
7. Grace ND et al. *Proc N Z Soc Anim Prod* 2001; 61:164.
8. Seimya Y et al. *J Vet Med Sci* 1991; 53:989.
9. Underwood EJ, Suttle NF. Iodine. In: The mineral nutrition of livestock, 3rd ed. Wallingford, Oxon: CAB International 1999: 343–373.
10. D'Amours GH et al. *Am J Vet Res* 2004; 65:1251.
11. Erosksuz EH et al. *Vet Hum Toxicol* 2004; 46:147.
12. Clark RG et al. *N Z Vet J* 1998; 46:216.
13. Takahashi K et al. *J Vet Med Sci* 2001; 63:175.
14. Grace ND, Waghorn GC. *N Z Vet J* 2004; 53:10.

### IRON DEFICIENCY

#### Synopsis

**Etiology** Dietary deficiency of iron.

**Epidemiology** Young animals on milk diet; most commonly nursing piglets which have not received supplemental iron. Housed nursing lambs. Occurs in veal calves fed milk with limited quantities of iron. Continued blood loss due to hemorrhage (lice, blood sucking helminths). Subclinical iron deficiency occurs in calves and foals of doubtful significance. May be more susceptible to infectious diseases.

**Signs** Pale white skin of well grown nursing piglets, dyspnea, pallor of mucosae, sudden death may occur. Stillbirths if sows iron deficient. Secondary infectious diseases.

**Clinical pathology** Subnormal levels of hemoglobin of serum iron, microcytic hypochromic anemia.

**Necropsy findings** Pallor, thin watery blood, anasarca, dilated heart, enlarged liver.

**Diagnostic confirmation** Low serum hemoglobin and serum iron with microcytic hypochromic anemia. Response to iron therapy.

**Differential diagnosis** Other causes of anemia. See Chapter 9.

**Treatment** Parenteral and oral iron salts.

**Control** Insure adequate iron intake. Parenteral iron dextran to nursing piglets and lambs.

## ETIOLOGY

Iron deficiency is usually primary and most likely to occur in newborn animals whose sole source of iron is the milk of the dam, milk being a poor source of iron. Deposits of iron in the liver of the newborn are insufficient to maintain normal hemopoiesis for more than 2–3 weeks, and are particularly low in piglets.

## EPIDEMIOLOGY

Iron-deficiency states are not common in farm animals except in the very young confined to a milk diet.

**Iron deficiency anemia occurs in nursing piglets** for three reasons:

1. They do not have access to soil, which is a main source of iron for young farm animals
2. They grow rapidly and their absolute requirements for iron are high
3. Milk is a poor source of iron.

The administration of iron dextran to the piglets at a few days of age is preventive and is a routine health management strategy in modern pig production. If they do not receive supplemental iron dextran, clinical disease occurs usually when the piglets are 3–6 weeks old. The losses that occur include those due to mortality, which may be high in untreated pigs and to failure to thrive. Under modern pig production systems, piglets do not have access to sufficient dietary iron until they are weaned to a dry diet containing supplemental iron. Thus, the need for parenteral iron dextran at a few days of age. Even piglets raised outdoors with access to soil perform better when supplemented with iron.<sup>1</sup> Iron injected piglets raised outdoors are heavier at weaning, there is less pre-weaning morbidity and mortality and they have higher blood hemoglobin concentrations compared to non-supplemented piglets.<sup>1</sup>

Iron deficiency in pigs increases the severity of *Trichuris suis* and *Ascaris suum* infections.<sup>2</sup>

**Iron deficiency anemia occurs in nursing lambs** that are housed and do not have access to soil, do not consume

much feed other than their dam's milk for the first 7–10 days of life, and grow at 0.4 kg/d.<sup>3</sup> The parenteral administration of iron dextran at 24 h of age prevents the anemia.<sup>3</sup> Abomasal bloat occurs in these lambs with lower serum iron concentration and iron dextran injections is preventive, as well as having a significant effect on weight gain, red blood cell and iron parameters.<sup>4</sup>

**Continued blood loss by hemorrhage** in any animal may result in subclinical anemia and iron deficiency. Cattle heavily infested with sucking lice may develop serious and even fatal anemia. The chronic form is characterized by a non-regenerative anemia with subnormal levels of serum iron, and treatment with iron is necessary for an optimal response. Horses carrying heavy burdens of bloodsucking strongylid worms often have subnormal hemoglobin levels and respond to treatment with iron. On occasions veal calves, and possibly young lambs and kids, may also suffer from an iron deficiency.

**Good quality veal** is traditionally pale in color and is produced by feeding calves an all-liquid milk replacer diet with a low concentration of available iron.<sup>5,6</sup> The pallor of veal is due largely to low concentrations of myoglobin and other iron-containing compounds in muscle. Milk replacers containing only 10 mg iron/kg DM results in marked anemia and reduced growth performance.<sup>6</sup> Feeding milk replacers with 50 mg iron/kg DM is considered, physiologically, the optimum amount of iron for veal calves but may be too high for acceptable carcass yield in some countries.<sup>6</sup> A severe iron deficiency with reduced growth rate in veal calves may be associated with a higher incidence of infectious disease because of an impaired immune system.<sup>7</sup> The objective in veal calf management is to walk the narrow line between the maximum production of white meat and a degree of anemia insufficient to interfere with maximum production.

**Subclinical iron-deficiency anemia** also occurs in newborn calves and kids but there is debate as to whether the condition has practical significance. In newborn calves affected with a normochromic, normocytic, and poikilocytic anemia the levels of serum iron are not significantly different from normal calves.<sup>8</sup> It has been proposed that severe poikilocytosis in calves is associated with abnormalities of hemoglobin composition and protein 4.2 in the erythrocyte membrane, and iron deficiency is the cause of moderate poikilocytosis in calves.<sup>9</sup>

Clinicopathological anemia, without clinical signs, is most likely to occur when calves are born with low hemoglobin and hematocrit levels, a relatively common occurrence in twins. It is possible that suboptimal growth may occur during the

period of physiological anemia in early postnatal life. There is some evidence for this in calves in which hemoglobin levels of 11 g/dL at birth fall to about 8 g/dL between the 30th and 70th days and only begin to rise when the calves start to eat roughage. The daily intake of iron from milk is 2–4 mg in calves, and their daily requirement during the first 4 months of life is of the order of 50 mg, so that iron supplementation of the diet is advisable if the calves are fed entirely on milk. Even when hay and grain are fed to calves and lambs in addition to milk, there is a marked growth response to the administration of iron-dextran preparations at the rate of 5.5 mg/kg BW. The dietary iron requirement for fast-growing lambs is between 40 and 70 mg/kg BW, and growth rate is sub-optimal on diets of less than 25 mg/kg BW.

**Low serum iron concentration and low serum ferritin have been observed in hospitalized young foals.**<sup>10</sup> Hemoglobin concentrations and packed cell volume decrease in foals from values at birth, which are similar to those for adult horses, to mean values during the first weeks and months of life below those reported in adults. Serum iron concentration, total iron-binding capacity, and packed cell volume decreased during the foal's first 24 h of life.<sup>11</sup> Based on the studies of foals from birth to 1 year of age, the potential for iron deficiency developing under 5 weeks of age is possible because 65% of foals had minimum ferritin concentrations = 45 ng/mL, and 81% of foals had these minimum values recorded between 2 and 4 weeks.

**Competition horses are frequently given iron supplementation** to treat anemia and to improve performance despite the fact that neither application has any scientific basis.<sup>10</sup> In contrast, iron overload and toxicity have occurred in competition horses.<sup>12,13</sup> Some studies have shown high total plasma iron in British 3-day event team horses prior to transport (77  $\mu$ mol/L compared with normal levels of 24  $\mu$ mol/L. Immediately after traveling for 3 days on the road, the plasma levels had declined to 29  $\mu$ mol/L.<sup>14</sup> The iron-binding antioxidant activity, an indicator of transferrin saturation, had also declined, suggesting greater saturation of available transferrin in the plasma or a decreased capacity to sequester iron. The saturation of mechanisms to sequester iron, such as may occur with excessive supplementation, may predispose the horses to iron-catalyzed oxidant injury.<sup>14</sup> The total iron intake exceeded the normal recommendation of between 550 and 600 mg/d. Anemia (or a low packed cell volume) is not synonymous with iron deficiency but is frequently associated with disease processes. Poor performance in an iron-

deficient animal is more likely due to a reduction in the activity of metabolically active iron-containing enzymes rather than a reduction in oxygen transport. In addition, iron deficiency is unlikely to occur in healthy horses.

**Calcium carbonate** added to the diet of weaned and finishing pigs may cause a conditioned iron deficiency and a moderate anemia but this effect is not apparent in mature pigs. Manganese may exert a similar antagonistic effect.

## **PATHOGENESIS**

More than half the iron in the animal body is found as a constituent of hemoglobin. A relatively small amount is found in myoglobin and in certain enzymes which play a part in oxygen utilization.

Piglets at birth have hemoglobin levels of about 90–110 g/L. A physiological fall to 40–50 g/dL occurs in all pigs, the lowest levels occurring at about the 8th–10th day of life. Levels of iron in the liver at birth are unusually low in this species and cannot be increased appreciably by supplementary feeding of the sow during pregnancy. The IM injection of iron-dextran preparations to sows during late pregnancy does elevate the hemoglobin levels of the piglets during the first few weeks of life but not sufficiently to prevent anemia in them. Piglets with access to iron show a gradual return to normal hemoglobin levels starting at about the 10th day of life, but in pigs denied this access the hemoglobin levels continue to fall.

One of the important factors in the high incidence of anemia in piglets is the rapidity with which they grow in early postnatal life. Piglets normally reach four to five times their birth weight at the end of 3 weeks, and 15 times their birth weight at the end of 8 weeks. The daily requirement of iron during the first few weeks of life is of the order of 15 mg. The average intake in the milk from the sow is about 1 mg/d and the concentration in sow's milk cannot be elevated by feeding additional iron during pregnancy or lactation. Apart from the specific effect on hemoglobin levels, iron-deficient piglets consume less creep feed, and after the first 3 weeks of life make considerably slower weight gains than supplemented piglets. Although specific pathogen-free pigs show a less marked response to the administration of iron than pigs reared in the normal manner, it is obvious that they need supplementary iron to prevent the development of anemia. Iron-deficient piglets appear to be more susceptible to diarrhea at about 2 weeks of age than are piglets that have received iron. A marked impairment of gastric secretion of acid and chloride and atrophic gastritis occurs in iron-deprived piglets. Villous atrophy of

the small intestine and changes in the gastrointestinal flora also occur in iron-deficient piglets which may contribute to the increased susceptibility to diarrhea.

In iron deficient piglets, lymphocyte activity is impaired resulting in a decrease in circulating B-lymphocyte numbers and decreased immunocompetence.<sup>15</sup>

Severe iron deficiency in veal calves is characterized by impaired growth and reduced feed intake and utilization. The growth rate is reduced only when hemoglobin concentrations fall below 70 g/L.<sup>16</sup> The reduced growth rate may be due to reduction in the half-life of growth hormone.

## **CLINICAL FINDINGS**

The highest incidence of iron deficiency anemia in piglets occurs at about 3 weeks of age, but it can occur up to 10 weeks of age.

Affected pigs may be well grown and in good condition, but the growth rate of anemic pigs is significantly lower than that of normal pigs and feed intake is reduced. A mild diarrhea may occur but the feces are usually normal in color. Dyspnea, lethargy and a marked increase in amplitude of the apex beat of the heart can be felt after exercise. The skin and mucosae are pale and may appear yellow in white pigs. Edema of the head and forequarters, giving the animal a fat, puffed-up appearance may be present. A lean, white hairy look is probably more common. Death usually occurs suddenly, or affected animals may survive in a thin, unthrifty condition. A high incidence of infectious diseases, especially enteric infection with *Escherichia coli*, is associated with the anemia, and streptococcal pericarditis is a well-recognized complication. Under experimental conditions, similar signs occur in calves and there is, in addition, an apparent atrophy of the lingual papillae. A high incidence of stillbirths is recorded in the litters of sows suffering from iron-deficiency anemia.

## **CLINICAL PATHOLOGY**

In normal piglets there is a postnatal fall of hemoglobin levels to about 8 g/L and sometimes to as low as 4–5 g/L during the first 10 days of life. In iron-deficient pigs there is a secondary fall to 20–40 g/L during the 3rd week. The hemoglobin level at which clinical signs appear in pigs is about 40 g/L.<sup>17</sup> Erythrocyte counts also fall from a normal of  $5-8 \times 10^{12}/L$  down to  $3-4 \times 10^{12}/L$  and may be a better index of iron status than hemoglobin levels. Iron-deficiency anemia in piglets is a microcytic hypochromic anemia. In chronic blood loss anemia in cattle infested with sucking lice, there is a non-regenerative anemia and a decrease in serum iron levels. Serum levels of iron considered to be normal in

sheep and cattle are 100–200 µg/dL (17.9–35.8 µmol/L). In newborn calves, the levels are 170 µg/dL (30.4 µmol/L) at birth and 67 µg/dL (12.0 µmol/L) at 50 days of age. Serum ferritin concentration is an index for monitoring pre-latent iron deficiency of calves.<sup>18</sup>

The borderline of iron-deficiency anemia of veal calves at 16–20 weeks of age has been defined as a hemoglobin concentration of 9 g/L and a saturation of total iron binding capacity of 10%.<sup>19</sup>

## **NECROPSY FINDINGS**

The carcass is characterized by pallor, watery blood and moderate anasarca. The heart is always dilated, sometimes extremely so. The cardiac dimensions in severely anemic neonatal pigs indicate that dilatation and hypertrophy occur consistently. The liver in all cases is enlarged, and has a mottled tan-yellow appearance. Histological examination of the bone marrow reveals maturation asynchrony of the erythroid line and a lack of hemosiderin stores. Other microscopic changes described include peri-acinar hepatocellular changes typical of hypoxia and decreased numbers of parietal cells in the gastric mucosa.

## **Samples for confirmation of diagnosis**

- **Toxicology** – 50 g liver (ASSAY (Fe))  
(Note that serum ferritin from surviving littermates is a better indicator of iron status)
- **Histology** – liver, heart, bone marrow, stomach (LM).

## **DIFFERENTIAL DIAGNOSIS**

Confirmation of the diagnosis will depend upon hemoglobin determinations and curative and preventive trials with administered iron. The possibility that anemia in piglets may be caused by copper deficiency should not be overlooked especially if the response to administered iron is poor. Isoimmunization hemolytic anemia can be differentiated by the presence of jaundice and hemoglobinuria, and the disease occurs in much younger pigs. Eperythrozoonosis occurs in pigs of all ages and the protozoan parasites can be detected in the erythrocytes.

## **TREATMENT**

The recommendations for the prevention of the disease are set out below and can be followed when treating clinically affected animals. Horses with poor racing performance often have suboptimal blood levels of hemoglobin and a blood loss anemia due to parasitism, and respond well to treatment with iron. Treatment is usually parenteral and consists of organic iron preparations such as iron-dextran, iron-



sorbitol-citric acid complex, iron saccharate, or gluconate. These must be given exactly as prescribed by the manufacturer as some are quite irritant, causing large sloughs when injected IM. The dose rate is 0.5–1 g elemental iron in one injection per week. When given IV, or even IM, some horses show idiosyncratic reactions and literally drop dead. Vitamin B<sub>12</sub> (cyanocobalamin) is often used in the same injection at a dose rate of 5000 µg/week in a single dose. Other additives, especially folic acid and choline, are also used but with little justification. Oral treatment with iron sulfate or gluconate at a dose rate of 2–4 g daily for 2 weeks is as effective and much cheaper, but lacks the style of the parenteral injection. It has the disadvantage of being unpalatable and is best dispensed in liquid form to be mixed with molasses and poured onto dry feed.

### CONTROL

Preventive measures must be directed at the neonatal piglets because treatment of the sows before or after farrowing is generally ineffective, although some results are obtained if the iron preparations are fed at least 2 weeks before farrowing. Ferric choline citrate appears to have some special merit in this field. Allowing the nursing piglets access to pasture or dirt yards, or periodically placing sods in indoor pens, offer adequate protection. Where indoor housing on impervious floors is necessary, iron should be provided at the rate of 15 mg/d until weaning either by oral dosing with iron salts of a commercial grade or by the IM injection of organic iron preparations. These methods are satisfactory, but the results are not usually as good as when piglets are raised outdoors. However, indoor housing is practiced in many areas to avoid exposure to parasitic infestation and some bacterial diseases, especially erysipelas. If sods are put into pens care must be taken to insure that these diseases are not introduced.

### Dietary supplementation

#### Sows

Feeding sows a diet supplemented with 2000 mg iron/kg DM of diet will satisfactorily prevent iron-deficiency anemia in the piglets. The piglets will ingest about 20 g of sows feces per day, which will contain sufficient iron and obviate the need for IM injection of iron-dextran. The piglets grow and thrive as well as those receiving the iron-dextran.

#### Veal calves

Milk replacers for veal calves may contain up to 40 mg/kg DM of iron for the first months, but commonly only 10–15 mg/kg DM for the finishing period. The best indicator of the onset of anemia in calves on vealer diets is loss of appetite, which is a

more sensitive indicator than biochemical measurement.

#### Heifer calf herd replacements

The National Research Council recommends that milk replacers fed to herd replacements or dairy beef contain 100 mg/kg of DM, with an upper limit of 1000 mg/kg DM.<sup>17</sup> The pre-ruminant calf can tolerate between 2000 and 5000 ppm DM iron in milk replacer.<sup>17</sup>

### Oral dosing

Daily dosing with 4 mL of 1.8% solution of ferrous sulfate is adequate. Iron pyrophosphate may also be used (300 mg/d for 7 days). To overcome the necessity for daily dosing, several other methods of administering iron have been recommended. A single oral treatment with iron-dextran or iron-galactan has been recommended, provided an excellent creep feed is available, but the method seems unnecessarily expensive. With this oral treatment it is essential that the iron be given within 12 h of birth because absorption has to occur through the perforate neonatal intestinal mucosa; later administration is not followed by absorption. Reduced iron (British Veterinary Codex) can be administered in large doses because it does not cause irritation of the alimentary mucosa. A single dose of 0.5–1 g once weekly is sufficient to prevent anemia. Alternatively, the painting of a solution of ferrous sulfate on the sow's udder has been recommended (450 g ferrous sulfate, 75 g copper sulfate, 450 g sugar, 2 L water – applied daily) but has the disadvantage of being sticky and of accumulating litter. Pigs raised on steel gratings can derive enough iron from them to avoid the need for other supplementation. Excessive oral dosing with soluble iron salts may cause enteritis, diarrhea, and some deaths in pigs. High intakes of ferric hydroxide cause diarrhea, loss of weight, and low milk production in cattle. The presence of diarrhea in a herd prevents absorption of orally administered iron, and treatment by injection is recommended in this circumstance.

### Intramuscular injection of iron preparations

Suitable preparations must be used and are usually injected IM in piglets on one occasion only, between the 3rd and 7th day of life. Iron-dextran, fumarate, and glutamate are most commonly used. A dose of 200 mg of a rapidly absorbed and readily utilizable form of iron within the first few days of life will result in greater body weights at 4 weeks of age than piglets given only 100 mg.<sup>20</sup> Multiple injections give better hemoglobin levels but have not been shown to improve weight gain and, thus, a second injection at 2–3 weeks

of age may not be economical. A total dose of 200 mg is usually recommended as being required to avoid clinically manifest iron-deficiency anemia, but in order to avoid any chance of a subclinical deficiency the feed should contain additional iron at the level of 240 mg/kg. A new preparation (Heptomer) contains 200 mg/mL of iron, permitting a full dose in one injection. Contrasting information is that one injection of 100 mg of iron is adequate for baby pigs. Acute poisoning and rapid death occurs in piglets given iron-dextran compounds parenterally if the piglets were born from sows which were deficient in vitamin E and selenium during gestation. This is discussed under iron-dextran poisoning. In normal piglets, the iron-dextran compounds are safe and are usually not toxic even on repeated injection. These preparations are ideal for treatment because of the rapid response they elicit and the absence of permanent discoloration of tissues after their use if given during the first month of life. A combination of sodium selenite and iron-dextran has been given to piglets at 3 days of age and is superior to treatment with iron alone when the piglets are deficient in selenium.

Iron supplementation should also be administered to suckling piglets raised outdoors.<sup>1</sup>

**Iron deficiency anemia in housed lambs** is preventable by the IM injection of 300 mg iron dextran at 24 h of age.<sup>3</sup> At 12 and 24 days after treatment, the hematological values in the treated group were significantly different from the unsupplemented group, and at weaning, the treated lambs were 1.0 kg heavier than untreated lambs.<sup>3</sup> An oral iron supplement given to these housed lambs improved red cell and iron parameters but did not improve performance.<sup>21</sup>

Comparable doses of parenteral iron-dextran compounds have been used for the treatment of iron-deficiency or iron-loss anemias in other species, but accurate doses have not been established and the use of these preparations in cattle and horses is expensive. In addition, iron-dextran preparations given IM to horses may cause death within a few minutes after administration. The most inexpensive method of supplying iron is to use ferrous sulfate orally at a dose of 2–4 g daily for 2 weeks to adult cattle and horses with iron-deficiency anemia.

Iron injection of beef calves in the first week after birth will result in an increase in packed cell volume (PCV), hemoglobin (Hb), mean corpuscular volume (MCV), and mean corpuscular hemoglobin (MCH) which persists for 12 weeks. However, weight gains during the first 18 weeks of life were not affected.

## REFERENCES

1. Szabo P, Bilkei G. *J Vet Med A Physiol Pathol Clin Med* 2002; 49:390.
2. Pedersen S et al. *Parasitol* 2001; 122:589.
3. Green LE et al. *Vet Rec* 1997; 140:219.
4. Vatn S, Torsteino WO. *Vet Rec* 2000; 146:462.
5. Lindt F, Blum JWJ. *Vet Med A* 1994; 41:237.
6. Lindt F, Blum JWJ. *Vet Med* 1994; 41:333.
7. Gygax M et al. *J Vet Med A* 1993; 40:345.
8. McGillivray SR et al. *Can J Comp Med* 1985; 49:286.
9. Okabe J et al. *J Vet Med Sci* 1996; 58:629.
10. Smith JE et al. *J Am Vet Med Assoc* 1986; 188:285.
11. Harvey JW et al. *Am J Vet Res* 1987; 48:1348.
12. Edens IM et al. *Equine Vet J* 1993; 25:81.
13. Lavoie JP, Teuscher E. *Equine Vet J* 1993; 25:552.
14. Mills PC, Marlin DJ. *Vet Rec* 1996; 139:215.
15. Svoboda M et al. *J Vet Med B Infect Dis Vet Pub Hlth* 2004; 51:231.
16. Ceppi A et al. *Ann Nutr Metab* 1994; 38:281.
17. Jenkins KJ, Hidiogrou M. *J Dairy Sci* 1988; 70:2349.
18. Miyata Y et al. *J Dairy Sci* 1984; 67:1256.
19. Welchman D DeB et al. *Vet Rec* 1988; 123:505.
20. Daykin MM et al. *Vet Rec* 1982; 110:535.
21. Vatn S, Framsted T. *Acta Vet Scand* 2000; 41:273.

## SODIUM CHLORIDE DEFICIENCY

A dietary deficiency of sodium is most likely to occur:

- During lactation, as a consequence of losses of the element in the milk, in rapidly growing young animals fed on low-sodium, cereal-based diets
- Under very hot environmental conditions where large losses of water and sodium occur in the sweat and where the grass forage and the seeds may be low in sodium
- In animals engaged in heavy or intense physical work and in animals grazing pastures on sandy soils heavily fertilized with potash, which depresses forage sodium levels.<sup>1</sup>

Naturally occurring salt deficiency causing illness in grazing animals is uncommon except under certain circumstances. The most commonly cited occurrences are on alpine pastures and heavily fertilized pasture leys. Pasture should contain at least 0.15 g/100 g dry matter (DM) and clinical signs are evident after about 1 month on pasture containing 0.1 g/100 g DM. Under experimental conditions, lactating cows give less milk until the chloride deficiency is compensated. After a period of up to 12 months there is considerable deterioration in the animal's health and anorexia, a haggard appearance, lusterless eyes, rough coat, and a rapid decline in body weight occur. High-producing animals are most severely affected and some may collapse and die. The oral administration of sodium chloride is both preventive and rapidly curative. Experimental sodium depletion in horses for up to 27 days has no deleterious effect on general health.

In **dairy cattle on a sodium-deficient diet** there is polyuria, polydipsia, salt hunger, pica, including licking dirt and each other's coats, drinking urine, loss of appetite and weight, and a fall in milk production.<sup>2</sup> Urination is frequent and the urine has a lower than normal specific gravity and the urine concentrations of sodium and chloride are decreased and the potassium increased. The salivary concentration of sodium is markedly decreased, the potassium is increased, and the salivary sodium:potassium ratio is decreased. The concentration of serum sodium and chloride are also decreased, but the measurement of urinary or salivary sodium concentration is a more sensitive index of sodium intake than plasma sodium concentration.<sup>2</sup> Of these, it is urinary sodium which is depressed first and is therefore the preferred indicator in cattle<sup>3</sup> and horses.<sup>4</sup> The polyuria associated with severe sodium depletion may be an antidiuretic hormone insensitivity due to lack of an effective countercurrent mechanism and hyperaldosteronism.<sup>2</sup>

**Supplementation of salt to dairy cows** on a pumice soil in New Zealand resulted in a 12.8% increase in milk yield with unaltered composition.<sup>5</sup> The cows were grazing ryegrass/clover pastures averaging 0.05% sodium whereas the recommended concentration for dairy cows is 0.12%. Measurement of the sodium content of the pasture is the most simple and reliable method of diagnosing salt deficiency compared to saliva sodium:potassium ratio. It is considered likely that sodium deficiency will become more prevalent on dairy farms in the future and that there cost-effective benefits to using salt where deficiencies occur.

**Experimental restriction of chloride** in the diet of dairy cows in early lactation results in a depraved appetite, lethargy, reduced feed intake, reduced milk production, scant feces, gradual emaciation and severe hypochloremia and secondary hypokalemic metabolic alkalosis.<sup>6</sup> Lethargy, weakness, and unsteadiness occur after about 6 weeks on the chloride-deficient diet.<sup>7</sup> Bradycardia is also common. The concentration of chloride in cerebrospinal fluid is usually maintained near normal, while the serum concentrations decline.<sup>8</sup> The experimental induction of a severe, total body chloride deficit by the provision of a low-chloride diet and the daily removal of abomasal contents results in similar clinical findings to those described above and lesions of nephrocalcinosis.<sup>9</sup>

The **diagnosis of salt deficiency** is dependent on the clinical findings, analysis of the feed and water supplies, serum levels of sodium and chlorine and determination of the levels of sodium in the saliva, urine, and feces of deficient

animals.<sup>10</sup> The concentration of sodium in saliva is a sensitive indicator of sodium deficiency. In cattle receiving an adequate supply of sodium and chlorine, the sodium levels in saliva vary from 140 to 150 mmol/L, in deficient cattle the levels may be as low as 70–100 mmol/L.<sup>10</sup> The levels of sodium in the urine are low, with a reciprocal rise in potassium.<sup>4</sup> The serum sodium levels are less reliable, but licking begins when the level falls to 137 mmol/L and signs are intense at 135 mmol/L.

The biochemical methods have been evaluated to estimate the sodium intake of dairy cows.<sup>11</sup> Groups of cows were given 10–20, 30–50, or 70–100 g salt per day, and two groups were given salt ad libitum either in bowls or in salt blocks. The concentrations of sodium and potassium were measured in serum and urine. Cows receiving 70–100 g salt daily, and those in the ad libitum group, had higher urinary sodium concentrations than the other groups. Those receiving 10–20 g/day had a higher urinary ratio of potassium:sodium in their urine than all other groups, in which the ratio decreased as the level of supplementary salt increased.

**Experimentally induced sodium deficiency in young pigs** causes anorexia, reduced water intake and reduced weight gains.<sup>12</sup>

The provision of salt in the diet at a level of 0.5% is considered to be fully adequate for all farm animal species. Under practical conditions, salt mixes usually contain added iodine and cobalt. In some situations the salt mixes are provided on an ad libitum basis rather than adding them to the diet. However, voluntary consumption is not entirely reliable. The daily amount consumed by animals having unrestricted access to salt can be highly variable and often wasteful. Two factors influencing voluntary salt intake include the physical form of the salt and the salt content of the water and feed supplies. Some cattle consume much more loose than block salt, though the lower intakes of block salt may be adequate. Also, animals dependent on high saline water for drinking consume significantly less salt than when drinking non-saline water. Voluntary salt consumption is generally high in cows on low-sodium pastures, which are low inherently or as a result of heavy potash fertilization. Lactating gilts may require 0.7% salt in their diets<sup>13</sup> and energy efficiency in feedlot cattle may be improved by feeding high levels (5% of diet) of salt in the diet of finishing steers.<sup>14</sup>

## REVIEW LITERATURE

Aitken FC. Sodium and potassium in nutrition of mammals. Commonwealth Bureau of Animal Nutrition Technical Communication 1976: No. 26.

Michell AR. Sodium in health and disease: a comparative review with emphasis on herbivores. *Vet Rec* 1985; 116:653-657.

## REFERENCES

- Underwood EJ. The mineral nutrition of livestock, 2nd ed. Farnham: Royal, Commonwealth Agricultural Bureau, 1981.
- Whitlock RH et al. *Cornell Vet* 1975; 65:512.
- Launer P, Storm R. *Mh Vet Med* 1979; 34:364.
- Meyer H, Ahlswede L. *Zentralbl Vet Med* 1979; 26A:212.
- O'Connor MB et al. *Proc New Zealand Grassland Assoc* 2000; 62: 49.
- Fettman MJ et al. *J Dairy Sci* 1984; 67:2321.
- Fettman MJ et al. *J Am Vet Med Assoc* 1984; 185:167.
- Fettman MJ et al. *Am J Vet Res* 1984; 45:403.
- Blackmon DM et al. *Am J Vet Res* 1984; 45: 1638.
- Murphy GM, Gartner RJW. *Aust Vet J* 1974; 50:280.
- Eicher R et al. *Vet Rec* 2003; 153:358.
- Yusken JW, Reber EF. *Trans Ill Acad Sci* 1957; 50:118.
- Friend DW, Wolynetz MS. *Can J Anim Sci* 1981; 61:429.
- Croom WJ et al. *Can J Anim Sci* 1982; 62:217.

## MAGNESIUM DEFICIENCY

A nutritional deficiency of magnesium plays a role in causing lactation tetany in cows and hypomagnesemic tetany of calves, and these diseases are dealt with in Ch. 28 on metabolic diseases. In both diseases, there are complicating factors that may affect the absorption and metabolism of the element.

Hypomagnesemia may occur in up to 50% of adult horses hospitalized for severe gastrointestinal disease such as colic, acute diarrhea, and infectious respiratory disease.<sup>1</sup> Young horses were able to regulate serum total magnesium concentrations more efficiently than adult horses which were more likely to be hospitalized longer, but the mortality rate was not higher.

Magnesium is an essential constituent of rations for recently weaned pigs.<sup>2</sup> Experimentally induced deficiency causes weakness of the pasterns, particularly in the forelegs, causing backward bowing of the legs, sickled hocks, approximation of the knees and hocks, arching of the back, hyperirritability, muscle tremor, reluctance to stand, continual shifting of weight from limb to limb, and eventually tetany and death. A reduction in growth rate, feed consumption and conversion, and levels of magnesium in the serum also occur. The requirement of magnesium for pigs weaned at 3-9 weeks of age is 400-500 mg/kg of the total ration.

## REFERENCES

- Johansson AM et al. *J Vet Intern Med* 2003; 17:860.
- Mayo RH et al. *J Anim Sci* 1959; 18:264.

## ZINC DEFICIENCY (PARAKERATOSIS)

### Synopsis

**Etiology** Dietary deficiency of zinc and factors which interfere with zinc utilization.

**Epidemiology** Growing pigs, cattle and sheep. Excess of calcium favors disease in pigs.

### Signs

**Pigs** Loss of body weight gain. Symmetrical, crusty skin lesions (parakeratosis) over dorsum and ears, tail; become thick and fissured. No pruritus.

**Ruminants** Alopecia, over muzzle, ears, tail-head, hindlegs, flank, and neck. Stiff gait and swelling over coronets. Loss of wool and thickened skin in sheep.

Infertility in rams. Poor growth in goats and skin lesions.

**Clinical pathology** Serum zinc levels lower than normal.

**Necropsy findings** Parakeratosis.

**Diagnostic confirmation** Histology of skin lesions and serum zinc levels.

### Differential diagnosis list

- Sarcoptic mange in cattle and pigs
- Exudative epidermitis in piglets.

**Treatment** Add zinc to diet.

**Control** Supplement zinc in diet.

## ETIOLOGY

### Pigs

A zinc deficiency in young, growing pigs can cause parakeratosis, but it is not due to a simple zinc deficiency. The availability of zinc in the diet is adversely affected by the presence of phytic acid, a constituent of plant protein sources such as soybean meal.<sup>1</sup> Much of the zinc in plant protein is in the bound form and unavailable to the monogastric animal such as the pig.<sup>2</sup> The use of meat meal or meat scraps in the diet will prevent the disease because of the high availability of the zinc. Another unique feature of the etiology of parakeratosis in swine is that an excess of dietary calcium (0.5-1.5%) can favor the development of the disease, and the addition of zinc to such diets at levels much higher (0.02% zinc carbonate or 100 mg/kg zinc) than those normally required by growing swine prevents the occurrence of the disease. The level of copper in the diet may also be of some significance, increasing copper levels decreasing the requirement for zinc. A concurrent enteric infection with diarrhea exacerbates the damage done by a zinc deficiency in pigs.

### Ruminants

A primary zinc deficiency due to low dietary zinc in ruminants is rare but does occur.<sup>3</sup> Many factors influence the availability of zinc from soils, including the degree of compaction of the soil, and the

nitrogen and phosphorus concentration. The risk of zinc deficiency increases when soil pH rises above 6.5 and as fertilization with nitrogen and phosphorus increases. Some legumes contain less zinc than grasses grown on the same soil, and zinc concentration decreases with aging of the plant. Several factors may deleteriously affect the availability of zinc to ruminants and cause a secondary zinc deficiency. These include the consumption of immature grass, which affects digestibility, the feeding of late-cut hay, which may be poorly digestible, and the presence of excessive dietary sulfur. The contamination of silage with soil at harvesting can also affect the digestibility of zinc.<sup>3</sup>

## EPIDEMIOLOGY

### Pigs

Parakeratosis in pigs was first recorded in North America in rapidly growing pigs, particularly those fed on diets containing growth promoters. The disease occurs most commonly during the period of rapid growth, after weaning and between 7 and 10 weeks of age. From 20 to 80% of pigs in affected herds may have lesions, and the main economic loss is due to a decrease in growth rate. In general, the incidence is greater in pigs fed in dry lot on self-feeders of dry feed than in pigs with access to some pasture, which is preventive and curative.

A low level of dietary zinc intake during pregnancy and lactation of gilts can result in skin lesions, stressful parturition, and an increased incidence of intrapartum mortality of piglets and deleterious effects on neonatal growth.<sup>4</sup>

It has been suggested that parakeratosis occurs because very rapidly growing pigs outstrip their biosynthesis of essential fatty acids, and when the diet is high in calcium the digestibility of fat in the diet is reduced at the same time. The net effect in rapidly growing pigs could be a relative deficiency of essential fatty acids.

### Ruminants

There are naturally occurring cases in cattle, sheep, and goats. The disease is well-recognized in Europe, especially in calves. It is common in some families of cattle and an inherited increased dietary requirement for zinc is suspected. The inherited disease occurs in Friesian and Black Pied cattle and is known as lethal trait A46.<sup>5</sup> Signs of deficiency appear at 4-8 weeks of age. The main defect is an almost complete inability to absorb zinc from the intestine; zinc administration is curative.

The disease in **cattle** has been produced experimentally on diets low in zinc, and naturally occurring cases have responded to supplementation of the diet

with zinc.<sup>3</sup> Calves remain healthy on experimental diets containing 40 mg/kg zinc, but parakeratosis has occurred in cattle grazing pastures with a zinc content of 20–80 mg/kg (normal 93 mg/kg) and a calcium content of 0.6%. There is also an apparently improved response in cattle to zinc administration if copper is given simultaneously. Parakeratosis has also been produced experimentally in goats and sheep.

Zinc nutrition may be involved in the immune responses of feedlot calves.<sup>6</sup> When calves are stressed by transportation or challenged with the infectious bovine rhinotracheitis virus, they tend to have reduced fevers, higher dry matter intake and less body weight loss when fed organic zinc and manganese sources than the corresponding oxide forms.

Outbreaks of the disease have occurred in **Sudanese Desert ewes** and their lambs fed on a zinc-deficient diet of Rhodes grass containing less than 10 mg/kg of zinc. The disease has also been diagnosed in **mature sheep and goats** and the cause of the deficiency could not be determined. A marginal zinc deficiency, characterized by subnormal growth and fertility and low concentration of zinc in serum, but without other clinical signs, can occur in sheep grazing pastures containing less than 10 mg/kg zinc.<sup>7</sup>

In Germany, skin lesions have occurred in alpacas and llamas with low zinc and copper status.<sup>8</sup> In the affected herd, the average serum zinc and copper levels were 0.17 and 0.49 µg/mL for alpacas and 0.22 and 0.38 µg/mL for llama, respectively. The levels considered normal in llamas is 0.30 µg for zinc and 0.40–0.70 µg copper per mL.

## PATHOGENESIS

The pathogenesis of zinc deficiency is not well-understood. Zinc is a component of the enzyme carbonic anhydrase, which is located in the red blood cells and parietal cells of the stomach, and is related to the transport of respiratory carbon dioxide and the secretion of hydrochloric acid by the gastric mucosa. Zinc is also associated with RNA function and related to insulin, glucagon, and other hormones. It also has a role in keratinization, calcification, wound healing, and somatic and sexual development. Because it has a critical role in nucleic acid and protein metabolism a deficiency may adversely affect the cell-mediated immune system.

A zinc deficiency results in a decreased feed intake in all species<sup>7</sup> and is probably the reason for the depression of growth rate in growing animals and body weight in mature animals. Failure of keratinization resulting in parakeratosis, loss and failure

of growth of wool and hair and lesions of the coronary bands probably reflect the importance of zinc in protein synthesis. There are lesions of the arteriolar walls of the dermis. The bones of zinc-deficient ruminants reveal abnormal mineralization and reduction of zinc concentration in bones. Retarded testicular development occurs in ram lambs, and complete cessation of spermatogenesis suggests impairment of protein synthesis.

## CLINICAL FINDINGS

### Pigs

A reduced rate and efficiency of body weight gain is characteristic. Circumscribed areas of erythema appear in the skin on the ventral abdomen and inside the thigh. These areas develop into papules 3–5 mm in diameter, which are soon covered with scales followed by thick crusts. These crusts are most visible in areas about the limb joints, ears and tail and are distributed symmetrically in all cases. The crusts develop fissures and cracks, become quite thick (5–7 mm) and easily detached from the skin. They are crumbly and not flaky or scaly. No greasiness is present except in the depths of fissures. Little scratching or rubbing occurs. Diarrhea of moderate degree is common. Secondary subcutaneous abscesses occur frequently, but in uncomplicated cases, the skin lesions disappear spontaneously in 10–45 days if the ration is corrected.

### Ruminants

In the naturally occurring disease in cattle, in severe cases, parakeratosis and alopecia may affect about 40% of the skin area. The lesions are most marked on the muzzle, vulva, anus, tailhead, ears, backs of the hindlegs, kneefolds, flank, and neck. Most animals are below average body condition and are stunted in growth. After treatment with zinc, improvement is apparent in 1 week and complete in 3 weeks. Experimentally produced cases exhibit the following signs:

- Poor growth
- A stiff gait
- Swelling of the coronets, hocks, and knees
- Soft swelling containing fluid on the anterior aspect of the hind fetlocks
- Alopecia
- Wrinkling of the skin of the legs, scrotum and on the neck and head, especially around the nostrils
- Hemorrhages around the teeth
- Ulcers on the dental pad.

The experimental disease in cattle is manifested by parakeratotic skin, mainly on the hindlimbs and udder, and similar lesions on teats, which tend to become

eroded during milking. The fetlocks and pasterns are covered with scabby scales. There is exudation first with matting of hair, then drying and cracking. The skin becomes thickened and inelastic. Histologically, there is parakeratosis. Clinical signs develop about 2 weeks after calves and lambs go onto a deficient diet so that there is no evidence of storage of zinc in tissues in these animals. In goats, hair growth, testicular size, and spermatogenesis are reduced, and growth rate is less than normal. Return to a normal diet does not necessarily reverse these signs and the case fatality rate is high. There is a marked delay in wound healing.

### Sheep

The natural disease in sheep is characterized by loss of wool and the development of thick, wrinkled skin. Wool-eating also occurs in sheep and may be one of the earliest signs noticed in lambs after being on a zinc-deficient diet for 4 weeks. Induced cases in lambs have exhibited reduced growth rate, salivation, swollen hocks, wrinkled skin and open skin lesions around the hoof and eyes. The experimental disease in goats is similar to that in lambs.

One of the most striking effects of zinc deficiency in **ram lambs** is impaired testicular growth and complete cessation of spermatogenesis. Diets containing 2.44 mg/kg dry matter (DM) caused poor growth, impaired testicular growth, cessation of spermatogenesis, and other signs of zinc deficiency within 20–24 weeks. A diet containing 17.4 mg/kg DM of zinc is adequate for growth, but a content of 32.4 mg/kg DM is necessary for normal testicular development and spermatogenesis. On severely deficient experimental diets, other clinical signs in young rams are:

- Drooling copious amounts of saliva when ruminating
- Parakeratosis around eyes, on nose, feet, and scrotum
- Shedding of the hooves
- Dystrophy and shedding of wool, which showed severe staining
- Development of a pungent odor.

In naturally occurring cases in rams the animals stood with their backs arched and feet close together.

A marginal zinc deficiency in ewes may be characterized by only a reduction in feed intake and a slightly reduced body weight, and no other external signs of disease. This is important because, in grazing ruminants, the lack of external signs indicates that zinc deficiency could easily pass undetected.

Infertility in ewes

Infertility in ewes and a dietary deficiency of zinc have not been officially linked, but

a zinc-responsive infertility has been described in ewes. Again, attention is drawn to the need for response trials when soil and pasture levels of an element are marginal.

An **experimental zinc deficiency in pregnant ewes** results in a decrease in the birth weight of the lambs and a reduced concentration of zinc in the tissues of the lambs; these effects are due to the reduced feed intake characteristic of zinc deficiency.<sup>7</sup> The zinc content of the diet did not significantly influence the ability of the ewes to become pregnant or maintain pregnancy. The combination of pregnancy and zinc deficiency in the ewe leads to highly efficient utilization of ingested zinc, and the developing fetus will accumulate about 35% of the total dietary intake of zinc of the ewe during the last trimester of pregnancy. The disease is correctable by the supplementary feeding of zinc.

### Goats

Experimentally induced zinc deficiency in goats results in poor growth, low food intake, testicular hypoplasia, rough dull coat with loss of hair, and the accumulation of hard, dry, keratinized skin on the hindlimbs, scrotum, head, and neck. On the lower limbs the scabs fissure, crack, and produce some exudate. In naturally occurring cases in pygmy goats there was extensive alopecia, a kyphotic stance, extensive areas of parakeratosis, abnormal hoof growth, and flaky, painful coronary bands. A zinc-responsive alopecia and hyperkeratosis in Angora goats has been described. Affected animals had recurrent pruritus, hyperemia, exfoliation, fleece loss over the hindquarters, face and ears, and a decline in reproductive performance.

Immediately before parturition in cows, there is a precipitate fall in plasma zinc concentration, which returns to normal slowly after calving. The depression of zinc levels is greater in cows that experience dystocia. This has led to the hypothesis that dystocia in beef heifers may be caused in some circumstances by a nutritional deficiency of zinc and that preparturient supplementation of the diet with zinc may reduce the occurrence of difficult births. This phenomenon does not appear to occur in sheep. The level of serum zinc increased in cattle during the season of facial eczema when sporidesmin intoxication causes depletion of liver zinc.<sup>9</sup>

### CLINICAL PATHOLOGY

#### Skin scraping

Laboratory examination of skin scrapings yields negative results, but skin biopsy will confirm the diagnosis of parakeratosis.

### Zinc in serum and hair

Serum zinc levels may have good diagnostic value. Normal levels are 80–120 µg/dL (12.2–18.2 µmol/L) in sheep and cattle. Calves and lambs on deficient diets may have levels as low as 18 µg/dL (3.0 µmol/L). Normal serum zinc levels in sheep are above 78 µg/dL (12 µmol/L), and values below 39 µg/dL (6 µmol/L) or less are considered as evidence of deficiency.<sup>7</sup> There is a general relationship between the zinc content of the hair and the level of zinc in the diet, but the analysis of hair is not considered to be a sufficiently accurate indicator of an animal's zinc status. In experimental disease in piglets, there is a reduction in serum levels of zinc, calcium, and alkaline phosphatase, and it is suggested that the disease could be detected by measuring the serum alkaline phosphate and serum zinc levels. Levels of zinc in the blood are very labile and simple estimations of it alone are likely to be misleading. For example, other intercurrent diseases commonly depress serum calcium and copper levels. In addition, zinc levels in plasma fall precipitately at parturition in cows; they are also depressed by hyperthermal stress. After 1 week on a highly deficient diet, serum zinc levels fall to about 50% of normal, or pretreatment levels.

### NECROPSY FINDINGS

Necropsy examinations are not usually performed, but histological examination of skin biopsy sections reveals a marked increase in thickness of all the elements of the epidermis. Tissue levels of zinc differ between deficient and normal animals but the differences are statistical rather than diagnostic.

### DIFFERENTIAL DIAGNOSIS

Sarcoptic mange may resemble parakeratosis, but is accompanied by much itching and rubbing. The parasites may be found in skin scrapings. Treatment with appropriate parasiticides relieves the condition.

Exudative epidermitis is quite similar in appearance, but occurs chiefly in unweaned pigs. The lesions have a greasy character that is quite different from the dry, crumbly lesions of parakeratosis. The mortality rate is higher.

### TREATMENT

In outbreaks of parakeratosis in swine, zinc should be added to diet immediately at the rate of 50 mg/kg DM (200 mg of zinc sulfate or carbonate per kg of feed). The calcium level of the diet should be maintained at between 0.65 and 0.75%. The injection of zinc at a rate of 2–4 mg/kg BW daily for 10 days is also effective. Zinc

oxide suspended in olive oil and given IM at a dose of 200 mg of zinc for adult sheep and 50 mg of zinc for lambs will result in a clinical cure within 2 months. The oral administration of zinc at the rate of 250 mg zinc sulfate daily for 4 weeks resulted in a clinical cure of zinc deficiency in goats in 12–14 weeks.

### CONTROL

#### Pigs

The calcium content of diets for growing pigs should be restricted to 0.5–0.6%. However, rations containing as little as 0.5% calcium and with normal zinc content (30 mg/kg DM) may produce the disease. Supplementation with zinc (to 50 mg/kg DM) as sulfate or carbonate has been found to be highly effective as a preventive and there appears to be a wide margin of safety in its use, diets containing 1000 mg/kg DM added zinc having no apparent toxic effect. The standard recommendation is to add 200 g of zinc carbonate or sulfate to each tonne of feed. Weight gains in affected groups are appreciably increased by the addition of zinc to the diet. The addition of oils containing unsaturated fatty acids is also an effective preventive. Access to green pasture, reduction in food intake, and the deletion of growth stimulants from rations will lessen the incidence of the disease but are not usually practicable.

#### Ruminants

For cattle, the feeding of zinc sulfate (2–4 g daily) is recommended as an emergency measure followed by the application of a zinc-containing fertilizer. As an alternative to dietary supplementation for ruminants, an intra-ruminal pellet has been demonstrated in sheep. It was effective for 7 weeks only and would not be satisfactory for long-term use. The creation of subcutaneous depots of zinc by the injection of zinc oxide or zinc metal dust has been demonstrated. The zinc dust offered a greater delayed effect. A soluble glass bolus containing zinc, cobalt, and selenium was able to correct experimentally induced zinc deficiency in sheep.<sup>10</sup> The bolus supplied the daily requirement of the sheep for zinc with no detrimental effect on their copper status.

Zinc-methionine, an organic zinc supplement for dairy goats improved udder health and enhanced the absorption of nitrogen and increased nitrogen retention.<sup>11</sup>

### REVIEW LITERATURE

- Lamand M. Zinc deficiency in ruminants. *Irish Vet J* 1984; 38:40–47.  
Luecke RW. Domestic animals in the elucidation of zinc's role in nutrition. *Fed Proc* 1984; 43:2823–2828.

## REFERENCES

1. Luecke RW. *Fed Proc* 1984; 43:2823.
2. Forbes RM. *Fed Proc* 1984; 43:2835.
3. Lamand M. *Irish Vet J* 1984; 38:40.
4. Kalinowski J, Chavez ER. *Can J Anim Sci* 1986; 66:201–217.
5. Machen M et al. *J Vet Diagn Invest* 1996; 2:219.
6. Chirase NK, Greene LW. *Anim Feed Sci Tech* 2001; 93:217.
7. Underwood EJ. *The mineral nutrition of livestock*, 2nd ed. Farnham: Royal Commonwealth Agricultural Bureaux, 1981.
8. Clauss M et al. *Vet J* 2004; 167:302.
9. Dewes HF, Lowe MD. *N Z Vet J* 1987; 35:16.
10. Kendall NR, Telfer SB. *Vet Rec* 2000; 146:634.
11. Salamal AAK et al. *J Dairy Res* 2003; 70:9.

## MANGANESE DEFICIENCY

A dietary deficiency of manganese (Mn) may cause infertility and skeletal deformities both congenitally and after birth.

### ETIOLOGY

A primary deficiency occurs endemically in some areas because of a geological deficiency in the local rock formations.<sup>1</sup> Apart from a primary dietary deficiency of manganese, the existence of factors depressing the availability of ingested manganese is suspected. An excess of calcium and/or phosphorus in the diet is known to increase the requirements of manganese in the diet of calves,<sup>2</sup> and is considered to reduce the availability of dietary manganese to cattle generally.

Congenital chondrodystrophy in calves has been associated with a manganese deficiency,<sup>3</sup> and an outbreak of congenital skeletal defects in Holstein calves due to manganese deficiency has been reported.<sup>4</sup>

### EPIDEMIOLOGY

Soils containing less than 3 mg/kg of manganese are unlikely to be able to support normal fertility in cattle. In areas where manganese-responsive infertility occurs, soils on farms with infertility problems have contained less than 3 mg/kg of manganese, whereas soils on neighboring farms with no infertility problems have had levels of more than 9 mg/kg. A secondary soil deficiency is thought to occur and one of the factors suspected of reducing the availability of manganese in the soil to plants is high alkalinity. Thus, heavy liming is associated with manganese-responsive infertility. There are three main soil types on which the disease occurs:

- Soils low in manganese have low output even when pH is less than 5.5
- Sandy soils where availability starts to fall
- Heavy soils where availability starts to fall at pH of 7.0.

Many other factors are suggested as reducing the availability of soil manganese

but the evidence is not conclusive. For example, heavy liming of soils to neutralize sulfur dioxide emissions from a neighboring smelter is thought to have reduced the manganese intake of grazing animals.

Herbage on low manganese soils, or on marginal soils where availability is decreased (possibly even soils with normal manganese content), is low in manganese. A number of figures are given for critical levels. It is suggested that pasture containing less than 80 mg/kg of manganese is incapable of supporting normal bovine fertility, and that herbage containing less than 50 mg/kg is often associated with infertility and anestrus. The Agricultural Research Council feels that, although definite figures are not available, levels of 40 mg/kg dry matter (DM) in the diet should be adequate. Other authors state that rations containing less than 20 mg/kg DM may cause anestrus and reduction in conception rates in cows and the production of poor quality semen by bulls. Most pasture contains 50–100 mg/kg DM. Skeletal deformities in calves occur when the deficiency is much greater than the above; for example, a diet containing more than 200 mg/kg DM is considered to be sufficient to prevent them.

Rations fed to pigs usually contain more than 20 mg/kg DM of manganese, and deficiency is unlikely unless there is interference with manganese metabolism by other substances.

There are important variations in the manganese content of seeds, an important matter in poultry nutrition.<sup>1</sup> Maize and barley have the lowest content. Wheat or oats have three to five times as much, and bran and pollard are the richest natural sources with 10–20 times the content of maize or wheat. Cows' milk is exceptionally low in manganese.

### PATHOGENESIS

Manganese plays an active role in bone matrix formation, and in the synthesis of chondroitin sulfate, responsible for maintaining the rigidity of connective tissue. In manganese deficiency, these are affected deleteriously and skeletal abnormalities result. Only 1% of manganese is absorbed from the diet and the liver removes most of it, leaving very low blood levels of the element.<sup>3</sup>

### CLINICAL FINDINGS

In cattle, the common syndromes are infertility, calves with congenital limb deformities, and calves which manifest poor growth, dry coat, and loss of coat color. The deformities include knuckling over at the fetlocks, enlarged joints and, possibly, twisting of the legs. The bones of affected lambs are shorter and weaker than normal and there are signs of joint

pain, hopping gait, and reluctance to move.

A severe congenital chondrodystrophy in Charolais calves occurred on one farm.<sup>3</sup> The limbs were shortened and the joints enlarged. The pregnant cows were fed on apple pulp and corn silage both of which were low in manganese.

An outbreak of congenital skeletal malformations in Holstein calves was characterized clinically by small birth weights (average 15 kg). Abnormalities included joint laxity, doming of the foreheads, superior brachygnathia, and a dwarflike appearance due to the short long-bones. The features of the head were similar to those of the wildebeest. The majority of affected calves were dyspneic at birth, and snorting and grunting respiratory sounds were common. Affected calves failed to thrive and most were culled due to poor performance.

A manganese-responsive infertility has been described in ewes and is well known in cattle. In cattle, it is manifested by slowness to exhibit estrus, and failure to conceive, often accompanied by subnormal size of one or both ovaries. Subestrus and weak estrus have also been observed.

Functional infertility was once thought to occur in cattle on diets with calcium to phosphorus ratios outside the range of 1:2 to 2:1. This was not upheld on investigation but may have been correct if high calcium to phosphorus intakes directly reduced manganese (or copper or iodine) availability in diets marginally deficient in one or other of these elements.

In pigs, experimental diets low in manganese cause reduction in skeletal growth, muscle weakness, obesity, irregular, diminished or absent estrus, agalactia and resorption of fetuses or the birth of still-born pigs. Leg weakness, bowing of the front legs and shortening of bones also occur.

### CLINICAL PATHOLOGY

The blood of normal cattle contains 18–19 µg/dL (3.3–3.5 µmol/L) of manganese (Mn), although considerably lower levels are sometimes quoted. The livers of normal cattle contain 12 mg/kg (0.21 mmol/kg) of manganese and down to 8 mg/kg (0.15 mmol/kg) in newborn calves, which also have a lower content in hair. The manganese content of hair varies with intake. The normal level is about 12 mg/kg (0.21 mmol/kg) and infertility is observed in association with levels of less than 8 mg/kg (0.15 mmol/kg). In normal cows, the manganese content of hair falls during pregnancy from normal levels of 12 mg/kg (0.21 mmol/kg) in the first month of pregnancy to

4.5 mg/kg (0.08 mmol/kg) at calving. All of these figures require much more critical evaluation than they have had, before they can be used as diagnostic tests.

Although tissue manganese levels in normal animals have been described as being between 2 and 4 mg/kg (0.04 and 0.07 mmol/kg), in most tissue<sup>1</sup> there appears to be more variation between tissues than this. However, tissue levels of manganese do not appear to be depressed in deficient animals, except for ovaries in which levels of 0.6 mg/kg (0.01 mmol/kg) and 0.85 mg/kg (0.02 mmol/kg) are recorded in contrast to a normal level of 2 mg/kg (0.04 mmol/kg).

There is then no simple, single diagnostic test permitting detection of manganese deficiency in animals. Reproductive functions, male and female, are most sensitive to manganese deficiency and are affected before possible biochemical criteria, e.g. blood and bone alkaline phosphatase, and liver arginase levels, are significantly changed. The only certain way of detecting moderate deficiency states is by measuring response to supplementation. Clinical findings in response to treatment which may provide contributory evidence of manganese deficiency are set out below.

#### NECROPSY FINDINGS

In congenital chondrodystrophy in calves, the limbs are shortened and all the joints are enlarged. Histologically, there is poor cartilage maturation with excessive amounts of rarefied cartilage matrix. There are degenerative changes in the chondrocytes and severe reduction in the mucopolysaccharide content of all body hyaline cartilage.<sup>3,4</sup>

#### TREATMENT AND CONTROL

The NRC estimated the maintenance requirement (0.002 of available Mn/kg BW) of dairy cows from dietary concentrations of Mn reported to cause Mn deficiency in cattle.<sup>5</sup> Based on NRC of 2001<sup>2</sup> equations, the maintenance requirement for Mn represents 82% of the total Mn requirement for a nonlactating, late gestation cow and 53% for a cow producing 40 kg/d of milk. Fecal loss of endogenous Mn is assumed to comprise the entire maintenance requirement. Assuming typical DMI, a diet with approximately 14 mg Mn/kg DM will meet the requirement for a 700 kg non-lactating cow during the last month of lactation. Recent research has determined that Mn intake had to equal 580 mg/d to meet the metabolic fecal Mn requirement. The corresponding dietary concentration, assuming DMIs of 21 and 12 kg/d for lactating and dry cows, respectively, were 28 and 49 mg/kg DM. These concentrations are approximately 1.6 and 2.7 times higher than those needed

to meet the Mn requirements for lactating and dry cows, respectively, as calculated using the 2001 NRC dairy nutrient requirements model.<sup>5</sup>

For pigs, the recommended dietary intakes are 24–57 mg manganese per 45 kg BW. Expressed as a proportion of food intake, the recommended dietary level is 40 mg/kg DM in feed. The manganese requirements for gestation and lactation are 20 ppm of the diet.<sup>6</sup>

#### REFERENCES

1. Underwood EJ. The mineral nutrition of livestock, 2nd ed. Farnham: Royal Commonwealth Agricultural Bureau, 1981.
2. National Research Council. Minerals nutrient requirements of dairy cattle, Ch. 7, 7th revised ed. Washington, DC: National Academy of Sciences; 2001.
3. Valero G et al. *N Z Vet J* 1990; 38:161.
4. Staley GP et al. *J South African Vet Assoc* 1994; 65:73.
5. Weiss WP, Socha MT. *J Dairy Sci* 2005; 88:2517.
6. National Research Council. Minerals nutrient requirements of swine, Ch. 4, 10th revised ed. Washington, DC: National Academy of Sciences; 1998.

#### POTASSIUM DEFICIENCY

Naturally occurring dietary deficiency of potassium is thought to be rare. However, calves fed on roughage grown on soils deficient in potassium, or in which the availability of potassium is reduced, may develop a clinical syndrome of poor growth, anemia, and diarrhea. Supplementation of the diet with potassium salts appears to be curative. A similar syndrome has been produced experimentally in pigs<sup>1</sup> that manifested poor appetite, emaciation, rough coat, incoordination, and marked cardiac impairment as indicated by electrocardiographic examination. The optimum level of potassium in the diet of young, growing pigs is about 0.26%, and in ruminants 0.5% (i.e. 65 mg/kg BW).<sup>2</sup> Electrocardiographic changes have also been observed in cattle on potassium-deficient diets and these are probably related to the degeneration of Purkinje fibers of the myocardium which occurs on such diets. Similar changes have been recorded on diets deficient in magnesium or vitamin E.

An intake of potassium above requirement is more likely to occur than a deficiency and, although very large doses of potassium are toxic, ruminants are capable of metabolizing intakes likely to be encountered under natural conditions.<sup>3</sup> It seems probable, however, that potassium interferes with the absorption of magnesium and heavy applications of potash fertilizers to grass pastures may contribute to the development of the hypomagnesemia of lactation tetany.

**Hypokalemia in cattle** may occur secondary to anorexia, diarrhea, upper

gastrointestinal obstruction, right-side displacement and torsion of the abomasum, and impaction of the abomasum. In most cases, the hypokalemia is not severe enough to cause weakness and recumbency. Hypokalemia resulting in severe weakness and recumbency has occurred in dairy cattle treated with isoflupredone acetate for ketosis.<sup>4</sup> Serum potassium levels were below 2.3 mEq/L. Cows ranged in age from 2 to 7 years, all had a history of moderate to severe ketosis and had calved within the previous 30 days. Most had been treated with insulin, glucose IV, and propylene glycol orally. Affected cows were recumbent, profoundly weak, appeared flaccid, and lay in sternal or lateral recumbency. They were unable to support the weight of their heads off the ground and they were commonly held in their flanks. Anorexia was common. Cardiac arrhythmias were detectable on auscultation, and atrial fibrillation was confirmed on electrocardiography. Treatment included IV and oral administration of potassium chloride and fluid therapy, but the response was ineffective. Most affected cattle died or were euthanized. At necropsy, muscle necrosis was present in the pelvic limbs, and histological examination of non-weight bearing muscle revealed multifocal myonecrosis with macrophage infiltration and myofiber vacuolation, which is characteristic of hypokalemic myopathy in man and dogs. It is important to note that myopathy was also present in muscles not subject to ischemia or recumbency.

Potassium excretion by the kidneys is via secretion by the distal tubular cells. Aldosterone or other steroids with mineralocorticoid activity enhance distal tubular secretion of potassium by increasing permeability of the tubular luminal membranes to potassium and increasing losses of potassium in the urine. Glucocorticoids are often used to treat ketosis; the most commonly used are dexamethasone and isoflupredone acetate. Dexamethasone has little mineralocorticoid activity compared with prednisone and prednisolone, which are related chemically to isoflupredone. It is recommended for the treatment of ketosis in dairy cattle at a single dose of 10–20 mg IM, and repeated if necessary, 12–24 h later. Field observations indicate that repeated doses of isoflupredone acetate decreases plasma concentrations of potassium by 70–80%, which suggests a strong mineralocorticoid activity. It is recommended that isoflupredone be used judiciously and animals be monitored for plasma potassium and any evidence of weakness and recumbency. Treatment with oral potassium chloride may be required, but may be ineffective.



## REFERENCES

1. Cox JL et al. *J Anim Sci* 1966; 25:203.
2. Telle PP et al. *J Anim Sci* 1964; 23:59.
3. Ward GM. *J Dairy Sci* 1966; 49:268.
4. Sielman ES et al. *J Am Vet Med Assoc* 1997; 210:240.

## SELENIUM AND/OR VITAMIN E DEFICIENCIES

Several diseases of farm animals are associated with a deficiency of either selenium or vitamin E alone or in combination, usually in association with predisposing factors such as dietary polyunsaturated fatty acids, unaccustomed exercise and rapid growth in young animals. These are summarized in Table 30.5. All of these diseases are described under one heading because both selenium and vitamin E are important in the etiology, treatment and control of the major diseases caused by their deficiencies.

They are also known as selenium-vitamin E-responsive diseases because, with some exceptions, they can be prevented by adequate supplementation of the diet with both nutrients.

The term '*selenium-responsive disease*' has created some confusion relative to the selenium-deficiency diseases. In some regions of the world, particularly New Zealand and in parts of Australia and North America, diseases such as ill-thrift in sheep and cattle and poor reproductive performance respond beneficially to selenium administration. While these usually occur in selenium-deficient regions, they may not be due solely to selenium deficiency. Thus, there are some reasonably well-defined selenium-deficiency diseases and some ill-defined 'selenium-responsive' diseases.

### ETIOLOGY

The selenium- and vitamin E-responsive or deficiency diseases of farm animals are caused by diets deficient in selenium and/or vitamin E, with or without the presence of conditioning factors such as an excessive quantity of polyunsaturated fatty acids in the diet. Almost all of the diseases that occur naturally have been

### Synopsis

**Etiology** Dietary deficiencies of selenium and vitamin E and conditioning factors like dietary polyunsaturated fatty acids.

### Epidemiology

- **Enzootic muscular dystrophy** occurs in young growing calves, lambs, goat kids, and foals born to dams in selenium-deficient areas and unsupplemented. Occurs worldwide and common in Australasia, UK, Great Plains of North America where soils are deficient in selenium. Vitamin E deficiency in animals fed poor quality forage and diets high in polyunsaturated fatty acids. Outbreaks of muscular dystrophy precipitated by exercise.
- **Mulberry heart disease** in finishing pigs.
- **Selenium-responsive diseases** occur in Australasia and are not obvious clinically but respond to selenium supplementation. Selenium and vitamin E deficiency may be involved in reproductive performance, retained placenta in cattle, resistance to infectious disease like bovine mastitis. Controversial.

**Signs** Muscular dystrophy characterized by groups of animals with stiffness, weakness, recumbency, severe in myocardial form. Mulberry heart disease characterized by outbreaks of sudden death in finishing pigs.

**Clinical pathology** Increased plasma levels of creatine kinase. Low serum levels of selenium and vitamin E. Glutathione peroxidase activity.

**Necropsy findings** Bilaterally symmetrical pale skeletal muscle, pale streaks in myocardial muscle. Hyaline degeneration of affected muscle.

**Diagnostic confirmation** Low selenium and vitamin E in diet and tissues, increased creatine kinase and muscle degeneration.

### Differential diagnosis list

#### Acute muscular dystrophy in calves and yearlings

- *Haemophilus somnus* septicemia
- Pneumonia.

#### Subacute enzootic muscular dystrophy:

- **Musculoskeletal diseases** polyarthritis, traumatic or infectious myopathies (blackleg), osteodystrophy, and fractures of long bones

- **Diseases of the nervous system:** spinal cord compression, *Haemophilus somnus* meningoencephalitis and myelitis, organophosphatic insecticide poisoning
- **Diseases of the digestive tract:** carbohydrate engorgement resulting in lactic acidosis, shock, dehydration and weakness.
- **Muscular dystrophy in lambs and kids:** Enzootic ataxia and swayback
- **Muscular dystrophy in foals:** Traumatic injury to the musculoskeletal system and polyarthritis; meningitis; traumatic injury to the spinal cord.

**Treatment** Vitamin E selenium parenterally.

**Control** Selenium and vitamin E supplementation of diet, strategic oral and/or parenteral vitamin E and selenium to pregnant dams or young animals on pasture.

reproduced experimentally using diets deficient in selenium and/or vitamin E. Conversely, the lesions can usually be prevented with selenium and vitamin E supplementation. In certain instances, as for example in hand-fed dairy calves, the incorporation of excessive quantities of polyunsaturated fatty acids was a major factor in the experimental disease and this led to the conclusion that certain myopathic agents were necessary to produce the lesion, which is no longer tenable. The presence of polyunsaturated fatty acids in the diet may cause a conditioned vitamin E deficiency because the vitamin acts as an antioxidant. In the case of naturally occurring muscular dystrophy in calves, lambs and foals on pasture, the myopathic agent, if any, is unknown and selenium is protective. However, selenium is not protective against the muscular dystrophy associated with the feeding of cod liver oil to calves.

Selenium is an essential nutrient for animals and diseases due to selenium inadequacy in livestock are of worldwide distribution.<sup>1,2</sup>

### Biological functions of selenium and vitamin E

Glutathione peroxidases and tissue peroxidation

Selenium is a biochemical component of the enzyme glutathione peroxidase (GSH-PX).<sup>3</sup> The activity of the enzyme in erythrocytes is positively related to the blood concentration of selenium in cattle, sheep, horses, and pigs and is a useful aid for the diagnosis of selenium deficiency and to determine the selenium status of the tissues of these animals. The enzyme from the erythrocytes of both cattle and sheep contains 4 g atoms of

Table 30.5 Diseases considered to be associated with a deficiency of either selenium or vitamin E or both (including 'selenium-responsive' diseases)

Cattle	Horse	Pigs	Sheep
Nutritional (enzootic) muscular dystrophy	Nutritional muscular dystrophy (feeds)	Mulberry heart disease	Nutritional (enzootic) muscular dystrophy
Retained fetal membranes		Hepatitis dietetica	Ill-thrift (selenium responsive)
Resistance to mastitis		Exudative diathesis	Reproductive inefficiency (selenium responsive)
		Iron hypersensitivity	Bone marrow abnormalities
		Nutritional muscular dystrophy	
		Anemia	

selenium per mol of enzyme.<sup>1</sup> Selenium is also a component of thyroid gland hormones.

Plasma GSH-PX protects cellular membranes and lipid-containing organelles from peroxidative damage by inhibition and destruction of endogenous peroxides, acting in conjunction with vitamin E to maintain integrity of these membranes.<sup>2</sup> Hydrogen peroxide and lipid peroxides are capable of causing irreversible denaturation of essential cellular proteins, which leads to degeneration and necrosis. GSH-PX catalyzes the breakdown of hydrogen peroxide and certain organic hydroperoxides produced by glutathione during the process of redox cycling. This dependence of GSH-PX activity on the presence of selenium offers an explanation for the interrelationship of selenium, vitamin E and sulfur-containing amino acids in animals. The sulfur-containing amino acids may be precursors of glutathione, which in turn acts as a substrate for GSH-PX and maintains sulfhydryl groups in the cell. Selenium is also a component of several other proteins such as selenoprotein of muscle, selenoflagellin, Se-transport proteins and the bacterial enzymes, formate dehydrogenase, and glycine reductase. Selenium also facilitates significant changes in the metabolism of many drugs and xenobiotics. For example, selenium functions to counteract the toxicity of several metals such as arsenic, cadmium, mercury, copper, silver, and lead.

The arachidonic cascade, phagocytosis, and the immune response

Glutathione peroxidase may be involved in the arachidonic acid cascade.<sup>3</sup> Eicosanoids are important mediators of immune and reproductive function.

### Vitamin E

Vitamin E is an antioxidant that prevents oxidative damage to sensitive membrane lipids by decreasing hydroperoxide formation. The vitamin has a central role in protection of cellular membranes from lipoperoxidation, especially membranes rich in unsaturated lipids, such as mitochondria, endoplasmic reticulum, and plasma membranes.

Interrelationships between selenium and vitamin E

An important interrelationship exists between selenium, vitamin E and the sulfur-containing amino acids in preventing some of the nutritional diseases caused by their deficiency. If vitamin E prevents fatty acid hydroperoxide formation and the sulfur amino acids (as precursors of GSH-PX) and selenium are involved in peroxide destruction, these nutrients would produce a similar biochemical result, that is, lowering of the con-

centration of peroxides or peroxide-induced products in the tissues.<sup>1,2</sup> Protection against oxidative damage to susceptible non-membrane proteins by dietary selenium, but not by vitamin E, might explain why some nutritional diseases respond to selenium but not to vitamin E. On the other hand, certain tissues or subcellular components may not be adequately protected from oxidant damage because they are inherently low in GSH-PX even with adequate dietary selenium. Damage to such tissues would be expected to be aggravated by diets high in unsaturated fatty acids and to respond adequately to vitamin E but not to selenium. The variations in GSH-PX activity between certain tissues, such as liver, heart, skeletal, and myocardial muscles, would explain the variations in the severity of lesions between species.

There are both selenium-dependent GSH-PX and non-selenium-dependent GSH-PX activities in the tissues and blood. The non-selenium-dependent enzyme does not contain selenium and does not react with hydrogen peroxide but shows activity toward organic hydroperoxide substrates. The spleen, cardiac muscle, erythrocytes, brain, thymus, adipose tissue, and striated muscles of calves contain only the selenium-dependent enzyme. The liver, lungs, adrenal glands, testes, and kidney contain both enzymes. Hepatic tissue contains the highest level of non-selenium-dependent enzyme.

Vitamin E can prevent a toxic reaction to oral iron (ferrous sulfate) or iron dextran IM. When 0.1 ppm of selenium and 50 IU vitamin E/kg are added to the gestation of sows, glutathione peroxidase activity increased in 2-day-old pigs, especially if the iron injection is given prior to colostrum ingestion.<sup>4</sup>

### EPIDEMIOLOGY

#### Enzootic nutritional muscular dystrophy (NMD)

##### Occurrence

This muscular dystrophy occurs in all farm animal species, but most commonly in young, rapidly growing calves, lambs, goat kids, and foals born from dams that have been fed for long periods, usually during the winter months, on diets low in selenium and vitamin E.<sup>5</sup> It is an important cause of mortality in goat kids from birth to about 3 months of age.<sup>1</sup> Goat kids may require more selenium than lambs or calves, which may explain the higher incidence of the disease in kids. The disease in kids may also be associated with low  $\alpha$ -tocopherol levels and normal selenium status. The literature on selenium and vitamin E deficiency in sheep and goats has been reviewed.<sup>2</sup>

NMD in horses occurs most commonly in foals to about 7 months of age.<sup>6</sup> In reported cases, the concentration of selenium in the blood of the mares was subnormal, the concentrations of selenium and vitamin E in the feedstuffs were subnormal, the level of unsaturated fatty acids in the feed was high and vitamin E and selenium supplementation prevented the disease. The disease is not well-recognized in adult horses, but sporadic cases of dystrophic myodegeneration are recorded in horses from 5 to 10 years of age. Some baseline data for selenium and vitamin E concentration in horses from breeding farms is available.<sup>1</sup>

The disease also occurs in grain-fed yearling cattle. Stressors such as being turned outdoors after winter housing, walking long distances, the jostling and movement associated with vaccination, and dehorning procedures and the like are often precipitating factors. The disease has occurred in steers and bulls 12–18 months of age under feedlot conditions. There may even be laboratory evidence of subclinical myopathy in normal animals in a group from which an index case occurred. Outbreaks of severe and fatal NMD have occurred in heifers, at the time of parturition, which were previously on a diet deficient in both selenium and vitamin E. The disease may also occur sporadically in adult horses that are deficient in selenium. Muscular dystrophy has occurred in Bohemian Red Poll mature dairy cows in the Czech Republic moved from a stanchion barn into loose box housing which resulted in increased locomotor activity and stress associated with the change in housing conditions.<sup>7</sup>

Myopathy and hepatic lipidosis in weaned lambs deficient in vitamin E without concurrent selenium deficiency has been described.<sup>8</sup>

There are two major syndromes of myopathy:

- An acute form: myocardial dystrophy, which occurs most commonly in young calves and lambs and occasionally foals
- A subacute form: skeletal muscular dystrophy, which occurs in older calves and yearling cattle.

The two forms are not mutually exclusive.

##### Geographical distribution

NMD occurs in most countries of the world but is common in the UK, the USA, Scandinavia, Europe, Canada, Australia, and New Zealand. In North America, it is common in the north-east and north-west and uncommon on the relatively high selenium soils of the Great Plains, where selenium toxicity has occurred. It is one of

most common deficiency diseases of farm livestock in the USA.<sup>1</sup> In the Czech Republic, the incidence of selenium deficiency in cattle is high and most frequently diagnosed in heifers, feeder bulls, grazed beef cattle, and dairy cows in the dry period.<sup>9</sup> Surveys of live cattle in the Czech Republic and in cattle tissues obtained at slaughter have found significant deficiency of selenium.<sup>10,11</sup> Poor selenium status, as assessed from blood, muscle, and liver selenium concentrations, was found in 80%, 70%, and 73% of the tested animals, respectively.<sup>11</sup> White muscle disease has occurred in lambs in Turkey where the levels of selenium in the hay and soil are deficient.<sup>12</sup> The mean values of selenium in the soil and hay were 0.03 ppm and 0.07 ppm, respectively.

NMD is endemic in grazing goats on the Mexican plateau because of selenium deficiency in the soil and forages.<sup>13</sup> In two different locations of the plateau, the concentration of selenium in the soil was 0.047 and 0.051 ppm, in the forages 0.052 and 0.075 ppm, in the serum of goats, 0.02 and 0.21 ppm, respectively.<sup>13</sup> The pH of the soil was 6.1 and 5.9, respectively. The mean concentration of selenium in the serum of kids with clinical signs of NMD was 36% lower compared with kids from the same farm which were normal.

Based on bulk tank milk selenium concentrations compared with serum selenium concentrations in dairy herds in Prince Edward Island, Canada, 59% of the herds were at some point marginal or deficient in selenium, which places them at risk of disease and suboptimal production.<sup>14</sup> The periods of greatest risk were in the fall and winter when 5% and 4%, respectively, of herds fell in the range of true deficiency. Herds in which selenium supplementation was provided from a commercial dairy concentrate, were over 4 times more likely to be selenium-adequate than herds not using this method and adjusted average daily milk yield was 7.6% greater in herds determined to be selenium-adequate when compared with selenium-marginal herds.

Soils and therefore the pastures they carry, vary widely in their selenium content, depending largely on their geological origin. In general, soils derived from rocks of recent origin, e.g. the granitic and pumice sands of New Zealand, are notably deficient in selenium. Soils derived from igneous rocks are likely to be low in selenium. Sedimentary rocks, which are the principal parent material of agricultural soils, are richer in selenium. Forage crops, cereal grains, and corn grown in these areas are usually low in selenium content (below 0.1 mg/kg dry matter, DM), compared with the concentration in crops (above 0.1 mg/kg DM) grown in

areas where the available soil selenium is much higher and usually adequate. The disease occurs in pigs, usually in association with other more serious diseases, such as mulberry heart disease and hepatitis dietetica.

Selenium in soil, plants and animals

**Selenium in soils.** Soils containing <0.5 mg/kg of selenium are likely to support crops and pastures with potentially inadequate selenium concentrations (<0.05 mg/kg DM).<sup>1,3</sup>

**Selenium in plants.** Plants vary in their uptake of selenium but selenium is not a requirement for plant growth.<sup>3</sup> The selenium content of different pasture species on the same soil type does vary widely but slow growing and more deeply rooting species contained slightly higher concentrations.<sup>3</sup> In New Zealand, the most deficient soils consist of rhyolitic pumice in the central volcanic plateau of the North Island. Peat soils in the Waikaito River Valley are also deficient. North Island coastal sands and stony soils in the several locations are considered to be selenium-responsive, while most of the South Island is at least marginally deficient.

In the USA, the States of the Pacific North-west and of the north-eastern and south-eastern seaboard are generally low in selenium.<sup>5</sup> In Canada, western prairie grains generally contain relatively high levels of selenium, whereas in the eastern provinces, soils and feedstuffs usually have low selenium concentrations. Most soils in the Atlantic provinces of Canada are acidic and, consequently, the forages are deficient in selenium. Most forage samples contain less than 0.10 mg/kg DM of selenium and enzootic nutritional muscular dystrophy is common throughout the region.

Surveys in the UK found that the selenium status may be low in sheep and cattle fed locally produced feedstuffs without any mineral supplementation. In some surveys, up to 50% of farms are low in selenium, which places a large number of animals at risk. There are also differences in the selenium concentrations of different feeds grown in the same area. For example, in some areas 75% of cattle fed primarily corn silage, or 50% of the cattle fed sedge hay, might be receiving diets inadequate in selenium.

**Several factors influence the availability of soil selenium to plants.**

- **Soil pH:** alkalinity encourages selenium absorption by plants – and the presence of a high level of sulfur, which competes for absorption sites with selenium in both plants and animals, are two factors reducing availability

- Variation between plants in their ability to absorb selenium; '**selector**' and '**converter**' plants are listed under the heading of selenium poisoning; legumes take up much less selenium than do grasses
- **Seasonal conditions also influence the selenium content of pasture**, the content being lowest in the spring and when rainfall is heavy. Blood selenium in dairy cows in the USA were lower during the summer and fall than during the winter and spring.<sup>15</sup> In this way, a marginally deficient soil may produce a grossly deficient pasture if it is heavily fertilized with superphosphate, thus increasing its sulfate content, if the rainfall is heavy and the sward is lush and dominated by clover as it is likely to be in the spring months.

**Environmental sulfur** from various anthropogenic activities has been suspected to be a significant factor in contributing to several health problems in livestock.<sup>1</sup> Livestock producers near natural sour gas desulfurization plants have reported that sulfur emissions are responsible for an increased occurrence of nutritional muscular dystrophy, weak calves, and retarded growth. Experimentally, a moderate increase in dietary sulfur does not impair selenium and copper status, or cause related disease in cattle.

**Selenium in animals.** There may be wide variations in the serum selenium concentrations and glutathione peroxidase activities in cattle grazing forages of various selenium concentrations within the same geographical area. The selenium status of beef cows can vary between geographical areas within a region of a country, which is likely due to variations in selenium concentration of the soil and plants in these areas. Beef herds from areas with adequate soil levels of selenium, herds provided with supplemental feed on pasture and herds in which pregnancy diagnosis was done, had higher average herd blood selenium values than other herds.

Vitamin E

Vitamin E deficiency occurs most commonly when animals are fed inferior quality hay or straw or root crops. Cereal grains, green pasture, and well-cured fresh hay contain adequate amounts of the vitamin.

$\alpha$ -Tocopherol levels are high in green grasses and clovers, but there are wide variations in the concentrations from one area to another. The serum  $\alpha$ -tocopherol levels are higher in calves born from cows fed grass silage than in those born from cows fed the same grass as hay. Many factors influence the  $\alpha$ -tocopherol content of pasture and hence the animals' intake.

The level of  $\alpha$ -tocopherol in pasture declines by up to 90% as it matures. Levels as low as 0.7 mg/kg DM have been reported in dry summer pastures grazed by sheep. The  $\alpha$ -tocopherol content of ryegrass and clover pasture ranges from 22 to 350 mg/kg DM and 90–210 mg/kg DM, respectively. After harvesting and storage, the  $\alpha$ -tocopherol content of pasture and other crops may fall further, sometimes to 0. Preservation of grain with propionic acid does not prevent the decline. Thus, the dietary intake of  $\alpha$ -tocopherol by cattle and sheep may be expected to vary widely and lead to wide variations in tissue levels. The plasma vitamin E status of horses is highest from May to August in Canada when fresh grass is being grazed and lowest when the horses are being fed harvested or stored feed during the same period. Plasma vitamin E levels in dairy cows in the USA were higher during the summer and fall than during the winter and spring.<sup>15</sup>

Outbreaks of NMD may occur in yearling cattle fed on high-moisture grain treated with propionic acid as a method of inexpensive storage and protection from fungal growth. There is a marked drop in the vitamin E content of acid-treated grain and an increase in the levels of peroxides of fat, which is consistent with a loss of naturally occurring antioxidants such as the tocopherols (secondary vitamin E deficiency). In these situations, the levels of selenium in the feed were below 0.05 mg/kg DM, which is inadequate and emphasizes the interdependence of selenium and vitamin E. The  $\alpha$ -tocopherol content of moist grain (barley and maize) stored for 6 months, with or without propionic acid, falls to extremely low levels compared with conventionally stored grain in which the  $\alpha$ -tocopherol levels usually persist over the same length of time. Selenium-deficient barley treated with sodium hydroxide to deplete it of vitamin E can be used to induce NMD when fed to yearling cattle. The disease may occur in sucking lambs with low plasma  $\alpha$ -tocopherol levels and an adequate selenium status, which indicates that the sparing effect of each nutrient may not occur over the broad spectrum of clinical deficiencies.

#### Polyunsaturated fatty acids (PUFAs) in diet

Diets rich in PUFA such as cod liver oil, other fish oils, fishmeal used as a protein concentrate, lard, linseed oil, soybean, and corn oils have been implicated in the production of NMD, particularly in calves fed milk replacers containing these ingredients. The disease can be reproduced experimentally in young ruminant cattle, 6–9 months of age, by feeding a diet low in vitamin E

and selenium and adding a linolenic acid. There are widespread lesions of myodegeneration of skeletal and myocardial muscles.<sup>16</sup> Fresh spring grass containing a sufficient concentration of linolenic acid to equal the amount necessary to produce NMD in calves may explain the occurrence of the naturally occurring disease in the spring months. The oxidation during rancidification of the oils causes destruction of the vitamin, thus increasing the dietary requirements (a conditioned vitamin E deficiency) and the presence of myopathic agents in the oils may also contribute to the occurrence of the disease. A secondary vitamin E deficiency occurs when NMD develops on rations containing vitamin E in amounts ordinarily considered to be adequate, but the disease is prevented by further supplementation with the vitamin. The lack of specificity of vitamin E in the prevention of muscular dystrophy in some circumstances is indicated by its failure and by the efficiency of selenium, as a preventive agent in lambs on lush legume pasture.

#### Other myopathic agents in diet

Not all of the myopathic agents that may be important in the development of NMD in farm animals have been identified. Unsaturated fatty acids in fish and vegetable oils may be myopathic agents in some outbreaks of NMD of calves and lambs. Lupinosis-associated myopathy in sheep is a substantial skeletal muscle myopathy encountered in weaner sheep grazing lupin stubbles infected with the fungus *Phomopsis* spp.<sup>17</sup> Affected sheep have a stiff gait, walk reluctantly, stand with their back humped and their feet under the body, and have difficulty getting to their feet.

#### Unaccustomed exercise

Historically, NMD occurred most commonly in rapidly growing, well-nourished beef calves 2–4 months of age, shortly following unaccustomed exercise. This was commonplace in countries where calves were born and raised indoors until about 6–8 weeks of age when they were turned out onto new pasture in the spring of the year. This has been a standard practice in small beef herds in the UK, Europe, and North America. A similar situation applies for ewes that lambed indoors and the lambs were let out to pasture from 1 to 3 weeks of age. Thus, unaccustomed activity in calves and lambs running and frolicking following their turnout onto pasture is an important risk factor but is not necessarily a prerequisite for the disease. In lambs, the vigorous exertion associated with running and sucking may account for the peracute form of myocardial dystrophy in young lambs on deficient pastures and from deficient ewes. In older

lambs up to 3 months of age, outbreaks of acute NMD and stiff-lamb disease may be associated with the driving of flocks long distances. A similar situation applies for calves that are moved long distances from calving grounds and early spring pastures to lush summer pastures. The wandering and bellowing that occurs in beef calves weaned at 6–8 months of age may precipitate outbreaks of subacute NMD. Degenerative myopathy of yearling cattle (feedlot cattle, housed yearling bulls and heifer replacements) is now being recognized with increased frequency. The disease resembles subacute NMD of calves and in the UK is often seen when yearlings are turned outdoors in the spring of the year after being housed during the winter and fed a poor quality hay or straw or propionic acid-treated grain. Unaccustomed exercise is a common precipitating factor. However, the disease has occurred in housed yearling bulls with no history of stress or unaccustomed exercise but whose diet was deficient in selenium and vitamin E.

In horses subjected to exercise, there is an increase in erythrocyte malondialdehyde, a product of peroxidation, but selenium supplementation has no beneficial effect. There is inconclusive evidence that a selenium-vitamin E deficiency causes NMD in adult horses. There is no evidence that paralytic myoglobinuria and the 'tying-up' syndrome are due to a deficiency of selenium and vitamin E.

#### Congenital nutritional muscular dystrophy

**Congenital NMD** is rare in farm animals. Isolated cases have been reported.<sup>18</sup>

Similarly, NMD can occur in calves and lambs only a few days of age but rarely. Selenium readily crosses the bovine placenta and fetal selenium is always higher than the maternal status.<sup>9</sup> There is no evidence that the weak-calf syndrome is associated with selenium deficiency. Long-term parenteral supplementation with neither selenium alone nor in combination with vitamin E had any effect on the incidence of the weak-calf syndrome.

An investigation of aborted bovine fetuses with lesions of heart failure, specifically cardiac dilatation or hypertrophy along with a nodular liver and ascites compared with aborted fetuses without such lesions and non-aborted fetuses from the abattoir found myocardial necrosis and mean selenium levels of 5.5  $\mu\text{mol/kg}$  in the fetuses with heart lesions, 6.5  $\mu\text{mol/kg}$  in the fetuses without heart lesions and 7.5  $\mu\text{mol/kg}$  selenium in the fetuses from the abattoir.<sup>19</sup> This suggests that selenium deficiency in bovine fetuses may cause myocardial necrosis and heart failure.

Normal levels of selenium in liver and kidney tissue of bovine fetuses derived from the abattoir were  $7.5 \pm 5.2 \mu\text{mol/kg}$  and  $4.4 \pm 1.1 \mu\text{mol/kg}$ , respectively.

In pigs, NMD has been produced experimentally on vitamin E- and selenium-deficient rations but is usually only a part of the more serious complex of mulberry heart disease and hepatitis dietetica.

### Vitamin E-Selenium Deficiency

#### (VESD) syndrome

**Mulberry heart disease, hepatitis dietetica, exudative diathesis and nutritional myopathy**, also known as the **VESD syndrome** (vitamin E and selenium deficiency) occur in pigs, usually as serious diseases. Nutritional muscular dystrophy may also occur in pigs. The occurrence of edema in various tissues has also been suggested as a possibility of Se or vitamin E deficiency. Impaired spermatogenesis and increased susceptibility to the effects of swine dysentery have also been suggested as responses to reduced levels of these two substances. There is a suspicion that the problems have become more common as the pig grows more quickly, the requirements have increased and the demands for anti-oxidants is increased at the same time that the provision of fat soluble vitamins is increasingly difficult. In addition, there is very small difference between the therapeutic and toxic levels of Se and Se toxicosis has occurred in an attempt to prevent Se deficiency. A more recent complication is the realization that we have been using inorganic Se to provide Se in the diet but that in the plant most of the Se is organic in the form of L-selenomethionine, a Se analogue of the amino acid methionine.<sup>20</sup> In the pig as in other species they are believed to serve as antagonists to toxic free radicals and act in concert with other substances such as Vitamin C. Little is known about their metabolism in the pig. In the pig, there is very little transfer of fat soluble products across the placenta so there is very little reserve of vitamin E in the new born pig. Immediately after birth, the young pig gets its vitamin E from the colostrum and milk of the sow. If the sow has low body stores or is fed a ration low in vitamin E then the piglet will be very low in vitamin E when it is weaned. Each can substitute for the other in a limited way in the pig. In the pig the diet has the most influence. Diets rich in polyunsaturated fatty acids, copper, Vitamin A or mycotoxins may reduce the availability of vitamin E. As dietary vitamin A levels increase, serum and liver  $\alpha$ -tocopherol concentrations decline, suggesting a reduced absorption and retention of  $\alpha$ -tocopherol when weaned pigs were fed high dietary vitamin A levels.<sup>21</sup> Se antagonists or crops from

inherently low soil Se fields may also make the situation worse. In pigs, NMD has been produced experimentally on vitamin E- and Se-deficient rations but is usually only a part of the more serious complex of mulberry heart disease and hepatitis dietetica. Microangiopathy is most common in weaned pigs<sup>22</sup> and may be particularly related to vitamin E deficiency.<sup>23</sup>

There is conflicting evidence on the effect of the anti-oxidative vitamins C and E on the reproductive performance of sows. In some studies,<sup>24,25</sup> increasing dietary vitamin E in the diet during gestation may have increased the litter size and reduced the pre-weaning piglet mortality. A similar response has been seen following intramuscular injection of sows with vitamin E and Se<sup>26,27</sup> but the injection of vitamin C has produced no improvement.<sup>28,29</sup> A recent study<sup>30</sup> has confirmed that there was no effect on reproductive performance of sows and growth performance of piglets when supplemented by both vitamin E and C. Vitamin E and Se given to immature gilts for flushing purposes led to the formation of fewer but larger *corpora lutea* after ovulation, probably due to the progression of a smaller number of follicles to the ovulatory stage.<sup>31</sup> Vitamin E and the Se increased the development of the uterus but did not influence the number of piglets at farrowing.

VESD occurs naturally in rapidly growing pigs, usually during the post-weaning period (3 weeks to 4 months), particularly during the early finishing period. The lowest concentration of vitamin E in piglets was day 45 after farrowing<sup>32</sup> but it may be that the Se status of the newborn piglets may be more important for their health than their vitamin E status. The first 3–4 weeks following the move to the finishing house is the most dangerous period for a low vitamin E level<sup>33</sup> and it is important to remember that there is considerable individual variation. Serum vitamin E declines after weaning and even with vitamin E supplementation it takes 2–3 days for levels to rise.<sup>34,35</sup> There appears to be a temporary decreased absorption of the vitamin in the immediate post-weaning period and this in turn leads to the reduction of the stored vitamin E reserves. It is usually associated with diets deficient in both Se and vitamin E and those that may contain a high concentration of unsaturated fatty acids. Such diets include those containing mixtures of soybean, high-moisture corn and the cereal grains grown on soils with low levels of Se. The feeding of a basal ration of cull peas, low in Se and vitamin E, to growing pigs can cause the typical syndrome and low tissue levels of Se are present in pigs with spontaneously occurring hepatitis dietetica. It

has been shown that feeding diets that contain linseed oil unfortunately reduced the vitamin E levels in the diet but increased the skatole levels.<sup>36</sup> However, there are reports of naturally occurring mulberry heart disease of pigs in Scandinavia in which the tissue levels of Se and vitamin E are within normal ranges compared with normal pigs.<sup>37</sup> In Ireland, in spite of supplementation of pig rations with vitamin E and Se at levels higher than that necessary to prevent experimental disease, spontaneous mulberry heart disease may still occur.<sup>23</sup> Affected pigs have lower tissue vitamin E levels than control pigs, which suggests an alteration in  $\alpha$ -tocopherol metabolism unrelated to dietary Se and PUFA contents.

Natural occurrence of the disease complex in pigs is not uncommonly associated with diets containing 50% coconut meal, fish-liver oil emulsion, fish scraps with a high content of unsaturated fatty acids, or flaxseed, which produces yellow and brown discoloration of fat preventable by the incorporation of adequate amounts of  $\alpha$ -tocopherol or a suitable antioxidant. The quality of the dietary fat does not necessarily influence blood vitamin E levels, but the presence of oxidized fat reduces the resistance of the red blood cells against peroxidation. The higher requirement for vitamin E by pigs fed oxidized fat may be due to the low vitamin E content in such fat. It has recently been shown<sup>38</sup> that the inclusion of 0.3 ppm Se to the diet of post-weaning piglets resulted in better performance than non-Se supplemented diets irrespective of the level of vitamin E in the ration (up to 200 ppm).

#### Mulberry heart disease

This is the most common form of Se and vitamin E deficiency of pigs. It occurs most commonly in rapidly growing feeder pigs (60–90 kg) in excellent condition being fed on a high-energy diet low in vitamin E and Se. The true causal mechanism is not known but it can be prevented by supplementation with vitamin E. It can also occur when it would appear that the level in the diet and in the serum or tissues appear to be satisfactory. The diets most commonly incriminated are soybean, corn, and barley. Mean liver concentrations of vitamin E were lower in pigs with MHD than in pigs that died of causes other than MHD.<sup>39</sup> The  $\alpha$ -tocopherol content of corn is usually low and it is virtually absent from solvent-extracted soybean meal. Both are low in Se. The use of high-moisture corn may further exacerbate the tocopherol deficiency. The level of PUFAs in the diet was thought to be an important etiological factor but this is now not considered to be a

necessary prerequisite. Outbreaks of the disease may occur in which 25% of susceptible pigs are affected and the case mortality rate is about 90%. The disease has occurred in young piglets and in adult sows.

#### Hepatositis dietetica

Hepatositis dietetica appears to be less common than mulberry heart disease but the epidemiological characteristics are similar. It appears to be less common since the Se levels in supplements were raised to 0.3 ppm. It affects young growing pigs up to 3–4 months of age. NMD in pigs usually occurs in cases of mulberry heart disease and hepatosis dietetica but it has occurred alone in gilts.

#### Selenium-responsive disorders

A variety of diseases have been known as selenium-responsive disorders<sup>3,40</sup> because they respond beneficially to the strategic administration of selenium. These include: **ill-thrift** in lambs and calves on pasture; **lowered milk production** in cows; **white muscle disease** in lambs, calves, and kids; **lowered fertility** and **embryonic death** in sheep and cattle; **retained fetal membranes, metritis, poor uterine involution**, and **cystic ovaries** in cows; subclinical **mastitis** and **impaired immune function** in cattle; and **pre-maturity, perinatal death**, and **abortion** in cattle.<sup>3</sup> Of these, only ill-thrift, lowered fertility, lowered milk production, and white muscle disease have been reported in New Zealand.<sup>3</sup> The literature on the roles of selenium deficiency in grazing ruminants in New Zealand and a rational approach to diagnosis and prevention has been reviewed.<sup>3</sup>

The pathogenesis of these selenium-responsive diseases is not well understood but it would appear that the selenium deficiency is only marginal. Most investigations into selenium-responsive diseases have occurred in selenium-deficient areas in which diseases such as NMD of calves and lambs occur. The evidence that selenium deficiency in breeding ewes can result in a decline in reproductive performance has not been substantiated experimentally. Reproductive performance was not affected in ewes on a selenium-depleted diet.

Selenium-responsive unthriftiness in sheep has received considerable attention in New Zealand where the response to selenium administration has been most dramatic compared with Australia where the syndrome has also been recognized but where the response is much smaller. The oral administration of selenium to lambs in these areas results in greater body weight gains from weaning to 1 year of age compared with lambs not receiving selenium supplementation. The mean fleece weight of selenium-treated lambs is also greater.

The diagnosis of selenium-responsive unthriftiness depends on analyses of the soil, pasture and animal tissues for selenium and response trials to selenium supplementation. A deficiency state might be encountered when the selenium content of the soil is below 0.45 mg/kg, the pasture content below 0.02 mg/kg DM, the liver content below 21 µg/kg (0.27 µmol/kg) (WW), and wool concentrations below 50–60 µg/kg (0.63–0.76 µmol/kg). For the blood in selenium-responsive unthriftiness of sheep the following criteria are suggested:

- Mean blood selenium status (µg/dL)
- Deficient = 1.0
- Doubtful 1.1–1.9
- Normal ~2.0.

The GSH-PX activity is a good index of the selenium status of sheep with a selenium-responsive disease. If measured on a regular basis, it can provide an indication of the selenium status of grazing sheep in individual flocks. Single measurements of GSH-PX activity may fail to detect recent changes in grazing area, differences in pasture species and pasture composition and alterations in the physiological state of the animals.

#### Subclinical selenium insufficiency

Subclinical insufficiencies of selenium in grazing ruminants are widespread over large areas of southern Australia.<sup>1</sup> The plasma concentrations of affected sheep flocks are low, there are no obvious clinical signs of insufficiency in the ewes and there are significant responses in wool production and fiber diameter to selenium supplementation. The incidence of estrus and fertility is not affected by selenium supplementation. Live weights at birth, in mid-lactation, and at weaning were increased in lambs born to selenium-supplemented and crossbred ewes and in lambs born as singletons. Clean fleece weight at 10 months of age was increased by 9.5% and fiber diameter by 0.3 µm in lambs born to ewes that had received supplementary selenium. Differences in fleece weight and live weight were not detected at 22 months, suggesting that subclinical selenium insufficiency in early life did not permanently impair productivity if selenium status subsequently increased.

Temporal variations in glutathione peroxidase activity in sheep can be used to identify seasons of the year with the highest risk of selenium deficiency.<sup>41</sup> In the Mediterranean area, lambs born in the spring/summer are at higher risk to selenium-deficiency related diseases.<sup>41</sup> Lambs born in autumn/winter are from ewes gestating during the summer, when supplementation with cereal grains is provided.

Selenium is a component of type-I iodothyronine deiodinase, which catalyzes the extrathyroidal conversion of thyroxine (T4) to the more active tri-iodothyronine (T3). Sheep grazing pastures low in selenium frequently have higher circulating T4 and lower circulating T3 concentrations than sheep receiving selenium supplementations.

When ewes grazing pastures low in selenium were supplemented thiocyanate (to cause iodine insufficiency), iodide and selenium, there was no evidence of clinical deficiencies. Growth rates of lambs were not affected by thiocyanate of their dams during mid-pregnancy, but plasma T3 and T4 concentrations were depressed in ewes receiving thiocyanate. The iodide supplementation increased thyroid hormone concentrations in ewes, but depressed plasma T3 concentrations in lambs. Supplementation of sheep grazing pastures low in selenium with both selenium and thyroid hormones improved wool characteristics, live weight gain, and blood selenium, but there was no evidence of an interaction between the selenium and the hormones. Thus, it seems unlikely that the decline in the quantity of T3 produced, or of T4 utilized for T3 production, in selenium-deficient sheep is responsible for the observed differences in the productivity of selenium-deficient and supplemented sheep. The thyroids have a major role in regulating thermogenesis and lambs born to ewes supplemented with iodide tend to have higher rectal temperatures during cold stress. The thermoregulatory ability of the perinatal lamb is not adversely affected by subclinical selenium deficiency.

In a survey of the status of vitamin E and selenium of the livers of cull ewes and market lambs raised in Ontario, selenium was present at marginal levels in 3.3% of cull ewe samples and in 43% of market lamb samples.<sup>16</sup> Vitamin E was low to deficient in 10% of cull ewe samples and in 90% of market lamb samples. In cull ewes, there was a strong relationship between selenium and vitamin E. A large percentage of samples with marginal selenium values had adequate vitamin E, which may indicate that the sheep had access to high levels of vitamin E but received inadequate levels of supplement containing selenium.

An evaluation of the trace mineral status of beef cows in Ontario found that 96% of cull cows were deficient in blood selenium.<sup>42,43</sup> Based on analysis of serum samples from cattle in Iowa and Wisconsin, subclinical selenium deficiency is common in the cattle population.<sup>44</sup> The serum levels may be adequate for reproductive performance but marginal for optimal resistance to mastitis or for adequate transfer of selenium to the calf.

## Reproductive performance

The published information on the effects of vitamin E and selenium deficiency or of dietary supplementation with one or the other or both on reproductive performance in farm animals are conflicting and controversial. Reproductive performance is complex and dependent on the interaction of many factors. Reproductive inefficiency is likewise complex and it is difficult to isolate one factor like a deficiency of vitamin E or selenium as a cause of reproductive inefficiency. Conversely, it is difficult to prove that supplementation with these nutrients will ensure optimum reproductive performance.<sup>45</sup>

### Sheep

The evidence about the effect of selenium and vitamin E deficiency on reproductive performance in sheep is conflicting. Observations in the 1960s concluded that selenium deficiency caused embryonic deaths 20–30 days after fertilization in ewes. But supplementation of ewes, low or marginal in selenium status, with selenium did not improve reproductive performance. Experimental studies using selenium-deficient diets in ewes have been unable to find any adverse effects of selenium depletion on ewe conception rates, embryonic mortality, or numbers of lambs born. The parenteral administration of selenium to pregnant ewes between 15 and 35 days after mating resulted in a reduced embryonic survival rate and is not recommended during the first month of pregnancy.<sup>46</sup>

### Cattle

Vitamin E supplementation can have significant effects on the health and some aspects of fertility in lactating dairy cows.<sup>17</sup> When used at four times the current recommendations. Vitamin E supplementation of dairy has its most beneficial effect of reducing the incidence of mastitis when used at rates of at least 1000 IU per day during the dry period and early lactation. The primary effect of vitamin E supplementation is on the immune system. The importance of selenium and vitamin E for the maintenance of optimum reproductive performance is not clear.<sup>47</sup> The IM injection of dairy cattle with selenium and vitamin E 3 weeks prepartum did not have any effect on average days to first estrus or first service, average days to conception, services per conception, or number of uterine infusions required. The prepartum IM injection of vitamin E and selenium 3 weeks prepartum increased the percentage of cows pregnant to first service, reduced the number of services per conception, decreased the incidence of retained placenta and reduced the interval from calving to conception. In a randomized field trial in a large dairy herd in the USA,

oral supplementation of pregnant first-calf dairy heifers with selenium using a commercially available sustained-release intra-ruminal selenium bolus, increased blood selenium concentrations in treated animals at 30 days after treatment until after calving.<sup>48</sup> However, based on data analyzed mid-lactation and late lactation, there were no differences between treated and control groups in somatic cell count, days not pregnant, total milk production, or times bred. The use of an intra-ruminal pellet of selenium at two different levels in dairy herds in New Zealand was evaluated in yearling heifers.<sup>49</sup> The recommended dose was effective in elevating whole blood GSH-PX activity and selenium concentrations to over 10 times those of control animals. Milk production was increased and there was a trend to decreased somatic cell counts. There were no differences in calving-first-service or calving-conception intervals, or in the percentage of animals pregnant to first or all services. In other observations, following the treatment of dairy cows with oral selenium pellets there was an improvement in first service conception rate and significantly higher blood levels of GSH-PX. The inconsistent results obtained following the use of selenium and vitamin E in pregnant cows may be related to the selenium status of the animals; in some herds the blood levels are marginal and in others the levels are within the normal range.

Winter-fed lactating Norwegian dairy cows were found to have an adequate plasma levels of vitamin E and marginal-to-adequate levels of blood selenium. Silage was the most important source of vitamin E and selenium-supplemented commercial concentrates the most important source of selenium. No significant differences in vitamin E or selenium status was found between cows with or without recorded treatments of mastitis, parturient paresis, or reproductive abnormalities.<sup>50</sup>

### Retained fetal placenta

A high incidence (more than 10%) of retained fetal membranes has been associated with marginal levels of plasma selenium compared with herds without a problem. In some cases, the incidence could be reduced to below 10% by the injection of pregnant cattle with selenium and vitamin E about 3 weeks prepartum, while in other studies similar prepartum injections neither reduced the incidence nor improved reproductive performance. A single injection of selenium 3 weeks prepartum can reduce the number of days postpartum required for the uterus to reach minimum size and to reduce the incidence of metritis and cystic ovaries during the early postpartum period. The parenteral administration of a single

injection of 3000 mg vitamin E prepartum to dairy cows of all ages decreased the incidence of retained placenta and metritis to 6.4% and 3.9%, respectively, in the treated group, compared with 12.5% and 8.8%, in the control group.<sup>51</sup> The injection, 20 days pre-partum, of 50 mg of selenium and 680 IU of vitamin E reduced the incidence of retained fetal membranes in one series, but did not in another series. The plasma selenium concentration at parturition ranged from 0.02 to 0.05 ppm in control cows in which there was an incidence of 51% retained membranes and from 0.08 to 0.1 ppm in treated cows in which the incidence was reduced to 9%. A dietary level of 0.1 mg/kg DM selenium is recommended to minimize the incidence of the problem. The complex nature of the etiology of retained fetal membranes also requires a well-designed experimental trial to account for all of the possible factors involved.

## Resistance to infectious disease

Many studies have examined the role of selenium and vitamin E resistance to infectious disease. Most of the evidence is based on in vitro studies of the effects of deficiencies of selenium or vitamin E or supplementation with the nutrients on leukocyte responses to mitogens, or on the antibody responses of animals to a variety of pathogens. The status of selenium and vitamin E in an animal can alter antibody response, phagocytic function, lymphocyte response and resistance to infectious disease. The administration of vitamin E and selenium during the dry period can influence mammary gland health and milk cell counts in dairy ewes.<sup>52</sup> In general, a deficiency of selenium results in immunosuppression and supplementation with low doses of selenium augments immunological functions. A deficiency of selenium has been shown to inhibit:

- Resistance to microbial and viral infections
- Neutrophil function
- Antibody production
- Proliferation of T and B lymphocytes in response to mitogens
- Cytodestruction of T lymphocytes and natural killer lymphocytes<sup>53</sup>

Vitamin E and selenium have interactive effects on lymphocyte responses to experimental antigens.<sup>54</sup>

Vitamin E supplementation of transport-stressed feedlot cattle is associated with reduced serum acute-phase protein concentrations compared with control animals.<sup>55</sup> Supplementation of the diet of cattle arriving in the feedlot with vitamin E had beneficial effects on humoral immune response and recovery from respiratory disease.<sup>56</sup>



The parenteral administration of selenium and vitamin E during pregnancy in dairy cows has a positive effect on the increase of selenium and vitamin E concentrations in blood, increase of selenium and immunoglobulins concentrations in colostrum and an increase of T3 concentration in blood on the day of parturition.<sup>57</sup> In addition, there was a trend toward a decreased incidence of clinical mastitis.

#### Neutrophil function

Selenium deficiency can affect the function of polymorphonuclear neutrophils (PMNs), which are associated with physiological changes in GSH-PX levels. In calves on an experimental selenium-deficient diet, the oxygen consumption and the activities of GSH-PX are lower than normal in neutrophils. The feeding of 80–120 mg of selenium/kg of mineral mixture provided ad libitum is an effective method of increasing blood selenium in a group of cattle and optimizing the humoral antibody response experimentally. It is suggested that blood selenium levels over 100 µg/L are necessary to maintain optimum immunocompetence in growing beef cattle.<sup>58</sup> In selenium-deficient goats, the production of leukotriene B<sub>4</sub>, a product of neutrophil arachidonic acid lipoxygenation and a potent chemotactic and chemokinetic stimulus for neutrophils, is decreased, resulting in dysfunction of the neutrophils. A deficiency of selenium in pregnant sows impairs neutrophil function and vitamin E deficiency impairs function of both neutrophils and lymphocytes, which may result in increased susceptibility of their piglets to infectious diseases.<sup>59</sup> It is suggested that selenium supplementation be maintained at 0.3 mg/kg of the diet.

Neutrophils from postparturient dairy cows with higher levels of selenium have greater potential to kill microbes and cattle with greater superoxide production may have higher milk production.<sup>49</sup> Vitamin E is a fat-soluble membrane anti-oxidant which enhances the functional efficiency of neutrophils by protecting them from oxidative damage following intracellular killing of ingested bacteria. Peripartum immunosuppression in dairy cows is multifactorial but is associated with endocrine changes and decreased intake of critical nutrients. Decreased phagocytosis and intracellular killing by neutrophils occur in parallel with decreased dry matter intake and decreased circulating vitamin E. Since neutrophils are the primary mechanism of uterine defense and mammary health, the role of vitamin E on the health of dairy cows during the transition period have been examined. Compared with control cows given a placebo, the parenteral administration of vitamin E

1 week prepartum had no effect on the incidence of retained placenta, clinical mastitis, metritis, endometritis, ketosis, displaced abomasum or lameness.<sup>60</sup> However, there was a decreased incidence of retained placenta in cows with marginal pretreatment vitamin E status. An increase in  $\alpha$ -tocopherol of 1 µg/mL in the last week prepartum reduced the risk of retained placenta by 20%.<sup>61</sup> In addition, serum non-esterified fatty acid concentration  $\geq 0.5$  mEq/L tended to increase the risk of retained placenta by 80% and in the last week pre-partum, a 100 ng/mL increase in serum retinol was associated with a 60% decrease in the risk of early lactation clinical mastitis.<sup>61</sup>

#### Immune response

The effects of selenium deficiency and supplementation on the immune response of cattle to experimental infection with the infectious bovine rhino tracheitis virus and sheep to parainfluenza-3 virus, indicates that a deficiency can affect the humoral response and supplementation enhances the response. The administration of selenium either alone or in combination with vitamin E can improve the production of antibodies against *E. coli* in dairy cows.<sup>62</sup> Pigs fed a vitamin E- and selenium-deficient diet develop an impaired cell-mediated immunity as measured by lymphocyte response to mitogenic stimulations. Supplementation of the diets of young pigs with selenium at levels above those required for normal growth have increased the humoral response, but not in sows. The wide variations in antibody responses that occur in these experiments indicate that there is a complex relationship between the selenium status of the host, humoral immune responses and protective immunity. The concept of using selenium supplementation to enhance antibody responses in sheep to vaccines is probably unfounded. However, the administration of sodium selenite to sheep vaccinated against enzootic abortion (*Chlamydomphila abortus*) increased the antibody response but not when given with vitamin E.<sup>63</sup>

Vitamin E can stimulate the immune defense mechanisms in laboratory animals and cattle, experimentally. In most cases, the immunostimulatory effects of additional vitamin E are associated with supplementation in excess of levels required for normal growth. The parenteral administration to calves of 1400 mg of vitamin E weekly increases their serum vitamin E concentrations and lymphocyte stimulation indices. Similarly in growing pigs, a serum vitamin E concentration above 3 mg/L was necessary to achieve a significant response of the lymphocytes to stimulation with mitogens.

#### General resistance

These changes may render selenium-deficient animals more susceptible to infectious disease, but there is no available evidence to indicate that naturally occurring selenium and vitamin E deficiencies are associated with an increase in the incidence or severity of infectious diseases. Neutrophils from selenium-deficient animals lose some ability to phagocytose certain organisms, but how relevant this observation is in naturally occurring infections is unclear. Field studies of the incidence and occurrence of pneumonia in housed calves found that selenium status was not a risk factor.

#### *Transfer of selenium and vitamin E to the fetus, colostrum, and milk*

**Selenium.** In sheep, selenium is transferred across the placenta to the fetus and maternal selenium status during gestation is positively associated with fetal and newborn lamb selenium status.<sup>2</sup> Supplementation of gestating ewes with selenium will improve the selenium status of the lambs at birth. However, after birth the selenium of the lamb is depleted quickly by about 18 days after birth. Thus, continued intake of selenium by the lamb is necessary to maintain normal selenium status during the postnatal period. The colostrum of ewes contains higher levels of selenium than ewe milk. The selenium content of ewe's milk decreases rapidly after parturition, reaching a stable level by 1 week post partum. Supplementation of ewes during lactation results in higher milk selenium concentration and higher blood selenium in lambs. Supplementation of ewes has been shown to prevent nutritional myodegeneration in nursing lambs in selenium-deficient flocks.<sup>2</sup>

There is a highly significant relationship between blood selenium of cattle and milk selenium concentration.<sup>64</sup> As in sheep, in cattle, selenium is transferred across the placenta to the fetus and across the mammary barrier into the colostrum and milk.<sup>9</sup>

**Pigs.** The maternal intake of selenium affects fetal liver selenium and newborn piglets have lower liver selenium concentrations compared with their dams, regardless of selenium intake of sows during gestation.<sup>65</sup> Thus compared with cattle and sheep, the relatively high concentration of selenium needed in the diets of young rapidly growing piglets may be partially a function of limited placental transport or hepatic deposition of selenium and why the piglet is more susceptible to selenium deficiency than the sow.

**Vitamin E.** The transfer of vitamin E across the placenta to the fetus in sheep and cattle is limited.<sup>2</sup> Plasma levels of vitamin E in the fetus and in newborn lambs

(before ingestion of colostrum) are lower than in the ewe.<sup>2</sup> Vitamin E supplementation of the ewe in late gestation results in insignificant increases of the serum vitamin E in the lamb. However, supplementation of the ewe in the last month of pregnancy increases the vitamin E content of colostrum and milk.<sup>2</sup> Colostrum of the ewe is a rich source of vitamin E for the neonatal lamb, containing 5–11 times more vitamin E than milk at 1 week post partum. The parenteral administration of sodium selenite to ewes at lambing increases the vitamin E content of milk of ewes over the first 5 weeks of lactation, indicating a potential positive effect of selenium repletion on vitamin E transfer to milk.<sup>2</sup>

#### Neonatal morbidity and mortality

Based on some preliminary observations of the selenium content of hair samples of young calves, higher selenium levels in newborn calves may have some protective effect against morbidity due to neonatal disease. Similarly, neonatal piglets with high blood levels of GSH-PX activity may be more resistant to infectious diseases or other causes of neonatal mortality. Administration of vitamin E and selenium to dairy cows in late pregnancy resulted in the production of increased quantities of colostrum and the calves have increased quantities of GSH-PX at birth and 28 days of age, but the improved selenium status did not provide any improvement in passive immunity or growth.<sup>66</sup> Supplementing selenium to beef cows grazing selenium-deficient pastures with a salt mineral mix containing 120 mg selenium/kg of mix increased the selenium status of the cows and increased the serum IgG concentration, or enhanced transfer of IgG from serum to colostrum and increased the selenium status of the calves.<sup>67</sup> The parenteral administration of 0.1 mg Se and 1 mg of vitamin E/kg BW at mid-gestation did not affect the production of systemic or colostrum antibodies. Supplementation of dairy cows at dry-off with selenium at 3 mg/d as selenite via an intraruminal bolus resulted in sufficient transfer of selenium to meet a target concentration of more than 2.2 µg of selenium/g of liver DM in newborn calves.<sup>68</sup>

#### Mastitis in dairy cattle

There is some evidence that a dietary deficiency of vitamin E may be associated with an increased incidence of mastitis in dairy cattle.<sup>18</sup> An increased incidence of mastitis during the early stages of lactation coincides with the lowest plasma concentration of vitamin E. Supplementation of the diet of dairy cows beginning 4 weeks before and continuing for up to 8 weeks after parturition with vitamin E at 3000 IU/cow per day, combined with an injection of 5000 IU, 1 week before

parturition, prevented the suppression of blood neutrophil and macrophage function during the early postpartum period compared with controls. The vitamin E prevented the suppression of blood neutrophils during the postpartum period.<sup>69</sup> Cows in both the treated and control groups were fed diets containing selenium at 0.3 ppm of total dry matter. When selenium status in dairy cows is marginal, plasma concentrations of  $\alpha$ -tocopherol should be at least 3 µg/mL.<sup>70</sup> Cows receiving a dietary supplement of about 1000 IU/d of vitamin E had 30% less clinical mastitis than did cows receiving a supplement of 100 IU/d of vitamin E.<sup>70</sup> The reduction was 88% when cows were fed 4000 IU/d of vitamin E during the last 14 days of the dry period.<sup>70</sup>

The selenium status of dairy cows may also have an effect on the prevalence of mastitis and mammary gland health.<sup>57</sup> Dairy herds with low somatic cell counts had significantly higher mean blood GSH-PX and higher whole blood concentrations of selenium than in herds with high somatic cell counts. The prevalence of infection due to *Streptococcus agalactiae* and *Staphylococcus aureus* was higher in herds with the high somatic cell counts compared with those with the low somatic cell counts. This suggests that phagocytic function in the mammary gland may be decreased by a marginal selenium deficiency. In a survey of cattle in herds in Switzerland, those with chronic mastitis had lower serum levels of selenium than healthy control herds. Experimental coliform mastitis in cattle is much more severe in selenium-deficient animals than selenium-adequate animals. The severity was in part due to the increased concentrations of eicosanoids.

Milk neutrophils from cows fed a selenium-deficient diet have significantly reduced capacity to kill ingested *Escherichia coli* and *Staph. aureus*, compared with cells from cows fed a selenium-supplemented diet. However, other experimental results are not as convincing.

#### Blood abnormalities

In young cattle from areas where NMD is endemic and particularly at the end of winter housing, the erythrocytes have an increased susceptibility to hemolysis following exposure to hypotonic saline. During clinical and subclinical white muscle disease in calves, there is a significant increase in both the osmotic and the peroxidative hemolysis of the erythrocytes. This defect is thought to be the result of alterations in the integrity of cell membranes of which tocopherols are an essential component. Abnormalities of the bone marrow associated with vitamin E deficiency in sheep have been described

and abnormal hematological responses have been described in young growing pigs on an experimental selenium- and vitamin E-deficient diet. Vitamin E deficiency in sheep results in increased hemolytic susceptibility of erythrocytes, which may provide a basis for a single functional test for vitamin E deficiency in sheep.

Anemia characterized by a decreased packed cell volume, decreased hemoglobin concentration and Heinz body formation has been observed in cattle grazing on grass grown on peaty muck soils in the Florida everglades. Selenium supplementation corrected the anemia, prevented Heinz body formation, increased the body weight of cows and calves and elevated blood selenium.

#### Equine degenerative myeloencephalopathy

Equine degenerative myeloencephalopathy, which may have an inherited basis, has been associated with a vitamin E deficiency. The vitamin E status is low in some affected horses and supplementation with the vitamin was associated with a marked reduction in the incidence of the disease. However, serum vitamin E and blood GSH-PX activities determined in horses with histologically confirmed diagnosis of the disease compared with age-matched controls failed to reveal any differences and the findings did not support a possible role for vitamin E deficiency as a cause. Foals sired by a stallion with degenerative myeloencephalopathy and with neurological deficits consistent with the disease during their first year of life had lower plasma levels of  $\alpha$ -tocopherol when the levels were determined serially beginning at 6 weeks to 10 months of age than age-matched controls. Absorption tests with vitamin E revealed that the lower  $\alpha$ -tocopherol levels were not due to an absorption defect.

#### Equine motor neuron disease

This is a neurodegenerative disease of the somatic lower motor neurons resulting in a syndrome of diffuse neuromuscular disease in the adult horse.<sup>71</sup> Case-control studies found the mean plasma vitamin E concentrations in affected horses were lower than that of control horses. Adult horses are affected with the risk peaking at 16 years of age. In addition to the role of vitamin E depletion, other individual and farm-level factors, contribute to the risk of developing the disease.

#### Generalized steatitis

Steatitis in farm animals and other species may be associated with vitamin E and/or selenium deficiency. Most cases in horses have involved nursing or recently weaned foals. Generalized steatitis in the foal has

been described as either generalized cachexia due to steatitis alone, or as a primary myopathy or myositis with steatitis of secondary importance. The terms used have included steatitis, generalized steatitis, fat necrosis, yellow fat disease, polymyositis, and muscular dystrophy. The relationships between steatitis and vitamin E and selenium deficiency in the horse are not clear and there may be none. Many more clinical cases must be examined in detail before a cause-effect relationship can be considered.

### **PATHOGENESIS**

The literature on the antioxidant roles of selenium and vitamin E have been reviewed.<sup>2</sup> Dietary selenium, sulfur-containing amino acids and vitamin E act synergistically to protect tissues from oxidative damage.<sup>1,2</sup> GSH-PX, which is selenium-dependent, functions by detoxifying lipid peroxides and reducing them to non-toxic hydroxy fatty acids. Vitamin E prevents fatty acid hydroperoxide formation. High levels of PUFAs in the diet increase the requirements for vitamin E and, with an inadequate level of selenium in the diet, tissue oxidation occurs, resulting in degeneration and necrosis of cells. Vitamin E protects cellular membranes from lipoperoxidation, especially membranes rich in unsaturated lipids, such as mitochondrial, endoplasmic reticulum and plasma membranes. Thus, dietary PUFA are not a prerequisite for the disease. Diets low in selenium and/or vitamin E do not provide sufficient protection against the 'physiological' lipoperoxidation that occurs normally at the cellular level.

The relative importance of selenium, vitamin E and sulfur-containing amino acids in providing protection in each of the known diseases caused by their deficiency is not clearly understood. Selenium has a sparing effect on vitamin E and is an efficient prophylactic against muscular dystrophy of calves and lambs at pasture, but does not prevent muscular dystrophy in calves fed on a diet containing cod liver oil. The current understanding of the biochemical function of selenium and its relation to vitamin E and the mechanisms of action of selenium and vitamin E in protection of biological membranes has been reviewed.<sup>72</sup>

### **Nutritional muscular dystrophy**

A simplified integrated concept of the pathogenesis of the NMD would be as follows. Diets deficient in selenium and/or vitamin E permit widespread tissue lipoperoxidation leading to hyaline degeneration and calcification of muscle fibers. One of the earliest changes in experimental selenium deficiency in lambs is the abnormal retention of calcium in muscle fibers undergoing dystrophy and selenium supplementen-

tion prevents the retention of calcium. Unaccustomed exercise can accelerate the oxidative process and precipitate clinical disease. Muscle degeneration allows the release of enzymes, such as lactate dehydrogenase, aldolase and creatine phosphokinase, the last of which is of paramount importance in diagnosis. Degeneration of skeletal muscle is rapidly and successively followed by invasion of phagocytes and regeneration. In myocardial muscle, replacement fibrosis is the rule.

In calves, lambs, and foals, the major muscles involved are skeletal, myocardial and diaphragmatic. The myocardial and diaphragmatic forms of the disease occur most commonly in young calves, lambs, and foals, resulting in acute heart failure, respiratory distress, and rapid death, often in spite of treatment. The skeletal form of the disease occurs more commonly in older calves, yearling cattle, and older foals and results in weakness and recumbency, is usually less severe and responds to treatment. The biceps femoris muscle is particularly susceptible in calves and muscle biopsy is a reliable diagnostic aid.

In foals with NMD, there is a higher proportion of type IIC fibers and a lower proportion of type I and IIA fibers than in healthy foals. The type IIC fibers are found in fetal muscle and are undifferentiated and still under development. During the recovery period, fibers of types I, IIA, and IIB increase and the proportion of type IIC fibers decreases. A normal fiber type composition is present in most surviving foals 1–2 months after the onset of the disease.

Acute NMD results in the liberation of myoglobin into the blood, which results in myoglobinuria. This is more common in horses, older calves, and yearling cattle, than in young calves whose muscles have a lower concentration of myoglobin. Hence, the tendency to myoglobinuria will vary depending on the species and age of animal involved.

### **Subclinical selenium insufficiency**

Selenium deficiency affects thyroid hormone metabolism and may explain the cause of ill-thrift. The conversion of the iodine-containing hormone, thyroxine (T4) to the more potent triiodothyronine (T3) is impaired in animals with low selenium status and iodothyroninedeiodinase is a selenoprotein which mediates this conversion.<sup>72</sup>

### **VESD syndrome and others**

The pathogenesis of mulberry heart disease, hepatosis dietetica, exudative diathesis, and muscular dystrophy of pigs is not yet clear. Vitamin E and Se are necessary to prevent widespread degeneration and necrosis of tissues, especially liver, heart, skeletal muscle, and blood vessels. Se

and vitamin E deficiency in pigs results in massive hepatic necrosis (hepatosis dietetica), degenerative myopathy of cardiac and skeletal muscles, edema, microangiopathy, and yellowish discoloration of adipose tissue. Myocardial and hepatic calcium concentrations are increased in pigs with mulberry heart disease.<sup>73,74</sup> In addition, there may be esophagogastric ulceration, but it is uncertain whether or not this lesion is caused by a Se and/or vitamin E deficiency. Anemia has also occurred and has been attributed to a block in bone marrow maturation, resulting in inadequate erythropoiesis, hemolysis or both. However, there is no firm evidence that anemia is a feature of Se and vitamin E deficiency in pigs. The entire spectrum of lesions has been reproduced experimentally in pigs with natural or purified diets deficient in Se and vitamin E, or in which an antagonist was added to inactivate vitamin E or Se. However, in some studies, the Se content of tissues of pigs that died from mulberry heart disease was similar to that of control pigs without the disease.

The extensive tissue destruction in pigs may account for the sudden death nature of the complex (mulberry heart disease and hepatosis dietetica) and the muscle stiffness that occurs in some feeder pigs and sows of farrowing time with muscular dystrophy. The tissue degeneration is associated with marked increases in serum enzymes related to the tissue involved. An indirect correlation between vitamin E intake and peroxide hemolysis in pigs on a deficient diet suggests that lipoperoxidation is the ultimate biochemical defect in pigs and that vitamin E and Se are protective.

### **CLINICAL FINDINGS**

#### **Acute enzootic muscular dystrophy**

Affected animals may collapse and die suddenly after exercise without any other premonitory signs. The excitement associated with the hand-feeding of dairy calves may precipitate peracute death. In calves under close observation, a sudden onset of dullness and severe respiratory distress, accompanied by a frothy or blood-stained nasal discharge, may be observed in some cases. Affected calves, lambs, and foals are usually in lateral recumbency and may be unable to assume sternal recumbency even when assisted. When picked up and assisted to stand, they feel and appear limp. However, their neurological reflexes are normal. Their eyesight and mental attitude are normal and they are usually thirsty and can swallow unless the tongue is affected. The heart rate is usually increased up to 150–200/min and often with arrhythmia, the respiratory rate is increased up to 60–72/min and loud breath sounds are audible over the entire

lung fields. The temperature is usually normal or slightly elevated. Affected animals commonly die 6–12 h after the onset of signs in spite of therapy. Outbreaks of the disease occur in calves and lambs in which up to 15% of susceptible animals may develop the acute form and the case fatality approaches 100%.

### Subacute enzootic muscular dystrophy

This is the most common form in rapidly growing calves, 'white muscle disease' and in young lambs, 'stiff-lamb disease'. Affected animals may be found in sternal recumbency and unable to stand but some make an attempt to stand. If they are standing, the obvious signs are stiffness, trembling of the limbs, weakness and, in most cases, an inability to stand for more than a few minutes. The gait in calves is accompanied by rotating movements of the hocks and in lambs a stiff, goose-stepping gait. Muscle tremor is evident if the animal is forced to stand for more than a few minutes. On palpation the dorsolumbar, gluteal and shoulder muscle masses may be symmetrically enlarged and firmer than normal (although this may be difficult to detect). Most affected animals retain their appetite and will suck if held up to the dam or eat if hand-fed. Major involvement of the diaphragm and intercostal muscles causes dyspnea with labored and abdominal-type respiration. The temperature is usually in the normal range but there may be a transient fever (41°C, 105°F) due to the effects of myoglobinemia and pain. The heart rate may be elevated, but there are usually no rhythmic irregularities. Following treatment, affected animals usually respond in a few days and within 3–5 days they are able to stand and walk unassisted.

In some cases, the upper borders of the scapulae protrude above the vertebral column and are widely separated from the thorax. This has been called the 'flying scapula' and has occurred in outbreaks in heifers from 18 to 24 months of age within a few days after being turned out in the spring following loose-housing throughout the winter. The abnormality is due to bilateral rupture of the serratus ventralis muscles and has been reported in a red deer.<sup>75</sup> Occasionally, the toes are spread and there is relaxation of carpal and metacarpal joints or knuckling at the fetlocks and standing on tip-toe, inability to raise the head, difficulty in swallowing, inability to use the tongue and relaxation of abdominal muscles. Choking may occur when the animals attempt to drink. In 'paralytic myoglobinuria' of yearling cattle, there is usually a history of recent turning out on pasture following winter housing. Clinical signs occur within 1 week and consist of

stiffness, recumbency, myoglobinuria, hyperpnea, and dyspnea. Severe cases may die within a few days and some are found dead without premonitory signs. In rare cases, lethargy, anorexia, diarrhea and weakness are the first clinical abnormalities recognized, followed by recumbency and myoglobinuria.

**Congenital muscular dystrophy** has been described in a newborn calf.<sup>18</sup> The calf was still recumbent 13 h after birth, had increased serum creatine kinase and decreased serum vitamin E and selenium levels. Recovery occurred following supportive therapy and vitamin E and selenium.

**Subcapsular liver rupture in lambs** has been associated with vitamin E deficiency in lambs usually under 4 weeks of age.<sup>76</sup> Affected lambs collapse suddenly, become limp, and die within a few minutes or several hours after the onset of weakness.

In **foals, muscular dystrophy** occurs most commonly during the first few months of life and is common in the first week.<sup>6</sup> The usual clinical findings are failure to suck, recumbency, difficulty in rising and unsteadiness and trembling when forced to stand. The temperature is usually normal but commonly there is polypnea and tachycardia. The disease in foals may be characterized by an acute, fulminant syndrome, which is rapidly fatal, or a subacute syndrome characterized by profound muscular weakness. Failure of passive transfer, aspiration pneumonia, and stunting are frequent complications. In the subacute form, mortality rates may range from 30 to 45%.<sup>6</sup>

In **adult horses with muscular dystrophy**, a stiff gait, myoglobinuria, depression, inability to eat, holding the head down low, and edema of the head and neck are common. The horse may be presented initially with clinical signs of colic.

In **pigs, muscular dystrophy** is not commonly recognized clinically because it is part of the more serious disease complex of mulberry heart disease and hepatitis dietetica. However, in outbreaks of this complex, sucking piglets, feeder pigs and sows after farrowing, may exhibit an uncoordinated, staggering gait suggestive of muscular dystrophy.

**Subclinical nutritional muscular dystrophy** occurs in apparently normal animals in herds at the time clinical cases are present. The serum levels of creatine phosphokinase levels may be elevated in susceptible animals for several days before the onset of clinical signs; following treatment with vitamin E and selenium the level of serum enzymes returns to normal. Grossly abnormal electrocardiograms occur in some animals and may be detectable before clinical signs are evident.

Vitamin E selenium deficiency in pigs. Usually they occur separately but rarely MHD and HD occur together and even more rarely, you may find that there is NMD as well. There is a suspicion that the occurrence of two or more together has recently become more common but this in fact may be due to the greater awareness of both conditions. Two or more requires the supplementation with both Vitamin E and Se.

### Mulberry heart disease

Usually seen in pigs from a few weeks to 4 months of age. These pigs are nearly always the best of the group and it may be that this rate of growth increases the demand for vitamin E and Se.

In mulberry heart disease, affected animals are commonly found dead without premonitory signs. More than one pig may be found dead. When seen alive, animals show severe dyspnea, cyanosis and recumbency and forced walking can cause immediate death. In some outbreaks, about 25% of pigs will show a slight inappetence and inactivity, these are probably in the subclinical stages of the disease. The stress of movement, inclement weather, or transportation will precipitate further acute deaths. The temperature is usually normal, the heart rate rapid and irregularities may be detectable. The feces are usually normal. A good 'classical outbreak' has been described.<sup>77</sup>

### Hepatitis dietetica

In hepatitis dietetica, most pigs are found dead. Very few cases show other signs. In occasional cases, before death there will be dyspnea, severe depression, vomiting, staggering, diarrhea and a state of collapse. Some pigs are icteric. Outbreaks also occur similar to the pattern in mulberry heart disease. Muscular dystrophy is almost a consistent necropsy finding in both mulberry heart disease and hepatitis dietetica but is usually not recognized clinically because of the seriousness of the two latter diseases. Clinical muscular dystrophy has been described in gilts at 11 months of age. About 48 h after farrowing, there was muscular weakness, muscular tremors, and shaking. This was followed by collapse, dyspnea, and cyanosis. There were no liver or heart lesions. In experimental Se and vitamin E deficiency in young growing pigs, a subtle stiffness occurs along with a significant increase in the creatinine phosphatase (CPK) and serum glutamic-oxaloacetic transaminase (SGOT) values.

## CLINICAL PATHOLOGY

### Myopathy

Plasma creatine kinase (CK)

This is the most commonly used laboratory aid in the diagnosis of NMD. The enzyme is highly specific for cardiac and skeletal

muscle and is released into the blood following unaccustomed exercise and myodegeneration. In cattle and sheep, its half-life is 2–4 h and plasma levels characteristically decline quickly unless there is continued myodegeneration, but remain a good guide to the previous occurrence of muscle damage for a period of about 3 days. The normal plasma levels of CK (IU/L) are: sheep  $52 \pm 10$ ; cattle  $26 \pm 5$ ; horses  $58 \pm 6$ ; and pigs  $226 \pm 43$ . In cattle and sheep with NMD, the CK levels will be increased usually above 1000 IU/L, commonly increased to 5000–10 000 IU/L and not uncommonly even higher. Following turnout of housed cattle onto pasture the CK levels will increase up to 5000 IU/L within a few days. The CK levels will usually return to normal levels within a few days following successful treatment. Persistent high levels suggest that muscle degeneration is still progressive or has occurred within the last 2 days. Measurement of plasma CK activity could be used to monitor recovery of animals treated for nutritional myopathy.

Aspartate aminotransferase

**Aspartate aminotransferase (AST) activity** is also an indicator of muscle damage, but is not as reliable as the CK because increased AST levels may also indicate liver damage. The AST activity remains elevated for 3–10 days because of a much longer half-life than CK. In acute cases, levels of 300–900 IU/L in calves and 2000–3000 IU/L in lambs have been observed. In normal animals of these species, serum levels are usually less than 100 IU/L.

The magnitude of the increase in AST and CK is directly proportional to the extent of muscle damage. Both are elevated initially; an elevated AST and declining CK would suggest that muscle degeneration is no longer active. The levels of both enzymes will be increased slightly in animals that have just been turned out and subjected to unaccustomed exercise, horses in training and in animals with ischemic necrosis of muscle due to recumbency caused by diseases other than muscular dystrophy. However, in acute muscular dystrophy, the levels are usually markedly elevated.

### Selenium status

Although information on the critical levels of selenium in soil and plants is accumulating gradually, the estimations are difficult and expensive. Most field diagnoses are made on the basis of clinicopathological findings, the response to treatment and control procedures using selenium. The existence of NMD is accepted as presumptive evidence of selenium deficiency, which can now be confirmed by analyses of GSH-PX and the concentrations of

selenium in soil, feed samples, and animal tissues. Tentative critical levels of the element are as follows:

- **Forages and grains:** A content of 0.1 mg/kg DM is considered adequate
- **Soil:** Soils containing less than 0.5 mg/kg are likely to yield crops inadequate in selenium concentration<sup>5</sup>
- **Animal tissues, blood and milk:** The concentration of selenium in various tissues are reliable indicators of the selenium status of the animal. There is a positive correlation between the selenium content of feed and the selenium content of the tissues and blood of animals ingesting that feed and the values fluctuate with the dietary intake of the element.<sup>5</sup>

Three tests can be used to assess selenium status in cattle and sheep: serum and whole blood selenium and glutathione peroxidase activity.<sup>78</sup> Serum selenium responds more rapidly to the administration of selenium than whole blood selenium. There is a similar delay in glutathione peroxidase activity to selenium supplementation. Blood or serum selenium status is most consistently measured at the herd-level. Interlaboratory differences in thresholds for deficiency exist and results should be considered based on laboratory-specific guidelines.

The recommended blood selenium reference ranges for New Zealand livestock have been used in several publications (see Table 30.7).<sup>40,79,80</sup>

Reference ranges for selenium and vitamin E in serum, blood, and liver of sheep and goat in the USA are available.<sup>2</sup>

### Selenium status in horses

In New Zealand, the reference ranges for blood used for selenium status in horses are: adequate  $>1600$  nmol/L (128 ng/mL); marginal 450–1600 nmol/L (36–128 ng/mL); and deficient  $<450$  nmol/L (36 ng/mL).<sup>81</sup>

### Kidney cortex and liver

Normal liver selenium concentrations range from 1.2 to 2.0  $\mu\text{g/g}$  DM, regardless of species or age.<sup>82</sup> Levels of 3.5–5.3  $\mu\text{g/g}$  (44–67 nmol/g) DM in the kidney cortex and 0.90–1.75  $\mu\text{g/g}$  (11–22 nmol/g) DM in the liver of cattle are indicative of adequate selenium. Levels of 0.6–1.4  $\mu\text{g/g}$  (8–18 nmol/g) in the kidney cortex and 0.07–0.60  $\mu\text{g/g}$  (0.9–8 nmol/g) in the liver represent a deficient state.

The selenium content of bovine fetal liver samples collected at an abattoir contained 0.77  $\mu\text{g/mL}$  WW and 0.13  $\mu\text{g/mL}$  WW, from dairy breeds and beef breeds of cattle, respectively.<sup>83</sup> Mean liver selenium levels from aborted bovine fetuses with myocardial lesions were 5.5  $\mu\text{mol/kg}$ , 6.5  $\mu\text{mol/kg}$  in fetuses without myocardial

lesions and 7.5  $\mu\text{mol/kg}$  in fetuses from the abattoir, which suggests that selenium deficiency may be the cause of abortion.<sup>84</sup>

### Blood and milk

Blood and milk levels of selenium are used as indicators of selenium status in cattle and the effect of dietary supplementation.<sup>85</sup> Serum selenium values increase gradually with age from starting ranges for neonates of 50–80 ng/mL for calves and sheep and 70–90 for foals and pigs.<sup>82</sup> Expected or normal values for adults are in the ranges of 70–100 for cattle, 120–150 for sheep, 130–160 for horses, and 180–220 for pigs.

Dams of affected calves have had levels of 1.7 ng/mL (22 nmol/L) (blood) and 4.9 ng/mL (62 nmol/L) (milk); their calves have blood levels of 5–8 ng/mL (63–102 nmol/L). Normal selenium-supplemented cows have 19–48 ng/mL (241–609 nmol/L) in blood and 10–20 ng/mL (127–253 nmol/L) in milk and their calves have blood levels of 33–61 ng/mL (419–774 nmol/L). Mean selenium concentrations in the blood of normal mares have been 26–27 ng/mL (329–342 nmol/L). In Thoroughbred horses, selenium concentrations in serum range from 39.5 to 118.5 ng/mL (40–160 ng/mL) (0.5–2.0  $\mu\text{mol/L}$ ) and there are significant differences between various stables of horses.

### Bulk tank milk

The bulk tank milk selenium levels are closely related to the mean herd blood and milk levels and have the potential to be a low-cost, non-invasive means of evaluating herd selenium levels in order to determine selenium deficiency in the dairy herd.<sup>64,86</sup> Bulk tank selenium concentrations are an accurate reflection of the herd selenium status over the range of selenium intakes typical of dairy herds in an area.

### Glutathione peroxidase

There is a direct relationship between the GSH-PX activity of the blood and the selenium levels of the blood and tissues of cattle, sheep, horses, and pigs.<sup>1</sup> The normal selenium status of cattle is represented by whole blood selenium concentration of 100 ng/mL (1270 nmol/L) and blood GSH-PX activity of approximately 30 mU/mg hemoglobin.

There is a high positive relationship ( $r = 0.87-0.958$ ) between blood GSH-PX activity and blood selenium concentrations in cattle. Blood selenium levels less than 50 ng/mL are considered as selenium-deficient, while levels between 50 and 100 ng/mL (126.6 nmol/L) are marginal and greater than 100 ng/mL are adequate.<sup>1</sup> Comparable whole blood levels of GSH-PX are deficient if less than 30 mU/mg

hemoglobin, marginal if 30–60 mU/mg and adequate if greater than 60 mU/mg hemoglobin.<sup>1</sup> There is some evidence of variation in GSH-PX activities between breeds of sheep; levels may also decrease with increasing age. Low levels in some breeds of sheep may also be a reflection of adaptation to low selenium intake because of low levels of selenium in the soil and forages.

The GSH-PX activity is a sensitive indicator of the level of dietary selenium intake and the response to the oral or parenteral administration of selenium.<sup>5</sup> Because selenium is incorporated into erythrocyte GSH-PX only during erythropoiesis, an increase in enzyme activity of the blood will not occur for 4–6 weeks following administration of selenium. Plasma GSH-PX will rise more quickly and will continue to increase curvilinearly with increasing dietary selenium levels because it is not dependent on incorporation of the selenium into the erythrocytes. The liver and selenium concentration and serum GSH-PX activity may respond to changes in dietary selenium more rapidly than either whole blood selenium or erythrocyte GSH-PX activity. The response in GSH-PX activity may depend upon the selenium status of the animals at the time when selenium is administered. Larger increases in the enzyme activity occur in selenium-deficient animals. The GSH-PX activity in foals reflects the amount of selenium given to the mare during pregnancy.

The sandwich ELISA is a simplified method for the estimation of GSH-PX activity and selenium concentration in bovine blood and can be used for rapid screening of the selenium status of a large number of cattle.<sup>87</sup> The GSH-PX activity of whole blood samples has been used to assess the selenium status of cattle in the Czech Republic.<sup>88</sup>

The GSH-PX activity can be determined rapidly using a spot test which is semi-quantitative and can place a group of samples from the same herd or flock into one of three blood selenium categories: defi-

cient, low marginal and marginal adequate.<sup>89</sup> A commercial testing kit known as the Ransel Kit is now available. Because of the instability of GSH-PX plasma, GSH-PX activity in sheep, cattle, and pigs should be measured in fresh plasma or stored at  $-20^{\circ}\text{C}$  ( $-4^{\circ}\text{F}$ ). For absolute measurements, it is suggested that pigs plasma GSH-PX activity be measured immediately after separation from the blood cells, or be assayed within 24 h under specified laboratory conditions.

#### Vitamin E status

Vitamin E occurs in nature as a mixture of tocopherols in varying proportions. They vary widely in their biological activity so that chemical determination of total tocopherols is of much less value than biological assay. Tocopherol levels in blood and liver provide good information on the vitamin E status of the animal. However, because of the difficulty of the laboratory assays of tocopherols, they are not commonly done and insufficient reliable data are available. Analysis of liver from clinically normal animals on pasture reveal a mean  $\alpha$ -tocopherol level of 20 mg/kg WW for cattle and 6 mg/kg WW for sheep. The corresponding ranges were 6.0–53 mg/kg WW for cattle and 1.8–17 mg/kg WW in sheep. The critical level below which signs of deficiency may be expected are 5 mg/kg WW for cattle and 2 mg/kg WW for sheep. Tocopherol levels in the serum of less than 2 mg/L in cattle and sheep are considered to be critical levels below which deficiency diseases may occur. However, if the diet contains adequate quantities of selenium, but not an excessive quantity of PUFAs, animals may thrive on low levels of serum tocopherols. In growing pigs, the serum vitamin E levels are between 2 and 3 mg/L. In summary, there are insufficient reliable data available on the vitamin E status on animals with NMD to be of diagnostic value.

The mean plasma vitamin E levels in clinically normal horses of various ages and breeds were 2.8  $\mu\text{g}/\text{mL}$ .<sup>90</sup> The optimal

method for storing equine blood prior to  $\alpha$ -tocopherol analysis is in an upright position in the refrigerator for up to 72 h. If a longer period is needed, the serum or plasma should be separated, blanketed with nitrogen gas and frozen in the smallest possible vial; the  $\alpha$ -tocopherol in these samples will be stable at  $-16^{\circ}\text{C}$  ( $3^{\circ}\text{F}$ ) for at least 3 months.

A summary of the GSH-PX activity, tocopherol and selenium levels in blood and body tissues of animals deficient in selenium appears in Table 30.6. Normal values are also tabulated for comparison.<sup>91</sup> Both the abnormal and normal values should be considered as guidelines for diagnosis because of the wide variations in levels between groups of animals. The level of dietary selenium may fluctuate considerably, which may account for variations in GSH-PX. Selenium reference ranges to determine selenium status of sheep and cattle in New Zealand are shown in Table 30.7.

In the early stages of the subclinical form of NMD in lambs, there may be a decrease in serum selenium and glutathione peroxidase activity and an increase in the activity of aspartate aminotransferase (AST), creatine kinase (CK), and lactate dehydrogenase (LDH) compared with healthy lambs.<sup>92</sup> The LDH-isoenzyme activity is useful for detection of subclinical forms of NMD because of significant increases in the activity of the LDH<sub>5</sub>-muscle fraction.

#### Farmed red deer

Reference range data for liver and blood selenium in red deer are limited.<sup>93,94</sup> White muscle disease has occurred in young deer with blood and liver selenium concentrations of 84–140 nmol/L and 240–500 nmol/kg fresh tissue, respectively. No growth rate response to selenium supplementation occurred in 1-year-old deer when blood selenium concentrations were less than 130 nmol/L, the range in which a growth rate response would be expected in sheep.

Table 30.6 Glutathione peroxidase (GSH-PX) activity and selenium levels in blood and body tissues of animals deficient in selenium

Species	Clinical state or degree of deficiency	Erythrocyte GSH-PX activity $\mu\text{mol}/\text{min}$ at $37^{\circ}\text{C}/\text{g}$ hemoglobin	Serum selenium ( $\mu\text{g}/\text{mL}$ )	Liver selenium ( $\mu\text{g}/\text{g}$ DM)
Cattle	Normal or adequate	19.0–36.0	0.08–0.30	0.90–1.75
	Marginal	10.0–19.0	0.03–0.07	0.45–0.90
	Deficient	0.2–10.0	0.002–0.025	0.07–0.60
Sheep	Normal or adequate	60–180	0.08–0.50	0.90–3.50
	Marginal	8–30	0.03–0.05	0.52–0.90
	Deficient	2–7	0.006–0.03	0.02–0.35
Pigs	Adequate	100–200	0.12–0.30	1.40–2.80
	Deficient	<50	0.005–0.60	0.10–0.35
Horse	Adequate	30–150	0.14–0.25	1.05–3.50
	Deficient	8–30	0.008–0.055	0.14–0.70

TABLE 30.7 Selenium reference ranges to determine selenium status of sheep and cattle in New Zealand

	Deficient	Marginal	Adequate
<b>Sheep</b>			
Blood selenium (nmol/L)	<130	130–250	>250
Liver selenium (nmol/kg fresh tissue)	<250	250–450	>450
<b>Cattle</b>			
Blood selenium (nmol/L)	<130	130–250	>250
Liver selenium (nmol/kg fresh tissue)	<600	600–850	>850
Serum selenium (nmol/L)	<85	85–140	>250
Blood glutathione peroxidase (Ku/L – 25°C)	<0.5	0.5–2.0	>2.0

## Pigs

An increase in the activity of several plasma enzymes occurs in Se and vitamin E deficiencies of pigs. The measurement of AST, CPK, lactic acid dehydrogenase, and isocitrate dehydrogenase can be used to detect the onset of degeneration of skeletal and myocardial muscles and liver. However, these are not commonly used for diagnostic purposes because of the acuteness of the illness. The determination of the levels of Se in feed supplies, tissues, and blood of affected pigs is much more useful as an aid to diagnosis and for guidelines for supplementation of the diet.

In Se-vitamin E deficiency in pigs, serum Se values of less than 2.5 ng/mL (3.2 nmol/L), hepatic Se of less than 0.10 mg/kg (1.3 μmol/kg), plasma α-tocopherol values of <0.40 μg/mL and hepatic α-tocopherol concentrations of <0.75 μg/g of tissue are common. In a recent study, the vitamin E level was <2 ppm in 25% of pigs with gross and microscopic lesions of MHD.<sup>39</sup> In a recent study results suggested that supplementation with a surfeit level of vitamin E reduced the response to endotoxin, i.e. a reduced response to the peak levels of IL-6.<sup>95</sup>

The diagnostic criteria for the VESD complex in pigs in New Zealand indicate that liver vitamin E concentrations >10 μmol/kg are adequate, with <2.5 μmol/kg associated with deficiency. Corresponding estimates for serum vitamin E are >2.5 μmol/L and <0.8 μmol/L, respectively. Liver Se concentrations of >2200 nmol/kg are adequate, with 1100–2200 nmol/kg being in the marginal range and <1100 nmol/kg being deficient. Deficiency levels for blood are in the range of 400–1500 nmol/L. These values must be interpreted along with the concentration of PUFAs in the diet.

There is a close relationship between blood vitamin E and resistance of erythrocytes against lipid peroxidation. The supplementation of the diet of pigs with vitamin E will increase both the serum levels of vitamin E and the resistance of the erythrocytes to lipid peroxidation.<sup>96</sup>

## NECROPSY FINDINGS

The gross appearance of the muscle lesions is quite constant, but the distribution of affected muscles varies widely in different animals. Affected groups of skeletal muscle are bilaterally symmetrical and contain localized white or gray areas of degeneration and necrosis. These areas may be in streaks, involving a large group of muscle fibers that run through the center of the apparently normal muscle or as a peripheral boundary around a core of normal muscle. In the diaphragm, the distribution of damaged bundles gives the tissue a radially striated appearance. The affected muscle is friable and edematous and may be mineralized. Secondary pneumonia often occurs in cases where the muscles of the throat and chest are affected. In cases with myocardial involvement, white areas of degeneration are visible, particularly under the endocardium of the left ventricle in calves and of both ventricles in lambs. The lesions may extend to involve the interventricular septum and papillary muscles and have a gritty character consistent with mineralization. Pulmonary congestion and edema is common.

Histologically, the muscle lesions in all species are **non-inflammatory**. Hyaline degeneration is followed by coagulation necrosis and variable degrees of mineralization.

Other than a variable degree of muscular atrophy, gross lesions are not seen in horses with **equine motor neuron disease**. Confirmation of the diagnosis relies on histological identification of characteristic degeneration and loss of motor neurons of the spinal cord ventral horns. However, a very strong presumptive diagnosis can be achieved by microscopic confirmation of neurogenic atrophy in the sacrocaudalis dorsalis muscle or axonal degeneration in the spinal accessory nerve.<sup>97</sup>

A generalized **steatitis** has been described in newborn foals less than 2 months of age. The microscopic appearance of this yellow-brown fat consists of necrotic fat infiltrated by neutrophils, macrophages and giant cells. Steatitis and

nodular panniculitis have also been reported in a 3-year-old vitamin E/selenium-deficient mare.<sup>98</sup> Supplemental vitamin E is believed to protect against steatitis in foals.

In **mulberry heart disease** the carcass is in good condition. All body cavities contain excessive amounts of fluid and shreds of fibrin. In the peritoneal cavity, the fibrin is often in the form of a lacy net covering all the viscera. The liver is enlarged, mottled and has a characteristic nutmeg appearance on the cut surface. The lungs are edematous and excessive fluid in the pleural cavities is accompanied by collapse of the ventral lung field. The pericardial sac is filled with gelatinous fluid interlaced with bands of fibrin. Beneath the epicardium and endocardium are multiple hemorrhages of various sizes. Usually, this hemorrhage is more severe on the right side of the heart. This gives the heart the typical mottled appearance which is caused by areas of necrosis and areas of hemorrhage. Histologically, the characteristic lesion is widespread myocardial congestion, hemorrhage, and myofiber degeneration. Multiple fibrinous microthrombi are within the myocardial capillaries and, occasionally, degenerative changes are visible in walls of small arterioles in many organs, including the heart. Malacia of cerebral white matter, or more rarely the molecular layer of the cerebellum, may occur and is attributable to microvascular damage. It should be stressed that, in some cases, the disease course is so rapid that morphologic changes are not discernible in the myocardial cells. Since it can be extremely difficult to distinguish mulberry heart disease from *S. suis* septicemia histologically, it is prudent to also attempt bacteriologic culture when attempting to confirm the diagnosis.

In **hepatosis dietetica**, the liver is swollen and has a mottled to mosaic-like appearance throughout its lobes. Many of the lobules are distended and reddish in color. There is in fact an irregular distribution of hepatic necrosis and hemorrhage. The gall bladder may be edematous and there may also be myocardial necrosis and pulmonary edema. Typically, the disease course is so rapid that jaundice does not develop. Histologically, there is a distinct lobular distribution of hemorrhage, degeneration, and necrosis.

In **NMD** of pigs, the lesions are often only visible at the microscopic level and consist of areas of bilaterally distributed areas of muscular degeneration. The changes include hyalinization, loss of striations and fragmentation of myofibers. The sections are difficult to cut because of the presence of calcium in the myocytes.



A mild degree of NMD may accompany some cases of *hepatosis dietetica*.

### Samples for confirmation of diagnosis

- **Toxicology** – 50 g liver (ASSAY (Se) (Vitamin E))
- **Histology** – formalin-fixed skeletal muscle (multiple sites), heart (both left and right ventricular walls), brain (including cerebral hemisphere) (LM). May require special stains to show the presence of calcium in the sections
- **Bacteriology** (for mulberry heart disease only) – heart, liver, swab from pericardial sac (CULT).

### DIFFERENTIAL DIAGNOSIS

#### Nutritional muscular dystrophy

NMD is most common in young rapidly growing animals fed a selenium-vitamin E-deficient ration or whose dams were on a deficient, unsupplemented ration throughout the winter months.

Characteristically, the disease is sudden in onset and several animals are affected initially or within a few days, particularly following unaccustomed exercise. In the acute form, generalized weakness and a state of collapse are common. In the subacute form, the major clinical findings are stiffness in walking, long periods of recumbency or total recumbency, inability to stand, a normal mental attitude and appetite and no abnormal neurological findings to account for the recumbency. The CP levels are markedly elevated.

#### Calves and yearlings

Acute enzootic muscular dystrophy in calves with myocardial involvement must be differentiated from other diseases causing generalized weakness, toxemia and shock.

These include:

- **Septicemias:** *Haemophilus* septicemia resulting in weakness, recumbency and fever
- **Pneumonia:** Pneumonic pasteurellosis causing dyspnea, toxemia, fever and weakness.

#### Subacute enzootic muscular dystrophy

In which skeletal muscle lesions predominate must be differentiated from other diseases of young calves and yearlings characterized clinically by paresis and paralysis. The subacute form is more common in yearlings and young cattle and is characterized by recumbency with other body systems being relatively within normal ranges. The other diseases include:

- **Musculoskeletal diseases:** Polyarthritis, traumatic or infectious myopathies (blackleg), osteodystrophy and fractures of long bones
- **Diseases of the nervous system:** Spinal cord compression, *Hemophilus* meningoencephalitis and myelitis, organophosphatic insecticide poisoning
- **Diseases of the digestive tract:** Carbohydrate engorgement resulting in lactic acidosis, shock, dehydration, and weakness.

#### Lambs and kids

In lambs with 'stiff-lamb' disease, there is stiffness and a stilted gait, affected animals prefer recumbency, they are bright and alert and will suck the ewe if assisted. The serum levels of CPK and SGOT are also markedly elevated. Differentiation may be necessary from enzootic ataxia and swayback, but in these two diseases, stiffness is not characteristic but rather weakness and paresis.

#### Foals

In foals, NMD must be differentiated from acute diseases of the musculoskeletal and nervous system causing abnormal gait, weakness and recumbency. They include:

- Polyarthritis
- Meningitis
- Traumatic injury to the spinal cord.

#### Mulberry heart disease

Mulberry heart disease must be differentiated from other common causes of sudden death in pigs in which the diagnosis is made at necropsy and include:

- Acute septicemias due to salmonellosis, erysipelas, pasteurellosis and anthrax
- Porcine stress syndrome
- Gut edema
- Intestinal volvulus, heat exhaustion, suffocation during transportation.

### TREATMENT

Because of the overlapping functions of selenium and vitamin E and because it is not always possible to know the relative etiological importance of one nutrient or the other in causing some of the acute conditions already described, it is recommended that a combined mixture of selenium and  $\alpha$ -tocopherol be used in treatment.  $\alpha$ -Tocopherol is the most potent form of the tocopherols and is available in a number of pharmaceutical forms, which also vary in their biological activity. It has become necessary to express the unitage of vitamin E in terms of international units of biological activity (1IU:1 mg synthetic racemic  $\alpha$ -tocopherol acetate. Natural D- $\alpha$ -tocopherol acetate 1 mg: 1 IU and natural D- $\alpha$ -tocopherol 1 mg: 0.92 IU).

#### Nutritional muscular dystrophy

For treatment of NMD in calves, lambs, and foals a mixture containing 3 mg selenium (as sodium or potassium selenite) and 150 IU/mL of DL- $\alpha$ -tocopherol acetate, given IM at 2 mL/45 kg BW is recommended. One treatment is usually sufficient. Animals with severe myocardial involvement will usually not respond to treatment and the case mortality rate is about 90%. However, all in-contact animals in the herd (calves, lambs, and foals) should be treated prophylactically with the same dose of selenium and vitamin E. They should be handled carefully during treatment to avoid pro-

cipitating acute muscular dystrophy. Animals with subacute skeletal muscular dystrophy will usually begin to improve by 3 days following treatment and may be able to stand and walk unassisted within 1 week.

Animals sometimes do not respond to either vitamin E or Se or treatment with both.

In outbreaks of mulberry heart disease, *hepatosis dietetica* and related Se and vitamin E deficiency diseases in pigs, all clinically affected pigs and all pigs at risk should be treated individually with a combination of Se and vitamin E parenterally at first to prevent any further sudden death. It can then be followed by oral administration.

### CONTROL

The control and prevention of the major diseases caused by selenium and vitamin E deficiencies can generally be accomplished by the provision of both nutrients to susceptible animals fed on deficient rations. The following points are relevant and applicable to most situations:

- Provide selenium and vitamin E
- Maternal transfer to newborn
- Selenium is potentially toxic
- Selenium in milk supplies
- Dietary requirement of selenium
- High sulfate diets
- Glutathione peroxidase activity
- Different methods of supplementation.

#### Provide selenium and vitamin E

Over the years, both the vitamin E levels and Se levels in the diets have increased but particularly the former. This is in response to the more rapid growth rates of pigs but also the realization that pigs are coping with many more oxidative disease states. Outdoor pigs usually have sufficient of both unless the soil is Se deficient. A recent Chinese paper<sup>99</sup> has suggested that dietary zinc at 85 mg/kg, Se at 0.40 mg/kg, and vitamin E at 45 IU/kg is appropriate for crossbred sows.

While Se alone is protective against a greater spectrum of diseases than is vitamin E, there are situations in which vitamin E is more protective. Both Se and vitamin E should be provided when the diets are deficient in both nutrients, but this may not apply in every situation. Most of the emphasis has been on Se supplementation at the expense of vitamin E, which is more expensive and less stable. Most injectable vitamin E and Se preparations are adequate in Se but insufficient in vitamin E.

There have been several attempts to supplement weaner pigs with a vitamin E preparation. Besides individual injections, it

is possible to supplement weaner pigs with water supplementation.<sup>100</sup> Pigs will usually drink even if they are not eating. A recent study<sup>101</sup> showed that the supplementation of drinking water with high doses of vitamin E (150 mg of DL- $\alpha$ -tocopherol acetate) was effective in maintaining serum vitamin E levels over the weaning period. This was even true when over the weaning period the intake of food was very low (it can be as low as 0.2–0.3 kg) and there is a temporary malabsorption in the intestine. It takes about 100 IU/L of water to provide a good vitamin E blood serum value.

### Maternal transfer to newborn

Diseases caused by selenium deficiency are preventable by the administration of selenium to the dam during pregnancy or directly to the young growing animal. Selenium is transported across the placenta and provides protection for the neonate. Oral supplementation with selenium in beef cattle will provide enough to maintain blood levels in the dam and for adequate transfer to the fetus, which can sequester selenium when the levels are low in the dam. The colostrum of selenium-supplemented cattle also contains an adequate amount of selenium to prevent severe selenium-deficiency diseases.<sup>68</sup> However, by 7 days after parturition, the levels in milk may be inadequate to maintain adequate serum levels in calves. The strategic administration of selenium and vitamin E before the expected occurrence of the disease is also a reliable method of preventing the disease.

### Selenium is potentially toxic

Se is toxic and any treatment and control program using it must be carefully monitored.<sup>102</sup> Se injected into or fed to animals concentrates in liver, skeletal muscle, kidney, and other tissues and withdrawal periods before slaughter must be allowed. There is some concern that Se may be a carcinogen for man. The only tissues that appear likely to consistently accumulate more than 3–4 mg/kg of Se are the kidney and liver and these are very unlikely to constitute more than a very small part of the human diet. There have been no reports of untoward effects of Se on human health when it has been used at nutritional levels in food-producing animals. The incorporation of Se into commercially prepared feeds for some classes of cattle and pigs has been approved in some countries. A recent case in Norway showed the hazards of Se contamination in the case of an iron supplement.<sup>103</sup> Se toxicosis has been fairly regularly reported.<sup>104–106</sup>

Pigs that are deficient may be more susceptible to other diseases. Pigs with NMD often have the appearance of pneu-

monic pigs because the diaphragm is weak and the pigs are dyspneic.

Deficient and small pigs may be more susceptible to the effects of iron and when this is given by injection there may be large numbers of dead piglets as a result of iron toxicity. In these cases, the heart lesions resemble those of MHD.

### Selenium in milk supplies

The use of selenium in the diet of lactating dairy cows has caused concern about possible adulteration of milk supplies. However, the addition of selenium to the diets of lactating dairy cows at levels that are protective against the deficiency diseases does not result in levels in the milk that are hazardous for human consumption. The feeding of excessive quantities of selenium to dairy cattle would cause toxicity before levels became toxic for man.

### Dietary requirement of selenium

The dietary requirement of selenium for both ruminants and non-ruminants is 0.1 mg/kg DM of the element in the diet. There may be nutritionally important differences in the selenium status between the same feeds grown in different regions and between different feeds within a region. Even within a region featuring high selenium concentrations, some feeds may contain levels of selenium below the 0.1 mg/kg minimum requirement for livestock. Thus a selenium analysis of feeds appears necessary in order to supplement livestock appropriately. Some geographical areas are known to be deficient in selenium and the feeds grown in these areas must be supplemented with selenium and vitamin E on a continuous basis. Some reports indicate that surveys have found that dairy producers are providing insufficient supplementary selenium in the ration to meet the recommended selenium intake for lactating dairy cows.<sup>14</sup> Long-term administration of organic selenium in the form of selenium yeast provides higher blood and tissue concentrations than repeated parenteral administration of recommended therapeutic doses of inorganic selenium.<sup>71</sup>

### High sulfate diets

Avoidance of high sulfate diets is desirable, but provision of adequate Se overcomes the sulfate effect.

### Glutathione peroxidase activity

Whole blood GSH-PX activity is a way of monitoring Se status but is not as reliable in pigs as in sheep and cattle.

**Pigs.** In growing pigs, both Se and vitamin E at 30 IU/kg DM of feed are necessary for the prevention of the diseases caused by diets deficient in vitamin E and Se. Supplementation of the diet of the sow will result in an adequate transfer

to the piglets. Satisfactory protection of the diseases of pigs caused by vitamin E Se deficiency depends on the correct balance between Se,  $\alpha$ -tocopherol, PUFAs in the diet and the presence of a suitable antioxidant to conserve the  $\alpha$ -tocopherol.<sup>107</sup>

### Different methods of supplementation

The prevention of the major diseases caused by selenium and vitamin E deficiencies can be achieved by different methods, including:

- Dietary supplementation in the feed or water supplies
- Individual parenteral injections
- Oral administration
- Pasture top-dressing.

The method used will depend on the circumstances of the farm, ease of administration, cost, the labor available, severity of the deficiency that exists and whether or not the animals are being dosed regularly for other diseases such as parasitism. The subcutaneous injection of barium selenate, the administration of an intra-ruminal pellet and the addition of selenium to the water supply were compared in cattle; each method was effective for periods ranging from 4 to 12 months.

### Dietary supplementation

The inclusion of selenium and vitamin E in the feed supplies or salt and mineral mixes has been generally successful in preventing the major diseases caused by deficiencies of these two nutrients.

### Selenium dose

#### Individual injections

Injections of Se and vitamin E have been used successfully for prevention, particularly in circumstances where the diet cannot be easily supplemented. Following IM injections of sodium selenite into calves, lambs, and piglets, the Se concentration of the tissues, particularly the liver, increases and then declines to reach preinjection levels in 23 days in calves and 14 days in lambs, and piglets. Adequate sources of vitamin E also must be provided. Injectable preparations of Se and vitamin E are usually adequate in Se and deficient in vitamin E and it may not be possible to correct a marginal deficiency of vitamin E in pregnant beef cattle, for example, by IM injection of a Se and vitamin E preparation which contains an inadequate concentration of vitamin E.<sup>108</sup> The current label dose of injectable Se, 0.055 mg Se/kg BW, which is therapeutically adequate for NMD, is not sufficient for long-term Se supplementation of cattle on a Se-deficient diet.<sup>109</sup> Copper and Se supplementation by parenteral administration can be combined when both deficiencies are present.<sup>110</sup>

### Subcutaneous injections

**Cattle and sheep.** A slow-release preparation of barium selenate for SC injection is now available for use in cattle and sheep.<sup>89</sup> A SC injection of 1 mg selenium/kg BW to ewes 3 weeks before breeding elevated the selenium level in milk during lactation and increased the selenium concentration and GSH-PX in the blood of the lambs during the period when they are at greatest risk from selenium-deficiency diseases.<sup>111</sup> At a dose of 1 mg selenium/kg BW to pregnant ewes, the GSH-PX activity is increased and maintained at adequate levels for up to 5 months. There is adequate transfer of selenium to the lambs, providing protection for up to 12 weeks of age, which covers the period when lambs are at greatest risk. A dose of 1.2 mg selenium/kg BW provided adequate selenium status for as long as two consecutive lambing seasons. Barium selenate at 1 mg selenium/kg BW SC provides protection in young sheep for at least 3 months and is not associated with risk of selenium toxicity or unacceptable residues of selenium in tissues other than the site of injection.<sup>89</sup> A dose of 1 mg selenium/kg BW (barium selenate) to cattle SC increased the GSH-PX activity within 4 weeks and was maintained at high levels for up to 5 months.

**Pigs.** The SC injection of barium selenate of pregnant sows at 0.5–1.0 mg selenium/kg BW resulted in a significant difference in GSH-PX activity in the piglets from treated sows compared with untreated controls. The SC injection of barium selenate at 2.5 mg selenium/kg BW into pigs weighing 20 kg also maintained blood levels of selenium and GSH-PX activity during the most rapid growing period. The relative safety of barium selenate is due to its slow rate of release from the site of injection. By comparison, when selenium is administered as a soluble salt, such as sodium selenite, acute toxicity may occur at doses of 0.45 mg selenium/kg BW. Treatment with barium selenate increases the concentration of selenium in blood, liver and muscle and persists for at least 4 months. One disadvantage of barium selenate is that a large residue persists at the site of injection for long periods. The use of sodium selenite also increases tissue and blood concentrations of selenium, but they begin to decline by 23 days. The bovine liver rapidly removes approximately 40% of injected selenium salts (soluble) from the systemic plasma, binds it to a plasma component and within 1 h of injection releases it back into circulation.

**Farmed red deer.** A long-acting barium sulfate given subcutaneously to red deer on pasture, at 0.5, 1.0, or 2.0 mg Se/kg BW, elevated blood selenium concentrations from 105 nmol/L pre-injection for at least

377 days with peak levels of 1894, 1395, and 818 nmol/L for high, medium, and low doses, respectively.<sup>112</sup> Pastures contained 10–30 mg Se/kg DM. There was no significant difference in growth rate between treated and control deer. The preparation produced fewer and less severe subcutaneous tissue reactions than previous preparations. Young growing deer seem less sensitive to selenium deficiency as measured by weight gain, than sheep and cattle, suggesting that reference ranges for those species are not appropriate for deer.

### Oral selenium and anthelmintics

Oral dosing using sodium selenite is sometimes combined with the administration of anthelmintics and vaccinations. The dose should approximate 0.044 mg/kg BW. A routine program in a severely deficient area comprises three doses of 5 mg of selenium (11 mg sodium selenite) each to ewes, one before mating, one at mid-pregnancy and one 3 weeks before lambing and four doses to the lambs. The first dose to lambs (of 1 mg) is given at docking and the others (2 mg each) at weaning and then at 3-month intervals. A 100-day controlled release anthelmintic capsule containing 13.9 mg of selenium will protect lambs from selenium deficiency for at least 180 days.<sup>113</sup>

Both selenium and cobalt can be incorporated into an anthelmintic program. The levels of GSH-PX activity may be monitored on a regular basis following the drenching with selenium and provide a good indication of selenium availability and selenium status of grazing sheep.

### Pasture top-dressing

The application of sodium selenate as a top-dressing to pasture is now practiced and permitted in some countries. Top-dressing at the approved rate of 10 g selenium/ha is effective for 12 months and has a toxicity margin of safety of about 20 times. Sodium selenate is now used in preference to sodium selenite because only about one-fifth is required to raise the pasture level of selenium to the same concentrations provided by sodium selenite. Top-dressing severely deficient pumice soils in New Zealand prevented deficiency for at least 12 months, sheep were protected against white muscle in lambs and reproduction performance and weight gains were improved. It is recommended that sodium selenate be applied annually to all selenium-deficient soils at the rate of 10 g selenium/ha added to the superphosphate fertilizer, or as prills of sodium selenate alone. Top-dressing is an economical alternative to individual animal dosing, particularly in severely deficient areas with a high stocking rate. At the approved rate, no adverse effects are anti-

ipated in human or animal health or on the environment.

### Muscular dystrophy

Under most conditions, NMD of calves and lambs can be prevented by providing selenium and vitamin E in the diets of the cow or ewe during pregnancy at 0.1 mg/kg DM of actual selenium and  $\alpha$ -tocopherol at 1 g/d per cow and 75 mg/d per ewe. If possible, the supplementation should be continued during lactation to provide a continuous source of selenium to the calves and lambs. Under some conditions the level of 0.1 mg/kg DM may be inadequate. In some circumstances, the optimal selenium concentration in the feed is considerably higher than 0.1 mg/kg DM and levels up to 1.0 mg/kg DM in the feed result in increases in GSH-PX activity which may be beneficial; however, the cost-effectiveness has not been determined. Pregnant ewes being fed on alfalfa hay may require selenium at a level of up to 0.2 mg/kg DM to prevent white muscle disease in their lambs. Young growing cattle, particularly beef cattle likely to receive hay and straw deficient in selenium and those which are fed high-moisture grain, should receive a supplement of selenium at the rate of 0.1 mg/kg DM and  $\alpha$ -tocopherol at 150 mg/d per head. If selenium-supplemented concentrates are used as part of a feeding program for dairy cows, it is not necessary to provide additional selenium by parenteral injection.

Lambs are born with a low serum level of vitamin E but the concentration increases rapidly after the ingestion of colostrum.<sup>1</sup> Supplementation of pregnant ewes with  $\alpha$ -tocopherol, either as a single IM dose (500 mg 2 weeks before lambing) or orally (150 mg daily during 3–4 weeks before lambing) results in a marked increase in the levels of the vitamin in the serum and colostrum. The vitamin E concentration in colostrum was 5–11 times higher than in milk 1 week after lambing.

Vitamin E supplementation of the feed of weaner sheep by oral drench or feed additive is effective in increasing plasma  $\alpha$ -tocopherol concentrations. This is the most practical method for housed sheep and prevents subclinical myopathy.<sup>114</sup> The IM oily injection was slow to increase plasma levels of tocopherols and did not prevent myopathy in grazing experiments. Vitamin E supplements have no beneficial effects on wool quality or quantity in grazing sheep and unless certain flocks are susceptible to vitamin E deficiency myopathy it is not recommended.

### Beef cattle and sheep

**Salt-mineral mixture.** NMD can be prevented in unweaned beef calves and lambs by the inclusion of selenium

(14.8 mg/kg) and vitamin E (2700 IU/kg) in the mineral supplement provided ad libitum to the pregnant cows and ewes on a selenium-deficient ration during the latter two-thirds of gestation and for the first month of lactation. Under most conditions this will provide selenium at 0.1 mg/kg DM in the diet.

The provision of **sodium selenite in a salt-mineral mixture** to provide 90 mg of selenium/kg salt-mineral mixture on a year-round basis, even under range conditions, increased GSH-PX activity levels into normal ranges in beef cows for 3 months when fed to extremely deficient animals. Calves of these cows had increased weaning weights and decreased incidence of infectious diseases, but the trial was uncontrolled. The provision of 30 mg selenium/kg salt-mineral mixture was insufficient to raise the GSH-PX activity levels to normal ranges. Peak blood selenium levels were achieved in weaned beef calves supplemented with 80 and 160 mg selenium/kg in free-choice salt-mineral mixtures for a period of 108 days. In some jurisdictions, it may be necessary for the veterinarian to prescribe a supplement containing higher levels than those permitted by legislation. A level of 25 mg/kg selenium of a salt-mineral mixture provided ad libitum for sheep will result in sufficient levels of selenium in the dam's blood and milk to prevent selenium deficiency diseases. Each ewe must consume from 8 to 12 g of the salt-mineral mixture per day.

Selenium deficiency in grazing and forage fed cattle is widespread in the United States and other countries.<sup>115</sup> Calves may be severely depleted of selenium and selenium-dependent glutathione peroxidase but exhibit no clinical signs of deficiency unless they are subjected to an oxidant or other types of stress. Nursing beef calves may be at risk of selenium deficiency if their dams are not supplemented with selenium. Even when sodium selenite is used in a free-choice mineral supplement designed to deliver 2 mg of selenium daily, calves are still at risk for selenium deficiency for up to 90 days. Selenium supplementation of pregnant beef cows with seleno-yeast in a free-choice mineral mixture increased the whole blood selenium and GSH-PX activity of both cows and calves much superior to sodium selenite.<sup>115</sup>

The supplementation of beef cattle in late gestation with oral vitamin E, 1000 IU/head per day, influenced the vitamin E status of cows which calved in late winter to a greater extent than cows calving in late summer because of the high vitamin E content in the pasture-based summer diet.<sup>116</sup> Calves from supplemented cows had higher serum vitamin E levels than calves from unsupplemented cows.

Winter-born calves from supplemented Hereford cows had heavier 205-day adjusted weaning weights than did winter-born calves from unsupplemented cows. Supplementation did not affect vitamin E or IgG concentrations in cows which calved in late summer and it did not affect calf growth.

#### Dairy cattle

**Selenium.** The legal commercial selenium supplementation of complete rations for dairy cattle in the USA has recently been increased from 0.1 to 0.3 mg/kg DM of complete feed.<sup>117</sup> At this rate, a lactating cow consuming 20 kg of DM/d would consume about 6 mg supplemental selenium in addition to that naturally present in the feedstuffs. Current recommendations indicate that selenium intake for lactating and gestating dairy cattle should range from 5 to 7 mg/d for adequate concentrations in serum or plasma which would range from 70 to 100 ng of selenium/mL serum. Such supplementation should result in improved selenium status of the newborn, improved concentration of selenium in colostrum and improved health of the calves. The effects of selenium supplementation in dairy cattle on reproductive performance is equivocal. Some studies over a period of two lactations revealed no effect on reproductive performance, while others report an improvement in dairy cattle in a district considered to be marginally deficient in selenium. Intakes of inorganic selenium as sodium selenite in amounts of 50 mg/d for 90 days or 100 mg/d for 28 days by adult dairy cows (10–30 times the nutritional requirement) did not cause any health problems.<sup>118</sup> The toxic dose for cattle ranges from 0.25 to 0.5 mg/kg BW.

Milk replacers for dairy calves should contain a suitable antioxidant and be supplemented with 300 IU/kg DM of  $\alpha$ -tocopherol acetate at the rate of 0.1 mg/kg DM of the milk replacer.

**Vitamin E.** Dietary or parenteral supplementation of vitamin E to dairy cows during the peripartum period has consistently improved the function of neutrophils and macrophages.<sup>117</sup> However, the effects of supplementation of dry dairy cows with vitamin E in the feed or parenteral administration of vitamin E before parturition on the incidence of disease have been variable. The amount of supplemental vitamin E fed per day during the prepartum period has ranged from 1000 to 3000 IU/day. Feeding 1000 IU/day of supplemental vitamin E to dry cows when adequate selenium was supplemented reduced the incidence of retained placenta. The prepartum subcutaneous injection of dairy cows with 3000 IU of vitamin E, 1 week before expected calving had no significant difference on the incidence of retained placenta, clinical

mastitis, metritis, endometritis, ketosis, displaced abomasum, or lameness.<sup>60</sup> Vitamin E administered to cows with marginal pre-treatment vitamin E status had a reduced risk of retained placenta. In cows, with adequate serum vitamin E, there was no reduction in the incidence of any disease.<sup>60,61</sup>

Based on health and immune function in cows, plasma concentrations of  $\alpha$ -tocopherol in peripartum cows should be approximately 3  $\mu$ g/mL. To maintain these blood values, dry cows and heifers fed stored forages during the last 60 days of gestation require approximately 1.6 IU of supplemental vitamin E/kg BW (approximately 80 IU/kg DMI). Increased intake of vitamin E of cows and heifers during the prepartum period also increases the vitamin E in colostrum. Milk is not a major source of vitamin E but colostrum contains high concentrations of  $\alpha$ -tocopherol (3 to 6  $\mu$ g/mL). For lactating cows, being fed stored forages, to reduce the incidence of mastitis, the recommendation for vitamin E is 0.8 IU/kg BW (approximately 20 IU/kg DMI).<sup>117</sup> When fresh forage is fed, there is less need for supplemental vitamin E. The intake of polyunsaturated fatty acids increases the vitamin E requirement and additional vitamin E may be required when protected unsaturated fats are fed.

#### NMD in the neonate

The injection of Se 0.06 mg/kg BW into piglets under 1 week of age, repeated at weaning time and into the sow 3 weeks before farrowing will be effective. The minimum lethal dose of Se for piglets is 0.9 mg/kg BW, which provides a reasonably wide range of safety. A high concentration of Se in the diet of pregnant sows in the last half of gestation has been associated with hemorrhagic lesions on the claws of newborn piglets.<sup>119</sup>

While selenium alone is protective against a greater spectrum of diseases than is vitamin E, there are situations in which vitamin E is more protective. Both selenium and vitamin E should be provided when the diets are deficient in both nutrients, but this may not apply in every situation. NMD can occur in ruminants with vitamin E deficiency and an adequate selenium status. Most of the emphasis has been on selenium supplementation at the expense of vitamin E, which is more expensive and less stable. Most injectable vitamin E and selenium preparations are adequate in selenium but insufficient in vitamin E.

#### Selenium responsive reproductive performance and growth

##### Sheep

In selenium deficient situations, reproductive performance of ewes may be improved by selenium or selenium and vitamin E. Survival of lambs, live weights

at birth and at weaning may be increased by selenium supplementation. Single injections of selenium before mating and lambing had no significant effects on estrus, fertility, prolificacy, and the number of lambs born and reared to 28 days in 2-year-old ewes.<sup>120</sup> Two consecutive injections of selenium (before mating and lambing) significantly increased the incidence of estrus, fertility, and lamb body weight at 28 days and daily weight gains for 28 days in 3-year-old ewes compared with controls. The injection of selenium plus vitamin E did not significantly improve reproductive performance in 2- nor 3-year-old ewes in the flock not considered selenium deficient.

#### Weak-calf syndrome

The parenteral injection of selenium and iodine to pregnant cattle in Ireland did not significantly reduce the incidence of the weak-calf syndrome, which is often attributed to a selenium deficiency.

#### Pigs

The injection of selenium 0.06 mg/kg BW into piglets under 1 week of age, repeated at weaning time and into the sow 3 weeks before farrowing will be effective. The minimum lethal dose of selenium for piglets is 0.9 mg/kg BW, which provides a reasonably wide range of safety. A high concentration of selenium in the diet of pregnant sows in the last half of gestation has been associated with hemorrhagic lesions on the claws of newborn piglets.<sup>121</sup>

#### Horses

Little information is available on the need of horses for selenium but the optimum intake is 6 mg/week or 2.4 µg/kg BW daily. The oral supplementation of 1 mg selenium/d increases blood selenium concentrations above levels associated with myodegeneration in horses and foals. In New Zealand, for horses on pasture, the injection of barium selenate, at a dose of 0.5 mg Se/kg BW, aseptically at a deep intramuscular site was efficacious in correcting the selenium status of mares grazing pasture with a selenium content of 0.01 to 0.07 mg/kg DM.<sup>81</sup> Some local swelling will occur.

To ensure nutritional adequacy and to have an adequate safety margin, adult Standardbred horses should receive 600–1800 mg DL- $\alpha$ -tocopherol daily in their feed. The parenteral administration of vitamin E and selenium to mares in late pregnancy and to their foals beginning at birth, will increase blood selenium to adequate levels. In selenium-deficient areas or when mares are fed selenium-deficient hay, the prepartum injections of selenium and vitamin E are indicated followed by intermittent injection of the foals, or

supplementation of the diet with selenium at 0.1 mg/kg DM.

#### Intra-ruminal selenium pellets

##### Sheep

Intra-ruminal selenium pellets, similar to those used in cobalt deficiency, have produced satisfactory blood levels of selenium for up to 4 years in ewes at pasture.<sup>89</sup> A satisfactory pellet is composed of 0.5 g elemental selenium and finely divided metallic iron. The technique is efficient, but not completely, due to wide variations between animals in the absorption rate of the selenium. The average delivery of selenium is 1 mg/d and there is no danger of toxicity. In sheep grazing selenium-deficient pastures, the ruminal pellets increase the selenium status and weight gains compared with controls. About 15% of treated sheep reject the pellets within 12 months and in varying degrees the pellets acquire deposits of calcium phosphate. Sheep fed pellets recovered from sheep have low selenium levels, which suggests a low release of selenium from pellets that have been in the rumen of other sheep for several months. The peak levels of selenium occur 3 months after administration; there is a rapid decline in activity between 5 and 13 months. Sustained-release boluses containing sodium selenite, cobalt sulfate, potassium iodide, manganese sulfate, zinc oxide, and sulfate and vitamins A, D, and E have also been formulated to provide long-term maintenance of selenium.

A zinc, cobalt, and selenium soluble glass bolus administered to ram lambs increased the selenium status of the animals and increased sperm motility, percentage of live sperm and sperm responding to hypo-osmotic swelling test (an assay to determine plasma membrane permeability).<sup>122</sup>

High density compressed pellets containing both sodium selenite and cobalt carbonate have been developed for cattle and sheep.<sup>43</sup> The sheep pellet weighs 6 g and contains 276 mg Se and 765 mg Co. A 6 g bolus given to ewes before mating resulted in improved lambing performance, an increase in the percentage of twin lambs.<sup>43</sup>

##### Cattle

A selenium pellet containing 10% selenium and 90% iron grit is available for cattle and will maintain plasma selenium and GSH-PX activity above the critical level for up to 2 years.<sup>123</sup> When given to beef cows in the last 3 months of pregnancy, the selenium levels in milk are higher than in controls and the selenium status of the calves was sufficient to prevent NMD. The use of these pellets at two, three, and four times the recommended dose in growing cattle weighing 300–350 kg did not cause toxicosis and the selenium

levels in the tissues at slaughter were not a risk for humans.

Use of the intra-ruminal selenium pellets in dairy cattle in New Zealand resulted in improved growth and milk production in herds where the selenium status was below the adequate range, but there was no effect on udder health and reproductive performance.

High density compressed pellets containing both sodium selenite and cobalt carbonate have been developed for cattle and sheep.<sup>43</sup> For cattle, the pellets weigh 18 g and contain 4.6% selenium and 12.75% cobalt (828 mg Se and 2295 mg Co). In both beef cows and growing cattle, the boluses increased blood glutathione peroxidase activity for at least 1 year.

A sustained-release intra-reticular bolus is an osmotic pump designed to release 3 mg selenium into the reticulorumen. It is intended to provide selenium supplementation for 120 days in grown heifers and pregnant beef cattle.

#### Selenium toxicity and residues

Selenium intoxication can occur following the administration of toxic amounts of a selenium salt. The use of selenium selenite instead of sodium selenate and giving a dose of five times the intended dose resulted in a high mortality within several hours after administration.<sup>1</sup> Animals deficient in selenium are more susceptible to selenium toxicosis than those that are selenium-adequate. The pharmacokinetics of selenium toxicity in sheep given selenium selenite parenterally has been examined. When oral preparations of selenium and monensin are given concurrently as part of a routine dietary management practice, there is greater risk of selenium intoxication than if the selenium is given alone. Administration of monensin sodium at a constant, safe dosage enhanced the toxicity of selenium as demonstrated by increased severity of the signs of intoxication, fatalities, tissue selenium concentrations and intensified gross, histopathological, and biochemical changes. There is some concern about selenium supplementation of beef cattle being a potential source of contamination for nearby aquatic systems, but there is no evidence that this has occurred.

#### Selenium responsiveness

The response to selenium supplementation is proportional to the degree of deficiency and supplementation of animals that have adequate selenium intakes is unlikely to significantly improve growth rate. In New Zealand, for selenium-deficient lambs, the potential for a growth response to selenium supplementation is strongly related to blood selenium concentration.<sup>79</sup> Economically significant live weight gains of >10 g/d can occur when initial blood

selenium concentrations are <130 nmol/L. This is the basis for the development of reference curves using blood selenium concentration to diagnose selenium deficiency and predict growth responses to lambs.<sup>79</sup>

Although many methods of supplementation of selenium are efficacious, they can differ widely in their cost and convenience of administration. The objective of any micronutrient supplementation program should be to optimize the return on investment.<sup>40</sup> The least cost option which provides adequate supplementation for the required period should be recommended initially.

Veterinarians are the professionals in the best position to offer advice on cost-effectiveness supplementation.<sup>40</sup> To retain this position, they must provide sound recommendations based on micronutrient analysis of animal tissue and defensible reference ranges which are supported by production response data. Monitoring micronutrient status in animal tissue should be encouraged so as to ensure that regulatory requirements are met and that deficiency and excessive use are avoided. Circumvention of veterinary involvement in the diagnosis and treatment of micronutrient supplementation can lead to greater use of supplements when not indicated, higher costs to farmers and low cost-benefit ratios for the industry.

Depot and bolus preparations have revolutionized the treatment of deficiencies of cattle and sheep that are grazed extensively where there is little opportunity for frequent administration (Table 30.8). The relatively short duration of a single drench or injection of selenium salts such as sodium selenite should be noted. The use of fertilizer applications selenium prills is gaining widespread acceptance on farms with high stocking rates.

## REVIEW LITERATURE

McDowell LR. Vitamin nutrition of livestock species. Nutrition Abstracts and Reviews Series B, Livestock Feeds and Feeding. Wallingford, Oxon: CAB International 2001; 71: 33R-41R.

Kim YY Mahan DC. Biological aspects of Se in farm animals. *Asian Aust J Anim Sci* 2003; 16:435-444.

Underwood EJ, Suttle NF. Selenium. In: The mineral nutrition of livestock, 3rd ed. Wallingford, Oxon: CAB International, 1999: 421-475.

Wichtel JJ. A review of selenium deficiency in grazing ruminants. Part I: New roles for selenium in ruminant metabolism. *N Z Vet J* 1998; 46:47-52.

Wichtel JJ. A review of selenium deficiency in grazing ruminants. Part 2: Towards a more rational approach to diagnosis and prevention. *N Z Vet J* 1998; 46:54-58.

VanMetre DC, Callan RJ. Selenium and vitamin E. In: *Vet Clin North Am Food Anim Pract* 2001; 17:373-402.

Wilson PR, Grace ND. A review of tissue reference values to assess the trace element status of farmed red deer (*Cervus elaphus*). *N Z Vet J* 2001; 49:126-132.

Allison RD, Laven RA. Effect of vitamin E supplementation on the health and fertility of dairy cows: a review. *Vet Rec* 2000; 147:703-708.

Lofstedt J. White muscle disease of foals. In: *Vet Clin North Am Equine Pract* 1997; 13:169-185.

Hemingway RG. The influences of dietary intakes and supplementation with selenium and vitamin E on reproduction diseases and reproductive efficiency in cattle and sheep. *Vet Res Commun* 2003; 27:159-174.

Clark RG. Copper and selenium toxicity. In: Proceedings of the 25th Seminar of the Sheep and Beef Cattle Society of the New Zealand Veterinary Association. Massey University, Palmerston North: The Foundation for Veterinary Continuing Education, 1995: 111-119.

Subcommittee on Dairy Cattle Nutrition, Committee on Animal Nutrition, Board on Agriculture, National Research Council Subcommittee on Dairy Cattle Nutrition. Nutrient requirements of dairy cattle, 7th ed. Washington, DC: National Academy Press, 2000.

Subcommittee on Beef Cattle Nutrition, Committee on Animal Nutrition, Board on Agriculture, National Research Council. Nutrient requirements of beef cattle, 7th revised ed. Washington, DC: National Academy Press, 2000.

Subcommittee on Swine Nutrition, Committee on Animal Nutrition, Board on Agriculture, National Research Council. Nutrient requirements of swine, 10th revised ed. Washington, DC: National Academy Press, 1998.

## REFERENCES

- Underwood EJ, Suttle NF. Selenium. In: The mineral nutrition of livestock, 3rd ed. Wallingford, Oxon: CAB International, 1999: 421-475.
- VanMetre DC, Callan RJ. *Vet Clin North Am Food Anim Pract* 2001; 17:373.

- Wichtel JJ. *N Z Vet J* 1998; 46:47.
- Hill GM et al. *J Anim Sci* 1999; 77:1762.
- National Academy of Science. Selenium in Nutrition. Washington, DC: National Research Council, 1983.
- Lofstedt J. *Vet Clin North Am Equine Pract* 1997; 13:169.
- Pavlatá L et al. *Acta Vet Brno* 2001; 70:269.
- Menzies P et al. *Can Vet J* 2004; 45:244.
- Pavlatá L et al. *Acta Vet Brno* 2003; 72:639.
- Pavlatá L et al. *Acta Vet Brno* 2002; 71:3.
- Pavlatá L et al. *Acta Vet Brno* 2001; 70:277.
- Beytut E et al. *Vet J* 2002; 163:214.
- Ramirez-Briebesca JE et al. *Small Rum Res* 2001; 41:81.
- Wichtel JL et al. *Can Vet J* 2004; 45:124.
- Miller GY et al. *J Am Vet Med Assoc* 1995; 206:1369.
- Menzies PI et al. *Can Vet J* 2003; 44:898.
- Smith GM, Allen JG. *Aust Vet J* 1997; 75:341.
- Abutarbush SM, Radostits OM. *Can Vet J* 2003; 44:738.
- Orr JP, Blakley BR. *J Vet Diagn Invest* 1997; 9:172.
- Schrauzer GN. *J Nutr* 2000; 130:1653.
- Ching S. *J Anim Sci* 2002; 80:2396.
- Van Fleet JF, Kennedy S. *Compendium on Continuing Education for the Practicing Veterinarian* 1989; 11:662.
- Rice DA, Kennedy S. *Am J Vet Res* 1989; 50:2101.
- Cline JH et al. *J Anim Sci* 1974; 39:974.
- Mahan DC et al. *J Anim Sci* 1991; 78:110.
- Migdal W, Kaczmarczyk J. *World Rev Anim Prod* 1993; 28:68.
- Mavromatis J et al. *J Vet Med* 1999; 46:543.
- Chavez ER. *Can J Anim Sci* 1983; 63:683.
- Yen JT, Pond WG. *J Anim Sci* 1983; 56:621.
- Pinelli-Saavedra A et al. *Proc 18th Int Pig Vet Soc, Hamburg, Germany, 2004*: 740.
- Alba C de et al. *J Anim Fd Science* 2000; 9:479.
- Pherson B et al. *J Vet Med* 2001; 48:569.
- Fellstrom C. *Proc 15th Int Pig Vet Soc Cong* 1998; 3:30.
- Hidiroglou M et al. *Reprod Nutr Develop* 1995; 35:443.
- Wang YH et al. *Brit J Nutr* 1996; 75:81.
- Kovra M et al. *J Anim Sci* 2003; 81:1967.
- Nielsen TK et al. *Vet Rec* 1989; 124:535.
- Díaz A et al. *Invest Agraria Prod San Anim* 2000; 15:21.
- Pallares FJ et al. *J Vet Diagn Inv* 2002; 14:412.
- Wichtel JJ. *N Z Vet J* 1998; 46:54.
- Andres S et al. *Vet J* 1999; 157:186.
- Hoff B et al. *Can Vet J* 2001; 42:384.
- Hemingway RG et al. *Cattle Pract* 2003; 11:167.
- Villar D et al. *Bov Pract* 2002; 38: 73.
- Hemingway RG. 2003; 27:159.
- van Niekerk FE et al. *J South Afr Vet Ass* 1996; 67:209.
- Allison RD, Laven RA. *Vet Rec* 2000; 147:703.
- Coe PH et al. *J Am Vet Med Assoc* 1993; 202:875.
- Cebra CK et al. *J Vet Intern Med* 2003; 17:902.
- Sivertsen T et al. *Acta Vet Scand* 2005; 46:177-191.
- Erskiner RJ et al. *J Am Vet Med Assoc* 1997; 211:466.
- Morgante M et al. *J Dairy Sci* 1999; 82:623.
- Stabel JR et al. *Nutr Res* 1996; 10:1053.
- Pollock JM et al. *Res Vet Sci* 1994; 56:100.
- Carter JN et al. *Am J Vet Res* 2002; 63:1111.
- Rivera JD et al. *J Anim Sci* 2002; 80:933.
- Pavlatá L et al. *Vet Med Czech* 2004; 49:149.
- Nicholson JWG et al. *Can J Anim Sci* 1993; 73:355.
- Wuryastuti W et al. *J Anim Sci* 1993; 71:2464.
- LeBlanc SJ et al. *J Dairy Sci* 2002; 85:1416.
- LeBlanc SJ et al. *J Dairy Sci* 2004; 87:609.
- Panousis N et al. *Vet Rec* 2001; 149:643.

Table 30.8 Dose rates and duration for selected selenium supplements for adult cattle<sup>(1)</sup>

Product	Dose rate per animal	Dose rate per unit body weight	Approximate effective duration
Sodium selenite drench	10-30 mg	0.05 mg/kg	3 weeks
Daily sodium selenate drench	1-8 mg/day		12 months
Barium selenate injection	1 mL/50 kg	1 mg/kg	5 months
Sodium selenate injection	1-5 mL	0.1 mg/kg	6 weeks
Selenium-iron intraruminal pellet	2 pellets	6 g	12 months
Topdressing	1 kg prills/ha	10 g/ha	12 months

63. Giadinis N et al. *Comp Immunol Microbiol Infect Dis* 2000; 23:129.

64. Grace ND et al. *N Z Vet J* 2001; 49:24.

65. Hostetler CE, Kincaid RL. *Biol Trace Elem Res* 2003; 96:1.

66. Lacerta, N et al. *Am J Vet Res* 1996; 57:1176.

67. Swecker WS Jr et al. *Am J Vet Res* 1995; 56:450.

68. Abdelrahman MM, Kincaid RL. *J Dairy Sci* 1995; 78:625.

69. Politis I et al. *Am J Vet Res* 1996; 57:468.

70. Weiss WP et al. *J Dairy Sci* 1997; 80:1728.

71. Pavlata L et al. *Acta Vet Brno* 2001; 70:19.

72. David GP, Winterbottom AJ. *Vet Rec* 1996; 139:20.

73. Pallares FJ et al. *J Vet Diagn Invest* 2002; 14:412.

74. Korpela HJ. *Am Coll Nutr* 1991; 10:127.

75. Macpherson, A. In: Garnsworthy PC, Cole DJA, eds. *Recent advances in animal nutrition*. Nottingham: Nottingham Press, 1994: 3–30.

76. Green LE et al. *Vet Rec* 1995; 136:197.

77. Pettifer EBC. *Pig J* 1998; 42:144.

78. Waldner C et al. *Can Vet J* 1998; 39:225.

79. Grace ND, Knowles SO. *N Z Vet J* 2002; 50:163.

80. Thompson JC et al. *N Z Vet J* 1998; 46:65.

81. Wichtel JJ et al. *N Z Vet J* 1998; 46:186.

82. Stowe HD, Herdt TH. *J Anim Sci* 1992; 70:3928.

83. Kirk JH et al. *Am J Vet Res* 1995; 56:1460.

84. Orr JP, Blakley BR. *J Vet Diagn Invest* 1997; 9:172.

85. Züst J et al. *Vet Rec* 1996; 139:391.

86. Lean IJ et al. *Cornell Vet* 1990; 80:41.

87. Kinoshita C et al. *J Dairy Sci* 1996; 79:1543.

88. Pavlata L et al. *Acta Vet Brno* 2000; 69:281.

89. Archer JA, Judson G. *Aust J Exp Agric* 1994; 34:581.

90. Steiss JE et al. *Equine Vet J* 1994; 26:417.

91. Puls R. *Veterinary trace mineral deficiency and toxicity information Publication*, No. 5139. Ottawa: Information Series, Agriculture Canada 1981: 1–101.

92. Sobiech P, Kuleta Z. *Small Rum Res* 2002; 45: 209.

93. Wilson PR, Grace ND. *N Z Vet J* 2001; 49:126.

94. Grace ND, Wilson PR. *N Z Vet J* 2002; 50:252.

95. Hoppeler H, Weibel ER. *Acta Physiol Scand* 2000; 168:445.

96. Jensen M et al. *Acta Vet Scand* 1990; 31:129.

97. Diver TJ et al. *Vet Clin North Am: Equine Pract* 1997; 13:97.

98. Menzies-Gow NJ et al. *Vet Rec* 2002; 151:416.

99. Liang MZ et al. *Chin J Vet Sci* 2003; 23:620.

100. Van Heugten E et al. *J Am Vet Med Assoc* 1997; 211:1039.

101. Andersson M et al. *Proc 16th Int Pig Vet Soc Cong, Melbourne, Australia, 2000*: 259.

102. Clark RG. Copper and selenium toxicity. In: *Proceedings of the 25th Seminar of the Sheep and Beef Cattle Society of the New Zealand Veterinary Association*. Massey University, Palmerston North: The Foundation for Veterinary Continuing Education, 1995: 111–119.

103. Sivertsen T, et al. *Vet Hum Toxicol* 2003; 45:31.

104. Penrith ML, Robinson JTR. *Ond J Vet Res* 1996; 63:171.

105. Davidson-York D et al. *J Vet Diagn Invest* 1999; 11:352.

106. Stowe HD et al. *J Am Vet Med Assoc* 1992; 201:292.

107. Mahan D. *Proc Maryland Nutrition Conf*, 2000; 47:26.

108. Cohen RDH et al. *Can Vet J* 1991; 32:113.

109. Maas J et al. *J Vet Intern Med* 1993; 7:342.

110. Van Niekerk FE et al. *J South Afr Vet Ass* 1995; 66:11.

111. Zachara BA et al. *Small Rum Res* 1993; 11:135.

112. Grace ND et al. *N Z Vet J* 2000; 48:53.

113. Grace ND et al. *N Z Vet J* 1994; 42:63.

114. Fry JM et al. *Aust J Agric Res* 1996; 47:853, 869.

115. Gunter SA et al. *J Anim Sci* 2003; 81:856.

116. Bass IRT et al. *Am J Vet Res* 2001; 62:821.

117. Subcommittee on Dairy Cattle Nutrition, Committee on Animal Nutrition, Board on Agriculture, National Research Council Subcommittee on Dairy Cattle Nutrition. *Nutrient requirements of dairy cattle*, 7th ed. Washington, DC: National Academy Press, 2000.

118. Ellis RA et al. *Am J Vet Res* 1997; 58:760.

119. Mensink CG et al. *Vet Rec* 1990; 126:620.

120. Gabyszuk M, Klewiec J. *Small Rum Res* 2002; 43:127.

121. Mensink, C G et al. *Vet Rec* 1990; 126:620.

122. Kendall NR et al. *Anim Reprod Sci* 2000:277.

123. Campbell DT et al. *Am J Vet Res* 1990: 51:813.

### DIETARY DEFICIENCY OF PHOSPHORUS, CALCIUM, AND VITAMIN D AND IMBALANCE OF THE CALCIUM:PHOSPHORUS RATIO

A dietary deficiency or disturbance in the metabolism of calcium, phosphorus, or vitamin D, including imbalance of the calcium:phosphorus ratio, is the principal cause of the **osteodystrophies**. The interrelation of these various factors is often very difficult to define and because the end result in all these deficiencies is so similar the precise etiological agent is often difficult to determine in any given circumstance.

In an attempt to simplify this situation, the diseases in this section have been dealt with in the following order:

#### Calcium deficiency (hypocalcemia)

- Primary: an absolute deficiency in the diet
- Secondary: when the deficiency is conditioned by some other factor, principally an excess intake of phosphorus

#### Phosphorus deficiency (hypophosphatosis)

- Primary: an absolute deficiency in the diet
- Secondary: when the deficiency is conditioned by some other factor; although in general terms an excessive intake of calcium could be such a factor, specific instances of this situation are lacking

#### Vitamin D deficiency (hypovitaminosis-D)

- Primary: an absolute deficiency intake of the vitamin
- Secondary: when the deficiency is conditioned by other factors of which excess carotene intake is the best known.

In different countries with varying climates, soil types and methods of husbandry, these individual deficiencies are of varying importance. For instance in South Africa, northern Australia, and North America the most common of the above deficiencies is that of phosphorus; vitamin D deficiency is

uncommon. In Great Britain, Europe and parts of North America, a deficiency of vitamin D can also be of major importance. Animals are housed indoors for much of the year, they are exposed to little ultraviolet irradiation, and their forage may contain little vitamin D. Under such conditions, the absolute and relative amounts of calcium and phosphorus in the diet need to be greater than in other areas if vitamin D deficiency is to be avoided. In New Zealand, where much lush pasture and cereal grazing is used for feed, the vitamin D status is reduced not only by poor solar irradiation of the animal and plant sterols, but in addition, an anti-vitamin D factor is present in the diet possibly in the form of carotene.

Now that the gross errors of management with respect to calcium and phosphorus and vitamin D are largely avoided, more interest is devoted to the marginal errors; in these, diagnosis is not nearly so easy and the deficiency can be evident only at particular times of the year. The conduct of a response trial in which part of the herd is treated is difficult unless they are hand-fed daily; there are no suitable reticular retention pellets or long-term injections of calcium or phosphorus because the daily requirement is so high. Two methods suggest themselves:

1. Analysis of ash content of samples of spongy bone from the tuber coxae
2. The metabolic profile method.

The latter program may have some value as a monitoring and diagnostic weapon in the fields of metabolic disease, nutritional deficiency and nutritional excesses.

### Absorption and metabolism of calcium and phosphorus

In ruminants, dietary calcium is absorbed by the small intestine according to body needs. Whereas young animals with high growth requirements absorb and retain calcium in direct relation to intake over a wide range of intakes, adult male animals, irrespective of intake, absorb only enough calcium to replace that lost by excretion into urine and intestine, retaining none of it. Calcium absorption is increased in adult animals during periods of high demand, such as pregnancy and lactation, or after a period of calcium deficiency, but a substantial loss of body stores of calcium appears to be necessary before this increase occurs. The dietary factors influencing the efficiency of absorption of calcium include the nature of the diet, the absolute and relative amounts of calcium and phosphorus present in the diet and the presence of interfering substances. Calcium of milk is virtually all available for absorption, but calcium of forage-containing diets has an availability of only about 50%. The



addition of grain to an all-forage diet markedly improves the availability of the calcium.

Phosphorus is absorbed by young animals from both milk and forage-containing diets with a high availability (80–100%), but the availability is much lower (50–60%) in adult animals. Horses fed diets containing adequate amounts of calcium and phosphorus absorb 50–65% of the calcium, and slightly less than 50% of the phosphorus present in a variety of feedstuffs. In grains, 50–65% of the phosphorus is in the phytate form which is utilizable by ruminants, but not as efficiently by non-ruminants like the horse and pig. An average availability of 70% has been assumed for phosphorus in early weaning diets for young pigs, and a value of 50% in practical cereal-based feeds as supplied to growing pigs, sows and boars.

The metabolism of calcium and phosphorus is influenced by the parathyroid hormone calcitonin and vitamin D. Parathyroid hormone is secreted in response to hypocalcemia and stimulates the conversion of 25-dihydroxycholecalciferol to 1,25-dihydroxycholecalciferol (1,25-DHCC). Parathyroid hormone and 1,25-DHCC together stimulate bone resorption and 1,25-DHCC alone stimulates intestinal absorption of calcium. Calcium enters the blood from bone and intestine, and when the serum calcium level increases above normal, parathyroid hormone is inhibited and calcitonin secretion stimulated. The increased calcitonin concentration blocks bone resorption and the decreased parathyroid hormone concentration depresses calcium absorption.

## CALCIUM DEFICIENCY

Calcium deficiency may be primary or secondary, but in both cases, the end result is an osteodystrophy, the specific disease depending largely on the species and age of the animals affected.

### Synopsis

**Etiology** Primary dietary deficiency of calcium uncommon. Secondary calcium deficiency due to marginal calcium intake and high phosphorus intake.

**Epidemiology** Sporadic. Not common if diets adequate.

**Signs** Poor growth and dentition. Tetany may occur in lactating ewes. Inappetence, stiffness, fracture of long bones. Specific diseases include: rickets, osteomalacia and osteodystrophia fibrosa.

**Clinical pathology** Serum calcium and phosphorus. Radiography.

**Necropsy findings** Osteoporosis; low ash content of bone.

**Diagnostic confirmation** Histology of bone and bone ash analyses.

**Differential diagnosis list** See differential diagnosis of each specific disease.

**Treatment** Calcium salts parenterally and orally.

**Control** Adequate calcium and phosphorus levels in diet.

## ETIOLOGY

A primary deficiency due to a lack of calcium in the diet is uncommon, although a secondary deficiency due to a marginal calcium intake aggravated by a high phosphorus intake is not uncommon. In ponies, such a diet depresses intestinal absorption and retention of calcium in the body and the resorption of calcium from bones is increased. The effects of reduced calcium intake and parathyroidectomy are understandably additive in pigs, but parathyroid insufficiency seems an unlikely natural phenomenon.

## EPIDEMIOLOGY

Calcium deficiency is a sporadic disease occurring in particular groups of animals rather than in geographically limited areas. Although death does not usually occur, there may be considerable loss of function and disabling lesions of bones or joints.

Horses in training, cattle being fitted for shows, and valuable stud sheep are often fed artificial diets containing cereal or grass hays which contain little calcium and grains which have a high content of phosphorus. The secondary calcium deficiency that occurs in these circumstances is often accompanied by a vitamin D deficiency because of the tendency to keep animals confined indoors. Pigs are often fed heavy concentrate rations with insufficient calcium supplement. Dairy cattle may occasionally be fed similarly imbalanced diets, the effects of which are exaggerated by high milk production.

There are no well-established records of calcium deficiency in grazing sheep or cattle, but there are records of low calcium intake in feedlots accompanied by clinical osteodystrophy. There is also a well-recognized field occurrence of calcium deficiency in young sheep in southeast Australia. Outbreaks can affect many sheep and are usually seen in winter and spring, following exercise or temporary starvation. In most outbreaks the characteristic osteoporosis results from a long-term deprivation of food due to poor pasture growth. Occasional outbreaks occur on green oats used for grazing. The calcium intake in some cases is as low as 3–5 g/week in contrast to the requirement of 3–5 g/d.

High protein intake and rapid growth have been suggested as contributory factors in the development of skeletal problems in

young horses. However, a concentration of dietary protein of 20%, which is significantly above the NRC recommended level of 14%, is neither helpful nor harmful to growing horses. The high protein intake did not affect the rate of growth, height, and circumference of cannon bones compared with horses receiving the lower 14% diet. The high protein diet did not result in hypercalciuria and did not affect calcium absorption or calcium retention.

In females there is likely to be a cycle of changes in calcium balance, a negative balance occurring in late pregnancy and early lactation and a positive balance in late lactation and early pregnancy and when lactation has ceased. The negative balance in late pregnancy is in spite of a naturally occurring increased absorption of calcium from the intestine at that time, at least in ewes.

## PATHOGENESIS

The main physiological functions of calcium are the formation of bone and milk, participation in the clotting of blood and the maintenance of neuromuscular excitability. In the development of osteodystrophies, dental defects and tetany the role of calcium is well understood but the relation between deficiency of the element and lack of appetite, poor growth, loss of condition, infertility and reduced milk flow is not readily apparent. The disinclination of the animals to move about and graze and poor dental development may contribute to these effects.

Experimentally, feeding young lambs a diet low in calcium and phosphorus for 12 weeks results in soft and pliable ribs with thickening of the costochondral junctions, reduction in feed intake by about 34%, significant changes in plasma calcium and phosphorus concentrations and changes in dry matter digestibility.<sup>1</sup> Feeding repletion diets results in complete remineralization of rib bones, but only partial remineralization of the metatarsal bones.

Nutritional factors other than calcium, phosphorus and vitamin D may be important in the production of osteodystrophies, which also occur in copper deficiency, fluorosis and chronic lead poisoning. Vitamin A is also essential for the development of bones, particularly those of the cranium.

## CLINICAL FINDINGS

The clinical findings, apart from the specific syndromes described later, are less marked in adults than in young animals, in which there is decreased rate or cessation of growth and dental maldevelopment. The latter is characterized by deformity of the gums, poor development of the incisors, failure of permanent teeth to erupt for periods of up to 27 months and abnormal wear of the permanent teeth due to

defective development of dentine and enamel, occurring principally in sheep.

A calcium deficiency may occur in lactating ewes and sucking lambs whose metabolic requirements for calcium are higher than in dry and pregnant sheep. There is a profound fall in serum calcium. Tetany and hyperirritability do not usually accompany hypocalcemia in these circumstances, probably because it develops slowly. However, exercise and fasting often precipitate tetanic seizures and parturient paresis in such sheep. This is typical of the disease as it occurs in young sheep in southeast Australia. Attention is drawn to the presence of the disease by the occurrence of tetany, convulsions and paresis but the important signs are ill-thrift and failure to respond to anthelmintics. Serum calcium levels will be as low as 5.6 mg/dL (1.4 mmol/L). There is lameness, but fractures are not common even though the bones are soft. A simple method for assessing this softness is compression of the frontal bones of the skull with the thumbs. In affected sheep, the bones can be felt to fluctuate.

Pigs fed on heavy concentrate rations may develop a hypocalcemic tetany, which responds to treatment with calcium salts. Tetany may also occur in young growing cattle in the same circumstances.

Inappetence, stiffness, tendency of bones to fracture, disinclination to stand, difficult parturition, reduced milk flow, loss of condition, and reduced fertility are all non-specific signs recorded in adults.

### SPECIFIC SYNDROMES

#### Primary calcium deficiency

No specific syndromes are recorded.

#### Secondary calcium deficiency

Rickets, osteomalacia, osteodystrophia fibrosa of the horse and pig and degenerative arthropathy of cattle are the common syndromes in which secondary calcium deficiency is one of the specific causative factors. In sheep, rickets is seldom recognized, but there are marked dental abnormalities. Rickets has been produced experimentally in lambs by feeding a diet low in calcium.

#### CLINICAL PATHOLOGY

Because of the effect of the other factors listed above on body constituents, examination of specimens from living animals may give little indication of the primary cause of the disturbance. For example, hypocalcemia need not indicate a low dietary intake of calcium. Data on serum calcium and phosphorus and plasma phosphatase levels, radiographical examination of bones and balance studies of calcium and phosphorus retention are all of value in determining the presence of osteodystrophic disease, but determination of

the initial causative factor will still depend on analysis of feedstuffs and comparison with known standard requirements. The levels of serum calcium may be within the normal range in most cases.<sup>2</sup> However, in spite of evidence to the contrary it seems that calcium deficiency is followed, at least in sheep, by a marked fall in serum calcium levels to as low as 3.5 mg/dL (0.87 mmol/L). In an uncomplicated nutritional deficiency of calcium in sheep, there is only a slight reduction in the radiopacity of bone, in contrast to sheep with a low phosphorus and vitamin D status which show marked osteoporosis. The response to dietary supplementation with calcium is also of diagnostic value.

#### NECROPSY FINDINGS

True primary calcium deficiency is extremely rare but when it does occur, severe osteoporosis and parathyroid gland hypertrophy are the significant findings. The cortical bone is thinned and the metaphyseal trabeculae appear reduced in size and number. The ash content of the bone is low because the bone is resorbed before it is properly mineralized.

Calcium deficiency secondary to other nutritional factors is common and typically induces the form of osteodystrophy known as osteodystrophia fibrosa (see subsequent description). In most instances, the confirmation of a diagnosis of hypocalcemia at necropsy includes an analysis of the diet for calcium, phosphorus, and vitamin D content.

#### Samples for confirmation of diagnosis

**Toxicology** – long bone (ASSAY (ash)); feed (ASSAY (Ca) (P) (Vit D))

**Histology** – formalin-fixed section of long bone (including metaphysis), parathyroid (LM).

#### DIFFERENTIAL DIAGNOSIS

A diagnosis of calcium deficiency depends upon proof that the diet is, either absolutely or relatively, insufficient in calcium, that the lesions and signs observed are characteristic and that the provision of calcium in the diet alleviates the condition. The diseases that may be confused with calcium deficiency are described under the diagnosis of each of the specific disease entities described below.

The close similarity between the dental defects in severe calcium deficiency of sheep and those occurring in chronic fluorosis may necessitate quantitative estimates of fluorine in the teeth or bone to determine the cause.

#### TREATMENT

The response to treatment is rapid and the preparations and doses recommended

below are effective as treatment. Parenteral injections of calcium salts are advisable when tetany is present. When animals have been exposed to dietary depletion of calcium and phosphorus over a period of time, it is necessary to supplement the diet with calcium and phosphorus during dietary mineral repletion.<sup>1</sup>

#### CONTROL

The provision of adequate calcium in the diet, the reduction of phosphorus intake where it is excessive and the provision of adequate vitamin D are the essentials of both treatment and prevention. Some examples of estimated minimum daily requirements for calcium, phosphorus, and vitamin D are set out in Table 30.9. These are estimated minimum requirements and may need to be increased by a safety factor of 10% to allow for variation in individual animal requirements, the biological availability of nutrients in the feedstuffs and the effect which total amount of feed intake has on absolute intake of minerals. For example, the use of a complete pigs ration on a restricted basis may require that the concentration of both calcium and phosphorus be increased in order for that ration to deliver the actual total quantity of calcium and phosphorus necessary to meet a particular requirement for growth, pregnancy, or lactation. The information in Table 30.9 is presented merely as a guideline. When investigating a nutritional problem of formulating rations, it is recommended that the most recently available publications on the nutrient requirements of domestic animals be consulted.

Ground limestone is most commonly used to supplement the calcium in the ration, but should be prepared from calcite and not from dolomite. Variations in availability of the calcium in this product occur with variations in particle size, a finely ground preparation being superior in this respect. Bone meal and dicalcium phosphate are more expensive and the additional phosphorus may be a disadvantage if the calcium:phosphorus ratio is very wide. Alfalfa, clover, and molasses are also good sources of calcium but vary in their content. The optimum calcium:phosphorus ratio is within the range of 2:1 to 1:1. In cattle, absorption of both elements is better at the 2:1 ratio. For optimum protection against the development of urolithiasis in sheep a ratio of 2–2.5 calcium to 1 phosphorus is recommended.

The dustiness of powdered limestone can be overcome by dampening the feed or adding the powder mixed in molasses. Addition to salt or a mineral mixture is subject to the usual disadvantage that not all animals partake of it readily when it is provided free-choice, but this method of

Table 30.9 Some examples of estimated daily requirements of calcium, phosphorus and vitamin D

Species, kg body weight and function	Calcium	Phosphorus	Vitamin D
	(g/animal)		
<b>Dairy cattle</b>			
Growing heifers (large breeds)			300 IU/kg dry matter (DM) intake
159	15	12	
300	24	18	
400	26	20	
Growing heifers (small breeds)			
100	9	7	
200	15	11	
300	19	14	
Growing bulls (large breeds)			
300	27	20	
400	30	23	
500	30	23	
Maintenance of mature lactating cows			
400	17	13	
500	20	15	
600	22	17	
Maintenance and pregnancy			
400	23	18	
500	29	22	
600	34	26	
Milk production	Add 2–3 g calcium and 1.7–2.4 g phosphorus to the maintenance requirements for each kg of milk produced.		
	(% of ration)		
<b>Beef cattle</b>			
Dry mature pregnant cows	0.16	0.16	300 IU/kg DM intake
Cows nursing calves	0.30	0.25	
Bulls, growth and maintenance	0.26	0.20	
Growing heifers (200 kg live-weight gaining 0.8 kg/d)	0.33	0.26	
Growing steers (200 kg live-weight gaining 0.8 kg/d)	0.36	0.28	
<b>Pigs</b>			
Growing pigs (from 10 to 100 kg live weight)	0.65	0.50	200 IU/kg ration
Breeding pigs (gilts, sows, boars)	0.75	0.50	275 IU/kg ration
<b>Sheep</b>			
<b>Ewes</b>			
Maintenance	0.30	0.28	250–300 IU/kg DM intake
Pregnant (early)	0.27	0.25	
Pregnant (late)	0.24	0.23	
Lactating	0.52	0.37	200 IU/kg DM intake
<b>Rams</b>			
(40–120 kg live weight)	0.35	0.19	200 IU/kg DM intake
<b>Lambs</b>			
Early weaned (10–30 kg live weight)	0.40	0.27	150 IU/kg DM intake
Finishing (30–55 kg live weight)	0.30	0.20	
<b>Horses</b>			
Mature horses (400–600 kg live weight)	0.30	0.20	6–8 IU/kg body weight
<b>Mares (400–600 kg live weight)</b>			
Last 90 days pregnancy	0.38	0.30	
Peak of lactation	0.50	0.40	
<b>Growing horses (400 kg mature weight)</b>			
3 months old	0.68	0.43	
6 months old	0.68	0.48	
12 months old	0.45	0.30	
<b>Growing horses (500 kg mature weight)</b>			
3 months old	0.69	0.44	
6 months old	0.82	0.51	
12 months old	0.43	0.28	

supplementation is often necessary in pastured animals. High-producing dairy cows should receive the mineral mixture in their ration as well as having access to it in boxes or in blocks.

## REFERENCES

1. Ternouth JH, Sevilla CC. Aust J Agric Res 1990; 41:413.
2. Heaney DP et al. Can J Anim Sci 1985; 65:163.

## PHOSPHORUS DEFICIENCY

Phosphorus deficiency is usually primary and is characterized by pica, poor growth, infertility and, in the later stages, osteodystrophy. Hypophosphatemia in dairy cattle is also associated with increased fragility of red blood cells and post-parturient hemoglobinuria.

### Synopsis

**Etiology** Usually a primary deficiency in diet; may be conditioned by vitamin D deficiency.

**Epidemiology** Primary phosphorus deficiency occurs worldwide. Soils and crops commonly deficient in phosphorus. Primary deficiency may occur in lactating dairy cattle in early lactation. Occurs under range conditions in beef cattle and sheep. In pigs not supplemented with sufficient phosphorus.

**Signs** Young animals grow slowly; develop rickets. Adults develop osteomalacia, unthriftiness, weight loss, reduced feed consumption, reluctance to move, leggy appearance, fractures, impaired fertility. Recumbency in high-producing cows on marginally phosphorus-deficient diet.

**Clinical pathology** Serum phosphorus. Phosphorus content of diet.

**Necropsy findings** Rickets and osteomalacia; lack of mineralization of bones.

**Diagnostic confirmation** Histology of bone lesions; bone ash analyses.

**Differential diagnosis** Those diseases resembling rickets and osteomalacia.

**Treatment** Phosphates parenterally and orally and vitamin D.

**Control** Supplement diets with adequate phosphorus, calcium, and vitamin D.

### ETIOLOGY

Phosphorus deficiency is usually primary under field conditions but may be exacerbated by a deficiency of vitamin D and possibly by an excess of calcium.

### EPIDEMIOLOGY

#### Geographical occurrence

In contrast to calcium deficiency, a dietary deficiency of phosphorus is widespread under natural conditions.<sup>1</sup> It has a distinct geographical distribution depending largely upon the phosphorus content of the parent rock from which the soils of the area are derived, but also upon the influence of other factors, such as excessive calcium, aluminum, or iron, which reduce the availability of phosphorus to plants. Large areas of grazing land in many countries are of little value for livestock production without phosphorus supplementation. In New Zealand, for example, where fertilization of pasture with superphosphate has been practiced for many years, phosphorus deficiency may still occur in dairy herds because of inadequate maintenance of

application over several years.<sup>2</sup> There is evidence also that the quality of the superphosphate declined over a period of several years. Soil reserves of phosphorus may also be low because of high phosphate retention soils. Animals in affected areas mature slowly and are inefficient breeders and additional losses due to botulism and defects and injuries of bones may occur. Apart from areas in which frank phosphorus deficiency is seen, it is probable that in many other areas a mild degree of deficiency is a limiting factor in the production of meat, milk, and wool.

Heavy leaching by rain and constant removal by cropping contribute to phosphorus deficiency in the soil and the low phosphorus levels of the plant cover may be further diminished by drought conditions. Pastures deficient in phosphorus are classically also deficient in protein.

### Cattle

The literature on phosphorus nutrition of grazing cattle has been reviewed.<sup>3</sup> The degree of naturally occurring phosphorus deficiency in grazing cattle, the lack of uniformity in response to phosphorus supplementation and the suggested phosphorus requirements have resulted in considerable confusion in the United States and worldwide. Much of the confusion arises because animals have the ability to draw on skeletal phosphorus reserves when dietary phosphorus levels are inadequate. The mechanisms which control skeletal phosphorus withdrawal, the conditions which trigger withdrawal and the rate and extent of withdrawal without affecting animal performance are not well understood.

The earliest report of naturally occurring phosphorus deficiency in grazing cattle was at Armoedsvlakte in the Northern Cape of South Africa. The disease was called aphosphorosis and animals with the disease demonstrated a depraved appetite characterized by the desire to eat wood, bones, rocks, and other such materials. In severe deficiencies, cattle often died from botulism from eating bones from old carcasses contaminated with *Clostridium botulinum*. In advanced states of aphosphorosis, animals developed a stiffness in the forelegs resulting in a characteristic lameness referred to as 'stysiekte' in South Africa, 'creeps' in Texas and 'pegleg' in Australia.<sup>3</sup>

A primary dietary deficiency of phosphorus in dairy cattle within the first several weeks of lactation can result in postparturient hemoglobinuria. In high-producing dairy cows, small restrictions in dietary phosphorus intake compared with National Research Council recommendations can result in acute recumbency in early lactation.<sup>4</sup>

Under range conditions, milking cows are most commonly affected, but under intensive conditions, it is the dry and young stock receiving little supplementation which will be affected. The incidence of the disease varies: it is most common in animals at pasture during drought seasons but can also be a serious problem in housed cattle fed on hay only.

A survey of the mineral status of bones of cattle at abattoirs in western New South Wales, Australia, found evidence of osteodystrophy based on ash density.<sup>5</sup> They represented cattle attempting to grow in a poor season, often female and in poor body fat condition and light in body weight and mostly from red soils known to be deficient in phosphorus.

The dietary requirements of phosphorus are given in Table 30.10. Cattle constantly grazing pasture in the southern hemisphere appear to require somewhat less phosphorus in their diet (0.20% is probably adequate) than do higher-producing, partly housed livestock. The dietary requirements of phosphorus recommended by the National Research Council for beef cows weighing 450 kg may exceed the basic requirements.<sup>6</sup> Over a period of several gestations a daily allowance of 12 g of phosphorus/day/animal was adequate for beef cows.<sup>6,7</sup> Cattle given a phosphorus-deficient diet did not develop detectable signs of phosphorus deficiency until they had been on a severely deficient diet for 6 months.

### Sheep and horses

Sheep and horses at pasture are much less susceptible to the osteodystrophy of phosphorus deficiency than are cattle and their failure to thrive on phosphorus-deficient pasture is probably due in part to the low protein content of the pasture. In fact, there has been no clear demonstration of a naturally occurring phosphorus deficiency in sheep, nor is there any record of infertility in sheep caused by phosphorus deficiency.

There is some limited evidence that the serum inorganic phosphorus levels in Thoroughbred racehorses may be related

to certain feeding regimens and to racing performance.<sup>8</sup> Horses fed cubed or pelleted dietary supplement have serum inorganic phosphate concentrations consistently below an accepted mean of 1.032 mmol/L.<sup>8</sup> It is suggested that a rapid rate of passage of the ingesta may affect absorption of phosphorus. Other observations indicate that some of the best track performers had significantly lower inorganic serum phosphorus concentrations compared with some of the worst performers.

### Pigs

A primary deficiency can occur in pigs kept in confinement and not provided with sufficient dietary phosphorus. Lactating sows are more commonly affected than growing pigs. In some situations, in the cereal grains, the phytate levels are so high and phytase levels so low, rickets and osteomalacia are common in the pig population.<sup>9</sup>

### Secondary phosphorus deficiency

This is of minor importance compared with the primary condition. A deficiency of vitamin D is not necessary for the development of osteodystrophy, although with suboptimal phosphate intakes deficiency of this vitamin becomes critical. Excessive intake of calcium does not result in secondary phosphorus deficiency, although it may cause a reduction in weight gains, due probably to interference with digestion and may contribute to the development of phosphorus deficiency when the intake is marginal. The presence of phytic acid in plant tissues, which renders phosphate unavailable to carnivora, is a major consideration in pigs but of only minor importance in herbivora, except that increasing intakes of calcium may reduce the availability of phytate phosphorus even for ruminants. Rock phosphates containing large amounts of iron and aluminum have been shown to be of no value to sheep as a source of phosphorus. A high intake of magnesium, such as that likely to occur when magnesite is fed to prevent lactation tetany, may cause hypophosphatemia if the phosphorus intake of dairy cows is already low.

Table 30.10 Approximate levels of phosphorus in soil and pasture (quoted as phosphate radical) at which phosphorus deficiency occurs in cattle

	Levels at which deficiency does not occur	Levels at which deficiency does occur
Soil	0.005%	0.002%
Pasture	0.3%	0.2% - osteophagia <0.01% - rickets and osteomalacia
Daily intake (cattle)	40-50 g	25 g

All figures are on a dry matter (DM) basis and soil phosphate is citrate-soluble.

**Hypophosphatemia** has been induced in pigs by experimental supplementation of their diets with aluminum hydroxide.<sup>10</sup> After 3 weeks, severe hypophosphatemia, intense hypercalcemia, decreased growth rate, and a lower concentration of 2,3-diphosphoglycerate in the erythrocytes developed.<sup>10</sup>

### PATHOGENESIS

From 80 to 85% of the phosphorus of the body is located in the skeleton where it occurs as hydroxyapatite in a 1.0:1.7 ratio with calcium. These two minerals provide bone strength necessary for normal activities, such as grazing.<sup>3</sup> Bone phosphorus also functions as an important phosphorus reservoir for resorption when body requirements temporarily exceed dietary intake. From 17 to 42% of bone could be resorbed in cattle and sheep in times of phosphorus deficiency.

Phosphorus is also essential for a broad range of enzymatic reactions, especially those concerned with energy metabolism and transfer. Phosphorus is also essential for the transfer of genetic information and is a vital component of various buffering systems. Phospholipids are necessary for maintenance of cell wall structure and integrity and as a integral components of myelin.

Rumen microbes have a phosphorus requirement apart from the animal's requirement which must be met for optimum rumen microbial activity to occur.

Phosphorus is essential for the laying down of adequately mineralized bones and teeth and a deficiency will result in their abnormal development. Inorganic phosphate, which may be ingested as such, or liberated from esters during digestion or in intermediary metabolism, is utilized in the formation of proteins and tissue enzymes and is withdrawn from the plasma inorganic phosphate for this purpose.

Experimentally, female beef cattle fed diets containing <6 g of phosphorus/day developed an insidious and subtle complex syndrome characterized by weight loss, rough hair coat, abnormal stance, and lameness.<sup>6</sup> Spontaneous fractures occurred in the vertebrae, pelvis, and ribs. Some affected bones were severely demineralized and the cortical surfaces were porous, chalky white, soft, and fragile. The osteoid tissue was not properly mineralized.

Experimental acute depletion of phosphorus in cattle results in a marked decline in serum inorganic phosphorus and affected animals display an avid appetite for old bones.<sup>11</sup> The signs include:

- Failure to gain weight and maintain body condition
- Reduced bone weight
- Osteopenia radiographically
- Evidence of reduced bone formation.

Prolonged phosphorus deficiency was associated with increased plasma concentrations of total calcium and 1,25-dihydroxyvitamin D and reduced plasma concentrations of parathyroid hormone.

The pathophysiological effects of low dietary phosphorus in pigs have been examined.<sup>9</sup> Determination of the serum concentrations of parathyroid hormone, 1,25-(OH)<sub>2</sub> D and osteocalcin were monitored in Romanian Landrace pigs originating from herds with dietary P deficiency. Serum P concentrations were negatively correlated with those of 1,25-(OH)<sub>2</sub> D. In lactating animals and sucklings, the linear relationships were not present. Serum P concentrations positively correlated with those of PTH and 1,25-(OH)<sub>2</sub> D concentrations were negatively correlated. The serum concentrations of 1,25-(OH)<sub>2</sub> D and osteocalcin were positively correlated. Milk P concentrations ranging from 3.10 to 7.49 mmol/L were correlated positively with urinary P concentrations ranging from 0.26 to 11.37 mmol/L. In conclusion, similar to other species, P homeostasis is achieved in pigs by feedback mechanisms between P, PTH, and 1,25-(OH)<sub>2</sub> D and osteocalcin production is induced by 1,25-(OH)<sub>2</sub> D

Inorganic phosphate also plays an important role in the intermediary metabolism of carbohydrate and of creatine in the chemical reactions occurring in muscle contraction. This may be of importance in those cows that are recumbent after calving and have hypophosphatemia. The loss of phosphorus in the phospholipids of milk due to the onset of profuse lactation may be the crucial factor in the development of postparturient hemoglobinuria. An increased susceptibility to bloat has been postulated as an effect of phosphorus deficiency.

### CLINICAL FINDINGS

Primary phosphorus deficiency is common only in cattle. Young animals grow slowly and develop rickets. In adults there is an initial subclinical stage followed by osteomalacia. In cattle of all ages a reduction in voluntary intake of feed is a first effect of phosphorus deficiency and is the basis of most of the general systemic signs. Retarded growth, low milk yield, and reduced fertility are the earliest signs of phosphorus deficiency. For example, in severe phosphorus deficiency in range beef cattle, the calving percentage has been known to drop from 70 to 20%. Although it is claimed that relative infertility occurs in dairy heifers on daily intakes of less than 40 g of phosphate, the infertility being accompanied by anestrus, subestrus, and irregular estrus and delayed sexual maturity this has not been borne out by other experimental work, which indicates

that fertility is independent of the calcium or phosphorus content or the calcium:phosphorus ratio of the diet in cattle. The effects of malnutrition on fertility are likely to be general and the infertility may often be related to lack of total energy intake rather than to specific deficiency. The development and wear of teeth are not greatly affected, in contrast with the severe dental abnormalities that occur in a nutritional deficiency of calcium. However, malocclusion may result from poor mineralization and resulting weakness of the mandible.

In the experimental production of phosphorus deficiency in beef cows, several months on a deficient diet are necessary before clinical signs develop.<sup>7</sup> The clinical signs included general unthriftiness, marked body weight loss, reduced feed consumption, reluctance to move, abnormal stance, bone fractures, and finally impaired reproduction. The detectable signs of phosphorus deficiency developed in the following sequence:

- Loss of body weight and condition
- Decreased whole blood phosphorus associated with increased whole blood calcium concentration
- Allotriphagia
- Abnormal stance, locomotion and recumbency.<sup>6</sup>

In a severely deficient area, a characteristic conformation develops and introduced cattle revert to the district type in the next generation. The animals have a leggy appearance with a narrow chest and small girth, the pelvis is small, and the bones are fine and break easily. The chest is slab-sided due to weakness of the ribs and the hair coat is rough and staring and lacking in pigment. In areas of severe deficiency, the mortality rate may be high due to starvation, especially during periods of drought when deficiencies of phosphorus, protein and vitamin A are exaggerated. Osteophagia is common and may be accompanied by a high incidence of botulism. Cows in late pregnancy often become recumbent and, although they continue to eat, are unable to rise. Such animals present a real problem in drought seasons because many animals in the area may be affected at the same time. Parenteral injections of phosphorus salts are ineffective and the only treatment that may be of benefit is to terminate the pregnancy by the administration of corticosteroids or by cesarean section.

Acute recumbency in high-producing dairy cows on a marginally phosphorus-deficient diet may become recumbent in early lactation.<sup>4</sup> Affected animals are recumbent and cannot stand. They may be bright and alert and their vital signs are within normal range.

Although sheep and horses in phosphorus-deficient areas do not develop clinically apparent osteodystrophy they are often of poor stature and unthrifty and may develop perverted appetites. An association between low blood phosphorus and infertility in mares has been suggested but the evidence is not conclusive. The principal sign in affected sows is posterior paralysis.

## CLINICAL PATHOLOGY

### Serum phosphorus

Blood levels of phosphorus are not a good indicator of the phosphorus status of an animal because they can remain at normal levels for long periods after cattle have been exposed to a serious deficiency of the element. Serum inorganic phosphorus levels are affected by such factors as age of animal, milk yield, stage of pregnancy, season of year, breed, feeding patterns, and dietary phosphorus. The times of sampling in a herd must be standardized to reduce the effect of diurnal variation in serum concentrations of inorganic phosphorus. Attention is drawn to the need to use standard methods of collection because of the effect that technique can have on phosphorus levels in blood. In cattle, the recommended procedure is to collect blood from the coccygeal vein and preserve it in buffered trichloroacetic acid. Hair does not reflect the status either. However, a marked hypophosphatemia is a good indicator of a severe phosphorus deficiency. The mild-to-moderate deficiencies, which are the most common ones, are usually accompanied by normal blood levels of phosphorus. Generally, clinical signs occur when blood levels have fallen from the normal of 4–5 mg/dL (1.3–1.7 mmol/L) to 1.5–3.5 mg/dL (0.5–1.2 mmol/L) and a response to phosphate supplementation in body weight gain can be anticipated in cattle that have blood inorganic phosphorus levels of less than 4 mg/dL (1.3 mmol/L). Levels may fall as low as 1 mg/dL (0.3 mmol/L) or less in severe clinical cases. Serum levels of calcium are usually unaffected.

### Phosphorus content of diet

Estimation of the mineral content in pasture and drinking water is a valuable aid in diagnosis, but has major difficulty in representing what the animal has actually been taking in. A technique has been devised for determining phosphorus intake of sheep by estimating the phosphorus content of feces. A pool of three pellets from each of 30 sheep is used as a sampling technique.

### Bone ash concentrations

Determination of total bone ash concentrations and bone calcium and phosphorus concentrations from sample of rib can

provide useful diagnostic information and comparison to normal values.<sup>12</sup>

There is usually a marked deterioration in the radiopacity of the bones. However, the bone content of phosphorus is still considered the most accurate indication of phosphorus status.

## NECROPSY FINDINGS

The necropsy findings are those of the specific diseases, rickets and osteomalacia.

## DIFFERENTIAL DIAGNOSIS

A diagnosis of phosphorus deficiency depends upon evidence that the diet is lacking in phosphorus and that the lesions and signs are typical of those caused by phosphorus deficiency and can be arrested or reverted by the administration of phosphorus. Differentiation from those diseases that may resemble rickets and osteomalacia is dealt with under those headings.

## TREATMENT

The preparations and doses recommended under control can be satisfactorily used for the treatment of affected animals. In cases where the need for phosphorus is urgent, as in postparturient hemoglobinuria and in cases of parturient paresis complicated by hypophosphatemia, the intravenous administration of sodium acid phosphate (30 g in 300 mL distilled water) is recommended.

## CONTROL

Phosphorus (P) deficiencies in grazing livestock can be prevented by direct treatment of the animal through supplementing the diet or the water supply, or indirectly by approximate fertilizer treatment of the soils. Hand-fed animals are supplemented with P in their diets.

## Phosphorus requirements

### Cattle

The phosphorus requirements for cattle in various stages of the production cycle have varied widely worldwide.<sup>3</sup> Accurate P requirements must be established for all classes of cattle grazing under various conditions before producers can determine whether diets are adequate in P to meet animal needs or whether P supplements must be provided to optimize production.<sup>3</sup> Apparent P requirements vary for a variety of reasons: differences among breeds of cattle, P availability in the feed, whether animals are pen fed or free grazing, possible interactions between nutrients, and the effects of disease and parasitism.

### Dairy cattle

There is widespread belief among producers and consultants that reproductive

performance in dairy cows can be improved by feeding phosphorus above recommended levels.<sup>4</sup> The current NRC recommendations for early lactation (90 days in milk) diets are 0.36% P (DM basis) for cows milking 45 kg/d and 0.35% P for cows milking 35 kg/d. The NRC recommends up to 0.42% for the highest producing cows during the first few weeks of lactation.

Several studies indicate that dietary P at 0.38 to 0.40% is sufficient for high producing dairy cows.<sup>13,14</sup> This concentration of P can be obtained with no supplementation or minimum supplementation of P, depending on feed ingredients. Dietary P at 0.31% can support high milk production but cannot sustain comparable high yield when cows proceed into late lactation. Cows conserve P when fed diets low in P by reducing P excretion in feces and urine. They may experience some negative balance in the first few weeks of lactation due to mobilization of P from bone, but this mobilized P can be restored in later lactation.

However, there has been a lack of information about the minimum intake level of P on which dairy cows can maintain health and milk production. In essence, the current requirements developed in various countries are mainly based on studies with non-lactating sheep and goats.

### Environmental implications of phosphorus feeding of livestock

In the European Union and the USA, phosphorus (P) losses from dairy manure to the environment are becoming a more severe pollution problem.<sup>15,16</sup> Ideally, P is recycled into the soil/plant/animal system from which only the P incorporated into the animal system escapes. In a sustainable dairy farming system, the amount of P expelled in the form of manure must be limited to that amount which crops need for maximum growth. However, due to high livestock intensities, overapplication of P from manure occurs, leading to P accumulation in the soil and finally leaching, thus causing eutrophication of lakes. Reducing P intake by dairy cows and thus also that excreted in the manure will contribute to reducing environmental pollution.

In Delaware County of New York, more P enters dairy farms than is exported in milk, meat, or crops sold, thus resulting in a net annual accumulation of P on the farm ranging from 19 to 41 kg/cow.<sup>17</sup> Purchased feed is the single largest source of imported P on dairy farms, accounting for 65–85% of the 28–51 kg imported annually per cow for typical commercial dairy herds in New York. Similar amounts

have been reported for dairy farms in the Netherlands.<sup>18</sup>

Dairy farms in the states of New York, Pennsylvania, Delaware, Maryland, and Virginia, fed P to lactating cows averaging 34% above the NRC recommendations.<sup>19</sup> In 84% of the survey farms, ration formulation was provided by professionals rather than producers themselves. Most producers were feeding more P than cows needed because it was recommended by these consultants. Surveys in the USA show that dairy diets are formulated to contain approximately 0.45–0.50% P (DM basis), an amount that is about 20% in excess.<sup>16</sup> This oversupplementation of P is costing the US dairy industry about US\$100 million (in 1999). Most lactating dairy cow diets could have their P content reduced by 20%.<sup>16</sup> This would result in a 25–30% reduction in P content of manure and a similar reduction in the amount of land required to accommodate the manure. Phosphorus is the most expensive nutrient in typical mineral-vitamin formulations for dairy cattle. Feeding a diet containing 0.45% P versus one containing 0.55% would save about \$0.05/cow daily; for a 100 cows over 1 year, would save about \$1825.00

Three factors which lead to excessive feeding of P include the notion that increasing P intake would improve reproduction, the absence of lactation trials showing the absolute minimum of P required to support milk production and the aggressive marketing of P supplements.<sup>16</sup>

Simulation models of the long-term effects of changes in feeding, cropping, and other production strategies on P loading and the economics of 100-cow and 800-cow dairy farms in south-eastern New York found that the most easily implemented change was to reduce the supplemented mineral P fed to that required to meet the current NRC recommended amounts, which would provide an annual increase in farm profit of about \$22.00 per cow.<sup>20</sup> Dairy farms in some areas can maintain a long-term P balance by: feeding P according to the NRC requirements; a cropping strategy and land base use supplies all of the forage needed; all animals are fed a high forage diet; replacement heifers are produced on the farm.

The effects of feeding low amounts of phosphorus to high yielding dairy cows has been examined.<sup>21</sup> Lactating dairy cows were fed diets containing 67, 80, and 100%, respectively, of the phosphorus requirements recommended by the Dutch Committee on Mineral Nutrition for a period of 21 months. Nearly 5 months after the beginning of the feeding trial, the milk yield and milk lactose content of the 67% group decreased significantly.

After 2 years, on the 80% diet, postparturient hemoglobinuria occurred in one high producing cow. It was concluded that rations for high yielding dairy cows should not contain phosphorus content lower than 3.0 g/kg DM. The P supply with the 80% ration was considered to be just sufficient.

The supplementation of dietary P above levels recommended by the NRC (0.38% considered adequate or 0.48% excessive) did not improve duration or intensity of estrus in dairy cows under Wisconsin conditions.<sup>4</sup> Large lactation studies have shown that feeding P in excess of 0.37% of diet DM, which corresponds closely to the NRC P requirements, did not affect milk production, milk composition, or animal health.<sup>22</sup> Digestion studies and P retention data also support the NRC recommendations.<sup>23</sup> Biochemical markers of bone turnover in the dairy cow during lactation and the dry period are being used to measure bone formation and resorption during a complete lactation in dairy cattle.<sup>24</sup>

Based on calculation of P losses and the true absorption coefficient using data on saliva production, saliva-P content, and the efficiency of P absorption under conditions in the Netherlands, the P requirement recommended for dairy cows: P requirement (g/d per 600 kg cow) =  $19 + 1.43 \times \text{kg milk}$ . The recommendation is up to 22% lower than the current recommendation for high yielding dairy cows used in the UK.<sup>15</sup>

The overfeeding of P has important environmental implications. Phosphorus excretion increases linearly as P intake is increased above the requirement. Once P requirements are met, all of the excess dietary P is excreted in the feces. This excess P accumulates in the environment, primarily by the recycling of manure to land as fertilizer for crop production. The surface runoff of this excess P promotes the eutrophication of surface waters. (Eutrophication is the accidental or deliberate promotion of excessive growth of one kind of organism to the disadvantage of other organisms in the ecosystem.) Therefore, close monitoring of P inputs in the livestock industry is important to reduce the risk of eutrophication of lakes and streams. Reducing dietary intake closer to requirement will require frequent and accurate feed analysis, quantification of dry matter intake and ration management to ensure that formulated diets are mixed and delivered to the cows properly. Phosphorus reduction will be achieved by precision of feeding of dairy cattle.<sup>17</sup> Portable and rapid tests are now available to determine the level of P in dairy cattle manure.<sup>25</sup> These hand-held tools can

yield real-time measurements of dissolved P and total P in manure.

As part of the US Environmental Protection Agency's concentrated animal feeding operation (CAFO) final rule, all CAFOs will be required to develop and implement a **nutrient management plan**.<sup>26</sup> The emphasis on better management of nutrients appropriately targets a critical environmental issue associated with animal production. The concentration of animals in livestock feeding operations, often separate from feed grain production, requires importing of substantial quantities of feed nutrients. Due to inefficiencies of nutrient utilization in livestock production, quantities of nitrogen and phosphorus in manure greater than can be utilized in local crop production often result. In a survey of 994 dairy farms in Pennsylvania, only 20% of the farms reported manure nutrient testing, compared with over 90% which did soil testing.<sup>27</sup> Farm advisors and their services can be of vital importance in assisting producers make conscientious management decisions for enhanced nutrient utilization. Ration balancing involved the services of feed and mineral representatives on 85% of the farms, independent consultants on 12% and veterinarians only on 5% of farms. Nutrient management strategies and efforts must address the specific needs of farms with different animal densities and nutrient balances in order to be effective and applicable on the majority of farms.

Under field conditions, the difficulty usually encountered is that of providing phosphorus supplements to large groups of cattle grazing under extensive range conditions. The new recommendations for dairy cattle in 2001, are to provide phosphorus at 0.36–0.4% of dry matter intake.<sup>28</sup> These are lower than the previous recommendation of 0.5% of dry matter intake.

Bone meal, dicalcium phosphate, disodium phosphate, and sodium pyrophosphate may be provided in supplementary feed or by allowing free access to their mixtures with salt or more complicated mineral mixtures. The availability of the phosphorus in feed supplements varies and this needs to be taken into consideration when compounding rations. The relative biological values for young pigs in terms of phosphorus are: dicalcium phosphate or rock phosphate 83%, steamed bone meal 56%, and colloidal clay or soft phosphate 34%. It is suggested that in deficient areas adult dry cattle and calves up to 150 kg BW should receive 225 g bone meal/week, growing stock over 150 kg BW 350 g/week, and lactating cows 1 kg weekly, but experience in particular areas may indicate the need



for varying these amounts. The top-dressing of pasture with superphosphate is an adequate method of correcting the deficiency and has the advantage of increasing the bulk and protein yield of the pasture, but is often impractical under the conditions in which the disease occurs.

The addition of phosphate to drinking water is a much more satisfactory method provided the chemical can be added by an automatic dispenser to water piped into troughs. Adding chemicals to fixed tanks introduces errors in concentration, excessive stimulation of algal growth, and precipitation in hard waters. Monosodium dihydrogen phosphate (monosodium orthophosphate) is the favorite additive and is usually added at the rate of 10–20 g/20 L of water. Superphosphate may be used instead but is not suitable for dispensers, must be added in larger quantities (50 g/20 L) and may contain excess fluorine. A reasonably effective and practical method favored by Australian dairy farmers is the provision of a supplement referred to as 'super juice'. Plain superphosphate at a rate of 2.5 kg in 40 L of water is mixed and stirred vigorously in a barrel. When it has settled for a day the 'super juice' is ready for use and is administered by skimming off the supernatant and sprinkling 100–200 mL on the feed of each cow.

#### Beef cattle

The literature on the phosphorus nutrition of grazing beef cattle in the USA and other parts of the world has been reviewed.<sup>3</sup> There has been a notable lack of research into the P requirements of grazing beef cattle of various age groups, under varying soil and forage conditions which has created considerable confusion and disagreement about the P requirements. The effects of P fertilizer on forage P levels and seasonal changes in P concentration are well understood, but the availability of P in different forage species, at different stages of maturity and grown under different management schemes and environmental conditions is not well understood.

The details of the phosphorus requirements for beef cattle of various age groups are available in the National Research Council. (2000) Nutrient Requirements of Beef Cattle, 7th revised ed., updated 2000.<sup>29</sup>

#### Feedlot cattle

The phosphorus requirement of finishing feedlot calves is <0.16% of diet dry matter (DM) or 14.2 g/d.<sup>30</sup> Typical grain-based feedlot cattle diets do not require supplementation of inorganic mineral P to meet P requirements. Plasma P, performance and bone characteristics indicate

that P requirements are less than the predicted requirements and should be modified. Supplementation of mineral P in finishing diets is an unnecessary economic and environmental cost for beef feedlot producers and should discontinue.

#### Pigs

The estimated dietary requirements for phosphorus for maximum growth and feed efficiency of pigs at 3–5, 5–10, 10–20, 20–50, 50–80, and 80–120 kg, as a percentage of diet (90% DM) are 0.70, 0.65, 0.60, 0.50, 0.45, and 0.40%, respectively.<sup>31</sup> The form in which phosphorus exists in natural feedstuffs influences the efficiency of its utilization. In cereal grains, grain by-products, and oilseed meals, about 60–75% of the phosphorus is organically bound in the form of phytate which is poorly available to the pig. The biological availability of P in cereal grains is variable ranging from less than 15% in corn to approximately 50% in wheat which has naturally occurring phytase enzyme. The phosphorus in inorganic phosphorus supplements also varies in bioavailability. The P in ammonia, calcium, and sodium phosphates is highly available.<sup>31</sup>

#### Toxicity of supplements

The use of phosphate supplements in the diet is not without hazards. Phosphoric acid is directly toxic and should not be used and monosodium phosphate is unpalatable to many animals; the depression of appetite that results may discount the improved feed utilization it provides. Superphosphate used as fertilizer can cause toxicosis in ruminants.<sup>32</sup> Clinical signs in sheep include teeth grinding, diarrhea, nervous system depression, apparent blindness, stiffness, and ataxia and high fatality rate.<sup>32</sup>

#### REVIEW LITERATURE

- Valk H, Beyen AC. Proposal for the assessment of phosphorus requirements of dairy cows. *Livestock Prod Sci* 2003; 79:267–272.
- Karn JF. Phosphorus nutrition of grazing cattle: a review. *Anim Feed Sci Technol* 2001; 89:133–153.
- Satter L. What goes in must come out – phosphorus balance on dairy farms. *Proc Ann Conv Am Assoc Bov Pract* 2002; 35:125–130.
- National Research Council. Minerals. Nutrient requirements of beef cattle, 7th revised ed. Updated 2000. Washington, DC: National Academy of Sciences, 2000: Ch. 5.
- National Research Council. Minerals. Nutrient requirements of dairy cattle, 7th revised ed. Washington, DC: National Academy of Sciences, 2001: Ch. 7.
- National Research Council. Minerals. Nutrient requirements of swine, 10th revised ed. Washington, DC: National Academy of Sciences, 1998: Ch. 4.
- Underwood EJ, Suttle NF. Phosphorus. In: The mineral nutrition of livestock, 3rd ed. Wallingford, Oxon: CAB International, 1999.

#### REFERENCES

- Underwood EJ, Suttle NF. Phosphorus. In: The mineral nutrition of livestock, 3rd ed. Wallingford, Oxon: CAB International, 1999.
- Brooks HV et al. *N Z Vet J* 1984; 32:174.
- Karn JF. *Anim Feed Sci Technol* 2001; 89:133.
- Lopez I et al. *Theriogenol* 2004; 61:437.
- Holst PJ et al. *Aust J Agric Res* 2002; 53:947.
- Shupe JL et al. *Am J Vet Res* 1988; 49:1629.
- Call JW et al. *Am J Vet Res* 1986; 47:475.
- Denny JEFM. *J South Afr Vet Assoc* 1987; 58:85.
- Riond JL et al. *Vet J* 2001; 161:165.
- Haglin L et al. *Acta Vet Scand* 1988; 29:91.
- Blair-West JR et al. *Am J Physiol* 1992; 263:R656.
- Beigle DE et al. *Am J Vet Res* 1994; 55:85.
- Wu Z et al. *J Dairy Sci* 2000; 83:1028.
- Wu Z, Satter LD. *J Dairy Sci* 2000; 83:1052.
- Valk H, Beyen AC. *Livestock Prod Sci* 2003; 79:267.
- Satter L. *Proc Ann Conf Am Assoc Bov Pract* 2002; 35:125.
- Cerosaletti PE et al. *J Dairy Sci* 2004; 2314.
- Valk H et al. *J Dairy Sci* 2002; 85:2642.
- Dou Z. et al. *J Dairy Sci* 2003; 86:3787.
- Rotz CA et al. *J Dairy Sci* 2002; 85:3142.
- Valk H et al. *Vet Rec* 1999; 145:673.
- Lopez H et al. *J Dairy Sci* 2004; 87:139.
- Weiss WP, Wyatt DJ. *J Dairy Sci* 2004; 87:2158.
- Holtenius K, Ekelund A. *Res Vet Sci* 2005; 78:17.
- Lugo-Ospina A et al. *Environ Pollut* 2005; 135:155.
- Koelsch R. *J Environ Qual* 2005; 34:149.
- Dou Z et al. *J Dairy Sci* 2001; 84:966.
- National Research Council. Minerals. Nutrient requirements of dairy cattle, 7th revised ed. Washington, DC: National Academy of Sciences, 2001: Ch. 7.
- National Research Council. Minerals. Nutrient requirements of beef cattle, 7th revised ed. Washington, DC: National Academy of Sciences, 2000: Ch. 5.
- Erickson GE et al. *J Anim Sci* 2002; 80:1690.
- National Research Council. Minerals. Nutrient requirements of swine, 10th revised ed. Washington, DC: National Academy of Sciences, 1998: Ch. 4.
- East NE. *J Am Vet Med Assoc* 1993; 203:1176.

#### VITAMIN D DEFICIENCY

Vitamin D deficiency is usually caused by insufficient solar irradiation of animals or their feed and is manifested by poor appetite and growth and in advanced cases by osteodystrophy.

#### Synopsis

**Etiology** Lack of ultraviolet solar irradiation and/or deficiency of preformed vitamin D in diet.

**Epidemiology** Uncommon because diets are supplemented. Occurs in animals in countries with relative lack of UV irradiation especially in winter months; animals raised indoors for long periods. May occur in young grazing animals in winter months. May be antivitamin D factor.

**Signs** Reduced productivity; poor weight gain; reduced reproductive performance. Rickets in young; osteomalacia in adults.

**Clinical pathology** Serum calcium and phosphorus. Plasma vitamin D.

**Necropsy findings** Lack of mineralization of bone.  
**Diagnostic confirmation** Histology of bone lesions.  
**Differential diagnosis list** See Rickets and osteomalacia.  
**Treatment** Administer vitamin D parenterally and oral calcium and phosphates.  
**Control** Supplement diets with vitamin D. Injections of vitamin D when oral supplementation not possible.

## ETIOLOGY

A lack of ultraviolet solar irradiation of the skin, coupled with a deficiency of preformed vitamin D complex in the diet, leads to a deficiency of vitamin D in tissues.

## EPIDEMIOLOGY

Although the effects of clinically apparent vitamin D deficiency have been largely eliminated by improved nutrition, the subclinical effects have received little attention. For example, retarded growth in young sheep in New Zealand and southern Australia during winter months has been recognized for many years as responding to vitamin D administration.

However, general realization of the importance of this subclinical vitamin D deficiency in limiting productivity of livestock has come only in recent years. This is partly due to the complexity of the relations between calcium, phosphorus, and the vitamin and their common association with protein and other deficiencies in the diet. Much work remains to be done before these individual dietary essentials can be assessed in their correct economic perspective.

## Ultraviolet irradiation

The lack of ultraviolet irradiation becomes important as distance from the equator increases and the sun's rays are filtered and refracted by an increasing depth of the earth's atmosphere. Cloudy, overcast skies, smoke-laden atmospheres, and winter months exacerbate the lack of irradiation. The effects of poor irradiation are felt first by animals with dark skin (particularly pigs and some breeds of cattle) or heavy coats (particularly sheep), by rapidly growing animals and by those that are housed indoors for long periods. The concentration of plasma vitamin D<sub>3</sub> recorded in grazing sheep varies widely throughout the year. During the winter months in the UK, the levels in sheep fall below what is considered optimal, while in the summer months the levels are more than adequate.<sup>1</sup> There is a marked difference in vitamin D status between sheep with a long fleece and those that have been recently shorn, especially in periods of maximum sunlight. The higher blood levels of vitamin D in the latter

group are probably due to their greater exposure to sunlight. Pigs reared under intensive farming conditions and animals being prepared for shows are small but important susceptible groups.

## Dietary vitamin D

The importance of dietary sources of preformed vitamin D must not be underestimated. Irradiated plant sterols with anti-rachitic potency occur in the dead leaves of growing plants. Variation in the vitamin D content of hay can occur with different methods of curing. Exposure to irradiation by sunlight for long periods causes a marked increase in anti-rachitic potency of the cut fodder, whereas modern hay-making technique with its emphasis on rapid curing tends to keep vitamin D levels at a minimum. Grass ensilage also contains very little vitamin D.

Based on a survey of the concentrations of vitamin D in the serum of horses in the UK, the levels may be low.<sup>2</sup> In the absence of a dietary supplement containing vitamin D, the concentration of 25-OH D<sub>2</sub> and 25-OH D<sub>3</sub> are, respectively, a reflection of the absorption of vitamin D<sub>2</sub> from the diet and of biosynthesis of vitamin D<sub>3</sub>.

Information on the vitamin D requirements of housed dairy cattle is incomplete and contradictory. It appears, however, that in some instances natural feedstuffs provide less than adequate amounts of the vitamin for optimum reproductive performance in high-producing cows.<sup>3</sup>

## Grazing animals

The grazing of animals, especially in winter time, on lush green feed including cereal crops, leads to a high incidence of rickets in the young. An antivitamin D factor is suspected because calcium, phosphorus and vitamin D intakes are usually normal, but the condition can be prevented by the administration of calciferol. Carotene, which is present in large quantities in this type of feed, has been shown to have antivitamin D potency but the existence of a further rachitogenic substance seems probable. The rachitogenic potency of this green feed varies widely according to the stage of growth and virtually disappears when flowering commences. Experimental overdosing with vitamin A causes a marked retardation of bone growth in calves. Such overdosing can occur when diets are supplemented with the vitamin and may produce clinical effects.<sup>4</sup>

The importance of vitamin D to animals is now well-recognized and supplementation of the diet where necessary is usually performed by the livestock owner. Occasional outbreaks of vitamin D deficiency are experienced in intensive systems where animals are housed and

in areas where specific local problems are encountered, e.g. rickets in sheep on green cereal pasture in New Zealand.

## PATHOGENESIS

Vitamin D is a complex of substances with anti-rachitogenic activity. The important components are as follows:

Vitamin D<sub>3</sub> (cholecalciferol) is produced from its precursor 7-dehydrocholesterol in mammalian skin and by natural irradiation with ultraviolet light

Vitamin D<sub>2</sub> is present in sun-cured hay and is produced by ultraviolet irradiation of plant sterols. Calciferol or viosterol is produced commercially by the irradiation of yeast. Ergosterol is the provitamin

Vitamin D<sub>4</sub> and D<sub>5</sub> occur naturally in the oils of some fish.

Vitamin D produced in the skin or ingested with the diet and absorbed by the small intestine is transported to the liver. In the liver, 25-hydroxycholecalciferol is produced, which is then transported to the kidney where at least two additional derivatives are formed by 1- $\alpha$ -hydroxylase.<sup>5</sup> One is 1,25-dihydroxycholecalciferol (DHCC) and the other is 24,25-DHCC. Under conditions of calcium need or calcium deprivation the form predominantly produced by the kidney is 1,25-DHCC. At present, it seems likely that 1,25-DHCC is the metabolic form of vitamin D most active in eliciting intestinal calcium transport and absorption and is at least the closest known metabolite to the form of vitamin D functioning in bone mineralization. The metabolite also functions in regulating the absorption and metabolism of the phosphate ion and especially its loss from the kidney. A deficiency of the metabolite may occur in animals with renal disease, resulting in decreased absorption of calcium and phosphorus, decreased mineralization of bone, and excessive losses of the minerals through the kidney. A deficiency of vitamin D *per se* is governed in its importance by the calcium and phosphorus status of the animal.

Because of the necessity for the conversion of vitamin D to the active metabolites, there is a lag period of 2–4 days following the administration of the vitamin parenterally before a significant effect on calcium and phosphorus absorption can occur. The use of synthetic analogs of the active metabolites such as 1- $\alpha$ -hydroxycholecalciferol (an analog of 1,25-DHCC) can increase the plasma concentration of calcium and phosphorus within 12 h following administration<sup>6</sup> and has been recommended for the control of parturient paresis in cattle.

### Maternal status

Maternal vitamin D status is important in determining neonatal plasma calcium concentration. There is a significant correlation between maternal and neonatal calf plasma concentrations of 25-OH D<sub>2</sub>, 25-OH D<sub>3</sub>, 24,25-(OH)<sub>2</sub> D<sub>2</sub>, 24,25-(OH)<sub>2</sub> D<sub>3</sub> and 25,26-(OH)<sub>2</sub> D<sub>3</sub>. This indicates that the vitamin D metabolite status of the neonate is primarily dependent on the 25-OH D status of the dam.<sup>7</sup> The maternal serum concentrations of calcium, phosphorus, and magnesium do not determine concentrations of these minerals found in the newborn calf. The ability of the placenta to maintain elevated plasma calcium or phosphorus in the fetus is partially dependent on maternal 1,25-(OH)<sub>2</sub> D status. Parenteral cholecalciferol treatment of sows before parturition is an effective method of supplementing neonatal piglets with cholecalciferol via the sow's milk and its metabolite via placenta transport.<sup>6</sup>

### Calcium:phosphorus ratio

When the calcium:phosphorus ratio is wider than the optimum (1:1 to 2:1), vitamin D requirements for good calcium and phosphorus retention and bone mineralization are increased. A minor degree of vitamin D deficiency in an environment supplying an imbalance of calcium and phosphorus might well lead to disease, whereas the same degree of vitamin deficiency with a normal calcium and phosphorus intake could go unsuspected. For example, in growing pigs, vitamin D supplementation is not essential provided calcium and phosphorus intakes are rigidly controlled, but under practical circumstances, this may not be possible.

The minor functions of the vitamin include maintenance of efficiency of food utilization and a calorogenic action, the metabolic rate being depressed when the vitamin is deficient. These actions are probably the basis for the reduced growth rate and productivity in vitamin D deficiency. Some evidence suggests that vitamin D may have a role in the immune system.<sup>8</sup> Local production of 1,25-(OH)<sub>2</sub> D by monocytes may be important in the immune function, particularly in the parturient dairy cow.

### CLINICAL FINDINGS

The most important effect of lack of vitamin D in farm animals is reduced productivity. A decrease in appetite and efficiency of food utilization cause poor weight gains in growing stock and poor productivity in adults. Reproductive efficiency is also reduced and the overall effect on the animal economy may be severe.

In the late stages lameness, which is most noticeable in the forelegs, is accompanied in young animals by bending

of the long bones and enlargement of the joints. This latter stage of clinical rickets may occur simultaneously with cases of osteomalacia in adults. An adequate intake of vitamin D appears to be necessary for the maintenance of fertility in cattle, particularly if the phosphorus intake is low. In one study in dairy cattle, the first ovulation after parturition was advanced significantly in vitamin D-supplemented cows.<sup>3</sup>

### CLINICAL PATHOLOGY

#### Serum calcium and phosphorus

A pronounced hypophosphatemia occurs in the early stages and is followed some months later by a fall in serum calcium. Plasma alkaline phosphatase levels are usually elevated. The blood picture quickly returns to normal with treatment, often several months before the animal is clinically normal. Typical figures for beef cattle kept indoors are serum calcium 8.7 mg/dL (10.8 normal), 2.2 mmol/L (2.7 normal); serum inorganic phosphate 4.3 mg/dL (6.3 normal), 1.1 mmol/L (1.6 normal); and alkaline phosphatase 5.7 units (2.75 normal).

#### Plasma vitamin D

The normal ranges of plasma concentrations of vitamin D and its metabolites in the farm animal species are now available<sup>9</sup> and can be used to monitor the response of the administration of vitamin D parenterally or orally in sheep.<sup>10,11</sup> The serum concentrations of vitamin D in the horse have been determined.<sup>2</sup>

### NECROPSY FINDINGS

The pathological changes in young animals are those of rickets, while in older animals there is an osteomalacia. In all ages, a variable amount of osteodystrophia fibrosa may develop and distinction of the origin of these osteodystrophies based on only gross and microscopic examination is impractical. A review of management factors and a nutritional analysis of the feed is essential. The samples for confirmation of the diagnosis at necropsy are as per calcium deficiency.

### DIFFERENTIAL DIAGNOSIS

A diagnosis of vitamin D deficiency depends upon evidence of the probable occurrence of the deficiency and response of the animal when vitamin D is provided. Differentiation from clinically similar syndromes is discussed under the specific osteodystrophies.

### TREATMENT

It is usual to administer vitamin D in the dose rates set out under control. Affected animals should also receive adequate calcium and phosphorus in the diet.

### CONTROL

#### Supplementation

The administration of supplementary vitamin D to animals by adding it to the diet or by injection is necessary only when exposure to sunlight or the provision of a natural ration containing adequate amounts of vitamin D is impractical.

A total daily intake of 7–12 IU/kg BW is optimal. Sun-dried hay is a good source, but green fodders are generally deficient in vitamin D. Fish liver oils are high in vitamin D, but are subject to deterioration on storage, particularly with regard to vitamin A. They have the added disadvantage of losing their vitamin A and D content in premixed feed, of destroying vitamin E in these feeds when they become rancid and of seriously reducing the butterfat content of milk. Stable water-soluble vitamin A and D preparations do not suffer from these disadvantages. Irradiated dry yeast is probably a simpler and cheaper method of supplying vitamin D in mixed grain feeds.

Stable water-soluble preparations of vitamin D are now available and are commonly added to the rations of animals being fed concentrate rations. The classes of livestock that usually need dietary supplementation include:

- Calves raised indoors on milk replacers
- Pigs raised indoors on grain rations
- Beef cattle receiving poor quality roughage during the winter months
- Cattle raised indoors for prolonged periods and not receiving sun-cured forage containing adequate levels of vitamin D. These include calves raised as herd replacements, yearling cattle fed concentrate rations, bulls in artificial insemination centers and purebred bulls maintained indoors on farms
- Feedlot lambs fed grain rations during the winter months or under totally covered confinement
- Young growing horses raised indoors or outdoors on rations that may not contain adequate concentrations of calcium and phosphorus. This may be a problem in rapidly growing, well-muscled horses receiving a high level of grain.

Because there is limited storage of vitamin D in the body, compared to the storage of vitamin A, it is recommended that daily dietary supplementation be provided when possible for optimum effect.

#### Injection

In situations where dietary supplementation is not possible, the use of single IM injections of vitamin D<sub>2</sub> (calciferol) in oil will protect ruminants for 3–6 months. A

dose of 11 000 units/kg BW is recommended and should maintain an adequate vitamin D status for 3–6 months.

In mature non-pregnant sheep weighing about 50 kg, a single IM injection of 6000 IU/kg body weight produced concentrations of 25-hydroxyvitamin D<sub>3</sub> at adequate levels for 3 months.<sup>11</sup> The parenteral administration of vitamin D<sub>3</sub> results in both higher tissue and plasma levels of vitamin D<sub>3</sub> than does oral administration and IV administration produces higher plasma levels than does the IM injection.<sup>12</sup> The timing of the injection should be selected so that the vitamin D status of the ewe is adequate at the time of lambing.<sup>11</sup> The vitamin D<sub>3</sub> status of lambs can be increased by the parenteral administration of the vitamin to the pregnant ewe.<sup>13</sup> Dosing pregnant ewes with 300 000 IU of vitamin D<sub>3</sub> in a rapidly available form, approximately 2 months before lambing, provides a safe means of increasing the vitamin D status of the ewe and the newborn lambs by preventing seasonally low concentrations of 25-hydroxyvitamin D<sub>3</sub>.<sup>14</sup> In adult sheep there is a wide margin of safety between the recommended requirement and the toxic oral dose, which provides ample scope for safe supplementation if such is desirable.<sup>10</sup> In adult sheep given 20 times the recommended requirements for 16 weeks there was no evidence of pathological calcification.<sup>10</sup> Oral dosing with 30–45 units/kg BW is adequate, provided treatment can be given daily. Massive oral doses can also be used to give long-term effects, e.g. a single dose of 2 million units is an effective preventive for 2 months in lambs. Excessive doses may cause toxicity, with signs of drowsiness, muscle weakness, fragility of bones, and calcification in the walls of blood vessels. The latter finding has been recorded in cattle receiving 10 million units/d and in unthrifty lambs receiving a single dose of 1 million units, although larger doses are tolerated by healthy lambs.

## REVIEW LITERATURE

- Dobson RC, Ward G. Vitamin D physiology and its importance to dairy cattle: a review. *J Dairy Sci* 1974; 57:985.
- Horst RL, Reinhardt TA. Vitamin D metabolism in ruminants and its relevance to the periparturient cow. *J Dairy Sci* 1983; 66:661–678.
- Wasserman RH. Metabolism, function and clinical aspects of vitamin D. *Cornell Vet* 1975; 65:3.

## REFERENCES

- Smith BSW, Wright H. *Vet Rec* 1984; 115:537.
- Smith BSW, Wright H. *Vet Rec* 1984; 115:579.
- Ward G et al. *J Dairy Sci* 1971; 54:204.
- Grey RM et al. *Pathol Vet* 1965; 2:446.
- Engstrom GW et al. *J Dairy Sci* 1987; 70:2266.
- Goff JP. *J Nutr* 1984; 114:163.
- Goff JP et al. *J Nutr* 1982; 112:1387.
- Reinhardt TA, Hustmyer FG. *J Dairy Sci* 1987; 70:952.

- Horst RL et al. *Anal Biochem* 1981; 116:189.
- Smith BSW et al. *Res Vet Sci* 1985; 38:317.
- Smith BSW, Wright H. *Res Vet Sci* 1985; 39:59.
- Hidiroglou M et al. *Can J Anim Sci* 1984; 64:697.
- Hidiroglou M, Knipfel JE. *Can J Comp Med* 1984; 48:78.
- Smith BSW et al. *Vet Rec* 1987; 120:199.

## VITAMIN D TOXICITY

Vitamin D toxicity has occurred in cattle,<sup>1</sup> horses<sup>2</sup>, and pigs<sup>3</sup> following the parenteral or oral administration of excessive quantities of the vitamin.

In cattle, large parenteral doses of vitamin D<sub>3</sub> 15–17 million IU, results in prolonged hypercalcemia, hyperphosphatemia and large increases in plasma concentrations of vitamin D<sub>3</sub> and its metabolites.<sup>1</sup> Clinical signs of toxicity occur within 2–3 weeks and include marked anorexia, loss of body weight, dyspnea, tachycardia, loud heart sounds, weakness, recumbency, torticollis, fever and a high case fatality rate.<sup>1</sup> Pregnant cows 1 month before parturition are more susceptible than non-pregnant cows.

Hypercalcemia and hypervitaminosis D in 17-day-old lambs being fed a milk replacer has been described.<sup>4</sup> The vitamin D content of the milk replacer was not excessive; there was no explanation for the abnormalities in the lamb which recovered when the milk replacer was changed. Serum concentrations of calcium were high at 23.61 mg/dL and 23.09, respectively in two lambs.

Accidental vitamin D<sub>3</sub> toxicity has occurred in horses fed a grain diet that supplied 12 000–13 000 IU/kg BW of vitamin D<sub>3</sub> daily for 30 days,<sup>2</sup> equivalent to about 1 million IU vitamin D<sub>3</sub>/kg of feed. Clinical findings included anorexia, stiffness, loss of body weight, polyuria, and polydipsia. There was also evidence of hyposthenuria, aciduria, soft-tissue mineralization, and fractures of the ribs.<sup>2</sup> Calcification of the endocardium and the walls of large blood vessels are characteristic.

Severe toxicity in pigs occurs at a daily oral dose of 50 000–70 000 IU/kg BW. Signs include a sudden onset of anorexia, vomiting, diarrhea, dyspnea, apathy, aphonia, emaciation, and death.<sup>2</sup> Clinical signs are commonly observed within 2 days after consumption of the feed containing excessive vitamin D. At necropsy, hemorrhagic gastritis and mild interstitial pneumonia are commonly present.<sup>3</sup> Arteriosclerosis with calcification of the heart base vessels may also be visible macroscopically in poisoned cattle. Osteoporosis with multiple fractures has been observed in subacute to chronic hypervitaminosis D in pigs. Histologically, there is widespread soft tissue mineralization, with a predilection for the lung

and gastric mucosa, as well as elastin-rich tissue, such as blood vessels. Changes in bone vary with the duration of exposure to toxic levels of the vitamin.

Assay of the various metabolites of vitamin D in tissues is difficult. The diagnosis is therefore usually confirmed by correlating microscopic changes with a history of exposure to toxic levels of vitamin D.

## Samples for confirmation of diagnosis

- **Toxicology** – 500 g of suspect feed (ASSAY (Vit D))
- **Histology** – formalin-fixed lung, stomach/abomasum, proximal aorta, lung, bone (LM).

## REFERENCES

- Littlelidge ET, Horst RL. *J Dairy Sci* 1982; 65:749.
- Harrington DD, Page EH. *J Am Vet Med Assoc* 1983; 182:1358.
- Long GC. *J Am Vet Med Assoc* 1984; 184:164.
- Roberson JR et al. *J Am Vet Med Assoc* 2000; 216:1115.

## RICKETS

Rickets is a disease of young, growing animals characterized by defective calcification of growing bone. The essential lesion is a failure of provisional calcification with persistence of hypertrophic cartilage and enlargement of the epiphyses of long bones and the costochondral junctions (so-called 'rachitic rosary'). The poorly mineralized bones are subject to pressure distortions.

## Synopsis

**Etiology** Deficiencies of any or combination of calcium, phosphorus, and vitamin D.

**Epidemiology** Young growing animals. No longer common. In calves on phosphorus-deficient diets (range or housed). In grazing lambs due to lack of solar irradiation. Rare in foals and pigs.

**Signs** Stiff gait and lameness, enlargement of ends of long bones, curvature of long bones, prolonged periods of recumbency. Delayed dentition.

**Clinical pathology** Elevated alkaline phosphatase, low serum calcium and phosphorus. Lack of density of bone radiographically.

**Necropsy findings** Abnormal bones and teeth. Bone shafts are soft, epiphyses enlarged. Ratio of bone ash to organic matter is decreased.

**Diagnostic confirmation** Histology of bone, especially epiphyses.

### Differential diagnosis list

- Epiphysitis
- Congenital and acquired abnormalities
- Infectious synovitis.

**Treatment** Vitamin D injections, calcium and phosphate orally.

**Control** Supplement deficient diets with calcium, phosphorus, and vitamin D.

## ETIOLOGY

Rickets is caused by an absolute or relative deficiency of any or a combination of calcium, phosphorus, or vitamin D in young, growing animals. The effects of the deficiency are also exacerbated by a rapid growth rate.

An inherited form of rickets has been described in pigs. It is indistinguishable from rickets caused by nutritional inadequacy.

## EPIDEMIOLOGY

Clinical rickets is not as important economically as the subclinical stages of the various dietary deficiencies that produce it. The provision of diets adequate and properly balanced with respect to calcium, phosphorus and sufficient exposure to sunlight, are mandatory in good livestock production. Rickets is no longer a common disease because these requirements are widely recognized, but the incidence can be high in extreme environments, including purely exploitative range grazing, intensive feeding in fattening units and heavy dependence on lush grazing, especially in winter months.

Rickets is a disease of young, rapidly growing animals and occurs naturally under the following conditions.

### Calves

Primary phosphorus deficiency in phosphorus-deficient range areas and vitamin D deficiency in calves housed for long periods are the common circumstances. Vitamin D deficiency is the most common form of rickets in cattle raised indoors for prolonged periods in Europe and North America. Grazing animals may also develop vitamin D deficiency rickets at latitudes where solar irradiation during winter is insufficient to promote adequate dermal photobiosynthesis of vitamin D<sub>3</sub> from 7-dihydrocholesterol. Rickets has occurred in yearling steers in New Zealand wintered on swede (*Brassica napus*) crop deficient in phosphorus.<sup>1</sup>

In young, rapidly growing cattle raised intensively indoors a combined deficiency of calcium, phosphorus and vitamin D can result in leg weakness characterized by stiffness, reluctance to move, and retarded growth. In some cases, rupture of the Achilles tendon and spontaneous fracture occur.<sup>2</sup> The Achilles tendon may rupture at the insertion of, or proximal to, the calcaneus.

### Lambs

Lambs are less susceptible to primary phosphorus deficiency than cattle, but rickets does occur under the same conditions. Green cereal grazing and, to a lesser extent, pasturing on lush ryegrass during winter months may cause a high incidence of rickets in lambs; this is

considered to be a secondary vitamin D deficiency. An outbreak of vitamin D deficiency rickets involving 50% of lambs aged 6–12 months grazing new grass and rape occurred during the early winter months in Scotland.<sup>3</sup> In the South Island of New Zealand, where winter levels of solar irradiation are low, rickets occurs in hoggets grazing green oats, or other green crops, which have been shown to contain high levels of rachitogenic carotenes.<sup>1</sup> A vitamin D responsive rickets has occurred in twin lambs 3–4 weeks of age.<sup>4</sup>

### Pigs

Rickets in young pigs occurs in intensive fattening units where the effects of diet containing excessive phosphate (high cereal diets) are exacerbated by vitamin D and calcium deficiencies.

### Foals

Rickets is uncommon in foals under natural conditions, although it has been produced experimentally.

## PATHOGENESIS

Dietary deficiencies of calcium, phosphorus, and vitamin D result in defective mineralization of the osteoid and cartilaginous matrix of developing bone. There is persistence and continued growth of hypertrophic epiphyseal cartilage, increasing the width of the epiphyseal plate. Poorly calcified spicules of diaphyseal bone and epiphyseal cartilage yield to normal stresses, resulting in bowing of long bones and broadening of the epiphyses with apparent enlargement of the joints. Rapidly growing animals on an otherwise good diet will be first affected because of their higher requirement of the specific nutrients.

## CLINICAL FINDINGS

The subclinical effects of the particular deficiency disease will be apparent in the group of animals affected and have been described in the earlier general section. Clinical rickets is characterized by:

- **Stiffness in the gait**
- **Enlargement of the limb joints, especially in the forelegs**
- **Enlargement of the costochondral junctions**
- **Long bones show abnormal curvature, usually forward and outward at the carpus in sheep and cattle**
- **Lameness and a tendency to lie down for long periods.**

Outbreaks affecting 50% of a group of lambs have been described.<sup>3</sup> Arching of the back and contraction, often to the point of virtual collapse, of the pelvis occur and there is an increased tendency for bones to fracture.

**Eruption of the teeth is delayed** and irregular, and the teeth are poorly calcified with pitting, grooving, and pigmentation. They are often badly aligned and wear rapidly and unevenly. These dental abnormalities, together with thickening and softness of the jaw bones, may make it impossible for severely affected calves and lambs to close their mouths. As a consequence, the tongue protrudes and there is drooling of saliva and difficulty in feeding. In less severely affected animals, dental malocclusion may be a significant occurrence. Severe deformity of the chest may result in dyspnea and chronic ruminal tympany. In the final stages, the animal shows hypersensitivity, tetany, recumbency and eventually dies of inanition.

## CLINICAL PATHOLOGY

The plasma alkaline phosphatase is commonly elevated, but serum calcium and phosphorus levels depend upon the causative factor. If phosphorus or vitamin D deficiencies are the cause, the serum phosphorus level will usually be below the normal lower limit of 3 mg/dL. The serum concentrations of 25-hydroxyvitamin D<sub>3</sub> and 25-hydroxyvitamin D<sub>2</sub> are markedly decreased in vitamin D-deficient rickets compared with the normal values of >5 ng/mL.<sup>3</sup> Serum vitamin D concentrations as low as 0.4 ng/mL have been reported in lambs with vitamin D responsive rickets.<sup>4</sup> Serum calcium levels will be low only in the final stages. In leg weakness of young, rapidly growing cattle, the serum concentration of 25-hydroxyvitamin D may be non-detectable and the serum levels of calcium and inorganic phosphorus may be low.<sup>2</sup>

**Radiographic examination of bones and joints** is one of the most valuable aids in the detection of rickets. Rachitic bones have a characteristic lack of density compared with normal bones. The ends of long bones have a 'woolly' or 'moth-eaten' appearance and have a concave or flat, instead of the normal convex, contour. Surgical removal of a small piece of costochondral junction for histological examination has been used extensively in experimental work and should be applicable in field diagnosis.

## NECROPSY FINDINGS

Apart from general poorness of condition, the necropsy findings are restricted to abnormal bones and teeth. The bone shafts are softer and larger in diameter, due in part to the subperiosteal deposition of osteoid tissue. The joints are enlarged and on cutting, the epiphyseal cartilage can be seen to be thicker than usual. Histological examination of the epiphysis is desirable for final diagnosis. In sheep, the best results are obtained

from an examination of the distal cartilages of the metacarpal and metatarsal bones.

A valuable diagnostic aid is the ratio of ash to organic matter in the bones. Normally the ratio is three parts of ash to two of organic matter but in rachitic bone this may be depressed to 1:2, or 1:3 in extreme cases. A reduction below 45% of the bone weight as ash also suggests osteodystrophy. Because of the difficulty encountered in repeating the results of bone ash determinations, a standardized method has been devised in which the ash content of green bone is determined, using either the metacarpus or metatarsus and the ash content related to the age of the animal, as expressed by the length of the bone. Although normal standards are available only for pigs, the method suggests itself as being highly suitable for all species.

#### Samples for confirmation of diagnosis

**Toxicology** – long bone (ASSAY (ash)); 500 g feed (ASSAY (Ca) (P) (Vit D))

**Histology** – formalin-fixed long bone (including growth plate) (LM).

#### DIFFERENTIAL DIAGNOSIS

Rickets occurs in young, rapidly growing animals and is characterized by stiffness of the gait and enlargement of the distal physes of the long bones, particularly noticeable on the metacarpus and metatarsus as circumscribed painful swellings. A history of a dietary deficiency of any of calcium, phosphorus, or vitamin D will support the clinical diagnosis. Radiographic evidence of widened and irregular physes suggests rickets. Copper deficiency in young cattle under 1 year of age can also result in clinical, radiographic and pathological findings similar to rickets. Clinically, there is an arched back, severe stiffness of gait, reluctance to move, and loss of weight. There are marked swellings of the distal aspects of metacarpus and metatarsus and radiographically there is a widened zone of cartilage and lipping of the medial and lateral areas of the physal plate. Copper concentration in plasma and liver are low and there is usually dietary evidence of copper deficiency.

**Epiphysitis** occurs in rapidly growing yearling cattle raised and fed intensively under confinement. There is severe lameness, swelling of the distal physes and radiographic and pathological evidence of a necrotizing epiphysitis. The etiology is uncertain but thought to be related to the type of housing.

**Congenital and acquired abnormalities** of the bony skeletal system are frequent in newborn and rapidly growing foals. Rickets occurs, but only occasionally. 'Epiphysitis' in young foals resembles rickets and is characterized by enlargements and abnormalities of the

distal physes of the radius, tibia, third metacarpal and metatarsal bones and the proximal extremity of the proximal phalanx. There may or may not be deviation of the limbs caused by uneven growth rates in various growth plates. The suggested causes include improper nutrition, faulty conformation and hoof growth, muscle imbalance, overweight and compression of the growth plate. Recovery may occur spontaneously or require surgical correction.

**Rickets in pigs** is uncommon and the diagnosis may be difficult. The disease is usually suspected in young, rapidly growing pigs in which there is stiffness in the gait, walking on tiptoes, enlargements of the distal ends of long bones, and dietary evidence of a marginal deficiency of calcium or phosphorus. The radiographic and pathological findings may suggest a rickets-like lesion.

**Mycoplasmal synovitis and arthritis** clinically resemble rickets of pigs. There is a sudden onset of stiffness of gait, habitual recumbency, a decrease in feed consumption, and enlargements of the distal aspects of the long bones which may or may not be painful, spontaneous recovery usually occurs in 10–14 days. The locomotor problems in young, growing pigs raised in confinement and with limited exercise must be considered in the differential diagnosis. In performance testing stations, up to 20% of boars may be affected with leg weakness.

Rickets in lambs must be differentiated from chlamydial and erysipelas arthritis, which are readily diagnosed at necropsy.

#### TREATMENT AND CONTROL

Recommendations for the treatment of the individual dietary deficiencies (calcium, phosphorus and vitamin D) are presented under their respective headings. Lesser deformities recover with suitable treatment but gross deformities usually persist. A general improvement in appetite and condition occurs quickly and is accompanied by a return to normal blood levels of phosphorus and alkaline phosphatase. The treatment of rickets in lambs with vitamin A, vitamin D<sub>3</sub>, calcium borogluconate solution containing magnesium and phosphorus parenterally and supplementation of the diet with bone meal and protein resulted in a dramatic response.<sup>3</sup> Recumbent animals were walking within a few days.

#### REFERENCES

1. Thompson KC, Cook TG. *N Z Vet J* 1987; 35:11.
2. Sturen M. *Acta Vet Scand* 1985; 26:169.
3. Bonniwell MA et al. *Vet Rec* 1988; 122:386.
4. Van Saun RJ. *Can Vet J* 2004; 45:841.

#### OSTEOMALACIA

Osteomalacia is a disease of mature animals affecting bones in which endo-

chondral ossification has been completed. The characteristic lesion is osteoporosis and the formation of excessive uncalcified matrix. Lameness and pathological fractures are the common clinical findings.

#### Synopsis

**Etiology** Absolute or relative deficiency of any one or combination of calcium, phosphorus, and vitamin D in adult animals.

**Epidemiology** Primarily in cattle and sheep on phosphorus-deficient diets. In feedlot animals due to excessive phosphorus without complementary calcium and vitamin D.

**Signs** Reduced productivity, licking and chewing inanimate objects, stiff gait, moderate non-specific lameness, shifting from leg to leg, crackling sounds while walking, arched back, lying down for long periods. 'Milk lameness' in high-producing dairy cows on deficient diet.

**Clinical pathology** Increased alkaline phosphatase, decreased serum phosphorus levels. Decreased density of long bones radiographically.

**Necropsy findings** Decreased density of bones, erosions of articular cartilages.

**Diagnostic confirmation** Histology of bones.

#### Differential diagnosis list

- Chronic fluorosis
- Polysynovitis and arthritis
- Spinal cord compression.

**Treatment** As for calcium, phosphorus, and vitamin D deficiency.

**Control** Adequate supplementation of diet.

#### ETIOLOGY

In general, the etiology and occurrence of osteomalacia are the same as for rickets except that the predisposing cause is not the increased requirement of growth but the drain of lactation and pregnancy.

#### EPIDEMIOLOGY

Osteomalacia occurs in mature animals under the same conditions and in the same areas as rickets in young animals, but is recorded less commonly. Its main occurrence is in cattle in areas seriously deficient in phosphorus. It is also recorded in sheep, again in association with hypophosphatemia. In pastured animals, osteomalacia is most common in cattle, and sheep raised in the same area are less severely affected. In feedlot animals, excessive phosphorus intake without complementary calcium and vitamin D is likely as a cause, especially if the animals are kept indoors. It also occurs in sows that have recently weaned their pigs after a long lactation period (6–8 weeks) while on a diet deficient usually in calcium. A marginal deficiency of both phosphorus and vitamin D will exaggerate the condition. Intensively-fed yearling cattle with inadequate mineral supplementation

may be affected with spontaneous fractures of the vertebral bodies, pelvic bones and long bones, leading to recumbency.<sup>1</sup> Simply handling the animals through a chute for routine activities such as tuberculin testing may precipitate the fractures

### PATHOGENESIS

Increased resorption of bone mineral to supply the needs of pregnancy, lactation and endogenous metabolism leads to osteoporosis, and weakness and deformity of the bones. Large amounts of uncalcified osteoid are deposited about the diaphyses. Pathological fractures are commonly precipitated by sudden exercise or handling of the animal during transportation.

### CLINICAL FINDINGS

#### Ruminants

In the early stages, the signs are those of phosphorus deficiency, including lowered productivity and fertility and loss of condition. Licking and chewing of inanimate objects begins at this stage and may bring their attendant ills of oral, pharyngeal, and esophageal obstruction, traumatic reticuloperitonitis, lead poisoning, and botulism.

The signs specific to osteomalacia are those of a painful condition of the bones and joints and include a stiff gait, moderate lameness often shifting from leg to leg, crackling sounds while walking, and an arched back. The hindlegs are most severely affected and the hocks may be rotated inwards. The animals are disinclined to move, lie down for long periods and are unwilling to get up. The colloquial names 'pegleg', 'creeps', 'stiffs', 'cripples', and 'bog-lame' describe the syndrome aptly. The names 'milkleg' and 'milk-lameness' are commonly applied to the condition when it occurs in heavily milking cows. Fractures of bones and separation of tendon attachments occur frequently, often without apparent precipitating stress. In extreme cases, deformities of bones occur and when the pelvis is affected dystocia may result. Finally, weakness leads to permanent recumbency and death from starvation.

#### Pigs

Affected sows are usually found recumbent and unable to rise from lateral recumbency or from the dog-sitting position. The shaft of one femur or the neck of the femur is commonly fractured. The fracture usually occurs within a few days following weaning of the pigs. The placing of the sow with other adult pigs usually results in some fighting and increased exercise, which commonly precipitates the pathological fractures.

### CLINICAL PATHOLOGY

In general, the findings are the same as those for rickets, including increased

serum alkaline phosphatase and decreased serum phosphorus levels. Radiographic examination of long bones shows decreased density of bone shadow.

### NECROPSY FINDINGS

It can be difficult to discern any gross changes as the epiphyses are seldom enlarged and the altered character of cancellous bone may not be macroscopically visible. Cortical bone may be somewhat thinned and erosions of the articular cartilages have been recorded in cattle suffering from primary phosphorus deficiency. The parathyroid glands may be enlarged. Histologically, abnormal osteoid covers trabeculae and a degree of fibrous tissue proliferation is often evident. Analysis reveals the bones to be lighter than normal with a low ratio of ash to organic matter.

### Samples for confirmation of diagnosis

**Toxicology** – long bone (ASSAY (ash)); 500 g feed (ASSAY (Ca) (P) (Vit D))

**Histology** – formalin-fixed bone, parathyroid (LM).

### DIFFERENTIAL DIAGNOSIS

The occurrence of non-specific lameness with pathological fractures in mature animals should arouse suspicion of osteomalacia. There may be additional evidence of subnormal productivity and reproductive performance and dietary evidence of a recent deficiency of calcium, phosphorus, or vitamin D.

A similar osteoporotic disease of cattle in Japan has been ascribed to a dietary deficiency of magnesium. The cattle are on high-concentrate, low-roughage diets, have high serum calcium and alkaline phosphatase levels, but a low serum magnesium level. The osteoporosis is observable at slaughter and clinical signs observed are those of intercurrent disease, especially ketosis, milk fever, and hypomagnesemia. Reproductive and renal disorders occur concurrently.

In **cattle** it must be differentiated from **chronic fluorosis** in mature animals, but the typical mottling and pitting of the teeth and the enlargements on the shafts of the long bones are characteristic. In some areas, e.g. northern Australia, where the water supply is obtained from deep sub-artesian wells, the two diseases may occur concurrently. Analysis of water supplies and foodstuffs for fluorine may be necessary in doubtful cases.

In sows, **osteomalacia** with or without pathological fractures must be differentiated from **spinal cord compression** due to a vertebral body abscess and chronic arthritis due to erysipelas.

### TREATMENT AND CONTROL

Recommendations for the treatment and control of the specific nutritional deficiencies have been described under their respective headings. Some weeks will elapse before improvement occurs and deformities of the bones are likely to be permanent.

### REFERENCE

- Gunning RF et al. *Vet Rec* 2000; 147:172.

### OSTEODYSTROPHIA FIBROSA

Osteodystrophia fibrosa is similar in its pathogenesis to osteomalacia, but differs in that soft, cellular, fibrous tissue is laid down as a result of the weakness of the bones instead of the specialized uncalcified osteoid tissue of osteomalacia. It occurs in horses, goats, and pigs.

### ETIOLOGY

A **secondary calcium deficiency due to excessive phosphorus feeding is the common cause in horses** and probably also in pigs. The disease can be readily produced in horses on diets with a ratio of calcium:phosphorus of 1:2.9 or greater, irrespective of the total calcium intake. Calcium:phosphorus ratios of 1:0.9 to 1:1.4 have been shown to be preventive and curative. With a very low calcium intake of 2–3 g/d and a calcium:phosphorus ratio of 1:13 the disease may occur within 5 months. With a normal calcium intake of 26 g/d and a calcium:phosphorus ratio of 1:5, obvious signs appear in about 1 year, but shifting lameness may appear as early as 3 months. The disease is reproducible in pigs on similar diets to those described above and also on diets low in both calcium and phosphorus. The optimum calcium:phosphorus ratio is 1.2:1 and the intake for pigs should be within the range of 0.6–1.2% of the diet.

### EPIDEMIOLOGY

Osteodystrophia fibrosa is principally a disease of horses and other Equidae and to a lesser extent of pigs. It has also occurred in goats. Among horses, those engaged in heavy city work and in racing are more likely to be affected because of the tendency to maintain these animals on unbalanced diets. The major occurrence is in horses fed a diet high in phosphorus and low in calcium. Such diets include cereal hays combined with heavy grain or bran feeding. Legume hays, because of their high calcium content, are preventive.

The disease may reach endemic proportions in army horses moved into new territories, whereas local horses, more used to the diet, suffer little. Although horses may be affected at any age after weaning it is the 2–7-year age group that suffer most, probably because they are the group most likely to be



exposed to the rations that predispose to the disease.

A novel occurrence has been recorded of an endemic form of the disease affecting large numbers of horses at pasture. The dietary intake of calcium and phosphorus and their proportions, were normal. The occurrence was thought to be due to the continuous ingestion of oxalate in specific grasses: *Cenchrus ciliaris*, *Panicum maximum* var. *trichoglume*, *Setaria anceps*, *Brachiaria nutica* and *Pennisetum clandestinum*.

### PATHOGENESIS

Defective mineralization of bones follows the imbalance of calcium and phosphorus in the diet and a fibrous dysplasia occurs. This may be in response to the weakness of the bones or it may be more precisely a response to hyperparathyroidism stimulated by the excessive intake of phosphorus. The weakness of the bones predisposes to fractures and separation of muscular and tendinous attachments. Articular erosions occur commonly and displacement of the bone marrow may cause the development of anemia.

### CLINICAL FINDINGS

#### Horse

As in most osteodystrophies, the major losses are probably in the early stages before clinical signs appear or on diets where the aberration is marginal. In horses, a shifting lameness is characteristic of this stage of the disease and arching of the back may sometimes occur. The horse is lame, but only mildly so and in many cases, no physical deformity can be found by which the seat of lameness can be localized. Such horses often creak badly in the joints when they walk. These signs probably result from relaxation of tendon and ligaments and appear in different limbs at different times. Articular erosions may contribute to the lameness. In more advanced cases severe injuries, including fracture and visible sprains of tendons, may occur but these are not specific to osteodystrophia fibrosa, although their incidence is higher in affected than in normal horses. Fracture of the lumbar vertebrae while racing has been known to occur in affected horses.

The more classical picture of the disease has largely disappeared because cases are seldom permitted to progress to this advanced stage. Local swelling of the lower and alveolar margins of the mandible is followed by soft, symmetrical enlargement of the facial bones, which may become swollen so that they interfere with respiration.<sup>1</sup> Initially these bony swellings are firm and pyramidal and commence just above and anterior to the facial crests. The lesions are bilaterally symmetrical. Flattening of the ribs may be

apparent and fractures and detachment of ligaments occur if the horse is worked. There may be obvious swelling of joints and curvature of long bones. Severe emaciation and anemia occur in the final stages.

#### Pigs

In pigs, the lesions and signs are similar to those in the horse and in severe cases, pigs may be unable to rise and walk, show gross distortion of limbs and enlargement of joints and the face. In less severe cases, there is lameness, reluctance to rise, pain on standing and bending of the limb bones, but normal facial bones and joints. With suitable treatment, the lameness disappears, but affected pigs may never attain their full size. The relationship of this disease to atrophic rhinitis is discussed under the latter heading.

#### Goats

An outbreak of the disease has been recorded in goats receiving a diet of wheat straw (60%) and 40% barley for 89 months.<sup>2</sup> The ratio of calcium to phosphorus in the diet was 1:1.8. Affected goats were 9–10 months of age with a history of stunted growth, lameness, diarrhea, and tongue protrusion. Clinically there was symmetrical enlargement of the face and jaws, tongue protrusion, prominent eyeballs, and tremor. The enlarged bones were firm and painful on palpation. The hindlimbs were bent outwards symmetrically from the tarsal joints.

### CLINICAL PATHOLOGY

There are no significant changes in blood chemistry in horses affected with severe osteodystrophia fibrosa. However, the serum calcium level will tend to be lower than normal, the serum inorganic phosphorus higher than normal, and the alkaline phosphatase activity higher than normal. The levels of diagnostic alkaline phosphatase have not been determined. Affected horses may be unable to return their serum calcium levels to normal following the infusion of a calcium salt. Radiographic examination reveals increased translucency of bones.

### NECROPSY FINDINGS

The entire skeleton is abnormal in this severe form of metabolic bone disease, but the change is most notable in the mandibular, maxillary, and nasal bones, which may appear thickened and distorted. The fleshy tissue that replaces normal cancellous bone in these sites is also present in the metaphyses of the long bones. Microscopically, there is proliferation of fibrous tissue and markedly increased osteoclast activity along thinned and abnormally oriented bony trabeculae. The parathyroid glands are enlarged. It must be remembered that osteo-

dystrophia fibrosa is a lesion, not a disease. The pathway to this lesion usually involves a dietary imbalance in calcium and phosphorus, but the kidneys should also be examined to rule out the possibility of renal secondary hyperparathyroidism.

### Samples for confirmation of diagnosis

- **Toxicology** – bone (ASSAY (ash)); 500 g feed (ASSAY (Ca) (P) (Vit D))
- **Histology** – formalin-fixed bone, parathyroid gland, kidney (LM).

### DIFFERENTIAL DIAGNOSIS

In the early stages, the diagnosis may be difficult because of the common occurrence of traumatic injuries to horses' legs. A high incidence of lameness in a group of horses warrants examination of the ration and determination of their calcium and phosphorus status. An identical clinical picture has been described in a mare with an adenoma of the parathyroid gland. Inherited multiple exostosis has been described in the horse.

In pigs, osteodystrophia can be the result of hypovitaminosis A and experimentally as a result of manganese deficiency.

### TREATMENT AND CONTROL

A ration adequately balanced with regard to calcium and phosphorus (calcium:phosphorus should be in the vicinity of 1:1 and not wider than 1:1.4) is preventive in horses and affected animals can only be treated by correcting the existing imbalance. Even severe lesions may disappear in time with proper treatment. Cereal hay may be supplemented with alfalfa or clover hay, or finely ground limestone (30 g daily) should be fed. Dicalcium phosphate or bone meal are not as efficient because of their additional content of phosphorus.

### REFERENCES

1. Clarke CJ et al. *Vet Rec* 1996; 138:568.
2. Aslani MR et al. *J Vet Med A* 2001; 48:385.

### 'BOWIE' OR 'BENTLEG'

This is a disease of lambs of unknown etiology. There is a characteristic lateral curvature of the long bones of the front legs, but the lesions differ from those of rickets. It has been observed only on unimproved range pasture in New Zealand. The cause is unknown, although phosphorus deficiency has been suggested.

Improvement of the pasture by top-dressing with superphosphate and sowing improved grasses is usually followed by disappearance of the disease. Only sucking lambs are affected and cases occur only in the spring at a time when rickets does not occur. Up to 40% of a group of lambs may be affected without breed differences in incidence. A

similar syndrome has been produced by the feeding of wild parsnip (*Trachemene glaucifolia*) and, experimentally, by the feeding of a diet low in both calcium and phosphorus.

The disease has also been reported from South Africa where it occurs primarily in ram lambs and develops from as early as 3 months up to 1 year of age.<sup>1</sup> There is gradual bending of the forelimbs with hooves turned inwards and the carpal joints turned outwards. Animals of the South African Mutton Merino breed had significantly higher plasma phosphorus concentrations than those of the Merino and Dohne Merino breeds. The plasma calcium:phosphorus ratio was lower in affected lambs and their ewes and this converse ratio is thought to result in an induced plasma ionized calcium deficiency leading to improper calcification of bone.

Some tenderness of the feet and lateral curvature at the knees may be seen as early as 2-3 weeks of age and marked deformity is present at 6-8 weeks with maximum severity at weaning. The forelimbs are more commonly affected than the hindlimbs. Medial curvature occurs in rare cases. The sides of the feet become badly worn and the lateral aspects of the lower parts of the limbs may be injured and be accompanied by lameness. The lambs grow well at first, but by the time of weaning, affected lambs are in poor condition because of their inability to move about and feed properly. A rather similar syndrome has been observed in young Saanen bucks, but the condition showed a tendency to recover spontaneously.

At necropsy, in spite of the curvature of the limbs, there is no undue porosis and although the epiphyseal cartilages are thickened, they are supported by dense bone. There may be excessive synovial fluid in the joints and, in the later stages, there are articular erosions. Increased deposition of osteoid is not observed.

Supplementation of the diet with phosphorus or improvement of the pasture seems to reduce the incidence of the disease. Dosing with vitamin D or providing mineral mixtures containing all trace elements is ineffective.<sup>2</sup>

#### REFERENCES

1. van Niekerk FE et al. *J South Afr Vet Med Assoc* 1989; 60:36.
2. Cunningham IJ. *N Z Vet J* 1957; 5:103.

#### DEGENERATIVE JOINT DISEASE

Degenerative arthropathy occurs in cattle of all breeds, but reaches its highest incidence as a sporadic disease of young beef bulls. The disease has been identified as hip dysplasia because of the pre-

existing shallow contour of the acetabulum. It is considered to be inherited as a recessive characteristic and exacerbated by rapid weight gain in young animals. The occurrence of the condition in these animals is usually associated with rearing on nurse cows, housing for long periods, provision of a ration high in cereal grains and byproducts (i.e. a high phosphorus:calcium ratio), and possibly with an inherited straight conformation of the hindlegs. Although the disease occurs in all beef breeds, there is a strong familial tendency which appears to be directly related to the rate of body weight gain and the straightness of the hindleg. If the potential for rapid weight gain is being realized in animals being force fed, the rate of occurrence appears to be dependent on their breeding and animals in the same herd that are allowed to run at pasture under natural conditions are either not affected or are affected at a much later age. Thus, animals in a susceptible herd may show signs as early as 6 months of age if they are heavily hand-fed and raised on dairy cow foster mothers. In the same herd, signs do not appear until 1-2 years of age if supplementary feeding is not introduced until weaning and not until 4 years if there is no significant additional feeding.

Clinically there is a gradual onset of lameness in one or both hindlegs. The disease progresses with the lameness becoming more severe over a period of 6-12 months. In some animals, there is a marked sudden change for the worse, usually related to violent muscular movements, as in breeding or fighting. In severely affected animals, the affected limb is virtually useless and, on movement, distinct crepitus can often be felt and heard over the affected joints. This can be accomplished by rocking the animal from side to side or having it walk while holding the hands over the hip joints.

An additional method of examination is to place the hand in the rectum close to the hip joint, while the animal is moved. Passive movement of the limb may also elicit crepitus, or louder clinking or clicking sounds. The hip joints are always most severely affected, but in advanced cases, there may be moderate involvement of the stifles and minimal lesions in other joints. Affected animals lie down most of the time and are reluctant to rise and to walk. The joints are not swollen, but in advanced cases, local atrophy of muscles may be so marked that the joints appear to be enlarged. There is a recorded occurrence in which the lesions were confined mainly to the front fetlocks.

Radiographic examination may provide confirmatory or diagnostic evidence.

At necropsy, the most obvious finding is extensive erosion of the articular surfaces, often penetrating to the cancellous bone and disappearance of the normal contours of the head of the femur or the epiphyses in the stifle joint. The synovial cavity is distended, with an increased volume of brownish, turbid fluid; the joint capsule is much thickened and often contains calcified plaques. Multiple, small exostoses are present on the periarticular surfaces. When the stifle is involved the cartilaginous menisci, particularly the medial one, are very much reduced in size and may be completely absent. In cattle with severe degenerative changes in the coxofemoral joint, an acetabular osseous bulla may be present at the cranial margin of the obturator foramen.<sup>1</sup>

Adequate calcium, phosphorus, and vitamin D intake and a correct calcium:phosphorus ratio in the ration should be insured. Supplementation of the ration with copper at the rate of 15 mg/kg has also been recommended for the control of a similar disease.

Degenerative joint disease of cattle is recorded on an enzootic scale in Chile and is thought to be due to gross nutritional deficiency. The hip and tarsal joints are the only ones affected and clinical signs appear when animals are 8-12 months old. There is gross lameness and progressive emaciation. An inherited osteoarthritis is described under that heading. Sporadic cases of degenerative arthropathy, with similar signs and lesions, occur in heavy-producing, aged dairy cows and are thought to be caused by long-continued negative calcium balance. Rare cases also occur in aged beef cows but are thought to be associated with an inherited predisposition. In both instances the lesions are commonly restricted to the stifle joints.

#### REFERENCE

1. Weaver AD. *BrVet J* 1982; 138:123.

## Diseases associated with deficiencies of fat-soluble vitamins

### VITAMIN A DEFICIENCY (HYPOVITAMINOSIS-A)

A deficiency of vitamin A may be caused by an insufficient supply of the vitamin in the ration or its defective absorption from the alimentary canal. In young animals, the manifestations of the deficiency are mainly those of compression of the brain and spinal cord. In adult animals, the syndrome is characterized by night blindness, corneal keratinization, pityriasis, defects in the hooves, loss of weight and infertility. Congenital defects are common in the

offspring of deficient dams. Vitamin A may also provide a protective effect against various infectious diseases and enhance many facets of the immune system.

### Synopsis

**Etiology** Dietary deficiency of vitamin A or its precursors.

**Epidemiology** Primary vitamin A deficiency in animals fed diet deficient in vitamin A or its precursors. Common in cattle grazing dry pastures for long periods. Occurs when diet of hand-fed animals is not supplemented with vitamin A.

**Signs** Cattle: Night blindness. Loss of body weight. Convulsions followed by recovery. Episodes of syncope. Permanent blindness with dilated pupils and optic disc edema. Pigs: Convulsions, hindleg paralysis, congenital defects.

**Clinical pathology** Low levels plasma vitamin A.

**Neuropathology findings** Squamous metaplasia of interlobular ducts of parotid gland. Compression of optic nerve tracts and spinal nerve roots. Degeneration of testes.

**Diagnostic confirmation** Low levels of plasma vitamin A and squamous metaplasia of interlobular ducts of parotid glands.

### Differential diagnosis list

#### Cattle

- Polioencephalomalacia
- Hypomagnesemic tetany
- Lead poisoning
- Rabies
- Meningoencephalitis
- Peripheral blindness due to bilateral ophthalmitis.

#### Pigs

- Salt poisoning
- Pseudorabies
- Viral encephalomyelitis
- Spinal cord compression due to vertebral body abscess.

**Treatment** Vitamin A injections.

**Control** Feed diets with adequate carotene. Supplement diet with vitamin A. Parenteral injections of vitamin A at strategic times.

## ETIOLOGY

Vitamin A deficiency may be primary disease, due to an absolute deficiency of vitamin A or its precursor carotene in the diet, or a secondary disease in which the dietary supply of the vitamin or its precursor is adequate, but their digestion, absorption, or metabolism is interfered with to produce a deficiency at the tissue level.

## EPIDEMIOLOGY

### Primary vitamin A deficiency

Primary vitamin A deficiency is of major economic importance in groups of young growing animals on pasture or fed diets deficient in the vitamin or its precursors.<sup>1</sup> In the UK, primary vitamin A deficiency occurs in housed cattle fed a ration containing little or no green forage.<sup>2</sup>

Animals at pasture receive adequate supplies of the vitamin, except during prolonged droughts, but animals confined indoors and fed prepared diets may be deficient if not adequately supplemented. For example, a diet of dried sugar beet pulp, concentrates and poor quality hay can result in hypovitaminosis-A in confined beef cattle.

### Ruminants on pasture

Primary vitamin A deficiency occurs in beef cattle and sheep on dry range pasture during periods of drought. Clinical vitamin A deficiency does not always occur under these conditions because hepatic storage is usually good and the period of deprivation not sufficiently long for these stores to reach a critically low level.<sup>3</sup> Young sheep grazing natural, drought-stricken pasture can suffer serious depletion of reserves of the vitamin in 5–8 months, but normal growth is maintained for 1 year at which time clinical signs develop. Adult sheep may be on a deficient diet for 18 months before hepatic stores are depleted and the disease becomes evident. Cattle may subsist on naturally deficient diets for 5–18 months before clinical signs appear. However, during the annual dry season (October–June), herds of cattle, sheep and goats in the Sahelian region of West Africa are managed on dry grasses and shrubby ligneous plants, which fail to provide maintenance levels of crude protein and vitamin A. These substandard conditions result in vitamin A deficiency characterized by night blindness, xerophthalmia, retarded growth rates, reproductive failures, and increased mortality.<sup>4</sup> The pastoral herders associate the cure of night blindness with the consumption of green vegetation and will purposefully herd livestock into green vegetation areas when available. Certain ethnic groups of pastoral herders depend on ruminant milk as their principal source of vitamin A and night blindness in lactating and pregnant women as well as in young children appears after the onset of night blindness in their cattle and sheep during the latter half of the dry season. Therefore, increasing vitamin A levels in the milk of cows may alleviate the clinical signs of vitamin A deficiency in herder families.

Primary vitamin A deficiency is still relatively common in beef cattle that depend on pasture and roughage for the major portion of their diet. Beef calves coming off dry summer pastures at 6–8 months of age are commonly marginally deficient.

### Maternal deficiency

A maternal deficiency of vitamin A can result in herd outbreaks of congenital hypovitaminosis-A in calves.<sup>5</sup> In one such

occurrence, out of 240 heifers fed a vitamin A-deficient ration, 89 calves were born dead, 47 were born alive but blind and weak and died within 1–3 days after birth. Blindness with dilated pupils, nystagmus, weakness, and incoordination were characteristic. In another occurrence in the UK, 25% of the calves born from maternally vitamin A deficient heifer dams had ocular abnormalities.<sup>2</sup>

The status of the dam is reflected in that of the fetus only in certain circumstances, in that carotene, as it occurs in green feed, does not pass the placental barrier and a high intake of green pasture before parturition does not increase the hepatic stores of vitamin A in newborn calves, lambs, or kids and only to a limited extent in pigs. However, vitamin A in the ester form, as it occurs in fish oils, will pass the placental barrier in cows. Feeding of these oils, or the parenteral administration of a vitamin A injectable preparation before parturition, will cause an increase in stores of the vitamin in fetal livers. Antepartum feeding of carotene and the alcohol form of the vitamin does, however, cause an increase in the vitamin A content of the colostrum. Young animals depend on the dam's colostrum for their early requirements of the vitamin which is always highest in colostrum and returns to normal levels within a few days of parturition. Pigs weaned very early at 2–4 weeks may require special supplementation. Pregnant beef cows wintered on poor quality roughage commonly need supplementation with vitamin A throughout the winter months to insure normal development of the fetus and an adequate supply of the vitamin in the colostrum at parturition.

### Adequacy of supplements

The addition of vitamin A supplements to diets may not always be sufficient to prevent deficiency. Carotene and vitamin A are readily oxidized, particularly in the presence of unsaturated fatty acids. Oily preparations are thus less satisfactory than dry or aqueous preparations, particularly if the feed is to be stored for any length of time. Pelleting of feed may also cause a serious loss up to 32% of the vitamin A in the original feedstuff.

Heat, light, and mineral mixes are known to increase the rate of destruction of vitamin A supplements in commercial rations. In one study, 47–92% of the vitamin A in several mineral supplements was destroyed after 1 week of exposure to the trace minerals, high relative humidity, sunlight and warm temperatures.<sup>6</sup>

### Feedlot cattle

The disease still occurs in feedlot cattle in some parts of North America when feedlot cattle are fed rations low in

carotene or vitamin A over a period of several months.<sup>7</sup> The onset of clinical signs in growing feedlot cattle is typically seen 6–12 months after feeding a diet deficient in carotene or vitamin A. Small farm feedlots may feed their cattle a cereal grain such as barley and barley straw with no vitamin supplementation<sup>8</sup> or inadequate supplementation.<sup>9</sup> Grains, with exception of yellow corn, contain negligible amounts of carotene and cereal hay is often a poor source. Any hay cut late, leached by rain, bleached by sun, or stored for long periods loses much of its carotene content. The carotene content of yellow corn also deteriorates markedly with long storage. Moreover, under conditions not yet completely understood, the conversion by ruminants of carotene present in feeds such as silage may be much less complete than was formerly thought.

In feedlot cattle, the disease is most common in steers fed the same ration as heifers which may remain clinically normal.<sup>6,7</sup> It is suggested that sexual dimorphism may be due to the production of vitamin A by the corpus luteum of heifers.<sup>7</sup>

#### Pigs

Young pigs on a deficient diet may show signs after several months, but as in other animals, the length of time required before signs appear is governed to a large extent by the status before depletion commences. As a general rule it can be anticipated that signs will appear in pigs fed deficient rations for 4–5 months, variations from these periods probably being due to variations in the vitamin A status of the animal when the deficient diet is introduced. Congenital defects occur in litters from deficient sows, but the incidence is higher in gilts with the first litter than in older sows. It is presumed that the hepatic stores of vitamin A in older sows are not depleted as readily as in young pigs. Feeding white maize bran without supplementation can result in congenital defects in litters and paralysis in adult pigs.<sup>10</sup>

#### Horses

Adult horses may remain clinically normal for as long as 3 years on a deficient diet.

#### Secondary vitamin A deficiency

Secondary vitamin A deficiency may occur in cases of chronic disease of the liver or intestines because much of the conversion of carotene to vitamin A occurs in the intestinal epithelium and the liver is the main site of storage of the vitamin. Highly chlorinated naphthalenes interfere with the conversion of carotene to vitamin A and animals poisoned with these substances have a

very low vitamin A status. The intake of inorganic phosphorus also affects vitamin A storage, low phosphate diets facilitating storage of the vitamin. This may have a sparing effect on vitamin A requirements during drought periods when phosphorus intake is low and an exacerbating effect in stall-fed cattle on a good grain diet. However, phosphorus deficiency may lower the efficiency of carotene conversion. Vitamins C and E help to prevent loss of vitamin A in feedstuffs and during digestion. Additional factors which may increase the requirement of vitamin A include high environmental temperatures, a high nitrate content of the feed, which reduces the conversion of carotene to vitamin A and rapid rate of gain. Both a low vitamin A status of the animal and high levels of carotene intake may decrease the biopotency of ingested carotene.

The continued ingestion of mineral oil, which may occur when the oil is used as a preventive against bloat in cattle, may cause a depression of plasma carotene and vitamin A esters and the carotene levels in buffer fat. Deleterious effects on the cattle are unlikely under the conditions in which it is ordinarily used because of the short period for which the oil is administered and the high intake of vitamin A and carotene.

#### PATHOGENESIS

Vitamin A is essential for the regeneration of the visual purple necessary for dim-light vision, for normal bone growth and for maintenance of normal epithelial tissues. Deprivation of the vitamin produces effects largely attributable to disturbance of these functions. The same tissues are affected in all species. However, there is a difference in tissue and organ response in the different species and particular clinical signs may occur at different stages of development of the disease. The major pathophysiological effects of vitamin A deficiency are as follows.

#### Night vision

Ability to see in dim light is reduced because of interference with regeneration of visual purple.

#### Cerebrospinal fluid pressure

An increase in CSF pressure is one of the first abnormalities to occur in hypovitaminosis-A in calves. It is a more sensitive indicator than ocular changes and, in the calf, it occurs when the vitamin A intake is about twice that needed to prevent night blindness. The increase in CSF pressure is due to impaired absorption of the CSF due to reduced tissue permeability of the arachnoid villi and thickening of the connective tissue matrix of the cerebral dura mater. The increased CSF pressure is

responsible for the syncope and convulsions, which occur in calves in the early stages of vitamin A deficiency. The syncope and convulsions may occur spontaneously or be precipitated by excitement and exercise. It is suggested that the CSF pressure is increased in calves with subclinical deficiency and that exercise further increases the CSF pressure to convulsive levels.

#### Bone growth

Vitamin A is necessary to maintain normal position and activity of osteoblasts and osteoclasts. When deficiency occurs there is no retardation of endochondral bone growth, but there is incoordination of bone growth in that shaping, especially the finer molding of bones, does not proceed normally. In most locations this has little effect but may cause serious damage to the nervous system. Overcrowding of the cranial cavity occurs with resulting distortion and herniations of the brain and an increase in CSF pressure up to four to six times normal. The characteristic nervous signs of vitamin A deficiency, including papilledema, incoordination and syncope, follow. Compression, twisting and lengthening of cranial nerves and herniations of the cerebellum into the foramen magnum, causing weakness and ataxia and of the spinal cord into intervertebral foraminae results in damage to nerve roots and localizing signs referable to individual peripheral nerves. Facial paralysis and blindness due to constriction of the optic nerve, are typical examples of this latter phenomenon. The effect of excess vitamin A on bone development by its interference with vitamin D has been discussed elsewhere. Dwarfism in a group of pigs in a swine herd was suspected to be due to vitamin toxicosis.<sup>11</sup>

#### Epithelial tissues

Vitamin A deficiency leads to atrophy of all epithelial cells, but the important effects are limited to those types of epithelial tissue with a secretory as well as a covering function. The secretory cells are without power to divide and develop from undifferentiated basal epithelium. In vitamin A deficiency these secretory cells are gradually replaced by the stratified, keratinizing epithelial cells common to non-secretory epithelial tissues. This replacement of secretory epithelium by keratinized epithelium occurs chiefly in the salivary glands, the urogenital tract (including placenta but not ovaries or renal tubules) and the paraocular glands and teeth (disappearance of odontoblasts from the enamel organ). The secretion of thyroxine is markedly reduced. The mucosa of the stomach is not markedly affected. These changes in epithelium

lead to the clinical signs of placental degeneration, xerophthalmia and corneal changes.

Experimental vitamin A deficiency in lambs results in changes in the epithelium of the small intestine characterized by vesicular microvillar degeneration and disruption of the capillary endothelium.<sup>12</sup> Diarrhea did not occur.

### Embryological development

Vitamin A is essential for organ formation during growth of the fetus. Multiple congenital defects occur in pigs and rats and congenital hydrocephalus in rabbits on maternal diets deficient in vitamin A. In pigs, administration of the vitamin to depleted sows before the 17th day of gestation prevented the development of eye lesions but administration on the 18th day failed to do so. A maternal deficiency of vitamin A in cattle can result in congenital hypovitaminosis-A in the calves, characterized by blindness with dilated pupils, nystagmus, weakness, and incoordination. Constriction of the optic canal with thickening of the dura mater results in ischemic necrosis of the optic nerve and optic disc edema resulting in blindness. Retinal dysplasia also occurs. Thickening of the occipital and sphenoid bones and doming of the frontal and parietal bones with compression of the brain also occur. Dilated lateral ventricles may be present and associated with increased CSF pressure.

### Immune mechanisms

The effects of vitamin A and  $\beta$ -carotene on host defense mechanisms have been uncertain and controversial for many years.<sup>13</sup> Some workers claim that the incidence and severity of bacterial, viral, rickettsial and parasitic infections are higher in vitamin A-deficient animals.<sup>13</sup> It is possible that vitamin A and  $\beta$ -carotene afford protection against infections by influencing both specific and non-specific host defense mechanisms. The protective effect of vitamin A may be mediated by enhanced polymorphonuclear neutrophil function but this effect is also influenced by the physiological status of the animal such as lactation status in dairy cattle.<sup>14</sup> Experimentally, a severe vitamin A deficiency in lambs is associated with alterations in immune function, but the exact mechanism is unknown.<sup>15</sup>

### CLINICAL FINDINGS

In general, similar syndromes occur in all species, but because of species differences in tissue and organ response, some variations are observed. The major clinical findings are set out below.

#### Night blindness

Inability to see in dim light (twilight or moonlit night) is the earliest sign in all

species, except in the pig in which it is not evident until plasma vitamin A levels are very low. This is an important diagnostic sign.

#### Xerophthalmia

True xerophthalmia, with thickening and clouding of the cornea, occurs only in the calf. In other species a thin, serous mucoid discharge from the eyes occurs, followed by corneal keratinization, clouding and sometimes ulceration, and photophobia.

#### Changes in the skin

A rough, dry coat with a shaggy appearance and splitting of the bristle tips in pigs is characteristic, but excessive keratinization, such as occurs in cattle poisoned with chlorinated naphthalenes, does not occur under natural conditions of vitamin A deficiency. Heavy deposits of bran-like scales on the skin are seen in affected cattle. Dry, scaly hooves with multiple, vertical cracks are another manifestation of skin changes and are particularly noticeable in horses. A seborrheic dermatitis may also be observed in deficient pigs but is not specific to vitamin A deficiency.

#### Body weight

Under natural conditions, a simple deficiency of vitamin A is unlikely to occur and the emaciation commonly attributed to vitamin A deficiency may be largely due to multiple deficiencies of protein and energy. Although inappetence, weakness, stunted growth and emaciation occur under experimental conditions of severe deficiency, in field outbreaks severe clinical signs of vitamin A deficiency are often seen in animals in good condition. Experimentally, sheep maintain their body weight under extreme deficiency conditions and with very low plasma vitamin A levels.

#### Reproductive efficiency

Loss of reproductive function is one of the major causes of loss in vitamin A deficiency. Both the male and female are affected. In the male, libido is retained but degeneration of the germinative epithelium of the seminiferous tubules causes reduction in the number of motile, normal spermatozoa produced. In young rams, the testicles may be visibly smaller than normal. In the female, conception is usually not interfered with, but placental degeneration leads to abortion and the birth of dead or weak young. Placental retention is common.

#### Nervous system

Signs related to damage of the nervous system include:

- **Paralysis** of skeletal muscles due to damage of peripheral nerve roots
- **Encephalopathy** due to increased intracranial pressure

- **Blindness** due to constriction of the optic nerve canal.

These defects occur at any age but most commonly in young, growing animals and they have been observed in all species except horses.

#### Paralysis

The paralytic form is manifested by abnormalities of gait due to weakness and incoordination. The hindlegs are usually affected first and the forelimbs later. In pigs, there may be stiffness of the legs, initially with a stilted gait or flaccidity, knuckling of the fetlocks and sagging of the hindquarters. Complete limb paralysis occurs terminally.

#### Convulsions

Encephalopathy, associated with an increase in CSF pressure, is manifested by convulsions, which are common in beef calves at 6–8 months, usually following removal from a dry summer pasture at weaning time. Spontaneously, or following exercise or handling, affected calves will collapse (syncope) and during lateral recumbency a clonic-tonic convulsion will occur, lasting for 10–30 s. Death may occur during the convulsion or the animal will survive the convulsion and lie quietly for several minutes, as if paralyzed, before another convulsion may occur. Affected calves are usually not blind and the menace reflex may be slightly impaired or hyperactive. Some calves are hyperesthetic to touch and sound. During the convulsion there is usually ventroflexion of the head and neck, sometimes opisthotonos and, commonly, tetanic closure of the eyelids and retraction of the eyeballs. Outbreaks of this form of hypovitaminosis-A in calves have occurred and the case fatality rate may reach 25%.<sup>9</sup> The prognosis is usually excellent; treatment will effect a cure in 48 h but convulsions may continue for up to 48 h following treatment.

Seizures and acute death attributable to hypovitaminosis-A and hypovitaminosis-D have occurred in feeder pigs fed ground red wheat and whole milk and housed in a barn with no exposure to sunlight.<sup>16</sup> Lethargy, inappetence, diarrhea, and vomiting and progression to convulsions were characteristic.

#### Blindness

The ocular form of hypovitaminosis-A occurs usually in yearling cattle (12–18 months old) and up to 2–3 years of age. These animals have usually been on marginally deficient rations for several months. Night blindness may or may not have been noticed by the owner. The cattle have usually been fed and housed for long periods in familiar surroundings and the clinical signs of night blindness may have been subtle and not noticeable.

The first sign of the ocular form of the disease is blindness in both eyes during daylight. Both **pupils are widely dilated and fixed** and will not respond to light. Optic disc edema may be prominent and there may be some loss of the usual brilliant color of the tapetum. Varying degrees of peripapillary retinal detachment, papillary and peripapillary retinal hemorrhages, and disruption of the retinal pigment epithelium may also be present.<sup>6</sup> The **menace reflex** is usually totally absent, but the **palpebral and corneal reflexes** are present. The animal is aware of its surroundings and usually eats and drinks, unless placed in unfamiliar surroundings. The CSF pressure is increased in these animals, but not as high as in the calves described earlier. Convulsions may occur in these cattle if forced to walk, or if loaded onto a vehicle for transportation. The prognosis for the ocular form with blindness is unfavorable and treatment is ineffective because of the degeneration of the optic nerves. Exophthalmos and excessive lacrimation are present in some cases.

#### Congenital defects

These have been observed in piglets and calves. In calves, the defects are limited to congenital blindness due to optic nerve constriction and encephalopathy. In piglets, complete absence of the eyes (**anophthalmos**), or small eyes (**microphthalmos**), incomplete closure of the fetal optic fissure, degenerative changes in the lens and retina, and an abnormal proliferation of mesenchymal tissue in front of and behind the lens are some of the defects encountered. Ocular abnormalities in newborn calves from maternally vitamin A deficient heifers included corneal dermoid, microphthalmos, aphakia (absence of lens) and in some cases, both eyes covered by haired skin.<sup>2</sup>

Other congenital defects attributed to vitamin A deficiency in pigs include cleft palate and harelip, accessory ears, malformed hindlegs, subcutaneous cysts, abnormally situated kidneys, cardiac defects, diaphragmatic hernia, aplasia of the genitalia, internal hydrocephalus, herniations of the spinal cord, and generalized edema. Affected pigs may be stillborn, or weak and unable to stand, or may be quite active. Weak pigs lie on their sides, make slow paddling movements with their legs, and squawk plaintively.

#### Other diseases

Increased susceptibility to infection is often stated to result from vitamin A deficiency.<sup>9,13</sup> The efficacy of colostrum as a preventive against diarrhea in calves was originally attributed to its vitamin A

content, but the high antibody content of colostrum is most important.

**Anasarca.** Edema of the limbs and brisket have been associated with vitamin A deficiency in feedlot cattle, especially steers.<sup>17</sup> The pathogenesis is not understood. The edema can be extensive, include all four limbs, ventral body wall and extending to the scrotum. Heifers were unaffected.

#### CLINICAL PATHOLOGY

##### Plasma vitamin A

Vitamin A levels in the plasma are used extensively in diagnostic and experimental work. Plasma levels of 20 µg/dL are the minimal concentration for vitamin A adequacy.<sup>18</sup> Papilledema is an early sign of vitamin A deficiency which develops before nyctalopia and at plasma levels below 18 µg/dL. Normal serum vitamin A concentrations in cattle range from 25 to 60 µg/dL. In pigs, levels of 11.0 µg/dL have been recorded in clinical cases, with normal levels being 23–29 µg/dL.<sup>16</sup> In experimental vitamin A deficiency in lambs, serum levels declined to 6.8 µg/dL (normal lambs at 45.1 µg/dL).<sup>12</sup>

The clinical signs may correlate with the serum concentrations of vitamin A.<sup>8</sup> In one outbreak, feedlot cattle with serum concentrations between 8.89 and 18.05 µg/dL had only lost body weight, those between 4.87 and 8.88 µg/dL had varying degrees of ataxia and blindness and those below 4.88 µg/dL had convulsions and optic nerve constriction.<sup>8</sup> Clinical signs can be expected when the levels fall to 5 µg/dL.<sup>9</sup> For complete safety, optimum levels should be 25 µg/dL or above.

##### Plasma retinol

Some information on the plasma retinol values in stabled Thoroughbred horses is available. The mean plasma level of retinol in 71 horses 2–3 years of age was 16.5 µg/dL. The serum retinol levels in racing Trotters in Finland are lower than during the summer months, which is a reflection of the quality of the diets.<sup>19</sup>

##### Plasma carotene

Plasma carotene levels vary largely with the diet. In cattle, levels of 150 µg/dL are optimum and, in the absence of supplementary vitamin A in the ration, clinical signs appear when the levels fall to 9 µg/dL. In sheep, carotene is present in the blood in only very small amounts even when animals are on green pasture.

##### Hepatic vitamin A

A direct relationship between plasma and hepatic levels of vitamin A need not exist since plasma levels do not commence to fall until the hepatic stores are depleted. A temporary precipitate fall occurs at parturition and in acute infections in most

animals. The secretion of large amounts of carotene and vitamin A in the colostrum of cows during the last 3 weeks of pregnancy may greatly reduce the level of vitamin A in the plasma.

Hepatic levels of vitamin A and carotene can be estimated in the living animal from a biopsy specimen. Biopsy techniques have been shown to be safe and relatively easy, provided a proper instrument is used. Hepatic levels of vitamin A and carotene should be of the order of 60 and 4.0 µg/g of liver, respectively. These levels are commonly as high as 200–800 µg/g. Critical levels at which signs are likely to appear are 2 and 0.5 µg/g for vitamin A and carotene, respectively.

##### Cerebrospinal fluid

CSF pressure is also used as a sensitive indicator of low vitamin A status. In calves, normal pressures of less than 100 mm of saline rise after depletion to more than 200 mm. In pigs, normal pressures of 80–145 mm rise to above 200 mm in vitamin A deficiency. An increase in pressure is observed at a blood level of about 7 µg vitamin A/dL plasma in this species. In sheep, normal pressures of 55–65 mm rise to 70–150 mm when depletion occurs. In the experimentally induced disease in cattle, there is a marked increase in the number of cornified epithelial cells in a conjunctival smear and distinctive bleaching of the tapetum lucidum as viewed by an ophthalmoscope. These features may have value as diagnostic aids in naturally occurring cases.

#### NECROPSY FINDINGS

Gross changes are rarely observed at necropsy. Careful dissection may reveal a decrease in the size of the cranial vault and of the vertebrae. Compression and injury of the cranial and spinal nerve roots, especially the optic nerve, may be visible. In outbreaks in which night blindness is the primary clinical sign, atrophy of the photoreceptor layer of the retina is evident histologically, but there are no gross lesions.

Congenital ocular abnormalities in newborn calves from vitamin A deficient heifer dams included aphakia, absence of a uveal tract and aqueous humour, microphthalmos, bony outgrowths of the occipital bone, compression of the cerebellum and cardiac abnormalities similar to the tetralogy of Fallot.<sup>2</sup>

Squamous metaplasia of the interlobular ducts of the parotid salivary gland is strongly suggestive of vitamin A deficiency in pigs, calves, and lambs, but the change is transient and may have disappeared 2–4 weeks after the intake of vitamin A is increased. This microscopic change is

most marked and occurs first, at the oral end of the main parotid duct. Abnormal epithelial cell differentiation may also be observed histologically in a variety of other sites such as the tracheal, esophageal, and ruminal mucosae, preputial lining, pancreatic ducts, and urinary epithelium. Hypovitaminosis-A has also been associated with an increased incidence of pituitary cysts in cattle. Secondary bacterial infections, including pneumonia and otitis media, are also common, due at least in part to the decreased barrier function of the lining epithelia.

The abnormalities that occur in congenitally affected pigs have already been described.

### Samples for confirmation of diagnosis

**Toxicology** – 50 g liver, 500 g feed ASSAY (Vit A)

**Histology** – formalin-fixed parotid salivary gland (including duct), rumen, pituitary, pancreas, brain (including optic nerves), cervical spinal cord (including nerve roots); Bouin's-fixed eye (LM).

### DIFFERENTIAL DIAGNOSIS

When the characteristic clinical findings of vitamin A deficiency are observed, a deficiency of the vitamin should be suspected if green feed or vitamin A supplements are not being provided. The detection of papilledema and testing for night blindness are the easiest methods of diagnosing early vitamin A deficiency in ruminants. Incoordination, paralysis, and convulsions are the early signs in pigs. Increase in CSF pressure is the earliest measurable change in both pigs and calves. Laboratory confirmation depends upon estimations of vitamin A in plasma and liver, the latter being most satisfactory. Unless the disease has been in existence for a considerable time, response to treatment is rapid. For confirmation at necropsy, histological examination of parotid salivary gland and assay of vitamin A in the liver, are suggested.

The salient features of the differential diagnosis of diseases of the nervous system of cattle are summarized in Table 32.3.

#### Cattle

Convulsive form of vitamin A deficiency in cattle must be differentiated from:

- **Polioencephalomalacia:** characterized by sudden onset of blindness, head-pressing, and tonic-clonic convulsions, usually in grain-fed animals but also in pastured animals ingesting an excess of sulfate in water and grass
- **Hypomagnesemic tetany:** primarily in lactating dairy cattle on pasture during cool windy weather; characterized by hyperesthesia, champing tonic-clonic convulsions, normal eyesight and tachycardia, and loud heart sounds

- **Lead poisoning:** in all age groups, but most commonly in pastured calves in the spring; characterized by blindness, tonic-clonic convulsions, champing of the jaw, head-pressing, and rapid death
- **Rabies:** in all age groups; characterized by bizarre mental behavior, gradually progressive ascending paralysis with ataxia leading to recumbency, drooling saliva, inability to swallow, normal eyesight, and death in 4–7 days.

**Ocular form of vitamin A deficiency in cattle** must be differentiated from those diseases of cattle characterized by central or peripheral blindness:

- **Central blindness:**  
Polioencephalomalacia  
Lead poisoning  
Meningoencephalitis.
- **Peripheral blindness:**  
Bilateral ophthalmitis due to ocular disease.

**Loss of body condition** in cattle, failure to grow and poor reproductive efficiency are general clinical findings not limited to vitamin A deficiency.

#### Pigs

#### Convulsive form of vitamin A

**deficiency in pigs** must be differentiated from:

- Salt poisoning
- Pseudorabies
- Viral encephalomyelitis
- Organic arsenic poisoning.

**Paralytic form of vitamin A deficiency in pigs** must be differentiated from:

- Spinal cord compression due to vertebral body abscess.

**Congenital defects** similar to those caused by vitamin A deficiency may be caused by deficiencies of other essential nutrients, by inheritance or by viral infections in early pregnancy in all species. Maternal vitamin A deficiency is the most common cause of congenital defects in piglets. Final diagnosis depends upon the necropsy findings, analysis of feed and serum vitamin A of the dams.

### TREATMENT

#### Vitamin A

Animals with curable vitamin A deficiency should be treated immediately with vitamin A at a dose rate equivalent to 10–20 times the daily maintenance requirement. As a rule, 440 IU/kg BW is the dose used. Parenteral injection of an aqueous rather than an oily solution is preferred. The response to treatment in severe cases is often rapid and complete, but the disease may be irreversible in chronic cases. Calves with the convulsive form due to increased CSF pressure will usually return to normal in 48 h following treatment. Cattle with the ocular form of the deficiency and that are blind will not respond to treatment and should be slaughtered for salvage.

#### Hypervitaminosis-A

Daily heavy dosing (about 100 times normal) of calves causes reduced growth rate, lameness, ataxia, paresis, exostoses on the planter aspect of the third phalanx of the fourth digit of all feet, and disappearance of the epiphyseal cartilage. Persistent heavy dosing in calves causes lameness, retarded horn growth and depressed CSF pressure. At necropsy, exostoses are present on the proximal metacarpal bones and the frontal bones are thin. Very high levels fed to young pigs may cause sudden death through massive internal hemorrhage and excessive doses during early pregnancy are reputed to result in fetal anomalies. However, feeding vitamin A for prolonged periods at exceptionally high levels is unlikely to produce severe embryotoxic or teratogenic effects in pigs.

### CONTROL

#### Dietary requirement

The minimum daily requirement in all species is 40 IU of vitamin A/kg BW, which is a guideline for maintenance requirements. In the formulation of practical diets for all species, the daily allowances of vitamin A are commonly increased by 50–100% of the daily minimum requirements. During pregnancy, lactation, or rapid growth the allowances are usually increased by 50–75% of the requirements. The supplementation of diets to groups of animals is governed also by their previous intake of the vitamin and its probable level in the diet being fed. The rate of supplementation can vary from 0 to 110 IU/kg BW/d (1 IU of vitamin A is equivalent in activity to 0.3 µg of retinol; 5–8 µg β-carotene has the same activity as 1 µg of retinol).

Nutrient studies have indicated that pre-ruminant Holstein calves being fed milk replacer should receive 11 000 IU of vitamin A/kg DM for optimum growth and to maintain adequate liver vitamin A stores.<sup>20</sup>

The amounts of the vitamin to be added to the ration of each species to meet the requirements for all purposes should be obtained from published recommended nutrient requirements of domestic animals. Some examples of daily allowances of vitamin A for farm animals are set out in Table 30.11.

#### Supplementation method

The method of supplementation will vary depending on the class of livestock and the ease with which the vitamin can be given. In **pigs**, the vitamin is incorporated directly into the complete ration, usually through the protein supplement. In **feedlot and dairy cattle** receiving complete feeds, the addition of vitamin A to the diet is simple. In **beef cattle**, which may



Table 30.11 Daily dietary allowances of vitamin A

Animal	Vitamin A (IU/kg BW daily)
<b>Cattle</b>	
Growing calves	40
Weaned beef calves at 6–8 months	40
Calves 6 months to yearlings	40
Maintenance and pregnancy	70–80
Maintenance and lactation	80
Feedlot cattle on high energy ration	80
<b>Sheep</b>	
Growth and early pregnancy and fattening lambs	30–40
Late pregnancy and lactation	70–80
<b>Pigs</b>	
Growing pigs	40–50
Pregnant gilts and sows	40–50
Lactating gilts and sows	70–80
<b>Horses</b>	
Working horse	20–30
Growing horse	40
Pregnant mare	50
Lactating mare	50

be fed primarily on carotene-deficient roughage during pregnancy, it may not be possible to supplement the diet on a daily basis. However, it may be possible to provide a concentrated dietary source of vitamin A on a regular basis by feeding a protein supplement once weekly. The protein supplement will contain 10–15 times the daily allowance, which permits hepatic storage of the vitamin.

#### Parenteral injection

An alternative method to dietary supplementation is the IM injection of vitamin A at intervals of 50–60 days at the rate of 3000–6000 IU/kg BW. Under most conditions, hepatic storage is good and optimum plasma and hepatic levels of vitamin A are maintained for up to 50–60 days. In pregnant beef cattle the last injection should not be more than 40–50 days before parturition to insure adequate levels of vitamin A in the colostrum. Ideally, the last injection should be given 30 days before parturition but this may not be practical under some management conditions. However, the most economical method of supplementing vitamin A is, in most cases, through the feed and when possible should be used.

The use of injectable mixtures of vitamins A, D, and E is not always justifiable. The injection of a mixture of vitamins A, D, and E of feeder cattle in northern Australia prior to transport did not, contrary to anecdotal evidence, reduce weight loss associated with transportation.<sup>21</sup> Cattle in Queensland and north-western Australia have very high concentrations of hepatic vitamin A and in fact, drought-stricken cattle in the terminal stages of malnutrition have also had high liver concentration. The indiscriminate use of vitamin A preparations in cattle is a public health

concern because some bovine livers may contain high levels of vitamin A which are potentially teratogenic for pregnant women.<sup>22</sup>

#### Oral vitamin A

The oral administration of a single bolus of vitamin A at a dose of 2.8 mg/kg BW to debilitated Sahelian cattle during the dry season was effective in raising the milk levels of vitamin A and was as effective as adding 10 g of the powder to the drinking water.<sup>4</sup> Both the powder and bolus products provided high levels of vitamin A in milk within 3 days of treatment and according to herder testimonials, night-blind people consuming milk from cattle previously treated with either oral vitamin A preparation were no longer affected with night blindness.

#### REFERENCES

- Davies IH. *Cattle Pract* 2000; 8:139.
- Mason CS et al. *Vet Rec* 2003; 153:213.
- Molokwu ECI. *Br Vet J* 1978; 134:493.
- Remillard RL et al. *Prev Vet Med* 1990; 9:173.
- van der Lugt JJ, Prozesky L. *Onderstepoort J Vet Res* 1989; 56:99.
- Divers TJ et al. *J Am Vet Med Assoc* 1986; 189:1579.
- Paulsen ME et al. *J Am Vet Med Assoc* 1989; 194:933.
- Booth A et al. *J Am Vet Med Assoc* 1987; 190:1305.
- Sustronck B et al. *Vlaams Diergen Tijdschrift* 1993; 62:95.
- Salum MR, Njavike SM. *Bull Anim Health Prod Africa* 1993; 41:163.
- Doige CE, Schoonderwoerd M. *J Am Vet Med Assoc* 1988; 193:691.
- Holland RE et al. *Dig Dis Sci* 1993; 38:333.
- Chew BP. *J Dairy Sci* 1987; 70:2732.
- Tjoelker LW et al. *J Dairy Sci* 1988; 71:3112, 3120.
- Bruns NJ, Webb KE Jr. *J Anim Sci* 1990; 68:454.
- Lakritz J et al. *J Am Vet Med Assoc* 1993; 202:1276.
- Brenner J et al. *Israel J Vet Med* 1998; 53:78.
- Chew BP et al. *J Dairy Sci* 1984; 67:1316.
- Maepaa PH et al. *Equine Vet J* 1987; 19:237.

20. Swanson KS et al. *J Dairy Sci* 2000; 83:2027.

21. Jubb TF et al. *Aust Vet J* 1993; 70:171.

22. Rutter JM. *Vet Rec* 1990; 127:433.

#### VITAMIN K DEFICIENCY

A primary deficiency of vitamin K is unlikely under natural conditions in domestic animals because of the high content of substances with vitamin K activity in most plants and the substantial synthesis of these substances by microbial activity in the alimentary canal. Sporadic cases may occur when impairment of the flow of bile reduces the digestion and absorption of this fat-soluble vitamin. Experimentally produced vitamin K deficiency in piglets is manifested by hypersensitivity, anemia, anorexia, weakness, and a marked increase in prothrombin time. The minimum daily requirement for newborn pigs is 5 µg/kg BW and the minimum curative injection dose is four times larger.

A hemorrhagic disease of recently weaned pigs from 6 to 15 weeks of age is considered to be associated with vitamin K deficiency.<sup>1</sup> Affected pigs fail to grow, become pale, develop large subcutaneous hematomas and exhibit lameness and epistaxis.<sup>1</sup> Excessive and fatal hemorrhage following routine castration may occur in pigs from 30 to 40 days of age, but not at 15–20 days of age.<sup>2</sup> Subcutaneous massive hemorrhage is more common in pigs at 40–70 days of age. Prothrombin time and activated partial thromboplastin time are prolonged along with decreased levels of vitamin K-dependent factors II, VII, IX, and X.<sup>2</sup> At necropsy, hemorrhages are extensive in the muscles of the hindlimbs, forelimbs, and axillary and mandibular region.

Vitamin K, or vitamin K<sub>2</sub>, given at a dose of 3 mg/kg BW IM as a single dose will restore the blood coagulation defects to normal.<sup>3</sup> Vitamin K<sub>3</sub> added to the feed at a rate of 25 mg/kg for 4 days was also effective. The cause of the vitamin K deficiency was considered to be related to the use of antibacterial drugs in the feed but this has not been substantiated.

The most important therapeutic use of vitamin K in domestic animals is in sweet clover poisoning where toxic quantities of coumarin severely depress the prothrombin levels of the blood and interfere with its clotting mechanism. Industrial poisons used in rodent control which contain anticoagulants of the coumarin type, e.g. warfarin, cause fatal hypothermia; vitamin K is an effective antidote. For warfarin-induced anticoagulation in the horse, the administration of 300–500 mg of vitamin K<sub>1</sub> SC every 4–6 h until the prothrombin time returns to baseline values is recommended.<sup>4</sup>

## REVIEW LITERATURE

Mount ME, Feldman BF. Vitamin K and its importance. *J Am Vet Med Assoc* 1982; 180:1354-1356.

## REFERENCES

1. Newsholme SJ et al. *J South Afr Vet Assoc* 1986; 56:101.
2. Sasaki Y et al. *Jap J Vet Sci* 1982; 44:933.
3. Sasaki Y et al. *Jap J Vet Sci* 1985; 47:435.
4. Byars TD et al. *Am J Vet Res* 1986; 47:2309.

## Diseases associated with deficiencies of water-soluble vitamins

Water-soluble vitamins, including vitamin C and the B complex, are of minor importance in ruminants (except for vitamin B<sub>12</sub>) because of their synthesis in the alimentary tract of these animals.

The dairy cow's requirements for the B-complex vitamins were established in the 1940-1950s. At that time, vitamin requirements were defined as the smallest dietary amount necessary to prevent clinical signs of deficiency.<sup>1</sup> It was demonstrated that even when fed a vitamin-free diet, the synthesis of B-complex vitamins by the rumen microflora was sufficient to avoid deficiencies. Consequently, it was concluded that a dietary supply of B-complex vitamins was unnecessary in ruminants. However, there is now evidence that in high-producing dairy cows the requirements for biotin, nicotinic acid, folic acid, and vitamin B<sub>12</sub> are increased under certain circumstances and the amounts supplied by the diet and by ruminal synthesis are not always adequate to maximize health and productivity of dairy cows.<sup>1</sup>

**Niacin** requirements per feed unit are higher with high-energy feeds. Niacin increases the number of ruminal protozoa and in cows with clinical or subclinical ketosis, repeated doses of niacin lead to a rapid decrease of non-esterified fatty acids. Dietary supplementation of niacin at 6 mg/d, have improved milk production.

**Biotin** supplementation of 20 mg/head per day in early lactation can result in improved hoof horn health. After 5 months of biotin supplementation, there is an improvement in the quality and resistance of cow heel and sole horns but 10 months of supplementation is required before an improvement in quality of coronary horn is observed.

**Folic acid** is essential for cell division and growth for protein synthesis. Supplementation of folic acid may increase milk production but there is insufficient data available to make a recommendation.

**Vitamin B<sub>12</sub>** requirements are usually met by ruminal microflora synthesis if the dietary supply cobalt is adequate. High concentrate diets can modify bacterial

synthesis of the vitamin and metabolic utilization of propionate increases the demand for *Vitamin B<sub>12</sub>*.

Thiamin, nicotinic acid, riboflavin, pantothenic acid, pyridoxine, biotin, and folic acid are all synthesized by microbial activity. Nicotinic acid and vitamin C are synthesized by other means. The young calf or lamb, in the period before ruminal activity begins, is likely to receive inadequate supplies of these vitamins and deficiency states can be produced experimentally. In the pre-ruminant stage, colostrum and milk are good sources of the water-soluble vitamins, ewes' milk being much richer than cows' milk. The production of signs of deficiency of the B vitamins in horses by the feeding of deficient diets has raised some doubts as to the availability of the B vitamins synthesized in the large intestine in this species.

Vitamin C is synthesized by all species and is not an important dietary essential in any of the domestic animals. Synthesis occurs in tissues and, although blood levels fall after birth, in the newborn calf they begin to rise again at about 3 weeks of age. However, a dermatosis of young calves has been associated with low levels of ascorbic acid in their plasma and responds to a single injection of 3 g of ascorbic acid. A heavy dandruff, followed by a waxy crust, alopecia and dermatitis commences on the ears and spreads over the cheeks, down the crest of the neck and over the shoulders. Some deaths have been recorded, but spontaneous recovery is more usual.

There is some interest in the administration of high doses of ascorbic acid orally to horses to counteract the effects of stress and minimize the effects of infections. A single oral dose of 20 g of ascorbic acid does not result in any increase in plasma concentrations. However, daily administration of either 4.5 g or 20 g results in significant increases in plasma concentrations.<sup>2</sup>

## REVIEW LITERATURE

Girard CL. B-complex vitamins for dairy cows: A new approach. *Can J Anim Sci* 1998; 78:Supplement 71-90.

Blair R, Newsome F. Involvement of water-soluble vitamins in diseases of the swine. *J Anim Sci* 1985; 60:1508.

## REFERENCES

1. Girard CL. *Can J Anim Sci* 1998; 78:Supplement 71.
2. Snow DH et al. *Equine Vet J* 1987; 19:520.

## THIAMIN DEFICIENCY (HYPOTHIAMINOSIS)

The disease caused by deficiency of thiamin in tissues is characterized chiefly by nervous signs.

## ETIOLOGY

Thiamin deficiency may be primary, due to deficiency of the vitamin in the diet, or secondary, because of destruction of the vitamin in the diet by thiaminase. A primary deficiency is unlikely under natural conditions because most plants, especially seeds, yeast, and milk contain adequate amounts.

Thiamin is normally synthesized in adequate quantities in the rumen of cattle and sheep on a well-balanced roughage diet. The degree of synthesis is governed to some extent by the composition of the ration, a sufficiency of readily fermentable carbohydrate causing an increase of synthesis of most vitamins of the B complex and a high intake in the diet reducing synthesis. The etiology of polioencephalomalacia has been discussed in detail under that heading. Microbial synthesis of thiamin also occurs in the alimentary tract of monogastric animals and in young calves and lambs, but not in sufficient quantities to avoid the necessity for a dietary supply, so that deficiency states can be readily induced in these animals with experimental diets. Thiamin is relatively unstable and easily destroyed by cooking.

The coccidiostat amprolium is a thiamin antagonist and others are produced by certain plants, bacteria, fungi, and fish.

## EPIDEMIOLOGY

One of the best examples of secondary thiamin deficiency is inclusion of excess raw fish in the diet of carnivores, resulting in destruction of thiamin because of the high content of thiaminase in the fish.

Two major occurrences of secondary thiamin deficiency are recorded. In horses, the ingestion of excessive quantities of **bracken fern** (*Pteridium aquilinum*) and **horsetail** (*Equisetum arvense*) causes nervous signs because of the high concentration of thiaminase in these plants. The disease has been induced in a pig fed bracken rhizomes and the possibility exists of it occurring under natural conditions. It has also been reported in horses fed large quantities of turnips (*Beta vulgaris*) without adequate grain. The second important occurrence of thiamin deficiency is in the etiology of polioencephalomalacia and is discussed under that heading.

A thiaminase-induced subclinical thiamin deficiency causing suboptimal growth rate of weaner lambs has been described.<sup>1</sup> Higher levels of thiaminase activity were present in the feces and rumen contents of lambs with poor growth rate compared with normal lambs. *Bacillus thiaminolyticus* was isolated from the feces and ruminal fluids of affected lambs and supplementation of thiaminase-excreting lambs with

IM injections of thiamine hydrochloride was associated with significantly improved growth rate.<sup>1</sup>

Thiamin deficiency occurs in sheep being subjected to live export from Australia to the Middle East.<sup>2</sup> Sheep that died or were clinically ill and euthanized had significantly lower hepatic and ruminal thiaminase concentrations than clinically healthy control sheep. A high proportion had thiamin concentrations comparable with those found in sheep that die with polioencephalomalacia. The evidence indicates that the thiamin deficiency is a primary one associated with deprivation of feed during transportation to the pre-embarkation feedlots. The low feed intake and failure of the ruminal microbes to adapt, thrive and synthesize a net surplus of thiamin during alterations in the ruminal environment are considered to be major contributing factors.

### **PATHOGENESIS**

The only known function of thiamin is its activity as a cocarboxylase in the metabolism of fats, carbohydrates and proteins and a deficiency of the vitamin leads to the accumulation of endogenous pyruvates. Although the brain is known to depend largely on carbohydrate as a source of energy, there is no obvious relationship between a deficiency of thiamin and the development of the nervous signs which characterize it. Polioencephalomalacia has been produced experimentally in pre-ruminant lambs on a thiamin-free diet. There are other prodromal indications of deficiency disease. For example, there is a decrease in erythrocyte precursors and in erythrocyte transketolase. Additional clinical signs also in the circulatory and alimentary systems, but their pathogenesis cannot be clearly related to the known functions of thiamin. Subclinical thiamin deficiency due to thiaminases in the alimentary tract is associated with low erythrocyte transketolase activities and elevated thiamin pyrophosphate effects, which may explain the poor growth rate.<sup>1</sup>

### **CLINICAL FINDINGS**

#### **Bracken fern (*Pteridium aquilinum*) and horsetail (*Equisetum arvense*) poisoning in the horse**

Incoordination and falling and bradycardia due to cardiac irregularity, are the cardinal clinical signs of bracken fern poisoning in the horse. These signs disappear after the parenteral administration of thiamin. Similar clinical effects occur with horsetail. Swaying from side to side occurs first, followed by pronounced incoordination, including crossing of the forelegs and wide action in the hindlegs. When standing, the legs are placed well apart and crouching and arching of the back are evident. Muscle tremor develops

and eventually the horse is unable to rise. Clonic convulsions and opisthotonos are the terminal stage. Appetite is good until late in the disease when somnolence prevents eating. Temperatures are normal and the heart rate slow until the terminal period when both rise to above normal levels. Some evidence has also been presented relating the occurrence of hemiplegia of the vocal cords in horses with a below normal thiamin status. Neither plant is palatable to horses and poisoning rarely occurs at pasture. The greatest danger is when the immature plants are cut and preserved in meadow hay.

### **Experimental syndromes**

These syndromes have not been observed to occur naturally but are produced readily on experimental rations.

In **pigs**, inappetence, emaciation, leg weakness and a fall in body temperature, respiratory rate, and heart rate occur. The electrocardiogram is abnormal and congestive heart failure follows. Death occurs in 5 weeks on a severely deficient diet. In calves, weakness, incoordination, convulsions, and retraction of the head occur and in some cases anorexia, severe scouring and dehydration.

**Lambs** 1–3 days old placed on a thiamin-deficient diet show signs after 3 weeks. Somnolence, anorexia, and loss of condition occur first, followed by tetanic convulsions.

**Horses** fed amprolium (400–800 mg/kg BW daily) developed clinical signs of thiamin deficiency after 37–58 days. Bradycardia with dropped heart beats, ataxia, muscle fasciculation and periodic hypothermia of hooves, ears, and muzzle were the common signs, with blindness, diarrhea, and loss of body weight occurring inconstantly.

### **CLINICAL PATHOLOGY**

Blood pyruvic acid levels in horses are raised from normal levels of 2–3 µg/dL to 6–8 µg/dL. Blood thiamin levels are reduced from normal levels of 8–10 µg/dL to 2.5–3.0 µg/dL. Electrocardiograms show evidence of myocardial insufficiency. In pigs, blood pyruvate levels are elevated and there is a fall in blood transketolase activity. These changes occur very early in the disease. In sheep subjected to export, liver and rumen thiamin concentrations and erythrocyte transketolase activities, were all below levels found in clinically normal sheep.<sup>2</sup>

### **NECROPSY FINDINGS**

No macroscopic lesions occur in thiamin deficiency other than non-specific congestive heart failure in horses. The myocardial lesions are those of interstitial edema and lesions are also present in the liver and intestine.

In the experimental syndrome in pigs, there are no degenerative lesions in the nervous system, but there is multiple focal necrosis of the atrial myocardium accompanied by macroscopic flabbiness and dilatation without hypertrophy of the heart.

### **DIFFERENTIAL DIAGNOSIS**

Diagnosis of secondary thiamin deficiency in horses must be based on the signs of paralysis and known access to bracken fern or horsetail. A similar syndrome may occur with poisoning by:

- *Crotalaria* spp.
- Perennial ryegrass
- *Indigofera enneaphylla*
- Ragwort (*Senecio jacobaea*).

It is accompanied by hepatic necrosis and fibrosis. The encephalomyelites are usually accompanied by signs of cerebral involvement, by fever and failure to respond to thiamin therapy.

### **TREATMENT**

In clinical cases the injection of a solution of the vitamin produces dramatic results (5 mg/kg BW given every 3 h). The initial dose is usually given IV followed by IM injections for 2–4 days. An oral source of thiamin should be given daily for 10 days and any dietary abnormalities corrected.

### **CONTROL**

The daily requirement of thiamin for monogastric animals is, in general, 30–60 µg/kg BW. The addition of yeast, cereals, grains, liver, and meat meal to the ration usually provides adequate thiamin.

### **REFERENCES**

1. Thomas KW. Vet Res Commun 1986; 10:125.
2. Thomas KW et al. Aust Vet J 1990; 67:215.

### **RIBOFLAVIN DEFICIENCY (HYPORIBOFLAVINOSIS)**

Although riboflavin is essential for cellular oxidative processes in all animals, the occurrence of deficiency under natural conditions is rare in domestic animals because actively growing green plants and animal protein are good sources and some synthesis by alimentary tract microflora occurs in all species. Synthesis by microbial activity is sufficient for the needs of ruminants but a dietary source is required in these animals in the pre-ruminant stage. Milk is a very good source. Daily requirements for pigs are 60–80 µg/kg BW and 2–3 g/tonne of feed provides adequate supplementation. The trend towards confinement feeding of pigs has increased the danger of naturally occurring cases in that species.

On experimental diets the following syndromes have been observed:

- **Pigs:** slow growth, frequent scouring, rough skin, and matting of the hair coat with heavy, sebaceous exudate are characteristic. There is a peculiar crippling of the legs with inability to walk and marked ocular lesions, including conjunctivitis, swollen eyelids, and cataract. The incidence of stillbirths may be high
- **Calves:** anorexia, poor growth, scours, excessive salivation and lacrimation, and alopecia occur. Areas of hyperemia develop at the oral commissures, on the edges of the lips, and around the navel. There are no ocular lesions.

### **NICOTINIC ACID DEFICIENCY (HYPONIACINOSIS)**

Nicotinic acid or niacin is essential for normal carbohydrate metabolism. Because of the high content in most natural animal feeds, deficiency states are rare in ordinary circumstances, except in pigs fed rations high in corn. Corn has both a low niacin content and a low content of tryptophan, a niacin precursor. A low protein intake exacerbates the effects of the deficiency, but a high protein intake is not fully protective.

In ruminants, synthesis within the animal provides an adequate source. Even in young calves, signs of deficiency do not occur and because rumen microfloral activity is not yet of any magnitude, extraruminal synthesis appears probable.

The oral supplementation of niacin in the diet of periparturient dairy cows may result in an increase in serum inorganic phosphorus and a decrease in serum potassium, calcium, and sodium concentrations. Niacin has been used to study the effects of artificially induced ketonemia and hypoglycemia in cattle.

The daily requirements of niacin for mature pigs are 0.1–0.4 mg/kg BW, but growing pigs appear to require rather more (0.6–1 mg/kg BW) for optimum growth.

Experimentally induced nicotinic acid deficiency in pigs is characterized by inappetence, severe diarrhea, a dirty yellow skin with a severe scabby dermatitis and alopecia. Posterior paralysis also occurs. At necropsy, hemorrhages in the gastric and duodenal walls, congestion and swelling of the small intestinal mucosa, and ulcers in the large intestine are characteristic and closely resemble those of necrotic enteritis caused by infection with *Salmonella* spp.

Histologically, there is severe mucoid degeneration followed by local necrosis in the wall of the cecum and colon. Experimental production of the disease in pigs by the administration of an anti-metabolite to nicotinamide causes ataxia

or quadriplegia, accompanied by distinctive lesions in the gray matter of the cervical and lumbar enlargements of the ventral horn of the spinal cord. The lesions are malacic and occur in the intermediate zone of the gray matter. The identical lesions and clinical picture have been observed in naturally occurring disease.

The oral therapeutic dose rate of nicotinic acid in pigs is 100–200 mg; 10–20 g/tonne of feed supplies sufficient nicotinic acid for pigs of all ages. Niacin is low in price and should always be added to pig rations based on corn.

### **PYRIDOXINE (VITAMIN B<sub>6</sub>) DEFICIENCY (HYPOPYRIDOXINOSIS)**

A deficiency of pyridoxine in the diet is not known to occur under natural conditions. Experimental deficiency in pigs is characterized by periodic epileptiform convulsions and at necropsy by generalized hemosiderosis with a microcytic anemia, hyperplasia of the bone marrow, and fatty infiltration of the liver. The daily requirement of pyridoxine in the pig is of the order of 100 µg/kg BW or 1 mg/kg of solid food, although higher levels have been recommended on occasions. Certain strains of chickens have a high requirement for pyridoxine and the same may be true of pigs.

Experimentally induced deficiency in calves is characterized by anorexia, poor growth, apathy, dull coat and alopecia. Severe, fatal epileptiform seizures occur in some animals. Anemia with poikilocytosis is characteristic of this deficiency in cows and calves.

### **PANTOTHENIC ACID DEFICIENCY (HYPOPANTOTHENOSIS)**

Pantothenic acid is a dietary essential in all species other than ruminants, which synthesize it in the rumen. Deficiency under natural conditions has been recorded mainly in pigs on rations based on corn.

In pigs, a decrease in weight gain due to anorexia and inefficient food utilization occurs first. Dermatitis develops with a dark brown exudate collecting about the eyes and there is a patchy alopecia. Diarrhea and incoordination with a spastic, goose-stepping gait are characteristic. At necropsy, a severe, sometimes ulcerative, colitis is observed constantly, together with degeneration of myelin.

Calcium pantothenate (500 µg/kg BW/d) is effective in treatment and prevention. As a feed additive, 10–12 g/tonne is adequate.

Experimentally induced pantothenic acid deficiency in calves is manifested by rough hair coat, dermatitis under the lower jaw, excessive nasal mucus, anorexia

and reduced growth rate, and is eventually fatal. At necropsy, there is usually a secondary pneumonia, demyelination in the spinal cord and peripheral nerves and softening and congestion of the cerebrum.

### **BIOTIN (VITAMIN H) DEFICIENCY (HYPOBIOTINOSIS)**

Biotin or vitamin H, has several important biochemical functions. It is a cofactor in several enzyme systems involved in carboxylation and transcarboxylation reactions and consequently has a significant effect on carbohydrate metabolism, fatty acid synthesis, amino acid deamination, purine synthesis, and nucleic acid metabolism. Biotin is found in almost all plant and animal materials and, being required in very small quantities, is unlikely to be deficient in diets under natural conditions, especially as microbial synthesis occurs in the alimentary tract.

#### **Cattle**

Biotin is now considered a significant factor in lameness of cattle.<sup>1</sup> Biotin is important for the differentiation of epidermal cells which are required for normal production of keratin and hoof horn tissue. Biotin also acts as a co-factor in carboxylase enzymes and is an important factor in both gluconeogenesis and fatty acid synthesis. Significant differences in the fatty acid profile of horn tissue of cattle with claw lesions have been observed. Biotin supplementation reduces clinical white line disease, reduces horn lesions, and improves horn quality by strengthening the intercellular cementing material between keratinocytes.<sup>2</sup> Improved hoof integrity in intensively managed dairy cows has occurred following biotin supplementation.<sup>3</sup> However, a long period of supplementation is required before the effect of the vitamin on hoof health care is expressed. In addition, there may be improved milk production, milk composition, and cow fertility with biotin supplementation.

Biotin is synthesized in the rumen and absolute biotin deficiency has not been recognized. However, ruminal synthesis of biotin may be compromised by acidic conditions in the rumen, which may increase the need for supplementation of biotin in the diet of high-producing dairy cows. In the dairy cow in the periparturient period and early lactation, the levels of biotin may decrease. A decrease in plasma biotin levels of dairy cows at 25 days in milk (DIM), returning to constant levels from 100 DIM until the end of lactation.<sup>3</sup> Feeding supplemental biotin at 20 g/d during the last 16 days post partum and at 30 g/d from calving through to 70 days post partum elevated concentrations of plasma and milk com-

pared with cows unsupplemented with biotin.<sup>4</sup> Supplemental biotin also elevated plasma glucose and lowered non-esterified fatty acids, which indicates that supplemental biotin is involved in hepatic gluconeogenesis. The triacylglycerol concentration in liver tended to decrease at a faster rate within 2 days after parturition.

The supplementation of Holstein cows in the Atherton Tablelands in Australia, with biotin at 20 mg/head per day resulted in improved locomotion scores compared to unsupplemented cows.<sup>5</sup> In the wet summer period, the number of lame cows observed by the farmer, were significantly fewer during the rainy period for the biotin-supplemented herds and required fewer antibiotic treatments than unsupplemented herds. Most hoof lesions were most commonly observed in the outer claws of the hind limb.

In a randomized control field trial on five commercial dairy farms in Gloucestershire, south-west UK, the effect of parity and duration of supplementation with oral biotin at 20 mg/d on white line disease was studied over a period of 18 months.<sup>6</sup> The incidence of white line disease increased with increasing parity independent of biotin supplementation from two cases per 100 cow years in primiparous cows to 15.5 cases per 100 cow years in all multiparous cows, but up to 47.7 cases per 100 cow years for cows in parities =5. Supplementation with biotin reduced white line disease lameness by 45% in multiparous cows down to 8.5 cases per 100 cow years, whereas the effect of biotin supplementation in primiparous cows was not significant. A supplementation of length of at least 6 months was required to reduce the risk of white line lameness in multiparous cows. The overall incidence rate of lameness (per 100 cows per year) was 68.9 with a range of 31.6 to 111.5 per farm.<sup>5,7</sup> The incidence rates of the four most frequently reported causes of lameness were sole ulcer, 13.8; white line separation, 12.7; digital dermatitis, 12.0; and interdigital necrobacillosis, 7.1 per 100 cows per year. The incidence of lameness was highly variable between farms. However, when the data from all farms were pooled, the risk of lameness caused by white line separation in cattle supplemented with biotin was approximately 50%. Approximately 130 days of biotin supplementation is required before a significant difference in white line lesion lameness occurs.

A controlled 14-month field trial evaluated the effect of biotin supplementation on hoof lesions, milk production and reproductive performance of dairy cows housed in the same free-stall facility with the same environment, base diet, and management.<sup>8</sup> Supplemented cows

received 20 mg/d by computer feeder. The feet of a select number of cows were trimmed three times at 6-month intervals and hoof health was evaluated. At the final hoof trimming, the incidence of sole hemorrhages was significantly higher in the control group (50%) compared with the supplemented group at 24%. No cases of lameness occurred. Milk production and fat yield increased in all parities and fertility was improved in first calf heifers.

It is possible that biotin improves the quality of claw horn, which encourages the replacement of defective horn, improves healing and makes it less likely for sole lesions to develop from laminitis in its early stages. The administration of biotin at 40 mg per day for 50 days to dairy cows with uncomplicated sole ulcers, resulted in significant improvement in histological horn quality of the newly formed epidermis covering the sole ulcer.<sup>9</sup> Biotin supplementation at 20 mg/d did not affect the tensile strength of the white line.<sup>10</sup>

Vertical fissures, or sandcracks, are vertical cracks of the hoof that may extend across the coronary band and continue to the bearing surface of the dorsal wall of the claw.<sup>11</sup> Sandcracks are common in beef cattle in western Canada. One survey, 37.5% of beef cows were affected with one or more cracks. Supplementary dietary biotin at 10 mg/head per day significantly increased serum levels of biotin and increased claw hardness compared with unsupplemented cows. After 18 months, 15% of the biotin supplemented cows had vertical fissures compared with 35% in the unsupplemented cows.

#### Pigs

The principal source of biotin for the pig is the feed it receives and feeds vary greatly in their biotin content and in the biological availability of that biotin. Diets based on cereals with a low available biotin content may provide insufficient dietary biotin for the maintenance of hoof horn integrity in pigs. The biotin content in basal diets fed to pigs has varied from 29 to 15 µg/kg available biotin and supplementation of these diets has resulted in improvements in litter size. Continuous feeding of sulfonamides or antibiotics may induce a deficiency. An antivitamin to biotin (avidin) occurs in egg white and biotin deficiency can be produced experimentally by feeding large quantities of uncooked egg white.<sup>12</sup>

In pigs, experimental biotin deficiency is manifested by alopecia, dermatitis, and painful cracking of the soles and the walls of the hooves.<sup>13,14</sup>

Naturally occurring outbreaks of lameness in gilts and sows associated with

lesions of the soles and the walls of the hooves, which responded to biotin supplementation, have now been well-described.<sup>13,14</sup> The severe lameness and long course of convalescence have been responsible for a high rate of culling in breeding animals. In gilts fed a basal diet with a low level of biotin (32 µg available biotin/kg) from 25 kg live weight to 170 days of age, there were no significant differences in the number of lesions and claws affected compared with gilts fed a biotin-supplemented diet (350 µg available biotin/kg).<sup>15</sup> However, between 170 days of age and the first weaning, the incidence of hoof lesions increased markedly. Over the next four litters, the incidence of lesions increased with the age of the sow. The predominant lesions in the foot were cracks, which occurred mainly in two associated regions: the heel/toe junction and the heel and the sidewall and adjacent white-line region of the toe.<sup>15</sup> Supplementation of the diet of breeding sows with biotin at an early stage of development makes a significant contribution to the maintenance of horn integrity.

Affected animals become progressively lame after being on a biotin-deficient ration for several months. Arching of the back and a haunched stance with the hindlegs positioned forward occurs initially. This posture has been described as a 'kangaroo'-sitting posture. The foot pads become softer and the hoof horn less resilient. The feet are painful and some sows will not stand for breeding. Deep fissures at the wall-sole junction may extend upwards beneath the wall horn and gaping cracks may separate the toe and heel volar surfaces. The foot pads initially show excessive wear, later longitudinal painful cracks develop. In well-developed cases, the foot pads appear enlarged, the cracks are obvious and covered by necrotic debris. The foot pads of the hindfeet are usually more severely affected than those of the forefeet and the lateral digit is more frequently affected. The dewclaws also are affected by cracks and the accumulation of necrotic tissue.

Skin lesions also develop in affected gilts and sows. There is gradual alopecia, particularly over the back, the base of the tail, and the hindquarters. The hairs are more bristly than normal and break easily. The alopecia is accompanied by a dryness of the skin.

As the lesions of the feet and skin develop there is a marked drop in the serum biotin concentrations, which is considered as a sensitive index of biotin deficiency.<sup>12</sup> Adequate biotin status may be indicated by serum biotin levels (ng/L) >700; marginal, 600–700; inadequate,

400–600; and deficient below 400.<sup>12</sup> Compression and hardness tests made on external hoof have also been used as an indirect measure of biotin adequacy in pigs.<sup>16</sup> The tests indicate that significant improvements in the strength and hardness of pig hoof horn are produced by biotin. Supplementation of the diet with biotin does not affect either horn growth or wear rates.<sup>14</sup> Biotin supplementation does affect the structure of the coronary epidermis; there is an increase in the density of the horn tubules in the stratum medium, the horny squames in the stratum medium are more tightly packed and the tubules are more clearly defined.<sup>17</sup>

Reproductive performance of sows is also influenced by their biotin status.<sup>18</sup> Supplementation of the diet with biotin may increase litter size, increase the number of pigs weaned, decrease the mean interval in days from weaning to service and improve conception rate. Over a period of four parities, piglet production increased by 1.42 pigs/sow year.<sup>18</sup>

#### Biotin requirements

##### Pigs

The daily requirements of biotin for pigs have not been well-defined, but certain amounts have been associated with an absence of lameness and improved reproductive performance. Basic diets for gilts contain 35–50 µg/kg and the addition of 350–500 µg/kg is recommended. This provides a daily intake of 4.0–5.0 mg/sow per day. The response to dietary supplementation may take several months; therefore, supplementation should begin at weaning. The details of biotin studies in pigs, including experimental deficiency, the absorption and synthesis of biotin, biotin availability in feedstuffs, and the biotin requirements of the growing pig are available.<sup>19</sup>

Supplementation of a basal diet, calculated to contain 56 µg/kg available biotin with daily allowances of biotin at 1160 µg/sow per day in pregnancy and 2320 µg/sow per day in lactation, produced significant improvements in litter size in second and fourth parity sows. It is suggested that the requirement is in excess of 175 µg available biotin per kg of diet.<sup>18</sup> In a swine herd with a lameness problem, the supplementation of the sow's ration during pregnancy and lactation with daily intakes of biotin of 400 and 800 µg/sow per day, respectively and the rations of the weaners and growers to 150 and 250 was effective.

##### Horses

The dietary supplementation of horses with 10–30 mg biotin/d for 6–9 months is considered to be effective as an aid in the treatment of weak horn hoof in

horses.<sup>20</sup> The hoof horn quality of more than two-thirds of the Lippizaner horses had moderate to severe changes: micro-cracks visible in the transition from the middle to the inner zone of the coronary horn; separation of the sole from the coronary horn in the region within the white zone. Biotin supplementation for 19 months improved horn quality.<sup>21</sup> Continuous dietary supplementation with biotin at a daily dose of 20 mg is necessary to improve and maintain hoof horn quality in horses with less than optimum quality hoof.<sup>22</sup>

#### REFERENCES

- Hedges VJ et al. *Cattle Pract* 2002; 10:157.
- Mulling CK et al. *Anat Histol Embryol* 1999; 28:103.
- Midla LT et al. *Am J Vet Res* 1998; 59:733.
- Rosendo O et al. *J Dairy Sci* 2004; 87:2535.
- Fitzgerald T et al. *J Dairy Sci* 2000; 83:338.
- Potzsch CJ et al. *J Dairy Sci* 2003; 86:2577.
- Hedges J et al. *J Dairy Sci* 2001; 84:1969.
- Bergsten C et al. *J Dairy Sci* 2003; 86:3953.
- Lischer CHJ et al. *Vet J* 2002; 163:51.
- Collis VJ et al. *J Dairy Sci* 2004; 87:2874.
- Campbell JR et al. *Can Vet J* 2000; 41:690.
- Misir R et al. *Can Vet J* 1986; 60:106.
- Thomas KW et al. *Aust Vet J* 1990; 67:215.
- Johnston AM, Penny RHC. *Vet Rec* 1989; 125:130.
- Simmins PH, Brooks PH. *Vet Rec* 1988; 122:431.
- Webb NG et al. *Vet Rec* 1984; 114:185.
- Kempson SA et al. *Vet Rec* 1989; 124:37.
- Simmins PH, Brooks PH. *Vet Rec* 1983; 112:415.
- Kopinski JS et al. *Br J Nutr* 1989; 62:751, 761, 767, 773, 781.
- Comben N et al. *Vet Rec* 1984; 115:642.
- Zenker W et al. *Equine Vet J* 1995; 27:183.
- Jossek H et al. *Equine Vet J* 1995; 27:175.

#### FOLIC ACID DEFICIENCY (HYPOFOLICOSIS)

Folic acid (pteroylglutamic acid) is necessary for nucleic acid metabolism and its deficiency in humans leads to the development of pernicious anemia. A dietary source is necessary to all species and an adequate intake is provided by pasture. Although naturally occurring deficiencies have not been diagnosed positively in domestic animals, folic acid has numerous and complex interrelationships with other nutrients and the possibility of a deficiency playing a part in inferior animal performance should not be overlooked. The vitamin has a particular interest for equine nutritionists. Permanently stabled horses and some horses in training may require additional folic acid, preferably on a daily basis by the oral route.<sup>1</sup> Folic acid deficiency can be induced in fetal foals and adult horses by administration of folate orally coincident with administration of inhibition of folate metabolism (pyrimethamine trimethoprim, sulfonamides).<sup>2,3</sup> Folic acid at a dose of 1 mg/kg BW orally daily for 2 weeks was used successfully for the treatment of acquired alopecia in a 3-week-old

Charolais calf, but spontaneous recovery without treatment was a possibility.<sup>4</sup>

#### REFERENCES

- Roberts MD. *Aust Vet J* 1983; 60:106.
- Toribio RE et al. *J Am vet med Assoc* 1998; 212:697.
- Piercy RJ et al. *Equine Vet J* 2002; 34:311.
- Bouvet A et al. *Vet Rec* 1988; 123:533.

#### CHOLINE DEFICIENCY (HYPOCHOLINOSIS)

Choline is a dietary essential for pigs and young calves. Calves fed on a synthetic choline-deficient diet from the second day of life develop an acute syndrome in about 7 days. There is marked weakness and inability to get up, labored or rapid breathing, and anorexia. Recovery follows treatment with choline. Older calves are not affected. On some rations, the addition of choline increases daily gain in feedlot steers, particularly during the early part of the feeding period.

Supplementation of 20 g/day of rumen protected choline to dairy cows 14 days before parturition increased milk production during the first month of lactation and the concentration of choline in milk, but did not affect fat or protein concentration in the milk, or plasma levels of glucose, β-hydroxybutyrate, cholesterol and non-esterified fatty acids (NEFA).<sup>1</sup> The NEFA concentrations at the time of parturition were lower in treated animals than in controls, indicating improved lipid metabolism. Choline also increased α-tocopherol plasma concentrations.

In pigs, ataxia, fatty degeneration of the liver and a high mortality rate occur. Enlarged and tender hocks have been observed in feeder pigs. For pigs, 1 kg/tonne of food is considered to supply sufficient choline.<sup>2</sup>

Congenital splayleg of piglets has been attributed to choline deficiency but adding choline to the ration of the sows does not always prevent the condition.

#### REFERENCES

- Pinotti L et al. *J Vet Med Assoc* 2003; 50:18.
- Simmins PH, Brooks PH. *Vet Rec* 1983; 112:415.

#### VITAMIN B<sub>12</sub> DEFICIENCY (HYPOCYANOCOBALAMINOSIS)

Vitamin B<sub>12</sub> deficiency is unlikely to occur under natural conditions other than because of a primary dietary deficiency of cobalt, which is an important disease in many countries of the world.

Although microbial synthesis of the vitamin occurs in the rumen in the presence of adequate cobalt and in the intestines of other herbivores such as the horse, it is probably a dietary essential in the pig and young calf. Animal protein is a good source. A deficiency syndrome has been produced in young calves on

a synthetic ration. Signs include anorexia, cessation of growth, loss of condition, and muscular weakness. The daily requirement under these conditions is 20–40 µg of vitamin B<sub>12</sub>. Sows vary in their ability to absorb the vitamin and those with poor absorption ability, or on deficient diets, show poor reproductive performance. For pigs, 10–50 mg/tonne of feed is considered to be adequate.<sup>1</sup>

The vitamin is used empirically in racing dogs and horses to alleviate parasitic and dietetic anemias in these animals at a dose rate of 2 µg/kg BW. Cyanocobalamin zinc tannate provides effective tissue levels of vitamin B<sub>12</sub> for 2–4 weeks after one injection and normal and abnormal blood levels have been established for all species. It is also used as a feed additive for fattening pigs,

usually in the form of fish or meat meal or as 'animal protein factor'. It is essential as a supplement if the diet contains no animal protein and maximum results from the feeding of antibiotics to pigs are obtained only if the intake of vitamin B<sub>12</sub> is adequate.

#### REFERENCE

1. Simmins PH, Brooks PH. *Vet Rec* 1983; 112:415.





## Diseases associated with physical agents

## 31

Environmental pollutants and noise  
1785

Radiation injury 1786  
Brisket disease (mountain  
sickness) 1788

Lightning stroke and  
electrocution 1789  
Stray voltage 1790  
Volcanic eruptions 1791  
Bushfire (grassfire) injury (thermal  
burns) 1792

Wetness 1793  
Drowning 1793  
Cold injury (frostbite, chilblains) 1794  
Electric and magnetic fields 1795

ENVIRONMENTAL POLLUTANTS  
AND NOISE

## Pollution from outside the farm

Deposition of contaminants in soil and water and on plants can derive from a large number of sources including atmospheric pollution, residues from the petroleum and metaliferous industries – both mining and smelting, persistent pesticides, and the application of sludge. Deposition in soil, but not on plants, does not preclude animal toxicity as soil can comprise a significant proportion of the dry matter (DM) intake of grazing ruminants.<sup>1</sup> Pollutants may exert their effect through direct toxicity, immunosuppression<sup>2,3</sup> or, in the case of some heavy metals, also by the competitive induction of trace element deficiencies.

**Mine spills and smelter emissions** have been associated with soil and water contamination with a number of different heavy metals. Water from mines is also potentially toxic to livestock that drink it.<sup>4</sup> Pastures adjacent to **major roads** and animals grazing them, are also contaminated by heavy metals from vehicle emissions.<sup>5</sup> Cattle will readily ingest petroleum products and the toxicology of **oil field pollutants** has been reviewed.<sup>6</sup> Another important group of compounds is the polychlorinated biphenyls and the **polybrominated biphenyls** and the chlorinated hydrocarbons generally. These substances are extensively used in agriculture and in industry. They have very long half-lives and although they are not in themselves dangerous, they cause a great deal of trouble if they get into the human food chain and become deposited in fatty tissues.

## Pollution from farms

Pollution of the environment by animal feces and urine is now a matter of great importance especially to intensive animal farmers located near population centers. There are increasing regulations govern-

ing livestock farming, effluent disposal, nitrogen and mineral cycles, odor emission and increasing regulatory actions, or private law suits, against farms that offend. This is not a subject for a text on veterinary medicine although efforts to minimize nitrogen, phosphorus, and potassium fecal outputs by dietary manipulation and water restriction<sup>7-9</sup> have potential veterinary and welfare implications.

**Slurry** application to pastures and run off to streams and ground water introduces health problems such as salmonellosis, cryptosporidiosis, leptospirosis, and mycobacteriosis, under which headings the subject is discussed. Shallow wells near animal accommodation are also likely to contain high levels of nitrates derived from nitrogen filtering through surrounding earth. Such water is a potential source of nitrate poisoning especially in pigs.

One of the important pollutants for housed animals is **ammonia** from urine. When it is combined with dust, it can cause severe inflammation of the respiratory mucosae. **Dust** may be the carrier of pathogenic bacteria or viruses, or antigens which provoke a hypersensitivity reaction, e.g. interstitial pneumonia.<sup>10</sup> Carbon monoxide and hydrogen sulfide from **slurry pits** can cause mortality in both animals and humans. The highest risk is during agitation of the slurry, when they are released. Sulfur dioxide is also an environmental contaminant capable of causing respiratory tract irritation in animals.

## Noise

Animals are more susceptible to high-pitched noise than are humans and the elimination of such noises in working facilities improves the **orderly handling** of cattle and sheep.<sup>11</sup> Pollution by noise,<sup>12</sup> a matter of increasing importance for veterinarians who police codes of practice

for animal welfare and for those who are called upon to act as expert witnesses in cases involving excessive noise and its effects on animals, is also an important subject.

The effects of a sonic bang from **aircraft** are shortlived and are due to fear reactions but include injury due to sudden flight, killing of young by mink and rabbits, suffocation in panic-stricken chickens and reduced egg production. Cattle are unaffected and the effect on livestock and wildlife of the noise produced by low flying aircraft appears minimal.<sup>13-15</sup>

## REVIEW LITERATURE

- Lillie RJ. Air pollutants affecting the performance of domestic animals us department of agriculture, agricultural research service. Agricultural Handbook 1970; 380.  
Kopecky KE. Ozone depletion implications for the veterinarian. J Am Vet Med Assoc 1978; 173:729.  
Jones PW. Disease hazards associated with slurry disposal. Br Vet J 1980; 136:529.  
Collins M, Algers B. Effect of stable dust on farm animals. A review. Vet Res Commun 1986; 10:415.

## REFERENCES

1. Beresford NA, Howard B. J Sci Total Environ 1991; 107:237.
2. Black RD, McVey DS. Vet Hum Toxicol 1992; 34:438.
3. Gummow B et al. Onderstepoort J Vet Res 1994; 61:303.
4. Harper GS et al. Aust J Agric Res 1997; 48:155.
5. Ward NI, Savage JM. Sci Total Environ 1994; 146/147:185.
6. Coppock RW et al. Vet Hum Toxicol 1995; 37:569.
7. Jongbloed AW et al. Vet Quart 1997; 19:130.
8. Basi P. Pig News Info 1997; 18:117N.
9. Voermans JAM et al. Pig News Info 1994; 15:51N.
10. Collins M, Algers B. Vet Res Commun 1986; 10:415.
11. Grandin T. J Am Vet Med Assoc 1996; 209:757.
12. Ewbank R. Vet Ann 1977; 17:296.
13. Maier JAK et al. J Wildl Dis 1988; 62:752.
14. Talling JC et al. Appl Anim Behav Sci 1995; 48:187.
15. Head HH et al. J Dairy Sci 1993; 76:1558.

## RADIATION INJURY

### Synopsis

**Etiology** Ionizing radiation from radionuclides in environment or feed resulting from nuclear bombs or nuclear power plant accidents.

**Epidemiology** Type, severity and extent of exposure will depend on atmospheric conditions and the radionuclides released.

**Clinical findings** Anorexia, depression, and severe diarrhea in acute sickness. Bone marrow depression with anemia and septicemic disease.

**Clinical pathology** Neutropenia and thrombocytopenia, bone marrow depression.

**Necropsy findings** Hemorrhagic and ulcerative lesions in the alimentary tract. Pneumonia, general septicemia.

**Diagnostic confirmation** Radiation exposure from nuclear disaster.

Animals exposed to radioactive material may suffer radiation injury. They may also serve as reservoirs for radioactive material which could be passed to humans in meat, milk, and other animal products. This hazard to humans is a problem of public health and is primarily addressed by establishing tolerance limits for contamination in animal products for human food and by changes in agronomic practices and policy. Reviews of measures taken following the Chernobyl accident are cited in the Review Literature at the end of this section. The following discussion is restricted to the effects of irradiation on the health of animals exposed to it.

### ETIOLOGY

Radiation injury can be caused in a number of ways including nuclear bombs, contamination from nuclear power plant accidents and exposure to X-rays, but the effects on the tissues are the same, differences occurring only in depth of penetration and degree of injury caused. The radiation emitted by radionuclides has a similar biological effect to external irradiation by X-rays because both sources are **ionizing** – they remove electrons from their orbits causing atoms within animal tissue and produce pairs of charged ions, which are the instruments of the biological damage.

Atomic explosions can also injure through the effects of blast and heat.

### EPIDEMIOLOGY

#### Incidence and case fatality

There is considerable variation in the effects of an atomic explosion, or a nuclear power plant accident, depending on the distance from and the time after the blast, whether the explosion occurs in the air or on the ground surface and the types of radionuclides released.<sup>1,2</sup> With nuclear explosions, animals within the range of immediate irradiation are

more severely affected than those exposed only to the 'fallout' of radionuclides on pasture. However, grazing animals are exposed to very great risk because of this fallout. The area where direct radiation effects occur is significantly smaller than that where 'intervention levels' for radionuclides are exceeded.<sup>1</sup>

### Risk factors

#### Animal

Radio sensitivity differs between animal species when death is defined as the end point. Horses are more resistant to whole body radiation than other animal species. Sheep appear the most susceptible and die earlier than cattle at equivalent exposure doses. Pigs are the least susceptible to low radiation. Age is also a risk factor and calves are more susceptible than adult cattle and are prone to develop respiratory and enteric disease, effects that are uncommon in adult cattle which commonly show hemorrhagic disease.<sup>2</sup>

#### Nature of radiation

Of the radioactive materials produced by an atomic explosion, a number of **radionuclides**, including iodine-131, barium-140, strontium-89 and strontium-90, cesium-134 and cesium-137, are likely to enter biological systems. Of these, radioactive iodine, barium, and strontium-89 are of less importance because of their short **half-lives**. On the other hand, strontium-90, cesium-134, and cesium-137 may occur in very large quantities, have long half-lives and are therefore of greatest biological significance. If sufficient of these radionuclides is ingested and tissue levels of them reach critical points, injury similar to that produced by external irradiation will occur. Cesium-134 and cesium-137 are of particular concern because of their biological mobility. They behave metabolically like potassium and are distributed widely through the body. Both are beta and gamma emitters and effectively will administer a dose of whole-body radiation to an animal ingesting pasture contaminated with them. Iodine-131 (<sup>131</sup>I) behaves like stable iodine and is concentrated in the thyroid gland.

**Soil type** can influence radionuclide intake by animals grazing contaminated pastures. Persisting concentrations of radiocesium in plants are associated with acid soils with high organic and low clay content.<sup>3</sup> In mineral soils, cesium is strongly bound to clay particles which limits its uptake by plants; clay minerals, such as bentonite, fed to ruminants will reduce the alimentary absorption of radiocesium.<sup>4</sup> Animal contamination is further influenced by **differences in uptake** of radionuclides by different pasture species and animal breed differences in **grazing behavior**.<sup>5,6</sup>

### Zoonotic implications

Radionuclides are excreted in the **milk** of animals<sup>7,8</sup> and are present in the **meat**,<sup>5,9,10</sup> posing a risk for humans consuming them. Radioiodine transfer to the milk of sheep and goats is considerably greater than to that of cows.<sup>10</sup> The half-life of radioiodine is sufficiently short that contaminated milk could be diverted to stored dairy products, although this would not have public acceptance. The **maximum permissible concentration** of radioactive substances in meat is reached at much lower levels of pasture contamination than would be required to cause physical injury to the cattle or sheep; in most countries it is set at around 1000–2000 Becquerels (Bq) per kg fresh weight.

### PATHOGENESIS

The acute radiation syndromes and from acute radiation usually occur within the first few days after exposure to whole body radiation to 30–60 days depending on the radiation dose. Based on the dose the major manifestations have been divided into three major presentations, CNS, gastrointestinal, and hemorrhagic, but there is considerable overlap in clinical signs at all but the high doses that result in the per-acute CNS syndrome.<sup>2</sup>

Doses greater than 80–100 Gray (Gy) induce rapid damage to blood vessels, changes in permeability and an increase in intracranial pressure with death in 2–5 days. Gastrointestinal disease results when the radiation dose ranges between 10 and 80 Gy and results from damage to the rapidly dividing undifferentiated cells in crypts of intestinal villi which are the progenitor cells to the differentiated enterocytes of the intestinal villi. Damage to bone marrow stem cells is the main cause of death at whole body doses between 2 and 10 Gy with death in large animals occurring 6–8 weeks after exposure. Clinical disease is slow in development after exposure as the effect of this damage is not evident until the death of existing circulating blood cells. The effects are the result of decreased granulocytes, platelets, and red cells and are manifest with increased susceptibility to infection, bleeding syndromes, and anemia.

Initially there is a lymphopenia followed by a depression of granulocyte and platelet counts. The leukopenia permits invasion by bacteria from the alimentary tract and **bacteremia** and septicemia develop 1–4 weeks after irradiation. The clotting mechanism and antibody production are impaired and facilitate the invasion. Progressive necrosis of the gut wall without inflammation is characteristic. Thrombocytopenic hemor-

rhage into the lymphatic system and other tissues lead to the development of a profound anemia.

The activity of **germinative epithelium** is also profoundly depressed; if the animal survives the early stages listed above, the hair commences to shed, the skin to ulcerate, and a gross reduction in fertility occurs. Degenerative changes in the lens of the eye, particularly cataract, may also occur. **Long-term effects** in animals are of less concern than in man because of the short life span of animals and any genetic damage can be removed by selective breeding. Very long-term effects of irradiation include a high rate of **mutations** and a high incidence of tumors, mostly of the hemopoietic system but also an increased risk for squamous cell carcinoma of the skin.

**Thyroid damage** by  $^{131}\text{I}$  does not appear a major risk for ruminants. The thyroid gland of the sheep is more radiosensitive than that of the cow but very high and sustained doses of  $^{131}\text{I}$  are required to produce damage and clinical signs in thyroid-damaged ruminants are minimal.

## CLINICAL FINDINGS

### Acute syndrome

After immediate irradiation with high doses death occurs from damage to the CNS. At lesser doses damage to the alimentary tract occurs and, particularly in young animals, there is a resulting intense, refractory diarrhea. Death occurs in a few days due to dehydration and electrolyte imbalance. Local contact of radioactive materials to skin causes changes within a few hours. Observable lesions vary from depilation and slight desquamation to extensive necrosis depending upon the irradiation dose.

### Subacute syndrome

Immediately after irradiation with median doses there is an **initial phase** of 'radiation sickness' characterized by anorexia, vomiting in pigs, and profound lethargy which lasts from several hours to several days.

The **second phase** is one of apparent normality lasting until 1-4 weeks after irradiation. This is followed by a **third phase** in which most deaths occur associated with damage to stem cells in bone marrow and secondary infections. Clinical signs vary with the nature of the infection and the age of the animal. Calves commonly develop respiratory and enteric disease with fever, weakness, and diarrhea developing to melena and dysentery, sometimes with tenesmus. Anorexia is complete but there is great thirst. Weakness, recumbency and hyperirritability are present. Respiration is rapid and panting and there is a profuse nasal discharge,

sometimes blood-stained. In adult cattle severe anemia and septicemia occur.

In general, if the animal survives this period, there is a **long period of convalescence** which is accompanied by failure to make normal weight gains, alopecia, sterility, and lenticular defects. The sterility may be permanent, or normal fertility may be restored by the end of 8 months in pigs and 2 years in cattle. During the ensuing years, recovered animals may produce mutant offspring. Tumors, especially of the hemopoietic system and of areas of skin which suffer radiation injury are also likely to occur.

Experimental irradiation of pregnant animals causes fetal death and resorption, defects of individual organ and limb development, decreased survival of young born alive and depressed growth rate and fertility of surviving young, the type of abnormality depending upon the stage of pregnancy at which exposure is experienced.

### Chronic exposure

Chronic exposure to gamma and mixed neutron-gamma radiation for several years produces lenticular opacities.<sup>11</sup> At levels of irradiation which cause lesions in the human lens similar opacities occur in the lens of cattle, but not of pigs or burros.

## CLINICAL PATHOLOGY

In cattle receiving median somatic doses, the **total leukocyte count** falls precipitately during the first few days after irradiation with the peak of fall at the 15th-25th post-irradiation (PI) day. In this species, the most sensitive leukocyte is the **neutrophil**, in contrast to the lymphocyte which is most seriously affected by irradiation in humans.

**Platelet counts** begin to decrease from a normal of 500 000/mm<sup>3</sup> on the 7th PI day to 40 000/mm<sup>3</sup> at about PI day 21.

**Erythrocyte counts** and hematocrit levels also fall and prothrombin times increase in parallel to the other changes mentioned. The return to pre-irradiation levels requires about a year for granulocytes and platelets, but from 4 to 5 years for agranulocytes.<sup>12</sup>

## NECROPSY FINDINGS

Gastroenteritis, varying from hemorrhagic to ulcerative, is constant and ulceration of the pharyngeal mucosa and pulmonary edema occur commonly. Hemorrhages into tissues are also characteristic and include all degrees from petechiae and ecchymoses to hematomas and large extravasations. In experimentally produced irradiation sickness, a severe fibrinous pneumonia, pleuropneumonia, and peri-

carditis are common. Degeneration of many tissues,<sup>13</sup> but especially bone marrow, intestinal mucosa, and lymphoid tissue is evident histologically. Evidence of secondary bacterial invasion is usually seen. Confirmation of the diagnosis usually requires documentation of exposure to radiation.

## Samples for confirmation of diagnosis

- **Histology: jejunum, lymph node, bone marrow.**

## DIFFERENTIAL DIAGNOSIS

The subacute syndrome closely resembles poisoning by bracken fern in cattle and by trichloroethylene-extracted soybean meal, but the diagnosis will usually depend upon a knowledge of exposure to irradiation.

## CONTROL

The problems of veterinary civil defence in the event of thermonuclear warfare are too extensive to discuss here and the necessary information is provided by most governments. The use of clay minerals and iron-hexacyanoferrates in the feed can bind and **restrict the uptake** of radiocesium from the alimentary tract of ruminants but is impractical for widespread use.<sup>4,14</sup> Long-term control of exposure rests with changes in agronomic practices.<sup>1,10,15</sup>

## REVIEW LITERATURE

- Alexakhim RM. Countermeasures in agricultural production as an effective means of mitigating the radiological consequences of the Chernobyl accident. *Sci Total Environ* 1993; 137:9-20.
- Howard BJ. Management methods of reducing radionuclide contamination of animal food products in semi-natural ecosystems. *Sci Total Environ* 1993; 137:249-260.
- Renaud P, Maubert H. Agricultural countermeasures in the management of a post-accidental situation. *J Environ Radioact* 1997; 35:53-69.
- Von Zallinger C, Tempel K. The physiologic response of domestic animals to ionizing radiation. *Vet Radiol Ultrasound* 1998; 39:495-503.

## REFERENCES

1. Alexakhin RM. *Sci Total Environ* 1993; 137:9.
2. Von Zallinger C, Tempel K. *Vet Radiol Ultrasound* 1998; 39:495.
3. Howard BJ, Beresford NA. *Br Vet J* 1989; 145:212.
4. Hansen HS et al. *Small Rumin Res* 1994; 14:199.
5. Beresford NA et al. *Sci Total Environ* 1996; 177:85.
6. Rosen K et al. *J Environ Radioact* 1995; 26:237.
7. Kirchner G. *Health Phys* 1994; 66:635.
8. Karlein G, Johanson KJ. *J Environ Radioact* 1995; 28:1.
9. Jones BEV. *Br Vet J* 1989; 145:20.
10. Howard B. *J Sci Total Environ* 1993; 137:249.
11. Brown DG et al. *Am JVet Res* 1972; 33:309.
12. Noonan TR et al. *Radiation Res* 1976; 66:626.
13. Koch F et al. *Mh Vet Med* 1978; 35:138.
14. Giese WW. *Sci Tot Environ* 1989; 85:317.
15. Renaud P, Maubert H. *J Environ Radioact* 1997; 35:53.

## BRISKET DISEASE (MOUNTAIN SICKNESS)

### Synopsis

**Etiology** Cor pulmonale from effects of alveolar hypoxia.

**Epidemiology** Sporadic disease, at high altitudes, of cattle, particularly young or newly introduced. Genetic susceptibility. Exacerbated by grazing locoweed.

**Clinical findings** Right-sided congestive heart failure. The name derives from the edema that occurs in the brisket region.

**Clinical pathology** None usually practiced because of location. Pulmonary arterial pressures. Echocardiography.

**Necropsy findings** Right-sided congestive heart failure.

**Diagnostic confirmation** Clinical and epidemiological. Recovery with movement to lower altitudes.

**Treatment** Move to lower altitudes.

**Control** Identification of susceptible cattle. Avoidance of grazing locoweed.

### ETIOLOGY

Alveolar hypoxia in cattle at high altitudes results in pulmonary hypertension and the resultant increase in pressure load on the right ventricle can lead to cor pulmonale and heart failure. Any additional factor such as myocardial dystrophy, anemia, pulmonary disease, or hypoproteinemia may exacerbate the primary condition. The additional effort required to obtain feed on sparse pasture at high altitudes may also be a predisposing cause.

### EPIDEMIOLOGY

#### Occurrence

Brisket disease occurs sporadically in high mountainous areas in North America and South America. The disease also occurs in the highlands of Ethiopia and India.<sup>1</sup> Cattle residing above 1500 m are predisposed and at altitudes above 2200 m an annual incidence of 0.5–2% is recorded.<sup>2</sup>

#### Risk factors

Brisket disease can occur in all ages and breeds of **cattle** that are maintained at high altitudes for some months. The incidence is highest in calves, yearlings, in late pregnant cattle, and in cattle newly introduced to these altitudes. Cattle can adapt to high altitudes and the morbidity rate in indigenous cattle seldom exceeds 1%. In affected cattle, case fatality is high unless they are moved to lower altitudes. Susceptibility is **inherited**.<sup>2</sup>

The ingestion of **locoweed** (*Oxytropis sericea*) intensifies the effect of high altitude on the development of congestive heart failure. The mechanism is unknown,<sup>3,4</sup> but when groups of cattle at high altitude graze locoweed the annual incidence may approach 100% with high case fatality.<sup>5</sup>

An unidentified plant is also believed to potentiate the disease in mountainous areas of Brazil.

The congestive heart failure that develops at altitude is peculiar to cattle although other animal species may show an effect from altitude. **Horses** which are moved up from 300 to 2400 m above sea level show standard increases in pulse and respiratory rates and hemoglobin and erythrocyte levels. **Mules** are much less susceptible and appear to be unaffected by altitudes as high as 3200 m. **Goats, sheep, and donkeys** are also reputed to be affected in that order of reducing susceptibility. **Llamas and alpacas** are adapted to hypoxia at high altitudes, in particular by an oxygen dissociation curve in their hemoglobin which increases oxygen uptake.<sup>6</sup>

### PATHOGENESIS

Acute alveolar hypoxia (lowered alveolar  $PO_2$ ) is a potent cause of constriction of the precapillary pulmonary vessels and pulmonary hypertension in several species, but cattle are especially reactive and there is a genetic predisposition that determines the magnitude of the response. Prolonged hypoxia and persistent pulmonary vasoconstriction leads to medial muscular hypertrophy of the small pulmonary arteries and arterioles with a further increase in pulmonary vascular resistance and the development of cor pulmonale.

The disease can be produced experimentally in low-pressure chambers. The movement of cattle from an altitude of 1100 up to 3000 m has been shown to cause hypertrophy of the right ventricle, an increase in pulmonary arterial pressure from 27 mmHg (3.6 kPa) to 45 mmHg (6.0 kPa) to over 100 mmHg (13.3 kPa) and the development of right heart failure.

### CLINICAL FINDINGS

Affected cattle have a dejected appearance, loose condition rapidly, have a rough, lusterless coat and stand with the elbows abducted. Jugular vein engorgement is followed by the appearance of edema of the brisket, spreading up the neck to the intermandibular space and back along the ventral aspect of the body. Abdominal enlargement due to the development of ascites is accompanied by diarrhea.

There is hyperpnea at rest and dyspnea and weakness on slight exertion. The mucosae may be cyanotic, particularly after exercise and the lung sounds vary from an increased vesicular murmur to moist crackles and an absence of breath sounds when pneumonia is present and to crepitant crackles in the presence of emphysema.

Auscultation of the heart reveals tachycardia, increased absolute intensity of the sounds, or a decrease when there is hydropericardium and an increase in the size of the heart. A systolic murmur is usually present and a '**pistol shot**' sound can often be heard with auscultation over the jugular vein. The appetite is normal until the late stages and the temperature is normal unless secondary pneumonia develops.

**Horses** at high altitude lose weight, fatigue easily, become weak and rough-coated and show pain; many suffer from flatulent colic but do not develop congestive heart failure.

### CLINICAL PATHOLOGY

In sheep and cattle, a change to altitudes of 1800–3500 m causes rises in hemoglobin (35% in sheep, 9% in cattle) and packed cell volumes (27% in sheep but no change in cattle) and hemoglobin concentration in red cells (8–9% increase in cattle and sheep).<sup>7</sup> Central pulmonary arterial pressures increase significantly immediately after cattle are moved to high altitudes, but the high pressures subside as adaptation develops. Pressures rise from a normal of 22–26 mmHg (2.9–3.5 kPa) up to 37–55 mmHg (4.9–7.3 kPa) depending on whether the calf is susceptible or resistant to the effects of altitude.<sup>8</sup> Cattle accustomed to live at high altitudes have much less pulmonary hypertension than introduced cattle.<sup>9</sup>

In clinical cases, there can be a significant reduction in the packed cell volume and in hemoglobin levels.

### NECROPSY FINDINGS

There is enlargement of the heart, with dilatation of the right ventricle and hypertrophy of the right ventricular wall.<sup>8</sup> Slight thickening of the heart valves may be present and there may be areas of calcification in the large arteries. Accumulations of edema fluid are within the pericardial sac, peritoneal and pleural cavities and in subcutaneous tissues. This edema may also involve the wall of the alimentary tract. Typical congestive changes are evident in the liver – enlargement, rounding of the edges, an enhanced zonal pattern on capsular and cut surfaces, dilatation of the hepatic veins and a marked deposition of fibrous tissue around the central veins. In the lungs, there is often severe alveolar emphysema and in some cases, bronchitis and pneumonia are also present. Histologically, the changes include thickening of the tunica media of vessels in the pulmonary arterial tree and hypertrophy of cardiac myofibers. Microscopic findings in the liver are typical of chronic passive congestion.

### Samples for diagnostic confirmation

- **Histology** – lung, liver, right ventricular myocardium (LM).

### DIFFERENTIAL DIAGNOSIS

Other causes of congestive heart failure. Cor pulmonale associated with chronic pneumonia

### TREATMENT

The only effective treatment is to move the affected cattle to a **lower altitude**. Pending this, avoidance of excessive exercise is advisable. Temporary improvement in severely affected animals may be achieved by treatment with digoxin and this may help counteract the stress associated with the movement off altitude, but this is only a short-term expedient. Diuretics to promote fluid loss and antibiotics to combat secondary infection may be indicated in individual cases.

### CONTROL

Control measures are difficult to implement as the prime predisposing factor is the grazing of cattle at high altitudes. Avoidance of grazing of locoweed is easy to state but almost impossible to implement. Restriction of grazing of cattle showing signs by hand-feeding a high-protein diet and prompt treatment of cases of pulmonary disease are recommended as worthwhile procedures although they are really more treatment methods. The testing of cattle for pulmonary artery reactivity as a method of selection is also a possible method of long-term control in view of the heritable predisposition.

### REVIEW LITERATURE

Bisgard GE. Pulmonary hypertension in cattle. *Adv Vet Sci* 1977; 21:151-172.

James JF, Molyneux RJ, Alexander AF. Congestive right-heart failure in cattle High mountain disease and factors influencing incidence. In: Keeler RF, Tu AT, eds. *Handbook of natural toxins*. New York: Marcel Dekker, 1991; 6:635-643.

### REFERENCES

1. Njam BC, Kasali OB. *Bull Anim Hlth Prod Afr* 1989; 37:179.
2. Alexander AF. *Effects of poisonous plants on Livestock*. New York: Academic Press, 1978: 285.
3. James LF et al. *J Am Vet Med Assoc* 1986; 189:1549.
4. Panter KE et al. *Vet Hum Toxicol* 1988; 30:318.
5. James LF et al. *Am J Vet Res* 1983; 44:254.
6. Reynafarje C et al. *J Appl Physiol* 1975; 38:806.
7. Hansen RW et al. *Am Soc Agric Eng Papers* 1984; No. 4523.
8. Will DH et al. *J Appl Physiol* 1975; 38:495.
9. Will DH et al. *Proc Soc Exp Biol Med* 1975; 150:564.

## LIGHTNING STROKE AND ELECTROCUTION

### Synopsis

**Etiology** Exposure to high-voltage electric currents.

**Epidemiology** Single or multiple cases. Following a thunderstorm dead animals at pasture may be under trees or along fence lines. Posterior paralysis in housed pigs.

**Clinical findings** Bone fractures, temporary unconsciousness, or immediate death. In recovered animals residual nervous signs may persist. Posterior paralysis in pigs.

**Necropsy findings** Singe and burn marks with some cases. Fractures of long bones in some cases and of lumbar vertebrae in swine.

**Diagnostic confirmation** Difficult. History and environmental evidence of lightning or electric shock exposure and no postmortem lesions of other causes of disease.

### ETIOLOGY

The three common causes are flashes of linear lightning during thunderstorms, broken overhead electrical transmission wires which usually carry very high voltages and faulty electrical wiring in cowsheds and barns.

In lightning stroke, trees, fences, barns, and pools of water may become electrified and it is not unusual for damp ground to act as a conductor for electricity passing along the roots of stricken trees. Animals electrocuted by standing on electrified earth are unlikely to show burn marks on the body. Oak trees are particularly prone to lightning stroke and because of their spreading foliage and extensive root system, are common mediators of electrocution deaths in pastured animals. Poplar, elm, walnut, beech, ash, and conifer are also mediators of electrocution to animals that shelter under them.

**Electrical transmission wires** are most dangerous when they fall into pools of water, as they are likely to do during the storms which bring the wires down. In such cases, the entire pool is electrified and animals passing through it may be killed instantly. Electrocution can also occur from this source without obvious evidence of line fault.<sup>1</sup>

In accidents caused by **faulty wiring**, voltages of 110-220 V are sufficient to kill adult cattle provided they make good contact with the source and the ground. Water pumps and milking machines are the common sources of electricity which may electrify water pipes or the milk line through the earth wire or a short circuit. The use of very heavy fuse wire (30-60 A) may cause continuance of the trouble, which could be avoided if lower capacity

fuses were used. In situations of electrical fault, certain farm owners will chose to try to circumvent it by improper use of fuse breakers that can lead to substantial risk of electrocution hazard.

### EPIDEMIOLOGY

The area incidence is never high but heavy mortalities may occur on individual farms when a barn or a group of animals sheltering under a tree is struck. As many as 20 head of cattle may be killed by one lightning flash. Behavioral abnormalities of housed animals may indicate the presence of faulty wiring in barns.

Most fatalities caused by lightning stroke occur during the summer months when the cattle are at pasture. Deaths due to electrocution in barns may occur at any time.

### PATHOGENESIS

Tissue damage from electrical trauma is induced by the direct effects of the electric current and the development of heat and tissue ischemia. Exposure to high-voltage electrical currents causes severe **nervous shock** with complete unconsciousness and flaccid paralysis. In some instances, focal destruction of nervous tissue occurs and **residual signs of damage** to the nervous system persist after nervous shock disappears.<sup>2</sup> Death when it occurs is usually due to paralysis of vital medullary centers. Ventricular fibrillation may also occur and contribute to the fatal outcome.<sup>1</sup> **Superficial burns** may be evident at the site of contact with the current or along the path of flow from the point of contact to ground. The burn is produced by heat generated from the resistance of tissues to the passage of the electricity. **Fractures** are believed to be the result of sudden and profound muscular contraction.

### CLINICAL FINDINGS

Varying degrees of shock occur. With high-voltage currents and good earth contacts such as wet concrete floors, water, and damp earth, the animal may fall dead without a struggle. Singeing and burning are likely to occur because of the severity of the shock. The burns may be localized to the muzzle or feet and be in the form of radial deposits of carbon with or without disruption of tissue, or they may appear as tree-like, branching patterns of singeing running down the trunk and limbs.

In less severe shocks, the animal falls unconscious, **sudden collapse**, or there may be some struggling, followed by a period of unconsciousness varying from several minutes to several hours. When consciousness is regained, or the animal is removed from the electric field, the animal may rise and be perfectly normal,<sup>1</sup>

or show depression, blindness, ataxia, posterior paralysis, monoplegia, and cutaneous hyperesthesia. In some cases there may be more local signs including nystagmus and unilateral paralysis. Sloughing of the skin at the sites of burns may occur after a few days. These signs may persist or disappear gradually over a period of 1–2 weeks. With electrocution in pigs caused either by lightning stroke or wiring faults, the major signs are related to spinal injury or to fracture of the ileum, ischium, and the transverse processes of the lumbar vertebrae with a large number of animals exhibiting apparent lameness and especially posterior paralysis.<sup>3,4</sup> Vestibular disease is described as a sequela to lightning strike in horses.<sup>5</sup>

The actual occurrence of electric shock often is not observed and electrocution should always be considered in the differential diagnosis of spinal or pelvic fracture or injury in pigs.

With minor shocks, especially as they occur in barns on low-voltage domestic current, the animal may be knocked down or remain standing. Consciousness is not lost and the clinical picture is one of restlessness. The animal may kick violently at the stanchion or the dividing rail. The attacks may be intermittent and occur only when the cattle supply a good ground contact such as standing in the gutter, when they are drinking, or when they are wet. Dairy farmers are often unaffected in the same environment because their boots provide effective insulation.

#### CLINICAL PATHOLOGY

Laboratory examinations are of no value in diagnosis.

#### NECROPSY FINDINGS

If electrocution is suspected it is best to ensure that possible **sources of electric power** are shut off before proceeding with a postmortem examination.

Diagnostic lesions are often minimal<sup>3</sup> but singe marks on or under the skin, or damage to the environment, or both, occur in about 90% of lightning deaths. Rigor mortis develops but passes off quickly.

In cattle, anthrax is often a consideration as the carcass decomposes rapidly and blood may exude from the external orifices. The pupils are usually dilated and the anus relaxed. All viscera are congested and the blood is dark and unclotted. Petechial hemorrhages may occur throughout the body, including the trachea, endocardium, meninges, and central nervous system. The superficial lymph nodes, particularly the prescapular and the interior cervical, are often hemorrhagic. Superficial singeing of the hair, burn marks on the feet or muzzle, and internal or subcutaneous extrava-

sations of blood in arboreal patterns also occur.

In some cases of electrocution there are longitudinal **fractures** of long bones and in incidents involving pigs, local hemorrhage and extensive fractures of the bones in the pelvic area are observed.<sup>3</sup> Fractures of the lumbar vertebrae have also been described in electrocuted swine.

Theoretically, the passage of electric current through tissue may cause cell nuclei to elongate and assume orientations parallel to one another. Skin lesions can be examined histologically for this change and hyperconcentration of skeletal muscle fibers may also be observed.

#### DIFFERENTIAL DIAGNOSIS

Great care must be taken in accepting an owner's suggestion that an animal has been killed or injured by lightning stroke. Insurance against loss by lightning is commonly carried and the many other causes of sudden death or injury are seldom covered by insurance. In order to minimize the possibility of conflict and potential future legal problems it is wise to have a representative of the insurance company present at the autopsy so that all may agree on the diagnosis.

To make the diagnosis, there should be a history of exposure and evidence of sudden injury or death. In the latter case, half-chewed food may still be present in the mouth. Burns on the skin, scorching of the grass and tearing of the bark on nearby trees are also accepted as contributory evidence. The possibility of electrocution caused by faulty wiring should be considered when sudden shocks or death occur in animals confined in stanchions. Differentials include:

- Other causes of sudden death
- Pigs: Other causes of posterior paresis/paralysis.

#### TREATMENT

Central nervous system stimulants and artificial respiration should be provided for unconscious animals but in most instances the animals are dead or recovered before treatment can be instituted.

#### CONTROL

Precautions taken to avoid lightning stroke in animals are largely ineffective, but proper installation of all electric equipment in barns and milking parlors is essential to prevent losses. All motors should be earthed to a special iron spike or pipe driven at least 2.5 m into the ground, preferably in a damp spot and electrical machinery that has potential contact with animals should be shielded. Earthing to water pipes should not be permitted. Minimum amperage fuses should be used to provide protection in cases of short-circuiting.

#### REFERENCES

1. Novalés M et al. *Vet Rec* 1998; 142:68.
2. Boeve MH et al. *Vet Rec* 2004; 154:402.
3. Bildfell RJ et al. *J Vet Diagn Investig* 1991; 3:364.
4. Steffen DJ et al. *J Am Vet Med Assoc* 1992; 200:812.
5. Bedenice D et al. *Vet Rec* 2001; 149:519.

#### STRAY VOLTAGE

##### Synopsis

**Etiology** Electrical shock.

**Epidemiology** Risk with any electrified housing system but most recognized in dairy cattle and pig housing.

**Clinical findings** Behavioral changes in feeding or eating patterns, reluctance to move freely in some areas of buildings. Claims for increased disease incidence and decreased production not substantiated experimentally.

##### Diagnostic confirmation

Demonstration of stray voltage with amelioration of the problem when this is corrected.

#### ETIOLOGY

Stray voltage can produce minor electrical shock and discomfort to animals. The term 'stray voltage' is used to denote an electrical voltage between two points that can result in a current flow through an animal when it contacts them. The voltages are usually low and are usually not detected by humans because of the insulation provided by clothing and footwear. **Other terms** that have been used for stray voltage include 'free electricity', 'tingle voltage', and 'transient voltage'. The term 'neutral to earth voltage' or 'neutral to ground voltage' usually applies to the voltage measured between the service entrance neutral bus and a reference ground rod. **Cow contact voltage** refers to voltage measured between a potential cow contact, such as a drinker and the ground.

The source and cause of the problem is complex. Stray voltage can be associated with the electrical distribution network and the farmstead wiring system and the contribution from both sources can be superimposed. **Seven potential sources** have been identified, five of which originate on the farm.<sup>1</sup>

#### EPIDEMIOLOGY

The potential presence of stray voltage has been recognized for many years but the possible relation to production and disease gained particular attention in the 1980s when different surveys indicated that over 50% of dairy farms had significant cow contact voltage and more current studies indicate a continuing problem.<sup>2–4</sup> Deteriorating wiring, poor wire insulation, and older buildings are **risk factors**.



Heavy milking cows are believed more sensitive to electric shock; scratched, infected, and sore muzzles and hooves may increase sensitivity.

### PATHOGENESIS

The reaction of the animal to stray voltage will depend upon the current flow, or shock, which is related directly to the voltage and inversely to the **impedance** to flow in the animal.<sup>5</sup> The impedance decreases as body weight increases owing to increase of the surface of contact and the pressure exerted by the hooves on the floor and, with pigs, current flow at the same voltage is higher through a gilt or sow than through a piglet.<sup>6,7</sup> There are some differences in impedance between different pathways in animals (e.g. mouth to hooves or udder to hooves) but there can also be individual animal **variation in sensitivity** to stray voltage.<sup>8</sup> In general, the problem will only be suspected if the stray voltage is high enough so that a significant proportion of the herd shows signs.

The reactivity of **cows** to different voltage levels has been studied and the **lowest behavioral perception** is observed at 1–2 V for the most sensitive cows and moderate behavioral responses at 1.5–3 V.<sup>2,3,9</sup> With **pigs**, feeding and drinking behavior is affected at 5 V but not at 2 V, and resting time is disturbed at 8 V.<sup>10,11</sup>

### CLINICAL FINDINGS

#### Behavioral changes

The behavioral responses exhibited by **cows** exposed to stray voltage depend upon the site at which the voltage occurs and the strength of the current flow.<sup>12</sup> Stray voltage in the **milking parlor** results in a reluctance to enter the parlor, a reluctance to cross the floor grids, extreme nervousness while in the parlor and rapid exit or stampeding from the parlor. Where stray voltage occurs at **drinkers** cows may show reluctance to drink, with lapping of water rather than full drinking and crowding at the drinker to result in one cow being the ground while others drink.<sup>1,3</sup> Cows that are experiencing current flow are restless, they may tremble and the back is arched and the head is elevated with the ears held back rigidly and there is frequent urination and defecation.

In **pigs**, restlessness, increased aggressiveness and changes in drinking and feeding patterns have been associated with stray voltage.<sup>10</sup>

#### Effects on production and disease

Field observations have indicated that stray voltage in the milking parlor at milking time can result in incomplete milk letdown, increased milking times, elevated somatic cell counts, an increased

incidence of clinical mastitis, and poor production.<sup>3,4</sup> However, **controlled trials** have found no effect of stray voltage on the incidence of disease nor an effect on production in dairy cattle<sup>12–14</sup> or pigs.<sup>10,11,15</sup>

### DIFFERENTIAL DIAGNOSIS

The presence of stray voltage should be suspected where animals exhibit behavioral abnormalities and for the present, it is probably wise to consider it as part of the differential of problems of production inefficiency.

Cow contact voltage can be measured with a sensitive voltmeter but the ground must be well established. The measurement of the neutral to earth voltage does not give a good prediction of cow contact voltage and is not recommended as the sole measure for the risk of stray voltage on the farm.<sup>2</sup> In most instances a qualified electrician is required to correct the problem. The use of a commercially available tingle voltage filter has been recorded to significantly reduce stray levels.<sup>3</sup>

### REFERENCES

1. Appleman RD, Gustafson RJ. *J Dairy Sci* 1985; 68:1554.
2. Southwick LH et al. *J Dairy Sci* 1989; 72:2417.
3. Albright JL et al. *Agri Pract* 1991; 129:23.
4. Wilson DJ et al. *Agri Pract* 1996; 17:24.
5. Gorewit RC et al. *J Dairy Sci* 1985; 68:718.
6. Robert S et al. *Pig News Inf* 1994; 15:45N.
7. Robert S et al. *Can Agric Eng* 1994; 36:37.
8. Norell RJ et al. *Trans Am Soc Agric Eng* 1983; 26:1506.
9. Kirk JH et al. *J Am Vet Med Assoc* 1994; 204:1152.
10. Robert S et al. *Can J Vet Res* 1991; 55:371.
11. Robert S et al. *Am J Vet Res* 1996; 57:1245.
12. Watson ED et al. *J Am Vet Med Assoc* 1992; 201:441.
13. Gorewit RC et al. *J Dairy Sci* 1989; 72:2184.
14. Gorewit RC et al. *J Dairy Sci* 1992; 75:2719, 2726.
15. Godcharles L et al. *Vet Res Commun* 1993; 17:41.

### VOLCANIC ERUPTIONS

Active and potentially active volcanic chains exist in several countries in close proximity to significant livestock production areas. Major volcanic eruptions are rare but the experiences of the eruptions of Hecla in Iceland, Mount St Helens in the USA, the Lonquimay complex in the Southern Andes, and Ruapehu in New Zealand suggest that most are inconvenient to orderly livestock production, but have minimal effects on animal health.

#### Blast and gas damage

Volcanic eruption can result in devastation of land areas from the effects of lateral blast and pyroclastic, laval, and mud flows. Livestock losses which occur in this way can be total, but the affected areas are restricted to the immediate vicinity of the eruption. Toxic gases from

the eruption may accumulate in close low-lying areas and result in mortality.

#### Ash hazards

Significantly greater land areas can be affected by tephra fallout consisting of ash and rock fragments from the volcanic eruption. The size of the sector affected by ash fallout will be determined by the strength and direction of winds at the altitude reached by the ash column at the time of the eruption, but several thousand square kilometers can receive ash fallout varying from a light dusting to falls several centimeters in depth.

The hazards to livestock during the fallout period appear minimal, although in areas where the ash fall is heavy, there is virtually total darkness. Animals, particularly sheep, mill about excessively and some die of **suffocation** or **misadventure** including drowning.

The immediate effect of the fallout is to blanket pastures with ash and in heavy fallout areas, taller succulents may become lodged and unavailable for grazing. Livestock may be forced to graze more robust, but toxic, plant species if stored feeds are not provided and loss from **plant poisoning** was observed following the Mount St Helens eruption. **Hypocalcemia**, apparently resulting from food deprivation, was also observed in the immediate post-fallout period with Mount St Helens and was also recorded following the Mount Hecla eruption.<sup>1</sup>

Ash fallout may have a devastating effect on insect life and this may be followed soon afterwards by death from starvation of **insectivorous avian species**. This may be misinterpreted by the public as evidence for ash toxicity.

#### Toxic chemicals

Potential hazards to livestock health exist in the chemical composition of ash. In the fallout from Mount St Helens and from Ruapehu several potentially toxic heavy metals and trace elements were present, but none in a concentration sufficient to be a hazard to livestock health.<sup>2,3</sup> During the air-borne stage, wind sorting of the dust into particles of varying size, shape, and density results in area variation in the composition of the fallout. Consequently, area variations in chemical analysis over the fallout area can occur. Analyses based on acid-leachable or water-soluble analysis are more relevant to immediate animal health than those reporting total content.

Mortality resulted from acute **fluorine poisoning** in association with high fluoride levels in ash and ash-contaminated grasses and water in the period immediately following the Mount Hecla and Lonquimay eruptions.<sup>1,4</sup> It is therefore advisable to remove livestock from

ash-contaminated pastures until this hazard is determined. In most circumstances, this will necessitate removal to indoor housing and *feeding of stored feed and well water if they are available.*

#### Physical properties

The ash particulate count in air and the respiratory exposure to livestock is highest during the fallout period, but can remain high for long periods following the fallout when ground ash is disturbed by animal movement, winds, and normal farming practices. A significant proportion of this material is of **small particulate size** and is **respirable**.<sup>2</sup> Chemical and/or physical irritation of the respiratory tract, with a significant increase in the prevalence of respiratory disease, might be expected in these circumstances. This did not occur following the Mount St Helens eruption, even in animals with known pre-existing respiratory disease, nor was it a reported problem following the eruption of Mount Hecla.<sup>1</sup> Signs of irritation such as lacrimation were observed widely, but with no untoward sequelae.

#### Long-term effects

Volcanic ash is composed predominantly of pumiceous volcanic glass and crystalline mineral silicates such as feldspar. These materials have no innate pulmonary toxicity. Volcanic ash may also contain variable amounts of free crystalline silica such as quartz, cristobalite and tridymite which, if present in respirable sized particles for prolonged exposure periods, can induce pulmonary fibrosis.

**Silicosis** is primarily a human health concern, although spontaneous silicosis is recorded in livestock.<sup>5</sup> While it is a concern with all eruptions, the long-term health history of animals and man following volcanic eruptions suggests this hazard is minimal.

In the vicinity of Mount St Helens there have been two appreciable effects on livestock health:

- The first has been a marked increase in the incidence of **hypomagnesaemia** in cattle in the semiarid channelled scab lands of central Washington. This has possibly resulted from the reflective nature of the ash layer on the soil reducing soil temperature increase during early grass growth and thus reducing magnesium uptake. Grass magnesium concentrations are low and potassium levels are high but there are no pre-eruption values for comparison
- The second effect has been an increase in the severity of **selenium deficiency**. The association between selenium deficiency and recent

volcanic origin soils is well recognized. Problems have been corrected by additional and more intensive selenium supplementation.

Animals may ingest considerable quantities of ash from grazing contaminated pastures or from hay subsequently prepared from these areas. There is little field evidence for disturbance of **digestive function** in livestock following the Mount St Helens or Ruapehu eruptions and feeding trials of ash to cattle and sheep have shown no clinical or postmortem evidence of untoward effects nor any depression of production except that associated with decreased feed palatability at high ash feed levels.<sup>6</sup>

#### REFERENCES

1. Georgsson G, Petursson G. Fluoride Q Rep 1973; 5:58.
2. Fruchter JS et al. Science 1980; 209:1116.
3. Gregory NG, Neall VE. Surveillance 1996; 23:14.
4. Araya O et al. Vet Rec 1993; 35:437.
5. Schwartz L et al. Proceedings of the 23rd Aspen Lung Conference, Aspen, Colorado, 1980.
6. Preston RL. Mount St Helens: One year later. Proceedings of a Symposium, Eastern Washington University, 17-18 May, 1981.

### BUSHFIRE (GRASSFIRE) INJURY (THERMAL BURNS)

#### Synopsis

**Etiology** Thermal or smoke inhalation injury from fire.

**Epidemiology** Large numbers of livestock with thermal burns in bush and prairie fires. Smoke inhalation injury more common in horses rescued from barn fires.

**Clinical findings** Edema and thermal injury in skin. Upper respiratory signs in short term and lower respiratory disease in the longer term, with smoke inhalation.

**Treatment** Palliative local therapy, fluid therapy to prevent shock with superficial thermal injury. Maintenance of airway and lower respiratory function with smoke inhalation. The major dilemma with treatment is the conflict between the welfare of the animals and the responsibility to the owner.

#### ETIOLOGY

Heat, carbon monoxide, and toxic gases are the cause of injury and death in fires. Most fire victims have thermal burns. The treatment of burns is, by common consent a surgical subject, but there are aspects of bushfire or forest fire injury which warrant discussion in a textbook of large animal medicine. For example, when large numbers of animals are affected the most important questions to be decided are whether to treat them and what to treat them with and, if they are not to be treated, whether they are to be summarily destroyed or salvaged for meat. When

large numbers of animals are burnt there is also a major moral conflict for the veterinarian between the welfare of the animals and the responsibility to the owner.

#### EPIDEMIOLOGY

##### Forest fires

Although no written information is readily available about forest fires in **softwood forests** it is assumed that few animals would survive the suffocating effects of intense heat and high smoke concentration. The intensity of the heat arises from the fact that the entire forest from leaves to trunks is burned.

In **hardwood forests**, such as eucalyptus forests in Australia, the heat is not so severe because the tops only are destroyed. Underbrush is burned but the tree trunks are only scorched and usually survive to regrow. Depending on the density of the forest and the amount of underbrush there may be many survivors as badly burned animals. The most severe burns are on the lower surfaces and undersurfaces of the body and are caused by burning of the litter on the forest floor.

##### Grass fires

The most serious situation is caused by a grass or prairie fire which, because of the short period of intense heat that is generated by the wind-driven fire, burns but does not necessarily kill animals. The fires can be extensive and involve large numbers of animals. Many animals will die of suffocation, especially sheep, but the majority survive in various states of burn injury.

##### Barn fires

Animals may die of carbon monoxide poisoning and asphyxiation, or be burned all over, but some may be rescued without burn but with the risk of smoke-induced respiratory injury (Chapter 10).<sup>1</sup> Animals trapped, but subsequently rescued, in barn fires are more usually horses.

**The problems for veterinarians** created by large-scale burnings are several-fold:

- The first is that **national disaster services** are usually recruited to deal with the damage to property and welfare problems of humans. They are often poorly equipped to deal with animal problems yet assume authority over their fate in the temporary absence of the owners. The normal reaction of the average person is to judge that burn injuries are much more serious than in fact they are and to shoot burned animals out of hand
- The second problem is that the facilities for penning and treating burned animals have usually been destroyed in the fire so that a general feeling of helplessness prevails,

especially if several hundred animals are affected

- **Insurance** also exerts an influence on the owner's decision on the course to be followed. Most livestock are protected by fire insurance and there will be no argument with a veterinarian's decision that burned animals should be destroyed for humane reasons. This is often done unnecessarily if the interests of insurers are to be protected
- **Salvage** for slaughter is often difficult to arrange at such short notice for such large numbers and public sentiment is against the practice. However, delayed salvage must be kept in mind for animals which will have impaired functions because of burns, e.g. ewes with teat injuries, rams with preputial injuries, bulls with scrotal injury.

## CLINICAL FINDINGS

### Burn injury

The parts most affected by burning are the face, especially the eyelids, conjunctivae and lips, the undersurface of the body especially udder, teats, and perineum and the coronets.<sup>2,3</sup> Badly damaged corneas take many weeks to heal but badly swollen lips and eyelids can be almost normal within 48 h. Marked edema is always a feature of skin burns in animals, but badly burned skin will be dry and ready to slough in a week.

The teats of **dairy cows** may be damaged to the point where they will not be milkable again; wethers and rams may suffer urethral obstruction. In dairy cattle it is heifers that have the worst prognosis with respect to machine milkability.

Separation of the coronary band from the **hoof** is a common occurrence as a result of burning and there may be sufficient weeping at the separation to suggest that the hoof is about to slough, but they seldom do and hooves that appear quite loose do heal normally.

## TREATMENT

### Decision criteria

A major decision must be made at the outset whether to treat an affected animal or whether to destroy it on humane considerations. This decision is more easily made when an individual, rather than several hundred animals, is the consideration.

Recommended **criteria** for deciding the fate of sheep burnt by **pasture fire** depend on the presence of burns to the hooves and legs below the carpal and tarsal joints which cause local swelling and a dry leathery appearance of the skin. Such sheep are likely to be recumbent and immobile and to die. Burns which do not cause swelling of the lower limbs,

or to other parts of the body are not likely to be fatal, nor to produce chronic ill-health,<sup>3,4</sup> unless they affect a large part, more than 15–20%, of the body surface.

Animals which are unconscious or very distressed, cannot walk, or have severe difficulty in breathing are poor prospects for recovery and are best **euthanized** forthwith. It may be necessary to monitor sheep for 10 days after a fire before deciding what to do with them. It is necessary at all times to consider the need to avoid inflicting suffering on the animals, but to also consider the farmer's need to retrieve his assets. If the animals are insured against fire it is also highly desirable to keep the insurer advised of developments.

Animals which have been trapped in a **burning building** are likely to be burned all over and to have upper and lower respiratory damage from smoke inhalation. Bronchoscopy can aid in establishing the severity of injury.

### Skin burns

Extensive skin burns are accompanied by fluid shifts, vascular leakage, protein loss, and the potential for hypovolemia. The initial therapy is with crystalloid and colloid fluids as discussed in the section on shock. Tetanus prophylaxis is appropriate. Topical antibiotics, silver sulfadiazine and aloe vera are topical therapies. Non-steroidal anti-inflammatory agents can decrease the inflammatory response and help in pain management.<sup>5</sup> Glucocorticoids may potentiate burn sepsis. In horses, euthanasia is recommended if greater than 50% of the body surface is affected.<sup>5</sup>

### Smoke inhalation

Tracheostomy may be required to maintain the upper airway. Bronchodilators such as aminophylline or terbutaline sulfate are used to relieve reflex bronchoconstriction and humidified oxygen and local hydration by fluid nebulization to relieve hypoxemia. Corticosteroids are used to reduce airway inflammation in animals with minimal cutaneous burns.<sup>1</sup>

## REVIEW LITERATURE

Geiser DR et al. Management of thermal injuries in large animals. *Vet Clin North Am: Large Anim Pract* 1984; 6:91–105.

## REFERENCES

1. McFarlane D. *J Equine Vet Sci* 1995; 15:159.
2. Willson RL. *Aust Vet J* 1966; 42:101.
3. McAuliffe RR et al. *Aust Vet J* 1980; 56:123.
4. Morton JM et al. *Aust Vet J* 1987; 64:69.
5. Duckett WM. *J Equine Vet Sci* 1995; 15:157.

## WETNESS

Frequent exposure to wetting, sufficient to keep the skin permanently wet for long periods, predisposes to fleece rot in sheep and mycotic dermatitis in all

species. In horses it leads to a superficial dermatitis along the dorsum, especially over the croup and is known as scald. Frequent immersion of the lower limbs of cattle on irrigated pasture causes dermatitis on the backs of the pasterns leading to mycotic dermatitis. Wetting also predisposes to hypothermia in the young.<sup>1</sup>

Standing in cold water for a period of more than 3 days causes the immersed parts to become edematous and congested and slough their skin in the form of a cuff around the limb. Recovery is slow and incomplete.<sup>2</sup>

## REFERENCES

1. McArthur AJ, Ousey JC. *J Thermal Biol* 1994; 19:81.
2. Bracken FK et al. *Vet Med* 1986; 81:562, 564, 566.

## DROWNING

Near drowning has been defined as survival following asphyxia and aspiration of water while submerged. Cases are rare in large animals but there is increased potential with the increasing popularity of swimming as a method of exercising and training horses.<sup>1</sup> Fresh water can inactivate pulmonary surfactant and lead to collapse of the alveolus with a loss of pulmonary compliance and the resultant ventilation-perfusion mismatch coupled with alveolar damage can lead to severe hypoxemia. The inhalation of water may also carry bacteria and the risk of a secondary bacterial aspiration pneumonia.<sup>2</sup> Affected animals present with an elevated heart rate, tachypnea, and dyspnea. There is a decrease in normal air flow sounds on auscultation, which may occur in all areas of auscultation or be more pronounced in one lung and rales or crackles may be heard in local areas.<sup>1,2</sup> Consolidation may be detected with thoracic radiography. The mucous membranes may be congested, cyanotic, or muddy. Arterial blood gas analysis has shown a metabolic acidosis and hypoxemia.<sup>1,2</sup>

Therapy has been based on experience with near drowning cases in humans<sup>3</sup>; horses have been successfully treated by nasal insufflation of humidified oxygen, the correction of the base deficit with sodium bicarbonate and lactated Ringer's solutions administered intravenously, treatment with bronchodilators and non-steroidal anti-inflammatory drugs and the pulmonary infusion with a surfactant transplant from a recently euthanized horse.<sup>1</sup> Antibacterials are given to cover the risk or the presence<sup>2</sup> of a bacterial pneumonia and the cover should include the possibility of infection with anaerobic organisms. Respiratory distress can be more severe when the animals are recumbent and enforced standing may be

indicated. Near drowning requires immediate and aggressive therapy and the recovery can be prolonged.

#### REFERENCES

1. Humber KA. J Am Vet Med Assoc 1988; 192:377.
2. Austin SM et al. J Equine Vet Sci 1988; 8:216.
3. Ornatós JP. J Am Med Assoc 1986; 256:75.

### COLD INJURY (FROSTBITE, CHILBLAINS)

#### Synonyms

**Etiology** Exposure to cold temperatures, usually below freezing, without adequate protection.

**Epidemiology** Cooler seasons of the year, primarily in young animals, especially beef calves, debilitated from other disease. Teats of lactating dairy cows also susceptible.

**Clinical findings** Lesions may occur on extremities of limbs, especially hindfeet, ears, and tail. Demarcated lesions with initial swelling with edema followed by necrosis and sloughing. Teats and udder of adult cows may be affected.

**Clinical pathology** None specific.

**Necropsy findings** Subcutaneous edema and hemorrhage in affected areas.

**Diagnostic confirmation** Clinical findings and history of exposure to cold.

**Treatment** Warm, dry environment. Improve peripheral circulation.

**Control** Remove debilitated calves from cold environments. Adequate and dry bedding.

#### ETIOLOGY AND EPIDEMIOLOGY

The injury occurs during cold weather in the winter or spring months and is most common in **calves** which are weak or in which the peripheral circulation of the limbs is impaired, usually because of diarrhea and dehydration. In a retrospective study of frostbite in calves, 80% of cases were associated with a concurrent disease such as pneumonia, diarrhea, omphalitis, septicemia and ocular disease.<sup>1</sup> Hypothermia (<37.5°C) was present in about 50% of the calves. The disease in calves appears more common in beef breeds, possibly because of management risk factors.

In **dairy herds** with loose housing, access to outdoor exercise yards without adequate bedding can be a risk factor. There can be a high incidence of teat lesions in drylot-housed herds in temperate areas when freak cold weather fronts invade the region. Regional differences in teat chapping in winter are associated with regional differences in winter temperature.<sup>2</sup>

#### PATHOGENESIS

Physiologically, body heat is lost from the skin surface by radiation and convection and by conduction and evaporation when

the skin and hair-coat are wet. **Newborn calves** are particularly susceptible to cold because of their inadequate insulation and high ratio of body surface area (through which heat is lost) to body volume (in which heat is generated). The core and trunk body temperature is preferentially conserved during cold stress at the expense of the peripheral tissues which are most susceptible to cold injury.

The **peripheral tissues** are also most susceptible because of their contact with the ambient temperature and wet environments. When cattle are in sternal recumbency, the uppermost pelvic limb is fully exposed and the distal aspect of the opposite limb from the hoof to above the fetlock joint is exposed to the environment. The distal extremities of the thoracic limbs are usually covered by the thorax. Thus, any situation which results in prolonged sternal recumbency will allow the distal extremities of the pelvic limbs to cool excessively and if there is impairment of circulation because of pre-existing dehydration, varying degrees of cold injury can occur. Field observations suggest that if a weak calf does not move from a sternally recumbent position for several hours, the cold injury can progress to the stage of severe irreversible frostbite before the clinical signs are recognized by the owner.

The **teats of dairy cows** are also exposed when standing and lying. Residual teat dip after milking predisposes to cold injury.

Cold injuries of extremities vary from mild to severe. Exposure to cold results in vasoconstriction and coolness of the affected part. Most dry-cold injury is superficial and the skin may become gangrenous resulting in a hard shell or carapace over healthier tissue. Deeper cold injury causes inflammation, redness or cyanosis, local swelling and pain or loss of sensation.

#### CLINICAL FINDINGS

Frostbite of the **feet** of calves is not readily obvious even to the experienced observer. The normal hair covering and pigmentation of the skin often mask the early changes of frostbite. Commonly, cases are identified during the treatment with fluids of scouring, recumbent calves, when further clinical examination reveals that the hindfeet are cool and clammy.

In the **early stages** of frostbite of the distal parts of the limbs, the tissues are swollen, edematous and may have well demarcated limits. After several hours of warming indoors, the feet remain cool and close examination reveals some moistness and dark red to bluish coloration of the skin. There may be a line of demarcation between normal and affected

tissue at about the level of the fetlock joints. If the injury is not severe, complete recovery may occur in a few days.

In more **severe cases**, within 24–48 h, necrosis and sloughing of the skin may occur and the hooves may become detached several days later. Pain on palpation of affected tissues, especially at the line of demarcation, is obvious.

When there is avascular necrosis of the affected part, the skin may be hard like a shell (known as a carapace) and moderate palpation will elicit pain.

Freezing of the **ears** results in loss of pliability of the ears, gangrene, and loss of the affected parts and curling of the affected skin adjacent to the affected parts. Some sloughing of affected parts will occur and after several days the ears appear shortened.

Freezing of the **tail** occurs most commonly at the distal end resulting in stiffness and loss of flexibility because of a carapace. Varying portions of the tail may be affected but usually 5–10 cm of the distal end is involved. The distal parts of the tail of adult cattle may freeze in very cold weather.

In adult cattle, freezing of the **teats and base of the udder** can occur in lactating cattle which have inadequate bedding and shelter from wind and snow. Affected teats are swollen and cold and the skin begins to vesiculate and peel. Freezing of the teats of cows may result in permanent injury, chronic thelitis and the possibility of mastitis with gangrene. Less severe lesions predispose to mastitis.<sup>3</sup>

Freezing of the **scrotum** occurs in yearling beef bulls kept outdoors during the cold winter months but the lesions are not commonly recognized until the spring of the year.

#### NECROPSY FINDINGS

Necrosis of the skin of the affected area with severe diffuse hemorrhagic subcutaneous edema is typical of frostbite.

#### TREATMENT

Affected calves should be moved to a warm well-bedded **dry environment** and circulation should be improved by providing **fluid therapy** as necessary. In early cases, affected calves will recover in a few days and the swelling and pain will regress. Field observations suggest that superficial freezing of the skin between the fetlock and coronets will heal over a period of several weeks providing the lesion does not extend into the coronary bands and the laminae of the feet which commonly results in sloughing of the hoof.

In severe cases with extensive necrosis, the skin will begin to slough. Such open wounds should be treated with suitable antibiotic ointments and bandaged for

several days. Calves with extensive freezing of the hindlimbs extending from the feet up to hock joints are incurable and should be euthanized.

There is no specific treatment for freezing of the ears and tails of calves or the teats of cows.

### CONTROL

The prevention of cold injury in newborn calves requires daily surveillance of calves to insure that any animal which is inactive for any reason is examined for evidence of illness and treated immediately and placed in a protected environment.

When an exceptional cold period is forecast for dairy cows at risk, teat dipping should be temporarily suspended during the cold period. Additional bedding should be provided for loose-housed cows and bedding with some manure

can be piled in the center of drylot yards to provide composting heat upon which the cows can bed.

### REFERENCES

1. Cruz A, Naylor JM. *Can Vet J* 1993; 34:306.
2. Burmeister JE et al. *J Dairy Sci* 1995; 78:2073.
3. Fox LK, Cumming MS. *J Dairy Sci* 1996; 63:369.

### ELECTRIC AND MAGNETIC FIELDS

Electric and magnetic fields are generated from the transmission of electricity through high tension lines and livestock are exposed to these fields when high-voltage lines pass through rural areas. There is no apparent effect of high-voltage transmission lines on the behavioral or feeding patterns or the reproductive performance of cattle grazed under them or near them<sup>1</sup> but experimental studies have observed equivocal effects on mela-

tonin production<sup>2</sup> dry matter intake milk yield and milk components.<sup>3,4</sup>

German veterinarians have expressed concern for livestock health from the effect of radiofrequency electromagnetic fields associated with the establishment of a national mobile phone network. Alterations in behavior and an increase in birth defects are reported in cows with high exposure but there is little hard data.<sup>5,6</sup>

### REFERENCES

1. Ganskopp D et al. *Appl Anim Behav Sci* 1991; 30:1.
2. Burchard JF et al. *J Dairy Sci* 1998; 81:722.
3. Roderiguez M et al. *J Dairy Sci* 2002; 85:2843.
4. Burchard JF et al. *J Dairy Sci* 1996; 79:1549.
5. Wenzel C et al. *Prakt Tierarzt* 2003; 83:260.
6. Loscher W. *Prakt Tierarzt* 2003; 84:850.

## Diseases associated with inorganic and farm chemicals

Mineral tolerance of animals 1798  
Principles of treatment in cases of poisoning 1798

### DISEASES ASSOCIATED WITH INORGANIC POISONS 1799

Lead poisoning 1799  
Arsenic poisoning 1808  
Selenium poisoning 1811  
Phosphorus poisoning 1813  
Mercury poisoning 1814  
Fluorine poisoning 1815  
Aluminum poisoning 1819  
Molybdenum poisoning 1819  
Primary copper poisoning 1820  
Secondary copper poisoning 1823  
Sodium chloride poisoning 1824  
Zinc poisoning 1826  
Sulfur poisoning 1828

Poisoning by organic iron compounds 1828  
Iodine poisoning 1829  
Cadmium poisoning 1829  
Chromium poisoning 1829  
Vanadium poisoning 1829  
Bromide poisoning 1830  
Cobalt poisoning 1830  
Boron poisoning 1830

### DISEASES ASSOCIATED WITH FARM CHEMICALS 1830

Poisoning by anthelmintics 1830  
Insecticides: chlorinated hydrocarbons (organochlorides) 1832  
Organophosphorus compounds and carbamates 1834  
Rotenone 1837  
Amitraz 1837  
Herbicides 1837

Defoliants 1838  
Fungicides 1838  
Rodenticides 1839  
Sodium fluoroacetate 1839  
Alpha-naphthylthio urea 1839  
Warfarin and other anticoagulant rodenticides 1839  
Molluscicides 1840  
Wood preservatives 1840  
Seed dressings 1840  
Additives in feeds 1841  
Estrogenic substances 1841  
Urea 1842  
Ionophore poisoning 1844

### MISCELLANEOUS FARM CHEMICALS 1846

Oil products 1846  
Manure gas poisoning and related confinement effects 1848

Suspicion of poisoning is aroused when illness occurs in a number of previously healthy animals; all affected at the same time and showing the same signs and necropsy findings, to the same degree of severity. These conditions, of course, may also apply to some infections, metabolic and nutritional deficiency diseases. It is only by acquaintance with the syndromes produced by the common poisons, particularly those likely to occur locally, that this primary differentiation can be made.

Poisonous plants often show a geographical limitation in distribution; particular industrial enterprises may create poison hazards in local areas; certain agricultural practices, including the spraying of orchards, the dipping or spraying of cattle for ectoparasites, and the use of prepared concentrate feed for pigs and cattle, may also lead to poisoning in groups of animals. So many chemical agents are used in agriculture today that a section of miscellaneous farm chemicals likely to be associated with the poisoning of animals has been included.

The appearance of clinical illness soon after feeding, after a change of ration, after medication or spraying, or after change to new pasture, is a common history in many outbreaks of disease associated with chemical agents. The report which accompanies material for toxicological analysis should include a full record of history, clinical signs and necropsy findings and particularly the results of a search of the environment for access to a poison. If the animal has been

treated, the drugs that were used and the dates of administration should be given as they may create difficulties for the analyst. The poison or group of poisons suspected should be defined.

Specimens for analysis should include a sample of the suspected source material. Next most important is a specimen of alimentary tract contents, so that ingestion of the material can be proven, and a sample of tissue, usually liver, to prove that absorption of the poison has occurred. Kidney also provides a route for concentrating many toxicants for excretion and is an important specimen for chemical poisoning. Most toxic chemicals are ingested but percutaneous absorption and inhalation must be considered as possible portals of entry. One of the advantages of an examination of alimentary tract contents is that qualitative tests can be carried out and in many cases this determines whether or not further examination of tissues is necessary.

Additional specimens required other than liver and alimentary tract and contents, vary with the poison and the following list is suggested for the common chemicals:

- Arsenic – kidney, skin, and hair
- Lead – kidney, liver, bones, and whole blood
- Phosphorus – kidney and muscle
- Mercury – kidney, brain if organomercurials are suspected
- Copper – kidney, liver, and blood
- Sodium chloride – alimentary tract and contents, brain, and serum

- Fluorine – bones, teeth, and urine, contaminated forages
- Hydrocyanic acid – ingesta in a filled and airtight container, blood and muscle
- Nitrate and nitrite – ingesta (plus chloroform or formalin) in an airtight, filled container, blood, ocular vitreous humor
- Strychnine – blood, kidney, and urine
- Insecticides – liver, kidney, brain, fat, ingesta.

Careful packing of specimens is necessary to avoid loss of some poisons by escape as gas or conversion by bacterial fermentation, and to prevent contamination. No preservative should be added except in the case of suspected nitrite poisoning. If a preservative is necessary because of distance from the laboratory, packing in dry ice or ethyl alcohol (1 mL/g of tissue) is advisable; in the latter instance a specimen of the alcohol should also be sent. Ingesta and tissues must be kept separate as diffusion is likely to occur between the two. Specimens should be packed in glass or plastic to prevent contamination by lead in soldered joints of cans. Metal tops on jars should also be separated from the tissues by a layer of plastic or other impervious material. A suitable amount of material should be submitted for analysis: 1 kg of ingesta, 1 kg of liver, 0.5 kg of kidney, and proportionate amounts of other viscera are suggested to cover all contingencies. Urine (200 mL or whatever is available) may allow quick analysis of some toxicants.

Both blood and serum are helpful for rapid testing of some toxicants and for characterizing a potential poisoning through complete blood count and clinical chemistry. Special action is needed when plant poisoning is suspected. First examine the premises for evidence that known toxic plants actually appear to have been eaten. It is possible to ascertain the identity of the plants eaten recently by a careful examination of the ruminal contents. The freshest, least macerated material is best and whole leaves preferred. Atlases of epidermal plant fragments are available to aid in identification of ingested plant species in agricultural animals. Laboratories with sophisticated equipment can now identify most plant toxins in ruminal contents by spectrometric analysis, leaving the veterinarian with the simpler task of deciding whether any of the plants which contain the toxin are present in the environment. At such times access to a computerized data bank of plants and their toxins<sup>1</sup> is a great advantage.

Commonly, with plant poisonings, there are perplexing epidemiological features. For example, animals already grazing in the dangerous field are often unaffected and only those recently introduced may be poisoned. Some of the factors which affect susceptibility to plant poisonings are:

- Hungry, ravenous animals are more likely to be affected
- Animals thirsty or recently moved to a new location may sample toxic plants
- Curious, excited animals are likely to sample the plants they would not otherwise eat
- Young animals are less discerning and are less easily put off
- Plants that are different in texture, e.g. sprayed weeds, lopped foliage, often appear to be attractive
- Pica due to mineral deficiency or some other association may encourage toxic plant consumption
- Genetic selection of animals toward tolerance of a particular poison, e.g. fluoroacetate.

Poisoning is in most instances accidental, although it may occasionally be deliberate. Deliberate or criminal poisoning is often suspected but is rarely proved. If there is a strong suspicion of criminal poisoning, or if litigation appears possible in accidental poisoning, specimens should be collected in duplicate and placed in sealed containers in the presence of witnesses. A complete set of specimens should be available to both plaintiff and defending parties for independent analysis. Also, if litigation appears possible, the veterinarian should make detailed observations of the clinical, pathological, and epidemiological findings

and record them in detail. The taking of photographs of affected animals and the environmental surroundings is also recommended for future reference and documentation if necessary.

### MINERAL TOLERANCE OF ANIMALS

One of the very important aspects of toxicology as it applies to agricultural animals is the determination of levels of dietary constituents which the animals will tolerate for a limited period without impairing their performance and without producing unsafe residues in products destined for the human food chain. There is a great deal of information on this subject and it has been collated and published.<sup>2</sup> Table 32.1 is an adapted summary of the information.

### PRINCIPLES OF TREATMENT IN CASES OF POISONING

There are certain principles which apply to all cases of poisoning and they are listed briefly below. The three main principles are:

- Removal of the residual poison from the alimentary tract or skin
- Provision of chemical and physiological antidotes to the poison that has been absorbed
- Effective supportive care, nursing, and convalescent care.

In farm animals, gastric lavage and emetics are of little or no practical value and the removal of residual poison from

the alimentary tract depends largely upon the use of adsorbents and purgatives. The only effective adsorbent is activated charcoal. The dose rate is 1–3 g/kg BW repeated as necessary. It adsorbs chlorinated hydrocarbons, organophosphorus compounds, mycotoxins and plant alkaloids, the common feed additives, antibacterial agents and bacterial toxins. It does not adsorb cyanide, heavy metals, halogens, nitrite, alcohols, caustics, sodium chloride, or chlorate. A purgative is necessary to remove the combined adsorbent and poison; it can be administered simultaneously with the adsorbent. The use of irritant purgatives is not advisable when the poison is an irritant and has already been associated with gastroenteritis, and non-absorbable oily purgatives (e.g. mineral oil) are preferable in these cases. Saline purgatives (sodium sulfate) are of value in the treatment of non-irritant poisons such as cyanogenetic glucosides. Neutralization of residual poison in the alimentary tract includes use of oxidizing agents or tannic acid preparations for precipitating alkaloids; proteins, including milk and eggs, are effective chemical antidotes for poisons that coagulate proteins; lead is precipitated by the addition of sulfates to the alimentary tract contents.

Poison that has already been absorbed can in some instances be inactivated or its excretion facilitated by the provision of chemical antidotes. For instance, sodium nitrite and sodium thiosulfate are effective systemic antidotes to hydrocyanic acid, and calcium versenate is an effective antidote against lead.

Table 32.1 Maximum tolerance levels of dietary minerals for domestic animals

	Cattle	Sheep	Pig	Horse
Arsenic mg/kg				
inorganic	50	50	50	(50)
inorganic	100	100	100	(100)
Cobalt mg/kg	10	10	10	(10)
Copper mg/kg	100	25	250	(800)
Fluorine mg/kg				
dairy	40 breeding	60	150	(40)
mature beef	50 finishing	150		
finishing beef	100			
Iodine mg/kg	50	50	400	(5)
Iron mg/kg	1000	500	3000	(500)
Lead mg/kg	30	30	30	(30)
Mercury mg/kg	2	2	2	(2)
Molybdenum mg/kg	10	10	20	(5)
Phosphorus %	1	0–6	1–5	(1)
Selenium mg/kg	(2)	(2)	(2)	(2)
Silicon %	(0–2)	(2)	2	(2)
Sodium chloride %				
lactating	4	9	8	(3)
non-lactating	9			
Sulfur %	(0.4)	(0.4)	no data	no data
Zinc mg/kg	500	300	1000	(500)

Courtesy of National Research Council, USA (Figures in parentheses are extrapolation from data on other species)



Treatment of the effects of a poison includes provision of physiological antidotes, e.g. the injection of a calcium salt in cases of overdosing with magnesium salts. Ancillary or supportive treatment, including the provision of fluids in dehydration due to diarrhea, demulcents in gastroenteritis, sedatives in excitement, stimulants in cases of central nervous system depression, all treat the effects of poisoning.

It is essential when undertaking the treatment of animals for poisoning, especially those which are producing milk or which are destined to become meat in a short time, to take into account the possible unsuitability of the product for human consumption because of the presence of the poison or the antidote. Carefully planned sampling in concert with regulatory authorities can avoid unwanted contamination of the human food supply.

#### REFERENCES

- McKenzie RA et al. PHYTOX, an international index of poisonous plants, fungi and algae. Brisbane, 1993.
- National Research Council, Subcommittee on Mineral Toxicity Mineral tolerance of domestic animals. National Academy of Sciences. Washington, DC: National Academy Press, 1980.

## Diseases associated with inorganic poisons

### LEAD POISONING (PLUMBISM)

#### Synopsis

**Etiology** Accidental ingestion of lead or ingestion of feed or grazing pasture containing excessive lead.

**Epidemiology** Occurs in all age groups. One of the most common poisonings of farm livestock especially in young calves after turn out in spring. In cattle, usually sporadic and due to ingestion of single source of lead but outbreaks occur when feed is contaminated. High case fatality rate if untreated. Sources include discarded lead batteries, lead-based paints, industrial sources of lead, pastures near motor vehicle highways and smelters. Occurs in sheep and horses grazing contaminated pastures.

#### Signs

**Cattle:** Acute – convulsions, blindness, tremors, charging, rapid death unless treated. Subacute – blindness, stupor, head-pressing, rhythmic ear tics, blepharospasm, rumen stasis and eventual death.

**Sheep:** Lambs on pasture with posterior paresis.

**Horses:** On pasture. Signs highly variable. Inspiratory dysnea, roughened hair coat, weight loss most commonly. Occasionally convulsions.

**Clinical pathology** Lead levels in blood, feces, liver, kidney; elevated porphyrins in blood

**Lesions** Encephalopathy, degeneration of liver and kidney; pale musculature, brain laminar cortical necrosis, intranuclear renal inclusion bodies.

**Diagnostic confirmation** Toxic levels of lead in blood and tissues.

#### Differential diagnosis list

**Cattle:** See Table 32.3.

- Polioencephalomalacia
- Hypovitaminosis-A
- Ophthalmitis
- Hypomagnesemic tetany
- Nervous acetoneemia
- Arsenic poisoning
- Claviceps paspali toxicity
- Meningoencephalitis
- Rabies

**Horses:** See Table 22.1.

- Laryngeal hemiplegia
- Viral encephalomyelitis/West Nile virus
- Rabies
- Hepatoencephalopathy due to hepatotoxic plants
- Equine degenerative myeloencephalopathy
- Protozoal encephalomyelitis
- Equine motor neuron disease
- Horsetail poisoning
- Chronic weight loss
- Chronic upper respiratory tract disease
- Botulism

#### Sheep:

- Enzootic ataxia
- Polyarthritis
- Muscular dystrophy

**Treatment** Calcium versenate and thiamin hydrochloride.

**Control** Prevent access of animals to sources of lead.

#### ETIOLOGY

Lead poisoning is associated with the accidental ingestion of sources of lead metal or compounds or the ingestion of feed, usually forage, containing lead usually from pollution of the environment.

#### EPIDEMIOLOGY

##### Occurrence

Lead is one of the most common poisonings in farm animals, especially young cattle. Sheep and horses are also affected but not as commonly. Pigs are not often exposed to lead and appear to be more tolerant to it than other species.

**Cattle.** Data from diagnostic toxicology laboratories illustrate that lead poisoning is the most common toxicosis in cattle.<sup>1,2</sup> The disease occurred most commonly in younger cattle with 52% of the cases reported in animals 6 months of age or less. Approximately 60% of the cases occurred during the summer months from May to August, when the cattle have ready access to lead-containing materials such as crankcase oil and

batteries that are being changed in agricultural machinery. In many countries the incidence of the disease is highest in cattle in the spring of the year a few days after the animals have been turned out onto pasture.<sup>3</sup> Lead poisoning occurs most commonly in young cattle soon after spring turnout when animals gain access to discarded waste materials including batteries, dump oil, oil paint containers, and bonfire ash where painted lumber has been burned.<sup>4</sup> In Alberta, Canada, over a period of 22 years, lead poisoning was the most frequently diagnosed toxicosis of cattle, representing 0.68% of all bovine submissions to the provincial diagnostic laboratories.<sup>5</sup> Young cattle, particularly, are curious and amazingly seem to find sources of lead.

Lead poisoning in cattle is usually due to the accidental ingestion of a toxic quantity of lead over a short period of time. The natural curiosity, licking habits, and lack of oral discrimination of cattle makes any available lead-containing material a potential source of poisoning. Cattle will readily drink crankcase oil, lick machinery grease, and chew batteries. Present-day machinery grease does not commonly contain lead. Compared to earlier times, used crankcase oil may not contain lead if leaded gasoline is banned in a country or region, or if diesel engines are used where lead additive is not utilized in the fuel. In ruminants there is a tendency for metallic lead particles to settle in the reticulum and poisoning results from the gradual conversion of lead particles to soluble lead acetate. Horses, on the other hand, are much more selective than cattle in their eating habits. They usually do not lick old paint cans, lead storage batteries, and peeling paint, nor do they seem to find the taste of used motor oil attractive.<sup>6</sup> Several epidemics of lead poisoning in domestic animals have been recorded throughout the world where the source of the metal was contamination of pasture or crops by nearby industrial lead operation.<sup>6</sup> Animals eating vegetation in these areas may accumulate amounts of lead sufficient to produce clinical signs of lead poisoning.

**Sheep** are usually affected by eating forage contaminated by environmental sources of lead.

**Horses.** Lead poisoning in horses occurs most commonly when they graze lead-contaminated pastures rather than by the accidental ingestion of a toxic amount of lead. Young horses are particularly more susceptible than older horses and cattle grazing on the same pasture. Some cases in horses have been due to ingestion of paint chips from a fence on pasture.<sup>7</sup>

**Buffalo.** Lead poisoning in buffalos has been reported and provides interesting comparative data<sup>8</sup>; they may have a higher tolerance to lead than cattle.

### Morbidity and case fatality

Where groups of animals have access to the same source of lead, outbreaks occur and the morbidity rate ranges from 10 to 30%. The case fatality rate may reach 100% but early intensive therapy can be successful and reduce the figure to less than 50%. In one recorded outbreak, in which a discarded 24-volt battery was accidentally mixed and ground up into the feed of 80 heifers, 55 of the animals died or were destroyed on humane grounds.<sup>9</sup>

### Sources of lead

**Cattle on pasture.** Lead poisoning occurs most commonly in cattle at pasture, particularly if the pasture is poor and the animals are allowed to forage in unusual places, such as rubbish dumps. Phosphorus deficiency may also be a predisposing factor, in that affected animals will chew solid objects as a manifestation of osteophagia. However, cattle on lush pasture may also seek out foreign material to chew. Confined housing of calves with or without overcrowding is often followed by the appearance of pica which may be associated with boredom or mineral deficiency.

**Lead paint and lead batteries.** The common sources of lead are lead-bearing paints and metallic lead. Discarded lead batteries are one of the most common sources of lead poisoning in cattle. In Alberta, Canada, over a period of 22 years, discarded batteries or used crankcase oil accounted for more than 80% of cases for which the source of lead was determined: batteries, 39.5%; used crankcase oil, 31.6%.<sup>10</sup> The batteries are commonly placed in garbage dumps on the farm and, in temperate climate countries, the batteries freeze during the winter months and break open, exposing the plates which are attractive and palatable for cattle to lick and chew.

**Lead contaminated feed.** The contamination of forage supplies with shotgun lead pellets used in hunting and shooting exercises, can serve as a source of lead for cattle grazing the pasture or consuming haylage or silage made from the contaminated field. Automobile batteries have been accidentally added to feed mixers where they are ground by powerful augers and mixed into the feed supply of cattle.<sup>9</sup> Feed accidentally contaminated with lead affected some 15 000 cattle on 330 farms in the Netherlands within a 3-month period.<sup>11,12</sup> Discarded lead-based paint cans are particularly dangerous but fences, boards, and the

walls of pens, painted canvas and burlap are also common sources in calves. Painted silos may cause significant contamination of the ensilage. One outbreak of lead poisoning in cattle was associated with silage containing 1200 mg/kg DM lead which had become contaminated by ash and debris left after burning an old lead-containing electrical cable in the silo before it had been filled.<sup>13</sup>

**Industrial lead.** Metallic lead in the form of lead shot, solder, or leaded windows has been associated with mortalities, although, experimentally, sheet lead is not toxic. Lead sheeting which has been exposed to the weather or subjected to acid corrosion appears to be more damaging, possibly because of the formation of a fine coating of a soluble lead salt. Lead poisoning can be a major hazard in the vicinity of oil fields, and engine sump oil may contain over 500 mg lead per 100 mL. Automotive and other mineral oils are very palatable to young beef calves. In one study, used crankcase oil was the most common source of lead poisoning in cattle, followed by paint, grease, and lead car batteries. As lead use becomes more restricted in many countries, grease and lead contaminated engine oil have become less common sources of lead. Less common but still potent sources of lead are linoleum, roofing felt, putty, automobile oil filters, and aluminum paint. Some of the latter paints contain large quantities of lead, others none at all. Only lead-free aluminum paint should be used on fixtures to which animals have access.

**Lead parasiticide sprays,** particularly those containing lead arsenate, was once associated with heavy losses in cattle grazing in recently sprayed orchards or vegetable crops. These are not commonly used now, except in some countries, but cattle may accidentally ingest old stores of the compound.<sup>14</sup>

### Environmental pollution with lead

Environmental pollution with lead is a common occurrence in cities and on their edges. For farm animals, significant pollution is more likely to occur near smelters or other industrial enterprises, or near major highways where pasture is contaminated by exhaust fumes of automobiles, only if leaded gasoline is still used in the region. Much of the poisoning is subclinical because of the low level of absorption, and any program intending to use domestic animals as monitors of pollution would need to be based on tissue lead levels.

**Lead in pastures near highways.** The lead levels in whole blood of sheep grazing near main highways in three areas of the Nile delta region of Egypt

were 0.062, 0.067, and 0.083 mg/mL (ppm).<sup>15</sup> Pasture adjacent to heavily used roads may carry as much as 390 mg/kg of lead, in contrast to 10 mg/kg on lightly used roads. The concentration of lead on pasture varies markedly with proximity to the traffic, falling rapidly the greater the distance, and with the time of the year. Pastures contaminated by smelters are recorded as carrying 325 mg/kg of lead (equivalent to a daily intake for an animal of 6.4 mg/kg BW). In some locations near lead smelters, lead poisoning is considered to be a predictable occurrence in horses which are allowed to graze on local pastures. As a result horses are either not raised in these areas or hay is imported from other areas. Although ingestion is the principal method of poisoning of animals, inhalation may also be a significant method of entry for cattle grazing close to smelters or highways.

**Lead, cadmium, and zinc.** Lead as an environmental contaminant is often combined with cadmium which has some effects similar to those of lead so that the effects may be somewhat additive. Experimental poisoning with both elements is associated with reduced weight gains in calves at dose levels up to 18 mg/kg BW of each, and clinical signs appear at levels above 18 mg/kg BW of each. Lead is also combined with chromate for industrial purposes. It is not toxic when combined with lead at lead intake levels of 100 mg/kg BW.

Environmental pollution in the vicinity of lead and zinc-ore processing factories can result in varying degrees of poisoning with lead, zinc, and cadmium. These can be monitored by the analysis of blood, hair, and tissues obtained at necropsy.<sup>16,17</sup>

**Lead in human food chain.** There is some concern that toxic levels of lead may occur in the human food chain. Canadian studies of the lead and mercury residues in kidney and liver of slaughter animals have shown that all levels were below the official tolerance level of 2 mg/kg WW for lead and 0.5 mg/kg for mercury. Levels of lead in beef randomly selected from supermarkets in the US were for muscle 0.46, liver 0.50, and kidney 0.45 mg/kg (WW).<sup>18</sup> The upper range of liver levels exceeded the 1 mg/kg WW guideline which may cause for concern about the source of the lead. Moderate exposure of people to meat, including liver and kidney, from animals exposed to lead poisoning is thought not to represent a human health hazard. The biological monitoring of cadmium and lead from contaminated sandy soil into sudan-sorghum hay consumed by pregnant dairy goats over a period of 98 days revealed that only minuscule amounts of soil cadmium and

lead were retained in the selected animal tissues (liver and kidney) via the ingestion of the hay.<sup>19</sup> It was concluded that if these animal tissues were used as food, no deleterious effect to human health would be induced.

#### Lead in blood, milk, kidneys, and liver.

The relationship between lead concentrations in blood of cattle with lead poisoning and those in the milk is exponential.<sup>20</sup> The lead level in milk is relatively constant up to a blood level of 0.2–0.3 mg/L, and increases sharply at higher blood levels. The biological half-life of lead in blood is approximately 9 weeks. Recent studies in six affected dairy herds reported a variable half-life ranging from 48 to 2507 days.<sup>21</sup> A probable reason for this great variance is the ability of the ruminant to retain variable amounts of metallic lead in the rumen which thus acts as a continuing reservoir. Since classical biological half-life studies do not account for variable intake and retention of a persistent reservoir of toxicant, the concept of half-life in dealing with lead-poisoned cattle is likely not accurate. Owners of such cattle should be advised of the potentially long withdrawal period. It may be advisable to test periodically and allow marketing based on actually measured levels, or to estimate the costs of such a plan and consider salvage. This recent work casts doubt on the economic utility of holding recovered animals. In acutely sick cows which were emergency slaughtered, the range of lead levels in edible muscle tissue was 0.23–0.50 mg/kg WW. The concentrations in the kidneys ranged from 70 to 330 mg/kg WW and in the livers 10–55 mg/kg WW.

**Background blood lead** is the concentration of lead in whole blood resulting from the daily exposure to lead which does not produce any clinical evidence of disease.<sup>21</sup> The background levels of blood lead which have been reported ranged from 3 to 50 µg/dL,<sup>22</sup> but most were less than 10 µg/dL. A recent analysis of 266 blood samples from dairy cattle submitted to the diagnostic laboratory at the New York State College of Veterinary Medicine, for reasons other than heavy metal toxicity, indicated that 259 (97%) had levels lower than minimum detectable level of 2.5 µg/dL (0.025 ppm).<sup>22</sup> Six had concentrations between 2.6 and 5.8 and one had 10 µg/dL. Blood lead concentrations in cows with lead poisoning ranged from 56.4 to 1390.0 µg/dL.

#### Toxic levels of lead

The toxic level of lead varies between species and the chemical composition of the compound containing lead may influence its toxicity. Lead acetate is very

soluble and more toxic than insoluble lead oxide, or solid lead sheeting.

**Acute lethal single doses.** In calves, acute single lethal doses range from 400 to 600 mg/kg body weight (BW), in adult cattle 600–800 mg/kg and for goats 400 mg/kg. The acute dose for horses is less than for ruminants, one horse having survived 1000 mg/kg BW on two occasions 6 months apart. Pigs are also less susceptible but single lethal dose levels are not recorded. Buffalo calves given a single oral dose of 600 mg/kg BW of lead acetate died within 120 hours.<sup>23</sup>

Young animals, e.g. milk-fed calves, are more susceptible. A daily intake of 2.7 mg/kg BW of lead can be associated with the death of calves fed a milk diet in 20 days or less, while 5 mg/kg BW of lead is consistently associated with signs of poisoning or death within 7 days. The absorption rate of lead is rapid and tissue depositions are high in calves on a milk replacer diet and given lead. In toxicity studies, calves on a milk diet absorb lead much more quickly than calves fed a grain diet. The addition of lactose to a grain diet will also increase the absorption of lead.

**Daily dose levels likely to lead to chronic poisoning** are important because of the impact that contamination of the environment by industrial effluents has had. Daily dose levels likely to lead to chronic plumbism in cattle are 6–7 mg/kg BW (equivalent to 100–200 mg/kg DM of diet). This dose level must be close to the definitive point because dose levels of 100 mg/kg (in diet) may be without effect. A dose level of 15 mg/kg BW results in the loss of weight gain and normochromic anemia. In sheep, dose levels of more than 4.5 mg/kg BW are necessary to produce a toxic effect. Horses are more susceptible to the daily administration of lead, 100 mg/kg BW producing toxic effects in 28 days. A dose rate of 15–30 mg/kg BW of lead for up to 190 days is associated with toxicity and some deaths, and deaths are recorded on pastures carrying 100–300 mg/kg on foliage. Pigs appear to be more resistant, and daily doses of 33–66 mg/kg BW are required for periods of up to 14 weeks to produce fatal effects, a more serious end-point than for the other dose rates quoted.

#### PATHOGENESIS

Regardless of the chemical form of the ingested lead, only a small proportion is absorbed because of the formation in the alimentary tract of insoluble lead complexes which are excreted in the feces. For example, only 1–2% of lead ingested as lead acetate or carbonate is absorbed from the alimentary tract of sheep. Of the

lead absorbed, some is excreted in the bile, milk, and urine and the blood levels of lead provide a reliable indication of the lead status of the animal. Urine levels may not be as reliable. Deposition in tissues occurs, particularly in the liver and renal cortex and medulla in acute poisoning and in the bones in chronic poisoning. The deposition of lead in the brain is not high compared to other tissues but deposited lead is gradually liberated from tissues into the bloodstream and excreted via the bile and urine. Consideration must be given to these aspects of lead metabolism when assessing the results of chemical analyses of tissues.

Although acute lead poisoning usually develops rapidly there may be a delay of several days after toxic material has been ingested before clinical signs appear.

#### Toxic effects of lead

The toxic effects of lead are manifested in three main ways:

- Lead encephalopathy
- Gastroenteritis
- Degeneration of peripheral nerves.

In general, acute nervous system involvement occurs following the ingestion of large doses in susceptible animals such as calves, alimentary tract irritation following moderate doses, and peripheral nerve lesions following long-term ingestion of small amounts of lead. The nervous signs of encephalopathy and the lesions of peripheral nerve degeneration are due to the degenerative changes of nervous system tissue. Lead localizes principally in the cytoplasm of capillary endothelial cells and these localizations are later associated with the development of edema. The basic lesion is likely to be vascular with a basic change in transport mechanisms between the blood and brain.<sup>24</sup> Gastroenteritis is associated with the caustic action of lead salts on the alimentary mucosa. Ruminant atony occurs in cattle and sheep and initially is associated with scant feces, followed later in some cases by diarrhea due to gastroenteritis. The rumen protozoa in cattle with acute lead poisoning are commonly absent or inactive. Peripheral nerve degeneration occurs principally in horses.

The lesions, including degeneration of the liver and kidney, vary in their severity with the tissue levels of lead attained. Lead does not remain in tissues for long periods except in bone where it is deposited in an inert form, but from which it can be liberated at a later date in sufficient quantities to be associated with chronic lead poisoning. This is particularly likely to occur during periods of acidosis.

**The blue 'lead-line' at the gum-tooth junction**, which is seen in man and the

dog does not commonly occur in ruminants because of failure to form tartar but may be present in the horse. The 'lead-line' is a deposit of lead sulfide formed by the combination of lead with sulfide from the tartar.

**Lead is transferred across the placental barrier** and high liver levels occur in the lambs of ewes fed more than normal amounts of lead. Calves born from cows experimentally poisoned with lead have elevated levels of lead in bone, kidney, and liver. In a naturally occurring case of lead poisoning in a pregnant heifer, the blood and liver concentrations in the fetus were 0.425 ppm and 4.84 ppm, respectively, which was 72% and 84% of the same tissue lead concentrations of the dam.<sup>25</sup> Hepatic lysosomes of the fetus contained metallic electron densities which may have been lead.

The pathogenesis of the **osteoporosis in young lambs** with chronic lead poisoning has not been explained, nor has the paresis and paralysis of lambs which occur in the same circumstances. The paralysis in the former condition is caused by compression of the spinal cord by collapsed lumbar vertebrae.

**Anemia may occur in chronic lead poisoning.** The erythrocytes are microcytic and hypochromic, and reticulocytosis and basophilic stippling may be observed. However, basophilic stippling is non-specific and probably does not correlate well with levels of lead exposure. The basophilic stippling of erythrocytes is usually an indication of bone marrow response to anemia, although it can occur, rarely, in chronic lead poisoning. It may be related to the effects of lead on pyrimidine nucleotidase activity. The anemia in chronic lead poisoning is associated with two basic defects: a shortened erythrocyte lifespan and impairment of heme synthesis. Lead is associated with an increased concentration of protoporphyrin by inhibiting heme synthetase, the enzyme which combines protoporphyrin and iron to form heme. The measurement of free erythrocyte porphyrin is considered to be a sensitive indicator of chronic lead poisoning in calves. Lead is also associated with an inhibition of the enzyme delta-aminolevulinic acid dehydratase (ALA-D), resulting in a failure of utilization of delta-aminolevulinic acid which is excreted in increased quantities in the urine.

## CLINICAL FINDINGS

### Cattle

Both acute and subacute poisoning occurs in cattle. The acute form is more common in calves and the subacute form in adults.

**In the acute form** there is usually a sudden onset of signs and a short course of

12–24 hours so that many animals, especially those at pasture, are found dead without signs having been observed. **Staggering**, and **muscle tremors** particularly of the head and neck, with **champing of the jaws (chewing gum fits)** and frothing at the mouth are obvious. Snapping of the eyelids, rolling of the eyes and bellowing are common. Blindness and cervical, facial and auricular twitching are consistent in acute lead poisoning of cattle. The animal eventually falls and intermittent tonic-clonic convulsions occur and may continue until death. Pupillary dilatation, opisthotonos and muscle tremor are marked and persist between the convulsive episodes. There is hyperesthesia to touch and sound, and the heart and respiratory rates are increased. In some cases, particularly in adults, the animal remains standing, is blind, maniacal, charges into fences, attempts to climb or jump over walls, and head-presses strongly against walls or fences. Frenzy is common and some animals appear to attack humans but the gait is stiff and jerky and progress is impeded. Death usually occurs during a convulsion and is due to respiratory failure.

**In the subacute form** the animal remains alive for 3–4 days. There is dullness, total anorexia, blindness, and some abnormality of gait including incoordination and staggering, and sometimes circling. The circling is intermittent and not always in the same direction and usually occurs when the animal is confined in a small space like a box stall. Muscle tremor and hyperesthesia are common but not as pronounced as in the acute form. Grinding of the teeth is common, excessive salivation may occur, and mild abdominal pain may be seen occasionally. Alimentary tract dysfunction is one of the most common abnormalities. Ruminal atony is accompanied by constipation in the early stages. Later a fetid diarrhea occurs in most cases.

The animal presents a picture of extreme dullness, will not eat or drink, and stands immobile for very long periods. Death frequently occurs by misadventure, the animal walking blindly into a waterhole or being trapped in a fence or between trees. In other circumstances the animal becomes recumbent and dies quietly. In both the acute and subacute forms, the palpebral eye preservation reflex is absent or markedly diminished. This is a useful distinguishing feature from polioencephalomalacia in which this reflex is usually normal. Edema of the optic disc may be present but is not common.

**Experimental lead poisoning in young milk-fed calves**, initially is characterized

by severe depression and hypoglossal paresis which interferes with sucking. Within the next 12–24 hours, the calves become unsteady, ataxic, and exhibit muscular tremors of the head and forelimbs and finally convulsions, opisthotonos; they die in respiratory failure during status epilepticus.

### Sheep

Lead poisoning in sheep is usually manifested by a subacute syndrome similar to that seen in adult cattle. There is anorexia and scant feces followed by the passage of dark, foul-smelling feces. Weakness and ataxia follow, often with abdominal pain, but there is no excitement, tetany, or convulsions. Polyuria occurs when the intake of lead is small but with large amounts there is oliguria.

Although ruminants are relatively resistant to chronic lead intoxication, two syndromes of posterior paresis have been described in young lambs in old lead-mining areas and tissue levels of lead are abnormally high in both instances. In both syndromes there is impairment of the gait. Osteoporosis is present in one but in the other there is no suggestion of skeletal changes. In the osteoporotic disease the signs occur only in lambs 3–12 weeks of age and never in adults. There is stiffness of gait, lameness, and posterior paralysis. Affected lambs are unthrifty and the bones, including the frontal bones, are very fragile. The paralysis is caused by lesions of the vertebrae, usually affecting one or more of the lumbar bones, and resulting in compression of the spinal cord. In the other form, gait abnormalities occur in the same lamb age group and are manifested initially by incomplete flexion of the limb joints so that the feet drag while walking. In a later stage the fetlocks are flexed, the extensor muscles paretic, and the lamb soon becomes recumbent. Recovery is common, although many lambs die of intercurrent disease.

Chronic ingestion of metallic lead by pregnant sheep can be associated with abortion and transitory infertility.<sup>26</sup>

### Horses

Horses are not commonly affected by lead poisoning, although the chronic form occurred occasionally in the vicinity of lead mines and processing works.<sup>27</sup> The clinical findings are extremely variable.<sup>7</sup> A roughened hair coat, pharyngeal dysfunction, and weight loss were the most common clinical findings in 10 case reports involving a total of 68 animals.<sup>7</sup> Some horses died without any previous clinical illness but where clinical signs are apparent they were usually distinct and dramatic rather than subtle. Inspiratory dyspnea associated with paralysis of the recurrent laryngeal nerve is the most

common finding. This may be accompanied by pharyngeal paralysis in which recurrent choke and regurgitation of food and water through the nostrils occur. Aspiration pneumonia may result after inhalation of ingesta through the paralyzed larynx. Paralysis of the lips occasionally accompanies the other signs. General muscle weakness and stiffness of the joints occur commonly and the hair coat is usually harsh and dry. When chronic poisoning with both lead and zinc occurs the signs in zinc poisoning predominate despite high lead levels in liver and kidney. In experimental chronic lead poisoning in horses, there is noisy breathing constantly, but no lesions in the pharynx or larynx. Muscle fasciculations over the triceps are prominent in some horses and recumbency and convulsions may occur.<sup>7</sup>

When large amounts of lead are ingested by horses a syndrome similar to that of the subacute form in cattle occurs. There is complete anorexia, severe nervous depression, partial paralysis of the limbs followed in most cases by complete paralysis and recumbency. Mild-to-severe abdominal pain and clonic convulsions may also occur. The response to experimental lead poisoning in the horse is highly variable.<sup>7</sup> The dose-response effect is highly variable and unpredictable.

### Pigs

Early signs include squealing as though in pain, mild diarrhea, grinding of the teeth, and salivation. The disease is usually a prolonged one and listlessness, anorexia, and loss of weight develop followed by muscle tremor, incoordination, partial or complete blindness, enlargement of the carpal joints, and disinclination to stand on the front feet. Convulsive seizures occur in the terminal stages.

### Subclinical lead poisoning

Because of the present concern about environmental pollution, the effects of the chronic low-level intake of lead have been examined and defined. In cattle, at intake levels below those which are associated with clinical signs, there are metabolic changes and changes in blood variables accompanied by a decreased rate of growth.<sup>28</sup> One concern is that continuous low-level consumption by pregnant females will result in teratogenic effects in the newborn. Trials to detect this manifestation in ewes have shown no effect on their lambs.

### CLINICAL PATHOLOGY

In the living animal which has ingested lead, the element can be detected in blood, feces, urine, and milk.

### Blood lead

The estimation of blood levels is generally useful for determining the lead status of

the animal and is used most frequently to support or refute a clinical diagnosis of lead poisoning. Bovine blood lead reference materials are available and have been certified for many years.<sup>29</sup> Whole blood levels of lead in normal ruminants are usually below 0.05–0.25 ppm; poisoned animals usually have levels above 0.35 ppm and deaths begin at 1.0 ppm. Interestingly, buffalo may have blood levels above 1.0 ppm and still survive, which suggests that they have a higher tolerance level than cattle. However, when used alone, blood lead concentrations do not permit evaluation of length of exposure, amount of lead deposition in the body or the effects of lead on physiological systems. Blood lead concentrations also fluctuate markedly after administration of lead and consequently the clinical importance of blood lead concentrations is often questionable and a diagnosis based on this single determinant is equivocal. Blood lead concentration also has limited value for assessing the effectiveness of therapy for lead poisoning. Blood level concentrations may change rapidly during chelation therapy, often decreasing by 50% or more within 24 hours after initiation of treatment despite certain body tissues still containing high concentrations of lead. Thus the evaluation of biochemical indicators such as ALA-D may be useful. The blood and liver levels of fetuses from pregnant cattle with lead poisoning may be higher than what are considered toxic levels in adults which suggests concentration in the fetus.<sup>25</sup>

Representative values of lead for normal and poisoned animals are summarized in Table 32.2. The levels found in the liver and the kidneys are presented under necropsy findings.

### Milk lead

Only limited information is available on the concentrations of lead which occur in cattle affected with field cases of lead poisoning. Lead levels of 0.13 mg/L of milk have occurred in natural cases with a half-life of 4.6 days.<sup>12</sup> The regulatory limit for lead in bovine milk in the Netherlands is 0.05 mg/L milk. In acute lead poisoning in lactating buffalo pastured near smelters in India, the lead concentrations in milk were 1.13 ppm compared to 0.24 ppm in the milk from buffaloes in unpolluted

areas.<sup>8</sup> The mean lead concentrations in the forage of poisoned animals were 706 ± 73.0 ppm, compared to the unpolluted area of 78 ± 12 ppm.

### Fecal lead

Fecal levels of lead represent unabsorbed and excreted lead deriving from the bones, and are of limited value unless considered in conjunction with blood levels because ingested lead may have been in an insoluble form and harmless to the animal. When fecal levels are high it can be assumed that the lead has been ingested in the preceding 2–3 weeks but high blood levels may be maintained for months after ingestion. Thus high blood and low fecal levels indicate that the lead was taken in some weeks previously but high blood and high fecal levels suggest recent ingestion and significant absorption.

### Urinary lead, ALA-D

Urine lead levels are variable, rarely high (0.2–0.3 mg/L), and although elevated urine levels are usually associated with high blood levels, this relationship does not necessarily hold.

Because of some of the limitations of blood lead, other indirect measurements of lead poisoning, such as the levels of **delta-aminolevulinic acid dehydratase (Delta-ALA-D)** in blood, are being used to supplement blood lead determinations.<sup>30</sup> For example, the best method of detecting the presence of lead poisoning in its early stages, except in the horse, is the estimation of ALA-D in the blood. At dietary intakes as low as 15 mg/kg DM of lead in cattle there are detectably lowered levels of ALA-D. At the same time, the urinary levels of **delta aminolevulinic acid (Delta-ALA)** are increased. **Delta-ALA-D** is important in the synthesis of heme and is probably the most sensitive enzyme in the heme pathway. Inhibition of the enzyme results in a block in the utilization of delta-ALA, a subsequent decline in heme synthesis and a marked increase in the urinary excretion of delta-ALA. In cattle, sheep, and pigs affected with chronic lead poisoning, the plasma levels of **delta-ALA-D** are decreased and the urinary levels of **delta-ALA** are increased before clinical signs are detectable. In sheep, erythrocyte **delta-ALA-D** is recommended as the most sensitive diagnostic test available.

Table 32.2 Lead levels in blood and feces of normal and poisoned animals

Specimen	Lead levels (ppm)	
	Normal	Poisoned
Whole blood (ruminants and horses)	0.05–0.25	More than 0.35 (deaths commence at 1.0)
Whole blood (pigs)	0.05–0.25	1.2
Feces (dry matter) (cattle)	1.5–35	Up to 1000
Pasture		350

The disadvantages of the assay for blood delta-ALA-D include age-related variations particularly in calves; the methods used for analysis are not yet uniform and blood must be collected in polystyrene or polyethylene tubes rather than glass tubes and an anticoagulant other than EDTA must be used. The levels of delta-ALA-D increase in calves from birth to 10 weeks of age and age-matched controls should be evaluated simultaneously when conducting the test in calves of under 6 months of age.<sup>30</sup> In cattle under 1 year of age, delta-ALA-D values of less than 200 mmol of porphobilinogen (PBG)/mL of RBC/hour should raise suspicion of their having ingested lead. In this same age range values below 100 mmol would confirm ingestion of lead. In cattle equal to or less than 2 years of age, values of delta-ALA-D of less than 100 mmol of PBG/mL of RBC/hour would indicate ingestion of lead. Severe inhibition of delta-ALA-D occurs rapidly in calves given 1 mg of lead/kg BW per day or 5 mg of lead/kg BW/d. Inhibition of delta-ALA-D will reach approximately 50% of pre-exposure levels when blood lead concentrations are above 0.5 mg/kg, and if the initial dose of lead increases blood lead concentration above 0.5 mg/kg the delta-ALA-D becomes maximally depressed and remains so with continued exposure. The delta-ALA-D is so sensitive to lead that it remains inhibited even after lead exposure has ceased. Following treatment with a chelating agent the blood lead levels will often decline giving a false indication of a positive treatment effect. If the delta-ALA-D levels do not decrease following therapy, it indicates that there is sufficient lead present to continue to depress the enzyme. In summary, the evaluation of delta-ALA-D and blood lead concentrations together can assist in resolving diagnostic situations in which the blood lead concentration is in the questionable range of 0.25–0.35 ppm.

#### Erythrocyte protoporphyrin

The levels of free erythrocyte zinc protoporphyrin increase in lead poisoning and this is indicative of the chronic metabolic effect of lead on the erythroid cells being released from bone marrow into the peripheral circulation.<sup>5</sup> A mean value of 21.56 µg coproporphyrin/100 mL of erythrocytes has been determined. It may be of some value along with determinations of blood lead and delta-ALA-D. The use of delta-ALA-D activity and erythrocyte protoporphyrin content as cumulative lead exposure indicators in cows environmentally exposed to lead is recommended.<sup>31</sup> Plasma exposed to ultraviolet light may fluoresce due to high concentrations of porphyrins, and this may be a useful early diagnostic test.

#### Environmental lead

Because of the frequency with which lead appears in the environment as a pollutant, there is often concern for the validity of the normal values for establishment of a diagnosis. In the average city-polluted atmosphere it seems that lead intake will be significantly elevated. The lead content of hair of cattle and horses, and of the wool of sheep, is reported to be raised significantly in poisoned animals but hair is not routinely used in diagnosis of acute poisoning. However, the lead content of hair when cattle are exposed to long-term ingestion as a result of industrial contamination can reach as high as 88 mg/kg (in a clean environment comparable figures are of the order of 0.1 mg/kg). There is likely to be a seasonal variation in deposition and intake of lead. Hair is also a valuable source of information on environmental pollution with cadmium, copper, and zinc.

#### Hematology

In chronic lead poisoning, hematological examination may reveal a normocytic, normochromic anemia in some and, although basophilic stippling does not occur often enough to be diagnostic, it is recorded in some experimental poisonings. It is recorded as occurring in lead-exposed pigs and a horse. In some, poikilocytosis and anisocytosis were marked.<sup>22</sup> The cerebrospinal fluid (CSF) is approximately normal with slightly elevated leukocyte numbers but no increase in protein or other biochemical components.

#### NECROPSY FINDINGS

In most acute cases there are no gross lesions at necropsy. In cases of longer standing there may be some degree of abomasitis and enteritis, diffuse congestion of the lungs and degeneration of the liver and kidney. Epicardial hemorrhages are common. Congestion of meningeal and cerebral vessels may also be observed and hemorrhages may be present in the meninges. An increase in cerebrospinal fluid is often recorded but is of minor degree in most cases. In chronic cases gross lesions are recorded in cattle.<sup>24</sup> These include cerebrocortical softening, cavitation and yellow discoloration with most severe lesions in the occipital lobes. Histological lesions were most severe at the tips of the gyri. Similar lesions were produced experimentally. Acid-fast inclusion bodies deep in the renal cortex have diagnostic significance. Examination of the contents of the reticulum in ruminants for particulate lead matter is essential. Flakes of paint, lumps of red lead, or sheet lead usually accumulate in this site. Their absence is not remarkable especially if animals have licked fresh paint but their presence does give weight to the provisional diagnosis.

#### Liver and kidney lead

The submission of alimentary tract contents and tissues for analysis forms an important part of the diagnosis of lead poisoning but results must be interpreted with caution.

**Cattle:** 25 mg/kg of lead WW (wet weight) in kidney cortex is diagnostic and is a more reliable tissue for assay than liver which may contain 10–20 mg/kg WW. The concentrations in kidney are always much higher than in liver.<sup>13,23</sup> A diagnostic laboratory found mean levels in livers of poisoned cattle of 93.3 µg/g WW weight, and 437.7 µg/g in kidneys.<sup>1</sup> Tissue lead levels in cattle from industrial areas are significantly higher (liver 0.23 mg/kg WW, kidney 0.42 mg/kg WW) than in cattle from clear air zones (liver and kidney less than 0.1 mg/kg WW). Tissues which have been fixed in formalin are useful when they are the only tissues available.

**Horses:** Levels of 4–7 mg/kg WW of lead have been found in the livers of horses dying of chronic lead poisoning but 25–250 mg/kg are more likely, and 40 mg/kg WW may occur in the livers of affected pigs. Mean levels in livers of poisoned horses are 5.5 µg/g WW.<sup>1</sup>

#### Samples for confirmation of diagnosis

- **Toxicology** – 50 g liver, kidney, and reticulum content (ASSAY (Pb))
- **Histology** – formalin-fixed cerebral cortex, kidney (LM).

#### DIFFERENTIAL DIAGNOSIS

In all cases, much importance must be attached to the possibility of access to lead and the environmental circumstances which may arouse suspicion of other poisonings or errors in management. Estimation of the lead content of blood and feces should be carried out at the earliest opportunity and tissues from necropsy specimens submitted for analysis.

#### Cattle

Lead poisoning in cattle must be differentiated from the common diseases of the nervous system of cattle and other diseases in which neurological signs occur. The differential diagnosis of brain dysfunction and lead poisoning in cattle is summarized in Table 32.3. The diseases which closely resemble bilateral blindness are as follows: **Rabies** characterized by normal eyesight, incoordination, gradual ascending paralysis, inability to swallow, bellowing and death in 4–7 days.

**Polioencephalomalacia** characterized by sudden onset of blindness, normal palpebral reflexes to touch, head pressing, tremors of head and neck, nystagmus, normal ruminal contractions.

**Hypovitaminosis-A** characterized by blindness, dilated and fixed pupils, optic disc edema, convulsions followed by recovery.

**Ophthalmitis** characterized by blindness due to lesions of the eyes but normal mentation.

**Other diseases** in which blindness is not characteristic but tremors, ataxia, convulsions, and bizarre behavior occur include: hypomagnesemic tetany, nervous ataxonia, arsenic poisoning, *Claviceps paspali* toxicity, meningoenkephalitis.

#### Horses

Lead poisoning in horses must be differentiated from diseases causing loss of body weight, muscle fasciculations, incoordination, roughened hair coat, laryngeal and pharyngeal dysfunction. The differential diagnoses of diseases of the nervous system of the horse are summarized in Table 22.1. The diseases most closely resembling lead poisoning in horses include: Laryngeal hemiplegia  
Viral encephalomyelitis, including West Nile virus  
Rabies  
Hepatoencephalopathy due to hepatotoxic plants  
Equine degenerative myeloencephalopathy  
Protozoal encephalomyelitis  
Equine motor neuron disease  
Horsetail poisoning  
Chronic weight loss  
Chronic upper respiratory tract disease  
Botulism  
Fumonisin toxicosis (equine leucoencephalomalacia)

#### Sheep

The chronic forms of lead poisoning in lambs must be differentiated from other forms of posterior paralysis, particularly:

- **Enzoitic ataxia due to copper deficiency**
- **Polyarthritis** due to bacterial infection
- **Enzoitic muscular dystrophy** which may be associated with lameness and paresis but may be distinguished clinically by careful examination of the joints and skeletal muscles.

## TREATMENT

### Sedation and care

The case fatality rate of acute lead poisoning of cattle is high because of their high susceptibility and the nature of the material ingested. Sedation by IV injection of anesthetic doses of pentobarbital sodium in calves and chloral hydrate in adults temporarily relieves the convulsions.

### Calcium versenate

Calcium versenate (calcium disodium ethylenediamine tetra-acetate, CaEDTA) has been used successfully in cases of lead poisoning produced experimentally in calves and in natural cases in cattle. CaEDTA is available as a 6.6% solution for IV administration. The manufacturer's recommendations are to use 1 mL/kg BW per day given in divided doses 2–3 times daily over a period of 3–5 days. Based on the treatment of experimentally induced lead poisoning in calves, the optimum conditions for lead mobilization in calves are provided by concentrations of about

135  $\mu$ mol EDTA/mL, or higher, maintained for 10–12 hours. This is attained by the IV infusion of calcium EDTA at a dose of 110–220 mg/kg BW over 12 hours, which is approached by rapid IV injections of two doses of 110 mg/kg BW weight, 6 hours apart. This can be done daily for 3–5 days.

CaEDTA removes lead directly from bone-sensitive sites and not from parenchymatous organs because cell membranes form a barrier to the therapeutic removal of intracellular lead. The lead is removed from soft tissues by equilibration with bone. The process takes time and thus necessitates multiple treatment. Thus it is recommended that calcium versenate be given on alternate days to allow redistribution of lead from soft tissues to available bone sites. An increase in the heart and respiratory rates and the development of muscle tremors during injection indicates a toxic reaction but can be avoided by slow administration. Recovery may take 5–15 days and parenteral or stomach tube alimentation may be required. Blindness may persist for several days after general recovery and may continue indefinitely. Dramatic improvement has also been reported in cases of chronic lead poisoning in horses after the use of calcium versenate.

### Thiamin hydrochloride

In combination with CaEDTA, thiamin is now being used for the treatment of lead poisoning.<sup>32</sup> Thiamin hydrochloride reduced the deposition of lead in most tissues especially liver, kidney, and the central and peripheral nervous system of experimentally poisoned calves. However, the levels of erythrocyte delta-aminolevulinic acid dehydratase (ALA-D) activity were decreased by 70% from pretreatment levels which indicated that thiamin had no protective effect on the ability of lead to inhibit the enzyme.<sup>33</sup> In experimental lead poisoning in mature dairy cows, the use of thiamin was not successful in reducing blood lead concentration, but treatment with disodium CaEDTA and thiamin was effective.<sup>33</sup> The use of thiamin also induced a remission of clinical signs of lead poisoning in cattle. Thus thiamin increases the elimination of lead from the body and may be beneficial in chelation therapy.

In naturally occurring cases in cattle, the use of thiamine and CaEDTA increases urinary lead output nearly a thousand times the untreated urinary level.<sup>24</sup> The blood and urinary lead half-lives with CaEDTA and thiamine therapy were 2.08 and 1.38 days, respectively.<sup>25</sup>

In experimental lead poisoning in calves, thiamin at 25 mg/kg BW SC BID cured 50% of affected calves.<sup>34</sup> The same dose of thiamin combined with

110 mg/kg BW of calcium versenate IV BID cured 100% of affected calves which had been given lead acetate at 5 mg/kg BW orally until clinical signs occurred. CaEDTA chelates lead from blood and bone while thiamine chelates lead in soft tissues and restores lead-induced biochemical alterations.<sup>34</sup>

In experimental lead poisoning in laboratory rats and mice, thiamin at a dose of 25 or 50 mg/kg BW along with CaEDTA at 50 mg/kg BW was more effective than the respective individual treatments alone.<sup>31,35</sup> Thiamin alone decreased the blood, liver, and kidney concentrations of lead, and thiamin at 50 mg/kg BW reduced the tissue concentrations in tissues more effectively than 25 mg/kg BW.

In experimental lead poisoning in sheep, the use of thiamin at 75 mg/kg BW SC along with CaEDTA at 100 mg/kg BW IV, increased the excretion of lead via the bile and urine. Overall, thiamin, CaEDTA, and thiamin and CaEDTA increased lead excretion by 72%, 595%, and 842%, respectively over basal levels.<sup>36</sup> It appears that thiamin can mobilize intracellular lead into blood and increase lead excretion via bile and urine.

### Rumenotomy

Rumenotomy to remove the ingested lead has been used but may be unsatisfactory because of the difficulty of removing particulate material from the recesses of the reticular mucosa. However, it may be appropriate when a valuable animal is affected and it is known that the animal ingested a certain compound of lead which may be removable from the reticulum and rumen. Oral dosing with small amounts of magnesium sulfate has been used on the basis that soluble lead salts will be precipitated as the insoluble sulfate and excreted in the feces. However, the lead is often present in large quantities and in the form of particles which are only slowly dissolved.

### Public health aspects of lead in meat and milk

A major concern with the treatment of lead poisoned animals, particularly food-producing animals, is the assurance that the edible tissues of recovered animals do not contain toxic levels of lead. The length of time required after successful treatment of cattle with typical clinical lead poisoning before such animals can be sent to slaughter or before the milk can be used safely is not known. It is suggested that treated animals should be appropriately identified and blood lead levels determined once or twice monthly for several months. When the blood lead levels have dropped to background levels for three consecutive samplings at least 2 weeks apart, the animals are assumed



Table 32.3 Differential diagnosis of diseases of cattle with clinical findings referable to brain dysfunction

Disease	Epidemiology	Clinical findings	Clinical pathology and pathology	Response to treatment
Lead poisoning	All ages calves and cows on pasture with access to dumps. Discarded lead batteries, used crankcase oil, lead-based paint common sources. Case fatality rate high	Acute in calves. Blindness and 'chewing gum' champing of jaws, convulsions, charging, rapid death. Subacute in adults: blindness, stupor, head-pressing, grinding teeth, rumen static, protozoa dead	Blood and tissue for lead. Encephalomalacia	Will respond favorably to treatment in early stages if not too severe but most cases do not return to normal. Calcium versenate and thiamin hydrochloride. Must be concerned about disposition of meat and milk of treated animals
Polioencephalomalacia	Grain-fed rapidly growing feedlot cattle. May occur on pasture containing plants and water high in sulfates. Outbreaks occur	Sudden onset, blindness, tremors and shaking of head, twitching of ears, head-pressing, opisthotonos, nystagmus, strabismus, rumen contractions normal, CSF pressure increased	Blood biochemistry (see text). Brain for histopathology	Responds to thiamin in early stages. Those due to sulfate toxicity may not respond
Hypovitaminosis A	Calves 6–8 months of age most commonly but mature cows too off dry summer pasture (CSF form). Young rapidly growing cattle fed deficient ration for several months (ocular form)	CSF form: sudden onset; syncope and convulsions followed by recovery, eyesight and pupils normal. Nyctalopia. CSF pressure increased. Ocular form: blindness in daylight, pupils dilated and fixed, optic disc edema. Syncope and convulsions may also occur. Usually preceded by nyctalopia but missed by owner	Plasma and liver vitamin A. Optic nerve constriction. Squamous cell metaplasia of parotid ducts	CSF form: recover in 48 hours following treatment with vitamin A injections. Ocular form: will not recover because of optic nerve degeneration
<i>Haemophilus meningoen­cephalitis (thromboembolic meningoen­cephalitis)</i>	Feedlot cattle (8–12 months), outbreaks, preceded by respiratory disease in group. High case fatality if not treated early	Found down, fever common, ataxic, not usually blind, fundic lesions, irritation signs uncommon, weakness and paresis common, synovitis, laryngitis, pleuritis, May die in 8–10 hours. Myocardial abscesses may also occur	Neutrophilia CSF contains neutrophils. Typical gross lesions in brain. Pleuritis, pneumonia, synovitis, myocardial abscesses	Respond favorably to antimicrobials if treated early. Later, high case fatality rate
<i>Listeria meningoen­cephalitis</i>	Sporadic. Fed silage. Yearlings and adults	Unilateral facial paralysis, deviation of head and neck, mild fever, endophthalmitis, may be recumbent	CSF for cells. Brain for histopathology	Recovery may occur. Antimicrobials. Residual signs in survivors common
Nervous signs with coccidiosis (see text)	In 20% of young cattle affected with dysentery due to coccidiosis. Case fatality may exceed 50%	Tonic-clonic convulsions, normal eyesight, hyperesthesia, normal temp., dysentery, may live 2–4 days	Oocysts in feces	Unfavorable response to treatment. Must control coccidiosis
Rabies	Cattle exposed to wildlife, one or more affected, all ages, incubation 3 weeks to few months	Quiet and dull (dumb form) or excitable and easily annoyed (furious form). Bellowing, yawning, drooling, saliva, eyesight normal, tenesmus, ascending paralysis beginning with anesthesia over tail head, progressive course, dies in 4–6 days, usually no gross muscular tremors or convulsions, mild fever early	Hemogram normal. Brain for laboratory diagnosis	Nil
Bovine spongiform encephalopathy (BSE)	Mostly in dairy cattle; Epizootic began in Britain in 1986; long incubation period; caused by scrapie-like agent in protein concentrate made from sheep carcasses following change in processing procedures	Insidious onset, clinical course several weeks, change in behavior, hyperesthesia, ataxia, loss of body weight, stare, agnostic behavior, kick during milking, knuckling, falling, progressive weakness leading to recumbency	Nil	Nil
Pseudorabies	Disease of pigs transmitted to cattle by bites.	Intense, local pruritus at site of bite, excitement, bellowing, convulsions, paralysis, death 2–3 days	Tissues for injection into rabbit. Histopathology of brain	Nil
Hypomagnesemic tetany (lactation tetany)	Lactating dairy cows on lush pasture, late pregnant beef cows, cold, windy weather in spring. May be precipitated by long transportation or deprivation of feed and water. Outbreaks occur. Seen in yearlings too. Case mortality can be high	Acute: sudden onset of irritability, hyperesthesia; convulsions, recumbency, loud heart sounds, tachycardia, polypnea. Subacute: gradual onset (2–4 days), hyperirritable, difficult to handle, stilted gait, falling, stumbling, sudden movement may precipitate convulsion	Serum magnesium level slow	Responds to magnesium sulfate early

Table 32.3 (Cont'd) Differential diagnosis of diseases of cattle with clinical findings referable to brain dysfunction

Disease	Epidemiology	Clinical findings	Clinical pathology and pathology	Response to treatment
Nervous acetonemia	2–6 weeks postpartum. High-producing cow. Single animal	Sudden onset, bizarre mental behavior, chewing, licking, bellowing, hyperesthesia, sweating	Ketonuria, hypoglycemia	Responds to glucose parenterally and/or propylene glycol orally
Bovine bonkers (Bovine hysteria)	Mature cattle and calves consuming ammoniated feeds (lucerne hay, bromegrass hay, fescue hay, wheat hay, maize stalks or silage). May also occur when animals have access to molasses-urea-protein blocks. Toxic agent may be substituted imidazole formed by combination of soluble carbohydrates and ammonia. Usually occurs when high quality forage treated with ammonia concentrate of more than 3% dry matter by weight. Can occur in nursing cows fed ammoniated feedstuffs	Periodic episodes of hyperexcitability, bellowing, running, charging, circling, convulsions, weaving, episodes last 30 seconds and may recur every 5–10 minutes. Some die. Most recover following removal of feed	Information not available	Recover spontaneously following removal of feed source
Hepatic encephalopathy (i.e. ragwort poisoning)	Cattle with access to plants containing pyrrolizidine alkaloids. Many cattle may be affected	Loss of body weight, gradual onset of aggressive behavior, ataxia, muscular tremors, recumbency, convulsions, tenesmus and bellowing	Hyperbilirubinemia, decreased excretion of BSP. Liver lesions	No treatment
Brain abscess	Sporadic, young cattle (6 months to 2 years of age) may have history of previous infections	Localizing signs, rotation or deviation of head and neck, loss of equilibrium, circling, mild fever, may be blind in one eye, nystagmus one eye	Neutrophilia, neutrophils in CSF	Unfavorable response to therapy
Enterotoxemia due to <i>Clostridium perfringens</i> type D	Calves 2–4 months of age sucking high producing cows grazing on lush pastures. Outbreaks occur. Uncommon	Peracute: found dead. Acute: bellowing, mania, convulsions, blindness, death in 1–2 hours. Subacute: dull, depressed, blind	Hyperglycemia (150–200 mg/dL), glycosuria marked. Smear intestinal contents. Recover toxin (mouse protection tests)	Hyperimmune serum. Most die. Vaccination effective
Whole milk hypomagnesemic tetany of calves	Calves 2–4 months of age on whole milk. Also in calves on milk replacers, concentrates and hay and occasionally in nursing calves on pasture	Sudden alertness, hyperesthesia, head-shaking, opisthotonos, muscular tremors, frothing at mouth, convulsions, heart rate 200–250/min	Serum magnesium levels usually below 0.8 mg/dL	Magnesium sulfate intravenously gives good response, must follow up daily because of previous depletion of bone reserves

to be safe for slaughter. Undocumented field observations suggest that at least 6 months are necessary for background levels to be achieved. Recently, a study in dairy cattle determined a blood lead half-life that ranged from 48 to 2507 days. This was presumed due in part to exposure to batteries which may have been associated with prolonged retention of large pieces of metallic lead in the rumen or reticulum.<sup>21</sup> Although this study did not determine milk concentrations of lead, the low ratio of milk lead to blood lead may allow marketing of the milk. Decisions about reaching acceptable residue levels will depend on national or local regulations as well as the economics of maintaining a herd for long periods without sales of milk or meat, and appropriate food safety and public health officials should be consulted in this decision. The lead concentrations in blood

and milk from periparturient heifers 7 months after an episode of acute lead poisoning revealed no lead in the milk. Animals which had been severely affected by lead poisoning experienced a transient increase in whole blood lead concentration at parturition which was not high enough to be considered toxic.<sup>6</sup>

#### CONTROL

The following practices are recommended to reduce the incidence of lead poisoning:

Adequate nutrition and consistent feeding practices will minimize pica or abnormal feeding behavior in livestock. Garbage should always be dumped at a single, isolated, fenced-off location, and preferably buried and burned if appropriate. Pastures are unsuitable sites for garbage. Used lead batteries and crankcase oil should be stored and disposed of safely,

without spillage, and confined to areas where animals have no access.

Vehicle service and machinery storage areas should be separate from areas used by livestock.

Holding of animals in farm yards should be minimized, because such yards tend to be multipurpose areas with high risk for contamination. Only lead-free paints should be used on surfaces and fixtures to which livestock have access.

All pastures should be inspected before cattle are introduced to them.

#### REFERENCES

- Hoff B et al. *Can Vet J* 1998; 39:39.
- Blakley, BR *Can Vet J* 1984; 25:17.
- Blakeley BR, Brockman RP. *Can Vet J* 1976; 17:16.
- Preece BE. *Vet Rec* 1995; 136:475.
- Wada Y. et al. *Vet Human Toxicol* 1993; 35:393.
- Galey FD. et al. *J. Vet Diagn Invest* 1990; 2:222.

7. Sojka JE et al. J Vet Int Med 1996; 10:420.
8. Dee S et al. Vet Rec 1996; 138:336.
9. Vet Invest. Service Vet Rec 1991; 128:143.
10. Yonge KS, Morden BB. Can Vet J 1989; 30:42.
11. Wubenga A et al. Tyd voor Diergenes, 1992; 117:78.
12. Baars AJ et al. Food Add. Contam 1992; 9:357.
13. McEvoy JD, McCoy M. Vet Rec 1993; 132:89.
14. Stair EL et al. J Am Vet Med Assoc., 1995; 207:341.
15. Takla PG et al. Vet Rec 1989; 124:300.
16. Milhaud GE, Mehennaqui S. Vet Human Toxicol., 1988; 30:513.
17. Mennaqui S et al. Vet Human Toxicol., 1988; 30:550.
18. Edwards WC et al. Vet Toxicol., 1976; 18:70.
19. Brams E et al. J Environ Qual., 1989; 18:317.
20. Oskarsson A et al. Sci Total Environ., 1992; 111:83.
21. Rumbieha WK et al. J Vet Diagn Invest., 2001; 13:373.
22. Carmichael DT et al. Cornell Vet 1987; 77:277.
23. Brar R S et al. Vet Res Commun 1994; 18:109.
24. Christian RG, Tryphonas L. Am J Vet Res 1971; 32:203.
25. O'Hara TM et al. J Vet Diagn Invest., 1995; 7:531.
26. Sharma RM, Buck WB. Vet Toxicol., 1976; 18:186.
27. Knight HD, Bureau RG. J Am Vet Med Assoc., 1973; 162:781.
28. Lynch GP et al. J Dairy Sci., 1976; 59:1490.
29. Cox DH et al. J Anal Toxicol., 1989; 30:204.
30. Bratton GR et al. Am J Vet Res 1986; 47:2068.
31. Telisman S et al. Toxicol Lett., 1990; 52:347.
32. Kim JS et al. Can J Vet Res., 1992; 56:256.
33. Coppock RW et al. Am J Vet Res., 1991; 52:1860.
34. Dey S et al. Vet Human Toxicol., 1995; 37:230.
35. Kim JS et al. J Appl Toxicol., 1990; 10:93.
36. Olkowski AA et al. Toxicol Lett., 1991; 59:153.

## ARSENIC POISONING

### Synopsis

**Etiology** Insecticidal dipping fluids, sprays; herbicides; wood preservatives, pharmaceuticals, feed additives. Inorganic compounds most toxic; organic arsenicals least.

**Epidemiology** Outbreaks due to accidental access to source, or due to use of excessive amounts as a dose rate or over time. Most cases result from ingestion but percutaneous absorption also possible.

**Clinical signs** Enteric form a highly fatal gastroenteritis with diarrhea, dehydration. Nervous form with incoordination and blindness, or a syndrome of incoordination, restlessness, squealing, convulsions.

**Clinical pathology** High levels of arsenic in feces, urine, milk for 5 days (organic arsenicals), 10 days (inorganic arsenic). Chronic cases best assayed in hair or skin.

**Necropsy lesions** Gastroenteritis in enteric form, no lesions in nervous form.

**Diagnostic confirmation** Higher than normal levels of arsenic in body fluids or tissues.

### Treatment

**Primary:** 2,3-dimercaptopropanol (BAL) or sodium thiosulfate.

**Supportive:** fluids, electrolytes for dehydration.

## ETIOLOGY

Arsenic compounds likely to be encountered by large animals are as follows:

*Inorganic compounds used as insecticidal dips or as herbicides*

- Oxide, e.g. arsenic trioxide
- Trivalent, e.g. sodium arsenite
- Pentavalent, e.g. sodium arsenate.

*Organic compounds*

Aliphatic organic arsenicals:

- Pharmaceuticals, e.g. cacodylic and phenylarsonic acids
- Weedicides, e.g. monosodium, and disodium methanearsonates (MSMA & DSMA).

Aromatic organic arsenicals, used as pharmaceuticals:

- Trivalent phenylorganic arsenicals, e.g. thiacetarsamide and arspencomplexamine
- Pentavalent phenylorganic arsenicals, e.g. arsanilic acid, roxarsone (4-hydroxy-3-nitrophenylarsonic acid), nitarsone (4-nitrophenylarsonic acid).

## Relative toxicities

**Inorganic and aliphatic organic compounds.** The organic pharmaceuticals are the least toxic, while the insoluble oxides of medium toxicity and the trivalent inorganic compounds are associated with the most severe syndrome. Toxic oral doses may range from 1 to 25 mg/kg for the arsenite, 30–100 mg/kg for the arsenate, cacodylic acid 25 mg/kg daily for 8–10 days, and 10–25 mg/kg for 5–6 days for the methanearsonates.<sup>1,2</sup>

**Aromatic organic arsenicals** are toxic when the recommended cumulative dose is exceeded by 2–4 times the recommended dose, delivered by either exceeding the recommended percentage in the feed or feeding it for too long. Seven to 10 days feeding of Arsanilic acid at 500 mg/kg diet or 3-nitro,4-hydroxyphenylarsonic acid at 250 mg/kg diet will be associated with toxicosis in swine; approximately twice these concentrations will result in poisoning of poultry.<sup>1</sup>

## EPIDEMIOLOGY

### Occurrence

Arsenic is less commonly associated with the poisoning of livestock nowadays because of the displacement of arsenic from almost all phases of farming activity.

### Source of toxin

Arsenic is indestructible and remains in the environment permanently so that the source may not be recorded in contemporary history.

**Dips and sprays.** Fluids used for dipping and spraying of animals to control

ectoparasites are the commonest source. Animals may swallow the solution while in the dip or in the draining yards after dipping. Animals that are not allowed to drain completely and faulty disposal of drainage from yards and dips may contaminate the pasture. Opened containers of dipping solutions or powders may accidentally contaminate feed or be mistakenly applied as a skin dressing. Appreciable amounts of arsenic are absorbed through the skin after dipping in sodium arsenite. The absorption is increased if the animals are dipped when hot, if the fleece is long, if they are crowded too tightly in draining yards or driven too soon after dipping. However, in most outbreaks of poisoning some ingestion appears to occur and supplements the cutaneous absorption. There is some danger in dipping rams at mating time when erythema of the skin of the thighs and scrotum is present. Dipping immediately after shearing and jetting at too high pressure or with excessively strong solutions may also be associated with increased absorption.

**Herbicides** include sodium or potassium arsenite, arsenic pentoxide, and monosodium or disodium acid methanearsonate sprays used to kill potato haulms prior to mechanical harvesting.

**Insecticidal sprays** used in orchards and pasture contaminated by calcium arsenate applied to kill Colorado beetle grubs are sources. In most instances poisoning occurs when animals accidentally gain access to recently sprayed areas, although drifting of windblown spray may result in accidental contamination of pasture. Grass clippings from lawn areas treated with arsenical herbicides 6 months earlier may carry 15 000 mg/kg arsenic. With lead arsenate the major effects are usually ascribed to the effects of the lead but this does not always appear to be so.

**Insect baits** may contain Paris green (cupric acetoarsenite) mixed with bran and when these are laid over large areas of land in an attempt to control grasshopper plagues they constitute a major hazard to livestock.

**Wood preservatives** especially arsenic-copper-chromium are used to treat pine in wooden calf pens. The compound has a salty taste and is licked avidly. Ashes from burned treated pine posts are also palatable to cattle.

**Some metal-bearing ore deposits** including iron, arsenic pyrites in volcanic soils, gold and copper ores contain large quantities of arsenic which may be licked *in situ*, or carried off in the fumes from

smelters and contaminate surrounding pastures and drinking water supplies.

**Pharmaceuticals and growth stimulants** including arsanilic acid and sodium arsenilate, and phenylarsonic acid preparations such as roxarsone, nitarsone, are used both as feed additives and in the control and treatment of vibronic dysentery in animals, and as antidotes to selenium poisoning. Overdosing with them can occur accidentally by carrying on the administration for too long or when there is an error in mixing a batch of feed. The toxicity of feed containing arsanilic acid depends to a certain extent on the intake of drinking water but moderate water restriction does not make normal dose rates dangerous.

#### Route of poisoning

Arsenic poisoning usually occurs after ingestion of the toxic substance but percutaneous absorption can occur especially if the skin is abraded or hyperemic and percutaneous toxic dose is much lower (probably one-tenth) of the oral toxic dose.

#### Poison risk factors

Soluble salts are highly poisonous; arsenic trioxide and sodium arsenate are much less soluble and thus less toxic than sodium arsenite. Organic chemicals used as weedicides are as poisonous as the arsenite but organic arsenicals used as growth stimulants are less toxic, although they are absorbed rapidly.

**Host risk factors.** The LD<sub>50</sub> of sodium arsenite varies between species with pigs, horses, cattle, and sheep requiring increasing doses to be affected.

#### Importance

In cases in which gastroenteritis is the predominant lesion, the case fatality rate approximates 100%. In cases characterized by nervous system involvement the illness is incidental and losses minimal if access to the poison denied, but residues become a problem.

**Meat and milk residues** reduce the safety of the products for human consumption. Arsenic is excreted rapidly after absorption, chiefly in the urine, and after the ingestion of non-toxic amounts by the cow there is no detectable excretion in the milk. When much larger doses are taken arsenic may be excreted in the milk, as well as in urine and feces, but the concentration is still low. The biological half-life of arsenic taken orally in the form of arsenilate is 4.2 days in liver, 5.7 days in kidney, and 15 days in muscle. In pigs fed arsanilic acid at 200 mg/kg in the feed the level of arsenic in muscle is still more than the admissible level of 0.1 mg/kg 18 days after withdrawal. The usual recommendation is to withdraw

arsanilic acid 5–7 days before slaughter. This is adequate at normal dose levels.

#### PATHOGENESIS

**Mode of action.** Arsenic is a general tissue poison. The inorganic salts and the enteric-oriented organic compounds exert their toxic effects by combining with and inactivating the sulfhydryl groups in tissue enzymes. Trivalent arsenicals are most toxic because of their greater affinity for these sulfhydryl groupings. The efficiency of sulfur-containing compounds such as BAL (dimercaptopropanol) as antidotes depends on the ability of these compounds to compete with sulfur containing compounds of enzyme systems for the available arsenic.

**Tissue susceptibility.** Although all tissues are affected, deposition and toxic effects are greatest in those tissues which are rich in oxidative enzyme systems. Thus alimentary tract wall, liver, kidney, spleen, and lung are most susceptible to the general depression of metabolic activity which results.

**Alimentary tract lesions** produce the most obvious clinical signs due to the extensive damage to capillaries causing increased permeability and exudation of serum into tissue spaces. The mucosa lifts from the underlying muscle coat and is shed with the resulting loss of large quantities of body fluids. Arsenic does not precipitate protein and there is no direct local effect on alimentary tract mucosa; this is indicated by the fact that the parenteral injection of arsenic produces lesions in the gut wall which are identical with those associated with ingestion.

**Time lag.** Because arsenic does not precipitate protein it does not limit its own absorption, and there is a considerable time lag after ingestion before clinical signs appear; corrosive substances produce lesions and signs immediately.

**Percutaneous absorption.** Arsenic absorbed from the skin may be associated with local necrosis without systemic signs if the peripheral circulation is poor or the concentration of arsenic is excessively high, but if the cutaneous circulation is good, the arsenic is quickly carried away and is associated with a systemic disease without skin necrosis.

**Chronic poisoning.** The chronic toxicity of arsenic at low levels of intake is due to its accumulation in particular organs, especially the liver, kidney, alimentary tract wall, epidermis, spleen, and lung.

**Nervous tissue lesions.** The nervous signs associated with organic arsenicals are the result of inhibition of dehydrogenase enzyme systems (e.g. pyruvate and alpha-ketoglutarate systems), causing

degenerative changes in peripheral nerves. These appear as demyelination and axonal degeneration in prolonged cases. Animals recumbent longer than 7 days are unlikely to recover and will remain paralyzed until death from other associated conditions. In poisoning with the arsanilic acid compounds the lesions are mostly in the optic nerves, causing blindness. In poisoning with the phenylarsonic acid group the nerves to the limbs appear to be affected most.<sup>2</sup>

#### CLINICAL FINDINGS

##### Ruminant gastroenteritis syndromes

**Acute cases** are the commonest syndromes in ruminants; the onset of signs of illness is delayed 20–50 hours from the intake of the poison, the length of time varying with the fullness of the forestomachs. Distress develops suddenly, commencing with severe abdominal pain, restlessness, groaning, an increased respiratory rate, salivation, grinding of the teeth, complete ruminal stasis, and vomiting, even in cattle. A fluid and fetid diarrhea develops later. The heart rate is greatly increased, the pulse small in amplitude; dehydration, and oliguria are marked.

**Peracute cases** show little except depression and prostration and die before signs of enteritis develop. A fluid sound in the abdomen can be elicited by shaking the animal. Death occurs 3–4 hours after commencement of the illness and is usually preceded by clonic convulsions and diarrhea.

**Subacute cases** give the same signs as acute cases but the course may extend over 2–7 days. Nervous signs of muscle tremor, incoordination, and clonic convulsions are followed by terminal coma.

**Chronic cases.** Commonly observed signs include low body weight, a dry, staring coat which is easily shed, loss of vigor and spirit, capricious appetite, bouts of indigestion, conjunctival and mucosal erythema, eyelid edema and conjunctivitis. Buccal mucosal ulceration may extend to the muzzle. Milk yield is seriously reduced and abortions and stillbirths may occur. Local skin lesions include initial hyperemia followed by necrosis and sloughing leaving indolent lesions which are extremely slow to heal.

##### Horses

Signs include marked congestion of the mucosae and a very sudden onset of severe colic which passes off in a few hours in horses which survive. Severe diarrhea may be followed by a period of complete stasis of the alimentary tract with diarrhea recurring just before death.

**Nervous syndromes in pigs and lambs** Chronic poisoning resulting from overdosing with arsanilic acid is manifested by

incoordination and blindness appearing about 7 days after the compound is first fed. Consciousness, body temperature, and appetite are unaffected. If feeding is continued the signs gradually worsen but disappear within a few days if the feed is changed. Some pigs remain permanently blind or paralyzed.

In chronic poisoning with roxarsone and nitarsone the emphasis is on restlessness, frequent urination, and defecation, incoordination due to loss of balance, frequent shrill 'screaming', tremor, and convulsions, all of which are stimulated by rousing the pig. If it is left alone in a recumbent position it may appear normal.

### CLINICAL PATHOLOGY

Arsenic can be detected in the urine, feces, and milk for periods of up to about 10 days, beginning shortly after the toxic material is ingested. The rate of excretion is faster with organic compounds than with inorganic arsenic and urine levels may be back to normal in 5 days. The most satisfactory material for laboratory examination from a living animal is a large volume (about 1 L) of urine in which arsenic levels may be as high as 16 mg/kg. Levels in milk are low. Normal levels of up to 0.25 mg/kg in cows' milk may be elevated to 0.34–0.47 mg/kg in cases of acute poisoning and to 0.8–1.5 mg/kg in the milk of normal cows which graze arsenic-contaminated pasture for long periods. Deposition in the hair occurs and the arsenic persists there until the hair is shed, making possible the detection of prior arsenic ingestion in the absence of arsenic from the blood and feces. The hair of animals not exposed to arsenic should contain less than 0.5 mg/kg, but that of normal, exposed animals may contain as much as 5–10 mg/kg. Estimations of amounts of arsenic present in suspected materials are mandatory, but delay in sampling of herbage after a contaminating incident may distort results because of leaching of soluble compounds.

### NECROPSY FINDINGS

In acute and subacute cases of **inorganic arsenic poisoning** there are pronounced hyperemia and patchy submucosal hemorrhage in the stomach, duodenum, and cecum. Hemorrhage and multifocal ulceration of the cecum and large colon have been observed in horses.<sup>3</sup> In ruminants the forestomachs are unaffected but typical lesions are present in the abomasum. The gut contents are very fluid, and contain much mucus and shreds of mucosa. Profuse subendocardial hemorrhages are common and ulceration of the gallbladder mucosa is often observed in sheep. Macroscopic lesions may be minimal in cases which die after a very short course. Histologically, most

of the hemorrhages can be attributed to the necrosis of capillaries, although damage to the walls of larger vessels may sometimes be found.<sup>3</sup> Severe intravascular hemolysis has been observed in sheep. Degenerative changes are common in the liver and kidney of animals suffering from arsenic toxicosis and these changes become more pronounced if the disease course is prolonged. In some cases of chronic poisoning, loss of myelin may be observed in the peripheral nerves, with secondary neural degeneration in the central nervous system.

The liver is the best organ for assay of acute arsenic poisoning, while kidney may contain high levels in subacute or chronic poisoning. Levels of over 10–15 mg/kg wet matter of arsenic trioxide in the kidney or liver are considered to be diagnostic of arsenic poisoning. However, it is probable that many animals die of arsenic poisoning when their hepatic levels are much lower than this. Maximum concentrations of arsenic in tissues occur about 8 hours after ingestion and animals which survive for 2–3 days may have levels as low as 3 mg/kg. Conversely, normal animals which are dipped routinely in arsenical dips may have hepatic levels of the element as high as 8 mg/kg. Levels of 1–3 mg/kg are obtained in cattle dying from arsenic poisoning after percutaneous exposure and levels of over 10 mg/kg in cattle which ingest arsenical dip. The toxic dose in ingesta varies widely but averages about 36 mg/kg. Assay of the arsenic level in hair may be useful in chronically poisoned animals.

Animals poisoned with **organic arsenicals** show no significant gross pathological changes. Histologically, degeneration of the optic nerves, optic tracts, and peripheral nerves is apparent.<sup>3</sup> The animals maintain tissue levels of arsenic for as long as exposure continue, although the levels fall rapidly during the first 7 days after feeding of the arsenic ceases, and normal levels are not reached until a further 7 days. Levels of about 6 mg/kg arsenic trioxide in liver and kidney on a fresh, wet-matter basis indicated poisonous levels of intake. Arsenic levels in brain, spinal cord, and peripheral nerves are retained longer after poisoning than are liver and kidney values. Because the stomach and intestinal wall appear to attain maximum concentrations of arsenic most rapidly after poisoning, the use of these tissues for quantitative assay has been recommended. Therefore a part of the upper alimentary tract including contents should accompany the liver and kidney samples submitted for analysis. However, animals that are no longer exposed to

arsenic or are recovering after exposure stops will have relatively little arsenic retained after the initial acute episode.

### Samples for confirmation of diagnosis

- **Toxicology** – 50 g liver, kidney; segment of stomach/intestine including content; sample of suspected poison (ASSAY(As))
- **Histology:**
  - *inorganic As*: formalin-fixed stomach, intestine, cecum, large colon, liver, kidney, peripheral nerve;
  - *organic As*: formalin-fixed optic nerve and tract, peripheral nerve (LM).

### DIFFERENTIAL DIAGNOSIS

Diagnostic confirmation in all kinds of arsenic poisoning is by detection of toxic levels of arsenic in tissues and fluids of the patient.

**Acute inorganic arsenic poisoning** presents a clinical syndrome of gastroenteritis with minor signs of nervous system involvement, which is common in other diseases.

#### Differential diagnosis list

- **Lead poisoning:** the emphasis is on nervous system signs with gastroenteritis an inconstant accompaniment
- **Bovine malignant catarrh** develops in somewhat the same manner especially in the alimentary tract form but there are diagnostic lesions in the eyes and buccal mucosa
- **Mucosal disease** is also characterized by erosions in the buccal and nasal mucosae
- **Salmonellosis** is often confused with arsenic poisoning especially when the disease is seen in the later stages and the fever has subsided
- **Poisonous plants** which are associated with nervous signs and gastroenteritis include bracken, mustards, and a miscellaneous group in which specific toxins have not been identified

#### Chronic inorganic arsenical poisoning

is associated with a syndrome of diarrhea and weight loss in areas around mining and smelting plants. It may be confused with:

- inanition
- internal parasitism especially ostertagiasis, trichostrongylosis and oesophagostomiasis.

**Organic arsenical poisoning** is characterized by dramatic but mild nervous signs, but a normal appetite and no fever.

#### Differential diagnosis list:

- Organic mercury poisoning
- Salt poisoning
- Encephalitis.
- Tri-ortho-cresyl phosphate or other industrial organophosphates that could contaminate swine feeds
- Selenium toxicosis (chronic) in swine with focal symmetrical poliomyelomalacia.

## TREATMENT

In acute cases treatment is of little value because of the large amounts ingested and the delay between ingestion and the appearance of illness, but affected animals are unsuitable for human consumption so that treatment is not usually undertaken.

### Primary treatment

Compounds containing sulfur are theoretically the best antidotes and of these **BAL (2,3-dimercaptopropranol)** is an efficient antidote for poisoning by organic arsenicals, but is often disappointing in cases of poisoning by inorganic salts, unless therapy is begun before clinical signs appear. Dosing at 4-hourly intervals is necessary and the oily injection is associated with some local pain. Although BAL has a general beneficial effect and is recommended as a treatment, the drug is quite toxic itself and in the doses required may be associated with deaths in sheep. It also is associated with a reaction at the injection site sometimes serious enough to warrant the animal's destruction.

**Sodium thiosulfate** is a practicable and frequently used treatment. The compound is almost completely non-toxic and can be given in large amounts and without accurate measurement. Intravenous injection is desirable as an initial treatment using 15–30 g of the salt in 100–200 mL of water and this should be followed by oral dosing of 30–60 g at 6-hour intervals. Treatment should be continued until recovery occurs which may require 3–4 days.

A comparison of these treatments in experimentally poisoned cattle shows little benefit from sodium thiosulfate administration and most effect with a combination of BAL and thioctic acid.<sup>1</sup> Dimercaptosuccinate is a water soluble analog of dimercaprol, is less toxic than BAL, is available in the USA and should be more effective than BAL. The antioxidants zinc, methionine, and cysteine, used with chelation therapy, have been reported to enhance excretion of arsenic in experimental poisoning. Their use may be helpful as adjuncts to recommended chelation therapy.<sup>5</sup>

### Supportive treatment

Attempts should be made to adsorb the residual arsenic in the gut by administering charcoal (1–4 g/kg BW *per os*), and then removed by the administration of an oil demulcent, or osmotic aperient like magnesium sulfate. Drastic purgatives should be avoided. Several products are used in an attempt to precipitate arsenic in the gut lumen. Ferric hydrate is most commonly used but has little apparent effect on the course of the disease.

Severe dehydration occurs and supportive treatment must include the provision of ample fluids preferably by parenteral injection. An adequate supply of drinking water containing electrolytes should be provided and the animals should be disturbed as little as possible and provided with shelter from the sun. Astringent preparations given by mouth may help to reduce the loss of body fluids. Recovering animals should receive a bland diet and high-quality protein.<sup>1</sup>

**Withdrawal time.** After the treatment of pigs with arsenilic acid the arsenic content of their livers may exceed 1 mg/kg, the statutory level of arsenic in food for human consumption. At least 10 days should be permitted between ceasing to feed the arsenilate and slaughter to avoid poisoning of humans.

### Control

Arsenical preparations must be handled and stored with care and contamination of feed and pasture avoided. Therapeutic preparations containing arsenic should be labelled 'Poison' and strict instructions given on dosage, particularly the length of time for which administration should continue. Animals to be dipped in arsenical solutions should be allowed to cool off before dipping, to drain properly afterwards and to dry before being driven. They should be watered before dipping to prevent them drinking the dip. Much mortality has occurred when instructions for mixing dip solutions were not closely followed. Dipping solutions containing more arsenic than is safe usually occur when tanks which have lost water by evaporation are reconstituted by guesswork. The maximum safe concentration of arsenic trioxide in a dip for cattle is 0.20%.

### REVIEW LITERATURE

Bahri LE. Arsenic poisoning in livestock. *Vet Human Toxicol*, 1991; 33:259–264.

### REFERENCES

1. Ensley SM. Arsenic, In Plumlee KH. (editor) *Clinical Veterinary Toxicology*, Mosby, St. Louis. 2004; p.193.
2. Kennedy S. et al. *Ve Pathol* 1986; 23:454.
3. Pace LW et al. *Vet Pathol*, 1997; 34:160.
4. Blakley BR et al. *Can Vet J* 1990; 31:385.
5. Patrick L. *Altern Med Rev*. 2003; 8:106.

## SELENIUM POISONING

### Synopsis

**Etiology** Ingestion of or injection with excessive amounts of selenium.

**Epidemiology** Enzootic disease where soils and pasture contain toxic amounts of selenium. Outbreaks after errors in feed supplementation or oral or injection doses.

### Clinical signs

**Acute:** dyspnea, diarrhea, prostration, short course, death.

**Chronic:** emaciation, rough coat, stiff gait, lame, hoof deformity.

**Clinical pathology** toxic levels of selenium in body tissues and fluids.

**Necropsy lesions** All forms – liver necrosis.

**Diagnostic confirmation** High selenium levels in body fluids and tissues.

**Treatment** Nil. Avoid toxic pasture. Care with medication and feed additives containing selenium.

## ETIOLOGY

Selenium poisoning is associated with the ingestion of organic or inorganic selenium compounds as follows:

- Organic selenocompounds (selenocysteine, selenocystine) occurring in pasture plants
- Inorganic selenium compounds administered as feed supplements
- Pharmaceutical preparations administered orally, frequently combined with vitamin E, for prophylaxis or by injection in treatment.

**Toxic dose.** Discrepancies exist in the toxic doses quoted in the literature and the following information is subject to that limitation. Daily intakes of 0.25 mg/kg BW are toxic for sheep and cattle; feed containing 44 mg/kg selenium for horses and 11 mg/kg for pigs is associated with poisoning. The daily intake of a diet containing 2 mg/kg of selenium can be marginally toxic for sheep. Toxic single oral doses (as mg/kg BW) are 2.2 for horses and sheep, 9 for cattle, and 15 for pigs. An oral dose of 10–15 mg of selenium has been known to kill lambs. Recommended limits for selenium in feed are given under Control, and for injection in the section on treatment.

## EPIDEMIOLOGY

### Occurrence

- **Pastoral.** Selenium poisoning occurs in restricted areas in North America, Ireland, Israel, Canada, Australia, and South Africa where the soils are derived from particular rock formations containing a high content of selenium. No authoritative reason has been advanced to explain why the reported occurrence of the disease in these areas is much less now than it used to be
- **Dosing errors.** Substantial losses due to selenium poisoning also occur because of misunderstanding about the dose rates of selenium compounds used therapeutically or prophylactically.

### Source of toxin

**Pastoral.** The effective selenium is contained in the top 60–90 cm of the soil

profile, selenium at lower levels than this not being within reach of most plants. Selenium poisoning may occur on soils containing as little selenium as 0.01 mg/kg, but some soils may contain as much as 1200 mg/kg. Most pasture plants seldom contain selenium in excess of 100 ppm, but a number of species, the so-called **converter or indicator plants**, take up the element in such large quantities that selenium levels may reach as high as 10 000 ppm. Included in this category are *Acacia cana*, *Artemisia canescens*, *Aster* spp., some of the *Astragalus*, *Atriplex* and *Castilleja* spp., *Comandra pallida*, *Descurainia pinnata*, *Grindelia* spp., *Machaeranthera ramosa*, *Morinda reticulata*, *Neptunia amplexicaulis*, *Oenopsis*, *Penstemon* and *Sideranthus* spp., *Stanleya pinnata* and *Xylorrhiza* spp.

These plants tend to grow preferentially on selenium-rich soils and are thus 'indicator' plants. They are in general unpalatable because of a strong odor so that an acute syndrome is unlikely but heavy losses have been attributed in the past to two chronic forms of the disease known as **blind staggers** and **alkali disease**. Much of these data are now discounted and losses due to chronic selenosis in cattle in the western USA in recent years have been small.

**Industrial deposition**, e.g. fly ash from soft coal deposited in fields has been shown to be associated with increased selenium levels in tissues from sheep grazing there.

**Dietary supplement** is used in the prevention of known deficiency syndromes such as white muscle disease in lambs, as a non-specific growth stimulant, and as a prophylactic for a large number of other vague syndromes. It is not surprising that the careless use of selenium compounds has induced selenium poisoning on a wider scale.

**Prophylactic.** It is now common practice to combine a selenium compound with an anthelmintic drench or injection and, if the mixture is not thoroughly shaken, poisoning may occur. Concurrent administration of monensin and selenium also increases the toxicity of the selenium being fed.<sup>1</sup> There are many case reports of unexpected illness and mortality in animals dosed with selenium preparations and it is apparent that not all of the factors affecting selenium toxicity are known. Identified factors include the cobalt and protein status of the animal, deficiencies of either causing increased susceptibility.

#### Risk factors

**Environment factors.** Selenium poisoning in animals grazing plants growing on

seleniferous soils may be restricted to very distinct areas as small as individual fields. A low rainfall predisposes to selenium poisoning because soluble, available selenium compounds are not leached out of the topsoil and lack of competing forage may force animals to eat large quantities of indicator plants.

**Toxin factors.** Organic selenium compounds, especially those occurring naturally in plants, are generally considered to be much more toxic than inorganic compounds but this difference may not be apparent in ruminants because of alterations in ingested compounds produced by digestive processes in the rumen. Selenite is more toxic than selenate and both are more damaging than selenium dioxide.

**Host factors.** Cattle are more tolerant than sheep. Pigs are unlikely to be exposed but can develop the disease in the field.

#### PATHOGENESIS

Acute oral poisoning is associated with chemical erosion of alimentary tract mucosa. Poisoning with a single injection, e.g. in pigs, is associated with sudden death due to vasogenic circulatory failure, a vasculogenic shock.<sup>2</sup>

The mechanism forming the basis of chronic poisoning has not been identified. Selenium occurs in plants in analogs of the sulfur-containing amino acids, e.g. selenocysteine, and a possible mechanism of intoxication is by interference with enzyme systems which contain these amino acids. Selenium reduces the sulfur and protein content of sheep's liver and high protein diets have a protective effect against selenium poisoning. Selenium is deposited in greatest concentration in the liver, kidney, and hair. It has a marked dystrophic effect on skeletal musculature and is associated with a marked rise in SGOT levels after subcutaneous administration.

#### CLINICAL FINDINGS

The terms **blind staggers** and **alkali disease**, used previously in this section have been discontinued as misleading and being based on misunderstandings about the etiological agents involved.

**Acute poisoning.** In naturally occurring and experimental poisoning there is severe respiratory distress, restlessness, complete anorexia, salivation, watery diarrhea, fever, tachycardia, abnormal posture and gait, prostration, and death after a short illness. Mildly affected pigs show posterior ataxia, walking on tiptoe, difficulty in rising, sternal recumbency, tremor, and vomiting in some. Extreme cases assume a posture of lateral recumbency.

**Chronic poisoning** is manifested by dullness, emaciation, rough coat, lack of vitality, stiffness, and lameness. In cattle, horses, and mules the hair at the base of the tail and switch is lost and in pigs, goats, and horses there may be general alopecia. There are hoof abnormalities including swelling of the coronary band, and deformity or separation and sloughing of the hooves in all species. Lameness is severe. Congenital hoof deformities may occur in newborn animals. Hemorrhagic lesions on the proximal wall and soles of claws on all four feet may accompany these deformities.<sup>3</sup> Chronic poisoning in pigs on rations containing 20–27 mg/kg is also associated with a syndrome of reduced feed intake, paraplegia and quadriplegia<sup>4</sup> due to **poliomyelomalacia**. Pigs on marginal levels of intake of selenium (10 mg/kg) develop necrosis of the coronary band, low conception rates, and increased neonatal mortality.

#### CLINICAL PATHOLOGY

Selenium can be detected in the urine, milk, and hair of affected animals. Clinical illness is evident at blood levels of 3 mg/kg and at urine levels of more than 4 mg/kg of selenium. Normal serum levels of 140–190 ng/mL are elevated to the 1500 ng/mL level.

Critical levels of selenium in hair include the following:

- Less than 5.0 mg/kg suggests that chronic selenosis is unlikely
- From 5.0 to 10.0 mg/kg suggests that borderline problems will occur
- More than 10 mg/kg is diagnostic of chronic selenosis.

A moderate anemia occurs in acute and chronic poisoning and a depression of hemoglobin levels to about 7 g/dL is one of the early indications of selenium poisoning.

#### NECROPSY FINDINGS

In confirmed cases of natural or experimentally produced<sup>5</sup> acute selenium poisoning most of the macroscopic findings can be attributed to cardiovascular compromise. There is pulmonary edema and congestion, petechiation of the thoracic viscera, and congestion of the liver, kidneys, and gastrointestinal tract. In parenterally overdosed lambs and piglets there is usually hydrothorax, hydropericardium, and ascites<sup>6</sup>. Histologic lesions may be minimal if the clinical course is brief. Changes which may be observed in animals surviving more than 24 hours include a serous effusion within pulmonary alveoli, mild hyaline or granular degeneration of skeletal muscle fibers, hydropic degeneration in renal tubular epithelial cells and periacinar degeneration and necrosis of hepatocytes. Cardiac



myocytes may appear swollen and contain areas of cytoplasmic granularity and lysis.

The causal link between selenium intoxication and blind staggers is weak and the lesions described in accounts of this largely historical disease are in dispute. It is probable that this clinical entity is the result of other etiologic factors.<sup>7</sup> In animals suffering from subacute to chronic selenium poisoning there is a skeletal and cardiac myopathy. Deformities of the feet and skin are usually apparent, as described under Clinical findings. Atrophy and dilatation of the heart and pulmonary edema, cirrhosis and atrophy of the liver, glomerulonephritis, mild gastroenteritis, and erosion of articular surfaces have also been recorded.<sup>2</sup> Symmetrical poliomyelomalacia has been identified in both natural and experimental settings in pigs fed excessive selenium. The areas primarily affected are the ventral horns of the cervical and lumbar enlargements, with lesser damage in brainstem nuclei. The microscopic appearance of affected spinal cord includes vacuolation of the neuropil and sometimes of the cytoplasm of neurons. Neuronal chromatolysis, axonal swelling, and endothelial cell swelling and proliferation are consistently present.

#### Samples for confirmation of diagnosis

- **Toxicology** – 50 g liver, kidney; 500 g of suspect feed (ASSAY (Se))
- **Histology** – formalin-fixed skeletal muscle, heart, liver, kidney, +/- spinal cord from cervical and lumbar enlargements (LM).

**Selenium levels in tissue.** In chronic selenosis in sheep hepatic and renal levels of selenium are about 20–30 mg/kg and levels in wool are in the range of 0.6–2.3 mg/kg. In horses hair levels of more than 5 mg/kg are recorded.

#### DIFFERENTIAL DIAGNOSIS

The diagnosis of selenium poisoning rests largely on the recognition of the typical syndromes in animals in areas where the soil content of selenium is high, or when there has been administration of selenium as medication or as a feed additive. The clinical and necropsy lesions associate with the poisoning cover a wide range of signs and lesions and are not easily summarized. Diagnostic confirmation depends on an assay of toxic levels of selenium in body tissues or fluids.

#### Differential diagnostic list:

##### Acute poisoning

- Anaphylaxis
- Septicemia
- Toxemia
- Acute arsenic toxicosis.

##### Chronic poisoning

- Hypovitaminosis A.

#### TREATMENT

A number of substances have been tried in the treatment of selenium poisoning, including potassium iodide, ascorbic acid, and beet pectin but without apparent effect. BAL is contraindicated.

#### CONTROL

The manufacturers' advice on dose rates for pharmaceutical and feed additive preparations should be followed at all times. As a further guide to safe dose levels which avoid toxicity the following guidelines are provided:

- In general, the ratio between acute toxic and therapeutic doses is 50–100:1 and dosing accidents should not be common
- **Sheep.** The subcutaneous injection of selenium, as sodium selenite, is associated with poisoning in sheep at doses of 0.8 mg/kg BW and doses of 1.6 mg/kg are lethal. A single injection of 5 mg of selenium may kill some lambs and the toxic level for single injections in lambs has been reported as 455 µg/kg BW
- **Cattle.** Lethal doses by injections are 1.2 mg/kg BW
- **Pigs.** Lethal doses are between 1 and 2 mg/kg BW
- **Ponies.** Only relatively large doses, e.g. 6–8 mg/kg BW is associated with fatality.

Selenium in feeds should not exceed 5 mg/kg dry matter if danger is to be avoided and feeding on pasture containing 25 mg/kg dry matter for several weeks can be expected to be associated with chronic selenium poisoning. Pasture may contain as much as 2000–6000 mg/kg of selenium and is associated with the acute form of the disease when fed for a few days.

Protection against the toxic effects of selenium in amounts up to 10 mg/kg in the diet has been obtained by the inclusion in the ration fed to pigs of 0.01–0.02% of arsanilic acid or 0.005% of 3-nitro-4-hydroxyphenyl arsonic acid. In cattle 0.01% arsanilic acid in the ration or 550 mg/day to grazing steers gives only slight protection. The addition of linseed oil to the ration improves the efficiency of this protection. A high protein diet also has a general protective effect. Pretreatment with copper is also known to be an effective preventive measure in all species. The mechanism of this protection is unknown. A single oral dose of 20–40 mg/kg of copper given 24 hours before administration of selenium protects ponies.

#### REVIEW LITERATURE

O'Toole, D. et al. Selenium-induced blind staggers and related myths – A comment on the extent of

historical livestock losses attributed to selenosis on western US range lands. *Vet Pathol.*, 1996; 33:104.

Traub-Dargatz JL et al. Selenium toxicity in horses. *Comp Cont Educ.*, 1986; 8:771–775.

#### REFERENCES

1. Smyth JBA et al. *J Comp Pathol.*, 1990a; 102:443.
2. Nebbia C et al. *Res Vet Sci* 1991; 50:269.
3. Mensink CG et al. *Vet Rec* 1990; 126:620.
4. Penrith ML, Robinson JTR. *Onderst J Vet Res.*, 1996; 63:171.
5. Ahmed KE et al. *Vet Human Toxicol.*, 1990; 32:249.
6. Smyth JBA et al. *J Comp Pathol.*, 1990; 102:197.
7. O'Toole D et al. *Vet Pathol.*, 1996; 33:104.

#### PHOSPHORUS POISONING

Phosphorus is rarely used as a rodent poison nowadays and this is the only likely source of phosphorus for animals. Toxic effects are increased when the phosphorus is finely divided and mixed with oils or fats which facilitate its absorption. Phosphorus used for military purposes is associated with extensive contamination of pasture.

Phosphorus has a local caustic action and on ingestion is associated with severe irritation of the alimentary mucosa with signs of gastroenteritis appearing within an hour or two. Some phosphorus may be absorbed and is associated with acute hepatic necrosis but signs do not appear for several days.

#### CLINICAL FINDINGS

These include severe diarrhea, acute abdominal pain, salivation, and intense thirst. Pigs vomit violently and the vomitus is luminous and has a garlic odor. The patient often dies of acute shock during this stage. Survivors show jaundice, weakness and anorexia, oliguria and hematuria. Death may occur in coma or be accompanied by convulsions. Phosphorus can be detected in the vomitus and feces of affected animals.

#### NECROPSY FINDINGS

Macroscopically there is congestion and hemorrhage of the alimentary mucosa. The carcass is often jaundiced and the liver is swollen and pale. Histologically there is fatty degeneration of both the liver and kidney, sometimes accompanied by hepatic necrosis. The acute stages of phosphorus poisoning may appear similar to acute stages of inorganic arsenic, mercury, or selenium poisoning.

#### Samples for confirmation of diagnosis

- **Toxicology** – 50 g liver, kidney and a portion of alimentary tract with content (ASSAY (P))
- **Histology** – formalin-fixed liver, kidney (LM).

**Diagnostic confirmation** requires evidence of access to the poison and the detection of large amounts of it in the alimentary tract.

**Treatment.** An emetic or hydragogue purgative should be given immediately. Supportive treatment includes the administration of astringents to allay the gastroenteritis and parenteral electrolyte solutions to relieve the dehydration. Hypotension and shock as well as coagulopathy may occur and should be treated supportively as needed.

## MERCURY POISONING

### Synopsis

**Etiology** Rarely inorganic mercury, commonly organic preparations.

**Epidemiology** Inorganic salts in preparations used as rubifacients. Organic preparations used in seed grain fed accidentally to livestock.

### Clinical signs

Inorganic salts: Acute – vomiting, diarrhea, abdominal pain; Chronic – weight loss, depression, alopecia, scabby dermatitis, long course.

Organic preparations: blindness, incoordination, paralysis.

**Clinical pathology** High levels of mercury in all tissues and fluids; high blood urea nitrogen, urine alkaline phosphatase in cases of nephrosis.

### Necropsy lesions

- Inorganic salts: Acute – gastroenteritis; Chronic – nephrosis.
- Organic preparations: neuronal necrosis in brain and spinal nerves.
- Poisoning by mercury is associated with inflammation of the alimentary mucosa and damage to the kidneys. It is manifested clinically by gastroenteritis and terminally by signs of uremia.
- Diagnostic confirmation. High blood, urine, tissue levels of mercury.

### Treatment

**Primary:** Sodium thiosulfate orally and parenterally; BAL by injection.

**Supportive:** Astringents orally, fluids parenterally.

**Control** Care in the handling of agricultural and pharmaceutical mercurials.

## ETIOLOGY

Mercuric chloride and mercury biniodide are highly poisonous, the toxic dose for horses and cattle being about 8 g and for sheep 4 g. Organic mercury taken regularly in the diet at a level of 1 mg/kg is associated with chronic poisoning in pigs. A level of 6 mg/kg is associated with deaths in pigs within 5 days.

## EPIDEMIOLOGY

### Source of toxin

Mercury poisoning in farm animals occurred in the past almost exclusively as a result of accidental feeding of grain, pellets, or concentrate mixtures treated with organic mercurial antifungal agents.

Because of the availability of fungicidal agents other than mercury it is possible to limit the use of mercuric agents by legislation to those excreted rapidly by animals, the phenylmercury compounds, and prohibiting those which are retained in animal tissues, the ethyl and methyl compounds. Worldwide use of mercurial fungicides has declined and poisoning is much less common than in the past. The commonest agents, when used, are dusts of 5.25% methoxyethylmercury silicate or methylmercury dicyandiamide. These and ethylmercuric chloride are toxic when fed to pigs at the rate of 0.19–0.76 mg of mercury per kg BW per day for 60–90 days. Methylmercury dicyandiamide fed to pigs at the rate of 5–15 mg/kg is associated with illness, and 20 mg/kg is associated with some deaths with a delay of 3 weeks between dosing and illness.

Treated seed is usually not harmful if it comprises only 10% of the ration and must be fed in large amounts for long periods before clinical illness occurs. A single feeding even of large amounts of grain is thought to be incapable of causing mercury poisoning in ruminants but horses may be susceptible.

Accidental administration of medicines containing mercury, licking of skin dressings (e.g. mercuric oxide), and absorption from liberally applied skin dressings or combined with dimethyl sulfoxide may be associated with sporadic cases as occurs in horses after application of mercury containing 'blisters'.<sup>1</sup> Inorganic mercury salts contaminating lakes or other anaerobic ecological areas can be reduced and converted to methyl mercury and serve as a source of organic mercurial poisoning or food contamination through accumulation in fish or fish meal.<sup>2</sup>

### Risk factors

The toxicity of mercury compounds depends on their solubility and the susceptibility of the animals. Cattle are highly susceptible, toxicosis occurring on an average daily intake of mercury, in organic mercury form, of 10 mg/kg per day, while toxic effects are only obtained in sheep with intakes of 17.4 mg/kg BW per day. In horses, feeding inorganic mercury at the rate of 0.4 mg/kg BW produces only mild signs of poisoning and feeding methylmercury chloride (10 g over 10 weeks) is associated with serious illness.

### Importance

Meat from animals poisoned by mercury is unsuitable for human consumption. Milk is probably safe as little mercury is excreted in it.

The toxicity of mercury compounds depends on their solubility and the susceptibility of the animals.

## PATHOGENESIS

**Inorganic mercury compounds** are associated with coagulation of the alimentary mucosa, leading to the rapid development of gastroenteritis. Animals that survive the alimentary tract disorder and absorb mercury may show signs of damage to peripheral capillaries especially those at the sites where mercury is excreted, in the kidney, colon, and mouth. Nephrosis, colitis, and stomatitis may result.

**Organic mercurials** in small doses liberate their mercury slowly into tissues and are associated with degenerative changes in brain, segmental degeneration in peripheral nerves, and degeneration in kidney. Extensive subcutaneous hemorrhages and a bleeding tendency occur in some cases of phenylmercuric acetate poisoning.

## CLINICAL FINDINGS

**Acute** mercurialism occurs when large amounts of inorganic mercury are ingested, there is an acute gastroenteritis with vomiting of blood-stained material and severe diarrhea. Death occurs within a few hours due to shock and dehydration. In less acute cases the patient survives several days and the syndrome includes salivation, a fetid breath, anorexia, oliguria, tachycardia, hyperpnea and, in some cases, posterior paralysis and terminal convulsions.

**Chronic** mercurialism occurs when small amounts of inorganic mercury are ingested over long periods. The syndrome includes depression, anorexia, emaciation, a stiff, stilted gait which may progress to paresis, alopecia, scabby lesions around the anus and vulva, pruritus, petechiation and tenderness of the gums and shedding of the teeth, persistent diarrhea, weakness, incoordination, and convulsions.

**Chronic organic mercurial poisoning** is associated with neurological syndromes. In **pigs** blindness is accompanied by staggering, continuous walking, and inability to eat, although the appetite is good. **Cattle** poisoned in this way show a staggery gait, standing on tiptoe, and paresis, lying down most of the time; they appear normal in other respects, often eating well. Clinical signs may not develop until 30 days after feeding is commenced. Cattle poisoned experimentally show more severe nervous signs including incoordination, head-pressing, muscle tremor with twitching of the eyelids, tetanus-like spasms on stimulation, excessive salivation, recumbency, and inability to eat or drink, followed by tonic-clonic convulsions with opisthotonos.

## CLINICAL PATHOLOGY

Mercury can be detected at higher levels than normal in the blood, feces, and urine of affected animals and in the toxic source material. Nephrosis can be diagnosed by examination of blood and urine; the earliest and most accurate indicators are the urinary concentrations of alkaline phosphatase and gamma-glutamyl transpeptidase. Less than 0.2% of ingested mercury is excreted in cow's milk.<sup>3</sup>

## NECROPSY FINDINGS

In acute cases there is severe gastroenteritis with edema, hyperemia, and petechiation of the alimentary mucosa. The liver and kidneys are swollen and the lungs are congested and show multiple hemorrhages. There may be an accompanying catarrhal stomatitis. A crusting focus of dermatitis may be identified if exposure was percutaneous.

Histologically the renal tubular epithelial cells are swollen and vacuolated, and proteinuria is evident. An ulcerative colitis may also be visible. In chronic mercurialism associated with organic mercury compounds there are also degenerative changes in nerve cells in the cortex of cerebrum, brain stem, and spinal cord. The lesions include neuronal necrosis, neuronophagia, cortical vacuolation, and gliosis. Fibrinoid necrosis of leptomeningeal arterioles may be seen. Other common microscopic changes include degeneration of granular cells of the cerebellar cortex and of Purkinje cells of the myocardium.

Mercury reaches its greatest concentration in kidney and this tissue should be submitted for assay. Levels of 100 mg/kg may be present in the kidney of animals poisoned with inorganic mercury. With chronic organic mercurial poisoning in swine levels of mercury up to 2000 mg/kg may be present in the kidney.

## Samples for confirmation of diagnosis

- ▷ **Toxicology** – 50 g kidney, brain – half fresh and half in formalin, 500 g of suspect feed (ASSAY (Hg)); muscle tissue for potential residues in food animal edible tissues.
- **Histology** – formalin-fixed kidney, heart, oral and/or skin lesions; half of midsagittally sectioned brain (LM).

## DIFFERENTIAL DIAGNOSIS

Acute mercury poisoning is rare but should be suspected in animals which are exposed to inorganic mercury compounds and which show signs of gastroenteritis and nephritis. **Diagnostic confirmation** depends on a positive tissue assay for mercury.

## Differential diagnosis list

When there are indications of gastroenteritis or nephrosis the syndrome resembles:

- Lead poisoning
  - Arsenic poisoning.
- Pigs poisoned by organic mercury compounds and showing nervous signs of blindness and incoordination resemble:
- Pigs poisoned by organic arsenicals.

## TREATMENT

**Primary.** In **acute** cases large amounts of coagulable protein such as eggs should be given by mouth immediately, followed by mild purgatives to facilitate removal from the gut before digestion and absorption occur. In **acute and chronic** cases treatment with sodium thiosulfate as described in arsenic poisoning is recommended. BAL can be used but has the same limitations here as in arsenic poisoning, and delay in treatment of any sort is likely to be fatal. An injection of BAL (6.5 mg/kg BW) should be given every 4 hours. Dimercapto succinic acid (DMSA) at 10 mg/kg B.W. *t.i.d.* is reported effective in hastening the elimination of mercury in urine.<sup>4</sup>

**Supportive** treatment includes astringents given orally to control the gastroenteritis and fluids given parenterally to correct the dehydration.

## CONTROL

Seed grains dusted with mercury compounds should not be fed to animals.

## REFERENCES

1. Guglick MA et al. J Am Vet Assoc 1995; 206:210.
2. Osweiler GD et al. Clinical and Diagnostic Veterinary Toxicology, Dubuque, IA. Kendall-Hunt. 1985.
3. Neathery MW, Mille WJ. Dairy Science 1975; 58:1767.
4. Murphy M. A Field Guide to Common Animal Poisons. Ames, IA. Iowa State University Press. 1996.

## FLUORINE POISONING

### Synopsis

**Etiology** Inorganic or organic (in plants) fluorides.

**Epidemiology** Associated with continuous ingestion of small but toxic amounts of fluorine in the diet or drinking water.

**Clinical signs** Dental fluorosis – mottling and erosion of permanent teeth. Osteofluorosis – lameness and unthriftiness.

**Clinical pathology** High blood, urine, and tissue levels of fluorine.

**Necropsy lesions** Osteoporosis, widespread exostoses. Dental enamel and dentine hypoplasia. High bone content of fluorine.

**Diagnostic confirmation** Assay of food, water, bones, teeth for fluorine content.

### Treatment

**Primary:** aluminum salts orally, calcium salts parenterally but little chance of improvement.

**Supportive:** parenteral glucose solutions.

**Control** Drinking water held in tanks, fluorine precipitated by aluminum salts; applicable only for small water volumes.

## ETIOLOGY

The severity of the poisoning depends on the amount ingested, the solubility of the fluorine compound, and the animal's age.

## Dose rate

The most satisfactory measure is the concentration in the total dry matter consumed. Levels in excess of 100 ppm of dry ration are likely to be associated with disease in cattle, sheep, and pigs when the fluorine is contained in rock phosphate or cryolite. At this or lower levels minor teeth lesions may occur but not to such a degree that they will affect the animal's well-being during a commercial life span. Fluorine in the form of calcium fluoride or sodium fluorosilicate is much less poisonous; intakes of 400 mg to 2 g/kg BW are necessary for fatal effects. Sodium fluoride is approximately twice as toxic as rock phosphate and a general level of 50 mg/kg of dry ration should not be exceeded.

In **experimentally induced** fluorosis in cattle mottling of the tooth enamel occurs at intakes of 27 mg/kg in the diet but there is no pitting until levels of 49 mg/kg are fed. Bony lesions are slight at intakes of 27 mg/kg, moderate at 49 mg/kg, and marked at 93 mg/kg, and milk production in dairy cows is supposed not to be affected by intakes of 50 mg/kg of fluorine in the diet until about the fourth lactation. A more recent view is that the existing tolerance level for dairy cows of 40 mg/kg is too high and will lead to serious loss of production and some dental fluorosis in high producing cows.

## EPIDEMIOLOGY

### Occurrence

Fluorine intoxication has been observed in most countries, usually in association with specific natural or industrial hazards. In Europe and Great Britain losses are greatest on summer grazing of pastures contaminated by **industrial fumes**, including dust from factories converting rock phosphate to superphosphate as well as effluent from aluminum smelters. Iceland and parts of the southern Andes mountains are extensively affected by contamination from **volcanic ash**. Drinking water from deep wells, industrial contamination of

pasture and the feeding of fluorine-bearing phosphatic supplements are the common associations in North America. **Deep wells** also are an important source in Australia and South America. In Africa the important association is the feeding of **phosphatic rock supplements**.

### Sources

Fluorine occurs naturally in rock, particularly in association with phosphate, and these rocks, the soils derived from them and surface water leaching through the soils, may contain toxic quantities of fluorine. In such areas the **soil content** of fluorine may be as high as 2000–4000 mg/kg even up to 12 000 mg/kg and the levels in **water** up to 8.7 mg/kg; soil fluorine varies in its solubility from 10 to 20%. Levels of fluorine likely to be toxic to animals are not usually encountered in natural circumstances, interference by man being necessary in most instances to increase fluorine ingestion above the critical level.

Plants, with few exceptions, do not absorb appreciable quantities of fluorine. Two exceptions are *Camellia* spp., the decorative camellias, and *Thea chinensis* (tea) plant. Major outbreaks of intoxication occur as the result of the ingestion of pasture contaminated with fluorine, and drinking water and mineral supplements which contain excessive amounts of fluorine.

Contamination from **industrial factories** by smoke, vapor, or dust may produce pasture containing 20–50 mg/kg of fluorine. Factories producing aluminum by the electrolytic process, iron and steel with fluorine-containing fluxes, superphosphate, glazed bricks, copper, glass and enamels are likely to be potent sources and may be associated with toxic levels of contamination as far as 14 km downwind from the factory. Dust from factories manufacturing superphosphate from rock phosphate may contain as much as 3.3% fluorine. Industrial plants engaged in the calcining of ironstone have also been incriminated as sources of fluorine.

Contamination by **effluent** is a complex problem because of variation in the form of the contaminating compound. Grass can absorb and retain gaseous fluoride from the ambient air but physical deposit of liquids and dust is the critical form of contamination. Two of the common effluent substances are **hydrofluoric acid** and **silicon tetrafluoride**, both of which are as toxic as sodium fluoride, and dental lesions occur in 100% of young ruminants on an intake of 14–16 mg/kg dry matter of these substances. Severe cases occur on pasture or hay containing more than 25 mg/kg dry matter and similar lesions

develop much more rapidly on pasture containing 98 mg/kg dry matter.

**Fluoracetamide** is also known to be a toxic factory effluent.

Dust and gases from **volcanic eruptions** may also be associated with acute fatal fluorine intoxication in the period immediately after the eruption, and contamination of pasture may be sufficient to be associated with subsequent chronic intoxication in animals eating the herbage, although the fluorine content of the contaminated materials decreases very rapidly if rain falls. Iceland is particularly afflicted with fluorine intoxication deriving from this source.

Top-dressing of pasture with **phosphatic limestone** is commonly associated with fluorosis. Most phosphatic limestones, particularly those from North Africa, are rich in fluorine (0.9–1.4%). Non-phosphatic limestones contain insignificant amounts.

### Supplementary feeding of phosphates.

The common occurrence of phosphorus deficiency in animals has led to the search for cheap phosphatic materials suitable for animal feeding. Rock phosphates are commonly used and many deposits contain dangerous amounts of fluorine (3–4%). The fluorine content of the mineral can be reduced but the cost encourages the use of marginally safe material.

**Water.** The major occurrence of water-borne fluorine intoxication is from water obtained from deep wells or artesian bores. The available data suggest that, although minor teeth lesions occur at 5 mg/kg of fluorine it is not until levels of 10 mg/kg are exceeded that excessive tooth wear occurs and the nutrition of the animal is impaired. More serious systemic effects do not occur until the water contains 30 mg/kg.

**Miscellaneous sources** of fluorine include the ingestion of superphosphate itself, but a supernatant liquid of a suspension of the fertilizer will contain no fluorine. Some wood preservatives may contain large quantities of fluoride which may be associated with acute poisoning in some circumstances.

### RISK FACTORS

Host factors are age and species. Daily intakes of 0.5–1.7 mg/kg of fluorine as sodium fluoride produce dental lesions in growing animals without affecting general well-being. Intakes equal to twice these amounts are consumed by adult animals without ill-effect. In heifers a continuous intake of 1.5 mg/kg BW per day is sufficient to be associated with severe dental fluorosis without affecting growth rate or reproductive function.

However, extensive osteofluorosis and periods of severe lameness will occur. The fluorine content of the bones of newborn calves depends on the dam's intake of fluorine in the last 3–4 months of pregnancy and not on her own bone composition.

Most recorded occurrences of fluorosis are in cattle. Sheep are less susceptible than cattle. A continuous intake of 1 mg/kg BW is the maximum safe limit for **ruminants**, an intake of 2 mg/kg BW produces clinical signs. In pigs an intake of 1 mg/kg BW added fluorine for long periods has no deleterious effect.

### Importance

Death losses are rare and restricted largely to acute poisoning, the major losses taking the form of unthriftiness associated with chronic fluorosis. Although it is possible for animal tissues to contain amounts of fluorine in excess of permissible amounts this is not usually so in chronic fluorosis. The fluorine content of **milk** in these circumstances is below that permitted in fluoridated drinking water (1 mg/L).

### PATHOGENESIS

Fluorine is a general tissue poison; its exact mode of action does not appear to have been closely examined.

Acute intoxication, due to the ingestion of large amounts of soluble **inorganic fluorides**, is characterized by the immediate development of gastrointestinal irritation due to the formation of hydrofluoric acid in the acid medium of the stomach. Nervous signs including tetany and hyperesthesia, and inhibition of blood clotting, may follow as a result of the fixation of serum calcium to form physiologically inactive calcium fluoride in the blood plasma. Death occurs quickly.

**Organic fluorides**, including sodium fluoracetate, also known as compound 1080, and fluoracetamide, are associated with sudden death by poisoning the enzyme aconitase, leading to the accumulation of diagnostically significant levels of citrate in tissues and permanent damage to myocardium.

**Metabolic effects** due to the ingestion of small amounts of **inorganic fluorides** over long periods are associated with an initial marked reduction in the activity of ruminal infusoria, a reduction in food intake, and a decreased production of fatty acids. The level of fluorine intake is critical and intakes of 150 mg/kg or less have no effect on food intake. At intakes of 150–200 mg/kg there is a depressing effect on milk production, and at 200 mg/kg the intake of grain is reduced.

**Detoxication by deposition** of fluorine occurs in association with phosphate in the teeth and bones. Deposition in bone

occurs throughout life but in teeth only in the formative stages. Fluorides inhibit the action of ameloblasts and odontoblasts during tooth formation, resulting in failure of the developing tooth to accept minerals.<sup>1</sup> In bones, fluorides alter mineralization and remodeling of bone by replacing hydroxyapatite in the bone crystalline structure.<sup>2</sup> The degree of deposition varies, being greatest on the periosteal surface of the long bones where exostoses commonly develop. Thus **teeth lesions** occur only if the intake is high before the teeth have erupted but bone lesions occur at any stage. When the tissue levels of fluorine are moderate, characteristic lesions due to hypoplasia of the enamel appear in the teeth. At higher levels the storage capacity of these organs is exceeded and blood and urine levels rise. General signs of toxicity thus appear in tissues at the same time as bone lesions develop. The **bone lesions** of osteomalacia, osteoporosis, and exostosis formation, with accompanying pathological fractures, are associated with excessive mobilization of calcium and phosphorus to compensate for their increased urinary excretion in conjunction with fluorine.

The other tissues particularly prone to fluorine intoxication and in which degenerative changes occur are bone marrow, kidney, liver, adrenal glands, heart muscle, and central nervous system. A severe **anemia** may rarely occur as a result of toxic depression of bone marrow activity, although this is not a constant or expected sign. The facility of storage in bone explains the long **latent period** which occurs in animals subjected to chronic intoxication.

There has been controversy about whether fluorine passes the **placental barrier** in significant amounts. Although the current view is that placental passage is infinitesimal in amount,<sup>3</sup> cases of neonatal dental fluorosis have been identified in cattle.<sup>4</sup>

Fluorine does not occur in significant quantities in the **milk** or colostrum of poisoned cows.

**Detoxification** by leaching of fluorine from bones and teeth occurs after a decrease in the intake of fluorine leads to lowering of blood levels and mobilization from deposits commences. This is of importance when interpreting urine and blood levels of the element.

## CLINICAL FINDINGS

### Acute intoxication

The syndrome includes dyspnea, complete anorexia, vomiting, and diarrhea in pigs, and ruminal stasis with constipation or diarrhea in ruminants. Vomiting acts as a protective mechanism and toxic doses in pigs may be eliminated in this way

without the development of other signs. Nervous signs are characteristic and include muscle tremor and weakness, a startled expression, pupillary dilatation, hyperesthesia, and constant chewing. Tetany and collapse and death follow within a few hours.

### Chronic intoxication-fluorosis

Because of the distinct clinical separation between animals with dental lesions and those which have, in addition, signs of lameness and general ill-health it is customary to refer to two forms of the disease: dental fluorosis and osteofluorosis. Lesions of the teeth and bones are characteristic and the signs are largely referable to these lesions. Teeth changes are the earliest and most diagnostic sign but may not produce clinical effects until other signs have developed. Consequently, they are often missed until other clinical findings suggest that the teeth be examined. Severe dental fluorosis results in excessive dental wear, inability to graze properly, difficulty mastication and lapping of water due to tooth pain. Continued impaired dentition leads to reduced milk production and poor weight gain or actual weight loss. Reproductive function may be reduced due to locomotor dysfunction and poor nutrition as a result of reduced feed intake.

### Osteofluorosis

**Lameness** most marked in the loins, hip joints, and hind limbs and unthriftiness in animals of any age are the signs usually observed first. The occurrence of hip lameness or **fractures of the third phalanx** on a herd scale in cattle is thought to be diagnostic of fluorosis. Pain is evinced on pressure over limb bones and particularly over the bulbs of the heels. The bones may be palpably and visibly enlarged. This is most readily observed in the mandible, sternum, metacarpal, and metatarsal bones and the phalanges. This overall thickness may be subsequently replaced by well-defined exostoses. The bones are subject to easy fracture. These well-defined lesions occur only in advanced cases and are often accompanied by extensive tooth lesions in young animals. In addition to the cases affected by generalized lameness there are cases which show a sudden onset of very severe lameness, usually in a forelimb, associated with transverse fracture of the third phalanx.

### Dental fluorosis

Temporary teeth of animals poisoned while *in utero* and permanent teeth exposed to intoxication before eruption will be affected. The earliest and mildest sign is **mottling** with the appearance of pigmented (very light yellow, green, brown,

or black) spots or bands arranged horizontally across the teeth. Occasional vertical bands may be seen where pigment is deposited along enamel fissures. Mottling and staining occur on incisors and cheek teeth and are not evident when the affected tooth erupts and in fact may not appear until some months later. The cheek teeth are usually worse affected than the incisors but are very difficult to examine clinically. If the period of exposure to intoxication has been limited only some of the teeth may be affected but the defects will always be bilateral.

Mottling may not progress any further but if the intoxication has been sufficiently **severe defective calcification** of the enamel leads to accelerated attrition or erosion of the teeth, usually in the same teeth as the mottling. The mottled areas become pits and the teeth are brittle and break and wear easily and unevenly. Patterns of accelerated attrition are dependent upon the chronological occurrence of the intoxication and the eruption time of the teeth. Uneven and **rapid wear** of the cheek teeth makes proper mastication impossible. Infection of the dental alveoli and shedding of teeth commonly follow. The painful condition of the teeth and the inability to prehend and masticate seriously **reduce the food intake** and are associated with poor growth in the young and unthriftiness and acetonemia in adults. Affected cattle may lap cold drinking water to avoid the discomfort occasioned by normal drinking. Eruption of the teeth may be abnormal, resulting in irregular alignment.

A standard for the **classification of fluorosis** has been proposed based on the degree of mottling, pitting, and rate of wear of the teeth. The effects of dental mottling, pitting, and excessive wear of incisors can be used to estimate the lifetime exposure periods of cattle at risk during dentition.<sup>5</sup> The additional clinically apparent abnormalities include delayed eruption of permanent incisor teeth, necrosis of alveolar bone resulting in recession of bone and gingiva, oblique eruption of permanent teeth, hypoplasia of teeth, wide spaces between teeth, and rapid development of any dental lesions.

### Other effects

Reproduction, milk yield, and wool growth are not usually considered to be adversely affected except indirectly by the reduced food intake. Severely lame animals may have lowered reproductive performance indirectly due to physical dysfunction that interferes with mating.

Additional signs including diarrhea and anestrus and other forms of infertility in cattle, diarrhea in sheep, and polydipsia and polyuria in pigs are recorded in the

naturally occurring disease but cannot be considered as constant or pathognomonic.

**Housed animals.** In animals that are grazed for only part of the year on pasture contaminated by factory effluent during the summer, there may be considerable clinical improvement during the winter and an annual recrudescence of signs when the animals are outside.

**Horses** with chronic fluorosis have lameness, dental lesions including excessive molar abrasion, and hyperostotic lesions of the metatarsus, metacarpus, mandible, and ribs.

### CLINICAL PATHOLOGY

Normal cattle have blood levels of up to 0.2 mg fluorine per mg/dL of blood and 2–6 mg/kg in urine. Cattle on fluorine intakes sufficient to cause intoxication may have blood levels of 0.6 mg/dL, and urine levels of 16–68 mg/kg, although blood levels are often normal. Such high levels may not be an indication of high intakes immediately preceding the examination, as heavy deposits in bones may be associated with abnormally high blood and urine fluorine levels for some months after the intake has been reduced to normal. Urine levels should be corrected to a specific gravity of 1.040. Serum calcium and phosphorus levels are usually normal and there is a significant correlation between the amount of fluoride fed and the concentration of alkaline phosphatase in the serum. The increase in phosphatase activity is probably related to the abnormal formation of bone. The increased SAP activity may be three to seven times the normal level.

**Radiographic changes** of bones containing more than 4000 mg/kg of fluorine include increased density or abnormal porosity, periosteal feathering, and thickening, increased trabeculation, thickening of the compact bone, and narrowing of the marrow cavity. Spontaneous rib fractures show incomplete union. Good data are available for fluorine concentrations in rib bones, and estimations of fluorine content in biopsy samples of ribs have been used in the clinicopathological study of the disease. Samples of tail bone and the spongiosa of the tuber coxae have also been used for these purposes.

**Organic fluorides** are difficult to assay in excretions and tissues, and even in contaminated feed sources. In affected animals indirect measurement based on tissue concentrations of citrate may be necessary. An additional suggested procedure is the administration of an aqueous extract of suspected poisoned tissues or feed material to guinea-pigs

and the measurement of tissue levels of citrate in them.

### NECROPSY FINDINGS

Severe gastroenteritis is present in acute poisoning. In chronic fluorosis the bones have a chalky, white appearance, are brittle and have either local or disseminated exostoses, particularly along the diaphyses. Intra-articular structures are not primarily affected, although there may be some spurring and bridging of the joints. Histologically there is defective and irregular calcification of newly formed trabecular bone and active periosteal bone formation. Hypoplasia of the enamel and dentine are consistent physical and histological defects in the teeth of affected young animals. Young animals may also develop thickened growth plates and widened metaphyses that are grossly similar to rachitic changes. Degenerative changes in kidney, liver, heart muscle, adrenal glands, and central nervous system have been reported in severe cases. Degeneration of the bone marrow and consequent aplastic anemia also occur.

Chemical examination of necropsy specimens is valuable in the diagnosis as the fluorine content of bones from poisoned animals is greatly increased. Levels of up to 1200 mg/kg are observed in normal animals but may be increased up to 3000 mg/kg in animals exposed to fluorine and showing only mottling of the teeth. Animals showing severe clinical signs have levels greater than 4000 mg/kg of bone on a dry, fat-free basis and after prolonged heavy feeding levels may be as high as 1.04%. Care must be taken in selecting the bone samples because of the great variation in the concentration of fluorine which occurs between different bones. Good data are available for comparison between metacarpal, metatarsal, rib, pelvic, and mandibular bones and antlers of deer.<sup>3</sup> Mandibles usually show the greatest concentrations and in the long bones the distal and proximal quarters are more sensitive indicators than the center half.

Soft tissues are unreliable as a criterion for fluorosis because of their low levels of fluorine. In bone and teeth, ash levels of 0.01–0.15% fluorine are found in normal animals. Levels up to 1.5% fluorine indicate excessive intake but are not usually accompanied by anatomical changes. Where clinical signs of intoxication appear there is usually up to 2% fluorine in bone ash and 1% in teeth ash.

### Samples for confirmation of diagnosis

- **Toxicology** – mandible/metacarpal/metatarsal; rib, vertebrae for evidence of osteofluorosis. Urine from affected

animals for evidence of recent exposure (ASSAY (F))

- **Histology** – formalin-fixed metacarpal/metatarsal/mandible (LM).

**Diagnostic confirmation** depends on fluorine assay of food and water, of blood and urine of affected animals, and bones and teeth at necropsy.

### DIFFERENTIAL DIAGNOSIS

Diseases causing lameness and stiff gait at herd level:

- Nutritional deficiency of phosphorus
- Nutritional deficiency of vitamin D
- Osteodystrophia fibrosa in horses
- Chronic selenium poisoning
- Enzootic calcinosis
- White muscle disease
- Ephemeral fever in cattle.

### TREATMENT

**Primary treatment**, apart from removing the animals from the source of fluorine, is largely impractical. Acute cases require gastrointestinal sedatives.

**Supportive treatment** to neutralize residual fluorine in the alimentary tract and calcium salts intravenously is recommended. Aluminum salts act as neutralizers of the hydrofluoric acid produced in the stomach and because of their insolubility they are safe even in large quantities (30 g of aluminum sulfate daily for prevention, more for treatment). The calcium salts given intravenously should be given to effect, using the disappearance of tetany and hyperesthesia as a guide. This treatment will probably have to be repeated. The parenteral administration of glucose solutions is recommended because of the interference by fluorine with glucose metabolism. Irrespective of treatment used, no improvement in dental or osseous lesions can be anticipated but there may be amelioration of the other clinical signs.

### CONTROL

#### Fluorine content of feed

Phosphatic feed supplements should contain not more than 0.2% fluorine for milking or breeding cattle or 0.3% for slaughter cattle, and should not comprise more than 2% of the grain ration if the fluorine content is of this order. In spite of this recommendation the feeding of rock phosphate containing 1–1.5% fluorine to cattle for long periods is maintained in some areas without major deleterious effects on health. Some deposits of rock phosphate have much higher contents of fluorine than others and commercial

**defluorination** makes these toxic deposits safe for animal feeding.

**Bone meal** in some areas may contain excessive quantities of fluorine and should be checked for its fluorine content. Access to **superphosphate** made from rock phosphate with high fluorine content should be avoided. Water from **deep wells and artesian bores** should be assayed for fluorine content before use.

### Nutritional management

Where fluorine levels are marginal careful husbandry, including the watering of young, growing stock on fluorine-free supplies, and permitting only adults to be watered on the dangerous supplies, and rotating the animals between safe and dangerous waters at 3-month intervals may make it possible to utilize land areas otherwise unsuitable for stock raising. In some areas dairy herds may have to be maintained by the purchase of replacements rather than by the rearing of young stock. In areas where long-term ingestion of fluorine is likely to occur the aim should be to provide a diet of less than 50 mg/kg of the total diet of dairy cows. Adequate calcium and defluorinated phosphorus intakes should be insured as these reduce bone storage of fluorine.

### Detoxication

Aluminum salts are the principal substances used to detoxicate food and water. They are relatively ineffective, reducing the accumulation of fluorine in bone by only 20–30%, and are thus referred to as 'alleviators'. The sulfate and phosphate have been used but all the salts are unpalatable and can only be administered daily to animals being hand-fed relatively large amounts of concentrates. It is presumed that highly insoluble aluminum fluoride is formed in the alimentary canal.

Extensive field trials of aluminum as an alleviator have not justified its use as a practicable control measure in average circumstances. Best results are obtained by improvement in nutrition of the animals and better grassland management. If effective control measures are introduced it will be some years before the affected teeth have erupted and become visible and affected animals culled.

**Slaked lime.** The fluorine content of drinking water can be reduced (from 10 to 0.95 mg/kg) by adding freshly slaked lime to the water; 500–1000 mg/kg should be added and the water must be allowed to settle for 6 days. The method requires the use of large storage tanks.

**Legislation** to control fluoride emission from factories is now general but the usual limitation of not more than 1 µg/m<sup>3</sup> does not completely avoid danger and serious

losses can still occur at these emission levels. Prevailing tolerances for pasture contamination also appear to be incompletely protective.

### REVIEW LITERATURE

- Ammerman CB et al. Symposium on fluoride toxicosis in cattle. *J Anim Sci* 1980; 51:744 et seq.  
 Krook L, Maylin GA. Industrial fluoride pollution. *Cornell Vet* 1979; 69, Suppl. 8:69.  
 Wheeler SM, Fell LR. Fluorides in cattle nutrition. *Nutrit Abst Rev* 1983; 53:741–766.

### REFERENCES

1. Shearer TRAm *J Vet Res* 1978; 39:597.
2. Shupe JL, Alther EW. Handbook of Experimental Pharmacology. Pharmacology of fluorides. Vol. XX/1. New York, 1966. Springer-Verlag, 1966.
3. Shupe JL et al. *Vet Human Toxicol* 1992; 34:1.
4. Maylin GA et al. *Cornell Vet* 1987; 77:84.
5. Shupe JW. *J Anim Sc* 1980; 51:756.

### ALUMINUM POISONING

Aluminum is one of the potentially toxic elements introduced into the diets of animals by the deposition of soluble salts in acid rain, or by powder particles in factory effluent. Absorption by plants may also be a factor. Overt effects are rare but at high levels of intake, the aluminum suppresses the absorption of phosphorus and may be associated with the patient being in negative phosphorus balance. Retarded growth and hypophosphatemia have been produced experimentally in pigs.<sup>1</sup>

### REFERENCE

1. Haglin L et al. *Acta Vet Scand* 1994; 35:263.

### MOLYBDENUM POISONING

Synopsis
<p><b>Etiology</b> Ingestion of toxic amounts of molybdenum.</p> <p><b>Epidemiology</b> Enzootic in areas where soil, especially peat soils, contain high levels of molybdenum. Epizootics when molybdenum used in excessive amounts as an agricultural chemical.</p> <p><b>Clinical signs</b> Signs of secondary hypocuprosis (weight loss, hair coat depigmentation, anemia) plus persistent, debilitating diarrhea.</p> <p><b>Clinical pathology</b> High blood levels of molybdenum, low levels of copper.</p> <p><b>Necropsy lesions</b> No significant lesions.</p> <p><b>Diagnostic confirmation</b> High levels of molybdenum in feed and blood.</p> <p><b>Treatment</b></p> <p><b>Primary:</b> copper salts orally.</p> <p><b>Supportive:</b> none necessary.</p> <p><b>Control</b> Dietary supplementation with copper.</p>

### ETIOLOGY

A daily intake of 120–250 mg of molybdenum has proved to be toxic for cattle, although the toxic dose varies widely with the intake of sulfate, copper, and possibly other factors.

### EPIDEMIOLOGY

#### Occurrence

The major occurrence of molybdenum poisoning is on pasture growing on molybdenum-rich soils, usually derived from particular geological formations, e.g. the 'teart' pastures of Somerset (UK), the USA, and Canada, marine black shales in the UK and pastures containing excess molybdenum intake with or without a marginal deficiency of copper in New Zealand, Canada, Ireland, and Australia.

#### Source

Toxic intakes

**Soil** molybdenum levels in problem areas vary between 10 and 100 mg/kg. Illness may occur on **pasture** containing 3–10 mg/kg. Although levels of less than 3 mg/kg are usually considered to be safe, signs of toxicity may occur at levels as low as 1 mg/kg if the sulfate intake is high and the copper status low; the trigger level of molybdenum at which the interference with the metabolism of copper may occur is 2.4 mg/kg dry matter in the diet.

**Forage** containing 10 mg/kg must be considered dangerous at all times and, on pasture affected by aerial contamination levels of 10–200 mg/kg may be encountered. Such intakes can be provided by:

- **Industrial fallouts** of 5–40 ng/m<sup>3</sup> of air or 2 mg/m<sup>2</sup> per month on pasture
- Contamination of pasture by **motor oil** containing molybdenum as an additive<sup>1</sup>
- **Aerial contamination** by fumes from aluminum and steel alloy factories and oil refineries using molybdenum is associated with secondary copper deficiency
- The use of molybdenum in **fertilizer mixtures** to increase nitrogen fixation by legumes may lead to excessive amounts of molybdenum in soils.

**Drinking water** may not be as toxic as the same amount in fresh forages. For calves, the minimum toxic concentration in drinking water is between 10 and 50 mg/kg when dietary copper and sulfur intake in the diet is normal.

#### Risk factors

**Sheep and cattle** are clinically affected in field outbreaks of the disease and signs are most marked in young growing animals. Cattle are much more susceptible than sheep. Horses also appear to be susceptible.<sup>2</sup>

The concentration of molybdenum in forage varies with the season, being highest in the spring and autumn and with the plant species, legumes, particularly alsike clover, taking up molybdenum in much greater quantities than grasses.



### Importance

The disease is not highly fatal but severe stunting and loss of production does occur.

### PATHOGENESIS

**Copper metabolism.** An extended discussion of the role of molybdenum in copper metabolism is provided in the section on secondary deficiency. Excess molybdenum intake is associated with an increased formation of thiomolybdates, important enzyme inhibitors which interfere with the hepatic storage of copper and produce a state of copper deficiency.<sup>3</sup> This situation is exacerbated by a high intake of sulfur or a low intake of copper. The syndrome of molybdenum intoxication resembles that of copper deficiency and treatment and prevention by the administration of copper is effective.

**Molybdenum poisoning.** Some of the signs of molybdenum poisoning, particularly diarrhea, are not characteristic of copper deficiency, and may represent a specific toxic effect of molybdenum. An identified specific toxic effect is that of causing the development of exostoses and hemorrhages about the long bones, and separation of the great trochanters of the femur in some sheep fed molybdenum experimentally. The lesions appear to be due to defects in connective tissue at muscle insertion points, and to defects in the epiphyseal growth plates.

**Experimental feeding** of molybdenum, and its intravenous injection,<sup>4</sup> produce a syndrome identical with that seen in the naturally occurring disease in cattle but liver and plasma levels of copper may not be depressed as is usual in naturally occurring cases. Experimental feeding of a large dose, up to 40 g, of molybdenum may be associated with only transient diarrhea. Most of the molybdenum is rapidly absorbed and excreted, 90% in the first week.

### CLINICAL FINDINGS IN CATTLE

- **Persistent scouring** commences within 8–10 days of the animals having access to affected pasture
- **Emaciation** and a dry, staring coat develop and there is profound depression of milk production
- **Depigmentation** of black hair causes a red or gray tinge to appear. This may be particularly noticeable around the eyes, giving a bespectacled appearance. Intense craving for copper supplement has been noted
- Young cattle (3 months to 2.5 years) also show abnormalities of locomotion including marked **stiffness** of the legs and back, difficulty in rising, and great reluctance to move. The gait is suggestive of laminitis but the feet appear normal. The lameness may be

due to the periosteal lesions described above. The appetite remains good

- Rare cases in horses<sup>2</sup> show diarrhea and impaction colic and a high mortality rate.

### CLINICAL PATHOLOGY

**Blood copper** levels are reduced from the normal of 1.0 µg/mL to 0.25 µg/mL. Seasonal variations occur depending on the intake of molybdenum.

**Blood Molybdenum** levels in normal animals are of the order of 0.05 mg/kg and rise to about 0.10 mg/kg when excess molybdenum is ingested. Levels as high as 0.70 and 1.4 mg/kg have been recorded in cattle and horses grazing on pasture contaminated by smelter fumes. On very large intakes of molybdenum cattle which are clinically normal may have molybdenum levels of 1000 mg/kg in feces, 45 mg/kg in urine, 10 mg/kg in blood, and 1 mg/kg in milk.

### NECROPSY FINDINGS

There are no gross or histological findings which characterize the disease, enteritis being conspicuously absent. The carcass is emaciated and dehydrated and there may be anemia if there is an accompanying copper deficiency. Tissue copper levels will be below normal.

### DIFFERENTIAL DIAGNOSIS

**Diagnostic confirmation.** The most effective method is to treat affected animals orally with copper sulfate (2 g daily or 5 g weekly for adult cattle and 1.5 g for adult sheep). The diarrhea ceases in 2–3 days and improvement in the other signs is rapid.

The persistence of the diarrhea without other clinical signs, particularly in young cattle and sheep, may suggest:

- Internal parasitism, e.g. trichostrongylosis, ostertagiasis; examination of feces for worm eggs is necessary for differentiation
- Johne's disease which affects only adults; usually only one animal in a herd shows clinical signs at any one time
- Acute enteritides including salmonellosis, winter dysentery and virus diarrhea, acute diseases accompanied by other diagnostic signs.

### PRIMARY TREATMENT AND CONTROL

Molybdenum toxicity can be treated by the administration of copper, and controlled by increasing the copper content of the diet by 5 mg/kg. But the administration of copper to large numbers of animals presents a number of problems. For long-term control, the recommended ratio of Cu:Mo is 4:1 to 10:1, and a Sulfur:Mo ratio of <100:1 is considered safe vs. copper accumulation.<sup>5,6</sup>

### REFERENCES

1. Sas B. *Vet Human Toxicol* 1989; 31:29.
2. Ladefoged O, Sturup S. *Vet Human Toxicol* 1995; 37:63.
3. Mason J. *Toxicology*, 1986; 42:99.
4. Auza N et al. *Vet Human Toxicol* 1989; 31:535.
5. Buck WB. *J Am Vet Med Assoc* 1970; 46:1078.
6. National Research Council. *Nutrient Requirements of Beef Cattle*, ed. 4. Washington, D.C., National Academy Press, 1996.

### PRIMARY COPPER POISONING

- **Primary copper poisoning is associated with the intake of excessive amounts of copper**
- **Secondary copper poisoning, which occurs on low intakes of copper, is dealt with on p. 1823.**

#### Synopsis

**Etiology** Acute or chronic accidental intake of copper.

**Epidemiology** Usually occurs as major outbreaks. Sheep most susceptible, horses least. Significant differences in breed susceptibility. Copper originates from copper-rich soils, industrial contamination of pasture or copper preparations used pharmaceutically, as a feed ingredient, or as an agricultural chemical.

**Pathogenesis** Acute poisoning due to ingestion of a single large dose is associated with alimentary tract mucosal necrosis and fatal shock. Acute intravenous or chronic oral intake is associated with fatal hemolytic anemia.

#### Clinical signs

- Acute oral poisoning: abdominal pain, diarrhea, vomiting, shock, short course, death.
- Chronic oral poisoning: anemia, jaundice, hemoglobinuria.

**Clinical pathology** Chronic oral poisoning: very high blood and liver copper levels, low PCV, hemoglobinuria, elevated liver enzymes in serum.

**Necropsy lesions** Acute oral poisoning: severe gastroenteritis.

Chronic oral poisoning: high tissue levels of copper, tissue jaundice, swollen liver, kidneys, spleen, hemoglobinuria.

**Diagnostic confirmation** High copper levels in tissues.

**Treatment** Primary: edetate or molybdate parenterally. Supportive: blood transfusion if practicable.

**Control** Removal from source, prophylactic administration of molybdate.

### ETIOLOGY

**Acute oral poisoning** is associated with the accidental ingestion of large amounts of copper salts at one time. **Acute systemic poisoning** and **chronic oral poisoning** are associated with the accumulation of small amounts of copper ingested over a long period.

### EPIDEMIOLOGY

#### Occurrence

Sporadic outbreaks of primary copper poisoning occur in many circumstances.

In both acute and chronic cases the mortality rate approximates 100%.

### Acute or chronic oral poisoning

- Accidental administration of large quantities of soluble copper salts, e.g. as parasiticide drench
- Contamination of plants with fungicidal sprays
- Contamination of drinking water during snail eradication
- Grazing pasture too soon after it has been top-dressed with:
  - a copper salt to correct a mineral deficiency in the soil
  - poultry manure or dried chicken waste where the birds have been fed on a copper-rich diet
  - similarly with pig manure, dried pig wastes or pig slurry when the pigs have been fed on a copper-enriched ration as a growth supplement
- Grazing pasture growing on soils rich in copper
- Grazing pasture contaminated by smelter fumes or by drippings from overhead power cables made of copper but corroded by the constituents of an industrially polluted area
- Feeding of seed grain which has been treated with antifungal agents containing copper
- Feeding mineral or salt licks or mixtures containing excessive amounts of copper
- Salt or mineral mixtures containing copper ingested accidentally by salt-hungry livestock
- Copper-enriched concentrate rations fed as growth supplements to poultry or pigs in excessive quantities or fed to ruminants. Pigs can survive rations providing up to 250 mg/kg; these levels are toxic for ruminants in which 20 mg/kg is maximum copper content. For sheep, continued ingestion of cattle diets that contain elevated copper and limited molybdenum results in copper accumulation.
- Miscellaneous other sources of copper causing poisoning are palm oil cake, treated pine lumber containing arsenic, copper, and chromium.

### Acute parenteral poisoning

Prophylactic injections of copper salts, especially the more soluble, aqueous preparations, are very toxic if recommended dose rates are exceeded. This procedure is being increasingly used to prevent copper deficiency in grazing ruminants when other cheaper methods are not applicable. The paste preparations, usually copper glycinate, appear to be non-toxic but the soluble preparations, e.g. copper edetate, when given at recommended doses, can be associated with heavy

mortalities in sheep and calves.<sup>1</sup> Copper as the diethylamine oxyquinoline sulfonate has also been associated with deaths in sheep after injection of recommended dose rates. The absorption is fast and the blood levels high with these toxic compounds but not with copper methionate which has a good safety record. Deaths commence 24 hours after injection and continue for up to 7 days. Postmortem findings include hepatic centrilobular necrosis, nephrosis, pleural and peritoneal effusions.

### Toxic doses

There is a great deal of published anecdotal evidence about the amount of copper in specific feeds fed to specific species which was associated with illness or deaths but almost no evidence of MD50s or similar levels for the several animal species. **The following** toxic dose rates are provided as a rough guide:

- **Single doses** of 20–110 mg of copper per kg BW produce acute copper poisoning in sheep and young calves
- The status of goats generally is uncertain
- In cattle a dose rate of 220–880 mg/kg BW is necessary to cause death
- **Chronic poisoning** occurs in sheep and calves with daily intakes of 3.5 mg of copper/kg BW, 25 ppm being the maximum tolerated concentration in the feed. Even lower concentrations (15 ppm) may poison sheep if adequate molybdenum and sulfate are not present in the diet.

None of these data on toxic intakes come with information on competing and contributory dietary factors such as sulfate, molybdenum, and zinc and these are critical in determining the toxic effects of the copper intake.

### Risk factors

Environmental factors

Both acute and chronic copper poisoning occurs under field conditions. Acute poisoning usually occurs because of the accidental administration of large quantities of soluble copper salts, but chronic poisoning occurs principally as a result of ingesting feed containing or contaminated by copper derived from the soil or by its application to the diet as an agricultural chemical or feed supplement.

The toxicity of the copper ingested in this way is governed not only by the absolute amount of copper but also by the interaction of a number of factors including the amount of **molybdenum** and of **sulfate** present in the diet and the presence or absence of specific plants and the level of protein in the diet. In fact either copper deficiency or copper poisoning can occur on soils with appar-

ently normal copper levels, the syndrome depending on the particular conditioning factors present. High molybdenum and sulfate levels in the rumen lead to the microbiological synthesis of non-absorbable thiomolybdates, and a high sulfate diet also leads to lower retention of copper in tissues.

There is also a competitive relationship between copper and **zinc** in the internal metabolism of ruminants, a high level of zinc in the diet reducing the intake of copper.

Host factors

**Species susceptibility.** **Horses** are the least susceptible with a tolerance to levels of 800 ppm in the diet. **Cattle** will usually tolerate 100 ppm and swine 250 ppm, but lethal hemolysis has occurred in cattle fed a low copper level mineral supplement (38 mg/kg BW for lactating cows) for 2 years.<sup>2</sup> **Goats** are not featured in the literature on this subject and sheep criteria are recommended as guides. **Sheep** are the most susceptible species, tolerating as little as 25 mg/kg BW; they are peculiar in the way in which copper is handled metabolically. Increased absorption is not easily achieved but abnormally high excretion is more difficult still, so that there is the general tendency for copper to accumulate.

**Breed susceptibility.** **Sheep**, e.g. the Texel and the Finnish Landrace, are more resistant while others, e.g. the Ronaldsay and the Orkney, are much more susceptible. The Angora goat appears to be most susceptible and Nubian goats appear to be more resistant than sheep. Angus cattle are much more susceptible than Charolais.<sup>3</sup>

### Importance

Many deaths due to copper poisoning are followed by deaths from general debility in sheep in poor condition. Dairy cows, especially those lactating at the time, fail to produce well, and special care is needed to bring them back to full production.<sup>4</sup>

### PATHOGENESIS

Soluble copper salts in high concentrations are protein coagulants. The ingestion of large quantities is associated with intense irritation of the alimentary mucosa and profound shock. Severe intravascular hemolysis occurs if the animal survives long enough. When excessive amounts of copper are injected the response is rapid and animals begin to die the next day and with a peak of mortality about the third day after dosing. Early deaths appear to be due to severe hepatic insufficiency and later deaths to renal failure due to tubular necrosis. There appear to be no renal lesions in sheep affected

with chronic copper poisoning, unless a hemolytic crisis occurs, in which case there is a hemoglobinuric nephrosis.

The frequent ingestion of small amounts produces no ill-effects while copper accumulates in the liver. When maximum hepatic levels are reached after periods of exposure often as long as 6 months, the copper is released into the bloodstream and the animal dies of acute intravascular hemolysis. Thus there is really no such thing as 'chronic' copper intoxication; syndromes so called are fatal as acute hemolytic crises. One of the dangers of cumulative copper poisoning is that the animal shows normal health until the hemolytic crisis, when it becomes acutely ill and dies very quickly. Death is ascribed to acute anemia and hemoglobinuric nephrosis.

Two other abnormalities have been observed during and after the hemolytic crisis. One is the occurrence of methemoglobinemia; the other is the presence of degenerative lesions in the white matter of the brain. The accumulated copper can lead to the occurrence of a hemolytic crisis after ingestion of copper has ceased, and recurrent attacks can therefore occur in sheep that survive the attacks. There are a number of explanations for the development of hemolysis. One is that the erythrocytes in affected sheep become immunogenic as a result of the copper accumulation. It is suggested that this immunogenicity leads to the development of an autoantibody and the final result of an autoimmune hemolytic anemia. Alternatively, copper may act as an oxidant on the red cell membrane, leading to membrane damage and acute hemolysis as a result of oxidant injury. This is consistent with the formation of methemoglobin, a result of oxidant effects during the acute hemolytic crisis.

The liberation of the hepatic copper is incompletely understood, but the favored hypothesis is that the accumulation of copper ions in the liver cells is associated with the accumulation of electron-dense lysosomes in the hepatocytes and their eventual necrosis.<sup>5</sup> Various stresses including a fall in plane of nutrition, traveling, and lactation, are considered to precipitate the liberation. Complex mechanisms relating to disorders of cell membranes, a marked change in hemoglobin composition, including the development of methemoglobinemia and an increase in the oxidative status of the sheep, are described as occurring during the critical stages. During the prehemolytic stage of several weeks before the crisis there is hepatic necrosis and an elevation of levels of liver-specific enzymes. A much more serious necrosis of liver occurs at the time of the hemolytic crisis.

Sheep on a selenium-deficient diet and with low blood levels of glutathione peroxidase are more susceptible to chronic copper poisoning. Some sheep are also conditioned by inheritance to have low blood glutathione levels in spite of a normal dietary intake of selenium. They also have low glutathione peroxidase blood levels and may be more susceptible for this reason.

There is also a difference between breeds in their capacity to reduce copper absorption in response to the administration of zinc, Texels being much more responsive than Friesians and North Ronaldsays are also known to be highly susceptible. These sheep normally subsist on seaweed which has a very low content of copper and molybdenum. When the sheep are fed on terrestrial herbage containing normal levels of copper and molybdenum and high levels of zinc they develop copper poisoning.

## CLINICAL FINDINGS

### Acute intoxication

Severe gastroenteritis occurs accompanied by abdominal pain and severe diarrhea and vomiting in some species. The feces and vomitus contain much mucus and have a characteristic green to blue color. Vomiting occurs in the pig and dog and intense thirst is apparent. Severe shock with a fall in body temperature and an increase in heart rate is followed by collapse and death usually within 24 hours. If the animal survives for a longer period, dysentery and jaundice become apparent.

Acute poisoning associated with the injection of copper salts is manifested only by anorexia, depression, and dehydration. In calves that survive the illness for 3 days or more massive ascites, hydrothorax, hydropericardium, hemoglobinuria and massive hemorrhages, dyspnea, head-pressing, aimless wandering, circling, and ataxia occur. Lambs similarly poisoned and with similar postmortem lesions die within 24 hours of injection.

### Chronic intoxication

In ruminants anorexia, thirst, hemoglobinuria, pallor, and jaundice appear suddenly. There is no disturbance of alimentary tract function. Depression is profound and the animal usually dies 24–48 hours after the appearance of signs. In pigs signs of illness are uncommon, most pigs being found dead without premonitory signs, although dullness, anorexia, poor weight gain, melena, weakness, pallor, hyperesthesia, and muscle tremor may be observed occasionally.

### CLINICAL PATHOLOGY

Levels of copper in the blood and liver are markedly increased in chronic

copper poisoning. In acute intoxications several days are required after ingestion before these levels rise appreciably. Fecal examination may show large amounts (8000–10 000 mg/kg) of copper. Liver biopsy is a satisfactory diagnostic technique and serves a most useful purpose in the detection of chronic copper poisoning as blood levels do not raise appreciably until the hemolytic crisis occurs just before death. Because of the greater concentration of copper in the caudate lobe as compared to other parts of the liver, an autopsy specimen is to be preferred.

Blood levels of copper during the hemolytic crisis are usually of the order of 78–114  $\mu\text{mol/L}$  (4.9–7.2 ppm), compared with about 15.7  $\mu\text{mol/L}$  (1 ppm) in normal animals. Normal liver levels of less than 5.5 mmol/kg dry matter (349 ppm) rise to above 15.7 mmol/kg (997 ppm) in the latter stages of chronic copper poisoning in sheep, to 95 mmol/kg in pigs, and to 30 mmol/kg in calves. In sheep, liver values greater than 7.85 mmol/kg and kidney values of greater than 1.25–1.57 mmol/kg dry matter are diagnostic. After a massive single dose it is important to include kidney among specimens submitted for copper assay, because levels may be high (more than 25 mg/kg dry matter) while liver copper levels have not yet risen. When comparing normal and toxic values it should be remembered whether results are expressed as dry weight basis or wet weight basis. Assuming approximately 20% dry matter in tissue, a wet weight value of 1.5 ppm copper is actually 7.5 ppm on a dry weight basis, comparable to the toxic range reported for blood above. Thus, a commonly observed toxic value of 200 ppm copper in liver (wet weight basis) would be reported as 1000 ppm copper on a dry weight basis.

The packed cell volume of the blood decreases sharply, from 40 down to 10% in 48 hours, during an acute hemolytic episode. Methemoglobinemia may be present and the urine should be checked for hemoglobin.

Serum enzyme activity is greatly increased just before the hemolytic episode, and there is a significant reduction in the rate of bromosulfalein clearance during this period in sheep and in calves poisoned experimentally. In sheep the aspartate amino transferase (AST) levels may rise as high as 880 SF units per mL up to 6 weeks before obvious clinical signs appear, and the test is regarded as a suitable monitor of copper poisoning in this species. Plasma aspartate aminotransferase and sorbitol dehydrogenase levels in blood are elevated at 60 days after the copper feeding begins, but diethyl succinate carboxylesterase levels rise within 7 days and are therefore

the better indicator. The hepatic enzymes GGT and AST were determined in one experimental study to be the best enzymes to assess copper-load in sheep during the pre-hemolytic phase. GGT increases were evident 28 days before the hemolytic crisis and AST concentrations increased from 14 days prior to onset of acute copper toxicosis.<sup>6</sup>

### NECROPSY FINDINGS

**Acute copper poisoning** via oral exposure is uncommon in ruminants but gross changes include severe gastroenteritis with erosion and ulceration particularly in the abomasum. Macroscopic changes in calves poisoned by injected solutions of copper salts include hepatomegaly with an enhanced zonal pattern and massive fluid accumulations in body cavities. Characteristic microscopic findings in such acute copper toxicoses include extensive periarterial hepatic necrosis and a variable amount of renal tubular nephrosis.

**In chronic copper poisoning**, jaundice and hemoglobinuria are usual but not constant findings. The liver is swollen, yellow and may contain hemorrhagic foci. The spleen is enlarged with a soft pulp and the kidneys are swollen and have a dark gunmetal color. The hemolytic crisis typical of ovine copper toxicosis results in massive acute hepatocellular necrosis, which masks most of the chronic hepatic damage. These changes include hepatocellular vacuolation and degeneration, increased single cell necrosis of hepatocytes, a variable amount of periportal fibrosis, and proliferation of cholangiolar cells. These chronic lesions are more easily identified in cattle suffering from copper poisoning. Granular casts are often present in the renal tubules, especially in affected sheep. Hemosiderin deposits are increased in the liver and spleen.

Details of the critical copper levels of tissues are provided in the clinical pathology discussion. Although the lesions described above do occur in some outbreaks of the disease in pigs, they are not as pronounced as in ruminants and they are often accompanied by pulmonary edema and by severe hemorrhage from ulcers in the *pars esophagea* or large intestine.

### Samples for confirmation of diagnosis

- **Toxicology** – 5 mL blood; 50 g liver, kidney; 100 g stomach content; 500 g suspect feed (ASSAY (Cu))
- **Histology** – formalin-fixed liver, kidney, abomasum, spleen (LM).

### TREATMENT

**Primary treatment.** For chronic copper poisoning daily oral treatment of lambs with 100 mg ammonium molybdate and

### DIFFERENTIAL DIAGNOSIS

**Diagnostic confirmation** is by demonstration of high blood and liver levels of copper plus histological evidence of liver damage. The history and the examination of feedstuffs and pastures are valuable aids in determining the cause.

#### Differential list

Acute hemolytic diseases which may be mistaken for chronic copper poisoning include:

- Leptospirosis in calves
  - Postparturient hemoglobinuria
  - Bacillary hemoglobinuria
  - Plant poisoning including SMCO in rape, kale, etc., hepatotoxins in *Pithomyces chartarum*
  - Babesiosis
  - Anaplasmosis
  - Red maple (*Acer rubrum*) toxicosis
  - Excessive intake of onions (*Allium* sp.)
  - Many other associations with hemolytic anemia
  - Some cases of acute pasteurellosis.
- The bacterial infections are usually accompanied by fever and toxemia but rape poisoning and postparturient hemoglobinuria can only be diagnosed tentatively by an examination of the environment and consideration of the history.

The **differential diagnosis list** for acute copper poisoning includes other associations with gastroenteritis. It can usually be identified by the blue-green color of the ingesta.

1 g anhydrous sodium sulfate significantly reduces the copper content of tissues and appears to prevent deaths in lambs known to have toxic amounts of copper. The mode of action is by increasing the fecal excretion of copper. Under experimental conditions injection intravenously or subcutaneously has an ameliorating effect on copper poisoning by reducing the capacity of circulating copper to enter erythrocytes and cause their lysis. Injection of ammonium tetrathiomolybdate (three to six times intravenously at 2–3-day intervals at a dose rate of 2.7 mg/kg BW is also effective.<sup>3</sup> So too is the daily intravenous injections of sodium calcium edetate (70 mg/kg BW) for 2 days to calves. Different countries may have particular restrictions on the form of molybdenum approved for use, so locally available approved therapy should be determined and be a part of the veterinary pharmacy before acute hemolytic crises are encountered.

**Supportive treatment** should include blood transfusion.

In **acute cases** gastrointestinal sedatives and symptomatic treatment for shock are recommended.

### CONTROL

When chronic intoxication is occurring or appears probable the provision of

additional molybdenum in the diet as described under the control of phyto-genous chronic copper poisoning should be effective as a preventive measure. Ferrous sulfide is effective but difficulty is usually encountered in getting the animals to eat it. In pigs and sheep the administration of iron and zinc reduces the risk of copper poisoning on diets supplemented by this element and a diet high in calcium encourages the development of copper poisoning, probably by creating a secondary zinc deficiency. A lick which contains dicalcium phosphate, sulfur, and zinc sulfate has been used to advantage as a prophylactic.<sup>7</sup>

### REVIEW LITERATURE

- Gooneratne SR et al. Review of copper deficiency and metabolism in ruminants. *Can J Anim Sci* 1989; 69:819.
- Mason J. Thiomolybdates: mediators of molybdenum toxicity and enzyme inhibitors. *Toxicology*, 1986; 42:99–102.
- Odell BL. The concept of trace-element antagonism; the Cu-Mo-S triangle. *J Nutr Supp* 1997; 5:S1045.
- van Saun RJ. Copper toxicosis in sheep. *Mod Vet Pract* 1988; 69(1):1–5.
- Soli NE. Chronic copper poisoning in sheep. *NordVet. Med* 1980; 32:75–77.
- Solaiman WG et al. Effects of high copper supplements on performance, health, plasma copper and enzymes in goats. *Small Ruminant Research* 2001; 41:127.

### REFERENCES

1. Galey FD et al. *J Vet Diag Invest* 1991; 3:260.
2. Bradley CH. *Can Vet* 1993; 34:287.
3. Sargison ND, Scott PR. *Agri Pract* 1996; 17:36.
4. Perrin DJ et al. *Can Vet J* 1990; 31:629.
5. Kumaratilake JS et al. *J Comp Pathol* 1989; 100:381.
6. Ortolan EL et al. *Vet Human Tox* 2003; 45:289
7. Gummow B et al. *Onderstepoort J Vet Res* 1991; 58:33.

### SECONDARY COPPER POISONING ('TOXEMIC JAUNDICE' COMPLEX)

Copper poisoning is a complex problem because of the many factors that influence the intake, metabolism, and excretion of the element. Consequently secondary copper poisoning ('toxemic jaundice') can occur on intakes of copper which are, in other dietary circumstances, non-toxic. The common syndromes include the following:

- **Phyto-genous chronic copper poisoning** is a condition in which relatively small amounts of copper are ingested but excessive retention occurs because of the presence of specific plants which have no apparent association with liver damage
- **Hepato-genous chronic copper poisoning** results from excessive retention of copper from the ingestion of specific plants which are associated with liver damage

- One of the plants that commonly contribute in this way is *Heliotropium europaeum* which is also capable of causing uncomplicated toxipathic hepatitis without abnormality of copper metabolism.

The 'toxemic jaundice' group of diseases includes all of these forms of secondary copper poisoning and toxipathic hepatitis associated with *Heliotropium europaeum*.

### Phytogenous chronic copper poisoning

This occurs in sheep grazing pasture containing normal amounts of copper. Although the copper intake may be low, liver copper levels are high and a hemolytic crisis typical of chronic copper poisoning occurs. The predominant association is the domination of the pasture by subterranean clover (*Trifolium subterraneum*) which may contain lower than normal quantities of copper (15–20 mg/kg). British breeds of sheep and their crosses with Merinos are most susceptible.

Control of this disease is by encouragement of grass growth in the pastures. Outbreaks can also be avoided if sheep are prevented from grazing lush, clover-dominant pastures in the autumn. Avoidance of stress, particularly malnutrition, is also important. The daily administration of molybdenum in the feed (7 mg/kg molybdenum) has been shown to greatly reduce the uptake of copper by lambs on diets of high copper content and this has been used as a practical preventive measure. Molybdenized superphosphate (70 g/ha), and molybdenized licks or mineral mixtures (86 kg salt, 63 kg finely ground gypsum, 0.45 kg sodium molybdate) are suitable alternatives. When an outbreak occurs, the administration of ammonium molybdate (50–100 mg/head per day) together with sodium sulfate (0.3–1.0 g/head per day) will stop further deaths in sheep within 3 days. Solutions of the above salts may be sprayed onto hay and administration should be continued for several weeks.

### Hepatogenous chronic copper poisoning

This form of the disease occurs most commonly following the ingestion of sufficient quantities of the plant *Heliotropium europaeum*, (*Senecio* spp. and *Echium plantagineum*) over a period of 2–5 months to produce morphological and biochemical changes in liver cells without major impairment of liver function. After ingestion of these plants the liver cells have an increased affinity for copper and abnormally high amounts accumulate in the liver with an increased risk of a hemolytic crisis. Sheep grazed on

*H. europaeum* and then on subterranean clover are particularly prone to this form of the disease. Control depends upon preventing the ingestion of hepatotoxic plants and restricting copper retention by the methods described above.

### Poisoning by *Heliotropium europaeum*

Heliotrope contains hepatotoxic alkaloids and continued ingestion of the plant is associated with liver damage. If a high copper storage occurs, hepatogenous chronic copper poisoning may develop. On the other hand, if the sheep's copper status remains normal liver damage proceeds until the animal suffers from simple toxipathic hepatitis. The effects of the plant are cumulative and grazing for one season may be associated with little apparent harm but further grazing in the subsequent year may be associated with heavy mortality. Control must aim at eradication of the plant.

### REVIEW LITERATURE

- Mason J Thiomolybdates: mediators of molybdenum toxicity and enzyme inhibitors. *Toxicology*, 1986; 42:99–102.
- van Saun RJ. Copper toxicosis in sheep. *Mod Vet Pract* 1988; 69(1):1–5.
- Soli NE. Chronic copper poisoning in sheep. *Nord Vet Med* 1980; 32:75–77.

## SODIUM CHLORIDE POISONING

### Synopsis

**Etiology** Ingestion of excessive amounts of sodium chloride OR normal intake but limited water intake.

**Epidemiology** Source of salt includes:

- Artesian bore water used as drinking water
- Water accumulating in pasture containers of salt mixture or lick
- Animals allowed access to salt after previous deprivation
- Excess salt in prepared feeds.

### Clinical signs

**Very large doses:** vomiting, diarrhea, dehydration.

**Average doses in cattle:** opisthotonos, Nystagmus, blindness, convulsions, death.

**Continuous intake in pigs:** blindness, deafness, aimless wandering, head pressing, regularly periodic convulsions.

**Continuous intake in ruminants:** bawling, restlessness, anorexia.

**Clinical pathology** High blood levels of sodium and sodium chloride. High salt content in water, feed. Eosinopenia only in pigs.

### Necropsy lesions

**Very large doses:** gastroenteritis.

**Average doses:** eosinophilic meningitis in pigs; polioencephalomalacia in cattle. High tissue levels of sodium and chloride.

**Diagnostic confirmation** Elevated sodium and chloride content of tissues. Cerebrospinal fluid sodium exceeds serum sodium. Elevated aqueous or vitreous humor sodium.

### Treatment

**Primary:** remove source of salt, restrict water intake and allow acclimation to water slowly.

**Supportive:** gastroenteric sedatives and fluid/electrolyte replacement for gastroenteritis form; sedative and cerebral decompressant in convulsive form.

**Control** Limit intake of salt-rich water, whey, concentrate mixes; insure adequate drinking water supply at all times.

### ETIOLOGY

Feed and water containing excessive quantities of salt are unpalatable to animals but excessive quantities of salt are sometimes ingested, especially in saline drinking waters. Specific details about the degree of salinity of drinking water that is compatible with health in animals are difficult to provide, because of the variation in the kinds of salts which occur in natural saline waters.

**Toxic doses** quoted for acute sodium chloride poisoning are for pigs, horses, and cattle 2.2 g/kg BW and for sheep 6 g/kg. The toxicity of salt is significantly influenced by the age and body weight of the subject. For example, dose rates which kill pigs of 6.5–10 kg BW have little effect on pigs of 16–20 kg.

It is probable that the pathophysiological disturbance described here is one of water intoxication rather than salt poisoning in the absolute sense. High salt intakes are extensively used in sheep to restrict food intake during drought periods and in the control of urolithiasis in feeder wethers but salt poisoning does not occur if there is free access to water. Rations containing up to 13% of sodium chloride have been fed to ewes for long periods without apparent ill-effects, although diets containing 10–20% and water containing 1.5–2% sodium chloride do reduce food consumption. This may be of value when attempting to reduce feed intake but can be a disadvantage when sheep are watered on saline artesian water.

### EPIDEMIOLOGY

#### Occurrence

Salt poisoning will occur wherever bore water is used for livestock drinking. It is reported principally from Australia, North America, and South Africa.

#### Sources of toxin

- Saline drinking water, especially after a change from fresh water, and especially if the animals are thirsty
- Water accumulating in salt troughs during drought periods
- Animals previously deprived of salt may eat excessive amounts if suddenly allowed access to unlimited quantities

- In animals kept in barns and small yards when prepared feeds contain too much salt, or salt is provided only intermittently, when trough space is limited and animals tend to gorge on swill or concentrate
- Swill fed to pigs may contain excessive amounts of salt when it contains dough residues from bakeries, brine from butchers' shops, salt whey from cheese factories, or salted fish waste
- Excessive sodium sulfate given to pigs as treatment for gut edema if the water intake is restricted
- Environmental pollution by oil wells. Cattle are attracted to oil residues of their salty flavor and may ingest toxic amounts
- Temporary restriction of the water supply to pigs of 8–12 weeks of age, lambs and calves fed prepared feeds containing the standard recommendation of 2% salt. Poisoning occurs when the animals are again allowed access to unlimited water. Similarly pigs brought into new pens where drinking water is supplied in automatic drinking cups may not be accustomed to their use and fail to drink for several days until they learn to operate the cups. Feeder lambs and calves may also be deprived of water when their troughs are frozen over.

### Risk factors

#### Host factors

Sheep, beef cattle, and dry dairy cattle appear to be less susceptible than dairy cows in milk, which are in turn less susceptible than horses. Heavy milking cows, especially those in the early stages of lactation, are highly susceptible to salt poisoning because of their unstable fluid and electrolyte status.

### Toxin factors

Saline waters often contain a mixture of salts and those containing high levels of magnesium or fluorine may be quite toxic. Water containing 0.2–0.5% magnesium chloride may be associated with reduced appetite and occasional diarrhea in sheep, especially if the sodium chloride content is also high, but water containing similar quantities of sodium sulfate does not have any harmful effect.

Variation between bore waters includes differences in the relative proportions of the acid radicals, particularly sulfates, carbonates, and chlorides.

### Environment factors

Environmental temperatures have an effect on toxicity, signs occurring in the summer on water containing levels of salt which appear to be non-toxic in the winter. Australian recommendations are that the maximum concentration for sodium

chloride or total salts in drinking water should not exceed 1.3% for sheep, 1% for cattle, and 0.9% for horses. South African and Canadian recommended levels are much lower but there does not appear to be any proof that such low levels of total and individual salts are necessary.

### Importance

Many animals may be clinically affected and the mortality rate may be high where animals are kept under range conditions and have to depend on saline water supplies for drinking purposes. In animals kept under intensive conditions salt poisoning occurs only sporadically but most affected animals die and heavy losses may occur in groups of pigs.

### PATHOGENESIS

#### Acute poisoning

When excessive amounts of salt are ingested gastroenteritis occurs because of the irritating effects of the high concentrations of salt. Dehydration results and is exacerbated by the increased osmotic pressure of the alimentary tract contents. Some salt is absorbed and may be associated with the involvement of the central nervous system as in chronic poisoning.

#### Chronic poisoning

Where the defect is one of decreased water but normal salt intake, there is an accumulation of sodium ions in tissues, including the brain, over a period of several days. An initial high sodium accumulation may inhibit anaerobic glycolysis, preventing active transport of sodium out of the cerebrospinal compartment. When water is made available in unlimited quantities, it migrates to the tissues to restore normal salt-water equilibrium. This is associated with acute cerebral edema and the appearance of signs referable to a sudden rise in intracranial pressure. The response is the same in all species but in pigs there is, in addition, an accumulation of eosinophils in nervous tissue and the meninges. The sodium ion is the one that accumulates in the tissues, identical syndromes being produced by the feeding of sodium propionate or sodium sulfate. It has also been observed that the feeding of soluble substances such as urea, which are excreted unchanged by the kidney, may be associated with anhydremia and an increase in the sodium ion concentration in brain tissue and the development of encephalomalacia.

This form of salt poisoning is chronic only in the sense that the sodium ion accumulates gradually. The clinical syndrome is acute in much the same way as the syndrome is acute in chronic copper poisoning. There is an apparent relationship between this form of salt poisoning and polioencephalomalacia in all species. Many outbreaks of this latter

disease occur in circumstances which suggest chronic salt poisoning. Sheep become adapted to a continuous high salt intake (up to 1.3% sodium chloride in the drinking water) by significant changes in numbers of microflora in the rumen but this is not usually accompanied by any change in total metabolic activity. The same level of intake in sheep is associated with some mortality, chronic diarrhea and reduction in fertility, weight gain and wool growth.

### CLINICAL FINDINGS

#### Acute salt poisoning in cattle

With very large doses the clinical signs are vomiting, diarrhea with mucus in the feces, abdominal pain, and anorexia. The more common syndrome, accompanying the dose of salt usually encountered, includes opisthotonos, nystagmus, tremor, blindness, paresis, and knuckling at the fetlocks. There may be a nasal discharge and polyuria occurs constantly. A period of recumbency with convulsions follows and affected animals die within 24 hours of first becoming ill. Sheep show similar signs. In swine the signs include weakness and prostration, muscle tremor, clonic convulsions, coma and death after a course of about 48 hours.

#### Chronic salt poisoning

In pigs this is ushered in by the appearance of constipation, thirst and pruritus 2–4 days after exposure. A characteristic nervous syndrome follows within 12–24 hours. Initially there is apparent blindness and deafness, the pig remaining oblivious to normal stimuli and wandering about aimlessly, bumping into objects and pressing with the head. There may be circling or pivoting on one front leg. Recovery may occur at this stage or epileptiform convulsions begin, recurring at remarkably constant time intervals, usually 7 minutes, accompanied by tremor of the snout and neck. Clonic contractions of the neck muscles may be associated with jerky opisthotonos until the head is almost vertical causing the pig to walk backwards and assume a sitting posture. This may be followed by a clonic convulsion in lateral recumbency, with jaw champing, salivation, and dyspnea. Death may occur due to respiratory failure or the pig relaxes into a state of coma for a few moments, revives and wanders about aimlessly until the next episode occurs. The pulse and temperature are normal except in convulsive pigs when both may be elevated. The course is variable and death may occur in a few hours or not for 3–4 days after the first appearance of illness.

#### Subacute poisoning

This syndrome in cattle and sheep on saline drinking water includes depression of

appetite, thirst, constant bawling, especially in calves, loss of body weight, dehydration, hypothermia, weakness, and occasional diarrhea. Incoordination, collapse, and tetanic convulsions with frothing from the mouth and nose may occur if the animals are forced to exercise. Acetonemia may be a complication in lactating cows.

**Eosinophilic dermatitis** has been observed at meat inspection in pigs transported in trucks salted to prevent slipping. The condition can be reproduced experimentally by rubbing salt in the skin.

**Subclinical salt poisoning** Lower levels of intake can suppress food intake and growth without overt clinical signs. This occurs in heifers drinking water containing 1.75% sodium chloride; the animals only maintain weight at a salt level of 1.5% and show suboptimal weight gains when the water contains 1.25% sodium chloride. Drinking water containing 0.25% salt significantly reduces the milk yield of high-producing dairy cows.

#### CLINICAL PATHOLOGY

In pigs serum sodium levels are elevated appreciably above normal levels (135–145 mmol/L), to about 170–210 mmol/L during the severe stage of chronic sodium salt poisoning.<sup>1</sup> Also polydipsia is recorded at blood serum levels of sodium chloride of 900 mg/dL, typical signs of salt poisoning at 1300 mg/dL, and death when levels exceed 1500 mg/dL. An eosinopenia is also evident during this stage and a return to normal levels usually indicates recovery. In cattle the same changes occur but there is no eosinopenia. Samples of feed and drinking water should be collected for salt assay.

#### NECROPSY FINDINGS

In acute salt poisoning of cattle there is marked congestion of the mucosae of the omasum and abomasum. The feces are fluid and dark. Animals that have survived for several days show hydropericardium and edema of the skeletal muscles. The blood appears to be thinner than normal. Gastroenteritis may be evident in some pigs poisoned with large doses of salt but in chronic poisoning there are no gross lesions. Histologically the neurologic lesions of acute poisoning are restricted to expansion of perivascular spaces in the brain. In contrast, the microscopic changes in chronic salt poisoning in pigs are quite diagnostic. The expansion of perivascular spaces typical of acute cerebral edema is accompanied by meningitis featuring large numbers of eosinophils, which extend along Virchow–Robin spaces into the brain tissue. In pigs that survive there may be residual polioencephalomalacia, especially of the cerebral cortex. Chemical

estimation of the amount of sodium and chloride in tissues, especially brain, may be of diagnostic value. Levels exceeding 150 mg/kg of sodium in the brain and liver, and of chlorides in excess of 180 mg in the brain, 70 mg in muscle and 250 mg/kg in the liver are considered to indicate salt poisoning. Brain sodium concentrations from 2230 to 4250 µg/g tissue have been recorded in water deprivation/salt intoxication of cattle.<sup>2</sup> Aqueous humor sodium values in these circumstances have ranged from 172 to 218 meq/L.

#### Samples for confirmation of diagnosis

- **Toxicology** – 50 g liver, skeletal muscle, brain, serum, cerebrospinal fluid, aqueous, or vitreous humor, feed, water (ASSAY (Na)(Cl))
- **Histology** – formalin-fixed half of sagittally-sectioned brain (LM).

#### DIFFERENTIAL DIAGNOSIS

The appearance of typical signs in pigs which have been recently moved to new quarters, or subjected to a change of ration during the preceding week, or which have not had access to water at all times, should suggest sodium salt poisoning. Diagnostic confirmation depends on the detection of elevated levels of sodium chloride in blood or in tissues and fluids, and in pigs on the presence of aggregations of eosinophils in the brain.

#### Differential diagnosis list

Diseases which have a similar clinical profile to salt poisoning include:

- Encephalitis
- Pseudorabies which is restricted in its occurrence to young sucking pigs
- Viral encephalomyelitis
- Polioencephalomalacia in pigs and ruminants is almost identical with chronic salt poisoning and occurs in many instances under the same set of circumstances
- Gut edema occurs in rapidly growing pigs in the same age group as chronic salt poisoning. There are some differences in the clinical syndromes as they occur in the field, particularly the periodicity of the convulsive episodes in salt poisoning and the altered squeal in gut edema, but in many instances it will be impossible to decide on the diagnosis without reference to the history of salt and water intake
- Mulberry heart disease may be accompanied by nervous signs similar to those of salt poisoning but the disease is usually restricted to older pigs and deaths occur quite suddenly.

**Gastroenteritis** associated with excessive ingestion of saline drinking water has few diagnostic features and **diagnostic confirmation** from other causes of enteritis depends upon identification of a high salt intake.

#### TREATMENT

**Primary treatment** of both acute and chronic salt poisoning is the immediate removal of the toxic feed or water. Serum sodium levels should not be reduced by more than 0.5 mEq/hour.<sup>3</sup> If possible, serum sodium should be measured and a formula used to calculate the free water deficit as follows:

$$\text{Free water deficit (L)} = 0.6 \times \text{body weight (kg)} \times [(\text{current serum sodium concentration}/\text{reference range serum sodium concentration}) - 1]^4$$

Initially access to fresh water should be restricted to small amounts at frequent intervals; unlimited access may be associated with a sudden increase in the number of animals affected. In advanced cases animals may be unable to drink and water may have to be administered by stomach tube.

**Supportive treatment** includes alimentary tract sedatives when gastroenteritis is present and administration of isotonic fluids when dehydration has occurred. When there is evidence of cerebral edema it may be necessary to administer a sedative, and cerebral decompression may be attempted by the use of diuretics or hypertonic solutions injected parenterally.

#### CONTROL

Drinking water for all classes of livestock should not contain more than 0.5% sodium chloride or total salts, although sheep and beef cattle can survive on water containing as much as 1.7% sodium chloride or total salts. Waters containing a high concentration of fluoride or magnesium are particularly dangerous to livestock. Both salt and water should be freely available at all times. Diets fed to pigs should not contain more than 1% salt. The way in which whey is fed to pigs – with minimum water intake – makes prevention difficult unless the whey can be kept free of salt at the cheese factory.

#### REFERENCE

1. Pringle JK, Berthiaume L. *J Vet Intern Med* 1988; 2:66.
2. Osweiler GD et al. *J Vet Diag Invest* 1995; 7:583.
3. Angelos SM, Van Metre DC. *The veterinary clinics of North America: Food animal practice*. Philadelphia, PA, W.B. Saunders, 1999.
4. Angelos WM et al. *J Am Vet Med Assoc* 1999; 214:1364.

#### ZINC POISONING

##### Synopsis

**Etiology** Soluble zinc salts in drinking water.

**Epidemiology** Rare occurrence due to contamination of water from galvanized vessels, or industrial pollution.



**Clinical signs**

**Pigs:** lameness due to degenerative arthritis.

**Cattle:** constipation, reduced milk yield.

**Clinical pathology** Elevated serum and tissue levels of zinc.

**Necropsy lesions**

**Pigs:** degenerative arthritis.

**Cattle:** degenerative lesions in all organs especially pancreas.

**Diagnostic confirmation** Elevated serum and tissue levels of zinc.

**Treatment**

**Primary:** remove zinc source.

**Supportive:** symptomatic treatment.

**Control** Rinse galvanized pipes and utensils after each carriage of milk or milk products. Supplement diet with additional calcium.

**ETIOLOGY**

Toxic doses are not well defined but drinking water containing 6–8 mg/kg of zinc is associated with constipation in cattle and 200 g of zinc as lactate fed over a period of 2 months as a 0.1% solution is associated with arthritis in pigs. The maximum amount tolerated by pigs is 0.1% zinc (as zinc carbonate) in the diet. Experimental zinc poisoning in sheep and cattle is associated with reduced weight gains and feed efficiency when zinc is fed at the rate of 1 g/kg BW. At 1.5–1.7 g/kg BW there is reduced feed consumption in both species and depraved appetite in cattle.

**EPIDEMIOLOGY****Occurrence**

Zinc poisoning in livestock is a rare occurrence and poorly documented.

**Source of toxin**

- Zinc released from galvanized surfaces when:
  - subjected to electrolysis when galvanized and copper pipes are joined
  - galvanized bins flake zinc when used for storage of pig swill
  - an outbreak of poisoning has occurred in pigs fed buttermilk from a dairy factory. The buttermilk was piped to the pig pens each day through a long galvanized iron pipe. The buttermilk lay in pools in the pipe after each batch was run through; souring occurred and the lactic acid produced was associated with the formation of zinc lactate which was passed to the pigs in the next batch of buttermilk. The concentration of zinc in the milk (0.066%) was slightly higher than the minimum toxic strength (0.05%)

The addition of zinc to pig rations as a preventive against parakeratosis is unlikely to be associated with poisoning because of the unpalatability of rations containing excessive amounts

- Zinc chromate used as a paste in joining electrical cables
- Fumes from a nearby galvanizing factory
- Zinc, often associated with cadmium, is a common pollutant from industrial plants handling a variety of ores; nearby pasture may contain more than 500 mg/kg of zinc
- Zinc-based paints, with a 50–55% zinc content when cattle lick freshly painted ironwork
- Zinc added to calf-grower rations as a non-specific dietary supplement
- Accidental inclusion of zinc oxide in a prepared dairy cow ration
- Zinc dust as an industrial hazard; dose rates up to 45 mg/kg BW have no effect on cattle; 50 mg/kg is associated with anemia; daily dose rates of 110 mg/kg BW are associated with deaths
- Careless use of zinc sulfate as a prophylactic and treatment for:
  - poisoning by fungi, especially *Pithomyces chartarum*
  - ovine footrot
  - lupinosis. It is apparent that daily doses of 50–100 mg zinc/kg BW in these circumstances can be associated with severe abomasal lesions, pancreatic damage and death in sheep, provided the material is administered with a drenching gun. The same dose administered by ruminal intubation is non-toxic, because the zinc triggers a closure of the reticular groove resulting in its immediate deposition in the abomasum
- Accidental oral dosing with large doses of zinc oxide can also be associated with hypocalcemia and a syndrome comparable to milk fever.

Dietary levels of zinc associated with poisoning in different species have been summarized.<sup>1</sup> Pigs develop abnormal articular cartilage at 500 ppm dietary zinc, while 2000 ppm zinc in the ration is associated with copper deficiency, anorexia, and subcutaneous hematomata. For horses, approximately 3600 ppm in the diet, or 90 mg/kg body weight reduces growth rate. Sheep and cattle generally are adversely affected by 900 ppm zinc in their diet.

**Importance**

Zinc is one of the least important agricultural industrial poisons but individual farms may suffer serious losses.

**PATHOGENESIS**

Zinc obtained orally is absorbed primarily from the proximal small intestine and approximately one-third of absorbed zinc is protein bound in the plasma.<sup>2</sup> Phytic acid content of plant proteins interferes with

absorption of zinc in monogastric diets. Other nutrients or elements that reduce zinc absorption include calcium, cadmium, and copper.<sup>3</sup> Once absorbed, zinc accumulates rapidly in liver and pancreas with slower accumulation in muscle and bone. Excretion is primarily in feces contributed from bile and from secretion via intestinal mucosa and bile.<sup>4</sup>

The pathogenesis of zinc poisoning has not been determined, but it is likely that the arthritic lesions observed will be due to faulty calcium absorption. This lesion in equines has also been suggested related to interactions of zinc and copper with interference in collagen metabolism.<sup>5</sup> The development of anemia in some animals is poorly understood, but may be a result of interactions of zinc, copper, and calcium.<sup>6</sup>

**CLINICAL FINDINGS****Acute poisoning**

**Cattle.** Large doses are associated with light green-colored diarrhea and drastic reduction in milk yield. Severe cases show additional signs including somnolence and paresis.

**Pigs.** Large doses are associated with decreased food intake, arthritis, hemorrhages in the axillae, gastritis, and enteritis. Death may occur within 21 days.

**Chronic poisoning**

**Dairy cattle** show chronic constipation and a fall in milk yield.

**Pigs** fed buttermilk containing zinc show anorexia, lethargy, unthriftiness, rough coat, subcutaneous hematomas, stiffness, lameness, progressive weakness with enlargement of the joints, particularly the shoulder joint, and finally recumbency.

**Horses.** Chronic poisoning is associated with a non-specific, degenerative arthritis especially at the distal end of the tibia. The lesion is accompanied by an effusion into the joint capsule and the obvious enlargement of the hock joint. There may also be a generalized osteoporosis, lameness, and illthrift.

**Experimental dosing** with large quantities of soluble zinc salts is associated with diarrhea, dysentery, or subcutaneous edema, jaundice, posterior weakness and death. Zinc fed experimentally to foals is associated with pharyngeal and laryngeal paralysis, stiffness and lameness resulting from swelling of the epiphyses of long bones.

**CLINICAL PATHOLOGY**

After experimental feeding high levels of zinc are detectable in tissues, especially liver, pancreas and kidney, and serum and liver levels of copper are reduced. Serum zinc levels in affected cattle may be as high as 500 µg/mL, in contrast with the

usual levels of about 140 µg/mL in normal cattle. Estimated as zinc protoporphyrin, the levels in poisoned donkeys and mules reach 900–1900 µg/mL.<sup>7</sup> Fecal levels of zinc are likely to be elevated from an average of 220 mg/kg in normal animals to 8740 mg/kg in affected ones.

### NECROPSY FINDINGS

Severe, acute poisoning in sheep is associated with an abomasitis and duodenitis, in which the mucosa may appear green in color. In survivors a severe, fibrosing pancreatitis may develop. Acute poisoning in cattle has been accompanied by generalized pulmonary emphysema, a pale flabby myocardium, renal hemorrhages, and severe hepatic degeneration. Chronic poisoning in this species may result in lesions in many organs but the most consistent damage is in the pancreas. Atrophy of exocrine pancreatic acini with extensive interstitial fibrosis have also been described in piglets receiving a total parenteral nutrition diet.<sup>8</sup>

In chronic zinc poisoning in pigs there is a non-specific, degenerative arthritis affecting particularly the head of the humerus, the articular cartilage being separated from the underlying osteoporotic bone. In foals, similar joint lesions and nephrosclerosis may be seen.

The hepatic zinc content in normal animals is high (30–150 mg/kg wet matter in calves) and may reach levels of 400–600 mg/kg wet matter after continued ingestion of zinc chromate paste without being accompanied by signs of zinc poisoning. In acute poisoning by zinc oxide in cattle, levels of 2000 mg/kg dry matter in liver and 300–700 mg/kg dry matter in kidney may be achieved; tissue copper levels in these animals may be reduced to 10–20 mg/kg. Tissue levels in calves dying of experimental zinc poisoning are much lower: 200–400 mg/kg.<sup>8</sup>

### Samples for confirmation of diagnosis

- **Toxicology** – 50 g liver, kidney; 500 g suspect feed or ingesta (ASSAY (Zn))
- **Histology** – formalin-fixed pancreas (LM).

**Tissue assay** The zinc content of liver in normal animals is high (30–150 mg/kg wet matter in calves) and may reach levels of 400–600 mg/kg wet matter after continued ingestion of zinc chromate paste without being accompanied by signs of zinc poisoning. In acute poisoning by zinc oxide in cattle levels of 2000 mg/kg dry matter in liver and 300–700 mg/kg dry matter in kidney may be achieved; tissue copper levels in these animals may be reduced to 10–20 mg/kg. Tissue levels in calves dying of experimental zinc poisoning are much lower – 200–400 mg/kg.

### DIFFERENTIAL DIAGNOSIS

Diagnostic confirmation of zinc poisoning depends on identification of elevated levels of zinc in fluids or tissues.

#### Differential diagnosis list

Diseases with similar clinical profiles include, in pigs:

- Rickets limited in occurrence to young pigs
- Erysipelas

### TREATMENT

**Primary:** Other than removal of the source of the zinc, none are recommended.

**Supportive treatment** is limited to symptomatic treatment.

### CONTROL

Galvanized utensils and piping should be rinsed after each use in carrying milk. The addition of extra amounts of calcium to the diet of pigs is capable of preventing the toxic effects of zinc if the calcium supplementation is heavy and the zinc intake is not too high.

### REFERENCES

1. Dziwenka MM, Coppock R. *Clinical Veterinary Toxicology*, Mosby, St. Louis, 2004; pp. 221–226.
2. Ogden L et al. *Vet Hum Toxicol* 1988; 30:577.
3. Miller WJJ. *Dairy Sci* 1970; 53:1123.
4. Poulsen HD. *Livestock Prod Sci* 1995; 43:235.
5. Glade MJ. *Equine Vet Sci* 1986; :175.
6. Pritchard GC et al. *Vet Rec* 1985; 23: 545.
7. Ostrowski SR et al. *Vet Human Toxicol* 1990; 32:53.
8. Gabrielson KL et al. *Vet Pathol* 1997; 33:692.

### SULFUR POISONING

#### ETIOLOGY

Poisoning occurs due to ingestion of toxic amounts of the element or inhalation of sulfur dioxide gas. Sulfur and sulfates in the feed and drinking water play a significant role in the etiology of polioencephalomalacia. The feeding of 85–450 g per head to cattle has been fatal, as has 45 g of sulfur in feed pellets to ewes, and the minimum lethal dose of a sulfur-protein concentrate for sheep is estimated to be 10 g/kg BW. Continuous feeding of sulfur at the rate of 7 g per day can be fatal to adult sheep. Sulfur given to adult horses at a dose level of 0.2–0.4 kg per horse has been associated with poisoning.

#### EPIDEMIOLOGY

Accidental or uninformed use of sulfur (flowers of sulfur) occurs in the conventional uses of the element:

- Fed to livestock as a tonic and to control external parasites
- Used in feedlots to restrict the consumption of feed by lambs and thus reduce the incidence of enterotoxemia.

Sodium metabisulfite and **sulfur dioxide gas** are used in the preparation of ensilage but at the levels used are unlikely to have toxic effects in animals eating the ensilage. **Hydrogen sulfide gas** is often present in gases emanating from oil and natural gas wells, in cesspools, and in wells. However, animals are not likely to be exposed to concentrations of the gas which are sufficiently high to be associated with illness, although a slatted floor system of manure disposal, if functioning imperfectly, might present problems.

### PATHOGENESIS

In small doses the substance is relatively non-toxic, but excessive doses can be associated with fatal gastroenteritis and dehydration. Conversion of the sulfur to hydrogen sulfide in the rumen, and the absorption of the gas can result in the development of polioencephalomalacia.<sup>1</sup> It is possible that sulfur is most toxic when fed in a ration containing a high level of protein. Sulfur can react with metalloproteins or proteins containing disulfides leading to production of H<sub>2</sub>S which is inhaled and inhibits cytochrome oxidase and is directly cytotoxic.<sup>2</sup> Elevated hydrogen sulfide in blood also is associated with depression of respiratory and cardiovascular control in the CNS.

### CLINICAL FINDINGS

The syndrome in **sulfur poisoning** is characterized by dullness, abdominal pain, muscle twitching, black diarrhea, and a strong odor of hydrogen sulfide on the breath. Dehydration is severe and the animals soon become recumbent and dyspneic, develop convulsions and die in a coma. Pigs exposed to an environment containing 35 mg/kg of **sulfur dioxide** for long periods show increased salivation accompanied by clinical and histological evidence of irritation of the conjunctiva and respiratory mucosa.

### NECROPSY FINDINGS

The lungs are congested and edematous, the liver is pale, the kidneys congested and black in color, there is severe gastroenteritis with peritoneal effusion and petechial hemorrhages occur extensively in all organs and in musculature. Polioencephalomalacia, unresponsive to thiamin, may occur in a high proportion of cases.<sup>1</sup>

### REFERENCE

1. Bulgin MS et al. *J Am Vet Med Assoc* 1996; 208:1063.
2. Gunn MF et al. *Can Vet J* 1987; 28:188.

### POISONING BY ORGANIC IRON COMPOUNDS

Fatal poisoning in piglets and in horses and calves is associated with the injection of organic iron preparations as prophylaxis against juvenile anemia.

### Piglets

Within 1 or 2 hours of injection sudden deaths occur, sometimes accompanied by vomiting and diarrhea. By necropsy examination there is severe myodegeneration of skeletal but not cardiac muscle. The progeny of vitamin E deficient sows are most susceptible, and the most toxic compounds are those which contain a high proportion of their iron in ionic, and therefore readily absorbable, form. In the state of deficiency of vitamin E the muscle cell membranes are damaged and extensive biochemical changes result, including a great increase in extracellular potassium levels causing cardiac arrest and sudden death.

**Age resistance.** Pigs at 2 days of age are much more susceptible to the toxic effects of these iron compounds than are 8-day-old pigs. A suggested reason for this age resistance is the older pigs' better renal functional ability to excrete iron. Another possible reason is the greater mobilization of calcium by older pigs in response to iron administration. This mobilization, or calciphylaxis, can be great enough to result in deposition of calcium in damaged tissues or to cause death. This effect appears to be precipitated by simultaneous or immediately preceding (within 24 hours) injection of vitamin D<sub>3</sub> but the injection is not essential to it.

Much of the administered iron is taken up by the reticuloendothelial (monocyte-macrophage) system, and this blockage of the system by the iron preparation may remove the buffering action of the system against absorbed inorganic and bacterial toxins.

There is an additional possible damaging effect of iron injection in young pigs, the development of **asymmetric hind-quarters**. In this condition there is asymmetry but the muscles are normal in composition and appear to have asymmetric blood supplies.

### Horses

Deaths have occurred in horses within a few minutes of intramuscular injection of iron compounds. Others have shown severe shock but recovered. Death when it occurs appears to be due to acute heart failure. Newborn foals also die soon after the oral administration of a 'digestive inoculant' which contains ferrous fumarate (16 mg/kg) or the iron compound alone. Naturally occurring cases<sup>1</sup> and experimental cases point to acute hepatitis as the critical lesion, and the iron compound as the cause. Commencing 2 days after dosing the signs include depression, ataxia, recumbency, jaundice, and nystagmus. The mortality rate is 66% and the lesions are hepatitis and jaundice.

### Cattle

Acute hepatitis and sudden deaths have occurred in 6–9-month-old bulls about 24 hours after injection of an organic iron preparation.<sup>2</sup>

### REFERENCES

1. Mullaney TP, Brown CM. *Equine Vet J* 1988; 20:119.
2. Holter JA et al. *J Vet Diag Invest* 1990; 2:229.

## IODINE POISONING

### ETIOLOGY

Poisoning with **inorganic iodine** is not as common and is associated with illness in animals, because the toxic dose is so great. Doses of 10 mg/kg BW daily are usually required to produce fatal illness in calves. There is a special occurrence of goiter in foals when the foal and the dam are fed excessive amounts of iodine, when kelp is fed as a dietary supplement. Intakes of 35–40 mg iodine/day to a mare can be associated with the development of goiter in her foal. Toxicity has also occurred at much lower levels of intake (e.g. 160 mg/day per cow) and appears to be a practical risk when cows or calves are fed **organic iodides** such as ethylene diamine dihydroiodide constantly as a prophylactic against footrot.

### CLINICAL FINDINGS

**Inorganic iodine.** In **cattle and sheep** signs include heavy dusting of the hair coat with large-sized dandruff scales, hair loss, dryness of the coat, lacrimation, hyperthermia, nasal discharge, hypersalivation, coughing due to bronchopneumonia, and anorexia. Exophthalmos occurs in some cases and severely affected animals may die of bronchopneumonia. In **horses** alopecia and heavy dandruff are characteristic.

**Organic iodine.** Toxic effects include a serious increased susceptibility to calf pneumonia and to abortion in pregnant cows.

### CLINICAL PATHOLOGY/NECROPSY

Squamous metaplasia of tracheal and parotid duct epithelium is visible histologically, and serum vitamin A levels are reduced. Serum iodine levels are elevated above the normal level of 5–10 µg/100 mL up to 20–130 µg/mL.

### REVIEW LITERATURE

Stowe CM. Iodine, iodides and iodism. *J Am Vet Med Assoc* 1981; 179:334–335.

## CADMIUM POISONING

There is much interest in cadmium as an **environmental pollutant** and the likelihood of its entering the human food chain via animals used as food. The chances of cadmium accumulating in lean meat are not very great because the levels of ingestion required to produce

significant levels are so high that they would be associated with observable clinical illness. However, kidney and liver do accumulate cadmium much more readily than other tissues. Naturally occurring cases of poisoning by cadmium salts are rare in animals, most cases result from accidental administrations of farm chemicals, e.g. a cadmium-containing fungicide.

**Sewage** and sewage sludge may have higher than desirable levels of cadmium but have not been shown to be associated with poisoning when used as pasture top-dressing or as feed. Conversely, cattle are seen to be effective screens or filters between the high content of cadmium in the diet and the human consumer of the meat.

### Ruminants

Chronic poisoning in cattle is associated with inappetence, weakness, loss of weight, poor hoof keratinization, dry brittle horns, matting of the hair, keratosis, and peeling of the skin. At necropsy there is hyperkeratosis of forestomach epithelium and degenerative changes in most organs. In sheep, levels of 60 µg/g of feed for 137 days are needed to be associated with illness. Experimental poisoning of sheep is associated with anemia, nephropathy, and bone demineralization at a dose rate of 2.5 mg/kg body weight per day. Abortion, congenital defects, and stillbirths are also listed as toxic outcomes. The cutaneous lesions can be partly offset by the administration of zinc.

### Pigs

In young pigs, levels in the feed of 50 mg/kg for 6 weeks reduce growth rate and are associated with an iron-responsive anemia.

## CHROMIUM POISONING

Use of protein concentrates prepared from tannery waste as an animal feed is not recommended because of the material's high chromium content. Trivalent chromium salts given orally to pigs at the rate of 0.5–1.5 and at 3 mg/kg BW is associated with transient diarrhea. With the higher dosage there is also tremor, dyspnea, and anorexia.

## VANADIUM POISONING

Experimental and natural poisoning of adult cattle and calves are recorded. Signs include diarrhea, sometimes dysentery, oliguria, difficulty in standing, and incoordination. Field cases are only likely to be encountered when industrial contamination of pasture occurs. Careful ploughing-in of the pasture, especially when the vanadium is contained in a fertilizer such as basic slag, reduces the toxic risk.<sup>1</sup>

## REFERENCE

1. Frank A et al. Science of the Total Environment, 1996; 18:73.

## BROMIDE POISONING

Accidental access to sodium bromide can result in a syndrome of somnolence, lateral recumbency, drooping of the ears, eyelids, and tail and dribbling of urine.

## COBALT POISONING

Overdosing with cobalt compounds is associated with weight loss, rough hair coat, listlessness, anorexia, and muscular incoordination. Toxic effects appear in calves at dose rates of about 40–55 mg of elemental cobalt per 50 kg BW per day. Sheep are much less susceptible, ingesting 15 mg/kg BW of cobalt without apparent effect. Pigs tolerate up to 200 mg cobalt/kg of diet but intakes of 400 and 600 mg/kg are associated with growth depression, anorexia, stiffness of the legs, incoordination, and muscle tremors. Supplementation of the diet with methionine, or with additional iron, manganese, and zinc alleviate the toxic effects.

## BORON POISONING

Because boron is now accepted as an essential plant food, it is being added to agricultural fertilizers and adding another toxic chemical to the list of farm hazards for animals. To improve the availability of the element a solubilized form of it is used, increasing its toxicity and its palatability. Signs include depression, weakness, tremor, ataxia, and short seizures of gait spasticity, dorsiflexion of the head, flutter of the periorbicular muscles, followed by stumbling backwards and sternal recumbency, then lateral recumbency and a quiet death. The case fatality rate is 100%. There are no gross lesions on necropsy examination.

Experimental dosing with the fertilizer in goats is associated with the above syndrome plus head-shaking, ear-flicking, star-gazing (staring), phantom dodging, oral champing, restless weight shifting from foot to foot, sawhorse stance, mild diarrhea, and frequent urination. The goats do not eat or drink but paw and nuzzle the food and water as though they are hungry but unable toprehend.<sup>1</sup>

## REFERENCE

1. Sisk DB et al. Vet Human Toxicol 1990; 32:205.

## Diseases associated with farm chemicals

Poisoning of animals by agricultural chemicals has become a major area of study in farm-animal medicine. It is a

problem area because of the multiplicity of the products used, their extraordinary potency, and the difficulty of determining their generic composition from their trade names. It is possible to arrive at a diagnosis by observing clinical signs and necropsy lesions if one of the more common compounds has been used, but in many other instances it is not possible to do so. It is necessary in the case of any suspected poisoning to inquire in great detail into the history of exposure of the affected animals to any noxious materials. Having identified possible exposure it is then necessary to identify exactly the compound used and then consult a suitable information source, usually the manufacturer, about toxicity problems.

Poisoning of animals has been the prime concern of veterinarians when dealing with agricultural chemicals, but there is now an additional involvement, the need to certify animals and their products as being free of residues of agricultural chemicals. Part of this responsibility is to adequately warn owners of the dangers when dispensing drugs which are regarded as contaminants in human food. The additional involvement for the veterinarian is to identify the source of violative residues when public health authorities advise that rules concerning food purity have been disregarded.

The subject has now become so large that it forms a complete new literature. It is not possible to review all the known toxic compounds in a few pages, and only the more common substances are dealt with here.

## REVIEW LITERATURE

- Burrows GE (ed.) Clinical toxicology, Vet Clin North Am Food Anim. Pract 1989; 5(2), 237–447.

## POISONING BY ANTHELMINTICS

### Carbon tetrachloride poisoning

#### Synopsis

**Etiology** Overdosing or standard dose to susceptible animals.

**Epidemiology** Outbreaks occur when cold or nutritionally stressed, or when lactating sheep or animals with liver damage are drenched with a recommended dose.

#### Clinical signs

**Inhalation dose:** collapse, coma, death within a few minutes.

**Ingestion dose:** acute hepatic insufficiency (anorexia, depression, jaundice) 3 days after dosing.

**Clinical pathology** Elevated SGOT levels.

**Necropsy lesions** Acute hepatitis nephrosis.

**Diagnostic confirmation** History of dosing plus hepatic lesion.

**Treatment** Inhalation dose: artificial respiration. Ingestion dose: supportive treatment for hepatic insufficiency.

## ETIOLOGY

Carbon tetrachloride is sometimes accidentally administered in excessive quantities but deaths more commonly occur when sheep are given standard doses or cattle are dosed by mouth, instead of by injection. Standard doses of 2 mL per sheep to kill adult *Fasciola hepatica* or 1 mL/10 kg BW to obtain efficiency against immature forms, have been widely used but in some circumstances these doses can be highly toxic. Doses as low as 0.5 mL/10 kg BW can be associated with liver damage in calves and clinical effects are apparent at 1 mL/10 kg BW in goats.

## EPIDEMIOLOGY

### Risk factors

Factors which increase the likelihood that carbon tetrachloride will be toxic in a particular dosing incident are:

- Lush pasture
- Concurrent administration of a hepatotoxic anthelmintic, or dieldrin or phenobarbital
- Damage to the liver by plant or chemical poisons
- Ingestion of oxalate-rich plants
- Cold stress in shorn sheep
- Lactating ewes are more susceptible than dry sheep
- Accidental administration of the dose directly into the respiratory tract or inhalation of vapor due to faulty placement of the dose.

## PATHOGENESIS

**Inhalation** of carbon tetrachloride is associated with an immediate and acute depression of the central nervous system and peripheral and circulatory collapse. Diffuse pulmonary edema occurs and sheep that survive show hepatic and renal damage.

**Ingestion** of toxic doses may result in death within 24 hours due to anesthetic depression and severe pulmonary edema, or may occur 3–7 days later resulting from renal and hepatic insufficiency. Deaths are associated with almost complete liver and kidney failure.

## CLINICAL FINDINGS

In **gross overdosing or inhalation** there is an immediate onset of staggering, falling, progressive narcosis, collapse, convulsions, and death due to respiratory failure. Animals that survive this stage or, as in the most common form of carbon tetrachloride poisoning in which animals absorb insufficient dose to produce narcosis, additional signs may be manifested in 3–4 days. These comprise anorexia, depression, muscle weakness, diarrhea, and jaundice. After a further 2–3 days affected sheep go down and mild-to-moderate clonic convulsions may occur, but death is always preceded by a period of coma. Survivors

are emaciated and weak, and may develop photosensitization or shed their wool. They are very susceptible to environmental stresses, particularly inclement weather, and isolated deaths may occur for several months.

### CLINICAL PATHOLOGY

In the first 3 days after dosing, liver dysfunction is suggested by a pronounced elevation of AST levels and renal dysfunction by an elevation of blood urea levels. After 4 days from dosing the AST levels return to normal but elevated blood urea levels remain. The BSP test is highly positive and gamma-glutamyltransferase levels are increased.

### NECROPSY FINDINGS

Animals dying after inhalation of the drug show marked pulmonary, hepatic, and renal damage. Those dying of massive oral overdosing may show abomasitis and inflammation of the duodenum. In addition acute hepatic swelling, pallor, and mottling accompanied by centrilobular necrosis and fatty degeneration, and renal lesions of extensive tubular necrosis and degeneration, are observed in animals which die after the ingestion of small doses.

### DIFFERENTIAL DIAGNOSIS

The history of deaths during dosing or commencing in sheep 3–4 days after drenching with carbon tetrachloride usually suggests the diagnosis. Diagnostic confirmation depends on demonstration of lesions of acute hepatitis.

#### Differential diagnosis list

Diseases manifested by acute hepatitis include:

- Facial eczema which requires the presence of *Pithomyces chartarum*
- Lupinosis
- Poisoning by *Senecio*, *Crotalaria*, or *Heliotropium* spp.

### TREATMENT

**Primary.** In **inhalation poisoning**, artificial respiration and respiratory center stimulants are indicated. For the **hepatitis** there is no specific treatment.

**Supportive treatment.** should include the parenteral administration of calcium solutions and the provision of readily digestible carbohydrate. In valuable and seriously affected animals, the latter are probably best provided by the repeated parenteral injection of glucose and protein hydrolysate solutions.

### CONTROL

Alternative, less toxic flukicides are almost universally used now. Carbon tetrachloride should not be used if sheep are stressed by cold or lack of feed, or if they have been grazing hepatotoxic plants. It should never

be given simultaneously with anthelmintics that damage the liver. Sheep should be drenched into the pharynx when standing naturally so that the dose can be swallowed immediately.

### Phenothiazine poisoning

Exposure to phenothiazine and potential poisoning has occurred in the past from its extensive use as an anthelmintic. Today, one of the remaining common uses may be for control of small strongyles in horses. Keratitis, the noteworthy sign of poisoning, occurs most commonly in calves, rarely in pigs and goats, and usually after a heavy single dose of phenothiazine, but it can occur in a program of daily intake in a dietary premix. Phenothiazine is absorbed from the rumen as the sulfoxide, conjugated in the liver and excreted in the urine as leucophenothiazine and leucothionol. As urine is voided, further oxidation turns the metabolic products to a red-brown dye, phenothiazine and thionol which may be confused as hematuria or hemoglobinuria.<sup>1</sup> Cattle are unable to detoxify all the sulfoxide and some escapes into the circulation and can enter the aqueous humor of the eye, causing photosensitization. Other photodynamic agents which cannot enter the eye may also be produced, and they, with the sulfoxide, are associated with photosensitization of light-colored parts of the body. Hyperlacrimation, with severe blepharospasm and photophobia commences 12–36 hours after treatment and is followed by the development of a white opacity on the lateral or dorsal aspects of the cornea, depending on which is exposed to sunlight. Most animals recover within a few days, particularly if kept inside or in a shaded paddock. If the animals continue to be exposed a severe conjunctivitis with keratitis may result.

### Tetrachlorethylene poisoning

Tetrachlorethylene rarely produces incoordination which may be evident for 1 or 2 hours after dosing in cattle or sheep. Treatment is not usually necessary.

### Hexachloroethane poisoning

Hexachloroethane is preferred to carbon tetrachloride for the treatment of fascioliasis in cattle but it is not completely without danger. Deaths are rare (1 in 20 000 cattle treated), and in sheep (1 in 40 000) but non-fatal illness is not uncommon. Susceptible groups may show narcosis, muscle tremor, and recumbency after administration of the standard dose (**cattle:** 15 g per 6 months of age up to a maximum of 60 g; **sheep:** 0.4 g/kg BW); such animals should be given half this dose on two occasions at 48-hour intervals.

### CLINICAL SIGNS

In severe cases these take the form of ataxia, dullness, anorexia, dyspnea, ruminal

tympany, and sometimes abdominal pain, diarrhea, and dysentery. The groups include:

- Emaciated animals
- Occasional idiosyncratic animals
- When the liver damage is associated with fluke, infestation is severe
- Animals on high protein diets, or grazing rape or kale
- Parturient or heavily lactating cows.

**Necropsy lesions** include acute abomasitis and enteritis, edema of the abomasal mucosa, and hepatic centrilobular necrosis.

**Treatment** with calcium borogluconate as in milk fever elicits a good response.

### Hexachlorophene

At high dose rates (25–50 mg/kg BW) hexachlorophene is associated with atrophy of seminiferous epithelium of the testis of young adult rams. Repeated dosing is associated with periportal fatty changes in liver.

### Rafoxanide and closantel

Rafoxanide and closantel, both highly regarded anthelmintics, and clixonide, a discredited drug, are all halogenated salicylanilides, and have approximately the same low level of toxicity. They are capable of causing temporary or permanent blindness if overdosed.<sup>2</sup> In the latter case there is degeneration of optic nerve tracts and other optic pathways in the brain.

### Nicotine poisoning

Nicotine poisoning seldom occurs in animals except in lambs and calves where nicotine sulfate is still incorporated in some vermifuges. Doses of 0.2–0.3 g nicotine sulfate have been toxic for lambs weighing 14–20 kg. Animals in poor condition are more susceptible than well-nourished animals. Animals are affected within a few minutes of dosing and show dyspnea with rapid shallow respirations, muscle tremor and weakness, recumbency, and clonic convulsions. Animals that survive the acute episode may show abdominal pain, salivation, and diarrhea. At necropsy there may be abomasitis and inflammation of the duodenum.

**Treatment** should include artificial respiration and the administration of respiratory center stimulants. Oral dosing with tannic acid preparations will precipitate the alkaloid and retard further absorption.

### Piperazine

Piperazine compounds are relatively non-toxic but poisoning can occur in horses on normal or excessive doses. Signs follow a delay of 12–24 hours and include incoordination, pupillary dilatation, hyperesthesia, tremor, somnolence, and either swaying while at rest or lateral recumbency. Recovery follows in 48–72 hours without treatment.

### Thiabendazole (2-(4'-thiazolyl)-benzimidazole)

At an oral dose rate of 800 mg/kg BW in sheep transient signs of salivation, anorexia, and depression appear. There are similar signs at larger dose rates and death is likely at a dose rate of 1200 mg/kg BW. Toxic nephrosis is the cause of death and is reflected in the clinical and pathological findings of hypokalemia, hypoproteinemia, and uremia.

### Levamisole

All commercial preparations of levamisole consist of the levo isomer. Its mechanism of action is similar to nicotine by causing prolonged depolarization and neuromuscular junction blockade. In pigs, concurrent treatment with levamisole and pyrantel tartrate resulted in enhanced toxicity of the levamisole.<sup>3</sup> Following treatment at standard doses, some **cattle** and, more rarely, **sheep** show signs of lip-licking, increased salivation, head-shaking, skin tremors, and excitability. The excitability is more marked in calves; when released they tend to raise their tails and run around the paddock. Coughing may commence within 15–20 minutes, but this is due to the death and expulsion of lung worms and stops in 24 hours. With higher doses the signs are more pronounced, defecation is frequent and hyperesthesia in the form of a continuous twitching of the skin may be seen. Double doses in **goats** produce mild depression and ptosis, while higher doses produce, in addition, head-shaking, twitching of facial muscles, grinding of teeth, salivation, tail-twitching, increased micturition, and straining. Accidental injection of **pigs** caused vomiting, salivation, ataxia, recumbency, and a high mortality within a few minutes of injection.

### Parbendazole, cambendazole, and albendazole

Parbendazole and cambendazole are teratogens and are specifically contraindicated in pregnant animals especially during the first third of pregnancy and at dose rates higher than normal. The safety margin is small and their use at any dose level is not recommended in these females. Defects produced include rotational and flexing deformities of the limbs, overflexion of the carpal joints, abnormalities of posture and gait, vertebral fusion and asymmetric cranial ossification, cerebral hypoplasia and hydrocephalus. Albendazole at 4 times the standard dose also produces some abnormalities if given early in pregnancy.

### Fenbendazole

A dose of fenbendazole and the flukicide, bromsalans, to cattle either simultaneously or within a few days of each other may be

accompanied by deaths. As fenbendazole and the other tertiary benzimidazoles, oxfendazole, and albendazole, are extremely valuable in removing dormant *Ostertagia ostertagi* larvae, it is suggested that fascal (bromsalans) should not be used where this is an important problem or that 2 weeks should elapse between treatments.

### Ivermectin

The intravenous injection into horses of a cattle formulation of ivermectin, contrary to the recommended usage, may cause immediate collapse with coma and periodic nystagmus. Treatment intravenously with flumethasone and flunixin meglumine is effective. Intramuscular injection of the ivermectin is associated with ventral midline edema, due possibly to a reaction to dead microfilariae, edema of limbs and eyelids, fever, dyspnea, disorientation, colic, and sudden death. Transient swelling at the injection site is common.

Occasional outbreaks of severe neurological disorders occur in only Murray Grey cattle after the administration of normal dose rates. Signs include incoordination, knuckling of the fetlocks, a swaying gait, muscle fasciculations, ear droop, blindness, and drooling of saliva, all apparent within 24 hours of dosing. The tongue is paralyzed and protrudes in some. Exercise enhances the syndrome and the patients collapse. Some are dead within 24 hours, some survive for 3 weeks, but all die. There are no gross necropsy lesions but the concentration of ivermectin in the brain is 10 times normal. A genetic penetrability of the meninges is suspected.

### Organophosphatic anthelmintics

These are dealt with in the next section on insecticides. Industrial organophosphates and organophosphatic defoliant are dealt with in the section on miscellaneous farm chemicals.

### Sumicidin

Sumicidin (fenvalerate) is a synthetic pyrethroid anthelmintic capable of causing non-fatal restlessness, yawning, frothing at the mouth, dyspnea, ear and tail erection, pupillary dilatation, ruminal tympany, regurgitation of ruminal contents, staggering, tremor, clonic convulsions and recumbency after a single oral dose. Single oral doses of >450 mg/kg are lethal. Repeated daily dosing (113 or 225 mg/kg BW) also causes death after 5–15 days.<sup>4</sup>

### REFERENCES

1. Beasley VR. Veterinary Toxicology, IVIS, Web Publication, [http://www.ivis.org/advances/Beasley/Cpt11a/chapter\\_frm.asp?LA=1](http://www.ivis.org/advances/Beasley/Cpt11a/chapter_frm.asp?LA=1), 2004.
2. ObwoloMJ et al. Aust Vet J 1989; 66:229.
3. Cook WO et al. Vet Hum Toxicol 1985; 27:388.
4. Muhamed OSA, Adam SEI. J Comp Pathol 1990; 102:1.

## INSECTICIDES

### CHLORINATED HYDROCARBONS (ORGANOCHLORIDES)

#### Synopsis

**Etiology** Poisoning by any of the group of insecticides including aldrin, hexachloride, chlordane, DDT, dieldrin, endrin, heptachlor, isodrin, lindane, methoxychlor, toxaphene.

**Epidemiology** Accidental or misinformed overdosing. Usage on animals now superseded by other less toxic compounds. Stored or leftover products may accidentally be accessed by animals. Importance now due to residues in animal products used in human food chain.

**Clinical signs** Excitement, tremor, intermittent convulsions, hyperthermia, death.

**Clinical pathology** Assay of compounds in animal tissues.

**Necropsy lesions** No consistent significant lesions; some animals show pale musculature.

#### Diagnostic confirmation

Chemical assay of liver or brain for acute poisoning; fat or other animal tissue for chronic poisoning.

**Treatment Primary:** nil. **Supportive:** by sedation, control of hyperthermia, removal of residual chemical; activated charcoal for oral detoxification.

**Control** Use alternative insecticides.

Avoid mixed farming enterprises which include use of these insecticides for insect control in crops.

## ETIOLOGY

This group of poisons includes DDT, benzene hexachloride (and its pure gamma isomer – lindane), aldrin, dieldrin, chlordane, toxaphene, methoxychlor, DDD, isodrin, endrin, and heptachlor. General toxicity data for the more common compounds are given in Table 32.4. Methoxychlor is less toxic than DDT, and isodrin and endrin are more toxic than aldrin and dieldrin. Camphor (2-bornanone) is chemically similar to toxaphene and is associated with a similar syndrome when fed accidentally.

## EPIDEMIOLOGY

### Occurrence

Poisoning with these compounds has been recorded in all animal species. The chlorinated hydrocarbons have come under so much criticism as environmental contaminants that they are rarely used directly on animals nowadays, so that outbreaks of clinical illness associated with them are much less common than they were.

### Source of toxin

Ingestion, inhalation, aspiration, and percutaneous absorption are all possible portals of entry so that contamination of feed and application of sprays and dips can all be associated with poisoning.

Table 3244 Toxic oral doses and maximum concentrations of insecticides

Compound	Method of application	Calves to 2 weeks	Cattle	Sheep	Pig	Goat	Horse
DDT	Oral single dose (mg/kg BW)	—	450	200	200	200	200
	Maximum safe spray (%)			In general above 5%	In general above 5%		
Benzene hexachloride	Oral single dose (mg/kg BW)	—	1000	1000	1000	1000	1000
	Maximum safe spray (%)						
Lindane	Oral single dose (mg/kg BW)	5	25	25	—	—	—
	Maximum safe spray (%)	0.025	0.1	1	1	—	0.5
Aldrin	Oral single dose (mg/kg BW)	2.5–5.0	10–25	>10	—	—	—
	Oral daily dose (mg/kg BW)	—	2–5	2–5	—	—	—
Dieldrin	Oral single dose (mg/kg BW)	5–10	10–25	<25	25–50	—	<25
	Maximum safe spray (%)	0.1–0.25	1–2	0.2–0.3	4	4	100
Toxaphene	Oral single dose (mg/kg BW)	5	—	25	—	50	—
	Maximum safe spray (%)	0.5	2	1.5	4	—	—
Chlordane and heptachlor	Oral single dose (mg/kg BW)	25	—	100	—	—	—
	Maximum safe spray (%)	0.5	2–3	2–3 1.0 lambs)	—	—	—

Organochlorides are closely regulated and banned in some countries but still widely used in agriculture, principally on growing plants to control insect pests, and on stored seed grain to control fungi. If the plants or grain, even milled and by products, e.g. bran, are fed to animals they can be associated with problems of tissue residues; if they are fed in sufficient quantities they can be associated with clinical illness. Many outbreaks are associated with the application to animals of products intended for crops, e.g. endosulfan, and labelled specifically 'Not For Animal Use'. These insecticides may also contaminate soil and persist there for many years. Rooting animals such as pigs are particularly susceptible to this source of poisoning. These compounds are also sometimes fed accidentally and in large amounts in lieu of feed additives, and are associated with acute poisoning. In feedlot or shedded animals cases may continue for periods as long as a year because of repeated contamination from the environment. Insect baits, e.g. grasshopper baits containing toxaphene and chlordane, used on pasture and for leaf-eating insects on market gardens can be associated with poisoning in livestock, which may eat large quantities of them. These insecticides, especially heptachlor, are incorporated in the soil before the crop of potatoes or maize is sown to control soil pests. Subsequent grazing of the field will cause contamination of the livestock for several years.

#### Method of application

Dipping of animals is the most hazardous method of application because entry may

occur through all portals. Spraying is safer, percutaneous absorption and inhalation being the only portals of entry. The small particle size of the compound and concentration of animals in confined spaces while spraying, increase the possibility of poisoning. Oily preparations are not used for animal treatment but are used inadvertently and are readily absorbed through the skin.

#### Formulation used

Concentrations of insecticide in formulations used for spraying barns are much higher than those used for animals. Amongst spray preparations simple solutions are most dangerous followed by emulsions and least of all suspensions of wettable powder. Dusting is safest and is preferred to other methods. Preparations for use on plants are often unstable emulsions, which come out of suspension quickly when they reach the plant. If these preparations are used in animal dips the first few animals through the dip can be heavily contaminated and suffer acute, lethal toxic effects. Although the treatment of pastures to control their insect pests is usually safe to animals grazing, the treated pasture or hay made from it can cause contamination of animal products. This contamination can be avoided by incorporating the insecticide into superphosphate granules ('prills') instead of applying it as sprays or dusts. The use of chlorinated hydrocarbons to protect stored seeds provides a hazard to animals if they are fed on the treated seed.

#### Risk factors

The compounds vary in their ability to pass the skin barrier. Benzene hexachloride,

aldrin, dieldrin, and chlordane are readily absorbed. Species susceptibility to skin absorption also varies widely. Very young animals of any species are more susceptible than adults, and lactating and emaciated animals also show increased susceptibility.

When these compounds were first used in dips, skin and foot infections occurred frequently because of contamination of the dip in the absence of a bactericidal agent. Cases of otitis media have occurred for the same reason, but more rarely.

#### Importance

All of these compounds are capable of causing death due to acute poisoning but these are increasingly rare. Because the compounds are soluble in fat and accumulate in body stores of it they are formidable threats to the meat industry. They are also excreted in significant amounts in milk and enter the human food chain at this point. They are concentrated still further in cream and butter. They also represent a threat to sucklings, but the degree of contamination in fetuses and suckling animals is much less than in their dams.

The principal importance of organochlorine poisoning is the contamination of animal tissues at levels which are not acceptable by modern health standards. These contaminations become the subject of veterinary investigations, and are susceptible to standard techniques of epidemiological examination.

#### PATHOGENESIS

The mode of action of organochlorides is to induce repetitive discharge of motor and sensory neurons by interference with



axonal transmission of nerve impulses. After absorption, cyclodiene insecticides are activated by the mixed function oxidase (MFO) system and any prior chemical or environmental exposures that increase the MFO system may exacerbate the onset of poisoning. The diphenyl aliphatic (DDT) organochlorines affect sodium channels, prolonging sodium influx and inhibiting potassium efflux at the nerve membrane. The cyclodiene organochlorines competitively inhibit the binding of gamma amino butyric acid (GABA) at receptor sites, resulting in loss of GABA inhibition and resultant stimulation of the neuron. In all organochlorine poisonings recovery may occur, but with smaller animals paralysis follows and finally collapse and death ensue.

Most of the substances accumulate in the fat depots, where they are a potential source of danger in that sudden mobilization of the fat may result in liberation of the compound into the bloodstream and the appearance of signs of toxicity.

### CLINICAL FINDINGS

The speed of onset of illness after exposure varies from a few minutes to a few hours, depending on the portal of entry and the compound and its formulation, but it is never very long.

The toxic effects produced by the members of this group include complete anorexia, increased excitability and irritability followed by ataxia, muscle tremor, weakness and paralysis and terminal convulsions in severe cases. Salivation and teeth grinding occur in large animals and vomiting in pigs. Variations on this clinical syndrome which is common to all organochlorine intoxications include:

- DDT and methoxychlor chronic poisoning may be associated with moderate liver damage
- Benzene hexachloride, lindane, chlordane, toxaphene, dieldrin, endrin, aldrin, heptachlor are associated with an exaggerated syndrome including teeth grinding, champing of jaws, dyspnea, tetany, snapping of the eyelids, auricular spasms, opisthotonus, frequent micturition, frenzied movements, walking backwards, climbing walls, violent somersaults, and aimless jumping. Fever of 5–7% above normal may occur, possibly a result of seizure activity. Seizures may persist for 2 or 3 days if the animal does not die.

### CLINICAL PATHOLOGY

Blood, hair, and ingesta can be assayed chemically for specific toxins. The removal of a biopsy from the fat pad near the cow's tail offers a satisfactory means of providing samples for tissue analysis. Organochlorine

residues in acutely poisoned animals may reach 4–7 ppm in brain or liver.

### NECROPSY FINDINGS

At necropsy there are no specific major lesions in the nervous system but toxic hepatitis and tubular nephritis appear in some cases. For **assay** specimens of hair, if the portal is percutaneous, and of the ingesta, if oral intake is probable, are appropriate. Tissue levels need to be high to be good indicators of recent intoxication. If possible the specimens should be deep frozen and the suspected compound should be nominated as assay procedures are long and involved.

### DIFFERENTIAL DIAGNOSIS

The predominantly nervous syndrome attracts attention to encephalitis, encephalomalacia and toxic and metabolic encephalomyelopathies in all species. Diagnostic confirmation depends on a positive assay on animal tissues.

#### Differential diagnosis list:

- Lead poisoning, confirmed by a positive assay for lead on tissue
- Rabies confirmed by histopathological examination
- Pseudorabies of cattle in early stages with pruritis and the accompanying frenzy
- Polioencephalomalacia confirmed by histopathological examination
- Thromboembolic meningoencephalitis in cattle confirmed by the isolation of *Histophilus somni*
- Salt poisoning in pigs identifiable by the characteristic lesions of eosinophilic meningoencephalitis.

### TREATMENT

There is no specific primary treatment.

**Supportive treatment** includes sedation with pentobarbital sodium; repeated doses until signs disappear are preferred, with intravenous injections of glucose and calcium and the administration of a non-oily purgative. Activated charcoal (2 g/kg) given early by stomach tube will bind pesticide in rumen and reduce further absorption. Residual chemical should be removed from the coat, and this may be facilitated by judicious washing with soap and copious water rinse.

**Toxic residues.** Treatment to reduce the contamination of tissues is unsuccessful, and in most cases the time required for the contamination to subside naturally is long, of the order of 3–6 months, but varying between specific compounds. For example, cows fed DDT prepartum have required an average of 189 days from parturition for the level in the milk fat to decline to 125 ppm. Contamination in

other species and with other chlorinated hydrocarbon compounds also tends to be persistent. After the source of contamination is removed drenching of cows with up to 2 kg of activated charcoal followed by daily incorporation in their feed for 2 weeks, or small amounts of mineral oil by mouth at short intervals, have been recommended for this purpose. Neither of these procedures is really practical in the average farm operation. The common procedure for reducing the level of contamination in animals is to put them in a feedlot without any contact with pasture and feed them on energy intensive rations. Sheep decontaminate much more quickly than cattle and animals on a high plane of nutrition eliminate the toxins more quickly.

### CONTROL

Mixed enterprise farms, especially vegetable cropping and cattle farming, are the main sources for contamination incidents. Avoidance of the use of the compounds is recommended.

### REVIEW LITERATURE

Raisbeck MF et al. Organochlorine insecticide problems in livestock. *Vet Clin North Am Food Anim Pract*, 1989; 5(2):391–410.

Ensley SM. Organochlorine Insecticides, in Plumlee, K.H. (editor) *Clinical Veterinary Toxicology*, Mosby, St. Louis, 2004; pp. 186–188.

## ORGANOPHOSPHORUS COMPOUNDS AND CARBAMATES (ORGANOPHOSPHATES)

### Synopsis

**Etiology** Poisoning by accidental exposure or overdosing with any one of the very large number of insecticides in these two groups of organic compounds.

**Epidemiology** Outbreaks occur due to overdosing, use of oil-based preparations formulated for use on non-animal surfaces, dehydrated animals, drift of spray from orchards, field crops to pasture.

#### Clinical signs

Acute disease in **cattle**: salivation, diarrhea, tremor, pupillary constriction, dyspnea, moist rales, ataxia, weakness.

**Horses**: abdominal pain, diarrhea, dyspnea, ataxia; bilateral laryngeal paralysis.

**Delayed neurotoxicity** occurs only with some compounds, characterized by incoordination, posterior paralysis, with few or no cholinergic signs. Congenital defects in piglets.

**Clinical pathology** Marked depression of blood cholinesterase levels.

**Necropsy lesions** Acute disease: no diagnostic lesions. Delayed neurotoxicity: degenerative lesions in peripheral nerves and spinal cord.

**Diagnostic confirmation** Depressed cholinesterase levels in blood; organophosphate or carbamate in feed or environment.

**Treatment** Acute disease: primary treatment is atropine in large doses to effect or atropine plus oxime, remove residual toxin from hair coat and prevent absorption from GI tract with activated charcoal and cathartics.

**Control** Avoid use in stressed, especially dehydrated, animals. Special constraints with Chlorpyrifos.

## ETIOLOGY

Organophosphorus compounds and carbamates act in essentially the same way therapeutically and toxicologically, but bonding of the compound to the esterase enzyme is irreversible in the organophosphorus compounds and spontaneously degradable with the carbamates, rendering the carbamates potentially less dangerous. A large number of compounds are included in the group and those used for the direct treatment of animals have been selected for their low toxicity. A vast amount of information is available on the relative toxicities of the many compounds but it is not possible to provide details here and the information does not lend itself to summarization.

## EPIDEMIOLOGY

### Occurrence

All animal species are affected. OP compound and carbamate poisoning is a common poisoning encountered by veterinarians in animal agriculture but the losses are still very small.

### Source of toxin

- Grazing in recently sprayed areas, particularly orchards where the most toxic compounds are frequently used
- Spray used on cereal crops and in orchards carried by wind onto pasture fields
- Hay or cubes made from plants sprayed with organophosphate compounds
- Inadvertent access to granular insecticides intended for crops
- Use of old insecticide containers as feeding utensils
- Contamination of water supplies
- Too high a concentration of the insecticide in a spray
- Application to animals of products containing oily bases and designed specifically for spraying on walls or plants.

### Risk factors

#### Host factors

These include susceptible groups such as:

- Young animals (but with some compounds adults are more so), stressed, water-deprived, and chilled animals. The increased susceptibility due to restriction of water intake is

noted especially after oral treatment to control warble-fly infestations

- Pregnant females in that congenital defects occur in their offspring
- Brahman and Brahman-cross cattle appear to be more susceptible to some compounds than other cattle
- Dorset Down sheep may be especially susceptible
- Chlorpyrifos is more toxic for male animals with high blood levels of testosterone and is not recommended for use in bulls over 8 months of age.

#### Toxin factors

These include:

- Formulation used, especially the solvent or vehicle used and droplet size
- Method of application, e.g. the toxicity of pour-ons is delayed by 24 hours compared to sprays
- Toxicity of some compounds appears to increase with storage.

### Importance

The introduction of these compounds into animal therapeutics as treatments for nematode, botfly, sheep nasal botfly, and warble-fly infestations and as insecticidal sprays on plants and soil has increased their importance as possible causes of poisoning, and as causes of pollution of milk, meat, and eggs. They also have a role in the poisoning of the native birdlife. They are now one of the most important causes of poisoning of agricultural animals.

### PATHOGENESIS

Organophosphorus compounds are highly toxic and are readily absorbed by ingestion, inhalation and by percutaneous and perconjunctival absorption. Once absorbed, sulfur containing organophosphates (phosphorothioates and phosphorodithioates) are metabolized by MFOs and sulfur is exchanged for oxygen thus increasing toxicity. There are two forms of toxicity, cholinesterase inactivation and an organophosphorus-induced, delayed neurotoxicity.

### Cholinesterase inactivation

The **inactivation of cholinesterase** by these organophosphorus compounds is associated with an increase in acetylcholine in tissues and increased activity of the parasympathetic nervous system and of the postganglionic cholinergic nerves of the sympathetic nervous system. The toxic effects thus reproduce the muscarinic and nicotinic responses of acetylcholine administration. Differences between the toxicities of compounds depend on the stability of this bonding between esterase and compound, and the toxicity of the substance formed by the bonding.

**The muscarinic effects** of acetylcholine are the visceral responses of the respir-

atory system and include marked respiratory distress due to a decrease in dynamic lung compliance and arterial oxygen tension and an increase in total pulmonary resistance; there is bronchial constriction and increased mucous secretion by bronchiolar glands. In the alimentary tract there is increased peristalsis and salivation. Effects in other systems include hypotension and bradycardia, pupillary constriction, sweating and abortion.

**The nicotinic effects** are the skeletal muscle responses of twitching, tremor and tetany, convulsions, opisthotonos, weakness and flaccid paralysis. There is a difference in the relative muscarinic and nicotinic responses between species, the visceral effects being more marked in ruminants and the muscular effects more evident in pigs in which posterior paralysis is the common manifestation.

### Organophosphorus-induced delayed neurotoxicity

This form of toxicity is manifested by distal axonopathy commencing 1 or 2 weeks after the poisoning incident. There is a dieback of neurons causing regional flaccid paralysis, especially in long neurons. The pathogenesis of this lesion is the toxic end-product produced by the interaction between some OP compounds and the esterase, a phosphorylated neuropathy toxic esterase. Typical examples of this effect are:

- **Congenital defects** in young carried by poisoned pregnant females
- **Bilateral laryngeal hemiplegia** in horses
- Possibly the **paralytic ileus** is associated with by chlorpyrifos
- The most severe effects in this category are associated with **industrial organophosphorus compounds** and are discussed under that heading.

Haloxon has this neurotoxic effect in that it is associated with only a slight depression in cholinesterase levels, but a neurotoxic response in the form of hindlimb ataxia has been reported in a proportion of treated sheep and pigs. The susceptibility of sheep is determined by their ability to metabolize this class of organophosphorus compound and this is genetically controlled.

## CLINICAL FINDINGS

### Acute poisoning

Illness may occur within minutes of inhalation or ingestion of solutions of the more toxic compounds and deaths may commence 2–5 minutes later. After cutaneous application of dichlorvos to calves clinical signs appear within 30 minutes, peak at about 90 minutes and disappear in 12–18 hours. With less toxic compounds

in solid form signs may not appear for some hours and deaths may be delayed for 12–24 hours.

### Cattle, sheep and goats

**In acute cholinesterase inactivation cases** in ruminants the premonitory signs, and the only signs in mild cases, are salivation, lacrimation, restlessness, nasal discharge, cough, dyspnea, diarrhea, frequent urination, and muscle stiffness with staggering. Grunting dyspnea is the most obvious, often audible from some distance because of the number affected. Additional signs include protrusion of the tongue, constriction of the pupils with resulting impairment of vision, muscle tremor commencing in the head and neck and spreading over the body, bloat, collapse, and death with or without convulsions or severe respiratory distress. In sheep and goats<sup>1</sup> the signs are similar and include also abdominal pain. Signs disappear at 12–18 hours.

**In delayed neurotoxicity cases** signs do not appear for at least 8 and up to 90 days after the poisoning. Signs include posterior incoordination and paralysis. Chlorpyrifos is a specific example of this kind of poisoning. It should neither be applied to adult dairy cattle nor to any mature bulls. The signs include anorexia, depression, recumbency, a distended abdomen, ruminal stasis and diarrhea, and fluid splashing sounds on percussion of the right flank. Severe dehydration develops and may cause death.

### Pigs

**Cholinesterase inactivation syndrome.** Visceral effects except vomiting are less pronounced than in ruminants and salivation, muscle tremor, nystagmus, and recumbency are characteristic. In some instances, the syndrome is an indefinite one with muscle weakness and drowsiness the only apparent signs. Respiratory distress and diarrhea do not occur.

**Delayed neurotoxicity syndromes.** Outbreaks of posterior paralysis occur 3 weeks after dosing with an organophosphorous anthelmintic; clinical signs vary in severity from knuckling in the hindlimbs to complete flaccid paralysis. The hindlimbs may be dragged behind while the pigs walk on the front legs. Affected pigs are bright and alert and eat well.

Piglets with **congenital defects** of the nervous system manifested clinically by ataxia and tremor are produced by sows dosed with OP compounds during pregnancy. Teratogenicity may be a characteristic of only some organophosphorus compounds, e.g. trichlorfon is teratogenic. dichlorvos is not.

### Horses

**Cholinesterase inactivation syndrome.** Signs include abdominal pain and grossly increased intestinal sounds, a very fluid diarrhea, muscle tremor, ataxia, circling, weakness, and dyspnea. Increased salivation occurs rarely.

**Delayed neurotoxicity syndrome.** Bilateral laryngeal paralysis develops in foals after dosing with an organophosphatic anthelmintic. It is described under laryngeal hemiplegia.

### Miscellaneous OP poisoning

Syndromes include:

- A significant drop in conception rate when the administration is at the beginning of estrus
- The fluid diarrhea which is a transient sign in moderate intoxication in foals may be expanded to a severe gastroenteritis with heavier dose rates
- Most organophosphorus compounds are associated with only temporary interference with cholinesterase and are not associated with any permanent effects in recovered animals but with some compounds, especially coumaphos and ronnel, the recovery period may be quite long, up to 3 months in the case of ronnel, because of slow excretion of the compound and the combined compound-esterase complex
- Absorption of an organophosphorus compound may also be associated with significant changes in the patient's cholinesterase status without causing clinical signs
- Potentiation of the action of succinylcholine chloride for up to 1 month after the administration of the organophosphorus compound in horses. The administration of the relaxant to a sensitized horse can be followed by persistent apnea and death. This, and a number of other interactions with drugs which may themselves have toxic effects, mean that the manufacturer's instructions with organophosphorus compounds must be followed explicitly.

### CLINICAL PATHOLOGY

The estimation of cholinesterase in body tissues and fluids is the most satisfactory method of diagnosing this poisoning, but it is essential that proper methods and standards of normality be used. Convincing figures are of the order of 50–100% reduction from normal controls. The degree and the duration of the depression of blood cholinesterase levels varies with the dose rate and the toxicity of the compound used. Blood cholinesterase levels are depressed for much longer than the clinical signs, e.g. after dichlorvos poisoning the depression

of cholinesterase level in the blood does not reach bottom until 12 hours after application and the return to normal levels takes 7–14 days.<sup>2</sup> Similarly, cholinesterase levels in cattle poisoned with terbufos, an agricultural insecticide, do not commence to rise toward normal until 30 days and are not normal for 150 days after the poisoning incident. Unlike organophosphate insecticides, carbamate insecticide cholinesterase inhibitors may spontaneously reverse binding and cholinesterase depression may not be detectable in recently poisoned animals.

Suspected food material can be assayed for its content of organophosphorus compounds but assay of animal tissues or fluids is virtually valueless and may be misleading.

### NECROPSY FINDINGS

There are no gross or histological lesions at necropsy in acute cholinesterase inactivation cases, but tissue specimens could be collected for toxicological analysis. Material sent for laboratory analysis for cholinesterase should be refrigerated but not deep frozen.

Distinctive degenerative lesions in peripheral nerves and spinal cord can be seen in **delayed neurotoxicity** cases, and hypoplasia is visible in the cerebrum, cerebellum, and spinal cord in congenitally affected piglets.

### DIFFERENTIAL DIAGNOSIS

Outbreaks of a syndrome of dyspnea, salivation and muscle stiffness and constriction of the pupils after exposure plus a history of exposure and depressed blood levels of cholinesterase suggest intoxication with these organophosphorus compounds but **diagnostic confirmation** requires positive assay results on suspected toxic materials. In cattle the morbidity and case fatality rates approximate 100% but in pigs the recovery rate is good and all pigs may recover if the intake has been low and access is stopped. With the other poisons listed below death is much more common in pigs and residual defects, including blindness and paralysis occur in a proportion of the survivors.

#### Differential diagnosis list:

Diseases with a similar clinical profile include:

In cattle:

- Sporadic cases of **anaphylaxis**
- Groups of cattle affected by **acute bovine pulmonary emphysema and edema** (fog fever) may show a sudden onset of dyspnea but pulmonary edema is obvious on auscultation, and salivation and muscle stiffness are absent.
- Early stages of nicotine poisoning, with transient muscle tremors and salivation.

In pigs:

- Arsenic poisoning
- Rotenone poisoning
- Salt poisoning
- Mercury poisoning
- Avitaminosis-A.

## TREATMENT

**Primary treatment** is urgent and critical, especially in cattle because of the usually high case fatality rate. **Atropine** in large (about double the normal) doses is the rational and approved treatment.<sup>3</sup> Recommended doses are 0.25 mg/kg BW in cattle and 1 mg/kg BW in sheep. In very sick animals about one-third of this dose should be given very slowly intravenously in a dilute (2%) solution and the remainder by intramuscular injection. Injections may have to be repeated at 4–5-hourly intervals as signs return, and continued over a period of 24–48 hours. Multiple continued dosing with atropine may not be effective and could result in atropine overdose. Cows that have received very large doses of the poison may not respond to treatment. Atropine does not reverse the nicotinic effects of the OP compound, i.e. the tremor, spasms, and convulsions, but it does block the muscarinic effects. Atropine appears to have low efficacy in sheep. This is not a serious drawback as sheep are much less susceptible than cattle to larger doses of atropine. It should be remembered that reactions in cattle following organophosphorus treatment for warble flies may be due either to the drug or to the damaged grub, and treatment with atropine would be contraindicated in the latter.

**Oximes** have some efficiency in the treatment of OP compounds, but not all carbamates some of which may have their toxicity enhanced; this is because of their ability to reactivate acetylcholinesterase (ACHE) by dephosphorylation. Also their usefulness as antidotes declines rapidly with the passage of time after the poisoning occurs, and they are of doubtful usefulness after 24 hours. For these reasons oximes are not recommended unless their specific relationship to the particular carbamate is known.<sup>4</sup> The oxime trimedoxime bromide is superior to 2-pyridine aldoxime methiodide (2-PAM) and diacetylmonoxime (DAM). Recommended dose rates for 2-pyridine aldoxime methiodide are 50–100 mg/kg BW given intravenously and for trimedoxime bromide 10–20 mg/kg BW. These dose rates can also be used for subcutaneous and intraperitoneal injection. Administration by any route is as a 10% solution in normal saline. In horses 2-pyridine aldoxime methiodide at doses of 20 mg/kg BW has given good results. Treatment may need to be repeated for up to 10 days to counteract slower acting compounds such as coumaphos.

**Combined oxime and atropine**, e.g. 2,3-butanedione monoxime and atropine, is recommended as superior to either drug alone.<sup>5</sup> The value of the treatment is greatest if it is carried out early, before 24 hours after poisoning, and is of little

**Removal of residual toxin.** Animals that have been dipped or sprayed should be washed with water to which soap, soda or a detergent is added to remove residual organophosphorus material. When oral intake has occurred activated charcoal will adsorb residual toxin in the gut.

## CONTROL

Most outbreaks occur after accidental access to compounds and this cannot always be avoided. Animals to be treated orally with organophosphorus insecticides should be permitted ample fresh drinking water beforehand. Chlorpyrifos is restricted to use in beef cattle and then not in calves less than 12 weeks old nor in bulls over 8 months of age.

## REVIEW LITERATURE

- Abdelsalam EB. Factors affecting the toxicity of organophosphorus compounds in animals. *Vet Bull* 1987; 57, 441–448.
- Barrett DS et al. A review of organophosphorus ester-induced delayed neurotoxicity. *Vet Human Toxicol* 1985; 27:22–37.
- Meerdink GL. Organophosphorus and carbamate insecticide poisoning in large animals. *Vet Clin North Am Food Anim. Pract* 1989; 5(2):375–389.
- Meerdink GL. Anticholinesterase Insecticides, in Plumlee, K.H. (editor) *Clinical Veterinary Toxicology*, Mosby, St. Louis, 2004; pp. 178–180.

## REFERENCES

- Mohamed O et al. *Br Vet J* 1990; 146:358.
- Awal MA. *Vet Human Toxicol* 1992; 34:229.
- Bakima M et al. *Res Vet Sci* 1989; 13:127.
- Dawson RM. *Vet Rec* 1994; 134–687.
- Raina R, Malik JK. *Vet Res Commun* 1991; 15:319.
- Mosha RD, Gyrd-Hansen N. *Vet Human Toxicol* 1990; 32:6.

## ROTENONE

Rotenone has commonly been used in the past to control bovine Hypoderma larvae (cattle grubs). It has a reputation for low mammalian toxicity but relatively high toxicity to aquatic life. The mammalian oral LD<sub>50</sub> is 100–300 mg/kg while the LD<sub>50</sub> for fish is less than 100 µg/L of water. Oral absorption in mammals is limited but enhanced by fat in the diet. Rotenone is relatively non-toxic but toxic effects appear in pigs fed a ration containing 2.5% rotenone. Pyrethrins are believed to enhance toxicity of rotenone. Ingesta at necropsy may contain as much as 2000 ppm of rotenone. Signs include salivation, muscle tremor, vomiting, ascending paralysis, incoordination, quadriplegia, respiratory depression, coma, and death. Accidental oral exposure may be treated with activated charcoal and an osmotic cathartic for decontamination followed by control of seizures are needed. Phenothiazine tranquilizers are contraindicated in

## REVIEW LITERATURE

Oswailer GD. *Toxicology*, Williams & Wilkins, Philadelphia, 1996; pp. 243–245.

## AMITRAZ

This acaricide is widely used in most species but is prohibited in horses; when it is applied to them accidentally it is associated with a syndrome characterized by somnolence, incoordination, depression, reduction of intestinal sounds; impaction of the large intestine may occur within 24–48 hours. The susceptibility of the compound for equids is probably due to its much greater persistence in the body.<sup>1</sup> Salivation, depression, anorexia, ataxia, tremors, and coma are signs attributed to amitraz in other species.<sup>2</sup> Concentration of the dipping fluid, environmental temperature and the condition of the skin may influence absorption of the compound and the susceptibility of the animal. Residual amitraz should be removed from affected animals by hosing with cold water and the animal should be treated with large volumes of lubricant by stomach tube at intervals of 12–24 hours. Oral fluids containing electrolytes should be given by stomach tube to counter dehydration and intravenous fluids may be necessary.

## REFERENCES

- Pass MA, Mogg TD. *J Vet Pharmacol Therap* 1995; 18:210.
- Gwaltney-Brant S. Insecticides and Molluscicides in Plumlee, K.H. (editor) *Clinical Veterinary Toxicology*, Mosby, St. Louis, 2004; pp. 177–178.

## HERBICIDES

Herbicides vary widely in their composition and also in their toxicity.

- Arsenicals** is associated with arsenic poisoning
- Sodium chlorate is also toxic by causing methemoglobinemia
- One hazard of the relatively safe organic compounds set out below is their contamination by highly toxic ones as a result of faults in the manufacturing process, e.g. the dioxins which have been found to be significant contaminants of the 2,4,5-T chemical. Today, restrictions on registration and changes in the manufacturing process have drastically reduced contamination by dioxins.
- Some herbicides, e.g. glyphosate, make pasture that is sprayed with them more palatable, thus creating their own toxicity hazard. The phenoxy acetic acid herbicides can increase palatability of some plants after spraying as well as induce elevated nitrate concentration in plants for several days after spraying.

## Dinitrophenol compounds

**Dinitrophenols.** Animals can be poisoned

percutaneous absorption of these compounds which have the effect of increasing the basal metabolic rate. Poisoning is manifested by an acute onset of restlessness, sweating, deep rapid respiration, fever, and collapse. In ruminants, but not in non-ruminants, the metabolites of these compounds are associated with intravascular hemolysis, methemoglobinemia and hypoproteinemia. Death may occur 24–48 hours later.

**Dinitrophenol (DNP) and Dinitro-orthocresol (DNOC)** are the commonest members of this group. In all species, doses of 25–50 mg/kg BW are usually toxic but much smaller doses produce toxicity when environmental temperatures are high. There is no accumulation of the drug within the body. Dinoseb, now rarely used, is a highly toxic DNP.

#### Hormone weed killers

2,4-D, silvex, MCPA and 2,4,5-T are non-toxic in the concentrations used on crops and pasture but dosing with 300–1000 mg/kg as a single dose is associated with deaths in 50% of cattle. They have also been tentatively linked with the high prevalence of small intestinal carcinomas in sheep. The picolinic acid herbicides picloram and clopyralid have also been suspected of the same relationship.

Barban is toxic at doses of 25 mg/kg, for cattle.

**2,4-D** at oral doses between 150 and 188 mg/kg BW is fatal to adult cows and at 10 mg/kg BW for sheep. Reversible toxic effects are produced with single doses in calves with doses of 200 mg/kg and in pigs with 100 mg/kg. Repeated administration of 50 mg/kg is toxic to pigs. In adult cows signs include recumbency, ruminal stasis, salivation, and tachycardia. In calves the signs are dysphagia, tympanites, anorexia, and muscular weakness; in pigs additional signs include incoordination, vomiting, and transient diarrhea. Long-term administration to pigs (500 ppm in the diet for 12 months) is associated with moderate degenerative changes in kidney and liver. 2,4-D may cause poisoning indirectly by its effect on the metabolism of weeds and sugar beets, resulting in a significant increase in the nitrate content of the leaves.

A commonly used **mixture of 2,4-D, 2,4,5-T and a brushwood killer, monosodium methyl arsenate**, is very toxic by mouth or after application to the skin; signs include anorexia, diarrhea, weight loss, and death in most cases.

Repeated dosing of sheep with silvex for about 30 days at 150 mg/kg BW causes death.

Single doses of the herbicides diallylacetamide, carbamate, triazine, and propionanilide at 250 mg/kg BW are fatal to sheep. Repeated small doses of

carbamate are associated with marked alopecia. Acute poisoning with any of these compounds is unlikely unless large amounts are ingested accidentally.

**Paraquat** is associated with fibrosing pneumonitis in pigs but this does not develop in sheep or cattle with fatal doses. Poisoning with it is unlikely to occur unless it is administered accidentally or maliciously. A dose rate of 100 mg/kg BW is uniformly fatal in pigs with signs of vomiting, diarrhea, and dyspnea. Renal damage may also be a part of acute poisoning by paraquat.

Accidental poisoning of sheep due to contamination of pasture by diquat has been associated with widespread illness with signs of diarrhea and a significant mortality. In cattle accidental poisoning with diquat has been associated with fatal abomasitis and enteritis, hepatic and myocardial degeneration and pulmonary emphysema.

The herbicide **triallate** is associated with severe illness and some deaths with single oral doses of 300 mg/kg BW to sheep and 800 mg/kg to pigs. Salivation, bradycardia, vomiting, muscular weakness, dyspnea, tremor and convulsions are followed by death in 2–3 days. It is also toxic when given in small amounts continuously.

The triazine herbicides atrazine and prometon appear to be non-toxic at usual levels of ingestion. Accidental poisoning of sheep with atrazine is associated with paralysis, exophthalmos, grinding of the teeth, diarrhea, dyspnea, and tachycardia, and of cattle is associated with salivation, tenesmus, stiff gait, weakness. Experimental dosing of heifers with large doses of atrazine is associated with fatal poisoning, but animals treated with activated charcoal survive.

Simazine and aminonitrazole in combination have been associated with death in sheep, and horses allowed access to pasture sprayed with the mixture. In sheep the signs are staggering, inappetence, and depression. In horses colic is the important feature.

Simazine on its own, with continuous access is associated with tremor, tetany and paraplegia, and a prancing gait with the head held against the chest. Death occurs after 2–4 days and mild-to-moderate myocardial pathology at necropsy.<sup>1</sup>

Tricopyr, a selective postemergence herbicide, is toxic to horses at five times the estimated maximum intake from herbage. It is associated with digestive and respiratory signs, ataxia, stiff gait, sometimes tremor and mild to moderate renal damage.

#### Sodium chlorate

Animals seldom ingest sufficient sprayed plant material to produce clinical illness

and the principal danger is from accidental dosing or permitting salt-hungry cattle to have access to the chemical. The lethal oral dose is 2–2.5 g/kg BW for sheep, 0.5 g/kg for cattle and 3.5 g/kg for dogs. Irritation of the alimentary tract is associated with diarrhea and deep, black erosions of the abomasal and duodenal mucosae. Hemoglobinuria, anemia and methemoglobinemia result and somnolence and dyspnea are characteristic. At necropsy the blood, muscles, and viscera are very dark. No specific treatment is available. Sodium thiosulfate and methylene blue are used in treatment but have little effect but copious blood transfusions have been recommended.

#### Delrad

This algicide is used to control the growth of algae on ponds and other water reservoirs. Cattle and sheep are unharmed by the ingestion of water containing 100 ppm of the compound. Dose rates of 250 g/kg BW in adult cattle, 150 mg/kg in calves and 500 mg/kg sheep are associated with toxic effects.

#### DEFOLIANTS

Substances used to remove the leaves from plants to facilitate harvesting of seed may represent a toxic hazard if the residual stalks are fed to livestock.

Monochloroacetate (SMCA) is commonly used for this purpose and, although it is unlikely to cause poisoning unless very large quantities of the stalks are fed, sheep and cattle which gain access to recently sprayed fields may be seriously affected. Toxic signs in cattle include diarrhea, colic, muscular tremor, stiff gait, ataxia, and dyspnea. Terminally there may be convulsions, hyperexcitability, and aggressiveness. The course is short, most animals dying within a few hours.

An organophosphorus compound, tributyl triphosphorotrithioite used as a defoliant for cotton plants, produces typical signs of organophosphorus poisoning.

Thidiazuron, a cotton defoliant, appears not to be toxic for animals, but may enter the human food chain via goat's milk and chicken eggs.

#### REFERENCE

1. Allender WJ et al. *Vet Human Toxicol* 1992; 34:442.

#### FUNGICIDES

Zinc ethylene dithiocarbonate (zineb) may be associated with thyroid hyperplasia and hypofunction, degeneration of myocardium and skeletal muscle, testicular weight reduction, and germ cell depletion<sup>1</sup>.

Thiram (tetramethyl thiuram sulfide) is a widely used agricultural fungicide which is associated with conjunctivitis,

rhinitis and bronchitis on local contact; it is thought to be associated with abortion in ewes on ingestion, and is a known teratogen but no specific poisoning incidents have been recorded in animals.<sup>2</sup>

## REFERENCES

1. Soffietti MG et al. Schweiz. Arch. Tierheilkd, 1988; 130:657.
2. Dalvi RR. Vet Human Toxicol 1988; 32:480.

## RODENTICIDES

The commonly used rodenticides in some countries are sodium fluoroacetate and alphanaphthylthiourea (ANTU), but their use is banned in other countries. Anticoagulants, include warfarin ((3-acetylbenzyl)-4-hydroxycoumarin) and its analogs, as well as newer 'second generation' anticoagulants (brodifacoum, bromodiolone, chlorphacinone). Zinc phosphide is often used as an alternative to anticoagulant rodenticides. They are all toxic to domestic animals and may cause death when ingested accidentally. 'Quintox', a rodenticide containing cholecalciferol (0.75 g/kg), has been associated with hypercalcemia, hyperphosphatemia, and death in dogs, and could cause death in farm animals.

## SODIUM FLUOROACETATE

### ETIOLOGY

Fluoroacetate occurs naturally in some plants, and in the form of compound 1080 is used as a rodenticide in agriculture. The toxic dose level for domestic animals is 0.3 mg/kg BW, and 0.4 mg/kg is lethal for sheep and cattle. Sublethal doses may be cumulative if given at sufficiently short intervals.

### EPIDEMIOLOGY

Fluoroacetate's use in agriculture poses a hazard for grazing farm animals because it is usually spread out across fields combined with cereals, carrots, or bread as bait and is attractive to ruminants.

### PATHOGENESIS

Its mode of action is by inhibition of the enzyme aconitase, thus blocking the intracellular energy cycle. Two actions are manifest: **myocardial depression** with ventricular fibrillation, and central nervous system stimulation producing convulsions. In sheep the predominant effect with acute poisoning is on myocardium; in dogs it is the nervous system.

### CLINICAL FINDINGS

In **herbivores** generally there is sudden death in **acute** cases, the animals being found dead without evidence of a struggle; or there are tetanic convulsions and acute heart failure with the animals showing weakness and dyspnea

accompanied by cardiac arrhythmia, a weak pulse and electrocardiographic evidence of ventricular fibrillation.

In sheep with **subacute** poisoning the signs are similar but are not apparent when the animal is at rest. When they are disturbed the nervous signs of tremor and convulsions appear but disappear when the sheep lies down.

**Pigs** manifest the nervous form of the disease, including hyperexcitability and violent tetanic convulsions. In all cases there is a period of delay of up to 2 hours after ingestion before signs appear.

### CLINICAL PATHOLOGY/NECROPSY FINDINGS

There are no specific lesions but the tissues contain elevated levels of citrate.

### DIFFERENTIAL DIAGNOSIS

A history of access to toxic material plus appropriate clinical signs and assay of fluoroacetate in ingesta provide good circumstantial evidence and approximate **diagnostic confirmation**.

#### Differential diagnosis list:

- Many poisonous plants associated with sudden death linked to acute cardiac arrest
- Lightning strike or electrocution
- Inherited cardiomyopathy
- Ionophore poisoning especially warfarin and in horses
- Other less common causes of sudden death.

### TREATMENT/CONTROL

Care in the disposition of baits and highly dependable retrieval of uneaten baits before allowing livestock access to baited fields preempt most mortalities. No specific treatment is available.

## ALPHA NAPHTHYLTHIO UREA (ANTU)

Horses, pigs, calves, and dogs are susceptible as well as rats. Tolerance develops after the ingestion of sublethal doses. Death occurs within 24–48 hours after ingestion due to marked pleural effusion, pulmonary edema, and pericardial effusion. The toxic dose rate is of the order of 20–40 mg/kg BW in a single dose.

## WARFARIN AND OTHER ANTICOAGULANT RODENTICIDES

### ETIOLOGY

Warfarin is a well known anti-vitamin K anticoagulant rodenticide available since the 1940s and is known as a 'first generation' anticoagulant. Related compounds are dicoumarol, coumatetralyl, and pindone.<sup>1</sup> Brodifacoum, bromodiolone, diphacinone, difethialone, and chlor-

phacinone are known as 'second generation' anticoagulants and may be associated with poisoning from a single dose because of their quite prolonged elimination half lives. Single doses, are less likely to be associated with poisoning but repeated ingestion 'for some days may do so. Daily doses of warfarin of 0.2–0.5 mg/kg BW are fatal to pigs in 6–12 days. In cattle 200 mg/kg daily for 5 days is associated with 50% mortality. At 0.25 mg/kg for 10 days prothrombin times are depressed 20% and at 0.1–0.3 mg/kg abortions occur. Coumatetralyl was introduced to overcome the problem of resistance to warfarin which developed in some rodent populations. It is more hazardous for domestic animals than the original warfarin because it can be used in a concentrated form by laying it across rodent tracks; the rodents lick it from their paws. Brodifacoum<sup>2</sup> acts over a long period and is detectable in liver up to 128 days after intake.

### EPIDEMIOLOGY

These products are used by incorporating them into baits and they are in widespread use because they cause no poison shyness. Although most deaths occur because of misuse by farmers, contamination of feed-stuffs at the milling plant is not unknown. Calves and poultry are not usually affected, most outbreaks being recorded in pigs, cats, and dogs. Horses are not commonly affected, but warfarin poisoning has been produced experimentally in ponies.

### PATHOGENESIS

The poisons exert their effects by interfering with reactivation of vitamin K, thus inhibiting the blood-clotting mechanism by preventing the operation of the thrombin to prothrombin complex. Sudden massive hemorrhage into body cavities or brain may cause immediate death, or death may occur slowly with accompanying lameness due to hemorrhage into subcutaneous tissues. Death due to rupture of a major blood vessel may also occur in 3–4-day-old calves born of cows given a non-fatal dose of warfarin during pregnancy.

### CLINICAL FINDINGS

Most cases are of sudden death or found dead. The clinical syndrome includes mucosal pallor, weakness, recumbency, mild dyspnea. Coumatetralyl is associated with more specific signs in pigs, with lameness due to hemorrhage in and swelling of the legs.

### CLINICAL PATHOLOGY

There are reduced values for packed cell volume, erythrocyte count, and hemoglobin content. Activated clotting time, prothrombin time, and PIVKA assays are prolonged. Anticoagulants or their metabolites can be detected chemically in

blood or urine, or in liver for animals that have died of toxicosis.

### NECROPSY LESIONS

Pallor of tissues and massive hemorrhages are characteristic.

#### DIFFERENTIAL DIAGNOSIS

Assay of feed supply for the toxin, plus severe anemia evident on clinical, clinicopathological or necropsy findings provide diagnostic confirmation. The differential list includes other causes of acute hemorrhagic anemia.

### TREATMENT

**Primary treatment.** Intravenous injection of a single dose of 50–75 mg/kg BW of vitamin K<sub>1</sub> is an effective antidote for a horse. The prothrombin time is returned to normal in 12–24 hours after this treatment and persists at this level for as long as 96 hours. Animals with acute blood loss must be treated for shock and provided plasma or whole blood which will immediately restore clotting factors and provide immediate coagulation factors for clotting.

#### Red squills

Poisoning by red squills seldom occurs because the material is extremely unpalatable and when eaten is usually vomited. In all species large doses (100–500 mg/kg BW) must be administered to produce toxic effects. Young calves are most susceptible and goats least. Experimental poisoning is associated with convulsions, gastritis and bradycardia.

#### Zinc phosphide

Zinc phosphide is also unpalatable to domestic animals, and requires an acid stomach to release its toxic phosgene gas. It is not therefore a likely poison for ruminants, but could be a hazard for pigs and horses. Experimental poisoning with doses of about 40 mg/kg BW is associated with death in most species. A general toxemia with depression of appetite, dullness, and some increase in respiratory rate occurs but there are no diagnostic signs. Necropsy lesions include congestion and hemorrhages in all organs, fatty degeneration of the liver and inflammation in the small intestine. Chemical assay is necessary to establish a diagnosis.<sup>3</sup>

### REFERENCES

1. Martin GR et al. *Aust Vet J* 1991; 68:241 & 69, 176.
2. Boemans HJ et al. *Can J Vet Res* 1991; 55:21.
3. Guale FG et al. *Vet Human Toxicol* 1994; 36:517.

### MOLLUSCICIDES

#### Metaldehyde

Metaldehyde is in common use as a molluscicide. It is usually dispensed in

a bran base and is toxic to farm livestock. Outbreaks occur in cattle, horses, and sheep. Lethal dose rates include **cattle** 0.2 g/kg BW in adults, and less in calves; **horses** 0.1 g/kg BW.

Clinical signs in ruminants include incoordination, hyperesthesia, muscle tremor, salivation, dyspnea, diarrhea, partial blindness, unconsciousness, cyanosis, and death due to respiratory failure. Hyperthermia (43.58°C or 110.8°F) occurs in sheep. All the signs are exacerbated by excitement or activity. A mortality rate of 3% may be expected.

Signs in horses are similar plus heavy perspiration, hypersalivation, muscle fasciculation, and death in 3–5 hours.

The only effective treatment in cattle is likely to be rumenotomy, supplemented by sedation with a tranquilizer, sedative or muscle relaxant. In horses, mineral oil by stomach tube is recommended to delay further absorption of the metaldehyde.

#### Methiocarb

This carbamate molluscicide has anticholinesterase and nicotinic and muscarinic activities. Poisoning of sheep is associated with depression, hypersalivation, diarrhea, dyspnea, aimless wandering, and ataxia. Death is due to pulmonary edema. Horses show sweating, dribbling, muscle tremor, hypersalivation, and finally recumbency and death due to pulmonary edema.

The compound is usually in pellet form and dyed blue so that affected animals can be detected by the blue staining of their mouths. Atropine is an effective antidote but may be required to be repeated if the amount of bait taken is large. For a wider discussion of carbamate poisoning see p. 1834.

### WOOD PRESERVATIVES

#### Phenolic compounds

Lumber used in the construction of barns, stables, pens and yards is often treated with phenolic wood preservatives, chiefly pentachlorophenol, dinitro-orthophenols, dinitro-orthocresols (DNOC), dinitrophenol, and coal tar creosote, or mixtures of these, and animals that have access to freshly treated material or the neat preservative may be poisoned. The toxic cresols may be imbibed orally or absorbed percutaneously, and contact with freshly treated wood may be associated with local cutaneous necrosis.

Acute fatal doses in all species are in the range of 120–140 mg/kg BW for pentachlorophenol, and chronic fatal doses range from 30 to 50 mg/kg BW. Fatal doses for coal tar creosote are 4–6 g/kg BW as a single dose, or 0.5 g/kg BW daily. A high mortality may be encountered in newborn pigs and there may be a greater than normal incidence

of stillbirths when sows are farrowed in treated crates. Weaned pigs may show depression, skin irritation and occasionally death.

**Coal tar sealers** for concrete floors may be associated with similar phenolic poisoning.

**Creosote** applied as a treatment for ring-worm, has shown marked toxic effects in cattle.

Besides the known toxic effects of these chemicals there has been interest in possible **subclinical intoxications**. There is a lack of definitive evidence on the subject, but horses bedded on shavings from pentachlorophenol-treated wood, prepared wrongly by treating the rough lumber and then dressing it instead of applying the preservative to the dressed lumber, have been poisoned by **dioxin**, a common contaminant in the preservative. Clinical signs include depression of appetite, severe weight loss, ventral and limb edema, hair loss, anemia, a crusty, scaly dermatitis around the eyes, muzzle, the axilla and inguinal region, and on the neck. Exudation through cracks in the skin is a feature of the lesion. Lesions in liver biopsies include necrosis and severe vacuolar changes in the hepatocytes.<sup>1</sup>

#### Copper–chrome–arsenate

Softwood preserved against rot by the application of a patented mixture containing copper, chromate, and arsenic, has become very popular for use in yards and buildings used by livestock. The materials have been carefully tested to insure that there is virtually no risk of poisoning. It is recorded that animals would need to eat at least 28 g of the treated wood daily for a month before a chronic poisoning occurred. Horses that have the chewing habit could eat more than that and could theoretically become poisoned. Burning of treated lumber can make arsenic available and toxic to animal. This route of poisoning has occurred in cattle because of their tendency to lick ashes or soil where burning of wood has occurred.

### REFERENCE

1. Kerkvliet NI et al. *J Am Vet Med Assoc* 1992; 201:296.

### SEED DRESSINGS

Many poisoning incidents are caused by livestock gaining access to seed which has been treated in some way. The more common ones are listed below, and each is dealt with under the heading of the toxic agent:

- Grain treated with arsenic used to poison birds



- Grain treated with highly toxic organophosphorus substances used to make baits for market garden pests
- Bran mixed with metaldehyde as a bait for snails
- Grain to be used as seed which has been treated with a mercury-based fungistatic agent.

Additional poisonous substances are bird repellants, grain fumigants, and fungistatic agents.

### Bird repellants

Baits of corn or wheat are mixed with various substances and spread over areas to protect them from damage by bird droppings or to avoid damage to aircraft. One of these bird repellants, 4-aminopyridine, has caused poisoning in **horses**. Clinical signs include signs of fright, profuse sweating, severe convulsions, fluttering of the third eyelid, and death 2 hours after the onset of signs and 6–8 hours after ingesting the material.

In **cattle** signs include anorexia, frequent passage of small amounts of feces, and tenesmus, with some animals also showing tremor, ataxia, erratic behavior, especially walking backwards, and some sudden deaths.

### Grain fumigants

Grain treated by the fumigant dibromoethane is associated with mortality in sheep. The principal lesions are pulmonary edema, septal fibrosis, alveolar epithelialization, and pleural effusion. Death occurs 48–120 hours after exposure. Methyl bromide, described under soil fumigants, is also used for stored grain.

### Fungistatic agents

Hexachlorobenzene (HCB) is widely known because of its indestructibility and capacity to pass from grain through cattle and into humans. Legislation against chlorinated hydrocarbons being found in the human food chain is very harsh and hexachlorobenzene is a prime target for public health veterinarians. Its specific toxicity is not high, although experimental poisoning in pigs is associated with hepatic injury.

### ADDITIVES IN FEEDS

Many antibiotics, fungistatics, vermicides, estrogens, arsenicals, urea, iodinated casein, and copper salts are added to prepared feed mixes to improve food utilization and hasten growth. Many of them are toxic if improperly used. Miscellaneous agents include amprolium, an antithiamine coccidiostat which is associated with polioencephalomalacia in ruminants, and iodinated casein, used experimentally at one time to stimulate milk production in cows but which is associated with cardiac

irregularity, dyspnea, restlessness and diarrhea in hot weather. Toxic additives listed elsewhere in this book are arsanilic acid and copper compounds.

### ESTROGENIC SUBSTANCES

#### ETIOLOGY

Poisoning by estrogenic substances occurs in the following circumstances:

- Natural substances in plants and as zearalenone in fungi
- Dietary supplements to fattening cattle
- Overdosage of clinical infertility cases
- Pigs fed hexestrol implants in capon necks
- Pasture contaminated by manure from cattle treated orally especially or by subcutaneous implants with estrogenic substances and which pass significant amounts in the feces. Ensilage made from the pasture may also be contaminated
- Cattle fed on chicken litter from farms where estrogens are used as supplements
- Steers implanted with an estrogen at a standard dose rate may respond in an exaggerated manner and show signs of toxicity. Estradiol implants are reputed to be associated with more such problems than zeranone.

#### EPIDEMIOLOGY

Estrogenic substance administration as a managemental tool is regarded unfavorably in many countries, because of the risk of intoxication occurring in humans eating contaminated meat. Their use is banned in some and strictly controlled in others. The supplementation may be by addition to the feed, but more commonly is by subcutaneous implants.

#### PATHOGENESIS

Signs and lesions are the direct result of amplification of the pharmacological effects of the substances.

#### CLINICAL SIGNS

**Male estrogenism.** Steers in feedlots include **excessive mounting** by other steers, sometimes to the point of causing death, head injuries are caused by **head-to-head butting**, frequent bawling, leading of mobs, pawing the ground to the point of **hole-digging**. These problems tend to pass off after a short time. **Preputial prolapse** can be a problem in *Bos indicus* cattle. Experimental feeding of zeranone to young bulls is associated with retardation of testicular and epididymal development.<sup>1</sup>

**Urethral obstruction.** Heavy mortalities have occurred in feeder lambs after the use of implants of estrogens as a result of prolapse of the rectum, vagina, and uterus, together with urethral obstruction

by calculi. The calculi consist largely of desquamated epithelial and pus cells which form a nidus for the deposition of mineral, the desquamation probably being stimulated by the estrogen. Also urethral narrowing caused by the estrogen facilitates complete obstruction by the calculi.

**Pig estrogenism.** The clinical signs include straining, prolapse of the rectum, incontinence of urine, anuria, and death. At necropsy there is inflammation and necrosis of the rectal wall, enlargement of the kidneys, thickening of the ureters and distension of the bladder, and gross enlargement of the prostate and seminal vesicles. Estrogens such as zearalenone ingested by sows after day 11–13 of the estrus cycle can be associated with retention of corpora lutea and a syndrome of anestrus or pseudopregnancy that typically persists for 45–60 days post estrus. This effect may occur at zearalenone concentrations of 3–10 ppm in the diet. Pregnant sows given zearalenone post breeding may have failure of implantation and early fetal abortion.

**Nymphomania in cows.** Larger doses of stilbestrol, usually administered accidentally to cows, may be associated with prolapse of the rectum and vagina and **raising of the tail head** due to relaxation of the pelvic ligaments. Susceptibility to fracture of the pelvic bones and dislocation of the hip are common sequels. Nymphomaniac behavior in such animals invites other skeletal injury, especially fracture of the wing of the ilium.

**Idiopathic female estrogenism.** Besides the toxic effects associated with estrogens in specific plants, increased estrogenic activity is also encountered in mixed pasture, often only at certain times and on particular fields. Clinically the effects are those of sterility, some abortions, swelling of the udder and vulva in pregnant animals and in virgin heifers, and endometritis with a slimy, purulent vaginal discharge in some animals. Estrus cycles are irregular. In milking cows there is depression of the milk yield, reduction in appetite, and an increase in the cell count of the milk.

#### CLINICAL PATHOLOGY

High blood levels of estrogens are characteristic. In swine, the syndrome of anestrus associated with zearalenone, will be accompanied by elevated progesterone concentrations due to the retention of corpora lutea.

#### NECROPSY FINDINGS

Enlargement and vascular engorgement of accessory sex organs, especially in neutered animals, are characteristic. Uterine

enlargement and keratinization of vaginal epithelium may be detected, and in mature female swine there may be persistent multiple retained corpora lutea.

#### DIFFERENTIAL DIAGNOSIS

The clinical profile is almost diagnostic, a search of the environment usually reveals a source of estrogen and estrogen assay on blood provides diagnostic confirmation.

##### Differential diagnosis list:

- Acute, especially traumatic, vaginitis
- Urethral obstruction in males
- Cantharidin poisoning.

## UREA

### ETIOLOGY

Urea is a common form of non-protein nitrogen (NPN) used in ruminant rations and as a fertilizer. Accidental access to the powder or liquid form of the compound can cause heavy mortalities. Poisoning occurs when cattle or sheep accidentally gain access to large quantities of urea, or are fed large quantities when they are unaccustomed to it, or when feeds are improperly mixed, or the water supply is polluted. Feed grade urea contains approximately 45% nitrogen and protein is approximately 16% nitrogen, and each gram of urea is equivalent to 2.81 g of protein. Thus, a ration containing 1% urea supplies the protein equivalent of 2.81% natural protein. Some care is required in bringing the animals onto urea gradually and an adequate proportion of carbohydrate must be included in the ration.

### EPIDEMIOLOGY

Urea is used in agriculture as a feed additive for ruminants to provide a cheap protein substitute in the diet, and as a fertilizer on crop and pasture fields. Protein production from urea is dependent on rumen microorganisms assimilating the ammonia released from urea and converting it to bacterial protein useful to the animal. Natural urease in the rumen supports the hydrolysis of urea to release ammonia. The degree of toxicity of urea depends on the rapidity with which ammonia is released from the urea in the rumen, and this may be increased if soybean meal is being fed; soybeans contain urease which facilitates the breakdown of urea to ammonia. Ruminants are better able to assimilate ammonia into protein when adequate amounts of readily available carbohydrates are provided. This is usually from grain or a sugar source such as molasses. In the absence of sufficient digestible carbohydrate, as when only roughages are fed, urea is more toxic. At one time mixtures of molasses and urea

were popular as feed supplements for cattle and are associated with outbreaks of poisoning with signs similar to those of urea poisoning and those associated with feeding ammoniated hay.

### Toxic dose levels

**In cattle** which have been starved beforehand dose levels up to 0.33 g/kg BW is associated with increases in blood levels of ammonia and dose levels of 0.44 g/kg BW produce signs of poisoning within 10 minutes of dosing and dose rates of 1–1.5 g/kg BW are associated with death.

### Tolerance to urea

Animals unaccustomed to urea may show clinical illness when fed 20 g/50kg BW, but by gradually increasing the quantity fed this amount can be tolerated. This tolerance is lost rapidly and animals which receive no urea for 3 days are again susceptible. Tolerance is also reduced by starvation, by lack of readily available dietary carbohydrate and by a low protein diet. **SHEEP** can eat 6% of their total ration as urea provided it is well mixed with roughage and fed throughout the day, preferably by spraying the urea mixed with molasses onto the roughage. Much more urea is tolerated if given to sheep in molasses (18 g), than if given as a drench (8 g) and prior feeding on lucerne further increases the tolerance and fasting for 24 hours reduces it. A dose rate of 1 g/kg BW to sheep appears to be non-toxic, but 2 g/kg is quickly fatal. In general, urea should not constitute more than 3% of the concentrate ration of ruminants.

**Horses** appear to be tolerant to relatively large doses of urea but the disease has been produced experimentally in ponies by administering 450 g by stomach tube. The clinical picture is similar to that in cattle, being largely related to the central nervous system. There is a sharp increase in blood ammonia levels after ingestion of the urea, and it is assumed that hydrolysis of the urea occurs in the cecum.

**Pigs** are quite unaffected by very large doses of urea unless they are deprived of water or have developed a cecal flora which produces urease.

### PATHOGENESIS

The toxic effects are due to the sudden production of large quantities of ammonia and its rapid absorption from the rumen results in the onset of signs in 10–30 minutes after feeding. The severity of signs is related to blood ammonia levels and not to levels of ammonia in the rumen. However, the alkaline conditions in the rumen created by rapid release of ammonia can be associated with more of the ammonia to be present in a non-ionized form which favors rapid absorption

from the rumen with resultant increase in blood ammonia concentration. Excess blood ammonia is toxic to intermediary metabolism and results in systemic lactic acidosis and elevated blood potassium, which can lead to hyperkalemic heart failure.

### CLINICAL SIGNS

**Cattle and sheep.** Signs of toxicity commence as early as 10 minutes after the urea is eaten and include severe abdominal pain, frothing at the mouth and nose, hypersensitivity to sound and movement to the point of being aggressive, muscle tremor, incoordination, weakness, dyspnea, bloat, and violent struggling and bellowing. In severe cases the course is short and death occurs sometimes in a few minutes but usually in about 4 hours after ingestion. Less severe cases are drowsy and recumbent. The case fatality rate in affected animals is high.

### CLINICAL PATHOLOGY

**Cattle.** Signs are visible when rumen ingesta levels of ammonia are 1000 mg/L, serum levels of ammonia nitrogen (NH<sub>3</sub>-N) are 10–13 mmol/L (10–18 mg/L)<sup>2</sup> and when blood ammonia nitrogen concentrations reach 0.7–0.8 mg/dL.

**Sheep** deaths occur at levels of ammonia nitrogen of 33 µg/mL of blood; the ruminal contents are alkaline when tested with litmus paper (pH elevated from 6.94 to 7.90) and ruminal ammonia levels rise from 6 to 50 mg/dL.

### NECROPSY FINDINGS

There are no characteristic lesions at necropsy, but most cases show generalized congestion, hemorrhages, and pulmonary edema. Death is thought to result from respiratory arrest due to ammonia intoxication.

**Pigs.** Encephalomalacia has been produced by feeding a ration containing 15% urea. The clinical picture and histopathological findings were similar to those of salt poisoning except that no eosinophilic aggregations are present in the cerebral lesions.

#### DIFFERENTIAL DIAGNOSIS

Outbreaks of this poisoning are usually closely linked to known exposure to urea and achieve **diagnostic confirmation** by assay of high blood levels of ammonia.

Without the historical link to a source of urea the **differential list is very long** because of the similarity of the syndrome to other diseases in which nervous excitation is accompanied by muscle tremor, dyspnea, convulsions, and a high case fatality rate.

##### Differential diagnosis list:

- Acute hepatic insufficiency
- Anaphylaxis

- Poisoning by *Clavibacter toxicus*
- Acute poisoning by cyanobacteria
- Hypomagnesemia
- Acute salt poisoning
- Acute bovine pulmonary emphysema and edema
- Acute organochlorine insecticide poisoning
- Acute 4-Methylimidazole poisoning from ammoniated forages (bovine bonkers syndrome)
- Any of the many forms of encephalitis or encephalomalacia.

### TREATMENT

No primary treatment is likely to be effective but the oral administration of a weak acid such as vinegar (0.5–1 L to a sheep, 4 L to a cow), or 5% acetic acid is recommended. Cold water (10–30 L for adult cattle) will dilute excess urea and temporarily lower rumen pH. This may reduce the amount of ammonia absorbed<sup>3</sup> but it must be administered as soon as the first clinical signs appear and repeated dosings may be necessary as clinical signs tend to recur about 30 minutes after treatment. The only really effective treatment is prompt and efficient emptying of the rumen, either via a large bore stomach tube or by rumenotomy, but the results are indifferent because the damage has usually been done already.

### CONTROL

Urea is highly toxic and care is essential when handling it in the vicinity of animals. Feed manufacturers' recommendations about maximum concentration of urea in prepared rations and acclimatization to the diet with inclusion of adequate readily available carbohydrates should be adhered to.

### Propylene glycol poisoning

Propylene glycol is an unlikely poison but it is used extensively as an oral treatment for acetoneemia in cattle and can be associated with poisoning if it is accidentally administered to horses, usually in mistake for mineral oil. Dose rates of 3 L to horses of 500 kg BW by stomach tube is associated with an immediate but short duration episode of abdominal pain, sweating, salivation, severe ataxia and depression, and a fetid odor of the feces.<sup>4</sup> Much larger doses (8 L) can be fatal. Moderate-to-severe inflammation of the lining of the gut and edema of the brain are noticeable at necropsy examination.

### Dried poultry wastes

Feeding dried poultry wastes to ruminants provides them with a source of nitrogen, and gets rid of the chicken farmer's disposal problem. Deleterious effects include:

- Copper poisoning when the chickens are fed on diets supplemented with copper
- Estrogen poisoning when the chickens are fed on estrogen-supplemented diets
- An unidentified problem arises of hepatic necrosis, hypoalbuminemia, and ascites in lambs fed large amounts of poultry waste from hen batteries
- Litter from broiler houses is associated with renal damage but not to the point of causing mortality
- Botulism.

### Brewer's residues

Diseases associated with the feeding of by-products of brewing and distilling include:

- Carbohydrate engorgement in cattle fed wet brewer's grains
- Possibly spinal cord degeneration in adult cattle fed sorghum beer residues contaminated by *Aspergillus flavus* and containing aflatoxin
- Excess sulfur (>0.45% in the diet) from some methods of processing which can lead to polioencephalomalacia.

### Chemically treated natural feeds

#### Formalin-treated grain

This is a special diet fed to dairy cows to produce dairy products containing an increased proportion of polyunsaturated fats for special human diets. Fats in the grain are protected against hydrogenation in the rumen by coating the grains with formalin. If the formalin and the grain are not properly mixed, the free formalin left as a residue is associated with rumenitis and severe diarrhea.

#### Caustic-treated grain

Grain treated with caustic to improve its digestibility is recorded as causing focal interstitial nephritis, rumenitis, and abomasal ulceration in feedlot steers. The lesions have been produced experimentally. They may not be detected until the animals are slaughtered.

#### Ammoniated forage

Anhydrous ammonia is added to hay to improve its digestibility and nitrogen content. Environmental risk factors enhancing the production are low dry matter content of the feed, high environmental temperature, and high concentrations of ammonia in the treatment mixture. If the forage is high quality and has a high carbohydrate content it may undergo chemical change, possibly with the formation of a substituted imidazole, 4-methylimidazole (MeI) which is associated with hysteria (bovine bonkers) in the cattle eating it. Calves sucking cows fed ammoniated hay may also be affected by this same syndrome. Experimental

feeding with MeI produces the same syndrome but it is not the sole cause; other substances are also involved.<sup>5</sup>

**Clinical signs** include hyperexcitability, hyperesthesia, restlessness, rapid blinking, pupillary dilatation, ear-flicking, frequent urination and defecation, dyspnea, frothing at the mouth, bellowing, charging, circling, and convulsions. Tremor, commencing at the head and opisthotonos are obvious early signs. Between convulsions affected sheep walk in circles and have a stiff gait. Nursing calves may show signs even though their dams are unaffected. No clinicopathological abnormalities occur, blood ammonia levels are normal, and no specific necropsy lesions have been identified.

**Treatment** consists of sedation but many patients do not respond to agents such as acepromazine. Dilution of toxic forage with normal feed is not recommended because the toxin may be cumulative. The maximum rate of ammoniation to avoid toxicity, for poor forage is 3% and 1% for high-moisture forage.<sup>6</sup>

#### Newsprint

Newsprint is fed commercially to ruminants as an alternative roughage. Toxicological hazards of the material in sheep fed colored magazines for 6 months and comprising 23% of their ration included a significant deposition of lead in tissues and an increase in enzyme activity in liver, but there were no clinical signs and no histopathological lesions. Feeding for periods of several weeks has no detectable clinicopathological effects and there is evidence that the known toxins are not secreted in cows' milk.<sup>7</sup>

#### Sewage sludge

Urban sewage sludge is used as top-dressing for pasture and may be associated with the spread of infectious disease as well as goiter. Sewage sludge may also be fed directly to animals, but may lead to dissemination of lead, cadmium, and polybrominated and polychlorinated biphenyls to animals and the food products derived from them. Potential damage due to illness or contamination of animal-produced feed can be minimized by leaving treated pasture exposed to weather for a period of several weeks before allowing animals access to it.

### IONOPHORE POISONING

#### Synopsis

**Etiology** Carboxylic ionophores used commercially as coccidiostats and growth promotants are associated with poisoning if dose rate is excessive; horses are very susceptible.

**Epidemiology** Mixing errors; left-over cow feed fed to horses.

**Pathogenesis** Muscle damage leading to acute heart failure or limb weakness and paralysis.

**Clinical signs** Sudden death, paralysis, red urine or a less acute syndrome of skeletal muscle weakness, paresis, and paralysis.

**Clinical pathology** Myoglobinuria, elevated levels of CPK. Ionophore found in ingesta.

**Necropsy lesions** Myocardopathy plus skeletal myopathy. Lesions may only be apparent by microscopic examination

**Diagnostic confirmation** Assay of stomach contents and representative feed samples for the ionophore.

**Treatment** No primary treatment recommended. Supportive treatment is oral charcoal or mineral oil.

## ETIOLOGY

Monensin, lasalocid, maduramicin, narasin, and salinomycin are carboxylic ionophores used as polyether antibiotics for the control of coccidiosis in poultry and with a secondary role as growth promotants in ruminants. Monensin has minor additional uses in the treatment of acetoneemia, lactic acidosis, bloat and atypical interstitial pneumonia. Used properly the compounds are effective in both roles but the margin of safety is small and careless use has been associated with major losses. All of the compounds are cationic agents, causing altered balance of cations (especially  $\text{Ca}^{2+}$ ,  $\text{Na}^{+}$  and  $\text{K}^{+}$ ) in cells and organelles. Pharmacological effects of ionophores are similar, but they differ chemically and have differing toxicities.

The recommended doses of monensin vary depending on the age and size of the livestock and the purpose for which it is administered and the manufacturer's recommendations should be adhered to strictly. Approximate recommended levels, orally and usually in the feed, are: cattle, 50–200 mg per head per day, 16.5–33 ppm; sheep 5–10 ppm in feed.

For monensin, dosage levels at which clinical signs of poisoning can be expected to occur are: cattle 10, sheep 4, pig 7.5, and horse 1 mg/kg BW. Deaths in cattle are likely to commence at intakes of 10 mg/kg BW and in horses at 2–3 mg/kg. Toxic feed concentrations for pigs are 200–220 mg/kg of feed. Comparative  $\text{LD}_{50}$  in mg/kg BW are: cattle 26.4<sup>12</sup> horse 2–3, sheep 12, pig 16–50, and goat 24. It is common for cattle to be poisoned with more than 10 times the recommended dose. The  $\text{LD}_{50}$  for salinomycin for the horse is 0.6 mg/kg BW. The effects of the compounds are cumulative and may not be observed for some weeks after administration is discontinued.

## EPIDEMIOLOGY Occurrence

All animal species are affected, including zoo ruminants.<sup>8</sup> Poisoning incidents are most often reported in countries where animal husbandry is intensive and high levels of stall feeding are practiced.

## Source of toxin

The poisonous properties of the agent are well known and poisoning is usually accidental due to failure to dilute a concentrate, poor mixing or because of wrong identification of containers. Also some liquid preparations settle out and need to be constantly mixed before and during mixing with a batch of feed. Cattle carrying reticular retention boluses of monensin to control bloat by delivering accurate daily doses of the drug, may die suddenly of acute heart failure due to myocardopathy, a condition likely to be associated with the monensin but by an unknown mechanism.<sup>9</sup> The compound's main use as a coccidiostat is in poultry, and deaths from congestive heart failure have occurred in cattle and sheep fed dried poultry litter from farms feeding salinomycin or maduramicin.<sup>10</sup>

## Risk factors

These compounds are specifically prohibited for use in horses at any time because of their toxicity for that species. Concurrent administration of monensin or salinomycin and tiamulin or chloramphenicol or triacetyloleandomycin at safe doses can be associated with ionophore poisoning in pigs. Outbreaks may occur when tiamulin is introduced into the pigs' drug regimen to control swine dysentery when the pigs' ration already includes the ionophore as a growth promotant, or when the two drugs are combined as a coccidia prevention package. The dose and time relationships are complicated and are dealt with separately. The concurrent administration of monensin and selenium to lambs also enhances the toxicity of the selenium.<sup>11</sup>

## PATHOGENESIS

The principal pathogenesis of monensin poisoning is damage to muscles. The origin of muscle damage appears due to loss of ion control and balance in cells and mitochondria leading to impaired intermediary metabolism.<sup>12</sup> In cattle, the cardiac and skeletal muscles are affected about equally; in sheep and pigs the skeletal muscle is most seriously affected; in horses the myocardium is the focus of the damage. In the latter case acute or congestive heart failure may result, signs often being delayed for weeks until additional stress, such as late pregnancy or parturition, precipitates

cardiac insufficiency. When the damage is principally to skeletal muscle the syndrome is one of weakness, ataxia, and recumbency; myoglobinuria is a common accompaniment.

Besides these major involvements of monensin and lasalocid there are a number of less well-known ones. There is a risk that cattle fed on a nitrogen-rich diet will be likely to suffer an outbreak of nitrite poisoning if they are also fed monensin. Another undesirable outcome may be a fall in butterfat because of shift from acetate to propionate production in the rumen. Continuous feeding of monensin to male pigs (50 ppm for 52 days) reduces blood levels of testosterone, and is associated with dystrophy of seminiferous tubules and reduced sperm counts.

## CLINICAL SIGNS

**In cattle** signs commence within 24 hours with heavy doses but may be delayed for up to 5 days when the intake is lower. Signs commence with feed refusal followed by diarrhea, tremor, weakness, tachycardia, and ruminal atony, and animals may die at this stage from acute heart failure. Those that survive for a day or two develop congestive heart failure manifested by brisket edema, engorgement of the jugular veins, ascites, fluid feces, dyspnea, and tachycardia. Deaths may occur months after the major outbreak, usually due to the exertion of calving. When smaller doses are taken over a long period the syndrome is one of congestive heart failure in all of the cases.<sup>13</sup>

**In sheep** the syndrome may be acute followed by hyperesthesia, tremor, especially of the head, disappearance of the pupillary light reflex, recumbency, and convulsions with death occurring during a convulsion.<sup>14</sup> More commonly the disease commences with feed refusal, diarrhea, rumen stasis and depression, followed by muscle weakness, a stilled gait, and recumbency. Chronic cases show atrophy of the muscles of the hindquarters and a stiff gait.

**In pigs** monensin poisoning is associated with dyspnea, anorexia, ataxia, paresis, myoglobinuria and cyanosis, diarrhea, tympany, and pruritus. Death follows in about 6 hours. Salinomycin is associated with the same general syndrome but includes also unwillingness to stand and, when forced to stand, tremor, especially in the hindlimbs, swaying, fetlock knuckling, and abrupt lying down. Exercise exacerbates the signs. Respiratory distress is in the form of irregular breathing. Feed intake is down 50% and sham drinking is characteristic. Red urine is evident for up to 5 days after the drug is discontinued.<sup>15</sup>

In horses cardiac and skeletal muscle are affected. In most cases it is the myocardium that creates the prominent syndrome. Horses affected by the cardiac disease may be found dead. In others there is restlessness, respiratory distress, diarrhea, mucosal congestion, profuse sweating, sometimes myoglobinuria, cardiac irregularity, and tachycardia (50–60/min). The course of the cardiac disease is short and affected horses may not show much clinical evidence of heart failure at the time of the poisoning but survivors, and survivors of an acute attack, may develop a poor performance syndrome or congestive heart failure up to several months later.<sup>16</sup>

Horses with skeletal muscle involvement have a syndrome including anorexia, fever, and red or dark urine, due to the extensive muscle breakdown, frequent lying down, difficulty in rising, stiff gait, especially the hindlimbs, and with knuckling of the fetlocks, followed by final recumbency after a period of as long as several months. Colic is also recorded during the acute phase but this may be the restlessness and frequent lying down and getting up of acute myositis. Euthanasia is the common outcome of these cases because of irreparable muscle damage.

#### CLINICAL PATHOLOGY

In all species tests show increases in serum levels of creatinine phosphokinase, lactate dehydrogenase and aspartate aminotransferase; myoglobinuria is frequent and often prolonged. However, results of clinical pathology tests may vary substantially among individual affected animals. Samples of feed and stomach contents, obtained by stomach tube, are desirable specimens for analysis. Some feeds fed to horses have contained as much as 125–250 g/tonne of feed and their stomach contents have contained 50–100 ppm.

#### NECROPSY FINDINGS

In cattle there is myocardiopathy, pulmonary edema, and enlargement of the liver and heart, hydropericardium, hydrothorax, and ascites. Gross lesions at necropsy are not always evident, and multiple samples of susceptible tissues should be collected and preserved in formalin for microscopic evaluation.

In sheep postmortem changes include necrosis in both skeletal and cardiac muscles but there are no lesions suggestive of heart failure. Lambs less than 1 month old show only gastrointestinal hemorrhage.

In horses necropsy lesions in acute cases include acute myocardial necrosis, pul-

monary congestion, hepatic swelling, and in some cases pulmonary petechiation. Skeletal muscle necrosis may also be evident. Myoglobinuric nephrosis and myoglobinuria are secondary lesions. Chronic cases show marked cardiac myopathy, and possibly skeletal myopathy with obvious fibrosis.

Stomach contents are an obligatory sample in cases likely to go to litigation.

#### DIFFERENTIAL DIAGNOSIS

In all species syndromes of acute or congestive heart failure due to acute cardiac myopathy or limb paresis or recumbency due to skeletal myopathy are sufficiently common to necessitate a positive assay for one of the ionophores in the feed or stomach contents for **diagnostic confirmation**.

#### Differential diagnosis list:

Cattle:

- Nutritional deficiency of vitamin E or selenium
- Poisonings with such plants as *Karwinskia humboldtiana*, *Cassia occidentalis* and *Vicia villosa*.

In pigs additional diagnostic alternatives include:

- Gossypol poisoning
- Porcine stress syndrome.

In horses there are clinical similarities to:

- Colic
- Laminitis
- Rhabdomyolysis.

#### TREATMENT

There is no effective primary treatment and only supportive procedures are recommended. Selenium and vitamin E are ineffective after signs begin, although selenium or vitamin E given prior to appearance of clinical signs may be beneficial. Activated charcoal or mineral oil has been standard treatments aimed at removing the residue of the poison from the alimentary tract. They are of no value if the poison has already been absorbed; recovery is unlikely once the myocardium is affected.

#### CONTROL

Horses are very susceptible to poisoning by these antibiotics and great care is needed to insure cattle rations containing them are not left around for horses to eat. Pretreatment with vitamin E-selenium reduces the effects of monensin poisoning without completely preventing it.

#### MONENSIN-TIAMULIN OR SALINOMYCIN-TIAMULIN POISONING IN PIGS

The myotoxicity of monensin for pigs is enhanced by the simultaneous administration of the two antibiotics (monensin or salinomycin and tiamulin). All three of

the substances are used as coccidiostats and it is not unusual for farmers to combine them. However, all of the agents use the same detoxication pathways in the liver with tiamulin having the priority. Tiamulin inhibits mitochondrial CYP3A enzymes that stimulate monensin metabolism, allowing accumulation of monensin.<sup>17</sup> Monensin (or salinomycin) accumulates to the point of being toxic. The clinical syndrome consists of anorexia and weight loss and at necropsy there are lesions of myonecrosis in the tongue, diaphragm, and limbs. A similar toxicological situation arises in pigs with simultaneous dosing with tiamulin and salinomycin in which the toxic interaction is dose-related.

When tiamulin is used at therapeutic levels, in feed, water, or by injection and salinomycin is used at 60 ppm, toxic reactions and some deaths occur. The interaction does not occur when the two antibiotics are used concurrently and the tiamulin is used at the recommended prophylactic (30–40 ppm) or growth promotant (11 ppm) levels, and independently of whether the administration is oral or by injection,<sup>18</sup> but only if a gap of 72 hours has elapsed between the last exposure to salinomycin and the first exposure to therapeutic levels of tiamulin and *vice versa*.

#### Pluronic poisoning

These substances are administered to adult cattle in their feed as prevention against bloat. They are unpalatable and unlikely to be consumed in dangerous amounts unless they are well masked in feed. When they are fed accidentally to calves in their milk they are associated with dyspnea, ruminal tympany, bellowing, protrusion of the tongue, nystagmus, opisthotonos, recumbency, and convulsions. Death after 24 hours is the usual outcome.

#### Carbadox poisoning

Carbadox, Mecadox or Fortigro – methyl 3-(2-quinoxalinylmethylene)carbazate-N<sup>1</sup> – is used in pig feeds as a growth promotant and in the treatment of swine dysentery and other enteric diseases at the recommended rate of 50 mg/kg of feed/head per day. Toxic effects occur at rates of 150 mg/kg. A related compound **olaquinox** is similarly toxic. Affected pigs refuse the ration, but will eat other rations, are gaunt and emaciated, pass hard fecal pellets, and have a long rough coat, pale skin, severe tachycardia, weak hindquarters, and a swaying walk, followed by knuckling of the hind fetlocks, posterior paralysis, and death in 8–9 days. In the early stages the pigs screech frequently. Sows are agalactic, and produce stillborn or weak, undersized piglets.

Necropsy lesions are diagnostic, with extensive damage to the zona glomerulosa of the adrenal gland accompanied by renal tubular necrosis. The resulting hypoaldosteronism is manifested by low serum sodium levels, elevated serum potassium (8 mmol/L) and elevated blood urea nitrogen levels. The condition is irreversible and the outcome is severe disability or death.<sup>19</sup>

### Bronopol poisoning

Bronopol – 2 bromo-2-nitropropane-1, 3-diol – is used as a laboratory preservative for milk, e.g. in milk samples used for butterfat estimation. This milk is usually fed to calves or pigs and may be toxic on occasional feedings. Affected calves salivate, are depressed, collapse and die within 24 hours of feeding. Necropsy lesions include severe necrotizing abomasitis and local peritonitis on the serosal surface of the abomasum.<sup>20</sup>

### REVIEW LITERATURE

- Fries GF. Ingestion of sludge-applied organic chemicals by animals. *Science of the Total Environment*, 1996; 185, 93.
- Haliburton JC, Morgan SE. Nonprotein nitrogen-induced ammonia toxicosis and ammoniated feed toxicity syndrome. *Vet Clin North Am Food Anim Pract* 1989; 5(2):237–249.
- Longstaffe JA. Pruritus, pyrexia and hemorrhage syndrome in cattle. *Vet Ann* 1989; 29:64–68.
- Matsuoka T et al. Review of monensin toxicosis in horses. *J Equ Vet Sci* 1996; 16:8.
- Novilla MN. The veterinary importance of the toxic syndrome induced by ionophores. *Vet Human Toxicol* 1992; 34, 66–70.
- Whitechair CK. Urea (NH<sub>2</sub>)<sub>2</sub> toxicosis in cattle. *Bovine Pract* 1989; 24:67–73.

### REFERENCES

1. Veernachinini DNR et al. *Fund Appl Toxicol* 1988; 10:73.
2. Nielsen TK, Wolstrup C. *Dansk Veterinaertidsk.*, 1988; 71:529.
3. Mulei CM, Munyua SJM. *Bull. Anim Prod. Africa* 1988; 36:279.
4. Dorman DC, Hascheck WM. *J Am Vet Med Assoc* 1991; 198:1643.
5. Sivertsen T et al. *Acta Vet Scand* 1993; 34:227.
6. Brazil TJ et al. *Can Vet J* 1994; 35:45.
7. Shane BS et al. (1993) *J. Agri. Food Chem.*, 41, 240.
8. Miller RE et al. *J Am Vet Med Assoc* 1990; 196:131.
9. Mathieson AO et al. *Vet Rec* 1989; 125:656.
10. Shlosberg A et al. *Vet Res Commun* 1992; 16:45.
11. Smyth JBA et al. *J. Comp Pathol* 1990; 102:443.
12. Hall JO. Ionophores in Plumlee, K.H. (editor) *Clinical Veterinary Toxicology*, Mosby, St. Louis, 2004; pp. 121–127.
13. Bastianello SS et al. *J South Afr Vet Assoc* 1996; 67:38.
14. Syngh BH *Vet Rec* 1989; 124:15.
15. Miskimins DW, Neiger RD. *J Vet Diagn Inq* 1996; 8:396.
16. Peek SF et al. *J Vet Int Med* 2004; 18:761.
17. Kamashi KL et al. *Indian J Physiol Pharmacol* 2004; 48:89.
18. Pott JM. *Vet Rec* 1990; 127:554.
19. Power SB et al. *Vet Rec* 1989; 124:367.
20. Hindmarsh M. *Aust Vet J* 1990; 67:309.

## MISCELLANEOUS FARM CHEMICALS

### Polybrominated biphenyls

Mixtures of polybrominated biphenyls find a great deal of use in industry, particularly as flame retardants. They are not especially poisonous, nor are they a greater risk to farm animals because of degree of exposure, than many other industrial chemicals, but they happen to have found their way into the cattle food chain in much discussed incidents in the USA.

**Cattle.** Experimental dosing with 67 mg/kg BW daily for long periods is associated with poisoning but levels of 10 mg/kg BW are not toxic. Clinical signs of illness are anorexia, diarrhea, lacrimation, salivation, emaciation, dehydration, depression, and abortion. Similar signs plus extensive cutaneous hyperkeratosis occur in natural cases. Necropsy lesions include mucoid enteritis, degenerative renal lesions in natural and experimental cases, hyperkeratosis in the glands, and epithelium of the eyelids.

**Pigs.** Experimental poisoning in pigs causes no ill-effects in sows, but high concentrations of polybrominated biphenyls (PBB) develop in the sow's milk with death of some nursing pigs resulting.

Most of the losses due to these compounds are due to destruction of animals because they are contaminated and there is fear of adverse effects on humans who consume them or their products. However, neither animals nor humans exposed to the biphenyls showed any signs of illness. PBBs pass the placenta and are found in fetuses but appear to be associated with no health problems in the offspring.

The excretion of these compounds occurs principally in feces and urine but as much as 25% of ingested substance may be present in the milk. Also these compounds are lipotropic and accumulate in fat depots, especially in the liver. Attempts to hasten excretion have not produced a satisfactory method. Grazing wool sheep on contaminated ground may be an option for utilization of contaminated land.<sup>1</sup>

### REVIEW LITERATURE

- Lemesh RA. Polybrominated biphenyls. An overview of metabolic, toxicological and health consequences. *Vet Human Toxicol* 1992; 34:256–260.

### REFERENCE

1. Gill IJ et al. *Aust Vet J* 1992; 69:155.

### Polychlorinated biphenyls

These substances have a number of industrial uses and are common environmental contaminants. They are lipophilic so that they accumulate in body fat, and have low rates of biotransformation

and excretion so that they persist in animal tissues for long periods. Although deleterious effects of the compounds in animal tissues are not often recorded, their presence in animal tissues is likely to cause rejection of meat from the human food chain. Recorded damage refers to unidentified reproductive inefficiency and reduction in efficiency of food conversion and possibly hepatic hypertrophy and gastric erosion, but in the same species a positive growth stimulating effect has also been recorded. Experimental poisoning of gnotobiotic pigs has been associated with diarrhea, erythema of the nose and anus, distension of the abdomen, growth retardation and, at doses of more than 25 mg/kg BW, coma and death.

### Soil fumigant: methyl bromide

Soil fumigants used to prepare fields for planting may be associated with toxicity hazards in animals grazing them or in feed harvested from them. Methyl bromide has been associated with poisoning in horses, cattle, and goats when used in this way. Clinical signs in horses, cattle, and goats include ataxia, stumbling, and somnolence.

### Formalin

Formalin is used to preserve colostrum for calf feeding, and in the preparation of formalin-treated grain. Milk containing too much formalin is associated with severe gastroenteritis and some deaths in calves that drink it. The clinical signs include salivation, abdominal pain, diarrhea, and recumbency.

### Oil- and petroleum-product poisoning

Crude oil or petroleum distillates, including diesel oil, lamp oil, kerosene, and gasoline, are all poisonous to animals. Cattle will drink all of them and appear to have a positive liking for some products, especially used sump oil and liquid paraffin (mineral oil).

### Oil-well installations

Crude oil coming directly from wells is usually repellent to animals, but they can consume lethal quantities of it if they are salt-deficient and salt-hungry: a characteristic of crude oil is that it is usually mixed with salty water which is often left lying in ponds nearby. After extraction most crude oils are temporarily stored in installations where lead paint is available so that salt and lead poisoning commonly occur with oil poisoning and may be confused with it.

## OIL PRODUCTS

### ETIOLOGY

The toxicity of the various products varies:

- Of natural crude oils those with the highest content of sulfur ('sour

crude) are most unpalatable and most toxic

- Amongst the commercial oil products those with the highest content of volatile and inflammable components, especially naphtha and petrol (gasoline) fractions, are the most toxic
- **Gasoline** up to the level of 3 ppm in the drinking water does not appear to depress water intake or to interfere with growth performance of pigs
- With commercial gasoline and oily lubricants the additives used, especially lead, may also contribute significantly to the poisoning
- Other toxic agents of all kinds can be encountered when reject sludge oil is available to animals.

Accurate dose levels are difficult to determine in field outbreaks. In experimental trials crude oil at the rate of 37 mL/kg BW in a single dose or 123 mL/kg in 5 divided daily doses were poisonous to cattle. Kerosene at 20 mL/kg BW as a single dose and 62 mL/kg BW in 5 equal daily doses was poisonous. Tractor paraffin (kerosene) at a single dose rate of 13 mL/kg BW is associated with severe illness and at 21 mL/kg was fatal to cattle.

#### EPIDEMIOLOGY

On farms access to **tractor fuel** (paraffin, gasoline, kerosene) is the most likely hazard. When highly chlorinated naphthalenes were used as lubricants, access to oil dumps could lead to hyperkeratosis. **Kerosene** has an unwarranted reputation as a therapeutic agent for bloat and constipation, but it is unlikely to be given in amounts sufficient to be associated with more than slight illness, unless it is given repeatedly.

The common occurrence of natural cases is in cattle, but sheep and goats can also be affected.

#### PATHOGENESIS

The early signs are thought to be due to regurgitation of the oil, aspiration of it causing pneumonia, and absorption of the volatile components through the pulmonary mucosa causing toxemia. The later signs are thought to be associated with the direct effect of the oil on the alimentary tract.

#### CLINICAL FINDINGS

**Natural cases.** When large volumes of crude oil are consumed by cattle and goats, there are signs of toxemia and incoordination; regurgitation (vomiting) may or may not occur; death is quick. Bloating is inconstant. In the terminal stages the pupils are dilated and tachycardia, hyperpnea, and hyperthermia are evident. The animals smell of oil, and oil is often present on the skin around the mouth and anus, and in the feces. The feces vary from constipation to diarrhea.

Recovered animals usually do so poorly after the incident that they are slaughtered after a history as long as 6 months. The oil persists in the alimentary tract for very long periods and may be found in the cud and feces, and at postmortem as long as 16 days after ingestion. Animals that survive the acute toxic syndrome eat poorly, lose weight and die at variable periods from 16 to 36 days later. Oil appears at the anus on about the 8th day after administration. It may also appear in the nasal discharge, reaching there via the lungs. The vomitus always contains the oil. The feces are usually oily, often soft to semifluid, and frequently black if the oil taken has been crude oil. With kerosene the feces are often dry and firm in the later stages and the regurgitus may be in the form of gelatin-like cuds, smelling strongly of kerosene.

**Experimental cases.** Early signs include incoordination, shivering, head-shaking, and mental confusion. Within 24 hours anorexia, vomiting, and moderate-to-severe bloating occur. Experimental kerosene inhalation is associated with persistent severe intrapulmonary physiological shunting resulting in prolonged hypoxemia and acidemia and may account for the clinical disease in survivors.

#### CLINICAL PATHOLOGY

There are no specific clinicopathological findings but hypoglycemia, acetonemia and transient hypomagnesemia are all recorded.

#### NECROPSY FINDINGS

In crude oil or kerosene poisoning aspiration pneumonia is recorded constantly in naturally occurring and experimentally produced cases. It is thought to be the result of vomiting and aspiration from the alimentary tract of already swallowed oil. In longstanding cases of kerosene poisoning in cattle the lungs are colored gray-blue and are enlarged and firm but there are no significant histopathological changes, neither are there in the kidney or liver. Oil is always still present in the alimentary tract and there may be thickening and inflammation of the alimentary mucosa. Degenerative changes in liver and kidney are recorded in some cases.

DIFFERENTIAL DIAGNOSIS
<p>The clinical syndrome of aspiration pneumonia, bloat, regurgitation, and obvious fouling with oil or kerosene in an environment where access is permitted to the oil products provides <b>diagnostic confirmation</b>.</p> <p><b>Differential diagnosis list:</b></p> <ul style="list-style-type: none"> <li>• Aspiration pneumonia due to other causes</li> <li>• Misguided owner medication with kerosene.</li> </ul>

#### TREATMENT

No **primary treatment** is undertaken. **Supportive treatment** if the animal survives the initial acute phase should include the replacement of the ruminal contents with material from a normal rumen.

#### REVIEW LITERATURE

Coppock RW et al. Toxicopathology of oil-field poisoning in cattle - a review. *Vet Human Toxicology* 1996; 38:36.

Edwards WC. Toxicology of oil field wastes. Hazards to livestock associated with the petroleum industry. *Vet Clin North Am Food Anim Pract* 1989; 5(2):363-374.

Edwards WC, Gregory DG. Livestock poisoning from oil field drilling fluids, muds and additives. *Vet Human Toxicol* 1991; 33:502-504.

Khan AA et al. Biochemical effects of pembina cardium crude-oil exposure in cattle. *Archives of Environmental Contamination and Toxicology* 1996; 30:349.

#### Tin poisoning

Dibutyltin dilaurate is a coccidiostat fed to chickens in their feed. Errors in mixing may lead to cattle receiving toxic amounts in concentrates or pellets. Calves usually die acutely with signs of tremors, convulsions, weakness, and diarrhea. Older animals usually suffer a chronic illness characterized by persistent diarrhea, severe weight loss, inappetence, polyuria, and depression, reminiscent of arsenic poisoning. Affected animals may not be suitable for human consumption because of the high content of tin in their tissues.

#### Sodium fluorosilicate

A white, odorless, and tasteless powder used as a poison in baits for crickets, grasshoppers, and the like. Because of the way it is prepared in pellets in a bran base it is attractive to all animal species and poisoning is recorded in cattle, sheep, and horses, usually because unused baits were not retrieved after baiting programs.

In sheep mild illness occurs after doses of 25-50 mg/kg BW and death after 200 mg/kg. Clinical signs include drowsiness, anorexia, constipation, ruminal stasis, teeth grinding, abdominal pain, and diarrhea.

#### Highly chlorinated naphthalenes

The naphthalenes were extensively used in industry as lubricants, insulants, and wood-preserving agents. Recognition of their toxicity resulted in their exclusion from the farm environment and virtual elimination of the disease.

Local application or ingestion of highly chlorinated naphthalenes to cattle produces hyperkeratosis characterized by thickening and scaldiness of the skin, emaciation, and eventual death. The pathogenesis of the skin lesions is due to interference with the conversion of carotene to vitamin A, causing hypovitaminosis-A. When poisoning results from accidental emission



from industrial plants there are additional signs due to ocular, nasal, and tracheo-bronchial irritation; infertility and abortion also occur.

### Coal tar pitch poisoning

Pigs may be exposed to coal tar pitch and its toxic cresols when housed in pens with tarred walls or floors, which they nibble, or when they have access at pasture to fragments of 'clay pigeons' used as targets by gun clubs. Bitumen and asphalt appear to be non-toxic. Young pigs 6–20 weeks of age are most commonly affected.

Clinical findings include an acute illness of a few days or a chronic course of some weeks. In the **acute illness** there are non-specific signs of inappetence, rough coat, tucked-up abdomen, weakness, and depression. The **chronic illness** is characterized by anorexia, depression, weakness, anemia, and jaundice. A sub-clinical syndrome includes a reduction in growth rate of up to 20–30%, a severe reduction in hemoglobin concentration and erythrocyte count, and reduced vitamin A storage.

**Necropsy findings** include jaundice, ascites, and anemia but the characteristic finding is a red and yellow mottling of the hepatic surfaces, and histologically a hepatic lesion of severe centrilobular necrosis. Cresols can be detected in the ingesta and liver of affected pigs.

### Methyl alcohol

Accidental ingestion of methyl alcohol by cattle is associated with vomiting, recumbency, death, and a high concentration of methyl alcohol in the ruminal contents. Methyl alcohol is used as antifreeze in gasoline engines for pumps working continuously on oilfields in cold regions. Accidental access to the pump enclosure may result in a poisoning incident.

### Ethylene glycol

Accidental poisoning with antifreeze mixture containing ethylene glycol may occur in swine, goats, and calves. The pathogenesis of the disease is dependent upon the development of acidosis and oxalate nephrosis.

**In pigs** this is manifested by ascites, hydrothorax and hydropericardium, depression, weakness, and posterior paralysis.

**In cattle** there is dyspnea, incoordination, paraparesis, recumbency, and death. There is accompanying uremia and hypocalcemia. Calcium oxalate crystals are present in large numbers in the kidney and brain and there is a fatal nephrosis. The presence of the chemical in tissue can be detected by thin-layer chromatography. The toxic dose rates determined experimentally for cattle are 5–10 mL/kg BW in adults and 2 mL/kg in non-ruminant

calves. The treatment recommended for companion animals, ethanol or preferably 4-methylpyrazole, should be worth trying.

### Industrial organophosphates

Principal industrial uses of organophosphates are as fire-resistant hydraulic fluids, as lubricants, and as coolants. A number of compounds including tri-*o*-tolyl phosphate, tri-*o*-cresyl phosphate (TOCP), and triaryl phosphates (TAP) have come to veterinary notice as being associated with poisoning in animals. Triaryl phosphates contain a number of isomers as well as TOCP, e.g. *m*-cresol, *p*-cresol, *o*-cresol, all of them more poisonous than TOCP. They have also been associated with serious outbreaks of poisoning in humans when they accidentally contaminate food. Poisoning may occur by ingestion or cutaneous absorption.

**Clinical signs** of delayed neurotoxicity do not occur until several weeks after contact and comprise irreversible neurological signs of respiratory stertor, dyspnea, dysuria, knuckling, leg weakness, and posterior paralysis.

**Necropsy lesions** characteristically include neuronal degeneration in the spinal cord and peripheral nerves.

**Diagnostic confirmation** depends on evidence of exposure to the toxicant, signs referable to the nervous system lesions, and a positive assay for the toxicant in the animal's tissues.<sup>1</sup>

### REFERENCE

1. Prantner, M. M. & Sosalla, M. J. (1993) *J. Am. Vet. Med. Assoc.*, 203, 1453.

### Superphosphate

This is the usual form in which phosphorus-rich fertilizers are applied to the soil and is therefore available to animals on most farms in most countries. It is not highly palatable but sheep will eat it when it is in pill form (small granular, resembling grain in texture and particle size). The fertilizer is also used to prepare 'superjuice' which is administered to cows as a phosphorus supplement. Higher than normal intakes of the fertilizer either by dosing or by pasture application will cause poisoning, due largely to the fluorine present.<sup>1</sup> Calcium pyrophosphate and calcium orthophosphate also contribute to the toxicosis causing proximal renal tubular nephrosis.<sup>2</sup> The LD<sub>50</sub> of superphosphate for sheep is 100–300 mg/kg BW.

**Clinical signs** of poisoning include anorexia, thirst, diarrhea, weakness, ataxia, and death in about 48 hours.

### REFERENCES

1. Hornitzky M et al. *Aust Vet J* 1989; 66:121.
2. East NE. *J Am Vet Med Assoc* 1993; 203:1176

## MANURE-GAS POISONING AND RELATED CONFINEMENT EFFECTS

### ETIOLOGY

Confinement housing of cattle and swine is accompanied by manure storage for varying periods of time, in large holding pits, usually under slatted floors. Oxygen is excluded from the storage so that anaerobic bacteria degrade the organic and inorganic constituents of manure yielding **hydrogen sulfide, ammonia, methane, and carbon dioxide** as major gases. When diluted with water to facilitate handling, liquid manure in storage separates by gravity. The solid wastes form sediment, the lightweight particles float to the top leaving a middle layer which is relatively fluid. Thorough remixing is necessary before pits are emptied to prevent the fluid fraction from flowing out and the solids remaining. The remixing or agitation results in the release of large quantities of toxic gases from the slurry.

Besides the well-established gaseous toxicants listed, certain other agents with detrimental inhalation risks are present in confinement operations, and have been best characterized for swine confinement operations. Total dust is a major contaminant in swine barns and may range for 2–7 mg/m<sup>3</sup>. Particulates may adsorb gases and be part of the objectionable odors released and reaching neighbors near confinement operations. Respirable dusts may be 10% or more of the total dusts generated in swine barns. Such dust is contaminated with bacteria, fungi, endotoxins, and glucans.<sup>1</sup> Dusts are primarily composed of feed or fecal material. Both endotoxins and glucans have been suggested as potential contributors to swine respiratory disease as well as respiratory complications for workers in swine buildings. So far, however, high mortality and acute death losses in confinement operations are most commonly due to excessive concentrations of hydrogen sulfide and carbon dioxide, while subacute or chronic irritation and disease of the upper respiratory tract may also be contributed by elevated ammonia levels. Methane is explosive and may act as an asphyxiant, but is not implicated as a toxicant.

Additional factors that must be considered in a differential diagnosis include possible power loss during electrical storms or equipment failure; this results in the cessation of the artificial ventilation required to cool the building and exhaust carbon dioxide from the respiration of animals. In these situations, CO<sub>2</sub> levels build rapidly and environmental temperatures increase dramatically as well, especially when weather conditions are hot and humid. Acute losses from

hyperthermia or heat stroke may be mistaken for manure gas poisoning. This is important for veterinarians, as they may be called to establish a diagnosis that affects insurance claims for many thousands of dollars. Besides overheating and CO<sub>2</sub> accumulation, electrocution should be considered whenever there are large numbers of acute losses in a confinement building.

#### **PATHOGENESIS**

The exposure of humans, cattle, and swine to high concentrations (above 700 ppm of H<sub>2</sub>S) of manure gases, particularly hydrogen sulfide, can be associated with peracute deaths in cattle and swine. Hydrogen sulfide is both an irritant as well as an acute toxicant. The inhalation of H<sub>2</sub>S causes interaction with moist mucous membranes of the upper respiratory tract and lungs. Fatal or severe exposure often is associated with respiratory distress and pulmonary edema. Exposure to low concentrations of hydrogen sulfide over long periods is thought to be associated with reduced performance in cattle and swine. At high concentrations, from 500 to 1000 ppm, carotid body receptors are stimulated causing rapid breathing. As high concentrations continue or increase the respiratory center is depressed, animals become depressed and comatose, and die. High concentrations of H<sub>2</sub>S depress olfactory sensors and the offensive rotten egg odor is no longer detected as a warning sign.

High concentrations of **ammonia** (100–200 ppm) combine with moisture in the air and at mucous membranes with the production of ammonia, which is

associated with irritation to the conjunctiva and respiratory mucosa. An increased incidence of pneumonia and reduced daily weight gains in pigs are associated with exposure to a combination of ammonia at levels of 50–100 ppm and the presence of atmospheric dust in barns.

#### **CLINICAL FINDINGS**

In acute hydrogen sulfide poisoning the animals die suddenly. Affected animals may be found dead throughout a building in various postures of lateral or sternal recumbency. There may be little or no evidence of struggle or excitement, since high concentrations can be associated with nearly immediate respiratory paralysis. In acute ammonia poisoning the syndrome includes conjunctivitis, sneezing, and coughing for a few days but pigs will soon acclimatize after which no effects may be detectable. At very high ammonia concentrations (>500 ppm) there is pharyngeal and laryngeal irritation, laryngospasm, and coughing. Concentrations above 2000 ppm can be associated with death within 30 minutes. Carbon dioxide overexposure first is associated with mild-to-moderate excitement followed by depression, weakness, coma, and death. Concentrations above 30% in air are serious and 40% CO<sub>2</sub> for more than a few minutes can cause death.

#### **NECROPSY FINDINGS**

In cattle which have died from acute hydrogen sulfide poisoning, lesions include pulmonary edema, extensive hemorrhage in muscles and viscera, and bilaterally symmetrical cerebral edema and necrosis. Ammonia exposure results in lacrimation,

conjunctivitis, corneal opacity, tracheal hyperemia or hemorrhages, and pulmonary edema. Secondary bacterial pneumonia may be evident in exposed animals. For carbon dioxide, the principal lesions are of cyanosis.

#### **CONTROL**

Production of hydrogen sulfide in manure can be inhibited by aeration using air as the oxidizing agent or the use of chemical oxidizing agents. The use of ferrous salts virtually eliminates hydrogen sulfide evolution. Adequate ventilation with all doors and windows wide open during remixing and agitation of the slurry will reduce the concentration of hydrogen sulfide to non-toxic levels. Animals and personnel should not enter closed barns when the pits are being emptied. In confinement buildings, ammonia usually does not accumulate to fatal levels, but much of the economic loss is from reduced feed consumption and possibly increased susceptibility to acute or chronic respiratory disease. Limiting protein supplementation to actual needs has been considered a means for reducing nitrogen losses and the resultant production of ammonia in feces and urine.

#### **REVIEW LITERATURE**

Nordstrom GA, McQuitty JB. Manure gases in the environment. A literature review (with particular reference to cattle housing). Edmonton, Canada: Dept. of Agricultural Engineering, Faculty of Agriculture & Forestry, Univ. of Alberta, 1976.

Carson TL. Gases, in Plumlee, K.H. (editor) *Clinical Veterinary Toxicology*, Mosby, St. Louis, 2004; pp. 155–163.

#### **REFERENCE**

1. Donham KJ et al. *Am Ind Hyg Assoc* 1986; 47:404.

# Diseases associated with toxins in plants, fungi, cyanobacteria, plant-associated bacteria, and venoms in ticks and vertebrate animals

## DISEASES ASSOCIATED WITH MAJOR PHYTOTOXINS 1851

Cyanogenic glycoside poisoning (cyanide, hydrocyanic acid) 1852  
 Nitrate and nitrite poisoning 1855  
 Oxalate (soluble forms) poisoning 1858  
 Oxalate-induced equine nutritional secondary hyperparathyroidism 1860  
 Oxalate (insoluble calcium oxalate raphide crystal) poisoning 1861  
 Calcinogenic glycoside poisoning (enzootic calcinosis) 1861  
 Cardiac glycoside poisoning 1862  
 Dicoumarin derivatives (including sweet clover) poisoning 1864  
 Diterpenoid alkaloid poisoning 1865  
 Glucosinolate poisoning 1866  
 Indole alkaloid poisoning 1868  
 Indolizidine alkaloid poisoning 1870  
 Diterpene acids and vasoactive lipids 1872  
 Nitrocompound poisoning 1872  
 Phytoestrogen poisoning 1873  
 Ptaquiloside poisoning 1875  
 Pyrrolizidine alkaloid poisoning 1878  
 S-Methyl-L-cysteine-sulfoxide (SMCO) and dipropyl/dipropenyl disulfide poisoning 1881  
 Thiaminase poisoning 1882

Poisoning by miscellaneous phytotoxins 1883

Plant materials causing physical damage 1895

Plant poisonings due to unidentified toxins 1895

## POISONING BY MYCOTOXINS 1897

Aflatoxins (aflatoxosis) 1899  
 Citrinin 1901  
 Cyclopiazonic acid 1901  
 Ergot alkaloids 1901  
 Fumonisin 1905  
 Ipomeanol 1906  
 Muscarine 1906  
 Ochratoxin 1906  
 Patulin 1906  
 Phomopsin 1906  
 Peptide 1908  
 Rubratoxin 1908  
 Slaframycin 1908  
 Sporidesmin 1908  
 Sterigmatocystin 1910  
 Tremorgens 1910  
 Trichothecenes 1910  
 Zearalenone 1911  
 Miscellaneous fungi lacking identified toxins 1912

## POISONING BY CYANOBACTERIA 1913

Cyanobacteria in fresh water blooms 1913

Alpine pasture cattle deaths 1914

## POISONING BY TUNICAMINYLRACILS (CORYNETOXINS) 1914

*Rathayibacter toxicus* in nematode galls on pasture grasses (annual rye-grass toxicity, flood plain staggers, Stewart's Range syndrome) 1914  
 Tunicaminyluracil toxin in water-damaged grain 1915

## DISEASES ASSOCIATED WITH ZOOTOXINS (ANIMAL BITES AND STINGS) 1915

Snakebite 1916  
 Bee stings 1918  
 Ant bites 1918  
 Tick paralysis 1918  
 Cantharidin poisoning (blister beetle poisoning, cantharidiasis) 1918  
 Mare reproductive loss syndrome (early fetal loss, late fetal loss, epidemic fibrinous pericarditis, epidemic unilateral endophthalmitis) 1918  
 Lophyrotomin and pergidin (sawfly larvae) poisoning 1920  
 Moth damage 1920

## Diseases associated with major phytotoxins

Plant poisonings in farm animals have particular importance in areas where extensive pastoral management is practiced; therefore, this part of the book has limited appeal to veterinarians who work in intensive farming areas except when feedstuffs are contaminated by poisonous weed seeds or dried poisonous plants in hays. Conversely the amount of information on the subject of phytotoxins is very great because of the large number of poisonous plants. In order to maintain parity with the other parts of the book, material related to the pathogenesis of these diseases has been restricted. No botanical material has been included and only a minimum of the plant chemical information available. It is the botanical and chemical material which is best founded. The clinical data are often fragmentary, much of it anecdotal, a limited

number of plants having been subjected to careful experimental scrutiny. Many plants are included in lists because they have been found to contain dangerous amounts of known toxins, without cases of poisoning ever having been recorded. Because the world list of definitely poisonous plants includes about 1500 species, only a limited number of them – those considered to be common or important enough, or whose identity as poisonous plants has been well established – have been included.

## METABOLIC POISONS

Poisonous substances produced in the animal, especially the rumen, from innocuous substances in the plants ingested are not dealt with in this chapter. Examples are:

- Lactic acid produced in the rumen by anaerobic fermentation of starch and the cause of acute carbohydrate engorgement

- Indole and 3-methyl-indole, metabolites of tryptophan, and of etiological significance in acute bovine pulmonary emphysema and edema

## HUMAN FOOD CHAIN

Besides the damage to animals associated with plants, there is the additional passage of plant poisons into the human food chain through animal products, especially eggs, meat, milk, and honey. Plant toxicants for humans originating in this way are not subjects for this book.

## PHYTOTOXINS

The material in the chapter is arranged on the basis of the toxin present in the plant. This has been prompted by developments in the diagnosis of plant poisoning in countries with advanced technologies in which the toxin is identified by physico-chemical examination of clinical or necropsy samples, usually by spectrometry, the plants containing the toxin are listed, and the environment then examined for

them. The procedure avoids the difficulty of trying to identify plants botanically from fragments of plants in the alimentary tract, but requires sophisticated laboratory techniques which are not universally available. It does not and cannot replace thorough field investigation.

#### DIFFERENTIAL DIAGNOSIS

Establishing a diagnosis of plant poisoning depends on the completion of all or several of the following tasks:

- Matching the circumstances of the case and the clinical signs, clinical pathology, and pathological lesions with those known to be associated with poisoning by the suspected plants
- Establishing that the suspected plants have been eaten or that the affected animals had access to them
- Precisely identifying the suspected plants through professional botanists
- Demonstrating the presence of the suspected plants in the stomach contents of affected animals
- Demonstrating hazardous concentrations of particular toxins in the plants, the stomach contents, or the tissues of affected animals
- On rare occasions, conducting feeding experiments.

#### CONTROL

Prevention of plant poisonings by restricting grazing of, or hay-making on, land areas containing poisonous plants needs no explanation but presents the difficulty that large areas of rangeland suited to domestic animal production are then not used. Control measures under development which limit toxin intake by grazing animals or provide effective defense within the animal's body include:

- **Immunization against toxins** for a number of phyto- and mycotoxins including phytoestrogens, pyrrolizidine alkaloids, sporidesmin, and *Pimelea* spp. toxins, all of which have failed so far. Rare successes have been achieved with phomopsins and corynetoxins. Important attributes of candidate toxins for attempted commercial immunogen production include producing syndromes with little initial tissue damage, slow onset, wide (preferably international) distribution, and frequent occurrence, being readily degraded by the body's detoxification mechanisms after capture by antibodies, and having potentially large, steady and cheap supply sources.<sup>1,2</sup>
- **Genetic engineering** of ruminal microbes for selective catabolism of ingested toxins has been successful with bacteria which break down fluoroacetate. Obstacles to be

overcome in such work include finding the required microbial gene and a suitable recipient organism, survival of the modified organism in the rumen, and obtaining permission to release it. The simpler technique of introducing ruminal bacteria, which naturally detoxify mimosine into ruminant populations that do not have them, has solved toxicity problems with *Leucaena leucocephala*.

Creating a **conditioned aversion** to specific plants is under trial in a number of centers in the USA. Groups of animals are penned and fed intensively on the plant to which an aversion is to be created, or on a chemical component of it identified as an aversion-creating chemical, e.g. ingenol in *Euphorbia* spp.<sup>3</sup> The method has a number of deficiencies, including the difficulty of managing hard-to-handle livestock in this sort of intensive conditioning program. Also, a conditioned aversion can be retained in the animals' memories for years but can be quickly lost if the averted cattle are grazed with non-averted ones which readily consume the target plant.<sup>4</sup>

Naturally acquired aversion may be the mechanism permitting cattle to graze infested pasture, and to consume small amounts of the target plant, without developing a significant intoxication.<sup>5</sup> An interesting side issue from this work is the observation that adversity conditioning varies between animal species, being easy to create in cattle and sheep, but much less so in goats. This may be related to the ability of the ruminal microflora of goats to digest the aversion-inducing chemical.<sup>6</sup> Other range plants against which aversion conditioning control methods have been attempted are *Delphinium* and *Astragalus* spp.

#### REVIEW LITERATURE

- Burrows GE, Tyril RJ. Toxic Plants of North America. Ames, Iowa: Iowa State University Press, 2001.
- Cheeke PR (ed.) Toxicants of Plant Origin. Boca Raton, FL: CRC Press, 1989
- Cheeke PR (ed.) Natural Toxicants in Feeds and Poisonous Plants, 2nd edn. Danville, IL: Interstate Publishers, 1988.
- Cheeke PR. Endogenous toxins and mycotoxins in forage grasses and their effects on livestock. J Anim Sci 1995; 73:909.
- Connor HE. The Poisonous Plants of New Zealand, 2nd edn, Bulletin 99. Wellington, NZ: NZ Dept Sci Ind Res, 1977.
- Cooper MR, Johnson AW. Poisonous Plants and Fungi in Britain. Animal and Human Poisoning. 2nd edn. London: HMSO, 1998.
- Everist SL. Poisonous Plants of Australia, 2nd edn. Sydney, Australia: Angus & Robertson, 1981.
- Hails MR, Crane TD. Plant Poisoning in Animals: a Bibliography from the World Literature 1960-1979. Vet Bull 1982; 52:557-991.
- Hails MR. Plant Poisonings in Animals: a Bibliography from the World Literature, No. 2, 1980-1982, Vet

Bull 1986; 56:1-69.

- Hails MR. Plant Poisonings In Animals: a Bibliography from the World Literature, No. 3, 1983-1992. Wallingford, Oxon: CAB International, 1994.
- Kellerman TS et al. Plant Poisonings and Mycotoxins of Livestock in Southern Africa. Capetown: Oxford University Press, 1988.
- Kellerman TS et al. Distribution, diagnoses and estimated economic impact of plant poisonings and mycotoxins in South Africa. Onderst. J Vet Res 1996; 63:65.
- Panter KE, James LF. Natural plant toxicants in milk; a review. J Anim Sci 1990; 68:892-904.
- Tokarnia CH et al. Plantas Toxicas do Brasil. Rio de Janeiro: Editora Helianthus, 2000.

#### REFERENCES

1. Edgar JA Vaccines in Agriculture. Melbourne: CSIRO. p. 149, 1994.
2. McKenzie RA. Vaccines in Agriculture. Melbourne: CSIRO. p. 145, 1994.
3. Kronberg SL et al. J Chem Ecol 1995; 21:1387.
4. Ralphs M H. J Range Mgt 1997; 50:367.
5. Pfister JA et al. J Chem Ecol 1997; 23:759.
6. Kronberg SL, Walker JW. J Chem Ecol 1993; 19:2007.

#### CYANOGENIC GLYCOSIDE POISONING (CYANIDE, HYDROCYANIC ACID)

##### Synopsis

**Etiology** Ingestion of specific plant species containing cyanogenic glucosides.

**Epidemiology** Seasonal and other variations in glucoside content lead to periods of enhanced toxicity of pasture.

**Clinical findings** Acute poisoning – soon after access to toxic material sudden onset of dyspnea, tremor, recumbency, clonic convulsions, death within a few minutes to an hour. Chronic poisoning – neonatal goiter or arthrogryposis, adult posterior ataxia, dysuria, frequent urination.

**Clinical pathology** Assay of hydrocyanic acid in body tissues and fluids and in feed.

**Necropsy lesions** Nil.

**Diagnostic confirmation** Positive assay on rumen contents (difficult).

**Treatment** Primary treatment with sodium thiosulfate with or without sodium nitrite or other antidote.

**Control** Test feed for cyanide content.

#### ETIOLOGY

Most outbreaks of hydrocyanic acid (HCN) poisoning are associated with the ingestion of plants that contain cyanogenic glucosides. The glucosides are non-toxic but HCN may be liberated from them by  $\beta$ -glycosidase and lyase present in the plant tissue. Ruminal microorganisms also produce  $\beta$ -glycosidase. Horses and pigs are much less susceptible to the glucosides because the acidity of the stomach in monogastric animals inactivates  $\beta$ -glycosidase and is not great enough to be associated with acid hydrolysis of the glucosides.

Plants that contain enough cyanogenic glycosides to cause poisoning number about 120. The following list contains only the genera recognized as hazardous:

*Acacia* (a few spp. only) – wattle trees  
*Adenia*, e.g. *A. digitata*  
*Amelanchier alnifolia* – Saskatoon serviceberry  
*Amygdalus communis* – almond  
*Aquilegia vulgaris* – columbine  
*Bahia oppositifolia*  
*Brachyachne* spp., e.g. *B. convergens* – Gulf star grass  
*Breynia oblongifolia* – coffee bush  
*Bridelia* spp., e.g. *B. leichhardtii* – scrub ironbark  
*Calotis scapigera* – tufted burr daisy  
*Carex vulpina*  
*Castalis spectabilis* – Transvaal bitou  
*Cercocarpus*, e.g. *C. breviflorus* – mountain mahogany  
*Chenopodium* spp., e.g. *C. carinatum* – green crumbweed (see also nitrate-nitrite poisoning)  
*Cydonia oblonga* – quince tree  
*Cynodon* spp., e.g. *C. aethiopicus* – couch grasses  
*Digitaria* spp., e.g. *D. sanguinalis* – summer grass  
*Dimorphotheca* spp., e.g. *D. cuneata* – karoo bietou  
*Drosera* spp. – Sundew  
*Dysphania* spp., e.g. *D. rhadinostachya* – red crumbweed (see also nitrate-nitrite poisoning)  
*Eleusine* spp., e.g. *E. indica* – crowfoot  
*Eremophila maculata* – native fuchsia  
*Eriobotrya japonica* – loquat  
*Eucalyptus* (a few spp. only), e.g. *E. cladocalyx* – sugar gum tree  
*Euphorbia* spp., e.g. *E. drummondii* – caustic creeper  
*Flagellaria indica*  
*Florestina tripteris*  
*Glishrocaryon* spp., e.g. *G. aureum* – yellow pop flower  
*Glyceria* spp., e.g. *G. maxima* – reed sweet grass  
*Goodia* spp., e.g. *G. lotifolia* – clover-leaf poison  
*Heterodendron*, e.g. *H. oleifolium* – boonaree  
*Holcus lanatus* – Yorkshire fog grass  
*Jatropha* spp., e.g. *J. multifida* – umbrella tree  
*Juncus* spp., e.g. *J. effusus* – blue rush  
*Leptopus decaisnei* – andrachne  
*Linum* spp., e.g. *L. usitassimum* – linseed or flax  
*Lotus* spp., e.g. *L. australis* – birdsfoot trefoils  
*Macadamia* spp., e.g. *M. integrifolia* – macadamia  
*Malus* spp., e.g. *M. sylvestris* – common apple  
*Manihot esculenta* – cassava

*Mimosa* spp., e.g. *M. invisa* – giant sensitive plant  
*Nandina domestica* – nandina, sacred bamboo  
*Olax benthamiana*  
*Osteospermum* spp., e.g. *O. ecklonis* – South African daisy  
*Papaver nudicaule* – Iceland poppy  
*Passiflora* spp., e.g. *P. aurantia* – red passion flower  
*Perralderia coronopifolia* – tafes  
*Phaseolus cuneatus* – Java bean  
*Photinia* spp. – Christmas berry  
*Phyllanthus* spp., e.g. *P. gasstroemii*  
*Pomax umbellata*  
*Prunus* spp., e.g. *P. laurocerasus* – cherry laurel  
*Sambucus* spp., e.g. *S. nigra* – common elder  
*Sorghum* spp., e.g. *S. halepense* – Johnson grass (see also nitrate-nitrite poisoning)  
*Stillingia trecaleana* – Queen's delight  
*Suckleya suckleyana* – poison suckleya  
*Triglochin* spp., e.g. *T. maritima* – arrowgrass  
*Triraphis mollis* – purple plume grass  
*Vicia sativa* – vetch  
*Ximenia americana* – yellow plum  
*Xylomelum* spp., e.g. *X. pyriforme* – woody pear  
*Zea mays* – maize, corn (see also nitrate-nitrite poisoning)  
*Zieria laevigata*.

#### Toxic variability

The content of cyanogenetic glucosides in these plants varies widely between seasons and between different parts of the plant, with young, growing leaf usually having the greatest concentration.

Differences between plant species  
 Varieties of the same species often have different toxicities, e.g. *Amelanchier alnifolia* var *cusickii* has three times the toxicity of *A. alnifolia* var *alnifolia*.<sup>1</sup> Of greatest importance are the cultivated and pasture plants. Sudan grass (*Sorghum sudanense*) and sorghum (*S. bicolor*) are used extensively in some countries for forage and may be associated with heavy mortalities in particular circumstances. Sugar cane contains a cyanogenetic glucoside from which HCN can be released. Release occurs through the action of an enzyme in algarrobo pods (*Prosopis glandulosa*) when the two are fed together.

#### Plant products

Linseed in the form of cake or meal may also be highly toxic if eaten in large quantities.

#### Fodder storage

Drying, hay-making, and physical factors, such as chilling and freezing, may appear to reduce the toxicity of cyanogenic material through destruction of  $\beta$ -glucosidase, but

the plant material remains as potentially toxic as it was originally, requiring only the enzyme from ruminal microbes to become actively poisonous. Ensiled toxic forage loses much of its cyanide content and on exposure to air may give off large quantities of free HCN.

#### Glycosides

A number of specific glycosides have been isolated and include linamarin from linseed and flax, lotaustralin from *Lotus australis*, dhurrin from sorghum, lotusin from *Lotus arabicus*, and amygdalin from bitter almonds. The glycosides are byproducts of the plant's metabolism and probably form part of its defense system against herbivores such as insects and molluscs. Their concentration in the different plant species is variable depending upon climatic and other conditions which influence plant growth.

The minimum lethal dose of HCN is about 2 mg/kg BW for cattle and sheep when taken in the form of a glycoside. The minimum lethal dose (MLD) of lotaustralin for sheep approximates 4 mg/kg BW. Plant material containing more than 20 mg of HCN per 100 g (200 ppm) is likely to have toxic effects, and highly poisonous samples may contain as much as 6000 ppm. The toxic doses quoted must be accepted with some reservation, as the toxicity of a particular specimen varies with a number of factors including the concentration of the hydrolyzing enzyme in the plant, the preceding diet of the animals, and particularly the speed with which the material is eaten.

#### EPIDEMIOLOGY

##### Occurrence

Hydrocyanic acid poisoning occurs in most countries because of the common occurrence of plants containing toxic quantities of cyanogenetic glycosides. When the disease occurs, most affected animals die and, although the overall economic effects are not great, the losses may be heavy on individual farms.

##### Risk factors

###### Plant factors

Poisoning is most likely to occur when the cyanide content of the material is high and it is eaten quickly. Plants with a cyanide potential of more than 200 mg HCN/kg plant dry matter are potentially toxic. Plants must be unwilted at time of testing or falsely low results may be obtained. The glucoside content is highest when:

- Plants grow rapidly after a previous period of retardation, e.g. after autumn rains on drought-stunted pasture, after a crop is eaten back by livestock or grasshoppers, or after spraying with herbicides

- Plants are wilted, frostbitten, or just young
- In drought years<sup>2</sup>
- Plants are growing in soil with a high nitrogen content
- Plants growing in soil with low phosphorus content.

#### Animal factors

The greatest danger exists in the following circumstances:

- Hungry animals allowed access to dense plant growths
- Traveling, recently introduced or other animals unaccustomed to local plants; animals accustomed to the plants and the poison can tolerate increasing doses with experience
- Cattle or sheep may break out of dry, summer pastures into fields of young, lush, immature sorghum or Sudan grass and gorge on it.

#### Speed of cyanogenesis

The rate of conversion of the glycoside to HCN in the rumen also affects the toxicity of the feed<sup>3</sup>; factors affecting the conversion rate include:

- High pH values increase the rate and the risk of poisoning
- The rate is less when the diet includes grain and long hay rather than fresh or cubed pasture or hay
- The rate of conversion, and onset of signs, may be delayed if the ingested material is relatively indigestible, such as crabapples.<sup>4</sup>

#### Linseed meal or cake

Deaths due to the ingestion of excessive amounts occur when:

- Sheep are fed large quantities of linseed meal at the end of a period of starvation
- Calves are fed on milk replacer containing linseed that has been soaked but not boiled.

#### Other sources

Occasional cases of HCN poisoning occur when animals are exposed to:

- Chemicals used for fumigation
- The fertilizer, calcium cyanamide.

### PATHOGENESIS

#### Acute intoxication

This is associated with tissue anoxia by its inhibition of the cytochrome  $a_3$  moiety of complex IV (the terminal cytochrome  $c$  oxidase) in the electron transport chain, thus preventing cellular aerobic respiration. Oxygen exchange is suspended and oxygen is retained in the blood. If the course is prolonged the blood may be dark red due to inhibition of respiration and restriction of oxygen intake. The major manifestation of cyanide poisoning is cerebral anoxia resulting from heart failure.

### Chronic poisoning

Doses which do not produce clinical effects appear to be well-tolerated. HCN is volatile and is exhaled or converted to thiocyanate by hepatic rhodanase and then excreted in the urine. The tolerance appears to increase with experience. Cyanides ingested in small amounts, however, are known to be **goitrogenic** through the effects of thiocyanate, e.g. pregnant ewes grazing on star grass (*Cynodon nlemfuensis*) develop goiter due partly to a low iodine intake and partly to the cyanide intake. Their lambs may also be goitrous and have skeletal deformities. **Leucomyelomalacia** (cystitis-ataxia syndrome) in ruminants and horses is also attributed to chronic cyanide intake. Urinary incontinence, loss of hair due to scalding, and incoordination of the hindlimbs occur in horses, cattle, and sheep grazing *Sorghum sudanense* (Sudan or hybrid Sudan grass). In horses, the signs are most marked when the animal is backed or turned. In sheep, the syndrome includes weakness, ataxia, head shaking, fetlock knuckling, recumbency, and opisthotonos. Mares and cows grazing sorghum may rarely produce offspring with arthrogryposis, probably the result of fetal central nervous system damage by cyanide.

### CLINICAL FINDINGS

Affected animals rarely survive for more than 1–2 hours. In the most acute cases, animals become affected within 10–15 minutes of eating toxic material and die within 2–3 minutes of first showing signs. Clinical signs include dyspnea, anxiety, restlessness, stumbling gait, tremor, moaning, recumbency, and terminal clonic convulsions with opisthotonos. The mucosae are bright red in color. In the more common, acute, cases the animals show depression, staggering, gross muscle tremor and dyspnea. There may be hyperesthesia and lacrimation. The muscle tremor is evident first in the head and neck, but soon spreads to involve the rest of the body; the animal becomes weak and goes down. The pulse is small, weak and rapid, and may be irregular. There is dilatation of the pupils, nystagmus, with congestion and cyanosis of the mucosae in the terminal stages, usually accompanied by clonic convulsions and in some cases by hypersalivation, vomiting, and aspiration of ingesta into the lungs. Vomition is not a typical sign in cyanide poisoning and, when it does occur, may be the result of bloating in the recumbent animal and during the final convulsions. The course in these cases may be as long as 1–2 hours.

### CLINICAL PATHOLOGY

Most tests for the presence of cyanogenic glycosides are conducted in the laboratory

but suspected plants or ruminal contents can be tested in the field by the Henrici (picric acid) test. The material is placed in a test tube containing a little water and a few drops of chloroform and heated very gently in the presence of sodium picrate paper. A rapid change in the color of the reagent paper from yellow to red indicates the presence of free HCN. Once started, the color change occurs rapidly, although it may require 5–10 minutes of gentle warming before the change commences. The tube should be corked while being warmed and the paper hung from the top without touching the test material. Reagent papers are easily prepared by mixing 0.5 g picric acid, 5 g sodium carbonate in 100 mL water. Filter paper is dipped in the reagent and allowed to dry in a dark place. The reagent is stable for at least 6 months if kept in a cool place, but the papers deteriorate if kept for more than 1 week. Ruminal contents may also be tested by placing a drop of ruminal fluid on a test paper. A red discoloration is a positive reaction. The test is designed to detect free HCN and may not be positive even when cyanides are present if the gas is not liberated. Commercial test papers may give superior results.<sup>5</sup>

### NECROPSY FINDINGS

In very acute cases the blood may be bright red in color, but in most field cases it is dark red due to anoxemia. The blood clots slowly, the musculature is dark, and there is congestion and hemorrhage in the trachea and lungs. Patchy congestion and petechiation may be evident in the abomasum and small intestines. Subepicardial and subendocardial hemorrhages occur constantly. A smell of 'bitter almonds' in the rumen is described as typical of HCN poisoning. It may occur with some plants but is not apparent with others. There are no characteristic histological changes. Specimens submitted for laboratory examination should include rumen contents, liver, and muscle. Much HCN may be lost from specimens during transit unless the samples are shipped in a very tightly stoppered, air-tight bottle. Muscle is least likely to lose its HCN and is the preferred tissue if the delay between death and necropsy has been long. To be satisfactory, liver samples must be taken within 4 hours of death and muscle tissue within 20 hours. A level of HCN of 0.63  $\mu\text{g}/\text{mL}$  in muscle justifies a diagnosis of poisoning. Serum and rumen fluid of poisoned cattle have been assayed using GC-MS.<sup>6</sup>

### Chronic cases

In arthrogryposis and in cystitis-ataxia there is focal axonal degeneration and demyelination in the spinal cord, with some cases of pyelonephritis in the cystitis-ataxia patients.

Samples for confirmation of diagnosis

- Toxicology – 50 g rumen content, liver, muscle in *air-tight container* (ASSAY (cyanide)).

### DIFFERENTIAL DIAGNOSIS

The development of an acute anoxic syndrome in ruminants grazing on plants, or being fed on feeds known to be cyanogenic, usually suggests the occurrence of HCN poisoning. **Diagnostic confirmation** is dependent on a positive assay for hydrogen cyanide in blood or cyanogenic glucosides in rumen contents. The **differential list for acute poisoning** includes:

- Acute pulmonary edema and emphysema may resemble it but is less acute, and auscultation of the lungs usually indicates the presence of fluid and emphysema
- In nitrite poisoning the blood is dark and tends to be brown
- Poisoning by cyanobacteria associated with obvious blooms in water sources
- Occasional cases of anaphylaxis cases in cattle, particularly young calves, are manifested by acute dyspnea, but there are usually additional signs of an allergic reaction including bloat and sometimes urticaria or angioneurotic edema, and, if the case is sufficiently severe, there is a profuse discharge of blood-stained froth from the nose. Cases occur only sporadically, whereas HCN poisoning is likely to affect a number of animals at one time.

Differential diagnosis lists for goiter, myelomalacia, and arthrogryposis are listed elsewhere.

### TREATMENT

The standard **primary treatment** is the IV injection of a mixture of sodium nitrite and sodium thiosulfate (5 g sodium nitrite, 15 g sodium thiosulfate in 200 mL water for cattle; 1 g sodium nitrite, 3 g sodium thiosulfate in 50 mL water for sheep), and field experience with it has been very good. However, the results in cattle can be improved by using:

- Sodium thiosulfate in a much heavier dose (660 mg/kg BW compared to the previous level of 66 mg/kg)
- Sodium thiosulfate heavy dose combined with sodium nitrite (22 mg/kg BW)
- Sodium thiosulfate heavy dose combined with *p*-aminopropiophenone (1–1.5 mg/kg)
- *p*-aminopropiophenone (1–1.5 mg/kg) used alone
- Sodium thiosulfate heavy dose plus cobaltous chloride (10.6 mg/kg BW).

Treatment, whichever product is used, may have to be repeated because of further

liberation of HCN. There is an upper limit of safe methemoglobinemia beyond which anemic anoxia occurs and doses of nitrite greater than those recommended may exacerbate the tissue anoxia. The inclusion of cobalt is based on its marked antagonistic effect against cyanide, which is enhanced by combination with thiosulfate or nitrite.

In all cases and in animals exposed but showing no signs, doses of 30 g of sodium thiosulfate are given orally to cattle and are repeated at hourly intervals.

Non-specific **supportive treatment**, including respiratory stimulants and artificial respiration are unlikely to have any effect on the course of the disease.

### CONTROL

Hungry cattle and sheep should not be allowed access to toxic plants, especially cultivated *Sorghum* spp. when they are chronically drought-stressed, immature, wilted, frostbitten, or growing rapidly after a stage of retarded growth. For most *Sorghum* cultivars, stock should be allowed to graze them, or be fed green chop made from them, only after the plants exceed 75 cm in height. Hay should not be made from *Sorghum* which is potentially toxic, as toxicity may persist. *Sorghum* silage is much safer than hay.

Sulfur deficiency in ruminants causing depressed feed intake and animal production may result from grazing *Sorghum* with high cyanide potential. This results from ruminal detoxification of cyanide with sulfur to form thiocyanate. Supplementation with salt licks containing 5% sulfur can counter this problem.

If there is doubt as to the toxicity of a field of these plants, a sample may be tested by the method described under clinical pathology, or the field can be tested to a small group of animals. Linseed meal can be fed in small quantities without soaking, but gruel containing linseed should be thoroughly boiled to drive off any free HCN.

### REVIEW LITERATURE

Bradley GA et al. Neuraxonal degeneration in sheep grazing sorghum pastures. *J Vet Diag Inv* 1995; 7:229.

### REFERENCES

1. Broock BM et al. *Can J Plant Sci* 1988; 68:543.
2. Pickrell JA et al. *Vet Hum Toxicol* 1991; 33:247.
3. Majak W et al. *J Anim Sci* 1990; 68:1648.
4. Shaw JM. *Vet Rec* 1986; 119:242.
5. Dalefield RR. *Vet Human Toxicol* 2000; 42:356.
6. Meiser H et al. *Am J Vet Res* 2000; 61:658.

### NITRATE AND NITRITE POISONING

#### ETIOLOGY

The **toxic principle** as it occurs in growing plants is always nitrate, usually as potassium nitrate, and may be ingested in sufficient quantities to be associated

### Synopsis

**Etiology** Nitrate – as sodium or potassium nitrate fertilizer, food preservative. Nitrite preformed in nitrate-rich, moldy plant material or as nitrate converted in rumen to nitrite.

**Epidemiology** Outbreaks due to access to abnormal materials, including species which accumulate nitrate or moldy hay, or any plant growing profusely after a long drought or on high nitrate content soil.

**Clinical findings** Sudden onset of severe dyspnea, brown mucosae and blood, short course, high case fatality rate.

**Clinical pathology** Very high blood levels of methemoglobin.

**Necropsy findings** Brown blood in some.

**Diagnostic confirmation** Positive assay for nitrate in feed, blood or aqueous humor.

**Treatment** Methylene blue.

**Control** Avoidance of nitrate-rich feeds, monensin supplementation; supplement ration with carbohydrate.

with gastroenteritis. Ruminal microbes convert nitrate to nitrite. **Toxic doses** are hard to compute because of variation in susceptibility, and in the rate of production of nitrite from nitrate.

**Roots and stems** usually contain more nitrate than leaves, and a total plant content of 6000–10 000 ppm dry matter (DM) of nitrate is considered to be potentially toxic. Plants that accumulate more than 1.5% potassium nitrate in dry matter are potentially toxic. For animals at pasture probably 2% DM as nitrate is safe. Levels of potassium nitrate in plants may be as high as 20% of DM and 3% is not uncommon in recognized forage plants such as sorghum and Sudax, and heavy mortality has occurred on them. Dried plants retain their toxicity.

#### Cattle

The minimum lethal dose of nitrite is 88–110 mg/kg BW or about 0.6 g of potassium nitrate per kg BW. Daily doses of about 0.15 g potassium nitrate have been associated with abortion after 3–13 doses. Cattle can eat sufficient quantities of toxic plants to be associated with death in 1 hour.

#### Sheep

The lethal dose of nitrite is 40–50 mg/kg BW. Continued low-level dosing does not appear to affect sheep. Drinking water containing 1000 ppm of nitrate nitrogen is associated with appreciable methemoglobin formation but has no obvious clinical effect.

#### Pigs

The lethal dose of sodium nitrite is 88 mg/kg BW. Doses of 48–77 mg/kg will be associated with moderate-to-severe,



but not fatal, methemoglobinemia. Potassium nitrate in doses of 4–7 g/kg BW is associated with fatal gastritis, and the lethal dose of potassium or sodium nitrite is about 20 mg/kg. Measured as nitrate nitrogen, the LD<sub>50</sub> is 19–21 mg/kg BW. At dose levels of 12–19 mg/kg BW clinical signs occur but the pigs recover.

## EPIDEMIOLOGY

### Source

The common sources of nitrate for farm animals include:

- Cereal crops used as pasture, e.g. immature green oats, barley, wheat, and rye or hay; or green fodder, e.g. Sudan grass, corn. Oat hay may contain 3–7% nitrate
  - Very heavy growths of rye-grass (*Lolium* spp.) in pastures
  - Freshly pulled mangels. Turnip tops may contain 8% nitrate, and sugar beet tops and rape have been associated with nitrite poisoning
  - Water from deep wells, contaminated with fertilizer or from reservoirs created with explosives
  - The plants listed below are recognized important sources of hazardous nitrate concentrations:
- Alternanthera denticulata*  
*Amaranthus* spp., e.g. *A. retroflexus* – redroot, Prince of Wales feather (see also oxalate poisoning)  
*Aneilema accuminatum*  
*Arctotheca calendula* – capeweed  
*Atriplex muelleri* – annual saltbush  
*Avena sativa* – oats  
*Beta vulgaris* – sugar beets, feed beets, beetroots  
*Bidens frondosa* – beggar tick  
*Brassica* spp., e.g. *B. napus* – rape, turnips, etc.  
*Bromus catharticus* – prairie grass  
*Carduus* spp., e.g. *C. tenuifloris*, winged, slender thistle  
*Chenopodium* spp., e.g. *C. ambrosioides* – mexican tea, goosefoot  
*Chromolaena odorata* – Siam weed  
*Cirsium arvense* – Canada thistle  
*Claoxylon australe*  
*Cleome serrulata* – Rocky Mountain bee plant  
*Dactyloctenium radulans* – button grass, but only when growing in high-nitrogen soil, such as in stockyards  
*Daucus carota* – wild carrot, Queen Anne's lace  
*Dysphania* spp. – crumbweeds (see also cyanogenic glycoside poisoning)  
*Echinochloa* spp., e.g. *E. crus-galli* – barnyard grass, Japanese millet  
*Ehretia membranifolia*  
*Eleusine* spp., e.g. *E. indica* – crowfoot (see also cyanogenic glycoside poisoning)

*Franseria discolor* – white ragweed  
*Galenia pubescens*  
*Glaucium corniculatum*  
*Glycine max* – soybean  
*Gnaphalium purpureum* – purple cudweed  
*Helianthus annuus* – sunflower  
*Lolium* spp., e.g. *L. multiflorum* – rye grasses  
*Lygodesmia juncea* – skeleton weed  
*Malva parviflora* – small-flowered mallow  
*Medicago sativa* – alfalfa, lucerne  
*Mollitia greevesii* – creeping millotia  
*Montia perfoliata* – miners lettuce  
*Panicum capillare* – witchgrass  
*Parsonia* spp., e.g. *P. lilacina*  
*Pennisetum* spp., e.g. *P. clandestinum* – kikuyu  
*Plagiobothrys* spp. – popcorn flower  
*Polygonum aviculare* – wireweed  
*Portulacca* spp., e.g. *P. oleracea* – pigweed (see also oxalate poisoning)  
*Rafinesquia californica* – California chicory  
*Raphanus sativus* – radish  
*Salvia reflexa* – mintweed  
*Sigesbeckia orientalis*  
*Silybum marianum* – variegated thistle  
*Sinapis* spp., e.g. *S. alba* – white mustard  
*Sonchus* spp. – sow thistle  
*Sorghum* spp., e.g. *S. bicolor* – grain sorghum  
*Spartothamnella juncea*  
*Stellaria media* – chickweed  
*Thelypodium lasiophyllum* – mustard  
*Tribulus terrestris* – caltrop  
*Triticum aestivum* – wheat  
*Urochloa* spp., e.g. *U. panicoides* – liverseed grass  
*Vigna unguiculata* (*catjang*) – cowpea  
*Zaleya galericulata*  
*Zea mays* – maize, corn  
*Zygophyllum* spp., e.g. *Z. ammophilum* – twin leaf.

### Risk factors

Environmental factors

Higher than normal levels of nitrate in plants are usually associated with:

- Application of excessive nitrogen-containing fertilizer, human sewage, animal manure from intensive accommodation units, or with high levels of nitrogen-fixing bacteria
- Soil nitrate being taken up but not used by plants because weather conditions are unsuitable for photosynthesis which would provide the energy to convert the nitrogen into protein. Conditions which retard photosynthesis include cloudy or cold weather, at night, herbicide application, disease in the plants, wilting of plants, after a prolonged drought.<sup>1</sup> High levels

of nitrate accumulate in the soil during the drought and are not leached out by rain. Plants absorb large amounts when the drought ends

- Green chop fed indoors is more hazardous than grazing material, probably because the intake is more rapid
- Cereals and root crops are likely to contain high concentrations when heavily fertilized with nitrogenous manures, especially crude sewage, and when growth is rapid during hot, humid weather
- Ensiled material usually contains less nitrate than the fresh crop, because normal silage fermentation destroys nitrate, but juices draining from silos containing high-nitrate materials may be toxic
- Hay made from nitrate-rich material contains almost as much as when it was made, unless some of it is converted to nitrite by overheating and the activities of molds
- Heavily fertilized grass made into grass cubes
- Nitrate combined with possible iodine deficiency is statistically associated with congenital deformities and hypothyroidism in foals in western Canada where mares were fed oaten hay or green oat forage during pregnancy.<sup>2</sup>

Cereal hay, especially oat hay, grown under drought conditions and cut when sappy, may develop a high concentration of nitrite when the stacked material develops some heat. Dry oat hay that is damp for some time before it is eaten, either in the stack or loose in the field in the hot sun, is also likely to contain a high concentration of nitrite.

Nitrate-nitrite poisoning by drinking polluted water can result from:

- Industrial contamination from rubber processing plants
- Nitrogenous fertilizer contamination
- Effluent from butchers' shops and meat processors where sodium nitrate is used in meat-pickling brine
- Effluent from premises where cheese is manufactured; the whey may contain potassium nitrate
- Deep wells filled by seepage from highly fertile soils may contain levels as high as 1700–3000 ppm of nitrate
- Open surface storage tanks collecting rain runoff from roofs may also contain toxic amounts of nitrite in the plant debris which collects at the bottom
- Juices draining from silage containing high-nitrate material may be toxic
- Water of condensation in barns may trap ammonia and eventually contain 8000–10 000 ppm of nitrate

- Composition lining board in animal barns may become highly impregnated with nitrite and is associated with poisoning if chewed
- Water containing 2300 ppm of nitrate and less than 10 ppm of nitrite when mixed into a swill, stored in tins and then cooked has resulted in the production of a mixture containing 1200–1400 ppm of nitrite.

Boiling does not reduce the nitrate content of water.<sup>3</sup>

Accidental poisoning with **commercial nitrate compounds** occurs sporadically when:

- Sodium or potassium nitrate is used in mistake for sodium chloride or magnesium sulfate, or when ammonium nitrate solution is used instead of whey
- Nitrates used as explosives to blast out water holes used to store drinking water for cattle can be dangerous if the nitrate is left in the hole and the dam fills soon afterwards.<sup>4</sup>

#### Animal factors

##### *Species differences*

There is considerable variation between species in their susceptibility to nitrite poisoning, pigs being most susceptible, followed by cattle, sheep, and horses in that order. The susceptibility of cattle relative to sheep is due either to their ability to convert nitrate to nitrite in the rumen or because of the known greater ability of sheep to convert nitrite to ammonia. Pigs are highly susceptible to nitrite poisoning but are affected only if they ingest it preformed.

##### *Dietary differences*

Cattle reduce nitrate to nitrite in the rumen and their capacity to do this is enhanced by continued feeding of nitrate. The enhanced capacity, due to changes in microbial activity, is transferred naturally to nearby animals not receiving additional nitrate. Cases of nitrate poisoning that occur in sheep are associated with either the ingestion of preformed nitrite or ruminal conditions, which favor reduction of nitrate. A diet rich in readily fermentable carbohydrate reduces nitrite production in the rumen of the sheep. Nitrite poisoning also occurs in sheep fed an inadequate ration after dosing with nitrite at a level innocuous to sheep fed on a good ration. There is often a delay of a few days in the appearance of signs of poisoning after sheep go onto toxic forage. It seems likely that ruminal flora need to adapt to the changed nutrients. The degree of methemoglobinemia also varies with the quality of the diet.

#### *Differences in susceptibility*

- The most important factor influencing susceptibility appears to be the rate of ingestion of the nitrate-bearing plant
- Poorly fed animals, especially traveling or recently transported stock, are more susceptible to nitrite poisoning than those on good diets, probably because of the greater intake in hungry animals, and possibly their need to adapt their ruminal flora to the conversion of nitrite to ammonia
- Prior exposure to nitrate reduces susceptibility under experimental conditions, and cattle on high nitrate hay taken off the hay for a few days and then returned to it in self-feeders where they can gorge on it may be poisoned<sup>5</sup>
- Monensin facilitates the conversion of nitrate to nitrite in the rumen and may result in poisoning in cattle or sheep on high nitrate fodder.

#### **PATHOGENESIS**

Nitrates have a direct caustic action on alimentary mucosa and the ingestion of sufficiently large quantities is associated with gastroenteritis. Absorption of nitrites is associated with methemoglobinemia and the development of hypoxia. Nitrites are also vasodilators which may contribute to the development of tissue hypoxia by causing peripheral circulatory failure, but this effect appears to be of little significance compared to that of methemoglobin formation. When nitrite is ingested preformed, the effects may be very rapid, but when conversion of nitrate to nitrite occurs in the rumen there is a delay of some hours before clinical illness occurs. In cattle and sheep, the maximum methemoglobinemia occurs about 5 hours after ingestion of nitrate. In pigs, it is 90–150 minutes after nitrite is ingested. Death usually occurs within 12–24 hours of ingestion of the toxic material, although in acute poisoning the duration of illness may be even shorter, and clinical signs may not be observed.

Death does not occur until a certain level of methemoglobinemia is attained. In farm animals, lethal levels in cattle are about 9 g methemoglobin per 100 mL blood; in pigs death occurs when 76–88% of hemoglobin has been altered to methemoglobin.

In cattle, prolonged ingestion of sublethal amounts of nitrite is not known to have any significant effect on productivity. However, abortion is commonly recorded as a sequel to an acute outbreak of poisoning, and it is possible that severe anoxic episodes could damage the conceptus.

#### **CLINICAL FINDINGS**

In animals poisoned by **nitrate** there is salivation, abdominal pain, diarrhea, and

vomiting, even in ruminants. The more typical syndrome is that associated with the anoxia of **nitrite** poisoning. Dyspnea, with a gasping, rapid respiration is the predominant sign. Muscle tremor, weakness, stumbling gait, severe cyanosis followed by blanching of the mucosae, a rapid, small, weak pulse, and a normal or subnormal temperature are other typical signs. In the most severe cases the mucosal and conjunctival vessels and the mucosae generally, are brown because of the high content of methemoglobin in the blood.

Fatally affected animals go down, show severe depression and terminal clonic convulsions, and death occurs from a few minutes to an hour after onset. Frequent urination and abortion are other recorded signs, and in some outbreaks in cattle the principal problem is abortion a few days after exposure.<sup>6</sup>

#### **CLINICAL PATHOLOGY**

Nitrite poisoning is difficult to diagnose unless blood samples are collected during life and their content of nitrite, or more commonly nitrate, is estimated by the diphenylamine test.<sup>7</sup> Blood and ocular fluid levels of nitrate are stable for 24 hours at 23°C (73.4°F), 1 week at 4°C (39.2°F), and 1 month at –20°C (–4°F).<sup>8</sup> Contributory information is provided by blood levels of methemoglobin, but inaccuracy creeps in because of the rapid reversion of methemoglobin to hemoglobin. Methemoglobinemia may be detected by examination of the blood in a reversion spectrometer but it is not diagnostic of nitrite poisoning, and results are not dependable unless the blood has been collected for less than 1 or 2 hours. Methemoglobin levels of 9 g/dL of blood are lethal in cattle; levels of 1.65–2.97 g/dL are recorded in association with obvious clinical signs compared to normal levels of 0.12–0.2 g/dL. An alternative method is the diphenylamine blue test, which is very sensitive to the presence of nitrite but not entirely specific. A satisfactory test can be conducted on a thick, air-dried blood smear. Laboratory tests are available for the rough estimation of the nitrite or nitrate content of fodder but they are neither sufficiently simple for field use nor accurate enough for critical assay. A modified diphenylamine reagent provides a qualitative test suitable for field use. The test solution (0.5 diphenylamine, 20 mL distilled water and concentrated sulfuric acid to make up to 100 mL) is placed on the tissues of the inside of the stem (to avoid contact with possible iron contamination on the outside surface). An intense blue color within 10 seconds indicates a concentration of greater than 1% of nitrate. Commercial test strips are

available for detection of nitrate and nitrite in the field.

The diphenylamine test does have disadvantages and can give inaccurate results. To avoid these errors it is recommended that the blood be diluted with phosphate buffer (1 part in 20). It is also worthwhile submitting a sample of urine, as nitrite appears to pass unchanged into the urine.

### NECROPSY FINDINGS

In nitrate poisoning, the gastrointestinal mucosa is congested and hemorrhagic. In nitrite poisoning, the blood is dark red to coffee-brown in color, and it clots poorly. Petechial hemorrhages may be present in the heart muscle and trachea, and there is general vascular congestion. There are no characteristic microscopic changes. Specimens for laboratory examination should include blood for methemoglobin estimation, ingesta and suspected plants or water, with added chloroform or formalin to prevent conversion of nitrates by bacterial fermentation. If the animals have been dead for some time, chemical analysis should be attempted on the aqueous humor of the eye and the cerebrospinal fluid. All of these specimens are subjected to the diphenylamine test. Postmortem blood specimens for methemoglobin assay must be collected within 1–2 hours of death to be of any value.

### Samples for confirmation of diagnosis

◦ **Toxicology** – 1 cc aqueous humor (frozen); 1 cc urine (frozen); suspect forage material (dry) or other possible source of poison; 100 g ingesta (with chloroform or formalin added) (ASSAY (nitrate/nitrite)); 2 cc blood in 4 cc phosphate buffer (ASSAY (methemoglobin)).

### DIFFERENTIAL DIAGNOSIS

The acute dyspnea, short course, and nervous signs of tremor and convulsions resemble the signs of other forms of anoxia. Although the rapid response to treatment with methylene blue is a good criterion for field use, diagnostic confirmation is by a positive assay for nitrite in body fluid and tissues. The differential diagnosis list includes:

- Hydrocyanic acid poisoning
- Acute bovine pulmonary edema and emphysema
- Anaphylaxis occurs only as sporadic cases
- Cyanobacterial poisoning.

### TREATMENT

Methylene blue is the specific antidote; in large amounts it is associated with methemoglobinemia, hence its use in cyanide poisoning, but in small amounts

it is associated with rapid reconversion of methemoglobin to hemoglobin. The standard dose rate is traditionally 1–2 mg/kg BW, injected IV as a 1% solution, but in ruminants it has been shown that high dose rates of methylene blue are not associated with dangerous methemoglobinemia; a higher dose rate of 20 mg/kg BW can be used, but the standard dose rate appears to be adequate. Treatment may have to be repeated when large amounts of toxic material have been ingested. The half-life of methylene blue in tissues is about 2 hours, and a repetition of treatment is recommended if necessary at intervals of 6–8 hours. Methylene blue has come under a cloud because of claimed mutagenic properties, but alternative treatments for methemoglobinemia have so far proved inadequate.

### CONTROL

Ruminants likely to be exposed to nitrites or nitrates should receive adequate carbohydrate in their diet, and traveling or hungry animals should not be allowed access to dangerous plants. Haylage or silage suspected of dangerous levels of nitrate should be allowed to aerate overnight before feeding.

### Toxic levels

Less than 0.6% of nitrate in the total diet is recommended. Plants, to be safe for feeding, should contain less than 1.5% potassium nitrate on a dry matter basis. For safety it is recommended that cows not be grazed on feed containing more than 1% nitrate, and slightly less when zero grazing. Cattle can eat material containing up to 8% potassium nitrate in dry matter if introduced to it gradually to allow ruminal microbes to adapt.

### Dietary supplements

If hazardous feed is to be fed, supplementation of the diet of sheep and cattle with chlortetracycline (30 mg/kg of feed) or sodium tungstate is partially effective for a period of about 2 weeks in suppressing the reduction of nitrate to nitrite. Cattle adapted to potentially toxic feed should not be supplemented with monensin. L-cysteine feeding has been experimentally effective in preventing nitrate-nitrite poisoning in sheep.<sup>8</sup>

### Ration dilution

Hungry animals should be fed hay or dry pasture as a filler to reduce their rate of intake before access to potentially toxic feed. Risks of nitrate-nitrite poisoning from pasture grass is minimized if the pasture is a mixed legume/grass one.

### REVIEW LITERATURE

Castel SW et al. *Amaranthus retroflexus* (redroot, pigweed) poisoning in cattle. *J Am Vet. Med Assoc* 1994; 204:1068.

Jones TO. Nitrate/nitrite poisoning in cattle. *In Practice*, 1988; 10:199–203.

### REFERENCES

1. Pickrell JA et al. *Vet Hum Toxicol* 1991; 33:247.
2. Allen AL et al. *Toxic Plants and Other Natural Toxicants*. Walingford, UK: CAB International, p. 334, 1998.
3. Dalefield RR, Oehme FW. *Vet Human Toxicol* 1997; 31:313.
4. Yong C. *Can Vet J* 1990; 31:118.
5. Brown CM. *Vet Hum Toxicol* 1990; 3:481.
6. Norton JH, Campbell RSF. *Vet Bull* 1990; 60:1137.
7. Bhikane AU, Bhoop, Singh. *Ind Vet J* 1990; 67:808.
8. Boermans HJ. *Am J Vet Res* 1990; 51:491.
9. Takahashi J et al. *Anim Feed Sci Technol* 1998; 74:273.

### OXALATE (SOLUBLE FORMS) POISONING

#### Synopsis

**Etiology** Ingestion of soluble oxalates in specific poisonous plants.

**Epidemiology** Occurrence limited to habitats of the specific plants. Sheep most susceptible. Most severe when plant profuse and lush and livestock hungry.

**Clinical findings** In ruminants – hypocalcemic recumbency, nephrotic syndrome, rumenitis.

**Clinical pathology** Low blood calcium; azotemia; proteinuria.

**Necropsy findings** Nephrosis associated with calcium oxalate crystals.

**Diagnostic confirmation** High oxalate content of ingesta, plants. Nephrosis with oxalate crystals.

**Treatment** Calcium borogluconate parenterally.

**Control** Limit access to toxic plants; dilute feed with non-toxic materials.

### ETIOLOGY

Plants usually contain soluble oxalate in the form of the potassium salt, and this is much less toxic than if it is given experimentally as the pure salt. High concentrations are present in about 70 plants included in the world list, of which important examples are listed below:

*Acetosella vulgaris* – sheep sorrel

*Amaranthus* spp., e.g. *A. cruentus* – redshank (see also nitrate-nitrite poisoning)

*Atriplex* spp., e.g. *A. muelleri* – annual saltbush (see also nitrate-nitrite poisoning)

*Bassia* spp., e.g. *B. hyssopifolia* – red burr

*Beta vulgaris* – fodder beet, sugar beet, mangal

*Cenchrus ciliaris* – buffel grass

*Chenopodium* spp., e.g. *C. album* – fat hen (see also nitrate-nitrite poisoning)

*Delosperma* spp.

*Drosanthemum* spp.

*Emex australis* – spiny emex

*Halogeton glomeratus* – halogeton, barilla  
*Mesembryanthemum* spp., e.g.

*M. nodiflorum* – slender ice plant<sup>1</sup>

*Neobassia* (*Threlkeldia*) *proceriflora* –  
 soda bush

*Oxalis* spp., e.g. *O. cernua*, *O. pescaprae*  
 – soursob

*Portulaca* spp., e.g. *P. oleracea* – pigweed

*Plantago varia* – plantain

*Psilocaulon* spp., e.g. *P. absimile* –  
 loogbos

*Rheum rhaponticum* – rhubarb

*Rumex* spp., e.g. *R. crispus* – curly dock<sup>2</sup>

*Salsola* spp., e.g. *S. kali* – tumbleweed

*Sarcobatus vermiculatus* – greasewood

*Sceletium* spp.

*Sclerolobium atriplicinum* – lambs tongue

*Sclerolaena* spp., e.g. *S. muricata* –  
 prickly rolypoly

*Setaria sphacelata* – setaria

*Spinacia oleracea* – spinach

*Trianthema* spp., e.g. *T. portulacastrum*  
 – giant pigweed

*Zaleya galericulata* – hogweed.

Soluble oxalates in plants reach their greatest concentration in the young, growing leaves. Some fungi are capable of producing significant amounts of oxalate, and moldy feedstuffs may be associated with oxalate poisoning.

#### Toxic dose

Large quantities of a toxic plant must be ingested to be associated with poisoning because not all the oxalate is absorbed and much is broken down in the alimentary tract. Up to 450 g of sodium oxalate given by mouth is required to produce fatal effects in horses (in which natural cases are almost unknown), and 6 g/day of anhydrous oxalic acid is required to produce toxic effects in sheep. Cattle can eat as much as 685 g of oxalic acid without harmful effect; buffalo are similarly tolerant of the poison. Deaths in sheep can occur on pasture containing as little as 2% soluble oxalate.<sup>3</sup>

#### EPIDEMIOLOGY

##### Occurrence

Oxalate poisoning is most prevalent under extensive grazing systems where it is impossible to control the occurrence in the pasture of the specific plants which contain large amounts of oxalate.

##### Risk factors

Animal factors

##### Species susceptibility

Oxalate poisoning is commonest in sheep that are more likely to be grazed on the kind of pasture in which the toxic plants commonly occur, but occurs also in cattle and very rarely in horses. Acute oxalate poisoning and death have been observed in cattle eating *Setaria sphacelata*, *Halogeton glomeratus*, and *Rumex venosus* containing up to 13.9% of oxalate.

The natural disease does not appear to have been recorded in pigs, but renal damage has been produced in this species by experimental administration of oxalate.

##### Adaptation

Oxalate is normally metabolized by ruminal bacteria and the continued ingestion of oxalate in small quantities results in increased ability to decompose the oxalate to the point where relatively large quantities can be ingested without toxic effects. The ruminal microflora requires 3–4 days to adapt to the introduction of oxalate into the diet. Thus, sheep and cattle may be very susceptible when they are grazed for the first time on pasture containing the toxic plants. Of the factors in the rumen which will affect the amount of oxalate rendered insoluble as calcium oxalate or digested to bicarbonate, the level of calcium in the diet and the activities of bacteria in the rumen are considered to be important.

##### Susceptible animal groups

Plants containing oxalates in dangerous quantities grow prolifically in specific areas, and heavy mortalities occur in traveling and recently introduced animals and other very hungry animals whose intake of potentially toxic plants is likely to be higher than normal. As a group, pregnant and lactating animals are probably more susceptible than others.

##### Environmental factors

##### State of pasture

Young, rapidly growing, fresh plants may contain as much as 17% potassium oxalate whilst old, dry plants rarely contain more than 1%, but *Halogeton*, one of the most dangerous plants, becomes more toxic as the growing season progresses, and is most dangerous when frosted and dried, when it may contain as much as 16.6% of soluble oxalate. The grass *Setaria sphacelata*, much favored for tropical conditions, may contain up to 7% oxalate and be associated with acute poisoning in cattle and horses.

#### PATHOGENESIS

Clinical effects vary with the amount of oxalate ingested. With large quantities the major effect is the absorption of free oxalate and precipitation of blood calcium as calcium oxalate to produce a hypocalcemia. Severe nephrosis occurs with precipitation of calcium oxalate crystals in renal tubules. There may be marked damage to vascular tissues, especially in the alimentary tract and lungs. Invasion of the chemical rumenitis that results may lead to an irreversible fungal or bacterial rumenitis or hepatitis.

Continuous ingestion of smaller amounts of soluble oxalates from pastures dominated by *Oxalis pres-caprae* over 2–12 months is associated with a chronic

nephrosis with precipitation of oxalate crystals in the renal tubules. Up to 25% of sheep may be affected in some flocks. Such damage is likely to be cumulative if the sheep are periodically exposed to oxalate-bearing plants.

#### Other syndromes

Include **urolithiasis**, and ruminal dysfunction in sheep due to changes in pH of its contents and interference with cellulose digestion.

#### CLINICAL FINDINGS

Clinical signs may appear within 2–4 hours of eating oxalate-containing plants if the animals are hungry and consume large quantities.

#### Hypocalcemia syndrome

In acutely poisoned sheep, the clinical signs include anorexia, hyposensitivity, paresis, muscle tremor, especially of facial muscles, clear mucus dripping from the nostrils, ruminal atony, dyspnea, hypersensitivity to touch, stumbling gait, and final recumbency with the head turned into the flank, pupillary dilation, and death in coma. The heart rate is rapid, and the ruminal movements are decreased. There may be slight bloating, frequent getting up and lying down, eventually recumbency, frequent attempts to urinate, frothy blood-tinged nasal discharge, and occasionally red-brown urine. In sheep, chronic cases of nephrosis show poor appetite, failure to grow, poor bodily condition, ascites, and a significant anemia. Acute nephrosis in cattle is marked by hyposensitivity leading to coma, recumbency, proteinuria, and elevated blood urea nitrogen levels.

#### CLINICAL PATHOLOGY

Suspected plants should be assayed for soluble oxalate content. Hypocalcemia is a key finding in the acute disease with azotemia in cases with significant kidney damage. In sheep with chronic nephrosis, albuminuria, and sometimes hematuria may be observed, the packed cell volume may be as low as 15–20%, the blood urea nitrogen is of the order of 85 mg/dL (30.3 mmol/L) and there may be an accompanying elevation of blood potassium. The proteinuria is almost diagnostic of the disease in sheep grazing *Oxalis* spp.

#### NECROPSY FINDINGS

There are no gross findings at necropsy which are characteristic of acute oxalate poisoning, but perirenal edema and ascites may be evident in chronic cases. Nephrosis is the standard finding at histopathological examination, and there is usually deposition of birefringent rosettes of crystals in the renal tubules and pelvis, and even in the ureters and urethra. In experimental acute poisoning in the horse

and sheep, severe gastroenteritis and dehydration have been observed.

### Samples for confirmation of diagnosis

- **Toxicology** – samples of suspect feed/forage for identification of plants and assay for soluble oxalate
- **Clinical pathology** – serum or plasma for calcium, urea, and creatine assays
- **Histology** – formalin-fixed kidney (LM).

### DIFFERENTIAL DIAGNOSIS

Diagnostic confirmation is provided by a positive assay of toxic levels of soluble oxalate in the pasture plus the presence of nephrotic kidneys containing calcium oxalate crystals.

#### Differential diagnosis lists:

For the acute syndrome:

- Parturient paresis
- Hypocalcemia due to starvation or forced exercise
- Lactation tetany
- Transport tetany
- Severe toxemia due to coliform mastitis
- Carbohydrate engorgement
- Uremia.

For the chronic syndrome:

- Pyelonephritis
- Obstructive urolithiasis
- Amyloidosis.

### TREATMENT

#### Primary

The parenteral injection of solutions of calcium salts is a specific treatment of the acute hypocalcemic disease. Calcium borogluconate as a 25% solution given IV or SC in doses of 300–500 mL in cattle, and 50–100 mL in sheep usually effects recovery. A proportion of cases will succumb to kidney failure despite treatment.

#### Supportive

Treatment should include the provision of ample fluids to decrease precipitation of oxalate crystals in the urinary tract. There is no recommended treatment for chronic cases.

#### CONTROL

Hungry sheep and cattle should not be allowed to feed on large quantities of the toxic plants. Ample water should be available at all times to facilitate the elimination of the oxalate, but poisoning is likely to occur when hungry sheep are watered and then allowed to graze. Alternative sources of food should be provided for animals grazing pasture dominated by one of the oxalate-bearing plants. Prophylactic feeding of dicalcium phosphate is effective, other calcium salts and bone meal being ineffective, and adequate salt should be made available.

### REFERENCES

1. Jacob RH, Peet RL. Aust Vet J 1989; 66:91.
2. Panciera RJ. J Am Vet Med Assoc 1990; 196:1981.
3. McKenzie RA et al. Aust Vet J 1988; 65:26.

### OXALATE-INDUCED EQUINE NUTRITIONAL SECONDARY HYPERPARATHYROIDISM

#### Synopsis

**Etiology** Grazing of pure or near-pure swards of some tropical pastures.

**Epidemiology** Signs appear after 2 or more months on the pasture.

**Clinical findings** Lameness, swelling of maxillae and/or mandibles; body weight loss.

**Clinical pathology** High blood levels of parathormone, normal blood calcium levels.

**Necropsy lesions** Fibrous osteodystrophy of jawbones, joint surface erosion, parathyroid gland enlargement.

**Diagnostic confirmation** Ratio of calcium: total oxalate in feed less than 0.5 (feed total oxalate > 0.5%), plus biopsy of jaw bone swelling.

### ETIOLOGY

Cases have occurred on pastures of:

- Setaria sphacelata* – setaria
- Cenchrus ciliaris* – buffel grass
- Panicum maximum* – guinea grass, green panic
- Pennisetum* spp.
- Brachiaria* spp.
- Digitaria* spp.

Other species of *Setaria*, e.g. *S. incrassata* (purple pigeon grass), and species of *Urochloa* may also be toxic. Hazardous grasses have a calcium:total oxalate ratio of less than 0.5 and they usually contain more than 0.5% total oxalate in the dry matter.<sup>1</sup> Ruminants grazing the same pastures are unaffected because of ruminal bacterial catabolism of most of the crystals, releasing the calcium for absorption.

### EPIDEMIOLOGY

#### Occurrence

This syndrome has occurred in northern Australia, the Pacific, south-eastern Asia, South America, and southern Africa. It affects horses and donkeys.

#### Risk factors

Animal factors

Horses confined to pure or near-pure swards of hazardous grasses without other sources of feed have developed clinical disease in 2–8 months after starting grazing. All ages and both sexes are susceptible, but nursing mares and weaned foals are more at risk. Removal of affected horses to non-hazardous pasture usually leads to recovery.

### PATHOGENESIS

Water-insoluble calcium oxalate crystals (prismatic or druse types) in the leaf cells of these grasses store most of their calcium. These crystals are not digested in the horse's alimentary tract until they reach the large intestine. Because the main site of calcium absorption in horses is the duodenum, the calcium is unavailable for absorption, thus producing a negative calcium balance in the horse and leading to hyperparathyroidism.

### CLINICAL FINDINGS

Affected horses have a stiff, stilted action, most evident at gaits faster than walking. This progresses to reluctance to move, and recumbency in severe cases. Exercise initiates or exacerbates the lameness. Some affected horses lose weight despite an ample supply of feed. There is bilateral firm swelling of the maxilla, the mandible or both, over the roots of the cheek teeth.

### CLINICAL PATHOLOGY

Concentrations of parathyroid hormone in blood will be abnormally increased. Concentrations of calcium, phosphorus, magnesium, and alkaline phosphatase in plasma do not change consistently from normal. Some horses will have increased concentrations of alkaline phosphatase. Biopsy of the jaw swellings will reveal lesions of *osteodystrophia fibrosa*.

### NECROPSY FINDINGS

Swellings of the jaws, erosions or pitting of joint surfaces, and enlargement of both the upper and lower parathyroid glands are seen. Fractures of bones may occur. Histological lesions of *osteodystrophia fibrosa* are seen in the jaw swellings, osteoporosis in long bones, and hyperplasia in the parathyroid glands.

### DIFFERENTIAL DIAGNOSIS

The syndrome of lameness and bony swelling of the head is distinctive and, in the presence of the plants in the pasture, confirms the diagnosis. The differential list includes:

- Nutritional secondary hyperparathyroidism is identical but is associated with excessive phosphorus intake in hand-fed horses
- Renal hyperparathyroidism is very rare in horses and will be accompanied by signs of uremia.

### TREATMENT

Affected horses should be moved to non-hazardous pasture if possible. Remineralization of the bones can be effected by feeding each horse 2 kg of rock phosphate of low fluorine content, or 2 kg of a mixture of 1 part calcium carbonate and

2 parts dicalcium phosphate weekly for at least 6 months. Each dose of the mineral supplement should be mixed with 3 kg molasses to encourage the horse to eat it. Alternative supplements should contain calcium and phosphorus in the ratio of 2:1. The use of parenteral vitamin D or parenteral calcium preparations is insufficient to correct the problem.

### CONTROL

Horses should not be grazed on hazardous pastures for more than 1 month. A legume component should be encouraged in the pasture to provide an oxalate-free source of calcium. Supplementation of each horse with minerals at half the rate used for treatment will protect them against the disease while grazing hazardous pastures.

### REVIEW LITERATURE

McKenzie RA. In: Plant Toxicology. Proceedings of the Australia-USA Poisonous Plants Symposium, Brisbane, Australia, 14-18 May 1984, eds Seawright, A. A., Hegarty, M. P., James, L. F. & Keeler, R. F. Yeerongpilly 4105, Australia: Queensland Poisonous Plants Committee, Animal Research Institute. p. 150, 1985.

### REFERENCE

1. McKenzie RA. Aust Vet J 1988; 65:329.

## OXALATE (INSOLUBLE CALCIUM OXALATE RAPHAIDE CRYSTAL) POISONING

This is a rare occurrence in agricultural animals because the source of the microscopic needle-like calcium oxalate crystals is limited to a small number of usually-inaccessible horticultural plants:

- Alocasia brisbanensis* – conjevo
- Arisaema* spp. – jack-in-the-pulpit, indian turnip
- Arum* spp., e.g. *A. italicum* – arum lily
- Caladium* spp.
- Dieffenbachia* spp. – dumbcane
- Monstera deliciosa* – monstera
- Philodendron* spp. – philodendron
- Schefflera actinophylla* – umbrella tree
- Symplocarpus foetidus* – skunk cabbage
- Xanthosma* spp.<sup>1</sup>
- Zantedeschia aethiopica* spp. – calla lily.

Goats and horses are more likely to be affected than other livestock. Insoluble calcium oxalate crystals of the needle-shaped, **raphide** form are the probable 'toxins' in these non-grass plants. When their concentration is sufficiently high they are associated with damage to the buccal mucosa. The principal lesion is an erosive stomatitis causing salivation, swelling and protrusion of the tongue, and dysphagia. These are the only significant lesions. Most animals recover from exposure to these plants.

The physical form of the needle-like calcium oxalate crystals in the specialized cells (idioblasts) of members of the *Araceae*

family of plants is the basis for their irritant effects on the buccal mucosa. Calcium oxalate crystals in grasses are structurally different and are prismatic or druses, neither of which are sharp or likely to penetrate mucosa.

### REFERENCE

1. Wood PA et al. J S Afr Vet Ass 1997; 68:2.

## CALCINOGENIC GLYCOSIDE POISONING (ENZOOTIC CALCINOSIS)

### Synopsis

**Etiology** Calcinogenic glycosides in a few specific poisonous plants.

**Epidemiology** Enzoootic disease in all species in regions where toxic plants occur.

**Clinical findings** Chronic lameness, recumbency, wasting, eventual death.

**Clinical pathology** Elevated blood calcium, phosphorus. Tissue calcification visible radiologically.

**Necropsy findings** Calcification of all tissues, degenerative arthritis in all limb joints.

**Diagnostic confirmation** Identification of specific plant.

**Treatment** Nil.

**Control** Avoid toxic plants.

### ETIOLOGY

Calcinogenic glycosides occur in very small quantities in plant leaves. The aglycone (non-sugar) radical is a vitamin D<sub>3</sub> sterol, a 1,25-(OH)<sub>2</sub>D<sub>3</sub>-like compound. Hydrolysis of the glycoside releases the vitamin D<sub>3</sub> analog causing the development of calcification of soft tissues, reminiscent of hypervitaminosis D. The plants in which these glycosides have been identified are *Solanum malacoxylon* (i.e. *S. glaucophyllum*, *S. glaucum*, *S. glaucescens*, *S. glaucumfrutescens*), *Nierembergia veitchii*, and *Cestrum diurnum* (wild jessamine).

Other plants known to be associated with the same disease, and in which the presence of calcinogenic glycosides is suspected, are *Stenotaphrum secundatum* (crab grass) in Jamaica,<sup>1</sup> *S. linnaeanum* (= *S. hermannii*, *S. sodomaeum*) (apple of Sodom), *S. torvum* (devils fig), and *Trisetum flavescens* (yellow or golden oat grass) in Europe.<sup>2</sup>

The plants are weeds of pasture and are readily eaten by livestock. The glycosides are very stable and resist drying and storage for periods of longer than 1 year. Heating reduces the toxicity of *Solanum malacoxylon* significantly, but has little effect on that of *Trisetum flavescens*.

### EPIDEMIOLOGY

#### Occurrence

Enzoootic calcinosis and its causative plants occur in most countries. The

disease associated with *Solanum* spp. occurs in tropical and subtropical regions including Africa, Argentina, Brazil, Papua New Guinea, West Indies, and Hawaii, and *Cestrum diurnum* poisoning in southern United States, especially Florida, Texas, and California. Tentative diagnoses have been made in India and Israel. In Jamaica the disease is known as 'Manchester wasting disease', in Hawaii as 'naalehu', and in South America as 'espichamento' or 'enteque seco'.

In Austria and Germany, *Trisetum flavescens* is a common component of alpine pasture and is associated with the disease about 18 months after cattle are put onto the infested pasture. Resident cattle show clinical signs at about 3 years of age. The grass is most toxic when it is young and the clinical signs are worst when the cattle are at pasture. Silage made from the grass is toxic but hay is not.

### Animal risk factors

Both sexes and all ages of all animal species are affected; ruminants most commonly, horses less so. Pigs and sucking lambs are least susceptible.

### PATHOGENESIS

The glycoside ingested in the plant is hydrolyzed in the rumen by microbial activity, by intestinal mucosal enzymes, and by bone cells, to form the vitamin D<sub>3</sub> analog. Absorption of the active substance results in a dramatic increase in the uptake of calcium from the diet. Blood levels of calcium are markedly increased and this is followed by deposition of calcium in soft tissues. The mode of action of the glycoside is consistent with it having a mode of action similar to that of 1,25-dihydroxycholecalciferol.

### CLINICAL FINDINGS

The disease is chronic and may persist for several years. It is characterized by wasting, reluctance to walk, a stiff gait, constant shifting of the weight from foot to foot, and a disinclination to get up or to lie down. Forced exercise is associated with severe distress; some animals may become aggressive. Affected animals stand for long periods with the back arched and the legs stiffly extended. Calcification of blood vessels may be palpable, for example during rectal examination. Cardiac murmurs are audible. Clinical signs subside if the animals are removed from the causative feed, but resorption of calcium deposits in tissues is minimal even 5 years after removal from the affected pastures. Animals left on the toxic pasture eventually become recumbent and die. Fetuses may be affected.<sup>3</sup>

### CLINICAL PATHOLOGY

There are 20–25% increases in serum calcium (up to 3.4 mmol/L) and serum

phosphorus (up to 4 mmol/L) concentrations. Tissue calcification should be detectable radiologically. Anemia is common in animals poisoned by *Solanum malacoxylon*.

### NECROPSY FINDINGS

Non-specific emaciation, anasarca, and ascites are common. Calcification of all blood vessels, including the aorta and coronary arteries, and of the endocardium is the most readily visible, characteristic lesions. Calcification is also present in the pleura, and the lung parenchyma, which is usually emphysematous, in most other viscera, and in tendons and ligaments. Degenerative arthritis occurs in the limb joints.

### DIFFERENTIAL DIAGNOSIS

The history, clinical findings, and discovery of specific toxic plants provide diagnostic confirmation. Repeated overdosing with vitamin D, by injection or administration in compounded feeds, replicates the clinical and necropsy findings.

### TREATMENT AND CONTROL

No practicable treatment is available. Careful management of affected pasture in Europe has been shown to significantly reduce the losses due to the disease.

### REVIEW LITERATURE

- Mello JRB. Calcinosis – calcinogenic plants. *Toxicon* 41, 1. [Note: *Solanum esuriale* included erroneously], 2003.
- Weissenberg M. In: *Toxicants of Plant Origin*. Ed. Cheeke, P. Boca Raton, FL: CRC Press, 1989.
- Woodard JC. Toxic effects of *Solanum malacoxylon* on sheep bone. *Bone* 1994; 15:1.

### REFERENCES

- Arnold RM, Fincham IH. *Trop Anim Hlth* 1997; 29:174.
- Braun U et al. *Vet Rec* 2000; 146:161.
- Gorniak SL. *Reprod Toxicol* 2003; 17:67.

## CARDIAC GLYCOSIDE POISONING

### Synopsis

**Etiology** Poisoning associated with naturally occurring organic compounds (cardenolides and bufadienolides) found in specific plants which have specific effects on the myocardium.

**Epidemiology** Widespread, in most countries; all species affected. Many toxic plants unpalatable but hay and garden waste containing them are toxic; so are seeds in grains and meals contaminated by them.

**Clinical findings** Two syndromes – acute heart failure and krimpsiekte, comprising poor exercise tolerance, torticollis, dysphagia.

**Clinical pathology** Significant electrocardiographic abnormality, azotemia.

**Necropsy findings** Multifocal myocardial degeneration.

**Diagnostic confirmation** Identification of plant and toxin.

**Treatment** Activated charcoal and fluids by mouth, parenteral atropine and propranolol; plus spasmolytics and analgesics in horses

**Control** Avoid pasture or stored feed containing toxic plants.

### ETIOLOGY

Cardiac glycosides consist of an aglycone, related chemically to the steroidal hormones, and one or more sugar molecules. There are two groups of the very large number of these compounds, the **cardenolides** and the **bufadienolides**, with different chemical characteristics. Bufadienolides in some plants from southern Africa are cumulative and produce chronic nervous system damage, others are found in other plants produce acute toxicity. Toxins in toads, e.g. *Bufo marinus*, have affinities with the aglycones of bufadienolides and can poison dogs but poisoning of farm animals seems unlikely.

The plant genera with species known to contain cardiac glycosides and which can be associated with an acute syndrome or a chronic cumulative disease (cotyledonosis or krimpsiekte) are listed below.

### Acute poisoning:

*Acokanthera (Carissa)*  
*Adenium*  
*Adonis*<sup>1</sup>  
*Antiaris*  
*Apocynum*  
*Araujia*  
*Asclepias*<sup>2</sup>  
*Bersama*  
*Bowiea*  
*Bryophyllum*<sup>3, 4</sup>  
*Calotropis*  
*Cascabela (Thevetia)*  
*Cerbera*  
*Convallaria*  
*Corchorus*<sup>5</sup>  
*Cotyledon*  
*Cryptostegia*<sup>6</sup>  
*Digitalis*  
*Diplarrhena*  
*Euonymus*  
*Gomphocarpus*  
*Gynandris*  
*Haemanthus*  
*Helleborus*  
*Homeria*  
*Hyacinthus*  
*Iris*  
*Kalanchoe*  
*Lidneria*  
*Linaria*  
*Melampyrum*  
*Melianthus*  
*Moraea*  
*Morgania*

*Nerium*  
*Ornithogalum*  
*Ornithoglossum*  
*Parsonia*  
*Scilla*  
*Scrophularia*  
*Sisyrinchium*  
*Strophanthus*  
*Tacazzea*  
*Thesium*  
*Urginea*  
*Vinca*

### Chronic poisoning – Cotyledonosis or krimpsiekte:

*Cotyledon*  
*Kalanchoe*  
*Ornithogallum*<sup>7</sup>  
*Tylecodon*<sup>8</sup>.

### EPIDEMIOLOGY

#### Occurrence

Poisoning occurs wherever the plants grow and local plant-lists need to be consulted for exact details. Many other related plants, and some in other species, are associated with clinical illness similar to those of cardiac glycoside poisoning. The acute poisoning syndrome is seen in several parts of the world, principally in southern Africa, northern America, and in Australia, but chronic poisoning (cotyledonosis or krimpsiekte) is confined to southern Africa.

#### Risk factors

##### Animal factors

Ruminants are most commonly affected, horses less so. Wild animals appear to avoid the plants and some are reputed not to be susceptible. Morbidity rates vary with the intake; case fatality rates are very high.

##### Plant factors

Some of the plants are most readily eaten when they are in the flowering stage. Many are so unpalatable that they are unlikely to be eaten unless they are cut in with other plants and fed as hay, or seed contaminates a crop of feed grain. Some of them, like *Nerium oleander* (oleander), are decorative plants, and animals get access when they break into gardens or are fed prunings. The plants do not lose their toxicity when dry. Insects and other plants that eat or parasitize plants containing cardiac glycosides may contain the substances in significant amounts.

### PATHOGENESIS

Cardiac irregularity and insufficiency, leads to acute or subacute heart failure. Animals that live for several days also develop severe diarrhea. The cardiac arrhythmia is probably the result of the acute effects of cardiac glycosides on the heart, including inhibition of the sodium pump (Na<sup>+</sup>-K<sup>+</sup>-ATPase) of the cardiac muscle cell membrane, enhanced vagal activity and



reduced coronary artery blood flow through vasoconstriction. Prolonged intake of small amounts of toxic material from the cumulative bufadienolide-containing plants in Southern Africa, produce the paraplegic syndrome known as cotyledonosis or krimpsiekte.

## CLINICAL FINDINGS

### Acute poisoning

Common signs are apathy, a tendency to stand with head bowed and abdomen tucked up, teeth grinding or groaning, cardiac arrhythmia (tachycardia or bradycardia, heart block), dyspnea, ruminal atony, bloat, diarrhea with mucoid or blood-stained feces, dehydration, and posterior paresis. Sudden death may occur, particularly during exertion. Poisoning by *Homeria* spp. in some parts of southern Africa only results in constipation rather than diarrhea. Additional signs include drooling of saliva, tenesmus, dribbling of urine, muscular tremors, dilated pupils, and seizures. Pigs are likely to vomit.

### Chronic poisoning

Cotyledonosis or krimpsiekte in small ruminants is characterized by animals lagging behind the flock, tiring easily, walking with the head loosely dangling and then lying down, usually with the head and neck stretched flat along the ground. Many assume a characteristic posture with the feet gathered together beneath the body, the back arched, the head down, and the neck sometimes twisted towards one side. This torticollis can persist for months or years. Signs are aggravated by exertion; hyperesthesia, trembling, and tetanic spasms may also occur. Additional signs include drooping of the lower jaw, drooling of saliva, paralysis and protrusion of the tongue, and dysphagia with accumulation of half-masticated feed at the back of the mouth. Horses have pronounced torticollis and hyperesthesia and may show signs of colic or be paralyzed. Secondary intoxication of dogs or humans who eat meat from affected livestock occurs even after cooking.

## CLINICAL PATHOLOGY

Acute poisoning of sheep by *Homeria pallida* produces progressive hemoconcentration, hyperkalemia, hypochloremia, progressive hyperglycemia associated with rises in catecholamines, cortisol and lactate, and progressive increases in plasma creatinine concentration, plasma  $\alpha$ -hydroxybutyrate, dehydrogenase, and lactate dehydrogenase activities. Acute poisoning of cattle by *Bryophyllum* spp. also produces hemoconcentration, pro-

gressive hyperglycemia, glycosuria, and progressive increases in plasma urea and creatinine concentrations.<sup>9</sup>

Electrocardiographs (ECGs) may show significant changes in the ECG of affected animals indicating the presence of ventricular fibrillation and ectopic foci in the myocardium. These effects of cardiac glycosides on the ECG of livestock include prolonged P-R interval, depressed or elevated ST segment and increased amplitude and inverted T wave. The QRS complex may widen from delayed AV conduction. Other effects include AV dissociation, varying degrees of heart block, evidence of ectopic foci, and runs of ventricular tachycardia.

Because of the sudden death in many cases, the toxic plant can often be identified in stomach contents by botanical characteristics. In digitalis poisoning, the digitoxin can be assayed in the ruminal contents.

## NECROPSY FINDINGS

In acute poisoning, mild-to-severe multifocal myocardial degeneration and necrosis is often present if the patient survives for more than 12 hours. Sub-endocardial and subepicardial hemorrhages and hemorrhages into the mucosa and lumen of the large intestine are common in acute cases. Atelectasis of lung lobules is common, and pulmonary congestion and edema secondary to cardiac failure may be seen. Fragments of the plants responsible for poisoning may be recognized in stomach contents. Nephrosis has been seen occasionally. Hemorrhages of the rumen wall, and necrosis and ulceration of the omasal leaves have been seen in animals affected for several days. Evidence of hepatic insufficiency, including jaundice, is present in some poisonings, but its pathogenesis is unclear.

Toxins may be detected in rumen or stomach contents using chromatographic techniques.<sup>10-12</sup>

## DIFFERENTIAL DIAGNOSIS

The diagnosis depends on the detection of one of the toxic plants, either in the pasture or in conserved roughage, in the environment of animals showing characteristic clinical signs, or sudden death. Diagnosis confirmation is established by identification of the plant, the cardiac glycoside in it, or both, in ingesta in association with myocardial lesions.

### Differential diagnosis list

Other poisonings which are associated with cardiomyopathy and similar clinical signs include:

- *Urechites lutea*
- *Albizia tanganyicensis*, *A. versicolor*
- *Fadogia homblei* (*F. monticola*)

- Fluoroacetate
- *Galenia africana*
- Gossypol
- Ionophore antibiotics, e.g. monensin
- *Pachystigma* spp.
- *Pavetta* spp.
- *Ornithoglossum viride*
- *Pseudogaltonia* (*Lidneria*) *clavata*

and by nutritional deficiencies of:

- vitamin E/selenium
- copper

and other is associated with sudden death.

## TREATMENT AND CONTROL

### Primary treatment

Removal of animals from the suspect pasture or changing the source of conserved roughage is usually obligatory. Activated charcoal is effective. A dose of 5 g/kg is recommended for ruminants and may need to be repeated.

### Supportive treatment

Oral fluid replacement therapy for rehydration (150 mL/kg in divided doses over 24 hours) and parenteral antiarrhythmic drug therapy with atropine (0.5 mg/kg) for heart block and propranolol (5 mg doses to effect) for tachycardia are also recommended.<sup>9</sup> The recovery rate declines sharply with the lapse of time between ingestion of the plant and treatment.

## REVIEW LITERATURE

- Cheeke PR. Cardiac glycosides. In: Toxicants of Plant Origin, Vol 2. ed. Cheeke, P. R. Boca Raton, FL: CRC Press, 1989.
- Kellerman TS, Coetzer JAW, Naude T W. Plant Poisonings and Mycotoxicoses of Livestock in Southern Africa. Cape Town: Oxford University Press, 1988.
- Knight AP. Milkweed poisoning. Comp Cont Educ 1987; 9:F348-349.
- Knight AP. Oleander poisoning. Comp Cont Educ 1988; 10:262.
- Seiber JN et al. In: Handbook of Natural Toxins, Vol 1. Plant and Fungal Toxins, eds Keeler, R. F. & Tu, A. T. New York: Marcel Dekker. p. 43, 1983.

## REFERENCES

1. Davies RL, Whyte PBD. Aust Vet J 1989; 66:141.
2. Salyi G, Petri A. Magyar Allator Lapja 1987; 42:56.
3. McKenzie RA et al. Aust Vet J 1987; 64:298.
4. McKenzie RA et al. Aust Vet J 1989; 66:374.
5. McKenzie RA et al. Aust Vet J 1992; 69:117.
6. Cook DR et al. Aust Vet J 1990; 67:344.
7. Botha CJ et al. J S Afr Vet Ass 2000; 71:6.
8. van Rooyen JM, van der Walt JJ. Onderstepoort J Vet Res 1990; 57:223.
9. McKenzie RA, Dunster PJ. Aust Vet J 1987; 64:211.
10. Galey FD et al. J Vet Diagn Invest 1996; 8:358.
11. Tor ER et al. J Agric Food Chem 1996; 44:2716.
12. Holstege DM et al. J Agric Food Chem 2000; 48:60.



evidence of toxicity in sheep occurs on diets containing 10 mg/kg of dicoumarol. However, significant changes in clotting time do not occur on diets containing less than 20–30 mg/kg. Similar changes commence in lambs and calves when the dietary intake of dicoumarol rises to above 2 mg/kg BW.

Quantitative determination of dicoumarol levels in blood and tissues are now available, and are especially valuable in aborted fetuses and newborn calves in which there may have been inadequate opportunity for clinical examination. High levels of dicoumarol in the feed (20–30 ppm) and in the liver (1 ppm) are supportive evidence.

#### NECROPSY FINDINGS

Subcutaneous hemorrhages and large hematomata occur in areas where normal activity produces mild contusion, such as the flanks, carpal and tarsal joints, and the side of the body where the animal exerts pressure while lying down. Hemorrhages of the peritoneal surface of the rumen and massive retroperitoneal hemorrhage around the kidneys are frequently observed. In contrast to hemorrhages typical of septicemia, extravasation is uncommon in the lungs, kidneys, and adrenals. The carcass is pale and there is no intravascular hemolysis, jaundice, hemoglobinuria, or hemosiderosis. Histological examination is unrewarding, other than as a means of eliminating other potential causes of diathesis, such as vascular diseases. The collection of feed samples and tests required for confirmation of the diagnosis are as described for clinical pathology.

#### DIFFERENTIAL DIAGNOSIS

Diagnostic confirmation is based on detection of dicoumarol, or similar compound, in the feed. Differential list includes those diseases characterized by blood loss anemia resulting from spontaneous hemorrhage:

- Poisoning by other specific plants, with or without their contamination by molds (see above)
- In purpura hemorrhagica, but this disease is uncommon except in horses and rarely affects more than one animal in a group; clotting and prothrombin times are not abnormal, the defect being one of vascular damage
- Angioneurotic edema cases are not usually accompanied by an anemia
- Ptaquiloside poisoning
- Trichloroethylene-extracted soybean meal poisoning, but large extravasations of blood are unusual.

#### TREATMENT

##### Primary

Feeding of the suspected hay or silage should be stopped immediately, but

new cases may continue for up to about 6 days. Vitamin K<sub>1</sub> (naturally occurring vitamin K<sub>1</sub>) is an effective antidote for sweet clover poisoning. A single dose of vitamin K<sub>1</sub> at a rate of 1.1–3.3 mg/kg BW intramuscularly is effective in restoring the prothrombin times to within normal range within 24 hours in cattle which have been fed moldy sweet clover hay containing 90 mg/kg of dicoumarol. Vitamin K<sub>3</sub> (synthetic vitamin K, menadione sodium bisulfite) is ineffective as treatment or prevention.

#### Supportive treatment

Animals with clinical evidence of severe hemorrhage should be given a whole blood transfusion at the rate of 10 mL/kg BW. This will usually return the prothrombin time to normal within several hours.

#### CONTROL

Sweet clover forage must be carefully prepared, and not fed if it is damaged or spoiled during curing. Moldy portions of hay or silage should be discarded and representative samples of suspected feed should be submitted for analysis of dicoumarol content.

If the disease is suspected, discontinue the feed immediately. After 3 weeks, the sweet clover forage may be fed alone, but preferably mixed with another type of unspoiled roughage at the rate of one part sweet clover to three parts unspoiled feed. This mixture should be alternated with unspoiled hay on a weekly basis, or for longer periods if experience shows this to be safe.

Suspected feed should not be fed for at least 3 weeks before surgery such as castration or dehorning. Pregnant cows should not receive sweet clover during the last 3 weeks of pregnancy.

#### REFERENCES

1. Barto JM et al. J Am Vet Med Ass 2000; 216:1605.
2. Runciman DJ et al. Aust Vet J 2002; 80:28.
3. Dyer CJ et al. Aust Vet J 2003; 81:332.
4. Puschner B et al. J Am Vet Med Ass 1998; 212:857.
5. Tligui N et al. Am J Ve Res 1994; 55:1558, 1564.

#### DITERPENOID ALKALOID POISONING

##### Synopsis

**Etiology** Toxic plants in genera *Aconitum*, *Delphinium*, *Erythrophleum* spp. Toxins include aconitine, delphinine.

**Epidemiology** *Delphinium* spp. occur over extensive range lands in USA. Toxic *Erythrophleum* spp. occur in northern Australia, Asia, Africa. Poisoning commonest in cattle; all species susceptible.

**Clinical findings** Tremor, incoordination, paralysis; salivation, vomiting, ruminal tympany; death due to respiratory paralysis or heart failure.

**Clinical pathology** Toxic alkaloids in blood, tissues, and plants.

**Necropsy** Incidental aspiration pneumonia in a few.

**Diagnostic confirmation** Toxic alkaloids in blood and tissues (*Delphinium*).

**Treatment** Physostigmine (*Delphinium*).

**Control** Pasture only on mature *Delphinium* plants; avoid all consumption of *Erythrophleum* plants.

#### ETIOLOGY

Diterpenoid alkaloids occur in *Delphinium* spp. (larkspurs), *Erythrophleum* and *Aconitum* spp. and are associated with poisoning in grazing animals. There are a very large number of alkaloids (not identified here) in five types: aconitine, barbitine, lycocotinine, delphinine, and heteratisine. The number of alkaloids in a single plant species may also be large, e.g. *D. glaucescens* contains 14. All of the alkaloids exert the same effect but they vary widely in their toxicity and in their concentration in plants at different times.

There are over 100 species of these plants but a full alkaloid content profile has been completed in only a few. The commonest species known to contain toxic diterpenoid alkaloids and to be associated with disease in livestock are:

- Aconitum napellus* – monkshood, wolfsbane
- Delphinium barbeyi*
- D. bicolor*
- D. geyeri*
- D. glaucescens*
- D. glaucum*
- D. nuttallianum*
- D. occidentale*
- D. tricornis*
- D. virescens* – larkspurs
- Erythrophleum* spp., e.g. *E. chlorostachys* – Cooktown ironwood.

Some of the species assumed to contain the alkaloids because of their known association with the disease are:

- Delphinium ajacia*
- D. andersonii*
- D. consolida*
- D. elatum*
- D. hybridum*
- D. nelsonii*
- D. parryi*
- D. ramosum*
- D. robustum*
- D. trollifolium*.

The taxonomy of *Delphinium* spp. is unsettled and the nomenclature used may vary from other sources.

## EPIDEMIOLOGY

### Occurrence

North America and Europe are the principal locations of *Delphinium* and *Aconitum* spp. poisonings. *Erythrophleum* spp. occur in Africa, Asia, and Northern Australia.

### Risk factors

#### Plant factors

*Aconitum* spp. are found in the UK and Europe but poisoning occurs rarely. Rangeland larkspurs (*Delphinium* spp.) are important pasture plants in North America. Many of them are associated with heavy mortalities in livestock. The incidence of poisoning varies widely with season and climate, due probably to wide variations in the concentration and chemical composition of specific alkaloids in the subject plants.

#### Animal factors

All animal species are susceptible but most cases are seen in cattle, less often in sheep, and rarely in horses. Cattle may develop a strong aversion, up to 40%, to larkspur plants in the pasture and refuse to eat them after the first exposure. The aversion is associated with identifiable substances in the plant and these are being used experimentally to attempt to control ingestion of the plants. Continued exposure to larkspurs does not reduce either the animals' sensitivity, or their ability to metabolize the alkaloids.<sup>1</sup>

## PATHOGENESIS

Experimentally, tall larkspur administered to cattle produces muscle tremor, ataxia, recumbency, and death from respiratory paralysis. Cattle are more susceptible than sheep. Methyllycaconitine acts as a post-synaptic cholinergic blocker in cattle. Physostigmine appears to be an effective antidote. The skeletal muscle weakness and, later, paralysis, result from the inactivation of the motor unit of the muscle fibers. Some of the alkaloids are known to be associated with malfunction of the neuromuscular junction, but interference with the other parts of the neuromuscular arc is also possible. At sublethal doses, signs peak at 5–9 hours after first appearance, but the effects can be cumulative. The signs in the herd disappear about 4 days after the plant is withdrawn from the diet.<sup>2</sup> The alkaloids in *Erythrophleum chlorostachys* have a cardiac glycoside-like action.

## CLINICAL FINDINGS

Initially in larkspur poisoning there is an episodic weakness with muscle tremor and staggery gait, followed by paralysis of the limbs and recumbency. There is drooling of saliva, vomiting, and ruminal tympany, all probably due to paralysis of the striated muscle of the esophagus. Bloat animals can still belch. Constipation is a common sign and is thought to

be due to failure to drink any water. Diarrhea is reported in *Aconitum* spp. poisoning, possibly due to the presence of additional toxins. Cases that have ingested a lethal dose usually die of paralytic respiratory failure.<sup>3</sup> This may happen after a very short course if the intake of toxin is high. Aspiration of ruminal contents after regurgitation also causes some deaths. In the terminal stages, the pupils are dilated and the pulse and respiration may be barely perceptible.

*Erythrophleum chlorostachys* (ironwood) and *E. guineense* are both poisonous to all animal species. Clinical signs include anorexia, a staring expression, partial blindness, tremor, ataxia, contraction of abdominal muscle, increased heart sounds, mucosal pallor, and terminal dyspnea. Horses poisoned by *E. chlorostachys* have loud and often irregular heart sounds, dyspnea, sporadic contraction of abdominal muscles, and die rapidly.

## CLINICAL PATHOLOGY

There are no specific findings in larkspur poisoning other than identification of toxic alkaloids in plants, ingesta, blood, and tissues. Many cases will be dehydrated because of the inability to drink.

## NECROPSY FINDINGS

There are no specific findings. Aspiration pneumonia may be an incidental finding in some cases.

## DIFFERENTIAL DIAGNOSIS

Differentiation from other plant poisonings causing incoordination, recumbency, and death in cattle on extensive grazing is usually based on botanical identifications. Diagnostic confirmation of larkspur poisoning depends on chemical identification of the causative alkaloids in the rumen contents and the plants. The differential diagnosis list includes:

- *Phalaris* spp. (tyramine poisoning)
- *Paspalum* spp. Infested with *Claviceps paspali* (paspalitre poisoning)
- *Lolium rigidum*, *Agrostis avenacea* infested with grass nematodes, and *Clavibacter toxicus* (tunicaminyluracil poisoning)
- Lead poisoning
- Organophosphorus compounds.

## TREATMENT

### Primary

Physostigmine and carbachol are effective antidotes for *Delphinium* spp. poisoning, but require repeated injections and will have only limited practical value.<sup>4</sup> No specific treatment has been identified for *Erythrophleum* spp. poisoning, but access to immature plants, suckers, and foliage of mature trees should be prevented.

## CONTROL

Control of *Delphinium* spp. poisoning is only possible by careful management of pasture and denying animals' access to badly infested areas. Deferring grazing until after the flowering stage, when the concentration of toxin has declined, avoids poisonings but the quality of the forage has declined badly. Sheep are more resistant to the poisoning than cattle, but are not fond of the plant and may have to be restricted to areas where it does not occur. Weedicides are variable in their efficacy against *Delphinium* spp. and have low efficacy against the deep-rooted perennial species.<sup>5</sup> Attempts to create and maintain a long-standing aversion to the plants to prevent ingestion of them and allow grazing of infested pastures have encountered disabling difficulties.<sup>6,7</sup> Long-term administration of carbachol and supplementation of the diet with salt also have no value as control measures.<sup>8</sup>

## REVIEW LITERATURE

- Knight AP. Larkspur poisoning. *Comp Cont Educ* 1987; 9:F60–F69.
- Olsen JD, Manners GD. Toxicology of diterpenoid alkaloids in rangeland larkspur (*Delphinium* spp.). In: *Toxicants of Plant Origin*, Vol. 1. Ed. Cheeke P. R. Boca Raton, FL: CRC Press, 1989.
- Pfister JA et al. Toxic alkaloid levels in tall larkspur (*Delphinium barbeyi*) in Western Colorado. *J Range Mgt* 1994; 47:355.

## REFERENCES

1. Siemion RS et al. *Vet Hum Toxicol* 1992; 34:206.
2. Olsen JD, Sisson DV. *J Vet Res Am* 1991; 52:488.
3. Pfister JA et al. *J Chem Ecol* 1990; 16:1697.
4. Pfister JA et al. *Vet Hum Toxicol* 1994; 36:511.
5. Ralphs MH et al. *J Anim Sci* 1988; 66:2334.
6. Ralphs MH. *J Range Mgt* 1997; 50:367.
7. Pfister JA et al. *J Chem Ecol* 1997; 23:759.
8. Pfister JA, Manners GD. *J Range Mgt* 1995; 48:343.

## GLUCOSINOLATE POISONING

### Synopsis

**Etiology** Glucosinolates in *Brassica* spp. and related plants used as fodder.

**Epidemiology** Outbreaks in cattle grazing fodder crop or fed crop by-products, especially cake or meal made from residues of oil extraction from seeds.

**Clinical signs** Two syndromes – goiter and reduced growth rates, or diarrhea; depending on the chemical composition of the glucosinolate.

**Clinical pathology** Assay of blood levels of glucosinolate or metabolic end-products.

**Necropsy findings** Goiter.

**Diagnostic confirmation** Positive blood assay of glucosinolate.

**Treatment Primary.** Nil. **Supportive:** symptomatic.

**Control** Avoid toxic plants, meals.

## ETIOLOGY

Glucosinolates are organic substances containing a sulfonated oxime group, combined with glucose in the form of glycosides. The metabolic by-products include isothiocyanates, nitriles, oxazolidinethiones, and carbinols. These plants also contain thioglucosidase (myrosinase), the enzyme needed to hydrolyze the glucosinolate to glucose and the toxic radical. Although the toxic substances may be excreted in cows' milk, the observed goitrogenic effect when the milk is fed may be due to the low iodine content of the milk.

A special group, mustard oil glucosinolates, occurs in the foliage of some plants and is concentrated in their seeds and the seeds of some of the others. Plant sources of glucosinolates are mostly from the family Brassicaceae (Cruciferae) as listed in Table 33.1.

## EPIDEMIOLOGY

### Occurrence

Outbreaks of glucosinolate poisoning are common wherever intensive animal husbandry is practiced, especially where plant wastes from the food industries are fed to livestock in feedlots.

### Risk factors

#### Plant factors

Plants in several uncommon botanical families contain glucosinolates, but animal poisoning is largely limited to the agriculturally important members of the Brassi-

caceae (Cruciferae) family, all members of which contain these substances. The common fodder plants and commercial vegetables listed in Table 33.1 have all been associated with poisoning. Seed oil crops, such as seed rape and mustard seed, may be fed as roughage after the seed has been harvested, and represent a possible source of poison. Large quantities of seed also become available for animal feed, and because of the large quantity fed may be associated with the enteric form of the disease.<sup>1,2</sup> Glucosinolates are present in the vegetative parts of these plants but are in much higher concentration in the seeds. The glucosinolate concentration varies widely between species of plants, e.g. *Brassica napus* is much more goitrogenic than *B. campestris*, and even between cultivars of the same species at different times of the year and under different conditions of growth. Including the rapeseed in ensilage does not reduce its goitrogenicity. Plant stress, including drought and overcrowding of plants, and the feeding of high sulfate diets are known to increase the concentration of the toxin, and small young leaves may contain as much as five times more glucosinolate than large, mature leaves. The high content of sulfate and glucosinolates in cabbages makes it a damaging feed.<sup>3</sup> The commonest and most serious cases of poisoning occur in animals fed rapeseed or rapeseed meal. Diets containing as low as 3% of rapeseed meal may be associated with goiter and

reduced weight gain in pigs. The meal is often fed in amounts up to 20% of the diet. An extensive plant-breeding program has produced varieties of seed rape that have very low concentrations of glucosinolate.

## PATHOGENESIS

Glucosinolate metabolites and the relative proportions of them, produced by enzymatic breakdown of the glucosinolates depend largely on the composition of the glucosinolate present, but factors such as pH also have an effect. There are three groups of glucosinolates, each producing a particular metabolite:

Glucosinolates producing principally **isothiocyanates** – some of these (e.g. allyl-isothiocyanate, 3-butenyl isothiocyanate) are the irritant components of mustard oils, contained in plant seeds, and are irritant to alimentary tract mucosa causing gastroenteritis, diarrhea, and dysentery. Others, present in the leaves of the plants, are hydrolyzed further to form thiocyanate ion. Glucosinolates producing principally **thiocyanate** ion, which, when taken in small amounts over long periods, is a goitrogen. It is likely to be associated with goiter only when the iodine status of the diet is low. This substance reduces iodine capture by the thyroid gland and the condition can be alleviated by the administration of iodine (see also cyanogenic glycoside poisoning, p. 1852)

**Thiones** (e.g. 5-vinylloxazolidine-2-thione or goitrin), produced by the hydrolysis of glucosinolates present in the seeds of cruciferous plants, are more potent goitrogens than thiocyanate ion. They interfere with the synthesis of thyroxine, and iodine is ineffective in the treatment of the poisoning. Clinically, the effects of low level intakes of isothiocyanate and thiones include goiter and a related reduction of the growth rate in the young, and possibly an indirect, depressing effect on reproduction in adults. The reduction in growth rate may be due to the observed hypothyroidism but there is, in addition, a reduction in palatability with diets containing high levels of glucosinolates. This effect is most noticeable in young pigs but may also be evident in high-producing cows

Polioencephalomalacia – there is a positive correlation between cruciferous plants (*Brassica* spp.) and polioencephalomalacia in ruminants, e.g. in **rape blindness**, but the brain lesion is probably associated with the high sulfur content of the plant.<sup>4</sup>

Table 33.1. Plants containing glucosinolates and their botanical families.

### Goitrogenic effect

#### Pasture and forage plants

Rape (syn. Canola)  
Kale, Kohlrabi, Chou Moellier  
Cabbage, cauliflower, Broccoli  
Brussels sprouts, Calabrese  
Chinese cabbage  
Turnip rape, Cole  
Swede, Rutabaga  
Turnip  
Radish

*Brassica napus*  
*Brassica oleracea*  
  
*Brassica chinensis*  
*Brassica campestris*  
*Brassica napobrassica*  
*Brassica rapa*  
*Raphanus sativus*

#### Plant byproducts

Rapeseed oil cake

#### Weeds

Turnip weed

*Rapistrum rugosum*

### Diarrhea, unpalatability, taint effects (caused by mustard oil glucosinolates)

#### Culinary plants

Horse radish  
Cress, mustard greens  
Wild radish  
White mustard  
Black mustard  
Oriental mustard

*Armoracia rusticana*  
*Lepidium*, *Nasturtium*, *Tropaeolum* spp.  
*Raphanus raphanistrum*  
*Sinapis alba*  
*Sinapis nigra*  
*Brassica juncea*<sup>1,2</sup>

#### Weeds

Fanweed  
Charlock

*Thlaspi arvense*<sup>3</sup>  
*Sinapis arvensis*  
*Erysimum cheiranthoides*

NB: The taxonomy of the *Brassica* spp. varies between countries.

Tainting of milk occurs in cows fed plants, more commonly plant seed by-products, containing glucosinolates. The odor and off-flavor are due to volatile thiocyanates and not to isothiocyanates. Treatment of the feed with caustic soda prevents the tainting. Tainting of chicken and turkey meat by diets containing glucosinolates has not been matched by unequivocal evidence of similar problems in mammalian meat, but the occurrence is suspected.

Mustard oil glucosinolates are associated with violent diarrhea, sometimes dysentery, and abdominal pain in animals eating large amounts of seeds. The rape blindness is regarded as a mild form of polioencephalomalacia. No identifiable pathogenesis is advanced as being associated with acute pulmonary emphysema and interstitial pneumonia, or the ill-defined 'digestive disturbance' seen in some outbreaks of poisoning with these plants.

### CLINICAL FINDINGS

#### Goiter

Enlargement of the thyroid may occur at any age, including the newborn of dams fed the plants during pregnancy. Deaths due to hypothyroidism, after a period of hyperthermia, weakness, recumbency, and coma, are more likely in the latter age group. In older animals the accompanying syndrome will be weight loss or failure to gain weight. In bad outbreaks the thyroid is enlarged by 50% in most lambs, with more than 10% showing gross enlargement. Affected flocks have longer than usual gestation periods and lamb mortality is increased three-fold, due to poor vigor of the lambs.<sup>5</sup>

#### Enteritis

Abdominal pain, salivation, vomiting in some cases, diarrhea, dysentery, and a short course with a fatal outcome is common after animals have access to large amounts of reject seeds of these plants.

#### Polioencephalomalacia (rape blindness)

Frank polioencephalomalacia, characterized by blindness, head pressing, aimless walking, ataxia, and recumbency, occurs in cattle, and rape blindness is manifested by the sudden appearance of blindness in cattle and sheep grazing these crops. The eyes are normal on ophthalmoscopic examination; the pupils show some response to light and may or may not be dilated. Complete recovery usually occurs but may take several weeks.

#### Acute pulmonary emphysema and interstitial pneumonia

This has been observed only in cattle. Affected animals show severe dyspnea, with stertorous rapid respiration, mouth breathing, and subcutaneous emphysema.

The temperature may or may not be elevated. Affected animals may survive but often remain chronically affected and do poorly.

### Other unrelated diseases

**Digestive disturbances** in steers on rape are usually accompanied by anorexia, the passage of small amounts of feces, absence of ruminal sounds, and the presence of a solid, doughy mass in the rumen. Only a small quantity of sticky, black material is present on rectal examination. **Photosensitization** and **bloat** are also encountered in cattle grazing rape.<sup>6</sup>

### CLINICAL PATHOLOGY

The clinical pathology of goiter, weight loss, diarrhea, and dysentery are included in the articles on those diseases. Assays of blood levels of glucosinolates and their metabolic products are available. The diet and the pastoral environment should be examined for the presence of the plants and plant by-products known to contain glucosinolates.

### NECROPSY FINDINGS

The goiter, enteritis, pulmonary emphysema, and interstitial pneumonia are non-specific and dealt with at other points in the text. In *Thlaspi arvense* poisoning there may be massive edema of the forestomach walls.<sup>7</sup>

### DIFFERENTIAL DIAGNOSIS

Diagnostic confirmation is detection of glucosinolates in the blood of animals with access to relevant plants or feedstuffs made from them.

#### Differential diagnosis list:

##### Goiter:

- Nutritional deficiency of iodine
- A low-level but continuous intake of cyanogenetic glucosides in, e.g. pasture plants such as *Cynodon aethiopicus*, *C. nlemfuensis* (couch grasses), and *Trifolium repens* (white clover)
- Inherited goiter.

##### Diarrhea with or without dysentery.

There are many infections and toxins associated with diarrhea and dysentery. Those most commonly associated with outbreaks include:

- Arsenic poisoning
- Salmonellosis
- Other poisonous plants in which the toxin has not been identified.

### TREATMENT

#### Primary

There are no specific treatments.

#### Supportive

Attention should be directed at relieving the clinical signs.

### CONTROL

Avoidance of losses can be best achieved by avoiding the use of the poisonous substance or the grazing of the affected area. Some of the goiters can be relieved by the administration of iodine (see under nutritional deficiency of iodine), and avoidance of high sulfate diets reduces the level of glucosinolate production. Plant by-products containing glucosinolate derivatives can be treated with alkali solutions to destroy their toxicity.

### REVIEW LITERATURE

- Cheeke PR. Natural Toxicants In Feeds, Forages and Poisonous Plants. 2nd edn. Danville, Illinois: Interstate Publishers Inc., 1998.
- Fenwick GR et al. Glycosinolates. In: Toxicants of Plant Origin, Vol 2. Glycosides. Ed. Cheeke, P. R. Boca Raton, FL: CRC Press, 1989.

### REFERENCES

1. Kernaleguen A et al. Can Vet J 1989; 30:524.
2. Semalulu SS, Rousseaux CG. Can Vet J 1989; 30:595.
3. Taljaard TL. J South Afr Vet Assoc 1993; 64:96.
4. Hill FI, Ebbett PC. NZ Vet J 1997; 45:37.
5. Alexander G et al. Aust J Exp Agric 1990; 30:749.
6. Morton JM, Campbel PH. Aust Vet J 1997; 75:109.
7. Smith RA, Crowe SP. Vet Hum Toxicol 1987; 29:155.

### INDOLE ALKALOID POISONING

A large number of indole alkaloids occur in fungi, especially the *Claviceps* and *Acremonium* spp. In plants there are also some groups of toxins with similar toxic effects, and similar to those of the fungi. The important two are the  $\beta$ -carbolines and the dimethyltryptamines; and then there are hydroxymethyltryptamines, and a miscellaneous group of alstonine and related toxins. Plants included in the latter group and which are associated with an incoordination syndrome like phalaris staggers are *Gelsemium sempervirens* (yellow jessamine), *Alstonia constricta* (bitter bark tree) and the mushroom *Psilocybe* spp. (mad or magic mushroom). *Poa hueca*, *Urtica* spp. (stinging nettle) are associated with a more acute syndrome of convulsions and sudden death. *Phalaris* spp. are unusual in that they contain both  $\beta$ -carbolines and methylated tryptamines. Related indole alkaloids of the pyrrolidinoindoline type have poisoned livestock in Australia (idiospermuline in *Idiospermum australiense*) and North America (calycanthine in *Calycanthus* spp.), producing tetanic convulsions.

### $\beta$ -CARBOLINE INDOLEAMINE ALKALOID POISONING

There is a long list of carbolines in plants, including harmaline, norharmine, tetrahydroharmine, harmine, harmol, and 3-methyl harmine. Administration of synthetic forms of these compounds is associated with the appearance of clinical

signs identical with those occurring in poisonings with *Peganum harmala* (African or Turkish rue), *Peg. mexicana* (Mexican rue), *Phalaris* spp., *Tribulus terrestris* (caltrop, catshead burr), *T. micrococcus* (yellow vine), *Kallstroemia hirsutissima* (hairy caltrop, carpet weed) and *K. parviflora*.<sup>1</sup> The characteristic syndrome, similar to that of an upper motor neuron lesion, includes hyper- or hypomotility, sometimes sequentially in the same patient, muscle tremor, partly flexed paresis of the thoracic and/or the pelvic limb, hypermetria, a wide-based stance, crossing of the limbs, extension of the neck, swaying of the head, walking backwards, sudden jumping movements, sham eating, and terminal convulsions. The net effect, seen in all farm animal species and camels, is one of easy stimulation, by harassment, of gait incoordination and stumbling, fetlock knuckling, easy falling, and recumbency. The signs appear gradually, are similar to, but less severe than, those associated with the methylated tryptamines and are irreversible. There is axonal degeneration in peripheral nerves. Long-term cases of *T. terrestris* poisoning pivot on their front limbs while their hindlimbs trace a circle. The pivoting is related to the unilateral muscle atrophy of limbs of one or other side.<sup>2</sup>

## DIMETHYLTRYPTAMINE AND PHENYLETHYLAMINE POISONING

### Synopsis

**Etiology** Associated with the ingestion of the *Phalaris* spp. grasses containing dimethyltryptamine (causing an incoordination syndrome), phenylethyltryptamines (causing a cardiac arrest-sudden death syndrome), a thiamine analog (causing a polioencephalomalacia).

**Epidemiology** Outbreaks on lush, rapidly growing pasture; sheep most commonly affected.

**Clinical findings** Incoordination, later convulsions in sheep. In cattle also incoordination of tongue and pharynx. Sudden death cases have very brief course with little to observe.

**Clinical pathology** Isolation of tryptamines in plants and affected animals.

**Necropsy lesions** Green-gray discoloration of renal medulla, medulla oblongata, brain stem.

**Diagnostic confirmation** By detection of tryptamines in body fluids or cadaver.

**Treatment** Nil.

**Control** Limitation of access to causative plants.

- *P. arundinacea* – reed canary grass
- *P. caroliniana*
- *P. brachystachys*
- *P. canariensis* – commercial canary grass
- *P. minor* – wild canary grass
- *P. paradoxa* – paradoxa grass and rhompa grass (a hybrid).

Acute death due to cardiac arrest, originally ascribed to the methylated tryptamines, is now thought to be the related phenylethylamines, and the sudden death-polioencephalomalacia to thiamin analogs produced by the ruminal flora.

### EPIDEMIOLOGY

#### Occurrence

The disease has been recorded in many parts of Australia, New Zealand, South Africa, Spain, California, and South America where the phalaris grasses are in common use as pasture plants. Heavy losses occur on individual farms due to sudden deaths, but careful management relieves the burden of the incoordination syndrome.

#### Risk factors

##### Plant factors

The individual tryptamine alkaloids associated with the disease vary significantly in their toxicity so that plants in a pasture can vary greatly in the danger they present. The concentration of tryptamines in the grass is increased by high environmental temperature and their growing in the shade, and toxicity is greatest when the plants are young and growing rapidly, especially after a break in a dry season. Provision of cobalt appears to stimulate the proliferation in the rumen of microorganisms which are capable of destroying the causative agent, but sheep affected with phalaris staggers do not usually show any signs of cobalt deficiency. Under some circumstances, plants with low tryptamine content will be associated with the syndrome.

##### Animal factors

Up to 30% of a flock may be affected when the *P. aquatica* dominates the pasture or is preferentially grazed. On lightly stocked pastures the **sudden death syndrome**, with signs appearing within 4 hours but usually between 12 and 72 hours after going onto the pasture, is most likely to occur. Deaths are most common in hungry sheep in the early morning or in foggy or cloudy weather. This syndrome is also recorded in cattle on irrigated *Phalaris* spp. pasture in hot humid weather.

The **incoordination syndrome** occurs in similar circumstances, but in sheep that have protracted or repeated exposure. In this case, clinical signs appear 2–3 weeks after sheep are put onto pasture showing new growth, usually in the autumn or

early winter. Both forms may occur in the one flock of sheep, and also in feedlots. Sheep of all ages are affected and mild cases may occur among cattle.

### PATHOGENESIS

The tryptamines, structurally similar to serotonin, are present in the grass under certain conditions and are associated with the incoordination syndrome by a direct action on serotonergic receptors in specific brain and spinal cord nuclei.<sup>3</sup> By interfering with the functions of serotonin, a chemical transmitter in the autonomic nervous system with functions analogous to those of acetylcholine, the alkaloids are associated with both neurological signs and the cardiac abnormalities of tachycardia and ventricular block. The nervous disturbances of the incoordination syndrome are the direct result of dimethyltryptamine, and the cardiorespiratory disorder by phenylethylamine. The nervous disturbance appears to be functional in contrast to that associated with  $\beta$ -carbolines, which is accompanied by axonal degeneration and an irreversible syndrome. The nervous signs are probably tremorigenic, rather than convulsive, so that the limb movements observed are the result of the patient attempting to regain its feet rather than a centrally mediated convulsion.

A characteristic of the disease is a greenish-gray discoloration of the brain stem, diencephalon and dorsal root ganglia, and kidneys. The pigmentation is due to the accumulation of indole-like pigments at the locations where the causative alkaloids act, but the pigments themselves do not have any effect on the signs.

The variability in the numbers affected and the severity of the disability in sheep flocks from day to day appear to be due to the variation in the amount of toxin absorbed, possibly affected by the degree of detoxication of the tryptamines in the rumen. The reduction in severity of an outbreak associated with dietary supplementation with cobalt is thought to be effected in this way.

### CLINICAL FINDINGS

The **sudden cardiac death syndrome** is manifested by sudden collapse, especially when excited, a short period of respiratory distress with cyanosis, and then death or rapid recovery. During the stage of collapse there is arrhythmic tachycardia followed by ventricular fibrillation and cardiac arrest. Consciousness is retained.

The **sudden death-polioencephalomalacia syndrome** cases are rarely observed alive, but occur commonly after short periods of feed deprivation.

In the initial stages of the **incoordination syndrome** in sheep, signs appear only when the animals are disturbed. Hyperexcitability and generalized muscle

### ETIOLOGY

The incoordination syndrome is associated with dimethyltryptamines in:

- Phalaris aquatica* (synonym *P. tuberosa*)
- P. angusta*



tremor, including nodding of the head, occur first. On moving, the limb movements are stiff and the hocks are not bent, causing dragging of the hind feet. Incoordination and swaying of the hind-quarters follow. Some cases walk on their knees, others bound or hop, others knuckle at the fetlocks; some show splaying of the digits. In the most severe cases collapse into lateral recumbency is accompanied by paddling movements of the legs and irregular involuntary movements of the eyeballs. There is rapid respiration and irregular tachycardia. The sheep may die at this stage but if left undisturbed they may recover and walk away apparently unaffected. If the sheep are left on the pasture the condition worsens in individual cases, the animal becoming recumbent and manifesting repeated convulsive episodes until death supervenes.

There is a great deal of variation from day to day in the number of sheep showing signs and in the severity of the signs observed. Even after sheep are removed from the pasture the clinical state may deteriorate and, although some appear to recover, clinical signs can usually be elicited by forcing them to exercise. Deaths are reported to continue for 1 week after removal of sheep from toxic pasture and clinical signs of the nervous form of the disease may persist for as long as 2 months. The extraordinary situation is recorded where new cases continue to occur for as long as 12 weeks after sheep are moved onto pasture that contains no *Phalaris* spp.

In cattle, the signs may be restricted to stiffness of the hocks and dragging of the hind toes, but severe cases similar to the common syndrome in sheep also occur. Additional, and more common, signs observed in cattle include an extraordinary incoordination of the tongue and lips in prehension so that the hungry animal, trying desperately to eat, can onlyprehend a few stalks of grass at a time. The jaw movements are quite strong, but the tongue stabs and darts, and lacks the sinuous curling movements normally present. There may also be an inability to put the muzzle to the ground so that prehension can only be effected from a raised manger or hayrack. Affected cattle are often hyperexcitable and difficult to handle.

#### CLINICAL PATHOLOGY

Laboratory tests on antemortem material can detect the presence of the causative tryptamines in plant material but are unlikely to be generally available.

#### NECROPSY FINDINGS

Other than the characteristic green-gray pigmentation of tissues in the renal medulla, brain stem, midbrain and dorsal root ganglia, gross lesions are absent. Degeneration of spinal cord tracts and of

the ventral portion of the cerebellum has been observed in terminal cases of the incoordination syndrome, but is not a consistent finding. In the sudden death or cardiac syndrome sheep are usually found dead on their sides with their heads strongly dorsiflexed and legs rigidly extended. Some sheep have blood-stained nasal discharges and many have been frothing at the mouth. Abdominal visceral congestion, epicardial and duodenal hemorrhages are present and indicate acute heart failure. Polioencephalomalacia is characteristic of the sudden-death-polioencephalomalacia syndrome.

#### DIFFERENTIAL DIAGNOSIS

The association between the nervous disease and the plants should suggest the diagnosis. The appearance of these signs only on exercise is significant, suggesting a functional rather than a physical lesion. Diagnostic confirmation rests on the identification of the causative tryptamines in the feed materials and the tissues and fluids on antemortem or postmortem examination.

Differential diagnosis lists for the incoordination syndrome:

- Paspalum staggers
- Ryegrass staggers
- Floodplain staggers (tunicaminyluracil poisoning)
- Poisoning associated with marshmallow, stagger weed, and other plants produces a very similar syndrome and the diagnosis must depend on the identification of the toxic plant.

For the sudden death syndrome:

- Annual ryegrass toxicity
- Cyanogenic glycoside poisoning
- Nitrite poisoning.

For the sudden-death-polioencephalomalacia syndrome is as for polioencephalomalacia.

#### TREATMENT

Flocks of affected sheep should be removed immediately from the toxic pasture. There is no specific antidotal treatment.

#### CONTROL

No preventive measures are available against the sudden death syndrome, but the nervous form can often be prevented by the oral administration of cobalt. Affected pastures may be grazed if sheep are dosed with cobalt (at least 28 mg per week) at intervals of not more than 1 week, or if alternative grazing is provided in rotation. Dosing at too long intervals or with inadequate amounts may account for some failures in prevention. The parenteral administration of cobalt or vitamin B<sub>12</sub> is not effective. The additional cobalt can be provided by drenching the sheep individually or spreading it on the

pasture mixed with fertilizer as described under cobalt deficiency. Unfortunately, the genetic selection of *P. aquatica* cultivars with low contents of methylated tryptamines favors a significant increase in toxic  $\beta$ -carbolines.

#### REVIEW LITERATURE

Bourke C.A. The clinico-toxicological differentiation of *Phalaris* spp. syndromes in ruminants. Plant-Associated Toxins. Eds, Colegate, S. M. & Dorling, P. R. CAB International, p. 523, 1994.

#### REFERENCES

1. Bourke CA et al. Aust Vet J 1992; 69:163.
2. Bourke CA. Res Vet Sci 1987; 43:347.
3. Bourke CA. Aust Vet J 1990; 67:356.

### INDOLIZIDINE ALKALOID POISONING

The two indolizidine alkaloids of plant origin are swainsonine and castanospermine both of them affecting cellular enzymic activity. Slaframine is a mycotoxin in this group.

#### SWAINSONINE POISONING

##### Synopsis

**Etiology** Poisoning by *Astragalus*, *Oxytropis*, *Swainsona* spp. is associated with induced mannosidosis.

**Epidemiology** Grazing toxic plants for 2-6 weeks is associated with signs, reversible if pasture changed.

**Clinical signs** Incoordination, paresis, star-gazing posture.

**Clinical pathology** Urine content of mannose-containing oligosaccharides elevated.

**Necropsy findings** Vacuolation of neurones.

**Diagnostic confirmation** Swainsonine can be detected in animal tissues or fluids, but the tests are not widely available.

#### ETIOLOGY

Swainsonine is an indolizidine alkaloid found in *Astragalus*, *Oxytropis* and *Swainsona* spp., and some *Ipomoea* spp. plants.<sup>1</sup> Ingestion of the toxic plants over a long period is associated with an induced lysosomal storage disease in all animal species. The common plants in which the alkaloid's presence has been identified are:

*Swainsona galegifolia*, *S. brachycarpa*, *S. canescens*, *S. grayana*, *S. luteola*, *S. procumbens*, *S. swainsonioides*

*Astragalus lentiginosus*, *A. emoryanus*.

Plants of this genus that are associated with a similar disease, and in which the presence of swainsonine is assumed, are *A. mollisimus*,

*A. northoxys*, *A. lentiginosus* var.

*waheapensis*, *A. lusitanicus*,<sup>2</sup>

*A. wootonii*, *A. thurberi*

*Oxytropis sericea*, *O. ochrocephala*.<sup>3</sup>

Plants of this genus that are associated

with a similar disease, and in which the presence of swainsonine is assumed, are *O. besseji*, *O. condensata*, *O. lambertii*, *O. puberula*.<sup>4</sup>

Swainsonine is synthesized by the fungus *Rhizoctonia leguminicola*, but the disease associated with this fungus is due to its slaframine content.

#### EPIDEMIOLOGY

The disease is most common in North America (as locoism associated with *Astragalus* and *Oxytropis* spp.) and in Australia as Darling pea (*Swainsona* spp.) poisoning, but *Oxytropis* spp. have been associated with poisoning in China. Grazing animals must ingest the plants for at least 2 weeks, more usually 6 weeks, before clinical signs appear. Addiction to these plants, in preference to other available pasture is generally accepted but there is no initial preference for or subsequent addiction to *A. lentiginosus*.<sup>5</sup> All grazing animal species are affected, and experimental administration of the alkaloid to monogastric, farm, and laboratory animals is associated with the typical neuronal lesions. The death rate need not be high if access to the source plants ceases.

#### PATHOGENESIS

Swainsonine is a specific inhibitor of lysosomal  $\alpha$ -mannosidase causing accumulation of mannose in lysosomes and thus widespread neurovisceral cytoplasmic vacuolation. The vacuoles are accumulations of mannose-rich oligosaccharides, including abnormal glycoproteins.<sup>6</sup> Vacuolation reaches its greatest intensity in the central nervous system and this is probably related to the predominance of nervous signs in the disease. Vacuolation of the chorionic epithelium may be related to the occurrence of abortion, and a transient infertility suspected in rams to be the result of a similar lesion in the epithelium of the male reproductive tract.<sup>7</sup> The lesion appears quickly and is reversible if the swainsonine intake ceases. There is no information available about the mechanism by which the accumulated oligosaccharide causes the nervous dysfunction which characterizes the disease. The lesions and clinical syndrome are identical with those in the inherited mannosidoses in cattle and goats except that fetal deformity and abortion occur in the poisoning. The mechanisms for those occurrences are also unknown, although there appears to be a direct link with the combined maternal and fetal mannosidosis.

#### CLINICAL SIGNS

After several weeks of grazing affected pasture adult animals begin to lose condition and young animals cease to grow.

The appetite is diminished and the coat becomes dull and harsh. Several weeks later nervous signs of depression, gait incoordination, muscle tremor, difficulty in rising, in eating and drinking become apparent. Sheep commonly adopt a 'stargazing' posture, and horses may show ventroflexion of the head and rearing over backwards if handled. Cases may become overexcited if harassed. Recovery is likely if the animal is removed from the source of the toxin soon after signs appear. Recovery may be complete or there may be a residual gait incoordination if the animal is excited. Advanced cases may show no improvement and others become recumbent and die. Calves at high altitudes and fed *A. lentiginosus* or *O. sericea* develop a higher incidence of congestive heart failure than calves not fed on the plants.<sup>8</sup>

Pregnant ewes ingesting *Astragalus* spp. plants may abort or produce abnormal offspring. The defects take the form of small, edematous or dead fetuses or skeletal deformity. There are no such abnormalities recorded with *Swainsona* spp.

#### CLINICAL PATHOLOGY

Vacuolation in circulating lymphocytes occurs in poisoning due to *Swainsona* spp., and may have diagnostic significance. Serum levels of  $\alpha$ -mannosidase are significantly reduced and swainsonine levels increased.<sup>9</sup> Swainsonine levels reflect the amount being ingested and not the duration of exposure, and quickly return to normal when ingestion of the plants ceases. The urine content of mannose-containing oligosaccharides is greatly increased during the period of intake of swainsonine.<sup>10</sup>

#### NECROPSY FINDINGS

The characteristic microscopic lesion is fine vacuolation of the cytoplasm in neurons throughout the central nervous system. Similar vacuolation is present in cells of other organs, especially the kidney, and the fetus in animals poisoned by *Astragalus* spp. High blood and tissue levels of swainsonine are detectable, including in frozen material.<sup>9</sup>

In aborted calves, lambs, and foals there is extensive vacuolation of the chorionic epithelial cells. The skeletal deformities include arthrogryposis and rotation of the limbs about their long axis.

#### TREATMENT

Removal of the affected animals from access to source plants may result in partial or complete recovery, provided the cases are not too advanced.

#### CONTROL

Pregnant animals should not be exposed to sources of swainsonine, but other stock may be grazed on the plant without ill effect for short, specified periods, namely

#### DIFFERENTIAL DIAGNOSIS

Diagnostic confirmation depends on identification of the alkaloid.

#### Differential diagnosis list

The combination of gait incoordination and congenital skeletal deformities in *Astragalus* spp. poisoning is also a characteristic of:

- *Conium* spp. piperidine alkaloids
- *Nicotiana* spp. alkaloids
- *Lupinus* spp. quinolizidine alkaloids

The necropsy lesion of cytoplasmic vacuolation is a characteristic of:

- Inherited mannosidosis.

4 weeks for sheep and cattle, and 2 weeks for horses.<sup>10</sup> Attempts to reduce consumption of the toxic plants by creating conditioned reflex aversion,<sup>11</sup> to reduce absorption of ingested swainsonine, or by supplementing the diet with bentonite,<sup>12</sup> have not been rewarding.

#### CASTANOSPERMINE POISONING

Found in the seeds of *Castanospermum australe* (Moreton Bay chestnut), castanospermine inhibits mononuclear cell  $\alpha$ -glucosidase activity so that affected cattle have been misdiagnosed as heterozygotes for generalized glycogenosis type II (Pompe's disease). The seeds are also associated with hemorrhagic gastroenteritis if eaten in large quantities, causing the passage of bloody diarrhea but the cause, originally thought to be saponins, is unknown.<sup>13</sup>

#### REVIEW LITERATURE

- Dorling PR et al. Swainsonine; a toxic indolizidine alkaloid. In: Toxicants of Plant Origin, Vol. 1, Ed. Cheeke, P. R. Boca Raton, FL. CRC Press, 1989.
- Molyneux RJ, James LF. Swainsonine, the locoweed toxin: analysis and distribution. Chapter 10 in Keeler RF, Tu AT (eds) Handbook of Natural Toxins. Vol.6. Toxicology of Plant and Fungal Compounds. Marcel Dekker, Inc., New York. pp. 191-214, 1991.
- Stegelmeier BL et al. The lesions of locoweed (*Astragalus mollisimus*), swainsonine and castanospermine in rats. *Vet Pathol* 1995; 32:289.

#### REFERENCES

1. Molyneux RJ et al. *J Nat Prod* 1995; 58:878.
2. El-Hamidi M, Leipold HW. *J Vet Med A*, 1989; 36:115.
3. Cao GR et al. *Chn J Vet Sci Tech* 1988; 3:41.
4. Moldagulov MA. *Veterinariya, Moscow*, No.1, p. 56, 1989.
5. Ralphs MH et al. *J Anim Sci* 1990; 68:1354.
6. Tulsiani DRP et al. *Arch Biochem Biophys* 1988; 264:607.
7. Panter KE, Hartley WJ. *Vet Hum Toxicol* 1989; 31:42.
8. James LF et al. *Vet Hum Toxicol* 1991; 33:217.
9. Stegelmeier BNL et al. *Vet Hum Toxicol* 1995; 37:336.
10. Stegelmeier BL et al. *Am J Vet Res* 1955; 56:149.

11. Ralphs MH et al. J Range Mgt 1997; 50:361.
12. Pulsipher ML et al. J Anim Sci 1994; 72:1561.
13. McKenzie RA et al. Aust Vet J 1988; 65:165.

## DITERPENE ACIDS AND VASOACTIVE LIPIDS

Phytotoxic abortion, in which serum progesterone levels of the patient are reduced by the effects of the ingested agent, is associated with the ingestion of *Pinus ponderosa* (yellow pine), *P. cubensis*, *P. radiata*, *Cupressus macrocarpa* (Monterey cypress), *Cupressus sempervirens*, and *Cupressocyparis leylandii* (Leyland cypress). These plants are associated with **pine needle abortion** in cattle but the abortifacient activity, originally thought to be estrogenic in origin, remains uncertain but candidate toxins include diterpene acids, including isocupressic acid,<sup>1-3</sup> and vasoactive lipids.<sup>4,5</sup> The tips and bark, and to a lesser extent the needles, of these trees are associated with abortion in cows, but not ewes. Poisoning is most likely to occur when cattle graze amongst the trees and have access to the wilted foliage on lopped or broken branches. Denial of access to pasture by heavy snowfalls may force intense browsing of trees. The fetus in cases of poisoning by *Cupressus* spp. has a typical leukoencephalomalacia.

## REFERENCES

1. Gardner DR et al. J Agri Food Chem 1994; 42:756.
2. Stegelmeier BL et al. Vet Patho 1996; 33:22.
3. Panton K et al. NZ Vet J 1996; 44:109.
4. Al-Mahmoud MS et al. J Agri Food Chem 1995; 43:2154.
5. Ford SP et al. J Amin Sci 1999; 77:2187.

## NITROCOMPOUND POISONING

### Synopsis

**Etiology** Several toxins in the group; miserotoxin in certain *Astragalus* spp. the most important.

**Epidemiology** Disease limited to geographical distribution of the toxic plants; mostly North America.

**Clinical findings** Degenerative lesions in CNS are associated with dyspnea with stertor, incoordination leading to recumbency; long course and high case fatality rate.

**Clinical pathology** Laboratory identification of miserotoxin in blood.

**Necropsy findings** Degenerative lesions in peripheral nerves and spinal cord.

**Diagnosis confirmation** Associated with isolation of miserotoxin in patient tissues and fluids.

**Treatment** Nil.

**Control** Management of pasture to avoid grazing pasture when relevant plants are abundant.

## ETIOLOGY

Nitrocompounds (nitrotoxins) poisonous to animals occur in a number of plants,

especially *Astragalus* spp. They are all glycosides of 3-nitro-1-propionic acid (NPA), or of 3-nitro-1-propanol (NPOH). The only common one is miserotoxin. The best known occurrences of the nitrocompounds are:

- Miserotoxin in *Astragalus canadensis*, *A. emoryanus*, *A. miser*, *A. pterocarpus*, *A. tetraapterus*, and others
- Karakin in *Corynocarpus laevigatus* (karak tree)
- *Oxytropis* spp., a plant genus very similar botanically to *Astragalus* spp., is associated with the same diseases as the latter but its toxic agent has not been identified
- *Coronilla varia* also contains a nitrocompound
- *Indigofera linnaei* (Birdsville indigo), also contains karakin and other nitrocompounds.<sup>1</sup>

## EPIDEMIOLOGY

### Occurrence

The occurrence of these plant poisonings is determined by the presence and ingestion of the specific plants. *Astragalus* and *Oxytropis* spp. are, for the most part, limited in distribution to North America, but poisoning of sheep by *A. lusitanicus* is recorded in Morocco,<sup>2</sup> and of all species by *Oxytropis puberula* in Kazakhstan.<sup>3</sup> *Corynocarpus* spp. occur in New Zealand and *Indigofera* spp. are widespread, occurring in North America, Australia, Africa, and Southeast Asia.

### Risk factors

#### Plant factors

*Astragalus* and *Oxytropis* spp. are herbaceous legumes, most of them perennial, and they dominate the desert range over large areas of the United States. They provide excellent forage. Only some species contain miserotoxin, but this makes them very destructive and very heavy losses of sheep and cattle may occur.

#### Animal factors

Cattle are the more susceptible. Lactating animals are more susceptible than dries. There are reports of the disease in horses in North America,<sup>4</sup> and a similar disease in horses in China after grazing *Oxytropis kansuensis*.

### Importance

Miserotoxin and its metabolic end-products may be excreted in the milk of cows eating these plants.

## PATHOGENESIS

In ruminants the glycosides are hydrolyzed in the rumen to NPOH and NPA. Both are absorbed from the rumen. NPOH is converted in the liver to NPA. NPA may be metabolized to nitrite, and acute poisoning is characterized by signs and necropsy lesions of nitrite poisoning.

Chronic poisoning is associated with the accumulation of NPA and a resulting syndrome, characterized principally by nervous signs and the development of degenerative lesions in the central nervous system. In experimental animals the dose rate and length of exposure to the toxin determine whether the acute or chronic disease occurs.

## CLINICAL FINDINGS

### Acute poisoning

The syndrome of dyspnea, tremor, and sudden death is characteristic of nitrite poisoning. Death may occur as soon as 3 hours after the commencement of signs but the course is more commonly about 24 hours.

### Chronic poisoning

Affected animals lose weight, and develop a poor hair coat, nasal discharge, and poor exercise tolerance. Respiratory distress, with loud stertor (roaring), is more marked in sheep than in cattle and knuckling of the fetlocks and incoordination, followed in some by paraplegia, is more common in cattle. Temporary blindness and drooling of saliva may also be evident. The mortality rate is very high, the course lasting over several months. Animals that recover have a long convalescence. Death may occur suddenly if affected animals are stressed.

*Indigofera linnaei* poisoning in horses (synonym Birdsville horse disease) is associated with weight loss, gait incoordination, easy falling, toe dragging, dyspnea, and convulsions. The plant is equally poisonous when dry or green, although most cases occur in the spring when the plant is succulent. Horses need to graze the plant for about 10 days before signs appear. Characteristic signs include segregation and somnolence, the animal often standing out in the open in the hot sun, apparently asleep, when unaffected horses have sought the shade. There is marked incoordination, the front legs being lifted and extended in an exaggerated manner. The hocks are not flexed, causing the fronts of the hind hooves to be dragged on the ground. The head is held in an unnaturally high position and the tail is held out stiffly. There is difficulty in changing direction and incoordination increases as the horse moves. The horse commences to sway and at the canter there is complete disorientation of the hindlegs so that the animal moves its limbs frantically but stays in the one spot with the legs becoming gradually abducted until it sits down and rolls over. Terminally there is recumbency with intermittent tetanic convulsions, which may last for up to 15 minutes and during which death usually occurs.

A chronic syndrome may develop in some horses subsequent to an acute attack. Affected animals can move about but there is incoordination and dragging of the hind feet with wearing of the toe and inspiratory dyspnea (roaring) may also occur. No lesions have been described in the nervous system of affected animals. *I. linnaei* contains the toxic amino acid, indospicine, an analog of arginine, but poisoned horses do not develop the liver damage typical of intoxication by indospicine. However, supplementation of the diet with arginine-rich protein feeds prevents development of the disease. Peanut meal (0.5–1 kg/day) and gelatin provide readily available and cheap sources of arginine.

### CLINICAL PATHOLOGY

Laboratory findings related to the methemoglobinemia of nitrite poisoning are discussed under nitrite poisoning. Laboratory procedures for the determination of blood levels of miserotoxin and NPOH and NPA are available.<sup>4</sup>

### NECROPSY FINDINGS

Brown discoloration of the blood, and extensive petechiation in tissues, are common findings in the acute form of the disease. In the chronic disease there are degenerative changes in the spinal cord and peripheral nerves, especially the sciatic nerve. Gross lesions include pulmonary emphysema and pneumonia.

### DIFFERENTIAL DIAGNOSIS

The differentiation of association with nitrite poisoning is discussed under that heading. The syndrome of a chronic course, dyspnea, and incoordination, with or without paraplegia, is also common. Diagnosis confirmation depends on the identification of the poisonous plants in the environment and the toxins in the plants and animal tissues.

#### Differential diagnosis list (chronic form)

- Phalaris staggers
- Rye-grass staggers
- Paspalum staggers
- Chronic cyanide poisoning.

### TREATMENT

**Primary** treatment for acute poisoning is described under nitrite poisoning. There is no treatment for the chronic form of the disease, although some cases may recover spontaneously after a recovery period of several months.

### CONTROL

Control of the growth of the plants by stimulating growth of competitive grasses, or the widespread use of selective herbicides, is recommended but unlikely to be a practicable procedure in many of

the situations in which the plants occur. Experimentally, the use of some herbicides significantly reduces the content of miserotoxin in *A. miser* var. *oblongifolia* in pasture. Variations between species of *Astragalus* spp. in their capacity to produce miserotoxin and store selenocompounds (some of them, e.g. *A. toanus*, do both) provides opportunities to manipulate the grazing of particular fields to best advantage.<sup>5,6</sup>

### REVIEW LITERATURE

Majak W, Pas MA. Aliphatic nitrocompounds. In: Toxicants of Plant Origin, Ed. Cheeke, P. R. Boca Raton, FL: CRC Press, 1989.

Pass MA. Toxicity of plant-derived aliphatic nitrotoxins. Chapter 97 in Colegate, S.M. & Dorling, P.R. (eds) Plant-associated Toxins, CAB International, Wallingford UK, pp. 541–545, 1994.

### REFERENCES

1. Majak W et al. Phytochemistry 1992; 31:2393.
2. El-Hamidi M, Leipold HW. J Vet Med 1989; 36:115.
3. Moldagulov MA. Vet Moscow, 1989; No. 1:56-57.
4. Majak W, Pass MA. In: Toxicants of Plant Origin. Ed. Cheeke, P.R. Boca Raton, FL: CRC Press, 1989.
5. Williams MC, Ralphs MH. Weed Sci 1987; 35:746.
6. Williams MC. Range Mgt 1989; 42:366.

### PHYTOESTROGEN POISONING

#### Synopsis

**Etiology** Hyperestrogenism is associated with phytoestrogens, usually in pasture legumes.

**Epidemiology** Pastures dominated by specific strains of legumes, in lush growth mode, or hay or ensilage made from such pasture, is associated with problems if exposure is prolonged. Sheep much more susceptible than cattle.

**Clinical signs** Severe flock infertility, in cows, prolongation of estrus periods, interestrus periods shortened.

**Clinical pathology** Positive estrogen assay in blood.

**Necropsy findings** Ewes – cystic endometrial degeneration.

**Diagnosis confirmation** Elevated serum estrogen levels.

**Treatment** Nil.

**Control** Grazing management, use of low-phytoestrogen cultivars.

### ETIOLOGY

Important estrogenic substances found in plants and fungi include:

- Plants – coumestans (coumestrol, 4-methoxycoumestrol, repensol, trifoliol); isoflavones (daidzein, formononetin, genistein, biochanin A); isoflavan (equol)
- Fungi – resorcylic acid lactones (zearalenone).

Compared to pharmaceutical agents these substances have low estrogenic

activity but they are associated with serious clinical effects because of the high concentrations they reach in some plants, and the daily intake over long periods. The coumestans occur most commonly in plants of the *Medicago* genus, isoflavones most commonly in the *Trifolium*, *Baptisia*, and *Cytisus* genera. Only *Medicago* and *Trifolium* spp. are of any importance to animals. Those likely to contain sufficient amounts to be associated with disease are:

*Fusarium roseum*; contains zearalenone

*Glycine max* – soybean; contains coumestans and isoflavones; affects pigs

*Medicago sativa* – alfalfa, lucerne; contains coumestans; affects cattle, sheep

*Trifolium alexandrinum* – isoflavones

*T. alpestre*<sup>1</sup> – alpestrine clover; contains isoflavones

*T. pratense* – red clover; contains isoflavones; affects sheep

*T. repens* – white clover, Ladino clover; contains coumestans

*T. subterraneum* – subterranean clover; contains isoflavones; affects sheep.

### EPIDEMIOLOGY

#### Occurrence

Animals at pasture are at the greatest risk but poisoning can also occur on diets containing prepared feeds such as soybean (*Glycine max*) meal, or moldy feed containing *Fusarium roseum*.

#### Risk factors

Plant factors

The estrogenic activity of pastures depends on the degree of domination of the pasture by the toxic plants, the variety of the plant species, and the duration of the animal's exposure to them. Newly sown pastures are usually most toxic because of domination by the sown legume. Pastures deficient in phosphorus are also likely to be clover-dominant. High nitrogen fertilizer applications reduce phytoestrogen content. Varieties of *Trifolium subterraneum*, e.g. Yarloop, Dwalganup, Dinninup and Geraldton, are much more toxic than Bacchus Marsh and Daliak. Pastures containing more than 30% of the first four varieties are likely to be unsafe. In some clovers, e.g. red clover, the estrogen content varies with the season, being high in early spring, low in midsummer, and high again in the autumn, after the hay has been taken off. Insect damage to pasture can increase its estrogen content 10-fold, bacterial infection, e.g. by *Pseudopezzia medicaginis*, a leaf-spotting organism on alfalfa, and fungal infection can increase it 100-fold. Plants that have matured in the field and set seed have no estrogenic potency, but

the making of potent fodder into hay causes little depression of estrogen content. Clover ensilage can contain high levels of estrogens and the ensiling process is considered to increase the estrogenic effect of clover three- to fivefold.

*Trifolium repens* (white clover, in contradistinction to Ladino clover), does not have a high content of estrogens. However, when heavily infested with fungi it can contain significant amounts. It is believed that the production of estrogens is a by-product of the plant's mechanism of resistance to the fungal infection. Ladino clover, a large-growing variety of white clover, may contain large quantities of a highly active estrogen (coumestrol), and when it dominates a pasture and is grazed when the pasture is lush, it may be associated with the cornification of vaginal epithelium and functional infertility in ewes. Three estrogenic compounds have been isolated from *T. pratense* (red clover), and where this plant dominates the pasture a clinical syndrome similar to that associated with subterranean clover may be observed. Ewes grazing on red clover pasture, especially a toxic cultivar of the plant, may have their conception rate at the first mating cycle reduced from 75% to as low as 25%.

#### Animal factors

Sheep eating a lot of estrogenic clover in the spring can become temporarily infertile, but are normally fertile again by the usual breeding season in the autumn. However, ingestion of the plant in several successive years is associated with '**permanent clover disease**' – infertility from which ewes do not recover. The disease is important only in sheep. Cattle are generally considered to be unaffected but the subject is still a controversial one with the weight of evidence against cattle being affected. For example, cows can ingest large amounts of estrogens (over 40 g/day/cow) in red clover without showing any reduction in reproductive efficiency. Horses usually graze the toxic pasture without ill-effects.

#### Importance

Massive reproductive wastage has been experienced in sheep on pastures dominated by such plants as *Trifolium subterraneum*, and the death rate due to dystocia and prolapse of the uterus can also be high. The most commonly observed abnormality is a failure to conceive, even with multiple matings, and the flock breeding status worsens progressively, with the lambing percentage falling from a normal 80% down to 30%. Under these conditions sheep farming becomes unprofitable and large areas of country have been made unsuitable for sheep-raising by this disease.

#### PATHOGENESIS

Much of the metabolism of phytoestrogens in ruminants occurs in the rumen, as well as in the liver. The differences between sheep and cattle in the ruminal metabolism of these compounds are thought to be the reason for the comparative freedom of cattle from the clinical disease.

The amount of phytoestrogen ingested by a ewe on a highly poisonous pasture may equal her daily estrogen secretion at the peak of her estrus cycle. The effect of the phytoestrogens is exerted mainly on the uterus and ovaries. Structurally, there is hyperplasia and hypertrophy of the epithelium of the uterus, vagina, and cervix, and dysplasia of the granulosa cells of the ovary, with a consequent reduction in secretion of estradiol. Increases in teat size and milk secretion are additional, secondary effects.

The functional abnormality is not one of estrus; in sheep the demonstration and duration of estrus may be normal or depressed, and the defect is one of **sperm transport** due to changes in the composition of cervical mucus, and the structure of cervical glands. The change is to more watery mucus and this is the basis of a test in affected sheep in which the watery mucus is more readily absorbed by a cottonwood plug inserted in the vagina. The increased weight of the plug is a positive test.

It is possible that a good deal of the infertility seen in ewes on improved clover pasture may be associated with its high estrogen content, in spite of the absence of the more dramatic evidence of hyperestrogenism described above. Because of the necessity to utilize this pasture, a great deal more needs to be known about the seasonal occurrence of the estrogenic substances and the management of sheep grazing the pasture so that the effects of the disease can be minimized.

Another syndrome associated with subterranean clover and unrelated to the infertility syndrome is that of **obstructive urolithiasis** in sheep, discussed under that heading. This disease occurs in outbreaks in spring in Merino wethers grazing estrogenic strains of the clover. As the isoflavone concentrations in the plants rise, the daily excretion of phenols and acid-precipitable material in the urine increases, so does the occurrence of obstruction by the characteristic soft yellow calculi containing benzocoumarins.

#### CLINICAL FINDINGS

##### Ewes

**Clover disease**, the severe clinical manifestation of the poisoning, and rarely seen today, includes dystocia, prolapse of the uterus or vagina, and severe infertility in ewes. Wethers show teat elongation,

mammary gland and bulbourethral gland enlargement. Deaths occur in both groups. The more common, and less severe, field expression of phytoestrogen poisoning is a significant fall in fertility rate. The infertility may be temporary, normal reproductive efficiency returning soon after the ewes are moved to clover-free pasture. In ewes exposed to a low level intake of estrogens over a long period, e.g. in excess of two grazing seasons, a process of irreversible 'defeminization' may occur. This is a state of permanent subfertility. The estrus cycle is normal, the main problem being the failure of an abnormally large number of ewes to conceive.

In affected flocks there may also be a high incidence of maternal dystocia due to uterine inertia, or failure of the cervix or vagina to dilate. Affected ewes show little evidence of impending parturition and many full-term fetuses are born dead.

Because of the similarity between this form of the disease and the disease '**ringwomb**' in ewes in the UK, it has been suggested that the latter may be associated with an excessive intake of phytoestrogens. The mortality rate in lambs may be as high as 40%, and 15–20% of ewes may die of metritis and toxemia. Uterine prolapse may also occur in unbred and virgin ewes and in mature ewes some months after lambing. The incidence of prolapse is usually 1–2% but may be as high as 12%. There is marked udder development and copious milk secretion in the ewes.

##### Male castrates

Wethers may also secrete milk, and metaplasia of the prostate and bulbourethral glands is evident. These can be detected at an early stage of development by digital rectal palpation. Continuing hyperplasia and cystic dilatation of these glands is associated with their prolapse in a subanal position, followed by rapid weight loss and fatal rupture of the bladder. Rams usually show no clinical abnormality and their fertility is not impaired.

Neither clover disease nor permanent subfertility occurs in **cows**. Temporary infertility, discharge of cervical mucus, and swelling of the mammary gland, the vulva, and uterus, have been recorded. Obstructive urolithiasis is described in Chapter 11.

#### CLINICAL PATHOLOGY

Laboratory assays of endocrines are available and essential to diagnosis and monitoring of feed contents of phytoestrogens. Chemical assays are not as sensitive as biological assessments based on increased size of genitalia in subject animals.

#### NECROPSY FINDINGS

In the worst cases there is severe cystic degeneration of the endometrium. Similar

clinical and histopathological changes have been produced by the daily injection of 0.03 mg of diethylstilbestrol per ewe for a period of 6 months. There is also a long-term change in the cervix with an increased incidence of cervicitis and a histologically observable transformation to a uterine-like appearance. In ewes on a long-term intake of toxic pasture, the lesions include elevation of the tail head, partial fusion of the vulvar labia, and clitoral hypertrophy.

#### DIFFERENTIAL DIAGNOSIS

Diagnostic confirmation of phytoestrogen poisoning requires laboratory assay of feed, blood, and tissue, and the appearance of genital pathology at necropsy or via peritoneoscopy or uterine biopsy. Differential diagnosis list – the only other diagnoses of the distinctive hyperestrogenism syndrome of phytoestrogen poisoning are:

- Overdosing with a pharmaceutical preparation as part of a program to improve fertility in a herd
- Overdosing by implant or feed additive with a growth stimulant which has estrogenic capability.

#### TREATMENT

Administration of testosterone is a logical response to poisoning but appears to be an unlikely commercial proposition.

#### CONTROL

Avoidance of high estrogenic activity strains of the respective plants, grazing management to avoid dangerous pasture at the most toxic part of the season, dilution of the estrogen intake by providing additional, alternative feeds, are all used. Prevention of clover disease can only be achieved by proper management of sheep and pasture to avoid ingestion of excessive amounts of estrogens. Vaccination with a phytoestrogen-immunogenic protein conjugate has produced good levels of antibodies, but has not been successful in preventing the problem. Careful management of flocks on estrogenic pasture can significantly improve reproductive output.<sup>2</sup>

#### REVIEW LITERATURE

Adams NR. Phytoestrogens. In: Toxicants of Plant Origin, vol. 4, Ed. Cheeke, P. R. Boca Raton, FL: CRC Press, 1989.

#### REFERENCES

1. Vetter J et al. Magy Allatorv Lapja 1991; 46:665.
2. Little DL. Aust Vet J 1996; 73:192.

#### PTAQUILOSIDE POISONING

Ptaquiloside is a carcinogen, found in the ferns *Pteridium* spp. (bracken), *Cheilanthes sieberi* and *Onychium contiguum* (fuh); the former two also contain thiaminases. In ruminants, two principal syndromes

occur. Ingestion of the plants for 2–4 weeks is associated with hemorrhagic disease known widely as bracken poisoning, here referred to as osteomyelotoxic ptaquiloside poisoning to differentiate its bone marrow-damaging effects from its carcinogenic effects and to avoid the use of 'acute' ptaquiloside poisoning which is a misnomer. Ingestion of much smaller amounts of the ferns over a period of years is associated with bovine enzootic hematuria, the carcinogenic manifestation of ptaquiloside poisoning. Other less well-known diseases associated with ptaquiloside are intestinal carcinomas of sheep and cattle, and bright blindness of sheep.

#### OSTEOMYELOTOXIC PTAQUILOSIDE POISONING (POISONING BY BRACKEN (*PTERIDIUM* SPP.) AND MULGA OR ROCK FERN (*CHEILANTHES SIEBERI*))

##### Synopsis

**Etiology** *Pteridium* spp. (bracken), *Cheilanthes sieberi* (rock fern).

**Epidemiology** Most common in cattle grazing young fronds. Signs appear after 2 weeks on affected pasture.

**Clinical findings** High fever, severe diarrhea, dysentery. Ecchymotic hemorrhages in mucosae.

**Clinical pathology** Depression of bone marrow activity with pancytopenia.

**Necropsy findings** Multiple hemorrhages plus bacterial invasion in all tissues.

**Diagnostic confirmation** Laboratory identification of ptaquiloside not generally available. Clinical signs and exposure to plant plus pancytopenia, low platelet count, abnormal bone marrow.

**Treatment** Blood transfusion.

**Control** Bracken eradication.

#### ETIOLOGY

Ptaquiloside (PT) is a norsesquiterpene glucoside of the illudane type found in some ferns and used to reproduce depression of the bone marrow, hematuria, bladder and bowel neoplasia, and retinal degeneration in experimental animals. Ferns known to contain ptaquiloside are *Pteridium* spp. (the bracken ferns), *Cheilanthes sieberi* (mulga fern or rock fern),<sup>1</sup> possibly other *Cheilanthes* spp., and *Onychium contiguum* (fuh). The fern commonly called bracken is in fact several different species of *Pteridium* in various parts of the world, known toxic species of which are *P. aquilinum* in northern temperate countries, *P. esculentum* in Australia and New Zealand, and *P. revolutum* in northern Australia and Asia. All species should be regarded as toxic. Large amounts of the plants must be eaten before poisoning occurs. Other cytotoxins

in bracken are quercetin, shikimate and cyclohexanecarboxylate, but no relationship between them and animal disease has been established.<sup>2</sup>

#### EPIDEMIOLOGY

##### Occurrence

Bracken fern poisoning occurs in most countries as a sporadic disease. Although the losses are usually small because of the high intake of the fern required to produce illness, heavy mortalities have been observed in some outbreaks. *Cheilanthes sieberi* (mulga fern or rock fern) poisoning is confined to Australia.

##### Risk factors

###### Plant factors

The toxicity of bracken varies significantly with its geographical distribution within countries, e.g. plants from southern Australia may contain twice the concentration of ptaquiloside than those from the north, suggesting genetic variation.<sup>3</sup> Toxicity also varies with the stage of growth and time of the year, younger plants being more toxic. The underground stems (rhizomes) and the curled new fronds (croziers) of the fern also contain the toxic principle in approximately five times the concentration of that found in mature fronds, and have been used to produce the disease experimentally in cattle. In most outbreaks, cattle have had access to the plants in their grazing for 2–4 weeks. Bracken is most prolific and most dangerous on light sandy soil where its wide climatic and soil type tolerance quickly lead to its domination of the pasture. In these circumstances it is very difficult to control or eradicate.

*C. sieberi* grows in close association with pasture grasses or in large numbers in mulga (*Acacia aneura*) communities in eastern Australia, and infrequently is associated with disease in livestock. They are most hazardous after drought-breaking rain.

###### Animal factors

The disease is most common in, and highly fatal to, cattle. Sheep are very rarely affected by bracken poisoning but natural outbreaks have been recorded<sup>4</sup> and it has been produced experimentally in them by feeding the fern over a very long period. Cattle allowed access to recently plowed fields of bracken eat the rhizomes avidly and may suffer heavy mortalities.

Meadow hay may contain toxic amounts of bracken, and animals at pasture may eat large quantities, especially when young, green fronds appear after drought or burning off or when other forage is sparse. Bracken used as bedding may also be ingested in dangerous amounts by animals with a poor nutritive status.

### Importance

The toxin is excreted in the milk in significant quantity, and has been associated with neoplasia in the offspring of experimental animals drinking it. The toxin is thought to have health significance for humans drinking milk from their own bracken-grazing cows, or water which has percolated through fields containing bracken populations. Dilution of the toxin in metropolitan pasteurized milk supplies probably eliminates any significant human health risk from that source.

### PATHOGENESIS

Bracken fern poisoning in ruminants is manifested by the depression of bone-marrow activity, prolonged bleeding time, and defective clot retraction but with normal prothrombin times.

In the bone marrow there is depression of granulopoiesis and thrombopoiesis. The myeloid cells are particularly affected, leading to a severe reduction in circulating platelets and granular leukocytes. The erythrocyte series in bone marrow is affected, but only in the terminal stages.

Bacteremia is a significant part of the pathogenesis in osteomyelotoxic ptaquiloside poisoning. The suggested pathogenesis is that hemorrhage into the alimentary mucosa or submucosa occurs as a result of the thrombocytopenia, and ulcers develop at these hemorrhage sites. Bacterial invasion is facilitated by the neutropenia, and the resulting bacteremia may be associated with infarction in the liver if small vessels are blocked by clumps of bacteria, or the organisms may be carried into the systemic circulation and be associated with infarction in other organs, including the kidneys, lungs, and heart.

The capillary fragility, intestinal ulceration, and laryngeal edema that occur in some cases are thought to be due to damage to tissue mast cells and the liberation of histamine.

### CLINICAL FINDINGS

Initially, there is loss of condition and dryness and slackness of the skin. Clinical signs occur suddenly and include high fever (40.5–43°C, 105–109°F), severe diarrhea with dysentery or melena in most cases, bleeding from the nose, eyes and, vagina, and drooling of saliva. Nasolabial ulcers and hematuria may be observed. Petechial and ecchymotic hemorrhages may be visible under mucosae and skin, and in the anterior chamber of the eye. An increase in respiratory and heart rates occurs at this stage. Death usually follows in 1–3 days.

Cattle may continue to become ill for up to 6 weeks after being taken off the bracken fern. Calves 2–4 months of age show essentially the same clinical and

necropsy picture as adult animals, except that marked bradycardia and death from heart failure occur, and a laryngitic form, with marked dyspnea due to laryngeal edema, is not uncommon. Although only a few animals in a group are affected, most of those showing clinical signs die.

Sheep grazing dense stands of young bracken for periods of 2 or more months may develop a less severe form of the hemorrhagic disease.<sup>4</sup> The sheep lose weight, are depressed, lethargic and exercise-intolerant, anorexic, and anemic. The anemia is normocytic and hypochromic, and is accompanied by a leukopenia (lymphopenia and granulocytopenia) and, at necropsy, a gross deficiency of bone marrow, and widespread petechial and ecchymotic hemorrhages.

### CLINICAL PATHOLOGY

Estimations of the occurrence of platelets in blood smears appear to be the most valuable laboratory test in diagnosis and prognosis of the disease. Platelet counts fall gradually from normal levels of about 500 000/ $\mu$ L to about 40 000/ $\mu$ L just before death. Total leukocyte levels fall gradually at first and then precipitously to about 1000/ $\mu$ L in the terminal stages. Polymorphonuclear leukocytes are the most profoundly depressed and often none are visible in a smear.

Bone-marrow biopsy is valuable as an indication of the status of the platelet and granulocyte series. Increase in capillary fragility is detectable, and defective clot retraction is also a feature of this disease. A fall in erythrocyte count and hemoglobin content may be detectable in the late stages. Depression of erythropoiesis is more marked in sheep than in cattle. Urine examination may reveal the presence of erythrocytes and many epithelial cells.

### NECROPSY FINDINGS

Death is due to the effects of multiple internal hemorrhages, combined in some cases with bacteremia. The hemorrhages, varying in size from petechiae to large extravasations, occur in all tissues. In some organs, particularly the alimentary tract mucosa, necrosis, and sloughing occur over the hemorrhages. Areas of edema are also common in the gut wall, and particularly around the pharynx in calves. The bone marrow is paler than normal. Multiple small, pale, or red areas representing infarcts and areas of necrosis are present in the liver, kidney, and lungs.

### DIFFERENTIAL DIAGNOSIS

Diagnosis confirmation is by identifying the typical signs and lesions in cattle having access to bracken, plus hematological examination of thin blood smears for

platelets in live animals, and bone marrow histopathology from necropsies.

### Differential diagnosis list

Osteomyelotoxic ptaquiloside poisoning may be readily confused with many of the acute septicemias and other hemorrhagic diseases of cattle, including:

- Anthrax
- Septicemic pasteurellosis
- Furazolidone poisoning
- Trichlorethylene-extracted soybean meal poisoning
- Sweet clover poisoning
- Pyrexia-pruritis-hemorrhage syndrome
- Radiation injury.

However, bacteriological findings in ptaquiloside poisoning are negative for these specific infections except for the occasional occurrence of a *Pasteurella* septicemia.

### TREATMENT

Supportive treatment may include antibiotics and blood transfusions in those animals in which serious depression of erythrocyte and leukocyte counts have occurred. The transfusions should be large and 4.5 L is considered to be a minimum dose in adult cattle.

### CONTROL

Fields containing large quantities of bracken fern should not be harvested for hay, and animals forced to graze affected areas should be supplied with a supplementary diet when the pasture is short.

### CARCINOGENIC PTAQUILOSIDE POISONING

The diseases associated with years of ingestion of brackens, *Cheilanthes sieberi* or *Onychium contiguum*, are bovine enzootic hematuria and alimentary tract neoplasia.

### BOVINE ENZOOTIC HEMATURIA

#### Synopsis

**Etiology** Long-term ingestion of bracken, *Cheilanthes sieberi* or *Onychium contiguum*.

**Epidemiology** Enzootic to areas with significant populations of specific ferns. Fatal, chronic disease of adult cattle.

**Clinical signs** Hematuria, anemia, sometimes palpable lesions in bladder.

**Clinical pathology** Hematuria.

**Necropsy findings** Hemangiomas and other neoplastic lesions in bladder mucosa.

**Diagnostic confirmation** Bladder lesion histopathology.

**Treatment** Nil.

**Control** Eradication of bracken.

### ETIOLOGY

Chronic ptaquiloside poisoning due to the ingestion of *Pteridium* spp., *Cheilanthes*



*sieberi* or *Onychium contiguum*<sup>1</sup> is associated with enzootic hematuria in cattle. A high incidence of vesicular carcinomas, similar to the bladder lesions of enzootic hematuria in cattle, has also been recorded in sheep grazing bracken for long periods.

### EPIDEMIOLOGY

Enzootic hematuria occurs as an area problem on all continents. The overall incidence is not great, but the disease may be associated with heavy losses in areas where bracken is a common plant. The disease is usually fatal. Cattle over 3 years of age are most commonly affected, and the disease has also been recorded in sheep and water buffalo exposed to infested pastures for periods exceeding 2 years. The disease occurs mainly on poor, neglected or recently opened up land, and tends to disappear as soil fertility and land management improves. It is not closely associated with a particular soil type, although it is recorded most commonly on lighter soils. The ptaquiloside content of bracken varies considerably between geographical locations and there is good correlation between its concentration and neoplasia in rats fed bracken from those areas.<sup>3</sup>

### PATHOGENESIS

Ptaquiloside converts to an aglycone dienone intermediate at high pH and this substance is the ultimate carcinogen. It has been suggested that the dienone reacts with DNA, particularly with adenosine, to initiate carcinogenesis.<sup>5</sup> Hemorrhage from the bladder wall lesions occurs intermittently and results in ongoing blood loss. Deaths are due to hemorrhagic anemia.

### CLINICAL FINDINGS

Severe cases are manifested by the passage of large quantities of blood, often as clots, in the urine. Hemorrhagic anemia develops and the animal becomes weak and recumbent, and may die after an illness lasting 1–2 weeks. Less severe cases are characterized by intermittent, mild clinical hematuria or persistent subclinical hematuria. In these cases there is a gradual loss of condition over several months and eventually clinical evidence of anemia. On rectal examination there may be thickening of the bladder wall. Secondary bacterial infection of the bladder may lead to the development of cystitis and pyelonephritis.

### CLINICAL PATHOLOGY

In the absence of gross hematuria, a urine sample should be centrifuged and the deposit examined for erythrocytes. Repeated examinations may be necessary. Non-specific anemia is detectable by hematological examination. Granulocyte and thrombocyte numbers are typically normal.

### NECROPSY FINDINGS

All tissues of the carcass are pale and the animal is usually emaciated. The urinary bladder contains blood clots or blood-stained urine. The presence of hemangiomas in the submucosa of the urinary bladder is typical of the disease. A range of other neoplasms may be present, including transitional cell carcinoma, hemangiosarcoma, adenoma, fibroma, and papilloma. The malignant types may have invaded the deeper structures of the bladder and have metastasized to regional lymph nodes or lungs. The neoplastic changes in the bladder are accompanied by inflammatory changes of the mucosa and submucosa, including proliferative changes of mucosal epithelium, lymphocytic infiltrates, congestion, edema, and hemorrhage. In some cases, lesions are seen in the ureters and renal pelvis. The severity of the blood loss is not necessarily related to the size or extent of the lesions, and animals may bleed to death when only small localized lesions are present.

### DIFFERENTIAL DIAGNOSIS

Diagnosis confirmation is by signs in animals grazing fern-infested pasture and preferably by histopathology of bladder lesions. The differential list includes:

- Cystitis
- Pyelonephritis.

Both are usually accompanied by fever, frequent urination, and the presence of pus and debris in the urine. Bacteriological examination of the urine will reveal the presence of infection.

### TREATMENT

#### Primary

No treatment should be attempted and affected animals should be disposed of at the first opportunity.

#### Supportive

Blood transfusion may be justified in severe cases and hematinic mixture should be provided in other cases.

### CONTROL

A general improvement in nutrition is often followed by a decrease in the number of animals affected. A specific recommendation is to apply gypsum (225–335 kg/hectare) to the pasture as a fertilizer, a measure reputed to delay the onset of the disease. Bracken eradication is difficult and should not be undertaken without the advice of the local weed control officer.

#### Alimentary tract neoplasia

Alimentary tract neoplasia, including the jaws and liver, is recorded in sheep

grazing pasture heavily infested with bracken and has been produced experimentally in sheep fed bracken or ptaquiloside.<sup>6</sup> Dairy cattle on farms infested with bracken may have a high prevalence of carcinoma of the intestine and tumors of the urinary bladder. Cancer of the alimentary tract, generally with lesions on the lateral dorsum of the tongue, the soft palate and oropharynx, esophagus, esophageal groove, and the rumen is also common in upland Scotland and northern England. Similar cases are recorded from South America. The epidemiological evidence suggests that papillomas associated with the papilloma virus are transformed into carcinomas by the carcinogenic effect of an environmental agent, probably bracken. Alimentary tract neoplasms in cattle grazing on bracken may be associated in the herd or in the individual with enzootic hematuria, or it may occur on its own. Depending on where the lesions are located, clinical signs may include masticatory disability, dysphagia, or chronic bloat.

#### 'Bright blindness' of sheep

A progressive retinal degeneration associated with ptaquiloside observed in sheep kept for more than 3 years in the UK on pastures heavily infested with bracken, the disease has been produced experimentally in sheep fed bracken. Affected sheep are blind, reluctant to move, but bright and alert. The pupils are dilated and show poor light and menace reflexes, and on ophthalmoscopic examination there is retinal degeneration. This degeneration may be observable in many more sheep than the clinically blind ones. Leukopenia is a characteristic.

### REVIEW LITERATURE

- Dawra RK, Sharma OP. Enzootic bovine haematuria – past, present and future. *Vet Bull* 2001; 71:1R-27R.
- Fenwick GR. Bracken (*Pteridium aquilinum*) – toxic effects and toxic constituents. *J Sci Food Agric* 1988; 46:147–173.
- Hopkins A. Bracken (*Pteridium aquilinum*). Its distribution and animal health implications. *Br Vet J* 1990; 146:316–326.
- Jarrett WFH. Environmental carcinogens and papillomatosis in the pathogenesis of cancer. *Proc R Soc Lond B* 1987; 231:1–11.

### REFERENCES

1. Smith BL et al. *Aust Vet J* 1989; 66:154.
2. Ngomuo AJ, Jones RS. *Vet Hum Toxicol* 1996; 38:14.
3. Smith BL. In: *Plant-Associated Toxins*. CAB International. Ed. Colegate, S. M. & Dorling, P. R. p. 45, 1994.
4. Sunderman FM. *Aust Vet J* 1987; 64:25.
5. Smith BL, Seawright AA. *Natural Toxins* 1995; 3:1.
6. Hirono M et al. *Vet Med* 1993; 55:979.

## PYRROLIZIDINE ALKALOID POISONING

### Synopsis

**Etiology** Pyrrolizidine alkaloids in *Crotalaria*, *Echium*, *Heliotropium*, *Senecio* spp., and other plants.

**Epidemiology** Outbreaks are in or enzootic to very large areas where toxic plants dominate pasture, mostly in cattle and horses. Pyrrolizidine alkaloid-containing weed seeds in feed grains or dry plants in hay also lead to poisoning. Range of diseases associated with primary cumulative toxicosis and effect of metabolites.

**Clinical findings** Chronic wasting. Hepatic encephalopathy with blindness, head pressing, bouts of frenzy, jaundice, photosensitization, and intravascular hemolysis.

**Clinical pathology** Liver function tests and blood levels of hepatic enzymes indicate hepatic inefficiency. In some cases there is only hypoalbuminemia.

**Necropsy lesions** Hepatic megalocytosis, fibrosis, and biliary hyperplasia.

### Diagnostic confirmation

Histopathology of liver. Assay of whole blood or liver for pyrrolic metabolites.

### Treatment

**Control** Avoidance of significant exposure to plants. Biological control of plants.

### ETIOLOGY

Most hepatotoxic pyrrolizidine alkaloids (PAs) are esters of two amino alcohols, retronecine and heliotridine, and occur in three groups – monoesters, non-cyclic (open) diesters and cyclic diesters – in ascending order of toxicity. To be hepatotoxic, PAs require a 1,2 double bond in the pyrrolizidine nucleus and a branch in the ester group. Non-toxic N-oxides of PAs may be converted to the toxic free base in the alimentary tract. A complete list of known PAs would be too long to be useful; for example, *Echium plantagineum* contains at least ten of them known to be toxic to grazing animals. Most PA-containing plants are classified in the plant families Boraginaceae, Fabaceae (Leguminosae), and Asteraceae (Compositae). The recorded plant sources of hepatotoxic PAs include:

- Amsinckia intermedia* – tarweed, ironweed; contain intermedine, lycopsamine, echiumine
- Arnebia hispidissima* – contains monocrotaline, echimidine<sup>1</sup>
- Crotalaria anagyroides*
- C. crispata* – Kimberley horse poison
- C. dura* – wild lucerne
- C. eremaea* – bluebush pea
- C. globifera* – wild lucerne, jaagsiektebossie

- C. goreensis* – Gambia pea; contains monocrotaline
- C. incana* – woolly rattlepod; contains fulvine
- C. juncea* – sunn hemp; contains retusine
- C. mauensis* – contains junceine
- C. mesopotica*
- C. mitchellii*
- C. novae-hollandiae* – New Holland rattlepod
- C. ramosissima* – Kimberley horse poison
- C. retusa* – wedge-leaved rattlepod; contains monocrotaline, retusine
- C. spectabilis* – showy rattlepod; contains monocrotaline, spectabiline
- Cynoglossum officinale*<sup>2</sup> – hound's tongue; contains heliotridine,<sup>3</sup> heliosupine, echinatine
- Echium plantagineum* (*E. lycopsis*) – Patterson's curc, Salvation Jane; contains echiumine, echimidine
- E. sericeum* – contains echiumine
- E. vulgare* – viper's bugloss; contains echimidine
- Heliotropium europaeum* – common heliotrope, potato weed; contains indicine, heliotrine, lasiocarpine, europine, supinine, heleurine
- H. amplexicaule*<sup>4</sup> – blue heliotrope; contains lasiocarpine, echinatine
- H. ovalifolium*
- Ligularia amplexicaulis* – dola
- L. mortonii* – bong dok pu
- Lithospermum arvense* (*Buglossoides arvensis*) – corn gromwell
- Senecio abyssinicus*
- S. alpinus*<sup>5</sup>
- S. aquaticus* – marsh ragwort
- S. brasiliensis*
- S. burchellii* – geelgifbossie
- S. cineraria* – dusty miller
- S. cisplatinus*
- S. cunninghamii*
- S. erraticus*<sup>6</sup>
- S. glabellus*
- S. harvieanus*
- S. heterotrichus*
- S. integerrimus*
- S. isatideus* – Dan's cabbage, inkanga
- S. jacobaea* – ragwort; contains seneciophylline, senecionine, jacobine, jaconine, jacoline, jacozone
- S. latifolius* – Dan's cabbage, dunsiektebossie
- S. bragalouensis*<sup>7</sup> – fireweed
- S. linearifolius* – fireweed
- S. longilobus*<sup>8</sup> – thread-leaf groundsel; contains retrorsine, riddelline, seneciophylline
- S. madagascariensis* – Madagascan fireweed; contains senecionine
- S. magnificus* – tall yellowtop; contains seneciophylline
- S. moorei*
- S. oxyphyllus*<sup>9</sup>
- S. plattensis*
- S. pterophorus* – African daisy
- S. quadridentatus* – cotton fireweed
- S. retrorsus* – staggers bush, dunsiektebossie
- S. riddellii*<sup>8</sup> – Riddell's groundsel
- S. ruwenzoriensis*
- S. scleratus*
- S. selloi*<sup>10</sup>
- S. spartioides* – broom groundsel
- S. spathulatus*
- S. squalidus* – Oxford ragwort
- S. tweediei*
- S. vernalis*
- S. vulgaris* – common groundsel; contains senecionine, seneciophylline, retrorsine
- Symphytum officinale* – comfrey; contains echimidine, lycopsamine, symphytine
- Trichodesma incanum* – contains trichodesmine
- T. ehrenbergii* – contains senkirikine
- T. zeylanicum* – camel bush; contains supinine.

Some pyrrolizidine alkaloids have their most significant effect on the lungs. Plants containing these include: *Crotalaria dura*, *C. globifera*, *C. juncea*, *C. mitchellii*, *C. spartioides*.

Some effect on the lungs is produced by *C. ramosissima*/*C. crispata*. As well as its dominant hepatotoxic effect, *C. retusa* is associated with nephrosis in affected pigs.

### EPIDEMIOLOGY

#### Occurrence

Diseases associated with PAs occur in most animal species in most countries, causing syndromes such as 'Molteno straining disease' of cattle, 'walking disease', 'Winton disease' of horses and cattle, and 'Kimberley horse disease' (Walkabout disease), 'zard disease', 'jaagsiekte' (panting disease), and 'dunsiekte' (thin disease), or stomach staggers of horses. Poisoning of humans, causing hepatic veno-occlusive disease also occurs.

Clinical manifestations of poisoning may be delayed for up to 18 months after ingestion of a toxic dose of PAs; the reason is unknown.

#### Risk factors

##### Plant factors

The plants are not very palatable and are usually eaten in sufficient quantity to be associated with illness only when other feed is short, or when they are included accidentally in conserved fodder such as hay or when their seeds contaminate feed grains. The toxicity of plants containing PAs is not significantly reduced by conversion of the plants to hay or ensilage or by pelleting, but hot air drying of the

plants considerably reduces their toxicity. Flowers are more toxic than herbage. Mature plants are avoided, the largest intake by animals being when the plants are sending out new shoots. With *Senecio* spp. it is the foliage that is the source of the poisoning. With *Crotalaria*, *Heliotropium*, and *Amsinckia* spp. the seeds are a common source, either as contaminants of grain crops harvested for animal feed, or in the cake made from the seeds after the extraction of oils. This is usually the way in which pigs are poisoned.

**Environmental stress**, including drought and high temperatures and especially spraying with herbicide, appears to increase the plants' content of PAs. The differences in PA concentration in different samples of the same plant species, invalidates the evaluation of the toxicity of the plant on the basis of intake by the animal.

#### Animal factors

##### Species

Cattle and horses are very susceptible to PA poisoning, being 30–40 times as susceptible as sheep and goats. The difference appears to be related to the animal's ability to detoxify the pyrrolizidine alkaloids in the liver, probably related to the diet consumed before domestication. Small herbivores are more likely to be browsers and to develop resistance to the toxins. It is possible that detoxication of the PAs may occur in the rumen as a result of microbial activity but there are opposing opinions about this.<sup>11</sup>

##### Stored feeds

Although most field cases of poisoning occur in animals grazing pasture infested with the toxic plants, the disease may result from the feeding of contaminated, stored feeds, especially hay, or the use of the plants in bedding. The effects of the intoxication are cumulative and fatal intoxication may develop over a period of years.

#### Importance

PAs and their metabolites are excreted in cows' milk but are thought not to represent a health threat to humans. Experimental feeding of goats' milk containing PA metabolites has produced hepatic lesions in rats. Concentrations of these substances in the meat of animals eating the plants are similarly not thought to be dangerous to humans. Mass mortalities are possible among intensively housed livestock such as pigs, poultry,<sup>12</sup> and feedlot cattle.<sup>13</sup>

#### PATHOGENESIS

##### Hepatic injury

PAs themselves are not poisonous but their pyrrolic metabolites,<sup>14</sup> produced in the liver, are serious, cumulative hepatotoxins which combine with pyrrol groups to form pyrrolic thioethers that damage

liver cells by inhibiting mitosis leading to loss of hepatocyte numbers and megalocytosis, and thus causing the clinical signs and death due to hepatic dysfunction.<sup>15</sup> The relative resistance of **sheep** to PA toxicity may be related to the relatively low capacity of the sheep's liver to produce pyrrols. In **cattle**, as well as the megalocytosis, there is damage to the centrilobular and hepatic veins leading to occlusion of the vessels.

The progress of the disease in **ponies** may be in one of two patterns. In the chronic disease there is a gradual worsening of signs until death at 6–22 weeks. In the chronic-delayed form the lesions progress, as measured by biopsy, but there are no clinical signs until a sudden onset of illness at 38–58 weeks.<sup>16</sup> Similarly, the signs of the disease may not occur until several months after the last ingestion of the toxic material, with death occurring soon afterwards.<sup>17</sup>

##### Hepatic encephalopathy

One of the consequences of liver insufficiency is the systemic accumulation of metabolites such as ammonia, which is associated with cerebral edema. This results in the nervous signs of depression, aimless walking, and head-pressing. The spongy degeneration (status spongiosis) produced in the CNS is characteristic of hyperammonemia. Other metabolites may also be significantly involved, but ammonia is best studied.

##### Toxic jaundice

Liver damage due to ingestion of PAs, commonly *Heliotropium europaeum*, results in the accumulation of copper in the liver, but only if the copper intake in the diet is above normal,<sup>18</sup> and may be associated with clinical cases of chronic copper poisoning in sheep, leading to the development of one of the forms of 'toxic jaundice'. *Echium plantagineum* has the double disadvantage of containing PAs and a high copper:molybdenum ratio so that copper accumulation occurs readily in the plant.<sup>19</sup> Similar accumulations of zinc and iron also occur. There is some evidence for an impairment of storage of vitamins A and E by PAs, but there are no field occurrences of resulting wastage.

The **reactive metabolites of hepatotoxic pyrrolizidines** produced during their toxic attack on the liver escape into the general circulation and are associated with damage to other tissues, and are also associated with the **nephrosis** and **interstitial pneumonia** that occur in some poisonings and in some incidents are associated with poisoning by known hepatotoxins. They also react with erythrocytes and the pyrrolic esters formed there are bound to hemoglobin so that they could be used as markers of past intake of

the PAs.<sup>14</sup> The usefulness of the technique is limited by the short life span of erythrocytes. Besides the incidental escape of toxic metabolites into the circulation and the subsequent damage to pulmonary tissue, the PAs from some plants, e.g. some southern African *Crotalaria* spp., exert their major effect on lung tissue and produce pulmonary as well as hepatic signs.<sup>20</sup>

An unusual outcome to pyrrolizidine toxicosis of horses is the development of **gastric impaction** with the dried stalks of the plant, causing colic with nasal regurgitation and, in some cases, a fatal gastric rupture.<sup>21</sup>

#### CLINICAL SIGNS

Although the causative lesions develop slowly in most cases, the onset of clinical signs is usually sudden. The prominent signs are hyposensitivity to external stimuli, anorexia, precipitate drop in milk yield and, in cases surviving for more than 2 days, there is often jaundice and photosensitive dermatitis. The onset of illness may occur many months after the animals have been removed from the toxic pasture. Sheep may have serious liver damage but the effects may be limited to loss of body weight and reduction in wool yield.<sup>22</sup> Most animals poisoned with PAs develop the hepatic syndrome detailed below. However, some cases will have signs of uremia or interstitial pneumonia, described elsewhere in this book. For example, horses fed large amounts of *Crotalaria juncea* seeds in their feed develop severe dyspnea associated with massive consolidation of lungs.<sup>23</sup>

#### Cattle

In poisoning due to *Senecio* spp., there is a sudden onset of depression and poor sensitivity to external stimuli. This hyposensitivity is sometimes punctuated by short outbursts of excitability and frenzy, and often by aggressive behavior. During these episodes there is usually severe diarrhea and straining to defecate. This may result in a high incidence of rectal prolapse. Other signs include abdominal pain, staggy gait, with dragging of the hooves, walking in circles, and partial blindness. Such cases usually die within 2–3 days of the onset of signs.

Some cases may linger on for several weeks. There are no excitable episodes, the animal remains hyposensitive, loses weight and becomes anorexic, is afflicted with diarrhea and tenesmus, and usually develops jaundice, mucosal pallor and, rarely, photosensitive dermatitis.

#### Horses

Horses poisoned by *Senecio jacobaea*<sup>24</sup> or *Crotalaria crispata*/*C. ramosissima* lose much weight, are mildly jaundiced, and profoundly hyposensitive to external

stimuli, often standing with the head held down and stopping eating halfway through a mouthful of hay or grass. There is muscle tremor, especially of the head and neck, frequent yawning, and difficulty in swallowing. The latter may be sufficiently severe to cause aspiration of food into the lungs or its regurgitation through the nasal cavity. Affected horses appear to be blind. They walk in circles or straight ahead, bumping into objects and becoming wedged in places from which they cannot back out; they also walk into streams, houses, or outbuildings. Death due to misadventure is a frequent outcome. Head-pressing is common and there may be attacks of frenzy and violent, uncontrollable galloping. Multiple skin abrasions of the head and chest are indicators of this deranged behavior. The disease is usually fatal, the course lasting from a week to several months. Poisoning of horses by *Echium plantagineum* is associated with weight loss, severe hyposensitivity, and jaundice. **Paralysis of the pharynx and larynx** are thought to be associated with an unusual occurrence of severe inspiratory dyspnea in ponies with severe pyrrolizidine toxicosis.<sup>25</sup> A further unusual effect in horses may be intravascular hemolysis, manifested as hemoglobinuria. Pseudo-neoplastic proliferation of bronchiolar epithelium is the basis of jaagsiekte of horses manifest as progressive severe dyspnoea associated with pneumotoxic pyrrolizidine alkaloids such as dicrotaline, monocrotaline, fulvine, and crispatine in some *Crotalaria* spp., including *C. dura*, *C. globifera*, *C. juncea*, *C. spartioides* in southern Africa and *C. ramosissima*, *C. crispata*, and *C. mitchellii* in Australia.

### Pigs

Pigs poisoned with *Crotalaria* spp. show anasarca, pale mucosae and conjunctiva, ruffled bristles, emaciation, and apathy.<sup>26</sup> The disease is chronic and progressive, and the mortality rate is high.

### CLINICAL PATHOLOGY

Direct diagnosis of a patient's exposure to pyrrolizidines is possible by the detection of pyrrolic metabolites bound to hemoglobin in erythrocytes. Contributory evidence is the presence of hyperammonemia, hyperbilirubinemia, and hypoalbuminemia. The bromsulphalein (BSP) clearance rate is impaired and levels of serum enzymes are transiently elevated. For the prediction of early hepatic damage in cattle grazing on *Senecio* spp., measurements of serum  $\gamma$ -glutamyl transpeptidase and glutamyl dehydrogenase are recommended. In horses,  $\gamma$ -glutamyltransferase and alkaline phosphatase estimations are favored, especially the former which is recommended as a screening test to identify

subclinical cases in horse herds.<sup>27</sup> The changes in serum liver enzymes precede the changes detectable histologically in liver biopsy specimens. For assessment of the degree of damage to the liver in chronic cases a combination of BSP clearance test and liver biopsy is regarded as most helpful in cattle and horses.

### NECROPSY FINDINGS

Hepatic megalocytosis, fibrosis, which may be veno-occlusive, and biliary hyperplasia are the common histopathological findings. In cases of sufficient duration there is jaundice, general edema, and ascites. Secondary histopathological changes occur in intestinal mucosal cells and may be responsible for impaired absorption of nutrients. In some cases, and in some poisonings associated with PA-bearing plants, necropsy findings will be dominated by lesions of nephrosis, particularly in pigs, or interstitial pneumonia, particularly in horses.

### DIFFERENTIAL DIAGNOSIS

Diagnostic confirmation depends on positive identification of pyrrolic metabolites in blood or liver. Presumptive diagnosis is provided by hepatic histopathology detecting megalocytosis, which needs to be differentiated from that seen in aflatoxicosis. Cases in which exposure to toxic plants occurred some time ago can only be diagnosed presumptively.

#### Differential diagnosis lists

Cattle, hepatopathies due to:

- Phytotoxins, e.g. in *Lantana* spp., *Myoporum*
- Mycotoxins as in *Aspergillus* spp., *Phomopsis*, *Diaporthe toxica*, *Myrothecium* spp.
- Tunicamyluracil poisoning as in *Clavibacter toxicus*
- Cyanobacterial toxins
- Zootoxins as in *Lophyrotoma*, *Arge* spp.

Encephalopathies such as:

- Rabies
- Lead poisoning
- Polioencephalomalacia.
- Other causes of jaundice also need to be taken into account. Special attention needs to be given to chronic copper poisoning in sheep because sheep poisoned by PAs are much more inclined to develop high levels of copper in the liver than are other sheep.<sup>28</sup>

Horses:

- Equine viral encephalomyelitis
- Nigropallidal encephalomalacia
- Leukoencephalomalacia.

### TREATMENT

**Primary** treatment of the hepatic lesion is unlikely to be attempted. **Supportive**

treatment requires provision of a high nutrient diet during the convalescent period plus symptomatic treatment for photosensitization and dehydration. Horses that have recovered clinically may never regain their former physical fitness and any exertion will lead to rapid exhaustion.

### CONTROL

Populations of these plants undergo cyclic changes and the diseases associated with them tend to wax and wane. Artificial reduction of plant numbers using herbicides is attempted. Because of the comparative resistance of sheep to PA poisoning they may also be used to keep infested pasture under control by having them graze it only intermittently, for example for a 1-month period once a year, or for only one season during their lifetime. Biological control, using insects such as the cinnabar moth (*Tyria jacobea*), which feeds only on plants that contain PAs, may be an effective control procedure for their specific host plants. A concerted effort at biological control of *Heliotropium europaeum* and *Echium plantagineum* is currently underway in Australia using several insect herbivores and fungal pathogens in combination. Attempts to control *H. europaeum* poisoning by administration of cobalt or an antimethanogen have been unsuccessful.<sup>29</sup> Attempts at immunization against PAs, manipulation of ruminal flora, manipulation of hepatic metabolism, protection by thiol compounds, and selection for heritable resistance, have all failed to date.

### REVIEW LITERATURE

- Cheeke PR. A review of the functional and evolutionary roles of the liver in the detoxification of poisonous plants with special reference to pyrrolizidine alkaloids. *Vet Hum Toxicol* 1994; 36:240.
- Habermehl GG et al. Livestock poisoning in South America by species of *Senecio* spp plants *Toxicol* 1988; 26:275-286.
- Winter CK, Segall HJ. Metabolism of pyrrolizidine alkaloids. In: *Toxicants of Plant Origin*. Ed. Cheeke, P. R. Boca Raton, FL: CRC Press, 1989.

### REFERENCES

1. Wassell G et al. *Acta Pharmacol Suecica* 1987; 24:199.
2. Stegelmeier BL et al. 1996; *J Vet Diag Invest* 1987; 8:81.
3. Baker DC et al. *J Comp Pathol* 1991; 104:403.
4. Ketterer PJ. *Aust Vet J* 1987; 64:114.
5. Grabner A. *Pferdeheilkunde* 1990; 6:119.
6. Araya O, Fuentealba IC. *Vet Hum Toxicol* 1990; 32:555.
7. Noble JW et al. *Aust Vet J* 1994; 71:196.
8. Molyneux RJ et al. *Vet Hum Toxicol* 1988; 30:201.
9. Barros CSL et al. *Vet Hum Toxicol* 1992; 34:241.
10. Odriozola E et al. *Vet Hum Toxicol* 1994; 36:205.
11. Cheeke PR et al. In: *Toxicants of Plant Origin*, Chaps. 1 & 2. Boca Raton, FL: CRC Press, 1989.
12. Gaul K et al. In: *Plant-Associated Toxins*. Ed. Colgate, SM & Dorling, PR CAB International, p. 137, 1994.

13. Hill D et al. Aust Vet J 1997; 75:360.
14. Seawright AA. Vet Hum Toxicol 1991; 33:286.
15. Seawright AA et al. Vet Rec 1991; 129:198.
16. Craig AM et al. J Equine Vet Science 1991; 11:261.
17. Molyneux RJ et al. Vet Hum Toxicol 1988; 30:201.
18. Howell JM et al. J Comp Pathol 1991; 105:49.
19. Seaman JT et al. Aust Vet J 1989; 66:279:286.
20. Cheeke PR. J Anim Sci 1988; 66:2343.
21. Milne EM et al. Vet Rec 1990; 126:502.
22. Seaman JT et al. Aust Vet J 1989; 66:279:286.
23. Nobre D et al. Vet Hum Toxicol 1994; 36:445.
24. Molyneux RJ et al. Am J Vet Res 1991; 52:146.
25. Pearson EG. J Am Vet Med Assoc 1991; 198:1651.
26. Souza AC et al. Pesquisa Vet. Brasileira 1997; 17:12.
27. Curran JM et al. Aust Vet J 1996; 74:236.
28. Howell JM et al. Aust J Agric Res 1991; 42:978.
29. Peterson JE et al. 1992; Aust Vet J 1991; 69:51.

## 5-METHYL-L-CYSTEINE-SULFOXIDE (SMCO) AND DIPROPYL/DIPROPENYL DISULFIDE POISONING

### Synopsis

**Etiology** *Brassica* spp. contain SMCO.

*Allium* spp. contain N-propyl disulfide.

**Epidemiology** Outbreaks when mature plants grazed. Heavy morbidity and case fatality rates.

**Clinical findings** Acute onset, pallor, hemoglobinuria, jaundice if the patient survives long enough.

**Clinical pathology** Low blood levels of hemoglobin, erythrocytes. Hemoglobinuria.

**Necropsy findings** Pallor, jaundice, hemoglobinuria.

**Diagnosis confirmation** High blood levels of dimethyl disulfide in SMCO poisoning. The test is not generally available.

**Treatment** No primary treatment; supportive treatment is blood transfusion.

**Control** Dilute toxic feed with, e.g. pasture hay.

### ETIOLOGY

Plants of all the *Brassica* species are associated with several syndromes, including hemolytic anemia due to SMCO poisoning recorded here; blindness, pulmonary emphysema, and digestive disturbances, dealt with under glucosinolate poisoning; and photosensitization. These syndromes may occur separately or in combination.

**S-methyl-L-cysteine sulfoxide (SMCO)** is a rare sulfur-containing  $\alpha$  amino acid which occurs in some genera of plants in the family Brassicaceae (e.g. *Brassica*, *Raphanus*). Its metabolic products in ruminants are associated with serious hemolysis and anemia. The plants known to contain SMCO are *Brassica campestris* (turnip rape, cole), *B. napobrassica* (swede, rutabaga), *B. napus* (rape = canola), *B. oleracea* (kale, kohlrabi, chou moellier,

cabbage, cauliflower, broccoli, Brussels sprouts, calabrese), *Raphanus raphanistrum* (wild radish),<sup>1</sup> and possibly *Thlaspi arvense* (fanweed)<sup>2</sup> and *Berteroa incana* (hoary alysum).<sup>3</sup> The green parts of the plants are the usual material involved in outbreaks.

The anemia-producing agent in poisonings by these plants is **dimethyl disulfide**, produced by ruminal bacteria from SMCO. The SMCO content of forage brassicas increases as the plant matures. The toxic dose of SMCO is 15 g/100 kg BW daily to produce severe, fatal anemia. Intakes of 10 g/100 kg BW are associated with a subacute, low-grade anemia.

### Culinary vegetables

Particular note should be taken of the occurrence of SMCO in cabbages, swedes, and stubble turnips. The level may be insufficiently high to be associated with anemia, but may be associated with failure to gain weight satisfactorily, or clinically evident ill-thrift. *Allium* spp. (family Liliaceae), e.g. *Allium canadense* (wild onion, Canada garlic), *A. cepa* (commercial onion), *A. sativum* (garlic), *A. schoenoprasum* (chives), *A. triquetrum* (three cornered garlic), *A. ursinum* (ransoms), and *A. validum* (wild onions), the plants responsible for onion-induced anemia, are usually bracketed with this group of plants because the hemolytic agents, propyl disulfide, 1-propenyl and 2-propenyl disulfides,<sup>4</sup> are chemically similar to, and their effects are the same as, those of the SMCO-induced anemia.

### Hypophosphorosis

Although there may be no etiological relationship, it is not uncommon for the hemolytic disease to occur in the presence of hypophosphorosis, and therefore at the same time as postparturient hemoglobinuria.

The seeds and leaves of these plants also contain another glucosinolate, **sinigrin**, and its breakdown products, allyl cyanide and allyl isothiocyanate, which may depress food intake but appear to exert no hemolytic activity.<sup>5</sup> The plants may also contain significant quantities of **cyanogenetic glycosides** but rarely are associated with cyanide poisoning. Nitrate and **nitrite poisoning** have also been recorded on kale feeding.

### EPIDEMIOLOGY

#### Occurrence

Rape and kale poisoning are well known where these plants are grown for fodder and in some areas they are no longer used because of the danger. The overall prevalence of poisoning is probably not great but on individual farms the number affected is usually significant, and the mortality rate is high.

### Risk factors

#### Plant factors

The plants are more toxic as they mature and when secondary growth begins; the flowers and seeds are particularly poisonous. The toxicity of the plants varies from year to year, and on rape grazing most outbreaks occur in wet years when early frosts occur and the leaves turn a purple color. The toxicity of kale also varies significantly between varieties of the plant but the important factors in most outbreaks are the maturity of the crop and the amount eaten. The toxic principle in kale is destroyed in heat-dried or ensiled material but is still present in frozen and dried material. Onions fed at greater than 25% of the ration for cattle can be associated with hemolytic disease.

#### Animal factors

Only ruminants are affected by the poisoning, and the hemolytic effect is produced only when the diet consists largely of the plants and when the animals are on the feed for at least 1 and usually 3 weeks. Sheep are less susceptible to onion poisoning than cattle.

### PATHOGENESIS

Dimethyl disulfide and the propyl disulfides are agents that oxidize hemoglobin, lead to Heinz-Ehrlich body formation from denatured hemoglobin in erythrocytes, and ultimately to hemolysis. The resulting hemolytic anemia affects all classes of ruminants but its effects are most serious in heavily pregnant and recently parturient females. The reasons for the observed tendency for cycles of spontaneous improvement followed by recrudescence of the anemia are not explained. A previous suggestion that they were related to variations in the cellular content of reduced glutathione, which prevents the formation of Heinz-Ehrlich bodies, has been discredited.

### CLINICAL FINDINGS

In the anemia syndrome, the onset in severe cases may be so sudden that no signs are observed before the animal collapses and dies. If clinical illness is apparent, hemoglobinuria is observed first and is soon followed by weakness and dejection. Pallor of the mucosae, moderate jaundice, tachycardia, and a slight increase in respiratory rate and depth are also observed. Diarrhea occurs commonly and, although body temperatures are usually normal to low, there may be fever up to 40.5°C (105°F). Death is common unless effective treatment is provided, and surviving animals require a long period of convalescence. A normal hematological status may not be regained for up to 6 weeks. In an affected herd it is common to find a number of animals that

are not seriously ill, but with a subclinical anemia.

### CLINICAL PATHOLOGY

The erythrocyte count, hemoglobin concentration, hematocrit, and leukocyte count are reduced, and Heinz-Ehrlich bodies are present in up to 100% of erythrocytes. They are significantly increased in numbers before anemia appears. The anemia is macrocytic and the hemoglobin level falls from 110 g/L to 6 g or less. Hemoglobin is present in the urine. There is often a concurrent hypophosphatemia. The dimethyl disulfide content of the blood, which will be high at the time of occurrence of the poisoning, can be measured chromatographically.

### NECROPSY FINDINGS

There is pallor, jaundice, hemoglobinuria, thin, watery blood, dark coloration of the kidney, accentuation of the lobular appearance of the liver and, in peracute cases, swelling of the spleen. Histologically there is moderate periarterial, hepatocyte necrosis in the liver, compatible with the effects of hypoxia.

### DIFFERENTIAL DIAGNOSIS

The occurrence of the disease when cattle or sheep are grazing on plants of the family Brassicaceae or consuming *Allium* spp. suggests the presumptive diagnosis. Diagnostic confirmation is by measurement of dimethyl sulphide levels in the blood. The differential diagnosis list includes:

- Postparturient hemoglobinuria, which is limited to cows that have calved recently
- Leptospirosis in calves
- Bacillary hemoglobinuria
- Babesiosis
- Chronic copper poisoning.

### TREATMENT

**Primary treatment** in the form of an antidote to SMCO is unavailable. **Supportive treatment** includes, in severe cases of anemia, an immediate blood transfusion. Hematinic preparations and the provision of a highly nutritious diet are also used.

### CONTROL

The provision of ample hay either daily before the animals are pastured on the rape, as a stack in the rape field, or allowing access to a field of rough grass, are recommended to reduce the consumption of rape. Rape showing purple discoloration should be regarded with suspicion and only limited grazing permitted until doubts as to its safety are satisfied. Cattle and sheep grazing on these plants should be kept under close observation so that affected animals can be treated in the early stages of the

disease. An adequate phosphorus intake is particularly necessary. If feeding is stopped, the hemoglobin levels return to normal in about 3 weeks. Even if feeding is continued there is a strong tendency for a spontaneous recovery and further similar cycles to occur. Some varieties of kale have lower concentrations of SMCO and a genetic approach to preventing the disease might be worth examining.

The disposal of superfluous onions is a major horticultural problem, best solved by feeding them to animals. This can be done without fear of causing anemia by feeding them mixed into a balanced ration containing less than 25% of onions. Sheep appear to tolerate the toxins in onions more than cattle and have been adapted to a 100% onion diet without ill effect.<sup>6</sup>

### REVIEW LITERATURE

Prache S. Hemolytic anemia in ruminants fed forage brassicas: a review. *Vet Res* 1994; 25:497.

### REFERENCES

1. Duncan AJ et al. *Anim Sci* 1995; 60:93.
2. Smith RA, Crowe SP. *Vet Hum Toxicol* 1987; 29:155.
3. Hovda LR et al. *Vet Hum Toxicol* 1993; 35:39.
4. Munday R, Mann E. *J Agri Food Chem* 1994; 42:959.
5. Duncan AJ, Milne JA. *Br J Nutr* 1993; 70:631.
6. Knight AP et al. *Vet Human Toxicol* 2000; 42:1.

### THIAMINASE POISONING

#### Synopsis

**Etiology** Thiaminases occur in the *Marsilea*, *Cheilanthes*, *Pteridium*, and *Equisetum* spp. ferns, and are generated by microbes in the rumen of animals affected by polioencephalomalacia.

**Epidemiology** Outbreaks in ruminants with access to ferns, horses fed hay containing bracken; pigs eating bracken, especially rhizomes.

**Clinical signs** Ruminants – blindness, depression; horses – muscle tremor, cardiac irregularity, crouched posture, incoordination, recumbency, death; pigs – dyspneic sudden death.

**Clinical pathology** Low blood levels of thiamin, transketolase, high levels of pyruvate.

**Necropsy findings** Polioencephalomalacia in ruminants, not in horses; cardiac lesions in pigs.

**Diagnostic confirmation.** Low blood levels of thiamin.

**Treatment** Thiamin injected gives excellent results, provided thiaminase source is withdrawn.

**Control** Denial of access to toxic plants.

### ETIOLOGY

The identified thiaminases which are important to animals occur in ferns and catalyze the decomposition of thiamin. The most widespread occurrence of a thiaminase-induced thiamin deficiency is polioencephalomalacia in ruminants.

The ferns which are sources of thiaminase, and the animal species affected are:

- Horses – *Pteridium* spp., *Equisetum arvense*, *E. fluviatile*, *E. hyemale*, *E. palustre*, *E. ramossissimum*, *E. sylvaticum*, *Marsilea drummondii*
- Sheep – *Marsilea drummondii*, *Cheilanthes sieberi*
- Cattle – *C. sieberi*, *Dryopteris borrieri*, *D. filix-mas*.<sup>1</sup> See also *Phalaris aquatica* sudden death syndromes.

Thiaminases are of two types, methyltransferase, and a hydrolase. The hydrolases are not found in plants but only in the rumen, presumably as metabolites produced by ruminal bacteria from specific precursors in the plants.<sup>2</sup> Plants containing thiaminases are usually deficient in thiamin.

### EPIDEMIOLOGY

Thiaminase poisoning associated with *Pteridium* spp. and *Equisetum* spp. occurs almost always in **horses** fed on hay contaminated by the ferns, and is most toxic if the hay is cut when the fronds are very young. The standing plants are unpalatable and rarely eaten by these animals. Signs of poisoning in grazing horses do not occur until the horses have had access to the fern for 3–4 weeks, but the period is much shorter if they are fed in stables on heavily contaminated hay. The thiaminase content of the ferns varies widely, being highest at a period of rapid growth and after being grazed severely.

Grazing **pigs** may root out and eat *Pteridium* rhizomes, which contain a much higher concentration of the thiaminase than the fronds. Sheep grazed on pastures dominated by *Marsilea drummondii* (nardoo) on floodplains in inland Australia or forced to graze *Cheilanthes sieberi* are poisoned.

Grazing **cattle** may be forced to eat the ferns because of lack of other feed and when the fern is at a toxic, rapidly growing stage, but are not affected by a thiamin deficiency. They succumb to a hemorrhagic disease. Thiaminase activity occurs in the fronds of the ferns *Marsilea drummondii*, *Cheilanthes sieberi* and *Pteridium aquilinum* in descending order of magnitude.

### PATHOGENESIS

A state of thiamin deficiency is created by the destruction of thiamin in the alimentary tract. The activities of enzymes that require thiamin are impaired and there is an accumulation in tissues of pyruvate and lactate. The relationship between the intake of the thiaminase and the nervous signs is not adequately explained. That there is such a relationship is suggested by the development of brain lesions of polioencephalomalacia in sheep poisoned by *Marsilea drummondii* and in those fed

experimentally on the rhizomes of *Pteridium aquilinum*.

### CLINICAL SIGNS

Affected horses sway from side to side, show gait incoordination, including crossing the forelimbs and a wide action in the hindlimbs. Abnormal postures include a wide stance, arching of the back, and crouching. Muscle tremor, cardiac irregularity, and bradycardia are evident and the appetite and demeanor are normal. Terminally, the animal falls easily, becomes recumbent and hyposensitive to external stimuli, and makes convulsive movements. The heart rate and the temperature become elevated. Additional signs seen in horses poisoned by *Marsilea drummondii* include carrying the head close to the ground, whinnying, partial blindness, nodding of the head, twitching of the ears, and frequent yawning.

The clinical syndrome in pigs fed bracken rhizomes in excess of 25% of their diet includes anorexia, recumbency, dyspnea, and death after a course of about 6 hours.

Sheep poisoned by *Marsilea drummondii* may be affected by an acute or a chronic syndrome. The chronic syndrome is indistinguishable from polioencephalomalacia, and is dealt with under that heading. The acute form of the disease is characterized by the sudden onset of dyspnea, depression, and recumbency and death in 6-8 hours. Sheep affected by *Cheilanthes* spp. poisoning are hyposensitive to external stimuli, including being blind, and walk slowly and with an uncoordinated gait.

Cattle poisoned by *Dryopteris* spp. are also blind and hyposensitive. Many recover but remain blind.

### CLINICAL PATHOLOGY

The characteristic findings attributable to a nutritional deficiency of thiamin are present. These include depression of blood levels of thiamine and transketolase, and elevation of levels of blood pyruvate.

### NECROPSY FINDINGS

In naturally occurring cases in horses there are no lesions recorded other than the non-specific ones of acute or congestive heart failure. Polioencephalomalacia has been seen in sheep and, in pigs, an enlarged mottled heart and congestion of the lungs and liver indicate the presence of congestive heart failure.

### DIFFERENTIAL DIAGNOSIS

Diagnostic confirmation is based on low blood thiamin levels. The differential diagnosis list includes:

- Hepatic encephalopathy is similar but the course is usually

much longer. There are also signs of hepatic insufficiency

- Infectious encephalitis
- Toxic encephalomalacias
- Staggers syndromes, e.g. rye-grass staggers, paspalum staggers, phalaris staggers.

### TREATMENT

In the early stages the administration of thiamin and removal of the dietary source of thiaminase are the critical procedures, and recovery is to be expected. In large animals the IV or IM injection of 100 mg of thiamin, twice on day 1, followed by similar daily IM injections for 7 days (with double doses in severe cases) is recommended.<sup>3</sup> The response to treatment is dramatic.

### CONTROL

Large-scale control of bracken is attempted by a combination of pasture management, application of herbicide and mechanical slashing, but is expensive and subject to error so that professional agrostological advice is desirable.

### REVIEW LITERATURE

Chick BF et al. Thiaminases. In: Toxicants of Plant Origin, Ed. Cheeke, P. R. Boca Raton, FL: CRC Press, 1989.

### REFERENCES

1. Kellerman TS et al. In: Plant Poisonings in Livestock in Southern Africa. Cape Town, SA: Oxford University Press, 1988.
2. Meyer P. Onderstepoort J Vet Res 1989; 56:145.
3. Mayer S. In Pract 1990; 12:215.

## POISONING BY MISCELLANEOUS PHYTOTOXINS

### AESCULIN

The hydroxycoumarin glycoside aesculin occurs in *Aesculus* spp. plants including *A. californica*, *A. glabra*, *A. hippocastanum*, *A. octandra*, *A. pavia* (buckeyes or horse-chestnuts), *A. pavia*<sup>1</sup> being the most toxic. Ingestion of the seeds and nuts is usually reported, but toxicity also occurs after eating foliage. In monogastric animals the glycoside is associated with gastroenteritis with vomiting, but its digestion in ruminants to a soluble aglycone results in the more common syndrome of depression, straddled posture, stiff and incoordinated gait, tremor, easy falling, recumbency, and convulsions with opisthotonos. Signs are exacerbated by handling or harassment. No necropsy lesions are reported.

### ALCOHOL (COMPLEX PLANT)

Included are cicutoxin, occurring in *Cicuta* spp. (water hemlock), oenanthotoxin, isomeric with cicutoxin, in *Oenanthe* spp. (water hemlock dropwort), and tremetol in *Eupatorium rugosum* (snakeroot) and *Haplopappus heterophyllus* (goldenrod).

Cicutoxin poisoning in all species is characterized by early tremor, restlessness and stumbling gait, followed by violent clonic convulsions with bellowing, opisthotonos, and frothing at the mouth. Between convulsions there is ruminal tympany, dyspnea, profuse salivation, teeth grinding and chewing movements, frequent urination and defecation, tachycardia, hyperthermia, and pupillary dilation. Most affected animals die of respiratory failure after a course of a few minutes, but more usually several hours.<sup>2</sup> Serum levels of muscle enzymes are elevated as a result of the muscle activity. Necropsy lesions comprise skeletal and cardiac myodegeneration. The characteristic roots may be found in the forestomachs, more commonly lodged in the esophageal groove than in the rumen proper.<sup>3</sup> In experimentally produced cases, IV sodium pentobarbital administered at the onset of the first convulsion prevents further convulsions and the myodegeneration,<sup>4</sup> but no practicable remedy is available for natural cases. Prevention depends on keeping animals away from the plant, including the roots, which may be exposed during excavation or after flooding

Oenanthotoxin poisoning is associated with an identical syndrome, most commonly in cattle. The roots of the plant are the common source of the poison<sup>5</sup>

Tremetol is associated with stiffness and incoordination of gait, severe tremor, salivation, depression, recumbency, and coma preceding death in ruminants. In horses there is heavy sweating, regurgitation of food through the nostrils and the passage of dark, hard feces, and there may be congestive right heart failure with electrocardiographic abnormalities and extensive myocardial damage. The alcohol is excreted in the milk of cattle which ingest the plant and may be associated with clinical illness and even death in humans drinking the milk.<sup>6</sup> Liver damage and nephrosis are detectable as necropsy lesions.

### ALIPHATIC ACETOGENIN (MONOGLYCERIDE)

The toxin responsible for poisoning by *Persea americana* (avocado, alligator pear) is a biologically active aliphatic acetogenin, persin, with the form of a monoglyceride.<sup>7</sup> Only varieties of Guatemalan origin are toxic; Mexican varieties are not. All parts of the plants can be toxic. Horses, ruminants, and ostriches have been affected.<sup>8,9</sup> In lactating females, poisoning



produces sterile mastitis and agalactia with necrosis of secretory epithelium of mammary glands. Horses are affected by a heart failure syndrome, usually non-fatal, with severe subcutaneous edematous swelling of the head and dyspnea. In some cases, there is ischemic necrosis of masseter and tongue muscles.<sup>10</sup> Fatal cases have myocardial necrosis. Colic and diarrhea have been reported in foals. Poisoned ostriches have paresis of neck muscles, edema of the neck, pulmonary edema, and necrosis of cardiac muscle.<sup>11</sup>

#### AMINE TOXICITY

Two toxic amines identified in plants are the teratogen cycloamine in *Veratrum californicum* and tyramine (*N*-methylphenylethyl-amine) found in *Acacia berlandieri* (guajillo), and two mistletoes *Phoradendron villosum* and *Viscosum album*.

#### Tyramine

Clinical signs in poisoning by the acacia include gait incoordination, limb weakness and recumbency, all exacerbated by exercise or harassment, and all of which disappear if the patient is removed from contact with the plant. No signs are attributed to poisoning by mistletoe, the only event recorded being the patient being found dead.

#### Cycloamine

Cycloamine, the toxic amine found in *Veratrum californicum* (skunk cabbage) is associated with severe congenital cyclopean deformities of the head, absence or displacement of the pituitary gland with prolonged gestation, and gigantism in lambs, calves and kids when fed to the dams in early pregnancy (between the 14th and 30th days in ewes). Many other defects, including cleft palate, harelip, syndactyly, various leg deformities, supernumerary claws, tracheal stenosis, and fetal death and resorption have been induced in neonatal lambs by feeding ewes at specific times in their pregnancies. For example, feeding ewes root material on day 29 is associated with shortening of the metatarsal, metacarpal, and tarsal bones, medial bowing of the forelimbs at the fetlock, and severe articular surface defects and arthrogryposis in some cases.<sup>12</sup> Dosing ewes at day 31–33 is associated with lateral flattening of the trachea and death due to asphyxia within 5 minutes of birth. Early fetal death, possibly with resorption occurs, after dosing on day 14.<sup>13</sup>

#### AMINO ACID TOXICITY

The best-known toxic amino acids are:

Indospicine in *Indigofera spicata* (creeping indigo)

Indospicine in *Indigofera linnaei* (*I. dominii*, *I. emeaphylla*, Birdsville indigo),

Canavanine in *Canavalia* spp.,

*Indigofera linnaei*

Mimosine in *Leucaena leucocephala* (lead tree) and *Mimosa pudica* (sensitive plant).

#### Indospicine

Poisoning by *Indigofera linnaei* has generally been ascribed to indospicine but is now considered to be associated with a nitro-compound. Indospicine transmitted to dogs fed on meat from poisoned horses is associated with fatal liver damage in the dogs.<sup>14</sup> *Canavalia* spp. and *I. spicata* in sheep and cattle are associated with a similar syndrome including anorexia, hyposensitivity, gait incoordination, and abortion in some.

#### Canavanine

Canavanine poisoning is also associated with a syndrome including stiff gait, stumbling, recumbency, and diarrhea, with loss of weight and reduction of feed intake. Necropsy findings include gastroenteritis, nephritis, and pulmonary emphysema.

#### Mimosine

The non-protein amino acid mimosine occurs in *Mimosa pudica* (sensitive plant) and *Leucaena leucocephala*, a leguminous fodder shrub. Mimosine plus an enzyme in plant tissue produces 3,4-dihydroxypyridone (3,4-DHP), a potent goitrogen, which on mastication yields 2,3-DHP through the action of rumen flora. Mimosine, 3,4-DHP and 2,3-DHP are all toxic. Both plants are associated with alopecia but *Leucaena* spp. is associated with the disease known as 'jumbey' (Bahamas) or 'lamtoro' (Indonesia). Some varieties of the tree contain more mimosine than others. Safe daily intakes of mimosine are 0.18 g/kg BW for cattle, 0.14 g/kg BW for sheep, and 0.18 g/kg BW for goats. There is a great deal of variation in the effects of poisoning with *L. leucocephala*, depending on the variety of the tree, the amount of other fodder available, and the selection of the feed by the animal. Horses, sheep, and cattle are commonly affected, goats not so commonly.

Cattle and goats in Indonesia, Hawaii and the Virgin Islands, where the tree is indigenous, eat very large amounts of the plant without ill-effect. This immunity is due to the adaptation of ruminal microflora to degrade the mimosine, the degree of degradation varying with the diet, being much greater on a concentrate diet than on a roughage one. A transfer of rumen contents from resistant to susceptible cattle is a successful preventive veterinary procedure. The bacterium capable of degrading the toxins is *Synergistes jonesii*.<sup>15</sup> In some areas, if ruminants are introduced to the plant gradually enough, the ruminal microflora may develop the capacity of

metabolizing mimosine so that poisoning is not a problem.

Alopecia (depilation), commencing at the tail switch and the preputial orifice, and nervous signs are constant clinical findings. Inconstant signs are cataract, gingival atrophy, lingual epithelial ulceration, goiter, infertility, and low birth weight. In experimental animals, hepatic injury is one of the most marked effects, but this is not recorded in field cases.

In horses the loss of hair is most marked in the mane and tail, and around the hocks and knees. Ring formation in the hooves and emaciation also occur. In cattle and sheep shedding of hair or wool occurs soon (7–14 days) after the first exposure to the plant, when very large amounts are fed. The alopecia is not necessarily general but is symmetrical. Experimental feeding of large amounts of the plant to steers has been associated with hair loss especially on the tail, pizzle, and escutcheon. Cattle fed on the plant for long periods develop other chronic syndromes including incoordination, temporary blindness, and hyperactivity to the point of severely interfering with normal handling procedures. A secondary phase of poisoning is associated with the formation of DHP is recorded in some countries, but not others. It is characterized by enlarged thyroid glands, poor breeding performance and goitrous, weak calves. The goitrogenic effect is limited to ruminants, is associated with 3,4-DHP, and is not responsive to iodine administration. A further complication, seen in goats on low-level feeding over a long period, is fibrous osteodystrophia of the mandible, causing salivation, slow eating, and weight loss. The long bones are normal.

In pigs, the feeding of diets containing up to 15% of dried *L. leucocephala* to pregnant gilts is associated with a high proportion of fetuses being resorbed and some having limb deformities. Feeding 1% ferrous sulfate in the diet reduces these effects, and supplementation of the diet of ruminants with iron, copper, and zinc is also claimed to reduce the toxic effects.

All toxic effects are quickly reversible by removing animals from access to the plants, so the case fatality rate is usually low. Necropsy lesions are limited to alopecia, oral and esophageal ulcers, and thyroid enlargement.

Animals grazing heavily on *L. leucocephala* are likely to have low blood levels of thyroxine, and high blood and urine levels of DHPs.<sup>16</sup>

#### AMINOPROPIONITRILE

3-Aminopropionitrile is a poisonous substance found in *Lathyrus* spp. (wild peas),<sup>17</sup> e.g. *Lathyrus hirsutus* (wild winter pea), sometimes sown with grasses to

provide early spring grazing. Signs of toxicity in cattle grazing mature plants bearing seed pods<sup>18</sup> consist of salivation, sawhorse stance, head held low, continuous head and ear movements, trance-like gaze, diminished responsiveness, reluctance to move, pain in the feet causing lameness, sitting with the feet under the body, and a marked disinclination to rise. Other signs include lameness, stumbling gait, recumbency, and paddling convulsions. The signs are exacerbated by driving or other harassment. Necropsy findings are limited to non-specific lesions such as pulmonary congestion.

#### ANDROMEDOTOXIN

Andromedotoxin (synonym acetyl-andromedol, grayanotoxin) is a resinoid substance, a member of the diterpenoid group of substances, found in plants of the Ericaceae including:

- Agauria salifolia*
- Clethra arborea*
- Kalmia* spp. – laurels
- Ledum* spp. – labrador tea
- Leucothoe* spp. – sierra laurel, hanahiri
- Lyonia ligustrina* – staggerbush
- Menziezia ferruginea* – mock azalea
- Pieris* (= *Andromeda*) spp.<sup>19</sup>
- Rhododendron* spp., most of them ornamental trees and bushes<sup>20</sup>

They are very poisonous; deaths occurring mostly after clippings from the plants are thrown into animal grazings. Clinical signs commence a few hours after the plant is eaten and include dullness, salivation, projectile vomiting, bloat, repeated swallowing or belching, tenesmus, abdominal pain, a staggering gait, recumbency, convulsions with opisthotonos, tremor, dyspnea, groaning and bleating, and a course of 2–3 days. Tachycardia and cardiac irregularity occur in some cases. Aspiration pneumonia is a common sequel and is the only common gross necropsy finding.<sup>21</sup> Histopathological changes are limited to minor lesions in the gray matter of the spinal cord.<sup>22</sup> The toxins are transferred to the honey made from these plants and is associated with toxicity in humans.

#### ANTHRAQUINONE

Anthraquinones are still extracted commercially from plants for use as irritant cathartics. Plants growing wild that contain these compounds are:

- Senna* (= *Cassia*) *occidentalis* – coffee senna
- S. obtusifolia* – sicklepod<sup>23</sup>
- C. roemeriana*
- C. italica*
- Fragula alnus* – alder buckthorn
- Rhamnus* spp. – buckthorns.

Pigs<sup>24</sup> and cattle<sup>25</sup> may be poisoned by *Senna occidentalis* seeds which contaminate prepared rations. All of these plants are associated with severe gastroenteritis manifested by diarrhea, often with transitory signs of abdominal pain, if the dose is large and taken at one time.<sup>26</sup> Liver damage is also a common lesion in experimental and field cases and may dominate the necropsy findings.<sup>27</sup> Smaller doses of *Senna* spp. over a period of a week are associated with necrosis of striated muscle fibers characterized by limb weakness, incoordination, dragging the hind toe tips, and eventually paralysis in sternal or lateral recumbency. Necropsy lesions are cardiac and skeletal muscle necrosis, but these have not been shown to be direct effects of the anthraquinones.

#### ARISTOLOCHINE

This alkaloid occurs in:

- Aristolochia bractea*
- A. clematitis* – birthwort
- A. densivena*
- A. elegans*.

In goats, poisoning takes the form of diarrhea, dyspnea, alopecia, and hindlimb weakness. In horses, signs include straining to urinate, passing small amounts of urine frequently, polyuria, and tachycardia.

#### CANNABINOID

Cannabinoids are resinoids found in the plant *Cannabis sativa* (marihuana). The toxic principle is the alkaloid tetrahydrocannabinol. Clinical signs of poisoning in horses include restlessness, hypersensitivity, tremor, sweating, salivation, dyspnea, staggering gait, and death or recovery after a few hours. No significant necropsy lesions are recorded. Toxin is detectable in stomach (rumen) contents.<sup>28</sup>

#### COLCHICINE

The alkaloid colchicine, found in *Colchicum autumnale* (autumn crocus) and *Gloriosa superba* (flame or glory lily), is associated with acute diarrhea, abdominal pain, tenesmus, vomiting, and salivation in sheep, cattle, and pigs.<sup>29</sup> At necropsy, subserosal hemorrhages and gastroenteritis are evident. Mortalities are likely when cattle graze dense patches of *C. autumnale* in pasture or are fed hay containing the plant.<sup>30</sup> The toxin is excreted in the milk.<sup>31</sup>

#### CREPENYNIC ACID

Necrosis of cardiac and skeletal muscle, manifested clinically by a staggy gait and recumbency, or sudden death during exercise, is the significant lesion in poisoning of sheep by crepenynic acid, which is found in mature seed heads of *Ixiolaena brevicompta* (button weed).<sup>32</sup>

#### CYCAD GLYCOSIDE

All cycads that have been investigated contain one or more glycosides of methylazoxymethanol (MAM) known as cycasin, macrozamin, and pakoein. These include species of:

- Bowenia*
- Cycas*
- Dioon*
- Encephalartos*
- Lepidozamia*
- Macrozamia*
- Stangeria*
- Zamia* – cycads or zamia palms.

These robust cone-bearing plants grow in greatest numbers in poor soil in hot climates, and their young leaves and seeds are eaten eagerly by ruminants when other feed is short. MAM glycosides are much more concentrated in seeds than in leaves. The MAM glycosides are hydrolyzed in the rumen. MAM is further metabolized to a highly reactive methylating agent in the liver, producing periacinal hepatocyte necrosis and damage to blood vessels leading to hepatic veno-occlusion. Long-term intake results in liver cirrhosis. The liver lesions result in anorexia, weight loss, jaundice, and photosensitization. In addition, acute poisoning is associated with hemorrhagic necrosis of the abomasum and small intestine in sheep and cattle, causing severe diarrhea. Sheep are more likely than cattle to consume seeds and develop hepatogastrointestinal MAM poisoning. Pigs and horses have been experimentally poisoned with seeds. MAM is mutagenic and carcinogenic in laboratory animals, but this effect has not been described under natural conditions.

An unidentified neurotoxin in *Bowenia*, *Cycas*, *Macrozamia*, and *Zamia* produces posterior ataxia in cattle, a syndrome recognized in Australia where it is called zamia staggers, some Japanese islands, and in the Caribbean region. This is the most likely result of cattle consuming these plants under natural conditions; however, affected cattle often have some degree of chronic liver damage. This ataxia syndrome in sheep has been produced experimentally but is rare under natural conditions. Clinically, the condition is a proprioceptive defect affecting the hindlimbs causing an irregular, stiff, overextension ('goose-stepping'), and knuckling over at the fetlocks. Atrophy of hindlimb muscles and posterior paralysis may follow. There are degenerative lesions of the fasciculus gracilis, dorsal spinocerebellar tracts, and corticospinal tracts of the spinal cord. Affected cattle do not recover.

#### CYNANCHOSIDE

Cynanchoside is found in *Cynanchum* spp. (monkey rope) and a very similar

toxin is found in *Marsdenia rostrata* (milk vine), *Sarcostemma brevipedicellatum* (= *S. australe*) (caustic vine), and *S. viminale* (caustic bush). It is associated with hypersensitivity, restlessness, stumbling gait, tremor, recumbency, tetanic and clonic convulsions, and opisthotonos. Additional signs include teeth grinding, dyspnea, salivation, and vomiting.

#### DIANTHRONE DERIVATIVES

Hypericin is a complex derivative of dianthron, and is found in *Hypericum perforatum* (St John's wort or Klamath weed) and *H. triquetrifolium* is the prototypical primary photosensitizing agent. All parts of these plants are associated with photosensitive dermatitis when ingested by sheep and cattle, but have to be eaten in large quantities. They are not very palatable and most outbreaks occur when they are in the young stage and dominate the pasture. Narrow leaf varieties contain two or three times as much hypericin as broad leaf varieties, and the flowering tops are six to eight times as toxic as other parts.<sup>33</sup> Clinical signs may appear within a few days of livestock going onto affected fields and usually disappear within 1–2 weeks after removal from them. Experimental production of poisoning with *H. perforatum* has shown that the plant contains a primary photodynamic agent. There is neither liver damage nor loss of hepatic function.

Fagopyrin, a red helianthron pigment found in *Fagopyrum sagittatum* (buckwheat), is associated with primary photosensitization in all species.

#### DIHYDROXYCOUMARIN GLYCOSIDE

Toxins in the dihydroxycoumarin glycoside group are daphnetin and daphnin. Plants that contain them are:

- Daphne* spp.
- Pimelea* spp. (some only)
- Gnidia* spp.
- Wikstroemia indica* – tie-bush.

In some of *Pimelea* spp. the dihydroxycoumarin glycoside has been isolated. In most others its presence is suspected because of the similarity of the signs produced.

Clinical findings include abdominal pain, diarrhea, dysentery, stomatitis and salivation, and vomiting. Some cases have a short course and terminate fatally preceded by convulsions. Necropsy lesions include stomatitis and gastroenteritis. The clinical picture can be confused by the occurrence of simplexin (see under diterpene poisoning) in the same plant, in which case the signs of congestive heart failure are added.

In *Wikstroemia* spp. the alternative signs seen in red deer are those of a hemorrhagic disease, including mucosal pallor,

bounding pulse, loud heart sounds, nasal bleeding, dysentery, and low erythrocyte count and hemoglobin level; platelet numbers are normal. Necropsy lesions include widespread hemorrhages and tissue pallor.

#### DITERPENOID (KAURENE) GLYCOSIDES (ATRACTYLOSIDE, CARBOXYATRACTYLOSIDE, PARQUIN, CARBOXYPARQUIN, AND WEDELOSIDE)

Diterpenoid glycoside toxins have been found in species of:

- Atractylis*
- Atractylodes*
- Callilepis*
- Cestrum*
- Iphiona*
- Wedelia*
- Xanthium*.

*Xanthium strumarium* (cocklebur, Noogoora burr) includes the taxa *X. canadense*, *X. italicum*, *X. orientale*, *X. pungens*, *X. chinense*, and is poisonous to pigs and ruminants. *X. spinosum* (Bathurst burr) is also toxic and assumed to contain diterpenoid glycosides. The two cotyledonary leaves, either within the spiny burrs or just after sprouting, contain the largest amount of toxin and are the usual source of poisoning. The cockleburs occur on most continents. Poisonings are reported from North America, UK, Europe, and Australia. Most deaths occur on flood plains where the weed is allowed to grow in abundance. After heavy rain the seeds in the burrs sprout and are palatable to all species, especially calves and pigs. Mortalities are also recorded in adult cows and sheep. Burrs may contaminate feed grains and poison livestock fed on the compounded ration.

*Cestrum* spp., e.g. *C. parqui*, *C. laevigatum*,<sup>34</sup> are garden plants originating from South and Central America which, except for *C. diurnum*, also contain a carboxyatractyloside toxin.

*Wedelia asperima* (yellow daisy), *W. biflora*, and *W. glauca* contain wedeloside. Severe hepatic necrosis is the principal necropsy finding, and the clinical syndrome and clinical pathology are characteristic of hepatic encephalopathy.

The disease in pigs and calves is an acute one, manifested by hyperexcitability, so that the entire herd appears restless, followed by severe depression, rigidity of the limbs and ears, weakness and a stumbling gait, falling easily and recumbency, and clonic convulsions with opisthotonos. Calves may be belligerent. Acute cases die during the first convulsive episode.<sup>35</sup> The course may be as long as 48 hours and terminate in recovery, but

death is the usual outcome. The characteristic lesion is hepatic necrosis.

Treatment is not undertaken. Control depends on keeping livestock away from pasture dominated by these weeds, especially when there are large quantities of sprouted *Xanthium* spp. seeds available.

#### IRRITANT DITERPENOID

The two important irritant diterpenoids are simplexin, an irritant diterpenoid daphnane ester found in *Pimelea simplex*, *P. trichostachya* and others, and 12-deoxyphorbol found in *Euphorbia* spp. (spurges).

Poisoning by 12-deoxyphorbol is associated with a syndrome of stomatitis and enteritis. Cattle generally avoid leafy spurge (*Euphorbia esula*), apparently because they develop a conditioned aversion to it,<sup>36</sup> but sheep and goats will graze it.

**Simplexin** is associated with a syndrome of congestive heart failure with diarrhea and anemia only in cattle in eastern Australia called St. George disease or Marree disease. Sheep and horses are resistant.

The disease in cattle associated with *Pimelea trichostachya*, *P. simplex*, *P. latifolia*, *P. elongata*, *P. neo-anglica* (desert rice flower, flaxweed, wild flax, mustard weed, broom bush) is characterized clinically by massive edema under the jaw and down the brisket, distended jugular veins, persistent diarrhea, anemia, loss of condition, and death. Ingested simplexin is associated with constriction of pulmonary venules, pulmonary venous hypertension, and right heart failure. Diarrhea is caused by direct irritation of the intestinal lining. Inhalation of the powdered plant is associated with the pulmonary-cardiac lesion only. There is also a severe anemia shown to be due to a significant hemodilution of unknown pathogenesis. The usual field picture is that cattle graze looking for feed between old, dry flaxweed plants and inhale it so that the pulmonary cardiac form is the common one and the commonest occurrence is in summer. Experimentally, it has been possible to produce two forms of the disease, the subacute with diarrhea, weakness, and anemia as the predominant signs, and the chronic form characterized by circulatory failure as evidenced by anasarca, hydrothorax, and cardiac dilatation.

Fatal necrotic gastroenteritis is produced by feeding *Pimelea* spp. to sheep and horses, but it is unlikely they would eat the plant in natural circumstances.

#### FLUOROACETATE

Plants containing toxic amounts of fluoroacetate include:

- Acacia georginae* – Georgina gidgee (Australia)

*Dichapetalum* spp. (Africa)  
*Gastrolobium* spp. (Australia)  
*Oxylobium* spp. (some only)<sup>37</sup>  
*Palicourea* spp. (South America)  
*Mascagnia* spp. (possibly) (South America)  
*Spondianthus preussi* (Africa)

The general syndrome appears about 12 hours after the toxic plant is ingested and includes sudden death without other signs, or hypersensitivity, frenzy, dyspnea, cyanosis, tachycardia with rates up to 300/min, cardiac irregularity, ataxia, recumbency, and convulsions. Minor signs include moderate bloat, appearance of signs when animals are driven, and frequent micturition. Death may follow in a few minutes to several hours. Necropsy lesions include necrosis of myocardium, pulmonary congestion and edema, and generalized venous congestion.

In northern inland Australia, poisoning by *Acacia georginae* has been associated with heavy mortalities in cattle and sheep, and seriously reduced the productivity of large areas of grazing land. The fluoroacetate ion is concentrated in the young leaves and seed pods. At necropsy, there is congestion of the alimentary mucosa, flabbiness of the myocardium, and multiple subendocardial and subepicardial hemorrhages. There may be edema and congestion of the lungs. *Gastrolobium* spp. (42 species known or suspected to be toxic) are also sources of poisoning in Australia, mostly in the southwest, *Palicourea* and *Mascagnia* are responsible for many outbreaks in South America. Twelve *Dichapetalum* spp., e.g. *D. cymosum* (Gifblaar), *D. ruhlandii*, *D. barteri*, are poisonous shrubs in Africa but also in the tropics generally. Their fresh green leaves contain fluoroacetate. Acetamide (2 g/kg) given experimentally soon after the ingestion of *Dichapetalum* spp. appears to have helped animals against the poison.

Similar to other organic fluorides, fluoroacetate is known to exert its effect by poisoning the enzyme aconitase leading to the accumulation of significant amounts of citrate in tissues and to irreversible cardiac damage. Native herbivorous mammals in south-western Australia have evolved a high level of genetic tolerance to this toxin and this has been used as a genetic marker to trace the evolutionary history of some of the continent's indigenous marsupials.

#### FURANOCOUMARIN (FUROCOUMARIN)

Plants containing furanocoumarins (including psoralens) include:

*Ammi majus* – bishop's weed, meadow sweet  
*A. visnaga* – visagna

*Cooperia pedunculata* – thunder lily  
*Cymopterus longipes*  
*C. watsonii* – wild or spring parsley  
*Heracleum mantegazzianum* – giant hogweed  
*Petroselinum* spp. – parsley  
*Thamnosma texana* – Dutchman's breeches, blister weed.

Similar furocoumarins, identified as 4,5,8-trimethylpsoralen, 5-methoxypsoralen, and 8-methoxypsoralen, are also present in *Pastinaca sativa* (parsnip root) infested with the fungus *Ceratocystis fimbriata*, and *Apium graveolens* (celery) infested with *Sclerotinia* spp. (pink rot fungus).<sup>38</sup> These toxins have the particular characteristic of being photosensitizing by contact, without the need for ingestion, and are associated with serious lesions in humans. *Ammi majus* is most poisonous to livestock when there are ripe seeds in the seedheads. Its most serious occurrence is as a contaminant in hay.<sup>39</sup> *Cooperia pedunculata*, a perennial forb of western range country in the United States occurs at times of high humidity or after rain has wet the foliage, and the live as well as dead leaves are toxic.

The clinical syndrome is associated with plants containing furanocoumarins is one of photosensitizing dermatitis. It includes severe cutaneous dermatitis, sometimes as severe as cutaneous gangrene, on the white parts of the skin on the dorsal and lateral sides of the body, edema of the head and ears, and the lateral aspects of the teats, the unpigmented conjunctivae, muzzle and the oral mucosa inside the lower lip, and the undersurface of the tip of the tongue. Photosensitive dermatitis in pigs may be associated with distinctive vesicles on the snout and raise a false alarm of viral vesicular disease. One serious international incident arose out of a feeding of moldy parsnips.

#### GALEGINE

Galegine, an isoprenoid guanidine, is found in:

*Galega officinalis* – French honeysuckle  
*Schoenus asperocarpus* – poison sedge (Australia)  
*S. rigens* (Australia)  
*Verbesina encelioides* – crown beard (North America and Australia)

It is associated with a syndrome of severe dyspnea, frothing from the nose, convulsions, and sudden death in ruminants due to pulmonary edema with large fluid accumulations in the thoracic cavity, the result of a direct effect on pulmonary vascular permeability.<sup>40</sup> Sheep may find access via these plants being mixed in with hay or amongst a standing crop.<sup>41</sup>

#### IFORRESTINE

Iforrestine, a heterocyclic nephrotoxin in six *Isotropis* spp. lamb poisons, e.g. *I. forrestii*, *I. atropurpurea*, and *I. cuneifolia* is associated with severe renal damage and uremia in cattle and sheep.<sup>42</sup> Clinical signs include anorexia, depression, diarrhea, oliguria, anuria, recumbency, and death. Proteinuria and glycosuria are constant and there is severe renal tubular necrosis.

#### ISOQUINOLINE ALKALOID

**Berberine**, a pyridine alkaloid, a subgroup of the isoquinoline alkaloids, occurs in the weeds:

*Argemone mexicana* – Mexican poppy  
*A. ochroleuca*  
*A. subfusiformis*  
*Berberis* spp.  
*Mahonia* spp.

The clinical syndrome in cattle and pigs includes weight loss, dyspnea, and subcutaneous edema. Diarrhea, abdominal pain, and recumbency are also recorded. At necropsy the principal lesion is cardiomyopathy accompanied by fluid in body cavities and pulmonary edema, and gastroenteritis in some cases. The toxic effect of *A. mexicana* seeds may be due to their total content of isoquinoline alkaloids rather than to their berberine content.<sup>43</sup>

**Bulbocapnine** is an isoquinoline alkaloid found in *Corydalis flavula* (fitweed, fumatory) and *Dicentra spectabilis* (bleeding heart) and is associated with a transient syndrome of tremor, tetanic convulsions, frenzy, including biting at surrounding objects, opisthotonos, drooling of saliva, and vomiting in grazing ruminants. Some patients die during the first episode.

**Chelidonine**, a toxic isoquinoline alkaloid found in *Chelidonium majus* (greater celandine or celandine poppy) is associated with a syndrome of gait incoordination, dribbling urine, drooling saliva, and convulsions in cattle, especially if they are harassed.

**Corydaline** is an isoquinoline alkaloid found in *Corydalis caseana* (fitweed) and is associated with acute diarrhea, frenzy and excitement exacerbated by harassment, clonic convulsions, and a quick death in grazing animals. The same toxin in *Dicentra cucullaria* is associated with a similar syndrome except that vomiting occurs and diarrhea is not recorded but gastroenteritis at necropsy is.

**Unspecified isoquinolines** found in *Eschscholtzia californica* may be associated with poisoning.

#### JUGLONE

A poisonous resinoid found in the shavings of *Juglans nigra* (black walnut tree) has been suspected as being associated with lameness and edema of the

lower limbs in horses bedded on the shavings, but juglone is present in the bark and leaves, not the heart wood from which the shavings are made.<sup>44</sup> The lesions are produced by an increase in local capillary blood pressure.<sup>45</sup>

A similar syndrome is associated with *Berberoa incana* (hoary alyssum).<sup>46</sup> Signs appear 18–36 hours after ingestion of the plant, and disappear 2–4 days after the plant is removed. Fever and red urine are additional signs seen in some cases. An alternative syndrome of severe gastroenteritis plus intravascular hemolysis is also recorded in horses fed hay contaminated by *Berberoa incana*.<sup>47</sup>

### JUNIPERINE

An alkaloid, juniperine, occurs in *Juniperus* spp. trees and is reputed to be associated with nephrosis, cystitis, and rumenitis when eaten. Signs include abdominal pain, diarrhea, proteinuria, elevation of blood urea nitrogen (BUN) levels, and abortion.

### LECTINS (TOXALBUMINS)

Lectins are very important glycoproteins in human nutrition because of their occurrence in common foods. They are associated with damage to the gut epithelium, leading to defective digestion and absorption, and to increased permeability of the intestinal mucosa. They are of minor importance in animals. The toxins are present in foliage and seeds but are concentrated in the latter. Recorded occurrences are of nephrosis and hepatitis in ruminants. The clinical syndrome includes inappetence, vomiting, diarrhea, and sometimes dysentery, dyspnea, dehydration, rapid weight loss, recumbency, and death in most cases. Serum liver enzymes and BUN and creatinine levels are elevated. Necropsy lesions include abomasal, intestinal erosions, hepatocyte and renal tubular injury, pulmonary hemorrhage, edema, and emphysema. Plants known to be associated with lectin poisoning are:

- Abrus precatorius* containing abrin<sup>48</sup>
- Adenia* spp.
- Jatropha curcas*
- Phaseolus vulgaris* containing PHA (*Phaseolus* hemolytic agent)
- Robinia pseudoacacia*
- Ricinus communis* containing ricin
- Wisteria sinensis* – wisteria.

### LYCORINE

Lycorine, an alkaloid found in the bulbs or roots of many garden plants, e.g. *Amaryllis*, *Clivia*, *Lycoris*, *Narcissus*, and *Nerine* spp., is associated with salivation, vomiting, and diarrhea when eaten.

### 4-METHOXYPYRIDONE

4-Methoxypyridone, a pyridoxine analog found in *Albizia* spp. (*A. versicolor*, fever

tree), *Albizia tanganyicensis* (paperbark *albizia*), especially in the dried pods<sup>49</sup> is a cardiotoxin. Clinical signs in cattle include hypersensitivity, hyperthermia, dyspnea, ataxia, and tetanic convulsions with rapid blinking and nystagmus. Most cases recover spontaneously. Cardiomyopathy is the diagnostic necropsy finding. Lesions also include petechiation in many tissues, pulmonary edema, degenerative changes in myocardium and other organs and in some cases in the brain. Pyridoxine is a satisfactory antidote even if signs have already appeared.<sup>50</sup>

### IRRITANT OILS

Irritant oils in plants are associated with gastroenteritis, with salivation, oral mucosal lesions, abdominal pain, diarrhea, and sometimes dysentery. Plants known to contain these oils include:

- Actaea spicata* – baneberry
- Artemisia filifolia*
- Barbarea vulgaris* – yellow rocket
- Bryonia dioica* – white bryony
- Croton* spp. – croton
- Cryptocarya pleurosperma* – poison walnut; contains cryptopleurine and pleurospermine
- Dittrichia graveolens* – (stinkwort)
- Inula conyza* – ploughman's spikenard
- Sambucus* spp. – elders, elderberry.

Bryonin is an irritant oil found in the roots and seeds of *Bryonia dioica* (white bryony or British mandrake) and is associated with a syndrome of depression, dyspnea, diarrhea, polyuria, stumbling gait, tremor, recumbency, and convulsions. Sweating, agalactia, and sudden death are also recorded.

### PLANT PHENOLS (POLYPHENOL, CALLED ALSO PHENOLICS)

Two groups of plant phenols (hydroxyl derivatives of benzene), of which carbolic acid is one, are **gossypol** and the **tannins**.

#### Gossypol

##### ETIOLOGY

Gossypol, a poisonous phenolic substance present in variable amounts in cottonseed cake made from the seeds of *Gossypium* spp. and hybrids (commercial cotton), and in the seeds and their hulls, is associated with damage to the myocardium and liver. Toxic meal usually contains 300–400 ppm but may contain as much as 18 000 ppm of free gossypol in a 17% protein ration.

##### EPIDEMIOLOGY

Preruminant calves may be most susceptible, diets containing 100–200 mg/kg BW, of gossypol mortality.<sup>51</sup> Most recorded outbreaks of gossypol poisoning refer to pigs. Sheep are susceptible if the toxin is injected but appear to be unaffected when it is fed. Calves die of heart failure if fed

800–1000 g cottonseed meal/day. Illness and mortality have also been produced by feeding gossypol to adult dairy cows. Goats are more susceptible, daily intakes of 350–400 mg gossypol are fatal after 3 months.<sup>52</sup> Adverse effects on spermatogenesis with an increase in sperm morphology abnormalities occur in bulls on low intakes and without clinical signs.<sup>53</sup> Cottonseed cake should not be fed to pigs at all, especially young pigs. Adults may tolerate up to 60 ppm in the feed of gossypol.<sup>54</sup> Horses appear to be resistant to gossypol toxicity, no natural cases being on record.

### CLINICAL FINDINGS

These do not usually appear until animals have been fed on rations containing cottonseed cake for 1–3 months. Poisoned calves show anorexia, dyspnea, cough, brisket edema, ascites, distension of the jugular vein, and weakness; hematuria occurs occasionally, and death follows an illness of several days. Pigs poisoned by gossypol are thin, lack tolerance to exercise, cough, and are dyspneic. Sublethal rates of ingestion are associated with stunting of growth and reduction of fertility in bulls. Feeding cottonseed meal to young bulls and rams is not recommended because of the risk of permanent damage to spermatogenic tissues<sup>55</sup> but the risk is considered to be negligible.<sup>56</sup> Feeding cottonseed meal to pregnant sows at the rate of 20–40% of the ration is associated with shortening of the gestation length, and at 40% some piglets are born prematurely and soon die.<sup>57</sup>

### CLINICAL PATHOLOGY

Elevation of serum sorbitol levels is the best laboratory indicator of gossypol poisoning; levels of 18 units/L in normal calves are elevated to 34 units/L in poisoned ones. Thoracic radiographs will demonstrate the presence of fluid, which can be examined for protein content after collection via paracentesis.

### NECROPSY FINDINGS

There is generalized edema, including high protein fluid in all the serous cavities, and hepatomegaly, due to congestive heart failure, and histologically there is degeneration of the myocardium and skeletal musculature. Centrilobular necrosis in the liver is also a characteristic lesion, and the liver will contain as much as 42  $\mu$ g/g gossypol.<sup>58</sup>

### CONTROL

Cottonseed cake may be fed with safety to adult cattle provided the daily intake of meal containing = 1000 ppm of gossypol is less than 10–12 kg.<sup>59</sup> and to pigs provided it constitutes less than 10% of the ration, or in large quantities if the material is detoxified. Cooking of the cake or the addition of 1% calcium hydroxide or 0.1% ferrous sulfate to it are efficient methods

of detoxification. In experimental trials the addition of iron in equal proportions to gossypol up to 600 mg/kg of the ration will protect pigs. Significant quantities of cations (particularly calcium and iron) in water supplies or rations appear to be protective. Providing calcium carbonate at a rate of 12 g/kg of whole cotton seed (WCS) for every 0.5% of free gossypol in the WCS prevents reproductive effects in cattle.<sup>60</sup>

### Tannins

These include the **condensed tannins** (proanthocyanidins), which are insoluble and non-toxic, except that they may be associated with oral mucosal lesions, and the **hydrolyzable tannins**, which are soluble and potentially toxic; pyrogallol, a degradation product of hydrolyzable tannins is hepatotoxic and nephrotoxic. Oaks (*Quercus* spp.) and yellow-wood tree (*Terminalia oblongata* ssp. *oblongata*) are important in this group. Miscellaneous other toxic plants in this group include:

- Acacia melanoxylon* – black wattle
- A. salicina* – black sally wattle
- Clidemia hirtia* – harendong
- Elephantorrhiza elephantina*
- Stryphnodendron* spp.
- Thiloa glaucocarpa* – sipauba, vaqueta
- Ventilago viminalis* – supple jack.

### Oak (*Quercus* spp.)

The leaves and windfall acorns<sup>61</sup> of many varieties of oak trees, including *Q. robur* (synonym *Q. pedunculata*, European oak) *Q. havardii* (sand shin oak), *Q. marilandica* (blackjack oak), and *Q. garryanna*, are browsed by animals and are associated with no illness when they form only a small part of the diet. The toxic principles are hydrolyzable tannins and simple phenols in the leaves, especially the young buds. All species of animals are affected, losses in sheep and cattle being reported most commonly, with occasional cases occurring in horses. Goats are thought to be capable of surviving much greater intakes of tannin than cattle because of greater concentrations of tannase enzymes in their ruminal mucosae. Experimental administration of tannic acids to goats has produced anemia, but there is no record of the natural occurrence of the disease.

If little else is eaten, oak foliage and acorns may be associated with nephrosis manifested by polyuria, ventral edema, abdominal pain, and constipation followed by the passage of feces containing mucus and blood. Blood urea nitrogen (BUN) levels are elevated, the specific gravity of the urine is low and there is proteinuria. At necropsy there is edema of the gastrointestinal wall and mesentery, a characteristic nephrosis and hepatic damage.<sup>61</sup> There may also be ulcerations of gut wall consistent with the presence of uremia.

Survivors of an initial attack of nephrosis make compensatory weight gains and perform well in situations like feedlots.<sup>62</sup>

Extensive areas of oak-brush range in the United States can be utilized for cattle grazing, but require careful management if losses are to be avoided. The phenol content varies between species so that stands of *Q. alba* can be much less toxic than those of *Q. rubra* or *Q. velutina*. Calcium hydroxide (15% of the ration) is an effective preventive under experimental conditions.

### Yellow-wood tree (*Terminalia oblongata* ssp.)

The foliage contains a hepatotoxic tannin punicalagin<sup>63</sup> and an unidentified nephrotoxin, and is associated with losses in cattle.

**Acute** poisoning of cattle is manifested by a sudden onset of hepatopathy/jaundice/ photosensitization with some nephrosis and signs of abdominal pain and dehydration. Necropsy reveals a swollen congested liver, swollen gray-green kidneys and gray-green pigmentation of the gastrointestinal mucosa with multiple small hemorrhagic erosions of the abomasal mucosa. **Chronic** poisoning of cattle is dominated by severe nephrosis with pigment accumulation and fibrosis in the kidney cortex, polyuria, and wasting of the body. Yellow-wood poisoning of sheep is a nervous derangement, manifested by seizures if sheep are excited by handling, and from which they recover spontaneously.

### Piperidine alkaloids

#### ETIOLOGY

The important, identified piperidine alkaloids include coniine, cynapine, nicotine, and lobeline. The diseases they produce are set down below.

#### Conium

*Conium maculatum* (poison hemlock) contains five major acetate-based piperidine alkaloids – coniine, *N*-methylconiine, conhydrine, pseudoconhydrine, and  $\gamma$ -coniceine – and a number of other, lesser, alkaloids.  $\gamma$ -Coniceine is probably a precursor of the others, and is much more toxic. The concentration of each of the alkaloids in different parts of the plant, in different climates, and at different times of the year is very variable. For example, the concentration of the  $\gamma$ -coniceine is high in the fruits when they are formed, but there is no significant content in the roots. In the dormant stage the toxicity of the roots is very high.

#### EPIDEMIOLOGY

The weed occurs in most parts of the world. All animal species are affected, with cattle, sheep, goats, horses, and pigs showing the nervous form of the disease. Poisoned cattle, pigs, and sheep also

produce deformed offspring, with ewes being much less susceptible than cows and sows. Grazing animals are poisoned by eating the standing plant, the seeds or roots at the appropriate time of their development. The plant may also be fed in hay or green feed or the seeds may contaminate harvested grain. Milking cows secrete the alkaloids in their milk.

### PATHOGENESIS

The alkaloids are associated with two modes of poisoning, paralysis of skeletal muscle by blocking transmission at neuromuscular junctions and by acting as teratogens. All of the major alkaloids are associated with the acute disease. Only coniine and  $\gamma$ -coniceine are known to be teratogenic. Teratogenesis is effected through reduced fetal movements in utero.<sup>64</sup>

### CLINICAL FINDINGS

In the acute, nervous form of the disease signs include tremor, staggy gait, knuckling of fetlocks, frequent belching, sometimes with vomiting, frequent urination and defecation, drooling of saliva, tachycardia, and pupillary dilation. In cows and sows there is also prolapse of the nictitating membrane, and in cows there is a characteristic mousy odor of the milk and urine of affected animals. The course in cattle, goats, and horses is a few hours only and terminates in recumbency and death by respiratory paralysis, without convulsions. Sheep are least affected and recovery is common.<sup>65</sup>

Serious congenital deformities, including carpal flexure, limb malalignments, scoliosis, and torticollis, occur in piglets and calves. Lambs have similar, but lesser, defects and in many cases they are temporary, disappearing in the first few weeks after birth. By ultrasound scanning the fetal movements of lambs in ewes treated with *C. maculatum* can be seen to reduce significantly for a short period. At birth some of the lambs will have limb deformities and kinked tails, all of which recover spontaneously.<sup>66</sup> Cleft palate, sometimes with hare lip, is also a common accompaniment in calves and piglets but not in lambs or foals. The sensitive period of the pregnancy, during which the fetus is susceptible to the teratogen, is day 55–75 for calves, day 30–53 for sows, and day 30–60 for lambs.

The piperidine alkaloids of *C. maculatum*, *Nicotiana glauca* and the quinolizidine alkaloids of *Lupinus* spp. are all teratogenic to goat does in the 30–60-day period of pregnancy. The carpal, tarsal, and fetlock joints are fixed in flexion or extension and the spinal column is deformed with scoliosis, lordosis, or torticollis, and there are deformities of the rib cage.<sup>67</sup>

## NECROPSY LESIONS

Other than the fetal abnormalities, neither significant necropsy nor clinicopathological findings are recorded.

### DIFFERENTIAL DIAGNOSIS

Poisoning by *Trachymene* spp. (wild parsnip) in ruminants is thought to be associated with a conium piperidine alkaloid. The syndrome includes sudden death, gait incoordination stimulated by harassment, acute diarrhea in some cases, and congenital limb deformity. Limb deformities also occur after birth in lambs 8–16 weeks old grazing on *T. glauca* (wild parsnip), *T. ochracea* (white parsnip), and *T. cyanantha*.<sup>68</sup> Heifers and calves are not affected. There is outward bowing of all four limbs, most obvious in the pectoral limbs. Ewes preferentially graze the plant when it is in flower and their fetuses will be deformed. The deformity is reversible in mild cases.

### Cynapine

Cynapine, a piperidine alkaloid found in *Aethusa cynapium* (fool's parsley, lesser hemlock) is associated with dyspnea and gait incoordination in cattle, goats, and pigs.

### Nicotiana

The commonly poisonous members of the tobacco family of plants are:

- Nicotiana tabacum* – commercial tobacco
- N. attenuata* – wild tobacco
- N. exigua*
- N. glauca* – tree tobacco
- N. megalosiphon*
- N. trigonophylla* – wild tobacco
- N. velutina*.

The principal toxins include nicotine, anabasine, and anagryne. Other alkaloids occurring in *Nicotiana* spp., but which are not recorded as having poisoned animals, are nornicotine and anatabine. Other plants containing these alkaloids include *Duboisia hopwoodii* (pituri). Several alkaloids may be present in the one plant but most plant species have a particular alkaloid that predominates. The concentration of the alkaloid varies between parts of the plant, and between different stages of growth. There are two forms of intoxication.

Anabasine is a teratogen and the feeding of stalks of *Nicotiana tabacum* to pregnant sows, 10–48 days pregnant and *N. glauca* to cows, 40–75 days pregnant, is associated with the congenital defects of arthrogryposis of limb and intervertebral joints. There are no abnormalities of the nervous system. The leaves and bark of *N. glauca* contain more teratogen than the woody parts. The feeding of *N. glauca* to sows also is associated with cleft palate in their offspring. Fed to pregnant ewes this plant is associated with lambs being born

with cleft palates, flexed limb joints, rotation of limb joints, and lordosis. The ewes show hypersalivation, ataxia, recumbency, and death. Acute poisoning of livestock ingesting *Nicotiana* spp. or *Duboisia hopwoodii* is associated with muscle tremor, weakness, incoordination, pupil dilation, recumbency, with limb paddling progressing to paralysis. There may be diarrhea.

Tobacco-specific nitrosamines, formed from *Nicotiana* spp. alkaloids, are known to be carcinogenic to laboratory animals, but there is no record of this association in agricultural animals.

### Lobeline

The piperidine alkaloid lobeline is found in the plant *Lobelia berlandieri*.<sup>69</sup> Ingestion of the plant is associated with mouth erosions, salivation, and diarrhea. Necropsy lesions are limited to the lesions of enteritis.

### PODOPHYLLIN POISONING

Podophyllin is a resin found in *Podophyllum peltatum* and is associated with enteritis with signs of excessive salivation and severe, acute diarrhea.

### PROTOANEMONIN POISONING

Protoanemonin exists in the plant as a glucoside ranunculin, which releases protoanemonin when the leaves are macerated. Plants containing ranunculin include:

- Anemone* spp.
- Caltha palustris*
- Clematis* spp.
- Pulsatilla* spp.
- Ranunculus* spp. – buttercups
- Thalictrum* spp.
- Trollius* spp.

Ingestion of these plants may be associated with salivation, stomatitis, abdominal pain, diarrhea, dysentery, hematuria, blindness, ataxia, and convulsions.

### QUINOLIZIDINE ALKALOID POISONING

Quinolizidine alkaloids occur most frequently in plants of the *Lupinus* spp. There are two groups of alkaloids, those causing nervous signs and those acting as teratogens. Liver damage in animals grazing lupins is associated with the mycotoxin, phomopsin, produced by the fungus *Diaporthe toxica*, and not by the plant itself.

#### Neurogenic quinolizidine alkaloids

### ETIOLOGY

Alkaloids causing the nervous syndrome include sparteine, lupinine, lupanine, hydroxylupanine, spathulatine, and thermopsine. These vary widely in their toxicity and their concentration in plant species, and within the same species between years, depending largely on the climate. Species of lupin known to contain them are: *L. angustifolius*, *L. cosentini*

(synonym *L. digitatus*). Species that are associated with the characteristic nervous syndrome and in which the presence of the alkaloids in the plant is assumed are:

- L. argenteus*
- L. caudatus*
- L. cyaneus*
- L. greenei*
- L. laxiflorus*
- L. leucophyllus*
- L. leucopsis*
- L. onustus*
- L. pusillus*.

### EPIDEMIOLOGY

The alkaloids are present in all parts of the plant but are in their greatest concentration in the seeds and pods; most outbreaks of poisoning occur when livestock graze mature, standing lupins, carrying many pods. Sheep eat the plant more readily and are more commonly affected than cattle or horses. The mortality rate in sheep is high. In cattle it is usually low, but may be as high as 50%.

Other plants in which the alkaloids occur, and which are associated with the nervous disease are:

- Cytisus* (synonym *Laburnum*, *Sarothamnus* spp.)
- Baptisia* spp.
- Sophora* spp.
- Spartium junceum* – spanish broom
- Thermopsis* spp.

### CLINICAL FINDINGS

In the nervous disease, affected animals may develop dyspnea and depression, followed by coma and death without a struggle. More acute cases have convulsive episodes in which they are dyspneic and staggy, and show frothing at the mouth, clonic convulsions, and grinding of the teeth. A more prolonged disease is reported in cattle poisoned experimentally with *T. montana*.<sup>70</sup> There is anorexia, depression, edematous swelling of the eyelids, tremor, a stilted gait, arching of the back and a tucked-up abdomen, rough hair coat, and prolonged recumbency.

### PATHOLOGY

High blood levels of serum glutamic-oxaloacetic transaminase (SGOT), creatinine phosphokinase (CPK) and lactic acid dehydrogenase (LDH) are accompanied by a severe myopathy. The possibility of a myopathy being associated with lupins has been raised because the prevalence of enzootic muscular dystrophy appears to be much higher on lupin than on other pasture. Lupins are low in selenium and vitamin E content, and classical white muscle disease may also occur. Histological and biochemical examination of affected calves discount myopathy as the primary lesion. In poisoning by *Cytisus* spp., both



*C. laburnum* (laburnum) and *C. scoparius* (broom) are associated with fatalities.

### Teratogenic quinolizidine alkaloids ETIOLOGY

The best known congenital defect is crooked calf disease, recorded only in the western United States, Kodiak Island, Alaska, and Canada in cows grazing *Lupinus sericeus* or *L. caudatus* in the 40th–120th day of pregnancy. The cause is the neurogenic quinolizidine alkaloid anagryne, which has been identified in potentially teratogenic concentrations in *L. formosus* and *L. arboreus*, and are toxic when levels in the feed exceed 1.44 g/kg dry matter. In some cases the alkaloid may be contained in an aphid, *Aphis craccivora*, infesting the plant. Teratogenesis is effected by reduction of fetal movement *in utero*.<sup>64</sup> Only cattle are affected.

### CLINICAL SIGNS

Affected calves have arthrogryposis, with excessive flexure, malpositioning, malalignment, and rotation of limbs, principally the forelimbs at the elbows and carpal joints, or scoliosis and torticollis, or both. Cleft palate is an occasional occurrence. The flexion of the joints is severe and may be associated with difficulty at calving. Surviving calves cannot stand to suckle, do not improve after birth, and have to be killed.

### DIFFERENTIAL DIAGNOSIS

The defects are similar to those recorded in calves after poisoning of cows by *Nicotiana* spp. or *Conium maculatum*, or a nutritional deficiency of manganese. Similar defects occur after poisoning with the lathrogen, aminoacetonitrile. Although the classical deformities are associated with anagryne are not recorded in lambs, hemimelia has been recorded in lambs from ewes fed on *L. cosentini*.

### CONTROL

This can only be achieved by arranging calving to occur when the lupins are not in a heavy growth stage at the same time as the cows in the herd are in the dangerous phase of 40–120 days pregnant.

### RHOEADINE

Rhoeadine is an alkaloid found in the seed capsules of *Papaver rhoeas* (field poppy), and probably *P. nudicaule* and *P. somniferum*, which is associated with restlessness, hypersensitivity, ataxia, ruminal stasis, dyspnea, and convulsions, but no significant necropsy lesions.

### SAPONIN POISONING

Saponins are naturally occurring glycosides with the physical properties of soaps; that is they produce a stable froth in water. They have a bitter taste. They also

lyse erythrocytes *in vitro*. There are two classes of saponins, those with a triterpene aglycone radical and those in which the non-sugar radical is a steroid.

### Diterpene saponins

In plants, almost all saponins are **triterpene** saponins. The compounds are concentrated in the rapidly growing shoots, the bark and the roots, and are thought to have an insect-repellent role in these sensitive areas of the plant. They are absorbed very slowly, if at all, from the alimentary tract and it seems unlikely that they will exert any systemic effect unless there is pre-existing damage to the intestinal mucosa. Notwithstanding this, a great deal of research has been done on the systemic pharmacological effects in humans of plant pharmacologicals such as ginseng.

Knowledge of the toxicity of triterpene saponins for animals is scrappy. The principal pathogenic effect is enteritis and gastroenteritis, manifested by diarrhea and dysentery. Other less common signs include abdominal pain, vomiting, and salivation. Plants known to have this effect are:

*Agrostemma githago*  
*Aleurites fordii*  
*Dialopsis africana*  
*Gutierrezia microcephala*  
*Hedera helix*  
*Jatropha curcas*  
*J. hyssopifolia*  
*Phytolacca americana*  
*P. dioica* – packalacca<sup>71</sup>  
*P. dodecandra*  
*Saponaria officinalis*  
*Sesbania* spp.

*Bulnesia sarmientii* (Palo santo tree) seed pods and foliage contain an unspecified toxic saponin that is associated with convulsions, licking of forelimbs, geophagia, chewing movements, ruminal atony, bradycardia and frequent urination, and defecation. The bitter taste of saponins may result in a decrease in feed intake and a reduction in growth rate in monogastric animals.

### Steroidal saponins

These are associated with Scandinavian photosensitization disease (aalveld) and occasionally nephrosis in ruminants<sup>72,73</sup>; they occur in:

*Agave lecheguilla*<sup>74</sup>  
*Brachiaria decumbens* grass<sup>75,76</sup>  
*Kochia scoparia* – summer cypress  
*Narthecium ossifragum* – also associated with aalveld  
*Panicum* spp. grasses  
*P. schinizii*<sup>77</sup>  
*P. miliaceum* – French millet  
*P. coloratum* – kleingrass<sup>78</sup>

*P. dichotomiflorum* – smooth witch grass<sup>79</sup>

*Tribulus terrestris*.

Other *Panicum* spp. grasses which should now be on the suspicious list for this kind of poisoning are:

*P. decompositum*  
*P. effusum*  
*P. maximum*  
*P. queenslandicum*  
*P. whitei*.

Birefringent crystals composed of the glucuronides of epismilagenin and episarsasapogenin formed from an ingested saponin accumulate in the biliary system, blocking it and causing damage to it and surrounding hepatocytes. Jaundice, photosensitization, and hepatitis result.<sup>80</sup> Blockage of the bile canaliculi and bile ducts, and cramming of hepatocytes, Kupffer and renal tubules cells by acicular crystals and clefts are characteristic. Necrosis of the distal renal tubules, papillary muscles of the heart, and the adrenal cortex are accompanying lesions.<sup>81</sup> Other steroidal saponins are present in *Tribulus terrestris*, but appear to be non-lithogenic.

### SELENOCOMPOUNDS

Organic selenocompounds occur in two classes of plants which preferentially accumulate selenium, primary converter or indicator plants that grow only in soils with abnormally high selenium content, and secondary converters that grow anywhere but accumulate selenium if it is available. Primary converters are more toxic, attaining levels of greater than 1000, and up to 10 000 ppm. Secondary converters reach levels of about 1000 ppm.

Primary converters include:

*Astragalus* spp. – milk vetch  
*A. bisulcatus*  
*A. pattersonii*  
*A. praelongus*  
*A. pectinatus*  
*A. racemosus*  
*Oenopsis condensata* – goldenweed  
*Stanleya pinnata* – prince's plume  
*Xylorrhiza* spp. – woody aster.

Secondary selenium indicators include:

*Acacia cana*  
*Aster* spp. – woody aster  
*Astragalus* spp. – poison vetch  
*Atriplex canescens* – saltbush  
*Castilleja* spp.  
*Comandra pallidai*  
*Grindelia squarrosai*  
*Machaeranthera ramosa*  
*Morinda reticulata*  
*Neptunia amplexicaulis*  
*Penstemon* spp.  
*Sideranthus* spp. – ironweed.

Clinical findings include the common, acute form with signs of aimless wandering, circling, apparent blindness, head-pressing, dyspnea, lameness and recumbency, teeth grinding and salivation. The chronic form is characterized by alopecia, weight loss, coronitis, hoof deformity, and hoof shedding in all species, including pigs.<sup>82</sup> Assay of selenium in the feed is usually necessary to confirm the diagnosis. Daily intakes of more than 30 ppm are usual in the subacute form. In chronic cases the intake is usually below this level and has been maintained for some months.

Necropsy findings are non-specific and include hepatic, myocardial and renal injury, and erosion of joint cartilages.

### SESQUITERPENES

Sesquiterpenes are common plant poisons. Subgroups of them are listed elsewhere in this chapter, are:

- furanoid sesquiterpenes
- ipomeanols
- ngaiones
- sesquiterpene lactones
- sporidesmin.

Unspecified sesquiterpenes are also listed as being associated with other poisonings. For example, *Flourensia cernua* and *Vernonia* spp. is associated with heavy losses in South America and Africa due to hepatic necrosis in grazing ruminants. Affected animals show non-specific signs of anorexia, ruminal atony, hypothermia, staggering gait, recumbency, and convulsions. Serum levels of liver enzymes are elevated, accompanying a massive liver necrosis.

#### Furanoid sesquiterpenes (furanos sesquiterpenoid) poisoning

Furanos sesquiterpenoids, including ngaione and myodesmone, are essential oils in:

- Lasioppermum bipinnatum* – ganskweed
- Myoporium* spp. – boobialla, Ellangowan poison bush, etc.

Ingestion of these plants usually is associated with jaundice, photosensitization, ruminal stasis, constipation, tenesmus, and abdominal pain. Necropsy findings are limited to hepatic necrosis, jaundice, and photosensitive dermatitis. Ingestion of *L. bipinnatum* by lambs also is associated with the same hepatic insufficiency syndrome, but the same plant from a different part of a farm may be associated with pulmonary and mediastinal emphysema and interstitial pneumonia reminiscent of the ipomeanols.<sup>83</sup> The fungi *Ceratocystis* spp. is associated with the same problems as *L. bipinnatum*. The following are associated with acute hepatic injury and deaths in ruminants:

- Myoporium laetum* – ngaio tree
- Eremophila deserti* (= *M. deserti*) – Ellangowan poison bush
- M. tetrandrum* – Australian boobialla
- M. tetrandrum*
- M. sp. aff. insulare.*

### Ipomeanol

Ipomeanols are produced in sweet potatoes in response to infection by the fungi *Fusarium solani*, *F. oxysporum*, *F. javanicum*, and *Ceratostomella fimbriata* and are associated with pulmonary emphysema and edema and interstitial pneumonia when fed to animals. Ipomeanols are also suspected of being associated with the poisoning of *Perilla frutescens* (purple mint weed)<sup>84</sup> and *Zieria arborescens* (stinkwood tree). *P. frutescens* is toxic only after the plant has flowered and then loses its toxicity once it has been wilted by frost. Cases appear in calves 3–12 days after they begin eating the plant. Pulmonary edema develops because of damage to endothelial cells and young pneumocytes.<sup>85</sup> *Zieria arborescens*, a small tree in Tasmania and eastern Australia, is associated with interstitial pneumonia in cattle, and the disease is reproducible by feeding the foliage. Clinical signs appear as tachypnea, abdominal, grunting respiration with extension of the head, mouth breathing, and a nasal discharge. In bad cases the temperature and pulse are elevated. Most cases die after an illness of 1–21 days. Necropsy lesions include massive pulmonary edema and emphysema.

### Sesquiterpene lactones

There are very many plant lactones suspected of being poisonous. Plant genera known to owe their toxicity to their content of sesquiterpene lactones include *Centaurea* spp., (especially *C. repens*, *C. solstitialis*), *Chrysanthemum* spp., which are associated with contact dermatitis, *Geigeria* spp., *Helenium* spp., *Hymenoxys* spp.,<sup>86</sup> *Iphiona aucheri* and *Parthenium hysterophorus* (parthenium weed).

#### Vomiting syndrome

*Geigeria*, *Helenium* and *Hymenoxys* spp. poisonings in cattle are associated with a syndrome of regurgitation (spewing sickness, vermeersiekte), salivation, dysphagia, and coughing. An ELISA is available for the quantitative detection of the sesquiterpene lactone dihydrogriesenin in *Geigeria* spp. Contrast radiography of the esophagus, and biopsy of skeletal and esophageal muscle are helpful in diagnosis.<sup>87</sup> Dietary supplements used to prevent poisoning by sesquiterpene lactones, including a soybean meal-sodium sulfate combination, are useful provided they add thiol groups to the ration. Urea potentiates the poisoning.<sup>88</sup>

Encephalomalacia syndrome *Centaurea solstitialis* (yellow star thistle) and *C. repens* (Russian knapweed) poisoning in horses is associated with a well-known syndrome of severe depression, constant chewing movements, salivation, tongue flicking, dysphagia, intestinal bloat, paralysis, recumbency, and death. Yawning and somnolence are evident but the horse is easily aroused. Some horses show aimless, slow walking and, in the early stages transient circling. The gait is not grossly abnormal, a slight stiffness at the walk being the only abnormality except for weakness in the terminal stages. A fixed facial expression is common, the mouth being held half-open or the lips drawn into a straight line. Wrinkling of the skin of the lips and muzzle and protrusion of the tongue are present in many cases. Signs fluctuate in severity for 2–3 days and then remain static until the animal dies or is destroyed. Nigropallidal encephalomalacia and fluid accumulations in body cavities are characteristic necropsy lesions. Areas of necrosis or softening are visible macroscopically in the brain, in the globus pallidus and substantia nigra. The lesions are bilateral in most cases.

The plants do not appear to be toxic to ruminants, rodents, or monkeys and sheep do well on sole diets of the plants.

### STEROIDAL (SOLANUM SPP.) ALKALOIDS

*Solanum* spp. plants contain many poisonous glycosidic steroidal alkaloids including solanidine, soladulcidine, solasodine, tomatidine, etc. The best known plants in the group include:

- Solanum bonariensis*
- S. dulcamara*
- S. elaeagnifolium*<sup>89</sup>
- S. esuriale*
- S. fastigiatum*
- S. kwebense*
- S. pseudocapsicum* (nightshades)
- S. tuberosum* (potato – sprouted).

The other important member of the genus is *S. malacoxylon* the principal association in enzootic calcinosis. *Lycium halimifolium* and *Lycopersicum esculentum* (tomato) are also listed as containing these alkaloids.

Acute poisoning with steroidal alkaloids, associated with large doses, appears in experimental animals as a syndrome of gastroenteritis, with diarrhea and necropsy lesions of mucosal necrosis in the stomach and intestines.<sup>89</sup> Subacute poisoning with smaller doses, which are not associated with an enteric lesion but are absorbed, is associated with nervous signs of exercise induced gait incoordination, easy falling, a straddled gait, nystagmus and convulsions with opisthotonos, complemented in some

cases by cardiac irregularity, hemolysis, and sometimes diarrhea. Records of necropsy lesions include only occasional references to the presence of encephalomalacia and cerebellar agangliosidosis associated with the incoordination syndromes. *Solanum esuriiale* has been suggested as being associated with **humpy back**, a common disease in sheep in Australia, but the association is unproven.<sup>90</sup> On forced exercise affected sheep show gait stiffness in the hindlimbs with shortness of steps. This is followed by an inability to keep walking and the adoption of a peculiar hump-backed stance. The disease occurs only in summer in full-wooled sheep. At necropsy, there is degeneration of spinal cord tracts. In the United States *S. dimidiatum* is associated with a 'crazy cow syndrome' of staggering and incoordination, with a selective loss of Purkinje cells from the cerebellum. A similar syndrome is associated with *S. kwebense* in South Africa, one by *Brunfelsia pauciflora*,<sup>91</sup> one by *S. cinereum* in goats in Australia,<sup>92</sup> and one by *S. fastigiatum* var. *fastigiatum* in Brazil.<sup>93</sup> The latter appears to be an acquired gangliosidosis. It is characterized by cytoplasmic membranous bodies in the Purkinje cells and a syndrome identical to that described above for subacute poisoning with steroidal (*Solanum* spp.) alkaloids. After an attack lasting up to 60 seconds, the animal returns to normal. Affected animals do not recover but do not die unless by misadventure. The animals can be provoked to have an attack by raising their heads, or by holding them in lateral recumbency and then letting go. It is probable that these are not true 'convulsive' diseases but cerebellar incoordinations in which frantic efforts by a seriously ataxic animal give a superficial resemblance to convulsive episodes. It is also probable that the lesions in this disease are not associated with steroidal alkaloids but with  $\beta$ -carbolines. Other plants, e.g. *S. fastigiatum* var. *acicularium* and *S. bonariensis*, also appear to be associated with this disease.

Potatoes are toxic only if they are green and sprouted and the toxic alkaloid solanine is concentrated in those parts; potatoes must constitute more than 50% of the diet before toxicity occurs. Pigs are most commonly affected but all species are susceptible. In pigs there is dullness, copious diarrhea, anorexia, hypothermia, and coma in the terminal stages. The mortality rate may be high. In horses the signs include depression and prostration but usually there are no signs of alimentary tract irritation. In cattle dermatitis, comprising vesicles and scabs on the legs, is a more common syndrome. At necropsy in all species there is a moderate hyperemia

of the alimentary mucosa. Sprouted or diseased potatoes can be fed safely if they are boiled and the amount fed restricted to less than 25% of the diet.

Some of these plants also contain specific teratogenic steroidal alkaloids which contain  $\alpha$ -piperidine moiety. The plants, in decreasing order of toxicity in terms of producing craniofacial deformities in laboratory animals<sup>94</sup> are:

- S. elaeagnifolium*
- S. saccharoides*
- S. dulcamara*
- S. melongena*
- S. tuberosum*.

### STRYCHNINE

Strychnine poisoning is an uncommon occurrence in farm animals and is usually associated with accidental overdosing with strychnine preparations, or accidental access to grain treated with strychnine and to be used for rodent control. Cattle are particularly susceptible to parenteral administration (30–60 mg of strychnine hydrochloride may be fatal) but less susceptible to oral administration because of destruction of the drug in the rumen. Lethal doses by parenteral injection are 200–250 mg in horses, 300–400 mg in cattle, and 15–50 mg in pigs.

In strychnine poisoning there is greatly increased reflex excitability and, after an initial period of muscle stiffness and tremor, tetanic convulsions occur. These can be provoked by the application of minor external stimuli. In these convulsive episodes there is extension of the limbs, opisthotonos and protrusion of the eyeballs. The seizures may last for 3–4 minutes and are followed by periods of partial relaxation which become progressively shorter as the disease develops. Respiratory arrest leads to death. The diagnosis is confirmed by the detection of strychnine in the gut contents.

Strychnine is rapidly excreted and detoxicated and sedation of the animal for a sufficiently long period may result in recovery. Tannic acid preparations administered orally precipitate the alkaloid in the alimentary tract and interfere with further absorption.

### STYPANDROL

Stypandrol (synonym hemerocallin), a binaphthoquinone (binaphthalene tetrol) found in *Dianella revoluta* (flax lily), *Stypandra glauca* (= *S. imbricata*, *S. grandiflora* – nodding blue lily),<sup>95</sup> and *Hemerocallis* spp. (day lily).<sup>96</sup> Field cases occur only with *S. glauca* and are characterized by blindness, incoordination, posterior weakness and, eventually, flaccid paralysis and recumbency in grazing ruminants. Dilatation and immobility of the pupil, with retinal vascular congestion, hemorrhage, and

papilledema visible ophthalmoscopically,<sup>97</sup> are characteristic and at necropsy there is diffuse status spongiosus in the brain, general neuronal vacuolation, and axonal degeneration of optic nerve fibers and the photoreceptor cells of the retina. Only the young green shoots are poisonous, so that outbreaks occur only in the spring when the plant is flowering.

### TAXINE

Taxine is a mixture of alkaloids found in the seeds and needles of *Taxus baccata* (yew tree) and other *Taxus* spp., and have a strong depressive effect on the heart. Commonly there is sudden death without obvious clinical signs. Intakes of 0.35–0.70 g/kgBW of fresh plant are sufficient to cause death.<sup>98</sup> Signs in horses and cattle, if they appear, include dyspnea, muscle tremor, bradycardia, severe cardiac arrhythmia, hypothermia, weakness, and collapse. There are no significant findings at necropsy, other than the consequences of acute heart failure. Mortalities may be limited to calves sucking on clinically normal dams.<sup>99</sup> *Taxus cuspidata*, the Japanese yew tree, is as toxic as *T. baccata* and is a more common decorative tree. Removal of the ruminal contents of goats via a rumenotomy has been followed by recovery.

### TRITERPENES

Toxic triterpenes include:

- Cucurbitacins, tetracyclic triterpenes found in *Cucumis africanus* and *C. myriocarpus*,<sup>100</sup> *Stemodia kingii* and *S. florulenta*<sup>101</sup> and, in *Ecballium elaterium*
- Lantadenes A and B, and triterpene acids found in *Lantana* spp.
- Icterogenins A, B, and C in *Lippia* spp.
- Meliatoxins A and B, tetranortriterpenes, derived from the berries of *Melia azederach* var. *australasica* (white cedar)
- Colocynthin, a glucoside found in the fruit of the vine *Citrullus colocynthis* (synonym *Colocynthis vulgaris*).

Cucurbitacins are a group of tetracyclic triterpenes found in the fruits of the vines *Cucumis africanus*, *C. melo* var. *agrestis* (Ulcardo melon)<sup>102</sup> *C. myriocarpus* (prickly paddymelon), and *Ecballium elaterium* (squirting cucumber). The ripe fruits are most toxic, and in cattle, sheep, and horses are associated with a syndrome of lethargy, dehydration, abdominal pain, diarrhea, dyspnea, and death in a matter of a few hours. Necropsy findings include edema and necrosis of the ruminal epithelium, intense congestion and hemorrhage in the intestinal mucosa, pulmonary congestion and edema, and hepatopathy in some cases. Seeds of the plant are conspicuous in the ruminal contents.

Icterogenins and lantadenes are associated with liver damage and nephrosis, neither of which is specific,<sup>103</sup> but the lantadenes cause damage to bile canaliculi, gallbladder paralysis, and intrahepatic cholestasis. Jaundice, photosensitization, and ruminal stasis result. *Lantana* is a very pungent plant and cattle will eat it only if other feed is scarce. *Bos taurus* cattle are more susceptible to lantadene poisoning than *Bos indicus* cattle. Treatment with activated charcoal is effective. So is treatment with bentonite, which is recommended as a cheaper alternative to the charcoal. The dosage of either is 5 g/kg BW as a single dose.<sup>103</sup>

Meliatoxin administered to pigs also is associated with a syndrome of gastroenteritis manifested by diarrhea, melena, and vomiting, plus dyspnea due to pulmonary edema.

### TROPANE ALKALOIDS

Tropane alkaloids include atropine, hyoscyamine, hyoscyne, and scopolamine, found in:

- Atropa belladonna* – deadly nightshade
- Datura* spp. – thornapple
- Duboisia leichhardtii*
- D. myoporoides* – corkwoods
- Hyoscyamus niger* – henbane.

Ingestion of these plants in sufficient quantity is associated with a syndrome of restlessness, tremor, pupil dilation, blindness, frenzied actions, convulsions, and recumbency. There are no significant necropsy lesions. *Datura stramonium* grows universally but cases of poisoning are few, possibly due to its unpalatability, its high toxic dose, and because it produces ruminal atony in cattle. The seeds of the plant are likely to contaminate grain supplies and may be associated with poisoning.

### TUTIN

Tutin is a poisonous constituent of the *Coriaria* spp. (tutu trees) in New Zealand. It is associated with hypersensitivity, restlessness, convulsions, a short course and death, without any lesions visible at necropsy.

### VELLEIN

The toxin vellein, found in the plant *Velleia discophora*, is associated with hyposensitivity, dyspnea, tachycardia, and recumbency but no specific necropsy lesions.

### VERATRINE

The mixture of alkaloids found in *Veratrum californicum* is associated with a syndrome of salivation, dyspnea, vomiting, diarrhea, frequent urination, cardiac irregularity, and convulsions. The plant also contains the teratogen cyclophamine.

### ZIGADINE (ZIGADENINE)

The phytotoxin zigadine occurs in the plants *Zigadenus* spp. (death camas),

especially the bulb, and is associated with a syndrome of salivation, vomiting, tremor, ataxia, and dyspnea. The toxin has been identified in the rumen of dead cattle by electron impact mass spectrometry, avoiding the necessity of identifying the plant botanically.<sup>104</sup>

### REVIEW LITERATURE

Bush LP, Crowe MW. In: Toxicants of Plant Origin, Vol. 1, Alkaloids. Ed. Cheeke, P. R. Boca Raton, FL: CRC Press, 1989.

Cheeke PR. Biological effects of feed and forage saponins and their impacts on animal production. *Adv Exp Med Biol* 1996; 405:377.

Cole RJ et al. Carboxyatractylosides. In: Toxicants of Plant Origin. Ed. Cheeke, P. R. Boca Raton, FL: CRC Press, 1989.

Flaoyen A. Role of steroidal saponins in sheep hepatogenous photosensitization. *Adv Exp Med Biol* 1996; 405:395.

Keeler RF. Quinolizidine alkaloids in grain and range lupins. In: Toxicants of Plant Origin. Ed. Cheeke, P. R. Boca Raton, FL: CRC Press, 1989.

Kerr LA. Gossypol toxicosis in cattle. *Comp Cont Educ* 1988; 11:1139–1344.

Knight AP. Poison hemlock. *Comp Cont Educ* 1987; 9:F256–257.

Knight AP. *Veratrum californicum* poisoning. *Comp Cont Educ* 1989; 11:528–531.

Morgan S. Gossypol as a toxicant in livestock. *Vet Clin North Am Food Anim Pract* 1989; 5(2): 251–262.

Panther KE, Keeler RF. Piperidine alkaloids of poison hemlock (*Conium maculatum*). In: Toxicants of Plant Origin. Ed. Cheeke, P. R. Boca Raton, FL: CRC Press, 1989.

Pusztai A. Lectins. In: Toxicants of Plant Origin, Vol 3. Ed. Cheeke, P. R. Boca Raton, FL: CRC Press. p. 29, 1989.

Reed JD. Nutritional toxicology of tannins and related polyphenols in forage legumes. *J Anim Sci*. 1995; 73:1516.

Tokarnia CH et al. Poisonous plants affecting heart function of cattle in Brazil. *Pesquisa Vet. Brasileira*, 1990; 10:1–11.

Zhu J et al. Rumen involvement in sheep tannic acid metabolism. *Vet Hum Toxicol* 1995; 37:436.

### REFERENCES

1. Casteel SW, Wagstaff DJ. *Vet Hum Toxicol* 1992; 34:55.
2. Panther KE et al. *J Anim Sci* 1988; 66:2407.
3. Smith RA, Lewis D. *Vet Hum Toxicol* 1987; 29:240.
4. Panther KE et al. *J Vet Diag Invest* 1996; 8: 474.
5. van Inzen C, Gunn D. *Vet Rec* 1989; 125:212.
6. Beier JT et al. *Vet Hum Toxicol* 1990; 32, Suppl, 81.
7. Oelrichs PB et al. *Natural Toxins* 1995; 3:344.
8. Grant R et al. *J South Afr Vet Med Assoc* 1991; 62:21 & 186.
9. McKenzie RA, Brown OP. *Aust Vet J* 1991; 68:77.
10. Galey FD et al. In: *Plant-Associated Toxins*. CAB International. p. 101, 1994.
11. Burger WP et al. In: *Plant-Associated Toxins*. CAB International. p. 546, 1994.
12. Keeler RF, Stuart LD. *Clin Toxicol* 1987; 25:273.
13. Keeler RF. *Cornell Vet* 1990; 80:203.
14. Hegarty MP et al. *Aust Vet J* 1988; 65:337.
15. Hammond AC. *J Anim Sci* 1995; 73:1487.
16. Quirk MF et al. *J Agric Sci (Camb.)*, 1988; 111:165.
17. Burrows GE et al. *Vet Hum Toxicol* 1993; 35:262.
18. Rowe LD et al. *Vet Hum Toxicol* 1993; 3:127.

19. Visser IJR. *Tijdschr. Diergeneesk* 1988; 113:185.
20. Knight AP. *Comp Cont Educ* 1987; 9:F26.
21. Casteel S, Wagstaff J. *Vet Hum Toxicol* 1989; 31:176.
22. Armien AG et al. *Pesquisa Vet Brasileira* 1995; 15:1.
23. Lewis DC, Shibamoto T. *Toxicon* 1989; 27:519.
24. Barth AT et al. *Vet Hum Toxicol* 1994; 36:541.
25. Colvin BM et al. *J Am Vet Med Assoc* 1986; 189:423.
26. Rowe LD et al. *Am J Vet Res* 1987; 48:992.
27. Irigoyen LF et al. *Pesquisa Vet Brasileira* 1991; 11:35.
28. Driemeier D. *Vet Hum Toxicol* 1997; 39:351.
29. Lohner E, Gindele HR. *Tierarzt Umschau*, 1989; 44:314.
30. Kamphues J, Meyer H. *Tierarzt Praxis* 1990; 18:273.
31. Panariti E. *Vet Hum Toxicol* 1996; 38:227.
32. Walker KH, Ford GL. In: *Plant Toxicology. Proc Aust-USA Poison Plants Symposium*, Brisbane, Australia., p. 401, 1985.
33. Southwell IA, Campbell MH. *Phytochemistry*, 1991; 30:475.
34. Collazo L, Rietcorrea F. *Vet Hum. Toxicol* 1996; 38:200.
35. Witte ST et al. *J Vet Diag Invest* 1990; 2:263.
36. Kronberg SL et al. *J Range Mgt* 1993; 46:364.
37. Campbell GWJ, Kingston GC. *Vet Hum Toxicol* 1992; 34:265.
38. Rowe LD. *Vet Clin North Am.: Food Anim Pract* 1989; 5(2):301.
39. Lopez TA, Odriozola ER. *Rev Vet Med Argentina*, 1987; 68:98.
40. Huxtable CR et al. *Aust Vet J* 1993; 70:169.
41. Gresham ACJ et al. *Vet Rec* 1991; 129:197.
42. Colegate SM et al. *Aust J Chem* 1989; 42:1249.
43. Takken G et al. *Aust J Agric Res* 1993; 44:277.
44. Galey FD et al. *J Comp Pathol* 1991; 104: 313.
45. Eaton SA et al. *Am J Vet Res* 1995; 56:1338.
46. Geor RJ et al. *J Am Vet Med Assoc* 1992; 201:63.
47. Howda LR, Rose ML. *Vet Hum Toxicol* 1993; 35:39.
48. Barri MES et al. *Vet Hum Toxicol* 1990; 32:541.
49. Soldan AW et al. *J South Afr Vet Assoc* 1996; 67:217.
50. Gummow B et al. *Onderstepoort J Vet Res* 1990; 57:109.
51. Zelski RZ et al. *Aust Vet J* 1995; 72:394.
52. East NE et al. *J Am Vet Med Assoc* 1994; 204:642.
53. Chenoweth PJ et al. *Theriogenology*, 1994; 42:1.
54. Penrith ML et al. *J South Afr Vet Assoc* 1994; 65:148.
55. Arshami J, Ruttle JL. *Theriogenology*, 1988; 30:507.
56. Jimenez DA et al. *J Dairy Sci* 1989; 72:1866.
57. Love RJ et al. *Aust Vet J* 1990; 67:223.
58. Holmberg CA et al. *Vet Pathol* 1988; 25:147.
59. Hudson LM. *J Am Vet Med Assoc* 1988; 192:1303.
60. Cusack PMV, Perry V. *Aust Vet J* 1995; 72:463.
61. Garg SK et al. *Vet Hum Toxicol* 1992; 34:161.
62. Ostrowski SR et al. *J Am Vet Med Assoc* 1989; 195:481.
63. Filippich LJ. *Res Vet Sci* 1991; 50:170.
64. Panther KE, Keeler RF. *Vet Clinics North Am. Food Anim Pract* 1993; 9:33.
65. Panther KE et al. *Am J Vet Res* 1988; 49:281.
66. Panther KE et al. *Clin Toxicol* 1988; 26:175.
67. Panther KE et al. *Toxicon* 1990; 28:1377.
68. Philby AW. *Aust Vet J* 1990; 67:468.
69. Williams HJ et al. *J Agric Food Chem* 1987; 35:19.
70. Baker DC, Keeler RF. *J Am Vet Med Assoc* 1989; 194:1269.

71. Storie GJ et al. *Aust Vet J* 1992; 69:21.
72. Hoefler WC et al. *Agri-practice* 1988; 9(3):30.
73. Flayoyen A et al. *Vet Res Comm* 1997; 21:137.
74. Burrows GE, Stair EL. *Vet Hum Toxicol* 1990; 32:259.
75. Graydon RJ et al. *Aust Vet J* 1991; 68:234.
76. Lajis NH et al. *Steroids* 1993; 58:387.
77. Miles CO et al. *Aust Vet J* 1992; 69:34.
78. Camp BJ et al. *Vet Hum Toxicol* 1988; 30:533.
79. Munday SC et al. *J Agric Food Chem* 1993; 41:267.
80. Bridges CH et al. *Vet Pathol* 1987; 24:525.
81. Aas O, Ulvund S. *Vet Rec* 1989; 124:563.
82. Baker DC et al. *Am J Vet Res* 1989; 50:1396.
83. Williams MC. *Onderstepoort J Vet Res* 1990; 57:249-263.
84. Kerr LA et al. *Vet Hum Toxicol* 1986; 28:412.
85. Guerry-Force ML et al. *Am J Vet Res* 1988; 133:285.
86. Gao F et al. *Phytochemistry* 1990; 29: 551.
87. Vanheerden J et al. *J South Afr Vet Assoc* 1993; 64:76-82.
88. Post LO, Bailey EM. *Vet Hum Toxicol* 1992; 34:209.
89. Baker DC et al. *Toxicol* 1989; 27:1331.
90. Dunster PJ, McKenzie RA. *Aust Vet J* 1987; 64:119.
91. Tokarnia CH et al. *Pesquisa Vet Brasileira*, 1991; 11:9.
92. Bourke CA. *Aust Vet J* 1997; 75: 363.
93. Riet-Correa F et al. *Cornell Vet* 1983; 73:240.
94. Keeler RF et al. *Toxicol* 1990; 28:873.
95. Whittington RJ et al. *Aust Vet J* 1988; 65:176.
96. Chen HT et al. *Acta Vet Zoot Sinica* 1987; 18:256.
97. Barlow RM, Middleton DJ. *Neuropathol Appl Neurobiol* 1989; 15:602.
98. Helman RG et al. 1996; *Agri-Pract* 1989; 17:16.
99. Panter KE et al. *J Am Vet Med Assoc* 1993; 202:1476.
100. McKenzie RA. *Aust Vet J* 1988; 65:167.
101. Allen JG, Mitchell AA in Garland T, Barr AC (eds) *Toxic Plants and other Natural Toxicants*. CAB International, Wallingford UK, pp. 120-124, 1998.
102. Jubb TF et al. *Aust Vet J* 1995; 72:274.
103. McKenzie RA. *Aust Vet J* 1991; 68:146.
104. Smith RA, Lewis D. *Vet Hum Toxicol* 1991; 33:615.

## PLANT MATERIALS CAUSING PHYSICAL DAMAGE

Ingestion of indigestible fiber is associated with colic in horses due to:

- Gastric impaction – *Senecio jacobea*
- Impaction of the ileocecal valve – *Sorghum* spp.
- Ruminant impaction in cattle – loppings of :  
*Fraxinus excelsior* – ash tree  
*Chrysocoma tenuifolia* – bitter weed  
*Eriocephalus* spp.  
*Pinus taeda* – loblolly pine  
*Prosopis juliflora* – mesquite  
*Eremocarpus setigerus* – turkey mullein
- Gastric impaction in pigs – *Nicotiana* spp. stalks.

Tough fiber in *Romulea rosea* (onion weed) is associated with an enzootic problem of bovine intestinal and abomasal impaction by phytobezoars in parts of Australia. Phytobezoars can be a problem

wherever indigestible fiber is available to ruminants. Cocoon silk of *Gonometa* spp. (Molopo moth) can be associated with ruminal impaction in cattle that eat foliage of *Acacia eriloba* or *A. mellifera* trees, the preferred habitat for the moth larvae.

Other physical injuries associated with plant material include persistent corneal ulcers from the bristles of *Arctium lappa* (burdock seeds); ulcers in the mouth from the spines of *Setaria lutescens* (yellow bristle grass), and the awns of *Triticosecale* (= triticale). *S. lutescens* carries heavy bristles which are associated with mechanical stomatitis in cattle and horses. Triticale is a hybrid between wheat and rice used mainly for grain production. If it is harvested green as a crop and made into hay the dried awns are prohibitively irritating to the pharynx and mouth of cattle and horses. Affected horses are slow eaters, refuse to eat hay, and show excess salivation. The clinical signs that result in about a week include cough, mucoid nasal discharge, foul breath, hypersalivation, quidding, and loss of body weight. Some horses develop submandibular edema and there are severe ulcerations at the gum-tooth margins, with many awns embedded in the ulcers. The ulcers are very painful, up to 5 cm in diameter at the labial-gingival junction, the lingual frenulum, the base of the lingual dorsum, soft palate, and the sides of the tongue. After careful cleaning up, the lesions heal slowly over about 3 weeks.

Grass seed abscesses are frequent when there is a large population of *Stipa* and *Stipagrostis* spp. (spear grass), *Tagetes* spp., *Aristida arenaria* (silver or kerosene grasses), *Opuntia* spp. (prickly pear), and *Hordeum jubatum* (barley grass) in the pasture. The hairs on the plant *Dittrichia* (= *Inula*) *graveolens* (stinkwort) are thought to be associated with the fatal enteritis which occurs in sheep eating the plant.

## PLANT POISONINGS DUE TO UNIDENTIFIED TOXINS

In many plant poisonings the identity of the toxin is unknown. The more common of these plants are listed below in categories according to the principal sign of the syndrome they produce. Because the information about most of them is meager, no attempt is made to provide a complete picture of each of them. There will be other plants in the main section of the chapter which also are associated with diseases similar to those outlined.

### ABORTION

- Iva angustifolia* – narrow-leafed sumpweed
- Salvia coccinea* – red salvia
- Tanacetum vulgare* – tansy
- Verbena bonariensis* – purple top.

## CONGENITAL DEFECT

*Lysichiton americanus* – skunk cabbage; is associated mostly with cranio-facial deformity.

## CYSTITIS

*Gyrostemon* (= *Didymotheca*) *cupressiformis* – double-seeded emu bush.

## DERMATITIS

*Entandrophragma cylindricum* – redwood; shavings as bedding are associated with balanoposthitis in rams

*Excoecaria* spp.

*Heracleum mantegazzianum* – cow parsnip

*Vicia benghalensis* – popany vetch; is associated with dermatitis, conjunctivitis, rhinitis, fever, and multiple eosinophilic granulomas in many organs<sup>1</sup>

*V. dasycarpa* – woolly pod vetch; same symptoms as *V. benghalensis*

*V. villosa* – hairy vetch; same signs as *V. benghalensis*.

## DIARRHEA – WITHOUT GASTROENTERITIS AS A LESION

*Anredera cordifolia* – lamb's tail

*Blechnum* spp. – bungwall fern

*Bulbine bulbosa* – native leek

*Cadaba rotundifolia*

*Centaurium* spp.

*Chaerophyllum sylvestre*

*Cichorium intybus* – chicory

*Chlorozophora* spp.

*Datisca glomerata* – Durango root

*Dichrocephalia chrysanthemifolia*

*Juncus inflexus* – blue rush

*Linum catharticum* – purging flax

*Mentha australis* – native mint

*Pipturus argenteus*

*Philydrum lanuginosum* – woolly water lily

*Polyga klotzchii*

*Salvia coccinea* – red salvia

*Synadenium arborescens* – African milk bush.

## DIARRHEA – WITH GASTROENTERITIS AS A LESION, OFTEN WITH ABDOMINAL PAIN AND INCOORDINATION, SOMETIMES WITH DYSENTERY AND VOMITING

*Azadirachta indica* – neem

*Brunfelsia australis* (= *B. bonodora*) – yesterday, today, and tomorrow

*Buxus sempervirens* – common box bush

*Centaurium beyrichii* – rock centaury

*Chrysocoma tenuifolia* – bitter bush

*Cissua quadrangularis*

*Cuscuta* spp. – dodder

*Datisca glomerata* – durango root

*Dichrocephalia chrysanthemifolia*

*Dipcadi glaucum* – poison onion

*Diplocyclos palmatus*

*Diplophium africanum*  
*Drymaria* spp.  
*Ephedra viridis*  
*Fagus sylvatica* – European beech tree<sup>2</sup>  
*Galanthus nivalis* – snowdrop  
*Gymnocladus dioica* – Kentucky coffee tree  
*Ligustrum vulgare* – privet hedge  
*Ludwigia peploides* – water primrose  
*Ornithogalum longibracteatum* – chinchinerchee  
*Robinia pseudoacacia* – black locust, locust tree  
*Rudbeckia* spp.  
*Sapium sebiferum* – Chinese tallow wood  
*Scrophularia aquatica* – water betony  
*Sisyrinchium* spp. – scour weed  
*Sium angustifolium*  
*Tulipa* spp. – tulips  
*Turraea robusta*.

#### DYSPHAGIA

*Buxus sempervirens* – box tree  
*Descurainia pinnata* – tansy mustard; difficulty in swallowing due to paralysis of the tongue and the masseter and pharyngeal muscles is accompanied by spasmodic contractions of neck muscles, causing head bobbing in sheep, may occur after sheep ingest *D. pinnata*; there is doubt about the relationship.<sup>3</sup>  
*Prosopis juliflora*.<sup>4</sup>

#### ESOPHAGEAL ULCERATION

*Crotalaria aridicola* – horses only  
*C. medicaginea* – horses only

#### GESTATION PROLONGED

*Iysichiton americanus* – skunk cabbage  
*Salsola tuberculatiflora* – cauliflower saltwort; in ewes, is associated with atrophy of the pituitary, adrenal and thymus glands of the fetus and prolongation of pregnancy to as long as 213 days.

#### HEART FAILURE – WITH SUDDEN DEATH OR CONGESTIVE FAILURE AND CARDIOMYOPATHY

*Atalaya hemiglauca* – whitewood  
*Galenia africana*<sup>5</sup>  
*Phalaris coerulescens* (blue canary grass)<sup>6</sup>  
*Phalaris paradoxa*<sup>7</sup>  
*Tanaecium exitosium*  
*Tetrapteris* spp.  
*Urechites lutea*.

The following contribute to the African syndrome of gousiekte ('quick sickness'):

*Fadogia homblei*<sup>8</sup>  
*Pachystigma latifolium*  
*P. pygmaeum*  
*P. thamnus*  
*Pavetta harborii*  
*P. schumaniana*.

#### HEMOLYTIC DISEASE – WITH SIGNS OF HEMOGLOBINURIA, ANEMIA, AND JAUNDICE

*Acacia nilotica* subsp. *kraussiana* – scented thorn  
*Acer rubrum* – red maple; wilted leaves only, to horses<sup>9</sup>  
*Mercurialis* spp. – mercury  
*Secale cereale* – cereal rye.

#### HEPATIC INJURY – WITH DUMMY SYNDROME OF CIRCLING, HEAD PRESSING, COMPULSIVE WALKING, BLINDNESS

In many cases, an expression of hepatic encephalopathy with hepatic necrosis and status spongiosus in the brain, e.g. *Helichrysum argyrosphaerum* which is associated with blindness, paresis, and spongy degeneration of the brain in sheep and cattle, and *H. blandoskianum* (woolly daisy) has caused death and similar brain lesions in cattle. *Oxytenia acerosa* (copperweed), *Phyllanthus* spp. (spurge), and *Riedelliella graciliflora*, are associated with hepatic injury. *Trema tomentosa* (synonym *T. aspera*) is associated with acute hepatic necrosis in cattle and horses. In *Matricaria nigellifolia* poisoning, affected cattle become clumsy and docile, and head push against fixed objects, hence the common name 'pushing disease'. Sheep are not affected.

#### HEPATIC INJURY – WITH JAUNDICE AND/OR PHOTSENSITIZATION

*Acanthospermum hispidum* – star burr  
*Athanasia trifurcata*  
*Callicarpa longifolia*  
*Capparis tomentosa*  
*Chlorozoa plicata* – terba<sup>10</sup>  
*Enterolobium* spp.  
*Fallopia convolvulus* – black bindweed  
*Ficus tsiela* – fig tree  
*Galeopsis* spp. – hedge nettle  
*Hertia pallens* – springbokbush  
*Heterophyllaea pustulata* – cegadera  
*Kochia scoparia* – summer cypress<sup>11</sup>  
*Lythrum hyssopifolia*  
*Nidorella foetida*  
*Nolina texana* – sacahuiste  
*Persicaria lapathifolia* (synonym *Polygonum lapathifolium*) – pale willow weed<sup>12</sup>  
*Pongamia glabra* – Indian beech  
*Psathyrotes annua*  
*Pteronia pallens* – Scholtz bush  
*Sartwellia flaveriae* – sartwell  
*Sesaea brasiliensis*<sup>13</sup>  
*Stryphnodendron coriaceum*<sup>14</sup>  
*Tetradymia canescens* – spineless horsebrush  
*Trifolium hybridum* – alsike clover.<sup>15</sup>

The *Polygonum* spp. (= *Persicaria* spp.) listed below also are associated with photosensitive dermatitis but are credited with causing a primary hepatic injury.

Many of the findings about these plants are equivocal:

*P. convolvulus*<sup>16</sup>  
*P. orientale* – smartweeds  
*P. sagittatum*.

#### INCOORDINATION OF GAIT, WITH OR WITHOUT RECUMBENCY, CONVULSIONS, OR LESIONS OF NERVOUS SYSTEM

*Ageratina altissima*  
*Araujia hortorum* – cruel vine  
*Berula erecta*  
*Brachychiton populneus* – kurrajong tree  
*Brachyglottis repanda* – rangiora  
*Catharanthus* spp.  
*Centella uniflora*  
*Combretum platypetalum*  
*Craspedia chrysantha*  
*Doronicum hungaricum* – wild sunflower  
*Echinopogon* spp. – roughbearded grass  
*Ervum* spp.  
*Euphorbia mauritanica*  
*Gomphrena celosiooides* – soft khaki weed  
*Hoya* spp. – wax flower  
*Idiospermum australiense*  
*Melantherium hybridum*  
*M. virginicum* – bunchflower  
*Melica decumbens* – dronggras  
*Melochia pyramidata*  
*Modiola caroliniana* – creeping mallow  
*Pennisetum clandestinum* – kikuyu grass<sup>17</sup>  
*Rhodomyrtus macrocarpa* – finger cherry; also is associated with blindness.

The following are associated with paralysis in ewes and horses, with lesions of a lysosomal storage disease and include prominent neuronal pigmentation in the brain and spinal cord:

*Romulea* spp. – onion weed  
*Solidago chinensis*  
*Stachys arvensis* – stagger weed  
*Stephania* spp.  
*Trachyandra* spp.  
*T. laxa*  
*T. divaricata*.

*Romulea bulbocordium* is associated with a high incidence of phytobezoars, a level of fertility in ewes as low as 20%, and a severe gait incoordination when stimulated to move. Affected sheep walk with their heads held high, fall easily, struggle momentarily, then relax and get up and walk normally. If they are left on the same pasture for 3 or 4 weeks they become permanently recumbent.

*Gomphrena celosiooides* associated with outbreaks of incoordination in horses in northern Australia. Spontaneous recovery follows removal from the pasture.

*Echinopogon mauritanica* is associated with hypersensitivity, stiffness, tremor, incoordination, recumbency, and convul-

sions in sheep. *E. ovatus* poisoning in calves and lambs is characterized by harassment-induced episodes of stiff-legged incoordination, easy falling and bellowing, followed by spontaneous recovery.

*Pennisetum clandestinum* poisoning was originally attributed to lactic acid indigestion, but the more recent suggestion is that it is a poisoning associated with the fungi *Myrothecium verrucaria* and *Phoma herbarum* growing on the grass, an unlikely association in some outbreaks.<sup>18</sup> The disease occurs in sheep and cattle in late summer and autumn. There is depression, salivation, abdominal pain, ruminal tympany and stasis, paralysis of the tongue and pharynx, sham drinking, fine muscle tremor, incoordination, recumbency, diarrhea, cyanosis of mucosae, and dehydration. In the fore-stomachs there is distension, mucosal reddening, and extensive microscopically visible necrosis in the rumen and abomasum.

Epidemiologically, the disease occurs concurrently with circumstances conducive to fungal growth, including warmth, moisture, and litter under the grass, often due to the depredations of heavy infestations with army caterpillars (*Pseudaletia separata*, *Pseudocalymma elegans*, *Spodoptera exempta*). Cattle that eat the flower spikes, or sometimes the young leaves, of *Xanthorrhoea* spp. (grasstrees) in Australia develop loss of condition, urinary incontinence, a high carriage of the tail, and posterior incoordination with the hindquarters lurching consistently to one side. Cattle overbalance easily and fall heavily, which has caused farmers to call the disease 'wamps' in imitation of the sound of the body hitting the ground. Onset of clinical signs may be delayed for 2-3 weeks or more after consumption of the plants has stopped. Complete recovery usually occurs in most affected cattle removed from the plants and nursed well. Degenerative changes have been seen in spinal cord white matter in some severe cases. *Lomandra longifolia* (iron grass, long-leaved mat-rush), probably is associated with a similar syndrome.

**MANIA – WITH WILD RUNNING, HYPEREXCITABILITY, INCOORDINATION, CIRCLING, AIMLESS WANDERING, BLINDNESS**

*Burtia prunoides*<sup>19</sup>  
*Pisum sativum*<sup>20</sup>

**MYOPATHY – WITH GAIT INCOORDINATION, RECUMBENCY, ELEVATED CPK**

*Karwinskia humboldtiana* – coyotillo.

Small amounts of *Senna* (= *Cassia*) spp. ingested over a long period are associated

with skeletal muscle myopathy and paralysis, or a combination of the two syndromes can occur. For example, in *Senna occidentalis* poisoning in horses and goats, the early signs are anorexia and diarrhea and these are followed by hyperpnea, tachycardia, ataxia, staggering, and recumbency. At autopsy there is a fatal cardiomyopathy. The muscle lesion is accompanied by marked elevations of SGOT and CPK levels. Similarly, in pigs, early diarrhea may be followed by lateral recumbency and skeletal muscle myopathy.

**PHOTOSENSITIZATION – PRIMARY; WITHOUT HEPATIC LESION**

*Echinochloa utilis* – Japanese millet  
*Erodium cicutarium* – storksbill  
*Holocalyx glaziovii*  
*Lachnanthes tinctoria*  
*Mentha satuireioides*  
*Sphenosciadium capitellatum*  
*Medicago polymorpha* – burr trefoil  
*Verbena* spp.

Dermatitis associated with *M. polymorpha* occurs in all animal species on pasture dominated by the plant, usually in the spring. Lesions on the unpigmented parts of the skin disappear quickly when animals are taken off the pasture; there is no liver damage or permanent after-effect. Aphids, which commonly infest the plant in very large numbers, contain large amounts of a photodynamic agent and may be important in some outbreaks of the disease.

**POLYDIPSIA, POLYURIA**

*Orobanche minor* – broom rape.

**PULMONARY DISEASE – WITH DYSPNEA AND PULMONARY EDEMA ETC.**

*Glechoma hederacea* (= *Nepeta hederacea* – ground ivy)  
*Gyrostemon* spp. – camel poison.

The following are associated with pulmonary consolidation and fibrosis, characterized by dyspnea and cough, in horses:

*Eupatorium* (= *Ageratina*) *adenophorum* – crofton weed  
*E. riparium* – mist flower  
*Lactuca scariola* – prickly lettuce.

**RED URINE – DUE TO A PIGMENTED SUBSTANCE FROM THE PLANT**

*Haloragis odontocarpa* – raspwort  
*Swartzia madagascariensis*  
*Trifolium pratense* – red clover; in deer  
*Xanthorrhoea minor*; in cattle; probably associated with plant resins.

**SALIVATION WITH OR WITHOUT STOMATITIS**

*Arenaria serpyllifolia* – thyme-leaved sandwort

*Puccinia graminis*  
*Scabiosa succisa* – devil's bit.

**SUDDEN DEATH – WITHOUT CARDIOMYOPATHY**

*Arrabidaa bilabiata*  
*Burtia prunoides*  
*Eupatorium wrightii*  
*Lamium amplexicaule* – dead nettle  
*Laurelia novae-zealandiae* – pukatea  
*Nicandra physalodes* – apple of Peru  
*Viguiera annua* – annual goldeneye.

**Uremia, Nephrosis – with high bun**

*Amaranthus* spp.  
*Anagallis arvensis*  
*Azadirachta indica*  
*Cassine buchanani*  
*Catha edulis* – ghat  
*Dimorphandra gardneriana*<sup>21</sup>  
*Lythrum hyssopifolia*  
*Petiveria alliacea* – anamu  
*Psilostrophe* spp. – paperflowers  
*Sapium sebiferum* – Chinese tallow tree  
*Sarcobolus globosus*  
*Sartwellia flavariae*.

**VOMITING**

*Cephaelis ipecacuanha*  
*Tamus communis* – black bryony; plus colic, paralysis, and death.

**REFERENCES**

1. Odriozola E et al. *Vet Hum Toxicol* 1991; 33:278.
2. Wilkens WM, Cranwell MP. *Vet Rec* 1990; 127:435.
3. Pfister JA. *Vet Hum Toxicol* 1989; 31:225.
4. Tabosa IM et al. *Vet Human Toxicol* 2000; 42:155.
5. van der Lugt JJ. *J South Afr Vet Assoc* 1988; 59:100.
6. Colegate SM et al. *Aust Vet J* 1999; 77:537.
7. Bourke CA et al. *Aust Vet J* 2003; 81:635.
8. Fourie N. *Onderstepoort J Vet Res* 1989; 56:73.
9. Plumlee KH. *Vet Hum Toxicol* 1991; 33:66.
10. Galal M, Adam SEI. *Vet Hum Toxicol* 1988; 30:447.
11. Thilsted J, Hibbs C. *Vet Hum Toxicol* 1989; 31:34.
12. McKenzie RA. *Aust Vet J* 1988; 65:128.
13. Chaulet JHF et al. *Pesquisa Vet Brasileira*, 1990; 10:71.
14. Tokarnia CH et al. *Pesquisa Vet Brasileira* 1991; 11:25.
15. Nation PN. *Can Vet J* 1991; 32:602.
16. Cantero JJ et al. *Rev Med Vet (Buenos Aires)*, 1990; 71.
17. Huxtable CR et al. *Aust Vet J* 1987; 64:105.
18. Wong PTW et al. *Aust Vet J* 1987; 64:229.
19. Msengi LMKT et al. *Vet Hum Toxicol* 1987; 29:398.
20. Reardon CR, McKenzie RA. *Aust Vet J* 2002; 80:16.
21. Torres MB et al. *Vet Hum Toxicol* 1997; 39:94.

**POISONING BY MYCOTOXINS**

Recognition of the importance of mycotoxicoses has developed only in recent



times, partly because of improved diagnostic techniques which make possible the identification of the fungi, and of their toxins and metabolites, plus a greater accuracy in differentiating between mycotoxicoses and their bacterial, viral, helminthological, and inorganic chemical look-alikes. The need for this greater accuracy came about because of the significant increase in prevalence of the mycotoxicoses, in pastured animals fed on lush, improved pasture, and in housed livestock in feedlots, and intensive pig and chicken units where a large part of the ration consists of stored grain. A high moisture content of stored feeds is conducive to fungal growth.

### CAUSES OF LOSS

- Sickness and death of animals
- Production loss due to reduced feed intake or subclinical intoxication
- Costs of treating feeds known to be contaminated by mycotoxins
- Discarding of large amounts of feed on suspicion or diagnosis of mycotoxic contamination
- Risk of flow-on to humans who consume animal meat or other food product contaminated by mycotoxins passed through the animal. Besides obvious poisoning there are two potent threats, those of neoplasia and immunosuppression.

### VETERINARY SERVICES REQUIRED RELATIVE TO MYCOTOXICOSES

- Diagnosis to establish rational treatment and control measures to prevent further loss. Differentiation from diseases with similar epidemiological, clinical, clinicopathological and histopathological profiles, but associated with other pathogens, presents serious difficulties for field veterinarians because the fungal agent may be invisible to the naked eye – e.g. *Pithomyces chartarum* on plant debris and causing facial eczema, and infections with the endophytes *Neotyphodium lolii* and *N. coenophialum* – diseases in which diagnostic attention is directed to the plant rather than to the toxin
- Identification of the toxin in the feed or the animal by analytical techniques including immunoassay and chromatography. The chemicals concerned are complex organic compounds and identification may be difficult and is usually expensive. Toxins need to be identified for purposes of recuperative litigation and so that toxic feeds can be identified and either discarded, detoxified, or diverted to feeding less susceptible animals

- Identification of the fungus by culture of suspect feed requires special laboratory services. It is very important to realize that isolation of a known toxigenic fungus does not provide a diagnosis of mycotoxicosis of itself. Growth conditions in the substrate may not have suited mycotoxin production. For a diagnosis to be made it is essential to identify and quantify the mycotoxin itself in the feed or the animal. Knowledge of the identity of the fungus is essential if control of its growth is contemplated, e.g. by spraying fungistatic material on pasture, or prediction of outbreaks is to be undertaken. The difficulty is compounded by the common occurrence of mixed infections, and the often fleeting period of growth of the fungus. Fungi have very exact requirements of moisture and temperature, in particular, for optimum growth, and when these are achieved the fungus can multiply very rapidly and produce large amounts of toxin in a matter of hours
- Prediction of environmental conditions conducive to outbreaks of mycotoxicosis, especially on pasture, is possible only with an exact knowledge of the growth requirements of the particular fungus, requiring expensive monitoring of pastoral microclimate. A common compromise is to monitor fungal growth by counting the yield of spores obtained from a given area or volume of the substrate. However, this does not provide information on the growth requirements of the fungus if any attempt is to be made to restrain its growth in agricultural materials.

### CONTROL MEASURES

Most of the measures identified below are at a trial level and have not been used widely in a range of climatic and industrial environments:

- Spraying of pasture with a fungistat, e.g. thiabendazole for *Pithomyces chartarum* control.
- Adding adsorbents, e.g. hydrated sodium calcium aluminosilicate,<sup>1</sup> activated charcoal, a range of clays (bentonite, zeolite), and synthetic ion-exchange resins.
- Immunizing animals against some mycotoxins, e.g. phomopsin.<sup>2</sup>

Much of the feed fed to animals is contaminated by fungi, the harvesting techniques used and the variability of the weather predicate it, and animals can tolerate even heavy contaminations.<sup>3</sup> To reject all feed showing contamination

would result in unnecessary financial loss. Standard management procedures used widely and traditionally to deal with a flawed feed system and limit losses due to mycotoxicoses include:

- Limitation of the use of high moisture grain as feed. Any grain containing more than 20% moisture is liable to some degree of fungal spoilage
- Avoidance of grazing mature pasture or field crop in which molds grow commonly on seed heads, e.g. *Claviceps* spp. on rye and paspalum, *Diaporthe toxica* on lupins, and *Corallocytostroma ornicoopreoides* on Mitchell grass
- Avoidance of very close grazing of pasture because herbivores can ingest toxic amounts of soil fungi, e.g. *Penicillium* spp.
- Feeding of obviously moldy hay to a small group of test animals because many of the molds on feeds do not produce toxic metabolites, many do but only at certain times, and many have an as yet undetermined status. This procedure has the disadvantage that certain modes of loss may go unrecognized. For example, reduction in feed consumption, and a resulting loss of productivity, is becoming increasingly recognized as a subclinical mode of loss in mycotoxicoses
- Small amounts of feed can be used as feed by diluting it to, at the most, 10% with undamaged feeds, and preferably fed to a sample, pilot group of animals. Lactating, pregnant, and growing animals are most likely to be seriously affected and should not be put at risk.

The known syndromes are summarized in Table 33.2. A list of the mycotoxicoses in which the toxin has not been identified is included at the end of the section. The invasion of tissues by fungi is dealt with in Chapter 24.

### REVIEW LITERATURE

- Cheeke PR. Endogenous toxins and mycotoxins in forage grasses and their effects on livestock. *J Anim Sci* 1995; 73:909.
- Coulombe RA. Biological action of mycotoxins. *J Dairy Sci* 1993; 76:880.
- Dunne C et al. Multimycotoxin detection and cleanup method for aflatoxins, ochratoxin and zearalenone in animal feed ingredients using high performance liquid-chromatography and gel-permeation chromatography. *J. Chromatography*, 1993; 629:229.
- Gbodi TA, Nwude N. Mycotoxicoses in domestic animals: a review. *Vet Hum. Toxicol* 1988; 30:235–245.
- Kellerman TS et al. The distribution, diagnosis and estimated economic impact of plant poisonings and mycotoxicoses in South Africa. *Onderst. J Vet Res* 1996; 63:65.
- Porter JK. Analysis of endophyte toxins - fescue and other grasses toxic to livestock. *J AnimSci* 1995; 73:871.

Table 8.2 Common mycotoxicoses in farm animals

Mycotoxin	Fungus	Disease	Clinical syndrome	Pathogenesis
Aflatoxins	<i>Aspergillus flavus</i> etc.	Aflatoxicosis	Blind, circle, fall, convulsions, teeth grind, mouth frothing,	Hepatic necrosis
Citrinin	<i>Penicillium citrinum</i> etc.	1. Citrinin poisoning 2. Pyrexia-Pruritus-Hemorrhagic syndrome	Uremia (depression, recumbency, high BUN) Exudative dermatitis with pruritus, fever, hemorrhages on mucosae	Nephrosis. Often combined with <i>Aspergillus ochraceus</i> Unknown
Ergot alkaloids	<i>Claviceps purpurea</i>	1. Ergotism (vascular) 2. Hyperthermia	Lameness, gangrene of lower limbs, tail, ear tips, loss of tail switch Hyperthermia, salivation, dyspnea	Arteriolar spasm causes deficient blood supply to part Reduced blood supply to skin reduces heat loss
Ergot alkaloids	<i>Neotyphodium coenophialum</i>	1. Fescue summer toxicosis 2. Fescue foot 3. Prolonged gestation	Low milk yield or weight gain, hyperthermia, hypersalivation, seek shade Loss of tail switch, distal limb, ear tips, tail tip gangrene Long gestation, dystokia, abortion, stillbirth, agalactia	Depression of blood levels of prolactin Local vasoconstriction impairs blood supply Vasoconstriction causes placental edema, reduced circulating prolactin
Paspalitremis	<i>Claviceps paspali</i>	Paspalum staggers	Cerebellar ataxia. Non-fatal	Unknown
Fumonisin	<i>Fusarium verticilloides</i>	Equine leucoencephalomalacia	Tremor, stagger, unable to swallow, depression, recumbency, fatal	Necrosis and hemorrhage in cerebral white matter
Lolitremis	<i>Neotyphodium lolii</i>	Rye-grass staggers	When disturbed gross incoordination, falling, hypersensitivity	Functional derangement of nervous tissue function. No histological lesions
Ochratoxin	<i>Aspergillus ochraceus</i>	Nephropathy	Diarrhea, polydipsia, polyuria, BUN elevated	Nephrosis, immunosuppressant. Carries over into human food chain
Phomopsis	<i>Diaporthe toxica</i>	Lupinosis	Jaundice, depression, recumbency. Survivors have photosensitive dermatitis	Hepatitis. Skeletal muscle myopathy
Slaframine	<i>Rhizoctonia leguminicola</i>	Slaframine toxicosis	Lacrimation, diarrhea, urination frequent. Hypersalivation	Unknown
Sporidesmin	<i>Pithomyces chartarum</i>	Facial eczema	Photosensitive dermatitis, conjunctivitis, stomatitis, lethargy, anorexia, jaundice	Obliterating cholangitis
Unspecified tremorgens	<i>Penicillium Aspergillus</i> spp.	Staggers	Hypersensitivity, incoordination of gait, falling, when driven or startled	Functional nervous derangement
Macrocytic trichothecenes	<i>Stachybotrys chartarum</i> (patratoxin, verrucarol, roridin)	Stachybotrytoxicosis	Fever, diarrhea, dysentery, necrotic ulcers and hemorrhages oral, nasal mucosae, epistaxis, nasal discharge, dermatitis peroral, periorbital	Agranulocytosis, bone marrow suppression, immunosuppression
Non-macrocytic trichothecenes (T <sub>2</sub> toxin, deoxynivalenol, diacetoxyscirpenol)	<i>Fusarium sporotrichoides</i> , <i>F. roseum</i> , <i>F. culmorum</i> etc.	Fusarotoxicosis	Vomiting, feed refusal, diarrhea, mucosal ulcers, and hemorrhage	Immunosuppression and hemorrhagic disease
Zearalenone	<i>Fusarium roseum</i> , <i>F. culmorum</i>	Vulvovaginitis	Infertility, anestrus, stillbirths, neonatal mortality, swelling vulva, mammary glands, vagina and rectum prolapse	Vulvovaginitis

Only the common mycotoxicoses are listed. Many minor ones are listed in the text.

Ramos AJ et al. Prevention of toxic effects of mycotoxins by means of non-nutritive adsorbent compounds. *J Food Protection*, 1996; 59:631.  
Sharma RP. Immunotoxicity of mycotoxins. *J Dairy Sci* 1993; 76:892.

## REFERENCES

- Galvan F et al. *J Food Protection* 1996; 59:551.
- Allen JG et al. In: *Plant-Associated Toxins*. Ed. Colgate, S. M. & Dorling, P. R. CAB International, p. 427, 1994.
- Blaney BJ, Williams KC. *Aust J Agric Res* 1991; 42:993.

## POISONING BY AFLATOXINS (AFLATOXICOSIS)

### Synopsis

**Etiology** Aflatoxins produced by *Aspergillus* spp. growing on stored feed.  
**Epidemiology** All species affected; toxin excreted in milk.  
**Clinical signs** Blindness, circling, photosensitization abortion, tenesmus, stumbling gait.  
**Clinical pathology** Elevated levels of liver enzymes in serum. Assay of aflatoxins in feed and tissues.

**Necropsy** Hepatic necrosis, megalocytosis, fibrosis; jaundice.  
**Diagnostic confirmation** Positive assay of aflatoxin in tissue, fluids.  
**Treatment** Symptomatic only.  
**Control** Preventive assay of large quantities of feed stock. Detoxification of contaminated feed currently being attempted.

### ETIOLOGY

Aflatoxins (AF) are metabolites produced by fungi growing on spoiled feeds. They include AFB<sub>1</sub>, B<sub>2</sub>, G<sub>1</sub>, G<sub>2</sub>, and the second

generation metabolites  $M_1$  and  $M_2$ . They are related chemically to, and probably derived from, dicoumarin compounds. Much the most important disease associated with the ingestion of *Aspergillus* spp. is aflatoxicosis, which is associated with the aflatoxins, but other important toxins produced by the fungi are ochratoxin, patulin, and sterigmatocystin.

Levels of AF attained in feed may be as high as 3500 ng/kg for all aflatoxins, 2000 ng/kg for AFB<sub>1</sub> and 1000 for AFB<sub>2</sub>. In sheep, a dose rate of 4 mg/kg is associated with death at 15–18 hours due to acute hepatic insufficiency; at dose rates of 2 mg/kg there is increased respiratory rate, a rise in temperature of 1.5°C (34°F) and diarrhea with blood and mucus; at a dose rate of 0.2 mg/kg there is anorexia and diarrhea. Similar dose relationships have been established for calves and for pigs. A great deal of aflatoxin ingested in the feed by cattle is physically bound to ruminal contents, and as little as 2–5% reaches the intestine. Levels of AFB<sub>1</sub> in excess of 100 µg/kg of feed are considered to be poisonous for cattle.

#### EPIDEMIOLOGY

Aflatoxicosis has been reported in most countries and on many spoiled feeds, especially harvested peanuts, peanuts-in-shells on hay, cottonseed meal, sorghum grain, corn, moldy bread, green chop sorghum, or rarely on a standing crop, e.g. ears of sweet corn.<sup>1</sup> Common sources are *Aspergillus flavus*, *A. parasiticus*, *Penicillium puberulum*. All animal species are susceptible but outbreaks occur mostly in pigs, sheep, and cattle. The mycotoxin is not destroyed by milling of the grain.

Because the toxin is excreted in cows' milk the disease has public health importance. Aflatoxin is now an important consideration in the etiology of human hepatocellular carcinoma.<sup>2</sup> The concentration of AF in cows' milk may be as high as 0.33 µg/L and may continue to be as high for 3–4 days after ingestion of the feed. Aflatoxins can also be present in the meat from animals eating contaminated feed, but the risks to humans eating the meat are thought to be small.<sup>3</sup>

#### PATHOGENESIS

Hepatitis and hepatic insufficiency are the principal effects, but mutagenic and teratogenic effects are recorded in laboratory animals and suspected in humans on epidemiological grounds.

#### CLINICAL FINDINGS

##### Cattle

Clinical signs include blindness, walking in circles, ear twitching, teeth grinding, frothing at the mouth, photosensitive dermatitis and keratoconjunctivitis, diarrhea, severe tenesmus, abortion, and anal

prolapse. Terminally recumbency is followed by convulsions. The appetite is normal. Affected animals usually die within 48 hours, calves in the 3–6 month group being most susceptible. Aflatoxicosis is also reputed to interfere with clotting of the blood in cattle, leading to the development of hematomas. Amounts of toxin insufficient to overt disease in cows may be sufficient to reduce food intake, weight gains, and milk production, and to be associated with diarrhea.

##### Pigs

In pigs, the period between when the toxin is ingested and when signs appear is thought to be quite long, at least 6 weeks, and varies with the toxicity of the batch of feed. The mortality rate is often 20%, but may be as high, including euthanasias, as 90%.<sup>4</sup> Feeder pigs are more susceptible than adults. The clinical syndrome includes rough coat, depression, anorexia, weight loss, muscle tremor, staggy gait, walking in a daze, and recumbency. Some have intermittent or hemorrhagic diarrhea, and some have seizures just before death. The course of the disease may be as short as 6–12 hours. Abortion is a commonly reported sequel, but there is doubt about the relationship. At necropsy there is icterus, ascites, swelling of the liver, and mesenteric edema.

##### Horses

Aflatoxicosis in horses is recorded,<sup>5</sup> but is unusual probably because horses are not likely to be fed damaged feeds. No clinical signs are reported but illness, lasting 5 days after a prodromal 3–4-day period of anorexia, begins a few days after access to contaminated feeds. Necropsy lesions include encephalomalacia, hepatocyte necrosis and hepatic fibrosis, bile duct hyperplasia, hemorrhagic enteritis, and myocardial degeneration. The experimental disease is characterized by depression, inappetence, tremor, and prostration, with death following in 2–6 weeks.

#### CLINICAL PATHOLOGY

Estimation of AFs in feed materials, urine, blood, and tissues is standard practice. Serum hepatic enzyme levels are increased during the acute phase. Laboratory assay methods include chromatography and a quicker and more accurate ELISA.<sup>6</sup>

#### NECROPSY FINDINGS

Necropsy findings in all species are those of hepatitis, including megalocytosis, multiple foci of necrosis and fibrosis, portal round cell infiltration, and bile duct hyperplasia.<sup>7</sup> Jaundice and serous exudates in body cavities may occur in some animals. A pronounced lower enterocolitis with diarrhea and dysentery is common, but not constant, in pigs.

#### DIFFERENTIAL DIAGNOSIS

Diagnosis confirmation depends on the detection of aflatoxin in the feed and blood serum, and the characteristic gross and histopathological findings in the liver and nervous tissue.

##### Differential diagnosis list:

There are strong similarities to:

- Pyrrolizidine alkaloid poisoning
- Cyanobacterial toxin poisoning
- Phomopsis poisoning
- Sporidesmin poisoning
- Lantadene poisoning
- Steroidal saponin poisoning
- Fascioliasis.

Therapeutic administration of *Aspergillus oryzae* to newborn foals as a digestive inoculant to promote fast development of digestion is suspected of producing mycotoxins and being associated with acute hepatic insufficiency, including encephalopathy.

#### TREATMENT

Symptomatic treatment of hepatic insufficiency is all that can be attempted.

#### CONTROL

Since the advent of reliable and accurate methods of assaying AF in feeds there has been a notable tendency for feed to be less contaminated. Supplementation of the diet with zinc, selenium, vitamin E are not effective in preventing aflatoxicosis, and those procedures which have shown promise in experimental trials have not been translated into practicable, cost-effective techniques.<sup>8</sup> Useful, experimental dietary procedures include hydrated sodium calcium aluminosilicate<sup>9</sup> (several formulations of the compound are already used as anti-caking agents in the animal feed industry) and sodium bentonite in the form of clay.<sup>10</sup> Agronomic methods to reduce aflatoxin contamination of peanuts have recently been successful.<sup>11</sup> Ammoniation of feed has been useful in reducing contamination.<sup>12</sup>

#### REVIEW LITERATURE

- Pitt JL. The current role of *Aspergillus* and *Penicillium* in human and animal health. *J Med Hum Mycol* 1994; 32(Supp 1):17.
- Ramos AJ, Hernandez E. Prevention of aflatoxicosis in farm animals by means of hydrated sodium-calcium aluminosilicate addition to feed stuffs - a review *Anim Feed Sci Technol* 1997; 65:197.
- Robens JF, Richard JL. Aflatoxins in animal and human health. *Rev Environ Contam Toxicol* 1992; 127:69.

#### REFERENCES

1. Hall RF et al. *J Am Vet Med Assoc* 1989; 194:938.
2. Mclean M, Dutton MF. *Pharmacol Ther* 1995; 65:163.

3. Fernandez A et al. *J Sci Food Agric* 1997; 74:161.
4. Coppock RW et al. *J Am Vet Med Assoc* 1989; 195:1380.
5. Vesonder R et al. *Arch Environ Contam Toxicol* 1991; 20:151.
6. Adachi Y et al. *J Vet Med Sci* 1991; 53:49.
7. Cook WO et al. *J Am Vet Med Assoc* 1989; 194:554.
8. Piva G et al. *Nutr Res* 1995; 15:767.
9. Smith EE et al. *J Anim Sci* 1994; 72:677.
10. Schell TC et al. *J Anim Sci* 1993; 71:1209-1226.
11. Rachaputi N et al. *Aust J Exptl Agric* 2002; 42:595.
12. Park DL, Price WD. 2001; *Rev Environ Contam Toxicol* 2002; 171:139.

## CITRININ

Citrinin is most widely known as a nephrotoxin produced by the fungi *Penicillium citrinum*, *P. viridicatum*, *P. palitans*, and *Aspergillus ochraceus* and *A. terreus*. It is commonly found in combination with *A. ochraceus*, and the signs and lesions associated with poisoning by the metabolites of all of the fungi are the same. Citrinin plays a different role in the disease pyrexia-pruritis-hemorrhagic diathesis.

## EPIDEMIOLOGY

Serious outbreaks of this idiopathic disease have been recorded in the UK since 1977. The epidemiology of a variable number of cows being affected simultaneously in a number of herds in the same locality suggested a chemical intoxicant. Suggested poisons were diureidisoobutane (DUIB), the hairy vetch (*Vicia villosa*) or the additive 'sylade', a combination of formalin and sulfuric acid, used in the making of ensilage. This was unlikely given the rarity of the outbreaks when the use of the additive was widespread. The cause is still not certain, but citrinin is now thought to be at least one of the causes.<sup>1</sup> A fortuitous outbreak in half a dairy herd in which moldy citrus pulp cubes were being fed, while there were no cases in the other half of the herd not fed the cubes, suggested that citrinin, which was present in the cubes (30–40 ppb), was causative.

## CLINICAL SIGNS

These include pruritus, hair loss, papular dermatitis, variable appetite with roughage being taken but not concentrates, fever (40–41.5°C, 104–106.7°F), petechiation on conjunctiva, and visible mucosae. The dermatitis is widespread, exudative, initially papular, and itching. It occurs principally on the head, neck, perineum, and udder. Pruritus is variable in degree, but is often so marked that rubbing is associated with the affected skin to become raw and bleeding. The dermatitis subsides but the fever persists, and over a period of 4–7 weeks the animal becomes so unthrifty that it is usually sent for slaughter. The

morbidity rate is usually 10%, but may be as high as 100%. Seriously affected animals die. A similar but more severe syndrome occurs in which there is petechiation in all tissues, especially subserosally. In these cases there are multiple hemorrhages in all mucosae and free blood at the anus and other orifices.

## NECROPSY

Examination shows petechiation in all organs and tissues, although they are absent altogether in some cases. Histological findings include low-grade, longstanding interstitial nephritis, and very little else of significance. Hematology, blood chemistry, and serum enzymes are similarly normal. Antibody reactivity to some components of ruminal contents may be elevated, but not apparently significantly.

## REFERENCE

1. Griffith IB, Done SH. *Vet Rec* 1991; 129:113.

## CYCLOPIAZONIC ACID

An indoletetramic acid, a secondary metabolite produced by *Aspergillus* and *Penicillium* spp. growing on stored grain, including sunflower seeds, is associated with feed refusal and conception problems in sows.<sup>1</sup> Isolated from *A. flavus*, cyclopiazonic acid is associated with weakness, anorexia, loss of body weight, and diarrhea in pigs. Necropsy lesions include gastric ulceration and hemorrhages throughout the alimentary tract.

## REFERENCE

1. Ross PF et al. *Vet Hum Toxicol* 1991; 33:284.

## ERGOT ALKALOIDS

Ergot alkaloids are a subset of indole alkaloids, many of which, like the tryptamines of *Phalaris* spp., occur naturally in plants and produce similar diseases. The individual toxins, and the plants they parasitize, are only partially identified. A list of the fungi, the toxins they contain and the syndromes attributed to them is as follows:

*Neotyphodium (Acremonium)* spp.

*Neotyphodium (Acremonium)*

*coenophialum*; contains the ergopeptine alkaloids ergovaline, ergotamine, and is associated with hyperthermia, milk yield drop, peripheral gangrene

*Neotyphodium (Acremonium) lolii*;

contains lolitrem alkaloids and paxilline, and is associated with gait incoordination (rye-grass staggers)

*Balansia epichloe*; gait incoordination, peripheral gangrene

*Claviceps africana* – sorghum ergot;

contains dihydroergosine; is associated with agalactia, hyperthermia

*C. cinerea*; gait incoordination

*C. fusiformis*; agalactia

*C. paspali*; gait incoordination

*C. purpurea*; hyperthermia, peripheral gangrene.

## NEOTYPHODIUM (ACREMONIUM) SPP.

Infestation of the grasses *Achnatherum inebrians* (drunken horse grass) in China<sup>1</sup> and *Stipa robusta* (sleepy grass) in North America by endophytes is associated with a syndrome of incoordination in horses and sheep grazing on the grass. Identification of the fungi is not completed but they contain ergonovine and lysergic acid amide. Low levels of paxilline and lolitrem B (indo-terpenoids) are also present.

## NEOTYPHODIUM (ACREMONIUM) COENOPHIALUM

There are four diseases associated with this endophytic fungus whose toxic hyphae are present, invisible without microscopy, in the tissues of the grass *Festuca arundinacea* (tall fescue), and which do not produce fruiting bodies. Spread of the endophyte is via infected seeds. There is no visible effect on the growth of the grass. The fungus produces the ergopeptine alkaloids, principally ergovaline, and many other pharmacologically active compounds including peramine and ergine (lysergic acid amine).

Two major diseases are associated in cattle and sheep, fescue summer toxicosis and fescue foot, and two minor ones, fat necrosis and agalactia in mares. All four syndromes could theoretically occur on the one pasture, but summer toxicosis occurs only in the summer, fescue foot in the winter.

## Fescue summer toxicosis (summer slump, epidemic hyperthermia)

Associated with *Neotyphodium (Acremonium) coenophialum* (synonym *Sphacelia typhina*), this disease has assumed a significant place amongst the loss in dairying in the United States, New Zealand, and Australia because of the high rate of use of tall fescue as a pasture grass.

The syndrome is a period of poor production manifested in cattle at pasture in the summer by a fall in milk production or a failure to grow adequately in fat cattle, both in the presence of what looks like an optimum amount of nutritious pasture. The same poor weight gain is experienced by steers fed on fescue seed, and in sheep. In cattle grazing at pasture the depressing effect on production is made worse by environmental temperatures

above 31°C (87°F). Affected cattle show hyperthermia with temperatures as high as 40.5°C (104.5°F) dyspnea, hypersalivation, inappetence, rough coat, and they may compulsively seek out water or tree shade in which to stand. The hyperthermia may not recede until about 6 weeks after the cattle are moved from the pasture.

The **mycotoxin** responsible is ergovaline, an ergopeptide similar to, but more powerful than, ergotamine.<sup>2,3</sup> The lowered milk yield is accompanied by low blood levels of prolactin, resulting in an indifferent prolactin surge when the premilking stimuli are applied.<sup>4</sup> Prolactin levels can be significantly increased by the administration of metoclopramide, a dopamine antagonist,<sup>5</sup> or phenothiazine or cimetidine.<sup>6</sup> The fescue foot is associated with vasoconstriction of sensitive blood vessels, leading to inadequate blood supply to the extremities. Vasoconstriction is also thought to be associated with the hyperthermia, the diminished cutaneous blood supply reducing heat loss.<sup>7</sup>

The **mode of action** of the mycotoxin is unsure but it appears to be mediated via the pineal and pituitary glands, causing an alteration in the metabolism of dopamine and serotonin.<sup>8</sup> Thiamin is thought to be involved in the pathogenesis because of the way in which it improves feed intake during periods of hyperthermia.<sup>9</sup> There is a great deal of variation in the toxicity of different varieties of the grass: KY-31 is most toxic; Kenhy, Mo-96 and Kenmont are intermediate; and Fawn is least toxic. The disease also occurs in animals fed on hay made from affected pastures.

**Control** of the disease can be effected by growing endophyte-resistant varieties, by rotating cattle through fescue and other grass and clover varieties. Treatment of parental plants with the fungicide benomyl produces seed, which results in pasture with a reduced infection rate and lower toxicity for cattle grazing it. Oral administration of thiabendazole just before the cattle go onto the toxic pasture prevents the onset of signs. The recommended regimen is a dose rate of 5 g/45.5 kg BW repeated every 7 days. Ammoniation of the affected hay removes its toxicity so that serum prolactin levels return to normal.<sup>10</sup> A similar disease is recorded as occurring with poisoning by *Claviceps purpurea*.

#### Fescue foot

Fescue foot also occurs in cattle which are grazing pasture dominated by tall fescue, usually within 10–14 days of being turned onto the pasture during cold weather. Cattle permanently pastured on the field do not appear to be affected and horses appear to be able to graze it with impunity. The lesions and clinical signs include severe lameness followed 2 or

more weeks later by gangrene and sloughing of the extremities especially the digits and to a less extent the tail. There is a close similarity to the disease associated with the ingestion of *Claviceps purpurea* and the ergotoxins are also present in fescue (*Festuca octoflora*) so that identifying the specific cause of gangrene of the extremities may not be possible. The incidence in a herd may be as high as 10%. The lesions are associated with the vasoconstrictive agent ergovaline produced by *N. coenophialum*. In freezing temperatures, frostbite may be a complicating factor. New cases may continue to appear for up to 1 week after removal from the affected pasture. The grass heads are commonly infested by *C. purpurea* but the disease occurs in its absence.

#### Infertility and poor weight gain in horses

Pregnant mares fed on *Neotyphodium (Acremonium) coenophialum*-infested pasture can experience a much higher incidence of dystocia, longer gestation, low foal survival, small udder development, and poor milk yield, compared with mares on unaffected pastures.<sup>11</sup> Prolongation of luteal function, an increase in cycles bred per pregnancy rate, and early embryonic death significantly reduce reproductive efficiency.<sup>12</sup>

#### CLAVICEPS PURPUREA (ERGOTISM)



**Etiology** Poisoning associated with the ingestion of large quantities of the naturally occurring ergots of *Claviceps purpurea*.

**Epidemiology** Warm, wet climate; ingestion of pasture or cereal rye or hay made from them.

**Clinical signs** Gangrene of the extremities of the limbs, tip of tail and ears, hyperthermia in cattle. Abortion, poor mammary development, early neonatal deaths in mares and sows.

**Clinical pathology** Assay of ergot toxins in feed and animal tissues.

**Necropsy findings** Gangrene of extremities.

**Diagnosis confirmation** Ergot alkaloids in assay.

**Treatment** Amputation of gangrenous parts.

**Control** Avoid exposure or dilute feed with non-toxic material.

#### ETIOLOGY

*Claviceps purpurea* is a fungus which under natural conditions infests cereal rye and, less commonly, other cereals and many grasses, including the rye-grasses, tall fescue grass, *Phleum pratense* (timothy, cocksfoot, Yorkshire fog), *Cynosurus cristatus* (crested dogstail, tall oat grasses, the brome grasses), *Brachiaria decumbens*, *B. humidicola*,

and *Pennisetum typhoides* (bulrush millet).<sup>13</sup> Ingestion of large quantities of seed heads infested with the sclerotia (ergots) of the fungus is associated with ergotism in cattle, sheep, pigs, horses, dogs, and birds. The ergots contain a number of alkaloids and amines with pharmacological activity and these vary in concentration with the maturity of the ergot. The pharmacologically active compounds in the group, known collectively as ergotoxins, include ergotamine, ergotoxine, and ergometrine, and stimulate the smooth muscle of arterioles, intestines and the uterus.

There is some evidence that corn smut may have pharmacological activity similar to that of *C. purpurea*. An unidentified ergot *Claviceps* spp. on *Cynodon dactylon* (Bermuda or couch grass), may be related to the tremor syndrome which occurs occasionally in cattle grazing this grass.

#### EPIDEMIOLOGY

Ergot of rye is widespread in its distribution, but it is seldom that sufficient is ingested in its toxic stage to be associated with poisoning. Poisoning is most likely to occur during or after warm, wet seasons which favor the growth of the fungus. Ergotism occurs commonly only in cattle and usually in stall-fed animals feeding on heavily contaminated grain over a considerable period of time. Other species are not usually exposed to the infested grain.

Ergot-infested pasture may be associated with the disease, and the toxicity is preserved through the ensiling process.<sup>14</sup> Cows may show early signs of lameness in as short a period as 10 days after going onto an infested pasture, but most animals do not become affected until 2–4 weeks after exposure. Peripheral gangrene occurs in the cooler months, hyperthermia in hot weather.

#### PATHOGENESIS

The peptide alkaloids of ergot, particularly ergotamine, are associated with arteriolar spasm and capillary endothelial damage, with restriction of the circulation and gangrene of the extremities when small amounts are taken over long periods. In spite of the known abortifacient action of *Claviceps purpurea*, abortion does not usually occur in poisoned animals.

The experimental feeding of ergots (1–2% of ration) is associated with severe reduction in feed intake and growth rate in young pigs without producing overt signs of ergotism. Experimental feeding of ergot-infested *Lolium perenne* seeds to cattle can be associated with hyperthermia, without other lesions.<sup>15</sup>

#### CLINICAL FINDINGS

There are three syndromes: **classical ergotism** characterized by gangrene of

the extremities, a **hyperthermia syndrome** in cattle, and a **reproductive syndrome**.

### Classical ergotism – peripheral gangrene

The extremities, particularly the lower part of the hindlimbs, the tail, and ears are affected. There are reddening, swelling, coldness, loss of hair or wool, and lack of sensation of the parts initially, followed by the development of a blue-black color, dryness of the skin, and its separation from normal tissues. The gangrene usually affects all local tissues and, after the lapse of some days, the affected part becomes obviously separated and may eventually slough. The lesions are not painful but some lameness is evident even in the early stages and the animal may remain recumbent most of the time. Severe diarrhea is often an accompanying sign. In sheep under experimental conditions there is no gangrene of the limbs, but there is ulceration and necrosis on the tongue, the mucosae of the pharynx, rumen, abomasum, and small intestine.

### Hyperthermia form

Affected cows have temperatures of 41–42°C (105–107°F), dyspnea, and hyper-salivation. Milk production and growth rate are depressed and morbidity is about 100%. The syndrome occurs in hot weather conditions when affected animals seek water or shade, but exposure to sunlight under normal conditions of air temperature and humidity can be enough to be associated with clinical signs.<sup>16,17</sup> Affected animals stressed by exercise in ambient temperatures over 30°C (86°F) commonly die. Long-term low-level feeding of ergot to fattening beef cattle can result in reduced feed intake and weight gain, increased water intake and urination, failure to shed winter coat and increased susceptibility to heat stress.

### Reproductive form

This is an uncommon manifestation in cows, but there is one report of a brief exposure to a heavily ergotized pasture causing abortion in late pregnant cows. It also occurs as a single outbreak of agalactia, lack of mammary gland development, abortions, prolonged gestations, and early foal deaths in mares fed oats containing *Lolium multiflorum* seeds heavily infested with *C. purpurea*.<sup>18</sup> In sheep, the feeding of ergot reduces the chance of fetuses surviving, so that relative infertility occurs, and feeding pregnant ewes on ergotized grain is not recommended.

In pigs, ergotism is manifested by lack of udder development and agalactia in sows, and the birth of small pigs which suffer a heavy neonatal mortality. Some

of the piglets survive and subsequently suffer gangrene of the ear edges and tail tip. In sows, the chronic feeding of *C. purpurea* may not disturb existing pregnancies, but premature births, mummified fetuses, and low litter size are recorded. Levels up to 0.2% in the diet appear to be safe. A specific ergot, *Claviceps fusiformis*, which grows on *Pennisetum typhoides* (bulrush millet), is known to be associated with agalactia in sows in Zimbabwe. *Claviceps africana*, the ergot of sorghum, has been associated with agalactia in sows and perinatal mortality of piglets in Australia.<sup>19</sup>

### CLINICAL PATHOLOGY

Samples of fungus-infested material may be submitted for assay or test feeding. Chromatographic and mass spectrophotometrical techniques can be used to identify the presence of ergot in feed.<sup>20</sup>

### NECROPSY FINDINGS

In cattle, gangrene of the extremities is the principal gross lesion. There may be evidence of congestion, arteriolar spasm, and capillary endothelial degeneration in the vicinity of the gross lesions and in the central nervous system. Ulceration and necrosis of the oral, pharyngeal, ruminal, and intestinal mucosae are recorded in sheep.

### DIFFERENTIAL DIAGNOSIS

Diagnosis confirmation depends on a positive assay of ergot alkaloids in feed or tissues. Differential diagnosis list includes:

For classical ergotism:

- Poisoning by *Neotyphodium coenophialum*
- Arterial thrombosis and embolism
- Trauma causing obstruction of circulation to the part
- Bacteremia, e.g. in salmonellosis.

For hyperthermic ergotism:

- Heat stroke
- Water deprivation.

For **reproductive ergotism** consult other texts dealing with diseases of the reproductive tract.

### TREATMENT

Treatment is not usually attempted, although vasodilator drugs may have some beneficial effect. The infested grain should be withdrawn from the ration immediately.

### CONTROL

Heavily ergotized grain or pasture fields containing ergotized grasses should not be used for animal feeding. They may be grazed if they are first mowed with the mower blade set high to remove the seed

heads. Feed should not contain more than 0.1% of ergot-infested heads. It is probably safest not to feed ergot-infested feed to pregnant females.

### REVIEW LITERATURE

- Bourke CA. The evidence against the existence of so-called convulsive ergotism in ruminants. In Plant-Associated Toxins. Eds Colegate, S. M. & Dorling, P. R. CAB International, p. 387; 1994.
- Rowan DD. Lolitrems. Peramine and Paxilline – mycotoxins of the ryegrass endophyte interaction. *Agric Ecosystems Environ* 1993; 44:103.
- van Heeswijk R, McDonald G. Acremonium endophytes in perennial ryegrass and other pasture grasses in Australia and New Zealand. *Aust J Agric Res* 1992; 43:1683–1709.

### REFERENCES

1. Miles CO et al. *J Agric Food Chem* 1996; 44:1285.
2. Rowan DD, Shaw GJ. *NZ Vet J* 1987; 35:197.
3. Yates SG, Powell RG. *J Agric Food Chem* 1988; 36:337.
4. Jackson JA et al. *Nutr Rep Int* 1988; 37:1265.
5. Lipham LB et al. *J Dairy Sci* 1989; 67:1090.
6. Boling JA et al. *J Anim Sci* 1989; 67:2377.
7. Niederman CN et al. *Agri-prac* 1987; 8(5):11.
8. Porter JK et al. *J Anim Sci* 1990; 68:3285.
9. Dougherty CT et al. *J Anim Sci* 1991; 69:1008.
10. Kerr LA et al. *Am J Vet Res* 1990; 51:76.
11. Putnam MR et al. *Am J Vet Res* 1991; 52:2071.
12. Brendemuehl JP et al. *Theriogenology*, 1994; 42:489.
13. Coppock RW et al. *J Am Vet Med Assoc* 1989; 194:549.
14. Hogg RA. *Vet Rec* 1991; 129:313.
15. Ross AD et al. *Aust Vet J* 1989; 66:247.
16. Bourke CA. *Aust Vet J* 2003; 81:553.
17. Bourke CA et al. *Aust Vet J* 2000; 78:618.
18. Riet-Correa F et al. *Aust Vet J* 1988; 65:192.
19. Blaney BJ et al. *Aust Vet J* 2000; 78:102.
20. Mantle PG. *J Dairy Sci* 1996; 79:1988.

### NEOTYPHODIUM LOLII (RYE-GRASS STAGGERS, MIGRAM)

Synopsis
<p><b>Etiology</b> Tremorgens (lolitrems) from <i>Neotyphodium (Acremonium) lolii</i>, an endophytic fungus growing in <i>Lolium perenne</i>.</p> <p><b>Epidemiology</b> All species affected; an inconvenient disease associated with almost no fatalities. Outbreaks in late summer when pasture is short. Disappears when rain stimulates pasture growth.</p> <p><b>Clinical signs</b> Gross incoordination when disturbed; limbs not flexed; fall easily, struggling violently attempting to rise. If left alone calm down, rise and graze normally.</p> <p><b>Clinical pathology</b> Lolitrem can be assayed in feed and animal tissues.</p> <p><b>Necropsy findings</b> No identifying lesions.</p> <p><b>Diagnosis confirmation</b> Positive pasture or blood assay of lolitrems; &gt;20 endophyte hyphae/mm leaf sheath width.</p> <p><b>Treatment</b> Nil. Remove animals from affected pasture.</p> <p><b>Control</b> Limit access to affected pasture.</p>

## ETIOLOGY

Knowledge about the cause of rye-grass staggers has changed dramatically during the past decade. It is now known to be associated with tremorgenic mycotoxins produced by the endophytic fungus *Neotyphodium (Acremonium) lolii* in *Lolium perenne* (perennial ryegrass). The mycotoxins are intensely fluorescent complex indoles called lolitrems. Lolitrem B is the abundant one, and lolitrems A, C, and D are present in only small quantities. *N. lolii* produces other metabolites including paxilline, a weak tremorgen, and peramine, a pyrrolopyrazine alkaloid which is repellent to insect pests, especially the devastating Argentine stem weevil. *N. lolii* also has an ameliorating effect on the growth of the plants that it infests, causing increases in dry matter production of 30–40%. This may be due to the deterrent effect of peramine on insect pests.

## EPIDEMIOLOGY

### Occurrence

Rye-grass staggers occurs chiefly in New Zealand, but also to a limited extent in Australia and Great Britain. The incidence is extremely variable depending on climatic conditions. Rye-grass staggers affects a variable number of animals (5–75%) but is associated with few, if any, deaths. Sheep, cattle, horses, and wapiti deer are all affected.

### Risk factors

#### Plant factors

The endophytes grow in the plant tissues and are also present in the seeds. They are concentrated in the outer, lower leaf sheaths so that the disease is most likely to occur at the end of the summer when the pasture is short, and in animals that graze closest to the ground.<sup>1</sup> Different cultivars of perennial rye-grass vary in their degree of contamination by the endophyte; some, such as Nui and Ruanui, carry only 30% infection, whereas Yatsyn and Droughtmaster are 100% infected. Lolitrems A and B are present in high concentrations in the seeds of *L. perenne*, and feeding the seed to sheep is associated with rye-grass staggers syndromes. Rye-grass staggers has also occurred in horses fed on the cleanings of perennial rye-grass seed; heavier cleanings containing more seed are more toxic than the husk-rich cleanings.

#### Environment factors

Rye-grass staggers occurs most commonly in the autumn, but when the grass is dry and short and making only a small amount of slow growth. A sudden fall of rain and rapid growth of the grass is followed by disappearance of the disease. For this reason facial eczema and rye-

grass staggers do not occur together in the same flocks at the same time.

### Importance

The disease is an inconvenience because animals cannot be easily moved. A few deaths may occur due to misadventure.

## PATHOGENESIS

Because of the transient nature of the disease, the nervous signs in rye-grass staggers are presumed to be associated with a functional derangement of nervous tissue. The disease produced experimentally by the administration to sheep of material containing the tremorgenic mycotoxin penitrem A is very similar to naturally occurring rye-grass staggers. Fine tremor, manifested as muscle fasciculations, is followed by coarse tremor causing movement of the head and body. The tremor is enhanced by movement. There is incoordination with a bounding gait, and abnormal postural reflexes leading to lateral recumbency, or sternal recumbency with the hindlegs stretched out behind. Eating and drinking are unaffected. There are no diagnostic lesions except in prolonged cases and the disease is likely to be a reversible biochemical toxicosis. Bulls grazing toxic rye-grass pastures have lower than normal blood levels of testosterone, and sheep make lower weight gains than normal.

## CLINICAL FINDINGS

In **sheep**, the disease occurs commonly in animals in very good bodily condition. In mild cases, signs are observed only on driving, the limbs being moved without flexion of the joints, so that the gait is bounding. In severe cases, the animal is unable to make any movement without the legs becoming extended and abducted, causing it to fall. Vigorous attempts to rise, which may be interpreted as convulsions, follow. If the sheep are left undisturbed they appear to recover, get up and move off, only to repeat the performance within a few yards or metres. In extreme cases, the sheep are permanently prostrate.

In **cattle**, the syndrome is similar to that which occurs in sheep. There is some nodding of the head at rest and occasionally head tremor, but the convulsions are more severe and flexion of the limbs is more marked than extension.

In **horses**, there is tremor, hypersensitivity, and a reeling, drunken gait which may proceed to posterior paralysis. Recovery occurs in a few days when the animals are moved to new pasture. Horses and cattle affected mildly are unable to move quickly because of limb and trunk stiffness and a tendency to fall. Turning is achieved only with difficulty. The signs are not apparent when the

animals are grazing, occurring only when they are disturbed.

## CLINICAL PATHOLOGY

There are no animal-based tests available to aid in the diagnosis of rye-grass staggers. Heinz-body anemia is common in cattle grazing rye-grass, but its significance in relation to rye-grass staggers is unknown. Toxic pastures are reported to have ~35 hyphal strands/mm of leaf sheath, non-toxic pastures have about 10 strands/mm. An ELISA is available for the estimation of the lolitrems.

## NECROPSY FINDINGS

The necropsy findings in rye-grass staggers include macroscopic pallor of skeletal muscles and focal areas of hyaline necrosis on histological examination. Degenerative lesions of Purkinje cell neurons are described in longstanding cases. There are no specific, identifying lesions.

## DIFFERENTIAL DIAGNOSIS

Diagnosis confirmation depends on positive assays for lolitrems in the feed and in animal tissues.

### Differential diagnosis list:

- Rye-grass staggers resembles many other functional diseases of the nervous system, especially those associated with poisonous plants
- Nervous syndromes associated with *Claviceps paspali*, *C. cinerea*, *Balansia epichloe*, *Phalaris aquatica* and *Echinopogon ovatus* (rough-bearded grass) are very similar to rye-grass staggers.

## TREATMENT

Livestock should be immediately removed from affected pasture but no treatment is required since spontaneous recovery is rapid. Tranquilizers may be useful in severe cases.

## CONTROL

Sheep and cattle should not be allowed to graze potentially toxic pasture for more than 2–3 hours a day unless it is more than 30 cm high. Supplementation of the diet with vitamin E, vitamin A, and minerals has had no effect on the incidence of the disease. Replacing existing toxic *L. perenne* swards with *L. perenne* infected with a strain of *A. lolii* that produces peramine that prevents insect attack while not producing either lolitrem or ergovaline that is associated with livestock disease is an effective control.<sup>2,3</sup>

## REVIEW LITERATURE

Smith BL, Towers NR. Mycotoxicoses of grazing animals in New Zealand. N. Z. Vet J 2002; 503 Supplement: 28.

## REFERENCES

1. Galey FD et al J Am Vet Med Assoc 1991; 199:466.



2. Bluett SJ et al. Aust J Exptl Agric 2005; 45:11.
3. Fletcher LR. Grassland Research and Practice Series, 1999; 7:133.

## PASPALITREMS (*CLAVICEPS PASPALI* - *PASPALUM* STAGGERS)

### ETIOLOGY

*Claviceps paspali* is an ergot-producing fungus which infects the seed heads of:

- Paspalum dilatatum* – paspalum or dallas grass
- P. distichum* – salt water-couch grass
- P. notatum* – Argentine bahiagrass
- P. paspalodes* – water couch
- P. scrobiculatum* (= *P. commersonii*) – scrobic or ditch millet
- P. urvillei* – Vasey grass.

It produces tremorgens called paspalitremes, which are chemically related to the tremorgen of *Penicillium cyclopium* rather than to the ergot alkaloids. The neurological effect of the *Penicillium* spp. and *Claviceps paspali* ergots is almost identical. The ergots are most toxic when they are passing from the sticky 'honeydew' (sphaelial) stage to the hard, black (sclerotial) stage. The 'honeydew' stage itself is comparatively non-toxic. Illness can occur when mature ergots are eaten but the disease is not so severe.

### EPIDEMIOLOGY

The degree of infestation of pastures varies widely with climatic conditions, being heaviest after wet, humid summers. Outbreaks of the disease occur in autumn when animals at pasture graze the seed heads because of a shortage of other feed. Cattle are most commonly affected, sheep and horses less so.

### CLINICAL SIGNS

Signs include manifestations of nervous system derangement. There is hypersensitivity to noise or movement, but not to touch. Muscle tremor is at first only noticeable on exercise but is later continuous, even at rest, and is sufficiently severe to be associated with shaking of the limbs and trunk and nodding or rocking of the head. Involuntary movements may prevent grazing. There is a severe ataxia with gross incoordination of movement, sideways progression and frequent falling into unusual postures. Animals which fall, paddle violently in attempts to rise. After a period of rest they can usually rise unassisted.

The appetite is always unaffected but there may be scouring, salivation, and some loss of condition. Abortion does not occur. Some deaths are associated with misadventure but recovery occurs quickly in most cases if the animals are removed from affected pastures.

### NECROPSY FINDINGS

There are no gross changes, except for some increase in cerebrospinal fluid volume, and histological examinations are negative.

## DIFFERENTIAL DIAGNOSIS

There are many other causes of incoordination in animals at pasture, some of them phytotoxins and mycotoxins. One of the infrequently reported ones is *Balansia epichloe*, an ergot-producing fungus found on many pasture plants, especially *Cynodon* spp. A very similar syndrome is produced by *Claviceps cinerea* on the seed heads of the grasses *Hilaria mutica* (tobosa grass) and *H. jamesii* (galeta grass).

### TREATMENT

Unnecessary for paspalum staggers, but livestock should be removed from the affected pasture, which may, however, be used by permitting only intermittent grazing or after mowing and raking of the seed heads.

### FUMONISINS

Fumonisin is a mycotoxin produced by *Fusarium verticillioides* (synonyms *F. moniliforme*, *Gibberella fujikuroi*) growing on moldy corn (maize) grain. Fourteen other *Fusarium* species and *Alternaria alternata* also can produce fumonisins.<sup>1</sup> They block the synthesis of sphingolipids leading to the intracellular accumulation of sphingosine and sphinganine and coagulation necrosis of cells in sensitive organs, especially the brain, heart, liver, and kidney, in which lesions occur. Horses and pigs are much more susceptible to the poisoning than cattle and poultry. Of the known toxic fumonisins, FB<sub>1</sub> (fumonisin B<sub>1</sub>) is the most common cause of animal disease and is a known carcinogen in humans (esophagus) and rats (liver). Sphinganine and sphingosine are excreted in the urine and serum and this is used as a biological marker of exposure to fumonisins.<sup>2</sup> Fumonisin is not excreted in the milk of cows<sup>3</sup> or sows,<sup>4</sup> ingesting the toxin. Horse and pig feed should contain less than 10 µg fumonisin B<sub>1</sub>/g. Fumonisin-contaminated feed may be salvaged by feeding it to ruminants.<sup>5</sup>

### EQUINE LEUKOENCEPHALOMALACIA

The commonest clinical entity is equine leukoencephalomalacia (ELE), a disease of horses and donkeys associated with the ingestion of fumonisins, produced by *Fusarium verticillioides* and *F. proliferatum*.<sup>6</sup> The disease has been produced experimentally by dosing with cultures of the fungus,<sup>7</sup> and the pure mycotoxin. Of the known fumonisins, B<sub>1</sub> and B<sub>2</sub> are the most important, and B<sub>1</sub> has been shown to be the specific cause of ELE.<sup>8</sup> The fungus is commonly found growing on moldy corn (maize) grain that has been affected by rain while on the stalk or

stored wet. The disease also occurs in horses fed commercial, including pelleted, feeds; the disease incident is usually in the form of an outbreak, some of them large-scale. Most feeds associated with ELE have ~10 ppm of fumonisin B<sub>1</sub> and exposure for 7–35 days to the feed contaminated with it is necessary to produce the disease.<sup>9</sup>

Clinically the disease is manifested either, and more commonly, by a neurotoxic, or by a hepatotoxic syndrome. In the **neurotoxic syndrome** the signs are initial anorexia, lethargy, and absence of gastrointestinal sounds,<sup>10</sup> then hypersensitivity and agitation, sweating, muscle tremor and weakness, hypermetria, staggering, circling, inability to swallow, lower lip paralysis, protrusion of a flaccid tongue, apparent blindness, absent menace reflex, pupillary dilation, absent pupillary light reflex, circling, head pressing, collapse, and tonic-clonic convulsions. In the **hepatotoxic syndrome** signs are edematous swelling of the lips, nose, supraorbital fossa, and lower limbs. Jaundice, cyanosis, mucosal petechiae, and dyspnea are common signs. Death occurs after a course of 48–72 hours. Many horses are found dead without signs having been observed. At necropsy there are macroscopic areas of softening accompanied by hemorrhages in the white matter of the cerebral hemisphere, and hepatic periarterial fibrosis with fatty change and abnormal nuclei in hepatocytes.

### EQUINE DUODENITIS PROXIMAL- JEJUNITIS

This idiopathic disease may be confused with colic due to intestinal obstruction. Its characteristic lesions have been produced incidentally, without the clinical signs of the disease, during the experimental production of ELE by poisoning with fumonisin. A link to the mycotoxin was established by the elevated levels of sphingosine in the duodenal lumen.<sup>11,12</sup>

### PORCINE PULMONARY EDEMA/HEPATOSIS

The fungus *F. verticillioides* and the fumonisins B<sub>1</sub> and B<sub>2</sub> are associated with fatal pulmonary edema or hepatitis, the former lesion with higher doses of the toxin.<sup>13</sup> This syndrome results from acute left-sided heart failure and increased pulmonary artery pressure.<sup>14</sup> More chronic cases of the hepatitis syndrome are accompanied by hyperkeratosis and parakeratosis of the distal esophageal mucosa.<sup>15</sup> A reduction in cardiac and vascular efficiency is also part of the chronic intoxication with fumonisins in pigs.<sup>16</sup>

**Fusaric acid**, a mycotoxin also produced by *F. moniliforme*, is associated with depression and vomiting in pigs.<sup>17</sup>

## REVIEW LITERATURE

Diaz G, Boermans HJ. Fumonisin toxicosis in domestic animals – a review *Vet Hum Toxicol* 1994; 36:548.

## REFERENCES

1. Rheeder JP et al. *Appl Environ Microbiol* 2002; 68:2101.
2. Bucci TJ, Howard PC. *J Toxicol Toxin Rev* 1996; 15:293.
3. Richard JL et al. *Mycopathologia* 1996; 133:123.
4. Becker BA et al. *Am J Vet Res* 1995; 56:1253.
5. Gurung NK et al. *J Anim Sci* 1998; 76:2863.
6. Ross PF et al. *J Vet Diag Inv* 1994; 6:263.
7. Marasas WFO et al. *Onderstepoort J Vet Res* 1988; 55:197.
8. Kellerman TS et al. *Onderstepoort J Vet Res* 1990; 57:269.
9. Ross RF et al. *J Vet Diagn Invest* 1991; 3:238.
10. Christley RM et al. *Aust Vet J* 1993; 70:225.
11. Schumacher J et al. *Vet Hum Toxicol* 1995; 37:39.
12. Schumacher J et al. *Vet Hum Toxicol* 1996; 38:265.
13. Colvin BM et al. *J Vet Diag Inv* 1993; 5:232.
14. Smith GW et al. *Am J Vet Res* 1999; 60:1292.
15. Casteel SW et al. *J Vet Diag Inv* 1993; 5: 413
16. Casteel SW et al. *Fundamen Appl Toxicol* 1994; 23:518.
17. Smith TK, McDonald EJ. *J Anim Sci* 1991; 69:2044.

## IPOMEANOLS

4-Ipomeanol is a furanoterpenoid mycotoxin produced by *Fusarium solani* (synonym *F. javanicum*) and *F. semitectum* growing on garden refuse.<sup>1</sup> It has the effect of causing lesions indistinguishable from those of atypical interstitial pneumonia. Other known causes of these lesions are 3-methylindole and the ketone produced by *Perilla frutescens*, *Zieria arborescens*, and one of the fungi *Fusarium solani* or *Oxysporum* spp. on *Ipomoea batatas* (sweet potatoes) tubers. Catabolism by the fungus of phytoalexins induced in the tubers by the fungus produces four closely related ipomeanols. These are not toxic until activated by pulmonary microsomal enzymes.<sup>2</sup> Experimental administration of infected potatoes to calves is associated with bronchiolitis and interstitial pneumonia.<sup>3</sup>

## REVIEW LITERATURE

Thibodeau MS, Poore MH, Rogers GM. Health and production aspects of feeding sweetpotato to cattle. *Vet Clin Food Anim* 2002; 18:349.

## REFERENCES

1. Linnabarry RD, Tarrier MP. *Vet Hum Toxicol* 1988; 30:255.
2. Hill BD, Wright HF. *Aust Vet J* 1992; 69:36.
3. Li X, Castleman WL. *Vet Pathol* 1990; 27:141.

## MUSCARINE

A mycotoxic alkaloid found in the macrofungi *Inocybe* and *Clitocybe* spp; is associated with excessive salivation, bradycardia, diarrhea, and vomiting. Atropine is an effective antidote. Muscarine is not responsible for poisoning by *Amanita* spp.

## OCHRATOXIN

### ETIOLOGY

Ochratoxin A is the most potent of isocoumarin derivative mycotoxins. It is a powerful renal toxin which is associated with organellar damage, especially to epithelial cells. It, and ochratoxins B and C, are produced by *Aspergillus alutaceus* (synonym *A. ochraceus*), and other *Aspergillus* and *Penicillium* spp., e.g. *P. viridicatum*. This fungus also produces viomellein and citrinin, both potent nephrotoxins and capable of enhancing the lesion. Modern radioimmunoassay makes chemical identification of the toxin so much easier that identification of the specific fungus is becoming less necessary, and many contemporary accounts of ochratoxin poisoning do not include the identity of the causative fungus.<sup>1</sup>

### EPIDEMIOLOGY

The species most often involved is pigs. Experiments with cattle indicate that they are likely to be affected only at very high dose rates, but goats are rather more susceptible. There is some evidence that chickens and horses can also be affected. The fungus grows on stored barley or corn grain, and nephrosis results when the grain is fed. Affected pigs placed on an ochratoxin-free diet are decontaminated in about 1 month. The ochratoxin residues have been detected as a 'carryover' in pigs and poultry meats and have some significance for persons eating contaminated pig meats.

### PATHOGENESIS

A nephrosis occurs naturally, has been widespread in Denmark for many years and has been produced experimentally. The principal lesion is a degenerative change of the renal tubules and there is a consequential impairment of tubular function.

### CLINICAL FINDINGS

The disease is characterized by diarrhea, polyuria, and polydipsia. Blood urea nitrogen levels are elevated and proteinuria is evident.

### NECROPSY FINDINGS

These include dehydration, enteritis, generalized edema, renal enlargement, fibrosis, and necrosis of renal tubular epithelium. Poisoning by ochratoxin in pigs resembles Balkan nephropathy, a naturally occurring disease of humans. Ochratoxin is also an immunosuppressant, is associated with poor sperm quality in boars, and is thought to be associated with fetal death and resorption, and thus abortion.

### CLINICAL PATHOLOGY

Assessment of ochratoxin levels in tissue is now performed with radioimmunoassay techniques.

## CONTROL

Animal feeds should not be used unless they have levels of ochratoxin less than 10 ppb.<sup>2</sup> Experimental work with antidotes, principally aspartame, which will wash out the toxins from poisoned animals, is proceeding.<sup>3</sup>

## REVIEW LITERATURE

Marquardt RR, Frohlich AA. A review of recent advances in understanding ochratoxicosis. *J Anim Sci* 1992; 70: 3968.

## REFERENCES

1. Fukal L. *Food Add Contam* 1990; 7:253.
2. Ewald C et al. *Berl Munch Tierarztl Wochenschr* 1991; 104:161.
3. Creppy EE et al. *J Toxicol Toxin Rev* 1996; 15:207.

## PATULIN

Patulin, an important toxin in human medicine, is produced by a number of fungi including *Aspergillus clavatus*, *Byssoschlamys nivea*, *Penicillium urticae*, *P. claviforme* and *P. patulum*, and is most commonly associated with rotting apples or apple juice. Cattle and sheep poisoned by patulin-producing fungi develop brain hemorrhage, pulmonary edema or liver and kidney damage with abomasal hemorrhage. Fed to piglets it is associated with vomiting, salivation, anorexia, poly-pnea, weight loss, leukocytosis, and anemia.<sup>1</sup> Patulin has an antibiotic effect on ruminal bacteria.<sup>2</sup>

## REFERENCES

1. Obrazhevi AF. *Vet Moscow*, 1987; 4:58.
2. Tapia MO et al. *Anim Feed Sci Technol* 2005; 119:247.

## PHOMOPSISIN

### Synopsis

**Etiology** Mycotoxin produced by fungus *Diaporthe toxica* growing on dead lupin plants or seeds.

**Epidemiology** Cattle and sheep grazing lupin stubble or fed seeds in ration.

**Clinical findings** Lupinosis is associated with hepatic encephalopathy (blindness, aimless wandering) accompanied by jaundice and photosensitization. Also skeletal myopathy syndrome with stiff gait, difficulty rising.

**Clinical pathology** Serum levels of liver and muscle-associated enzymes elevated.

**Necropsy findings** Jaundice, swollen liver, diffuse hepatic fibrosis, biliary hyperplasia, myopathy.

**Diagnosis confirmation** Positive assay for phomopsisin.

**Treatment** Change feed.

**Control** Do not feed infected lupin stubble. Plant phomopsisin-resistant lupins. A vaccine is under development.

## ETIOLOGY

*Diaporthe toxica* (anamorph *Phomopsis* spp.), a saprophytic fungus, is the source

of the toxins causing lupinosis of cattle and sheep grazing on the stubble of lupin crops infected with this fungus. Phomopsins A, B, C, D, and E, cyclic hexapeptide mycotoxins, are the specific cause. *Diamorpha woodii* (anamorph *Phomopsis leptostromiformis*) was originally, and erroneously, considered to be the source of these toxins.<sup>1</sup> *Phomopsis emecis*, a saprophyte of *Emex australis* produces phomopsins *in vitro*, but is not associated with natural disease incidents.

## EPIDEMIOLOGY

### Occurrence

The disease is common in Europe, Australia, New Zealand, and South Africa. Cattle, and especially sheep, are most commonly affected, probably because of their greater exposure. Poisoning of pigs and horses occurs, but rarely.

### Risk factors

#### Plant factors

Most occurrences are in animals which graze lupin stubble in which there is dry foliage, seed pods, and seeds. The disease occurs rarely in sheep fed only on the seeds, and has also occurred in pigs fed ground lupin seeds.

Factors increasing the chances of poisoning associated with fungal infection of the senescent plants include summer rain, which is conducive but not essential to fungal growth; the time lapse since rain, toxic lupins remain poisonous for several months; and the provision of alternative feed or the presence of other plants, including weeds, in a crop, both of which may reduce its lupin intake and hence its toxicity. Similarly, if good quantities of lupin seed are available either still in the pods on the standing plant, or spilled onto the ground, there is less chance of poisoning. The mature stalks are the most poisonous so that a heavy stocking rate which encourages the ingestion of all parts of the plants increases its prevalence. Stubble from which lupin seeds have been harvested is the most common cause of lupinosis. Some varieties of lupins are much more susceptible to fungal infections than others.

#### Animal factors

Naturally occurring cases are more commonly seen in sheep, cattle appearing to be less susceptible to the toxin.

## PATHOGENESIS

Phomopsins injected intra-uminally have variable effects depending on dose and duration of administration. Subcutaneous dosing results in anorexia, weight loss, lethargy, jaundice, elevation of serum levels of liver enzymes, recumbency, and death in 90% of sheep. Clinical biochemistry findings suggest that the hepatitis is accompanied by injury to muscle, kidney,

and adrenal cortex.<sup>2</sup> Necropsy lesions include jaundice and patchy hepatitis with arrested mitoses.<sup>3</sup>

Affected sheep have a higher hepatic concentration of copper and selenium and a lower concentration of zinc, due to necrosis of liver cells. The affinity for copper may lead to the development of a complicating chronic copper poisoning in affected sheep.

## CLINICAL FINDINGS

In sheep, signs include anorexia, constipation, hepatoencephalopathy, stumbling gait, recumbency, and a variable degree of jaundice and photosensitization.<sup>4</sup> In cattle, three syndromes may be encountered. Most common is ketosis precipitated by inappetence, seen in pregnant or just-calved cows. Less common is hepatic cirrhosis, seen in cattle usually several weeks after they are removed from lupin stubble. The course of the disease is 1-3 days, and signs include anorexia, depression, staggered gait, jaundice, and bleeding from orifices. Photosensitization occurs in cases which survive for more than a few days. Death may occur within a few days of first illness or be delayed for months, affected animals standing immobile for long periods or wandering aimlessly, often dying from misadventure. More chronic cases exhibit ill-thrift and photosensitization. Recovery may occur if animals in the early stages of the disease are taken off the dangerous pasture, but severely affected animals usually die. Animals that recover appetite will completely recover.

A substantial skeletal muscle myopathy has also been observed in sheep poisoned by phomopsins or infected lupin stubble.<sup>5</sup> Affected animals have a stiff gait, walk reluctantly, and stand with their back humped and their feet under the body, and have difficulty getting to their feet.

Experimental phomopsin poisoning at mating time is associated with reduced reproductive efficiency in ewes.<sup>6</sup>

## CLINICAL PATHOLOGY

In the early stages of lupinosis, serum enzyme tests are the best aids to diagnosis. The  $\gamma$ -glutamyl transpeptidase test is preferred in the early subacute stages, and aspartate transaminase when the disease is more severe. In the late stages of the disease liver function tests are preferred.

## NECROPSY LESIONS

There are jaundice and either a swollen, mottled bright yellow or pale orange, firm, friable liver in acute cases, or a small and fibrotic liver in chronic cases, plus extensive hemorrhages under the skin and serous membranes. Spongy transformation of the brain has been recorded in naturally occurring cases and has also been produced

experimentally. Histological lesion mitosis figured in many hepatocytes and necrosis of individual hepatocytes, biliary hyperplasia, and diffuse hepatic fibrosis.<sup>7</sup>

## DIFFERENTIAL DIAGNOSIS

Diagnosis confirmation depends on liver histopathology and detection of phomopsins in rumen contents and feeds by ELISA.<sup>10</sup> The differential diagnosis list contains many cases of illness in pregnant and recently calved cows in lupin country which are diagnosed as lupinosis but which are actually cases of pregnancy toxemia or fat cow syndrome. Other fungal or plant hepatopathies will need to be differentiated.

## TREATMENT AND CONTROL

Lupin crops should be grazed after seed harvest in early summer, not late autumn. Sheep stocking rates should be less than 30 per hectare. It is an advantage to train sheep to eat lupin seed before they are exposed to crops, thus reducing the intake of stubble as the sheep will forage for seed on the ground. Lupins can be managed to reduce their intake during summer grazing by establishing crop mixtures with wheat, oats, or barley. Prevention is assisted by restricting grazing on mature, standing, dry plants during warm, humid weather which favors fungal growth, by avoiding copper supplementation near danger periods and by encouraging the administration of cobalt. Hay made from lupins appears to be free of toxicity and this may be a useful technique in the prevention of the disease. Fungistatic agents, such as benomyl, are also sprayed onto lupins to reduce fungal growth but no specific recommendations have been made. Additional protection may be gained by the oral administration of zinc which has been shown to reduce the severity of liver damage associated with lupins/fungal poisoning, but commercial application of this knowledge is not yet possible, partly because of the toxicity of the administered zinc. It is advisable to be wary at all times when grazing mature lupin crops. If they are used the crops should be inspected regularly for evidence of fungal infection. If this does occur livestock should be permitted to have access for short periods only, and alternate and supplementary feed should be available.

A satisfactory measure of prevention has been achieved by the development of a phomopsin-resistant strain of *Lupinus angustifolius*, which is capable of reducing the mortality rate from 57 to 8%.<sup>8</sup> A phomopsin-conjugate vaccine has been successfully tested under field conditions<sup>9</sup> but is not yet commercially available.

## REVIEW LITERATURE

Allen JG. Phomopsins. In Plumlee, K.H. (ed.) *Clinical Veterinary Toxicology*. Mosby, St.Louis, Missouri. p. 259, 2004.

## REFERENCES

- Williamson PM et al. *Mycol Res* 1994; 98:1364.
- Allen JG, Randall AG. *Aust Vet J* 1993; 70:283.
- Peterson JE et al. *Aust Vet J* 1987; 64:293.
- Rodriguez FR et al. *Vet Hum Toxicol* 1990; 33:492.
- Allen JG et al. *Aust Vet J* 1992; 69:75.
- Barnes AL et al. *Aust J Agr Res* 1996; 47:1305.
- Mackie JT et al. *Aust Vet J* 1992; 69:172.
- Morcombe P, Allen J. *Aust J Exp Agr* 1993; 33:713.
- Allen JG et al. (1994) In: *Plant-Associated Toxins*. Ed. Colegate, S. M. & Dorling, P. R. CAB International. p. 427.

## PEPTIDE POISONING

Toxic peptides occur in the macrofungi (the mushrooms and toadstools), in *Diaporthe toxica* above, cyanobacteria and in sawfly larvae.

## MUSHROOM AND TOADSTOOL POISONING

Reports of poisoning associated with mushrooms and toadstools in farm animals are rare. *Amanita verna* is associated with fatal poisoning in cattle, but large quantities must be eaten before toxic effects occur. Severe pain at defecation and matting of the perianal regions with feces are associated with vesicular and necrotic eruption about the anus and vulva. At necropsy there is severe inflammation of the alimentary mucosa.

The large cauliflower-like fruiting body *Ramaria flavobrunnescens* is credited with poisoning cattle and sheep<sup>1</sup> and causing:

- Salivation
- Lingual and esophageal ulcers
- Anorexia
- Abortion
- Loss of hair, especially of the tail brush
- Pain in, and loss of, hooves.

*Cortinarius speciocissimus* has been associated with deaths in sheep in Norway with renal tubular necrosis and terminal uremia. *Scleroderma citrinum* fed to miniature Chinese pot-bellied pigs has been associated with vomiting, depression, and recumbency. The pupillary light reflex is lost but the eye preservation reflex remains. There is pain on abdominal palpation, hyperthermia, tachycardia, mucoid feces passed with some straining, and death in about 5 hours.<sup>2</sup>

## REFERENCES

- Kommers GD, Santos MN. *Vet Hum Toxicol* 1995; 37:297.
- Galey FD et al. *Vet Hum Toxicol* 1990; 32:329.

## POISONING BY RUBRATOXIN

*Penicillium rubrum* and *P. purpurogenum* produce rubratoxins suspected of causing hepatic and hemorrhagic diseases,<sup>1</sup> and rubratoxin administered experimentally to calves has produced mild liver damage. Naturally occurring cases of *P. purpurogenum* poisoning in horses fed cornmeal and cotton seed cake is associated with an acute illness with anorexia, depression, vomiting, profuse bloody diarrhea with foul-smelling feces, recumbency on the day 4 or 5, and convulsions terminally. Necropsy lesions include icterus, liver damage, and severe hemorrhagic enteritis.<sup>1</sup>

## REFERENCE

- Ocholi RA et al. *Vet. Rec.*, 1992; 130:495.

## POISONING BY SLAFRAMINE

Slaframine is an indolizidine alkaloid of the fungus *Rhizoctonia leguminicola* found on leguminous pasture plants, especially during wet weather, and associated with the disease of pasture known as 'black patch'.<sup>1</sup> Swainsonine, the phytotoxin found in *Swainsona* and *Astragalus* spp., is very similar to slaframine and has also been isolated from this fungus. Ingestion of slaframine is associated with a syndrome, identified colloquially as 'slobbers', characterized by profuse salivation in cattle, goats, and horses. Excessive lacrimation, stiff gait, tremor, frequent urination, dyspnea, bloat, anorexia, and diarrhea also occur. The salivation is at its peak at 5–6 hours after ingestion and disappears at about 24 hours. No necropsy lesions are recorded. Slaframine is metabolized in the liver to an active metabolite resembling acetylcholine.

The fungus infests standing alfalfa or red clover plants and clover hay, especially red clover hay. Infested plants carry bronze to black spots or rings, and the hay is usually dusty and discolored by black patches on the stems and leaves. Clinical signs usually subside within several days of substituting normal hay. Atropine may be used to control the salivation.

## REFERENCE

- Croom WJ et al. *J. Anim. Sci.*, 1995; 73:1499.

## POISONING BY SPORIDESMIN

### Synopsis

**Etiology** Toxic metabolites of fungus *Pithomyces chartarum* growing on litter from pasture plants, particularly ryegrass.  
**Epidemiology** Outbreaks only at pasture, commonest in sheep, in warm moist climates when pasture short and grazing animals consume the dead plant litter.

**Clinical findings** Facial eczema – acute hepatic injury characterized by dullness, anorexia, jaundice, photosensitization. High case fatality rate, long chronic course in survivors.

**Clinical pathology** Elevated serum levels of liver enzymes in early stages.

**Necropsy findings** Liver swollen, discolored early, later tough, contracted. Obliterative cholangitis.

**Diagnosis confirmation** High spore count on pasture. Elevated assay of sporidesmin in serum.

**Treatment** Change to rough, mature pasture.

**Control** Destroy fungus on pasture with fungicide, restrict access to dangerous pasture; daily oral dosing with zinc preparation.

## ETIOLOGY

Sporidesmins are metabolites of the fungus *Pithomyces chartarum* (*Sporidesmium bakeri*) infesting dead plant material in standing pasture. The sporidesmins A to H are pyrrolidiones and are associated with facial eczema, a major disease of sheep and cattle. The occurrence of non-toxicogenic strains of *P. chartarum* probably accounts for the wide variation in disease occurrence between countries.<sup>1</sup>

## EPIDEMIOLOGY

### Occurrence

The disease has been recorded most commonly in New Zealand and occurs to a limited extent also in Europe, Australia, and South Africa. The incidence varies widely depending on climatic conditions; in some years the disease does not occur, in others the morbidity rate in affected flocks of sheep may be 70–80% and 5–50% of these may die. Of the survivors, many are unthrifty and make less than normal weight gains. In cattle, the morbidity rate is much lower and rarely exceeds 50%. In spite of the obvious weight loss associated with the non-fatal form of the disease, there is no appreciable effect on the palatability of the carcass meat.

### Risk factors

#### Animal factors

Sheep, cattle, goats, South American camelids, and kangaroos are affected. Experimental production of the disease in Saanen goats requires 2–4 times the sheep dose, and feral goats need 4–8 times the dose.<sup>1</sup>

#### Plant factors

The environmental factors which encourage the growth of the fungus and the production of sporidesmin include the type of plants in the pasture, and the climatic conditions. Facial eczema is commonly associated with rye-grass pastures, but the causative fungus is capable of growing on all kinds of dead leaf material, including

cereal hay, and causing facial eczema. In South Africa the ingestion of *Pithomyces chartarum* is thought to enhance the toxicity of *Tribulus terrestris*.

Facial eczema occurs extensively only when pasture is short and contains abundant dead, recently killed plant material, and during warm, humid weather, which favors growth of the fungus. This is most likely to be a problem in autumn when the summer has been hot and dry, the pasture well eaten back, and good rains fall when the ground is still warm. In such circumstances the grass and the fungus grow rapidly.

#### PATHOGENESIS

Sporidesmin is associated with severe damage to biliary epithelium, leading to acute biliary obstruction and a resulting severe hepatic insufficiency manifested by loss of condition, obstructive jaundice, and photosensitization. Sporidesmin administered by mouth is excreted unchanged in high concentrations in urine and bile, especially the latter where it reaches 100 times the concentration in serum. The resulting inflammation of the bile ducts and progressive obliterative cholangiolitis, slow down the rate of bile flow to negligible levels over a period of about 14 days. The photodynamic agent is phylloerythrin, a normal metabolic product of chlorophyll, which is retained in tissues because of failure of its excretion through the damaged liver and bile ducts. The frequent observation that only part of the liver is involved is probably explained by the deposition of toxin in particular parts of the liver, due to portal streaming, on its first passage through hepatic sinusoids. The toxin which reaches the general circulation is probably destroyed.

#### CLINICAL FINDINGS

In cattle and sheep the disease starts suddenly with the appearance of lethargy, dullness, anorexia, jaundice, and photosensitive dermatitis. The skin lesion and jaundice are both variable in occurrence and sheep may die without either having been observed. Many animals die during this acute stage, but some survive and pass into a state of chronic ill-health manifested by poor bodily condition and a susceptibility to minor environmental stresses. Many others show no clinical signs but have significant changes in serum enzyme systems indicative of an acute hepatic injury, and measurable reductions in reproductive efficiency and lamb weights. Occasional animals develop the syndrome of hepatic encephalopathy manifested by dullness, depression, progressing to tremor and lateral recumbency. Spongy vacuolation of brain tissue is observable histologically in these cases. A moderate fall in the plane of nutrition,

parasitic infestation, and pregnancy may be associated with further mortalities, and photosensitive dermatitis may recur if the animals are fed on lush green pasture. Cattle are not as commonly affected by the chronic form of the disease as are sheep but dermatitis of the teats may lead to the development of mastitis.

#### CLINICAL PATHOLOGY

Tests of hepatic function, especially the bromosulfalein clearance test, should be of value in determining the presence of liver damage. In the very early stages, serum enzyme estimations should also be of value. Serum  $\gamma$ -glutamyltransferase levels are regarded as the best indicator of hepatic damage in cattle and continue high for at least several months after an attack of facial eczema.

#### NECROPSY FINDINGS

In the acute stages of facial eczema there is jaundice and a swollen, mottled liver with thickened bile-duct walls. In the chronic phase there is extensive hepatic fibrosis, the liver is tough and contracted, and the left lobe is almost completely atrophic. Areas of regeneration are usually apparent macroscopically. Histologically there is perlobular fibrosis with obliteration of the bile ducts and pressure atrophy of hepatic cells. The changes are much more marked in the left lobe.

#### DIFFERENTIAL DIAGNOSIS

Diagnosis confirmation depends on a positive assay of sporidesmin in fluids and tissues of affected animals. High spore counts on pasture are circumstantial evidence. Facial eczema must be differentiated from those other diseases in which photosensitization and hepatitis occur.

##### Differential diagnosis list:

- Pyrrolizidine alkaloid poisoning
- Aflatoxin poisoning
- Steroidal saponin poisoning
- Lantadene poisoning
- Cyanophyte (cyanobacterial) poisoning
- Fascioliasis
- Phomopsis poisoning
- A disease of cattle in the southern United States believed to be associated with the ingestion of dead forage on which a *Periconia* spp. fungus is growing.

#### TREATMENT

There is no **primary** treatment, except to change animals to new pasture. **Supportive** treatment for hepatitis and photosensitization, as outlined under those headings, and the administration of antibiotics and antihistamines to control secondary infection and shock may be

applicable in animals of sufficient economic value. The provision of drinking water containing 6 g zinc sulfate per 100 L for 28 days is claimed to hasten recovery of affected cattle.

#### CONTROL

One of the major difficulties in the control of the disease is that of predicting the occurrence of an outbreak so that the flock can be changed to non-dangerous pasture. Meteorological observation can be of value, but the counting of spores by a mobile spore catcher is now routinely used in danger areas.

In bad seasons the incidence of facial eczema can be reduced by **alternating grazing** between native and improved pastures or by reducing the intake of the fungus in any other way. Because of the proclivity of the fungus for dead grass, two acceptable management procedures for prevention are summer irrigation and hard grazing, both of which reduce the amount of foliar substrate available for fungal growth. Avoidance of sandy soils in bad seasons is also advisable because of the greater tendency for grass death on this kind of soil. Allowing pasture to flower, the sward to grow long, the pasture to be damaged by diseases and pests, and frequent mowing, encourages facial eczema.

In a comparison of **fungicides** used to control the growth of *P. chartarum*, carbendazim was best (at 0.15 and at 0.30 kg/hectare of active ingredient), while benomyl and thiophanate methyl was effective only at 0.30 kg/hectare. The original methods of applying fungistatic agents to pasture included thiabendazole or benomyl (Benlate) sprayed on at the rate of 272 g/hectare in January. The growth of *P. chartarum* was controlled and the development of facial eczema prevented.

The discovery of **non-toxic strains** of *P. chartarum* in New Zealand and South Africa which sporulate profusely but produce no sporidesmin, and compete aggressively with sporidesmin-producing strains, raises the question of controlling facial eczema by dominating the pastoral fungal population with the sporidesmin-negative strain.<sup>2</sup>

The daily oral administration of **zinc** (30 mg/kg zinc BW/day) to lactating dairy cows has been shown to reduce the toxic effects of sporidesmin. The zinc salt can be administered by drench as slurry of zinc oxide, by spraying zinc oxide onto pasture, and adding zinc sulfate to the drinking water. Zinc poisoning is reported as a result of overzealous applications of zinc for these purposes. Iron salts, including ferric ammonium citrate, ferric and ferrous sulfates, have the same protective effect but the volume required makes their application impractical.<sup>3</sup>

Attempted **vaccination** against sporidesmin has so far been unsuccessful in protecting sheep against facial eczema. Resistance to sporidesmin is strongly inherited but flocks containing increased numbers of resistant animals do not have superior productivity.<sup>4</sup> Finnish Landrace sheep are significantly more resistant to *P. chartarum* poisoning than Romneys, with cross-breds in an intermediate position.<sup>5</sup>

#### REVIEW LITERATURE

Smith BL, Towers NR. Mycotoxicoses of grazing animals in New Zealand. N Z Vet J 2002; 503 Supplement: 28-34.

#### REFERENCES

- Collin RG et al. Mycol Res 1998; 102:163.
- Smith BL, Embling PP NZ Vet J 1991; 39:18.
- Collin RG, Towers NR. NZ Vet J 1995; 43:149.
- Munday R, Manns E. NZ Vet J 1989; 37:65.
- Morris CA et al. NZ J Agric Res 1989; 32:379.
- Morris CA et al. NZ J Agric Res 1994; 37:547.

#### POISONING BY STERIGMATOCYSTIN

Sterigmatocystin is a fungal toxin capable of causing hepatic carcinoma. It has been isolated from *Bipolaris* spp. and *Aspergillus nidulans* growing on groundnuts, and from *A. versicolor*,<sup>1</sup> *A. flavus*, *A. parasiticus*. It is a precursor of aflatoxins. Carcinogenesis in farm animals is not reported.

#### REFERENCE

- Lepom, P. & Kloss, H. (1988) *Mycopathologia*, 101, 25.

#### POISONING BY TREMORGENS

Tremorgens include a number of specific mycotoxins including penitrem A, B, and C, verrucologen, roquefortine from *Penicillium* spp., fumitremorgen A and B from *Aspergillus fumigatus*, and flavus tremorgen from *A. flavus*. They produce no necropsy lesions and the clinical syndrome associated with them has the general pattern of the condition known universally as staggers. It includes muscle tremor, gait incoordination, rigid stance, falling easily, recumbency, and paddling convulsions.

Small repeated doses of *P. cyclospium* cultures to sheep are associated with a disease identical with rye-grass staggers. *P. palitans* has been shown to produce ataxia and convulsions in cattle. **Penitrem A** has been isolated from *P. puberulum* and *P. crustosum*, and a more potent one, verrucologen, from *P. crustosum* and *P. simplicissimum*. Penitrem A closely resembles the tremorgen produced by *Claviceps paspali*. It produces tremor, ataxia, muscular rigidity, and convulsive episodes in calves. The tremor is very fine, and increases with excitement. It increases until calves sway rhythmically, standing with their legs wide apart and stiff. The gait is stiff and ataxic and the

calves fall often. The worst affected calves are laterally recumbent, with tetanic convulsions, opisthotonos, and severe tremor. Nystagmus and profuse salivation occur sometimes.

Other soil penicillia produce tremorgens. *P. piscarium* produces **verrucologen** and **fumitremorgen B**. *P. estinogenum* also produces verrucologen. *P. nigricans* yields penitrem A. *P. jantinelum* and *P. cyclospium* also produce penitrem A. *P. rubrum* is associated with frothing at the mouth, champing of the jaws, jaundice, cutaneous erythema, and collapse in goats and pigs. In horses, the clinical signs of intoxication include incoordination, chronic spasm, jaundice, diarrhea, abdominal pain, and vomiting. These fungi are soil-borne and could be accidentally ingested by cattle and sheep while grazing. *A. fumigatus* in moldy corn silage produces tremorgens and toxins capable of causing enteritis.

The disease '**rye-grass staggers**' is now known to be associated with the endophyte *Neotyphodium lolii* but it is possible that some outbreaks of incoordination in sheep and other species may be contributed to or even associated with other tremorgens such as those listed above. A subsidiary effect of tremorgenic fungi is a depression of testosterone production in rams and bulls. To confirm a diagnosis that fungal intoxication is the cause of cases of staggers depends on the isolation of tremorgenic fungi from the feces of affected animals. The fungal elements survive passage through the ruminant gut and can be cultured from the feces.

Other fungi causing similar incoordination syndromes but in which no toxin has been identified are listed.

#### POISONING BY TRICHOHECENES

Trichothecenes are the largest group of mycotoxins, and amongst the most toxic. They are divided into two groups, the macrocyclic and the non-macrocyclic trichothecenes, on the basis of their molecular structure.

#### MACROCYCLIC TRICHOHECENES (SATRATOXIN, VERRUCARIN, RORIDIN, ETC.)

The standard nomenclature for the diseases associated with this group of mycotoxins is retained, stachybotryotoxicosis, and myrotheciotoxicosis.

#### Stachybotryotoxicosis

Toxins in the fungus *Stachybotrys chartarum* (*S. atra*, *S. alternans*), which is associated with this disease, are the macrocyclic trichothecenes, satratoxins G and H, roridin E, and verrucarins J. Horses, cattle, sheep, and pigs may be affected and the

disease is characterized by fever, ruminal atony, diarrhea, dysentery, necrotic ulceration, and hemorrhages of the nasal and oral mucosae, causing epistaxis and purulent nasal discharge, and conjunctivitis causing lacrimation. Drying and cracking of the skin are visible, especially periorbitally and on the face. At necropsy there are hemorrhages into all tissue and under all serous membranes. An important abnormality is the depression of leukocyte formation, causing agranulocytosis, and producing a disease not unlike that associated with bracken poisoning in cattle. Hemorrhages are visible in the mucosae, there is also hemorrhagic enteritis and, in sheep, *Pasteurella haemolytica* can often be isolated from tissues. The infection is thought to occur as a result of the immunosuppression associated with the toxins. In horses there is also a subacute or acute myositis. The disease resembles alimentary toxic aleukia, associated with the ingestion of toxin from *Fusarium poae* and *F. sporotrichioides*, in humans.

#### Myrotheciotoxicosis

Roridin, a toxin in the fungus *Myrothecium roridum* and *M. verrucaria* growing on rye-grass and white clover plants in pasture, or on stored feeds, is associated with sudden death in sheep and cattle, with necropsy lesions of abomasitis, hepatitis, and pulmonary congestion and edema. Smaller intakes are associated with similar lesions, but over a course of 7-10 days. Very small doses administered over a 30-day period are associated with loss of weight but no deaths.

A bizarre involvement in what appears to be a plant poisoning is the role that *M. verrucaria* plays in *Baccharis* spp. poisoning. *Baccharis* spp., including *B. cordifolia*, *B. drunculifolia*, *B. pteronioides* (synonym *B. ramulosa*), and *B. glomeruliflora*, are associated with tremor, stiff gait, and convulsions and some deaths in cattle and sheep. Roridin, a toxin produced by *Myrothecium* spp. growing in close apposition to the roots of the plants, is absorbed and, when eaten by animals, poisons them. In other plants roridin is lethal to the plant when present in very small amounts.

#### NON-MACROCYCLIC TRICHOHECENES (T<sub>2</sub> TOXIN, DEOXYNIVALENOL, DIACETOXYSCIRPENOL ETC.)

Fungi which produce these mycotoxins are not fully defined in terms of which toxins they produce. Many of them produce more than one. Accordingly the syndromes described below, and attributed to specific fungi and toxins, are

tentative. A partial list of fungi includes the following best known ones:

*Cephalosporium* spp.  
*Fusarium culmorum*  
*F. graminearum*  
*F. moniliforme*  
*F. nivale*  
*F. poae*  
*F. roseum*  
*F. semitectum*  
*F. sporotrichioides*  
*F. tricinctum*  
*Trichoderma* spp.  
*Trichothecium* spp.

The standard syndrome associated with these fungi includes vomiting, feed refusal, anorexia, diarrhea, gait incoordination, mucosal hemorrhages, and ulcerative stomatitis. Necropsy lesions consist of generalized hemorrhages and hemorrhagic enteritis.

Any one or combination of them can be implicated in the production of the following diseases if they produce the specified toxin at the specified time. The specific toxins involved, and the syndromes they are associated with include those discussed below.

### T<sub>2</sub> toxin

A sesquiterpene compound, the T<sub>2</sub> toxin is produced by *F. tricinctum*, *F. nivale*, and *F. sporotrichioides* growing on grain may be associated with generalized hemorrhages, but experimental administration of the purified toxin parenterally produces a quite different range of signs including emesis, posterior paresis, lethargy, hunger, and frequent defecation of normal stools. Other experimental evidence is that the oral administration of the T<sub>2</sub> toxin or cultures containing it to piglets and calves is associated with no hemorrhagic disease. Field evidence of the relationship between the ingestion of the fungus and the appearance of hemorrhagic disease is strong, but the identity of the specific toxic agent may be in doubt. Confusion about the effects of the toxin may be due to the refusal of pigs to eat contaminated feed, while cattle will eat it. T<sub>2</sub> toxin fed to pigs is associated with necrotic, contact lesions on the snout, and commissures of the mouth and the prepuce.<sup>1</sup> Topical application of T<sub>2</sub> toxin to pig skin is associated with initial swelling and purple discoloration, followed by separation and sloughing by day 14.<sup>2</sup> It has also been cited as the probable cause of congenital skin defects about the head and tarsus of pigs.

T<sub>2</sub> toxin is associated with immunosuppression when fed to laboratory animals, sheep, and pigs. This leads to leukopenia, lymphopenia, and atrophy of lymph nodes, thymus, and spleen, but the immunosuppression is minor. Blood

coagulability is reduced due to toxic effects on platelets.<sup>3</sup>

The toxin also is associated with reproductive inefficiency when given experimentally to pigs, causing small litters, repeat breeders, and abortion.

### Deoxynivalenol

Deoxynivalenol (synonym vomitoxin), is a sesquiterpene compound found in *Fusarium graminearum* (*roseum*), *F. sporotrichiella*, and *F. culmorum*. It is a potent central emetic, to which pigs are very sensitive; sheep and cattle are quite resistant, and horses much less so.<sup>4</sup> The toxin may be associated with acute diarrhea, dysentery, ataxia, mucosal hemorrhages, and sudden death. The commonest field observation about the toxic effect of deoxynivalenol fed to pigs is that it is associated with absolute feed refusal or reduction in weight gain and feed intake.<sup>5</sup> This effect is magnified when the toxic feed also contains **fusaric acid**.<sup>6</sup> Deoxynivalenol is not excreted in the milk.<sup>7</sup>

The only effective method of preventing losses due to deoxynivalenol is to dilute affected corn with uncontaminated feed. Mixing the feed with bentonite, sweeteners, or sodium-calcium aluminosilicate is ineffective as a detoxification method,<sup>8</sup> but rinsing and removing floating material is recommended.<sup>9</sup> Feed toxic to pigs may be utilized by feeding it to ruminants.

### Diacetoxyscirpenol

The most important disease in those associated with the non-macrocyclic trichothecenes is the one associated with *F. tricinctum*, a fungus common on ear corn. It produces a potent toxin (diacetoxyscirpenol) which is associated with necrotic lesions and hemorrhages in the skin, mouth, intestine, liver, and kidneys. In cattle, the clinical syndrome includes mucosal hemorrhages and erosions, intermittent salivation, and depression. The stomatitis is characteristic and needs to be differentiated from similar lesions associated with viruses. Continued exposure to the fungus can be associated with heavy mortalities in cattle. In pigs, the experimental disease is manifested by hemorrhagic bowel lesions, but the toxin also produces a syndrome including emesis, lethargy, hunger, frequent defecation of normal stools, and posterior paresis.

### Fusaritoxicosis syndromes without specified toxins

*F. graminearum* (*roseum*) produces toxins associated with emesis and refusal of feed and toxins lethal to pigs, as well as estrogenic substances causing infertility in pigs. *F. culmorum* also is associated with inappetence, scouring, ataxia, and a fall in milk yield when fed to cattle. The fungus

*F. moniliforme* is associated with food refusal in cattle. Food refusal is also recorded with zearalenone.

### REVIEW LITERATURE

Harris JB. (Ed.) *Natural Toxins, Animal, Plant and Microbiological*. Oxford: Clarendon Press, 1986.

### REFERENCES

1. Harvey RB et al. *Am J Vet Res* 1990; 51:1688.
2. Pang VF et al. *Fund Appl Toxicol* 1987; 9, 41, 50, 588.
3. Gentry PA et al. *Can J Vet Res* 1987; 51:490.
4. Johnson P H et al. *J Vet Diag Inv* 1997; 9:219.
5. Trenholm H L et al. *Can J Anim Sci* 1994; 74: 361.
6. Smith TK et al. *J Anim Sci* 1997; 75:2184.
7. Charmley E et al. *J Dairy Sci* 1993; 76:3580.
8. Patterson R, Young L.G. *Can J Anim Sci* 1993; 73:615.
9. Rotter RG et al. *J Sci Food & Agric* 1995; 68:331.

### POISONING BY ZEARELENONE

*Fusarium graminearum*, *F. roseum* (*Gibberella zeae*) growing on moldy maize or barley grain produces estrogenic substances, especially F<sub>2</sub>, or zearalenone, a non-steroidal estrogenic mycotoxin which acts by depressing serum gonadotropin levels. Swine are most commonly affected but cases occur in cattle and sheep. *F. culmorum* growing on oat herbage also produces much zearalenone but not when growing on perennial rye grass. Zearalenone has been detected in pastures in New Zealand, where it has been associated with infertility in ewes and cows.<sup>1</sup>

In pigs, vulvovaginitis, including swelling of the vulva to three to four times normal size, enlargement of mammary glands, a thin, catarrhal exudate from the vulva, and increased size and weight of the ovaries and uterus is the severest form of the poisoning. Prolapse of the vagina occurs commonly (up to 30% of affected pigs), and prolapse of the rectum in some (5–10%). The toxin does reduce serum progesterone levels in sows but the administration of progesterone to affected gilts does not counteract the estrogenic effects.<sup>2</sup> The syndrome is indistinguishable from that produced by long-term overdosing with diethyl stilbestrol. Signs appear 3–6 days after feeding of the moldy grain commences and disappear soon after the feeding stops. Pigs of all ages are affected, including sucklings feeding on sows which themselves show no signs of estrogenism.<sup>3</sup> Worst affected are gilts 6–7 months old. The mortality rate is high due to the secondary development of cystitis, uremia, and septicemia.

The more important manifestation of the poisoning may be infertility, including absence of estrus, high levels of stillbirth, neonatal mortality, and reduced litter size. Small fetal size, fetal malformations, splayleg and hindlimb paresis, pseudo-pregnancy, and constant estrus are also recorded.



Experimental feeding of zearalenone to boars has some depressing effect subsequently on libido but all structural parameters, such as testicular size, are unaffected. There is no effect on the volume or concentration of the ejaculate, or the motility of spermatozoa in rams.<sup>4</sup> In small pigs, zearalenone is associated with degenerative changes in seminiferous tissue, but does not delay the onset of puberty or have any subsequent effect on female reproductive efficiency, provided the toxin is withdrawn from the diet at least 2 weeks before mating.<sup>5</sup>

In cattle, the effect is largely on conception rate, and the rate of services per conception may rise but the overall effect is less than in sows. Behavioral estrus occurs at times unrelated to ovarian cycles and in late pregnant cows. There is idiopathic vaginitis.<sup>6</sup> Symmetrical enlargement of the mammary glands is recorded in prepubertal dairy heifers feeding on fungus-infected corn. Estrogenic disturbances are also suspected in sheep. Abortion is suspected to result, and mild vulvovaginitis and hypertrophy of the uterus are recorded. Experimental feeding of zearalenone to lactating cows and ewes does result in minor contamination of their milk sufficient to produce hyperestrogenism in a lamb sucking a poisoned ewe.

#### CLINICAL PATHOLOGY

The toxin can be identified by chromatographic analysis and confirming the presence of the specific fungus may not be necessary. The feed should not contain more than 10 ppb of zearalenone. Assay of the feed for estrogenic activity by feeding it to laboratory animals may be attempted. Complete recovery follows when the feeding of the affected grain is stopped and no treatment other than surgical repair of the prolapsed organs is attempted.

#### REFERENCES

1. Smith BL, Towers NR. *N Z Vet J* 2002; 50(3) Supplement: 28.
2. Green ML et al. *Am J Vet Res* 1991; 52:1871.
3. Dacasto M et al. *Vet Hum Toxicol* 1995; 37:359.
4. Milano GD et al. *Vet Rec* 1991; 129:33.
5. Green ML et al. *J Anim Sci* 1990; 68:171.
6. Coppock W. *Vet Hum Toxicol* 1990; 32:46.

#### MISCELLANEOUS FUNGI LACKING IDENTIFIED TOXINS

Diseases associated with fungi without the causative toxin having been identified, are arranged in order of the predominant clinical disorder, and are outlined below.

##### HEPATIC DAMAGE

*Helminthosporium ravenelli* growing on esparto grass is credited with producing a syndrome of excitement, dyspnea, tachycardia, hypersalivation, tremor, jaundice, and some deaths in Argentinian

cattle. *Drechslera campanulata* (synonym *Helminthosporium* spp.) occurs as brown-red spots on the leaves of cereal oat plant and is associated with diarrhea, milk yield reduction, and death in some cows. Similar syndromes are found in sheep and goats, except that photosensitivity is also apparent in goats. At necropsy there is ulceration of the forestomach mucosae. A fungus, *Periconia* spp., which grows on forage in the field, is also suspected of being associated with hepatic damage and photosensitization in cattle in the southern United States. There is a close resemblance in clinical signs and circumstances of occurrence to facial eczema and myrotheciotoxicoxis. Sesquiterpenes found in moldy sweet potato tubers are listed under that heading.

#### CONGENITAL DEFECTS

##### Congenital spinal stenosis

In calves whose dams were fed moldy hay during pregnancy, this defect may affect 100% of the calf drop in a particular year.<sup>1</sup> Clinical signs include posterior paralysis or paresis, shortened limbs, varus deformity of the front limbs, brachygnathia of the upper jaw, and dome-shaped cranium.

##### BLACK SOIL BLINDNESS

This is a newly-identified mycotoxicosis of grazing cattle, associated with the fungus *Coralocystostroma ornicoopreoides* growing on Mitchell grass (*Astrelba* spp.) in pastures on heavy basalt (black soil) soil in tropical north-west Australia.<sup>2,3</sup> The disease has occurred only once, in a year marked by heavy, seasonal rainfall and a longer than usual growing season. Morbidity and mortality were high at the peak of the outbreak. Clinical characteristics include blindness and death within 24 hours. Necropsy lesions include renal tubular nephrosis, rumenoreticulitis, and moderate liver cell damage.

##### NERVOUS SIGNS

Nervous signs of tremor, gait incoordination, recumbency, and convulsions predominate in the toxic effects ascribed to the ingestion of *Trichothecium roseum* and *Penicillium cyclopium*. *Diplodia maydis* (synonym *D. zaeae*, *Stenocarpella maydis*) is associated with a serious disease of maize crops, corn cob rot. Infected cobs fed to cattle, sheep, goats, and horses are associated with diplodiosis, a neuromycotoxicosis, reported only in South Africa. If the subjects are females in the second and third trimesters of pregnancy, there may be a very high mortality, up to 87%, of stillborn or newborn lambs or calves,<sup>4</sup> many of the dead neonates have widespread degeneration of the central nervous system.<sup>5</sup> The fungus develops its toxin only after a prolonged (more than 6 weeks) period of growth. This may

explain frequent reports that the fungus is not poisonous. The same applies to cultured fungus used to produce the disease experimentally; it must be a culture at least 8 weeks old. Affected animals recover if feeding of the infected grain is stopped. Clinical signs in adults include lacrimation, salivation, tremor, ataxia, paresis, and paralysis, but signs disappear when the corn is removed from the diet. A status spongiosus lesion may occur in the brain of affected animals, but in most cases there are no necropsy lesions. Fetuses are much more susceptible and spongiform lesions in the brain are present in most. Their body weights are less than normal and the gestation period is also reduced.

##### Aspergillus clavatus poisoning

Substrates for *A. clavatus* include distillery by-products, sprouted barley grain, sorghum beer residues and sprouted maize.<sup>6</sup> Muscle tremor, frequent falling, ataxia, progressive paresis, knuckling at the fetlocks, especially in the hind limbs, seizures, paralysis, and death occur in cattle and sheep. Degenerative lesions of large neurons have been recorded in the brain stem, the gray matter in the spinal cord, and spinal ganglia in cattle and sheep. Muscle necrosis occurs in some cases.<sup>7</sup>

#### REPRODUCTIVE DYSFUNCTION

*Penicillium roqueforti*, growing on moldy mixed grain and ensilage, is suspected of causing bovine abortion and retained placenta. *Trifolium repens* (white clover) does not normally contain estrogens but when heavily infested with fungi it may contain significant amounts. *Ustilago hordei* (barley smut) fungus is thought to be toxic to farm animals; feeding it to experimental animals has been associated with infertility and stillbirths. In southeastern Australia a common infertility syndrome, including abortion and fetal mummification, has been ascribed to an onion-like weed, *Romulea rosea*. There is a suspicion that the disease may be due to a toxin produced by a fungus, *Helminthosporium biseptatum*, growing on the weed.

##### UREMIA

*Tilletia tritici* (wheat smut) fungus should not be included in rations for pigs because it is thought to be associated with glomerulonephritis and failure to gain weight. Estimates of the maximum safe content of infected grain that can be fed in the ration vary from 5% to 30%.<sup>8</sup>

#### REFERENCES

1. Ribble CS et al. *Can Vet J* 1993; 34:221.
2. Jubb TF et al. *Aust Vet J* 1996; 73:49.
3. Shivas RG et al. *Mycol Res* 1997; 101:849.
4. Kellerman T S et al. *Onderstepoort J Vet Res* 1991; 58:297.
5. Prozesky L et al. *Onderstepoort J Vet Res* 1994; 61:247.
6. McKenzie RA et al. *Aust Vet J* 2004; 82:635.

7. Loretti AP et al. *J Vet Diagn Invest* 2003; 15:123.  
 8. Herzig I. *Vet (Czechoslovakia)* 1987; 37(1):20.

## POISONING BY CYANOBACTERIA

### CYANOBACTERIA IN FRESH WATER BLOOMS

#### Synopsis

**Etiology** Toxins from cyanobacteria in blooms on still fresh water in lakes, ponds, billabongs, lagoons.

**Epidemiology** Outbreaks with heavy mortality when only drinking water is polluted by water bloom in stagnant, nutrition-rich water.

**Clinical findings** Sudden death syndrome due to massive hepatic necrosis or to neurotoxins. Anorexia, jaundice, photosensitization syndrome due to lesser hepatic necrosis.

**Clinical pathology** Elevation of liver enzymes in blood (hepatotoxic), or possibly cholinesterase depression (neurotoxic).

**Necropsy findings** Hepatic necrosis or nil; cyanobacteria in alimentary tract.

**Diagnosis confirmation** Positive assay (including bioassay) of toxins in water.

**Treatment** Nil.

**Control** Avoidance of contaminated water or treatment of it with algacide or hay immersion.

#### ETIOLOGY

Toxic cyanobacteria, or blue-green algae, which form dense blooms in fresh water bodies, include:

- Anabaena circinalis*
- A. spiroides*
- Aphanizomenon* spp.
- Coelosphaerium* spp.
- Cylindrospermopsis raciborskii*  
(containing the hepatoin-  
cylindrospermopsin)
- Gloetrichia* spp.
- Gomphosphaeria* spp.
- Microcystis aeruginosa* (synonym  
*Anacystis cyanea*),
- Nodularia spumigena* (brackish water)
- Nostoc rivulare*
- Oscillatoria* spp.

They contain toxins which survive in water when the cells die or are damaged. Toxicity occurs from ingestion of live cyanobacterial cells or their toxins liberated from ruptured cells.

#### EPIDEMIOLOGY

##### Occurrence

Cyanobacterial toxins are associated with outbreaks of poisoning in farm animals that drink contaminated water. Lakes, dams, ponds, stagnant rivers, and water-holes are all affected, especially when the

organisms are concentrated by onshore winds so that large quantities may be ingested. In small waterholes, dams, and dugouts the surface water is often completely covered with a very thick coat of gelatinous organisms (water bloom), and animals are unable to drink without ingesting some of it. The disease has been recorded in most countries, especially the United States, Canada, Scandinavia, Japan, South Africa, Australia, and New Zealand, and affects all animals and birds. The cyanobacteria occur also in brackish and marine waters and are associated with mortalities in fish. Deaths do not necessarily occur, especially if animals are able to avoid large concentrations.

#### Risk factors

Heavy growth commonly occurs in the late summer to autumn period. Factors promoting growth of the organisms and increasing the chances of animals being poisoned include high water temperature, especially sunny weather when the water is very shallow, high electrolyte concentration as a result of massive water loss by evaporation, and a high concentration of other nutrients such as nitrogen and phosphorus, associated with animals defecating and urinating in the water, by fertilizer run-off or human sewage inflow.

#### PATHOGENESIS

The toxins in a variety of cyanobacteria appear to be the same or similar and fall into two groups: neurotoxic and hepatotoxic. The known neurotoxins are a combination of at least three compounds:

- Anatoxin-a, an alkaloid and a potent postsynaptic depolarizing neuromuscular blocking agent<sup>1</sup>
- Anatoxin-A (s), an organophosphorus compound and potent cholinesterase inhibitor
- Saxitoxin and related paralytic shellfish toxins (sodium channel blockers).

These are known to come from *Anabaena* spp. most commonly, but also from *Oscillatoria* and *Aphanizomenon* spp. The known hepatotoxins are the cyclic peptides microcystin from *Microcystis aeruginosa*<sup>2,3</sup> and others, including other *Microcystis* spp., *Anabaena flos-aquae*, *Oscillatoria* spp., and nodularin from *Nodularia spumigena*, which prefers brackish water, and the alkaloid cylindrospermopsin from *Cylindrospermopsis raciborskii*.

The toxic effects of cyanobacteria vary widely depending on the species present and the amounts of toxic material consumed. Many blooms are not toxic, but all should be considered potentially so.

#### CLINICAL FINDINGS

Affected animals are commonly found dead, particularly so with neurotoxic

blooms. Clinical signs may become apparent within 15 minutes after exposure. In acute cases the affected animals have muscle tremor, stupor, increased salivation in some outbreaks in cattle, staggering, recumbency, and in some cases hyperesthesia to touch so that slight stimulation provokes a convulsion with opisthotonos. Abdominal pain, diarrhea, and dyspnea are additional signs. After experimental dosing, death may occur within a few minutes of the first appearance of clinical signs, but in field cases the course may be prolonged for several hours.

In the less acute hepatotoxic cases there is severe liver damage manifested by anorexia, stupor or hypersensitivity, ruminal atony, dehydration, recumbency, jaundice, and photosensitization in cattle and sheep. Many of the apparently unaffected and recovered animals die in the ensuing 3 months.<sup>4</sup>

Affected pigs are anorexic and show dullness, vomiting, lethargy, tremor, frothing at the mouth, coughing, sneezing, dyspnea, and dysentery.<sup>5</sup>

#### CLINICAL PATHOLOGY

The toxins may disappear from the water within 2–3 days and samples should be taken as soon as possible after the poisonings occur.<sup>6</sup> Laboratory examination for the presence of high concentrations of known toxic cyanobacteria is required. Not many laboratories are equipped to carry out the examination, and a negative result should be treated with caution, especially as there may be as yet unidentified cyanobacteria. Because there is a great deal of variation in the toxicity of strains of the known toxic species, ELISA and other analytical laboratory tests for the toxins produced by the organisms have been introduced.<sup>7</sup> A specimen of the bloom material should be collected and be immediately preserved for identification, as degeneration of cyanophyte cells is rapid during transport to the laboratory. Add 1 mL of 10% formalin to 20 mL of bloom material. For toxicity testing submit at least 20 mL of bloom material without added preservative (1 L preferred).

Clinical pathological findings rated in order of frequency in sheep exposed to microcystin are high levels of bile acids, glutamate dehydrogenase,  $\gamma$ -glutamyl transferase, and serum bilirubin, and reduced levels of albumin.<sup>8</sup>

#### NECROPSY FINDINGS

Necropsy lesions are usually absent in animals that die suddenly of the neurotoxic syndrome. In cases of the hepatotoxic syndrome, lesions may include massive hepatic necrosis, generalized petechiation, plasma transudates in body cavities, and congestion of most viscera. Severe gastroenteritis with intestinal hemorrhage and

severe bloody diarrhea have also been observed in some outbreaks.

### DIFFERENTIAL DIAGNOSIS

Diagnosis confirmation is by positive assay for the algal toxins in water or preferably body tissues or fluids.

#### Differential diagnosis list:

Neurotoxic (sudden death) syndrome:

- Electrocutation or lightning strike
- Cyanide poisoning
- Anthrax
- Nutritional deficiency of selenium or vitamin E
- Nutritional deficiency of copper (falling disease)
- Poisoning by *Phalaris* spp.
- Poisoning by cardiac glycosides in plants
- Poisoning by fluoroacetate as 1080 compound or in plants
- Poisoning by a number of miscellaneous plants which are associated with cardiac arrest but in which the cardiotoxin has not been identified
- Poisoning by monensin or other ionophore, especially in horses.

Hepatotoxic syndrome:

- Pyrrolizidine poisoning
- Steroidal saponin poisoning
- Lantadene poisoning
- Phomopsin poisoning
- Sporidesmin poisoning
- Aflatoxin poisoning
- Fascioliasis.

### TREATMENT

There are no specific **primary** antidotes. **Supportive** treatment includes activated charcoal orally intended to prevent further absorption of toxin.

### CONTROL

The two principles involved are the prevention of ingestion of floating bloom material by animals and preventing the addition of nutrients that promote cyanobacterial growth to the water.

Prevent the ingestion of toxins by:

- Moving livestock to clean water sources, or drawing drinking water from a site away from the bloom
- Keeping bloom away from water intake by a floating boom
- Add precipitants, e.g. lime, ferric alum, gypsum; removes algae without release of toxin; removes phosphates (see below). Alternatively spread straw on top of water and suspend bales of straw in the water.
- Killing cyanobacteria with algicides such as copper sulphate added to the

water was a common recommendation, but is no longer advocated. The killed cyanobacteria release toxins into the water, so as it is contaminated it cannot be used for stock drinking water for at least 5 days. The algicides also damage other vegetation and may ultimately promote further cyanobacterial blooms.

Prevention of the addition of nutrients to water by:

- Fencing off water sources from direct livestock access and providing drinking water by piping it to troughs
- Precipitate phosphates with lime, gypsum, ferric alum; useful only for small reservoirs
- Mechanical aeration of bottom layers of water body; useful only for large water reservoirs
- Exert catchment control and minimize use of phosphatic fertilizer, inflow of sewage, filter the inflow by enhancing reed bed and wetland growth, and buffer afforestation and vegetation generally along the banks of watercourses
- Remove feral fish, e.g. European carp, which increase the availability of phosphate in the stream by stirring up the sediment on the bottom.

### REVIEW LITERATURE

Chorus, I, Bartram J. Toxic Cyanobacteria in Water. London, E & FN Spon, 1999.

### REFERENCES

1. Harada K et al. *Toxicon* 1989; 1298.
2. Runnegar MTC et al. *Toxicon* 1988; 26:143.
3. Hooser SB et al. *Vet Pathol* 1990; 29:9.
4. Carbis CR et al. *Vet Rec* 1995; 137:12.
5. Chengappa MM et al. *J Am Vet Med Assoc* 1989; 194:1724.
6. Smith RA, Lewis D. *Vet Hum Toxicol* 1987; 29:153.
7. Chu FS et al. *J Official Anal Chem* 1990; 73:451.
8. Carbis CR et al. *Res Vet Sci* 1994; 57:310.

### ALPINE PASTURE CATTLE DEATHS

Cattle grazing high alpine pastures in summer have access to oligotrophic drinking water in ponds and lakes containing the cyanobacteria *Oscillatoria limosa* and *O. tenuis* (synonym *Phormidium konstantinosum*) growing as dense mats on submerged rocks and sediments and producing hepatotoxic microcystin which can be in sufficient quantity to be associated with fatal hepatotoxicosis.<sup>1</sup>

### REFERENCE

1. Mez, K. et al. (1997) *Eur J Phycol* 32, 111.

## POISONING BY TUNICAMINYLRACILS (CORYNETOXINS)

### RATHAYIBACTER TOXICUS IN NEMATODE GALLS OF PASTURE GRASSES (ANNUAL RYE-GRASS TOXICITY, FLOOD PLAIN STAGGERS, STEWART'S RANGE SYNDROME)

#### Synopsis

**Etiology** Bacteriophage-infected *Rathayibacter toxicus* plus grass nematode *Anguina funesta* infesting grass, e.g. *Lolium rigidum*, *Lachnagrostis filiformis*, *Polypogon monspeliensis* eaten by all species.

**Epidemiology** Outbreaks when grass mature and infected seed head galls ingested.

**Clinical findings** Fall when disturbed; paddling convulsion, hypermetric, stiff gait; death during a convulsion. High morbidity and mortality rates; up to 100% in sheep.

**Clinical pathology** Increased activity of hepatic enzymes in serum.

**Necropsy finding** Diagnostic perivascular edema in meninges and brain.

#### Diagnosis confirmation

Tunicaminyluracil in pasture seed heads.

**Treatment** Cyclodextrin.

Chlordiazepoxide effective but lacks practicality.

**Control** Close up paddocks when pasture grasses mature.

### ETIOLOGY

Nematode larvae infest and are associated with galls in the seedheads of *Lolium rigidum* (Wimmera or annual rye-grass), *Festuca nigrescens* (Chewing's fescue), *Polypogon monspeliensis* (annual beard grass)<sup>1</sup> and *Lachnagrostis filiformis* (formerly *Agrostis avenacea*) (blowaway grass). The nematodes *Anguina funesta*, *Anguina* spp. and *Vulpia myros* carry *Rathayibacter toxicus* (formerly *Corynebacterium rathayi* or *Clavibacter toxicus*) into the grass seeds attached to their cuticles. Provided these bacteria are infected by a bacteriophage, they produce toxins in the seedhead gall, and the sheep, cattle, and horses grazing the pasture are poisoned, with the development of a characteristic clinical picture.

The **toxins** are glycolipid tunicaminyluracils (corynetoxins) which originate from galls containing the yellow-pigmented *R. toxicus*. They reach peak concentration when the grass is fully mature.

Lethal oral dose of corynetoxins for sheep is 3–5 mg/kg. The subcutaneous lethal dose is much smaller, 30–40 µg/kg as a single dose or a set of small sequential doses. The toxins are cumulative

if the intervals between doses are less than weeks<sup>2</sup>

## EPIDEMIOLOGY

### Occurrence

The disease which occurs in livestock pastured on *L. rigidum* (termed annual ryegrass toxicity, or ARGT) or in those grazing *Lachnagrostis filiformis* (*Agrostis avenacea*) (flood plain staggers) has become a very important cause of death losses on farms in western and southern Australia, and is also recorded in South Africa. Toxicity on *Polypogon monspeliensis* (termed Stewart's Range syndrome) is restricted to a small part of southern Australia. Clinical signs do not occur until the stock has been on the pasture for several days or up to weeks. Forced exercise and high ambient temperatures precipitate or exacerbate clinical signs.

### Plant risk factors

Pasture improvement based on annually alternating crop-pasture rotations seem to predispose to the disease, with the worst outbreaks occurring after the end of a cropping year. This can be avoided by burning the pasture in the autumn. It is introduced onto farms by the introduction of infested grass seed or agricultural implements contaminated with it. *Lolium rigidum* has become a weed in southern Australia and herbicide-resistant strains have evolved, complicating control measures. The standing grass becomes toxic as soon as the seed head appears, and loses the toxicity as soon as heavy rain falls. Hay made from infested grass remains poisonous for 5–6 years. The disease, associated with *Agrostis avenacea*,<sup>3</sup> has occurred in cattle on extensive pasture recently subjected to severe flooding, hence the name flood plain staggers.

### PATHOGENESIS

The causative toxin is similar structurally to the antibiotic tunicamycin, and the diseases associated with each of the two compounds are indistinguishable. The tunicamycin interferes with glycoprotein synthesis and is capable of causing cerebral vascular lesions in experimental animals.<sup>4</sup> Interference with cardiovascular function and vascular integrity leads to interference with oxygenation of tissues, particularly the brain.

### CLINICAL SIGNS

Signs appear when the cattle or sheep are disturbed or stressed, especially by driving. The animals fall in a convulsion with paddling of limbs, nystagmus, opisthotonos, jaw champing and salivation, sometimes neck ventroflexion, head nodding, tetanic extension of limbs and, in sheep, posterior extension of the hindlimbs. Death may occur during a convulsion or, if left alone, the animal may

recover to the point of being able to stand, but there may be gait incoordination, due to hypermetria, stiff gait, a broad-based stance, head swaying, rocking backwards and forwards, and loss of balance. Intermittent convulsive episodes recur and the patients soon go down again and death occurs in up to 24 hours. Further cases occur for up to 10 days after affected animals are removed from the pasture. Morbidity and mortality rates may reach as high as 100% in sheep flocks.

### CLINICAL PATHOLOGY

Blood levels of liver enzymes, bilirubin and bile acids are elevated.

### NECROPSY FINDINGS

Necropsy findings are inconsistent and non-specific. The liver may be enlarged and pale. There may be haemorrhages in a range of tissues. Histologically, there may be perivascular edema in the brain, particularly in cerebellar meninges. Other lesions may include significant liver damage.

### DIFFERENTIAL DIAGNOSIS

Staggers/convulsion syndromes associated with a high mortality rate are not common.

Diagnosis confirmation depends on:

- combination of a convulsive syndrome with access to mature pasture carrying seed
- detection of severe inhibition of liver microsomal N-acetylglucosamine-1-phosphate transferase activity from liver biopsy or necropsy samples
- histopathology of brain and liver
- identification of bacterial galls in seedhead material
- quantitative detection of *Rathayibacter toxicus* antigens by ELISA on pasture, fodder, rumen contents, faeces
- a positive assay of corynetoxins in pasture or fodder.

The differential diagnosis list includes:

- Phalaris staggers
- Perennial ryegrass staggers
- Lead poisoning
- Poisoning by any one of a large number of plants in which the toxic agent has not been identified.

### TREATMENT

Affected flocks or herds should be removed from a toxic pasture as slowly and quietly as possible to good-quality feed with shade and water in a place free of disturbance. Pharmacological measures are impractical. An antidote was developed by CSIRO in Australia for use early in outbreaks of poisoning. It is a cyclo-dextrin, a cyclic glucose molecule with a hydrophobic central cavity which sequesters the corynetoxin molecules. It is formulated as a gel for intra-

peritoneal injection. Field trials have been disappointing.

### CONTROL

Pasture management in endemic areas should aim to reduce exposure of livestock to mature pastures with seedheads. This may be achieved by a variety of measures such as heavy stocking during winter and spring, harvesting pasture for silage or hay before seeding followed by heavy grazing to remove ryegrass seedlings, burning crop and pasture residues and herbicide application. Biological control measures being pursued include development of early-flowering *L. rigidum* cultivars that carry fewer bacterial galls and the pasture application of *Dilophospora alopecuri*, a fungal pathogen of *Anguina funesta*. Administration of cobalt orally may have some prophylactic effect against the poisoning.<sup>5</sup> Immunization against the toxin is promising and is being actively researched.

### REVIEW LITERATURE

- Allen JG. Annual ryegrass. In Plumlee, K.H. (ed.) *Clinical Veterinary Toxicology*. Mosby, St. Louis, Missouri. p.422, 2004.
- Cheeke PR. Endogenous toxins and mycotoxins in forage grasses and their effects on livestock. *J Anim Sci* 1995; 7:909.
- Davis EO et al. Clinical, pathological, and epidemiological aspects of flood plain staggers. *Aust Vet J* 1995; 72:187.
- Edgar JA. Toxins in temperate grasses; implications and solutions. *NZ J Agric Res* 1994; 37:341.

### REFERENCES

1. Finnie JW. *Aust Vet J* 1991; 68:370.
2. Jago MV, Culvenor CCJ. *Aust Vet J* 1987; 64:232.
3. Bourke CA, Carrigan MJ. *Aust Vet J* 1993; 70:188.
4. Finnie JW, O'Shea JD. *J Comp Pathol* 1990; 102:363.
5. Davies SC et al. *Aust Vet J* 1993; 70:186.

### TUNICAMINYLRACIL TOXIN IN WATER-DAMAGED GRAIN

A similar tunicaminylracil has been isolated from water-damaged wheat which when fed to pigs is associated with clinical signs and deaths similar to those associated with the tunicaminylracil on grasses.<sup>1</sup>

### REFERENCE

1. Cockrum PA et al. *Aust J Agric Res* 1988; 39:245.

### DISEASES ASSOCIATED WITH ZOOTOXINS (ANIMAL BITES AND STINGS)

Disease associated with zootoxins in farm animals are limited to bites of snakes, stings of bees, tick bite, and ingestion of preformed toxins, including cantharidin and the octapeptide of sawfly larvae. Spiders, centipedes, scorpions, fish, and marine mammals are not listed as being associated.

## SLAKEBITE

### Synopsis

**Etiology** Venom injected into victim by a bite with specially adapted fangs.

**Epidemiology** Isolated attacks during summer months. A rare clinical disease in large animals.

**Clinical findings** Muscle weakness, stumbling gait, recumbency, pupillary dilation, swallowing paralysis, salivation, muscle tremor. May be swelling and tissue necrosis at bite site.

**Clinical pathology** Venom detectable in blood, urine, body tissues and fluids generally.

**Necropsy findings** May be local swelling and tissue necrosis.

**Diagnosis confirmation** Based on detection of venom in body tissues or fluids.

**Treatment** Injection of type-specific antivenene.

### ETIOLOGY

At least four toxic actions can result from snake venoms, and different snakes have varying combinations of toxins in their venoms (Table 33.3). The toxins include necrotizing, anticoagulant, and coagulant fractions as well as neurotoxic, cardiotoxic, and hemolytic fractions. Although there is often insufficient toxin injection to cause death in large animals, a serious secondary bacterial infection may be set up in the local swelling and cause the subsequent death of the animal. The common venomous snakes include *Crotalus* spp. (rattlesnakes and pit vipers of North America), the true vipers, e.g. *Vipera berus* (northern viper, the United Kingdom's only venomous snake), and the elapid snakes including the cobra, mamba, and most of Australia's venomous snakes including *Notechis scutatus* (tiger

snake) and *Pseudonaja (Demansia) textilis* (common brown snake).

### EPIDEMIOLOGY

The incidence of snakebite is controlled by the geographical distribution of the snakes and their numbers. Asia, India, Africa, Central and South America, Australia, and the southern United States are areas in which snake populations are large. In general, the morbidity rate in farm animals is low, although a mortality rate of 20% has been recorded in a small group of bitten animals.

Most snakebite accidents occur during the summer months and bites are mainly about the head because of the inquisitive behavior of the bitten animal. Pigs are not highly susceptible but not, as generally believed, because of their extensive subcutaneous fat depots. Sheep may be bitten

Table 33.3 Important venomous snakes of the world (adapted from Dorland's Illustrated Medical Dictionary, 28 edition, 1994, W.B. Saunders).

Family and common name	Scientific name	Type of venom	Distribution	Commentary
<b>Colubridae</b>	Colubrids	Mostly mild	Warm parts of both hemispheres	Over 1000 species; a few poisonous but not dangerous
Boomslang	<i>Dispholidus typus</i>	Hemorrhagin	South Africa	Arboreal, timid
<b>Elapidae</b>	Elapids	Predominantly neurotoxin	Mostly in Old World	Over 150 species; very poisonous
Cobras	<i>Naja</i> spp.	Mostly neurotoxin	Africa, India, Asia, Philippines, Celebes	Spitting cobra in Africa aims at eyes
Kraits	<i>Bungarus</i> spp.	Strong neurotoxin	India, S.E. Asia, Indonesia	Sluggish; often buried in dust
Mambas	<i>Dendroaspis</i> spp.	Neurotoxin	Tropical W. Africa	Arboreal
Blacksnake	<i>Pseudechis</i> spp.	Neurotoxin	Australia	Large snake; wet terrain
Copperhead (Australian)	<i>Austrelaps superbus</i>	Neurotoxin	Australia, Solomons	Damp environment
Brown snake	<i>Pseudonaja</i> spp.	Neurotoxin	Australia, New Guinea	Slender snake
Tiger snake	<i>Notechis scutatus</i> , <i>N. ater</i>	Strong neurotoxin	Australia	Dry environment, aggressive, very dangerous
Taipan	<i>Oxyuranus</i> spp.	Strong neurotoxin	Australia	Dry environment; very dangerous
Death adder	<i>Acanthophis antarcticus</i>	Neurotoxin	Australia, New Guinea	Sandy terrain
Coral snakes	<i>Micrurus</i> spp., <i>Micruroides</i> spp.	Neurotoxin	United States, tropical America	About 26 species; two in southern USA
<b>Hydrophidae</b>	<i>Hydrophis</i> spp., <i>Pelampus platurus</i> , <i>Laticauda</i> spp., <i>Aipysurus</i> spp., etc.	Some mildly toxic; others very toxic	Tropical, Indian and Pacific oceans	Gentle, rudder-like tail; over 50 species
<b>Viperidae</b>	<i>Vipera</i> , <i>Bitis</i> spp.	Predominantly hematoxin	Entirely in Old World	About 50 species
True vipers, viperids				
European viper	<i>Vipera berus</i>	Hematoxin	Europe (rarely), N. Africa, Near East	Dry, rocky country
Russell's viper	<i>Vipera russelli</i>	Hematoxin	S.E. Asia, Java, Sumatra	Mostly in open terrain; deadly
Sand vipers	<i>Vipera ammodytes</i>	Hematoxin	N. Sahara	Buried in sand
Puff adder	<i>Bitis arietans</i>	Hematoxin	Arabia, Africa	Open terrain; sluggish
Gaboon viper	<i>Bitis gabonica</i>	Neurotoxin and hematoxin	Tropical W. Africa	Forests; deadly
Rhinoceros viper	<i>Bitis nasicornis</i>	Hematoxin	Tropical Africa	Wet forests
<b>Crotalidae</b>	Crotalids, Pit Vipers	Predominantly hematoxin	Old and New Worlds; none in Africa	More than 80 species; sensitive pit between eye and nostril
Habu viper	<i>Trimerurus flavoviridis</i>	Neurotoxin	Warmer parts of E. Asia, Ryuku Islands	Caves and dry, rocky country
Rattlesnakes	<i>Crotalus</i> , <i>Sistrurus</i> spp.	Predominantly hematoxin	N., Central and S. America	All rattlesnakes venomous; S. American form is neurotoxic
Bushmaster	<i>Lachesis muta</i>	Hematoxin	Central and S. America	Large; in wet forests
Fer-de-lance	<i>Bothrops lanceolatus</i> , <i>B. Atrox</i> (wrongly)	Hematoxin	Central and N. South America; few in West Indies	Common in plantations
Palm vipers	<i>Bothrops schlegelii</i> , <i>B. neuwiedi</i>	Hematoxin (?)	S. Mexico, Central and S. America	Arboreal, small, greenish; bites face
Copperhead	<i>Agkistrodon contortrix</i>	Hematoxin	United States	Dry, stony terrain
Water moccasin	<i>Agkistrodon piscivorus</i>	Hematoxin	S.E. USA to Texas	Swamps
Asiatic pit viper	Not listed	Hematoxin	S.E. Asia, Taiwan	Mostly arboreal

on the udder but their long wool coat is generally effective as a protective mechanism on other parts of the body. Large animals tend to be resistant because of their large size and the large dose rate required to cause death. However, horses appear to be much more susceptible to venom than any other species.

### **PATHOGENESIS**

The effects of snakebite (envenomation) depend upon the size and species of the snake, the size of the bitten animal and the location of the bite, particularly with reference to the thickness of the hair coat and the quantity of subcutaneous fat. As a general rule the venom is injected by fangs which leave a bite mark comprising a row of small punctures with two large punctures outside them. An exception is the coral snake, which must chew to inoculate the venom. The bites may be visible on hairless and unpigmented skin but can only be seen on reflection of the skin at necropsy in many instances. Non-poisonous snakes may bite animals, but the bite mark is in the form of two rows of small punctures.

The toxins in venom include:

- Neurotoxins, causing flaccid paralysis, pupillary dilatation and paralytic respiratory failure
- Cytolins, which are associated with tissue necrosis, including platelets, leading to intravascular coagulation
- Hemolysins, coagulant or
- Thrombase, anticoagulants leading to a hemorrhagic tendency
- Myotoxins, causing muscle necrosis and myoglobinuria.

The overall effect of a bite by a snake depends on the mix of specific venoms in the dose delivered and the actual dose which depends on the size of the snake and the period since the snake last bit. Tiger snake venom contains neurotoxins and coagulants. Death adder venoms contain only neurotoxin, brown snake has coagulant and some neurotoxin. Rattlesnake venom is associated with necrosis of arterioles and arteriolar thrombus formation, and in most species contains an anticoagulant, causing a bleeding diathesis. The Mojave rattlesnake *Crotalus scutulatus* is an exception.<sup>1</sup>

### **CLINICAL FINDINGS**

Bites by adder-type snakes (crotalids) are associated with a local swelling which develops rapidly and is associated with severe pain, usually sufficient to produce signs of excitement and anxiety. Bites about the head may be followed by swellings of sufficient size to cause dyspnea. If sufficient neurotoxin has been injected a secondary stage of excitement occurs

and is followed by marked dilatation of the pupils, salivation, hyperesthesia, tetany, depression, recumbency, and terminal paralysis. In small animals, death may occur due to asphyxia during convulsions in the excitement stage of the disease. In animals that recover there is usually local sloughing at the site of the swelling.

Bites by cobra-type snakes (elapids) are associated with local swelling in animals that survive the effects of the neurotoxin. These commonly develop local swellings due to bacterial infection 3–4 days later. The major effects after bites of cobra-type snakes are excitement with convulsions, and death due to asphyxia. The signs appear quickly and death occurs usually in up to 48 hours in horses. In calves, the effects of the neurotoxin are manifested by marked pupillary dilatation, excitement, incoordination, and later paralysis.

Clinical signs in horses bitten by tiger snakes (*Notechis scutatus*) in Australia include pronounced pupillary dilatation without pupillary response to light, but the menace reflex is present and the animal can see. Muscle tremor is most obvious in the standing patient and the horse is very fidgety and wants to lie down. The tremor disappears when the animal lies down, but it will not stay down and insists on rising and wandering about in a compulsive way.

Clinical signs in foals bitten by brown snakes (*Pseudonaja textilis*) in Australia are similar to those associated with tiger snake envenomation. There is drowsiness, drooping of eyelids and lips, partial tongue paralysis, muscle tremor and weakness, leading to recumbency; pupillary dilatation occurs in some. The respiration becomes labored and abdominal. Sweating and inability to suck, swallow or whinny, occur late in the course. Adults also show inability to swallow, with salivation and accumulation of food in the mouth.

Rattlesnake bite in calves is associated with restlessness, teeth grinding, vomiting, hypersalivation, dyspnea, ataxia, and convulsions.

### **CLINICAL PATHOLOGY**

An ELISA for identification of venom in blood, urine or other body tissue or fluid is available. It is highly accurate, suitable for field or office use, immediate but expensive. It is limited to the snake species for which reagents are available.

### **NECROPSY FINDINGS**

Local swellings at the site of the bite are due to exudation of serous fluid, which is often deeply blood-stained. Fang marks are usually visible on the undersurface of the reflected skin.

### **DIFFERENTIAL DIAGNOSIS**

Diagnosis confirmation depends on a positive assay for venom in the patient's blood, urine, and tissues generally. In acute cases death has usually occurred by the time the animal is seen. If the actual bite is observed the diagnosis is made on the history.

#### **Differential diagnosis list:**

Nervous syndrome:

- Tick paralysis
- Organophosphate poisoning
- Fluoroacetate poisoning.

Local swelling, consider also a diagnosis of:

- Blackleg
- Anthrax in horses and pigs
- Non-specific phlegmonous infections.

### **TREATMENT**

In human medicine the application of a tourniquet proximal to a limb bite site has been replaced; a firm pressure bandage is applied over the bite to restrict the distribution of the venom via the lymphatics and retain it in the site and prevent systemic effects. Excision of the bite site is recommended for the bites of snakes (crotalids) which are associated with a serious local reaction.

Systemic treatment should include antivenin, antibiotics, and antitoxin. Antivenin containing antibodies against the venoms of all the snakes in the area can usually be obtained locally, often in highly purified form. It is expensive to use but highly effective. Speed is essential and the IV route is preferred. A portion of the antivenin should be injected locally around the bite. The dose rate varies widely with the size of the animal, one unit often being sufficient for animals weighing 70 kg or more, but smaller animals of 9–18 kg BW require about 5 units. A broad-spectrum antibiotic should also be administered to control the local infection at the site of the bite. The occurrence of clostridial infections after snakebite suggests the administration of antitoxins against tetanus and gas gangrene. Supportive fluid treatment may be advisable when shock is severe and the administration of a sedative may be necessary to control pain and excitement.

Many other treatments have been used in snakebite, including particularly ACTH, cortisone, and antihistamines. These drugs have been found to be valuable as a protection against possible anaphylaxis after treatment with antivenin, but in cases where local tissue damage is evident they are without value and in many cases exert deleterious effects. Adrenaline or epinephrine have little or no value and calcium salts do not significantly reduce mortality.

The application of chemicals to the incised bite area is also of no value and may exacerbate tissue damage. Attention has been drawn to the need to appreciate the mode of action of one's local snakes before attempting a general program of treatment – what may be effective in one country may very well be lethal in another.

#### REVIEW LITERATURE

- Fowler ME. Veterinary Zootoxiology. Boca Raton, FL: CRC Press, 1993.
- Iyaniwura T. Snake venom constituents; biochemistry and toxicology. *Vet Hum Toxicol* 1991; 33: 468-479.
- Mattison P. Snakes of the World: London: Blandford Press, 1986.

#### REFERENCE

1. Corrigan JJ, Jeter MA. *Vet Hum Toxicol* 1990 32:439.

#### BEE STINGS

Multiple stings by bees may be associated with severe local swelling up to 6 cm diameter, similar to those in angioedema but with a stinger in the center. The lips, eyelids, tongue, and vulva are often swollen and painful. Pain may result in pronounced excitement, and in severe cases in horses there may be diarrhea, hemoglobinuria, jaundice, tachycardia, cardiac arrhythmia, rapid breathing, sweating, and prostration. Animals attacked about the head may show dyspnea because of severe local swelling. Horses often show mild-to-moderate colic.<sup>1</sup> In rare cases the attack may be fatal, usually after a course of 4–12 hours. Necropsy lesions include hemorrhages and edema of all connective tissues and the bowel wall. Treatment includes the local application of a weak solution of ammonia or sodium bicarbonate, nervous system stimulants if prostration is severe, and tracheotomy if asphyxia threatens.

#### REFERENCE

1. Staempfli HR et al. *Equine Vet Educ* 1993; 5:250.

#### ANT BITES

Bites from the aggressive red imported fire ant (*Solenopsis invicta*) have been associated with focal necrotic ulcers of the cornea and conjunctiva of newborn calves.<sup>1</sup> Weak calves are most likely to be injured.

#### REFERENCE

1. Joyce JR. *Vet Med* 1983; 78:1109.

#### TICK PARALYSIS

Infestations with a variety of species of ticks are associated with paralysis of animals. Dogs are most commonly affected but losses can occur in lambs, calves, goats, foals, and even children. *Ixodes holocyclus* have been shown to paralyze calves of 25–50 kg BW. Between four and ten adult female ticks are

required to produce this effect and paralysis occurs 6–13 days after infestation occurs. The ticks under natural conditions parasitize wild fauna, and infestations of other species occur accidentally. The disease is limited in its distribution by the ecology of the ticks and the natural host fauna. The paralysis characteristic of the disease is associated with a toxin secreted by the salivary glands of female ticks and which is present in much greater concentration in the glands of adults than in other stages. The severity of the paralysis is independent of the number of ticks involved; susceptible animals may be seriously affected by a few ticks.

The toxin of *Dermacentor andersoni* interferes with liberation or synthesis of acetylcholine at the motor end plates of muscle fibers. The disturbance is functional and paralysis of the peripheral neurons is the basic. Continuous secretion of toxin by a large number (35–150) of partly engorged female ticks which have been attached for 5–8 days is necessary to produce paralysis, complete recovery occurring within 24 hours when the ticks are removed. The disease is confined to calves and yearlings.<sup>1</sup> Clinically, there is an ascending, flaccid paralysis commencing with incoordination of the hindlimbs, followed by paralysis of the forelimbs and chest muscles, causing lateral recumbency. The respiration is grossly abnormal because of its diaphragmatic form; there is a double expiratory effort and the rate is slow (12–15/min) but deep. All limb and eye touch reflexes are absent, the pupils dilate widely and death is due to respiratory paralysis. In dogs there are additional signs, including vomiting, absence of voice, and secondary aspiration pneumonia. Death, due to respiratory failure, may occur in 1–2 days but the course is usually 4–5 days. The mortality rate may be as high as 50% in dogs, but is usually much lower in farm animals. Since tick-borne diseases, such as tularemia, often coexist with tick paralysis, this possibility should always be considered in arriving at a diagnosis.

Hyperimmune serum is used in the treatment of dogs but in farm animals, removal of the ticks in the early stages is usually followed by rapid recovery. Control necessitates eradication of the ticks or host fauna. The use of appropriate insecticides is an effective preventive.

#### REFERENCE

1. Schofield LN, Saunders JR. *Can Vet J* 1992; 33:190.

#### CANTHARIDIN POISONING (BLISTER BEETLE POISONING, CANTHARIDIASIS)

Poisoning of horses by the consumption of blister beetles (*Epicauta* spp.) is now a

common event in the United States.<sup>1</sup> There are 200 named species of the beetle, the commonest being *E. occidentalis* and *E. temexa*.<sup>2</sup> Originally the disease was confined to the southern States, but outbreaks now occur elsewhere because of the widespread shipment of alfalfa hay, and occasionally weedy meadow hay, infested with the beetles. The beetles contain cantharidin, and administration of 1 g of ground beetles by stomach tube is fatal to a pony. Cattle are not affected. The cantharidin content of the beetles varies widely (0.77–3.31% dry weight) between species, and male beetles contain more toxin than females. Other insects containing cantharidin include Chinese blister beetle or fly (*Mylabris phalerata*).

Signs include anorexia, oral mucosal erosions, frequent urination, colic and, occasionally, synchronous diaphragmatic flutter. Severe depression, shock, and death follow in approximately 50% of cases. Clinicopathologically there may be hematuria, azotemia, hemoconcentration, and a neutrophilic leukocytosis, but these lesions are not diagnostic and the presence of beetles in the feed should be established. Unexplained hypocalcemia and hypomagnesemia are usual. Vesiculating gastropathy of the gastric squamous mucosa is highly diagnostic but no necropsy findings occur in many cases. Mass spectrometric and gas or liquid chromatographic methods facilitate detection of cantharidin in field specimens of blood, urine, gut contents, and feed.<sup>3</sup>

Treatment is symptomatic. Inspection of hay for the beetles can avoid the problem. Infested fields should not be harvested.

#### REVIEW LITERATURE

- Helman RG, Edwards WC. Clinical features of blister beetle poisoning in equids; 70 cases (1983-1996). *J Am Vet Med Assoc* 1997; 211:1018.
- Schmitz DG. Cantharidin toxicosis in horses. *J Vet Intern Med* 1989; 3:208-215.

#### REFERENCES

1. Gucklick MA et al. *Comp Cont Educ Prac Vet* 1996; 18:77.
2. Edwards WC et al. *Vet Hum Toxicol* 1989; 31:442.
3. Ray AC et al. *Am J Vet Res* 1989; 50:187.

#### MARE REPRODUCTIVE LOSS SYNDROME (EARLY FETAL LOSS, LATE FETAL LOSS, EPIDEMIC FIBRINOUS PERICARDITIS, EPIDEMIC UNILATERAL ENDOPHTHALMITIS)

##### ETIOLOGY AND EPIDEMIOLOGY

A syndrome of increased incidence of early fetal loss (< 70 days of gestation) and late-term abortion was recognized in north central Kentucky and southern Ohio, Illinois, and Indiana in 2001 and,



affecting fewer horses, in 2002. At the same time there was also a marked increase in incidence of birth of weak foals, and **pericarditis** and **endophthalmitis** in adult horses in the same region.<sup>1</sup>

The early fetal loss in mare reproductive loss syndrome is associated with the ingestion of **Eastern Tent caterpillars** (*Malacosoma americanum*).<sup>1-3</sup> Abortion of mares at 40–80 days of gestation is induced by gavage with starved Eastern Tent caterpillars, feeding of whole caterpillars, or feeding of caterpillar exoskeleton, but not gavage or feeding of caterpillar frass (excreta), autoclaved homogenate of caterpillars, or filtrate of homogenized caterpillars.<sup>1-3</sup> Abortion is induced by feeding or intragastric administration of 50 g of caterpillars/day for 10 days.<sup>1-3</sup> Mares abort from 8 to 28 days after first ingestion of caterpillars.<sup>1-3</sup> The lag time between ingestion of caterpillars and abortion is longer for ingestion of lesser amounts of caterpillars.<sup>2</sup> The association between ingestion of Eastern Tent caterpillars and late term abortion, birth of weak or non-viable foals of normal gestational age, pericarditis, and endophthalmitis has not been demonstrated experimentally. However, there is strong epidemiologic and circumstantial evidence to support a role for *M. americanum* in the etiology of these diseases.

*Actinobacillus* spp. is often isolated from pericardial fluid of horses with pericarditis during outbreaks of epidemic pericarditis, which has a temporal relationship with early fetal loss and late-term abortion, but is likely not the inciting agent.<sup>4</sup>

### Occurrence

The documented outbreak of the syndrome occurred from April 26 through mid-June of 2001, with a lower incidence of disease during the same months in 2002. The disease has been recorded only in the Ohio river valley and north-central Kentucky. The disease caused early fetal loss in 25–63% of mares on one-third of farms, 14–24% on another third, and 2–13% on the remaining one-third.<sup>5</sup> Approximately 21% of mares pregnant at 42 days of gestation were not pregnant when examined at 70–90 days of gestation.<sup>6</sup> The expected pregnancy loss rate between 42 days and parturition is 12%.<sup>6</sup> Over 3000 mares aborted during the outbreak.<sup>4</sup>

### Risk factors

Risk factors for the disease are those associated with exposure to Eastern Tent caterpillars and include the presence of large numbers of caterpillars on pasture, pasturing or feeding hay to horses at pasture, and presence of mares with pericarditis on the farm.<sup>5,6</sup>

For late-term abortion the risk factors include increased amount of time at

pasture, less time in stall, feeding concentrate on the ground, increased proportion of feed obtained from pasture, and being fed exclusively in pasture during the final 4 weeks of gestation.<sup>7</sup> All of these factors favor exposure to Eastern Tent caterpillars.

Risk factors for **pericarditis** include presence of mares or foals with mare reproductive loss syndrome on the farm, grazing, and exposure to Eastern Tent caterpillars.<sup>7</sup> Risk factors for endophthalmitis have not been defined.

**Eastern Tent caterpillars** are endemic to the eastern United States including the Ohio River valley.<sup>8</sup> Egg masses are laid on many trees in the Rosaceae family including cherry trees, the preferred host.<sup>8</sup> Eggs hatch in the early spring at the time that the cherry trees bud. Local populations of the caterpillars fluctuate dramatically from year to year, but mares are likely exposed to small numbers of the caterpillars every spring.<sup>4,8</sup> Climatic conditions that favor survival of Eastern Tent caterpillars and synchronize their maturation result in simultaneous hatching of large numbers of eggs. The rapid emergence of large numbers of caterpillars results in abrupt and heavy exposure of horses and consequent development of mare reproductive loss syndrome.<sup>4</sup> Weather conditions believed to contribute to the 2001 outbreak include a period of low temperatures in March, above normal temperatures in April, and a frost and freeze in late April immediately followed by several warm days.<sup>9</sup>

The **economic losses** incurred because of mare reproductive loss syndrome during 2001 are estimated to be \$US330 million.<sup>4</sup>

### PATHOGENESIS

The **pathogenesis** of the diseases associated with mare reproductive loss syndrome has not been defined.

### CLINICAL SIGNS

#### Early fetal loss

This is detected by *per rectum* uterine examination, either manual or using ultrasonographic visualization of uterine contents, during early pregnancy. Fetal loss occurs after 35 days, conception not being affected, and affected mares do not come into estrus because of the presence of endometrial cups, which do not regress until 100–150 days after ovulation.<sup>9</sup> Mares have no clinically detectable premonitory signs of fetal loss. Ultrasonographic examination of the uterus of pregnant mares reveals that the allantoic fluid of fetuses <80 days of age has increased echogenicity on the day of fetal death.<sup>1</sup> Allantoic fluid increases in echogenicity with increasing fetal age and care should be taken when interpreting this observation.

### Late fetal loss

This occurs as a late-term abortion (final several weeks of gestation), birth of a stillborn foal at full term, and the birth of a foal that is weak and of reduced viability.<sup>10-11</sup> The birth of an affected foal is associated with premature placental separation ('red bag' deliveries), foaling while standing, and explosive expulsion of the fetus and placenta.<sup>10,11</sup> Foals born alive are weak, have sunken eyes, progressive neurologic signs consistent with hypoxia, and have a high death rate (50%) despite intensive care.<sup>10,11</sup> Severe leucopenia at birth often progresses to leucocytosis at 24–48 hours of age. Serum biochemical abnormalities include elevated serum creatinine concentrations, hypoglycemia, and increased serum creatine kinase activity.<sup>10</sup> Bacteria isolated from stillborn foals at necropsy or on culture of blood samples from sick foals are non-specific organisms including non-hemolytic streptococci and *Actinobacillus* spp.

### Fibrinous pericarditis

This manifests as signs of congestive heart failure secondary to cardiac tamponade in adult horses. Horses often have a history of fever but not other clinical abnormalities. There is accumulation of large quantities of pericardial fluid and fibrin deposition on the parietal and visceral pericardial surfaces evident on ultrasonographic examination of the chest.<sup>12</sup> The lungs have ultrasonographic evidence of consolidation consistent with pneumonia in approximately 50% of cases. Pericardiocentesis yields abundant fluid that is light yellow and has a low white blood cell count (<5 × 10<sup>9</sup>/L) characterized by well-preserved neutrophils.<sup>12</sup> Horses with a prolonged course of the disease (>2 weeks) can have elevated white cell counts in pericardial fluid secondary to opportunistic infection, usually with *Actinobacillus* spp.<sup>4,12</sup> Hematologic abnormalities are minimal and characterized by a slight leukocytosis in approximately 50% of cases.<sup>12</sup> Azotemia occurs in horses with severe cardiac tamponade.

Diagnostic confirmation is based on the presence of appropriate clinical signs with a history of exposure of affected horses to Eastern Tent caterpillars.

### NECROPSY FINDINGS

Examination of placenta, stillborn foals and foals that die after birth reveals inflammation of the intra-amniotic umbilical cord (funisitis), diffuse alveolitis, and hemorrhage in a variety of organs.<sup>10</sup> Horses with pericarditis have impressive accumulation of hairy fibrin in the pericardial space with marked thickening of the visceral and parietal pericardium (a hoary heart).

## TREATMENT

Treatment of affected foals is based upon the principles delineated in 'Principles of the care of newborns' and is primarily supportive. Horses with pericarditis should have the fluid drained to relieve or prevent cardiac tamponade and to minimize the accumulation of fibrin. Pericardial fluid might need to be drained on a number of occasions and its accumulation should be monitored ultrasonographically. Administration of broad spectrum antibiotics and dexamethasone phosphate or equivalent (30–40 mg IV or IM once daily for 3–5 days) is successful in approximately 50% of horses with disease of <5 day's duration. Horses with disease of longer duration might require more aggressive therapy including pericardial lavage and pericardiectomy. The prognosis for survival for such horses is grave to hopeless.

## CONTROL

This is based on prevention of ingestion of Eastern Tent caterpillars by horses.<sup>11,13</sup> The control measures include: removing wild or black cherry trees, the favored host species for Eastern Tent caterpillars, from pastures, hedges, and fence rows; applying pesticides to trees to kill overwintering eggs or, after hatching, caterpillars; installation of barriers to caterpillar migration on to pasture; manual removal of egg tents; and restricting access of mares to pasture.<sup>11,13</sup> Application of bifenthrin or permethrin, but not 3% horticultural oil, to egg masses (tents) during the winter prevents emergence of caterpillars in the spring.<sup>13</sup> Insecticidal soap or oils sprayed on neonatal caterpillars is minimally effective. Bifenthrin or spinosad are effec-

tive against all instars for 7 days when sprayed on foliage.<sup>13</sup> Injection of trunks of cherry trees with dicrotophos or emamectin is effective against all instars but injection with milbemectin or avermectin is not effective.<sup>13</sup> A spray of 50 mL of 39% permethrin diluted in 4 L of water and applied to a 2-m wide band of pasture outside the fence line kills migrating caterpillars and prevents them obtaining access to pasture.<sup>14</sup> This solution can also be sprayed on the trunks of trees to kill caterpillars as they leave the tree.

Preventing horses ingesting caterpillars by minimizing access to pasture and feeding hay in stalls is likely to be beneficial. Farms that have aggressively implemented measures to prevent horses ingesting Eastern Tent caterpillars have prevented the disease.<sup>11</sup>

## REFERENCES

- Bernard WV et al. J Am Vet Med Assoc 2004; 225:717.
- Sebastian M et al. Vet Therapeutics 2003; 4:324.
- Webb BA et al. J Insect Physiol 2003; 50:185.
- Bolin DC et al. J Vet Diagn Invest 2005; 17:38.
- Cohen ND et al. J Am Vet Med Assoc 2003; 222:210.
- Dwyer RM et al. J Am Vet Med Assoc 2003; 222:613.
- Cohen ND et al. J Am Vet Med Assoc 2003; 222:199.
- Morehead JP et al. J Am Vet Med Assoc 2002; 220:1828.
- Fitzgerald TD. The tent caterpillars. Cornell University Press, Ithaca, NY, 1995.
- Bain FT, Williams NM. Proceedings. Am Coll Vet Int Med 2002; 135.
- Dwyer RM. Equine Vet Educ 2003; 15:45.
- Reimer J. Proceedings. Am Coll Vet Int Med 2002; 133.
- Potter DA et al. Pest Management Sci 2005; 61:3.
- www.uky.edu/Ag/VetScience/q/2003/july03/q\_july03.htm accessed August 29th, 2005.

## LOPHYROTOMIN AND PERGIDIN (SAWFLY LARVAE) POISONING

Larvae of the sawflies *Lophyrotoma interrupta* in Australia, *Arge pullata* (birch sawfly)<sup>1</sup> in Denmark, and *Perreyiea flavipes* in South America<sup>2</sup> are eaten by cattle, sheep or pigs<sup>3</sup> as they lie on the pasture under the infested trees. The toxins they contain, the peptides lophyrotomin<sup>4</sup> and pergidin,<sup>5</sup> are associated with severe liver necrosis and a syndrome of tremor, dyspnea, recumbency convulsions, and sudden death in acute cases. Less acute cases show hyposensitivity, jaundice, photosensitization, diarrhea, and dysentery. Necropsy lesions include periacinar or panacinar hepatic necrosis, some nephrosis, and extensive hemorrhages in the alimentary tract, and fluid transudates in serous cavities in longer surviving cases.<sup>6</sup>

## REFERENCES

- Thamsborg SM et al. Vet Rec 1987; 121:253.
- Dutra F et al. Vet Hum Toxicol 1997; 39:281.
- Soares MP et al. Toxicon 2001; 39:669.
- Kannan R et al. Toxicon 1988; 26:224.
- MacLeod JK et al. Aust J Chem 2000; 53:293.
- McKenzie RA et al. Bull Qld Dept Prim Ind 1985; 48.

## MOTH DAMAGE

Insect-generated fiber, e.g. in the cocoons of Molopo moths can be indigestible and, if eaten in large quantities, can be associated with ruminal impaction. The body scales of the brown-tail moth and its larvae have a **nettling** effect, causing skin irritation on contact, and bronchial mucosal irritation on inhalation.

## Diseases associated with allergy

Alloimmune hemolytic anemia of the newborn (neonatal isoerythrolysis, isoimmune hemolytic anemia of the newborn) 1921  
Purpura hemorrhagica 1925

Equine seasonal allergic dermatitis (queensland itch, sweet itch) 1927  
Seasonal allergic dermatitis 1928  
Recurrent airway obstruction (heaves) 1928

Pasture-associated heaves (pasture-associated obstructive pulmonary disease of horses) 1935  
Milk allergy 1935  
Enzootic nasal granuloma of cattle (eng, bovine atopic rhinitis) 1936

### ALLOIMMUNE HEMOLYTIC ANEMIA OF THE NEWBORN (NEONATAL ISOERYTHROLYSIS, ISOIMMUNE HEMOLYTIC ANEMIA OF THE NEWBORN)

#### Synopsis

**Etiology** Maternal alloantibodies to neonate's blood group antigens are transferred to the neonate in colostrum and cause lysis of the neonate's red blood cells.

**Epidemiology** Disease in progeny of multiparous mares or sows. The dam lacks blood group antigens possessed by the sire and inherited by the foal, calf, or piglet. The majority of cases in foals are due to the presence of Aa or Qa antigens and antibodies. Sows vaccinated with crystal violet vaccine or cows with babesia or anaplasmosis vaccines can be associated with disease in their newborns.

**Clinical findings** Lethargy, recumbency, tachycardia, tachypnea, icterus, and hemoglobinuria.

**Clinical pathology** Anemia, hyperbilirubinemia.

**Diagnostic confirmation** Positive antiglobulin (Coombs test) or hemolysis test using mare's serum or colostrum and foal's red blood cells.

**Treatment** Transfusion of blood or packed red blood cells from suitable donor, or of mare's washed red blood cells. Supportive care.

**Control** Identify at-risk mares by blood typing. Examine mare's serum or colostrum for presence of incompatible antibodies before allowing foal to suckle.

#### ETIOLOGY

Hemolytic anemia of **newborn horse and mule foals, calves, and piglets** occurs because of immune-mediated (**antibody-dependent cellular cytotoxicity or type II hypersensitivity**) destruction of the neonate's red blood cells by antibodies acquired from the dam. The specific antibodies are present in the colostrum, absorbed by the neonate, and cause lysis and/or agglutination of red blood cells.

The disease is associated with the natural occurrence of **inherited blood groups** and only occurs if the dam is

exposed to red blood cell antigens that she does not possess. In response to such exposure the dam produces antibodies directed against the foreign red blood cell epitopes. If the neonate possesses a blood type against which the dam has developed antibodies and depending on the red blood cell factor involved, red blood cell destruction can occur. The newborn acquires the red blood cell types that are foreign to the dam through inheritance from the sire. Disease occurs after birth because the fetus is not exposed to the antibodies *in utero* because of the epitheliochorial placentation in mares and sows and the syndesmochorial placentation of cattle. Antibodies in serum are secreted into the colostrum in the peripartum period and are subsequently ingested and absorbed by the newborn. Mares that have anti-red blood cell factor antibodies in their serum almost invariably have the same antibody in their colostrum.<sup>1</sup> The serum concentration of anti-Aa and Qa antibodies is highest in the last 3 months of gestation and peaks about 1 week after parturition. For neonatal isoerythrolysis to occur:

- The fetus must have blood group antigens (factors) that the dam does not. These are inherited from the sire
- The dam must be exposed to the foreign blood group antigens that the fetus possesses
- The dam must produce antibodies against the blood group antigens of the fetus. Not all blood group antigens are highly immunogenic or are associated with disease in the neonate
- The newborn must ingest and absorb colostrum that contains antibodies directed against antigens on the newborn's red blood cells.

The disease occurs naturally in **foals** and **piglets** but is usually iatrogenic in calves. Exposure of the dam to foreign red cell epitopes may occur at **parturition or during gestation** as a result of placental lesions although most incompatible pregnancies do not result in sensitization of the mare.

Mares may also be exposed by **transfusion of incompatible blood**. While whole blood transfusions to mares or fillies are unusual, plasma transfusions are increasingly being used to treat failure or partial failure of transfer of passive immunity to foals. Because plasma usually contains some red blood cells, transfusion of plasma from donors possessing blood group antigens that the foal does not could immunize the filly against these factors with the potential for disease when the foal matures and gives birth. However, most commercial plasma products are harvested from donors that do not have the blood group antigens identified as being problematic.

**32 blood group antigens** are recognized in **horses**:<sup>2</sup>

- A, a, b, c, d, e, f, g
- C, a
- K, a
- U, a
- D, a, b, c, d, e, f, g, h, i, k, l, m, n, o, p
- P, a, b, c, d
- Q, a, b, c

Neonatal isoerythrolysis is attributable in over 90% of cases to antibodies directed against either Aa or Qa antigens, although disease due to antibodies against Ab, Dc, Da, Db, Ka, Qb, Qc, Qrs, Pa, and Ua is reported.<sup>2,3</sup> The presence in the mare of antibodies against Ca decreases the probability that she will develop anti-Aa antibodies.<sup>4</sup>

15 blood groups have been identified in **pigs** and the disease is recorded as occurring spontaneously associated with antibodies to the E group antigens. Historically, the main occurrence of neonatal isoerythrolysis in pigs was manmade and related to repeated vaccination against hog cholera using the pooled blood, inactivated by addition of **crystal violet**, of affected pigs.

The disease has also occurred in **calves** whose dams had been vaccinated against babesiosis or anaplasmosis using a vaccine containing bovine blood.<sup>5</sup> As a result of vaccination the dam develops lytic antibodies against sire antigens, usually of the

A and F blood groups, and antibodies in colostrum cause acute hemolytic anemia in the calves.

## EPIDEMIOLOGY

### Horses and mules

From 1 to 2% of Thoroughbred and Standardbred mares have antibodies capable of causing neonatal isoerythrolysis.<sup>1</sup> The **incidence** is partially related to the proportion of the mare population at risk. An at-risk mare is one that lacks either the Aa or Qa blood group factor. The proportion of mares that lack one or both of these factors is breed dependent, with 19% of Thoroughbreds lacking either Aa or Qa antigens and 17% of Standardbred mares lacking Aa antigens.<sup>1,6</sup> All Standardbred horses lack the Qa factor; neonatal isoerythrolysis in this breed is usually due to antibodies against the Aa factor, with 10% of Standardbred mares having anti-Aa antibodies.<sup>1</sup> Only 2% of Thoroughbred mares lack the Aa antigen but this low proportion is important because approximately 50% of these mares will develop anti-Aa antibodies.<sup>2</sup> Conversely, 16% of Thoroughbred mares lack the Qa antigen, but only 3% of these mares have the anti-Qa antibody.<sup>2</sup> The risk of mares developing antibodies against certain red blood cell types is also related to the prevalence of the antigen in the horse population. For instance, Standardbred mares lack the Qa antigen, but because this antigen is not found in the breed any Standardbred stallion the mare is mated to will not be Qa positive, neither will the foal, and there is no risk of the mare being exposed to the antigen.

The incidence of neonatal isoerythrolysis in **mule foals** (donkey sire X horse dam) can be 10% and is attributable to the universal presence of a unique blood group antigen, 'donkey factor', in jacks and mule foals.<sup>7,8</sup> Mares do not possess this factor and therefore all donkey sire X horse dam pregnancies are incompatible.<sup>7</sup> Progeny of horse sire X donkey dam matings are not affected.

A feature of naturally occurring neonatal erythrolysis in **foals and piglets** is that it rarely if ever occurs in offspring of **primiparous dams** because the induced anti-red blood cell antibody titer is not sufficiently high to induce the disease. Subsequent exposure during later pregnancies elicits an anamnestic response that results in higher anti-RBC antibodies, and disease in the newborn. However, first pregnancy offspring are often affected after vaccination of the dam with blood products.

## PATHOGENESIS

The interaction between the antibody and the red cells of the newborn is followed by

hemolysis with resultant **anemia, hemoglobinuria, and jaundice**. Following ingestion and absorption into the systemic circulation, antibodies bind to red blood cell membranes. Parts of the cell membrane of the antibody coated cells are removed from the circulation, probably by the spleen and associated reticulo-endothelial tissues, and affected cells are eventually lysed and release hemoglobin into the circulation. The affected animal develops **normovolemic anemia** and, if the destruction of red blood cells is sufficient, develops anemic hypoxia and dies. The reaction between red blood cells and antibodies occurs sufficiently quickly that the bone marrow is unable to compensate immediately for the loss of red blood cells. Disseminated intravascular coagulation (DIC) occurs and may contribute to the death.

Permeability of the intestine of the newborn foal to antibody disappears by 36 hours and in most cases much less. Hourly milking of the mare rapidly reduces the antibody content of the colostrum. The duration of the alimentary permeability in piglets has not been determined.

## CLINICAL FINDINGS

### Horses and mules

Pregnancy and parturition are uneventful and the foal is normal for some hours after birth. Signs appear only if the foal ingests and absorbs colostrum containing anti-red blood cell factor antibody. The severity of disease ranges from clinically inapparent to fulminant with death ensuing soon after birth.

**Peracute cases** develop within 8–36 hours of birth, and the first indication of the disease may be collapse. Severe hemoglobinuria and pallor are evident but icterus is not apparent initially. The mortality rate is high.

In **acute cases** signs do not develop until 2–4 days after birth and jaundice is marked, with only moderate pallor and hemoglobinuria.

**Subacute cases** may not show signs until 4–5 days after birth. **Jaundice** is marked, but there is no hemoglobinuria and only mild pallor of mucosae. Many subacute cases recover without treatment.

The severity of the disease is related to the type and quantity of antibody ingested. Antibodies against Aa usually produce severe disease apparent within 24 hours of birth, while ingestion of anti-Qa antibodies causes a milder disease apparent at 3–4 days after birth.

General signs include lassitude, weakness, and disinclination to suck. The foal lies down in sternal recumbency for long periods and yawns frequently. There is no febrile reaction but the heart rate is increased up to 120/min. Respiration is normal until severe anemia develops

when tachypnea (respiratory rate up to 80/min) and yawning are observed. Terminally, dyspnea and convulsions may develop. Peripheral edema does not occur and there are no signs of involvement of the central nervous system. **Bilirubin encephalopathy** or kernicterus is a rare complication of neonatal isoerythrolysis. It is apparent as altered mentation and seizures in foals with high serum bilirubin concentration.<sup>9</sup>

**Isoimmune thrombocytopenia** of foals and mules may be evident as ecchymotic hemorrhages and a tendency to bleed from relatively minor wounds. A syndrome in foals characterized by ulcerative dermatitis, neutropenia, and thrombocytopenia appears to be related to ingestion of colostrum antibodies.<sup>10</sup> Affected foals have oral and lingual ulcers, and crusting and erythema around the eyes, muzzle, perineum, trunk, and neck. There are ecchymotic and petechial hemorrhages in mucus membranes. Treatment with corticosteroids and antibiotics is associated with a good prognosis.

### Pigs

Piglets show essentially the same syndrome, being normal at birth but developing jaundice at 24 hours and weakness at 48 hours, with most affected pigs dying by the 5th day. Peracute cases occur and piglets may die within 12 hours of birth, showing acute anemia but no jaundice or hemoglobinuria. A proportion of subclinical cases also occurs in which hemolysis can be detected only by hematological examination. **Isoimmune thrombocytopenic purpura** of piglets may manifest as increased bleeding following routine management procedures such as tail docking.<sup>11</sup>

### Cattle

In calves clinical signs develop within 24–48 hours after birth and the calves die during the first week of life. Surviving calves are returned to normal health in 2–3 weeks. Peracute cases die within 24 hours, and at necropsy examination are characterized by pulmonary edema and splenomegaly.

## CLINICAL PATHOLOGY

**Hematological examination reveals acute anemia**; erythrocyte counts, packed cell volumes, and hemoglobin concentrations are low and there is greatly increased erythrocyte fragility and sedimentation rate. Depending on the severity of the disease and its duration, there can be **leukocytosis**, attributable to neutrophilia and monocytosis, and the presence of nucleated red blood cells (in piglets and calves but rarely in foals). Affected mule foals, but not horse foals, are often **thrombocytopenic**.<sup>8</sup> Isoimmune throm-

bocytopenia occurs rarely in foals and is not associated with neonatal isoerythrolysis, as it is in mule foals. In piglets, the erythrocyte count may be as low as 1 million/ $\mu\text{L}$ , the hemoglobin level below 2 g/dL, and thrombocytopenia is present. **Serum biochemical analysis reveals** an increased serum concentration of unconjugated bilirubin.

**Diagnostic confirmation** is achieved by demonstration of the presence of antibodies in the mare's serum or colostrum that cause hemagglutination or lysis of foal red blood cells.<sup>11</sup> Tests to demonstrate hemagglutination or lysis of foal red blood cells exposed to mare serum or colostrum have been developed. Of these, the standard hemolysis test appears to have the greatest utility.<sup>12</sup> However, for practical purposes a positive direct antiglobulin test (**direct Coombs' test**), confirming the presence of antibodies on the surface of red blood cells in a foal with anemia, provides a diagnosis of neonatal isoerythrolysis. False negative (foal has the disease but the Coombs' test is negative) results occur occasionally because of the hemolytic nature of the antibodies. The same principle is applicable to all species. Detection of antibodies on the surface of the neonate's red blood cells is possible using direct immunofluorescence flow cytometry.<sup>13</sup> The test identifies the presence of antibodies on red cells in some instances when the Coombs' test is negative.

The use of blood typing and other prepartum predictive tests in the prevention of the disease are discussed under control.

#### NECROPSY FINDINGS

In peracutely affected foals, there is marked pallor but only slight jaundice. The liver may be mildly swollen and friable but the spleen is greatly enlarged and is almost black due to the accumulation of lysed and lysing erythrocytes. In less severe cases jaundice is marked but pallor is only moderate in degree. The kidneys are usually pale and the urine is dark brown. The histopathological changes may include ischemic tubular nephrosis and periacinar hepatic necrosis and degeneration. Erythrophagocytosis is prominent and depending on the clinical course and therapeutic regime, there may be widespread hemosiderin deposition.

Hemoglobinuria is an important sign in piglets, and jaundice or port wine coloration of tissues occur constantly. The presence of blood-stained peritoneal fluid and an enlarged spleen is also typical of the disease in piglets.

Samples for postmortem confirmation of diagnosis

Formalin-fixed liver, spleen, bone marrow, kidney, and lymph node for light microscopic examination

#### DIFFERENTIAL DIAGNOSIS

- There are no diseases of the newborn that present the same clinical picture as that of alloimmune hemolytic anemia.

#### Differential diagnosis list for unexpected death and/or lethargy of neonates

##### Foals and calves

- Septicemia
- Neonatal maladjustment syndrome
- Uroperitoneum
- Prematurity
- Birth trauma
- Hypoglycemia
- Equine herpesvirus-1 infection

##### Piglets

- Septicemia
- Birth trauma
- Hypoglycemia.

#### TREATMENT

The aims of treatment are to:

- Prevent the deleterious effects of anemia
- Prevent or treat hemoglobinuric nephrosis
- Prevent ingestion of further colostrum
- Prevent secondary infection in severely ill animals
- Restore normal fluid, electrolyte, and acid-base status
- Provide adequate nutrition
- Minimize stress.

The **treatment of choice** for neonatal isoerythrolysis depends on the severity of the disease. The choice of treatment should be based first and foremost on the severity of the clinical signs and secondarily on the hematocrit and red blood cell count. Foals or piglets with **mild clinical signs** (minimal lethargy, mild tachycardia, slight exercise intolerance) need only protection from environmental and nutritional stresses in order to recover. However, such animals should be carefully monitored to insure that their clinical condition does not worsen.

**Severely affected** animals need a transfusion of compatible blood to alleviate the anemia and intravenous fluids to insure adequate urine flow and minimize the risk of hemoglobin-nephrosis. In general, the younger the animal at the time the disease is evident, the more severe the disease and the more likely the need for intensive treatment. See Chapter 9 for a discussion of 'transfusion triggers'.

#### Foals

Transfusion

**Transfusion** of an adequate quantity of whole blood or packed red blood cells results in dramatic resolution of clinical signs and anemia. **The decision to**

**transfuse blood** should be based on the foal's clinical condition, and not solely on the presence of a low hematocrit or red blood cell count (see Blood transfusion, in Chapter 9). In general, foals that are tachycardic, tachypneic, unable or reluctant to suck, have severe exercise intolerance or are unable to stand should receive blood. These foals will usually have a hematocrit less than 15% (0.15 L/L). Recumbent foals usually have a hematocrit less than 10% (0.10 L/L). Foals that are mildly tachycardic and tachypneic but are able to suckle vigorously and keep up with the mare generally have hematocrits above 15% (0.15 L/L) and do not require transfusion of red blood cells. The hematocrit should be monitored and foals in which the hematocrit is declining rapidly will likely require transfusion of blood or packed red cells.

The **volume of blood transfused** depends on the clinical condition of the foal and the progression of the anemia. Foals often require transfusion of 1–4 L (20–100 mL/kg body weight) of whole blood or 500 mL (approximately 10 mL/kg body weight) of packed red blood cells, and might require more than one transfusion. Blood should be administered slowly, 1 L/hour, and the foal's condition monitored closely during the infusion. Packed red cells are preferred for transfusion because of the small volume administered. Transfusion of large quantities of blood should be performed slowly because of the risk of fluid overload of the circulatory system. The half-life for mare erythrocytes transfused into foals is about 5 days.<sup>14</sup>

The **optimal donor** is a horse that does not have Aa and Qa blood group factors nor anti-Aa and Qa alloantibodies. The former should not be present as the maternal antibodies against Aa or Qa in the recipient foal's plasma will destroy the transfused cells. Similarly, donor antibodies against Aa or Qa will cause further lysis of foal red blood cells. Such donors must be identified in advance, because of the time required for the blood type testing, and are only likely to be available on large breeding farms or in specialized veterinary hospitals.

An **ideal source of red blood cells** is the **dam** because the maternal alloantibodies in the foal's plasma will not react with the mare's red blood cells. However, whole blood transfusions from the dam are contraindicated because of the presence of alloantibodies in the dam's plasma. This problem can be avoided by transfusing only the mare's washed red blood cells. Blood is collected from the mare (up to 25 mL/kg) into acid citrate dextrose or sodium citrate (10 mL of a 3.8% solution per 90 mL of blood). The mare's red cells are then washed by removing the plasma, resuspending the cells in isotonic (0.9%)

saline, thorough mixing, and subsequent removal of the saline. Plasma and red cells can be separated by large volume centrifugation or sedimentation. Adequate separation of red cells and plasma occurs by sedimentation within 1–2 hours if the blood is undisturbed.

If an ideal blood-typed donor is not available and the mare's red cells cannot be washed in time, or are unavailable, then a donor should be chosen based on routine cross-matching. The **sire** will not be a suitable donor, since the antigens against which the mare's antibodies are directed were inherited from him. A cross-match should match the foal's (or dam's) serum against the donor's red blood cells, and the donor's plasma against the foal's red blood cells. The chance of finding a suitable donor is enhanced by selecting ponies or breeds other than Thoroughbreds, Standardbreds, and Arabians, because of the higher prevalence of Aa and Qa negative animals in these breeds.

Emergency support of severely affected foals can be achieved by administration of a solution containing **polymerized bovine hemoglobin**.<sup>15</sup> This compound increases the hemoglobin concentration of blood thereby increasing oxygen carrying capacity. It is not a replacement for transfusion of blood or packed red cells, but is a useful bridging procedure while a donor is identified and blood collected. The recommended dose rate is 10–30 mL/kg administered slowly (10 mL/kg/h) intravenously. However, the cost of the compound might necessitate the use of lower doses (3–5 mL/kg).

#### Nutritional support

The foal should not be permitted to nurse the mare until it is >36 hours old. Therefore, **nutritional support** should provide approximately 100 kcal/kg per day in the form of mare's milk (10 L per day per 50 kg foal), goat's milk, or commercial mare's milk substitutes. If the foal is more than 36 hours old, then it is highly unlikely that either the mare's milk will still contain a significant quantity of antibodies or that the foal will be able to absorb them, and the foal should be allowed to continue to suckle the mare. In younger foals, an alternative feed should be supplied until the foal is at least 36 hours old. The mare should be milked out every 3–4 hours during this time to remove the colostrum.

**The fluid, electrolyte, and acid-base status** of moderately to severely ill foals should be assessed and corrected with intravenous administration of balanced polyionic fluids and sodium bicarbonate. Fluid administration should be used to insure an adequate flow of urine to prevent hemoglobinuric nephrosis.

#### Antibiotics

**Broad-spectrum antibiotics** should be administered to severely ill foals to prevent secondary infection (see Principles of providing care to the critically ill neonate).

**Nursing care** should be provided to minimize stress and prevent the development of complications such as pressure sores in recumbent foals.

#### Piglets

In pigs the prevention of sucking for periods of up to 24 hours does not prevent the disease. The safest procedure is to remove piglets from the sow, feed them artificially for 48 hours, and then return them to the sow. Frozen bovine colostrum collected as soon as possible after calving is a satisfactory substitute for sow colostrum but is improved by the addition of pig serum. When transfusion is necessary the intraperitoneal route is practical and safe.

#### CONTROL

The principles of control are:

- Identification of incompatible matings by blood group typing
- Identification of at-risk foals by testing of mare serum or colostrum for the presence of alloantibodies directed against blood factors possessed by the foal.

**Blood group typing** permits the identification of mares that are at risk of developing antibodies against Aa or Qa antigens. If an Aa or Qa negative mare is mated to a stallion that has Aa or Qa factors then there is the potential for neonatal isoerythrolysis. If the stallion is Aa and Qa negative, then there is no risk of the disease caused by antibodies to these blood groups.

**Measurement of alloantibodies** in the serum or colostrum of at-risk mares is

useful in identifying mares at increased risk of having affected foals. Serum from at-risk mares is collected during the last month (preferably 3–5 weeks before expected parturition) of pregnancy and examined for the presence of antibodies against the blood of the sire or, if a sample of the sire's blood is not available, a range of blood group factors including Aa and Qa. Mares that have such alloantibodies causing hemolysis at >1:16 are not permitted to suckle at risk newborn foals. If the titer is between 1:2 and 1:16, it is measured again 1–2 weeks before anticipated parturition to determine if the titer is rising, in which case the mare is likely carrying a foal with an incompatible blood group. Equine blood typing and detection of isoantibodies is performed by specialized laboratories in a number of countries:

- Australia – [www.aegrc.uq.edu.au/services](http://www.aegrc.uq.edu.au/services)
- New Zealand – [www.ivabs.massey.ac.nz/centres/centre\\_blood.asp](http://www.ivabs.massey.ac.nz/centres/centre_blood.asp)
- USA – [www.uky.edu/Agriculture/VetScience/textpages/epvrl.HTM](http://www.uky.edu/Agriculture/VetScience/textpages/epvrl.HTM) and <http://www.vgl.ucdavis.edu/service/horse/index.html>

The **jaundiced foal agglutination test (JFA)** is useful in determining the compatibility of mare's colostrum and foal's red blood cells (Table 34.1).<sup>16,17</sup> In this test foal red blood cells are added to serial dilutions (1:2 through 1:32) of colostrum and the presence of agglutination examined. Agglutination at dilutions of 1:16 in horses and 1:64 in mules are considered significant and the foal should not be permitted to receive the mare's colostrum.<sup>1</sup> The foal should be fed colostrum from another, compatible,

Table 34.1 Method for performing the jaundiced foal agglutination test<sup>16,17</sup>

1. Assemble eight 5–10 mL clean glass tubes. Label one as control (saline), and the others 1:2, 1:4, 1:8, 1:16, 1:32, 1:64, 1:128
2. Place 1 mL of 0.9% isotonic sterile saline in each tube
3. Add 1 mL of colostrum to the tube labeled 1:2. Mix this tube well and then transfer 1 mL of the contents of this tube to the tube labeled 1:4. Repeat this procedure until all tubes have had colostrums added. This procedure produces serial dilution of the colostrums.
4. Add one drop of well mixed, anticoagulated blood (e.g. blood collected into a tube containing EDTA) to each tube.
5. Centrifuge the tubes at 300–500 g for 2–3 minutes
6. Pour off the supernatant and observe the red cell pellet.

#### Interpretation

If no agglutination is present the red cells will flow evenly down the side of the glass tube whereas with complete agglutination (4+) the cells remain tightly packed at the bottom of the glass tube. Strong agglutination (3+) causes the cells to form large clumps that are visible to the naked eye. Agglutination of grade 3 or 4 is considered a positive test.

If there is agglutination in the saline control tube, then the foal might have already ingested colostrum containing antibodies to the foal's red blood cells. Some authorities recommend running a parallel test using mare's red blood cells in place of foal's red cells. This provides a negative control (there should be no agglutination of mare red cells by her colostrum) and aids interpretation of results especially for inexperienced operators.

mare or from a colostrum bank. The mare should be milked out every 2–4 hours until the JFA titer is less than 1:16 or for 36 hours, after which the concentration of antibodies in the milk is negligible,<sup>1</sup> and the foal can be permitted to suckle its dam. It is critical to the successful use of this test that it is performed before the foal is permitted to suckle the mare. If an incompatibility is detected the foal should be fed colostrum from a mare that does not have a positive jaundiced foal agglutination test to the current foal's red cells.

Avoidance of vaccines based on whole blood or cellular parts of blood is recommended, and if they have to be used it should be as far away as possible from parturition and should be restricted to one injection and one booster.

## REVIEW LITERATURE

McClure JJ. Strategies for preventing neonatal isoerythrolysis. *Comp Cont Educ Pract Vet* 2002; 24:562.

## REFERENCES

- Bailey E. *Am J Vet Res* 1982; 4:1917.
- Bailey E et al. *Am Assoc Equine Pract Proc* 33 Ann Conv 1987; pp. 341-353.
- MacLeay JM. *J Am Vet Med Assoc* 2001; 219:79.
- Bailey E et al. *Am J Vet Res* 1988; 49:1218.
- Dowsett KF et al. *Aust Vet J* 1978; 54:65.
- Stormont C et al. *Cornell Vet* 1964; 54:439.
- McClure JJ et al. *Animal Genetics*, 1994; 25:119.
- Traub-Dargatz JL et al. *J Am Vet Med Assoc* 1995; 206:67.
- David JB et al. *Comp Cont Educ Pract Vet* April, 1998; 517.
- Perkins GA et al. *J Vet Int Med* 2005; 19:211.
- Dimmock CK et al. *Aust Vet J* 1982; 59:157.
- Becht JL, Page EH. *Am Assoc Equine Pract Proc* 25 Ann Conv 1980; p. 247.
- Wilkerson MJ et al. *J Vet Int Med* 2000; 14:190.
- Smith JE et al. *J Vet Int Med* 1992; 6:183.
- Perkins GA et al. *J Vet Emerg Crit Care* 2001; 11:141.
- Stormont C. *Adv Vet Sci Comp Med* 1975; 19:23.

## PURPURA HEMORRHAGICA

### Synopsis

**Etiology** Deposition of immune complexes in the walls of capillaries with subsequent vasculitis and extravasation of blood and plasma.

**Epidemiology** Sporadic disease of horses, and rarely cattle and pigs. The disease in horses is often associated with upper respiratory tract disease, especially *Strep. equi* infection.

**Clinical signs** Swellings of the head, limbs, and body. The swellings are usually asymmetrical, not painful on palpation and pit with gentle pressure. Tachycardia and tachypnea are characteristic. Petechial hemorrhages are present in mucosal surfaces. Skin of the limbs may slough.

**Clinical pathology** None specific. High anti-streptococcal in protein liter in serum thrombocytopenia is not present.

**Diagnostic confirmation** Clinical signs, skin biopsy.

**Treatment** Corticosteroids (dexamethasone) and antibiotics. Supportive care.

## ETIOLOGY

The disease is acute and non-contagious. The cause of the **vasculitis** that characterizes purpura hemorrhagica is likely the deposition of complexes of antigen and immunoglobulin in the walls of capillaries and small blood vessels. The disease appears to be **immune complex-mediated** and due to a **type III hypersensitivity reaction**. The common association of the disease is with *Strep. equi* infection of the upper respiratory tract. The high concentrations of antibodies to *Strep. equi* M protein in affected horses, and the presence of complexes of IgA and streptococcal M protein in sera are evidence that the disease is associated with an immune reaction to streptococcal protein.<sup>1-3</sup> The immune complexes are not found in the serum of horses recovering from *Strep. equi* infection that do not have purpura hemorrhagica. However, in many instances there is no history of streptococcal infection.<sup>4</sup> There is a suggestion that the disease might be associated with an adverse reaction to therapeutic drugs. Vaccination using modified live *Strep. equi* M protein or killed *Strep. equi* vaccines is strongly suspected of inducing the disease.

## EPIDEMIOLOGY

Purpura hemorrhagica is an uncommon, non-contagious, sporadic disease of horses. It has been recorded in pigs and cattle. Estimates of the incidence of the disease are uncommon and imprecise. There was an incidence of 27 cases in 1438 horses housed over a 3-year period in a Swedish Army remount facility.<sup>5</sup> All cases of purpura hemorrhagica followed upper respiratory infections, of which 11 were typical of strangles. Only a small proportion of horses are affected but the incidence is highest when extensive outbreaks of strangles occur, possibly because of reinfection with streptococci of horses already sensitized by previous infection.

Of 53 horses with purpura hemorrhagic treated at a referral center, 17 had been exposed to or infected with *Streptococcus equi*, 5 had been vaccinated with *Streptococcus equi* M protein, 9 had been infected with *Corynebacterium pseudotuberculosis*, and 5 had a history of apparently infectious respiratory disease of undiagnosed cause. Fifteen of 53 horses had no history of recent infectious disease.<sup>4</sup>

There is a strong suspicion among clinicians of an association between purpura hemorrhagica and vaccination.<sup>6</sup> However, vaccination against *Strep. equi* infection has not been clearly demonstrated to be a risk factor for purpura hemorrhagica. Certainly, cases of purpura do occur in horses that have been vaccinated against strangles, but presumably

there was a high probability that such horses were at increased risk of developing strangles. The consensus is that vaccination with vaccines containing M protein or avirulent *Strep. equi* is associated with increased risk of purpura. Edema of the lower limbs does occur after vaccination with streptococcal M protein and may represent a mild form of the disease.<sup>7</sup> It is recommended by some authorities that horses with high serum antibody titers to streptococcal M protein not be vaccinated against strangles,<sup>6</sup> although definitive data to support this recommendation are not available.

There does not appear to be breed, age, or sex predisposition to the disease. Horses as young as 6 months of age, and possibly younger, can be affected.

The case fatality rate with appropriate treatment is approximately 10%.<sup>4</sup> Purpura accounted for 2 and 8% of 2028 and 1245 deaths among horses shipped from Great Britain and the United States, respectively, to South Africa during the Boer War.<sup>8</sup> This mortality rate was before the advent of antimicrobials or corticosteroids which have presumably decreased the case fatality rates.

## PATHOGENESIS

The basis of the disease process is an **aseptic vasculitis** of capillary walls that is accompanied by extravasation of plasma and blood into the tissues. Thrombocytopenia does not occur, nor is there a defect in coagulation in most cases. Prolonged clotting times (activated clotting time, partial thrombin time, and thromboplastin time) occur in severely affected horses with infarctive purpura hemorrhagica.<sup>3</sup> Skin lesions predominate but other organs, including the kidney, muscles, and gastrointestinal tract, are affected.<sup>3,9</sup>

## CLINICAL FINDINGS

Affected horses are usually depressed and have reduced or absent appetite. The temperature is elevated in approximately 60% of cases,<sup>4</sup> as is the heart rate. **Extensive subcutaneous edematous swellings** are the characteristic sign of the disease. They occur most commonly about the face and muzzle, but are often present on other parts of the body and are not necessarily symmetrical in distribution. The swellings may appear suddenly or develop gradually over several days. They are cold and painless, pit on pressure, and merge gradually into normal tissue without a definite line of demarcation. There is no discontinuity of the skin, although it may be tightly distended and even ooze red-tinged serum. Swellings about the head may cause pressure on the pharynx with subsequent dyspnea and dysphagia. Lesions in the lungs are usually not clinically apparent without radiographic or ultrasonographic



examination of the chest. Extensive edema of the limbs occurs in almost all cases.<sup>4</sup> Rare cases of the disease in horses do not have edema.<sup>10</sup>

**Submucous hemorrhages** occur in the nasal cavities and mouth, and petechiae may be present under the conjunctiva in over 80% of cases. Hemorrhage and edema of the gut wall may cause colic but in most cases there is no diarrhea or constipation. Severely affected skin, and especially that of the legs, may slough and leave granulating wounds.

**Infarctive purpura hemorrhagica** is an uncommon manifestation of the disease characterized by infarction of multiple tissues including the gastrointestinal tract and muscle.<sup>3</sup> Affected horses have signs of colic and muscle swelling. The course is usually over 3–5 days and death, which is the most common outcome, is associated with severe colic and rapidly deteriorating metabolic status.

The course of the disease is usually 1–2 weeks and many animals die from blood loss, dyspnea due to laryngeal or pharyngeal swelling, and secondary bacterial infections. Relapses are uncommon among appropriately treated horses.

#### CLINICAL PATHOLOGY

There are no characteristic abnormalities detected on routine hematological or biochemical examinations of affected animals.

**Hematological changes** are typically a mild anemia (usually <32% but >20%, <0.32 L/L but >0.20 L/L) with a neutrophilic leukocytosis and hyperfibrinogenemia. **The platelet count is normal.** Hypergammaglobulinemia can be present. There is an elevation in serum activity of creatine kinase (CK) and aspartate aminotransferase (AST) in affected horses, likely a result of muscle lesions, in approximately 25–30% of cases.<sup>4</sup> Horses with infarctive purpura have marked elevations in serum activity of creatine kinase and aspartate aminotransferase, neutrophilia, and in severely affected horses, there is evidence of disseminated intravascular coagulation.<sup>3</sup>

**Diagnostic confirmation** is achieved by **skin biopsy**, especially of early lesions, and reveals leukocytoclastic vasculitis.<sup>7</sup> Immunofluorescence staining of sections of skin may reveal the presence of antibodies, antigens, or complement in the walls of small blood vessels.

#### NECROPSY FINDINGS

Echymotic and petechial hemorrhages are present generally throughout the body. The subcutaneous swellings contain plasma which may be blood-stained, or sometimes whole blood. The lungs are edematous and congested. Histologically, the changes are also dominated by bland hemorrhage but a leucocytoclastic vascu-

litis is usually observed in scattered vessels. Sample of lung, muscle, and gastrointestinal tract, in addition to skin, should be examined via light microscopy to check for the presence of vasculitis.

Horses with infarctive purpura have dark red to black, multifocal coalescing hemorrhages in skeletal muscles.<sup>3</sup> Hemorrhages also occur in the lungs and gastrointestinal tract. Histological examination reveals coagulative necrosis of muscle and other tissues. There is inflammation of the blood vessels.<sup>3</sup>

#### DIFFERENTIAL DIAGNOSIS

##### Horses

Causes of edematous swelling include:

- Equine viral arteritis and equine herpesvirus 1 or 4 infection, which do not have petechiation and are readily distinguished by their epidemiological characteristics and by serological testing
- Equine granulocytic anaplasmosis (ehrlichiosis) which can be differentiated by the presence of granular inclusions in the cytoplasm of neutrophils
- Congestive heart failure, which should be apparent on clinical examination
- Angioneurotic edema, which is not associated with petechiation
- Stachybotryotoxicosis.

Causes of petechial hemorrhages include:

- Equine infectious anemia
- Thrombocytopenic purpura
- Stachybotryotoxicosis.

##### Cattle

Hemorrhagic septicemia, poisoning by bracken fern and sweet clover, thrombocytopenia associated with bovine viral diarrhea, and stachybotryotoxicosis are more likely causes of a hemorrhagic syndrome than is purpura hemorrhagica.

#### TREATMENT

The **principles of treatment** are to reduce inflammation of the blood vessels, remove the inciting cause, and provide supportive care. Because of the possibility that the disease is due to an adverse drug reaction, administration of any drugs that the horse is receiving at the time the disease develops should be discontinued.

**Reduction of inflammation of the blood vessels** involves mitigation of the immune response and removal of the source of the antigenic stimulus. The immune response, and its associated inflammatory reaction in blood vessels, should be treated with corticosteroids such as **dexamethasone** (0.05–0.2 mg/kg, IV or IM every 24 hours) or **prednisolone** (0.5–1 mg/kg, IM or IV every 24 hours). Prednisolone might not be as effective as

dexamethasone. The dose of corticosteroid can be gradually reduced as the clinical signs improve, and the drug can be given orally. **Non-steroidal anti-inflammatory drugs** (phenylbutazone 2.2 mg/kg orally or IV every 12 hours, or flunixin meglumine 1.1 mg/kg orally or IV every 12 hours) may reduce inflammation and provide some analgesia.

**Removal of the source of the antigenic stimulus** of the disease is difficult, especially in cases when an antecedent infection or disease is not readily identified. On the assumption that purpura hemorrhagica is often a sequela to *Strep. equi* infection, and the suspicion that occult *Strep. equi* infection is present and the source of antigen associated with the disease; affected horses are usually treated with **penicillin** (procaine penicillin, 20 000 IU/kg, IM every 12 hours, or potassium penicillin, 20000 IU/kg, IV every 6 hours) until the clinical signs resolve. Treatment with antibiotics might need to be continued for as long as 20 days.<sup>4</sup>

**Supportive care** includes bandaging of swollen limbs, care of wounds, hydrotherapy, and intravenous fluid administration. Swelling of the head and pharynx may necessitate placement of a nasogastric feeding tube to permit enteral feeding of dysphagic horses. Respiratory distress can develop very rapidly and emergency tracheotomy may be required to relieve respiratory distress and prevent asphyxiation.

#### CONTROL

There are no specific preventive measures. However, control and prevention of upper respiratory tract infections in horses should lead to a reduction in the incidence of purpura hemorrhagica. Careful consideration should be given to the use of vaccines containing streptococcal M protein or avirulent *Strep. equi* in horses at low risk of developing strangles. Although the relationship between M protein containing vaccines and purpura hemorrhagica is not definitive, circumstantial evidence and the opinion of authorities in the field support such an association. Measurement of serum antibodies to M protein might be useful in determining the need for vaccination of horses in endemic areas or at high risk.<sup>6</sup> Horses with antibody titers >1:3200 should not be vaccinated.<sup>6</sup>

#### REFERENCES

1. Galan JE, Timoney JF. J Immunol 1985; 135:3134.
2. Heath SE et al. J Vet Intern Med 1991; 5:263.
3. Kaese HJ et al. J Am Vet Med Assoc 2005; 226:1893.
4. Pusterla N et al. Vet Rec 2003; 153:118.
5. Hofer B et al. Proc 3rd Int Conf Equine Infect Dis 1973; 527.

6. Sweeney CR et al. *J Vet Int Med* 2005; 19:123.
7. Morris DD. *J Am Vet Med Assoc* 1987; 191:460.
8. Smith F. *A Veterinary History of the war in South Africa*. H&W. Brown. London. P. 265, 1919.
9. Roberts MC, Kelly WR. *Vet Rec* 1982; 110:144.
10. Garcia-Secco E et al. *Equine Vet Educ* 2002; 14:243

## EQUINE SEASONAL ALLERGIC DERMATITIS (QUEENSLAND ITCH, SWEET ITCH)

This is an intensely pruritic dermatitis of horses caused by hypersensitivity to insect bites.

### ETIOLOGY

The disease is caused by type I (immediate) hypersensitivity to salivary antigens introduced into the skin by the bites of sandflies and other insects. There may be a lesser role for type IV (cell-mediated) hypersensitivity in the disease. *Culicoides brevitarsus* is the cause in Australia,<sup>1</sup> *C. pulicaris* in the United Kingdom and Europe,<sup>2</sup> and *C. obsoletus* in Canada.<sup>3</sup> *Stomoxys calcitrans*, the stable fly, and *Simulium* spp. cause the disease. The distribution of the skin lesions is related to the feeding habits of the inciting insect. For instance, *C. pulicaris* has a predilection for landing at the mane and tail, and this is where the lesion is most commonly seen.

### EPIDEMIOLOGY

The prevalence of the disease varies depending on environmental factors, and possibly characteristics of the local horse population. Up to 60% of horses are reported affected in areas of Queensland, Australia, 22% in Israel, and 18% of Icelandic horses in Norway.<sup>4</sup> The prevalence in Switzerland is very low in regions above 1000 m and 1.6% in lower areas.<sup>5</sup>

The disease is quite common worldwide in areas where **hot and humid summer weather** favors the causative insects: Sweden, the United Kingdom, Japan, Israel, Hong Kong, North America, Australia, the Philippines, India, and France. Most cases occur during **summer** and lesions disappear during cooler weather. Lesions disappear when the horses have been stabled in insect-proof barns for several weeks or are moved outside the geographical range of the inciting insect.

The disease is characteristically sporadic and affects only a few of a group of horses. However, because the predilection to the disease is likely inherited, there may be multiple cases among related animals on a farm.<sup>5,6</sup> The prevalence of the disease increases with age; 3.4% of Icelandic horses 1–7 years of age compared to 32% of horses older than 14 years were affected.<sup>4</sup>

### PATHOGENESIS

Reaginic antibodies (IgE) produced in response to exposure to proteins in insect

saliva bind to mast cells in the skin and, when exposed to the antigen, are associated with degranulation of the mast cell. Horses with sweet itch have IgE antibodies that react with constituents of the salivary gland of *Culicoides* sp., whereas horses that do not have the disease have IgG, but not IgE, antibodies against *Culicoides* salivary gland antigens.<sup>6</sup> Horses that have not been exposed to *Culicoides* sp. do not have either antibody to the insect salivary gland antigen.<sup>6</sup> **Degranulating mast cells** and intradermal or subcutaneous lymphocytes release various vasoactive substances and cytokines that cause inflammation and accumulation of eosinophils in the skin of affected areas and eosinophilia.<sup>7</sup> The distribution of the lesions on patients reflects the insects' preferred feeding sites. Ponies with seasonal allergic dermatitis have greater numbers of circulating CD5+ and CD4+ T-lymphocytes than do normal animals.<sup>8</sup> Increased numbers of CD3+ T-lymphocytes, most of which are CD4+, and eosinophils are present in the skin of affected ponies after injection of *Culicoides* antigen.<sup>8</sup> Furthermore, eotaxin and monocyte chemoattractant protein (MCP) 1, but not MCP-2 or MCP-4, mRNA expression is upregulated in skin biopsies of sweet itch lesions, demonstrating a mechanism for accumulation of eosinophils and T-2 lymphocytes in the lesions.<sup>9</sup>

### CLINICAL FINDINGS

**Lesions** are usually confined to the base of the tail, rump, along the back, withers, crest, poll, ears and, less commonly, ventral midline. In severe cases the lesions may extend down the sides of the body and neck and onto the face and legs.

**Pruritis** is intense, especially at night, and the horse scratches against any fixed object for hours at a time. In the early stages slight, discrete papules, with the hair standing erect, are observed. Constant scratching may cause self mutilation, severe inflammatory lesions, and loss of hair. Scaliness and loss of hair on the ears and tail-base may be the only lesions in mildly affected horses.

### CLINICAL PATHOLOGY

Affected animals have **eosinophilia** and thrombocytosis.

**Diagnosis** is facilitated by skin biopsy, fungal culture, and parasitological examination of skin scrapings, and intradermal sensitivity testing. **Skin biopsy** of early lesions, before trauma masks the true picture, reveals edema, capillary engorgement, and eosinophilic and mononuclear perivascular infiltration. Fungal culture and parasitological examination of **skin scrapings** are useful only in that they rule out dermatophycosis, onchocerciasis, and strongyloidosis. **Intradermal skin testing**

demonstrates immediate and delayed sensitivity reactions to extracts of *Culicoides* and *Stomoxys* spp.<sup>1</sup>

### DIFFERENTIAL DIAGNOSIS

Infection with larvae of *Onchocerca* sp. or *Strongyloides* sp., or *Dermatophilus congolensis* can produce similar lesions. Alopecia of the tail head may be caused by *Oxyuris equi*.

### TREATMENT

The principles of treatment are removal of the inciting cause and suppression of the hypersensitivity reaction.

**Removal of the inciting cause** is achieved by preventing horses from being exposed to the inciting insects. This can be achieved by relocating the horse to a geographical region where the insects do not occur, stabling of the horse in an insect-proof stable during the periods of the day (early evening) when the insects are most active, or applying agents that kill the insect or otherwise prevent them from alighting on and biting the horse.

**Suppression of the immediate hypersensitivity reaction** or its sequelae can be achieved by administration of corticosteroids (prednisolone, 1 mg/kg every 24 hours initially then reducing to as low a maintenance dose as possible). Theoretically, hyposensitization may be effective, but the only controlled clinical trial to date did not demonstrate a beneficial effect, although the placebo effect on the owners was impressive.<sup>10</sup>

### CONTROL

Prevention of the disease necessitates protection against sandfly bites by stabling in insect-proof quarters. Continuous spraying of the horses with insecticides or repellents may be of some value. A 4% permethrin pour-on gives effective protection. Most horses need only one application a week; others need an application every second day.<sup>11</sup>

### REFERENCES

1. Quinn PJ, Baker KP. *Equine Vet J* 1983; 15:266.
2. Anderson L, Bergman A. *Acta Vet Scand* 1980; 21:559.
3. Kleider N, Lees MJ. *Can Vet J* 1984; 25:26.
4. Halldorsdottir S, Larsen HJ. *Equine Vet J* 1991; 23:296 & 300.
5. Marti E et al. *Equine Vet J* 1992; 24:113.
6. Wilson AD et al. *Equine Vet J* 2001; 33:707.
7. McKelvie J et al. *Res Vet Sci* 2001; 70:115.
8. McKelvie J et al. *Equine Vet J* 1999; 31:466.
9. Benarafa C et al. *Vet Rec* 2002; 151:691.
10. Barbet JL et al. *Equine Vet J* 1990; 22:232.
11. Stevens DP et al. *Vet Rec* 1988; 122:308.

## SEASONAL ALLERGIC DERMATITIS

A disease similar to sweet itch of horses occurs in sheep in the UK.<sup>1</sup> The lesions

are similar to those in horses and are located principally on the teats, udder, and ventral midline, but also on the tips of the ears, around the eyes, and on the nose and the lips. Because of their appearance only in summer, and in senior ewes, and at a time when midges are plentiful enough to cause signs of insect worry, a cutaneous sensitivity to *Culicoides* spp., especially *C. obsoletus*, is suspected. Histologically the lesions represent the changes characteristic of immediate hypersensitivity. Cutaneous sensitivity to ground up *Culicoides* spp. was demonstrated. A very similar disease occurs in cattle in Japan. It is thought to be due to an allergy to the bite of an external parasite.<sup>2</sup>

#### REFERENCES

1. Connan RM, Lloyd S. *Vet Rec* 1988; 123:335.
2. Arisawa M. *Bull Nippon Vet Zootech Coll* 1971; 19:46.

### RECURRENT AIRWAY OBSTRUCTION (HEAVES)

#### Synopsis

**Etiology** Inhalation of barn and feed dust containing inciting agents which can include particles of molds, endotoxin, mites, plant debris, and inorganic material.

**Epidemiology** Predominantly a disease of horses stabled in poorly ventilated barns and fed poor quality hay containing molds. Occurs worldwide but more commonly in the northern hemisphere. No breed or sex predilection.

**Clinical signs** Chronic cough, mucopurulent nasal discharge, poor athletic performance, increased respiratory rate, increased expiratory effort, wheezes on thoracic auscultation, and abundant mucopurulent material in the trachea on endoscopic examination.

**Clinical pathology** Neutrophilia in tracheal aspirate and bronchoalveolar lavage fluid.

**Lesions** Bronchiolitis with mononuclear cell infiltration, epithelial, and goblet cell hyperplasia, neutrophil accumulation in airway lumens, and alveolar hyperinflation.

**Diagnostic confirmation** Clinical signs, examination of bronchoalveolar lavage fluid, and the response to treatment.

**Treatment** Remove the inciting cause by providing a dust-free environment, and administer corticosteroids. Bronchodilators are useful for treatment of acute bronchoconstriction.

**Control** Prevent exposure to inciting cause. Insure optimal air quality in stables or maintain horses at pasture.

Heaves is a recurrent or chronic disease of stabled adult horses (previously known as chronic obstructive pulmonary disease) characterized by neutrophilic airway inflammation and airway obstruction manifest clinically by the presence of

coughing, excess mucus accumulation in airways, tachypnea and increased respiratory effort, and exercise intolerance. It should be differentiated from the usually transient inflammatory airway disease of young adult horses in which there is no significant impairment of pulmonary function. The disease is included in this section because it is classically considered to have an allergic component, although this assumption is increasingly questioned.

#### ETIOLOGY

Heaves, previously referred to as chronic obstructive pulmonary disease, is caused by inhalation by susceptible horses of dust particles found in barns, bedding, and feed materials such as dusty hay. The inhaled particles include endotoxin, mites, plant debris, inorganic materials, and conidia and fragments of molds. *Faenia rectivirgula* (formerly known as *Micropolyspora faeni*), *Aspergillus fumigatus*, and *Thermoactinomyces vulgaris* are molds commonly associated with respiratory disease in susceptible horses, as evidenced by experimental studies involving inhalation of mold or mold fragments by horses.<sup>1</sup> Molds contain a number of inflammatory substances including various allergens, glucans, mycotoxins, and proteases and it is not clear which of these agents are the inciting cause of heaves.<sup>2</sup> Furthermore, dust containing mold also contains endotoxin. Endotoxin contamination of molds contributes to the airway response to inhalation of preparations of molds used in experimental studies<sup>3</sup> and inhalation of endotoxin alone produces airway inflammation and impaired respiratory function in horses in a dose-dependent manner, with heaves-susceptible horses having an exaggerated response at lower doses.<sup>4</sup> However, the response to endotoxin is less than that of susceptible horses exposed to hay dust containing endotoxin indicating that endotoxin alone is not sufficient to cause the clinical signs of heaves. Other compounds in hay dust are integral to the development of heaves.<sup>5</sup>

It is emphasized that there is not one causative agent acting alone but rather a range of agents that, when inhaled in sufficient concentration by susceptible horses, induce airway disease. It is likely that heaves is associated with the potentiating interactions among several agents present in barn or hay dust and is not simply a response to one agent.<sup>3,6</sup> The mechanisms underlying development of airway inflammation and respiratory dysfunction are provided under 'Pathogenesis'. Viral infections and 3-methylindole intoxication are not considered important causes of heaves.<sup>7</sup>

#### EPIDEMIOLOGY

##### Occurrence

Although heaves is one of the more common diseases of horses, and is a major cause of loss of performance and wastage in European horses,<sup>8</sup> there are few reports of its epidemiological characteristics. The disease is common in Europe and North America but is rare in Australia. In Germany, 83% of horses believed to be healthy at an auction were found to have clinical evidence of chronic pulmonary disease.<sup>8</sup> Inflammatory airway disease is very common in horses, with 96% of racehorses in Hong Kong examined at necropsy and 12% of horses examined in an abattoir in the northern U.S. having histological evidence of bronchitis.<sup>9,10</sup> Twenty-seven per cent of healthy racehorses in training had an increased proportion (>20%) of neutrophils in tracheal aspirate, indicating inflammatory airway disease.<sup>11</sup> However, the airway inflammation common in young athletic horses is not generally considered to be heaves, or a prodrome of heaves. The prevalence of heaves is not well documented.

The **case-fatality rate** for moderately to severely affected horses is approximately 20% over a 2-4-year period.<sup>12</sup> Most mildly to moderately affected horses respond well to treatment and continue to perform at a satisfactory level.<sup>12</sup>

##### Risk factors

###### Animal risk factors

The disease occurs in adult horses and ponies, and animals >7 years of age are 6 to 7 times more likely to be examined because of the disease than are horses <4 years of age.<sup>13</sup> There is no apparent breed or sex predisposition with the exception that Thoroughbreds are 3 times more likely to be examined for the disease than are ponies,<sup>13</sup> although this could represent a sampling bias in that owners of Thoroughbreds might be more likely to seek veterinary attention than owners of ponies. The finding of increased likelihood of Thoroughbred horses having the disease is not consistent among studies. Horses are approximately 2 times more likely to be examined by a veterinarian because of the disease in winter or spring compared to summer, suggesting a seasonality to the occurrence of the disease<sup>13</sup> perhaps as a result of increased stabling during winter.

There are horses that develop the disease and other horses, maintained in an identical situation, that do not. Development of disease is dependent upon the horse being susceptible to the inflammatory effect of inhaled dust but the reasons for this individual susceptibility are poorly understood. A familial predisposition has been suggested based on the observation that

Lipizaners and German and Swiss Warmbloods are 3.2 times more likely to have heaves if one parent was affected and 4.6 times as likely if both parents had heaves.<sup>14</sup> There is no association between major histocompatibility markers (equine leucocyte antigens) and occurrence of heaves.<sup>14</sup> However, genetic and environmental factors are often closely associated, in that horses of similar genetic background are often housed in similar situations, making elucidation of inherited susceptibility to heaves difficult.

Exposure to inciting agents is associated with a variety of environmental factors, including potentially outdoor concentrations of aeroallergens and climatic factors,<sup>15</sup> but most importantly housing and feeding practices.

#### Environmental risk factors

There is a clear association between housing, feeding of hay, and development of the disease.<sup>16,17</sup> Typically, susceptible horses are clinically normal when at pasture and develop signs of disease within hours to days of being housed in stables and fed dusty hay. Moving affected horses to pasture, or improving air quality by increasing ventilation and feeding processed feedstuffs, results in resolution of the disease.<sup>16</sup>

Development of disease is related to inhalation of **respirable particles** that gain access to the lower respiratory tract. Respirable particles are less than 5 µm diameter, the principal source of these particles in stalls is hay, and the majority of particles are fungal spores.<sup>18</sup> The concentration of particles in air of the stable is determined by the rate of release of particles from hay, which is dependent in large part on the quality of the hay, concentration of fungal spores in the hay, and the rate of clearance of dust from the stable, a function of the ventilation rate.<sup>19,20</sup> Concentrations of respirable dust particles in the breathing zone of stabled horses can be as high as 20 mg/m<sup>3</sup>.<sup>3,21</sup> The severity of increases in neutrophil count and proportion and decreases in pulmonary function in experimental models of heaves are related in a dose-dependent fashion to the amount of dust inhaled.<sup>4</sup> The presence of dust particles, and not the soluble products in hay dust, is responsible for most of the airway neutrophilia induced by inhalation of hay dust.<sup>5</sup>

**Hay** is the usual original source of spores in stable air. However, **decomposing wood shavings** are also a source of spores of fungi that multiply during degradation of plant-based materials, and housing horses in poorly ventilated stalls deeply bedded with wood shavings may be detrimental to their respiratory health.<sup>22</sup> Spores from hay enter the bedding either

directly or after dispersal through the air and multiply in the bedding if it is not removed regularly. **Diced paper** and **wood shavings**, when fresh, usually contain very few spores. Barley and wheat straw are usually free of any small spores such as *A. fumigatus* or *M. faeni*.<sup>19</sup> Bedding horses on fresh wood shavings, and feeding a nutritionally complete pelleted ration, results in a respirable dust burden 3% of that of horses fed hay and bedded with straw.<sup>23</sup> Dust burdens measured in the air of the stall underestimate the respirable particle challenge of horses because of the high concentration of particles in hay and bedding, areas from which the horse inhales while eating.<sup>23</sup>

Respiratory health of horses is related to **stable design and ventilation**, with horses in poorly ventilated barns having more respiratory disease than horses in well-ventilated barns.<sup>22</sup> See 'Control' for recommendations regarding stable design.

#### PATHOGENESIS

Susceptible horses, when exposed to adequate concentrations of respirable dust in the breathing zone, develop airway inflammation, excess mucus accumulation, and respiratory dysfunction within hours to days of exposure. The putative inciting agents include fungal spores and debris, endotoxin, and particulate matter; however, the exact role for each of these agents is unclear, partly because of the difficulty in obtaining uncontaminated material. For instance, fungal material is commonly contaminated with endotoxin which has a synergistic interaction with hay dust in inducing airway neutrophilia in susceptible horses.<sup>3</sup>

The mechanisms underlying these responses to inhalation of dust are not well defined but can be considered in the contexts of immune and inflammatory responses, mucus secretion, and pulmonary dysfunction.

Inflammatory and immune responses  
Inflammation is associated with excessive mucus production, airway swelling, and abnormal lung function.<sup>6,24</sup> The inflammatory response in horses with heaves is neutrophilic, with lesser numbers of mast cells and rarely eosinophils. The mechanisms underlying this inflammatory response have not been fully elucidated, although it involves activation of nuclear factor kappaB and there is support for an acquired immune-mediated process.<sup>25-28</sup>

The presence of allergen-specific IgE antibodies in bronchoalveolar lavage fluid is supportive of a hypersensitivity reaction, although others have proposed type 3 and type 4 immune reactions as the basis of the disease.<sup>25</sup> One proposed explanation is that heaves-susceptible horses exhibit a Th2-like immune

response to inhalation of hay or barn dust characterized by increased expression of interleukins 4 and 5 and decreased expression of interferon-γ in cells obtained by bronchoalveolar lavage.<sup>29,30</sup> Others have not detected a pure Th2-like cytokine profile finding instead a mixed inflammatory response including increases in expression (mRNA) in cells obtained from bronchoalveolar lavage fluid of affected horses of interferon-γ, tumor necrosis factor-α, interleukins 1β and 4, and interleukins 8 and 17 (potent attractors of neutrophils) but not interleukins 2, 5, and 10.<sup>31-35</sup> However, all the studies cited above were performed on crude preparations of cells obtained by bronchoalveolar lavage and the results could have been influenced by the varying proportions of types of cells in these preparations.<sup>32</sup> A study examining just CD4 and CD8 lymphocytes in blood and bronchoalveolar lavage fluid of heaves-affected horses demonstrated a general down regulation in expression of interferon-γ, and interleukins 4, 5, and 13 and no evidence of a cytokine profile consistent with either sole or predominate Th1 or Th2-like responses.<sup>26</sup> The magnitude of the inflammatory response varies depending on the challenge (i.e. nature of the inhaled material) with responses to endotoxin characteristically being less than that of hay dust.<sup>35a</sup> Regardless of the underlying mechanism, exposure to inciting agents results in airway inflammation and interference with normal respiratory function.

Following inhalation of inciting agents there is recruitment of neutrophils, but not eosinophils or platelets, into the lungs in most horses that develop changes in lung function.<sup>36,37</sup> Histologically there is peribronchiolar accumulation of lymphocytes and luminal accumulations of neutrophils in affected horses. The entry of neutrophils into the airways is mediated at least in part by IL-8 and IL-17.<sup>31,33</sup> The neutrophils of horses during episodes of heaves, but not when the horses are asymptomatic, have increased adherence *in vitro* to protein coated plastic suggesting a mechanism for the increased migration of neutrophils into airways of affected horses.<sup>38</sup> Inhibition of neutrophil phosphodiesterase-4 activity does not alleviate clinical signs of heaves or decrease neutrophil numbers in bronchoalveolar lavage fluid in affected horses suggesting that neutrophils are not primarily involved in the genesis of airway obstruction.<sup>39,40</sup> The extent to which neutrophils in the airways are activated has not been determined and their role in the development of respiratory dysfunction is unclear given that glucocorticoid administration attenuates the

respiratory dysfunction but not airway neutrophilia in horses with heaves (see under 'Treatment').<sup>41</sup>

Airway inflammation is associated with increases in concentration of inflammatory mediators including leukotriene B<sub>4</sub>, prostanoids including thromboxane, and proteases.<sup>42</sup> Activity of matrix metalloproteinase-9 is higher in horses with heaves than in unaffected horses and is induced in a dose-dependent manner by inhalation of inciting substances including hay dust and endotoxin.<sup>42-45</sup> MMP-9 is likely important in the inflammatory process associated with heaves through excessive gelatinolytic proteolysis that can contribute to lung injury, and through a role in lung remodelling.<sup>43</sup> Inflammation is also associated with increased oxidative stress in lungs of horses with heaves as indicated by elevated concentrations of epi-PGF<sub>2a</sub> and redox ratio of glutathione in pulmonary lavage fluid.<sup>24,46</sup>

#### Mucus

Accumulation of excessive quantities of mucus in the large airways is characteristic of horses affected by heaves and can contribute to nonbronchospastic airway obstruction.<sup>6,47</sup> Accumulation of mucus is attributable to decreased clearance and increased production.<sup>48,49</sup> The mucus in horses with heaves differs in both composition and viscoelasticity from that of clinically normal horses<sup>63,65</sup> and this might contribute to its decreased clearance. The viscosity of mucus can increase threefold in heaves susceptible horses stabled and exposed to hay dust.<sup>48</sup> Increased production of mucus is associated with up-regulation of the equine MUC5AC gene, which is responsible for production of mucin, in particular in small airways of horses with heaves.<sup>49</sup>

#### Airway function and gas exchange

Inhalation of inciting agents causes changes in lung function characterized by an increase in pulmonary resistance, lower dynamic compliance, altered distribution of ventilation, impaired gas exchange, increased functional residual capacity, and an altered breathing strategy.<sup>7</sup> **Airway obstruction** is a result of bronchospasm, inflammatory thickening of airways, and accumulation of mucus and cells in the airways. Bronchospasm is largely relieved by administration of bronchodilator drugs or removal of the inciting cause, but residual effects on lung function remain and are attributable to inflammation and fibrosis and bronchoconstriction of small airways.<sup>7</sup> **Bronchoconstriction** in both normal and affected horses is caused by parasympathetic activity and release of acetylcholine that reacts with muscarinic receptors on air-

way smooth muscle. However, the response is exaggerated in horses with heaves. Stimulation of airway sensory receptors results in an exaggerated bronchoconstrictive response, possibly because of the action of inflammatory mediators and/or by-products. The exaggerated bronchoconstrictive response is not specific for allergens, and any substance that activates airway sensory receptors may incite bronchoconstriction once the sensitivity of the receptors is enhanced by inhalation of the inciting allergens. Exaggerated airway responsiveness to inhaled irritants persists for up to 3 days after a single exposure to the inciting agent and is likely important in the development of clinical signs of the disease.<sup>50</sup> Bronchoconstriction increases work of breathing but hypoventilation probably contributes little to the hypoxemia of affected horses, given that PaCO<sub>2</sub> is rarely increased.<sup>51</sup>

**Hypoxemia**, which can be severe (<60 mmHg, 8 kPa), is due to ventilation-perfusion mismatches and increased dead space ventilation.<sup>51</sup> The increased minute ventilation of affected horses, a result of maintained tidal volume and increased respiratory rate, mainly supplies dead space and regions with high V/Q ratios.<sup>51</sup> Pulmonary hypertension in affected horses is probably due to hypoxia and perhaps inflammatory mediators with vasoconstrictor activity.<sup>7,51</sup>

The **elevated functional residual capacity** and characteristic breathing strategy of affected horses is due to airway obstruction. Airway obstruction causes trapping of air in alveoli and a higher end-inspiratory volume. The high end-inspiratory volume maximizes airway diameter and facilitates the high expiratory and inspiratory flow rates necessary for affected horses to maintain a normal tidal volume while increasing their respiratory rate.

**Bronchiectasis** (irreversible dilation and deformation of bronchi or bronchioles) occurs in some horses affected with heaves for a prolonged duration.<sup>52</sup> Neutrophilic inflammation is essential for the development of bronchiectasis.

#### CLINICAL FINDINGS

The degree to which horses are affected varies considerably. Minimally affected horses have airway inflammation evident on endoscopic or cytological examination of the airways, but few other signs on physical examination, whereas severely affected horses have very obvious clinical signs.

The usual **history** is that of chronic cough in a stabled horse.<sup>12</sup> Typically, the disease is precipitated by exposure to hay and stabling, and disease remission occurs in most horses when pastured and

removed from hay. There may be a history of reduced exercise tolerance.

Affected horses are usually bright and alert and have a normal appetite and rectal temperature. Severely affected horses appear anxious and have a greatly increased respiratory effort.

**Coughing** is common in horses with heaves, although it is neither particularly specific nor sensitive as an indicator of the disease. Coughing may consist of a single cough every few seconds to minutes or there may be a paroxysm of coughing. The cough can also be elicited by digital massage of the larynx and proximal part of the trachea because horses with airway inflammation have increased sensitivity of the cough reflex. Stimulation of the larynx or proximal trachea by digital massage does not elicit coughing in normal horses. The cough becomes more pronounced and wheezing with exercise. It also occurs more frequently when the horse is exposed to cold air, physical activity, excitement, and when placed in a dusty environment, or if dusty feed is offered. The amount of coughing, which must be counted over at least 15 minutes and preferably 1 hour for accurate determination of its severity, correlates closely with the amount of mucus in airways, maximal change in pleural pressure (a measure of bronchoconstriction), and neutrophil count in bronchoalveolar lavage fluid.<sup>41</sup> Coughing is more frequent in horses with heaves, and affected horses often have paroxysmal coughing especially after barn cleaning and feeding.

An intermittent, bilateral mucopurulent to serous **nasal discharge** is a common sign in affected horses.

The resting **respiratory rate** is increased from a normal of 12/min up to 24-36/min. There is a pronounced effort during expiration and markedly affected horses have an obvious abdominal component to respiration. Normal horses have a biphasic pattern of airflow during inspiration and expiration while affected horses lack the second phase of respiration.<sup>53</sup> Long-standing cases develop a 'heave-line' in the flank due to hypertrophy of the abdominal oblique musculature. It is evident as a trough or furrow along the costal arch. In advanced cases the nostrils may be visibly dilated during inspiration and the force of the expiratory effort causes the anus to protrude.

Heart rate is commonly within the normal range or only slightly increased. In horses with heaves, the heart rate is significantly higher during exercise than in healthy horses.

**Abnormal lung sounds** are one of the most frequent abnormalities detected on clinical examination and the sensitivity of this finding can be increased from 70%

to almost 90% by auscultating the thorax while the horse breathes for 60 to 120 seconds with an airtight plastic bag over its nostrils.<sup>12</sup> The bag should be large enough to enable the horse to breathe unhindered (10–15 L) and should not leak. Accumulation of carbon dioxide in the bag increases the horse's respiratory rate and tidal volume and accentuates lung sounds. Auscultation of the lungs in the early stages of the disease may reveal only a slight increase in the amplitude of normal breath sounds. Abnormal lung sounds become audible as the disease progresses. **Wheezing and crackling sounds** occur at the end of inspiration and the end of expiration. These abnormal sounds are audible over most of the lung but are usually easiest to detect over the upper one-half of both lung fields. **Auscultation of the trachea** usually reveals moist sounds characteristic of fluid in the trachea. Some affected horses have quieter than expected lung sounds.

Percussion of the thorax may reveal an increase in the area of resonance by as much as one to two intercostal spaces caudally. However, the area of resonance delineated by percussion is too labile and ill-defined to be of diagnostic value.

**Endoscopic examination** of the upper airways, trachea, and bronchi reveals an abundance of mucopurulent material in the trachea which, in severe cases, is also present in the nasopharynx. The amount of mucus can be graded on a 0–5 scale<sup>41</sup>:

- Grade 0 – no visible mucus
- Grade 1 – small blobs of mucus that are not confluent
- Grade 2 – multiple blobs of mucus some of which are confluent
- Grade 3 – mucus confluent in a stream in the ventral aspect of the trachea or multiple large blobs around the circumference of the lumen
- Grade 4 – large pool of mucus in the ventral aspect of the airway
- Grade 5 – Profuse amounts of mucus occupying more than 25% of the tracheal lumen.

Observation of tracheal mucus of grade 4 or 5 has a high specificity (92%) but low sensitivity (52%) for detection of heaves.<sup>47</sup>

**Radiographic examination** of the thorax usually reveals evidence of bronchial disease with some evidence of interstitial disease. Radiography is more useful in ruling out other diseases, such as granulomatous or interstitial pneumonia, than in confirming heaves.

Sophisticated techniques for measuring pulmonary function, such as determination of tidal flow–volume loops, nitrogen wash-out or forced expiratory flow–volume loops, may identify mildly or subclinically affected

animals but have limited day-to-day clinical utility.<sup>53–55</sup>

Measurement of **pleural pressure changes** by insertion of an esophageal balloon is relatively simple and may be useful in monitoring response to treatment. Affected horses have pleural pressure changes during respiration greater than 6 cm H<sub>2</sub>O.<sup>54</sup> Administration of atropine (0.02 mg/kg, IM or IV), isoproterenol (isoprenaline), or a  $\beta_2$ -adrenergic agonist such as terbutaline (0.04 mg/kg, PO) reduces the maximal change in pleural pressure of horses with heaves.

The **course of the disease** is dependent on the removal or continual presence of the precipitating cause. If the cause is removed in the early stages, complete recovery can occur. In the continual presence of the precipitating cause relapses occur commonly or the disease becomes progressive and affected horses become severely incapacitated. **Bronchiectasis**, evident on radiographic examination of the thorax, develops in horses with heaves of prolonged duration.<sup>52</sup> With conscientious management and adequate housing, breeding animals and hunters or show-jumpers with heaves can remain useful for many years.<sup>56</sup>

#### CLINICAL PATHOLOGY AND SPECIAL EXAMINATIONS

There are no significant changes in the hemogram or serum biochemistry of affected horses. The PaO<sub>2</sub> is below normal in moderately to severely affected horses and the PaCO<sub>2</sub> is usually normal although it may be increased in severely affected horses. Blood oxygen tension measurements should be corrected for the temperature of the animal and the altitude. At approximately sea level, PaO<sub>2</sub> values of normal horses are usually greater than 90 mmHg (12 kPa), whereas affected horses have PaO<sub>2</sub> less than 82 mmHg (10.9 kPa). With increases in altitude the values in both normal and affected horses decrease.<sup>54</sup> The normal hypoxemia that occurs in horses during intense exercise is exacerbated by heaves.

**Bronchoalveolar lavage fluid** from affected horses during symptomatic episodes has a relative neutrophil count greater than 5 to 10%, and usually over 50%, of the absolute nucleated cell count.<sup>12,57,58</sup> It is recommended that horses not be considered to have airway inflammation unless >15% of cells in bronchoalveolar lavage fluid are neutrophils. During periods of remission, the bronchoalveolar lavage fluid of previously affected horses is not different from that of normal horses. Absolute nucleated cell counts in bronchoalveolar lavage fluid of affected horses are reported<sup>12,57,58</sup> but the values depend on the collection technique used.<sup>59</sup>

The relative proportions of macrophages and lymphocytes in bronchoalveolar lavage fluid of affected horses are lower than those of normal horses. Eosinophil numbers in bronchoalveolar or tracheal aspirate fluid of affected horses may be mildly elevated (up to 10%), but are usually low (<3–5%). Higher values should raise the index of suspicion for *Dictyocaulus armfieldi* or *Parascaris equorum* infestation. Aspirates of **tracheal fluid** reveal a profound neutrophilia (>90%).<sup>57</sup>

Measurement or identification of **precipitins** in serum of horses is not useful in identifying horses with heaves.<sup>60</sup>

**Intradermal testing** using putative allergens has been investigated as a means of identifying horses with heaves or of identifying antigens with which to hyposensitize affected horses with variable or undetermined efficacy.<sup>1,61,62</sup> Retrospective examination of records of horses with a history of heaves suggests that they are more likely to react, and react to a larger number, of intra-dermally injected allergens than horses without a history of heaves.<sup>63</sup> However, reactions to individual allergens cannot be used to determine hypersensitivity to particular allergens, although it is suggested that overall patterns of reactivity, with a history of exposure of the horse to these allergens, might be useful in guiding management of affected horses.<sup>63</sup> Contrary to these results, a prospective study demonstrated that horses with heaves did not have a greater rate of reaction to intradermal skin tests than did horses not affected by heaves.<sup>64</sup> Intradermal testing did not distinguish clinically relevant reactions from those that were not clinically relevant.<sup>64</sup> Horses with heaves have greater sensitivity to intradermal injection of histamine, which is commonly used as a positive control, than horses without heaves.<sup>65</sup> Overall, intradermal skin testing is neither useful in detecting horses with heaves nor in determining hypersensitivity to particular allergens in individual horses. Results of such testing might be useful in management of horses, but this has not been demonstrated. The usefulness of intradermal skin testing and subsequent administration of preparations of antigens selected on the basis of intradermal testing, in an effort to hyposensitize horses with heaves, has not been determined. The apparent lack of efficacy of intradermal testing might be because the extent of reactivity to intradermal injection of mold preparations does not correlate with the severity of pulmonary dysfunction after inhalation of the same preparation in horses with heaves.<sup>1</sup>

**Lung biopsy** demonstrates peribronchiolar lymphoplasmacytic inflammation, goblet cell metaplasia, alveolar

fibrosis, and bronchial lumen exudate and neutrophils.<sup>12</sup> The severity of bronchiolar neutrophil and mast cell infiltration correlates well with the severity of the clinical signs.<sup>12</sup>

### NECROPSY FINDINGS

The major findings are restricted to the lungs, which are pale, voluminous, and do not collapse when the chest cavity is opened. The tissue damage is primarily centered on airways which are less than 2 mm in diameter. Microscopically, a variable degree of alveolar emphysema is accompanied by a chronic bronchiolitis featuring diffuse epithelial hyperplasia, goblet cell metaplasia, peribronchiolar fibrosis, and cellular infiltration by lymphocytes, plasma cells, mast cells, and sometimes eosinophils. Plugs of mucus with entrapped neutrophils often occlude bronchiolar lumina.

Samples for postmortem confirmation of diagnosis

Formalin-fixed lung for light microscopic examination.

### DIAGNOSTIC CONFIRMATION

Confirmation of the disease is based on the presence of a history and clinical signs consistent with the disease, in particular the response to stabling and pasturing, and demonstration of reversible airway obstruction. Objective confirmation can be achieved by measuring the response of maximal changes in pleural pressure in response to bronchodilator drug (atropine or glycopyrolate) administration.

### DIFFERENTIAL DIAGNOSIS

Horses with respiratory distress may have:

- Interstitial pneumonia
- Heart failure
- Bacterial pneumonia
- Pleuritis
- Pulmonary or mediastinal neoplasia including leiomyosarcoma<sup>66</sup>
- Parasitic pneumonia (*D. arnfieldi*).

Nasal discharge may be caused by:

- Guttural pouch diseases including empyema
- Dysphagia of any cause
- Esophageal obstruction
- Sinusitis
- Pneumonia.

### TREATMENT

The **principles of treatment** are:

- Removal of the inciting cause
- Reduction of airway inflammation
- Bronchodilation
- Correction of hypoxemia.<sup>55</sup>

Heaves is an inflammatory disease caused by inhalation exposure to inciting agents. Bronchoconstriction is secondary

to inflammation. Control of the disease is based upon preventing inhalation of inciting agents and suppression of inflammation by administration of corticosteroids. Relief of bronchoconstriction should be necessary only during acute exacerbations of the disease, and administration of bronchodilatory drugs for more than several days is not optimal treatment in most horses. Drugs used in the treatment of heaves are summarized in Table 34.2.

*It is essential that the horse is not exposed to the inciting agents and irritant substances that could provoke or worsen the disease.* Even relatively brief exposure of susceptible horses to the inciting agents, such as can occur if a horse is brought into a poorly ventilated barn to be fed, can result in airway hypersensitivity and the development or maintenance of clinical signs. Affected horses should be moved to a clean environment, **ideally pasture**, in which the concentration of airborne allergens is reduced to an absolute minimum. If the horse cannot be kept at pasture, then it should be housed in a well ventilated barn (see 'Control' for details), bedded with clean wood shavings or shredded paper, and fed a complete pelleted ration. If affected horses are fed hay, it should be thoroughly wetted to minimize the release of spores. Remission of clinical signs can be expected in 4–21 days if the environmental changes are adequate.<sup>67</sup> This may be all that is necessary to control the disease in many horses.

Antiinflammatory drugs

The disease is essentially one of inflammation of the airways and therefore one of the mainstays of treatment is administration of anti-inflammatory drugs. Nonsteroidal anti-inflammatory drugs such as phenylbutazone and flunixin meglumine are not effective. Corticosteroids including dexamethasone, prednisolone, triamcinolone, and betamethasone are effective in controlling the disease. **Dexamethasone** (0.04–0.1 mg/kg, intravenously, intramuscularly or orally every 24–48 hours) can be given to control the acute signs of the disease, and then the dose reduced and eventually discontinued as environmental alterations have their effect. Similarly, **prednisolone** (1–2 mg/kg, orally once daily), but not prednisone<sup>68,69</sup> can be given initially, then the dose reduced by approximately one half every 5–10 days as the disease is controlled. Often prednisolone or dexamethasone sodium phosphate is effective when administered every second day when the disease has been controlled. **Dexamethasone-21-isonicotinate** (0.04 mg/kg, intramuscularly) is effective

when administered every 3 days, but not when administered only once.<sup>69,70</sup> **Isoflupredone** (0.03 mg/kg, intramuscularly once daily) is as effective as dexamethasone in alcohol in control of exacerbations of heaves, although it does cause hypokalemia.<sup>71</sup> **Triamcinolone** (0.09 mg/kg, intramuscularly) administered once provides long-term (weeks) relief of signs in some horses.<sup>72</sup>

**Inhaled corticosteroids**, such as beta-methasone, beclomethasone, or fluticasone, are useful in controlling the disease.<sup>73,74</sup> Both inhaled and parenterally administered corticosteroids suppress adrenal function of horses<sup>75</sup> but 500 µg of beclomethasone propionate inhaled twice daily effectively alleviated signs of heaves and causes less adrenal suppression than doses of 1000 µg or 1500 µg.<sup>76</sup> It is important to reiterate that the use of glucocorticoids should only be as an adjunct to control of the horse's environment and reduction in the inhaled particle burden.

**Clebuterol** decreases the production of inflammatory cytokines by cells obtained from bronchoalveolar lavage fluid of horses with heaves, suggesting that clenbuterol can have anti-inflammatory effects in such horses.<sup>35</sup> The clinical applicability of this finding remains to be determined.

In summary, a number of different corticosteroid preparations are useful in the control of heaves. Drugs administered by inhalation appear to have a reduced potential for adverse effects including adrenal suppression, but are more difficult to administer and require more frequent administration than drugs administered orally, intravenously, or intramuscularly. Improvements in respiratory effort and clinical signs are evident in approximately 3 days and persist for the duration of treatment. Cell counts and the neutrophilia in bronchoalveolar lavage fluid are not reduced by administration of corticosteroids. Affected horses, after institution of appropriate measures to control inhalation of hay and barn dust, should be treated with the lowest dose that controls the disease and only for as long as necessary. The dose of corticosteroid can be reduced gradually and the frequency of administration decreased from once daily to once every second or third day (or greater, depending on the preparation) to achieve this end. Administration of the lowest effective dose is important because of the effects of corticosteroids in suppressing immune and adrenal function. It is suggested that dexamethasone and triamcinolone increase the likelihood of horses developing laminitis, but this relationship has not been conclusively demonstrated.



Table 34.2 Drugs used in the treatment of heaves in horses

	Drug	Dose and frequency	Route	Comments
<b>Bronchodilators</b> $\beta_2$ -agonists	Clenbuterol	0.8 to 3.2 $\mu\text{g}/\text{kg}$ q12 hourly	Oral or IV	Initial therapy with lowest dose. Gradual increments depending on response. For short-term therapy pending environmental control and corticosteroid administration
	Albuterol	50 $\mu\text{g}/\text{kg}$	Oral	Unknown and doubtful efficacy
	Albuterol	1–3 $\mu\text{g}/\text{kg}$ q6–12 hours	Inhalation	Has short duration of action (1 hour). Can be combined with ipratropium to prolong duration of bronchodilation.
	Fenoterol	2–4 $\mu\text{g}/\text{kg}$ as needed	Inhalation	Short duration of action.
	Pirbuterol	1–2 $\mu\text{g}/\text{kg}$ as needed	Inhalation	Short duration of action.
	Salmeterol	0.5–1.0 $\mu\text{g}/\text{kg}$ q6–12 hours	Inhalation	Longest acting $\beta_2$ -agonist available for inhalation
	Terbutaline	0.2 mg/kg as needed	Inhalation	Marked adverse effects including tachycardia. Not absorbed after oral administration.
Parasympatholytics	Terbutaline	0.01 mg/kg as needed	IV	Marked adverse effects including sweating and tachycardia
	Ipratropium	0.5–2.0 $\mu\text{g}/\text{kg}$ q4–6 h	Inhalation	Usually combined with albuterol for rapidity of onset of bronchodilation
	Glycopyrolate	0.7 $\mu\text{g}/\text{kg}$ as needed	IV or IM	Useful for short-term or emergency relief of bronchoconstriction
Miscellaneous	Atropine	0.1–0.02 mg/kg as needed	IV or IM	Useful for diagnosis of reversible airway obstruction and short term relief of bronchoconstriction. Can cause colic.
	Theophylline	5–10 mg/kg q8–12 hours	Oral	Antiquated therapy. Moderate bronchodilation, variable absorption, narrow therapeutic index, frequent adverse CNS effects. Not recommended.
Antiinflammatory drugs	Pentoxyfylline	36 mg/kg q12 hourly	Oral	Not used clinically. Experimental evidence of efficacy.
	<b>Corticosteroids</b>			
Corticosteroids	Dexamethasone phosphate or in alcohol	0.02–0.1 mg/kg q24 hourly	IV, IM, or oral	Effective at reducing clinical signs within 3 days. Gradually reduce dose and frequency to lowest efficacious dose.
	Dexamethasone-21 isonicotinate	0.04–0.06 mg/kg q 3 days	IM	Effective. Infrequent dosing.
	Prednisolone	1–2 mg/kg q24 hourly	Oral or IM	Effective at reducing clinical signs within 3 days. Gradually reduce dose and frequency to lowest efficacious dose.
	Prednisone	1–2 mg/kg q24 hourly	Oral	Variable efficacy and not efficacious in most horses. Do not use.
	Triamcinolone acetonide	0.9 mg/kg q2–4 weeks	IM	Infrequent dosing and therefore lack of ability to taper dose. Should not be repeated at <3 month intervals.
	Beclomethasone	1–3 $\mu\text{g}/\text{kg}$ q12 hourly	Inhalation	Relief of bronchoconstriction within 3 days. Lowest dose does not cause adrenal suppression and is effective in relief of bronchoconstriction.
Other	Fluticasone	2–4 $\mu\text{g}/\text{kg}$ q12 hourly	Inhalation	Potent and effective. Expensive.
	Cromolyn sodium	200 mg q12 hourly	Inhalation	Undetermined efficacy. Should be used before exposure to inciting agent.
	Montelukast	0.11 mg/kg q24 hourly	Oral	Leukotriene receptor antagonist. Not efficacious at this dose.

Modified from: Robinson, N.E. (2001) *Equine Vet. Educ.* 13, 247 and Couetil, L.L. & Hinchcliff K.W. (2004) *Equine Sports Medicine and Surgery*. Elsevier Health Sciences, p 613.

### Bronchodilator drugs

Bronchodilator drugs might be needed to provide acute relief of airway obstruction but should not be used as maintenance therapy. **Atropine** (0.02–0.04 mg/kg, intramuscularly) can be used to provide

short-term relief of bronchoconstriction, but its use is associated with gastrointestinal side-effects, including colic, that preclude its long-term use. **Glycopyrolate** (0.1 mg/kg, intramuscularly every 8–12 hours) is a potent bronchodilator

with minimal gastrointestinal effects. **Ipratropium bromide**, a parasympatholytic drug with minimal extrapulmonary effects when given by inhalation, is very effective in relieving airway obstruction in severely affected horses.<sup>77</sup>

**$\beta_2$ -adrenergic agonists** are potent bronchodilators frequently used in the management of horses with heaves. They can be administered orally or by inhalation.<sup>73,78</sup> **Clenbuterol hydrochloride** is used as maintenance therapy at a dose of 0.8–3.2  $\mu\text{g}/\text{kg}$ , orally every 12 hours, and is effective in controlling signs in 75% of affected horses.<sup>79</sup> The lower dose should be used initially and then increased in 0.8  $\mu\text{g}/\text{kg}$  increments until the desired effect is achieved or side-effects of tachycardia, muscle fasciculation, and sweating are apparent. Gradual, incremental increases in dose lessen the frequency and severity of side-effects. **Terbutaline** is not absorbed after oral administration to horses.<sup>80</sup> Terbutaline and clenbuterol can also be given intravenously, at a dose one-tenth of that given orally, to severely affected horses in which the need for bronchodilation is urgent. Side-effects of  $\beta_2$ -agonist administration include tachycardia, sweating, and apprehension.<sup>79</sup> Prolonged administration of clenbuterol is associated with potentially adverse effects on cardiac structure, alterations in body composition, and an impaired response to training.<sup>81–83</sup> Delayed parturition may occur in mares treated in late pregnancy.  $\beta_2$ -adrenergic agonists may transiently exacerbate hypoxemia in severely affected horses. Intra-tracheal administration does not produce detectable bronchodilation.<sup>84</sup>

Bronchodilators administered by inhalation to horses include the  $\beta_2$ -agonists **Albuterol, salbutamol, and salmeterol**, and the parasympatholytic ipratropium. The efficacy and duration of action of each of these drugs varies somewhat, but all are effective in producing bronchodilation in affected horses. Salmeterol produces bronchodilation in horses with heaves that persists for up to 6 hours, although onset of action requires 30–60 minutes.<sup>85</sup> Similarly, ipratropium reduces pleural pressure changes and attenuates clinical signs of airway obstruction in horses with heaves.<sup>77,86</sup>

**Theophylline** (aminophylline) is a non-adrenergic bronchodilator given at a dose of 10–12 mg/kg, orally every 12 hours. Signs of toxicity include tachycardia, excitement, and convulsions. Theophylline is not a drug of first choice for the treatment of heaves and is now used infrequently because of the availability of efficacious anti-inflammatory drugs and other bronchodilators.

Other drugs

**Sodium cromoglycate** is useful for the prophylaxis of heaves, but has no direct bronchodilatory activity.<sup>55</sup> Its mechanism of action is unclear, but it may act to prevent the degranulation of mast cells. It

can be given at a dose of 20–30 mg per 425 kg horse by inhalation once daily for 4 days, and then repeated in 1–2 weeks.<sup>87</sup>

**Pentoxifylline** at high doses improves respiratory function, but not bronchoalveolar lavage fluid cytology, of horses with heaves.<sup>88</sup> However, bioavailability after oral administration is quite variable, contributing to variations in the responses of horses to the drug.

Drugs that reduce **leukotriene** production or activity do not appear to be useful in the treatment of heaves. An experimental leukotriene D<sub>4</sub> receptor antagonist was not effective in relieving signs of heaves.<sup>89</sup> Similarly, montelukast did not improve respiratory function in 5 horses with heaves.<sup>88</sup>

**Mucolytics** are often used but their efficacy is not established and is doubtful. **Cough suppressants** should not be used as they may impair clearance of mucopurulent material from the airways.

**Antibiotics** are often given to affected horses but are probably not necessary in the vast majority of cases.

**Acupuncture** is not effective in the treatment of heaves.<sup>90</sup>

Administration of large quantities of **isotonic electrolyte solution** intravenously is associated with a decrement in respiratory function in both normal and heavy horses and is not recommended as a treatment for heaves.<sup>91</sup>

Integrated therapy

Initial treatment of affected horses usually involves changes to the horse's environment and feed in combination with administration of corticosteroids. Corticosteroids and  $\beta_2$ -adrenergic agonists can be given as combined therapy to severely affected horses until the disease is controlled, at which time therapy should consist of environmental control and, if needed, administration of the lowest effective dose of corticosteroids. Bronchodilators are sometimes used as sole therapy, but their use without correction of the housing and feeding factors, and attempts to control inflammation, is not rational. Long-term administration of bronchodilators is not optimal therapy and, given the documented adverse effects, is not recommended. Long-term control of heaves is achieved by environmental management and administration of corticosteroids.

## CONTROL

Housing horses in stalls with good air quality is essential in reducing the occurrence of the disease. **Adequate ventilation** is critical in maintaining good air quality in stalls. Few horse housing units have adequate ventilation<sup>19,22</sup> although a well-designed individual box stall can meet the needs of the horse both for air hygiene and thermal comfort.<sup>19</sup> Many

horse barns have inadequate open space for ventilation in still air conditions when the doors are closed at both ends of the building. When the release rate of spores is low, ventilation rates of 4 air changes per hour are satisfactory. However, suggested minima are 8–10 air changes per hour, airspace of 44 m<sup>3</sup>/head, and floor space of 9.2 m<sup>2</sup>/head.<sup>23</sup> In practical terms, if the upper half of the stable door is open, and faces open air and not into a barn, the natural ventilation should exceed the minimum specifications.<sup>23</sup> Hay and dusty feed materials should not be stored above stalls or in the same airspace as horses. Bedding should be changed frequently, preferably daily. Use of cardboard as bedding material is effective as part of an overall regimen to improve air quality.<sup>92</sup>

A portable slit sampler is an accurate, quick, and simple semiquantitative method of assessing the mold contamination of source materials such as hay, straw, and other feeds and bedding collected from stables.<sup>18</sup> The health hazard posed by any moldy source material depends on the types of organisms present and their abundance. The size of the respirable challenge from heated hays and straws arises from the prolificacy of the species involved and their small spore size. The highest respirable challenges are from the presence of thermotolerant and thermophilic mold species. The most critical factors in determining the microbial development in plant-based materials are water content and thermal environment. Hay baled at 15–20% moisture heats little, it is virtually dust-free and contains few spores. Baling hay with 20–30% moisture leads to temperatures of up to 35–45°C. At these temperatures, hazardous contamination may develop with the appearance of thermotolerant fungi and actinomycetes.<sup>18</sup> The heaviest contamination of hay and straw occurs with baling at 35–50% moisture when spontaneous heating up to 50–60°C may occur. Microscopically, these hays show large numbers of fungal spores in the 2–5  $\mu\text{m}$  size range.

## REVIEW LITERATURE

- Mair TS, Derksen FJ. Chronic obstructive pulmonary disease: a review. *Equine Vet Educ* 2000; 12:35.  
Robinson NE, et al. Management of heaves. *Equine Vet Educ* 2001; 13:247

## REFERENCES

- McGorum BC et al. *Equine Vet J* 1993; 25:273.
- McGorum BC. *Proc Am Coll Vet Int Med* 2004; 22:186.
- Pirie RS et al. *Clin Exp Allergy* 2003; 33:676.
- Pirie RS et al. *Equine Vet J* 2002; 34:337.
- Pirie RS et al. *Equine Vet J* 2002; 34:343.
- Robinson NE et al. *Equine Vet Educ* 2001; 13:247.
- Robinson NE et al. *Br Vet J* 1996; 152:283.
- Bracker V et al. *Equine Vet J* 1991; 23:136.
- Larson VL, Busch RH. *Am J Vet Res* 1985; 46:144.

10. Mason DK et al. *Equine Exerc Physiol* 1982; 1:57.
11. Sweeney C et al. *Am J Vet Res* 1992; 53:1172.
12. Naylor JM et al. *Can Vet J* 1992; 33:591.
13. Couetil LL, Ward MP. *J Am Vet Med Assoc* 2003; 223:1645.
14. Marti E et al. *Equine Vet J* 1991; 23:457.
15. Ward MP, Couetil LL. *Am J Vet Res* 2005; 66:818.
16. Thomson JR, McPherson EA. *Equine Vet J* 1983; 16:35.
17. Derksen FJ et al. *J Appl Physiol* 1985; 58:598.
18. Clarke AF, Madelin T. *Equine Vet J* 1987; 19:442.
19. Webster AJF et al. *Equine Vet J* 1987; 19:448.
20. McGorum BC et al. *Equine Vet J* 1998; 30:430.
21. Woods PS et al. *Equine Vet J* 1993; 25:208.
22. Clarke AF et al. *Equine Vet J* 1987; 19:524.
23. Jones RD et al. *Equine Vet J* 1987; 19:454.
24. Kirschvink N et al. *Equine Vet J* 2002; 34:563.
25. Halliwell REW et al. *Vet Immunol Immunopathol* 1993; 38:201.
26. Sandersen C et al. *Vet Immunol Immunopathol* 2001; 80:315.
27. Bureau F et al. *Am J Resp Crit Care Med* 2000; 161, 1314.
28. Bureau F et al. *J Immunol* 2000; 165:5822.
29. Lavoie J et al. *Am J Resp Crit Care Med* 2001; 164:1410.
30. Cordeau M et al. 2004; *Vet Immunol Immunopathol* 2001; 97:87.
31. Ainsworth DM et al. *Vet Immunol Immunopathol* 2003; 96:83.
32. Giguere S et al. *Vet Immunol Immunopathol* 2002; 85:147.
33. Debrue M et al. *Vet Immunol Immunopathol* 2005; 105:25.
34. Tamarinde TJM et al. *J Vet Int Med* 2005; 19.
- 35a. Laan TTJM et al. *Am J Vet Res* 2005; 66:1584.
- 35b. Loan TT et al. *Vet J* 2006; 171:429.
36. Fairbairn SM et al. *Clin Exp Allergy* 1993; 23:821.
37. Marr KA et al. *Res Vet Sci* 1997; 62:253.
38. Marr K et al. *Equine Vet J* 2002; 34:65.
39. Rickards KJ et al. *Vet Immunol Immunopathol* 2000; 76:319.
40. Lavoie JP et al. *J Vet Int Med* 2006; 20.
41. Robinson NE et al. *Am J Vet Res* 2003; 64:550.
42. Simonen-Jokinen T et al. *Equine Vet J* 2005; 37:155.
43. Raulo SM et al. *Equine Vet J* 2001; 33:128.
44. Brazil TJ, McGorum BC. *Equine Vet J* 2001; 33:113.
45. Nevalainen M et al. *Equine Vet J* 2002; 34:150.
46. Art T et al. *Equine Vet J* 1999; 31:397.
47. Gerber V et al. *J Vet Int Med* 2004; 18:92.
48. Gerber V et al. *Equine Vet J* 2000; 32:411.
49. Gerber V et al. *Equine Vet J* 2003; 34:252.
50. Fairbairn SM et al. *J Vet Pharmacol Therap* 1993; 16:469.
51. Nyman G et al. *Equine Vet J* 1991; 23:253.
52. Lavoie JP et al. *J Vet Int Med* 2004; 18:757.
53. Gallivan GJ et al. *Can J Vet Res* 1990; 54:99.
54. McPherson EA et al. *Equine Vet J* 1978; 10:47.
55. Couetil LL et al. *J Appl Physiol* 2000; 88:1870.
56. Aviza GA et al. *Equine Vet Educ* 2001; 13:243.
57. Derksen FJ et al. *Equine Vet J* 1989; 21:23.
58. Tremblay GM et al. *Equine Vet J* 1993; 25:194.
59. Sweeney C R et al. *Am J Vet Res* 1992; 53:1376.
60. Madelin TM et al. *Equine Vet J* 1991; 23:247.
61. Evans AG et al. *Am J Vet Res* 1992; 53:203.
62. McPherson EA et al. *Equine Vet J* 1979; 11:159.
63. Jose-Cunilleras E et al. *J Am Vet Med Assoc* 2001; 219:1115.
64. Lorch G et al. *Am J Vet Res* 2001; 62:389.
65. Wong DM et al. *Am J Vet Res* 2005; 66:1341.
66. Rosedale PD et al. *Equine Vet Educ* 2004; 16:21.
67. Jackson CA et al. *Equine Vet J* 2000; 32:432.
68. Peroni DL et al. *Equine Vet J* 2002; 34:283.
69. Robinson NE et al. *Equine Vet J* 2002; 34:17.
70. Couetil LL et al. *J Vet Int Med* 2006; 20.
71. Picandet V et al. *Equine Vet J* 2003; 35:419.
72. LaPointe JM et al. *Am J Vet Res* 1993; 54:1310.
73. Hoffman AM. *Vet Clin North Am Equine Pract* 1997; 13:519.
74. Rush BR et al. *Am J Vet Res* 1998; 59:1039.
75. Rush BR et al. *Am J Vet Res* 1998; 59:1044.
76. Rush BR et al. *Am J Vet Res* 2000; 217:359.
77. Duvivier DH et al. *Vet J* 1997; 154:149.
78. Duvivier DH et al. *Vet J* 1997; 154:189.
79. Erichsen DF et al. *Equine Vet J* 1994; 26:331.
80. Torneke MK et al. *Am J Vet Res* 2000; 61:761.
81. Kearns CF, McKeever KH. *Med Sci Sports Exerc* 2002; 34:1976.
82. Sleeper MM et al. *Med Sci Sports Exerc* 2002; 34:643.
83. Beekley MD et al. *Vet J* 2003; 165:234.
84. Harkins JD et al. *J Vet Pharmacol Therap* 2000; 23:251.
85. Hendrikson SL, Moore BR. *J Am Vet Med Assoc* 1986:1961.
86. Bayly WM et al. *Equine Vet J* 2002; 34:36.
87. Thomson JR, McPherson EA. *Equine Vet J* 1981; 13:243.
88. Kolm G et al. *Vet Rec* 2003; 152:804.
89. Lavoie JP et al. *Am J Vet Res* 2002; 63:579.
90. Wilson DV et al. *Equine Vet J* 2004; 36:489.
91. Jean D et al. *Equine Vet J* 2004; 36:628.
92. Kirschvink N et al. *Vet J* 2002; 163:319.

### PASTURE-ASSOCIATED HEAVES (PASTURE-ASSOCIATED OBSTRUCTIVE PULMONARY DISEASE OF HORSES)

Summer pasture-associated heaves occurs in horses in the southeastern region of the United States and in Great Britain.<sup>1-3</sup> It appears to be a disease of adult horses that are on pasture most of the time in the summer. It occurs most commonly in the warm, humid summer months of June to September. Affected horses gradually recover during the cooler months of winter and early spring, and the disease may recur in the same horse each successive summer. Most severe signs occurred during late spring and early summer during times of high airborne pollen counts. It has been suggested that pulmonary allergy to pollens is a factor but this has not been validated. Affected horses have increased expression of interleukin-4 and interferon- $\gamma$  in cells of bronchoalveolar lavage fluid and peripheral blood mononuclear cells<sup>4</sup> but not increased concentrations of IgE in bronchoalveolar lavage fluid.<sup>5</sup> Affected horses have clinical findings typical of heaves including nasal discharge, coughing, tachypnea, labored expiratory effort, and crackles and wheezes on auscultation.<sup>6</sup> There is moderate-to-severe accumulation of mucus in the large airways evident on endoscopic examination. Lung function testing is consistent with bronchoconstriction. Bronchoalveolar lavage fluid contains large numbers of nondegenerate neutrophils and lesser numbers of lymphocytes and mast cells.<sup>6</sup> Necropsy reveals overinflated lungs that do not collapse when the chest is opened

and that retain the impressions made by the ribs.<sup>6</sup> The predominant histologic finding is accumulation of mucus in small airways. Inflammation is not severe and most inflammatory cells present are neutrophils and lymphocytes in peribronchial tissues.<sup>6</sup> Treatment includes stabling and administration of corticosteroids and bronchodilators, as discussed for heaves and Table 34.2).<sup>1,2,7</sup>

### REVIEW LITERATURE

McGorum BC, Dixon PM. Summer pasture-associated obstructive pulmonary disease (SPAOD): an update. *Equine Vet Educ* 1999; 11:121.

### REFERENCES

1. Seahorn TL, Beadle RE. *J Am Vet Med Assoc* 1993; 202:779.
2. Mair TS. *Vet Rec* 1996; 138:89.
3. Dixon PM, McGorum B. *Vet Rec* 1990; 12:9.
4. Beadle RE et al. *Equine Vet J* 2002; 34:389.
5. Seahorn TL et al. *Am J Vet Res* 1997; 58:1408.
6. Rodrigues LR et al. *Am J Vet Res* 2000; 61:167.
7. Hudson NPH. *Equine Vet Educ* 1999; 11:116.

### MILK ALLERGY

Signs of allergy, principally urticaria, are often manifested by cows during periods of milk retention.<sup>1,2</sup> Most of these occur as the cow is being dried off. The Channel Island breeds of cattle are most susceptible and the disease is likely to recur in the same cow at subsequent drying off periods; it is almost certainly inherited as a familial trait.

The important clinical signs relate to the skin. There is urticaria which may be visible only on the eyelids or be distributed generally. Local or general erection of the hair may also be seen. A marked muscle tremor, respiratory distress, frequent coughing, restlessness to the point of kicking at the abdomen and violent licking of themselves, and even maniacal charging with bellowing may occur. Other cows may show dullness, recumbency, shuffling gait, ataxia, and later inability to rise. The temperature and pulse rates are usually normal or slightly elevated but the respiratory rate may be as high as 100/min.

Diagnosis of milk allergy can be made by the intradermal injection of an extract of the cow's own milk. A positive reaction occurs with milk diluted as much as 1 in 10 000, and the edematous thickening is present within minutes of the injection. Other clinicopathological observations include the development of eosinopenia, neutrophilia, and hyperphosphatemia during an attack.

Spontaneous recovery is the rule but antihistamines are effective, especially if administered early and repeated at short intervals for 24 hours. Prevention is usually a matter of avoiding milk retention in susceptible cows, but in many cases it is preferable to cull them.

## REFERENCES

1. Campbell SG. *Cornell Vet* 1970; 60:684.
2. Campbell SG. *Allergy Clin Immunol* 1971; 48:230.

### ENZOOTIC NASAL GRANULOMA OF CATTLE (ENG, BOVINE ATOPIC RHINITIS)

Of the three known clinical types of chronic nasal obstruction in cattle, two have been identified etiologically and have clinical or epidemiological features that distinguish them from enzootic nasal granuloma. One is recorded predominantly in beef cattle appears to be caused by a fungus, most commonly *Rhinosporidium* spp., or *Drechslera* spp.<sup>1,2</sup> Another is caused by the parasite *Schistosoma nasalis*.<sup>3</sup> The third type, enzootic nasal granuloma, occurs commonly in southern Australia, less commonly in New Zealand and is recorded as a sporadic disease in South America and an occasional disease in North America, Britain, and Europe.<sup>4,5</sup>

Enzootic nasal granuloma occurs sporadically in some herds but may reach an incidence of 30%. In one area, as much as 75% of herds may have the disease. Animals aged between 6 months and 4 years are most commonly affected, and the chronic disease may or may not be preceded by an attack of acute rhinitis. Most cases commence in the summer and autumn months. It is apparent that nasal granuloma develops as a continuous and progressive response to acute episodes of hypersensitivity to an allergen present in the summer months. This accords with the gradual development of the stertorous respiration<sup>6</sup> and the observations, in biopsies of nasal mucosa, of the presence of mast cells in all seasons, but the regression of eosinophils in the winter months.<sup>4</sup>

An extensive survey of Australian dairying areas showed that 22% of cattle had lesions, and that the prevalence was greater in areas where the average annual rainfall was over 70 cm, than where it was less than 70 cm; the prevalence varied be-

tween 4% and 48%; Jerseys were more commonly affected than Friesians. In New Zealand, 40% of farms and 36% of culled cattle were affected, whereas only 3.6% of young beef cattle showed lesions.

The disease has been identified as an allergic rhinitis and has been produced experimentally.<sup>7</sup> Specific antigens have not been identified as the cause but cows with nasal granuloma are much more sensitive to a number of common allergens in the environment than are unaffected cows. Bovine herpesvirus 1 is often isolated from lesions of ENG and is thought by some to predispose animals to the development of the disease. Additional possible causes include infestation of the nasal cavities with pasture mites (*Tyrophagus palmarum*). An allied condition has been described in the United States as maduromycosis but there are nasal granulomas plus multiple granulomatous lesions of the skin of the ears, tail, vulva, and thigh.<sup>8</sup> The granulomas contain many eosinophils and fungal elements identified provisionally as *Helminthosporium* sp.

In enzootic nasal granuloma acute cases are characterized by a sudden onset of bilateral ocular and nasal discharge and swelling of the nasal mucosa causing difficult, noisy breathing. Affected animals shake their heads and snort and rub their noses in hedges. As a result they commonly block their nostrils with twigs. This form of the disease is commonest in cattle of the Channel Island breeds and their cross-breeds. The nasal discharge in these breeds is usually yellow to orange in color.

Established cases of enzootic nasal granuloma have lesions, consisting of granulomatous nodules 1–4 mm in diameter and height, in both nostrils. The lesions extend from just inside the nostril posteriorly for 5–8 cm. They may be few in number or be packed closely together. Their texture is firm and the mucosa over them is normal. They have a characteristic histopathology of epithelial metaplasia and hyperplasia,

and contain large numbers of eosinophils and mast cells.<sup>4,9</sup>

The predominant clinical sign is respiratory stertor and dyspnea caused by obstruction to the air flow. The severity of these signs may fluctuate but in general they progress slowly over several months and then remain static. Although the respiratory distress may be sufficiently severe to cause a loss of condition and marked reduction in milk yield, affected animals do not die. A good proportion of them have to be culled as uneconomic units.

The clinical picture in **mycotic nasal granuloma** is superficially similar with respect to noisy breathing, respiratory distress, and nasal discharge, but there is no seasonal association. Also, the visible and palpable lesions in the anterior part of the nasal cavities are polyps up to 5 cm in diameter which occur singly or in confluent masses. Their cut surfaces are yellow to green and they are sometimes ulcerated.<sup>4,10</sup> Histologically the lesions are eosinophilic granulomas containing fungal spores and sometimes hyphae. Fungi (*Drechslera rostrata*) have been isolated from the lesions.

**Equine allergic rhinitis** is a clinically and epidemiologically similar condition, but without mucosal lesions, recorded in horses as a common cause of persistent head shaking.<sup>11</sup>

## REFERENCES

1. Penrith ML et al. *J South. Afr Vet Med Assoc* 1994; 65:179.
2. Conti Diaz IA et al. *Rev Inst Med Trop St. Paulo* 2003; 43:163.
3. Agrowal MC, Alwar VS. *Helminthol Abstr* 1992; 61:373.
4. Bosschere H de et al. *Vet Rec* 2000; 146:322.
5. Rivero R et al. *Veterinaria Uruguay*, 1987; 24:5.
6. Pemberton DH, White WE. *Aust Vet J* 1974; 50:85.
7. Pemberton DH et al. *Aust Vet J* 1977; 53:201.
8. Patton CS. *Cornell Vet* 1977; 67:236.
9. Carbonell PL. *Vet Pathol* 1979; 16:60.
10. McKenzie RA, Connole MD. *Aust Vet J* 1977; 53:268.
11. Mair T, Lane G. *In Pract* 1990; 12:183.

# Diseases associated with the inheritance of undesirable characters

## INTRODUCTION 1938

### DISEASES CHARACTERIZED BY CHROMOSOMAL ANOMALIES 1939

Freemartinism in calves 1939  
Chromosomal translocations in cattle 1939  
Chromosomal translocations in sheep 1940

### INHERITED DEFECTS OF THE BODY AS A WHOLE 1940

Deficiency of UMP synthase (dumps) 1940  
Inherited goiter 1940  
Inherited immunodeficiencies 1940  
Bovine leukocytes adhesion deficiency (BLAD) 1941  
Inherited deficiency of lymphocyte maturation (lethal trait A46, parakeratosis, adema disease) 1941  
Inherited deficiency of immunoglobulin synthesis 1941  
Chediak-Higashi syndrome 1941  
Pseudoalbinism and lethal whites 1942  
Fell pony syndrome 1942

### INHERITED DEFECTS OF THE ALIMENTARY TRACT 1943

Inherited defects of the mouth and jaw 1943  
Inherited rectovaginal constriction 1944  
Hepatic lipodystrophy in Galloway calves 1944  
Inherited atresia of alimentary tract segments 1944

### INHERITED DEFECTS OF THE CIRCULATORY SYSTEM 1944

Bovine hereditary dilated cardiomyopathy 1944  
Inherited lymphatic obstruction 1945  
Inherited ventricular septal defect 1945  
Inherited aortic aneurysm 1945  
Bovine Marfan syndrome 1945  
Inherited congenital porphyria 1945  
Inherited erythrocytic protoporphyria 1946  
Hemochromatosis 1946  
Familial polycythemia 1947  
Inherited bleeding disorders 1947  
Inherited anemias 1947

### INHERITED DEFECTS OF THE URINARY TRACT 1948

Inherited nephrosis (mesangiocapillary glomerulonephritis) 1948  
Chronic interstitial nephritis 1948  
Inherited cystic renal dysplasia 1948  
Inherited bilateral renal hypoplasia 1948  
Inherited renal tubular dysplasia 1948  
Inherited renal lipofuscinosis in Danish slaughter cattle 1948

### INHERITED DEFECTS OF THE NERVOUS SYSTEM 1948

Inherited lysosomal storage diseases 1948  
Mannosidosis 1948  
Gangliosidoses 1949  
Ceroid lipofuscinosis 1950  
Globoid cell leukodystrophy 1950  
Inherited nervous system abiotrophies 1950  
Caprine progressive spasticity 1951  
Cerebellar abiotrophy 1951  
Inherited neurodegeneration (shaker calf syndrome) 1951  
Inherited progressive degenerative myeloencephalopathy (weaver syndrome) 1951  
Inherited spinal dysmyelination 1951  
Inherited progressive ataxia 1952  
Inherited spinal dysraphism 1952  
Inherited spinal myelinopathy 1952  
Inherited multifocal symmetrical encephalopathy 1952  
Inherited bovine degenerative axonopathy 1952  
Inherited ovine degenerative axonopathy (neuraxonal dystrophy) 1952  
Inherited spontaneous lower motor neuron disease 1953  
Inherited maple syrup urine disease (branched chain ketoacid decarboxylase deficiency - BCKAD) 1953  
Inherited citrullinemia 1953  
Equine degenerative myeloencephalopathy 1953  
Inherited congenital hydrocephalus 1954  
Inherited prosencephaly 1954  
Inherited hydranencephaly and arthrogryposis 1954  
Inherited congenital cerebellar defects 1954  
Inherited spastic paresis (also heel) 1955  
Inherited periodic spasticity of cattle 1956  
Inherited neonatal spasticity 1956  
Inherited congenital myoclonus (hereditary neuraxial edema) 1956  
Inherited congenital posterior paralysis 1956  
Inherited congenital myotonia 1957  
Inherited hypomyelinogenesis (congenital tremor of pigs) 1957  
Exophthalmos with strabismus 1957  
Familial undulatory nystagmus 1957  
Inherited idiopathic epilepsy of cattle 1957  
Familial narcolepsy 1957  
Doddler calves 1957

### INHERITED DEFECTS OF THE MUSCULOSKELETAL SYSTEM 1957

Inherited diseases of bones 1957  
Inherited osteoarthritis 1957

Inherited osteogenesis imperfecta 1957  
Inherited dwarfism 1958  
Congenital osteopetrosis 1959  
Inherited probatocephaly (sheepshead) 1959  
Inherited atlanto-occipital deformity 1959  
Inherited agnathia 1959  
Inherited displaced molar teeth 1959  
Inherited jaw malapposition 1959  
Inherited cranioschisis (cranium bifidum) 1959  
Inherited craniofacial deformity 1959  
Inherited arachnomelia (inherited chondrodysplasia) 1959  
Complex vertebral malformation in Holstein calves 1960  
Inherited acroteriasis (amputates) 1960  
Inherited reduced phalanges (amputates, acroteriasis, ectromelia) 1960  
Inherited claw deformity 1961  
Inherited multiple exostosis 1961  
Inherited congenital hyperostosis (thick forelimbs of pigs) 1961  
Inherited rickets 1961  
Inherited taillessness and tail deformity 1961

### INHERITED DISEASES OF JOINTS 1961

Inherited arthrogryposis (inherited multiple tendon contracture) 1961  
Inherited multiple ankylosis 1962  
Inherited patellar subluxation 1962  
Inherited hypermobility (laxity) of joints 1962  
Inherited hip dysplasia 1962

### INHERITED DISEASES OF MUSCLES 1962

Generalized glycogenosis (glycogen storage disease Type II) 1962  
Glycogen storage disease Type V (muscle glycogen phosphorylase deficiency) 1963  
Familial polysaccharide storage myopathy (equine rhabdomyolysis syndrome) 1963  
Inherited diaphragmatic muscle dystrophy 1963  
Congenital myasthenia gravis 1963  
Bovine familial degenerative neuromuscular disease 1963  
Inherited umbilical and scrotal hernias, cryptorchidism, and hermaphroditism 1963  
Myofiber hyperplasia (double muscling, doppelender, culard) 1964  
Pietrain creeper pigs 1965  
Inherited progressive muscular dystrophy 1965  
Inherited spinal muscular atrophy 1965  
Inherited splayed digits 1965  
Equine hyperkalemic periodic paralysis 1965

Recurrent exertional rhabdomyolysis in thoroughbred horses (azoturia, tying up, chronic intermittent rhabdomyolysis) 1966  
 Porcine stress syndrome (PSS; malignant hyperthermia) 1968

#### INHERITED DEFECTS OF THE SKIN 1973

Inherited symmetrical alopecia 1973  
 Inherited congenital hypotrichosis 1973  
 Inherited hair coat-color-linked follicle dysplasia 1974  
 Inherited birthcoat retention 1974

Inherited leukoderma 1974  
 Inherited albinism and lethal white foal syndromes 1974  
 Inherited epidermal dysplasia (baldy calves) 1974  
 Inherited parakeratosis (lethal trait A46, adema disease) 1975  
 Inherited dyserythropoiesis-dyskeratosis 1975  
 Inherited congenital absence of the skin 1975  
 Inherited crop ears 1975  
 Inherited hyperbilirubinemia and photosensitization 1975

Inherited congenital ichthyosis (fish-scale disease) 1976  
 Inherited dermatosis vegetans 1976  
 Dermatosparaxis (hyperelastosis cutis) 1976  
 Inherited melanoma 1976  
 Inherited hyperhidrosis 1976

#### MISCELLANEOUS INHERITED DEFECTS 1976

Inherited eye defects 1976  
 Inherited prolonged gestation (adenohypophyseal hypoplasia) 1977

## Introduction

### GENERAL

Genetic disorders are a small but important cause of wastage in farmed animals. Most occur in pure-bred animals and are inherited as autosomal recessive traits because dominant disorders tend to be self limiting, or affected animals are excluded from the breeding pool. Incomplete dominants occasionally occur in which there are three potential phenotypes, i.e. normal, affected, and more severely affected. The classic example is in the original Dexter cattle where the slightly dwarfed Dexter phenotype is dominant to the normal and is selected for. Animals homozygous for the gene abort with a non-viable 'bulldog' type fetus.<sup>1,2</sup> Sex-linked disorders may occur but are uncommon. Some monogenic disorders may arise *de novo* due to new mutations of germ plasm. Those with a dominant mode of inheritance are present in offspring of the animal in question, usually affecting genes for structural proteins such as collagen. A new mutation should be considered with disorders such as *osteogenesis imperfecta* or skin fragility.<sup>3</sup> The proportion of offspring with the defect may vary depending on what stage of gametogenesis the mutation occurred.

In-breeding, knowingly or unknowingly practiced, is an important feature in the manifestation of most outbreaks of a recessive disorder. Founder effect is an aspect of this that has been important when new breeds have been introduced to a country by importation of genetic material from a small number of individuals. Artificial breeding on a large and international scale has sometimes exacerbated this, particularly in cattle.

Genetic disorders may be manifested as disease or bodily malformation. When diagnosed, an entity may reflect the tip of an iceberg only and it can be expected that many other cases go undiagnosed. Spread across an industry their economic importance may be limited, but as particular disorders tend to be concentrated

in certain herds/flocks they may have considerable importance to an individual breeder, particularly those involved with pedigree breeding. Animal welfare is also a concern to be addressed, being driven by a greater awareness of ethical standards in livestock production and by potential market access requirements.

The two main problems for the clinician investigating a suspected inherited disorder are to confirm a primary genetic cause and then to institute control in a cost-effective manner.

### DIAGNOSIS

For a number of inherited diseases or malformations known to occur in a breed, morphology or histopathology may be so characteristic as to be essentially pathognomonic. However, for some disorders environmental agents (teratogens) may cause similar morphological anomalies, e.g. arthrogyposis, so care should be taken. Pedigree analysis may help if there are sufficient animals of known breeding to show that the incidence of the disorder follows a Mendelian pattern. However, in many herds/flocks animals may be closely related and pedigree analysis can sometimes be misleading and produce a fictitious relationship between inheritance and disease. As the biochemical anomaly is now known for many diseases, or perhaps can be deduced from histopathological lesions, laboratory tests may confirm a presumptive diagnosis. Test mating of a sire to daughters, related females, or females that have given birth to an affected animal is the ultimate confirmation of the genetic nature of a disorder, provided the appropriate numbers of progeny are generated. Disproving a genetic cause of a disorder may be as important as proving it. Matings of a sire to produce a minimum of 24 progeny from his daughters or 12 from putative heterozygotes (females that have given birth to affected individuals) are usually considered satisfactory numbers to exclude a likely inherited cause if no affected individuals are born ( $P < 0.5$ ). The birth of a proportion of affected off-

spring is strong evidence of inheritance. The use of super-ovulation and embryo transfer techniques may facilitate this, particularly if insufficient daughters or putative heterozygotes are available. The time to accomplish this may be decreased by caesarian section of the surrogate dams if the defect can be detected in the fetuses.

The degree of in-breeding is an important indicator of whether a congenital disorder is inherited or not. Consistency of the defect is a characteristic of inherited disorders but there may be some variation in age of onset or expressivity of lesions. Other epidemiological factors include the occurrence of the defect over more than 1 year and occurrence or repetition of it in the same mating group, but not in others on the property.

### CONTROL OF INHERITED DISEASE

Appropriate control measures may vary, depending on the importance of the disorder and may be aimed at the herd/flock level or at the breed as a whole. It may be prospective but, at the farm level, it is mainly reactive with the purpose of preventing further losses by immediate action. This should include not breeding from putative heterozygous sires or females which should preferably be culled. Replacement sires are best acquired from another breeder but, if the defect is common in the breed, then the risk may remain and cross breeding with a sire from another breed may be considered if the type of farm operation permits it. If a test is available for detecting heterozygous animals then this can be used in new sire selection.

Control of genetic disorders in pedigree herds is more complex and to be effective depends on ability to detect heterozygotes or prove animals do not carry the recessive gene in question. Test mating is time consuming, expensive, and of limited application. The explosion of knowledge concerning the biochemical and molecular genetic basis of inherited diseases across species has opened up effective means of diagnosing genotype

for many of them. Control may be at an individual herd/flock level or applied to all at risk. It is best instigated with the help of breed societies who may exert control over the fate of animals diagnosed as heterozygous through control of registrations. Apart from the accuracy of genetic tests in genotype diagnosis, there is the added advantage that particularly valuable animals may be kept within the herd/flock for breeding as their offspring can in turn be tested as normal or heterozygous.

The first generation of tests for heterozygotes was biochemical being based on knowledge of the enzyme deficiency and the gene dosage phenomenon. Heterozygous animals having one normal and one mutant gene have enzyme values midway between normal and diseased values, although there may be some overlap. Supplementary tests or knowledge of the parents' genotype may assist with clarification of equivocal results. Such tests were used to control the economically important lysosomal storage diseases  $\alpha$ -mannosidosis in Angus and Murray Grey cattle in New Zealand and Australia<sup>4</sup> and Glycogen storage disease type II in Shorthorn and Brahman cattle in Australia.<sup>5</sup> These have now given way to more accurate second-generation technology based on DNA for these diseases as well as a number of others.<sup>6-8</sup> Such tests may be performed on blood samples but are increasingly being done on hair roots.

The genome for the major farm species is essentially known and, given the will and enough affected families, the technology exists to develop tests for most disorders. If the disorder in question is poorly defined biochemically, then tests are still possible by finding a closely linked polymorphic gene marker. This is usually the first step in investigating the molecular genetics of an unknown disease but it is expensive. In contrast, if a candidate gene can be deduced from the pathology of the disease, then it is much simpler to define the mutation and through polymerase chain reaction (PCR) technology develop a DNA based test.

Artificial breeding techniques have the capacity to spread undesirable genotypes widely before they are recognized. Many artificial breeding organizations involved in the dairy industry prospectively screen for genetic disorders by mating prospective sires over a proportion of their daughters. This is possible because of the time taken to prove a sire before he enters the industry on a large scale.

disorders and traits in animal species (other than human and mouse) authored by Professor Frank Nicholas of the University of Sydney, Australia, with help from many people over the years. The database contains textual information and references, as well as links to relevant records from OMIM, PubMed, Gene, and soon to be NCBI's phenotype database.

#### REVIEW LITERATURE

- Agerholm JS et al. Investigations on the occurrence of hereditary diseases in the Danish cattle population. *Acta Vet Scand* 1993; 34:245.
- Healy PJ. Testing for undesirable traits in cattle. *J Anim Sci* 1996; 74:917.
- Huston K. Hereditability and diagnosis of congenital abnormalities in food animals. *Vet Clin North Am: Food Anim Pract* 9.1, 1993; 1.
- Jolly RD, Healy PJ. Screening for carriers of genetic diseases by biochemical means. *Vet Rec* 1986; 119:264.
- Jolly RD, Blair HT, Johnstone AC. Genetic disorders of sheep in New Zealand: A review and perspective. *NZ Vet J* 2004; 52:52-64.
- Nicholas FW, Harper PAW. Inherited disorders; the comparative approach. *Aust Vet J* 1995; 73:64.

#### REFERENCES

1. Harper PAW et al. *Aust Vet J* 1998; 76:199.
2. Harper PAW. Proc. First World Congress on Dexter Cattle. (Ed., A. Sheppy), The Dexter cattle Society, Dulverton, U.K. 1998; 92.
3. Arthur DG et al. *New Z Vet J* 1992; 40:112.
4. Jolly RD. *New Z Vet J* 50 (Suppl). 2002; 90:2002.
5. Healy PJ. Diagnosis of genotypes for generalized glycogenesis in cattle. *Biochem Med* 1982; 28:224.
6. Berg T et al. *Res Vet Sci* 1997; 63:279.
7. Dennis JA, Healy PJ. *Aust Vet J* 2001; 79:773.
8. Dennis JA et al. *Aust Vet J* 2002; 80:286.

### Diseases characterized by chromosomal anomalies

The principal advance in cytogenetics in agricultural animals has been in the field of fertility in cattle but freemartinism and structural translocations are the only groups to have been well documented. Other chromosomal abnormalities in other species are recorded but not in sufficient numbers to make a coherent account possible; details of them should be sought in the theriogenology literature. Besides the many identifications of individual infertile males and females by this means there is the probability that chromosomal aberrations characterized by aneuploidy are the cause of many stillbirths and multisystemic anomalies that make neonates non-viable.<sup>1,2</sup> A true hermaphrodite in a horned goat with 60 XX/60 XY chimerism has been described.<sup>3</sup>

Chromosomal analysis techniques are based on tissue culture using leukocytes collected in a highly aseptic manner. The blood is placed in tissue culture medium containing a stimulant to cell division.

After brief incubation, cell division is arrested by the addition of a cytotoxic agent and the cells are then swollen osmotically by treatment with a hypotonic solution, then fixed and dried onto slides and stained. Microscopic examination of dividing cells allows the total number of chromosomes in each cell to be counted, and the sex chromosomes and abnormal chromosomes identified. The individual chromosomes are cut out from photographic prints, paired, and stuck onto cards to create the document used for identification – the **karyotype**. The number of cells subjected to chromosomal analysis in each case is usually 10–20, but 50 are recommended for satisfactory accuracy.

#### FREEMARTINISM IN CALVES

A freemartin is defined as a sterile female partner of a pair of heterosexual twins. In cattle, 92% of females born co-twins to males are freemartins.

In normal calves the chromosomal identification of females is 60 XX (60 chromosomes, both X chromosomes) and of males is 60 XY (the Y being smaller and not readily paired with its opposite X chromosome).

The freemartin is the classical example of the chimera in cytogenetics. They are the individuals which contain two or more cell types which originated in separate individuals. The only way in which chimera can develop is via the fusion of circulations or zygotes *in utero*. Sex chromosome chimerism is also reported in goats, sheep, and pigs, and, although the male partners of female twins are usually anatomically normal, they often have reduced fertility. Bulls born co-twin with freemartin females may also be chimeric and have low reproductive efficiency.

The diagnosis of freemartinism has been based on physical examination, karyotyping, or blood typing and each has its limitations. There is variation in the degree of reproductive tract abnormalities in freemartins. The external genitalia may appear normal, the vulval hair may be coarser than usual or the clitoris may be enlarged. The vagina is generally expected to be shorter than normal. The cervix, uterus, uterine tubes, and ovaries may be absent, present in underdeveloped form, or may appear normal on rectal palpation.

Special cytogenetic techniques are also available which facilitate the diagnosis of freemartinism in a female calf of a male-female twinning. In freemartins (phenotypically female, but carrying also male cells) there is a mixture of mostly 60 XX chromosomes to a cell, and a small proportion of 60 XY cells. A large number of cells need to be analyzed if only the

#### ONLINE MENDELIAN INHERITANCE IN ANIMALS (OMIA)

Online Mendelian Inheritance in Animals (OMIA) is a database of genes, inherited



freemartin calf is available because the proportion of abnormal cells present may be as low as 2%. It is, however, possible to make a diagnosis on the examination of 10–20 cells, provided the male twin is also analyzed; the female may have very few XY chromosomes but the male will have a very high proportion of XX chromosomes. The technique is much more accurate than blood group analysis, or clinical observations of a short vagina, enlarged clitoris and the presence of a vulval tuft of hair. Karyotyping is a definitive method of freemartin diagnosis but it is tedious, time consuming, and expensive. Blood typing analysis may be performed on both the male and female co-twins in order to demonstrate two blood group populations, but it is expensive and requires blood samples from both co-twins.

The **polymerase chain reaction (PCR)** method of freemartin diagnosis using sex-specific DNA sequences is rapid, accurate, relatively simple, and inexpensive to perform and a blood sample is required only from the female co-twins.<sup>4</sup> It allows for the accurate decision of freemartinism down to a level of 0.05% of male chimeric cells present.

### CHROMOSOMAL TRANSLOCATIONS IN CATTLE

When two chromosomes which have previously been broken have fused to form a morphologically distinct chromosome this is known as a translocation. It is further identified by the chromosomal series involved. Thus a 1/29 translocation represents a fusion between a chromosome of each of the pairs numbered 1 and 29.

**Translocation 1/29** has been identified in many breeds of cattle and has been associated with significant reductions in the fertility of cows bred by artificial insemination (AI) services. Early embryonic death occurs in embryos produced by fertilization of affected gametes or fertilization of normal gametes by spermatozoa carrying the 1/29 translocation. There is no abnormality of serving behavior or semen quality. The translocation has been shown to be inherited in most European beef breeds including the Blonde d'Aquitaine, Swedish Red and White, Charolais,<sup>5</sup> Danish Limousin,<sup>6</sup> British Friesian<sup>7</sup> and Red Poll breeds and in the wild British White cattle. In Bolivian Creole cattle breeds, the Creole-like cattle, the average frequency was 10.42% with a variation from 0 to 28.2%.<sup>8</sup> In contrast, Yacumeno and Creole-type cattle did not show the centric fusion. The highly significant differences between Creole cattle breeds in relation to the 1/29 translocation could be the consequence of factors such as founder group, genetic drift, and selection.

The low frequency observed in the Saavendreh Creole dairy cattle might be due to breeding under a more intensive system, and selection according to milk yield and fertility traits. The frequency of affected animals in a breed may vary between 1 and 20%. Karyotyping and culling of abnormal bulls in most artificial breeding centers has reduced the impact of the defect.

**Translocations 1/21, 2/4, 14/20, and 13/2** have also been identified in bulls, the 1/21 in Holstein Friesian cattle,<sup>9</sup> and the latter two seeming to be widespread in Simmental cattle.<sup>10</sup> None of them has been linked with a disease but it is becoming accepted practice not to use such animals for artificial insemination, and in some countries to refuse their importation.

A cytogenetic survey of Holstein bulls at a commercial AI unit to determine the prevalence of bulls with centric fusion and chimeric anomalies found that chimeric fusion is extremely rare in Holstein blood lines available by AI in the United States.<sup>11</sup> However, chimeric bulls are more common and reportedly have decreased reproductive performance. Because of the possibility of de novo onset of chimeric fusion at any time, early cytogenetic screening should be encouraged for prospective bulls intended for AI programs.

**Translocation 27/29** is suspected of being associated with reduced fertility in Guernsey cattle. These and other abnormalities of chromosomal structure were detected in an examination of a large number of infertile dairy heifers.

### CHROMOSOMAL TRANSLOCATIONS IN SHEEP

The literature on chromosomal aberrations in sheep has been reviewed.<sup>12</sup> Centric-fusion (Robertsonian) translocations have been described in sheep in New Zealand. There is no evidence to suggest that these centric-fusions, in a variety of combinations, affect the overall total reproductive performance of domestic sheep, as unbalanced spermatids failed to mature and take part in fertilization.

#### REVIEW LITERATURE

- Jolly RD, Blair HT, Johnstone AC. Genetic disorders of sheep in New Zealand: A review and perspective. *New Z Vet J* 2004; 52–64.
- McFeely RA. Chromosomal abnormalities. *Vet. Clin. North Am* 1993; 91, 11.
- Weber AF et al. Low fertility related to the 1/29 centric fusion anomaly in cattle. *J Am Vet Med Assoc* 1989; 195:643–646.

#### REFERENCES

- Coates JW et al. *Can J Vet Res* 1988; 52:258.
- Schmutz SM et al. *J Vet Diagn Invest* 1996; 8:91.
- Batista M et al. *Can Vet J* 2000; 41:662.
- Ennis S et al. *Res Vet Sci* 1999; 67:111.
- Buoen LC. *Can Vet J* 1988; 29:455.

- Nielsen JS, Christensen K. *Dansk Veterinaertidssk* 1990; 73:1036.
- Wilson TD. *Vet Rec* 1990; 126:37.
- De Luca JC et al. *Therigenol* 2002; 58:1273.
- Miyake Y et al. *J Vet Med Sci* 1991; 53:113.
- Weber AF et al. *J Am Vet Med Assoc* 1992; 200:1216.
- Seguin BE et al. *J Amer Vet Med Assoc* 2000; 216:65.
- Jolly RD et al. *New Z Vet J* 2004; 52.

### Inherited defects of the body as a whole

Many inherited defects, other than those listed in this section, probably have a metabolic defect as their basic cause, for example the abiotrophies, but they are listed elsewhere because of lack of certainty about their exact cause. Three known inherited enzyme deficiencies – bovine citrullinemia, bovine protoporphyria – are described in system groupings where their clinical signs are most prominent. Inherited vitamin C, D, and E deficiencies are dealt with in the chapter on nutritional deficiency diseases. Inherited immune deficiencies are listed in this section.

### DEFICIENCY OF UMP SYNTHASE (DUMPS)

This is a partial deficiency of an enzyme which is involved in the conversion of orotate to uridine 5'-monophosphate (UMP) as a step in the synthesis of pyrimidine nucleotides. It is recorded at a high prevalence in Holstein Friesian cattle in the US and is characterized by an autosomal recessive form of inheritance and the secretion of high levels of orotate in the milk. Heterozygous animals have a partial deficiency of UMP synthase<sup>1</sup>; they have no individual or herd clinical abnormalities but can be detected biochemically by their half-normal levels of erythrocyte UMP synthase. Bovine homozygotes die at about the 40th day of pregnancy.<sup>2</sup> Embryonic mortality is the only form of loss.

#### REFERENCES

- Robinson JL et al. *Livestock Prod Sci* 1993; 36:287.
- Shanks RD et al. *J Dairy Sci* 1989; 72:3035.

### INHERITED GOITER

This disease is recorded in Merino sheep, Afrikaner cattle, crossbred Saanen dwarf goats, Boer goats, possibly Poll Dorset sheep, and pigs,<sup>1</sup> and appears to be inherited as a recessive character. The essential defect is in the synthesis of abnormal thyroid hormone leading to increased production of thyrotropic factor in the pituitary gland, causing in turn a hyperplasia of the thyroid gland. In Afrikaner cattle the defect stems from an abnormality of the basic RNA, and

heterozygotes can be identified by blot hybridization analysis.<sup>2</sup>

Clinically in **sheep** there is a high level of mortality, enlargement of the thyroid above the normal 2.8 g, but varying greatly up to 222 g, and the appearance of 'lustrous' or 'silky' wool in the fleeces of some lambs. Other defects which occur concurrently are edema and floppiness of ears, enlargement of, and outward or inward bowing of, the front legs at the knees, and dorsoventral flattening of the nasal area. The thyroglobulin deficiency in the neonatal lamb may result in defective fetal lung development and the appearance of a neonatal respiratory distress syndrome; there is dyspnea at birth.

The clinical picture in **goats** is the same as for lambs. It includes retardation of growth, sluggish behavior, rough, sparse hair coat, which worsens as the goats get older, and a thick scaly skin.

In **Afrikaner cattle** most of the losses are from stillbirths or from early neonatal deaths. Some are caused by tracheal compression from the enlarged gland. It is the calves with the largest glands that have the greatest mortality. In these cattle there may be a concurrent inherited gray coat color, a defect in a red breed.

In **pigs** hairless and swollen piglets with enlarged thyroid glands occur, in the proportions with normal piglets consistent with an autosomal recessive mode of inheritance.

## REFERENCES

1. Welchman DD et al. *Vet Rec* 1994; 135:589.
2. Ricketts MH, Vandenplas SJ. *J South Afr Vet Assoc* 1990; 61:9.

## INHERITED IMMUNODEFICIENCIES

Many of these diseases have been previously characterized as diseases of other body systems but are now correctly classified by the wider acceptance of clinicopathological examinations, especially those involving immunological studies. The group is probably still in a period of transition (see Chapter 9).

## REVIEW LITERATURE

McVey DS, Tizard I. (1993) Primary immunodeficiencies of food animals. *Vet. Clin. North Am.*, 9.1, 65.

## BOVINE LEUKOCYTE ADHESION DEFICIENCY (BLAD)

This granulocytopenia is inherited as an autosomal recessive trait in Holstein-Friesian cattle. Homozygotes are not viable because of their low resistance to infection. Heterozygotes are unaffected. Signs are observed first between 2 weeks and 8 months, and are characterized in most cases by bouts of infectious disease, e.g. persistent fever, diarrhea, cough,

dyspnea, delayed wound healing, and stunted growth.<sup>1</sup> Some cases exhibit a striking periodontal gingivitis with marked retraction of the gingiva, and severe resorption of mandibular bone causing premature teeth loss.<sup>2</sup> In a small proportion of cases the signs are limited to unthriftiness.<sup>3</sup> Severe ulcers on oral mucosa, severe periodontitis, loss of teeth, chronic pneumonia, and recurrent or chronic diarrhea are common.<sup>1</sup>

The clinical pathology is characterized by a severe and persistent neutrophilia, without a left shift, and a significantly increased cellularity of bone marrow.<sup>4</sup> At necropsy there are very large numbers of intravascular neutrophils in all tissues, especially the spleen, but not in infected tissues, which may include bronchopneumonia, pseudomembranous or necrotizing enteritis, and granulomatous gingivitis.<sup>5</sup> Intestinal ulcers are an essential part of the pathogenesis of the disease in chronically affected animals which receive intensive medical care.<sup>6</sup> Affected animals are stunted and unlikely to live as long as 2 years.

The gene frequency is widespread in the Holstein-Friesian breed. The genetic basis for the disease is a single point mutation in the gene coding for CD18, a subunit of the  $\beta_2$  integrins, surface glycoproteins which are important to cell adhesion processes, causing a deficiency of adhesion on the surface of leukocytes.<sup>7</sup> Neutrophils from BLAD cattle have impaired expression of  $\beta_2$  integrin (CD11a, b, c/CD 18) of the leukocyte adhesion molecule. The biochemical basis for the disease is a deficiency of interaction between receptors on the leukocytes with adhesion glycoproteins in the mediation of immunological functions.<sup>8</sup> A polymerase chain reaction test is available for the detection of heterozygotes<sup>9</sup> and an eradication program is operating in Japan<sup>10</sup> and the US.<sup>11</sup> Heterozygotes have poorer feed utilization and growth rates than non-carriers of the inheritance.<sup>12</sup> Control of BLAD in Holstein cattle requires publishing the genotypes and avoiding the mating between BLAD carriers which is successful.<sup>1</sup> Heterozygote calves are not affected.<sup>13</sup>

## REVIEW LITERATURE

Nagahata H. Bovine leukocyte adhesion deficiency (BLAD): A review *J Vet Med Sci* 2004; 66:1475-1482.

## REFERENCES

1. Nagahata H. *J Vet Med Sci* 2004; 66:1475-1482.
2. Nagahata H et al. *Can J Vet Res* 1995; 59:316.
3. Agerholm JS et al. *Acta Vet Scand* 1993; 34:237.
4. Nagahata H et al. *Am J Vet Res* 1995; 56:167.
5. Stadler P et al. *J South Afr Vet Assoc* 1993; 64:172.

6. Ackerman MR et al. *Vet Pathol* 1996; 33:273.
7. Mirck T et al. *Cell Mol Biol* 1995; 41:695.
8. Worku M et al. *Am J Vet Res* 1995; 56:435.
9. Tammen I et al. *Res Vet Sci* 1996; 60:218.
10. Nagahata H et al. *World Assoc. Buiatrics*, 19th Congress, 1996; 1-3, 489.
11. Powell RL et al. *J Dairy Sci* 1996; 79:895.
12. Jorgensen JM, Madsen P. *Acta Agric Scand Section A, Animal Sci* 1997; 47:1.
13. Arrayet JL et al. *J Anim Sci* 2002; 80:545.

## INHERITED DEFICIENCY OF LYMPHOCYTE MATURATION (LETHAL TRAIT A46, PARAKERATOSIS, ADEMA DISEASE)

This defect is recorded in Black Pied Danish cattle but probably occurs in a number of European breeds of cattle, including Friesian-type cattle, and in beef Shorthorn calves in the US.<sup>1</sup> It is a defect of lymphocyte maturation and is inherited as an autosomal recessive character.

Calves are normal at birth and signs appear at 4-8 weeks of age; untreated animals die at about 4 months of age. There is exanthema and loss of hair, especially on the legs, parakeratosis in the form of scales or thick crusts around the mouth and eyes, under the jaw, and on the neck and legs, and a very poor growth rate. Lymphocyte numbers and function are reduced when the patient is in a zinc-deficient state,<sup>2</sup> and antibody responses are suppressed.

At necropsy the characteristic skin lesion is acanthosis and hyperkeratosis and there is atrophy of the thymus, spleen, lymph nodes, and gut-associated lymphoid tissue.

There is a significant response to oral treatment with zinc (0.5 g zinc oxide/day) and an apparently complete recovery can be achieved in a few weeks if treatment is continued. The disease reappears if treatment is stopped. The dose rate needs to be increased as body weight increases. It is thought that the disease is an inherited excessive requirement for zinc and that the thymic hypoplasia is due to the dietary deficiency. Absorption studies with radioactive zinc have shown that there is impaired absorption of the element.

## REFERENCES

1. Vogt DW et al. *Am J Vet Res* 1988; 49:120.
2. Perryman LE et al. *Vet Immunol Immunopathol* 1989; 21:239.

## INHERITED DEFICIENCY OF IMMUNOGLOBULIN SYNTHESIS

An inherited complete deficiency of IgG<sub>2</sub> occurs in Red Danish cattle at a low level of incidence. Affected animals are unusually susceptible to severe infections including gangrenous mastitis and pneumonia.

## CHEDIAK-HIGASHI SYNDROME

This inherited disease occurs in humans, in mink, and in Hereford, Japanese Black, Brangus cattle,<sup>1,2</sup> and possibly other breeds of cattle. Clinically affected animals grow poorly; they are incomplete albinos with generalized oculocutaneous hypopigmentation, e.g. pale gray hair, ocular iridal and fundic hypopigmentation, photophobia and lacrimation, and have anemia, enlarged, edematous lymph nodes, and a defect in immune defense mechanisms so that they often die of septicemia. Their average life span is about 1 year. The immunological defect has been identified as one of insufficient bactericidal activity within abnormal leukocytes. The clinical, morphologic, and biochemical characteristics of Chediak-Higashi syndrome in Japanese cattle has been described.<sup>2</sup>

A mutation in the Chediak-Higashi 1/LST gene is likely responsible for the disease in Japanese Black cattle.<sup>3</sup> The LYST gene responsible for the mutation has been cloned.<sup>4</sup>

The disease is readily diagnosed by the detection of anomalous enlarged cytoplasmic granules in neutrophils, lymphocytes, monocytes, and eosinophils. The granules are swollen lysosomes, and the disease is a lysosomal storage disease. There is also a defect in blood clotting, and this has been identified as a metabolic defect within structurally abnormal platelets. The platelets have a storage pool deficiency of dense granules and produce much less serotonin, ATP, and ADP than normal platelets. The platelets also fail to aggregate normally in response to the presence of collagen.<sup>5</sup> The disease is conditioned by a factor inherited as a single autosomal recessive.<sup>6</sup>

A DNA diagnostic system using allele-specific PCR for detection of the nucleotide substitution has been developed as an effective DNA diagnostic aid.<sup>7</sup>

### REVIEW LITERATURE

Scott-McVey D, Tizard I Primary immunodeficiencies of food animals. *Vet Clin North Am* 9.1, 1993; 65.

### REFERENCES

1. Ayers JR et al. *Vet Pathol* 1988; 25:432.
2. Ogawa H et al. *Amer J Vet Res* 1997; 58:1221.
3. Kuneida T et al. *Animal Genetics* 1999; 31:87.
4. Kuneida T et al. *Mammalian Genome* 1999; 10:1146.
5. Suzuki T et al. *J Vet Med Sci* 1996; 58:647.
6. Tu CH et al. *J Vet Med Sci* 1996; 58:501.
7. Nakagiri M et al. *Animal Science Journal* 1999; 70:372.

## PSEUDOALBINISM AND LETHAL WHITES

There are a number of forms of pseudoalbinism in domestic animals. There is a non-lethal form in cattle and a lethal dominant in horses in which 25% of conceptions produced by mating dominant white

horses die *in utero* in early gestation. The only pigment in the affected foals is in the eyes.

The disease in **cattle** occurs in Angus, Brown Swiss, Holstein, and Hereford cattle. The Angus cattle have a brown coat and two-tone irises with an outer pale brown ring and an inner blue one. There appears to be no defect in digestion or metabolism. Hereford incomplete albinos have the Chediak-Higashi syndrome. The other breeds do not appear to have defects other than in pigmentation and the defect in Angus is probably more accurately called 'oculocutaneous hypopigmentation'. They do have one problem; they are photophobic and prefer to be out of the sun.

A complete albinism in Icelandic **sheep** is manifested by white skin color, pink eyes, and impaired vision in bright light. It is an autosomal recessive. Albinism is also a problem in Karakul sheep.

True albino **horses** rarely if ever occur in nature, but white horses with pigmented eyes do. They are more accurately called pseudoalbinos. A recessive lethal white can also be produced by mating two Overo paint horses (an Overo is a horse with a coat color pattern where white is continuous over the body, but there is pigmented hair in a patch stretching from the ears to the tail). Affected foals develop colic soon after birth, fail to pass meconium, and die at 2-4 days of age. At necropsy there is an irreparable atresia or contraction of the colon associated with a congenital absence of myoenteric ganglia in the terminal portion of the ileum and the cecum and colon. The colon is patent but unable to dilate. Another variety of paint horses, the Tobiano (white markings extend from the dorsal midline ventrally with limbs usually white, and white covering a large part of the horse or very little), are expected to produce lethal whites also but there is no record of it.<sup>1</sup> Both of these varieties of paints have blue or heterochromic irises.

### REFERENCE

1. Hultgren BD et al. *Equine Pract* 9(10) 1987; 38.

## FELL PONY SYNDROME

This is a familial disease of Fell ponies characterized by immunodeficiency, anemia, opportunistic infection, and death at 2-3 months of age.

### ETIOLOGY

The disease is a putative autosomal recessive genetic defect of the immune system, although the exact nature of the defect has yet to be determined.

### EPIDEMIOLOGY

The disease is restricted to Fell pony foals less than 3 months of age. The disease is

reported in this breed in the United Kingdom, one case is reported in the United States (which has a total population of Fell ponies of <200) and a case is reported in the Czech Republic.<sup>1-3,7</sup> The frequency of the disease is not reported. The case fatality rate is 100%.

### PATHOGENESIS

There is immunodeficiency associated with low concentrations of immunoglobulins in serum and B lymphocytes in blood. T lymphocytes are present in normal concentration and respond appropriately to *in vitro* proliferation tests. Death is coincident with declines in concentrations of antibodies derived from colostrum. Immunodeficiency results in development of opportunistic infections including glossitis, adenoviral pneumonia, and cryptosporidial diarrhea. Aplastic anemia develops and can contribute to death. Anemia is associated with aplasia of red cell series in bone marrow and is not due to hemolysis or blood loss.

### CLINICAL FINDINGS

Affected foals are lethargic at birth, are unable to keep up with the herd, and do not establish a strong bond with the dam. Foals develop ill-thrift, exercise intolerance, and diarrhea beginning at approximately 3 weeks of age. Clinical signs are attributable to anemia and opportunistic infections. At the time that foals develop other clinical abnormalities they are pyrexemic and tachypneic. Most foals have bilateral mucopurulent nasal discharge and abnormal lung sounds consistent with pneumonia. The tongue is covered by a pseudomembranous, hyperkeratotic membrane suggestive of *Candida* sp. infection. Foals develop diarrhea and progressive illness with death occurring by 3-4 months of age even in cases treated aggressively.

### CLINICAL PATHOLOGY

The underlying hematology and serum biochemistry is influenced by the opportunistic infections that develop in all foals affected with Fell pony syndrome. Abnormalities consistently associated with the syndrome and likely as a result of the underlying disease, include anemia, B cell lymphopenia, and variable to low concentrations of immunoglobulins in serum.<sup>1,2,4</sup>

Normocytic, normochromic anemia (6-26%, 6-26 L/L) is present in almost all affected foals. There is no evidence of regeneration in the blood and examination of bone marrow reveals an elevated myeloid:erythroid ratio (21:1 to 62:1, reference values 0.5:1 to 1.5:1).<sup>1</sup> There is no evidence of hemolysis.

White blood cell concentration in affected foals is usually below or in the

lower range of the reference range of normal, age-matched foals, and is attributable to a B-cell lymphopenia.<sup>5,6</sup> Concentrations of CD4+ and CD8+ cells in blood are normal in affected foals.<sup>5,6</sup> The concentration of neutrophils is often elevated in affected foals.

Concentrations of immunoglobulins (IgG<sub>a</sub>, IgG<sub>b</sub>, IgG(T), and IgM) in serum are variable and depend on the amount of immunoglobulin ingested in colostrum and the age of the foal. Affected foals are unable to produce immunoglobulins and therefore have declining concentrations of immunoglobulins with age. Serum concentrations of IgM and IgA become

undetectable before does IgG – a consequence of the shorter half-life of the former immunoglobulins in foals. Measurement of low to undetectable concentrations of IgM at >4 weeks of age provides a reasonable means of diagnosing the disease.<sup>6</sup>

**NECROPSY FINDINGS**

Gross lesions include pale bone marrow, small thymus and lymph nodes, pneumonia, and pseudomembranous glossitis. The underlying disease is characterized by lesions in bone marrow and lymphoid tissue. Bone marrow has evidence of abnormal hemopoiesis with an elevated myeloid:erythroid ratio. Lymph nodes

have sparse to moderate numbers of lymphocytes in cortices and paracortices. The thymus has no clear demarcation of cortex and medulla and the thymic lobules are small.<sup>1,2</sup> Germinal centers are not present in the spleen and the red pulp is markedly contracted and contains siderophages. Ganglionopathy reported in foals in the original report of the disease has not been found in subsequent cases.

**DIFFERENTIAL DIAGNOSIS**

The differential diagnosis of immunodeficiency in foals is provided in Table 35.1.

Table 35.1 Defects of acquired immunity causing disease in foals and horses

Disease	Etiology	Epidemiology and clinical signs	Diagnostic confirmation	Treatment and prevention
Failure of transfer of passive immunity	Failure of mare to produce adequate quantities of colostrum with specific gravity >1.060; prepartum loss of colostrums; failure of foal to ingest or absorb colostrum	<i>Epidemiology:</i> Most common immunodeficiency of foals. Affects 5–35% of foals. Rate is reduced by good management. <i>Clinical signs:</i> Bacterial infections including bacteremia, septicemia, pneumonia, diarrhea, or septic arthritis/osteomyelitis develop between 2 days and 4 weeks of age.	Measurement of foal blood or serum concentrations of immunoglobulin >18 hours after birth. Concentration should be >800 mg/dL (8 g/L).	<i>Treatment:</i> Administration of plasma (20–40 mL/kg) IV. <i>Prevention:</i> Check colostrum specific gravity at foaling. Ensure foal nurses mare within 3 hours of birth. Supplement with banked colostrum. Routinely measure foal serum IgG at 18–24 hours of age.
Severe combined immunodeficiency of Arabians	Failure of V(D)J recombination secondary to a defect of the catalytic subunit of DNA-protein kinase coded for by the DNA-PKcs gene.	<i>Epidemiology:</i> Restricted to Arabians. Autosomal inheritance <i>Clinical signs:</i> Adenoviral pneumonia or diarrhea develop after ~ 4 weeks of age.	Severe lymphopenia (<1 × 10 <sup>9</sup> cells/L); no IgM in presuckle serum sample or sample collected at 4–5 weeks of age; histologic demonstration of lack of lymphoid tissue. Confirmation by demonstration of homozygosity for the abnormal DNA-PKcs gene.	<i>Treatment:</i> None. <i>Prevention:</i> Identification and removal of carrier animals from the breeding population.
IgM deficiency	Unknown.	<i>Epidemiology:</i> Arabian or Quarter horse foals 2–8 months of age. <i>Clinical signs:</i> Pneumonia, septic arthritis, or enteritis.	Low to undetectable serum IgM concentrations with normal to elevated concentrations of other immunoglobulins.	<i>Treatment:</i> None specific. Symptomatic treatment. Rare foal reported to recover. <i>Prevention:</i> None
Fell pony syndrome	Unknown, likely heritable genetic defect.	<i>Epidemiology:</i> Fell Pony foals <4 months of age. <i>Clinical signs:</i> Depression, fever, diarrhea, anemia, and pneumonia in foals <4 months of age.	No single confirmatory test. Presence of disease refractory to treatment in a Fell pony foal with anemia, lymphopenia and, after 4 weeks of age, low IgM concentration, is strongly suggestive. Histologic examination of bone marrow and lymphoid tissues.	<i>Treatment:</i> None effective. <i>Control:</i> Unknown pending elucidation of transmission.
Agammaglobulinemia	Unknown. Suspect sex-linked heritable defect	<i>Epidemiology:</i> Male foals. Sporadic. <i>Clinical signs:</i> Chronic infections develop at >2 months of age (corresponds with declining colostrum immunity).	Low to absent concentrations of all immunoglobulin classes in serum. No B lymphocytes detectable in blood. Normal concentrations of T lymphocytes.	<i>Treatment:</i> None specific. Supportive and symptomatic but all affected foals die. <i>Prevention:</i> None.
Common variable immunodeficiency <sup>8,9</sup>	Unknown in horses	<i>Epidemiology:</i> Adult horses. Sporadic. Either sex. <i>Clinical signs:</i> Chronic or recurrent infections unresponsive to medical treatment. Meningitis. Liver disease can occur in combination with CVI.	Low to undetectable concentrations of IgG, IgG(T), IgM, and IgA in serum. No or few B lymphocytes in blood or lymph nodes. Elevations in serum markers of liver disease.	<i>Treatment:</i> None specific. Affected animals die because of the opportunistic infections. <i>Prevention:</i> Prolonged antimicrobial administration of affected horses.

### CONFIRMATION OF DIAGNOSIS

The disease is confirmed by presence of characteristic lesions at necropsy. Antemortem diagnosis is confounded by the presence of opportunistic infections, but should be suspected in any Fell pony foal with anemia, ill-thrift, and declining serum concentrations of immunoglobulin.

### TREATMENT

There is no effective treatment. Supportive treatment of transfusions of blood or plasma, and administration of antibiotics does not affect the eventual outcome of the disease.

### CONTROL

There are no control measures for the disease pending determination of the nature of its genetic transmission. Should the presumed autosomal recessive inheritance be demonstrated, then identification of carriers and elimination of these animals from the breeding population will permit control of the disease.

### REFERENCES

1. Richards AJM et al. *Equine Vet J* 2000; 32:386.
2. Scholes SFE et al. *Vet Rec* 1998; 142:128.
3. Flaminio MJ et al. *J Vet Int Med* 2005; 19.
4. Thomas GW et al. *Vet Rec* 2003; 152:618.
5. Bell SC et al. *Equine Vet*, 2001; 33:687.
6. Thomas GW et al. *Equine Vet J* 2005; 37:48.
7. Jelinek F et al. *Vet Med A* 2006; 53:69.
8. Flaminio MJ et al. *J Am Vet Med Assoc* 2002; 221:1296.
9. Pellegrini-Masini A et al. *J Am Vet Med Assoc* 2005; 227:114.

## Inherited defects of the alimentary tract

### INHERITED DEFECTS OF THE MOUTH AND JAW

Harelip in cattle often has a distinct familial tendency but little work appears to have been done on the mode of inheritance. An apparently inherited harelip combined with poor growth and accompanying cryptorchidism is recorded in Holstein-Friesian cattle. Bilateral cleavage of the lip which also involves the maxilla is recorded in Texel sheep as being conditioned by a single recessive autosomal gene.

Cleft palate is inherited as a simple recessive character in Hereford and Charolais cattle, concurrent with arthrogryposis in the latter, and is commonly thought to be inherited in sheep and pigs. The progeny of a commercial swine herd (Landrace x Duroc) and Large White Boar contained a number of piglets with cleft palates.<sup>1</sup> Chromosomal analysis of affected piglets found all had identical unbalanced karyotype with partial monosomy of

chromosomes 16 and partial trisomy of chromosome 3, compared to normal piglets in the litters with balanced karyotypes.

Jaw deformity. Shortness of the maxilla is thought to be inherited in Jersey cattle and Large White pigs, sometimes in association with chondrodysplasia. Shortness of the mandible is also inherited in cattle, in Angus in combination with cerebellar hypoplasia and osteopetrosis.

Smooth tongue (epitheliogenesis imperfecta linguae bovis). A defect of Holstein-Friesian and Brown Swiss cattle, this condition is inherited as an autosomal recessive factor. The filiform papillae on the tongue are small, there is hypersalivation and poor hair coat, and the calves do not fare well. The heterozygote is normal.

Tongue aplasia. Congenital absence of the median part of the tip of the tongue occurs rarely in piglets, often in association with cleft palate and/or harelip.

Rectal prolapse may be inherited in piglets as a result of agenesis of the anal sphincter (see below).

### INHERITED RECTOVAGINAL CONSTRICTION

The defect is inherited in Jersey cattle and is manifested as stenosis of the rectum in either sex and stenosis of the vaginal vestibule in females. The tone of both rectal and vaginal sphincters is increased but attempts to detect heterozygotes by electromyographic measurement of these tones have been unsuccessful.<sup>2</sup> The defect is regulated by an autosomal recessive gene. Affected cows are difficult to inseminate and have difficulty in calving. Their udders are small and hard and productivity is low. The condition is due to the presence of bands of non-elastic fibrous tissue. Edema of the udder is also a common complication. Some assistance in the identification of affected animals is available by the detection of collagen type II in muscle biopsies. 50% of heterozygotes also test positively, and so do a small percentage of normals.<sup>3</sup>

### HEPATIC LIPODYSTROPHY IN GALLOWAY CALVES

Hepatic lipodystrophy has been reported occurring in Galloway calves on 5 farms in the UK over a 10-year period.<sup>4</sup> Calves appear normal after birth but die by 5 months of age. Clinically there is tremor, opisthotonus, and dyspnea before affected calves become recumbent and die. At necropsy the liver is enlarged, pale and mottled. Histologically there is evidence of hepatic encephalopathy. The cause is unknown, but limited evidence suggests a storage disease is possible.

### REFERENCES

1. Ducos A et al. *Vet Rec* 2004; 154:659.
2. Tuler SM et al. *J Vet Med A* 1988; 35:252.
3. Dawe DL et al. *J Vet Diagn Invest* 1991; 3:242.
4. Macleod NSM, Allison CJ. *Vet Rec* 1999; 144:143.

### INHERITED ATRESIA OF ALIMENTARY TRACT SEGMENTS

**Anal sphincter atresia** occurs rarely in piglets, causing rectal prolapse.

**Atresia ani** occurs quite commonly in pigs, sheep, and, to a less extent, in cattle. Affected animals may survive for up to 10 days and are identified by their depression, anorexia, colic, marked abdominal distension and lack of feces, feces being replaced by thick white mucus.<sup>1</sup> Abdominal distension in utero occasionally causes dystocia.<sup>2</sup> Surgical repair is possible in some cases but in others a large segment of rectum is missing and creation of a colonic fistula in the inguinal region is necessary. The condition is thought to be inherited in pigs and calves but supporting evidence is slim: the evidence is less clear still in sheep. A suggestion that the defect may be also associated with the manipulation of the fetus during pregnancy examination has not been supported.<sup>2</sup> A calf with atresia ani and diphallus and separate scrota has been described.

Inherited **atresia coli**, with complete closure of the ascending colon at the pelvic flexure, has been recorded in Percheron horses. A clinically similar defect in Overo horses, described in the section on pseudo-albinism, is in fact an aganglionosis. Death occurs during the first few days of life. The defect appears to be inherited as a simple recessive character.

Inherited **atresia ilei** has been recorded in Swedish Highland cattle. Affected calves manifest marked abdominal distension causing fetal dystocia. The distension is caused by accumulation of intestinal contents. Inheritance of a single recessive gene conditions the occurrence of the defect in some species and breeds but the prevalence may be higher than would be expected with that form of inheritance, especially in Jersey cattle with atresia coli.

### REFERENCES

1. Dreyfuss DJ, Tulleners EP. *J Am Vet Med Assoc* 1989; 195:508.
2. Jubb TF. *Aust Vet J* 1990; 67:382.

## Inherited defects of the circulatory system

### BOVINE HEREDITARY DILATED CARDIOMYOPATHY

Bovine hereditary dilated cardiomyopathy is a group of progressive degenerative diseases of the myocardium causing conges-

tive heart failure.<sup>1</sup> At least three different types have been reported: dilatated cardiomyopathy in cattle of Canadian Holstein origin; cardiomyopathy in Japanese Black cattle; and, cardiomyopathy in Hereford cattle.

Pedigree analysis of 75 animals in three age classes and five diagnostic classes based on clinical and pathological findings using the Pedigree Analysis Package provided strong evidence for autosomal recessive inheritance of a single major gene responsible for the disease.<sup>2</sup> Pedigree analyses of affected animals in Canada, Japan, and Switzerland, revealed that the Holstein bull 'ABC Reflection Sovereign', the son of Canadian Holstein sire Montwick Red Apple Sovereign, as the common ancestor.<sup>2</sup> The disease in cattle is being used as a research model of human dilated cardiomyopathy.<sup>3</sup> Using proteomic analysis, the examination of tissue from younger that are genetically diseased but have not yet developed clinical disease, a number of proteins have been identified whose abundance is altered significantly to suggest a possible pathogenetic mechanism for the onset of the disease.<sup>3</sup>

The disease has now been reported in Denmark in the Red Danish Dairy breed, Holsteins, and Red Holsteins.<sup>1,4</sup> Pedigree analysis of 12 cases found both maternal and paternal relationship to the Canadian sire Monwick Red Apple Sovereign, and several sires were identified as carriers of the disease. These sires originated from breeding lines used to upgrade Danish cattle populations and pose a potential animal health problem. The introduction of the defect into the Danish cattle population is an example of how widespread a genetic disease can become in a short period of time. During their active life, two sires used for artificial insemination obtained a total of approximately 62 000 living progeny.

There can be a high incidence in certain herds, possibly associated with some unrecognized environmental precipitating factor but probably caused by autosomal recessive trait concentrated by a high coefficient of inbreeding.

There are three types recorded in cattle:

#### **Type 1 calf – acute heart failure**

Sudden death of Poll Hereford and horned Hereford<sup>5</sup> calves up to 3 months of age may be due to inherited cardiomyopathy. The calves are often identifiable before death by their very rapid growth rate, short curly coat, and moderate bilateral exophthalmos. Death is usually precipitated by stress or exercise and is characterized by dyspnea, the passage of bloody froth from the nose, and a course of a few minutes to a few hours. Less acute cases have a syndrome

of congestive heart failure for several days before death. Life expectancy is less than 6 months. At necropsy there is an obvious patchiness of the myocardium, reminiscent of a bad case of white muscle disease. The disease appears to be conditioned by a single autosomal recessive gene.

#### **Type 2 calf – pulmonary edema**

A second form of inherited cardiomyopathy is recorded in Japanese Black cattle. Death is preceded by a brief period (a few minutes to a few hours) of agonizing dyspnea in calves aged 30 up to 120 days. At necropsy there is edema, ascites, hydrothorax, and marked dilatation of the left ventricle. This is matched by acute myocardial necrosis. A new autosomal recessive gene is credited with initiating the disease.

#### **Type 3 – young adult congestive heart failure**

This occurs in young adult cattle and has been reported in Holstein-Friesian cattle in Japan, Canada, the UK,<sup>6,7</sup> and Australia,<sup>8</sup> and in Simmental-Red Holstein crossbred<sup>9</sup> cattle and Black Spotted Friesian cattle in Switzerland. Similar family lines in Holstein breed have been identified in affected cattle in all three countries and it has been suggested that there is an inherited predisposition to cardiomyopathy in the Holstein breed.<sup>8</sup> Pedigree analysis of hereditary dilatated cardiomyopathy in Holstein-Friesian cattle in Japan suggests an association with hereditary myopathy of the diaphragmatic muscles.<sup>10</sup> The disease is endemic in Switzerland, occurring mainly in the Simmentaler x Red Holstein crossbreed of cattle.<sup>3</sup>

The disease occurs in cattle from 1.5 to 6 years of age with the peak prevalence in 3- and 4-year-old cattle. The stress of pregnancy and lactation may precipitate clinical disease and the majority of cases occur in late pregnancy or early lactation. The onset is sudden and the majority of cases have signs of congestive right heart failure. Edema of the submandibular area, brisket, ventral abdomen, and udder is prominent and there is venous engorgement, hepatomegaly, interstitial nephritis, pleural and pericardial effusion, and ascites. Muffling of the heart sounds, tachycardia, and a gallop rhythm are evident on auscultation of the heart. There is no characteristic biochemical or hematological change.<sup>7</sup>

Necropsy findings include congestive heart failure and histological findings compatible with congestive cardiomyopathy. There is dilation of the chambers of the heart, thickening or thinning of the ventricular wall, subcutaneous, mesenteric and pulmonary edema, hydrothorax, hepatomegaly, and ascites. Histologically there is fibrosis, myocardial degeneration, and vacuolation of cardiomyocytes and infil-

tration of mononuclear cells into the myocardium. In some cases, interstitial non-suppurative nephritis is present.<sup>7</sup> Electron microscopically, the sarcoplasm of the hypertrophic fibers is filled with fine structures of low electron-density, together with thin filamentous material, suggesting myofibrillar lysis.<sup>10</sup>

Following introduction of an eradication program based on culling of carriers in the sire population, the incidence in Switzerland has decreased.<sup>1</sup>

#### **REFERENCES**

1. Leifsson PS, Agerholm JS. *J Vet Med A* 2004; 51:332.
2. Dolf G et al. *J Anim Sci* 1999; 76:1824.
3. Weekes J et al. *Electrophoresis* 1999; 20:898.
4. Agerholm J, Leifsson P. 23<sup>rd</sup> World Buiatrics Congress. Quebec City, Canada. July 11–16. 2004; Abstack No. 622(157).
5. Storie GJ et al. *Aust Vet J* 1991; 68:119.
6. Bradley R et al. *J Comp Pathol* 1991; 104:101.
7. Nart P et al. *Vet Rec* 2004; 155:355.
8. McLennan MW, Kelly WR. *Aust Vet J* 1990; 67:75.
9. Graber HU et al. *Dtsch Tierärztl Wochenschr* 97 1990; 447:451.
10. Furuoka H et al. *J Comp Pathol* 2001; 125:159.

#### **INHERITED LYMPHATIC OBSTRUCTION**

This defect has been recorded in Ayrshire and Hereford<sup>1</sup> calves. Males are more often affected than females; it has been suggested that some affected females may not be detected. The defect is inherited as a single, autosomal recessive character, with variable expressivity and incomplete penetrance.

The outstanding clinical feature is edema, the degree varying from slight to severe; severe cases causing dystocia to the point where embryotomy or cesarean sections is necessary. Some mortality occurs among the dams. Many calves are dead at birth and those born alive may be reared but the edema persists. Before parturition the cow may show evidence of hydrops amnii and have difficulty in rising. In calves the edema may be generalized or, more commonly, be localized to the head, neck, ears, legs, and tail. Drooping of the ears caused by increased weight is characteristic, and accessory lobes are commonly situated behind and at the base of the ears.

The edema is caused by a developmental abnormality of the lymphatic system. The lymph nodes are small and contain cystic dilatations and the lymphatic vessels are enlarged, tortuous, and dilated. Edema of the subcutaneous tissues and body cavities varies in degree; the skin is usually thickened and there is edema of the stomach wall.

#### **REFERENCE**

1. Schild AL et al. *J Vet Diagn Invest* 1992; 3:47.

## INHERITED VENTRICULAR SEPTAL DEFECT

Ventricular septal defects are common in food animals; reports of their occurrence in lambs and Hereford cattle suggest that the condition can be inherited.

## INHERITED AORTIC ANEURYSM

An inherited defect of the abdominal aorta, resulting in a high mortality from intra-abdominal hemorrhage, has been observed in an unidentified breed of cattle in Holland, and is an important feature in Marfan syndrome of humans.

## BOVINE MARFAN SYNDROME

A model of human Marfan syndrome, this disease of cattle is an autosomal dominant disorder caused by mutations in the fibrillin-1-gene.<sup>1</sup> It is manifested primarily by cardiovascular lesions and signs, but lacks the skeletal abnormalities of the human disease.<sup>2</sup> Necropsy lesions include aortic and pulmonary artery aneurysm, with consequent cardiac tamponade in some cases. Fragmentation of elastic laminae in the vessels is also characteristic.<sup>3</sup>

## REFERENCES

1. Singleton AC et al. Hum Mutat 2005; 348.
2. BesserTE et al. Am J Med Genet 1990; 37:159.
3. Potter KA, BesserTE. Vet Pathol 1994; 31:501.

## INHERITED CONGENITAL PORPHYRIA

### Synopsis

A congenital defect of porphyrin metabolism in cattle and swine characterized by excessive excretion of porphyrins in urine and feces and deposition of porphyrins in tissues, especially bones and teeth. Photosensitization occurs in affected cattle.

## ETIOLOGY

Congenital porphyria is similar to erythropoietic or Gunther's porphyria of humans. Most cases in cattle are due to the inheritance of a single recessive factor, heterozygotes being clinically normal. A deficiency of uroporphyrinogen III co-synthetase results in the accumulation of porphyrin type I isomers. Although there is no strict sex linkage in the mode of inheritance, the incidence is higher in females than in males. In pigs the pattern of inheritance is uncertain but may be due to one or more dominant genes.

## EPIDEMIOLOGY

**Porphyria** is recorded only in cattle and pigs. Shorthorn, Holstein, Black and White Danish, Jamaica Red and Black cattle, and Ayrshires carry the defect.

There are no serious losses except that affected cattle suffer from incapacitating photosensitization when exposed to sunlight and must be kept indoors. In countries where sunlight hours are limited the disease may go unnoticed. Affected pigs appear to suffer little harm. Porphyria is of little economic importance because of its rarity.

## PATHOGENESIS

The porphyrins are natural pigments but in these diseases they are present in larger than normal concentrations in the blood, urine, and feces. In porphyria the metabolic defect is one of abnormal synthesis of heme due to an enzymatic insufficiency at the stage of conversion of pyrrol groups to series 3 porphyrins. Excess series 1 porphyrins, physiologically inactive substances are produced as a result, and there is flooding of the tissues with these coloring and photosensitizing substances. The high tissue levels of porphyrins sensitize the skin to light and photosensitive dermatitis follows.

## CLINICAL FINDINGS

In **cattle** the passage of amber to port wine colored urine, a pink to brown discoloration of the teeth and bones, and severe photosensitization are characteristic. Additional signs include pallor of the mucosae and retardation of growth.

Affected **pigs** are usually normal and photosensitivity does not occur, but the disease can be recognized by the red-brown discoloration of the bones and teeth, which is present even in the newborn.

## CLINICAL PATHOLOGY

In porphyria the urine is amber to port wine in color when voided, due to the high content of porphyrins. The urine of affected cattle may contain 500–1000 µg/dL of uroporphyrins and 356–1530 µg/dL of coproporphyrins. The urine of normal cattle contains 1.84 µg/dL of coproporphyrins and no significant quantity of uroporphyrins. The color of the urine darkens to brown on exposure to light. Spectroscopic examination is necessary to identify the pigment as porphyrin. Erythrocyte survival time is reduced considerably. A macrocytic, normochromic anemia occurs and its severity appears to be related to the level of uroporphyrins in the erythrocytes, and there is evidence of a hemolytic anemia. Cattle with the highest erythrocyte uroporphyrin levels are also the most sensitive to sunlight.

## NECROPSY FINDINGS

In porphyric animals the teeth and bones are stained brown or reddish purple, the pigment occurring chiefly in the dentine in teeth and often in concentric layers in the bones. Affected bones and teeth show a red fluorescence under illumination with

ultraviolet light. The histological findings are unique to this disease.

## DIFFERENTIAL DIAGNOSIS

Confirmation of the diagnosis depends on identification of greatly increased levels of porphyrins in the blood and urine. Presumed affected cattle and pigs can be detected at birth by the discoloration of the teeth. Breeding trials are necessary to detect heterozygous, normal carrier animals.

Differential diagnosis list. Other causes of photosensitive dermatitis.

## TREATMENT

Non-specific treatment for photosensitization may be necessary. Affected cattle should be reared indoors.

## CONTROL

Elimination of affected carrier animals from the breeding program is the only measure available. Periodic examination of the urine and feces for excessive quantities of coproporphyrin is carried out on bulls used for artificial insemination in breeds in which the disease occurs.

## REVIEW LITERATURE

Franco DA et al. Bovine congenital erythropoietic porphyria. Comp Cont Educ 1992; 14:822–825.

## INHERITED ERYTHROCYTIC PROTOPORPHYRIA

Inherited erythrocytic protoporphyria is an autosomal recessive disease which occurs in Limousin<sup>1</sup> and Blonde d'Aquitaine<sup>2</sup> cattle. It is similar to the same disease in humans and to porphyria but is milder. There is deficient activity of the enzyme ferrochelatase, resulting in excessive photosensitizing protoporphyrin accumulation with high levels appearing in the erythrocytes and feces. The total amount of the enzyme is normal but up to 96% of it is non-functional.<sup>3</sup>

Protoporphyria is clinically differentiated from porphyria by the absence of anemia and discoloration of the teeth and urine. The major clinical abnormality is photosensitive dermatitis affecting particularly the tips of the ears and the edges of the nostrils. There may be intense pruritus and exudative dermatitis involving the head and upper aspect of the thorax.<sup>4</sup> The hematocrit values are within normal ranges, the teeth are normochromic, and there is no fluorescence of urine; however, whole blood fluoresces under ultraviolet light.<sup>4</sup> Protoporphyrin binds to proteins that are not excreted by the kidney and thus protoporphyrin will not be detected in the urine. In a Limousin calf, the disease was characterized by ataxia, and intermittent seizures.<sup>5</sup> At necropsy



there is hepatic portal fibrosis, bile ductule hyperplasia, and swelling of parenchyma cells. Phagocytic cells in the dermis contain large heterogeneous lysosomes.<sup>6</sup> Histologically, in some cases, the earliest lesions are moderate to severe acanthosis, hyperkeratosis, and parakeratosis with dermal angiofibroplasia. There may be intercellular edema, and intraepithelial vesicles and pustules.<sup>4</sup> Elimination of affected carrier animals from the breeding program is the only control measure available.

#### REFERENCES

1. Healy PJ et al. *Aust Vet J* 1991; 69:144.
2. Schelcher F et al. *Vet Rec* 1991; 129:403.
3. Straka JG et al. *Am J Hum Genet* 1991; 48:72.
4. Pence ME, Liggett AD. *J Arner Vet Med Assoc* 2002; 221:277.
5. Armstrong SC et al. *Vet Rec* 2002; 150:608.
6. Troyer DL et al. *J Vet Med A* 1991; 38:300.

#### HEMOCHROMATOSIS

Hemochromatosis is rare in domestic animals.<sup>1</sup> This inherited defect of iron metabolism in humans has also been observed in yearling Salers cattle in circumstances in which an inherited etiology is suggested.<sup>1,2</sup> The pattern of inheritance is uncertain because of the small number of pedigrees available from affected cattle.<sup>1</sup> Hemochromatosis occurs when inappropriately large amounts of iron are absorbed from the intestine over an extended period. The excessive accumulation of iron causes iron-induced lysosomal injury and peroxidation by free radicals, which are the two major mechanisms responsible for hepatocellular necrosis and for sequelae such as fibrosis, bile duct hyperplasia, veno-occlusive disease, and hepatic neoplasia. Unlike hemosiderosis, hemochromatosis is associated with high transferrin saturation values in serum (>60%). Clinical disease develops between 9 and 22 months of age. Animals are normal until weaning but then lose weight, develop rough hair coats, and lose incisor teeth. The skeletal changes in hemochromatosis are due to abnormal bone development.<sup>3</sup> Bone analysis reveals iron levels in affected animals may be 30 to 50 times greater than normal and decreased percent ash in the outer cortex. Periosteal dysplasia and osteopenia are responsible for the pathologic fractures and tooth loss.<sup>3</sup>

At necropsy, there is emaciation, firm dark brown livers and lymph nodes, soft bones, and brown-colored small intestine.<sup>1</sup> The major histological changes are hepatocellular siderosis and periportal bridging, and perivenular fibrosis. Heavy deposits of iron in the liver, and deposits of hemosiderin are visible in liver tissue obtained by biopsy. Hepatic iron concentrations in clinically affected cattle range

from 1500 to 10 500 wet weight (reference range for cattle = <300 g/g. Ultrastructurally, the heaviest intrahepatic deposition is in the hepatocyte. Iron in bone is associated with osteopenia.

#### REFERENCES

1. O'Toole D et al. *Vet Pathol* 2001; 38:372.
2. House JK et al. *J Vet Int Med* 1994; 8:105.
3. Norriddin RW et al. *Vet Pathol* 2004; 41:612.

#### FAMILIAL POLYCYTHEMIA

This inherited defect has been observed only in Jersey cattle. Attention is drawn to the presence of the disease by early calthood deaths and a clinical syndrome including congestion of mucosae, dyspnea, and poor growth. Hematologically there is marked elevation of erythrocyte count, hemoglobin concentration, and packed cell volume. The disease appears to be a primary polycythemia inherited as a simple autosomal recessive.

#### INHERITED BLEEDING DISORDERS

##### Hemophilia

**Hemophilia A** (deficiency of factor VIII, or classic hemophilia) occurs in Thoroughbred, Standardbred, Arab, and Quarter horses,<sup>1,2</sup> causing uncontrollable bleeding after injury or surgery, or spontaneously. This may be manifested by the sudden appearance of swellings over joints or the upper cervical region causing dyspnea, or into joints or body cavities causing acute hemorrhagic anemia, and blood can be aspirated from them. The platelet-dependent bleeding time is normal but the fibrin-dependent bleeding time is markedly prolonged. The defect is genetically transmitted as a sex-linked recessive trait, appearing clinically only in males.

**von Willebrand's disease** has been identified in a Quarter horse which experienced bleeding episodes and a low blood level of vWF, after a normal platelet count and negative coagulation screening tests.<sup>3</sup>

##### Bovine factor XI deficiency

Factor XI (partial thromboplastin antecedent) is involved in coagulation but animals afflicted by a deficiency of it may be clinically normal even though their whole blood clotting time is very prolonged. Others may have a severe bleeding tendency but the frequency of hemorrhagic episodes with factor XI deficiency is very low.<sup>4</sup> Heterozygotes experience minor episodes, homozygotes may have serious ones, especially neonates, which may die at birth and be classified as uncomplicated neonatal mortality. Affected cows also experience

an increase in repeat breeder problems, apparently associated with a slower luteolysis and the development of small graafian follicles.<sup>5</sup> Both males and females transmit the trait<sup>6</sup> which is inherited as an autosomal recessive.

##### Prekallikrein deficiency

Prekallikrein is necessary to activate factor XII in the coagulation process. An inherited deficiency of it is recorded in a family of Belgian horses,<sup>7</sup> as a cause of a bleeding tendency in the presence of the conventional coagulation factors. The deficiency is of the order of <1% of normal levels of 63–150%. The activated partial thromboplastin time is markedly prolonged.

##### Inherited thrombopathia

Thrombopathia causes uncontrolled bleeding in Simmental cattle.<sup>8,9</sup> Collected blood undergoes good clot retraction but platelet aggregation in response to adenosine diphosphate and collagen in a whole blood aggregation system is badly impaired. Clinical findings include epistaxis, hematuria, the sudden development of subcutaneous swellings, hemorrhagic anemia due to internal bleeding, or bleeding after external lacerations or surgery. Restriction of the problem to the Simmental breed suggests inheritance of a recessive trait. A study of the inheritance of the abnormality using embryo transfer technology and superovulating a donor cow which previously had a calf with platelet aggregation disorder found a very low incidence of the abnormality.<sup>10</sup> This suggests inheritance of the defect is not simple Mendelian recessive.

##### Afibrinogenemia (related diseases are hypofibrinogenemia, dysfibrinogenemia)

Afibrinogenemia is a rare cause of bleeding diathesis recorded in cattle, sheep, and goats, especially the newborn. Confirmation of the diagnosis and differentiation from the related diseases (above) requires sophisticated laboratory technology.<sup>11</sup>

#### REFERENCES

1. Henninger RW. *J Am Vet Med Assoc* 1988; 193:91.
2. Littlewood JD et al. *Equine Vet J* 1991; 23:70.
3. Brooks M et al. *J Am Vet Med Assoc* 1991; 198:114.
4. Gentry PA, Ross ML. *Can J Vet Res* 1994; 58:242.
5. Liptrap RM et al. *Vet Res Commun* 1995; 19:463.
6. Brush PJ, Gentry PA. *Vet Rec* 1988; 122:134.
7. Geor RJ et al. *J Am Vet Med Assoc* 1990; 197:741.
8. Searcy GP et al. *Can J Vet Res* 1990; 54:394.
9. Searcy GP, Petrie L. *Can Vet J* 1990; 31:101.
10. Mapletoft RJ et al. *Can Vet J* 2000; 41:791.
11. Fecteau G et al. *Can Vet J* 1997; 38:443.

## INHERITED ANEMIAS

### Inherited dyserythropoiesis and dyskeratosis (bovine congenital anemia, dyskeratosis, and progressive alopecia)

This disease occurs in 1–16-month old calves in some Poll Hereford families.<sup>1</sup> It is thought to be inherited as a simple autosomal recessive character.<sup>2</sup> Clinical signs commence at about 2 months of age and include skin lesions which commence on the face and neck, especially around the muzzle and along the edges of the ears, then extend in the midline down the back, then down the sides, and onto the limbs; the long hairs on the tail tip are shed.<sup>3</sup> The hyperkeratotic muzzle accumulates dust. The skin lesions comprise alopecia, with surviving hairs wiry, kinked or tightly curled, accumulations of sebum, and hyperkeratosis and marked wrinkling. The alopecia and hyperkeratotic dermatitis extend and the calves do not thrive, becoming small in stature, intolerant of exercise, susceptible to heat stress, and eventually pining away until they die or are euthanized. Histologically the skin is affected by dyskeratosis, hyperkeratosis, and orthokeratosis, and there are morphological abnormalities of the nucleus in erythroid precursors; anemia results from ineffective erythropoiesis. There is a persistent, non-regenerative anemia due to a failure of maturation of erythrocytes; the blood contains many nucleated erythrocytes, and bone marrow aspirates contain increased numbers of erythroid precursors.<sup>1</sup>

#### REFERENCES

1. Steffen DJ et al. *Vet Pathol* 1992; 29:203.
2. Steffen DJ et al. *J Hered* 1993; 84:263.
3. Vestweber JG et al. *J Am Vet Med Assoc* 1993; 203:223.

### Inherited glucose-6-phosphate dehydrogenase enzyme deficiency

A single case of this persistent hemolytic disease has been recorded in a yearling American Saddlebred colt.<sup>1</sup> The disease in humans is well recognized as an inherited defect. A similar clinical disease is recorded in Murray Grey calves in Australia.<sup>2</sup> Signs are observed first when affected calves are 3–8 weeks old. Both sexes are affected. Signs include poor growth, exercise intolerance, progressive weakness, severe jaundice, and death. There is a severe regenerative anemia, hemoglobin levels of 25–30 g/L, and an absolute nucleated erythrocyte count of  $9-18 \times 10^9/L$ .

Necropsy lesions include jaundice, a grossly enlarged, in some cases miss-hapen, greenish liver, and brown urine. Histological lesions are suggestive of a

persistent intravascular hemolysis. A series of cases of hemolytic anemia of undetermined origin, recorded in a familial pattern in horses, was characterized by high blood levels of methemoglobin.<sup>3</sup>

#### REFERENCES

1. Stockham SL et al. *Vet Pathol* 1994; 31:518.
2. Nicholls TJ et al. *Aust Vet J* 1992; 69:39.
3. Nixon PM et al. *Equine Vet J* 1977; 9:198.

## Inherited defects of the urinary tract

### INHERITED NEPHROSIS (MESANGIOCAPILLARY GLOMERULONEPHRITIS)

An apparently inherited mesangiocapillary glomerulonephritis occurs in Finnish Landrace lambs less than 4 months old,<sup>1</sup> and in newborn Yorkshire pigs.<sup>2</sup> The lambs absorb an agent from the colostrum which causes an immunological response in the lamb and the deposition of immune complexes within the glomerular capillary walls. Many affected lambs are asymptomatic before being found dead. Some have tachycardia, conjunctival edema, nystagmus, walking in circles, and convulsions. Enlarged, tender kidneys are palpable, and there is severe proteinuria, low plasma albumin, hyperphosphatemia, hypocalcemia, and BUN levels greater than 100  $\mu\text{g}/100 \text{ mL}$ . Necropsy findings include pale swollen kidneys and severe vascular lesions in the choroid plexuses and the lateral ventricles of the brain. Uremia supervenes in 75% of lambs by 27 days of age. Cases also occur in crossbred lambs.

### CHRONIC INTERSTITIAL NEPHRITIS

Chronic interstitial nephritis with diffuse zonal fibrosis (CINF) occurs in Japanese Black cattle (Wagyu) as an autosomal recessive disorder leading to death prior to puberty.<sup>3</sup> Clinically there is growth retardation between 3 and 5 months of age. A genome-wide scan using micro-satellite markers in a Wagyu pedigree segregated for CINF, mapped the CINF locus to bovine chromosome 1.

### INHERITED CYSTIC RENAL DYSPLASIA

Inherited, possibly conditioned by an autosomal dominant gene, this disease occurs in lambs sired by carrier Suffolk rams out of mixed ewes. Signs include recumbency and coma by days 2–3. Abortions and stillbirths occur in the same flocks at the same time. The kidneys are enlarged and cystic.<sup>4</sup>

## INHERITED BILATERAL RENAL HYPOPLASIA

This usually lethal condition is inherited as an autosomal recessive character in Large White pigs.

## INHERITED RENAL TUBULAR DYSPLASIA

This occurs in Japanese Black cattle.<sup>5</sup> Affected calves have intermittent diarrhea at 2 months of age, are unthrifty, behave sluggishly, have a rough hair coat, and overgrown hooves from 2 to 5 months of age. There is progressive renal failure, and a high level blood urea nitrogen and serum creatinine. However, appetites are almost normal or only slightly depressed. All affected calves have been sired by the same bull and the defect is due to an autosomal recessive trait.

At necropsy there are no gross lesions of the kidneys. Histologically, there are streaky masses of renal tubules without lumens. In calves over 3 months of age, there is interstitial fibrosis surrounding the abnormal tubules. It is suggested that the genes associated with the adhesion of epithelial cells, such as adhesion molecules, extracellular matrix components, and growth factors are abnormal in animals with renal tubular dysplasia. The causative gene (*rttd*) has been mapped to chromosome 1 by linkage analysis. A part of the *paracellin-1* gene, which encodes the renal epithelial tight junction protein is contained in the deletion and this deletion can be considered to be the cause of renal tubular dysplasia.<sup>6,7</sup> A DNA specific test for this mutation has been developed.<sup>8</sup>

## INHERITED RENAL LIPOFUSCINOSIS IN DANISH SLAUGHTER CATTLE

Dark brown or black discolored kidneys ('black kidneys') have been reported as incidental findings in slaughter cattle for more than 100 years.<sup>9</sup> A pigment with characteristics similar to those lipofuscin is present in secondary liposomes in epithelial cells of the proximal tubules. Cases occurred only in Holstein cattle or the Red Danish Dairy Breed and mainly in animals aged 3 years or older. The prevalences of the abnormality were 0.44% and 2.51%, respectively. Epidemiological and genealogical analyses strongly indicate an autosomal recessive inheritance.

#### REFERENCES

1. Frelrier PF et al. *Vet Pathol* 1990; .
2. Jansen JH. *Acta Path Microbiol. Immunol Scand* 1993; 101:281.
3. Kobayashi N et al. *Animal Genetics* 2000; 31:91.
4. Jones TO et al. *Vet Rec* 1990; 127:421.
5. Sasaki Y et al. *Vet Rec* 2002; 150:628.
6. Ohba Y et al. *Vet Rec* 2001; 149:153.
7. Ohba Y et al. *Vet Rec* 2001; 149:115.

8. Hirano T et al. *Int Soc Anim Genetics* 2002; 33:118.  
 9. Rude H et al. *J Comp Pathol* 2005; 132:303.

## Inherited defects of the nervous system

### INHERITED LYSOSOMAL STORAGE DISEASES

These are diseases in which there is a genetically determined deficiency of a specific lysosomal hydrolase enzyme causing a defective glycoprotein metabolism. As a result of the deficiency, metabolic substrates accumulate in the lysosomes. The lysosomes themselves are concerned with hydrolyzing polymeric material, which enters the vacuolar system, and converting it to monomeric units, such as amino acids, monosaccharides, and nucleotides, which can be dealt with by the better known metabolic processes.

There are other lysosomal storage diseases caused by poisonings and these are dealt with elsewhere. The best known ones are caused by poisoning with *Swainsona*, *Astragalus*, *Oxytropis*, and *Phalaris* spp. (the chronic form of that disease).

The diseases included in this section are not strictly diseases of the nervous system because the lysosomes in both **neuronal** and **visceral** sites are affected, but the effects of the disease are most obvious in terms of nervous system function.

### MANNOSIDOSIS

Mannosidosis is the best known group of the inherited lysosomal storage diseases in agricultural animals.

#### $\alpha$ -Mannosidosis

This is a lysosomal storage disease in which a deficiency of the enzyme  $\alpha$ -mannosidase results in the accumulation of a metabolite rich in mannose and glucosamine in secondary lysosomes in neurons, macrophages, and reticulo-endothelial cells of lymph nodes, causing apparent vacuolations in them. Similar vacuoles are found in exocrine cells in pancreas, abomasum, and lacrimal and salivary glands. Storage appears to be cumulative in the fetus, but after birth stored material is lost from the kidney into the urine via desquamated tubular epithelium. On the other hand, postnatal storage continues in the brain, pancreas, and lymph nodes. The disease occurs in Angus, Murray Grey, and Galloway cattle, is inherited as a simple recessive, and is recorded as occurring in the United States, Australia, and New Zealand.

**Clinically** it is characterized by ataxia, fine lateral head tremor, slow vertical nodding of the head, intention tremor, an aggressive tendency, failure to thrive, and

death or the necessity of euthanasia at about 6 months of age. These signs appear almost immediately after birth up to several months later and worsen over a period of up to 3–4 months. The signs are bad enough to require euthanasia during the first week of life in many cases.<sup>1</sup> The first sign observed is a swaying of the hindquarters, especially after exercise or with excitement. The stance becomes wide based and the gait jerky, stilted and high stepping, with slight overflexion of the hindquarters so that the animal appears to be squatting as it moves.

The nervous signs are exacerbated by excitement, diarrhea is common, and the calves are usually stunted and unthrifty. They are also aggressive and attempt to charge but are usually impeded by their incoordination. Many calves die after having shown general ill thrift and with minimal nervous signs. Death may occur due to paralysis and starvation, or to misadventure, and some calves appear to die during a 'fit' following a period of excitement. Many others are euthanized because of persistent recumbency. The nervous syndrome of mannosidosis is well known; affected calves will die. An  $\alpha$ -mannosidosis is recorded in Galloway cattle and is manifested by stillbirth, moderate hydrocephalus, enlargement of the liver and kidneys, and arthrogryposis.

### CLINICAL PATHOLOGY

Normal heterozygotes carrying genes for mannosidosis are identifiable because of their reduced tissue or plasma levels of  $\alpha$ -mannosidase. The mannosidase test for  $\alpha$ -mannosidase in goats is specific and does not cross-react with  $\alpha$ -mannosidase.

Advances in molecular biology have now led to the development of a more accurate test based on DNA technology.<sup>2</sup> DNA tests based on the PCR have been developed for the detection of two breed-specific mutations responsible for  $\alpha$ -mannosidosis.<sup>3</sup> One of the mutations is responsible for  $\alpha$ -mannosidosis in Galloway cattle. The other mutation is uniquely associated with  $\alpha$ -mannosidosis in Angus, Murray Grey, and Brangus cattle from Australia. The latter mutation was also detected in ion Red Angus cattle exported from Canada to Australia as embryos. The two breed-specific mutations may have arisen in Scotland and by the export of animals and germplasm disseminated to North America, New Zealand, and Australia.<sup>3</sup>

### CONTROL

A control program can be based on the identification of heterozygotes using the PCR based assays for detection of breed-specific mutations.<sup>3</sup> A program of screening cattle in herds which produce bulls for

sale to commercial herds should stop the spread of the disease very quickly because the number of heterozygous females in the population will be irrelevant to the continuation of the disease in the absence of affected sires.

The  $\alpha$ -mannosidosis gene prevalence is now insignificant and disease incidence has been reduced from an estimated 3000 cases/year to negligible levels.<sup>2</sup>

#### $\beta$ -Mannosidosis

$\beta$ -mannosidosis occurs in Salers cattle<sup>4</sup> and Anglo-Nubian goats<sup>5</sup> and has been recorded in a sheep. In the **cattle** some affected calves are stillborn. The remainder is euthanized forthwith because of the severity of the congenital defects.

### CLINICAL FINDINGS

All cases are affected at birth with craniofacial deformity and inability to stand. The cranium is domed and there is mild prognathism, narrow palpebral fissures, and a tough, hidebound skin. When in sternal recumbency the head is moved in a combined motion of circling and bobbing, eventually converting the calf to lateral recumbency, in which it remains until passively returned to the sternal position, where nystagmus and tremor become evident. There is no suck reflex at any time. In lateral recumbency there is opisthotonos and paddling convulsions.

### CLINICAL PATHOLOGY

The diagnosis is confirmed by a reduced level of  $\beta$ -mannosidase in the blood.

### NECROPSY FINDINGS

Include a deficiency of cerebral cortical and cerebellar substance, distended lateral ventricles, and bilateral renomegaly. The biochemical defect is one of acidic  $\beta$ -mannosidase,<sup>6</sup> and is conditioned by an autosomal recessive character. The carrier rate of the causative gene is very high in the Saler breed.<sup>7</sup>

### DIFFERENTIAL DIAGNOSIS

By the biochemical examination of ultrasound-guided fetal fluid aspiration at between 59 and 65 days of pregnancy in ewes and goat does is accurate but not without the risk of causing abortion.<sup>8</sup>

In the goats the condition is present at birth and characterized clinically by tetraplegia, tremor, deafness, and nystagmus, and an inexorably fatal termination. Additional signs include bilateral Horner's syndrome, carpal contractures, pastern joint hyperextension, thickened skin, and a dome-shaped skull. Although retinal ganglion cells are obviously badly affected, there appears to be no defect of vision.<sup>5</sup> It is an autosomal recessive defect, very similar to  $\alpha$ -mannosidosis.

## REVIEW LITERATURE

- Jolly RD. Lysosomal storage diseases in livestock. *Vet Clin North Am: Food Anim Pract* 1993; 9:1-41.
- Jolly RD. Mannosidosis in cattle and its control. *New Z J* 2002; 50: Suppl, 90.

## REFERENCES

1. Healy PJ et al. *Res Vet Sci* 1990; 49:82.
2. Jolly RD. *New Z Vet J* 2002; 50: Suppl, 90.
3. Berg T et al. *Res Vet Sci* 1997; 63:279.
4. Abbitt B et al. *J Am Vet Med Assoc* 1991; 198:109.
5. Render JA et al. *Vet Pathol* 1989; 26:437 & 444.
6. Jolly RD et al. *NZ Vet J* 1990; 38:102.
7. Bryan L et al. *Vet Pathol* 1993; 30:130.
8. Lovell KL et al. *Theriogenology* 1995; 44:517.

## GANGLIOSIDOSES

At least five types of gangliosidosis are known to occur in humans and animals. Two have so far been identified in agricultural animals.

### GM<sub>1</sub> gangliosidosis

GM<sub>1</sub> gangliosidosis occurs in cattle and sheep. In Friesian cattle it is inherited as an lysosomal storage disease in which the activity of an enzyme,  $\beta$ -galactosidase, in nervous tissue is greatly reduced. As a result there is an accumulation of the ganglioside (GM<sub>1</sub>) in the tissue. Clinical signs of progressive neuromotor dysfunction and a reduction in growth rate appear at about 3 months of age. The growth rate is reduced, and the animal is in poor condition, blind, and has a staring coat. The neuromotor signs include lack of response to external stimuli, sluggish mastication and swallowing, hindquarter sway while walking, a wide stance, a tendency to fall, reluctance to move, stiff high-stepping gait, aimless walking, head-pressing, and convulsions. Abnormal ECG tracings are common. The blindness results from lesions in the retina and the optic nerve. Ophthalmoscopic examination of the retina is recommended as an aid to diagnosis. A positive diagnosis is made on the grounds of intraneuronal lipid storage plus reduced  $\beta$ -galactosidase activity plus identification of the stored lipid. The stored ganglioside is visible under the electron microscope as stacks and concentric whorls of lamellae. In the live animal enzyme assays are carried out on leukocytes. The enzymatic defect is also detectable in liver, skin, and leukocytes.

The disease is also present in Suffolk and Suffolk-cross sheep. Visceral and neuronal lysosomal storage are both evident but the neuronal lesion is more severe. Deficiencies of  $\beta$ -galactosidase and  $\alpha$ -neuraminidase are evident. Affected sheep become ataxic at 4-6 months old and worsen to recumbency and death in up to 2 months.

GM<sub>1</sub> gangliosidosis has been reported from England in 'Coopworth Romney' lambs closely related to a ram imported from New Zealand.<sup>1</sup>

### GM<sub>2</sub> gangliosidosis

This has been identified in Yorkshire pigs and also causes decreased growth rate, incoordination appearing after 3 months of age, gray-white spots in the retina and dark blue granules in neutrophils, and azurophilic granules in lymphocytes. A serum enzyme assay is a suitable method of detecting 'carrier' heterozygous pigs. The test is based on the amount of N-acetyl- $\beta$ -D-hexosaminidase in tissues.

## REVIEW LITERATURE

- Jolly RD, Blair HT, Johnstone AC. Genetic disorders in sheep in New Zealand: A review and perspective. *New Z Vet J* 2004; 52:52-64.
- Jolly RD. Lysosomal storage diseases in livestock. *Vet Clin North Am: Farm Animals* 1993; 9:1-43.

## REFERENCE

1. Jolly RD et al. *New Z Vet J* 2004; 52:52.

## CEROID LIPOFUSCINOSIS

The ceroid-lipofuscinoses are a group of inherited storage diseases, inherited as autosomal recessive traits. They are grouped together because of common clinical and pathological phenomena related to brain and retinal atrophy, premature death, and accumulation of a fluorescent lipopigment in neurons and many other cell types within the body.

The disease is recorded in South Hampshire sheep,<sup>1</sup> Rambouillet sheep,<sup>2,3</sup> Borderdale sheep,<sup>4</sup> Merino sheep,<sup>5</sup> Nubian goats, and Devon cattle.<sup>6</sup> It resembles neuronal ceroid lipofuscinosis of humans and is not strictly a primary lysosomal disorder; it is classified as a proteolipid proteinosis, and provides a good animal model for discussing the similar disease (Batten's disease) of humans. It is inherited as an autosomal recessive trait.<sup>7</sup> Secondary lysosomes fill with subunit C of mitochondrial ATP synthase because of excessive peroxidation of polyunsaturated fatty acids.<sup>8</sup> The mechanism of the accumulation is that protein is formed which is normal for mitochondria but is misdirected so that it accumulates in the lysosome.<sup>9</sup> The brains of affected lambs grow till they are 4 months old, then they commence to atrophy.<sup>10</sup> The disease in Merino sheep is a subunit c-storing abnormality, clinically and pathologically similar to ceroid-lipofuscinosis in South Hampshire sheep.<sup>5</sup> The South Hampshire form of the disease maps to chromosome 7q13-15, which is syntenic with human chromosome 15q21-23, the site of human CLN6.<sup>1</sup>

The occurrence of a neuronal ceroid-lipofuscinosis in Borderdale sheep in New Zealand has been described.<sup>4</sup> The severity of neurodegeneration and minor differences in the ultrastructure of storage material suggests this is a different disease from other forms of ovine ceroid-

lipofuscinosis which accumulate subunit-c of mitochondrial ATP synthase.<sup>4</sup> An autosomal recessive mode of inheritance is considered probable.

**Clinical findings** include slowly progressive ataxia of the hindlimbs, commencing usually at about 4 months but possibly as late as 18 months of age, and lasting for 6 months leading to euthanasia at up to 4 years. Inability to keep up with the flock is noticed first, followed by a sawhorse stance, obvious ataxia, severe depression, and an increasing failure of the menace and pupillary light reflexes. Terminal blindness is a constant sign. Positional nystagmus, circling, and head pressing occur in some. Eating, drinking, and defecation are normal, but there is slight weight loss.<sup>11</sup>

The lesion in lambs and calves<sup>12</sup> is atrophy of the cerebrum, especially the optic cortex, with eosinophilic granulation of neurons and macrophages in the central nervous system followed by progressive retinal atrophy. There is a progressive storage of lipopigment in nervous tissue, especially retinal photoreceptors; its presence can be demonstrated by quantitative autofluorescence using a modified slit lamp microscope.<sup>11</sup> Other clinicopathological aids include lysosomal enzyme assay, organ biopsy, and computed tomography, which reveals the enlargement of the lateral ventricles of the brain resulting from cerebral atrophy.<sup>12</sup>

Neuronal ceroid lipofuscinosis has been described in three horses.<sup>13</sup> Clinically, there was developmental retardation, slow movements and loss of appetite at 6 months of age. Torticollis, ataxia, head tilt, and loss of eyesight were present at 1 year of age. There were abnormalities in posture and movements, decreased spinal reflexes, and some cranial nerve dysfunction, dorsal strabismus, and absence of the menace reflex. At necropsy, there was flattening of the gyri and discoloration of the brain. Histologically, eosinophilic, autofluorescent material in the perikarya of neurons were present throughout the brain, spinal cord, neurons of the retina, submucosa, and myenteric ganglia and in glial cells.

## REVIEW LITERATURE

- Jolly RD, Blair HT, Johnstone AC. Genetic disorders in sheep in New Zealand: A review and perspective. *New Z Vet J* 2004; 52:52-64.

## REFERENCES

1. Jolly RD et al. 2004; *New Z, Vet. J.*, 52, 52.
2. Edwards JF et al. *Vet Pathol* 1994; 31:48.
3. Woods PR et al. *J Vet Intern Med* 1994; 8:37.
4. Jolly RD et al. *New Z Vet J* 2002; 50:199.
5. Cook RW et al. *New Z Vet J* 2002; 80:292.
6. Harper PAW et al. *Acta Neuropathol* 1988; 75:632.
7. Prieur DJ et al. *J Hered* 1990; 81:245.
8. Fiske RA, Shorts RW. *Vet Pathol* 1988; 25:171.
9. Fearnley IM et al. *Biochem J (Lond)* 1990; 268:751.

10. Jolly RD et al. *Can J Vet Res* 1990; 54:15.
11. Armstrong D et al. *Vet Res Commun* 1988; 12:453.
12. Woods PR et al. *Vet Radiol Ultrasound* 1993; 34:259.
13. Uhl A et al. *Acta Neuropathol* 2001; 101:410.

### GLOBOID CELL LEUKODYSTROPHY (GALACTOCEREBROSIDOSIS)

Globoid cell leukodystrophy has been identified in Poll Dorset sheep in Australia<sup>1</sup>. Incoordination in the hindlimbs progresses until the animals are tetraplegic. Only histological changes are evident at necropsy. These include myelin destruction and the accumulation of characteristic globoid cells in nervous tissue. There is greatly decreased galactocerebrosidase activity in affected tissue.

#### REFERENCE

1. Jolly RD. *Vet. Clin. North Am.: Food Animal Pract.* 1993; 9.1, 44.

### INHERITED NERVOUS SYSTEM ABIOTROPHIES

These diseases are characterized by premature, progressive loss of nervous function due to spontaneous, late degeneration of nervous tissue. As a result most affected animals are born normal but develop signs of a progressive neurological disease that is either fatal or leads to such a serious neurological deficit that euthanasia is the only reasonable solution. In a few rare diseases the patient is abnormal at birth but worsens, and usually dies, during the neonatal period. Again there are exceptions and rare cases in calves recover completely. The genetic nature of some of the cases included may not be certain; they are included here if the evidence that they are inherited can be reasonably presumed. The lysosomal storage diseases, listed in the preceding section, are a specific group of abiotrophic diseases.

#### REVIEW LITERATURE

- de Lahunta A. Abiotrophy in animals, a review. *Am J Vet Res* 1990; 54:65-76.

### CEREBELLAR ABIOTROPHY

This disease occurs in Holstein and Poll Hereford cross<sup>1</sup> calves, pigs, and Merino sheep.

#### Cattle

In the calves ataxia appears for the first time when they are 3-8 months old. The calves are not blind but they often fail to exhibit a menace reflex. The onset of clinical signs is sudden but progression is slow or inapparent. Some become recumbent. Those that remain standing have a spastic, dysmetric ataxia, and a broad-based stance; they fall easily and have a fine head tremor.

All are strong and have good appetites. Abiotrophy, or premature aging, is evident only microscopically and consists of axonal swellings and segmental degeneration and loss of cerebellar Purkinje cells. The disease appears to be inherited, but recovery of some late cases is recorded.

#### Sheep

The disease in sheep does not appear until about 3 years of age. There is incoordination and dysmetria so that the gait is awkward and disorganized and there is frequent falling. There are also a reduced menace response, an apprehensive manner, and a wide-based stance in the hindlimbs. At necropsy there is diffuse cerebellar degeneration and severe loss of Purkinje cells.

#### Pigs

A congenital progressive cerebellar abiotrophy is also reported in piglets of the offspring of Saddleback sows and an unrelated Large White boar. The disorder behaves epidemiologically like an inherited disease conditioned by a simple autosomal recessive trait. Clinical signs include dysmetria, ataxia, and tremor at standing but not at rest. There is gradual adjustment so that the piglets can walk and stand at 5 weeks of age but by 15 weeks they are no longer able to do so. Affected pigs also have a coarse matted hair coat caused by a disproportionate number of coarse hairs to fine hairs. Histopathological lesions are confined to the cerebellum where there is a significant loss of Purkinje cells.

#### Horses

The disease is recorded principally in Arabs but occurs also in the Australian pony, which was developed from the Arab, and in the Gotland breed from Sweden. A similar clinical syndrome occurs in the Oldenberg breed but the pathological picture is quite different.

The disease may be present at birth but is often not observed until the foal is 6-9 months old. The characteristic signs are vertical head-nodding (some cases show horizontal head tremors), especially when excited, and ataxia which is most noticeable at a fast gait. It may not be evident while the foal is walking. Very badly affected foals are unable to stand or suckle at birth, less severe ones are normal until about 4 months of age when head-nodding becomes obvious. The degree of ataxia varies from slight incoordination to inability to stand. A 'goose-stepping' gait which slams the front feet into the ground occurs in some. All foals can see but there is an absence of the menace reflex in many. Nystagmus is not recorded as occurring in this disease.

Necropsy findings are limited to histopathological lesions in the cerebellum. These include widespread loss of Purkinje cells and the presence of a gliosis. There are no degenerative lesions in the spinal cord. In the similar disease in Oldenberg horses the cerebellum is often reduced in size. The disease is an abiotrophy, a premature aging of tissues.

There have been doubts about the heritability of the disease but analysis of European data confirms that it can be inherited as an autosomal recessive.<sup>2</sup>

**Familial convulsions and ataxia**, especially of Angus cattle, is an abiotrophy and on histopathological criteria belongs in this group, but because it is usually present at birth it is included, for ease of diagnosis, in the section on congenital cerebellar defects.

#### REFERENCES

1. Whittington RJ et al. *Aust Vet J* 1989; 66:12.
2. Gerber H et al. *Pferdeheilkunde* 1995; 11:423.

### CAPRINE PROGRESSIVE SPASTICITY

A possibly inherited progressive paresis of Angora goats is recorded in Australia.<sup>1</sup> Signs first appear at about 2 months of age, commencing with lethargy, followed by ataxia, then paresis progressing to sternal recumbency and eventual euthanasia. Tendon reflexes are normal but the kids have difficulty getting to their feet, especially in the hindlimbs. The gait is ataxic with frequent stumbles, and the kids are unwilling to run. At necropsy there are many large, clear vacuoles in many neurons of the spinal cord, posterior brainstem and midbrain, and degeneration of nerve fibers in the same areas and peripheral nerves.

#### REFERENCE

1. Lancaster MJ et al. *Aust Vet J* 1987; 64:123.

### INHERITED NEURODEGENERATION (SHAKER CALF SYNDROME)

This is an inherited, degenerative disorder of horned **Hereford** calves. Newborn calves show severe tremor, difficulty in rising, spastic gait, and aphonia. Terminally there is spastic paraplegia. Histologically there are accumulations of neurofilaments within neurons. A similar disease in **Holstein-Friesians** occurs only in males. There are severe degenerative changes in the spinal cord with spongiform lesions and some cavitation. It has the epidemiological distribution of a sex-linked recessive mutation.<sup>1</sup>

#### REFERENCE

1. Bethlehem M et al. *Vet Q* 1992; 14:54.

### INHERITED PROGRESSIVE DEGENERATIVE MYELOENCEPHALOPATHY (WEAVER SYNDROME)

The defect is inherited in Brown Swiss cattle. It appears first in calves when they are 6 months to 2 years old with a small number more than 2 years, and is manifested by progressive bilateral hindlimb weakness and proprioceptive deficits causing difficulty in rising and a weaving, hypermetric gait, goose stepping with the forelimbs, and dragging the hindlimbs. The limb reflexes are normal. The calves are bright and alert throughout. There is a broad-based stance and finally recumbency<sup>1</sup> and, after a course of 12–18 months, inevitable euthanasia. Necropsy lesions include axonal degeneration, including spheroid formation, and vacuolation of white matter in the cerebellum and at all levels of the spinal cord<sup>2</sup> but especially in the thoracic segment.<sup>3</sup> There is some neurogenic atrophy of muscles but there is no muscular dystrophy.<sup>4</sup> The defect can be identified by examination of chromosomes.<sup>5</sup> The defect appears to be linked chromosomally with high milk yield traits.<sup>6</sup>

#### REFERENCES

1. Doll K et al. Tierärztliche Umschau 1993; 48:467.
2. Leipold HW et al. Bovine Pract 1990; 24:145.
3. Baird JD et al. Can Vet J 1988; 29:370.
4. Oyster R et al. J Vet Med A 1992; 39:321.
5. Georges M et al. Proc Natl Acad Sci USA 1993; 90:1058.
6. Lidauer M, Essl A. Zuchtungskunde, 1994; 66:54.

### INHERITED SPINAL DYSMYELINATION

Bovine spinal dysmyelination is a congenital neurological disease occurring in several national cattle breeds upgraded with American Brown Swiss cattle.<sup>1</sup> The disease was first described in Red Danish Dairy breed. In Denmark, all cases are genetically related to the ABS bull White Cloud Jason's Elegant. It is inherited as an autosomal recessive trait. Genetic mapping of the gene in cross-bred American Brown Swiss cattle to the bovine Chromosome II has been done.<sup>1</sup>

Clinically, in calves there is lateral recumbency, opisthotonos, limb extension, normal to increased reflexes and mental alertness and by dysmyelination, including axonal degeneration and astrogliosis, in spinal tracts, especially the ascending gracile funiculus and dorso-lateral spinocerebellar tracts and the descending sulcomarginal tract.<sup>2,3</sup> This is probably the same defect as spinal muscular atrophy.

#### REFERENCES

1. Nissen PH et al. Mammalian Genetics 2001; 12:180.

2. Hafner A et al. J Vet Med B 1993; 40:413.
3. Agerholm JS et al. J Vet Med A 1994; 41:180 & 42:9.

### INHERITED PROGRESSIVE ATAXIA

This well-recognized disease occurs in Charolais cattle.<sup>1</sup> The first onset of signs is at about 12 months of age when the gait is seen to be stiff and stumbling, especially in the hindlimbs, and the hind toes are dragged. The ataxia may be asymmetric, and the animal cannot back up. The ataxia progresses over a period of 1–2 years. Affected animals tend to be down a lot and have difficulty in rising and posturing for urination. Urination is abnormal, being a squirting but continuous flow which soils the tail. Some affected animals nod their heads from side to side when excited. Both males and females are affected. It has been described occurring in 2-year-old Charolais steer in New Zealand.<sup>1</sup> Characteristic necropsy lesions are confined to the central nervous system and are histopathological. The white matter of the cerebellum and internal capsule contains multiple foci of oligodendroglial dysplasia. The somatic lymph nodes contain nodules of hyperplastic lymphoid follicles, some catarrh of the medullae of the nodes, and an accumulation of eosinophils.

### INHERITED SPINAL DYSRAPHISM

This is found as a congenital defect in Charolais calves, and is associated with arthrogryposis and cleft palate.

### INHERITED SPINAL MYELINOPATHY

There is a progressive spinal myelinopathy of Murray Grey cattle, similar to that seen in Charolais cattle. It is possibly genetic in origin. Some calves are affected at birth; others do not become affected until 1 year old. The syndrome is one of a progressing paresis, without significant ataxia leading to paresis and permanent recumbency. There are degenerative lesions in spinal cord, midbrain, and cerebellum. The disease is conditioned by an autosomal recessive gene.<sup>1,2</sup>

#### REFERENCES

1. Hill FI et al. New Z Vet J 2002; 50:166.
2. Edwards JR et al. Aust Vet J 1988; 65:108.

### INHERITED MULTIFOCAL SYMMETRICAL ENCEPHALOPATHY

Two forms of the disease are recorded, in **Simmentals**<sup>1</sup> and in **Limousin** and **Limousin-cross** cattle.<sup>2</sup> The **Limousin** calves are normal at birth but from about 1 month of age develop a progressive forelimb hypermetria, hyperesthesia, blindness,

nystagmus, weight loss, and behavioral abnormalities, especially aggression. The signs gradually worsen for up to 4 months when euthanasia is necessary. Necropsy lesions include brain swelling, optic chiasma necrosis, and multifocal, symmetrical areas of pallor, up to 0.5 cm diameter in the brain. These lesions show partial cavitation and multiple, pathological abnormalities especially myelin lysis and vacuolation and demyelination.<sup>3</sup> The distribution of cases suggests an inherited defect.

The disease in **Simmental** and **Simmental-cross** cattle recorded in Australia and New Zealand<sup>4</sup> also has a distribution suggesting an inherited defect. The disease is clinically similar to that in **Limousin** cattle except that affected animals are not blind and it develops later, 5–8 months; calves may survive longer, up to 12 months and, although the characteristic abnormality of gait is hypermetria, the hindlimbs are affected, not the forelimbs. Other signs observed are dullness, a swaying gait and, terminally, gradually developing opisthotonos and forelimb hypertonia in extension. Necropsy lesions are also similar to those in the **Limousins** but the distribution is in the midbrain and the entire brainstem.<sup>5</sup>

A multifocal symmetrical necrotizing encephalomyelopathy in **Angus** calves has been described.<sup>6</sup> Clinically calves exhibited ataxia, nystagmus, strabismus, muscular tremors, opisthotonos, bruxism, hyperaesthesia, tetanic spasms, and episodic convulsions at 2–6 weeks of age. Death occurred 4–7 days after the onset of clinical signs. Lesions consisted of symmetrical degenerative foci affecting the dorsal vagal motor, lateral cuneate and olivary nuclei in the medulla oblongata and occasionally in the spinal cord, substantia nigra and cerebellar peduncles. While an inherited basis for the disease is suspected, the etiology is unknown.

#### REFERENCES

1. Palmer AC et al. Vet Rec 1988; 123:114.
2. Harper PAW et al. Aust Vet J 1990; 67:111.
3. Palmer AC et al. Neuropathol Appl Neurobiol 1991; 17:457.
4. Harper PAW et al. Vet Rec 1989; 124:122.
5. Finnie JW, Phillips PH. Aust Vet J 1991; 68:213.
6. Philbey AW, Martel KS. Aust Vet J 2003; 81:226.

### INHERITED BOVINE DEGENERATIVE AXONOPATHY

Reported in **Holstein-Friesian** calves in Australia,<sup>1</sup> most affected calves are affected at birth by recumbency, hyperesthesia or depression, rigidity of limbs, tremor, especially of the head, nystagmus, apparent blindness, and the development

of opisthotonos and tetanic spasms when stimulated. At necropsy the consistent lesion is a severe, diffuse, axonal swelling and loss in the spinal cord and brainstem. The cause is unknown but the indicators point to heredity.

#### REFERENCE

1. Harper PAW, Healy PJ. *Aust Vet J* 1989; 66:143.

### **INHERITED OVINE DEGENERATIVE AXONOPATHY (NEURAXONAL DYSTROPHY)**

A heterogeneous group of diseases of genetic or acquired etiology is characterized by spheroidal swellings of axons, the result of accumulation of axoplasmic organelles including neurofilaments.<sup>1</sup>

This is reported in Suffolk, Merino, and Coopworth<sup>2</sup> sheep. An inherited defect is suspected in all three diseases.

In **Coopworths** the lambs are affected at birth but have a progressive syndrome in which cerebellar and proprioceptive signs predominate. Most die by 6 weeks of age. Large axonal spheroids are present in the spinal cord and midbrain, and there is a severe depletion of Purkinje cells in the cerebellum.

In **Suffolks** the disease does not appear until 1–6 months; signs are a gradual onset of ataxia, followed by recumbency, leading to death or euthanasia. Spheroids in central nervous system axons are characteristic, mostly in the spinal cord and cerebellum.

The disease in **Merinos** is in fine-wool sheep, is probably the same disease as that previously called **Murrurrundi disease**, and does not appear until 4–6 years of age. Most cases require to be euthanized after about 2 months but some mild cases survive for up to 3 years. The clinical signs include a wide-based stance, dysmetria of all limb movements with a pronounced hypermetria of the forelimbs resulting in frequent falling, a fine intention tremor of the head, and a diminished menace reflex. A similar disease of medium-wool Merinos, characterized by progressive posterior ataxia and degeneration of sensory tracts in thoracic segments of spinal cord, commencing after 5 months of age and terminating fatally before 2 years of age, is also recorded in Australia.<sup>3</sup> The probability is that it is also an inherited defect.

#### REVIEW LITERATURE

Jolly RD, Blair HT, Johnstone AC. Genetic disorders of sheep in New Zealand: A review and perspective. *New Z Vet J* 2004; 52:52–64.

#### REFERENCES

1. Jolly RD et al. *New Z Vet J* 2004; 52:52.
2. Johnstone AC. *New Z Vet J* 1992; 40:35.
3. Harper PAW et al. *Aust Vet J* 1991; 68:357.

### **INHERITED SPONTANEOUS LOWER MOTOR NEURON DISEASE**

This progressive disease of Yorkshire piglets 5–10 weeks of age is presumed to be inherited.<sup>1</sup> Clinical signs include hindlimb tremor, weakness, and ataxia appearing at 2–5 weeks of age. The gait includes fetlock knuckling, short choppy steps, and a tendency to collapse after a few steps. Segmental and postural reflexes are normal. By 10 weeks there is complete hindlimb paralysis, the pig is in sternal recumbency and front limb paralysis has begun. The appetite is good and the pig is bright and alert. On necropsy there is symmetrical degeneration and loss of motor neurons in the spinal cord, in some ventral spinal nerve roots.

A lower motor neuron disease in newborn Romney lambs has been described.<sup>2</sup> Lambs are normal at birth but within 1 week they developed weakness and ataxia, which progressed until they were unable to stand. The principal histological lesions were degeneration and loss of neurons in the ventral horns of the spinal cord and brain stem, Wallerian degeneration of ventral rootlets and motor nerves, and associated denervation atrophy of skeletal muscle fibers. Large fibrillar spheroids were found in white and gray matter including nuclei in the brain stem. A similar, though not identical, disease of newborn lambs has been recorded in a Dorset Down flock affecting about 20% of lambs. They lay with hindlimbs tucked under the body and forelimbs splayed sideways.

#### REVIEW LITERATURE

Jolly RD, Blair HT, Johnstone AC. Genetic disorders of sheep in New Zealand: A review and perspective. *New Z Vet J* 2004; 52:52–64.

#### REFERENCES

1. O'Toole D et al. *J Vet Diagn Investig* 1994; 6(2):230.
2. Jolly RD et al. *New Z Vet J* 2004; 52:52.

### **INHERITED MAPLE SYRUP URINE DISEASE (BRANCHED CHAIN KETOACID DECARBOXYLASE DEFICIENCY – BCKAD)**

Calves affected by this disease may be stillborn. Live calves are normal at birth and develop signs only at 1–3 days of age. It is inherited as an autosomal recessive and occurs principally in Poll Hereford, Hereford, and Poll Shorthorn<sup>1</sup> cattle but probably occurs also in other breeds.<sup>2</sup> There is molecular heterogeneity between the breeds, and tests based on detection of the mutation could be prone to error.<sup>3</sup> Hair roots are good sources of target DNA for genotyping cattle for the mutation. This avoids the errors created by hemopoietic chimerism when blood is

used for the test.<sup>4</sup> The disease is caused by an accumulation of branched chain amino acids – including valine, leucine, and isoleucine – due to an absence of branched chain ketoacid decarboxylase.<sup>5</sup> The mutation responsible for maple syrup urine disease in Poll Shorthorns and genotyping Poll Shorthorns and Poll Herefords for the maple syrup urine disease alleles has been determined.<sup>6</sup> The mutations responsible for maple syrup urine disease and inherited congenital myoclonus are present in the Australian Poll Hereford population.<sup>7</sup>

Clinical signs include dullness, recumbency, tremor, tetanic spasms and opisthotonos, a scruffy coat, blindness, and severe hyperthermia. When held in a standing position some calves have tetanic paralysis, others have flaccid paralysis. Terminal coma is followed by death after a course of 48–72 hours. The urine smells of burnt sugar.

At necropsy there is a characteristic severe spongiform encephalopathy similar to that found in comparable hereditary aminoacidurias in humans. Final identification can be made based on the elevated ratios of branched: straight chain amino acids in nervous tissue.<sup>8</sup>

#### REFERENCES

1. Healy PJ *Aust Vet J* 1992; 69:143.
2. Baird JD et al. *Can Vet J* 1987; 28:505.
3. Healy PJ, Dennis JA *Anim Genet* 1994; 25:329.
4. Healy PJ, Dennis JA *Aust Vet J* 1995; 72:346.
5. Zang B et al. *J Biol Chem* 1990; 265:2425.
6. Dennis JA, Healy PJ *Res Vet Sci* 1999; 67:1.
7. Healy PJ et al. *Aust Vet J* 2002; 80:695.
8. Harper PAW et al. *Aust Vet J* 1989; 66:46.

### **INHERITED CITRULLINEMIA**

This autosomal recessive disease is inherited in Australian Holstein-Friesians, USA Holsteins,<sup>1</sup> and Red Holsteins in Europe.<sup>2</sup> A previous report of a high incidence of the disease in a German Holstein herd has been refuted by a negative result in the breed in a wide-ranging survey.<sup>3</sup>

Affected calves are normal at birth but develop signs in the first week of life and die 6–12 hours after the onset of illness. The signs are depression, compulsive walking, blindness, head-pressing, tremor, hyperthermia, recumbency, opisthotonos, and convulsions. Arginosuccinate synthetase deficiency is the likely cause. Blood citrulline levels are of the order of 40–1200 times normal and the assay can be used to detect heterozygotes.<sup>4</sup> The alternative method of detecting heterozygotes is to use a polymerase chain reaction, a restriction endonuclease test designed to identify the mutation that causes the disease.<sup>5</sup> Prenatal diagnosis has been achieved by examination of cell cultures derived from amniotic fluid.<sup>6</sup>



## REFERENCES

1. Robinson JL et al. *J. Dairy Sci* 1993; 76:853.
2. Coumotte GHM, Smidt WJ. *Tijdschr Diergeneesk* 1990; 115:958.
3. Grupe RS et al. *Livestock Prod. Sci* 1996; 45:35.
4. Dennis JA et al. *Proc Natl Acad Sci USA* 1989; 86:7947.
5. Thornton RN et al. *NZ Vet J* 1991; 39:145.
6. Healy P et al. 1993; *Res Vet Sci* 55:271.

## EQUINE DEGENERATIVE MYELOENCEPHALOPATHY

Equine degenerative myeloencephalopathy is characterized by **symmetrical, slowly progressive spasticity and ataxia** in foals and horses less than 2 years of age. The disease occurs in most breeds in North America and Europe and is reported in captive zebra and Mongolian Wild Horses in North America.<sup>1,2</sup> Neuronal dystrophy of the cuneate and gracilis nuclei is considered a form of equine degenerative myeloencephalopathy.<sup>3</sup>

The prevalence of the disease varies widely, with up to 40% of susceptible animals on a farm being affected, although the disease is usually sporadic. There is a familial predisposition to the disease apparently involving an increased requirement for vitamin E, although other factors, including housing, are contributory.<sup>4-7</sup>

The pathogenesis of the disease is unknown. Abnormal expression of integral synaptic vesicle, synaptic vesicle-associated presynaptic plasma membrane and cytosolic proteins was observed in two Arabian horses with equine degenerative myeloencephalopathy.<sup>8</sup> These proteins have a role in trafficking, docking, and fusion of neuronal synaptic vesicles, and this finding suggests that there is disruption of axonal transport in equine degenerative myeloencephalopathy.<sup>8</sup> Loss of axons leads to defects in neurological function and consequent gait abnormalities.

The clinical signs are those of a slowing progressive spinal ataxia that stabilizes when the animal is 2-3 years of age. Affected foals and yearlings have symmetrical signs that are most severe in the hind limbs, of ataxia characterized by pivoting, circumduction, truncal sway, and difficulty performing complex movements such as backing or walking with the head elevated. At rest, severely affected horses may have an abnormal posture. The cutaneous trunci reflex may be absent. Spontaneous recovery does not occur, but progression to death is unusual. Radiography and myelography of the cervical spine does not reveal evidence of compression of the spinal cord.

Serum vitamin E concentrations may be normal or low. The hemogram, serum biochemical profile, and cerebrospinal fluid analysis are normal. There are no

gross lesions on necropsy. Histological lesions include neuronal atrophy, accumulation of lipofuscin-like pigment, and glial cell proliferation.

Differential diagnoses are listed in Table 36.1. Diagnosis is achieved by exclusion of other causes, of abnormal gait without fever or disease in other body systems in horses, such as compressive myelopathy and equine protozoal myeloencephalopathy.

No treatment is curative, but vitamin E (6000 IU orally once daily) may prevent progression of signs. Supplementation of at-risk foals and yearlings with vitamin E can prevent the disease.<sup>2</sup>

## REFERENCES

1. Montali RJ et al. *Vet Path* 1974; 11:68
2. Liu K et al. *J Am Vet Med Assoc* 1983; 183:1266
3. Beech J. *Vet Pathol* 1984; 21:384
4. Blythe LL et al. *J Am Vet Med Assoc* 1991; 198:1005.
5. Mayhew IG et al. *J Vet Intern Med* 1987; 1:45.
6. Dill SG et al. *Am J Vet Res* 1990; 51:1300.
7. Gandini G et al. *Equine Vet J* 2004; 36:83
8. Siso S et al. *Vet J* 2003; 166:238

## INHERITED CONGENITAL HYDROCEPHALUS

### Cattle

Congenital hydrocephalus without abnormality of the frontal bones occurs sporadically but is also known to be an inherited defect in Holstein and Hereford and possibly in Ayrshire and Charolais cattle. Two specific inherited entities have been described. In one there is obstruction to drainage of the cerebrospinal fluid from the lateral ventricles which become distended with fluid and may cause bulging of the forehead, often sufficient to cause fetal dystocia. Hereford calves with this defect have partial occlusion of the supraorbital foramen, a domed skull, and poorly developed teeth; at necropsy the cerebellum is found to be small and there may be micropthalmia and skeletal muscle myopathy. They are usually born a few days prematurely, are small in size and unable to stand or suck. In some cows the amniotic fluid is increased in volume.

Another form of inherited hydrocephalus due to malformation of the cranium and with no enlargement of the cranium has also been observed in Hereford cattle. The ventricular dilatation is not marked, and micropthalmia and cerebellar hypoplasia are not features. Affected calves may be alive at birth but are blind and unable to stand. Some bawl continuously and some are dumb. They do not usually survive for more than a few days. At necropsy there is internal hydrocephalus of the lateral ventricles with marked thinning of the overlying cerebrum. Other lesions include constriction of the optic nerve, detachment of the retina, cataract,

coagulation of the vitreous humor, and a progressive muscular dystrophy. The condition is inherited as a recessive character.

Internal hydrocephalus inherited in combination with multiple eye defects in White Shorthorns is dealt with elsewhere, as are non-inherited forms of the disease.

### Sheep

A defect comparable to the Dandy-Walker syndrome in humans and characterized by internal hydrocephalus caused by obstruction of the foramina of Magendie and Lushka occurs in several breeds of sheep, especially Suffolks,<sup>1</sup> and in cattle. Affected lambs are stillborn or die within a few hours of birth; because of the grossly enlarged cranium many cause dystocia which can only be relieved by a fetotomy.

### Pigs

Congenital hydrocephalus in Yorkshire and European pigs has been recorded. The abnormality varies from a small protrusion of dura (meningocele) to an extensive brain hernia in which the cerebral hemispheres protrude through the frontal suture, apparently forced there by increased fluid pressure in the lateral and third ventricles. The condition is thought to be inherited in a recessive manner, but exacerbated in its manifestation by a coexisting hypovitaminosis-A. An outbreak of congenital meningoencephalocele in Landrace pigs is recorded in circumstances suggesting that it was inherited.

### Horses

A Standardbred stallion sired a number of hydrocephalic foals in a pattern that suggested the inheritance of a dominant mutation in the germ line and in the form of a single locus defect.<sup>2</sup> Affected foals caused dystocia and were all stillborn.

## REFERENCES

1. Pritchard GC et al. *Vet Rec* 1994; 135:163.
2. Ojala M, Huikku J. *Equine Vet J* 1992; 24:140.

## INHERITED PROSENCEPHALY

Recorded in Border Leicester sheep, this defect takes the form of fusion of the cerebral hemispheres and a single lateral ventricle. It is widespread in the breed in Australia<sup>1</sup> and is inherited as an autosomal recessive character. Most affected lambs are stillborn. Live ones have dyspnea due to gross shortening of the nasomaxillary region creating a severely overshot mandible and interference with sucking. Blindness, nystagmus, and recumbency are constant signs. The cerebrum and the cranial cavity are much smaller than normal.

## REFERENCE

1. Roth IJ et al. *Aust Vet J* 1987; 64:271.

## **INHERITED HYDRANENCEPHALY AND ARTHROGRYPOSIS**

The defect is recorded in Corriedale sheep, and breeding trials indicate that it is inherited as an autosomal recessive character.<sup>1</sup> Most affected lambs are found dead but facial deformity, including shortening of the mandible and distortion of the facial bones will be evident. At necropsy the predominant finding is the fixation and deformity of the joints of the limbs and vertebral column, and the almost complete absence of a cerebral cortex.

### **REFERENCE**

1. Whittington RJ et al. *Aust Vet J* 1988; 65:124.

## **INHERITED CONGENITAL CEREBELLAR DEFECTS**

Several inherited cerebellar defects occur congenitally in calves, lambs, and foals. Lesions of the cerebellum may or may not be obvious. They all need to be differentiated from similar defects known to be caused by intrauterine viral infections such as swine fever, bovine mucosal disease, and bluetongue.

### **Cerebellar hypoplasia**

This occurs in Herefords, Guernseys, Holsteins, Shorthorns, and Ayrshires and appears to be conditioned by a factor inherited in a recessive manner. Most calves are obviously affected at birth. While lying down there is no marked abnormality, although a moderate lateral tremor of the neck occurs, causing a gentle side-to-side swaying of the head. Severely affected calves are blind; they have widely dilated pupils and their pupils do not react to light. Such calves are unable to stand, even when assisted, because of flaccidity of limb muscles. When less severely affected animals attempt to rise the head is thrown back excessively, the limb movements are exaggerated in force and range and are grossly incoordinated, and many calves are unable to rise without assistance. If they are placed on their feet the calves adopt a straddle-legged stance with the feet wide apart and the legs and neck extended excessively. On attempting to move, limb movements are incoordinated and the calf falls, sometimes backwards because of overextension of the forelimbs. Affected animals drink well but have great difficulty in getting to the teat or pail, attempts usually being wide of the mark. There are no defects of consciousness and no convulsions. Tremor may be evident while standing and there may be postrotational nystagmus after rapid lateral head movements. Sight and hearing are unimpaired and, although com-

plete recovery does not occur, the calf may be able to compensate sufficiently to enable it to be reared to a weaning weight. Diagnosis can be confirmed by magnetic resonance imaging.<sup>1</sup>

At necropsy the most severe defect comprises complete absence of the cerebellum, hypoplasia of the olivary nuclei, the pons and optic nerves and partial or complete absence of the occipital cortex. Less severe defects include a reduction in size of the cerebellum and absence of some neuronal elements in a cerebellum of normal size.

Although the disease is dealt with generally as an inherited one there is no firm evidence to substantiate this view, and there are sporadic, non-inherited cases in other breeds.

### **Cerebellar atrophy of lambs (daft lamb disease 1)**

This has been recorded in many sheep breeds in Britain, Corriedales in Canada and New Zealand, and in Drysdale.<sup>2</sup> Affected lambs are normal at birth but are weak and unable to rise without assistance. At 3 days of age it is obvious that there is severe incoordination of limb movement, opisthotonos, tremor, and a straddle-legged stance. At necropsy the cerebellum may be of normal size but on histological examination there is gross atrophy of cerebellar neurons. The disease appears to be conditioned by a recessive gene but not as a simple homozygous recessive. A clinically similar disease has been observed in Border Leicester lambs. There is no histopathological lesion in the cerebellum, but there are significant lesions in the cervical muscles and the nerve supply to them. The disease is inherited, most likely as an autosomal recessive trait.

### **Star-gazing lambs (daft lamb disease 2)**

An hereditary disease clinically similar to cerebral cortical atrophy has been described in newborn Leicester lambs in the UK but without histological evidence of Purkinje cell loss or reactive changes, considered the hallmark of 'cerebellar cortical atrophy'. Affected lambs exhibit 'dorsal arching of the neck with the head being pressed backwards', which has also been described as 'star-gazing'. Histological lesions are present in neck muscles and nerves but it is uncertain if these are primary or secondary.

### **Inherited ataxia of calves**

This is a true cerebellar ataxia inherited as a recessive character in Jerseys, Shorthorns, and Holsteins. Clinically the condition resembles cerebellar hypoplasia except that signs may not occur until the calves are a few days to several weeks old. At necropsy the cerebellum is normal in size

but histologically aplasia of neurons is evident in the cerebellum and also in the thalamus and cerebral cortex. An inherited condition, manifested by cerebellar ataxia which does not develop until calves are 6 weeks to 5 months old, has also been recorded but the cerebellum is small and macroscopically abnormal. Conspicuous degeneration of cerebellar Purkinje cells is evident on histological examination.

### **Cerebellar abiotrophy**

This fourth disease in this group is described under the heading of abiotrophies.

### **Familial convulsions and ataxia in cattle**

A neurological disease is recorded as being inherited in Aberdeen Angus cattle and their crossbreds and Charolais. In young calves there are intermittent attacks of convulsions, and in older animals these are replaced by a residual ataxia. The first signs appear within a few hours of birth; up to several months later there are single or multiple tetanic convulsions lasting for 3–12 hours. As these episodes disappear a spastic goose-stepping gait becomes apparent in the forelimbs and there is difficulty placing the hindlimbs. The characteristic necropsy lesion is a very selective cerebellar cortical degeneration. A proportion of cases make a complete recovery.<sup>3</sup> The epidemiology of the disease is consistent with the operation of an autosomal dominant gene with incomplete penetrance.

### **Inherited congenital spasms of cattle**

This condition has been recorded only in Jersey cattle and appears to be conditioned by a factor inherited in a recessive manner. Affected calves show intermittent, vertical tremor of the head and neck, and there is a similar tremor of all four limbs which prevents walking and interferes with standing. Although the calves are normal in all other respects, they usually die within the first few weeks of life. No histological examinations have been reported but a cerebellar lesion seems probable.

### **REVIEW LITERATURE**

Jolly RD, Blair HT, Johnstone AC. Genetic disorders of sheep in New Zealand: A review and perspective. *New Z Vet J* 2004; 52:52–64.

### **REFERENCES**

1. Gordon PJ, Dennis R. *Vet Rec* 1995; 137:671.
2. Jolly RD et al. *New Z Vet J* 2004; 52:52.
3. Kemp J et al. *Vet Rec* 1995; 136:198.

## **INHERITED SPASTIC PARESIS (ELSO HEEL)**

This disease occurs in the Holstein, Aberdeen Angus, Red Danish, Ayrshire, Beef Shorthorn, Poll Hereford, Murray Grey, and many other breeds of cattle. It has been observed in crossbred Brahman

cattle<sup>1</sup> and in an Ayrshire x Beef Shorthorn crossbred steer. The disease occurs principally in calves, with signs appearing from several weeks to 6 months or more after birth. Occasional cases are reported as developing in adult European cattle and there is one report of the occurrence of the disease in adult Indian cattle.

It has been held for a long time that the disease is inherited, and the principal argument has centered on the mode of inheritance. Attempts to determine this have shown that the rate of occurrence in planned test matings is so low that, if inheritance is involved, it can only be the inheritance of a susceptibility to the disease. It is suggested that different time appearances represent a single disease entity with varying expressivity, the late forms being affected by cumulative environmental factors. A hypothesis proposed is of a gene with increased penetrance in the homozygote, with weak penetrance in the heterozygote, acting on a polygenic basis dependent on external factors.<sup>2,3</sup> Infectious agents causing transmissible sub-acute spongiform encephalopathies interacting with trace elements such as lithium have been suggested as etiological agents but there is no evidence to support the hypothesis.<sup>3</sup>

In all forms of the disease there is excessive tone of the gastrocnemius muscle and straightness of the hock, usually more marked in one hindleg. If only one leg is affected it may be thrust out behind while the calf is walking and advanced with a restricted, swinging motion often without touching the ground. There is no resistance to passive flexion of the limb. The gastrocnemius and perforatus muscles are rigid and in a state of spastic contraction. There is a characteristic elevation of the tail. The lameness becomes progressively worse and affected animals spend much time lying down. Much body weight is lost and the animal is usually destroyed between 1 and 2 years of age.

Minor lesions described as regressive changes in the neurons of the red nucleus, in the reticular substance and the lateral vestibular nucleus are of doubtful significance, as are the observed reduction in inorganic phosphate and ascorbic acid levels in the blood and cerebrospinal fluid of affected calves. A lower CSF concentration than normal of a central neurotransmitter, dopamine, could also be an effect rather than a cause.

There are demonstrable lesions on radiologic examination of the tarsus but exhaustive examinations of muscles and tendons fail to reveal histological abnormalities. The absence of any structural lesion and the variation in intensity of the abnormality suggests that it is a functional one. The hypersensitivity of the myotic

reflex which has been observed could be such a defect.

In Europe affected animals are kept for breeding purposes, especially if they are double-muscling. They are kept for this reason because of the efficacy of the curative surgical operation of partial tibial neurectomy and in view of the high incidence of double muscling in such calves. In the Holstein breed, and several German breeds, bulls which sire affected calves have been observed to have very straight hocks and to suffer from various forms of stifle and hock lameness early in life.

Several surgical techniques including tenectomy, partial tibial neurectomy, and triple tenectomy have been described.<sup>2</sup> Partial tibial neurectomy under caudal epidural anaesthesia was done on 113 Belgian blue calves with spastic paresis.<sup>2</sup> A telephone follow-up of the owners 3 months later revealed good results in 83%; a considerable improvement in 4.4%; and severe hyperflexion of the hock necessitated early culling for slaughter; and in 8% there was little or no improvement.<sup>2</sup>

#### REVIEW LITERATURE

Ledoux JM. Bovine spastic paresis: etiological hypotheses. *Med Hypotheses* 2001; 57:573-579.  
Hanset R et al. Bovine spastic paresis and its inheritance. *Ann Med Vet* 1993; 137:237.

#### REFERENCES

1. Harper P. *Aust Vet J* 1993; 70:456.
2. Vlaminc L et al. *Vet Rec* 2000; 147:16.
3. Ledoux JM. *Med Hypotheses* 2001; 57:573.

#### INHERITED PERIODIC SPASTICITY OF CATTLE

This disease has been observed in Holstein and Guernsey cattle and usually does not appear until the animals are adults. A recent report described it in a Canadian Hereford bull with an early onset between 1 and 2 years of age.<sup>1</sup> It is a particular problem in mature bulls maintained in artificial insemination centers. In the early stages the signs are apparent only on rising, the hindlimbs being stretched out behind and the back depressed. Marked tremor of the hind-quarters may be noted. Initially the attacks persist only for a few seconds but are of longer duration as the disease progresses and may eventually last for up to 30 minutes. Movement is usually impossible during the attacks. The tetanic episodes fluctuate in their severity from time to time but there is never any abnormality of consciousness. Lesions of the vertebrae have been recorded but no lesions have been found in the nervous system. Idiopathic muscle cramps have been suggested as a cause. The disease is familial and the mode of inheritance appears to be by inheritance of a single recessive factor with incomplete penetrance.

Administration of the spinal cord depressant, mephenesin (3-4 g/100 kg body weight given orally in 3 divided doses and repeated for 2-3 days) controls the more severe signs. A single course of treatment may be effective for some weeks.

#### INHERITED NEONATAL SPASTICITY

The defect is recorded in Jersey and Hereford cattle. Affected calves are normal at birth but develop signs 2-5 days later. The signs commence with incoordination and bulging of the eyes and a tendency to deviation of the neck causing the head to be held on one side. Subsequently, the calves are unable to stand and on stimulation develop a tetanic convulsion in which the neck, trunk, and limbs are rigidly extended and show marked tremor. Each convulsion is of several minutes' duration. Affected calves may survive for as long as a month if nursed carefully. There are no gross or histological lesions at necropsy. Inheritance of the defect is conditioned by a single, recessive character.

#### INHERITED CONGENITAL MYOCLONUS (HEREDITARY NEURAXIAL EDEMA)

This congenital defect of the nervous system has been reported only in Poll Hereford cattle or their crossbreds and appears to be transmitted by inheritance in an autosomal recessive pattern. A similar disease has been tentatively recorded in Peruvian Pasos horses.<sup>2</sup> At birth affected calves are unable to sit up or rise and are very sensitive to external stimuli, manifested by extreme extensor spasm, including fixation of thoracic muscles and apnea, especially if lifted and held upright. The response is one of hyperesthesia with myoclonic jerks of skeletal muscles in response to external stimuli or spontaneously.<sup>3</sup> The intellect of the calves seems unaffected, vision is normal, they drink well, and can be reared but at a great cost in time. Intercurrent disease is common and calves usually die of pneumonia or enteritis before they are 1 month old.

All affected calves have subluxations of the hip joints or epiphyseal fractures of the femoral head caused by muscle spasms in the fetus. Their gestation length is shorter than that of normal calves by 9 days.

There are no microscopic lesions in the central nervous system, but there is a biochemical defect, severe alterations in spinal cord glycine-mediated neurotransmission.<sup>4</sup> The specific and marked defect in glycine receptors and the increase in neuronal

uptake of glycine are accompanied by a change in the major inhibitory system in the cerebral cortex. It has also been shown that there is a specific and marked deficit of [<sup>3</sup>H] strychnine-binding sites in the spinal cord. The disease needs to be differentiated from two other congenital, presumed hereditary, diseases of newborn Herefords – maple syrup urine disease and 'congenital brain edema' – in which spongy degeneration of the CNS is accompanied by severe edema of the gray and white matter. These two diseases are assumed to represent those cases of congenital disease, originally bracketed with inherited congenital myoclonus, in which there was vacuolation of nervous tissue in the central nervous system.

#### REFERENCES

1. Tenszen A. *Can Vet J* 1998; 39:716.
2. Gundlach AL et al. *Brain Res* 1993; 628:263.
3. Gundlach AL et al. *Science* 1988; 241:1807.
4. Lummis SCR et al. *J Neurochem* 1990; 55:421.

#### INHERITED CONGENITAL POSTERIOR PARALYSIS

Two inherited forms of congenital posterior paralysis are recorded in cattle. In Norwegian Red Poll cattle posterior paralysis is apparent in affected calves at birth. Opisthotonos and muscle tremor are also present. No histological lesions have been found. The disease is conditioned by an inherited recessive factor. In Red Danish and Bulgarian Red cattle a similar condition occurs but there is spastic extension of the limbs, particularly the hindlimbs, and tendon reflexes are exaggerated. Histological examination has revealed degenerative changes in midbrain motor nuclei. Both defects are lethal because of prolonged recumbency.

An inherited posterior paralysis has been recorded in several breeds of swine in Europe. Affected pigs are able to move their hindlimbs but are unable to stand on them. They are normal in other respects. Degeneration of neurons is evident in cerebral cortex, midbrain, cerebellum, medulla, and spinal cord. The disease is conditioned by the inheritance of a recessive character. An inherited progressive ataxia is also recorded in Yorkshire pigs.

#### INHERITED CONGENITAL MYOTONIA

This disease has been observed in goats and possibly in a horse. Because of its great similarity to Thomsen's disease (myotonia congenita) of humans, affected goats have been used in experimental studies to determine the nature of the disease. There is no apparent defect of the nervous system and the condition is thought to be due to abnormality of the muscle fibers. The specific defect is thought

to be one of generalized cell membrane abnormality including muscle fibers. Affected animals run when startled but quickly develop extreme rigidity of all four limbs and are unable to move. Relaxation occurs in a few seconds and the animal can then move again. Signs are not usually present until some time after birth and may vary from day to day for no apparent reason. They tend to diminish immediately before and after parturition. Clinical signs disappear when water is withheld from affected goats for 2–3 days but reappear when drinking is permitted. The disease is inherited but the mode of inheritance is unknown.

#### INHERITED HYPOMYELINOGENESIS (CONGENITAL TREMOR OF PIGS)

Congenital tremor of pigs has a multiple etiology and some of the causes are not yet identified. For this reason the disease as a whole is dealt with in Chapter 36. The inherited diseases are noted here. There are two of them, congenital tremor type A-IV of British Saddleback pigs, and congenital tremor type A-III, a sex-linked inherited form of cerebrospinal hypomyelination of Landrace pigs. The A-IV disease is characterized by the presence of poorly myelinated axons in all parts of the central nervous system. The specific defect in A-IV is one of fatty acid metabolism. The structural abnormalities in the A-III disease have been identified; splayleg is a common accompaniment.

Both diseases are characterized by muscle tremor, incoordination, difficulty in standing, and some squealing. The A-III disease occurs only in males. Both are inherited as recessive characters.

#### EXOPHTHALMOS WITH STRABISMUS

This disease has been recorded in Shorthorn, in which it is not manifested until the first pregnancy or lactation, in Jerseys, in which it may appear at 6–12 months of age, and in German Brown Swiss.<sup>1</sup> Defective vision is the first sign and is followed by severe protrusion and anteromedial deviation of both eyeballs. The defects may get worse over a long period and appear to be inherited in a recessive manner, with relative absence of neurons in the abducens nerve.

#### REFERENCE

1. Distl O. *J Ani Breeding* 1993; 110:393.

#### FAMILIAL UNDULATORY NYSTAGMUS

This is an inherited defect of Finnish Ayrshire cattle characterized by a tremor-like, synchronous movement of the eye-

balls. The tremor has small amplitude (1–2 mm) and fast (200/min) rate and is usually vertical. It is present at all times, there is no sign of impaired vision, and the eye reflexes are normal. The condition is a blemish rather than a disease because there is no functional deficiency.

#### INHERITED IDIOPATHIC EPILEPSY OF CATTLE

Idiopathic epilepsy has been reported as an inherited condition in Brown Swiss cattle and appears to be inherited as a dominant character. Typical epileptiform convulsions occur, especially when the animals become excited or are exercised. Attacks do not usually commence until the calves are several months old and disappear entirely between the ages of 1 and 2 years.

#### FAMILIAL NARCOLEPSY

Affected horses, including Shetlands, Miniature Horses,<sup>1</sup> and Suffolks, suffer recurrent episodes of several minutes duration during which they fall and lie motionless, without voluntary or involuntary movements except respiratory and eye movements. Between episodes there is no clinical abnormality. Handling or the excitement of feeding may precipitate an attack, and a sharp blow may terminate one.

#### REVIEW LITERATURE

Mignot EJM, Dement WC. Narcolepsy in animals and man. *Equine J* 1993; 25:476.

#### REFERENCE

1. Lunn DP et al. *Equine Vet J* 1993; 25:483.

#### DODDLER CALVES

This is an inherited congenital defect in Hereford cattle produced by intensive breeding of half-siblings. It is no longer recorded. It was characterized by continuous clonic convulsions, nystagmus, and pupillary dilatation. Stimulation by touch or sound exacerbated the convulsions.

### Inherited defects of the musculoskeletal system

#### INHERITED DISEASES OF BONES

##### INHERITED OSTEOARTHRITIS

There are strong indications from field evidence that both **degenerative arthropathy**, in which the hip joint is principally involved, and **degenerative osteoarthritis**, affecting particularly the stifle joint, are inherited in cattle. In both diseases other factors, particularly nutritional deficiency and the stress of lactation, exert an

important influence on the appearance of the clinical disease, and in **degenerative arthropathy**, described in the chapter on nutritional deficiency diseases, there is no clear evidence that it is in fact inherited. On the other hand there is good evidence that osteoarthritis can be inherited, at least in Holstein-Friesian and in Jersey cattle.

In **inherited degenerative osteoarthritis**, in which the stifle joints are most severely affected, there is usually a gradual onset of lameness in both hindlimbs in aged animals of both sexes. Occasionally only one limb appears to be involved. Progression of the disease takes place over a period of 1–2 years and is evidenced by failure to flex the limb, resulting in the foot not being lifted high from the ground. Crepitation in the stifle joint can be heard and felt, the muscles of the limb atrophy, and the joints are enlarged. Movement is slow, the hindlimbs at rest are placed further forward than normal, the stifles are abducted and the feet held together. Joint fluid can be aspirated and is clear and straw-colored. Appetite and milk yield remain normal until the late stages, except in cattle running at pasture.

At necropsy there is severe osteoarthritis involving particularly the stifle, with extensive erosion of the articular cartilages, great increase in synovial fluid, and the development of many osteophytes around the edges of the articular surfaces. Less severe changes are evident in other joints. It is suggested that the disease is conditioned by the inheritance of a single autosomal recessive character.

### **INHERITED OSTEOGENESIS IMPERFECTA**

The term osteogenesis imperfecta covers a heterogeneous group of connective tissue diseases caused by quantitative or qualitative defects in Type 1 collagen.<sup>2</sup>

The disease is recorded as being inherited in Holstein-Friesian cattle and New Zealand Romney sheep.<sup>1</sup>

#### **Cattle**

It is transmitted as an autosomal dominant trait. Calves are clinically abnormal at birth with the main presenting signs being bright pink teeth and slackness of the flexor tendons on all four feet so that they are unable to stand. The calves become progressively worse to the point where they cannot walk. The full list of abnormalities in this syndrome includes smaller than normal body size at birth, a dome-shaped cranial vault, and fragility of bones, manifested by multiple fractures occurring during birth. The defect is one of connective tissue cells so that there is a faulty production of collagen and inter-

cellular cement. Radiological examination demonstrates growth-arrest lines and multiple fractures in the long bones, and thin dentine and enamel layers on the teeth which are pink because of the exposed condition of the enlarged pulp. The excessive mobility of the joints results from the small bulk of the ligaments and tendons.

A syndrome of simple bone fragility occurs in Charolais cattle and is called osteogenesis imperfecta.

#### **Sheep**

The disease in New Zealand Romney sheep<sup>2</sup> is similar to that in Holstein-Friesian cattle with additional lesions of thickness of the diaphyses and reduction in size of the medullary cavity, moderate brachygnathia inferior, subcutaneous edema, skin fragility, and a dark blue color of the sclera. It is inherited as an autosomal dominant trait, and was thought to have developed as a new mutation in the testicular cell line of the parent ram.<sup>2</sup>

### **REVIEW LITERATURE**

Jolly RD, Blair HT, Johnstone AC. Genetic disorders of sheep in New Zealand: A review and perspective. *New Z Vet J* 2004; 52:52–64.

### **REFERENCES**

1. Arthur DG et al. *NZ Vet J* 1992; 40:107.
2. Jolly RD et al. *New Z Vet J* 2004; 52:52.

### **INHERITED DWARFISM**

Most inherited food animal dwarfs are chondrodysplastic; they occur commonly only in cattle and are of two kinds, snorter dwarfs and Dexter bulldog calves.

#### **Snorter dwarfs**

Snorter dwarfs are no longer important because of successful efforts in eliminating carriers of the gene. These calves are short-legged with short, wide heads and protruding lower jaws. The mandibular teeth may protrude 2–4 cm beyond the dental pad, preventing effective grazing and necessitating hand-feeding if the animal is to survive. There is protrusion of the forehead and distortion of the maxillae, and obstruction of the respiratory passages results in stertorous respiration and dyspnea. The tip of the tongue usually protrudes from the mouth and the eyes bulge. There is some variation between affected animals in their appearance at birth. In most cases the defects are as described above but they become more exaggerated as the calf grows. In addition abdominal enlargement and persistent bloat develop. The head is disproportionately large. The calves fail to grow normally and are about half the weight of normal calves of the same age.

The predominant form of the condition appears to be inherited as a simple recessive character, although the relationship of

the 'comprest' types to the total syndrome is more complex. Heterozygotes vary widely in conformation but some of them show minor defects which may be attractive to cattle breeders who were seeking a chunkier, short-legged type of animal. For this reason, indiscriminate selection towards the heterozygote undoubtedly occurred, resulting in widespread dissemination of the character. Herefords and Aberdeen Angus are the breeds most commonly affected but similar dwarfs occur also in Holstein and Shorthorn cattle, and typical dwarf animals have been produced by mating heterozygous Aberdeen Angus and Herefords. Besides the shortness of limbs there is also a looseness of attachment of limbs and abnormal mobility of joints.

Bovine chondrodysplastic dwarfism in Japanese brown cattle is an autosomal recessive defect with the phenotype of short limbs, joint abnormality, and ateliosis.<sup>1</sup> Long bones of affected animals have insufficient endochondrial ossification with irregularly arranged chondrocyte, abnormal formation of cartilaginous matrix, and partial disappearance of the epiphyseal growth plates. The gene *LBN* is the causative gene for bovine chondrodysplastic dwarfism.<sup>1</sup> The bovine fibroblast growth factor receptor 3 (*FGFR3*) gene is not the locus responsible for the defect.<sup>2</sup>

Inherited congenital achondroplasia with hydrocephalus

First recorded as **bulldog calves** in Dexter cattle, this inherited defect has since been observed in a variety of forms in other breeds, including Jerseys, Guernseys, Holsteins, and Japanese Brown cattle.<sup>3</sup> Chondrodysplasia in the Holstein-Friesian breed sharing morphological features with the Dexter bulldog calves have been reported from the United States, the Netherlands, Great Britain, and recently in Denmark.<sup>4</sup> Dexter bulldog type calves have occurred in French and Danish Holstein calves in a familial pattern related to the sire Igale Masc, and it is likely that the genetic disorder is present in the Holstein breed worldwide.<sup>4</sup>

Characteristic features of lethal chondrodysplasia (Dexter bulldog) calves in Australian Dexter cattle include abortion, disproportionate dwarfism, a short vertebral column, marked micromelia, a relatively large head with retruded muzzle, cleft palate and protruding tongue and a large abdominal hernia.<sup>5</sup> Histological changes in limb bones are consistent with failure of endochondral ossification. Dexter chondrodysplasia is considered to be inherited in an incompletely dominant manner with the homozygous form producing the congenital lethal condition. Based on analysis of the contribution of

three obligate heterozygotes whose semen has been widely used in artificial insemination in Australia, it is estimated that the heterozygote frequency is 19% within the registered Australian Dexter herd.<sup>5</sup>

Affected calves are often aborted but some reach full term and cause fetal dystocia because of the extreme hydrocephalus. The forehead bulges over a foreshortened face with a depressed, short nose. The tongue protrudes, the palate is cleft or absent, the neck is short and thick, and the limbs are shortened. Accompanying defects are fetal anasarca and hydrops amnii in the dam.

The defect is primarily chondrodystrophy rather than achondroplasia; the nasal bones and maxillae do not grow. Hydrocephalus develops because of the deformed cranium. In most breeds the condition is inherited as a simple recessive character but a dominant form has occurred in Jerseys. The heterozygous form in Dexters is easily recognized by the shortness of the limbs. The heterozygote in other breeds is normal in appearance.

#### Miscellaneous dwarfs

Other types of dwarfs have been described and include 'comprest' and 'compact' cattle in Herefords and Short-horns and various other forms of **proportional dwarfs**. For example, in Charolais, miniature calves that are exact replicas of normal calves but weigh only 5–16 kg at birth and are born 2 or more weeks prematurely, have been recorded. Most are dead at birth or die soon after so that the condition is effectively lethal. Proportional dwarfs occur also in Simmentals.

Other forms of chondrodystrophy, including 'bulldog calves' and one which causes fatal nasal obstruction in the German Black Spotted breed of cattle, have also been recorded. In the latter there are multiple deformities of limb bones and the condition appears to be inherited due to the influence of a single recessive gene.

**Dwarf lambs** occur sporadically. The best known is the mutant **Ancon** which has appeared and disappeared three times, with one incidence in New Zealand and one in the United Kingdom. The defect is chondrodysplasia and the lambs are not viable.

#### REFERENCES

1. Takeda H et al. Proc New York Acad Sci 2002; 99:10549.
2. Takami M et al. Int Soc Anim Genet 2002; 33:351.
3. Moritomo Y et al. J Jpn Vet Med Assoc 1989; 42:173.
4. Agerholm JS et al. J Vet Diagn Invest 2004; 16:293.
5. Harper PA et al. Aust Vet J 1998; 199.

### CONGENITAL OSTEOPETROSIS

This inherited defect is recorded in Aberdeen Angus calves which are still-born and undersized. The major manifestations are shortening of the mandible with protrusion of the tongue, impaction of the lower molars, a patent fontanelle, and the characteristic lesion of shortness of the long bones and absence of a marrow cavity in them. The absence of the marrow cavity, caused by defective remodeling of the bone, gives it a homogeneous shaft leading to the colloquial name of 'marble bone'. Radiographic examination makes antemortem diagnosis simple. It is considered to be an autosomal recessive trait. It is reported also in foals but there is doubt about its genetic origin in that species.

### INHERITED PROBATOCEPHALY (SHEEPSHEAD)

This defect is inherited in Limousin cattle. The cranial bones are deformed so that the head resembles that of a sheep. The accompanying defects in heart, buccal cavity, tongue, and abomasum increase the chances of an early death.

### INHERITED ATLANTO-OCCIPITAL DEFORMITY

(See Congenital defects of the nervous system).

### INHERITED AGNATHIA

Partial or complete absence of the mandibles with ventral displacement of the ears is common in sheep and is categorized as a lethal recessive because the sheep are unable to graze properly.

### INHERITED DISPLACED MOLAR TEETH

Inherited as a simple recessive character this defect usually results in the death of affected calves within the first week of life. The six premolars of the lower jaw are impacted or erupted in abnormal positions, often at grotesque angles. The mandible is shorter and narrower than normal. There is no abnormality of the incisors or upper jaw.

### INHERITED JAW MALAPPOSITION

Defective apposition of upper and lower incisors, or lower incisors and dental pad in ruminants may result in inefficient grazing and malnutrition. Abnormal protrusion of the mandible (**mandibular prognathism**) is of most importance in ruminants and there is good evidence that abnormal length of the mandible is inherited. Amongst British breeds of **cattle**

the defect is more common in beef than in dairy breeds. In Herefords and Angus the inheritance is thought to be conditioned by a single recessive gene.

**Brachygnathia**, underdevelopment of the mandible, has also been recorded in Dairy Shorthorn, Jersey, Holstein, Ayrshire, and Simmental cattle, with the defect so severe in some cases that the animals are unable to suck. In Angus brachygnathia can occur linked to a generalized degenerative joint disease, in which all joint surfaces are involved. Affected animals, detected at a few days to 4 months of age, are not viable.<sup>1</sup> Inheritance of the defect is probably conditioned by a recessive gene.

A less severe degree of **brachygnathia** has been recorded in Merino and Rambouillet **sheep**. The mode of inheritance is suggested to be by the interaction of several pairs of genes.

**Mandibular prognathism** occurs as a part of other more general defects including achondroplastic dwarfism and inherited displaced molar teeth.

**Brachygnathia** is also seen in **horses**.<sup>2</sup> The defect is present at birth but is often not apparent until much later.

#### REFERENCES

1. Jayo M et al. Vet Pathol 1987; 24:148.
2. Gift LJ et al. J Am Vet Med Assoc 1992; 200:715.

### INHERITED CRANIOSCHISIS (CRANIUM BIFIDUM)

The disease occurs in a number of pig breeds, but has been shown to be inherited only in Poland China pigs and their crossbreds. There is a deficit in the cranial bones and meningoceles or encephalocèles may result. The pigs are not viable. Genetic experiments have shown the inheritance to be of a recessive character with varying penetrance.

Many single cases of cranial and spinal deformity in farm animals have been likened to the human Arnold-Chiari malformation but a specific syndrome of protrusion of the medulla oblongata and the cerebellum through the foramen magnum into the spinal canal has not been identified in a hereditary context in these species.

### INHERITED CRANIOFACIAL DEFORMITY

The defect is incompatible with life. One form in Border Leicester lambs is characterized by a variable degree of nasomaxillary hypoplasia, often associated with incomplete cerebral development with less pronounced sulci and gyri than normal. It appears to be inherited in a simple autosomal recessive mode. A similar lethal defect is recorded in Angus cattle (as brachygnathia superior) in association with generalized degenerative joint disease.<sup>1</sup>

**Cyclops anomaly** occurs sporadically without known cause, but attracts attention when it is part of an inherited, prolonged gestation syndrome when it is often the cause of the investigation being mounted.

#### REFERENCE

1. Jayo M et al. *Vet Pathol* 1987; 24:148.

### **INHERITED ARACHNOMELIA (INHERITED CHONDRODYSPLASIA)**

#### Cattle

This suspected inherited disease of Simmental, Brown Swiss, Italian Brown calves,<sup>1</sup> and other European breeds of cattle is manifested by excessively long, thin, distal extremities which give the calves a spidery look, hence arachnomelia. The bones are very fragile, there is curvature of the spine, foreshortening of the mandible, and associated cardiac and vascular defects. In Swiss Braunvieh cattle it is combined with arthrogryposis.<sup>2</sup> It is thought to be inherited as a simple recessive.

#### Sheep

##### *Spider lamb syndrome*

A hereditary chondrodysplasia is recorded in Suffolk and Hampshire lambs<sup>3</sup> in which the limbs are thin, disproportionately long, and have abnormal positions of the bones about the joints causing abnormalities of posture. There is also less muscle than normal. In severe cases the deformities are obvious at birth and may be lethal. In less severe cases the deformities do not become apparent until the lambs are several weeks old. The defects are readily visible in X-rays before clinical signs develop, and affected lambs can be detected in this way. The diagnostic lesion is multiple irregular islands of ossification in the upper limb joints.<sup>4</sup> Spinal deformities, especially kyphoscoliosis, and cranial deformities including a roman nose, deviation of the nose poll axis, and shortening of the mandible are observed in some lambs. Inheritance by an autosomal recessive gene with complete penetrance and variable expressivity has been established as the cause in Suffolks.<sup>5</sup> The defect is thought to be one of deficiency of an insulin-like growth factor (IGF) and IGF-binding proteins.<sup>6</sup> Differentiation from arthrogryposis-hydranencephaly is important because of the superficial similarity of the two diseases.

##### *Inherited chondrodysplasia in Texel sheep*

A chondrodysplasia resulting in a dwarfing phenotype has occurred in a Texel sheep flock as a newly recognized recessively inherited genetic disease of the Texel breed.<sup>7</sup> Affected lambs appear normal at

birth but show evidence of dwarfism, wide-based stance and exercise intolerance as early as 1 week of age. Death usually occurs within 3 months, often after developing bilateral varus deformity of the forelimbs. Some severely affected lambs die with respiratory distress, probably due to tracheal collapse. Gross and microscopic lesions of variable severity were present in the tracheal, articular, epiphyseal, and physeal cartilage. In severe cases, articular cartilage in major joints was eroded from weight-bearing surfaces. The trachea was flaccid, abnormally kinked, and had thickened cartilaginous rings and a narrow lumen. Affected sheep which survived to breeding age commonly developed severe degenerative joint disease. Histologically, chondrocyte were disorganized, surrounded by concentric rings of abnormal fibrillar material and the matrix often contained focal to coalescing areas of chondrolysis. The disease has considerable potential as a suitable model for studying various forms of therapy for human chondrodysplasia.

#### REFERENCES

1. Testoni S, Gentile A. *Vet Rec* 2004; 155:372.
2. König H et al. *Tierärztl. Umschau* 1987; 42:692 & 695.
3. Rook JS et al. *J Am Vet Med Assoc* 1988; 193:713.
4. Vanek J et al. *J Am Vet Med Assoc* 1989; 194:244.
5. Oberauer AM et al. *Small Rumin Res* 1996; 18:179.
6. Osborne JM et al. *Domest Anim Endocrinol* 1992; 9:25.
7. Thompson KG et al. *New Z Vet J* 2005; 53:208.

### **COMPLEX VERTEBRAL MALFORMATION IN HOLSTEIN CALVES**

A lethal congenital defect of the axial skeleton of purebred Holstein calves has been reported in Denmark,<sup>1</sup> the United States,<sup>2</sup> and in the UK which are not carriers of the CVM gene.<sup>3,4</sup> It is caused by a mutation in the gene *SLC35A3* coding an uridine-diphosphate-*N*-acetylglucosamine transporter. A single-base transversion of guanine to thymine has been located in the abnormal allele at position 559.<sup>5</sup> It is present in both copies of the allele and the mutation is lethal. It is a simple recessive genetic defect which requires that both the sire and the dam of an affected calf are carriers.

Most affected calves are born between day 250 and 285 of gestation. Approximately 80% of homozygous affected fetuses are aborted before gestation day 260.<sup>6</sup> Birth weights are reduced. Most affected calves are stillborn, but affected calves occasionally are born alive. Euthanasia must be performed for humanitarian reasons.

In premature, stillborn, and neonatal affected calves, the defect is characterized by congenital growth retardation, malformed vertebrae, and tetramelic arthrogryposis.<sup>1,5,7</sup> There is shortening of the cervical and thoracic parts of the vertebral column due to multiple hemivertebrae, fused and misshaped vertebrae, and scoliosis. Growth retardation and vertebral malformation are typical lesions. Malformation of the head, primarily in the form of dysplasia or palatoschisis, also occurs.

Symmetrical flexures of the carpal and joints and the metacarpophalangeal joint in combination with a slight lateral rotation of the phalanges are also present. Similar low-grade arthrogryposis are present in the pelvic limbs. Heart defects were present in 50% of affected calves (interventricular septal defects, dextro-position of the aorta, and eccentric hypertrophy of the right ventricle).<sup>1</sup>

Retrospective genotyping of affected calves according to the mutation in the *SLC35A3* gene, and there were homozygous affected, heterozygotes, and homozygous normal.<sup>5</sup> The morphological expression of the malformation is wide but certain aspects such as growth retardation, vertebral malformation, and symmetrical arthrogryposis are almost constant findings. A presumptive diagnosis of the malformation can be made in most cases based on necropsy findings combined with pedigree analysis and genotyping.<sup>5</sup> Breeding studies were carried out in Denmark using selected cows that were progeny of sires with a heterozygous genotype for the malformation, and were pregnant after insemination with semen from another sire with heterozygous malformation genotype. The number of calves born with the malformation was less than expected suggesting increased intrauterine mortality.<sup>7</sup> Fertility traits in Holsteins are severely affected by the malformation phenotype of the fetus.<sup>6</sup> If the fetus is homozygous for the malformation, 29% of the cows will abort before gestation day 100 increasing to 45% at day 150, and 77% at day 260. Non-return to service rates, frequency of calvings after the first insemination, and interval from insemination to next calving were significantly reduced by a fetal malformation phenotype.

Pedigree analysis and DNA analyses of semen from sires used for insemination have found a widely branched familial occurrence of the malformation in the Holstein breed.<sup>5</sup> The mutation in the *SCL35A3* gene has been traced to the US sire Penstate Ivanhoe Star born in 1963 and his widely used son Carlin-M Invanhoe Bell born in 1974. The malformation mutation is not restricted to



descendants of the American Holstein Friesian bull-Carlin-M Ivanhoe Bell. Through these sires and elite sires genetically related to them, the defect has been disseminated in the Holstein breed worldwide. Using a hair root sample from the dam of the calf, a DNA test is available. Testing is available on registered or registerable Holstein animals only through the Holstein Association (Holstein USA) or through one of the National Association of Animal Breeders' member AI organizations or at the Van Haeringen Laboratory, Wageningen, The Netherlands. A PCR test is being developed.<sup>8</sup>

#### REFERENCES

1. Agerholm JS et al. *J Vet Diagn Invest* 2001; 13:283.
2. Duncan RB Jr et al. *J Vet Diagn Invest* 2001; 13:333.
3. Johnson VS et al. *Vet Rec* 2003; 153:598.
4. Revell S. *Vet Rec* 2001; 149:659.
5. Nielsen US et al. *Livestock Prod Sci* 2003; 79:223.
6. Agerholm JS et al. *J Vet Diagn Invest* 2004; 16:548.
7. Agerholm JS et al. *Acta Vet Scand* 2004; 45:133.
8. Kanae Y. *J Vet Diagn Invest* 2005; 17:258.

#### INHERITED ACROTERRIASIS (AMPUTATES)

Patients affected by this deformity, e.g. 'mole' calves of the Danish Black and White breed, are characterized by shortened and malformed limbs, especially the extremities which are sometimes missing altogether. In male calves there is also hydrocephalus, hypoplasia of the mandible, and absence of part of the face. The body is edematous. Many are aborted during the latter part of pregnancy. The deformity is conditioned by a single recessive gene.

#### INHERITED REDUCED PHALANGES (AMPUTATES, ACROTERRIASIS, ECTROMELIA)

This defect has been recorded in cattle and appears to be inherited as a single recessive character. The limbs are normal down to the metacarpal and metatarsal bones, which are shorter than usual, but the first two phalanges are missing and the normal hooves and third phalanges are connected to the rest of the limb by soft tissues only. The calves are unable to stand but can crawl about on their knees and hocks.

Hereditary hemimelia. Bilateral absence of the distal half of the limb, e.g. the patella, and shortening or absence of the tibia, often accompanied by hydrocephalus, meningoceles, ventral abdominal hernia, and cryptorchidism, comprise the syndrome known as **tibial hemimelia**. It is inherited in the Galloway breed of cattle. An autosomal recessive mode of inheritance is assumed. A concerted program of eradicating the defect has been undertaken,

based on test matings and examination for defects of 90-days fetuses obtained by terminating pregnancy with prostaglandin.

Hereditary peromelia of mohair goats. This syndrome includes agenesis of the phalanges and parts of the metacarpus and metatarsus affecting one or more limbs, and an autosomal recessive mode of inheritance.<sup>1,2</sup>

Amputates. An even more serious defect, in which the mandible and all the bones below the humerus and stifle are vestigial or absent, has been reported in British, French, and German Friesians. It appears to be conditioned by the inheritance of a single recessive gene. Similar 'amputates' have been shown not to be inherited.

#### REFERENCES

1. Nielsen JS, Arnbjerg J. *J Vet Med A* 1992; 39:142.
2. Agerholm JS et al. *J Vet Sect A* 1997; 44:233.

#### INHERITED CLAW DEFORMITY

Extra claws (**polydactylism**) and fusion of the claws (**syndactylism**) are known hereditary defects of cattle, the former in the Normandy breed and the latter in Holsteins,<sup>1</sup> Angus, Hereford, and Chianina.

**Dactylomegaly** (enlarged dew claws), often associated with syndactyly or deviation of the adjacent major digit and creating a clubfooted appearance, may be inherited in Shorthorn cattle. In most cases they cause no more than inconvenience but an association of syndactyly with susceptibility to hyperthermia is recorded, and some of these animals die of hyperthermia when subjected to high environmental temperatures.

**Adactyly** is a recorded but less well defined defect in cattle and sheep in which the hooves are absent at birth.

There is good field evidence that **corkscrew claw** or **curled toe** is an inherited defect in cattle, especially in beef breeds, but also in Holstein-Friesians. It is almost always the lateral claw which is affected; in some breeds it is more common in the hind feet, and in others it is more common in the front feet. In the affected digit the third phalanx is much smaller than normal and is narrower and longer. The soft tissue and the horn are correspondingly deformed so that the horn grows much longer and narrower and tends to curl over the sole so that the cow walks on the wall of the hoof. The claw also curls over the front of the other digit of the limb. There are often cracks in the front of the claw, originating at the coronet and causing serious lameness. All affected animals suffer gait abnormalities as they get older and heavier. Much of this is due to distortion and wear of the articular

surfaces in the companion claw which has to carry much more weight than is usual. Marked changes in the affected digit are detectable by anteroposterior radiography.<sup>2</sup>

#### REFERENCES

1. Hart-Elcock L et al. *Vet Pathol* 1987; 24:140.
2. Edwards GB. *Vet Ann* 1987; 27:81.

#### INHERITED MULTIPLE EXOSTOSIS

Multiple exostosis affecting both cortical and medullary bone of the limbs and ribs has been described in Quarter horses and Thoroughbreds in the US. The lesions are visible externally but cause little apparent inconvenience. It is inherited as a single dominant autosomal gene. Restriction nuclease analysis is used to diagnose the disease.<sup>1</sup>

#### REFERENCE

1. Leone NC et al. *J Hered* 1987; 78:171.

#### INHERITED CONGENITAL HYPEROSTOSIS (THICK FORELIMBS OF PIGS)

This defect is thought to be caused by the inheritance of a simple recessive character. Affected piglets show obvious lesions at birth and, although many of them die or are destroyed immediately, a proportion of them may survive. The forelimbs are markedly enlarged below the elbows and the skin is tense and may be discolored. There is difficulty in standing and moving about, and starvation and crushing contribute to the mortality rate. There is extensive edema of the subcutaneous tissues, thickening of the bones, and roughness of the periosteum. It is thought that the primary lesion is a separation of the periosteum from the bone.

#### INHERITED RICKETS

This disease of pigs is indistinguishable from rickets due to nutritional inadequacy. The pigs are healthy at birth. Subsequently there is hypocalcemia, hyperphosphatemia, and increased serum alkaline phosphatase. The defect is a failure of active transport of calcium through the wall of the small intestine.

#### INHERITED TAILLESSNESS AND TAIL DEFORMITY

Complete absence of the tail or deformity of the appendage occur relatively commonly as a congenital defect. The condition is thought to be inherited in Holstein cattle and in Landrace and Large White pigs. It is often seen in combination with other deformities of the hind-quarters such as atresia ani and urogenital tract abnormalities.

## INHERITED DISEASES OF JOINTS

### INHERITED ARTHROGRYPOSIS (INHERITED MULTIPLE TENDON CONTRACTURE)

Inherited fixation of limb joints present at birth is recorded in many breeds of cattle especially in the Shorthorn, Charolais, Piedmont, and Swedish Dole. It is thought to be inherited as a single recessive character. There are many environmental causes of the disease, the most common of which is Akabane virus infection of early pregnancy and discussed under that heading.

#### Simple arthrogryposis

The limbs of affected calves are fixed in flexion or extension and cause dystocia due to abnormal positioning and lack of flexibility. There is no involvement of joint surfaces and the joints can be freed by cutting the surrounding tendons or muscles. There is atrophy of limb muscles and those calves which are born alive are unable to stand and usually die or are destroyed within a few days.

#### Arthrogryposis with dental dysplasia

This defect in cattle appears to be inherited in a dominant manner. The teeth are soft, fleshy, and easy to bend. There is no defect of bones or joints other than marked softness and the presence of excess cartilage at the epiphyses. There is abnormal ossification of the cartilage. The calves are of normal size, do not cause dystocia, and, although they are unable to stand because of the excessive flexibility of the limbs, they can suck. Hypostatic pneumonia usually develops and causes death of the calf.

#### Arthrogryposis with palatoschisis (SAP)

This is inherited as a simple recessive with low penetrance in pure French Charolais in France and high penetrance in 7/8 Charolais cattle in Canada, where the gene frequency is high in purebred and crossbred Charolais. Among crossbred Charolais cattle the homozygous condition is almost always markedly expressed and lethal, but a high percentage of purebred homozygous cattle show slight to no visible effect of the gene and survive. Because of the low rate of prevalence in France, attempted eradication does not appear to be economical.

In this syndrome all limbs are usually affected but the front limbs more than the hindlimbs, and the more distal joints are more rigidly fixed than proximal ones. The muscles of affected limbs are atrophic and pale in color. Histological changes in the spinal cord suggest that the muscle atrophy is neurogenic. In affected calves the gestation period may be longer than normal by an average of 2 weeks.

Arthrogryposis with multiple defects In Simmentals a combined set of defects includes arthrogryposis, often with the limbs in a wraparound position around the body, underdevelopment of the mandible, curvature of the spine, and defects of the heart and main vessels.

Arthrogryposis in other species than cattle

Inherited arthrogryposis has also been recorded in Merino and Corriedale **sheep**, and in Norwegian Landrace **pigs** in which it is thought to be inherited as a simple recessive. The Corriedale defect is associated with other lesions including brachygnathia inferior, hydranencephaly, and thoracic scoliosis. Inherited arthrogryposis in pedigree Suffolk lambs has been described.<sup>1</sup> Breeding studies using superovulation and embryo transfer were used to increase the numbers of offspring from females which were carrying the gene or genes responsible for the defect which was inherited as an autosomal recessive trait.

An inherited arthrogryposis also occurs in Norwegian Fjord **horses**. The arthrogryposis affects the hindlimbs and there are accompanying defects of polydactyly, palatoschisis, and brachygnathia in some. Most foals are unable to stand and the defect must be considered to be a lethal one.

### INHERITED MULTIPLE ANKYLOSIS

Multiple ankylosis affecting all limb joints has been recorded as an inherited congenital defect of Holstein calves. The abdomen of the dam shows marked enlargement at the 6th to 7th month of pregnancy and this may occasion some respiratory distress. Excessive fetal fluids are present and insertion of the hand per rectum is impeded by the distended uterus. Abortion during the last month of pregnancy is a common occurrence. Affected fetuses have a very short neck, ankylosed intervertebral joints, and varying degrees of ankylosis of all limb joints. The limbs are fixed in flexion and there is some curvature of the spine. Fetal dystocia always occurs and embryotomy or cesarean section is necessary to deliver the calf.

Ankylosis of limb joints combined with **cleft palate** occurs occasionally in Charolais cattle and is suspected of being inherited. **Ankylosis of the coffin joint**, developing at several weeks of age, has been reported in Simmental calves. The etiology of the condition is not clear.

### INHERITED PATELLAR SUBLUXATION

Unilateral or bilateral subluxation occurs as an inherited defect in *Bos indicus* cattle

and in water buffalo (*Bubalus bubalis*). Shetland ponies also have a predisposition and a monogenic autosomal recessive transmission is suspected.<sup>1,2</sup> There is periodic lameness with the affected limb held in rigid extension; the patella is displaced medially. If the animal shakes the limb the patella may go back into its normal position and the problem is relieved.

### REFERENCES

1. Doherty ML et al. Vet Rec 2000; 748.
2. Hermans WA et al. Vet Q 1987; 9:1.

### INHERITED HYPERMOBILITY (LAXITY) OF JOINTS

This inherited disease is recorded only in Jersey cattle. It has assumed great importance because of the great popularity of a sire which carried the gene. There is abnormal flexure and extension of all joints but especially the hock, stifle, hip, knee, elbow, and shoulder joints. The muscles are much atrophied and the joints look very enlarged as a result. It is impossible for the calves to stand but they are bright, alert, and eat well. The limbs are so flexible that they can be bent into extraordinary positions, and almost tied in knots. A drawer sign, a displacement of the articular surfaces laterally, and produced by manual pressure, can be elicited easily and with a displacement of up to 2 cm. There are no detectable lesions in the nervous or musculoskeletal systems. Although the disease is known to be inherited as a simple autosomal recessive, it has also been seen in circumstances which preclude inheritance being the cause.

### INHERITED HIP DYSPLASIA

An inherited defective development of the acetabulum occurs in Dole horses. There is no clinical evidence of the disease at birth but osteoarthritis of the joint and disruption of the round ligament develop subsequently. For this disease in cattle see 'Degenerative joint disease'.

## INHERITED DISEASES OF MUSCLES

### GENERALIZED GLYCOGENOSIS (GLYCOGEN STORAGE DISEASE TYPE II)

Generalized glycogenosis is a glycogen storage disease of Corriedale sheep,<sup>1</sup> Shorthorn, and Brahman beef cattle which resembles Pompe's disease in humans.<sup>2,3</sup> Glycogenosis type II in Shorthorn and Brahman cattle is a lysosomal storage disease in which acidic

$\alpha$ -glucosidase is the defective enzyme. In Shorthorn cattle, glycogenosis type II is caused by a single mutation, but the initial DNA/PCR restriction enzyme test of amplicons, was occasionally compromised by inhibition of the restriction enzyme by undefined factors. This was overcome by introduction of wild and mutant allele-specific amplifications and the use of two restriction enzymes, which clarified the anomalies and provided a more accurate testing system.<sup>2</sup>

In Brahman cattle, glycogenosis type II is associated with loss-of-function alleles affecting the  $\alpha$ -glucosidase gene that differ from that in Shorthorns. There is a common mutation affecting many Australian Brahmans and a less common one affecting descendants of one imported bull. In addition, a third mutation was associated with significantly reduced  $\alpha$ -glucosidase activity, but not sufficient to cause clinical disease in the homozygous state.<sup>3</sup>

Clinical signs include poor growth, muscle weakness, incoordination of gait, and difficulty in rising. The animals become permanently recumbent. The disease is identified as a lysosomal storage disease with lesions present in skeletal and cardiac muscle, and central nervous tissue. During the course of the disease there is progressive muscular damage and acute degeneration of muscle fibers in the terminal stage. Affected Brahman calves die at 8–9 months of age and British breed cattle at over 1 year. Only histopathological lesions are evident and include extensive vacuolation and accumulations of granular material in affected tissues. Amongst the biochemical lesions are greatly diminished  $\alpha$ -glucosidase activity in liver and muscle, and a correspondingly high level of glycogen. Animals in affected herds are divisible into normal heterozygotes and homozygotes on the basis of  $\alpha$ -1,4-glucosidase activity in lymphocytes or in muscle, especially the semitendinosus muscle.

Genotyping methods using hair root and blood samples to test Shorthorn cattle for generalized glycogenosis are available,<sup>2</sup> and PCR assays have been developed to genotype Brahman cattle for loss-of-function alleles within the acidic  $\alpha$ -glucosidase gene.<sup>3</sup>

#### REVIEW LITERATURE

- Jolly RD, Blair HT, Johnstone AC. Genetic disorders in sheep in New Zealand: A review and perspective. *New Z Vet J* 2004; 52:52–64.  
 Jolly RD. Lysosomal storage diseases in livestock. *Vet Clin North Am* 1993; 9:1:43.

#### REFERENCE

- Jolly RD et al. *New Z Vet J* 2004; 52:52.
- Dennis JA, Healy PJ. *Aust Vet J* 2001; 79:773.
- Dennis JA et al. *Aust Vet J* 2002; 80:286.

### GLYCOGEN STORAGE DISEASE TYPE V (MUSCLE GLYCOGEN PHOSPHORYLASE DEFICIENCY)

Glycogen storage disease Type V is one of a number of inherited diseases affecting glycogen metabolism and resulting in abnormal accumulation of glycogen in cells. Glycogen storage disease Type V has been recorded in Charolais cattle in North America.<sup>1</sup> As in Type II glycogenosis, Type V is inherited as an autosomal recessive trait  $\alpha$ -glucosidase. There is a deficiency of myophosphorylase, mildly elevated muscle glycogen and elevated serum creatine and aspartate aminotransferase. Severely affected animals may develop rhabdomyolysis which may be accompanied by myoglobinuria.<sup>2</sup>

In Charolais cattle, glycogen storage disease Type V is usually seen in calves at several weeks or months of age and is associated with exercise. Calves lag behind their dam or herd and may become temporarily recumbent for several minutes; with continuous exercise there are further periods of collapse and recumbency which may become prolonged. Not all homozygous animals are clinically affected if they are allowed to 'pace their exercise' and some animals have been known to breed despite muscle weakness.

A polymerase chain reaction-restriction fragment length polymorphism test has been used to identify heterozygous individuals in a Charolais herd in New Zealand that were otherwise normal.<sup>2</sup> Using a similar test, a Blonde d'Acquitaine cross-bred calf with a double-muscled phenotype and suspected of having myophosphorylase deficiency based on clinical findings of brown-colored transparent urine after exercise, pain, and an elevated creatine kinase was considered negative.<sup>3</sup>

### FAMILIAL POLYSACCHARIDE STORAGE MYOPATHY (EQUINE RHABDOMYOLYSIS SYNDROME)

This myopathy is associated with exertional rhabdomyolysis and occurs with a high incidence in some Quarter Horse, American Paint, Appaloosa, and Quarter Horse cross-bred families. An autosomal recessive pattern of inheritance is proposed.<sup>4</sup> Recurrent episodes occur at intervals of about 2 weeks. Clinical signs include exercise intolerance with prolonged recumbency in some. Discomfort varies between stiffness and pain suggestive of colic. Myoglobinuria is common during episodes of clinical illness. Serum activity of creatine kinase are elevated. Biopsy of gluteal or semitendinosus muscles reveals polysaccharide inclusion bodies in some muscle fibers and widespread sarcolemmal vacuoles. The defect is basically an error of glycolysis.

#### REFERENCES

- Bilstrom JA et al. *Amer J Vet Res* 1998; 59:267.
- Johnstone AC et al. *New Z Vet J* 2004; 52:404.
- Soethout EC et al. *J Vet Med A* 2002; 49:289.
- Valberg SJ et al. *Am J Vet Res* 1996; 57:286.

### INHERITED DIAPHRAGMATIC MUSCLE DYSTROPHY

This is an inherited defect in diaphragmatic muscle of Meuse-Rhine-Yssel and Holstein-Friesian cattle<sup>1</sup> appearing in adults and characterized by anorexia, decreased rumination, and eructation leading to recurrent bloat, dyspnea, abdominal respiration, nostril dilation, and death from asphyxia after a course of several weeks. Necropsy lesions comprise degenerative changes in diaphragmatic and thoracic muscles. The immunohistochemical evaluation of some cytoskeletal proteins of affected muscles found an increase in the amount of desmin and vimentin immunoreactivities and similar amounts of actin and  $\alpha$ -actinin compared with controls.<sup>2</sup>

#### REFERENCES

- Furuoka H et al. *Acta Neuropathol* 1995; 90:339.
- Furuoka H et al. *Acta Neuropathol* 1999; 97:177.

### CONGENITAL MYASTHENIA GRAVIS

Congenital myasthenic syndrome has been reported in Brahman cattle in South Africa.<sup>1</sup> Affected calves develop progressive muscular weakness, beginning at birth and up to 3–4 weeks of age. Within 1 week they are unable to stand without assistance. Some calves are able to stand and walk for 30 to 45 minutes before collapsing, but are still able to suck their dams. The calves remain alert and continue sucking but may collapse after 20 to 60 seconds. The weakness becomes progressively worse and affected calves are usually euthanized. Hematology and serum biochemistry are normal, and muscle biopsies do not reveal any abnormalities.

The underlying defect is a homozygous 20-base pair (bp) deletion in the gene, muscular acetylcholine receptor (*bovCHRNE*), coding for the  $\epsilon$ -subunit of the nAChR at the neuromuscular junction.<sup>2</sup> A PCR-based DNA test, using blood or semen has been developed and validated.<sup>3</sup> The test makes it possible to differentiate rapidly and accurately between homozygous wild-type, heterozygous and homozygous affected animals. Preliminary testing of Brahman cattle in South Africa revealed several carrier animals, some of them influential in the breeding population.

#### REFERENCES

- Thompson PN. *Vet Rec* 1998; 143:526.
- Kraner S et al. *Neurogenetics* 2002; 4:87.
- Thompson PN et al. *Vet Rec* 2003; 153:779.

## BOVINE FAMILIAL DEGENERATIVE NEUROMUSCULAR DISEASE

This disease has been reported occurring in Gelbveih cattle in several separate beef herds in the United States.<sup>1</sup> Affected animals are 4 to 20 months of age, and the mortality rate is 100%. Clinical findings include ataxia, weakness, and terminal recumbency. Gross and histological muscle lesions were indicative of nutritional muscular dystrophy with no myocardial lesions. Acute to chronic lesions in most large skeletal muscle groups consist of degeneration, necrosis, regeneration, fibrosis, and atrophy. Fibrinoid necrosis of arterioles is a common feature in multiple tissues. Lesions in the spinal cord white matter and peripheral nerves consisted of degeneration of the dorsal columns and axons, respectively. Chronic interstitial nephritis with fibrosis, hyaline droplet change, and tubular epithelial vacuolar change were most severe in older calves. Vitamin E levels were deficient in most affected calves. Pedigree analysis found a common ancestry for all but one of the affected calves. It is hypothesized that a hereditary metabolic defect, possibly involving anti-oxidant metabolism may be the causative factor.

### REFERENCE

1. Moisan PG et al. *J Vet Diagn Invest* 2002; 14:140.

## INHERITED UMBILICAL AND SCROTAL HERNIAS, CRYPTORCHIDISM, AND HERMAPHRODITISM

Umbilical hernias in cattle and scrotal hernias and cryptorchidism in pigs have been considered to be inherited defects for many years but the evidence is uncertain.

### Umbilical hernias

Umbilical hernias are commonly identified in dairy heifers. In 18 commercial dairy herds in New York, 15% of heifer calves had umbilical hernias during the first 3 months of age.<sup>1</sup> The economic costs of umbilical hernias include the cost of medical and surgical treatment and the loss in value for breeding animals.

It has been generally accepted that umbilical hernias may be inherited in a dominant or recessive mode. Some studies have found the risk of hernias was higher in some breeds: the incidence being much higher in Holstein cattle than other breeds such as Angus, Ayrshire, Brown Swiss, Charolais, Guernsey, Hereford, Jersey, and Shorthorn. However, factors other than genetic may be important. For example, many veterinarians have observed that umbilical infections commonly lead to umbilical hernia by slowing closure of

the umbilicus. It is unlikely that the responsible genes are sex-linked, in spite of the apparent greater incidence in females. Umbilical hernias in Holstein-Friesian cattle can also be conditioned by a dominant character with incomplete penetrance, or be due to environmental factors. In a case control study to determine risk factors associated with identification of an umbilical hernia during the first 2 months after birth in Holstein heifers, the sire and umbilical infection were associated with risk of a hernia.<sup>2</sup> Heifers born to sires with = 3 progeny with an umbilical hernia were 2.31 times as likely to develop a hernia as were heifers born to sires with = 2 progeny with an umbilical hernia. Heifers with umbilical infection were 5.65 times as likely to develop a hernia as were heifers without umbilical infection. Attributable proportion analysis found that the frequency of umbilical hernias in Holstein heifers with umbilical infection would have been reduced by 82% if umbilical infection had been prevented.<sup>3</sup>

The risk factors for congenital umbilical hernias in German Fleckvieh calves offered for sale at livestock markets were examined.<sup>4,5</sup> An umbilical hernia was defined as a palpable opening in the abdominal wall of the umbilical region >1.5 cm, even if no hernia had developed. Inflammation, abscesses or fistulae were excluded. Data from 53 105 calves were collected from 77 livestock markets over a 2-year period. The overall incidence of congenital hernia was 1.8%. The analyses found significant effects for sex of calf, birth type, age of calf at examination, market place and date, sire line, sire, and frequency of affected herdmate calves in male calves, the incidence was 2.2%, in females 1.5%. The calves varied from 3 to 8 weeks of age. The diameter of hernial openings was between 1.5 and 9 cm with 47% of affected calves with a hernia measuring greater than 3 cm. A significantly higher incidence occurred in twin or triplet calves. Shorter gestation periods increased the risk of hernias linearly by a factor of 1.3% for 10 days. There were differences in the incidence of hernias according to sire lines but the heritability estimates were low varying from  $h^2 = 0.04$  (>100 progeny) or  $h^2 = 0.05$  (>25 or 50 progeny). However, analysis of the data found no evidence for an autosomal monogenic recessive inheritance. The analyses indicated that the incidence of congenital umbilical hernia observed could not be explained by one autosomal recessive gene locus, but it seemed much more likely that more than one gene locus is involved or a mixed multifactorial monogenic mode of inheritance may be the

underlying genetic mechanism. It is suggested that the incidence of congenital umbilical hernias could be reduced if all breeding bulls are examined as calves and a veterinary certificate confirms a closed umbilical ring.

Breeders should be aware of the implications of congenital hernias and thus, congenital hernia should get more attention in the selection process of young sires.

Breeding studies and genotyping using the Canadian Holstein bull 'Glenhpton Enhancer', have provided evidence that Enhancer is the carrier of major dominant or codominant gene with partial penetrance for umbilical hernia.<sup>3</sup> Five sons of Enhancer produced progeny with >10% frequency of umbilical hernia, whereas the progeny of 3 sons had <3% umbilical hernia. Genotyping of grand-progeny found significant differences in paternal allele frequencies between the affected and unaffected progeny groups for a marker BMS1591 on bovine chromosome 8(BTA8). The umbilical hernia-associated paternal allele originated from Enhancer.

### Scrotal hernias

Scrotal hernias of pigs have also been shown to be inherited in some breeds, e.g. Duroc and Landrace, but not in others, e.g. Yorkshires.<sup>6</sup>

### Cryptorchidism

Evidence suggesting the inheritance of cryptorchidism in swine, sheep, horses, and Hereford cattle and hermaphroditism in swine is also available. Cryptorchidism in horses appears to be inherited with a polygenic pattern of transmission.

### REFERENCES

1. Virtala AMK et al. *J Dairy Sci* 1996; 79:1040.
2. Steenholt C, Hernandez J. *J Amer Vet Med Assoc* 2004; 224:1487.
3. Ron M et al. *Anim Genet* 2004; 35:431.
4. Herrmann R et al. *Vet J* 2001; 162:233.
5. Herrmann R et al. *Berl Munch Tierarztl Wochenschr* 2001; 114:22.
6. Vogt DW et al. *Amer J Vet Res* 1990; 51:1501.

## MYOFIBER HYPERPLASIA (DOUBLE MUSCLING, DOPPELENDER, CULARD)

### EPIDEMIOLOGY

This is an inherited condition, characterized by an increased bulk of skeletal muscles due to the presence of a greater than normal number of muscle fibers; it is well known in many breeds of cattle but appears to be most common in the Charolais, Belgian Blue, Piedmont, and South Devon breeds. The condition is recorded only rarely in sheep. The mode of inheritance has not been established but heterozygotes usually show some degree of muscle hypertrophy. Many of

the muscle changes are in the direction of the current demand for lean, meaty carcasses, and there is interest, especially in Europe, in the exploitation of this anomaly for meat production. Pietrain pigs (see below) exhibit many of the characteristics of double-muscling cattle, including large muscle mass and susceptibility to stress.

### CLINICAL FINDINGS

Severely affected cattle show a marked increase in muscle mass most readily observed in the hindquarters, loin, and shoulder, an increase in the muscle:bone ratio and a decrease in body fat. Affected calves demonstrate above-average weight gains during the first year of life if well fed and managed, although mature size is somewhat reduced. Well-marked grooves along the intramuscular septa in the hindquarters are a distinguishing feature as is an apparent forward positioning of the tail head. Macroglossia, prognathism, and a tendency toward muscular dystrophy and rickets have been observed in affected calves. Electrocardiographic abnormalities have been reported.<sup>1</sup> The condition often gives rise to dystocia, possibly due to increased gestation length, and affected females are said to be less fertile than normal.<sup>2</sup> There is also a very high incidence of Elso heel in affected cattle and this interferes greatly with their economic value. Other associated defects are brachygnathia and deviation of the incisor arch and, in Belgian Blue and White cattle, greater susceptibility than normal to laryngitis and bronchopneumonia.<sup>3</sup>

### CLINICAL PATHOLOGY

Blood lactate is increased, as is susceptibility to stress. These findings are interpreted as being indicators of cell membrane fragility, which is also manifested by fragility of the erythrocytes.

### NECROPSY FINDINGS

The skin is thinner than normal, and the muscle mass is characterized by a disproportionate number of glycolytic, anaerobic fibers.

### REFERENCES

1. Amory H et al. *Am J Vet Res* 1992; 53:1540.
2. Ott RS. *J Am Vet Med Assoc* 1990; 196:413.
3. Gustin P et al. *Res Vet Sci* 1988; 45:405.

### PIETRAIN CREEPER PIGS

A progressive muscular weakness is found in stress-susceptible Pietrain pigs. The syndrome commences with muscle tremor at 2–4 weeks of age, leading to complete recumbency by 12 weeks of age. At this stage the pigs move with a creeping gait with the limbs flexed. There are no neuropathological lesions but there are myopathic changes, especially in the forelimbs.

### INHERITED PROGRESSIVE MUSCULAR DYSTROPHY

This is a primary skeletal muscle disease of sheep with a strong probability of having a genetic mode of transmission.<sup>1</sup> It is recorded in Merino flocks in Australia and is characterized by a gradually progressive failure to flex the joints of the hindlimbs commencing at 3–4 weeks of age. Eventually the limbs are rigid at all times, and running becomes impossible. The forelimbs and the head and neck are normal. Affected sheep are easily detected when they are 1 year old and will have mobility problems by the time they are 2–3 years old. At necropsy there are pale areas in skeletal muscle and sometimes the muscles of the diaphragm in those sheep which have a tendency to bloat. The histopathology and histochemistry of the muscle lesions is comparable with that of inherited muscle atrophies in humans.<sup>1,2</sup>

### REFERENCES

1. Richards RB et al. *Aust Vet J* 1988; 65:93.
2. Richards RB et al. *Acta Neuropathol* 1988; 77:95 & 161.

### INHERITED SPINAL MUSCULAR ATROPHY

A progressive ataxia, weakness, muscle atrophy, and recumbency develops in young calves, mostly during the first 2 weeks of life. Sensory functions are unimpaired. Some are already affected at birth and some may be stillborn. No new cases occur after 3 months of age. Conditioned by an autosomal recessive gene the defect occurs in Red Danish cattle which originated from Brown Swiss, and from German Braunvieh and American Brown Swiss. The primary lesion is degeneration of ventral horn cells of the spinal cord, without involvement of the brainstem or cerebellum. The visible lesion is the secondary atrophy of the denervated muscles.<sup>1,2</sup>

### REFERENCES

1. Nielsen JJ et al. *Acta Vet Scand* 1990; 31:253.
2. Dahme VB. *Neuropathol Appl Neurobiol* 1991; 17:517.

### INHERITED SPLAYED DIGITS

Recorded only in Jersey cattle, this defect appears to be conditioned by an inherited gene; probably a monogenic autosomal recessive. Lameness becomes apparent at 2–4 months of age, the toes becoming increasingly widely spread and the toes themselves misshapen. Walking and standing are painful, especially on the front feet so that some animals graze and walk on their knees. Affected animals either lie down increasingly or stay standing for very

long periods. The apparent abnormality is a defect of the muscles and ligaments holding the phalanges together.

### EQUINE HYPERKALEMIC PERIODIC PARALYSIS

#### Synopsis

**Etiology** Defect in sodium channel of skeletal muscle.

**Epidemiology** Disease of Quarter Horses and crossbreds. Inherited as an autosomal dominant trait with variable penetrance.

**Clinical signs** Episodes of muscle fasciculation, stridor, muscle weakness, and flaccid paralysis.

**Clinical pathology** Hyperkalemia during episodes. Gene probe to detect mutated gene.

**Lesions** None.

**Treatment** Palliative. Potassium-free intravenous fluids. Acetazolamide.

**Control** Selective breeding. Low potassium diet.

### ETIOLOGY

The disease is caused by a heritable defect in the sodium channel of skeletal muscle.<sup>1</sup> The mutation, of which only one form has been identified, results in substitution of a cytosine for guanine, with consequent replacement of phenylalanine by leucine in a transmembrane protein regulating sodium flux across the cell membrane and T-tubule. The disease is transmitted as an autosomal codominant with the result that homozygotes are more severely affected than heterozygotes, and phenotypic expression (disease severity) differs among heterozygotes.

### EPIDEMIOLOGY

The disease is familial and affects Quarter Horse and crossbred descendants of a single Quarter Horse sire, Impressive.<sup>2,3</sup> More than 50 000 registered Quarter Horses are related to known carriers of the disease.<sup>4</sup> Quarter Horses with the disease are presumably selected because they outperform unaffected animals in the halter classes in which they compete at horse shows,<sup>5</sup> although recent rule changes have changed this practice. The disease is occurs in breeds derived from or crossed with Quarter horses including Appaloosas, American Paint horses, and crossbreds.

The disease is inherited in an **autosomal codominant** manner.<sup>1</sup> Therefore, 50% of the offspring of the breeding of a heterozygote and a normal animal will carry the trait, as will 75% of the offspring of the breeding of two heterozygotes. Of the breeding of 2 heterozygotes, 50% of progeny will be heterozygotes, 25% homozygotes for the mutated gene, and 25% homozygotes for the normal gene.

Animals homozygous for the abnormal gene are uncommon, representing only 0.9% of animals tested for the disease.<sup>6</sup> The low prevalence of the homozygote genotype is likely a reflection of severity of disease and the reduced likelihood that homozygotic animals will reach sexual maturity.

The risk of a **heterozygous** animal being affected with periodic paralysis is variable. Most heterozygous horses appear normal and never experience an attack, while others have severe episodes starting at a young age. **Homozygous** horses are much more likely to have severe manifestations of the disease at a young age.

### PATHOGENESIS

The abnormality in the sodium channel coded for by the mutated gene predisposes the horse to episodes of complete depolarization of the muscle membrane and flaccid paralysis. The mutation in the sodium channel increases the probability that any one channel is open, with the result that the resting membrane potential in affected horses is higher (less negative and closer to the depolarization threshold) than that of normal horses.<sup>7</sup> This results in frequent depolarizations of individual muscle fibers causing muscle fasciculations. The weakness associated with severe episodes of the disease results from failure of sodium channels to close after depolarizations. Opening of potassium channels when the muscle is depolarized results in movement of potassium out of the muscle cell, and the development of hyperkalemia.

### CLINICAL SIGNS

The disease in **heterozygous** animals is characterized by periods of muscle fasciculation and tremor that progress to weakness, paralysis, and recumbency. Such episodes may last minutes to hours, and most resolve spontaneously. Horses often sweat, have prolapse of the third eyelid, and contraction of facial and locomotor muscles during episodes. Episodes may be mistaken for colic. Inspiratory stertor commonly noted during episodes is probably due to laryngeal and pharyngeal dysfunction.

Episodes are more frequent and severe in **homozygous** animals and signs of **laryngeal and pharyngeal dysfunction**, such as stridor and dysphagia, occur in almost all of these animals.<sup>6,8</sup> Endoscopic examination of homozygotes reveals pharyngeal collapse, laryngopalatal dislocation, and laryngeal paralysis.<sup>6,8</sup> The disease can manifest in foals as young as 7 days of age. The severity of signs in some homozygotes diminishes with age.

**Electromyographic** demonstration of myotonic discharges, prolonged insertional activity, and doublets and triplets is a sensitive and specific indicator of the disease.<sup>9</sup>

Horses with HYPP have reduced exercise tolerance compared to normal horses.<sup>10</sup> Homozygotic horses have laryngospasm, airway obstruction, hypoxia, hypercapnia, and ventricular depolarizations during intense exercise, which is not recommended for these horses.<sup>11</sup>

### CLINICAL PATHOLOGY

**Hyperkalemia** (>5.5 mEq/L, 5.5 mmol/L) during or immediately after episodes is characteristic of the disease, although the existence of a normokalemic variant has been suggested.<sup>12</sup>

**Diagnostic confirmation** has in the past been achieved by provocative testing by administering potassium chloride (88–166 mg/kg, orally) to suspect horses.<sup>13</sup> However, the development of genotyping has rendered provocative testing obsolete and, for humane reasons and because of the risk of death, its use is not recommended. The **test of choice** for demonstrating the presence of the mutated gene is a specific **gene probe**.<sup>4</sup> The probe can be applied to various tissues, but blood or hair, with attached root (a plucked hair), are preferred for diagnostic testing of live animals. This test classifies horses as normal, heterozygous, or homozygous but does not indicate the propensity of heterozygotes to exhibit the disease. Samples can be analyzed in the United States at the Veterinary Genetics Laboratory, University of California ([www.vgl.ucdavis.edu](http://www.vgl.ucdavis.edu)).

### DIFFERENTIAL DIAGNOSIS

- Colic
- Laminitis
- Hypocalcemia
- Botulism
- Exertional rhabdomyolysis
- Upper airway obstruction.

### NECROPSY FINDINGS

There are no characteristic findings on necropsy examination.

### TREATMENT

#### Acute episodes

Most acute episodes resolve spontaneously or with only minor treatment. The aim in treating more severe or prolonged episodes is to **reduce the plasma potassium concentration** by intravenous infusion of isotonic, potassium free fluids such as sodium chloride, sodium bicarbonate, or dextrose. Some authors recommend infusion of calcium gluconate but others caution against its use. A practical approach is the slow intravenous administration of 0.25 to 0.5 mL of 23% calcium gluconate per kg of body weight (125–250 mL for a 500 kg horse) diluted in isotonic sodium chloride or, preferably, 5% dextrose.

Administration of NaHCO<sub>3</sub> at 1 mL/kg intravenously has been suggested.

### Prevention of episodes

Maintaining affected horses on a **low potassium diet** reduces the frequency with which episodes occur. Alfalfa (lucerne), some oils including soyabean, molasses, lite salt (a mixture of KCl and NaCl), and many sweet feeds are potassium rich and should be avoided. Grass hay (timothy) and straw and oats, corn, and barley are low in potassium. There are commercial feeds that have a guaranteed low concentration of potassium. Alternatively, diets can be formulated using feed of known potassium concentration, as determined by feed analysis. Care should be taken that diets are nutritious and contain appropriate concentrations and ratios of calcium and phosphorus.

Acetazolamide (2–4 g/kg, every 12 hours) reduces the severity and frequency of episodes and is widely used to control the disease. The drug is poorly absorbed in horses but the concentration required in plasma of horses to achieve a pharmacodynamic effect is lower than that of humans.<sup>14</sup>

### CONTROL

The disease is heritable and carriers are readily identified so a breeding program to eliminate the disease is feasible.

### REVIEW LITERATURE

- Naylor JM. Hyperkalemic periodic paralysis. *Vet Clin North Am: Equine Pract* 1997; 13:129-144.  
Meyer TS et al. Hyperkalaemic periodic paralysis in horses: a review. *Equine Vet J* 1999; 31:362.

### REFERENCES

1. Rudolph JA et al. *Nature Gen* 1992; 2:144.
2. Bowling AT et al. *Anim Gen* 1996; 27:279.
3. Naylor JM et al. *J Am Vet Med Assoc* 1992; 200:340.
4. Spier SJ. *J Equine Vet Sci* 1993; 13:140.
5. Naylor JM. *J Am Vet Med Assoc* 1994; 204:926.
6. Carr EA et al. *J Am Vet Med Assoc* 1996; 209:798.
7. Hanna WJ et al. *J Physiol* 1996; 497:349.
8. Traub-Dargatz JL et al. *J Am Vet Med Assoc* 1992; 201:85.
9. Naylor JM et al. *Can J Vet Res* 1990; 54:495.
10. Steele D, Naylor JM. *J Equine Vet Sci* 1996; 202:933.
11. Maxson-Sage A et al. *Am J Vet Res* 1998; 59:615.
12. Stewart RH et al. *J Am Vet Med Assoc* 1993; 203:421.
13. Spier SJ et al. *J Am Vet Med Assoc* 1990; 197:1009.
14. Alberts MK et al. *Am J Vet Res* 2000; 61:965.

### RECURRENT EXERTIONAL RHABDOMYOLYSIS IN THOROUGHbred HORSES (AZOTURIA, TYING UP, CHRONIC INTERMITTENT RHABDOMYOLYSIS)

Recurrent exertional rhabdomyolysis of Thoroughbred horses is a common dis-

ease characterized by repeated episodes of muscle disease. A similar disease occurs in Standardbred horses but its etiology and epidemiology are not well documented.

### ETIOLOGY

Recurrent exertional rhabdomyolysis in Thoroughbred race horses is inherited as an autosomal dominant trait with variable expression influenced by temperament, diet, and sex.<sup>1,2</sup> Horses with recurrent exertional rhabdomyolysis have abnormal muscle contraction and a defect in myoplasmic calcium regulation.<sup>3,4</sup> These abnormalities are evident after caffeine or halothane challenge of muscle fibers from affected horses examined *in vitro*.<sup>2,4</sup> Myotubules from affected horses have higher concentrations of calcium after caffeine stimulation and muscle fibers from affected horses are more likely to contract when exposed to low concentrations of caffeine.<sup>3</sup> The defect does not resemble that found in the ryanodine receptor in animals with malignant hyperthermia, and there is no defect in calcium-ATPase activity or its affinity for calcium in the sarcoplasmic reticulum of Thoroughbred horses with recurrent exertional rhabdomyolysis.<sup>5</sup>

A genetic basis to a similar disease in Standardbreds is suspected, based on analysis of pedigree information of trotters in Sweden.<sup>6</sup>

### EPIDEMIOLOGY

Interpretation of reports of prevalence and risk factors for exertional rhabdomyolysis is difficult because studies to date have mostly not differentiated between the recurrent exertional rhabdomyolysis of Thoroughbreds, polysaccharide storage myopathy of Quarterhorses and related breeds, and the sporadic disease in other breeds.

The **incidence** or 1-year-period prevalence of exertional rhabdomyolysis in Thoroughbreds is 4.9–6.7% in Thoroughbred racehorses in the United States, Australia, and Great Britain, and 6.1% in National Hunt Thoroughbreds in Great Britain.<sup>7–10</sup> The disease occurs repeatedly in 74% of affected Thoroughbred race horses in Great Britain.<sup>10</sup>

**Risk factors** for exertional rhabdomyolysis in Thoroughbred horses, not all of which have the familial disease, include exercise, diet, use, and sex. Horses used for racing are more likely to have episodes of the disease than are horses used for pleasure riding or 'other' uses,<sup>7</sup> although racing and breed (Thoroughbred or Standardbred) are confounding factors. Female race horses are three times more likely to have episodes of exertional rhabdomyolysis than are male (intact or castrated) race horses,<sup>7–10</sup> and young, female Thoroughbreds are at greatest

risk.<sup>7–10</sup> Among National Hunt horses in Great Britain, females are 24 times as likely to have an episode of the disease as are males.<sup>9</sup> Female polo ponies are not more likely to develop the disease.<sup>11</sup> Thoroughbred racehorses and polo ponies, but not National Hunt horses, with a nervous or 'flighty' temperament are more likely to experience episodes of the disease.<sup>8,12,13</sup> Other apparent risk factors include a rest day before hard exercise,<sup>8</sup> feeding >4.5 kg of grain per day,<sup>8</sup> lameness,<sup>8</sup> and training gallops of shorter distance.<sup>9</sup> Susceptible horses consuming a high calorie diet (>30 mCal/day) with a large proportion of the calories provided by readily digestible carbohydrate, such as starch, are at increased risk of the disease.<sup>14,15</sup>

The disease is of considerable **economic impact** because of its frequent occurrence in athletic horses, recurrent nature, and need to rest affected horses. On average, affected Thoroughbred race horses cannot train for 6 days after an episode, and approximately two-thirds of affected horses are unable to race because of the disease.<sup>9,10</sup> The effect of the loss of training days for each episode is magnified because of the recurrent nature of the disease in a large proportion of affected horses. Approximately 6% of the wastage of Thoroughbred race horses in Australia is attributable to exertional rhabdomyolysis,<sup>16</sup> though it is not known if all of these horses are affected by recurrent exertional rhabdomyolysis.

### PATHOGENESIS

The underlying cause is described above under 'Etiology'. The disease is due to dysfunction and death of myocytes with subsequent release of cellular constituents, including the enzymes creatine kinase, aspartate aminotransferase and carbonic anhydrase, and myoglobin. Cell death is likely linked to abnormal accumulation of calcium in intracellular fluids secondary to deranged energy and/or membrane function.<sup>17</sup> Necrosis of myocytes caused pain and inflammation in the muscle, with infiltration of inflammatory cells. Healing and regeneration of myocytes occurs over a period of weeks in the absence of further episodes of myonecrosis.

The release of cellular constituents results in electrolyte abnormalities, primarily hypochloremic metabolic alkalosis, systemic inflammatory response, and pigmenturia. Severely affected horses can have a metabolic acidosis. Myoglobin and, possibly, other cell constituents are nephrotoxic and acute renal failure can develop as a result of myoglobinuric nephrosis. Pain and loss of muscle function are associated with stilted, short stepping gait.

### CLINICAL FINDINGS

The cardinal feature of the disease is the occurrence of multiple episodes of rhabdomyolysis following exercise of Thoroughbred horses. Clinical findings are **variable** and range from poor performance to recumbency and death. Signs are usually mild and resolve spontaneously within 1–6 days.

The **usual presentation** is a young (2–5-year-old) female racehorse with recurrent episodes of stiff gait after exercise. The horse does not perform to expectation and displays a **short stepping gait** that may be mistaken for lower leg lameness. The horse may be reluctant to move when placed in its stall, be apprehensive and anorexic, and frequently shift their weight. More severely affected horses may be unable to continue to exercise, have **hard and painful muscles** (usually gluteal muscles), sweat excessively, be apprehensive, refuse to walk, and be tachycardic and tachypneic. Affected horses may be hyperthermic. Signs consistent with abdominal pain are present in many severely affected horses. Deep red urine (myoglobinuria) occurs but is not a consistent finding. Severely affected horses may be recumbent.

### CLINICAL PATHOLOGY

Mildly or inapparently affected horses have moderate increases in **serum creatine kinase (CK)** (20 000–50 000 iu/L), **aspartate aminotransferase (AST)** and **lactate dehydrogenase (LDH)** activity. Severely affected horses have large increases in CK (>100 000 iu/L) and other muscle-derived enzymes. Serum CK and AST activities peak approximately 5–6 and 24 hours after exercise, respectively<sup>11,18</sup> and in the absence of further muscle damage serum AST might not return to normal levels for 7–10 days. The half-life of CK activity in serum is approximately 12 hours and in the absence of continuing muscle damage serum CK declines rapidly.<sup>11</sup> The persistence of increased AST activity, compared to CK, is useful in identifying affected horses days or weeks after the episode.<sup>18</sup>

**Serum myoglobin** concentrations increase markedly during exercise in affected horses, and decline within 24–48 hours.<sup>18</sup> Serum carbonic anhydrase III activity is increased in horses with exertional rhabdomyolysis.<sup>12</sup>

Severely affected horses are often **hyponatremic** (<130 mEq/L), **hyperkalemic** (>5.5 mEq/L), **hypochloremic** (<90 mEq/L), azotemic (increased serum urea nitrogen and creatinine concentrations) and **acidotic** or **alkalotic**. Hematocrit (>50%, 0.5 L/L) and increased serum total protein concentration (>80 g/L) indicative of dehydration



are common. Serum bicarbonate concentration can be falsely markedly elevated in animals with severe rhabdomyolysis because of cellular constituents released from damaged muscle that interfere with the analytical method when automated clinical chemistry analyzers are used.<sup>13</sup> Measurement of urinary excretion or fractional excretion of electrolytes is not useful in detecting horses susceptible to recurrent exertional rhabdomyolysis.<sup>19</sup>

**Myoglobinuria** is detectable either grossly or on chemical analysis and should be differentiated from hemoglobinuria or hematuria. Measurement of urinary excretion of electrolytes, although popular in the past, is of no use in diagnosing, treating, or preventing exertional rhabdomyolysis.

**Muscle biopsy** during the acute or convalescent stages reveals myonecrosis of Type II (fast twitch, oxidative) fibers, mild myositis, and fibrosis.

### NECROPSY FINDINGS

Horses dying of exertional rhabdomyolysis have widespread degeneration of striated muscle; principally, the muscles of exertion, but often involving the diaphragm and heart. Affected muscles tend to be dark and swollen, but may have a pale, streaked appearance. The kidneys are swollen and have dark brown medullary streaks. Dark brown urine is present in the bladder. Histologic examination reveals widespread necrosis and hyaline degeneration of predominantly Type II (fast twitch, oxidative) fibers. In horses with recurrent disease there may be evidence of myofiber regeneration. Myoglobinuric nephrosis is present in severely affected horses.

Samples for postmortem diagnostic confirmation

Formalin-fixed kidney and affected muscle for light microscopic examination.

### DIAGNOSTIC CONFIRMATION

Biochemical confirmation of muscle damage by demonstration of increased serum CK or AST activity, in conjunction with appropriate clinical signs, provides the diagnosis.

### DIFFERENTIAL DIAGNOSIS

- Ear tick (*Otobius megnini*) induced muscle cramping<sup>20</sup>
- Polysaccharide storage myopathy of Quarter horses
- *Casia occidentalis* toxicosis
- Hyperkalemic periodic paralysis
- Laminitis
- Colic
- Pleuritis
- Aorto-iliac thrombosis.

### TREATMENT

The treatment chosen depends on the severity of the disease. The **general principles** are rest, correction of dehydration and electrolyte abnormalities, prevention of complications including nephrosis and laminitis, and provision of analgesia.<sup>21</sup>

**Mildly affected horses** (heart rate <60 bpm, normal rectal temperature and respiratory rate, no dehydration) may be treated with rest and phenylbutazone (2.2 mg/kg, orally or IV every 12 hours for 2–4 days). Horses should be given mild exercise with incremental increases in workload as soon as they no longer have signs of muscle pain. Access to water should be unrestricted.

Severely affected horses (heart rate >60 bpm, rectal temperature >39°C (102°F), 8–10% dehydrated, reluctant or unable to walk) should not be exercised, including walking back to their stable, unless it is unavoidable. Isotonic, polyionic fluids, such as lactated Ringer's solution, should be administered IV to severely affected horses to correct any dehydration and to insure a mild diuresis to prevent myoglobinuric nephropathy. Less severely affected horses can be treated by administration of fluids by nasogastric intubation (4–6 L every 2–3 hours). Affected horses should not be given diuretics.

**Analgesia** can be achieved by administration of phenylbutazone (2.2–4.4 mg/kg, IV or orally, every 12–24 hours), flunixin meglumine (1 mg/kg IV every 8 hours) or ketoprofen (2.2 mg/kg IV every 12 hours). **Mild sedation** (acepromazine or acetylpromazine 0.02–0.04 mg/kg IM, or xylazine, 0.1 mg/kg IM, both with butorphanol, 0.01–0.02 mg/kg) may decrease muscle pain and anxiety. Tranquillizers with vasodilatory activity, such as acetylpromazine, should only be given to horses that are well hydrated. Muscle relaxants, such as methocarbamol, are often used but have no demonstrated efficacy.

Recumbent horses should be deeply bedded and repositioned by rolling every 2–4 hours. Severely affected horses should not be forced to stand.

### CONTROL

Prevention centers on insuring that horses are fed a balanced ration with adequate levels of vitamin E, selenium and electrolytes, and have a regular and consistent program of exercise.

Thoroughbred race horses in training consume diets providing over 30 Mcal/day. The high energy intake is associated with increased risk of exertional rhabdomyolysis, especially if the diet provides a large (40%) of calories as readily digested carbohydrate (starch). **Diets** in which fat provides 20% of digestible energy calories and 7%

as starch are associated with lower serum creatine kinase activities after exercise on a treadmill.<sup>14</sup> These findings have been extrapolated to provide the recommendation that race horses in training receive no more than 20% of daily digestible energy from hydrolysable carbohydrate (starch) and at least 20% of DE from fat.<sup>22</sup> Fat can be incorporated into the diet as rice bran, soy bean hulls, and vegetable (but not animal) fats and oils. High fat, high fiber commercial diets that are formulated for treatment of horses with polysaccharide storage myopathy or recurrent exertional myopathy are available.

Despite lack of clear evidence for a widespread role for **vitamin E or selenium** deficiency in exertional rhabdomyolysis, horses are often supplemented with 1 IU/kg of vitamin E and 2.5 µg/kg of selenium daily in the feed. Care should be taken not to induce selenium toxicosis. **Sodium bicarbonate** and other electrolytes are often added to the feed of affected horses, but their efficacy is not documented and is suspect.<sup>14</sup>

**Phenytoin** has proven useful in the treatment of recurrent rhabdomyolysis. It is administered at a dose rate of 6–8 mg/kg, orally, every 12 hours, and the dose adjusted depending on the degree of sedation produced (a reduced dose should be used if the horse becomes sedated) or lack of effect on serum CK or AST activity. Phenytoin can be administered to horses for months. Dantrolene (800 mg, approximately 2 mg/kg, orally 60 minutes before exercise) was demonstrated in a controlled, cross-over field trial of 77 horses, to be effective in reducing exercise-induced increases in CK and incidence of episodes of recurrent exertional rhabdomyolysis in Thoroughbred race horses.<sup>23</sup> Similar results were obtained in 4 horses with recurrent exertional rhabdomyolysis administered 4 mg/kg orally 90 minutes before exercise on a treadmill.<sup>24</sup>

**Dimethylglycine, dantrolene, altrenogest and progesterone** are all used on occasion in horses with recurrent rhabdomyolysis, but again without demonstrated efficacy.

### REVIEW LITERATURE

Beech J. Equine muscle disorders 1: chronic intermittent rhabdomyolysis. *Equine Vet Educ* 2000; 12:163.

### REFERENCES

1. MacLeay JM et al. *Am J Vet Res* 1999; 60:250.
2. Dranchak PK et al. *J Am Vet Med Assoc* 2005; 227:762.
3. Lentz LR et al. *Am J Vet Res* 2002; 63:1724.
4. Lentz LR et al. *Am J Vet Res* 1999; 60:992.
5. Ward TL et al. *Am J Vet Res* 2000; 61:242.
6. Collinder E et al. *Equine Vet J* 1997; 29:117.
7. Cole FL et al. *Vet Rec* 2004; 155:625.
8. MacLeay JM et al. *Am J Vet Res* 1999; 60:1562.
9. Upjohn MM et al. *Vet Rec* 2005; 156:763.

10. McGowan CM et al. *Vet Rec* 2002; 151:623.
11. Toutain PL et al. *J Vet Pharmacol Therap* 1995; 18:226.
12. Nishita T et al. *Am J Vet Res* 1995; 56:162.
13. Collins ND et al. *Vet Clin Pathol* 1998; 27:85.
14. McKenzie EC et al. *J Vet Int Med* 2003; 17:693.
15. MacLeay JM et al. *Am J Vet Res* 2000; 61:1390.
16. Bailey CJ et al. *Vet Rec* 1999; 145:487.
17. Piercy RJ, Rivero JL. *Equine Sports Medicine and Surgery*. Elsevier. London. 2004; p. 77.
18. Valberg S et al. *Equine Vet J* 1993; 25:11.
19. McKenzie EC et al. *Am J Vet Res* 2002; 63:1053.
20. Madigan JE et al. *J Am Vet Assoc* 1995; 207:74.
21. Andrews FM. *Vet Clin North Am: Equine Pract* 1994; 10:567.
22. Geor RJ. *Equine Sports Medicine and Surgery: Basic and clinical sciences of the equine athlete*. Elsevier. London. 2004; p. 827.
23. Edwards JGT et al. *Equine Vet J* 2003; 35:707.
24. McKenzie EC et al. *Am J Vet Res* 2004; 65:74.

## PORCINE STRESS SYNDROME (PSS; MALIGNANT HYPERTHERMIA)

### Synopsis

**Etiology** Inherited defect caused by an autosomal recessive gene at a single locus with incomplete penetrance. Also known as the halothane sensitivity gene, or PSS mutation, which is a single point mutation of nucleotide 1843 in the skeletal muscle gene for the calcium-release channel of the sarcoplasmic reticulum.

**Epidemiology** Worldwide in major breeds of swine: Landrace, Yorkshire, Duroc, Pietrain, and Poland China. Market weight pigs, and adult sows and boars. Prevalence of defective gene varies between breeds and countries. Syndromes precipitated by stress of transportation, high environmental temperatures and humidity, exhaustive exercise, and by halothane anesthesia. Major economic importance because of deaths and poor quality pork.

### Signs

- *Porcine stress syndrome*: death during transportation
- *Malignant hyperthermia*: induced by halothane anesthesia resulting in muscular rigidity and death
- *Pale, soft, exudative pork*: rapid rigor mortis after slaughter followed by excessive dripping of carcass and pale watery pork. Dark, firm, and dry pork is variation
- *Back muscle necrosis*: reluctance to move, acute swelling and pain over back and some may die; subacute form too.

**Clinical pathology** Halothane test. Blood creatine kinase test. Blood typing. DNA-based test for PSS mutation gene.

**Lesions** Pale skeletal muscles in PSS deaths. Pale muscles in back muscle necrosis.

**Diagnostic confirmation** Necropsy findings. Identification of homozygous animals with tests.

### Differential diagnosis list

- Mulberry heart disease
- Acute septicemias due to salmonellosis, erysipelas, pasteurellosis, and anthrax
- Intestinal volvulus
- Heat exhaustion
- Suffocation during transportation.

**Treatment** None.

**Control** Genetic selection. Reduction of environmental and management stressors.

### ETIOLOGY

Three closely related stress syndromes occur in pigs. The **porcine stress syndrome (PSS)** is characterized by acute death induced by stressors such as transport, high ambient temperature, exercise and fighting, which results in progressive dyspnea, hyperthermia, disseminated vasoconstriction and the rapid onset of rigor mortis. **Pale, soft and exudative pork (PSE)** occurs post mortem in some pigs slaughtered by conventional methods. **Malignant hyperthermia (MH)** is a drug-induced stress syndrome characterized by muscle rigidity and hyperthermia occurring in susceptible pigs following the use of halothane or the muscle-relaxant suxamethonium. **Back muscle necrosis** of pigs is a special manifestation of the PSS.

Malignant hyperthermia also occurs in humans.<sup>1</sup>

PSS is caused by an inherited defect due to an autosomal recessive gene at a single locus with incomplete penetrance. It is also known as the halothane sensitivity gene, or PSS mutation, which is single point mutation of nucleotide 1843 in the skeletal muscle gene for the calcium-release channel of the sarcoplasmic reticulum. The PSS defect renders muscle hypersensitive to stimulation by various stressors. In stress-susceptible pigs there is a rapid onset of anaerobic glycolysis and loss of control of skeletal muscle metabolism in response to stress and anoxia.

The gene is commonly known as the *halothane-sensitivity gene* (HAL gene) because pigs with the homozygous genotype can be identified with the halothane test which results in malignant hyperthermia. The halothane gene is located within a group of blood type genes on the same chromosome allowing identification of affected pigs by blood typing. A single point mutation in the porcine gene for the skeletal muscle ryanodine receptor is associated with malignant hyperthermia in five major breeds of heavily muscled swine.<sup>2,3</sup> Comparison of the sequences of the HAL genes of porcine stress syndrome and normal pigs revealed a single mutation at nucleotide 1843 in the cDNA derived from the HAL gene.<sup>2</sup> The litera-

ture on the causative mutation for the porcine stress syndrome has been reviewed.<sup>4</sup>

### EPIDEMIOLOGY

#### Prevalence and occurrence

This subject needs to be kept in perspective. It has recently been suggested that only 4% of inferior quality meat is due to genetics (halothane positive) with the remainder being due to pre-slaughter and post-slaughter treatment.<sup>5</sup>

PSS occurs worldwide, but there is considerable breed and area variation in its prevalence. In some European countries the prevalence is a major problem in pig production because of the inadvertent selection for this trait in genetic improvement programs. This underlies the problems of selection based purely on performance and production characteristics.

The prevalence of PSS in the swine population can be determined by the use of screening tests applied on the farm or when pigs enter swine performance test stations. The halothane test and the creatine kinase (CK) test are useful for this purpose. A DNA-based test with 99% accuracy is also available.<sup>6</sup> Surveys in the UK found that the prevalence in the British Landrace varies from 0 to 23% of herds with an average of 11%. In European breeds, the prevalence varies from 0 to 88% with up to 100% in the Pietrain breed. None is present in the Large White breed although one isolated report describes malignant hyperthermia in a single Large White pig. The prevalence of halothane susceptibility is low in the Danish Landrace breed in Denmark.<sup>7</sup> Based on the halothane test, 1.5% of young boars entering a Record of Performance Test Station in Canada were positive reactors. The reactors originated from 7.5% of 107 herds. The halothane succinylcholine test was a more sensitive test because 18% of the same pigs were identified as reactors.

Using a DNA-based test, in a survey of 10 245 breeding swine of various breeds from 129 farms in the US, Canada, and England, approximately 1 of 5 pigs was a heterozygous carrier of the PSS mutation, and 1% were homozygous.<sup>6</sup> The prevalence of the PSS mutation was 97% for 58 Pietrain, 35% for 1962 Landrace, 15% for 718 Duroc, 19% for 720 Large White, 14% for 496 Hampshire, 19% for 1727 Yorkshire, and 16% for 3446 crossbred swine. The PSS gene frequencies for these breeds were 0.72, 0.19, 0.08, 0.10, 0.07, 0.10, and 0.09, respectively. The PSS mutation has also been identified in Poland China and Berkshire breeds. These gene frequencies were 30–75% lower in Canadian swine than in US swine, with the exception of Yorkshires, for which the

gene frequency is threefold in Canadian swine.<sup>6</sup>

### Risk factors

#### Animal risk factors

Susceptibility to the PSS is inherited and the biochemical events leading to PSE, transport death, or malignant hyperthermia are triggered by several external influences or stressors in the living animal. PSS probably occurs in all breeds of pigs, but the incidence is highest in pigs selected for heavy muscling, and stress-susceptible pigs are leaner and more meaty. These include the Pietrain and Poland China breeds and also some European strains of Landrace where a score for muscling as well as growth rate, feed conversion, and back fat has been included in the selection index. A recent study has shown that there are considerable breed differences in that halothane stress susceptible pigs and Hampshires suffer more severely from heat stress than Yorkshires, Danish Landrace, and Duroc boars.<sup>8</sup>

#### There is a correlation between halothane susceptibility and carcass traits.

Halothane status is the most important factor influencing pork quality, although pre-slaughter handling and stunning method also influence the carcass quality.<sup>9,10</sup>

Halothane-positive animals usually score higher for visual conformation of the loin and ham than pigs which are halothane-negative. The progeny of reactor boars are also more susceptible than the progeny of non-reactors. Until recently it was thought that the major limitation of the halothane test was that it identified only those pigs which are stress-susceptible to the syndrome. It is now known that the halothane-sensitivity gene is expressed in heterozygous pigs where it is likely to cause poor carcass quality.

The **gene for the porcine calcium channel** has been sequenced and the site of the causative mutation located.<sup>2</sup> The mutation was found in 5 major breeds of swine: Landrace, Yorkshire, Duroc, Pietrain, and Poland China. The prevalence of the gene in certain breeds in North America and England is given above.

Landrace pigs can be divided into those which are sensitive to halothane and develop pale, soft, exudative pork post mortem, those which are resistant to halothane but develop pale, soft, exudative pork, and those resistant to halothane and pale, soft, exudative pork (the normal pig). Muscle from pigs susceptible to malignant hyperthermia and pale, soft, exudative pork has significantly higher glucose-6-phosphate levels and lower phosphocreatine under thiopentone anesthesia than muscle from pigs susceptible to PSE and normal pigs. Altered

muscle fiber type is not the primary basis of the disease complex.

#### Environmental and management risk factors

The most important precipitating factors are **transportation at high environmental temperatures and humidity, exhaustive exercise**, and under experimental conditions, the more specific reaction towards the **anesthetic halothane**. Response of pigs to transport is dependent on genotype particularly at high temperatures such as 36°C.<sup>11</sup> Experimentally, psychological mechanisms can precipitate the PSS. The effects of mixing, transportation, and duration of lairage can have profound effects on carcass characteristics of susceptible pigs. Death during transportation and PSE are associated with fear, defensive or aggressive reactions in unfamiliar social environments, or conflict with other strange pigs or man. Other activities which may trigger malignant hyperthermia include restraint, mating, farrowing, fighting, and vigorous exercising.

#### Economic importance

The economic losses associated with the PSS are due to mortality from transport death and inferior meat quality due to pale, soft, exudative pork. As a result of the excessive rates of production of lactic acid and heat, sarcoplasmic proteins denature, thereby causing a deterioration of the water-binding capacity of muscle. The increased osmotic activity due to end-products of hypermetabolism causes an influx of water from the extracellular space resulting in hemoconcentration and increased intramyofiber water content. The muscle becomes pale, soft, and exudative, sour-smelling and loose-textured. The shrinkage due to water loss during storage, transport and processing of the carcass is the major cause of wholesale losses at pork packing plants. PSE carcasses yield less bacon and the drip loss from fresh PSE meat is more than doubled compared to normal carcasses. Another cause of lost revenue with malignant hyperthermia susceptible swine is their decreased average daily weight gains, conception rates, litter sizes, and boar breeding performance.

#### Pathogenesis

The molecular basis for susceptibility to the PSS is a hypersensitive triggering mechanism of the calcium-release channel of skeletal muscle sarcoplasmic reticulum.<sup>6</sup> The calcium channel, also known as the ryanodine receptor, plays a critical role in the initiation of muscle contraction. The PSS defect renders muscle hypersensitive to stimulation by various stressors. Stress-susceptible pigs cannot tolerate stress and lose control of skeletal muscle metabolism.

The stress may be from external influences such as transportation, fear and excitement, or halothane anesthesia. There is excessive catecholamine release and the sudden onset of anaerobic glycolysis of skeletal muscle, excessive production of lactate and excessive heat production which, in conjunction with peripheral vasoconstriction, leads to hyperthermia. Following exertional or thermal stress, susceptible pigs undergo more extensive physiological change than do resistant pigs. Halothane sensitive pigs are more susceptible to becoming non-ambulatory and when subjected to multiple stressors and may be more prone to producing inferior pork products.<sup>10</sup> The blood glucose concentrations are dependent on the malignant hyperthermia genotype; the homozygous positive animals having the highest levels and the homozygous negative animals having the lowest.<sup>12</sup> The changes in carbohydrate metabolism at rest in malignant hyperthermia positive animals are caused by latent increases of intracellular Ca<sup>2+</sup> concentrations. Under physical load conditions there is higher lipolysis which may be the result of an indirect activation of the lipolytic system via catecholamine induced cAMP turn-over.

Depending upon the nature, severity, and duration of the stress, the syndrome may manifest in different ways:

- The **porcine stress syndrome** causes rapid death following severe stress.
- The **pale, soft, and exudative (PSE) pork** and **dark, firm, dry (DFD) pork** are seen after slaughter which may have been preceded by mild stressors during lairage
- The **malignant hyperthermia** is drug-induced.

**Pale, soft, exudative pork** is attributed to increased glycolysis after slaughter. In muscles which develop **dark, firm, dry pork**, the muscle glycogen is already depleted before slaughter.<sup>13</sup> When PSE develops in a muscle, pH drops to values lower than 5.8 at 45 minutes after death. In normal muscles, the pH decreases from approximately 7 in living muscles to 5.3 to 5.8 at 24 hours after death. The lower pH in PSE muscles, combined with a high carcass temperature within the first hour after death, causes the proteins in the muscles to denature. This contributes to the pale color of PSE meat and to its reduced water-holding capacity. Development of muscles with PSE characteristics seems to be initiated by a combination of lower muscle pH already at exsanguination and a faster pH decrease.<sup>13</sup>

**Malignant hyperthermia** is the drug-induced, often fatal, stress syndrome occurring in susceptible pigs within 3 minutes following the inhalation of a

mixture of halothane and oxygen.<sup>14</sup> Susceptible pigs develop limb rigidity and a hyperthermia which are not easily reversed and may result in death. There is an increased rate of intracellular ATP hydrolysis leading to a progressive failure of ATP-dependent  $\text{Ca}^{2+}$  accumulation by sarcoplasmic reticulum and/or the mitochondria with a rise in myoplasmic concentration of  $\text{Ca}^{2+}$  and consequent contraction of muscle. The same molecular defect occurs in lymphocytes from affected susceptible pigs. There is no histomorphometric evidence of cardiac abnormalities in malignant hyperthermia susceptible pigs.<sup>15</sup> The mitochondria from predominantly red muscle fibers have a greater calcium binding capacity than those from predominantly white muscle fiber areas. There is extreme rigidity of skeletal muscles, hyperthermia, tachycardia, cardiac arrhythmia, an increase in oxygen consumption, lactate formation and high-energy phosphate hydrolysis in muscle, respiratory and metabolic acidosis and a rise in the creatine kinase activity and concentration of potassium, lactate, glucose, free fatty acids and catecholamines in blood. There is a large release of glucose and potassium from the liver which contributes to the hyperglycemia and hyperkalemia. There is a marked  $\alpha$ -adrenergic stimulation which is responsible for the heat production in malignant hyperthermia susceptible pigs. However, the  $\beta$ -adrenergic response in stress-sensitive and stress-resistant pigs is inconsistent.<sup>16</sup> The lactic acidemia is severe due to the overproduction of lactate peripherally and failure of normal lactate uptake.

Malignant hyperthermia can also be induced using methoxyflurane, isoflurane and enflurane, and succinylcholine.

Exposing stress-susceptible pigs to halothane or exercise induces glycolysis but the mechanisms are different. There are no histochemical differences between muscles of susceptible and normal swine. There is some indication that halothane causes a transient but significant vasoconstrictive action which could be a contributing factor in initiating the severe reactions in malignant hyperthermia. Electron microscopy of platelets from stress-susceptible pigs reveals a defect characterized by dilatation of the open canalicular system.

## CLINICAL FINDINGS

### Porcine stress syndrome (transport death)

Death during or following transport to market may be significant and is more prevalent when overcrowding occurs and during the hot summer period.<sup>17</sup> If seen alive, affected pigs initially show a rapid

tremor of the tail, general stiffness associated with increased muscular rigidity, and dyspnea to the extent of mouth-breathing. The body temperature is elevated, often beyond the limits of the clinical thermometer, and there are irregularly shaped areas of skin blanching and erythema. At this stage the affected pig is frequently attacked by other pigs within the group. The pig collapses and dies shortly afterwards and the total time course of the syndrome is generally of the order of 4–6 minutes.

### Malignant hyperthermia

Malignant hyperthermia is also a manifestation of the PSS. It may be induced in stress-susceptible pigs by anesthesia with potent volatile anesthetics such as halothane or by the administration of succinylcholine. It is characterized by the development during anesthesia of increased muscle metabolism with muscular rigidity, lactic acidosis, and a marked increase in basal metabolic rate, increased oxygen consumption, carbon dioxide production and severe hyperthermia and tachycardia, tachyarrhythmia and death. Once fully developed the syndrome is irreversible. The syndrome poses a hazard in swine anesthesia which can be averted by prior medication with dantrolene and has received considerable study as a model for an analogous syndrome in man. It has also been used as a method for determining stress susceptibility for genetic selection programs.

### Pale, soft, and exudative pork (PSE)

In stress-susceptible pigs, after slaughter, the inferior quality of the meat with its pale, soft, exudative characteristics is obvious. This is due to excessive post-mortem glycolysis with lactic acid production and a rapid fall in muscle pH with depigmentation and reduced water binding as a consequence. In affected muscle, rigor mortis occurs rapidly after slaughter, but then decreases so that affected carcasses have been 'set' and postmortem drip is excessive. Affected pork has a pH of less than 6 and generally a temperature of 41°C (106°F) or greater 45 minutes after slaughter, compared to the normal pork with a pH above 6 and a temperature less than 40°C (104°F). This causes denaturation of muscle proteins leading to affected meat which has inferior taste, cooking and processing qualities, and does not accept curing as readily. The occurrence of this syndrome is considerably influenced by the stress of transport and handling prior to and during slaughter, and this aspect of the syndrome is of major economic importance.<sup>9,18,19</sup> Rapid chilling helps prevent PSE but chill type has no effect.<sup>20</sup>

### Dark, firm, and dry pork (DFD)

Dark, firm, dry pork has darker color and higher ultimate pH than normal meat. In muscles which develop DFD the muscle glycogen is already depleted before slaughter, which may be related to prolonged transport with fasting.

### Back muscle necrosis

Acute necrosis of the longissimus dorsi occurs in German Landrace pigs and other breeds. The acute syndrome lasts approximately 2 weeks and is characterized by swelling and pain over the back muscles with arching or lateral flexion of the spine and reluctance to move. The swelling and pain then subside, but there is atrophy of the affected muscle and development of a prominent spinal ridge. Some regeneration may occur after several months. Acute cases may die. The syndrome occurs in young adults weighing from 75 to 100 kg. The mild form may be undetectable except for pigs lying down near the feed trough. In the severe form, affected pigs may assume the dog-sitting position with a hunched-up back.

## CLINICAL PATHOLOGY

Several testing methods are available for predicting susceptibility.

### Halothane test

The halothane test is highly reliable for the identification of pigs which are homozygous for the single recessive gene responsible for susceptibility to the PSS. However, the test is not 100% accurate because of the incomplete penetrance of the halothane sensitivity trait (not all homozygous malignant hyperthermic susceptible pigs react by developing limb rigidity). Penetrance of the halothane sensitivity trait is estimated to vary from 50 to 100% depending on the breed, herd, and investigators. The test detects the worst clinical outcomes, and will not identify all the pigs which will develop PSE. There is now evidence that it will detect the heterozygote.<sup>21</sup> Stress-susceptible pigs are sensitive to halothane at 8 weeks of age and if the anesthetic challenge is removed immediately after obvious signs of limb rigidity develop and before the development of fulminant hyperthermia, the mortality from the procedure is negligible. Pigs that remain unreactive for a challenge period of 5 minutes are considered normal.

A halothane-sensitive muscle defect can be present in certain individuals which do not develop rigid malignant hyperthermic episodes on brief exposure to halothane. A longer halothane exposure combined with succinylcholine is required if these false negatives are to be identified. The halothane test has good predictive value for the occurrence of PSE.

However, there may be breed variations as mentioned above.

A decrease in the amplitude of the phosphocreatine (PCr) signal in the *in vivo*  $^{31}\text{P}$  nuclear magnetic resonance spectrum of skeletal pigs is an early and 100% predictive measurement for the detection of malignant hyperthermia in anesthetized piglets.<sup>22</sup> Nuclear magnetic resonance techniques such as magnetic resonance imaging and magnetic resonance spectroscopy are sensitive diagnostic aids for detecting the onset of PSS in young animals and for following the metabolic changes in muscle tissue during the syndrome.<sup>7</sup>

Halothane concentration markedly affects the outcome of halothane testing, and either higher halothane concentrations or longer exposure might be required to identify positive reactors in a heterogeneous population. The ionophore A23187, a lipophilic carboxylic antibiotic which binds and transports divalent cations across both natural and artificial membrane bilayers, allows clear differentiation between the muscles of normal and pathological animals and may be a useful adjunct to the halothane test.

#### Blood creatine kinase levels

The blood creatine kinase (CK) levels are higher in stress-susceptible pigs. Pigs are subjected to a standard exertion test and blood samples taken 8–24 hours later and analyzed for CK. The original work indicated a good correlation between the CK levels and the halothane test. There is also an increase in CK levels in pigs as they are transported from the farm to the abattoir. However, not all pigs which develop PSE have increased serum levels of CK. Increased CK activity is highest in stress-susceptible pigs of a certain phenotype Phi-B, and their total plasma CK levels are higher than non-reactors.<sup>23</sup> The initial test was modified so that blood could be collected as drops on a filter paper and sent to a laboratory for identification by a bioluminescent technique. A recent evaluation of a commercial CK screening test using the method of bioluminescence compared with the halothane challenge test on young boars entering a Record of Performance Test Station revealed that it was an inadequate indicator of susceptibility to the PSS or MH. In a different study the CK levels of piglets 8–10 weeks of age predicted halothane-induced stress syndrome with an accuracy of 87–91%.

**Plasma pyruvate kinase activity** has been compared with CK activity as indicators of the PSS. Both enzymes are increased significantly in homozygous halothane-reacting pigs compared to

non-reacting pigs. Pyruvate kinase activity was less variable within groups than CK activity which may allow more effective discrimination between the two different genotypes. However, age-related effects and the failure to identify heterozygotes may restrict the use of plasma pyruvate activity as a diagnostic test.

#### Blood typing

Blood typing is also used as a method for the identification of susceptible pigs. On one of the chromosomes of the pig, a region with four known loci has been identified. These loci contain the genes responsible for variants of the enzymes 6-phosphogluconate dehydrogenase and phosphoferose isomerase (PHI). The H-blood group system is determined by one of the loci, and halothane sensitivity is also determined by genes at a locus in this region. This region is of special interest because a close connection has been found between this and important carcass traits such as the PSE condition. Thus, blood grouping may be used to detect halothane-sensitive pigs as well as heterozygote carriers.

**A DNA-based blood test** can now be used to detect the HAL gene status.<sup>2,3</sup> It can be adapted for rapid batch analysis of many samples simultaneously, is less invasive, and can be applied to as little as 50  $\mu\text{L}$  of blood. The test is more than 99% accurate, is cost-effective, and can be used to determine the prevalence of the PSS mutation in various breeds of swine in various countries.<sup>6</sup> A recent study showed that 23% of pigs classified as Hal-1843 free based on a DNA test responded abnormally to halothane anesthesia.<sup>24</sup>

#### Pale, soft, and exudative pork

This is evaluated by a meat quality index which combines meat color, pH at 24 hours postmortem, and water-binding capacity. Susceptible lines can be identified by carcass inspection and the results applied to sibling or progeny selection. A recent approach is the measurement of mitochondrial calcium efflux. Mitochondria isolated from Mm longissimus dorsi muscle exhibit a rate of  $\text{Ca}^{2+}$  efflux twice that of normal pigs. Most of the tests readily predict the worst examples of the syndrome but are not sufficiently precise to be able to identify tendencies towards it, which restricts their value in breeding programs.

#### Erythrocyte osmotic fragility

Erythrocyte osmotic fragility may be correlated with malignant hyperthermia and is being examined as a possible aid in the determination of susceptibility.<sup>21</sup>

#### Other tests

Any reliable test which can identify stress-susceptible pigs without using

halothane testing is attractive. Increased peroxidation of the erythrocytes may be an improved diagnostic test for PSS.<sup>25</sup> Differences in the levels of cortisol, creatinine, aspartate aminotransferase, and lactate dehydrogenase are highly significant between halothane-sensitive and halothane-negative lines of pigs.<sup>26</sup>

An allele specific PCR (AS-PCR) technique has been developed.<sup>27</sup> A PCR followed by reduction endonuclease assay has been developed and used<sup>28</sup> on plucked hair as a source of genomic DNA. In a test with this method 9 of 12 Pietrains were tested homozygous or heterozygous. A one-step procedure has been developed called mutagenically separated PCR (MS-PCR).<sup>29</sup>

#### NECROPSY FINDINGS

In the PSS, rigor mortis is present immediately following death, and carcass putrefaction occurs more rapidly than normal. The viscera are congested and there is usually an increased quantity of pericardial fluid as well as pulmonary congestion and edema. The muscles – especially the gluteus medius, biceps femoris, and longissimus dorsi – are pale, wet, and soft. In back muscle necrosis, these changes appear grossly to be confined to the epaxial musculature. Histologically, the lesions in skeletal muscle may be minimal, and are easily obscured by autolysis. In some instances only interstitial edema is visible while in animals which have survived repeated episodes there is obvious phagocytosis of degenerate myofibers, with ongoing regeneration and fibrosis. The most typical microscopic finding is hypercontraction of myofibers, characterized by division of the cell into irregularly-sized segments by transverse and sometimes branching bands. Degenerate sarcoplasm of a floccular or sometimes hyaline character may be present. Degenerative changes may also be detected in myocardial cells.

#### Samples for confirmation of diagnosis

- **Genetic analysis** – 50 g frozen muscle (DNA ANALYSIS) and hair for PCR tests.
- **Histology** – formalin-fixed skeletal muscle (several sections, including longissimus dorsi), heart (LM).
- **Biochemistry** – it has been reported that pigs with PSS develop metabolic acidosis in association with respiratory acidosis<sup>30</sup> which is manifested as lower values of acid-base excess and  $\text{HCO}_3^-$  – with higher  $\text{H}^+$  concentrations and  $\text{pCO}_2$  than resistant pigs.

## DIFFERENTIAL DIAGNOSIS

The acute nature of the PSS and its relation to stress serve to differentiate it from most other syndromes causing sudden death in market and adult sized pigs. The sudden death syndrome must be differentiated from:

- Mulberry heart disease
- Acute septicemias due to salmonellosis, erysipelas, pasteurellosis, and anthrax
- Other causes of sudden death including intestinal volvulus, heat exhaustion, suffocation during transportation
- Hypocalcemic tetany resulting from severe vitamin D deficiency can produce a similar clinical syndrome
- Porcine viral encephalomyelitis may also result in a similar clinical syndrome in postweaned pigs. Pathological and biochemical examinations differentiate these from the PSS.

## TREATMENT

The acute syndromes are usually not treated. Several drugs are available for the protection of pigs against drug-induced malignant hyperthermia. A combination of acepromazine and droperidol will delay the onset or prevent the occurrence of halothane-induced malignant hyperthermia. Dantrolene is also effective for treatment and prevention.<sup>9</sup> The therapeutic dose is 7.5 mg/kg BW. Carazolol is effective for the prevention of transport death when given 3–8 hours before transportation and improves meat quality compared to untreated susceptible animals. Acute back necrosis has been treated successfully with isopyrin and phenylbutazone. Experimentally, the supplementation of the diets of stress-susceptible pigs with vitamin E and C will provide some protective effect on cell membrane integrity.

## CONTROL

The control of this syndrome depends on genetic selection and possible eradication of the PSS mutation and reduction of the severity of stress imposed on pigs.

## Genetic selection

The best strategy for control of this complex is not clear.<sup>6</sup> Several factors must be considered. Swine homozygous for the PSS mutation are at very high risk for developing PSS and severe PSE to make them useful for market pigs. They are used primarily as a source of the PSS mutation for breeding programs and research purposes. Using swine which are heterozygous for the PSS mutation as market pigs may be advantageous. They benefit from the positive effects of the mutation, have minimal risk of developing PSS, and may have acceptable prevalence and severity of PSE, if during marketing and slaughter

the environmental and management risk factors which precipitate PSE are minimized. The mutation is not a prerequisite for leanness and muscularity and it is possible for breeders to eradicate the gene from their breeding stock. The negative effects of the halothane gene on fresh pork quality are well known.<sup>31</sup> However, such a policy may result in the loss of an easily accessible and cost-effective selection criterion for favorable carcass characteristics. The PSS mutation has been used successfully in most swine breeds for increasing leanness and muscling. With the development of the DNA-based test for the PSS mutation, the mutation can be selected for with high precision and accuracy, and its expression finely controlled in a breeding program.

The various testing methods described under clinical pathology are used to identify pigs with the halothane gene. The tests can be applied to breeding stock entering swine performance test stations or on a herd basis. A reliable diagnostic test such as a DNA-based blood test to identify it will provide the basis for elimination of the gene or its controlled inclusion in swine breeding programs.<sup>2</sup>

## Management of stressors

Control through reduction of stress is not easily applied because frequently the syndrome is induced by routine minor procedures within the piggery. The incidence of transport deaths or the necessity for immediate slaughter salvage of severely stressed pigs on arrival at the abattoir and the occurrence of pale, soft, exudative meat characteristics are a significant economic problem in some countries. The necessity to climb an upper deck in the transport poses a significant stress, and the use of single-deck transports or mechanical lifts for multiple-deck transports, and the shipment of pigs in containers has resulted in a decreased incidence. The provision of spacious, well-ventilated transport vehicles and spray-cooling of pigs on arrival at the holding pens is also beneficial. Pigs should not be slaughtered directly after arrival at the abattoir but should be rested for at least 1–2 hours if they have been stressed only by transportation. In cases of severe physical exertion even more time should be allowed for recovery. Where possible transport distance should be kept to a minimum and transport should be avoided on excessively hot days.

## REVIEW LITERATURE

- O'Brien PJ. The causative mutation for porcine stress syndrome. *Comp Cont Educ Pract Vet* 1995; 17:257–269.
- Shen H, Lahucky R, Kovac L, O'Brien PJ. Comparison of HAL gene status with <sup>31</sup>P NMR-determined muscle metabolites and with Ca sequestration

activity of anoxia-challenged muscle from pigs homozygous and heterozygous for porcine stress syndrome. *Pig News Info* 1992; 13:105N–109N.

## REFERENCES

1. Louis CF et al. *Pig News Info* 1990; 11:341.
2. Fujii J et al. *Science* 1991; 253:448.
3. Shen H et al. *Pig News Info* 1992; 13:105N.
4. O'Brien PJ. *Comp Cont Educ Pract Vet* 1995; 17:257.
5. Cassens RG et al. *Fd Chem* 2000; 69:357.
6. O'Brien PJ et al. *J Am Vet Med Assoc* 1993; 203:842.
7. Janzen EG et al. *Can J Anim Sci* 1994; 74:37.
8. Tauson AH et al. *Anim Sci* 1998; 66:431.
9. Channon HA et al. *Meat Sci* 2000; 56:291.
10. Allison CP. *Proc 18<sup>th</sup> Int Pig Vet Soc Cong* 2004; 799.
11. Yoshioka GO et al. *Jap J Swine Sci* 2001; 38:4.
12. Otten W, Eichner HM. *Anim Sci* 1996; 62:581.
13. Enfalt AC et al. *Meat Sci* 1993; 34:131.
14. Bjurström S et al. *J Vet Med A* 1995; 42:659.
15. O'Brien PJ et al. *Can J Vet Res* 1987; 51:50.
16. Jones CA et al. *J Vet Pharmacol Ther* 1989; 12:14.
17. Carrott RF et al. *Res Vet Sci* 1998; 64:51.
18. D'Souza DN et al. *Aust J Agric Res* 1998; 49:1021.
19. Van der Wal PG et al. *Meat Sci* 1999; 53:101.
20. O'Neill DJ et al. *Pig J* 2003; 51:74.
21. Gallant EM et al. *Am J Physiol* 1989; 257:C781.
22. Decanniere C et al. *J Appl Physiol* 1993; 75:955.
23. Doize F et al. *Can Vet J* 1992; 33:263.
24. Rempel WE et al. *J Anim Sci* 1993; 71:1395.
25. Duthie GG et al. *Am J Vet Res* 1989; 50:84.
26. Schafer AL et al. *Can J Anim Sci* 1990; 70:845.
27. Lee SH et al. *Anim Gen* 2002; 33:237.
28. Bastos RG et al. *Gen Molec Biol* 2000; 23:815.
29. Lockley AK et al. *Meat Sci* 1996; 43:93.
30. Guborgvieva TM et al. *Rev Med Vet* 1999; 150:543.
31. Hamilton DN et al. *J Anim Sci* 2000; 78:2862.

## Inherited defects of the skin

### INHERITED SYMMETRICAL ALOPECIA

This is an inherited skin defect of cattle in which animals born with a normal hair coat lose hair from areas distributed symmetrically over the body. It has been observed in Holstein cattle as a rare disease but its appearance among valuable purebred cattle has economic importance. It appears to be inherited as a single autosomal recessive character. Loss of hair commences at 6 weeks to 6 months of age. The alopecia is symmetrical and commences on the head, neck, back, and hind-quarters, and progresses to the root of the tail, down the legs, and over the forelimbs. Affected skin areas become completely bald. Pigmented and unpigmented skin is equally affected; there is no irritation and the animals are normal in other respects. Failure of hair fibers to develop in apparently normal follicles can be detected by skin biopsy.

## INHERITED CONGENITAL HYPOTRICHOSIS

In this congenital disease there is partial or complete absence of the hair coat with or without other defects of development. The main importance of the disease is in cattle, in which there are six syndromes, but it is also inherited in **pigs**, in which it is associated with low birth weights, weakness, and high mortality, and in Poll Dorset **sheep**, in which the face, ears, and lower legs are bald, there are no eyelashes, and the patient lacrimates excessively. The skin is thick, wrinkled, greasy, scaly, and erythematous. Hair fibers are completely absent from the follicles, but wool fibers and follicles are normal.<sup>1</sup>

### Viable hypotrichosis

The condition is recorded in North America in Guernsey and Jersey cattle. Calves are viable provided they are sheltered. They grow normally but are unable to withstand exposure to cold weather or hot sun. In most instances hair is completely absent from most of the body at birth but eyelashes and tactile hair are present about the feet and head. Occasionally hair may be present in varying amounts at birth but is lost soon afterwards. There is no defect of horn or hoof growth. The skin is normal but has a shiny, tanned appearance and on section no hair follicles are present in the skin. The condition is inherited as a single, recessive character.

Congenital hypotrichosis has been reported in a Perheron draught horse.<sup>2</sup> At birth there were circumscribed patchy areas alopecia which was progressive becoming almost complete by 1 year of age. Skin biopsy at 7 months of age revealed severe follicular hypoplasia and the animal was still alive at 6 years of age.

### Non-viable hypotrichosis

This is a complete hypotrichosis in which the thyroid is abnormally small and hypofunctional and the calves die shortly after birth.

### Hypotrichosis with anodontia

Congenital X-linked hypotrichosis with missing teeth in cattle is characterized by abnormal morphogenesis to teeth, hair follicles, and eccrine sweat glands.<sup>3</sup> Two different forms can be distinguished according to the severity of the tooth defects: (1) congenital hypotrichosis with complete or almost complete anodontia; (2) congenital hypotrichosis with completely missing incisors or defective incisors. Impaired body condition and growth of the affected animals result from missing teeth. In addition, animals with sparse hair are more susceptible to cold and more prone to skin lesions.

The phenotype and inheritance of hypotrichosis with nearly complete anodontia has been recorded in pedigreed German Holstein calves.<sup>3</sup> The phenotype is inherited as a monogenic X-linked recessive trait. A reverse transcription-PCR assay was used to identify the causative large genomic deletion in the bovine *EDI* gene. The *EDI* gene for the hypotrichosis and anodontia phenotype appears to have pleiotropic effects on hair follicles, eccrine nasolabial glands, apocrine sweat glands, individually expressed contours of the muzzle, and on development of incisor and premolar/molar teeth. A molecular genetic test for the pathological mutation allows the unequivocal classification of animals with congenital hypotrichosis and anodontia and identification of heterozygous carriers and their exclusion from further breeding.<sup>3</sup>

### Streaked hairlessness

A sex-linked semidominant gene causes development of a streaked hairlessness in which irregular narrow streaks of hypotrichosis occur in female Holsteins.

### Partial hypotrichosis

Recorded in polled and horned Hereford cattle. At birth there is a fine coat of short, curly hair which later is added to by the appearance of some very coarse, wiry hair. The calves survive but do not grow well. The character is inherited as a simple recessive. The disease in Poll Herefords has the same short curly coat but there is also a deficiency of hair in the switch, and over the poll, brisket, neck, and legs in some cattle. Some have a much lighter hair coat color. Histologically there is a characteristic accumulation of large trichohyaline granules in the hair follicles.

### Rat tail syndrome in calves

The 'rat tail' occurred following the importation of continental European breeds of cattle into the United States when those breeds were crossed with Angus or Holsteins.<sup>4</sup> The abnormality is characterized by short, curly, malformed, sometimes sparse hair and lack of normal tail switch development. Histologically, there are enlarged, irregularly distribute, and clumped melanin granules in the hair shafts, which are asymmetrical, short, curled, and small. The scale surface is rough and pitted, and scale fails to form in some areas. A study of the inheritance of the abnormality found that all rat-tail calves were sired by Simmental bulls and were from cows with various percentages of Angus breeding.<sup>4</sup> The abnormality had no effect on birth weight, weaning weight, or gain from birth to weaning. However, rat-tail calves had significantly lower rates of gain during the winter months from weaning to yearling than non-rat-tail calves. The syndrome is controlled by

interacting genes at 2 loci. Cattle which express the syndrome must have at least one dominant gene for black color and be heterozygous at the other locus I

## REFERENCES

1. Mackie JT, McIntyre B. 1992; Aust Vet J 69:147.
2. Valentine BA et al. Vet Dermatol 2001; 12:215.
3. Drogemuller C et al. Vet Dermatol 2002; 13:307.
4. Schalles RR, Cundiff LV. J Anim Sci 1999; 77:1144.

## INHERITED HAIR COAT-COLOR-LINKED FOLLICLE DYSPLASIA

Some 'buckskin'-colored follicular dysplasia occurs in so-called 'Portugese' Holstein cattle, a grade variant of Red Holsteins with a tan color instead of the red. This defect consists of a coat-color-linked hair follicle dysplasia, in which the colored hairs are shorter and less lustrous than the white hair, making the coat much finer and smoother. Test matings seem to confirm an autosomal dominant inheritance.<sup>1</sup>

A black hair colored follicular dysplasia is also recorded in Holstein cattle.<sup>2</sup> Patches of hair loss varying from hypotrichosis to complete alopecia occur in a random fashion but only on black areas. Follicular dysplasia is evident in biopsy samples. The abnormality persists for the life of the animal and is of cosmetic importance only. An inherited etiology is assumed.

A follicular dysplasia in a mature Brangus-cross cow and a mature Angus cow has been described.<sup>3</sup> Adult onset alopecia occurred and skin biopsy revealed follicular distortion and atrophy, with melanin clumping in follicular epithelium, hair bulb matrix cells, hair shafts, and infundibular keratin.

## REFERENCES

1. Ostrowski S, Evans A. Agri-Pract 1989; 10(4):12.
2. Miller WH, Scott DW. Cornell Vet 1990; 80:273.
3. Mansell JL. Vet Dermatol 1999; 10:143.

## INHERITED BIRTHCOAT RETENTION

This is recorded in Merino and Welsh mountain sheep and characterized by a coat of hairy medullated fibers in contrast with the non-medullated wool fibers of the normal sheep fleece.

## INHERITED LEUKODERMA

The Arab fading syndrome commences in young horses in particular families of Arab horses as round, unpigmented patches of skin around the lips, eyes, perineum, preputial orifice. Some cases recover spontaneously but the blemish is usually permanent.



## INHERITED ALBINISM AND LETHAL WHITE FOAL SYNDROMES

Albinism is a congenital lack of melanin pigment in the skin, hair, and other normally pigmented structures such as the uveal tract. Albinism is classified as generalized or localized and as complete or partial or incomplete. The affected skin in albinism is characterized microscopically as melanopenic rather than melanocytopenic, which distinguishes partial albinism from piebaldism. Most of the normal, inherited white markings which occur on horses are localized forms of piebaldism. Generalized and complete albino animals (oculocutaneous albinism) have white hair, white skin, pink irides and usually exhibit photophobia.<sup>2</sup> Generalized albinism in the horse is inherited as autosomal dominant trait which is only viable in the heterozygous states. These horses have incomplete albinism as there is some coloration to the iris. Matings of heterozygous albino horses produce a nonviable embryo 25% of the time which is resorbed in gestation. This is one form of lethal white foal syndrome. A second form of lethal white foal syndrome is an autosomal recessive defect which occurs by mating of overo paint horses. Lethal white foals from such breedings are characterized by albinism and congenital defects of the intestinal tract.

## INHERITED EPIDERMAL DYSPLASIA (BALDY CALVES)

This is a lethal defect of Holstein-Friesian calves inherited as an autosomal recessive character. The calves, most commonly heifers, are normal at birth but at 1–2 months of age begin to lose condition in spite of good appetites. The skin over most of the body is slightly thickened, scaly, and relatively hairless. There are also patches of scaly, thickened, and foiled skin especially over the neck and shoulders, and hairless, scaly, and often raw areas in the axillae and flanks and over the knees, hocks, and elbow joints. The skin over the joints is immovable. There is usually alopecia about the base of the ears and eyes. The tips of the ears are curled backwards. The horns fail to develop and there is persistent slobbering, although there are no mouth lesions. The hooves are long, narrow, and pointed because of gross overgrowth of the walls; these and stiffness of joints cause a shuffling, restricted gait. Calves assume a recumbent posture for most of the time. Severe emaciation leads to destruction at about 6 months of age.

Histological changes in the skin include acanthosis, hyperkeratosis, and patchy neutrophil invasion. The similarity of this

condition to inherited parakeratosis and to experimental zinc deficiency suggests an error in zinc metabolism, but treatment with zinc had no effect on the course of the disease.<sup>1</sup>

### REFERENCES

1. Stannard AA. *Vet Dermatol* 2000; 11:205.
2. Jubb TF. *Aust Vet J* 1990; 67:16.

## INHERITED PARAKERATOSIS (LETHAL TRAIT A46, ADEMA DISEASE)

See 'Lymphocyte maturation deficiency'.

## INHERITED DYSERYTHROPOIESIS-DYSKERATOSIS

See 'Inherited blood diseases'.

## INHERITED CONGENITAL ABSENCE OF THE SKIN

### Classical epitheliogenesis imperfecta

Absence of mucous membrane, or more commonly, absence of skin over an area of the body surface has been recorded at birth in pigs, calves, lambs,<sup>1</sup> and foals. There is complete absence of all layers of the skin in patches of varying size and distribution. In **cattle** the defect is usually on the lower parts of the limbs and sometimes on the muzzle and extending onto the buccal mucosa. The disease is best known in Holstein-Friesians, but is also recorded in Japanese Black, Shorthorn, Sahiwal,<sup>2</sup> and Angus cattle. In **pigs** the skinless areas are seen on the flanks, sides, back, and other parts of the body. The defect is usually incompatible with life and most affected animals die within a few days. Inheritance of the defect in cattle is conditioned by a single recessive gene. Tissue-cultured fibroblasts from affected animals produce subnormal amounts of collagen and lipids.<sup>3</sup>

### Familial acantholysis

Suspected of being inherited, this defect in Angus calves is characterized by defective collagen bridges in the basal and prickle layers of the epidermis so that skin, normal at birth, is subsequently shed at carpal and metacarpophalangeal joints and coronet, and there is separation of horn at the coronet.

### Epidermolysis bullosa

This congenital disease of Suffolk and South Dorset Down sheep<sup>4</sup> and Simmental<sup>5</sup> and Brangus calves is characterized by the formation of epidermal bullae in the mouth and on exposed areas of skin, such as the extremities of the limbs, the muzzles and ears, leading to shedding of the covering surface and separation of the horn from the coronet. Lesions may be present at birth. Simmental calves grow poorly, have hypotrichosis, and suffer

repeated breaks in the skin, apparently due to an abnormal susceptibility to trauma. Most calves die but some survive and the lesions subside. In Simmentals the disease is inherited as an autosomal dominant trait. The disease in Brangus calves is very similar to familial acantholysis in Angus cattle.

The severe form of Herlitz junctional epidermolysis bullosa, which occurs in humans has been recorded in foals of the French draft horse breeds.<sup>6</sup> A mutation in the *LAMC2* gene is responsible for the defect. Affected foals were born with skin blistering, skin and buccal ulceration followed by loss of hooves. In the affected skin there was disjunction of the epidermis from the underlying dermis at the dermal-epidermal junction. Genomic DNA testing is used to determine the presence of the mutation in carrier animals.

### Hereditary junctional mechanobullous disease

This defect is inherited in Belgian foals, Angus and Simmental calves, and Suffolk and South Dorset Down lambs.<sup>7,8</sup> It is usually recorded under the heading of epidermolysis bullosa. There may be no shedding of skin but the initial bullous lesions at the coronet, considered to be initiated by abrasions, lead to sloughing of the hooves.

### Red foot disease of sheep

This is similar to both of the above diseases. It is recorded in Scottish Blackface and Welsh mountain<sup>9</sup> sheep. The lesions are not present at birth but become apparent at 2–4 days of age when there is sloughing of skin of the limbs, the accessory digits, the ear pinna, and of the epidermal layers of the cornea and buccal mucosa, especially the dorsum of the tongue. There is also an absence of head horn and a separation of hoof horn from the coronet. Pieces of horn become completely detached exposing the red corium below, hence 'red foot'. The cutaneous and mucosal lesions often commence as blood-filled or fluid-filled blisters. The corneal lesions are similarly the result of sloughing of epidermal layers. Although the cause is unknown there are indications that it is inherited.

### REVIEW LITERATURE

Jolly RD, Blair HT, Johnstone AC. Genetic disorders of sheep in New Zealand: A review and perspective. *New Z Vet J* 2004; 52:52–64.

### REFERENCES

1. Tontis A, Hofstetter H. *Schweiz Arch Tierheilkd* 1991; 133:287.
2. Fordyce G et al. *Aust J Agric Res* 1987; 38:2.
3. Frey T et al. *J Invest Dermatol* 1989; 93:83.
4. Jolly RD et al. *New Z Vet J* 2004; 52:52.
5. Bassett H. *Vet Rec* 1987; 121:8.
6. Milkenovic D et al. *Genet Sel Evol* 2003; 35:249.
7. Frame SR et al. *J Am Vet Med Assoc* 1988; 193:1420.
8. Johnson CC et al. *J Comp Pathol* 1988; 98:329.
9. Davies IH. *Vet Rec* 1988; 122:464.

## INHERITED CROP EARS

Inherited as a single autosomal, incomplete dominant character in Bavarian Highland cattle, this anomaly affects both ears, appears at birth, and varies from a minor trimming up to a complete deformity and reduction in size.<sup>1</sup>

### REFERENCE

1. Scheider A et al. *Berl. Munch. Tierarz. Wochenschrift* 1994; 107:348.

## INHERITED HYPERBILIRUBINEMIA AND PHOTOSENSITIZATION

An inherited photosensitization with hyperbilirubinemia has been observed in Southdown sheep in New Zealand and the United States, and in Corriedales in California.<sup>1</sup> It is inherited as an autosomal recessive trait.

Liver insufficiency is present but the liver is histologically normal. Phylloerythrin and bilirubin excretion by the liver is impeded and the accumulation of phylloerythrin in the bloodstream causes the photosensitization. There is also a significant deficiency in renal function. Symptomatic treatment of photosensitization and confining the animals indoors may enable the lambs to fatten to market weight. The persistent hyperbilirubinemia is accompanied by an inability of the kidneys of these sheep to concentrate urine and the eventual death of the sheep from renal insufficiency.

Affected sheep live for several years if they are protected from sunlight and tend to die from renal failure associated with progressive fibrosis of the kidney.

A similar disease in Corriedale sheep in California is inherited as an autosomal recessive trait.<sup>1</sup> The functional defect is not in the uptake of unconjugated bilirubin and phylloerythrin, but rather its excretion from liver into bile. It affects lambs as they begin to eat pasture. Lambs live until 6 months of age if provided with some shade. There is also marked melanin-like pigmentation of the liver.

These two diseases are examples of the involvement of external environmental disease factors with a genetic disease: a diet of green forage (chlorophyll) and sunlight, working in concert with the inborn error of metabolism to induce photosensitization.<sup>1</sup>

## INHERITED CONGENITAL ICHTHYOSIS (FISH-SCALE DISEASE)

Congenital ichthyosis is a disease characterized by alopecia and the presence of plates of horny epidermis covering the entire skin surface. It has been recorded only in Holstein and Norwegian Red Poll

and probably in Brown Swiss calves among the domestic animals, although it occurs also in humans.

The newborn calf appears to be either partly or completely hairless and the skin is covered with thick, horny scales separated by fissures which follow the wrinkle lines of the skin.<sup>2</sup> These may penetrate deeply and become ulcerated. There are plenty of normal hair follicles and normal hairs but these are lost in the areas covered by the growth of scales. A skin biopsy section will show a thick, tightly adherent layer of keratinized cells. The disease is incurable and, although it may be compatible with life, most affected animals are disposed of for esthetic reasons. The defect has been shown to be hereditary and to result from the influence of a single recessive gene.

## INHERITED DERMATOSIS VEGETANS

This disease appears to be conditioned by the inheritance of a recessive, semilethal factor. Affected pigs may show defects at birth but in most instances lesions appear after birth and up to 3 weeks of age. The lesions occur at the coronets and on the skin.<sup>3</sup> Those on the coronets consist of erythema and edema with a thickened, brittle, uneven hoof wall. Lesions on the belly and inner surface of the thigh commence as areas of erythema and become wart-like and covered with gray-brown crusts.

Many affected pigs die but some appear to recover completely. Many of the deaths appear to be due to the giant-cell pneumonitis which is an essential part of the disease. The pathology of the disease indicates that it is the result of a genetic defect which selectively affects mesodermal tissue. It is known to have originated in the Danish Landrace breed.

### REFERENCES

1. Jolly RD et al. *New Z Vet J* 2004; 52:52.
2. Raoofi A et al. 2001; *Vet Rec* 149:563.
3. Webb RF, Bourke CA *Aust Vet J* 1987; 64:287.

## DERMATOSPARAXIS (HYPERELASTOSIS CUTIS)

This is an extraordinary fragility of skin and connective tissue in general, with or without edema. It is probably inherited as a recessive character. It occurs in cattle, horses, in Finnish and White Dorper<sup>1</sup> sheep, and a mild form is seen in Merino sheep. The latter is inherited as a simple autosomal recessive. The skin is hyperelastic, as are the articular ligaments; marked cutaneous fragility, delayed healing of skin wounds, and the development of papyraceous scars are also characteristic. Pieces of skin may be ripped off when affected sheep are being handled.

In horses the skin in some parts of the body is thinner than elsewhere, e.g. the skin of the ventral abdomen and the collagen bundles in the area are more loosely packed and are curved rather than straight. The proportion of acid-soluble collagen is also much higher in this abnormal skin. The disease involves a molecular defect of a collagen-binding protein,<sup>2</sup> and is related to a recognized problem in dogs and cats identified as 'dominant collagen packing defect'.<sup>3</sup>

Hereditary equine regional dermal asthenia has been recorded in related Quarter horses in Brazil similar to that reported in the United States.<sup>4</sup> Reported cases of horses with hyperextensible skin have involved Quarter Horses.<sup>5</sup> Clinically there were bilateral asymmetrical lesions of the trunk and lumbar regions, where the skin was hyperextensible. Handling of the skin elicited a painful response and superficial trauma led to skin wounds. The skin was thinner than normal in affected areas, with thickened borders and harder fibrotic masses. Histologically, the collagen fibrils were thinner and smaller, which created a loose arrangement of collagen fibers within the deep dermis. The deep dermis contains a distinctive horizontal linear zone in which separation of collagen bundles results in formation of large empty cleft-like spaces between the upper and lower regions of the deep dermis: 'zonal dermal separation'.<sup>5</sup> Pedigree analysis indicates an autosomal recessive type of inheritance.

The Ehlers-Danlos syndrome, recorded in Charolais and Simmental cattle, and Ripposlea sheep,<sup>6</sup> is also characterized by extreme fragility of skin and laxness of joints in the newborn. There is a defect in collagen synthesis, and histopathological findings include fragmentation and disorganization of collagen fibers.

The syndrome has also been recorded in lambs.<sup>7</sup> The skin was loose and present in excessive amounts, with folds over the carpal joints and lower regions of the legs. In some lambs, there may be separation of epidermis from dermis with blood-filled cavitations and intact skin which can be easily torn.

### REVIEW LITERATURE

- Jolly RD, Blair HT, Johnstone AC. Genetic disorders of sheep in New Zealand: A review and perspective. *New Z Vet J* 2004; 52:52-64.

### REFERENCES

1. van Halderen A, Green JR. *JS Afr Vet. Assoc* 1988; 59:45.
2. Mauch G et al. *J Cell Biol* 1988; 106:205.
3. Hardy MW et al. *J Lab Invest* 1988; 59:253.
4. Borges AS et al. *Vet Dermatol* 2005; 16:125.
5. Brounts SH et al. *Vet Dermatol* 2001; 12:219.
6. Pumarola M et al. *Med Vet (Spain)* 1990; 7:533.
7. Jolly RD et al. *New Z Vet J* 2004; 52:52.

## INHERITED MELANOMA

Inherited cutaneous malignant melanoma are found in National Institute for Health (NIH miniature) and Sinclair miniature swine. Its expression is associated with two genetic loci, one of them associated with the swine major histocompatibility complex.<sup>1</sup> Familial melanoma have also been recorded in members of successive litters from an individual Duroc x Slovak White sow.<sup>2</sup>

## REFERENCES

1. Tissot RG et al. *Anim Genet* 1993; 24:191.
2. Levkut M et al. *J Comp Pathol* 1995; 113:233.

## INHERITED HYPERHIDROSIS

A condition characterized by excessive sweating, and thought to be inherited, is recorded in beef Shorthorn calves. The syndrome includes conjunctivitis, some cases progressing to complete opacity of the cornea, heavy dandruff, and persistent wetness of the hair coat.

## Miscellaneous inherited defects

### INHERITED EYE DEFECTS

An inherited, congenital **corneal opacity** occurs in Holstein cattle. The cornea is a cloudy blue color at birth and both eyes are equally affected. Although the sight of affected animals is restricted they are not completely blind, and there are no other abnormalities of the orbit or the eyelids. Histologically there is edema and disruption of the corneal lamellae.

With **lens dystrophy** Brown Swiss cattle are affected by an inherited congenital blindness with a cloudy shrunken lens as the cause. Japanese Black cattle also suffer from an inherited blindness caused by defects in the pupil, retina, and optic disk.

Bilateral **cataract** has been observed to be an inherited defect in Romney sheep. It is inherited as an autosomal dominant and can be eradicated easily by culling.

Complete **absence of the iris** (aniridia) in both eyes is also recorded as an inherited defect in Belgian horses. Affected foals develop secondary cataract at about 2 months of age. Total **absence of the retina** in foals has also been recorded as being inherited in a recessive manner.

**Microphthalmia** is reported to be an inherited defect in Texel sheep, but the incidence is low. It is a well-recognized genetic defect of Texel sheep in Europe.<sup>1,2</sup> Following importation and 'breeding up'

of the breed in New Zealand in the 1990s, animals were released from quarantine for further expansion of the breed. The abnormality has occurred in a number of flocks in New Zealand and an experimental breeding flock is maintained to study the molecular genetics.<sup>3</sup> It is inherited as an autosomal recessive trait. An outbreak in Texel sheep in New Zealand has been recorded.<sup>1</sup> The optic globes are approximately one half normal size and the optic nerves at the chiasma are approximately one half normal size. No other lesions are present in any organs. The retina is composed of an irregular mass attached to and continuous with the ciliary apparatus at one pole, and connected to the optic nerve posteriorly by a short stalk.<sup>1</sup> The morphology and morphogenesis of the defect has been followed in embryos at different ages from ewes known to be carriers of the microphthalmia factor.<sup>2</sup> The primary event was abnormal development of the lens vesicle, with disintegration of the lens and subsequent overgrowth of mesenchymal tissue. The mesenchymal tissue later differentiated in various directions, whereas the epithelial structures found in the microphthalmic eyes at days 56 and 132 of gestation and in newborn lambs appeared to be remnants of the epithelial lens vesicle.

**Typical colobomata**, ophthalmoscopically visible defects of one or more structures of the eye, caused by an absence of tissue, have assumed a more prominent position than previously because of their high level of occurrence in Charolais cattle. The lesions are present at birth and do not progress beyond that stage. They affect vision very little, if at all. However, because they are defects they should be named in certificates of health but they are not usually considered as being a reason for disqualification from breeding programs. In Charolais cattle the inheritance of the defect is via an autosomal dominant gene with complete penetrance in males and partial (52%) penetrance in females. The prevalence may be as high as 6% and in most cases both eyes are affected. The defect is due to incomplete closure of one of the ocular structures at or near the line of the embryonic choroidal fissure. Failure of the fissure to close represents the beginnings of the coloboma. The retina, choroid, and sclera are usually all involved.

**Entropion** is inherited in a number of sheep breeds including Oxfords, Hampshires, and Suffolks. Affected lambs are not observed until about 3 weeks of age when attention is drawn to the eyelids of the apparent conjunctivitis. A temporary blindness results but even without treatment there is a marked improvement

in the eyelids and the lambs do not appear to suffer any permanent harm.

**Ocular dermoids** are recorded as genetically transmitted in Hereford cattle. They occur as multiple small masses of dystrophic skin complete with hair on the conjunctiva of both eyes of affected cattle. They can be anywhere on the cornea, on the third eyelid, or the eyelid and may completely replace the cornea; there may be a resulting marked dysplasia of the internal ocular structures.

### Combined ocular defects

Although the vision appears unaffected a large number of congenital defects of the eye have been observed in cattle, including Herefords, affected by partial albinism. The defects include iridal heterochromia, tapetum fibrosum, and colobomas. Congenital blindness is also seen in cattle with white coat color, especially Shorthorns. The lesions are multiple and include retinal detachment, cataract, microphthalmia, persistent pupillary membrane, and vitreous hemorrhage. Internal hydrocephalus is present in some, and hypoplasia of optic nerves also occurs.

A combination of **iridal hypoplasia, limbic dermoids and cataracts** was recorded in the eyes of progeny of a Quarter Horse stallion, presumably as a result of a mutation in the stallion and transmission to the foals via an autosomal, dominant gene.<sup>4</sup> The inheritance is a simple autosomal recessive.

**Iridiremia** (total or partial absence of iris), **microphakia** (smallness of the lens), ectopia lentis and cataract have been reported to occur together in Jersey calves. The mode of inheritance of the characters is as a simple recessive. The calves are almost completely blind but are normal in other respects and can be reared satisfactorily if they are hand-fed. Although the condition has been recorded only in Jerseys, similar defects, possibly inherited, have also been seen in Holsteins and Shorthorns.

**Inherited night blindness** occurs in Appaloosa horses which have otherwise normal sight. No defect has been described in the eyes.

### REVIEW LITERATURE

- Jolly RD, Blair HT, Johnstone AC. Genetic disorders of sheep in New Zealand: A review and perspective. *New Z Vet J* 2004; 52:52-64.

### REFERENCE

1. Roe WD et al. *New Z Vet J* 2003; 51:194.
2. van der Linde-Sipman JS et al. *J Comp Pathol* 2003; 128:269.
3. Jolly RD et al. *New Z Vet J* 2004; 52:52.
4. Joyce JR et al. *Equine Vet J Suppl* 1990; 10:26.

## INHERITED PROLONGED GESTATION (ADENOHYPOPHYSEAL HYPOPLASIA)

Prolonged gestation occurs in cattle and sheep in several forms and is usually, although not always, inherited. The two recorded forms of the disease are prolonged gestation with fetal giantism and prolonged gestation with deformed or normal or small size fetuses.

### Prolonged gestation with fetal giantism

The inherited disease is recorded in Holstein, Ayrshire, and Swedish cattle with prolongation of pregnancy from 3 weeks to 5 months. The cows may show marked abdominal distension but in most cases the abdomens are smaller than one would expect. Parturition, when it commences, is without preparation. Udder enlargement, relaxation of the pelvic ligaments, and loosening and swelling of the vulva do not occur and there is also poor relaxation of the cervix and a deficiency of cervical mucus.<sup>1</sup> Dystocia is usual and cesarean section is advisable in Holstein cattle but the Ayrshire calves have all been reported as having been born without assistance. The calves are very large (48–80 kg body weight) and show other evidence of post-term growth, with a luxuriant hair coat and large, well-erupted teeth which are loose in their alveoli, but the birth weight is not directly related to the length of the gestation period.

The calves exhibit a labored respiration with diaphragmatic movements more evident than movements of the chest wall. They invariably die within a few hours in a hypoglycemic coma. At necropsy there is adeno-hypophyseal hypoplasia and hypoplasia of the adrenal cortex and the thyroid gland. The progesterone level in the peripheral blood of cows bearing affected calves does not fall before term as it does in normal cows.

### Prolonged gestation with craniofacial deformity

This form of the disease has been observed in Guernsey, Jersey, and Ayrshire cattle. It differs from the previous form in that the fetuses are dead on delivery, show gross deformity of the head, and are smaller than the normal calves of these breeds born at term. In Guernseys the defect has been shown to be inherited as a single recessive character and it is probable that the same is true in Jerseys. The gestation period varies widely with a mean of 401 days.

**Clinical examination** of the dams carrying defective calves suggests that no development of the calf or placenta

occurs after the seventh month of pregnancy. Death of the fetus is followed in 1–2 weeks by parturition unaccompanied by relaxation of the pelvic ligaments or vulva or by external signs of labor. The calf can usually be removed by forced traction because of its small size. Mammary gland enlargement does not occur until after parturition.

The calves are small and suffer varying degrees of hypotrichosis. There is hydrocephalus and in some cases distension of the gut and abdomen due to atresia of the jejunum. The bones are immature and the limbs are short. Abnormalities of the face include cyclopic eyes, microphthalmia, absence of the maxilla, and the presence of only one nostril. At **necropsy** there is partial or complete aplasia of the adeno-hypophysis. The neural stalk is present and extends to below the diaphragm sellae. Brain abnormalities vary from fusion of the cerebral hemispheres to moderate hydrocephalus. The other endocrine glands are also small and hypoplastic.

The disease has been produced experimentally in ewes by severe ablation of the pituitary gland, or destruction of the hypothalamus, or section of the pituitary stalk in the fetus and by adrenalectomy of the lamb or kid. Infusion of ACTH into ewes with prolonged gestation due to pituitary damage produces parturition but not if the ewes have been adrenalectomized beforehand.

### Prolonged gestation with arthrogryposis

A form of prolonged gestation, which occurs in Hereford cattle and is thought to be inherited, is accompanied by arthrogryposis, scoliosis, torticollis, kyphosis, and cleft palate.

### REFERENCE

1. Graves TK et al. *Cornell Vet* 1991; 81:277.

## INHERITED COMBINED IMMUNODEFICIENCY (CID) IN FOALS OF ARABIAN BREEDING

### Synopsis

**Etiology** Inherited immunodeficiency in foals of Arabian parentage caused by a mutation in the gene coding for DNA-protein kinase catalytic subunit.

**Epidemiology** Familial pattern of occurrence with autosomal recessive inheritance. Approximately 8% of Arabian horses are heterozygous for the mutation (carriers). Random mating results in approximately 1 in 600 foals being affected, but not all matings are random and the incidence of the disease is less than this number.

**Clinical findings** Foals normal at birth but succumb to systemic infection soon after birth and die before 3 months of age.

Death from acute septicemia, or recurrent or chronic continuous infection, usually of respiratory tract. Poor response to normally effective antibiotic therapy.

**Clinical pathology** Lymphopenia, hypogammaglobulinemia. PCR test detects animals heterozygous (carriers, parents of affected foals) or homozygous (affected foals) for the mutated gene.

**Necropsy findings** Thymic, lymph node, and splenic hypoplasia and a marked reduction in the numbers of splenic and lymph node lymphocytes.

**Diagnostic confirmation.** PCR detection of mutated gene (homozygous in affected foals). Lymphopenia and agammaglobulinemia in a foal of Arabian breeding.

**Treatment** Nil.

**Control** Ideally, elimination of the mutated gene by not breeding carrier animals. The disease can be prevented by not breeding a carrier animal to another carrier.

### ETIOLOGY

The fundamental defect is a 5 base-pair deletion in the specific gene that codes for DNA-dependent protein kinase.<sup>1–3</sup> The gene is located on chromosome ECA9.<sup>4</sup> This mutation causes a lack of activity of the catalytic subunit of DNA-dependent protein kinase.<sup>1,2,3</sup> The deficiency of protein kinase activity, which is absolute in affected foals, results in the inability to join DNA strands that have been broken as part of the normal process of creation of V (variable) regions of T cell and B cell antigen receptors on lymphocytes. Without these receptors the lymphocytes are unable to respond to antigens and thus the foal is not capable of mounting adaptive, either cellular or humoral (antibody), immune responses.<sup>1</sup>

### EPIDEMIOLOGY

The immunodeficiency is inherited as an autosomal recessive defect. The disease occurs in purebred and part-Arabian horses. It has also occurred in an Appaloosa foal that had an Arab stallion in the fifth past generation of its mother's pedigree. In one survey of Arabian foals in the United States, the prevalence rate of affected foals was 2.3% of 257 foals of Arabian breeding, and 25.7% of the parents of affected foals were estimated to be carriers of the genetic defect.<sup>5</sup> However, this likely represents an over-estimation of the incidence of the disease and prevalence of the mutation in the population of Arabian horses because of selective testing.<sup>6</sup> The frequency of carriers of the mutation for severe combined immunodeficiency is approximately 8%, with an estimated 0.2% (1 in 600) of foals of random matings between Arabian horses affected with the disease, based on

a survey of 250 horses.<sup>6</sup> Approximately 17% of Arabian horses are heterozygous for the mutation and 0.3% of foals are homozygous among > 6000 horses tested by a commercial laboratory.<sup>7</sup>

Affected foals usually appear normal at birth, but are highly susceptible to infections from 2 to 65 days after birth and usually die from one or more infections by 3 months of age. The sires and dams of affected foals are clinically normal and have normal lymphocyte counts and serum immunoglobulin concentrations.

#### **PATHOGENESIS**

Affected foals are born with a combined immunodeficiency associated with a deficiency in both B-lymphocytes (which produce immunoglobulins) and T-lymphocytes (which provide cellular immunity). There is a marked lymphopenia and failure of immunoglobulin (Ig) synthesis and absence of delayed hypersensitivity of skin responses. Foals that receive immunoglobulins from the dam's colostrum derive passive immunity and can survive for as long as 4 months. Foals that do not receive colostrum die much earlier. The cause of death is infectious disease.

Affected foals are susceptible to infections of all kinds, but mostly of the respiratory tract. Adenoviral pneumonia is considered to be the most common secondary complication, probably because adenovirus infection is so widespread in the horse population. Affected foals may also die from hepatitis, enteritis, or infection of other organs without pulmonary involvement. While adenoviral pneumonia is the most common complication, infections with bacteria and *Pneumocystis carinii* also occur. *Cryptosporidium* sp. has also been recorded in a number of foals with diarrhea, which is also a common complication.

#### **CLINICAL FINDINGS**

Affected foals usually become ill from 10 to 35 days of age. Commonly there is a history suggesting a mild disease of the respiratory tract, especially the appearance of a bilateral nasal discharge, which often becomes sufficiently thick to interfere with sucking. The foal is unthrifty, lethargic, and tires easily but still nurses and eats solid feed. A deep dry cough and a serous to mucopurulent ocular and nasal discharge are common when pneumonia is present. There is moderate fever (39.5°C, 103°F) and an increase in the heart and respiratory rates. The depth of respirations is increased and a double expiratory effort is common. On auscultation, loud bronchial tones and moist and dry crackles are common over the anterior ventral aspects of both lungs. A chronic diarrhea is present in some

foals, and alopecia and dermatitis, commonly associated with an infection by *Dermatophilus congolensis*, also occur. An important clinical feature is that affected foals do not respond favorably to treatment with antimicrobial agents. The course of the illness will vary from a few days to a few weeks and probably depends on the degree of immunodeficiency and the nature of the infection. Most affected foals become progressively worse over a period of 2–4 weeks, and death by 3 months of age is the usual outcome.

#### **CLINICAL PATHOLOGY**

Lymphopenia is a constant finding with counts often less than 1000/mL and there is a concurrent hypogammaglobulinemia in foals that have not received colostrum. There is no IgM in precolostral serum of the foal. Following ingestion of colostrum, all subclasses of immunoglobulin will be present but in affected foals the level of IgM will steadily decrease weekly until at about 36 days when IgM is detectable. The lack of IgM is because of lack of synthesis and the shorter half life of this isotype of immunoglobulin in foals – serum IgG concentrations decline more slowly. Until the development of the PCR test for detection of homozygous foals and confirmation of the disease, the measurement of serum Ig concentrations was considered essential for a definitive diagnosis. Additional tests include enumeration of B-lymphocyte and T-lymphocyte responses to phytolectin stimulation and other tests of lymphocytic immunological function, but these tests are no longer required for diagnostic confirmation of the disease.

#### **NECROPSY FINDINGS**

The lymph nodes are small and splenic follicles are not visible. A viral interstitial pneumonia and a secondary bacterial bronchopneumonia are common. The thymus gland is usually hypoplastic. Histologically the lymph nodes and spleen are depleted of lymphocytes, and germinal centers are absent. In some foals there are foci of necrosis of the intestinal epithelium but with minimal infiltration of inflammatory cells. Inclusion bodies of adenovirus may be present in the cells of several different body systems. In Australian foals *Rhodococcus equi* can be commonly isolated from pulmonary abscesses. Additional histological findings include a severe adenoviral pancreatitis and adenitis of the salivary glands.

#### **DIFFERENTIAL DIAGNOSIS**

Diagnostic confirmation in an apparently chronic case of pneumonia in a young foal depends on the identification of the characteristic lymphopenia.

The differential diagnosis list includes:

- Septicemia and pneumonia of foals, caused by *Rhodococcus equi*
- Agammaglobulinemia due to failure of transfer of maternal immunoglobulins from colostrum. In many foal populations as many as 20% of foals are immunodeficient for this reason
- Other immunodeficiencies (Table 35.1). Foals with these deficits are very susceptible to a variety of infectious diseases and are usually chronically ill, most often with respiratory infections. However, because they have partial protection, they survive and their life span is much longer than that of foals with CID, usually over 1 year and often 18 months. Hematologically the foal is normal unless an infection is in process, but electrophoretic examination usually reveals a marked deficiency of beta globulins. Further tests are needed to identify the exact deficiency. A radioimmunoassay is used to quantitate serum immunoglobulins – IgA and IgM levels are usually at negligible levels, but IgG levels are discernible, although diminished. An intradermal test by injection of phytohemagglutinin determines T-lymphocyte status – a normal response is migration of mononuclear cells
- An isoimmune neonatal leukopenia can cause immune deficiency in foals; antibodies to the sire's lymphocytes are detectable in the mare's serum
- Neonatal septicemias.

#### **TREATMENT**

There is no satisfactory treatment for CID in foals. Hyperimmune serum, whole blood transfusions, and broad-spectrum antibiotics are all used without more than a temporary response. Affected foals may be kept alive by twice-weekly injections of hyperimmune serum and a constant antibiotic cover. Immunotherapy using a transplant of bone marrow and a fetal thymus transplant has been attempted without success. Corticosteroids are contraindicated.

#### **CONTROL**

Horses heterozygous for the mutation can be detected using a commercial PCR assay.<sup>6,7</sup> These horses have normal serum immunoglobulin concentrations and lymphocyte counts. Detection of heterozygous animals, which is required by some national breed organizations, is

useful for several reasons. Firstly, it should, ideally, permit elimination of the disease from the population by breeding of only homozygous normal animals. However, this approach has not met with success because of the financial and emotional value of some heterozygous animals. Secondly, identification of the status of an animal permits controlled breeding such that the risk of producing homozygous affected foals is eliminated. This is achieved by mating only pairs of homozygous normal animals, in which case none of the off-spring will carry the

mutated gene, or by mating a heterozygous animal with a homozygous normal animal. In this instance 1 in 4 of the progeny will carry the mutated gene, but none of the progeny will be homozygous for the mutated gene and, therefore, afflicted with the disease. This second approach, if applied consistently, should almost eliminate the disease.

#### REVIEWS

Perryman LE. Molecular pathology of severe combined immunodeficiency in mice, horses, and dogs. *Vet Pathol* 2004; 41:95.

#### REFERENCES

1. Leber R et al. *Vet. Immunol. Immunopathol* 1998; 65:1.
2. Wiler R et al. *Proc. Nat. Acad. Sci* 1995; 92:485.
3. Shin EK et al. *J. Immunol* 1997; 158:3565.
4. Bailey E. et al. *Animal Genetics* 1997; 28:268.
5. Poppi MJ & McGuire TC *J Am Vet Med Assoc* 1977; 170:31.
6. Bernoco D & Bailey E. *Animal Genetics* 1998; 29:41.
7. <http://www.vetgen.com/scidstats.html>. Accessed August 13th, 2006.

**INTRODUCTION 1981****DISEASES CHARACTERIZED BY SYSTEMIC INVOLVEMENT 1981**

- Unthriftiness in weaner sheep (weaner illthrift) 1981  
 Buller steer syndrome 1982  
 Stillbirth/perinatal weak calf syndrome 1983  
 Watery mouth of lambs (rattle belly, slavers) 1986  
 Cold cow syndrome 1987  
 Thin sow syndrome 1987  
 Acute hepatitis (postvaccinal hepatitis) of horses (Theiler's disease, serum hepatitis) 1988  
 Granulocytopenic disease of calves 1989  
 Sweating sickness (tick toxicosis) 1989

**DISEASES CHARACTERIZED BY ALIMENTARY TRACT INVOLVEMENT 1990**

- Equine grass sickness (equine dysautonomia, grass disease, mal seco) 1990  
 Idiopathic chronic inflammatory bowel diseases of horses 1992  
 Granulomatous enteritis of horses 1992  
 Lymphocytic-plasmacytic enterocolitis 1993  
 Chronic eosinophilic gastroenteritis of horses 1993  
 Ovine mouth and gum obscure disease 1993  
 Ulceration of the *pars esophagea* of the stomach of swine (gastric ulcer, hyperkeratosis) 1994  
 Chronic inflammatory bowel disease of sheep 1997

**DISEASES CHARACTERIZED BY RESPIRATORY TRACT INVOLVEMENT 1998**

- Interstitial pneumonia of cattle 1998  
 Tracheal stenosis of feedlot cattle 2004  
 Interstitial pneumonia of adult horses 2004  
 Acute broncho-interstitial pneumonia in foals 2005  
 Chronic interstitial pneumonia of foals 2005

**DISEASES CHARACTERIZED BY NERVOUS SYSTEM INVOLVEMENT 2006**

- Polioencephalomalacia (cerebrocortical necrosis) of ruminants 2006  
 Equine neonatal encephalopathy (neonatal maladjustment syndrome of foals, dummy foal, barkers and wanderers) 2012  
 Congenital tremor syndromes of piglets 2015  
 Ovine humpyback 2015  
 Equine cervical vertebral stenotic myelopathy, (**wobbler**, 'wobbles', equine sensory ataxia, cervical vertebral instability) 2016  
 Stringhalt 2018  
 Ovine 'kangaroo gait' 2019  
 Equine motor neuron disease 2020  
 Crushed tail head syndrome in cattle 2020  
 Polyneuritis equi (equine cauda equina syndrome) 2021  
 Head shaking in horses 2022  
 Congenital necrotizing encephalopathy in lambs 2023

**DISEASES CHARACTERIZED BY INVOLVEMENT OF THE MUSCULOSKELETAL SYSTEM 2023**

- Hyena disease of cattle 2023  
 Asymmetric hindquarter syndrome of pigs 2024  
 Splayleg syndrome in newborn pigs 2024  
 Degenerative joint disease (osteocondrosis, osteoarthritis, epiphyseolysis, and apophysiolysis; leg weakness in pigs) 2025  
 Sporadic lymphangitis (bigleg, weed) 2029  
 Laminitis of horses 2030  
 Laminitis in ruminants and pigs 2034  
 'Acorn' calves 2035  
 Congenital joint laxity and dwarfism in beef calves (dyschondroplasia in non-inherited congenital dwarfism in beef calves) 2035  
 Slipped capital femoral epiphysis in calves 2036  
 Tail-tip necrosis in beef cattle 2036  
 Toe ulcer and necrosis of the apex of the pedal bone of cattle 2037

**DISEASES CHARACTERIZED BY INVOLVEMENT OF THE SKIN 2037**

- Pityriasis rosea 2037  
 Anhidrosis (non-sweating syndrome, puff disease, dry coat) 2038  
 Bovine ocular squamous-cell carcinoma 2039  
 Equine ocular squamous-cell carcinoma 2040  
 Ocular squamous cell carcinoma in goats 2041  
 'Cockle' 2041  
 Woolslip, wool loss 2041  
 Wool eating 2042

**Introduction**

It was anticipated that, with time, this chapter would shrink in succeeding editions and, eventually, disappear. As the causes of individual diseases are demonstrated they are removed to other chapters but in the past newly identified diseases have been added at almost the same rate so that the net effect on the chapter has been small. The process could have been hastened by moving diseases when the consensus of opinion, short of proof, was that the cause had been identified. We have thought it preferable to leave those diseases here, together with those in

which the combination of causes is complex, such as 'weaner illthrift'.

**Diseases characterized by systemic involvement****UNTHRIFTINESS IN WEANER SHEEP (WEANER ILLTHRIFT)****ETIOLOGY**

A number of different diseases have been associated with this syndrome in both lambs and calves. In many cases an association has been established by a response trial but in others the association has not been established as causal. These include

**Synopsis**

**Etiology** Several causes including parasitism, trace element deficiencies, pasture palatability and fungal infestations of pasture.

**Epidemiology** Loss of weight at weaning and failure to make satisfactory weights subsequently, in spite of the presence of ample feed and when adult sheep are faring well.

**Clinical findings** Poor body condition and failure to thrive.

**Lesions** Inanition

**Diagnostic confirmation** Laboratory testing for specific cause. Correction-response trial.

**Treatment** Correction

**Control**



intestinal parasitism, coccidiosis, infection with hemoplasma (eperythrozoosis), deficiencies of copper, cobalt, selenium, zinc, thiamin, vitamin A, and vitamin D. A combination of these deficiencies has also been suspected.

Palatability of pasture appears a cause of illthrift in some instances, or at least associated with it, and moving the animals to a different pasture will sometimes alleviate the condition. This has been observed with perennial rye-grass (*Lolium perenne*), setaria grass (*Setaria sphacelata*), tall fescue (*Festuca arundinaceae*), and turnips (*Brassica repens*). Infestation of grass species with endophyte fungi may prove an important cause of illthrift and poor growth rates occur in calves with the 'summer syndrome' associated with the endophyte *Acremonium coenophialum* in tall fescue pastures. Infection of pasture species with toxigenic *Fusarium* spp. has been associated with illthrift in lambs in South Africa, New Zealand, and Australia. Pasture and soil fungi have also been suspected of being associated with illthrift in sheep in eastern Canada.

#### EPIDEMIOLOGY

- The problem has seemed to be most severe in the **southern hemisphere** but this may be because sheep are so prevalent there
- It may also be due partly to the predominance of **Merino** and Merino-type sheep; the disease is most common in these breeds which have their own particular timorous nature which makes weaning and the need to shift for themselves more traumatic than in most other breeds
- This trait is particularly noticeable if there is **overcrowding** on pasture
- Lambs that are **weaned at light weights** are more prone to illthrift following weaning and ideally they should be 45% of mature weight when weaned
- Merino ewes have a low persistency of milk production and consequently management of the flock and the pastures is critical for effective weaning weights
- **Other management** factors likely to lead to low weaning weights and subsequent unthriftiness are multibirth lambs, small ewes, ewes with little milk, and lambs born late in the season.

Weaner illthrift does occur in breeds other than Merino and is also reported from several countries in the **northern hemisphere**. Weaner illthrift has been reported on a variety of different pastures and under a variety of different management systems.

In bad years there may be many **deaths**; in any circumstance there is a gross **delay in maturation** so that maiden lambing

may be delayed to as late as 3 years of age. The economic effects can be disastrous. Illthrift syndromes are also recorded in calves although with less frequency.

#### CLINICAL AND NECROPSY FINDINGS

As the name indicates the disease in weaned sheep is manifest primarily by **poor body condition and failure to thrive**. Within an affected group not all lambs are equally affected and there will be a range of conditions. Those lambs in very poor condition are usually anemic, frequently have diarrhea, and there is a sporadic but continuing death loss amongst them. Commonly the sheep have been treated with anthelmintics with no response. There are usually no abnormal findings at post-mortem other than those associated with emaciation but villous atrophy is often found on histological examination of the small intestine.

This lack of significant findings is probably the **defining factor** for placing a problem in this disease category.

#### DIFFERENTIAL DIAGNOSIS

When faced with this problem the initial approach should be to examine for the most likely cause which is a deficiency in energy or protein intake.

An examination of the **teeth** to insure that there is no excessive attrition of the teeth, or even breaking of the incisors if the sheep are being fed roots, is also a logical preliminary step in any investigation of an illthrift problem.

**The Parasite Status** of the group should be examined by techniques appropriate to their detection as outlined in previous chapters. Clinical or subclinical infestations with nematodes are common occurrences at this time in the sheep's life, before immunity is properly developed and when pasture contamination can be high.

Infections with coccidia, cryptosporidia, or *Mycoplasma (Eperythrozoon)* should be significant causes of illthrift and ought to be examined as outlined in previous chapters.

**The Trace Element Status** of the group should be examined if the cause cannot be found with the above examinations. Many trace element deficiencies are area deficiencies or in an area are strongly associated with certain soil types. If trace element deficiency is a cause it is likely that there will be some prior history of this problem in the area. Diagnosis by response to supplementation is a common approach and the diagnostic aspects of the trace element deficiencies are outlined under their specific headings in this text.

Examination of the above-mentioned possible causes is time-absorbing and costly and, if there is a residuum of unsolved cases, they are likely to remain undiagnosed.

**Infectious Agents** can produce enteric lesions and illthrift (e.g. coronavirus and yersiniosis) and the malabsorption which results may be manifested by weight loss and by chronic diarrhea. They are differentiated on the initial postmortem examinations.

## BULLER STEER SYNDROME

#### Synopsis

**Etiology** Unknown. Behavioral problem of steers in feedlots

**Epidemiology** Prevalence varies and increases with increasing age and weight at entry.

**Clinical findings and lesions** Areas of denuded hair, subcutaneous hematomas, other traumatic injuries

**Treatment** Symptomatic

**Control** Removal from pen.

#### ETIOLOGY

The buller steer syndrome is a **behavioral** problem in cattle confined in feedlots<sup>1</sup> of unknown etiology. Within a pen of cattle, one or more cattle persistently ride a particular individual or individuals of the group. The ridden animals are referred to as bullers. There have been several suspect etiologies. Improper placement of hormonal growth implants has been suspected as being associated.

#### EPIDEMIOLOGY

##### Occurrence

The syndrome occurs only in cattle in feedlots. The prevalence varies, but in one study ranged from 0 to 11% with a mean of 2.7%.<sup>1,2</sup> The prevalence increases with increasing weight and age.<sup>1,2</sup> The case fatality has been estimated at 1%.<sup>3</sup> The incidence of occurrence is higher in the summer and the fall and during the first 30 days of the feeding period.<sup>4</sup>

Epidemiological studies indicate that bullers occur as a point source epidemic with the cause occurring soon after cattle arrive in the feedlot and mingle into pen groups.<sup>1</sup> The peak incidence of bullers occurs much sooner after arrival and declines much quicker in older cattle. Bullers occur significantly sooner after mixing in older cattle than in younger cattle. The pen prevalence also increases as cattle become older on arrival at the feedlot and are more aggressive. As the prevalence of intact bulls increases in pens of cattle, so does the prevalence of bullers, presumably due to more aggressiveness in the bulls.

##### Risk factors

Postulated causative and risk factors include the incorrect timing and administration of hormonal growth implants, reimplantation and double dosing, estrogenic substances in feeds, pheromones in the urine of certain cattle, improper or late castration of young cattle, daily feedlot management, weather and seasonal factors, disease, group size, and dominance behaviour. However, these factors have not been well substantiated and controlled studies have found little influence of

implant type and implant timing on buller incidence.<sup>5</sup>

The mixing and confinement of **unfamiliar cattle** into pen groups, with subsequent agonistic interactions as these cattle established a social hierarchy, are considered as important risk factors. Both riding behavior and antagonistic behavior cease once cattle establish a stable social hierarchy. This suggests that riding behavior and subsequent identification of bullers is associated with this dominance behavior. It is possible that when a dominant animal becomes ill in a pen, other more subordinate animals in the pen that were previously subdued in dominance contests may want to fight the sick animal to achieve higher social status

### Economic importance

The syndrome has been ranked along with acute undifferentiated bovine respiratory disease and footrot as **one of the three most important disease syndromes** in beef feedlots in North America. In addition to the economic loss from decreased weight gain, injury, treatment, death, and carcass condemnation, there is economic losses associated with extra handling necessary to accommodate affected cattle, the disruption of uniform marketing of cattle, especially in custom feedlots, and the need for extra pens in which to house the bullers. The importance of the syndrome includes the animal welfare aspects.

Bullers may be at significantly greater risk of illness and mortality (from bacterial pleuropneumonia) than other steers.<sup>2</sup> The association between illness, mortality, and bullers among individuals was greatest among the oldest yearling steers.<sup>2</sup>

### CLINICAL FINDINGS

Two types of bullers are identified.<sup>3</sup>

**Type 1 or true bullers** stand as if they were a heifer in estrus and do not move away or show agonistic behaviour when being mounted by rider cattle. There can be several rider cattle in a pen and type 1 bullers are rapidly damaged.

**Type 2 bullers** are animals that appear low in social dominance. They use aggression to discourage riders and will lie down to avoid being ridden.

Affected animals show areas of denuded hair and have extensive subcutaneous hemorrhage. The hematomas may become infected and develop to subcutaneous pockets of pus and gas. Other traumatic injuries, such as limb fractures, also occur.

### CONTROL

Management of the syndrome has usually involved identification and removal from the pen to prevent injury and even death from riding-related injuries.

The high rate of risk of illness and mortality in bullers relative to other feedlot

steers suggests that bullers should always be checked for evidence of illness in addition to their removal from their designated pen to prevent severe riding-related injuries. Treating sick bullers may improve the chance of settling them back into their designated pen by allowing them to resume their original position in the social hierarchy.

### REVIEW LITERATURE

Blackshaw JK, Blackshaw AW, McGlone JJ. Buller steer syndrome review. *Applied Anim Behav Sci* 1997; 54:97.

### REFERENCES

1. Taylor LF et al. *Aust Vet J* 1997; 75:45
2. Taylor LF et al. *Aust Vet J* 1997; 75:732.
3. Meyer BD et al. *Bov Practit* 2002; 36:27.
4. Apley M *Comp Cont Educ Pract Vet: Food Anim Pract* 1999; 21:S250.
5. Voyles BL et al. *Prof Anim Scientist* 2004; 20:344.

## STILLBIRTH/PERINATAL WEAK CALF SYNDROME

### Synopsis

**Etiology** Multifactorial

**Epidemiology** Most commonly multiple cases on a farm. Several farms affected in a geographic region in a single season. Problem may not occur for several years and then occur as 'epidemic' in a region.

**Clinical findings** Calves may be born weak and unable to stand. More commonly are born apparently normal and stand but subsequently collapse with hypothermia and die within a few hours of birth.

**Lesions** Petechial hemorrhages, subcutaneous edema, and hemorrhage commonly in the subcutaneous tissue of the carpal and tarsal joints.

**Diagnostic confirmation** Specific to cause

**Treatment** Heat and supportive.

**Control** Correction of underlying nutritional deficiency.

### HISTORICAL ASPECTS

A disease of newborn calves called the 'weak calf syndrome' was first recognized in Montana in 1964.<sup>1</sup> It has been recognized throughout the US and other countries since then, and is considered a major economic loss in beef cattle herds. In the earlier descriptions of the syndrome, calves were affected by 10 days of age, and approximately 20% were affected at birth.<sup>2</sup> Morbidity ranged from 6 to 15%. In some herds, sporadic abortions occurred before calving season of the herd began. In some cases, affected calves died within minutes after being born with varying degrees of obstetrical assistance.<sup>3</sup>

In calves which survived for a few days, clinical findings included lassitude, depression, weakness, variable body tem-

perature, a reddened and crusty muzzle, lameness, and reluctance to stand, enlargement of the carpal and tarsal joint capsules along with periarticular subcutaneous swellings, and a hunched-up back if they stood. Diarrhea occurred in some calves after a few days of illness but was not a major clinical finding. Treatment was ineffective and the case fatality rates ranged from 60 to 80%.

At necropsy, the prominent lesions were hemorrhage and edema of the subcutaneous tissues over the tarsal and carpal joint regions and extending distally. Polysynovitis with hemorrhagic synovial fluid often containing fibrin was also common. Erosive and hemorrhagic lesions of the forestomachs and abomasum also occurred. Several different pathogens were isolated from these calves but no consistent relationship between the pathogens and the lesions was ever determined.<sup>1</sup>

In retrospect, the **case definitions** were not well described and it is possible that several different diseases of newborn calves were lumped into the enigma of the weak calf syndrome. As more detailed clinical and laboratory examinations of sick newborn calves have been done over the years, some of the causes of the original syndrome have been identified as certain diseases of newborn calves which are characterized by such non-specific signs as lack of desire to suck, weakness, and failure to respond to therapy.

A wide spectrum of clinical and pathological findings has been associated with the weak calf syndrome. In the most common situation, which is a major diagnostic challenge, calves are born weak and die within 10–20 minutes after birth; sometimes they live for up to a few days. At necropsy there are no obvious or only few lesions to account for the illness. Calves which are weak after birth due to traumatic injuries associated with dystocia or other significant lesions can be accounted for according to the nature and severity of the lesions. Reports from Northern Ireland in recent years indicate that in dairy herds the incidence of the weak calf syndrome has ranged from 10 to 20% of all calves born.<sup>4</sup> Field observations in problem herds found that the gestation period is of normal duration but parturition is usually prolonged with the first and second stages of labor lasting 24 hours.<sup>5</sup> Affected calves usually are born alive but are unable to sustain breathing following birth. Despite resuscitation efforts, they commonly die within 10 minutes often accompanied by prominent incoordinated movements of the limbs.<sup>4</sup> Some calves are stillborn and whether or not this is a variation of the syndrome is uncertain. In a report from the UK, the syndrome occurred in calves born from heifers and was characterized

by failure to breathe at birth, or breathing with difficulty, and/or failing to move after birth, and failure to suck.<sup>6</sup> The term still-birth/perinatal weak calf syndrome has been suggested as more appropriate.

#### Dummy calf syndrome

A variation of the weak calf syndrome is the dummy calf syndrome reported from the southern US.<sup>7</sup> Affected calves appear normal at birth, are generally alert, but lack the instinct or the desire to seek the teat or suck after birth and for up to several hours later. The syndrome may occur in calves of any birth weight. The incidence has been highest in purebred Brahman females but it has also occurred in Aberdeen Angus, Hereford, Chianina, and Brown Swiss breeds of cattle. Field observations indicate that affected calves did not stand for up to 1–2 hours after birth to initiate teat-seeking.<sup>7</sup> Dummy calves appear to lack the sensitivity to teat-see and if they fail to locate a teat by about 4–5 hours after birth they commonly lose the sucking reflex and then require intensive nursing care by bottle feeding to initiate sucking. In calves which fail to suck and ingest colostrum, hypothermia, hypoglycemia, and neonatal infections are common complications. Concurrently, the dam loses interest in the calf and may abandon it. The cause is unknown but is thought to be a behavioral disorder inherent in some breeds; this has not been supported with any scientific evidence.

#### ETIOLOGY AND EPIDEMIOLOGY

The etiology of the weak calf syndrome is unclear, but several epidemiological observations have suggested some possible causes.<sup>8</sup> These include:

- Fetal infection near term
- Underdevelopment because of nutritional inadequacy of the maternal diet during pregnancy
- Placental insufficiency
- Maternal dietary deficiencies of selenium and vitamin E
- Hypothyroidism
- Traumatic injuries associated with dystocia and excessive force during obstetrical assistance
- Fetal hypoxia from prolonged parturition.

#### Fetal infections

Fetal infections in the last few days before term can result in stillbirth or weak calves which may die within hours or days after birth. In one series of 293 weak calves in Northern Ireland, leptospiral infection was present in 25% of them.<sup>8</sup> Calves in which leptospiral antigen was detected in the placenta were significantly lighter by an average of 6 to 10 kg than calves with no antigen in the placenta.<sup>9</sup> Calves infected with *Leptospira* in the uterus were more

likely to be infected by *Arcanobacterium pyogenes* or *Bacillus* species, and infection of the placenta is associated with a lower bodyweight. The adrenal gland, lung, and placenta are most useful tissues to examine for leptospiral antigen.<sup>9</sup>

There is some evidence that an immune inadequacy based on T lymphocyte function may be associated with the weak calf syndrome in Japanese Black calves but the data are not compelling.<sup>10</sup>

An unidentified type of adenovirus has been associated with the weak calf syndrome on a large dairy farm in Israel.<sup>11</sup> At birth the calves were reluctant to suck or drink colostrum and were force fed colostrum with a gastric tube. Affected calves were weak at birth, unable to rise without assistance and when forced to move, walked stiffly, suggestive of polyarthritis. An adenovirus was detected in the feces, synovial fluid, and aqueous humor of affected calves.

#### Maternal nutritional deficiency causing fetal underdevelopment

**Hypothyroidism due to iodine deficiency** in the pregnant dam has been considered on the basis of thyroid hyperplasia in some calves.<sup>12</sup> Analysis of the laboratory data from 365 calves which died from the stillbirth/perinatal weak calf syndrome in Ireland, found some differences between calves with an abnormal and normal thyroid gland.<sup>13</sup> Glands weighing more than 30 g were probably abnormal. Abnormal glands were heavier, constituted a greater percentage of the calves bodyweight and had a lower iodine concentration. A higher proportion of calves with an abnormal thyroid gland had uninflated lungs and pneumonia. Abnormal thyroid glands had a lower selenium concentration in the kidneys.

However, the experimental reproduction of iodine deficiency in pregnant heifers by feeding an iodine deficient diet over the last 4 to 5 months of pregnancy resulted in clinicopathological changes and pathological changes in the thyroid glands of both the heifers and their calves, but all calves in the iodine deficient group were born clinically normal.<sup>8</sup>

**A maternal dietary deficiency of selenium** in pregnant cattle has also been examined but field trials have failed to show any protective effect from the parenteral administration of pregnant cattle with selenium.<sup>4,5</sup> The parenteral administration of both selenium and iodine to pregnant cattle did not have any effect on the incidence of the syndrome between treated and untreated herds where the incidences were 7.9% and 7.4%, respectively.<sup>14</sup> A general nutritional inadequacy in the maternal diet can result in underdevelopment of the fetus and the birth of smaller than normal calves

but the deficiency usually must be grossly inadequate. Radiographic examination of affected calves found that intrauterine growth retardation is not a common feature in calves dying with the syndrome.<sup>15</sup>

#### Placental insufficiency

Intrauterine growth retardation associated with fetoplacental dysfunction has been described in Japanese Black beef calves.<sup>16</sup> Affected calves were weak when born at term and were underweight compared to normal calves. Anemia due to bone marrow dysfunction was present in affected calves and presumably was associated with intrauterine growth retardation. Dams delivering weak calves had lower serum concentrations of estrone sulfate during late pregnancy than those of normal calves suggesting a fetoplacental dysfunction. The dysfunction was influenced by sires and maternal families.

#### Fetal hypoxemia

Fetal hypoxemia due to a prolonged parturition or dystocia may be a cause of the weak calf syndrome.<sup>17</sup> While asphyxia is not an integral part of normal delivery, it is still an important cause of fetal death during abnormal parturitions. Various predisposing factors can cause prolonged interference with fetal blood or oxygen supply, which results in death during delivery or shortly after.<sup>18</sup>

In newborn mammals subjected to anoxia, initially there is a period of struggling and rapid gasping during which blood pressure rises and bradycardia becomes profound. A relatively short period of primary apnea follows, after which there is a period of more regular and deeper gasping, which may become more frequent terminally. This is followed by a period of secondary apnea, the heart rate continues to beat at a slowly declining rate, and blood pressure falls slowly. The brain lesions begin in lower brainstem nuclei and, as asphyxia becomes prolonged, progress to involve the cerebellar and thalamic nuclei and the cerebral cortex. Examination of blood gas values on newborn calves has shown that a prolonged parturition or delivery terminated by forced extraction may result in a severe acidosis due to oxygen deprivation. As blood pH drops, first vitality is reduced, subsequently vital organs like the brain are damaged and ultimately the fetus dies.<sup>19</sup>

The bovine fetus appears relatively susceptible to anoxia which has been studied experimentally by clamping the umbilical cords of fetuses for 4–8 minutes, at 24–48 hours before expected birth, followed by a cesarean section 30–40 minutes later. Calves born following this procedure may die in 10–15 minutes after birth or survive for only up to 2 days. Under these experimental conditions, fetuses can survive anoxia for 4 minutes

but most will die following 6 or 8 minutes of anoxia.<sup>17</sup> During the clamping of the umbilical cord, there is a decline in the blood pH,  $PO_2$  and standard bicarbonate levels and an increase in the  $PCO_2$  and lactate levels.<sup>17</sup> Hypoxia in neonatal calves can result in high plasma lactate concentrations, which contributes to a progressive primary metabolic acidosis.<sup>20</sup>

During the clamping there is also increased fetal movement and a release of meconium which stains the calf and the amniotic fluid. Those which survive for a few hours or days are dull, depressed, cannot stand, have poor sucking and swallowing reflexes, and their temperatures are usually subnormal. They respond poorly to supportive therapy.

Some calves whose umbilical cords were clamped for 4 minutes were born weak, and made repeated efforts to raise their heads and move onto their sternum but were unable to maintain an upright position for long. These calves become hypothermic, dull, and their sucking and swallowing reflexes are present but weak. These calves are usually too weak to suck the cow even when assisted, and commonly develop diarrhea and other complications.

#### *Dystocia and traumatic injuries at birth*

Dystocia is a major cause of neonatal mortality in range beef cattle and may be a cause of the weak calf syndrome because of fetal hypoxia or traumatic injuries associated with obstetrical assistance.<sup>21,22</sup> In a study of 13 296 calvings over a period of 15 years in two research herds in Montana, calf mortality due to dystocia accounted for the single largest loss category through the first 96 hours postpartum.<sup>21</sup> Dystocia accounted for 51% of calf deaths and 53% of dystocia deaths occurred in calves which were born without assistance. Calf deaths from primiparous 2- and 3-year-old dams accounted for 41% of total mortality. Necropsies done on 798 of 893 calves found that 77.7% were anatomically normal and 22.3% abnormal. At necropsy of the calves which died associated with dystocia the findings included a froth-filled trachea, non-functional lungs, bruises, contusions, hemorrhages, bone fractures, and joint dislocations. It was concluded that the provision of adequate obstetrical assistance at the right time could have reduced the mortality associated with dystocia.

Similar reports of weakness following dystocia have been reported; in some cases a collapsed trachea is present.<sup>23</sup> In a study of parturient calf mortality in Australia, death rates as high as 44% from heifer groups have been reported.<sup>24</sup> The death rate was significantly higher in male calves than female calves. Pathological changes in many of the dystocia-related deaths were

minimal but a congested swollen tongue was a definitive lesion.

**Traumatic injuries of calves at birth** are caused primarily by the mechanical influence of traction during delivery and can result in asphyxia and a high perinatal mortality rate.<sup>25</sup> Excessive traction is the most important cause of rib and vertebral fractures in the calf during dystocia. A series of 235 calves which died perinatally were examined by necropsy to determine the possible causes of death related to dystocia. Most of the parturitions were protracted and needed veterinary assistance, and 58% of the calves had pathological evidence of asphyxia. Calves delivered by extraction had pathological evidence of asphyxia more often than those born unassisted or delivered by cesarean section. Intrapulmonary amniotic material may be present in the lungs<sup>26</sup> and represent evidence of perinatal respiratory distress.<sup>27</sup> The aspiration of small amounts of amniotic fluid with or without meconium is common in calves and is not associated with hypoxemia, respiratory acidosis, or failure of passive transfer.<sup>28</sup>

#### *Premature expulsion of placenta*

Premature expulsion of the placenta has been associated with perinatal calf mortality.<sup>29</sup> Field observations indicate that the majority of affected fetuses die from fetal hypoxia during stage two of calving. The most significant risk factor associated with premature expulsion of the placenta was fetal malpresentation and malposture. Prolongation of the second stage of parturition allows for sufficient detachment of the placenta for it to occupy the posterior part of the genital tract. The placenta is frequently expelled together with the calf.<sup>30</sup> In one series of cases, there was no significant relationship between the occurrence of premature expulsion of the placenta and parity, calving difficulty, previous calving history, or sex of the calf.<sup>29</sup>

#### **NECROPSY FINDINGS**

All calves which die should be examined by necropsy to identify possible causes. It is important to establish if there is one disease complex or several different diseases of newborn calves.

In the weak calf syndrome described in Northern Ireland, at necropsy, many calves had petechial hemorrhages in the thymus gland, on the ventricular epicardium and the parietal pleura and endocardium.<sup>8</sup> These lesions were similar to those present in animals which died of acute terminal asphyxiation.<sup>18</sup> The gasps made in response to asphyxia in utero result in amniotic fluid being inhaled into the respiratory tract. In one study, 84% of stillborn calves had these lesions of asphyxia. It is well established that asphyxiation during birth is a major factor in intrapartum stillbirth in piglets and contributes to early post-

natal mortality.<sup>18</sup> Froth may be present in the caudal trachea of some calves which die within 10–20 minutes after birth.

Varying degrees of subcutaneous edema of the head and/or bruising of the rib cage are also common. Fractures of the ribs are common, accompanied by intrathoracic hemorrhage. Vertebral body fractures occur commonly at the thoracolumbar region and may be accompanied by intra-abdominal hemorrhage. The lungs may be inflated normally, partially inflated, or not inflated. Severe bruising and hemorrhage occur around the costochondral junctions, the sternal extremities of the costal cartilages, and over the sternum and shoulder regions. In some cases, the traumatic lesions are severe and may involve primarily the right side of the rib cage.<sup>6</sup> Severe subcutaneous hemorrhage and edema may be present over the carpal and fetlock joints due to the pressure applied by the obstetrical chains or ropes.

In the syndrome described in the US, the lesions either appeared at birth or developed in the first few weeks of life.<sup>1</sup> At necropsy the prominent lesions are marked edema and hemorrhages of the subcutaneous tissues over the carpal and tarsal joints and extending distally down the limbs. The synovial fluid may be blood-tinged and contain fibrinous deposits. Erosions or ulceration of the gastrointestinal tract, petechial hemorrhage of internal organs, involution of the thymus gland, and hemorrhages in skeletal muscle have also been present.

Samples for confirmation of diagnosis

- Bacteriology – fetal liver, lung, stomach content, adrenal gland; placenta (CULT). Special detection techniques for *Leptospira* antigens.
- Histology – fixed placenta, lung, spleen, brain, liver, kidney; maternal caruncle (LM, IHC)

#### **DIFFERENTIAL DIAGNOSIS**

Determination of the cause of the weak calf syndrome in a herd is often difficult because the limits of the case definition cannot be determined. Several risk factors may interact to contribute to the disease. The most common definition is a calf that is alive at birth, appears normal otherwise, but either fails to breathe or breathes for less than about 10 minutes and then dies. If they survive for several hours or a few days, affected calves are usually in sternal recumbency, depressed, reluctant to stand unassisted, reluctant to walk, and not interested in sucking. They may not respond favorably to supportive therapy.

#### **Case definition**

When an epidemic of the disease is encountered, an epidemiological investigation of the herd is necessary in an attempt to identify possible risk factors.

The patterns of occurrence should be determined:

- Is the problem more common in calves born to heifers than cows? In some situations, the owner may provide more surveillance for the calving heifers and less for the mature cows with a consequent greater incidence of weak calves born from the cows
- Is there any evidence that parturition is prolonged in the heifers or the cows and what are the possible reasons?
- How long are heifers and cows in the herd allowed to calve unassisted before obstetrical assistance is provided?
- Is it possible that some nutritional, management or environmental factor is interfering with normal parturition?
- Is the condition more common in male or female calves and what are the relative birth weights?
- How soon after birth are the calves affected?
- What is the course of the illness after the first clinical abnormalities are noted?
- What level of calving surveillance and assistance is being provided by the attendants?
- The veterinarian should make every effort to clinically examine a representative number of affected calves.

## TREATMENT

Calves born weak, unable to stand, lacking the instinct to seek the teat or lacking a suck reflex, need intensive care including force-feeding of colostrum and the provision of warm surroundings to prevent hypothermia and other complications. Affected calves must be assisted to suck the dam normally. Bottle feeding for a few days may be necessary until the calf becomes strong enough to suck the dam on its own.

## CONTROL AND PREVENTION

Control and prevention of the weak calf syndrome is based on empirical observations beginning with insuring **adequate nutrition of the dam** to avoid any possible nutritional factors affecting neonatal calf vitality. The provision of **adequate surveillance at calving time** and competent obstetrical assistance when necessary is also crucial to avoid prolonged parturition and fetal hypoxia in calves.

When epidemics of the disease are occurring, the surveillance of calving must be intensified, and it may be necessary to intervene with obstetrical assistance earlier than usual. Determination of the cause may require that the veterinarian attend several calvings, make detailed clinical examinations of the length of parturition and observe the parturition process and the health of the calves at birth.

## REVIEW LITERATURE

Meijering A. Dystocia and stillbirth in cattle – A review of causes, relations and implications. *Livestock Sci* 1984; 11:143–177.

Randall GCB. Perinatal mortality: some problems of adaptation at birth. *Adv Vet Sci Comp Med* 1978; 22:53–81.

Mee JF. The role of micronutrients in bovine periparturient problems. *Cattle Pract* 2004; 12:95–108.

## REFERENCES

1. Stauber EH. *J Am Vet Med Assoc* 1976; 168: 223.
2. Card CS et al. *Proc 77th Ann Mtg US Anim Hlth Assoc* 1974; 67.
3. Ward JK. *Proc 6th Ann Mtg Am Assoc Bovine Pract* 1973; 97.
4. Logan EF et al. *Vet Rec* 1990; 126:163.
5. Rice DA et al. *Vet Rec* 1986; 119:571.
6. Simpson VR. *Vet Rec* 1990; 127:459.
7. Kim Hak-Nam et al. *Agri-Pract* 1988; 9:23.
8. McCoy MA et al. *Vet Rec* 1997; 141:544.
9. Smyth JA et al. *Vet Rec* 1999; 145:539.
10. Ohtsuka H et al. *J Vet Med Sci* 2003; 65:793.
11. Brenner J et al. *J Vet Med B* 2005; 52:98.
12. Logan EF et al. *Vet Rec* 1991; 129:99.
13. Smyth JA et al. *Vet Rec* 1996; 139:11.
14. McCoy MA et al. *Vet Rec* 1995; 136:124.
15. Smyth JA, Ellis WA. *Vet Rec* 1996; 139:599.
16. Ogata Y et al. *J Vet Med A* 1999; 46:327.
17. Dufty JH, Sloss V. *Aust Vet J* 1977; 53:262.
18. Randall GCB. *Adv Vet Sci Comp Med* 1978; 22:53.
19. Meijering A. *Livestock Prod Sci* 1984; 11:143.
20. Tyler H, Ramsey H. *J Dairy Sci* 1991; 74:1957.
21. Patterson DJ et al. *Theriogenology* 1987; 28: 557.
22. Bellows RA et al. *Theriogenology* 1987; 28:573.
23. Kasari TR. *Agri-Pract* 1989; 10:19.
24. Gee CD et al. *Aust Vet J* 1989; 66:293.
25. Schuijt GJ. *Am Vet Med Assoc* 1990; 197:1196.
26. Kelly DF, Rowan TG. *Vet Rec* 1993; 133:475.
27. Lopez A, Bildfell R. *Vet Pathol* 1992; 29:104.
28. Lopez A et al. *Am J Vet Res* 1994; 55:1303.
29. Mee JF. *Vet Rec* 1991; 128:521.
30. Sluitjer FJH. *Vet Rec* 1990; 127:355.

## WATERY MOUTH OF LAMBS (RATTLE BELLY, SLAVERS)

### Synopsis

**Etiology** Non-enteropathogenic *E. coli* endotoxemia predisposed by failure of passive transfer

**Epidemiology** Higher risk with intensive housing with poor hygiene

**Clinical findings** Loss of sucking reflex, retention of meconium or feces, excessive mucoid saliva, abomasal distension.

**Lesions** None specific

**Diagnostic confirmation** Nothing pathognomonic.

**Treatment** Fluids and energy via stomach tube. Antimicrobials.

**Control** Antimicrobials at birth, pen hygiene, ensure adequate colostrum transfer

## ETIOLOGY

This disease is believed to be the result of **endotoxemia** in young lambs. It is postulated that the neutral pH of the abomasum in newborn lambs, coupled with

low concentrations of colostral immunoglobulin in the gut, allow rapid multiplication of non-enteropathogenic strains of *Escherichia coli* in the gut, and to some extent systemically, to result in endotoxemia.<sup>1</sup>

## EPIDEMIOLOGY

### Occurrence

The syndrome is primarily reported in **lambs in Great Britain** but has also been reported in New Zealand and in goat kids in Spain and North America.<sup>1,2</sup>

### Animal and environmental risk factors

Lambs 12 to 72 hours of age are affected. The disease is seen under all management systems but is rare in pastured flocks and occurs most commonly in lambs kept in **intensive housing** where there is **poor hygiene** of the lambing environment. Lambs from prolific ewes are at risk and the disease is more common in triplets than twins or singles.

Delayed or **poor colostrum intake** is a major risk factor and situations that predispose this may lead to outbreaks. A high prevalence has occurred in ram lambs castrated by the use of an elastic band at a very young age and the resulting pain may have dissuaded them from feeding.

Other risk factors, all of which reduce sucking by the lamb, are inclement weather, mismothering, maternal agalactia, competition between twins or triplets, low vitality, and ewes in poor condition.

### Experimental reproduction

An equivalent clinical syndrome is reproducible by administering non-enterotoxigenic strains of *E. coli* by mouth to colostrum-deprived lambs, all of whom died within 24 hours.<sup>3</sup>

### Economic importance

Watery mouth disease is a major cause of mortality of housed newborn lambs in Great Britain and is reported to be the cause of approximately 25% of all deaths of lambs in indoor intensive lambing systems.<sup>1</sup> Where conditions allow morbidity rates may approach 24% and without early treatment case fatality rates are high.<sup>4</sup>

## PATHOGENESIS

Gram-negative bacteria, non-enterotoxigenic and non-enteropathogenic *E. coli* in the environment, are ingested as a result of a contaminated environment, or from a contaminated fleece, and survive passage through the neutral pH of the abomasum to be absorbed into the systemic circulation by the natural pinocytosis that occurs in the intestinal epithelium of newborn ruminants, to produce an endotoxemia.

## CLINICAL FINDINGS

Affected lambs are normal at birth but become sick at 24–48 hours and up to 72 hours old. The disease is characterized by dullness, a complete failure to suck, and excessive mucoid saliva around and drooling from the mouth. As the disease progresses there is hypothermia, failure to pass feces, cold extremities, depression to the point of coma, anorexia and, in the late stages, abdominal distension and recumbency, but rarely diarrhea. The alimentary tract is full of fluid and the lamb rattles when it is shaken. Some lambs are hypothermic but the temperature is normal at the onset of the condition and falls to subnormal as the disease progresses. Progress is rapid with death 6–24 hours after the first signs of illness.

## CLINICAL PATHOLOGY

Total protein concentrations and base excess values are significantly elevated compared to normal lambs.<sup>5</sup> Blood glucose concentrations are normal but may be low in the terminal phase of the disease.

## NECROPSY FINDINGS

There are no findings specific to the syndrome. The abomasal contents are fluid and mucoid, and contain small milk curds and the intestine is gas filled.

## TREATMENT

Treatment with intramuscular amoxicillin and clavulanic acid, intravenous flunixin meglumine, and oral rehydration fluid, when administered early in the clinical course, has resulted in a high recovery rate in field cases.<sup>5</sup> Dextrose solution should also be given to those lambs that are hypoglycaemic and external warming should be provided. Other recommended treatments include emptying the alimentary tract by purgation or enema.

## DIFFERENTIAL DIAGNOSIS

Most neonatal disease of lambs is manifest with diarrhea which is not present in watery mouth. The early stages of Colisepticemia and *Clostridium perfringens* type B or C present with similar clinical signs but are easily differentiated later in the clinical course or at post mortem examination. Hypothermia/starvation/cold stress can present with similar clinical findings but the history and environmental circumstances of occurrence differ.

## CONTROL

In outbreaks the administration of antibiotics to all newborn lambs within 15 minutes to 2 hours of birth dramatically reduces the occurrence of further cases.<sup>4,6</sup> Fresh or frozen sheep or cow colostrum should be supplemented to lambs at risk. The provision of ewe colostrum at 50 mL/kg body

weight within 6 hours of birth prevents the disease.

Lambing areas and associated pens and yards should be kept clean and fresh bedded. Contaminated fleece should be removed from around the udder of the ewe prior to lambing and every effort should be made to insure early and adequate colostrum intake by newborn lambs, especially for twins and triplets.

## REVIEW LITERATURE

- Eales FA. Watery mouth. In Pract 1987; 9(1):12–13.  
Linklater KH. Watery mouth of lambs. Vet Ann 1989; 29:88–92.  
King T, Hodgson C. Watery mouth in lambs. In Practice 1993; 13:23–24.  
Hodgson C. Watery mouth in newborn lambs. Vet Ann 1993; 23:103–105.

## REFERENCES

- Hodgson JC. Vet Ann 1993; 23:93.
- Sargison ND et al. NZ Vet J 1997; 45:67.
- Hodgson JC et al. Res Vet Sci 1989; 47:119.
- Eales FA et al. Vet Rec 1986; 119:543.
- Scott PR, Gessert ME. Vet Rec 1996; 139:117.
- Hodgson JC et al. Vet Rec 1999; 145:67.

## COLD COW SYNDROME

This is a herd disease problem reported from the UK in cows freshly turned out onto lush pasture with a high (27–43%) soluble carbohydrate content.<sup>1</sup> There is a high morbidity (up to 80%) and a large number of outbreaks in an area. The syndrome includes hypothermia, dullness, inappetence, agalactia, and profuse diarrhea. Affected cows feel cold to the touch. Some have perineal edema, some collapse. The herd milk yield falls disastrously but there is a quick return to normal if the cows are moved to a different field. The problem may occur on the same pasture each year and recur if the cows are returned to the same pasture. There is no obvious clinicopathological abnormality. It is postulated that the syndrome might be due to zearalenone or related metabolites produced by field micro fungi in the pasture.<sup>2</sup>

## REFERENCES

- Veterinary information service. Vet Rec 1984; 114:603.
- Schoental R. Vet Rec 1983; 112:594.

## THIN SOW SYNDROME

### Synopsis

**Etiology** The syndrome is the result of inadequate nutrition and unbalanced nutrition in pregnancy and lactation but can also result from parasitic or chronic infectious disease.

**Epidemiology** Loss of weight to the point of inanition particularly in first and second litter gilts.

**Clinical findings** Inanition

**Control** Recognition of the relation between voluntary feed intake in pregnancy and lactation, feeding based on condition scores.

## ETIOLOGY

The 'thin sow syndrome' is discussed in this chapter because of its multiple etiology. Regardless of etiology the effects of this syndrome on fertility and overall farm productivity can be formidable. There are a number of causes of wasting and the occurrence of thin sows:

- The major cause of sow abnormality under this heading results from **errors in feeding** and management, which are likely to be exaggerated and multiplied on farms where intensive management is practiced. The most common errors are incorrect feeding in pregnancy and lactation. These can be exacerbated by cold or drafty housing, fluctuating temperatures, too high a temperature in the farrowing house, low-level feeding to avoid obesity, wet bedding, and lack of drinking water. Early weaning increases the risk for the thin sow syndrome, especially if nutrition is inadequate.
- Parasitic disease**, particularly associated with infestation with *Oesophagostomum* spp. and *Hyostromylus* spp. Is a cause of wasting in sows and the occurrence of the thin sow syndrome and is discussed under those headings (Ch. 27)
- Thin sows can be a component of the syndrome of **infectious diseases** such as cystitis and pyelonephritis.

## EPIDEMIOLOGY AND PATHOGENESIS.

The syndrome is most common in first and second litter gilts but can affect all parities when nutrition is inadequate. It emerged as a problem in the 1970s as a result of poor understanding of the **inter-relation between feed intake in pregnancy and that in lactation**, combined with the move to intensive indoor housing of pregnant sows. Penning of sows exacerbated social dominance/submissive relationships. The voluntary intake of food by sows during lactation is inversely related to the intake in pregnancy. Consequently sows that are fed at high levels during pregnancy will gain excessive weight during pregnancy but will voluntarily restrict feed intake during lactation and lose excessive weight during lactation. In contrast sows that are fed what is basically a maintenance ration 2.0–2.5 kg (4.5–5.5 lbs) of a balanced sow ration during pregnancy will gain adequate weight for conceptus and body growth and during lactation will consume adequate feed for lactation requirements and lose minimal weight in this period. Knowledge of sow nutrition has improved such that major problems with this syndrome should not occur but there is still a risk of

inadequately feeding sows selected for lean genotype and high litter size and weaning weights. First and second litter gilts may require more feed to provide for body growth.

#### CLINICAL FINDINGS

Within a herd the thin sow syndrome develops over a period of months and often one or two pregnancy cycles, with a gradually declining of body condition of the group until 20% to 30% of sows have a low body condition score. No abnormalities are evident on clinical examination but the sow fails to regain weight after weaning, particularly sows after their first litter. The most critical period for weight loss is the first 2 weeks after weaning. Affected sows have a poor appetite but often show pica and excessive water intake and may be anemic.

#### CONTROL

##### Feeding during pregnancy

Currently the risk for the thin sow syndrome exists where it is assumed that all pregnant sows can be fed a standard amount of ration. Problems are likely to occur when sows are run in groups and fed as a group where timid sows are likely to be bullied out of their required share of food.

Individual feeders or stall feeding will prevent this.

##### Feeding during lactation

The critical issue is to ensure adequate feed and energy intake during lactation. This can be achieved by:

- not feeding to excess during pregnancy restricting the feed intake of sows in the first few days after farrowing to encourage better feed intake in later lactation
- ensuring an adequate and constant supply of water
- ad lib feeding during lactation
- a high-energy-density lactation diet
- enclosing the creep with heat for the piglets so that the farrowing house can be kept at a lower temperature 65°F (65°C) for the sow
- control of parasitic disease.

**Condition scoring** is a valuable guide to the feeding of individual sows and for a judgement of feeding practices in the herd as a whole. On a score of 1 to 5 it should be very rare to find sows with condition scores of 1 or 5. The optimum is to have sows entering the farrowing house between condition score 3 and 4 and not less than 2.5 at weaning. First and second parity sows in poor condition at weaning are best 'skipped' at the first heat and mated on the second heat.

Methods for condition scoring and guidelines can be found at [http://www.](http://www.defra.gov.uk/animalh/welfare/farmed/pigs/pb3480/pigscotc.htm)

[defra.gov.uk/animalh/welfare/farmed/pigs/pb3480/pigscotc.htm](http://defra.gov.uk/animalh/welfare/farmed/pigs/pb3480/pigscotc.htm)

### ACUTE HEPATITIS (POSTVACCINAL HEPATITIS) OF HORSES (THEILER'S DISEASE, SERUM HEPATITIS)

An acute hepatopathy of horses often associated with administration of equine biological products such as tetanus antitoxin.

#### ETIOLOGY

Etiology is unknown, although an infectious agent is suspected.

#### EPIDEMIOLOGY

The disease occurs in horses administered equine serum or tissue products. The first reports of the disease were in horses in South Africa administered equine serum as prophylaxis for Africa Horse Sickness. Outbreaks of the disease have occurred in horses in Africa, Europe, and North America administered equine serum as prophylaxis for a variety of diseases including African horse sickness, encephalomyelitis, botulism, *Strep. equi* infection, tetanus, and influenza and in mares given pregnant mare serum.<sup>1</sup> Most sporadic cases of the disease appear to be associated with administration of tetanus antitoxin.

The disease is reported only from adult horses (>1 year of age) and most cases are reported in the summer and autumn.<sup>2</sup> There is a suspicion that pregnant mares are at increased risk.

The **morbidity rate** in outbreaks among horses administered equine serum ranges between 2 and 18%,<sup>3</sup> although the rate among horses administered tetanus antitoxin as prophylaxis following injuries is clearly much lower. Acute hepatitis developed in 4 (0.4%) of 1260 horses >1 year of age administered commercial equine plasma at one institution in the United States over a 6-year period.<sup>4</sup> The disease can occur after intrauterine infusion of equine serum to mares.

The **case fatality rate** is between 50 and 90%.

The disease occurs sporadically in horses that have not been administered equine biological products. There are reports of in-contact, non-treated horses developing the disease.

#### PATHOGENESIS

Destruction of hepatocytes results in hepatic dysfunction. Hepatoencephalopathy develops in severely affected horses.

#### CLINICAL FINDINGS

The disease usually occurs after an **incubation period** of 40–70 days (range 27–165 days). Depression, anorexia, and

icterus are evident in mildly affected cases. There may be mild to moderate colic. Body temperature and heart rate are usually normal. Acutely affected, or horses observed infrequently, can die unexpectedly. Signs of **hepatoencephalopathy** include restlessness, excitement, compulsive walking and head pressing, abnormal head position, seizures, apparent blindness, muscle tremors, and ataxia. Affected horses often injure themselves by walking into fences and troughs.

#### CLINICAL PATHOLOGY

Leukocytosis with neutrophilia and mild lymphocytopenia is common. The hematocrit and plasma total protein concentrations may be mildly increased. Hyperbilirubinemia and an increase in direct (conjugated) bilirubin concentration are present and serum bile acid concentration is increased, as is serum activity of liver specific enzymes aspartate aminotransferase (AST), gamma-glutamyl transferase (GGT), and sorbitol dehydrogenase (SDH). Increases in serum GGT activity is often less than expected for the increases in serum AST, SDH, and bile acid concentrations, likely reflecting the primary insult to hepatocytes.

Hypoglycemia (<2 mmol/L, 40 mg/dL) and hyperammonemia (>150 μmol/L) may be severe. Clotting time, especially the one stage prothrombin time, may be prolonged.

#### NECROPSY FINDINGS

The liver may be enlarged, normal or shrunken and discolored slightly yellow to green. There is severe centrilobular necrosis of hepatocytes with mild infiltration of lymphocytes and plasma cells. Alzheimer type II astrocytes are present in the brains of horses with encephalopathy.

#### DIFFERENTIAL DIAGNOSIS

Diagnostic confirmation antemortem is achieved by examination of a liver biopsy, although this should not be performed in animals with coagulation abnormalities.

##### Differential diagnosis list:

- Acute aflatoxicosis
- Rubratotoxicosis (Penicillin rubrum)
- Pyrrolizidine alkaloid intoxication
- Dioxin intoxication
- Idiopathic hyperammonemia.<sup>5</sup>

#### TREATMENT

Treatment is essentially supportive and consists of correction of metabolic and acid–base abnormalities, reduction of plasma ammonia concentration, and preventing horses with hepatoencephalopathy from injuring themselves.

Hypoglycemia and dehydration can be corrected by intravenous administration of



5% dextrose and isotonic electrolyte solutions. Metabolic acidosis can be corrected by infusion of sodium bicarbonate. Plasma transfusions may be necessary to correct coagulation abnormalities.

Hyperammonemia can be treated by giving neomycin (20 mg/kg, orally, every 6 hours for 4 doses) or lactulose (0.25 mL/kg, orally every 8 hours) to decrease absorption of ammonia from the gastrointestinal tract.

**Sedation** with xylazine or similar compounds may be necessary to prevent the animal injuring itself. The affected horse should be housed in an area where it has the least opportunity to injure itself, and may need to be fitted with a padded helmet.

### CONTROL

Minimal use of biologics, including plasma, of equine origin is prudent.

### REFERENCES

1. Tennant B. Proc Am Assoc Equine Pract 1978; 24:465.
2. Hjerpe CA. J Am Vet Med Assoc 1964; 144:734.
3. Panciera RJ. J Am Vet Med Assoc 1969; 155:408.
4. Aleman M et al. J Vet Int Med 2005; 19:120.
5. Peek SF et al. Equine Vet J 1997; 29:70.

## GRANULOCYTOPENIC DISEASE OF CALVES

A fairly widespread disease of recent origin, granulocytopenic disease of calves is commonly ascribed to poisoning with furazolidone. Affected calves are those being reared on milk replacer and sometimes, but not always, receiving prophylactic antibiotics.<sup>1,2</sup>

Affected calves show persistent fever, and increased salivation and nasal discharge, and there are hemorrhages and necrotic lesions in the mouth and lower alimentary tract. The disease is characterized by decreased myelopoiesis in bone marrow, neutropenia, and thrombocytopenia. The course varies from 2 to 5 days, and the mortality rate is high, apparently from bacterial invasion. Pneumonia, peritonitis, and enteritis are common accompaniments. *Fusobacterium necrophorum* can be isolated from necrotic lesions.<sup>1</sup> These clinical, pathological, and hematological findings resemble those of radiation sickness, and poisoning by bracken fern.

The disease has been related to long-term feeding of furazolidone (2 mg/kg BW daily), either in the milk replacer or as specific therapy, and the disease can be reproduced by this means. At higher dose rates (20–30 mg/kg BW) nervous signs, including convulsions, and death follow within a few days; both syndromes may occur at the same time in a group of calves.<sup>3</sup>

### REFERENCES

1. Nimmo-Wilkie J, Radostits OM. Can Vet J 1981; 22:166.
2. Sheldon IM. Vet Rec 1994; 135:498.
3. Finnie JW. Aust Vet J 1992; 69:21.

## SWEATING SICKNESS (TICK TOXICOSIS)

### Synopsis

**Etiology** Unknown, associated with bites of *Hyalomma truncatum*.

**Epidemiology** Reported in Africa, India, and Sri Lanka affecting calves 2 to 6 months of age.

**Clinical findings** Fever, salivation, lacrimation, hyperemia of mucosae, epistaxis, and extensive and severe dermatitis, necrosis of oral epithelium

**Lesions** Dermatitis and necrotic stomatitis, disseminated intravascular coagulopathy.

**Treatment** Symptomatic and use of hyperimmune serum

**Control** Tick control

### ETIOLOGY

The cause has not been identified, but it behaves as though it were an epitheliotropic toxin produced by the salivary glands of certain strains of the tick *Hyalomma truncatum*. Not all strains of *H. truncatum* have the ability to produce the disease and antigens unique to sweating sickness-inducing strains are described.<sup>1,2</sup>

### EPIDEMIOLOGY

Attempts to transmit the disease between animals by mediate or immediate contact and by injections of tissue or blood are unsuccessful. The disease occurs in Central, East and South Africa, Sri Lanka, and probably southern India. Only calves 2–6 months of age are affected as a rule but rare cases occur in adults. Sheep, pigs, and goats are susceptible, although the disease does not naturally occur in them, and the disease has been produced experimentally in dogs. Sweating sickness occurs at all times of the year but is most prevalent during the wet season when ticks are more plentiful. The morbidity rate varies with the size of the tick population but is usually 10–30%. The case fatality rate is up to 30%.

### PATHOGENESIS

The clinical signs begin 4–7 days after the ticks attach, probably 3 days in experimental infestations. The effects are dose-specific; if the ticks are removed very early there is no clinical response and the animal remains susceptible; with a longer exposure before the ticks are removed the animal becomes immune but shows no clinical signs. With longer exposure of more than 5 days the subject develops the

full-blown clinical disease and may die. If it recovers it has a solid and durable immunity.

### CLINICAL FINDINGS

There is a sudden onset of fever up to 41°C (106°F), anorexia, hyperemia of the mucosae, and hyperesthesia. The animal is lethargic, depressed, dehydrated, and has a serous then mucopurulent oculonasal discharge, an arched back, and a rough coat. There is an extensive, moist dermatitis commencing in the axilla, groin, perineum, and at the base of the ears which extends to cover the entire body in bad cases. 'Sweating' refers to this moist dermatitis. The hair is matted together by exudate and moisture collects in the form of beads on the surface. The eyelids may be stuck together. Subsequently patches of the skin and hair are rubbed off or can be pulled off to leave raw, red areas of subcutaneous tissue exposed. The tips of the ears and tail may slough.

Affected calves seek shade and their skin is very sensitive to touch. Later it becomes dry and hard, and cracks develop. Secondary bacterial infection and infestation with blowflies or screw-worm larvae are common sequelae. The oral mucosa is hyperemic at first and then becomes necrotic with the formation of ulcers and diphtheritic membranes. The calf salivates profusely, cannot eat or drink, and becomes emaciated and rapidly dehydrated. There are similar mucosal lesions in the vagina and nasal cavities, the latter causing dyspnea. The severity of the mucosal lesions appears to vary with different 'strains' of the toxin.<sup>3</sup> There may be abdominal pain and diarrhea in some calves.

The course may be as short as 2 days but is usually 4 or 5 days. In recovered animals the skin may heal and the hair may regrow, but there may be permanent, patchy alopecia and the calves may remain stunted and unthrifty.

### CLINICAL PATHOLOGY

There is a severe neutropenia and eosinopenia and a degenerative left shift.  $\alpha$ -globulin and beta-globulin levels are raised. Urinalysis indicates the existence of nephrosis but serum creatinine levels are normal.<sup>4</sup> Dermatological examination fails to reveal the presence of any of the usual infectious causes of dermatitis.

### NECROPSY FINDINGS

The lesions are essentially those seen clinically. There is also evidence of severe toxemia, dehydration, emaciation, and hyperemia of all internal organs and disseminated intravascular coagulation. The necrosis of the oral epithelium extends into the esophagus and may reach the forestomachs.

**DIFFERENTIAL DIAGNOSIS**

The combination of extensive dermatitis and mucosal necrosis is unusual. Mucosal disease and bovine malignant catarrh may bear some resemblance and there could be difficulty in differentiation in areas where the tick *Hyalomma truncatum* occurs.

**TREATMENT**

There is no specific treatment; efforts should be directed at relieving the severity of the dermatitis and mucosal loss. Non-steroidal anti-inflammatory drugs (NSAIDs) and broad-spectrum antibiotic cover is a logical regimen. Hyperimmune serum, produced in sheep and cattle by infesting them with *Hyalomma truncatum* at 6-week intervals for 2–5 occasions, is an effective treatment in pigs, sheep, and to a less extent calves.<sup>2,5</sup>

**CONTROL**

Control is limited to control of the causative tick. No vaccine is available.

**REVIEW LITERATURE**

Bwangamoi O. In: Muger GM, ed. Diseases of cattle in tropical Africa. Nairobi: Kenya Literature Bureau, 1979; p. 405.

**REFERENCES**

1. Burger DB et al. Exp Appl Acarol 1991; 13:59.
2. Spickett AM et al. Onderstepoort J Vet Res 1991; 58:223.
3. Bezuidenhout JD, Oberem PT. Proc 13th World Congr Dis Cattle 1984; 1:515.
4. van Amstel SR. Proc 13th World Congr Dis Cattle 1984; 1:520.
5. Oberem PT et al. Onderstepoort J Vet Res; 1985; 52:283.

## Diseases characterized by alimentary tract involvement

### EQUINE GRASS SICKNESS (EQUINE DYSAUTONOMIA, GRASS DISEASE, MAL SECO)

**Synopsis**

**Etiology** Unknown

**Epidemiology** Horses of all breeds and both sexes in the UK, Western Europe, Scandinavia, and southern South America. Greatest incidence in early summer.

**Clinical signs**

**Acute grass sickness:** Colic, nasogastric reflux, absent gut sounds, depression, dysphagia, and small intestinal distension of <2 days duration at time of death.

**Subacute grass sickness:** Tachycardia with or without signs of colic, reduced intestinal sounds, impaction of the colon, and clinical course of 2–7 days.

**Chronic grass sickness:** Insidious onset weight loss, intermittent colic, decreased appetite, rhinitis sicca, patchy sweating, and mild dysphagia.

**Clinical pathology** None is specific or diagnostic.

**Lesions** Both forms of the disease have degeneration of neurons of the autonomic nervous system, especially of the myenteric and submucosal plexuses.

**Diagnostic confirmation** Examination of ileal biopsy.

**Treatment**

**Acute grass sickness/subacute grass sickness:** Supportive. None effective.

**Chronic grass sickness:** Nursing care. Cisapride.

**Control** None

**ETIOLOGY**

The cause is unknown but is suspected to be a neurotoxin, possibly *Clostridium botulinum* toxin, based on epidemiologic data.<sup>1,2</sup> Evidence supporting a role for *Cl. botulinum* in the etiology of the disease included the isolation of toxin (BoNT/c) producing strains of *Cl. botulinum* type C from the ileum of 45% of horses with grass sickness and 4% of clinically normal control horses.<sup>2</sup> In addition to preventing the release of acetylcholine at cholinergic nerve terminals and thereby causing paralysis, a function that it shares with other botulinum toxins, BoNT/C is neurotoxic. Other studies have demonstrated increased numbers of bacterial organisms, including anaerobes, and number of species of clostridia in feces of horses with grass sickness compared with normal horses.<sup>3</sup> Whether these findings represent a causative role of *Cl. botulinum* in grass sickness, or an effect of the modified gastrointestinal motility and on intestinal flora remains to be determined. Further evidence to support a role for *Cl. botulinum* in the etiology of grass sickness include the observations that low serum concentrations of antibodies to *Cl. botulinum* are associated with increased risk of the disease.<sup>1,4</sup> However, the hypothesis of a role for toxicoinfectious botulism in grass sickness of horses does not explain the geographic distribution of the disease given that botulism occurs worldwide in horses and grass sickness does not.

**EPIDEMIOLOGY****Occurrence**

Grass sickness is not common and appears to be restricted in its distribution to all parts of Great Britain (including possibly Ireland), Sweden, and the northern and western coasts of Europe. A clinically and histologically indistinguishable disease, *mal seco* occurs in the Patagonia region of Argentina, southern Chile, and in the Falkland (Malvinas) Islands.<sup>5,6</sup>

Horses, ponies, donkeys, zebra, Przewalski's horses, rabbits, and hares are the predominant species affected.<sup>7</sup> The morbidity and mortality rates are not reported, but the incidence on farms with a history of the disease ranges between 0.4 and 16% per year<sup>8</sup> or 2.1 grass sickness cases per 100 horses per year.<sup>9</sup>

The case fatality rate for acute grass sickness is 100%, while that for the chronic form of the disease in horses treated at a referral hospital is 60–70%.<sup>10,11</sup> Horses that survive the chronic form of the disease are often destroyed because of weakness and emaciation, although make complete recoveries.<sup>12</sup> However, given the difficulty in establishing an antemortem diagnosis, it is unclear whether horses that fully recovered actually had chronic grass sickness.

**Risk factors****Animal risk factors**

The risk of disease is greatest in 4–5 year old horses (adjusted odds ratio of 1.9 compared with 0–3 year olds) and then declines such that the risk of disease is lowest in horses >12 years old (odds ratio 0.02 compared to that of 0–3 year olds).<sup>1</sup> Cases in horses 10 months to 20 years of age have been encountered. Foals born of affected mares are clinically normal.<sup>13</sup> There is no apparent breed predilection.<sup>8</sup>

Horses at pasture are at increased risk (hence the colloquial name of the disease), although the disease does occur rarely in stabled horses. A recent (<14 day) change of pasture carries an increased risk (odds ratio 24) of development of the disease.<sup>14</sup> Horses that have been on the farm for less than 2 months are at increased risk of developing the disease.<sup>8</sup> Horses on farms with previous cases of the disease are at increased risk (odds ratio 2.2–45) of the disease,<sup>14,15</sup> although horses that have been in contact with animals with the disease are at reduced risk (odds ratio 0.1) of developing the disease.<sup>14</sup>

**Environmental risk factors**

There is a marked seasonal distribution of cases, with the peak incidence occurring in early summer in the British Isles.<sup>8,9,16</sup> Outbreaks of the disease are associated with the occurrence of cooler and drier weather than normal during the 2 weeks preceding the outbreak,<sup>9,17</sup> although this is not consistently reported.<sup>15</sup>

**Farm or premise risk factors**

As mentioned, farms with a history of horses with the disease are at increased risk of having further cases. For premises with previous cases of grass sickness there is an increased risk of the disease developing as the number of horses on the farm increases, with the presence of young horses, on stud farms and livery/riding schools, on farms having sandy or loamy

soil, and those rearing of domestic birds and using mechanical fecal removal.<sup>9</sup> The risk of recurrence of disease on a farm decreased with presence of chalk soil, cograzing ruminants, grass cutting of pastures, and manual removal of feces.<sup>9</sup> There is no association between the disease and the type of pasture, nor with provision of supplementary feeds.<sup>8</sup> Feeding hay or haylage is associated with a decreased risk of the disease.<sup>1</sup> Any disturbance of the soil, such as by ploughing, increases the risk of disease.

#### Transmission

The disease is not contagious. Injection of normal horses with serum of affected horses causes lesions, but not clinical signs, consistent with the disease.

#### PATHOGENESIS

The clinical signs are attributable to widespread damage to the autonomic nervous system, resulting in sympathetic and parasympathetic dysautonomia that is most clinically evident in the gastrointestinal tract. Coincident with damage to the autonomic nervous system are increases in plasma concentrations of dihydroxyphenylalanine, epinephrine, norepinephrine, and dopamine,<sup>18</sup> possibly because of increased secretion of these compounds from affected sympathetic ganglia and neurons.<sup>19</sup> Lesions in the cranial nerves and brain stem are probably responsible for dysphagia and drooling evident in most cases. Rhinitis is associated with diminished nonadrenergic, noncholinergic (NANC) innervation, greatest in neurons positive for substance P or calcitonin gene-related peptide, of the nasal mucosa in subacute and chronic cases.<sup>20</sup>

Electrocardiographic examination of affected horses reveals evidence of loss of parasympathetic innervation of the heart, which is consistent with lesions in the terminal cardiac ganglia.<sup>21</sup> Splanchnic lesions are most severe in the myenteric and submucosal plexuses of the ileum, with less severe changes in the large colon and celiaco-mesenteric ganglion.<sup>22</sup> There is also a reduction in interstitial cells of Cajal (cells involved in pacemaker activity and autonomic transmission within the gut).<sup>23</sup> These neuronal changes are associated with a marked impairment of cholinergic activity in ileal tissue of affected horses.<sup>24</sup> Because of the altered autonomic activity, peristalsis decreases (in chronic cases) or ceases (in acute cases) with subsequent accumulation of ingesta in the small intestine, stomach, and large colon. Death is due to emaciation in chronic cases or rupture of the stomach or intestine in acute cases.

#### CLINICAL FINDINGS

The clinical signs of grass sickness are varied, and accurate diagnosis on clinical

signs alone is very difficult. The incubation period of the disease is approximately 10–14 days<sup>17</sup>. **Acute, subacute, and chronic** forms of the disease are recognized,<sup>25</sup> although some authorities use a designation of acute and chronic.<sup>26</sup> In all cases, there is some dysphagia, resulting in drooling of saliva and trickling of ingesta from the nose. Dried food is impacted between the cheeks and the teeth and the animal plays at drinking. These signs are attributable to lesions in the cranial nerves. Most animals are depressed.

**Acute cases** the onset is sudden and the course of the disease is 1–4 days. Abdominal pain may be severe but also may be absent even in the presence of severe tachycardia. There is tachycardia (80–90/min may be >100), decreased to absent gut sounds, lack of defecation, and abdominal distension. On rectal examination, there are hard, dry pellets of feces, the large colon contains firm ingesta which has a corrugated feel that is quite distinct to the smooth surface of a primary colonic impaction. The small intestine is distended with fluid and readily palpable in the caudal abdomen. Nasogastric intubation yields a large (20 L) quantity of fluid. Urination is frequent and may be accompanied by tenesmus. Affected horses may wander about in a restless manner and a fine muscle tremor occurs constantly, especially in the upper forelimb. Periodic attacks of patchy sweating occur commonly. There is noticeable salivation. Esophageal endoscopy reveals linear ulcerations resulting from reflux esophagitis.

**Subacute** cases have signs of mild colic, or may not have any signs of colic, in the presence of tachycardia, depression, reduced gastrointestinal sounds, and impaction of the large colon with characteristic corrugated appearance.<sup>25</sup> The clinical course is 2 to 7 days and death is inevitable. Esophageal endoscopy reveals the presence of linear erosions in many affected horses.

**Chronic cases** the course is usually >7 days and is characterized by weight loss, patchy sweating, and intermittent colic. Horses stand with all four feet close together under them ('elephant on a tub stance') and have a tucked up abdomen. Dysphagia is evident and the gut is empty except for the colon and rectum which contain dry, hard feces. In the late stages the patient snores, the penis droops, and attempts are made to eat abnormal materials. Most cases of the chronic form have rhinitis, characterized by crusting of mucopurulent material on the turbinates and this is considered, in the presence of appropriate history and other clinical signs, almost pathognomonic for grass sickness.

Application of phenylephrine (0.5 mL of a 0.5% solution) into one eye causes a dorsal deviation of the eyelashes of the upper eyelid in horses with grass sickness, but not in normal horses.<sup>27</sup>

There is a radiological discernible defect in esophageal motility in horses with grass sickness.<sup>28</sup>

Recurrence of the disease in a horse is exceedingly rare.

#### CLINICAL PATHOLOGY

Serum biochemical profiles and hematological examinations do not demonstrate pathognomonic changes.<sup>29</sup> Signs of dehydration, electrolyte imbalances, hyperbilirubinemia, and elevations of serum activity of liver derived enzymes are all secondary to the disease.<sup>30</sup> Urine from horses with grass sickness has higher specific gravity, protein and creatinine concentrations, and lower pH than that from unaffected horses,<sup>31</sup> consistent with dehydration and electrolyte imbalances that occur with the disease. Peritoneal fluid is often abnormal, having an increased protein concentration and leukocyte count but, because of the considerable overlap with values in horses with lesions of the gastrointestinal tract requiring surgery, is of limited diagnostic value.<sup>32</sup>

Antemortem diagnostic confirmation can only be achieved by examination of biopsy specimens of the ileum,<sup>33</sup> although biopsy of nasal mucosa has been suggested as an alternative.<sup>18</sup> Examination of rectal biopsy is specific, but not sensitive, for the disease.

#### NECROPSY FINDINGS

In cases of short duration, the stomach and small intestines are distended with an excess of fluid and gas, and the colon is often impacted with corrugated ingesta coated with black material. In chronic cases, the alimentary tract is empty.

Histologically there is extensive degeneration of neurons of the autonomic nervous system without evidence of inflammation.<sup>33</sup> These neurons include those of the ganglia (cranial cervical, stellate, coeliaco-mesenteric, etc.) and those of the myenteric and submucosal plexi of the intestines. Degenerative neuronal changes may also be observed in the central nervous system, including the oculomotor, facial, lateral vestibular, hypoglossal and vagal nuclei, the ventral horns of spinal cord and the dorsal root ganglia. This neuropathy is difficult to confirm unless fresh, well-fixed samples are submitted for histological examination. Immunohistochemical staining for synaptophysin aids in the differentiation between autolytic tissue and tissue from horses with grass sickness.<sup>34</sup>

Samples for post-mortem confirmation of diagnosis

Samples for light microscopic examination: formalin-fixed sympathetic ganglia, brain stem, spinal cord with dorsal root ganglia, gastric fundus, duodenum, jejunum, distal ileum, ventral colon, and dorsal colon.

### DIFFERENTIAL DIAGNOSIS

#### Differential diagnosis list:

##### Acute grass sickness

- Small intestinal strangulation or volvulus
- Large colon torsion
- Anterior enteritis
- Peritonitis
- Terminal ileal impaction
- Ileocecal intussusception.

##### Subacute or chronic grass sickness

- Impaction of the large or small colon
- Helminthiasis
- Mesenteric abscessation or other chronic inflammatory disease
- Gastric squamous cell carcinoma
- Alimentary lymphosarcoma or other neoplasia
- Inadequate diet
- Poor dentition
- Equine motor neuron disease.

### TREATMENT

Acute cases respond transiently to gastric decompression and intravenous fluid administration, but death is inevitable. Selected chronic cases may benefit from careful nursing care and the administration of the promotility, indirect acting cholinergic agent, cisapride (0.5–0.8 mg/kg orally every 8 hours for 7 days).<sup>35</sup> Administration of brotizolam (a putative appetite stimulant), acetylcysteine (antioxidant and neuroprotectant), and aloe vera gel (antioxidant, anti-inflammatory and laxative) was without beneficial effect in 29 cases.<sup>36</sup>

### CONTROL

Successful measures have not been satisfactorily established and no definitive recommendation can be made. However, consideration should be given to the factors identified as increasing the risk of disease, such as pasturing, movement to new properties and especially those on which previous cases of this disease have occurred, and the disturbance of soil. Feeding of hay and haylage is associated with a reduced risk of developing the disease. Although administration of ivermectin is associated with an increased risk of the disease, appropriate parasite control should not be ignored in horses in areas in which grass sickness is endemic.

### REVIEW LITERATURE

McCarthy HE et al. Epidemiology of equine grass sickness: a literature review (1909–1999). *Vet Rec* 2001; 146:600.

### REFERENCES

1. McCarthy HE et al. *Equine Vet J* 2004; 36:123.
2. Hunter LC et al. *Equine Vet J* 1999; 31:492.
3. Garrett LA et al. *Vet Microbiol* 2002; 87:81.
4. Hunter LC, Poxton IR. *Equine Vet J* 2001; 33:547.
5. Uzal FA, Robles CA. *Vet Res Commun* 1993; 17:449.
6. Araya O et al. *Vet Rec* 2002; 150:695.
7. Hahn CN et al. *Vet Rec* 2005; 156:778.
8. Doxey DL et al. *Equine Vet J* 1991; 23:365.
9. Newton JR et al. *Equine Vet J* 2004; 36:105.
10. Milne EM et al. *Br Vet J* 1996; 152:537.
11. Milne EM et al. *Vet Rec* 1994; 143:438.
12. Doxey DL et al. *Vet Rec* 1999; 144:386.
13. Whitwell KE. *Br Vet J* 1992; 148:81.
14. Wood JLN et al. *Vet J* 1998; 156:7.
15. McCarthy HE et al. *Equine Vet J* 2004; 36:130.
16. French NP et al. *Epidemiol Infect* 2005; 133:343.
17. Doxey D et al. *Equine Vet J* 1991; 23:370.
18. McGorum BC et al. *Equine Vet J* 2003; 35:121.
19. John HA et al. *Vet Rec* 2001; 148:180.
20. Prince D et al. *Equine Vet J* 2003; 35:60.
21. Perkins JD et al. *Vet Rec* 2000; 146:246.
22. Scholes SFE et al. *Vet Rec* 1993; 132:647.
23. Hudson N et al. *Auton Neurosci* 2001; 92:37.
24. Murray A et al. *Vet Res Commun* 1994; 18:199.
25. Hudson NPH, Pirie RS. *Equine Vet Educ* 2005; 17:19.
26. Proudman CJ. *Equine Vet Educ* 2005; 17:25.
27. Hahn CN, Mayhew IG. *Vet Rec* 2000; 147:603–606.
28. Greet TRC, Whitwell KE. *Equine Vet J* 1986; 18:294.
29. Doxey DL et al. *Res Vet Sci* 1992; 53:106.
30. Marrs J et al. *J Vet Med* 2001; 48:243, *Vet Rec* 2001; 151:381.
31. Fintl C et al. *Vet Rec* 2002; 151:721.
32. Milne EM et al. *Vet Rec* 1990; 127:162.
33. Hahn CN et al. *Acta Neuropathol* 2001; 102:153.
34. Hilbe M et al. *J Comp Pathol* 2005; 132:223.
35. Milne EM et al. *Br Vet J* 1996; 152:537.
36. Fintl C, McGorum B. *Vet Rec* 2002; 151:381.

### IDIOPATHIC CHRONIC INFLAMMATORY BOWEL DISEASES OF HORSES

A syndrome of combinations of weight loss, ill thrift, diarrhea, intestinal malabsorption, and hypoproteinemia attributable to chronic inflammatory disease of the small and/or large intestine of horses is well described. The syndrome has been subdivided into granulomatous enteritis, eosinophilic enteritis, lymphocytic-plasmacytic enterocolitis, basophilic enterocolitis, and multisystemic eosinophilic epitheliotropic disease.<sup>1</sup> Other causes of chronic inflammatory bowel disease in horses include alimentary lymphosarcoma, tuberculosis, pithyosis, and histoplasmosis.<sup>2</sup>

### REFERENCES

1. Schumacher J et al. *J Vet Int Med* 2000; 14:258.
2. Roberts MC. *Comp Cont Educ Pract Vet* 1985; 7:S637.

### GRANULOMATOUS ENTERITIS OF HORSES

The etiology of granulomatous enteritis is unknown. Infection with *Mycobacterium* spp. is suggested as a cause but demonstration of acid fast bacteria in tissue sections or by culture of gut or mesenteric

lymph nodes of affected horses is rare and inconsistent. The disease occurs with greatest incidence in Standardbred horses between 1 and 6 years of age, although it does affect other breeds of horses. The disease is usually sporadic, although it has been recorded in siblings raised on the same farm.<sup>1</sup> Estimates of incidence are not available. The disease has an almost 100% case fatality rate.

Accumulation of lymphocytes and multinucleated giant cells in the lamina propria is associated with villous blunting in the small intestine. There is malabsorption of carbohydrates and fats and excessive loss of protein in feces<sup>2</sup> with subsequent hypoalbuminemia, edema, and weight loss. Weight loss and anorexia are the most common presenting signs. Fever is uncommon. Approximately one-third of horses have diarrhea or a history of abdominal pain. Affected horses may have a diffuse, scaling alopecia and excoriations especially of the coronary band. Rectal examination may reveal enlarged, soft mesenteric lymph nodes. Exploratory laparotomy in horses with signs of colic attributable to inflammatory bowel disease often reveals constricting circumferential bands in the large or small intestine.<sup>3</sup>

**Hematological and serum** biochemical examination reveals:

- A mild, macrocytic anemia (hemoglobin <100 g/L, hematocrit <30%) with a normal leukogram
- Hypoalbuminemia is a consistent finding (<25 g/L, <2.5 g/dL) while the globulin concentration may be normal, low or, more commonly, high (>50 g/L, >5.0 g/dL)
- Plasma fibrinogen concentration is usually increased (>4 g/L, 400 mg/dL)
- There are no characteristic changes on serum biochemical analysis
- Peritoneal fluid is normal.

**Absorption tests** using (D(+)-xylose, glucose, or starch) may indicate diminished absorption of carbohydrate by the small intestine. The **D(+)-xylose absorption test** is performed by administering D(+)-xylose at a dose of 0.5 or 1 g/kg as a 10% solution by nasogastric intubation after an overnight fast. The concentration of D(+)-xylose in blood samples collected at 0, 1, 2, 3, 4, and 5 hours after dosing is determined. An abnormal test is one in which there is not an obvious peak in the D(+)-xylose curve and in which the peak concentration is lower than expected for a normal horse on a similar diet. Administration of a 10% glucose solution orally at a dose of 1 g/kg body weight results in an increase in plasma glucose concentration of >85% the baseline values in horses with normal small intestine. An increase of <15% over baseline is found in horses with small intestinal disease that impairs

glucose absorption. Intermediate values are found in both normal and diseased horses.<sup>4</sup>

**Diagnostic confirmation** is achieved by histological examination of biopsy of rectum or small intestine. **Rectal biopsy** has a low sensitivity (less than 50%) but high specificity for diagnosis of granulomatous enteritis.<sup>5</sup> **Biopsy of small intestine** and mesenteric lymph nodes has a much higher sensitivity than rectal biopsy and is the recommended test.

#### NECROPSY FINDINGS

**Necropsy examination** reveals that the intestinal wall is thickened uniformly especially in the jejunum and ileum. Mesenteric lymph nodes may be enlarged. There is villous atrophy with a diffuse and patchy granulomatous infiltration of the lamina propria of the small intestine. Crypt abscesses are common. Granulomas are also present in the liver, spleen, kidney, and bone marrow of many cases. The predominant cell types are macrophages and epithelioid cells with occasional giant cells. The disease may be difficult to distinguish from alimentary lymphosarcoma.

#### DIFFERENTIAL DIAGNOSIS

The differential diagnosis includes:

- Parasitism
- Poor nutrition or dentition
- Alimentary lymphosarcoma
- Basophilic enterocolitis
- Eosinophilic enteritis
- Intrabdominal abscessation
- Gastric squamous cell carcinoma
- Small intestinal adenomatous polyposis.<sup>6</sup>

#### TREATMENT

Attempts at treatment with a variety of anti-inflammatory and antimicrobial drugs, including prednisone and sulfasalazine, have been almost universally unsuccessful.<sup>7</sup> Resolution of the disease occurred for up to 7 months while a horse was treated with a decreasing dose of dexamethasone, beginning at 40 mg (0.1 mg/kg) intramuscularly every 4 days for 4 weeks, and then slowly decreasing.<sup>7</sup> Surgical resection of defined, solitary lesions is reported but this is an unusual manifestation of the disease.

#### CONTROL

There are no effective control measures.

#### REFERENCES

1. Sweeney RW et al. *J Am Vet Med Assoc* 1986; 188:1192.
2. Lindberg R et al. *Zbl Vet Med A* 1985; 32:526.
3. Scott EA et al. *J Am Vet Med Assoc* 1999; 214:1527.
4. Mair TS et al. *Equine Vet J* 1991; 23:344.
5. Lindberg R et al. *Equine Vet J* 1996; 28:275.
6. Patterson-Kane JC et al. *Vet Pathol* 2000; 37:82.
7. Durvea TH et al. *Equine Vet J* 1997; 29:164.

#### LYMPHOCYTIC-PLASMACYTIC ENTEROCOLITIS

This is an uncommon disease of horses, in contrast to dogs, affecting horses of any age and without discernible breed or sex predilection.<sup>1,2</sup> The etiology is unknown. Presenting signs include weight loss, diarrhea, and lethargy. Clinicopathologic abnormalities include hypoproteinemia and hypoalbuminemia in approximately one-half and three-quarters of cases, respectively.<sup>2</sup> Results of an oral glucose tolerance test are abnormal in approximately 75% of cases. Histologic examination of a rectal mucosal biopsy reveals abnormal tissue suggestive of the disease in about one-half of cases. The diagnosis is confirmed by biopsy of ileum or necropsy examination. Differential diagnoses are similar to those for granulomatous enteritis. There is marked infiltration of the lamina propria with lymphocytes and plasma cells. Effective treatment has not been described. Control measures are not available.

#### REFERENCES

1. Schumacher J et al. *J Vet Int Med* 2000; 14:258.
2. Kemper DL et al. *Equine Vet J* 2000; Suppl 32: 108.

#### CHRONIC EOSINOPHILIC GASTROENTERITIS OF HORSES

Eosinophilic enterocolitis occurs either as part of the multisystemic, eosinophilic, epitheliotropic disease complex or as a lone entity. Multisystemic, eosinophilic, epitheliotropic disease is characterized by eosinophilic infiltrates in the gastrointestinal tract and other organs, while horses with eosinophilic enterocolitis have no evidence of extraintestinal disease.

**Multisystemic, eosinophilic, epitheliotropic disease** occurs in adult horses of any age and without apparent breed or sex predilection. The etiology is unknown, but some cases are associated with lymphosarcoma, suggesting that the disease in these horses is due to clonal expansion of a T-lymphocyte population that secretes interleukin-5.<sup>1</sup> The disease is idiopathic in most horses. Clinical signs include weight loss in all cases and diarrhea or dermatitis in approximately two-thirds of cases.<sup>2</sup> The dermatitis occurs mainly on the face, limbs, and ventral abdomen and is exudative with alopecia, hyperkeratosis, and lichenification.<sup>3</sup> Lesions of the coronary band and mouth are common. Urticaria occurs in some horses. Most affected horses have low serum protein and albumin concentrations. Hypereosinophilia is not a consistent feature of the disease and blood leukocyte concentrations are usually within the reference range. There are often elevations in serum activity of gammaglutamyl transpeptidase (GGT) and alkaline phosphatase, consistent with lesions in the

biliary tree. This can be useful in differentiating horses with this disease from horses with granulomatous enteritis.<sup>2</sup> Histologic examination of tissues reveals eosinophilic infiltration of skin, liver, and gastrointestinal tract. Rectal biopsy can reveal the presence of eosinophilic granulomas, but these must be differentiated from the more common eosinophilic infiltrate secondary to parasitism. Treatment is usually ineffective and the prognosis for recovery is very poor. Affected horses should be administered an anthelmintic in case the disease is due to nematodiasis. Administration of corticosteroids (dexamethasone, prednisolone) is the usual treatment but is only transiently effective in most cases. Hydroxyurea, which is used to treat a similar syndrome in people, was only transiently effective in one horse.<sup>4</sup> There are no recognized control measures.

**Idiopathic eosinophilic enteritis** is a sporadic disease of horses of any age. Affected horses rarely have weight loss or diarrhea.<sup>2</sup> The common form of the disease is one in which the infiltration is segmental and associated with acute colic due to obstruction of the small intestine or large colon by mural lesions.<sup>5,6</sup> The D(+)-xylose absorption curve is usually normal in affected horses.<sup>7</sup> Histologically, the disease is characterized by the presence of eosinophilic infiltrates in a chronic inflammatory reaction affecting the small or large intestines. The infiltrates are restricted to the intestinal tract. The cause has not been identified but the lesion suggests a continuing hypersensitivity reaction to an ingested allergen. Antemortem diagnostic confirmation is achieved by rectal or small intestinal biopsy. Successful treatment is usually surgical. Control measures are not reported.

#### REFERENCES

1. La Perle KMD et al. *Vet Pathol* 1998; 35:144.
2. Schumacher J et al. *J Vet Int Med* 2000; 14:258.
3. Nimmo Wilkie JS et al. *Vet Pathol* 1985; 22:297.
4. Hillyer MH, Mair TS. *Vet Rec* 1992; 130:392.
5. Edwards GB et al. *Equine Vet J* 2000; Suppl 32:86.
6. Swain JM et al. *Vet Rec* 2003; 152:648.
7. Lindberg R et al. *Zbl Vet Med A* 1985; 32:526.

#### OVINE MOUTH AND GUM OBSCURE DISEASE (OMAGOD)

During the outbreak of foot-and-mouth disease (FMD) in the UK in 2001, field investigations reported the appearance of oral lesions, initially in sheep and then in cattle which complicated the diagnostic process.<sup>1,2</sup> While the lesions appeared to have a common, though obscure, etiology, prior to that they had not been identified as a differential diagnosis for FMD. The lesions were usually singular, located predominantly (but not exclusively) in the gingival mucosa ventral to the incisors, often in the midline; circular to nearly circular in shape and usually ranging in

diameter from 4 to 10 mm; never vesicular but always erosive with a raised edge, giving the ulcer a crater-like appearance; and were more prevalent in adult sheep than in lambs.<sup>2</sup>

Experienced sheep veterinarians in the UK have reported ulceration of the gums of sheep as a regular occurrence in late winter and spring.<sup>1</sup> It has been suggested that grazing sparse rough or short pasture, the provision of feed or salt blocks, and the use of feeding troughs with sharp edges, could be predisposing causes.

An abattoir survey of sheep in New Zealand examined the lesions of the anterior lips and gums of the animals after slaughter.<sup>3</sup>

Lesions of the midline of the lips and gums of traumatic or irritant etiology were common, and the prevalence was higher in adult sheep than in lambs. The lesions probably arose from the fright/flight response behaviour of sheep, resulting in the mouth impacting against wire fences or yard railings while being handled. A smaller percentage of lesions may have been due to abrasive or irritant feed or soil. The presence of plant material and bacteria in lesions delayed healing and contributed to the formation of ulcers.

## REFERENCES

1. Ayers E et al. *Vet Rec* 2001; 148:720.
2. de la Rua R et al. *Vet Rec* 2001; 149:30.
3. Black H et al. *New Z Vet J* 2004; 52:95.

## ULCERATION OF THE PARS ESOPHAGEA OF THE STOMACH OF SWINE (GASTRIC ULCER, HYPERKERATOSIS)

Naturally occurring ulcers of the stomach in swine occur in the *pars esophagea* (non-glandular part) of the stomach. They are single or multiple bleeding ulcers often associated with hyperkeratosis. Experimental lesions in the stomach are usually produced in the glandular part of the stomach as a model for the condition in humans. The condition was first reported in Illinois in 1897.

### Synopsis

**Etiology** Fine particle and pelleted feed. Certain bacterial species may contribute.

**Epidemiology** Highly variable incidence but has increased with greater intensification of swine industry, emphasis on improving digestibility and feed efficiency and use of fine particle and pelleted feed. Growing and finishing pigs, adult sows, and boars.

**Signs** Sudden death from peracute gastric hemorrhage. Subacute form causes anemia, pallor, unthriftiness, black tarry feces.

**Clinical pathology** Hemorrhagic anemia.

**Lesions** Hyperkeratosis, erosions, ulcers of *pars esophagea*, gastric hemorrhage, anemia.

**Diagnostic confirmation** Lesions at necropsy.

### Differential diagnosis list

- Proliferative enteritis of swine
- Enteric salmonellosis
- Swine dysentery.

**Treatment** None.

**Control** Use of diets prepared through hammer mill screen of at least 6 mm. Incorporate 5-methylmethionine-sulphonium chloride in diet.

## ETIOLOGY

The etiology is multifactorial. Finely ground and pelleted feed are important causes. *Helicobacter heilmannii*<sup>1</sup> and *Gastropillium suis*,<sup>2</sup> have been found in gastric ulcers, but not ulcers of the *pars esophagea* of pigs and are unlikely to be the primary cause of the lesion.<sup>3</sup> Certain environmental stressors may also be contributing factors.

## EPIDEMIOLOGY

### Occurrence

The disease is most common in pigs of 45–90 kg BW<sup>4</sup> but the disease may also occur in pigs after weaning and in adult sows and boars. All breeds are susceptible. Prevalence in groups of pigs may vary anywhere in the world from 5 to 90%. In some countries the rate is 1% and in others 87%.<sup>5</sup>

Most gastric ulcers of pigs are localized in the *pars esophagea* and are referred to as esophagogastric ulceration. Examination of the stomachs of pigs at abattoirs in various countries has revealed a high proportion of pigs with varying degrees of hyperkeratosis, erosions, and ulcers of the *pars esophagea*. Extensive erosions of the *pars esophagea* may be present in up to 63% of sows and 36% of finishing pigs.<sup>6</sup>

The incidence is variable between countries which may reflect differences in feeding or husbandry methods. In the Netherlands 11% of the pigs may be affected.<sup>7</sup> The incidence of ulceration may be increasing in pigs in the UK compared to earlier studies.<sup>8</sup> An abattoir survey of the stomachs of pigs in the UK found ulceration of the *pars esophagea* in 23% with a range from 4 to 57%.<sup>8</sup> The ulcers were mild in 9.5% and severe in 13.4%.

The disease has assumed increased economic importance with increased intensification of the swine industry.<sup>9</sup> The feed manufacturing industry is faced with the dilemma of finely ground pelleted feed providing high digestibility and feed efficiency in growing and finishing pigs but with a high incidence of lesions of the *pars esophagea* which may affect performance. Pelleting swine feed is also advan-

tageous because it flows more easily and effectively in automated distribution systems in swine farms compared to finely ground meal which may bridge and clog in distribution systems, decrease dustiness and segregation of ingredients and increase bulk density. Meal is less damaging than pellets.

The incidence of clinical disease is low but the case fatality rate is high when severe hemorrhage occurs. The effects of the lesions on performance may vary considerably. In one study, pigs with extensive lesions gained 50–75 g/day less than pigs with no lesions<sup>10</sup> while in another the presence of ulcers as determined at the abattoir did not influence growth rate.<sup>8</sup> The disease has increased in significance with the occurrence of PMWS and PDNS associated with porcine circovirus 2. There is also an increased occurrence where there is a problem with porcine respiratory disease complex (PRDC) particularly during summer months.

### Risk factors

Anything that causes an empty stomach which potentially increases the acidity in the *pars esophagea* region of the stomach is a risk factor.<sup>7</sup> Back in the 1960s all that was needed to produce an esophageal ulcer in a pig was to keep the pig restricted in a feeding or farrowing crate and deprive it of water for 24 hours and it would have an ulcer. This would therefore include intermittent feeding and watering, respiratory disease and hot weather.

### Dietary risk factors

The disease occurs primarily in penned pigs receiving a grain diet and growing rapidly. It has also occurred in pigs fed large quantities of cheese whey or skimmed milk. Too much copper and not enough zinc may also be a factor. The incidence is highest in pigs receiving diets containing a higher proportion of corn (maize) than other grains. The incidence is even greater if the corn is finely ground or is gelatinized or expanded. Ulceration in some pigs may be associated with *Ascaris suis* infection, but in other studies there is no significant association between the parasite and ulcers.

### Finely ground feed

This is the most important risk factor.<sup>11</sup> One of the explanations of this may be the rapid emptying of the stomach when fine particles are used.<sup>12</sup> There is normally a gradation of ascending pH from the cardia to the oesophagus but with rapid emptying there is the possibility of the low pH reaching the esophageal region.<sup>11,12</sup>

Feeding a diet based on finely ground barley to pigs beginning at 10–11 weeks results in lesions as early as 1 month later, and the incidence and severity of lesions increased progressively over the next

2 months. Diets high in wheat or corn starch may be worse than diets based on barley. The incidence and severity of hyperkeratosis may be greater in some breeds compared to others, but the effects of previous diets and environmental factors may have influenced the results.

The particle size and the physical form of the feed are important risk factors. Finely ground diets and pelleting have detrimental effects on the gastric mucosa of finishing pigs.<sup>13</sup> A pelleted diet uses grain that is finely ground before it is compressed into a pellet but on reaching the stomach it reverts to the fine particles. A diet finely ground through a 3 mm screen in a hammer mill and then pelleted will be associated with a 75% incidence of pigs with hyperkeratosis of the *pars esophagea* and 11% of the pigs may have severe erosions and ulceration of the *pars esophagea*.<sup>10</sup> The incidence of lesions decreases when the diet is ground through a 6 mm screen.<sup>14</sup> Finely ground barley or wheat is associated with a marked increase in gastric abnormalities compared to the use of coarsely ground grains. The size of particles in feed is significant whatever feed is used, even straw; coarsely ground barley straw at 5–10% of the ration gives almost complete protection. In growing pigs, dietary fiber rich in structural polysaccharides has been shown to be important in preventing the development of parakeratotic lesions in the *pars esophagea*.<sup>15</sup> But an increase in the crude fiber content of a diet which is finely ground does not affect the occurrence of severe erosions and/or ulcers of the *pars esophagea*.

Grinding barley through a 1.56 mm screen results in finely ground feed, which is associated with an increased incidence and severity of gastric ulcers in pigs. Grinding through a 4.68 mm screen approximates the screen size used most frequently for grinding barley for pigs in practice and is associated with a low incidence of ulcers.<sup>15</sup>

Reducing particle size and pelleting improves growth performance of finishing pigs.<sup>16</sup> For every 100 microns of decrease in size of the particle size there is an approximately 1.3% increase in gain efficiency but each time the level of ulcers increases.<sup>17</sup> The processes have additive effects on digestibilities of dry matter, nitrogen, and energy, with maximum nutrient digestibility in pelleted diets with corn milled to a particle diameter size of 400  $\mu\text{m}$ . Reducing the particle size to below 400  $\mu\text{m}$  causes practical problems with milling and an increased incidence of gastric lesions and it is suggested that a particle size of 600  $\mu\text{m}$ , or slightly less, is optimal for corn in either meal or pelleted diets for finishing pigs.

Using endoscopic examination of the stomachs of pigs fed a fine particle diet (geometric mean size of 578  $\mu\text{m}$ ) it was found that as ulcer severity increases, the growth performance of individually fed pigs decreases. Feeding a coarse particle diet (geometric mean size of 937  $\mu\text{m}$ ) for 3 weeks resulted in a decrease in the severity of the ulcers.<sup>18</sup>

High levels of unsaturated dietary fat are not helpful especially if they are accompanied by low levels of vitamin E. Similarly pigs fed waste food had more severe gastric lesions.<sup>19</sup>

#### Environmental and management risk factors

It has been suggested that confinement, crowding, transportation, changes in environment, and exposure to other pigs, were important in the etiopathogenesis of gastric ulcers of pigs. All of these stresses and many others including anxiety, fear, pain, fatigue, fasting, etc., will be associated with an increase of ulcers. There is an even greater occurrence in summer when water demands are higher. Males are always more affected in prevalence and severity but that may be that they are more easily stressed. One of the most important factors is time in the lairage. Pre-mortem handling is extremely important.<sup>20</sup> Pigs kept overnight in the lairage have more ulcers than pigs killed on the day of arrival.<sup>21</sup> Similarly there is no difference in the prevalence of lesions in small and medium farms but there is a considerable increase in the prevalence in these two groups compared to the larger producer.<sup>22</sup> Larger herds always show more of the problem<sup>23</sup> and it is probably a reflection of the different diets that they use (based on wheat and pelleted). The larger farms also have more infection pressure, more selection pressure, and more feed-related factors.

Pigs that receive porcine somatotrophin may have an increased level of ulcers possibly due to the elevated circulating gastrin.<sup>24</sup>

There are a variety of foreign bodies reported from the pigs' stomach including stones, which outside sows chew all the time, and also sand. The majority of stones is probably passed in the feces, but may accumulate in and stretch the stomach. The stomach capacity is normally about 3–6 L. This may lead to reduced appetite and gastritis but is not believed to be a contributor to esophageal ulceration. Similarly, hairballs are a common finding, reaching 10–15 cm in size in the stomach. The occurrence of rubbish indicates pica or a depraved appetite which is often an indicator of inadequate feeding. One of the other substances found in outdoor pigs stomachs is the flakes of bitumen that remain from clay pigeon shooting, which are toxic.

Increased frequencies of any of four combinations of behavioral indicators of stress, recorded 4 weeks after weaning, were weakly associated with increased risk of acute fundic ulcers in slaughter pigs from a conventional farrow-to-finish herd.<sup>25</sup>

#### Pathogen risk factors

##### *Gastric bacteria*

The spiral-shaped *Gastrospirillum suis* has been found in 84% of the stomach of pigs with frank gastric ulcers of the *pars esophagea*. The organisms were mainly in the mucus layer and in gastric foveolas of the antral and oxyntic mucosa and only occasionally in the cardiac-*pars esophagea* region.<sup>2</sup> The presence of the organism has been associated with lesions of the pyloric mucosa in pigs.<sup>26</sup>

There is no known cause and effect relationship but the gastric environment associated with gastric ulcer may favor colonization of the organism. The oral inoculation of *Gastrillum*-like bacteria into laboratory animals is capable of inducing gastric ulceration.<sup>27</sup> *Helicobacter heilmannii* type 1<sup>28</sup> has been found more frequently in the stomachs of pigs with ulcers (100%) and in those with pre-ulcer lesions (90%) than in stomachs with macroscopically normal *pars esophagea* (35%).<sup>1</sup> It has been suggested that *Helicobacter heilmannii* may play a role in the pathogenesis of gastric ulcers in swine by causing increased acid secretion. *H. pylori* can colonise the pig stomach. Experimental reproduction of *Helicobacter suis* infection has recently been described.<sup>29</sup> The pigs had no ulcers and infection was only accompanied by a mild superficial gastritis.

#### **PATHOGENESIS**

In pigs, nearly all naturally occurring gastroduodenal ulcers are localized in the *pars esophagea* of the stomach. Excessive gastric acid production, depletion of the gastric buffering system resulting in prolonged activation of pepsinogens, and changes in mucus composition are suggested as important factors related to gastric ulceration in swine. The physical texture of the feed can influence pepsin and acid secretion, and the fluidity of the stomach contents induced by ulcerogenic diets may alter the normal pH gradient within the stomach. This allows greater pepsin and acid contact to the esophago-gastric area.

The concentrations of short chain fatty acids are high in the proximal gastric contents of pigs and associated with intakes high in readily fermentable carbohydrates, like ground corn. These products of bacterial metabolism, principally acetate and lactate, reach high concentrations within 4 hours after feeding because of high pH



in the proximal gastric contents which may allow some types of bacteria to proliferate. These weak acids are lipid soluble in their undissociated form and could penetrate and acidify underlying tissue more readily than free hydrogen ions. In this way, rapid production of short chain fatty acids, followed by their absorption and tissue acidification, may be similar to ruminal acidosis and rumenitis in ruminants following the ingestion of large quantities of readily fermentable carbohydrates.<sup>30</sup>

The rumen epithelium, also a stratified squamous mucosa, is easily injured by short chain fatty acids at pH  $\leq$  5.0. The breaking of the barrier by short chain fatty acids could result in underlying inflammation and widespread tissue destruction. Experimentally, exposing undissociated short chain fatty acids to swine gastric mucosa results in rapid penetration of the outer barrier and acidification of the underlying viable tissue.<sup>30</sup> This results in cell swelling and vesicle formation, followed by sloughing of the outer barrier, erosion into deeper zones, and finally, ulceration.<sup>30</sup>

Weak organic acids, at pH  $\leq$  2.5 induce a greater degree of functional and histological injury in 3 stomach zones (squamous, cardiac, and oxyntic) than does hydrochloric acid. The predilection for the squamous mucosa in naturally occurring ulcers may be attributed to the lack of defense or repair mechanisms that are present in the cardiac and oxyntic mucosa, which are capable of HCO<sub>3</sub><sup>-</sup> and mucus secretion, which may raise the pH adjacent to these epithelial layers.<sup>30</sup> Thus the increased digestibility associated with decreased particle size of the diet may promote rapid fermentation following eating resulting in the production of increased concentrations of short chain fatty acids. Any increase in fluid content will also contribute to the changes in pH gradient that exist in the stomach. Excessive gastrin is then stimulated and more acid secretion follows.

Normally, the *pars esophagea* is white, smooth, and glistening and may be bile stained. The first stage in ulceration is hyperkeratosis. This is followed by erosions, ulcerations, and hemorrhage. The erosions may heal, resulting in a fibrous contraction. Chronic ulceration may occur with the development of several ulcers in combination with fibrous tissue involving all of the squamous mucosa. Advanced hyperkeratosis may cause partial stenosis of the terminal esophagus.

The erosion of a blood vessel within the ulcer will result in acute to subacute gastric hemorrhage. These cases are usually sporadic, causing deaths of individuals within a group, with cases occurring over a period of several weeks. Clinical signs are often not observed, affected pigs being

found dead from acute hemorrhage into the stomach.

The regurgitation of bile into the stomach and the intensity of bile staining of esophagogastric tissue have been linked to the pathogenesis of esophagogastric ulcers in pigs. Almost all stomachs of pigs contain bile and bile staining of the *pars esophagea*; there is no evidence for the hypothesis that the regurgitation of bile into the stomach is associated with esophagogastric lesions in finishing pigs.<sup>31</sup> There is no evidence of an association between gastritis and ulcer.<sup>32</sup>

### CLINICAL FINDINGS

Most cases are sub-clinical but sows will die from blood loss. Pigs frequently die from ulcers during concurrent disease such as respiratory disease<sup>33</sup> and in this case anorexia may disturb the gastric contents and allow material of high acidity to reach the cardia. Similarly where there is a reduced consumption of water the integrity of the mucus may be broken by the desiccation that results on mucosal surfaces.

Gastric ulceration is most common in pigs over 6 weeks of age and occurs in adult sows and boars; the clinical findings are dependent on the severity of the ulcers. The effects of ulceration on production may be highly variable. Most pigs with esophagogastric ulcers are clinically normal, and growth rate and feed intake appear unaffected. Some observations suggest that there is no effect of ulceration on growth rate, while others indicate that the presence of esophagogastric ulcers results in a marked decrease in growth rate and an increase in the length of time required for the pig to reach market weight. Some affected pigs also eat slowly and regurgitate frequently. Endoscopic monitoring of the stomachs of pigs fed ulcerogenic diets found that as the severity of the ulcer increased growth performance was decreased.<sup>18</sup> The greatest economic losses were associated with sudden deaths due to hemorrhage and marked decreases in performance associated with fine particle size.

The erosion of a blood vessel within the ulcer will result in acute to subacute gastric hemorrhage. These cases are usually sporadic, causing deaths of individuals within a group, with cases occurring over a period of several weeks. Clinical signs are often not observed, affected pigs being found dead from acute hemorrhage into the stomach. When pigs are found dead from peracute hemorrhage, inspection of the in-contact pigs may reveal other animals with pallor and black tarry feces which represent those with subacute hemorrhage.

Cases with subacute gastric hemorrhage may survive for a few days and there is

evidence of marked pallor, weakness, anorexia, and black-pasty feces changing to mucus-covered pellets in small amounts. The weakness may be sufficient to cause recumbency. Vomiting frothy bile-stained fluid and grinding of the teeth may occur. Abdominal pain may be elicited by deep palpation over the xiphisternum and there may be a reluctance to walk along with a rigid back indicative of pain.<sup>6</sup> Animals that survive are often unthrifty, usually due to anemia from chronic blood loss with a few cases affected by chronic peritonitis. When the disease is occurring careful observation may detect early cases. Suggestive signs are a darkening of the feces and the development of pallor.

### CLINICAL PATHOLOGY

Laboratory testing is not indicated. Animals with gastric ulceration generally have lower hematocrit values, haemoglobin concentrations, and erythrocyte counts than normal. The black tarry feces can be examined for the presence of blood.

### NECROPSY FINDINGS

Ascarids have been found in the stomach but these are not a factor in the field.<sup>34</sup>

At necropsy, the ulcers are confined to the esophageal region of the stomach. Affected stomachs consistently have more fluid contents than unaffected ones. If severe blood loss from the ulcer has been the cause of death then the carcass is pale and fresh blood is usually present in the stomach (there may be large blood clots) and intestines. The colonic contents may also appear melanic. Early lesions in clinically unaffected animals include hyperkeratinization of the mucosa (usually pale raised areas without bile staining initially) which progresses to epithelial erosion without actual ulceration. Ulcers usually initially occur along the junction of the *pars esophagea* with the glandular stomach but may enlarge to efface the entire squamous portion of the stomach. These more diffuse ulcers are easily missed on cursory examination due to their uniform appearance. Chronic gastric ulcers develop thickened, raised edges due to ongoing fibrosis, occasionally resulting in a gastroesophageal stricture. The histological appearance varies with the stage of lesion development but in fatalities there is typically complete loss of the epithelial layer, with exudation of neutrophils from a bed of mature granulation tissue. Recent studies have demonstrated *Helicobacter*-like bacteria in porcine stomachs but further research is required to determine if this infection plays a significant role in ulcer formation. Small clusters of *H. hellmanii* have been seen in the gastric crypts,<sup>35</sup> but are not associated with histological changes.<sup>36</sup> A recent survey suggested no correlation between infection

in the cardiac mucosa and the severity of the lesions shown by the esophagogastric region.<sup>37</sup> The macroscopic findings are usually sufficient for the confirmation of a diagnosis of esophagogastric ulceration. The initial lesion of hyperkeratosis leads to parakeratosis with fissures and the lamina propria is then exposed. The epithelium sloughs off and then ulcers of the epithelium develop with haemorrhage from the vessels.

#### Severity and extent of esophagogastric lesions can be graded according to the following scheme<sup>6</sup>:

- 0: intact epithelium
- 1: small degree of hyperkeratosis (< 50% of total surface)
- 2: distinct hyperkeratosis (= 50% of the total surface)
- 3: hyperkeratosis and less than 5 erosions smaller than 2.5 cm in size
- 4: hyperkeratosis and more than 5 erosions or erosions larger than 2.5 cm in size
- 5: hyperkeratosis and more than 10 erosions or erosions larger than 5 cm in size, and/or an ulcer (with or without bleeding) or stenosis of the esophagus towards the stomach.

No difference in lesion score was found between Duroc, Landrace, and Iberian pigs.<sup>38</sup>

#### DIFFERENTIAL DIAGNOSIS

The occurrence of sudden death with a carcass that shows extreme pallor and a marble-white skin suggests the possibility of peracute hemorrhage from an esophagogastric ulcer. The disease must be differentiated at necropsy from proliferative hemorrhagic enteropathy, swine dysentery, and salmonellosis. Black tarry feces in growing and finishing pigs are characteristically due to subacute hemorrhage associated with esophagogastric ulceration.

It is possible to detect stomachs with *Helicobacters* by covering the stomach with urea gel containing an indicator sensitive to pH change. If there are large numbers of urease-positive bacteria then the pH changes.<sup>39</sup>

Severe infestation with whipworms is a differential. The clinical diagnosis can be confirmed by endoscopy<sup>40</sup> which requires an empty stomach (may cause ulceration in itself) and anesthesia.

#### TREATMENT

Vitamin K and hematinics have been tried with little success. Bovine serum concentrate given as a 1% solution is supposed to have reduced the extent and severity of signs associated with ulcers in growing pigs but in general medication does not help.<sup>41</sup> If a diagnosis is made euthanasia is advised.

#### CONTROL

Control of esophagogastric lesions of growing and finishing pigs is dependent on using diets with a particle size and physical form which will provide the most economical performance in terms of digestibility and feed efficiency and minimize the incidence of lesions.

The most desirable particle size or physical form of diet, meal, or pelleted form, has not been determined. The use of a diet ground through a 6 mm screen instead of 3 mm screen is recommended. However, screen size is not the only factor affecting particle size. Other factors include the condition of the screen and hammer, the type and variety of grain and its moisture content, the speed of the mill, the pelleting process and the flow rate in the distribution of the feed to the pigs. A particle size of 600 µm, or slightly less is suggested as optimal for corn in either meal or pelleted diets for finishing pigs.<sup>16</sup>

The incorporation of S-methyl-methionine-sulphonium chloride (MMS), a nutritional component of many vegetables such as cabbage and carrots, has anti-gastric ulcer properties. Its addition to the diet, ground through a 3 mm screen, and fed to grower pigs from 45 to 107 kg liveweight, at 400 ppm decreased the incidence of severe erosions or ulcers by about 50%.<sup>14</sup> The addition of lucerne meal to increase the crude fiber content of one of the experimental diets did not have an effect on the incidence or severity of the lesions.

The diet should contain adequate amounts of vitamin E and selenium. Where applicable a reduction of the amount of corn in the ration and the feeding of meal rather than pellets may also be of value. The reduction of environmental and managerial stressors with attention to stocking rates may be of value.

#### REVIEW LITERATURE

Elbers ARW, Dirkwager A. Esophagogastric lesions in swine: a literature review. *Tijdschr Diergeneeskd* 1994; 119:669-674.

Friendship RM, Melnichouk SI, Smart NL. *Helicobacter* infections; What should a swine practitioner know? *Swine Health and Production* 1999; 7:167-172.

Friendship RM. Gastric ulceration in swine. *Swine Health and Production* 2004; 12:34-35.

#### REFERENCES

1. Magalhaes Queiroz DMDe et al. *Vet Rec* 1996; 131:420.
2. Barbosa AJA et al. *Vet Pathol* 1995; 32:134.
3. Melnichouk SI et al. *Swine Hlth Prod* 1999; 7:201.
4. Deen J. *Proc 16th Int Pig Vet Soc Cong* 2000; p 96.
5. Melnichouk SI et al. *Swine Hlth Prod* 1999; 7:201.
6. Hessing MJC et al. *Tijdsch Diergen* 1992; 117: 445.
7. Elbers ARW et al. *Vet Rec* 1995; 136:583.
8. Guise HJ et al. *Vet Rec* 1997; 141:563.

9. Eisseman IH, Argenzio RA. *J Anim Sci* 1999; 77:2709.
10. Elbers ARW et al. *Vet Rec* 1995; 136:588.
11. Wondra KJ. *J Anim Sci* 1995; 73:414.
12. Lang J et al. *Am J Vet Res* 1998; 59:1170.
14. Elbers ARW et al. *Vet Rec* 1995; 137:290.
15. Potkins ZV et al. *Res Vet Sci* 1989; 47:60, 67.
16. Wondrak KJ et al. *J Anim Sci* 1995; 73:757.
17. Friendship RM. *Proc Allen D Leman Conf. Univ Minn* 2000; p 92.
18. Ayles HL et al. *Swine Hlth Prod* 1996; 4:211.
19. Fjetland O, Tarp J. *Proc 15th Int Pig Vet Cong* 1998; 277.
20. Guise HJ. *Brit Vet J* 1995; 152:659.
21. Davies PR et al. *Proc Int Pig Vet Soc Cong* 1994; 13:471.
22. Ramis G et al. *Vet Rec* 2004; 155:210.
23. Amory JR, Pearce GP. *Proc 16th Int Pig Vet Soc Cong Melbourne* 2000; 364.
24. Buonomo F et al. *J Anim Sci* 1997; 75, Suppl. 1:226.
25. Dybker L et al. *Prev Vet Med* 1994; 19:101.
26. Mendes EN et al. *J Med Microbiol* 1991; 35:345.
27. Eaton KA et al. *Vet Pathol* 1995; 32:489.
28. Melnichouk SI et al. *Swine Hlth Prod* 1999; 7:201.
29. Hellems A et al. *Proc 17th Int Pig Vet Soc* 2002; 192.
30. Argenzio RA et al. *Am J Vet Res* 1996; 57:564.
31. Elbers ARW et al. *Vet Quart* 1995; 17:106.
32. Silva JCP da et al. *Rev Bras Cien Vet* 2001; 8:403.
33. Dionisopoulos L et al. *Can J Anim Sci* 2001; 81:779.
34. Hani H, Indermuhle NA. *Vet Pathol* 1979; 16:617.
35. De Groote D et al. *Proc 15th Int Pig Vet Soc Cong Birmingham* 1998; 84.
36. Szeredi L et al. *Proc 18th Int Pig Vet Soc Cong Hamburg* 2004; 609.
37. Choi Y et al. *Proc Allen J Leman Conf Univ Minn* 2001; 28:1.
38. Ramis G et al. *Proc 17th Int Pig Vet Soc Cong* 2002; 282.
39. Melnichouk SI et al. *Swine Hlth Prod* 1999; 9:201.
40. Mackin AJ et al. *Canad J Vet Res* 1997; 61:121.
41. Kelly J. *Proc Am Assoc Swine Pract* 2001; 32:21.

#### CHRONIC INFLAMMATORY BOWEL DISEASE OF SHEEP

This syndrome of unknown etiology is manifest with wasting, ill thrift and mortality, or culling for poor production, and is reported in England and Canada.<sup>1,2</sup> It affects both housed and pastured sheep predominantly in their first year of life, but cases up to 3 years of age have been seen. Affected sheep are dull and anorectic with pale mucous membranes and have fecal staining of the perineum. The rumen fill is reduced and the feces are soft and malodorous. Blood examination shows hypoalbuminemia, an elevated blood urea nitrogen, and leukocytosis with neutrophilia. On post mortem there is lymphocytic enteritis with gross thickening of segments or the entire or distal part of the small intestine. There is no evidence for Johne's disease or parasitic gastroenteritis and the syndrome has similarities to the proliferative enteropathies of swine and horses.

## REFERENCES

1. Rae CA. Can Vet J 1994; 35:622.
2. Wilson DJ, Scott PR. Vet Rec 2001; 149:84.

## Diseases characterized by respiratory tract involvement

### INTERSTITIAL PNEUMONIA OF CATTLE

Interstitial pneumonia of cattle has been known for many years under many different terms including: atypical interstitial pneumonia, acute pulmonary emphysema and edema, bovine pulmonary emphysema, 'panthers', 'lungers', bovine asthma, pneumoconiosis, and 'fog fever'.

Diffuse or patchy damage to alveolar septa is the essential feature of interstitial pneumonia which may be acute or chronic and can be caused by many forms of pulmonary injury. There is an obvious lack of lesions of the small airways which differentiates interstitial pneumonia from bronchopneumonia. Traditionally it was thought that interstitial pneumonias were characterized by chronic inflammation in which there is a predominantly proliferative response involving the alveolar walls and supporting stroma. However, acute diffuse damage of the alveolar walls accompanied by an early intra-alveolar exudative phase, which can be followed by proliferation of type 2 alveolar epithelial cells and fibroblasts, is now commonly recognized.

The recognition that interstitial pneumonia can have an acute exudative phase was the reason for the designation of acute interstitial pneumonia in cattle as 'atypical' interstitial pneumonia. The use of the word 'atypical' may create some confusion in the interpretation and diagnosis of lesions and in the conveying of information. It may be more appropriate to use the term interstitial pneumonia and specify where possible, clinically, epidemiologically, and pathologically the various forms of interstitial pulmonary disease in cattle.

The diseases in which interstitial pneumonia is the essential lesion are listed in Table 36.1. Pulmonary congestion and edema, alveolar exudation, hyaline membrane formation, interstitial emphysema, and alveolar epithelial cell hyperplasia and fibrosis of the supporting stroma without lesions of the smaller airways are the characteristic lesions, with their presence and extent varying according to the stage of the disease process.

The term atypical interstitial pneumonia as originally proposed is still useful in describing some of the diseases clinically and sets them apart from the common acute infectious diseases, especially the viral diseases of the respiratory tract of cattle. Clinically, they are atypical with regard to most clinical signs, especially when compared to the bacterial pneumonias:

Some are acute, like fog fever, while others are chronic as in 'bovine farmer's lung'

- There is usually acute or chronic respiratory distress and a relative absence of toxemia
- Most are progressive and non-responsive to treatment
- Pathology consists of varying degrees of pulmonary emphysema, edema, hyaline membrane formation, and alveolar epithelial cell and interstitial tissue hyperplasia.

While there are obvious clinical, and particularly epidemiological, differences between the various diseases, there are fewer differences between the pathological findings which tend to merge from one to another.

#### Synopsis

**Etiology** D, L-tryptophan in forage. Inhalation of certain gases. Hypersensitivity to molds. Mycotoxicosis and plant poisonings. Viral and bacterial infections.

**Epidemiology** Primarily in adult cattle moved from dry to lush pasture.

Outbreaks of acute pulmonary emphysema and edema occur primarily in adult cattle moved from dry to lush pasture in autumn in North America. In UK and Europe other interstitial pneumonias due to hypersensitivity to molds occur.

**Signs** Outbreaks of acute respiratory distress in pasture form of disease; severe dyspnea, mouth breathing, expiratory grunt, subcutaneous emphysema, and rapid death. Subacute form less severe and may survive but develop cor pulmonale later. Individual cases of interstitial pneumonia in UK and Europe are subacute and chronic.

**Clinical pathology** None clinically applicable.

**Lesions** Enlarged firm lungs which do not collapse, diffuse congestion and edema, interstitial and bullous emphysema, cranioventral consolidation, hyaline membrane formation, alveolar epithelial hyperplasia, fibrosis.

**Diagnostic confirmation** Lesions at necropsy.

#### Differential diagnosis list

- Pneumonic pasteurellosis
- Organophosphatic insecticide poisoning
- Nitrate poisoning
- Other interstitial pneumonias
- Bovine farmer's lung or extrinsic allergic alveolitis
- Lungworm pneumonia
- Verminous pneumonia caused by aberrant migration of *Ascaris suis* larvae
- Feedlot interstitial pneumonia
- Enzootic pneumonia of calves

**Treatment** None.

**Control** Grazing management. Use of antimicrobials to control conversion of tryptophan to 3-methylindole. Adequate housing and ventilation to control hypersensitivity pneumonias.

Table 36.1 Diseases of the lungs of cattle in which the essential lesion is interstitial pneumonia

#### A. Diseases of uncertain etiology

1. Acute bovine pulmonary emphysema and edema (ABPEE) also known as 'fog fever', in cattle moved from dry to lush pasture (may be due to D,L-tryptophan). Usually occurs in outbreak form
2. Diffuse fibrosing alveolitis. Chronic disease which occurs sporadically in mature cows
3. Sporadic cases of acute interstitial pneumonia of young cattle (6–18 months of age). May be due to bovine respiratory syncytial virus or sequel to pneumonic pasteurellosis

#### B. Hypersensitivity diseases

1. Extrinsic allergic alveolitis (bovine farmer's lung). Epidemiologically associated with moldy feeds in housed cattle. May be sudden in onset in individual animals or develop insidiously as a chronic disease in several cows
2. Milk allergy. Occurs sporadically and is sudden in onset

#### C. Plant poisoning

1. *Ipomoea batatas* (sweet potatoes infested with the mold *Fusarium solani*)<sup>3</sup>
2. *Ziera aborescens* (stinkweed)
3. *Perilla frutescens* (purple mint)
4. *Brassica* spp.

#### D. Parasitic diseases

1. *Dictyocaulus viviparus* (including the hypersensitivity aspect)
2. *Ascaris suum*

#### E. Exposure to irritant gases and fumes

1. Nitrogen dioxide
2. Zinc dioxide

#### F. Endotoxic or metabolic

Shock lung due to endotoxemia such as in peracute coliform

## ETIOLOGY

There are several different possible causes.

Acute bovine pulmonary emphysema and edema (ABPEE) or fog fever

This is an acute atypical interstitial pneumonia also known as acute respiratory distress syndrome of cattle. The cause in adult cattle which have been moved from a dry to a lush pasture in the autumn season is related to the ingestion of a toxic level of D,L-tryptophan in the forage.<sup>1</sup> The experimental oral administration of toxic amounts of D,L-tryptophan to cattle causes clinical and pathological findings similar, if not identical, to those of the naturally occurring disease. D,L-tryptophan is converted in the rumen to 3-methylindole which, when given orally or intravenously, also produces the characteristic lesions in cattle and goats. The 3-methylindole exerts a direct effect upon cells and cell membranes of bronchioles and alveolar walls, perhaps as a result of strong lipophilic properties.

Specific forages have not been implicated, but affected cattle have often been consuming alfalfa, kale, rape, turnip tops, rapidly growing pasture grass, and several other feeds. However, pasture levels of tryptophan are not necessarily higher in those associated with the disease compared to normal pastures. In some naturally occurring cases of fog fever in beef cows changed from a dry summer range to a lush green pasture, there is a marked increase in the ruminal levels of 3-methylindole while in other cases the levels are not abnormal. Failure to detect abnormally high levels in the rumen and plasma of naturally occurring cases may be related to the rapid metabolism and elimination of 3-methylindole.

The levels of tryptophan in lush pasture are sufficient to yield toxic doses of 3-methylindole. A 450 kg cow eating grass at an equivalent DM intake of 3.5% of BW/day with a tryptophan concentration of 0.3% of DM would ingest 0.11 g tryptophan/kg BW/day. The total amount ingested over a 3-day period would approximate the single oral dose of 0.35 g/kg BW needed to reproduce the disease experimentally.

Diffuse fibrosing alveolitis

This is a chronic interstitial pneumonia of cattle which occurs sporadically and is suspected of being caused by repeated subclinical incidents of ABPEE or from recovered cases of the disease. Experimentally, repeated oral doses of 3-methylindole can result in diffuse pulmonary fibrosis and alveolitis in cattle.

Parasitic infestation

For many years it was thought that massive infestation of the lungs by large numbers of lungworm larvae in a lungworm-

sensitized animal could cause an allergic reaction resulting in the development of acute bovine pulmonary emphysema. The possibility of such hypersensitivity as being associated cannot be totally ignored but at the present time there is no evidence to support such a theory. Such hypersensitivity may occur when the level of larval infestation of pasture is extremely high but it is not involved in the great majority of cases. In most cases of naturally occurring fog fever there is no laboratory evidence of lungworms in the lungs or feces of affected and in-contact animals. Reinfection of cattle with lungworm will occur 2-3 weeks following introduction to an infected pasture and cause acute respiratory distress which is indistinguishable clinically from fog fever. The migration of abnormal parasites, particularly *Ascaris suum*, has been observed to cause an acute interstitial pneumonia in cattle which were allowed access to areas previously occupied by swine.<sup>1</sup>

Inhalation of irritant gases

The experimental inhalation of nitrogen dioxide gas is capable of causing acute interstitial pneumonia in cattle<sup>1</sup> and severe alveolar edema and emphysema in pigs but it seems unlikely that animals of either species would be exposed naturally to a significant concentration of the gas for a sufficiently long period to produce such lesions.

Pigs which survived experimental exposure to silo gas did not have the lesions seen in silo-fillers' disease in man, and experimental exposure of cattle to nitrogen dioxide gas produces lesions which do not occur in naturally occurring fog fever. Acute pulmonary emphysema and deaths have occurred in cattle exposed to zinc oxide fumes produced by the welding of galvanized metal in an enclosed barn housing cattle.

Hypersensitivity to molds

The ingestion or inhalation of molds may be a cause of the disease in cattle.<sup>1</sup> The disease has been associated with hypersensitivity to moldy hay based on the presence of serum precipitins of the thermophilic antigens of *Thermopolyspora polyspora*, *Micropolyspora faeni*, and *Thermoactinomyces vulgaris* in cattle affected with extrinsic allergic alveolitis or bovine farmer's lung.

In Switzerland, a high incidence of serum precipitins against *Micropolyspora faeni* (60%) and moldy hay antigen (80%) was demonstrated in exposed but apparently healthy cattle from an area where 'allergic pneumonia' is common. The precipitins decreased during the pasture season and increased during winter housing.

Outbreaks of acute respiratory disease in adult cattle due to acute allergic pneu-

monitis can occur 15 hours after the introduction of severely moldy hay. Serological investigation and provocative challenge may reveal a hypersensitivity pneumonitis due to allergens of *Micropolyspora faeni*. A hypersensitivity pneumonitis has been produced experimentally in calves by exposure to aerosols of *Micropolyspora faeni* with or without prior sensitization by subcutaneous injection of the antigen.

In some Canadian cattle barns the disease occurred in cattle located near the hay chute from which hay and bedding are thrown down from the hay storage above the floor where the animals are kept. It has been suggested that the degree of exposure to dusty hay was greater in these cattle but that has not been substantiated. Similarly, it has been proposed that feeding finely ground feed may be associated with interstitial pneumonia in feedlot cattle but there is little evidence to support the observation.

The high incidence of ABPEE in the autumn when many legumes and other pasture plants are flowering, and the common occurrence at this time of allergic rhinitis in cattle, suggest that the inhalation of pollen may cause an allergic response of the alveolar epithelium. However, many outbreaks of the disease have occurred in cattle solely on grass pasture with no flowers; intradermal tests of sensitivity to many pasture plants and to the ruminal contents of affected animals have been negative, and blood histamine levels are within the normal range.

Mycotoxicosis and plant poisonings

In North America, the ingestion of sweet potatoes infested with the mold *Fusarium solani* has been incriminated as a cause of acute interstitial pneumonia in cattle. Growth of the mold on the potatoes produces the toxins ipomeamarone and ipomeamaranol, and a lung edema factor. The latter is a collective term for a group of substances capable of causing death associated with severe edema and a proliferative alveolitis of the lungs of laboratory animals. It produces a respiratory syndrome which is clinically and pathologically indistinguishable from ABPEE.

The fungus *Fusarium semitectum* growing on moldy garden beans, *Phaseolus vulgaris*, which were discarded on pasture, was associated with acute pulmonary emphysema in cattle that consumed the beans and their vines. The fungus produces a pulmonary toxin. The pulmonary toxin, 4-ipomeanol (ipomeanol), accumulates in mold-damaged sweet potatoes and induces pulmonary edema, bronchiolar necrosis and interstitial pneumonia in many mammalian species. Outbreaks have occurred in lactating cows following ingestion of sweet potatoes damaged by *Myzus persicae*.<sup>2</sup> Other *Fusarium* spp. have been found in

peanut-vine hay, which has been associated with acute respiratory distress and atypical interstitial pneumonia in adult beef cattle.<sup>3</sup> The population mortality rate due to respiratory disease was about 12% and the case fatality rate 77%. Clinical signs occurred within a few days to 2 months after the animals were fed the peanut-vine hay.

A weed, *Perilla frutescens*, is considered to be a cause of the disease in cattle in the US and wherever the plant is found. High morbidity and high case fatality rates are characteristic, and the plant contains a perilla ketone which can be used to produce the disease experimentally.

Turf-quality perennial ryegrass straw (*Lolium perenne*) infected with the endophyte (*Acremonium lolii*) which yields toxic substances, including lolitrem-B has been associated with atypical pneumonia in weaned beef calves.<sup>4</sup> However, feeding the suspect hay resulted in typical ryegrass staggers but not atypical interstitial pneumonia.

#### Bacterial and *Mycoplasma* spp. infections

There is no evidence that any of the common bacterial pathogens of cattle such as *Mannheimia haemolytica*, *Pasteurella multocida*, *Histophilus (Haemophilus) somni*, or *Mycoplasma* spp. are primarily associated with acute interstitial pneumonia. In a series of feedlot cattle with clinical findings consistent with acute interstitial pneumonia, the pathogens were present in the lung tissues of some animals at necropsy but their presence was not considered as a primary cause of the pneumonia but rather secondary to the initial injury of the lung which was undetermined.<sup>5</sup>

#### Viral infections

Certain viral infections of the lung may result in interstitial pneumonia. In the interstitial pneumonias caused by the bovine respiratory syncytial virus (BRSV) there is a bronchiolitis and alveolitis and these should be termed bronchiointerstitial pneumonias. The BRSV is an important cause of outbreaks of acute interstitial pneumonia in beef calves 2–4 weeks after weaning. Pathologic evaluation of the lung tissues of feedlot cattle which had acute interstitial pneumonia found that BRSV was not a causative agent.<sup>6</sup> In a series of cases of interstitial pneumonia in feedlot cattle in Saskatchewan the presence of the BRSV antigen was demonstrated in only 7% of cases and there was more severe bronchiolar epithelial necrosis than in the other cases which were negative for the virus.<sup>7</sup>

### EPIDEMIOLOGY

**Acute pulmonary emphysema and edema (ABPEE) or fog fever** occurs

almost exclusively in adult cows and bulls, usually 4–10 days after they are moved abruptly from a dry or overgrazed summer pasture to a lush autumn pasture. The new pasture may or may not have been grazed during that summer and the species of grass or plants does not seem to make a difference, but usually there is some lush regrowth of grass, legume or other palatable plants. Merely changing pasture fields in the autumn has precipitated the disease. In the mountainous areas of North America the disease occurs commonly in cattle brought down from high altitude grasslands to the cultivated and perhaps irrigated lush pastures.

ABPEE usually occurs in outbreaks, the morbidity ranging from 10% in some herds up to 50% and higher in others, with a case fatality ranging from 25 to 50%. It is not unusual to observe a mild form of the disease in about one-third of the adults at risk but only 10% of those at risk may be severely affected. Often, a number of cows are found dead without premonitory signs; many others are severely ill and die within 24 hours and the owner believes that the entire herd will die because of the sudden onset and the large number of animals which are affected at once. Calves and young growing cattle up to 1 year of age grazing the same pasture are usually unaffected.

A retrospective analysis and random sample survey of cattle ranches in northern California found that the type of forage management has a significant effect on the occurrence of the disease. The greatest occurrence of the disease was in herds where the cattle were moved from summer ranges to second-growth hay fields or to irrigated pastures, or from one irrigated field to another. The adult morbidity rate was 2.6% and the case fatality rate about 55%. The disease did not occur on ranches with limited or no movement of cattle from summer ranges to lush autumn pastures.

Placing cattle on rape or kale forage fields or in fields where turnips have been pulled and the cattle allowed access to the tops may have the same effect. The disease has also occurred commonly in western Canada when cattle have been placed in a stubble field following harvesting of any of the cereal crops. Veterinarians have noted that the timespan over which the disease occurs during the autumn months is only 2–4 weeks and that, following the first frost in the fall, the incidence of the disease declines rapidly. The disease has also occurred in the same herd on the same pasture in successive years.

**ABPEE in adult cattle in autumn** has been recorded in Canada and the US, Great Britain, Holland, and New Zealand. The disease is rare in Australia. The

chronic form of the disease in housed cattle appears to be the predominant form of the disease in Switzerland, but the acute form in cattle which have been changed from a dry to lush pasture is now reported. The disease has been recognized in France for many years as aftermath disease or aftermath emphysema, especially in the Normandy region. Some reports have suggested a breed incidence, Herefords being more commonly affected than the Jersey, Holstein, Shorthorn, and Angus breeds, but there are few exact epidemiological data to support the observation. One report suggested that the chronic type in housed cattle was more common in the Channel Island breeds.

#### **Acute interstitial pneumonia in feedlot**

**cattle.** Interstitial pneumonia is recognized as important cause of economic loss in feedlot cattle in western Canada and the United States.<sup>8</sup> The disease occurs sporadically and the incidence is about 3.1% of all cattle placed in feedlots.<sup>9</sup> Cases occur most commonly during the summer and fall months and new cases occur in an even distribution across all stages of the finishing period. In southern Alberta, the disease is most common during hot, dry, dusty, spring and summer days, and typically affects animals expected to be ready for slaughter within 15 to 45 days. Some feedlot operators have observed that the disease is more common in cattle exposed to excessive dust from bedding.

In southern Alberta feedlots the disease occurred late in the finishing period, when animals had been on feed an average of 114 days and weighed 475 kg.<sup>10</sup> All confirmed cases were in heifers and plasma concentrations of 3-methylindole metabolites (adducts) were higher in heifers with interstitial pneumonia than in controls. Most of the heifers were receiving melengestrol (MGA) to suppress estrus. The BRSV antigen was not found in lung tissue of confirmed cases. The odds of an animal with acute interstitial pneumonia being a heifer were 3.1 times greater than the odds that an animal with the disease was a steer.<sup>9</sup> In some large feedlots the estimated relative risk was 4.9.

The role of 3-methylindole (3MI) has been examined as a possible cause of interstitial pneumonia in feedlot cattle.<sup>10</sup> Anaerobic ruminal fermentation of large amounts of tryptophan leads to a surge in 3-methylindole concentrations, which is readily absorbed across the ruminal and intestinal wall and disseminated throughout the body. Bioactivation of 3MI by Clara cells leads to profound cellular injury in Clara and type-1 alveolar epithelial cells and, ultimately, acute interstitial pneumonia. It is postulated that the compound

responsible for causing the injury is the electrophilic metabolite of 3MI, 3-methylenedolenine (3MEIN) which forms stable adducts with cellular macromolecules. (Adducts are compounds formed by an addition reaction.)

Concentrations of 3-methyleneindolenine (3MEIN) in lung tissue and blood were higher in feedlot cattle that had died of acute interstitial pneumonia than in healthy feedlot cattle.<sup>9</sup> However, lung tissue concentrations of 3MEIN were similar in samples from cattle with interstitial pneumonia and bronchopneumonia.<sup>9</sup> Time-dependent patterns and magnitudes of plasma concentrations of 3MI and blood concentrations of 3MEIN-adduct in feedlot cattle during the first 8 weeks after arrival have been followed.<sup>11</sup> Mean concentration of 3MEIN-adduct increased to a maximum value on day 33 and then decreased to a minimum on day 54. Plasma 3MI concentrations initially decreased and remained low until after day 54. Neither 3MEIN-adduct concentrations nor plasma 3MI concentrations were associated with deleterious effects on weight gains. A single dose of acetylsalicylic acid (aspirin) to feedlot cattle on arrival did not affect serum or rumen concentrations of 3MI.<sup>12</sup> The combination of aspirin and vitamin E fed daily to feedlot cattle did not decrease the risk of developing respiratory tract disease.<sup>13</sup>

**Sheep.** Acute interstitial pneumonia has been recorded in sheep and there was extensive alveolar epithelialization. In Norway, an acute respiratory distress syndrome has occurred in lambs moved from mountain pastures onto lush aftermath pasture. The lesions were those of acute interstitial pneumonia and alveolar epithelial hypersensitivity to molds in the grass is being explored. The experimental oral administration of 3-methylindole to lambs will result in acute dyspnea and lesions similar to those which occur in cattle and adult sheep following dosing with 3-methylindole. However, the lesions in experimental lambs are different from those which occur in lambs affected with the naturally occurring disease.

The other types of interstitial pneumonia occur sporadically and may affect only a single animal or several over a period of time. There is not necessarily a seasonal incidence except in areas where cattle are housed and fed dusty and moldy hay during the winter months. The disease has occurred in feedlot cattle in open feedlots and in young cattle fed on fattening rations indoors.<sup>6</sup> Acute interstitial pneumonia occurs in weaned beef calves about 4 weeks after weaning. The interstitial pneumonia which may be the result of anaphylaxis also occurs

sporadically and therefore not in outbreaks.

### PATHOGENESIS

Because of the number and variety of circumstances in which acute or chronic interstitial pneumonia occurs, it is difficult to suggest a basic underlying cause, or to explain the mechanisms for the development of the lesions and the variations which occur from one circumstance to another. The reaction which occurs is a non-specific but fundamental reaction of the pulmonary parenchyma to a wide variety of insults which may be ingested, inhaled or produced endogenously. The reaction to sublethal injury is a combination of congestion, edema, an outpouring of protein-rich fluid into the alveolus, hyaline membrane formation, alveolar and interstitial emphysema which is secondary, and proliferation of alveolar septal cells and fibrosis of the interstitial spaces. Unlike the bacterial pneumonias, the emphasis is on edema and proliferation rather than on necrosis. Because mild cases of ABPEE may recover completely, it is suggested that the lesion can be reversible.

### Experimental ABPEE

There has been considerable effort to experimentally induce ABPEE similar to the naturally occurring disease, by the oral administration of D,L-tryptophan or one of its metabolites, 3-methylindole, to cattle, sheep, and goats. The L-isomer of tryptophan is metabolized by ruminal microorganisms to indolacetic acid which is then converted to 3-methylindole. The conversion of L-tryptophan to 3-methylindole is maximal at a ruminal pH near neutrality. When cattle are moved from a relatively dry pasture to a lush green pasture, there is an increase in ruminal ammonia, a decrease in ruminal pH, and a decrease in ruminal buffering capacity. The 3-methylindole is absorbed from the rumen and metabolized by a mixed-function oxidase system to an active intermediate which has pneumotoxic properties.

Pulmonary edema is the first morphological change occurring in ruminants given 3-methylindole, and the severity and extent of the lesion is probably the single most important factor which determines the severity of the clinical response and the likelihood of survival. The edema is preceded by degeneration, necrosis, and exfoliation of type I alveolar septal cells. During the acute phase, there is flooding of the alveoli with serofibrinous exudate, congestion, and edema of alveolar walls, and hyaline membrane formation. Varying degrees of severity of interstitial emphysema also occur. The interstitial emphysema may spread within the lymphatics to the mediastinum and into the subcutaneous tissues over the withers, over the entire

dorsum of the back and, occasionally, over the entire body including the legs. If the acute phase is severe enough there is marked respiratory distress and rapid death from hypoxemia.

In the experimental disease, the typical clinical signs of respiratory disease appear within 24–36 hours after the oral administration of L-tryptophan to adult cattle and within 4 days 50% of the dosed cows will die. The predominant pulmonary lesions include edema, interstitial emphysema, hyaline membranes, and hyperplasia of alveolar lining cells. The L-tryptophan is converted to indolacetic acid, which is decarboxylated to 3-methylindole, which is absorbed and metabolized by a mixed function oxidase system in the lung to produce pneumotoxicity.

The lesions have also been produced in cattle, sheep, and goats following oral or IV administration of 3-methylindole. Calves may be more resistant to experimental toxicity with 3-methylindole than adults, which supports the observation that the naturally occurring disease is uncommon in calves grazing the same pasture in which adults are affected. Young calves, 30–45 days of age, are susceptible to pulmonary injury induced by 3-methylindole characterized by pulmonary edema and damage to type-1 alveolar epithelial cells and non-ciliated bronchiolar epithelial cells. The 3-methylindole injury does not make the bovine lung more susceptible to the bovine respiratory syncytial virus as is the case for the parainfluenza-3 virus.

**Proliferative stage.** If the animal survives the acute phase, proliferation of alveolar type II cells marks the beginning of the shift from the exudative to the proliferative stages of pneumonia. There is alveolar epithelialization and interstitial fibrosis, the latter being progressive and irreversible. The central features of chronic interstitial pneumonia are intra-alveolar accumulation of mononuclear cells, proliferation and persistence of alveolar type 2 cells, and interstitial thickening by accumulation of lymphoid cells and fibrous tissue. Diffuse fibrosing alveolitis is a form of chronic interstitial pneumonia of uncertain etiology, but possibly the chronic form of ABPEE. Repeated oral administration of 3-methylindole in cattle provides a good experimental model for diffuse pulmonary fibrosis.

### Effects of 3-methylindole on pulmonary function

The effects of 3-methylindole on pulmonary function and gas exchange have been examined in cattle, goats, and horses. In cattle there is impairment of sympathetic pulmonary vasoconstriction, and changes in intra-acinar pulmonary arteries which may be related to a sudden elevation in arterial

and venous pressures in the pulmonary system. There are large increases in respiratory rate, minute viscous work,  $PCO_2$  and large decreases in tidal volume dynamic lung compliance, and  $PO_2$ . All of these are compatible with the severe pulmonary edema and alveolar injury.

In goats there is a pronounced decrease in lung compliance, a moderate increase in airway resistance, a concomitant hypoxemia, a progressive decrease in tidal volume and alveolar ventilation and an increase in the dead-space-to-tidal volume ratio. These changes are characteristic of a restrictive type of respiratory tract disease in goats in which pulmonary edema and the pulmonary function changes are similar to those of adult respiratory distress syndrome in man.

### CLINICAL FINDINGS

Acute bovine pulmonary emphysema and edema

This disease, also known as 'fog fever', is usually obvious, because of its characteristic clinical presentation. The onset is sudden. Within 4–10 days after adult cattle have been moved onto a new pasture, they may be found dead without any premonitory signs. Many cattle exhibit labored breathing, often with an expiratory grunt, open-mouthed breathing, frothing at the mouth, and anxiety. Severely affected cattle do not graze, stand apart from the herd, and are reluctant to walk. If forced to walk they may fall and die within a few minutes. Often, removal of the affected herd from the pasture will result in an increased number of deaths. Moderately affected cattle continue to graze but their respirations are increased above normal. Coughing is infrequent regardless of the severity. The temperature is normal to slightly elevated (38.5–39.5°C, 102–103°F) but may be up to 41–42°C (106–108°F) during very warm weather. There is a similar variation in the heart rate (80–120/min) and those with a rate of more than 120/min are usually in the terminal stages of the disease. Bloat and ruminal atony are common in severe cases. Subcutaneous emphysema is common over the withers and may extend to the axillae and ventral aspects of the thorax. The nostrils are flared and the nasal discharge is normal. Diarrhea may occur but is mild and transient.

Loud, clear breath sounds audible over the ventral aspects of the lung, indicating consolidation without bronchial involvement, are the characteristic findings on auscultation in the early stages of the acute disease. The intensity of the breath sounds may be less than normal over the dorsal parts of the lung if involvement is severe, but in animals which survive for several days the loud crackles characteristic of interstitial emphysema are of diagnostic significance. Most severely affected cases

will die within 2 days of onset but less severe cases will live for several days and then die from diffuse pulmonary involvement. Those which survive longer than 1 week will often have chronic emphysema and remain unthrifty. Of those moderately affected cattle which recover in a few days, some will develop congestive heart failure a few months later, due to chronic interstitial pneumonia (cor pulmonale). Calves running with their adult dams will usually not be affected.

### Other interstitial pneumonias

These diseases usually occur sporadically, but several animals may be affected over a period of time. There may or may not be a history of a change of feed or the feeding of moldy or dusty feed. In many cases, a few days elapse after the appearance of signs before the owner is aware of the affected animals. The animal may have been treated with an antimicrobial for a bacterial pneumonia with little or no response. Dyspnea, increased respiratory effort sometimes with a grunt, deep coughing, a fall in milk production, an absence of toxemia, a variable temperature (38.5–40°C, 102–104°F) and a variable appetite are all common. On auscultation there are loud breath sounds over the ventral aspects of the lungs and crackles over both dorsal and ventral aspects. The presence of moist crackles suggests secondary bacterial bronchopneumonia. Subcutaneous emphysema is uncommon in these and most will become progressively worse.

Yearling cattle with acute interstitial pneumonia which may be viral in origin may become much worse and die in a few days in spite of therapy. Mature cattle affected with bovine farmer's lung will survive in an unthrifty state with the chronic disease for several weeks and even months.

The major clinical features of all these other interstitial pneumonias are obvious respiratory disease, lack of toxemia, poor response to treatment, progressive worsening, and abnormal lung sounds distributed over the entire lung fields.

### CLINICAL PATHOLOGY

There are no abnormalities of the hemogram or serum biochemistry which have any diagnostic significance. Examination of feces and forage for lungworm larvae will aid in differentiation from verminous pneumonia if past the prepatent period. The observed high levels of farmer's lung hay' antibodies in serum are not of much value diagnostically because of the similar levels found in many clinically normal cows; many cases of classic fog fever have negative serum precipitin levels.

### NECROPSY FINDINGS

In ABPEE, the lungs are enlarged and firm and do not collapse on cutting. In the early

stages of acute cases they contain much fluid which is more viscid than usual edema fluid. The pleura is pale and opaque and appears to be thickened. In peracute cases, the entire lungs are homogeneously affected in this way. Such cases usually have edema of the larynx.

In the more common acute case, the lung has a marbled appearance. Adjacent lobes may be affected with any one of four abnormalities. Areas of normal, pink lung are restricted to the dorsal part of the caudal lobes. There are areas of pale tissue indicative of alveolar emphysema, areas of a dark pink color affected by early alveolar exudation, yellow areas in which the alveoli are filled with coagulated protein-rich fluid, and dark red areas where epithelialization has occurred. The latter two lesions are firm on palpation and resemble thymus or pancreas. They are more common in the ventral parts of the cranial lobes.

In chronic cases, as a sequel to the acute form described above, the obvious differences in the age of the lesions suggest that the disease progresses in steps by the periodic involvement of fresh areas of tissue. In all cases there is usually a frothy exudate, sometimes containing flecks of pus, in the bronchi and trachea, and the mucosa of these passages is markedly hyperemic.

Histologically, the characteristic findings are an absence of inflammation, except in the case of secondary bacterial invasion, and the presence of an eosinophilic, protein-rich fluid which coagulates in the alveoli, or may subsequently be compressed into a hyaline membrane. This is more apparent in acute cases and, if animals live for a few days, there is evidence of epithelialization of the alveolar walls. In longstanding cases, there is extensive epithelialization and fibrosis.

The pathology of bovine farmer's lung and diffuse fibrosing alveolitis has been described and consists of variations of the lesions of chronic interstitial pneumonia.

Bacteriological examination of the lungs is often negative, although in long-standing cases in which secondary bacterial pneumonia has developed *Pasteurella multocida*, *Mann. haemolytica*, *Streptococcus* spp., and *Arcanobacterium pyogenes* may be found. A careful search should be made for nematode larvae.

### TREATMENT

The treatment of fog fever in cattle is empirical and symptomatic. The lesion is irreversible in severe cases and treatment is unlikely to be effective. When outbreaks of the disease occur on pasture the first reaction is to remove the entire herd from the pasture to avoid the development of new cases. However, almost all new cases will usually occur by the 4th day after the onset of the outbreak and removal from



## DIFFERENTIAL DIAGNOSIS

**Acute bovine pulmonary emphysema and edema****Acute bovine pulmonary emphysema and edema**

is usually obvious when presented with an outbreak of acute respiratory disease in adult cattle which have recently been moved onto a new pasture. The onset is sudden, many cattle are found dead and many are dyspneic. ABPEE must be differentiated from:

**Pneumonic pasteurellosis****Pneumonic pasteurellosis**

is characterized by fever, toxemia, mucopurulent nasal discharge and less dyspnea; young cattle are more commonly affected and there is a beneficial response to therapy within 24 hours.

**Organophosphatic insecticide poisoning****Organophosphatic insecticide poisoning**

may resemble the pasture form of pulmonary emphysema because of the dyspnea but additionally there is pupillary constriction, mucoid diarrhea, muscular tremor and stiffness of the limbs, and no abnormal lung sounds.

**Nitrate poisoning**

may occur in cows moved into a new pasture with high levels of nitrate. Many cows are affected quickly, they are weak, stagger, gasp, fall down, and die rapidly. The chocolate brown coloration of the mucous membranes, the lack of abnormal lung sounds, and the response to treatment are more common in nitrate poisoning.

**Other interstitial pneumonias**

All of the other types of acute interstitial pneumonia in cattle not associated with a change of pasture in the autumn are difficult to diagnose clinically and pathologically, especially when they occur in a single animal. Their epidemiological characteristics summarized on p. 513 will often offer some clues.

The chronic and subacute types of interstitial pneumonia are difficult to differentiate from each other and from other pneumonias of cattle.

**Bovine farmer's lung**

**Bovine farmer's lung** or extrinsic allergic alveolitis occurs in housed cattle exposed to dusty or moldy feeds for a prolonged period and is characterized by a history of chronic coughing, weight loss, poor milk production, occasionally green-colored nasal discharge, and dry crackles over most aspects of the lungs. Not infrequently, acute cases occur and die within a week after the onset of signs.

**Lungworm pneumonia**

**Lungworm pneumonia** occurs in young cattle on pasture in the autumn months and causes subacute or acute disease which may resemble bovine farmer's lung clinically but not epidemiologically. Necropsy is necessary for the diagnosis.

**Verminous pneumonia**

**Verminous pneumonia** caused by aberrant migration of *Ascaris suis* larvae may be indistinguishable from acute interstitial pneumonia, but a history of previous occupation of the area by pigs may provide the clue to the diagnosis which can only be confirmed on histological examination of tissues. It is impossible to differentiate clinically between verminous pneumonia and some of the acute interstitial pneumonias seen in yearling cattle except by identification of the larvae in the feces or tissues of affected animals.

**Feedlot interstitial pneumonia**

**Feedlot interstitial pneumonia** occurring in recently weaned beef calves or feedlot cattle is characterized by the sudden onset of acute respiratory distress, absence of toxemia, lack of abnormal nasal discharge, and a poor response to treatment with antibiotics. It is difficult to differentiate clinically from acute viral interstitial pneumonia or pneumonic pasteurellosis. However, in acute interstitial pneumonia there is marked dyspnea and the abnormal lung sounds are usually distributed over the entire lung fields.

**Enzootic pneumonia of calves**

**Enzootic pneumonia of calves** may resemble acute or chronic interstitial pneumonia but is almost entirely restricted to housed calves less than 6 months of age. They respond to treatment gradually over a few days.

the pasture usually will not prevent new cases. Conversely, leaving the herd on pasture usually will not result in additional cases. Severely affected cattle should be removed from the pasture with extreme care, very slowly and only if necessary, and moved to shelter from the sun. Immediate slaughter for salvage may be indicated in severe cases. Mild or moderately affected cases will commonly recover spontaneously without any treatment if left alone and not stressed, a fact that has not been given due consideration when claims are made for the use of certain drugs.

Several different drugs have been advocated and used routinely for the treatment of ABPEE in cattle. However, none has been properly evaluated and definitive recommendations cannot be made.

Treatment of the chronic interstitial pneumonias is unsatisfactory because the lesion is progressive and irreversible.

**CONTROL**

There are no known reliable methods for the prevention of ABPEE in pastured cattle

but there are some strategies which merit consideration.

**Grazing management**

If lush autumn pasture contains toxic levels of the substance that causes the acute disease it would seem rational to control the introduction of cattle to the new pasture. This can be done by controlling the total grazing time during the first 10 days: allow the cattle to graze for 2 hours on the first day, increasing by increments of 1 hour per day, and leave them on full time at the end of 10–12 days. Such a management procedure is laborious, requires supplementation with other feeds and daily removal of cattle from the pasture, and may not be practical depending on the size and terrain of the pasture and the holding yards which are available.

**Inhibition of 3-methylindole production in rumen**

Controlling the conversion of D,L-tryptophan in forage to 3-methylindole is a plausible control strategy. Experimental tryptophan-induced ABPEE can be prevented by the simultaneous oral administration of chlortetracycline or polyether antibiotics such as monensin. The daily oral administration of 2.5 g/head of chlortetracycline beginning 1 day before and for 4 days following administration of a toxin of L-tryptophan will prevent clinical signs.<sup>14</sup>

The daily oral administration of monensin at the rate of 200 mg/head/day beginning 1 day before and for 7 days after an abrupt change from a poor quality hay diet to a lush pasture reduced the formation of 3-methylindole during the 7 days of treatment, but the effect of the drug was diminished on day 10, 3 days after its withdrawal. Because the effects of monensin on ruminal 3-methylindole are diminished within 48 hours after withdrawal of the drug, effective prevention of acute pulmonary edema and emphysema may require continuous administration of monensin for the critical period of approximately 10 days after the mature animals are exposed to the lush pasture. The daily feeding of monensin in either an energy or protein supplement will effectively reduce ruminal 3-methylindole formation in pasture-fed cattle.

Successful prevention of the disease requires monensin supplementation with organized grazing management to reduce the intake of lush pasture by hungry cows. This may be accomplished in several ways: feed dry, mature hay ad libitum to adult cattle just before and during the transition period of a pasture change, then continue to feed hay for at least 4 days into this grazing period; cut all lush forage and allow to wilt before allowing adult cattle access to the

pasture. Alternatively, over a 7-day period, gradually increase the amount of time cattle spend grazing lush pasture. If possible, this may be accomplished by rotating cattle back and forth, either between the summer and fall pastures, or between the fall pasture and a drylot where ample supply of dry, mature hay is available. Any combination of these management practices while providing monensin at 200 mg/head per day in an energy or protein supplement may reduce 3-methylindole production to a greater extent than just providing monensin or implementing grazing management techniques.<sup>6</sup>

To maximize the effectiveness of monensin in reducing 3-methylindole formation, dry hay plus wilted forage should be fed to pastured cattle for at least 4 days after they are allowed access to lush pasture. Lasalocid at a dose of 200 mg per head once daily in ground grain for 12 days reduced the conversion of tryptophan to 3-methylindole and prevented pulmonary edema.<sup>15</sup>

The daily administration of inhibitors during the critical period immediately before and after the cattle are turned onto the lush pasture may be a practical problem.

Other interstitial pneumonias

The control of non-pasture cases of interstitial pneumonia depends on the suspected cause and removal of it from the environment of the animals. Every attempt must be made to control the concentration of dust and moldy foods to which cattle are exposed. Feed supplies must be harvested, handled, and stored with attention to minimizing dust and molds. In the preparation of mixed ground feed for cattle, the fineness of grind must be controlled to avoid dusty feed particles which may be inhaled. Because of the creation of dust, the grinding and mixing of dry feeds like hay, straw, and grains should not be done in the same enclosed area in which cattle are housed. If dusty feeds must be used they should be wetted to assist in dust control.

**Lungworm control** is essential in endemic areas where the disease occurs. This may necessitate careful monitoring and regular treatment to reduce the level of infestation on pasture.

**Viral interstitial pneumonias.** In countries where cattle are housed, especially during the winter months, the provision of adequate ventilation is necessary to minimize aerosol viral interstitial pneumonias. Vaccination is a consideration.

#### REVIEW LITERATURE

Andrews GA, Kennedy GA. Respiratory diagnostic pathology. In: Bovine respiratory disease update. Vet Clin North Am: Food Anim Pract, 1997; 13:515-547.

#### REFERENCES

1. Andrews GA, Kennedy GA. In: Bovine respiratory disease update. Vet Clin North Am: Food Anim Pract 1997; 13:515.
2. Medediro RM et al. Vet Hum Toxicol 2001; 43:205.
3. Roberson JR et al. Vet Med July 1997; 644.
4. Pearson EG et al. J Am Vet Med Assoc 1996; 209:1137.
5. Woolums AR et al. Am J Vet Res 2004; 65:1525.
6. Loneragan GH et al. Am J Vet Res 2001; 62: 1519.
7. Sorden SD et al. J Vet Diagn Invest 2000; 12: 510.
8. Loneragan GH, Gould DH. Proc Amer Assoc Bov Pract 2000; 33:129.
9. Loneragan GH et al. Am J Vet Res 2001; 62:1525.
10. Ayrud M et al. Can Vet J 2000; 41:547.
11. Loneragan GH et al. Am J Vet Res 2002; 63:591.
12. Bingham HR et al. Am J Vet Res 2000; 61:1209.
13. Loneragan GH et al. Am J Vet Res 2002; 63: 1641.
14. Hammond AC et al. Am J Vet Res 1978; 39:1404.
15. Nocerini MR et al. J Anim Sci 1985; 60:232.

#### TRACHEAL STENOSIS OF FEEDLOT CATTLE

Tracheal stenosis, also known as 'honker cattle', occurs in feedlot cattle.<sup>1</sup> The etiology is unknown. It is characterized by extensive edema and hemorrhage of the dorsal wall of the trachea, resulting in coughing (honking), dyspnea, and respiratory stertor. Complete occlusion of the trachea may occur. Affected animals may be found dead without any premonitory signs.

In tracheal stenosis of feedlot cattle, there is marked submucosal hemorrhage dorsal and ventral to the tracheal is muscle resulting in ventral displacement of the mucosa and partial to complete occlusion of the tracheal lumen. Diffuse hemorrhage in the peritracheal connective tissue and surrounding muscles of the neck is common in animals dying of asphyxia. Histologically there is hyperemia and hyperplastic tracheal mucosa with focal erosions, squamous metaplasia, and loss of cilia. In acute cases the mucosa is markedly thickened because of hemorrhage and edema. Culture reveals a mixed bacterial flora.

#### REFERENCE

1. Erickson ED, Doster AR. J Vet Diagn Invest 1993; 5:449.

#### INTERSTITIAL PNEUMONIA OF ADULT HORSES

In its most severe form, this is a disease characterized by insidious progression of pulmonary inflammation and fibrosis. Less severe forms, associated with transient viral or bacterial infections of the lungs, resolve when the infection is cleared from the lungs.

#### ETIOLOGY

There are many potential agents but few have been conclusively implicated as

being associated with the disease. In most instances of the disease no causal association is identified.

Interstitial pneumonia is a common finding in horses associated with various infectious agents (Hendra virus infection, *Rhodococcus equi* in foals, *Aspergillus* sp., *Cryptococcus* sp. and *Histoplasma* sp., *Pneumocystis carinii*,<sup>1</sup> *Parascaris equorum*, and *Dictyocaulus arnfeldi*). Intoxication with perilla ketone, derived from *Perilla frutescens*, causes acute restrictive lung disease of horses.<sup>2,3</sup> Similarly, ingestion of *Eupatorium* sp. in Australia and Hawaii causes interstitial pneumonia in horses.<sup>4</sup> Inhalation of silica causes a similar disease in horses in California.<sup>5</sup> Inhalation or ingestion of agricultural chemical or environmental toxins (e.g. paraquat) has the potential to cause interstitial pneumonia in other species, but this has not been demonstrated in horses.

Hypersensitivity reactions may cause severe respiratory disease in horses. Incriminating allergens include fungi (unspecified) and chicken dust.<sup>6,7</sup>

Interstitial pneumonia has also been reported subsequent to administration of an immunostimulant containing mycobacterial cell wall extract.<sup>8</sup>

#### EPIDEMIOLOGY

The disease occurs in adult horses without apparent breed, sex, or age predisposition. In cases in which the cause is infectious, the epidemiology of the disease is characteristic of that of the causal organism.

#### PATHOGENESIS

The initial insult causes injury to parenchymal cells and an acute alveolitis.<sup>9</sup> Alveolitis results from damage to epithelial and endothelial cells by toxic, metabolic (free radicals), or infectious agents. This is followed by a phase of cellular proliferation of type 2 pneumocytes and fibroblasts with connective tissue deposition.<sup>3</sup> At this time there is an influx of inflammatory cells, the exact type depending to some extent on the cause of the disease. Infiltration of neutrophils, lymphocytes, and macrophages is common. Continued injury to the lung results in development of severe interstitial fibrosis and destruction of gas exchange units.

Interstitial pneumonia results in altered pulmonary function including reduced compliance, impaired pulmonary gas exchange, and a reduction in total and vital lung capacity. The work of breathing is increased.<sup>10</sup>

#### CLINICAL SIGNS

Horses with idiopathic interstitial pneumonia have various combinations of: weight loss, recurrent cough, depression,

anorexia, fever, or respiratory distress. Signs of respiratory disease are not readily apparent at initial examination in all affected horses. As the disease progresses respiratory distress develops in most, but not all, cases. The usual history of is a gradual onset of increased respiratory effort, although some horses have a sudden onset of respiratory distress.<sup>11</sup> Heart and respiratory rates may be elevated. Pyrexia is not a constant finding. There may be a nasal discharge. Thoracic auscultation may reveal only increased intensity of normal breath sounds or the presence of occasional crackles and wheezes. Typically, there is tachypnea with an increased respiratory effort.

Thoracic radiography reveals pulmonary disease, usually apparent as severe, diffuse interstitial disease. The interstitial opacity may be diffuse or nodular with multiple well defined opacities against an overall background of increased interstitial density. Ultrasonographic examination may reveal the presence of multiple nodules in the lung parenchyma confluent with the pleural surface. There is no excess pleural fluid.

Intradermal skin testing may be useful to identify the inciting allergen in cases of allergic interstitial pneumonia.<sup>7</sup>

The prognosis is poor in most cases of the idiopathic disease. Should recovery occur, it does so within approximately 2 weeks of diagnosis.

#### CLINICAL PATHOLOGY

Hematologic examination usually reveals a neutrophilic leukocytosis.<sup>11,12</sup> Mild anemia and hyperfibrinogenemia are common. Examination of a tracheal aspirate reveals neutrophil inflammation. In cases of verminous pneumonia, there may be an increased proportion of eosinophils in tracheal aspirate. Bronchoalveolar lavage fluid can reveal a similar neutrophilic leukocytosis or may be normal.<sup>13</sup> Serologic testing for antibodies to fungi or other inciting agents may be useful.<sup>9</sup>

Definitive diagnosis is provided by examination of tissue obtained by lung biopsy.

#### NECROPSY FINDINGS

The lungs do not deflate as anticipated and there may be indentations from the ribs on the surface of the lungs. Multiple pale, yellowish-white nodules 3–4 cm in diameter may be apparent on the surface of the lung and throughout the lung parenchyma. There is histologic evidence of severe, fibrosing alveolitis with minimal airway involvement. The acute phase of the disease is evident as extensive alveolar edema and hemorrhage.<sup>14</sup>

#### TREATMENT

Treatment should be directed toward any cause of the disease that is identified such as administration of anthelmintics. In cases of idiopathic disease, treatment is frequently unrewarding as by the time the animal is examined the disease is often advanced. Treatment includes anti-inflammatory drugs including dexamethasone or prednisolone, antimicrobials, and supportive care. Immunosuppressive drugs, such as vincristine, are not effective. Bronchodilating drugs, such as clenbuterol, may be considered, but bronchoconstriction is not a prominent component of the disease.

#### CONTROL

Prevention of exposure to potential infectious, toxic or environmental causes is prudent.

#### REVIEW LITERATURE

Buergelt CD. Interstitial pneumonia in the horse: a fledgling morphological entity with mysterious causes. *Equine Vet J* 1995; 27:4.

Bruce EH. Interstitial pneumonia in horses. *Comp Cont Educ Pract Vet* 1995;17:1145.

#### REFERENCES

- Franklin RP et al. *J Vet Intern Med* 2002; 16:607.
- Breeze RG et al. *Equine Vet J* 1984; 16:180.
- Schmidbauer SM et al. *J Comp Pathol* 2004; 131:186.
- O'Sullivan B. *Aust Vet J* 1979; 55:19.
- Berry CR et al. *J Vet Int Med* 1991; 5:248.
- Gerber H. *Equine Vet J* 1973; 5:26.
- Mansmann RA et al. *J Am Vet Med Assoc* 1975; 166:673.
- Viel L, Kenney D. *Proceed 12th Veterinary Respiratory Symposium* 1994.
- Bruce EH. *Comp Cont Educ Pract Vet* 1995; 17:1145.
- Derksen FJ et al. *J Am Vet Med Assoc* 1982; 181:887.
- Kelly DF et al. *Equine Vet J* 1995; 27:76.
- Winder C et al. *Equine Vet J* 1988; 20:298.
- Donaldson MT et al. *Equine Vet J* 1998; 30:173.
- Buergelt CD et al. *Vet Pathol* 1986; 23:750.

#### ACUTE BRONCHO-INTERSTITIAL PNEUMONIA IN FOALS

This is a disease of foals less than 7 months of age, and usually <2 months of age, characterized by a rapid onset of respiratory distress. The **etiology** is unclear in many cases, but suggested causes or agents associated with the disease include equine influenza virus infection,<sup>1</sup> *R. equi*, equine herpes virus II, equine arteritis virus,<sup>2</sup> or *Pneumocystis carinii*.<sup>3–6</sup> The disease is likely a result of severe pulmonary injury by any of a number of infectious or toxic agents. The respiratory distress results from loss of pulmonary function because of necrosis of the epithelium of alveoli and terminal bronchioles.

Foals typically present with an acute onset (<4 days) of respiratory distress, pyrexia and tachycardia. Foals are depressed and reluctant to eat. There is a pronounced

respiratory effort with a marked abdominal component in most affected foals. Crackles, wheezes, and increased bronchial breath sounds are auscultable in most foals. Radiographic examination reveals a broncho-interstitial pattern which is always diffuse, although in some foals there is also a focal interstitial pattern. The prognosis is guarded, with approximately 50% of affected foals dying of the disease.

There is a neutrophilic leukocytosis and hyperfibrinogenemia in most cases. Arterial hypoxemia is present in severely affected foals. Tracheal aspirate demonstrates neutrophilic inflammation. Culture of the tracheal aspirate yields *Rhodococcus equi*, *Strep. zooepidemicus*, *Actinobacillus* sp., and other organisms of questionable significance. Serology might demonstrate evidence of infection by equine influenza virus or equine herpes virus II.<sup>1,3,4</sup> Viral isolation can identify equine influenza virus.<sup>1</sup>

#### NECROPSY FINDINGS

**Necropsy** examination reveals the presence of diffusely reddened, wet and firm lungs that fail to collapse.<sup>3,4</sup> The predominant histologic lesion is necrosis of the epithelium of terminal bronchioles and alveoli.

#### TREATMENT

Principles of **treatment** are correction of hypoxemia, reduction of inflammation and removal of inciting causes. Severely affected foals may require nasal insufflation of oxygen to ameliorate or correct hypoxemia. Administration of corticosteroids has been associated with improved survival.<sup>3</sup> Broad spectrum antibiotics are administered to treat concurrent bacterial infections and prevent secondary infection.

#### CONTROL

There are no specific control measures, but reduction of exposure of foals to infectious respiratory disease would be prudent.

#### REFERENCES

- Peck SF et al. *J Vet Intern Med* 2004; 18:132.
- Szeredi L et al. *J Vet Med B* 2003; 50:270.
- Lakritz J et al. *J Vet Int Med* 1993; 7:277.
- Prescott JF. *Can Vet J* 1991; 32:421.
- Ainsworth DM et al. *Equine Vet J* 1993; 25:103.
- Ewing PJ et al. *J Am Vet Med Assoc* 1994; 204:929.

#### CHRONIC INTERSTITIAL PNEUMONIA OF FOALS

A sporadic disease of foals less than 10 months of age characterized by respiratory distress of several weeks duration is caused by chronic interstitial pneumonia.<sup>1</sup> The etiology is unknown, but the disease likely represents a common final response to injury caused by any one of a number of infectious or toxic agents (see 'interstitial pneumonia of horses' and 'acute bronchointerstitial pneumonia of foals').

Affected foals are bright and alert and have markedly increased respiratory effort. The respiratory rate is elevated and there is a prominent abdominal component to respiratory effort. Fever is low grade and intermittent. Thoracic auscultation reveals increased intensity of normal breath sounds and the presence of wheezes and crackles in most affected foals. Ultrasonographic examination of the thorax reveals extensive 'comet tail' signs in most cases. Radiography demonstrates the presence of moderate to severe interstitial pneumonia which in some cases can include focal opacities suggestive of alveolar disease. The prognosis with appropriate treatment is excellent.

Affected foals have neutrophilic leukocytosis and hyperfibrinogenemia. Serological examination for antibodies to common respiratory viruses is unrewarding. Culture of tracheal aspirates does not consistently yield growth of known pathogens. Lung biopsy is not warranted because the characteristic changes on radiographic examination, combined with the clinical signs, are diagnostic for the disease. The risk of adverse events associated with lung biopsy outweighs any diagnostic utility given the good prognosis for complete recovery from the disease.

Treatment consists of administration of corticosteroids such as dexamethasone phosphate at an initial dosage of 0.1–0.25 mg/kg intravenously for 3–5 days followed by a declining dose administered orally over 2–3 weeks. Prednisolone can be substituted for dexamethasone. Broad spectrum antibiotics (combination of penicillin and aminoglycoside, trimethoprim-sulfonamide, or doxycycline) should be administered for 1–2 weeks.

There are no recognized control measures, although control of infectious respiratory disease in the herd is prudent.

#### REFERENCE

1. Nout YS et al. *Equine Vet J* 2002; 34:542.

## Diseases characterized by nervous system involvement

### POLIOENCEPHALOMALACIA (CEREBROCORTICAL NECROSIS) OF RUMINANTS

#### Synopsis

**Etiology** Several different causes including thiamin inadequacy, sulfate toxicity.

**Epidemiology** Sporadic disease in young well-nourished ruminants on high level grain diets and not synthesizing sufficient thiamin. Ingestion of preformed

thiaminase in certain plants or production by ruminal microbes may also cause destruction of thiamin. May also occur in cattle and sheep of all ages ingesting excess amount of sulfates in feed and water.

**Signs** Sudden blindness, ataxia, staggering, head-pressing, tremors of head and neck, ear twitching, champing fits, clonic-tonic convulsions, recumbency, opisthotonos, rumen contractions normal initially, pupils usually normal and responsive, nystagmus, death may occur in 24–48 hours. Hydrogen sulfide odor of ruminal gas in sulfate toxicity.

**Clinical pathology** Erythrocyte transketolase activity decreased and thiamin pyrophosphate effect increased but both measurements difficult to interpret; blood thiamin levels decreased but not reliable.

**Lesions** Diffuse cerebral edema, flattened dorsal gyri, coning of cerebellum, multifocal to linear areas of fluorescence in gray and white matter borders of cortical gyri and sulci.

**Diagnostic confirmation** Fluorescence of gray and white matter of cortical gyri and sulci of brain.

#### Differential diagnosis list Cattle:

- Lead poisoning
- Hypovitaminosis-A
- *Histophilus meningoenephalitis*.

#### Sheep:

- Pregnancy toxemia
- *Clostridium perfringens* Type D Enterotoxemia
- Focal symmetrical encephalomalacia
- Lead poisoning.

#### Goats:

- Caprine leukoencephalomyelitis
- *Listeria meningoenephalitis*
- *Clostridium perfringens* Type D Enterotoxemia
- Lead poisoning.

**Treatment** Thiamin hydrochloride parenterally.

**Control** Thiamin supplementation of diet. Avoid excess feeding or access to sulfate in feed and water supplies.

#### ETIOLOGY

Historically, PEM was considered to be caused by a thiamin inadequacy. It is now known that there are several different causes of the disease.

#### Thiamin inadequacy

The evidence that a thiamin inadequacy can be associated with the disease includes the following<sup>1</sup>:

- Affected animals respond to the parenteral administration of thiamin if given within a few hours after the onset of clinical signs
- Affected animals have biochemical findings consistent with thiamin diphosphate (TDP) inadequacy
- The clinical signs and pathological lesions can be reproduced in sheep

and cattle by the administration of large daily doses of pyrimidine containing structural analogs of thiamin, principally amprolium, given orally or intraperitoneally.<sup>1</sup>

#### Excess dietary sulfur

The ingestion of excessive quantities of sulfur from the diet and water supply can cause the disease in cattle<sup>2</sup> and sheep<sup>3</sup> without any change in the thiamin status of the tissues.

#### EPIDEMIOLOGY

##### Occurrence

PEM occurs sporadically in young cattle, sheep, and goats, and other ruminants. In North America, UK, Australia, and New Zealand, the disease has been most common in cattle and sheep which are being fed concentrate rations under intensified conditions such as in feedlots. An inadequate amount of roughage can result in a net decrease in the synthesis of thiamin. The disease occurs most commonly in well-nourished thrifty cattle 6–18 months of age (peak incidence 9–12 months of age) which have been in the feedlot for several weeks. Feedlot lambs may also be affected only after being on feed for several weeks. The disease also occurs in goats and in antelope and whitetail deer.<sup>4</sup> The disease may affect goats from 2 months to 3 years of age and is commonly associated with milk-replacer diets in kids or concentrate feeding in older goats. The disease occurs only rarely in adult cattle which may be a reflection of the greater quantities of roughage they usually consume. However, there are recent reports of the disease occurring in adult cows on pasture with access to drinking water containing excessive concentrations of sulfates.<sup>2</sup>

In Cuba, the disease occurred in feedlot cattle fed primarily on molasses with a minimal quantity of roughage, and was reproduced by feeding a molasses-urea and roughage diet by gradual removal of the roughage without the use of thiamin analogs.

#### Morbidity and case fatality

Accurate morbidity and case fatality data are not available, but outbreaks can occur suddenly in which up to 25% of groups of feeder cattle may be affected, with case fatality rates from 25 to 50%. Case fatality rates are higher in young cattle (6–9 months) than in the older age group (12–18 months) and mortality increases if treatment with thiamin is delayed for more than a few hours after the onset of signs. In feedlot lambs, it has been suggested that approximately 19% of all deaths are due to polioencephalomalacia.

#### Risk factors

When PEM was first described in 1956, and for about 30 years, it was considered

to be a thiamin deficiency conditioned by dietary factors such as high-level grain feeding and inadequate roughage. PEM occurred most commonly in well nourished young cattle from 6 to 12 months of age which were being fed high-level grain rations. The scientific investigations centered on the effects of dietary factors such as grain diets, and the presence of thiaminases in certain diets on thiamin metabolism in the rumen. In recent years, it has become clear that the disease is not etiologically specific because many different dietary factors have been associated with the occurrence of the disease, and in some instances the thiamin status of the affected animals is within the normal range. Notable examples are the recent observations linking dietary sulfate with the occurrence of the disease.

#### Dietary risk factors

While there has been general agreement that thiamin inadequacy is associated with the cause of PEM, the possible mechanisms by which this occurs are uncertain.<sup>5</sup> Thiamin inadequacy in ruminants could, theoretically, occur in any of the following situations where inadequate net microbial synthesis of thiamin in the rumen may occur:

- Concentrate-fed animals receiving inadequate roughage
- Impaired absorption and/or phosphorylation of thiamin
- The presence of a thiamin inhibitor in the tissues of the host
- Lack of sufficient or appropriate apoenzyme or coenzyme-apoenzyme binding for thiamin dependent systems
- Increased metabolic demands for thiamin in the absence of increased supply
- Increased rate of excretion of thiamin resulting in its net loss from the body.

Thiamin can be destroyed by thiaminases of which significant amounts can be found in the rumen contents and feces of cattle and sheep affected with naturally occurring polioencephalomalacia.

#### Thiamin inadequacy

In cattle under farm conditions, using transketolase activity as a measurement of thiamin status, up to 23% of cattle under 2 years of age and 5% over 2 years may be in a thiamin-low state. Newly weaned beef calves on a hay diet are not subject to a thiamin deficiency but a low and variable proportion of young cattle on barley-based feedlot diets (1.7%) may have some evidence of thiamin deficiency based on a thiamin pyrophosphate activity effect in excess of 15%.<sup>2</sup> The supplementation of the diet of feedlot steers on an all-concentrate barley-based diet with thiamin at 1.9 mg/kg DM resulted in an increase in average

daily gain and final carcass weights. Thus some animals may be marginally deficient in thiamin which may be associated with decreased performance in cattle fed all-concentrate diets. However, thiamin supplementation of cattle on all-concentrate diets does not consistently result in improved animal performance. The experimental disease can be produced in young lambs fed a thiamin-free milk diet and it may be unnecessary to postulate that thiamin analogs produced in the rumen are essential components of the etiology.

#### Thiaminases

A major factor contributing to PEM in cattle and sheep is a progressive state of thiamin deficiency caused by the destruction of thiamin by bacterial thiaminases in the rumen and intestines. Certain species of thiaminase-producing bacteria have been found in the rumen and intestines of animals with PEM. *Bacillus thiaminolyticus* and *Clostridium sporogenes* produce thiaminase type I and *Bacillus aneurinolyticus* produces thiaminase type II. While there is good circumstantial evidence that the thiaminases from these bacteria are the real source of thiaminases associated with the disease, it is not entirely certain. The experimental oral inoculation of large numbers of thiaminase type I producing *Clostridium sporogenes* into lambs did not result in the disease.

Certain species of fungi from moldy feed are also thiaminase producers but the evidence that they destroy thiamin and are associated with PEM is contradictory and uncertain.

The factors which promote the colonization and growth of thiaminase-producing bacteria in the rumen are unknown. Attempts to establish the organism in the rumen of healthy calves or lambs have been unsuccessful. Thiaminases have also been found in the rumen contents and feces of normal animals which may suggest the existence of a subclinical state of thiamin deficiency.<sup>5</sup> Poor growth of unweaned and weaned lambs can be associated with a thiaminase-induced subclinical thiamin deficiency. Weekly testing of young lambs over a period of 10 weeks revealed that 90% of unthrifty lambs were excreting high levels of thiaminase in their feces; low levels of thiaminase activity were present in 20% of clinically normal animals, and there were significant differences in the mean erythrocyte transketolase activity of the unthrifty animals excreting thiaminase compared to the thiaminase-free normal animals.<sup>5</sup>

Field and laboratory investigations have supported an association between inferior growth rate of weaner sheep in Australia and a thiaminase-induced

thiamin deficiency.<sup>5</sup> Thiaminase activity has been detected in the feces of lambs at 2–5 days of age, with the levels increasing for 10 days and then declining over the next 3–4 weeks.<sup>5</sup> Decreased erythrocyte transketolase activity indicated a thiamin insufficiency in lambs with high thiaminase activity and mean growth rates were 17% less than lambs with low thiaminase activity. The oral supplementation with thiamin at 2–3 weeks of age was the most appropriate prevention and treatment for subclinical thiamin deficiency.<sup>5</sup>

The parenteral or oral administration of thiamin to normal calves raised under farm conditions resulted in a marked reduction in the percentage thiamin pyrophosphate effect which is an indirect measurement of thiamin inadequacy. Goats with PEM were found to have elevated ruminal and fecal thiaminase activities, low erythrocyte transketolase activity, elevated thiamin pyrophosphate effect, low liver and brain thiamin levels, and elevated plasma glucose levels compared with goats not affected with the disease. With the increased interest in goat farming, some breeders attempt to improve body condition of breeding stock for sale or show by feeding grain or concentrate, which creates a situation similar to feedlot rearing of sheep and cattle which is conducive to the establishment of thiaminases in the rumen and the occurrence of polioencephalomalacia.

High levels of thiaminase type I are present in the rhizomes of bracken fern (*Pteridium aquilinum*) and horsetail (*Equisetum arvense*). The feeding of the bracken fern rhizomes (*Pteridium esculentum*) to sheep will cause acute thiamin deficiency and lesions similar to those of polioencephalomalacia but neither of these plants is normally involved in the natural disease. The disease has occurred in sheep grazing the Nardoo fern, *Marsilea drummondii*, in flood-prone or low-lying wet areas in Australia. The fern contains a high level of thiaminase type I activity.

*Amaranthus blitoides* (prostrate pigweed) may contain high levels of thiaminase and be associated with polioencephalomalacia in sheep.<sup>6</sup>

#### Sulfates

Polioencephalomalacia has been associated with diets high in sulfur, particularly in the form of sulfate. A high concentrate of sulfates in the diet of cattle has been associated with episodes of the disease in 6–18-month-old cattle. **Inorganic sulfate salts in the form of gypsum (calcium sulfate)** added to feedlot rations to control the total daily intake of the diet may cause PEM.<sup>7</sup> Seasonal outbreaks have occurred in feedlot beef cattle between 15 and 30 days after introduction to a **high-sulfur**

diet and the risk may increase when water is an important source of dietary sulfur, and during hot weather, when the ambient temperatures exceeded 32°C.<sup>8</sup>

Initial outbreaks may follow the use of a **new well of water containing more sulfate** than water used previously from another well, increasing from a monthly incidence of 0.07% to 0.88%. Growing cattle consume 2.4 times more water when the temperature is 32°C than at 4°C and consequently total ingestion of sulfur by consumption of high sulfate water increases during hot weather. The feed contained 2.4 g of SO<sub>4</sub>/kg DM with a total sulfur content of 0.20%. Samples of drinking water contained between 2.2 and 2.8 g of SO<sub>4</sub>/L. During hot weather daily sulfur ingestion from feed and water combined was estimated to be 64 g/animal corresponding to total dietary sulfur of approximately 0.67% of DM. Daily SO<sub>4</sub> ingestion was approximately 160 g/animal.<sup>8</sup> The ruminal sulfide levels were much higher 3 weeks after entering the feedlot, when the incidence of the disease was greatest, than 2 months after entering the feedlot when the risk of the disease was low.

In western Canada, there is an association between PEM and high levels of sodium sulfate in water, and range cows are usually affected when certain waters become concentrated with this salt during the summer months.<sup>2</sup> Water containing high levels of magnesium sulfate, often called '**gyp water**', is common in the western plains and intermountain areas of the United States and Canada.<sup>9</sup> Ideally, water for livestock consumption should contain less than 500 ppm sulfate, and 1000 ppm is considered the maximum safe level in water for cattle exposed to moderate dietary sulfur levels or high environmental temperatures. A level of 2000 ppm of sulfate in drinking water is the taste discrimination threshold for cattle. Performance of feedlot cattle is reduced when offered water with sulfate levels of 2000 ppm or higher. The National Research Council states that the requirement of sulfur in feed to be 1500 to 2000 ppm for both growing and adult beef cattle; 4000 ppm is considered the maximum tolerated dose.<sup>9</sup> Ruminant diets normally contain between 1500 to 2000 ppm (0.15–0.20% sulfur).

Based on National Research Council guidelines, 30 g of sulfur is the calculated maximum tolerated dose of sulfur for a 650 lb (294 kg) steer consuming 16.25 (7.39 kg; 2.5% BW) of feed daily. If the ambient temperature reaches 32°C, a 650 lb steer can drink 14.5 gallons (53.9 L) of water daily. Consumption of 14.5 gallons of water containing 3000 ppm sulfate results in a daily intake of 55 g sulfur. A feed intake of 2.5% BW would also consume 22.2 g of sulfur from feed containing 3000 ppm

sulfur for a total daily intake of 77.2 g of sulfur from both feed and water which is 2.5 times the maximum tolerated dose.

In some surveys, water supplies in western Canada contained contained 8447 ppm of total dissolved solids and 5203 ppm of sulfate. A survey of the sulfate concentrations in water on farms, found that high levels of sulfate can have a detrimental effect on the thiamin status of the cattle on those farms.<sup>10</sup> Cattle exposed to sulfate concentrations >1000 ppm had blood thiamin levels lower than those drinking water with low levels <200 ppm. This raises the possibility that a sub-population of cattle under such circumstances could be marginally deficient in thiamin.

**The total dietary intake of sulfur** by cattle must be considered when investigating sulfur as a cause of PEM. In a study of one farm, water from a 6.1 m well containing 3875 mg/L of total dissolved solids with 3285 mg/L of sodium sulfate was associated with PEM in heifers 6 months of age.<sup>11</sup> However, the water contributed about 20% of the total sulfur content in the diet of the heifers, and 60% of the dietary sulfur intake was supplied by the hay and 20% by the grain supplement. The hay contained 0.4% total sulfur which is at the maximum tolerable level for cattle and at the upper limit for hay.<sup>11</sup> The hay consisted of variable amounts of kochia (*Kochia scorpia*) and Canada thistle (*Cirsium arvense*). *Kochia scorpia* (summer cypress or Mexican fireweed), is high in sulfur content and has been associated with the disease in range cattle.

PEM has occurred in pastured cattle usually 5–10 days after change from a poor to a good pasture, and may occur in range cattle grazing on dry, short, grama grass pasture.<sup>12</sup>

The levels of sulfate in water which have affected feed intake in cattle have varied from 2800 to 3340 mg sulfate per/L while other studies found no reduction in feed intake with levels up to 7000 mg/L.<sup>11</sup> It appears that the different effects of sulfur toxicity for similar sulfur contents in saline water are attributed to the total sulfur intake. Outbreaks of the disease may occur in adult cattle on pasture drinking water containing 7200 ppm of sodium sulfate.<sup>2</sup> Thus established guidelines for saline drinking water are not applicable when cattle are fed feeds grown in saline areas.

A combination of excessive intake of sulfur and a low dietary intake of trace minerals, especially copper, may affect the thiamin status of a cattle herd and contribute to PEM.<sup>13</sup> Sulfur adversely affects both thiamin and copper status in sheep.<sup>14</sup> A nutritionally related PEM has also been reproduced in calves fed a semipurified,

low-roughage diet of variable copper and molybdenum concentrations and it was not related to copper deficiency.<sup>15</sup> The disease has occurred in cattle in New Zealand fed chou moellier (*Brassica oleracea*) which contained sulfur concentrations of 8500 mg/kg DM.<sup>16</sup> The morbidity was 25% and mortality 46% despite rapid conventional therapy.

**Ammonium sulfate** used as a urinary acidifier in the rations of cattle and sheep has been associated with outbreaks of PEM.<sup>3</sup> Morbidity rates ranged from 16 to 48% and mortality rates from 0 to 8%. Affected animals did not respond to treatment with thiamin.

Outbreaks have occurred in sheep exposed to an alfalfa field previously sprayed with 35% **suspension of elemental sulfur**.<sup>17</sup> The disease can be induced experimentally in lambs by the administration of sodium hydrosulfide into the esophagus<sup>18</sup> and has occurred in lambs 3–4 weeks after being fed a concentrate ration containing 0.43% sulfur.<sup>19</sup> Feeding experimental diets containing inorganic sulfur to young lambs was associated with PEM and supplementation of those diets with thiamin decreased the severity of the lesions.<sup>20</sup> Rumen microbes are able to reduce sulfate to sulfides which may be directly toxic to the nervous system. Feeding calves (115–180 kg) a semipurified diet high in readily fermentable carbohydrate, without long fiber, and with added sodium sulfate for a total sulfur content of 0.36% resulted in PEM within 21 days of the introduction of the experimental diet.<sup>21</sup> An odor of hydrogen sulfide was frequently detected upon passage of a stomach tube into the rumen of all calves during the experiment. The total thiamin concentrations in affected and control calves remained within normal limits.

The dietary content of copper, zinc, iron, and molybdenum may also have important modifying influences on sulfur toxicosis. Molybdenum and copper can combine with sulfur to form insoluble copper-thiomolybdate. Copper, zinc, and iron form insoluble salts with sulfide, and their expected effect would be to decrease the bioavailability of sulfide in the rumen. Conversely, low, but not necessarily deficient, dietary contents of these divalent metals could be prerequisites for excess absorption of sulfide to occur. PEM is not associated with copper deficiency but copper and sulfur metabolism are interdependent. An excess of dietary sulfur may result in depression of serum copper, or alternatively, low serum copper may potentiate the actions of toxic levels of sulfur. Chronic copper poisoning in a lamb has been associated with PEM.<sup>22</sup> It is suggested that the copper toxicity may have caused decreased hepatic function resulting in

increased plasma concentration of sulfur containing amino acids which may have predisposed to sulfur toxicity encephalomalacia.

**Molasses toxicity occurs in Cuba in cattle** fed on a liquid molasses-urea feeding system with limited forage. The clinical and necropsy findings are identical to polioencephalomalacia. However, molasses toxicity is not thiamin responsive and can be reversed by feeding forage. Molasses has high inorganic sulfur content and the thiamin concentrations in the brain and liver with PEM which were fed molasses and urea did not differ from those in normal cattle.

Other dietary circumstances

**Deprivation of feed and water.** In some outbreaks there is a history of deprivation of feed and water for 24–28 hours, because of either a managerial error or frozen water supplies. In other cases, a rapid change in diet appears to precipitate an outbreak. Some outbreaks are associated with a temporary deprivation of water for 24–36 hours, followed by sudden access to water and an excessive supply of salt, a situation analogous to salt poisoning in pigs, but these require more documentation to insure that they indeed are not salt poisoning.

In sheep flocks, a drastic change in management, such as occurs at shearing time, will precipitate outbreaks in which only the yearlings are affected. Changing the diet of sheep from hay to corn silage resulted in a decrease in thiamin concentrations in ruminal fluid to about 25% of control values on hay. The cause of the drop in thiamin concentrations is unknown.

**Phalaris aquatica 'polioencephalomalacia-like' sudden death in sheep and cattle.** The Mediterranean perennial grass, *Phalaris aquatica* (formerly *Phalaris tuberosa*) can cause sudden death in sheep and cattle throughout southern Australia.<sup>23</sup> The nervous form of disease is similar clinically to polioencephalomalacia but atypical because of the very rapid onset and the absence of either neuronal necrosis or malacia in cerebral cortical sections from affected animals. The available evidence suggests that this form of phalaris sudden death is more likely to involve a peracute form of ammonia toxicity than a peracute form of polioencephalomalacia.

## PATHOGENESIS

### Thiamin inadequacy polioencephalomalacia

High levels of thiaminases are formed in the rumen, which destroy thiamin that is naturally synthesized.<sup>1</sup> The circumstances in the diet or in the rumen which allow for the development of high levels of

thiaminases are unknown but may be related to the nature of the ruminal microflora in young cattle and sheep fed concentrate rations which results in the development of ruminal acidosis. These rations may also allow for the development and growth of thiaminase-producing bacteria which, combined with a smaller net synthesis of thiamin in the rumens of concentrate-fed ruminants, could explain the higher incidence in feedlot animals. Experimentally PEM has been produced in lambs by continuous intraruminal infusion of a highly fermentable diet. Animals changed very rapidly to high concentrate rations develop increased ruminal thiaminase levels.

The possibility that intraruminal thiaminases may also create thiamin analogs capable of acting as thiamin antimetabolites and accentuating the disease has been studied but the results are inconclusive. The presence of naturally occurring second substrates (cosubstrates) in the rumen could produce, by the thiaminase type I reaction, a potent thiamin antimetabolite capable of accentuating the condition. In vitro studies have shown that thiaminase only caused rapid destruction of thiamin when a second substrate was added, and a large number of drugs commonly used as anthelmintics or tranquilizers may be active as second substrates. Many compounds found in the rumen of cattle are potential cosubstrates.

Amprolium has been used extensively to produce the lesions in the brains of cattle and sheep that are indistinguishable from the naturally occurring disease.<sup>1</sup> However, since amprolium has been found in the brain tissue, the experimental disease should perhaps be known as 'amprolium poisoning encephalopathy'. The administration of other antagonists such as oxythiamin and pyrithiamin does not produce the disease. This suggests that polioencephalomalacia is a particular form of thiamin deficiency in which the supply of thiamin is reduced by the action of intraruminal thiaminase. Thus, the thiamin status of the animal will be dependent on dietary thiamin intake, thiamin synthesis, the presence of thiaminase in the rumen and the effects of possible antimetabolites. Subclinical states of thiamin deficiency probably exist in apparently normal cattle and sheep being fed diets which are conducive to the disease. This suggests that in outbreaks of the disease the unaffected animals of the group should be considered as potential new cases and perhaps treated prophylactically.

Thiamin is an essential component of several enzymes involved in intermediary metabolism and a state of deficiency results in increased blood concentration

of pyruvate, a reduction in the lactate to pyruvate ratio and depression of erythrocyte transketolase. These abnormalities affect carbohydrate metabolism in general, but in view of the specific requirements of the cerebral cortex for oxidative metabolism of glucose, it is possible that a thiamin inadequacy could have a direct metabolic effect on neurons.<sup>1</sup> The brain of the calf has a greater dependence on the pentose pathway for glucose metabolism, in which pathway the transketolase enzyme is a rate-limiting enzyme. Ultrastructural examination of the brain of sheep with the natural disease reveals that the first change which occurs is an edema of the intracellular compartment, principally involving the astrocytes and satellite cells. This is followed by neuronal degeneration which is considered secondary. It has been suggested that the edema may be due to a reduction in ATP production following a defect of carbohydrate metabolism in the astrocyte. There are three basic lesions which are not uniform: compact necrosis, edema necrosis, and edema alone. This may suggest that a uniform etiology such as thiamin deficiency cannot be fully supported.

In the cerebral cortex of affected animals, autofluorescent spots are observed under ultraviolet 365 nm illumination and are a useful diagnostic aid. The distribution of autofluorescence corresponds to that of mitochondria in cerebrocortical neurocytes in affected calves, suggesting that metabolic impairment occurs and the autofluorescent substance is produced in the mitochondria.<sup>24</sup> Mitochondrial swelling and disorganization of cristae are also observable in brain tissue, but are not specific to polioencephalomalacia.

### Sulfate-induced polioencephalomalacia

Diets high in sulfur result in hydrogen sulfide production in the rumen and anaerobic bacteria from rumen samples of cattle fed high-carbohydrate, short fiber diets with added sulfate will generate hydrogen sulfide in rumen fluid broth medium.<sup>18,25</sup> Rumen microflora adapt to higher dietary sulfate content over a period of 10–12 days before they are capable of generating potentially toxic concentrations of sulfide.<sup>26</sup> In experimental sulfate diets which induce PEM, the rumen pH decreases during the transition to the experimental diet and acidic conditions in the rumen favor increased rumen gas cap concentrations of hydrogen sulfide. With a change of pH from 6.8 to 5.2, the percent hydrogen sulfide in the rumen gas cap increased from 47 to 97%.<sup>7</sup>

If ruminants inhale 60% of eructated gases, inhalation of hydrogen sulfide could be a route of systemic sulfide absorption,



in addition to gastrointestinal absorption.<sup>21</sup> Sulfide inhibits cellular respiration leading to hypoxia which may be sufficient to create neuronal necrosis in polioencephalomalacia. The nervous system lesions of sulfur toxicosis are indistinguishable from lesions in the naturally occurring disease.

### Acute cerebral edema and laminar necrosis

Acute cerebral edema and laminar necrosis occur and the clinical signs are usually referable to increased intracranial pressure from the edema, and the widespread focal necrosis. Recovery can occur with early treatment which suggests that the lesions are reversible up to a certain point. ECGs of buffalo calves with amprolium-induced PEM found decreased frequency patterns, occasional spindles and decreased voltage patterns during the onset of clinical signs. In the comatose stage, there was little evidence of electrical activity. EEGs of animals treated with thiamin hydrochloride found normal awake patterns.<sup>27</sup>

### CLINICAL FINDINGS

#### Cattle

Animals may be found dead without premonitory signs especially in beef cattle on pasture.<sup>2</sup> The clinical findings are variable but characteristically, there is a sudden onset of **blindness, walking aimlessly, ataxia, muscle tremors**, particularly of the head with ear twitching, **champing of the jaws** and frothy salivation, **head-pressing**, and the animal is difficult to handle or move. Dysphagia may be present when one attempts to force feed hay by hand. Grinding of the teeth is common. Initially, the involuntary movements may occur in episodes, and convulsions may occur, but within several hours they become continuous. The animal usually then becomes recumbent, and there is marked opisthotonos, nystagmus, clonic-tonic convulsions, particularly when the animal is handled or moved, and tetany of the forelimbs is common. The temperature is usually normal but elevated if there has been excessive muscular activity. The heart rate may be normal, subnormal, or increased and is probably not a reliable diagnostic aid.

Rumen movements remain normal for a few days, which is an important distinguishing feature from lead poisoning in which the rumen is static.

The **menace reflex is always absent** in the acute stage and its slow return to normal following treatment is a good prognostic sign. The **palpebral eye-preservation reflex is usually normal**. The pupils are usually of normal size and responsive to light. In severe cases the pupils may be constricted. Dorsal strabismus due to stretching of the trochlear nerve is common. Nystagmus is common

and may be vertical or horizontal. Optic disc edema is present in some cases but is not a constant finding.

Calves 6–9 months of age may die in 24–48 hours, while older cattle up to 18 months of age may survive for several days. Recovery is more common in the older age group.

In less severe cases, affected animals are blind, head-press into walls and fences, and remain standing for several hours or a few days. In outbreaks, some cattle will be sternally recumbent; others remain standing with obvious blindness, while others are anorexic, mildly depressed, and have only partial impairment of eyesight. Those with some eyesight will commonly return to almost normal. Some survivors are permanently blind to varying degrees but may begin to eat and drink if provided with assistance. Some cases will recover following treatment and may grow and develop normally.<sup>3</sup>

Evidence of recovery within a few hours following treatment with thiamin indicates that the disease is associated with thiamin inadequacy. A failure of response indicates the possibility of sulfur toxicity polioencephalomalacia.

#### Sheep

Sheep usually begin to wander aimlessly, sometimes in circles, or stand motionless and are blind, but within a few hours they become recumbent with opisthotonos, extension of the limbs, hyperesthesia, nystagmus, and periodic tonic-clonic convulsions. Hoggets affected at shearing time may show blindness and head-pressing but, if fed and watered, usually recover within a few days. Occasional animals show unilateral localizing signs, including circling and spasmodic deviation of the head. In goats, early signs may include excitability and elevation of the head. Blindness, extreme opisthotonos, and severe extensor rigidity and nystagmus are common.

In sulfur-induced PEM in sheep introduced to a diet containing 0.43% sulfur, clinical signs occurred 15–32 days later and consisted of depression, central blindness, and head-pressing, but no hyperesthesia, nystagmus, or opisthotonos were observed.<sup>11</sup> In sulfur toxicity in lambs with PEM, the rumen contents may have a strong odor of hydrogen sulfide (rotten egg smell).<sup>17</sup>

There are some reports from Australia of unthriftiness in unweaned and weaned lambs being associated with thiamin deficiency due to the presence of thiaminases in the alimentary tract.<sup>5</sup> In affected flocks the incidence of illthrift in lambs is much higher than the usual incidence and other causes of unthriftiness were ruled out. Affected lambs lose weight, may have chronic diarrhea, and become emaciated

and die from starvation. In some flocks, clinical signs of PEM may occur in a small percentage of animals. The disease occurs most commonly in early July which is the coldest part of the year in Australia for lambs which are born in May and June. In affected lambs the fecal thiaminase levels are high and the blood transketolase level activity is increased above normal. Treatment of affected lambs with thiamin resulted in an increase in growth rate.<sup>5</sup>

### CLINICAL PATHOLOGY

#### Thiamin status and metabolism

The biochemical changes occurring in cattle and sheep with the thiamin-deficiency PEM have not been well-defined diagnostically based on thoroughly investigated naturally occurring clinical cases. However, some estimates are available including the changes which occur in the experimental disease. Interpretation of the values may also be unreliable if the animals have been treated prior to death.

The **erythrocyte transketolase activity** is decreased and the thiamin pyrophosphate (TPP) effect is increased. The erythrocyte transketolase activities in normal sheep will range from 40 to 60  $\mu\text{M}$ /mL red blood cells. A TPP effect of 30–50% is commonly found in normal healthy cattle and sheep and an increase to above 70–80% occurs in animals with polioencephalomalacia.

The **thiamin concentrations** of blood of animals with polioencephalomalacia have varied widely and may be difficult to interpret because of the possibility of thiamin analogs inducing deficiency even when blood thiamin levels are normal. However, this would not apply when blood thiamin levels are below normal. A normal reference range of 75–185 nmol/L is suggested for both cattle and sheep, and levels below 50 nmol/L are considered indicative of deficiency.<sup>28</sup> In normal goats, the mean thiamin content of blood was 108 nmol/L, with a range of 72–178 nmol/L.<sup>12</sup> In goats with polioencephalomalacia, blood thiamin levels were less than 66 nmol/L with a mean of 29 nmol/L. Levels as low as 1.8–3.6  $\mu\text{g}/\text{dL}$  (6–12 nmol/L) have been found in suspected cases of polioencephalomalacia. The thiamin concentrations of liver, heart, and brain of cattle and sheep with polioencephalomalacia are decreased. The levels of blood pyruvate and lactate are also increased and thiamin pyrophosphate-dependent enzymes such as pyruvate kinase are decreased.<sup>3</sup> The thiaminase activity of the feces is increased.<sup>5</sup>

The **hemogram** is usually normal; the total and differential leukocyte counts may indicate a mild stress reaction, a finding which may be useful in differentiation

from encephalopathies due to bacterial infections.

**Cerebrospinal fluid pressure** taken at the cisterna magna is increased from a normal range of 120–160 mm saline to levels of 200–350 mm. The level of protein in the CSF may be normal to slightly or extremely elevated. A range from 15 to 540 mg/dL with a mean value of 90 mg/dL in affected cattle is recorded. There may also be a slight to severe pleocytosis in the CSF in which monocytes or phagocytes predominate.

**Ruminal sulfide measurement.** Changes in rumen gas cap H<sub>2</sub>S concentrations are larger than changes in rumen fluid H<sub>2</sub>S concentrations and estimation of rumen gas H<sub>2</sub>S concentration may be a practical method of detecting pathological increases in ruminal hydrogen sulfide gas.<sup>29,30</sup> A simple, rapid, minimally invasive method may be useful for estimating the H<sub>2</sub>S concentration of ruminal gas under field conditions. A sterile 8.9 cm 18 g needle with stillete is introduced into the gas cap of the rumen by way of the left paralumbar fossa. The needle is then connected to calibrated H<sub>2</sub>S detector tube. In cattle, with sulfate-induced polioencephalomalacia, increases in ruminal gas H<sub>2</sub>S may be as high as 100 times more than control animals.<sup>29</sup>

**Brain function.** The effects of high dietary sulfur on brain function have been examined using evoked potentials techniques.<sup>31</sup> Altered nerve conduction pathways occur in sheep fed high sulfur diets without supplemental thiamin compared to animals which have received thiamin.<sup>31</sup> The visual evoked potentials are abnormal in ruminants with thiamin-responsive polioencephalomalacia.<sup>32</sup>

#### NECROPSY FINDINGS

Diffuse cerebral edema with compression and yellow discoloration of the dorsal cortical gyri is evident and the cerebellum is pushed back into the foramen magnum with distortion of its posterior aspect.

In recovered animals, there is macroscopic decortication about the motor area and over the occipital lobes. The lesion can be identified grossly using ultraviolet illumination which results in a fluorescence that indicates necrosis of brain and engulfment of necrotic tissue by lipophages. In general, there is a good correlation between the presence of characteristic fluorescence and the biochemical changes in cases of polioencephalomalacia. A small percentage of false negatives may occur.

Histologically the lesions are widespread but most common in the cerebral cortex. There is bilateral laminar necrosis and necrosis of deeper cerebral areas. The necrosis is most prominent in the dorsal

occipital and parietal cortex, but bilateral areas of necrosis are also seen less frequently in the thalamus, lateral geniculate bodies, basal ganglia, and mesencephalic nuclei. Lesions of the cerebellum are also present. The severity and distribution of the lesions probably depend on the interrelationships between clinical severity, age of affected animal, and length of illness before death.

Subnormal levels of thiamin are detectable in the liver and brain of calves with the natural disease and low levels are also found in the experimental disease.<sup>21</sup> In the molasses-induced disease in Cuba, the tissue thiamin levels were within the normal range.

In some cases of sulfur-associated polioencephalomalacia, the rumen contents have a strong odor of hydrogen sulfide – the rotten egg smell.

#### DIFFERENTIAL DIAGNOSIS

None of the biochemical tests described under clinical pathology is practical. The diagnosis must be made on the basis of clinical findings and the readily available simple tests which rule out other diseases that resemble polioencephalomalacia. A careful consideration of the epidemiological history often assists in the diagnosis.

#### Cattle

The differential clinical diagnosis for cattle is summarized in Table 32.3. Polioencephalomalacia in cattle occurs primarily in young growing animals 6–9 months of age on concentrate rations and is characterized clinically by a sudden onset of blindness, muscular tremors of the head and neck, head-pressing, nystagmus, and opisthotonos. The disease also occurs in mature beef cattle on pasture containing a high level of sulfate in their water and feed.

In cattle the disease must be differentiated from:

- **Acute lead poisoning** which is most common in calves after spring turnout but occurs in adult cattle too and is characterized by central blindness, tremors, convulsions, uncontrollable activity with bellowing, champing fits, hyperexcitability, rumen stasis, and death in several hours. Early treatment may be successful
- **Subacute lead poisoning** characterized by blindness, stupor, head pressing, rumen stasis, weak palpebral reflexes, and no response to therapy
- **Hypovitaminosis-A** characterized by a history of a vitamin A deficient diet and nyctalopia, peripheral blindness, dilated and fixed pupils, optic disk edema, and transient convulsions followed by recovery
- **Histophilus meningoencephalitis** characterized by sudden onset of ataxia, recumbency, fever, depression with eyes closed, lesions of the fundus, marked changes in hemogram, enlarged joints, and death in several hours if not treated early.

#### Sheep

In sheep polioencephalomalacia must be differentiated from:

- **Enterotoxemia (pulpy kidney disease) due to *Cl. perfringens* type D** in unvaccinated sheep, especially feedlot lambs, in which the clinical findings are almost identical; it occurs under the same management conditions as polioencephalomalacia. Enterotoxemia in lambs usually develops within several days after being placed on a grain ration, whereas polioencephalomalacia occurs after several weeks of grain feeding. Glycosuria in pulpy kidney disease may assist the diagnosis but a necropsy is usually more informative
- **Focal symmetrical encephalomalacia** also resembles polioencephalomalacia but is sporadic, usually involves only a few animals and will not respond to treatment.

#### Goats

In goats the disease must be differentiated from caprine leukoencephalomyelitis, listeriosis, enterotoxemia, pregnancy toxemia, lead poisoning, and meningoencephalitis.

#### TREATMENT

##### Thiamin hydrochloride

The treatment of choice for thiamin deficiency PEM is thiamin hydrochloride at 10 mg/kg BW IV initially and followed by similar doses every 3 hours for a total of 5 treatments. When treatment is given within a few hours of the onset of signs, a beneficial response within 1–6 hours is common and complete clinical recovery can occur in 24 hours. Goats and sheep will commonly respond within 1–2 hours. For those which take longer to recover, the eyesight and mental awareness will gradually improve in a few days and the animal will usually begin to eat and drink by the third day after treatment. Rumen transplants of rumen juice from roughage-fed cattle may improve appetite and rumen function in those responding slowly. In sheep, following treatment with thiamin the blood transketolase activity begins to return to normal in 2–4 hours and is considered normal 24 hours after treatment.

Some cattle improve to a subnormal level within a few days and fail to continue to improve. These are usually affected with diffuse cortical and subcortical necrosis and will usually not improve further in spite of continued treatment. Those which return to a clinically normal state will usually do so by 48 hours or sooner after initial treatment. Those which are still clinically subnormal and anorexic by the end of the third day will usually remain at that level and should be slaughtered for salvage.

Treatment is ineffective in advanced cases, but unless an accurate history is

available on the length of the illness, it is usually difficult to predict the outcome until 6–12 hours following treatment. Thus, it is usual practice to treat most cases with thiamin at least twice and monitor the response. If there is no beneficial response in 6–8 hours, emergency slaughter for salvage should be considered.

The oral administration of thiamin or thiamin derivatives is indicated when thiaminases are thought to be in the alimentary tract. Thiamin hydrochloride at a rate of 1 g for goats and lambs and 5 g for calves, in a drench, is recommended. However, because the action of thiaminase type I on thiamin may result in the production of thiamin analogs which may act as inhibitors of thiamin metabolism, the use of thiamin derivatives which are resistant to thiaminases, lipid soluble and absorbed from the intestine are being explored as therapeutic and prophylactic agents. Thiamin propylsulfide can depress the thiaminase activities in the ruminal fluid of sheep with polioencephalomalacia within 2 hours after oral administration. The blood pyruvate levels and transketolase activities are also restored to normal and treated animals recovered clinically.

#### Outbreak management

In outbreaks, the in-contact unaffected animals on the same diet as the affected animals may be on the brink of clinical disease. The diet should be changed to one containing at least 50% roughage or 1.5 kg of roughage per 100 kg BW. Thiamin may be added to the ration at the rate of 50 mg/kg of feed for 2–3 weeks as a preventive against clinical disease, followed by a level of 20–30 mg/kg of feed (cattle and sheep) if the animals remain on a diet that may predispose them to the disease.

#### Sulfur toxicity polioencephalomalacia

There is no specific treatment for PEM caused by sulfate toxicity. The use of thiamin hydrochloride in doses given above is recommended.<sup>7</sup>

#### CONTROL

##### Thiamin supplementation

A rational approach to the control of PEM associated with thiamin inadequacy is to supplement the rations of concentrate-fed cattle and sheep with thiamin on a continuous basis. The daily requirements for protection have not been determined using controlled feeding trials but a rate of 3 mg/kg DM of feed for cattle and sheep has been recommended. This level may not be protective in all situations and response trials may be necessary to determine protective levels for different situations. Levels up to 20–30 mg/kg of feed may be necessary for protection. Most

natural feedstuffs for ruminants contain thiamin at about 2 mg/kg DM which when combined with the thiamin synthesized in the rumen will meet the requirements. However, the presence of thiaminases in the rumen will necessitate dietary supplementation with thiamin, but the optimal amount that will provide protection under practical conditions is uncertain.

The IM injection of 500 mg thiamin 3 times weekly into 6-month-old calves raised under practical farm conditions will steadily reduce the percentage thiamin pyrophosphate effect to zero in about 6 weeks. The daily oral administration of 100 mg thiamin to young calves fed initially on milk substitutes and then on concentrates and hay results in a decrease in percentage pyrophosphate effect.

For animals which are fed diets associated with thiamin inadequacy, it is recommended that thiamin be added to the diet at the rate of 5–10 mg/kg DM.<sup>12</sup> Cattle and sheep on concentrate-fed rations must also receive supplements containing all necessary vitamins and minerals, especially cobalt, a deficiency of which may be associated with some outbreaks of the disease.

#### Feeding roughage

The minimum amount of roughage which should be fed to feedlot cattle and sheep in order to prevent the disease and still maintain them on high levels of concentrates is unknown. A level of 1.5 kg of roughage per 100 kg BW has been recommended but this may not be economical for the feedlot whose profits are dependent on rapid growth in grain-fed cattle. Supplementation of the diet with thiamin appears to be the only alternative.

The prevention of the disease in sheep which are being moved long distances or gathered together for shearing and other management practices will depend on insuring an ample supply of roughage and water and avoiding drastic changes in management.

#### Sulfate toxicity PEM

The prevention of the disease associated with a high sulfur intake in the feed and water supplies will depend on analysis of the feed and water for sulfate and making appropriate adjustments in the sources of feed and water in order to decrease the intake of sulfur to safe levels.

#### REVIEW LITERATURE

Niles GA, Morgan SE, Edwards WC. The relationship between sulfur, thiamine and polioencephalomalacia – a review. *Bovine Pract* 2002; 36:93–99.  
Gould DH. Polioencephalomalacia. *J Anim Sci* 1998; 76:309–314.

#### REFERENCES

- Loew FM. *World Rev Nutr Diet* 1975; 20:168.
- Hamlen H et al. *Can Vet J* 1993; 34:153.
- Jeffrey M et al. *Vet. Rec* 1994; 134:343.

- Smits JEG, Wobeser G. *Can Vet J* 1990; 31:300.
- Thomas KW, Griffiths FR. *Aust Vet J* 1987; 64:207.
- Ramos JJ et al. *Can Vet J* 2005; 46:59.
- Niles GA et al. *Bovine Pract* 2002; 36:93.
- McAllister MM et al. *J Am Vet Med Assoc* 1997; 211:1275.
- Niles GA et al. *Bovine Pract* 2002; 36:101.
- Olkowski AA et al. *Can J Anim Sci* 1991; 71:825.
- Beke GJ, Hironaka R. *Sci Total Environ* 1991; 101:281.
- Rammell CG, Hill JH. *NZ Vet J* 1988; 36:99.
- Gooneratne SR et al. *Can Vet J* 1989; 30:139.
- Olkowski AA et al. *Res Vet Sci* 1990; 48:82.
- Sager RL et al. *Am J Vet Res* 1990; 51:1969.
- Hill JH, Ebbett PC. *NZ Vet J* 1997; 45:37.
- Bulgin MS et al. *J Am Vet Med Assoc* 1996; 208:1996.
- McAllister MM et al. *J Comp Pathol* 1992; 106:267.
- Low JC et al. *Vet Rec* 1996; 138:327.
- Rousseaux CG et al. *J Vet Med A* 1991; 38:229.
- Gould DH et al. *Am J Vet Res* 1991; 52:1164.
- Sargison ND et al. *Vet Rec* 1994; 135:556.
- Bourke CA et al. *Aust Vet J* 2005; 83:168.
- Shibahara T et al. *Aust Vet J* 1999; 77:329.
- Cummings BA et al. *Vet Pathol* 1995; 56:1384.
- Cummings BA et al. *Am J Vet Res* 1995; 56:1390.
- Sundar NS et al. *Agri Pract* 1996; 17:34.
- Hill JH et al. *NZ Vet J* 1988; 36:49.
- Gould DH et al. *J Vet Diagn Invest* 1997; 9:72.
- Gould DH. *J Anim Sci* 1998; 76:309.
- Olkowski AA et al. *Can J Vet Res* 1990; 54:113.
- Strain G et al. *Am J Vet Res* 1990; 51:1513.

### EQUINE NEONATAL ENCEPHALOPATHY (NEONATAL MALADJUSTMENT SYNDROME OF FOALS, DUMMY FOAL, BARKERS, AND WANDERERS)

This is a syndrome of foals less than 36 hours of age characterized by a spectrum of changes in mentation ranging from failure to suckle, abnormal behavior, seizures, through coma in otherwise apparently healthy foals.

#### ETIOLOGY

A number of diseases cause the clinical signs consistent with this syndrome. These include antenatal, natal or postnatal hypoxia, congenital and metabolic anomalies, placental abnormalities, intracranial hemorrhage, prematurity, and thoracic trauma.<sup>1</sup> Of these causes, hypoxia before, during or soon after birth is considered the most common cause of neonatal encephalopathy, although hypoxia is rarely documented. It is important to realize the neonatal encephalopathy is one of many manifestations of hypoxia of the fetus or neonate, the other manifestations including gastrointestinal and renal damage.<sup>2,3</sup>

#### EPIDEMIOLOGY

The disease is sporadic and occurs worldwide with an annual **incidence** in foals of approximately 1%.<sup>4</sup> Foals of either sex and of any breed born to mares of any age

Table 36.2 Differential diagnosis of comatose (sleeper) neonatal foals

Disease	Epidemiology	Clinical findings	Clinical pathology	Lesions	Treatment and prognosis
<i>Actinobacillus equuli</i> septicemia	Foals to 3 months but usually <2 weeks. Enzootic to some farms.	Sudden onset recumbency, fever, abdominal pain, diarrhea, joint distension. Death.	<i>A. equuli</i> in blood or joint fluid	Septicemia, septic synovitis/arthritis, nephritis with abscesses in renal cortex.	Penicillin and gentamicin or other broad spectrum antibiotic, supportive care. Fair prognosis if treated early.
Septicemia	<i>E. coli</i> , <i>Klebsiella</i> sp., <i>Streptococcus</i> sp., <i>Salmonella</i> sp., <i>Actinobacillus suis</i> , Equine herpesvirus-1. Failure of transfer of passive immunity.	Abrupt onset of depression, fever, failure to nurse and recumbency. Later diarrhea, pneumonia and joint distension.	Culture of organism from blood or lesions (joints, lungs, feces).	Consistent with septicemia. Pneumonia. Septic synovitis, arthritis, osteomyelitis.	Broad spectrum antibiotics, supportive care (see 'Principles of providing care to the critically ill neonate'). Guarded to poor prognosis.
Isoimmune hemolytic anemia	Incompatible mating of Aa+ or Qa+ stallion with negative mare.	Normal at birth. Subsequent depression, cessation of nursing, exercise intolerance, icterus, anemia. Hemoglobinuria in severe cases.	Positive Coomb's test to demonstrate immunoglobulin on foal's red cells. Dam's colostrum agglutinates or lyses foal red cells.	Anemia, icterus. Death due to anemic hypoxia.	Transfusion of washed dam's red blood cells or of compatible donor (check dam's plasma with donor's red cells). Fair prognosis.
Uroperitoneum	Ruptured bladder, urachus or ureteral defect. Colts 1 to 3 days of age. Foals of either sex with other systemic diseases.	Normal at birth. Onset of abdominal distension, mild colic, depression and recumbency. May urinate small volumes.	Peritoneal fluid has high creatinine concentration. Hyperkalemia, hyponatremia, hypochloremia.	Uroperitoneum. Rupture bladder, urachus or ureter.	Surgical correction AFTER drainage of abdomen and resolution of hyperkalemia with intravenous dextrose or 0.9% NaCl. Good prognosis with appropriate care.
Hypoglycemia	Failure to nurse. Rejection by mare. Mare has no milk (agalactia)	Normal at birth, repeated attempts to nurse. Gradual onset (hours) of weakness and depression.	Low blood glucose concentration (<60 mg/dL, 3 mmol/L).	None. No food in stomach.	Excellent response to feeding or intravenous glucose.
Neonatal maladjustment syndrome	Sporadic	Onset of abnormal behavior, recumbency, failure to nurse or orient to mare. Aimless wandering and vocalization.	None characteristic. Frequently failure of transfer of passive immunity.	Usually none apparent. Occasional intracranial vascular accidents.	Supportive care (see 'Principles of providing care to critically ill neonates'). Good prognosis.
Congenital defects	Sporadic	Depends on nature of cardiac, gastrointestinal or central nervous system defect.	None	Consistent with defect.	Usually no treatment. Poor prognosis depending on defect.

or reproductive history can be affected. The **case fatality rate** is very low for appropriately treated foals without other systemic illness.

### PATHOGENESIS

It is speculated that hypoxia resulting from intracranial vascular accidents,<sup>5</sup> asphyxia at birth or placental insufficiency before birth damages the central nervous system. Neurological abnormalities and a failure to nurse, result in a failure of the transfer of maternal immunoglobulins, which predisposes the foal to septicemia and hypoglycemia.

### CLINICAL SIGNS

**Foals that are abnormal at birth** can display a range of behavioral abnormalities,

from lack of suckle reflex to convulsions with extensor rigidity. The placenta of affected foals is often abnormal or there is a history of prolonged parturition. Affected foals either do not develop or lose the suck reflex, and have no affinity for the mare and are unable to locate the udder or teat. Aimless wandering and a characteristic 'barking' vocalization are sometimes present. Recumbent foals struggle wildly and in an uncoordinated fashion to stand. Convulsing foals usually display opisthotonos with extensor rigidity. Other signs of convulsive activity include facial twitching and grimacing, nystagmus, rapid blinking, sucking, chewing, and drooling.<sup>1</sup> Between episodes foals are usually depressed or somnolent. Affected

foals display little or no interest in the mare. Convulsing foals are tachypneic, tachycardic (>180 bpm), and hyperthermic (>39°C, 102°F) during and immediately after convulsions. It is important to recognize that the severity of clinical signs varies from very mild (foals are often described by owners as being a bit slow or dimwitted) through to grand mal seizures.

**Foals that are normal** at birth may develop signs by 24 hours of age. The signs are similar to those described above, with the exception that the foals are initially able to ambulate. It is important to realize that healthy newborn foals lack a menace reflex, have a hypermetric gait and intention tremor, and become flaccid when restrained.

Affected foals can take days to weeks to recover completely. Blind foals that do not have ocular lesions can take as long as 4–6 weeks to regain vision.

Ancillary testing is not usually indicated unless the foal fails to respond after approximately 7 days. At that time, CT or MRI examination of the brain might be indicated to detect congenital anomalies such as hydrocephalus. Examination of cerebrospinal fluid should be performed in any foal with signs of CNS dysfunction in the presence of fever or other signs of sepsis.

### CLINICAL PATHOLOGY

There are no hematological or serum biochemical abnormalities characteristic of the disease:

- Affected foals usually have **failure of transfer** of maternal immunoglobulins (serum IgG <400 mg/dL)
- They may be **hypoglycemic** (<80 mg/dL, 4 mmol/L)
- **Cerebrospinal** fluid is often normal, although it may contain red blood cells or appear xanthochromic as a result of bleeding.

### DIAGNOSTIC CONFIRMATION

**Definitive diagnosis** of the disease is difficult and is based on exclusion of other diseases that can cause similar signs and, at necropsy, demonstration of intracranial lesions consistent with the disease.

### NECROPSY FINDINGS

Gross changes are typically limited to diffuse pulmonary congestion with a variable degree of atelectasis. In cases in which dystocia has been a contributing factor, fractured ribs, and foci of subcutaneous edema and hemorrhage are sometimes noted. Occasionally, macroscopic cerebral hemorrhages are visible. Histologically, the key findings are hemorrhagic foci within the brain and areas of ischemic necrosis in the cerebral cortex.<sup>6</sup> Meconium and other components of aspirated amniotic fluid accompanied by atelectasis and a mild inflammatory response may be present within the lung. In less affected foals the brain lesions are restricted to hemorrhage, cerebral swelling, and edema. Many affected foals have evidence of intracranial vascular accidents.<sup>7</sup> Affected foals that are euthanased often have no detectable lesions in the brain.

### Samples for post-mortem diagnostic confirmation

Formalin-fixed brain, including cerebral cortex, cerebellum and brain stem, and lung for light microscopic examination.

### DIFFERENTIAL DIAGNOSIS

The disease must be differentiated from other diseases that cause neurological or behavioral abnormalities in foals including: sepsis; renal, hepatic, or gastrointestinal disease, which can occur secondary to fetal hypoxia; hydrocephalus; hypoglycemia; meningitis; neonatal isoimmune hemolytic anemia; and prematurity, dysmaturity, or immaturity.

### TREATMENT

The principles of treatment are:

- Control of convulsions
- Treatment of cerebral edema and hemorrhage
- Correction of failure of transfer of passive immunity
- Nutritional support and general nursing care. The management of affected foals is mainly supportive and is time consuming and labor intensive.

Provision of nutritional support, treatment of failure of passive transfer of maternal immunoglobulins, and nursing care is dealt with in detail in the section 'Principles of care of the critically ill neonate'.

For other than emergency treatment of seizures, in which **diazepam** (0.1–0.4 mg/kg, intravenously, as required) or **midazolam** (0.05–0.1 mg/kg IV, as required) are useful, **phenobarbital** (phenobarbitone), **phenytoin** and **primidone** are the drugs of choice for long-term control of seizure activity. Phenobarbital is administered initially at a dose of 1–3 mg/kg intravenously in 30 mL of isotonic saline infused over 15–30 minutes. Maintenance therapy is a similar dose intravenously or orally, every 8 hours, and the dose adjusted to provide control of seizures while minimizing the degree of sedation. Because of the long elimination half life of phenobarbital in foals (~200 hours) and the transient nature of the disease, once seizure control is achieved administration of phenobarbital can be discontinued. Drug concentrations will be at or above the target concentration (5–30 µg/mL) for several days after the final dose. **Phenytoin** (5–10 mg/kg intravenously or orally initially, then 1–5 mg/kg every 4 hours) or **primidone** (20–40 mg/kg orally every 12–24 hours, to effect) are also used to control convulsions.

Definitive demonstration of the presence of cerebral edema or intracranial hemorrhage is impossible without sophisticated imaging devices, such as magnetic resonance imaging or computed tomography (CT).<sup>8</sup> However, treatment is often

initiated on the basis of clinical signs. None of the treatments have demonstrated efficacy, and some are controversial. **Dimethyl sulfoxide** (DMSO) is given intravenously at 0.5–1 mg/kg once or twice daily for 3 days as a 10% solution. **Mannitol** (0.25 g/kg, intravenously as a 20% solution) may be effective in treating cerebral edema but is contraindicated if intracranial hemorrhage is present. **Glucocorticoids** (dexamethasone, 0.2–1 mg/kg or prednisone, 1–2 mg/kg) might reduce intracranial inflammation and swelling. They might be contraindicated in foals with sepsis.

**Magnesium sulfate** (0.05 mg/kg per hour for one hour, then 0.025 mg/kg/h IV for up to 48 hours) is often administered to foals with suspected hypoxic encephalopathy in an attempt to minimize neuronal damage. There is no objective evidence of its efficacy in foals.

Foals with respiratory depression can be administered caffeine (10 mg/kg orally once and then 3.0 mg/kg orally q 24 hours).<sup>3</sup> Adverse effects include agitation, hyperesthesia, tachycardia, and convulsions.

**Good nursing care** is critical in affected foals, and a concerted and persistent effort should be made to encourage the foal to nurse the mare. Encouraging the foal to nurse can be frustrating for the handler and mare, but should be done regularly, about every 4 hours, and preferably when the foal is hungry. Affected foals often begin to nurse quite suddenly.

Affected foals can require up to 4–6 weeks to recover completely, although most do so within 1 week of birth, and hasty decisions regarding euthanasia should not be made without recognition of the sometimes long time required for complete recovery.

### CONTROL

Prevention of hypoxia in neonates by close monitoring of the health of the mare and of parturition may reduce the incidence of the disease.

### REVIEW LITERATURE

Rossdale PD. The maladjusted foal: influences of intrauterine growth retardation and birth trauma. *Proc Am Assoc Equine Pract* 2004; 50:75.

### REFERENCES

1. Hess-Dudan F, Rossdale PD. *Equine Vet Educ* 1996; 8:24.
2. Rossdale PD. *Proc Am Assoc Equine Pract* 2004; 50:75.
3. Vaala WE. *Proc Am Assoc Equine Pract* 1999; 45:247.
4. Rossdale PD. *Equine Vet J* 1972; 4:117.
5. Rossdale PD et al. *Vet Rec* 1976; 99:111.
6. Palmer AC, Rossdale PD. *Res Vet Sci* 1976; 20:267.
7. Mayhew IG. *J Reprod Fert* 1982; Suppl 32:569.
8. Chaffin MK et al. *Vet Radiol Ultrasound* 1997; 38:102.

## CONGENITAL TREMOR SYNDROMES OF PIGLETS

Tremors in pigs are not a common clinical sign. Recently, generalised tremors have been described in grower pigs<sup>1</sup> but until this report the condition has only been described as a neonatal condition. The condition has been known for a long time in Britain.

This group of at least four etiologically distinct congenital diseases of the nervous system has a similar clinical and pathological identity. In particular they all have congenital tremor (*myoclonia congenita*) and these rhythmic tremors are most evident while the piglet is standing, are reduced when it lies down, and disappear when it is asleep. It is therefore not encephalitis but an increased sensitivity of the spinal cord reflexes.

Although the tremor is present at birth it may not be observed until the piglets are 2 or 3 days old and beginning to move about actively. The tremor varies from a very rapid twitch affecting only the head to a slow tremor causing the pig to 'dance'; there may be such a severe tremor that the body and head tremble violently and rock from side to side. There is no muscular weakness and the piglets get up and scamper about, but there may be ataxia and dysmetria so that the gait may be badly affected. Mildly affected piglets are not greatly incapacitated and can survive and eventually recover in 2-8 weeks; the tremor fades gradually, and near the end of the course it may be evident only during exercise. Badly affected piglets may be unable to get to the teat to suck and may die of starvation. Many are fatally crushed or trampled by the sow.

For convenience, entities within the syndrome have been classified into two types.

**Type A** has morphological lesions and there are 5 types AI, AII, AIII, and AIV for which the causes are known.

Type AI (*myoclonia congenita*) results from transplacental infection of the fetus by particular strains of swine fever virus.<sup>2-4</sup> In litters affected by swine fever virus usually about 40% of the litter is affected. The characteristic lesions are cerebellar hypoplasia and cerebrosplinal dysmyelinogenesis. When the disease caused by the unidentified viral infection of the fetus first appears in a piggery all litters are affected. Most pigs in each litter have the disease, but after a period of several months the disease disappears, apparently because of herd immunity. The principal sign as in the swine fever induced disease is myoclonia, and most piglets recover. Spinal dysmyelinogenesis is the characteristic lesion.

Type AII (*myoclonia congenita*) is caused by transplacental infection with an agent presumed to be a virus and it is believed to be the most common type of congenital tremor.

Type AIII (congenital cerebrosplinal hypomyelinogenesis) is a hereditary form so far found only in Landrace and known as Landrace trembles.<sup>5</sup> The inherited sex-linked disease occurs in the progeny of Landrace or Landrace-cross sows. Up to 11% of Landrace piglets may be affected compared to only 0.3-0.8% in the Yorkshire, Hampshire, and Duroc breeds. The mode of transmission is via a monogenic sex-linked recessive character, and half of all male pigs born are affected. Histologically, there is cerebrosplinal myelinogenesis. Most affected pigs die. It is essentially a deficiency of oligodendrocytes.

Type AIV is also a genetically determined condition due to an autosomal recessive condition found in Saddlebacks. It is seen in about 25% of the progeny, and is fatal in most of them. Cerebrosplinal dysmyelinogenesis is the characteristic lesion. It is characterised by a deficiency of myelin throughout the CNS.<sup>6</sup> A type distinct from this has also been reported in Saddleback x Large White sows.<sup>7</sup>

Type AV occurs naturally in Scandinavia<sup>8</sup> and is characterized by cerebellar hypoplasia and has been experimentally produced following dosing of pregnant sows between 45 and 75 days of gestation with trichlorfon.<sup>9</sup>

**Type B** is a form of congenital tremor not yet adequately characterized and without morphological lesions and is of unknown etiology. The differentiation of these diseases is now possible on the basis of histopathological and neurochemical findings and relating these to the epidemiological data. In piglets born from sows inoculated with the Weybridge congenital tremor strain of the swine fever virus in early pregnancy, the severity of the clinical signs was related to the degree of spinal myelin deficiency. Semiautomated planimetry can be used to determine the cross-sectional areas of spinal gray and white matter of affected piglets. The spinal cord cross-sectional area is significantly reduced in piglets affected with Type AI congenital tremor. The reduction is similar to Type AII. The neurochemical findings relate to the presence of particular fatty acid profiles in the cholesterol esters in the lipids of the spinal cord.

Control of the disease depends on its cause. If it is inherited the recommended procedure is to keep none of the affected recovered pigs for breeding. If the cause is one of the maternal infections of early pregnancy it is recommended practice to deliberately expose empty females to affected piglets so that they become

immunized before pregnancy. Failure to identify the cause may necessitate adopting both procedures.

The disease appears to occur sporadically but when it does occur it may assume great importance. As many as 15% of litters born in a piggery may be affected, and of these 72% of the piglets may be affected and the case fatality rate amongst these may be as high as 50%. There is a feeling amongst veterinarians that the condition has increased recently but this may just be an increased awareness. If there is an increase, the specific cause of the increased prevalence has not been identified but it is possibly the unidentified virus referred to above: the virus of congenital tremor Type AII. There is also the possibility that the observed concurrent increase in prevalence of both splayleg and congenital tremor may indicate that they are possibly caused by the same virus. In this context, there is conjecture, that the PCV2 virus which is extremely small and similar in size to the particles that were described in the early electron micrographs of the spinal cord of affected piglets may be responsible. As yet there is no confirmation that splayleg and congenital tremor are PCV2 associated disorders.<sup>10</sup>

## REVIEW LITERATURE

- Done JT. The congenital tremor syndrome in pigs. *Veterinary Annual* 1976; 16:98.  
Faulkes JA. Myelin and demyelination in domestic animals. *Vet Bull* 1974; 44:441.

## REFERENCES

- Desrosiers R et al. *Swine Hlth Prod* 1998; 6:174.
- Done JT, Harding JDJ. *Proc Roy Soc Med* 1966; 59:1083.
- Done JT, Harding JDJ. *Exc Med Int Cong Ser* 1969; 173:112.
- Harding JDJ et al. *Vet Rec* 1966; 79:388.
- Harding JDJ et al. *Vet Rec* 1973; 79:527.
- Blakemore WF, Harding JDJ. *Res Vet Sci* 1974; 17:248.
- Kidd ARM et al. *Brit Vet J* 1986; 142:275.
- Kronevi T et al. *Vet Rec* 1975; 96:403.
- Pope AM et al. *J Am Vet Med Ass* 1986; 189:781.
- Stevenson GW. *J Vet Diag Invest* 2001; 13:57.

## OVINE HUMPYBACK

This is a disease of sheep, mainly Merino wethers, in western Queensland, characterized by stiffness and shortness of steps when forced to walk for about a kilometer. The sheep stops walking and adopts an arched back posture. At this time the body temperature is significantly elevated and the level of lymphocytes in the blood is lowered. The greatest incidence is in summer after rain and when the sheep are in full wool, and the hyperthermia and ataxia disappear when the sheep are shorn. Environmental temperatures at the time of the greatest prevalence of the disease are high,

commonly 40°C. This occurs in spite of the presence of a characteristic degeneration of spinal cord tracts.<sup>1</sup> The obvious explanation of the phenomenon is that it is a form of heat stroke and that the nervous system lesions are incidental.

## REFERENCE

1. Pearse BHG et al. *Aust Vet J* 1992; 69:94.

## EQUINE CERVICAL VERTEBRAL STENOTIC MYELOPATHY, (WOBLER, 'WOBBLES', EQUINE SENSORY ATAXIA, CERVICAL VERTEBRAL INSTABILITY)

### Synopsis

**Etiology** Unknown.

**Epidemiology** Sporadic or endemic disease of young horses. Young, rapidly growing male horses are most commonly affected. Separate presentation in middle-aged horses in which it is sporadic.

**Clinical signs** Spinal ataxia evident as truncal sway, ataxia and paresis usually more severe in the hind limbs. Radiographic evidence of narrow spinal canal.

**Clinical pathology** None.

**Lesions** Malacia and Wallerian degeneration in the cervical spinal cord.

**Differential diagnosis** Equine degenerative myelopathy, equine protozoal myeloencephalitis, trauma, equine infectious anemia, cerebrospinal nematodiasis, West Nile encephalomyelitis, equine herpesvirus-1 myelopathy, aortoiliac thrombosis, congenital vertebral malformation, diskospondylitis, and ryegrass staggers.

**Diagnostic confirmation** Radiography. Positive contrast myelography. Necropsy.

**Treatment** Anti-inflammatory drugs. Surgical fusion of vertebrae.

**Control** None.

## ETIOLOGY

The cause of neurologic disease is compression of the cervical spinal cord, hence the term compressive myelopathy. The compression may be **static**, that is the compression is present constantly with the neck in a neutral position, or **dynamic** and only present intermittently when the neck is either flexed or extended. The second situation is often referred to as cervical vertebral instability. The etiology of equine cervical stenotic myelopathy (CSM) in most cases is not known. Several basic syndromes of compressive myelopathy, based on age of occurrence, are recognized:

- Equine stenotic myelopathy (ESM) in immature horses (<3 years of age, depending on breed) that is often associated with developmental joint disease in the axial and appendicular skeleton. The fundamental underlying

defect appears to be a narrow diameter of the cervical vertebral canal.

- Cervical vertebral instability (CVI), a disease of horses less than 1 year of age, is often associated with malformations of one or more of the cervical vertebrae.<sup>1</sup>
- Compressive myelopathy in mature horses, >4 years (usually >7 years) of age, associated with osteoarthritis of the articular facets of the caudal cervical vertebrae, with subsequent impingement of the vertebral canal by bony and soft tissue proliferative lesions.
- Miscellaneous causes of cervical cord compression by neoplasia (melanoma, sarcoma, lymphoma),<sup>2-4</sup> trauma (cervical vertebral fractures), arachnoid or synovial cysts<sup>1</sup> or, rarely, diskospondylitis.<sup>5</sup>

An alternative categorization is based on the nature of the bony lesion and not on the cause of compression of the spinal cord. **Type I cervical vertebral malformation** occur in horses <2 years of age that have vertebral changes that likely began in the first few months of life, and include malformations causing stenosis of the vertebral canal, malformations at the articulations of the vertebrae including osteochondrosis, and enlarged physal growth regions.<sup>6</sup> **Type II cervical vertebral malformations** tend to occur in older horses with severe osteoarthritic lesions of the vertebral articulations.<sup>6</sup>

## EPIDEMIOLOGY

### Occurrence

The disease in mature horses occurs sporadically throughout the world.

The disease in young horses is sometimes endemic on farms or studs, and in particular lines of horses. There is a suggestion of a familial tendency for the disease, although this has not been well documented.

The **morbidity rate** may be as high as 25% of each foal crop on individual Thoroughbred farms, although the overall frequency of the disease in the general horse population is much lower.<sup>7</sup>

### Risk factors

Animal risk factors

The disease in young horses is commonly recognized in Thoroughbred, Standardbred, Warmblood, and Quarter horses, but other breeds can be affected. Ponies are rarely, if ever, affected. The disease occurs in horses less than 4 years of age, with most cases occurring in 1-3-year-old horses. Males are more commonly affected than are females. Horses with cervical stenotic myelopathy have a narrower spinal canal than do unaffected animals and this condition, with degenerative joint disease of

the articular facets and thickening of the ligamentum flavum, contributes to the greater likelihood that the horse will have spinal cord compression.<sup>7-9</sup>

It is suspected that predisposition to the disease is heritable, but this has not been demonstrated by appropriate studies. The stenotic myelopathy is believed to be the result of a combination of fast growth rate and over nutrition, and dietary restriction may reduce the incidence of the disease.<sup>7</sup> A relationship of ESM to developmental bone disease (osteochondrosis) and dietary copper has been suggested, but is unproven.

The disease in mature horses tends to be in horses used for athletic endeavours, and is uncommon in brood mares or retired animals.

## PATHOGENESIS

The disease is attributable to injury to the spinal cord as a result of compression by either soft tissue (joint capsule, intervertebral ligaments, or, rarely, intervertebral disk material) or cartilage and bone.

Constant or intermittent pressure on the spinal cord causes necrosis of white matter and neurons at the site of compression, and degeneration of fibers of ascending tracts cranial to the site of compression, and of descending tracts caudal to the compression.<sup>10</sup> The ascending tracts are those associated with general proprioception whereas the descending tracts are upper motor neurons. These tracts are located superficially in the dorsolateral aspect of the cervical spinal cord and damage to them results in signs of ataxia and weakness. Tracts from the caudal limbs are more superficial, and therefore more easily injured, than are tracts associated with the cranial limbs. Consequently, clinical signs are usually more severe in the hind limbs. The spinal cord lesions are usually, but not always, bilaterally symmetrical, as are the clinical signs.<sup>10</sup> Proprioceptive pathways are disrupted, causing the signs of ataxia (incoordination) typical of the disease. Clinical signs vary depending on the site of the lesion (see below).

## CLINICAL FINDINGS

The onset of clinical signs is sometimes acute in both ESM and CVI in young horses and there may be a history of trauma, such as falling. However, the onset of clinical signs in ESM in both young and mature horses is usually gradual and insidious and in mildly affected horses the nervous disease may be mistaken for lameness of musculoskeletal origin. Affected horses are bright and alert and have a normal appetite. There may be evidence of pain on manipulation of the neck, especially in mature horses, or on firm pressure over the lateral facets.



The severity of clinical signs varies from barely detectable to recumbency. There are no defects of cranial nerves, with the exception of the cervicofacial reflex.

**Mildly affected horses** may have deficits that are difficult to detect and only apparent under saddle or at high speed. The owner may complain of poor performance of a race horse or dressage animal, of an animal that frequently changes leads or that is poorly gaited. Careful examination may reveal excessive circumduction of the hind feet, stumbling, and pacing when the head is elevated.

**Moderately affected** animals have truncal sway, the body of the horse and hind quarters swaying laterally when the horse is walked in a straight line, and excessive circumduction of the hind feet. Having the horse move in a very tight circle about the examiner often causes the circumduction to become worse in the outside hind leg and the horse to place one foot on top of the other. Affected horses will sometimes pace when walked in a straight line with the head elevated. Blindfolding the horse does not exacerbate the signs. Affected horses will stumble when walked over low objects, such as a curb, and will **knuckle** at the fetlocks and stumble when walked down a steep hill.

**Severely affected** horses often fall easily when moved or are unable to stand. The horses are bright and alert, but anxious, and display marked truncal sway and ataxia. When standing they will often have their legs in markedly abnormal positions.

Mature horses with disease secondary to arthritis of the articular facets can have hypalgesia of the skin overlying those regions and atrophy of the cervical musculature.

Horses with lesions in the cervical spinal cord cranial to C6–C7 have signs in both fore and hind limbs. The hindlimbs are more severely affected and the signs are usually, but not always,<sup>10</sup> bilaterally symmetrical. Lesions of the cervical intumescence (C6 to T2) may cause signs that are more severe in the forelimbs than in the hindlimbs. Lesions at this site may also cause signs typical of brachial plexus injury. Focal muscle atrophy is not characteristic of ESM or CVI and there are never signs of cranial nerve, cerebral, or cerebellar disease.

After initial progression the clinical signs usually stabilize or partially resolve. However, complete spontaneous recovery is very unusual. Death is unusual unless it is by misadventure, although many affected animals are killed for humane reasons.

#### Ancillary diagnostic tests

The 'slap test', in which the response of the arytenoid cartilages to a slap on the

thorax is examined through an endoscope, has poorer sensitivity and specificity for detecting spinal cord disease than does a routine neurological examination.<sup>11</sup>

Acupuncture has no proven value in the diagnosis of ESM or CVI and should not be used for this purpose.

#### Radiographic examination

Radiographic examination of cervical vertebral column of affected horses reveals narrowing of the spinal canal.<sup>7,8</sup> This has diagnostic utility, e.g. a ratio of spinal canal to vertebral body diameter of less than 50% for C4 is associated with a 28-fold increase in the probability of ESM.<sup>8</sup> Other measures of spinal canal diameter are useful in the detection of stenosis and compressive myelopathy.<sup>12–14</sup> Other radiographic signs consistent with ESM or CVI include:

- Encroachment of the caudal vertebral physis dorsally into the spinal canal ('ski jump lesion')
- Extension of the arch of the vertebra over the cranial physis of the next vertebra
- Sclerosis of the spinal canal
- Kyphosis between adjacent vertebra
- Degenerative joint disease of the articular facets.

However, these signs are also common in normal horses and have poor predictive value.<sup>1,8,12,13</sup>

**Myelography** has been considered to provide the definitive ante mortem confirmation of spinal cord compression.<sup>4</sup> However, the sensitivity of this technique, using a 50% reduction in the width of the dorsal dye column as a cut-off for diagnosis of the disease is 53% (95% confidence interval 34–72%,  $n = 22$ ) and the specificity is 89% (95% confidence interval of 84–93%,  $n = 228$ ).<sup>16</sup> Others have found similar values for sensitivity and specificity.<sup>12</sup> These results indicate that a positive finding on myelography is highly suggestive of the disease, but that a negative finding does not eliminate the possibility of the disease. The false-positive rate is increased to 12–27% for compression at mid-cervical sites during neck flexion.<sup>16</sup> Myelography is superior in diagnosing compressive lesions at C6–C7 than at more proximal sites.<sup>16</sup> Occasionally the compression is lateral rather than dorso-ventral and is not readily apparent on routine myelography.

#### CLINICAL PATHOLOGY

Hematological and serum biochemical values are usually within reference ranges in affected horses. Cerebrospinal fluid from affected horses may have increased protein concentration, but this finding is neither characteristic nor specific for ESM or CVI. However, other causes of spinal

ataxia may cause characteristic changes in the cerebrospinal fluid. Measurement of creatine kinase activity in CSF has no diagnostic value in horses.<sup>17</sup>

#### NECROPSY FINDINGS

Gross examination reveals degeneration of the articular facets in many affected horses.

Impingement of soft tissues, especially the ligamentum flavum and joint structures, or cartilage and osteophytes into the spinal canal may be apparent. The spinal canal may be narrow. The spinal cord may be indented and soft at the site or sites of compression. Histologically, there is nerve fiber swelling, widespread degeneration of myelin, and astrocytic gliosis. Cranial to the compressive lesion, Wallerian degeneration is evident in the dorsal and lateral funiculi, while caudal to the compression these changes are most evident in the ventral and central lateral funiculi.<sup>10</sup> Slight atrophy of cervical muscles is sometimes evident. There is histological evidence of stretching and tearing of the ligamentum flavum and joint capsule at affected joints especially C6 or C7.

#### DIFFERENTIAL DIAGNOSIS

Equine degenerative myelopathy, equine protozoal myeloencephalitis, trauma, equine infectious anemia, cerebrospinal nematodiasis (*Hypoderma* spp., *Setatia* sp., *Halicephalobus deletrix*), equine herpesvirus-1 myelopathy, aorto-iliac thrombosis, West Nile encephalomyelitis, congenital vertebral malformation (especially in Arabian foals), discospondylitis, tumors involving the spinal canal (melanoma, lymphoreticular neoplasia), and rye-grass staggers. See Table 36.3.

#### TREATMENT

Medical treatment of the acute disease consists of rest and administration of anti-inflammatory drugs (dexamethasone 0.05–0.25 mg/kg, IV or IM every 24 hours; flunixin meglumine 1 mg/kg, IV every 8–12 hours; phenylbutazone 2.2–4.4 mg/kg, orally every 12–24 hours; and/or dimethyl sulfoxide, 1 g/kg as a 10% solution in isotonic saline, IV every 24 hours for 3 treatments).

Treatment of arthritis of the facets of mature horses can be achieved by injection of the articular facet joints with corticosteroids (40 mg methylprednisolone acetate).<sup>18</sup> Injection of the joint is facilitated by ultrasonographic guidance.<sup>18</sup> Injection of the joints with anti-inflammatory drugs is assumed to result in reduction in inflammation and soft tissue swelling with consequent reduced compression of the cervical spinal cord.

Table 36.3 Differential diagnosis of disease causing spinal ataxia in horses

Disease	Etiology and epidemiology	Clinical signs and lesions	Treatment and prognosis
Cervical compressive myelopathy (cervical stenotic myelopathy, cervical vertebral instability)	Sporadic. Young, rapidly growing males. More common in Thoroughbreds, Standardbreds, and Warmblood horses. Syndrome in mature horses caused by arthritis or articular facets.	Symmetrical ataxia often of sudden onset. May be associated with trauma. Hind limbs most severely affected. Compression of cervical spinal cord demonstrated by myelography. CSF normal.	Medical treatment of rest and antiinflammatory drugs. Poor prognosis. Surgical correction by ventral stabilization. Guarded prognosis.
Equine degenerative myelopathy	Young horses (<3 years). Familial incidence of increased requirement for vitamin E.	Gradual onset symmetric ataxia that stabilizes at about 3 years of age. No radiographic abnormalities in cervical spinal cord. CSF normal.	Vitamin E 5–20 iu/kg per day in feed may prevent progression. No cure. Death uncommon.
Equine protozoal myeloencephalitis	<i>Sarcocystis neurona</i> in spinal cord or brain. Americas only. Infectious but not contagious.	Any sign of central nervous system dysfunction. Usually gradual onset of asymmetric spinal ataxia, focal muscle atrophy or weakness. CSF contains antibody to <i>S. neurona</i> , but also found in normal horses.	Ponazuril 5–10 mg/kg orally daily for 28 days. Older, but effective, treatment is pyrimethamine, 1 mg/kg orally and sulfadiazine, 20 mg/kg orally every 24 hours for 90–120 days. Nitazoxonide 25 mg/kg orally once daily for 2 days followed by 50 mg/kg orally for 26 days. Vaccination not recommended.
Equine herpesvirus-1 myeloencephalopathy	EHV-1. Infectious and contagious. Sporadic. Outbreaks occur often preceded by fever or upper respiratory tract disease.	Ascending paralysis with fecal and urinary incontinence, recumbency, normal mentation. CSF xanthochromic and increased protein concentration. Lesion is vasculitis and malacia.	Corticosteroids controversial. Nursing care. Poor prognosis. Vaccination minimally effective.
West Nile encephalitis	West Nile virus. Transmitted by bite of infected mosquito. Horse is 'dead end' host and does not develop sustained viremia. Enzootic to Mediterranean littoral and North America. Peak disease risk is late summer.	Weakness, muscle fasciculations, altered mentation. Recumbency.	No specific treatment. Nursing care. Corticosteroids controversial. Hyperimmune serum available in some areas. Interferon has been used but efficacy uncertain.
Trauma	Sudden onset. More common in young horses.	Spinal ataxia, varying degrees of weakness and proprioceptive deficits. Recumbency. Radiographic lesions present occasionally. CSF may contain red blood cells.	Anti-inflammatory drugs. Rest.
Rye grass staggers	Intoxication by lolitrems produced by <i>Acremonium lolii</i> growing on perennial rye grass. Outbreaks of disease in horses on affected pasture.	Ataxia, stiff gait, tremor, hypersensitivity, recumbency. No histologic lesions.	Remove source of toxin. Rapid recovery without other treatment.
Parasite migration	Sporadic. <i>Strongylus</i> sp., <i>Hypoderma</i> sp., and filarioids ( <i>Setaria</i> sp.).	Wide variety of clinical signs. Progressive ataxia. CSF may contain eosinophils.	Ivermectin 200 µg/kg. Antiinflammatory drugs.
Congenital anomalies	Sporadic. Cause spinal cord compression or lack of neural tissue, e.g. spina bifida.	Recumbency, ataxia present at birth.	No treatment.

A 'paced growth' program of slowed growth achieved by nutritional restriction of young horses (foals and weanlings) has been suggested as conservative treatment for immature horses with compressive myelopathy or at high risk of developing the disease.<sup>19</sup>

**Surgical fusion** of cervical vertebrae is useful in the treatment of mildly to moderately affected horses,<sup>20,21</sup> although because of issues of safety of future riders there are concerns by some authorities about the advisability of this treatment.

## CONTROL

Control measures are not usually employed, although insuring an appropriate diet and growth rate of at-risk animals would be prudent. Because of the possible inherited nature of the disease, a corrective breeding program may be advisable.

## REVIEW LITERATURE

- Nout YS, Reed SM. Cervical stenotic myelopathy. *Equine Vet Educ* 2003; 15:212.  
 Mayhew GJ. The healthy spinal cord. *Proc Am Assoc Equine Pract* 1999; 45:56.  
 Mayhew GJ. The diseased spinal cord. *Proc Am Assoc Equine Pract* 1999; 45:67.

## REFERENCES

- Allison N, Moeller RB. *J Vet Diagn Invest* 2000; 12:279.
- Van Biervliet J et al. *J Vet Int Med* 2004; 18:248.
- Patterson-Kane JC et al. *J Comp Pathol* 2001; 125:204.
- Adolf JE et al. *Comp Cont Educ Pract Vet* 2001; 23:194.
- Furr MO et al. *J Am Vet Med Assoc* 1991; 198:2095.
- Mayhew GJ. *Proc Am Assoc Equine Pract* 1999; 45:67.
- Mayhew IG et al. *Equine Vet J* 1993; 25:435.
- Moore BM et al. *Am J Vet Res* 1994; 55:5.
- Moore BM et al. *Equine Vet J* 1992; 24:197.
- Yovich JV et al. *Aust Vet J* 1991; 68:326, 334.

- Newton-Clarke MJ et al. *Equine Vet J* 1994; 26:358.
- Hudson NPH, Mayhew IG. *Equine Vet Educ* 2005; 17:34.
- Tomizawa N et al. *J Vet Med Sci* 1994; 56:227.
- Tomizawa N et al. *J Vet Med Sci* 1994; 56:1119.
- Rantanen NW et al. *Comp Cont Educ Pract Vet* 1981; 3:S161.
- Van Biervliet J et al. *Equine Vet J* 2004; 36:14.
- Jackson C et al. *J Vet Int Med* 1996; 10:246.
- Mattoon JS et al. *J Vet Radiol Ultrasound* 2004; 45:238.
- Donawick WJ et al. *Proc Am Assoc Equine Pract* 1989; 35:525.
- Moore BR et al. *J Am Vet Med Assoc* 1993; 203:108.
- Walmsley JP. *Equine Vet Educ* 2005; 17:39.

## STRINGHALT

Stringhalt is an involuntary, exaggerated flexion of the hock during walking. It can affect one or both hindlimbs. Classic

stringhalt occurs sporadically, is usually unilateral, and is usually irreversible without surgical intervention. Stringhalt can also occur secondarily to injury to the dorsal metatarsus.<sup>1</sup>

A clinically identical disease, Australian stringhalt, occurs in outbreaks in Australia, New Zealand, California, Japan, and Chile.<sup>2,3</sup> The outbreaks tend to occur in late summer or autumn and are related to drought conditions or overgrazing of pasture with consequent ingestion of plants that would otherwise not be eaten.<sup>4</sup> Outbreaks in Australia, California, and Virginia are related to the ingestion of *Hypochaeris radicata* (flatweed, cats ear).<sup>4-8</sup> Other plants suspected to play a role in the etiology include *Taraxacum officinale* (dandelion), *Arctotheca calendula* (capeweed) or *Malva parviflora* (mallow) but good evidence of the role of any of these plants is lacking.

The abnormal movement is only elicited when the horse begins to move forward. The characteristic movement occurs in mildly affected horses when they are backed or turned. Most cases are manifested by a flexion of the hock that can be violent enough for the horse to kick itself in the abdomen. The hoof is held in this position for a moment and then stamped hard on the ground. If both hind legs are affected progress is very slow and difficult and the horses often use a 'bunny hopping' gait. In the most severe cases the horse is unable to rise without assistance. The horse's general health is unaffected although it may be difficult for it to graze. Some cases have other signs of neurologic disease such as stiffness of the forelimbs or respiratory distress due to laryngeal paralysis. Many affected horses have unilateral (usually left) laryngeal hemiplegia evident on endoscopic examination of the larynx. Electromyographic examination reveals markedly abnormal activity including prolonged insertion activity, fibrillation potentials, and positive waves at rest and enhanced EMG activity in the right lateral digital extensor muscle on muscle contraction consistent with denervation. The changes are most severe in the long digital extensor muscle.<sup>6</sup> Most horses recover without treatment, although complete recovery might not occur for over 1 year.<sup>2,5</sup>

There are no characteristic abnormalities in a complete blood count or serum biochemical profile. Pathological findings are restricted to a peripheral neuropathy in the tibial, superficial peroneal and medial plantar nerves and in the left and right recurrent laryngeal nerves.<sup>9,10</sup> Lesions in affected muscles are consistent with denervation atrophy and fiber type grouping.

The signs of the disease are characteristic. Differential diagnosis of the disease

involving one leg is ossifying myopathy of the semimembranosus and semitendinosus muscles. Lead toxicosis can induce similar signs in horses.

Treatment with phenytoin (15 mg/kg orally daily for 14 days) effected some improvement but the signs recurred within 1 or 2 days after treatment was discontinued.<sup>11</sup> Myotectomy of the lateral digital extensor muscle and tendon is reported to provide immediate relief in affected horses, even in those horses with severe bilateral disease.<sup>12</sup> However, recovery is spontaneous in most cases and there might only be a need for surgery in the most severely affected horses. Control involves the prevention of overgrazing of pastures, particularly during droughts.

## REFERENCES

1. Crabill MR et al. J Am Vet Med Assoc 1994; 15:205, 867.
2. Araya O et al. Vet Rec 1998; 142:462.
3. Takahashi T et al. J Equine Sci 2002; 13:93.
4. Huntington PJ et al. Equine Vet J 1989; 21:266.
5. Pemberton DH, Caple IW. Vet Ann 1980; 20:167.
6. Galey FD et al. Vet Human Toxicol 1991; 33:176.
7. Gay CC et al. Equine Vet J 1993; 25:456.
8. Gardner SY et al. Equine Vet Educ 2005; 17:118.
9. Huntington PJ et al. Aust Adv Vet Sci 1987; 38.
10. Slocombe RF et al. Equine Vet J 1992; 24:174.
11. Huntington PJ et al. Aust Vet J 1991; 68:221.
12. Torre F. Equine Vet J 2005; 37:181.

## OVINE 'KANGAROO GAIT'

### Synopsis

**Etiology** Not known  
**Epidemiology** Seasonal occurrence involving only adult female sheep that are lactating, or in some cases, pregnant. Spontaneous recovery following cessation of lactation.  
**Clinical findings** Bilateral forelimb locomotor disorder  
**Lesions** Axonal degeneration of the radial nerve followed by regeneration.  
**Treatment** Supportive  
**Control** None recognized

## ETIOLOGY

A neuropathy of unknown cause.

## EPIDEMIOLOGY

### Occurrence

This condition is recorded in New Zealand and the United Kingdom and is manifest with acute onset of bilateral radial nerve paralysis followed by spontaneous recovery.

### Risk factors

It occurs only in adult ewes with an onset in late pregnancy or early lactation.<sup>1-5</sup> Spontaneous recovery occurs following cessation of lactation<sup>1-3</sup> but also occasionally while ewes are still nursing lambs.<sup>4</sup> Average annual cumulative incidence varies between flocks but is less than 1%.<sup>5</sup>

In the areas of northern England and southern Scotland the condition is significantly more common in upland and lowland flocks than in those hill grazing. Stocking density is higher in affected flocks than that in non-affected flocks. Onset occurs while on pasture between March and June with a separate smaller peak in October. This seasonal occurrence could be a reflection the parturition status of flocks or an effect of seasonal influences.<sup>5</sup>

## PATHOGENESIS

Clinical signs can be attributed to the generalized polyneuropathy affecting principally the radial nerves. Subsequent to the axonal degeneration a remyelination of the radial nerve occurs, explaining the clinical recovery. Bilateral compression of the radial nerves appears to be the cause but there is no indication of how such an injury can occur.<sup>3</sup>

## CLINICAL FINDINGS

The name comes from the gait exhibited by affected ewes which are unable to move their forefeet except in a synchronized bounding action. There is bilateral forelimb paresis, a palpable loss of muscle bulk in the forelimbs, and some cases also have proprioceptive deficits. The hind limbs are normal. Affected ewes lie down more frequently and may graze on their knees but continue to eat and effectively suckle their lambs.

## CLINICAL PATHOLOGY

There are no consistent abnormalities in haematology, blood biochemistry, or trace element analysis of affected sheep.<sup>4</sup>

## NECROPSY FINDINGS

There is axonal degeneration of the myelinated fibers of the radial nerve fibers and regeneration in recovering cases.<sup>1-3</sup> Ventral root gangliopathy and neuronal degeneration within the spinal cord is reported<sup>1-3</sup> but may not be evident in all cases.<sup>4</sup>

## DIFFERENTIAL DIAGNOSIS

Foot rot or foot abscess involving the front feet can have the same grazing behaviour but there is no problem in differentiation when the limbs and feet are examined.

Hypocalcemia in sheep occurs in late pregnancy or during lactation and in the developing stages there is incoordination and muscle weakness. However there is rapid progression to complete muscular paresis and a dramatic response to treatment.

Spinal abscess or fracture.

## TREATMENT

Without the knowledge of etiology there is no specific treatment. Easy access to food and water should be provided.

## REFERENCES

1. Barlow RM, Greig A. *Vet Rec* 1986; 119:174.
2. Duffel SJ et al. *Vet Rec* 1986; 118:296.
3. O'Toole D et al. *J Comp Pathol* 1989; 100:245.
4. Clements ACA et al. *Vet Rec* 2002; 150:485.
5. Clements AC et al. *Prev Vet Med* 2003; 61:147.

## EQUINE MOTOR NEURON DISEASE

Equine motor neuron disease is a recently recognized **neurodegenerative disease** of horses in the US and Canada, with a small number of cases being recorded in Europe and South America. The disease affects horses of all breeds, with Quarter horses most commonly affected, and the incidence of the disease increases with age.<sup>1</sup> Horses older than 2 years of age are affected. The disease is associated with stabling and lack of access to pasture, and the risk of the disease increases with decreasing serum vitamin E concentration.<sup>2,3</sup> The etiology of the disease is unknown but is suspected to be due to oxidative injury to neurons subsequent to vitamin E deficiency.<sup>3</sup> The clinical signs are attributable to degeneration of motor neurons in the ventral horns of the spinal cord, with subsequent peripheral nerve degeneration and widespread neurogenic muscle atrophy.

The onset of clinical signs is usually gradual but in a small proportion of affected horses the first sign is an acute onset of profound muscle weakness. Chronically affected horses have weight loss in spite of a normal or increased appetite, pronounced trembling and fasciculation of antigravity muscles, increased recumbency, and a short-strided gait; they often assume a posture with all feet under the body and a low head carriage, and frequently shift weight – all signs attributable to muscle weakness.<sup>4</sup> The tail head is elevated in a large proportion of severely affected horses, likely a result of atrophy of the *sacrocaudalis dorsalis medialis* muscle. Retinal examination often reveals accumulation of lipofuscin-like pigment in the tapetal fundus.<sup>5</sup> Electromyography, under either general or regional anesthesia, is a useful diagnostic aid.<sup>6,7</sup> Characteristic findings include spontaneous fibrillation potentials and trains of positive sharp waves. The prognosis is poor and most affected horses do not return to normal function and are destroyed, although the disease stabilizes in some cases that can then live for a number of years after diagnosis.

There is often a mild increase in serum creatine kinase activity. Horses with equine motor neuron disease have abnormal oral and intravenous glucose tolerance tests characterized by peak glucose concentrations that are lower than expected.<sup>8</sup> The lower peak plasma glucose concentration

is attributable to a 3x greater rate of glucose metabolism (removal from blood) in affected horses compared to normal horses.<sup>9</sup> There is also evidence that horses with equine motor neuron disease are more sensitive to insulin than are normal horses.<sup>9</sup> Affected horses often have serum vitamin E concentrations that are below the reference range (<1.0–2.0 µg/dL, <1.0–2.0 µmol/L).<sup>3</sup> Horses with equine motor neuron disease have higher spinal cord copper concentrations than do normal horses, but the diagnostic or clinical significance of this observation is unclear.<sup>10</sup> Examination of cerebrospinal fluid is not useful in arriving at a diagnosis.

Examination of muscle from horses with equine motor neuron disease reveals a coordinated shift from characteristics of slow muscle to those of fast twitch muscle including contractile and metabolic functions of muscle.<sup>11</sup> There is a lower percentage of myosin heavy chain type 1 fibers, higher percentages of hybrid IIX and IIX fibers, atrophy of all fibers, and reduced oxidative capacity, increased glycolytic capacity, and diminished intramuscular glycogen concentrations, among other changes, in affected horses compared to normal horses.<sup>11</sup>

**Diagnostic confirmation** can be achieved by examination of a biopsy of the *sacrocaudalis dorsalis medialis* muscle or the spinal accessory nerve.<sup>7,12</sup> The *sacrocaudalis dorsalis medialis* muscle is preferred because that muscle is predominantly composed of type 1 fibers and is severely affected by the disease.

Necropsy examination reveals moderate to severe diffuse muscle atrophy. Predominant histologic findings at necropsy examination include degeneration of neurons in ventral horns at all levels of the spinal cord.<sup>13</sup> Muscle atrophy is evident as angular fibers, with predominantly type 1 fibers, or a combination of type 1 and type 2 fibers, affected.<sup>10,11</sup> There is accumulation of lipofuscin in the fundus and in capillary endothelium of the nervous tissue.

**Treatment** consists of administration of vitamin E, although the efficacy of this treatment has not been determined. Administration of lyophilized, water soluble D-α-tocopherol is apparently superior to administration of the DL-α-tocopherol acetate in increasing concentrations of vitamin E in blood of horses. The usual dose is 4 iu of D-α-tocopherol per kg body weight orally once daily. Control measures should insure that horses have adequate access to pasture or are supplemented with good quality forage and/or vitamin E.

## REVIEW LITERATURE

- Divers TJ et al. Equine motor neurone disease. *Equine Vet Educ* 2001; 13:63.

## REFERENCES

1. de la Rúa-Domenech R et al. *Neuroepidemiology* 1995; 14:54.
2. de la Rúa-Domenech R et al. *J Am Vet Med Assoc* 1997; 211:1261.
3. de la Rúa-Domenech R et al. *Vet J* 1997; 154:203.
4. Divers TJ et al. *Equine Vet J* 1994; 26:409.
5. Riis RC et al. *Equine Vet J* 1999; 31:99.
6. Podell M et al. *Prog Vet Neurol* 1995; 6:128.
7. Kyles KWJ et al. *Vet Rec* 2001; 148:536.
8. Benders NA et al. *Am J Vet Res* 2005; 66:93.
9. van der Kolk JH et al. *Am J Vet Res* 2005; 66:271.
10. Polack EW et al. *Am J Vet Res* 1999; 61:609.
11. Palencia P et al. *Acta Neuropath* 2005; 109:272.
12. Jackson CA et al. *Equine Vet J* 1996; 28:215.
13. Valentine BA et al. *Vet Pathol* 1994; 31:130.

## CRUSHED TAIL HEAD SYNDROME IN CATTLE

The crushed tail head syndrome is a recently recognized neuromusculoskeletal disease of dairy cattle which has occurred in the US and UK.<sup>1–3</sup> It occurs most commonly in housed lactating dairy cattle in mid-lactation and that have calved 60 days or more previously. The onset is sudden and characterized clinically by hindlimb weakness, prolonged recumbency in alleyways, but still able to stand. The hindlimbs are drawn forward under the abdomen. Walking is awkward because of hindlimb weakness or pain and affected animals walk with a still rolling gait. Knuckling of the fetlocks and hock joints are characteristic. There is flaccid paralysis of the tail and defecation and urination are not usually affected. During urination and defecation the tail is not lifted and becomes covered with feces and wet with urine. The anal reflex is commonly diminished. There may be some evidence of traumatic injury to the sacral area of the vertebral column with either visible abnormal alignment of the sacral area on movement by the animal or if the animal is rocked from side to side. In other cases, there is no external evidence of trauma or misalignment of the sacrum. No other clinical abnormalities have been observed; appetite is normal, vital signs are normal, and rumen function and the feces are normal in amount and character.

The cause is unknown. In some cases, estrus activity was observed a few days before the onset of signs which suggests that affected animals were mounted by others in the herd causing injury to the tail head and sacrum. It is suggested that traumatic injury to the sacral nerves is the cause of the paresis.

Most cases respond spontaneously and recover within a few weeks. Some reports describe the successful use of long-acting corticosteroids<sup>4</sup> but there is insufficient clinical information available to make any useful recommendation.

## REFERENCES

1. Watson C, Penny C. *Vet Rec* 2003; 152:542.
2. Kerby MJ et al. *Vet Rec* 2003; 152:603.
3. Milne M. *Vet Rec* 2003; 152:666.

## POLYNEURITIS EQUI (EQUINE CAUDA EQUINA SYNDROME)

Polyneuritis equi (formerly cauda equina neuritis) is a demyelinating, inflammatory disease of peripheral nerves of adult horses. The **etiology** of the disease is unknown although infectious (adenovirus, equine herpesvirus type 1), immune (autoimmune disease), and toxic etiologies have been suggested, without conclusive substantiation. Adenovirus was isolate from 2 of 3 horses with the disease, but this observation has not been repeated and it appears unlikely at this time that adenovirus is the cause of polyneuritis equi.<sup>1</sup> Equine herpesvirus-1 is not consistently isolated from affected horses.<sup>2</sup>

The disease occurs in adult horses in Europe and North America but has not been reported from the Southern Hemisphere. The disease is usually sporadic with single animals on a farm or in a stable affected. However, outbreaks of the disease can affect multiple horses from the same farm over a number of years.

The **pathogenesis** of the disease involves nonsuppurative inflammation of the extradural nerves and demyelination of peripheral nerves. Initial inflammation of the nerves causes hyperesthesia which is followed by loss of sensation as nerves are demyelinated. Both motor and sensory nerves are affected, with subsequent weakness, paresis, muscle atrophy, urinary and fecal retention and incontinence, and gait abnormalities.

The **acute disease** is evident as abrupt onset of hyperesthesia of the perineum and tail head, and perhaps the face, evident as avoidance of touching, and chewing or rubbing of the tail. The hyperesthesia progresses to hypalgesia or anesthesia of the affected regions.

The disease usually has a more **insidious onset** with loss of sensation and function occurring over days to weeks. The most common presentation is that of cauda equina syndrome with bilaterally symmetrical signs of posterior weakness, tail paralysis, fecal and urinary incontinence and retention, and atrophy of the gluteal muscles. Tail tone is decreased or absent and the tail is easily raised by the examiner. The anus is usually atonic and dilated. There are signs of urinary incontinence with urine scalding of the escutcheon and hind legs. Rectal examination reveals fecal retention and a distended bladder that is readily expressed. Male horses can have prolapse of the penis with maintained sensation in the prepuce – a finding consistent with the separate innervation of these

anatomic regions. Affected horses can also have ataxia of the hind limbs, but this is always combined with signs of cauda equina disease.

Signs of **cranial nerve dysfunction** occur as part of the disease, but not in all cases. Cranial nerve dysfunction can be symmetrical, but is usually asymmetric. Nerves prominently involved in the genesis of clinical signs are the trigeminal (cranial nerve V), facial (CN VII), and hypoglossal nerve (CN XII), although all cranial nerves can be affected to some extent. Involvement of the cranial nerves is evident as facial paralysis (CN VII), weakness of the tongue (CN XII), and loss of sensation in the skin of the face (CN V). There can be loss of movement of the pinnae (CN VII) and head tilt (CN VIII). Laryngeal paralysis can be present (CN X). The buccal branches of CN VII can be enlarged and palpable over the masseter muscles ventral to the facial crest.

Electromyography is consistent with denervation with prolonged insertion potentials, positive sharp waves, and fibrillation.

Not all clinical signs occur in all horses and, depending on the stage and severity of the disease, some animals can have loss of sensation as the only abnormality, especially during the early stages of the disease.

The disease is inexorably progressive, the prognosis for life is hopeless, and the course of the disease is usually less than 3 months.<sup>3</sup>

**Clinical pathologic** abnormalities are not diagnostic. There is sometimes a mild neutrophilic leukocytosis and hypergammaglobulinemia. Serum vitamin E concentrations are usually normal. Analysis of cerebrospinal fluid demonstrates mild mononuclear pleocytosis and increased protein concentrations, but these changes are not diagnostic of the disease. Horses with polyneuritis equi have antibodies to P2 myelin protein in serum, but the diagnostic value of this test has not been determined.<sup>4</sup>

**Necropsy findings** are definitive for the disease. Gross findings include thickening of the epidural nerve roots that is most severe in the cauda equina. The bladder and rectum can be distended. There can be evidence of fecal and urine scalding and self-trauma of the perineum. There can be thickening of the facial nerves. Microscopic changes are characterized by a granulomatous inflammation of the extradural nerves although radiculoganglioneuritis and myelitis can also occur. There is loss of axons with demyelination and signs of remyelination. The inflammatory cells are initially lymphocytes, plasma cells, and macrophages. As the inflammation becomes more

severe or chronic there is extensive proliferation of fibroblasts and fibrocytes in addition to infiltration of lymphocytes and macrophages.<sup>2</sup> There is axonal degeneration with proliferation of the perineurium. The chronic inflammatory changes result in loss of peripheral neural architecture. Lesions are present in many regions of the spinal cord, but are most severe in the sacral division and cauda equina.<sup>2</sup> Lysosomal accumulations are present in the semilunar, geniculate, and sympathetic chains and granulomatous lesions in the celiaco-mesenteric ganglion.<sup>5</sup> Lesions of the cranial nerves similarly involve infiltration with lymphocytes and histiocytes, and the inflammation can extend to the terminal branches of the nerves.<sup>3</sup>

The **diagnosis** of polyneuritis equi is based on the presence of clinical signs of the disease, rule out of other diseases causing similar clinical signs, and necropsy examination. Diseases with manifestations similar to polyneuritis equi include:

- Equine herpesvirus-1 myeloencephalopathy
- Migrating parasites (Table 36.3)
- Sorghum–Sudan grass neuropathy
- Equine protozoal myeloencephalitis
- Rye grass staggers (*Acremonium lolii*) Dourine
- Trauma to the sacral vertebral column
- Abscess or neoplasia involving the sacral or caudal lumbar vertebral column
- Meningitis
- Intentional alcohol sclerosis of tail head nerves in Quarter horses.

There is no definitive **treatment** for polyneuritis equi. Administration of anti-inflammatory agents, including corticosteroids, appears to be without sustained benefit. Supportive care includes evacuation of the rectum and bladder and maintenance of hydration and provision of adequate nutrition. Feeding a diet that softens feces, or administration of fecal softeners or lubricants can be beneficial. Bethanacol (0.05 to 0.1 mg/kg q8–12 hours, orally) might increase bladder tone. Topical administration of petroleum jelly or similar products can protect the skin of the perineum and escutcheon from fecal and urine scalding.

## REVIEW LITERATURE

Yvorchuk-St Jean K. Neuritis of the cauda equina. *Vet Clin Nth Am* 1987; 3:421.

## REFERENCES

1. Edington N et al. *Res Vet Sci* 1984; 37:252.
2. Rousseaux CvG et al. *Can Vet J* 1984; 25:214.
3. Vatisas NJ et al. *Prog Vet Neurol* 1991; 2:67.
4. Fordyce PS et al. *Equine Vet J* 1987; 19:55.
5. Wright JA et al. *J Comp Pathol* 1987; 97:667.

## HEAD SHAKING IN HORSES

Headshaking by horses is a perplexing and troubling syndrome for which there is often no readily identifiable cause or treatment. The disorder is characterized by repeated, sudden shaking or tossing of the head.

### ETIOLOGY

The etiology is complex and often unclear and conditions associated with head shaking include:<sup>1,2</sup>

- Ear mites
- Otitis interna/externa
- Ophthalmic disease (uveitis)
- *Trombicularis autumnalis* (chiggers) infestation of the muzzle
- Guttural pouch disease (mycosis)
- Stylohyoid arthropathy
- Osteitis of the petrous temporal bone
- Dental disease (wolf teeth, ulceration, periodontal disease, periapical abscess)
- Behavioral abnormalities
- Trigeminal neuralgia
- Optic neuritis
- Photic head shaking (optic-trigeminal summation)
- Neck pain
- Rhinitis or sinusitis
- Ethmoidal disease including hematoma
- Infraorbital neuritis
- Excessive neck flexion by rider
- Equine protozoal myeloencephalitis
- Ill-fitting tack including bit and bridle
- Obstructive airway disease (heaves, laryngeal hemiplegia, epiglottic cysts, etc.).

Most cases of the disease are idiopathic despite intensive investigation of affected horses.<sup>1</sup> Photic head shaking is a common cause of the disease.<sup>3</sup> Most cases have some seasonal distribution, though the reason for this is undetermined. Trigeminal neuralgia is considered an important cause of the disease.<sup>3</sup>

### EPIDEMIOLOGY

The epidemiology of the disease is not well defined. The syndrome occurs in horses throughout the world.<sup>4</sup> The syndrome is sporadic, usually affects only one horse on a farm, and does not occur as outbreaks. The syndrome has a seasonal occurrence in approximately 60% of horses with the majority first demonstrating head shaking, or being most affected, during spring and summer.<sup>4,5</sup> Head shaking is worst on sunny days and less severe on cloudy days, in approximately 60% of horses.<sup>5</sup> Seventy five percent and 80% of affected horses have less severe signs at night or when ridden indoors, respectively.<sup>5</sup>

Affected horses are usually mature adults with onset of head shaking at 7–9 years of age in over one-half of cases,<sup>4,5</sup> although signs can occur in horses as young as 1 year. The disease is reported twice as often in geldings as in mares.<sup>4,5</sup> There is an apparent predisposition to the disease in Thoroughbred horses<sup>4</sup> but this is not consistently reported.<sup>5</sup> Most affected horses are used for general riding, although this might represent an age effect because the syndrome tends to occur in older horses which are not used for racing.<sup>5</sup> There is no apparent association of temperament and risk of head shaking.

### PATHOGENESIS

The pathogenesis of headshaking depends on the cause, but is assumed to involve the trigeminal nerve in most cases because of its role in sensory function of the nose and nasal mucosa.<sup>2</sup> Headshaking is related to exposure to bright light in some animals, a condition referred to as photic or optic-trigeminal summation because of its similarity to a syndrome in people. Trigeminal neuralgia is believed to cause acute, sharp, and intense pain in the face. Although this cannot be definitively diagnosed in horses, its presence is inferred from the horse's behavior and response to analgesia of the infraorbital or posterior ethmoidal nerves.

### CLINICAL FINDINGS

The **clinical signs** of head shaking are unmistakable. Movements of the head are sudden and apparently spontaneous and involve lateral, dorsal, ventral, or rotatory movement of the nose usually during exercise. Horses rarely have the behavior only at rest, with most being affected both at rest and during exercise and about 10% exhibiting signs only during exercise.<sup>4,5</sup> The action often resembles that of a horse trying to dislodge something from its nose. Approximately 90% of horses have vertical movement of the head (as if flipping the nose).<sup>5</sup> The headshaking can be so severe as to cause lateral, dorsal, or ventral flexion of the neck to the level of the caudal cervical vertebrae, although more commonly on the rostral one-third of the neck is involved, if it is involved at all. Some horses rub their nose on objects, the ground, or their front limbs, sometimes during exercise. Affected horses often snort or sneeze. There can be twitching of the facial muscles and flipping of the upper lip. The movements are sudden and at times appear to catch the horse by surprise. The frequency and/or severity of movements are usually increased during exercise. Severely affected horses can stumble and fall if headshaking occurs during exercise, rendering the horse unsafe to ride.

A grading system to classify the severity of signs is<sup>1</sup>:

0. No signs of head shaking
  1. Intermittent and mild clinical signs. Facial muscle twitching. Rideable.
  2. Moderate clinical signs. Definable conditions under which head shaking occurs. Rideable with some difficulty.
  3. Rideable to unpleasant to do so. Difficult to control.
  4. Unrideable and uncontrollable.
  5. Dangerous with bizarre behavior patterns.

This system might be useful for assessing response to therapy and concisely describing the severity of the signs.

**Ancillary testing** involves radiography of the skull; endoscopic examination of both nostrils and ethmoidal regions, nasopharynx, larynx, and guttural pouches; otoscopic examination of the external auditory canal and tympanic membrane (difficult to achieve in a conscious horse, a small endoscope is necessary); desensitization of the infraorbital and posterior ethmoidal nerves; biopsy of the nasal mucosa (in horses with suspected rhinitis); radiographic examination of the neck; and therapeutic trials including application of contact lenses or masks, or administration of medications (see 'Treatment').

### CLINICAL PATHOLOGY

There are no characteristic hematologic or serum biochemical abnormalities.

### NECROPSY FINDINGS

There are no characteristic findings on necropsy, apart from those of any underlying disease. Evidence of lesions in the trigeminal nerve is lacking.

### DIFFERENTIAL DIAGNOSIS

The disease must be differentiated from the stereotypic weaving that occurs during stabling and not during exercise.<sup>6</sup>

### TREATMENT

The principles of treatment include relief of specific underlying diseases, removal of management or environmental conditions that cause head shaking, and administration of medications.

If underlying conditions are detected, such as ear mites, dental disease, and others listed under 'Etiology', then these conditions should be treated effectively. Effective treatment of these conditions will alleviate head shaking, if in fact the condition was the cause of the disease. However, most horses with head shaking have seasonal or photic disease and treatment is more difficult. A survey of owners of 254 horses with head shaking revealed that

only 129 horses had been treated by a veterinarian and, of those, only 6% had complete resolution of head shaking, whereas 72% had no response to treatment.<sup>7</sup> Other treatments used were on the advice of lay 'back specialists', homeopathy, alternative therapies or face or head masks. Success rates for these interventions varied between 6 and 27%, with the most success obtained by use of a nose net (27%).<sup>7</sup> Nose nets provided better control of signs than did face or eye masks. These figures on the success of treatment illustrate the refractory, and therefore frustrating, nature of the disease.

Fitting of **nose masks** alleviates or lessens head shaking in some horses.<sup>7,8</sup> The design of the nose mask does not appear to be important at least in regard to whether it covers the entire rostral face or just the nostrils.<sup>8</sup> The nose masks were most effective for treatment of up-and-down head shaking, but not for side-to-side or rubbing behavior.<sup>8</sup>

Blue tinted **contact lenses** have been suggested for use in horses with photic head shaking.<sup>9</sup> Others have not found this intervention useful.<sup>4</sup>

**Sclerosis** of the infraorbital or posterior ethmoidal nerves is performed in those horses that have reduced or eliminated head shaking after injection of local anesthetic into the infraorbital foramen or around the posterior ethmoidal nerve.<sup>1</sup> Sclerosis is achieved by injection of 5 mL of 10% phenol in oil.<sup>1</sup> Care must be taken to ensure that the phenol is deposited only around the nerve. The procedure should be done under general anesthesia.

**Cyproheptadine** (0.3 mg/kg, orally q12 hourly) improved head shaking in 43 of 61 horses, based on owner reported efficacy.<sup>4</sup> Responses were usually observed within 1 week of the start of therapy. Others have not replicated this success<sup>1</sup> but found that the combination of **carbamazepine** (4 mg/kg orally q6–8 hours) and cyproheptadine improved clinical signs in 7 horses within 3 to 4 days of starting treatment.<sup>1</sup>

**Acupuncture** and **chiropractic** manipulation appear to be minimally effective.<sup>4,7</sup>

Prevention of exposure to bright light is an obvious recommendation, but not practical for most horse owners.

## CONTROL

There are no recognized measures for preventing development of the disease.

## REFERENCES

1. Newton SA et al. *Equine Vet J* 2000; 32:208.
2. Newton SA. *Equine Vet Educ* 2005; 17:83.
3. Madigan JE et al. *Equine Vet J* 1995; 27:306.
4. Madigan JE, Bell SA. *J Am Vet Med Assoc* 2001; 219:334.
5. Mills DS et al. *Vet Rec* 2002; 150:236.
6. Cooper JJ et al. *Appl Animal Behav Sci* 2000; 69:67.
7. Mills DS et al. *Vet Rec* 2002; 150:311.
8. Mills DS, Taylor K. *Vet Rec* 2003; 152:41.
9. Madigan JE, Bell SA. *Equine Vet J* 1998; Suppl 27:28.

## CONGENITAL NECROTIZING ENCEPHALOPATHY IN LAMBS

This condition is reported as the most common diagnosis of neurological disease in lambs under 7 days of age by VLA diagnostic laboratories in the north of England and is defined by its pathology.<sup>1</sup> Affected flocks have single or multiple cases with up to 10% morbidity in lambs of a flock. Cases have all come from ewes carrying multiple fetuses. There is variation in the clinical manifestations between sibling lambs. The most severely affected may be stillborn. Less severely affected lambs are born weak, are small, maybe unable to rise or show ataxia and head tremor. Some lambs survive but may have residual signs of cerebellar dysfunction. The common lesion is superficial cerebrocortical neuronal necrosis. A significant proportion also has necrosis of the Purkinje cells in the cerebellum and leucoencephalopathy of the thalamus and brainstem. It is possible that this syndrome reflects hypoglycemia consequent to negative energy balance in late pregnancy.

## REFERENCE

1. Scholes SFE, Watson PJ. *Vet Rec* 2004; 154:32.

## Diseases characterized by involvement of the musculoskeletal system

### HYENA DISEASE OF CATTLE

Hyena disease of cattle occurs worldwide and is characterized clinically by a lateral body appearance similar to the hyena.<sup>1,2</sup> The cause is unknown but excessive intake of vitamins A and D may be contributing factors.

In some naturally occurring cases in yearlings from one large dairy herd approximately 1% of calves were affected annually. Affected calves had received vitamins A and D<sub>3</sub> immediately after birth, and from birth to weaning received the same vitamins from fresh milk, whole corn, a customized feed mix, and a milk supplement.<sup>2</sup> The mean daily intake of vitamin A from birth to 6 weeks of age was approximately 80 000 iu and 6300 iu of vitamin D<sub>3</sub>, and progressively less vitamin A and D<sub>3</sub> was fed from 6 weeks until weaning at 3 months. The National Research Council recommendations for daily vitamin intake are 2100 iu of vitamin A at birth, increasing to 6360 iu at 2 months and 330 iu of D<sub>3</sub> increasing to 990 iu over

the same period.<sup>2</sup> Experimentally, the IM injection of vitamins A and D (2 000 000 iu and 300 000 iu, respectively) on the first day after birth followed by 30 000 iu/kg BW added to the milk replacer daily results in gross lesions in the proximal tibial growth plates in 3 weeks.<sup>3</sup> Excessive vitamin A and vitamin D<sub>3</sub> administration to young calves can cause hyena disease by suppression of the activity of differentiation and proliferation in chondrocytes and osteoblasts.<sup>4,5</sup> The administration of excessive amounts of vitamins A, D<sub>3</sub>, and E to Holstein sucking calves can cause hyena disease characterized clinically by severe emaciation, generalized alopecia, dome-like cranial deformation, and high mortality.<sup>6</sup>

There is premature closure of the growth plates of the long bones resulting in a marked dissimilarity in growth and development between the forequarters and the hindquarters, the latter being comparatively underdeveloped. This gives the animal the classic contours of the hyena and this resemblance is heightened by a crest of thick, stiff bristles along the back in the midline. An aggressive attitude also develops. Affected calves are normal at birth and only develop the abnormality at 5–6 months of age. There is no apparent abnormality of sex hormones. The femur and tibia are shorter in affected than in normal animals. There are accompanying difficulties of locomotion with a tendency to fall sideways, and to frequently adopt a position of lateral recumbency. The gait is described as 'bunny-hopping'.

German Simmental, Charolais, Black Pied, German Holstein-Friesian, and German Red Pied cattle have been involved. Genetic analysis appears to indicate that the disease is inherited as a simple recessive with incomplete penetrance but this is obviously not so in some herds.

The lesion is a chondrodystrophy affecting particularly the long bones and the lumbar vertebrae. Gross examination and radiography of the longitudinal slabs of the humeri, tibiae, and femurs reveal focal to almost complete closure of the physes and physes subjected to compression are affected more than those subjected to tension.<sup>2</sup>

## REVIEW LITERATURE

- Espinasse J, Parodi AL, Constantin A, Viso M, Laval A Hyena disease in cattle: a review. *Vet Rec* 1986; 118:328–330.

## REFERENCES

1. Espinasse J et al. *Vet Rec* 1992; 118:328.
2. MacKay RJ et al. *J Am Vet Med Assoc* 1992; 201:902.
3. Woodard JC et al. *J Comp Path* 1997; 116:353.
4. Takaki H et al. *J Vet Med Sci* 1996; 58:311.
5. Takaki H et al. *J Vet Med Sci* 1996; 58:407.
6. Yamamoto K et al. *Vet Hum Toxicol* 2003; 45:85.



## ASYMMETRIC HINDQUARTER SYNDROME OF PIGS

This condition was first reported in Germany<sup>1</sup> and Belgium<sup>2</sup> and was recognized in the UK in 1968 and reported later.<sup>3</sup> In these cases perineurial fibrosis was a feature and it was thought that the condition resulted from either a neurogenic atrophy or a periarticular fibrosis extending to the peripheral nerves. There is variable asymmetry of the hindquarters which is generally evident during the early grower period and obvious by 80 kg liveweight stage. An asymmetrical distribution of subcutaneous fat is also noted and possibly skin dimpling.<sup>4,5</sup> The muscle most frequently affected was the *M. semimembranosus*, followed by the *M. semitendinosus*, *M. biceps femoris*, *M. adductor femoris*, and *M. gracilis*. The muscles show changes that can be described as myofibre degeneration, interstitial fibrosis, and dystrophic changes. Several breeds, including Landrace, Large White, and Hampshire have been found affected but the problem is generally restricted to certain herds and to certain families within these herds, suggesting that a genetic liability exists for this condition.<sup>2</sup> The mechanism of inheritance studied from test matings is not simple.<sup>3</sup> Whatever the cause, there is a marked reduction in the number of muscle fibres. Both sexes may be involved and the condition may involve either hindlimb. Despite a marked reduction in muscle mass there is no detectable abnormality in gait. The cause is unknown, although it appears to result from suboptimal muscle growth rather than degenerative loss.<sup>6</sup> In the only cases recorded from outside Europe a group of 7 Australian pigs were examined in detail<sup>7</sup> and in one of these the affected *M. semitendinosus* weighed only 41% of the normal unaffected one. Perineurial fibrosis and myopathy have been observed in some cases but have not been found consistently.<sup>6</sup>

### REFERENCES

1. Bickhardt K et al. Dtsch Tierarztl Wschr 1967; 74:324.
2. Hoorens J, Oyaert W. Vlaams Diergeneesk Tijdschr 1970; 39:246.
3. Done JT et al. Vet Rec 1975; 96:482.
4. Penny RHC. Vet Rec 1957; 69:528.
5. Parish WE, Done JT. J Comp Path 1962; 72:286.
6. Swatland HJ, Cassens RG. J Anim Sci 1972; 35:336.
7. Mercy AR, Peet RL. Aust Vet J 1983; 60:267.

## SPLAYLEG SYNDROME IN NEWBORN PIGS

This syndrome is also called spraddle leg, but more usually myofibrillar hypoplasia. This may be an erroneous term as this hypoplasia occurs in many normal pigs and may be a normal feature of post-natal

muscle growth. This clinical condition of splayleg occurs in newborn piglets in most countries and is characterized by a temporary inability to stand with the hindlimbs.<sup>1</sup>

### ETIOLOGY

The etiology is unknown, but based on epidemiological evidence it is multifactorial.<sup>1</sup> The current hypothesis is that the disease is caused by an interaction of genetic and non-genetic factors, a polygenic mode or expression of many genes without dominance.

The studies of Czech workers<sup>2,3</sup> have suggested that the pathomorphology of the condition resembles that of glucocorticoid induced myopathy in man and animals.<sup>4</sup> Dexamethasone given to minisows from the first to the last days of pregnancy produced in newborn piglets a disorder characterized by the splayleg syndrome with retardation of both muscle growth and myofibrillogenesis.<sup>3,5</sup> It has also been experimentally produced following the administration of pyrimethamine.<sup>6</sup>

### EPIDEMIOLOGY

The prevalence of the disease in the UK is 0–4% and the morbidity in affected herds varies from 2 to 27%. The case fatality rate is approximately 50% and is due to crushing, chilling, and starvation because affected piglets are not able to move around normally. The disease is more common in the Pietrain, Welsh, Landrace, and Large White breeds of swine; Landrace pigs may be especially susceptible. This suggests a genetic basis, but test-matings, with the exception of a few, have not been successful in reproducing the disease.<sup>1</sup> On most farms the disease affects both male and female piglets. In a recent retrospective analysis of the incidence of the disease in a swine herd over a period of 5 years, the overall frequency was 1.74 times more in males than females and the birth weight of splayleg piglets tended to be subnormal.<sup>7</sup> The environmental factors which have been associated with some outbreaks include slippery floors, a dietary choline deficiency and the ingestion of **Fusarium toxin** by pregnant sows. Choline deficiency is unlikely to be a factor<sup>8</sup> and none of the other factors have been substantiated as etiological factors or epidemiological determinants.<sup>1</sup>

### PATHOGENESIS

The pathogenesis of the disease is unclear. In affected pigs there is myofibrillar hypoplasia<sup>9,10</sup> but this is also a feature of many muscles in normal pigs. There are simply too few maturing type 1 fibrils in the muscles, particularly of the foreleg, lumbar epaxial group and the hind limb to carry weight. The *Mm semitendinosus* appears to be the worst affected muscle. However,

because myofibrillar hypoplasia may also be present in normal unaffected littermates<sup>1</sup> it has been difficult to explain the pathogenesis of the muscular weakness. The use of morphometrics has enabled the detailed determination of the myofibrillar hypoplasia.<sup>11</sup> In addition to myofibrillar hypoplasia, in splayleg pigs there is a higher content of sarcoplasmic RNA, reflected ultrastructurally by the presence of numerous ribosomes.<sup>12</sup> The extramyofibrillar space was also filled with glycogen in splayleg pigs.<sup>13</sup> In myofibrillar hypoplasia induced with glucocorticoids given to the pregnant sow, none of the pigs had splaylegs but the extramyofibrillar space contained little glycogen. There were also many glycogen-filled phagosomes and residual bodies which indicate a difference in the metabolism of glycogen in the first 2 or 3 days after birth. In a study of natural cases there was hypoplasia but there was an increased accumulation of glycogen especially within the large extramyofibrillar spaces in comparison with the normal pigs.<sup>14</sup> These authors also found an anomalous distribution of glucose-6-phosphatase in splaylegged muscles in that the activity was concentrated at the periphery of the extremely dilated cisternae of the sarcoplasmic reticulum. In the normal muscles this enzyme activity was normal. This distribution could account for the slower utilization of glycogen in affected muscles and therefore would account for the build up.<sup>14</sup> Quantitative image analysis of skeletal muscle revealed that the arrangement of the myofibrils within the fascicles of affected and unaffected pigs was different.

Some studies have found both quantitative (hypoplastic-type) and qualitative (dystrophic-type) insufficiencies in affected pigs which represent a temporary perinatal developmental disturbance. This could explain the muscular weakness and the recovery which occurs.

### CLINICAL FINDINGS

Larger litters may be more affected possibly because these tend to be born earlier. The clinical signs are usually obvious in 2–3 hours after birth when the litter should be standing and walking around the creep area. Affected piglets are unable to stand, and their hindlimbs are splayed sideways or forwards and the animals are resting in sternal recumbency. Sometimes the fore limbs are also splayed. Most severely affected piglets are unable to move; less severely affected animals are able to move slightly. Many pigs have soiled hindlimbs and perineum as a result of being unable to stand. As a result, the piglets are likely to be crushed or have difficulty gaining access to their source of

nourishment. Affected piglets are normal in other respects and have a normal appetite and will suck the sow if placed near a teat. In the experimental induction<sup>5</sup> there was hypoplasia but there were no clinical signs, which is further evidence for suggestions<sup>15</sup> that the condition has a threshold for clinical signs and has strong maternal influences.

### TREATMENT

Treatment can be successful.<sup>16</sup> If the pigs are able to suck or if they are fed artificially for 2–4 days, recovery will occur within 1 week in about 50% of cases. The ambulatory capacity of affected pigs can be improved, and mortality reduced, by taping or loosely tying together the hindlimbs for a period of up to 1 week. The method of loose tying of the hindlimbs consists of a figure-of-eight bandage (2.5 cm wide adhesive tape) being fixed around the metatarsal bones, leaving a space between the legs of up to 7 cm depending on the size of the piglet. The legs should be tied together within a few hours after the syndrome is obvious; a delay of several hours will decrease the prognosis. The provision of a non-slip floor surface such as a carpet or sack may also be helpful. Many farmers will tell you that repeated massaging of the limbs will also improve the survival rate.

### CONTROL

Whether or not to cull the boar depends on the pedigree value of the animal, the incidence of the disease, and the probability that the boar is responsible. There is no evidence that the disease is monogenic. However, the incidence is highest in the Landrace breed, which suggests a hereditary predisposition. In deciding whether to use a suspected carrier animal, there is a need to distinguish between different situations. The consequences of disease are felt differently at the different levels of organization of the pig industry. A boar of high merit for performance traits may be more economical to retain as breeding stock even though some progeny are affected with the disease than a less superior boar whose progeny are unaffected. If stress of the pregnant sow is a factor, control of the disease may be dependent upon the selection of stress-resistant boars and sows.

Concurrent disease should be controlled as producers will tell you that after a period of PRRS infection they had a higher percentage of splayleg piglets. There are also suggestions that induced early farrowing and zearalenone poisoning may also be complicating factors to prevent.

### REVIEW LITERATURE

Ward PS. The splayleg syndrome in newborn pigs: a review. Part I *Vet Bull* 1978; 48:279–295. Part II *Vet Bull* 1978; 48:381–399.

### REFERENCES

1. Tucek S, Hanzikova V. *Physiol Bohemoslav* 1984; 33:147.
2. Zelena J, Jirmanova I *Zentralbl Vetmed* 1979; 26:652.
3. Jirmanova I, Lodja L. *Zentralbl Vetmed A* 1985; 32:445.
4. Jirmanova I. *Vet Res Comm* 1983; 6:91.
5. Ducatelle R et al. *J Comp Path* 1986; 96:433.
6. Ohnishi N et al. *J Vet Sci* 1989; 51:146.
7. Vogt DW et al. *Am J Vet Res* 1984; 45:2408.
8. Lax T. *J Hered* 1971; 62:250.
9. Bradley R et al. *J Comp Path* 1980; 90:433.
10. Gilbert FR et al. *Vet Rec* 1967; 80:302.
11. Curvers P et al. *Dtsch Tierarztl Wschr* 1989; 96:189.
12. Hajek I. *Physiol Bohemoslav* 1980; 29:145.
13. Lukas Z et al. *Acta Vet Brno* 1978; 47:51.
14. Antalikova L et al. *Reprod Nutr Dev* 1996; 36:205.
15. Sellier P, Ollivier L. *Ann Gen Sel Anim* 1982; 14:77.
16. Blackburn P. *The Pig J* 1988; 21:185.

### DEGENERATIVE JOINT DISEASE (OSTEOCHONDROSIS, OSTEOARTHRITIS, EPIPHYSEOLYSIS AND APOPHYSIOLYSIS, LEG WEAKNESS IN PIGS)

Leg weakness in pigs is a very loose term which includes a wide variety of conditions and is best discarded. In Finland 15% of gilts are culled due to leg weakness.<sup>1</sup> Degenerative joint disease would be a much better general term to describe the lameness of young rapidly growing pigs affected with a non-infectious joint disease which includes osteochondrosis (OC), epiphyseolysis, and degenerative osteoarthritis (OA). The disease is characterized by varying degrees of intermittent but progressive lameness in rapidly growing pigs from 4 to 8 months of age, and pathologically by the presence of OA and OC. The disease is of major economic importance because of the high culling rate of breeding age swine.

#### Synopsis

**Etiology** The cause is unknown.

**Epidemiology** Occurs in majority of breeds of rapidly growing pigs and young breeding females and males. Lesions are commonly present at slaughter. May be related to nutrition and rapid growth rate, genetic predisposition, and type of flooring but no reliable correlations.

**Signs** These may be no clinical findings or possibly lameness and inability to breed.

**Clinical pathology** Radiographic evidence of osteochondrosis.

**Lesions** Osteochondrotic lesions of varying degrees of development, severity and healing.

**Diagnostic confirmation** Lesions at necropsy.

### Differential diagnosis list

Other causes of lameness include:

- Polyarthritis due to infectious causes
- Laminitis
- Nutritional osteodystrophy due to calcium, phosphorus, and vitamin D imbalance
- Hypovitaminosis A causing hindlimb paresis.

**Treatment** None.

**Control** Uncertain. Select breeding stock with sound legs and gait.

### ETIOLOGY

The cause of the articular abnormalities is not known. The etiology and factors underlying these syndromes are poorly defined, partly because of the difficulty of definitive clinical examination of affected pigs and the frequent lack of apparent significant pathological changes in necropsy examination of mild cases. There are no specific associations between degenerative joint disease and infectious diseases.<sup>2</sup>

### EPIDEMIOLOGY

#### Occurrence

Recently, a study of 9411 newborn piglets showed that 9.8% were treated for lameness. For parity 3 sows, the level had risen to 11.4%, but by parities 4–7 only 8% were treated. The treatments were in pigs of less than 3 weeks of age in 73% of the cases. Litters with 12 or more pigs had the highest incidences of lameness.<sup>3</sup> Osteoarthritic changes are strongly associated with osteochondrotic changes in the humeral and femoral condyles.<sup>4</sup> Osteochondrosis has been recorded as early as 1 day of age so the lesions may be congenital. There may be some degree of change in up to 85% of pigs.

The intensification of the swine industry has required that pigs grow rapidly and with high feed efficiency. Under such intensified conditions, rapidly growing pigs develop lesions of the bones and joints, especially the femur. Most pigs near market weight have varying degrees of osteochondrosis (OC). Except for severe lesions, which usually occur in a relatively small proportion of the total population examined, the lesions seen at slaughter often have no detrimental effect on growth rate of pigs up to market weight. An advanced degree of OC however, can result in severe degenerative joint disease and lameness in breeding stock. It is not associated with adventitious bursitis.<sup>5</sup>

The disease occurs in both male and female pigs and the incidence of lame pigs can be as high as 20–30%. It is a particular problem in gilt and boar testing stations where it may necessitate slaughter of affected animals before the testing period is complete. The lesions develop

most commonly in growing pigs, particularly boars from 20 to 30 weeks of age, raised in confinement. The onset occurs when pigs are between 4 and 8 months of age which coincides with a period of maximal growth rate. The peak period of clinical manifestation is from the late grower stage until 18 months of age, although the effect of OA may carry through to the adult period. Extensive multicentric degenerative joint disease in adult sows and boars can cause severe lameness which often warrants euthanasia.<sup>6</sup> However, sows ranging in age from 1.5 to 3.0 years and culled for impaired reproductive performance, with no history of lameness may have lesions of the femoral condylar surface.<sup>7</sup>

### Risk factors

Numerous risk factors contribute to the disease. They include nutrition and rate of growth, genetic, and breed predisposition, sex, type and quality of floor, and exercise and confinement. The pig carries 53–51% of its weight on the fore limbs and 46–48% on the hind but the weight supported on the hind is higher at 90 and 105 kg body weight.<sup>8</sup> In a study of gilts and sows in Denmark about 12% of gilts showed stiff locomotion but at some point 53% of gilts had at some time showed the same sign. Buck-kneed forelegs, upright pasterns, legs turned out wide, standing under position, and swinging hindquarters were associated with stiff locomotion or lameness. Weak pasterns on the hind feet were associated with stiff locomotion and lameness.<sup>9</sup> Weak pasterns on hindlegs and splayed digits on forelegs were associated with brisk movement (freedom from locomotor problems). The following leg weakness signs at the gilt stage were found to have a significant effect on the longevity of the sows: buck-kneed forelegs, swinging hindquarters, and standing under position on the hind legs.

**Nutrition and rate of growth.** The disease is associated with rapid early growth,<sup>10</sup> but it does not appear to be related to protein, vitamins A and D or calcium and phosphorus imbalance in the ration.<sup>11</sup> Maximal mineralization of bones is not necessary to prevent leg weakness. Only almost complete absence of calcium and phosphorus causes lameness. Disturbances of the Ca:P ratio below 0.5 or over 3.0 are necessary to produce lameness. Recently, it has been suggested that long-term acidosis may be associated, as bone is not formed as phosphorus is removed from the bone. In this context the acidification of pig diets has been suggested as a contributory cause. It has also been shown that the presence of deformed forelimbs is not associated with low levels of vitamin C in plasma.<sup>12</sup> Rapid

growth, especially during the early period, was thought to have a significant influence on the occurrence<sup>13</sup> and there is also some breed variation in susceptibility. However, in some feeding trials of pigs from weaning to slaughter weight there was no direct effect of rapid growth rate on the incidence and severity of OC. In other feeding trials, average daily gain of gilts was an important factor in the severity of lesions of OC. Decreasing the rate of gain by restricting energy intake appeared to decrease the prevalence and severity of OC when gilts were slaughtered at 110 kg.<sup>14</sup> However it was shown that when pigs were fed waste food, and grew more slowly, they had an increased prevalence and score for OC when compared with pigs fed a commercial feed concentrate.<sup>15</sup> Decreasing the concentration of protein in the diet of gilts from 16 to 12% resulted in less longitudinal bone growth but did not decrease the incidence of OC.<sup>16,17</sup> A simple association between growth rate and the incidence or severity of joint lesions has not been consistently demonstrated and a reduction in growth rate of pigs does not control the disease. A significant favourable association between leg action and daily gain has been noted.<sup>18</sup> There has also been speculation that growth hormone could influence the development of lesions of OC by exerting a direct effect on differentiation and colonization of epiphyseal chondrocytes. There is no consistent relationship between the incidence of osteochondrosis and selection of pigs for lean tissue growth rate.<sup>19</sup> It may be simply that more feed means more growth which makes stress on developing cartilage worse and therefore predisposes to OC.

**Genetic and breed predisposition.** It has been proposed for many years that selection of pigs for increased growth rate resulted in a concomitant increase in the incidence and severity of musculoskeletal disease. Genetic studies indicate that the heritabilities of leg weakness are low to moderate (0.1–0.3).<sup>20</sup> A more recent study suggested from 0.01 to 0.42 for leg weakness and OC and that both are associated with production traits (lean% and backfat thickness).<sup>14</sup> Genetic analysis of the incidence of OC and leg weakness in the Swedish pig progeny testing scheme revealed a low to moderate heritability. Genetic control of leg weakness has been achieved by various researchers and thus inheritance is probably an important risk factor for this disease complex. The genetics of leg weakness have been described in Finnish Large White and Landrace populations.<sup>21</sup> Meaty breeds are worst affected including the Duroc and the Dutch and Swedish Landrace.

Osteochondrosis also occurs in cross-bred Wild boar-Yorkshire pigs with a genetically decreased growth rate, raised under the same conditions as finishing pigs.<sup>22</sup> The distribution and extent of OC was similar to that of purebred Swedish Yorkshire pigs. This suggests that it is not limited to rapidly growing pigs. Synovial bursae at the hock joints were higher in Large White pigs with straight or bowed hind legs and in Landrace with sickle shaped hind legs.<sup>23</sup> There are significant breed differences in the peri-articular and meniscal ossifications seen on X-ray.<sup>24</sup> Recently, the quantitative trait loci for locomotion and osteochondrosis-related traits have been identified in Large White × Meishan pigs.<sup>25</sup> Correlations between breeding values for longevity and for OC were low but significant, and in a favourable direction. Higher OC scores were associated with a higher risk of being culled.<sup>26</sup> It has been seen in wild boar in Slovenia.<sup>27</sup>

**Sex.** The differences in the incidence and severity of OC between the sexes of different breeds has also been analyzed. The degree of leg weakness and OC of one sex in a breed can neither be translated to the other sex within that breed nor to the same sex of another breed.

**Type of floor.** Insecure footing because of unfavorable floor surfaces and the presence of foot lesions may change the posture of the animal and cause local overloading of certain joints. The effect of the quality of floor has been examined and there is no clear evidence that hardness of floor contributes to an increased incidence of leg weakness associated with joint disease. However, the incidence and severity of joint lesions may be related to the duration of confinement in pigs confined individually. Exercise will prevent abnormalities such as bow legs, flexion of the carpus and sickle-legs from impairing the mobility of boars, but does not influence the severity of joint lesion. The milder syndromes of poor movement and lameness associated with defects in leg conformation in the grower stage are not necessarily associated with bone or joint lesions and may regress spontaneously or improve if affected pigs are placed on pasture. However, severe lameness at this age, and that which occurs in replacement stock and young adults is frequently associated with severe bone and joint lesions which may be irreversible. A recent study has looked at type of floor (solid floor plus straw, solid floor no straw, and fully slatted).<sup>28</sup> The slatted floors were worst for leg weakness and the floors with straw best. The different types of floor affected leg weakness and claw disorders differently.

**Exercise and confinement.** There is some limited evidence that high lean growth rate may predispose toward leg weakness under confinement rearing. Trauma during handling, penning, and transportation may be associated with a relatively high frequency of OC but the evidence is very limited.<sup>29</sup> A high stocking density had an adverse effect on 4 of the leg weakness signs (knock knees, turned out front or hind limbs, standing with the legs under the body).<sup>28</sup> A recent study of housing and treadmill training did not show any adverse effects on leg weakness.<sup>30</sup> It has even been seen in pigs on grass, on deep litter and in wild boar

#### Economic importance

In Scandinavia, breeding pigs culled because of lameness had a 100% frequency of OC or OA, and up to 40% of boars in a performance test station had osteochondrosis or osteoarthritis.<sup>6</sup> A conservative estimate suggests that 3% of sows and 10% of boars are culled for unsoundness associated with OC and OA.<sup>6</sup> The hidden costs include a reduced pool for selection of high-performance boars and gilts, the maintenance of pigs which cannot be used for breeding, increased mortality among piglets crushed by lame sows, reduced feed intake and growth rate in lame pigs, and transportation costs of replacement stock.

#### PATHOGENESIS

The condition has been seen as early as 1 day and with age the lesions develop. The essential lesion is the necrosis of cartilage canals and surrounding cartilage.<sup>31,32</sup> They may be seen to be developing and healing at the same time. In growing animals, the superficial layer of joint cartilage is articular cartilage, and the deeper layer is epiphyseal cartilage which undergoes endochondral ossification as the animal matures. The articular cartilage persists in the mature animal while the epiphyseal cartilage becomes a layer of calcified cartilage and underlying subchondral bone. The cartilage of the physis is known as the growth plate and is involved in metaphyseal growth. The normal growth plate cartilage has a well-ordered structure with the chondrocytes of the proliferative and hypertrophic regions arranged into columns.

Osteochondrosis is a generalized disease in which there are focal areas of failure of endochondral ossification in the physal (metaphyseal growth) and epiphyseal growth cartilages. The underlying defect may be an abnormality of the chondrocytes which do not undergo normal hypertrophic ossification. They accumulate rough endoplasmic reticulum, lipid droplets and mitochondria. The surrounding matrix contains deposits of electron-dense material which

may prevent normal vascularization and therefore ossification. The hypertrophic region is disorganized and greatly extended compared to normal tissue.<sup>33</sup> The matrix surrounding the clustered chondrocytes is altered compared to that in normal cartilage.<sup>34</sup> The primary abnormality is an increased thickness of the joint cartilages combined with degenerative changes which result in infoldings and erosion of articular cartilages. Defects of the growth plates (physes) result in short deformed bones.

Pathologically, severe clinical cases are characterized by osteochondrosis and secondary degenerative joint disease especially involving the medial aspects of the larger joints, epiphyseolysis and lumbar intervertebral disc degeneration and spondylosis. Osteochondrosis has been used to encompass lesions involving the physes and the articular epiphyseal complexes. However, because of morphological changes that have been observed in growing pigs, dyschondroplasia is now the preferred term to be used generically and then qualified by the location and nature of the morphological description since the causes may be different.

Osteochondrosis occurs commonly in growing pigs at predilection sites of the medial condyle of the humerus and femur, the epiphyseal plates of the distal ulna and the femoral head and the intervertebral joints. The 6th–8th costochondral junctions may also be affected. It may heal spontaneously or it may progress to *osteochondritis dissecans* and OA. Its progression in either direction is influenced by local loading and by joint stability which depends upon joint shape and muscle and ligamentous support. The age-related changes and OC in the articular and epiphyseal cartilage have been described.<sup>35</sup> The cartilage increases with age up to 5 weeks and then begins to decrease in thickness. Deleterious influences such as defects in conformation, heavy muscling with skeletal immaturity, muscular weakness resulting from myofibrillar hypoplasia, myopathies or lack of exercise, inadequate flooring or even simple trauma may adversely affect this progression and lead to severe skeletal change.

Porcine synovial fluid contains both hyaluronic acid and chondroitin sulfate and the chondroitin sulfate-to-hyaluronic acid ratio is not influenced by relatively advanced stages of osteochondrosis. Treatment of lame boars with glycosaminoglycan polysulfate improves leg soundness score and results in an increase in the hyaluronic acid concentration of the cubitus joint synovial fluid, and an increase in the proportion of aggregated proteoglycans in the articular cartilage of the medial femoral condyle. It is suggested that the

hyaluronic acid accounts for most of the viscosity of synovial fluid and for efficient lubrication of the joint.

Well-established lesions typical of OC associated with the physes can be found in young pigs between 25 and 30 days of age.<sup>6</sup> The earliest change associated with a dyschondroplasia of the physis is a focus of persistent hypertrophied chondrocytes which do progress but heal. Lesions associated with physes and articular epiphyseal complexes develop continuously and regress as pigs grow older. Changes in cartilage canal vessels appear to be important in the pathogenesis.<sup>36</sup> There is no evidence that vascular damage is a factor in the pathogenesis of the lesions.

Because foci of dyschondroplastic lesions are associated with physes of pigs between birth and the stage of rapid growth, they could be regarded as part of the usual growth patterns in contemporary commercial swine. However, clinical signs of dyschondroplasias, or degenerative joint disease secondary to dyschondroplasias, usually do not appear until pigs are almost 6 months of age.

#### Radiological monitoring of lesions

Osteochondrosis can be diagnosed radiologically.<sup>13</sup> Radiologically the lesions were similar in Yorkshire, and Landrace<sup>37</sup> but more severe in the Landrace and similar to the Danish Landrace.

The development of epiphyseal osteochondrosis in pigs from 42 to 147 days of age has been followed radiologically.<sup>38</sup> Osteochondrotic lesions were seen radiologically in the articular-epiphyseal (A–E) complexes of the humeral condyles of 42-day-old pigs and in the femoral condyles at 63 days of age in contrast to earlier reports which indicated that lesions were not visible radiologically until 100 days of age. The osteochondrosis lesions of the A–E complexes develop, become progressive, and subsequently become either stable, regressive, or even more progressive as the pigs grow. This supports the observations that the lesions develop and become progressive and regress as the pigs grow. The humeral medial condyles have more pronounced lesions and are more frequent than the lateral ones.

Radiological monitoring of the development and sequelae of physal osteochondrosis lesions of the growth plate cartilage and A–E complexes of the fore and hind limbs in young breeding swine found that the majority of distal ulna lesions healed by 18–20 months and some started fusing at 18–21 months. The distal ulna healed without complications in most animals and the most severe lesions healed faster than the mild or moderate ones.<sup>38</sup> In a recent study periarticular ossifications at the elbow joint

were found in the radiographs at a prevalence of 0.9%.<sup>4</sup> Meniscal ossifications were seen as single or multiple foci at the cranial aspect of the joint at a prevalence of 2.6% and had a bilateral occurrence of 20%.<sup>4,39</sup> Meniscal ossifications were associated with hind legs turned out and stiff locomotion in the hind leg and negatively associated with growth rate.

### CLINICAL FINDINGS

The syndrome is called leg weakness and varies in severity from locomotor abnormality that results from conformation and leg defects such as narrow lumbar area and broad hips, hyperflexion of the carpus, bowing of the forelimbs and 'knock knees', hyperextension of the phalanges, lateral angulation of the foot and sickle hocks to more severe lameness and, in the extreme, inability to rise and paresis. Nine leg weakness signs were described.<sup>28</sup> The signs listed include buck kneed forelegs, steep hock joints, fore and hind limbs turned out, upright pasterns on the hind legs, stiff locomotion, standing under on the hind limbs, swaying hindquarters, goose stepping hind legs, lameness and tendency to slip,<sup>4</sup> and the four most common signs were buck knees, small inner claws on forefeet, small inner claws on hind feet, and upright pasterns on the hind legs.<sup>4,40</sup>

The clinical syndrome is a locomotor disorder usually involving the hindlimbs. Often the most rapidly growing pigs are lame. The lameness may be acute, intermittent, chronic, progressive, or a combination of these. An insidious onset is common, and pigs are unwilling to move, the stride is shortened, and the limbs are held in partial flexion. The carpal joints may be under extended, the metacarpophalangeal joints are overextended, giving the limb an abnormal S-shaped profile.<sup>6</sup> The pelvic limbs are commonly held straight and the back is slightly arched. In some cases, affected animals will assume a kneeling position with flexed carpal joints and walk on those joints.

Mild cases show stiffness, especially immediately after a period of lying down and lameness. Slowness to rise and a tendency to walk with short steps on tiptoes frequently in association with a marked inward curve of hindlimb motion during forward progression and side-to-side motion of the buttocks is frequently seen. More severely affected pigs sit on their hindquarters and are reluctant to stand. They carry one or both hindlimbs more forward under the body and walk with a short goose-stepping gait. Wasting is not a feature except in severely affected animals and the locomotor disorder may be minor unless exacerbated by physical exertion.

The syndrome is of particular importance in breeding animals where it may interfere with successful mating. Boars may show initial interest in mounting but subsequently slide off the sow or dummy before mating is complete, presumably due to the pain of the limb lesions. In Europe this problem has been called *impotentia coeundi*.

There may be no meaningful association between visual scores for physical soundness in the live animal and the degree of joint damage.<sup>41</sup> Some pigs with severe lesions are not lame and conversely other pigs are severely lame with minor lesions. Epiphyseolysis of the femoral head produces severe unilateral lameness and if bilateral is usually manifest by marked reluctance to rise and severe locomotor disability. Initial signs are frequently deceptively mild and follow physical exertion such as mating, transport, farrowing, or fighting but they progress to severe lameness over a 7–10-day period.

Epiphyseolysis of the tuber ischii (Apophyseolysis) may also occur following physical exertion but is more common in second or third parity sows and is manifest by 'paralysis' with the hindlimbs in forward extension under the body of the sow.<sup>42</sup> These animals 'dog sit', and are unable to rise. In many instances the injury occurs when the animals arrive on the farm or are first mated.

Because of the pain and muscle contraction, it is frequently difficult to determine the site and severity of the lesion by simple clinical examination, and palpation following general anesthesia or radiography may be required for proper clinical assessment. Physical examination should include complete palpation of all limbs for warmth, swelling, and pain. The palpable parts of the pelvis should be examined with particular emphasis on the ischial tuberosities. Passive flexion, extension and rotation of each limb along with auscultation over the joint may reveal evidence of crepitus or a pain response.

While the lesions of the physes and articular epiphyseal complexes are detectable in pigs under 14 days of age they are not detectable radiographically in live animals until the pigs are over 100 days of age. Only 21% of the lesions associated with the physes and 22% of the lesions associated with the articular epiphyseal complexes were detectable in radiographs of bones of live pigs.

Meniscal ossifications were observed as simple or multiple small smooth firm and irregular swellings in the cranial horn of the lateral meniscus.<sup>24</sup> The peri-articular osseous foci were seen as focal firm swellings at the cranio-medial aspect of the elbow joint.<sup>24</sup>

### CLINICAL PATHOLOGY

The carpal, elbow, tarsal, and stifle joints can be radiographed for evidence of joint lesions, and the lesions scored according to a system.<sup>38</sup> It is also possible to use ultrasonics for diagnosis.<sup>43</sup>

### NECROPSY FINDINGS

The histological, radiological, and angiographic findings of dyschondroplasias of the growth cartilages in crossbred commercial pigs at 1 and 15 days of age have been described. The bone lesions in clinically normal and lame pigs have been described.<sup>44,45</sup> The scapulohumeral, humeroradioulnar, carpal, coxofemoral, femorotibial, and tarsal joints should be examined. Typically, in osteochondrosis, the changes are feathery hypertrophy of villi, focal full-thickness cartilage buckles, ulcers of flaps, and no change in the draining lymph node. Joint mice and synovitis may also be seen. Deformation may take place in the long bones or even fractures. Histologically, osseous trabeculae may be seen with clusters of chondrocytes, and between the trabeculae lined by flat osteoblasts there are adipocytes. The osseous center was formed of mineralized cartilage that blended into more or less fibrous cartilage but towards the joint cavity the meniscal ossifications were covered by hyaline cartilage.<sup>24</sup>

Occasional cases involve the patella in breeding age pigs.<sup>16</sup>

The ultrastructural characteristics of normal epiphyseal cartilage of the articular epiphyseal cartilage complex in growing swine has been examined and found to be different from the articular cartilage and the cartilage of the physis.<sup>46</sup> Histochemical techniques are now used to characterize lesions of osteochondrosis and the lesions associated with articular-epiphyseal cartilage complexes should be considered as different entities.<sup>35</sup> Osteopenic lesions have been described.<sup>47</sup>

### DIFFERENTIAL DIAGNOSIS

The syndrome must be differentiated from other diseases which cause lameness and paralysis in growing and young adult pigs which includes: infectious polyarthritis, laminitis, traumatic foot lesions, foot lesions produced by biotin deficiency and footrot, osteodystrophy resulting from calcium, phosphorus and vitamin D imbalance in rations, vitamin A deficiency and viral encephalomyelitis.

### TREATMENT

There is no effective treatment. Early cases may recover spontaneously after being placed outside on pasture or housed individually inside on deep straw litter. Recently, it has been suggested that meloxicam at a dosage of 0.4 mg/kg is

efficacious and safe for the treatment of non-infectious locomotor disorders in pigs. Treatment with 2,5-D vitamin D had no effect on the incidence and severity of OC/OA lesions.<sup>48</sup> Animals that are affected with clinical signs should be removed from the herd quickly and, if necessary, should be humanely destroyed as soon as possible.

### CONTROL

Because the etiology is unknown, it is not possible to provide specific control measures. The hereditary nature of the disease suggests that the selection of breeding stock with sound legs and a low incidence of lesions would be an effective long-term control measure. Genetic control of leg weakness has been documented by various researchers.<sup>41</sup> Selection of boars for leg soundness has dramatic effects on the structural soundness of their crossbred progeny and therefore selection of structurally sound replacements must be maintained if leg weakness in market or breeding pigs is to be avoided.<sup>49</sup> Divergent selection for leg soundness in Duroc pigs has been dramatic.<sup>49</sup> Progeny of leg-soundness sires had significantly better measures for all leg traits at 104 kg than did progeny of leg-weakness sires.<sup>35</sup> Differences between the two progeny groups indicated that the realized heritability for front leg soundness exceeded 0.50.<sup>35</sup>

Selection of breeding stock will require careful genetic selection, examination of all pigs which are to be retained for breeding, necropsy of siblings of affected pigs and of the same gender, to identify genetic lines of pigs which have a low incidence of lesions. A recent study showed that the increase in wild boar alleles in crosses with Large White pigs reduced the prevalence of OC.<sup>50</sup> It has been suggested that the selection of pigs based on the joint lesion score could lead to a better leg and joint condition both optically and pathologically.<sup>51</sup> The reduction of growth rate and exercise may help but are not a real method of control. Increase in calcium and phosphorus in the diet also does not help.

### REVIEW LITERATURE

- Grondalen T. Osteochondrosis, arthrosis and leg weakness in pigs. *Nord VetMed* 1974; 26:534.
- Hill MA. Economic relevance, diagnosis and countermeasures for degenerative joint disease (osteoarthrosis) and dyschondroplasia (osteochondrosis) in pigs. *J Am Vet Med Assoc* 1990; 197:254-259.
- Hill MA. Locomotory Diseases of Swine. Keynote lecture *Proceedings of the 15th International Pig Veterinary Society Congress*, Birmingham, England, July 1998; Vol 1, p. 181-194.
- Ytrehus B, Carlson CS, Lundeheim N, Mathiesen L, Reinholt FP, Teige J, Ekman S. Vascularisation and osteochondrosis of the epiphyseal growth cartilage of the distal femur in pigs-development with age, growth rate, weight and joint shape. *Bone*, 34:454-465.

- Orth MW. The replication of growth plate cartilage turnover. *J Anim Sci* 1999; 77:S183-S189.
- Ekman S, Carlson CS. The pathogenesis of articular osteochondrosis. *Veterinary Clinics of North America Small Animal Practice*, (1998) 28:17-29.

### REFERENCES

- Kangasniemi R. *Proc NJF-Seminar*, no 25 Foul UMN 1996; 40:59.
- Kawrisuk LS et al. *Am J Vet Res* 1987; 48:1395.
- Zoric M et al. *Vet Rec* 2003; 153:323.
- Jorgensen B. *Acta Vet Scand* 2000; 41:123.
- Mouttrotou N et al. *Prev Vet Med* 1999; 39:31.
- Hill MA. *J Am Vet Med Assoc* 1990; 197:254.
- Nakano T, Aherne FX. *Can J Anim Sci* 1993; 73:1005.
- Deguchi E. *Anim Sci Tech* 1997; 68:399.
- Jorgensen B. *Acta Vet Scand* 2000; 41:105.
- Lium B. *Norsk Vet Med* 2002; 114:209.
- Kornegay ET et al. *Can J Anim Sci* 1990; 70.
- Armocida A et al. *J Vet Med Sci A* 2001; 48:165.
- Jorgensen B. *Live Prod Sci* 1995; 41:171.
- Fukawa K, Kusuhara S et al. *Asian-Aust J Anim Sci* 2001; 14:114.
- Fjetland O et al. *Proc. 15th Int Pig Vet Soc Cong* 1998; p. 278.
- Blowey RW. *Vet Rec* 1994; 134:601.
- Woodard JC. *Vet Pathol* 1989; 24:109.
- Webb AJ et al. *Anim Prod* 1983; 36:117.
- Stern S et al. *Livestock Prod Sci* 1995; 44:45.
- Jorgensen B, Vestergaard T. *Acta Agric Scand* 1990; 40:59.
- Serenius T et al. *Live Prod Sci* 2001; 69:101.
- Uhlorn H et al. *Acta Vet Scand* 1995; 36:41.
- Schulze V et al. *Zuchtungskunde* 1998; 70:43.
- Jorgensen B, Jensen HE. *J Vet Med A* 2002; 49:353.
- Lee GJ et al. *Anim Sci* 2003; 76:155.
- Yazdi MH et al. *Anim Sci* 2000; 71:1.
- Stukelj M. *Vet Novice* 2002; 28:40.
- Jorgensen B et al. *Anim Sci* 2003; 77:439.
- Nakano T, Aherne FX. *Can J Vet Res* 1988; 52:154.
- Petersen JS et al. *Anim Sci* 1998; 66:725.
- Carlson CS et al. *J Orthop Res* 1991; 9:317.
- Carlson CS et al. *Am J Vet Res* 1988; 49:396.
- Wardale RJ, Duance VC. *J Cell Sci* 1994; 107:47.
- Ekman S, Heinegard D. *Vet Pathol* 1992; 29:514.
- Hill MA et al. *Vet Rec* 1990; 127:29.
- Visco DM et al. *Vet Rec* 1991; 128:221.
- Jorgensen B, Andersen S. *J Anim Sci* 2000; 71:427.
- Bittegeko SBP, Arnbjerg J. *J Vet Med Assoc* 1994; 41, 369:377.
- Jorgensen B, Jensen HE. *J Vet Med A* 2002; 49:353.
- Serenius T et al. *Live Prod Sci* 2001; 69:101.
- Bogge MV et al. *J Anim Breed Gen* 1989; 106:44.
- Done SH et al. *Vet Rec* 1979; 105:520.
- Takahara M et al. *Am J Roentgenol* 2000; 174:411.
- Yamasaki K et al. *J Comp Pathol* 1989; 100:313.
- Yamasaki K, Itakura C. *J Comp Pathol* 1988; 98:415.
- Farnum CE et al. *Vet Path* 1984; 21:141.
- Hagemoser WA. *J Vet Diag Invest* 2000; 12:525.
- Jefferies D et al. *Vet Rec* 2002; 23:383.
- Rothschild MF, Christian LL. *Livestock Prod Sci* 1988; 19: 459, 473.
- Anderson-Eklund I. et al. *Genet Res (Camb)* 2000; 75:223.
- Fukawa K et al. *J Anim Sci* 2000; 71:353.

### SPORADIC LYMPHANGITIS (BIGLEG, WEED)

This is a non-contagious disease of horses characterized by acute fever, lymphangitis

and severe swelling of one or both hindlegs - forelimbs are rarely, if ever, affected. The disease commences abruptly with fever (40.5-41°C, 105-106°F), shivering and a rapid pulse rate and respiration. Pain in the acute disease can be severe. There is severe pain on palpation of the affected leg and lameness may be so severe that the horse may refuse to put its foot to the ground. The limb is swollen and hot; the swelling extends from the top of the leg and down to the coronet. There is cording of the lymphatics on the medial aspect of the leg and palpable enlargement of the lymph nodes in some horses. The acute disease resolves into a chronic phase with persistent and variable swelling of the leg, intermittent fever, and variable lameness. Occasionally abscesses develop in the lymph nodes and vessels but usually there is no localization of the infection. There is a tendency for the disease to recur and cause chronic fibrotic thickening of the lower part of the limb extending to the level of the stifle in many horses. Swelling of the leg is often exacerbated by late pregnancy.

Sporadic lymphangitis can be associated with superficial wounds and ulcers on the lower parts of the limbs, but often there are no wounds detected. The disease is thought to develop as a lymphangitis and, potentially, lymphadenitis of the deep inguinal nodes as a result of these wounds. The affected lymph nodes and swelling of the limb obstruct lymphatic and venous drainage causing lymphatic obstruction, edema and, in some cases, cellulitis.<sup>1</sup> Ultrasonographic examination reveals distended lymph vessels that contain fluid that is not echogenic. Ultrasound guided aspiration of this fluid yields fluid with a low total protein concentration and mild neutrophilia (high proportion of the cells present in the fluid are neutrophils, although the absolute count is usually less than  $1.0 \times 10^9$  cells/L. Culture of the fluid is recommended, and *Actinobacillus* sp. have been obtained. The clinical significance of results of culture of the fluid is unknown, but results could be used to guide choice of antibiotics. Radiographic examination is usually unremarkable apart from demonstrating the soft tissue swelling. Affected horses, in both the acute and chronic stages, have a mild neutrophilia and hyperfibrinogenemia.

Acutely affected horses should be treated aggressively. The principles of treatment are control of the presumed infection, reduction of inflammation, and reduction of swelling. Penicillin or other antimicrobials should be administered parenterally to control the infection. Non-steroidal antiinflammatory drugs (phenylbutazone, flunixin meglumine, carprofen, or similar) should be administered to

control the inflammation and provide pain relief. The limb should be hosed with cold water once to twice daily to reduce heat and provided with gently massage therapy. Manual massage of the limb might be beneficial. Supportive, compressive bandaging of the limb can reduce the swelling. The horse should be exercised as much as is practical and humane.

Horses with chronic disease should be treated with prolonged courses of antimicrobials (penicillin, sulfonamide-trimethoprim combinations, enrofloxacin, or rifampin in combination with sulfonamides-trimethoprim), non-steroidal drugs, and local therapy. Acute exacerbations can be managed by administration of dexamethasone (40 µg/kg orally or parenterally, once daily for 5 days, and then gradually tapering). This dose is not abortifacient in pregnant mares. Exercise and supportive bandaging are important in minimizing the swelling. The chronic disease requires prolonged and intermittent therapy, often for the rest of the horse's life.

Prevention of the disease necessitates prompt and careful treatment of all wounds of the lower limbs. Provision of daily exercise, restriction of the diet during prolonged rest periods and dry standing in the stable also help to prevent the disease.

#### REFERENCE

1. Tufvesson G. Nord VetMed 1952; 4:529, 729, 817, 1046.

### LAMINITIS OF HORSES

#### Synopsis

**Etiology** Degeneration of the sensitive laminae of the hoof.

**Epidemiology** Disease involving single animals. As a sequela to severe systemic disease including colic, diarrhea, metritis, and grain engorgement. Horses or ponies at pasture. Horses worked on hard surfaces. Obese horses and ponies. Horses with unilateral lameness may develop laminitis in the contralateral, supporting limb.

**Clinical signs** Lameness, ranging from mild to sufficiently severe to cause the horse to be recumbent, involving both front feet, and occasionally all four feet.

**Clinical pathology** None characteristic of the disease.

**Diagnostic confirmation** Physical examination. Radiography.

**Treatment** There is no single effective treatment. Non-steroidal anti-inflammatory drugs, dimethyl sulfoxide, vasodilatory agents, anticoagulants, frog and sole support, and corrective hoof trimming and shoeing are all used with variable success.

**Control** Prophylaxis for acute, severe diseases. Aggressive treatment of metritis, colic and diarrhea. Prevent unrestricted access to feeds rich in soluble carbohydrates. Maintain optimal body condition.

#### ETIOLOGY

Laminitis is caused by **acute degeneration of the sensitive primary and secondary laminae** of the hoof. The cause of this degeneration is unknown although a number of theories have been propounded and are summarized under 'Pathogenesis'. Situations that are associated with increased risk of laminitis include access to lush pasture (suspected as the cause in 46% of field cases), grain overload (7%), retained placenta (2%), and colic or diarrhea (3%).<sup>1</sup> Ingestion of large quantities of soluble carbohydrate, such as grain, bread, calf feed, or exposure to shavings of black walnut (*Juglans nigra*) causes laminitis.

#### EPIDEMIOLOGY

##### Occurrence

Single sporadic cases are the rule for horses in which the disease is usually related to individual risk factors such as obesity, systemic illness, or lameness. An estimated 13% of horse operations in the United States have a horse with laminitis at any one time, and laminitis accounts for 7.5 to 15.7% of all lameness in horses.<sup>1</sup> Laminitis accounts for up to 40% of hoof problems in horses, depending on the use of the horse.<sup>1</sup> Approximately 5% of horses with laminitis die or are euthanized.<sup>1</sup> Among cases occurring in the field (as opposed to veterinary hospitals) approximately 74% recover and become sound, with 8% improving but continuing to be lame.<sup>1</sup> However, approximately 10% of horses that developed laminitis had a permanent change in their primary use as a result of having developed laminitis.<sup>1</sup>

##### Risk factors

Animal risk factors

With the exception of overweight ponies and horses with systemic disease, there are only a few identified innate factors that predispose individual horses to the development of laminitis:

- Any association between the disease and age, sex or breed is weak, again, with the exception of ponies.<sup>2</sup> There is no difference in risk among horses used for pleasure riding, showing, breeding, racing, or farm and ranch work.<sup>1</sup>
- The disease is more common in the United States during spring and summer (1.3% in spring and 0.4% in winter in the central US).<sup>1</sup>
- The disease is very uncommon in foals and horses < 8 months of age, and then increases in frequency with increasing age such that horses >20 years of age have an incidence of the disease roughly 3 times that of horses between 5 and 20 years of age.<sup>1</sup>
- **Overweight ponies** appear to be most susceptible and the disease

occurs four times as commonly in them as in other classes of horse.<sup>3</sup>

Fat ponies at pasture and getting little exercise commonly develop the chronic form of the disease.

- Laminitis is common in horses with tumors of the intermediate lobe of the pituitary (pars intermedia dysfunction, equine Cushing's disease).

##### Trauma and other physical factors

such as excessive work on hard surfaces, increased weight bearing on one limb, and persistent pawing contribute to the development of the disease in horses. Standing for periods of days during transport may predispose to laminitis. For horses that are severely lame, and not bearing weight in the affected limb, the risk of developing laminitis in the contralateral limb is related solely to the duration of lameness and not to body weight.<sup>4</sup>

Laminitis is associated with many **systemic illnesses** of horses. Horses with illness attributable to colic, diarrhea, pleuropneumonia, and metritis are prone to develop laminitis. **Potomac horse fever** (equine neorickettsiosis) is frequently a cause of laminitis in horses and laminitis is the major cause of mortality from this disease. Approximately 28% of horses with **anterior enteritis** (duodenitis/proximal jejunitis) develop laminitis, usually within 2 days of developing enteritis.<sup>5</sup> There are anecdotal reports that suggest that administration of **corticosteroids** (dexamethasone, triamcinolone) causes or exacerbates laminitis, but this association has not been proved. Laminitis is common in horses that engorge on grain or similar feeds containing a high concentration of soluble carbohydrates. Ingestion of large quantities of lush pasture has been anecdotally associated with increased risk of laminitis, especially amongst ponies. It is believed that the presence of a high concentration of soluble carbohydrates fructans in the grass is responsible for the increased risk of laminitis.<sup>6</sup> Fructans are metabolized in the large colon and may mimic the situation after ingestion of a large quantity of soluble carbohydrate.

##### Importance

Death is unusual, but the severe lameness may cause a great deal of inconvenience and affected horses may develop permanent deformities of the feet. Many have to be euthanized.

#### PATHOGENESIS

The basic lesion of laminitis is the separation of the sensitive laminae of the third phalanx from the interdigitating laminae lining the internal surface of the hoof, so that the third phalanx drops through the hoof and comes to rest on the sole. Exactly



what the mechanism is that links the risk factors listed above to the laminar degeneration, the basis of the separation, is unknown. Briefly, the theories are:

- o Ischemia of the laminae with subsequent necrosis. Proposed causes of ischemia include vasoconstriction, development of arterio-venous shunts, interstitial edema, and presence of microthrombi in digital vessels.<sup>7-13</sup> Ischemia due to microthrombus formation is considered an unlikely cause of laminitis.<sup>7,8</sup> However, there is evidence from experimental laminitis that changes in circulating concentrations of vasoactive amines or contractile activity of vessels in the hoof might contribute to ischemia. Alternatively, increases in capillary filtration pressure, resulting from venoconstriction, might cause edema and increased interstitial pressure with subsequent ischemia of the laminae.<sup>13</sup> It is plausible that there is a combination of these mechanisms, beginning with digital venoconstriction and ending in arteriovenous shunting and development of microthrombi.<sup>14</sup> There is evidence in horses with gastrointestinal disease treated by emergency celiotomy that endotoxemia after surgery is associated with lower digital blood flow and higher concentrations of endothelin-1, providing evidence for a role of decreased laminar blood flow in the pathogenesis of the natural disease.<sup>15</sup>
- o Inflammation, with subsequent degeneration of sensitive laminae.<sup>16-18</sup>
- o Enzymatic digestion of laminae by matrix metalloproteins (MMPs) induced by circulating factors including products of *Streptococcus bovis* infection.<sup>19,20</sup>
- o Abnormalities in local (hoof) metabolism of corticosteroid resulting in increased glucocorticoid activity in lamellar tissues.<sup>21</sup>

There is evidence of each of these mechanisms. The evidence is often based on experimental models of laminitis and the findings differ somewhat with respect to the model used and markedly with the stage of disease studied. More recent studies, focusing on the developmental stage before clinical signs are apparent, have identified evidence of inflammation associated with a marked increase in expression of cyclooxygenase-2, an enzyme critical in the metabolism of vasoactive and inflammatory prostaglandins and inhibited by non-steroidal antiinflammatory drugs.<sup>16</sup>

It is speculated that a **pain-hypertension-vasoconstriction** cycle develops in horses with acute laminitis. The pain associated with the laminar degeneration causes release of vasoconstrictor substances such as the catecholamines, angiotensin II, and vasopressin. These substances then cause peripheral vasoconstriction with a subsequent reduction in blood flow to the foot, and systemic hypertension.

The common thread is that degeneration of the sensitive laminae. Loss of the connection between the third phalanx and hoof allows the third phalanx to **rotate** within the hoof capsule, likely in response to the torque applied by the deep digital flexor tendon, and to displace ventrally (**sink**) within the hoof as a result of weight transmitted through the third phalanx; or there may be a combination of these changes. Rotation of the third phalanx causes the sole to be pushed downward or 'dropped', and the point of the toe of the third phalanx may actually penetrate the sole. Serum accumulates in the space created by degeneration of the laminae and displacement of the third phalanx and there is breakdown of the white line.

Many of the inciting causes of laminitis are diseases that may be associated with **endotoxemia**, and in experimental models endotoxin was detectable in the blood of horses that developed laminitis, suggesting that endotoxin may contribute to the development of the disease. However, infusions of endotoxin do not cause laminitis, although endotoxin does impair endothelium-dependent relaxation and augments adrenergic contraction of palmar digital arteries.<sup>22</sup>

The disease occurs in 3 distinct phases: (1) a developmental stage in which lesions are detectable in the sensitive laminae but during which there are no clinical signs; (2) the acute phase from the development of the first clinical signs through to rapid resolution or to rotation or ventral displacement of the third phalanx; and (3) the chronic stage evidenced by rotation of the third phalanx with or without ventral displacement and characterized by variable but persistent pain.

#### CLINICAL FINDINGS

The disease presents as both an acute disease and as a chronic disease. The severity of the acute disease varies considerably from very mild with rapid (5-7 days) recovery, to severe with progression to the chronic, refractory stage.

**The acute disease** develops rapidly; apparently normal horses can founder within hours. Signs of the disease are entirely attributable to pain in the feet. All hooves may be affected, but more commonly the fore feet are affected and the

hind feet are spared. The disease is rarely unilateral except in cases in which the disease develops because of severe lameness in the contralateral limb or repeated pawing. Mild, or early, disease is apparent as a resistance to movement and repetitive and frequent shifting of weight from one foot to the other. There is a characteristic shuffling gait.

**More severe disease** is apparent as refusal to move or to lift a hoof. At this stage the horse wears an expression of great **anxiety**, accompanied by **muscle fasciculation**, **sweating**, a marked increase in heart rate to as high as 75/min, rapid, shallow respiration, and a moderate elevation of temperature. There is a **characteristic posture** with all four feet being placed forward of their normal position, the head held low, and the back arched. There is usually a great deal of difficulty in getting the animal to move and when it does so the gait is shuffling and stumbling and the animal evidences great pain when the foot is put to the ground. The act of lying down is accomplished only with difficulty, often after a number of preliminary attempts. There is also difficulty in getting the animals to rise and some horses may be recumbent for long periods. It is not unusual for horses to lie flat on their sides. In occasional cases the separation of the wall from the laminae is acute and the hoof is shed. There may be exudation of serum at the coronet and this is considered a sign of impending sloughing of the hoof and a poor prognosis.

**The diagnostic signs** in laminitis include pain on palpation around the coronet and a marked withdrawal response when hoof testers are applied to the hoof. The **intensity of the pulse** in the palmar digital artery, palpable over the abaxial aspects of the proximal sesamoid, of affected feet is markedly increased over normal. In horses in which the third phalanx is displaced distally (sinks), a concavity may be palpable at the coronary band. Infiltration of the palmar digital nerves at the level of the proximal sesamoid with local anesthetic agents provides marked, but not complete, relief.

**In the chronic stages** of the disease there is separation of the wall from the sensitive laminae and a consequent dropping of the sole. The hoof wall spreads and develops marked horizontal ridges, and the slope of the anterior surface of the wall becomes accentuated and concave. Horses with chronic or refractory laminitis may continue to feel much pain, lose weight, and develop **decubitus ulcers** over pressure points because of prolonged recumbency. Loss of integrity of the sole and disruption of the white line may

allow **infection** to develop in the degenerate laminae. The infection may spread to involve the pedal bone, causing a septic pedal osteomyelitis. The lameness may abate but the animal becomes lame easily with exercise and may suffer repeated, mild attacks of laminitis.

**Radiographic examination** of the feet may not reveal, initially and in mild cases, changes in the position of the pedal bone. Radiographs of more severe or advanced cases will demonstrate **rotation of the pedal bone** within the hoof, evident as a tilting of the most distal aspect of the third phalanx toward the sole. The space created by rotation of the pedal bone may fill with gas or serum and be evident as a radiolucent line between the pedal bone and the dorsal hoof wall. **Displacement of the pedal bone** toward the sole will be evident in approximately 25% of cases as a thickening of the dorsal hoof wall and reduction of the distance between the sole and solar aspect of the pedal bone. Chronic or refractory cases may have **osteopenia** of the pedal bone with proliferation of bone at the toe.

**Prognosis.** The **radiographic examination** provides information of **prognostic value**. Horses that return to their previous level of athletic function after a bout of laminitis have pedal bone rotation of less than 5.5°, whereas horses that can no longer perform as athletes usually have more than 11.5° of rotation.<sup>23</sup> However, there is considerable overlap between groups and these values should only be used as rough guidelines. The general rule is that the greater the degree of rotation, the worse the prognosis for return to function and pain-free living.

Objective radiographic variables include the distance between the proximal aspect of the hoof wall (marked on the radiographic image by a piece of wire or strip of metal stuck to the dorsal hoof wall) and the proximal limit of the extensor process of the distal phalanx (the 'founder' distance), and the distance between the dorsal hoof wall and the dorsal cortex of the distal phalanx.<sup>24</sup> While values for these measures vary among breeds and with the size of the horse, most normal horses will have a 'founder' distance of  $4.1 \pm 2.2$  (standard deviation) mm and a wall thickness of  $16.3 \pm 2.4$  mm.<sup>24</sup>

#### CLINICAL PATHOLOGY

There are no changes that are characteristic of the disease.

#### NECROPSY FINDINGS

The disease is not usually fatal but if a necropsy examination is carried out on an acute case, the stomach usually contains excessive amounts of grain, which has a pasty, mealy consistency and an odor

suggestive of putrefaction of protein. Retained placenta and metritis may be present in postparturient laminitis in mares. No other reliable gross findings are visible, although the vessels of the sensitive laminae of the digital cushion may appear engorged if the cut surface of the hoof is examined.

In subacute and chronic cases the diagnosis can easily be confirmed by gross examination of sagittal sections of the foot. This permits assessment of the horny, soft, and osseous components of the foot. In some cases the degree of rotation of P3 results in perforation of sole.

Histological examination is required only in acute cases and confirmation of the diagnosis in such instances demands that the foot be cut into slab sections and fixed shortly after the death of the animal, before even moderate autolysis can ensue. Microscopically, the sequence of acute changes in experimentally induced laminitis begins with the loss of some of the keratogenic structures of the epidermal laminae. This is followed by vascular engorgement, edema and some necrosis of laminar tissues.

#### DIFFERENTIAL DIAGNOSIS

##### Horses

Rhabdomyolysis, tetanus, colic, and spinal ataxia may all mimic the immobility and pain of laminitis, but there is no pain in the feet in these diseases, and other distinguishing characteristics are apparent on careful clinical examination.

#### TREATMENT

**Acute laminitis is an emergency** and treatment should be started without delay, as early and aggressive therapy might enhance the chances of recovery.

The adage 'where facts are few experts are many' (Donald R. Gannon) applies well to the treatment of laminitis. There are no well-designed studies of the treatment of naturally occurring laminitis and thus the choice of treatment is based on personal experience, extrapolation from our imperfect understanding of the pathogenesis of the disease, the availability of certain drugs, and current fashion. In general, the treatments can be grouped into several classes, based on the intended intervention. These are:

- **Removal of the causative agent or treatment of the inciting disease**
- **Pain relief and minimization of inflammation**
- **Vasodilation of blood vessels in the foot**
- **Prevention of formation of microthrombi in dermal capillaries**
- **Prevention of rotation or distal displacement of the pedal bone**

#### • Promotion of keratinization and hoof growth.

The efficacy of administration of analgesic, anti-inflammatory, anticoagulant and vasodilatory drugs, local therapy such as ice baths of the hoof or having the horse stand in cold water, and mechanical support of the hoof has never been demonstrated in appropriate clinical trials.

#### *Treatment of inciting disease*

The inciting disease should be treated aggressively and every attempt made to remove any causative agent. Horses with traumatic laminitis should be rested and housed in stalls that are well bedded with sand or soft shavings. Horses suspected of having a tumor of the intermediate lobe of the pituitary gland should have the diagnosis confirmed and appropriate therapy instituted.

#### *Analgesics and anti-inflammatory drugs*

A mainstay of the treatment of both acute and chronic laminitis is the use of non-steroidal anti-inflammatory drugs (NSAIDs). Apart from the obvious humane requirement of providing pain relief, the use of NSAIDs is speculated to be beneficial by breaking the pain-hypertension-peripheral vasoconstriction cycle that may be important in the pathogenesis of laminitis. Furthermore, recent evidence suggesting that inflammation mediated by COX-2 plays a role in the developmental phase of laminitis supports the early and aggressive use of NSAIDs.<sup>16</sup> **Phenylbutazone**, at doses of 2.2–4.4 mg/kg intravenously or orally every 12–24 hours, is an effective analgesic in cases of mild to moderate laminitis. Higher doses (6.6 mg/kg every 12–24 hours) may be required in severe cases. However, the potential for phenylbutazone toxicosis, evident as colic, gastrointestinal ulceration, nephrosis, hypoproteinemia, leukopenia, and hyponatremia, is dose related and high doses of phenylbutazone should only be used for at most several days and only in severely painful horses. **Flunixin meglumine** (1.1 mg/kg, IM or IV every 8–12 hours) and **ketoprofen** (2.2 mg/kg, IM every 12–24 hours) are also effective analgesics.<sup>25</sup> Their concurrent use with phenylbutazone may enhance pain relief but also increases the risk of NSAID toxicosis. The use of aspirin is dealt with under Anticoagulants.

**Dimethyl sulfoxide (DMSO)**, a putative anti-inflammatory drug that is also reputed to scavenge free radicals, has been used in the treatment of acute laminitis, again without clear demonstration of its efficacy. DMSO is administered at a rate of 1 g/kg, intravenously as a 10% solution in isotonic sodium chloride. The treatment can be repeated daily for several days.

**Narcotic analgesics** such as butorphanol and meperidine (pethidine) provide some pain relief but in general are not as effective as the NSAIDs. Similarly,  $\alpha$ -2 agonists such as **xylazine and detomidine** provide only brief respite from the pain, and may be contraindicated because of the vasoconstriction associated with their use.

**Local analgesia** of the foot with agents such as lidocaine or bupivacaine provides marked pain relief. However, analgesia is usually only brief, depending on the agent used, and has the disadvantage of causing the horse to bear more weight on the affected limbs. Local analgesia may be useful in facilitating relocation of the horse, hoof trimming, corrective shoeing, or application of sole and frog support but not as a routine treatment.

Because of suspicion that **corticosteroids** induce or exacerbate laminitis, at this time their use is contraindicated in the treatment of laminitis.

#### *Vasodilatory drugs*

Vasodilatory drugs are used on the premise that vasoconstriction is an important mechanism underlying the development or progression of acute laminitis. Several classes of drugs have been used including  $\alpha$ -adrenergic antagonists such as phenoxybenzamine and phentolamine, drugs with multiple mechanisms of action such as acetylpromazine and isoxuprine, and nitric oxide donors including glyceryl trinitrate (nitroglycerine) and L-arginine.<sup>26</sup> None of the vasodilatory drugs should be used in horses with compromised cardiovascular function or dehydration.

Phenoxybenzamine and phentolamine are not readily available and have limited use. Phenoxybenzamine causes sedation. **Acetylpromazine** is a potent vasodilator, principally because of its  $\alpha$ -adrenergic antagonist activity, that is currently used frequently in the treatment of acute laminitis. Acetylpromazine increases blood flow to the digit, but its effect on nutritive flow to the laminae is unknown, as is the case for all the vasodilators.<sup>27</sup> The effect of acetylpromazine persists for approximately 90 minutes after intravenous administration.<sup>27</sup> Acetylpromazine can be administered at dose rates ranging from 0.01 to 0.05 mg/kg, IM, every 6–12 hours. Sedation may be considerable at the higher doses and/or with more frequent administration. **Isoxuprine** is a combined  $\alpha$ -antagonist and  $\beta$ -agonist that increases blood flow to the leg but not to the foot in normal horses.<sup>27,28</sup> It has been used at doses of 1–1.5 mg/kg orally every 12 hours. Pentoxifylline (4.4 mg/kg orally q8 hours) does not increase digital blood flow in normal horses.<sup>27</sup>

Application of **glyceryl trinitrate**, a nitric oxide donor, to the palmar digital

arteries of affected horses has been reported to increase or not affect blood flow to the dorsal hoof wall.<sup>29,30</sup> However, the effect of these substances on the course of the disease is unknown. In spontaneous cases of acute laminitis glyceryl trinitrate has been applied to the skin over both palmar digital arteries of affected feet at a dose of 15–30 mg per artery, once daily. However, because of lack of evidence of efficacy and the potential for systemic hypotension secondary to systemic absorption of the drug, its use is no longer recommended.

#### *Anticoagulants*

Anticoagulant drugs are administered to prevent the development of microthrombi within the hoof. **Aspirin and heparin** are commonly used. Aspirin is a very poor analgesic in horses but is used because it reduces platelet aggregation in normal horses by blocking formation of thromboxane A<sub>2</sub>. However, thromboxane may not be an important cause of platelet aggregation in horses.<sup>31</sup> Aspirin is administered at a dose of 10 mg/kg orally every 48 hours.

**Heparin** in sufficient doses prolongs blood clotting, provided that there is adequate antithrombin III in the patient's blood. Heparin has been reported to prevent or to have no effect on the development of laminitis in horses with anterior enteritis or colic, respectively. Heparin can be administered at 40 to 80 iu/kg IV or subcutaneously every 8–12 hours for 3–5 days. Anemia may develop during heparin administration, but resolves rapidly when administration of the drug is stopped.

#### *Mechanical support*

Mechanical support to provide pain relief and in an attempt to prevent rotation or distal displacement of the pedal bone is an important part of the care of horses with acute laminitis.

**Support of the frog and/or sole** can be achieved using packing material such as dental acrylic or firm plastic that is molded to conform to the shape of the sole. Some clinicians prefer to use **wedge pads** to elevate the heel and reduce tension in the deep digital flexor tendon with the aim of preventing rotation of the pedal bone.

Housing the horse on sand or other soft bedding is frequently recommended.

Corrective shoeing of horses with chronic laminitis is widely practiced and there are proponents of a wide variety of shoe types (fullered egg-bar, heart bar, glue-on shoes). Appropriate hoof care, which might include shoeing, is important in managing horses with chronic laminitis. Interestingly, there was not a difference among shoe types in efficacy for pain relief in horses with chronic laminitis.<sup>32</sup>

#### *Promotion of healing*

**Methionine** has been given to both acute and chronic laminitis cases on the known requirement for methionine in the chondroitin complex of collagen. There is some rationale for the treatment but it seems more appropriate as a supportive than as a principal treatment. The recommended oral dose rate is 10 g/day for 3 days followed by 5 g/day for 10 days.

**Antibiotics** may be indicated to prevent secondary infection of the degenerate laminae.

**Rest** is important in the convalescent phase. Horses with no rotation or sinking of the pedal bone should be given 21 days of rest after resolution of the clinical signs. Return to work should be gradual. Horses that develop rotation or sinking of the pedal bone should be monitored both by physical examination and radiographic examination. It will be many months before horses with even mild rotation can be returned to work. Horses with severe rotation will likely never resume active work, although they may become pasture sound.

#### **Summary of treatment of acute laminitis**

Depending on the cause, treatment of acute laminitis should include:

- The administration of non-steroidal anti-inflammatory drugs (preferably phenylbutazone)
- Vasodilators (acetylpromazine)
- Support of the frog and/or sole
- Housing on sand or similar soft bedding
- The inciting disease should be treated aggressively
- After the acute phase has passed, likely in 5–7 days, attention should be given to trimming the hoof and corrective shoeing.

#### *Chronic, refractory laminitis*

The **prognosis** for chronic or refractory laminitis (laminitis of more than 1 week's duration) is poor (see above for the use of radiography to determine prognosis). Treatment includes NSAIDs for pain relief, corrective shoeing (egg bar or heart bar shoes), and trimming of the hoof (shortening the toe or complete removal of the dorsal hoof wall). **Tenotomy** of the deep digital flexor may provide temporary relief but does not affect the long-term prognosis.

#### **CONTROL**

The disease is not readily subject to control because of its sporadic nature. Heavily fed or fat horses should be given some exercise when not working; if possible, horses in transit should be removed from the transport vehicle, given light exercise and rested for several hours at the end of each day; retained placenta in mares should

be treated promptly. Heavy carbohydrate feeding should be avoided. Susceptible ponies should have limited access to pasture either by limiting the time that they spend at pasture or by application of a grazing muzzle.

## REVIEW LITERATURE

- Baxter GM. Diagnosing and treating acute laminitis. *Vet Med* 1996; 91:940-952.  
 Parks AH. Treatment of acute laminitis. *Equine Vet Educ* 2003; 15:273.

## REFERENCES

1. USDA. Lameness and Laminitis in U.S. Horses. 2000; USDA:APHIS:VS.. #N318.0400.
2. Polzer J, Slater MR. *Prev Vet Med* 1996; 29:179.
3. Treiber, KH et al. *J Am Vet Med Assoc* 2006; 228:1538.
4. Peloso JG et al. *J Am Vet Med Assoc* 1996; 209:1746.
5. Cohen ND et al. *J Am Vet Med Assoc* 1994; 204:250.
6. van Eps AW, Pollitt CC. *Equine Vet J* 2006; 38:203.
7. Weiss DJ et al. *Am J Vet Res* 1995; 56:986.
8. Weiss DJ et al. *Res Vet Sci* 1996; 61:157.
9. Elliot J et al. *Am J Vet Res*. 2003; 64:1124.
10. Schneider DA et al. *Am J Vet Res*. 1999; 60:233.
11. Eaton SA et al. *Am J Vet Res* 1995; 56:1338.
12. Morgan SJ et al. *Am J Vet Res* 2003; 64:829.
13. Adair HS et al. *Am J Vet Res* 2000; 61:853.
14. Moore JN, Allen D. *Vet Med* 1996; 91:936.
15. Menzies-Gow NJ. *Am J Vet Res* 2005; 66:630.
16. Waguespack RW et al. *Am J Vet Res* 2004; 65:1724.
17. Rodgerson DH et al. *Am J Vet Res* 2001; 62:1957.
18. Fontaine GL et al. *Am J Vet Res* 2001; 62:714.
19. Pollitt CC. *Proceedings Am Assoc Equine Pract* 1999; 45:188.
20. Mungall BA et al. *Vet Microbiol* 2001; 79:209.
21. Johnson PJ et al. *Equine Vet J* 2004; 36:41.
22. Baxter GM. *Vet Surg* 1995; 24:87.
23. Stick JA et al. *J Am Vet Med Assoc* 1982; 180:251.
24. Cripps PJ, Eustace RA. *Equine Vet J* 1999; 31:427.
25. Reed SK et al. *Am J Vet Res* 2006; 67:398.
26. Parks AH. *Equine Vet Educ* 2003; 15:273.
27. Ingle-Fehr JE, Baxter GM. *Vet Surg* 1999; 28:154.
28. Harkins JD et al. *Equine Vet J* 1998; 30:294.
29. Ragle CA. *Comp Cont Educ Pract Vet* 1999; 21:170.
30. HoffTK et al. *Am J Vet Res* 2002; 63:648.
31. Jarvis GE, Evans RJ. *Blood Coag Fibrin* 1996; 7:194.
32. Taylor D et al. *Am J Vet Res* 2002; 63:1629.

## LAMINITIS IN RUMINANTS AND PIGS

### Synopsis

**Etiology** Degeneration of the sensitive laminae of the hoof.

### Epidemiology

**Cattle:** An endemic disease of some herds of high producing dairy cattle, and in feedlots. Associated with ruminal acidosis, either clinical or subclinical.

### Clinical signs

**Cattle:** Inapparent to severe lameness, most common in the hind feet. Predisposition to other infectious or traumatic diseases of the foot.

**Clinical pathology** None characteristic of the disease.

**Diagnostic confirmation** Physical examination. Radiography.

### Treatment

**Cattle:** Non-steroidal anti-inflammatory drugs. Corrective hoof care.

### Control

**Cattle:** Dietary control to prevent ruminal acidosis. Correction of housing and flooring problems.

## ETIOLOGY

Laminitis is caused by acute degeneration of the sensitive primary and secondary laminae of the hoof. The cause of this degeneration is unknown. The disease is less well characterized than that of horses and several conditions are often classified as laminitis.

## EPIDEMIOLOGY

### Occurrence

In **cattle** the disease may occur as clusters in herds and on farms where a predisposition appears to be inherited or where access to large quantities of soluble carbohydrate are available such as for high producing dairy cows or feedlot cattle. On farms of high-producing dairy cattle the prevalence may be as high as 78%.<sup>1</sup> The disease is also reported in calves and first calf heifers.

### Risk factors

Cattle and sheep

**Subclinical laminitis** that predisposes to the development of other diseases of the hoof occurs in calves and first calf heifers and is common in intensively fed feedlot cattle.<sup>2</sup> Laminitis, conditioned by the inheritance of an autosomal recessive gene, is recorded in Jersey heifers.<sup>3</sup> There may be an association between the disease in feedlot ruminants and **ruminal acidosis**.

Beef cattle being prepared for shows are often grossly overfed on high grain rations and become affected with a chronic form of the disease which markedly affects their gait and may cause permanent foot deformity. The disease occurs in dairy cattle fed improper rations, and especially first calf heifers and cattle of herds attempting to increase milk production<sup>1,4</sup> and it is not uncommon for the disease to present as a herd problem.

Among **dairy cattle** the heifers are usually worst affected and the disease usually develops soon after calving, with more than 50% of cases occurring in the period 30 days before and 30 days after calving. There may be a relationship between being introduced to the herd, with the frequent harassment by dominant cows, when heavily pregnant and when the surface of the yards is rough. Housing may be important including standing in slurry or having to twist and turn in narrow passageways and races, and there is an

association between the prevalence of the disease and rough concrete floors.<sup>5,6</sup>

Diet is an important risk factor for development of laminitis in heifers. Diets of wet, fermented grass silage are associated with a greater risk of laminitis than are diets rich in dry unfermented straw and a concentrate.<sup>7</sup> Furthermore, transition from a low net energy diet to a high net energy diet immediately after calving increases the risk of subclinical mastitis in Holstein dairy cows.<sup>8</sup>

The disease is also reported to occur after metritis, retained placenta, mastitis, and mammary edema but the incidence is not usually very high.

### Pigs

Laminitis has been recorded in pigs but the disease is difficult to diagnose in this species and many cases secondary to other diseases, e.g. postparturient fever, may be missed. The disease is also recorded when pigs are fed very heavy concentrate diets.

### Importance

Subclinical laminitis of dairy cattle predisposes to other hoof disease that may decrease milk production.

## PATHOGENESIS

The pathogenesis of laminitis in cattle, sheep, and pigs is unclear, but likely has some similarity to that in horses (see Laminitis in horses). Subclinical laminitis can predispose to white line disease.

## CLINICAL FINDINGS

Cattle and sheep

In these species the clinical picture is similar to but less marked than that observed in the horse.

In **calves 4-6 months** of age, and in heifers, an acute syndrome similar to that seen in the horse has been described. Affected animals lie down much of the time, and are reluctant to rise. When they attempt to rise they remain kneeling for long periods. Their standing posture is with all four feet bunched together and the back is arched; they shift their weight from foot to foot frequently and walk with a shuffling painful gait. The feet are painful when squeezed and later become flattened and enlarged and look as though slippers are being worn. There is severe ventral rotation of the third phalanx.

In **adult cows** some cases have acute signs, others show only local lesions. These include sole ulcers and patchy changes in the horn including softening, waxy yellow discoloration, and red-brown patches suggestive of previous hemorrhage. The cow is chronically lame.<sup>9</sup>

**Young bulls** are very susceptible to laminitis and may develop abnormalities

of gait and posture, such as a stilted gait and frequent knuckling of the fetlocks, which may mislead the diagnostician.

**Chronic laminitis in adult cows** is characterized by a smaller anterior hoof wall-sole angle, down from 558 to 358, a concave anterior wall, and the appearance of horizontal grooves (growth arrest lines) around the entire claw. The sole is usually dropped a little and bruising and sole ulcers may be present. Overgrowth of the sole of the lateral claw may reach the point of creating a false or double sole. The white line is greatly widened and disrupted and stones and other debris may be impacted in it.<sup>10</sup>

Chronic, traumatic laminitis is most common in heifers when they are first introduced into the milking or dry herds. Housing them on concrete and exposing them to frequent confrontations with bossy cows lead to the development of sole hemorrhages and inflammation of the laminae.

**Radiographic signs** in cattle include rarefaction of the pedal bone, particularly the toe, and the development of osteophytes at the heel and on the pyramidal process.

#### Pigs

In sows the clinical signs are similar and include arching of the back, bunching of the feet, awkwardness of movement, increased pulsation in the digital arteries and pain when pressure is applied to the feet.

#### CLINICAL PATHOLOGY

There are no changes that are characteristic of the disease.

#### NECROPSY FINDINGS

Histological findings in the feet of cows affected by laminitis are similar to those in horses.

#### DIFFERENTIAL DIAGNOSIS

##### Cattle

White muscle disease, epiphysitis.

#### TREATMENT

Although similar principles to those used to determine treatment of laminitis in horses are likely to apply to cattle, treatment in cattle is usually limited to administration of NSAID (aspirin 0.3 grains/kg, orally every 12 hours, phenylbutazone 4.4 mg/kg orally every 48 hours or flunixin meglumine 1.0 mg/kg IV every 12 hours). The inciting cause (metritis, ruminal acidosis) should be treated aggressively.

#### CONTROL

Cattle and lambs which are brought into feedlots should be gradually introduced

to grain feeds and a higher forage:grain ratio provided in the feed. Calves should not be fed intensively on grain until they are 14 months old because of the high frequency of internal hoof lesions at the earlier ages. Some protection against laminitis in dairy cattle in intensive units is gained by careful planning of housing cubicles to make them more comfortable and less damaging to the feet, and by providing more straw in the cubicles. Exercise should be provided around calving time. Vaccination with a Gram-negative bacterin-endotoxoid combination vaccine has provided some protection against laminitis induced by grain overload. Dietary supplementation of biotin (20 mg per head per day) improves hoof health of primiparous dairy cows<sup>11</sup> and may be beneficial in reducing the incidence or severity of lameness in a herd. This treatment might not improve objective indicators of hoof health, but it does improve production.<sup>12</sup>

#### REVIEW LITERATURE

Edwards GB. Acute and subacute laminitis in cattle. *Vet Ann* 1982; 22:99-106.

Logue D. Lameness, lesions of the claw of the dairy cow and subclinical laminitis. *Br Vet J* 1995; 151:343.

Nocek JE. Bovine acidosis: implications for laminitis. *J Dairy Sci* 1997; 80:1005-1028.

#### REFERENCES

1. Bass RT, Whittier WD. *Vet Med* 1996; 91:1033.
2. Greenough PR et al. *Can Vet J* 1990; 31:202.
3. Hoyer MJ. *J S Afr Vet Assoc* 1991; 62:62.
4. Moser EA, Divers TJ. *J Am Vet Med Assoc* 1987; 190:1575.
5. Bergsten C. *Acta Vet Scand* 1994; 35:55.
6. Cook NB. *J Am Vet Med Assoc* 2003; 223:1324.
7. Offer JE et al. *Vet J* 2003; 165:221.
8. Donovan GA et al. *J Dairy Sci* 2004; 87:73.
9. Greenough PR. *Bovine Pract* 1985; 20:144.
10. Weaver AD. *Bovine Pract* 1988; 23:85.
11. Midla LT et al. *Am J Vet Res* 1998; 59:733.
12. Bergsten C et al. *J Dairy Sci* 2003; 86:3953.

#### 'ACORN' CALVES

A non-inherited condition has been described in the US and Australia which resembles inherited dwarfism.<sup>1</sup> The disease occurs on poor range country and is thought to be due to a maternal nutritional deficiency during the middle trimester of pregnancy. The specific dietary factors involved have not been determined, although supplementary feeding during pregnancy eliminates the condition.

Abnormal osseous development of the head causes it to be either shorter or longer. Shortening of the shafts of the long bones of the limbs is accompanied by bending at the joints, and calves nurse and stand with difficulty. Incoordination, arching of the back and a tendency to bloat, which may cause death, also occur. The dentition is normal. Muscle spasticity, wry

neck, circling, falling backwards, and goose-stepping occur rarely.

Most of the calves are born alive and, in badly affected herds, as many as 15% of calves may be affected. The condition derives its name from the common occurrence of acorns in the diet of affected herds, although the acorns are not thought to have any etiological significance.

#### REFERENCE

1. Barry MR, Murphy WJB. *Aust Vet J* 1964; 40:195.

#### CONGENITAL JOINT LAXITY AND DWARFISM IN BEEF CALVES (DYSCHONDROPLASIA IN NON-INHERITED CONGENITAL DWARFISM IN BEEF CALVES)

Congenital joint laxity and dwarfism is a skeletal anomaly which has affected beef calves in Canada,<sup>1-3</sup> Australia,<sup>4</sup> and Ireland.<sup>5</sup> The disease has been recognized in beef cattle ranches in north central British Columbia and Alberta, and northwestern Ontario.<sup>1</sup>

#### ETIOLOGY AND EPIDEMIOLOGY

The etiology is unknown. Epidemiologically, the disease has been associated with feeding clover silage or grass silage without dry feed or grain supplementation to pregnant cows over the winter months.<sup>3</sup> The disease is seen almost exclusively in beef herds where pit silage makes up the bulk of the ration. In an outbreak in a beef herd in Prince Edward Island, Canada, feeding spoiled silage to pregnant cattle may have been a risk factor.<sup>3</sup> An apparent greater incidence in beef herds in the northern part of the UK may be associated with longer periods of winter feeding in the northern part of the country.<sup>6,7</sup> There is no evidence that manganese deficiency is a causative factor.<sup>3,5</sup>

The problem can be eliminated by supplementation of the silage diet with a combination of hay and rolled barley.<sup>2</sup> In one study, calves born to first-calf heifers were 3.2 times more likely to be affected compared to calves born to mature cows.<sup>8</sup> In the Australian report, the pregnant dams had experienced severe nutritional deficiency between 3 and 6 months of gestation.<sup>4</sup>

Controlled feeding trials have supported the epidemiological observations that the disease occurs in calves born to cows fed exclusively grass or clover silage over the winter months.<sup>2</sup> Supplementation of the grass and clover silage diet with hay (2.5-4.5 kg/head per day) and rolled barley (0.75-1.5 kg/head per day) eliminated the problem. Supplementation with grain but no hay reduced the risk of abnormal calves to a lesser degree. The period of gestation during which the fetus is

susceptible to the abnormality ranges from 107 to 230 days. It is suggested that irreversible injury to the fetus occurs by day 180 of gestation.

Prenatal rickets was considered as a possibility in the early stages of the investigations. The overgrowth of chondrocytes and delayed mineralization of the growth plates of affected calves in previous years were similar to those described for neonatal rickets. In addition, the vitamin D concentration of silage may be low and the wavelengths of ultraviolet light necessary for transformation of the provitamin 7-hydroxycalciferol to vitamin D<sub>3</sub> are almost entirely filtered out by the atmosphere during the winter months because of the acute angle of the sun in northern latitudes. In Canada, pregnant beef cows fed exclusively a diet of grass or clover silage during the winter months may have low levels of vitamin D. However, supplementation of pregnant cows with vitamin D<sub>3</sub> during one winter season did not reduce the risk of abnormal calves.

The disease resembles 'acorn calves' which have occurred in California and Australia. One possible hypothesis suggests that the two conditions may share a common pathway.<sup>2</sup> Certain unspecified seasonal and environmental conditions or stressors may convert forage into a teratogenic substance. In areas where acorn calves occur, supplementation feeding of the cows on pasture practically eliminates the problem.

#### CLINICAL AND PATHOLOGIC FINDINGS

The abnormalities are obvious at birth and characterized clinically by generalized joint laxity, disproportionate dwarfism and, occasionally, superior brachygnathia.<sup>2</sup> The anomaly has occurred in some beef herds for several consecutive years and has affected 2–46% of the calf crop.<sup>9</sup> In a case reported from Ireland, the affected beef herd consisted of Hereford, Simmental, and Friesian cows bred to a Hereford or Charolais bull. The pregnant cattle were self-fed grass silage preserved with Kofasalt (calcium formate, sodium nitrite, and hexamethylene tetramine). Affected calves, were characterized clinically by disproportionate dwarfism, varying degrees of micromelia, limb rotation, joint laxity, and skull abnormalities.<sup>5</sup> Inferior and superior brachygnathia were present. Radiographically, the diaphyses were grossly foreshortened and thickened, the epiphyses were enlarged, misshapen and flared with increased opacity on some radiographs.<sup>5</sup> Histologically, there was chondrodystrophic of the metaphysis of the dwarf long bones. Consistent changes in organ weights or in trace element

status were not present, and there was no evidence of infectious agents. There was no evidence of an inherited basis for the abnormal calves.

The epiphyses of the long bones are abnormal with overgrowth of chondrocytes and delayed mineralization. The common defect is one of growth plate maturation. The secondary ossification centers are slow to develop. Perinatal mortality is higher in affected calves than for normal calves in the same herd. The joint laxity may cause problems with dystocia. Within a few weeks after birth, the joints in surviving calves become stable, and calves walk normally.

#### REFERENCES

1. Ribble CS, Janzen ED. *Can Vet J* 1987; 28:160.
2. Ribble CS et al. *Can Vet J* 1989; 30:331.
3. Cebra CK et al. *Vet Rec* 1999; 215:519.
4. Peet RL, Creeper J. *Aust Vet J* 1994; 71:58.
5. Mee JF. *Irish Vet J* 1995; 48:93.
6. Davies S. *Vet Rec* 2000; 147:144.
7. Gunn G et al. *Vet Rec* 2000; 147:200.
8. Proulx JG, Ribble CS. *Can Vet J* 1992; 33:129.
9. Ribble CS, Janzen ED. *Proc Am Assoc Bov Pract* 1989; 21:96.

#### SLIPPED CAPITAL FEMORAL EPIPHYSIS IN CALVES

This occurs in newborn calves of the well-muscled, rapidly growing European breeds, such as the Charolais, Maine-Anjou, and Simmental. It is characterized by varying degrees of lameness, palpable crepitus over the greater trochanter on passive manipulation of the affected limb, muscle atrophy in longstanding cases, and prolonged recumbency. Some calves carry the affected limb or drag the foot, whereas others tolerate slight weight-bearing during standing or walking. Most calves are lame at birth or within a few days after birth. About 75% of cases are associated with a dystocia and forced traction delivery.<sup>1</sup>

Laboratory stress testing of calf femurs found that mechanically induced fractures had configurations and locations similar to those found in clinical cases associated with forced extraction.<sup>2</sup> The breaking strength of all femurs was within the magnitude of forces calculated to be generated when mechanical devices are used to assist delivery during dystocia. It is suggested that the femur is compressed during force extraction when the pelvis of the calf is wedged in the pelvis of the dam in anterior presentation. Every effort must be employed to avoid premature engagement of the calf's stifle into the pelvic cavity to avoid or correct a 'stifle lock'.

Radiographically, there are varying degrees of displacement of the femoral neck from the head. In chronic cases there is partial resorption of the femoral head.

Excision arthroplasty has been attempted with some encouraging results.

The disease must be differentiated from perinatal **femoral nerve degeneration** and neurogenic atrophy of the quadriceps femoris muscle which also occurs most commonly in the same breeds of cattle. The right hindleg is most commonly affected and affected calves are unable to bear weight on the leg; there is obvious neurogenic atrophy of the quadriceps muscle.<sup>3</sup> The problem has been treated by stall rest, femoral head and neck excision, and open reduction by use of Knowles pins, multiple intramedullary pins, or interfragmentary compression screws.<sup>4</sup>

Slipped capital femoral epiphysis has also been reported in cattle 3–5 months and 1.5–2.3 years of age.<sup>3</sup> Trauma is the suspected cause. If early diagnosis can be made, intramedullary pinning can provide a good long-term prognosis in cattle when function as a breeding animal is important to their future value.

#### REFERENCES

1. Hamilton GF et al. *J Am Vet Med Assoc* 1978; 172:1318.
2. Ferguson JG. *Can Vet J* 1994; 35:626.
3. Tryphonas L et al. *J Am Vet Med Assoc* 1974; 164:801.
4. Hull BL et al. *J Am Vet Med Assoc* 1990; 197: 1509.

#### TAIL-TIP NECROSIS IN BEEF CATTLE

Tail-tip necrosis occurs in cattle housed in confinement on slatted floors. The disease has occurred in steers, heifers, and bulls being fed for beef production.<sup>1,2</sup>

The lesion is caused by a traumatic injury of the tail caused by tramping of the tail. The lesion begins at the tip of tail followed by varying degrees of extension proximally. Initially, the tip of the tail is swollen, followed by inflammation and suppuration. Histopathological changes are compatible with cutaneous ischemia as a pathogenetic mechanism.<sup>3</sup> Extension of the infection can result in metastases to other parts of the body, resulting in abscesses and osteomyelitis. Affected cattle do not grow normally and deaths from pyemia may occur. The morbidity is about 5%. Approximately 10% of affected animals may be condemned for osteomyelitis and abscessation.

#### Risk factors

These include slatted concrete floors, close confinement, warm seasons, and a body weight above 200 kg. The risk increases as the space allotment, expressed as kg animal per m<sup>2</sup> pen increases from approximately 165 kg/m<sup>2</sup>. Tail tramping is more frequent in slatted-floor pens with lower space allotment (1.5 m<sup>2</sup> per head) than in similar pens

with higher space allotment (2.4 m<sup>2</sup> per pen head). In an Ontario study, no case of tail-tip necrosis was diagnosed in solid-floor barns, while 1.36% of cattle in slatted-floor barns were either treated or slaughtered for tail-tip necrosis.<sup>2</sup> In a mail survey of feedlots in Ontario, 96% of 71 feedlots with slatted floors, but only 5% of 184 feedlots with solid floors, reported a problem with tail-tip necrosis from 1982 to 1986.<sup>3</sup> Of 441 tails inspected at slaughter plants, 34.5% were affected, with 3.4% involving skin lacerations and infection, and 4.3% amputated before slaughter.<sup>3</sup> Most cases occur from May to September when the temperature is above 18°C. This may be associated with increased contamination due to increased humidity and temperature under confinement conditions.

In slatted-floor barns, abnormal locomotor patterns occur from 20 to 25% of the times animals get up and lie down.<sup>2</sup> When animals get up abnormally, they first rise in their front, and consequently assume a dog-like sitting posture. In order to obtain momentum to rise in the rear, they then start to sway back and forth. The tail may become pinched between the hock of the rocking animal and the floor, resulting in blunt trauma to the tip of the tail.

#### TREATMENT

Treatment consists of early amputation combined with intensive antimicrobial therapy. Early detection is important. During warm months, cattle confined on slatted floors and weighing more than 200 kg should be closely inspected at least 2 or 3 times weekly. This includes palpation of all tail tips because early lesions are difficult to see.

#### CONTROL

This is dependent on providing sufficient space for housed cattle on slatted floors.

#### REFERENCES

1. Madsen EB, Nielsen K. *Nord VetMed* 1985; 37:349.
2. Droila H et al. *Prev Vet Med* 1990; 9:195.
3. Droila H et al. *Can Vet J* 1991; 32:23.

### TOE ULCER AND NECROSIS OF THE APEX OF THE PEDAL BONE OF CATTLE

#### ETIOLOGY

A toe ulcer is a defect in the white line at the apex of the sole in adult cattle.<sup>1</sup> Lameness does not occur in the early stages but discomfort gradually develops at which stage the animal carries the foot further forward than normal. The etiology is not well understood. In one series of cases, overtrimming using a grinding disc and/or perforation of the sole was considered a major cause (49%), laminitis in 30%, and traumatic injuries in 11%.<sup>2</sup>

#### EPIDEMIOLOGY

In South America, where dairy herds are pastured and supplemented with concentrate and corn silage, toe ulcers are common lesions in heifers from 15 to 60 days after calving.<sup>3</sup> Two types of toe lesions are usually presented. One is a single claw horn defect occurring in Zone 1 which after further examination, granulation tissue is often observed. This lesion responds well to local treatment and the application of an orthopedic block on the healthy claw. The second type of lesion is more severe and includes necrosis of the pedal bone, complicated by secondary infection.

#### CLINICAL SIGNS

Clinical signs of apical pedal bone necrosis vary widely depending on the severity of the lesions, the number of claws involved and the causative factors. A marked-to-severe lameness may occur in cows with one claw affected, and a severely stilted gait in cows with two or three affected claws. In some cases, the lameness is so severe that the initial impression from a distance was that of a neurological disease because of the severely stilted, convulsive limb movements at rest and walking. The involvement of the pedal bone can be determined by clinical examination, inserting a probe or by direct visualization of the discolored and exposed apex of the distal phalanx.

#### PATHOGENESIS

The gross pathological findings of affected claws vary from moderate topical inflammatory signs of the corium at the toe of the claw, to severe and extensive necrosis and osteomyelitis of the pedal bone.<sup>1</sup> Histologically, there are different types of demarcation of the necrotic bone. Mixed infections are common.

Radiographically, the degree of involvement of the distal phalanx can be clearly identified, facilitating the choice of surgical therapy.<sup>1</sup>

#### TREATMENT

Treatment options include excision of necrotic bone using a bone curette, resection of the necrotic apex of the distal phalanx, and digital amputation in severe cases.<sup>2</sup>

#### DIFFERENTIAL DIAGNOSIS

Toe ulcers must be differentiated from toe abscesses which occur in yearling cattle and beef calves grazing irrigated pastures in the fall at which time they may be lame due to a toe abscess.

#### REFERENCES

1. Kofler J et al. *Wiener Tierärztliche Monat* 1999; 86:192.

2. Kofler J. *Vet J* 1999; 157:139.
3. Acuna R, Scarsi R. 12th Int Symp on Lameness in Ruminants. Orlando, Florida, 2002; Jan. 9-13.

### Diseases characterized by involvement of the skin

#### PITYRIASIS ROSEA

Pityriasis rosea is a condition of man. The condition in pigs is not the same because of a prominent component of eosinophils and confluent zones of epidermal necrosis. Dermatopathological authorities have suggested that the condition be renamed pustular psoriasiform dermatitis of pigs.<sup>1</sup>

This skin disease of pigs resembles ringworm closely but skin scrapings do not reveal the presence of fungal hyphae or spores, and cultures for fungal growth are usually negative. Treatment with standard preparations used for ringworm is usually ineffective, although spontaneous recovery may occur.

The disease occurs in sucking pigs<sup>2</sup> and young pigs in the 10-14 weeks age group. Up to 50% of each litter and herd may be affected and in large groups of feeder pigs there may be only individual pigs or the majority of the group with lesions. The disease is usually innocuous, although digestive disturbances, particularly anorexia and, to a lesser extent, diarrhea and vomiting may accompany the appearance of lesions and affected pigs lose some body weight. There is no fever. Usually the condition resolves spontaneously after 2-4 months.

Lesions occur most commonly on the ventral abdomen but may spread to the rest of the body. They commence as small, red nodules which enlarge to flat plaques and become covered with thin, dry, brown scales. The lesions appear to enlarge centrifugally, leaving a center of normal appearance surrounded by a narrow zone of elevated, erythematous skin covered by typical scales. Individual lesions are generally circular except that they often coalesce to produce a large, irregular lesion. There is little irritation and the skin lesions, although obvious, are superficial. There is no loss of bristles. Histologically, the lesions show a progression from acute to chronic with a dense superficial and deep perivascular infiltrate of eosinophils, lymphocytes, and histiocytes.<sup>1</sup>

The cause is unknown, although infectious, genetic and allergic causes have been suggested and there is strong evidence of familial susceptibility, either through inheritance or by vertical transmission of an infectious agent.<sup>3,4</sup> Transmission experiments have been unsuccessful and the disease has been observed in SPF pigs



produced by cesarean section.<sup>5</sup> By analogy with a similar condition affecting man, it may be a viral infection. Treatment appears to be completely ineffective but in general consists of the local application of a salve containing 5% salicylic or iodized mineral oil. Affected pigs should be isolated from the group. Spontaneous recovery occurs in 6–8 weeks in most instances.

#### REFERENCES

- Dunstan RW, Rosser EJ. *Am J Dermatopath* 1986; 81:86.
- Thomson R. *Can Vet J* 1963; 1:449.
- Wellman G. *Berl Münch Tierärztl Wochenschr* 1963; 107.
- Corcoran CJ. *Vet Rec* 1964; 76:1407.
- McDermid KA. *Can Vet J* 1964; 5:95.

### ANHIDROSIS (NON-SWEATING SYNDROME, PUFF DISEASE, DRY COAT)

Reduced ability to sweat affects horses in hot and humid climates. Affected horses are unable to maintain their body temperature within safe limits, especially during or after exercise, and suffer heat stress and a reduction in athletic performance. The only effective treatment is to move the horses to a cooler environment.

#### ETIOLOGY

The etiology of anhidrosis is unknown, but involves a reduction in the sensitivity of the sweat gland to  $\beta$ -2 adrenergic stimulation, the normal stimulus for sweating in the horse.<sup>1</sup> Hypothyroidism does not contribute to anhidrosis.<sup>2</sup>

#### EPIDEMIOLOGY

The disease occurs in horses, and rarely in cattle, in countries with hot, humid climates including tropical and semi-tropical regions.<sup>1</sup>

The overall prevalence is approximately 6% in Florida, with the highest prevalence (25%) in horses in training and the lowest prevalence (1%) in young horses.<sup>2</sup> There is no reported sex or color predilection. Both native and imported horses are affected, apparently with similar prevalence.<sup>3</sup> Among native horses the age of onset of the condition ranges from 1 year to 10 years.<sup>3</sup> Foals, especially of draft breeds, can be affected. Horses imported to endemic areas usually do not develop the disease within 1 year.<sup>3</sup> The incidence and severity of the disease are highest in the hotter season.

The disease is rarely fatal unless severely affected horses are exercised in the heat, in which case death from heat stroke can occur. The major importance of the disease is inability of affected horses to exercise and compete in athletic events.

#### PATHOGENESIS

Sweat is produced in horses by apocrine sweat glands that have a single type of secretory cell. The sweat glands are well

innervated, and sweating is controlled by a combination of hormonal ( $\beta$ -2 adrenergic) and neural factors.<sup>4</sup> Sweat production increases with increasing concentrations of epinephrine in blood up to a peak value, after which sweating rates decline.<sup>4</sup> Anhidrotic horses have lower initial and peak rates of sweat production, and lower overall sweat production, than do normal horses during intravenous infusion of epinephrine.<sup>5</sup> Suggested, but unproved, mechanisms for decreased sweat production by anhidrotic horses includes diminished glandular sensitivity to epinephrine, failure of secretory function, blocking of sweat gland ducts, fatigue of the gland, and gland atrophy.

Sweating is the predominant means by which horses dissipate heat. Reduction in the capacity to produce sweat results in an inability to effectively control body temperature during exercise and when temperature and humidity are high. The elevation in body temperature results in tachypnea in an attempt to dissipate heat through the respiratory tract. Hyperthermia impairs performance and, if severe, can result in heat shock, a systemic inflammatory response syndrome, and death.

#### CLINICAL FINDINGS

The most apparent clinical sign is lack of sweating in response to an appropriate stimulus, such as exercise. In severely affected horses, sweating may be limited to the perineum, brisket, and areas under the mane and saddle. Less severely affected horses have a diminished sweat response and may not lather during exercise. The skin becomes dry and scurfy and loses its elasticity, and there may be alopecia, especially of the face.

Affected animals become extremely tachypneic when heat stressed, leading to the colloquial term for the disease 'dry puffer'. The animal's appetite declines and it loses weight. Athletic performance is severely compromised. High body temperatures are observed after exercise, sometimes reaching 41.5–42°C (107–108°F) and persist for long periods.

The **prognosis** is poor for athletic function for affected animals that remain in hot and humid environments, but the condition may resolve if the horse is moved to a cool climate.

#### CLINICAL PATHOLOGY

Plasma epinephrine concentrations are reported to be higher in affected horses than in unaffected horses,<sup>6</sup> but this has not been a consistent finding among studies.<sup>5</sup>

**Diagnostic confirmation** is achieved by demonstrating reduced sweating in response to **intradermal injection of epinephrine**, or the  $\beta$ -2 adrenergic agonists, terbutaline and salbutamol.<sup>7</sup> A

crude test involves the intradermal injection of 0.1 mL of a 1:1000 dilution of epinephrine. If the horse sweats then it is not considered to be completely anhidrotic. A **semiquantitative test** using epinephrine, terbutaline, or salbutamol may be useful in identifying partially anhidrotic horses.<sup>7</sup> Normal horses sweat when 0.1 mL of 1:1000 000 epinephrine is injected, while partially anhidrotic horses sweat only with higher concentrations (1:10 000 or 1:1000). Injections are usually made using small gauge needles (25 g) into the skin over the lateral aspects of the neck.

#### NECROPSY FINDINGS

There are no characteristic gross lesions at necropsy. Histologic examination of the skin of affected horses reveals abnormalities in sweat gland morphology including flattening of cells and loss of luminal microvilli and a reduction in the number of secretory vesicles. These findings are thought to be a consequence, rather than a cause, of the disease.

#### TREATMENT AND CONTROL

There is **no specific treatment** that restores the horse's ability to sweat, other than movement to a cooler climate. Affected horses for which translocation to a cooler environment is not feasible benefit from housing in air conditioned stables so that exposure to high ambient temperatures is minimized. Exercise of affected horses during the coolest periods of the day is sensible. Affected horses are frequently administered **electrolyte supplements**, but without demonstrated benefit. However, as with all working horses, an adequate intake of sodium, potassium, and chloride should be insured.

Administration of **thyroid hormone supplements** is not warranted, and may be dangerous by increasing the metabolic rate, and therefore heat production, of affected horses. **Vitamin E** administration has no demonstrated efficacy.

Removal of affected animals to cooler climates is often necessary, although air conditioning of stables and maintenance of horses in higher country where they can be returned after a day's racing may enable susceptible horses to be kept locally.

#### REVIEW LITERATURE

Hubert JD et al. Equine anhidrosis. *Vet Clin North Am Equine Pract* 2002; 18:355.

#### REFERENCES

- Bijman J, Quinton PM. *Am J Physiol* 1984; 246:R349.
- Mayhew IG, Ferguson HO. *J Vet Intern Med* 1987; 1:136.
- Warner DE, Mayhew IG. *J Am Vet Med Assoc* 1982; 180:627.
- Scott CM et al. *Equine Vet J* 2001; 33:605.
- Marlin DJ et al. *Equine Vet J* 1999; Suppl 30:362.
- Beadle RE et al. (1982) *Am. J. Vet. Res.* 43:1446.
- Guthrie AJ et al. *J South Afr Vet Assoc* 1992; 63:162.

## BOVINE OCULAR SQUAMOUS-CELL CARCINOMA

Ocular squamous-cell carcinoma, often referred to as 'cancer eye', is one of the most common neoplasms of cattle.

### Synopsis

**Etiology** Genetic-environmental interaction. Lack of pigmentation around the eye and solar radiation.

**Epidemiology** One of most common neoplasms of cattle; mostly in beef cattle breeds (Herefords, Simmental) lacking pigment around the eye; animals over 5 years of age.

Solar radiation major risk factor.

**Signs** Precursor lesions, single or multiple plaques on eyelid or conjunctiva except the cornea or pigmented lid may regress, or lead to carcinomas of sclera resembling papillomas with crumbly, necrotic ulcerated mass attached to the eyelid causing irritation to eye and conjunctiva and excessive lacrimation and pus. Invasion of surrounding tissues of eye and possibly to nearby lymph nodes.

**Clinical pathology** Histology of lesion.

**Lesions** Squamous cell carcinoma.

**Diagnostic confirmation** Biopsy and histology.

### Differential diagnosis list

- Pinkeye
- Lymphoma of periorbital tissues.

**Treatment** Excision by cryosurgery. Radical surgery may be necessary. Immunotherapy with vaccines has been attempted.

**Control** Breeding program to increase degree of pigmentation in Hereford cattle.

## ETIOLOGY

A genetic-environmental interaction has been proposed as the cause. A relative **lack of circumocular and corneoscleral pigmentation**, both of which are heritable, increases the probability of lesion development when the animal is exposed to a carcinogenic agent like the **ultraviolet component of sunlight**. The carcinoma has been regarded as a papilloma-associated tumor because papilloma virus can be found in the precursor lesions, and papillomavirus DNA in the carcinomas. However, advanced virological techniques have failed to reveal any association between the virus and the tumor.<sup>1</sup>

The p53 gene product is highly expressed in bovine BOSCC, which provides support for its role in BOSCC tumorigenesis.<sup>2</sup>

## EPIDEMIOLOGY

### Occurrence

Bovine ocular squamous cell carcinoma is a common neoplasm of the eyelids and the eyeball of cattle and one of the most common neoplasms of cattle. The disease is most common in beef cattle which are

exposed to more sunlight than dairy cattle. The tumors are uncommon in cattle younger than 5 years and are hardly ever seen in cattle younger than 3 years. The condemnation rate of cattle with ocular squamous cell carcinoma in Canada is about 30% of cases.<sup>3</sup> A squamous cell carcinoma of the anal and perianal area of a 15-year-old bull has been recorded.<sup>4</sup>

### Risk factors

The heritabilities, phenotypic, and genetic correlations of lid and corneoscleral pigment and eye lesions associated with eye cancer were investigated in 2831 Herefords from 34 herds in 21 states of the US and one Canadian province. The results indicated that lid and corneoscleral pigment were heritable and genetically correlated.<sup>5</sup> These findings lead to the general conclusion that the genetic effect on pigment determines to a large extent the degree to which the eye is susceptible to some carcinogenic agent such as ultraviolet light.

In Zimbabwe, ocular squamous cell carcinoma was frequently observed in five breeding herds of Simmental cattle.<sup>6</sup> In these herds, initial signs of the disease were evident in cattle about 3 years of age and gradually the prevalence increased to over 50% in animals over 7 years of age.<sup>6</sup> It is suggested that because most cattle in Zimbabwe are slaughtered by 10 years of age, that more than 67% of cattle without periorbital skin pigmentation would develop the tumor. The tumors were multiple and commonly bilateral. Simmental cattle have a complete or partly white face and the lack of facial pigmentation risks exposure to intense solar radiation when they are kept at a high altitude (1500 m) in a sunny and warm climate. The prevalence was much lower in white-faced Friesian cattle in the same environment which suggests a genetic predisposition for the tumors in Simmental cattle. In Zimbabwe, the tumor is not recorded in fully-pigmented cattle breeds.

The association between ocular squamous cell tumors and various measures of solar radiation indicate a significant association between increasing risks of developing eye cancer and increasing levels of radiation.<sup>7</sup> Ultraviolet light is generally regarded as an important risk factor. Most tumors are located only in the sun-exposed mucocutaneous areas not protected by hair. Tumors are predominantly localized in the third eyelid and the lateral limbus, and tumor growth usually starts at the outer edge which receives the most sunlight. Cattle exposed to high levels of radiation develop the disease at younger ages.<sup>7</sup>

### Economic importance

The disease results in serious economic consequences through lessened productivity and carcass condemnations.

Commercial cattle can be culled early without much loss, because only the head is condemned. Purebred cattle are more of a problem because of the difficulty of deciding when euthanasia must be the humane decision, rather than another attempted extirpation of the eye.

## PATHOGENESIS

The initial lesion may be on the eyelid or any structure in the conjunctival sac, except the avascular cornea or pigmented eyelid. Lesions can encroach on these tissues from others nearby, carrying a blood supply with them.

The lesions develop through three stages. The first two, a plaque and then a papilloma, are non-malignant and have high regression rates. The third stage is the squamous cell carcinoma which does not regress. The tumor is located in the sclera adjacent to the lateral limbus, in the membrana nictitans (third eyelid), or in the lower eyelid. It is an invasive tumor, metastasizing along the draining lymphatics into cervical lymph nodes. Primary lesions of the lids are most likely to metastasize to these nodes.

Animals do not appear to develop resistance to the cancer; only a few cows with the disease develop measurable antibodies in their sera. It is one of the characteristics of this disease that the carcinomas appear to produce immunosuppressive substances, and removal of tumor mass reduces blood levels of them.

In countries and in herds where ocular carcinoma is common, it is not unusual to encounter lesions on the labia of the vulva especially if there are patches of unpigmented skin.<sup>8</sup>

## CLINICAL FINDINGS

**Typical precursor lesions** are single or multiple plaques of gray-white, smooth or rough, hyperplastic to hyperkeratinized tissue anywhere in the conjunctiva.

**Plaques** may develop into papillomas and acanthomas of the skin of the eyelids, also included as precursor lesions. Squamous-cell carcinomas may develop from any of these precursors which may also regress spontaneously. The proportion that regresses is of the order of 80%.

**Classic BOSCC lesions** resemble papillomas with a fleshy, sometimes crumbly, often necrotic and ulcerated mass attached to the lid or the orbit by a wide base. They are visible even when the eyelids are closed, and cause obvious irritation to the surrounding conjunctiva, resulting in increased lacrimation and sometimes in the discharge of pus. Invasion of surrounding tissues is common but metastases to nearby lymph nodes and to viscera occur in only a few cases and then only late in the course of the disease.

## CLINICAL PATHOLOGY

Differentiation between carcinomas and precursor lesions is difficult clinically and cytological examination or biopsy is recommended for definitive diagnoses. The cytology of squamous cell carcinomas in domestic animals has been described.<sup>9</sup>

## DIFFERENTIAL DIAGNOSIS

One of the difficulties encountered in the field is the clinical differentiation of benign precursor lesions from the malignant carcinomas; failure to do so may account for the high rates of spontaneous regression recorded, especially in Hereford cattle, where a spontaneous recovery rate of 88% is recorded. To avoid this inaccuracy, exfoliative cytology by the examination of smears of lesions is helpful. Combined with a clinical assessment this is the recommended method of confirming the diagnosis. Differentiation from similar lesions that are not BOSCC can only be achieved by proper laboratory examination of tissues.

BOSCC must be differentiated clinically from:

- Pink eye and its complications which results in excessive lacrimation and purulent material, and
- Lymphoma of the periorbital tissues which usually manifests as exophthalmos.

## TREATMENT

Excision, sometimes by cryosurgery, is widely practiced in cattle. Results are good and treatment by the use of radioactive implants has also aroused favorable comment. Recurrence, or the development of new lesions at the same site, is a common sequel. Radical surgery, including removal of the local lymph nodes and parts of the salivary gland, may be desirable in some bovine cases. It is often combined with immunotherapy, e.g. with BCG vaccine injected systemically or into the lesion, or with vaccination with BOSCC tumor material. That there is a significant immune body response at the normal tissue-corneal interface has been demonstrated, but whether this plays any part in the rejection of the tumors is not known. One controlled trial in cattle showed that intralesional injection of BCG vaccine can interrupt neoplastic progression and prevent malignant disease. A permanent regression after BCG vaccination can be expected in 37% of cases, recurrence at the same site in 26%, and continued growth in 37%.<sup>10</sup>

A favorable response to a single injection of a saline phenol extract of fresh tumor tissue can induce a high rate of regression of ocular tumors with a higher recovery rate after the use of 200 mg of lyophilized tumor extract as compared with an injection of 100 mg. The injection may need to be repeated. Occasional tumors show

enhancement of growth after vaccination, especially if it is repeated. The vaccine does not need to be autologous, and only one injection is required. A freeze-dried preparation of tumor antigen has been used successfully. In general, the use of a vaccine seems likely to provide a satisfactory method for controlling an esthetically distressing and financially important disease. Reports on the effect of vaccination with a tumor vaccine on the vulvar form of squamous-cell carcinoma vary.<sup>11</sup>

Other treatments which have received favorable comment, but need to be evaluated in the light of the known natural recovery rate of the benign precursor lesions, include electrothermal hyperthermia and combinations of the above procedures.

## CONTROL

Because of the strong correlation between absence of pigmentation of the eyelids and the occurrence of the disease, and because of the high heritability of this pigmentation in Hereford cattle, it is suggested that a breeding program aimed at increasing the degree of pigmentation of eyelids could quickly reduce the incidence of the disease in this breed.<sup>5</sup> A positive approach to the problem would be to crossbreed susceptible *Bos taurus* cattle with *Bos indicus* cattle which always have pigmented eyelids and have much less eye cancer. In Ayrshires there is a corresponding predilection for squamous-cell carcinomata of the vulva, but the neoplasm does not occur on both sites in the one cow. Selection on the basis of the occurrence of lesions alone results in only limited reduction in incidence.

## REVIEW LITERATURE

- Gilger BC et al. Bovine ocular squamous cell carcinoma: a review. *Vet Ann* 1991; 31:73-84.
- Spradbrow PB, Hoffman D. Bovine ocular squamous cell carcinoma. *Vet Bull* 1980; 50:449.

## REFERENCES

1. Rutten VPMG. *Am J Vet Res* 1992; 53:1477.
2. Carvalho T et al. *Vet Pathol* 2005; 42:66.
3. Fisher M. *Can Vet J* 1994; 35:133.
4. Musser JMB et al. *Cornell Vet* 1993; 83:83.
5. Anderson DE. *J Hered* 1991; 82:21.
6. Otter WDen. *Am J Vet Res* 1995; 56:1440.
7. Anderson DE, Badzioch M. *J Am Vet Med Assoc* 1991; 52:784.
8. Omara-Opeyne AL et al. *Kenya Vet* 1984; 8:5.
9. Garma-Avina A. *J Vet Diagn Invest* 1994; 6:238.
10. Klein WR. *Tidschr Diergeneesk* 1990; 45:1149.
11. Samuel JL. *Aust Vet J* 1989; 66:186.

## EQUINE OCULAR SQUAMOUS-CELL CARCINOMA

Squamous cell carcinoma is one of the most common neoplasms of the horse and is the most common tumor of the eye and orbit but the rate of occurrence is low. The reported frequency has been highest in animals lacking periocular pigmen-

tation and is more common in Appaloosa, albino, and color dilute horses. An increased prevalence for ocular and adnexal SCC has been reported in draft horse breeds, Appaloosas, Paint Horses, Thoroughbreds, and Quarter Horses. A predisposition for the development of ocular and adnexal SCC has also been reported in geldings.<sup>1</sup> The risk has been higher in draft breeds than in other pigmented breeds, probably related to the large expanses of white skin on the face and around the eye of the heavy draft breeds. The overall mean age range of affected animals is 8-10 years.<sup>2</sup> In a series of limbal neoplasms in horses admitted to the Veterinary Teaching Hospital in the Netherlands, squamous cell carcinoma was the most predominant tumor type and Haflinger horses accounted for 69% whereas their occurrence in the hospital population was 5%.<sup>3</sup>

In a retrospective study of 50 cases submitted to the University of Florida Veterinary Medical Teaching Hospital, the Appaloosa accounted for the majority of cases<sup>4</sup> which may be a reflection of the high level of solar radiation in southeastern US. The average age at which the tumor was diagnosed initially was 11.8 years; males accounted for 64% and females 36% of the cases. The rate of metastasis was 18%.

In the Florida study, higher cure rates were associated with surgical excision followed by radiation therapy for a cure rate of 75%; whereas with only surgical excision the cure rate was 55%.<sup>4</sup> Best results with treatment are seen when surgical intervention is early.<sup>5</sup> In horses, treatment is largely surgical but all of the immunological techniques developed for cattle have been used including local irradiation therapy with <sup>90</sup>Sr or <sup>222</sup>Rn.<sup>2</sup>

The most frequent site for ocular involvement is the nictitating membrane and conjunctiva but the eyelids and cornea are also involved. A case of limbal squamous cell carcinoma with invasion into the cornea and uvea of 12-year-old Haflinger gelding has been described.<sup>6</sup> On initial presentation, a light-pink raised mass on the temporal limbus and conjunctiva of one eye was observed. Squamous cell carcinoma was confirmed histologically after keratectomy and cryotherapy. Seven months later, a smooth pink, progressively enlarging mass was observed within the cornea. Ultrasonographically, the mass was found infiltrating the corneal stroma and the anterior chamber. The globe was surgically removed. Histologically, a diagnosis of corneal ocular squamous cell carcinoma with deep stromal invasion, infiltration of the uveoscleral meshwork and iridocorneal angle and resulting intraocular extension was made.

A pigmented squamous cell carcinoma of the conjunctiva of a 17-year-old horse has been described.<sup>7</sup>

Treatment of ocular and adnexal SCC has included various types of therapy, with and without adjuvant radiation therapy. Types of treatment without adjuvant radiation therapy include excision, cryotherapy, radiofrequency hyperthermia, immunotherapy, chemotherapy with cisplatin, and carbon dioxide laser ablation. Treatment with adjuvant radiation therapy includes use of strontium 90 (<sup>90</sup>Sr) cobalt 60 (<sup>60</sup>Co), gold 198, iridium 192 (<sup>192</sup>Ir), cesium 137, iodine 125 (<sup>125</sup>I), and radon 222 (<sup>222</sup>Rn).<sup>1</sup> In a series of 157 cases of ocular and adnexal squamous cell carcinoma, those treated with adjuvant radiation therapy had a significantly lower recurrence rate, compared with those treated without adjuvant radiation therapy, independent of anatomic location.<sup>1</sup>

Superficial keratectomy followed by cryosurgery is a simple and effective procedure for the treatment of small-sized limbal tumors (less than 2 cm) in horses.<sup>3</sup> Sophisticated equipment is not required and the legal restrictions associated with the use of radioactive substances in many countries are not a consideration.

Ocular pseudotumors have been described in horses. They are proliferative inflammatory lesions involving the eye, adnexa or orbit, which clinically mimics true neoplasms.<sup>8</sup> Cases are characterized by a unioocular, pink proliferative limbal or perilimbal lesion. Affected horses may be from 5 to 9 years of age. Most cases occurred during the summer months and none of the affected animals had a history of trauma or recent deworming. The dorsal bulbar conjunctiva was most commonly affected, followed by the third eyelid. Lesions were relatively flat with indistinct margins or discrete and nodular. Histologically, the lesion is inflammatory characterized by predominantly lymphocytic infiltrates. The cause is unknown but an immune-mediated pathogenesis is suspected based on the preponderance of immunocytes consisting primarily of lymphocytes. Treatment consists of surgical excision alone, partial resection with anti-inflammatory therapy, or anti-inflammatory therapy alone.<sup>8</sup>

## REVIEW LITERATURE

Dugan SJ et al. Epidemiological study of ocular/adnexal squamous cell carcinoma in horses. J Am Vet Med Assoc 1991; 198:251-256.

## REFERENCES

1. Mosonic CP et al. J Amer Vet Med Assoc 2004; 225:1733.
2. Rebhun WC. Vet Surgery 1990; 19:297.
3. Bosch G, Klein WR. Vet Ophthalmol 2005; 8:241.
4. King TC et al. Equine Vet J 1991; 23:447.
5. Schwink IC. Equine Vet J 1987; 19:197.
6. Kaps S et al. Vet Ophthalmol 2005; 8:193.

7. McGowan C, Stanley RG. Vet Ophthalmol 2004; 7:421.

8. Moore CP et al. Vet Ophthalmol 2000; 3:57.

## OCULAR SQUAMOUS CELL CARCINOMA IN GOATS

A well-differentiated ocular squamous cell carcinoma has been described in twin goats.<sup>1</sup> The twin goats, one male and one female, were 3 years of age. Both animals had pigmented eyelids and had been reared at an altitude of 760 m above sea level in Italy. The lesions were very advanced when first examined. There was a history of bilateral ocular disease and impaired vision of 24 months duration. In the affected eyes, a firm mass with a fleshy appearance was evident, covering the entire cornea and protruding through the palpebral fissure. A bilateral ocular mucopurulent discharge, associated with corneal plaques, neovascularization and edema, was also present in both animals.

Histologically, cords and islands of squamous epithelial cells proliferated deeply throughout the cornea and invaded the basal layer, limbus, iris, and ciliary body, and other features, characteristic of a well-differentiated ocular squamous cell carcinoma.

Biomolecular studies to the identification of *Papillomavirus*-related DNA sequences within the neoplastic ocular parenchyma of both animals but immunohistochemical and ultrastructural examinations did not demonstrate viral particles.

## REFERENCE

1. Mara M et al. J Comp Pathol 2005; 132:96.

## 'COCKLE'

This is a superficial nodular dermatitis of sheep recorded only in New Zealand that results in nodules in the skin that are of economic importance to the leather industry. The presence of cockle downgrades the value of the pelt.

Cockle is not usually diagnosed clinically but examination by close inspection of the skin over the upper shoulder region after close shearing has high specificity for detection.<sup>1</sup> The lesions are the result of an immune response in some sheep to infestation with the biting louse *Bovicola ovis*. The occurrence of cockle and its severity is positively correlated with the severity of the louse infestation<sup>2</sup> and sheep that develop lesions have *B. ovis*-specific homocytotrophic antibody. Serum histamine concentrations are significantly higher in louse-infested lambs than louse-naive lambs.<sup>3</sup>

Lesions commence on the neck and shoulders and may extend over the entire pelt. Widely distributed lesions, 'scatter cockle', are attributed to infestation with *B. ovis*, and this is the most common cause

but 'rib cockle' may be a hypersensitivity to infestation with the sheep ked *Melophagus ovinus*. Pelt lesions in the dorsal midline region are usually due to infection with *Dermatophilus congolensis*.<sup>1</sup>

## CONTROL

This rests with the control of *B. ovis*. For cockle control sheep should be treated off-shears with pour-on or spray-on insecticide and, as soon as practical after shearing, treated by saturation dipping. Saturation dipping is required to significantly reduce louse populations.<sup>4</sup> Prelambing dipping is also recommended to reduce the risk of lambs acquiring louse infestations.

## REFERENCES

1. Pfeffer A et al. NZ Vet J 1996; 44:121.
2. Heath ACG et al. Vet Parasitol 1996; 67:259.
3. Pfeffer A et al. Vet Immunol Immunopath 1997; 57:315.
4. Heath ACG et al. NZ Vet J 1996; 44:135.

## WOOLSLIP, WOOL LOSS

Woolslip is a condition in which housed ewes, shorn in winter, lose part of their fleece and develop bald patches over a large area of the **rear half of the back**.<sup>1</sup> This commonly starts at the base of the tail and progresses to the rump and back and less commonly the neck. There is no systemic disease; the skin is normal. Histological examination of skin biopsies show that in affected sheep the wool follicles are in the active anagen stage rather than the inactive telogen phase of unaffected cohort sheep and the wool regrows immediately following loss.<sup>1</sup> The loss of wool **starts 2-3 weeks after shearing**. All breeds are equally susceptible and there is no effect of age or whether the sheep are carrying single or twin lambs; up to 40% of a flock may be affected. The wool loss occurs because of a premature and synchronized shedding of wool fibers and not because of a pathological process which damages the wool fiber. Wool shedding can be induced experimentally by prolonged treatments with corticosteroids and the current explanation for the wool shedding that occurs with the woolslip syndrome is that blood corticosteroid levels rise after the stress of shearing and are maintained for a long period because of the trauma of being housed and shorn and kept in the cold. Blood zinc concentrations in woolslip affected sheep are within the normal range and there is no epidermal change as occurs in zinc deficiency.

The **prevention** of the condition is aimed at reducing the severity and length of the stress period by shearing the sheep at the time of entry to winter housing and insuring a good nutritional plane in the post-shearing period.<sup>1</sup> This hypothesis as to cause may not be correct as the syndrome has also been seen in the

summer in Wiltshire shorn sheep which had little history of stress in the period immediately preceding the woolslip.<sup>2</sup>

Woolslip should not be confused with the normal shedding of wool that occurs in breeds such as the Wiltshire or Shetland in the spring period. Loss of wool along the backline also occurs in older longwool sheep and may be exacerbated by lambs playing or sleeping on the ewe.<sup>3</sup>

**Impairment of wool growth** and a **thinning of fiber diameter** can occur during the course of any **severe disease** such as bluetongue, pregnancy toxemia, or foot rot temporarily affecting the growth of the fleece. This results in a segment of the wool fiber that has decreased tensile strength and the condition has the name **tender wool**. Following recovery from the inciting disease the wool growth is normal but there is a line of wool with poor tensile strength in the staple. This can be observed in the intact fleece as a line of decreased fibre diameter, often with a change in crimp character and discoloration due to entrapment of dust. The wool may break if the staple on either side of this break is sharply snapped between the fingers. The fleece may subsequently be shed in part or in whole at the level of the defect, a condition known as **wool break**. Tender wool downgrades the value of a fleece and has economic significance in wool-producing sheep.

Zinc deficiency can reduce keratinization, reduce wool growth and occasionally result in fleece loss in sheep.<sup>4,5</sup> Wool loss associated with pruritus occurs in association with external parasite infestations (Ch. 27) and with scrapie and pseudorabies in ruminants.

**Pelodora dermatitis**, characterized by thickening of the skin and complete wool loss in affected skin areas is recorded in winter-housed sheep where there was poor bedding management. The condition affected the majority of the ewes at risk. The parasite, *Peladora (Rhabditis) strongyloides* is a free living nematode commonly present in decaying organic material but can invade hair follicles to produce an inflammatory response. Histological examination of the skin showed the presence of the parasite in wool follicles and infiltration of eosinophils and mast cells in connective tissue. Affected skin areas were those that had contact with the bedding when the sheep were lying down and large numbers of the nematode were found in the bedding. Clinical signs regressed with the more frequent provision of new bedding and disinfection of the stable.<sup>6</sup>

### WOOL EATING

Wool eating can occur as a result pica associated with micronutrient deficiency. A condition called **shimao zheng**, occur-

ring in a region of the Gansu province of China has wool eating as its primary manifestation. The disease has a seasonal occurrence with the peak incidence in January through April. Both goats and sheep are affected but the incidence and severity is much higher in goats where 90% may show signs. Affected animals bite the wool or hair off their own or other animals bodies particularly in the hip, belly, and shoulder areas. Histology on biopsies shows heavily keratinized epithelial cells, a decreased number of hair and aggregated foci of lymphocytes in the dermis. Controlled trials have shown the condition can be corrected by supplementation with sulphur, copper, and iron.<sup>7,8</sup> Wool eating is also recorded in Israel possibly associated with trace element copper and zinc deficiency.<sup>9</sup> Wool and hair loss in individual sheep and cattle in association with excessive licking is recorded and are postulated as psychogenic dermatoses.<sup>10</sup>

### REFERENCES

1. Morgan KL et al. *Vet Rec* 1986; 119:621.
2. French NP et al. *Vet Rec* 1990; 127:267.
3. Winter AC. *Vet Annual* 1995; 35:313.
4. White CL et al. *Brit J Nutrit* 1994; 71:425.
5. Masters DG et al. *Aust J Biol Sci* 1985; 38:355.
6. Ramos JJ et al. *Vet Rec* 1996; 138:474.
7. Youde H. *Vet Res Communications* 2002; 25:585.
8. Youde H. *Vet Res Communications* 2002; 26:39.
9. Akgul Y et al. *Vet Rec* 2001; 56:12.
10. Yeraham I, Hadini A. *Vet Rec* 2003; 152:304.

# APPENDICES

## Appendix 1

### CONVERSION TABLES

#### CONVERSION FACTORS FOR OLD AND SI UNITS

	Old units	Multiplication factors		
		Old units to SI units	SI units to old units	SI units
RBC	$\times 10^6/\text{mm}^3$	$10^6$	$10^{-6}$	$\times 10^{12}/\text{L}$
PCV	%	0.01	100	L/L
Hb	g/dL	None	None	g/dL
MCV	$\mu^3$	None	None	fL
MCH	$\mu\text{g}$	None	None	pg
MCHC	%	None	None	g/dL
WBC	$\times 10^3/\text{mm}^3$	$10^6$	$10^{-6}$	$\times 10^9/\text{L}$
Platelets	$\times 10^3/\text{mm}^3$	$10^6$	$10^{-6}$	$\times 10^9/\text{L}$
Total serum				
Protein	g/dL	10	0.1	g/L
Albumin	g/dL	10	0.1	g/L
Bicarbonate	mEq/L	None	None	mmol/L
Bilirubin	mg/dL	17.1	0.0585	$\mu\text{mol}/\text{L}$
Calcium	mg/dL	0.25	4.008	mmol/L
Chloride	mEq/L	None	None	mmol/L
Cholesterol	mg/dL	0.0259	38.7	mmol/L
Copper	$\mu\text{g}/\text{dL}$	0.157	6.35	$\mu\text{mol}/\text{L}$
Cortisol	$\mu\text{g}/\text{dL}$	27.6	0.0362	nmol/L
Creatinine	mg/dL	88.4	0.0113	$\mu\text{mol}/\text{L}$
Globulin	g/dL	10	0.1	g/L
Glucose	mg/dL	0.0555	18.02	mmol/L
Inorganic phosphate	mg/dL	0.323	3.10	mmol/L
Iron	$\mu\text{g}/\text{dL}$	0.179	5.59	$\mu\text{mol}/\text{L}$
Lead	$\mu\text{g}/\text{dL}$	0.0483	20.7	$\mu\text{mol}/\text{L}$
Magnesium	mg/dL	0.411	2.43	mmol/L
Molybdenum	$\mu\text{g}/\text{dL}$	0.104	9.6	$\mu\text{mol}/\text{L}$
Potassium	mEq/L	None	None	mmol/L
Selenium	$\mu\text{g}/\text{dL}$	0.126	7.9	$\mu\text{mol}/\text{L}$
Sodium	mEq/L	None	None	mmol/L
Triglyceride	mg/dL	0.0113	88.5	mmol/L
Urea nitrogen	mg/dL	0.3570	2.9	mmol/L
Urea	mg/dL	0.1665	6.01	mmol/L
Zinc	$\mu\text{g}/\text{dL}$	0.15	6.54	$\mu\text{mol}/\text{L}$

#### CONVERSIONS

To convert grams per 100 mL into grains per US fluid ounce	– multiply by 4.564
To convert grams per 100 mL into grains per Imperial fluid ounce	– multiply by 4.385
To convert grams into ounces avoirdupois	– multiply by 10 and divide by 283
To convert liters into US pints	– multiply by 2.114
To convert liters into Imperial pints	– multiply by 88 and divide by 50
To convert kilograms into pounds	– multiply by 1000 and divide by 454

#### TEMPERATURE

Celcius (centigrade)	Fahrenheit
110°	230°
100	212
95	203
90	194
85	185
80	176
75	167
70	158
65	149
60	140
55	131
50	122
45	113
44	111.2
43	109.4
42	107.6
41	105.8
40.5	104.9
40	104.0
39.5	103.1
39	102.2
38.5	101.3
38	100.4
37.5	99.5
37	98.6
36.5	97.7
36	96.8
35.5	95.9
35	95
34	93.2
33	91.4
32	89.6
31	87.8
30	86
25	77
20	68
15	59
10	50
+5	41
0	32
-5	23
-10	14
-15	+5
-20	-4

To convert Fahrenheit into Celcius: subtract 32, multiply the remainder by 5, and divide the result by 9.

To convert Celcius into Fahrenheit: multiply by 9, divide by 5, and add 32.



**MASS****Metric**

1 kilogram (kg)	= 15432 grains or 35.274 ounces or 2.2046 pounds
1 gram (g)	= 15.432 grains
1 milligram (mg)	= 0.015432 grains

**US/Imperial**

1 ton (2240 lb)	= 1016 kilograms
1 hundredweight (112 lb) (cwt)	= 50.80 kilograms
1 stone (14 lb) (st)	= 6.35 kilograms
1 pound (avoirdupois) (lb)	= 453.59 grams
1 ounce (avoirdupois) (oz)	= 28.35 grams
1 grain (gr)	= 64.799 milligrams

**CAPACITY****Metric**

1 liter (L)	= 2.114 US pints = 1.7598 Imperial pints
1 milliliter (mL)	= 16.23 US minims = 16.894 Imperial minims

**US Liquid**

1 gallon (128 fl oz) (gall)	= 3.785 liters
1 pint (pt)	= 473.17 milliliters
1 fluid ounce (fl oz)	= 29.573 milliliters
1 fluid dram (fl dr)	= 3.696 milliliters
1 minim (min)	= 0.061610 milliliters

**Imperial**

1 gallon (160 fl oz) (gal)	= 4.546 liters
1 pint (pt)	= 568.25 milliliters
1 fluid ounce (fl oz)	= 28.412 milliliters
1 fluid dram (fl dr)	= 3.5515 milliliters
1 minim (min)	= 0.059192 milliliters

**LENGTH****Metric**

1 kilometer (km)	= 0.621 miles
1 meter (m)	= 39.370 inches
1 decimeter (dm)	= 3.9370 inches
1 centimeter (cm)	= 0.39370 inch
1 millimeter (mm)	= 0.039370 inch
1 micrometer (µm)	= 0.000039370 inch

**US/Imperial**

1 mile	= 1.609 kilometers
1 yard	= 0.914 meters
1 foot	= 30.48 centimeters
1 inch	= 2.54 centimeters or 25.40 millimeters

**Pressure**

1 kiloPascal (kPa)	= 10.197 cm H <sub>2</sub> O
1 kiloPascal (kPa)	= 7.50 mm Hg
1 kiloPascal (kPa)	= 0.145 pounds square inch (PSI)
1 atmosphere	= 760 mm Hg
1 mm Hg	= 1.359 cm H <sub>2</sub> O = 0.133 kPa = 0.0193 PSI

## Appendix 2

### REFERENCE LABORATORY VALUES

Reference values for some frequently measured variables in blood and serum are provided as a guide. Values of these variables from healthy animals vary depending on many factors including age, breed, sex, diet, geographical habitat and methods of sample collection and laboratory measurement. The values listed below are compiled from a variety of sources including the clinical laboratories of the Western College of Veterinary Medicine at the University of Saskatchewan, the College of Veterinary Medicine at The Ohio State University, and Kaneko JJ. *Clinical biochemistry of domestic animals*, 5th edn. New York: Academic Press, 1997.

Tables of reference values for newborn foals and calves are provided elsewhere.

#### HEMATOLOGY

	<i>Cattle</i>	<i>Sheep</i>	<i>Goat</i>	<i>Swine</i>	<i>Horses</i>
Hemoglobin (g/dL)	8.0–15.0	9.0–15.0	8.0–12.0	10.0–16.0	11.0–19.0
Hematocrit (packed cell volume) (%)	24–46	27–45	22–38	32–50	32–53
RBC ( $\times 10^6/\mu\text{L}$ )	5.0–10.0	9.0–15.0	8.0–18.0	5.0–8.0	6.8–12.9
MCV (fL)	40–60	28–40	16–25	50–68	37–59
MCH (pg)	11.0–17.0	8.0–12.0	5.2–8.0	17.0–21.0	12.3–19.7
MCHC (g/dL)	30.0–36.0	31.0–34.0	30.0–36.0	30.3–34.0	31.0–38.6
RDW (%)	16.7–23.3	18.0–24.6			
Thrombocytes (per $\mu\text{L}$ )	100 000–800 000	250 000–750 000	300 000–600 000	320 000–520 000	100 000–350 000
WBC (per/ $\mu\text{L}$ )	4000–12 000	4000–12 000	4000–13 000	11 000–22 000	5400–14 300
Neutrophils (mature) (per/ $\mu\text{L}$ )	600–4000	700–6000	1200–7200	3100–10 500	2300–8500
Neutrophils (band cells) (per/ $\mu\text{L}$ )	0–120	Rare	Rare	0–880	0–100
Lymphocytes (per/ $\mu\text{L}$ )	2500–7500	2000–9000	2000–9000	4300–13 600	1500–7700
Monocytes (per/ $\mu\text{L}$ )	25–800	0–750	0–550	200–2200	0–1000
Eosinophils (per/ $\mu\text{L}$ )	0–2400	0–1000	0–650		0–1000
Fibrinogen (mg/dL)	200–700	200–500	200–300		200–400

#### Hematology (International units, SI)

	<i>Cattle</i>	<i>Sheep</i>	<i>Goat</i>	<i>Swine</i>	<i>Horses</i>
Hemoglobin (g/L)	80–150	90–150	80–120	100–160	110–190
Hematocrit (packed cell volume) (L/L)	0.24–0.46	0.27–0.45	0.22–0.38	0.32–0.50	0.32–0.53
RBC ( $\times 10^{12}/\text{L}$ )	5.0–10.0	9.0–15.0	8.0–18.0	5.0–8.0	6.8–12.9
MCV (fL)	40–60	28–40	16–25	50–68	37–59
MCH (pg)	11.0–17.0	8.0–12.0	5.2–8.0	17.0–21.0	12.3–19.7
MCHC (g/L)	300–360	310–340	300–360	303–340	31.0–38.6
RDW (%)	16.7–23.3	18.0–24.6			
Thrombocytes ( $\times 10^9/\mu\text{L}$ )	100–800	250–750	300–600	320–520	100–350
WBC ( $\times 10^9/\text{L}$ )	4.0–12.0	4.0–12.0	4.0–13.0	11.0–22.0	5.4–14.2
Neutrophils (mature) ( $\times 10^9/\text{L}$ )	0.6–4.0	0.7–6.0	1.2–7.2	3.1–10.5	2.3–8.5
Neutrophils (band cells) ( $\times 10^9/\text{L}$ )	0–0.1	Rare	Rare	0–0.1	0–0.1
Lymphocytes ( $\times 10^9/\text{L}$ )	2.0–7.5	2.0–9.0	2.0–9.0	4.3–13.6	1.5–7.7
Monocytes ( $\times 10^9/\text{L}$ )	0–0.8	0–0.8	0–0.6	0.2–2.2	0–1.0
Eosinophils ( $\times 10^9/\text{L}$ )	0–2.4	0–1.0	0–0.7		0–1.0
Fibrinogen (g/L)	2–7	2–5	2–3		2–4

**Serum constituents (US units)**

	<i>Cattle</i>	<i>Sheep</i>	<i>Swine</i>	<i>Horses</i>
<b>Electrolytes</b>				
Sodium (mEq/L)	132–152	145–152	140–150	132–146
Potassium (mEq/L)	3.9–5.8	3.9–5.4	4.7–7.1	3.0–5.0
Chloride (mEq/L)	95–110	95–103	94–103	98–110
Osmolality (mOsmol/kg)	270–306			270–290
<b>Acid:base status</b>				
pH (venous)	7.35–7.50	7.32–7.50		7.32–7.46
PCO <sub>2</sub> (venous) (mm of Hg)	34–45	38–45		38–46
Bicarbonate (mEq/L)	20–30	21–28	18–27	23–32
Total carbon dioxide (mEq/L)	20–30	20–28	17–26	22–31
Anion gap (mEq/L)	14–26	12–24	10–25	10–25
<b>Minerals</b>				
Calcium, total (mg/dL)	9.7–12.4	11.5–13.0	7.1–11.6	11.2–13.6
Calcium, ionized (mg/dL)	4.8–6.2	5.7–6.5	3.5–5.8	5.6–6.5
Phosphorus (mg/dL)	5.6–6.5	5.0–7.3	5.3–9.6	3.1–5.6
Magnesium (mg/dL)	1.8–2.3	2.2–2.8	1.1–1.5	2.2–2.8
Iron (µg/dL)	57–162	166–222	73–140	91–199
Iron binding capacity (µg/dL)	110–350		270–557	270–390
<b>Renal function</b>				
Urea nitrogen (mg/dL)	6.0–27	8.0–20	10–30	10–24
Creatinine (mg/dL)	1.0–2.0	1.2–1.9	1.0–2.7	0.9–1.9
<b>Liver function</b>				
Total bilirubin (mg/dL)	0.01–0.5	0.1–0.5	0–10	1.0–2.0
Direct (conjugated) bilirubin (mg/dL)	0.04–0.44	0–0.27	0–0.3	0–0.4
Bile acids (µg/mL)	<50	<9		4–8
<b>Metabolites</b>				
Ammonia (µg/dL)				13–110
Cholesterol (mg/dL)	65–220	43–103	28–48	46–180
Free fatty acids (mg/L)	< 30	30–100		
Glucose (mg/dL)	45–75	50–80	85–150	75–115
<b>Ketones</b>				
Acetoacetate (mg/dL)	0–1.1	0.24–0.36		0.24–0.36
Acetone (mg/dL)	0–10	0–10		0–10
β-hydroxybutyrate (mg/dL)	5.9–13.9	4.7–6.7		0.55–0.80
Lactate (mg/dL)	5–20	9–12		10–16
Triglyceride (mg/dL)	0–14			4–44
<b>Hormones</b>				
Cortisol (µg/dL)	0.47–0.75	1.40–3.10	2.6–3.3	1.3–2.9
Thyroxine (T4) (µg/dL)	4.2–8.6			See Table 29.8
Triiodothyronine (T3) (ng/dL)				See Table 29.8
<b>Enzymes</b>				
Alanine aminotransferase (ALT) (units/L)	11–40	22–38	31–58	3–23
Alkaline phosphatase (units/L)	0–500	70–390	120–400	140–4003
Amylase (units/L)				75–150
Aspartate aminotransferase (AST) (units/L)	78–132	60–280	32–84	220–600
Creatine kinase (units/L)	35–280			145–380
GOT see AST				
GPT see ALT				
γ-glutamyl transferase (units/L)	6.1–17.4	20–52	10–60	4–44
Isocitrate dehydrogenase (units/L)	9.4–21.9	0.5–8.0		5–18

**Serum constituents (US units) (cont'd)**

	<i>Cattle</i>	<i>Sheep</i>	<i>Swine</i>	<i>Horses</i>
Lactate dehydrogenase (units/L)	692–1445	240–440	380–630	160–410
Sorbitol dehydrogenase (units/L)	4.3–15.3	5.8–28	1.0–5.8	1.9–5.8
<b>Protein</b>				
Total protein (g/dL)	5.7–8.1	6.0–7.9	3.5–6.0	6.0–7.7
Albumin (g/dL)	2.1–3.6	2.4–3.0	1.9–2.4	2.9–3.8

**Serum constituents (International units, SI)**

	<i>Cattle</i>	<i>Sheep</i>	<i>Swine</i>	<i>Horses</i>
<b>Electrolytes</b>				
Sodium (mmol/L)	132–152	145–152	140–150	132–146
Potassium (mmol/L)	3.9–5.8	3.9–5.4	4.7–7.1	3.0–5.0
Chloride (mmol/L)	95–110	95–103	94–103	98–110
Osmolality (mmol/kg)	270–306			270–290
<b>Acid-base status</b>				
pH (venous)	7.35–7.50	7.32–7.50		7.32–7.46
PCO <sub>2</sub> (venous) (mm of Hg)	34–45	38–45		38–46
Bicarbonate (mEq/L)	20–30	21–28	18–27	23–32
Total carbon dioxide (mEq/L)	20–30	20–28	17–26	22–31
<b>Minerals</b>				
Calcium, total (mmol/L)	2.43–3.10	2.88–3.20	1.78–2.90	2.80–3.44
Calcium, ionized (mmol/L)	1.2–1.6	1.4–1.6	0.9–1.4	1.4–1.7
Phosphorus (mmol/L)	1.08–2.76	1.62–2.36	1.30–3.55	0.70–1.68
Magnesium (mmol/L)	0.74–1.10	0.90–1.26	0.78–1.60	0.74–1.20
Iron (μmol/L)	10–29	30–40		13–25
Iron binding capacity (μmol/L)	20–63		48–100	45–73
<b>Renal function</b>				
Urea nitrogen (mmol/L)	2.0–7.5	3.0–10.0	3.0–8.5	3.5–7.0
Creatinine (μmol/L)	67–175	70–105	90–240	110–170
<b>Liver function</b>				
Total bilirubin (μmol/L)	0.17–8.55	1.71–8.55	0–17.1	7.1–35
Direct (conjugated) bilirubin (μmol/L)	0.7–7.54	0–4.61	0–5.1	0–6.8
Bile acids (μmol/L)	<120	<25		10–20
<b>Metabolites</b>				
Ammonia (μmol/L)				7.6–63.4
Cholesterol (mmol/L)	1.0–5.6	1.05–1.50	3.05–3.10	1.20–4.6
Glucose (mmol/L)	2.5–4.2	2.8–4.4	4.7–8.3	4.2–6.4
<b>Ketones</b>				
Acetoacetate (mmol/L)	0.0–0.11	0.026–0.034		0.023–0.035
Acetone (mmol/L)	0–1.7	0–1.7		0–1.7
β-hydroxybutyrate (mmol/L)	0.35–0.47	0.47–0.63		0.052–0.076
Lactate (mmol/L)	0.6–2.2	1.0–1.3		1.1–1.8
Triglyceride (mmol/L)	0–0.2			0.1–0.5
<b>Hormones</b>				
Cortisol (nmol/L)	13–21	42–82	76–88	36–81
Thyroxine (T <sub>4</sub> ) (nmol/L)	54–110			See Table 29.8
Triiodothyronine (T <sub>3</sub> ) (nmol/L)				See Table 29.8
<b>Enzymes</b>				
Alanine aminotransferase (ALT) (units/L)	11–40	22–38	31–58	3–23
Alkaline phosphatase (units/L)	0–500	70–390	120–400	140–4003
Amylase (units/L)				75–150
Aspartate aminotransferase (AST) (units/L)	78–132	60–280	32–84	220–600

**Serum constituents (International units, SI) (cont'd)**

	<i>Cattle</i>	<i>Sheep</i>	<i>Swine</i>	<i>Horses</i>
Creatine kinase (units/L)	35-280			145-380
GOT see AST				
GPT see ALT				
$\gamma$ -glutamyl transferase (units/L)	6.1-17.4	20-52	10-60	4-44
Isocitrate dehydrogenase (units/L)	9.4-21.9	0.5-8.0		5-18
Lactate dehydrogenase (units/L)	692-1445	240-440	380-630	160-410
Sorbitol dehydrogenase (units/L)	4.3-15.3	5.8-28	1.0-5.8	1.9-5.8
<b>Protein</b>				
Total protein (g/L)	57-81	60-79	35-60	60-77
Albumin (g/L)	21-36	24-30	19-24	29-38

## Appendix 3

### DRUG DOSES AND INTERVALS FOR HORSES AND RUMINANTS

Suggested drug doses and intervals for horses and ruminants. Dosages listed are general recommendations and might not be optimal or efficacious in all instances and might need to be adjusted depending on the disease, its severity, patient factors including but not limited to age or diet, and because of regulatory considerations regarding milk and meat withholding times in animals intended as human food. Manufacturer's recommendations should be checked before administering any drug and the effect on withholding time of varying from the manufacturer's recommendation regarding dosing should be considered. Local regulations regarding use of drugs in animals that could be used for human food should be consulted.

Doses are given in milligrams per kilogram body weight (mg/kg) unless otherwise stated (g = gram, iu = international units). Drugs given as total doses, such as intramammary preparations, are denoted by TD. Dosing interval is given in hours, unless otherwise stated, or unless given as a single dose (SD). The route of administration is indicated as: intravenous (IV), intramuscular (IM), oral (PO), subcutaneous (SC), intrarticular (IA), intramammary (IMM), intraperitoneal (IP), inhalation (IH), per rectum (PR), topically (TO), or subconjunctivally (IO). Drugs recommended not to be given to certain species are indicated by NR.

Drug	Horses			Ruminants (cattle, sheep, goats)		
	Dose (mg/kg)	Interval (h)	Route	Dose (mg/kg)	Interval (h)	Route
Acepromazine maleate	0.04–0.1	SD	IM, IV, SC	0.03–0.1	SD	IM, IV, SC
Acetazolamide	2.2	6–12	PO			
Acetic acid				10–20	SD	PO
Acetylcysteine	8 g, TD (for retained meconium)	SD	PR			
	140	24	PO			
Acetylsalicylic acid (aspirin)	10–20	48	PO	50–100	12	PO
Acyclovir	10	12	IV as 1 h infusion			
Adrenaline <i>see</i> Epinephrine						
Albendazole	25–50	SD–12	PO	10–15	PO	SD
Albuterol	0.001–0.008	4–8	IH			
Alcuronium chloride	0.05	SD	IV			
Altranogest	0.044	24	PO			
Aluminum hydroxide	60	6–8	PO	15–60	SD, 8–24	PO
Amantadine hydrochloride	5	4	IV			
Amikacin sulfate	22	24	IM, IV	7.0 22	8 24	IM, IV
Aminocaproic acid	20	SD	IV			
Amiodarone	Intravenous infusion of 5 mg/kg/h for 1 h, then 0.8 mg/kg/h for 23 h, then 1.9 mg/kg/h. For atrial fibrillation					
Aminophylline	5–12	8–12	PO			
Aminopropazine fumarate	0.5	SD	IM, IV			
Amitraz	NR			Goats. 11 mL of 19.9% solution diluted in 7 liters		Topical
Ammonium chloride	20–520 6	24 6	PO PO	50–200	12–24	PO
Ammonium molybdate (with sodium sulfate)				50–200 TD	24	PO
Ammonium tetrathiomolybdate				1.7	48	
Amoxicillin sodium	11–50	6–8	IM, IV	22	12	SC
Amoxicillin/potassium clavulanate	15–25	6–8	IV			

Drug	Horses			Ruminants (cattle, sheep, goats)		
	Dose (mg/kg)	Interval (h)	Route	Dose (mg/kg)	Interval (h)	Route
Amoxicillin trihydrate	6–22 NR	6–12	IM	11–22	12–24	SC
Amphotericin B	0.3–0.6	24–48	IV (dilute, slow)			
Ampicillin sodium	10–50	6–8	IM, IV	22	12	SC, IV
Ampicillin trihydrate	10–22 NR	6–8	IM, PO	4–22	12–24	IM, SC
Amprolium hydrochloride	NR			5–10 (cattle) 15 (sheep)	24	PO
Apramycin sulfate				20–40	24	PO
Ascorbic acid (vitamin C)	30 1000	12–24, SD 24	IV PO (red maple poisoning)	3 g TD (calves)	SD	SC
Aspirin ( <i>see</i> acetylsalicylic acid)						
Atipamezole	0.05–1.0	SD	IV			
Atracurium besylate	0.15 then 0.06 to effect	SD or to effect	IV	0.5 then 0.2 to effect (sheep)	SD or to effect	IV
Atropine sulfate	0.001–0.003 (bron- chodilation) 0.22 (organophos- phate toxicity)	SD  As needed	IV  IV, IM, SC	0.06–0.12 (pre- anesthetic) 0.5 (organophos- phate toxicity)	SD  4	IV, IM, SC
Aurothioglucose	1	7d	IM			
Azathioprine	2–5 loading dose then	q48 h	PO			
Azlocillin	25–75	6–12	IV			
Azithromycin	10	24 h for 5 days then q48 h	PO			
Bacampicillin sodium	20	12	PO			
BAL (British anti-Lewisite) <i>see</i> dimercaprol						
Baquiloprim/sulfadimidine				40–80	48	IM, IV
Beclomethasone	0.001–0.003	12	IH			
Benztropin	2–4	12	IM			
Betamethasone	0.02–0.1	24	IM, PO			
Bethanechol chloride	0.05–0.75	SD, 8	SC, IV	0.07	8	SC
Bismuth subsalicylate	0.5 mL/kg	4–6	PO	60–90 mL, TD (calves)	6–12	PO
Boldenone undecylenate	1.1	3 weeks	IM			
Bretylium	5–10	10 min until conversion	IV			
Bromhexine hydrochloride	0.1–0.25	24	IM, PO	0.2–0.5	24	IM, PO
Bromide, potassium	20–40	24	PO			
Bromocriptine mesylate	0.01	12	IM			
Buprenorphine hydrochloride	0.004–0.006	SD	IV			
Buscopan®	<i>See</i> hyoscine					
Buserelin	0.04	SD	IM, IV, SC	0.02	SD	IM, IV, SC
Butorphanol tartrate	0.02–0.1	SD, 3–4	IV, IM	0.02–0.04	SD	IV, IM
Calcium EDTA	35	12	IV slow			
Calcium gluconate	150–250	SD	IV (slow)	150–250	SD	IV, SC, IP
Cambendazole	20	SD	PO			
Carbenicillin sodium	50–100 6 g, TD	6–12 SD	IV Uterus			



<i>Drug</i>	<b>Horses</b>			<b>Ruminants (cattle, sheep, goats)</b>		
	<i>Dose (mg/kg)</i>	<i>Interval (h)</i>	<i>Route</i>	<i>Dose (mg/kg)</i>	<i>Interval (h)</i>	<i>Route</i>
Carprofen	0.7–1.4	24	IV			
Casein (iodinated)	0.01	24	PO			
Cefamandole	10–30	4–8	IV, IM			
Cefazolin sodium	10–20	6–8	IV			
Cefoperazone sodium	30–50	6–8	IV, IM	250 TD	SD	IMM
Cefotaxime sodium	20–30	6–8	IV			
Cefoxitin sodium	20	4–6	IV			
Cefopodoxime prolextil	10–12	8–12	PO (foals)			
Ceftiofur sodium	2.2–5 10 (foals)	12–24 6	IV, IM IV (slow)	1.1–2.2	24	IM, IV
Ceftiofur crystalline free acid				6.6	SD or 7 days	SC into posterior aspect of ear
Ceftiofur hydrochloride				125 TD 500 TD (dry cow)	24 SD	IMM IMM
Ceftriaxone sodium	25–50	12	IV, IM			
Cefuroxime				250 TD	12	IMM
Cephacetrile sodium				250	SD	IMM
Cephalexin	25–33	6	PO			
Cephalothin sodium	10–30	6	IM, IV	55	6	SC
Cephapirin sodium	20–30 50	8–12 8–12	IM, IV PO	200 TD	12	IMM
Cephaparin benzathine				300, TD	SD	IMM
Charcoal (activated)	1–3 g	8–12	PO	1–3 g	8–12	PO
Chloral hydrate	20–200 40–100	SD 6–12	IV PO			
Chloramphenicol palmitate	25–50	6–8	PO	NR		
Chloramphenicol sodium succinate	20–60	6–8	IV, IM	NR		
Chlorpromazine hydrochloride	1 NR	SD	IM	0.22–1.0 (cattle) 0.6–4.4 (sheep and goats)	SD SD	IM IM
Chlortetracycline				6–10 10–20	24 24	IM, IV PO
Chorionic gonadotropin (HCG)	1000–3000 IU, TD	SD	IM, IV, SC	2500–5000 iu, TD (cattle) 10,000 iu, TD (cattle) 250–1000 iu, TD	SD SD SD	IV IM IV, IM
Cimetidine hydrochloride	6.6 18	4–6 8	IV PO	8–16 100	8 8	IV PO
Cisapride	0.1 0.5–1.0	8–12 8–12	IV PO			
Clenbuterol	0.0008– 0.0032 (0.8–3.2 µg/kg) 0.0008	12 12	PO IV			
Cloquinol	0.02	12–24	PO			
Cloprostenol sodium	0.1, TD	SD	IM	0.5, TD (cattle) 0.06–0.13, TD (goats and sheep)	SD	IM

Horses				Ruminants (cattle, sheep, goats)		
Drug	Dose (mg/kg)	Interval (h)	Route	Dose (mg/kg)	Interval (h)	Route
Closantel				10 (sheep)	SD	PO
Clorsulon				7	SD	PO
Cloxacillin, benzathine				500, TD	SD	IMM
Cloxacillin, sodium	10–30	6	IM, IV	200, TD	12	IMM
Colistin	2500 iu	6	IV (slow)			
Colony stimulating factor (granulocyte)	0.005	24	IV			
Cromolyn sodium	80–300, TD	24	IH			
Cyclophosphamide	2.0	3 weeks	IV			
Cyproheptadine hydrochloride	0.25–1.2	12–24	PO			
Dalteparin sodium	50 iu	24	SC			
Danofloxacin				6	Once	IM, IV
Dantrolene sodium	15–25 2–10	6 24	IV PO			
Decoquinat				0.5	24	PO
Dembrexine hydrochloride	300	12	PO			
Desferroxamine	10	SD	IM, IV	10	SD	IM, IV
Detomidine hydrochloride	0.005–0.08	SD, 2–4	IV, IM	0.01–0.06	SD	IV, IM
Dexamethasone	0.01–0.2 (anti-inflammatory)	24	IV, IM, PO	20–30 TD (cattle, induction of parturition)	SD	IM
	0.5–2 (shock)	SD	IV, IM	0.02–2 (cattle, anti-inflammatory dose)	24	IV, IM
				5–20, TD (cattle, ketosis)	SD, 24	IM
Dexamethasone sodium phosphate	<i>see</i> Dexamethasone					
Dexamethasone 21-isonicotinate,	<i>see</i> Dexamethasone					
Diazepam	0.04–2.0	SD, 0.5	IV, IM	0.4 (calves) 0.6–1.1	SD	IV
Diclofenac	12.5 cm strip of 1% cream	12	TO			IM
Dichlorvos	35	SD	PO			
Dicloxacillin sodium	10	6	IM			
Diethylcarbamazine hydrochloride				22	24	IM
Digoxin	0.002	12	IV	0.022 loading dose then		IV
	0.01–0.02	12–24	PO	0.0034	4	IV
Dihydrostreptomycin	11	12	IM, SC	11	12	IM, SC
Dimercaprol	5 then 3 then 1	SD 6 for 4 doses, then 6 for 8 doses	IM	3	4 for 2 days, then 6 for 1 day, then 12 for 10 days	IM
Dimethyl glycine	1–2	24	PO			
Dimethyl sulfoxide (DMSO)	0.5–2 100 g, TD	12–24 12–24	IV (as 10% solution, slowly), PO topical	1	12–24	IV

Horses				Ruminants (cattle, sheep, goats)		
Drug	Dose (mg/kg)	Interval (h)	Route	Dose (mg/kg)	Interval (h)	Route
Dimophebumine hydrochloride				1.0–1.5 g, TD (cattle)	SD	IM
				150–250, TD (sheep)	SD	IM
Dinoprost tromethamine	0.002–0.01	SD	IM	25 TD (cattle, estrus induction)	10–12 days	IM
				25 TD (cattle, abortifacient)	SD	IM
				8 TD (ewe, estrus induction)		
				8 TD (doe, estrus induction)	days 5 and 11 of cycle	IM
				10–15 TD (ewe, abortifacient)	days 4 and 11 of cycle	IM
				5–10 TD (doe, abortifacient)		IM
					<60 days pregnancy	IM
					entire pregnancy	IM
Diocetyl sodium sulfosuccinate (DSS)	10–20	48 (limit 2 doses)	PO			
Diphenhydramine hydrochloride	0.25–1	6–8	IV, IM	0.5–1.0	6–8	IV, IM
Diprenorphine	0.03 (horses) 0.015 (donkeys)	SD	IV	0.03 (cattle) 0.015 (sheep)	SD	IV
Dipyrrone	11–22	SD, 8	IV, IM	50	SD	IM, IV, SC
Dobutamine hydrochloride	1–10 µg	Infusion per min	IV			
Docusate <i>see</i> Diocetyl sodium sulfosuccinate						
Domperidone	0.2 1.1	SD, 12 24	IV PO			
Dopamine hydrochloride	1–10 µg	Infusion per min.	IV	2–10 µg	Infusion per min.	IV
Doramectin				0.2	SD	IM, SC
Doxapram hydrochloride	0.02–1	SD	IV	5–10	SD	IV
Doxycycline	10	12	PO (do not use IV)			
Doxylamine succinate	0.55	8	IM, SC, IV (slow)	0.5	12	PO, IM, SC
Edetate calcium disodium (EDTA)	75	24	IV (slow, dilute)	67	12	IV (slow)
Edrophonium chloride	0.5–1	SD	IV	0.5–1.0	SD	IV
Enrofloxacin	5 7.5	12 24	PO PO	7.5–12.5 2.5–5.0	SD 24	SC SC
Ephedrine sulfate	0.7	12	PO			
Epinephrine (1:1000)	0.01 mL	SD	IM, SC	0.01–0.02 mL	SD	IM, SC
(1:10 000)	0.1–0.2	SD	IM, SC	0.1–0.2 mL	SD	IV
Erythromycin base	0.1 (for ileus)	infusion per hour	IV	2.2–15	12–24	IM
Erythromycin estolate, ethylsuccinate	25–37.5	6–12	PO	4–44	12–24	IM
				300 TD	12	IMM

Drug	Horses			Ruminants (cattle, sheep, goats)		
	Dose (mg/kg)	Interval (h)	Route	Dose (mg/kg)	Interval (h)	Route
Erythromycin				600 TD (dry cows) 300 TD (lactating cows)	SD 12	IMM IMM
Estradiol	10–15 TD (estrus induction) 1	SD SD	IM IM	4–10	SD, 24	IM
Estrone sulfate	0.04	12	IM			
Famotidine	1.8–3.3 0.2–0.4	8 6–8	PO IV			
Febantel	6	SD	PO	5–10	SD	PO
Fenbendazole	5 (usual) 10 50	SD SD SD, 24	PO PO PO	5–10	SD	PO
Fenoterol	2–4	6–12	IH			
Fenprostalene	0.001	SD	IM	0.002	SD	SC
Ferrous sulfate	10–20	24	PO	10–30	24	PO
Fentanyl (transdermal)	2 × 20 mg patch per 400 kg					
Florfenicol				20 40	48 SD	IM IM
Fluconazole	4	24	PO			
Flumazenil	0.001–0.004	SD	IV (slow)			
Flumethasone	0.002–0.008	SD	IM, IV, IA			
Flunixin meglumine	0.25–1.0	6–24	IV, IM, PO	1.1–2.2	12–24	IM, IV
Fluoroprednisolone acetate	0.01–0.04	SD	IM			
Fluprostenol	0.55 µg	SD	IM			
Fluticasone	2–4 µg/kg	6–12	IH			
Folic acid	40–75 TD	SD	IM, PO			
Folinic acid	50–100 TD	SD, 24	PO			
Follicle stimulating hormone	10–50 TD	SD	IV, IM, SC	5 TD	12	IM, SC
Framycetin sulfate				5 10 (calves)	12 24	IM PO
Frusemide <i>see</i> Furosemide						
Furazolidone	4	8	PO	10 (calves)	24	PO
Furosemide	0.25–3	SD	IV, IM	0.5–4	12–24	IM
Gallamine triethiodide	1 then increments of 0.2	SD	IV	0.5 then 0.1 to effect (cattle) 0.4 (sheep)	SD SD	IV IV
Gentamicin sulfate	2.2 6.6	8 24	IV, IM IV, IM	2.2–6.6 100–150 TD	12–24 12	IM IMM
Glauber's salts <i>see</i> sodium sulfate						
Glycerol				180 mL TD (cattle) 90 mL TD (sheep)	12 12	PO PO
Glycerol guaiacolate ether <i>see</i> Guaifenesin	110	SD	IV			
Glycopyrrolate	0.001–0.01	SD, 12–24	IV, IM			
Glycopyrronium bromide <i>see</i> Glycopyrrolate						

<i>Drug</i>	<b>Horses</b>			<b>Ruminants (cattle, sheep, goats)</b>		
	<i>Dose (mg/kg)</i>	<i>Interval (h)</i>	<i>Route</i>	<i>Dose (mg/kg)</i>	<i>Interval (h)</i>	<i>Route</i>
Gonadorelin				100 µg TD	SD	IM
Glycosaminoglycan, polysulfated	250 TD 1	SD, 7 days 5 days	1A IM			
Griseofulvin	10	24	PO	10–20	24	PO
Guaifenesin	110, give first 1/3rd to cause recumbency	SD	IV	66–130	SD	IV
Haloxon	50–70	SD	PO			
Hemoglobin (bovine, polymerized)	10–30 mL/kg	SD	IV			
Heparin	30–100	6–12	SC, IV			
Hetastarch	10–20 mL	SD	IV slow			
Hyaluronate sodium	10–50 TD 1	SD 96	IA IM			
Hydralazine	0.5–1.5	12	PO			
Hydrochlorothiazide	0.5	24	PO	0.25–0.5	12–24	IV, IM
Hydrocortisone				0.1–1	SD, 24	IM, IV
Hydroxyzine hydrochloride or pamoate	0.5–1.0	12	IM, PO			
Hyoscine (scopolamine hydrobromide)	0.3	SD	IV			
Imipenemcilastatin sodium	15–20	4–6	IV			
Imidocarb dipropionate	2–4	24	IM	1.2	SD	SC
Imipramine	0.55–1.5	8	IM, IV, PO			
Insulin, protamine zinc suspension	0.15 u	12	IM, SC	0.15–0.3 u	36	SC
Interferon alfa-2a, human recombinant	0.1–0.3 u	24	PO			
Iodide sodium	20–40	24	PO	66	SD	IM
Iodochlorhydroxyquin	20	24	PO			
Ipratropium	2–3 µg	4–6	IH			
Iron cacodylate	2	SD	IV			
Iron dextran				2	SD	IM
Isoflupredone acetate	0.02	SD	IM			
Isoniazid	5–20	24	PO			
Isoproterenol	0.4 µ	SD	IV (slow)			
Isoxsuprine hydrochloride	0.4–1.2	12	PO			
Itraconazole	3	12	PO			
Ivermectin	0.2	SD	PO	0.2	SD	SC, IM
Kaolin pectate	2–4 mL	12	PO	0.25–1 mL	4	PO
Ketamine hydrochloride (after appropriate premedication)	1.1	SD	IV	2 4	SD SD	IV IM
Ketoconazole	10–30	12–24	PO			
Ketoprofen	2.2	12	IM, IV	2–4	24	IM, IV
Ketorolac tromethamine				0.3–0.7 (goats)	8	IM, IV, Sc, PO
Lactulose	120–300	12	PO			
Lasalocid				1	24	PO
Levamisole	8–11	24	PO	5.5–11 3.3–8	SD SD	PO SC

<i>Drug</i>	<b>Horses</b>			<b>Ruminants (cattle, sheep, goats)</b>		
	<i>Dose (mg/kg)</i>	<i>Interval (h)</i>	<i>Route</i>	<i>Dose (mg/kg)</i>	<i>Interval (h)</i>	<i>Route</i>
Levothyroxine	0.02	24	PO			
Lidocaine	1.3 mg/kg as bolus then 0.05 mg/kg/min	Infusion	IV			
Lincomycin hydrochloride	NR			5–10	12–24	IM
Loperamide	0.1–0.2	6	PO			
Lufenuron	5–20	24	PO			
Luprostiol	7.5 TD	SD	IM	7.5–15 TD (cattle)	SD	IM
Magnesium hydroxide	0.5 mL	8	PO	400–450 g, TD (cattle)	8–24	PO
				10–30 g, TD (sheep)	8–24	PO
Magnesium oxide				1000–2000	SD	PO
Magnesium sulfate	0.2–1.0 2.2–6 (for ventricular tachycardia)	24 1 min	PO IV boluses every minute until conversion or total dose of 60 mg/kg	0.1 0.02	SD SD (with calcium gluconate)	SC IV (slow)
	50 mg/kg/h for 1 h then 25 mg/kg/h as CRI (for presumed neonatal hypoxic encephalopathy)					
Mannitol	0.25–2.0	SD	IV (slow)	1–3	SD	IV
Marbofloxacin				2	24	IM, IV, SC
Mebendazole	8.8–20	SD, 24	PO			
Meclofenamic acid	2.2	12–24	PO			
Meloxicam	0.6	24	IV, PO	0.5	SD, 24	IV, SC, IM
Meperidine	2–4 0.2–0.4	SD SD	IM, IV (slow)	3–4	SD	IM, SC
Methadone hydrochloride	0.05–0.2	SD	IV, IM			
Methicillin	25	4–6	IV			
Methionine-DL	20–50	24	PO	50	24	PO
Methocarbamol	5–55 40–60	6 24	IV PO	110	SD	IV
Methylene blue	NR			4.4–8.8	SD	IV
Methylprednisolone or methylprednisolone sodium succinate	0.5–1.0 0.5–1.0 10–20 (shock)	24 24 SD	PO IV IV			
Methylprednisolone acetate	0.5	SD, as necessary	IM			
Metoclopramide	0.02–0.25	6–8	IV	0.1–1.0	6–12	IV, IM
Metronidazole	15–25 20–25	6 12	IV, IM, PO, PR IV, IM, PO, PR			

<i>Drug</i>	<b>Horses</b>			<b>Ruminants (cattle, sheep, goats)</b>		
	<i>Dose (mg/kg)</i>	<i>Interval (h)</i>	<i>Route</i>	<i>Dose (mg/kg)</i>	<i>Interval (h)</i>	<i>Route</i>
Mezlocillin	25–75	6	IV			
Midazolam hydrochloride	0.011–0.044	SD	IV			
Mineral oil	10 mL	SD, 8	PO	8 mL	SD	PO
Minocycline	3	12	PO			
Misoprostol	1–4 µg	12–24	PO			
Monensin				1	24	PO
Morantel tartrate				8–10	SD	PO
Morphine sulfate	0.2–0.8	SD	IM, IV (slow)	1–10 TD (sheep and goats)	SD	IM
Moxalactam	50	8	IM, IV			
Moxidectin	0.4	SD	PO	0.4	SD	SC, PO
Nafcillin	10	6	IM			
Naloxone	0.01–0.02	SD	IV			
Naproxen	5–10	12–24	PO			
Neomycin	2–6 4.4	6–12 8–12	PO IV	3–6 88	6–12 8	PO SC
Neostigmine	0.004–0.02	SD, 6	SC	0.02	SD	SC
Netilmicin	2	8–12	IV, IM			
Netobimin				7.5	SD	PO
Niclosamide	100	SD	PO			
Nitazidone	6.6	8	PO			
Nitazoxanide	25 for days 1–5, then 50 for days 6–28	24	PO			
Nitrofurantoin	2.5–5	8	PO			
Nitroglycerin	15 TD (topical over each digital artery)	24	topical			
Nitroxynil				10–15	SD	SC
Norepinephrine	0.01	SD	IM			
Novobiocin	400 TD (dry cow) 150 TD (lactating cow)	SD 24	IMM IMM			
Nystatin	250 000– 1 000 000	SD	IU			
Omeprazole	1–4	24	PO			
Oxacillin	25–50	8–12	IM, IV			
Oxfendazole	10	SD	PO	2.5	SD	PO
Oxibendazole	10	SD	PO	10–20	SD	PO
Oxylozanide				10–15	SD	PO
Oxymorphone	0.01–0.02	SD	IM, IV			
Oxytetracycline	3.3–6.6 30–40 (foals)	12–24 SD	IV (slow) IV	5–20 300–400 TD	12–24 12	IV, IM IMM
Oxytocin	0.05–0.1 (induction of foaling) 0.01–0.02 (retained)	SD 1–1.5	IM IM	0.05–0.1 (retained placenta) 0.025–0.05 (milk let down)	1–1.5 SD	IM IV



Horses				Ruminants (cattle, sheep, goats)		
Drug	Dose (mg/kg)	Interval (h)	Route	Dose (mg/kg)	Interval (h)	Route
Pancuronium	0.04–0.066	SD	IV	0.04 then 0.008 (cattle) 0.025 then 0.005 (sheep)	SD	IV
Pantoprazole	1.5	24	IV or PO			
Paromomycin	100	24	PO			
Penicillamine	3–4	6	PO	52	24	PO
Penicillin G, benzathine	10 000– 40 000 iu	48–72	IM	44 000–66 000 iu	48–72	IM, SC
Penicillin G, procaine	20 000– 50 000 iu	12–24	IM	10 000–60 000 iu	12–24	IM, SC
Penicillin G, sodium or potassium	10 000– 50 000 iu	6–8	IV, IM			
Penicillin V, potassium	66 000– 110 000	6–8	PO			
Pentazocine	0.33	SD	IV, IM, SC			
Pentobarbital	2–20 (to effect)	SD	IV	30 (to effect)	SD	IV
	120–200 FOR EUTHANASIA	SD	IV	120–200 FOR EUTHANASIA	SD	IV
Pentobarbitone <i>see</i> pentobarbital						
Pentosan sulfate	250 (TD)	7 days	IA			
	3	7 days	IM			
Pentoxifylline	8	12	PO			
Pergolide	0.002–0.01	24	PO			
Perphenazine	0.3–0.5	12	PO			
Pethidine <i>see</i> meperidine						
Phenobarbital	5–25 10	SD, 8 8	IV PO	10	24	PO
Phenothiazine	55	SD	PO			
Phenoxybenzamine hydrochloride	0.6 0.6–1.2	6–8 12	IV PO			
Phenylbutazone	2–4.4	12–24	PO, IV	4 10–20 (loading dose) then 5–10	24 24–48	IV PO
Phenylephrine hydrochloride	0.02–0.04	SD	IV (over 10 min)			
Phenytoin sodium	5–10 then 1–5 (for seizures) 10–12 (for rhabdomyolysis) 10–22 (for arrhythmias)	SD 4–8 12 12	IV IV, IM, PO PO IV (slow), IM			
Physostigmine	0.1–0.6	SD	IM, IV			
Phytonadione (vitamin K1)	0.5–2.5	SD, 4–6	IV (slow)	0.5–2.5	SD, 8	IV (slow), IM
Piperazine	110–200	SD	PO			
Pipercillin	15–50	6–12	IV, IM			
Pirbuterol	0.001–0.002	12–24	IH			
Pirlimycin				50 TD	12–24	IMM
Pivampicillin sodium	20	12	PO			
Poloxalene				22–44	24	PO

Drug	Horses			Ruminants (cattle, sheep, goats)		
	Dose (mg/kg)	Interval (h)	Route	Dose (mg/kg)	Interval (h)	Route
Polysulfated glycosaminoglycan	1	96	IM			
	0.5	96	IA			
Polymixin B	6000	SD	IV	6000	SD	IV
Ponazuril	5–10	24	PO			
Potassium bromide	20–40	24	PO			
Potassium iodide	4–40	24	PO	1.5	24	IV
Potentiated sulfonamide ( <i>see</i> sulfonamide/trimethoprim)						
Pralidoxime chloride	20–50	4–6	IV	25–50	SD, 6	IV (slow)
Praziquantel	10	SD	PO	10–15	SD	PO
Prednisolone	0.2–4.4	12–24	IM, PO	1–4	SD, 24	IV
Prednisolone sodium succinate	0.25–1.0	SD	IV			
Primidone	10–20	6–12	PO			
Procainamide	0.5 to total dose of 4	10 min	IV			
Progesterone	0.3–0.6	24	IM			
Promazine	0.25–1	SD	IV			
	1–2	SD	PO			
Propafenone	0.5–1.0	SD	IV			
Propanteline bromide	0.014	SD	IV			
Propofol	2.4 (induction)	Infusion	IV			
	0.3 (maintenance)					
Propranolol	0.03–0.3	12	IV			
	0.4–0.8	8	PO			
Propylene glycol				110–225 mL TD (cattle)	24	PO
				110 mL TD (sheep)	24	PO
Protamine sulfate				0.2	SD	IV
Prostaglandin F2 $\alpha$	0.02	SD	IM			
Psyllium mucilloid	500	12–24	PO			
Pyrantel pamoate	6.6	SD	PO	25	SD	PO
Pyrantel tartrate	2.6	SD	PO			
Pyrilamine maleate	0.8–1.3	6–12	IV, IM, SC	1–3	SD	IV, IM
Pyrimethamine	1–2	24	PO			
Quinidine, gluconate	22	2–4	PO	50	Over 4 hours	IV
	0.5–2.2	10 min until conversion to sinus rhythm or suppression of arrhythmia	IV	210 loading dose then 180	6	PO
Ranitidine hydrochloride	6.6	6–12	PO	50	8	PO
	1.5	6–12	IV			
Reserpine	2–5	24	PO			
Rifampin	5–10	12	PO			
Romifidine	0.04–1.0	SD	IV, IM			
Salmeterol	0.0005–0.001	6–12	IH			
Scopolamine hydrobromide	See hyoscine					

Drug	Horses			Ruminants (cattle, sheep, goats)		
	Dose (mg/kg)	Interval (h)	Route	Dose (mg/kg)	Interval (h)	Route
Selenium	See text (p. 1735–1736)					
Sodium acid phosphate				60 g in 300 mL water IV and SC every 24 h for adult cattle		
Sodium chloride (hypertonic, 7.0%)	4 mL	SD	IV	4 mL	SD	IV
Sodium sulfate	1–2	SD, 24	PO	1–2	SD	PO
Sodium thiosulfate	30–40	SD	IV	660 (cyanide poisoning) 1 (copper poisoning)	SD 24	IV PO
Spectinomycin	20	8	IM	20	12–24	IV, IM, SC
Stanozolol	0.55	168	IM	2	SD	IM
Stilbestrol	0.3	SD	IM			
Streptomycin	11	12	IM, SC	11	12	IM, SC
Succinylcholine chloride	0.09–0.11	Sd	IV			
Sucralfate	10–20	6–12	PO			
Sulfachlorpyridazine				88–110 30–50 (calves)	12–24 8	IV PO
Sulfadimethoxine	55	24	IV	55–110 55 then 28	24 24	PO IV
Sulfadimidine				100–200 loading dose then 50–100	SD 24	IV
Sulfadoxine/trimethoprim	15	12–24	IM, IV (slow)	15	12–24	IM, SC, IV
Sulfamethoxyipyridazine				20	24	SC, IM, IV, IP
Sulfonamide/trimethoprim	15–30	12–24	PO, IV, IM	15–30 15–30 (pre-ruminant calves)	12–24 12–24	IM, IV PO
Suxamethonium chloride	0.1	SD	IV	0.02	SD	IV
Terbutaline sulfate	0.02–0.06 0.002	6–12 SD	PO IV			
Tetanus antitoxin	3 iu (tetanus prophylaxis) 100 iu (treatment of tetanus)	SD 72–120	IM, IV, SC IM, IV, SC			
Tetracycline <i>see</i> oxytetracycline hydrochloride						
Theophylline	8–12	8–12	PO			
Thiabendazole	44	SD	PO	50–100	SD	PO
Thiamine hydrochloride (vitamin B1)	0.5–5	SD	IV, IM, PO	5–50	12	IV, IM
Thiamylal sodium	2–4	SD	IV (to effect)	4.4–8.8	SD	IV
Thiopental	4–10	SD	IV	8–16	SD	IV
Thiophanate				2.4–4.8 g, TD (cattle) 240–480, TD (sheep)	SD	PO
Thyroxine L	0.01	24	PO			
Ticarillin (with or without clavulanate)	50	6–8	IV, IM			
Tiletamine hydrochloride with zolazepam hydrochloride	1.6–2.2	SD	IV			

<i>Drug</i>	<b>Horses</b>			<b>Ruminants (cattle, sheep, goats)</b>		
	<i>Dose (mg/kg)</i>	<i>Interval (h)</i>	<i>Route</i>	<i>Dose (mg/kg)</i>	<i>Interval (h)</i>	<i>Route</i>
Tilmicosin				10	72	SC
Tobramycin	1–2	8	IV			
Tocopherol acetate (vitamin E)	10–15 iu	24	PO			
Tolazoline	4	SD	IV slowly			
Trenbolone acetate				140–200 TD	SD	SC
Triamcinolone acetonide	0.1–0.2 6–18 TD	SD SD	IM, SC IA	0.02–0.04	SD	IM
Trichlorphon	35–40	SD	PO			
Triclabendazole				12	8–10 weeks	PO
Trilostane	0.4–1.0	24	PO			
Tripelenamine hydrochloride	1	6–12	IM	1.1	6–12	IV, IM
Tubocurarine chloride	0.3 then 0.05	SD	IV	0.06 then 0.01 (cattle) 0.04 then 0.01 (sheep)	SD, to effect SD, to effect	IV IV
Tulathromycin				2.5	SD	SC
Tylosin	NR			17	24	IM
Vancomycin	4–8	6–12	IV			
Verapamil	0.025–0.5	SD	IV (slow)			
Veruconium bromide	0.1 then 0.02	SD, to effect	IV	0.04 then 0.01 (sheep)	SD to effect	IV
Vitamin B <sub>1</sub> <i>see</i> thiamine				See text		
Vitamin C <i>see</i> ascorbic acid						
Vitamin E <i>see</i> tocopherol acetate						
Vitamin E micellated (water soluble)	6–10 iu	24	PO			
Vitamin K <sub>1</sub> <i>see</i> phytonadione						
Warfarin sodium	0.02 then slowly increasing to effect	24	PO			
Xylazine hydrochloride	0.1–1.1	SD	IV, IM	0.05–0.15	SD	IV, IM
Yohimbine hydrochloride	0.075	SD	IV	0.125	SD	IV
Zeranol				36–72 TD	SD	SC

Sources: Bishop Y. *The Veterinary Formulary*, 5th edn. London: The Pharmaceutical Press, 2001. Plumb DC. *Veterinary Drug Handbook*, 2005 (accessed online through [www.VIN.com](http://www.VIN.com)), and other sources.

## Appendix 4

### DRUG DOSES AND INTERVALS FOR PIGS

Suggested drug doses and intervals for pigs, and concentrations of medicaments in feed. Dosages listed are general recommendations and may not be optimal or efficacious in all instances and may need to be adjusted depending on the disease, its severity, patient factors such as age or diet, and because of regulatory considerations regarding milk and meat withholding times in food animals. Manufacturer's recommendations should be checked before administering any drug and the effect on withholding time of varying from the manufacturer's recommendation regarding dosing should be considered. Local regulations regarding use of drugs in animals that may be used for human food should be consulted.

Doses are given in milligrams per kilogram body weight (mg/kg) unless otherwise stated (g = gram, iu = international units). Drugs given as total doses are denoted by TD. Dosing interval is given in hours, unless otherwise stated, or unless given as a single dose (SD). The route of administration is indicated as: intravenous (IV), intramuscular (IM), oral (PO), subcutaneous (SC), or intraperitoneal (IP). One ton = 1016 kg.

<i>Drug</i>	<i>Pigs Dose (mg/kg) or (Concentration in feed or water)</i>	<i>Interval (h)</i>	<i>Route</i>
Acepromazine maleate	0.03–0.5	SD	IM, IV, SC
Acetazolamide	6–8	SD	IV, IM, PO
Acetylsalicylic acid (aspirin)	10	4	PO
Albendazole	5–10	SD	PO
Amoxicillin trihydrate	6.6–22	8–24	IM
	6.6–22	12–24	PO
Ampicillin sodium	6–8	8	IM, SC
Ampicillin trihydrate	4.4–22	8–24	IM
Amprolium hydrochloride	25–65	12–24	PO
Apramycin sulfate	10–20 (150 g/ton)	24	PO
Arsanilate, sodium	(700 mg per 4 L drinking water for 7 days)		
Aspirin	<i>see</i> Acetylsalicylic acid		
Atropine sulfate	0.02–0.04	SD	IM
Azaperone	1–2	SD	IM
Bacitracin zinc	(10–50 g/ton)		
Bacitracin methylene disalicylate	(250 g/ton)		
Baquiloprim/sulfadimidine	10	24	IM
Bismuth subsalicylate	2–5 mL, TD (piglets) (900)	6–12	PO
Bromhexine hydrochloride	0.2–0.5	24	IM, PO
Calcium gluconate	150–250	SD	IV, IM, SC, IP
Carbadox	(50 g/ton)		
Ceftiofur sodium	3–5	24	IM
Ceftiofur hydrochloride	3–5	24–158	IM
Chloramphenicol palmitate	NR		
Chloramphenicol sodium succinate	NR		
Chlorpromazine hydrochloride	0.6–3.3	SD	IV, IM
Chlortetracycline	10–20 (50–100 g/ton)	24	PO
Cimetidine hydrochloride	300, TD	12	PO
Cloprostenol sodium	0.18, TD	SD	IM
Dantrolene sodium	3.5	SD	IV
Dexamethasone	0.06 (1–10, TD)	SD, 24	IM
Dexamethasone sodium phosphate			
<i>see</i> Dexamethasone			
Dexamethasone 21-isonicotinate	0.02–0.1	SD, 96	IM
Diazepam	0.55–5.5	SD	IM
Dichlorvos	17 (334–500 g/ton)	SD	PO

<i>Drug</i>	<b>Pigs</b>		
	<i>Dose (mg/kg) or Concentration in feed</i>	<i>Interval (h)</i>	<i>Route</i>
Dimetridazole	10–25	24	PO
Dinoprost tromethamine	15 TD then 10 TD (estrus induction)	separate doses by 12 hours	IM
	5–10 TD (abortifacient)	SD	IM
	10–25 TD (induce parturition)	SD	IM
Diprenorphine	0.03	SD	IV
Dipyron	50	SD	IM, IV, SC
Doxapram hydrochloride	5–10	SD	IV
Doxylamine succinate	0.5	8	PO, IM, SC
Edrophonium chloride	0.5–1.0	SD	IV
Enrofloxacin	2.5	SD	IM
Epinephrine (1:1000)	0.01–0.02 mL	SD	IM, SC
(1:10 000)	0.1–0.2	SD	IV
Erythromycin estolate, ethylsuccinate	2.2–22	24	IM
Fenbendazole	5	SD	PO
	3	24	PO
	(10–80 g/ton)		
Ferrous sulfate	0.5–2	24	PO
Flunixin meglumine	1.1–2.2	8–12	IV, IM, SC
Follicle stimulating hormone	1000–1500 iu TD	SD	IM
Furazolidone	5–20 (piglets)	24	PO
Gallamine triethiodide	4 then 0.8 to effect	SD	IV
Gentamicin sulfate	2.2	24	PO, IM
	5.0	SD	PO, IM
Griseofulvin	20	24	PO
Guaifenesin	44–88	SD	IV
Hygromycin B	(12 g/ton)		
Iron dextran	100–200, TD (piglet)	SD	IM
Ivermectin	0.3	SD	IM / PO
	1.8–11.8 g/ton		
Kaolin pectate	0.2 mL	4	PO
Ketamine hydrochloride (after appropriate premedication)	11	SD	IM
Levamisole	8	SD	PO
	0.8 g/kg		
Lincomycin hydrochloride	11	24	IM
	2–10	24	PO
	(40–200 g/ton)		
Luprostiol	7.5 TD	SD	IM
Mannitol	1–3	SD	IV
Marbofloxacin	2	24	IM, IV, SC
Mineral oil	2–8	SD	PO
Morphine sulfate	0.2–0.9	SD	IM
Moxidectin	0.4	SD	SC, PO
Neomycin sulfate	7–12	12	PO
Neostigmine	0.06	SD	IM
Oxibendazole	15	SD	PO
Oxfendazole	3–4.5	SD	PO
Oxymorphone	0.075 (with ketamine and xylazine)	SD	IV
Oxytetracycline	2–10 / 10–30	12–24 / 12–24	IM, SC / PO
Oxytocin	0.1–0.2 (agalactia) (2–10 iu)	3–4	IM

<b>Pigs</b>			
<i>Drug</i>	<i>Dose (mg/kg) or Concentration in feed</i>	<i>Interval (h)</i>	<i>Route</i>
Pancuronium	0.11	SD	IV
Penicillin G, benzathine	4.5 (11 000–22 000 iu)	48–96	IM
Penicillin G, procaine	6–20 (6000–40 000 iu)	12–24	IM
Pentazocine	2.0	SD	IM
Pentobarbital	30 (to effect)	SD	IV
	120–200 FOR EUTHANASIA	SD	IV
Pentobarbitone <i>see</i> pentobarbital			
Phenylbutazone	4	24	PO, IV
Phytomenadione (vitamin K1)	0.5–2.5	SD	IM, IV (slow)
Piperazine	110	SD	PO
Prednisolone sodium succinate	0.2–1.0	SD, 24	IV, IM
Pyrantel pamoate	22	SD	PO
	6.6 (pot bellied pigs)	SD	PO
Pyrantel tartrate	22	SD	PO
	(96 g/ton)		
Pyrilamine maleate	0.5–1.0	SD	IM
Roxarsone	182 g/ton		
Sodium arsanilate <i>see</i> arsanilate, sodium			
Sodium chloride (hypertonic, 7.0%)	4 mL	SD	IV
Sodium sulfate	0.25–0.5	SD	PO
Spectinomycin HCl	10	12–24	PO
	6.6–22	24	IM
Streptomycin	13	12–24	IM
Sulfachlorpyridazine	44–70	24	PO
Sulfadiazine/trimethoprim	48	24	PO
Sulfadoxine/trimethoprim	15	12–24	IM
Sulfonamide/trimethoprim	15–30	24	IM, PO
Suxamethonium chloride	2	SD	IV
Tetracycline hydrochloride	10–40	12/24	PO
Thiabendazole	50–75	SD	PO
Thiamine hydrochloride (vitamin B1)	5–100	SD	IV, IM, PO
Thiamylal sodium	6.6–11	SD	IV
Tiaprost	0.3–0.6 TD	SD	IM
Thiopental	5.5–11	SD	IV
Tiamulin	2–10 / 10–15 (35–200 g/ton)	24 / 24	PO / IM
Tilmicosin	10–20	24	PO
	(180–360 g/ton)		
Tripelenamine hydrochloride	1	8–12	IV, IM
Tubocurarine chloride	0.4 then 0.08	SD, to effect	IV
Tylosin	5–10 / 2–5	24 / 24	IM / PO
	(40–100 g/ton)		
Valnemulin	1.25–10	24 / 24	PO
Virginiamycin	(25–100 g/ton)		

Sources: Bishop Y. The veterinary formulary, 5th edn. London: The Pharmaceutical Press, 2001. Cowart RP, Casteel SW. An outline of swine diseases. A handbook, 2nd edn. Iowa State University Press, 2001. Plumb DC. Veterinary drug handbook, 2005 (accessed on-line through [www.VIN.com](http://www.VIN.com)), and other sources.



# Index

## Notes

Entries in *italics* refer to figures and tables.

## A

- A23187, porcine stress syndrome, 1972  
Aalveld, 1891  
Abattoir surveillance, Johne's disease, 1038  
ABC Reflection Sovereign, 1945  
Abdomen, 303  
  examination of, 11–12, 301–304  
  abdominal pain detection, 307–308  
  auscultation, 16, 17, 303–304  
  distended rumen lavage, 303  
  finding interpretation, 309, 310  
  imaging, 308–309  
  inspection and palpation, 303  
  laparoscopy, 308  
  left flank, 303–304  
  rectal palpation, 305, 305  
  right flank, 304  
  silhouette, 301, 302  
  palpation, 16–17  
  traumatic reticuloperitonitis, 339–340  
  percussion, 16–17  
  size, equine colic, 220  
Abdominal distension, 195  
  calves, 308, 309  
  cattle, 301, 303  
  differential diagnosis, 302–303  
  edema, 73  
  equine colic, 220  
  intestinal obstruction, 379  
  left dorsal displacement of the large colon, 249  
  small colon obstruction, 256  
  treatment, 203  
  types, 302  
Abdominal fat necrosis (lipomatosis), 290  
Abdominal fluid  
  gastric dilatation, horses, 234  
  newborns, 166–167  
Abdominal pain, 190, 194–195  
  cattle, 194, 195  
  clinical examination, 17  
  colic, 230, 256  
  detection of, 307–308  
  diarrhea, acute, 270  
  differential diagnosis, 194  
  etiology, 194–195  
  gastrointestinal dysfunction, ruminants, 298  
  horses, 194–195  
  large intestine impaction, horses, 252  
  liver disease, 386  
  peritonitis, 283, 284  
  plant-induced, 1895–1896  
  reticuloperitonitis, traumatic, 339  
  treatment, 203  
  urinary tract disease, 547–548  
Abdominal situs inversus, 466  
Abdominal sounds  
  left abdomen  
  fluid-tinkling/splashing, 304  
  'pings,' 353, 358  
  'pung,' 303  
  left paralumbar fossa area, 304  
  right abdomen  
  fluid-splashing, 304, 353  
  'ping,' 304, 305, 353, 364, 365–366  
Abdominal surface ripples, 303, 348  
Abdominal ultrasonography, 196–197  
Abdominocentesis, 20  
  abdominal distension in calves, 308  
  cattle, 202–203  
  horses, 202  
  colic, 223, 224, 230  
  left-side displacement of abomasum, 359–360  
  peritoneal fluid extraction, 199–203  
  see also Peritoneal fluid  
  peritonitis, 202, 285–286  
  procedure, 202–203  
  reticuloperitonitis, traumatic, 340–341  
  risks of, 202  
  splenic abscess, 465  
  uroolithiasis, 568  
Abducent nerve (cranial nerve VI) assessment, 585  
Aberdeen Angus  
  congenital osteopetrosis, 1959  
  familial convulsions and ataxia, 1955  
Aberrant pigment synthesis, photosensitization, 660  
Abiotrophy, 602  
Abomasal bloat see Abomasal distension  
Abomasal dilatation, calves, 309  
Abomasal distension, 374  
  abomasal ulcer, 372  
  differential diagnosis, 302  
  rectal examination, 19  
Abomasal fluid analysis, 353  
Abomasal impaction, 348  
  cattle, 299, 367–369  
  clinical findings, 368  
  clinical pathology, 368  
  control, 369  
  differential diagnosis, 368  
  epidemiology, 367  
  etiology, 367  
  necropsy findings, 368  
  pathogenesis, 367–368  
  salvage, 368–369  
  surgery, 369  
  treatment, 368–369  
  sheep, 346, 348, 369–370  
  vagus indigestion, 348–349  
Abomasal luminal pressure, 354  
Abomasal volvulus, 358  
  left-side displacement of the abomasum, 358  
  right-side displacement of the abomasum, 363  
Abomasal phytobezoars, 370  
Abomasal reflux, 354  
Abomasal reflux syndrome, 348  
Abomasal sounds, 358  
Abomasal torsion see Abomasal volvulus (torsion)  
Abomasal trichobezoars, 370  
Abomasal ulcer in cattle, 300, 370–374  
  blood loss from, 372  
  clinical pathology, 372–373  
  *Clostridium perfringens*, type A, 837  
  differential diagnosis, 373  
  epidemiology, 370–372  
  etiology, 370  
  necropsy findings, 373  
  non-perforating, 372  
  pathogenesis, 372  
  perforating, 309, 372, 373  
  left-side displacement of abomasum and, 358, 359  
  peritonitis and, 372  
  prevention, 374  
  primary, 370–372  
  secondary, 370, 372  
  treatment, 373–374  
Abomasal volvulus (torsion), 300, 362–367  
  acute, 364  
  calves, 309  
  clinical findings, 364  
  clinical pathology, 364–365  
  control, 367  
  differential diagnosis, 365–366  
  epidemiology, 362–363  
  etiology, 362  
  fluid and electrolyte therapy, 92  
  necropsy findings, 365  
  pathogenesis, 363–364  
  postsurgical complication, 348, 364  
  prognostic indicators, 364–365  
  risk factors, 355–357, 362–363  
  surgery, 366  
  treatment, 366–367  
Abomasocentesis, 353, 365  
Abomasopexy, 360  
Abomasotomy, 369  
Abomasitis, 258–259  
  *Clostridium sordellii*, 821–822  
  salmonellosis, 909  
Abomasum  
  anatomy, 353–354  
  diseases of, 353–375  
  hypokalemia, 78  
  reticulorumen motility, primary contraction influence, 296  
  displacement  
  etiology, 1613–1614  
  metabolic tests, 1614  
  milk fever complication, 1630  
  see also Left-side displacement of abomasum (LDA); Right-side displacement of the abomasum (RDA)  
  examination, 353  
  hemorrhage into, 307  
  ingesta status and accumulation, 354  
  intubation of, 353  
  outflow abnormality, 347  
  pathophysiology, 353–354  
  torsion of, 300  
Abortion  
  *Actinobacillus suis* infection, 1052  
  African swine fever, 1170  
  anaplasmosis, 1456  
  *Arcanobacterium pyogenes*, 788  
  bluetongue, 1303  
  border disease, 1417  
  bovine herpesvirus-1 infection, 1352, 1354, 1355  
  bovine virus diarrhoea virus, 1257, 1260, 1263–1264  
  *Brucella abortus* infection, 970  
  *Brucella abortus* vaccine reaction, 980  
  *Brucella melitensis*, 992  
  *Campylobacter jejuni*, 1085–1086  
  caprine herpesvirus-1 infection, 1330  
  carbohydrate engorgement of ruminants, 319  
  cattle, 129, 966  
  differential diagnosis, 974, 975–977  
  necropsy findings, 1105  
  chlamydia see Ovine enzootic abortion (OEA)  
  cloned offspring, 146  
  congenital achondroplasia with hydrocephalus, 1959  
  encephalomyocarditis virus disease, pigs, 1184  
  endemic, neosporosis, 1510  
  epizootic, 977, 1509  
  equine arteritis virus, 1320–1321  
  equine colic, risk in, 230  
  equine herpesvirus 1, 1309, 1312–1316  
  equine herpesvirus 4, 1309, 1310  
  equine neorickettsiosis, 1467  
  ergotism, 1903  
  horses, 131, 919–920, 1105  
  hyperthermia-induced, 47  
  leptospirosis, 1095, 1098, 1101, 1102, 1103, 1107  
  *Listeria ivanovii*, 809  
  *Listeria monocytogenes* infection, 805, 808–809  
  mycotic, 1471–1472, 1473  
  neosporosis, 1509–1510  
  phytotoxic, 1872  
  pigs, 1056, 1095, 1105  
  plant-induced, 1895  
  pleuropneumonia, 1056  
  porcine circovirus 2, 1189–1190  
  porcine reproductive and respiratory syndrome, 1199  
  pseudorabies, 1399–1400  
  Q fever, 1468, 1469  
  Rift Valley fever, 1206  
  *Salmonella abortusequi*, 919–920  
  *Salmonella abortusovis*, 920  
  salmonellosis, 909  
  sarcocystosis, 1508  
  sheep, 128  
  swine influenza, 1333  
  tick-borne fever, 1461  
  toxoplasmosis, 1519, 1520, 1521  
  tuberculosis, 1009  
  *Yersinia pseudotuberculosis*, 954

- Abortion storms  
 bovine herpesvirus-1 infection, 1355–1356  
 equine herpesvirus 1, 1312, 1314  
*Salmonella abortusovis*, 920
- Abpee, 2000
- Abrus precatorius* poisoning, 1888
- Abscess(es)  
 brain, 606–607, 1375, 1807  
 cervical (pigs), 782–783  
 chronic, horses, 788–789  
 clinical findings, 111  
 definition, 111  
 demodectic mange, 1608  
 discharge, strangles transmission, 769  
 drainage, 111  
 epidural, 615  
 facial, 110, 666  
 foot, 1077–1079  
*Gasterophilus* infestation, 1586  
 grass seed, 1895  
 heel, 1077–1078  
 hepatic see Hepatic abscess  
 inguinal, 110  
 internal abdominal, 290  
 intracranial, 787  
 intrathoracic, 527  
 jowl, 782–783  
 kidney worm disease, 1570, 1571  
 lymph nodes, 111, 796–797  
 myocardial, 924  
 pectoral, 788–789  
 perirectal, 110  
 perivaginal, 110  
 pituitary, 110, 606  
 pulmonary, 489, 517–518, 925, 1587  
 reticular, 339, 340, 342, 344  
*Rhodococcus equi* pneumonia, 802  
 spinal, 787  
 spleen, 465  
 subcutaneous, 666–667, 787  
 tail, 110  
 toe, 1078  
 tooth rot, 110  
 types, 110  
 umbilical, 309  
 urachal, 159–160, 309
- Absidia corymbifera*, 1471, 1472, 1473, 1481  
 inoculation, 317
- Absorption abnormality/dysfunction, 191
- Absorption abnormality/dysfunction, 116, 1692
- Absorption tests  
 alimentary tract examination, 197–199  
 enteritis, 266  
 granulomatous, horses, 1992–1993
- Acacia aneura* (mulga trees), 386
- Acacia berlandieri* (guajillo) poisoning, 1884
- Acacia eriloba*, ruminal impaction, 1895
- Acacia georginae* poisoning, 1886–1887
- Acacia mellifera*, ruminal impaction, 1895
- Academy of Veterinary Consultants, bovine  
 virus diarrhoea virus position statement,  
 1267, 1275
- Acanthatrium oregonense*, 1466
- Acanthophis antarcticus* (death adder), 1916,  
 1917
- Acaricides/acaricide dipping  
 anaplasmosis, 1458  
 demodectic mange, 1608  
 dermatophilosis, 1050  
 East Coast fever, 1529  
 heartwater, 1463  
 screwworm, 1595  
 tick infestations, 1601–1602
- Acepromazine, 1968
- Acepromazine maleate, 2051, 2064
- Acer rubrum* (red maple) intoxication, 1492
- Acetate, dietary, 1661
- Acetated Ringer's solution, 94
- Acetazolamide, 1966, 2051, 2064
- Acetic acid, 313, 569, 2051
- Acetonemia see Ketosis
- Acetylcholine poisoning, 1885
- Acetylcysteine, 232, 539, 1992, 2051
- Acetylpromazine, 225, 1968, 2033
- Acetylsalicylic acid (aspirin), 106  
 coagulopathy treatment, 442  
 disseminated intravascular coagulopathy, 449  
 dosage/interval, 2051, 2064  
 endotoxemia secondary to colic, 225, 271  
 exercise-induced pulmonary hemorrhage, 506  
 laminitis, horses, 2033  
 pain, 106
- post-weaning multisystemic wasting  
 syndrome, 1191
- thrombasthenia, 446
- Achnatherium inebrians* (drunken horse grass)  
 poisoning, 1901
- Acholeplasma*, 1123, 1124
- Acholeplasma laidlawii*, 706, 1336, 1338
- Acholeplasma oculi*, 1142
- Achondroplasia, 633
- Achromotrichia, 662
- Achropachia ossea, 635
- Acid-base status, 73–102, 82–84, 87–102  
 assessment of, 82–83  
 clinical pathology, 89  
 colibacillosis, 860–861  
 diarrhea, 271, 276  
 enteritis, 264  
 equine colic, 223  
 reference laboratory values, 2048, 2049  
 reticulorumen motility, primary contraction  
 influence, 296  
 strong ion approach, 83–84  
 see also Electrolyte abnormalities/imbalance;  
 Fluid balance disorders
- Acidemia, 84–86  
 clinical findings, 85–86  
 etiology, 84, 85  
 pathogenesis, 84–85
- Acid hematin formation, 194
- Acidifying agents, 313, 366
- Acidosis, 84, 863
- Acid suppression, gastric ulcers, 240
- Acne, contagious, 800
- Aconitum*, diterpenoid alkaloid poisoning, 1865,  
 1866
- 'Acorn' calves, 2035
- Acquired immune deficiency syndrome (AIDS),  
 1513, 1520
- Acremonium*, indole alkaloid poisoning, 1868
- Acremonium lolii*, 2000
- Acriflavine disk assay, 700
- Acroteriasis (amputates), 1961
- Actaea spicata* (baneberry) poisoning, 1888
- Actinobacillosis (wooden tongue), 1046–1048  
 clinical findings, 1047  
 clinical pathology, 1047  
 control, 1047–1048  
 cutaneous, 1047  
 differential diagnosis, 1047  
 epidemiology, 1046  
 etiology, 1046  
 glossal, 1047  
 necropsy findings, 1047  
 pathogenesis, 1046–1047  
 risk factors, 1046  
 transmission, 1046  
 treatment, 1047
- Actinobacillus*, diseases associated with,  
 1044–1051  
 sporadic lymphangitis, 2029
- Actinobacillus equuli* septicemia, 2013
- Actinobacillus lignieresii*, 1046–1048
- Actinobacillus pleuropneumoniae* (APP),  
 1053–1060  
 antimicrobial resistance, 1054, 1057  
 antimicrobial sensitivity, 1057  
 serotypes, 1053–1054, 1056  
 virulence factors, 1054  
 see also Pleuropneumonia, pigs
- Actinobacillus seminis*, 1045
- Actinobacillus suis*, 1045, 1052–1053
- Actinobaculum*, 787–805
- Actinobaculum suis*, 559–560, 788, 791–793
- Actinomyces*, diseases associated with,  
 1044–1051
- Actinomyces actinoides*, 1044
- Actinomyces bovis*, 966, 1044, 1045–1046
- Actinomyces pyogenes* see *Arcanobacterium*  
 (*Actinomyces*) *pyogenes*
- Actinomycosis (lumpy jaw), 1045–1046
- Actinomycotic agents, mastitis, 728
- Activated clotting time test, 441
- Activated partial thromboplastin time, 441, 448,  
 449
- Acupuncture, 2017, 2023
- Acute bovine pulmonary emphysema and  
 edema (ABPEE), 1998  
 case fatality rate, 2000  
 clinical findings, 2002  
 control, 2003–2004  
 differential diagnosis, 2003  
 epidemiology, 2000–2001
- etiology, 1999  
 experimental, 2001  
 morbidity rate, 2001  
 necropsy findings, 2002  
 proliferative stage, 2001  
 treatment, 2002–2003  
 see also Interstitial pneumonia, cattle
- Acute pulmonary emphysema and edema see  
 Interstitial pneumonia
- Acute radiation syndromes, 1786
- Acute respiratory distress syndrome (ARDS), 501  
 cattle see Acute bovine pulmonary  
 emphysema and edema (ABPEE)
- Acyclovir, 1315, 2051
- Adactyly, 1961
- Adaptive immunity deficiencies, 466–467
- Adductor femoris muscle, asymmetric  
 hindquarter syndrome, 2024
- Adema disease, 1941
- Adenia* poisoning, 1888
- Adenohypophyseal hypoplasia, 1978  
 see also Gestation, prolonged
- Adenovirus  
 chronic enzootic pneumonia of sheep, 1362  
 combined immunodeficiency, Arabian foals,  
 1979  
 equine, 772  
 polyneuritis equi, 2021  
 stillbirth/perinatal weak calf syndrome, 1984
- Adrenal cortical response, stress, 108
- Adrenaline see Epinephrine
- Adrenal medullary response, stress, 108
- Adrenergic response, porcine stress syndrome,  
 1971
- Adrenocorticotrophic hormone (ACTH), 108, 1687
- Adrenocorticotrophic hormone (ACTH)  
 stimulation test, 1687
- Adsorbents, enteritis, 268
- Advisory Committee on Immunization Practices  
 (ACIP), 1391
- Aedes* mosquitoes, 1205, 1605
- Aedes sollicitans*, 1369
- Aedes vexans*, 1207, 1369
- Aesculin poisoning, 1883
- Aesculus* poisoning, 1883
- Aethusa cynapium* (fools parsley, lesser  
 hemlock) poisoning, 1890
- Afibrinogenemia, 1947
- Aflatoxicosis (aflatoxin poisoning), 1899,  
 1899–1901
- Africa  
 babesiosis vector control, 1497  
 bluetongue virus serotypes, 1301  
 bovine herpesvirus-1 infection, 1349  
 brucellosis status, 964  
 East Coast fever, 1527  
 lumpy skin disease, 1425  
 rabies, 1385  
 rinderpest, 1237
- African buffalo (*Syncerus caffer*), 1007, 1224
- African horse sickness (AHS), 1179–1183  
 acute (pulmonary; dunkop) form, 1181  
 clinical findings, 1181  
 clinical pathology, 1181–1182  
 control, 1182–1183  
 differential diagnosis, 1182  
 economic importance, 1181  
 epidemiology, 1180–1181  
 epizootics, 1181  
 etiology, 1180  
 horse sickness fever, 1181  
 hosts, 1180  
 immunity, 1181, 1183  
 mixed form, 1181  
 necropsy findings, 1182  
 occurrence, 1180  
 pathogenesis, 1181  
 risk factors, 1181  
 subacute (cardiac; dikkop) form, 1181, 1182  
 transmission, 1180  
 treatment, 1182  
 vaccination, 1182–1183  
 vectors, reduction, 1180, 1182  
 zoonotic disease, 1181
- African horse sickness virus (AHSV), 1180
- African horse sickness virus 9 (AHSV-9), 1183
- African pig disease see African swine fever  
 (ASF)
- African swine fever (ASF), 1167–1173  
 abortion, 1095  
 acute form, 1170–1171

- African swine fever (ASF) (Cont'd)  
 case fatality rates, 1168  
 clinical findings, 1171  
 clinical pathology, 1170–1171  
 control, 1172  
 diagnosis, 1171  
 differential diagnosis, 1171  
 epidemiology, 1167–1170  
 eradication program, 1172  
 etiology, 1167  
 fetal infection, 1170  
 immune mechanisms, 1169–1170  
 morbidity, 1168  
 necropsy findings, 1171  
 occurrence, 1167–1169  
 outbreaks, 1168  
 pathogenesis, 1170  
 pathogen factors, 1169  
 persistent infection, 1169  
 risk factors, 1169–1170  
 samples for diagnostic confirmation, 1171  
 transmission, 1168–1169  
 vaccines, 1172  
 vectors, 1168, 1169, 1601  
 virus, 1169, 1171
- African syndrome of gousiekte ('quick sickness'), 1896
- African trypanosomiasis see Nagana
- Afrikaner cattle, inherited goiter, 1941
- Agalactia, 752–753  
*Claviceps fusiformis*, 1903  
 contagious, 1138–1140  
 clinical findings, 1139  
 clinical pathology, 1139  
 control, 1139  
 epidemiology, 1138–1139  
 etiology, 1138  
 experimental reproduction, 1139  
 necropsy findings, 1139  
 prevalence, 1138  
 risk factors, 1139  
 transmission, 1138–1139  
 treatment, 1139  
 vaccination, 1139  
 toxicemic see Mastitis-metritis-agalactia (MMA) syndrome
- Agammaglobulinemia, 466, 1943
- Agar gel double diffusion test, 1481
- Agar gel immunodiffusion (AGID) test (Coggin's test)  
 bluetongue, 1303  
 bovine leukemia virus, 1217  
 caprine arthritis encephalitis, 1412  
 equine infectious anemia, 1175–1176  
 equine infectious anemia virus, 1173  
 Johne's disease, 1028, 1029, 1030, 1031  
 lumpy skin disease, 1426  
 ovine progressive pneumonia, 1365  
 rinderpest, 1239–1240
- Agar gel precipitation test, 1162
- Agglutination tests, *Brucella abortus*, 971–972
- Aggressive behavior, 578, 584
- Aging, arthropathy, 637–638
- Agkistrodon contortrix* (copperhead), 1916
- Agkistrodon piscivorus* (water moccasin), 1916
- Aglycone poisoning, 1862
- Agnathia, 280, 1959
- Agriculture and Agri-food Canada, Canadian Adaptation and Rural Development Fund, 883
- Agriostomum vryburgi*, 1552
- Agroterrorism, 1225
- Aimless wandering, 578, 1897
- Aino virus, 1207
- Aipysurus* (sea snake), 1916
- Aircraft noise, 1785
- Airway obstruction  
 exercise-induced pulmonary hemorrhage of horses, 502, 505–506  
 hypoxic hypoxia, 472  
 recurrent see Heaves
- Airway secretions, pneumonia, 510
- Akabane disease, 1207–1209  
 clinical findings, 1208  
 clinical pathology, 1208–1209  
 control, 1209  
 differential diagnosis, 1209  
 epidemiology, 1207–1208  
 etiology, 1207  
 experimental reproduction, 1208  
 infection sources, 1207  
 necropsy findings, 1209  
 occurrence, 1207  
 pathogenesis, 1208  
 risk factors, 1207–1208, 1208  
 treatment, 1209
- Akabane virus, 133, 627, 1207
- L-alanine aminotransferase (ALT), 389
- Albendazole  
 bovine lungworm, 1566–1567  
 dosage/interval, 2051, 2064  
*Fasciola magna* infection, 1580  
 fasciolosis, 1578–1579  
 giardiasis, 1517  
 ovine lungworm infestation, 1569  
 parasitic gastroenteritis, ruminants, 1545  
 poisoning, 1832
- Albinism, 1942, 1975
- Albizia tanganyensis* (paperbark albizia) poisoning, 1888
- Albizia versicolor* (fever tree) poisoning, 1888
- Albumin  
 cerebrospinal fluid, in, 593  
 glomerular filtrate, in, 544  
 serum, herd metabolic profile testing, 1622
- Albumin to globulin (A:G) ratio, hypoproteinemia, 440
- Albuterol, 2051
- Alcelaphine herpesvirus-1 (AHV-1), 1246
- Alces a. acles* (elk) see Elk (*Alces a. acles*)
- Alcohol ethoxylate detergents, 335
- Alcohol (complex plant) poisoning, 1883
- Alcuronium chloride, 2051
- Aldrin toxicity, 1833
- Alfalfa, 328–329, 334
- Alfasure, 332, 335
- Algae, 728
- Algal bacteremia, 1471
- Algal diseases, 1471
- Algorithm diagnosis method, 22–23
- Alimentary ketosis, 1662
- Alimentary sojourn, 1655
- Alimentary tract  
 abomasum, diseases of, 353–375  
 buccal cavity disease, 205–209  
 congenital defects, 280–281  
 diseases of, 189–382  
   uncertain etiology, 1990–1998  
   see also *specific diseases/disorders*  
 distension, 190  
 dysfunction  
   absorptive function, 191  
   digestive function, 191  
   manifestations of, 191–195  
   motor function, 189–191  
   principles of, 189–191  
   ruminants, 297–301, 298–301  
   secretory function, 191  
 esophagus, diseases of, 209–215  
 examination of, 195–203, 301–311  
   abdominocentesis for peritoneal fluid see Abdominocentesis; Peritoneal fluid  
   absorption, tests of, 197–199  
   appetite, 301  
   cattle, 301–311  
   digestion, tests of, 197–199  
   endoscopy, 197  
   exploratory laparotomy (celiotomy), 197, 309–310, 311  
   habitus, 301  
   history, 301  
   imaging, 196–197  
   intestinal biopsy, 203  
   liver biopsy, 203  
   nasogastric intubation, 195–196  
   systemic states, 301  
   see also *specific anatomical locations*  
 functions of, 189  
 hemorrhage, 194  
 hypermotility, 190, 204  
 hypomotility, 190, 204  
 inherited atresia, 1944  
 inherited defects, 1944  
 lacerations, actinomycosis, 1045  
 lesions, arsenic poisoning, 1809  
 mycotic infection, 1473  
 nematode diseases, 1541–1564  
 neoplasms, 281–282  
 nonruminants, stomach and intestines, 215–280  
 omasum, diseases of, 311–353  
 papillomas, 1421, 1422  
 peritoneum, diseases of, 282–291  
 pharynx, diseases of, 209–215  
 reticulum, diseases of, 311–353
- rumen, diseases of, 311–353
- ruminants  
 anatomy and physiology, 293–297  
 forestomach, diseases of, 293–301  
 intestines, diseases of, 375–382  
 spiking activity, 189  
 stasis, peritonitis, 284  
 treatment principles, 203–205
- Alimentary tract neoplasia, 1877
- Aliphatic acetogenin (monoglyceride) poisoning, 1883–1884
- Alkalemia, 86, 86–87
- Alkali diseases, selenium poisoning, 1812
- Alkaline phosphatase  
 equine colic, 223  
 liver function tests, 389  
 multisystemic, eosinophilic epitheliotropic disease, 1993  
 osteodystrophy, 634
- Alkalinizing agents  
 abomasal ulcer, 374  
 carbohydrate engorgement, 322  
 simple indigestion, 313
- Allele specific PCR (AS-PCR), 1972
- Allergic dermatoses, 785
- Allergic rhinitis, 925, 1355, 1936
- Allergy, 69–72  
 diseases associated with, 1921–1936  
 see also *specific diseases/disorders*  
 treatment, 69  
 see also Anaphylaxis
- Allerton virus infection, 1426, 1428
- Alligator pear (*Persea americana*, avocado) poisoning, 1883–1884
- All-in, all-out management system  
 cryptosporidiosis, 1515  
 swine influenza, 1334  
 transmissible gastroenteritis, pigs, 1283–1284
- Allium* poisoning, 1881–1882
- Alloantibody measurements, 1924
- Alloimmune hemolytic anemia of the newborn (neonatal isoerythrolysis), 1921–1925  
 acute, 1922  
 anaplasmosis vaccine, 1458  
 clinical findings, 1492, 1922  
 clinical pathology, 1492, 1922–1923  
 control, 1924–1925  
 diagnosis, 1923  
 differential diagnosis, 1923  
 epidemiology, 1492, 1922  
 etiology, 1921–1922  
 necropsy findings, 1923  
 pathogenesis, 1922  
 peracute, 1922  
 subacute, 1922  
 treatment, 1492, 1923–1924
- Allotriophagia, 112–113
- Aloe vera gel, 1992
- Alopecia, 661–662  
 biotin deficiency, 1781  
 bovine besnoitiosis, 1518  
 clinical findings, 662  
 clinical pathology, 662  
 differential diagnosis, 662  
 etiology, 661–662  
 iodine deficiency, 1724  
 mimosine poisoning, 1884  
 pathogenesis, 662  
 symmetrical, 1973  
 treatment, 662  
 viral papular dermatitis, 1426  
 zinc deficiency, 1731
- Alpacas, altitude effects, 1788
- A-2 agonists, equine colic, 225, 227
- Alphanaphthylthiourea (ANTU) poisoning, 1839
- Alpine pasture cattle deaths, 1914
- Alternaria alternata*, 1481, 1905
- Altitude effects, 1788
- Altranogest, 2051
- Aluminum hydroxide, 374, 2051
- Aluminum poisoning, 1819
- Alveolar-arterial PO<sub>2</sub> difference, 491
- Alveolar capillary membrane rupture, 502
- Alveolar hypoxia, 422, 1788
- Alveolar inspiratory pressure, increasing, 505–506
- Alveolar macrophages  
 bovine herpesvirus-1 infection, 1353  
 bovine virus diarrhea virus, 1256  
 bronchiolitis obliterans, 1340  
 porcine reproductive and respiratory syndrome, 1195, 1198, 1200

- Alveolar oxygen tension, 491  
Alveolar wall collapse, pulmonary emphysema, 507  
Alveolitis, 2004  
  diffuse fibrosing, 1998, 1999, 2001  
  extrinsic allergic, 1998, 2003  
Alvsborg disease (moose sickness), 1575, 1701, 1703, 1708–1709  
*Amanita verna* poisoning, 1908  
 $\alpha$ -mannosidase deficiency, 1949  
 $\alpha$ -mannosidosis, 1949–1950  
Amantadine, 1326  
Amantadine hydrochloride, 2051  
*Amaranthus blitoides* (prostate pigweed), 2007  
*Amblyomma americanum* (Lone Star tick), 1600  
*Amblyomma cajennense*, 1484  
*Amblyomma habraeum*, 1462  
*Amblyomma maculatum* (Gulf Coast tick), 1600  
*Amblyomma variegatum* (tropical bont tick), 1049, 1245, 1462  
American Association of Swine Practitioners, 1146  
Amicarbalide isothionate, 1491, 1493  
Amikacin sulfate, 2051  
Amine toxicity, 1884  
Amino acids  
  glucose metabolism role, 1661  
  toxicity, 1884  
Aminocaproic acid, 442, 2051  
Aminoglycosides, 181  
Aminolevulinic acid dehydratase (ALA-D), 1803–1804  
Aminonitrazole poisoning, 1838  
Aminophylline, 2051  
Aminopropazine fumarate, 2051  
Aminopropionitrile poisoning, 1884–1885  
Amiodarone, 2051  
Amitraz  
  dosage/interval, 2051  
  itchmites, 1607  
  poisoning, 1837  
  psoroptic mange, 1611  
  sheep ked, 1596  
  tick infestations, 1601  
*Ammi majus* poisoning, 1887  
Ammonia  
  forage, poisoning, 1843  
  manure release, poisoning, 1848–1849  
  from urine, 1785  
Ammonium chloride, 566, 1640, 2051  
Ammonium molybdate, 1823, 2051  
Ammonium sulfate, 2008  
Ammonium tetrathiomolybdate, 2051  
Amniotic fluid  
  examination, 138  
  inhalation, 1985  
Amoxicillin  
  administration, 181  
  arthritis, 646  
  dosage/interval, 2051  
  small intestine *Escherichia coli* overgrowth, 868  
Amoxicillin sodium, 2051  
Amoxicillin trihydrate, 868–869, 2052, 2064  
Amphotericin  
  equine aspergillosis, 1474  
  equine histoplasmosis, 1479  
  equine phycomycosis, 1481  
  systemic mycoses, 1473  
Amphotericin B, 646, 2052  
Ampicillin, 181, 868  
Ampicillin sodium, 2052, 2064  
Ampicillin trihydrate, 646, 868–869, 2052, 2064  
Amprolium, 1505, 1505, 1509  
Amprolium hydrochloride, 2052, 2064  
Amprolium poisoning encephalopathy, 2009  
Amputates (acroteriasis), 1961  
Amputation, tail-tip necrosis, 2037  
Amygdalin poisoning, 1853  
Amylase, 198  
Amyloidosis, 467–469  
  AA form, 467–468  
  AL form, 468  
  clinical findings, 468  
  clinical pathology, 468  
  differential diagnosis, 468  
  epidemiology, 467–468  
  etiology, 467–468  
  hypoalbuminemia, 440  
  liver rupture, 386  
  necropsy findings, 468  
  pathogenesis, 468  
  treatment, 468  
*Anabaena*, 1913  
*Anabaena flos-aquae*, 1913  
Anabasin poisoning, 1890  
Anabolic steroids, 1666  
Anaerobic metabolism, 117  
Anagryne poisoning, 1890  
Analgesia  
  administration routes, 106  
  balanced, 106  
  epidural, 106  
  pain, 104, 105–106  
  preemptive, 104  
  recurrent exertional rhabdomyolysis in Thoroughbred horses, 1968  
Analgesics  
  enteritis, anterior, 246  
  equine colic, 224, 225, 227  
  laminitis, horses, 2032–2033  
  pain, 105  
  small-intestinal obstruction, 244  
Anal neoplasia, 282  
Anal reflex, 591  
Anal sphincter atresia, 1944  
Anaphylactic reaction/shock see Anaphylaxis  
Anaphylaxis, 69–72  
  cattle, 70–71  
  clinical findings, 70–71  
  clinical pathology, 71  
  differential diagnosis, 71  
  etiology, 69–70  
  foot-and-mouth disease vaccine-induced, 1229  
  horses, 70, 71  
  *Hypoderma* infestations, 1588  
  necropsy findings, 71  
  pathogenesis, 70  
  pigs, 71  
  pulmonary congestion/edema, 500  
  ringworm vaccine side effect, 1478  
  sheep, 71  
  sudden death, 124, 125  
  treatment, 71  
  tuberculin testing, 1011  
*Anaplasma bovis*, 1455  
*Anaplasma centrale*, 1455  
*Anaplasma marginale*, 1455, 1600  
  vaccines, 1458–1459  
*Anaplasma ovis*, 1455  
*Anaplasma phagocytophila*  
  anaplasmosis, 1455  
  dogs, 1464  
  ecology, 1464–1465  
  geographic distribution, 1460, 1464  
  granulocytic ehrlichiosis, humans, 1460  
  horses see Equine granulocytic anaplasmosis  
  lifecycle, 1464  
  louping-ill intercurrent infection, 1409  
  strains, 1459  
  tick-borne fever, 1459  
  tick pyemia (lambs), 784  
*Anaplasma platys*, 1455  
Anaplasmosis, 1455–1459  
  animal movement, 1458  
  carriers, 1457  
  elimination, 1458  
  case fatality rates, 1456  
  cattle, 1457  
  clinical findings, 1457  
  clinical pathology, 1457  
  control, 1458–1459  
  economic importance, 1456  
  epidemiology, 1455–1456  
  equine granulocytic see Equine granulocytic anaplasmosis  
  etiology, 1455  
  geographic region, 1456  
  goats, 1457  
  hematophagous insect transmission, 1455–1456  
  infection source, 1455–1456  
  necropsy findings, 1457  
  outbreaks, 1458  
  patasitemia cycles, 1457  
  pathogenesis, 1456–1457  
  persistent infection, 1455  
  risk factors, 1456  
  sheep, 1457  
  transmission, 1455–1456, 1600  
  treatment, 1458  
  vaccination, 1458–1459  
  vectors, 1601  
Anasarca (subcutaneous edema), 73, 522, 664, 1775, 1925–1926  
Anatoxin-a, 1913  
Anatoxin-A (s), 1913  
Ancon, 1959  
Andromedotoxin poisoning, 1885  
Anemia, 450–459  
  anaplasmosis, 1457  
  aplastic, 1492, 1942  
  babesiosis, 1489  
  bacillary hemoglobinuria, 835  
  benign theileriosis, 1526  
  bovine babesiosis, 1488  
  bovine petechial fever, 1470  
  bunostomosis, 1552  
  chronic disease (inflammation), 1492  
  clinical findings, 455  
  clinical pathology, 454, 455–458  
  copper deficiency, 1711  
  eperythrozoonosis, 1155  
  equine infectious anemia, 1174, 1175  
  etiology, 450–453  
  exercise intolerance, 119  
  fasciolosis, 1577  
  fluorine poisoning, 1817  
  granulomatous enteritis, horses, 1992  
  hemolytic see Hemolytic anemia  
  hemochromosis, ruminants, 1550  
  hemorrhagic, 451  
  horses, 1492–1493  
  immune-mediated, 451  
  inherited, 1948  
  lead poisoning, 1802  
  lymphoproliferative diseases, 462  
  lymphosarcoma, 463  
  myelophthisic, 453  
  nagana, 1535  
  necropsy findings, 458  
  nonregenerative, 452–453  
  normovolemic, 451  
  oesophagostomosis, 1554  
  parasitic gastroenteritis, ruminants, 1545  
  pathogenesis, 453–455  
  plant-induced, 1896  
  postparturient hemoglobinuria, cattle, 1682  
  sarcocystosis, 1508  
  treatment, 458–459  
  tropical theileriosis, 1531  
  vitamin E deficiency, 1743  
Anemia syndrome, 1881  
Anemic hypoxia, 453–455, 472  
*Anemone* poisoning, 1890  
Anesthesia, 582  
  atrioventricular block and, 415  
  general, esophageal obstruction removal, 215  
  local, pain, 105  
Aneurysm, verminous, 257–258  
Angiocardigraphic examination, 412  
Angioedema, 664–665  
Angiomatosis, cutaneous, 668  
Angioneurotic edema, 664–665  
Angora goats  
  heartwater, 1462  
  louse infestations, 1597  
  progressive spasticity, 1951  
Angus cattle  
  follicular dysplasia, 1974  
  inherited multifocal symmetrical encephalopathy, 1952  
  pseudoalbinism, 1942  
Anhidrosis, 2038  
Anigropallidal encephalomalacia of horses (yellow-star thistle poisoning), 1376, 1892  
Animal and Plant Health Inspection Service (APHIS), 980, 982, 1032  
Animal bites, 1915–1920  
  see also *specific types*  
Animal-holding facilities, *Escherichia coli* source, 881  
Animal welfare  
  antimicrobial therapy, 173  
  downer cow syndrome, 1649–1650  
  recombinant bovine somatotropin, 1617  
  starvation, 113  
  stress, 109  
Anion feeds, 1642  
Anion gap (AG), 90–91, 857  
Anion salts, 1639, 1640  
Aniridia (complete absence of iris), 1977  
Ankylosis, artificial, 647  
*Anocenter nitens*, 1484–1485

- Anophagia, 112  
*Anopheles*, 1605  
*Anopheles stephensi*, 1425  
 Anophthalmos, 1775  
*Anoplocephala*, 1582  
*Anoplocephala perfoliata* infestation, 246  
 Anorectal lymphadenopathy, 464  
 Anorexia, 112  
   granulomatous enteritis, horses, 1992  
   peritonitis, 284  
   scrapie, 1444  
 Antacids, 373  
 Ant bites, 1918  
 Antebrachial joint osteoarthritis, 638  
 Anterior enteritis, 245–246  
   epidemiology, 245  
   treatment, 246  
 Anthelmintics  
   cerebrospinal elaphostrongylosis, 1576  
   choice of, 1546  
   cobalt administration and, 1706  
   *Fasciola magna* infection, 1580  
   poisoning, 1830–1832  
   resistance, 1546–1547, 1550–1551  
   selenium deficiency and, 1751  
   threadworm, 1563  
   whipworm, 1563  
 Anthraquinone poisoning, 1885  
 Anthrax, 815–819  
   acute, 817  
   carcass disposal, 818  
   cattle, 817  
   clinical findings, 817  
   clinical pathology, 817  
   control, 818–819  
   cutaneous, 817  
   diagnosis, 818  
   differential diagnosis, 818  
   disinfection of premises, 818–819  
   economic importance, 817  
   epidemiology, 816–817  
   etiology, 816  
   horses, 817  
   immunization, 819  
   lymphadenopathy, 464  
   necropsy findings, 818  
   pathogenesis, 817  
   peracute, 817  
   pigs, 817  
   risk factors, 816–817  
   sheep, 817  
   transmission, 816  
   treatment, 818  
   vaccination, 819  
 'Anthrax belts,' 816  
 Antibacterials  
   actinomycosis, 1046  
   bovine interdigital necrobacillosis control, 1066  
   neonatal infection, 149  
   newborn diarrhea, acute undifferentiated, 850  
 Antibiotics  
   alloimmune hemolytic anemia of the newborn, 1924  
   banned, 177  
   cystitis and pyelonephritis, 792, 793  
   dermatophilosis, 1050  
   diarrhea  
     chronic undifferentiated, 273  
     foals, 276  
     induction, 269  
   embolic nephritis, 559  
   enteritis, anterior, 246  
   enterohemorrhagic *Escherichia coli* control, 884  
   equine colic, 227  
   equine herpesvirus 1, 1315  
   equine influenza, 1326  
   foot rot, infectious, 1075–1076  
   growth promotion, 176–177  
   guttural pouch empyema, 539  
   infectious keratitis, 996  
   laminitis, horses, 2033  
   liver necrobacillosis control, 1063  
   malignant edema, 831  
   mare reproductive loss syndrome, 1920  
   osteomyelitis, 637  
   papillomatosis digital dermatitis of cattle, 1069  
   pericarditis, 430  
   pneumonic pasteurellosis, 949  
   porcine herpesvirus 2 infection, 1336  
   proliferative enteropathy, horses, 1094  
   rectal tears, 289  
   resistance  
   *Escherichia coli*, 894  
   *Streptococcus suis*, 781  
   *Rhodococcus equi* pneumonia, 804  
   shock, 68  
   snakebite, 1917  
   strangles, 773  
   swine influenza, 1334  
   tick pyemia, 784  
   watery mouth of lambs, 1987  
 Antibodies  
   administration, neonatal infection, 149  
   Borna disease virus, 1381  
   bovine virus diarrhea virus, 1252–1253  
*Anticarpa americana* (pronghorn antelope),  
   epizootic hemorrhagic disease, 1305  
 Anticholinergics, enteritis, 268  
 Anticoagulants  
   endotoxemia, 60  
   laminitis, horses, 2033  
   rodenticide poisoning, 1839–1840  
 Antidiarrheal drugs, 268  
 Antidiuretic hormone (ADH), 543  
 Anti-erysipelas serum, 814  
 Antifoaming agents, 332, 334, 336  
 Antifungals, guttural pouch mycosis, 541  
 Antigen-antibody reactions, anaphylaxis, 70  
 Antigen-capture enzyme-linked immunosorbent assay (ELISA)  
   hog cholera, 1162  
   salmonellosis, 911  
 Antigen detection  
   atrophic rhinitis, progressive, 960  
   bluetongue, 1303  
   bovine virus diarrhea virus, 1261  
   goatpox, 1430–1431  
   lumpy skin disease, 1425–1426  
   ovine progressive pneumonia, 1365  
   post-weaning multisystemic wasting syndrome, 1191  
   sheeppox, 1430–1431  
   swine influenza, 1333–1334  
 Antihistamine  
   biting midges, 1605  
   bovine lungworm, 1567  
 Anti-inflammatory agents  
   arthritis/synovitis, 647  
   equine protozoal myeloencephalitis, 1525  
   heaves, 1932, 1933  
   interstitial pneumonia, horses, 2005  
   laminitis, horses, 2032–2033  
   mastitis, 693–694  
   coliform, 717  
   mastitis-metritis-agalactia syndrome, 758  
   pneumonic pasteurellosis, 942  
   respiratory system disease, 494–495  
 Antimicrobials, 173–187  
   absorption, 181  
   administration, 178–180, 514  
   ease of, 182  
   inhalation, 495, 514  
   intramammary infusion procedure, 692  
   intramuscular, 178–179  
   intraoperative, 179  
   intrathecal injection, 595  
   intratracheal, 180  
   intravenous injection, 178  
   local, 180  
   newborns, 169, 169–170  
   oral, 179–180  
   parenteral, 180  
   peritoneal cavity, 287  
   principles of, 173–177  
   subcutaneous, 179  
   treatment duration, 181  
   aerosolization, 495, 514  
   agalactia, contagious, 1139  
   antagonism, 181  
   approved, 186  
   arthritis/synovitis, 646  
   atrophic rhinitis, progressive, 961, 962  
   bactericidal, 182, 182, 183  
   bacteriostatic, 182, 182, 183  
   blood-brain barrier permeability, 595, 595  
   bovine herpesvirus-1 infection, 1355  
   bovine interdigital necrobacillosis, 1065  
   bovine respiratory syncytial virus pneumonia, 1348  
   broad spectrum, 181, 182  
   bronchitis, 534  
   coccidiosis, 1506  
   colibacillosis, 865–869  
   combinations of, 181–182  
   costs, 173, 182  
   cystitis, 561  
   deterioration of, 183  
   diarrhea  
   acute, 271  
   extralabel use, 867, 868  
   foals, 276  
   mechanism of action, 867  
   diffusion barriers, 181  
   distribution, 181  
   drug interaction, 182  
   embolic nephritis, 559  
   endotoxemia, 58  
   enteritis, 267  
   enterocolitis, *Clostridium difficile*, 845, 846  
   enzootic pneumonia of calves, 1341–1342  
   equine pleuropneumonia, 527–528, 528  
   erysipelas of swine, 814  
   *Escherichia coli* bacteremia, 868–869  
   excretion, 181  
   extralabel use, 184, 186, 867, 868  
   fever, 50–51  
   guttural pouch empyema, 539  
   *Haemophilus* septicemia, 1002  
   ileitis, 1091–1092  
   infection, localized, 111  
   insensitivity to, 183  
   intestinal obstruction, 380  
   label dose, 178, 184  
   laryngitis, 534  
   leptospirosis, 1106–1107, 1109–1110  
   mass medication  
   atrophic rhinitis, progressive, 962  
   enteritis, 267  
   *Haemophilus* septicemia, 1002  
   pneumonic pasteurellosis, 942, 945–946  
   swine dysentery, 1119  
   undifferentiated bovine respiratory disease, acute, 931  
   mastitis, bovine, 174, 688–693  
   *Arcanobacterium pyogenes*, 724  
   coliform, 715–716  
   dry cow therapy see Dry cow therapy  
   environmental streptococci, 721–722  
   indications for, 689–690  
   intramammary, 691–692, 716  
   parenteral, 692, 715–716  
   prepartum, 695  
   selection of, 690–691  
   *Staphylococcus aureus*, 700–701, 709  
   *Streptococcus agalactiae*, 705  
   mastitis-metritis-agalactia syndrome, 757–758, 759  
   meningitis, 611  
   metaphylaxis, undifferentiated bovine respiratory disease, 931  
   milk, residues in, 185, 695–696  
   mode of action, 181–182, 182  
   mycoplasmal arthritis, 1142  
   mycoplasmal pneumonia, pigs, 1149, 1150  
   osteomyelitis, 637  
   papillomatosis digital dermatitis of cattle, 1068–1069  
   peritonitis, 287  
   phlebitis, 436  
   pleuritis (pleurisy), 524  
   pleuropneumonia of pigs, 1057–1058  
   pneumonia, 512, 513–514  
   pneumonic pasteurellosis, 940–942, 941, 945–946  
   poor response to, 183  
   prohibited, 183, 186  
   recommended dose, 173, 177–178, 184  
   resistance, 173, 176–177, 653  
   *Brachyspira hyodysenteriae*, 1117–1118  
   *Campylobacter*, 1086  
   enterohemorrhagic *Escherichia coli*, 879  
   *Escherichia coli*, 866–867  
   mechanisms, 176  
   *Salmonella*, 904–906, 914  
   *Staphylococcus aureus*, 701  
   variable, 174  
   respiratory disease, 495  
   reticuloperitonitis, traumatic, 344  
   salmonellosis, 913–914, 915  
   selection of, 173–174, 182–183  
   sensitivity  
   *Mannheimia haemolytica*, 941–942

- Antimicrobials (*Cont'd*)  
 tests, 175–176, 929  
 undifferentiated bovine respiratory disease, acute, 929  
 septicemia, 52  
 septic metritis, postpartum, 62  
 skin disease, 653  
 small intestine *Escherichia coli* overgrowth, 868  
 sporadic lymphangitis, 2030  
*Streptococcus suis* infection, 781  
 susceptibility  
 blood *Escherichia coli* isolates, 867  
 fecal *Escherichia coli* isolates, 866–867  
*Mycoplasma bovis*, 1130  
 swine dysentery, 1119  
 synergism, 181–182  
 tissue residues, 173, 178, 180  
 avoidance of, 183–186  
 compliance testing, 185  
 testing, 185  
 toxicity, 182–183  
 toxic nephrosis from, 557  
 tracheitis, 534  
 undifferentiated bovine respiratory disease, acute, 929, 930–931  
 urinary tract disease, 554  
 use of, 177–187  
 washout period, 184–185  
 withdrawal periods, 173, 178, 183–186
- Antimotility drugs, 268, 869
- Antioxidants  
 brain injury following head trauma, 595  
 copper deficiency effects, 1711
- Antiprotozoal drugs, 1525
- Antipyretics, 51
- Antisecretory drugs, 268
- Antiserum, endotoxemia, 59–60
- Antithrombin, 442  
 disseminated intravascular coagulopathy, 449
- Antitoxins, snakebite, 1917
- Antitussive drugs, 496
- Antivenin, snakebite, 1917
- Antrycide, 1536, 1538, 1540
- Anuria, 547, 548
- Anus  
 atresia, congenital, 280–281  
 nervous system examination, 591  
 paralysis, 586
- Anxiety, 9
- Aorta  
 coarctation, 433  
 rupture, 422
- Aortic aneurysm, inherited, 1946
- Aortic arch  
 right, persistence of, 280, 433  
 rupture, 422
- Aortic regurgitation, 432
- Aortic stenosis, 426, 433
- Aortic thrombosis, 629
- Aortic valve, 405, 426
- Aortocardiic fistula, 422
- Aorto-iliac thrombosis, 434–435
- Aphagia, 112
- Aphanizomenon*, 1913
- Aphis craccivora* poisoning, 1891
- Aphthous fever see Foot-and-mouth disease (FMD)
- Aplasia, red cell, 453
- Aplastic anemia, 1492, 1942
- Apnea, fetal hypoxemia, 1984–1985
- Apolipoproteins  
 bovine spongiform encephalopathy, 1451  
 fatty liver and, 1674  
 left-side displacement of abomasum, 359
- Apophysiolysis see Degenerative joint disease
- Apoptotic markers, transmissible gastroenteritis, 1282
- Appaloosa horses, equine ocular squamous-cell carcinoma, 2040
- Appetite  
 absence see Anorexia; Inappetence  
 alimentary tract disease, 301  
 alimentary tract examination, 301  
 definition, 112  
 disorders of, 112–115  
 examination of, 9  
 osteodystrophy and, 633  
 rabies, 1389
- Apprehension, 9
- Apramycin sulfate, 2052, 2064
- Apx toxins, 1054
- Aquatic birds, swine influenza transmission, 1332
- Aqueous humor analysis, 1104, 1105
- Arab fading syndrome, 1974
- Arabian foals  
 cerebellar hypoplasia, 1377  
 immunodeficiency, 803  
 combined see Combined immunodeficiency (CID), Arabian foals  
 cryptosporidiosis, 1512  
 equine adenovirus, 1308  
 equine infectious anemia virus, 1174
- Arachidonic cascade, 1736
- Arachnomelia (inherited chondrodysplasia), 1960
- Arborization diagnosis method, 22–23
- Arboviral encephalitis, 127
- Arcanobacterium*, 787–805
- Arcanobacterium (Actinomyces) pyogenes*, 787  
 abortion, 788  
 arthritis, 645, 646  
 bone infection, 635  
 cara inchada, 788  
 enzootic pneumonia of calves, 1340  
 foot rot, pigs, 1078  
 heel abscess, 1077–1078  
 localized infection, 110, 111  
 mastitis, 675  
 bovine see *Arcanobacterium pyogenes*  
 bovine mastitis  
 osteomyelitis, 636  
 perinatal disease, 788  
 periodontal disease, 788  
 postpartum metritis, 788
- Arcanobacterium pyogenes* bovine mastitis, 674–675, 722–724  
 clinical findings, 723–724  
 clinical pathology, 724  
 control, 724  
 differential diagnosis, 724  
 economic importance, 723  
 epidemiology, 723  
 etiology, 722–723  
 infection source, 723  
 pathogenesis, 723  
 risk factors, 723  
 transmission, 723  
 treatment, 724
- Arctic fox, rabies vector, 1385
- Arctium lappa* (burdock seeds), corneal ulcers, 1895
- Argasid tick (*Ornithodoros coriaceus*), 1169, 1300
- Argemone* poisoning, 1887
- Argentina, brucellosis status, 965
- Arge pullata* (birch sawfly) larvae poisoning, 1920
- Arginase, 388, 389
- Arginosuccinate synthetase deficiency, 1953
- Aristolochia* poisoning, 1885
- Aristolochine poisoning, 1885
- Arnold–Chiari malformation, 1959
- Arrhythmias (dysrhythmias), 412–420, 413  
 electrocardiography, 408  
 equine granulocytic anaplasmosis, 1465  
 myocardial disease and, 421  
 normal heart rate types, 414–416  
 physiological, 413, 414  
 pulse examination, 406  
 sinus, 414  
 treatment, 413  
 see also specific types
- Arsanilate, sodium, 2064
- Arsenic  
 itchmites, 1607  
 poisoning, 1808–1811  
 cattle, 1266  
 chronic, 1809  
 clinical findings, 1809–1810  
 clinical pathology, 1810  
 control, 1811  
 diagnosis, 1810  
 differential diagnosis, 1810  
 economic importance, 1809  
 epidemiology, 1808–1809  
 etiology, 1808  
 horses, 1809  
 necropsy findings, 1810  
 pathogenesis, 1809  
 peracute, 1809  
 pigs, 1809–1810  
 risk factors, 1809
- route of, 1809  
 source of, 1808–1809  
 specimen analysis, 1797  
 subacute, 1809  
 treatment, 1811
- Artemisia filifolia* poisoning, 1888
- Arterial blood gas analysis, 490–491  
 anemia, 457  
 normal values, 491, 491  
 sample collection, 491
- Arterial blood pressure  
 exercise, 117  
 measurement, 410  
 equine colic, 222, 224  
 fluid balance disorder, 91  
 shock, 66
- Arterial embolism, 433–435  
 clinical findings, 434–435  
 clinical pathology, 435  
 differential diagnosis, 435  
 epidemiology, 434  
 etiology, 433–434  
 necropsy findings, 435  
 pathogenesis, 434  
 treatment, 435
- Arterial oxygen tension, 490–491
- Arterial plasma ammonia concentration, 593
- Arterial pulse see Pulse
- Arterial thrombosis, 433–435  
 clinical findings, 434–435  
 clinical pathology, 435  
 differential diagnosis, 435  
 epidemiology, 434  
 etiology, 433–434  
 necropsy findings, 435  
 pathogenesis, 434  
 treatment, 435
- Arteritis  
 arterial thromboembolism, 433–434  
 strongylosis, 1559, 1560  
 verminous mesenteric, 257–258  
 viral, 434
- Arterivirus, equine arteritis virus, 1319
- Arthritis, 623, 642–648  
 caprine arthritis encephalitis, 1411–1412  
 clinical findings, 623, 644  
 clinical pathology, 623, 644–645  
 control, 646–647  
*Corynebacterium pseudotuberculosis*, 788  
 differential diagnosis, 645  
 epidemiology, 623, 642–643  
 equine cervical vertebral stenotic myelopathy, 2017  
 etiology, 642–643  
 experimental infectious, calves, 643  
 horses, 643, 644, 647  
 infectious, 643, 645  
 lambs, 769  
*Mycoplasma*, 1126–1127  
*Mycoplasma alkalescens*, 1141  
*Mycoplasma bovis*, 1141–1142  
*Mycoplasma californicum*, 1141  
*Mycoplasma capricolum*, 1127  
*Mycoplasma hyosynoviae*, 1152–1154  
*Mycoplasma mycoides* var. *mycoides*, 1127  
 necropsy findings, 623, 645  
 ovine progressive pneumonia, 1364–1365  
 pathogenesis, 643–644  
 pigs, 1152–1154  
 septic  
 foals, 170  
 horse(s), 644, 647  
 prognosis, 170, 644  
 ultrasonography, 626  
 septic pedal, cattle, 647  
*Streptococcus*, 769  
*Streptococcus dysgalactiae*, 769  
*Streptococcus suis* infection, 780  
 treatment, 646–647
- Arthrocentesis, 626, 644, 645
- Arthrodesis, 647
- Arthrogyposis  
 Akabane disease, 1208  
 cattle, 1962  
 congenital articular rigidity, 648  
 with dental dysplasia, 1962  
 horses, 1962  
 inherited, 1962  
 multiple defects, 1962  
 with palatoschisis (SAP), 1962  
 pathogenesis, 135  
 pigs, 1962

- Arthrogyposis (*Cont'd*)  
 prolonged gestation and, 1978  
 sheep, 1962  
 simple, 1962
- Arthropathy, 622, 637–642  
 clinical findings, 622, 639–640  
 clinical pathology, 622, 640  
 control and prevention, 642  
 differential diagnosis, 641  
 epidemiology, 622, 637–638  
 etiology, 637–638  
 necropsy findings, 622, 640–641  
 pathogenesis, 638–639  
 treatment, 641–642  
 see also Degenerative joint disease
- Arthropod parasites, 1585–1612
- Arthroscopy  
 arthritis/synovitis, 645, 647  
 arthropathy, 640  
 musculoskeletal system disease, 626
- Arthrosis, 640
- Arthrosonography, 645
- Arthrotomy, 647
- Arthus reaction, 69, 1313
- Articular cartilage, 638, 2027
- Artificial breeding techniques, 1939
- Artificial feeding, colostrum, 150, 151, 152, 156
- Artificial insemination  
 bovine herpesvirus-1 infection, 1352  
 bovine immunodeficiency-like virus transmission, 1222  
 bovine virus diarrhea virus, 1256–1257, 1268  
 bovine virus diarrhea virus transmission, 1251  
 enzootic bovine leukosis, 1210–1211  
 equine arteritis virus, 1320  
 equine infectious anemia virus transmission, 1174  
 foot-and-mouth disease transmission, 1224, 1229–1230  
 porcine reproductive and respiratory syndrome, 1196
- Artificial insemination centers, leptospirosis control, 1107
- Aryepiglottic fold, 537
- Arytenoid cartilage, 537
- Arytenoid chondritis, 537
- Ascarid infections, 1556–1558  
 cattle, 1556–1558  
 clinical pathology, 1556–1557, 1557  
 control, 1557–1558  
 diagnostic confirmation, 1557  
 differential diagnosis, 1557  
 epidemiology, 1556  
 etiology, 1556  
 horses, 1556–1558  
 necropsy findings, 1557  
 pathogenesis, 1556  
 pigs, 1556–1558  
 protective immunity, 1556  
 treatment, 1557
- Ascaris lumbricoides*, 385
- Ascaris suis* pneumonia, 925
- Ascaris suum*, 1556
- Ascarops*, 1555
- Ascarops dentata*, 1555
- Ascarops strongylina*, 1555
- Ascites, 73, 402, 1570
- Ascoli test, 818
- Ascorbic acid (vitamin C), 1778, 2052
- Aseptic fever, 49
- Aseptic polyarthritis, 802
- Ash hazards, volcanic eruptions, 1791–1792
- Asia, bluetongue virus serotypes, 1301
- Asian buffalo, foot-and-mouth disease reservoir, 1224
- Asian face fly (*Musca bezzii*), 995
- Asiatic pit viper, 1916
- Asinine herpesviruses, 1309
- Aspartate aminotransferase (AST)  
 copper poisoning, 1822–1823  
 downer cow syndrome, 1647  
 exertional rhabdomyolysis, 1684–1685  
 fasciolosis, 1578  
 left-side displacement of abomasum, 356, 359  
 liver function test, 389  
 myopathy, 629, 1746  
 postvaccinal hepatitis, 1988  
 recurrent exertional rhabdomyolysis, 1967
- Aspergillar mastitis, 1473
- Aspergillosis, 1471–1474  
 clinical findings, 1472–1473  
 clinical pathology, 1473  
 epidemiology, 1471–1472  
 etiology, 1471–1474  
 horses, 1474–1475  
 necropsy findings, 1473  
 pathogenesis, 1472  
 treatment, 1473
- Aspergillus*, 1471  
 aflatoxicosis, 1899–1901  
 cyclopiazonic acid poisoning, 1901  
 ochratoxin poisoning, 1906  
 reproduction, 1474
- Aspergillus alutaceus*, ochratoxin poisoning, 1906
- Aspergillus clavatus*, 1471, 1472, 1473, 1474  
 poisoning, 1906, 1912
- Aspergillus deflectus*, 1474
- Aspergillus flavus*, 1474  
 aflatoxicosis, 1899  
 cyclopiazonic acid poisoning, 1901  
 tremorgen poisoning, 1910
- Aspergillus fumigatus*, 1473, 1474  
 keratitis, 670  
 mastitis, 727–728  
 tremorgen poisoning, 1910
- Aspergillus nidulans*, 1474  
 mastitis, 727  
 sterigmatocystin poisoning, 1910
- Aspergillus niger*, 1474
- Aspergillus ochraceus*, 1899, 1901
- Aspergillus pneumonia*, 1474
- Aspergillus terreus* poisoning, 1901
- Asphyxia, perinatal, 152–153, 1985
- Aspiration pneumonia, 515–516, 925  
 dipping, 515  
 milk fever complication, 1634
- Aspirin see Acetylsalicylic acid (aspirin)
- Assisted traction during birth, femoral fracture, 633
- Astragalus*  
 congenital defects of the newborn, 134  
 nitrocompound poisoning, 1872–1873  
 selenocompound poisoning, 1891  
 swainsonine poisoning, 1870–1871, 1908
- Asymmetric hindquarter syndrome of pigs, 2024
- Ataxia  
 assessment, 588–589  
 cerebellar, 577, 587, 620  
 cerebellar abiotrophy, 1951  
 ceroid lipofuscinosis, 1950  
 definition, 621  
 horses, 615  
 inherited, calves, 1955  
 nervous system disease, 580–581  
 severity, 589  
 spinal cord compression, 615  
 spinal cord disease, 581  
 toxic/metabolic encephalomyelopathies, 612  
 visna, 1414
- Atelectasis, 500–501, 1334, 2014
- Atipamezole, 2052
- Atlanto-occipital cistern (cisterna magna), cerebrospinal fluid collection, 592
- Atopic rhinitis, bovine, 1936
- Atractyloside poisoning, 1886
- Atracurium besylate, 2052
- Atrazine poisoning, 1838
- Atresia, 1944
- Atresia ani, 1944
- Atresia coli, 309, 1944
- Atresia ilei, 1944
- Atrial contraction ('a' wave), 406–407
- Atrial fibrillation, 417–418  
 cattle, 418–419  
 goats, 419  
 horses, 418  
 benign fibrillation, 418, 419  
 treatment, 419–420  
 underlying disease, 418  
 left-side displacement of abomasum, 359  
 sheep, 419  
 treatment, 419–420
- Atrial jugular impulse, 415
- Atrial premature complexes, 415–416
- Atrioventricular block, 414–415
- Atrioventricular dissociation, 416
- Atrioventricular nodal premature complexes, 416
- Atrioventricular valves, 425–426
- Atrophic rhinitis, progressive, 956–963  
 clinical findings, 959  
 clinical pathology, 959–960  
 control, 961–962
- diagnosis, 960  
 differential diagnosis, 960  
 economic importance, 958  
 epidemiology, 956–958  
 etiology, 956  
 grading, 960  
 immune mechanisms, 957  
 infection prevalence, 956–957  
 necropsy findings, 960  
 outbreaks, 956  
 pathogenesis, 958–959  
 risk factors, 957–958  
 transmission, 957  
 treatment, 960–961  
 vaccination, 957, 959, 962
- Atropine  
 alimentary tract hypermotility treatment, 204  
 heaves, 1933  
 organophosphate poisoning, 1837  
 poisoning, 1894
- Atropine sulfate, 2052, 2064
- Attenuated vaccines  
 African horse sickness, 1183  
 anaplasmosis, 1459  
 bluetongue, 1304  
 bovine ephemeral fever, 1179  
 foot-and-mouth disease, 1228–1229  
 hog cholera, 1166  
 lumpy skin disease, 1426  
 Venezuelan equine encephalomyelitis, 1374, 1377
- Attractants, screwworm control, 1595
- Atypical interstitial pneumonia see Interstitial pneumonia
- Auditory tube diverticulum, 538–541
- Aujeszký's disease see Pseudorabies (Aujeszký's disease)
- Aujeszký's disease virus, 1394
- Aural flat wart (aural plaque), 667–668
- Auricular veins catheterization, 864
- Aurothioglucose, 2052
- Auscultation, 12–13  
 abdomen, 16, 17  
 cattle, 303–304  
 combined immunodeficiency, Arabian foals, 1979  
 equine colic, 220  
 foals, 230  
 equine pleuropneumonia, 526, 527  
 interstitial pneumonia, 2002, 2005  
 lungs/airway, 15–16, 475  
 murmurs, 424  
 pneumonia, 512  
 respiratory system examination, 481
- Rhodococcus equi* pneumonia, 802
- rumen, 303–304  
 sand colic, 254  
 ventricular septal defects, 432  
 volvulus of the large colon, 250
- Australia  
 anaplasmosis, 1455, 1456  
 bluetongue, 1300  
 bovine herpesvirus-1 infection, 1351  
 bovine ulcerative mamillitis, 1429  
 brucellosis associated with *Brucella abortus* eradication, 983  
 chronic enzootic pneumonia of sheep, 1362  
 Getah virus, 1383  
 Japanese encephalitis, 1377  
 orf, 1419  
 rabies quarantine measures, 1393
- Australian bat lyssavirus, 1385, 1386
- Australian Sheep Johnne's Disease Market Assurance Program (SheepMap), 1037
- Australian stringhalt, 2019
- Austria, bovine virus diarrhea virus eradication program, 1275
- Austrosimulium bancrofti*, 1605
- Austrosimulium ornatum*, 1605
- Austrosimulium pestilens*, 1605
- Autofluorescence microscopy, 1504
- Autoimmune hemolytic anemia, 455, 459, 1492
- Autoimmune hypersensitivity reaction, 69
- Autoinfection larvae, bovine ostertagiosis, 1543
- Autolysis, neosporosis, 1511
- Autonomic nervous system  
 abnormality, 583  
 alimentary tract motility dysfunction, 190  
 cardiac reserve and, 400  
 diseases of, 619  
 equine grass sickness, 1991  
 function, 576



- Autumn crocus (*Colchicum autumnale*) poisoning, 1885
- Avermectins see Macrocylic lactone anthelmintics (MLs)
- Aveyron disease, 1414
- Avian influenza viruses, swine infection, 1332
- Avian-like influenza A/MJilin89 (H3N8), 1322
- Avocado (*Persea americana*, alligator pear) poisoning, 1883–1884
- Awns, actinobacillosis (wooden tongue), 1046
- Ayrshire cattle
- bovine ocular squamous-cell carcinoma, 2040
  - lymphatic obstruction, inherited, 1945
- Azaperone, 2064
- Azathioprine, 2052
- Azithromycin, 804, 2052
- Azlocillin, 2052
- Azoles, 1473
- Azotemia, 552, 554
- Azoturia see Rhabdomyolysis, exertional/postexercise
- 
- B**
- 
- Baber's fly traps, 1605–1606
- Babesia*, 1483
- antigenic variation, 1487
  - culture, 1489
  - demonstration, 1489–1490
  - development, 1485
  - infection susceptibility, 1488
  - life cycle, 1485, 1486
  - preservation, 1489
  - strain differences, 1487
- Babesia argentina* see *Babesia bovis*
- Babesia berbera* see *Babesia bovis*
- Babesia bigemina*, 1483, 1484
- attenuation, 1495
  - clinical findings, 1489
  - cross protection, 1486
  - demonstration, 1489
  - life cycle/development, 1485, 1486
  - vaccines, 1495
- Babesia bovis*, 1483, 1484
- attenuation, 1495
  - clinical findings, 1488–1489
  - cross protection, 1486
  - demonstration, 1489
  - life cycle/development, 1485
  - pathogenesis, 1488
  - vaccines, 1495
- Babesia caballi*, 1483, 1484, 1484
- Babesia canis*, 1484
- Babesia cauxsica* see *Babesia divergens*
- Babesiaceae, 1496
- Babesia colchica* see *Babesia bovis*
- Babesia divergens*, 1483, 1484
- demonstration, 1489
  - human infections, 1487
- Babesia equi*, 1483, 1484
- Babesia gibsoni*, 1484
- Babesia karelica* see *Babesia divergens*
- Babesia major* see *Babesia divergens*
- Babesia microti*, 1487
- Babesia motasi*, 1483, 1484
- Babesia occidentalis* see *Babesia divergens*
- Babesia odocoilei*, 1484, 1488
- Babesia ovata*, 1484
- Babesia ovis*, 1483, 1484
- Babesia peroncitoi*, 1483
- Babesia tarandirangiferis*, 1484
- Babesia trautmanni*, 1483, 1484
- Babesiosis, 1483–1498
- bovine see Bovine babesiosis
  - carriers, 1485, 1488
  - clinical findings, 1488–1489
  - clinical pathology, 1489–1490
  - control, 1494–1497
  - differential diagnosis, 1490
  - economic importance, 1487
  - epidemiology, 1483–1488
  - equine see Equine babesiosis
  - etiology, 1483
  - experimental reproduction, 1488
  - geographical occurrence, 1483, 1484
  - goats, 1483–1484, 1485
  - host occurrence, 1483–1484
  - immunity, 1485
  - immunology, 1488
  - infection sources, 1484–1485
  - infection susceptibility, 1485
  - necropsy findings, 1490
  - pathogenesis, 1488
  - reinfection, constant, 1488
  - risk factors, 1486–1487, 1487
  - sheep, 1483–1484, 1485, 1489–1490, 1494
  - supportive treatment, 1494
  - transmission, 1484–1485
  - treatment, 1491–1494
  - vectors, 1600
- Baby hamster kidney (BHK) vaccine, 1228
- Bacampicillin sodium, 2052
- Baccharis* poisoning, 1910
- Bacillary hemoglobinuria, 834–836
- clinical findings, 835, 1491
  - clinical pathology, 835, 1491
  - Clostridium haemolyticum*, 834–836
  - control, 835–836
  - diagnosis, 835
  - differential diagnosis, 835
  - epidemiology, 834–835, 1491
  - etiology, 834
  - necropsy findings, 835
  - outbreaks, 834
  - pathogenesis, 835
  - risk factors, 834–835
  - treatment, 835
  - vaccination, 836
- Bacillus*, 815–819
- Bacillus aneurinolyticus*, 2007
- Bacillus anthracis*, 815–819
- Bacillus cereus*, 726
- Bacillus of Calmette and Guerin (BCG) vaccine, 1013, 1424, 2040
- Bacillus piliformis*, 836
- Bacillus subtilis*, 726
- Bacillus thiaminolyticus*, 2007
- Bacitracin methylene disalicylate, 2064
- Bacitracin zinc, 2064
- Backflushing, milking practice, 734
- Back muscle necrosis, 1969, 1971, 1973
- Back pain, horses, 617
- Back rubbers, *Haematobia* fly control, 1604
- BACTEC system, 1038
- Bacteremia
- definition, 51
  - endocarditis and, 427
  - neonatal infection, 148
  - salmonellosis, 907
- Bacteremia, radiation injury, 1786
- Bacteria
- bone access routes in osteomyelitis, 635
  - colonization, equine pleuropneumonia, 525
  - culture see Bacterial culture
  - diarrhea in foals, 274
  - diseases associated with, 765–1156
  - tick transmitted, 1599–1600, 1601
  - see also specific bacteria; specific diseases/disorders
  - enteritis, 260, 261, 262, 263
  - peritoneal fluid, in, 202
  - toxins, hemolytic jaundice, 384
- Bacterial arteritis, 434
- Bacterial bronchopneumonia, 511–512
- Bacterial culture
- Actinobacillus pleuropneumoniae*, 1056
  - atrophic rhinitis, progressive, 959–960
  - Brachyspira hyodysenteriae*, 1116
  - Brucella abortus*, 971
  - Brucella melitensis*, 992
  - Brucella suis*, 990
  - brucellosis associated with *Brucella ovis*, 986
  - Burkholderia mallei*, 1084
  - colibacillosis, 860
  - Haemophilus* septicemia, 1001
  - hemorrhagic septicemia, 922
  - leptospirosis, 1104–1105
  - localized infection, 111
  - Mycobacterium avium* subspecies *paratuberculosis* (*Map*), 1026–1028
  - Mycoplasma bovis*, 1129
  - Mycoplasma hyopneumoniae*, 1148
  - Mycoplasma mycoides* subsp. *Mycoides*, 1134
  - pneumonic pasteurellosis, 939
  - salmonellosis, 910
  - undifferentiated bovine respiratory disease, acute, 929
- Bacterial infection
- endocarditis, 427
  - enzootic pneumonia of calves, 1336
  - immune deficiency from, 467
  - myocardial disease, 421
  - pneumonia, 511
- Bacterial myocarditis, 420
- Bacterial pseudomycosis, 667
- Bactericidal antimicrobials, 182, 182, 183
- Bacteriology
- erysipelas of swine, 813–814
  - ileitis, 1090
  - infectious polyarthritis, 1005
- Bacteriostatic antimicrobials, 182, 182, 183
- Bacteriuria, 546
- Bacteroides*, 1061–1080
- Bacteroides asaccharolyticus*, 637
- Bacteroides fragilis*, 637
- Bacteroides nodosus*, 1064
- Badgers (*Meles meles*), tuberculosis, 1007
- Baermann technique, 1566, 1568, 1569
- 'Bagging' examination, 476
- Balance abnormalities, 580, 586
- Balanoposthitis see Enzootic posthitis
- Balansia epicloae* poisoning, 1901
- Baldy calves (inherited epidermal dysplasia), 1975
- Balling-gun-induced trauma, 209
- Ballottement, 12
- Baneberry (*Actaea spicata*) poisoning, 1888
- Bang's disease, 966–984
- carriers, 968
  - clinical findings, 970–971
  - clinical pathology, 971–973
  - control, 974–984
  - eradication, 981–984
  - guidelines, 974–978
  - herd based programs, 981
  - diagnosis, 974
  - differential diagnosis, 974, 975–977
  - economic importance, 969
  - epidemiology, 966–969
  - etiology, 966
  - immune mechanisms, 969
  - necropsy findings, 973–974
  - outbreaks, 966–967
  - pathogenesis, 969–970
  - prevalence, 966–967
  - risk factors, 968–969
  - transmission, 967–968
  - treatment, 974
  - vaccination, 974, 978–981
  - cessation due to eradication, 981–984
  - zoonotic implications, 969
- Bang test, 1450
- Baquiloprim, 2052
- Baquiloprim/sulfadimidine, 2064
- Barbarea vulgaris* (yellow rocket) poisoning, 1888
- Barbone see Hemorrhagic septicemia, cattle
- Barium-140, 1786
- Barium selenate, 1751
- Barium sulfate, 1751
- Barkers see Equine neonatal encephalopathy
- Barley smut (*Ustilago hordei*) fungus, 1912
- Barn fires, 1792–1793
- Barn itch (sarcoptic mange), 785, 1608–1609
- Base-apex lead system, 408, 408
- Basidiobolus haptosporus*, 1480, 1481
- Basioccipital bone fracture, 605
- Basisphenoid bone fracture, 605
- Bastard stranglers, 771
- Batch farrowing, 157
- Bats
- equine neorickettsiosis vector, 1466
  - rabies vaccination, 1393
  - rabies vector, 1386, 1387
  - vesicular stomatitis, 1233
- Batten's disease, 1950
- Bayes theorem, 28
- B-cell loss, post-weaning multisystemic wasting syndrome, 1188
- B-cell lymphoma, 462
- BCG vaccine, 1013, 1424, 2040
- Bears, pseudorabies, 1396
- Beclomethasone, 2052
- Bedding
- coliform mastitis and, 710–711, 717–718
  - downer cow syndrome, 1648
  - enterohemorrhagic *Escherichia coli* control, 884
  - environmental streptococci mastitis, 722
  - stress induction, 107
- Beef calves
- abomasal ulcer, 371–372, 372
  - birth size, 129
  - bovine herpesvirus-1 vaccination, 1359

- Beef calves (*Cont'd*)  
 bovine lungworm, 1565  
 bovine respiratory syncytial virus pneumonia, 1344, 1346  
 coccidiosis, 1498–1499  
 colibacillosis exposure reduction, 870–871  
 colostrum immunoglobulins transfer, guidelines to ensure, 873  
 colostrum administration, 156  
 congenital joint laxity and dwarfism, 2036  
 dietary diarrhea, 278, 279  
 enzootic pneumonia of calves, 1337  
 fetal disease, 130  
 mortality, 129–130  
 parturient disease, 130  
 passive immunity transfer failure, 854  
 postnatal disease, 130
- Beef cattle  
 abomasal displacement, 364  
 abomasal volvulus, 362, 364  
 antimicrobial residue violations, 185–186  
 bovine herpesvirus-1 vaccination, 1358  
 bovine virus diarrhea virus vaccination, 1272  
 carbohydrate engorgement, 316  
 colostrum, volume ingested, 151–152  
 degenerative coxofemoral arthropathy, 637  
 feed intake reduction manifestations, 112  
 intramuscular injection sites, 631, 821  
 Johne's disease control, 1033, 1035  
 laminitis, 2034  
 neosporosis, 1510  
 nutrient requirements, 369  
 nutritional management, 1693–1694  
 phosphorus deficiency control, 1763  
 pneumonic pasteurellosis vaccination program, 945  
 pregnancy toxemia, 300  
 right-side displacement of the abomasum, 362  
 salmonellosis risk factors, 901  
 urolithiasis, 567  
 see also Beef calves
- Beef Industry Food Safety Council (BIDSCo), 887
- Beef quality assurance, 883–884
- Beef tapeworm (*Taenia saginata*, *Cysticercus bovis*), 1583
- Beer residues, *Aspergillus clavatus*  
 contaminated, 1471, 1472, 1473
- Bee stings, 1918
- Behavior abnormality/changes  
 blowfly strike, 1591  
 border disease, 1416  
 bovine spongiform encephalopathy, 1450  
 chorioretinal mangle, 1612  
 clinical examination, 9  
 dehydration, 75–76  
 equine colic, 220, 223  
 equine neonatal encephalopathy, 2013  
 louse infestations, 1597  
 nervous system examination, 584  
*Oestrus ovis* infestation, 1587  
 pain, 102, 104  
 psoroptic mange, 1610  
 sarcoptic mange, 1609  
 toxic/metabolic encephalomyelopathies, 611
- Belgium  
 encephalomyocarditis virus disease, pigs, 1183  
 pseudorabies, 1394
- Belize, brucellosis status, 965
- Bellowing, rabies, 1389
- Bendixen key, 1219
- Benign enzootic paresis see Porcine viral encephalomyelitis
- Benign ovine theileriosis, 1526–1527, 1527
- Benign theileriosis, 1526, 1527
- Benomyl fungicide, 1902, 1909
- Bentleg (bowie), 632, 1770–1771
- Benzene hexachloride, 1611, 1833
- Benzimidazoles (BZDs)  
 giardiasis, 1517  
 parasitic gastroenteritis, ruminants, 1545, 1546  
 strongylosis, 1561  
 tapeworm infestations, 1582
- Benzotropin, 2052
- Benzyl benzoate, 1611
- Benzylpenicillin, 181
- Berbine poisoning, 1887
- Berenil see Diminazene aceturate
- Bergstrom muscle biopsy needle, 630
- Berteroia incana* (hoary alyssum) poisoning, 1888
- Besnoitia*, 1517, 1518  
*Besnoitia bennetti*, 1517  
*Besnoitia besnoiti*, 1517  
*Besnoitia capraei*, 1517  
 Besnoitiosis, 1517–1518
- Beta-2-adrenergic agonists  
 heaves, 1933, 1934  
 pneumonia, 514  
 respiratory disease, 495
- Beta-galactosidase reduction, 1950
- Beta-hydroxybutyrate (BHBA)  
 energy balance indicator, 1620  
 ketone formation, 1661  
 ketonemia, 1664  
 ketosis, subclinical, 1620  
 left-side displacement of abomasum, 356, 357, 359  
 periparturient disease prediction, 1620
- Beta irradiation, congenital defects of the newborn, 134
- $\beta$ -mannosidase defects, 1949
- $\beta$ -mannosidosis, 1949
- Betamethasone, 2052
- Bethanechol  
 alimentary tract hypomotility treatment, 204  
 polyneuritis equi, 2021
- Bethanechol chloride, 2052
- Bicarbonate requirements, acidosis, 863
- Bicarbonate system, acid-base balance, 82
- Biceps femoris, asymmetric hindquarter syndrome, 2024
- Biceps reflex, 590
- Big bale silage  
 botulism, forage, 825  
*Listeria monocytogenes* presence, 806
- 'Bighead' syndrome, 633
- Bighorn sheep (*Ovis canadensis*), 1455
- Big knee, caprine arthritis encephalitis, 1411
- Bigleg (sporadic lymphangitis), 2029–2030
- Bile acids, serum, 388, 390–391
- Bile duct carcinoma, 396
- Bile duct fasciolosis, 1577, 1578
- Bile duct tumor, 395–396
- Bile regurgitation, 1996
- Biliary atresia, 396
- Biliary disease, 396  
 manifestations of, 384–387
- Biliary obstruction, 385
- Biliary peritonitis, 387
- Biliary system concretions, 396
- Bilirubin  
 biliary obstruction, 385  
 jaundice, 384, 385  
 liver disease, 389
- Binary fission (merogony), 1485, 1514
- Biochemical abnormality, exercise intolerance, 119
- Biochemistry, serum see Serum biochemistry
- Biopsy  
 equine grass sickness, 1991  
 equine motor neuron disease, 2020  
 equine phycomycosis, 1481  
 lumpy skin disease, 1426  
*Mycobacterium avium* subspecies *paratuberculosis* (*Map*), 1027–1028  
 papillomatosis, 1422  
 sarcoid, 1424  
 summer sores, 1572  
 see also specific types
- Biosecurity  
 bovine babesiosis, 1494  
 bovine herpesvirus-1 infection, 1356  
 bovine virus diarrhea virus, 1264–1267, 1268, 1274  
*Brucella abortus*, 967  
 East Coast fever, 1528  
 enzootic bovine leukosis, 1212, 1221  
 foot-and-mouth disease, 1225  
 heartwater, 1463  
 herd replacement, 741–742  
 ileitis, 1091  
 Johne's disease, 1034, 1039  
 leptospirosis, 1107  
*Mycoplasma bovis* infection, 1130  
*Mycoplasma mastitis*, 707  
 nagana, 1534  
 ovine progressive pneumonia, 1366  
 papillomatosis digital dermatitis of cattle, 1070  
 peste des petits ruminants, 1242  
 porcine reproductive and respiratory syndrome, 1203
- rabies, 1393  
 rinderpest, 1239  
 salmonellosis, 915  
*Streptococcus agalactiae* mastitis, 705  
 swine dysentery, 1119  
 swine influenza, 1334  
 transmissible gastroenteritis in pigs, 1279, 1283
- Bioterrorism  
*Brucella melitensis*, 992  
*Coxiella burnetii*, 1469
- Biotin (vitamin H)  
 deficiency, 1780–1782  
 requirements, 1782  
 supplementation, 1778, 1780–1781
- Biot's breathing, 11, 610
- Birch sawfly (*Arge pullata*) larvae poisoning, 1920
- Bird repellents, poisoning, 1841
- Birds  
 aquatic, swine influenza transmission, 1332  
 enterohemorrhagic *Escherichia coli* transmission, 880
- Birdsville horse disease, 1872
- Birdsville indigo (*Indigofera linnaei*) poisoning, 1872, 1884
- Birthcoat retention, 1974
- Birth weight  
 colibacillosis risk factor, 852–853  
 summit metabolism and, 42  
 see also specific neonates
- Bismuth subnitrate, internal teat sealants, 740–741
- Bismuth subsalicylate, 2052, 2064
- Bison (*Bison bison*)  
*Brucella abortus* infection, 966, 980–981  
 Johne's disease, 1031  
 tuberculosis, *Mycobacterium bovis*, 1007
- Bites, 1915–1920  
 horse flies, 1603  
 midges, 1604–1605  
 nagana transmission, 1533  
 rabies transmission, 1387  
 stable flies, 1603
- Bitis arietans* (puff adder), 1916
- Bitis gabonica* (gaboon viper), 1916
- Bitis nasicornis* (rhinoceros viper), 1916
- Black disease, 832–834  
 cattle, 833  
 clinical findings, 833  
 clinical pathology, 833  
*Clostridium novyi*, type B, 832–834  
 control, 834  
 diagnosis, 834  
 differential diagnosis, 834  
 epidemiology, 833  
 etiology, 832–833  
*Fasciola hepatica* migration, 1577  
 hepatic abscess, 395  
 horses, 833  
 infection source, 833  
 liver biopsy complication, 387  
 necropsy findings, 833–834  
 outbreaks, 833  
 pathogenesis, 833  
 risk factors, 833  
 sheep, 833  
 treatment, 834  
 vaccination, 834
- Blackflies (*Simulium vittatum*), 1233, 1605
- Black-grain mycetomas, 1480
- Black hair colored follicular dysplasia, 1974
- 'Black kidneys,' 1948
- Blackleg, 828–830  
 cattle, 829, 830  
 clinical findings, 829  
 clinical pathology, 829  
 control, 830  
 diagnosis, 829  
 differential diagnosis, 829  
 economic importance, 828  
 epidemiology, 828  
 etiology, 828  
 false, 829  
 horses, 829  
 necropsy findings, 829  
 pathogenesis, 828  
 risk factors, 828  
 sheep, 829, 830  
 transmission, 828  
 treatment, 829  
 vaccination, 829

- Black livers, sheep, 386–387  
 Black patch, slaframine poisoning, 1908  
 Black Pied cattle, inherited deficiency of lymphocyte maturation, 1941  
 Black pox (black spot), 750, 1381  
 Blacksnake (*Denisonia superba*), 1916  
 Black soil blindness, 1912  
 Black spot (black pox), 750, 1381  
 Black-tail deer (*Odocoileus hemionus columbianus*), 1455  
 Black walnut tree (*Juglans nigra*) poisoning, 1887–1888
- Bladder**  
 abnormality, palpable, 548  
 catheterization, 548–549  
 diseases of, 561–571  
 eversion, 573  
 neoplasms, 571  
 paralysis, 561–562  
 rectal examination palpation, 19  
 rupture, 573  
   intermittent-flow peritoneal dialysis, 554  
   test of, 553  
   uroolithiasis, 568  
   see also Uroperitoneum  
*Blastomyces dermatitidis*, 1476  
 Blastomycosis, 1475–1476  
*Blattia orientalis* (Oriental cockroach) nymphs, 1020
- Bleeders see Exercise-induced pulmonary hemorrhage (EIPH) of horses (bleeders)
- Bleeding**  
 excessive, exercise-induced pulmonary hemorrhage, 506  
 inherited disorders, 1947  
 prolonged, hemorrhagic disease, 441
- Bleeding heart (*Dicentra spectabilis*) poisoning, 1887
- Bleeding time, 441
- Blindness**, 582–583, 588  
 brain abscess, 606  
 central, 582–583  
 GM<sub>1</sub> gangliosidosis, 1950  
 peripheral, 582–583  
 plant-induced, 1896, 1897  
 polioencephalomalacia, 2010  
 pregnancy toxemia, sheep, 1669  
 tests for, 18  
 vitamin A deficiency, 1774–1775
- Blind staggers, selenium poisoning, 1812
- Blink reflex see Menace reflex
- Blister beetle (*Epicauta*) poisoning, 1918
- Blisters, stable flies, 1603
- Blitz therapy, 693, 705
- Bloat (ruminal tympany), 298, 325–336  
 bovine leukosis, sporadic, 1216  
 case fatality rate, 327–328  
 chronic, 301, 327  
   persistence of the right aortic arch, 433  
 clinical findings, 330–331  
 control, 332–336  
 differential diagnosis, 331  
 economic impact, 329  
 emergency measures, 331–332  
 epidemiology, 327–329  
 esophageal obstruction, 213  
 etiology, 326–327  
 field management, 334  
 free-gas (secondary), 327, 330–331, 339  
 frothy (primary), 326–327, 328, 328–329, 330  
   see also Feedlot bloat; Pasture bloat  
 glucosinolate poisoning, 1868  
 morbidity, 327–328  
 pathogenesis, 329–330  
 severity, 330  
 tetanus-associated, 297  
 treatment, 331–332
- Blonde d'Aquitaine cattle, inherited erythrocytic protoporphyria, 1946
- Blood**  
 ammonia levels, 385–386, 390–391  
 biochemistry, stomach fluke disease, 1581  
 clotting defects, Chediak-Higashi syndrome, 1942  
 clotting failure, anthrax, 818  
 copper levels, 1820, 1822  
 diseases of  
   dyspnea/exercise intolerance from, 475  
   *Mycoplasma (Eperythrozoon) suis*, 1126  
   see also specific diseases/disorders  
 enzymes, fasciolosis, 1578  
 fluorine levels, 1818  
 lead in, 1801, 1803, 1803  
 loss  
   abomasal ulcer, 372  
   chronic, horse, 1492  
   hemochrosis, ruminants, 1550  
   see also Hemorrhage  
 manganese levels, 1733  
 oxygen content, 412, 490  
 pH, 82  
   acid-base status screening, 89  
   colibacillosis, 861  
   normal, 89  
   vitamin E deficiency effects, 1743  
 Blood-brain barrier permeability, 594  
 Blood clots, equine herpesvirus 1, 1313
- Blood culture**  
 bacillary hemoglobinuria, 835  
 endocarditis, 428  
 equine babesiosis, 1490  
*Mycobacterium avium* subspecies *paratuberculosis* (*Map*), 1027  
 neonatal infection, 148  
 newborns, 166  
 salmonellosis, 911  
 septicemia, 52
- Blood gas analysis**  
 acid-base status, 89  
 anemia, 457  
 cardiac catheterization, 411–412  
 diarrhea, acute, 270  
 fetal hypoxemia, 1984  
 newborns, 166
- Blood glucose levels**  
 energy balance indicator, 1620–1621  
 fluid balance disorders, 90  
 hepatic encephalopathy, 385  
 ketosis, 1664  
 normal, horse, 198  
 reticulorumen motility, primary contraction influence, 296
- Blood groups**, 1921, 1924  
 analysis  
   freemartinism diagnosis, 1940  
   porcine stress syndrome, 1972
- Blood ketones**, 1664
- Blood lactate**  
 anemia, 457  
 myofiber hyperplasia, 1965  
 plasma lactate and, 492  
 respiratory system examination, 492  
 sample collection and storage, 492  
 shock, 66
- Blood leukocyte count**, equine colic, 222  
 blood molybdenum levels, 1820
- Blood pressure measurement**, cattle, 410
- Blood selenium**, 1746, 1748
- Blood smears**  
 babesiosis, 1489  
 eperythrozoonosis, 1155
- Blood tests**  
 hemorrhagic disease, 441  
 post-weaning multisystemic wasting syndrome, 1191  
 timing of, herd metabolic profile testing, 1622  
 usefulness of, 1619
- Blood transfusion**  
 abomasal ulcer, 373  
 alloimmune hemolytic anemia of the newborn, 1923–1924  
 anaplasmosis, 1456, 1458  
 anemia, 458–459  
*Babesia* human infection, 1487  
 bovine enzootic hematuria, 1877  
 crossmatching, 458  
 donors, 1923–1924  
 enzootic bovine leukosis transmission, 1211  
 hemorrhagic shock, 67  
 incompatibility, 70, 1921  
 indications for, 458, 1923  
 leptospirosis, 1107  
 neonatal infection, 149  
 passive immunity transfer failure correction, 154  
 postparturient hemoglobinuria, cattle, 1683  
 volume, 1923
- Blood vessels**  
 copper deficiency effects, 1712  
 diseases of, 433–437  
 radiation injury, 1786
- Blowfly strike, 1590–1593  
 clinical findings, 1591  
 clinical pathology, 1591  
 control, 1592, 1593  
 diagnosis, 1591  
 economic importance, 1590  
 epidemiology, 1590–1591  
 etiology, 1590  
 life cycle, 1590–1591  
 myositis, 631  
 necropsy findings, 1591  
 pathogenesis, 1591  
 prevention, 1592–1593  
 primary flies, 1590  
 secondary flies, 1590  
 sheep, 1590, 1591  
 treatment, 1591–1592  
 vaccination, 1593
- Blue-eared pig disease see Porcine reproductive and respiratory syndrome (PRRS)
- Blue-green algae, 1913
- Blue tinted contact lenses, head shaking in horses, 2023
- Bluetongue**, 1299–1305  
 case fatality rates, 1301–1302  
 cattle, 1301, 1302, 1303  
 clinical findings, 1265, 1302–1303  
 clinical pathology, 1265, 1303  
 congenital defects, 1302, 1303  
 control, 1304  
 diagnosis, 1303  
 differential diagnosis, 1226, 1265, 1304  
 economic importance, 1302  
 enzootic areas, 1303  
 epidemic zones, 1300  
 epidemiology, 1265, 1299–1302  
 etiology, 1299  
 experimental reproduction, 1302  
 goats, 1303  
 immunity, 1301–1302  
 lameness, 1075  
 morbidity, 1301–1302  
 necropsy findings, 1303  
 occurrence, 1299–1300  
 over-wintering, 1300–1301  
 pathogenesis, 1302  
 persistent infection, 1301  
 revaccination, 1304  
 risk factors, 1301  
 sheep, 1302–1303  
 transmission, 1300, 1301  
 treatment, 1304  
 vaccination, 1304  
 vectors, 1300, 1301, 1304
- Bluetongue virus (BTV), 1299  
 congenital defects in newborns, 133  
 genetic variability, 1299  
 isolation, 1303  
 serotype occurrence, 1301
- B-lymphocyte deficiency**  
 combined immunodeficiency, Arabian foals, 1979  
 hog cholera, 1160, 1162
- Boars**  
 porcine reproductive and respiratory syndrome, 1196–1197, 1204  
 pseudorabies transmission, 1396  
 semen, 1196–1197
- Body condition examination**, 10
- Body condition score (BCS)**, 1624–1625, 1625  
 fatty liver prevention, 1677  
 international system relationships, 1625, 1626  
 ketosis risk factor, 1663  
 milk fever risk factor, 1629  
 voluntary dry matter intake, 1616
- Body conformation examination**, 10
- Body fat reserves**, metabolic profile test, 1624
- Body lice**, 1597, 1598
- Body mange** (psoroptic mange), 1610–1611
- Body slings**, downer cow syndrome, 1648
- 'Body strike'**, 1591
- Body temperature**, 39–40  
 see also Fever; Hyperthermia; Hypothermia
- Body wasting**, visna, 1414
- Body weight** see Weight
- Boer goats, persistent orf, 1420
- Boldenone undecylenate, 2052
- Bolo disease, 798
- Bonding, 143–144
- Bone(s)**  
 analysis, hemochromatosis, 1947  
 bending of, osteodystrophy, 633  
 congenital achondroplasia with hydrocephalus, 1958–1959

- Bone(s) (*Cont'd*)  
 congenital defects, 633  
 congenital joint laxity and dwarfism, 2036  
 copper deficiency effects, 1711–1712  
 discoloration, congenital porphyria, 1946  
 diseases of, 632–637  
   *see also specific diseases/disorders*  
 fluorine poisoning, 1817  
 growth, vitamin A deficiency, 1773  
 hyena disease of cattle, 2023  
 infection classification, 635  
 inherited diseases, 1957–1961  
 necrosis, sporadic bovine leukosis, 1216  
 Bone ash, phosphorus concentration, 1761  
 Bone grafts, osteomyelitis, 636–637  
 Bone marrow  
   aspirates, 457  
   collection of, 456–457  
   core samples, 457  
   examination, 456–457  
   Fell pony syndrome, 1943  
   hypoplasia in Standardbreds, 1492  
   inflammation, osteomyelitis and, 636  
   necrosis, sporadic bovine leukosis, 1216  
   stem cells, radiation injury, 1786  
 Bone meal supplement, 1762  
 Bonkers, bovine, 1807  
 Bont tick (*Amblyomma variegatum*), 1049, 1245, 1426  
 Boomslang (*Dispholidus typus*), 1916  
 Boophilus, 1456, 1484, 1600  
 Boophilus (*Margaropus*) *annulatus*, 1484  
 Boophilus *annulatus* eradication program, 1602  
 Boophilus *decoloratus*, 1484  
 Boophilus *microplus*  
   anaplasmosis, 1455, 1456  
   babesiosis vector, 1484  
   dermatophilosis, 1049  
   economic impact, 1599  
   equine babesiosis vector, 1485  
   eradication programs, 1602  
 Borborygmi sounds  
   absence, enteritis, 245  
   definition, 16  
   equine colic, 220  
 Border disease, 1414–1418  
   bovine virus diarrhea virus, 1415  
   clinical findings, 1416  
   clinical pathology, 1417  
   control, 1417  
   differential diagnosis, 1417  
   economic importance, 1415  
   enteric disease, 1416  
   epidemiology, 1414–1415  
   etiology, 1414  
   experimental reproduction, 1415  
   flock seroprevalence, 1414–1415  
   goats, 1416  
   growth rate, 1416  
   infection sources, 1415  
   necropsy findings, 1417  
   neurological dysfunction, 1416  
   occurrence, 1414–1415  
   pathogenesis, 1415–1416  
   persistent infection, 1415, 1417  
   reproductive performance, 1416  
   risk factors, 1415  
   sheep, 1258–1259  
   transmission, 1415  
   treatment, 1417  
 Border disease virus (BDV), 1414  
   abortion, 987  
   congenital defects in newborns, 133  
   genotypes, 1414  
   strains, 1414  
 Border Leicester sheep  
   craniofacial deformity, inherited, 1959  
   prosencephaly, inherited, 1954  
 Bordetella *bronchiseptica*  
   horses, 509  
   porcine reproductive and respiratory syndrome co-infection, 1199  
   progressive atrophic rhinitis, 956–963  
   vaccine, 962  
   virulence, 957–958  
 Bordetella *parapertussis*, 1361  
 Boreliosis, 1110–1113  
   *Borrelia burgdorferi*, 1110–1113  
   cattle, 1111, 1112  
   clinical findings, 1112  
   clinical pathology, 1112–1113  
   control, 1113  
   diagnosis, 1113  
   differential diagnosis, 1113  
   epidemiology, 1111–1112  
   etiology, 1110  
   horses, 1111, 1112  
   immune mechanisms, 1112  
   necropsy findings, 1113  
   pathogenesis, 1112  
   sheep, 1111, 1112  
   tick vectors, 1607  
   transmission, 1111–1112  
   treatment, 1113  
 Borna disease, 1375, 1381–1382  
 Borna disease virus (BDV), 1381  
 Born-after-the-ban (BAB, NAIF) animals, 1448, 1452  
 Born after the implementation of the reinforced feed ban (BARBs), 1448  
 Boron poisoning, 1830  
*Borrelia burgdorferi*, 1110–1113  
*Borrelia suilla*, 1123  
*Borrelia suis*, 1123  
*Bos indicus* (Zebu) cattle *see* Zebu (*Bos indicus*) cattle  
*Bos javanicus*, Jembrana disease, 1244  
*Bos taurus* breeds  
   babesiosis, 1486  
   bluetongue, 1301  
*Bothrops lanceolatus* (fer-de-lance), 1916  
*Bothrops neuwiedi* (palm viper), 1916  
*Bothrops schlegelii* (palm viper), 1916  
 Botryomycosis, 667  
 Bottle jaw, 386, 1578  
 Botulism, 824–828  
   antiserum, 827  
   antitoxin, 827  
   carrion-associated, 825  
   cattle, 826  
   clinical findings, 826, 1376  
   clinical pathology, 826–827  
   *Clostridium botulinum*, 824–828  
   control, 827, 1376  
   diagnosis, 827  
   differential diagnosis, 827  
   epidemiology, 825–826  
   etiology, 824–825  
   experimental reproduction, 825  
   forage, 825  
   horses, 826, 1376  
   importance, 826  
   infection sources, 825  
   necropsy findings, 827  
   pathogenesis, 826  
   peracute, 826  
   pigs, 826  
   recumbency in horses, 121  
   risk factors, 825  
   sheep, 826  
   subacute, 826  
   toxicoinfectious, 825, 826  
   treatment, 827, 1376  
   vaccination, 827  
   wound, 825  
*Bovicola ovis*, 2041  
 Bovine amyloidotic spongiform encephalopathy, 1451  
 Bovine asthma *see* Interstitial pneumonia  
 Bovine atopic rhinitis, 1936  
 Bovine babesiosis  
   age resistance, 1486–1487  
   breed susceptibility, 1486  
   clinical findings, 1488–1489, 1491  
   clinical pathology, 1491  
   control, 1494  
   differential diagnosis, 1490, 1491  
   economic importance, 1487  
   endemic stability, 1495  
   enzootic areas, 1487  
   epidemiology, 1483, 1491  
   eradication, 1494  
   immunity, 1485–1486, 1493  
   immunology, 1488  
   infection susceptibility, 1485  
   limitation of prevalence, 1494  
   natural endemic stability, 1497  
   outbreak control, 1496  
   pathogenesis, 1488  
   prevention, 1494  
   revaccination, 1496  
   risk factors, 1487  
   subacute syndrome, 1489  
   transmission, 1484  
   treatment, 1491–1494  
   vaccination, 1494–1497  
 Bovine besnoitiosis, 1517–1518  
 Bovine bonkers, 1807  
 Bovine chondrodysplastic dwarfism, 1958  
 Bovine congenital anemia, dyskeratosis and progressive alopecia (inherited dyserythropoiesis and dyskeratosis), 1948  
 Bovine coronavirus (BCV)  
   calf diarrhea, 1289, 1291, 1297  
   enteritis, 1292  
   respiratory tract infection, 1289, 1298, 1336  
   undifferentiated bovine respiratory disease, 926–927  
   vaccination, 874, 927, 1295  
   winter dysentery, 1289, 1297, 1298  
 Bovine degenerative axonopathy, inherited, 1952–1953  
 Bovine digital dermatitis *see* Papillomatosis, digital dermatitis of cattle (Mortellaro's disease)  
 Bovine enzootic hematuria, 1491, 1875, 1876–1877  
 Bovine ephemeral fever, 1177–1179  
 Bovine exfoliative dermatitis, 657  
 Bovine factor XI deficiency, 1947  
 Bovine familial degenerative neuromuscular disease, 1964  
 Bovine farcy, 1016–1017  
 Bovine farmer's lung *see* Interstitial pneumonia  
 Bovine hereditary dilated cardiomyopathy, 1944–1945  
 Bovine herpes mammillitis *see* Bovine ulcerative mammillitis  
 Bovine herpesvirus-1 (BHV-1) infection, 924, 1349–1361  
   abortion, 976  
   age susceptibility, 1350  
   alimentary form, 1354  
   alimentary tract form, 1265  
   antigenic difference, 1351  
   BHV-1.1 subtype, 1349, 1350  
   BHV-1.2 subtype, 1349, 1350  
   BHV-1.3 subtype, 1349, 1350, 1351  
   breed susceptibility, 1350  
   carriers, 1352  
   case fatality rates, 1350  
   clinical findings, 1353  
   clinical pathology, 1354–1355  
   control, 1355–1360  
   differential diagnosis, 1355  
   economic importance, 1351  
   epidemiology, 1349–1351  
   eradication, 1359–1360  
   experimental infection, 1352  
   export cattle, 1359  
   fetal infection, 1352  
   genital carrier state, 1349  
   genital disease, 1350  
   immune mechanisms, 1351  
   immunization, 1358–1359  
   latency, 1352, 1354, 1358–1359  
   morbidity, 1350  
   necropsy findings, 1355  
   outcomes, 1350  
   pathogenesis, 1351–1353  
   pneumonia, 1353  
   prevalence, 1349  
   reactivation, 1352  
   related alphaherpesviruses, 1349, 1354  
   reproductive failure, 1353  
   respiratory disease, 1351–1352, 1353  
   risk factors, 1350–1351  
   strains, 1351  
   transmission, 1350  
   treatment, 1355  
   undifferentiated bovine respiratory disease, 926  
   vaccination, 1352, 1356–1359  
   virus isolation/detection, 1354  
   wildlife, 1349–1350  
 Bovine herpesvirus-2 (BHV-2), 1359, 1426, 1428  
 Bovine herpesvirus-4 (BHV-4), 1349, 1353, 1428  
 Bovine herpesvirus-5 (BHV-5), 1349, 1350, 1351  
 Bovine hystera, 1807  
 Bovine immunodeficiency-like virus (BIV), 1221–1223  
 Bovine immunoglobulin, purified, 872  
 Bovine interdigital necrobacillosis, 1064–1066  
   clinical findings, 1064–1065  
   clinical pathology, 1065  
   control, 1066

- Bovine interdigital necrobacillosis (*Cont'd*)  
 differential diagnosis, 1065  
 economic importance, 1064  
 epidemiology, 1064  
 etiology, 1064  
 necropsy findings, 1065  
 outbreaks, 1064  
 pathogenesis, 1064  
 risk factors, 1064  
 transmission, 1064  
 treatment, 1065  
 vaccination, 1066
- Bovine ketosis, 1662, 1663  
 see also Ketosis
- Bovine lentivirus-1, 1221–1223
- Bovine leukemia virus (BLV), 1210, 1213, 1214  
 antibodies, 1212  
 exposure outcomes, 1214, 1214  
 milk production, 1214  
 see also Enzootic bovine leukosis (EBL)
- Bovine leukocyte adhesion deficiency (BLAD), 466, 467, 1941
- Bovine lungworm (verminous pneumonia), 925, 1564–1567  
 acute cases, 1565, 1566  
 clinical findings, 1565  
 clinical pathology, 1566  
 control, 1567  
 diagnostic confirmation, 1566  
 differential diagnosis, 1566  
 epidemiology, 1564–1565  
 etiology, 1564  
 immunity, 1564, 1565  
 interstitial pneumonia, 2003  
 larvae dispersal, 1564–1565  
 necropsy findings, 1566  
 pathogenesis, 1565  
 strategic anthelmintic programs, 1567  
 subacute cases, 1565, 1566  
 transmission, 1564  
 treatment, 1566–1567  
 vaccination, 1567
- Bovine lymphosarcoma see Enzootic bovine leukosis (EBL)
- Bovine malignant catarrh see Malignant catarrhal fever
- Bovine Marfan syndrome, 1946
- Bovine mastitis, 673–749  
 bovine herpesviruses infection, 1353  
 chronic, 741  
 clinical  
 categories of, 682  
 clinical findings, 681–682  
 definition, 688  
 diagnosis, 682–683  
 economic losses, 680–681  
 gland abnormality, 682, 688, 690, 690  
 herd-level measures of, 745–746  
 milk abnormality, 682, 683–684, 688, 690, 690  
 monitoring systems, 744  
 productivity loss, 748  
 recording, 744  
 systemic abnormality, 682, 688, 690, 690  
 clinical findings, 681–682  
 control, 728–749  
 cost-effectiveness of, 748–749  
 economic benefits, 729  
 eradication, 729  
 incentives, 729  
 infection dynamics and, 730  
 infection rate reduction, 729  
 legislation, 729–730  
 penalties, 729  
 principles of, 730  
 programs see Bovine mastitis control programs  
 udder health improvement, 728–729  
 voluntary program, 730  
 diagnosis, 682–687  
 herd level detection, 683, 683–684  
 individual cow level, 684–685  
 differential diagnosis, 688  
 drying off, permanent, 696  
 duration, 681  
 economic losses, 680–681, 744  
 epidemiology, 675–681  
 etiology, 675  
 genetic resistance, 677–678  
 incidence, 676  
 milk fever complication, 1630  
*Mycoplasma bovis*, 1125–1126, 1127–1131  
 necropsy findings, 687–688  
 pathogenesis, 681  
 pathogens, 674–675, 680, 697–728, 724–726  
 antimicrobial indications, 689  
 colonizing ability, 680  
 contagious, 674, 675, 676, 697–702  
 distribution of, 676  
 environmental, 674–675, 676, 677, 709–724, 729  
 intramammary, 676  
 opportunistic, 674, 675, 676, 677, 708–709  
 see also specific types  
 prevalence, 676  
 production loss from, 680–681  
 record keeping, 743–744  
 recurrent, 678, 744  
 risk factors, 677–680  
 seasonality, 679–680  
 severity, 681  
 subclinical  
 diagnosis, 683, 685–687  
 economic losses, 680  
 treatment, 693  
 transition period susceptibility, 1616  
 transmission methods, 677  
 traumatic, 728  
 treatment, 688–696  
 adjunctive therapy, 694  
 administration route, 690  
 bacteriological cure, 688  
 clinical cure, 688  
 frequency and duration, 691  
 lactating quarters, 692–693  
 response to, 694  
 supportive therapy, 694  
 vitamin E deficiency, 1743  
 zoonotic potential, 681
- Bovine mastitis control programs, 730–748  
 culling chronically infected cows, 741–742  
 dry cow management and therapy, 737–741  
 environment maintenance, 742–743  
 five-point plan, 730–742  
 lactation therapy, mastitis, 741  
 milking equipment installation, function and maintenance, 734–737  
 milking methods, 731–734  
 record keeping, 743–744  
 requirements, 729  
 ten-point plan, 730–748  
 udder health status monitoring/goal setting, 744–748  
 udder hygiene, 731–734
- Bovine norovirus, 1289
- Bovine ocular squamous-cell carcinoma (BOSCC), 2039–2040
- Bovine ostertagiosis, 1543, 1544, 1545
- Bovine papilloma virus-1 (BPV-1), 1421, 1423
- Bovine papilloma virus-2 (BPV-2), 1421, 1423
- Bovine papilloma virus-3 (BPV-3), 1421
- Bovine papilloma virus-4 (BPV-4), 1421, 1422
- Bovine papilloma virus-5 (BPV-5), 1421
- Bovine papilloma virus-6 (BPV-6), 1421
- Bovine papular stomatitis (BPS), 1265, 1277
- Bovine pestivirus disease complex see Bovine virus diarrhea virus (BVDV)
- Bovine petechial fever, 1469–1470
- Bovine pleuropneumonia, contagious see Contagious bovine pleuropneumonia (CBPP)
- Bovine pulmonary emphysema see Interstitial pneumonia
- Bovine respiratory disease, undifferentiated acute see Undifferentiated bovine respiratory disease (UBRD), acute
- Bovine respiratory syncytial virus (BRSV), 924  
 antigen subtypes, 1344  
 chronic enzootic pneumonia of sheep, 1362  
 clinical findings, 924  
 enzootic pneumonia of calves, 1336, 1337, 1339  
 clinical findings, 1340  
 necropsy findings, 1341  
 pathogenesis, 1340  
 epidemiology, 924  
 interstitial pneumonia, 1346, 2000  
 pneumonia, mature dairy cattle, 1347  
 pneumonia, older calves, 1343–1349  
 case fatality rate, 1344  
 clinical findings, 1346  
 clinical pathology, 1346–1347  
 control, 1348  
 differential diagnosis, 1347  
 epidemiology, 1343–1345  
 etiology, 1343  
 experimental reproduction, 1346, 1347  
 immune mechanisms, 1344–1345  
 immunization, 1348  
 malignant form, 1345  
 morbidity, 1344  
 necropsy findings, 1347  
 occurrence, 1343–1344  
 pathogenesis, 1345–1346  
 persistent infection, 1343  
 prevalence, 1343–1344  
 risk factors, 1344  
 transmission, 1344  
 treatment, 1348  
 vaccines, 1348  
 virus isolation, 1347  
 treatment response, 924  
 undifferentiated bovine respiratory disease, acute, 926, 928–929  
 vaccination, 934, 1343, 1345, 1348
- Bovine rotavirus  
 neonatal diarrhea, 1287–1289  
 case fatality rates, 1288  
 concurrent infections, 1287  
 experimental infection, 1288  
 immune mechanisms, 1288–1289  
 morbidity, 1288  
 occurrence, 1287  
 prevalence, 1287  
 risk factors, 1288  
 subclinical infections, 1287  
 transmission, 1288  
 serotypes, 1287  
 specificity determination, 1288
- Bovine rotavirus-coronavirus vaccines, 1295
- Bovine-serum-based colostrum supplement, 155–156
- Bovine spinal dysmyelination, 1952
- Bovine spongiform encephalopathy (BSE), 1446–1452  
 active surveillance, 1451  
 age incidence, 1448  
 brain dysfunction, 1806  
 clinical findings, 1450–1451, 1634  
 clinical pathology, 1451, 1634  
 control, 1451–1452  
 differential diagnosis, 1451  
 economic importance, 1449–1450  
 epidemiology, 1446–1450, 1634  
 etiology, 1446–1447  
 experimental reproduction, 1449, 1453  
 histology, 1451  
 human health protection measures, 1452  
 model age at onset, 1448  
 necropsy findings, 1451  
 occurrence, 1446–1448  
 OIE risk categories, 1447, 1449  
 passive surveillance, 1451  
 pathogenesis, 1450  
 pigs, 1449  
 samples for diagnostic confirmation, 1451  
 scrapie differentiation, 1453  
 sheep, 1452–1454  
 clinical signs, 1453  
 control, 1454  
 diagnosis, 1453–1454  
 disease-associated PrP disposition, 1453  
 experimental transmission, 1449, 1453  
 pathogenesis, 1453  
 tissue infectivity, 1449  
 trade implications, 1449–1450  
 transmission, 1448–1449  
 zoonotic implications, 1450
- Bovine spongiform encephalopathy, goats, 1453
- Bovine sterile eosinophilic folliculitis, 663
- 'Bovine teat skin summer sore,' 751
- Bovine torovirus, 1289, 1291
- Bovine tuberculin, 1010
- Bovine ulcerative mammillitis, 749, 751, 1428–1430  
 clinical findings, 1429  
 clinical pathology, 1381, 1429  
 control, 1429–1430  
 differential diagnosis, 1427  
 economic importance, 1429  
 epidemiology, 1381, 1428–1429  
 etiology, 1428  
 lesions, 1381, 1429  
 morbidity rate, 1429  
 necropsy findings, 1429  
 occurrence, 1428–1429

- Bovine ulcerative mammillitis (*Cont'd*)  
 origin of infection, 1429  
 pathogenesis, 1429  
 risk factors, 1429  
 transmission, 1381, 1429  
 treatment, 1429
- Bovine viral leukosis, 519
- Bovine virus diarrhoea virus (BVDV), 1248–1277  
 abortion, 977  
 acute infection diagnosis, 1262  
 antigen detection, 1261  
 antigenic diversity, 1253, 1271  
 benign, 1249  
 biocontainment, 1264–1267, 1268–1269  
 border disease, 1415  
 bovine rotavirus co-infection, 1291  
 case-fatality rate, 1250–1251  
 clinical findings, 1259–1260, 1265  
 clinical pathology, 1260–1263, 1265  
 combination vaccines, 1270  
 congenital defects, 1249, 1258, 1260, 1263–1264  
 congenital defects in newborns, 133  
 congenital infection, 1250  
 control and prevention, 1264–1275  
 controlled exposure, 1273  
 cytopathic, 1249, 1253, 1258  
 diagnosis, 1264  
 differential diagnosis, 1264, 1265–1266, 1293  
 economic importance, 1254, 1257  
 embryonic period infection, 1257  
 enzootic pneumonia of calves, 1336  
 epidemiology, 1249–1254, 1265  
 eradication, 1273–1275  
 etiology, 1249  
 experimental infection, 1250, 1256  
 fetal infection, 1250, 1251, 1254, 1257–1258  
 125–127 days gestation, 1258  
 180 day gestation to term, 1258  
 embryonic-early fetal period, 1257–1258  
 prevalence, 1260  
 genotypes, 1249, 1253, 1271  
 goats, 1250  
 herd laboratory tests, 1262–1263  
 herd monitoring, 1267  
 herd screening, 1262–1263  
 herd testing objectives, 1267  
 hog cholera antigenic relationship, 1158  
 immune mechanisms, 1251–1252  
 immunization programs, 1268–1269, 1273  
 schedules, 1269, 1272  
 strategies, 1271–1272  
 vaccination breaks, 1270  
 isolation, 1260–1261  
 Johne's disease stressor, 1020  
 morbidity, 1250–1251  
 NADL-A strain, 1253  
 necropsy findings, 1263–1264  
 neonatal disease, 1260  
 neosporosis concurrent infection, 1510, 1511  
 non-cytopathic, 1249, 1253, 1258  
 occurrence, 1249  
 pathogenesis, 1254–1259  
 peracute, 1255, 1259, 1263  
 persistent infection, 1249–1250, 1251, 1252, 1257–1258  
 carriers, 1262  
 clearance of, 1267  
 diagnosis, 1262  
 elimination, 1267–1268, 1269  
 identification, 1267–1268, 1269  
 prenatal diagnosis, 1262  
 self-clearance of, 1267–1268  
 serology, 1261  
 unthrifty calves, 1259
- pigs, 1250  
 pre-breeding testing, 1288  
 prevalence, 1249  
 prognosis, 1264  
 reproductive failure, 1260  
 risk factors, 1251–1254, 1253  
 sheep, 1250, 1251  
 subclinical, 1255, 1259  
 transmission, 1251  
 treatment, 1264  
 type I (BVDV-1), 1249, 1253  
 type II (BVDV-2), 1249, 1250, 1253, 1254  
 undifferentiated bovine respiratory disease, 926  
 vaccination, 1252, 1272–1273  
 vaccines, 934, 1269–1273  
 adverse reactions, 1270  
 boosters, 1272
- commercially available, 1271  
 cross-reactivity, 1271  
 efficacy, 1270–1271  
 failures, 1273  
 fetal protection, 1270–1271  
 heifers, 1270–1271  
 immune response, 1270–1271  
 postnatal protection, 1271, 1272  
 potency, 1271  
 temperature-sensitive, 1270
- Bowenia* poisoning, 1885
- Bowie (bentleg), 632, 1770–1771
- Brachycladium spiciferum*, 1481
- Brachygnathia, 280, 1959
- Brachygnathia superior, 1959
- Brachyspira hyodysenteriae*  
 antimicrobial resistance, 1117–1118  
 fecal survival, 1115  
 strains, 1114  
 swine dysentery, 1113–1120  
 vaccine, 1119  
 virulence, 1114
- Brachyspira innocens*, 1114
- Brachyspira pilosicoli*, 1114, 1120–1123
- Bracken fern (*Pteridium aquilinum*)  
 papillomatosis-induction, 1422  
 poisoning, 1779, 1875–1876  
 thiamin deficiency, 2007
- Bracken fern rhizomes (*Pteridium esculentum*), 2007
- Bradspot, 832
- Bradycardia, 414–416  
 acute heart failure etiology, 404  
 bovine spongiform encephalopathy, 1450  
 definition, 14  
 sinus, 413–414  
 third-degree atrioventricular block, 415
- Bradyzoite(s), 1507, 1518
- Bradyzoite cysts (cystozoites), 1517, 1518
- Brahman cattle  
 congenital myasthenia gravis, 1963  
 generalized glycogenosis, 1963  
 tick infestations, 1602
- Brahman-cross cattle, tick infestations, 1602
- Brain  
 border disease, 1417  
 bovine spongiform encephalopathy, 1449, 1451  
 caprine arthritis encephalitis, 1412  
 ceroid lipofuscinosis, 1950  
 compression, vitamin A deficiency, 1771  
 diffuse disease, 575, 596–605  
 dysfunction, diseases associated with, 1806–1807  
 equine encephalomyelitis, 1370  
 focal disease, 606–609  
*Halicephalobus* infestation, 1575  
 polioencephalomalacia, 2011  
 pseudorabies infection, 1397  
 swelling, 597–599  
 clinical findings, 598  
 clinical pathology, 598  
 differential diagnosis, 598  
 etiology, 597  
 necropsy findings, 598  
 pathogenesis, 597–598  
 treatment, 598  
 traumatic injury, 604–605  
 clinical findings, 605, 1375  
 clinical pathology, 605  
 craniocerebral missile injury, 605  
 epidemiology, 1375  
 etiology, 604, 1375  
 necropsy findings, 605  
 pathogenesis, 604–605  
 treatment, 595–596, 605, 1375  
 Venezuelan equine encephalomyelitis, 1373
- Brain abscess, 606–607, 1375, 1807
- Brainstem auditory evoked potentials (BAEP), 594
- Brainstem auditory evoked response (BAER)  
 test, 586
- Branched chain ketoacid decarboxylase  
 deficiency (BCKAD; maple syrup urine  
 disease), 135, 1953
- 'Brand cancer,' 668
- Branhamella ovis*, 994, 1142
- Brassica  
 glucosinolate poisoning, 1867, 1867  
 iodine deficiency, 1722  
 S-methyl-L-cysteine-sulfoxide (SMCO)  
 poisoning, 1881–1882
- Brassica oleracea* (chou moellier), 2008
- Braunvieh–Brown Swiss calves, congenital  
 myopathy, 627
- Braxy, 832
- Brazil  
 brucellosis status, 964  
 equine babesiosis, 1484
- Brazilian free-tailed bat, rabies reservoir, 1387
- Breathing abnormalities, 474–475
- Breath sounds, 475–478  
 abnormal, 477–478  
 acute bovine pulmonary emphysema and  
 edema, 2002  
 acute broncho-interstitial pneumonia, foal,  
 2005  
 bovine herpesvirus-1 infection, 1353  
 bovine respiratory syncytial virus pneumonia,  
 1346  
 chronic enzootic pneumonia of sheep, 1362  
 chronic interstitial pneumonia, foal, 2006  
 definition, 476  
 enzootic pneumonia of calves, 1340  
 generation, 475–476  
 interpretation, 476–478, 477  
 interstitial pneumonia, 2002, 2005  
 loudness decrease, 476–477  
 loudness increase, 476, 477  
 rebreathing ('bagging') examination, 476
- Breda virus, 1289, 1291
- 'Breech strike,' 1591, 1592
- Breeder herds, *Salmonella* surveillance program,  
 918
- Breeding history, 6
- Breeding stock selection, degenerative joint  
 disease, 2029
- Breeze flies, 1603
- Bretylum, 2052
- Brewer's residues, poisoning, 1843
- Bright blindness, sheep, 1877
- Brisket disease, 422, 1788–1789
- British anti-Lewisite (BAL), 1811, 1815
- 'Broken mouth,' 207, 208
- Bromhexine hydrochloride, 2052, 2064
- Bromide poisoning, 1830
- Bromocriptine mesylate, 2052
- Bronchi, lungworm infestation, 1569
- Bronchial angiogenesis, 506
- Bronchial sounds, 476  
 see also Breath sounds
- Bronchiectasis, 1930, 1931
- Bronchiointerstitial pneumonia, 2000
- Bronchioles, lungworm, 1568
- Bronchiolitis, 1345, 1347
- Bronchiolitis obliterans, 1339–1340
- Bronchitis, 533–534, 1345, 1347
- Bronchoalveolar lavage, 485, 486–487  
 blind, 487  
 cattle, 488  
 complications, 486  
 contraindications, 486  
 dilution correction, 487  
 endoscopic, 487  
 exercise-induced pulmonary hemorrhage of  
 horses, 504  
 heaves, 1931  
 horses, 487, 488  
 indications for, 486  
 interstitial pneumonia, horses, 2005  
 pigs, 488  
 sheep, 487, 488  
 tracheal aspirate comparison, 485
- Bronchoconstriction  
 bovine respiratory syncytial virus pneumonia,  
 1345  
 heaves, 1930
- Bronchodilators  
 contraindications, 495  
 enzootic pneumonia of calves, 1342  
 heaves, 1933, 1933  
 indications, 495  
 pneumonia, 514  
 respiratory system disease, 495–496  
 smoke inhalation, 1793
- Bronchography, 482
- Broncho-interstitial pneumonia, foal, 2005
- Bronchomucotropic agents (expectorants), 496
- Bronchopleural fistulae, equine  
 pleuropneumonia, 527
- Bronchopneumonia, 512, 513, 771, 1354, 1355
- Bronopol poisoning, 1846
- Brown dog tick (*Rhipicephalus sanguineus*),  
 1180, 1456, 1485

- Brown ear tick (*Rhipicephalus appendiculatus*), 1245, 1527, 1528
- Brown snake (*Pseudonaja*), 1916, 1917
- Brown Swiss cattle  
smooth tongue, 1944  
Weaver syndrome, 1952
- Brown-tail moth, 1920
- Brucella*, 963–994  
evolution of, 964  
vaccines, 978–981, 987–988
- Brucella abortus*, 963  
antibody response to, 969  
brucellosis, 966–984  
see also Bang's disease  
cattle outbreaks, 966  
horse outbreaks, 966  
pigs outbreaks, 966  
sheep outbreaks, 966  
strain 19 vaccine, 978–980, 987–988, 994  
adult, 979  
calthood, 978–979  
efficacy, 978–979  
systemic reactions to, 979–980  
strain RB51 vaccine, 980  
vaccination technique, 981  
virulence, 968–969
- Brucella melitensis*, 963  
brucellosis see Brucellosis, *Brucella melitensis* associated  
vaccine, 988, 992, 993–994
- Brucella ovis*, 963  
brucellosis see Brucellosis, *Brucella ovis* associated  
vaccines, killed, 987–988
- Brucella suis*, 963  
abortion, 1095  
brucellosis see Brucellosis, *Brucella suis* associated  
vaccine, 988, 994
- Brucellosis, 963–994  
abortion, 975  
*Brucella abortus* associated, 966–984  
see also Bang's disease  
*Brucella melitensis* associated, 991–994  
clinical findings, 992  
clinical pathology, 992–993  
control, 993–994  
differential diagnosis, 993  
economic importance, 991  
epidemiology, 991–992  
eradication, 993–994  
etiology, 991  
infection source, 991  
necropsy findings, 993  
outbreaks, 991  
pathogenesis, 992  
risk factors, 991  
transmission, 991  
treatment, 993  
vaccination, 993–994  
zoonotic implications, 991–992
- Brucella ovis* associated, 984–988  
clinical findings, 985–986  
clinical pathology, 986  
control, 986–988  
differential diagnosis, 986, 987  
economic importance, 985  
epidemiology, 985  
eradication, 986–987  
etiology, 985  
experimental reproduction, 985  
infection source, 985  
necropsy findings, 986  
outbreaks, 985  
pathogenesis, 985  
risk factors, 985  
transmission, 985  
treatment, 986  
vaccination, 987–988  
zoonotic implications, 985
- Brucella suis* associated, 988–991  
biovars, 988–989  
clinical findings, 989  
clinical pathology, 990  
control, 990  
diagnosis, 990  
differential diagnosis, 990  
economic importance, 989  
epidemiology, 988–989  
etiology, 988  
infection source, 989  
necropsy findings, 990
- outbreaks, 988–989  
pathogenesis, 989  
risk factors, 989  
transmission, 989  
treatment, 990  
vaccination, 990  
zoonotic implications, 989
- control programs, 963  
global status, 964–965  
history of, 963  
outbreaks, 964–965  
skin test, 973  
vectors, 1607
- Brush-tail possum (*Trichosurus vulpecula*), tuberculosis, 1007
- Bryonia dioica* (white bryony) poisoning, 1888
- Bryonin, 1888
- Bubalus bubalis* (water buffalo) see Water buffalo (*Bubalus bubalis*)
- Bubbling, 478
- Bubo, 111
- Buccal cavity disease, 205–209  
see also specific diseases/disorders
- Buccal mucosa  
abnormalities, 18  
wounds, actinomycosis, 1045
- Bucks, obstructive urolithiasis, 568
- 'Buckskin'-colored follicular dysplasia, 1974
- Buckwheat (*Fagopyrum sagittatum*) poisoning, 1886
- Bufadienolides poisoning, 1862
- Buffalo  
bovine ephemeral fever, 1178  
bovine herpesviruses, 1349  
fasciolosis, 1579  
lead poisoning, 1800  
rinderpest, 1237  
sporadic bovine encephalomyelitis, 1407  
tropical theileriosis, 1530  
see also specific types
- Buffalo calves  
ascarid infections, 1557, 1558  
toxoplasmosis, 1520
- Buffalo flies, 1603–1604
- Buffalo gnats, 1605
- Buffalo herpesvirus-1, 1349
- Buffy coat method  
nagana, 1535  
surra, 1538
- Bulbocapnine poisoning, 1887
- Bulk milk tank, 736, 911
- Bulk tank milk  
bovine herpesvirus-1 infection, 1355  
culture, 683–684, 745  
*Acholeplasma laidlawii*, 706  
record keeping, 743  
*Staphylococcus aureus* mastitis, 700  
*Streptococcus agalactiae* mastitis, 704  
*Listeria monocytogenes* detection, 806, 807  
selenium levels, 1746  
somatic cell count, 683, 683  
monitoring, 744–745  
record keeping, 743
- Bull(s)  
abomasal ulcer, 370–371  
bovine ephemeral fever, 1178  
bovine herpesvirus-1 vaccination, 1359  
*Brucella abortus* transmission, 967–968  
femoral-tibial osteoarthritis, 639, 641  
laminitis, 2034–2035  
osteochondrosis, 640  
replacements, bovine herpesvirus-1 vaccination, 1358  
spondylosis, 614  
transportation stress, 108
- Bullae, foot-and-mouth disease, 1225
- Bulldog calves, 1958, 1959
- Bullers, 1982, 1983
- Buller steer syndrome, 1982–1983
- Bullnose (necrotic rhinitis), 1080
- Bullosus stomatitis, 206
- Bulnesia sarmientii* (Palo santo tree) seed pod poisoning, 1891
- Bulrush millet (*Pennisetum typhoides*), 1903
- Bunching of animals, horse/stable flies, 1603
- Bungaras (krait), 1916
- 'Bunny hopping' gait, stringhalt, 2019
- Bunostomosis, 1552–1553
- Bunostomum phlebotomum*, 1552
- Bunostomum trigonocephalum*, 1552
- Bunyaviridae, 1382–1383
- Bunyaviruses*, 1207, 1208
- Buparvaquone  
East Coast fever, 1529  
equine babesiosis, 1494  
tropical theileriosis, 1531
- Bupivacaine, 2033
- Buprenorphine hydrochloride, 2052
- Burdock seeds (*Arctium lappa*), corneal ulcers, 1895
- Bureau of Veterinary Drugs (Canada), 733
- Burkholderia*, 1081–1085
- Burkholderia mallei*, 1083–1085
- Burkholderia pseudomallei*, 1082–1083
- Burn injury, 1792–1793  
electrocution, 1789  
location, 1793  
teats, 751  
udder, 751
- Bursattee, 1434, 1480–1481, 1571–1572
- Bursitis, 623, 788
- Buscopan, 2052
- Buserelin, 2052
- Bushbuck (*Tragelaphus scriptus*), 1470
- Bush clearing, tsetse fly control, 1536
- Bushfire (grassfire) injury, 1792–1793
- Bush flies (*Musca vetustissima*), 1606
- Bush foot see Foot rot, pigs
- Bushmaster (*Lachesis muta*), 1916
- Bush pig (*Potamochoerus porcus*), African swine fever transmission, 1168
- Buss disease, 1407–1408
- Butorphanol, 225, 1968
- Butorphanol tartrate, 2052
- Buttercup (*Ranunculus*) poisoning, 1890
- Button ulcers, African swine fever, 1171
- Button weed (*Ixiolaena brevicompta*) poisoning, 1885
- Butyrate, silage containing, 1662
- BVD Decision/Management Guidelines for Beef Cattle Veterinarians, 1267, 1275
- Byssochlamys nivea* poisoning, 1906
- Bystander cells, transmissible gastroenteritis, 1282

## C

- Cache valley virus disease, 1207–1209, 1382  
clinical findings, 1208  
clinical pathology, 1208–1209  
congenital defects in newborns, 133  
control, 1209  
differential diagnosis, 1209  
epidemiology, 1207–1208  
experimental reproduction, 1208  
infection sources, 1207  
necropsy findings, 1209  
occurrence, 1207  
outbreaks, 1208  
pathogenesis, 1208  
risk factors, 1208  
sheep, 1207  
treatment, 1209  
vectors, 1207
- Caddis flies (*Dicosmoecus gilvipes*), equine neorickettsiosis, 1466
- Cadmium  
environmental pollution, 1800  
poisoning, 1829
- Caesin, 2053
- Caffeine, 1967, 2014
- Calcification, arterial thromboembolism, 434
- Calcined magnesite, 1658
- Calcinogenic glycoside poisoning, 1861–1862
- Calcinosis, 634
- Calcium  
absorption, 1755–1756  
deficiency, 1755, 1756–1758  
clinical findings, 1756–1757  
clinical pathology, 1757  
control, 1757–1758, 1758  
diagnosis, 1757  
differential diagnosis, 1757  
epidemiology, 1756  
etiology, 1756  
necropsy findings, 1757  
osteodystrophy, 632  
outbreaks, 1755, 1756  
pathogenesis, 1756  
primary, 1756, 1757  
secondary, 1756, 1757  
treatment, 1757



- Calcium (Cont'd)
- dietary, 1757
  - daily requirements, 1758
  - milk fever prevention, 1638–1639
  - milk fever risk factor, 1629
  - uroolithiasis, 570
  - zinc deficiency and, 1732
  - fractional clearance, 552
  - homeostasis, milk fever risk factors, 1628–1629
  - intravenous administration, 81
  - ionized, milk fever, 1632–1633
  - loss of see Hypocalcemia
  - metabolism, 1755–1756
  - oral administration, 81
  - osteodystrophy, 634–635
  - serum
    - metabolic profile testing, herds, 1622
    - milk fever, 1632
    - osteodystrophy, 634
    - vitamin D deficiency and, 1765
  - subcutaneous administration, 81
  - supplementation, 80–81, 1642, 1657
- Calcium borogluconate
- bovine ephemeral fever, 1179
  - hypocalcemia, 80–81
  - hypomagnesemic tetany, 1657
  - intravenous, 1636
  - lactation tetany, mares, 1652
  - milk fever, 1636–1637
  - oral, 1637
  - oxalate poisoning treatment, 1860
  - properties, 95
  - subcutaneous, 1636–1637
  - toxicity, 1637
- Calcium carbonate
- crystalluria, 546
  - iron deficiency from, 1727
  - oxalate-induced equine nutritional secondary hyperparathyroidism, 1860
- Calcium chloride, 1640
- Calcium EDTA, 1646, 2052, 2055
- Calcium gel, 1642
- Calcium gluconate
- dosage/interval, 2052, 2064
  - equine hyperkalemic periodic paralysis, 1966
  - hypocalcemia, 80–81
  - properties, 95
- Calcium pantothenate, 1780
- Calcium:phosphorus ratio
- imbalance, 1755
  - milk fever prevention, 1639
  - optimum, 1757
  - vitamin D deficiency and, 1765
- Calcium salts, 1860
- Calcium versenate, lead poisoning, 1805
- Calculi
- clinical findings, 561
  - cystic, 570, 571
  - dissolution of, 569
  - prevention, cattle, 570
  - ruminants, 565
  - size, 567
  - urethra obstruction, 567–568
  - see also Urolithiasis
- Calf Antibiotic and Sulfa Test (CAST), 185
- Calf barns, enzootic pneumonia, 1338, 1342
- Calf enterotoxemia, 838, 839
- Calf hutchies (igloos), enzootic pneumonia, 1338, 1342
- Caliciviruses, vesicular exanthema of swine, 1236
- Calicivirus-like (Newbury) agent, 1291
- California Mastitis Test, 685–687, 686
- coliform mastitis, 714
  - Corynebacterium bovis* mastitis, 708
  - sheep, 760
  - Staphylococcus aureus* mastitis, 700
- Callitroga (Cochliomyia) macellaria*, 1594
- Caltha palustris* poisoning, 1890
- Calves
- abdomen examination, 308
  - abdominal distension, 308, 309
  - abdominocentesis, 203
  - abomasal bloat (distension), 374
  - abomasal volvulus, 362
  - acute bovine pulmonary emphysema and edema, 2001
  - Akabane disease, 1207, 1208
  - alimentary tract examination, 308
  - alloimmune hemolytic anemia of the newborn, 1922
  - anaplasmosis, 1456
  - aorto-iliac thrombosis, 435
  - arthritis, infectious, 642–643
  - ascarid infections, 1557
  - birth, assisted traction, 633
  - bluetongue experimental infection, 1302
  - bovine ephemeral fever, 1178
  - bovine hereditary dilated cardiomyopathy, 1945
  - bovine herpesvirus-1 infection, 1350, 1352, 1354, 1355
  - bovine immunodeficiency-like virus, 1222
  - bovine lungworm, 1567
  - bovine spinal dysmyelination, 1952
  - carbohydrate engorgement, 316
  - cerebellar abiotrophy, 1951
  - cerebellar hypoplasia, 1955
  - ceroid lipofuscinosis, 1950
  - chlamydial polyarthritis, 1435
  - cholangiohepatitis, 396
  - citrullinemia, inherited, 1953
  - coccidiosis, 1498–1499, 1501, 1502, 1503–1504
  - treatment, 1505, 1505
  - cold injury, 1793
  - colibacillosis, 851–852
  - clinical findings, 858–860
  - Escherichia coli* risk factors, 855–856
  - health and welfare, 870
  - infection source, 854–855
  - colostral immunoglobulin intake
  - recommendations, 853–854
  - congenital defects, 135
  - congenital ichthyosis, 1976
  - congenital spinal stenosis, 616
  - critical temperature, 142
  - cryptosporidiosis, 1512, 1514
  - dehydration, 75, 99
  - dermatophilosis, 1050
  - diarrhea, 99
  - acute undifferentiated risk factors, 849
  - antimicrobial treatment recommendations, 867–869
  - bacteremia in, 866
  - dietary, 277
  - intestinal flora changes, 866
  - neonatal, 1255
  - diarrhea, viral
  - clinical findings, 1291–1292
  - differential diagnosis, 1293
  - epidemiology, 1287–1289
  - experimental reproduction, 1297–1298
  - pathogenesis, 1291
  - systemic colostral antibody, 1296
  - vaccination, 1294–1295
  - diphtheria, 925
  - dystocia-related vertebral fractures, 614
  - enteropathogens, age occurrence, 849, 849
  - enterotoxemia, *Clostridium perfringens* type D associated, 841, 842, 843
  - enzootic bovine leukosis prevention, 1220–1221
  - epidermolysis bullosa, 1975
  - Escherichia coli* vaccination, 874–875
  - femoral nerve paralysis, 618
  - foot-and-mouth disease vaccination, 1228
  - fractional clearance of electrolytes, 552
  - functional systolic ejection murmurs, 425
  - glomerulonephritis, 556
  - glycogen storage disease type V, 1963
  - hand-fed, abomasal ulcer, 371
  - heart rates, fetal, 409
  - hemochosis, 1550
  - hyena disease, 2023
  - hypoglycemia, 1681
  - hypothermia, 40–41, 142
  - prevention, 46
  - risk factors, 43
  - treatment, 46
  - indigestion from milk replacers, 314
  - inherited ataxia, 1955
  - inherited deficiency of lymphocyte maturation, 1941
  - intravenous catheterization, 864
  - John's disease, 1021, 1032, 1035
  - laminitis, 2034, 2035
  - left-side displacement of abomasum (LDA), 355, 359
  - malnutrition, 114
  - $\alpha$ -mannosidosis, 1949
  - meningitis, 610
  - neonatal infection, 146, 147
  - oesophagostomosis, 1554
  - oral fluid therapy, 99–100
  - osteogenesis imperfecta, 1958
  - otitis media/interna, 607
  - parturition, premature induction, 144
  - passive immunity decline, 153
  - peritoneal fluid in, 203
  - portosystemic shunts, 394
  - prolonged gestation with fetal giantism, 1978
  - protein-energy malnutrition, 1697
  - pseudorabies, 1398
  - radiation injury, 1787
  - radiography, 482
  - rat tail syndrome, 1974
  - ricketts, 1767
  - rinderpest control, 1241
  - salmonellosis, 908, 914
  - screwworm, 1595
  - septicemia, 51
  - serum hepatic enzyme profiles, 390
  - slipped capital femoral epiphysis, 2036
  - sporadic bovine leukosis, 1216
  - streptococcal infection, 775–776, 776
  - sweating sickness, 1989
  - temperature, lower critical, 41
  - terminal colon atresia, 280–281
  - toxoplasmosis, 1521
  - transportation stress, 108
  - unthriftiness see 'Pine' (unthrifty)
  - vertebral osteomyelitis, 616
  - see also Beef calves; Dairy calves; Veal calves
- Calving
- area, enzootic pneumonia of calves, 1338
  - blind pocket size, abomasum displacement, 354
  - blood test timing, 1622
  - colibacillosis exposure reduction, 870
  - dairy cow management, 1615
  - environmental management, 46
  - hypomagnesemic tetany prevention, 1659
  - infectious disease control and prevention, 157
- Calving paralysis, 618
- Cambendazole, 2052
- poisoning, 1832
- Camels
- peste des petits ruminants, 1242
  - rinderpest, 1238
  - sarcoptic mange, 1609
  - surra, 1537
- CAMP test
- Streptococcus agalactiae* mastitis, 704
  - see also Latex agglutination test (LAT)
- Campylobacter coli* (*Vibrio coli*), 1085, 1086–1087
- Campylobacter faecalis*, 1066
- Campylobacter fetus*, 987
- Campylobacter fetus* subsp. *fecalis*, 1087
- Campylobacter fetus* subsp. *fetus*, 1085, 1086
- Campylobacter fetus* subsp. *intestinalis*, 1087
- Campylobacter fetus* var. *venerealis*, 1085
- Campylobacter hyointestinalis*, 1085
- Campylobacter* infection, 1085–1094
- antimicrobial resistance, 1086
  - antimicrobial sensitivity, 176
  - clinical findings, 1087
  - clinical pathology, 1087
  - control, 1087
  - epidemiology, 1085–1086
  - etiology, 1085
  - necropsy findings, 1087
  - pathogenesis, 1086–1087
  - prevalence, 1085–1086
  - risk factors, 1086
  - zoonotic implications, 1086
- Campylobacter jejuni*, 1085
- abortion, 987, 1085–1086
  - mastitis, 726
  - pathogenesis, 1086–1087
  - virulence, 1086
  - water supply contamination, 881
- Campylobacter lari*, 1085
- Canabis sativa* (marijuana) poisoning, 1885
- Canada
- beef cattle industry, 883
  - bluetongue, 1300
  - bovine herpesvirus-1 infection, 1349
  - bovine spongiform encephalopathy occurrence, 1448
  - bovine virus diarrhoea virus infection, 1250, 1254
  - brucellosis, 965, 983–984

- Canada (*Cont'd*)  
 chronic wasting disease, 1454  
 copper deficiency, 1708  
 downer cow disposition, 1649  
 enzootic bovine leukosis eradication program, 1219, 1220  
 ovine progressive pneumonia, 1363  
 rabies, 1385, 1387, 1392  
 Canada Health Accredited Herd program, 1220  
 Canadian Cattlemen's Association (CCA), 883-884  
*The Quality Starts Here* program, 883  
 Canadian Food Inspection Agency (CFIA)  
 Food Safety Enhancement Program, 883  
 non-ambulatory livestock transport, 1649-1650  
 Canadian horse pox, 800  
 Canadian on-Farm Food Safety (COFFS) Program, 883  
 Canadian Veterinary Medical Association  
 downer cow disposition, 1649  
 recombinant bovine somatotropin, 1617  
*Canavalia* poisoning, 1884  
 Canavanine poisoning, 1884  
 Cancer eye, 668, 2039-2040  
 Cancer of the horn core, 668  
*Candida*, 1471  
 mastitis, 727-728  
*Candida glabrata*, 1471  
*Candida krusei*, 1472  
*Candida parapsilosis*, 1471  
 Candidate genes, 1939  
 Candidiasis, 1471-1474  
 clinical findings, 1472-1473  
 clinical pathology, 1473  
 epidemiology, 1471-1472  
 etiology, 1471  
 necropsy findings, 1473  
 pathogenesis, 1472  
 treatment, 1473  
 Cannabinoid poisoning, 1885  
 Cannibalism, 113, 612-613  
 Cantharidiasis, 1918  
 Cantharidin poisoning, 1918  
 Capacity, conversion table, 2046  
 Capillary agglutination test (CAT), 1457, 1535  
 Capillary integrity, exercise-induced pulmonary hemorrhage, 506  
 Capillary permeability, edema, 72  
 Capillary refill time, equine colic, 223, 224, 230  
*Capreolus capreolus* (roe deer), louping-ill, 1408  
 Caprine adenocarcinoma virus, 1368  
 Caprine arthritis encephalitis (CAE), 1410-1413  
 clinical findings, 1411-1412  
 clinical pathology, 1412  
 control, 1412-1413  
 differential diagnosis, 1412  
 economic importance, 1411  
 epidemiology, 1410-1411  
 etiology, 1410  
 necropsy findings, 1412  
 pathogenesis, 1411  
 perinatal transmission, 1411, 1412-1413  
 persistent infection, 1411  
 risk factors, 1410-1411  
 transmission, 1411  
 Caprine arthritis encephalitis (CAE) viruses, 1410  
 Caprine besnoitiosis, 1517, 1518  
 Caprine contagious ophthalmia, 1142-1143  
 Caprine hepatic lipidosis, cobalt deficiency, 1702, 1703  
 Caprine herpesvirus-1 (CpHV-1) infection, 987, 1329-1330, 1349, 1362  
 Caprine herpesvirus-2 (CpHV-2), 1245  
 Caprine idiopathic dermatitis, 657  
 Caprine infectious keratoconjunctivitis, 1142-1143  
 Caprine mastitis, 761-762, 1411  
 Caprine pleuropneumonia, contagious, 1123, 1140-1141  
 Caprine progressive spasticity, 1951  
 Capripox infections, 1430-1431  
 Capripoxvirus, 1425, 1430  
 vaccine, 1241  
 Capsaicin, 106  
 Capsulitis, 638-639  
 Cara inchada, 788  
 Carapace, 1794  
 Carazolol, 1973  
 Carbachol, 1866  
 Carbadox  
 dosage/interval, 2064  
 poisoning, 1845-1846  
 swine dysentery, 1118  
 Carbamate poisoning see Organophosphate(s), poisoning  
 Carbamazepine, 2023  
 Carbamylcholine chloride, 313  
 Carbazochrome, 442  
 Carbendazim, 1909  
 Carbenicillin sodium, 2052  
 Carbicarb, 94  
 Carbohydrate(s)  
 loss of, excessive, 116  
 metabolism, endotoxemia and, 56  
 Carbohydrate engorgement of ruminants, 298, 314-325  
 accidental consumption, 315  
 beef breeding herds, 316  
 case fatality rates, 316  
 characteristics, 1634  
 clinical findings, 318-319, 320, 1266, 1633  
 clinical pathology, 319-321, 1266, 1633  
 complications, 319  
 control, 323-325  
 dairy cattle herds, 315-316  
 differential diagnosis, 321  
 epidemiology, 315-316, 1266, 1633  
 etiology, 314-315  
 feedlot cattle, 316  
 feed types, 316  
 lamb feedlots, 316  
 liquid-fed calves, 316  
 morbidity, 316  
 necropsy findings, 321  
 pathogenesis, 316-318  
 prevention, 323-325  
 severity, 318-319  
 speed of onset, 318-319  
 toxic feed amounts, 316  
 treatment, 320, 322-323, 1266, 1633  
 $\beta$ -carboline indoleamine alkaloid poisoning, 1868-1869  
 Carbon dioxide, manure release, 1848-1849  
 Carbon tetrachloride poisoning, 1830-1831  
 Carboxyatractyloside poisoning, 1886  
 Carboxyhemoglobinemia, 460  
 Carboxyparquin poisoning, 1886  
 Carcass(es)  
 condemnation for human consumption, caseous lymphadenitis, 796  
 contamination, 886, 899  
 disposal  
 anthrax, 818  
 blackleg, 830  
 botulism, 827  
 salmonellosis, 916  
 hemorrhage, coagulation defect, 444  
 Carcinogenic ptaquiloside poisoning, 1876  
 Card agglutination test (CAAT), 1538  
 Cardenolides poisoning, 1862  
 Cardiac area examination, 14-15  
 Cardiac catheterization, 411-412, 412  
 Cardiac congenital defects, 431-433  
 Cardiac dilatation (eccentric hypertrophy), 401  
 Cardiac function, acidemia effect, 85  
 Cardiac glycosides  
 heart failure, chronic (congestive), 403-404  
 poisoning, 1862-1863  
 Cardiac hypertrophy (concentric hypertrophy), 401  
 Cardiac index, 410  
 Cardiac insufficiency, 400, 407  
 Cardiac neoplasia, 433  
 Cardiac output  
 anemic hypoxia and, 453  
 exercise, 117  
 measurement, 410  
 Cardiac reserve  
 autonomic nervous system and, 400  
 cardiac insufficiency and, 400  
 heart failure, chronic (congestive), 402  
 heart rate and, 400  
 measurement, 401  
 mixed venous oxygen tension and, 400  
 stroke volume and, 400  
 valvular disease, 424  
 Cardiac tamponade, 422  
 Cardiac troponin I, 403, 409, 421  
 Cardiomyopathy, 420-422  
 bovine hereditary dilated, 1944-1945  
 clinical findings, 421  
 clinical pathology, 421  
 congenital, 421  
 differential diagnosis, 422  
 etiology, 420-421  
 inherited, 1944-1945  
 necropsy findings, 421-422  
 pathogenesis, 421  
 plant-induced, 1896  
 treatment, 422  
 Cardiopulmonary function, endotoxemia and, 55  
 Cardiotoxic venoms, 1916, 1916  
 Cardiovascular accidents, acute, 422  
 Cardiovascular disease, 399-437  
 blood vessel disease, 433-437  
 dyspnea/exercise intolerance from, 475  
 heart disease, 420-429  
 heart failure see Heart failure  
 manifestations, 401  
 pericardium disease, 429-433  
 principles of, 399-401  
 cardiac reserve see Cardiac reserve  
 cardiovascular enlargement, 401  
 circuit failure, 399  
 see also specific diseases/disorders  
 Cardiovascular enlargement, 401  
 Cardiovascular system  
 examination, 405-412  
 angiocardigraphic examination, 412  
 arterial blood pressure measurement, 410  
 arterial pulse see Pulse  
 cardiac catheterization, 411-412, 412  
 cardiac output, 410  
 echocardiography, 411  
 electrocardiography (ECG) see Electrocardiography (ECG)  
 exercise tolerance, 407  
 heart rate, 406  
 heart sounds see Heart sounds  
 jugular vein, 406-407  
 phonocardiography, 409-410  
 physical, 405-407  
 radiographic examination, 412  
 serum cardiac troponin I concentration, 409  
 exercise intolerance etiology, 119  
 Cardioviruses, 1183  
 Caribbean  
 bluetongue virus serotypes, 1301  
 rabies, 1385  
 Caribou  
 babesiosis, 1489  
*Hypoderma* infestations, 1588  
 Carlin-M Ivanhoe Bell, 1960-1961  
 Carolina chickadee, 1369  
 Carotene, plasma, 1775  
 Carotid artery aneurysm rupture, 124  
 Carpal joints, arthritis, 1364-1365, 1411  
 Carprofen, 106, 2053  
 'Carrier sow syndrome,' 1159  
 Carrion-associated botulism, 825  
 Cartilage  
 necrosis, degenerative joint disease, 2027  
 osteochondrosis, 640-641  
 Cascado, 1574  
 Castanospermine poisoning, 1871  
*Castanospermum australe* (Moreton Bay chestnut) poisoning, 1871  
 Casts, urine, 545  
 Cat(s)  
 control, toxoplasmosis, 1522  
 cowpox, 1427  
 equine hendra virus infection, 1329  
 equine protozoal myeloencephalitis  
 transmission, 1523  
 feces, toxoplasmosis transmission, 1519  
 pseudorabies, 1398  
 rabies vector, 1387  
 sarcocystosis, 1508  
 Cataract, bilateral, 1977  
 Catarrhal gastritis, 1572  
 Catarrhal stomatitis, 206  
 Catecholamines, 421  
 Cat-free areas, toxoplasmosis, 1519  
 Cationic salt, dietary, 1639  
 Catsear (*Hypochoeris radicata*) ingestion, 2019  
 Cattle  
 abdominal ultrasonography, 196-197  
 alimentary tract examination, 301-311  
 alpine pasture deaths, 1914  
 beef see Beef cattle  
 blood ammonia levels, 390  
 blood pressure measurement, 410  
 bronchoalveolar lavage, 488

- Cattle (*Cont'd*)  
 dairy see Dairy cattle  
 digits, skin disease, 664  
 drug doses/intervals, 2051–2063  
 endoscopic airway examination, 481–482  
 energy requirements, 94–95, 95  
 heart rate, resting, 413, 414  
 injection site lesions, 631  
 liver function tests, 388, 390  
 liver ultrasonography, 387–388  
 musculoskeletal examination, ultrasonography, 625–626  
 oral fluid therapy, 99–100  
 oxygen therapy, 494  
 periparturient period, 1613  
 peritoneal fluid properties, 199  
 phosphorus requirements, 1761  
 reference laboratory values, 2047–2050  
 rumen, nasogastric intubation, 195–196  
 serum bile acids, 390  
 serum hepatic enzyme profiles, 389–390  
 transportation stress, 108  
 water medication, 180  
 wet conditions, 1793
- Cattle egrets, heartwater vector, 1462
- Cattle Health Certification Standards (Checs), 1275
- CattleMap, 1037
- Cattlemen's Beef Board, carcass decontamination, 887
- Cattle plague see Rinderpest
- Cattle tick fever see Babesiosis
- Cauda equina syndrome see Polyneuritis equi
- Caudal vena caval syndrome, hepatic abscess association, 395
- Caudal vena caval thrombosis, 436, 516–517
- Cauliflower saltwort (*Salsola tuberculatiformis*), 1896
- Caustic bush (*Sarcostemma viminale*) poisoning, 1886
- Caustic-treated grain poisoning, 1843
- Caustic vine (*Sarcostemma brevipedicellatum*) poisoning, 1886
- Cecal catheters, fluid administration, 99
- Cecal dilatation, cattle, 300, 375–376
- Cecal distension, 221, 247
- Cecal impaction, 246–247, 248
- Cecal rupture, 247
- Cecal torsion, 247, 300
- Cecal tympany, 247
- Cecal volvulus, cattle, 375–376
- Cecocolic intussusception, 247
- Cecocolic intussusception, 247, 377
- Cecum, diseases of, 246–248  
 clinical findings, 247  
 clinical pathology, 247  
 epidemiology, 246–247  
 etiology, 246  
 necropsy findings, 247  
 pathogenesis, 247  
 treatment, 247–248
- Cedist blocking enzyme-linked immunosorbent assay (ELISA), 1262
- Cefamandole, 2053
- Cefazolin sodium, 2053
- Cefoperazone sodium, 2053
- Cefopodoxime prolextil, 2053
- Cefotaxime sodium, 2053
- Cefquinome, 716
- Ceftiofur  
 arthritis, 646  
 coliform mastitis, 716  
 enzootic pneumonia of calves, 1341  
 equine influenza, 1326  
*Escherichia coli* bacteremia, 868–869  
 pleuropneumonia of pigs, 1057  
 pneumonic pasteurellosis, 941
- Ceftiofur crystalline free acid, 2053
- Ceftiofur hydrochloride, 2053, 2064
- Ceftiofur sodium, 2053, 2064
- Ceftriaxone sodium, 2053
- Cefuroxime, 2053
- Celadine poppy (*Chelidonium majus*) poisoning, 1887
- Celiotomy (exploratory laparotomy), 197, 269, 309–310, 317
- Cell culture isolation  
 equine herpesvirus-1, 1314–1315  
 equine herpesvirus 4, 1311  
 Venezuelan equine encephalomyelitis, 1374
- Cell-mediated cytotoxic T-cell (CTL) responses, East Coast fever, 1528
- Cell-mediated hypersensitivity reaction, 69
- Cellular immunity  
 coccidiosis, 1501  
 hog cholera, 1160
- Cellulitis, 623  
 definition, 111  
 osteomyelitis, 636  
 traumatic, 110
- Centaurea*, sesquiterpene lactone poisoning, 1892
- Centaurea repens* (Russian knapweed) poisoning, 1892
- Centaurea solstitialis* (yellow star thistle) poisoning, 1376, 1892
- Centers for Disease Control and Prevention (CDC)  
 enterohemorrhagic *Escherichia coli* infection, 881  
 human rabies prevention advice, 1391  
*Salmonella*, 896
- Central America  
 bluetongue virus serotypes, 1301  
 brucellosis status, 965
- Central blindness, 582–583
- Central hypersensitivity, pain, 104
- Central nervous system (CNS)  
 cells of, 600  
 congenital defects, 619–620  
 degenerative disease, 602–604  
 see also Encephalomalacia  
 depressants, 596  
 equine encephalomyelitis, 1369–1370  
 equine grass sickness, 1991  
 equine herpesvirus 1 infection, 1313, 1315  
 equine protozoal myeloencephalitis, 1524–1525  
 infectious agent entry routes, 606  
 inflammation, 600  
 injury response, 596  
 masses associated with, 609  
 ovine progressive pneumonia, 1364  
 porcine viral encephalomyelitis, 1405  
 rabies infection, 1388–1389  
 stimulants, 596  
 stranglers, metastatic infection, 771  
 tumors, 608–609  
 viral infection, horses, 1375–1377
- Central pulmonary arterial pressure, altitude and, 1788
- Central venous pressure (CVP), 66, 91
- Centrifugation/flotation, tapeworm infestations, 1582
- Cephacetrile sodium, 2053
- Cephalexin, 2053
- Cephalosporins, 611
- Cephalosporium*, trichothecene poisoning, 1911
- Cephalothin sodium, 2053
- Cephapirin, 646
- Cephapirin benzathine, 2053
- Cephapirin sodium, 2053
- Cephenemyia titillator*, 1586
- Cereal crops/pastures  
 hypomagnesemic tetany risk factor, 1655  
 nitrate poisoning, 1856
- Cerebellar abiotrophy, 1951
- Cerebellar ataxia, 577, 587, 620
- Cerebellar atrophy of lambs (daft lamb disease 1), 1955
- Cerebellar disease  
 ataxia, 580  
 inherited congenital defects, 1955
- Cerebellar hypoplasia, 580  
 Arabian foals, 1377  
 bovine virus diarrhoea virus, 1258, 1260  
 congenital, 1955  
 Swedish Gotland foals, 1377
- Cerebral babesiosis, 1489
- Cerebral cortex lesions, blindness, 583
- Cerebral edema, 597–599  
 clinical findings, 598  
 clinical pathology, 598  
 cytotoxic, 597, 598  
 differential diagnosis, 598  
 etiology, 597  
 interstitial, 597  
 laminar necrosis and, 2010  
 necropsy findings, 598  
 pathogenesis, 597–598  
 polioencephalomalacia, 2011  
 treatment, 598  
 vasogenic, 597–598
- Cerebral hypoxia, 596–597
- Cerebral nematodiasis, 601
- Cerebral perfusion pressure, 594
- Cerebral shock, traumatic brain injury, 605
- Cerebral theileriosis (turning sickness), 1526, 1527, 1529
- Cerebrocortical necrosis, 603  
 see also Polioencephalomalacia (PEM)
- Cerebrospinal angiopathy, 895–896
- Cerebrospinal elaphostrongylosis (CSE), 1575
- Cerebrospinal fluid (CSF), 591–593  
 analysis, 592–593  
 albumin quotient, 593  
 blood contamination, 593  
 brain abscess, 606  
 creatine kinase, 593  
 encephalitis, 602  
 glucose concentration, 593  
 IgG index, 593  
 lactate dehydrogenase, 593  
 meningitis, 611  
 protein concentration, 592  
 white blood cell count, 592
- bovine spongiform encephalopathy, 1451  
 circulation, 591, 600  
 collection, 575, 591–592  
 atlanto-occipital cistern (cisterna magna), 592  
 lumbosacral cistern, 591, 591–592  
 congenital hydrocephalus, 1954  
 drainage obstruction, 1954  
 equine cervical vertebral stenotic myelopathy, 2017  
 equine herpesvirus 1, 1314  
 equine neonatal encephalopathy, 2014  
 equine protozoal myeloencephalitis, 1524  
 formation, 591  
*Listeria monocytogenes* infection, 809  
 magnesium concentrations, hypomagnesemic tetany, 1656  
 newborns, 166  
 pH, hypercapnia, 473  
 pressure  
 determination, 592  
 polioencephalomalacia, 2011  
 vitamin A deficiency, 1773, 1775  
 West Nile encephalitis, 1379
- Cerebrospinal nematodiasis, 1375
- Ceroid lipofuscinosis, 1950–1951
- Ceruloplasmin, 1711, 1717
- Cervical abscesses, pigs, 782–783
- Cervical adenitis, lymphadenopathy, 464
- Cervical esophagostomy alimentation, 215
- Cervical examination, equine colic, 229–230
- Cervical spinal cord compression, horses see Equine cervical vertebral stenotic myelopathy
- Cervical vertebrae  
 fracture, horses, 614  
 malformations, 2016  
 osteomyelitis, 636  
 surgical fusion, 2018
- Cervical vertebral instability (CVI), 2016–2017  
 see also Equine cervical vertebral stenotic myelopathy
- Cervicothoracic vertebral osteomyelitis, 636
- Cervico-vaginal mucus analysis, leptospirosis, 1104
- Cervids, chronic wasting disease, 1454
- Cervine herpesvirus-1 (CvHC-1), 1349
- Cervine herpesvirus-2 (CvHC-2), 1349
- Cervus elaphus* (red deer), louping-ill, 1408
- Cervus elaphus nelsoni* (Rocky Mountain elk), chronic wasting disease, 1454
- Cesarean section, pregnancy toxemia, 1670
- Cesium-134, 1786
- Cesium-137, 1786
- Cestode associated diseases, 1576–1583
- Cestrum*, diterpenoid glycoside poisoning, 1886
- C-fibers, 103
- Chabertia ovina*, 1563
- Chabertiosis, 1563
- Challenge feeding, fatty liver risk factor, 1673
- Chance nodes, 29–30
- Chancre, sleeping sickness, 1534
- Channel Island cattle, Johne's disease, 1020
- Chapping, teats, 750
- Charcoal, activated  
 cardiac glycoside poisoning, 1863  
 cyanobacterial toxins, 1914  
 dosage/interval, 2053  
 poison absorption, 1798
- Charm Farm and Disk Assays, 185

- Charm Inhibition Assay, 185
- Charolais cattle  
 cleft palate, 1944  
 familial convulsions and ataxia, 1955  
 glycogen storage disease type V, 1964  
 miniature, 1959  
 progressive ataxia, inherited, 1952  
 typical colobomata, 1977
- Chediak-Higashi syndrome, 466, 1942  
 amyloidosis, 467  
 mutation, 1942  
 thrombasthenia, 446
- Cheilanthes sieberi* (rock fern) poisoning, 1875–1877
- Cheliantes*, thiaminase poisoning, 1882–1883
- Chelidonium poisoning, 1887
- Chelidonium majus* (greater celadine/celadine poppy) poisoning, 1887
- Chemical agents  
 enteritis, 261  
 gastritis etiology, 258
- Chemical arthrodesis, 642
- Chemical rinse, carcass decontamination, 886
- Chemoprophylaxis  
 bovine babesiosis, 1494  
 heartwater, 1463  
 strongylosis control, 1561
- Chemotherapy, anaplasmosis, 1458
- Chestnuts (hoof/dew claw sloughing), 664
- Chewing abnormality, 588
- Chewing lice, 1597–1598
- Cheyne–Stokes breathing, 11, 610
- Chicken egg yolk immunoglobulin, 1296
- Chigger mites, 1606–1607
- Chilblains see Cold injury
- Children, cryptosporidiosis infection, 1513
- Chile  
 brucellosis eradication, 983  
 rabies, 1387
- Chilled vaccines, bovine babesiosis, 1495
- Chimera, freemartinism, 1939
- China, brucellosis status, 964
- Chinese blister beetle/fly (*Mylabris phalerata*), 1918
- Chiropractic manipulation, horses, 2023
- Chlamydia*, enzootic pneumonia of calves, 1336
- Chlamydial diseases, 1433–1437  
 diagnosis, 1434  
 organisms involved, 1433–1434  
 reproductive, 1434–1435  
 see also individual diseases
- Chlamydial polyarthritis, 1435
- Chlamydia abortion see Ovine enzootic abortion (OEA)
- Chlamydomyia abortus*, 1433  
 cattle, 1435  
 ovine enzootic abortion, 1435  
 swine, 1433–1434
- Chlamydomyia pecorum*, 1433–1434  
 chlamydial polyarthritis, 1435  
 contagious ophthalmia, 1142  
 sporadic bovine encephalomyelitis, 1407  
 swine, 1433–1434
- Chlamydomyia pneumoniae*, 1433
- Chlamydomyia psittaci*, 1435  
 biotype 1/serotype 1 see *Chlamydomyia abortus*
- Chlamydomyia suis*, 1433, 1434, 1435
- Chloral hydrate, 2053
- Chloramphenicol, 869, 1073
- Chloramphenicol palmitate, 2053, 2064
- Chloramphenicol sodium succinate, 2053, 2064
- Chloroquine toxicity, 1833
- Chlorfenvinphos, screwworm, 1595
- Chlorhexidine, postmilking teat sanitization, 733
- Chlorinated hydrocarbon (organochloride)  
 poisoning, 1832–1834  
 clinical findings, 1834  
 clinical pathology, 1834  
 control, 1834  
 differential diagnosis, 1834  
 economic importance, 1833  
 epidemiology, 1832–1833  
 etiology, 1832, 1833  
 necropsy findings, 1834  
 pathogenesis, 1833–1834  
 risk factors, 1833  
 source of, 1832–1833  
 treatment, 1834
- Chlorinated naphthalene poisoning, 1847–1848
- Chlorpromazine hydrochloride, 2053, 2064
- Chlortetracycline  
 acute bovine pulmonary emphysema and edema, 2003  
 coccidiosis, 1506  
 dosage/interval, 2053, 2064  
 ileitis, 1092  
*Listeria monocytogenes* infection, 809  
 nitrate/nitrite poisoning prevention, 1858
- Choanal atresia, 280
- Choke (acute esophageal obstruction), 213
- Cholangiohepatitis, 396
- Cholangitis, 385, 396
- Cholecalciferol (vitamin D<sub>3</sub>) see Vitamin D<sub>3</sub> (cholecalciferol)
- Cholecystocentesis, 387–388
- Choledocholithiasis, 396
- Cholelithiasis, 385, 396
- Cholestasis, 388, 388
- Cholesteatomas (cholesterinic granulomas), 609
- Choline deficiency, 1782
- Cholinesterase inactivation, organophosphate poisoning, 1835, 1836
- Chondrocytes, 638
- Chondrodysplasia, inherited (arachnomelia), 1960
- Chondrodystrophy, 633  
 congenital, manganese deficiency, 1733, 1734
- Chondroids, guttural pouch empyema, 538, 539
- Chondroprotective agents, 642
- Chordae tendinae rupture, 422, 428
- Chorionic gonadotropin, 2053
- Chorioptes bovis*, 1611
- Chorioptes texanus*, 1611
- Chorioretinitis, 1434, 1611–1612
- Chorioretinitis mites, 1611–1612
- Chou moellier (*Brassica oleracea*), 2008
- Chromium poisoning, 1829
- Chromogenic assays, 442
- Chromosomes  
 abnormalities, 1939–1940  
 congenital defects in newborns, 132  
 copper deficiency association, 1711  
 analysis techniques, 1939  
 translocations  
 blowfly control, 1592  
 cattle, 1940  
 sheep, 1940
- Chronic compressive myelopathy (wobbles), 615–616
- Chronic enzootic pneumonia of sheep, 1361–1362
- Chronic intermittent rhabdomyolysis, 1966–1969
- Chronic interstitial nephritis with diffuse zonal fibrosis (CINF), 1948
- Chronic non-progressive pneumonia, 1361–1362
- Chronic wasting disease (CWD), 1448, 1454
- Chrysanthemum*, sesquiterpene lactone poisoning, 1892
- Chrysomya*, 1590
- Chrysomya bezziana* (Old World Screwworm), 1594
- Chrysomya rufifacies*, 1591
- Chrysops* (deer fly), equine infectious anemia virus transmission, 1173
- Chrysops haematopota*, 1603
- Chuzan virus, 1209
- Cicuta* (water hemlock) poisoning, 1883
- Cicutoxin poisoning, 1883
- Cimetidine, 240, 373–374
- Cimetidine hydrochloride, 2053, 2064
- Ciprofloxacin, diarrhea induction, 269
- Circling, 587, 612  
 plant-induced, 1896, 1897  
 vestibular disease, 580
- Circuit failure, 399
- Circulatory hypoxia, 472
- Circulatory system  
 function, urogenital tract in foals, 564  
 inherited defects, 1944–1948
- Cirrhosis, 391, 392, 393
- Cisapride  
 alimentary tract hypomotility treatment, 204  
 dosage/interval, 2053  
 equine colic, 227  
 equine grass sickness, 1992
- Cisterna magna, cerebrospinal fluid collection, 592
- Cistus salvifolius* ingestion, 562
- Citrate, coliform mastitis risk factor, 712
- Citrin poisoning, 1899, 1901
- Citrullinemia, 135
- Citrullinemia, inherited, 1953–1954
- Clara cells, 1346, 1367
- Clarithromycin, 804
- 'Clasp-knife release,' 590
- Classic swine fever (CSF) see Hog cholera
- Claviceps*, indole alkaloid poisoning, 1868
- Claviceps africana*, ergot alkaloid poisoning, 1901
- Claviceps fusiformis*, 1903
- Claviceps paspali*  
 paspalum staggers, 1899, 1905  
 tremorgen poisoning, 1910
- Claviceps purpurea*, 1899, 1902–1903
- Claw abnormalities, 1961
- Cleft palate, 135, 280, 1944, 1962
- Clematis* poisoning, 1890
- Clenbuterol, 2053
- Clenbuterol hydrochloride, 1934
- Climate  
 blowfly strike, 1590–1591  
 bluetongue virus, 1301  
 equine seasonal allergic dermatitis, 1927  
 fasciolosis, 1577  
 hemochromosis, ruminants, 1549  
 history-taking, individual animals, 6  
 hypomagnesemic tetany risk factor, 1655  
 infectious foot rot risk factor, sheep, 1071–1072  
 sarcocystosis, 1507  
 screwworm, 1594  
 stress induction, 107  
 transmissible gastroenteritis, pigs, 1278–1279
- Clinical examination, herds, 3, 31–37  
 abnormality definition, 32–34, 33, 33  
 animal selection for, 35  
 approach to, 31–35  
 control animals, 36  
 defining the etiological group, 33, 34–35  
 defining the specific etiology, 33, 35  
 epidemiological investigations, 31, 767  
 etiology identification, 32  
 health programs, 37  
 intervention strategies, 36–37  
 laboratory testing, 35–37  
 methods, 31  
 pattern of occurrence definition, 33, 34  
 performance assessment, 36  
 response trials, 36–37  
 sample size, 36  
 sampling strategy, 35–37  
 steps of, 32–35, 33  
 technique, 35–37
- Clinical examination, individual animals, 3–22  
 abdomen, 11–12  
 auscultation, 12–13  
 ballottement, 12  
 behavior, 9  
 body condition, 10  
 body conformation, 10  
 close physical examination, 12–21  
 sequence of, 13–14  
 defecation, 9  
 eating, 9  
 environment, 4, 7–8  
 excitation states, 9  
 external genitalia, 12  
 feet, 20  
 gait, 10  
 general inspection, 9–10  
 head, 10–11, 17–19  
 limbs, 12  
 mammary glands, 12, 20  
 musculoskeletal system, 20  
 neck, 11, 17–19  
 nervous system, 20  
 palpation, 12  
 particular distant examination, 10–12  
 patient examination, 8–22  
 percussion, 12, 13  
 posture, 10  
 reproductive tract, 20  
 skin, 10, 20–21  
 succussion, 13  
 thorax, 11, 14–17  
 ultrasonography, diagnostic, 21  
 urinary system, 20  
 urination, 9–10  
 vital signs, 13–14  
 voice, 9  
 see also History-taking, individual animals
- Clipboard test, bovine spongiform encephalopathy, 1450
- Clitocybe*, muscarine poisoning, 1906

- Clofazimine, 1031  
 Cloned offspring, diseases of, 145–146  
 Cloprostenol sodium, 2053, 2064  
 Cloquinoxol, 2053  
 Clorsulon, 1579, 2054  
 Closantel  
   dosage/interval, 2054  
   fasciolosis, 1579  
   hemonchosis, ruminants, 1550, 1551  
   *Oestrus ovis* infestation, 1587  
   poisoning, 1831  
   tick infestations, 1602  
 Closed flocks/herds  
   cattle, bovine herpesvirus-1 infection, 1356  
   ewes, scrapie, 1445  
 Close housing, ovine pulmonary adenocarcinoma, 1367  
 Clostridial infection  
   diarrhea, foals, 276–277  
   enterotoxin, diarrhea, 270  
   localized, 110  
 Clostridial myonecrosis, 830–832, 1492  
   see also Malignant edema  
 Clostridial myositis of skeletal muscle see Blackleg  
 Clostridial *perfringens* ovine mastitis, 760  
 Clostridial vaccines, 821  
 Clostridium, 821–846  
   circulation entry mechanisms, 821  
   enteritis, 822  
   myositis and, 631  
 Clostridium botulinum  
   botulism, 824–828  
   carrion-associated botulism, 825  
   equine grass sickness, 1990  
   toxin types, 824  
   tremor, 579  
   type C, 825  
   type D, 825  
 Clostridium (feseri) chauvoei  
   blackleg, 828–830  
   malignant edema, 830–832  
 Clostridium difficile  
   diarrhea, 275  
   enteritis, 822  
   enterocolitis, 844–846  
   enteropathogen in piglets, 850  
 Clostridium haemolyticum, 834–836  
 Clostridium novyi, 1577  
   false blackleg, 829  
   malignant edema, 830–832  
   type B, black disease, 832–834  
   type D (Clostridium haemolyticum), 834–836  
 Clostridium perfringens  
   diarrhea in foals, 275  
   enteric disease, 836–844  
   enteritis, 822  
   malignant edema, 830–832  
   myositis and, 631  
   type A  
     enterotoxemia, 836–838  
     mastitis, 726–727  
   type B, enterotoxemia, 838–840  
   type C, enterotoxemia, 838–840  
   type D  
     brain dysfunction, 1807  
     enterotoxemia, 841–844  
     foal symmetrical encephalomalacia, 844  
   type E, enterotoxemia, 838–840  
 Clostridium piliformis, 836  
 Clostridium septicum, 829, 830–832  
 Clostridium sordellii, 821–822, 830–832  
 Clostridium tertium, 822  
 Clostridium tetani, 579, 822–844  
   see also Tetanus  
 Clotting factors, vitamin K<sub>1</sub>-dependent reduction, 443–444  
 Clover disease, phytoestrogen poisoning, 1874  
 Cloxacillin, 786, 2054  
 'Club lamb fungus,' 1476, 1477  
 Cluster dunking, 734  
 Cnephia pecuarum, 1605  
 Coagulants, abomasal ulcer, 373  
 Coagulation  
   defects, 443–445  
   diarrhea, acute, 270  
   equine colic, 219  
 Coagulopathies  
   arterial thromboembolism, 433  
   exercise-induced pulmonary hemorrhage, 506  
   treatment of, 442–443  
 Coal tar pitch poisoning, 1848  
 Coal tar sealer poisoning, 1840  
 'Coast disease,' sheep, 1701  
 Cobalt  
   anthelmintic administration and, 1706  
   controlled release glass boluses, 1706  
   deficiency, 1701–1707  
     anemia, nonregenerative, 452  
     clinical findings, 1703  
     clinical pathology, 1703–1704  
     congenital defects in newborns, 133  
     control, 1705–1706  
     diagnosis, 1704  
     differential diagnosis, 1705  
     epidemiology, 1701–1702  
     etiology, 1701  
     experimental reproduction, 1702  
     ketosis, 1662  
     metabolic defect, associated, 1699  
     necropsy findings, 1704  
     outbreaks, 1701, 1702  
     pathogenesis, 1702–1703  
     pathophysiology, 1699  
     primary, 1702  
     risk factors, 1701–1702  
     treatment, 1705  
   hepatic, normal levels, 1704  
   pasture top-dressing, 1705–1706  
   poisoning, 1830  
   serum concentration, 1703  
   status, biochemistry, 1703  
   supplementation, 1705  
   ketosis treatment, 1666  
   phenylethylamine poisoning prevention, 1870  
   toxicity, 1705  
 Cobalt-heavy pellets, 1706  
 Cobaltous chloride, cyanogenic glycoside poisoning, 1855  
 Cobras (Naja), 1916  
 Coccidioides immitis, 1475  
 Coccidioidin, 1475  
 Coccidioidomycosis, 1475  
 Coccidiosis, 1498–1507  
   brain dysfunction, 1806  
   case fatality, 1499  
   cattle, 1266, 1498, 1499, 1503, 1504  
   clinical findings, 1503  
   clinical pathology, 1503–1504  
   control, 1505–1506  
   convalescent period, 1503  
   diagnosis, 1504  
   differential diagnosis, 1504  
   economic importance, 1501  
   epidemiology, 1498–1501  
   etiology, 1498  
   experimental reproduction, 1503  
   goats, 1498, 1499  
   horses, 1498, 1503  
   housing, 1501  
   immune mechanisms, 1501  
   incubation period, 1503  
   infection source, 1500  
   morbidity, 1499  
   multiple infections, 1501  
   necropsy findings, 1504  
   nervous, 1502  
   occurrence, 1498  
   pathogenesis, 1501–1503  
   pigs, 1498, 1499  
   post-weaning, 1498, 1500  
   prevalence, 1498  
   production system used, 1501  
   risk factors, 1500–1501  
   sheep, 1498, 1503, 1504  
   transmission, 1500  
   treatment, 1505, 1505  
   vaccines, 1506  
 Coccidiostats, 1338, 1500, 1505–1506  
 Cochliomyia americana (screw worm fly), 776  
 Cochliomyia hominivorax (New World Screw worm), 1590, 1593–1594, 1595  
 Cochliomyia (Callitroga) macellaria, 1594  
 Cockle, 1597, 2041  
 Coconut meal, 1739  
 Cocoon silk, ruminal impaction, 1895  
 Coenurosis (gid, sturdy), 609, 1583  
 Coenurus cerebralis, 609  
 Coffin joint ankylosis, 1962  
 Coggin's test see Agar gel immunodiffusion (AGID) test (Coggin's test)  
 Coital transmission, dourine, 1539  
 Colchicine poisoning, 1885  
 Colchicum autumnale (autumn crocus) poisoning, 1885  
 Cold cow syndrome, 1987  
 Cold exposure  
   animal production in, 44  
   hypothermia, neonatal, 43  
   lethal limit, 41  
 Cold injury (frostbite), 1793–1795  
   clinical findings, 1794  
   control, 1795  
   epidemiology, 1793  
   etiology, 1793  
   necropsy findings, 1794  
   pathogenesis, 1793  
   peripheral tissues, 1794  
   teats, 750  
   treatment, 1794–1795  
 Cold stress  
   lambs, neonatal, 43, 141  
   neonatal response, 41  
   piglet mortality, 130  
 Cold thermogenesis, 42–43  
 Colesiota conjunctivae, 1142  
 Colibacillosis  
   attaching and effacing, 858, 862  
   control  
     animal management, 871–873  
     colostrum, 871–873  
     exposure reduction, 870–871  
     vaccination, 873–875  
   enteric, 851, 857–858, 859–860  
   clinical findings, 859, 859–860  
   diagnosis, 862  
   necropsy findings, 862  
   treatment, 862  
   enterotoxigenic, 857, 860  
   etiology, 852  
   newborns, 851–876  
     clinical findings, 858–860  
     clinical pathology, 860–861  
     control, 870–875  
     diagnosis, 862  
     differential diagnosis, 862  
     epidemiology, 851–856  
     Escherichia coli, 851–876  
     etiology, 851  
     infection source, 854–855  
     morbidity, 852  
     mortality, 852  
     necropsy findings, 861–862  
     outbreaks, 851–852, 870  
     pathogenesis, 856–858  
     prevalence, 851–852  
     risk factors, 852–856  
     transmission, 854–855  
     treatment, 862–870  
   septicemic see Coliform septicemia  
 Colic  
   flatulent, 226  
   gastric habronemiasis, 1572  
   pyelonephritis, contagious bovine, 790  
   sand, 226, 254–255  
   spasmodic, 216, 226, 256–257, 1582  
   thromboembolic, 257–258  
   tympenic, 226  
   see also Equine colic  
 Coliform bovine mastitis, 709–719  
   acute, 714  
   case fatality, 710  
   chronic, 714  
   clinical findings, 713–714  
   clinical pathology, 714  
   control, 717–719  
   diagnosis, 714, 715  
   differential diagnosis, 715  
   duration of infection, 710  
   endotoxin-induced, 713  
   epidemiology, 710–712  
   etiology, 709–710  
   infection source, 710  
   mastitis-metritis-agalactia syndrome, 754, 755, 756  
   morbidity, 710  
   necropsy findings, 714–715  
   outbreak management, 717  
   pathogenesis, 712–713  
   pathogens, 674–675  
   peracute, 713–714, 1634  
   risk factors, 710–712  
   severity, 712–713  
   subclinical, 714  
   transmission, 710

- Coliform bovine mastitis (*Cont'd*)  
 treatment, 92, 715–717  
 vaccination, 718–719, 740
- Coliform gastroenteritis, pigs, 891–895  
 case fatality rate, 892  
 clinical findings, 893  
 clinical pathology, 893  
 control, 894–895  
 diagnosis, 894  
 differential diagnosis, 894  
 epidemiology, 892–893  
 etiology, 891–892  
 necropsy findings, 893–894  
 pathogenesis, 893  
 risk factors, 892–893  
 treatment, 894  
 vaccination, 895
- Coliform septicemia, 851  
 clinical features, 1294  
 clinical findings, 858–859, 860  
 diagnosis, 862  
 necropsy findings, 861–862  
 pathogenesis, 856–857  
 predictors of, 859  
 treatment, 862
- Colistin, 2054
- Colitis  
 chronic idiopathic, 273  
 diarrhea, acute, 269  
*Lawsonia*, 1090  
 non-specific, 1120–1123  
 clinical findings, 1121  
 clinical pathology, 1121–1122  
 epidemiology, 1121  
 etiology, 1120  
 pathogenesis, 1121  
 risk factors, 1121  
 right dorsal, 255
- Colitis-X, 269
- Collagenase solution infusion, septic metritis, 63
- Collagenolytic granuloma, 667
- Colloids, 95–97  
 contraindications, 96  
 hypovolemic shock, 67  
 maldistributive shock, 67
- Colobomata, typical, 1977
- Colon  
 displacement, 222  
 left dorsal, 226  
 distension, 221, 221–222  
 intussusception, 377
- Colony stimulating factor, 2054
- Colostrum  
 administration, 156  
 antibodies/immunoglobulins, 149–157  
 absorption efficiency, 152–153  
 bovine herpesvirus-1 infection, 1351, 1354  
 bovine leukemia virus, 1217  
 bovine respiratory syncytial virus pneumonia, 1345  
 bovine virus diarrhea virus, 1252, 1272  
 breed differences, 151  
 caseous lymphadenitis immunity, 797–798  
*Clostridium perfringens*, types B, C and E, 840  
 colibacillosis, 853–854, 871–873  
 combined immunodeficiency, Arabian foals, 1979  
 concentration determinants, 150, 150, 151  
 dairy calf mortality, 129  
 diarrhea, acute undifferentiated risk factor, 848, 850  
 enteric colibacillosis, 858  
 enzootic pneumonia of calves, 1337–1338  
 equine encephalomyelitis, 1371  
 hog cholera, 1166  
 lactogenic immunity, 149  
 louping-ill, 1408  
 neonatal viral diarrhea, 1287  
 normal transfer, 149  
 pseudorabies, 1397, 1402  
*Rhodococcus equi* pneumonia immunity, 804  
 strangles resistance, 774  
 tick-borne fever, 1460  
 transfer, guidelines to ensure, 872–873  
 artificial feeding of, 150, 151, 152, 156  
 bacterial contamination, 151  
 banking of, 155  
 barrier, vaccine effectiveness, 1294  
 benefits of, 153  
 California Mastitis Test, 686  
 caprine arthritis encephalitis transmission, 1411  
 colibacillosis, 871–873  
 cross-species, 155  
 deprivation, septicemia, 51, 52  
 esophageal feeder administration, 314  
 frozen and thawed, 872  
 hypoglycemia prevention, 1682  
 management of, 871  
 natural suckling of, 150, 151, 152  
 neonatal hypothermia prevention, 43, 44  
 nutrition and, 1696  
 passive immunity transfer, 158  
 pasteurization of, 151, 872  
 pooling, 151  
 quality, 871–872  
 replacer, 155–156, 872  
 selenium transfer, 1742  
 specific gravity, 871–872  
 storage of, 155  
 supplements, 155–156, 167, 872, 1295  
 viral diarrhea, 1294, 1295–1296  
 vitamin E transfer, 1742–1743  
 volume ingested, 151–152  
 weight, 150, 151
- Colubriæ, 1916
- Coma, 578, 584
- Combined immunodeficiency (CID), Arabian foals, 466, 1943, 1978–1980  
 carriers, 1978  
 clinical findings, 1979  
 clinical pathology, 1979  
 complications, 1979  
 control, 1979–1980  
 differential diagnosis, 1943, 1979  
 elimination, 1980  
 epidemiology, 1978–1979  
 etiology, 1978  
 necropsy findings, 1979  
 pathogenesis, 1979  
 prevalence, 1978  
 treatment, 1979
- Combined vaccines  
 bovine herpesvirus-1 infection, 1358  
 bovine respiratory syncytial virus pneumonia, 1348
- 'Comet tail' signs, 2006
- 'Compact' cattle, 1959
- Compendium of Animal Rabies Control*, 1392
- Competitive enzyme-linked immunosorbent assay (C-ELISA)  
 bovine babesiosis, 1490  
 equine infectious anemia, 1175–1176  
 malignant catarrhal fever, 1247  
 neonatal viral diarrhea, 1292  
 peste des petits ruminants, 1243  
 vesicular stomatitis, 1235
- Complement fixation test (CFT)  
 anaplasmosis, 1457  
 bovine babesiosis, 1490  
*Brucella abortus*, 972  
*Brucella melitensis*, 992  
 chlamydial diseases, 1434  
 contagious bovine pleuropneumonia, 1134  
 dourine, 1539  
 equine arteritis virus, 1321  
 equine herpesvirus 1, 1314  
 equine herpesvirus 4, 1310  
 foot-and-mouth disease, 1226  
 glanders, 1084  
 Johne's disease, 1028, 1030  
 mycoplasma pneumonia, pigs, 1148  
 ovine enzootic abortion, 1437  
 pleuropneumonia of pigs, 1056  
 rinderpest, 1240  
 swine vesicular disease, 1231  
 vesicular stomatitis, 1235
- Complete heart block, 415
- Complex vertebral malformation, 134–135, 1960–1961
- Compression atelectasis, 500–501
- Compression stenosis, 377
- Comprest cattle, 1959
- Compromised animal definition, 1650
- Compton metabolic profile test, 1618–1619
- Compulsive walking, 578, 584, 1896
- Computed tomography (CT)  
 equine neonatal encephalopathy, 2014  
 nervous system, 594  
 newborns, 164  
 respiratory system, 482–483
- Computer-assisted diagnosis, 28–29
- Concentric hypertrophy (cardiac hypertrophy), 401
- Concussion, 604
- Condensed tannins (CTs), frothy bloat and, 328, 328, 333, 335
- Conditioning programs, pneumonic pasteurellosis control, 943
- Conduction disturbances, 413, 413  
 electrocardiography, 408  
 myocardial disease and, 421
- Confinement  
 degenerative joint disease, 2027  
 pseudorabies risk factor, 1395
- Conformation, 625, 638
- Congenital abnormalities  
 comatose foals, 2013  
 hog cholera, 1161, 1164  
 mycotoxicosis, 1912  
 plant-induced, 1895  
 spinal ataxia, horse, 2018
- Congenital absence of skin, 1975
- Congenital achondroplasia with hydrocephalus, 1958–1959
- Congenital arthrogryposis and hydranencephaly, 1207–1209
- Congenital articular rigidity, 648
- Congenital cerebrospinal hypomyelination (congenital tremor syndromes of piglets type AIII), 2015
- Congenital hydrocephalus, 599, 1954
- Congenital hyperostosis (thick forelimbs of pigs), 1961
- Congenital hyperplasia of myofiber, 648
- Congenital ichthyosis (fish-scale disease), 1976
- Congenital joint laxity and dwarfism, 2035–2036
- Congenital myasthenia gravis, 1963
- Congenital myoclonus (hereditary neuraxial edema), 1956–1957
- Congenital myotonia, 1957
- Congenital necrotizing encephalopathy, lamb, 2023
- Congenital osteopetrosis ('marble bone'), 1959
- Congenital porphyria, 1946
- Congenital posterior paralysis, 1957
- Congenital spasm of cattle, 1955
- Congenital trembles see Congenital tremor syndromes of piglets
- Congenital tremor of pigs (inherited hypomyelination), 1957
- Congenital tremor syndromes of piglets, 2015 control, 2015  
 type A, 2015  
 type AI (myoclonia congenita), 2015  
 type AII (myoclonia congenita)  
 hog cholera, 1162, 1164  
 porcine circovirus 2, 1185, 1186, 2015  
 type AIII (myoclonia congenita), 2015  
 type AIII, 1957, 2015  
 type AIV, 1957, 2015  
 type B, 2015
- Congestive heart failure see Heart failure, chronic (congestive)
- Congestive hepatitis, 393, 394
- Conidiobolus coronatus*, 1480, 1481
- Conium maculatum* (hemlock, poisonous), 134, 1889–1890
- Conium poisoning, 1889–1890
- Conjunctiva  
 diseases of, 651–653, 670  
 see also specific diseases/disorders  
 examination, 17  
 color, anemia, 455  
*Mycoplasma bovoculi* infection, 994
- Conjunctival habronemiasis, 1572
- Conjunctivitis, 670  
 bovine herpesvirus-1 infection, 1353  
*Branhamella ovis*, 994  
 follicular, 1143
- Conjunctivokeratitis, contagious, 1142–1143
- Connective tissue defects, copper deficiency, 1712
- Consciousness abnormalities, 611
- Consolidation  
 bovine lungworm, 1565, 1566  
 bovine respiratory syncytial virus pneumonia, 1347  
 enzootic pneumonia of calves, 1340, 1341  
 enzootic pneumonia of sheep, chronic, 1362
- Constipation, 193, 386, 755
- Constrictive pericarditis, 429
- CONSULTANT program, 28
- Contact lenses, head shaking in horses, 2023

- Contagious acne of horses, 800  
 Contagious bovine pleuropneumonia (CBPP), 925  
   acute, 1133–1134  
   carriers, 1132  
   chronic, 1134  
   clinical findings, 1133–1134  
   clinical pathology, 1134  
   combined rinderpest vaccine, 1241  
   control, 1135–1138  
     area basis, 1137  
     herd basis, 1136–1137  
   differential diagnosis, 1135  
   economic importance, 1133  
   epidemiology, 1131–1133  
   eradication, 1135–1136, 1137–1138  
   etiology, 1131, 1137  
   immune mechanisms, 1132  
   infection source, 1132, 1136  
   legislation, 1137–1138  
   *Mycoplasma mycoides*, 1123  
   *Mycoplasma mycoides* subsp. *Mycoides*, 1131–1138  
   necropsy findings, 1134–1135  
   outbreaks, 1131–1132, 1137  
   pathogenesis, 1133  
   prevalence, 1131–1132  
   risk factors, 1132–1133  
   subacute, 1134  
   transmission, 1132  
   treatment, 1135  
   vaccination, 1135–1137  
 Contagious caprine pleuropneumonia (CCPP), 1123, 1140–1141  
 Contagious ecthyma see Orf  
 Contagious ophthalmia, 1142–1143  
 Contagious ovine digital dermatitis (CODD), 1073  
 Contagious pustular dermatitis see Orf  
 Continuous-flow peritoneal dialysis, azotemia, 554  
 Continuous flow production systems, transmissible gastroenteritis (pigs), 1279  
 'Contracted' foals, 648  
 Contraction atelectasis, 501  
 Controlled release glass boluses  
   cobalt, 1706  
   copper, 1721  
   selenium, 1753  
 Contusion, traumatic brain injury, 604–605  
 Convalescence, radiation injury, 1787  
 Conversion tables, 2045–2046  
 Convulsions, 585  
   clonic, 579  
   congenital defects characterized by, 620  
   epilepsy, 613  
   equine neonatal encephalopathy, 2013  
   hypomagnesemic tetany, 1660  
   lactation tetany, 1656  
   nervous system disease, 579  
   plant-induced, 1896–1897  
   pregnancy toxemia, sheep, 1669  
   scrapie, 1444  
   tonic, 579  
   toxic/metabolic encephalomyelopathies, 612  
   vitamin A deficiency, 1774  
 Coombs testing, 456, 1923  
 Cooperative State Federal Brucellosis Eradication program, USA, 963–964, 982  
*Cooperia*, 1541  
   resistance to, 1542  
   see also Trichostrongylid worms  
*Cooperia pedunculata*, furanocoumarin poisoning, 1887  
 Coopworths sheep, inherited ovine degenerative axonopathy, 1953  
 Coordination examination, 584  
 Copper  
   absorption, 1713  
   deficiency, 1707–1722  
     anemia, nonregenerative, 452  
     breed/species susceptibility, 1709  
     cattle, 1714, 1716–1717  
     clinical findings, 1714–1715  
     clinical pathology, 1715–1717  
     congenital defects in newborns, 133  
     control, 1719–1722  
     diagnosis, 1715–1716, 1718, 1718  
     differential diagnosis, 1718–1719  
     encephalomalacia, 603  
     epidemiology, 1707–1711  
     etiology, 1707, 1708  
     geographical distribution, 1708–1709  
     goats, 1715  
     horses, 1715, 1717  
     incidence, 1698  
     metabolic defect, associated, 1699  
     necropsy findings, 1717–1718, 1718  
     osteodystrophy, 632  
     osteoporosis in lambs, 633  
     outbreaks, 1707–1708  
     pathogenesis, 1711–1714  
     pathophysiology, 1698, 1699  
     phases of, 1713, 1716, 1716  
     pigs, 1715  
     postparturient hemoglobinuria, cattle, 1682  
     primary, 1707, 1708, 1714, 1718  
     risk factors, 1709–1711  
     seasonality, 1709  
     secondary, 1266, 1707, 1708, 1708–1709, 1714, 1718  
     sheep, 1714–1715, 1716–1717  
     subclinical, 1714  
     treatment, 1719  
   dietary, 1710  
     requirements, 1719  
   hepatic storage, 1713  
   metabolism, molybdenum poisoning, 1820  
   molybdenum interaction, 1713–1714  
   parenteral injection, 1720–1721  
   poisoning see Copper poisoning  
   sulfate interaction, 1713–1714  
   supplementation  
     degenerative joint disease, 1771  
     osteodystrophy, 635  
   toxicity, 1707, 1719, 1821  
     see also Copper poisoning  
   utilization, 1713  
 Copper calcium edetate, 1720  
 Copper-chrome-arsenate poisoning, 1840  
 Copper edetate, 1721  
 Copper glycinate, 1720–1721  
 Copperhead (*Agkistrodon contortrix*), 1916  
 Copper heptonate, 1720  
 Copper methionate, 1720, 1721  
 Copper oxide needles, 1721–1722  
 Copper oxide powder, 1722  
 Copper oxquinoline sulfonate, 1720  
 Copper phenylalanine, 1721  
 Copper poisoning  
   cattle, 1821  
   chronic, 1491, 2008–2009  
   goats, 1821  
   hepatogenous chronic, 1823, 1824  
   horses, 1821  
   phytogenous chronic, 1823, 1824  
   primary, 1820–1823  
     acute, 1821, 1822, 1823  
     chronic, 1821, 1822, 1823  
     clinical findings, 1822  
     clinical pathology, 1822–1823  
     control, 1823  
     diagnosis, 1823  
     differential diagnosis, 1823  
     economic importance, 1821  
     epidemiology, 1820–1821  
     etiology, 1820  
     necropsy findings, 1823  
     outbreaks, 1820–1821  
     pathogenesis, 1821–1822  
     risk factors, 1821  
     treatment, 1823  
   secondary, 1823–1824  
   sheep, 390, 1821  
   specimen analysis, 1797  
 Copper soluble solution, 1069  
 Copper sulfate, 1719–1720  
   dietary supplementation, 1719–1720  
   enzootic posthitis, 794  
   footbath, 1074  
   oral dosing, 1719  
   papillomatosis digital dermatitis of cattle, 1070  
 Coprophagy, 113, 186  
 Coproporphyrins, 1946  
*Coralocystostroma ornicoepreoides*, 1912  
 Coral snake (*Micrurus micruroides*), 1916  
 Core lipopolysaccharide antigen vaccine, coliform mastitis prevention, 718–719  
*Coriaria* (tutu tree) poisoning, 1894  
 Corkscrew claw, 1961  
 Cornea  
   abnormalities, 17  
   burns, 1793  
   'cake frosting' appearance, 1472  
   congenital defects, 670  
   opacity  
     inherited, congenital, 1977  
     malignant catarrhal fever, 1247  
     ophthalmia, contagious, 1143  
 Corneal ulcer, plant sources, 1895  
 Coronary arteries, anomalous origin, 433  
 Coronary thrombosis, 421  
 Coronaviruses, 1286, 1291  
 Coronitis, bluetongue, 1303  
 Coronitis dermatitis, 624  
 Corpora amylacea, 750  
 Cor pulmonale, 422–423  
   at altitude, 422, 1788–1789  
   cattle, 423  
   clinical findings, 500  
   goats, 423  
   necropsy findings, 500  
   pulmonary hypertension, 500  
 Corridor disease, 1527, 1528, 1529  
   see also East Coast fever (ECF)  
 Corriedale sheep  
   arthrogryposis, 1962  
   black livers, 386–387  
   inherited hydranencephaly and arthrogryposis, 1955  
 Corticosteroids  
   anaphylaxis, 71  
   arthropathy, 641  
   brain injury following head trauma, 595  
   decompression, 595  
   equine herpesvirus 1 myeloencephalopathy, 1315  
   equine seasonal allergic dermatitis, 1927  
   heaves, 1932, 1933  
   laminitis-induced, horses, 2030  
   pneumonia, 514  
   chronic interstitial, foal, 2006  
   pregnancy toxemia, sheep, 1670  
   purpura hemorrhagica, 1926  
   shock, 68  
   smoke inhalation, 1793  
*Cortinarius speciocissimus* poisoning, 1908  
 Cortisol  
   plasma, 102, 107  
   salivary, 108  
 Corydaline poisoning, 1887  
*Corydalis caseana* (fitweed) poisoning, 1887  
*Corydalis flavula* (fitweed fumatory) poisoning, 1887  
*Corynebacterium*, 787–805  
   bolo disease, 798  
   osteomyelitis, 636  
*Corynebacterium bovis* mastitis, 675, 708  
   bulk tank milk somatic cell count, 683  
   control, 729  
   milk culture presence, 746  
*Corynebacterium cystitidis*, 559  
*Corynebacterium (Rhodococcus) equi*, 1103  
*Corynebacterium pilosum*, 559  
*Corynebacterium pseudotuberculosis*, 787–788  
   abscesses, chronic in horses, 788–789  
   arthritis, 788  
   bursitis, 788  
   contagious acne of horses, 800  
   localized infection, 110, 111  
   lymphadenitis, caseous, 795–798  
   lymphangitis, ulcerative, 798–800  
   mastitis, ovine, 760  
   pigeon fever, 788–789  
*Corynebacterium pyogenes* see *Arcanobacterium (Actinomyces) pyogenes*  
*Corynebacterium renale*  
   enzootic posthitis, 793–795  
   pyelonephritis, 559, 560, 789–790  
   vulvovaginitis, 793–795  
*Corynebacterium (Actinobaculum) suis*, 559–560, 788, 791–793  
 Corynetoxins, 1914–1915  
 Costa Rica, brucellosis status, 965  
 Cottonseed cake, gossypol poisoning, 1888–1889  
 Cotyledonosis, 1862, 1863  
 Cough/coughing  
   blood, 480, 532–533  
   bovine herpesvirus-1 infection, 1353  
   bovine lungworm, 1565  
   equine influenza, 1324  
   heaves, 1930



- Cough/coughing (*Cont'd*)  
housing and, 497  
laryngitis/tracheitis/bronchitis, 533  
lungworm, 1568, 1569  
ovine pulmonary adenocarcinoma, 1367  
respiratory insufficiency manifestation, 478-479  
suppressants, 496  
tuberculosis, 1009  
winter dysentery, cattle, 1298  
Cough reflex, 510  
Coumaphos, 1595, 1611  
Coumatetralyl poisoning, 1839  
Coumestans, phytoestrogen poisoning, 1873  
Counterimmunoelectrophoresis test, 1292  
Courmarin poisoning, 1864  
Cow(s)  
contact voltage, 1790, 1791  
greasy heel, 663  
lowest behavioral perception, stray voltage, 1791  
peripartum toxemia, 60-63  
Cow-calf operator good practice guides, 884  
Cowdriosis see Heartwater  
Cowpox, 1381, 1427  
Cowpox virus, 1427  
Cowside tests  
antimicrobial residues in milk, 695  
endotoxins, 685  
ketosis, 1664-1665  
left-side displacement of abomasum, 359  
Coxiella, 987  
Coxiella burnetii, 1468  
Coxiellosis, 1469  
Coxofemoral joint dislocation, 1635  
Crackles, 477, 477-478  
bovine lungworm, 1565  
heaves, 1931  
ovine pulmonary adenocarcinoma, 1367  
pneumonia, 512  
Cranial cavity, space-occupying lesion, 606  
Cranial mesenteric artery aneurysm, 422, 1559  
Cranial nerves (CN)  
equine protozoal myeloencephalitis and, 1524  
examination, 584-587, 584-588  
guttural pouch mycosis and, 540, 618  
polyneuritis equi and, 2021  
vestibular disease, 580  
see also specific nerves  
Cranial thoracic mass, 527  
Cranial trauma, 121  
Cranial vena caval thrombosis, 517  
Craniocerebral missile injury, 605  
Craniofacial deformity  
inherited, 1959-1960  
mannosidosis, 1949  
prolonged gestation and, 1978  
Craniocerebral, inherited (cranios bifidum), 1959  
Cranioventral laparoscopy, 308  
Cranium bifidum (inherited cranioschisis), 1959  
Cranium deformity  
congenital hydrocephalus, 1954  
spider lamb syndrome, 1960  
Crawling, downer cow syndrome, 1646  
Crazy cow syndrome, 1893  
Creatine kinase (CK)  
bovine ephemeral fever, 1179  
cerebrospinal fluid analysis, 593  
equine motor neuron disease, 2020  
myopathy, 629  
plasma, 1745-1746  
porcine stress syndrome, 1969, 1972  
recurrent exertional rhabdomyolysis in Thoroughbred horses, 1967  
Creatine phosphokinase (CPK)  
downer cow syndrome, 1645, 1647  
elevated, plant-induced, 1897  
Creatinine  
clearance, 550  
equine colic, 223  
plasma, 90  
renal clearance, 551  
renal insufficiency, 544  
serum, 165, 550  
Creatinine kinase (CK), exertional rhabdomyolysis, 1684-1685  
Creep feeds  
calculi prevention, 570  
coliform gastroenteritis, 892, 894  
pneumonic pasteurellosis control, 943  
Creeping, downer cow syndrome, 1646  
Creeping indigo (*Indigofera spicata*) poisoning, 1884  
Creole cattle, chromosomal translocation, 1940  
Creosote poisoning, 1840  
Creprenic acid poisoning, 1885  
Crepitus, 640  
Creutzfeldt-Jakob disease (CJD), 1450  
Crib-biting, 612  
Crohn's disease, humans, 1019, 1023, 1037, 1040, 1043  
Cromolyn sodium, 2054  
Crooked calf disease, 133-134, 1891  
Crop ears, inherited, 1976  
Crop maturity, bloated and, 328-329, 332  
Crotalaria, pyrrolizidine alkaloid poisoning, 1878-1881  
Crotalidae, 1916, 1917  
Crotaus (rattlesnake), 1916, 1917  
Croton poisoning, 1888  
Crown-rump length, gestational age, 131  
Cruciferous plants, postparturient hemoglobinuria, 1682  
Crude oil toxicity, 1846-1847  
Crushed tail syndrome, cattle, 2020-2021  
Crushing, piglet mortality, 130  
'Crutching,' 1592  
'Crutch strike,' 1591, 1592  
Cryosurgery  
bovine ocular squamous-cell carcinoma, 2040  
equine ocular squamous-cell carcinoma, 2041  
papillomatosis, 1422  
Cryotherapy, sarcoid, 1424  
Cryptocarya pleurosperma (poison walnut) poisoning, 1888  
Cryptococcosis (European blastomycosis, torulosis), 1475-1476  
Cryptococcus neoformans, 727-728, 1474, 1475  
Cryptorchidism, 1964  
Cryptosporidiosis, 1512-1515  
age-related resistance, 1513  
asymptomatic infection, 1512  
clinical findings, 1514  
clinical pathology, 1514  
concurrent infection, 1513  
control, 1515  
diagnosis, 1514  
differential diagnosis, 1293, 1514  
epidemiology, 1512-1514  
etiology, 1512  
experimental reproduction, 1513, 1514  
goats, 1512  
infection source, 1512-1513  
necropsy findings, 1514  
occurrence, 1512  
pathogenesis, 1514  
pigs, 1512  
prevalence, 1512  
risk factors, 1513  
sheep, 1512  
supportive therapy, 1515  
transmission, 1512-1513  
treatment, 1514-1515  
zoonotic implications, 1513-1514  
Cryptosporidium, 1513  
bovine rotavirus co-infection, 1287  
cryptosporidiosis, 1512  
life cycle, 1514  
Cryptosporidium andersoni, 1512  
Cryptosporidium muris, 1512  
Cryptosporidium parvum, 849, 1512  
Crystalline preparations, 183  
Crystalloid solutions, 92, 92-95  
nomenclature, 92-93  
polyionic, 97, 98  
see also specific types  
Crystalluria, 546  
Crystal violet dyes, 1429  
Crystal violet vaccine, 1166  
Cucumis africanus poisoning, 1893  
Cucurbitacin poisoning, 1893  
Cud-dropping, 211, 1047  
Cud transfer, 313  
Culard, 1964-1965  
Culex, 1605  
Culex annulirostris, 1177-1178  
Culex pipens, 1379  
Culex quinquefasciatus, 1425  
Culex tarsalis, 1369, 1605  
Culex tritaeniorhynchus, 1207  
Culicoides, 1604-1605  
bluetongue virus transmission, 1300  
breeding, 1300  
epizootic hemorrhagic disease transmission, 1305  
Culicoides actoni, 1300  
Culicoides bolitinos, 1180  
Culicoides brevipalpis, 1300  
Culicoides brevitarsis  
Akabane disease transmission, 1207  
bluetongue virus transmission, 1300  
bovine ephemeral fever transmission, 1177  
equine seasonal allergic dermatitis, 1927  
Culicoides filarifer, 1300  
Culicoides fulvis, 1300  
Culicoides imicola, 1180, 1300  
Culicoides insignis, 1300  
Culicoides nebeculosus, 1207, 1425  
Culicoides nudipalpis, 1300  
Culicoides obsoletus  
African horse sickness virus transmission, 1180  
bluetongue virus transmission, 1300  
equine seasonal allergic dermatitis, 1927  
seasonal allergic dermatitis, 1928  
Culicoides orientalis, 1300  
Culicoides oxystoma, 1207, 1300  
Culicoides peregrinus, 1300  
Culicoides pucillus, 1300  
Culicoides pulicaris, 1180, 1927  
Culicoides pusillus, 1300  
Culicoides variipennis, 1180  
Culicoides variipennis var. sonorensis, 1300  
Culicoides wadai, 1300  
Culiseta melanura, 1369  
Culling  
bovine mastitis control programs, 741-742  
brucellosis associated with Brucella ovis, 986  
caseous lymphadenitis, 797  
foot rot, infectious, 1077  
Johne's disease, 1033, 1034  
milk fever and, 1630  
Mycoplasma mastitis, 707  
neosporosis, 1511  
rate, history-taking, 5  
somatic cell count indication for, 747  
Staphylococcus aureus mastitis, 702  
Curling toe, 1961  
Curvularia geniculata, 1481  
Cushing's syndrome, 608  
Cutaneous actinobacillosis (wooden tongue), 1047  
Cutaneous angiomatosis, 668  
Cutaneous anthrax, 817  
Cutaneous cysts, 667  
Cutaneous habronemosis, 1571-1572  
Cutaneous lymphoma, 1216  
Cutaneous lymphosarcoma, 462, 463  
Cutaneous mastocytoma, 668  
Cutaneous melanoma, 668  
Cutaneous mycotic granulomata, 1473  
Cutaneous myiasis, 1589-1596  
primary, 1589-1590  
secondary, 1590  
see also specific types  
Cutaneous neoplasms, 667-669  
congenital, 669-670  
Cutaneous pain, 103  
Cutaneous papilloma, 667-668  
Cutaneous squamous-cell carcinoma, 668  
Cutaneous streptotrichosis see Dermatophilosis  
Cutaneous T-cell lymphoma, 1216  
Cutaneous trunci reflex, 590  
Cyanide poisoning see Cyanogenic glycoside poisoning  
Cyanobacteria, 1908, 1913-1914  
Cyanobacterial toxins, 1913-1914  
see also specific types  
Cyanocobalamin zinc tannate supplementation, 1783  
Cyanogenic glycoside poisoning, 1852-1855  
acute, 1854  
chronic, 1854-1855  
clinical findings, 1854  
clinical pathology, 1854  
diagnosis, 1855  
differential diagnosis, 1855  
epidemiology, 1853-1854  
etiology, 1852-1853  
necropsy findings, 1854-1855  
pathogenesis, 1854  
plants causing, 1853  
risk factors, 1853-1854  
toxic variability, 1853  
treatment, 1855  
Cyanosis, 479

- Cyathostomiasis  
diarrhea, acute, 269, 270  
diarrhea, chronic undifferentiated, 273  
larval, cecal disease, 246  
treatment, 273
- Cyathostominae, 1558
- Cycad glycoside poisoning, 1885
- Cycasin poisoning, 1885
- Cycas poisoning, 1885
- 2,3-cyclic nucleotide-3-phosphodiesterase, 1416
- Cyclodextrin, 1915
- Cydoxygenase inhibitors, 68
- Cyclopamine toxicity, 1884
- Cyclophosphamide, 2054
- Cyclopiazonic acid poisoning, 1901
- Cyclops anomaly, 1960
- Cyfluthrin, 1596, 1606
- Cyhalothrin, 1598, 1601
- Cylindrospermopsis raciborskii*, 1913
- Cymerlasan (RM110), 1538
- Cynanchoside poisoning, 1885–1886
- Cynanchum* (monkey rope) poisoning, 1885–1886
- Cynapine poisoning, 1890
- Cynodon aethiopicus*, diets based on, 1722
- Cypermethrin, 1601, 1606
- Cyproheptadine, 1688, 2023
- Cyproheptadine hydrochloride, 2054
- Cyromazine, 1592
- Cyst(s)  
bradyzoite (cystozoites), 1517, 1518  
cutaneous, 667  
dermoid, 670  
developmental, 667  
epidermoid, 667  
hydatid, 1583
- Cystic calculi, 570, 571
- Cysticercus bovis* (*Taenia saginata*, beef tapeworm), 1583
- Cysticercus cellulosae* (*Taenia solium*, pork tapeworm), 1583
- Cysticercus ovis*, 1583
- Cystic renal dysplasia, inherited, 1948
- Cystitis, 561  
plant-induced, 1895  
pyelonephritis with, sows, 791–793
- Cystocaulus ocreatus*, 1568
- Cystocentesis, 549
- Cystometry, 553
- Cystozoites (bradyzoite cysts), 1517, 1518
- Cytoecetes phagocytophila* see *Anaplasma phagocytophila*
- Cytokines  
fever and, 49  
mastitis, 694  
*Staphylococcus aureus* mastitis, 701
- Cytolysin venoms, 1917
- Cytomegalovirus, equine, 803, 1318–1319
- Cytotoxic cerebral edema, 597, 598
- Cytotoxic T-lymphocytes, 1174, 1313
- Czech Republic, coccidiosis, 1499
- D**
- Dactylomegaly (enlarged dew claws), 1961
- Daft lamb disease 1 (cerebellar atrophy of lambs), 1955
- Daft lamb disease 2 (star-gazing lambs), 1955
- Dairy calves  
bovine lungworm, 1565  
bovine respiratory syncytial virus pneumonia, 1346  
coccidiosis, 1498–1499  
colibacillosis exposure reduction, 870  
colostral immunoglobulins transfer, guidelines to ensure, 872–873  
colostrum administration, 156  
dehorning, stress, 108  
enteric disease, 853  
enzootic pneumonia of calves, 1337  
fetal disease, 129  
hand-fed, dietary diarrhea, 278–279  
hemonchosis, 1549  
management, 129  
mortality, 129  
newborn, transport of, 158  
parturient disease, 129  
postnatal disease, 129
- Dairy cattle  
abomasal ulcer, 370  
abomasal volvulus, 362  
behavioral needs, 1615  
bovine herpesvirus-1 infection, 1353  
bovine herpesvirus-1 vaccination, 1359  
bovine lungworm, 1565  
bovine virus diarrhea virus vaccination, 1272  
carbohydrate engorgement, 315–316  
crushed tail syndrome, 2020  
degenerative arthropathy, 637  
diet, 323–325, 355  
enzootic bovine leukosis, 1210  
feed intake reduction manifestations, 112  
hyperthermia management, 48  
John's disease control, 1033, 1035  
laminitis, 2034, 2035  
nutritional management, 1692–1693  
pasture-fed, hypocalcemia prevention, 1642  
periparturient period, voluntary dry matter intake, 1616  
phosphorus requirements, 1761–1763  
pneumonic pasteurellosis vaccination program, 945  
pregnancy  
fat cow syndrome, 392  
liver metabolism, 383  
productivity measurement, 1615  
productivity shortfalls, 116–117  
reticuloperitonitis, traumatic, 338  
right-side displacement of the abomasum, 362  
salmonellosis risk factors, 900–901  
selenium supplementation, 1752  
serum bile acids, 390  
sodium deficiency, 1729  
transition period, 1613–1616  
dry matter intake, 1676  
energy balance, 1676  
glucose demand, 1677  
immunosuppression, 1616–1617  
metabolic adaptation, 1676–1677  
non-esterified fatty acid supply reduction, 1677  
nutrient requirements, 1613  
nutritional management, 1614  
vitamin E supplementation, 1752
- Dairy Herd Health and Productivity Service (DHHPS), UK, metabolic profiling, 1618, 1620  
cow selection, 1623  
tests included in, 1623
- Dairy Herd Improvement Association (DHIA), test day, 1615
- Dairy Herd Improvement (DHI) program, urea nitrogen testing, 1621
- Dairy herds  
bovine ephemeral fever, 1178  
bovine respiratory syncytial virus pneumonia, 1344  
cold injury, 1793  
record system, 1615–1616
- Dalteparin, 442–443
- Dalteparin sodium, 2054
- Dams, giardiasis, 1516
- Danish Bacon and Meat Council, 918
- Danish mix-ELISA (DME), 911
- Danish Salmonella Surveillance and Control Program, 918
- Danofloxacin, 1057, 1341, 2054
- Dantrolene, 1968, 1973
- Dantrolene sodium, 630, 2054, 2064
- Daphnetin poisoning, 1886
- Daphnin poisoning, 1886
- Darien Gap, 1223
- Dark, firm, dry (DFD) pork, 1970, 1971
- Darrow's solution, 94
- Database diagnosis method, 24–25
- Datura stramonium* poisoning, 1894
- Day lily (*Hemerocallis*) poisoning, 1893
- DDT  
mosquito control, 1605  
poisoning, 1832  
toxic doses, 1833
- Deafness, 594
- Death, sudden see Sudden death
- Death adder (*Acanthophis antarcticus*), 1916, 1917
- Death by misadventure, volcanic eruptions, 1791
- Death camas (*Zigadenus*) poisoning, 1894
- Decision analysis, 29–31
- Decision nodes, 29–30
- Decision trees, 29, 29–30, 30
- Decompression  
gastric, 196, 246  
nervous system, 595, 598
- Decoquinat, 1506, 1522, 2054
- Decubital ulcers  
laminitis, horses, 2031  
recumbency complication, 123
- Deer  
bluetongue, 1303  
border disease, 1415  
bovine virus diarrhea virus, 1250  
copper deficiency, 1715, 1717  
epizootic hemorrhagic disease, 1305  
farmed/farmed red  
copper oxide needles, 1721–1722  
cryptosporidiosis, 1512  
John's disease, 1018  
selenium reference ranges, 1747  
foot-and-mouth disease reservoir, 1224  
*Hypoderma* infestations, 1588  
John's disease, 1018, 1030  
leptospirosis, 1097  
malignant catarrhal fever, 1245  
vesicular stomatitis, 1233  
zoonoses, 1487  
see also specific types
- Deer flies, 1603
- Deer herpesvirus (DVH), 1245
- Defecation, 19–20  
clinical examination, 9  
equine colic, 220  
frequency, 20  
frequency decrease (constipation), 193, 386, 755  
frequency increase see Diarrhea  
reference values, 19  
see also Entries beginning fecal
- Deficiency of UMP synthase (DUMPS), 1940
- Defoliant poisoning, 1838
- Deformity  
craniofacial see Craniofacial deformity  
facial, enzootic nasal adenocarcinoma of sheep and goats, 1368  
jaw see Jaw deformity  
joints, 621, 632  
degenerative disease, 2028  
musculoskeletal system, 621, 625, 648–649  
tail, inherited, 1961  
tongue, 206
- Degenerative disease  
hereditary/familial, 603  
idiopathic, 603  
peripheral nervous system, 618
- Degenerative joint disease, 1757, 1771, 2025–2029  
breeding stock selection, 2029  
breed predisposition, 2026  
characteristics, 645  
clinical findings, 2028  
clinical pathology, 2028  
control, 2029  
coxofemoral, 637  
differential diagnosis, 2028  
economic importance, 2027  
epidemiology, 2025–2027  
etiology, 2025  
floor type, 2026  
genetics predisposition, 2026  
horses, 639  
leg weakness signs, 2028  
necropsy findings, 2028  
occurrence, 2025–2026  
onset, 2026  
pathogenesis, 2027–2028  
risk factors, 2026–2027  
sex, 2026  
treatment, 2028–2029
- Degenerative lesions, 24
- Degenerative myopathy, 627, 645, 1635
- Degenerative osteoarthritis, inherited, 1958
- Dehorning, 108
- Dehydration, 74–76, 547  
alimentary tract dysfunction, 190–191, 195  
carbohydrate engorgement of ruminants, 319  
clinical findings, 75–76, 87–88  
clinical pathology, 76  
enteric colibacillosis, 857, 859, 859  
enteritis, 264, 265  
etiology, 74, 74  
evaluation of, 862–863  
horses, 75, 100–101  
hypertonic, 77, 78, 90

- Dehydration (*Cont'd*)  
 hypotonic, 77, 78, 90  
 isotonic, 77, 78, 90  
 pathogenesis, 74–75  
 treatment see Fluid and electrolyte therapy types, 90
- Delayed hypersensitivity reaction, 69
- Deldrad poisoning, 1838
- Deliberate/criminal poisoning, 1798
- Delphinium*, diterpenoid alkaloid poisoning, 1865, 1866
- Deltamethrin, 1592
- Delvotest-P, 185
- Dembrexine hydrochloride, 2054
- Demodectic mange, 1433, 1608
- Demodex bovis*, 1608
- Demodex caprae*, 1608
- Demodex equi*, 1608
- Demodex ovis*, 1608
- Demodex phylloides*, 1608
- Demodicosis, 1608
- Demyelination, 600, 1414
- Dendritic cells, post-weaning multisystemic wasting syndrome, 1188
- Dendroaspis* (mamba), 1916
- Denisonia superba* (blacksnake), 1916
- Denmark  
 bovine hereditary dilated cardiomyopathy, 1945  
 bovine herpesvirus-1 infection, 1355  
 bovine respiratory syncytial virus pneumonia, 1344  
 bovine virus diarrhoea virus eradication program, 1275  
 enzootic bovine leukosis compulsory eradication program, 1219  
 post-weaning multisystemic wasting syndrome control, 1192  
 pseudorabies transmission, 1396
- Dental alveoli, actinomycosis, 1045
- Dental fluorosis, 207, 1817
- Deoxyvalenol poisoning, 1910–1911
- 12-deoxyphorbol poisoning, 1886
- Depigmentation, molybdenum poisoning, 1820
- Depopulation  
 Bang's disease, 974  
 post-weaning multisystemic wasting syndrome, 1191–1192  
 swine vesicular disease, 1232  
 transmissible gastroenteritis, pigs, 1283
- Depopulation-repopulation  
 porcine reproductive and respiratory syndrome, 1202  
 pseudorabies, 1397, 1400, 1401  
 scrapie, 1445
- Depression  
 equine arteritis virus, 1320  
 nervous system disease, 578  
 states of, 578
- Dermacentor albipictus* (winter tick), 1456
- Dermacentor andersoni*, 1456, 1918
- Dermacentor nitens*, 1484–1485
- Dermacentor occidentalis* (Pacific coast tick), 1456
- Dermacentor variabilis*, 1456
- Dermatitis, 656–659  
 besnoitiosis, 1518  
*Candida* associated, 1473  
 caprine idiopathic, 657  
 cattle, 656, 657  
 clinical findings, 657–659  
 clinical pathology, 659  
 diagnosis, 659  
 differential diagnosis, 659  
 etiology, 656–657  
 goats, 656  
 horses, 657  
 idiopathic fibrosing, 658  
 multisystemic, eosinophilic epitheliotropic disease, 1993  
 pathogenesis, 657  
 pigs, 656–657  
 plant-induced, 1895, 1897  
 sheep, 656  
*Streptococcus*, 769  
 sweating sickness, 1989  
 treatment, 659  
 trombidiform mites, 1606  
 verrucose, 1065  
 see also specific types
- Dermatitis-nephropathy syndrome, 555
- Dermatobia hominis*, 1588
- Dermatomycosis, 1473, 1476–1481
- Dermatophilosis, 1048–1051  
 carriers, 1048  
 cattle, 1049, 1050  
 clinical findings, 1049–1050  
 clinical pathology, 1050  
 control, 1051  
 diagnosis, 1050  
 differential diagnosis, 1050  
 economic importance, 1049  
 epidemiology, 1048–1049  
 etiology, 1048  
 experimental reproduction, 1049  
 goats, 1050  
 horses, 1050–1051  
 infection source, 1048  
 necropsy findings, 1050  
 pathogenesis, 1049  
 risk factors, 1048–1049  
 sheep, 1048–1050  
 transmission, 1048  
 treatment, 1050–1051  
 wetness, 1793  
 zoonotic implications, 1049
- Dermatophilus*, diseases associated with, 1044–1051
- Dermatophilus congolensis*, 1048–1051
- Dermatosis, 656–659  
 cattle, 656  
 clinical findings, 657–659  
 clinical pathology, 659  
 diagnosis, 659  
 differential diagnosis, 659  
 etiology, 656–657  
 goats, 656  
 horses, 657  
 pathogenesis, 657  
 pigs, 656–657  
 sheep, 656  
 treatment, 659
- Dermatosis vegetans, 785, 1976
- Dermatosparaxis (hyperelastosis cutis), 669, 1976
- Dermis, diseases of, 654–661
- Dermoid cysts, 670
- Derriengue, 1389
- Descurainia pinnata* (tansy mustard), 1896
- Desferrioxamine, 2054
- Detomidine, 2033
- Detomidine hydrochloride, 2054
- Devon cattle, ceroid lipofuscinosis, 1950
- Dew claws  
 enlarged (dactylomegaly), 1961  
 sloughing (chestnuts), 664
- Deworming, colic prevention, 232–233
- Dexamethasone  
 chronic interstitial pneumonia, foal, 2006  
 coliform mastitis, 717  
 decompression, 595, 598  
 dosage/interval, 2054, 2064  
 endotoxemia, 59  
 equine cervical vertebral stenotic myelopathy, 2017  
 equine herpesvirus 1 myeloencephalopathy, 1315  
 equine herpesvirus 2 reactivation, 1318  
 equine neonatal encephalopathy, 2014  
 granulomatous enteritis, horses, 1993  
 heaves, 1932  
 hypokalemia, acute (cattle), 1651  
 sporadic lymphangitis, 2030
- Dexamethasone 21-isonicotinate, 2064
- Dexamethasone phosphate, 1920
- Dexamethasone suppression test, 1687
- Dexter cattle, 1938, 1958
- Dextran preparations, 96
- Dextrose  
 equine hyperkalemic periodic paralysis, 1966  
 hypoglycemia, neonatal, 1681  
 ketosis, 1665  
 pregnancy toxemia, sheep, 1670  
 properties, 94–95  
 watery mouth of lambs, 1987
- Dhurrin poisoning, 1853
- Diabetes insipidus, 547, 551, 558
- Diabetes mellitus, 396–397  
 cattle, 397  
 equine pars intermedia dysfunction, 1687  
 glucosuria, 546  
 horses, 396–397  
 insulin-dependent, spontaneous, 1258
- Diacetoxyscirpenol poisoning, 1910–1911
- Diagnosis, making a, 22–29  
 arborization/algorithm method, 22–23  
 computer-assisted, 28–29  
 database method, 24–25  
 diagnostic methods, 22–25  
 hypotheticodeductive reasoning, 22  
 key abnormality method, 23, 23–24  
 laboratory data interpretation, 25–28  
 syndrome/pattern recognition, 22
- Dianella revoluta* (flax lily) poisoning, 1893
- Dianthrone derivative poisoning, 1886
- Diapause (arrested development), *Haematobia* flies, 1604
- Diaphragmatic disease, 519–530
- Diaphragmatic hernia, 350–351, 521
- Diaphragmatic muscle dystrophy, 627, 629, 1963
- Diaphragm perforation, 522
- Diaporphthe toxica*, 1899, 1906–1908
- Diarrhea, 193  
 abnormal intestinal motility, 263  
 bunostomosis, 1552  
 carbohydrate engorgement of ruminants, 319  
 cattle, 1265–1266  
 coccidiosis, 1503  
 copper deficiency, 1711  
 cryptosporidiosis, 1512, 1514  
 dehydration, 74, 75, 191  
 dietary see Dietary diarrhea  
 enteric colibacillosis, 857  
 etiology, 193  
 exudative, 263  
 fluid and electrolyte therapy, 92  
 fluid/electrolyte/acid-base imbalance, 87, 88  
 giardiasis, 1516  
 glucosinolate poisoning, 1867  
 horses see Diarrhea, horses  
 hypomagnesemic tetany risk factor, 1655  
 intestinal bacterial flora changes, 865–866  
 liver disease, 386  
 malabsorption syndromes, 193  
 mechanisms of, 262–263  
 newborns, 847–851  
 control, 850–851  
 epidemic management, 850  
 etiology, 848  
 risk factors, 847, 848–850  
 osmotic, 262–263  
 pathophysiology, 193  
 pigs, 888  
 plant-induced, 1895–1896  
 porcine colonic spirochetosis, 1121  
 postweaning see Coliform gastroenteritis, pigs  
 secretory, 263  
 stomach fluke disease, 1581  
 threadworm, 1562  
 transmissible gastroenteritis, 1281  
 see also Enteritis
- Diarrhea, horses  
 acute, 100–101, 268–272  
 antibiotics, 269  
 clinical findings, 269–270  
 clinical pathology, 270  
 complications, 270  
 control, 272  
 diagnostic confirmation, 270  
 differential diagnosis, 270  
 epidemiology, 269  
 etiology, 268–269  
 necropsy findings, 270  
 pathogenesis, 269  
 risk actors, 269  
 treatment, 270–272
- acute, foals, 274–277  
 clinical findings, 275, 276  
 clinical pathology, 276  
 control, 276–277  
 epidemiology, 275  
 etiology, 274, 274–275  
 lesions associated with, 276  
 pathogenesis, 275  
 risk factors, 275, 850  
 treatment, 276
- chronic undifferentiated, 272–274  
 clinical findings, 272  
 clinical pathology, 272–273  
 control, 274  
 differential diagnosis, 273  
 epidemiology, 272  
 etiology, 272  
 necropsy findings, 273  
 pathogenesis, 272

- Diarrhea, horses (*Cont'd*)  
 treatment, 273  
 equine neorickettsiosis, 1466–1467
- Diastolic failure, 402
- Diastolic murmurs, 424–425
- Diazepam, 2014, 2054, 2064
- Diazinon  
*Haematobia* fly control, 1604  
 louse infestations, 1598  
 psoroptic mange, 1611  
 screwworm, 1595  
 sheep ked, 1596
- Dibromoethane poisoning, 1841
- Dicalcium phosphate, 1683, 1762, 1861
- Dicentra cucullaria* poisoning, 1887
- Dicentra spectabilis* (bleeding heart) poisoning, 1887
- Dichapetalum*, fluoroacetate poisoning, 1887
- Dichelobacter nodosus*  
 infectious foot rot in sheep, 1070–1077  
 vaccine, 1076  
 virulence, 1072
- Dichlorvos, 1556, 1595, 2054, 2064
- Diclofenac, 106, 2054
- Dicloxacillin sodium, 2054
- Dicosmoecus gilvipes* (caddis flies), equine neorickettsiosis, 1466
- Dicoumarin derivative poisoning, 1864–1865
- Dicoumarol analysis, 1864–1865
- Dicrocoelium dendriticum* infection, 1580
- Dicrocoelium dentriticum*, biliary obstruction, 385
- Dictyocaulus arnfieldi*, 1568
- Dictyocaulus filaria*, 1568
- Dictyocaulus viviparus*, 1564
- Dicyclanil, 1596
- Didelphis albiventris*, 1523
- Didelphis marsupialis*, 1523
- Didelphis virginiana*, 1523
- Dieldrin toxicity, 1833
- Diencephalon, scrapie, 1444
- Diet  
 buffers, carbohydrate engorgement prevention, 323, 324  
 cobalt deficiency risk factors, 1701–1702  
 colibacillosis, 869–870  
 coliform gastroenteritis, pigs, 892  
 copper deficiency risk factors, 1710  
 enteritis, 261, 267  
 enterohemorrhagic *Escherichia coli* control, 884  
 enzootic posthitis risk factor, 793–794  
 equine colic risk, 218  
 equine hyperkalemic periodic paralysis, 1966  
 fatty liver risk factors, 1673  
 frothy bloat and, 328  
 gastric ulcers, 238  
 iodine deficiency risk factors, 1723  
 laminitis, 2034  
 left-side displacement of abomasum risk, 355  
 liver necrobacillosis risk factors, 1062  
 medication in, 180  
 milk fever and, 1629–1630, 1638  
 nitrate poisoning risk factors, 1857  
 nutritional deficiency evidence, 1691  
 polioencephalomalacia, 2007–2009  
 post-weaning multisystemic wasting syndrome, 1191  
 ration change, carbohydrate engorgement of ruminants, 315  
 rhabdomyolysis, recurrent exertional, 1968  
 swine dysentery, 1119  
 total mixed rations, carbohydrate engorgement prevention, 323  
 see also *specific components*
- Dietary cation-anion difference (DCAD), 1639–1642  
 acid-base balance and pasture-based diets, 1640–1641  
 anion feeds, manipulation with, 1642  
 calculation, 1639, 1639  
 expression, 1639  
 milk fever and, 1629–1630, 1639–1642  
 optimum in lactating cows, 1641
- Dietary diarrhea, 277–279  
 clinical findings, 266, 278  
 clinical pathology, 278  
 differential diagnosis, 278  
 etiology, 277–278  
 necropsy findings, 278  
 pathogenesis, 278  
 treatment, 278–279
- Diethylcarbamazine hydrochloride, 2054
- O-diethyl toluamide (DEET), 1603, 1605
- Diffuse fibrosing alveolitis, 1998, 1999, 2001
- Diflubenzuron, 1603
- Digestion abnormality/dysfunction, 191  
 glucosinolate poisoning, 1868  
 lesions, enzootic bovine leukosis, 1215  
 weight loss, 116
- Digestion tests, 197–199, 266
- Digits, splayed, 1965
- Digoxin, 403–404, 2054
- Dihydrostreptomycin, 1106–1107, 1110, 2054
- Dihydrotachysterol, 1642
- Dihydroxycoumarin glycoside poisoning, 1886
- 1,25-dihydroxyvitamin D<sub>3</sub>, milk fever and, 1629, 1638
- 1,25-dihydroxyvitamin D<sub>3</sub>, milk fever prevention, 1643
- Dikkop, 1181
- Dimercaprol, 2054
- 2,3-dimercaptopropranol (BAL), 1811, 1815
- Dimercapto succinic acid (DMSA), 1815
- Dimethyltryptamine poisoning, 1869–1870
- Dimethyl disulfide, 1881
- Dimethyl glycine, 2054
- Dimethyl phthalate, 1605
- Dimethyl sulfoxide (DMSO)  
 dosage/interval, 2054  
 equine cervical vertebral stenotic myelopathy, 2017  
 equine neonatal encephalopathy, 2014  
 equine protozoal myeloencephalitis, 1525  
 laminitis, horses, 2032
- Dimetridazole, 1117, 1517, 2065
- Diminazene aceturate  
 bovine babesiosis, 1491, 1493  
 dourine, 1540  
 nagana, 1536  
 ovine babesiosis, 1494  
 surra (quinapyramine sulfate), 1536, 1538, 1540
- Dimophebamine hydrochloride, 2055
- Dinitroorthocresol (DNOC) poisoning, 1838
- Dinitrophenol (DNP) poisoning, 1837–1838
- Dinoprost tromethamine, 2055, 2065
- Diocetyl sodium sulfosuccinate (DSS), 227, 369, 2055
- Dioon* poisoning, 1885
- Dioxin poisoning, 1840
- Diphenhydramine hydrochloride, 2055
- Diphenylamine blue test, nitrite poisoning, 1857–1858
- Diphtheria, 1079
- Diplodia maydis*, 1912
- Dipping  
 arsenic poisoning, 1808  
 aspiration pneumonia, 515  
 blowfly strike prevention, 1592  
 caseous lymphadenitis risk factor, 796  
 dermatophilosis following, 1048  
*Haematobia* fly control, 1604  
 louse control, 1598  
 malignant edema risk factor, 831  
 poisoning from, 1833  
 tick-borne fever control, 1461  
 tick control, 1602  
 see also *specific methods*
- Diprenorphine, 2055, 2065
- Dipropyl/dipropenyl disulfide poisoning, 1881–1882
- Dipyrene, 225, 2055, 2065
- Diquat poisoning, 1838
- Direct fluorescence test, African swine fever, 1171
- Directigen flu A test, 1325
- Discoid lupus erythematosus, 658
- Disinfection  
 anthrax, 818–819  
 equine protozoal myeloencephalitis, 1525  
 pseudorabies, 1395  
 ringworm control, 1478  
 salmonellosis, 915  
 swine dysentery, 1119
- Disk sensitivity tests, 175
- Disodium phosphate, 1762
- Disophenol, 1550
- Dispholidus typus* (boomslang), 1916
- Disposition, non-ambulatory cattle, 1649–1650
- Disseminated aspergillosis, 1474
- Disseminated intravascular coagulopathy (DIC), 447–450  
 clinical findings, 448
- clinical pathology, 448–449  
 diagnosis, 449  
 diarrhea, acute, 271–272  
 endotoxemia and, 55  
 epidemiology, 447  
 etiology, 447  
 hog cholera, 1160  
 necropsy findings, 449  
 pathophysiology, 447–448  
 prevention, 271–272  
 prognosis, 447  
 septicemia and, 52  
 treatment, 60, 271–272, 449
- Distemper, equine see Strangles
- Diterpene acid poisoning, 1872
- Diterpene saponin poisoning, 1891
- Diterpenoid alkaloid poisoning, 1865–1866
- Diterpenoid (kaurene) glycoside poisoning, 1886
- Diterpenoids, irritant, 1886
- Dittrichia graveolens* (stinkwort) poisoning, 1888
- Diuretics, 403
- 'Diva' (differentiating infected from vaccinated animals) vaccines, bovine herpesviruses, 1359
- Diverticulitis, 279
- DNA analysis  
 complex vertebral malformation, Holstein calves, 1960–1961  
 mannosidosis, 1949  
 porcine stress syndrome, 1969–1970, 1972
- DNA arbovirus, African swine fever, 1167
- DNA probes  
 babesiosis, 1489  
 leptospirosis, 1104–1105  
*Mycoplasma bovis*, 1129  
 salmonellosis, 911  
 transmissible gastroenteritis, 1281
- DNA vaccines  
 porcine reproductive and respiratory syndrome, 1204  
 pseudorabies, 1403  
 vesicular stomatitis, 1235
- Dobutamine, 59
- Dobutamine hydrochloride, 2055
- Docking, blackleg transmission, 828
- Docusate (dioctyl sodium sulfosuccinate), 227, 369, 2055
- Doddler calves, 1957
- Dog(s)  
 African horse sickness, 1181  
*Brucella abortus* infection, 967  
 equine influenza infection, 1322  
 neosporosis host, 1509, 1510  
 pseudorabies, 1398  
 rabies vector, 1387, 1388  
 sarcocystosis, 1508
- 'Dog-sitting' posture, 581, 589–590, 616
- Dole horses, inherited hip dysplasia, 1962
- Domestic animals  
 rabies, 1385–1386, 1392  
 vaccination, 1392  
 see also *specific animals*
- Dominant collagen packing defect, 1976
- Domperidone, 2055
- Donkey(s)  
 altitude effects, 1788  
 babesiosis treatment, 1494  
 coccidiosis, 1498  
 equine infectious anemia, 1173  
 lungworm, 1568  
 ringworm, 1476  
 septicemia, 51  
 vesicular stomatitis, 1233
- Dopamine, 554
- Dopamine hydrochloride, 2055
- Doppellender, 1964–1965
- Doramectin  
 ascarid infections, 1557  
 bovine lungworm, 1566  
 bunostomosis, 1553  
 chorioptic mange, 1612  
 kidney worm disease, 1571  
 parasitic gastritis, pigs, 1555  
 parasitic gastroenteritis, ruminants, 1545  
 psoroptic mange, 1611  
 screwworm, 1595  
 tick infestations, 1602  
 wohlfahrtiosis, 1596
- Double-muscling, 627, 1964–1965  
 also heel, 1956
- Double outlet right ventricle, 432

- Dourine, 1532, 1538–1540  
 carriers, 1539  
 clinical findings, 1539  
 clinical pathology, 1539  
 control, 1540  
 differential diagnosis, 1540  
 epidemiology, 1538–1539  
 etiology, 1538  
 immune mechanisms, 1539  
 incubation period, 1539  
 necropsy findings, 1539–1540  
 occurrence, 1538–1539  
 pathogenesis, 1539  
 risk factors, 1539  
 secondary stage, 1539  
 systemic, 1539  
 tertiary stage, 1539  
 transmission, 1539  
 treatment, 1540
- Downer cow syndrome, 590, 1614, 1644–1650  
 clinical examination, 1647  
 clinical findings, 1646–1647  
 clinical pathology, 1647  
 coliform mastitis risk factors, 712  
 complications, 1647  
 control, 1650  
 course of, 1647  
 diagnosis, 1648  
 differential diagnosis, 1648  
 disposition, 1649–1650  
 epidemiology, 1644–1646  
 etiology, 1644  
 handling, 1649–1650  
 incidence, 1644–1645  
 milk fever associated, 1630, 1633, 1635, 1645  
 myopathy, 627, 629  
 necropsy findings, 1648  
 non-progressive neurological findings, 1644  
 occurrence, 1644  
 pathogenesis, 1646  
 prognosis, 1648  
 progressive neurological findings, 1644  
 risk factors, 1645  
 survival rate, 1645  
 transport, 1649–1650  
 treatment, 1648–1650
- Doxapram hydrochloride, 2065
- Doxycycline  
 dosage/interval, 2055  
 equine neorickettsiosis, 1467  
 heartwater, 1463  
 mycoplasma pneumoniae, pigs, 1149  
 pleuropneumonia of pigs, 1058
- Doxylamine succinate, 2055, 2065
- Draschia megastoma*, 1571–1572
- Drechslera*, 1936
- Drechslera campanulata*, 1912
- Drenching, magnesium supplementation, 1658
- 'Dribblers,' urethral obstruction, 568
- Drooling of saliva see Salivation, excessive
- 'Dropped pulse,' 406, 416
- Drowning, 1793–1794
- Drug doses/intervals  
 horses, 2051–2063  
 pigs, 2064–2066  
 ruminants, 2051–2063  
 see also *specific drugs*
- Drunken horse grass (*Achnatherium inebrians*)  
 poisoning, 1901
- Dry coat, 2038
- Dry cow  
 bovine mastitis control programs, 737–741  
 environment management, 740  
 external teat sealants, 741  
 internal teat sealants, 740–741  
 intramammary devices, 741  
 intramammary infection  
 epidemiology, 737–738  
 pathogens, 737  
 susceptibility risk factors, 737–738  
 treatment see Dry cow therapy  
 metabolic profile testing, 1623–1624  
 nutritional management, 740  
 secretions, 682  
 vaccination, 740
- Dry cow therapy, 688, 738–740  
*Bacillus* mastitis induction, 726  
 blanket, 694, 739  
 bovine mastitis control programs, 737–741  
 cow selection for, 747  
 environmental streptococci mastitis, 720–721, 722
- intramammary infusion, 738–739  
 lactation therapy *versus*, 694  
 mastitis, 694–695  
 prognosis indicators, 739–740  
 selective, 694, 739  
*Staphylococcus aureus* bovine mastitis, 738, 740  
*Staphylococcus aureus* mastitis, 702  
*Streptococcus agalactiae* mastitis, 705
- Drying off, 738
- Dry puffer, 2038
- Dubosia hopwoodii* (pituri) poisoning, 1890
- Dummy calf syndrome, 1984
- Dummy foal, 163  
 see also Equine neonatal encephalopathy
- Dummy syndrome, 9  
 hepatitis, 393  
 plant-induced, 1896
- Dunkop, 1181
- Duodenal-abomasal reflux, 354
- Duodenal ileus, 378, 379
- Duodenal ulceration, 279
- Duodenitis, 245–246
- Duodenum, stomach fluke disease, 1581
- Dust, 1785  
 caseous lymphadenitis risk factor, 796  
 inhalation, heaves, 1928
- Dusty feed  
 aspiration pneumonia, 516  
 rhinotracheitis, 925
- Dutch Animal Services, bovine herpesvirus-1  
 marker vaccine advise, 1360
- Duvenhage virus, 1386
- Dwarfism, 1958–1959
- Dye dilution, cardiac output measurement, 410
- Dyschondroplasia, 2027  
 in non-inherited congenital dwarfism, 2035–2036  
 see also Degenerative joint disease;  
 Osteochondrosis
- Dysentery  
 enteritis, acute, 265  
 hemorrhagic enteritis, 307  
 plant-induced, 1895–1896
- Dysmaturity, determination of, 160–163
- Dysmetria, 580, 589
- Dysphagia (swallowing difficulty), 9, 191–192  
 equine protozoal myeloencephalitis, 1524  
 esophageal obstruction, 213  
 etiology, 192  
 guttural pouch mycosis, 540  
 masseter myonecrosis, 1686  
 pharyngeal obstruction, 210  
 pharyngeal paralysis, 211  
 plant-induced, 1896  
 tuberculosis, 1009
- Dyspnea, 474  
 bloated and, 331  
 inspiratory, laryngitis/tracheitis/bronchitis, 533  
 ovine progressive pneumonia, 1364  
 plant-induced, 1897  
 respiratory tract disease, 474–475  
 at rest, 474, 474–475  
 tuberculosis, 1009
- Dysrhythmias see Arrhythmias (dysrhythmias)
- Dystocia  
 femoral nerve paralysis and, 618  
 horses, 200  
 milk fever complication, 1630  
 myofiber hyperplasia, 1965  
 neonatal hypothermia and, 43  
 stillbirth/perinatal weak calf syndrome, 1985  
 vertebral fractures, 614
- Dysuria, 547–548
- 
- E**
- E2 glycoprotein, bovine virus diarrhea virus, 1252
- Ear(s)  
 clinical examination, 20–21  
 cold injury, 1794  
 external, diseases of, 651–653, 670–671  
 mange, 1610–1611
- Ear cancer, 668
- Ear-chewing, 612–613
- Eartags, insecticidal-impregnated, 1604, 1606
- East Coast fever (ECF), 1527, 1527–1530  
 case fatality, 1527–1528  
 'classic,' 1527
- clinical findings, 1528–1529  
 clinical pathology, 1529  
 control, 1529–1530  
 differential diagnosis, 1529  
 economic importance, 1528  
 endemic stability, 1527  
 epidemiology, 1527–1528  
 etiology, 1527  
 experimental reproduction, 1528  
 immune mechanisms, 1528  
 morbidity, 1527–1528  
 necropsy findings, 1529  
 occurrence, 1527  
 pathogenesis, 1528  
 risk factors, 1528  
 transmission, 1528  
 treatment, 1529  
 vaccines, 1529–1530
- Eastern equine encephalomyelitis, 1368–1372  
 case fatality rate, 1369  
 clinical findings, 1370, 1375  
 clinical pathology, 1370  
 control, 1371, 1375  
 differential diagnosis, 1371, 1375–1377  
 epidemics, 1369  
 epidemiology, 1369, 1375  
 etiology, 1369, 1375  
 experimental transmission, 1370  
 meteorological factors, 1369  
 morbidity, 1369  
 necropsy findings, 1370–1371  
 pathogenesis, 1369–1370  
 pigs, 1370  
 risk factors, 1369  
 treatment, 1375  
 vaccination, 1371  
 virus isolation, 1370  
 zoonotic implications, 1369, 1371, 1605
- Eastern equine encephalomyelitis (EEE) virus, 1369
- Eastern Tent caterpillars (*Malacosoma americanum*) ingestion, 1919, 1920
- Eating, clinical examination, 9
- Ecballium elaterium* (squirting cucumber)  
 poisoning, 1893
- Ecbolic drugs, septic metritis, 63
- Eccentric hypertrophy (cardiac dilatation), 401
- ECG see Electrocardiography (ECG)
- Echinococcus granulosus* (hydatid cysts), 1583
- Echinopogon mauritanicus* poisoning, 1897
- Echinopogon ovatus* poisoning, 1897
- Echocardiography, 411  
 Doppler, cardiac output measurement, 410  
 endocarditis, 428  
 pericarditis, 430
- Eclampsia, 1651–1652  
 mastitis-metritis-agalactia syndrome, 754  
 see also Lactation tetany
- Ecthyma, contagious, 749–750, 1075
- Ectopic heart, 431
- Ectopic ureter, 572
- Ectromelia, 1961
- Edema, 72–73  
 African horse sickness, 1181  
 bovine besnoitiosis, 1517  
 bovine hereditary dilated cardiomyopathy, 1945  
 bovine respiratory syncytial virus pneumonia, 1345  
 brisket disease, 1788  
 cerebral see Cerebral edema  
 clinical findings, 73  
 clinical pathology, 73  
 differential diagnosis, 73  
 dourine, 1539  
 equine arteritis virus, 1320  
 equine babesiosis, 1489  
 equine granulocytic anaplasmosis, 1465  
 equine neorickettsiosis, 1467  
 etiology, 72  
 heart failure, right-sided chronic (congestive), 402  
 hepatitis, 393  
 liver disease, 386  
 lymphatic obstruction, inherited, 1945  
 malignant see Malignant edema  
 necropsy findings, 73  
 parturition trauma, 139  
 pathogenesis, 72–73  
 stillbirth/perinatal weak calf syndrome, 1985  
 subcutaneous, 73, 522, 664, 1775, 1925–1926  
 surra, 1537–1538

- Edema (*Cont'd*)  
 swine influenza, 1334  
 treatment, 73  
 trichostrongylid infection, 1544  
 udder, 749, 752, 752
- Edema disease, 889–891  
 clinical findings, 890  
 clinical pathology, 890  
 control, 890–891  
 diagnosis, 890  
 differential diagnosis, 890  
 epidemiology, 889–890  
 etiology, 889  
 necropsy findings, 890  
 pathogenesis, 890  
 treatment, 890
- Edetate calcium disodium (EDTA), 1646, 2052, 2055
- EDI gene, 1974
- Edrophonium chloride, 2055, 2065
- Education  
 Johne's disease, 1041  
 tuberculosis control, 1013
- EEG, 594, 607
- Effusive pericarditis, 429
- Eggs  
 house flies, 1605  
 stable flies, 1603  
 stomach fluke disease, 1581  
 tapeworm infestations, 1582
- Ehler–Danlos syndrome, 1976
- Ehrlichia bovis*, 1455
- Ehrlichia ondiri*, 1469
- Ehrlichia phagocytophila* see *Anaplasma phagocytophila*
- Ehrlichia platys*, 1455
- Ehrlichia risticii*, 1466
- Ehrlichia (Cowdria) ruminantium*, 1462
- Ehrlichiosis, granulocytic, 1460
- Eicosanoids, 65
- Eimeria*, 1498, 1501, 1502  
 see also Coccidiosis
- Eimeria alabamensis*, 1498
- Eimeria arloingi*, 1499, 1502
- Eimeria bovis*, 1498, 1502, 1503
- Eimeria crandallii*, 1499
- Eimeria ellipsoidalis*, 1498, 1502
- Eimeria gilruthi*, 1502, 1504
- Eimeria leuckarti*, 1499
- Eimeria ninakohlyakimovae*, 1499, 1503
- Eimeria ovinoidalis*, 1499, 1504
- Eimeria porci*, 1499
- Eimeria scabra*, 1499
- Eimeria weybridgeensis*, 1499
- Eimeria zuernii*, 1498, 1501, 1502
- Einhoven's triangle, 408
- Eisenmenger complex, 432
- Elaeophora bohmi*, 1573
- Elaeophora poeli*, 1573
- Elaeophora schneideri*, 1573
- Elaeophorosis, 1573–1574
- Elaphostrongylus*, 1575
- Elaphostrongylus cervi*, 1575
- Elaphostrongylus rangiferi*, 1575
- Elapidae, 1916, 1917
- Elderberry (*Sambucus*) poisoning, 1888
- Electrical cardioversion, atrial fibrillation, 419–420
- Electrical transmission wires, electrocution, 1789
- Electric fields, 1795
- Electrocardiography (ECG), 407–409  
 atrial fibrillation, 418  
 atrial premature complex, 416  
 atrioventricular block, 414  
 cardiac glycoside poisoning, 1863  
 depolarization, 408  
 endocarditis, 428  
 equine grass sickness, 1991  
 equipment, 407  
 fetal, 408–409  
 lead systems, 408, 408  
 pericarditis, 430  
 polyoencephalomalacia, 2010  
 repolarization, 408  
 second-degree atrioventricular block, 415  
 sinus arrhythmia, 414  
 uroperitoneum in foals, 564  
 ventricular premature complexes, 416  
 ventricular tachycardia, 416, 417
- Electrocution, 125, 1789–1790
- Electroencephalography (EEG), 594, 607
- Electrolyte(s)  
 reference laboratory values, 2048, 2049  
 renal clearance, 551  
 serum  
 downer cow syndrome, 1645  
 electrolyte imbalance analysis, 89–90  
 enteritis, 264  
 equine colic, 222–223  
 supplementation, anhidrosis, 2038
- Electrolyte abnormalities/imbbalances, 73–102, 87–102  
 clinical pathology, 88–91, 89  
 diarrhea, acute, 271  
 diarrhea in foals, 276  
 enteric colibacillosis, 857  
 enteritis, 264  
 exercise intolerance, 119  
 treatment see Fluid and electrolyte therapy  
 uroperitoneum in foals, 565  
 see also Acid-base status; Fluid balance disorders; *specific types*
- Electrolyte paste, 101
- Electromyography (EMG)  
 equine hyperkalemic periodic paralysis, 1966  
 equine motor neuron disease, 2020  
 nervous system examination, 594  
 polyneuritis equi, 2021
- Electron microscopy  
 neonatal viral diarrhea, 1292–1293  
 orf, 1420  
 transmissible gastroenteritis, 1282  
 winter dysentery, cattle, 1298
- Elementary bodies  
 chlamydial diseases, 1434  
*Chlamydophila abortus*, 1436  
 sporadic bovine encephalomyelitis, 1407
- 'Elephant on a tub stance,' 1991
- Elephants  
 African horse sickness, 1181  
 encephalomyocarditis virus disease, 1183
- Elephant skin disease, 1517–1518
- Elk (*Aces a. acles*)  
 babesiosis, 1484, 1488, 1489  
*Brucella abortus*  
 infection outbreaks, 966  
 strain RB51 vaccine, 981  
 louping-ill, 1408
- Elk herpesvirus, 1349
- El Salvador, brucellosis status, 965
- Elso heel, 1965
- Elso heel, 1955–1956
- Emaciation  
 liver disease, 386  
 molybdenum poisoning, 1820  
 ovine progressive pneumonia, 1364
- Emboli, strongylosis, 1559
- Embolic arteritis, 434
- Embolic infarction, 421
- Embolic nephritis, 558–559
- Embolic pneumonia, 516–517, 925
- Embolism  
 arterial see Arterial embolism  
 endocarditis, 428
- Embryological development, vitamin A deficiency and, 1774
- Embryonic tumors, 669
- Embryo transfer  
 bovine spongiform encephalopathy, 1449  
 foot-and-mouth disease transmission, 1230
- Embryo transplants, anaplasmosis transmission, 1456
- Emmonsia cresens*, horses, 509
- Empyema, subcutaneous, 665
- E<sup>ms</sup> (gp44-48) glycoprotein, bovine virus diarrhea virus, 1261
- Enamel erosion, 207
- Encephalartos* poisoning, 1885
- Encephalitis, 599–602  
 bovine herpesvirus-1 infection, 1352, 1355  
 cattle, 600, 808  
 clinical findings, 601  
 clinical pathology, 601–602  
 differential diagnosis, 602  
 etiology, 600  
 goats, 600, 808  
 horses, 600  
 leptospirosis, 1101  
 listerial, 808  
*Listeria monocytogenes* infection, 805, 806, 808  
 malignant catarrhal fever, 1246  
 necropsy findings, 602  
 non-suppurative, hog cholera, 1163  
 pathogenesis, 600–601  
 pigs, 600  
 pseudorabies, 1398  
 sheep, 600, 808  
 toxoplasmosis, 1520  
 treatment, 602
- Encephalomalacia, 602–604  
 cattle, 602  
 clinical findings, 603–604  
 clinical pathology, 604  
 definition, 602  
 differential diagnosis, 604  
 etiology, 602–603  
 horses, 603  
 necropsy findings, 604  
 pathogenesis, 603  
 pigs, 603  
 treatment, 604
- Encephalomalacia syndrome, sesquiterpene lactone poisoning, 1892
- Encephalomyelitis  
 caprine arthritis encephalitis, 1412  
 equine, 1368–1377, 1375  
 see also *individual diseases*  
 non-suppurative, toxoplasmosis, 1521  
 ovine see Louping-ill  
 verminous, 601
- Encephalomyelopathies, 611–612  
 see also *specific diseases/disorders*
- Encephalomyocarditis virus disease, pigs, 1183–1185  
 clinical findings, 1184  
 clinical pathology, 1184  
 control, 1185  
 diagnosis, 1185  
 differential diagnosis, 1185  
 economic losses, 1184  
 epidemiology, 1183–1184  
 etiology, 1183  
 experimental infection, 1184  
 necropsy findings, 1184–1185  
 outbreaks, 1183  
 in pregnancy, 1184  
 reproductive failure, 1184  
 treatment, 1185  
 vaccine, 1185  
 viral strain differences, 1184
- Encephalopathy, 577  
 mycotic, 1472, 1473  
 pregnancy toxemia, sheep, 1669  
 vitamin A deficiency, 1774  
 see also *specific diseases/disorders*
- Endocarditis, 427–429  
*Actinobacillus*, 1045  
*Arcanobacterium pyogenes*, 787  
 cattle, 427  
 clinical course, 428  
 clinical findings, 427–428  
 clinical pathology, 428  
 echocardiography, 411  
 epidemiology, 427  
 etiology, 427  
 horses, 427  
 necropsy findings, 428  
 pathogenesis, 427  
 pigs, 427  
 relapse, 428  
 sheep, 427  
*Streptococcus suis* infection, 780  
 treatment, 428  
 ventricular septal defects and, 432
- Endometritis, *Chlamydophila abortus*, 1435
- Endophthalmitis, epidemic unilateral, 1918–1920
- Endophyte fungi ingestion, 1982
- Endorphins, 104
- Endoscopy  
 airway examination, 481–482  
 alimentary tract examination, 197  
 cystitis and pyelonephritis (sows), 792  
 epiglottic entrapment, 537  
 equine colic, 231  
 esophageal obstruction, 214  
 guttural pouch empyema, 539  
 guttural pouch mycosis, 540  
 guttural pouch tympany, 541  
 heaves, 1931  
 laryngeal hemiplegia, 535  
 longus capitis muscle rupture, 541  
 nasal discharge, 480  
 pulmonary/pleural neoplasm, 519  
 pyelonephritis, contagious bovine, 790

- Endoscopy (*Cont'd*)  
 respiratory system examination, 481–482  
 retropharyngeal lymphadenopathy, 538  
 rhinitis, 530  
 soft palate paresis, 536  
 tracheal secretions sampling, 486  
 urinary system examination, 553
- Endothelial cells  
 African horse sickness, 1181  
 bluetongue, 1302  
 equine herpesvirus 1 infection, 1313  
 hog cholera, 1161, 1163
- Endothelin (ET)-1, joint disease in horses, 644
- Endotoxemia, 53–60  
 biochemical mediators, 54  
 clinical findings, 57  
 clinical pathology, 57–58  
 control, 60  
 definition, 53  
 diarrhea, acute, 271  
 equine colic, 219, 225–227  
 etiology, 53–54  
 laminitis, horses, 2031  
 necropsy findings, 58  
 panhypoproteinemia, 439  
 pathogenesis, 54–57  
 prophylaxis, 225–227, 271  
 reticulorumen motility, primary contraction influence, 295  
 ruminal atony, 294  
 treatment, 58–60, 225–227, 271  
 watery mouth of lambs, 1986
- Endotoxins, 53  
 inhalation, heaves, 1928
- Endozoites (tachyzoites) see Tachyzoites (endozoites)
- Energy balance  
 ketosis and, 1661  
 metabolic profile testing, herds, 1620–1621, 1623, 1624  
 negative, 1697  
 equine hyperlipidemia, 1679  
 fatty liver, 1673  
 pregnancy toxemia, sheep, 1669
- England  
 louping-ill, 1408  
 pseudorabies control program, 1401  
 see also United Kingdom
- Enilconazole, 1473, 1474
- Enophthalmos extent, dehydration evaluation, 863
- Enoxaparin, 442–443
- Enrofloxacin  
 dosage/interval, 2055, 2065  
*Escherichia coli* bacteremia, 869  
 pneumonic pasteurellosis, 941  
 polyserositis, pigs, 1154
- Enteral nutrition of newborns, 168–169
- Enteric colibacillosis, 1293, 1294
- Enteric disease  
*Clostridium perfringens*, 836–844  
*Yersinia pseudotuberculosis*, 954  
 see also specific diseases/disorders
- Enteritis, 193, 260–268  
 acute, 265  
 anterior, 245–246  
 calves, 309  
*Campylobacter* infection, 1086–1087  
 cattle, 260, 261  
 chronic, 264, 265  
 clinical findings, 265  
 clinical pathology, 265–266  
*Clostridium*, 822  
 control, 268  
 differential diagnosis, 266  
 drug pharmacodynamics in, 265  
 epidemiology, 260–262, 260–263  
 etiology, 260–262, 260–263  
 gastritis and, 265  
 glucosinolate poisoning, 1868  
 goats, 263  
 granulomatous, 1992–1993  
 horses, 261, 1992–1993  
 lesion location, 264  
*Listeria monocytogenes* infection, 809  
 necropsy findings, 266  
 pathogenesis, 262–265  
 pigs, 262  
 proximal, 245–246  
 salmonellosis, 907–909, 912–913  
 sheep, 263  
 stomach fluke disease, 1581
- Streptococcus*, 768  
 treatment, 267–268  
 see also Diarrhea
- Enterobacter aerogenes* mastitis see Coliform bovine mastitis
- Enterocolitis  
*Clostridium difficile* associated, 844–846  
 clinical findings, 845  
 clinical pathology, 845–846  
 control, 846  
 epidemiology, 844–845  
 etiology, 844  
 experimental reproduction, 845  
 horses, 844–845, 846  
 necropsy findings, 846  
 outbreaks, 844–845  
 pathogenesis, 845  
 pigs, 845, 846  
 risk factors, 845  
 treatment, 846
- Clostridium perfringens*, type A, 837  
 lymphocytic-plasmacytic, 1993  
*Yersinia enterocolitica*, 954
- Enterohemorrhagic *Escherichia coli* see *Escherichia coli*, enterohemorrhagic
- Enteroliths, 253–254
- Enteropathy see Enteritis; Proliferative enteropathy
- Enterotoxemia  
 brain dysfunction, 1807  
*Clostridium perfringens* type A, 836–838  
*Clostridium perfringens* type(s) B, C and E associated, 838–840  
 antiserum, 840  
 clinical findings, 839  
 clinical pathology, 839  
 control, 840  
 differential diagnosis, 840  
 epidemiology, 838–839  
 etiology, 838  
 goats, 838  
 necropsy findings, 839–840  
 outbreaks, 840  
 pathogenesis, 839  
 treatment, 840  
 vaccination, 840
- Clostridium perfringens* type D associated, 841–844  
 antitoxin, 843  
 clinical findings, 842  
 clinical pathology, 842  
 control, 843  
 diagnosis, 843  
 differential diagnosis, 843  
 epidemiology, 841  
 etiology, 841  
 experimental reproduction, 841  
 goats, 841, 842, 843  
 horses, 841  
 necropsy findings, 842–843  
 outbreaks, 841  
 pathogenesis, 841–842  
 risk factors, 841  
 sheep, 841, 842, 843  
 treatment, 843  
 vaccination, 843
- Escherichia coli* see Edema disease
- Enterotoxins, 53
- Enterovirus(es), pigs, 1230, 1405
- Entomophthora coronata* (*Conidiobolus coronatus*), 1480, 1481
- Entropion, 1977
- Environment  
 African horse sickness, 1181  
 Akabane disease, 1208  
 anaplasmosis, 1456  
 anthrax, 816  
 babesiosis, 1487  
 bacillary hemoglobinuria, 834–835  
 black disease, 833  
 blackleg, 828  
 botulism, 825  
 bovine ephemeral fever, 1178  
 bovine herpesvirus-1 (BHV-1) infection, 1350  
 bovine interdigital necrobacillosis, 1064  
 bovine mastitis, 679–680, 742–743  
 bovine virus diarrhea virus (BVDV), 1253  
 Cache valley virus disease, 1208  
 chronic enzootic pneumonia of sheep, 1362  
 cobalt deficiency, 1701–1702  
 coccidiosis, 1500–1501  
 colibacillosis, newborn, 854, 870–871
- coliform mastitis, 710–711, 717–718  
 congenital defects of the newborn, 134  
 copper poisoning, 1821  
 dermatophilosis, 1048–1049  
 downer cow syndrome, 1645  
 dyspnea/exercise intolerance from, 475  
 East Coast fever (ECF), 1528  
 enterocolitis, *Clostridium difficile* associated, 845  
 enterohemorrhagic *Escherichia coli*, 878, 880–881, 884  
 environmental streptococci mastitis, 722  
 enzootic pneumonia of calves, 1338  
 equine grass sickness, 1990  
 examination of, individual animals, 4, 7–8  
 fatty liver, 1673  
 fleece rot, 1081  
 foot-and-mouth disease (FMD), 1224  
 heaves, 1929  
 infectious foot rot, sheep, 1071–1072  
 iodine deficiency, 1723  
 Johne's disease and, 1021, 1034–1035, 1036  
 lameness, 625  
 leptospirosis, 1099  
 louping-ill, 1408–1409  
 lumpy skin disease (LSD), 1425  
 malignant catarrhal fever (MCF), 1246  
 malnutrition, 114  
 mastitis-metritis-agalactia syndrome, 758  
 milk fever, 1629–1630  
 musculoskeletal system disease, 625  
 mycoplasma pneumoniae, pigs, 1146, 1150–1151  
 mycotoxicosis outbreaks, 1898  
 nagana, 1533  
 neonatal streptococcal infection, 776  
 newborns, acute undifferentiated diarrhea, 848  
 nitrate poisoning, 1856–1857  
 nitrite poisoning, 1856–1857  
 osteodystrophy, 632–633  
 ovine pulmonary adenocarcinoma, 1367  
 oxalate (soluble forms) poisoning, 1859  
 papillomatosis digital dermatitis of cattle, 1067, 1070  
*pars esophagea* ulceration, 1995  
 pleuropneumonia of pigs, 1055  
 pneumonic pasteurellosis, 935–936, 948  
 porcine intestinal spirochetosis, 1121  
 porcine reproductive and respiratory syndrome, 1195  
 porcine stress syndrome, 1970  
 progressive atrophic rhinitis, 958  
 pseudorabies, 1395  
 pyrrolizidine alkaloid poisoning, 1879  
 respiratory system disease control, 497  
 Rift Valley fever, 1206  
 rinderpest, 1238  
 ringworm, 1476  
 ryegrass staggers, 1904  
 salmonellosis, 903–904  
 selenium poisoning, 1812  
 sodium chloride poisoning, 1825  
 splayleg syndrome, newborn pigs, 2024  
*Staphylococcus aureus* mastitis, 698  
*Streptococcus suis* infection, 778, 781  
 stress induction, 107, 108  
 swine dysentery, 1115  
 swine influenza, 1332  
 toxoplasmosis, 1519  
 transmissible gastroenteritis, 1278–1279  
 tuberculosis, *Mycobacterium bovis* associated, 1008  
 vesicular stomatitis, 1234  
 watery mouth of lambs, 1986  
 winter dysentery, cattle, 1298
- Environmental agents, congenital defects in newborns, 132
- Environmental pollutants, 1785
- Environmental streptococci mastitis, 674–675, 719–722  
 clinical findings, 721  
 clinical pathology, 721  
 control, 722  
 differential diagnosis, 721  
 economic importance, 721  
 epidemiology, 720  
 etiology, 720  
 infection source, 720  
 pathogenesis, 721  
 risk factors, 720–721



- Environmental streptococci mastitis (*Cont'd*)  
 treatment, 721–722  
 vaccination, 722
- Enzoic abortion of ewes see Ovine enzootic abortion (OEA)
- Enzootic ataxia, copper deficiency, 1714–1715
- Enzootic bovine leukosis (EBL), 1209–1221  
 calf management, 1212–1213  
 clinical findings, 1215, 1215–1216  
 clinical pathology, 1216–1218  
 congenital infection, 1211  
 control, 1219–1221  
 diagnosis, 1217  
 differential diagnosis, 1219  
 economic effects, 1213–1214  
 environmental risk factors, 1212  
 epidemiology, 1210–1214  
 eradication programs, 1219, 1220  
 etiology, 1210  
 experimental transmission, 1211–1212  
 forms, 1210  
 genetic resistance, 1212  
 genetic susceptibility, 1212  
 goats, 1211  
 immune mechanisms, 1212  
 infection sources, 1211–1212  
 lesions, 1214–1215  
 lymphosarcoma, 1212  
 necropsy findings, 1218–1219  
 pathogenesis, 1214–1215  
 prevalence, 1210  
 risk factors, 1212–1213  
 sheep, 1211  
 sporadic bovine leukosis vs., 1218  
 spread of infection prevention, 1220  
 susceptibility to other diseases, 1212  
 trade restrictions, 1213–1214  
 transmission, 1210–1212  
 vaccines, 1221  
 zoonotic implications, 1214
- Enzootic bovine pyelonephritis, 1491
- Enzootic calcinosis of muscles, 632
- Enzootic hematuria, bovine, 1491, 1875, 1876–1877
- Enzootic marasmus, cobalt deficiency, 1701
- Enzootic nasal adenocarcinoma, 531, 1368
- Enzootic nasal granuloma, 1936
- Enzootic nutritional muscular dystrophy (NMD), 627, 1736–1738
- Enzootic pneumonia  
 calves, 1336–1343  
 calf risk factor model, 1338  
 case fatality, 1337  
 clinical findings, 924, 1340  
 clinical pathology, 1340–1341  
 control, 1342–1343  
 differential diagnosis, 1341  
 economic importance, 1339  
 epidemiology, 924, 1337–1339  
 etiology, 1336  
 experimental infection, 1340  
 herd immunity, 1337  
 immunization, 1342–1343  
 morality related factors, 1338  
 morbidity, 1337  
 necropsy findings, 1341  
 occurrence, 1337  
 pathogenesis, 1339–1340  
 pathogen isolation, 1340–1341  
 risk factors, 1337–1338, 1337–1339, 1338–1339  
 secondary bacterial infection, 1340  
 transmission, 1337  
 treatment, 924, 1341–1342  
 vaccines, 1342–1343  
 weather, 1338
- pigs see Mycoplasmal pneumonia, pigs
- sheep, chronic, 1361–1362
- Enzootic posthitis, 793–795  
 caprine herpesvirus-1 infection, 1330  
 clinical findings, 794  
 clinical pathology, 794  
 control, 794  
 differential diagnosis, 794  
 economic importance, 794  
 epidemiology, 793–794  
 etiology, 793  
 experimental reproduction, 794  
 infection source, 793  
 pathogenesis, 794  
 risk factors, 793–794  
 transmission, 793
- treatment, 794
- Enzootic staphylococcosis of lambs, 783–784
- Enzyme-linked immunosorbent assay (ELISA)  
 African swine fever, 1171  
 anaplasmosis, 1457  
 atrophic rhinitis, progressive, 960  
 bluetongue, 1303  
 boreliosis, 1113  
 bovine babesiosis, 1490  
 bovine herpesvirus-1 infection, 1354  
 bovine immunodeficiency-like virus, 1222  
 bovine leukemia virus, 1217  
 bovine lungworm, 1566  
 bovine virus diarrhoea virus, 1261–1262  
*Brucella abortus*, 972  
*Brucella ovis*, 986  
 caprine arthritis encephalitis, 1412  
 contagious bovine pleuropneumonia, 1134  
 enterotoxemia, *Clostridium perfringens* type D associated, 842–843  
 enzootic pneumonia of calves, 1341  
 equine arteritis virus, 1321  
 equine encephalomyelitis, 1370  
 equine herpesvirus 1, 1314  
 equine herpesvirus 2, 1318–1319  
 equine herpesvirus 4, 1310  
 equine infectious anemia virus, 1173  
 equine protozoal myeloencephalitis, 1524  
 equine upper respiratory tract viral infection, 1307–1308  
 fasciolosis, 1578  
 foot-and-mouth disease, 1226  
*Fusobacterium necrophorum* detection, 1061–1062  
 heartwater, 1463  
 hog cholera, 1162  
*Hypoderma* infestations, 1589  
 Johne's disease, 1028–1029, 1030, 1031, 1032–1033, 1034  
 leptospirosis, 1104  
*Mycoplasma bovis*, 1129  
 mycoplasmal pneumonia, pigs, 1148  
 nagana, 1535  
 neonatal viral diarrhoea, 1292–1293  
 neosporosis, 1511  
 ovine enzootic abortion, 1437  
 ovine progressive pneumonia, 1365  
 passive immunity transfer assessment, 154  
 pleuropneumonia of pigs, 1056–1057  
 polyserositis, pigs, 1154  
 porcine herpesvirus 2 infection, 1336  
 pseudorabies, 1399  
 rabies, 1390  
 Rift Valley fever, 1206  
 rinderpest, 1240  
 salmonellosis, 911  
 sarcocystosis, 1508  
 sarcoptic mange, 1609  
*Staphylococcus aureus* mastitis, 700  
*Streptococcus suis* infection, 780  
 swine influenza, 1333  
 swine vesicular disease, 1231–1232  
 toxoplasmosis, 1521  
 tuberculosis, 1011  
 West Nile encephalitis, 1379, 1380  
 winter dysentery, cattle, 1298  
 see also *specific types*
- Enzyme reference laboratory values, 2048–2049, 2049–2050
- Enzymology, musculoskeletal system disease, 626
- Eosinophilia, 461, 1571
- Eosinophilic dermatitis, sodium chloride poisoning, 1826
- Eosinophilic enteritis, 1480, 1993
- Eosinophilic enterocolitis, 1993
- Eosinophilic gastroenteritis, 1993
- Eosinophilic myositis, 1509
- Eosinophilic pneumonia, 509
- Eosinophils, reference laboratory values, 2047
- Eperythrozoonosis, 1154–1156  
 cattle, 1154, 1155  
 clinical findings, 1155  
 clinical pathology, 1155–1156  
 control, 1156  
 epidemiology, 1154–1155  
 etiology, 1154  
 infection source, 1154–1155  
 outbreaks, 1154  
 pathogenesis, 1155  
 pigs, 1154, 1155, 1156  
 risk factors, 1155
- sheep, 1154–1155  
 transmission, 1154–1155  
 treatment, 1156
- Ephedrine sulfate, 2055
- Ephemeral fever, bovine, 1177–1179
- Ephemerovirus, 1177
- Epicauta* (blister beetle) poisoning, 1918
- Epidemic acute interstitial pneumonia, 924
- Epidemic curve examination, herds, 34
- Epidemic hyperthermia (fescue summer toxicosis), 1899, 1901–1902
- Epidemiological investigations  
 clinical examination of herds, 31  
 contagious bovine pleuropneumonia, 1132  
 infectious disease diagnosis, 767  
 newborn diarrhoea, acute undifferentiated, 850  
 undifferentiated bovine respiratory disease, acute, 930
- Epidermal dysplasia, inherited (baldy calves), 1975
- Epidermis, diseases of, 654–661  
 see also *specific diseases/disorders*
- Epidermolysis bullosa, 669, 1975
- Epididymitis, 970, 1045
- Epidural abscess, 615
- Epidural pressure, 592
- Epiglottic retroversion, 537–538
- Epiglottitis hypoplasia, 541
- Epiglottitis, 537
- Epilepsy, 613  
 electroencephalography, 594  
 idiopathic, 1376  
 inherited idiopathic, 1957  
 jacksonian, 613
- Epinephrine  
 anaphylaxis, 71  
 anhidrosis, 2038  
 dosage/interval, 2055, 2065  
 pulmonary edema, 500
- Epiphyseal cartilage, 2027
- Epiphysiolysis, 2025–2029  
 osteochondrosis in pigs, 639, 640  
 see also Degenerative joint disease
- Epiphysitis, 633
- Epiploic foramen, entrapment of small intestine, 242, 243
- Epistaxis, 480, 532–533  
 clinical examination, 532–533  
 etiology, 505, 532  
 exercise-induced pulmonary hemorrhage, 502, 503  
 guttural pouch mycosis, 540  
 treatment, 533
- Epithelial tissue atrophy, vitamin A deficiency, 1773–1774
- Epitheliogenesis imperfecta, 669, 1975
- Epitheliogenesis imperfecta linguae bovis (smooth tongue), 1944
- Epizootic abortion, 974, 977
- Epizootic cerebrospinal nematodosis, 1576
- Epizootic hemorrhagic disease, 1305
- Epizootic hemorrhagic disease virus (EHDV), 1305
- Epizootic lymphangitis, 1434, 1478–1479
- Eprinomectin, 1545, 1566
- Epsom salts, 82, 313
- Equine abortion virus see Equine herpesvirus 1 (EHV-1)
- Equine adenovirus (EAdV), 772, 1308
- Equine allergic rhinitis, 1936
- Equine arteritis virus (EAV), 1319–1322  
 carrier stallions, 1320, 1321  
 clinical findings, 772, 1320–1321  
 clinical pathology, 772, 1321  
 control, 1321–1322  
 diagnosis, 772  
 differential diagnosis, 803, 1321  
 economic importance, 1320  
 epidemiology, 772, 1319–1320  
 etiology, 1319  
 immunity, 1320, 1321  
 necropsy findings, 1321  
 occurrence, 1319–1320  
 origin of infection, 1320  
 pathogenesis, 1320  
 sample collection, 1321  
 systemic disease, 1320  
 transmission, 1320  
 treatment, 1321  
 vaccination, 1321–1322  
 virus isolation, 1321

- Equine babesiosis, 1483–1498  
 carriers, 1489  
 clinical findings, 1489, 1493  
 clinical pathology, 1489–1490, 1493  
 control, 1497  
 differential diagnosis, 1490, 1492–1493  
 economic importance, 1487  
 epidemiology, 1484, 1493  
 etiology, 1483  
 serology, 1490  
 transmission, 1484–1485  
 treatment, 1493, 1494
- Equine B-cell lymphoma, 462
- Equine besnoitiosis, 1517, 1518
- Equine blastomycosis (epizootic lymphangitis), 1434, 1478–1479
- Equine cauda equina syndrome *see* Polyneuritis equi
- Equine cervical vertebral stenotic myelopathy, 2016–2018, 2018  
 ancillary diagnostic tests, 2017  
 arthritis, 2017  
 clinical findings, 2016–2017  
 clinical pathology, 2017  
 control, 2018  
 differential diagnosis, 2017, 2018  
 epidemiology, 2016  
 etiology, 2016  
 morbidity rate, 2016  
 necropsy findings, 2017  
 occurrence, 2016  
 pathogenesis, 2016  
 risk factors, 2016  
 severity, 2017  
 surgery, 2018  
 treatment, 2017–2018
- Equine coital exanthema, 1308–1309, 1319
- Equine colic, 215–229  
 abortion risk, 230  
 acid-base, 223  
 acute, 215  
 case fatality rate, 216  
 chronic, 215  
 classification, 215–216, 216–217  
 clinical findings, 219–222, 230–231  
 clinical pathology, 222–223, 231  
 course of disease, 222  
 differential diagnosis, 225, 226, 232, 232  
 epidemiology, 216–218, 230  
 equine neorickettsiosis, 1467  
 etiology, 215–216, 216, 217, 229, 230, 231  
 evaluation protocol, 223–225  
 field management, 228  
 foals, 230–233, 231, 232  
 gastric ulcers and, 238, 239  
 impact of, 218  
 incidence, 216  
 infarctive, 217, 219  
 inflammatory, 216, 219  
 mortality, 216  
 necropsy findings, 225, 231  
 obstructive and strangulating, 217, 219  
 pathogenesis, 218–219  
 pathophysiology, 230  
 plants sources of, 1895  
 postparturient mare, 229–230  
 pregnant mare, 229–230  
 prevention, 228, 232–233  
 prognosis, 224–225  
 rectal examination, 221  
 recurrent, 215–216  
 referral indications, 224–225  
 risk factors, 216–218  
 simple obstructive, 216, 219  
 spasmodic, 216  
 surgery, 224, 232  
 treatment, 225–228, 227, 230, 231–232  
 trocarization, 221
- Equine Cushing's disease *see* Equine pars intermedia dysfunction
- Equine cytomegalovirus (herpesvirus-2), 803, 1318–1319
- Equine degenerative myeloencephalopathy, 580, 604, 617, 1743, 1954
- Equine degenerative myelopathy, 2018
- Equine distemper *see* Strangles
- Equine duodenitis proximal jejunitis, 1905
- Equine dysautonomia *see* Equine grass sickness
- Equine ear plaque, 658
- Equine ehrlichial colitis *see* Equine neorickettsiosis
- Equine encephalomyelitis, 1368–1377, 1375  
*see also individual diseases*
- Equine encephalosis, 1372
- Equine encephalosis virus (EEV), 1372
- Equine eosinophilic dermatitis, 658
- Equine eosinophilic granuloma, 667
- Equine granulocytic anaplasmosis, 1464–1466  
 case fatality rate, 1465  
 clinical pathology, 1465  
 clinical signs, 1465  
 control, 1465  
 diagnosis, 1465  
 differential diagnosis, 1465  
 distribution, 1464  
 epidemiology, 1464  
 etiology, 1464  
 necropsy findings, 1465  
 pathogenesis, 1465  
 risk factors, 1465  
 transmission, 1465  
 treatment, 1465  
 zoonotic potential, 1465
- Equine granulocytic ehrlichiosis *see* Equine granulocytic anaplasmosis
- Equine grass sickness, 1990–1992  
 acute cases, 1991  
 age susceptibility, 1990  
 case fatality rate, 1990  
 chronic, 1990, 1991  
 clinical findings, 1991  
 clinical pathology, 1991  
 control, 1992  
 diagnosis, 1992  
 differential diagnosis, 1992  
 epidemiology, 1990  
 etiology, 1990  
 farm/premises risk factors, 1990–1991  
 incidence, 1990  
 necropsy findings, 1991–1992  
 occurrence, 1990  
 pathogenesis, 1991  
 risk factors, 1990–1991  
 subacute, 1991  
 transmission, 1991  
 treatment, 1992
- Equine hendra virus infection, 1329
- Equine hepatic disease, 391
- Equine herpesvirus 1 (EHV-1) infection, 1309, 1311–1318  
 clinical findings, 1314  
 clinical pathology, 1314–1315  
 control, 1316–1317  
 differential diagnosis, 1315  
 economic importance, 1313  
 epidemiology, 1311–1313  
 equine herpesvirus 4 differentiation, 1310  
 etiology, 1311  
 experimental infection, 1314  
 fetal infection, 1313  
 immunity, 1313  
 infection cycling, 1312–1313  
 latency, 1312, 1317  
 necropsy findings, 1315  
 occurrence, 1311–1312  
 pathogenesis, 1313  
 reactivation, 1312, 1317  
 risk factors, 1313  
 strains, 1311  
 transmission, 1312  
 treatment, 1315–1316  
 vaccination, 1316  
 viral identification, 1314–1315  
 virulence, 1311
- Equine herpesvirus 1 (EHV-1) myeloencephalopathy, 1309, 1312, 2018  
 clinical findings, 1314, 1375  
 control, 1375  
 epidemiology, 1375  
 etiology, 1375  
 necropsy findings, 1315  
 outbreak control, 1317  
 pathogenesis, 1313  
 recumbency, 127  
 transmission, 1312  
 treatment, 1315, 1375  
 vaccination, 1316
- Equine herpesvirus 1 (EHV-1) rhinopneumonitis, 772
- Equine herpesvirus 2 (EHV-2), 803, 1318–1319
- Equine herpesvirus 3 (EHV-3) infection, 1308–1309, 1319
- Equine herpesvirus 4 (EHV-4) infection, 1309–1311  
 clinical findings, 1310  
 clinical pathology, 1310–1311  
 control, 1311  
 differential diagnosis, 803, 1311  
 epidemiology, 1309–1310  
 equine herpesvirus 1 differentiation, 1310  
 etiology, 1309  
 latency, 1309–1310  
 neurological disease, 1310  
 pathogenesis, 1310  
 risk factors, 1310  
 strains, 1309  
 transmission, 1309–1310  
 upper respiratory tract disease, 1309, 1310  
 vaccination, 1311  
 viral identification, 1310–1311
- Equine herpesvirus-4 (EHV-4) rhinopneumonitis, 772
- Equine herpesviruses, 1309
- Equine histoplasmosis (epizootic lymphangitis), 1434, 1478–1479
- Equine hyperkalemic periodic paralysis (HYPP), 1965–1966
- Equine hyperlipidemia, 1614, 1678–1680  
 clinical findings, 1678–1679  
 clinical pathology, 1679  
 control, 1679–1680  
 diagnosis, 1679  
 differential diagnosis, 1679  
 epidemiology, 1678  
 etiology, 1678  
 necropsy findings, 1679  
 pathogenesis, 1678  
 risk factors, 1678  
 treatment, 1679
- Equine infectious anemia (EIA), 451, 1173–1177  
 clinical findings, 1175, 1493  
 clinical pathology, 1175, 1493  
 control, 1176–1177  
 diagnostic confirmation, 1175–1176, 1176  
 differential diagnosis, 1176  
 economic importance, 1174  
 epidemiology, 1173–1174, 1493  
 eradication, 1176  
 etiology, 1173  
 experimental transmission, 1176  
 immune response, 1174  
 infection persistence, 1174–1175  
 insect vectors, 1173  
 morbidity, 1173  
 necropsy findings, 1176  
 occurrence, 1173  
 pathogenesis, 1174–1175  
 prevalence, 1173  
 relapse, 1174, 1175  
 risk factors, 1173  
 transmission, 1173–1174  
 treatment, 1176, 1493  
 vaccines, 1177
- Equine infectious anemia virus (EIAV), 1173, 1174
- Equine influenza, 1322–1328  
 antigenic differences, 1322  
 antigenic drift, 1323, 1324  
 antigenic shift, 1323  
 clinical findings, 772, 1324–1325  
 clinical pathology, 772, 1325  
 complications, 1325  
 control, 1326–1328  
 cross protection, 1322  
 diagnosis, 772, 1325  
 differential diagnosis, 803  
 disease severity, 1325  
 economic importance, 1324  
 epidemics, 1323  
 epidemiology, 772, 1323–1324  
 etiology, 1322  
 hygiene precautions, 1328  
 immunity, 1324, 1326–1328  
 localized outbreaks, 1323  
 management factors, 1324  
 mortality rate, 1323  
 necropsy findings, 1325–1326  
 occurrence, 1323  
 origin of infection, 1323  
 outbreaks, 1322, 1324–1325  
 pathogenesis, 1324  
 revaccination, 1327  
 risk factors, 1323–1324  
 sample collection, 1325  
 secondary infections, 1324, 1325  
 strains, 1322–1333

- Equine influenza (Cont'd)  
 supportive treatment, 1326  
 transmission, 1323  
 treatment, 1326  
 vaccination, 1324, 1326–1328  
 viral isolation, 1325  
 virus, 1322–1323, 1324  
 zoonotic potential, 1324
- Equine influenza A1 virus, 1322
- Equine influenza A2 virus, 1322
- Equine influenza A/H3N8 virus, 1322
- Equine influenza A/H7N7 virus, 1322
- Equine intestinal clostridiosis, 837
- Equine laryngeal hemiplegia, 618
- Equine leukoencephalomalacia, 604, 1376, 1899, 1905
- Equine mastitis, 762
- Equine monocytic ehrlichiosis, 269, 271, 1466–1468
- Equine morbillivirus (hendra virus) infection, 1329
- Equine motor neuron disease, 617, 2020  
 clinical findings, 2020  
 diagnostic confirmation, 1748, 2020  
 necropsy findings, 2020  
 recumbency, 121  
 treatment, 2020  
 vitamin E deficiency, 1743
- Equine neonatal encephalopathy, 2012–2014, 2013  
 case fatality rate, 2013  
 clinical findings, 2013–2014  
 clinical pathology, 2014  
 control, 2014  
 diagnostic confirmation, 2014  
 differential diagnosis, 2014  
 epidemiology, 2012–2013  
 etiology, 2012  
 hypoxia, 163  
 incidence, 2012–2013  
 necropsy findings, 2014  
 nursing care, 2014  
 pathogenesis, 2013  
 treatment, 2014
- Equine neorickettsiosis, 1466–1468  
 case fatality rates, 1466  
 clinical findings, 1467  
 clinical pathology, 1467  
 control, 1467–1468  
 differential diagnosis, 1467  
 epidemiology, 1466  
 etiology, 1466  
 laminitis, 2030  
 necropsy findings, 1467  
 occurrence, 1466  
 pathogenesis, 1466–1467  
 risk factors, 1466  
 transmission, 1466  
 treatment, 1467  
 vaccination, 1467–1468
- Equine nodular necrobiosis, 658
- Equine ocular squamous-cell carcinoma, 2040–2041
- Equine papillary ependymoma, 608
- Equine paralytic myoglobinuria, 627  
 see also Rhabdomyolysis, exertional/postexercise
- Equine pars intermedia dysfunction, 1686–1688  
 case-fatality rate, 1687  
 clinical findings, 1687  
 clinical pathology, 1687  
 diagnosis, 1687  
 differential diagnosis, 1688  
 epidemiology, 1687  
 etiology, 1686–1687  
 necropsy findings, 1687–1688  
 pathogenesis, 1687  
 treatment, 1688
- Equine phycomycosis, 1434, 1480–1481
- Equine piroplasmiasis see Equine babesiosis
- Equine pleuropneumonia, 525–530  
 acute, 526–527  
 chronic, 527  
 clinical findings, 526–527  
 clinical pathology, 527  
 complications, 527  
 control, 529  
 diagnostic confirmation, 527  
 differential diagnosis, 527  
 epidemiology, 525  
 etiology, 525  
 necropsy findings, 527  
 pathogenesis, 525–526  
 prognosis, 527  
 risk factors, 525  
 supportive therapy, 529  
 treatment, 527–529, 528
- Equine polysaccharide storage myopathy, 627
- Equine protozoal myeloencephalitis (EPM), 121, 617, 1522–1526, 2018  
 age-related risk, 1523  
 case fatality rate, 1523  
 clinical findings, 1524, 2018  
 clinical pathology, 1524  
 control, 1525  
 diagnosis, 1524, 1525  
 differential diagnosis, 1525  
 epidemiology, 1523, 2018  
 etiology, 1523, 2018  
 hosts, 1523  
 necropsy findings, 1524–1525  
 pathogenesis, 1523–1524  
 risk factors, 1523  
 transmission, 1523  
 treatment, 1525, 2018  
 vaccination, 1523, 1525
- Equine rhabdomyolysis syndrome (familial polysaccharide storage myopathy), 1963
- Equine rhinitis virus (ERV), 772, 1308
- Equine rhinitis virus A (ERVA), 1308
- Equine rhinitis virus B (ERVB), 1308
- Equine rotavirus, 1290–1291
- Equine rotavirus vaccine, 1296
- Equine sarcoid, 667–668
- Equine sarcoidosis, 667
- Equine seasonal allergic dermatitis (Queensland itch), 1433, 1927–1928
- Equine sensory ataxia see Equine cervical vertebral stenotic myelopathy
- Equine staphylococcal dermatitis, 657–658
- Equine stenotic myelopathy (ESM), 2016
- Equine tropical lichen, 658
- Equine viral arteritis (EVA) see Equine arteritis virus (EAV)
- Equine viral rhinopneumonitis see Equine herpesvirus 4 (EHV-4) infection
- Equisetum*, thiaminase poisoning, 1882–1883
- Equisetum arvense* (horsetail) poisoning, 1376, 1779, 2007
- Ergot alkaloid poisoning, 1899, 1901–1905  
 see also specific types
- Ergotamine, 1902
- Ergotism, 752, 1899, 1902–1903
- Ergovaline, 1902
- Ericaceae, andromedotoxin poisoning, 1885
- Eritea, brucellosis status, 964
- Erosions  
 foot-and-mouth disease, 1227  
 malignant catarrhal fever, 1247  
 mucosal disease, 1259  
*pars esophagea* ulceration, 1996  
 sarcocystosis, 1509  
 stomatitis, 206
- Eruption  
 esophageal obstruction in free-gas bloat, 327  
 failure etiology, 327  
 reticulorumen motility, 296–297
- Erysipelas of swine, 810–815  
 acute, 812–813  
 case fatality, 811  
 chronic, 813  
 clinical findings, 812–813, 813  
 control, 814–815  
 diagnosis, 813–814  
 differential diagnosis, 814  
 epidemiology, 810–812  
 eradication, 814  
*Erysipelothrix rhusiopathiae* (insidiosae), 810–815  
*Erysipelothrix tonsillarum*, 810, 811–812  
 etiology, 810  
 hyperacute, 812  
 immunization, 814–815  
 incubation period, 812  
 morbidity, 811  
 necropsy findings, 813–814  
 outbreaks, 810–811  
 pathogenesis, 812  
 prevalence, 811  
 risk factors, 811–812  
 'skin' form, 812–813  
 transmission, 811  
 treatment, 814  
 vaccination, 814–815  
 zoonotic implications, 812
- Erysipelothrix rhusiopathiae*, 639, 811–812
- Erysipelothrix rhusiopathiae* (insidiosae), 810–815
- Erysipelothrix tonsillarum*, 810, 811–812
- Erythema multiforme, 658
- Erythritol, 970
- Erythrocyte(s)  
 agglutination, anemia, 456  
 anaplasmosis, 1456–1457  
 bluetongue, 1302  
 content, anemia, 456  
 counts, radiation injury, 1787  
 decreased production, anemia from, 452–453  
 East Coast fever, 1528  
 function abnormality, 460  
 function disorders, 450–460  
 morphological abnormalities, anemia, 456  
 number disorders, 450–460  
 osmotic fragility, porcine stress syndrome, 1972  
 peritoneal fluid, in, 202  
 reference laboratory values, 2047  
 shape, anemia, 456  
 size, anemia, 456  
 tropical theileriosis, 1531
- Erythrocyte dismutase, 1717
- Erythrocyte fragility test, 93
- Erythrocyte protoporphyrin, lead poisoning, 1804
- Erythrocyte reticulocyte activity, poioencephalomalacia, 2010
- Erythrocytosis, 459–460
- Erythromycin, 181, 804, 2056
- Erythromycin base, 2055
- Erythromycin estolate, ethylsuccinate, 2055, 2065
- Erythromycin-rifampin side effects, 804
- Erythrophagocytosis, nagana, 1535
- Erythropelium*, diterpenoid alkaloid poisoning, 1865, 1866
- Erythropoietin  
 plasma concentration, 455  
 serum concentration, anemia, 457
- Escherichia coli*, 847–896  
 antibiotic resistance, 176  
 antimicrobial resistance, 866–867  
 antimicrobial sensitivity/susceptibility, 176, 866–867, 867  
 arthritis, 646  
 attaching and effacing, 878, 888  
 blood isolates, 867  
 bovine rotavirus co-infection, 1287  
 cerebrospinal angiopathy, 895–896  
 colibacillosis of newborns, 851–876  
 coliform gastroenteritis, 891–895  
 contagious ophthalmia, 1142  
 cystitis, 561  
 diarrhea of newborns, acute undifferentiated, 847–851  
 edema disease, 889–891  
 enterohemorrhagic, 876–888  
 acid resistance, 879  
 antimicrobial resistance, 879  
 cattle, 877  
 clinical pathology, 882–883  
 colibacillosis of newborns, 851  
 control, 883–887  
 ecology, 883  
 economic importance, 882  
 epidemiology, 877–882  
 etiology, 876–877  
 experimental reproduction, 882  
 goats, 878  
 immune mechanisms, 881  
 infection sources, 879–881  
 mechanisms of action, 878–879  
 outbreaks, 877–878  
 pathogenesis, 882  
 pigs, 878, 888–889  
 prevalence, 877–878  
 risk factors, 878–879  
 sheep, 878  
 transmission, 879–881, 881–882  
 vaccination, 881, 884–885  
 virulence attributes, 855, 878–879  
 zoonotic implications, 881–882
- enteropathogenic, 851
- enterotoxigenic, 851, 855, 888  
 vaccination, 874  
 see also Edema disease
- fecal isolates, 866–867

- Escherichia coli* (Cont'd)  
 mastitis  
   bovine, 674–675, 729, 730  
   see also Coliform bovine mastitis  
   caprine, 761  
   ovine, 759  
 mastitis-metritis-agalactia syndrome, 754, 755, 756  
 necrotogenic (NTEC), 851, 856  
 neonatal infection, 148  
 O157 in pigs, 888–889  
   see also *Escherichia coli*, enterohemorrhagic  
 pigs, weaned, 888–896  
 pyelonephritis, 559, 560  
 septic arthritis, 643  
 small intestine overgrowth, 868  
 telangiectasis of bovine liver, 395  
 verocytotoxin-producing, 855, 888  
 virulence attributes, 855–856  
 watery mouth of lambs, 1986  
 zoonotic implications, 856  
*Eschschoitzia californica* poisoning, 1887  
 Esophageal diverticulum, 212, 213  
 Esophageal feeder, colostrum administration, 151, 156  
 Esophageal groove  
   actinomycosis, 1045  
   closure  
     dysfunction, 314, 346  
     reticulorumen motility, 297  
 Esophageal lavage, 215  
 Esophageal neoplasia, 281  
 Esophageal obstruction, 212–215  
   acute/choke, 213  
   aspiration pneumonia, 515–516  
   cattle, 213  
   chronic, 213–214  
   clinical findings, 213–214  
   clinical pathology, 214  
   complications, 214  
   differential diagnosis, 214  
   etiology, 212–213  
   extraluminal, 212  
   fluid and electrolyte therapy, 92  
   horses, 213  
   intraluminal, 212  
   manual removal, 214–215  
   pathogenesis, 213  
   removal, 214–215  
   treatment, 214–215  
 Esophageal paralysis, 212, 213  
 Esophageal-pharyngeal (OP) fluid samples, 1226  
 Esophageal strictures, 212  
 Esophageal ulceration, plant-induced, 1896  
 Esophagitis, 211–212  
 Esophagogastric ulceration, 1994  
 Esophagostomy, 215  
 Esophagus  
   diseases of, 209–215  
   see also specific diseases/disorders  
   examination of, 301  
 Esp protein, 881  
 Estradiol, 2056  
 Estradiol cypionate, 1458  
 Estrogenic substance poisoning, 1841–1842  
 Estrogenic subterranean clover, 567  
 Estrogenism, idiopathic female, 1841  
 Estrone sulfate, 2056  
 Ethidium, 1536  
 Ethmoidal hematomas, 531  
 Ethmoidal nerve sclerosis, 2023  
 Ethylene-diamine dihydroiodide, 1481  
 Ethylenediamine tetra-acetic acid (EDTA), 1646, 2052, 2055  
 Ethylene glycol poisoning, 1848  
*Eubacterium (Actinobaculum) suis*, 559–560, 788, 791–793  
*Eupatorium rugosum* (snakeroot), tremetol poisoning, 1883  
*Euphorbia*, 12-deoxyphorbol poisoning, 1886  
 Europe  
   anaplasmosis, 1455  
   brucellosis status, 964  
   chronic enzootic pneumonia of sheep, 1362  
   continental  
     bovine spongiform encephalopathy, 1447  
     bovine virus diarrhoea virus eradication program, 1275  
   downer cow disposition, 1650  
   equine influenza viruses, 1322  
   ovine enzootic abortion, 1436  
   rabies, 1385, 1392  
   European bat lyssavirus I (EBLV-1), 1386  
   European bat lyssavirus II (EBLV-2), 1386  
   European blastomycosis (cryptococcosis), 1475–1476  
   European Union, brucellosis status, 965  
   European viper (*Vipera berus*), 1916  
   Eustachian tube diverticulum, 538–541  
 Euthanasia  
   burn injury, 1793  
   cold injury, 1795  
    $\alpha$ -mannosidosis, 1949  
 Ewes  
   abortion, 920, 986, 987  
   colostrum, 152  
     watery mouth of lambs, 1987  
   ecthyma, contagious, 749–750  
   infertility, zinc deficiency, 1731–1732  
   pregnancy, nutrition and, 1695–1697  
   ulcerative dermatosis, 750  
 Excitation states, 9, 577–578  
 Excystation, *Cryptosporidium*, 1514  
 Exercise, 117–120  
   aorto-iliac thrombosis examination after, 434  
   cardiac irregularities following, 414  
   degenerative joint disease, 2027  
   diseases associated with, 119–120  
   endurance, equine influenza, 1325  
   equine colic risk, 218  
   intolerance  
     benign atrial fibrillation, 418  
     diseases causing, 474, 474–475  
     horses, 118–119  
     respiratory tract disease, 474–475  
   laryngeal hemiplegia, 535  
   physiology, 117–118  
   recovery from, 117  
   sporadic lymphangitis, 2030  
   tolerance  
     cardiac reserve determination, 401  
     cardiovascular system examination, 407  
     myocardial disease, 421  
     unaccustomed, enzootic nutritional muscular dystrophy, 1738  
 Exercise-induced pulmonary hemorrhage (EIPH) of horses (bleeders), 501–507  
   breeds, 502  
   clinical findings, 503–504  
   clinical pathology, 504  
   control, 506–507  
   differential diagnosis, 504, 505  
   epidemiology, 501–502  
   etiology, 501  
   lesion location, 503  
   necropsy findings, 504  
   pathogenesis, 502–503  
   performance effects, 503  
   prevalence, 502  
   prevention, 506–507  
   prognosis, 504  
   severity of, 504  
   treatment, 504–506  
 Exercise testing, 118, 493  
 Exertional rhabdomyolysis see Rhabdomyolysis, exertional/postexercise  
 Exfoliative dermatitis, bovine, 657  
 Exhaled breath condensate examination, 492  
 'Exhausted horse syndrome,' 119–120  
 Exhaustion, 119–120, 122  
 Exhaustion syndrome, 75  
 Exophthalmos, 1216, 1957  
 Exotoxins, 53  
 Expectorants (bronchomucotropic agents), 496  
 Expiration prolongation, 11  
 Expiratory grunting, 477, 478, 1565  
 Exploratory laparotomy (celiotomy), 197, 269, 309–310, 311  
 Exposure, history-taking, 5  
 Exposure pressure, neonatal infection, 147–148  
 External ear, diseases of, 651–653, 670–671  
 External genitalia examination, 12  
 Extracranial convulsions, 579  
 Extralabel use of antimicrobials, 184, 186, 867, 868  
 Extrapyramidal system, 581  
 Extrasystoles (premature complexes), 413, 415–416  
 Extrinsic allergic alveolitis, 1998, 2003  
 Exudative diarrhea, 263  
 Exudative diathesis, 1739, 1744  
 Exudative epidermatitis see Greasy pig disease  
 Eye(s)  
   congenital defects, 620  
   defects in cattle, 1977  
   elaeophorosis, 1574  
   examination, 11, 17–18  
   inherited defects, 1977  
   lesions in *Haemophilus* septicemia, 1001  
   movement testing, 585  
   *Mycoplasma* infection, 1126  
   vitamin A deficiency effects, 1775  
   see also Entries beginning ocular; specific diseases/disorders  
 Eyeball  
   abnormality, 588  
   movement, 17  
   position in orbit, dehydration evaluation, 863  
   size, 17  
 Eye gnats (*Hippelates*), 1233  
 Eyelid(s)  
   abnormality, 17, 588  
   congenital defects, 670  
   pigmentation, infectious keratitis risk factor, 995  
 Eyesight impairment, polioencephalomalacia, 2010  
 Eyeworm (*Thelazia*), 1575  
 Eysipelas, 785
- 
- F**
- Face fly (*Musca autumnalis*), 1606  
 cattle, 1606  
 eyeworm (*Thelazia*) vectors, 1606  
*Moraxella bovis* transmission, 995  
 parafilariosis intermediate host, 1574  
 Facial abscess, 110, 666  
 Facial burns, 1793  
 Facial deformity, enzootic nasal adenocarcinoma, 1368  
 Facial dermatitis, 785  
 Facial eczema, 1899, 1908–1909  
 Facial nerve (cranial nerve VII)  
   assessment, 585–586  
   dysfunction, guttural pouch mycosis, 540  
   paralysis, 1375, 1524  
   polyneuritis equi, 2021  
 Facial paralysis, 585–586  
 Facial summer sores, 1572  
 Facial swelling, bluetongue, 1303  
 Factor VIII deficiency (hemophilia A), 444–445, 1947  
 Factor XI deficiency, 135, 445  
 Fagopyrin poisoning, 1886  
*Fagopyrum sagittatum* (buckwheat) poisoning, 1886  
 Fainting, 578  
 Fallen stock, bovine spongiform encephalopathy, 1451  
 Falling disease, 125, 1714  
 False blackleg, 829  
 FAMACHA chart/system, 455, 1551  
 Familial acantholysis, 1975  
 Familial convulsions and ataxia, 1955  
 Familial narcolepsy, 1957  
 Familial polycythemia, 1947  
 Familial polysaccharide storage myopathy (equine rhabdomyolysis syndrome), 1963  
 Familial undulatory nystagmus, 1957  
 Famotidine, 2056  
 Fanconi's syndrome, 558  
 Farm chemicals  
   congenital defects of the newborn, 134  
   diseases associated with, 1830–1849, 1846  
   see also specific chemicals  
   encephalomyelopathies, 611–612  
   hepatitis, 392  
 'Farmer's lung hay' antibodies, 2002  
 Farm visitors, enterohemorrhagic *Escherichia coli*, 881, 887  
 Farroe-finish herds, pigs, 1394–1395  
 Farrowing fever see Mastitis-metritis-agalactia (MMA) syndrome  
 Farrowing hysteria, 612  
 Farrowing pens  
   ascarid infections, 1557  
   hygiene, mastitis-metritis-agalactia syndrome, 758  
*Fasciola gigantica*, 1576  
*Fasciola hepatica*, 1576  
*Fasciola magna*, 1580

- Fasciolosis (liver fluke disease), 1576–1580  
 acute, 1577–1578  
 black disease risk factors, 833  
 carriers, 1576  
 cattle, 1577, 1578  
 chronic, 1577, 1578  
 clinical findings, 1577–1578  
 clinical outcome, 1577  
 clinical pathology, 1578  
 control, 1579  
 diagnostic confirmation, 1578  
 differential diagnosis, 1578  
 epidemiology, 1576–1577  
 etiology, 1576  
 goats, 1577  
 host snails, 1576–1577  
 necropsy findings, 1578  
 pathogenesis, 1577  
 sheep, 1577–1578  
 subacute, 1578  
 treatment, 1578–1579  
 vaccination, 1579
- Fast Antimicrobial Screen Test (FAST), 185
- Fat, dietary  
 bloat prevention, 334–335  
*pars esophagea* ulceration, 1995  
 recurrent exertional rhabdomyolysis, 1968
- Fat cow syndrome, 300, 383, 392  
 clinical findings, 1634  
 clinical pathology, 1634  
 epidemiology, 1634  
 prediction of, 1619  
 septic metritis, postpartum, 62  
 treatment, 1634  
 see also Fatty liver, cattle
- Fat necrosis, intestinal obstruction, 379
- Fatty cirrhosis, 392, 393–394
- Fatty liver, cattle, 1674, 1671–1678  
 classification of, 1672  
 clinical findings, 1674–1675  
 clinical pathology, 1675  
 control, 1676–1677  
 differential diagnosis, 1676  
 epidemiology, 1672–1673  
 etiology, 1672  
 incidence, 1672  
 left-side displacement of abomasum, 359  
 necropsy findings, 1675  
 outbreaks, 1672, 1676  
 pathogenesis, 1673–1674  
 risk factors, 1672–1673  
 transition period in dairy cows, 1613  
 treatment, 1676
- Fatty liver syndrome, 300
- Faulty wiring, electrocution, 1789
- Febantel  
 ascarid infections, 1557  
 bovine lungworm, 1567  
 dosage/interval, 2056  
 parasitic gastritis, pigs, 1555  
 parasitic gastroenteritis, ruminants, 1545
- Febrile response, 50  
 see also Fever (pyrexia)
- Fecal egg count  
 ascarid infections, 1557  
 bunostomosis, 1552  
*Haemonchus*, 1550  
 parasitic gastroenteritis, ruminants, 1547  
 strongylosis, 1560, 1561  
 trichostrongylid worms, 1544
- Fecal egg count reduction technique (FECRT), 1562
- Fecal examination, 19–20, 305–307  
 abomasal ulcer, 372  
 abomasal volvulus, 364  
 anemia, 457  
 colibacillosis, 860  
 color, 20, 305–307  
 composition, 20  
 consistency, 20, 307  
 diarrhea, acute, 270  
 diarrhea, chronic undifferentiated, 273  
 digestion, degree of, 307  
 enteritis, 266  
 enterocolitis, *Clostridium difficile* associated, 846  
 enterohemorrhagic *Escherichia coli*, 882  
 fibrin, 307  
 intestinal obstruction, 379  
 Johne's disease, 1032–1033, 1034  
 mastitis-metritis-agalactia syndrome, 756  
 mucus, 307
- Mycobacterium avium* subspecies  
*paratuberculosis*, 1026–1027, 1029, 1030  
 newborn diarrhea, acute undifferentiated, 850  
 odor, 20, 307  
 peritonitis, 284  
 pneumonia, 513  
 quantity, 305  
 salmonellosis, 910–911
- Fecaliths, 253–254
- Fecal softeners  
 equine colic, 227, 228  
 large intestine impaction, 228, 253
- Feces  
 absence of, 305, 307  
 blood in, 194, 305–307  
 coccidiosis, 1503  
*Brachyspira hyodysenteriae* survival, 1115  
 cryptosporidiosis transmission, 1513  
 equine colic, 220, 224  
 lead in, 1803, 1803  
 pollution from, 1785  
 protein loss in, 116  
 removal, strongylosis control, 1561  
 ruminant gastrointestinal dysfunction, 298  
 sand in, diarrhea, 273  
 scant, 305, 307  
*Streptococcus suis* survival in, 779
- Federal Meat and Poultry Inspection Service (USA), 783
- Feed  
 additives, poisoning from, 1841  
 aflatoxins in, 1900  
 analysis, osteodystrophy, 634  
 changes in, blood test timing, 1622  
 chemical treatment, poisoning, 1843  
 contamination  
 antibiotics, 179–180  
*Clostridium botulinum*, 827  
 lead, 1800  
*Mycobacterium avium* subspecies  
*paratuberculosis* 3, 1034  
*Mycobacterium bovis*, 1008  
*Salmonella*, 904, 918  
 costs, 1692  
 deprivation, polioencephalomalacia, 2009  
 equine hyperkalemic periodic paralysis, 1966  
 finely ground, *pars esophagea* ulceration, 1994–1995  
 fluorine content, 1818–1819  
 heat treatment, salmonellosis control, 916  
 liver necrobacillosis control, 1063  
 mass medication  
 pleuropneumonia of pigs, 1058  
 pneumonic pasteurellosis, 942, 945–946  
*Streptococcus suis* infection control, 781–782  
 moist preserved, *Listeria monocytogenes* presence, 806  
 mycotoxicosis control, 1898  
 pellets, *pars esophagea* ulceration, 1994, 1997  
 restriction, edema disease, 891  
 selenium in, 1813  
 shortages, controlled malnutrition, 114  
 storage  
 copper deficiency risk factors, 1710  
 pyrrolizidine alkaloid poisoning and, 1879  
 supplements  
 copper sulfate, 1719  
 phosphate, 1818–1819  
 phosphorus content, 1762–1763  
 supplies  
 enterohemorrhagic *Escherichia coli* source, 880  
 environmental examination, 7  
 withholding, gastric ulcers, 238
- Feeding  
 behavior, undifferentiated bovine respiratory disease, 927–928  
 blood test timing, 1622  
 practices  
 colibacillosis, newborn risk factors, 854  
 colostrum immunoglobulins absorption, 152  
 urolithiasis, 566  
 pregnancy, 1671
- Feedlot bloat  
 case fatality, 327–328  
 clinical findings, 330  
 control, 336  
 epidemiology, 327  
 etiology, 326
- morbidity, 327–328  
 treatment, 332  
 weather as a risk factors, 329
- Feedlot cattle  
 abomasal ulcer, 370–371  
 acute undifferentiated fever, 927  
 antimicrobials residues, 185  
 bovine herpesvirus-1, 1350, 1351, 1353, 1358  
 bovine respiratory syncytial virus pneumonia, 1344  
 bovine virus diarrhea virus, 1256, 1267, 1272  
 buller steer syndrome, 1982  
 carbohydrate engorgement, 316  
 coccidiosis, 1505  
 hepatic abscess, 395  
 hyperthermia management, 48  
 interstitial pneumonia, 2000–2001, 2003  
 nutritional management, 1694  
 phosphorus requirements, 1763  
 pneumonic pasteurellosis, 938–939, 942, 945  
 polioencephalomalacia, 2006  
 pseudorabies, 1398  
 salmonellosis, 901  
 tail-tip necrosis, 2037  
 vitamin A deficiency, 1772–1773  
 winter dysentery, 1298
- Feedlot lambs, 1503  
 coccidiosis, 1499, 1500, 1505  
 enterotoxemia, *Clostridium perfringens* type D associated, 841  
 polioencephalomalacia, 2006
- Feedlot plays, *Salmonella* contamination, 901
- Feedlot sheep, orf, 1418–1419
- Feedlot starter rations, carbohydrate engorgement prevention, 323
- Feet see Foot
- FEI, equine influenza vaccination requirements, 1327–1328
- FEI Passport, 1327–1328
- Feline spongiform encephalopathy (FSE), 1448
- Fell pony syndrome, 1492, 1942–1944
- Femoral fracture, 633
- Femoral head epiphyseolysis, 2028
- Femoral nerve paresis, 122
- Fenbendazole  
 ascarid infections, 1557  
 bovine lungworm, 1567  
 dosage/interval, 2056, 2065  
 giardiasis, 1517  
 kidney worm disease, 1571  
 lungworm infestation, sheep, 1569  
 parasitic gastritis, pigs, 1555  
 parasitic gastroenteritis, ruminants, 1545  
 poisoning, 1832  
 strongylosis, 1561  
 summer sores, horse, 1572  
 threadworm, 1563
- Fenclorophos, 1595, 1603
- Fenoterol, 2056
- Fenprostalene, 2056
- Fentanyl, 106, 2056
- Fenthion, 1598
- Fenthionmethyl, 1595
- Fenvalerate, 1606, 1611, 1612
- Feral cats, toxoplasmosis transmission, 1519
- Feral swine, pseudorabies transmission, 1396
- Fer-de-lance (*Bothrops lanceolatus*), 1916
- Ferric choline citrate, 1728
- Ferritin, serum, 1726
- Ferrochelataze deficiency, 1946
- Ferrous sulfate, 1728, 2056, 2065
- Fertility  
 equine coital exanthema, 1308, 1319  
 myofiber hyperplasia, 1965  
 nagana, 1534
- Fertilization/fertilizer  
 bloat control, 334  
 hypomagnesemic tetany risk factor, 1655  
 molybdenum in, 1820  
 nitrogenous, magnesium absorption effects, 1653
- Fescue foot, 1899, 1902
- Fescue summer toxicosis, 1899, 1901–1902
- Festuca arundinacea* (tall fescue), 1658, 1901
- Fetal anasarca, 664
- Fetal anoxia, 140
- Fetal diseases, 127
- Fetal electrocardiography (ECG), 408–409
- Fetal fluids, border disease, 1415
- Fetal hypoxemia, 1984–1985
- Fetal hypoxia, 140–141

- Fetal infection, stillbirth/perinatal weak calf syndrome, 1984
- Fetal loss  
border disease, 1415  
early, 1918–1920  
late, 1918–1920
- Fetal membrane retention, 61, 62  
see also Septic metritis, postpartum
- Fetal pleural fluid, neosporosis, 1511
- Fetus  
ballottement of, 12  
selenium transfer to, 1742  
stillborn, encephalomyocarditis virus disease, 1184  
vitamin E transfer to, 1742–1743
- Fever (pyrexia), 49–51  
*Actinobacillus suis* infection, 1052  
aseptic, 49  
bovine interdigital necrobacillosis, 1064  
bovine respiratory syncytial virus pneumonia, 1346  
clinical findings, 50  
clinical pathology, 50  
definition, 14  
encephalitis, 602  
equine influenza, 1324  
etiology, 49  
febrile response, 50  
horses, 50  
Japanese encephalitis, 1378  
lymphosarcoma, 463  
magnitude, 50  
necropsy findings, 50  
pathogenesis, 49–50  
pericarditis, traumatic, 351  
peritonitis, 284  
reticulorumen motility, primary contraction influence, 295  
septic, 49  
stages of, 49–50  
sweating sickness, 1989  
tick-borne fever, 1460, 1461  
treatment, 50–51
- Fever tree (*Albizia versicolor*) poisoning, 1888
- Fiber, dietary  
abomasal impaction, 369  
left-side displacement of abomasum, 355, 361  
*pars esophagea* ulceration, 1995
- Fiber-balls, luminal blockage, 377–378
- Fiberoptic gastroduodenoscopy, 197
- Fibrillin-1-gene mutations, bovine Marfan syndrome, 1946
- Fibrin degradation products (FDP), 442, 448
- Fibrinogen, 442  
deficiency, heritable, 445  
disseminated intravascular coagulopathy, 448, 449  
reference laboratory values, 2047  
reticuloperitonitis, traumatic, 340  
*Rhodococcus equi* pneumonia, 802
- Fibrinolysis  
diarrhea, acute, 270  
equine colic, 219  
exercise-induced pulmonary hemorrhage, 506
- Fibrinolytic therapy, pleuritis (pleurisy), 525
- Fibrinous pericarditis, 429
- Fibrinous synovitis, *Mycoplasma bovis* infection, 1129
- Fibroelastosis, 433
- Fibropapillomas, 1421, 1422
- Fibrosis, kidney worm disease, 1570, 1571
- Fick equation, 453
- Field poppy (*Papaver rhoeas*) poisoning, 1891
- Filarial dermatitis, 1573–1574
- 'Fingerprint lesions,' *Trichostrongylus axei*, 1545
- Finland  
bovine virus diarrhea virus eradication program, 1275  
enzootic bovine leukosis eradication program, 1219
- Finnish Landrace lambs, 555–556
- Fipronil, 1595
- Fire ant (*Solenopsis invicta*) bite, 1918
- First-degree atrioventricular block, 414
- Fish-scale disease (congenital ichthyosis), 1976
- Fits, 579  
see also Convulsions
- Fitweed fumatory (*Corydalis flavula*) poisoning, 1887
- Fitweed (*Corydalis caseana*) poisoning, 1887
- Flame lily (*Gloriosa superba*) poisoning, 1885
- Flash test, bovine spongiform encephalopathy, 1450
- Flatulent colic, 226
- Flatweed (*Hypochoeris radicata*) ingestion, 2019
- Flaviviruses, 1209
- Flax lily (*Dianella revoluta*) poisoning, 1893
- Flecainide, 419
- Fleece  
border disease, 1416  
chemical drying, 1082  
dermatophilosis, 1049  
loss of  
blowfly strike, 1591  
bluetongue, 1303  
caseous lymphadenitis, 796  
wetness  
dermatophilosis, 1048  
hypothermia, neonatal, 43  
Fleece rot, 1081–1082, 1793  
Fleece rot-resistant sheep, 1082  
Flesh fly (wohlfahrtiosis), 1590, 1595–1596
- Flexor reflex, 590
- Flexor spinal reflex, 590–591
- Flexural seborrhea, udder rot, 751
- Flies see *specific types*
- Flipping the nose, 2022
- Flood plain staggers, 1914–1915
- Flooring  
degenerative joint disease, 2026  
environmental examination, 8  
mycobacteriosis, 1015
- Florfenicol  
dosage/interval, 2056  
enzootic pneumonia of calves, 1341  
*Escherichia coli* bacteremia, 869  
*Haemophilus* septicemia, 1002  
pleuropneumonia of pigs, 1057  
pneumonic pasteurellosis, 941
- Florida horse leech (equine phycomycosis), 1433, 1480–1481
- Flotation fluid test  
fasciolosis, 1578  
lungworm infestation, pigs, 1570  
whipworm, 1563
- Flourensia cernua*, sesquiterpene poisoning, 1892
- Flow-volume loop measurement, 489
- Flubendazole, 1555, 1557
- Fluconazole, 1473, 1481, 2056
- Fluid and electrolyte status dynamics, 87
- Fluid and electrolyte therapy, 91–102, 203–204  
abomasal impaction (dietary), 369  
abomasal volvulus, 366  
administration, 97, 97–98  
rates, 98–99  
routes of, 98–99  
adverse responses, 98, 99  
anophagia, 112  
*Bacillus* mastitis, 726  
botulism, 827  
carbohydrate engorgement, 322  
coccidiosis, 1505  
cold injury, 1794  
colibacillosis, 862–865  
coliform mastitis, 716–717  
colloid solutions, 95–97  
cryptosporidiosis, 1515  
crystalloid solutions see Crystalloid solutions  
cystitis and pyelonephritis (sows), 792  
diarrhea, acute, 271, 863  
diarrhea, neonatal viral, 1294  
diarrhea in foals, 276  
downer cow syndrome, 1648  
electrolyte requirement calculation, 92  
endotoxemia, 58  
enteritis, 246, 267–268  
equine colic, 227  
equine herpesvirus 1, 1315  
exercise-induced exhaustion, 120  
exertional rhabdomyolysis, 1685  
fatty liver, cattle, 1676  
hyperthermia, 48  
indications for, 92, 97, 97–98  
intestinal obstruction, 380  
intravenous  
catheters, 99  
cecal disease, 247–248  
disseminated intravascular coagulopathy, 449  
fluid types, 92–97  
hypovolemic shock, 67  
maldistributive shock, 67
- newborns, 170  
oral, 99–101  
overinfusion, 865  
parenteral, 98  
composition, 863  
dehydration and acidosis, 863–864  
peritonitis, 287  
pregnancy toxemia, sheep, 1670  
quantities, 98, 98–99  
recurrent exertional rhabdomyolysis, 1968  
right-side displacement of the abomasum, 366  
salmonellosis, 914–915  
septic metritis, postpartum, 62  
transmissible gastroenteritis, pigs, 1282  
urinary tract disease, 553–554  
vagus indigestion, 350
- Fluid balance disorders, 73–102, 87–102  
clinical pathology, 88–89, 89, 90  
treatment see Fluid and electrolyte therapy  
see also Acid-base status; Dehydration; Electrolyte abnormalities/imbalance; Overhydration
- Fluid exudate accumulation, peritonitis, 283
- Fluid line, pleuritis (pleurisy), 523
- Fluid-rushing sounds, enteritis, 265
- Fluid thrill, 12
- Fluid wave, bladder/urethra rupture, 568
- Flukicides, fasciolosis, 1578
- Flumazenil, 2056
- Flumethasone, 2056
- Flumethrin  
chorioptic mange, 1612  
psoroptic mange, 1611  
tick control, 1464  
tick infestations, 1601
- Flunixin meglumine, 2032  
bovine ephemeral fever, 1179  
coliform mastitis, 717  
dosage/interval, 2056, 2065  
endotoxemia, 58–59, 225, 271  
equine cervical vertebral stenotic myelopathy, 2017  
equine colic, 225  
equine protozoal myeloencephalitis, 1525  
exertional rhabdomyolysis, 1685  
laminitis, ruminants/pigs, 2035  
mastitis, 693–694, 762  
pain, 105  
permanent drying off in bovine mastitis, 696  
recurrent exertional rhabdomyolysis, 1968
- Flu OIA (biostar) assay, equine influenza, 1325
- Fluorescent antibody test (FAT)  
hog cholera, 1162  
rabies, 1390  
transmissible gastroenteritis, 1281
- Fluorine poisoning, 1815–1819  
acute, 1817  
chronic, 1817  
clinical findings, 1817–1818  
clinical pathology, 1818  
control, 1818–1819  
detoxification, 1817, 1819  
diagnosis, 1818  
differential diagnosis, 1818  
dose rate, 1815  
economic importance, 1816  
epidemiology, 1815–1816  
etiology, 1815  
experimentally induced, 1815  
horses, 1818  
necropsy findings, 1818  
osteodystrophy, 632  
pathogenesis, 1816–1817  
risk factors, 1816  
sources of, 1816  
specimen analysis, 1797  
treatment, 1818  
volcanic ash, 1791–1792
- Fluoroacetate poisoning, 1886–1887
- Fluoroprednisolone acetate, 2056
- Fluoroquinolone(s)  
enzootic pneumonia of calves, 1342  
extralabel use, 868  
mycoplasmal pneumonia, pigs, 1149  
pleuropneumonia of pigs, 1057  
small intestine *Escherichia coli* overgrowth, 868
- Fluorosis, 1817  
see also Fluorine poisoning
- Fluprostenol, 2056
- Fluticasone, 2056

- Flying foxes, equine hendra virus infection, 1329
- Foal(s)
- African horse sickness, 1182
  - alloimmune hemolytic anemia of the newborn, 1922, 1923–1924
  - anhidrosis, 2038
  - antimicrobial drugs, 169, 169
  - arrhythmias, 414
  - arthritis, infectious, 170, 643
  - ascarid infections, 1556, 1557–1558
  - biliary atresia, 396
  - biochemistry values, serum, 166
  - bronchointerstitial pneumonia, 512
  - cerebral edema, 598
  - coccidiosis, 1499, 1504–1505
  - colibacillosis, 852, 856
  - colic, 230–233, 231, 232
  - colostrum administration, 156
  - comatose ('sleeper'), 2013
  - congenital cutaneous neoplasms, 669
  - congenital defects, 135
  - coxsack infection, 1432
  - critical plasma immunoglobulin G concentration, 167
  - cryptosporidiosis, 1512
  - diarrhea
    - acute, 274–277
      - see also Diarrhea, horses
      - dietary, 277, 279
      - equine adenovirus, 1308
      - viral, 1290–1291, 1292, 1294
    - dysmaturity, 139, 160
    - dystocia, 142
    - energy requirements, 168–169
    - enterotoxemia, 838, 839
    - epidermolysis bullosa, 669, 1975
    - equine arteritis virus, 1320, 1322
    - equine babesiosis, 1489
    - equine coital exanthem, 1319
    - equine herpesvirus 1, 1313, 1316
    - equine herpesvirus 2, 1318
    - equine herpesvirus 4, 1310
    - equine infectious anemia, 1176
    - equine influenza, 1325, 1327
    - equine protozoal myeloencephalitis, 1524
    - examination, 162–163
    - failure of transfer of passive immunity, treatment, 167
    - Fell pony syndrome, 1942–1944
    - fetal disease, 131
    - fluid therapy, 170
    - fractional clearance of electrolytes, 552
    - gastric ulcers, 234–237
      - see also Gastric ulcer(s), foals
    - gestation, 160
    - giardiasis, 1516
    - heart rates, fetal, 409
    - hematology, 165
    - hemolytic enterotoxemia, 837
    - hyperelastosis cutis, 669
    - hypoglycemia, 163, 1681
    - hypothermia, 142
      - prevention, 46
      - risk factors, 44
      - treatment, 46
    - hypoxia, 163
    - immunodeficiency, 1943
    - joint fixation, congenital, 648
    - lactose digestion test, 198
    - lethal whites, 1942
    - liver radiology, 388
    - maturity indications, 145, 161
    - mortality, 130–131
    - muscular dystrophy, 1745
    - neonatal infection, 146, 147
    - neonatal respiratory distress, 494
    - nursing care, 167
    - parenteral nutrition, 168
    - parturient disease, 131
    - parturition, premature induction, 144–145
    - passive immunity decline, 153
    - patent urachus, 573
    - peritoneal fluid reference values, 202
    - portosystemic shunts, 394
    - postnatal disease, 131
    - prematurity, 139, 142, 160
    - prognosis, 171
    - radiography, 482, 483
    - ricketts, 1767
    - salmonellosis, 914
    - sepsis, 160
    - sepsis score, 160, 161
    - septicemia, 51, 147, 160
      - bladder rupture, 563
      - Salmonella abortusequi*, 919–920
    - severe combined immunodeficiency, 1524
    - streptococcal infection, 775, 776
    - terminal colon atresia, 281
    - tetanus vaccination, 824
    - threadworm, 1563
    - xylose absorption test, 199
  - Foal heat diarrhea, 275, 850, 1294
  - Foaling paralysis, 122
  - Foal symmetrical encephalomalacia, 844
  - Fodder storage, cyanogenic glycoside poisoning, 1853
  - Fog fever see Acute bovine pulmonary emphysema and edema (ABPEE)
  - Folate deficiency, iatrogenic, 149, 1493
  - Foliar dusting or spraying, 1658
  - Folic acid
    - deficiency, 452, 1782
    - dosage/interval, 2056
    - equine protozoal myeloencephalitis, 1525
    - supplementation, 1778
  - Folinic acid, 2056
  - Follicle stimulating hormone, 2056, 2065
  - Follicular dysplasia, 1974
  - Follicular mange, 1433, 1608
  - Folliculitis, 663
    - facial, lambs, 783
  - Fomite transfer
    - bovine virus diarrhea virus, 1251
    - equine herpesvirus 1, 1312
    - equine influenza, 1323
  - Food and Agriculture Organization, hemorrhagic septicemia vaccination, 923
  - Food and Drug Administration (FDA), USA, 733
  - Food Animal Residue Avoidance Databank (FARAD), 185
  - Food deprivation, hypomagnesemic tetany risk factor, 1655
  - Food intake
    - decreased, 112
      - enterotoxemia, *Clostridium perfringens* type D associated, 843
      - disorders of, 112–115
      - increased, 112
    - Food-producing animals, lameness in, 625
  - Food products/stuffs
    - antibiotic contamination, 183–184
    - foot-and-mouth disease transmission, 1223, 1224
  - Fools parsley (*Aethusa cynapium*) poisoning, 1890
  - Foot
    - bluetongue, 1303
    - clinical examination, 20
    - cold injury, 1794
    - elaeophorosis, 1574
    - foot-and-mouth disease, 1225
    - laminitis, 2031, 2035
    - swine vesicular disease, 1231
    - traumatic injury, 624
    - vesicular exanthema of swine, 1236
  - Foot abscess
    - pigs, 1078–1079
    - sheep, 1077–1078
  - Foot-and-mouth disease (FMD), 1223–1230
    - animal importation, 1229
    - bacterial complications, 1225
    - carriers, 1224, 1229
    - case-fatality rates, 1223
    - cattle, 1223–1224, 1225–1226
    - clinical findings, 1225–1226, 1265
    - clinical pathology, 1226–1227, 1265
    - control, 1227–1230
    - differential diagnosis, 1226, 1227
    - economic importance, 1225
    - epidemiology, 1223–1225, 1265
    - etiology, 1223
    - experimental reproduction, 1225
    - free status, 1229
    - goats, 1224, 1225, 1226
    - herd-to-herd spread, 1224
    - immune mechanism, 1224–1225
    - immunity, 1225
    - lameness, 1075
    - morbidity, 1223
    - outbreaks, 1223, 1228
    - pathogenesis, 1225
    - pigs, 1226, 1229
    - prevalence, 1223
  - reservoirs, 1224
  - risk factors, 1224–1225
  - sheep, 1225, 1226, 1229
  - transmission, 1223–1224, 1227
  - treatment, 1227
  - vaccination, 1228–1229
  - viral isolation, 1226
  - zoonotic implications, 1225
- Footbaths
  - bovine interdigital necrobacillosis control, 1066
  - foot rot, infectious, 1074–1075, 1077
  - papillomatosis digital dermatitis of cattle, 1069–1070, 1070
- Foothills abortion, 974, 977
- Foot lice, sheep, 1597–1598
- Foot rot
  - benign, 1071, 1072, 1073
    - eradication, 1076
    - lameness, 1075
  - cattle, infectious, 1073
  - goats, infectious, 1073
  - pigs, 1078–1079
    - Arcanobacterium pyogenes*, 1078
    - clinical findings, 1078–1079
    - clinical pathology, 1079
    - control, 1079
    - differential diagnosis, 1079
    - epidemiology, 1078
    - etiology, 1078
    - necropsy findings, 1079
    - pathogenesis, 1078
    - treatment, 1079
  - sheep, infectious, 625, 1070–1077
    - carriers, 1073
    - clinical findings, 1072–1073
    - clinical pathology, 1073–1074
    - control, 1074–1076
    - differential diagnosis, 1074, 1075
    - economic importance, 1072
    - epidemiology, 1071–1072
    - eradication, 1076–1077
    - etiology, 1071
    - Fusobacterium necrophorum*, 1071
    - infection source, 1071
    - necropsy findings, 1073–1074
    - outbreaks, 1071
    - pathogenesis, 1072
    - risk factors, 1071–1072
    - scoring system, 1073
    - transmission, 1071
    - treatment, 1074–1076
    - vaccination, 1076
  - virulent, 1071, 1072–1073
    - eradication, 1076
- Foot scald (ovine interdigital dermatitis), 1072, 1077
- Foot warts see Papillomatosis, digital dermatitis of cattle (Mortellaro's disease)
- Forage(s)
  - acute bovine pulmonary emphysema and edema, 1999, 2000
  - alternative temperate, 333–334
  - bloat prevention, 332–333, 333–334
  - botulism, 825
  - frothy bloat and, 328
  - selenium content, 1746
- Forced expiratory flow-volume curves, 490
- Foreign body
  - esophageal, surgical removal, 215
  - pars esophagea* ulceration, 1995
  - pericardial sac penetration (traumatic pericarditis), 351–352, 429, 430
  - pharyngeal obstruction, 210
  - pneumonia, bovine lungworm, 1565
  - reticulum perforation see Reticuloperitonitis, traumatic
  - rumen impaction, 313–314
  - small intestinal obstruction, 242, 243
- Forelimbs, nervous system examination, 589–590
- Foremilk, mastitis check, 732
- Forest fires, 1792
- Forestomach
  - anatomy, 293
  - diseases of, 293–301
    - see also specific diseases/disorders
  - distension, reticulorumen motility role, 296
  - hypomotility, 296
- Formaldehyde, 818
- Formalin
  - coagulopathy treatment, 442



- Formalin (Cont'd)  
 foot rot, infectious, 1074–1075  
 papillomatosis digital dermatitis of cattle, 1070  
 poisoning, 1846  
 Formalin-treated grain, poisoning, 1843  
 Formiminoglutamic acid, serum, 1704  
 Foul in the foot see Bovine interdigital necrobacillosis  
 'Founder' distance, laminitis, 2032  
 Founder effect, 1938  
 Foxes, rabies vector, 1387  
 Fractional clearance/excretion, 551–552  
 Fracture(s)  
 electrocution, 1789, 1790  
 femoral, 633  
 long bone, horses, 122  
 pelvis, horses, 122  
 ribs, parturition trauma, 139  
 spontaneous, 625  
 osteodystrophy and, 634  
 vertebra, 613, 614  
 Framycetin sulfate, 2056  
 France  
 bovine spongiform encephalopathy, 1447  
 pseudorabies eradication program, 1401  
 rabies, 1385  
 winter dysentery, cattle, 1297  
*Francisella tularensis*, 952–954  
*Francisella tularensis* biovar *holarctica* (*palaeartica*), 952  
*Francisella tularensis* biovar *tularensis*, 952, 953  
 Frank-Starling mechanism, 400  
 Free electricity, 1790–1791  
 Free-gas (secondary) bloat, 327, 330–331, 339  
 Freemartinism, calves, 1939–1940  
 Free thyroxine (fT4), 1689, 1689–1690  
 Free water abnormalities see Fluid balance disorders  
 Frenzy, 9, 578  
 Fresh water blooms, cyanobacteria in, 1913–1914  
 Friesian cattle, GM<sub>1</sub> gangliosidosis, 1950  
 Fright/flight response, 1994  
 Frogleg attitude, 1646  
 Frog support, laminitis, 2033  
 Froin's syndrome, 592  
 Frontier vaccination, foot-and-mouth disease, 1229  
 Frostbite see Cold injury (frostbite)  
 Frothy (primary) bloat, 326–327, 328, 328–329, 330  
 Frozen vaccines, bovine babesiosis, 1495  
 Fructans, laminitis, 2030  
 Fructose supplementation, 1665  
 Fruitbats, equine hendra virus transmission, 1329  
 Frusemide see Furosemide  
 Fumarate, intramuscular injection, 1728  
 Fumitremorgen poisoning, 1910  
 Fumonisin poisoning, 1899, 1905–1906  
 Fumonisin toxicosis (equine leukoencephalomalacia), 604, 1376, 1899, 1905  
 Functional blindness, 583  
 Functional murmurs, 424, 425  
 Functional residual capacity, heaves, 1930  
 Functional systolic ejection murmurs, 425  
 Fungal culture, mycotoxins, 1898  
 Fungal diseases, 1471–1481  
 see also *specific diseases/disorders*  
 Fungal infection  
 enteritis, 260  
 mastitis, 675, 727–728  
 Fungal toxicosis, congenital defects of the newborn, 134  
 Fungal toxins, hemorrhagic disease, 444  
 Fungicide poisoning, 1814, 1838–1839, 1909  
 Fungistatic agent poisoning, 1841, 1909  
 Furanocoumarin poisoning, 1887  
 Furanoid sesquiterpene poisoning, 1892  
 Furanosquiterpenoid poisoning, 1892  
 Furanoterpinoid mycotoxin, 1906  
 Furazolidone  
 dosage/interval, 2056, 2065  
 giardiasis, 1517  
 poisoning, granulocytopenic disease of calves, 1989  
 Furocoumarin poisoning, 1887  
 Furosemide  
 dosage/interval, 2056  
 heart failure, chronic (congestive), 403  
 urinary tract disease, 553  
 Fusaric acid, 1905, 1911  
 Fusarotoxicosis, 1899, 1911  
*Fusarium*  
 ipomeanol poisoning, 1892  
 trichothecene poisoning, 1911  
*Fusarium culmorum*, 1899, 1911  
*Fusarium graminearum* (*roseum*), 1911  
*Fusarium moniliforme*, 1899, 1911  
*Fusarium nivale*, 1911  
*Fusarium roseum*, 1899  
*Fusarium semitectum*, 1906, 1999  
*Fusarium solani*, 1906, 1999–2000  
*Fusarium sporotrichiella*, 1911  
*Fusarium sporotrichoides*, 1899, 1911  
*Fusarium toxin*, splayleg syndrome, 2024  
*Fusarium tricinctum*, poisoning, 1911  
*Fusarium verticillioides*, fumonisin poisoning, 1905  
*Fusiformis necrophorum*, 1077–1078  
*Fusobacterium*, 1061–1080  
*Fusobacterium necrophorum*, 1061  
 biovars, 1061  
 bovine interdigital necrobacillosis, 1064–1066  
 enzootic pneumonia of calves, 1340  
 foot rot in sheep, 1071  
 granulocytopenic disease of calves, 1989  
 liver necrobacillosis, 1062–1063  
 localized infection, 110, 111  
 mastitis, 727  
 necrotic rhinitis, 1080  
 oral necrobacillosis, 1079–1080  
 pathogenicity, 1061  
 virulence, 1061, 1062
- 
- G**
- Gaboon viper (*Bitis gabonica*), 1916  
*Gaigeria pachycelis*, 1552  
 Gait  
 abnormality, 576, 580–581, 587  
 see also Ataxia; Paresis; Weakness  
 border disease, 1416  
 Borna disease, 1382  
 caprine arthritis encephalitis, 1412  
 claw deformities, 1961  
 equine motor neuron disease, 2020  
 evaluation, 587–589  
 examination, 10  
 forelimb evaluation, 589  
 goose-stepping see Goose-stepping gait  
 louping-ill, 1409  
 $\alpha$ -mannosidosis, 1949  
 nervous system examination, 587–589  
 plant-induced incoordination, 1896–1897  
 recurrent exertional rhabdomyolysis in Thoroughbred horses, 1967  
 short stepping, exertional rhabdomyolysis, 1684  
 stringhalt, 2019  
 Galactocerebroside(s) (globoid cell leukodystrophy), 1951  
*Galba bulimoides*, 1577  
*Galba bulimoides techella*, 1577  
*Galega officinalis* poisoning, 1887  
 Galegine poisoning, 1887  
 Gallamine triethiodide, 2056, 2065  
 Gallbladder  
 African swine fever, 1171  
 babesiosis, 1490  
 tumor, 395–396  
 Gallop rhythm, 406  
 Galloway cattle  
 hepatic lipodystrophy in calves, 1944  
 $\alpha$ -mannosidosis, 1949  
 Gallstones, 396  
 Gambian sleeping sickness, 1533, 1534  
 Gametogony, 1502, 1514  
 Gamma-glutamyl transferase (GGT)  
 colibacillosis, 861  
 equine colic, 223  
 left dorsal displacement of the large colon, 250  
 liver function, 388, 389, 390  
 multisystemic, eosinophilic epitheliotropic disease, 1993  
 passive immunity transfer assessment, 154  
 postvaccinal hepatitis, 1988  
 Gamma glutamyltransferase (GGT), renal tubular injury, 549  
 Gamma glutamyltransferase (GGT):creatinine ratio in urine, 549  
 Gamma-glutamyl transpeptidase, fasciolosis, 1578  
 $\Gamma$  irradiation, congenital defects of the newborn, 134  
 Gamonts (gametocytes), *Babesia*, 1485  
 Ganglioside (GM<sub>1</sub>), 1950  
 Gangliosidosis, 135, 1950  
 Gangrene, 666  
 ergotism, 1902–1903  
 etiology, 666  
 salmonellosis, 909  
*Staphylococcus aureus* mastitis, 700  
 teats, 750  
 terminal dry, 909  
 Ganjam virus, 1245  
 Ganskweed (*Lansiospermum bipinnatum*) poisoning, 1892  
 Garbage feeding  
 rinderpest, 1240  
 swine vesicular disease, 1231, 1232  
 vesicular exanthema of swine, 1236  
 Gas gangrene see Malignant edema  
 Gasoline toxicity, 1847  
*Gasterophilus haemorrhoidalis*, 1585–1586  
*Gasterophilus inermis*, 1585  
*Gasterophilus infestation*, 1585–1586  
*Gasterophilus intestinalis*, 1585–1586  
*Gasterophilus nasalis*, 1585  
*Gasterophilus pecorum*, 1585–1586  
 Gastric antacids, 240  
 Gastric bacteria, *pars esophagea* ulceration, 1995  
 Gastric center, reticulorumen motility control, 294, 295–296  
 Gastric decompression, 196, 246  
 Gastric dilatation  
 horses, 226, 233–234  
 pigs, 259  
 Gastric habronemosis, 1572  
 Gastric hemorrhage, *pars esophagea* ulceration, 1996  
 Gastric impaction  
 horses, 234  
 plants sources of, 1895  
 pyrrolizidine alkaloid poisoning, 1879  
 Gastric lavage, 259  
 Gastric lesions, grading system, 239  
 Gastric neoplasia, 281–282  
 Gastric perforation, *Gasterophilus infestation*, 1586  
 Gastric pH, gastric ulcers, 235, 236, 238  
 Gastric reflux, 192  
 enteritis, anterior, 245  
 equine colic, 222, 224  
 gastric decompression in horses, 196  
 Gastric rupture, 124  
 Gastric torsion, acute, 259  
 Gastric ulcer(s), 237–241, 1190  
 foals, 234–237  
 clinical findings, 235–236  
 clinical pathology, 236  
 control, 237  
 diagnostic confirmation, 236  
 differential diagnosis, 236  
 epidemiology, 235  
 etiology, 235  
 necropsy findings, 236  
 pathogenesis, 235  
 prevention, 170  
 treatment, 236, 236–237  
 horses, 237–241  
 clinical findings, 238–239  
 clinical pathology, 239  
 control, 240–241  
 differential diagnosis, 240  
 epidemiology, 237–238  
 etiology, 237  
 necropsy findings, 239–240  
 pathogenesis, 238  
 treatment, 240  
 Gastric ulcer hyperkeratosis see *Pars esophagea* ulceration  
 Gastrin, 373, 1544  
 Gastritis, 258–259  
 Gastrocnemius muscle, also heel, 1956  
 Gastrointestinal ulcer see Gastric ulcer(s)  
 Gastroenteritis  
 arsenic poisoning, 1809  
*Listeria monocytogenes* infection, 806  
 mycotic, 1472

- Gastroenteritis (Cont'd)  
 parasitic see Parasitic gastroenteritis (PGE)  
 radiation injury, 1787
- Gastroenteroscopy, 197
- Gastrointestinal disease/disorders  
 arrhythmia association, 414  
 atrial fibrillation and, 418–419  
 atrial premature complexes and, 416  
 dysfunction in cattle, 298–301  
 hemorrhagic anemia, 451  
 radiation injury, 1786  
 sudden death, 124  
 see also specific diseases/disorders
- Gastrointestinal motility, normal, 189–190
- Gastrointestinal stasis, edema disease, 890
- Gastrointestinal tympany, 309
- Gastrolobium* poisoning, 1887
- Gastrosocopy  
 gastric dilatation, 234  
 gastric ulcers, 235, 239
- Gastrospillum suis, pars esophagea* ulceration, 1994, 1995
- GC–GE–pseudorabies vaccine, 1402
- Geigeria* poisoning, 1892
- Gelatins, 97
- Gelbvieh cattle  
 bovine familial degenerative neuromuscular disease, 1964  
 glomerulopathy and peripheral neuropathy in calves, 556
- Geldings, urethral tears, 571
- Gene probes, equine hyperkalemic periodic paralysis, 1966
- Generalized cytomegalic inclusion body disease of swine, 1335–1336
- Generalized glycogenosis, 1962–1963
- Genetic control, blowfly, 1592
- Genetic engineering  
 foot-and-mouth disease vaccines, 1229  
 phytotoxin control, 1852
- Genetic testing, 1939  
 copper deficiency reduction, 1722  
 hyena disease of cattle, 2023
- Genital squamous-cell carcinoma, 668
- Genital tract disease/infection  
 dourine, 1539  
 equine herpesvirus 1, 1309  
 hemorrhagic anemia, 451  
*Mycoplasma*, 1125  
*Streptococcus*, 769
- Gentamicin  
 arthritis, 646  
 coliform mastitis, 716  
 equine influenza, 1326  
 small intestine *Escherichia coli* overgrowth, 868
- Gentamicin sulfate, 2056, 2065
- German Black Spotted cattle, chondrodystrophy, 1959
- German Fleckvieh cattle, umbilical hernia, 1964
- Germany  
 bovine virus diarrhea virus eradication program, 1275  
 coccidiosis, 1499, 1501  
 enzootic bovine leukosis eradication program, 1219  
 rabies, 1385
- Germinative epithelium, radiation injury, 1787
- Gestation  
 age and viability, 128  
 prolonged, 1978  
 arthrogryposis and, 1978  
 cattle, 1978  
 craniofacial deformity and, 1978  
 fetal giantism and, 1978  
 plant-induced, 1896, 1899
- Getah virus, 1383–1384
- GE vaccines, pseudorabies, 1402
- Giardia duodenalis*, 849, 1515–1516
- Giardiasis, 1515–1517  
 clinical findings, 1516  
 clinical pathology, 1516  
 economic importance, 1516  
 epidemiology, 1516  
 etiology, 1515–1516  
 experimental reproduction, 1516  
 necropsy findings, 1516–1517  
 pathogenesis, 1516  
 risk factors, 1516  
 treatment, 1517
- Gid (coenurosis, sturdv), 609, 1583
- Gilt breeding, kidney worm disease control, 1571
- Gingival sulcus deepening, 208
- Gingivitis, 205, 208, 1941  
 see also Stomatitis
- Glanders, 1083–1085  
 acute, 1084  
 chronic, 1084  
 clinical findings, 1084  
 clinical pathology, 1084, 1434  
 control, 1085  
 diagnosis, 1085  
 differential diagnosis, 1085  
 economic importance, 1084  
 epidemiology, 1083–1084, 1434  
 etiology, 1083  
 experimental reproduction, 1084  
 nasal form, 1084  
 necropsy findings, 1084–1085  
 pathogenesis, 1084  
 pulmonary form, 1084  
 risk factors, 1084  
 skin form, 1084, 1434  
 transmission, 1084, 1434  
 treatment, 1085
- Glanzmann's disease, 446–447
- Glasser's disease see Infectious polyarthritis
- Glauber's salts see Sodium sulfate
- Glenhaptan Enhancer, 1964
- Gliosis, 600
- Global Rinderpest Eradication Program (GREP), 1237, 1239, 1241
- Globoid cell leukodystrophy (galactocerebrosideosis), 1951
- Glomerular filtrate, 543
- Glomerular filtration rate, 544, 550
- Glomerular proteinuria, 550
- Glomerulonephritis, 555–556
- Glomerulopathy, 556
- Gloriosa superba* (flame/glory lily) poisoning, 1885
- Glory lily (*Gloriosa superba*) poisoning, 1885
- Glossal actinobacillosis, 1047
- Glossina* (tsetse fly), 1532, 1533, 1536  
 see also Nagana
- Glossitis, 205  
 see also Stomatitis
- Glossopharyngeal nerve (cranial nerve IX)  
 assessment, 587
- Glucagon  
 ketosis and, 1661–1662, 1676  
 supplementation, 1666, 1676
- Glucocorticoids  
 endotoxemia, 59  
 equine neonatal encephalopathy, 2014  
 fatty liver, cattle, 1676  
 hypokalemia, acute, 1651  
 immunosuppression, 467  
 ketosis, 1666  
 lymphopenia induction, 461  
 respiratory disease, 495
- Glucose  
 cerebrospinal fluid concentration, 593  
 metabolism, ruminants, 1661  
 transition period, dairy cows, 1676, 1677  
 milk fever, 1636  
 pregnancy toxemia, sheep, 1671  
 supplementation  
 ketosis, 1665  
 neonatal hypoglycemia, 1681  
 urine, loss in, 116
- Glucose-6-phosphatase, splayleg syndrome, 2024
- Glucose-6-phosphate dehydrogenase enzyme deficiency, inherited, 1948
- Glucose absorption test, 197–198, 273
- Glucose–glycine–electrolyte solution, oral, 1282, 1294
- Glucose tolerance test, 1992–1993, 2020
- $\alpha$ -glucosidase defects, 1963
- Glucosinolate poisoning, 1866–1868  
 clinical findings, 1868  
 clinical pathology, 1868  
 control, 1868  
 diagnosis, 1868  
 differential diagnosis, 1868  
 epidemiology, 1867  
 etiology, 1867, 1867  
 necropsy findings, 1868  
 pathogenesis, 1867–1868  
 treatment, 1868
- Glutamate, 1728
- Glutamate dehydrogenase, fasciolosis, 1578
- Glutamate dehydrogenase (GD), liver function tests, 389, 390
- Glutathione peroxidase, 1735–1736, 1746–1747, 1747, 1750
- Glycerine, 1665, 1670
- Glycerol supplementation  
 dosage/interval, 2056  
 fatty liver, cattle, 1677  
 ketosis, 1665, 1666  
 pregnancy toxemia, sheep, 1671
- Glyceryl trinitrate, 2033
- Glycine, 1671
- Glycogenosis, generalized, 1962–1963
- Glycogen storage disease type II, 1962–1963
- Glycogen storage disease type V (muscle glycogen phosphorylase deficiency), 1963
- Glycoprotein E (gE), 1351
- Glycopyrrolate, 1933, 2056
- Glycosaminoglycan, 2057
- Glycosaminoglycan polysulfate, 2027
- GM<sub>1</sub> gangliosidosis, 1950
- GM<sub>2</sub> gangliosidosis, 1950
- Gnats, epizootic hemorrhagic disease transmission, 1305
- Goat(s)  
 altitude effects, 1788  
 drug doses/intervals, 2051–2063  
 3-methylindole effects, 2002  
 milk, toxoplasmosis transmission, 1520  
 reference laboratory values, 2047–2050
- Goat lambs, border disease, 1416
- Goat plague see Peste des petits ruminants (PPR)
- Goatpox, 1430–1431
- Goatpox virus, 1430
- Goiter  
 congenital, 1723  
 cyanogenic glycoside poisoning, 1854  
 glucosinolate poisoning, 1867, 1868  
 inherited, 1940–1941  
 iodine deficiency, 1723
- Goldenrod (*Haplopappus heterophyllus*) poisoning, 1883
- Gomphrena celosioides* poisoning, 1897
- Gonadorelin, 2057
- Goose-stepping gait  
 cerebellar abiotrophy, 1951  
 degenerative joint disease, 2028  
 familial convulsions and ataxia, 1955
- Gossypium* poisoning, 1888
- Gossypol* poisoning, 1888–1889
- Gracilis muscle  
 asymmetric hindquarter syndrome of pigs, 2024  
 myositis, 631
- Graff–Reinert disease see Ovine progressive pneumonia
- Grain  
 gorging, ruminants, 190–191  
 selenium content, 1746  
 water-damaged, tunicaminyluracil poisoning, 1915
- Grain-based diets  
 adaptation to, 318, 323, 324  
 hepatic abscess, 395  
 left-side displacement of abomasum and, 355  
 liver necrobacillosis risks, 1062
- Grain fumigant poisoning, 1841
- Granular cell tumors, 518–519
- Granulocyte-macrophage colony stimulating factor (GM-CSF), 1403
- Granulocytic ehrlichiosis, 1460
- Granulocytopenic disease of calves, 1989
- Granulocytopenic syndromes, 183
- Granulomas  
 granulomatous enteritis, 1993  
*Pythium*, 1480
- Granulomata, mycotic pneumonia, 1473
- Granulomatous dermatitis, *Borrelia siulla*, 1123
- Granulomatous enteritis, horses, 1015, 1994–1995
- Granulomatous lesions, 667  
 actinomycosis, 1046
- Grasping, 612
- Grass disease see Equine grass sickness
- Grassfire (bushfire) injury, 1792–1793
- Grass seed abrasion, 1895

- Grass staggers see Hypomagnesemic tetany  
 Grass tetany see Hypomagnesemic tetany  
 Gravel ingestion, 367  
 Grayanotoxin poisoning, 1885  
 Grazing  
   management  
     acute bovine pulmonary emphysema and edema, 2003  
     bloat control, 334  
     bovine lungworm, 1567  
     vitamin D deficiency, 1764  
 Greasy heel, 663, 1434  
 Greasy pig disease, 784–787  
   clinical findings, 785, 786  
   clinical pathology, 786  
   control, 787  
   diagnosis, 786  
   differential diagnosis, 785, 786  
   epidemiology, 784–786, 785  
   etiology, 784  
   necropsy findings, 786  
   pathogenesis, 786  
   peracute, 786  
   risk factors, 786  
   transmission, 784–786  
   treatment, 785, 786–787  
   vaccination, 787  
 Great Britain  
   bovine herpesvirus-1 infection, 1349  
   enzootic bovine leukosis eradication program, 1219  
   ovine pulmonary adenocarcinoma, 1367  
   scrapie, 1440–1441  
   swine influenza, 1331  
 Greater celadine (*Chelidonium majus*) poisoning, 1887  
 Griseofulvin, 134, 2057, 2065  
 Ground barley, *pars esophagea* ulceration, 1995  
 Ground beef, *Escherichia coli* detection, 883, 885  
 Ground wheat, *pars esophagea* ulceration, 1995  
 Growth arrest lines, laminitis, 2035  
 Growth plate cartilage, degenerative disease, 2027  
 Growth plate defect, 633  
 Growth promoters/stimulants, 176–177  
   arsenic poisoning, 1809  
 Growth rate  
   arthropathy etiology, 637  
   degenerative joint disease, 2026  
   *pars esophagea* ulceration, 1996  
 Grunting  
   abdominal pain, 307–308  
   abomasal impaction, 368  
   alimentary tract disease in cattle, 301  
   eliciting in cattle, 307–308  
   etiology of, 345  
 Guaifenesin, 2057, 2065  
 Guajillo (*Acacia berlandieri*) poisoning, 1884  
 Guatemala, brucellosis status, 965  
 Guernsey cattle  
   chromosomal translocations, 1940  
   periodic spasticity, inherited, 1956  
   viable hypotrichosis, 1974  
 Guinea pigs  
   equine Hendra virus infection, 1329  
   foot-and-mouth disease, 1227  
 Gulf Coast tick (*Amblyomma maculatum*), 1600  
 Gum-tooth junction, 'Lead-line,' 1801–1802  
 Gunshot wound, 122  
 Gut-associated lymphoid tissue (GALT) system, 1163, 1280  
 Gut edema see Edema disease  
 Gut-mammary gland link (gut-associated lymphoid tissue (GALT) system), 1163, 1280  
 Gut tie, 377  
 Guttural pouch diseases, 538–541  
   horses, 1472  
   see also *specific diseases/disorders*  
 Guttural pouch empyema, 538–540  
   clinical findings, 538–539  
   clinical pathology, 539  
   control, 539  
   diagnostic confirmation, 539  
   differential diagnosis, 539  
   epidemiology, 538  
   etiology, 538  
   necropsy findings, 539  
   pathogenesis, 538  
   treatment, 539  
 Guttural pouch fluid evaluation, 484–485  
 Guttural pouch infection, 771, 773  
 Guttural pouch mycosis, 540–541  
 Guttural pouch neoplasms, 541  
 Guttural pouch tympany, 541  
 Guyana, rabies, 1385  
 Gypsum (calcium sulfate), 2007  
 'Gyp water,' 2008
- 
- ## H
- H1N1 avian virus, 1322, 1331  
 H1N1/H3N2 vaccine, 1334  
 H1N1 swine influenza virus, 1331, 1332  
 H1N2 influenza virus, 1331  
 H1N7 influenza virus, 1333  
 H3N2 influenza viruses, 1331, 1333  
 H5N1 avian influenza virus, 1332  
 H9N2 influenza virus, 1332  
 Habitus, alimentary tract examination, 301  
*Habronema majus* (*microstoma*), 1571–1572, 1603  
*Habronema muscae*, 1571–1572  
 Habronemosis, 1571–1572  
 Habu viper (*Trimerurus flavoviridis*), 1916  
*Haemaphysalis longicornis*, 1460, 1600  
*Haematobia*, 1603–1604  
*Haematobia irritans* see Hornfly (*Haematobia irritans*)  
*Haematobia irritans exigua*, 1603  
*Haematobia irritans irritans*, 1603  
*Haematobia minuta*, 1603  
*Haematopinus asini*, 1597  
*Haematopinus eurysternus* (short-nosed sucking louse), 1597  
*Haematopinus suis* (pig louse), 1169, 1431  
*Haemonchus*, 1548–1549  
*Haemonchus contortus*, 1549  
   drug-resistance strains, 1550–1551  
*Haemonchus placei*, 1549  
*Haemophilus agni* see *Histophilus somni*  
*Haemophilus influenzae suis*, 1003–1006  
*Haemophilus meningoenzephalitis*, 1806  
*Haemophilus parasuis*, 1003–1006  
*Haemophilus pleuropneumoniae* see *Actinobacillus pleuropneumoniae* (APP)  
*Haemophilus septicemia*, 998–1003  
   clinical findings, 1000–1001  
   clinical pathology, 1001  
   control, 1002  
   diagnosis, 1002  
   differential diagnosis, 1002  
   epidemiology, 998–1000  
   etiology, 998  
   immune mechanisms, 999–1000  
   necropsy findings, 1001–1002  
   outbreaks, 998  
   pathogenesis, 1000  
   risk factors, 999  
   transmission, 999  
   treatment, 1002  
   vaccination, 1002  
*Haemophilus somni* see *Histophilus somni*  
*Haemophilus somni* disease complex see *Haemophilus septicemia*  
 Hair  
   border disease, 1416  
   copper levels, 1717  
   fibers  
     abnormalities, 653, 661–664  
     graying of, 662  
     loss of, 662  
     normal shedding, 662  
   follicles  
     development failure, 661  
     fiber production failure, 661–662  
     loss of, 661  
     secondary bacterial infection, 1477  
     manganese concentration, 1733–1734  
     zinc concentration, 1732  
 Hairballs see Phytobezoars; Trichobezoars  
 Hair coat-color-linked follicle dysplasia, inherited, 1974  
 Hair coat palpation, 21  
 Hair perforation test, 1477  
 Hair worms see Trichostrongylid worms  
 Hairly foot warts see Papillomatosis, digital  
   dermatitis of cattle (Mortellaro's disease)  
 'Hairy panters,' 1226  
 Hair shakers see Border disease  
*Halicephalobus*, 1575  
*Halicephalobus gingivalis* (*Halicephalobus delatrix*, *Micronema delatrix*), 1575  
 Halofuginone, 1514, 1531  
 Halofuginone lactate, 1529  
 Halogeton poisoning, 1859  
 Halothane sensitive pigs, 1970  
 Halothane-sensitivity gene (HAL gene), 1969–1970, 1973  
 Halothane succinylcholine test, 1969  
 Halothane test, 1969, 1971–1972  
 Haloxon, 2057  
 'Hamburger disease,' 876  
 Hand-fed animals, nutritional history-taking, 6  
 Handling, non-ambulatory cattle, 1649–1650  
*Haplopappus heterophyllus* (goldenrod) poisoning, 1883  
 Hard bag (hard udder), 1364, 1412  
 'Hard milkers,' 1429  
 Hard udder (hard bag), 1364, 1412  
 Hardwood forest fires, 1792  
 Harelip, 280, 1944  
 Hares (*Lepus timidus*), louping-ill, 1408, 1410  
 Harleco apparatus, 860–861  
 Harmatomas, cutaneous, 669  
 Harrowing, strongylosis control, 1561  
 Harvest mites, 1606–1607  
 Hay  
   heaves risk factors, 1929  
   magnesium spray, 1658  
 Hay mites, scrapie, 1441  
 Hazard Analysis of Critical Control Points System (HACCP), 883, 884, 885–886, 1087  
 Head  
   behavior, 584  
   carriage abnormalities, 10, 586  
   clinical examination, 10–11, 17–19  
   coordination, 584  
   nervous system examination, 584–587  
   position, 584  
   posture, 579  
   scoliosis, congenital, 135  
 Head flies (*Hydrotaea irritans*), 723, 1606  
 Head-nodding, cerebellar abiotrophy, 1951  
 Head-pressing, 578, 584  
   plant-induced, 1896  
   polioencephalomalacia, 2010  
   Venezuelan equine encephalomyelitis, 1373  
 Head-shaking, 584, 2022–2023  
 Head trauma, 595–596  
 Health of Animals Regulations, non-ambulatory livestock transport, 1649–1650  
 Heart  
   auscultation, 14–15  
   bovine hereditary dilated cardiomyopathy, 1945  
   bovine leukemia virus, 1214  
   brisket disease, 1788  
   copper deficiency effects, 1712  
   defects, complex vertebral malformation, 1960  
   disease associated with, 420–429  
     see also *specific diseases/disorders*  
   ectopic, 431  
   encephalomyocarditis virus disease, pigs, 1184  
   enzootic bovine leukosis, 1215  
   rhythm, 15  
   rupture, 422  
   see also *Entries beginning cardiac*  
 Heart failure  
   acute, 399, 404–405  
     chordae tendineae, 428  
     clinical findings, 404  
     clinical pathology, 405  
     differential diagnosis, 405  
     etiology, 404  
     horses, 404  
     necropsy findings, 405  
     pathogenesis, 404  
     treatment, 405  
   chronic (congestive), 399, 401–404  
     clinical findings, 402–403  
     clinical pathology, 403  
     etiology, 401–402  
     horses, 1493  
     left-sided, 402, 403  
     necropsy findings, 403  
     pathogenesis, 402  
     plant-induced, 1896  
     right-sided, 402–403, 407  
     treatment, 403–404  
   compensatory mechanisms in, 399–401

- Heart failure (*Cont'd*)  
 plant-induced, 1896  
 principles of, 399
- Heart murmurs see Murmurs
- Heart rate  
 cardiac reserve and, 400, 401  
 cardiovascular system examination, 406  
 decreased, 413  
   see also Bradycardia  
 equine colic, 220, 224  
 fetal, 138  
 increased, 413  
   see also Tachycardia  
 resting, 413, 414  
   cardiac reserve measurement, 401  
   cattle, 413, 414  
   horses, 413, 414  
 shock, 66
- Heart sounds, 15, 405–406  
 abnormal, 15  
 enzootic pneumonia of calves, 1340  
 equine infectious anemia, 1175  
 first (S1), 405  
 fourth (S4), 405–406, 415  
 intensity variation, 401, 406  
 muffling, 406  
   pericarditis, traumatic, 352  
 normal, 15  
 phonocardiography, 409–410  
 second (S2), 405  
 sequence, 406  
 third (S3), 405
- Heart valves see Valvular disease
- Heartwater, 1462–1464  
 acute cases, 1463  
 carriers, 1462  
 clinical findings, 1463  
 clinical pathology, 1463  
 control, 1463–1464  
 differential diagnosis, 1463  
 economic importance, 1462–1463  
 epidemiology, 1462  
 etiology, 1462  
 immune mechanisms, 1462  
 mild form, 1463  
 mortality rates, 1462, 1463  
 necropsy findings, 1463  
 occurrence, 1462  
 pathogenesis, 1463  
 peracute cases, 1463  
 risk factors, 1462  
 subacute cases, 1463  
 transmission, 1462  
 treatment, 1463  
 vaccination, 1463–1464  
 vectors, 1462, 1601
- Heat exhaustion see Hyperthermia
- Heat loss, 39–40  
 conductive, 41  
 excessive, 40  
 lambs, 141  
 neonatal control of, 41
- Heat mount detectors, 30–31
- Heat production, 39, 40  
 insufficient, 40  
 neonates, 42
- Heat stress  
 colostral immunoglobulin concentration, 151  
 intrauterine growth retardation, 137  
 recumbency in horses, 722
- Heat stroke see Hyperthermia
- Heaves, 1928–1935  
 case-fatality rate, 1928  
 clinical examination, 1931–1932  
 clinical findings, 1930–1931  
 clinical pathology, 1931–1932  
 control, 1934  
 course of the disease, 1931  
 diagnosis, 1932  
 differential diagnosis, 1932  
 epidemiology, 1928–1929  
 etiology, 1928  
 immune response, 1929–1930  
 inflammatory response, 1929–1930  
 integrated therapy, 1934  
 necropsy findings, 1932  
 outbreaks, 1928  
 pasture-associated, 1935  
 pathogenesis, 1929–1930  
 risk factors, 1928–1929  
 treatment, 1932–1934, 1933  
 see also Cough/coughing
- Heavy cobalt pellets, 1706
- Heavy magnesium 'bullets,' 1658
- Heavy metal poisoning, 619
- Heel abscess, 1077–1078
- Heel warts see Papillomatosis, digital dermatitis of cattle (Mortellaro's disease)
- Heifers  
 bovine herpesvirus-1 vaccination, 1358, 1359  
 bovine virus diarrhoea virus vaccination, 1272  
 enzootic bovine leukosis prevention, 1221  
 interstitial pneumonia, 2000  
 laminitis, 2034  
 perianal warts, 1421  
 stillbirth/perinatal weak calf syndrome, 1983–1984, 1985  
 umbilical hernia, 1964
- Helicococcus ovis*, 517
- Helonium* poisoning, 1892
- Helichrysum argyrosphaerum*, 1896
- Helicobacter heilmannii, pars esophagea*  
 ulceration, 1994, 1995, 1996
- Helicobacter pylori*, 1995
- Heliotropium*, pyrrolizidine alkaloid poisoning, 1878–1881
- Heliotropium europaeum*, copper poisoning, 1824
- Helminthosporium ravenelli*, 1912
- Helminthosporium spiciferum*, 1481
- Helminth parasites, 1541–1583  
 enteritis, 260  
   see also specific types
- Hemadsorption–elution–hemagglutination assay test, 1292
- Hemagglutinating encephalomyelitis virus  
 disease in pigs, 1285–1286
- Hemagglutination inhibition (HI) testing  
 equine influenza, 1322, 1325  
 louping-ill, 1409  
 swine influenza, 1333
- Hemangioepithelioma (hemangiosarcoma), 436, 669
- Hemangioma, 436, 669
- Hemangiosarcoma, 436, 669
- Hematinics, 459
- Hematochezia, 265, 307
- Hematocrit  
 equine colic, 222, 224  
 hemorrhagic shock, 65, 67  
 metabolic profile testing, herds, 1622  
 reference laboratory values, 2047
- Hematogenous osteomyelitis, 635
- Hematogenous subcutaneous abscess, 667
- Hematologic abnormality, exercise intolerance, 119
- Hematology  
 African swine fever, 1171  
 alloimmune hemolytic anemia of the newborn, 1922–1923  
 anaplasmosis, 1457  
 anemia, 454, 456  
 babesiosis, 1489  
 brain abscess, 606–607  
 cobalt deficiency, 1704  
 colibacillosis, 860–861  
 coliform mastitis, 714  
 copper deficiency, 1717  
 diarrhoea, acute, 270  
 endotoxemia, 57  
 enteritis, 266  
 eperythrozoonosis, 1155  
 equine arteritis virus, 1321  
 equine colic, 222–223  
 equine neorickettsiosis, 1467  
 erysipelas of swine, 813  
 familial polycythemia, 1947  
 granulomatous enteritis, horses, 1992  
*Haemophilus* septicemia, 1001  
 hemorrhagic bowel syndrome, 381  
 hog cholera, 1162  
 interstitial pneumonia, horses, 2005  
 ketosis, 1665  
 lead poisoning, 1804  
 mastitis, 687  
 mastitis-metritis-agalactia syndrome, 757  
 meningitis, 611  
 metabolic profile testing, herds, 1622  
 newborns, 164–165, 165  
 osteochondrosis, 640  
 peritonitis, 285  
 pleuritis (pleurisy), 524  
 pneumonia, 512  
 pneumonic pasteurellosis, 939–940
- purpura hemorrhagica, 1926  
 reference laboratory values, 2047
- Rhodococcus equi* pneumonia, 802
- septic metritis, postpartum, 61
- sporadic bovine encephalomyelitis, 1407
- strongylosis, 1560
- undifferentiated bovine respiratory disease, acute, 929–930
- Hematoma  
 buller steer syndrome, 1983  
 scrapie, 1444  
 spleen, 465
- Hematuria, 545–546
- Hematuria, red urine in cattle, 1491
- Hemerocallin poisoning, 1893
- Hemerocallis* (day lily) poisoning, 1893
- Hemiacidrin, 569
- Hemic murmurs, 424
- Hemlock, poisonous (*Conium maculatum*), 134, 1889–1890
- Hemochromatosis, 392, 1947
- Hemodialysis, 554
- Hemoglobin  
 anemic hypoxia and, 453  
 babesiosis, 1489  
 bovine polymerized, dosage/interval, 2057  
 decreased production, anemia from, 452–453  
 hemonchosis, ruminants, 1550  
 levels, pigs, 1727
- Hemoglobin, reference laboratory values, 2047
- Hemoglobinopathies, 460
- Hemoglobinuria, 546  
 bovine babesiosis, 1488, 1489  
 plant-induced, 1896  
 post parturient, 1614  
 red urine in cattle, 1491  
 water intoxication, 76
- Hemogram  
 abomasal displacement/volvulus, 365  
 abomasal ulcer, 373  
 encephalitis, 601  
 fatty liver, cattle, 1675  
 intestinal obstruction, 380  
 left-side displacement of abomasum, 359  
 localized infection, 111  
 milk fever, 1633  
 pericarditis, traumatic, 352  
 polioencephalomalacia, 2010–2011  
 reticuloperitonitis, traumatic, 340  
 retroperitoneal abscess, 290  
 septicemia, 52  
 vagus indigestion, 349
- Hemolympathic system, diseases of, 439–469  
 lymphadenopathy, 464  
 plasma protein concentration abnormalities, 439–441  
 red cell number/function disorders, 450–460  
 spleen, diseases of, 464–466  
 thymus, diseases of, 464–466  
 white cell disorders, 460–464  
 see also specific diseases/disorders
- Hemolysins, *Actinobacillus pleuropneumoniae* (APP), 1054
- Hemolysis  
 anemia, 455  
 babesiosis, 1488  
 leptospirosis, 1100–1101
- Hemolytic anemia, 451–452, 1106  
 alloimmune of the newborn see Alloimmune hemolytic anemia of the newborn  
 autoimmune, 455, 459  
 Hemolytic crisis, copper poisoning, 1822
- Hemolytic disease  
*Clostridium perfringens*, type A, 837  
 plant-induced, 1896
- Hemolytic jaundice, 384–385
- Hemolytic-uremic-like syndrome, 556
- Hemolytic venoms, 1916, 1916, 1917
- Hemonchosis  
 goats, 1549  
 ruminants, 1548–1552  
   breed susceptibility, 1550  
   clinical findings, 1550  
   clinical pathology, 1550  
   control, 1551  
   diagnostic confirmation, 1550  
   differential diagnosis, 1550  
   epidemiology, 1549  
   etiology, 1548–1549  
   natural resistance, 1551  
   necropsy findings, 1550  
   pathogenesis, 1549–1550

- Hemonchosis (*Cont'd*)  
 predisposing causes, 1549  
 self-cure phenomenon, 1549  
 transmission, 1549  
 treatment, 1550–1551  
 vaccination, 1551  
 sheep, 1549, 1550
- Hemoperitoneum, 207
- Hemophilia, 444–445, 1947
- Hemophilia A, 444–445, 1947
- Hemoptysis, 480, 532–533
- Hemorrhage  
 African swine fever, 1170  
 alimentary tract, 194  
 babesiosis, 1490  
 central nervous system laceration, 605  
 diseases causing, 443–447  
 hemangiosarcoma, 436  
 hog cholera, 1163  
 internal, spontaneous, 124  
 iron deficiency anemia, 1726  
 Jembrana disease, 1244  
 panhypoproteinemia, 439  
 peritonitis, 283  
 pseudorabies, 1399  
 radiation injury, 1787  
 sarcocystosis, 1508, 1509  
 strongylosis, 1559  
 subcutaneous, 666
- Hemorrhagic anemia, 451, 1503
- Hemorrhagic bowel syndrome, cattle, 380–382  
 clinical findings, 381  
 clinical pathology, 381  
*Clostridium perfringens*, type A, 837  
 control, 382  
 differential diagnosis, 382, 382  
 epidemiology, 380–381  
 etiology, 380  
 necropsy findings, 381  
 pathogenesis, 381  
 treatment, 381
- Hemorrhagic diathesis, 386
- Hemorrhagic disease, 441–450  
 bovine virus diarrhoea virus, 1253, 1255, 1259–1260  
 diagnosis, 441–442  
 vitamin K deficiency, 1777
- Hemorrhagic enteritis, 307
- Hemorrhagic enterocolitis, 842, 1321
- Hemorrhagic enterotoxemia, 837, 1294
- Hemorrhagic jejunitis, 299
- Hemorrhagic pulmonary infarction, 1045
- Hemorrhagic septicemia, cattle, 921–923  
 clinical findings, 922  
 clinical pathology, 922  
 control, 922–923  
 epidemiology, 922  
 etiology, 921–922  
 necropsy findings, 922  
 outbreaks, 922  
 pathogenesis, 922  
 treatment, 922  
 vaccination, 922–923
- Hemorrhagic shock, 63–69  
 cattle, 64  
 clinical findings, 65  
 clinical pathology, 65–66  
 differential diagnosis, 66  
 etiology, 63–64  
 horses, 64  
 necropsy findings, 66  
 pathogenesis, 64–65  
 pigs, 64  
 sheep, 64  
 treatment, 66–68
- Hemorrhagic syndrome, pigs, 444
- Hemosiderin, 1947
- Hemosiderophages, exercise-induced pulmonary hemorrhage, 504
- Hemosiderosis, nagana, 1535
- Hemostatic system, endotoxemia and, 55
- Hemothorax, 519, 524
- Henderson–Hasselbalch equation, 83
- Hendra virus, equine, 1329
- Henipaviruses, 1383
- Henrici (picric acid) test, 1854
- Heparin  
 coagulopathy treatment, 442–443  
 disseminated intravascular coagulopathy, 449  
 dosage/interval, 2057  
 equine colic, 227  
 equine hyperlipidemia, 1679
- laminitis, horses, 2033
- Hepatic abscess(es), 393, 395  
 black disease, 395  
 carbohydrate engorgement, 317  
 cattle, 388, 395  
 caudal vena caval syndrome, 395  
*Fusobacterium necrophorum* associated, 1062–1063  
 goats, 395  
 ultrasonography, 388
- Hepatic biliary cystadenoma, 396
- Hepatic coma, 385
- Hepatic dysfunction  
 congenital, photosensitivity, 660  
 principles of, 383–384
- Hepatic encephalopathy, 385–386, 394, 603  
 brain dysfunction, 1807  
 cattle, 385–386  
 cobalt deficiency, 1703  
 horses, 385  
 pyrrolizidine alkaloid poisoning, 1879
- Hepatic fibrosarcoma, goats, 396
- Hepatic fibrosis, 393, 394
- Hepatic injury  
 mycotoxicosis, 1912  
 plant-induced, 1896  
 pyrrolizidine alkaloid poisoning, 1879
- Hepatic lipidosis see Fatty liver, cattle
- Hepatic lipodystrophy, Galloway calves, 1944
- Hepatic necrosis  
 caprine herpesvirus-1 infection, 1330  
 pigs, 392  
 post-weaning multisystemic wasting syndrome, 1190  
 pseudorabies, 1399  
 Rift Valley fever, 1206
- Hepatitis, 383, 391–394  
 acute, 391, 1988–1989  
 clinical findings, 393–394  
 clinical pathology, 394  
 congestive, 393, 394  
 differential diagnosis, 394  
 epidemiology, 391–392  
 etiology, 391–392  
 infectious, 392, 394  
 infectious necrotic see Black disease  
 nutritional (trophopathic), 392, 393  
 parasitic, 392–393, 394  
 pathogenesis, 392–393  
 postvaccinal (serum), 392, 393, 824, 1988–1989  
 sporidesmin poisoning, 1909  
 toxemia perfusion, 392  
 toxipathic, 383–384  
 traumatic, 352, 395  
 treatment, 394  
 see also *specific types*
- Hepatitis cysticercosis, 1583
- Hepatoencephalopathy, 1376, 1988
- Hepatogenous chronic copper poisoning, 1823, 1824
- Hepatogenous photosensitization, 660
- Hepatopathy, congestive, 392
- Hepatositis, 383, 392
- Hepatositis dietetica  
 clinical findings, 1745  
 epidemiology, 1740  
 necropsy findings, 1748  
 pathogenesis, 1744  
 treatment, 1749  
 vitamin E and selenium deficiency, 1739
- Heptachlor toxicity, 1833
- Herbicides, poisoning, 1808, 1837–1838
- Herd(s)  
 accreditation, caprine arthritis encephalitis, 1413  
 clinical examination see Clinical examination, herds  
 health programs, 37  
 productivity shortfalls, 116–117  
 size, pseudorabies, 1394, 1395  
 treatment methods, 31
- Herd Chek BVDV Antigen Serum Test Kit (IDEXX), 1261
- Herding instincts, stress induction, 108
- Hereditary equine regional dermal asthenia, 1976
- Hereditary hemimelia, 1961
- Hereditary junctional mechanobullous disease, 1975
- Hereditary neuraxial edema (inherited congenital myoclonus), 1956–1957
- Hereditary peromelia of mohair goats, 1961
- Hereford cattle  
 bovine hereditary dilated cardiomyopathy, 1945  
 bovine ocular squamous-cell carcinoma, 2040  
 cleft palate, 1944  
 congenital hydrocephalus, 1954  
 lymphatic obstruction, inherited, 1945  
 pseudoalbism, 1942  
 shaker calf syndrome, 1951
- Herlitz junctional epidermolysis bullosa, 1975
- Hermaphroditism, 1964
- Hernia(s)  
 congenital, 521  
 inguinal, 242, 243  
 scrotal, 1964  
 umbilical, 1964
- Herpesvirus see *specific types*
- Hetastarch, 2057
- Heterologous challenge, viruses, 1322
- Hexachlorethane poisoning, 1831
- Hexachlorobenzene (HCB) poisoning, 1841
- Hexachlorophene, 1581  
 poisoning, 1831
- HGE agent see *Anaplasma phagocytophila*
- High-level grain feeding see Grain-based diets
- Hindlimb(s)  
 ataxia, 1450  
 degenerative joint disease, 2028  
 equine cervical vertebral stenotic myelopathy, 2017  
 incoordination, 890  
 nervous system examination, 590–591  
 tying, splayleg syndrome, 2025
- Hip dysplasia, 1771, 1962
- Hip lifters, downer cow syndrome, 1648
- Hippelates (eye gnats), 1233
- Hippobosca equina, 1604
- Hippobosca maculata, 1604
- Hippobosca rufipes, 1604
- Hirsutism, 1687
- Hirudin, 443
- Histamine, carbohydrate engorgement, 317
- Histamine type 2 (H<sub>2</sub>) receptor antagonists, 236, 373–374
- Histiocytoma, 668–669
- Histology  
 acute bovine pulmonary emphysema and edema, 2002  
 African swine fever, 1171  
 ascarid infections, 1557  
 baldy calves, 1975  
 border disease, 1417  
 Borna disease, 1382  
 bovine hereditary dilated cardiomyopathy, 1945  
 bovine herpesvirus-1 infection, 1355  
 bovine lungworm, 1566  
 bovine papular stomatitis, 1277  
 bovine respiratory syncytial virus pneumonia, 1347  
 brisnet disease, 1788  
 coccidiosis, 1504  
 combined immunodeficiency, Arabian foals, 1979  
 cryptosporidiosis, 1514  
 dourine, 1539  
 encephalomyocarditis virus disease, pigs, 1184  
 enzootic bovine leukosis, 1219  
 enzootic pneumonia of calves, 1341  
 equine arteritis virus, 1321  
 equine cervical vertebral stenotic myelopathy, 2017  
 equine grass sickness, 1991  
 equine hendra virus infection, 1329  
 equine herpesvirus 1, 1315  
 equine infectious anemia, 1176  
 equine influenza, 1325  
 equine neonatal encephalopathy, 2014  
 equine neorickettsiosis, 1467  
 equine protozoal myeloencephalitis, 1525  
 erysipelas of swine, 814  
 foot-and-mouth disease, 1227  
 hemochromatosis, 1947  
 hog cholera, 1163, 1164  
 ileitis, 1091  
 infectious polyarthritis, 1005  
 inherited erythrocytic protoporphyria, 1947  
 itch mites, 1607  
 Jembrana disease, 1244  
 laminitis, horses, 2032

- Histology (Cont'd)  
 lumpy skin disease, 1426  
 lymphocytic-plasmacytic enterocolitis, 1993  
 malignant catarrhal fever, 1248  
 mycoplasmal pneumonia, pigs, 1149  
 neosporosis, 1511  
 ovine pulmonary adenocarcinoma, 1367–1368  
*pars esophagea* ulceration, 1996  
 polioencephalomalacia, 2011  
 polyserositis, pigs, 1153  
 porcine reproductive and respiratory syndrome, 1201  
 porcine stress syndrome, 1972  
 pseudorabies, 1399, 1400  
 rabies, 1390  
 recurrent exertional rhabdomyolysis, 1968  
 renal tubular dysplasia, inherited, 1948  
 rinderpest, 1240  
 sarcocystosis, 1509  
 sporadic bovine encephalomyelitis, 1407  
 swine influenza, 1334  
 toxoplasmosis, 1521  
 transmissible gastroenteritis, 1281  
 Venezuelan equine encephalomyelitis, 1374  
 viral papular dermatitis, 1426  
 visna, 1414
- Histophilus ovis* see *Histophilus somni*
- Histophilus somni*  
 localized infection, 111  
 mastitis, 727  
 myocardial abscess, 924  
 ovine mastitis, 759  
 pleuritis, 924  
 pleuropneumonia, 928  
 pneumonia, 924  
 septicemia, 997–998  
 synovitis, 646  
 thrombotic meningoencephalitis, 997–998  
 undifferentiated bovine respiratory disease, 926  
 vaccine, 933–934, 934, 1002  
 virulence, 999
- Histophilus somni* disease complex see *Haemophilus* septicemia
- Histoplasma capsulatum*, 1475
- Histoplasma capsulatum* var. *farciminosum*, 1479
- Histoplasmin skin test, 1475
- Histoplasmosis, 1475
- History-taking, individual animals, 3–7  
 case fatality rates, 5  
 climate, 6  
 culling rate, 5  
 disease history, 4–5  
 exposure, 5  
 general management, 6–7  
 management history, 5–7  
 methods, 4  
 morbidity, 5  
 nutritional history, 5–6  
 patient data, 4  
 population mortality rates, 5  
 prophylactic measures taken, 5  
 reproductive management/performance, 6  
 transit, 5  
 treatment, prior to, 5
- Histotoxic hypoxia, 472–473
- Hoary allyssum (*Berberoa incana*) poisoning, 1888
- 'Hobby farm malnutrition,' 115
- Hock, also heel, 1956
- Hog cholera, 1157–1167  
 abortion, 1095  
 acute disease, 1161–1162, 1163  
 carriers, 1159, 1162  
 case fatality rate, 1158–1159  
 chronic disease, 1162  
 clinical findings, 1162  
 clinical pathology, 1162–1163  
 congenital defects in newborns, 133  
 control, 1164–1165  
 diagnosis, 1161, 1162, 1164  
 differential diagnosis, 1161, 1164  
 differentiation from other viruses, 1162–1163  
 economic importance, 1160  
 epidemiology, 1158–1160  
 eradication, 1164, 1165  
 etiology, 1158  
 experimental infection, 1161  
 fetal infection, 1159, 1161, 1162, 1163–1164, 1166  
 goats, 1161  
 immune mechanisms, 1160  
 immunization methods, 1165–1166  
 laboratory samples, 1164  
 morbidity, 1158–1159  
 necropsy findings, 1161, 1163–1164  
 nervous manifestations, 1162  
 occurrence, 1158  
 outbreaks, 1158  
 pathogenesis, 1160–1161  
 peracute disease, 1161–1162, 1163  
 pregnancy, 1161  
 removal of source of infection, 1165  
 reproductive failure, 1162  
 risk factors, 1159–1160  
 secondary infection, 1161  
 transmission, 1159  
 treatment, 1164  
 vaccination, 1165–1166  
 viral detection, 1162  
 virulence characteristics, 1159–1160  
 virus resistance, 1160
- Hog louse (*Haematopinus suis*), 1169, 1431
- Holodiastolic murmurs, 426
- Holosystolic murmurs, 425, 426
- Holstein calves  
 colostrum, volume ingested, 151  
 inherited multiple ankylosis, 1962
- Holstein cattle  
 enzootic pneumonia of calves, 1337  
 periodic spasticity, inherited, 1956
- Holstein-Friesian cattle  
 bovine leukocyte adhesion deficiency, 1941  
 chromosomal translocations, 1940  
 deficiency of UMP synthase, 1940  
 factor XI deficiency, 445  
 harelip, 1944  
 shaker calf syndrome, 1951  
 smooth tongue, 1944  
 umbilical hernia, 1964
- Homeothermy, 39, 44
- Homeria pallida*, cardiac glycoside poisoning, 1863
- Homidium bromide, 1536
- Homidium chloride, 1536
- Homologous challenge, viruses, 1322
- Honduras, brucellosis status, 965
- 'Honker cattle' (tracheal stenosis of feedlot cattle), 2004
- Hoof  
 baldy calves, 1975  
 care, laminitis, 2033  
 clinical examination, 20–21  
 damage, 623  
 diseases of, 661–664, 663–664  
 sloughing, 664
- Hoof-coronary band separation, burn injury, 1793
- Hoof wall, laminitis, 2031
- Hoof wall-sole angle, laminitis, 2035
- Hookworm disease, 1552–1553
- Hoose see Bovine lungworm (verminous pneumonia)
- Hooves see *Entries beginning hoof*
- Hormone(s)  
 defects,agalactia, 753  
 growth implants, buller steer syndrome, 1982  
 reference laboratory values, 2048, 2049  
 reticulorumen motility, primary contraction influence, 296  
 therapy, ketosis, 1666  
 weed killers, poisoning, 1838
- Horn(s)  
 cancer of the core, 668  
 clinical examination, 20–21  
 damage, 623  
 disease of, 661–664, 663–664
- Horner's syndrome, 588, 589  
 equine aspergillosis, 1474  
 guttural pouch mycosis, 540
- Hornfly (*Haematobia irritans*), 1603–1604
- Corynebacterium pseudotuberculosis* transmission, 788
- Staphylococcus aureus* mastitis transmission, 698
- Horn report, 1446
- Horse(s)  
 abdominal ultrasonography, 196  
 antimicrobial use, 180  
 arterial blood pressure measurement, 410  
 blood glucose levels, 198  
 blood group antigens, 1921  
 bronchoalveolar lavage, 487, 488  
 dehydration, 75, 100–101  
 drug doses/intervals, 2051–2063  
 endoscopic airway examination, 481  
 energy requirements, 1679–1680  
 fluid therapy, oral, 100–101  
 gastric decompression, 196  
 heart rate, resting, 413, 414  
 heart:weight ratio, 401, 411  
 liver, normal structure, 386  
 liver biopsy, 387, 394  
 liver function tests, 388, 389  
 muscle fibers, histochemical characteristics, 628  
 neurological examination, 583  
 oxygen therapy, 494  
 peritoneal fluid, 200–201, 203  
 reference laboratory values, 2047–2050  
 riding, 638  
 selenium, 1746, 1753  
 serum bile acids, 390  
 serum hepatic enzyme profiles, 390  
 starvation, 113  
 sudden death, 124  
 tetanus vaccination, 824  
 transportation stress, 108  
 tying-up, 628  
 wet conditions, 1793  
 see also Mare(s); Stallions
- Horse flies (*Tabanus fuscicostatus*), 1603
- enzootic bovine leukosis transmission, 1211
- equine infectious anemia virus transmission, 1173
- surra transmission, 1537
- Horse louse flies, 1604
- Horsepox, 1432, 1433, 1434
- Horse sickness fever, 1181
- Horse Sickness Vaccine I (AHS I), 1183
- Horse Sickness Vaccine II (AHS II), 1183
- Horsetail (*Equisetum arvense*) poisoning, 1376, 1779, 2007
- Hospital pasture, newborns, 158
- Hot water rinse, carcass decontamination, 886
- House flies (*Musca domestica*), 1605–1606  
 dermatophilosis, 1049  
 insecticide resistant, 1605–1606  
 management, 1605–1606  
 porcine reproductive and respiratory syndrome transmission, 1197  
 transmissible gastroenteritis, 1279
- House sparrow (*Passer domesticus*), West Nile encephalitis host, 1379
- Housing  
 bovine mastitis risk factors, 679  
 caseous lymphadenitis risk factor, 796, 797  
 coccidiosis, 1501  
 colibacillosis, newborn risk factor, 854  
 coliform mastitis control, 717–718  
 dairy calf mortality, 129  
 dairy cows, 1615  
 enterohemorrhagic *Escherichia coli* risk factor, 878  
 environmental examination, 8  
 environmental streptococci mastitis risk factor, 720  
 equine colic risk, 218  
 greasy pig disease, 787  
 heaves, 1934  
 lactation, diseases of, 1618  
 mastitis control, 742–743  
 musculoskeletal system disease, 625  
 mycoplasmal pneumonia, pigs, 1146  
 newborns, 158  
 osteodystrophy, 632  
 papillomatosis digital dermatitis of cattle control, 1070  
*Pelodera strongyloides* infestation, 1573  
 performance shortfalls, 117  
 pneumonia, 514–515  
 pneumonic pasteurellosis risk factor, 948  
 respiratory system disease control, 497  
 salmonellosis and, 904, 916  
 stress induction, 107  
 toxoplasmosis, 1519  
 Venezuelan equine encephalomyelitis, 1373, 1377  
 watery mouth of lambs, 1986  
 West Nile encephalitis, 1380
- Human(s)  
*Actinobacillus lignieresii* infection, 1046  
*Actinobacillus suis* infection, 1052  
 African horse sickness, 1181  
*Anaplasma phagocytophila* infection, 1460

- Human(s) (Cont'd)
- anthrax, 817, 818
  - babesiosis, 1487–1488
  - boreliosis, 1111, 1112
  - botulism, 826
  - bovine leukemia virus, 1214
  - bovine papular stomatitis infection, 1277
  - Brucella abortus* infection, 969
  - Brucella melitensis* infection, 991–992
  - Brucella suis* infection, 989
  - brucellosis, 963, 989
  - Campylobacter* infection, 1086
  - caseous lymphadenitis, 796
  - Chlamydia abortus* infection, 1436
  - colibacillosis, 856
  - cryptosporidiosis, 1513–1514
  - Dermatobia hominis*, 1588
  - Eastern equine encephalomyelitis, 1369, 1371
  - ehrlichiosis, granulocytic, 1460
  - enterocolitis, *Clostridium diffi cile* associated, 845
  - enterohemorrhagic *Escherichia coli* infection, 876, 881–882
  - equine hendra virus infection, 1329
  - equine influenza, 1324
  - Erysipelothrix rhusiopathiae* infection, 812
  - foot-and-mouth disease transmission, 1224, 1225
  - Francisella tularensis* biovar *tularensis* infection, 953
  - giardiasis, 1516
  - glanders, 1084
  - influenza viruses, swine infection, 1332
  - leptospirosis, 1099–1100, 1108
  - Listeria monocytogenes* infection, 807
  - louping-ill, 1409
  - mycobacteriosis, 1015
  - Mycobacterium avium* subspecies *paratuberculosis* (Map), 1019, 1023
  - Oestrus ovis* infestation, 1587
  - orf, 1418, 1419
  - Pseudoallescheria boydii* infection, 1480
  - pseudocowpox, 1428
  - Q fever, 1468, 1469
  - rabies, 1387, 1388
    - post-exposure vaccination, 1392
    - pre-exposure vaccination, 1391–1392
  - Rhodococcus equi* infection, 801
  - Rift Valley fever, 1206
  - Salmonella* infection, 905, 906–907
  - Streptococcus suis* infection, 779–780
  - swine influenza, 1333
  - tapeworms, 1583
  - toxoplasmosis, 1520
  - trombidiform mites, 1607
  - trypanosomoses, 1532, 1533, 1534
  - tuberculosis, 1007, 1008, 1016
  - Venezuelan equine encephalomyelitis, 1373
  - vesicular stomatitis, 1235
  - Western equine encephalomyelitis, 1369
  - West Nile encephalitis, 1379
  - yersiniosis, 955
  - zygomycosis, 1472
- Human food chain
- arsenic residues, 1809
  - lead in, 1800–1801, 1805–1807
  - phytotoxins, 1851
- Human interferon, transmissible gastroenteritis, 1282
- Humpsore, 1574
- Humpy back, 1554, 1893
- Hungary, pseudorabies eradication program, 1400
- Hunger, 112, 113
  - see also Starvation
- Hunting reaction, 41
- Hurdle technology, slaughter practices, 886
- Husk see Bovine lungworm
- Hyalomma*, 1485
- Hyalomma anatolicum*, 1530
  - Hyalomma asticum*, 1049
  - Hyalomma detritum*, 1530
  - Hyalomma dromadarii*, 1180
  - Hyalomma truncatum*, 1989
- Hyaluronate sodium, 2057
- Hyaluronic acid, 642
- Hydatid cysts (*Echinococcus granuloma*), 1583
- Hydralazine, 2057
- Hydranencephaly, 1302, 1955
- Hydration
  - clinical examination, 14
  - maintenance therapy
    - diarrhea, acute, 271
    - oral administration, 99
    - quantities, 98, 98
    - restoration therapy
      - diarrhea, acute, 271
      - quantities, 98, 98
    - status indicators, 75
    - tetanus, 824
    - see also Dehydration
  - Hydrocephalus, 599, 1954
  - Hydrochlorothiazide, 2057
  - Hydrocortisone, 786, 2057
  - Hydrocyanic acid poisoning
    - minimum lethal dose, 1853
    - specimen analysis, 1797
    - see also Cyanogenic glycoside poisoning
  - Hydrofluoric acid poisoning, 1816
  - Hydrogen sulfide
    - manure release, poisoning, 1848–1849
    - polioencephalomalacia, 2009–2010
    - sulfur poisoning from, 1828
  - Hydronephrosis, 548, 560
  - Hydropericardium
    - African horse sickness, 1181
    - edema, 73
    - enzootic bovine leukosis, 1215
  - Hydrophidae, 1916
  - Hypodulsiion, urolithiasis, 569
  - Hydrostatic pressure increase, edema, 72, 664
  - Hydrotaea irritans* (head flies), 720, 723, 1606
  - Hydrothorax, 73, 519, 524
  - 25-hydroxycholecalciferol, 1643
  - Hydroxyethyl starch solution, 96–97, 444
  - 1,α hydroxyvitamin D<sub>3</sub>, 1643
  - Hydroxyzine hydrochloride, 2057
  - Hydroxyzine pamoate, 2057
  - Hyena disease of cattle, 2023

Hygiene
 
  - ascarid infections, 1557
  - Brucella melitensis* control, 993
  - colibacillosis, newborn risk factors, 854
  - contagious bovine pleuropneumonia control, 1136
  - environmental examination, 8
  - equine herpesvirus 4 control, 1311
  - equine influenza control, 1328
  - John's disease control, 1034–1035
  - mastitis control, 743
  - ringworm control, 1478
  - vesicular stomatitis, 1236
  - watery mouth of lambs, 1986

Hygromycin B, 2065

HYMAST diagnostic kit, 721

*Hymenoxys* poisoning, 1892

Hyoscine, 2057
 
  - poisoning, 1894

Hyoscine butylbromide, 225

Hyoscyamine poisoning, 1894

Hyostrongylosis, 1555

*Hyostrongylus rubidus*, 1555

Hyperadrenocorticism, 1687

Hyperalgesia, peripheral, 103

Hyperammonemia, 385, 593, 1989

Hyperbilirubinemia, 389
 
  - photosensitization and, 1976
  - postvaccinal hepatitis, 1988

Hypercalcemia, vitamin D toxicity and, 1766

Hypercoagulability, 450

Hypercoagulable states, 447–450
 
  - clinical findings, 448
  - clinical pathology, 448–449
  - diagnosis, 449
  - epidemiology, 447
  - etiology, 447
  - necropsy findings, 449
  - pathophysiology, 447–448
  - prognosis, 447
  - treatment, 449

Hyperelastosis cutis (dermatosparaxis), 669, 1976

Hyperemia
 
  - bluetongue, 1303
  - bovine herpesvirus-1 infection, 1353

Hyperesthesia, 582
 
  - bovine spongiform encephalopathy, 1450
  - congenital myoclonus (hereditary neuraxial edema), 1956
  - enzootic bovine leukosis, 1216
  - polyneuritis equi, 2021
  - spinal cord compression, 616

Hyperexcitability, 584
 
  - anaplasmosis, 1457
  - plant-induced, 1897
  - scrapie, 1444

Hyperfibrinogenemia, 441

sepsis in foals, 165

strangles, 771

Hypergammaglobulinemia, lymphosarcoma, 463

Hyperglobulinemia, 441

Hyperglycemia
 
  - endotoxemia, 56
  - enterotoxemia, 842
  - equine pars intermedia dysfunction, 1687

Hyperhidrosis, inherited, 1977

Hypericin poisoning, 1886

*Hypericum perforatum* (St John's wort) poisoning, 1886

*Hypericum triquetrifolium* poisoning, 1886

Hyperimmune bovine colostrum, 1515

Hyperimmune serum
 
  - enterotoxemia, *Clostridium perfringens* type D associated, 843
  - hog cholera, 1164
  - peste des petits ruminants, 1243
  - sweating sickness, 1990

Hyperkalemia, 80
 
  - enteric colibacillosis, 857, 863
  - equine hyperkalemic periodic paralysis, 1966
  - exertional rhabdomyolysis, 1685
  - uroperitoneum in foals, 565

Hyperkalemic periodic paralysis, 80, 122, 627, 629

Hyperkeratosis, 654, 1996

Hyperketonemia, pregnancy toxemia, 1668

Hypermetria, 580, 589

Hypernatremia, enteric colibacillosis, 857–858, 863–864

Hyperorexia, 112

Hyperparathyroidism, 633, 1860–1861

Hyperpnea, 474

Hyperproteinemia, 441, 771

Hypersensitivity
 
  - endotoxemia, 57
  - equine encephalomyelitis, 1370
  - interstitial pneumonia, 1998
  - itchmites, 1607
  - onchocercosis, 1573
  - pneumonitis, *Micropolyspora faeni* exposure, 1999
  - sarcoptic mange, 1608–1609

Hypersensitivity reaction, 69, 71–72
 
  - see also Anaphylaxis

Hypertension, 402, 410, 2031

Hyperthermia, 40, 47–49
 
  - Claviceps purpurea*, 1899
  - clinical findings, 47–48
  - clinical pathology, 48
  - congenital defects of the newborn, 134
  - control, 48
  - definition, 14
  - epidemic (fescue summer toxicosis), 1899, 1901–1902
  - ergotism, 1903
  - etiology, 47
  - horses, 47, 48
  - necropsy findings, 48
  - ovine humpyback, 2015
  - pathogenesis, 47
  - treatment, 48

Hyperthyroidism, 1688–1690

Hypertonic crystalloid solutions, 93, 94–95

Hypertonic dehydration, 77, 78, 90

Hypertonic saline, 98
 
  - colibacillosis, 864
  - coliform mastitis, 717
  - diarrhea, 863
  - hemorrhagic shock, 67
  - hyperkalemia, 80
  - hypovolemic shock, 67
  - maldistributive shock, 67
  - properties, 95
  - water intoxication, 76

Hypertonic saline-dextran solution, 96

Hypertonic sodium bicarbonate, 80

Hypertriglyceridemia, equine hyperlipidemia, 1678

Hypertrophic pulmonary osteoarthropathy, 635

Hyperventilation stimulation in rebreathing examination, 476

Hypervitaminosis A, 1776

Hypervitaminosis D, 1766

Hypervolemia, red cell, 460

*Hyphomyces destruens*, 1480

Hypoadrenal corticalism, premature foals, 139



- Hypoalbuminemia, 440  
 edema, 73  
 fasciolosis, 1577  
 granulomatous enteritis, horses, 1992  
 strangles, 771  
 trichostrongylid infection, 1544
- Hypobiosis  
*Dictyocaulus viviparus*, 1565  
*Haemonchus contortus*, 1549  
*Oestrus ovis*, 1587  
 trichostrongylid worms, 1542, 1543
- Hypobiotinosis, 1780–1782
- Hypocalcemia, 80–81  
 bovine ephemeral fever, 1179  
 diarrhea, acute, 271  
 downer cow syndrome, 1645  
 early, 299  
 energy imbalance, 1618  
 experimental, 1631, 1646  
 hypomagnesemia and, 82  
 hypomagnesemic tetany, 1653–1654, 1655  
 lactation tetany, mares, 1651–1652  
 left-side displacement of abomasum risk, 356–357  
 milk fever, 1630–1631  
 non-parturient, 1635  
 prevention strategies, 1641–1642  
 prolonged, experimental, 1646  
 recumbency in horses, 122  
 subclinical, milk fever, 1627–1628  
 volcanic ash fallout, 1791
- Hypocalcemia syndrome, oxalate poisoning, 1859
- Hypocalcemic paresis, 1636
- Hypocalciosis see Calcium, deficiency
- Hypochloremia, 77, 78  
 diarrhea, acute, 271  
 exertional rhabdomyolysis, 1685, 1967
- Hypochoeris radicata* (flatweed, catsear)  
 ingestion, 2019
- Hypocholinsis, 1782
- Hypochromic anemia, 1365
- Hypocuprosis see Copper, deficiency
- Hypocyanocobalaminosis, 1703, 1782–1783
- Hypoderma acteon*, 1588  
*Hypoderma bovis*, 1588  
*Hypoderma diana*, 1588  
*Hypoderma* infestations, 1587–1589  
 clinical findings, 1588–1589  
 clinical pathology, 1589  
 control, 1589  
 differential diagnosis, 1589  
 economic importance, 1588  
 epidemiology, 1588  
 eradication programs, 1589  
 etiology, 1588  
 horses, 1588  
 incomplete removal reaction, 1589  
 life cycle, 1588  
 manual removal, 1589  
 necropsy findings, 1589  
 pathogenesis, 1588  
 treatment, 1589  
 vaccination, 1589
- Hypoderma lineatum*, 1588  
*Hypoderma sinense*, 1588  
*Hypoderma tarandi*, 1588  
 Hypodermic needle reuse, bovine virus diarrhea virus transmission, 1251
- Hypoesthesia, 582
- Hypoferrremia, 56, 452
- Hypofibrinogenemia, 440
- Hypofolicosis, 452, 1782
- Hypogammaglobulinemia, 440  
 combined immunodeficiency, Arabian foals, 1979
- Hypoglossal nerve (cranial nerve XII)  
 assessment, 587  
 polyneuritis equi, 2021
- Hypoglycemia  
 endotoxemia and, 56  
 energy imbalance, 1618  
 foals, 2013  
 hepatic encephalopathy, 385  
 neonatal, 1680–1682  
 newborns, 163–164  
 postvaccinal hepatitis, 1988–1989  
 pregnancy toxemia, sheep, 1668, 1669, 1670  
 recumbency in horses, 122  
 transmissible gastroenteritis, pigs, 1281
- Hypoglycemic coma, prolonged gestation with fetal gigantism, 1978
- Hypokalemia, 77–80, 1734  
 acute, cattle, 1614, 1634, 1650–1651  
 downer cow syndrome, 1645  
 etiology, 77–78, 79  
 horses, 79  
 metabolic diseases, 1634  
 recurrent exertional rhabdomyolysis, 1967  
 treatment, 79–80
- Hypomagnesemia, 82  
 chronic, 1656  
 clinical findings, 1633  
 clinical pathology, 1633  
 downer cow syndrome, 1645  
 energy imbalance, 1618  
 epidemiology, 1633  
 metabolic diseases, 1634  
 milk fever, 1631, 1632, 1642  
 parturient paresis and, 1656  
 post-volcanic eruptions, 1792  
 sheep, 1655  
 treatment, 1633  
 winter, 1653, 1654
- Hypomagnesemic tetany, 1614, 1652–1661  
 brain dysfunction, 1806, 1807  
 calves, 1659–1661  
 clinical findings, 1660  
 clinical pathology, 1660  
 control, 1660–1661  
 differential diagnosis, 1660  
 epidemiology, 1659–1660  
 etiology, 1659  
 experimental reproduction, 1660  
 magnesium deficiency, 1730  
 necropsy findings, 1660  
 pathogenesis, 1660  
 risk factors, 1659  
 treatment, 1660  
 case-fatality rate, 1654  
 clinical findings, 1656  
 clinical pathology, 1656–1657  
 control, 1657–1659  
 diagnosis, herd, 1656–1657  
 differential diagnosis, 1657  
 epidemiology, 1654–1655  
 etiology, 1652–1654  
 morbidity, 1654  
 mortality, 1654  
 necropsy findings, 1657  
 occurrence, 1654  
 pathogenesis, 1655–1656  
 risk factors, 1654–1655  
 treatment, 1657
- Hypometria, 580, 589
- Hypomyelination, 1416, 1957
- Hypomyelination congenita see Border disease
- Hyponatremia, 77, 77  
 diarrhea, acute, 271  
 exertional rhabdomyolysis, 1685, 1967  
 recumbency in horses, 122  
 uroperitoneum in foals, 565
- Hyponiacinosi, 1780
- Hypopantothenosis, 619, 1780
- Hypophosphatemia, 81–82  
 downer cow syndrome, 1645  
 metabolic diseases, 1634  
 milk fever, 1631, 1632
- Hypophosphatosis see Phosphorus, deficiency
- Hypophosphorosis, S-methyl-L-cysteine-sulfoxide poisoning, 1881
- Hypophysis see Pituitary gland
- Hypoproteinemia, 439–441  
 absolute, 439  
 clinical pathology, 440  
 clinical signs, 440  
 etiology, 439–440  
 exercise intolerance, 119  
 hemochosis, ruminants, 1550  
 necropsy findings, 440  
 oesophagostomosis, 1554  
 pathophysiology, 440  
 proliferative enteropathy, horses, 1093  
 relative, 439  
 treatment, 440–441
- Hypoproteinemic edema, 664
- Hypopyridoxinosis, 452, 1780
- Hyporiboflavinosis, 1779–1780
- Hypospadias, 573
- Hypothalamus, pyrogen effects, 49–50
- Hypothermia, 40–46  
 clinical findings, 45  
 control, 46  
 definition, 14  
 epidemiology, 40–44  
 etiology, 40  
 neonatal, 40–41, 43–44, 45–46, 141–143  
 pathogenesis, 44–45  
 recumbency in horses, 122  
 treatment, 45–46  
 watery mouth of lambs, 1987
- Hypothermia/exposure/hypoglycemia/starvation complex, 128
- Hypotheticoductive reasoning, diagnosis, 22
- Hypothiaminosis, 1779
- Hypothyroidism, 1688–1690  
 clinical findings, 1688–1689  
 clinical pathology, 1689–1690  
 congenital, 1688, 1689, 1690  
 control, 1690  
 diagnosis, 1690  
 epidemiology, 1688  
 etiology, 1688  
 iodine deficiency, 1723  
 necropsy findings, 1690  
 stillbirth/perinatal weak calf syndrome, 1984  
 treatment, 1690
- Hypotonic crystalloid solutions, 93–94
- Hypotonic dehydration, 77, 78, 90
- Hypotrichosis, 661–662  
 inherited congenital, 1974
- Hypoventilation, hypoxic hypoxia, 472
- Hypovitaminosis A see Vitamin A, deficiency
- Hypovitaminosis D see Vitamin D, deficiency
- Hypovolemia  
 crystalloid solutions, 92  
 diarrhea in foals, 276  
 equine colic, 219
- Hypovolemic shock, 63–69, 399  
 clinical findings, 65  
 clinical pathology, 65–66  
 differential diagnosis, 66  
 etiology, 63–64  
 necropsy findings, 66  
 pathogenesis, 64  
 treatment, 66–68
- Hypoxemia  
 heaves, 1930  
 respiratory gas transport failure, 493  
 treatment, 493–494
- Hypoxia, 472–473  
 anemic, 472  
 cerebral, 596–597  
 circulatory, 472  
 encephalomalacia, 603  
 equine neonatal encephalopathy, 2012  
 histotoxic, 472–473  
 hypoxic (hypoxemic), 472  
 newborns, 163  
 pulmonary hypertension and, 500
- Hypoxic (hypoxemic) hypoxia, 472
- Hypozincemia, endotoxemia and, 56
- Hysteria, 584, 1807
- I**
- Iatrogenic death, 124
- Ibaraki disease, 1305
- Ibaraki virus in pregnancy, 1305
- Iberian Peninsular, bovine spongiform encephalopathy, 1447
- Iceland  
 ovine progressive pneumonia, 1363  
 ovine pulmonary adenocarcinoma, 1367, 1368  
 scrapie control, 1445  
 visna, 1413
- Icelandic horses, osteoarthritis, 638
- Icteric index, 389
- Icteroanemia, 1155
- Ictero-genin poisoning, 1893–1894
- Ictus, 579  
 see also Convulsions
- Identification and Recording system, hog cholera, 1158
- L-iditol dehydrogenase (ID; sorbitol dehydrogenase), 389, 390, 1988
- IFN  $\gamma$ , 1188
- Iforrestine poisoning, 1887
- IgA  
 bovine respiratory syncytial virus pneumonia, 1345

- IgA (Cont'd)  
secretory, transmissible gastroenteritis in pig, 1280  
swine influenza, 1333  
transmissible gastroenteritis in pig, 1279  
winter dysentery, cattle, 1298
- IgE, bovine respiratory syncytial virus pneumonia, 1345
- IgG  
bovine herpesvirus-1 infection, 1354  
cerebrospinal fluid index, 593  
combined immunodeficiency, Arabian foals, 1979  
critical plasma concentration, foals, 167  
equine neorickettsiosis, 1467  
transmissible gastroenteritis, 1279–1280
- IgG(T), Fell pony syndrome, 1943
- IgG<sub>2</sub>, enzootic pneumonia of calves, 1337
- IgGa, Fell pony syndrome, 1943
- IgGb, Fell pony syndrome, 1943
- IgM  
antibody response, equine neorickettsiosis, 1467  
bovine herpesvirus-1 infection, 1354  
bovine respiratory syncytial virus pneumonia, 1345  
combined immunodeficiency, Arabian foals, 1979  
deficiency, horse, 1943  
Fell pony syndrome, 1943  
indirect fluorescent antibody (IFA) test, porcine reproductive and respiratory syndrome, 1200  
Ross River virus, 1384  
winter dysentery, cattle, 1298
- Ileal biopsy, *Mycobacterium avium* subspecies *paratuberculosis*, 1027–1028, 1029
- Ileal impaction, 242, 377, 378
- Ileitis, 1087–1093  
case fatality rate, 1088  
clinical findings, 1089–1090  
clinical pathology, 1090  
control, 1091–1092  
diagnosis, 1090–1091  
differential diagnosis, 1091  
economic importance, 1088  
epidemiology, 1088–1089  
eradication, 1091  
etiology, 1087–1088  
*Lawsonia intracellularis*, 1087–1093  
morbidity, 1088  
necropsy findings, 1090–1091  
outbreaks, 1088  
pathogenesis, 1089  
proliferative, 279  
regional, enteritis, 264  
risk factors, 1088–1089  
transmission, 1089  
treatment, 1091–1092  
vaccination, 1092
- Ileocecal intussusception, 242, 243
- Ileocecal valve impaction, 226, 243
- Ileoceclic intussusception, 377
- Ileus, 193–194  
adynamic/mechanical, 193–194  
dynamic/paralytic, 193–194, 265, 283, 300  
equine colic, 219  
etiology, 194  
pathogenesis, 194  
postoperative, 56, 194  
treatment, 194
- Iliac artery thrombosis, myopathy, 629
- Ill-thrift, 115–116  
see also Weight, loss of
- Imaging  
abdomen examination, 308–309  
alimentary tract examination, 196–197  
brain abscess, 607  
equine colic, 231  
liver, 387–388  
nervous system examination, 593–594  
newborns, 164  
peritonitis, 285  
pleuritis (pleurisy), 523–524  
pneumonia, 512  
uroperitoneum (uroabdomen) in foals, 564  
see also specific methods
- Imbecility, 584, 620
- Imidazothiazoles, 1545
- Imidocarb, 1458, 1493–1494
- Imidocarb dipropionate, 1493
- Imidocarb dipropionate, 2057
- Imipenemcilastatin sodium, 2057
- Imipramine, 2057
- Immune deficiency, 466–467
- Immune-mediated anemia, 451
- Immune-mediated (idiopathic) thrombocytopenia, 446
- Immune response  
acquired, bovine virus diarrhea virus, 1252  
Johne's disease, 1024–1025  
neonatal infection, 147  
selenium and, 1736  
selenium deficiency and, 1742  
vitamin E deficiency, 1742
- Immune system  
copper deficiency effects, 1712–1713  
diseases of, 439–469  
see also specific diseases/disorders  
*Staphylococcus aureus* mastitis, 698  
tick-borne fever, 1460–1461  
vitamin A deficiency effects, 1774
- Immunity  
neonatal infection, 147  
tests, Johne's disease, 1029
- Immunoassay (commercial), colibacillosis, 861
- Immunoblotting assay, African swine fever, 1171
- ImmunoCardSTAT Rotavirus (ICS-RV) test, 1293
- Immunochromatography, neonatal viral diarrhea, 1293
- Immunocompromise, cryptosporidiosis, 1513
- Immunodeficiency, 1941, 1943  
see also specific types
- Immunodiffusion and electron microscopy, neonatal viral diarrhea, 1292
- Immunofluorescence  
alpha herpesvirus differentiation, 1354  
neonatal viral diarrhea, 1292  
Q fever, 1469  
ringworm, 1477
- Immunofluorescent antibody (IFA) test  
bovine babesiosis, 1490  
bovine respiratory syncytial virus pneumonia, 1347
- Immunoglobulins  
deficiency, 467  
Fell pony syndrome, 1943  
parenteral, passive immunity transfer failure correction, 154  
septicemia, 52  
serum concentration  
colibacillosis, 861  
lymphosarcoma, 463  
newborns, 164  
synthesis deficiency, inherited, 1941  
therapy, colibacillosis, 869  
see also specific types
- Immunohistochemistry  
bluetongue, 1303  
bovine virus diarrhea virus, 1261  
equine phycomycosis, 1481  
*Mycoplasma bovis*, 1129  
scrapie, 1444  
toxoplasmosis, 1521
- Immunoperoxidase monolayer assay (IMPA)  
bovine virus diarrhea virus, 1260–1261  
equine arteritis virus, 1321  
porcine reproductive and respiratory syndrome, 1200
- Immunoperoxidase test, 1390, 1399
- Immunostimulating complexes (ISCOMs), 1348
- Immunosuppression, 466  
bovine virus diarrhea virus, 1251–1252, 1255–1256  
equine herpesvirus 1, 1313  
neosporosis, 1510  
porcine reproductive and respiratory syndrome, 1198  
rinderpest, 1238  
transition period, dairy cows, 1616–1617
- Immunotherapy  
bovine ocular squamous-cell carcinoma, 2040  
East Coast fever, 1529–1530  
sarcoïd, 1424  
shock, 68
- Impaction, large intestine  
horses, 226, 228, 252–253  
pigs, 259–260
- Impedance, current flow, 1791
- Impetigo, 655  
differential diagnosis, 655  
*Staphylococcus*, 783  
treatment, 655  
udder, 751, 1381
- Impulse oscillometry, 489–490
- Inactivated vaccines  
African horse sickness, 1183  
bovine herpesvirus-1 infection, 1357  
bovine respiratory syncytial virus pneumonia, 1348  
bovine virus diarrhea virus, 1252, 1270  
equine herpesvirus 1, 1316  
equine herpesvirus 4, 1311  
equine influenza, 1326, 1327  
hog cholera, 1166  
pseudorabies, 1402  
rabies, 1392  
West Nile encephalitis, 1380
- Inanition see Malnutrition
- Inappetence, 112  
peritonitis, 284  
postparturient hemoglobinuria, cattle, 1683
- In-breeding, 1938
- Inclusion bodies (morulae)  
caprine herpesvirus-1 infection, 1330  
equine granulocytic anaplasmosis, 1465  
equine herpesvirus 1, 1315  
lumpy skin disease, 1426  
porcine herpesvirus 2 infection, 1336  
pseudorabies, 1399  
tick-borne fever, 1461
- Inclusion body rhinitis, 1335–1336
- Incontinence, bladder paralysis, 562
- Incoordination  
dimethyltryptamine poisoning, 1869–1870  
equine encephalomyelitis, 1370  
louping-ill, 1409  
plant-induced, 1895–1896, 1896–1897, 1897  
toxic/metabolic encephalomyelopathies, 612
- India, brucellosis status, 964
- Indigestion see Simple indigestion
- Indigestion of late pregnancy, cattle, 346, 349
- Indigofera linnaei* (Birdsville indigo) poisoning, 1872, 1884
- Indigofera spicata* (creeping indigo) poisoning, 1884
- Indirect enzyme-linked immunosorbent assay (I-ELISA)  
African horse sickness, 1182  
porcine reproductive and respiratory syndrome, 1200
- Indirect fluorescent antibody (IFA) test  
African swine fever, 1171  
anaplasmosis, 1457  
bovine immunodeficiency-like virus, 1222  
equine neorickettsiosis, 1467  
equine protozoal myeloencephalitis, 1524  
nagana, 1535  
neosporosis, 1511  
porcine reproductive and respiratory syndrome, 1200  
toxoplasmosis, 1521  
Venezuelan equine encephalomyelitis, 1374
- Indirect hemagglutination test (IHA), sarcocystosis, 1508
- Indirect immunoperoxidase staining technique, bovine virus diarrhea virus, 1261
- Indole alkaloid poisoning, 1868–1870
- Indolizidine alkaloid poisoning, 1870–1872
- Indonesia, Jembrana disease, 1244
- Indospicine poisoning, 1884
- Indurative mastitis (hard bag/udder), 1364, 1412
- Industrial fumes  
fluorine poisoning, 1815, 1816, 1819  
molybdenum poisoning, 1820
- Infantophagia, 113
- Infarctive purpura hemorrhagica, 1926
- Infection(s)  
clinical examination, 173–174  
congenital defects in newborns, 133  
gangrene from, 666  
gastritis etiology, 258  
laminitis, horses, 2032  
localized, 110–112  
lowered resistance, 466–467  
nervous system, elimination/control, 595, 595  
newborns, 160  
sampling for diagnosis, 174–175  
stress-related susceptibility, 109  
sudden death from, 125  
thrombocytopenia, 445–446  
viral see Viral diseases/infection
- Infection and treatment method, vaccination, 1529–1530, 1531
- Infectious bovine rhinotracheitis (IBR) see Bovine herpesvirus-1 (BHV-1) infection

- Infectious bovine rhinotracheitis virus (IBRV), 926  
vaccines, 932, 934, 945
- Infectious bulbar necrosis, 1075, 1077–1078
- Infectious disease control (IDC) program, salmonellosis, 916–917
- Infectious diseases, 765–768  
control, 767–768  
diagnosis, 767–768  
reportable see Reportable diseases  
resistance, 1741–1743  
risk of spread advice, 767  
see also *specific diseases/disorders*
- Infectious equine anemia, 387
- Infectious hepatitis, 392, 394
- Infectious keratitis of cattle, 994–997  
clinical findings, 995  
clinical pathology, 995  
control, 996  
differential diagnosis, 996  
economic importance, 995  
epidemiology, 994–995  
etiology, 994  
experimental reproduction, 995  
immune mechanisms, 995  
infection source, 995  
outbreaks, 994  
pathogenesis, 995  
risk factors, 995  
transmission, 995  
treatment, 996  
vaccination, 996
- Infectious necrotic hepatitis see Black disease
- Infectious pharyngitis, 209
- Infectious polyarthritis, 1003–1006  
clinical findings, 1004  
clinical pathology, 1004  
control, 1006  
diagnosis, 1005  
differential diagnosis, 1005  
epidemiology, 1003–1004  
etiology, 1003  
*Haemophilus parasuis*, 1003–1006  
necropsy findings, 1004–1005  
outbreaks, 1003, 1004  
pathogenesis, 1004  
transmission, 1003  
treatment, 1005–1006  
vaccination, 1006
- Infectious pustular balanoposthitis (IPB), 1349, 1354
- Infectious pustular vulvovaginitis (IPV), 1349, 1350, 1354
- Infectious stomatitis, 205–206
- Infertility  
ketosis and, 1664  
leptospirosis, 1102  
manganese deficiency, 1733  
*Neotyphodium (Acremonium) coenophialum* poisoning, 1902  
phytoestrogen poisoning, 1874  
tuberculosis, 1009  
zearalenone poisoning, 1911–1912  
zinc deficiency, 1731–1732
- Inflammation  
blowfly strike, 1591  
bovine ephemeral fever, 1178  
central nervous system, 600  
laminitis, horses, 2031  
peripheral nervous system disease, 618  
post-weaning multisystemic wasting syndrome, 1190
- Inflammatory bowel disease, chronic, 1992–1993, 1997–1998
- Inflammatory edema, subcutaneous, 664
- Inflammatory lesions, 24
- Inflammatory response  
bovine mastitis, 689  
coagulation, 448  
heaves, 1929–1930
- Influenza A viruses, 1331
- Inguinal abscess, 110
- Inguinal hernia, 242, 243
- Inguinal lymph nodes, post-weaning multisystemic wasting syndrome, 1189
- Inguinal ring palpation, 19
- Inhalation pneumonia see Aspiration pneumonia
- Inherited deficiency of lymphocyte maturation, 1941
- Inherited diseases/defects, 1937–1980  
alimentary tract, 1944  
circulatory system, 1944–1948  
control, 1938–1939  
diagnosis, 1938  
eye, 1977  
musculoskeletal system, 1957–1961  
nervous system, 1949–1957  
skin, 1973–1977  
urinary tract, 1948–1949  
whole body, 1940–1944
- Inherited dyserythropoiesis and dyskeratosis (bovine congenital anemia, dyskeratosis and progressive alopecia), 1948
- Inherited erythrocytic protoporphyria, 1946–1947
- Inherited myopathy, 627
- Inherited progressive muscular dystrophy, 1965
- Initial bodies, chlamydial diseases, 1434
- Injection site lesions, 631, 821
- Innate immunity  
bovine virus diarrhea virus, 1252  
deficiencies of, 466
- Inner ear infection see Otitis, interna
- Inoculation see Vaccination
- Inocybe*, muscarine poisoning, 1906
- Inorganic chemicals, diseases associated with, 1797–1830  
see also *specific chemicals*
- Inorganic fluorides poisoning, 1816
- Inotropic agents, endotoxemia, 59
- Insect bait, arsenic poisoning, 1808
- Insecticide(s)  
African horse sickness transmission prevention, 1182  
application methods, 1833  
arsenic poisoning, 1808  
bluetongue, 1304  
East Coast fever, 1529  
Eastern equine encephalomyelitis, 1371  
formulations used, 1833  
*Hypoderma* infestations, 1589  
maximum concentrations, 1833  
mosquito control, 1605  
poisoning, 1832–1837  
stable flies, 1603  
toxic disease, 1833  
tsetse fly control, 1536
- Insect repellent  
African horse sickness, 1182  
bluetongue, 1304  
Eastern equine encephalomyelitis, 1369, 1371  
equine infectious anemia, 1177  
face flies, 1606  
mosquito control, 1605  
Venezuelan equine encephalomyelitis, 1377
- In-situ hybridization (ISH)  
bluetongue, 1303  
foot-and-mouth disease, 1226  
porcine reproductive and respiratory syndrome, 1200
- Inspiration prolongation, 11
- Insulin  
dosage/interval, 2057  
equine hyperlipidemia, 1679  
fatty liver, cattle, 1676  
ketosis and, 1661–1662  
ketosis treatment, 1666  
pregnancy toxemia, sheep, 1670  
resistance  
equine hyperlipidemia, 1678  
left-side displacement of abomasum and, 358
- Insulin-dependent diabetes mellitus, spontaneous, 1258
- Insulin-like growth factor deficiency, 1960
- Insurance, 1790, 1793
- Intensive animal production, arthropathy and, 638
- Intention tremor, 584
- Interdigital dermatitis, 623, 625, 1065  
see also Foot rot
- Interdigital fibroma, 1065
- Interdigital phlegmon see Bovine interdigital necrobacillosis
- Interferon, respiratory disease, 495
- Interferon alpha-2a, human recombinant, 2057
- Interferon- $\gamma$  assay (IFN- $\gamma$ )  
John's disease, 1024–1025, 1029  
tuberculosis, 1011–1012
- Interleukin(s), endotoxemia, 54, 55–56
- Interleukin-10 (IL-10)  
bovine babesiosis, 1485–1486  
porcine circovirus 2, 1188
- porcine reproductive and respiratory syndrome, 1198
- Interleukin-12 (IL-12)  
bovine babesiosis, 1485–1486  
porcine reproductive and respiratory syndrome, 1198
- Intermittent-flow peritoneal dialysis, 554
- Internal abdominal abscess, 290
- International trade restrictions, bluetongue, 1302, 1304
- Interstitial cells of Cajal, 1991
- Interstitial cerebral edema, 597
- Interstitial fibrosis, 2001
- Interstitial inflammation, exercise-induced pulmonary hemorrhage, 506
- Interstitial nephritis, 558, 1100–1101
- Interstitial pneumonia, 513  
acute, 925  
caprine arthritis encephalitis, 1412  
cattle, 512, 1998, 1998–2004  
bovine respiratory syncytial virus pneumonia, 1346, 2000  
clinical findings, 2002  
clinical pathology, 2002  
control, 2003–2004  
differential diagnosis, 2003  
epidemiology, 2000–2001  
etiology, 1999–2000  
necropsy findings, 2002  
pathogenesis, 2001–2002  
treatment, 2002–2003  
chronic, 925  
clinical findings, 803, 2002  
clinical pathology, 803  
epidemic acute, 924  
epidemiology, 803  
equine hendra virus infection, 1329  
equine influenza, 1325  
foals, chronic, 2005–2006  
glucosinolate poisoning, 1868  
horses, 2004–2005  
lungworm infestation, 1999  
necropsy findings, 803  
ovine progressive pneumonia, 1364, 1365  
porcine reproductive and respiratory syndrome, 1201  
sheep, 2001  
swine influenza, 1333, 1334  
treatment, 803  
viral, 512
- Intervertebral disc degeneration/protrusion, 615
- Intestinal absorption, 262
- Intestinal accidents, 377
- Intestinal amphotomosis, 1580–1581
- Intestinal biopsy, 203, 273
- Intestinal fibrinous casts, 307
- Intestinal hairball, 309
- 'Intestinal hurry,' 263
- Intestinal hypermotility, 277
- Intestinal hypersensitivity, 892
- Intestinal infection, *Rhodococcus equi*, 802  
*Intestinalis lambia*, 849, 1515–1516
- Intestinal lactase testing, 1282
- Intestinal lubricants, equine colic, 227, 228
- Intestinal lymphosarcoma, 463
- Intestinal motility, enteritis, 264–265
- Intestinal mucosal injury, 264, 858
- Intestinal neoplasia, 282
- Intestinal obstruction  
cattle, 376–380  
clinical findings, 379  
clinical pathology, 379–380  
differential diagnosis, 380  
epidemiology, 377–378  
etiology, 377–378  
functional, 378–379  
intestinal accidents, 377  
luminal blockages, 377–378  
necropsy findings, 380  
pathogenesis, 378–379  
treatment, 380  
see also *specific types*  
clinical findings, 259  
etiology, 259  
fluid and electrolyte therapy, 92  
functional, peritonitis, 283  
horses, 200, 241–245  
pigs, 259  
sheep, 382  
see also Ileus; Large intestine, obstruction;  
Small intestine, obstruction
- Intestinal parasites, 768

- Intestinal protectants, colibacillosis, 869  
 Intestinal reflux, 259  
 Intestinal sounds, 16  
   enteritis, 265  
   equine colic, 220, 223  
 Intestinal stasis, enterotoxemia, 842  
 Intestinal strangulation, 377  
 Intestinal tympany, 260  
   abdominal distension, 195  
   horses, 257  
   pigs, 260  
 Intestinal ulcers, 279, 1941  
 Intestinal wall infarction, 194  
 Intestinal wall ischemia, 219  
 Intestine(s)  
   atresia, congenital, 280–281  
   bacterial flora, diarrhea effects, 865–866  
   diseases of  
     nonruminants, 215–280  
     ruminants, 375–382  
     vitamin A deficiency, secondary, 1773  
   see also *specific diseases/disorders*  
   distension, 302  
   endotoxin effects, 54  
   lesions, coccidiosis, 1504  
   tuberculosis, 1009  
 Intimim, 882  
 Intoxications  
   encephalomalacia, 603  
   horse, 1376  
   see also *Poisoning*  
 Intra-abdominal drain, peritonitis, 287  
 Intra-abdominal mass, equine colic, 221  
 Intra-abdominal neoplasia, 201  
 Intracranial abscess, *Arcanobacterium pyogenes*, 787  
 Intracranial convulsions, 579  
 Intracranial hemorrhage, parturition trauma, 139  
 Intracranial lesion, cerebral hypoxia secondary to, 597  
 Intracranial pressure  
   examination, 594  
   increase, 597–599  
     cerebral edema, 598  
     decompression, 595  
     hydrocephalus, 599  
 Intradermal testing, heaves, 1931  
 Intraluminal hemorrhage, acute, 265  
 Intramammary infection  
   bovine mastitis risk factor, 678–679  
   *Mycobacterium bovis* transmission, 1008  
 Intramuscular antimicrobials, 178–179  
 Intramuscular injection reactions, horses, 178  
 Intrapartum death, 139–140  
 Intrapartum hypoxemia, 140  
 Intraperitoneal antimicrobials, 179  
 Intrathoracic abscess, equine pleuropneumonia, 527  
 Intratracheal antimicrobials, 180  
 Intrauterine growth retardation  
   border disease, 1416  
   etiology, 137  
   maternal undernutrition, 143  
 Intrauterine infection, *Mycobacterium bovis* transmission, 1008  
 Intrauterine medication, postpartum septic metritis, 62  
 Intravenous antimicrobials, 178  
 Intravenous catheterization, calves, 864  
 Intussusception, 377  
*Inula conyza* (ploughman's spikenard)  
   poisoning, 1888  
 Inulin clearance, 550  
 Involuntary movements, 578–579, 585  
 Involuntary spastic contraction, 612  
 Involuntary spastic paresis, 579  
 Iodides  
   actinobacillosis (wooden tongue), 1047  
   fungal mastitis, 727  
   sporotrichosis, 1480  
   yeast mastitis, 727  
 Iodide sodium, 2057  
 Iodinated caesin, 1690  
 Iodine  
   deficiency, 1722–1725  
     clinical findings, 1724  
     clinical pathology, 1724–1725  
     congenital defects in newborns, 133  
     control, 1725  
     diagnosis, 1725  
     differential diagnosis, 1725  
   epidemiology, 1722–1723  
   etiology, 1722  
   maternal, stillbirth/perinatal weak calf syndrome, 1984  
   metabolic defect, associated, 1699  
   necropsy findings, 1725  
   outbreaks, 1722–1723  
   pathogenesis, 1723–1724  
   pathophysiology, 1699  
   risk factors, 1723  
   treatment, 1725  
     dietary sources, 1725  
     recommended intake, 1725  
 Iodine-131, 1786, 1787  
 Iodine poisoning, 1829  
 Iodine premilking teat disinfectant, 731–732  
 Iodism, 1481  
 Iodochlorhydroxyquin, 273, 2057  
 Iodophor, 733, 1429–1430  
 Ionizing radiation, 1786  
 Ionophore(s)  
   bloat, 335–336  
   carbohydrate engorgement prevention, 323, 325  
   coccidiosis, 1506  
   ketosis prevention, 1667  
   poisoning, 1843–1845  
   recumbency in horses, 122  
 Ipomeanol  
   interstitial pneumonia, 1999  
   poisoning, 1892, 1906  
 Ipratropium, 2057  
 Ireland  
   chronic enzootic pneumonia of sheep, 1362  
   louping-ill, 1408  
 Iridemia, 1977  
 Iris, complete absence (aniridia), 1977  
 Iritis, *Listeria monocytogenes* infection, 809  
 Iron  
   deficiency, 1725–1729  
     anemia, 1726  
     anemia, nonregenerative, 452  
     clinical findings, 1727  
     clinical pathology, 1727  
     control, 1728  
     diagnosis, 1727  
     differential diagnosis, 1727  
     epidemiology, 1726–1727  
     etiology, 1726  
     hemochromatosis, ruminants, 1550  
     horses, 1726–1727  
     necropsy findings, 1727  
     pathogenesis, 1727  
     polioencephalomalacia, 2008  
     treatment, 1727–1728  
   dietary, 1728  
     copper deficiency risk factors, 1710  
   intramuscular injection, 1728  
   metabolism, anemia, 457  
   poisoning, organic compounds, 1828–1829  
   supplementation, 1726–1727, 1728  
 Iron cacodylate, 2057  
 Iron dextran  
   anemia prevention, 1726  
   dosage/interval, 2057, 2065  
   intramuscular injection, 1728  
 Iron pyrophosphate supplementation, 1728  
 Irradiation, carcass decontamination, 887  
 Irritant diterpenoids, 1886  
 Irritant gases inhalation, interstitial pneumonia, 1998, 1999  
 Irritant oils, 1888  
 Irritation phenomena, 577  
 Irritation state, 577  
 Ischemia  
   myasthenia etiology, 626  
   myopathy and, 627, 628, 629  
   spinal cord traumatic injury, 613  
 Ischemic muscle necrosis (degenerative myopathy), 627, 645, 1635  
 Isoerythrolysis, neonatal see *Alloimmune hemolytic anemia of the newborn (neonatal isoerythrolysis)*  
 Isoflavones, phytoestrogen poisoning, 1873  
 Isoflupredone, 1932  
 Isoflupredone acetate, 2057  
 Isoimmune hemolytic anemia, comatose ("sleeper") foals, 2013  
 Isoimmune thrombocytopenia, 446, 1922  
 Isolation  
   bovine ulcerative mammillitis, 1429  
   coccidiosis, 1505  
   cryptosporidiosis, 1515  
   equine arteritis virus, 1321  
   equine herpesvirus 1, 1315, 1317  
   louse infestations, 1599  
   neonatal viral diarrhea, 1294  
   ovine enzootic abortion, 1437  
 Isometamidium chloride, 1536, 1538  
 Isoniazid  
   actinobacillosis (wooden tongue), 1047  
   dosage/interval, 2057  
   John's disease, 1031  
 Isoproterenol, 2057  
 Isoquinoline alkaloid poisoning, 1887  
*Isopora suis*, 1499  
   enteropathogen in piglets, 850  
   experimental reproduction, 1503  
   life cycle, 1502–1503  
 Isothiocyanates, glucosinolate poisoning, 1867  
 Isotonic crystalloid solutions, 67, 93, 94  
 Isotonic dehydration, 77, 78, 90  
 Isotonic fluid therapy, newborns, 169  
 Isotonic saline, 94  
*Isothrips*, iforrestine poisoning, 1887  
 Isoxsuprine hydrochloride, 2057  
 Isoxuprine, 2033  
 Itching see *Pruritus*  
 Itchmites, 1607–1608  
 Itraconazole, 1480  
   dosage/interval, 2057  
   equine aspergillosis, 1474  
   equine phycomycosis, 1481  
   systemic mycoses, 1473  
 Ivermectin  
   ascarid infections, 1557  
   blowfly strike, 1592  
   bluetongue prevention, 1304  
   bovine lungworm, 1566  
   cerebrospinal elaphostromylosis, 1576  
   chorioptic mange, 1612  
   demodectic mange, 1608  
   dosage/interval, 2057, 2065  
   fasciolosis, 1579  
   *Gasterophilus* infestation, 1586  
   hemochromatosis, ruminants, 1550  
   itchmites, 1607  
   kidney worm disease, 1571  
   louse infestations, 1598  
   lungworm, 1568, 1569  
   *Oestrus ovis* infestation, 1587  
   onchocercosis, 1573  
   parafilariosis, 1574  
   parasitic gastritis, pigs, 1555  
   parasitic gastroenteritis, ruminants, 1545, 1546  
   poisoning, 1832  
   psoroptic mange, 1611  
   sarcoptic mange, 1609  
   screwworm, 1595  
   stephano filariosis, 1574  
   strongylosis, 1561  
   summer sores, horse, 1572  
   thorny-headed worm (*Macracanthorhynchus hirudinaeus*), 1564  
   threadworm, 1563  
   tick infestations, 1601–1602  
   wohlfahrtiosis, 1596  
*Ixiolaena brevicompta* (button weed) poisoning, 1885  
 Ixodes  
   boreliosis transmission, 1111–1112  
   ecology, 1464–1465  
*Ixodes holocyclus*, 1918  
*Ixodes pacificus*, 1460, 1464  
*Ixodes persulcatus*, 1460, 1464  
*Ixodes ricinus*  
   *Anaplasma phagocytophila* vector, 1460, 1464  
   bovine babesiosis transmission, 1483  
   bovine babesiosis vector, 1484  
   lifecycle, 1408  
   louping-ill, 1408  
*Ixodes scapularis*, 1460, 1464
- J**
- Jaagsiekte see *Ovine pulmonary adenocarcinoma*  
 Jaagsiekte sheep retrovirus (JSRV), 1366  
 Jacksonian epilepsy, 613  
 Jaffe reaction, 550  
 Jamestown Canyon virus, 1382

- January disease, 1527  
 see also East Coast fever (ECF)
- Japanese B encephalitis virus, 133
- Japanese Black cattle, 1945, 1948, 1984
- Japanese bovine theileriosis, 1526
- Japanese brown cattle, 1958
- Japanese encephalitis, 1375, 1377–1378
- Japanese encephalitis flavivirus (JEV), 1377
- Jatropha curcas* poisoning, 1888
- Jaundice, 384–385  
 alloimmune hemolytic anemia of the newborn, 1922  
 classification, 384, 384  
 extrahepatic biliary obstruction, 385  
 hemolytic, 384–385  
 hepatic cell degeneration, 385  
 hepatitis, 393  
 intrahepatic primary cholestasis, 385  
 liver disease, 384–385  
 neonatal, 385  
 plant-induced, 1896
- Jaundiced foal agglutination (JFA) test, 1924, 1924
- Jaw bone osteomyelitis, 1045
- Jaw deformity, 1944  
 inherited defects, 1944, 1959  
 malapposition, 1959
- Jejunal hemorrhage syndrome see Hemorrhagic bowel syndrome, cattle
- Jejunitis, proximal, 245–246
- Jejunojejunal intussusception, 377
- Jembrana disease, 1244
- Jembrana disease virus, 1244
- Jersey cattle  
 familial polycythemia, 1947  
 inherited congenital spasm of cattle, 1955  
 inherited rectovaginal constriction, 1944  
 jaw deformity, 1944  
 viable hypotrichosis, 1974
- Jetting, blowfly strike prevention, 1592
- Jetting races, louse control, 1598
- Jockey Club, UK, 1328
- Johne's Absorbed enzyme-linked immunosorbent assay (ELISA), 1028
- Johne's disease, 1017–1044, 1266  
 accreditation programs, 1037  
 advanced clinical, 1026  
 bison, 1031  
 borderline form, 1025  
 case fatality rates, 1018  
 cattle, 1017–1019, 1025–1030, 1034–1035, 1036  
 clinical, 1024, 1025  
 clinical findings, 1025–1026  
 clinical pathology, 1026–1030  
 control, 1032–1043  
 countrywide, 1036–1039, 1041  
 diagnostics for, 1029, 1032–1033  
 farm-specific programs, 1033, 1040–1041  
 herd basis, 1033–1034  
 limitations of, 1032  
 recommendations, 1040–1041  
 state-federal program level, 1041  
 deer, 1030  
 diagnosis, 1026–1030, 1031, 1039–1043  
 recommendations, 1042  
 differential diagnosis, 1031  
 economic importance, 1022–1023  
 epidemiology, 1017–1023, 1041–1042  
 etiology, 1017  
 exotic species, 1018  
 goats, 1017–1018, 1026, 1030, 1031, 1035–1036  
 herd certification, 1029–1030, 1037  
 herd characteristics of, 1020–1021  
 incubation period, 1019, 1024, 1024, 1032  
 lepromatous extreme, 1025  
 lesion types, 1025  
 morbidity, 1018  
 necropsy findings, 1030–1031  
 outbreaks, 1017–1018  
 pathogenesis, 1024, 1024–1025  
 prepurchase testing, 1030  
 prevalence, 1018–1019, 1029, 1037  
 determination within a herd, 1033–1034  
 rabbits, 1030–1031  
 risk factors, 1020–1022  
 sheep, 1017–1018, 1019, 1026, 1030–1031, 1035–1036  
 flock classification, 1038  
 silent, 1025  
 stages, 1024, 1024, 1025–1026
- subclinical, 1022, 1024, 1025  
 transmission, 1019–1020  
 treatment, 1031–1032  
 tuberculoid extreme, 1025  
 vaccination, 1035–1036, 1042–1043  
 wildlife, 1018  
 zoonotic implications, 1023
- Johne's Disease Market Assurance Program, Australia, 1037
- Johnin tests, 1029, 1036
- Joint(s)  
 caprine arthritis encephalitis, 1411–1412  
 defect/deformity, 621, 632  
 disease, 637–648  
 see also specific diseases/disorders  
 fixation, 645, 648  
 hypermobility (laxity), 1962  
 inherited disease, 1962  
 lavage, arthritis/synovitis, 646–647  
*Mycoplasma* infection, 1126–1127  
 swollen, arthritis, 644
- Joint fluid  
 arthritis/synovitis, 641, 644–645  
 arthropathy, 640, 641  
 culture, 644–645  
 serology, 645
- Jowl abscesses, 782–783
- Juglans nigra* (black walnut tree) poisoning, 1887–1888
- Juglone poisoning, 1887–1888
- Jugular vein  
 catheterization, calves, 864  
 examination, 406–407  
 thrombophlebitis, 435
- Jugular venous pressure, 91
- Junctional premature complexes, 416
- Juniperine (*Juniperus*) poisoning, 1888
- Juvenile multicentric lymphosarcoma, 462
- 
- K**
- Kaolin and pectin mixture  
 abomasal ulcer, 374  
 enteritis, 268
- Kaolin pectate, 2057, 2065
- Karyotype/karyotyping, 1939  
 freemartinism diagnosis, 1940
- Kata see Peste des Petis ruminants (PPR)
- Ked infestations, 1596
- Kenya, bovine petechial fever, 1469
- Keratotomy, 2041
- Keratin plug, 740
- Keratitis  
 fungal see Keratomycosis  
 infectious, cattle see Infectious keratitis of cattle  
 lesions, 670  
 phenothiazine poisoning, 1831
- Keratoconjunctivitis, 670  
 caprine infectious, 1142–1143  
 equine herpesvirus 2, 1318  
*Mycoplasma bovoculi*, 1126
- Keratomycosis  
 clinical findings, 1472, 1474  
 clinical pathology, 1473  
 epidemiology, 1472  
 pathogenesis, 1472  
 treatment, 1473
- Keratouveitis, nonulcerative, 1098
- Kerosene poisoning, 1847
- Ketamine hydrochloride, 2057, 2065
- Ketoconazole, 1473, 2057
- Ketolac test strip, 1675
- Ketonemia, 1670
- Ketones, formation, 1661
- Ketouria, 546–547  
 pregnancy toxemia, sheep, 1670  
 septic metritis, postpartum, 61–62
- Ketoprofen  
 bovine ephemeral fever, 1179  
 coliform mastitis, 717  
 dosage/interval, 2057  
 endotoxemia, 59  
 equine colic, 225  
 exertional rhabdomyolysis, 1685  
 laminitis, horses, 2032  
 mastitis, 693  
 pain, 105  
 rhabdomyolysis, recurrent exertional, 1968
- Ketorolac tromethamine, 2057
- Ketosis, 1614, 1661–1668  
 clinical findings, 1663–1664  
 clinical pathology, 1664–1665  
 control, 1666–1667  
 diagnosis, 1665  
 differential diagnosis, 1665  
 economic importance, 1663  
 epidemiology, 1662–1663  
 etiology, 1661–1662  
 herd monitoring, 1667  
 left-side displacement of abomasum and, 355, 356, 358, 359, 361  
 milk fever complication, 1630, 1634  
 necropsy findings, 1665  
 nervous form, 1664, 1665  
 occurrence, 1662–1663  
 pathogenesis, 1663  
 potassium deficiency and, 1734  
 pregnancy toxemia, sheep, 1669–1670  
 primary, 300  
 risk factors, 1663  
 subclinical, 1614–1615, 1620, 1663, 1664  
 treatment, 1665–1666  
 wasting form, 1663–1664, 1665
- Key abnormality diagnosis method, 23, 23–24
- Kicking, 612
- Kid(s)  
 coccidiosis, 1499  
 colibacillosis, 860, 871  
 cryptosporidiosis, 1514  
 diarrhea, 849, 1289  
*Escherichia coli* vaccination, 875  
 herpesvirus-1 infection, 1330  
 maedi virus, 1411  
 shaker, 1416
- Kidney(s)  
 'black,' 1948  
 disease of, 555–561  
 function, 543  
*Halicephalobus* infestation, 1575  
 lead in, 1801, 1804  
 morphological abnormality, 548  
 porcine dermatitis and nephropathy syndrome, 1192  
 post-weaning multisystemic wasting syndrome, 1190  
 rectal examination palpation, 19  
 rhabdomyolysis, recurrent exertional, 1968  
 selenium levels, 1746  
 see also Entries beginning renal
- Kidney worm disease, 1570–1571
- Killed vaccines  
 anaplasmosis, 1458  
 bovine ephemeral fever, 1179  
 capripox viruses, 1431  
 equine arteritis virus, 1322  
 foot-and-mouth disease, 1228  
 louping-ill, 1410  
 ovine enzootic abortion, 1437  
 pleuropneumonia of pigs, 1059  
 porcine reproductive and respiratory syndrome, 1203  
 Rift Valley fever, 1206  
 vesicular stomatitis, 1235
- Kinetes, 1485
- Kirby-Bauer technique (antimicrobial sensitivity), 175  
 bovine respiratory disease, acute undifferentiated, 929  
*Escherichia coli* isolates, 866, 867
- Kirchi see Dermatophilosis
- Klebsiella* mastitis see Coliform bovine mastitis
- Klebsiella pneumoniae*, 754, 756
- Knopvelsiekte see Lumpy skin disease (LSD)
- Knuckling of the flexed foot, 589
- Korea, chronic wasting disease, 1454
- Kosovo, brucellosis status, 964
- Kraits (*Bungarus*), 1916
- Krimpsiekte, 1862, 1863
- Kumri, 1575
- 
- L**
- Laboratory data/tests  
 clinical examination, herds, 35–37  
 indications for, 25  
 infectious disease diagnosis, 767  
 interpretation, 25–28  
 liver disease, 388–391  
 properties of, 25–28

- Laboratory data/tests (*Cont'd*)  
 likelihood ratio, 25, 27, 27  
 predictive values, 25, 27–28  
 sensitivity, 25, 26–27, 27  
 specificity, 25, 26–27, 27  
 reference ranges, 26  
 limitations, 26  
 usefulness, 25–26  
 see also *specific tests*
- La bouhite see *Ovine progressive pneumonia*
- Laceration, traumatic brain injury, 605
- Lachesis muta* (bushmaster), 1916
- Lachnagrostis filiformis*, 1915
- Lactase deficiency  
 diarrhea, 191  
 lactose digestion test, 198
- Lactate, plasma  
 blood lactate and, 492  
 equine colic, 223  
 shock, 66
- Lactate dehydrogenase (LDH)  
 cerebrospinal fluid, 593  
 downer cow syndrome, 1647  
 exertional rhabdomyolysis, 1684–1685  
 liver function test, 389  
 myopathy, 629  
 recurrent exertional rhabdomyolysis, 1967
- Lactated Ringer's solution, 93–94
- Lactating cow therapy  
 cow selection for, 747
- Staphylococcus aureus* mastitis, 701–702  
*Streptococcus agalactiae* mastitis, 705
- Lactation  
 bovine mastitis risk factor, 677  
 diseases of, 1617  
 breed susceptibility, 1617–1618  
 energy requirements, 1616  
 failure see *Mastitis-metritis-agalactia (MMA)*  
 syndrome  
 feeding management in, 324–325  
 magnesium requirement, 1653  
 mastitis therapy versus dry cow therapy, 694  
 performance, health association, 1618  
 precocious, 139  
 sows, 1987, 1988  
 stage of  
 coliform mastitis, 711–712, 712–713  
 mastitis, 744  
 mastitis therapy, 689, 690  
 metabolic profile testing, 1623–1624  
 transition period effect on, 1613
- Lactation tetany  
 cows, 1654, 1656, 1730  
 ewes, 1654, 1656  
 mares, 1376, 1614, 1651–1652
- Lactate-secretion-based preparations, 155
- Lactic acidosis  
 experimental, 318  
 fluid and electrolyte therapy, 92  
 ruminal atony, 294  
 systemic, carbohydrate engorgement, 317  
 vaccination against, 325
- Lactoferrin, 712
- Lactogenesis, endotoxemia and, 56
- Lactogenic immunity, transmissible  
 gastroenteritis, 1279
- Lactose  
 intolerance, neonatal viral diarrhea, 1291  
 ketosis, 1665
- Lactose digestion test, 198
- Lactulose, 1989, 2057
- Lagos bat virus, 1386
- Lairage, *pars esophagea* ulceration, 1995
- Lamb(s)  
 abomasal bloat (distension), 374  
 abomasal impaction, 369–370  
 Akabane disease, 1207, 1208  
 anaplasmosis, 1457  
 arsenic poisoning, 1809–1810  
 arthritis, infectious, 643  
 bacterial meningoencephalitis, 601  
 birth size, 128  
 birth weight, 42  
 gaining of, 1671  
 maternal nutrition, 1695  
 mortality, 128  
 nutrition and, 1696  
 shearing effect, 1696  
 blackleg, 828  
 bluetongue experimental infection, 1302  
 border disease, 1258, 1415, 1416  
 bowie (bentleg), 1770–1771  
 caprine arthritis encephalitis, 1411  
 ceroid lipofuscinosis, 1950  
 chlamydial polyarthritis, 1435  
 coccidiosis, 1499, 1501, 1502, 1503, 1504  
 treatment, 1505, 1505  
 colibacillosis, 852, 854  
 clinical findings, 860  
*Escherichia coli* risk factors, 856  
 exposure reduction, 871  
 colostral immunoglobulins transfer,  
 guidelines to ensure, 873  
 colostrum administration, 156  
 critical temperature, 141  
 cryptosporidiosis, 1514  
 diarrhea, 101  
 acute undifferentiated, 849  
 viral, 1289, 1292, 1294  
 dipping, tick pyemia control, 784  
 dwarf, 1959  
 Ehler-Danlos syndrome, 1976  
 enterotoxemia, *Clostridium perfringens* type  
 D associated, 842, 843  
*Escherichia coli* vaccination, 875  
 feedlots, carbohydrate engorgement, 316  
 fetal disease, 128  
 fluid and electrolyte therapy, 101  
 glomerulonephritis, 555–556  
 goiter, 1723  
 growth rate, nutrition and, 1696  
 hypoglycemia, 1680–1681, 1682  
 hypothermia, 40, 141–142  
 pathogenesis, 44–45  
 prevention, 46  
 risk factors, 43  
 treatment, 45  
 infectious disease, 128  
 iron deficiency anemia, 1726, 1728  
 lead poisoning, 633  
 liver rupture, 386  
 lungworm infestation, 1569  
 meningitis, 610  
 mortality, 128–129  
 neonatal infection, 147  
 orf, 1418, 1419  
 osteoporosis from copper deficiency, 633  
 otitis media/interna, 607  
 ovine progressive pneumonia, 1363  
 ovine pulmonary adenocarcinoma, 1367  
 parasitic gastroenteritis, 1544  
 parturient disease, 128  
 parturition, premature induction, 145  
 passive immunity transfer failure, 854  
 polycystic kidney disease, congenital, 572  
 postnatal disease, 128  
 renal dysplasia, 572  
 rickets, 1767  
 septicemia, 51  
 septicemic pasteurellosis, 946–947  
 shaker, 1416  
 streptococcal infection, 776  
 sulfur-induced polioencephalomalacia, 2007–  
 2008  
 temperature, lower critical, 41  
 terminal ileitis, 382  
 thiamin deficiency, 1779  
 thrombocytopenia, 446  
 tick-borne fever, 1461  
 weaner illthrift, 1982
- Lambdacyhalothrin, 1601
- Lamb dysentery, 838, 839, 840
- Lambing  
 blackleg transmission, 828  
 environmental management, 46  
 infectious disease control and prevention,  
 157  
 management, 129  
 streptococcal infection, 776
- Lambliasis see *Giardiasis*
- LAMC2 gene mutation, 1975
- Lameness, 621, 625  
 biotin deficiency, 1780, 1781  
 bovine digit skin disease, 664  
 bovine interdigital necrobacillosis, 1064  
 cattle, 625, 664  
 definition, 621  
 degenerative joint disease, 1771, 2028  
 economics in food-producing animals, 625  
 also heel, 1956  
 exercise intolerance, 119  
 foot rot, virulent, 1072–1073  
 incidence/prevalence, 625  
 inherited splayed digits, 1965  
 onchocercosis, 1573  
 osteochondrosis, 637  
 osteodystrophia fibrosa, 1770  
 osteofluorosis, 1817  
 painful aspects, 625  
 pedal bone apex necrosis, 2037  
 polyserositis, pigs, 1153  
 rabies, 1390  
 sheep, 1075  
 sporadic lymphangitis, 2029  
 vitamin D deficiency, 1765
- Laminae ischemia, 2031
- Laminitis, 623  
 bluetongue, 1303  
 carbohydrate engorgement of ruminants, 319  
 cattle, 2034–2035  
 horses, 2030–2034  
 acute disease, 2031  
 chronic, 2031–2032  
 chronic refractory, 2033  
 clinical findings, 2031–2032  
 control, 2033–2034  
 diagnostic signs, 2031  
 differential diagnosis, 2033  
 epidemiology, 2030  
 equine neorickettsiosis, 1467  
 equine pars intermedia dysfunction, 1687  
 etiology, 2030  
 healing promotion, 2033  
 mechanical support, 2033  
 necropsy findings, 2032  
 occurrence, 2030  
 pain-hypertension-vasoconstriction cycle,  
 2031  
 pathogenesis, 2030–2031  
 phases, 2031  
 prognosis, 2032, 2033  
 recumbency, 122  
 risk factors, 2030  
 severe disease, 2031  
 treatment, 2032–2033  
 pigs, 2034–2035  
 ruminal acidosis and, 317  
 ruminants, 2034–2035  
 sheep, 2034–2035
- Landrace pigs  
 porcine stress syndrome, 1969  
 post-weaning multisystemic wasting  
 syndrome, 1186
- Landrace trembles, 2015
- Lansiospermum bipinnatum* (ganskweed)  
 poisoning, 1892
- Lantadene poisoning, 1893–1894
- Lantana* poisoning, 1894
- Laparoscopy  
 abdominal examination, 308  
 alimentary tract examination, 197
- Large colon, ascending  
 displacement, 248–252  
 clinical findings, 249–250  
 clinical pathology, 250–251  
 differential diagnosis, 251  
 epidemiology, 248, 249, 250  
 etiology, 248  
 left dorsal, 248, 249, 249  
 necropsy findings, 251  
 pathogenesis, 248–249  
 right dorsal, 248, 249–250, 250  
 treatment, 251, 251
- volvulus, 248–252  
 clinical findings, 250  
 clinical pathology, 250–251  
 differential diagnosis, 251  
 epidemiology, 248  
 etiology, 248  
 necropsy findings, 251  
 pathogenesis, 248–249, 250  
 treatment, 251
- Large intestine  
 impaction  
 horses, 226, 228, 252–253  
 pigs, 259–260  
 obstruction  
 abdominal distension, 195  
 acute, 226  
 equine colic, 219
- Large offspring syndrome, 146
- Large White pigs  
 jaw deformity, 1944  
 porcine stress syndrome, 1969
- Larvae  
 blowfly, 1590

- Larvae (Cont'd)
- Dictyocaulus viviparus*, 1564
  - Gasterophilus*, 1585–1586
  - habitat removal, West Nile encephalitis control, 1380
  - Haematobia* flies, 1604
  - Haemonchus contortus*, 1549
  - Hypoderma*, 1588
  - Metastrongylus*, 1569
  - Oesophagostomum*, 1553
  - Oestrus ovis*, 1587
  - screwworm, 1594
  - sheep ked, 1596
  - stable flies, 1603
  - Stephanurus dentatus*, 1570
  - Strongylus*, 1560
  - Strongylus edentatus*, 1558, 1560
  - Strongylus vulgaris*, 1558–1559
  - trichostrongylid worms, 1541–1542, 1543
  - Wohlfahrtia magnifica* (sarcophagid fly), 1595
- Larvicide, 1591–1592, 1594–1595
- Laryngeal adductory reflex, 590
- Laryngeal dysfunction, equine hyperkalemic periodic paralysis, 1966
- Laryngeal examination, 533
- Laryngeal hemiplegia (roarers), 478, 535–536, 618
- clinical findings, 535
  - diagnostic confirmation, 535
  - differential diagnosis, 536
  - epidemiology, 535
  - etiology, 535
  - guttural pouch mycosis, 540
  - necropsy findings, 535
  - pathogenesis, 535
  - pharyngeal paralysis, 211
  - prevalence, 535
  - respiratory sound spectrum analysis, 493
  - severity, 535
  - treatment, 536
- Laryngeal necrobacillosis, 1079–1080
- Laryngeal paralysis, 535, 1880
- Laryngitis, 533–534
- Laryngotracheitis, traumatic, 534
- Lasalocid
- acute bovine pulmonary emphysema and edema, 2004
  - coccidiosis, 1505, 1506
  - dosage/interval, 2057
  - poisoning, 1844–1845
- Laser ablation, equine phycomycosis, 1481
- Late agglutination test (LAT)
- contagious bovine pleuropneumonia, 1134
  - diarrhea, acute, 270
  - equine babesiosis, 1490
  - Japanese encephalitis, 1378
  - neonatal viral diarrhea, 1293
  - Streptococcus agalactiae* mastitis, 704
- Laticauda* (sea snake), 1916
- Latin America, rabies, 1385
- La tremblante see Scrapie
- Law of Laplace, 401
- Lawsonia intracellularis*
- antibiotics, 177
  - diarrhea, 275
  - ileitis, 1087–1093
  - proliferative enteropathy, horses, 1093–1094
- Laxatives, vagus indigestion, 350
- LBN gene, 1958
- Lead
- environmental pollution, 1800–1801
  - industrial, 1800
  - left-side displacement of abomasum and, 355 poisoning, 1799–1808
  - acute, 1801, 1802
  - case fatality rate, 1800
  - cattle, 1799, 1802, 1804
  - chronic, 1801
  - clinical findings, 1376, 1802–1803
  - clinical pathology, 1803–1804
  - control, 1807
  - diagnosis, 1804
  - differential diagnosis, 1804–1805, 1806–1807
  - dose levels, 1801
  - environmental, 1804
  - environmental factors, 583
  - epidemiology, 1376, 1799–1801
  - etiology, 1376, 1799
  - experimental reproduction, 1802
  - horses, 619, 1376, 1799, 1802–1803, 1804
  - morbidity, 1800
  - necropsy findings, 1804
  - osteodystrophy, 632, 633
  - pathogenesis, 1801–1802
  - peripheral nerve disease, 619
  - pigs, 1803
  - sheep, 1799, 1802
  - sources of, 1800
  - specimen analysis, 1797
  - subacute, 1802
  - subclinical, 1803
  - treatment, 1376, 1805–1807
  - sources of, 1800
  - toxic effects, 1801–1802
  - toxic levels, 1801
- Lead batteries, poisoning source, 1800
- 'Lead-line,' 1801–1802
- Lead paint, poisoning source, 1800
- 'Lead-pipe' rigidity, 590
- Lead tree (*Leucaena leucocephala*) poisoning, 134, 1884
- Lectin poisoning, 1888
- Left dorsal displacement of the large colon, 248, 249, 249
- Left-side displacement of abomasum (LDA), 299, 354–362
- acute, 358
  - anterior displacement, 359
  - atypical, exploratory laparotomy (celiotomy), 310
  - case fatality rate, 355, 360
  - clinical findings, 353, 358–359
  - clinical pathology, 359–360
  - control, 361
  - course of, 359
  - differential diagnosis, 360
  - economic impact, 357
  - epidemiology, 355–357
  - etiology, 354–355
  - 'floaters,' 358
  - genetic predisposition, 357, 361
  - lactational incidence rate, 355
  - metabolic predictors, 357, 359
  - necropsy findings, 360
  - non-esterified fatty acids concentration and, 1614
  - pathogenesis, 357–358
  - risk factors, 355–357
  - surgery, 360
  - treatment, 360–361
- Leg weakness
- osteochondrosis in pigs, 640
  - pigs, 638
  - porcine viral encephalomyelitis, 1406
  - see also Degenerative joint disease
- Lelystad virus, 1194
- Length conversion table, 2046
- Lens dystrophy, 1977
- Lepidozamia* poisoning, 1885
- Lepromatous extreme Johne's disease, 1025
- Leptospira*, 1094–1123
- incidental host, 1096
  - maintenance (reservoir) host, 1095–1096
  - mastitis, 675
  - nomenclature, 1095
  - serovars, 1096–1097
  - stillbirth/perinatal weak calf syndrome, 1984
- Leptospira borgpetersenii*, 1094–1110
- Leptospira borgpetersenii* type hardjo-bovis, 1096–1097
- Leptospira interrogans*, 1094–1110
- Leptospira interrogans* serovar bratislava, 1097
  - Leptospira interrogans* serovar canicola, 1096
  - Leptospira interrogans* serovar grippotyphosa, 1097
  - Leptospira interrogans* serovar hardjo, 1096, 1097, 1102, 1108
  - Leptospira interrogans* serovar hyos, 1096
  - Leptospira interrogans* serovar icterohaemorrhagiae, 1096
  - Leptospira interrogans* serovar pomona, 1097, 1098
  - abortion in horses, 1103
  - leptospirosis, 1102
  - outbreaks, 1096
  - pigs, 1102
- Leptospira tarassovi*, 1098, 1102
- Leptospirosis, 1094–1110
- abortion, 976, 1095, 1098, 1101, 1102, 1103, 1107
  - acute, 1100, 1100, 1102
  - capillary damage, 1100–1101
  - cattle, 1096–1097, 1102, 1105, 1108–1110
  - characteristics of, 1096–1098
  - chronic, 1100, 1100, 1102
  - clinical findings, 1102–1103, 1491
  - clinical pathology, 1103–1105, 1491
  - control, 1107–1110
  - diagnosis, 1105
  - differential diagnosis, 1105–1106, 1106
  - economic importance, 1099, 1107
  - encephalitis, 1101
  - epidemiology, 1095–1100, 1491
  - eradication, 1107–1108
  - etiology, 1094–1095
  - goats, 1097–1098, 1103
  - hemolysis, 1100–1101
  - horses, 1098, 1103
  - immune mechanisms, 1101–1102
  - infection source, 1107
  - interstitial nephritis, 1100–1101
  - necropsy findings, 1105
  - occult form, 1101
  - occupational hazard, 1099–1100, 1108
  - outbreaks, 1096–1098
  - pathogenesis, 1100–1102
  - periodic ophthalmia, 1101, 1103, 1107
  - pigs, 1098, 1102–1103, 1109
  - prevalence, 1096
  - risk factors, 1095–1096, 1099
  - septicemia, 1100–1101
  - sheep, 1097–1098, 1103
  - stillbirth, 1098
  - subacute, 1100, 1101, 1102
  - transmission, 1098–1099
  - treatment, 1106–1107
  - vaccination, 1107, 1108–1110
  - zoonotic implications, 1099–1100
- Leptospirosis, 1099
- Lepus timidus* (hares), louping-ill, 1408, 1410
- Lesser hemlock (*Aethusa cynapium*) poisoning, 1890
- Letdown failure, 752, 753, 753
- Lethal trait A46, 1941
- Lethal white foal syndrome, 1975
- Lethal whites, 1942
- Leucaena leucocephala* (lead tree) poisoning, 134, 1884
- Leucomyelomalacia, cyanogenic glycoside poisoning, 1854
- Leucopenia, rinderpest, 1239
- Leukemia, 461–464
- Leukocyte count, fluid balance disorders, 90
- Leukocytosis, 461
- bovine ephemeral fever, 1178–1179
  - ovine progressive pneumonia, 1365
- Leukoderma, 662, 1974
- Leukoencephalitis, 1412
- Leukoencephalomalacia, 602, 603, 604
- Leukoencephalomyelitis, 1411
- Leukopenia, 460–461
- African horse sickness, 1181
  - caprine herpesvirus-1 infection, 1330
  - coliform mastitis, 712
  - endotoxemia and, 55
  - hog cholera, 1162
- Leukoproliferative disease, 461–464
- Leukosis, sporadic bovine, 1210, 1216, 1218
- Leukotrichia, 662
- Levamisole
- ascarid infections, 1557
  - bovine lungworm, 1567
  - dosage/interval, 2057, 2065
  - kidney worm disease, 1571
  - lungworm infestation, pigs, 1570
  - parasitic gastritis, pigs, 1556
  - parasitic gastroenteritis, ruminants, 1545
  - poisoning, 1832
  - stephanofilariosis, 1574
- Levothyroxine, 1690, 2058
- 'Licking syndromes,' 653
- Lidocaine
- dosage/interval, 2058
  - equine colic, 225
  - laminitis, horses, 2033
  - ventricular tachycardia, 417
- Lifting, assisted, 1648
- Lifting devices, 1648–1649
- Ligament sprain, 645
- Lighting examination, 8
- Lightning strike
- horses, 1376, 1790
  - recumbency in horses, 122
  - sudden death, 125
- Lightning stroke, 1376, 1789–1790



- Likelihood ratio, laboratory data/tests, 25, 27, 27
- Limber neck, botulism, 826
- Limbs  
clinical examination, 12  
function assessment, 590
- Limestone, ground, 1757
- Limousin cattle  
inherited erythrocytic protoporphyria, 1946–1947  
inherited multifocal symmetrical encephalopathy, 1952
- Linamarin poisoning, 1853
- Lincomycin  
ileitis, 1092  
papillomatosis digital dermatitis of cattle, 1069  
polyserositis, pigs, 1154  
swine dysentery, 1118
- Lincomycin hydrochloride, 2058, 2065
- Lindane, 1595, 1833
- Linear dodecyl benzene sulfonic acid (LDBSA), 733
- Linear keratosis, 658
- Linseed meal/cake  
cyanogenic glycoside poisoning, 1853, 1854  
iodine deficiency, 1723
- Lipid metabolism, transition period in dairy cows, 1613, 1676–1677
- Lipid mobilization, fatty liver, 1673
- Lipid pneumonia, 515
- Lipid reserves, reproductive cycle and, 1673
- Lipoarabinomanann-based enzyme-linked immunosorbent assay (LAM-ELISA), John's disease, 1022, 1024
- Lipofuscin deposition, sheep liver, 386
- Lipoma, 379, 669  
pedunculated, horse, 242
- Lipomatosis (abdominal fat necrosis), 290
- Lipopolysaccharide-binding protein (LBP), 54
- Lipoproteins, fatty liver and, 1674
- Listeria*, 805–810  
*Listeria innocua*, 805  
*Listeria ivanovii*, 805, 809  
Listerial abortion, 808–809  
*Listeria meningoencephalitis*, 1806  
*Listeria monocytogenes*, 805  
contagious ophthalmia, 1142  
listeriosis, 805–810  
mastitis, 727  
pigs, 807  
virulence, 807
- Listeriosis, 805–810  
abortion, 976, 987  
clinical findings, 808–809  
clinical pathology, 809  
control, 809–810  
diagnosis, 809  
differential diagnosis, 809  
epidemiology, 805–807  
etiology, 805  
experimental reproduction, 807  
infection source, 806  
necropsy findings, 809  
outbreaks, 805  
pathogenesis, 808  
risk factors, 806–807  
transmission, 806  
treatment, 809  
vaccination, 810  
zoonotic implications, 807
- Lithuania, rabies, 1385
- Litter size, mortality in lambs, 128
- Live Animal Swab Test (LAST), 185
- Live attenuated vaccines  
bovine babesiosis, 1496–1497  
Rift Valley fever, 1206
- Liver  
African horse sickness, 1182  
ascarid infections, 1556, 1557  
black, sheep, 386–387  
brisket disease, 1788  
copper levels, 1717  
copper storage, 1713  
diseases of, 383–396  
cattle, 393  
diffuse, 383, 391–394  
focal, 383, 395–396  
hepatic dysfunction principles, 383–384  
horses, 393  
laboratory tests, 388–391  
liver failure and, 393  
manifestations of, 384–387  
abdominal pain, 386  
constipation, 386  
diarrhea, 386  
edema, 386  
emaciation, 386  
hemorrhagic diathesis, 386  
jaundice, 384–385  
liver displacement, 386  
liver rupture, 386  
liver size alterations, 386  
nervous signs, 385–386  
photosensitization, 386  
necropsy findings, 394  
portal circulation, 383–384  
primary, 383  
recumbency in horses, 122  
secondary, 383  
telangiectasis (sawdust liver), 395  
treatment, 391  
vitamin A deficiency, secondary, 1773  
*see also specific diseases/disorders*  
displacement, 386  
enlargement  
heart failure, right-sided chronic (congestive), 403  
pericarditis, traumatic, 352  
examination, 387–391  
biopsy *see* Liver biopsy  
imaging, 387–388  
palpation, 387  
percussion, 387  
radiography, 388  
ultrasonography, 387–388, 1675  
*Fasciola magna* infection, 1580  
fasciolosis, 1577, 1578  
hyperbilirubinemia and photosensitization, inherited, 1976  
insufficiency  
ketosis and, 1661  
photosensitization, 661  
kidney worm disease, 1570, 1571  
lead in, 1801, 1804  
palpation, cattle, 387  
postvaccinal hepatitis, 1988  
Rift Valley fever, 1206  
rupture  
liver disease, 386  
parturition trauma, 139  
subcapsular, vitamin E deficiency, 1745  
selenium, 1746, 1747  
size, 386  
*see also Entries beginning hepatic*  
Liver atrophy  
acute (serum hepatitis), 392, 393, 824, 1988–1989  
horses, 386  
Liver biopsy, 387  
alimentary tract examination, 203  
fatty liver, cattle, 1675  
horses, 387, 394  
ketosis, 1665  
technique, 387  
Liver enzymes, serum profiles, 389–390  
Liver failure  
horses, 1492  
liver disease and, 393  
Liver fluke disease *see* Fasciolosis (liver fluke disease)  
Liver function tests, 388–389  
cattle, 388, 390  
fasciolosis, 1578  
horses, 388, 389  
left-side displacement of abomasum, 359  
postvaccinal hepatitis, 1988  
reference laboratory values, 2048, 2049  
sheep, 389  
Liver necrobacillosis, 1062–1063  
Liver tumors, 395–396  
Live vaccines  
anaplasmosis, 1458–1459  
hog cholera, 1165  
ovine enzootic abortion, 1437
- Llamas  
altitude effects, 1788  
eperythrozoonosis, 1154  
immunodeficiency syndrome, 1411  
*Lobelia berlandieri* poisoning, 1890  
Lobeline poisoning, 1890  
Local analgesia, laminitis, 2033  
Locomotion impairment, scrapie, 1444  
Locoweed (*Oxytropis sericea*) ingestion, 1788
- Locus for enterocyte effacement (LEE), enterohemorrhagic *Escherichia coli*, 882
- Lolitrem poisoning, 1899
- Lolium perenne* (perennial ryegrass), 1658, 1903–1904, 2000
- Lolium rigidum*, 1915
- Lone Star tick (*Amblyomma americanum*), 1600
- Long bones, angular deformities, 632
- Longissimus dorsi necrosis, 1971
- Longus capitis muscle rupture, 541
- Long-woolled sheep, louse control, 1598
- Loperamide, 2058
- Lophyrotoma interrupta* larvae poisoning, 1920
- Lophyrotomina poisoning, 1920
- Lotastralin poisoning, 1853
- Lotusin poisoning, 1853
- Louping-ill, 1408–1410  
cattle, 1409  
clinical findings, 1409  
clinical pathology, 1409  
control, 1410  
differential diagnosis, 1409  
epidemiology, 1408  
etiology, 1408  
goats, 1409  
horses, 1409  
intercurrent infection, 1409  
necropsy findings, 1409  
neurological disease, 1409  
occurrence, 1408  
pathogenesis, 1409  
risk factors, 1408–1409  
seasonal occurrence, 1408  
sheep, 1409  
transmission, 1408, 1607  
treatment, 1410  
vaccination, 1410  
zoonotic implications, 1409
- Louping-ill virus, 1408, 1461
- Louse infestations, 1596–1599  
cattle, 1597, 1598  
chewing lice, 1597–1598  
clinical findings, 1597–1598  
control, 1598–1599  
diagnosis, 1597–1598  
epidemiology, 1597  
etiology, 1597  
goats, 1597, 1598  
horses, 1597, 1598  
insecticide resistant, 1598  
life cycle, 1597  
nymphal stages, 1597  
pigs, 1597  
sheep, 1597–1598  
sucking lice, 1597  
transmission, 1597  
treatment, 1598–1599
- Lower motor neuron disease, 617, 1377, 1953
- Lower motor neuron lesions, 581
- Lower respiratory tract  
*Pasteurella* colonization, 937  
pneumonia pathogenesis, 510–511
- Low milk fat syndrome, 1686
- Lucene meal, *pars esophagea* ulceration, 1997
- Lucilia cuprina*, 1590, 1591
- Lucilia sericata*, 1590
- Lufeneron, 2058
- Lumbosacral cistern, cerebrospinal fluid collection, 591, 591–592
- Luminal blockages, 377–378
- Lumpy jaw (actinomycosis), 1045–1046
- Lumpy skin disease (LSD), 1424–1426  
case fatality rates, 1425  
clinical findings, 1425  
clinical pathology, 1425–1426  
control, 1426  
differential diagnosis, 1426  
economic importance, 1425  
epidemiology, 1425  
etiology, 1425  
experimental production, 1425  
lesions, 1425  
morbidity rates, 1425  
necropsy findings, 1426  
occurrence, 1425  
origin of infection, 1425  
pathogenesis, 1425  
risk factors, 1425  
transmission, 1425  
vaccination, 1426  
vectors, 1425
- Lumpy wool of sheep *see* Dermatophilosis

- Lung(s)  
 acute bovine pulmonary emphysema and edema, 2002  
 ascarid infections, 1556, 1557  
 auscultation, 15–16  
 bovine lungworm, 1565  
 bovine respiratory syncytial virus pneumonia, 1347  
 brisket disease, 1788  
 chronic enzootic pneumonia of sheep, 1362  
 clinical examination, 15–16  
 diseases of, 497–519  
   see also *specific diseases/disorders*  
 interstitial pneumonia, 2002  
 lungworm, horse, 1568  
 ovine progressive pneumonia, 1364, 1365  
 palpation, 16  
 percussion, 16  
 post-weaning multisystemic wasting syndrome, 1190  
 rupture, pneumothorax, 520  
 stillbirth/perinatal weak calf syndrome, 1985  
 tuberculosis, 1009  
   see also *Entries beginning pulmonary*
- Lung biopsy  
 chronic interstitial pneumonia, foal, 2006  
 complications, 492–493  
 heaves, 1931–1932  
 procedure, 493  
 respiratory system examination, 492–493
- Lung edema factor, 1999
- 'Lungers' see Interstitial pneumonia
- Lung sounds  
 absence, 478  
 brisket disease, 1788  
 equine influenza, 1324–1325  
 heaves, 1930–1931
- Lungworm infestation, 1564–1570  
 cattle see Bovine lungworm (verminous pneumonia)  
 goats, 1568–1569  
 horses, 1568  
 interstitial pneumonia, 1999, 2004  
 pigs, 1569–1570  
 sheep, 1568–1569
- Lupinosis, 1899
- Lupins  
*Diaporthe toxica* growth, 1906–1908  
 toxins, fatty liver, 1673
- Lupinus*  
 congenital defects of the newborn, 133–134  
 quinolizidine alkaloid poisoning, 1890–1891
- Lupinus angustifolius*, 1907
- Lupinus caudatus*, 1891
- Lupinus sericeus*, 1891
- Luprostiol, 2058, 2065
- Lutzomyia shannoni* (phlebotamine sandfly), 1234
- Lycorine poisoning, 1888
- Lyme boreliosis see Boreliosis
- Lyme disease see Boreliosis
- Lymnaea columella*, 1577
- Lymnaea tomentosa*, 1577
- Lymnaea truncatula*, 1577
- Lymnaeid mud snails, 1576–1577, 1579, 1580
- Lymphadenitis, 464  
 actinobacillosis, 1047  
 caseous, 795–798  
   clinical findings, 796–797  
   clinical pathology, 797  
   control, 797–798  
   differential diagnosis, 797  
   economic importance, 796  
   epidemiology, 795–796  
   eradication, 798  
   etiology, 795  
   experimental reproduction, 796  
   infection source, 795  
   necropsy findings, 797  
   outbreaks, 795  
   pathogenesis, 796  
   prevention, 798  
   risk factors, 795–796  
   transmission, 795  
   treatment, 797  
   vaccination, 797–798  
 mastitis and, 760  
 mycobacteriosis, 1015  
*Rhodococcus equi* pneumonia, 803  
 streptococcal, pigs, 782–783
- Lymphadenopathy, 464  
 Jembrana disease, 1244
- malignant catarrhal fever, 1247  
 post-weaning multisystemic wasting syndrome, 1190  
 strangles, 770
- Lymphangitis, 623, 665  
 epizootic, 1434, 1478–1479  
 sporadic, 2029–2030  
*Streptococcus*, 768–769  
 ulcerative see Ulcerative lymphangitis
- Lymphatic flow obstruction, 72, 1945
- Lymph node(s)  
 abscess, 111, 796–797  
 East Coast fever, 1529  
 enzootic bovine leukosis, 1215  
 hog cholera, 1163  
 microgranulomas, mycobacteriosis, 1015  
 ovine progressive pneumonia, 1365  
 porcine dermatitis and nephropathy syndrome, 1192  
 retropharyngeal swelling, strangles, 770
- Lymph node granulomata, 1473
- Lymphocytes  
 babesiosis, 1488  
 reference laboratory values, 2047
- Lymphocytic-plasmacytic enterocolitis, 1993
- Lymphocytolysis, East Coast fever, 1528
- Lymphocytopenia, tick-borne fever, 1461
- Lymphocytosis, 461
- Lymphoid tissue atrophy, 467
- Lymphoma, 461–464, 608–609
- Lymphomatosis, 668  
 bovine leukemia virus, 1214  
 liver metastases, 395  
 spinal cord compression, 615
- Lymphopenia, 460, 461, 467  
 African swine fever, 1170  
 combined immunodeficiency, Arabian foals, 1979  
 endotoxemia and, 55  
 radiation injury, 1786
- Lymphoproliferative diseases, 462–464
- Lymphoreticular system, scrapie, 1443–1444
- Lymphosarcoma, 462–463, 519, 1216, 1218
- Lysosomal storage diseases, 603  
 Chediak–Higashi syndrome, 1942  
 inherited, 135, 1949
- Lyssavirus*, 1385, 1386–1387
- LYST gene, 1942

## M

- 'Machinery murmur,' 433
- Macracanthorhynchus hirudinaceus* (thorny-headed worm), 1563–1564
- Macrocyclic lactone anthelmintics (MLs)  
 blowfly strike, 1592  
 bovine lungworm, 1566  
*Hypoderma* infestations, 1589  
 louse infestations, 1598  
 parasitic gastroenteritis, ruminants, 1545, 1546  
 strongylosis, 1561
- Macrocyclic lactone endectocides, 1609, 1611
- Macrocyclic trichothecene poisoning, 1899, 1910
- Macrocytic, normochromic anemia, 1946
- Macrogametocyte, 1502
- Macrogamonts, 1507
- Macrophages  
 equine infectious anemia virus, 1174  
 hog cholera, 1163
- Macrozamia* poisoning, 1885
- Macrozamin poisoning, 1885
- 'Mad itch,' 1398
- Madura foot, 1480
- Maduramicin poisoning, 1844–1845
- Maduromycosis, 1481
- Maedi see Ovine progressive pneumonia
- Maedi-visna see Ovine progressive pneumonia
- Maedi-visna virus, 1363, 1413
- Magnesian limestone, 1658
- Magnesium  
 absorption factors, 1653  
 deficiency, 1730  
 dietary, 1652  
 lactation requirements, 1653  
 loss of see Hypomagnesemia  
 plasma levels, milk fever, 1627  
 renal excretion, 1652  
 reserves, 1652–1653  
 serum  
   hypomagnesemic tetany, 1656, 1660

- metabolic profile testing, herds, 1622  
 milk fever, 1633
- supplementation  
 hypocalcemia prevention, 1642  
 hypomagnesemia, 82  
 hypomagnesemic tetany, 1657–1658, 1660  
 palatability problems, 1657–1658  
 tetany risk factors, 1653  
 urolithiasis, 566
- Magnesium alloy bullets, 1660–1661
- Magnesium carbonate, 1660
- Magnesium chloride hexahydrate, 1658
- Magnesium homeostasis, 1652, 1659
- Magnesium hydroxide  
 abomasal ulcer, 374  
 carbohydrate engorgement, 322  
 dosage/interval, 2058  
 simple indigestion, 313
- Magnesium hypophosphite, 1636, 1657
- Magnesium oxide, 1657, 1660, 2058
- Magnesium-rich pellets, 1658
- Magnesium sulfate  
 dosage/interval, 2058  
 equine colic, 227  
 equine neonatal encephalopathy, 2014  
 hypomagnesemic tetany, 1658  
 parturient diet acidification, 1640  
 ventricular tachycardia, 417
- Magnetic fields, 1795
- Magnetic resonance imaging (MRI)  
 equine neonatal encephalopathy, 2014  
 nervous system, 594  
 newborns, 164  
 respiratory system, 483
- Main Drain virus, 1383
- Major histocompatibility complex, sarcoid, 1423
- Malabsorption  
 diarrhea, 193  
 granulomatous enteritis, horses, 1992  
 neonatal viral diarrhea, 1291  
   see also Enteritis
- Malacosoma americanum* (Eastern Tent caterpillars) ingestion, 1919, 1920
- Maladie du coit see Dourine
- Malassezia furfur*, 1471, 1476
- Malassezia globosa*, 1471
- Malassezia obtusa*, 1471
- Malassezia pachydermatis*, 1471
- Malassezia restricta*, 1471
- Malassezia slooffiae*, 1471
- Malassezia sympodialis*, 1471
- Malassezia* yeasts, 1471
- Malasseziosis, 1471–1474  
 clinical findings, 1472–1473  
 clinical pathology, 1473  
 epidemiology, 1471–1472  
 etiology, 1471  
 necropsy findings, 1473  
 pathogenesis, 1472  
 treatment, 1473
- Mal de caderas (surra), 1532, 1537–1538
- Maldistributive shock, 63–69, 399  
 clinical findings, 65  
 clinical pathology, 65–66  
 differential diagnosis, 66  
 etiology, 63–64  
 pathogenesis, 65  
 treatment, 66–68
- Male castrates, phytoestrogen poisoning, 1874
- Malignant catarrhal fever (MCF), 1245–1248  
 alimentary tract form, 1247  
 clinical findings, 1246–1247, 1265  
 clinical pathology, 1247, 1265  
 control, 1248  
 differential diagnosis, 1240  
 economic importance, 1246  
 epidemiology, 1245–1246, 1265  
 etiology, 1245  
 experimental reproduction, 1246  
 head and eye form, 1247  
 immunization, 1248  
 mild form, 1247  
 necropsy findings, 1247–1248  
 nervous signs, 1247  
 occurrence, 1245  
 pathogenesis, 1246  
 peracute form, 1247  
 prevalence, 1245  
 risk factors, 1246  
 transmission, 1246  
 treatment, 1248  
 viral isolation, 1247

- Malignant catarrhal fever virus, 1245–1246  
 Malignant edema, 830–832  
   antitoxin, 831  
   clinical findings, 831  
   clinical pathology, 831  
   control, 832  
   diagnosis, 831  
   differential diagnosis, 831  
   epidemiology, 830–831  
   etiology, 830  
   importance, 831  
   infection source, 830  
   necropsy findings, 831  
   pathogenesis, 831  
   transmission, 830–831  
   treatment, 831–832  
 Malignant head catarrh see Malignant catarrhal fever (MCF)  
 Malignant hyperthermia (MH)  
   clinical findings, 1971  
   economic importance, 1970  
   etiology, 1969  
   pathogenesis, 1970–1971  
   risk factors, 1970  
   treatment, 1973  
 Malignant lymphoma, congenital, 138  
 Malignant ovine theileriosis, 1526, 1527  
 Mallein test, 1084, 1479  
 Malnutrition, 113–114  
   congenital defects in newborns, 133  
   controlled (feed shortage periods), 114  
   horses, 114  
   maternal, offspring survival, 42  
 Mal seco see Equine grass sickness  
 Mambas (*Dendroaspis*), 1916  
 Mammary adenocarcinoma, 753  
 Mammary aspergillosis, 1473  
 Mammary gland(s)  
   biopsy, 687  
   caprine arthritis encephalitis, 1412  
   clinical examination, 12, 20  
   diseases of, 673–762  
     see also *specific diseases/disorders*  
   immunological function, bovine mastitis risk factor, 678  
   infection resistance mechanisms, 738  
   ovine progressive pneumonia, 1364, 1365  
   papillomas, 1421  
 Mammary hypoplasia, 754  
 Management practices  
   Bang's disease, 968  
   bovine herpesvirus-1 infection, 1350  
   bovine mastitis, 679–680  
   bovine virus diarrhea virus, 1253  
   coccidiosis, 1500–1501  
   colibacillosis, newborn, 854  
   contagious bovine pleuropneumonia, 1132–1133  
   dermatophilosis, 1048–1049  
   downer cow syndrome, 1645  
   enterohemorrhagic *Escherichia coli*, 878, 884  
   enterotoxemia, *Clostridium perfringens* type D associated, 841  
   environmental streptococci mastitis, 720  
   enzootic bovine leukosis, 1212  
   enzootic pneumonia of calves, 1338  
   giardiasis, 1516  
   history-taking, individual animals, 5–7, 6–7  
   hypomagnesemic tetany, 1655  
   infectious foot, sheep, 1072  
   Johne's disease and, 1021, 1034–1035, 1036  
   lactation, diseases of, 1618  
   leptospirosis, 1099, 1108  
   liver necrobacillosis, 1062  
   malignant edema, 831  
   mastitis control, 743  
   mastitis-metritis-agalactia syndrome, 755–756  
   milk fever prevention, 1643  
   mycoplasmal pneumonia, pigs, 1146  
   newborns, acute undifferentiated diarrhea, 848–849  
   papillomatosis digital dermatitis of cattle, 1067  
   *pars esophagea* ulceration, 1995  
   performance shortfalls, 117  
   pleuropneumonia of pigs and, 1055, 1058  
   pneumonic pasteurellosis, 935–936  
   porcine intestinal spirochetosis, 1121  
   porcine reproductive and respiratory syndrome, 1195  
   porcine stress syndrome, 1970  
   salmonellosis, 903–904  
   *Staphylococcus aureus* mastitis, 698  
   *Streptococcus suis* infection prevention, 781  
   swine dysentery, 1115  
   toxoplasmosis, 1519  
   transmissible gastroenteritis, 1278–1279  
 Manchester wasting disease, 1861–1862  
 Mandible  
   developmental deficiency, 280  
   partial/complete absence, 1959  
   swelling, osteodystrophia fibrosa, 1770  
 Mandibular prognathism, 1959  
 Manganese  
   deficiency, 133, 1699, 1733–1734  
   recommended dietary intake, 1734  
 Mange  
   body (psoroptic), 1610–1611  
   choriopic, 1434, 1611–1612  
   demodectic, 1433, 1608  
   sarcoptic (barn itch), 785, 1608–1609  
 Mania, 9, 584  
   encephalitis, 601  
   nervous system disease, 578  
   plant-induced, 1897  
*Mannheimia haemolytica*  
   antimicrobial sensitivity, 941–942  
   bovine herpesvirus-1 infection, 1353  
   bovine mastitis, 725  
   endotoxin, 937  
   fimbriae, 937  
   leukotoxin, 937–938, 943, 944, 948  
   lipopolysaccharide, 937, 948  
   mastitis, goats, 761  
   meningoencephalitis, 921  
   *Mycoplasma bovis* synergism, 938  
   ovine mastitis, 759–760  
   passive immunity to, 944  
   pasteurellosis, 946–947  
   pneumonic pasteurellosis, 934–946, 947–949  
   polysaccharide capsule, 937, 948  
   undifferentiated bovine respiratory disease, 926  
   vaccine, 934, 944  
     adverse reaction, 945  
     efficacy evaluation, 944–945  
     virulence factors, 936, 937–938  
 Mannitol  
   decompression, 595, 598  
   dosage/interval, 2058, 2065  
   equine neonatal encephalopathy, 2014  
   urinary tract disease, 553  
 Mannosidase test, 1949  
 Mannosidosis, 135, 1949–1950  
 Manometer, 592  
*Mansonella*, 1605  
 Manure  
   enterohemorrhagic *Escherichia coli* source, 880  
   Johne's disease and, 1021, 1034  
   phosphorus content, 1761  
 Manure-gas poisoning, 1848–1849  
 Maple syrup urine disease (branched chain ketoacid decarboxylase deficiency, BCKAD), 135, 1953  
 'Marble bone' (congenital osteopetrosis), 1959  
 Marbofloxacin, 646, 2058, 2065  
   coliform mastitis, 716  
 March flies, 1603  
 Mare(s)  
   dourine, 1539  
   pregnant  
     equine colic, 229–230  
     water consumption, 547  
 Mare reproductive loss syndrome, 1918–1920  
   clinical findings, 1919  
   control, 1920  
   epidemiology, 1918–1919  
   etiology, 1918–1919  
   necropsy findings, 1919  
   outbreaks, 1919  
   pathogenesis, 1919  
   risk factors, 1919  
   treatment, 1920  
 Mare's milk, electrolyte content, 563  
 Marfan's syndrome, 422  
*Margaropus winthemi*, 1600  
 Marie's disease, 635  
 Marihuana (*Canabis sativa*) poisoning, 1885  
 Marine animals, vesicular exanthema of swine, 1236  
 Marker vaccines  
   bovine herpesvirus-1 infection, 1357–1358  
   contamination, 1360  
   eradication programs, 1359–1360  
   side effects (Netherlands), 1360  
   hog cholera, 1165  
   pseudorabies, 1402–1404  
 Market Cattle Identification (MCI) program, 982  
 Market cattle testing, brucellosis, 982  
*Marsdenia rostrata* (milk vine) poisoning, 1886  
*Marsilea*, thiaminase poisoning, 1882–1883  
*Marsilea drummondii* (Nardoo fern), 1883, 2007  
 Mass, conversion tables, 2046  
 Masseter atrophy, 1524  
 Masseter myonecrosis, 1686  
 Mast cell tumors, 668  
 Mastication abnormalities, 9, 191–192  
 Mastitis  
   antimicrobials, 174  
   aspergillar, 1473  
   colostral immunoglobulin concentration, 151  
   foot-and-mouth disease, 1225  
   horses, 762  
   *Listeria monocytogenes* infection, 806, 808, 809  
   *Mycoplasma californicum*, 1125–1126  
   *Mycoplasma canadense*, 1125–1126  
   septic metritis, postpartum, 62  
   tuberculous, 1009  
   vesicular stomatitis, 1235  
   see also *specific types*  
 Mastitis-metritis-agalactia (MMA) syndrome, 752, 754–759  
   case fatality, 755  
   characteristics, 1636  
   clinical findings, 756–757  
   clinical pathology, 757  
   control, 758–759  
   diagnosis, 757  
   differential diagnosis, 757, 758  
   endotoxemia and, 56  
   epidemiology, 755–756  
   etiology, 754–755  
   morbidity, 755  
   necropsy findings, 757  
   pathogenesis, 756  
   risk factors, 755–756  
   treatment, 757–758  
 Mastitis-N-K test see California Mastitis Test  
 Mastocytoma, cutaneous, 668  
 Maternal antibodies  
   bovine respiratory syncytial virus pneumonia, 1345  
   bovine virus diarrhea virus, 1252  
   pseudorabies, 1403  
 Maternal immunity, pseudorabies, 1397  
 Maternal nutrition  
   caloric undernutrition, 137, 143  
   newborn disorders, 143  
   stillbirth/perinatal weak calf syndrome, 1984  
 Maternal obstetrical paralysis, 1635  
*Matricaria nigellifolia* poisoning, 1896  
 Matrix degradation, arthropathy, 639  
 Matrix metalloproteinases (MMPs), laminitis, 2031  
 Maxilla swelling, actinomycosis, 1045  
 Maximum permissible concentration, radioactivity in meat, 1786  
 McRebel system, 1203  
 McSherry's balanced electrolyte solution, 94  
 Mean corpuscular hemoglobin (MCH), 456, 2047  
 Mean corpuscular hemoglobin concentration (MCHC), 2047  
 Mean corpuscular volume (MCV), 2047  
 Measles vaccine, rinderpest, 1241  
 Meat  
   arsenic residues, 1809  
   consumer education on handling and cooking, 887  
   lead contamination, 1805–1807  
   radionuclides, 1786  
   tainting, glucosinolate poisoning, 1868  
 Meat-and-bone meal ingestion, 1448, 1452  
 Meat inspection service and surveillance, enterohemorrhagic *Escherichia coli* control, 885–886  
 Meat juice, enzyme-linked immunosorbent assay, 911, 918  
 Meat-producing animals, intramuscular injection avoidance, 178  
 Mebendazole, 1568, 2058  
 Mechanical ventilation, 170, 494  
 Mechanoheat nociceptors, 103  
*Mecistocirrus digitatus*, 1549  
 Meclofenamic acid, 2058  
 Meconium aspiration syndrome, 516

- Meconium impaction, 231, 232  
 Meconium retention, 195, 231  
 Meconium staining, fetal hypoxia indication, 140  
 Mediastinum granuloma, 1474  
*Medicago*, phytoestrogen poisoning, 1873  
 Mediterranean coast fever (tropical theileriosis), 1491, 1527, 1530–1531  
 Medulla oblongata, scrapie, 1444  
 Megaesophagus, 212  
 Melanoma  
   congenital, 138  
   cutaneous, 668  
   inherited, 1977  
 Melanosis, sheep liver, 386  
 Melanotropes, 1687  
 Melena  
   abomasal ulcer, 372–373  
   abomasum hemorrhage, 307  
   alimentary tract disease in cattle, 301  
   enteritis, acute, 265  
   stomach hemorrhage, 194  
*Meles meles* (badgers), tuberculosis, 1007  
 Meliatoxin, 1894  
 Melilolin, 1864  
 Mellioidosis, 1082–1083  
*Melolophagus ovinus* (sheep ked), 1300, 1596  
 Meloxicam, 2028–2029, 2058  
 Menace reflex, 582, 584–585  
   absence, 588  
   vitamin A deficiency, 1775  
   blindness test, 18  
   polioencephalomalacia, 585, 2010  
 Meningeal disease, 609–611  
   see also *specific diseases/disorders*  
 Meningeal tumors, 608  
 Meninges  
   diseases of, 609–611  
   see also *specific diseases/disorders*  
   equine encephalomyelitis, 1370  
 Meningitis, 609–611  
   cattle, 610  
   clinical findings, 610  
   clinical pathology, 611  
   differential diagnosis, 611  
   etiology, 610  
   horses, 610  
   necropsy findings, 611  
   neonatal streptococcal infection, 775  
   pathogenesis, 610  
   pigs, 610  
   porcine viral encephalomyelitis, 1406  
   primary bacterial, 610  
   sheep, 610  
   *Streptococcus suis* infection, 780  
   treatment, 611  
 Meningoencephalitis, 610  
   bacterial, 601  
   bovine herpesvirus-1 vaccine induced, 1350  
   bovine virus diarrhoea virus, 1255  
   *Haemophilus* septicemia, 1000–1001  
   *Mannheimia haemolytica*, 921  
   *Streptococcus*, 768  
   *Streptococcus suis*, 768  
 Meniscal ossifications, 2028  
 Mental depression, Venezuelan equine encephalomyelitis, 1373  
 Mental state/mentation, 576  
   abnormalities, 584  
   altered, 577–578  
   nervous system examination, 584  
 MEP (mucin type glycoprotein), 1280  
 Meperidine, 106, 2058  
 Mephensin, 1956  
*Mephitis mephitis* (striped skunks), rabies vector, 1385, 1387  
 Mercuric chloride toxicity, 1814  
 Mercury binitride toxicity, 1814  
 Mercury poisoning, 619, 1797, 1814–1815  
 Merino sheep  
   bolo disease, 798  
   brucellosis associated with *Brucella ovis*, 985  
   ceroid lipofuscinosis, 1950  
   inherited ovine degenerative axonopathy, 1953  
   itchmites, 1607  
   Johne's disease, 1020  
   weaner illthrift, 1982  
 Merogony (binary fission), 1485, 1514  
 Merozoites see Sporozoite(s) (merozoites)  
 Merthiolate, 728  
 Mesangiocapillary glomerulonephritis (inherited nephrosis), 555, 1948  
 Mesenteric lymph node biopsy, 1027–1028  
 Mesenteric rents, 242  
 Mesenteric torsion, 377, 379  
 Mesothelial cells, peritoneal fluid, 202  
 Metabolic acidosis, 83  
   blood gas analysis, 89  
   bovine babesiosis, 1488  
   clinical findings, 88  
   diarrhea, acute, 271, 864  
   enteric colibacillosis, 857  
   enteritis, 264  
   equine colic, 223  
   hyperkalemia, 80  
   hypochloremic, hypokalemic, 77, 98  
   right-side displacement of the abomasum and, 363  
   urinary tract disease, 553  
 Metabolic alkalosis, 83  
   blood gas analysis, 89  
   hypokalemia and, 78–79  
   right-side displacement of the abomasum and, 363  
   vagus indigestion, 348  
 Metabolic disease, 1613–1690  
   atrial fibrillation and, 418–419  
   encephalomalacia, 603  
   incidence, 1618  
   myasthenia etiology, 626  
   occurrence, 1618  
   periparturient period, 1613  
   prediction of, 1618–1619  
   salient features, 1614  
   stress and, 109  
   transition period, dairy cows, 1613–1616  
   see also *specific diseases/disorders*  
 Metabolic encephalomyelopathies, 611–612  
 Metabolic peripheral nervous system disease, 619  
 Metabolic profile test, 1618–1619  
   body condition score, 1624  
   herd testing, 1620–1625  
   individual cows, 1619–1626  
   optimum values, 1623, 1623  
   periparturient disease prevention, 1619–1620  
   usefulness of, 1619–1620  
   written advice from, 1624  
 Metabolic rate, exercise and, 117  
 Metabolism abnormality, weight loss, 116  
 Metabolites, reference laboratory values, 2048, 2049  
 Metacercaria  
   *Dicrocoelium dendriticum*, 1580  
   *Fasciola*, 1576, 1577, 1579  
   *Fasciola magna*, 1580  
 Metacestodes, 1583  
 Metal-bearing ore deposits, arsenic poisoning, 1808–1809  
 Metaldehyde poisoning, 1840  
 Metal toxins, toxic nephrosis, 557  
 Metastatic tumors, central nervous system, 608–609  
*Metastrongylus*, 1569  
*Metastrongylus apri* (*Metastrongylus elongatus*), 1569  
*Metastrongylus pudendotectusi* (pig lungworm), 1569  
*Metastrongylus salmi* (pig lungworm), 1569  
 Metazoan agents, gastritis etiology, 258  
 Methadone hydrochloride, 2058  
 Methallibure, 134  
 Methane gas poisoning, 1848–1849  
 Methemoglobinemia, 460  
   anemia, 455, 457  
   nitrate poisoning, 1857  
 Methicillin, 181, 2058  
 Methiocarb poisoning, 1840  
 Methionine, 2033, 2058  
 Methocarbamol, 2058  
 4-methoxypropyridone poisoning, 1888  
 Methyl alcohol poisoning, 1848  
 Methylazoxymethanol (MAM) glycoside poisoning, 1885  
 Methyl bromide poisoning, 1846  
 3-methylendolefine (3MEIN), 2001  
 Methylene blue, 1858, 2058  
 3-methylindole (3MI)  
   acute bovine pulmonary emphysema and edema, 1999, 2001, 2003–2004  
   goat pulmonary function, 2002  
   interstitial pneumonia in feedlot cattle, 2000–2001  
   pulmonary function, 2001–2002  
 Methylmalonic acid (MMA), 1703–1704  
 S-methyl-methionine-sulphonium chloride (MMSC), 1997  
 Methylprednisolone, 2058  
 Methylprednisolone acetate, 2058  
 Methylprednisolone sodium succinate, 2058  
 Methylxanthines, 496  
 Metoclopramide  
   alimentary tract hypomotility treatment, 204  
   contraindications, 204  
   dosage/interval, 204, 2058  
   indications for, 204  
   simple indigestion, 313  
 Metritis  
   *Arcanobacterium pyogenes*, 788  
   *Brucella suis*, 990  
   maternal, *Listeria monocytogenes* infection, 808  
   milk fever complication, 1630  
   septic postpartum see Septic metritis, postpartum  
 Metronidazole, 273, 2058  
 Mexico, brucellosis status, 965  
 Mezlocillin, 2059  
 Miconazole, 1481  
 Microangiopathy, 434  
 Microcystin, 1913  
*Microcystis aeruginosa*, 1913  
 Microfilariae  
   *Elaeophora*, 1573  
   *Onchocerca*, 1573  
 Microflora, antibiotic effects, 176  
 Microgametocyte, *Eimeria*, 1502  
 Microgamonts, *Sarcocystis*, 1507  
 Micrognathia, 280  
*Micronema delatrix* (*Halicephalobus gingivalis*), 1575  
 Microphakia, 1977  
 Microphthalmia, 1977  
 Microphthalmos, 1775  
*Micropolyspora faeni*, 1999  
 Microscopic agglutination test (MAT)  
   *Brachyspira hyodysenteriae*, 1116  
   *Haemophilus* septicemia, 1001  
   leptospirosis, 1101, 1103–1104  
   toxoplasmosis, 1521  
 Microscopy  
   bluetongue, 1303  
   bovine respiratory syncytial virus pneumonia, 1345–1346  
   caprine arthritis encephalitis, 1412  
   East Coast fever, 1529  
   equine herpesvirus 1, 1315  
   equine neorickettsiosis, 1467  
   nagana, 1535  
   neonatal viral diarrhoea, 1292  
   papillomatosis, 1422  
   peste des petits ruminants, 1243  
   porcine viral encephalomyelitis, 1406  
   post-weaning multisystemic wasting syndrome, 1190  
   Q fever, 1469  
   swine influenza, 1334  
*Microsporium canis*, 1476  
*Microsporium gypsum*, 1476, 1477  
*Microsporium nanum*, 1476, 1477  
 Microtiter techniques, antimicrobial sensitivity, 175–176  
*Micruroides* (coral snake), 1916  
*Micrurus* (coral snake), 1916  
 Micturition abnormalities, 547  
 Midazolam hydrochloride, 2059  
 Middle ear infection see Otitis, media  
 Midge (*Culicoides*)  
   African horse sickness virus transmission, 1180, 1182  
   biting, 1604–1605  
 Midline abscesses, horses, 788–789  
 Midstream voiding, urine sampling, 549  
 Migrating myoelectric complex, 189–190  
 Migrating parasite larvae, 121  
 Milbemycins see Macrocylic lactone anthelmintics (MLs)  
 Milk  
   antimicrobial residues, 185, 695–696  
   beta-hydroxybutyrate levels, 1664–1665  
   blood in, 751–752  
   bovine spongiform encephalopathy infectivity, 1449  
   bulk tank see Bulk tank milk  
   calcium concentration, 138  
   caprine arthritis encephalitis transmission, 1411

## Milk (Cont'd)

contamination, 684  
 arsenic, 1809  
*Brucella abortus*, 967, 972–973  
*Brucella melitensis*, 992–993  
*Coxiella burnetii*, 1468  
 lead, 1801, 1803, 1805–1807  
*Mycobacterium avium* subspecies  
*paratuberculosis* (Map), 1019, 1022, 1023  
*Salmonella*, 899  
*Salmonella typhimurium* DT104, 906–907  
 selenium, 1750  
 copper levels, 1717  
 culture  
 coliform mastitis, 714  
 cow selection for, 746–747  
 mastitis, 684–685  
*Mycobacterium avium* subspecies  
*paratuberculosis* (Map), 1027  
 sample collection timing, 746  
*Staphylococcus aureus* mastitis, 700  
*Streptococcus agalactiae* mastitis, 704  
 under health monitoring, 746  
 digestion, dietary diarrhea, 278  
 discoloration, bovine mastitis, 682  
 electrical conductivity, 685, 687  
 electrolyte concentration, mastitis diagnosis,  
 673  
 endotoxin tests, coliform mastitis, 714  
 fat:protein ratio, ketosis, 1665  
 ketone levels, 1664–1665, 1667, 1675  
 left-side displacement of abomasum, 359  
*Listeria monocytogenes* infection, 807  
 louping-ill virus excretion, 1408  
 mastitis, abnormalities in, 684–685  
 mastitis-metritis-agalactia syndrome, 757  
 overfeeding, dietary diarrhea, 277  
 pasteurization, *Mycobacterium avium*  
 subspecies *paratuberculosis* (Map)  
 survival, 1022  
 production/yield, 1617  
 bovine herpesvirus-1 infection, 1353  
 bovine mastitis effects, 681  
 bovine mastitis risk factor, 678  
 bulk tank milk somatic cell count, 683  
 clinical bovine mastitis, 748  
 cold cow syndrome, 1987  
 at dry off, 738  
 foot-and-mouth disease, 1225  
 Johne's disease, subclinical, 1022–1023  
 ketosis, 1663, 1664  
 left-side displacement of abomasum risk,  
 356  
 mastitis, bovine, 680–681  
 milk fever and, 1630  
 neosporosis, 1510  
 nutrition and, 1696  
 phosphorus supplementation effect, 1762  
 protein, dietary and, 1621  
 somatic cell count increase induced, 748  
 starvation, 113  
 stress and, 109  
 tick-borne fever, 1461  
 pseudorabies excretion, 1396  
 radionuclide excretion, 1786  
 regurgitation, persistence of the right aortic  
 arch, 433  
 sampling technique, 684  
 selenium levels, 1742, 1746  
 somatic cell count see Somatic cell count  
 (SCC)  
 tainting, glucosinolate poisoning, 1868  
 unpasturized consumption, 887, 989  
 vitamin E transfer to, 1742–1743  
 withholding, neonatal viral diarrhea, 1294  
 withholding period, 184, 695–696  
 anthrax vaccination, 819  
 failure, 185  
 see also Entries beginning milking  
 Milk allergy, 1935–1936  
 Milk claw, 735–736  
 Milk drop syndrome, 753, 1097, 1099, 1102  
 Milk ejection reflex failure, 754  
 Milk enzyme-linked immunosorbent assay  
 (ELISA), bovine leukemia virus, 1217  
 Milkers' nodule (pseudocowpox), 749, 750,  
 1381, 1427–1428  
 Milk fever, 80–81, 1614, 1626–1644  
 case fatality rate, 1628  
 cattle, 1632  
 clinical care procedures, 1638  
 clinical findings, 1632

clinical pathology, 1632–1633  
 complications, 1630, 1644, 1645  
 control, 1638–1643  
 diagnosis, 1633  
 differential diagnosis, 1633–1634, 1633–1636  
 economic importance, 1630  
 epidemiology, 1627–1630  
 etiology, 1627  
 goats, 1628, 1632  
 hypomagnesemia and, 1656  
 incidence, 1641  
 management, general, 1638  
 morbidity, 1628  
 outbreaks, 1627–1628  
 pathogenesis, 1630–1631  
 pigs, 1632  
 relapses, 1630  
 risk factors, 1628–1630  
 sheep, 1628, 1632  
 stages of, 1632  
 susceptibility to, 1627  
 treatment, 1636–1638  
 see also Hypocalcemia  
 'Milk impacts,' 735  
 Milking machine  
 attachment method, 732  
 backflushing, 734  
 bulk milk tank, 736  
 see also Bulk tank milk  
 cluster dunking, 734  
 coliform mastitis control, 718  
 components, 734–736  
 evaluation of, 736–737  
 function, 734–737  
 installation, 734–737  
 machine stripping minimization, 732  
 maintenance, 734–737, 736–737  
 milk claw, 735–736  
 milk pipeline, 736  
 milk transport system, 735  
 pulsation system, 735  
 removal, 732  
 system function, 734  
 teat liner (inflation), 735  
 disinfection, 734  
 replacement interval, 735  
 slip avoidance, 732  
 udder health relationship, 736  
 vacuum system, 734–735  
 Milking practices  
 characteristics, bovine mastitis risk factor, 677  
 coliform mastitis control, 718  
 mastitis check, 732  
 mastitis control program, 731–734  
 mastitis risk factors, 679  
 milking order establishment, 733–734, 747  
 postmilking udder hygiene, 732–733  
 premilking udder hygiene, 731–732  
 schedule management, 731  
 segregation programs, 733–734  
 volume measurement, 736  
 see also Bovine mastitis, control; Milking  
 machine  
 Milk line sampling, 684  
 Milk pipeline, 736  
 Milk replacers  
 abomasal bloat (distension), 374  
 abomasal ulcers and, 371–372  
 dietary diarrhea, 277, 278  
 hypomagnesemic tetany and, 1659  
 indigestion in calves, 314  
 iron supplementation, 1728  
 newborns, 158–159  
 Milk ring test, 972–973, 982  
 Milk transport system, 735  
 Milk urea nitrogen (MUN), 1621  
 Milk vine (*Marsdenia rostrata*) poisoning, 1886  
*Mimosa pudica* (sensitive plant) poisoning, 1884  
 Mimosine poisoning, 1884  
 Mineral(s)  
 deficiency, 1698–1771  
 developing countries, 1699  
 diagnosis, 1699, 1700–1701  
 economic importance, 1698–1699  
 incidence, 1698–1699  
 individual differences of impact, 1698  
 phases of, 1700–1701  
 trace element deficiency pathophysiology,  
 1699, 1699–1700  
 see also specific minerals  
 metabolism, endotoxemia and, 56  
 nutrition, metabolic profile testing, 1622

reference laboratory values, 2048, 2049  
 tolerance, 1798, 1798  
 Mineral oil  
 abomasal impaction (dietary), 369  
 bloat, 332  
 dosage/interval, 2059, 2065  
 equine colic, 227  
 sand colic, 254  
 Mine spills, 1785  
 Ministry of Food, Agriculture and Fisheries  
 (Denmark), salmonellosis surveillance  
 and control program, 918  
 Minocycline, 2059  
 Miosis, 588  
 Miracidia, 1576, 1577  
 Miserotoxin, 1872  
 Mis-mothering, hypothermic neonatal lambs,  
 141  
 Misoprostol, 2059  
 Mitchell grass, *Corallocystroma*  
*ornicoproides* growth, 1912  
 Mite infestations, 1606–1612  
 Mitral valve, 405, 422  
 Mixed venous oxygen tension, 400  
 Mobile phone network, electromagnetic fields,  
 1795  
 Mobitz type 1 second-degree atrioventricular  
 block, 415  
 Mobitz type 2 second-degree atrioventricular  
 block, 415  
 Modified live virus (MLV) vaccine  
 African swine fever, 1172  
 bovine herpesvirus-1 infection, 1356–1357  
 bovine respiratory syncytial virus pneumonia,  
 1348  
 bovine virus diarrhea virus, 1269–1270  
 calf diarrhea, 1294  
 equine arteritis virus, 1321–1322  
 equine herpesvirus 1, 1316  
 equine influenza, 1327  
 porcine reproductive and respiratory  
 syndrome, 1203–1204  
 pseudorabies, 1402  
 Modified Mules operation, 1593  
 Modified Ziehl-Neelsen, cryptosporidiosis, 1514  
 Mokola virus, 1386  
 Molar teeth, inherited displaced, 1959  
 Molasses, 1720, 2009  
 Mold  
 contamination assessment, 1934  
 hypersensitivity, interstitial pneumonia, 1999  
 inhalation, heaves, 1928, 1934  
 'Mole' calves, 1961  
 Molluscicide poisoning, 1840  
 Mollusc contagiosum, 658  
 Molopo moth ingestion, 1920  
 Molybdenosis, 1266  
 Molybdenum  
 copper deficiency risk factors, 1710  
 copper interaction, 1713–1714  
 excess  
 copper deficiency, secondary, 1707, 1708  
 soil, 1710–1711  
 poisoning, 1819–1820  
 polioencephalomalacia, 2008  
 sulfate interaction, 1713–1714  
 Monensin  
 acute bovine pulmonary emphysema and  
 edema, 2003–2004  
 bloat, 335–336  
 coccidiosis, 1505, 1506  
 controlled-release capsules (CRC), 1614, 1677  
 bloat, 335–336  
 left-side displacement of abomasum  
 prevention, 361  
 dosage/interval, 2059  
 Johne's disease, 1031–1032  
 liquid formulation, 335–336  
 mechanism of action, 1615  
 poisoning, 1844–1845  
 sarcocystosis, 1509  
 swine dysentery, 1118  
 toxoplasmosis, 1522  
 Monensin-tiamulin poisoning, 1845  
 Mongoose, rabies vector, 1385  
*Moniezia benedeni*, 1581  
*Moniezia expansa*, 1581  
 Monkey, vesicular stomatitis, 1233  
 Monkey rope (*Cynanchum*) poisoning,  
 1885–1886  
 Monochloroacetate (SMCA) poisoning, 1838  
 Monoclonal antibody, 15C5, 1261

- Monoclonal antigen-capture ELISA, bovine virus diarrhea virus, 1261  
 Monocyte phagocytic system, disseminated intravascular coagulopathy, 448  
 Monocytes  
   babesiosis, 1488  
   reference laboratory values, 2047  
 Monocytic hyperchromic regenerative anemia, 1190  
 Monogastric stomach inflammation, 258–259  
 Monoglyceride poisoning, 1883–1884  
 Moniodiacetate (MIA), 642  
 Monosodium dihydrogen phosphate, 1763  
 Monosodium methyl arsenate poisoning, 1838  
 Monosodium phosphate, 82  
*Monosporium apiospermum*, 1481  
 Montana progressive pneumonia see Ovine progressive pneumonia  
 Montwick Red Apple Sovereign, 1945  
 Moose sickness, 1575, 1701, 1703, 1708–1709  
 Morantel citrate monohydrate, 1545  
 Morantel tartrate, 2059  
*Moraxella bovis*, 994–997, 1142  
 Morbidity, history-taking, 5  
 Morbillivirus, 1237  
 Morel's disease, 797  
 Moreton Bay chestnut (*Castanospermum australe*) poisoning, 1871  
 Morphine sulfate, 2059, 2065  
 Mortellaro's disease see Papillomatosis, digital dermatitis of cattle (Mortellaro's disease)  
*Mortierella wolfii*, 395, 1471, 1472, 1473  
 Morulae see Inclusion bodies (morulae)  
 Mosquitoes, 1605  
   bluetongue transmission, 1300  
   bovine ephemeral fever transmission, 1177–1178  
   control, 1605  
   diseases transmitted, 1605  
   epizootic hemorrhagic disease transmission, 1305  
   Getah virus transmission, 1383  
   Japanese encephalitis, 1377  
   lumpy skin disease vector, 1425  
   Ross River virus transmission, 1383  
   Venezuelan equine encephalomyelitis, 1373  
   West Nile encephalitis, 1378–1379  
   see also *individual species*  
 Mosquito-proof screens, 1605  
 Moth damage, 1920  
 Mothering  
   colostral immunoglobulins absorption, 153  
   poor, neonatal mortality, 129, 143–144  
 Motor system, 581  
 Mountain sickness (brisket disease), 422, 1788–1789  
 Mount St Helens, 1791, 1792  
 Mouse inoculation test, rabies, 1390  
 Mouse neutralization tests, *Clostridium perfringens* type D enterotoxemia, 842  
 Mouth  
   examination, 11, 18–19  
   inherited defects, 1944  
 Mouth ulcer, plant sources, 1895  
 Movement abnormality, 621  
   peritonitis, 284  
 Movement restrictions  
   equine arteritis virus, 1320  
   equine babesiosis, 1490  
   equine infectious anemia, 1177  
   vesicular stomatitis, 1235  
 Moxalactam, 2059  
 Moxidectin  
   ascaris infections, 1557  
   bovine lungworm, 1566  
   bunostomosis, 1553  
   chorioptic mange, 1612  
   dosage/interval, 2059, 2065  
   *Gasterophilus* infestation, 1586  
   hemochromosis, ruminants, 1550  
   louse infestations, 1598  
   oesophagostomosis, 1554  
   onchocercosis, 1573  
   parasitic gastroenteritis, ruminants, 1545, 1546  
   psoroptic mange, 1611  
   sarcoptic mange, 1609  
   strongylosis, 1561  
   summer sores, horse, 1572  
   tick infestations, 1602  
   wohlfahrtiosis, 1596  
 M proteins, 770, 774  
 Mucokinetics, 496  
 Mucolytics, 496, 1326  
 Mucoprotein, calculi, 566  
 Mucormycosis, 1472, 1473, 1481  
 Mucosal disease, 1249, 1254  
   acute, 1259, 1263  
   chronic, 1259, 1263  
   clinical findings, 1265  
   clinical pathology, 1265  
   death, 1258, 1259  
   differential diagnosis, 1264  
   epidemiology, 1265  
   necropsy findings, 1263  
   pathogenesis, 1258  
   see also Bovine virus diarrhea virus (BVDV)  
 Mucous membranes  
   alimentary tract disease in cattle, 301  
   equine colic, 220, 223  
   foals, 230  
 Mucus  
   heaves, 1930  
   respiratory tract disease, 510  
 Mulberry heart disease  
   clinical findings, 1745  
   differential diagnosis, 1749  
   epidemiology, 1739  
   necropsy findings, 1748  
   pathogenesis, 1744  
   treatment, 1749  
   vitamin E and selenium deficiency, 1739  
 Mule(s)  
   alloimmune hemolytic anemia of the newborn, 1922  
   altitude effects, 1788  
   equine infectious anemia, 1173  
   septicemia, 51  
 Mule deer (*Odocoileus hemionus*)  
   bovine herpesviruses, 1349  
   chronic wasting disease, 1454  
   eleaophorosis, 1573  
   epizootic hemorrhagic disease, 1305  
   tuberculosis, *Mycobacterium bovis*, 1007  
 Mulesing, blowfly strike prevention, 1593  
 Mules operation, 1592, 1593  
 Mulga fern poisoning, 1875–1876  
 Mulga trees (*Acacia aneura*), 386  
*Mullerius capillaris*, lungworm, 1568–1569  
 Multifocal symmetrical encephalopathy, inherited, 1952  
 Multiple ankylosis, inherited, 1962  
 Multiple exostosis, 1961  
 Multiple myeloma, 462  
 Multiple organ defects, 281  
 Multiple tendon contracture, inherited, 1962  
 Multiplier herds, *Salmonella* surveillance program, 918  
 Multivalent vaccines, bovine herpesvirus-1 infection, 1358  
 Mummification, 1095, 1257  
 Murmurs, 423–427  
   acquired, 423  
   brisket disease, 1788  
   cattle, 423  
   clinical findings, 424–426  
   clinical pathology, 426  
   congenital, 423  
   continuous, 424  
   patent ductus arteriosus, 432–433  
   diastolic, 424–425  
   differential diagnosis, 426  
   endocarditis, 427–428  
   epidemiology, 423–424  
   etiology, 423  
   examination, 424–425  
   functional (innocent), 424, 425  
   functional systolic ejection, 425  
   hemic, 424  
   holodiastolic, 426  
   holosystolic, 425, 426  
   horses, 423  
   interpretation, 425–426  
   necropsy findings, 426  
   pansystolic, 426  
   pathogenesis, 424  
   physiological, 425  
   pigs, 423–424  
   point of maximum intensity (PMI), 425  
   presystolic, 425  
   systolic, 424, 426  
   treatment, 426  
   see also Valvular disease  
 Murray Grey cattle, inherited spinal myelinopathy, 1952  
 Murray's method, 1535  
 Murrina (surra), 1532, 1537–1538  
 Murrurrundi disease, 617, 1953  
*Musca autumnalis* see Face fly (*Musca autumnalis*)  
*Musca bezzii* (Asian face fly), 995  
*Musca confiscata*, lumpy skin disease vector, 1425  
*Musca domestica* see House flies (*Musca domestica*)  
 Muscarine poisoning, 1906  
*Musca vetustissima* (bush flies), 1606  
 Muscle(s)  
   asthenia, 622, 626  
   atrophy  
     central nervous system congenital defect, 619  
     equine protozoal myeloencephalitis, 1524  
   biopsy  
     exertional rhabdomyolysis, 1685  
     myopathy, 629–630  
     recurrent exertional rhabdomyolysis in Thoroughbred horses, 1968  
   bovine ephemeral fever, 1178  
   clostridial myositis see Blackleg damage, intravenous antimicrobials, 178  
   deformity, 621  
   degeneration, non-inflammatory see Myopathy  
   diseases associated with, 626–632  
   see also *specific diseases/disorders*  
   enzymes  
     milk fever, 1633  
     myopathy pathogenesis, 627  
   fasciculations, West Nile encephalitis, 1379  
   inherited diseases, 1962–1973  
   pain, exertional rhabdomyolysis, 1684  
   recurrent exertional rhabdomyolysis in Thoroughbred horses, 1967  
   spasms, central nervous system congenital defect, 619–620  
   tetany, 823  
   tone, 590  
   Venezuelan equine encephalomyelitis, 1373  
   weakness, 648  
     equine motor neuron disease, 2020  
 Muscle-derived serum enzymes, 629  
 Muscle fibers, 628  
 Muscle glycogen phosphorylase deficiency (glycogen storage disease type V), 1963  
 Muscular dystrophy  
   acute, 630  
   congenital, 1745  
   control, 1751–1752  
   enzootic  
     acute, 1744–1745  
     clinical findings, 1744–1745  
     differential diagnosis, 1749  
     pathogenesis, 1744  
     subacute, 1745  
   horses, 1745  
   inherited progressive, 1965  
   nutritional see Nutritional muscular dystrophy (NMD)  
   pigs, 1745  
 Muscular hypertrophy, intestinal obstruction, 244  
 Musculoskeletal (somatic) pain, 103, 104, 105, 625  
 Musculoskeletal system  
   bone disease, 632–637  
   congenital defects, 648–649  
   deformity, 621, 625, 648–649  
   differential diagnosis, 622–624  
   disease associated with, 621–649  
   see also *specific diseases/disorders*  
   dyspnea/exercise intolerance from, 475  
   examination, 625–626  
     cattle, ultrasonography, 625–626  
     clinical, 20  
     downer cow syndrome, 1647  
     sheep, 625  
   exercise intolerance etiology, 118, 119  
   inherited defects, 1957–1961  
   joint disease, 637–648  
   lameness see Lameness  
   manifestations, 621–626  
   movement abnormality, 621  
   muscle disease, 626–632  
   posture abnormality, 621  
   spontaneous fractures, 625  
   uncertain etiology, 2023–2037

- Mushroom poisoning, 1908  
Musk ox, orf, 1418  
Mustard oil glucosinolate poisoning, 1867, 1868  
Mutagen attenuated vaccine, Rift Valley fever, 1207  
Mutagenically separated PCR (MS-PCR), porcine stress syndrome, 1972  
Mutations, radiation injury, 1787  
Muzzle, diseases of, 205  
Muzzle foals, dietary diarrhea, 279  
Muzzle tremors, rabies, 1389  
Myasthenia (skeletal muscle asthenia), 622, 626  
Mycobacteriosis, 1014–1016  
  clinical findings, 1015  
  clinical pathology, 1015–1016  
  control, 1016  
  economic importance, 1015  
  epidemiology, 1015  
  etiology, 1014–1015  
  infection source, 1015  
  necropsy findings, 1015  
  transmission, 1015  
  treatment, 1016  
  zoonotic importance, 1015  
Mycobacterium, diseases associated with, 1007–1044  
  granulomatous enteritis, horses, 1992  
  mastitis, 727  
Mycobacterium avium, 1014–1015  
Mycobacterium avium-intracellulare complex, 1014–1016  
  see also Mycobacteriosis  
Mycobacterium avium subspecies paratuberculosis (Map)  
  chemotherapeutic agent resistance, 1031  
  environmental dormancy, 1022  
  epidemiology, 1041–1042  
  fetal infection, 1020  
  genome studies, 1042  
  Johne's disease, 1017–1044  
  risk factors associated with, 1021–1022  
  strains, 1017  
  survival, 1022  
  thermal resistance, 1022  
  vaccines, 1042–1043  
Mycobacterium bovis, 1007–1014  
  see also Tuberculosis  
Mycobacterium chelonae mastitis, 727  
Mycobacterium farcinogenes, 1017  
Mycobacterium fortuitum mastitis, 727  
Mycobacterium intracellulare, 1014  
Mycobacterium lacticola mastitis, 727  
Mycobacterium phlei, 111  
Mycobacterium senegalense, 1017  
Mycobacterium smegmatis mastitis, 727  
Mycobacterium tuberculosis, 1016  
Mycoplasma, 1123–1156, 1124  
  antimicrobial sensitivity, 1124  
  arthritis, 644, 1126–1127  
  enzootic pneumonia of calves, 1336, 1338–1339  
  necropsy findings, 1341  
  pathogenesis, 1339  
  treatment, 1341–1342  
  eye disease, 1126  
  genital tract disease, 1125  
  interstitial pneumonia, 2000  
  joint disease, 1126–1127  
  polyarthritis, 1126–1127  
  respiratory tract disease, 1126  
Mycoplasma adleri, 1126  
Mycoplasma agalactiae  
  contagious agalactia, sheep, 1138–1140  
  contagious ophthalmia, 1142  
  diseases associated with, 1125  
  mastitis, caprine, 761  
  respiratory tract disease, 1126  
  vaccine, 1139  
Mycoplasma agalactiae var. bovis, 1125  
Mycoplasma alkalescens, 926, 1141  
Mycoplasma arginini, 1125, 1142, 1336  
Mycoplasma bovigenitalium, 1124, 1125  
Mycoplasma bovirhinis, 1124, 1336, 1338  
Mycoplasma bovis  
  antibiotic resistance, 1342  
  antimicrobial susceptibility, 1142  
  arthritis, 1141–1142  
  bovine mastitis, 674, 1125–1126, 1127–1131  
  enzootic pneumonia of calves, 1336, 1337, 1340  
  epidemiology, 1123–1124  
  genital tract disease, 1125  
  Mannheimia haemolytica synergism, 938  
  mastitis see Mycoplasma mastitis  
  mechanism of action, 1124  
  otitis externa, 1129  
  otitis interna, 1128, 1129  
  otitis media, 1128, 1129  
  pathogenicity, 1128  
  pneumonia, 924  
  properties of, 1125  
  respiratory tract disease, 1126  
  undifferentiated bovine respiratory disease, 926  
  vaccines, 1130, 1142, 1343  
  virulence, 1128  
Mycoplasma bovis pneumonia, 1127–1131  
  clinical findings, 1129  
  clinical pathology, 1129  
  control, 1130  
  diagnosis, 1129  
  differential diagnosis, 1130  
  epidemiology, 1127–1128  
  etiology, 1127  
  necropsy findings, 1129–1130  
  outbreaks, 1127–1128  
  pathogenesis, 1128–1129  
  risk factors, 1128  
  transmission, 1128  
  treatment, 1130  
Mycoplasma bovis polyarthritis, 1127–1131  
  clinical findings, 1129  
  clinical pathology, 1129  
  control, 1130  
  diagnosis, 1129, 1130  
  differential diagnosis, 1130  
  epidemiology, 1127–1128  
  etiology, 1127  
  necropsy findings, 1129–1130  
  outbreaks, 1127–1128  
  pathogenesis, 1128–1129  
  risk factors, 1128  
  transmission, 1128  
  treatment, 1130  
Mycoplasma bovovulvi, 994, 1126  
Mycoplasma californicum, 1125–1126, 1141  
Mycoplasma canadense mastitis, 1125–1126  
Mycoplasma canis, 1124, 1336, 1339  
Mycoplasma capricolum, 1123, 1125, 1127  
Mycoplasma capricolum subsp. capricolum, 1138–1140  
Mycoplasma capricolum subsp. capripneumoniae, 1140–1141  
Mycoplasma conjunctivae, 1142–1143  
Mycoplasma dispar  
  enzootic pneumonia of calves, 1336, 1337, 1338–1339  
  epidemiology, 1124  
  respiratory tract disease, 1126  
  undifferentiated bovine respiratory disease, 926  
Mycoplasma equirhinis, 1127  
Mycoplasma haemosuis, 1154  
Mycoplasma hyopneumoniae  
  mechanism of action, 1147  
  peribronchiolar lymphoreticular hyperplasia, 1147  
  pneumonia, pigs, 1144–1152  
  porcine reproductive and respiratory syndrome virus co-infection, 1196, 1199  
  vaccine, 1151  
  post-weaning multisystemic wasting syndrome, 1186, 1187  
  virulence factors, 1145  
Mycoplasma hyorhinis, 1126–1127, 1152–1154  
Mycoplasma hyosynoviae, 1126–1127, 1152–1154  
Mycoplasma arthritis  
  cattle, 1141–1142  
  pigs, 1152–1154  
Mycoplasma pneumoniae, pigs, 1144–1152  
  case fatality rate, 1144  
  clinical findings, 1147–1148  
  clinical pathology, 1148  
  control, 1149–1151  
  diagnosis, 1149  
  economic importance, 1146–1147  
  epidemiology, 1144–1147  
  eradication, 1149  
  etiology, 1144  
  immune mechanisms, 1145  
  incubation period, 1147  
  isolated farrowing, 1150  
  low-level disease, 1150–1151  
  morbidity, 1144  
  necropsy findings, 1148–1149  
  pathogenesis, 1147  
  prevalence, 1144  
  risk factors, 1144–1146  
  transmission, 1144  
  treatment, 1149  
  vaccination, 1150, 1151  
Mycoplasma polyserositis, pigs, 1152–1154  
  clinical findings, 1153  
  clinical pathology, 1153  
  control, 1154  
  diagnosis, 1153–1154  
  epidemiology, 1152–1153  
  etiology, 1152  
  necropsy findings, 1153–1154  
  pathogenesis, 1153  
  treatment, 1154  
Mycoplasma mastitis, 705–708, 1125–1126, 1127–1131  
  clinical findings, 706–707, 1129  
  clinical pathology, 707, 1129  
  control, 707, 1130  
  diagnosis, 707  
  differential diagnosis, 707, 1130  
  economic importance, 706  
  epidemiology, 706, 1127–1128  
  etiology, 705–706, 1127  
  infection source, 706  
  necropsy findings, 707, 1129–1130  
  outbreaks, 1127–1128  
  pathogenesis, 706, 1128–1129  
  risk factors, 706  
  transmission, 706, 1128  
  treatment, 707, 1130  
Mycoplasma mycoides  
  contagious bovine pleuropneumonia, 1123  
  diseases associated with, 1125  
  mastitis, caprine, 761  
  respiratory tract disease, 1126  
Mycoplasma mycoides subsp. capri, 1126, 1361  
Mycoplasma mycoides subsp. mycoides  
  arthritis, 1127  
  chronic enzootic pneumonia of sheep, 1361  
  contagious agalactia, sheep, 1138–1140  
  contagious bovine pleuropneumonia, 1131–1138  
  properties of, 1125  
  seminal vesiculitis, 1125  
  vaccine, 1136–1137  
  variants, 1131  
  virulence, 1133  
Mycoplasma ovipneumoniae, 1362  
  chronic enzootic pneumonia of sheep, 1361  
  diseases associated with, 1125  
  respiratory tract disease, 1126  
Mycoplasma ovis, 1154  
Mycoplasma pneumoniae infection, 510  
Mycoplasma putrefaciens, 1125, 1138  
Mycoplasma putrefaciens, 1361  
Mycoplasma suis pneumoniae see Mycoplasma hyopneumoniae  
Mycoplasma (Eperythrozoon) suis, 1126  
Mycoplasma wenyonii, 1154  
Mycoplasmology  
  mycoplasma pneumoniae, pigs, 1149  
  polyserositis, pigs, 1153  
Mycoplasmosis, 57, 1127  
Mycosis-fungoides, 463  
Mycotic abortions, 976, 1471–1472, 1473  
Mycotic dermatitis see Dermatophilosis  
Mycotic nasal granuloma, 1936  
Mycotic placentitis, 1472, 1473  
Mycotic pneumonia, 1472, 1473  
Mycotic rhinitis, 530  
Mycotic stomatitis, 206  
Mycotoxins, 1898–1913  
  control measures, 1898  
  diagnosis, 1898  
  economic loss, 1898  
  identification of, 1898  
  interstitial pneumonia, 1999–2000  
  syndromes of, 1898, 1899  
  veterinary services for, 1898  
  see also specific types  
Mydriasis, 588  
Myelitis, 617  
Myeloencephalopathy, inherited progressive degenerative (Weaver syndrome), 1952  
Myelography, 593  
  equine cervical vertebral stenotic myelopathy, 2017  
  spinal cord compression, 616



Myelomalacia, 617–618  
 Myelopathy, chronic compressive (wobbles), 615–616  
 Myelophthistic disorders, 1492  
 Myeloproliferative diseases, 461–462  
 Myiasis, cutaneous see Cutaneous myiasis  
*Mylabris phalerata* (Chinese blister beetle/fly), 1918  
 Myocardial degeneration, 1521  
 Myocardial depression, sodium fluoroacetate poisoning, 1839  
 Myocardial disease, 420–422  
   atrial fibrillation and, 418  
   clinical findings, 421  
   clinical pathology, 421  
   congenital, 421  
   differential diagnosis, 422  
   etiology, 420–421  
   heart failure, chronic (congestive), 401  
   necropsy findings, 421–422  
   pathogenesis, 421  
   premature complexes, 416  
   treatment, 422  
 Myocardial fibrosis, 421–422  
 Myocardial necrosis, encephalomyocarditis virus disease, 1184  
 Myocardiopathy, poison-induced, 125  
 Myocarditis  
   acute focal, 1646  
   bacterial, 420  
   bovine virus diarrhoea virus and, 1263  
   equine influenza, 1325  
   *Haemophilus* septicemia, 998, 1001  
   parasitic, 420  
   viral, 420  
 Myoclonia congenita see Congenital tremor syndromes of piglets  
 Myoclonus, 579  
   congenital (hereditary neuraxial edema), 1956–1957  
   equine hendra virus infection, 1329  
 Myocytes, recurrent exertional rhabdomyolysis, 1968  
 Myodesmone poisoning, 1892  
 Myofiber hyperplasia, 1964–1965  
   congenital, 648  
 Myofibrillar hypoplasia, 2024–2025  
 Myoglobin, recurrent exertional rhabdomyolysis, 1967  
 Myoglobinuria, 546  
   exertional rhabdomyolysis, 1685  
   grazing horses, 1686  
   horses, 1686  
   myopathy and, 627, 630  
   nephrosis, 627  
   recurrent exertional rhabdomyolysis in Thoroughbred horses, 1968  
 Myoglobulin, exertional rhabdomyolysis, 1685  
 Myopathic agents, 1738  
 Myopathy, 626–631  
   acute nutritional, 628  
   atypical, grazing horses, 1686  
   clinical findings, 628–629  
   clinical pathology, 629–630, 1745–1746  
   control, 630  
   degenerative, 627, 645, 1635  
   differential diagnosis, 630  
   epidemiology, 626–627  
   etiology, 626–627  
   inherited, 627  
   mycotic, 1473  
   necropsy findings, 630  
   pathogenesis, 627–628  
   plant-induced, 1897  
   primary, 627, 628  
   secondary, 628, 629, 630  
   treatment, 630  
 Myophosphorylase deficiency, 1963  
*Mycoporum* poisoning, 1892  
 Myositis, 622, 631–632  
 Myositis ossificans, 631  
 Myotectomy, 2019  
 Myotoxins, venoms, 1917  
 Myrothecio toxicosis, trichothecene poisoning, 1910  
*Myrothecium roridum*, 1910  
*Myrothecium verrucaria*, 1897, 1910  
 Mystery swine disease see Porcine reproductive and respiratory syndrome (PRRS)  
 Myxedema, iodine deficiency, 1724

## N

*N*-acetyl- $\beta$ -D-glucosaminidase (NAGase), 685, 686  
 Nafcillin, 2059  
 Nagana, 1531–1537, 1532  
   carriers, 1533  
   case fatality rate, 1532–1533  
   clinical findings, 1534–1535  
   clinical pathology, 1535  
   control, 1536  
   differential diagnosis, 1535  
   drug resistance, 1535–1536  
   economic importance, 1534  
   epidemiology, 1532–1534  
   etiology, 1531–1532  
   experimental reproduction, 1534  
   goats, 1532–1533  
   immune mechanisms, 1533–1534  
   mixed infection, 1532, 1534  
   morbidity, 1532–1533  
   necropsy findings, 1535  
   occurrence, 1532  
   pathogenesis, 1534  
   pigs, 1532  
   prevalence, 1532  
   prophylaxis, 1536  
   relapse, 1536  
   risk factors, 1533  
   secondary infection, 1534  
   sheep, 1532–1533  
   transmission, 1533  
   treatment, 1535–1536  
   zoonotic implications, 1534  
 Naganol (suramin), 1536, 1538, 1540  
 NAGase activity, 685, 686  
 NAGase test, 686–687  
 Nairobi sheep disease, 1244–1245, 1601  
 Nairobi sheep disease virus (NSDV), 1244  
*Naja* (cobra), 1916  
 Naloxone, 204, 2059  
 Narasin poisoning, 1844–1845  
 Narcolepsy (catalepsy), 584  
   familial, horses, 1957  
   nervous system disease, 578  
 Narcotic analgesics, 106, 2033  
 Nardoo fern (*Marsilea drummondii*), 1883, 2007  
 Nasal bots, 1586–1587  
 Nasal cavity obstruction, 531–532  
 Nasal discharge  
   bluetongue, 1302  
   bovine besnoitiosis, 1517–1518  
   equine pleuropneumonia, 526  
   examination, 18, 480  
   lesion location, 480  
   origin of, 479  
   ovine pulmonary adenocarcinoma, 1367  
   respiratory insufficiency manifestation, 479–480  
   sampling, 480  
   strangles transmission, 769  
 Nasal granuloma, 1474, 1936  
   cattle, 1475, 1936  
   enzootic, 925, 1936  
   mycotic, 1936  
   *Rhinosporidium*, 1475  
 Nasal insufflation, oxygen therapy, 494  
 Nasal lavage, 484  
 Nasal mucosa inflammation see Rhinitis  
 Nasal reflux, esophageal obstruction, 213  
 Nasal swab, 484  
 Nasogastric intubation  
   abdominal examination, 17  
   alimentary tract examination, 195–196  
   equine colic, 222, 224, 231  
   esophageal obstruction, 213, 214  
   gastric dilatation, 233, 234  
   gastric (gastroduodenal) ulcer, 236  
 Nasopharyngeal exudate sample collection  
   equine herpesvirus 1, 1315  
   equine herpesvirus 4, 1311  
   equine influenza, 1325  
 Nasopharyngeal swab, 484  
 Nasopharynx, foot-and-mouth disease, 1224  
 Natamycin, 1474  
 National Academy of Sciences, 885  
 National Advisory Committee on Microbiological Criteria for Foods (NACMCF), 885  
 National Animal Health Monitoring System (NAHMS)  
   Dairy Study (2002), milk fever, 1628  
   digital dermatitis, 1066  
   intramuscular injection sites, 631  
   John's disease, 1022, 1040  
   pneumonic pasteurellosis, 935  
   undifferentiated bovine respiratory disease, acute, 929  
 National Cattlemen's Beef Association (NCBA), carcass decontamination, 887  
 National Committee on Clinical Laboratory Standards/Veterinary Antimicrobial Susceptibility Testing Subcommittee (NCCLS/ASTS), 929  
 National Institute for Research in Dairying (NIRD)  
   bovine mastitis control strategies, 728  
   udder health status monitoring, 730  
 National John's Disease Program Standard Definitions and Rules, 1038  
 National John's Working Group, 1041  
 National Mastitis Council (NMC)  
   bovine mastitis control strategies, 728  
   milking management practice, 732  
   udder health status monitoring, 730  
 National Paratuberculosis Certification Program, 1037  
 National Passport, equine influenza, 1328  
 National Research Council (NRC), USA  
   copper to molybdenum ratio, 1708  
   nutrient requirements, swine, 1695  
   nutritional management, dairy cows, 1677  
 National Research Council (NRC) of the National Academies, Washington DC, 2003, John's disease diagnosis and control, 1039–1043  
 National Scrapie Eradication Program, 1454  
 National Scrapie Flocks Scheme, UK, 1445  
 National Scrapie Plan, 1445, 1454  
 'Natural vaccination,' border disease, 1417  
 Navel (umbilical) bleeding, 444, 446  
 Navel ill, 148, 159–160, 309, 644  
 Near drowning, 1793–1794  
 Near East, brucellosis status, 964  
 Neck  
   examination, 11, 17–19, 589–590  
   posture, 579  
 Necrosis  
   cold injury, 1794  
   malignant catarrhal fever, 1247  
   subcutis, 666  
 Necrotic enteritis of pigs  
   clinical findings, 839  
   *Clostridium perfringens*, types B and C, 838–839  
   endemic, 839  
   etiology, 1088  
   outbreaks, 838  
   peracute, 839  
   prevention, 840  
   risk factors, 838–839  
   see also Ileitis  
 Necrotic granulomata, toxoplasmosis, 1521  
 Necrotic rhinitis, 1080  
 Necrotic stomatitis, 1079, 1080, 1266  
 Necrotic ulcer, *Borrelia suis*, 1123  
 Necrotizing bronchiolitis, swine influenza, 1334  
 Necrotizing endometritis, bovine herpesvirus-1 infection, 1353  
 Necrotizing pneumonia, *Actinobacillus suis*, 1045  
 Necrotizing vasculitis, 443, 1248  
 Neethling poxvirus, lumpy skin disease, 1425  
 Negative predictive value (NPV), 27, 27–28  
 Negri bodies, rabies, 1390  
 Nematode diseases, 1541–1576  
   alimentary tract, 1541–1564  
   eye, 1575–1576  
   nervous system, 1575–1576  
   skin conditions, 1571–1574  
   see also specific diseases/disorders  
 Nematode galls of pasture grasses, *Rathayibacter toxicus*, 1914–1915  
*Nematodirus*, 1541  
   age resistance, 1542  
   control, 1548  
   eggs, 1541, 1543  
   transmission, 1542  
   see also Trichostrongylid worms  
 Nematophagous fungi, strongylosis control, 1561

- Neomycin, 1989, 2059  
 Neomycin sulfate, 2065  
 Neonatal infection, 146–160  
   clinical findings, 148  
   clinical pathology, 148  
   control, 149  
   control and prevention, 157–159  
   differential diagnosis, 148  
   epidemiology, 147–148  
   etiology, 146–147  
   pathogenesis, 148  
   risk factors, 147  
   *Streptococcus*, 775–777  
   transmission, 147  
   treatment, 149  
 Neonatal isoerythrolysis see Alloimmune hemolytic anemia of the newborn (neonatal isoerythrolysis)  
 Neonatal jaundice, 385  
 Neonatal maladjustment syndrome of foals see Equine neonatal encephalopathy  
 Neonatal neoplasia, congenital, 137–138  
 Neonatal respiratory distress, 494  
 Neonatal spasticity, inherited, 1956  
 Neonate(s)  
   death, investigations following, 131  
   dietary diarrhea, 277–279  
   equine arteritis virus, 1320  
   equine herpesvirus 1 infection, 1312, 1314, 1315  
   hypothermia, 40–41, 43–44, 45–46  
   meningitis, 610  
   nutritional muscular dystrophy control, 1752  
   septicemia, 51, 52  
   streptococcal infection, 775–777  
     clinical findings, 776  
     clinical pathology, 776  
     control, 777  
     diagnosis, 776–777  
     differential diagnosis, 777  
     economic importance, 776  
     epidemiology, 775–776  
     etiology, 775  
     infection source, 776  
     necropsy findings, 776–777  
     pathogenesis, 776  
     treatment, 777  
     zoonotic implications, 776  
   sudden death, 125  
   tetanus, 822  
   thermoregulation, 41–43  
   transportation, hypothermia, 43  
   see also Newborn(s)  
 Neoplasms  
   alimentary tract, 281–282  
   myopathy etiology, 627  
   nasal cavity obstruction, 531  
   ovine pulmonary adenocarcinoma, 1367  
*Neorickettsia risticii*, 1466  
*Neospora caninum*, 1509  
*Neospora hughesi*, 1523  
 Neosporosis, 1509–1512  
   abortion, 975  
   bovine virus diarrhea virus concurrent infection, 1510, 1511  
   clinical findings, 1510–1511  
   clinical pathology, 1511  
   congenital infection, 1510–1511  
   control, 1511  
   differential diagnosis, 1511  
   economic importance, 1510  
   epidemiology, 1509–1510  
   etiology, 1509  
   experimental reproduction, 1510  
   herd seroprevalence, 1510  
   horses, 1511  
   necropsy findings, 1511  
   occurrence, 1509  
   pathogenesis, 1510  
   risk factors, 1510  
   transmission, 1510  
   treatment, 1511  
   vaccines, 1511  
 Neostigmine, 204, 313, 2059, 2065  
*Neotromyngylus linearis*, 1568  
*Neotyphodium (Acremonium)*, ergot alkaloid poisoning, 1901  
*Neotyphodium (Acremonium) coenophialum*, 1899, 1901–1902  
*Neotyphodium lolii*, 1899, 1903–1905, 1910  
 Nephroblastoma, 560  
 Nephropathy, *Aspergillus ochraceus*, 1899  
 Nephrosis, 556  
   inherited (mesangiocapillary glomerulonephritis), 555, 1948  
 Nervous acetoneuria, 1807  
 'Nervous' coccidiosis, 1502, 1503  
 Nervous dysfunction, 576–577  
   arsenic poisoning, 1809–1810  
   excitation (irritation) signs, 577  
   inhibition release signs, 577  
   lead poisoning, 1801–1802  
   modes, 577  
   nervous shock, 577  
   paresis/paralysis, 577  
   photosensitization, 661  
 Nervous shock, 577  
   electrocution, 1789  
   traumatic brain injury, 604  
 Nervous signs  
   liver disease, 385–386  
   mycotoxicosis, 1912  
 Nervous system  
   abiotrophies, inherited, 1951  
   acidemia effect, 85  
   bacterial infection, 592–593, 595  
   copper deficiency, 1712  
   diseases of, 575–620  
     altered mentation, 577–578  
     altered sensation, 582  
     autonomic nervous system abnormality, 583  
     blindness see Blindness  
     clinical manifestations of, 577–583  
     dyspnea/exercise intolerance from, 475  
     epilepsy, 613  
     exercise intolerance, 119  
     gait abnormality, 576, 580–581  
     involuntary movements, 578–579  
     meningeal disease, 609–611  
     mental state, 576  
     nervous dysfunction see Nervous dysfunction  
     pathophysiological mechanisms, 596  
     peripheral, 618–619  
     posture abnormality, 576, 579–580  
     primary, 576  
     psychoses/neuroses, 612–613  
     secondary, 576  
     sensory perceptivity, 576  
     spinal cord, 613–618  
     treatment, 594–596, 595  
     uncertain etiology, 2006–2023  
     see also Brain; specific diseases/disorders  
   endotoxemia effects, 57  
   enzootic bovine leukosis, 1215–1216  
   equine protozoal myeloencephalitis, 1524  
   examination, 583–594  
     anus, 591  
     brainstem auditory evoked potentials (BAEP), 594  
     cerebral perfusion pressure, 594  
     cerebrospinal fluid see Cerebrospinal fluid (CSF)  
     clinical, 20  
     cranial nerves, 584–587, 584–588  
     electroencephalography (EEG), 594, 607  
     electromyography (EMG) see Electromyography (EMG)  
     epidemiology, 583  
     forelimbs, 589–590  
     gait, 587–589  
     head, 584–587  
     hindlimbs, 590–591  
     history, 583–584  
     imaging, 593–594  
     intracranial pressure, 594  
     limitations, 576  
     neck, 589–590  
     neurological examination, 583  
     ophthalmoscopy, 594  
     palpation of bony encasement, 591  
     posture, 587–589  
     rhinolaryngoscopy (endoscopy), 594  
     serum biochemical analysis, 593  
     signalment, 583  
     tail, 591  
     trunk, 590–591  
   functions, 576  
   inherited defects, 1949–1957  
   plant-induced lesions, 1896–1897  
   viral infection, 595, 601  
   vitamin A deficiency effects, 1774–1775  
 Netherlands  
   bovine herpesvirus-1 eradication program, 1359, 1360  
     certification loss, 1360  
   bovine herpesvirus-1 infection, 1354–1355  
   coccidiosis, 1501  
   Johne's disease control, 1038  
   pseudorabies control program, 1401  
   pseudorabies risk factors, 1395  
 Netilmicin, 2059  
 Netobimin, 1545, 1567, 1579, 2059  
 Neuritis of the cauda equina see Polyneuritis equi  
 Neuroanatomical location of lesions, 575–576  
 Neuroaxonal dystrophy (inherited ovine degenerative axonopathy), 1953  
 Neurodegeneration, inherited (shaker calf syndrome), 1951  
 Neurofibromatosis, 668  
 Neurofilariosis, 1575  
 Neurogenic arthrogryposis, 619  
 Neurogenic muscular atrophy  
   clinical findings, 629  
   etiology, 627  
   paresis/paralysis, 582  
   pathogenesis, 628  
 Neurogenic quinolizidine alkaloid poisoning, 1890–1891  
 Neurological examination, 20, 583  
   downer cow syndrome, 1647  
   horses, 583  
 Neuromuscular disease, 588  
 Neuromuscular junctions,  
   encephalomyelopathies, 612  
 Neuronal satellitosis, 600  
 Neuronophagia, 600  
 Neuroses, 612–613  
 Neurotoxicity, organophosphate poisoning, 1835, 1836  
 Neurotoxic mycotoxins, encephalomalacia, 603  
 Neurotoxic venoms, 1916, 1916, 1917  
 Neutralizing antibodies  
   bovine virus diarrhea virus, 1252  
   encephalomyocarditis virus disease, pigs, 1184  
   equine infectious anemia virus, 1174  
   hog cholera, 1160  
 Neutralizing peroxidase-linked antibody assay,  
   hog cholera, 1163  
 Neutral to earth voltage, 1790  
 Neutral to ground voltage, 1790  
 Neutropenia, 460  
   coliform mastitis, 712  
   endotoxemia and, 55  
   tick-borne fever, 1461  
 Neutrophil(s)  
   babesiosis, 1488  
   coliform mastitis, 711, 713  
   cytoplasmic glucocorticoid expression, 1616  
   intestinal mucosal injury, 264  
   radiation injury, 1787  
   reference laboratory values, 2047  
   selenium deficiency and, 1742  
   tick-borne fever, 1460  
 Neutrophilia, 461, 1941  
 Nevus, vascular, 669  
 Newborn(s)  
   alloimmune hemolytic anemia see Alloimmune hemolytic anemia of the newborn  
   cloned offspring, diseases of, 145–146  
   colibacillosis see Colibacillosis, newborns  
   congenital defects, 132–138  
     clinical findings, 135–136  
     clinical pathology, 136  
     differential diagnosis, 136  
     epidemiology, 134–135, 136  
     etiology, 132–134  
     necropsy findings, 135–136  
     pathogenesis, 135  
   critically ill, 160–171  
   clinical examination, 160–164, 162–163  
   clinical pathology, 164–167  
   complications, 170  
   imaging, 164  
   prognosis, 170–171, 171  
   treatment, 167–170  
   diarrhea see Diarrhea, newborns  
   diseases of, 127–171  
     classification, 127–128  
     epidemiology, 128–131  
     see also specific diseases/disorders

- Newborn(s) (*Cont'd*)  
 fetal diseases, 127  
 iodine deficiency, 1724  
 lactose digestion test, 198  
 oxygen therapy, 494  
 parturient diseases, 127  
 perinatal disease, 127–132  
   physical/environmental causes, 138–145  
 postnatal disease, 127–132  
 resistance, improving, 158–159  
 see also Neonate(s); *specific species*
- Newsprint poisoning, 1843
- New World camelids, encephalitis, 600
- New World Screwworm (*Cochliomyia hominivorax*), 1590, 1593–1594, 1595
- New York State Cattle Health Assurance Program (NYSCHAP), 1035
- New Zealand  
 brucellosis associated with *Brucella abortus* eradication, 983  
 chronic enzootic pneumonia of sheep, 1362  
 microphthalmia, 1977  
 pseudorabies vaccination, 1403
- Ngaione poisoning, 1892
- Niacin, 1667, 1778
- 'Nibbling or scrapie scratch' reaction, 1444
- 'Nibbling' reaction, 582
- Nicaragua, brucellosis status, 965
- Niclosamide, 1581, 2059
- Nicoletella semolina*, 509
- Nicotiana glauca*, 134
- Nicotiana poisoning, 1890
- Nicotiana tabacum*, 134
- Nicotine poisoning, 1831, 1890
- Nicotinic acid, 1780
- Nigerian equine encephalitis, 1383
- Night blindness (nyctalopia), 582  
 inherited, 1977  
 testing for, 18  
 vitamin A deficiency, 1773, 1774
- Nipah virus, 1383
- Nitazidone, 2059
- Nitazoxanide, 1525, 2059
- Nitrate(s), 1785  
 poisoning, 1855–1858  
   accidental, 1857  
   cattle, 1855  
   clinical findings, 1857  
   clinical pathology, 1857–1858  
   control, 1858  
   diagnosis, 1858  
   differential diagnosis, 1858  
   epidemiology, 1856–1857  
   etiology, 1855–1856  
   minimum lethal dose, 1855–1856  
   necropsy findings, 1858  
   pathogenesis, 1857  
   pigs, 1855–1856  
   plant sources, 1856  
   risk factors, 1856–1857  
   sheep, 1855  
   source of, 1856  
   specimen analysis, 1797  
   toxic levels, 1858  
   treatment, 1858
- Nitrite poisoning, 1855–1858  
 cattle, 1855  
 clinical findings, 1857  
 clinical pathology, 1857–1858  
 control, 1858  
 diagnosis, 1858  
 differential diagnosis, 1858  
 epidemiology, 1856–1857  
 etiology, 1855–1856  
 minimum lethal dose, 1855–1856  
 necropsy findings, 1858  
 pathogenesis, 1857  
 pigs, 1855–1856  
 risk factors, 1856–1857  
 sheep, 1855  
 source of, 1856  
 specimen analysis, 1797  
 toxic levels, 1858  
 treatment, 1858
- Nitrocompound poisoning, 1872–1873
- Nitrofurantoin, 2059
- Nitrogen dilution test, 489
- Nitrogen dioxide gas, interstitial pneumonia, 1999
- Nitrogenous fertilizers, 1653
- Nitroglycerin, 2059
- Nitroprusside powder test, 1664–1665
- Nitroprusside tablet, 1665
- Nitroxinil  
 bunostomosis, 1553  
 dosage/interval, 2059  
 fasciolosis, 1579  
 parafilariosis, 1574
- Nocardia*, diseases associated with, 1044–1051
- Nocardia asteroides* mastitis, 725–726
- Nocardia brasiliensis* mastitis, 725–726
- Nocardia farcinia* mastitis, 725–726
- Nocardia* mastitis, 725–726, 739
- Nociception/nociceptors, 103
- Nodding blue lily (*Stypandra glauca*) poisoning, 1893
- Nodularia spumigenia*, 1913
- Nodularin, 1913
- Nodules  
 granulomatous, 667  
 lumpy skin disease, 1425  
 oesophagostomosis, 1553, 1554  
 strongylosis, 1559  
 summer sores, 1572
- Nodule worm disease see Oesophagostomosis
- Noise pollution, 1785
- Non-ambulatory animal definition, 1650
- Non-esterified fatty acids (NEFA)  
 dietary fatty acid effects on, 1677  
 energy balance indicator, 1620  
 fatty liver and, 1674, 1677  
 left-side displacement of abomasum, 357, 1614  
 metabolism by the liver, 1613  
 periparturient disease prediction, 1620
- Non-living vaccines, bovine babesiosis, 1497
- Non-parasitic scouring syndrome, 1543
- Nonregenerative anemia, 452–453
- Nonshivering thermogenesis, 39, 42–43
- Nonsteroidal anti-inflammatory drugs (NSAIDs)  
 arthritis/synovitis, 647  
 arthropathy, 641  
 bovine ephemeral fever, 1179  
 bovine lungworm, 1567  
 bovine respiratory syncytial virus pneumonia, 1348  
 coliform mastitis, 717  
 endotoxemia, 58–59  
 enzootic pneumonia of calves, 1342  
 equine colic, 225, 227  
 equine influenza, 1326  
 equine pleuropneumonia, 529  
 fever, 51  
 gastric ulcer in foals, 236–237  
 guttural pouch empyema, 539  
 intestinal obstruction, 380  
 laminitis, 2032, 2035  
 laryngitis/tracheitis/bronchitis, 534  
 malignant edema, 831  
 mastitis, 693–694  
 pain, 105–106  
 peritonitis, 287  
 pneumonia, 514  
 pneumonic pasteurellosis, 942  
 purpura hemorrhagica, 1926  
 respiratory disease, 495  
 sporadic lymphangitis, 2029–2030  
 toxic nephrosis from, 557  
 vesicular stomatitis, 1235  
 West Nile encephalitis, 1380
- Nonstructural protein (NSP) antibody tests,  
 foot-and-mouth disease, 1226–1227
- Non-sweating syndrome, 2038
- Norepinephrine, 59, 2059
- Normocytic, normochromic anemia, 1942
- Normovolemic anemia, 451
- Noroviruses, neonatal diarrhea, 1289
- North America  
 bovine herpesvirus-1 infection, 1353  
 bovine spongiform encephalopathy occurrence, 1448  
 bovine virus diarrhea virus eradication program, 1275  
 equine influenza viruses, 1322  
 rabies, 1386, 1392–1393  
 West Nile encephalitis, 1378
- North American blastomycosis, 1476
- North Country Cheviot lambs, liver rupture, 386
- Northern Ireland  
 bovine spongiform encephalopathy, 1447  
 pseudorabies control program, 1401
- Norwalk-like virus(es) (NLV), 1289
- Norway  
 bovine herpesvirus-1 infection, 1349
- bovine respiratory syncytial virus pneumonia, 1344
- bovine virus diarrhea virus eradication program, 1274–1275
- coccidiosis, 1501
- louping-ill, 1408
- scrapie control, 1445
- Nose masks, head shaking, 2023
- Nose nets, head shaking, 2023
- Nostril  
 bleeding from see Epistaxis  
 examination, 11, 18
- Notechis scutatus* (tiger snake), 1916, 1917
- Notifiable diseases see Reportable diseases
- Novidium, 1536
- Novobiocin, 2059
- Now Flue assay, equine influenza, 1325
- Nubian goats, ceroid lipofuscinosis, 1950
- Nuclear explosions, 1786
- Nuclear factor kappa B (NF- $\kappa$ B), endotoxemia, 54
- Nuclear 'fallout,' 1786
- Nuclear imaging see Scintigraphy (nuclear imaging)
- Nucleic acid recognition methods  
 bluetongue, 1303  
 foot-and-mouth disease, 1226  
 malignant catarrhal fever, 1247
- Nucleic probe analysis, anaplasmosis, 1457
- Nursery pasture, 158
- Nursing behavior, mastitis-metritis-agalactia syndrome, 755, 756
- Nursing care, general  
 newborns, 167  
 respiratory system disease, 496
- Nutrients, abnormal requirement/utilization of, 1692
- Nutrition  
 alimentary tract dysfunction, 195  
 arthropathy etiology, 637  
 colibacillosis, newborn risk factors, 854  
 coliform mastitis control, 718  
 degenerative joint disease, 2026  
 edema disease, 890  
 encephalomyelopathies, toxic/metabolic, 612  
 enterotoxemia, *Clostridium perfringens* type D associated risk factor, 841  
 fluorine poisoning control, 1819  
 hemonchosis, ruminants, 1550, 1551  
 lactation, diseases of, 1618  
 mastitis control, 743  
 mastitis-metritis-agalactia syndrome, 755–756, 758–759  
 myopathy and, 628  
 osteodystrophy, 632  
 performance shortfalls, 117  
 peripheral nervous system disease, 619  
 ringworm, 1478  
 salmonellosis risk factor, 900
- Nutritional deficiency, 1691–1783  
 anemia, nonregenerative, 452  
 botulism, 827  
 congenital defects in newborns, 133  
 diagnosis, 1691, 1692  
 diarrhea, acute undifferentiated risk factor, 848  
 disease association evidence, 1692  
 enteritis, 261, 262  
 enzootic pneumonia of calves, 1342  
 evidence for existence, 1691–1692  
   correction/prevention based, 1692–1697  
 feedlot cattle, 1694  
 immunosuppression, 467  
 intrauterine growth retardation, 137  
 ketosis, 1662  
 maternal, 143, 1984  
 myocardial disease/cardiomyopathy etiology, 420  
 stress induction, 107  
 sudden death, 125  
 vitamins, fat-soluble, 1771–1778  
 vitamins, water-soluble, 1778–1783
- Nutritional (trophopathic) hepatitis, 392, 393
- Nutritional history  
 history-taking, individual animals, 5–6  
 musculoskeletal system disease, 626  
 osteodystrophy, 634
- Nutritional management  
 beef herd, 1693–1694  
 dairy herds, 1620, 1692–1693  
   transition period, 1677  
 feedlot cattle, 1694

- Nutritional management (*Cont'd*)  
 metabolic profile test and, 1619  
 pigs, 1694–1695  
 sheep, 1695–1697
- Nutritional muscular dystrophy (NMD)  
 cattle, 1751–1752  
 congenital, 1738–1739  
 differential diagnosis, 1749  
 enzootic, 627, 1736–1738  
 necropsy findings, 1748–1749  
 pathogenesis, 1744  
 sheep, 1751  
 subclinical, 1745  
 treatment, 1749
- Nutritional myopathy, vitamin E and selenium deficiency, 1739
- Nutritional status  
 bovine mastitis risk factor, 677  
 coccidiosis, 1500  
 disorders of, 112–115  
*see also specific diseases/disorders*  
 monitoring, 1692
- Nutritional support  
 alloimmune hemolytic anemia of the newborn, 1924  
 diarrhea, chronic undifferentiated, 273  
 newborns, 168–169  
 pregnancy toxemia, sheep, 1671
- Nutritionists, professional, 1692
- Nyctalopia *see* Night blindness (nyctalopia)
- Nymphomania, 1841
- Nystagmus, 580, 585, 1957
- Nystatin, 1473, 2059
- 
- O**
- Oak (*Quercus*) poisoning, 1889
- Obliterative arteriopathy, 1248
- Obstacle test, blindness, 18
- Obstruction atelectasis, 500
- Obstructive pulmonary disease, pasture-associated, 1935
- Obstructive shock, 63–69  
 clinical findings, 65  
 clinical pathology, 65–66  
 differential diagnosis, 66  
 etiology, 63–64  
 necropsy findings, 66  
 pathogenesis, 65  
 treatment, 66–68
- Occupation time examination, 8
- Ochratoxin poisoning, 1899, 1906
- Ocular dermoids, 1977
- Ocular pseudotumors, horses, 2041
- Ocular squamous cell carcinoma, 608, 2041
- Oculocutaneous albinism, 1975
- Oculocutaneous hypopigmentation, 1942
- Oculomotor nerve (cranial nerve III) assessment, 585
- Odocoileus hemionus* (mule deer) *see* Mule deer (*Odocoileus hemionus*)
- Odocoileus hemionus columbianus* (black-tail deer), 1455
- Odocoileus virginianus* (white-tailed deer) *see* White-tailed deer (*Odocoileus virginianus*)
- Oenanthe* (water hemlock dropwort) poisoning, 1883
- Oenanthotoxin poisoning, 1883
- Oesophagostomosis, 1553–1555  
 clinical findings, 1554  
 control, 1554  
 diagnostic confirmation, 1554  
 differential diagnosis, 1554  
 epidemiology, 1553  
 etiology, 1553  
 necropsy findings, 1554  
 pathogenesis, 1553–1554  
 pigs, 1553, 1554  
 sheep, 1553–1554, 1554  
 treatment, 1554
- Oesophagostomum*, 1553–1555
- Oesophagostomum asperum*, 1553
- Oesophagostomum columbianum*, 1553–1554
- Oesophagostomum dentatum*, 1553
- Oesophagostomum quadrispinulatum*, 1553
- Oesophagostomum radiatum*, 1553
- Oesophagostomum venulosum*, 1553
- Oestrus ovis* infestation, 1586–1587
- Office International des Epizooties (OIE), 765–766, 766–767
- contagious bovine pleuropneumonia, 1131, 1137–1138
- Manual of Standards for Diagnostic Tests and Vaccines*, 973
- Offspring segregation, 1401
- Oil, bloat prevention, 334–335
- Oil-product poisoning, 1846–1847
- Oil-well installations, poisoning from, 1846
- Olaquinox poisoning, 1845
- Old World Screwworm (*Chrysomya bezziana*), 1594
- Olfactory nerve (cranial nerve I) assessment, 584
- Oliguria, 547, 548
- Ollulanus tricuspis*, 1555
- Omasum, 293  
 diseases of, 311–353  
*see also specific diseases/disorders*  
 impaction of, 301, 352–353, 367
- Omental bursitis, 290, 374–375
- Omentopexy, 360
- Omeprazole, 236, 240, 2059
- OMIA (Online Mendelian Inheritance in Animals) database, 1939
- Omphalitis, 159–160, 309
- Omphaloarteritis, 159
- Omphalophlebitis, 159–160, 309, 644
- Onchocerca*, 1573
- Onchocercosis, 1573
- Oncolytic agents, lymphosarcoma, 463
- Onderstepoort Bluetongue Vaccine, 1304
- Ondiri disease, 1469–1470
- Onion weed (*Romulea rosea*), 1895
- Online Mendelian Inheritance in Animals (OMIA) database, 1939
- Onychium contiguum*, 1876–1877
- Oocyst(s)  
 coccidiosis, 1500, 1503, 1504  
 count, 1503, 1504, 1514  
 cryptosporidiosis, 1513, 1514  
*Eimeria*, 1502  
*Toxoplasma gondii*, 1518, 1519
- Open-mouth breathing, 474
- Ophthalmia  
 caprine contagious, 1142–1143  
 periodic, leptospirosis, 1101, 1103, 1107
- Ophthalmitis, *Listeria monocytogenes* infection, 805, 809
- Ophthalmoscopy examination, 594
- Opiates, 225, 227, 268
- Opisthotonus posture, 577, 586
- Opossums, equine protozoal myeloencephalitis, 1523, 1525
- Optic chiasma disease, 582–583
- Optic nerve (cranial nerve II)  
 assessment, 584–585  
 disease, blindness, 582–583
- Optic-trigeminal summation, 2022
- Oral cavity examination, 301
- Oral lesions  
 bovine ulcerative mammillitis, 1429  
 cattle, 1265–1266  
 orf, 1419  
 rinderpest, 1239
- Oral necrobacillosis, 1079–1080
- Oral neoplasms, 281
- Orbital disease, 582
- Orbivirus*, 1299
- Orchitis  
 actinomycosis, 1045  
*Brucella abortus* infection, 970  
*Brucella suis*, 990
- Orf, 1418–1421  
 atypical disease, 1419  
 case fatality rates, 1418  
 clinical findings, 1419–1420  
 clinical pathology, 1420  
 control, 1420  
 differential diagnosis, 1420  
 economic importance, 1419  
 epidemiology, 1418–1419  
 etiology, 1418  
 experimental reproduction, 1418  
 goats, 1419–1420  
 lesions, 1419  
 malignant form, 1419, 1420  
 morbidity, 1418  
 necropsy findings, 1420  
 occurrence, 1418  
 pathogenesis, 1419  
 peste des petits ruminants and, 1243  
 risk factors, 1418–1419  
 sheep, 1419
- systemic invasion, 1419  
 transmission, 1418  
 treatment, 1420  
 vaccination, 1420  
 zoonotic implications, 1418, 1419
- Orf virus (ORFV), 1277, 1418
- Organic arsenicals, 1810  
 arsenic poisoning, 1808  
 relative toxicities, 1808  
 swine dysentery, 1118
- Organic fluorides, 1818  
 poisoning, 1816
- Organic mercurials, 1814
- Organochloride poisoning *see* Chlorinated hydrocarbon (organochloride) poisoning
- Organophosphate(s)  
 anthelmintics, 1550  
 poisoning, 1832  
 insecticides, 1592, 1596  
 louse infestations, 1598  
 poisoning, 1834–1837  
 acute, 1835–1836  
 cattle, 1836  
 clinical findings, 1835–1836  
 clinical pathology, 1836  
 congenital defects of the newborn, 134  
 control, 1837  
 differential diagnosis, 1836  
 economic importance, 1835  
 epidemiology, 1835  
 etiology, 1835  
 goats, 1836  
 horses, 1836  
 industrial, 1848  
 necropsy findings, 1836  
 pathogenesis, 1835  
 pigs, 1836  
 pulmonary congestion/edema, 500  
 residual toxin removal, 1837  
 risk factors, 1835  
 sheep, 1836  
 source of, 1835  
 treatment, 1837  
 tick infestations, 1601
- Organophosphorus compounds *Hypoderma* infestations, 1589
- Oribatid mites, 1582
- Oriental cockroach (*Blattia orientalis*) nymphs, 1020
- Oriental theileriosis, 1526
- Ornithine carbamoyl-transferase (OCT), 389
- Ornithodoros coriaceus* (argasid tick), 1169, 1300
- Ornithodoros erraticus*, 1169
- Ornithodoros moubata*, 1168, 1600
- Ornithodoros porcinus*, 1168
- Ornithodoros (Alectorobius) puertoricensis*, 1169
- Ornithodoros savignyi*, 1168, 1600
- Orthopoxviruses, 1427
- Oryctolagus cuniculus* (wild rabbit), Johne's disease, 1018
- Oscillatoria*, cyanobacterial toxins, 1913
- Oscillatoria limosa*, 1914
- Oscillatoria tenuis*, 1914
- Oscillometric sphygmomanometry, 410
- Osmolal gap, electrolyte imbalance assessment, 91
- Osmolality, 93
- Osmolarity, 93
- Osmotic diarrhea, 262–263
- Osseous sequestration, cattle, 635–636
- Osteitis, salmonellosis, 909
- Osteoarthropathy, 638–639  
*see also* Arthropathy; Degenerative joint disease
- Osteochondritis dissecans, 639, 2027
- Osteochondrosis  
 arthropathy etiology, 637  
 cattle, 640  
 definition, 637  
 horses, 637, 639, 640, 641  
 pathogenesis, 639  
 pigs, 639, 640  
*see also* Degenerative joint disease
- Osteochondrosis dissecans, 640
- Osteodystrophia fibrosa, 632, 633, 1757, 1769–1770
- Osteodystrophy, 622, 632–635  
 characteristics, 645  
 chronic fluorosis, 633  
 clinical findings, 622, 633–634

- Osteodystrophy (Cont'd)  
 differential diagnosis, 634  
 etiology, 632–633, 1755, 1756  
 necropsy findings, 622, 634  
 pathogenesis, 633  
 phosphorus deficiency, 1761  
 treatment, 634–635  
*see also specific diseases/disorders*
- Osteofluorosis, 633, 1817
- Osteogenesis imperfecta, 1958
- Osteomalacia, 1768–1769  
 calcium deficiency, 1757  
 clinical findings, 1769  
 clinical pathology, 1769  
 control, 1769  
 diagnosis, 1769  
 differential diagnosis, 1769  
 epidemiology, 1768–1769  
 etiology, 1768  
 necropsy findings, 1769  
 pathogenesis, 633, 1769  
 phosphorus deficiency, 1760  
 pigs, 1769  
 treatment, 1769  
 vitamin D deficiency, 1765
- Osteomyelitis, 622, 635–637  
 clinical findings, 622, 636  
 clinical pathology, 622, 636  
 differential diagnosis, 636  
 etiology, 635–636  
 hematogenous, 635  
 jaw bone, 1045  
 necropsy findings, 636  
 pathogenesis, 635–636  
*Pythium insidiosum*, 1480  
 treatment, 636–637
- Osteomyelotoxic ptaquiloside poisoning, 1875–1876
- Osteopetrosis, 1264
- Osteophagia, 113, 1760
- Osteoporosis, 633, 1711, 1802
- Osteosarcoma, 633
- Ostertagia, 1541, 1543–1544  
*see also Trichostrongylid worms*
- Ostertagia ostertagi, 1542, 1543
- Ostertagiasis, cattle, 1266
- Ostertagiosis, bovine, 1543, 1544, 1545
- Otitis  
 externa, 670–671  
*Mycoplasma bovis*, 1129  
*Haemophilus septemicus*, 1001  
 interna, 607–608  
 differential diagnosis, 608  
*Mycoplasma bovis*, 1128, 1129  
*Streptococcus suis* infection, 780  
 treatment, 608  
 media, 607–608, 671  
 differential diagnosis, 608  
*Mycoplasma bovis*, 1128, 1129  
 treatment, 608  
 parasitic, 670
- Otobius megnini (spinose ear tick), 1600, 1602
- Outflow abnormality, scant feces, 193
- Ovarian dysfunction, bovine virus diarrhea virus, 1256
- Ovarian lesions, bovine herpesvirus-1 infection, 1353
- Overcrowding, 7  
 environmental examination, 8  
 mycoplasmal pneumonia risk factor, pigs, 1146  
*Streptococcus suis* infection risk, 781  
 stress induction, 107  
 swine dysentery, 1115
- Overeating disease *see* Enterotoxemia, *Clostridium perfringens* type D associated
- Overfeeding, fatty liver risk factor, 1673
- Overhydration  
 acute, 76  
 fluid and electrolyte therapy, 865  
 large intestine impaction, horse, 253
- Overmilking avoidance, 732
- Overnourishment, intrauterine growth retardation, 137, 143
- Overo paint horses, lethal whites, 1942
- Ovine atopic dermatitis, 657
- Ovine contagious ophthalmia, 1142–1143
- Ovine degenerative axonopathy, inherited (neuroaxonal dystrophy), 1953
- Ovine encephalomyelitis *see* Louping-ill
- Ovine enzootic abortion (OEA), 1435–1437  
 cattle, 1437  
 clinical findings, 1436–1437  
 clinical pathology, 1437  
 control, 1437  
 differential diagnosis, 987  
 economic importance, 1436  
 epidemiology, 1435–1436  
 etiology, 1435  
 experimental reproduction, 1436  
 fetal infection, 1436  
 infection sources, 1436  
 necropsy findings, 1437  
 occurrence, 1435–1436  
 pathogenesis, 1436  
 persistent infection, 1436  
 transmission, 1436  
 vaccines, 1437  
 zoonotic implications, 1436
- Ovine herpesvirus 2 (OvHV-2), 1245, 1246
- Ovine humpyback, 2015–2016
- Ovine infectious keratoconjunctivitis, 1142–1143
- Ovine interdigital dermatitis, 1072, 1077
- Ovine John's Disease Control and Evaluation Program, 1037–1038
- Ovine 'kangaroo' gait, 2019–2020
- Ovine ketosis, pregnancy toxemia, 1669–1670
- Ovine lentiviruses, 1363, 1413
- Ovine mastitis, 759–761  
*Actinobacillus lignieresii*, 1047  
 clinical findings, 760  
 clinical pathology, 760  
 control, 760–761  
 differential diagnosis, 760  
 epidemiology, 759–760  
 etiology, 759  
*Mannheimia haemolytica*, 947  
 necropsy findings, 760  
 ovine progressive pneumonia, 1365  
 pathogenesis, 760  
 treatment, 760
- Ovine mouth and gum obscure disease (OMAGOD), 1993–1994
- Ovine nasal adenocarcinoma virus (ENT-1), 1368
- Ovine postdipping necrotic dermatitis, 657
- Ovine progressive pneumonia, 1362–1366  
 breed susceptibility, 1363  
 case fatality rate, 1364  
 clinical findings, 1364–1365  
 clinical pathology, 1365  
 control, 1365–1366  
 diagnosis, 1365  
 differential diagnosis, 1365  
 economic importance, 1364  
 epidemiology, 1363–1364  
 etiology, 1363  
 flock seroprevalence, 1363  
 genetic resistance, 1366  
 goats, 1363  
 host range, 1363  
 immune response, 1364  
 in-utero transmission, 1363  
 mortality rate, 1364  
 necropsy findings, 1365  
 occurrence, 1363  
 pathogenesis, 1364  
 prevalence, 1363  
 transmission, 1363–1364  
 virus, 1363, 1364
- Ovine pulmonary adenocarcinoma, 1366–1368  
 clinical findings, 1367  
 clinical pathology, 1367  
 complications, 1367  
 control, 1368  
 differential diagnosis, 1368  
 epidemiology, 1366–1367  
 etiology, 1366  
 experimental transmission, 1366, 1367  
 goats, 1367  
 necropsy findings, 1367  
 occurrence, 1366–1367  
 ovine progressive pneumonia, 1364  
 pathogenesis, 1367  
 prevalence, 1367  
 risk factors, 1367
- Ovine skin cancer, 668
- Ovine white liver disease, 1702, 1703
- Ovis canadensis* (Bighorn sheep), 1455
- Oxacillin, 2059
- Oxalate  
 insoluble calcium oxalate raphide crystal poisoning, 1861  
 soluble form poisoning, 1858–1860  
 clinical findings, 1859  
 clinical pathology, 1859  
 control, 1860  
 diagnosis, 1860  
 differential diagnosis, 1860  
 epidemiology, 1859  
 etiology, 1858–1859  
 necropsy findings, 1859–1860  
 pathogenesis, 1859  
 plant sources, 1858–1859  
 risk factors, 1859  
 susceptibility to, 1859  
 toxic dose, 1859  
 treatment, 1860  
 toxic nephrosis from, 557
- Oxalate-induced equine nutritional secondary hyperparathyroidism, 1860–1861
- Oxalic acid, 566
- Oxfendazole, 1545, 2059, 2065
- Oxibendazole  
 ascarid infections, 1557  
 dosage/interval, 2059, 2065  
 parasitic gastritis, pigs, 1555  
 threadworm, 1563
- Oxidative damage, anemia, 455
- Oxime, organophosphate poisoning, 1837
- Oximetry, anemia, 457
- Oxyclozanide, 1579, 1581, 2059
- Oxygen delivery, 453, 490
- Oxygen saturation, 490
- Oxygen tension, hypoxic hypoxia, 472
- Oxygen therapy, 493–494, 500
- Oxygen toxicity, 494
- Oxymorphone, 2059, 2065
- Oxytetracycline  
 anaplasmosis, 1458  
 arthritis, 646  
 atrophic rhinitis, progressive, 961  
 brucellosis associated with *Brucella ovis*, 986  
 coliform mastitis, 716  
 dosage/interval, 2059, 2065  
 enzootic pneumonia of calves, 1341  
 equine granulocytic anaplasmosis, 1465  
 equine neorickettsiosis, 1467  
 foot rot, infectious, 1073  
*Haemophilus septemicus*, 1002  
 infectious keratitis, 996  
 mycoplasmal pneumonia, pigs, 1150  
 osteodystrophy, 635  
 papillomatosis digital dermatitis of cattle, 1068–1069  
 pleuropneumonia of pigs, 1057, 1058  
 pneumonic pasteurellosis, 941, 945  
 tick-borne fever, 1461  
 undifferentiated bovine respiratory disease, acute, 931
- Oxytocin  
 coliform mastitis, 716  
 dosage/interval, 2059, 2065  
 environmental streptococci mastitis, 722  
 mastitis-metritis-agalactia syndrome, 758, 759  
 parturition, premature induction, 144  
 septic metritis, postpartum prevention, 63
- Oxytropis, 134, 1870–1871
- Oxytropis sericea* (locoweed) ingestion, 1788
- Oxyuranus* (taipan), 1916
- Oxyuris equi*, 1562
- ## P
- P26, equine infectious anemia, 1173, 1175–1176
- P30, African swine fever, 1171
- P53 gene, bovine ocular squamous-cell carcinoma, 2039
- P54, African swine fever virus, 1170
- P73, African swine fever, 1171
- P80, bovine virus diarrhea virus, 1253
- 'Paced growth program,' 2018
- Pachyderma, 654–655
- Pacific coast tick (*Dermacentor occidentalis*), 1456
- Packed cell volume (PCV)  
 equine colic, 224  
 fluid balance disorder, 88–89  
 metabolic profile testing, herds, 1622  
 nagana, 1535  
 peritoneal fluid, 202
- Paecilomyces*, 509
- Pain, 102–107  
 assessment, 102

- Pain, (*Cont'd*)  
 attitudes towards, 102–103  
 behavioral responses, 104  
 central hypersensitivity, 104  
 classification, 102  
 clinical findings, 104  
 cutaneous/superficial, 103  
 definition, 102  
 detrimental effects, 103  
 duration, 104  
 elicitation techniques, 104  
 equine colic, 218–219  
 etiology, 103  
 laminitis, horses, 2031  
 measurement difficulties, 102  
 musculoskeletal (somatic), 103, 104, 105  
 nociception, 103  
 pathogenesis, 103–104  
 perception, 103  
 periodicity, 104  
 physiological responses, 104  
 preemptive analgesia, 104  
 reticulorumen motility, primary contraction influence, 295–296  
 spinal cord compression, 616  
 sporadic lymphangitis, 2029  
 stress induction, 107  
 treatment, 105–107  
 types, 103  
 visceral, 103, 104, 105
- Pain receptors, 103
- Paintbrush lesions, dermatophilosis, 1050
- Pakoein poisoning, 1885
- Palatitis, 205  
 see also Stomatitis
- Pale, soft and exudative pork (PSE), 1969, 1970, 1971, 1972
- Palmar digital artery pulse, laminitis, 2031
- Palm viper (*Bothrops neuwiedii*), 1916
- Palo santo tree (*Bulnesia sarmientii*) seed pod poisoning, 1891
- Palpation, 12  
 abdomen, 16–17, 303, 339–340  
 bladder, 19  
 hair coat, 21  
 inguinal ring, 19  
 kidneys, 19  
 liver, 387  
 lungs, 16  
 nervous system examination, 591  
 penis, 568  
 pharynx, 209  
 rectal see Rectal palpation  
 rumen, 294, 297–298, 303  
 spleen, 19  
 terminology, 12  
 testicles, 986  
 tongue, 1047
- Palpebral (eye-preservation) reflex, 585  
 absence, 588  
 polioencephalomalacia, 2010
- Pan-African Rinderpest Campaign (PARC), 1239, 1241
- Panama, brucellosis status, 965
- Pancreas  
 copper deficiency effects, 1712  
 diseases of, 396–397  
 see also specific diseases/disorders
- Pancreatic adenocarcinoma, 397
- Pancreatic adenoma, 397
- Pancreatitis, 397
- Pancuronium, 2060, 2066
- Pancytopenia, 460–461
- Pangonia, 1603
- Panhyperproteinemia, 441
- Panhypoproteinemia, 439–440
- Panicum poisoning, 1891
- Panniculitis, 665–666, 1680
- Panniculus reflex, 582
- Pansystolic murmurs, 426
- 'Panters' see Interstitial pneumonia
- Pantoprazole, 2060
- Pantothenic acid deficiency, 619, 1780
- Papaver rhoeas (field poppy) poisoning, 1891
- Paperbark albizia (*Albizia tanganyensis*) poisoning, 1888
- Papillomas  
 alimentary tract, 1421  
 aural flat (aural plaque), 667–668  
 bovine ocular squamous-cell carcinoma, 2039  
 cattle, 1421  
 cutaneous, 667–668  
 goats, 1421  
 oral, 1421
- Papillomatosis, 1421–1423  
 cattle, 1422–1423  
 clinical findings, 1422  
 clinical pathology, 1422  
 control, 1423  
 differential diagnosis, 1422  
 digital dermatitis of cattle (Mortellaro's disease), 1066–1070  
 clinical findings, 1067–1068  
 clinical pathology, 1068  
 control, 1070  
 differential diagnosis, 1068  
 economic importance, 1067  
 epidemiology, 1066–1067  
 etiology, 1066  
 immune mechanisms, 1067  
 outbreaks, 1066–1067  
 pathogenesis, 1067  
 prevalence, 1066–1067  
 risk factors, 1067  
 treatment, 1068–1070  
 economic importance, 1421–1422  
 epidemiology, 1421–1422  
 etiology, 1421  
 experimental production, 1421  
 flat, round type, 1422  
 frond form, 1422  
 genital, 1422  
 goats, 1422  
 horses, 1422  
 pathogenesis, 1422  
 perianal, 1422  
 risk factors, 1421  
 transmission, 1421  
 treatment, 1422–1423  
 vaccination, 1422–1423
- Papillomaviruses, 1421
- Papillomavirus-related DNA, 2041
- Papules  
 psoroptic mange, 1610  
 swinepox, 1432
- Paracellin-1 gene, 1948
- Paracentesis, abdominal see Abdominocentesis
- Parachute left atrioventricular valve, 433
- Paradoxical vestibular syndrome, 580
- Parafilaria bovicola, 444, 1574
- Parafilaria multipapillosa, 1574
- Parafilariosis, 1574
- Paraguay, brucellosis status, 964
- Parainfluenza-3 (PI-3) virus, 924  
 chronic enzootic pneumonia of sheep, 1361–1362  
 enzootic pneumonia of calves, 1336, 1339–1340  
 equine upper respiratory tract disease, 1308  
 experimental inoculation of calves, 1339–1340  
 pneumonic pasteurellosis, 948  
 undifferentiated bovine respiratory disease, 926  
 vaccine, 934, 945  
 enzootic pneumonia of calves, 1342
- Parakeratosis, 654, 1730–1733, 1941  
 clinical findings, 785  
 differential diagnosis, 654  
 epidemiology, 785  
 forestomach, 301  
 ruminal, 325  
 treatment, 654, 785  
 see also Zinc, deficiency
- Paralysis, 577  
 bladder, 561–562  
 central nervous system, congenital defect, 619  
 equine encephalomyelitis, 1370  
 equine hyperkalemic periodic paralysis, 1966  
 flaccid, 586, 614  
 hyperkalemic periodic, 80  
 inherited spontaneous lower motor neuron disease, 1953  
 kidney worm disease, 1570  
 nervous system disease, 581–582  
 plant-induced, 1896  
 porcine viral encephalomyelitis, 1405  
 posterior, inherited congenital, 1957  
 posture abnormality, 586  
 pseudorabies, 1398  
 rabies, 1389  
 respiratory failure, 473  
 spastic, 586  
 spinal cord compression, 616  
 spinal injury, traumatic, 614  
 tick-induced, 1599, 1599  
 toxic/metabolic encephalomyelopathies, 612  
 Venezuelan equine encephalomyelitis, 1373  
 vitamin A deficiency, 1774  
 see also Paresis
- Paralytic ileus, 193–194, 265, 283, 300
- Paramphistome flukes, 1580
- Paramphistomum cervi, 1580
- Paramphistomum microbathriodes, 1580
- Paranasal abscessation, 1080
- Paranasal sinus(es)  
 endoscopy, 482  
 examination, 480  
 fluid, 484  
 granulomas, 1474  
 horses, 482
- Parapoxvirus (PPV), 1277, 1418, 1428
- Parapoxvirus bovis 1, 1277
- Parapoxvirus bovis 2 (pseudocowpox virus), 1277, 1428
- Paraquat poisoning, 1838
- Pararotaviruses, 1286
- Parascaris equorum, 1556
- Parasite(s), 1541–1612  
 arthropod, 1585–1612  
 diarrhea in foals, 274  
 helminth, 1541–1583  
 hemorrhagic anemia, 451  
 interstitial pneumonia, 1998, 1999  
 migration, spinal ataxia horse, 2018  
 spinal cord traumatic injury, 613  
 thin sow syndrome, 1987  
 weight loss from infection, 116
- Parasitemia, eperythrozoonosis, 1155
- Parasite refugia, 1546
- Parasite Status, weaner illthrift, 1982
- Parasitic arteritis, 433–434
- Parasitic bronchitis see Bovine lungworm (verminous pneumonia)
- Parasitic enteritis, 261, 262, 263, 266
- Parasitic gastritis, pigs, 1555–1556
- Parasitic gastroenteritis (PGE)  
 cattle, 1544, 1545  
 goats, 1543, 1545–1546  
 ruminants, 1541–1548  
 anthelmintic choice, 1546  
 anthelmintic reliance reduction, 1548  
 anthelmintic resistance, 1546–1547  
 clinical findings, 1544  
 clinical pathology, 1544–1545  
 contamination sources, 1543  
 control, 1546–1548  
 diagnostic confirmation, 1545  
 differential diagnosis, 1545  
 disease outbreaks, 1543  
 epidemiology, 1542–1543  
 etiology, 1541  
 necropsy findings, 1545  
 pathogenesis, 1543–1544  
 resilience, 1542  
 transmission, 1542–1543  
 treatment, 1545–1546  
 sheep, 1544, 1545
- Parasitic hepatitis, 392–393, 394
- Parasiticides, lead containing, 1800
- Parasitic lung disease, 514
- Parasitic myocarditis, 420
- Parasitic otitis, 670
- Parasitic pneumonia, 803
- Parasitic wasps, house fly control, 1606
- Parasympatholytic drugs, 496, 1933
- Parasympathomimetic drugs, 204, 313
- Parathyroid hormone, 1629
- Paratuberculosis see Johne's disease
- Paratyphoid see Salmonellosis
- Parbendazole poisoning, 1832
- Parelaphostrongylus tenuis, 1575
- Parenchymatous enzymuria, 549
- Parenteral nutrition, 101–102  
 colic in foals, 231–232  
 equine herpesvirus 1, 1315  
 newborns, 168–169
- Paresis, 577  
 assessment, 587–588  
 central nervous system congenital defect, 619  
 classification of, 581–582  
 hypocalcemic, 1636  
 nervous system disease, 581–582  
 parturient see Milk fever  
 posture abnormality, 586

- Paresis, (Cont'd)  
 toxic/metabolic encephalomyelopathies, 612  
 types, 582
- Parity, pregnancy toxemia and, 1669
- Paromomycin, 2060
- Paromomycin sulfate, 1514–1515
- Parotid salivary gland, squamous metaplasia, 1775–1776
- Parotitis, 208–209
- Paroxysmal tachycardia, 416
- Paroxysmic respiratory distress syndrome (PRDS), 1345
- Parquin poisoning, 1886
- Pars esophagea* ulceration, 1994–1997  
 case fatality rate, 1994  
 clinical findings, 1996  
 clinical pathology, 1996  
 control, 1997  
 dietary control, 1997  
 dietary risk factors, 1994–1995  
 differential diagnosis, 1997  
 economic importance, 1994  
 epidemiology, 1994–1995  
 etiology, 1994  
 grading scheme, 1997  
 necropsy findings, 1996–1997  
 occurrence, 1994  
 pathogenesis, 1995–1996  
 risk factors, 1994–1995, 1995  
 treatment, 1997
- Partial heart block, 414–415
- Partial tibial neurectomy, 1956
- Parturient diseases, 127
- Parturient injury, 139–140, 141
- Parturient paresis see Milk fever
- Parturition  
 bovine herpesvirus-1 infection, 1352  
*Brucella abortus* transmission, 967  
 cecal rupture, 247  
 coccidiosis transmission, 1500  
 induction  
 abomasal impaction, 369  
 pregnancy toxemia, 1670  
 premature, 144–145  
 prolonged, intrapartum hypoxemia, 140  
 prolonged gestation with fetal giantism, 1978  
 Q fever transmission, 1468  
 stillbirth/perinatal weak calf syndrome, 1983  
 trauma at, 139–140  
 zinc concentration, plasma, 1732
- Parturition syndrome, 1619
- Parvaquone, 1529
- Parvoviruses, 1286, 1289, 1291
- Paspalitre poisoning, 1899, 1905
- Paspalum staggers, 1899, 1905
- Passerine birds, Eastern equine encephalomyelitis, 1369
- Passive immunity  
 decline of, 153  
 equine arteritis virus, 1320  
 equine influenza, 1327  
*Mannheimia haemolytica*, 944  
 tetanus, 824  
 transfer, assessment of, 153–154  
 transfer failure, 153, 154, 467, 1943  
 avoidance, 155–156  
 colibacillosis, 853–854, 871  
 correction of, 154, 167–168  
 diarrhea incidence and, 866
- Pasteurella*, 921–963  
 vaccines, 932, 943–944
- Pasteurella haemolytica*  
 bovine herpesvirus-1 infection, 1353  
 bovine virus diarrhea virus, 1256  
 enzootic pneumonia of calves, 1336  
 stachybotryotoxicosis, 1910
- Pasteurella mastitis*, 725
- Pasteurella multocida*, 921
- Actinobacillus pleuropneumoniae* interaction, 1054  
 enzootic pneumonia of calves, 1336, 1338  
 mastitis, 725  
 pasteurellosis, pigs, 950  
 pneumonia, pigs, 1144–1152  
 pneumonic pasteurellosis, 934, 950–952  
 progressive atrophic rhinitis, 956–963  
 vaccine, 943, 944, 962  
 virulence, 957–958, 1145
- Pasteurella ovine mastitis*, 761, 933
- Pasteurella (Yersinia) pseudotuberculosis*, 921
- Pasteurella trehalosi*, 949–950
- Pasteurellosis, 921–923  
 goats, 950  
 pigs, 950–952  
 pneumonic see Pneumonic pasteurellosis  
 septicemic see Septicemic pasteurellosis  
 sheep, 946–950
- Pasture  
 abrasive, actinobacillosis (wooden tongue), 1046  
 clippings, bovine lungworm diagnosis, 1566  
 copper deficiency risk factors, 1710  
 dietary cation-anion difference and acid-base balance, 1640–1641  
 equine grass sickness, 1990  
 examination of, 7  
 hypomagnesemic tetany risk factors, 1654–1655  
 intensive utilization, salmonellosis risk factor, 903  
 lead poisoning source, 1800  
 magnesium in, 1653  
 oxalate (soluble forms) poisoning, 1859  
 palatability, weaner illthrift, 1982  
 spelling, tick infestation control, 1602  
 tetany risk factors, 1653
- top-dressing  
 calcined magnesite, 1658  
 cobalt, 1705–1706  
 copper sulfate, 1719–1720  
 lactation tetany risk, 1654  
 magnesic limestone, 1658  
 magnesium, 1658  
 phosphatic limestone, 1816  
 sodium selenate, 1751
- Pasture-associated heaves, 1935
- Pasture-associated obstructive pulmonary disease, 1935
- Pasture bloat  
 case fatality, 327  
 clinical findings, 330  
 control, 332–336  
 epidemiology, 327  
 etiology, 326  
 genetic control, 336  
 morbidity, 327
- Pastured livestock, nutritional history-taking, 6
- Pasture fever, cattle see Tick-borne fever
- Pasture fire, 1793
- Pathy atelectasis, 501
- Patellar reflex, 591
- Patellar subluxation, inherited, 1962
- Patent ductus arteriosus, 432–433
- Patent foramen ovale, 431–432
- Patent urachus, 547, 573
- Path models, clinical herd examination, 35
- Pathogen Reduction: Hazard Analysis and Critical Control Points Systems regulation, 906
- Pattern of disease occurrence clinical herd examination, 33, 34
- Pattern recognition diagnosis, 22
- Patulin poisoning, 1906
- Pawing, 612
- Peat scours, copper deficiency, 1708, 1708, 1714
- Pectoral abscesses, 788–789
- Pedal bone  
 apex necrosis, 2037  
 displacement, laminitis, 2032  
 rotation, laminitis, 2032
- Pediculosis see Louse infestations
- Pedigree analysis, 1938  
 bovine familial degenerative neuromuscular disease, 1964  
 bovine hereditary dilated cardiomyopathy, 1945  
 complex vertebral malformation, Holstein calves, 1960–1961
- Pedigree flocks/herds  
 genetic disorder control, 1938–1939  
 scrapie, 1443
- Pedunculated lipomas, 242, 290
- Pelamus planturus* (sea snake), 1916
- Pelodera (Rhabditis) strongyloides* dermatitis, 1572–1573, 2042
- Pelodora* dermatitis, 2042
- Pelvic limbs  
 parturition injuries, 1635  
 traumatic injury, 1645
- Pelvis  
 fracture, 124  
 parturition injuries, 1635  
 size, parturient injury, 139
- traumatic injury, downer cow syndrome, 1645
- Pemphigus, 658–659
- Pemphigus foliaceus, 658
- Pendular nystagmus, 586
- Penetrating wound, 111
- Penicillamine, 2060
- Penicillin  
 anthrax, 818  
 arthritis, 646  
 blackleg, 829, 830  
 cystitis and pyelonephritis, 792  
 enzootic pneumonia of calves, 1341  
 enzootic posthitis, 794  
 erysipelas of swine, 814  
*Haemophilus parasuis* resistance, 1006  
*Listeria monocytogenes* infection, 809  
 malignant edema, 831  
 neonatal streptococcal infection, 777  
 pleuropneumonia of pigs, 1057  
 pneumonic pasteurellosis, 941  
 purpura hemorrhagica, 1926  
 pyelonephritis, contagious bovine, 790  
 strangles, 771–772  
*Streptococcus suis* infection, 781
- Penicillin citrinum*, 1899
- Penicillin G  
*Arcanobacterium pyogenes* mastitis, 724  
 dosage/interval, 2060, 2066  
 guttural pouch empyema, 539
- Penicillin V, 2060
- Penicillium*  
 cyclopiazonic acid poisoning, 1901  
 ochratoxin poisoning, 1906  
 tremorgen poisoning, 1910
- Penicillium aspergillus*, 1899
- Penicillium citrinum* poisoning, 1901
- Penicillium claviforme*, 1906
- Penicillium cyclopium*, 1910, 1912
- Penicillium palitans*, 1901
- Penicillium patulum*, 1906
- Penicillium purpurogenum*, 1908
- Penicillium roqueforti*, 1912
- Penicillium rubrum*, 1908
- Penicillium urticae*, 1906
- Penicillium viridicatum*, 1901, 1906
- Penis  
 palpation, urethral obstruction, 568  
 ulceration, caprine herpesvirus-1 infection, 1330
- Penitrem poisoning, 1910
- Pennisetum clandestinum* poisoning, 1897
- Pennisetum typhoides* (bulrush millet), 1903
- Penstate Ivanhoe Star, 1960
- Pentazocine, 2060, 2066
- Pentobarbital, 2060, 2066
- Pentosan sulfate, 2060
- Pentoxifylline  
 dosage/interval, 2060  
 endotoxemia secondary to colic, 225, 271  
 heaves, 1934
- Pepsin, 1544
- Pepsinogen, 1544
- Peptide poisoning, 1908
- Percussion, 12, 13  
 abdomen, 16–17  
 classification of, 12  
 equine colic, 220  
 equine pleuropneumonia, 526  
 fluid wave, bladder/urethra rupture, 568  
 liver, 387  
 lungs, 16  
 respiratory system examination, 481
- Percutaneous absorption, arsenic poisoning, 1809
- Percutaneous transtracheal aspiration, 485–486
- Percutaneous ultrasound guided  
 cholecystocentesis, 387–388
- Percutaneous ultrasound guided portocentesis, 388
- Perennial ryegrass (*Lolium perenne*), 1658, 1903–1904, 2000
- Performance  
 assessment, clinical herd examination, 36  
 shortfalls, 116–117
- Pergidin poisoning, 1920
- Pergolide, 2060
- Perherton draught horse, viable hypotrichosis, 1974
- Peribronchiolar lymphoreticular hyperplasia, 1147
- Pericardial fluid examination, 430
- Pericardial friction sound, pericarditis, 352, 429



- Pericardiocentesis, 352
- Pericarditis, 429–431  
cattle, 429, 430  
clinical findings, 429–430  
clinical pathology, 430  
constrictive, 429  
differential diagnosis, 430  
effusive, 429  
epidemic fibrinous, 1918–1920  
etiology, 429  
fibrinous, 429  
goats, 429  
horses, 429, 430  
idiopathic effusive, 429, 430  
necropsy findings, 430  
pathogenesis, 429  
pigs, 429  
prognosis, 430  
sheep, 429  
traumatic, 351–352, 429, 430  
treatment, 430
- Pericardium  
diseases of, 429–433  
see also *specific diseases/disorders*  
inflammation see Pericarditis
- Periconia, 1912
- Perilla frutescens (purple mint weed), 1892, 2000
- Perilla ketone intoxication, 2004
- Perinatal disease  
*Actinobaculum suis*, 788  
*Arcanobacterium pyogenes*, 788  
foals, equine herpesviruses, 1309
- Perinatal weak calf syndrome, 1983–1986  
case definition, 1985–1986  
clinical findings, 1983  
control, 1986  
diagnosis, 1985  
epidemiology, 1984–1985  
historical aspects, 1983–1984  
hypothermia, 142  
necropsy findings, 1983, 1985  
occurrence patterns, 1986  
prevention, 1986  
selenium deficiency and, 1753  
treatment, 1986
- Perinatology, 138
- Perineal angioedema, 664
- Perineal reflex, 591
- Perineal squamous-cell carcinoma, 668
- Perineal urethrostomy, 569
- Perineum, urine scalding, 548
- Perineurial fibrosis, 2024
- Periodic ophthalmia, leptospirosis, 1101, 1103, 1107
- Periodic spasticity of cattle, inherited, 1956
- Periodontal disease, 207, 208  
*Arcanobacterium pyogenes*, 788  
sheep, 207, 208
- Periodontal gingivitis, 1941
- Periorbital eczema, 783
- Periosteum proliferation, 635
- Peritonitis, 1572
- Periparturient disease, 1615  
see also *specific diseases/disorders*
- Periparturient egg rise (PPER)  
elimination, parasitic gastroenteritis, 1548  
*Oesophagostomum*, 1553  
trichostrongylid worms, 1542
- Periparturient hypogalactia syndrome (PHS) see Mastitis-metritis-agalactia (MMA) syndrome
- Peripheral blindness, 582–583
- Peripheral nerves, 581  
injection injuries, 618  
injury, pharyngeal paralysis, 211
- Peripheral nervous system disease, 618–619
- Peripheral neuropathy  
glomerulopathy and, 556  
pressure, recumbency complication, 123
- Perirectal abscess, 110
- Peristalsis  
abnormality, diarrhea, 193  
enteritis, 265  
equine grass sickness, 1991  
failure, 193–194
- Peritoneal adhesions, 283
- Peritoneal dialysis, 554
- Peritoneal drainage, uoperitoneum in foals, 565
- Peritoneal effusion, reticuloperitonitis and, 342
- Peritoneal fluid, 199–203  
analysis  
cecal impaction, 247  
characteristics, 203  
colon displacement, 250–251  
diarrhea, chronic undifferentiated, 273  
equine colic, 223  
peritonitis, 285–286  
reticuloperitonitis, traumatic, 340–341  
uoperitoneum in foals, 564  
volvulus of the colon, 250–251  
equine grass sickness, 1991  
horses, 200–201, 203  
properties of, 199, 200–201, 201–202  
reference values, 199, 203  
vagus indigestion, 349
- Peritoneal lavage, 287
- Peritoneal leiomyomatosis, disseminated, 290
- Peritoneal mesothelioma, 291
- Peritoneal tumors, 290–291
- Peritoneum, diseases of, 282–291  
see also *specific diseases/disorders*
- Peritonitis, 282–287  
abdominocentesis, 202  
*Actinobacillus*, 1045  
acute, 279, 284–285, 286  
acute diffuse, 283, 286, 300  
abomasal ulcer and, 372  
calves, 309  
characteristics, 1634  
fluid and electrolyte therapy, 92  
septic metritis, postpartum, 62  
acute local, 286, 372  
case fatality rate, 286  
cattle, 282, 284, 286, 287  
chronic, 283, 285, 286, 290  
hypoalbuminemia, 440  
clinical findings, 284–285, 298  
clinical pathology, 200–201, 285–286  
colitis, right dorsal, 255  
diagnosis, 286  
differential diagnosis, 286  
etiology, 282–283  
goats, 283  
horses, 200, 282–283, 284, 286–287  
necropsy findings, 286  
pathogenesis, 283  
peracute diffuse, 285  
pigs, 283  
prognosis, 286–287  
reticulum, trauma see Reticuloperitonitis, traumatic  
septic, 286  
sheep, 283  
subacute, 284–285, 286  
treatment, 287
- Perivaginal abscess, 110
- Perivascular cuffing, 600
- Perivascular reaction, intravenous  
antimicrobials, 178
- Permanent clover disease, phytoestrogen poisoning, 1874
- Permethrin  
biting midges, 1605  
bluetongue prevention, 1304  
horse flies, 1603  
stable flies, 1603  
tick infestations, 1601
- Pernicious anemia, 1782
- Peroneal nerve damage, 618
- Perphenazine, 2060
- Perreyia flavipes larvae poisoning, 1920
- Persea americana (avocado, alligator pear) poisoning, 1883–1884
- Persistence of the right aortic arch, 433
- Persistent lymphocytosis (PL), 1212, 1215, 1218
- Persistent pulmonary hypertension of the neonate (PPHN), 423
- Persistent truncus arteriosus, 433
- Persistent (pervious) urachus, 547, 573
- Peste des petits ruminants (PPR), 1242–1244  
acute form, 1243  
case-fatality rate, 1242  
clinical findings, 1243  
clinical pathology, 1243  
control, 1243–1244  
differential diagnosis, 1243  
economic importance, 1242  
epidemiology, 1242  
etiology, 1242  
experimental reproduction, 1242  
immune mechanisms, 1242  
necropsy findings, 1243  
occurrence, 1242  
pathogenesis, 1242–1243  
pigs, 1242  
rinderpest, 1241  
risk factors, 1242  
sample collection, 1243  
subacute form, 1243  
transmission, 1242  
treatment, 1243
- Peste des petits ruminants virus (PPRV), 1242–1243
- Pestiviruses, 1249, 1414
- Petechiae, bovine herpesvirus-1 infection, 1355
- Petechial hemorrhages, 1335, 1790
- Pethidine (meperidine), 106, 2058
- Petridliidium (Allescheria) boydii, 1471
- Petroleum-product poisoning, 1846
- Petrous temporal bone fracture, 605
- Petting zoos, 1419, 1513
- Peyer's patches, 1025
- Phagocytosis, selenium and, 1736
- Phalanges, reduced, 1961
- Phalanx  
corkscrew claw, 1961  
third, laminitis, 2031
- Phalaris, 1869–1870, 1901
- Phalaris aquatica, 617, 2009
- Pharyngeal lymphoid hyperplasia, 209
- Pharyngeal neoplasia, 281
- Pharyngeal obstruction, 210, 1009
- Pharyngeal paralysis, 211
- 'Pharyngeal phlegmon,' 209
- Pharyngitis, 209–210, 534–535, 1472
- Pharynx  
diseases of, 209–215  
see also *specific diseases/disorders*  
dysfunction, equine hyperkalemic periodic paralysis, 1966  
examination, 18–19  
hemorrhage, 194  
palpation, 209  
paralysis, pyrrolizidine alkaloid poisoning, 1880
- Phaseolus vulgaris, 1888, 1999
- Phenobarbital, 2014, 2060
- Phenolic compound poisoning, 1840
- Phenolics poisoning, 1888–1889
- Phenolsulfonphthalein plasma clearance, 550
- Phenothiazine, 1831, 2060
- Phenoxybenzamine hydrochloride, 2060
- Phenylbutazone  
bovine ephemeral fever, 1179  
contraindications for, 106  
dosage/interval, 2060, 2066  
endotoxemia, 59  
endotoxemia secondary to colic, 225, 271  
equine cervical vertebral stenotic myelopathy, 2017  
exertional rhabdomyolysis, 1685  
indications for, 106  
laminitis, horses, 2032  
mastitis, 693  
pain, 105–106  
recurrent exertional rhabdomyolysis, 1968  
retropharyngeal lymphadenopathy, 538  
toxicity, venous thrombosis, 435–436  
toxicosis, laminitis, 2032
- Phenylephrine, 251, 1991
- Phenylephrine hydrochloride, 2060
- Phenylethylamine poisoning, 1869–1870
- Phenytoin  
equine neonatal encephalopathy, 2014  
exertional rhabdomyolysis, 1685  
recurrent exertional rhabdomyolysis in Thoroughbred horses, 1968  
stringhalt, 2019
- Phenytoin sodium, 417, 2060
- Phillips report, 1446
- Phlebitis, 436
- Phlebotamine sandfly (Lutzomyia shannoni), 1234
- Phleboviruses, 1205
- Phlegmon, 110, 111, 636
- Phoma herbarum poisoning, 1897
- Phomopsis poisoning, 1899, 1906–1908
- Phomopsis rossiana, 1899
- Phonocardiography, 409–410
- Phormidium konstantinosum, 1914
- Phosphate  
fractional clearance, 551–552  
retention, renal insufficiency, 544  
supplementation, fluorine poisoning, 1816

- Phosphoferose isomerase (PHI), 1972  
6-phosphogluconate dehydrogenase, 1972  
Phosphorus  
absorption, 1755–1756  
deficiency, 1755, 1758–1763  
carrion-associated botulism, 825  
cattle, 1759  
clinical findings, 1760–1761  
clinical pathology, 1761  
control, 1761–1763  
diagnosis, 1761  
differential diagnosis, 1761  
epidemiology, 1758–1760  
etiology, 1758  
horses, 1759  
ketosis, 1662  
necropsy findings, 1761  
osteodystrophy, 632  
outbreaks, 1755, 1758–1759  
pathogenesis, 1760  
pigs, 1759  
postparturient hemoglobinuria, cattle, 1682, 1683  
primary, 1759, 1760  
secondary, 1759–1760  
sheep, 1759  
treatment, 1761  
*Trichostrongylus colubriformis*, 1544  
dietary  
daily requirements, 1758, 1759, 1759, 1761–1763  
deficiency, 1755, 1831  
environmental implications of, 1761–1763  
estimation of, 1761  
milk fever and, 1629, 1639, 1642  
uroolithiasis, 570  
inorganic, serum, 1622, 1633  
metabolism, 1755–1756  
osteodystrophy, 634–635  
oversupplementation, 1762  
plasma levels, milk fever, 1627  
poisoning, 1797, 1813–1814  
serum  
osteodystrophy, 634  
phosphorus deficiency, 1761  
vitamin D deficiency and, 1765  
Photic-trigeminal summation, 2022  
Photodynamic agent ingestion, 659  
Photoperiod, lactation efficiency and, 1616  
Photosensitive dermatitis, 1303, 1946  
Photosensitive thelitis, 750–751  
Photosensitization, 659–661  
clinical findings, 660–661  
clinical pathology, 661  
congenital porphyria, 1946  
differential diagnosis, 661  
epidemiology, 659–660  
etiology, 659–660  
glucosinolate poisoning, 1868  
hepatitis, 393  
horse, 1433  
and hyperbilirubinemia, inherited, 1976  
liver disease, 386  
necropsy findings, 661  
pathogenesis, 660  
plant-induced, 1896, 1897  
primary, 659–660  
treatment, 661  
Phoxim  
chorioptic mange, 1612  
itchmites, 1607  
louse infestations, 1598  
psoroptic mange, 1611  
Phrenic nerve, synchronous diaphragmatic flutter, 521–522  
Phylloerythrin, 660, 661  
Physical agents, 1785–1795  
Physical effort, excessive, 107  
Physical examination  
abomasum, 353  
downer cow syndrome, 1647  
exercise-induced pulmonary hemorrhage, 503  
lameness, 625  
Physical exercise see Exercise  
Physical injury, recumbency, 1634  
Physical therapy, arthritis/synovitis, 647  
Physiological arrhythmias, 413, 414  
Phytitis, 632  
*Physocephalus sexalatus*, 1555  
Physostigmine, 1866, 2060  
Phytobezoars  
abomasal, 370  
luminal blockage, 377–378  
plant sources, 1895  
Phytoestrogen poisoning, 1873–1875  
clinical findings, 1874  
clinical pathology, 1874  
control, 1875  
diagnosis, 1875  
differential diagnosis, 1875  
economic importance, 1874  
epidemiology, 1873–1874  
etiology, 1873  
fungi sources, 1873  
necropsy findings, 1874–1875  
pathogenesis, 1874  
plant sources, 1873  
risk factors, 1873–1874  
treatment, 1875  
Phylogenous chronic copper poisoning, 1823, 1824  
Phytomenadione, 2066  
Phytonadione, 2060  
Phytotoxins, 1797, 1851–1897  
conditioned aversion to plants, 1852  
congenital defects in newborns, 133–134  
control, 1852  
diagnosis, 1852  
encephalomyelopathies, 611–612  
environmental examination for, 7  
hepatitis, 391–392  
human food chain, 1851  
immunization, 1852  
interstitial pneumonia, 1998, 1999–2000  
investigation, 1798  
metabolic poisons, 1851  
osteodystrophy, 632  
phenol, 1888–1889  
post-volcanic eruptions, 1791  
susceptibility factors, 1798  
unidentified toxins, 1895–1897  
see also *specific poisons*  
Pica, 112–113  
consequences of, 113  
definition, 112  
leptospirosis, 1099  
*pars esophagea* ulceration, 1995  
types, 113  
Pietrain pigs, 1965, 1970  
Pig(s)  
antimicrobial residue violations, 186  
blood groups, 1921  
bronchoalveolar lavage, 488  
cannibalism, 113, 612–613  
drug doses/intervals, 2064–2066  
hemoglobin levels, 1727  
leg weakness, 638  
nutrient requirements, 1695  
nutritional management, 1694–1695  
phosphorus requirements, 1763  
reference laboratory values, 2047–2050  
selenium reference ranges, 1748  
selenium supplementation, 1753  
stray voltage, 1791  
water medication, 180  
Pigeon fever, 788–789  
Pig estrogenism, 1841  
Pig Health Control Association, Britain, 1119  
Piglet(s)  
alloimmune hemolytic anemia of the newborn, 1922, 1924  
arthritis, infectious, 643  
birth weight, 130  
cleft palate, 1944  
coccidiosis, 1499, 1501, 1503, 1504, 1505  
colibacillosis, 852–853, 854, 856, 860, 871  
colostral immunoglobulins transfer, guidelines to ensure, 873  
colostrum administration, 156  
congenital defects, 135  
critical temperature, 142  
diarrhea  
acute undifferentiated risk factors, 849–850  
dietary, 277  
viral, 1289–1290, 1291, 1292, 1293–1294  
encephalomyocarditis virus disease, 1184  
enteritis, *Clostridium perfringens*, type A, 837  
*Escherichia coli* vaccination, 875  
feet, traumatic injury, 624  
fetal disease, 130  
fluid and electrolyte therapy, 101  
foot-and-mouth disease vaccination, 1228  
gastroenteritis, transmissible, 1278, 1281  
goiter, inherited, 1941  
hog cholera, 1161, 1166  
hypoglycemia, 758, 1680, 1682  
hypothermia, 44, 46, 142  
iron deficiency anemia, 1726, 1727  
iron (organic compounds) poisoning, 1829  
joint fixation, congenital, 648  
management, 130  
mastitis-metritis-agalactia syndrome and, 758  
meningitis, 610  
mortality, 130  
navel (umbilical) bleeding, 444  
neonatal infection, 146  
parturient disease, 130  
parturition, premature induction, 145  
passive immunity transfer failure, 854  
porcine herpesvirus 2 infection, 1335  
porcine reproductive and respiratory syndrome, 1195, 1197–1198, 1201  
porcine viral encephalomyelitis, 1406  
postnatal disease, 130  
post-weaning multisystemic wasting syndrome experimental infection, 1189  
pseudorabies vaccination, 1397, 1402  
septicemia, 51  
splaylegs, 627  
streptococcal infection, 775, 776  
teat skin necrosis, 749  
thrombocytopenia, 446  
toxoplasmosis, 1520  
Pig louse (*Haematopinus suis*), 1431  
Pig lungworm, 1569  
Pig pox (swinepox), 785, 1431–1432  
*Pilobolus*, 1565  
*Pimelia*, simplexin poisoning, 1886  
Pimply gut see Oesophagostomosis  
'Pine' (unthrifty)  
copper deficiency, 1714  
secondary, 1708, 1708  
lamb dysentery, 839  
Pine needle abortion, 1872  
Pinkeye, 1142–1143  
Pink teeth, 1958  
Pink test liquid, 1675  
Pinworm (*Oxyuris equi*), 1562  
Piperazine  
dosage/interval, 2060, 2066  
elaeophorosis, 1574  
poisoning, 1831  
Piperillin, 2060  
Piperidine alkaloid poisoning, 1889–1890  
'Pipe-stem' feces, 1489  
Pirbuterol, 2060  
Piric acid test, 1854  
Pirlimycin, 2060  
Piroplasms, 1528, 1529, 1531  
'Pistol shot' heart sound, 1788  
*Pithomyces chartarum*, 1899, 1908–1910  
Pithyosis hyphomycosis destruens (equine phycomycosis), 1434, 1480–1481  
Pituitary abscess syndrome, 606  
Pituitary gland  
abscess, 110, 606  
*pars intermedia* adenoma see Equine *pars intermedia* dysfunction  
tumors, 608  
Pituri (*Dubosia hopwoodii*) poisoning, 1890  
Pityriasis, 654  
Pityriasis rosea, 785, 2037–2038  
*Pityrosporum orbiculare*, 1471, 1476  
Pivampicillin sodium, 2060  
Pizzle drooping, 1593  
Pizzle rot see Enzootic posthitis  
'Pizzle strike,' 1591, 1593  
Placenta  
abnormalities/dysfunction  
cloned offspring, 146  
fetal hypoxia, 140  
intrauterine growth retardation, 137  
premature-like signs in foals, 139  
stillbirth/perinatal weak calf syndrome, 1984  
border disease, 1415  
bovine herpesvirus-1, 1352  
development, nutrition and, 1695–1696  
equine herpesvirus 1 infection, 1313  
equine neonatal encephalopathy, 2013  
fluorine transfer across, 1817  
lead transfer across, 1802  
lesions, alloimmune hemolytic anemia of the newborn, 1921  
ovine enzootic abortion, 1436

- Placenta (Cont'd)  
 premature expulsion, 140–141, 1985  
 pseudorabies, 1399–1400  
 Q fever, 1469  
 retention, 61, 1635  
   milk fever complication, 1630  
   monensin effect, 1674  
   selenium status and, 1741  
   treatment, 62–63  
   see also Septic metritis, postpartum  
 scrapie transmission, 1441, 1444  
 toxoplasmosis, 1519, 1521  
 Placental blood transfusion, 140  
 Placental cotyledons, 1437  
 Placenteritis  
 acute necrotizing, border disease, 1415  
 brucellosis associated with *Brucella ovis*, 985  
 fungal, 1473  
 horses, 131  
 mycotic, 1472, 1473  
 precocious lactation, 139  
 Planorbid snail, stomach fluke disease host, 1580  
 Plants  
 awns/spines, stomatitis, 205  
 ingestion  
   physical damage from, 1895  
   stringhalt, 2019  
 photosensitizing substances in, 659–660, 660  
 poisonous see Phytotoxins  
 selenium in, 1737  
 vitamin E deficiency and, 1737  
 Plaque(s)  
 bovine ocular squamous-cell carcinoma, 2039  
 dourine, 1539  
 granulomatous, 667  
 orf, 1420  
 peste des petits ruminants, 1243  
 Plaque reduction neutralization (PRN) test, 1379–1380  
 Plasma  
 administration of, 96  
 copper levels, 1716–1717  
 neonatal infection, 149  
 normal color, 389  
 oncotic pressure, 72, 500  
 osmolality, 93  
 osmolarity, 93  
 pH, 84  
 transfusion  
   disseminated intravascular coagulopathy, 449  
   hypoproteinemia, 440–441  
   newborns, 167–168  
 Plasmacytoma, 462  
 Plasmid-determined antimicrobial resistance, 176, 177  
 Platelet(s)  
 African swine fever, 1170  
 bluetongue, 1302  
 Chediak-Higashi syndrome, 1942  
 count, 442  
 disorders of, 445–447  
 disseminated intravascular coagulopathy, 448, 449  
 equine infectious anemia, 1174  
 exercise-induced pulmonary hemorrhage, 506  
 function, 442  
 radiation injury, 1787  
 thrombocytopenia, 445–446, 446  
 Pleocytosis, 1414  
 Pleural cavity drainage, 524  
 Pleural disease, 519–530  
   see also specific diseases/disorders  
 Pleural effusion  
   hemangiosarcoma, 436  
   pleuritis (pleurisy), 523  
 Pleural fluid examination  
   equine pleuropneumonia, 526, 527  
   pulmonary/pleural neoplasm, 519  
 Pleural lavage, 524, 529  
 Pleural neoplasm, 518–519  
 Pleural pain, 522  
 Pleural pressure change measurement, 489, 1931  
 Pleural visceral surface, pneumonia, 511  
 Pleurisy see Pleuritis (pleurisy)  
 Pleuritic friction sounds, 477, 478, 522  
 Pleuritis (pleurisy), 522–525  
   cattle, 522  
   chronic, 522  
   clinical findings, 513, 522–524  
   clinical pathology, 524  
   differential diagnosis, 524  
   etiology, 522  
   goats, 522  
   *Haemophilus* septicemia, 998, 1001  
   horses, 522  
   hypoalbuminemia, 440  
   necropsy findings, 524  
   pathogenesis, 522  
   pigs, 522  
   prognosis, 524  
   recovery, 523  
   sheep, 522  
   traumatic reticuloperitonitis and, 339  
   treatment, 524–525  
   tuberculosis, 1009  
   see also Equine pleuropneumonia  
 Pleurocentesis, 487–489  
 Pleuropneumonia  
   bovine contagious see Contagious bovine pleuropneumonia (CBPP)  
   caprine contagious, 1123, 1140–1141  
   pigs, 1053–1060  
   case fatality rate, 1053  
   clinical findings, 1055–1056  
   clinical pathology, 1056–1057  
   control, 1058–1059  
   diagnosis, 1057  
   differential diagnosis, 1057  
   economic importance, 1055  
   epidemiology, 1053–1055  
   eradication, 1058–1059  
   etiology, 1053  
   herd classification, 1058  
   morbidity, 1053  
   necropsy findings, 1057  
   pathogenesis, 1055  
   risk factors, 1053–1055  
   transmission, 1053  
   treatment, 1057–1058  
   vaccination, 1055, 1059  
 Pleuroscopy, 482, 523–524  
 Ploughman's spikenard (*Inula conyza*) poisoning, 1888  
 Plumbism see Lead, poisoning  
 Plunge dipping  
   caseous lymphadenitis risk factor, 796  
   heartwater, 1463  
   louse control, 1598  
   psoroptic mange, 1611  
 Pluronics poisoning, 1845  
 Pneumoconiosis see Interstitial pneumonia  
*Pneumocystis jiroveci* pneumonia, 509, 803  
 Pneumocytes, ovine pulmonary adenocarcinoma, 1367  
 Pneumonia, 508–515  
   aspiration, 515–516, 925  
   beef calf mortality, 130  
   bovine herpesvirus-1 infection, 1353, 1358–1359  
   cattle, 508  
   chronic non-progressive, 1361–1362  
   chronic obstructive, 423  
   clinical findings, 511–512, 524  
   clinical pathology, 512–513  
   development of, 511  
   differential diagnosis, 513  
   embolic, 516–517, 925  
   enzootic see Enzootic pneumonia  
   eosinophilic, 509  
   epidemiology, 509  
   etiology, 508–509  
   goats, 509  
   *Haemophilus* septicemia, 998, 1000, 1001  
   horses, 508–509  
   housing, 514–515  
   interstitial see Interstitial pneumonia  
   lamb, 128  
   lipid, 515  
   mass medication, 514  
   *Mycoplasma bovis* see *Mycoplasma bovis* pneumonia  
   mycotic, 1472, 1473  
   necropsy findings, 513  
   pathogenesis, 509–511  
   pathophysiology, 511  
   pigs, 508, 1144–1152  
   of pleural visceral surface, 511  
   porcine circovirus 2, 1190  
   recumbency complication, 123  
   *Rhodococcus equi* see *Rhodococcus equi*, pneumonia in foals  
   risk factors, 509  
   sheep, 509  
   species susceptibility, 511  
   *Streptococcus*, 768  
   supportive therapy, 514–515  
   traumatic reticuloperitonitis and, 339  
   treatment, 513–515  
   verminous see Bovine lungworm (verminous pneumonia)  
 Pneumonia-polyarthritis syndrome, chronic, 1129  
 Pneumonic pasteurellosis, 921  
 cattle (shipping fever), 934–946  
   chemoprophylaxis, 945–946  
   clinical findings, 924, 938–939  
   clinical pathology, 939–940  
   control, 942–946  
   diagnosis, 940  
   differential diagnosis, 940  
   economic importance, 935  
   epidemiology, 924, 935–937  
   etiology, 934–935  
   experimental, 938  
   immune mechanisms, 936–937  
   management strategies, 942–943  
   morbidity, 935  
   mortality, 935  
   necropsy findings, 940  
   outbreaks, 928, 935, 939  
   pathogenesis, 937–938  
   response, 924  
   risk factors, 935–936  
   transmission, 937  
   treatment, 940–942  
   vaccination, 933, 943–945  
 ovine pulmonary adenocarcinoma, 1367  
 pigs, 950–952  
   clinical findings, 951  
   control, 952  
   diagnosis, 951  
   differential diagnosis, 951  
   epidemiology, 951  
   etiology, 950–951  
   necropsy findings, 951  
   transmission, 951  
   treatment, 951–952  
 sheep and goats, 947–949  
   clinical findings, 948  
   clinical pathology, 948  
   control, 948  
   diagnosis, 948  
   differential diagnosis, 948  
   epidemiology, 947–948  
   etiology, 947  
   experimental reproduction, 947–948  
   necropsy findings, 948  
   outbreaks, 947  
   pathogenesis, 948  
   risk factors, 948  
   treatment, 948  
   vaccination, 949  
   wildlife, 947  
 Pneumoperitoneum, 195  
 Pneumothorax, 519–521  
 Podophyllin poisoning, 1890  
*Podophyllum peltatum* poisoning, 1890  
 Point infection control program, rabies, 1388, 1391  
 Poisoning  
   antidotes, 1798–1799  
   arthropathy etiology, 637  
   blindness, 583  
   cyanobacteria toxins, 1913–1914  
   deliberate/criminal, 1798  
   dyspnea/exercise intolerance from, 475  
   encephalomyelopathies, 611–612  
   epistaxis, 532  
   estrogenic substances, 1841–1842  
   farm chemicals, 1830–1849, 1846  
   feed additives, 1841  
   fungicides, 1838–1839  
   hemolytic jaundice, 384  
   herbicides, 1837–1838  
   indications, 1797  
   inorganic chemicals, 1797–1830  
   inorganic substances, 1799–1830  
   insecticides, 1832–1837  
   molluscicides, 1840  
   mycotoxins, 1898–1913  
   myelomalacia, 617  
   rodenticides, 1839–1840  
   seed dressings, 1840–1841

- Poisoning (*Cont'd*)  
specimen analysis, 1797  
stomatitis, 205  
sudden death, 125  
thrombocytopenia, 445  
treatment principles, 1798–1799  
wood preservatives, 1840  
see also *specific poisons*
- Poison walnut (*Cryptocarya pleurosperma*)  
poisoning, 1888
- Polioencephalomalacia (PEM), 603, 604, 2006–2012  
brain dysfunction, 1806  
case fatality rates, 2006  
cattle, 2010, 2011  
clinical findings, 2010  
clinical pathology, 2010–2011  
control, 2012  
definition, 602  
dietary risk factors, 2007–2009  
differential diagnosis, 2011  
epidemiology, 2006–2009  
etiology, 2006  
glucosinolate poisoning, 1867, 1868  
goats, 2006, 2007, 2010, 2011  
menace reflex, 585  
morbidity rate, 2006  
necropsy findings, 2011  
occurrence, 2006  
outbreak management, 2012  
pathogenesis, 2009–2010  
risk factors, 2006–2009  
sheep, 602, 2010, 2011  
sulfate-induced, 2007–2010, 2012  
treatment, 2011–2012
- Polioencephalomyelitis, 1379
- Poliomyelitis suum (subacute porcine viral encephalomyelitis), 1405–1406
- Poliomyelomalacia, selenium poisoning, 1812
- Pollakiuria, 547
- Pollen inhalation, interstitial pneumonia, 1999
- Poll Hereford cattle  
bovine hereditary dilated cardiomyopathy, 1945  
maple syrup urine disease, 1953
- Poll Shorthorn cattle, maple syrup urine disease, 1953
- 'Poll strike,' 1591
- Pollution, 1785
- Polo ponies, recurrent exertional rhabdomyolysis, 1967
- Poloxalene, 332, 335, 2060
- Polyacrylamide gel electrophoresis (PAGE), 1293
- Polyarthritis  
*Actinobacillus suis* infection, 1052  
chlamydial, 1435  
infectious see Infectious polyarthritis  
*Mycoplasma*, 1126–1127  
see also *Mycoplasma bovis* polyarthritis  
salmonellosis, 909
- Polybrominated biphenyl, 1785, 1846
- Polychlorinated biphenyl, 1785, 1846
- Polyclonal direct fluorescent antibody, hog cholera test, 1164
- Polycystic kidney disease, 572
- Polycythemia, familial, 1947
- Polydactylism (extra claws), 1961
- Polydipsia, 114, 551, 1897
- Polygonum*, 1896
- Polymerase chain reaction (PCR) test  
*Actinobacillus pleuropneumoniae*, 1056  
atrophic rhinitis, progressive, 960  
babesiosis, 1489–1490  
bluetongue, 1303  
bovine herpesvirus-1 infection, 1354  
bovine immunodeficiency-like virus, 1222  
bovine leukemia virus, 1217–1218  
bovine papular stomatitis, 1277  
bovine respiratory syncytial virus pneumonia, 1347  
bovine virus diarrhea virus, 1261, 1267  
*Brachyspira hyodysenteriae*, 1116  
*Brucella abortus*, 971  
coccidiosis, 1504  
combined immunodeficiency, Arabian foals, 1979  
contagious bovine pleuropneumonia, 1134, 1135  
dourine, 1539  
enterocolitis, *Clostridium difficile* associated, 846  
enterohemorrhagic *Escherichia coli*, 882  
eperythrozoonosis, 1155  
equine arteritis virus, 1321  
equine encephalomyelitis, 1370  
equine granulocytic anaplasmosis, 1465  
equine herpesvirus 1, 1314  
equine herpesvirus 4, 1310  
equine phycomycosis, 1481  
equine upper respiratory tract viral infection, 1307–1308  
freemartinin diagnosis, 1940  
glycogen storage disease type V, 1963  
hog cholera, 1162–1163  
ileitis, 1090–1091  
infectious polyarthritis, 1005  
Johne's disease, 1031, 1038  
*Lawsonia intracellularis*, 1090  
leptospirosis, 1104–1105  
malignant catarrhal fever, 1247  
*Mycobacterium avium* subspecies *paratuberculosis* (*Map*), 1026, 1027  
*Mycoplasma bovis*, 1129  
nagana, 1535  
neonatal viral diarrhea, 1293  
ovine progressive pneumonia, 1365  
polyserositis, pigs, 1153  
porcine circovirus 2, 1187  
porcine herpesvirus 2 infection, 1336  
porcine reproductive and respiratory syndrome, 1200  
post-weaning multisystemic wasting syndrome, 1191  
*Rhodococcus equi* pneumonia, 802–803  
salmonellosis, 911  
swine influenza, 1333–1334  
Venezuelan equine encephalomyelitis, 1374
- Polymerized bovine hemoglobin, 1924
- Polymethylmethacrylate beads, 646
- Polymicrobial infection, equine pleuropneumonia and, 525
- Polymyxin, 181, 225, 271
- Polymyxin B, 59, 2061
- Polymyxin B sulfate, 1050
- Polyneuritis equi, 618, 2021  
acute, 2021  
diagnosis, 2018  
differential diagnosis, 2018, 2021  
equine protozoal myeloencephalitis, 1524  
etiology, 2021  
necropsy findings, 2021  
pathogenesis, 2021  
treatment, 2021
- Polypeptide vaccine (protein VP1), foot-and-mouth disease, 1229
- Polyphagia, 112
- Polyphenol poisoning, 1888–1889
- Polypnea, 474
- Polypogon monspeliensis*, 1915
- Polyps, coccidiosis, 1504
- Polysaccharide storage myopathy, 629
- Polyserositis, 1152–1154
- Polysulfated glycosaminoglycans, 642, 2061
- Polyunsaturated fatty acids, dietary, 1735, 1738
- Polyuria, 547  
plant-induced, 1897
- Ponazuril, 1525, 2061
- Population mortality rates, history-taking, 5
- Porcine aminopeptide N, 1280
- Porcine arthritis see Infectious polyarthritis
- Porcine babesiosis, 1484
- Porcine brucellosis, 965, 984
- Porcine circovirus(es), 1186
- Porcine circovirus 1 (PCV1), 1185, 1192
- Porcine circovirus 2 (PCV2), 1185  
associated diseases, 1186  
epidemiology, 1186–1187  
fetal infection, 1188  
replication, 1186  
reproductive failure, 1189  
strains, 1186  
transmission, 1186  
vaccines, 1192
- Porcine colitoxicosis, 57
- Porcine colonic spirochetosis (PCS)  
clinical findings, 1121  
control, 1122  
diagnosis, 1122  
etiology, 1120–1121  
treatment, 1122  
see also Porcine intestinal spirochetosis
- Porcine coronavirus, 1290, 1291
- Porcine cytomegalic virus, 1335–1336
- Porcine dense deposit disease, 555
- Porcine dermatitis-nephropathy syndrome (PDNS), 657, 1192
- Porcine enteroviral encephalomyelitis see Porcine viral encephalomyelitis
- Porcine enterovirus group 1 (PEV-1), 1405
- Porcine epidemic diarrhea, 1290, 1292, 1294
- Porcine epidemic diarrhea virus, 1290
- Porcine hemorrhagic enteropathy, 1088
- Porcine herpesvirus 1, 1394
- Porcine herpesvirus 2 infection, 1335–1336
- Porcine idiopathic chronic recurrent dermatitis, 657
- Porcine intestinal adenomatosis, 1088, 1090, 1091  
see also ileitis
- Porcine intestinal spirochetosis, 1120–1123  
*Brachyspira pilosicoli*, 1120–1123  
clinical findings, 1121  
clinical pathology, 1121–1122  
control, 1122  
diagnosis, 1122  
etiology, 1120–1121  
immunology, 1122  
outbreaks, 1121  
pathogenesis, 1121  
risk factors, 1121  
transmission, 1121  
treatment, 1122  
vaccination, 1122  
zoonotic potential, 1122
- Porcine necrotic ear syndrome, 657
- Porcine necrotizing pneumonia (PMP), 1189, 1199
- Porcine parvovirus (PPV), 1095, 1187
- Porcine polyserositis see Infectious polyarthritis
- Porcine proliferative enteritis complex, 1087–1093
- Porcine proliferative enteropathy, 1089  
see also ileitis
- Porcine pulmonary edema, fumonisin poisoning, 1905
- Porcine pulmonary hepatosis, fumonisin poisoning, 1905
- Porcine reproductive and respiratory syndrome (PRRS), 1194–1205  
abortion, 1095  
aerosol transmission, 1197  
airborne spread, 1197  
carriers, 1196  
clinical findings, 1199–1200  
clinical pathology, 1200–1201  
colostral antibodies, 1195  
congenital infection, 1197  
control, 1202–1204  
diagnosis, 1200  
differential diagnosis, 1201  
economic importance, 1197  
endemic herds, 1194  
epidemiology, 1194–1197  
etiology, 1194  
experimental infection, 1195  
fetal infection, 1198–1199  
herd diagnosis, 1200–1201  
herd profile, 1201  
immune mechanisms, 1195  
maternal immunity, 1195  
morbidity, 1194–1195  
mortality, 1194–1195  
necropsy findings, 1201  
occurrence, 1194  
pathogenesis, 1197–1199  
persistent infection, 1196  
post-weaning multisystemic wasting syndrome, 1186, 1187, 1189  
predisposing infections, 1199  
prevalence, 1194  
protective immunity, 1195  
reproductive failure, 1198, 1199  
respiratory disease, 1199–1200  
risk factors, 1195–1196  
secondary bacterial infections, 1195, 1199, 1203  
splayleg syndrome and, 2025  
spread between herds, 1196  
transmission, 1196–1197  
treatment, 1201–1202  
in utero infection, 1197  
vaccines, 1203–1204  
virus isolation, 1200
- Porcine reproductive and respiratory syndrome virus (PRRSv), 1194, 1195–1196

- Porcine respiratory coronavirus (PRCV), 1278, 1279, 1284
- Porcine respiratory disease complex (PRDC)  
mycoplasmal pneumonia, 1144–1152  
porcine circovirus 2 associated, 1185  
porcine reproductive and respiratory syndrome virus associated, 1199–1200  
swine influenza, 1332
- Porcine rotavirus  
neonatal diarrhea, 1289–1290, 1296  
serotypes, 1290  
source of infection, 1290  
transmission, 1290  
vaccines, 1296
- Porcine somatotrophin, *pars esophagea* ulceration, 1995
- Porcine stress syndrome (PSS), 1969–1973  
clinical findings, 1971  
clinical pathology, 1971–1972  
control, 1973  
differential diagnosis, 1973  
drug-induced see Malignant hyperthermia (MH)  
economic importance, 1970  
epidemiology, 1969–1971  
etiology, 1969  
halothane status, 1970  
meat quality, 1970  
myopathy, 627  
necropsy findings, 1972  
occurrence, 1969–1970  
pathogenesis, 1970–1971  
prevalence, 1969–1970  
risk factors, 1970  
transport death, 1971  
treatment, 1973
- Porcine viral encephalomyelitis, 1404–1407  
case fatality rate, 1405  
clinical findings, 1405–1406  
clinical pathology, 1406  
control, 1406  
differential diagnosis, 1406  
epidemiology, 1405  
etiology, 1405  
morbidity, 1405  
necropsy findings, 1406  
occurrence, 1405  
pathogenesis, 1405  
prevalence, 1405  
risk factors, 1405  
transmission, 1405  
vaccines, 1406  
virus detection, 1406
- Porencephaly, bluetongue, 1302
- Pork tapeworm (*Taenia solium*, *Cysticercus cellulosae*), 1583
- Porphyria, congenital, 1946
- Porphyrins, 1946
- Portal circulation, liver disease, 383–384
- Portocentesis, percutaneous ultrasound guided, 388
- Portosystemic shunts, 394
- Portosystemic vascular anomaly, 392, 393
- Portugal  
African swine fever, 1168–1169  
bovine spongiform encephalopathy, 1447
- Portuguese Holstein cattle, 'buckskin'-colored follicular dysplasia, 1974
- Positive predictive value (PPV), 27, 27–28
- Postanesthetic myelopathy, 121
- Postanesthetic myositis, 628
- Posterior paralysis, inherited congenital, 1957
- Postexercise rhabdomyolysis see Rhabdomyolysis, exertional/postexercise
- Postharvest beef safety production programs, 885–887
- Posthitis, enzootic see Enzootic posthitis
- Postnatal disease, 127–128
- Postnatal infection, 147
- Postpartum dysgalactia syndrome (PPDS) see Mastitis-metritis-agalactia (MMA) syndrome
- Postpartum metritis, *Arcanobacterium pyogenes*, 788
- Postparturient hemoglobinuria, 384–385, 1491, 1682–1683
- Post-race gastric dilatation, 233
- Postrenal proteinuria, 545
- Postrenal uremia, 544
- Posture  
abnormality, 576, 579–580, 586, 621  
bovine ephemeral fever, 1178
- equine colic, 220
- equine encephalomyelitis, 1370  
evaluation, 587–589  
examination, 10  
laminitis, horses, 2031  
laminitis, ruminants/pigs, 2034  
nervous system examination, 587–589  
peritonitis, 284  
pregnancy toxemia, sheep, 1669  
respiratory insufficiency manifestation, 475  
reticuloperitonitis, traumatic, 339  
scrapie, 1444
- Postvaccinal (serum) hepatitis, 392, 393, 824, 1988–1989
- Postweaning diarrhea (pigs) see Coliform gastroenteritis
- Post-weaning multisystemic wasting syndrome (PMWS), 1185–1193  
clinical findings, 1189–1190  
clinical history, 1186  
clinical pathology, 1190  
co-infection, 1187, 1188  
control, 1191–1192  
diagnosis, 1185, 1189, 1191  
differential diagnosis, 1189  
distribution, 1186  
environmental influences, 1187  
epidemiology, 1186–1188  
etiology, 1185–1186  
experimental infection, 1188–1189  
genetic factors, 1186  
immunology, 1187  
litter effect, 1186  
mortality, 1189  
necropsy findings, 1190–1191  
occurrence, 1186  
pathogenesis, 1188  
risk factors, 1186–1187  
samples collected, 1191  
treatment, 1191  
vaccinations, 1187–1188
- Potamochoerus porcus* (bush pig), African swine fever transmission, 1168
- Potash, hypomagnesemic tetany risk factor, 1655, 1658
- Potassium  
deficiency, 452, 1734–1735  
dietary, milk fever prevention, 1641  
diet low in, equine hyperkalemic periodic paralysis, 1966  
excess see Hyperkalemia  
loss of see Hypokalemia  
mare's milk concentration, 563  
serum  
digoxin administration, 404  
hypokalemia, acute (cattle), 1650  
small intestine *Escherichia coli* overgrowth, 868  
supplementation, 1734  
hypokalemia, 79–80  
postparturient hemoglobinuria, cattle, 1683  
toxicity, 1734
- Potassium bromide, 2052, 2061
- Potassium chloride, 1650, 1966
- Potassium iodate supplementation, 1725
- Potassium iodide  
actinobacillosis (wooden tongue), 1047  
dosage/interval, 2061  
equine phycomycosis, 1481  
sporotrichosis, 1480  
supplementation, 1725
- Potassium salt, oxalate (soluble forms) poisoning, 1858
- Potato toxicity, 1893
- Potomac horse fever see Equine neorickettsiosis
- Poultry  
dried waste, poisoning, 1843  
litter, carrion-associated botulism, 825  
manure, carrion-associated botulism, 825  
*Salmonella* infection, 906
- Pour-on insecticides  
*Haematobia* fly control, 1604  
*Hypoderma* infestations, 1589  
louse infestations, 1598  
tick control, 1602
- Povidone-iodine solution, 696
- Powassan virus, 1383
- Power sprayers, screwworm treatment, 1595
- Poxviruses, horsepox, 1432
- P-Q interval, 406
- Prairie fire, 1792
- Pralidoxime chloride, 2061
- Praziquantel, 1582, 2061
- Precipitation  
bluetongue virus, 1301  
Eastern equine encephalomyelitis, 1369
- Precocious lactation, 139
- Precolostral serum, congenital defect investigation, 136
- Preconditioning programs, pneumonic pasteurellosis control, 942
- Precordial thrill, 425
- Predation, 129
- Predictive values, laboratory data/tests, 25, 27–28
- Prednisolone  
dosage/interval, 2061  
equine herpesvirus 1 myeloencephalopathy, 1315  
equine neonatal encephalopathy, 2014  
heaves, 1932
- Prednisolone sodium succinate, 2061, 2066
- Pregnancy  
calcium deficiency, 1756  
cow  
bovine babesiosis, 1488–1489  
bovine mastitis in, 689–690  
energy requirements, 1616  
ewes, toxoplasmosis, 1520  
failure, endotoxemia and, 56  
goat, toxoplasmosis, 1520  
human, toxoplasmosis, 1520  
left-side displacement of abomasum risk, 356  
mare, strongylosis, 1559–1560  
Q fever, 1468  
rectal palpation, congenital defects of the newborn, 134  
selenium administration, 1750  
sows  
feeding during, 1988  
hog cholera infection, 1161  
pseudorabies vaccination, 1402  
thin sow syndrome, 1987, 1988  
vitamin E supplementation, 1741, 1742
- Pregnancy toxemia, 300
- cattle, 1672  
see also Fatty liver, cattle  
goats, 1668  
scrapie, 1444  
sheep, 1674, 1668–1671  
clinical findings, 1669–1670  
clinical pathology, 1670  
control, 1670–1671  
differential diagnosis, 1670  
economic importance, 1669  
epidemiology, 1668–1669  
etiology, 1668  
experimental reproduction, 1669  
fat ewe, 1668  
flock monitoring, 1671  
necropsy findings, 1670  
occurrence, 1668–1669  
pathogenesis, 1669  
primary, 1668  
risk factors, 1669  
secondary, 1668  
starvation, 1668  
stress-induced, 1668  
treatment, 1670
- Preharvest beef safety production programs, 883–884, 884–885
- Prehension abnormality, 9, 191–192, 588
- Prekallikrein deficiency, 445, 1947
- Premature complexes, 413, 415–416
- Prematurity, 138  
colostral immunoglobulin concentration, 150  
colostral immunoglobulins absorption, 153  
determination of, 160–163, 161  
hematology, 165  
serum biochemistry, 166
- Premunity  
babesiosis, 1493  
East Coast fever, 1528  
tick-borne fever, 1460
- Prenatal infection, 147
- Prepartum nutrition  
acidification with anion salts, 1640  
carbohydrate formulation, 1677  
left-side displacement of abomasum, 355, 361  
milk fever prevention, 1638–1643
- Prepubic urethrostomy, 569
- Prepuce ulceration, caprine herpesvirus-1 infection, 1330

- Preputial catarrh, 1473  
 Preputial diverticulum, 791  
 Prerenal azotemia, 549  
 Prerenal uremia, 544  
 Pressure damage, prolonged recumbency, 1646  
 Pressure load, chronic heart failure, 402  
 Presystolic murmurs, 425  
*Prevotella melaninogenica*, 788, 1064  
 Primaquine phosphate, 1526  
 Primidone, 2014, 2061  
 P-R interval, 406  
 Prion associated diseases, 1439–1454  
   see also *specific diseases/disorders*  
 Prion protein genes, scrapie, 1442  
 Prion rods (scrapie-associated fibrils), 1440, 1445, 1451  
 Proanthocyanids (condensed tannins), bloat, 328, 328, 333, 335  
 Probatocephaly (sheephead), 1959  
 Probenzimidazole, 1545, 1582  
 Probiotics, enterohemorrhagic *Escherichia coli* control, 885  
 Problem-orientated diagnosis, 24–25  
 Procainamide, 2061  
 Procaine benzylpenicillin, 786  
 Procaine penicillin, 996, 1068, 1326  
 Procaine penicillin G, 705  
 Production diseases, 1618–1690  
   see also *specific diseases/disorders*  
 Production efficacy problems, clinical herd examination, 32–34  
 Production ketosis, 1662  
 Production system coccidiosis, 1501  
 Productivity indexes, 36  
 Progesterone, 2061  
 Progestogen, plasma, 138  
 Prognosis, 29–31  
 Progressive ataxia, inherited, 1952  
 Prohibition, African swine fever, 1172  
 Prolactin deficiency, 755  
 Proliferative and necrotizing pneumonia (PNP), 1331, 1333  
 Proliferative dermatitis (strawberry foot rot), 1051, 1075  
 Proliferative enteropathy  
   hemorrhagic, pigs, 1089, 1090, 1091  
   see also ileitis  
   horses, 1093–1094  
   necropsy findings, 1090  
   pathogenesis, 1089  
 Proliferative exudative pneumonia, 1361–1362  
 Proliferative ileitis, pigs, 279  
 Promazine, 2061  
 Prometone poisoning, 1838  
 Promotility agents  
   enteritis, anterior, 246  
   equine colic, 227, 228  
   large intestine impaction (horse), 253  
 Pronghorn antelope (*Antilocapra americana*), epizootic hemorrhagic disease, 1305  
 Pro-opiomelanocortin, 1687  
 Propafenone, 2061  
 Propantheline bromide, 2061  
 Propetamphos, 1611  
 Prophylaxis, history-taking, 5  
 Propionate, 1661  
 Propionic acid, 1665, 1666–1667, 1702  
 Propofol, 2061  
 Proportional dwarfs, 1959  
 Propranolol, 2061  
 Proprioceptive defect, encephalomyelopathies, 612  
 Propylene glycol  
   dosage/interval, 2061  
   fatty liver, cattle, 1676, 1677  
   ketosis, 1665, 1666  
   poisoning, 1843  
   pregnancy toxemia, sheep, 1670, 1671  
 Prosencephaly, inherited, 1954  
 Prostaglandins, fever and, 49  
 Prostaglandins F<sub>2α</sub>, 2061  
 Prostate pigweed (*Amaranthus blitoides*), 2007  
*Protostrongylus rufescens*, 1568, 1569  
 Protamine sulfate, 2061  
 Protectants, 240  
 Protectants, gastric, 268  
 Protein  
   deficiency, 825, 1698  
   diet high in, hemonchosis, 1550, 1551  
   feces, loss in, 116  
   loss, weight loss from, 116  
   metabolic profile testing, herds, 1621–1622, 1623, 1624  
   metabolism, endotoxemia and, 56  
   plasma  
   concentration abnormalities, 439–441  
   equine colic, 222, 224  
   reticuloperitonitis, traumatic, 340  
   reference laboratory values, 2049, 2050  
   serum total  
     colibacillosis, 861  
     passive immunity transfer assessment, 154  
 Protein-energy malnutrition, 467, 1697  
 Protein-losing enteropathy  
   enteritis, 264  
   panhypoproteinemia, 439–440  
   radioactive isotopes, 199  
   weight loss, 116  
 Proteinuria, 116, 545  
 Proteoglycans, arthropathy, 638, 639  
 Proteolytic enzymes, *Arcanobacterium pyogenes* mastitis, 724  
 Protexin Hoofcare, 1069  
 Prothridium, 1536  
 Prothrombin formation deficiency, 386  
 Prothrombin time, 441  
   disseminated intravascular coagulopathy, 448, 449  
 Protoanemonin poisoning, 1890  
 Protoporphyrin, 1946  
*Prototheca trispora* mastitis, 728  
*Prototheca wickerhammi*, 1471  
*Prototheca zopfii*, 728, 1471  
 Protothecosis, 1471  
 Prototype parapoxvirus ovis (Orf virus), 1277, 1418  
 Protozoa  
   diseases associated with, 1483–1540  
   tick transmitted, 1599, 1600  
   see also *specific diseases/disorders*  
   enteritis, 260, 262, 263  
   hemolytic jaundice, 384  
   myeloencephalitis, 1375  
 'Provirus,' 1222  
 Proximal enteritis see Anterior enteritis  
 PrPc (prion protein), 1439, 1442  
 Pruritus, 652–653  
   equine seasonal allergic dermatitis, 1927  
   pseudorabies, 1398, 1399  
   scrapie, 1444  
*Przhevalskiana silenus*, 1588  
 Pseudoalbumin, 1942  
*Pseudoallescheria boydii*, 1480, 1481  
 Pseudocowpox, 749, 750, 1381, 1427–1428  
 Pseudocowpox virus (PCPV), 1277, 1428  
 Pseudoglanders (epizootic lymphangitis), 1434, 1478–1479  
 Pseudo-infarcts, East Coast fever, 1529  
 Pseudo-lumpy skin disease, 1426, 1428  
 Pseudomonal mastitis, 760, 761  
*Pseudomonas*, 1081–1085  
*Pseudomonas aeruginosa*, 1080  
   fleece rot, 1081–1082  
   mastitis, 724–725  
   vaccine, 1082  
*Pseudomonas maltophilia*, 1081  
 Pseudomycosis, bacterial, 667  
*Pseudonaja* (brown snake), 1916, 1917  
 Pseudorabies (Aujeszky's disease), 1394–1404  
   abortion, 1095  
   brain dysfunction, 1806  
   carriers, 1397  
   case fatality rates, 1394  
   cattle, 1394, 1396, 1398, 1400  
   clinical findings, 1398  
   clinical pathology, 1398–1399  
   control, 1400–1404  
   breeding herd vaccination, 1403  
   economics, 1400–1401  
   programs, 1401–1402  
   strategies available, 1400  
   differential diagnosis, 1400  
   economic importance, 1397  
   epidemiology, 1394–1397  
   etiology, 1394  
   fetal infection, 1398  
   goats, 1398  
   immune mechanisms, 1397  
   latency, 1396, 1399  
   morbidity, 1394  
   necropsy findings, 1399–1400  
   nervous system disease, 1398  
   occurrence, 1394  
   other species infection, 1396–1397  
   pathogenesis, 1397–1398  
   pigs, 1398  
   prevalence determination, 1401  
   reproductive inefficiency, 1397  
   risk factors, 1394–1395, 1395  
   sheep, 1394, 1396, 1398  
   transmission, 1395–1397  
   in utero infection, 1396  
   uterus invasion, 1398  
   vaccination, 1402–1404  
   venereal transmission, 1396  
   viral detection, 1399  
 Pseudorabies glycoprotein gK, 1397  
 Pseudorabies virus, 133, 1394  
 Pseudothrombocytopenia, 442, 445  
*Psorergates bos*, 1607–1608  
*Psorergates ovis*, 1607–1608  
*Psorophora*, 1605  
*Psoroptes cervinus*, 1610  
*Psoroptes cuniculi*, 1610  
*Psoroptes equi*, 1610  
*Psoroptes natalensis*, 1610  
*Psoroptes ovis*, 1610  
 Psoroptic mange, 1610–1611  
 PSS mutation (halothane-sensitivity gene), 1969–1970, 1973  
 Psychic system function, 576  
 Psychogenic polydipsia, 551  
 Psychoses, 612–613  
 Psychosomatic disease, stress-related, 109  
 Psyllium mucilloid, 254  
 Ptaquiloside poisoning, 1875–1877  
   see also *specific types*  
*Pteridium aquilinum* see Bracken fern  
   (*Pteridium aquilinum*)  
*Pteridium esculentum* (bracken fern rhizomes), 2007  
 Pteridium poisoning, 1875–1876  
   bovine enzootic hematuria, 1876–1877  
   thiaminase poisoning, 1882–1883  
 Pteroylglutamic acid see Folic acid  
 Puff adder (*Bitis arietans*), 1916  
 Puff disease, 2038  
 Pulmonary abscess, 489, 517–518, 925, 1587  
 Pulmonary adenomatosis see Ovine pulmonary adenocarcinoma  
 Pulmonary blood flow, cardiac catheterization, 412  
 Pulmonary capillary pressure, 499–500, 505  
 Pulmonary capillary stress failure prevention, 505–506  
 Pulmonary congestion, 498–500  
   clinical findings, 499, 524  
   clinical pathology, 499  
   differential diagnosis, 499  
   etiology, 498  
   necropsy findings, 499  
   pathogenesis, 499  
   treatment, 499–500  
 Pulmonary defense mechanisms, pneumonia, 509–511  
 Pulmonary disease  
   equine arteritis virus, 1320  
   plant-induced, 1897  
   see also *specific diseases/disorders*  
 Pulmonary edema, 498–500  
   acute bovine pulmonary emphysema and edema, 2001  
   clinical findings, 499, 524  
   clinical pathology, 499  
   differential diagnosis, 499  
   East Coast fever, 1528, 1529  
   equine hendra virus infection, 1329  
   etiology, 498–499  
   heart failure, left-sided chronic (congestive), 402  
   necropsy findings, 499  
   pathogenesis, 499  
   plant-induced, 1897  
   treatment, 499–500  
 Pulmonary embolism, 435  
 Pulmonary emphysema, 507–508  
   bovine ephemeral fever, 1179  
   cattle, 507  
   clinical findings, 508, 524  
   clinical pathology, 508  
   differential diagnosis, 508  
   etiology, 507  
   glucosinolate poisoning, 1868  
   horses, 507  
   necropsy findings, 508

- Pulmonary emphysema (*Cont'd*)  
 pathogenesis, 507–508  
 treatment, 508
- Pulmonary function tests, 489–490
- Pulmonary hemorrhage, 480, 501–507
- Pulmonary hypertension, 418, 500
- Pulmonary inflammation, housing and, 497
- Pulmonary neoplasm, 518–519
- Pulmonary valve, 405, 426
- Pulpy kidney see Enterotoxemia, *Clostridium perfringens* type D associated
- Pulsatilla* poisoning, 1890
- Pulse, 406  
 amplitude, 14, 406  
 equine colic, 223  
 cardiac reserve determination, 401  
 clinical examination, 14  
 left atrioventricular valve insufficiency, 426  
 oximetry, 492  
 rate, 406  
 clinical examination, 14  
 equine colic, 223  
 reference values, 14, 14  
 rhythm, 14, 406  
 shock, 65
- Pupillary light reflex, 18, 585, 588
- Purgatives, 204
- Purple mint weed (*Perilla frutescens*) poisoning, 1892
- Purpura hemorrhagica, 443, 1925–1927  
 clinical findings, 1493, 1925–1926  
 clinical pathology, 1493, 1926  
 control, 1926  
 differential diagnosis, 1493, 1926  
 epidemiology, 1493, 1925  
 etiology, 1925  
 infarctive, 1926  
 pathogenesis, 1925  
 strangles complication, 771, 774  
 treatment, 1493, 1926
- Pus, bacterial influence of, 111
- Pustules  
 dermatitis, contagious, 800  
 orf, 1419  
 psoriasisiform dermatitis of pigs (pityriasis rosea), 2037–2038  
 rhabditid dermatitis, 1573
- Pyelonephritis, 559–560  
 bovine contagious, 789–790  
 cattle, 547, 559  
 cystitis with, 791–793  
 enzootic bovine, 1491  
 pigs, 559–560, 791–793  
 ultrasound, 552
- Pyloric achalasia, 346
- Pyloric obstruction, 348
- Pyogenic mastitis, 722  
 see also *Arcanobacterium pyogenes* bovine mastitis
- Pyogranulomatous pneumonia, 803
- Pyramidal tracts, 581
- Pyrantel embonate, 1557, 1582
- Pyrantel pamoate, 1525, 2061, 2066
- Pyrantel tartrate, 1557, 1562, 2061, 2066
- Pyrethroids, 1598, 1601, 1604
- Pyrexia see Fever (pyrexia)
- Pyrexia-pruritus-hemorrhagic syndrome, 1899
- Pyridoxine (vitamin B<sub>6</sub>) deficiency, 452, 1780
- Pyrimethamine, 1522, 1525, 2061
- Pyrimidine bromide, 1536
- Pyrogens, 49–50
- Pyrolizidine alkaloid poisoning, 1878–1881  
 associated diseases, 1878  
 cattle, 1879  
 clinical findings, 1879–1880  
 clinical pathology, 1880  
 control, 1880  
 diagnosis, 1880  
 differential diagnosis, 1880  
 economic importance, 1879  
 epidemiology, 1878–1879  
 etiology, 1878  
 horses, 1879–1880  
 necropsy findings, 1880  
 pathogenesis, 1879  
 pigs, 1880  
 risk factors, 1878–1879  
 sheep, 385  
 treatment, 1880
- Pyrolizidine poisoning, 385
- Pyruvate kinase activity, plasma, 1972
- Pysyllium mucilloid, 2061
- Pythium insidiosum*, 1480
- Pyuria, 546
- 
- ## Q
- Q fever, 1468–1469
- Quarantine  
 anthrax, 818  
 Bang's disease, 974  
 bovine virus diarrhea virus, 1266–1267  
 equine influenza, 1328  
 foot-and-mouth disease, 1236  
 glanders, 1085  
 Johne's disease, 1034  
 psoroptic mange, 1611  
 rabies, 1393  
 strangles, 774  
 vesicular exanthema of swine, 1237  
 vesicular stomatitis, 1234, 1235
- Quarter horses  
 equine hyperkalemic periodic paralysis, 1965  
 equine motor neuron disease, 2020  
 hereditary equine regional dermal asthenia, 1976  
 iridal hypoplasia, limbic dermoids and cataracts, 1977  
 multiple exostosis, 1961  
 nutritional myopathy, 628  
 von Willebrand's disease, 1947
- Quaternary ammonium compounds,  
 postmilking teat sanitization, 733
- Queckenstedt's test, 592
- Queensland itch (equine seasonal allergic dermatitis), 1433, 1927–1928
- Quercus* (oak) poisoning, 1889
- 'Quick sickness' (African syndrome of gousiekte), 1896
- QuickVue Influenza test, 1325
- Quinapyramine chloride, 1536
- Quinapyramine prosalt, 1538
- Quinapyramine sulfate (quintrycide), 1536, 1538, 1540
- Quinidine, 419, 2061
- Quinidine gluconate, 419
- Quinidine sulfate, 417, 419
- Quinolizidine alkaloid poisoning, 1890–1891
- Quintox poisoning, 1839
- Quintrycide (quinapyramine sulfate), 1536, 1538, 1540
- Quinuronium sulfate, 1493
- 
- ## R
- Rabbits, Johne's disease, 1030–1031
- Rabies, 576, 1384–1394  
 animal vectors, 1387–1388  
 brain dysfunction, 1806  
 cattle, 1389, 1391  
 clinical findings, 1375, 1389–1390  
 clinical pathology, 1390  
 control, 1375, 1391–1393  
 death, 1389  
 differential diagnosis, 1375–1377, 1390–1391  
 economic importance, 1388  
 epidemiology, 1375, 1385–1386  
 etiology, 1375, 1385  
 experimental infection, 1389  
 furious form, 1388, 1389, 1390  
 geographic boundaries, 1386–1387  
 goats, 1389  
 horses, 1375, 1389–1390, 1391  
 latent infection, 1388  
 necropsy findings, 1390  
 occurrence, 1385–1386  
 paralytic/dumb form, 1388, 1389  
 pathogenesis, 1388–1389  
 pigs, 1390, 1391  
 immunobency in horses, 121, 1390  
 seasonal spread, 1388  
 sheep, 1389, 1391  
 spontaneous recovery, 1389  
 transmission, 1387–1388  
 treatment, 1375, 1391  
 vaccines, 1391–1392  
 virus variant distribution, 1386–1387  
 zoonotic implications, 1388, 1390
- Rabies virus (RABV), 1385, 1386
- 'fixed,' 1385, 1389  
 intraspecific transmission, 1386  
 'street,' 1389  
 viral variant distribution, 1386–1387
- Raboral V-RG vaccine, 1392–1393
- Raccoons  
 pseudorabies, 1396  
 rabies vector, 1386, 1387
- Racehorses  
 anemia, 452  
 benign atrial fibrillation, 418  
 equine influenza vaccination, 1327  
 exercise-induced pulmonary hemorrhage, 503  
 gastric ulcers in, 238, 239  
 poor performance, 118–119
- Radial immunodiffusion  
 colibacillosis, 861  
 passive immunity transfer assessment, 154
- Radiation injury, 1786–1787
- Radiation sickness, 1787
- Radiation syndromes, acute, 1786
- Radiation therapy see Radiotherapy
- Radioactive isotopes, protein-losing enteropathy, 199
- Radiography  
 abdominal, 196  
 acute broncho-interstitial pneumonia, foal, 2005  
 alimentary tract examination, 196, 308–309  
 arthritis/synovitis, 645  
 arthropathy, 640  
 atrophic rhinitis, progressive, 960  
 caprine arthritis encephalitis, 1411–1412  
 cardiovascular system examination, 412  
 caudal vena caval thrombosis, 516  
 chronic interstitial pneumonia, foal, 2006  
 congenital joint laxity and dwarfism, 2036  
 degenerative joint disease, 2027–2028  
 also heel, 1956  
 enteroliths, 254  
 equine cervical vertebral stenotic myelopathy, 2017  
 equine colic, 222, 231  
 equine pleuropneumonia, 526, 527  
 esophageal, 196  
 exercise-induced pulmonary hemorrhage, 504  
 fluorine poisoning, 1818  
 gastric dilatation, 234  
 gastric ulcers, 236  
 guttural pouch empyema, 539  
 guttural pouch mycosis, 540  
 head shaking, 2022  
 heaves, 1931  
 interstitial pneumonia, 2005  
 laminitis  
 horses, 2032  
 pigs, 2035  
 ruminants, 2035  
 liver, 388  
 longus capitis muscle rupture, 541  
 musculoskeletal system disease, 625  
 nasal discharge, 480  
 nervous system, 593  
 newborns, 164  
 osteodystrophy, 634  
 osteomyelitis, 636  
 pedal bone apex necrosis, 2037  
 pericarditis, 430  
 pulmonary/pleural neoplasm, 519  
 respiratory system examination, 482–483, 483  
 reticulum, 341  
*Rhodococcus equi* pneumonia, 802  
 rickets, 1767  
 sand colic, 254  
 spider lamb syndrome, 1960  
 spinal cord compression, 616  
 urachitis, 159–160  
 urinary system examination, 553  
 uroperitoneum in foals, 564
- Radioimmunoassay (RIA), bovine leukemia virus, 1217
- Radioimmunodiffusion assay, combined immunodeficiency, Arabian foals, 1979
- Radioimmunoprecipitation assay (RIP), bovine leukemia virus, 1217
- Radionuclides, 1786
- Radiotherapy  
 equine ocular squamous-cell carcinoma, 2041  
 lymphosarcoma, 463  
 sarcoid, 1424
- Rafoxanide, 1553  
 poisoning, 1831



- Ragwort poisoning, 1266, 1807  
*Raillietia caprae*, 1610  
 Rainfall, toxoplasmosis, 1519  
*Ramaria flavobrunnescens* poisoning, 1908  
 Rams, obstructive urolithiasis, 568  
 Ranitidine  
   abomasal ulcer, 373–374  
   gastric ulcers, 236, 240  
 Ranitidine hydrochloride, 2061  
 Ranunculin poisoning, 1890  
*Ranunculus* (buttercup) poisoning, 1890  
 Rape blindness, 1867, 1868  
 Rapid chromatographic strip test, rinderpest, 1239  
 Rapid Mastitis Test see California Mastitis Test  
*Rathayibacter toxicus*, 1914–1915  
 Ration(s)  
   analysis, 37, 1693  
   dilution, nitrate/nitrite poisoning prevention, 1858  
   formulation, 1693  
 Rat tail syndrome, 1277, 1508, 1974  
 Rattle belly, 1986–1987  
 Rattlesnake (*Crotalus, Sistrurus*), 1916, 1917  
 Rattling, 478  
 Ray bodies, 1485  
 Rebreathing ('bagging') examination, 476  
 Recombinant bovine rotavirus-like vaccine, 1295  
 Recombinant bovine somatotropin (rBST)  
   animal welfare, 1617  
   bovine mastitis risk factor, 679  
   mastitis control, 743  
   milk production effect, 1617  
   pregnancy toxemia, sheep, 1670  
 Recombinant canary pox vector vaccine, 1327  
 Recombinant human erythropoietin, 453  
 Recombinant vaccines, pseudorabies, 1402–1403  
*Recommended Operating Procedures for Feedlot Animal Health*, 884  
 Record keeping, 4  
 Rectal biopsy, 203  
   diarrhea, chronic undifferentiated, 273  
   granulomatous enteritis, horses, 1993  
   multisystemic, eosinophilic epitheliotropic disease, 1993  
 Rectal examination, 19–20  
   abdomen examination, 19–20  
   aorto-iliac thrombosis, 434  
   cecal dilatation/volvulus, 376  
   cystitis and pyelonephritis, sows, 792  
   diarrhea, acute, 270  
   enteritis, anterior, 245  
   enteroliths/fecaliths, 254  
   equine colic, 221, 221–222, 223–224  
   foals, 231  
   late-term or postparturient mare, 229  
   equine grass sickness, 1991  
   gastric dilatation, horses, 233  
   intestinal obstruction, 379  
   large intestine impaction, horse, 252  
   left dorsal displacement of the large colon, 249  
   left-side displacement of abomasum, 359  
   normal anatomy, 221  
   peritonitis, 284–285  
   polyneuritis equi, 2021  
   procedure, rectal tear prevention, 289  
   pyelonephritis, contagious bovine, 790  
   reticuloperitonitis, traumatic, 340  
   retroperitoneal abscess, 290  
   right dorsal displacement of the large colon, 249–250  
   small colon obstruction, 256  
   urethral obstruction, 568  
   urinary system examination, 548  
   vagus indigestion, 348  
   volvulus of the large colon, 250  
 Rectal pack, 289  
 Rectal palpation, 305, 305  
   abdomen examination, cattle, 305, 305  
   enzootic bovine leukosis transmission, 1211  
   during pregnancy, 134  
   sand colic, 254  
 Rectal paralysis, luminal blockage, 378  
 Rectal prolapse, 279, 1944  
   postparturient mare, equine colic, 229  
   risk factors, 279  
   small colon obstruction, 256  
 Rectal stricture, 279–280  
 Rectal tears, 287–290  
   classification, 288  
   clinical findings, 288  
 clinical pathology, 288  
 epidemiology, 288  
 etiology, 287–288  
 iatrogenic rupture, 287–288  
 pathogenesis, 288  
 prevention, 289  
 prognosis, 288  
 risk factors, 288  
 spontaneous/non-iatrogenic rupture, 288  
 treatment, 288–289  
 Rectovaginal constriction, inherited, 1944  
 Recumbency  
   African horse sickness, 1181  
   bovine ephemeral fever, 1178, 1179  
   diseases causing, 1633–1634  
   downer cow syndrome, 1646  
   enzootic bovine leukosis, 1215  
   equine herpesvirus 1, 1314, 1315  
   horses, 120–124  
   causes of, 120, 121–122  
   complication prevention, 123–124  
   duration, 120  
   examination, 120–123  
   management, 123  
   hypokalemia, acute, 1650  
   laminitis, horses, 2031  
   mannosidosis, 1949  
   milk fever, 1632  
   plant-induced, 1897  
   rabies, 1390  
   scrapie, 1444  
   sternal  
     cold injury, 1794  
     experimental, 1646  
     transit (tetany), 1651  
 Red blood cells (RBCs) see Erythrocyte(s)  
 Red clover (*Trifolium pratense*) poisoning, 1874  
 Red Danish cattle, immunoglobulin synthesis deficiency, 1941  
 Red deer (*Cervus elaphus*), louping-ill, 1408  
 Red foot disease, 1975  
 Red fox (*Vulpes vulpes*), rabies vector, 1385, 1387  
 Red grouse, louping-ill, 1408, 1410  
 Red maple (*Acer rubrum*) intoxication, 1492  
 Red nose see Bovine herpesvirus-1 (BHV-1) infection  
 Red squills poisoning, 1840  
 Redwater see Hemoglobinuria  
 Redwater fever see Babesiosis  
 Redworms (strongyles), 1558–1559  
 Reference laboratory values/ranges, 2047–2050  
   laboratory data/tests, 26  
   limitations, 26  
 Refractometer, 861  
 Regional enteritis/ileitis  
   etiology, 1088  
   see also Ileitis  
 Regurgitation, 192–193  
 Reindeer  
   bovine papular stomatitis, 1277  
   *Hypoderma* infestations, 1588  
 Re-infection syndrome, bovine lungworm, 1565, 1566  
 Renal abscess, 558–559  
 Renal adenocarcinoma, 560  
 Renal amyloidosis, 664, 1266  
 Renal azotemia, 549  
 Renal biopsy, 552–553  
 Renal calculi, horses, 571  
 Renal carcinoma, 560  
 Renal clearance studies, 551  
 Renal dysplasia, 572  
 Renal excretion, magnesium, 1652  
 Renal failure  
   acute, 548, 792  
   chronic, 548  
   etiology, 544  
   horses, 553  
   pathogenesis, 544–545  
   treatment, 554  
 Renal function tests, 549–552  
   reference laboratory values, 2048, 2049  
 Renal hypoplasia, 571–572, 1948  
 Renal injury detection, 549–552  
 Renal insufficiency  
   causes, 544  
   pathogenesis, 544–545  
   principles of, 543–545  
   renal failure and, 544–545  
 Renal ischemia, 556–557  
 Renal lipofuscinosis, inherited, 1948–1949  
 Renal neoplasms, 560–561  
 Renal perfusion, hypovolemic shock, 64  
 Renal tubular acidosis (RTA), 558  
 Renal tubular dysplasia, inherited, 1948  
 Renal uremia, 544  
 Renin-angiotensin-aldosterone system, 64, 400  
 Renosplenic entrapment, 249, 251  
*Reovirus*, 1308, 1362  
 Reportable diseases, 765–767  
   2005 single list, 766–767, 766–767  
   limitations of, 767  
   anthrax, 818  
   list A, 765–766, 766  
   list B, 766, 766  
 Reproduction ratio, virus, 1395, 1400  
 Reproductive cycle, lipid reserves and, 1673  
 Reproductive history, 6  
 Reproductive performance  
   biotin deficiency, 1782  
   copper deficiency effects, 1712  
   endotoxemia and, 56  
   ergotism and, 1903  
   milk fever, 1630  
   mycotoxicosis, 1912  
   protein nutrition and, 1621  
   selenium deficiency and, 1741  
   selenium responsive, 1752–1753  
   tuberculosis, 1009  
   vitamin A deficiency, 1774  
   vitamin E deficiency and, 1741  
 Reproductive tract  
   abnormalities, freemartinism, 1940  
   clinical examination, 20  
   ultrasonography, 21  
 Republic of Ireland, bovine spongiform encephalopathy, 1447  
 Reserpine, 2061  
 Respiration  
   pseudorabies, 1398  
   types of, 11  
 Respiratory acidosis, 83  
 Respiratory alkalosis, 83  
 Respiratory depth examination, 11  
 Respiratory disease  
   bovine herpesvirus-1 infection, 1351–1352, 1353  
   bovine virus diarrhoea virus, 1259  
   combined immunodeficiency, Arabian foals, 1979  
   equine hendra virus infection, 1329  
   *Haemophilus* septicemia, 1001  
   horses, differential diagnosis, 803  
   volcanic ash, 1792  
 Respiratory distress  
   acute broncho-interstitial pneumonia, foal, 2005  
   interstitial pneumonia, 2005  
   pneumonic pasteurellosis, 948  
   syndrome, acute, 501  
 Respiratory insufficiency  
   carbon dioxide retention (hypercapnia), 473  
   compensatory mechanisms, 473  
   definitions, 471–472  
   hypoxia see Hypoxia  
   manifestations of, 473–480  
   principles of, 471–473  
   respiratory failure, 473  
 Respiratory mucociliary clearance, 510  
 Respiratory rate  
   equine colic, 220, 223  
   examination, 11  
   normal, 11  
   resting, heaves, 1930  
 Respiratory rhythm examination, 11  
 Respiratory secretion(s)  
   evaluation, 484–489  
   exercise-induced pulmonary hemorrhage (EIPH), 504  
   guttural pouch fluid, 484–485  
   nasal lavage, 484  
   nasal swab, 484  
   nasopharyngeal swab, 484  
   paranasal sinus fluid, 484  
   sampling, 484  
   tracheobronchial secretions see Tracheobronchial secretions  
   pneumonia, 512  
   yellow/green, 510  
 Respiratory sounds, 16  
   clinical examination, 11  
   respiratory insufficiency manifestation, 478  
   spectrum analysis, 493  
   types of, 11

- Respiratory stimulants, 494  
 Respiratory support, newborns, 170  
 Respiratory system  
   disease, 471–541  
     congenital defects, 541  
     control, 496–497  
     diagnosis, importance of, 496–497  
     diaphragmatic disease, 519–530  
     dyspnea/exercise intolerance from, 474–475  
     hemorrhagic anemia, 451  
     lung disease, 497–519  
     *Mycoplasma*, 1126  
     mycotic infection, 1473  
     pleural disease, 519–530  
     *Streptococcus zooepidemicus* infection, 803  
     treatment, 493–496  
     uncertain etiology, 1998–2006  
     see also *specific diseases/disorders*  
 examination, 480–493  
 arterial blood gas analysis see Arterial  
   blood gas analysis  
   auscultation, 481  
   blood lactate concentration, 492  
   endoscopic airway examination, 481–482  
   exercise testing, 493  
   exhaled breath condensate, 492  
   lung biopsy, 492–493  
   paranasal sinus endoscopy, 482  
   percussion, 481  
   pleuroscopy, 482  
   pulmonary function tests, 489–490  
   pulse oximetry, 492  
   radiography, 482–483, 483  
   respiratory secretion evaluation see  
     Respiratory secretion(s), evaluation  
   respiratory sound spectrum analysis, 493  
   scintigraphy (nuclear imaging), 483  
   ultrasonography, 483–484  
   venous blood gas analysis, 491–492  
   exercise intolerance etiology, 118, 119  
   lower tract see Lower respiratory tract  
   upper tract see Upper respiratory tract  
 Response trials, clinical herd examination, 36–37  
 Rest  
   laminitis, 2033  
   recurrent exertional rhabdomyolysis, 1968  
 Restlessness, 9  
 Resuscitation, neonate, 140  
 Reticular abscess, 339, 340, 342, 342, 344  
 Reticular adhesions, 346  
 Reticular magnet, 344, 345  
 Reticulitis, iatrogenic, 340  
 Reticulocytosis, 456  
 Reticuloperitonitis, traumatic, 298, 337–345, 522  
   acute, 298  
     diffuse, 339, 340, 343, 344  
     local, 339–340, 343–344  
   chronic, 298  
     local, 340  
   clinical findings, 339–340  
   clinical pathology, 340–341  
   complications, 346  
   differential diagnosis, 343–344, 345  
   digesta passage disturbance, 347  
   economic impact, 338  
   epidemiology, 338  
   etiology, 337–338  
   exploratory laparotomy (celiotomy), 310  
   laparoscopy, 341  
   metal detection, 341  
   necropsy findings, 342–343  
   pathogenesis, 338–339  
   prevention, 345  
   radiography, 341, 342  
   risk factors, 338  
   sequelae of, 337, 337  
   treatment, 343–345  
   ultrasonography, 341–342, 342, 342, 343  
 Reticulorumen  
   anatomy, 293  
   hypomotility, 294, 301  
   left-side displacement of abomasum and, 358  
   motility, 293–297  
     eructation of gas, 296–297  
     esophageal groove closure, 297  
     ingesta layers, 347  
     primary contraction cycle, 293–295,  
       294–295  
     retention time, 347  
     rumination, 297  
     secondary cycle contractions, 296–297, 303  
   outflow abnormality, vagus indigestion, 347  
 Reticulum, 293  
   biphasic contraction of, 293  
   diseases of, 311–353  
     see also *specific diseases/disorders*  
   foreign body penetration see  
     Reticuloperitonitis, traumatic  
   radiography, 341  
   ultrasonography, 341–342  
 Retina  
   bovine spongiform encephalopathy, 1449  
   diseases of, blindness from, 582  
   total absence of, 1977  
 Retinol, plasma, 1775  
 Retroperitoneal abscess, 290  
 Retropharyngeal lymphadenopathy, 538  
 Retroviruses, enzootic nasal adenocarcinoma,  
   1368  
 Return over feed (ROF) index, 1615–1616  
 Rev 1 vaccine, 993  
 Reverse passive hemagglutination (RPHA), 1293  
 Reverse transcription polymerase chain reaction  
   (RT-PCR)  
   African horse sickness, 1182  
   bovine virus diarrhea virus, 1261  
   equine influenza, 1325  
   foot-and-mouth disease, 1226  
   hog cholera, 1163  
   neonatal viral diarrhea, 1293  
   peste des petits ruminants, 1243  
   porcine reproductive and respiratory  
     syndrome, 1200  
   swine vesicular disease, 1232  
   winter dysentery, cattle, 1298  
 Rewarming, hypothermic calves, 142  
 Rhabditiid dermatitis, 1572–1573  
*Rhabditis bovis*, 670  
 Rhabdomyolysis, 1683–1686  
   exertional/postexercise  
     clinical findings, 628–629, 1684, 1967  
     clinical pathology, 1684–1685, 1967–1968  
     control, 1685, 1968  
     diagnosis, 1685, 1968  
     differential diagnosis, 1685, 1968  
     economic impact, 1684, 1967  
     epidemiology, 1684, 1967  
     etiology, 627, 1683–1684, 1967  
     incidence, 1684, 1967  
     inheritance, 1967  
     muscle enzyme serum levels, 629  
     myoglobinuria, 546  
     necropsy findings, 1685, 1968  
     pathogenesis, 627–628, 1684, 1967  
     prevention, 630  
     recurrent, Thoroughbred horses,  
       1966–1969  
     risk factors, 1684, 1967  
     sheep, 629  
     sporadic acute, 1683–1686  
     treatment, 1685, 1968  
   recumbency in horses, 122  
   strangles complication, 771  
 Rhabdomyosarcoma, 436  
 Rhinitis, 530–531  
   allergic, 925, 1355, 1936  
   atopic, bovine, 1936  
   bovine herpesvirus-1 infection, 1353  
   cattle, 530  
   clinical findings, 530  
   clinical pathology, 530  
   differential diagnosis, 531  
   equine grass sickness, 1993  
   etiology, 530  
   familial allergic, 530  
   goats, 530  
   horses, 530  
   mycotic, 530  
   necropsy findings, 531  
   necrotic, 1080  
   *Oestrus ovis* infestation, 1587  
   pathogenesis, 530  
   pigs, 530  
   sheep, 530  
   treatment, 531  
 Rhinoceros viper (*Bitis nasicornis*), 1916  
*Rhinoestrus*, 1586  
 Rhinolaryngoscopy (endoscopy), 481–482, 594  
 Rhinopneumonitis virus see Equine herpesvirus  
   4 (EHV-4) infection  
 Rhinosporidiosis, 1475  
*Rhinosporidium*, enzootic nasal granuloma of  
   cattle, 1936  
*Rhinosporidium seeberi*, 1475  
*Rhipicephalus appendiculatus* (brown ear tick),  
   1245, 1527, 1528  
*Rhipicephalus bursa*, sheep babesiosis, 1484  
*Rhipicephalus sanguineus* (brown dog tick),  
   1180, 1456, 1485  
*Rhipicephalus simus*, 1456  
*Rhipicephalus zambeziensis*, 1528  
*Rhizoctonia leguminicola*, slaframine poisoning,  
   1899, 1908  
*Rhizomucor* (*Mucor*) *pusillus*, 1409, 1471  
*Rhizopus oryzae*, 1471  
 Rhodesian sleeping sickness, 1533, 1534  
*Rhodococcus equi*  
   diarrhea, 275  
   localized infection, 111  
   pneumonia in foals, 800–805  
     clinical findings, 802  
     clinical pathology, 802–803  
     control, 804  
     diagnosis, 803  
     differential diagnosis, 803, 803  
     epidemiology, 800–801  
     etiology, 800  
     incubation period, 802  
     necropsy findings, 803  
     outbreaks, 800–801  
     pathogenesis, 801–802  
     prognosis, 802  
     transmission, 801  
     treatment, 803–804  
     zoonotic implications, 801  
   virulence, 800, 801  
 Rhoedine poisoning, 1891  
 'Rib cockle,' 2041  
 Rib fractures, 519, 1985  
 Riboflavin deficiency, 1779–1780  
 Rice grain fibropapilloma, 1421, 1422  
*Ricinus communis* poisoning, 1888  
 Ricketts, 1766–1768  
   calcium deficiency, 1757  
   clinical findings, 1767  
   clinical pathology, 1767  
   control, 1768  
   diagnosis, 1768  
   differential diagnosis, 1768  
   epidemiology, 1767  
   etiology, 1767  
   inherited, 1961  
   necropsy findings, 1767–1768  
   pathogenesis, 633, 1767  
   phosphorus deficiency, 1760  
   pigs, 1767  
   prenatal, congenital joint laxity and  
     dwarfism, 2036  
   treatment, 1768  
   vitamin D deficiency, 1765  
 Rickettsial diseases, tick transmitted, 1599–1600,  
   1601  
 Rickettsiales diseases, 1455–1470  
   see also *specific diseases/disorders*  
*Rickettsia melophagi*, 1596  
 Rida see Scrapie  
 Rifampin, 804, 2061  
 Rift Valley fever, 1205–1207  
 Rift valley fever virus, 133, 987  
 Right dorsal displacement of the large colon,  
   248, 249–250, 250  
 Right-side displacement of the abomasum  
   (RDA), 299, 362–367  
   clinical findings, 353, 364  
   clinical pathology, 364–365  
   control, 367  
   differential diagnosis, 365–366  
   epidemiology, 362–363  
   etiology, 362  
   necropsy findings, 365  
   pathogenesis, 363–364  
   postsurgical complications, 348  
   prognostic indicators, 365  
   risk factors, 362–363  
   surgery, 366  
   treatment, 366–367  
 Right ventricle  
   double outlet, 432  
   hypertrophy, 500  
 Rigid lamb syndrome, 1207  
 Rigor mortis  
   absence, anthrax, 818  
   porcine stress syndrome, 1971, 1972  
 Rimantadine, 1326  
 Rinderpest, 1237–1242, 1265  
   acute form, 1239

- Rinderpest (*Cont'd*)  
 case fatality rate, 1238  
 clinical findings, 1239, 1265  
 clinical pathology, 1239–1240, 1265  
 control, 1240–1241  
 differential diagnosis, 1240  
 economic importance, 1238–1239  
 epidemiology, 1237–1239, 1265  
 etiology, 1237  
 experimental reproduction, 1238  
 experimental transmission, 1240  
 goats, 1237, 1239  
 immune mechanism, 1238  
 laboratory diagnosis, 1239–1240  
 morbidity, 1238  
 necropsy findings, 1240  
 occurrence, 1237–1238  
 outbreaks, 1237  
 pathogenesis, 1239  
 peracute form, 1239  
 pigs, 1237, 1239  
 prevalence, 1238  
 risk factors, 1238  
 sheep, 1238, 1239  
 skin form, 1239  
 subacute form, 1239  
 transmission, 1238  
 treatment, 1240  
 vaccines, 1241, 1243  
 zoonotic implications, 1239
- Ringer's solution, 94
- Ringing, 1593
- Ring vaccination, foot-and-mouth disease, 1229
- Ringworm, phytoestrogen poisoning and, 1874
- Ringworm, 1476–1478  
 cattle, 1476, 1477  
 clinical findings, 785, 1477  
 clinical pathology, 1477  
 control, 1478  
 differential diagnosis, 1477–1478  
 economic importance, 1476  
 epidemiology, 785, 1433, 1476  
 etiology, 1476  
 goats, 1476  
 horses, 1433, 1476, 1477  
 infection sources, 1476  
 lesions, 1433  
 occurrence, 1476  
 pathogenesis, 1476–1477  
 pigs, 1476, 1477  
 risk factors, 1476  
 sheep, 1476, 1477  
 spontaneous recovery, 1478  
 transmission, 1433, 1476  
 treatment, 785, 1478  
 vaccination, 1478  
 zoonotic considerations, 1476
- Risk group analysis, 34
- Roarers/roaring see Laryngeal hemiplegia (roarers)
- 'Robber' ewes, 144
- Robinia pseudoacacia* poisoning, 1888
- Rock fern (*Cheilanthes sieberi*) poisoning, 1875–1877
- Rock phosphate, 1860
- Rocky Mountain elk (*Cervus elaphus nelsoni*), chronic wasting disease, 1454
- Rodenticide poisoning, 1839–1840
- Rodents  
 encephalomyocarditis virus disease reservoir, 1184  
 toxoplasmosis transmission, 1519
- Roe deer (*Capreolus capreolus*), louping-ill, 1408
- Roll-and-toggle-pin suture procedure, 360
- Romania, brucellosis, 964
- Romanowsky stain, sporotrichosis, 1480
- Romifidine, 2061
- Romney lambs, inherited spontaneous lower motor neuron disease, 1953
- Romulea bulbocordium* poisoning, 1896
- Romulea rosea* (onion weed), 1895
- Root of mesentery torsion, calves, 309
- Roridin poisoning, 1910
- Rose Bengal test, *Brucella*, 971–972, 992
- Ross River virus, 1383–1384
- Rotational grazing, tick infestation control, 1602
- Rotavirus(es)  
 coliform gastroenteritis, 892, 893  
 detection, 1292  
 diarrhea, 275, 276, 874
- neonatal diarrhea, 1286  
 concurrent infections, 1291  
 kids, 1289  
 lambs, 1289  
 pathogenesis, 1291  
 serogroups, 1276  
 vaccination, 874  
 see also *individual viruses*
- Rotazyme test, 1293
- Rotenone, 1589  
 poisoning, 1837
- Roughage  
 abomasal impaction, 367  
 polioencephalomalacia, 2012  
 simple indigestion, 311
- Roundworm infestations, 1562–1564
- Roxarsone, 2066
- Rtd* gene, 1948
- Ruapehu, 1791
- Rubbing, scrapie, 1444
- Rubratoin poisoning, 1908
- Rumen, 293  
 acidosis, liver necrobacillosis risk, 1062  
 atony, 294, 327, 348  
 auscultation, 16  
 diseases of, 311–353  
 see also *specific diseases/disorders*  
 distension, 348  
 decompression, 196  
 differential diagnosis, 302  
 vagus indigestion, 348  
 examination, 303–304, 319  
 flora, 204, 316  
 hypermotility, vagus indigestion, 348  
 impaction  
 foreign body, 313–314  
 indigestible foreign body, 313–314  
 plants sources of, 1895  
 lavage  
 carbohydrate engorgement, 322  
 distended rumen, 303  
 vagus indigestion, 350  
 microflora reconstitution, simple indigestion, 313  
 overload see Carbohydrate engorgement of ruminants  
 palpation of, 294, 297–298, 303  
 sodium:potassium ratio, magnesium absorption effects, 1653  
 sulfide measurement, polioencephalomalacia, 2011  
 volatile fatty acids  
 carbohydrate engorgement, 316–317  
 reticulorumen motility, primary contraction influence, 296
- Rumenatorics, 313
- Rumen collapse syndrome, 299, 303
- Rumen fluid/juice, 303  
 abomasum, flow into, 354  
 analysis, 304–305  
 chloride concentration, 305, 349  
 color, 195, 304–305  
 consistency, 195–196, 305  
 examination of, 304–305  
 frothy, bloat, 326  
 microscopic examination, 305  
 odor, 196  
 pH, 195–196, 305  
 carbohydrate engorgement, 319–321  
 correction of, 204  
 dietary change and, 318  
 simple indigestion, 312
- Rumenitis, 298–301  
 chemical, carbohydrate engorgement, 317  
 liver necrobacillosis, 1062  
 mycotic, carbohydrate engorgement, 317, 319
- Rumenocentesis, 321
- Rumenotomy  
 carbohydrate engorgement, 322  
 emergency, bloat, 331  
 lead poisoning, 1805  
 reticuloperitonitis, traumatic, 343, 344  
 vagus indigestion, 350
- Rumen transfaunation, 361
- Ruminal drinkers, 314
- Ruminal lactic acidosis see Carbohydrate engorgement of ruminants
- Ruminal neoplasia, 281–282
- Ruminal parakeratosis, 325
- Ruminal protozoa, carbohydrate engorgement, 321
- Ruminal tympany see Bloat (ruminal tympany)
- Ruminant(s)  
 arsenic poisoning, 1809  
 atrial fibrillation treatment, 419  
 cadmium poisoning, 1829  
 carbohydrate engorgement see Carbohydrate engorgement of ruminants  
 drug doses/intervals, 2051–2063  
 encephalomalacia, 602–603  
 enterohemorrhagic *Escherichia coli* reservoir, 879–880  
 glucose metabolism, 1661  
 hypothermia, neonatal, 40  
 ketonuria, 546–547  
 liver disease, 393–394  
 lymphoma/lymphosarcoma, 462  
 osteomalacia, 1769  
 renal failure, 553  
 Rift Valley fever, 1206  
 salmonellosis treatment, 914  
 vitamin A deficiency, 1772
- Ruminant-feed ban, UK, 1447, 1448, 1451–1452
- Rumination, 297  
 absence, traumatic reticuloperitonitis, 339  
 appetite and, 301  
 reduction in, causes, 297
- Runt see Intrauterine growth retardation
- Russell's viper (*Vipera russelli*), 1916
- Russian knapweed (*Centaurea repens*) poisoning, 1892
- Ryanodine receptor, 1970
- Ryegrass  
 nitrate poisoning, 1856  
 toxicity, annual, 1914–1915
- Ryegrass staggers, 1903–1905, 2018  
 cattle, 1904  
 horses, 1904  
*Neotyphodium lolii*, 1899, 1903–1905, 1910  
 sheep, 1904  
 tremorgen poisoning, 1910
- Ryegrass straw (*Lolium perenne*), interstitial pneumonia, 2000

## S

- Sabin–Feldman dye test, 1521
- Sacrocaudalis dorsalis muscle, 2020
- Sadism, 124
- SAG-2 vaccine, 1393
- Salem virus, 1383
- Salicylates, 106
- Saline purgatives, 1798
- Salinomycin, 1509  
 poisoning, 1844–1845
- Salinomycin-tiamulin poisoning, 1845
- Salivarian trypanosomes, 1531–1532
- Salivary cortisol, stress, 108
- Salivary duct atresia, 280
- Salivary glands  
 inflammation, 208–209  
 rabies infection, 1389
- Salivation  
 excessive, 18, 192  
 actinobacillosis (wooden tongue), 1047  
 swainsonine poisoning, 1908  
 frothy bloat role, 327  
 plant-induced, 1897  
 promotion of, bloat, 331
- Salmeterol, 2061
- Salmonella*, 896–920  
 antimicrobial resistance, 177, 904–906, 914  
 bovine rotavirus co-infection, 1287  
 cattle, 897  
 fibrial antigens, 904  
 goats, 897  
 horses, 897  
 nomenclature, 896  
 osteomyelitis, 636  
 pigs, 897  
 porcine circovirus 2 co-infection, 1187  
 sheep, 897  
 survival time, 903
- Salmonella abortusequi*, 919–920
- Salmonella abortusovis*, 901, 920
- Salmonella anatum*, 905
- Salmonella bongori*, 896
- Salmonella brandenburg*, 901, 915, 920
- Salmonella choleraesuis*  
 antimicrobial resistance, 906  
 carrier state, 899

- Salmonella choleraesuis* (Cont'd)  
 enteritis, 908–909  
 fecal culture, 910  
 pigs, 898, 901, 910  
 porcine reproductive and respiratory syndrome virus co-infection, 1199  
 vaccination, 917–918
- Salmonella dublin*  
 abortion, 909, 920  
 antimicrobial resistance, 905  
 carrier state, 899  
 cattle, 898, 900, 909  
 Danish National Surveillance Program, 918  
 enteritis, 908  
 fecal culture, 910–911  
 osteomyelitis, 636  
 outbreaks, 897  
 sheep, 901, 910  
 species affected by, 896  
 treatment, 914  
 vaccination, 917  
 vaccine, 874
- Salmonella enterica*, 896  
 horses, 903  
 pigs, 902  
 prevalence determination, 912  
 serovar *abortusequi*, 919–920  
 serovar *abortusovis*, 901, 920
- Salmonella enteritidis*, 902
- Salmonella infantis*, 897, 911
- Salmonella krefeld*, 903
- Salmonella montevideo*, 909
- Salmonella muenster*, 909
- Salmonella newport*, 905
- Salmonella panama*, 897
- Salmonella riuir*, 920
- Salmonella typhimurium*  
 abomasitis, 908–909  
 abortion, 920  
 antibiotic resistance, 898  
 antimicrobial resistance, 905, 906  
 carrier state, 899  
 cattle, 898, 900, 909  
 DT104, 906–907, 915  
 enteritis, 908  
 fecal culture, 910  
 horses, 903  
 outbreaks, 897  
 pigs, 898, 902, 910  
 rectal stricture, 279  
 sheep, 901  
 vaccination, 917, 918, 920
- Salmonellosis, 896–919  
 abomasitis, 909  
 abortion, 909, 987  
 bacteremia, 907  
 biosecurity, 915  
 carrier state, 899, 907  
 detection of, 912, 915  
 case fatality rate, 898  
 cattle, 909  
 clinical findings, 1266  
 clinical pathology, 1266  
 epidemiology, 1266  
 outbreaks, 898  
 treatment, 914, 1266  
 vaccination, 917  
 chronic, 273  
 clinical findings, 909–910  
 clinical pathology, 910–912  
 control, 915–918  
 diagnosis, 913  
 diarrhea, acute, 270  
 differential diagnosis, 913  
 economic importance, 907  
 enteritis, 907–909, 909, 912–913  
 epidemiology, 897–907  
 etiology, 896–897  
 gangrene, terminal dry, 909  
 genetic resistance, 900  
 goats, 901, 910  
 horses, 910  
 outbreaks, 898  
 pathogenesis, 908  
 risk factors, 902–903  
 supportive therapy, 914–915  
 treatment, 914  
 vaccination, 918  
 immune mechanisms, 903  
 infection portal, 900  
 infection process, 907  
 morbidity, 898
- necropsy findings, 912–913  
 osteitis, 909  
 outbreaks, 897, 898  
 pathogenesis, 907–909  
 pigs, 910  
 enteritis, 908–909  
 outbreaks, 898  
 risk factors, 901–902  
 treatment, 914  
 vaccination, 917–918  
 polyarthritis, 909  
 prevalence, 897–898, 912  
 risk factors, 899–906  
 septicemia, 907, 909, 912, 914  
 sheep, 910  
 enteritis, 908  
 outbreaks, 898  
 risk factors, 901  
 vaccination, 918  
 transmission, 898–899  
 treatment, 913–915  
 vaccination, 917–918  
 zoonotic implications, 906–907
- Salsola tuberculiformis* (cauliflower saltwort), 1896
- Salt see Sodium chloride
- Salt blocks, 1658
- Salt-lick, 1719–1720
- Salt-mineral mixture, 1752
- Salt sick, 1708
- Sambucus* (elders, elderberry) poisoning, 1888
- Samore see Nagana
- Samorin (isometamidium chloride), 1536, 1538
- Sand, abomasal impaction, 367
- Sand colic, 226, 254–255
- Sandflies, 1234, 1605
- Sand vipers (*Vipera ammodytes*), 1916
- San Miguel sea lion virus, 1236
- Saponin poisoning, 1891
- Sarcocystis*, 1507, 1507–1508
- Sarcocystis bovifelis* (*hirsuta*), 1507, 1507, 1508
- Sarcocystis capricanis*, 1507, 1508
- Sarcocystis cruzi*, 1507, 1507
- Sarcocystis gigantea*, 1507, 1508
- Sarcocystis hirsuta*, 1507, 1507, 1508
- Sarcocystis hominis*, 1507, 1507
- Sarcocystis medusififormis*, 1507, 1508
- Sarcocystis neuroma*, 1523
- Sarcocystis tenella*, 1507, 1508
- Sarcocystosis, 1507–1509  
 asymptomatic infection, 1508  
 clinical findings, 1508  
 clinical pathology, 1508  
 control, 1509  
 diagnosis, 1509  
 differential diagnosis, 1509  
 economic importance, 1508  
 epidemiology, 1507–1508  
 etiology, 1507, 1507  
 hosts, 1507  
 infection sources, 1507  
 necropsy findings, 1508–1509  
 occurrence, 1507  
 pathogenesis, 1508  
 perinatal fatality, 1508  
 piga, 1508  
 risk factors, 1507–1508  
 treatment, 1509
- Sarcoid, 667–668, 1423–1424
- Sarcophagid fly (*Wohlfahrtia magnifica*), 1590, 1595
- Sarcoplasmic RNA, splayleg syndrome, 2024
- Sarcoptes scabiei*, 1608
- Sarcoptic mange, 785, 1608–1609
- Sarcosporidiosis see Sarcocystosis
- Sarcostemma brevipedicellatum* (caustic vine) poisoning, 1886
- Sarcostemma viminale* (caustic bush) poisoning, 1886
- Sardinia, African swine fever, 1168, 1169
- Saria see Dermatophilosis
- Satratoin poisoning, 1910
- Saudi Arabia, African horse sickness, 1180
- Sawfly larvae poisoning, 1908, 1920
- 'Sawhorse' posture, 818, 823
- Saxitoxin, 1913
- Scabby dermatitis, 783
- Scabby mouth see Orf
- Scabby ulcer see Vulvovaginitis
- Scabs  
 bovine ulcerative mammillitis, 1429  
 choriopic mange, 1612
- cowpox, 1427  
 orf, 1419  
 pseudocowpox, 1428  
 psoroptic mange, 1610–1611  
 strawberry foot rot, 1051  
 swinepox, 1432
- Scald, horses, 1793
- Scandinavian countries, bovine virus diarrhea virus eradication, 1274–1275
- Scandinavian photosensitization disease, 1891
- Scant feces, 193
- 'Scatter cockle,' 2041
- Scedosporium prolificans*, 1481
- Schalm test see California Mastitis Test
- Schiff–Sherrington syndrome, 581, 616
- Schistosoma nasalis*, 1936
- Schizogony, 1485, 1502, 1508
- Schizonts  
 equine protozoal myeloencephalitis, 1523  
 sarcocystosis, 1509
- Theileria annulata*, 1531
- Theileria parva*, 1528, 1529
- Schoenus asperocarpus*, galegine poisoning, 1887
- Schoenus rigens*, galegine poisoning, 1887
- Schwartzmann reaction, 57
- Sciatic nerve damage, 618
- Scientific Committee on Animal Health and Animal Welfare of the European Commission, 1617
- Scintigraphy (nuclear imaging)  
 colitis, right dorsal, 255  
 respiratory system examination, 483
- Scopolamine hydrobromide, 2057
- Scopolamine poisoning, 1894
- Scotland  
 louping-ill, 1408  
 ovine pulmonary adenocarcinoma, 1367  
 rabies, 1385
- Scottish Blackface sheep  
 border disease, 1416  
 red foot disease, 1975
- Scours, 130, 1820
- Scour worms see Trichostrongylid worms
- Scrapie, 1440–1446  
 atypical strains, 1445  
 bovine spongiform encephalopathy differentiation, 1453  
 case fatality rate, 1441  
 clinical findings, 1444  
 clinical pathology, 1444–1445  
 co-infections, 1440  
 control, 1445–1446  
 differential diagnosis, 1445  
 economic importance, 1443  
 environmental transmission, 1441  
 epidemiology, 1440–1443  
 etiology, 1440  
 experimental reproduction, 1443  
 experimental transmission, 1440  
 fetal infection, 1441  
 genetic control, 1445–1446  
 genetics, 1441–1443, 1442, 1443  
 goats, 1441, 1443, 1444, 1445  
 histology, 1445  
 incidence, 1440  
 incubation period, 1444  
 infection sources, 1441  
 necropsy findings, 1445  
 occurrence, 1440–1441  
 pathogenesis, 1443–1444  
 risk factors, 1443  
 stigma associated, 1441  
 strains, 1440  
 targeted surveillance, 1441  
 transmission, 1439, 1441  
 zoonotic implications, 1443
- Scrapie-associated fibrils (prion rods), 1440, 1445, 1451
- Scrapie Flock Certification, 1445–1446
- Scrapie prion protein molecule (PrP<sup>Sc</sup>), 1439, 1440, 1442, 1451
- Scrapie signature, 1441
- Scratches (greasy heel), 663, 1434
- Screwworm, 1590, 1593–1595  
 clinical findings, 1594  
 clinical pathology, 1594  
 control, 1595  
 differential diagnosis, 1594  
 epidemiology, 1594  
 eradication program, 1595  
 etiology, 1593–1594

- Screwworm (Cont'd)  
 life cycle, 1594  
 myositis, 631  
 necropsy findings, 1594  
 pathogenesis, 1594  
 transmission, 1594  
 treatment, 1594–1595
- Screwworm adult suppression system (SWASS), 1595
- Screwworm fly (*Cochliomyia americana*), 776
- Scrotal hernia, 1964
- Scrotum  
 cold injury, 1794  
 lesions, orf, 1419
- Sea snakes, 1916
- Seasonal allergic dermatitis, 1928
- Sebaceous glands, secretion abnormality, 653
- Seborrhea, 662–663
- Second-degree atrioventricular block, 414–415
- Secretory diarrhea, 263
- Sedation  
 esophageal obstruction, 214  
 postvaccinal hepatitis, 1989  
 recurrent exertional rhabdomyolysis, 1968
- Sedimentation and decanting technique, 1581
- Seed dressing poisoning, 1840–1841
- Segmentation abnormality, diarrhea, 193
- Seizures, 579, 613  
 see also Convulsions
- Selenium  
 biological functions of, 1735–1736  
 coliform mastitis and, 711  
 deficiency, 1735–1755  
 clinical findings, 1744–1745  
 clinical pathology, 1745–1748  
 control, 1749–1754  
 copper poisoning risk, 1822  
 diagnosis, 1749  
 differential diagnosis, 1749  
 diseases associated with, 1735  
 epidemiology, 1736–1744  
 etiology, 1735–1736  
 metabolic defect, associated, 1699  
 myopathy, 626, 627  
 necropsy findings, 1748–1749  
 pathogenesis, 1744  
 pathophysiology, 1699  
 post-volcanic eruptions, 1792  
 stillbirth/perinatal weak calf syndrome, 1984  
 treatment, 1749  
 dietary requirements, 1750  
 dosage/interval, 1750–1751, 1754, 1754  
 dosing errors, 1811  
 exertional rhabdomyolysis, 1685  
 industrial deposition, 1812  
 injections, 1750–1751  
 intra-ruminal pellets, 1753  
 myopathy, 630  
 neonatal morbidity/mortality, 1743  
 pars esophagea ulceration, 1997  
 plants, in, 1737  
 poisoning, 1811–1813  
 acute, 1812  
 chronic, 1812  
 clinical findings, 1812  
 clinical pathology, 1812  
 control, 1813  
 diagnosis, 1813  
 differential diagnosis, 1813  
 epidemiology, 1811–1812  
 etiology, 1811  
 necropsy findings, 1812–1813  
 pathogenesis, 1812  
 risk factors, 1812  
 source of, 1811–1812  
 treatment, 1813  
 post-weaning multisystemic wasting syndrome, 1191  
 prophylactic use, 1812  
 reference ranges, pigs, 1748  
 residues, 1753  
 soil, in, 1737  
 status, 1746  
 subclinical insufficiency, 1740, 1744  
 supplementation, 1749–1750, 1812  
 cost-effectiveness, 1754  
 methods, 1750–1751  
 nutritional muscular dystrophy control, 1752  
 pigs, 1753  
 recurrent exertional rhabdomyolysis in Thoroughbred horses, 1968  
 responsiveness, 1753–1754  
 sheep, 1753  
 tissue levels, 1813  
 toxicity, 1750, 1753, 1811  
 see also Selenium, poisoning  
 vitamin E association, 1736
- Selenium-responsive disease, 1735, 1740
- Selenium-responsive unthriftiness, 1740
- Selenium sulfide shampoos, 1598
- Selenium-vitamin E responsive disease, 1735
- Selenocompound poisoning, 1891–1892
- Self-grooming, louse control, 1598
- Semen  
 analysis  
 brucellosis associated with *Brucella ovis*, 986  
 leptospirosis, 1105  
 bluetongue virus transmission, 1301, 1302, 1304  
*Brucella abortus* transmission, 967–968  
 equine arteritis virus transmission, 1320  
 hog cholera transmission, 1159  
 ovine progressive pneumonia transmission, 1363  
 Q fever transmission, 1468
- Semimembranous muscle, asymmetric hindquarter syndrome, 2024
- Seminal vesiculitis, 1125
- Semitendinosus muscle, asymmetric hindquarter syndrome, 2024
- Senecio, pyrrolizidine alkaloid poisoning, 1878–1881
- Senecio jacobea (ragwort) poisoning, 1266, 1807
- Senile collapse, 122
- Senkobo disease of cattle see Dermatophilosis
- Senna occidentalis, anthraquinone poisoning, 1885
- Senna poisoning, 1897
- Sensation, altered, 582
- Sensitive plant (*Mimosa pudica*) poisoning, 1884
- Sensitivity tests, 25, 26–27, 27, 582  
 antimicrobials, 175–176
- Sensorimotor ataxia, 587
- Sensorimotor system function, 576
- Sensory ataxia, 587
- Sensory nerve fibers, 103
- Sensory perceptivity, 576
- Sepsis see Septicemia
- Sepsis score, neonates/newborns, 52, 148, 160, 161
- Septicemia, 51–53, 147  
*Actinobacillus suis*, 1045, 1052  
*Brucella abortus* vaccine reaction, 980  
 cattle, 51  
 clinical findings, 52  
 clinical pathology, 52  
 coliform see Coliform septicemia  
 comatose ('sleeper') foals, 2013  
 definition, 51  
 epidemiology, 51  
 etiology, 51  
 foals, 644, 1045  
*Haemophilus* see *Haemophilus* septicemia  
*Histophilus somni*, 997–998  
 horses, 51  
 intravenous antimicrobials, 178  
 leptospirosis, 1100–1101  
*Listeria monocytogenes* infection, 805, 809  
 necropsy findings, 52  
 neonatal, 51, 52  
 neonatal infection, 148  
 newborns, 160, 161, 165–166  
 pathogenesis, 51–52  
 peritonitis, 283  
 pigs, 51  
 radiation injury, 1786  
*Salmonella abortusequi*, 919–920  
 salmonellosis, 907, 909, 912, 914  
 secondary, 51  
 sheep, 51  
*Staphylococcus*, 783  
*Streptococcus*, 768  
 treatment, 52–53  
 vasculitis, 443
- Septicemic pasteurellosis  
 cattle see Hemorrhagic septicemia, cattle  
 lambs, 946–947  
 pigs, 952  
 sheep, 949–950
- Septic fever, 49
- Septic metritis, postpartum, 60–63
- characteristics, 1634–1635  
 clinical findings, 61  
 clinical pathology, 61–62  
 epidemiology, 61  
 etiology, 60  
 identification of, 63  
 necropsy findings, 62  
 pathogenesis, 61  
 treatment, 62–63
- Septic pedal arthritis, 647
- Septic peritonitis, 286, 288
- Septic shock  
 clinical findings, 57  
 fluid therapy, newborns, 170  
 treatment, 58–60
- Sepulina hyodysenteriae* see *Brachyspira hyodysenteriae*
- Serial-dilution testing, antimicrobial sensitivity, 929
- Serofibrinous polyserositis, 1179
- Serology  
 acute broncho-interstitial pneumonia, foal, 2005  
 African horse sickness, 1181–1182  
 African swine fever, 1171  
 anaplasmosis, 1457  
 atrophic rhinitis, progressive, 960  
 babesiosis, 1490  
 bluetongue, 1303  
 boreliosis, 1112–1113  
 bovine babesiosis, 1490  
 bovine ephemeral fever, 1179  
 bovine herpesvirus-1 infection, 1354–1355  
 bovine immunodeficiency-like virus, 1222  
 bovine respiratory syncytial virus pneumonia, 1347  
 bovine ulcerative mammitis, 1429  
 bovine virus diarrhoea virus, 1261–1262  
*Brachyspira hyodysenteriae*, 1116–1117  
*Brucella abortus*, 971–972  
*Brucella melitensis*, 992–993  
*Brucella suis*, 990  
 brucellosis associated with *Brucella ovis*, 986  
 caprine arthritis encephalitis, 1412  
 caseous lymphadenitis, 797  
 chronic interstitial pneumonia, foal, 2006  
 contagious bovine pleuropneumonia, 1134, 1137  
 East Coast fever, 1529  
 encephalitis, 601  
 encephalomyocarditis virus disease, pigs, 1184  
 enzootic bovine leukosis, 1217  
 enzootic pneumonia of calves, 1341  
 eperythrozoonosis, 1155–1156  
 equine adenovirus, 1308  
 equine arteritis virus, 1321  
 equine herpesvirus 1, 1314, 1315  
 equine herpesvirus 4, 1310  
 equine infectious anemia, 1176  
 erysipelas of swine, 813  
 foot-and-mouth disease, 1226–1227  
 glanders, 1084  
 goatpox, 1431  
*Haemophilus* septicemia, 1001  
 heartwater, 1463  
 hemorrhagic septicemia, 922  
 hog cholera, 1162–1163  
 ileitis, 1091  
 infectious polyarthritis, 1005  
 Johne's disease, 1028–1029  
 leptospirosis, 1103–1104  
*Listeria monocytogenes* infection, 809  
 lumpy skin disease, 1426  
 malignant catarrhal fever, 1247  
 mycoplasma pneumoniae, pigs, 1148  
 nagana, 1535  
 Nairobi sheep disease, 1245  
 neonatal viral diarrhoea, 1293  
 ovine progressive pneumonia, 1365  
 papillomatosis digital dermatitis of cattle, 1068  
 pleuropneumonia of pigs, 1056–1057  
 pneumonia, 512  
 polyserositis, pigs, 1153–1154  
 porcine reproductive and respiratory syndrome, 1200  
 porcine viral encephalomyelitis, 1406  
 post-weaning multisystemic wasting syndrome, 1191  
 pseudorabies, 1398–1399  
*Rhodococcus equi* pneumonia, 802

- Serology (Cont'd)  
 salmonellosis, 911  
 septicemia, 52  
 sheepox, 1431  
 sporadic bovine encephalomyelitis, 1407  
*Streptococcus suis* infection, 780  
 swine influenza, 1333  
 tick-borne fever, 1461  
 toxoplasmosis, 1521, 1522  
 transmissible gastroenteritis, 1281  
 tropical theileriosis, 1531  
 tuberculosis, 1011–1012  
 undifferentiated bovine respiratory disease, acute, 929  
 vesicular stomatitis, 1235  
 vomiting and wasting disease in pigs, 1286  
 West Nile encephalitis, 1379–1380  
 winter dysentery, cattle, 1299
- Serotherapy, post-weaning multisystemic wasting syndrome, 1191
- Serovar-host specificity, *Salmonella*, 896, 907
- Serpulina pilosicoli* (*Brachyspira pilosicoli*), 1114, 1120–1123
- Serratia liquefaciens* mastitis, 727
- Serratia marcescens* mastitis, 727
- Serum biochemistry  
 abomasal displacement/volvulus, 364–365  
 African horse sickness, 1181–1182  
 anemia, 454, 457  
 carbohydrate engorgement, 321  
 colibacillosis, 860–861  
 coliform mastitis, 714  
 colitis, right dorsal, 255  
 diarrhea, acute, 270  
 endotoxemia, 57–58  
 enteritis, 266  
 equine colic, 222–223  
 equine neorickettsiosis, 1467  
 fatty liver, cattle, 1675  
 hemorrhagic bowel syndrome, 381  
 intestinal obstruction, 380  
 Johne's disease, 1030  
 left-side displacement of abomasum, 359  
 limitations, 26  
 mastitis, 687  
 mastitis-metritis-agalactia syndrome, 757  
 musculoskeletal system disease, 626  
 nervous system examination, 593  
 newborns, 165–166, 166  
 osteochondrosis, 640  
 porcine stress syndrome, 1972  
 recumbency in horses, 123  
 reference laboratory values, 2048–2050  
 renal function tests, 550–552  
 total solids, fluid balance disorder, 88–89  
 transmissible gastroenteritis, 1281  
 urolithiasis, 568  
 vagus indigestion, 349  
 see also specific tests
- Serum (postvaccinal) hepatitis, 392, 393, 824, 1988–1989
- Serum neutralization (SN) test  
 bovine virus diarrhea virus, 1261  
 encephalomyocarditis virus disease, pigs, 1184  
 porcine reproductive and respiratory syndrome, 1200  
 pseudorabies, 1398–1399  
 rinderpest, 1240  
 vesicular stomatitis, 1235
- Serum neutralizing (SN) antibodies  
 bovine herpesvirus-1 infection, 1351  
 bovine virus diarrhea virus, 1255
- Serum-virus vaccination, hog cholera, 1166
- Sesquiterpene lactone poisoning, 1892
- Sesquiterpene poisoning, 1892
- Setaria*, 1575–1576
- Setaria digitata*, 1575
- Setaria equina*, 1575
- Setaria labiata-papillosa*, 1575, 1576
- Setaria lutescens* (yellow bristle grass), 1895
- Setaria marshalli*, 1575
- Setaria sphaelata*, 1859
- Severe virulent ovine foot rot (SVOFR), 1066
- Sewage  
 cadmium poisoning source, 1829  
 sludge poisoning, 1843
- Sex chromosome chimerism, 1939
- Shaker calf syndrome (inherited neurodegeneration), 1951
- Shaker foal syndrome, 825
- Shaker kids, 1416
- Shaker lambs, 1416
- Shearing  
 blackleg transmission, 828, 830  
 caseous lymphadenitis risk factor, 795–796, 797  
 dermatophilosis following, 1048–1049  
 hypothermia, 44, 45  
 louse control, 1598  
 sheep ked, 1596  
 winter, lamb birth weight and, 42, 1696  
 woolslip, 2041
- Sheath rot see Enzootic posthitis
- Shed barns  
 equine influenza, 1324, 1328  
 lambing, ovine progressive pneumonia, 1366
- Sheep  
 altitude effects, 1788  
 bronchoalveolar lavage, 487, 488  
 drug doses/intervals, 2051–2063  
 liver function tests, 389  
 musculoskeletal examination, 625  
 nutritional management, 1695–1697  
 in pregnancy, 143  
 periparturient period, 1613  
 reference laboratory values, 2047–2050  
 selenium supplementation, 1753  
 shearing see Shearing  
 temperature, upper critical, 47  
 transportation stress, 108
- Sheep dipping see Dipping
- Sheep ked (*Melophagus ovinus*), 1300, 1596
- SheepMap (Australian Sheep Johne's Disease Market Assurance Program), 1037
- Sheepox, 1426, 1430–1431
- Sheep scab, 1610–1611
- Sheepshead (probatocephaly), 1959
- Shetland Islands, bovine virus diarrhea virus eradication program, 1275
- Shifting of weight, osteochondrosis, 640
- Shiga toxin (Stx) genes, 882
- Shimao zheng, 2042
- Shipping fever see Pneumonic pasteurellosis, cattle (shipping fever)
- Shivering thermogenesis, 39, 42
- Shizonts, 1502
- Shock  
 alimentary tract dysfunction, 190–191, 195  
 endotoxemia and, 55  
 enteritis, 265  
 equine colic, 219  
 hypovolemic, 399  
 maldistributive, 399  
 monitoring, 65–66  
 peritonitis, 283  
 postparturient, 1634–1635  
 treatment, 95  
 see also specific types
- Shoing, laminitis, 2033
- Short chain fatty acids, *pars esophagea* ulceration, 1995–1996
- Short-nosed sucking louse (*Haematopinus eurysternus*), 1597
- Short scrotum lambs, enzootic posthitis control, 794
- Short stepping gait, recurrent exertional rhabdomyolysis, 1967
- Short thermal test, tuberculosis, 1010
- Shower dipping  
 caseous lymphadenitis risk factor, 796  
 louse control, 1598
- Show horses, equine influenza vaccination, 1327
- Shunts  
 cardiac catheterization, 412  
 congenital, 401, 431  
 hypoxic hypoxia, 472  
 ventricular septal defects, 432
- Sideroleukocytes, equine infectious anemia, 1175
- Siggard-Andersen equation, 83
- Sigmoid flexure, 567
- Signalment, 583
- Silage  
 botulism, forage, 825  
 butyrate in, 1662  
 congenital joint laxity and dwarfism, 2035  
*Listeria monocytogenes* presence, 806, 810
- Silage eye see Listeriosis
- Silicon tetrafluoride poisoning, 1816
- Silicosis, volcanic eruptions, 1792
- Silo gas, interstitial pneumonia, 1999
- 'Silver dollar spots,' 1539
- Simazine poisoning, 1838
- Simmental cattle  
 bovine ocular squamous-cell carcinoma, 2039  
 inherited multifocal symmetrical encephalopathy, 1952  
 inherited thrombopathia, 1947
- Simonsia paradoxa*, 1555
- Simple indigestion, 298, 311–313  
 clinical findings, 312  
 clinical pathology, 312  
 differential diagnosis, 312–313  
 etiology, 311–312  
 pathogenesis, 312  
 spontaneous recovery, 313  
 treatment, 313
- Simplex poisoning, 1886
- Simulated shipping exercise, orf, 1418–1419
- Simulium arcticum*, 1605
- Simulium notatum*, 1233
- Simulium vittatum* (black flies), 1233, 1605
- Sinc* gene, 1442
- Singeing, electrocution, 1789, 1790
- Single-breath diagram for carbon dioxide, 489
- Single intradermal (SID) test, 1010
- Single radial hemolysis test, 1325
- Sinigrin, 1881
- Sink, laminitis, 2031
- Sinoatrial block, 414
- Sinus arrhythmias, 414
- Sinus bradycardia, 413–414
- Sinusitis, *Oestrus ovis* infestation, 1587
- Sinus tachycardia, 413
- Sip* (scrapie incubation period) gene, 1442
- Siphonage, repeated, 215
- Sistrurus* (rattlesnake), 1916, 1917
- SI unit conversion tables, 1664, 2045
- Skeletal deformity, 621, 625  
 border disease, 1416  
 manganese deficiency, 1733
- Skeletal muscle see Muscle
- 'Ski jump lesion,' 2017
- Skin  
 besnoitiosis, 1518  
 biopsy  
 bovine virus diarrhea virus, 1261  
 purpura hemorrhagica, 1926  
 burns, 1793  
 clinical examination, 10, 20–21  
 congenital absence, 1975  
 damage, orf, 1419  
 diseases of, 651–670  
 clinical examination, 651–652  
 clinical signs, 651–652  
 coloration abnormality, 652  
 congenital defects, 669–670  
 dermis, diseases of, 654–661  
 effects of, 651  
 epidermis, diseases of, 654–661  
 granulomatous lesions, 667  
 lesion types, 652  
 primary lesions, 651  
 pruritus, 652–653  
 secondary lesions, 651  
 secretion abnormalities, 653  
 subcutis, diseases of, 664–667  
 treatment, 653  
 uncertain etiology, 2037–2042  
 see also specific diseases/disorders
- elasticity, dehydration evaluation, 862–863  
 function of, 651  
 inherited defects, 1973–1977  
 lesions  
 biotin deficiency, 1781–1782  
 horses, 1434  
 photosensitization, 660–661  
 pigs, 785  
 porcine dermatitis and nephropathy syndrome, 1192  
 malignant catarrhal fever, 1247  
 necrosis, 785  
 pH, ringworm, 1477  
 pricking, cutaneous trunci reflex, 590  
 scrapings  
 demodectic mange, 1608  
 itchmites, 1607  
 ringworm, 1477  
 stephanofilariosis, 1574  
 zinc deficiency, 1732
- slough  
 bovine ulcerative mammillitis, 1429  
 cold injury, 1794  
 sweating sickness, 1989

- Skin (Cont'd)  
 tenting, equine colic, 224  
 vitamin A deficiency, changes in, 1774  
 see also *Entries beginning cutaneous*
- Skin tuberculosis, 1016
- Skunk(s)  
 rabies vaccination, 1392–1393  
 rabies vector, 1386, 1387
- Skunk cabbage (*Veratrum californicum*) toxicity, 133, 1884, 1894
- Slaframine poisoning, 1899, 1908
- Slaframine toxicosis, 1899
- Slaked lime, fluorine poisoning control, 1819
- Slap test, 590, 2017
- Slaughter  
 African horse sickness, 1182  
 attaching and effacing *Escherichia coli* infection prevalence, 878  
 bovine spongiform encephalopathy, 1452  
 contagious bovine pleuropneumonia, 1135–1136  
 enterohemorrhagic *Escherichia coli* control, 885–887  
 enterohemorrhagic *Escherichia coli* infection prevalence, 877–878  
 equine histoplasmosis, 1479  
 lumpy skin disease, 1426  
 on-farm, downer cows, 1649  
 ovine pulmonary adenocarcinoma, 1368  
 renal lipofuscinosis, inherited, 1948  
*Salmonella* surveillance program, pigs, 918  
 tuberculosis, 1012, 1013  
 undifferentiated bovine respiratory disease, acute, 931
- Slavers, 1986–1987
- SLC35A3, complex vertebral malformation, 1960
- 'Sleeper syndrome' see *Haemophilus* septicemia
- Sleepy grass (*Stipa robusta*) poisoning, 1901
- Slide agglutination test, *Brachyspira hyodysenteriae*, 1116
- Slinging, standing assistance, 123–124
- Slipped capital femoral epiphysis, 2036
- Slobbers, swainsonine poisoning, 1908
- Slurry, 903, 1785
- Slurry heel, 657
- Slurry pits, 1785
- Small colon  
 impaction, 256  
 obstruction, 255–256
- Small intestine  
 biopsy, granulomatous enteritis, 1993  
 cryptosporidiosis, 1514  
 distension, equine colic, 221, 227  
 epiploic foramen entrapment, 242, 243  
 equine grass sickness, 1991  
*Escherichia coli* overgrowth treatment, 868  
 giardiasis, 1516  
 hemorrhage, 194  
 incarceration, 377  
 intussusception, 378  
 calves, 309  
 exploratory laparotomy (celiotomy), 310  
 obstruction, 242, 243  
 neonatal viral diarrhea, 1293  
 obstruction  
 acute, 226  
 equine colic, 219  
 exploratory laparotomy (celiotomy), 310  
 phytozoars, 300  
 obstruction, horses, 241–245  
 acute, 242–243  
 caudal abdominal, 244  
 clinical findings, 242–244  
 clinical pathology, 244  
 differential diagnosis, 244  
 epidemiology, 241–242  
 etiology, 241  
 functional obstruction, 241, 243  
 infarction and, 241, 242–243  
 necropsy findings, 244  
 pathogenesis, 242  
 subacute, 243  
 treatment, 244  
 volvulus, 243, 377, 378
- SMEDI virus, abortion, 1095
- Smelter emissions, 1785
- S-methyl-L-cysteine-sulfoxide (SMCO) poisoning, 1881–1882
- Smoke inhalation, 499, 1793
- Smooth tongue (epitheliogenesis imperfecta linguae bovis), 1944
- Snakebite, 1916–1918  
 clinical findings, 1917  
 clinical pathology, 1917  
 diagnosis, 1917  
 differential diagnosis, 1917  
 epidemiology, 1916–1917  
 etiology, 1916  
 necropsy findings, 1917  
 pathogenesis, 1917  
 treatment, 1917–1918
- Snakeroot (*Eupatorium rugosum*), tremetol poisoning, 1883
- Snakes, venomous, 1916, 1916
- Snake venom, coagulation defect, 444
- Sneezing, 478  
*Oestrus ovis* infestation, 1587
- Snoring, 478
- Snorter dwarfs, 1958
- Snorting, 478
- Snout-rubbing, 612–613
- 'Snowflakes' (hair), 662
- Snowshoe hare virus, 1382
- Snuffling, 478
- SOAP acronym, 25
- Social hierarchy, buller steer syndrome, 1983
- Sodium  
 deficiency, magnesium absorption effects, 1653  
 fractional clearance, 551–552  
 loss of see Hyponatremia  
 mare's milk concentration, 563  
 postparturient hemoglobinuria, cattle, 1683  
 serum, metabolic profile testing, 1622
- Sodium acid phosphate, 1761, 2062
- Sodium aluminum silicate, 1638–1639
- Sodium bicarbonate, 98  
 carbohydrate engorgement, 322  
 diarrhea, acute, 100, 271  
 dietary cation-anion difference effect, 1639  
 equine hyperkalemic periodic paralysis, 1966  
 exertional rhabdomyolysis, 1685  
 hypertonic, 95  
 isotonic, 94  
 myopathy, 630  
 recurrent exertional rhabdomyolysis, 1968
- Sodium channel mutation, equine hyperkalemic periodic paralysis, 1966
- Sodium chlorate  
 poisoning, 1838  
 supplementation, enterohemorrhagic *Escherichia coli* control, 885
- Sodium chloride  
 bloat, 336  
 deficiency, 1729–1730  
 dosage/interval, 2062, 2066  
 equine hyperkalemic periodic paralysis, 1966  
 experimentally induced, 1729  
 milk fever, 1636  
 poisoning, 1824–1826  
 clinical findings, 1825–1826  
 clinical pathology, 1826  
 control, 1826  
 diagnosis, 1826  
 differential diagnosis, 1826  
 economic importance, 1825  
 epidemiology, 1824–1825  
 etiology, 1824  
 necropsy findings, 1826  
 pathogenesis, 1825  
 risk factors, 1825  
 specimen analysis, 1797  
 treatment, 1826  
 supplementation, 1729  
 urolithiasis, 566
- Sodium cromoglycate, 1934
- Sodium fluoroacetate poisoning, 1839
- Sodium fluorosilicate poisoning, 1847
- Sodium hyaluronate, 642
- Sodium hypochlorite, 733
- Sodium iodide, 1047, 1480, 1481
- Sodium iodine, 1478, 1479
- Sodium metabisulfite, sulfur poisoning from, 1828
- Sodium nitrite, cyanogenic glycoside poisoning, 1855
- Sodium pentosan polysulfate, 443
- Sodium propionate, 1665
- Sodium pyrophosphate, 1762
- Sodium selenate, 1751, 1752
- Sodium sulfanilate plasma clearance, 550
- Sodium sulfate  
 copper poisoning, 1823  
 dosage/interval, 2062, 2066  
 equine colic, 227  
 poisoning treatment, 1798
- Sodium sulfate turbidity test, 861
- Sodium sulfite precipitation and glutaraldehyde test, 154
- Sodium thiosulfate, 1811, 1855, 2062
- Sodium tungstate, 1858
- Soft palate  
 dorsal displacement (soft palate paresis), 536–537  
 ulceration, stomatitis, 206
- Softwood forest fires, 1792
- Soil  
 contamination, 1785  
*Bacillus anthracis*, 816  
*Clostridium*, 821  
*Clostridium haemolyticum*, 834  
 enterohemorrhagic *Escherichia coli*, 880–881  
*Erysipelothrix rhusiopathiae*, 811  
 copper deficiency risk factors, 1710–1711, 1711  
 fluorine content, 1816  
 hypomagnesemic tetany risk factors, 1655  
 Johne's disease risk factors, 1021  
 manganese levels, 1733  
 molybdenum levels, 1710–1711, 1820  
 pH, 1737  
 radionuclide uptake by animal, 1786  
 selenium content, 1737, 1746  
 temperature, lactation tetany risk, 1654  
 type examination, 7
- Soil fumigant poisoning, 1846
- Soil-plant-animal interaction, trace element deficiencies, 1699–1700
- Solanum dimidiatum* poisoning, 1893
- Solanum esuriale* poisoning, 1893
- Solanum* poisoning, 1892–1893
- Solar radiation, bovine ocular squamous-cell carcinoma, 2039
- Solenopsis invicta* (fire ant) bite, 1918
- Somatic cell count (SCC)  
 bulk tank milk, 683, 683, 744–745  
 herd average, 745, 746  
 individual cow monitoring, 746–748  
 mastitis  
 bovine, risk factor, 677, 678  
 coliform, 711, 714  
*Corynebacterium bovis*, 708  
 diagnosis, 673, 681, 685–686  
 goats, 761  
 sheep, 760  
*Staphylococcus aureus*, 700  
*Streptococcus agalactiae*, 704–705  
 problem solving using, 747–748  
 scoring system, 685–686, 686, 687  
 threshold, 745, 746
- Somatic-cell nuclear transfer, cloning, 145
- Somatic (musculoskeletal) pain, 103, 104, 105, 625
- Somatotropin, 1662
- Sonic bang, aircraft, 1785
- Sorbitol dehydrogenase (SDH), 389, 390, 1988
- Soremouth see Orf
- Sour crude oil toxicity, 1846–1847
- South Africa  
 African horse sickness, 1180  
 anaplasmosis, 1456  
 bovine babesiosis, 1483  
 equine babesiosis, 1484  
 rabies, 1385
- South America  
 bluetongue virus serotypes, 1301  
 rabies, 1385
- Southern Europe, bluetongue virus serotypes, 1301
- South Hampshire sheep, ceroid lipofuscinosis, 1950
- Sows  
 coccidiosis transmission, 1500  
 colostrum volume, 152  
 farrowing hysteria, 612  
 gastric torsion, acute, 259  
 iron supplementation, 1728  
 sudden death from endocarditis, 428  
 see also *specific diseases/disorders*
- Soybean products  
 dietary diarrhea, 277  
 iodine deficiency, 1723  
 milk fever prevention, 1639
- Space-occupying lesion, 24
- spinal cord compression, 615  
 see also *specific types*



- Spain, African swine fever, 1168–1169, 1172  
 Spasmodic colic, 216, 226, 256–257, 1582  
 Spasmolytics, 204, 227  
 Spasticity, upper motor neuron lesions, 581  
 Spastic paresis  
   inherited (Elsø heel), 1955–1956, 1965  
   involuntary, 579  
 Spatial patterns of disease, 34  
 'Species barrier,' transmissible spongiform encephalopathies, 1439  
 Specificity, laboratory data/tests, 25, 26–27, 27  
 Specific-pathogen-free (SPF) lambs, giardiasis, 1516  
 Specified-risk-materials (SRM), bovine spongiform encephalopathy, 1452  
 Spectinomycin  
   dosage/interval, 2062, 2066  
   enzootic pneumonia of calves, 1342  
   pleuropneumonia of pigs, 1057  
 Spider lamb syndrome, 1960  
 Spinal abscess, *Arcanobacterium pyogenes*, 787  
 Spinal accessory nerve (cranial nerve XI)  
   assessment, 587  
 Spinal ataxia  
   equine degenerative myeloencephalopathy, 1954  
   equine protozoal myeloencephalitis, 1524  
   horses, 2018  
 Spinal cord  
   bovine spongiform encephalopathy, 1449  
   compression, 615–617, 1771  
   disease, 613–618  
   see also *specific diseases/disorders*  
   *Halicephalobus* infestation, 1575  
   *Hypoderma* infestations, 1589  
   lumbosacral, bladder paralysis, 561  
   traumatic injury, 613–615  
     clinical findings, 614  
     clinical pathology, 614  
     etiology, 613  
     necropsy findings, 614  
     pathogenesis, 613–614  
     treatment, 615  
 Spinal dysmyelination, inherited, 1952  
 Spinal dysraphism, inherited, 1952  
 Spinal muscular atrophy, inherited, 1965  
 Spinal myelinopathy, inherited, 1952  
 Spinal myelitis, *Listeria monocytogenes* infection, 805, 808, 809  
 Spinal reflexes, 590  
 Spinal shock, 613, 614  
 Spinal stenosis, congenital, 1912  
 Spinose ear tick (*Otobius megnini*), 1600, 1602  
 Spiral colon testing, 1292  
 Spirochetal colitis see Porcine intestinal spirochetosis  
 Spirochetal granuloma, 1123  
 Splanchnic lesions, equine grass sickness, 1901  
 Splayed digits, inherited, 1965  
 Splaylegs, 627, 648  
 Splayleg syndrome, newborn pigs, 2024–2025  
 Spleen  
   babesiosis, 1488  
   congenital abnormalities, 466  
   diseases of, 464–466  
   see also *specific diseases/disorders*  
   displacement, equine colic, 221  
   functions of, 464  
   infarction, 465  
   neoplasms of, 465  
   rectal examination palpation, 19  
   rupture, 465  
 Splenectomy, 464–465  
 Splenic abscess, 465  
 Splenic hematoma, 465  
 Splenitis, traumatic, 352  
 Splenomegaly, 465, 1461  
 Spondylitis, 632–633  
 Spondylosis, bulls, 614  
 Spongiotic vesicular dermatitis, 658  
 Sporadic abortion, neosporosis, 1509–1510  
 Sporadic bovine encephalomyelitis (SBE), 1407–1408  
 Sporadic bovine leukosis, 1210, 1216, 1218  
 Sporadic lymphangitis, 2029–2030  
*Sporidiermium bakeri* (*Pithomyces chartarum*), 1899, 1908–1910  
 Sporidesmin  
   poisoning, 1899, 1908–1910  
   resistance, 1910  
 Sporoblasts, *Eimeria*, 1502  
 Sporocysts  
   *Eimeria*, 1502  
   *Sarcocystis*, 1507  
 Sporogony  
   *Babesia*, 1485  
   *Cryptosporidium*, 1514  
   *Sporothrix beurmannii*, 1479  
   *Sporothrix equi*, 1479  
   *Sporothrix schenckii*, 1479  
   Sporotrichosis, 1434, 1479–1480  
   *Sporotrichum schenckii*, 1479  
   Sporozoite(s) (merozoites)  
     *Babesia*, 1485, 1488  
     *Eimeria*, 1502  
     sarcocystosis, 1508  
     *Theileria annulata*, 1531  
     *Theileria parva*, 1528  
     toxoplasmosis, 1520  
 Spraddle leg, 2024–2025  
 Sprays  
   *Hypoderma* infestations, 1589  
   ringworm treatment, 1478  
   tick control, 1602  
 Squamous cell carcinoma  
   cutaneous, 668  
   esophageal, 281  
   oral, 281  
   pharyngeal, 281  
   stomach, 281  
   upper alimentary tract, 1266  
 Squirting cucumber (*Ecballium elaterium*)  
   poisoning, 1893  
 Sri Lanka, brucellosis status, 964  
 Stable fly (*Stomoxys calcitrans*) see *Stomoxys calcitrans* (stable fly)  
 Stachybotryotoxicosis, 1899, 1910  
*Stachybotrys atra*, 1899, 1910  
 Stagers see *specific types*  
 Stall confinement, gastric ulcer induction, 238  
 Stall-fed animals, nutritional history-taking, 6  
 Stallions  
   dourine, 1539  
   equine arteritis virus, 1320  
   urethral tears, 571  
 Stall rest, heart failure, 403  
 Standardbred horses, granulomatous enteritis, 1992  
 Standing assistance, 123, 1648  
*Stangeria* poisoning, 1885  
 Stanozolol, 2062  
 Staphylococcal dermatitis, 1433  
*Staphylococcus*, 783–787  
   coagulase negative, mastitis, 675  
   exudative epidermatitis (greasy pig disease), 784–787  
   folliculitis of the face, benign, 783  
   impetigo, 783  
   localized infection, 110  
   mastitis, 675  
   periorbital eczema, 783  
   scabby dermatitis, 783  
   septicemia, 783  
   tick pyemia, 783–784  
*Staphylococcus aureus*  
   contagious ophthalmia, 1142  
   mastitis see *Staphylococcus aureus* mastitis  
   septic arthritis in horses, 644  
   tick pyemia (lambs), 784  
   udder impetigo, 751  
*Staphylococcus aureus* mastitis  
   bovine, 674, 697–702  
     acute, 699–700  
     bulk tank milk culture, 683  
     bulk tank milk somatic cell count, 683  
     chronic, 699  
     clinical findings, 699–700, 709  
     clinical pathology, 700, 709  
     coagulase-negative, 708–709  
     coagulase-positive, 697  
     control, 702, 709, 729  
     cure rates, 688, 700–701, 702  
     diagnosis, 700  
     differential diagnosis, 700  
     economic importance, 699  
     epidemiology, 697–699, 708–709  
     etiology, 697, 708  
     genotype of strains, 699  
     immunization, 702  
     infection duration, 730  
     necropsy findings, 700  
     pathogenesis, 699  
     peracute, 699–700, 701–702  
     prevalence, 676  
   risk factors, 698–699  
   segregation of cows, 733–734  
   transmission, 697–698  
   treatment, 691, 700–702, 709, 738, 740  
   virulence, 698–699  
   zoonotic implications, 699  
     caprine, 761  
     ovine, 759, 760  
*Staphylococcus chromogenes* mastitis, 708  
*Staphylococcus epidermidis* mastitis, 708  
*Staphylococcus hyicus*  
   exudative epidermatitis (greasy pig disease), 784–787  
   mastitis, 708–709  
   scabby dermatitis, 783  
*Staphylococcus intermedius* mastitis, 708–709  
 Starch absorption test, 273  
 Starch digestion test, 198  
 Star-gazing lambs (daft lamb disease 2), 1955  
 Starvation, 113  
   incomplete see Malnutrition  
   piglet mortality, 130  
   recumbency in horses, 122  
   secondary, dental disease, 208  
 Starvation ketosis, 1662  
 Starvation pregnancy toxemia, sheep, 1668  
 Status spongiosa, 385  
 Steam pasteurization, carcass decontamination, 886  
 Steam vacuum, carcass decontamination, 886  
 Steatitis, 1680  
   necropsy findings, 1748  
   selenium deficiency, 1743–1744  
   vitamin E deficiency, 1743–1744  
 Stellate scar, glanders, 1084  
 Stenosis  
   anterior functional (achalasia), 347–348  
   compression, 377  
   posterior functional (achalasia), 348  
   vagus indigestion, 346  
   vagus nerve injury/dysfunction, 346  
*Stephanofilaria*, 1574  
*Stephanofilaria boomkeri*, 1574  
*Stephanofilaria dedoesi*, 1574  
*Stephanofilaria zaheeri*, 1574  
 Stephanofilariosis, cutaneous, 1574  
 Stephanurosis, 1570–1571  
*Stephanurus dentatus*, 1570  
 Sterigmatocystin poisoning, 1910  
 Sterile insect technique (SIT), screwworm, 1595  
 Sterile male technique  
   blowfly, 1592  
   *Hypoderma* eradication, 1589  
   tsetse fly control, 1536  
 Sterility  
   bovine besnoitiosis, 1518  
   radiation injury, 1787  
 Stern avirulent spore vaccine, anthrax, 819  
 Steroidal alkaloid poisoning, 1892–1893  
 Steroidal saponins, 660  
   poisoning, 1891  
 Steroid-induced arthropathy, 637  
 Steroids  
   anabolic, 1666  
   intra-articular, arthropathy, 641  
 Stertor, 477, 478  
 Stewart's Range syndrome, 1914–1915  
 St Helens, Mount, 1791, 1792  
 Stick test, bovine spongiform encephalopathy, 1450  
 'Stiff-lamb disease,' 1745  
 Stigma, scrapie, 1441  
 Stilbestrol, 2062  
*Stilesia hepatica*, 1582  
 Stillbirth(s), 1983–1986  
   case definition, 1985–1986  
   clinical findings, 1983  
   congenital defects, 135  
   control, 1986  
   diagnosis, 1985  
   epidemiology, 1984–1985  
   etiology, 1095  
   historical aspects, 1983–1984  
   horses, 1105  
   iodine deficiency, 1724  
   lambs, 128  
   leptospirosis, 1098  
   *Listeria monocytogenes* infection, 808  
   necropsy findings, 1105, 1983, 1985  
   occurrence patterns, 1986  
   pigs, 130, 1095

- Stillbirth(s) (*Cont'd*)  
 porcine reproductive and respiratory syndrome, 1199  
 prevention, 1986  
 treatment, 1986
- Stings, animals, 1915–1920  
*see also specific types*
- Stinkwood tree (*Zieria arborescens*) poisoning, 1892
- Stinkwort (*Dittrichia graveolens*) poisoning, 1888
- Stipa robusta* (sleepy grass) poisoning, 1901
- Stiropos, screwworm, 1595
- St John's wort (*Hypericum perforatum*) poisoning, 1886
- Stocking density  
 degenerative joint disease, 2027  
 sarcocystosis, 1508
- Stocking rate examination, 7
- Stock segregation, fasciolosis, 1579
- Stomach  
 diseases of  
   nonruminants, 215–280  
   *see also specific diseases/disorders*  
   equine grass sickness, 1991  
   hemorrhage, 194  
   *see also Entries beginning gastric*
- Stomach bot, 1585–1586
- Stomach fluke disease, 1580–1581
- Stomach tube, bloat, 331–332
- Stomach ulcers *see* Gastric ulcer(s)
- Stomatitis, 205–207  
 bullous, 206  
 catarrhal, 206  
 clinical findings, 206  
 clinical pathology, 206–207  
 differential diagnosis, 207  
 etiology, 205–206  
 foot-and-mouth disease, 1225  
*Gasterophilus* infestation, 1586  
 infectious, 205–206  
 mycotic, 206  
 necropsy findings, 207  
 necrotic, 1079, 1080, 1266  
 pathogenesis, 206  
 plant-induced, 1897  
 treatment, 207  
 vesicular *see* Vesicular stomatitis
- Stomoxys calcitrans* (stable fly), 1603  
 bovine ulcerative mammillitis vector, 1429  
 dermatophilosis, 1049  
 enzootic bovine leukosis transmission, 1211  
 equine infectious anemia virus transmission, 1173  
 equine seasonal allergic dermatitis, 1927  
 lumpy skin disease vector, 1425  
 management, 1603  
 as mechanical vector, 1603  
 surra transmission, 1537
- Stomoxys nigra*, 1603
- Stormont test, 1010, 1011
- Strabismus, 1957
- Straining *see* Tenesmus (straining)
- Strangles, 769–775  
 acute, 770–771  
 bastard, 771  
 clinical findings, 770–771, 772  
 clinical pathology, 771, 772  
 complications, 771  
 control, 773–774  
 diagnosis, 771, 772  
 differential diagnosis, 772, 772  
 epidemiology, 769–770, 772  
 etiology, 769  
 hepatic abscess, 395  
 importance of, 770  
 incubation period, 770  
 infection source, 769–770  
 lymphadenopathy, 464  
 metastatic infection, 770, 771, 773  
 necropsy findings, 771  
 pathogenesis, 770  
 resistance, 770, 774  
 risk factors, 770  
 transmission, 769–770  
   prevention, 773, 773–774  
   treatment, 771–773  
   vaccination, 774  
 venous thrombi, 436
- Strangles in burros, 771
- Stranguria, 547–548
- Strawberry foot rot (proliferative dermatitis), 1051, 1075
- Stray voltage, 1790–1791
- Streaked hairlessness, 1974
- Streptococcal arthritis, 646
- Streptococcus*, 768–783  
 arthritis (lambs), 769  
 dermatitis, 769  
 enteritis, 768  
 environmental, mastitis *see* Environmental streptococci mastitis  
 genital tract infections, 769  
 localized infection, 110  
 lymphadenitis (pigs), 782–783  
 lymphangitis, 768–769  
 meningoenkephalitis, 768  
 neonatal infection *see* Neonate(s), streptococcal infection  
 pneumonia, 768  
 septicemia, 768  
 strangles, 769–775
- Streptococcus agalactiae* culture media, 684
- Streptococcus agalactiae* mastitis  
 bovine, 674, 703–705  
   bulk tank milk culture, 683  
   bulk tank milk somatic cell count, 683  
   clinical findings, 704  
   clinical pathology, 704  
   control, 705, 729  
   cure rate, 688  
   differential diagnosis, 704  
   economic importance, 703  
   epidemiology, 703  
   etiology, 703  
   infection duration, 730  
   infection source, 703  
   intramammary antimicrobials, 691  
   pathogenesis, 703–704  
   prevalence, 676  
   risk factors, 703  
   transmission, 703  
   treatment, 704–705  
   vaccination, 705
- caprine, 761  
 ovine, 759
- Streptococcus bovis*, 316
- Streptococcus durans*, 768
- Streptococcus dysgalactiae* mastitis, 675
- Streptococcus dysgalactiae*  
 arthritis, lambs, 769  
 mastitis, 720, 721  
   *see also* Environmental streptococci mastitis  
 neonatal infection, 775, 776
- Streptococcus equi*  
 guttural pouch fluid examination, 484–485  
 neonatal infection, 775  
 purpura hemorrhagica association, 1925  
 strangles, 769–775
- Streptococcus equisimilis* septicemia, 768
- Streptococcus orisrattii* infection, 778
- Streptococcus pneumoniae*, 768
- Streptococcus suis*  
 antibiotic resistance, 781  
 culture, 780  
 genital tract infections, 769  
 infection, pigs, 777–782  
   case fatality rates, 778  
   clinical findings, 780  
   clinical pathology, 780  
   control, 781–782  
   diagnosis, 781  
   differential diagnosis, 781  
   epidemiology, 777–780  
   etiology, 777  
   morbidity, 778  
   necropsy findings, 780–781  
   outbreaks, 777–778  
   pathogenesis, 780  
   prevalence of, 778  
   risk factors, 778–779  
   transmission, 778  
   treatment, 781  
   vaccination, 782  
   zoonotic implications, 779–780
- meningoenkephalitis, 768  
 septicemia, 768  
 virulence markers, 779
- Streptococcus uberis*  
 mastitis, 675, 720, 721  
   *see also* Environmental streptococci mastitis
- neonatal infection, 775
- Streptococcus zooepidemicus*  
 genital tract infections, 769  
 infection, 775  
 lymphangitis, 768–769  
 neonatal infection, 775  
 pneumonia, 768  
 respiratory tract infection, 803  
 septicemia, 768
- Streptomycin  
 actinobacillosis (wooden tongue), 1047  
 anthrax, 818  
 dosage/interval, 2062, 2066  
 Johne's disease, 1031  
*Pasteurella* mastitis, 725
- Stress, 107–110  
 clinical pathology, 108–109  
 coliform gastroenteritis, 895  
 definition, 108  
 diarrhea, acute, 269  
 economic performance, 109  
 etiology, 107–108  
 gastric ulcers in foals, 235  
 glanders, 1084  
 immune deficiency from, 467  
 management, 109–110  
 milk fever etiology, 1628  
 pathogenesis, 108  
 pregnancy toxemia induction, 1668  
 syndromes, 109  
 undifferentiated bovine respiratory disease, acute, 932
- Stridor, 477, 478
- Stringhalt, 2018–2019
- String sampling, bovine mastitis, 684
- Strip cup, milk abnormality in bovine mastitis, 682
- Striped skunks (*Mephitis mephitis*), rabies vector, 1385, 1387
- Strip grazing, bloat control, 334
- Stripping of affected quarters  
 coliform mastitis, 716  
 environmental streptococci mastitis, 722
- Stroke volume, 400
- Stromal free hemoglobin, 96, 459
- Strong ion approach to acid-base imbalance, 83–84
- Strong ion gap (SIG), 91, 93, 93
- Strongyles (redworms), 1558–1559
- Strongyloides* (threadworm), 1075, 1562–1563
- Strongyloides papillosus*, 1562
- Strongyloides ransomi*, 1562
- Strongyloides westeri*, 1562
- Strongylosis, 1558–1562  
 clinical findings, 1493, 1559–1560  
 clinical pathology, 1493, 1560  
 control, 1561–1562  
 diagnostic confirmation, 1560  
 differential diagnosis, 1560  
 drug resistance, 1561, 1562  
 epidemiology, 1493, 1559  
 etiology, 1558  
 horses, 1493  
 necropsy findings, 1560  
 pathogenesis, 1559  
 treatment, 1493, 1561
- Strongylus edentatus*, 1558
- Strongylus vulgaris*, 433, 1558–1559
- Strontium-89, 1786
- Strontium-90, 1786
- Struck, 838, 839
- Strychnine poisoning, 1797, 1893
- Stunning, nervous shock, 577
- Sturdy (gid, coenurosis), 609, 1583
- Stypandra glauca* (nodding blue lily) poisoning, 1893
- Stypandro poisoning, 1893
- Subacute ruminal acidosis (SARA), 315  
 dairy cattle, 315–316  
 clinical findings, 319  
 pathogenesis, 318  
 prevention, 323–325
- Subcommittee of Enterobacteriaceae of the International Committee on Systematic Bacteriology, 896
- Subcorneal pustular dermatitis, 786
- Subcutaneous abscess, 666–667, 787
- Subcutaneous antimicrobials, 179
- Subcutaneous edema (anasarca), 73, 522, 664, 1775, 1925–1926
- Subcutaneous emphysema, 665

- Subcutaneous tissue needle aspirate, urolithiasis, 568
- Subcutis, diseases of, 664-667  
see also *specific diseases/disorders*
- Subepiglottic cysts, 537
- Sublactam, small intestine *Escherichia coli* overgrowth, 868
- Submandibular lymph node enlargement, 1310
- Submaxillary region examination, 19
- Submucous hemorrhages, 1926
- Subpleural emphysema, 1347
- Subterranean clover (*Trifolium subterraneum*) poisoning, 1824, 1873, 1874
- Subunit vaccines  
anaplasmosis, 1459  
bovine babesiosis, 1497  
bovine herpesvirus-1 infection, 1357  
equine influenza, 1327  
neonatal viral diarrhea, 1296  
pleuropneumonia of pigs, 1059  
pseudorabies, 1402-1404  
transmissible gastroenteritis, 1284
- Subvalvular aortic stenosis, 433
- Succinylcholine chloride, 2062
- Succussion, 13
- Sucking  
behavior, mastitis-metritis-agalactia syndrome and, 755  
drive  
hypothermia, neonatal, 44  
loss, hypothermic neonatal lambs, 141  
weak, 152  
natural  
colostral immunoglobulins absorption, 152  
colostrum administration, 156
- Sucking lice, 1597
- Suckling pigs, porcine viral encephalomyelitis, 1405
- Sucralfate, 240, 2062
- Sucrose absorption test, 199
- Sudanese Desert ewes, zinc deficiency, 1731
- Sudden collapse, 1789
- Sudden death, 124-125  
*Actinobacillus suis* infection, 1052  
bacillary hemoglobinuria, 835  
black disease, 833  
calcium borogluconate injection, 1637  
*Clostridium sordellii* abomasitis, 821  
coliform gastroenteritis, 893  
cystitis and pyelonephritis, 792  
encephalomyocarditis virus disease, pigs, 1184  
eperythrozoonosis, 1155  
groups of animals, 124-125  
horses, 124  
infectious polyarthritis, 1004  
investigation procedures, 125  
myocardial disease, 421  
plant-induced, 1896, 1897  
pneumonic pasteurellosis, 948  
reticuloperitonitis, traumatic, 340  
single animals, 124
- Sudden death-polioencephalomalacia syndrome, 1869
- Sudden death syndrome, 822, 1869
- Suffocation, volcanic eruptions, 1791
- Suffolk sheep  
GM<sub>1</sub> gangliosidosis, 1950  
inherited ovine degenerative axonopathy, 1953  
scrapie genetic susceptibility, 1443  
'Suicides,' 777
- Sulfachlorpyridazine, 2062, 2066
- Sulfadiazine, 269, 1525
- Sulfadiazine/trimethoprim, 2066
- Sulfadimidine (sulfamethazine)  
coccidiosis, 1505, 1505  
dosage/interval, 2062  
infectious keratitis, 996  
tick-borne fever, 1461  
toxoplasmosis, 1522
- Sulfadoxine/trimethoprim, 2062, 2066
- Sulfamethazine see Sulfadimidine (sulfamethazine)
- Sulfamethoxypyridazine, 728, 2062
- Sulfamethylphenazole, 1461
- Sulfate  
copper interaction, 1713-1714  
excess, copper deficiency, 1708  
molybdenum interaction, 1713-1714  
retention, renal insufficiency, 544
- Sulfathiazole, 1058
- Sulfobromophthalein sodium clearance test, 388-389
- Sulfonamides, 1463  
actinobacillosis (wooden tongue), 1047  
administration, 181  
coccidiosis, 1505, 1506  
equine influenza, 1326  
*Escherichia coli* bacteremia, 869  
resistance, progressive atrophic rhinitis, 962  
ruminant use, 179-180  
tissue residues in swine, 186
- Sulfonamide/trimethoprim, 2062, 2066
- Sulfur  
copper deficiency risk factors, 1710  
environmental, 1737  
excess, polioencephalomalacia, 2006, 2007-2009  
milk fever prevention, 1641  
poisoning, 1828
- Sulfur dioxide, 1785  
poisoning, 1828
- Suicidin poisoning, 1832
- Summer infertility, 47-48
- Summer mastitis, 722-724  
*Fusobacterium necrophorum*, 727  
goats, 761  
*Pasteurella* species isolation, 725  
see also *Arcanobacterium pyogenes* bovine mastitis
- Summer pneumonia, 1361-1362
- Summer slump (fescue summer toxicosis), 1899, 1901-1902
- Summer sniffles, 925
- Summer snuffles, 530
- Summer sores, horses, 1571-1572
- Summit metabolism, cold thermogenesis, 42
- Sunlight, bovine ocular squamous-cell carcinoma, 2039
- Superficial pain, 103
- 'Super foot rot,' 1064-1065
- 'Super foul,' 1064-1065
- Superinfection, oral antimicrobial-induced, 179
- 'Superjuice,' 1763, 1848
- Superphosphate, 1763  
poisoning, 1848
- Supportive therapy  
anemia, 459  
antimicrobials and, 183  
arsenic poisoning, 1811  
bacillary hemoglobinuria, 835  
carbon tetrachloride poisoning, 1831  
cardiac glycoside poisoning, 1863  
chlorinated hydrocarbon (organochloride) poisoning, 1834  
cyanogenic glycoside poisoning, 1855  
dermatitis, 659  
dermatosis, 659  
diarrhea, chronic undifferentiated, 273  
dicoumarin derivative poisoning, 1865  
fluorine poisoning, 1818  
mastitis, 694  
mercury poisoning, 1815  
myopathy, 630  
oxalate (soluble forms) poisoning, 1860  
pain, 106-107  
purpura hemorrhagica, 1926  
pyrrolizidine alkaloid poisoning, 1880  
salmonellosis, 914-915  
skin disease, 653  
sodium chloride poisoning, 1826  
tetanus, 824
- Suramin, 1536, 1538, 1540
- Surfactant  
bloat, 332  
ovine pulmonary adenocarcinoma, 1367  
respiratory system disease, 496  
transplantation, near drowning, 1793
- Surgery  
abomasal impaction, 369  
abomasal ulcer, 374  
abomasal volvulus, 366  
arthropathy, 642  
atresia ani, 1944  
bovine ocular squamous-cell carcinoma, 2040  
cecal dilatation/volvulus, 376  
enteritis, anterior, 246  
equine colic, 224, 228, 232  
equine ocular squamous-cell carcinoma, 2041  
intestinal obstruction, 380  
large intestine impaction (horse), 253  
left-side displacement of abomasum, 360  
omphalophlebitis, 159
- papillomatosis, 1422  
respiratory system disease, 496  
sarcoïd, 1424  
small-intestinal obstruction, 244  
urolithiasis, 569
- Surgical debridement  
actinomycosis, 1046  
blackleg, 829
- Surgical drainage  
arthritis/synovitis, 647  
bovine interdigital necrobacillosis, 1065
- Surgical instrument contamination, equine infectious anemia virus transmission, 1174, 1177
- Surra, 1532, 1537-1538
- Sustained-release intraruminal devices (boluses), bovine lungworm, 1567
- Suxamethonium chloride, 2062, 2066
- Swab Test of Premises (STOP), 185
- Swainsona, 1870-1871, 1908
- Swainsonine poisoning, 1870-1871, 1908
- Swallowing  
abnormalities, 191-192, 588  
difficulty see Dysphagia (swallowing difficulty)
- Swamp cancer (equine phycomycosis), 1434, 1480-1481
- Swamp fever see Equine infectious anemia (EIA)
- Swathing, bloat control, 334
- Swayback, lambs  
copper deficiency, 1714-1715  
copper deficiency, secondary, 1708, 1708
- Swaying, thiaminase poisoning, 1883
- Sway reaction, 589, 590
- Sweat glands, secretion abnormality, 653
- Sweating  
dehydration, 74  
equine colic, 220  
equine protozoal myeloencephalitis, 1524  
excessive, inherited, 1977  
exercise, 117
- Sweating sickness, 1989-1990
- Sweden  
bovine respiratory syncytial virus pneumonia, 1344  
bovine rotaviruses, 1288  
bovine virus diarrhea virus eradication program, 1274  
enzootic bovine leukosis eradication program, 1219  
pseudorabies control program, 1401  
pseudorabies eradication program, 1400  
pseudorabies vaccination, 1403  
winter dysentery, cattle, 1297
- Swedish Gotland foals, cerebellar hypoplasia, 1377
- Swedish Highland cattle, inherited atresia ilei, 1944
- Sweet clover poisoning, 1777, 1864-1865
- Sweet itch, 1433, 1927-1928
- 'Swelled head,' 831
- 'Swellers' see Bloat (ruminal tympany)
- Swill  
hog cholera, 1159  
salt content, 1825
- Swine dysentery, 1113-1120  
case-fatality rate, 1114  
clinical findings, 1116  
clinical pathology, 1116-1117  
control, 1119  
diagnosis, 1117  
differential diagnosis, 1117  
drug-associated, 1118  
economic importance, 1115  
epidemiology, 1114-1116  
eradication, 1119  
etiology, 1114  
immune mechanisms, 1114  
morbidity, 1114  
necropsy findings, 1117  
outbreaks, 1114  
pathogenesis, 1115-1116  
risk factors, 1114-1115  
transmission, 1115  
treatment, 1117-1119  
vaccination, 1119
- Swine fever, 1095  
African see African swine fever (ASF)  
classical see Hog cholera
- Swine infertility and respiratory syndrome (SIRS) see Porcine reproductive and respiratory syndrome (PRRS)

- Swine influenza, 1331–1335  
 clinical findings, 1333  
 clinical pathology, 1333–1334  
 control, 1334  
 differential diagnosis, 1334  
 epidemics, 1331, 1332  
 epidemiology, 1331–1333  
 etiology, 1331  
 experimental inoculation, 1332  
 immunity, 1332–1333  
 maternal protection, 1333  
 necropsy findings, 1334  
 occurrence, 1331  
 pathogenesis, 1333  
 pathogen factors, 1332  
 risk factors, 1332  
 secondary bacterial infection, 1332  
 transmission, 1332  
 treatment, 1334  
 vaccination, 1334  
 viral detection, 1333  
 viral replication, 1333  
 zoonotic implications, 1333
- Swine markets, pseudorabies transmission, 1396
- Swinepox, 785, 1431–1432
- Swinepox virus, 1431
- Swine vesicular disease, 1230–1232  
 clinical findings, 1231  
 clinical pathology, 1231–1232  
 control, 1232  
 detection, 1232  
 differential diagnosis, 1226  
 economic importance, 1231  
 epidemiology, 1230–1231  
 eradication programs, 1230, 1232  
 etiology, 1230  
 morbidity rate, 1231  
 necropsy findings, 1232  
 occurrence, 1230  
 outbreaks, 1230  
 pathogenesis, 1231  
 prevalence, 1230  
 risk factors, 1231  
 transmission, 1230–1231
- Switzerland  
 bovine herpesvirus-1 eradication program, 1359  
 bovine spongiform encephalopathy, 1447, 1451
- Symmetrical alopecia, 1973
- Syncerus caffer* (African buffalo), tuberculosis, 1007, 1224
- Synchronous diaphragmatic flutter (thumps), horses, 521–522
- Syncope, 578
- Syncytial giant cells  
 bovine respiratory syncytial virus, 1340  
 bovine respiratory syncytial virus pneumonia, 1347  
 equine Hendra virus infection, 1329
- Syndactylism (claw fusion), 1961
- Syndrome recognition diagnosis, 22
- Syngamy, 1485
- Synovial fluid  
 arthritis/synovitis, 645  
 caprine arthritis encephalitis, 1412  
 laboratory evaluation, 640, 641  
 newborns, 166  
 nutrition of articular cartilage, 638  
 polyserositis, pigs, 1153  
 porcine, 2027  
 protein concentration, 640  
 viscosity, 640
- Synovial membrane biopsy, 645
- Synovitis, 642–648  
*Bruceella abortus* infection, 970–971  
 clinical findings, 644  
 clinical pathology, 644–645  
 control, 646–647  
 differential diagnosis, 645  
 epidemiology, 642–643  
 etiology, 642–643  
*Haemophilus* septicemia, 1001  
 necropsy findings, 645  
 osteoarthritis, secondary, 638–639  
 pathogenesis, 643–644  
 treatment, 646–647
- Systemic blood flow, cardiac catheterization, 412
- Systemic inflammatory response syndrome (SIRS), 52
- Systemic lupus erythematosus (SLE), 658
- Systemic states/diseases, 39–125  
 acid-base balance disturbances, 73–102  
 appetite disturbances, 112–115  
 dyspnea/exercise intolerance from, 475  
 electrolyte disturbances, 73–102  
 food intake, 112–115  
 free water disturbances, 73–102  
 laminitis, horses, 2030  
 nutritional status, 112–115  
 uncertain etiology, 1981–1990  
 see also *specific diseases/disorders*
- Systolic failure, 402
- Systolic murmurs, 424, 426
- 
- T**
- T<sub>2</sub> toxin poisoning, 1910–1911
- Tabanid fly, 1211, 1456
- Tabanus fuscicostatus* (horse flies) see Horse flies (*Tabanus fuscicostatus*)
- Tachycardia, 416–420  
 acute heart failure etiology, 404  
 bloated and, 331  
 definition, 14  
 equine grass sickness, 1991  
 paroxysmal, 416  
 sinus, 413  
 ventricular, 416–417
- Tachypnea, 474  
 anhidrosis, 2038  
 fetal hypoxia, 140
- Tachyzoites (endozoites)  
*Besnoitia*, 1517  
*Neospora caninum*, 1510  
*Toxoplasma gondii*, 1518
- Taenia asiatica*, 1583
- Taenia hydatigena*, 1583
- Taenia multiceps*, 609
- Taenia (Multiceps) multiceps*, 1583
- Taenia ovis*, 1583
- Taenia saginata* (beef tapeworm, *Cysticercus bovis*), 1583
- Taenia solium* (pork tapeworm, *Cysticercus cellulosae*), 1583
- Tail  
 abscessation, 110  
 cellulitis, 110  
 cold injury, 1794  
 complete absence, 1961  
 deformity, inherited, 1961  
 docking, blowfly strike prevention, 1593  
 elevation, also heel, 1956  
 nervous system examination, 591  
 paralysis, 586  
 pulling, weakness assessment, 587–588, 589  
 tip necrosis, beef calves, 2036–2037  
 tone, polyneuritis equi, 2021  
 tramping, beef calves, 2036–2037
- Tail biting, 113, 612–613  
*Arcanobacterium pyogenes* abscesses, 787  
 pigs, 113
- Tail jack, pain distraction, 104
- Taillessness, inherited, 1961
- Tail reflex, 591
- 'Tail strike,' 1591, 1592
- Tail-strip operation, 1593
- Taipan (*Oxyuranus*), 1916
- Talfan disease (subacute porcine viral encephalomyelitis), 1405–1406
- Talfan virus, 1405
- Tall fescue (*Festuca arundinacea*), 1658, 1901
- Tannin poisoning, 1889
- Tansy mustard (*Descurainia pinnata*), 1896
- Tanzania, bovine petechial fever, 1469
- Tapeworm infestations, 1581–1583  
 adult tapeworms, 1581–1582  
 cattle, 1583  
 horses, 1582  
 larval, 1582–1583  
 lifecycle, 1582
- Taqman polymerase chain reaction (PCR), 1171
- Tarsal joints, caprine arthritis encephalitis, 1411
- Tavbanus*, 1603
- Taxine poisoning, 1893
- Taxus baccata* (yew tree) poisoning, 1893
- T-cell lymphoma, 462
- Teart (peat scours), 1708, 1708, 1714
- Teat(s)  
 abnormalities, 749–754  
 burns, 1793  
 burns, thermal, 751  
 chapping, 750  
 cleaning, 684  
 cold injury, 1794  
 congenital defects, 753  
 cowpox, 1427  
 cracking, 750  
 cups, 735  
 dipping, 732, 733  
 disinfection, dry cow, 741  
 duct contamination, coliform mastitis and, 712  
 external sealant, 718, 733, 741  
 frostbite, 750  
 internal sealants, 740–741  
 lesions, 750–751, 1419  
 morphology, bovine mastitis risk factor, 677  
 papillomatosis, 750, 753  
 photosensitization, 750–751  
 physical condition, bovine mastitis risk factor, 677  
 postmilking sanitization, 732–733, 737  
 premilking disinfection, 718, 731–732  
 premilking hygiene, 731–732  
 skin lesions, 749–752, 1381  
 supernumerary, 753  
 traumatic injuries, 750  
 ulcerative dermatosis, 750
- Teat fibroma, 753
- Teat fibropapilloma, 1381
- Teat fibrosarcoma, 753
- Teeth  
 congenital defects, 207  
 congenital hypotrichosis with anodontia, 1974  
 discoloration, congenital porphyria, 1946  
 diseases of, 207–208  
 eruption, delayed, rickets, 1767  
 examination, 18  
 weaner illthrift, 1982  
 lesions, fluorine poisoning, 1817  
 premature wear/loss, 207, 208  
 rot abscesses, 110
- Temperament changes, bovine spongiform encephalopathy, 1450
- Temperature  
 clinical examination, 13–14  
 conversion tables, 2045  
 equine colic, 223  
 lower critical, 41  
 reference values, 13, 13–14  
 upper critical, 47
- Temporal patterns of disease, 34
- Temporal-stylohyoid articulation arthritis, 1376
- Temporal-stylohyoid articulation fracture, 1376
- Tender wool, 1302, 2042
- Tendon deformity, 621
- Tendon sprain, 645
- Tenesmus (straining), 195, 585  
 cattle, 195  
 coccidiosis, 1503  
 horses, 195  
 pigs, 195  
 rabies, 1389  
 septic metritis, postpartum, 61  
 treatment, 204
- Tenosynovitis, 623
- Tenotomy, laminitis, 2033
- Teratogenic pathogens, 131, 132
- Teratogenic quinolizidine alkaloid poisoning, 1891
- Terbutaline, 1934
- Terbutaline sulfate, 2062
- Terminal colon atresia, 280–281
- Terminalia oblongata* (yellow-wood tree) poisoning, 1889
- Terminal ileal hypertrophy, 244
- Terminal ileitis, lambs, 382
- Terrestrial Animal Health Code (Terrestrial Code), 765
- Teschen disease (acute porcine viral encephalomyelitis), 1405
- Teschen virus, 1405
- 'Test and cull' control strategy  
 bovine virus diarrhoea virus, 1273–1275  
 caprine arthritis encephalitis, 1412–1413  
 ovine progressive pneumonia, 1365–1366  
 program components, 1273–1274
- Test and removal, pseudorabies, 1397, 1400, 1401
- Test and segregation method  
 caprine arthritis encephalitis, 1412–1413  
 enzootic bovine leukosis prevention, 1220

- Test-and-slaughter policy  
equine infectious anemia, 1176  
foot-and-mouth disease, 1236
- Testicle palpation, brucellosis, 986
- Test mating, 1938, 2024
- Testosterone propionate, subcutaneous implantation, 794
- Tetanic convulsions  
hog cholera, 1162  
inherited neonatal spasticity, 1956
- Tetanospasmin, 822–823
- Tetanus, 822–844  
antitoxin, 823, 824  
case fatality rate, 822  
clinical findings, 823, 1376  
clinical pathology, 823  
control, 824  
course of disease, 823  
differential diagnosis, 823  
epidemiology, 822  
etiology, 822  
horses, 1376  
idiopathic, 822  
importance, 822  
incubation period, 823  
infection source, 822  
necropsy findings, 823  
neonatal, 822  
outbreaks, 822  
pathogenesis, 822–823  
prognosis, 823  
recumbency in horses, 121  
risk factors, 822  
toxoid, 824  
transmission, 822  
treatment, 823–824, 1376  
vaccination, 824
- Tetanus antitoxin, 393, 2062
- Tetanus-associated bloat, 297
- Tetany  
calcium deficiency, 1757  
lactation see Lactation tetany  
nervous system disease, 579  
posture abnormality, 586  
transit recumbency, 1651
- Tetrachlorethylene poisoning, 1831
- Tetracycline(s)  
anaplasmosis, 1458  
bovine petechial fever, 1470  
dermatophilosis, 1050  
diarrhea induction, 269  
East Coast fever, 1529  
heartwater, 1463  
mycoplasmal pneumonia, pigs, 1149  
onchocercosis, 1573  
ophthalmia, contagious, 1143  
papillomatosis digital dermatitis of cattle, 1069  
*Pasteurella* mastitis, 725  
pleuropneumonia of pigs, 1057  
resistance, 936  
tick-borne fever, 1461, 1462  
see also *specific types*
- Tetracycline hydrochloride, 2066
- Tetrahydropyrimidines, 1545, 1561
- Tetralogy of Fallot, 432
- Texas fever see Babesiosis
- Texel sheep  
harelip, 1944  
inherited chondrodysplasia, 1960  
microphthalmia, 1977
- Thalictrum* poisoning, 1890
- Theileria*, 1526  
*Theileria annulata*, 1526, 1527, 1530–1531  
*Theileria buffeli*, 1526, 1527  
*Theileria hirci* (*lestoquardi*), 1526  
*Theileria mutans*, 1526, 1527  
*Theileria orientalis*, 1526  
*Theileria ovis*, 1526–1527  
*Theileria parva*, 1526, 1527, 1528  
*Theileria separata*, 1526–1527  
*Theileria sergenti*, 1526  
*Theileria taurotragi*, 1526, 1529  
*Theileria velifera*, 1526, 1527  
Theileriosis, 1526–1527, 1527, 1600  
see also *individual diseases*  
Theiler's disease (postvaccinal/serum hepatitis), 392, 393, 824, 1988–1989
- Thelazia* (eyeworm), 1575
- Thelitis, 750
- Theophylline, 1934, 2062
- Therapeutic decision-making, 29–31
- Thermactinomyces vulgaris*, 1999
- Thermal injury, 1792–1793
- Thermal nociceptors, 103
- Thermodilution, cardiac output measurement, 410
- Thermogenesis, cold-induced, 41
- Thermoneutral zone, 41
- Thermopolyspora polyspora*, 1999
- Thermoregulation  
endotoxemia and, 55–56  
mechanisms, 41–42  
neonates, 41–43
- Thiabendazole (2-(4'-thiazolyl)-benzimidazole)  
dosage/interval, 2062, 2066  
poisoning, 1832  
sporidesmin poisoning prevention, 1909
- Thiamin (vitamin B<sub>1</sub>)  
deficiency, 603, 1778–1779  
function of, 1779  
polioencephalomalacia, 2006, 2007, 2010–2011, 2012
- Thiaminase  
poisoning, 1882–1883  
polioencephalomalacia, 2007
- Thiamin hydrochloride  
dosage/interval, 2062, 2066  
lead poisoning, 1805  
polioencephalomalacia, 2011–2012
- Thiamin propyldisulfide, 2012
- Thiamin pyrophosphate (TPP) effect, 2010
- Thiamylal sodium, 2062, 2066
- Thick forelimbs (congenital hyperostosis), 1961
- Thidiazuron poisoning, 1838
- Thin ewe syndrome, 796, 797, 1364
- Thin sow syndrome, 1987–1988  
clinical findings, 1988  
condition scoring, 1988  
control, 1988  
epidemiology, 1987–1988  
etiology, 1987  
feeding errors, 1987  
management errors, 1987  
*Oesophagostomum*, 1553, 1554  
pathogenesis, 1987–1988  
thirst, 115
- Thiocyanate ion, glucosinolate poisoning, 1867
- Thiones, glucosinolate poisoning, 1867
- Thiopental, 2062, 2066
- Thiophanate, 1557, 2062
- Thiophanate methyl, 1909
- Thiram poisoning, 1838–1839
- Third-degree atrioventricular block, 415
- Third eyelid biopsy, scrapie, 1444
- Thirst, 47, 75, 114–115
- Thoracentesis (pleurocentesis), 487–489  
equine pleuropneumonia, 526–527  
pleuritis, 524  
pneumonia, 512  
procedure, 489
- Thoracic drainage, 528–529
- Thoracic limbs, spinal reflexes, 590
- Thoracic lymphosarcoma, 463
- Thoracic pain, respiratory insufficiency, 480
- Thoracic wall trauma, pneumothorax, 520
- Thoracocentesis (pleurocentesis) see Thoracentesis (pleurocentesis)
- Thoracotomy  
equine pleuropneumonia, 529  
pleuritis, 524
- Thorax  
auscultation, traumatic pericarditis, 352  
clinical examination, 11, 14–17  
symmetry of, 11  
ultrasound examination, 483
- Thorny-headed worm (*Macracanthorhynchus hirudinaeus*), 1563–1564
- Thoroughbred horses  
equine herpesvirus 1, 1312  
equine influenza, 1324  
equine neorickettsiosis, 1466  
multiple exostosis, 1961  
recurrent exertional rhabdomyolysis, 1966–1969
- Threadworm (*Strongyloides*), 1075, 1562–1563
- Thrombase, venoms, 1917
- Thrombasthenia, 446–447
- Thrombi see Thrombosis
- Thrombin time, 441
- Thrombocytes, reference laboratory values, 2047
- Thrombocytopenia, 445–446  
African swine fever, 1170
- bovine virus diarrhea virus, 1259–1260, 1263  
bovine virus diarrhea virus infection, 1255  
decreased platelet production, 445  
endotoxemia and, 55  
equine granulocytic anaplasmosis, 1465  
equine infectious anemia, 1174, 1175  
hog cholera, 1160  
horses, 446  
immune-mediated (idiopathic), 446  
increased platelet consumption, 446  
increased platelet destruction, 445–446  
isoimmune, 446  
tick-borne fever, 1461
- Thrombocytosis, 447
- Thromboembolic colic, 257–258
- Thrombopathia, inherited, 1947
- Thrombophlebitis, 73, 99
- Thrombosis, 450  
arterial see Arterial thrombosis  
kidney worm disease, 1570
- Thrombotic meningoencephalitis, *Histophilus somni* associated, 997–998
- 'Thumps,' swine influenza, 1333
- Thymic lymphosarcoma, 462, 1216
- Thymidine kinase-deficient (TK-) mutants, 1403
- Thymus  
diseases of, 464–466  
function, 466
- Thyoma, 519
- Thyroid adenoma, 1688–1690  
clinical findings, 1689  
clinical pathology, 1689–1690  
epidemiology, 1688  
etiology, 1688
- Thyroid damage, iodine-131 induced, 1787
- Thyroidectomy, 1688–1689
- Thyroid function disorders, 1688–1690  
see also *specific types*
- Thyroid gland enlargement, iodine deficiency, 1724
- Thyroid hormone assays, 1689, 1689–1690
- Thyroid hormone deficiency, 1416
- Thyroid releasing hormone (TRH) stimulation test, 1687
- Thyroid stimulating hormone (TSH), 1689, 1689–1690
- Thyroxine (T<sub>4</sub>), 1689, 1689–1690  
deficiency, border disease, 1416
- Thyroxine L, 2062
- Thysanosoma actinioides*, 1582
- Tiamulin  
dosage/interval, 2066  
ileitis, 1092  
mycoplasmal pneumonia, pigs, 1149, 1151  
pleuropneumonia of pigs, 1058  
polyserositis, pigs, 1154  
swine dysentery, 1117, 1118, 1119
- Tiaprostone, 2066
- Tibial hemimelia, 1961
- Tibial nerve damage, 618
- Ticarcillin, 2062
- Tick(s)  
babesiosis vectors, 1484–1485  
bacterial diseases transmitted, 1599–1600, 1601  
control  
babesiosis, 1497  
bovine babesiosis, 1494  
dermatophilosis control, 1050  
louping-ill, 1410  
direct loss causing, 1600  
infestations, 1599–1603  
acaricides, 1601–1602  
control, 1600–1602  
dermatophilosis and, 1049  
eradication, 1602  
life cycles, 1599, 1599  
one-host ticks, 1599  
three-host ticks, 1599  
treatment, 1600–1602  
two-host ticks, 1599  
vaccines, 1600  
louping-ill transmission, 1408  
paralysis causing, 1599, 1599, 1918  
protozoan disease transmission, 1599, 1600  
ricketsial disease transmission, 1599–1600, 1601  
viral diseases transmission, 1599–1600, 1601
- Tick-borne fever, 1459–1462  
abortion, 987  
cattle, 1461  
clinical findings, 1461

- Tick-borne fever (*Cont'd*)  
 clinical pathology, 1461  
 congenital infection, 1460  
 control, 1461–1462  
 differential diagnosis, 1461  
 epidemiology, 1460  
 etiology, 1459–1460  
 experimental reproduction, 1460  
 goats, 1461  
 infection sources, 1460  
 intercurrent disease, 1460, 1461  
 necropsy findings, 1461  
 occurrence, 1460  
 pathogenesis, 1460–1461  
 risk factors, 1460  
 sheep, 1461  
 transmission, 1460  
 treatment, 1461  
 vectors, 1460, 1601  
 zoonotic implications, 1460
- Tickgard, 1600  
 Tickgard 2, 1600  
 Tick paralysis, 1599, 1599, 1918  
 Tick pyemia, 1061, 1461  
 lambs, 783–784  
 Tick toxicosis, 1989–1990  
 Tics, nervous system disease, 579  
 'Tiger heart' appearance, foot-and-mouth disease, 1227  
 Tiger snake (*Notechis scutatus*), 1916, 1917  
 'Tiger stripe' pattern, large intestine mucosa, 1263  
 Tiletamine hydrochloride, 2062  
*Tilletia tritici* (wheat smut) fungus, 1912  
 Tilimicosin  
 atrophic rhinitis, progressive, 961  
 dosage/interval, 2063, 2066  
 enzootic pneumonia of calves, 1341  
 Johne's disease, 1031–1032  
 pleuropneumonia of pigs, 1058  
 pneumonic pasteurellosis, 938, 941, 945  
 undifferentiated bovine respiratory disease, acute, 931  
 Time-sign relationship, 583  
 Timulin, *Streptococcus suis* infection control, 782  
 Tinea versicolor, 1476  
 Tingle voltage, 1790–1791  
 Tin poisoning, 1847  
 Tip spraying, blowfly strike prevention, 1592–1593  
 Tir protein, enterohemorrhagic *Escherichia coli*, 881, 882  
 Tissue assay, zinc poisoning, 1828  
 Tissue culture infection test, rabies, 1390  
 Tissue culture rinderpest vaccine (TCRV), 1241  
 Tissue hypoxia, anemia, 455  
 Tissue necrosis, disseminated intravascular coagulopathy, 448  
 Tissue plasminogen activator, 443  
 Tissue residues, antimicrobials see Antimicrobials, tissue residues  
 Tissue swelling, pharyngeal obstruction, 210  
 Tissue thromboplastin, disseminated intravascular coagulopathy, 448  
 T-lymphocytes  
 bovine virus diarrhea virus, 1252  
 combined immunodeficiency, Arabian foals, 1979  
 Fell pony syndrome, 1942  
 loss, post-weaning multisystemic wasting syndrome, 1188  
 Toadstool poisoning, 1908  
 Tobacco plants, congenital defects of the newborn, 134  
 Tobiano, lethal whites, 1942  
 Tobramycin, 2063  
 $\alpha$ -tocopherol, 2020  
 plant levels, 1737–1738  
 supplementation, muscular dystrophy, 1751  
 Tocopherol acetate see Vitamin E (tocopherol acetate)  
 Toe abscess, 1078  
 Toe granuloma, 1078  
 Toe ulcers, 2037  
 Tolazoline, 2063  
 Toll-like receptor 4 (TLR4), 54  
 Toltrazuril, 1505, 1506  
 Tongue  
 aplasia, 1944  
 deformity, stomatitis, 206  
 examination, 18  
 laceration, stomatitis, 206  
 palpation, actinobacillosis, 1047  
 paralysis, equine protozoal myeloencephalitis, 1524  
 Tonsils  
 biopsy, scrapie, 1444  
 hog cholera, 1160, 1164  
*Streptococcus suis*, 778, 780  
 Tooth see Teeth  
 Topography, 7  
 Toroviruses, neonatal viral diarrhea, 1286  
 Torticollis, congenital, 135  
 Torulosis (cryptococcosis), 1475–1476  
 Toxalbumin poisoning, 1888  
 Toxaphene toxicity, 1833  
 Toxemia, 53–63  
 acute, 57  
 chronic, 57  
 clinical findings, 57, 1633  
 clinical pathology, 1633  
 definition, 53  
 epidemiology, 1633  
 etiology, 53–54  
 necropsy findings, 58  
 peracute endogenous, 124  
 peripartum, 60–63  
 peritonitis, 283, 284  
 postparturient, 1634–1635  
 treatment, 1633  
 Toxic agalactia see Mastitis-metritis-agalactia (MMA) syndrome  
 Toxicemic jaundice, pyrrolizidine alkaloid poisoning, 1879  
 Toxicemic jaundice complex, 1823–1824  
 Toxic encephalomyelopathies, 611–612  
 Toxic-infectious diseases, encephalomalacia, 603  
 Toxic nephrosis, 557–558  
 Toxicoinfectious botulism, 825, 826  
 Toxic peripheral nervous system disease, 619  
 Toxic shock, 57  
 Toxin(s)  
 antigenic, 53  
 binding, acute diarrhea, 271  
 immune deficiency from, 467  
 metabolic, 53–54  
 myasthenia etiology, 626  
*Toxocara vitulorum*, 1556  
*Toxoplasma gondii*, 1518  
 immunocompetence to, 1520  
 infective stages, 1518  
 louping-ill concurrent infection, 1409  
 Toxoplasmosis, 1518–1522  
 abortion, 987  
 cattle, 1519, 1520–1521  
 clinical findings, 1520–1521  
 clinical pathology, 1521  
 congenital, 1520  
 control, 1522  
 differential diagnosis, 1521  
 economic importance, 1520  
 epidemiology, 1518–1520  
 etiology, 1518  
 experimental reproduction, 1519–1520  
 fetal infection, 1519  
 goats, 1519, 1521  
 horses, 1519, 1520, 1521  
 necropsy findings, 1521  
 occupational risks, 1520  
 occurrence, 1518–1519  
 pathogenesis, 1520  
 pigs, 1518–1519, 1520, 1521  
 prophylaxis, 1522  
 risk factors, 1519  
 sheep, 1519, 1521  
 source of infection, 1519  
 treatment, 1522  
 vaccination, 1522  
 zoonotic implications, 1520, 1522  
 Trabecular bone abnormality, 632  
 Traberkrankheit see Scrapie  
 'Traceback,' tuberculosis, 1014  
 Trace element(s)  
 deficiency  
 dose-response trial, 1700  
 field observations, 1700  
 intrauterine growth retardation, 137  
 weight loss, 115  
 status, weaner illthrift, 1982  
 see also *specific elements*  
 Trachea  
 actinomycosis, 1045  
 auscultation, 19, 1931  
 collapse, 534  
 compression, 534  
 hypoplasia, 541  
 lungworm infestation, 1569  
 obstruction, tracheitis, 534  
 stenosis, 533–534, 2004  
 Tracheal aspirate(s), 485  
 acute broncho-interstitial pneumonia, foal, 2005  
 bronchoalveolar lavage fluid comparison, 485  
 chronic interstitial pneumonia, foal, 2006  
 contamination, 486  
 contraindications, 485  
 cytological examination, 486  
 equine influenza, 1325  
 equine pleuropneumonia, 526–527, 527  
 exercise-induced pulmonary hemorrhage, 504  
 indication for collection, 485  
 interstitial pneumonia, horses, 2005  
 Tracheitis, 533–534, 1353  
 Tracheobronchial secretions, 485–489  
 bronchoalveolar lavage, 486–487  
 endoscopic sampling of tracheal secretions, 486  
 laboratory assessment, 487, 488  
 percutaneous transtracheal aspiration, 485–486  
 results assessment, 486  
 thoracocentesis (pleurocentesis), 487–489  
 tracheal aspirate, 485  
 tracheal aspirate comparison with bronchoalveolar lavage fluid, 485  
 Tracheobronchoscopy, 481–482, 503–504  
 Tracheolaryngostomy, 534  
 Tracheotomy, 534  
 Track ponies, equine influenza, 1324  
 Traction, excessive at birth, 1985  
 Tractor fuel toxicity, 1847  
 Trade restrictions, enzootic bovine leukosis, 1213–1214  
*Tragelaphus scriptus* (Bushbuck), 1470  
 Trampling, piglet mortality, 130  
 Tranexamic acid, 442  
 Transcranial magnetic stimulation, 594  
 Transfaunation, diarrhea, 273  
 Transient voltage, 1790–1791  
 Transit recumbency (tetany) of ruminants, 1651  
 Translocation 1/21, 1940  
 Translocation 1/29, 1940  
 Translocation 2/4, 1940  
 Translocation 13/2, 1940  
 Translocation 14/20, 1940  
 Translocation 27/29, 1940  
 Transmissible gastroenteritis (TGE)  
 hypoglycemia and, 1680, 1681  
 pigs, 1277–1285  
 age-dependent resistance, 1281  
 case fatality rate, 1278  
 clinical findings, 1281, 1293  
 clinical pathology, 1281  
 control, 1282–1284  
 differential diagnosis, 1282  
 economic losses, 1280  
 endemic, 1278  
 epidemic, 1278, 1279  
 epidemiology, 1278–1280  
 etiology, 1277–1278  
 experimental infection, 1281  
 herd immunity levels, 1278  
 herd size, 1278  
 immune mechanisms, 1279–1280  
 lactogenic immunity, 1279, 1284  
 morbidity, 1278  
 necropsy findings, 1281–1282  
 occurrence, 1278  
 pathogenesis, 1280–1281  
 prevalence, 1278  
 recurrence, 1278, 1280  
 risk factors, 1278–1279, 1279  
 sow parity, 1278  
 transmission, 1279  
 treatment, 1282  
 vaccines/vaccination, 1284  
 viral detection, 1281  
 Transmissible gastroenteritis (TGE) virus, 1277–1278, 1279  
 antigenic differences, 1279  
 Korean strain, 1281  
 Nouzilly strain, 1284  
 replication, 1281  
 Transmissible serositis, 1407–1408

- Transmissible spongiform encephalopathies (TSEs), 1439, 1439–1440, 1443  
 see also individual diseases
- Transmission test, babesiosis, 1489
- Transplanted embryos, bluetongue virus transmission, 1301
- Transportation  
 history-taking, individual animals, 5  
 non-ambulatory cattle, 1649–1650  
 porcine stress syndrome, 1970, 1971, 1973  
 salmonellosis control, 917  
 salmonellosis transmission, 898, 915  
 stress, 108–109  
   induction, 107  
   management, 109–110  
 undifferentiated bovine respiratory disease, acute, 928
- Transtracheal oxygen delivery, 494
- Transurethral endoscopy, 553
- Traps  
 blowfly, 1592  
*Haematobia* flies, 1604  
 tsetse fly control, 1536
- Trauma  
 arthropathy and, 637  
 birth injury, stillbirth/perinatal weak calf syndrome, 1985  
 brain injury see Brain, traumatic injury  
 cutaneous injury, ringworm, 1477  
 degenerative joint disease, 2027  
 dermatophilosis and, 1049  
 endocarditis and, 427  
 hemorrhagic shock, 64  
 laminitis, horses, 2030  
 liver rupture, 386  
 myositis and, 631  
 necropsy findings, 1065  
 osteoarthritis, secondary, 638–639  
 osteomyelitis and, 636  
 peripheral nervous system, 618  
 recumbency in horses, 121  
 spinal ataxia, horse, 2018  
 spinal cord see Spinal cord, traumatic injury  
 subcutaneous abscess, 666–667  
 sudden death, 124
- Traumatic cellulitis, 110
- Traumatic laryngotracheitis, 534
- Traumatic mastitis, 728
- Traumatic pericarditis, 429, 430
- Traumatic pharyngitis, 209
- Traumatic reticuloperitonitis, 522
- Trehelose, *Nematodirus* eggs, 1543
- Trematode associated diseases, 1576–1583  
 hepatic, 1576–1580  
 see also specific diseases/disorders
- Tremetol poisoning, 1883
- Tremor, 585  
 border disease, 1416  
 congenital defects characterized by, 620  
 nervous system disease, 578–579  
 pregnancy toxemia, sheep, 1669  
 toxic/metabolic encephalomyelopathies, 612
- Tremorgen poisoning, 1899, 1903–1905, 1910
- Trenbolone acetate, 2063
- Treponema denticola*, 1066
- Treponema phagedenis*-like spirochete, 1067
- Trialate poisoning, 1838
- Triamcinolone, 1932
- Triamcinolone acetate, 2063
- Triazine poisoning, 1838
- Triazintriones, 1505
- Triceps reflex, 590
- Trichlorfon  
 congenital defects of the newborn, 134  
 dosage/interval, 2063  
*Gasterophilus* infestation, 1586
- Trichobezoars  
 abomasal, 370  
 luminal blockage, 378  
*pars esophagea* ulceration, 1995
- Trichoderma*, trichothecene poisoning, 1911
- Trichodesma*, pyrrolizidine alkaloid poisoning, 1878–1881
- Trichomonosis, 975
- Trichophyton*, 1476
- Trichophyton equinum*, 1476, 1477
- Trichophyton gypsum*, 1476
- Trichophyton verrucosum*, 1212, 1477
- Trichosporon* mastitis, 727
- Trichostrongylid worms, 1541, 1542  
 abomasal infection, 1543–1544  
 eggs, 1543  
 intestinal infections, 1544  
 lifecycle, 1541–1542  
 resistance to, 1542–1543  
 transmission, 1542–1543  
 type I disease, 1543  
 type II disease see Parasitic gastroenteritis (PGE), ruminants
- Trichostrongylosis*, 1543
- Trichostrongylus*, 1541, 1542
- Trichostrongylus axei*, 1545
- Trichostrongylus colubriformis*, 1544
- Trichosurus vulpecula* (brush-tail possum), tuberculosis, 1007
- Trichothecene poisoning, 1899, 1910–1911
- Trichothecium*, trichothecene poisoning, 1911
- Trichothecium roseum*, 1912
- Trichuris* (whipworm), 1563
- Triclabendazole, 1578, 1580, 2063
- Triclopyr poisoning, 1838
- Tricuspid valve, 405, 425–426
- Triflurazuron, 1592
- Trifolium*, phytoestrogen poisoning, 1873
- Trifolium pratense* (red clover) poisoning, 1874
- Trifolium repens* (white clover) poisoning, 1874, 1912
- Trifolium subterraneum* (subterranean clover) poisoning, 1824, 1873, 1874
- Trigeminal ganglion  
 bovine herpesvirus-1 infection, 1352  
 equine herpesvirus 1, 1312  
 equine herpesvirus 4, 1310  
 pseudorabies, 1398
- Trigeminal nerve (cranial nerve V)  
 assessment, 585  
 head shaking, horses, 2022  
 polyneuritis equi, 2021
- Triglycerides, equine hyperlipidemia, 1679
- Triiodothyronine (T<sub>3</sub>), 1689, 1689–1690  
 deficiency, border disease, 1416
- Trilostane, 2063
- Trimastix flavoviridis* (Habu viper), 1916
- Trimethoprim, 269, 1341, 1461
- Trimethoprim-sulfadoxine, 941, 945, 961
- Trimethoprim-sulfamethoxazole, 1517
- Trimethoprim-sulphadiazine, 646, 716
- Triphenylamine hydrochloride, 2063, 2066
- Trismus, masseter myonecrosis, 1686
- Trisodium citrate, clotting assays, 441
- Triterpene poisoning, 1893–1894
- Triterpene saponin poisoning, 1891
- Trocar and cannula, 331, 341
- Trocarization, 227–228, 330
- Trochlear nerve (cranial nerve IV) assessment, 585
- Trollius* poisoning, 1890
- Trombicula sarcina*, 1607
- Trombidiform mites, dermatitis, 1606
- Tromethamine, 94
- Tropane alkaloid poisoning, 1894
- Trophopathic (nutritional) hepatitis, 392, 393
- Tropical bont tick (*Amblyomma variegatum*), 1049, 1245, 1426
- Tropical theileriosis, 1491, 1527, 1530–1531
- Trunk, nervous system examination, 590–591
- Trypanidum (isometamidium chloride), 1536, 1538
- Trypanocidal drugs, 1535–1536
- Trypanosoma brucei*, 1531–1532, 1533, 1534, 1535
- Trypanosoma brucei gambiense*, 1534
- Trypanosoma brucei rhodesiense*, 1534
- Trypanosoma congolense*, 1531–1532, 1533, 1534, 1535
- Trypanosoma equinum*, 1537
- Trypanosoma equiperdum*, 1538
- Trypanosoma evansi*, 1537
- Trypanosoma melophagium*, 1596
- Trypanosoma simiae*, 1531–1532, 1534, 1535
- Trypanosoma vivax*, 1531–1532, 1533, 1534, 1535
- Trypanosomes, 1531–1540  
 antigenic variation, 1533, 1536  
 salivarian, 1531–1532
- Trypanosomosis, 1531–1540, 1532
- Trypanotolerance, 1533
- Trypsin inhibitor, colostrum, 153
- D,L-tryptophan, acute bovine pulmonary emphysema and edema, 1999, 2001
- Tsetse fly (*Glossina*), 1532, 1533, 1536
- Tsetse fly disease see Nagana
- Tube agglutination test, *Brucella abortus*, 971
- Tuberculin, 1010–1011
- Tuberculin test, 1009–1012  
 anergy, 1011  
 desensitization, 1010–1011  
 false-negative reactions, 1011  
 false-positive reactions, 1011  
 goats, 1011  
 herd use, 1012–1013  
 horses, 1011, 1016  
 Johne's disease vaccination, 1036  
 mycobacteriosis, 1015, 1016  
 pigs, 1011, 1016  
 retesting, 1013  
 sheep, 1011
- Tuberculous extreme Johne's disease, 1025
- Tuberculosis, 1007–1014, 1008  
 anergy, 1011  
 cattle, 1007, 1008, 1009, 1012  
 clinical findings, 1009  
 clinical pathology, 1009–1012  
 control, 1012–1014  
 diagnosis, 1012  
 differential diagnosis, 1012  
 economic importance, 1008  
 epidemiology, 1007–1008  
 eradication, 1012–1014  
 etiology, 1007  
 experimental reproduction, 1008  
 farmed deer, 1008  
 goats, 1008, 1009, 1012  
 horses, 1008, 1009, 1012  
 infection source, 1007–1008  
 miliary, 1012  
*Mycobacterium bovis* associated, 1007–1014  
*Mycobacterium tuberculosis* associated, 1016  
 necropsy findings, 1012  
 outbreaks, 1007  
 pathogenesis, 1008–1009  
 pigs, 1008, 1009, 1012, 1014  
 risk factors, 1008  
 sheep, 1008, 1009, 1012  
 skin, 1016  
 transmission, 1007–1008  
 treatment, 1012  
 vaccination, 1013  
 zoonotic importance, 1008, 1012
- Tuber ischii epiphyseolysis (apophysiolysis), 2028
- Tube sensitivity tests, 175
- Tubocurarine chloride, 2063, 2066
- Tubular enzymuria, 549
- Tubular necrosis, acute, 547
- Tubular proteinuria, 550
- Tularemia, 952–954  
 clinical findings, 953  
 clinical pathology, 953  
 control, 954  
 diagnosis, 953  
 differential diagnosis, 953  
 epidemiology, 952–953  
 etiology, 952  
 horses, 953  
 necropsy findings, 953  
 outbreaks, 952  
 pathogenesis, 953  
 pigs, 953  
 risk factors, 952–953  
 sheep, 953  
 transmission, 953  
 treatment, 954  
 vectors, 1061  
 zoonotic implications, 953
- Tulathromycin, 1149, 2063
- Tumor necrosis factor (TNF)- $\alpha$ , 1346  
 endotoxemia, 54  
 fever and, 49  
 hog cholera, 1161
- Tumorous calcinosis, 667
- Tumors  
 myocardial disease/cardiomyopathy etiology, 421  
 osteodystrophy etiology, 633  
 spinal cord compression, 615  
 see also specific types/locations
- Tunicamycin poisoning, 1914–1915
- Turbinate atrophy of swine see Atrophic rhinitis, progressive
- Turning sickness (cerebral theileriosis), 1526, 1527, 1529
- Tutin poisoning, 1894
- Tutu tree (*Coriaria*) poisoning, 1894
- Twin births, dairy calf mortality, 129
- Tying-up, 627, 628  
 see also Rhabdomyolysis, exertional/postexercise



- Tylosin  
atrophic rhinitis, progressive, 961  
dosage/interval, 2063, 2066  
ileitis, 1092  
polyserositis, pigs, 1154  
Tylosin tartrate, 1149  
Tympenic colic, 226  
Tympanocentesis, 607–608  
Tyramine toxicity, 1884  
Tyroglyphosis, horse, 1433  
Tyzzer's disease, 395, 836
- 
- ## U
- Uasin gishu, 1432  
Udder(s)  
abnormalities, 749–754  
actinomycosis, 1045  
angioedema, 664  
burns, thermal, 751  
caprine arthritis encephalitis, 1412  
cold injury, 1794  
congenital defects, 753  
development, nutrition and, 1696  
disinfection, *Corynebacterium bovis* mastitis reduction, 729  
edema, 749, 752, 752, 1429  
fibrosarcoma, 753  
hard (hard bag), 1364, 1412  
health status/management  
bovine mastitis, 689–690, 728–729, 744–748, 748  
dry cows, 738–741  
environmental control, 743  
milking machine effects, 736  
monitoring, 730, 744–746, 746–748  
productivity/profitability association, 748  
hygiene  
bovine mastitis, 677, 731–734  
postmilking, 732–733  
premilking, 731–732  
hygiene score, 731  
impetigo, 751, 1381  
inherited rectovaginal constriction, 1944  
insufflation, milk fever, 1638  
mastitis, 684  
mastitis check, 732  
morphology, bovine mastitis, 677  
neoplasms, 753  
ovine progressive pneumonia, 1364  
premilking hygiene, 731–732  
rot, 749, 751  
skin lesions, 749–752  
suspensory ligament rupture, 752  
Udder cleft dermatitis, 751  
UK see United Kingdom  
Ulcer(s)  
abomasal see Abomasal ulcer in cattle  
bluetongue, 1302  
bovine virus diarrhea virus infection, 1258  
caprine herpesvirus-1 infection, 1330  
equine coital exanthema, 1308, 1319  
granulomatous, 667  
orf, 1419  
sarcocystosis, 1509  
stomatitis, 206  
Ulcerative dermatitis, 1075, 1123  
Ulcerative dermatosis, 750, 1432–1433  
Ulcerative granuloma, 785, 1123  
Ulcerative lymphangitis, 798–800  
clinical findings, 799, 1434  
clinical pathology, 799  
control, 799–800  
differential diagnosis, 799  
economic importance, 799  
epidemiology, 799, 1434  
etiology, 798–799  
outbreaks, 799  
pathogenesis, 799  
risk factors, 799  
transmission, 799, 1434  
treatment, 799  
zoonotic implications, 799  
Ulcerative spirochetosis, 1123  
Ulna, degenerative disease, 2027–2028  
Ultrasonography, 21  
abomasum, 353  
alimentary tract examination, 196–197, 309  
aorto-iliac thrombosis, 434–435  
arthritis/synovitis, 645  
benefits, 21  
caudal abdominal obstruction, 244  
caudal vena caval thrombosis, 516–517  
cecal examination, 376  
chronic interstitial pneumonia, foal, 2006  
colitis, right dorsal, 255  
diagnostic, 21  
equine colic, 222, 230, 231  
equine influenza, 1325  
equine pleuropneumonia, 526, 527  
fatty liver, cattle, 1675  
gastric dilatation, 233–234  
interstitial pneumonia, 2005  
left dorsal displacement of the large colon, 249  
left-side displacement of abomasum, 359  
limitations, 21  
liver, 387–388  
mammary gland, 687  
mastitis, 687  
musculoskeletal system disease, 625–626  
newborns, 164  
omphalophlebitis, 159  
perinatal, 138  
pleuritis (pleurisy), 523, 523  
respiratory system examination, 483–484  
reticuloperitonitis, traumatic, 341–342, 342, 343  
reticulum, 341–342  
*Rhodococcus equi* pneumonia, 802, 804  
sporadic lymphangitis, 2029  
types of, 21  
uroolithiasis, 568  
uropertoneum in foals, 564  
volvulus of the large colon, 250  
Ultraviolet light  
bovine ocular squamous-cell carcinoma, 2039  
vitamin D deficiency and, 1764  
Umbilical abscess, calves, 309  
Umbilical bleeding, 444, 446  
Umbilical examination, 164  
Umbilical hernias, 1964  
Umbilicus occlusion, fetal hypoxia, 140  
Undernutrition see Nutritional deficiency  
Undifferentiated bovine respiratory disease (UBRD), acute, 923–934  
clinical case definition, 927–928  
clinical pathology, 929–930  
control, 931–934  
definition of the problem, 923–924  
diagnosis, 929  
differential diagnosis, 924, 924–925, 929  
epidemiology, 927–929  
etiology, 926–927  
morbidity rate, 923  
mortality ratio, 923  
necropsy findings, 930  
outbreaks, 928  
risk factors, 928–929  
management, 931–932  
treatment, 930–931  
vaccination, 932–934  
Unexpected death see Sudden death  
Ungulates, spongiform encephalopathy, 1448  
United Kingdom  
bovine immunodeficiency-like virus, 1221  
bovine spongiform encephalopathy, 1447, 1451, 1454  
bovine ulcerative mammillitis, 1429  
bovine virus diarrhea virus eradication program, 1275  
chronic enzootic pneumonia of sheep, 1362  
cryptosporidiosis, 1512  
ovine enzootic abortion, 1435–1436  
ovine progressive pneumonia, 1363  
rabies quarantine measures, 1393  
scrapie control, 1445  
transmissible gastroenteritis in pigs, 1278  
United Kingdom Food Standards Agency, 1023  
United States of America see USA  
Unthriftiness  
polioencephalomalacia, 2010  
weaner sheep, 1544, 1981–1982  
Upper motor neuron lesions, 581  
Upper respiratory tract  
diseases of, 530–541  
differential diagnosis, 772  
equine herpesviruses, 1309, 1312, 1313, 1314  
inflammation, 533  
obstruction, horses, 535–537  
*Pasteurella* colonization, 937  
pneumonia pathogenesis, 510  
viral infections, horses, 1307–1309  
animal movements, 1308  
causative organism isolation and identification, 1307–1308  
transmission, 1308  
young horses, 1308  
see also *individual diseases*  
Urachal abscess, 159–160, 309  
Urachitis, newborns, 159–160  
Urechus  
patent, 547, 573  
rupture, 563  
Urea  
poisoning, 1842–1843  
renal insufficiency, 544  
serum, 550  
tolerance to, 1842  
Urea nitrogen  
equine colic, 223  
fluid balance disorders, 90  
protein nutrition/metabolism indicator, 1621–1622, 1623, 1624  
renal clearance, 551  
*Ureaplasma*, 1123  
*Ureaplasma diversum*  
enzootic pneumonia of calves, 1336, 1339  
vaccination, 1125  
vulvitis, granular, 1125  
Uremia, 548  
causes, 544  
mycotoxicosis, 1912  
renal failure, 545  
Uremic encephalopathy, 548  
Ureter(s)  
congenital defect, 572–573  
diseases of, 561–571  
ectopic, 572  
morphological abnormality, 548  
Urethra  
abnormality, palpable, 548  
atresia, 573  
closure pressure, maximal, 553  
congenital defect, 573  
diameter, urolithiasis, 567  
diseases of, 561–571  
length, functional, 553  
pressure profile, 553  
rupture, 568, 569  
Urethral calculi, 567, 571  
Urethral obstruction  
bladder rupture from, 562  
calculi, 567–568  
clinical findings, 561  
estrogenic substance poisoning, 1841  
incomplete, cattle, 568  
urolithiasis in ruminants, 565  
Urethral recess dilatation, 569  
Urethral rents, 571  
Urethral tears, 571  
Urethritis, 561  
Urinalysis, 548  
abomasal displacement/volvulus, 365  
anemia, 457  
cystitis and pyelonephritis, 792  
equine grass sickness, 1991  
ketone levels, 359, 1664, 1667  
leptospirosis, 1104  
magnesium concentrations, 1656–1657  
newborns, 166  
pyelonephritis, contagious bovine, 790  
urolithiasis, 568  
see also Urine  
Urinary bladder, papillomatosis, 1422  
Urinary burn, 548  
Urinary nitrogen (UN) excretion, 1621  
Urinary system  
disease, 543–573  
see also *specific diseases/disorders*  
examination, 20, 548–553  
diagnostic examination techniques, 552–553  
renal function tests, 549–552  
renal injury detection, 549–552  
urinalysis see Urinalysis  
see also *specific tests*  
Urinary tract  
congenital defects, 571–573  
disease  
abdominal pain, 547–548  
clinical features, 545–548  
hemorrhagic anemia, 451  
treatment principles, 553–555

- Urinary tract (*Cont'd*)  
 urination, difficult, 547-548  
 urination, painful, 547-548  
 see also *specific diseases/disorders*  
 infection, bacteriuria, 546  
 inherited defects, 1948-1949  
 obstruction, hydronephrosis, 560
- Urination  
 clinical examination, 9-10  
 difficult, 547-548  
 painful, 547-548  
 progressive ataxia, inherited, 1952
- Urine  
 abnormal constituents, 545-547  
 amber to port wine color, congenital porphyria, 1946  
 blood in, 546, 790  
 collection of sample, 548-549  
 daily flow variation, 547  
 dribbling, 547  
 environmental pollution, 1785  
 enzymuria, 549  
 glucose loss in, 116  
 glucosuria, 549-550  
 hypomagnesemic tetany, 1656-1657  
 lead in, 1803-1804  
 left sided displacement of the abomasum, 359  
 leukocytes/pus in, 546  
 pH  
 calculi formation and, 570  
 carbohydrate engorgement, 321  
 cystitis and pyelonephritis, 792  
 dietary cation-anion difference monitoring, 1642  
 manipulation, 554  
 urolithiasis, 566  
 proteinuria, 550  
 red  
 bovine babesiosis, 1488  
 cattle, 1491  
 red-brown coloration, 546, 1897  
 specific gravity, 549  
 tests of, 549-550, 550-552
- Urine osmolality to serum osmolality ratio, 550-551
- Urine shedding, equine rhinitis virus A, 1308
- Uroabdomen see Uroperitoneum (uroabdomen)
- Urobilinogen, jaundice, 384, 385
- Urolithiasis  
 horses, 570-571  
 phytoestrogen poisoning, 1874  
 ruminants, 565-570  
 calculi composition, 567  
 clinical findings, 567-568  
 clinical pathology, 568  
 concretion, factors favoring, 566  
 differential diagnosis, 569  
 epidemiology, 565-567  
 etiology, 565  
 necropsy findings, 568-569  
 nidus formation, 566  
 occurrence, 567  
 pathogenesis, 567  
 precipitation of solutes, 566  
 prevention, 570  
 risk factors, 567  
 species affected, 565-566  
 treatment, 569-570
- Uroliths, 565  
 see also Calculi
- Uroperitoneum (uroabdomen), 562-565, 2013  
 foals, 562-565  
 clinical pathology, 564  
 clinical signs, 563-564  
 control, 565  
 differential diagnosis, 564  
 epidemiology, 563  
 etiology, 562-563  
 necropsy findings, 564  
 pathophysiology, 563  
 prevention, 565  
 treatment, 564-565  
 horses, 207  
 test of, 553  
 ultrasound, 552
- Uroporphyrinogen III cosynthetase deficiency, 1946
- Uroporphyrins, congenital porphyria, 1946
- Urticaria, 655-656, 1935
- USA  
 African swine fever, 1168, 1169  
 anaplasmosis, 1455  
 babesiosis vector control, 1497  
 bluetongue, 1300, 1301  
 bovine immunodeficiency-like virus, 1222  
 bovine spongiform encephalopathy, 1448, 1449, 1451  
 bovine ulcerative mammillitis, 1429  
 brucellosis, 965, 982  
 caprine arthritis encephalitis, 1410  
 chronic wasting disease, 1454  
 copper deficiency, 1708  
 cryptosporidiosis, 1512  
 downer cow disposition, 1649  
 encephalomyocarditis virus disease, pigs, 1183  
 enzootic bovine leukosis eradication program, 1219  
 equine neorickettsiosis, 1466  
 human rabies infections, 1388  
 Johne's disease control, 1038-1039  
 ovine progressive pneumonia, 1363  
 pseudorabies, 1400, 1401-1402  
 rabies occurrence, 1385-1386  
 scrapie, 1441, 1445-1446  
 sporadic bovine encephalomyelitis, 1407  
 swine influenza, 1331  
 transmissible gastroenteritis, pigs, 1278  
 vesicular stomatitis, 1233  
 US Animal Health Association, Johne's disease control, 1038  
 US Department of Agriculture (USDA)  
 Animal and Plant Health Inspection Service (APHIS), 980, 982, 1032  
 Genetics Based Flock Clean-Up and Monitoring Plan, 1446  
 Johne's disease diagnosis and control, 1039  
 Pathogen Reduction Hazard Analysis of Critical Points System (HACCP), 885  
 US Environmental Protection Agency, concentrated animal feeding operation (CAFO), 1762  
*Ustilago hordei* (barley smut) fungus, 1912  
 US Voluntary Johne's Disease Herd Status Program, 1034, 1037, 1038-1039, 1039  
 Uterine discharge, *Brucella abortus* transmission, 967  
 Uterine fluid analysis, 61
- Uterus  
 enlargement, 302-303  
 enzootic bovine leukosis, 1216  
 prolapse, 1635  
 rupture, 1635  
 tuberculosis, 1009
- Uveitis  
*Listeria monocytogenes* infection, 805  
 recurrent, leptospirosis, 1098, 1101, 1103  
*Rhodococcus equi* pneumonia, 802
- 
- V**
- 
- Vaccination  
 African horse sickness, 1182-1183  
 agalactia, contagious, 1139  
 Akabane disease, 1209  
 anaplasmosis, 1458-1459  
 anthrax, 819  
*Arcanobacterium pyogenes*, 787  
 atrophic rhinitis, progressive, 957, 959, 962  
 bacillary hemoglobinuria, 836  
 Bang's disease, 974, 978-981  
 black disease, 834  
 blackleg, 830  
 blowfly strike prevention, 1593  
 bluetongue, 1304  
 botulism, 827  
 bovine babesiosis, 1486, 1494-1497  
 bovine ephemeral fever, 1179  
 bovine herpesvirus-1 infection, 1356-1359  
 bovine interdigital necrobacillosis, 1066  
 bovine lungworm, 1567  
 bovine respiratory disease, acute undifferentiated, 932-934  
 brucellosis, 987-988, 990, 993-994  
 capripox viruses, 1431  
 caseous lymphadenitis, 797-798  
 colibacillosis control, 873-875  
 coliform gastroenteritis, 895  
 contagious bovine pleuropneumonia, 1135-1137  
 Eastern equine encephalomyelitis, 1371  
 enterohemorrhagic *Escherichia coli*, 881, 884-885  
 enterotoxemia, *Clostridium perfringens* associated, 840, 843  
 enzootic bovine leukosis, 1221  
 equine arteritis virus, 1321-1322  
 equine herpesvirus 1, 1316  
 equine herpesvirus 4, 1311  
 equine influenza, 1326-1328  
 equine neorickettsiosis, 1467-1468  
 equine phycomycosis, 1481  
 equine protozoal myeloencephalitis, 1523  
 erysipelas of swine, 814-815  
 fasciolosis, 1579  
 foot-and-mouth disease, 1226, 1228-1230  
 foot rot, infectious, 1076  
 gastroenteritis, transmissible, 1284  
 Getah virus, 1384  
 greasy pig disease, 787  
*Haemophilus* septicemia, 1002  
 heartwater, 1463-1464  
 hemonchosis, ruminants, 1551  
 hemorrhagic septicemia, 922-923  
 hog cholera, 1165-1166  
*Hypoderma* infestations, 1589  
 ileitis, 1092  
 infectious disease control, 768  
 Jembrana disease, 1244  
 Johne's disease, 1035-1036, 1036, 1042-1043  
 keratitis, infectious, 996  
 laminitis, ruminants/pigs, 2035  
 leptospirosis, 1107, 1108-1110, 1109  
 listeriosis, 810  
 liver necrobacillosis, 1063  
 louping-ill, 1410  
 lumpy skin disease, 1426  
 lungworm infestation, 1569  
 neonatal viral diarrhea, 1294-1296  
 orf, 1420  
 papillomatosis, 1422-1423  
 pleuropneumonia of pigs, 1055, 1059  
 pneumonia, mycoplasmal, 1150, 1151  
 pneumonic pasteurellosis, 933, 943-945, 949  
 polyarthritis, infectious, 1006  
 porcine intestinal spirochetosis, 1122  
 porcine reproductive and respiratory syndrome, 1203-1204  
 post-weaning multisystemic wasting syndrome, 1187-1188  
 ringworm, 1478  
 salmonellosis, 917-918  
 septicemic pasteurellosis, 950  
 strangles, 774  
*Streptococcus agalactiae* bovine mastitis, 705  
*Streptococcus suis* infection in pigs, 782  
 swine dysentery, 1119  
 swine vesicular disease, 1232  
 tetanus, 824  
 toxoplasmosis, 1522  
 tuberculosis, 1013  
 Venezuelan equine encephalomyelitis, 1374, 1377  
 vesicular exanthema of swine, 1237  
 Western equine encephalomyelitis, 1371  
 West Nile encephalitis, 1380  
 winter dysentery, 1299  
 see also Vaccine(s); *individual vaccines*  
 Vaccination Monitored Free Program, bovine virus diarrhea virus, 1275  
 Vaccine(s), 1326-1327  
 African swine fever, 1172  
 besnoitiosis, 1518  
 bovine respiratory syncytial virus pneumonia, 1348  
 coccidiosis, 1506  
 coliform bovine mastitis, 718-719, 740  
 coliform mastitis, 718-719  
 East Coast fever, 1529-1530  
 encephalomyocarditis virus disease, 1184  
 environmental streptococci mastitis, 722  
 enzootic pneumonia of calves, 1342-1343  
 equine herpesvirus 1, 1316  
 equine infectious anemia, 1177  
 equine protozoal myeloencephalitis, 1525  
*Mycobacterium avium* subspecies *paratuberculosis* (*Map*), 1042-1043  
*Mycoplasma* mastitis, 707  
 neosporosis, 1511  
 newborn resistance, 159  
 ovine enzootic abortion, 1437  
 peste des petits ruminants, 1243-1244  
 porcine viral encephalomyelitis, 1406

- Vaccine(s) (Cont'd)  
 post-weaning multisystemic wasting syndrome, 1192  
 pseudorabies, 1402–1404  
 Q fever, 1469  
 rabies, 1392  
 respiratory system disease control, 497  
 sarcoid, 1424  
*Streptococcus agalactiae* mastitis, 705  
 swine influenza, 1334  
 tick infestations, 1600  
 tropical theileriosis, 1531  
 vesicular stomatitis, 1235  
 Vaccine-baits, rabies, 1392  
 Vaccine SAD B19, 1393  
 Vaccinia virus mamillitis, 1427  
 Vagal tone excess, 414  
 Vaginal discharge, mastitis-metritis-agalactia syndrome, 756–757  
 Vaginal examination, postparturient mare, 229–230  
 Vaginal fluid analysis, septic metritis, 61  
 Vaginal trauma  
*Actinobaculum suis* infection, 791  
 cystitis and pyelonephritis, 793  
 Vagus indigestion, 299, 346–350  
 clinical findings, 348–349  
 clinical pathology, 349  
 differential diagnosis, 349–350  
 epidemiology, 346  
 etiology, 346  
 necropsy findings, 349  
 pathogenesis, 346–348  
 prevention, 350  
 reticulorumen contractions, 303, 304  
 treatment, 350  
 Vagus nerve (cranial nerve X), 294, 297, 346, 587  
 Valnemulin  
 dosage/interval, 2066  
 enzootic pneumonia of calves, 1342  
 mycoplasmal pneumonia, pigs, 1149  
 swine dysentery, 1118  
 Valve predilection, endocarditis, 427  
 Valvular disease, 423–427  
 acquired, 423  
 cattle, 423  
 clinical findings, 424–426  
 clinical pathology, 426  
 congenital, 423  
 differential diagnosis, 426  
 echocardiography, 411  
 effects of, 424  
 epidemiology, 423–424  
 etiology, 423  
 examination, 424–425  
 heart failure, chronic, 401  
 horses, 423  
 insufficiency, 425–426, 427  
 necropsy findings, 426  
 pathogenesis, 424  
 pigs, 423–424  
 rupture, 422  
 stenosis, 426  
 treatment, 426  
 see also Murmurs; specific valves  
 Vampire bats  
 rabies transmission, 1385  
 rabies vaccination, 1393  
 surra transmission, 1537  
 Vanadium poisoning, 1829–1830  
 Vancomycin, 2063  
 Vanilloids, 106  
 Variant Creutzfeldt–Jakob disease (vCJD), 1450  
 Vascular lesion(s)  
 sarcocystosis, 1508  
 subcutaneous edema, 664  
 Vascular nevus, 669  
 Vascular obstruction, gangrene from, 666  
 Vasculitis  
 besnoitiosis, 1517  
 bovine virus diarrhoea virus infection, 1258  
 equine herpesvirus 1, 1315  
 hemorrhage, 443  
 malignant catarrhal fever, 1246  
 necrotizing, 443  
 panhypoproteinemia, 439  
 porcine dermatitis and nephropathy syndrome, 1192  
 purpura hemorrhagica, 1925  
 septicemic diseases, 443  
 treatment, 443  
 viremic diseases, 443  
 Vasoactive lipid poisoning, 1872  
 Vasoconstriction, laminitis in horses, 2031, 2033  
 Vasoconstrictive agents, 68, 434  
 Vasodilatation, 41  
 Vasodilators, 68  
 laminitis, horses, 2033  
 Vasogenic cerebral edema, 597–598  
 Vasopressors, 59  
 Veal calves  
 abomasal ulcer, 371  
 bovine virus diarrhoea virus vaccination, 1272  
 colibacillosis exposure reduction, 871  
 enzootic pneumonia of calves, 1337  
 hemorrhagic enteritis, 859–860  
 iron deficiency, 1726  
 iron supplementation, 1728  
 Vector-based lead systems, 408  
 Vector control, bovine babesiosis, 1497  
 Vegetable oil supplement, 1639  
 Vegetables, S-methyl-L-cysteine-sulfoxide in, 1881  
 Vehicle emissions, 1785  
*Velleia discophora* poisoning, 1894  
 Vellein poisoning, 1894  
 Venezuela, brucellosis status, 964–965  
 Venezuelan equine encephalomyelitis, 1372–1377  
 clinical findings, 1373–1374  
 clinical pathology, 1374  
 control, 1374, 1377  
 diagnostic confirmation, 1374  
 differential diagnosis, 1374, 1375–1377  
 distribution, 1372  
 epidemic, 1372, 1373  
 epidemiology, 1372–1373  
 experimental infection, 1373–1374  
 inapparent infection, 1373  
 necropsy findings, 1374  
 pathogenesis, 1373  
 risk factors, 1373  
 transplacental transmission, 1373  
 treatment, 1374  
 vaccination, 1374, 1377  
 viral ecology, 1372–1373  
 Venezuelan equine encephalomyelitis virus (VEE), 1372–1373, 1377  
 Venom, 421, 1916, 1916, 1917  
 see also specific types  
 Venous blood gas analysis, 457, 491–492  
 Venous blood oxygen tension, shock, 66  
 Venous congestion, 402  
 Venous thrombosis, 435–436  
 Ventilation, environmental examination, 8  
 Ventilation/perfusion, hypoxic hypoxia, 472  
 Ventricular fibrillation, 417  
 Ventricular premature complexes, 416  
 Ventricular septal defect, 432, 1946  
 Ventricular tachycardia, 416–417  
 Verapamil, 2063  
 Veratrine poisoning, 1894  
*Veratrum californicum* (skunk cabbage) toxicity, 133, 1884, 1894  
*Verbena encelioides* poisoning, 1887  
 Vermiform appendage, 567  
 Verminous aneurysm, 257–258  
 Verminous bronchitis see Bovine lungworm  
 Verminous encephalitis, 1375  
 Verminous mesenteric arteritis, 257–258  
 Verminous pneumonia see Bovine lungworm (verminous pneumonia)  
*Vernonia* poisoning, 1892  
 Verrucarin poisoning, 1910  
 Verrucologen poisoning, 1910  
 Verrucose dermatitis, 1065  
 Vertebra(e)  
 fractures, 613, 614  
 parturition trauma, 139  
 spinal cord compression, 615  
 Vertebral body abscess (osteomyelitis), 615  
 Vertebral body fractures, 1985  
 Vertebral exostoses, 632–633  
 Vertebral osteochondrosis, 632–633  
 Vertebral osteomyelitis, 616  
 Vertebral subluxation, 615  
 Vertebral trauma, 121  
 Veruconium bromide, 2063  
 Very low-density lipoproteins (VLDLs), 1678  
 Vesicles  
 bovine ulcerative mammillitis, 1429  
 cowpox, 1427  
 foot-and-mouth disease, 1225  
 Vesicular exanthema of swine (VES), 1226, 1236–1237  
 Vesicular stomatitis, 206, 1232–1236  
 animal transmission experiments, 1176, 1236  
 cattle, 1235  
 clinical findings, 1235, 1265  
 clinical pathology, 1236, 1265, 1433  
 control, 1236  
 differential diagnosis, 1226, 1235  
 economic importance, 1234–1235  
 epidemiology, 1232–1235, 1265, 1433  
 etiology, 1232  
 experimental reproduction, 1234  
 horses, 1235, 1433  
 hosts, 1233–1234  
 immune mechanisms, 1235  
 infection sources, 1233  
 lesions, 1433  
 necropsy findings, 1236  
 occurrence, 1232–1233  
 pathogenesis, 1235  
 pigs, 1235  
 risk factors, 1234  
 teats, 749  
 transmission, 1233–1234, 1433  
 treatment, 1236  
 vaccines, 1236  
 viral serotypes, 1232, 1233, 1234  
 Vesicular stomatitis Indiana (VS-IN), 1232, 1233  
 Vesicular stomatitis New Jersey (VS-NJ), 1232  
 Vestibular disease, 121, 579–580  
 equine protozoal myeloencephalitis, 1524  
 Vestibulocochlear nerve (cranial nerve VIII)  
 assessment, 586  
 Veterinarian(s)  
 nutritional management role levels, 1693  
 salmonellosis in, 907  
 Veterinarian-client-patient relationship, 184  
 Veterinary Antimicrobial Support System (VASS), 185  
 Veterinary clinics/hospitals, salmonellosis control, 915–917  
 Vetrazin, 1592  
*Vibrio coli* (*Campylobacter coli*), 1085, 1086–1087  
 Vibriosis, 975  
*Vicia benghalensis*, 1895  
 Victorian Bovine Johne's Disease Test and Control Program (Australia), 1028, 1037  
 Villous epithelial cell replacement, 264  
*Vipera ammodytes* (sand vipers), 1916  
*Vipera berus* (European viper), 1916  
*Vipera russelli* (Russell's viper), 1916  
 Viperidae, 1916  
 Vipers, 1916  
 Viral arteritis, 434  
 Viral diarrhoea, neonates, 1286–1297  
 clinical findings, 1291–1292  
 clinical pathology, 1292–1293  
 control, 1294–1296  
 differential diagnosis, 1293–1294  
 epidemiology, 1286–1291  
 etiology, 1286  
 fecal sampling, 1292  
 immune mechanisms, 1287  
 lactogenic immunity, 1295  
 necropsy findings, 1293  
 occurrence, 1287  
 pathogenesis, 1291  
 transmission, 1287  
 treatment, 1294  
 vaccination, 1294–1296  
 viral detection, 1292–1293  
 Viral diseases/infection, 1157–1423  
 alimentary tract signs, 1223–1305  
 hemolytic jaundice, 384  
 immune deficiency from, 467  
 interstitial pneumonia, 924, 2000, 2004  
 intrauterine growth retardation, 137  
 myocarditis, 420  
 nervous signs, 1368–1418  
 papular dermatitis, 1426, 1433  
 pneumonia, 511, 1310  
 respiratory signs, 1307–1368  
 skin lesions, 1418–1433  
 teratogenesis, 135  
 tick transmitted, 1599–1600, 1601  
 whole body manifestations, 1157–1223  
 see also specific diseases/disorders  
 Viral excretion  
 caprine herpesvirus-1 infection, 1330  
 equine influenza, 1323

- Viral excretion (*Cont'd*)  
pseudorabies, 1396
- Viral shedding  
bovine herpesvirus-1 infection, 1357  
equine herpesvirus 4, 1309  
gastroenteritis, transmissible, 1279  
hog cholera, 1159  
swine vesicular disease, 1230
- Viremia, 51-53  
clinical findings, 52  
clinical pathology, 52  
definition, 51  
epidemiology, 51  
equine herpesvirus 4, 1310  
equine infectious anemia, 1174  
equine influenza, 1324  
equine rhinitis virus A, 1308  
etiology, 51  
louping-ill, 1409  
malignant catarrhal fever, 1246  
pathogenesis, 51-52  
porcine reproductive and respiratory syndrome, 1198  
treatment, 52-53  
Venezuelan equine encephalomyelitis, 1373
- Virginiamycin, 2066
- Virology  
African horse sickness, 1182  
African swine fever, 1171  
bovine ephemeral fever, 1179  
bovine herpesvirus-1 infection, 1355  
caprine herpesvirus-1 infection, 1330  
equine herpesvirus 1, 1315  
equine infectious anemia, 1176  
hog cholera, 1164  
porcine reproductive and respiratory syndrome, 1201  
porcine viral encephalomyelitis, 1406  
swine influenza, 1334
- Viruses  
congenital defects in newborns, 133  
diarrhea in foals, 274, 276  
enteritis, 260, 261, 262, 263  
isolation, undifferentiated bovine respiratory disease, 929
- Virus neutralization (VN) test  
bovine herpesvirus-1 infection, 1354  
bovine respiratory syncytial virus pneumonia, 1347  
equine herpesvirus 4, 1310  
foot-and-mouth disease, 1226  
peste des petits ruminants, 1243
- Virus neutralizing (VN) antibodies  
equine herpesvirus 1, 1313, 1314  
equine herpesvirus 4, 1310
- Visceral distention see Abdominal distension
- Visceral pain, 103-105, 190, 194-195  
see also Abdominal pain
- Vision tests, 18
- Visna, 1413-1414
- Visual system abnormalities, 588  
border disease, 1416
- Vital signs, clinical examination, 13-14
- Vitamin A  
deficiency, 1771-1777  
brain dysfunction, 1806  
clinical findings, 1774-1775  
clinical pathology, 1775  
congenital defects, 133, 1775  
control, 1776-1777  
diagnosis, 1776  
differential diagnosis, 1776  
encephalomalacia, 603  
environmental factors, 583  
epidemiology, 1772-1773  
etiology, 1772  
horses, 1773  
maternal, 1772  
menace reflex, 585  
necropsy findings, 1775-1776  
pathogenesis, 1773-1774  
pigs, 1773  
primary, 1772-1773  
secondary, 1773  
treatment, 1776  
dietary requirement, 1776-1777, 1777  
hepatic, 1775  
hyena disease of cattle, 2023  
hypervitaminosis, 1776  
oral, 1777  
parenteral injection, 1777  
plasma, 1775  
supplementation, 1776  
adequacy of, 1772  
method, 1776-1777
- Vitamin B<sub>1</sub> see Thiamin (vitamin B<sub>1</sub>)
- Vitamin B<sub>6</sub> (pyridoxine) deficiency, 452, 1780
- Vitamin B<sub>12</sub>  
daily requirement, 1782-1783  
deficiency, 1703, 1782-1783  
see also Cobalt, deficiency  
injections, 1706  
ketosis treatment, 1666  
microencapsulated in lactide/glycolide copolymers, 1706  
requirements, 1778  
serum concentration, 1703  
status, biochemistry determination, 1703  
supplementation, 1705
- Vitamin B-complex, 1778
- Vitamin C (ascorbic acid), 1778, 2052
- Vitamin D  
deficiency, 1755, 1763-1766  
clinical findings, 1765  
clinical pathology, 1765  
congenital defects in newborns, 133  
control, 1765-1766  
diagnosis, 1765  
differential diagnosis, 1765  
epidemiology, 1764  
etiology, 1764  
necropsy findings, 1765  
osteodystrophy, 632  
outbreaks, 1755  
pathogenesis, 1764-1765  
treatment, 1765  
dietary, 1757, 1764  
daily requirements, 1758  
hypervitaminosis, 1766  
injection, 1765-1766  
maternal status, 1765  
plasma, 1765  
supplementation, 1765  
daily intake, 1765  
milk fever prevention, 1638, 1642-1643  
osteodystrophy, 634-635  
toxicity, 1766
- Vitamin D<sub>2</sub>, 1764  
injection, 1765-1766  
milk fever prevention, 1642
- Vitamin D<sub>3</sub> (cholecalciferol), 1764  
hyena disease of cattle, 2023  
milk fever prevention, 1642
- Vitamin D<sub>4</sub>, 1764
- Vitamin D<sub>5</sub>, 1764
- Vitamin deficiencies  
fat-soluble, 1771-1778  
water-soluble, 1778-1783  
see also specific vitamins
- Vitamin E (tocopherol acetate)  
biological functions of, 1735-1736  
deficiency, 1735-1755  
clinical findings, 1744-1745  
clinical pathology, 1745-1748  
congenital defects in newborns, 133  
control, 1749-1754  
diagnosis, 1749  
differential diagnosis, 1749  
diseases associated with, 1735  
epidemiology, 1736-1744  
equine motor neuron disease, 2020  
etiology, 1735-1736  
myopathy, 626, 627  
necropsy findings, 1748-1749  
pathogenesis, 1744  
treatment, 1749  
equine degenerative myeloencephalopathy, 1954  
exertional rhabdomyolysis, 1685  
pars esophagea ulceration, 1997  
peripartum disease prevention, 1616-1617  
post-weaning multisystemic wasting syndrome, 1191  
selenium association, 1736  
status, 1747  
coliform mastitis risk, 711  
supplementation  
dietary, 1749-1750  
dosage/interval, 2063  
equine degenerative myeloencephalopathy, 1954  
methods of, 1750-1751  
muscular dystrophy, 1751-1752  
myopathy, 630  
nutritional muscular dystrophy control, 1751-1752  
pregnancy, 1741  
recurrent exertional rhabdomyolysis, 1968
- Vitamin E-selenium deficiency (VESD) syndrome, 1739-1740, 1744, 1745, 1748  
see also specific components
- Vitamin H see Biotin (vitamin H)
- Vitamin K  
daily requirement, 1777  
deficiency, 1777-1778  
supplementation, exercise-induced pulmonary hemorrhage, 506
- Vitamin K<sub>1</sub>  
dicoumarin derivative poisoning, 1865  
dosage/interval, 2060  
rodenticide poisoning, 1840
- Vitiligo, 662
- Voice, clinical examination, 9
- Volcanic ash, 1791-1792, 1815, 1816
- Volcanic eruptions, 1791-1792
- Voles, cowpox, 1427
- Volume load, heart failure, 402
- Voluntary Bovine Johne's Disease Control Program, 1032, 1040
- Voluntary Johne's Disease Herd Status Program, 1032
- Volvulus  
large colon see Large colon, ascending, volvulus  
small intestine, 243  
sudden death, 124
- Vomiting, 192-193  
equine colic, 220  
etiology, 192-193  
gastric dilatation, horses, 233  
gastritis, 259  
plant-induced, 1895-1896, 1897  
projectile, 192  
sesquiterpene lactone poisoning, 1892  
true, 192
- Vomiting and wasting disease, pigs, 1285-1286
- Vomitoxin, 1910-1911
- Vomitus, blood in, 194
- Von Willebrand's disease, 444-445, 1947
- Von Willebrand's factor, 442, 444-445
- Vulpes vulpes* (red fox), rabies vector, 1385, 1387
- Vulvar squamous-cell carcinoma, 668
- Vulvitis, granular, 1125
- Vulvovaginitis, 793-795  
caprine herpesvirus-1 infection, 1330  
clinical findings, 794  
clinical pathology, 794  
control, 794  
*Corynebacterium renale*, 793-795  
differential diagnosis, 794  
economic importance, 794  
epidemiology, 793-794  
etiology, 793  
experimental reproduction, 794  
*Fusarium culmorum*, 1899  
*Fusarium roseum*, 1899  
infection source, 793  
*Mycoplasma agalactiae* var. *bovis*, 1125  
outbreaks, 793  
pathogenesis, 794  
risk factors, 793-794  
transmission, 793  
treatment, 794  
zearalenone poisoning, 1911
- 
- ## W
- 
- Waddlia chondrophila*, 1433, 1435
- Wanderers see Equine neonatal encephalopathy
- Wandering pacemaker, 414
- Warble flies see *Hypoderma* infestations
- Warfarin, 442  
poisoning, 1839-1840
- Warfarin sodium, 2063
- Warming pens, 45
- Wart hog disease see African swine fever (ASF)
- Warts see Papillomatosis
- Washes, ringworm treatment, 1478
- Washout period, antimicrobials, 184-185
- Waste disposal, 7
- Wasting disease  
cattle, 1701  
moose, 1575, 1701, 1703, 1708-1709

- Water  
 consumption rates, 547  
 contamination  
*Campylobacter jejuni*, 881  
 carrion-associated botulism, 825  
 enterohemorrhagic *Escherichia coli*, 880, 881, 884  
 heavy metals, 1785  
*Mycobacterium avium* subspecies *paratuberculosis* (Map), 1034  
*Mycobacterium bovis*, 1008  
*Salmonella*, 900  
 copper sulfate supplementation, 1720  
 deprivation  
 adaptation, 74  
 fluid and electrolyte therapy, 92  
 polioencephalomalacia, 2009  
 recumbency in horses, 122  
 salmonellosis risk factor, 900  
 thirst, 115  
 environmental examination, 7  
 fluorine content, 1816  
 fluorine poisoning, 1816  
 immersion, hypothermic lambs, 45  
 intake, cystitis and pyelonephritis, 791, 793  
 intoxication, 76  
 magnesium supplementation, 1658  
 mass medication, 180  
 coliform gastroenteritis, 894  
 pneumonic pasteurellosis, 942, 945–946  
 molybdenum toxicity, 1820  
 nitrate-nitrite poisoning, 1856–1857  
 phosphorus supplementation, 1763  
 sulfate content, polioencephalomalacia, 2008  
 sulfate removal, 1720  
 Water buffalo (*Bubalus bubalis*)  
 foot-and-mouth disease reservoir, 1224  
 Jembrana disease, 1244  
 tuberculosis, 1007  
 Water deprivation test, 551  
 Water flotation tank, 1648–1649  
 Water-hammer pulse, 426  
 Water hemlock dropwort (*Oenanthe*)  
 poisoning, 1883  
 Water hemlock (*Cicuta*) poisoning, 1883  
 Watering behavior, undifferentiated bovine  
 respiratory disease, 927–928  
 Water moccasin (*Agkistrodon piscivorus*), 1916  
 Water vapor treatment, exercise-induced  
 pulmonary hemorrhage, 506  
 Watery mouth of lambs, 1986–1987  
 Weak calf syndrome see Perinatal weak calf  
 syndrome  
 Weakness, 580  
 assessment, 587–588, 588  
 bovine spongiform encephalopathy, 1450  
 definition, 621  
 eperythrozoonosis, 1155  
 hemoglobinuria, postparturient, 1683  
 hypokalemia, acute, 1650  
 severity, 589  
 spinal cord compression, 616  
 West Nile encephalitis, 1379  
 see also Paresis  
 Weaner illthrift, 1544, 1981–1982  
 Weaner producers, *Salmonella* surveillance  
 program, 918  
 Weaning  
 dietary diarrhea, 277–278  
 pneumonic pasteurellosis control, 942–943  
 stress reduction in, 895  
 Weanlings, equine herpesvirus 1 infection, 1313  
 Weather  
 bovine interdigital necrobacillosis risk factor,  
 1064  
 colibacillosis, newborn risk factor, 854  
 energy deficiency and, 1697  
 frothy bloat and, 329  
 left-side displacement of abomasum and, 356  
 malnutrition, 114  
 mycoplasma pneumonia risk factor,  
 1145–1146  
 Weaver syndrome (inherited progressive  
 degenerative myeloencephalopathy),  
 1952  
 Weaving, 612  
*Wedelia* poisoning, 1886  
 Wedeloside poisoning, 1886  
 Wedge pads, laminitis, 2033  
 Weed (sporadic lymphangitis), 2029–2030  
 Weed diagnosis, 24–25  
 Weight  
 coccidiosis, 1499  
 copper deficiency effects, 1711  
 excess, laminitis, 2030  
 loss of, 115–116  
 absorption abnormality, 116  
 carbohydrate loss, excessive, 116  
 digestion abnormality, 116  
 diseases associated with, 266  
 granulomatous enteritis, horses, 1992  
 metabolism abnormality, 116  
*Neotyphodium* (*Acremonium*)  
*coenophialum* poisoning, 1902  
 nutritional causes, 115  
 post-weaning multisystemic wasting  
 syndrome, 1189  
 protein loss, excessive, 116  
 thin sow syndrome, 1988  
 weaner ill thrift, 1979–1980  
 milk fever effect, 1630  
 osteodystrophy and, 633  
 vitamin A deficiency, 1774  
 Welfare see Animal welfare  
 Welfare of Farmed Animals Regulations, 870  
 Welsh mountain sheep, red foot disease, 1975  
 Wesselsbron virus, 133  
 Western blots, equine protozoal  
 myeloencephalitis, 1524  
 Western equine encephalomyelitis, 1368–1372  
 case fatality rate, 1369  
 clinical findings, 1370, 1375  
 clinical pathology, 1370  
 control, 1371, 1375  
 differential diagnosis, 1371, 1375–1377  
 epidemics, 1369  
 epidemiology, 1369, 1375  
 etiology, 1369, 1375  
 morbidity, 1369  
 necropsy findings, 1370–1371  
 pathogenesis, 1369–1370  
 risk factors, 1369  
 treatment, 1375  
 vaccination, 1371  
 virus isolation, 1370  
 zoonotic implications, 1369, 1605  
 Western equine encephalomyelitis (WEE) virus,  
 1369  
 West Nile encephalitis (WNE), 1378–1381, 2018  
 case fatality rate, 1379  
 clinical findings, 1375, 1379  
 clinical pathology, 1379–1380  
 control, 1375, 1380  
 differential diagnosis, 1375, 1380  
 distribution, 1378  
 epidemiology, 1375, 1378–1379  
 etiology, 1375, 1378  
 immunity, 1379  
 morbidity, 1379  
 necropsy findings, 1380  
 other species infected, 1379  
 outbreaks, 1378  
 pathogenesis, 1379  
 prognosis, 1379  
 risk factors, 1379  
 transmission, 1379  
 treatment, 1375, 1380  
 vaccination, 1380  
 zoonotic implications, 1379  
 West Nile virus, 1378–1379, 1380  
 Wetness, 1793  
 Wheals, 655–656  
 Wheat pasture poisoning, 1654  
 see also Hypomagnesemic tetany  
 Wheat smut (*Tilletia tritici*) fungus, 1912  
 Wheelbarrow test, ovine pulmonary  
 adenocarcinoma, 1367  
 Wheezes, 477, 477, 478, 1931  
 Whipworm (*Trichuris*), 1563  
 White blood cells (WBC)  
 disorders, 460–464  
 Fell pony syndrome, 1942–1943  
 function abnormality, 461  
 peritoneal fluid, 202  
 reference laboratory values, 2047  
*Rhodococcus equi* pneumonia, 802  
 White bryony (*Bryonia dioica*) poisoning, 1888  
 White Cloud Jason's Elegant, 1952  
 White clover (*Trifolium repens*) poisoning, 1874,  
 1912  
 White line disease, 1781  
 White liver disease, 392  
 White mice, foot-and-mouth disease, 1227  
 White muscle disease, 1745  
 Whiteside test see California Mastitis Test  
 'White spotted kidney,' 1100–1101  
 White-tailed deer (*Odocoileus virginianus*)  
 abomasal ulcers, 372  
 bovine herpesviruses, 1349  
 chronic wasting disease, 1454  
 epizootic hemorrhagic disease, 1305  
 tuberculosis, 1007  
 Wild bird, Western equine encephalomyelitis,  
 1369  
 Wild boar  
 hog cholera, 1158, 1164–1165  
 porcine circoviruses, 1186  
 pseudorabies, 1396–1397  
 Wildbeest, bovine herpesviruses, 1349  
 Wildlife  
 babesiosis, 1484, 1489  
 boreliosis, 1111  
 bovine herpesvirus-1 infection, 1349–1350  
*Brucella* vaccines, 980–981  
 enterohemorrhagic *Escherichia coli*, 878  
 foot-and-mouth disease reservoirs, 1224  
 Johne's disease, 1018  
 leptospirosis source, 1099  
 lumpy skin disease, 1425  
 ovine progressive pneumonia, 1363  
 pneumonic pasteurellosis, 947  
 rabies vaccination, 1392–1393  
 rinderpest, 1238  
 tuberculosis reservoir, 1007, 1014  
 vesicular stomatitis, 1233  
 see also specific types  
 Wild Norway rat, pseudorabies, 1396  
 Wild pigs, African swine fever, 1167–1168  
 Wild rabbit (*Oryctolagus cuniculus*), Johne's  
 disease, 1018  
 Wild ruminants  
 bluetongue, 1302  
 bovine coronavirus, 1289, 1297  
 Wild running, plant-induced, 1897  
 Willems reaction, 1136  
 Wilting, bloat control, 334  
 Wind chill factor, 44  
 Windsucking, 612  
 'Wind up,' 104  
 Winter coccidiosis, 1498, 1502  
 Winter (larval) cyanthostomiasis, 1560  
 Winter dysentery  
 cattle, 1297–1299  
 case fatality rates, 1297  
 clinical findings, 1266, 1298  
 clinical pathology, 1298–1299  
 control, 1299  
 differential diagnosis, 1299  
 epidemiology, 1266, 1297–1298  
 etiology, 1297  
 experimental reproduction, 1297–1298  
 morbidity, 1297  
 necropsy findings, 1299  
 occurrence, 1297  
 pathogenesis, 1298  
 prevalence, 1297  
 risk factors, 1298  
 transmission, 1297  
 treatment, 1299  
 vaccination, 1299  
 viral detection, 1298  
 sheep, 1298  
 Winter hypomagnesemia, 1653, 1654  
 Winter tick (*Dermacentor albipictus*), 1456  
*Wisteria sinensis* poisoning, 1888  
 Withdrawal periods, antimicrobials, 173, 178,  
 183–186  
 Withdrawal reflex absence, 582  
 Withers pinching, 308  
 Wobbler see Equine cervical vertebral stenotic  
 myelopathy  
 Wobbler horse, 615–616  
 'Wobblers' see Equine cervical vertebral stenotic  
 myelopathy  
 Wobbles, chronic compressive myelopathy,  
 615–616  
*Wohlfahrtia magnifica* (sarcophagid fly), 1590,  
 1595  
 Wohlfahrtiosis, 1590, 1595–1596  
 Wooden tongue see Actinobacillosis (wooden  
 tongue)  
 Wood preservative poisoning, 1808, 1840  
 Wood  
 abnormalities, 653, 661–664  
 blowfly strike, 1591  
 caseous lymphadenitis effect, 796

Wool (*Cont'd*)  
 copper deficiency effects, 1711  
 eating of, 1731, 2042  
 inherited goiter, 1941  
 loss/shedding, 2041–2042  
   fasciolosis, 1578  
   normal, 2042  
   zinc deficiency, 1731  
 palpation of coat, 21  
 psoroptic mange, 1610  
 Wool break, 2042  
 Woolslip, 2041–2042  
 Woo's method, 1535  
 World Health Organization (WHO), 896  
   post-exposure rabies vaccination regimen,  
   1392  
 World Trade Organization (WTO), Agreement  
   on the Application of Sanitary and  
   Phytosanitary Measures (SPS  
   Agreement), 765  
 'Wormkill' program, 1551  
 Wounds  
   blowfly strike, 1591  
   botulism, 825  
   screwworm infestation, 1594  
 Wright's stain, 202, 1480  
 Wryneck, bluetongue, 1303

## X

*Xanthium* poisoning, 1886  
 Xanthosis, 627  
 Xerophthalmia, 1774  
 Xylazine  
   alimentary tract hypomotility treatment, 204  
   exertional rhabdomyolysis, recurrent, 1968  
   laminitis, horses, 2033  
   pain, 106  
 Xylazine hydrochloride, 2063  
 Xylose absorption test, 198–199, 273, 1992, 1993

## Y

Yak, rinderpest, 1237  
 Yawning, 9  
   movements, rabies, 1389  
 Yeast infection, mastitis, 727–728  
 Yellow bristle grass (*Setaria lutescens*), 1895  
 Yellow calf, 1708  
 Yellow-crowned night-heron, 1369  
 Yellow fat disease, 1680

Yellow lamb disease, 837  
 Yellow rocket (*Barbarea vulgaris*) poisoning,  
 1888  
 Yellow star thistle (*Centaurea solstitialis*)  
 poisoning, 1376, 1892  
 Yellow-wood tree (*Terminalia oblongata*)  
 poisoning, 1889  
*Yersinia enterocolitica*, 954–956, 973  
*Yersinia pseudotuberculosis*, 761, 954–956  
 Yersiniosis, 954–956  
   clinical findings, 955  
   clinical pathology, 955  
   control, 955  
   diagnosis, 955  
   epidemiology, 954–955  
   etiology, 954  
   necropsy findings, 955  
   pathogenesis, 955  
   treatment, 955  
 Yew tree (*Taxus baccata*) poisoning, 1893  
 Yohimbine hydrochloride, 2063  
 Yorkshire pigs, 1950, 1953

## Z

*Zamia* poisoning, 1885  
 Zearalenone poisoning, 1899, 1911–1912  
 Zebra, African horse sickness virus transmission,  
 1180  
 'Zebra stripes'  
   Nairobi sheep disease, 1245  
   peste des petits ruminants, 1243  
   rinderpest, 1239  
 Zebu (*Bos indicus*) cattle  
   babesiosis, 1486  
   bluetongue, 1301  
   bovine farcy, 1016–1017  
   foot-and-mouth disease, 1225–1226  
   rinderpest, 1238  
   tuberculosis, 1008  
 Zeranol, 2063  
 Ziehl-Neelsen stained fecal smear,  
   *Mycobacterium avium* subspecies  
   *paratuberculosis* (*Map*), 1027  
*Zieria arborescens* (stinkwood tree) poisoning,  
 1892  
 Zigadenine poisoning, 1894  
*Zigadenus* (death camas) poisoning, 1894  
 Zigadine poisoning, 1894  
 Zimbabwe, bovine ocular squamous-cell  
   carcinoma, 2039  
 Zinc  
   deficiency, 1730–1732  
   clinical findings, 1731–1732  
   clinical pathology, 1732  
   control, 1732  
   differential diagnosis, 1732  
   epidemiology, 1730–1731  
   etiology, 1730  
   goats, 1732  
   metabolic defect, associated, 1699  
   necropsy findings, 1732  
   parakeratosis see Parakeratosis  
   pathogenesis, 1731  
   pathophysiology, 1699  
   pigs, 1730, 1731, 1732  
   polioencephalomalacia, 2008  
   ruminants, 1730–1731, 1732  
   sheep, 1731–1732  
   treatment, 1732  
   environmental pollution, 1800  
   plasma concentration, parturition, 1732  
   poisoning, 1826–1828  
   supplementation, 1732  
   inherited deficiency of lymphocyte  
   maturation, 1941  
   sporidesmin poisoning prevention, 1909  
 Zinc-bacitracin, 1092  
 Zinc ethylene dithiocarbonate poisoning, 1838  
 Zinc-methionine, 1732  
 Zinc oxide  
   coliform gastroenteritis control, 894  
   milk fever prevention, 1638–1639  
 Zinc phosphide poisoning, 1839, 1840  
 Zinc sulfate solution  
   foot rot, infectious, 1075  
   poisoning from, 1828  
 Zinc sulfate test, 154  
 Zona pellucida, bovine virus diarrhea virus, 1256  
 Zoo animals, spongiform encephalopathy, 1448  
 Zoo felids, feline spongiform encephalopathy,  
 1448  
 Zootoxins, 1915–1920  
   see also *specific types*  
 ZstatFlu test, 1325  
 Zwoergersiekte see Ovine progressive  
   pneumonia  
 Zygomycetes, 1472  
 Zygomycosis, 1471–1474  
   clinical findings, 1472–1473  
   clinical pathology, 1473  
   epidemiology, 1471–1472  
   etiology, 1471–1472  
   humans, 1472  
   necropsy findings, 1473  
   pathogenesis, 1472  
   treatment, 1473  
 Zygotes, *Babesia*, 1485